

# Verschleißteile

# Wear Parts

2017

**K24-F**

Bremsen-Ersatzteilprogramm

Brake Parts Program



**Brakethrough Technology**

# Kompetenz und Aktualität

## Competence and topicality



### ATE macht mobil

Unser Produktportfolio können Sie jetzt auch per Smartphone abrufen. Über Stichwort- Fahrzeug- und Artikelsuche finden Sie schnell den passenden Artikel – und per Händlersuche mit integriertem Routenplaner auch gleich den nächsten ATE Vertragspartner.

### Die ATE Katalog CD-Rom

Die zweimal pro Jahr erscheinende ATE Katalog CD-Rom „ETK“ basiert auf der TecDoc-Engine. Wer die TecDoc DVD kennt, kommt also genau so leicht mit der ATE Katalog CD zurecht.

### ATE Online-Katalog

Noch aktuellere Informationen finden Sie im Online-Katalog von ATE. Hier werden die Kataloginformationen mindestens monatlich aktualisiert. Sie finden den ATE Online-Katalog unter [www.ate.de](http://www.ate.de).

### ATE goes mobile

You can call up our product portfolio on your smartphone. Using keyword, vehicle and article searches, you can quickly find the right article – and then use the dealer search with the integrated route planner to immediately find the nearest ATE authorised distributor.

### The ATE catalog CD-Rom

The ATE catalog CD-Rom “ETK” appears twice a year and is based on the TecDoc engine. The ATE catalog CD will thus be easy to use for anyone familiar with the TecDoc DVD.

### ATE online-catalog

Even more current information you find in the ATE onlinenecatalog. Here the spare part information are posted at least monthly. You find the ATE online-catalog on [www.ate-brakes.com](http://www.ate-brakes.com).



ATE App  
ATE app



ATE Online-Katalog  
ATE online-catalog













ATE Katalog CD-Rom  
ATE catalog CD-Rom





# Artikelinformationen

|   |  | KURZNUMMER                           |    |  |  | KURZNUMMER       |    |
|---|---|--------------------------------------|---|---|--|------------------|---|
|   | 13.0460-xxxx.2 →<br>13.0460-0xxx.2 →<br>24.8190-xxxx.2 →<br>13.0470-xxxx.2 →      | 60xxxx<br>610xxx<br>62xxxx<br>LDxxxx | Scheibenbremsbelag<br>Einbausatz<br>Warnkontakt<br>ATE Ceramic  |  | 24.02dd-dxxx.x →   | 48nnnn           | Bremstrommel<br>(z. B. 24.0223-0: Ø=230)  |
|   | 20034 15,0<br>+<br>WE<br>WK<br>S<br>Zub   |                                      | WVA-Nummer / Dicke<br>weitere WVA-Nummern siehe Anhang<br>Warneinrichtung<br>mit Warnkontakt<br>mit Sattelschraube<br>mit Zubehör |   | 230/231×47   |                  | Durchmesser /<br>maximaler Durchmesser x Tiefe  |
| Bremsbelagsätze haben eine Allgemeine Betriebserlaubnis (ABE) oder eine Homologation nach ECE-R90, bzw. kommen aus derselben Fertigung und unterliegen derselben Qualitätssicherung wie der vom Fahrzeughersteller vorgesehene Belag.   |   |                                      |   |   |  |                  |   |
|   | 24.01dd-xxxx.x →<br>24.03dd-xxxx.x →  | 4ddxxx<br>5ddxxx                     | Bremsscheibe<br>ATE PowerDisc<br>dd = Dicke<br>(z. B. 24.0322- : Dicke = 22)  |  | 03.0420-xxdd.3 →<br>03.0520-xxdd.3 →   | 68xxdd<br>69xxdd | ATE Original Kit<br>ATE Original TopKit<br>(Radzylinder + Trommelbrems-<br>backen + Einbausatz)<br>dd = Nennmaß Radzylinder |
|   | 284 22 20 V L PD<br>B<br>V<br>L<br>S<br>PD  |                                      | Durchmesser / Dicke / Mindestdicke<br>beschichtet<br>belüftet<br>legiert / hochgekohlt<br>Fixierschraube<br>ATE PowerDisc         |   | 03.0137-0xxx.2 →<br>03.0137-9xxx.2 →   | 650xxx<br>669xxx | Feststellbremse<br>(Trommelbremsbacken)<br>Einbausatz   |
| Die Verwendung einer PowerDisc an der Hinterachse ist nur in Verbindung mit dem Einsatz einer PowerDisc an der Vorderachse zulässig. Die Allgemeine Betriebserlaubnis (ABE) zum Einsatz der PowerDisc ist auf deutschen Straßen gemäß der StVZO gültig. In anderen Ländern sind darüber hinaus ggf. weitere Gutachten für den Einsatz im Straßenverkehr erforderlich. |   |                                      |   |   |  |                  |   |
|    |   |                                      |   |   |  |                  |   |
| nnnn = Die letzten vier Ziffern entsprechen einer Zählnummer.   |   |                                      |   |   |  |                  |   |
| dd = Nennmaß  |   |                                      |   |   |  |                  |   |

Nachdruck, auch auszugsweise, nur mit unserer Genehmigung gestattet. Ersatzansprüche auf Grund von Angaben in diesem Katalog können nicht anerkannt werden. Konstruktionsänderungen vorbehalten. Soweit wir in unseren Unterlagen Bezug nehmen auf die Ersatzteilnummer des Fahrzeugherstellers, dient dies nur zu Vergleichszwecken. Eine Verwendung derartiger Angaben in Rechnungen an den Fahrzeugbesitzer ist nicht statthaft.

Die Modell- und Ersatzteilvervielfalt einiger Fahrzeughersteller erlaubt nicht immer eine genaue Zuordnung. Bitte beachten Sie daher besonders die im Katalog aufgeführten Bemerkungen und Ersatzteilbeschreibungen.





- D** Bremsen-Ersatzteilprogramm  
Verschleißteile
- EN** Brake parts programm  
Wear parts
- FR** Programme de pièces détachées pour freins  
Pièces d'usure
- IT** Programma in pianti frenanti  
Parti soggetti ad usura
- ES** Programa de repuestos para sistema de frenado  
Piezas de desgaste
- NL** Remonderdelenprogramma  
Slijtende onderdelen
- DA** Reservedelsprogram bremser  
Sliddele
- SV** Reservdelsprogram bromsar  
Slitdelar
- HU** Fékrendszer – Tartalékalkatrész-program  
Gyorsan kopó alkatrészek
- PT** Programa de peças sobressalentes dos travões  
Peças de desgaste
- RU** Программа запасных деталей тормозов  
Быстроизнашивающиеся детали
- CZ** Program náhradních dílů brzd  
Rychle opotřebitelné součásti
- PL** Program części zamiennych do układów hamulcowych  
Części podlegające zużyciu (wytarciu)
- EL** Πρόγραμμα ανταλλακτικών φρένων  
Αναλώσιμα εξαρτήματα
- TR** Fren yedek parça programı  
Aşınma parçaları
- ZH** 制动——替换件程序  
易损件
- JA** ブレーキ交換部品プログラム  
消耗部品
- AR** برنامج قطع غيار المكابح  
فيمكالكات حالاءازجالا

# K24-F



## D Inhaltsverzeichnis

|                                    |      |
|------------------------------------|------|
| Bremsflüssigkeiten                 | 10   |
| Neue Artikel                       | 15   |
| Ersetzte Artikel                   | 23   |
| Fahrzeugregister                   | 25   |
| Fahrzeugverwendungen               | 33   |
| Abbildungen Scheibenbremsbeläge    | 1063 |
| Abbildungen Bremsbelag-Einbausätze | 1421 |
| Abbildungen Warnkontakte           | 1443 |
| Abbildungen Trommelbremsbacken     | 1499 |
| Abbildungen TBB Einbausätze        | 1529 |
| Abbildungen Bremstrommeln          | 1553 |
| Abmessungen Bremsscheiben          | 1577 |
| Vergleichsliste WVA-ATE            | 1623 |
| Technische Übersetzungen           | 1655 |
| So benutzen Sie den K24-F          | 1685 |

## EN Table of contents

|   |      |
|---|------|
| Brake fluid                                 | 10   |
| New parts                                   | 15   |
| Replaced parts                              | 23   |
| Index of vehicles                           | 25   |
| Applications of vehicles                    | 33   |
| Illustrations disc brake pads               | 1063 |
| Illustrations brake pad installation kits   | 1421 |
| Illustrations wear indicators               | 1443 |
| Illustrations drum brake shoes              | 1499 |
| Illustr. drum brake shoes installation kits | 1529 |
| Illustrations brake drums                   | 1553 |
| Dimensions brake discs                      | 1577 |
| WVA Cross reference list                    | 1623 |
| Technical translations                      | 1655 |
| How to use the K24-F                        | 1685 |

## FR Table des matières

|   |      |
|---|------|
| Liquides de frein   | 10   |
| Nouvelles références  | 15   |
| Références remplacées   | 23   |
| Liste des véhicules   | 25   |
| Applications  | 33   |
| Illustrations plaquettes de frein à disque                      | 1063 |
| Illustrations lots de montage pour plaquettes de frein à disque | 1421 |
| Illustrations témoins d'usure                                   | 1443 |
| Illustrations mâchoires de frein à tambour                      | 1499 |
| Illustrations lots de montage pour mâchoires de frein à tambour | 1529 |
| Illustrations tambours de frein                                 | 1553 |
| Dimensions disques de frein                                     | 1577 |
| Liste des correspondances WVA                                   | 1623 |
| Traductions techniques  | 1655 |
| Utilisation du catalogue K24-F                                  | 1685 |

## IT Sommario

|   |      |
|---|------|
| Liquido freni                                   | 10   |
| Codici nuovi                                    | 15   |
| Codici sostitutivi                              | 23   |
| Indice autovetture                              | 25   |
| Applicazioni autoveicoli                        | 33   |
| Illustrazioni pastiglie freno                   | 1063 |
| Illustrazioni kit installazione pastiglie freno | 1421 |
| Illustrazioni rilevatori usura                  | 1443 |
| Illustrazioni ganasce freno                     | 1499 |
| Illustrazioni kit installazione ganasce freno   | 1529 |
| Illustrazioni tamburi freno                     | 1553 |
| Misure dischi freno                             | 1577 |
| Tabella di conversione codici WVA               | 1623 |
| Traduzioni tecniche                             | 1655 |
| Come consultare il catalogo K24-F               | 1685 |

## ES Índice

|   |      |
|---|------|
| Líquido de freno  | 10   |
| Nuevas referencias                                      | 15   |
| Referencias de sustitución                              | 23   |
| Índice de vehículos                                     | 25   |
| Aplicaciones  | 33   |
| Ilustraciones de pastillas                              | 1063 |
| Ilustraciones juegos de montaje pastillas               | 1421 |
| Ilustraciones contactos de desgaste                     | 1443 |
| Ilustraciones zapatas freno de tambor                   | 1499 |
| Ilustraciones juegos de montaje zapatas freno de tambor | 1529 |
| Ilustraciones tambores                                  | 1553 |
| Medidas disco de freno                                  | 1577 |
| Lista comparativa WVA                                   | 1623 |
| Traducciones técnicas                                   | 1655 |
| Use así el K24-F  | 1685 |

## NL Inhoudsopgave

|   |      |
|---|------|
| Remvloeistof                                    | 10   |
| Nieuwe artikelen                                | 15   |
| Vervangen artikelen                             | 23   |
| Voertuigregister                                | 25   |
| Voertuigtoepassingen                            | 33   |
| Afbeeldingen schijfremblokken                   | 1063 |
| Afbeeldingen inbouwsets voor remblokken         | 1421 |
| Afbeeldingen waarschuwingscontacten             | 1443 |
| Afbeeldingen trommelremschoenen                 | 1499 |
| Afbeeldingen inbouwsets voor trommelremschoenen | 1529 |
| Afbeeldingen remtrommels                        | 1553 |
| Afmetingen remschijven                          | 1577 |
| Vergelijkingslijst WVA                          | 1623 |
| Technische vertalingen                          | 1655 |
| Zo gebruikt u de K24-F                          | 1685 |

## DA Indholdsfortegnelse

|                                       |      |
|---------------------------------------|------|
| Bremsevæske                           | 10   |
| Nye artikler                          | 15   |
| Erstattede artikler                   | 23   |
| Køretøjsregister                      | 25   |
| Køretøjsanvendelser                   | 33   |
| Tegning bremseklodder                 | 1063 |
| Tegning monteringsæt for bremsebakter | 1421 |
| Tegning advarselskontakter            | 1443 |
| Tegning bremsebakter                  | 1499 |
| Tegning monteringsæt for bremsebakter | 1529 |
| Tegning bremsetromler                 | 1553 |
| Mål på bremsekiver                    | 1577 |
| Omsætningsliste WVA                   | 1623 |
| Tekniske oversættelser                | 1655 |
| Sådan anvendes K24-F                  | 1685 |

## SV Innehållsförteckning

|   |      |
|---|------|
| Bromsvätska                                 | 10   |
| Nya artiklar                                | 15   |
| Utbytta artiklar                            | 23   |
| Fordonsregister                             | 25   |
| Fordonsanvändningar                         | 33   |
| Avbildningar skivbromsbelägg                | 1063 |
| Avbildningar bromsbelägg monteringsatts     | 1421 |
| Avbildningar varningskontakter              | 1443 |
| Avbildningar trumbromsbackar                | 1499 |
| Avbildningar trumbromsbackar monteringsatts | 1529 |
| Avbildningar bromstrummor                   | 1553 |
| Dimensioner bromsskivor                     | 1577 |
| Jämförelselista WVA                         | 1623 |
| Tekniska översättningar                     | 1655 |
| Så använder du K24-F                        | 1685 |

## HU Tartalomjegyzék

|                                     |      |
|-------------------------------------|------|
| Fékfolyadék                         | 10   |
| Új termékek                         | 15   |
| Helyettesített alkatrészek          | 23   |
| Járműlista                          | 25   |
| Járműalkalmazások                   | 33   |
| Ábrák - betétek tárcsafékhöz        | 1063 |
| Ábrák - fékbetét-szerelőkészletek   | 1421 |
| Ábrák figyelmeztető érintkező       | 1443 |
| Ábrák - fékpofa dobfékhöz           | 1499 |
| Ábrák - dobfékpofa-szerelőkészletek | 1529 |
| Ábrák - fékdobok                    | 1553 |
| Féktárcsák méretei                  | 1577 |
| WVA összehasonlító lista            | 1623 |
| Műszaki fordítás                    | 1655 |
| How to use the K24-F                | 1685 |





## PT Índice

|   |      |
|---|------|
| Líquido para travões                                      | 10   |
| Novo artigos  | 15   |
| Artigos substituídos                                      | 23   |
| Registo automóvel   | 25   |
| Utilizações do veículo                                    | 33   |
| Figuras Calços do travão de disco                         | 1063 |
| Figuras Kits de instalação do calço do travão de disco    | 1421 |
| Figuras avisador de desgaste                              | 1443 |
| Figuras Calços de travão de tambor                        | 1499 |
| Figuras Kits de instalação de calços de travões de tambor | 1529 |
| Figuras Tambores do travão                                | 1553 |
| Dimensões dos discos dos travões                          | 1577 |
| Lista de comparação WVA                                   | 1623 |
| Glossário técnico   | 1655 |
| Como utilizar o K24-F                                     | 1685 |

## PL Spis treści

|   |      |
|---|------|
| Płyn hamulcowy  | 10   |
| Nowe artykuły   | 15   |
| Artykuły zastąpione                                   | 23   |
| Indeks pojazdów                                       | 25   |
| Zastosowania pojazdów                                 | 33   |
| Rysunki okładzin hamulców tarczowych                  | 1063 |
| Rysunki zestawów montażowych szczęk hamulca bębnowego | 1421 |
| Rysunki styki ostrzegawcze                            | 1443 |
| Rysunki szczęk hamulca bębnowego                      | 1499 |
| Rysunki zestawów montażowych szczęk hamulca bębnowego | 1529 |
| Rysunki bębnowych hamulcowych                         | 1553 |
| Wymiary tarcz hamulcowych                             | 1577 |
| Lista porównawcza numerów WVA                         | 1623 |
| Tłumaczenia techniczne                                | 1655 |
| Tak należy korzystać z K24-F                          | 1685 |

## ZH 目录

|                |      |
|----------------|------|
| 制动液            | 10   |
| 新件             | 15   |
| 替代件            | 23   |
| 汽吹登瑞翻          | 25   |
| 汽吹用户           | 33   |
| 制动摩擦片图片        | 1063 |
| 制动摩擦片——安群组件图片) | 1421 |
| 警示触点的图         | 1443 |
| 制动梯缴棍图片        | 1499 |
| 制动梯缴棍安群组件图片    | 1529 |
| 制动梯图片          | 1553 |
| 制动盘测测          | 1577 |
| 对比清单WVA        | 1623 |
| 技术翻群           | 1655 |
| 这样使用 K24-F     | 1685 |

## RU Содержание

|   |      |
|---|------|
| Тормозная жидкость                                      | 10   |
| Новые позиции   | 15   |
| Замененные номера                                       | 23   |
| Перечень автомобилей                                    | 25   |
| Применение в автомобилях                                | 33   |
| Рисунки дисковых тормозных колодок                      | 1063 |
| Изображения монтажных комплектов для тормозных накладок | 1421 |
| Изображение контактов предупредительного сигнала        | 1443 |
| Рисунки барабанных колодок                              | 1499 |
| Изображения монтажных комплектов барабанных колодок     | 1529 |
| Рисунки тормозных барабанов                             | 1553 |
| Размеры тормозных дисков                                | 1577 |
| Сравнительный перечень номеров WVA                      | 1623 |
| Перевод технических терминов                            | 1655 |
| Как пользоваться каталогом K24-F                        | 1685 |

## EL Πίνακας Περιεχομένων

|  |      |
|--|------|
| Υγρό φρένων  | 10   |
| Νέο προϊόν   | 15   |
| Αντικατεστημένοι αριθμοί                           | 23   |
| Κατάλογος οχημάτων                                 | 25   |
| Χρήσεις οχημάτων                                   | 33   |
| Εικόνες τακτικών δισκόφρενων                       | 1063 |
| Εικόνες σετ τοποθέτησης τακτικών φρένων            | 1421 |
| Εικόνες επαφών προειδοποίησης                      | 1443 |
| Εικόνες αιαγόνων τυλιπάνων πέδησης                 | 1499 |
| Εικόνες σετ τοποθέτησης αιαγόνων ταίπιούρων φρένων | 1529 |
| Εικόνες τυμπάνων πέδησης                           | 1553 |
| Φαστάσεις δίσκων φρένων                            | 1577 |
| Λίστα σύγκρισης αριθμών WVA                        | 1623 |
| Τεχνικές Ιεταφράσεις                               | 1655 |
| Έτσι χρησιμοποιείτε τον K24-F                      | 1685 |

## JA 目次

|                   |      |
|-------------------|------|
| ブレーキフルード          | 10   |
| 新商品               | 15   |
| 販売商品              | 23   |
| 然両索引              | 25   |
| 然両利用方法            | 33   |
| 図版 ブレーキパッド組み濡みキット | 1063 |
| 図版 ブレーキパッド組み濡みキット | 1421 |
| 図: ウェアインジケーター     | 1443 |
| 図版 ドラムブレーキシュー     | 1499 |
| 図版 TBB組み濡みキット     | 1529 |
| 図版 ブレーキドラム        | 1553 |
| 寸法 ブレーキディスク       | 1577 |
| WVA比峰             | 1623 |
| テクニカルトランスミッション    | 1655 |
| カタログNo.24のご利用法    | 1685 |

## CZ Obsah

|   |      |
|---|------|
| Brzdová kapalina                                | 10   |
| Nové výrobky                                    | 15   |
| Nahrazené výrobky                               | 23   |
| Rejstřík vozidel                                | 25   |
| Použití vozidel                                 | 33   |
| Zobrazení obložení kotoučových brzd             | 1063 |
| Zobrazení vestavných sad brzdového obložení     | 1421 |
| Zobrazení kontaktů indikátoru opotřeбенí        | 1443 |
| Zobrazení čelistí bubnových brzd                | 1499 |
| Zobrazení vestavných sad čelistí bubnových brzd | 1529 |
| Zobrazení brzdových bubnů                       | 1553 |
| Rozměry brzdových kotoučů                       | 1577 |
| Porovnávací seznam čísel                        | 1623 |
| Technické překlady                              | 1655 |
| Jak používat K24-F                              | 1685 |

## TR İçindekiler

|   |      |
|---|------|
| Fren sıvısı                               | 10   |
| Yeni ürün                                 | 15   |
| Değiştirilen ürün                         | 23   |
| Araç kaydı                                | 25   |
| Araç kullanımları                         | 33   |
| Fren disk kaplaması resimleri             | 1063 |
| Fren kaplaması montaj takımları resimleri | 1421 |
| İkaz kontağı resimleri                    | 1443 |
| Fren pabuçları resimleri                  | 1499 |
| TBB montaj takımları resimleri            | 1529 |
| Fren kampanası resimleri                  | 1553 |
| Fren disk ölçümleri                       | 1577 |
| Karşılaştırma listesi WVA                 | 1623 |
| Teknik çeviriler                          | 1655 |
| K24-F'i Broşürünü Nasıl Kullanacaksınız   | 1685 |

## AR

## الفهرس

|                                       |      |
|---------------------------------------|------|
| زيت المكابح                           | 10   |
| المنتجات الجديدة                      | 15   |
| المنتجات المعوّضة                     | 23   |
| سجل العربّة                           | 25   |
| إستعمالات العربّة                     | 33   |
| صور مزقات المكبح القرصي               | 1063 |
| صور طواقم ترأيب مزقات المكابح         | 1421 |
| صور تماس جهاز الإنذار                 | 1443 |
| صور فكّي المكبح الطبلي                | 1499 |
| صور طواقم الترابيب لفكي المكبح الطبلي | 1529 |
| صورطبالات المكبح                      | 1553 |
| مقاييس أقراص المكابح                  | 1577 |
| قائمة المقارنة WVA                    | 1623 |
| الترجمات التقنية                      | 1655 |
| طريقة استعمال الكتالوج K24-F          | 1685 |





# Erstklassig First-class

## Besser ist besser

Wenn es um Qualität geht, genügt uns ein „sehr gut“ noch lange nicht. Wir erfüllen hohe Ansprüche an das Qualitätsmanagement und die europäische Sicherheitsnorm ECE-R90 wird von ATE sogar übertroffen. Zudem führen wir zahlreiche zusätzliche Tests durch, unter anderem zu Verschleiß und Wärmeleistung.

Auch Nachhaltigkeit ist uns wichtig: Wir stellen die Mischungen für ATE Bremsbeläge auf kupferfreie Materialien um und setzen bei ATE Ceramic auf geringen Abrieb. Nutzen ausschließlich umweltfreundliches Material für die Beschichtung von Brems scheiben. Und bereiten Produkte wie Brems sätze wieder auf.

## Better is better

When it comes to quality, “very good” is simply not good enough for us. We meet high standards of quality management – and ATE even exceeds the European safety standard ECE-R90. We also perform many additional tests, including wear and thermal performance.

Sustainability is also important to us: we convert the compounds for ATE brake pads to copperfree materials and opt for low abrasion with ATE Ceramic. We only use environmentally friendly material for the coating of brake discs – and we remanufacture products like brake callipers.



## Original? Mit Sicherheit

Qualität ist für uns nicht nur während der Produktentwicklung und vor der Auslieferung ein Thema. Nach dem Kauf können Sie jederzeit überprüfen, ob Sie ein Original ATE Produkt vor sich haben – über ein zweistufiges Sicherheitsetikett.

Die erste Stufe ist der tesa Priospot®. Hier wurden die Merkmale des tesa Holospot® – der nach wie vor höchste Sicherheit bietet – noch weiter entwickelt. Die fälschungssichere Holografie-Technik mit verschiedenen Prüf- und Sicherheitsmechanismen schützt sogar das Etikett selbst vor Nachahmern.

Die zweite Stufe ist ein DataMatrix-Code, kurz MAPP-Code. Dessen letzte vier Ziffern werden auch im Holospot® bzw. Priospot® dargestellt – für ein Höchstmaß an Sicherheit.

Der Code kann per Scanner oder durch manuelle Eingabe auf der ATE Website überprüft werden und zeigt sofort an, ob es sich bei dem Produkt um ein Originalteil handelt. In Verbindung mit entsprechender Software wie der ATE App ist auch die Abfrage per Smartphone möglich.

## Original? Yes – and safe

For us, quality is not only a key issue during product development and before delivery – after purchase, a two-stage security label lets you check if you have an original ATE product at any time – the tesa Priospot.

Its predecessor, the tesa Holospot®, still offers a very high level of security – but the tesa Priospot® takes security to an entirely new level. With its range of inspection and security mechanisms, this holographic technology cannot be faked and prevents even the label itself from being copied.

The second stage is a Data Matrix code known as the MAPP code. Its last four digits are shown in the Holospot® or Priospot® – for absolute maximum security.

The code can be checked on the ATE website by scanner or by manual input and immediately shows whether or not the part is an original. Verification can also be performed via smartphone if appropriate software like the ATE app is used.



Mehrstufiges ATE Sicherheits-etikett mit DataMatrix-Code (Mitte) und Tesa Priospot® (oben rechts).

Multi-stage ATE security label with Data Matrix code (centre) and tesa Priospot® (top right).

Zur Online-Abfrage und zum App-Download:  
[www.ate.de/original](http://www.ate.de/original)

To online verification and app download:  
[www.ate-brakes.com/original](http://www.ate-brakes.com/original)



Wir engagieren uns bei MAPP –  
Manufacturers against Product Piracy.

We are committed to MAPP –  
Manufacturers against Product Piracy.

## Einfach mehr Tests: ATE Bremsbeläge

### More tests: ATE brake pads

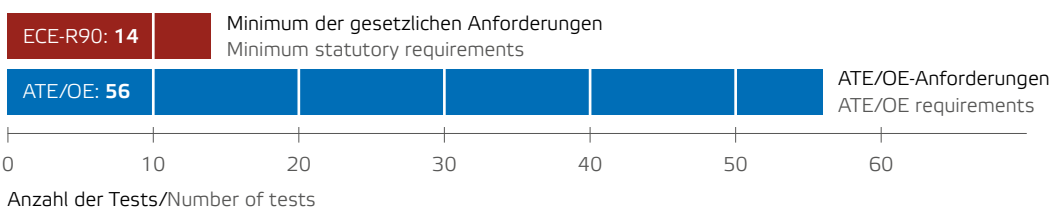

# Bremsbeläge

## Eine Klasse für sich

### Brake pads

### A class of their own

#### ATE Original Bremsbeläge

Andere Hersteller nutzen für Bremsbeläge zehn verschiedene Belagmischungen. Bei uns sind es mehr als 150 und unsere internen Tests sind weit strenger, als es die gesetzlichen Bestimmungen erfordern. So bieten wir für jeden Fahrzeugtyp den optimalen Bremsbelag – mit 98 Prozent Abdeckung in Europa, und das überwiegend mit Original-Erstausrüster-Mischungen. Dabei können sich die Autofahrer auf maximale Sicherheit ebenso verlassen wie auf maximalen Komfort. Es gibt eben nur ein Original.

#### ATE Original brake pads

Other manufacturers use ten different compounds for their brake pads. We use more than 150 – and our internal tests are far more stringent than required by the regulations. That's why we offer the optimum brake pad for every type of vehicle – with 98 per cent coverage in Europe, mainly with original equipment manufacturer compounds. So motorists can rely on maximum safety and maximum comfort. There is only one original.

#### ATE Ceramic Bremsbeläge

Wirklich eine saubere Sache. Durch die innovative Belagmischung entsteht bei ATE Ceramic Bremsbelägen nur sehr wenig Abrieb, der zudem kaum haftet. Deshalb setzt sich praktisch kein Bremsstaub ab und schöne Felgen behalten viel länger ihren Glanz. Ceramic Bremsbeläge sind so sicher wie ein konventioneller Belag, besonders langlebig und ideal in Kombination mit den beschichteten ATE Bremsscheiben. Und es gibt noch einen weiteren Vorteil: Sie lassen sich ganz einfach statt der üblichen Bremsbeläge einbauen.

#### ATE Ceramic brake pads

A clean solution. The innovative ATE Ceramic formula produces very few abraded particles, and they have hardly any adhesive characteristics. This means that hardly any brake dust settles and shiny wheel rims retain their lustre much longer. Ceramic brake pads are as safe as conventional pads, are particularly durable and ideal when used in combination with the coated ATE brake discs. Yet another advantage? They can be easily installed instead of the usual brake pads.

Auf unserer Website [www.ate.de/originalbelag](http://www.ate.de/originalbelag) können Sie sich näher informieren.

Learn more on our website at [www.ate-brakes.com/originalpad](http://www.ate-brakes.com/originalpad)

Auf unserer Website [www.ate.de/ceramic](http://www.ate.de/ceramic) erfahren Sie mehr.

Learn more on our website at [www.ate-brakes.com/ceramic](http://www.ate-brakes.com/ceramic)





## Bremsverhalten von Original ATE Bremsbelägen

### Braking behaviour of ATE Original brake pads

**Reibwert beim ersten Einbremsen der Beläge**  
Coefficient of friction at first application of the pads



**Reibwert bei kaltem Bremssystem**  
Coefficient of friction with cold braking system



**Reibwert beim Herunterbremsen aus hohen Geschwindigkeiten**  
Coefficient of friction when slowing from high speeds



**Reibwert, wenn zum ersten Mal im Hochtemperaturbereich gebremst wird**  
Coefficient of friction when first used at high temperature



■ ATE Original Bremsbeläge / ATE Original brake pads  
■ Standardbelag eines Wettbewerbers / Competitor's standard brake pads



# Bremsscheiben Für jeden Anspruch die Richtige

Brake discs  
The right one for every requirement

Die Details zur ATE Bremsscheiben finden Sie auf unserer Website  
[www.ate.de/produkte/scheibenbremsen/original-ate-bremsscheiben](http://www.ate.de/produkte/scheibenbremsen/original-ate-bremsscheiben)

You'll find more details about the ATE brake discs on our website at  
[www.ate.de/produkte/scheibenbremsen/original-ate-bremsscheiben](http://www.ate.de/produkte/scheibenbremsen/original-ate-bremsscheiben)





## Alles für die optimale Bremsleistung

Es gibt so viele unterschiedliche Fahrzeugmodelle und Anforderungen – ATE hat für jeden Bedarf die richtigen Brems Scheiben. Präzise gefertigt aus hervorragenden Erstausrüster-Materialien und in einer Qualität, die die ECE-R90-Norm schon heute im nahezu gesamten Portfolio übertrifft. Besser gehts nicht.

## Original ATE Brems Scheiben

In Original ATE Brems Scheiben stecken durchdachte Technologie, hochwertige Materialien und unser ganzes Know-how. Sie entsprechen genau den Brems Scheiben, die vom Hersteller verbaut wurden: Ob glatt, gelocht oder genutet, hochgekohlt, einteilig, gestiftet oder genietet, mit oder ohne Radlager – wir haben immer die passende Lösung für sicheres und komfortables Bremsen. Und auch den passenden Belag dazu. Eine gute Kombination sind zum Beispiel beschichtete Brems Scheiben und die staubarmen ATE Ceramic Bremsbeläge oder natürlich unsere Original Bremsbeläge. Die Original ATE Brems Scheiben sind mit 98 Prozent Abdeckung in Europa verfügbar und auch – wenn der Fahrzeughersteller es vorgibt – mit Befestigungsschrauben erhältlich.

## Everything for optimal braking performance

There are so many different vehicle models and requirements – and ATE has the right brake disc for each one. Precisely manufactured from excellent OEM materials, the quality of which already surpasses the ECE-R90 standard throughout most of our portfolio. It just couldn't get any better.

## Original ATE brake discs

ATE brake discs are packed full of sophisticated technology, high-quality materials and our entire expertise. They correspond exactly to the brake discs originally installed by the manufacturer. Whether smooth, perforated or grooved, high-carbon, one-piece, pinned or riveted and with or without wheel bearings – we always have the right solution for safe and comfortable braking. With the matching brake pad too. One good combination, for example – our coated brake discs and the low-dust ATE Ceramic brake pads, or our Original brake pads of course. Original ATE brake discs are available in 98 per cent of European countries and are also available with wheel bearings or – if prescribed by the vehicle manufacturer – with fixing screws.



**ATE PowerDisc**  
ATE PowerDisc



**Beschichtete Brems Scheibe mit Befestigungsschrauben**  
Coated brake disc with fixing screws



**Beschichtete zweiteilige Brems Scheibe**  
Coated two-piece brake disc



**Brems Scheibe mit Radlager**  
Brake discs with wheel



# Mehr als sicher More than safe

## Bremsflüssigkeiten

ATE hat für jedes Fahrzeugmodell und jede Fahrweise die optimale Bremsflüssigkeit. Und alle lassen die gesetzlichen und technischen Standards weit hinter sich. Das Highlight für elektronische Bremssysteme: ATE SL.6. Die dünnflüssige Textur sorgt bei Niedrigtemperaturen für eine schnelle Reaktion von ABS oder ESP® – und so für höchste Sicherheit.

## Brake fluids

ATE has the optimal brake fluid for every vehicle model and every driving style – and all our fluids leave the legal and technical standards far behind. Our highlight for electronic braking systems – the ATE SL.6. The low-viscosity texture ensures a quick response from ABS or ESP® at low temperatures, guaranteeing maximum safety.

## Die Eigenschaften von ATE Bremsflüssigkeiten The properties of ATE brake fluids

|  | Siedepunkt<br>Boiling point | Nass-Siedepunkt<br>Wet boiling point | Viskosität bei -40 °C<br>Viscosity at -40 °C                   | Wechselintervall<br>Replacement interval |
|--|-----------------------------|--------------------------------------|--|--|
| <b>ATE G DOT 3</b>   | min. 245 °C                 | min. 150 °C                          | max. 1.500 mm <sup>2</sup> /s<br>max. 1,500 mm <sup>2</sup> /s | bis 1 Jahr<br>up to 1 year               |
| <b>ATE SL DOT 4</b>  | min. 260 °C                 | min. 165 °C                          | max. 1.400 mm <sup>2</sup> /s<br>max. 1,400 mm <sup>2</sup> /s | bis 1 Jahr<br>up to 1 year               |
| <b>ATE SL.6 DOT 4</b><br>Ideal für/Ideal for<br>ESP®, ABS, ASR | min. 265 °C                 | min. 175 °C                          | max. 700 mm <sup>2</sup> /s                                    | bis 2 Jahre<br>up to 2 years             |
| <b>ATE TYP 200 DOT 4</b><br>New Racing Quality                 | min. 280 °C                 | min. 198 °C                          | max. 1.400 mm <sup>2</sup> /s<br>max. 1,400 mm <sup>2</sup> /s | bis 3 Jahre<br>up to 3 years             |
| <b>ATE SUPER DOT 4</b>   | min. 260 °C                 | min. 180 °C                          | max. 1.400 mm <sup>2</sup> /s<br>max. 1,400 mm <sup>2</sup> /s | bis 2 Jahre<br>up to 2 years             |



| Typ<br>Type   | ATE Sachnummer<br>ATE partnumber | EAN-Nr. 4006633<br>EAN-No. 4006633 | Gebinde<br>Container size | Paletteneinheit*<br>Pallet units* |
|---|----------------------------------|------------------------------------|---------------------------|-----------------------------------|
| <b>G</b> SAE Spezifikation<br>J1703-FMVSS 116/DOT 3   | 705302 03.9901-5302.2/02         | 10199 8                            | 1 l                       | D                                 |
|   | 705303 03.9901-5303.2/02         | 10201 8                            | 5 l                       | F                                 |
| größere Gebinde auf Anfrage – Bigger container sizes on demand  |                                  |                                    |                           |                                   |
| <b>SL</b> SAE Spezifikation<br>J1704-FMVSS 116/DOT 4  | 705808 03.9901-5808.2/02         | 49000 9                            | 1/4 l                     | A                                 |
|   | 705801 03.9901-5801.2/02         | 49001 6                            | 1/2 l                     | B                                 |
|   | 705802 03.9901-5802.2/02         | 49002 3                            | 1 l                       | D                                 |
|   | 705803 03.9901-5803.2/02         | 49003 0                            | 5 l                       | F                                 |
|   | 705811 03.9901-5811.2/02         | 29907 7                            | 20 l                      | R                                 |
|   | 705820 03.9901-5820.2/01         | 10824 9                            | 30 l                      | H                                 |
|   | 705814 03.9901-5814.2/01         | 10366 4                            | 50 l                      | P                                 |
| <b>SL.6</b> <b>NEW</b><br>SAE Spezifikation<br>J1704-FMVSS 116/DOT 4<br>ISO Klasse 6 – <b>niedrigviskos</b> | 706408 03.9901-6408.2/02         | 22762 9                            | 1/4 l                     | A                                 |
|   | 706402 03.9901-6402.2/02         | 20746 1                            | 1 l                       | D                                 |
|   | 706403 03.9901-6403.2/02         | 20748 5                            | 5 l                       | F                                 |
|   | 706411 03.9901-6411.2/02         | 20750 8                            | 20 l                      | R                                 |
|   | 706420 03.9901-6420.2/02         | 23120 6                            | 30 l                      | H                                 |
|   | 706414 03.9901-6414.2/02         | 23005 6                            | 50 l                      | P                                 |
|   | 706405 03.9901-6405.2/02         | 23121 3                            | 200 l                     | S                                 |
| <b>TYP 200</b> <b>New racing quality</b><br>SAE Spezifikation<br>J1704-FMVSS 116/DOT 4                      | 706202 03.9901-6202.2/02         | 10825 6                            | 1 l                       | D                                 |
|   | 706203 03.9901-6203.2/02         | 12166 8                            | 5 l                       | F                                 |
|   | 706220 03.9901-6220.2/01         | 12780 6                            | 30 l                      | H                                 |
|   | 706214 03.9901-6214.2/01         | 12779 0                            | 50 l                      | P                                 |
|   | 706205 03.9901-6205.2/01         | 12778 3                            | 200 l                     | S                                 |
| <b>SUPER DOT 4</b> SAE Spezifikation<br>J1704-FMVSS 116/DOT 4   | 706003 03.9901-6003.2/02         | 06249 7                            | 5 l                       | F                                 |
|   | 706020 03.9901-6020.2/01         | 14544 2                            | 30 l                      | H                                 |
|   | 706005 03.9901-6005.2/01         | 07769 9                            | 200 l                     | S                                 |
| <b>ATE Bremszylinder-Paste</b><br>ATE Brake Cylinder Paste  | 700009 03.9902-05XX.2/02         | 13536 8                            | 180 g                     | L                                 |
|   | 700010 03.9902-0503.2/01         | 13532 0                            | 5 kg                      | K                                 |
|   | 700011 03.9902-0504.2/01         | 13530 6                            | 40 kg                     | P                                 |
| <b>ATE Prüfflüssigkeit</b><br>ATE Testing Fluid   | 700002 03.9902-0116.2/02         | 10374 9                            | 5 l                       | F                                 |
| <b>ATE plastilube™</b>  | 700014 03.9902-1001.2/02         | 05176 7                            | 35 ml                     | I                                 |
|   | 700015 03.9902-1002.2/02         | 05184 2                            | 75 ml                     | J                                 |
| <b>ATE Leerkanne</b><br>ATE neutral empty container   | 740169 03.9302-1474.1/01         | 07782 8                            | 25 l                      | S                                 |
| <b>Ausgiesser für 5-l-Kanne</b><br>Spout for 5l container   | 760070 03.9314-5940.3/01         | 07786 6                            | 1 St.                     | S                                 |
| <b>Kannen-Auslass-Hahn für 5-l- und 20-l-Kanne</b><br>Tap for 5l and 20l tin                                | 760153 03.9314-5960.3/02         | 30855 7                            | 1 St.                     | S                                 |

**\*Paletteneinheit:**

|   |
|---|
| A = 1.728 Kannen je Palette (24 Kannen je Karton) |
| B = 1.200 Kannen je Palette (20 Kannen je Karton) |
| D = 600 Kannen je Palette (10 Kannen je Karton)   |
| E = 360 Kannen je Palette (10 Kannen je Karton)   |
| F = 144 Kannen je Palette ( 4 Kannen je Karton)   |
| G = 50 Kannen je Palette                          |
| H = 22 Kannen je Palette                          |
| I = 5.040 Tuben je Palette (24 Tuben je Karton)   |
| J = 1.728 Tuben je Palette (12 Tuben je Karton)   |
| K = 60 Eimer je Palette                           |
| L = 1.800 Tuben je Palette (40 Tuben je Karton)   |
| M = 18 Kannen je Palette                          |
| N = 300 Kannen je Palette (10 Kannen je Karton)   |
| O = 64 Kannen je Palette ( 4 Kannen je Karton)    |
| P = 12 Kannen je Palette                          |
| R = 36 Kannen je Palette                          |
| S = 1 Stück                                       |

**\*Pallet units:**

|   |
|---|
| A = 1.728 containers per pallet (24 containers per box) |
| B = 1.200 containers per pallet (20 containers per box) |
| D = 600 containers per pallet (10 containers per box)   |
| E = 360 containers per pallet (10 containers per box)   |
| F = 144 containers per pallet ( 4 containers per box)   |
| G = 50 containers per pallet                            |
| H = 22 containers per pallet                            |
| I = 5.040 tubes per pallet (24 tubes per box)           |
| J = 1.728 tubes per pallet (12 tubes per box)           |
| K = 60 buckets per pallet                               |
| L = 1.800 tubes per pallet (40 tubes per box)           |
| M = 18 containers per pallet                            |
| N = 300 containers per pallet (10 tubes per box)        |
| O = 64 containers per pallet ( 4 containers per box)    |
| P = 12 containers per pallet                            |
| R = 36 containers per pallet                            |
| S = 1 piece   |



# Mit sicherer Hand With a steady hand

Einen Überblick über alle Geräte und Werkzeuge bietet Ihnen unser Werkzeugkatalog unter [www.ate-info.de](http://www.ate-info.de)

For an overview of all the equipment and tools, see our tool catalogue at [www.ate-info.de](http://www.ate-info.de)



## Test- und Prüfgeräte

Ob Sie Bremsflüssigkeit, Sensoren oder andere Komponenten testen: ATE Geräte und die passenden Werkzeuge sind exakt und zuverlässig – das macht die Bremsendiagnose einfacher.

## Test and inspection equipment

Whether you're testing brake fluid, sensors or other components, ATE devices and their matching tools are accurate and reliable – and that makes brake diagnosis much easier.



## Entlüftungsgeräte

Bremsen schnell und effektiv entlüften: Sie haben die Wahl unter verschiedenen Geräten für unterschiedliche Fahrzeugtypen und Bremssysteme – auch mit integrierter Absauganlage.

## Brake bleeding units

Bleeding brakes quickly and effectively: choose from different units for different vehicle models and braking systems – integrated exhaust extraction systems are also available.

## Professionelle Ausstattung

Werkzeuge und Geräte von ATE sind genau auf unsere Produkte und Services abgestimmt. Das erleichtert Ihnen die Arbeit und gibt Ihnen die Sicherheit, immer einen zuverlässigen Job zu machen. Und wenn es um Fahrzeugelektronik geht, sind VDO Ersatzteile und Services die ideale Ergänzung.

## Professional equipment

ATE tools and devices are customised to exactly match our products and services. This makes your work easier and gives you the assurance that you're doing a dependable job. When it comes to vehicle electronics, VDO spare parts and services are also the perfect additions to your equipment.



## Entsorgungsgeräte

Um gebrauchte Bremsflüssigkeit umwelt-schonend und kostengünstig zu entsorgen, muss sie zunächst sortenrein gesammelt werden. Kein Problem mit unseren Entsorgungssystemen.

## Disposal devices

To dispose of used brake fluid in an environmentally friendly and cost-effective way, it must first be sorted into different types. That's no problem with our disposal systems.



## Spezial-Werkzeuge

Bei ATE finden Sie alles, was Sie für den Einbau und die Wartung der verschiedenen Bremsenkomponenten brauchen – in Top-Qualität und genau auf die Anwendung abgestimmt.

## Special tools

At ATE, you'll find everything you need for the installation and maintenance of different brake components – all in top quality and exactly tailored to suit their purpose.

# Noch besser sein

## Be even better

### Technische Trainings für ATE

Alles, was Sie zum Thema Bremsenwartung und -diagnose wissen müssen, anschaulich und praxisorientiert vermittelt. Zum Beispiel:

- | Diagnose und Instandhaltung moderner Bremsanlagen
- | Direktannahme: So nutzen Sie Potenziale für Ihr Geschäft
- | ATE Classic Training zu Bremsen für Old- und Youngtimer

### Technische Trainings für VDO

In Fahrzeugen werden immer mehr Elektronik- und Mechatronik-Teile verbaut – bleiben Sie auf dem Laufenden. Einige Themen:

- | Elektrische Grundlagenpraxis am Beispiel ATE/VDO
- | Reifendruckkontrollsysteme in der Werkstatt-Praxis
- | Diesel: moderne Common-Rail-Einspritzsysteme

### Produkt- und Verkaufstrainings

Steigern Sie Ihren Geschäftserfolg durch motivierte Mitarbeiter und neue Angebote für Ihre Kunden. Unter anderem mit diesen Trainings:

- | Produkttraining für aktuelle VDO Mehrmarken-Tester
- | Gewährleistung als geschäftliche Chance nutzen
- | Mitarbeiterführung und Entwicklung für Kfz-Betriebe

#### Die Vorteile für ATE BremsCenter

Sie nehmen an speziellen Informationsveranstaltungen und Trainings teil, die eigens für ATE BremsCenter konzipiert wurden. Regelmäßige fachspezifische Qualifikationen für Sie und Ihre Mitarbeiter sind kostenfrei.

#### The benefits for ATE BrakeCenters

You take part in special information events and training courses that have been specially designed for ATE BrakeCenters. Regular training for you and your employees is free of charge.





Unter [www.morecontinental.com](http://www.morecontinental.com) finden Sie eine Auswahl aus dem aktuellen Trainingsprogramm.

A selection from the current training programme is available at [www.morecontinental.com](http://www.morecontinental.com)



## Technical ATE training courses

Everything you need to know about brake maintenance and diagnosis, presented clearly and with a practical emphasis. For example:

- | Diagnosis and maintenance of modern brake systems
- | Service reception bay: helping you to utilise all the potential opportunities for your business
- | ATE Classic training for vintage and classic car brakes

## Technical VDO training courses

More and more electronic and mechanical parts are being installed in today's vehicles – stay up to date! Some topics:

- | Basic electrical practice using ATE/VDO as an example
- | Tyre pressure monitoring systems used in workshop tasks
- | Diesel: modern common-rail injection systems

## Product and sales training courses

Increase your business success through motivated employees and new offers for your customers – with these training courses (and more):

- | Product training for current VDO multibrand testers
- | Using a warranty as a business opportunity
- | Leadership and development for vehicle workshops







- D** Neue Artikel
- EN** New parts
- FR** Nouvelles références
- IT** Codici nuovi
- ES** Nuevas referencias
- NL** Nieuwe artikelen
- DA** Nye artikler
- SV** Nya artiklar
- HU** Új termékek
- PT** Novo artigos
- RU** Новые позиции
- CZ** Nové výrobky
- PL** Nowe artykuły
- EL** Νέα Βροϊόν
- TR** Yeni ürün
- ZH** 新件
- JA** 新商品
- AR** المنتجات الجديدة

# K24-F

# Neue Artikel

New parts - Codici nuovi - Nouvelles références - Nuevas referencias



|   |  |
|---|--|
| <b>03.0137-0505.2</b> 650505 FIAT DOBLO (10-)                             | <b>13.0460-2781.2</b> 602781 MERCEDES BENZ M-Klasse/GLE-Klasse (W166) (11-)    |
| <b>03.0137-0505.2</b> 650505 OPEL COMBO D / Vauxhall Combo D (11-)        | <b>13.0460-2782.2</b> 602782 MERCEDES BENZ GL-Klasse / GLS-Klasse (X166) (12-) |
| <b>03.0137-0519.2</b> 650519 NISSAN NAVARA (D40M) (05-)                   | <b>13.0460-2782.2</b> 602782 MERCEDES BENZ GLE-Klasse (C292) Coupe (15-)       |
| <b>03.0137-0519.2</b> 650519 NISSAN NAVARA Pick-up (D23) (15-)            | <b>13.0460-2782.2</b> 602782 MERCEDES BENZ M-Klasse/GLE-Klasse (W166) (11-)    |
| <b>03.0137-0519.2</b> 650519 NISSAN NP 300 (D40M) (08-)                   | <b>13.0460-2783.2</b> 602783 FIAT PANDA (12-)                                  |
| <b>03.0137-0519.2</b> 650519 FORD RANGER (11-)                            | <b>13.0460-2784.2</b> 602784 FORD B-MAX (12-)                                  |
| <b>03.0137-0521.2</b> 650521 SKODA RAPID / RAPID Spaceback (12-)          | <b>13.0460-2784.2</b> 602784 FORD FIESTA VI (08-)                              |
| <b>03.0137-0521.2</b> 650521 SKODA ROOMSTER (5J) (06-15)                  | <b>13.0460-2784.2</b> 602784 FORD TRANSIT COURIER / TOURNEO COURIER (14-)      |
| <b>03.0137-0521.2</b> 650521 SEAT TOLEDO IV (KG3) (12-)                   | <b>13.0460-2785.2</b> 602785 AUDI A3 / A3 (8V) Sportback (12-)                 |
| <b>03.0137-0532.2</b> 650532 DACIA LOGAN Limousine (LS_) (04-13)          | <b>13.0460-2785.2</b> 602785 SEAT ATECA (16-)                                  |
| <b>03.0137-0532.2</b> 650532 DACIA LOGAN MCV Kombi (KS_) (07-13)          | <b>13.0460-2785.2</b> 602785 AUDI A3 (8V) Cabrio (13-)                         |
| <b>03.0137-0532.2</b> 650532 DACIA LOGAN II Limousine (L52_) (12-)        | <b>13.0460-2785.2</b> 602785 SKODA OCTAVIA III (5E) (12-)                      |
| <b>03.0137-0532.2</b> 650532 RENAULT CLIO IV (B98_) (12-)                 | <b>13.0460-2785.2</b> 602785 SEAT LEON III (5F) / SC / ST (12-)                |
| <b>03.0137-0532.2</b> 650532 DACIA LOGAN II MCV Kombi (13-)               | <b>13.0460-2785.2</b> 602785 SEAT LEON III (5F) ST X-Perience (14-)            |
| <b>03.0137-0532.2</b> 650532 DACIA SANDERO (08-13)                        | <b>13.0460-2785.2</b> 602785 SKODA SUPERB III (15-)                            |
| <b>03.0137-0532.2</b> 650532 DACIA SANDERO II (B52_) (12-)                | <b>13.0460-2785.2</b> 602785 SKODA SUPERB III Combi (15-)                      |
| <b>03.0137-0532.2</b> 650532 RENAULT LOGAN II (L52) (13-)                 | <b>13.0460-2785.2</b> 602785 VOLKSWAGEN GOLF VII (12-)                         |
| <b>03.0137-0532.2</b> 650532 RENAULT LOGAN II Kombi (L52) (13-)           | <b>13.0460-2785.2</b> 602785 VOLKSWAGEN GOLF VII Variant (13-)                 |
| <b>03.0137-0532.2</b> 650532 RENAULT SANDERO (BS0_) (07-)                 | <b>13.0460-2785.2</b> 602785 VOLKSWAGEN GOLF VII Sportsvan (14-)               |
| <b>03.0137-0532.2</b> 650532 RENAULT SANDERO II (13-)                     | <b>13.0460-2785.2</b> 602785 VOLKSWAGEN GOLF VII ALLTRACK (14-)                |
| <b>03.0137-0532.2</b> 650532 RENAULT THALIA II / SYMBOL (LU_) (08-)       | <b>13.0460-2785.2</b> 602785 AUDI Q2 (16-)                                     |
| <b>03.0137-3040.2</b> 653040 LAND ROVER DISCOVERY III (04-09)             | <b>13.0460-2785.2</b> 602785 VOLKSWAGEN PASSAT / PASSAT VARIANT (14-)          |
| <b>03.0137-3040.2</b> 653040 LAND ROVER DISCOVERY IV (09-)                | <b>13.0460-2785.2</b> 602785 AUDI TT (14-)                                     |
| <b>03.0137-3040.2</b> 653040 LAND ROVER RANGE ROVER SPORT (LS) (05-13)    | <b>13.0460-2785.2</b> 602785 VOLKSWAGEN PASSAT ALLTRACK (15-)                  |
| <b>03.0137-3042.2</b> 653042 NISSAN PATHFINDER (R51M) (05-)               | <b>13.0460-2785.2</b> 602785 VOLKSWAGEN TIGUAN (16-)                           |
| <b>03.0137-9313.2</b> 669313 FORD B-MAX (12-)                             | <b>13.0460-2785.2</b> 602785 VOLKSWAGEN TOURAN II (15-)                        |
| <b>03.0137-9313.2</b> 669313 FORD FOCUS III (11-)                         | <b>13.0460-2787.2</b> 602787 SKODA OCTAVIA III (5E) (12-)                      |
| <b>03.0137-9313.2</b> 669313 FORD TRANSIT COURIER / TOURNEO COURIER (14-) | <b>13.0460-2787.2</b> 602787 SEAT LEON III (5F) / SC / ST (12-)                |
| <b>03.0137-9317.2</b> 669317 RENAULT THALIA II / SYMBOL (LU_) (08-)       | <b>13.0460-2787.2</b> 602787 SEAT LEON III (5F) ST X-Perience (14-)            |
| <b>03.0137-9317.2</b> 669317 RENAULT TWINGO II (CN0_) (07-14)             | <b>13.0460-2789.2</b> 602789 FIAT 500 L Kombi (12-)                            |
| <b>03.0137-9319.2</b> 669319 SUZUKI SX4 (06-15)                           | <b>13.0460-2792.2</b> 602792 MERCEDES BENZ C-Klasse (W205) Limousine (14-)     |
| <b>03.0137-9319.2</b> 669319 FIAT SEDICI (06-)                            | <b>13.0460-2792.2</b> 602792 MERCEDES BENZ C-Klasse (S205) Kombi (14-)         |
| <b>03.0520-5017.3</b> 695017 DACIA LOGAN II Limousine (L52_) (12-)        | <b>13.0460-2792.2</b> 602792 MERCEDES BENZ C-Klasse (C205) Coupe (15-)         |
| <b>03.0520-5017.3</b> 695017 RENAULT CLIO IV (B98_) (12-)                 | <b>13.0460-2792.2</b> 602792 MERCEDES BENZ C-Klasse (A205) Cabrio (16-)        |
| <b>03.0520-5017.3</b> 695017 DACIA SANDERO (08-13)                        | <b>13.0460-2792.2</b> 602792 MERCEDES BENZ E-Klasse (W213) Limousine (16-)     |
| <b>03.0520-5017.3</b> 695017 DACIA SANDERO II (B52_) (12-)                | <b>13.0460-2792.2</b> 602792 MERCEDES BENZ E-Klasse (S213) Kombi (16-)         |
| <b>03.0520-5017.3</b> 695017 RENAULT SANDERO II (13-)                     | <b>13.0460-2793.2</b> 602793 FIAT 500 L Kombi (12-)                            |
| <b>03.0520-5017.3</b> 695017 RENAULT THALIA II / SYMBOL (LU_) (08-)       | <b>13.0460-2793.2</b> 602793 OPEL CORSA E / Vauxhall Corsa Mk IV (14-)         |
| <b>03.0520-8219.3</b> 698219 SKODA FABIA II (5J) (07-14)                  | <b>13.0460-3867.2</b> 603867 PEUGEOT 301 (12-)                                 |
| <b>03.0520-8219.3</b> 698219 SKODA FABIA III (NJ) (14-)                   | <b>13.0460-3867.2</b> 603867 CITROEN C4 CACTUS (14-)                           |
| <b>03.0520-8219.3</b> 698219 SEAT IBIZA IV (6L1) (02-10)                  | <b>13.0460-3867.2</b> 603867 CITROEN C-ELYSEE (12-)                            |
| <b>03.0520-8219.3</b> 698219 VOLKSWAGEN POLO V (09-)                      | <b>13.0460-3870.2</b> 603870 PEUGEOT 308 II (T9) (13-)                         |
| <b>03.0520-8219.3</b> 698219 VOLKSWAGEN UP / LOAD UP (11-)                | <b>13.0460-3870.2</b> 603870 PEUGEOT 308 II SW (T9) (14-)                      |
| <b>03.0520-8920.3</b> 698920 TOYOTA YARIS (06-11)                         | <b>13.0460-3871.2</b> 603871 CITROEN C4 II PICASSO (13-)                       |
| <b>03.0520-9920.3</b> 699920 TOYOTA YARIS (11-)                           | <b>13.0460-3871.2</b> 603871 CITROEN C4 II GRAND PICASSO (13-)                 |
| <b>03.0521-0320.3</b> 690320 FIAT DOBLO (10-)                             | <b>13.0460-3871.2</b> 603871 PEUGEOT 308 II (T9) (13-)                         |
| <b>13.0460-2600.2</b> 602600 RENAULT KADJAR (HFE) (15-)                   | <b>13.0460-3871.2</b> 603871 PEUGEOT 308 II SW (T9) (14-)                      |
| <b>13.0460-2600.2</b> 602600 NISSAN QASHQAI (J11E) (14-)                  | <b>13.0460-3872.2</b> 603872 CITROEN C4 II PICASSO (13-)                       |
| <b>13.0460-2771.2</b> 602771 CHRYSLER GRAND VOYAGER (RT) (07-)            | <b>13.0460-3872.2</b> 603872 CITROEN C4 II GRAND PICASSO (13-)                 |
| <b>13.0460-2771.2</b> 602771 FIAT FREEMONT (11-15)                        | <b>13.0460-3872.2</b> 603872 PEUGEOT 308 II (T9) (13-)                         |
| <b>13.0460-2780.2</b> 602780 MERCEDES BENZ S-Klasse (W222) (13-)          | <b>13.0460-3872.2</b> 603872 PEUGEOT 308 II SW (T9) (14-)                      |
| <b>13.0460-2780.2</b> 602780 MERCEDES BENZ S-Klasse (C217) Coupe (14-)    | <b>13.0460-4869.2</b> 604869 MERCEDES BENZ S-Klasse (W222) (13-)               |
| <b>13.0460-2780.2</b> 602780 MERCEDES BENZ S-Klasse (A217) Cabrio (15-)   | <b>13.0460-4869.2</b> 604869 MERCEDES BENZ SL-Klasse (R231) (12-)              |
| <b>13.0460-2780.2</b> 602780 MERCEDES BENZ SL-Klasse (R231) (12-)         | <b>13.0460-4870.2</b> 604870 MERCEDES BENZ S-Klasse (W222) (13-)               |
| <b>13.0460-2781.2</b> 602781 MERCEDES BENZ GLE-Klasse (C292) Coupe (15-)  | <b>13.0460-4870.2</b> 604870 MERCEDES BENZ S-Klasse (C217) Coupe (14-)         |





# Neue Artikel

New parts - Codici nuovi - Nouvelles références - Nuevas referencias



|                |        |               |  |
|----------------|--------|---------------|--|
| 13.0460-4870.2 | 604870 | MERCEDES BENZ | S-Klasse (A217) Cabrio (15-)                   |
| 13.0460-4870.2 | 604870 | MERCEDES BENZ | SL-Klasse (R231) (12-)                         |
| 13.0460-4872.2 | 604872 | VOLKSWAGEN    | TOUAREG II (10-)                               |
| 13.0460-4873.2 | 604873 | AUDI          | A6 (4G2/C7) Limousine (11-)                    |
| 13.0460-4873.2 | 604873 | AUDI          | A6 (4G5/C7) Avant (11-)                        |
| 13.0460-4873.2 | 604873 | AUDI          | A7 Sportback (10-)                             |
| 13.0460-4873.2 | 604873 | AUDI          | A8 (09-)                                       |
| 13.0460-4875.2 | 604875 | BMW           | 1er Reihe/F20/F21 Limousine (11-)              |
| 13.0460-4875.2 | 604875 | BMW           | 2er Reihe/F22 Coupe (13-)                      |
| 13.0460-4875.2 | 604875 | BMW           | 2er Reihe/F23 Cabrio (14-)                     |
| 13.0460-4875.2 | 604875 | BMW           | 3er Reihe/F30 Limousine (11-)                  |
| 13.0460-4875.2 | 604875 | BMW           | 3er Reihe/F31 Touring (12-)                    |
| 13.0460-4875.2 | 604875 | BMW           | 3er Reihe/F34 GT (13-)                         |
| 13.0460-4875.2 | 604875 | BMW           | 4er Reihe/F32 Coupe (13-)                      |
| 13.0460-4875.2 | 604875 | BMW           | 4er Reihe/F33 Cabrio (14-)                     |
| 13.0460-4875.2 | 604875 | BMW           | 4er Reihe/F36 Gran Coupe (14-)                 |
| 13.0460-4882.2 | 604882 | MERCEDES BENZ | V-Klasse (BM447) (14-)                         |
| 13.0460-4882.2 | 604882 | MERCEDES BENZ | VITO (W447) (14-)                              |
| 13.0460-4884.2 | 604884 | MERCEDES BENZ | VITO (W447) (14-)                              |
| 13.0460-5641.2 | 605641 | HYUNDAI       | ix20 (10-)                                     |
| 13.0460-5641.2 | 605641 | HYUNDAI       | SONATA (YF) (09-)                              |
| 13.0460-5641.2 | 605641 | KIA           | SOUL (14-)                                     |
| 13.0460-5646.2 | 605646 | HYUNDAI       | ACCENT IV (10-)                                |
| 13.0460-5646.2 | 605646 | HYUNDAI       | i20 / i20 COUPE (GB) (14-)                     |
| 13.0460-5646.2 | 605646 | KIA           | RIO III (UB) (11-)                             |
| 13.0460-7275.2 | 607275 | BMW           | 5er Reihe/F10 Limousine (10-)                  |
| 13.0460-7275.2 | 607275 | BMW           | 5er Reihe/F11 Touring (10-)                    |
| 13.0460-7286.2 | 607286 | VOLKSWAGEN    | TRANSPORTER (T5) BUS / MULTIVAN / KASTEN (03-) |
| 13.0460-7286.2 | 607286 | VOLKSWAGEN    | TRANSPORTER (T5) PRITSCHKE / FAHRGESTELL (03-) |
| 13.0460-7286.2 | 607286 | VOLKSWAGEN    | TRANSPORTER (T6) (15-)                         |
| 13.0460-7288.2 | 607288 | FIAT          | 500 (07-)                                      |
| 13.0460-7288.2 | 607288 | FIAT          | 500 C Cabrio (09-)                             |
| 13.0460-7288.2 | 607288 | FIAT          | PUNTO / PUNTO EVO (09-)                        |
| 13.0460-7289.2 | 607289 | LANCIA        | YPSILON / Chrysler Ypsilon (11-)               |
| 13.0460-7289.2 | 607289 | FIAT          | PANDA (12-)                                    |
| 13.0460-7293.2 | 607293 | AUDI          | A3 / A3 (8V) Sportback (12-)                   |
| 13.0460-7293.2 | 607293 | SEAT          | ATECA (16-)                                    |
| 13.0460-7293.2 | 607293 | AUDI          | A3 (8V) Cabrio (13-)                           |
| 13.0460-7293.2 | 607293 | VOLKSWAGEN    | GOLF VII (12-)                                 |
| 13.0460-7293.2 | 607293 | VOLKSWAGEN    | GOLF VII Variant (13-)                         |
| 13.0460-7293.2 | 607293 | VOLKSWAGEN    | GOLF VII Sportsvan (14-)                       |
| 13.0460-7293.2 | 607293 | VOLKSWAGEN    | GOLF VII ALLTRACK (14-)                        |
| 13.0460-7293.2 | 607293 | AUDI          | Q2 (16-)                                       |
| 13.0460-7293.2 | 607293 | AUDI          | TT (14-)                                       |
| 13.0460-7293.2 | 607293 | VOLKSWAGEN    | TOURAN II (15-)                                |
| 13.0460-7294.2 | 607294 | AUDI          | A3 / A3 (8V) Sportback (12-)                   |
| 13.0460-7294.2 | 607294 | AUDI          | A3 (8V) Cabrio (13-)                           |
| 13.0460-7294.2 | 607294 | SKODA         | SUPERB III (15-)                               |
| 13.0460-7294.2 | 607294 | SKODA         | SUPERB III Combi (15-)                         |
| 13.0460-7294.2 | 607294 | VOLKSWAGEN    | GOLF VII (12-)                                 |
| 13.0460-7294.2 | 607294 | VOLKSWAGEN    | GOLF VII Variant (13-)                         |
| 13.0460-7294.2 | 607294 | VOLKSWAGEN    | GOLF VII ALLTRACK (14-)                        |
| 13.0460-7294.2 | 607294 | VOLKSWAGEN    | PASSAT / PASSAT VARIANT (14-)                  |
| 13.0460-7294.2 | 607294 | AUDI          | TT (14-)                                       |
| 13.0460-7294.2 | 607294 | VOLKSWAGEN    | PASSAT ALLTRACK (15-)                          |



|                |        |               |   |
|----------------|--------|---------------|---|
| 13.0460-7294.2 | 607294 | VOLKSWAGEN    | TIGUAN (16-)                            |
| 13.0460-7294.2 | 607294 | VOLKSWAGEN    | TOURAN II (15-)                         |
| 13.0460-7303.2 | 607303 | AUDI          | A3 / A3 (8V) Sportback (12-)            |
| 13.0460-7303.2 | 607303 | AUDI          | A3 (8V) Cabrio (13-)                    |
| 13.0460-7303.2 | 607303 | SKODA         | OCTAVIA III (5E) (12-)                  |
| 13.0460-7303.2 | 607303 | SEAT          | LEON III (5F) / SC / ST (12-)           |
| 13.0460-7303.2 | 607303 | SEAT          | LEON III (5F) ST X-Perience (14-)       |
| 13.0460-7303.2 | 607303 | VOLKSWAGEN    | GOLF VII (12-)                          |
| 13.0460-7303.2 | 607303 | VOLKSWAGEN    | GOLF VII Variant (13-)                  |
| 13.0460-7303.2 | 607303 | VOLKSWAGEN    | GOLF VII Sportsvan (14-)                |
| 13.0460-7303.2 | 607303 | VOLKSWAGEN    | GOLF VII ALLTRACK (14-)                 |
| 13.0460-7305.2 | 607305 | CITROEN       | C4 II PICASSO (13-)                     |
| 13.0460-7305.2 | 607305 | CITROEN       | C4 II GRAND PICASSO (13-)               |
| 13.0460-7307.2 | 607307 | AUDI          | A3 / A3 (8V) Sportback (12-)            |
| 13.0470-2781.2 | LD2781 | MERCEDES BENZ | GLE-Klasse (C292) Coupe (15-)           |
| 13.0470-2781.2 | LD2781 | MERCEDES BENZ | M-Klasse/GLE-Klasse (W166) (11-)        |
| 13.0470-2782.2 | LD2782 | MERCEDES BENZ | GL-Klasse / GLS-Klasse (X166) (12-)     |
| 13.0470-2782.2 | LD2782 | MERCEDES BENZ | GLE-Klasse (C292) Coupe (15-)           |
| 13.0470-2782.2 | LD2782 | MERCEDES BENZ | M-Klasse/GLE-Klasse (W166) (11-)        |
| 13.0470-2784.2 | LD2784 | FORD          | B-MAX (12-)                             |
| 13.0470-2784.2 | LD2784 | FORD          | FIESTA VI (08-)                         |
| 13.0470-2784.2 | LD2784 | FORD          | TRANSIT COURIER / TOURNEO COURIER (14-) |
| 13.0470-2785.2 | LD2785 | AUDI          | A3 / A3 (8V) Sportback (12-)            |
| 13.0470-2785.2 | LD2785 | SEAT          | ATECA (16-)                             |
| 13.0470-2785.2 | LD2785 | AUDI          | A3 (8V) Cabrio (13-)                    |
| 13.0470-2785.2 | LD2785 | SKODA         | OCTAVIA III (5E) (12-)                  |
| 13.0470-2785.2 | LD2785 | SEAT          | LEON III (5F) / SC / ST (12-)           |
| 13.0470-2785.2 | LD2785 | SEAT          | LEON III (5F) ST X-Perience (14-)       |
| 13.0470-2785.2 | LD2785 | SKODA         | SUPERB III (15-)                        |
| 13.0470-2785.2 | LD2785 | SKODA         | SUPERB III Combi (15-)                  |
| 13.0470-2785.2 | LD2785 | VOLKSWAGEN    | GOLF VII (12-)                          |
| 13.0470-2785.2 | LD2785 | VOLKSWAGEN    | GOLF VII Variant (13-)                  |
| 13.0470-2785.2 | LD2785 | VOLKSWAGEN    | GOLF VII Sportsvan (14-)                |
| 13.0470-2785.2 | LD2785 | VOLKSWAGEN    | GOLF VII ALLTRACK (14-)                 |
| 13.0470-2785.2 | LD2785 | AUDI          | Q2 (16-)                                |
| 13.0470-2785.2 | LD2785 | VOLKSWAGEN    | PASSAT / PASSAT VARIANT (14-)           |
| 13.0470-2785.2 | LD2785 | AUDI          | TT (14-)                                |
| 13.0470-2785.2 | LD2785 | VOLKSWAGEN    | PASSAT ALLTRACK (15-)                   |
| 13.0470-2785.2 | LD2785 | VOLKSWAGEN    | TIGUAN (16-)                            |
| 13.0470-2785.2 | LD2785 | VOLKSWAGEN    | TOURAN II (15-)                         |
| 13.0470-2789.2 | LD2789 | FIAT          | 500 L Kombi (12-)                       |
| 13.0470-2792.2 | LD2792 | MERCEDES BENZ | C-Klasse (W205) Limousine (14-)         |
| 13.0470-2792.2 | LD2792 | MERCEDES BENZ | C-Klasse (S205) Kombi (14-)             |
| 13.0470-2792.2 | LD2792 | MERCEDES BENZ | C-Klasse (C205) Coupe (15-)             |
| 13.0470-2792.2 | LD2792 | MERCEDES BENZ | C-Klasse (A205) Cabrio (16-)            |
| 13.0470-2792.2 | LD2792 | MERCEDES BENZ | E-Klasse (W213) Limousine (16-)         |
| 13.0470-2792.2 | LD2792 | MERCEDES BENZ | E-Klasse (S213) Kombi (16-)             |
| 13.0470-3870.2 | LD3870 | PEUGEOT       | 308 II (T9) (13-)                       |
| 13.0470-3870.2 | LD3870 | PEUGEOT       | 308 II SW (T9) (14-)                    |
| 13.0470-3871.2 | LD3871 | CITROEN       | C4 II PICASSO (13-)                     |
| 13.0470-3871.2 | LD3871 | CITROEN       | C4 II GRAND PICASSO (13-)               |
| 13.0470-3871.2 | LD3871 | PEUGEOT       | 308 II (T9) (13-)                       |
| 13.0470-3871.2 | LD3871 | PEUGEOT       | 308 II SW (T9) (14-)                    |
| 13.0470-3872.2 | LD3872 | CITROEN       | C4 II PICASSO (13-)                     |
| 13.0470-3872.2 | LD3872 | CITROEN       | C4 II GRAND PICASSO (13-)               |

# Neue Artikel

New parts - Codici nuovi - Nouvelles références - Nuevas referencias



|                |        |               |                                      |
|----------------|--------|---------------|--------------------------------------|
| 13.0470-3872.2 | LD3872 | PEUGEOT       | 308 II (T9) (13-)                    |
| 13.0470-3872.2 | LD3872 | PEUGEOT       | 308 II SW (T9) (14-)                 |
| 13.0470-4872.2 | LD4872 | VOLKSWAGEN    | TOUAREG II (10-)                     |
| 13.0470-7275.2 | LD7275 | BMW           | 5er Reihe/F10 Limousine (10-)        |
| 13.0470-7275.2 | LD7275 | BMW           | 5er Reihe/F11 Touring (10-)          |
| 13.0470-7288.2 | LD7288 | FIAT          | 500 (07-)                            |
| 13.0470-7288.2 | LD7288 | FIAT          | 500 C Cabrio (09-)                   |
| 13.0470-7288.2 | LD7288 | FIAT          | PUNTO / PUNTO EVO (09-)              |
| 13.0470-7294.2 | LD7294 | AUDI          | A3 / A3 (8V) Sportback (12-)         |
| 13.0470-7294.2 | LD7294 | AUDI          | A3 (8V) Cabrio (13-)                 |
| 13.0470-7294.2 | LD7294 | SKODA         | SUPERB III (15-)                     |
| 13.0470-7294.2 | LD7294 | SKODA         | SUPERB III Combi (15-)               |
| 13.0470-7294.2 | LD7294 | VOLKSWAGEN    | GOLF VII (12-)                       |
| 13.0470-7294.2 | LD7294 | VOLKSWAGEN    | GOLF VII Variant (13-)               |
| 13.0470-7294.2 | LD7294 | VOLKSWAGEN    | GOLF VII ALLTRACK (14-)              |
| 13.0470-7294.2 | LD7294 | VOLKSWAGEN    | PASSAT / PASSAT VARIANT (14-)        |
| 13.0470-7294.2 | LD7294 | AUDI          | TT (14-)                             |
| 13.0470-7294.2 | LD7294 | VOLKSWAGEN    | PASSAT ALLTRACK (15-)                |
| 13.0470-7294.2 | LD7294 | VOLKSWAGEN    | TIGUAN (16-)                         |
| 13.0470-7294.2 | LD7294 | VOLKSWAGEN    | TOURAN II (15-)                      |
| 13.0470-7303.2 | LD7303 | AUDI          | A3 / A3 (8V) Sportback (12-)         |
| 13.0470-7303.2 | LD7303 | AUDI          | A3 (8V) Cabrio (13-)                 |
| 13.0470-7303.2 | LD7303 | SKODA         | OCTAVIA III (5E) (12-)               |
| 13.0470-7303.2 | LD7303 | SEAT          | LEON III (5F) / SC / ST (12-)        |
| 13.0470-7303.2 | LD7303 | SEAT          | LEON III (5F) ST X-Perience (14-)    |
| 13.0470-7303.2 | LD7303 | VOLKSWAGEN    | GOLF VII (12-)                       |
| 13.0470-7303.2 | LD7303 | VOLKSWAGEN    | GOLF VII Variant (13-)               |
| 13.0470-7303.2 | LD7303 | VOLKSWAGEN    | GOLF VII Sportsvan (14-)             |
| 13.0470-7303.2 | LD7303 | VOLKSWAGEN    | GOLF VII ALLTRACK (14-)              |
| 13.0470-7305.2 | LD7305 | CITROEN       | C4 II PICASSO (13-)                  |
| 13.0470-7305.2 | LD7305 | CITROEN       | C4 II GRAND PICASSO (13-)            |
| 13.0470-9000.2 | LD9000 | MERCEDES BENZ | C-Klasse (W204) Limousine (07-14)    |
| 13.0470-9000.2 | LD9000 | MERCEDES BENZ | C-Klasse (S204) Kombi (07-14)        |
| 13.0470-9000.2 | LD9000 | MERCEDES BENZ | E-Klasse (W212) Limousine (09-)      |
| 13.0470-9000.2 | LD9000 | MERCEDES BENZ | E-Klasse (S212) Kombi (09-)          |
| 13.0470-9001.2 | LD9001 | MERCEDES BENZ | E-Klasse (W212) Limousine (09-)      |
| 13.0470-9001.2 | LD9001 | MERCEDES BENZ | E-Klasse (S212) Kombi (09-)          |
| 24.0108-0117.2 | 408117 | RENAULT       | CLIO II Limousine (BB_/CB_) (98-12)  |
| 24.0109-0168.1 | 409168 | HONDA         | CITY (08-)                           |
| 24.0109-0174.1 | 409174 | VOLKSWAGEN    | POLO IV (02-09)                      |
| 24.0109-0175.1 | 409175 | SUZUKI        | SWIFT IV (10-)                       |
| 24.0109-0181.1 | 409181 | MAZDA         | 3 (BM) (13-)                         |
| 24.0109-0182.1 | 409182 | SUZUKI        | SX4 (13-)                            |
| 24.0109-0182.1 | 409182 | SUZUKI        | VITARA (LY) (15-)                    |
| 24.0110-0380.1 | 410380 | HONDA         | CIVIC IX (5-tuerig) (12-)            |
| 24.0110-0384.1 | 410384 | SUBARU        | FORESTER (13-)                       |
| 24.0110-0384.1 | 410384 | SUBARU        | IMPREZA (GP) (11-)                   |
| 24.0110-0384.1 | 410384 | SUBARU        | XV (12-)                             |
| 24.0110-0388.1 | 410388 | HYUNDAI       | GRANDEUR (HG) (11-)                  |
| 24.0110-0388.1 | 410388 | KIA           | OPTIMA (TF) (12-15)                  |
| 24.0110-0388.1 | 410388 | HYUNDAI       | ix35 (09-)                           |
| 24.0110-0391.1 | 410391 | MERCEDES BENZ | SLK-Klasse / SLC-Klasse (R172) (11-) |
| 24.0110-0392.1 | 410392 | KIA           | CARENS IV (13-)                      |
| 24.0110-0393.1 | 410393 | FIAT          | 500 L Kombi (12-)                    |
| 24.0110-0396.1 | 410396 | MINI          | F55 (14-)                            |



|                |        |               |   |
|----------------|--------|---------------|---|
| 24.0110-0396.1 | 410396 | MINI          | F56 (13-)                                       |
| 24.0110-0396.1 | 410396 | MINI          | F57 Cabrio (15-)                                |
| 24.0110-0398.1 | 410398 | HYUNDAI       | ACCENT IV (10-)                                 |
| 24.0110-0398.1 | 410398 | HYUNDAI       | i20 / i20 COUPE (GB) (14-)                      |
| 24.0110-0398.1 | 410398 | KIA           | RIO III (UB) (11-)                              |
| 24.0111-0183.2 | 411183 | RENAULT       | CLIO III (BR_/CR_) (05-12)                      |
| 24.0111-0183.2 | 411183 | RENAULT       | MEGANE II Limousine 3/5-tuerig (BM/CM_) (02-08) |
| 24.0111-0185.1 | 411185 | FORD          | MONDEO V (14-)                                  |
| 24.0112-0210.1 | 412210 | SEAT          | ALHAMBRA II (10-)                               |
| 24.0112-0210.1 | 412210 | AUDI          | A3 / A3 (8V) Sportback (12-)                    |
| 24.0112-0210.1 | 412210 | SKODA         | SUPERB III (15-)                                |
| 24.0112-0210.1 | 412210 | SKODA         | SUPERB III Combi (15-)                          |
| 24.0112-0210.1 | 412210 | VOLKSWAGEN    | GOLF VII (12-)                                  |
| 24.0112-0210.1 | 412210 | VOLKSWAGEN    | GOLF VII Variant (13-)                          |
| 24.0112-0210.1 | 412210 | VOLKSWAGEN    | GOLF VII ALLTRACK (14-)                         |
| 24.0112-0210.1 | 412210 | AUDI          | Q3 (11-)  |
| 24.0112-0210.1 | 412210 | VOLKSWAGEN    | PASSAT / PASSAT VARIANT (14-)                   |
| 24.0112-0210.1 | 412210 | AUDI          | TT (14-)  |
| 24.0112-0210.1 | 412210 | VOLKSWAGEN    | PASSAT ALLTRACK (15-)                           |
| 24.0112-0210.1 | 412210 | VOLKSWAGEN    | SHARAN II (10-)                                 |
| 24.0112-0210.1 | 412210 | VOLKSWAGEN    | TIGUAN (16-)                                    |
| 24.0112-0210.1 | 412210 | VOLKSWAGEN    | TOURAN II (15-)                                 |
| 24.0112-0211.1 | 412211 | CITROEN       | C4 II PICASSO (13-)                             |
| 24.0112-0211.1 | 412211 | CITROEN       | C4 II GRAND PICASSO (13-)                       |
| 24.0112-0211.1 | 412211 | PEUGEOT       | 308 II (T9) (13-)                               |
| 24.0112-0211.1 | 412211 | PEUGEOT       | 308 II SW (T9) (14-)                            |
| 24.0112-0212.1 | 412212 | CITROEN       | C4 II PICASSO (13-)                             |
| 24.0112-0212.1 | 412212 | CITROEN       | C4 II GRAND PICASSO (13-)                       |
| 24.0112-0212.1 | 412212 | PEUGEOT       | 308 II (T9) (13-)                               |
| 24.0112-0212.1 | 412212 | PEUGEOT       | 308 II SW (T9) (14-)                            |
| 24.0112-0212.1 | 412212 | CITROEN       | JUMPY (K0) Kasten (16-)                         |
| 24.0112-0212.1 | 412212 | CITROEN       | SPACETOURER (16-)                               |
| 24.0112-0212.1 | 412212 | PEUGEOT       | EXPERT (K0) Kasten (16-)                        |
| 24.0112-0212.1 | 412212 | PEUGEOT       | TRAVELLER (16-)                                 |
| 24.0112-0213.1 | 412213 | MERCEDES BENZ | V-Klasse (BM447) (14-)                          |
| 24.0112-0213.1 | 412213 | MERCEDES BENZ | VITO (W447) (14-)                               |
| 24.0112-0214.1 | 412214 | JEEP          | CHEROKEE (KL) (13-)                             |
| 24.0113-0200.1 | 413200 | RENAULT       | KADJAR (HFE) (15-)                              |
| 24.0113-0200.1 | 413200 | NISSAN        | QASHQAI (J11E) (14-)                            |
| 24.0117-0110.1 | 417110 | MITSUBISHI    | i-MIEV (09-14)                                  |
| 24.0117-0110.1 | 417110 | CITROEN       | C-Zero (10-)                                    |
| 24.0117-0110.1 | 417110 | PEUGEOT       | iON (10-)                                       |
| 24.0120-0216.1 | 420216 | SUZUKI        | SWIFT III (05-10)                               |
| 24.0120-0221.2 | 420221 | BMW           | 3er Reihe/E46 Coupe (99-06)                     |
| 24.0120-0221.2 | 420221 | BMW           | 3er Reihe/E46 Cabrio (00-06)                    |
| 24.0120-0221.2 | 420221 | BMW           | Z4 Roadster/E85 (03-08)                         |
| 24.0120-0221.2 | 420221 | BMW           | Z4 Coupe/E86 (06-08)                            |
| 24.0120-0222.2 | 420222 | BMW           | 3er Reihe/E46 Coupe (99-06)                     |
| 24.0120-0222.2 | 420222 | BMW           | 3er Reihe/E46 Cabrio (00-06)                    |
| 24.0120-0222.2 | 420222 | BMW           | Z4 Roadster/E85 (03-08)                         |
| 24.0120-0222.2 | 420222 | BMW           | Z4 Coupe/E86 (06-08)                            |
| 24.0120-0228.1 | 420228 | BMW           | Z4 Roadster/E89 (09-)                           |
| 24.0120-0240.1 | 420240 | BMW           | 3er Reihe/F30 Limousine (11-)                   |
| 24.0120-0240.1 | 420240 | BMW           | 3er Reihe/F31 Touring (12-)                     |
| 24.0120-0240.1 | 420240 | BMW           | 3er Reihe/F34 GT (13-)                          |



# Neue Artikel

New parts - Codici nuovi - Nouvelles références - Nuevas referencias



|                |        |               |   |
|----------------|--------|---------------|---|
| 24.0120-0240.1 | 420240 | BMW           | 4er Reihe/F32 Coupe (13-)               |
| 24.0120-0240.1 | 420240 | BMW           | 4er Reihe/F33 Cabrio (14-)              |
| 24.0120-0240.1 | 420240 | BMW           | 4er Reihe/F36 Gran Coupe (14-)          |
| 24.0120-0243.1 | 420243 | BMW           | 3er Reihe/F30 Limousine (11-)           |
| 24.0120-0243.1 | 420243 | BMW           | 3er Reihe/F31 Touring (12-)             |
| 24.0120-0243.1 | 420243 | BMW           | 3er Reihe/F34 GT (13-)                  |
| 24.0120-0243.1 | 420243 | BMW           | 4er Reihe/F32 Coupe (13-)               |
| 24.0120-0243.1 | 420243 | BMW           | 4er Reihe/F33 Cabrio (14-)              |
| 24.0120-0243.1 | 420243 | BMW           | 4er Reihe/F36 Gran Coupe (14-)          |
| 24.0122-0283.1 | 422283 | FIAT          | 500 (07-)                               |
| 24.0122-0283.1 | 422283 | FIAT          | 500 C Cabrio (09-)                      |
| 24.0122-0287.1 | 422287 | MERCEDES BENZ | M-Klasse/GLE-Klasse (W166) (11-)        |
| 24.0122-0288.1 | 422288 | MERCEDES BENZ | GLE-Klasse (C292) Coupe (15-)           |
| 24.0122-0288.1 | 422288 | MERCEDES BENZ | M-Klasse/GLE-Klasse (W166) (11-)        |
| 24.0122-0292.1 | 422292 | MINI          | F55 (14-)                               |
| 24.0122-0292.1 | 422292 | MINI          | F56 (13-)                               |
| 24.0122-0292.1 | 422292 | MINI          | F57 Cabrio (15-)                        |
| 24.0122-0292.1 | 422292 | BMW           | 2er Reihe/F45 Active Tourer (14-)       |
| 24.0122-0292.1 | 422292 | MINI          | F54 Clubman (15-)                       |
| 24.0123-0119.1 | 423119 | DACIA         | DUSTER (HS_) (10-)                      |
| 24.0123-0119.1 | 423119 | RENAULT       | DUSTER (HS-) (11-)                      |
| 24.0123-0123.1 | 423123 | KIA           | CEE'D (12-)                             |
| 24.0123-0123.1 | 423123 | HYUNDAI       | i30 (GD) (11-)                          |
| 24.0123-0123.1 | 423123 | HYUNDAI       | i30 CW Kombi (12-)                      |
| 24.0124-0258.1 | 424258 | AUDI          | A3 / A3 (8V) Sportback (12-)            |
| 24.0124-0258.1 | 424258 | AUDI          | A3 (8V) Cabrio (13-)                    |
| 24.0124-0258.1 | 424258 | SKODA         | OCTAVIA III (5E) (12-)                  |
| 24.0124-0258.1 | 424258 | SEAT          | LEON III (5F) / SC / ST (12-)           |
| 24.0124-0258.1 | 424258 | SEAT          | LEON III (5F) ST X-Perience (14-)       |
| 24.0124-0258.1 | 424258 | VOLKSWAGEN    | GOLF VII (12-)                          |
| 24.0124-0258.1 | 424258 | VOLKSWAGEN    | GOLF VII Variant (13-)                  |
| 24.0124-0258.1 | 424258 | VOLKSWAGEN    | GOLF VII Sportsvan (14-)                |
| 24.0124-0258.1 | 424258 | VOLKSWAGEN    | GOLF VII ALLTRACK (14-)                 |
| 24.0124-0259.1 | 424259 | BMW           | 2er Reihe/F45 Active Tourer (14-)       |
| 24.0124-0259.1 | 424259 | BMW           | 2er Reihe/F46 Gran Tourer (15-)         |
| 24.0124-0259.1 | 424259 | BMW           | X1/F48 (15-)                            |
| 24.0124-0260.1 | 424260 | BMW           | 2er Reihe/F45 Active Tourer (14-)       |
| 24.0124-0260.1 | 424260 | MINI          | F54 Clubman (15-)                       |
| 24.0124-0260.1 | 424260 | BMW           | 2er Reihe/F46 Gran Tourer (15-)         |
| 24.0124-0260.1 | 424260 | BMW           | X1/F48 (15-)                            |
| 24.0125-0200.1 | 425200 | MERCEDES BENZ | A-Klasse (W176 ) (12-)                  |
| 24.0125-0200.1 | 425200 | MERCEDES BENZ | B-Klasse (W246/W242) (11-)              |
| 24.0125-0208.1 | 425208 | MAZDA         | 3 (BM) (13-)                            |
| 24.0125-0208.1 | 425208 | MAZDA         | CX-3 (15-)                              |
| 24.0125-0209.1 | 425209 | FORD          | FOCUS II (05-11)                        |
| 24.0125-0209.1 | 425209 | FORD          | FOCUS III (11-)                         |
| 24.0125-0209.1 | 425209 | FORD          | KUGA II (13-)                           |
| 24.0125-0209.1 | 425209 | FORD          | TRANSIT CONNECT / TOURNEO CONNECT (13-) |
| 24.0125-0210.1 | 425210 | FORD          | ECOSPORT II (14-)                       |
| 24.0126-0182.1 | 426182 | CHEVROLET     | TRAX (12-)                              |
| 24.0126-0182.1 | 426182 | OPEL          | MOKKA / Vauxhall Mokka (12-)            |
| 24.0126-0183.1 | 426183 | CITROEN       | C4 II PICASSO (13-)                     |
| 24.0126-0183.1 | 426183 | CITROEN       | C4 II GRAND PICASSO (13-)               |
| 24.0126-0183.1 | 426183 | PEUGEOT       | 308 II (T9) (13-)                       |
| 24.0126-0183.1 | 426183 | PEUGEOT       | 308 II SW (T9) (14-)                    |



|                |        |               |  |
|----------------|--------|---------------|--|
| 24.0126-0184.1 | 426184 | TOYOTA        | AURIS (12-)                            |
| 24.0126-0184.1 | 426184 | TOYOTA        | AURIS Touring Sports (13-)             |
| 24.0126-0184.1 | 426184 | TOYOTA        | COROLLA (13-)                          |
| 24.0126-0185.1 | 426185 | RENAULT       | KADJAR (HFE) (15-)                     |
| 24.0126-0185.1 | 426185 | NISSAN        | QASHQAI (J11E) (14-)                   |
| 24.0126-0185.1 | 426185 | NISSAN        | X-TRAIL (T32) (13-)                    |
| 24.0126-0186.1 | 426186 | RENAULT       | KANGOO II (KW_) (08-)                  |
| 24.0126-0186.1 | 426186 | RENAULT       | KANGOO Be Bop (KW0_) (09-10)           |
| 24.0126-0186.1 | 426186 | RENAULT       | KANGOO Express/Rapid (FW_) (08-)       |
| 24.0128-0264.1 | 428264 | PORSCHE       | 911 COUPE (997) (04-13)                |
| 24.0128-0264.1 | 428264 | PORSCHE       | 911 CABRIO (997) (05-13)               |
| 24.0128-0265.1 | 428265 | PORSCHE       | 911 COUPE (997) (04-13)                |
| 24.0128-0265.1 | 428265 | PORSCHE       | 911 CABRIO (997) (05-13)               |
| 24.0128-0269.1 | 428269 | CITROEN       | C4 II PICASSO (13-)                    |
| 24.0128-0269.1 | 428269 | CITROEN       | C4 II GRAND PICASSO (13-)              |
| 24.0128-0269.1 | 428269 | PEUGEOT       | 308 II (T9) (13-)                      |
| 24.0128-0269.1 | 428269 | PEUGEOT       | 308 II SW (T9) (14-)                   |
| 24.0128-0269.1 | 428269 | CITROEN       | C5 III Kombi (X7) (08-)                |
| 24.0128-0269.1 | 428269 | PEUGEOT       | 407 Limousine / SW (04-11)             |
| 24.0128-0269.1 | 428269 | PEUGEOT       | 508 (10-)                              |
| 24.0128-0269.1 | 428269 | PEUGEOT       | 508 SW (10-)                           |
| 24.0128-0280.1 | 428280 | KIA           | SPORTAGE (04-10)                       |
| 24.0128-0286.1 | 428286 | FORD          | MONDEO V (14-)                         |
| 24.0128-0288.1 | 428288 | RENAULT       | MEGANE III Coupe (DZ0_) (08-)          |
| 24.0128-0291.1 | 428291 | NISSAN        | X-TRAIL (T32) (13-)                    |
| 24.0130-0229.1 | 430229 | PEUGEOT       | RCZ (10-15)                            |
| 24.0132-0168.1 | 432168 | MERCEDES BENZ | C-Klasse (C204) Coupe (11-)            |
| 24.0132-0168.1 | 432168 | MERCEDES BENZ | E-Klasse (W212) Limousine (09-)        |
| 24.0132-0168.1 | 432168 | MERCEDES BENZ | E-Klasse (S212) Kombi (09-)            |
| 24.0132-0168.1 | 432168 | MERCEDES BENZ | E-Klasse (C207) Coupe (09-)            |
| 24.0132-0168.1 | 432168 | MERCEDES BENZ | E-Klasse (A207) Cabrio (10-)           |
| 24.0132-0175.1 | 432175 | MERCEDES BENZ | SLK-Klasse / SLC-Klasse (R172) (11-)   |
| 24.0133-0101.1 | 433101 | FORD          | TRANSIT (14-)                          |
| 24.0133-0101.1 | 433101 | FORD          | TRANSIT CUSTOM / TOURNEO CUSTOM (12-)  |
| 24.0134-0105.1 | 434105 | PORSCHE       | 911 COUPE (997) (04-13)                |
| 24.0134-0106.1 | 434106 | PORSCHE       | 911 COUPE (997) (04-13)                |
| 24.0136-0125.2 | 436125 | BMW           | 5er Reihe/F10 Limousine (10-)          |
| 24.0136-0125.2 | 436125 | BMW           | 6er Reihe/F12 Cabrio (11-)             |
| 24.0136-0125.2 | 436125 | BMW           | 6er Reihe/F13 Coupe (11-)              |
| 24.0136-0125.2 | 436125 | BMW           | 6er Reihe/F06 Gran Coupe (11-)         |
| 24.0136-0126.2 | 436126 | BMW           | 5er Reihe/F10 Limousine (10-)          |
| 24.0136-0126.2 | 436126 | BMW           | 6er Reihe/F12 Cabrio (11-)             |
| 24.0136-0126.2 | 436126 | BMW           | 6er Reihe/F13 Coupe (11-)              |
| 24.0136-0126.2 | 436126 | BMW           | 6er Reihe/F06 Gran Coupe (11-)         |
| 24.0308-0113.1 | 508113 | MERCEDES BENZ | A-Klasse (W169 ) (04-12)               |
| 24.0308-0113.1 | 508113 | MERCEDES BENZ | B-Klasse (W245) (05-11)                |
| 24.0309-0154.1 | 509154 | MERCEDES BENZ | C-Klasse (W204) Limousine (07-14)      |
| 24.0309-0154.1 | 509154 | MERCEDES BENZ | C-Klasse (S204) Kombi (07-14)          |
| 24.0309-0154.1 | 509154 | MERCEDES BENZ | C-Klasse (C204) Coupe (11-)            |
| 24.0310-0278.1 | 510278 | MERCEDES BENZ | CLS-Klasse (C218) Coupe (10-)          |
| 24.0310-0278.1 | 510278 | MERCEDES BENZ | CLS-Klasse (X218) Shooting Brake (12-) |
| 24.0310-0278.1 | 510278 | MERCEDES BENZ | E-Klasse (W211) Limousine (02-09)      |
| 24.0310-0278.1 | 510278 | MERCEDES BENZ | E-Klasse (S211) Kombi (03-09)          |
| 24.0310-0278.1 | 510278 | MERCEDES BENZ | E-Klasse (W212) Limousine (09-)        |
| 24.0310-0278.1 | 510278 | MERCEDES BENZ | E-Klasse (S212) Kombi (09-)            |



# Neue Artikel

New parts - Codici nuovi - Nouvelles références - Nuevas referencias



|                |        |               |   |                |        |            |   |
|----------------|--------|---------------|---|----------------|--------|------------|---|
| 24.0310-0291.1 | 510291 | OPEL          | ASTRA H TwinTop (06-10)                 | 24.0312-0169.1 | 512169 | SEAT       | ALTEA XL (5P5) (06-15)                                      |
| 24.0310-0291.1 | 510291 | OPEL          | COMBO / Vauxhall Combo (01-11)          | 24.0312-0169.1 | 512169 | AUDI       | A3 (8P) Cabrio (08-13)                                      |
| 24.0310-0291.1 | 510291 | OPEL          | MERIVA A / Vauxhall Meriva Mk I (03-10) | 24.0312-0169.1 | 512169 | VOLKSWAGEN | EOS (06-)   |
| 24.0310-0315.1 | 510315 | BMW           | 1er Reihe/E81/E87 Limousine (04-11)     | 24.0312-0169.1 | 512169 | SKODA      | OCTAVIA II (1Z) (04-13)                                     |
| 24.0310-0315.1 | 510315 | BMW           | 3er Reihe/E90 Limousine (05-12)         | 24.0312-0169.1 | 512169 | VOLKSWAGEN | GOLF V (03-08)  |
| 24.0310-0315.1 | 510315 | BMW           | 3er Reihe/E92 Coupe (06-13)             | 24.0312-0169.1 | 512169 | SEAT       | LEON II (1P1) (05-12)                                       |
| 24.0310-0356.1 | 510356 | AUDI          | A1 / A1 Sportback (10-)                 | 24.0312-0169.1 | 512169 | SKODA      | SUPERB II (08-15)   |
| 24.0310-0356.1 | 510356 | SEAT          | ALTEA (5P1) (04-15)                     | 24.0312-0169.1 | 512169 | VOLKSWAGEN | GOLF V Variant (07-09)                                      |
| 24.0310-0356.1 | 510356 | AUDI          | A3 / A3 (8P) Sportback (03-13)          | 24.0312-0169.1 | 512169 | SKODA      | SUPERB II Combi (09-15)                                     |
| 24.0310-0356.1 | 510356 | SEAT          | ALTEA XL (5P5) (06-15)                  | 24.0312-0169.1 | 512169 | VOLKSWAGEN | GOLF VI (08-)   |
| 24.0310-0356.1 | 510356 | AUDI          | A3 (8P) Cabrio (08-13)                  | 24.0312-0169.1 | 512169 | VOLKSWAGEN | GOLF VI Variant (09-)                                       |
| 24.0310-0356.1 | 510356 | VOLKSWAGEN    | CADDY III (04-15)                       | 24.0312-0169.1 | 512169 | SKODA      | YETI (09-)  |
| 24.0310-0356.1 | 510356 | AUDI          | A3 / A3 (8V) Sportback (12-)            | 24.0312-0169.1 | 512169 | SEAT       | TOLEDO III (5P2) (05-09)                                    |
| 24.0310-0356.1 | 510356 | VOLKSWAGEN    | CADDY IV (15-)                          | 24.0312-0169.1 | 512169 | VOLKSWAGEN | GOLF Plus (05-14)   |
| 24.0310-0356.1 | 510356 | AUDI          | A3 (8V) Cabrio (13-)                    | 24.0312-0169.1 | 512169 | VOLKSWAGEN | JETTA V (05-10)   |
| 24.0310-0356.1 | 510356 | VOLKSWAGEN    | EOS (06-)                               | 24.0312-0169.1 | 512169 | AUDI       | Q3 (11-)  |
| 24.0310-0356.1 | 510356 | SKODA         | OCTAVIA II (1Z) (04-13)                 | 24.0312-0169.1 | 512169 | VOLKSWAGEN | PASSAT Limousine (05-10)                                    |
| 24.0310-0356.1 | 510356 | SKODA         | OCTAVIA III (5E) (12-)                  | 24.0312-0169.1 | 512169 | VOLKSWAGEN | PASSAT Variant (05-10)                                      |
| 24.0310-0356.1 | 510356 | SEAT          | LEON II (1P1) (05-12)                   | 24.0312-0169.1 | 512169 | VOLKSWAGEN | PASSAT CC (08-11)   |
| 24.0310-0356.1 | 510356 | SKODA         | SUPERB II (08-15)                       | 24.0312-0169.1 | 512169 | VOLKSWAGEN | PASSAT CC (11-)   |
| 24.0310-0356.1 | 510356 | SEAT          | LEON III (5F) / SC / ST (12-)           | 24.0312-0169.1 | 512169 | VOLKSWAGEN | PASSAT / PASSAT VARIANT (10-14)                             |
| 24.0310-0356.1 | 510356 | SKODA         | SUPERB II Combi (09-15)                 | 24.0312-0169.1 | 512169 | VOLKSWAGEN | PASSAT ALLTRACK (12-14)                                     |
| 24.0310-0356.1 | 510356 | VOLKSWAGEN    | GOLF VI (08-)                           | 24.0312-0169.1 | 512169 | VOLKSWAGEN | SHARAN II (10-)   |
| 24.0310-0356.1 | 510356 | SEAT          | LEON III (5F) ST X-Perience (14-)       | 24.0312-0169.1 | 512169 | VOLKSWAGEN | TIGUAN (07-)  |
| 24.0310-0356.1 | 510356 | VOLKSWAGEN    | GOLF VI Variant (09-)                   | 24.0312-0169.1 | 512169 | VOLKSWAGEN | TOURAN I (03-15)  |
| 24.0310-0356.1 | 510356 | VOLKSWAGEN    | GOLF VI Cabriolet (11-)                 | 24.0312-0187.1 | 512187 | SAAB       | 9-5 II (10-12)  |
| 24.0310-0356.1 | 510356 | SKODA         | YETI (09-)                              | 24.0312-0187.1 | 512187 | OPEL       | INSIGNIA / Vauxhall Insignia (08-)                          |
| 24.0310-0356.1 | 510356 | VOLKSWAGEN    | GOLF VII (12-)                          | 24.0312-0187.1 | 512187 | OPEL       | INSIGNIA Country Tourer (13-)                               |
| 24.0310-0356.1 | 510356 | VOLKSWAGEN    | GOLF VII Variant (13-)                  | 24.0312-0187.1 | 512187 | OPEL       | INSIGNIA Sports Tourer / Vauxh. Insignia SportsTourer (08-) |
| 24.0310-0356.1 | 510356 | VOLKSWAGEN    | GOLF VII Sportsvan (14-)                | 24.0312-0188.1 | 512188 | CHEVROLET  | AVEO (T300) (11-)   |
| 24.0310-0356.1 | 510356 | VOLKSWAGEN    | GOLF VII ALLTRACK (14-)                 | 24.0312-0188.1 | 512188 | CHEVROLET  | CRUZE (09-)   |
| 24.0310-0356.1 | 510356 | VOLKSWAGEN    | JETTA VI (10-)                          | 24.0312-0188.1 | 512188 | OPEL       | ASTRA J / GTC / Vauxhall Astra MK VI (09-)                  |
| 24.0310-0356.1 | 510356 | VOLKSWAGEN    | BEETLE (11-)                            | 24.0312-0188.1 | 512188 | OPEL       | ASTRA J Sports Tourer/Vau.Astra Sports Tourer (10-)         |
| 24.0310-0356.1 | 510356 | VOLKSWAGEN    | BEETLE Cabriolet (12-)                  | 24.0312-0188.1 | 512188 | CHEVROLET  | TRAX (12-)  |
| 24.0310-0356.1 | 510356 | AUDI          | TT (14-)                                | 24.0312-0188.1 | 512188 | OPEL       | MOKKA / Vauxhall Mokka (12-)                                |
| 24.0310-0356.1 | 510356 | VOLKSWAGEN    | SCIROCCO (08-)                          | 24.0312-0189.1 | 512189 | OPEL       | AMPERA / Vauxhall Ampera (11-)                              |
| 24.0310-0356.1 | 510356 | VOLKSWAGEN    | TOURAN I (03-15)                        | 24.0312-0189.1 | 512189 | CHEVROLET  | CRUZE (09-)   |
| 24.0310-0356.1 | 510356 | VOLKSWAGEN    | TOURAN II (15-)                         | 24.0312-0189.1 | 512189 | OPEL       | ASTRA J / GTC / Vauxhall Astra MK VI (09-)                  |
| 24.0311-0145.1 | 511145 | LAND ROVER    | RANGE ROVER EVOQUE (SAL) (11-)          | 24.0312-0189.1 | 512189 | OPEL       | ASTRA J Sports Tourer/Vau.Astra Sports Tourer (10-)         |
| 24.0311-0145.1 | 511145 | FORD          | FOCUS II (05-11)                        | 24.0312-0189.1 | 512189 | CHEVROLET  | ORLANDO (11-)   |
| 24.0311-0145.1 | 511145 | LAND ROVER    | RANGE ROVER EVOQUE Cabriolet (16-)      | 24.0312-0189.1 | 512189 | OPEL       | CASCADA / Vauxhall Cascada (13-)                            |
| 24.0311-0145.1 | 511145 | FORD          | GALAXY II (06-)                         | 24.0312-0189.1 | 512189 | CHEVROLET  | VOLT (11-)  |
| 24.0311-0145.1 | 511145 | FORD          | KUGA I (08-12)                          | 24.0312-0189.1 | 512189 | OPEL       | ZAFIRA III Tourer / Vauxhall Zafira III Tourer (11-)        |
| 24.0311-0145.1 | 511145 | FORD          | MONDEO IV (07-14)                       | 24.0313-0184.1 | 513184 | CITROEN    | BERLINGO (MF) Kombi (96-08)                                 |
| 24.0311-0145.1 | 511145 | FORD          | S-MAX (06-)                             | 24.0313-0184.1 | 513184 | CITROEN    | BERLINGO (M_) Kasten (96-08)                                |
| 24.0312-0154.1 | 512154 | JAGUAR        | X-Type (CF1) Limousine (01-09)          | 24.0313-0184.1 | 513184 | CITROEN    | C2 (03-09)  |
| 24.0312-0154.1 | 512154 | JAGUAR        | X-Type (CF1) Kombi (03-09)              | 24.0313-0184.1 | 513184 | CITROEN    | C3 (02-09)  |
| 24.0312-0154.1 | 512154 | FORD          | MONDEO III (00-07)                      | 24.0313-0184.1 | 513184 | PEUGEOT    | 301 (12-)   |
| 24.0312-0166.1 | 512166 | AUDI          | A4 (B6/B7) (01-08)                      | 24.0313-0184.1 | 513184 | CITROEN    | C4 CACTUS (14-)   |
| 24.0312-0166.1 | 512166 | SEAT          | EXEO / ST (09-13)                       | 24.0313-0184.1 | 513184 | CITROEN    | C-ELYSEE (12-)  |
| 24.0312-0166.1 | 512166 | AUDI          | A4 Cabrio (02-08)                       | 24.0313-0184.1 | 513184 | PEUGEOT    | PARTNER Kombi (96-08)                                       |
| 24.0312-0167.1 | 512167 | MERCEDES BENZ | A-Klasse (W169 ) (04-12)                | 24.0313-0184.1 | 513184 | PEUGEOT    | PARTNER Kasten (96-08)                                      |
| 24.0312-0169.1 | 512169 | SEAT          | ALHAMBRA II (10-)                       | 24.0313-0185.1 | 513185 | PEUGEOT    | 206 Limousine (98-09)                                       |
| 24.0312-0169.1 | 512169 | SEAT          | ALTEA (5P1) (04-15)                     | 24.0313-0185.1 | 513185 | PEUGEOT    | 206 SW (02-07)  |
| 24.0312-0169.1 | 512169 | AUDI          | A3 / A3 (8P) Sportback (03-13)          | 24.0313-0185.1 | 513185 | PEUGEOT    | 206 PLUS (09-13)  |





# Neue Artikel

New parts - Codici nuovi - Nouvelles références - Nuevas referencias



|                |        |               |                                       |
|----------------|--------|---------------|---------------------------------------|
| 24.0313-0185.1 | 513185 | PEUGEOT       | 306 Limousine (3/5-tuerig) (93-01)    |
| 24.0313-0185.1 | 513185 | PEUGEOT       | 306 Limousine (4-tuerig) (94-01)      |
| 24.0313-0185.1 | 513185 | CITROEN       | XSARA (N1) Limousine (97-05)          |
| 24.0313-0185.1 | 513185 | CITROEN       | XSARA (N0) Coupe (97-05)              |
| 24.0320-0183.1 | 520183 | BMW           | 5er Reihe/E60 Limousine (03-10)       |
| 24.0320-0183.1 | 520183 | BMW           | 5er Reihe/E61 Touring (04-10)         |
| 24.0320-0183.1 | 520183 | BMW           | 6er Reihe/E63 Coupe (04-11)           |
| 24.0320-0183.1 | 520183 | BMW           | 6er Reihe/E64 Cabrio (04-11)          |
| 24.0320-0195.1 | 520195 | BMW           | 1er Reihe/E81/E87 Limousine (04-11)   |
| 24.0320-0195.1 | 520195 | BMW           | 3er Reihe/E90 Limousine (05-12)       |
| 24.0320-0195.1 | 520195 | BMW           | 3er Reihe/E91 Touring (05-12)         |
| 24.0320-0195.1 | 520195 | BMW           | 3er Reihe/E92 Coupe (06-13)           |
| 24.0320-0195.1 | 520195 | BMW           | 3er Reihe/E93 Cabrio (07-13)          |
| 24.0320-0204.1 | 520204 | BMW           | 1er Reihe/E81/E87 Limousine (04-11)   |
| 24.0320-0204.1 | 520204 | BMW           | 3er Reihe/E90 Limousine (05-12)       |
| 24.0320-0204.1 | 520204 | BMW           | 3er Reihe/E91 Touring (05-12)         |
| 24.0320-0204.1 | 520204 | BMW           | 3er Reihe/E92 Coupe (06-13)           |
| 24.0320-0204.1 | 520204 | BMW           | 3er Reihe/E93 Cabrio (07-13)          |
| 24.0320-0204.1 | 520204 | BMW           | X1/E84 (09-)                          |
| 24.0320-0234.1 | 520234 | BMW           | X3/F25 (10-)                          |
| 24.0320-0234.1 | 520234 | BMW           | X4/F26 (14-)                          |
| 24.0322-0197.1 | 522197 | LANCIA        | DEDRA (94-99)                         |
| 24.0322-0197.1 | 522197 | FIAT          | 500 (07-)                             |
| 24.0322-0197.1 | 522197 | FIAT          | 500 C Cabrio (09-)                    |
| 24.0322-0197.1 | 522197 | LANCIA        | MUSA (04-13)                          |
| 24.0322-0197.1 | 522197 | FIAT          | BRAVO (07-)                           |
| 24.0322-0197.1 | 522197 | LANCIA        | YPSILON (03-11)                       |
| 24.0322-0197.1 | 522197 | FIAT          | DOBLO (01-10)                         |
| 24.0322-0197.1 | 522197 | LANCIA        | YPSILON / Chrysler Ypsilon (11-)      |
| 24.0322-0197.1 | 522197 | ALFA ROMEO    | MITO (08-)                            |
| 24.0322-0197.1 | 522197 | FIAT          | FIORINO / QUBO (08-)                  |
| 24.0322-0197.1 | 522197 | FIAT          | IDEA (04-12)                          |
| 24.0322-0197.1 | 522197 | FIAT          | LINEA (07-11)                         |
| 24.0322-0197.1 | 522197 | FIAT          | PANDA (03-13)                         |
| 24.0322-0197.1 | 522197 | FIAT          | PANDA Cross (06-11)                   |
| 24.0322-0197.1 | 522197 | FIAT          | PANDA (12-)                           |
| 24.0322-0197.1 | 522197 | FIAT          | PUNTO (00-03)                         |
| 24.0322-0197.1 | 522197 | FIAT          | STILO / STILO Multi Wagon (01-08)     |
| 24.0322-0197.1 | 522197 | PEUGEOT       | BIPPER (08-15)                        |
| 24.0322-0197.1 | 522197 | CITROEN       | NEMO (08-)                            |
| 24.0322-0209.1 | 522209 | BMW           | 3er Reihe/E46 Limousine (98-05)       |
| 24.0322-0209.1 | 522209 | BMW           | 3er Reihe/E46 Touring (99-05)         |
| 24.0322-0209.1 | 522209 | BMW           | 3er Reihe/E46 Coupe (99-06)           |
| 24.0322-0209.1 | 522209 | BMW           | 3er Reihe/E46 Cabrio (00-06)          |
| 24.0322-0223.1 | 522223 | AUDI          | A6 (4F2/C6) Limousine (04-11)         |
| 24.0322-0223.1 | 522223 | AUDI          | A6 (4F5/C6) Avant (05-11)             |
| 24.0322-0231.1 | 522231 | OPEL          | ADAM / Vauxhall Adam (13-)            |
| 24.0322-0231.1 | 522231 | OPEL          | CORSA D / Vauxhall Corsa MK III (06-) |
| 24.0322-0231.1 | 522231 | OPEL          | CORSA E / Vauxhall Corsa Mk IV (14-)  |
| 24.0322-0231.1 | 522231 | FIAT          | PUNTO / PUNTO EVO (09-)               |
| 24.0322-0231.1 | 522231 | FIAT          | GRANDE PUNTO (06-11)                  |
| 24.0322-0232.1 | 522232 | MERCEDES BENZ | A-Klasse (W169 ) (04-12)              |
| 24.0322-0232.1 | 522232 | MERCEDES BENZ | B-Klasse (W245) (05-11)               |
| 24.0322-0247.1 | 522247 | MINI          | R55 Clubman (07-14)                   |
| 24.0322-0247.1 | 522247 | MINI          | R56 (06-14)                           |



|                |        |               |   |
|----------------|--------|---------------|---|
| 24.0322-0247.1 | 522247 | MINI          | R57 Cabrio (09-14)  |
| 24.0322-0247.1 | 522247 | MINI          | R58 Coupe (11-)   |
| 24.0322-0247.1 | 522247 | MINI          | R59 Roadster (12-)  |
| 24.0323-0114.1 | 523114 | SAAB          | 9-5 II (10-12)  |
| 24.0323-0114.1 | 523114 | CHEVROLET     | MALIBU (V300) (12-)   |
| 24.0323-0114.1 | 523114 | OPEL          | INSIGNIA / Vauxhall Insignia (08-)                          |
| 24.0323-0114.1 | 523114 | OPEL          | INSIGNIA Country Tourer (13-)                               |
| 24.0323-0114.1 | 523114 | OPEL          | INSIGNIA Sports Tourer / Vauxh. Insignia SportsTourer (08-) |
| 24.0325-0114.1 | 525114 | SEAT          | ALHAMBRA I (96-10)  |
| 24.0325-0114.1 | 525114 | FORD          | GALAXY I (95-06)  |
| 24.0325-0114.1 | 525114 | VOLKSWAGEN    | SHARAN I (95-10)  |
| 24.0325-0149.1 | 525149 | AUDI          | A6 (4F2/C6) Limousine (04-11)                               |
| 24.0325-0149.1 | 525149 | AUDI          | A6 (4F5/C6) Avant (05-11)                                   |
| 24.0325-0179.1 | 525179 | MERCEDES BENZ | C-Klasse (W204) Limousine (07-14)                           |
| 24.0325-0179.1 | 525179 | MERCEDES BENZ | C-Klasse (S204) Kombi (07-14)                               |
| 24.0325-0179.1 | 525179 | MERCEDES BENZ | C-Klasse (C204) Coupe (11-)                                 |
| 24.0325-0184.1 | 525184 | AUDI          | A4 (B8) Limousine (07-)                                     |
| 24.0325-0184.1 | 525184 | AUDI          | A4 (B8) Avant (08-)   |
| 24.0325-0184.1 | 525184 | AUDI          | A4 Allroad (09-)  |
| 24.0325-0184.1 | 525184 | AUDI          | A5 / A5 Sportback (07-)                                     |
| 24.0325-0184.1 | 525184 | AUDI          | A5 Cabrio (09-)   |
| 24.0325-0197.1 | 525197 | VOLVO         | C70 II Cabrio (06-13)                                       |
| 24.0325-0197.1 | 525197 | VOLVO         | S40 II (04-12)  |
| 24.0325-0197.1 | 525197 | FORD          | FOCUS II (05-11)  |
| 24.0325-0197.1 | 525197 | VOLVO         | V40 (12-)   |
| 24.0325-0197.1 | 525197 | VOLVO         | V50 (04-12)   |
| 24.0326-0115.1 | 526115 | SEAT          | ALHAMBRA I (96-10)  |
| 24.0326-0115.1 | 526115 | FORD          | GALAXY I (95-06)  |
| 24.0326-0115.1 | 526115 | VOLKSWAGEN    | SHARAN I (95-10)  |
| 24.0326-0115.1 | 526115 | VOLKSWAGEN    | TRANSPORTER (T4) (90-03)                                    |
| 24.0326-0119.1 | 526119 | SEAT          | ALHAMBRA I (96-10)  |
| 24.0326-0119.1 | 526119 | FORD          | GALAXY I (95-06)  |
| 24.0326-0119.1 | 526119 | VOLKSWAGEN    | SHARAN I (95-10)  |
| 24.0326-0119.1 | 526119 | VOLKSWAGEN    | TRANSPORTER (T4) (90-03)                                    |
| 24.0328-0154.1 | 528154 | LAND ROVER    | DISCOVERY SPORT (14-)                                       |
| 24.0328-0154.1 | 528154 | VOLVO         | S60 II (10-)  |
| 24.0328-0154.1 | 528154 | LAND ROVER    | FREELANDER 2 (FA) (06-)                                     |
| 24.0328-0154.1 | 528154 | VOLVO         | S80 II (06-)  |
| 24.0328-0154.1 | 528154 | LAND ROVER    | RANGE ROVER EVOQUE (SAL) (11-)                              |
| 24.0328-0154.1 | 528154 | LAND ROVER    | RANGE ROVER EVOQUE Cabriolet (16-)                          |
| 24.0328-0154.1 | 528154 | VOLVO         | V60 (10-)   |
| 24.0328-0154.1 | 528154 | FORD          | GALAXY II (06-)   |
| 24.0328-0154.1 | 528154 | VOLVO         | V70 III (07-)   |
| 24.0328-0154.1 | 528154 | VOLVO         | XC70 II CROSS COUNTRY (07-)                                 |
| 24.0328-0154.1 | 528154 | FORD          | S-MAX (06-)   |
| 24.0328-0176.1 | 528176 | MERCEDES BENZ | E-Klasse (W211) Limousine (02-09)                           |
| 24.0328-0176.1 | 528176 | MERCEDES BENZ | E-Klasse (S211) Kombi (03-09)                               |
| 24.0328-0250.1 | 528250 | FORD          | MONDEO IV (07-14)   |
| 24.0328-0254.1 | 528254 | BMW           | X3/F25 (10-)  |
| 24.0328-0254.1 | 528254 | BMW           | X4/F26 (14-)  |
| 24.0710-5012.3 | 360368 | TOYOTA        | YARIS (11-)   |
| 24.0710-5013.3 | 360416 | TOYOTA        | YARIS (11-)   |
| 24.0710-5017.3 | 360408 | BMW           | X5/E70 (07-13)  |
| 24.0710-5017.3 | 360408 | BMW           | X5/F15 (13-)  |
| 24.0710-5017.3 | 360408 | BMW           | X6/E71/E72 (08-14)  |

# Neue Artikel

New parts - Codici nuovi - Nouvelles références - Nuevas referencias



|                |        |               |   |
|----------------|--------|---------------|---|
| 24.0710-5017.3 | 360408 | BMW           | X6/F16 (14-)  |
| 24.0710-5018.3 | 360409 | BMW           | X5/E70 (07-13)  |
| 24.0710-5018.3 | 360409 | BMW           | X5/F15 (13-)  |
| 24.0710-5018.3 | 360409 | BMW           | X6/E71/E72 (08-14)  |
| 24.0710-5018.3 | 360409 | BMW           | X6/F16 (14-)  |
| 24.0710-5019.3 | 360410 | OPEL          | INSIGNIA / Vauxhall Insignia (08-)                          |
| 24.0710-5019.3 | 360410 | OPEL          | INSIGNIA Sports Tourer / Vauxh. Insignia SportsTourer (08-) |
| 24.0710-5020.3 | 360411 | OPEL          | INSIGNIA / Vauxhall Insignia (08-)                          |
| 24.0710-5020.3 | 360411 | OPEL          | INSIGNIA Sports Tourer / Vauxh. Insignia SportsTourer (08-) |
| 24.0710-5021.3 | 360412 | OPEL          | INSIGNIA / Vauxhall Insignia (08-)                          |
| 24.0710-5021.3 | 360412 | OPEL          | INSIGNIA Sports Tourer / Vauxh. Insignia SportsTourer (08-) |
| 24.0710-5022.3 | 360413 | OPEL          | INSIGNIA / Vauxhall Insignia (08-)                          |
| 24.0710-5022.3 | 360413 | OPEL          | INSIGNIA Sports Tourer / Vauxh. Insignia SportsTourer (08-) |
| 24.0711-5238.3 | 360441 | JAGUAR        | F-Type (X152) (12-)   |
| 24.0711-5238.3 | 360441 | JAGUAR        | XF (CC9) (08-)  |
| 24.0711-5238.3 | 360441 | JAGUAR        | XF Sportbrake (CC9) (12-)                                   |
| 24.0711-5238.3 | 360441 | JAGUAR        | XJ (X351) (09-)   |
| 24.0711-5238.3 | 360441 | JAGUAR        | XK Coupe (06-)  |
| 24.0711-5238.3 | 360441 | JAGUAR        | XK Convertible (06-)  |
| 24.0711-5330.3 | 360417 | MERCEDES BENZ | C-Klasse (W204) Limousine (07-14)                           |
| 24.0711-5330.3 | 360417 | MERCEDES BENZ | C-Klasse (S204) Kombi (07-14)                               |
| 24.0711-5330.3 | 360417 | MERCEDES BENZ | C-Klasse (C204) Coupe (11-)                                 |
| 24.0711-5330.3 | 360417 | MERCEDES BENZ | GLK-Klasse (X204) (08-15)                                   |
| 24.0711-5379.3 | 360422 | CITROEN       | C4 II PICASSO (13-)   |
| 24.0711-5379.3 | 360422 | CITROEN       | C4 II GRAND PICASSO (13-)                                   |
| 24.0711-5379.3 | 360422 | PEUGEOT       | 308 II (T9) (13-)   |
| 24.0711-5379.3 | 360422 | PEUGEOT       | 308 II SW (T9) (14-)  |
| 24.0711-5382.3 | 360423 | RENAULT       | CAPTUR (J87) (13-)  |
| 24.0711-5382.3 | 360423 | RENAULT       | CLIO IV (B98_) (12-)  |
| 24.0711-5382.3 | 360423 | RENAULT       | CLIO IV Grandtour (K98_) (12-)                              |
| 24.0711-5382.3 | 360423 | RENAULT       | ZOE (12-)   |
| 24.0711-5412.3 | 360415 | MERCEDES BENZ | GL-Klasse (X164) (06-12)                                    |
| 24.0711-5412.3 | 360415 | MERCEDES BENZ | R-Klasse (W251,V251) (06-12)                                |
| 24.0711-5529.3 | 360432 | MERCEDES BENZ | V-Klasse (BM447) (14-)                                      |
| 24.0711-5529.3 | 360432 | MERCEDES BENZ | VITO (W447) (14-)   |
| 24.0711-5530.3 | 360433 | MERCEDES BENZ | V-Klasse (BM447) (14-)                                      |
| 24.0711-5530.3 | 360433 | MERCEDES BENZ | VITO (W447) (14-)   |
| 24.0711-5531.3 | 360426 | VOLKSWAGEN    | CRAFTER (06-)   |
| 24.0711-5531.3 | 360426 | MERCEDES BENZ | Transporter (BM 906) SPRINTER (06-)                         |
| 24.0711-5532.3 | 360442 | MERCEDES BENZ | Transporter (BM 906) SPRINTER (06-)                         |
| 24.0711-6202.3 | 360362 | NISSAN        | CABSTAR E (F24E) (06-13)                                    |
| 24.0711-6238.3 | 360284 | BMW           | 5er Reihe/E60 Limousine (03-10)                             |
| 24.0711-6238.3 | 360284 | BMW           | 5er Reihe/E61 Touring (04-10)                               |
| 24.0711-6238.3 | 360284 | BMW           | 6er Reihe/E63 Coupe (04-11)                                 |
| 24.0711-6238.3 | 360284 | BMW           | 6er Reihe/E64 Cabrio (04-11)                                |
| 24.0711-6258.3 | 360434 | MERCEDES BENZ | SLK-Klasse / SLC-Klasse (R172) (11-)                        |
| 24.0711-6266.3 | 360435 | MERCEDES BENZ | SL-Klasse (R231) (12-)                                      |
| 24.0711-6342.3 | 360443 | CITROEN       | C4 II PICASSO (13-)   |
| 24.0711-6342.3 | 360443 | CITROEN       | C4 II GRAND PICASSO (13-)                                   |
| 24.0711-6342.3 | 360443 | PEUGEOT       | 308 II (T9) (13-)   |
| 24.0711-6342.3 | 360443 | PEUGEOT       | 308 II SW (T9) (14-)  |
| 24.0711-6343.3 | 360444 | CITROEN       | C4 II PICASSO (13-)   |
| 24.0711-6343.3 | 360444 | CITROEN       | C4 II GRAND PICASSO (13-)                                   |
| 24.0711-6343.3 | 360444 | PEUGEOT       | 308 II (T9) (13-)   |
| 24.0711-6343.3 | 360444 | PEUGEOT       | 308 II SW (T9) (14-)  |



|                |        |               |                                      |
|----------------|--------|---------------|--------------------------------------|
| 24.0711-6389.3 | 360436 | MERCEDES BENZ | SLK-Klasse / SLC-Klasse (R172) (11-) |
| 24.8190-0951.2 | 620951 | PORSCHE       | 911 COUPE (997) (04-13)              |
| 24.8190-0952.2 | 620952 | PORSCHE       | 911 COUPE (991) (11-)                |
| 24.8190-0952.2 | 620952 | PORSCHE       | 911 CABRIO (991) (12-)               |
| 24.8190-0952.2 | 620952 | PORSCHE       | 911 TARGA (991) (14-)                |
| 24.8190-0952.2 | 620952 | PORSCHE       | BOXSTER (981) (12-)                  |
| 24.8190-0952.2 | 620952 | PORSCHE       | BOXSTER Spyder (981) (15-)           |
| 24.8190-0952.2 | 620952 | PORSCHE       | 718 BOXSTER (982) (16-)              |
| 24.8190-0952.2 | 620952 | PORSCHE       | CAYMAN (981C) (13-)                  |
| 24.8190-0952.2 | 620952 | PORSCHE       | 718 CAYMAN (982) (16-)               |
| 24.8190-0953.2 | 620953 | PORSCHE       | 911 COUPE (991) (11-)                |
| 24.8190-0953.2 | 620953 | PORSCHE       | 911 CABRIO (991) (12-)               |
| 24.8190-0953.2 | 620953 | PORSCHE       | 911 TARGA (991) (14-)                |
| 24.8190-0953.2 | 620953 | PORSCHE       | BOXSTER Spyder (981) (15-)           |
| 24.8190-0954.2 | 620954 | PORSCHE       | CAYENNE I (03-10)                    |
| 24.8190-0955.2 | 620955 | MERCEDES BENZ | E-Klasse (W211) Limousine (02-09)    |
| 24.8190-0955.2 | 620955 | MERCEDES BENZ | E-Klasse (S211) Kombi (03-09)        |
| 24.8190-0956.2 | 620956 | PORSCHE       | 911 COUPE (997) (04-13)              |
| 24.8190-0956.2 | 620956 | PORSCHE       | CAYMAN (987C) (05-12)                |
| 24.8190-0957.2 | 620957 | PORSCHE       | 911 COUPE (997) (04-13)              |
| 24.8190-0957.2 | 620957 | PORSCHE       | CAYMAN (987C) (05-12)                |
| 24.8190-0959.2 | 620959 | MERCEDES BENZ | S-Klasse (W222) (13-)                |
| 24.8190-0959.2 | 620959 | MERCEDES BENZ | S-Klasse (C217) Coupe (14-)          |
| 24.8190-0959.2 | 620959 | MERCEDES BENZ | S-Klasse (A217) Cabrio (15-)         |
| 24.8190-0959.2 | 620959 | MERCEDES BENZ | SL-Klasse (R231) (12-)               |





- D** Ersetzte Artikel
- EN** Replaced parts
- FR** Références remplacées
- IT** Codici sostitutivi
- ES** Referencias de sustitución
- NL** Vervangen artikelen
- DA** Erstattede artikler
- SV** Utbytta artiklar
- HU** Helyettesített alkatrészek
- PT** Artigos substituídos
- RU** Замененные номера
- CZ** Nahrazené výrobky
- PL** Artykuły zastąpione
- EL** Αντικατεστημένοι αριθμοί
- TR** Değiştirilen ürün
- ZH** 替代件
- JA** 販売商品
- AR** المنتجات المعوّضة

# K24-F



# Ersetzte Artikel

Replaced parts - Codici sostitutivi - Références remplacées - Referencias de sustitución



|                       |        |                       |        |                       |        |                       |        |
|-----------------------|--------|-----------------------|--------|-----------------------|--------|-----------------------|--------|
| <b>13.0460-2749.2</b> | 602749 | <b>13.0460-2880.2</b> | 602880 | <b>13.0460-2880.2</b> | 602880 | <b>13.0460-2749.2</b> | 602749 |
| <b>13.0460-5469.2</b> | 605469 | <b>13.0460-4048.2</b> | 604048 | <b>13.0460-4048.2</b> | 604048 | <b>13.0460-5469.2</b> | 605469 |
| <b>13.0470-2749.2</b> | LD2749 | <b>13.0470-2880.2</b> | LD2880 | <b>13.0470-2880.2</b> | LD2880 | <b>13.0470-2749.2</b> | LD2749 |
| <b>24.0711-5193.3</b> | 360238 | <b>24.0711-5463.3</b> | 360385 | <b>24.0711-5330.3</b> | 360417 | <b>24.0711-5206.3</b> | 360241 |
| <b>24.0711-5206.3</b> | 360241 | <b>24.0711-5330.3</b> | 360417 | <b>24.0711-5463.3</b> | 360385 | <b>24.0711-5193.3</b> | 360238 |
| <b>24.0711-6142.3</b> | 360135 | <b>24.0711-6238.3</b> | 360284 | <b>24.0711-6238.3</b> | 360284 | <b>24.0711-6142.3</b> | 360135 |







- D** Fahrzeugregister
- EN** Index of vehicles
- FR** Liste des véhicules
- IT** Indice autovetture
- ES** Índice de vehículos
- NL** Voertuigregister
- DA** Køretøjsregister
- SV** Fordonsregister
- HU** Járműlista
- PT** Registo automóvel
- RU** Перечень автомобилей
- CZ** Rejstřík vozidel
- PL** Indeks pojazdów
- EL** Κατάλογος οχημάτων
- TR** Araç kaydı
- ZH** 汽吹登璦翻
- JA** 然両索引
- AR** سجل العربية

# K24-F



## ALFA ROMEO

|                 |    |
|-----------------|----|
| 145 (94-01)     | 34 |
| 146 (94-01)     | 34 |
| 147 (01-10)     | 35 |
| 155 (92-97)     | 36 |
| 156 (97-05)     | 36 |
| 159 (05-11)     | 37 |
| 164 (92-98)     | 38 |
| 166 (98-07)     | 38 |
| BRERA (06-11)   | 39 |
| GIULIETTA (10-) | 39 |
| GT (04-10)      | 40 |
| GTV (95-05)     | 41 |
| MITO (08-)      | 41 |
| SPIDER (95-05)  | 42 |
| SPIDER (06-11)  | 42 |

## ASTON MARTIN

|                |    |
|----------------|----|
| CYGNET (11-13) | 43 |
|----------------|----|

## AUDI

|                                |     |
|--------------------------------|-----|
| A1 / A1 Sportback (10-)        | 43  |
| A2 (00-05)                     | 45  |
| A3 (8L) (96-03)                | 46  |
| A3 / A3 (8P) Sportback (03-13) | 47  |
| A3 (8P) Cabrio (08-13)         | 51  |
| A3 / A3 (8V) Sportback (12-)   | 52  |
| A3 (8V) Cabrio (13-)           | 56  |
| A4 (B5) (95-01)                | 59  |
| A4 (B6/B7) (01-08)             | 61  |
| A4 (B8) Limousine (07-)        | 66  |
| A4 (B8) Avant (08-)            | 70  |
| A4 Allroad (09-)               | 74  |
| A4 Cabrio (02-08)              | 75  |
| A4 / A4 Avant (B9) (15-)       | 76  |
| A4 Allroad (16-)               | 77  |
| A5 / A5 Sportback (07-)        | 77  |
| A5 Cabrio (09-)                | 82  |
| A6 / A6 Avant (4A/C4) (94-97)  | 85  |
| A6 / A6 Avant (4B/C5) (97-05)  | 86  |
| A6 Allroad (00-05)             | 88  |
| A6 (4F2/C6) Limousine (04-11)  | 88  |
| A6 (4F5/C6) Avant (05-11)      | 91  |
| A6 Allroad (06-11)             | 95  |
| A6 (4G2/C7) Limousine (11-)    | 96  |
| A6 (4G5/C7) Avant (11-)        | 101 |
| A6 Allroad (12-)               | 105 |
| A7 Sportback (10-)             | 106 |
| A8 (94-02)                     | 109 |
| A8 (03-09)                     | 110 |
| A8 (09-)                       | 111 |
| CABRIO (91-00)                 | 113 |
| Q2 (16-)                       | 113 |
| Q3 (11-)                       | 113 |
| Q5 (08-)                       | 115 |
| Q7 (06-15)                     | 118 |
| Q7 (15-)                       | 120 |
| R8 / R8 Spyder (07-15)         | 120 |
| TT Coupe (98-06)               | 120 |
| TT Roadster (99-06)            | 121 |
| TT Coupe (06-14)               | 122 |
| TT Roadster (07-14)            | 123 |
| TT (14-)                       | 124 |

## BENTLEY

|             |     |
|-------------|-----|
| ARNAGE      | 125 |
| AZURE       | 125 |
| CONTINENTAL | 125 |

## BMW

|                                     |     |
|-------------------------------------|-----|
| 1er Reihe/E81/E87 Limousine (04-11) | 125 |
| 1er Reihe/E82 Coupe (07-13)         | 127 |
| 1er Reihe/E88 Cabrio (08-13)        | 128 |
| 1er Reihe/F20/F21 Limousine (11-)   | 130 |
| 2er Reihe/F22 Coupe (13-)           | 132 |
| 2er Reihe/F23 Cabrio (14-)          | 134 |
| 2er Reihe/F45 Active Tourer (14-)   | 135 |
| 2er Reihe/F46 Gran Tourer (15-)     | 135 |
| 3er Reihe/E36 Limousine (90-98)     | 136 |
| 3er Reihe/E36 Touring (95-99)       | 137 |
| 3er Reihe/E36 Coupe (92-99)         | 138 |
| 3er Reihe/E36 Cabrio (93-99)        | 139 |
| 3er Reihe/E36 Compact (94-00)       | 139 |
| 3er Reihe/E46 Limousine (98-05)     | 140 |
| 3er Reihe/E46 Touring (99-05)       | 142 |
| 3er Reihe/E46 Coupe (99-06)         | 144 |
| 3er Reihe/E46 Cabrio (00-06)        | 145 |
| 3er Reihe/E46 Compact (01-05)       | 146 |
| 3er Reihe/E90 Limousine (05-12)     | 147 |
| 3er Reihe/E91 Touring (05-12)       | 152 |
| 3er Reihe/E92 Coupe (06-13)         | 156 |
| 3er Reihe/E93 Cabrio (07-13)        | 158 |
| 3er Reihe/F30 Limousine (11-)       | 160 |
| 3er Reihe/F31 Touring (12-)         | 163 |



## BMW

|                                     |     |
|-------------------------------------|-----|
| 3er Reihe/F34 GT (13-)              | 167 |
| 4er Reihe/F32 Coupe (13-)           | 169 |
| 4er Reihe/F33 Cabrio (14-)          | 172 |
| 4er Reihe/F36 Gran Coupe (14-)      | 174 |
| 5er Reihe/E39 (96-03)               | 177 |
| 5er Reihe/E60 Limousine (03-10)     | 179 |
| 5er Reihe/E61 Touring (04-10)       | 182 |
| 5er Reihe/F10 Limousine (10-)       | 184 |
| 5er Reihe/F11 Touring (10-)         | 186 |
| 5er Reihe/F07 GT GRAN TURISMO (09-) | 188 |
| 6er Reihe/E63 Coupe (04-11)         | 189 |
| 6er Reihe/E64 Cabrio (04-11)        | 189 |
| 6er Reihe/F12 Cabrio (11-)          | 190 |
| 6er Reihe/F13 Coupe (11-)           | 191 |
| 6er Reihe/F06 Gran Coupe (11-)      | 191 |
| 7er Reihe/E38 (93-01)               | 192 |
| 7er Reihe/E65/E66 (02-08)           | 193 |
| 7er Reihe/F01/F02/F03/F04 (08-15)   | 194 |
| 8er Reihe/E31 (90-99)               | 195 |
| i8/i12 (14-)                        | 195 |
| X1/E84 (09-)                        | 195 |
| X1/F48 (15-)                        | 197 |
| X3/E83 (03-10)                      | 197 |
| X3/F25 (10-)                        | 198 |
| X4/F26 (14-)                        | 199 |
| X5/E53 (00-07)                      | 200 |
| X5/E70 (07-13)                      | 200 |
| X5/F15 (13-)                        | 202 |
| X6/E71/E72 (08-14)                  | 203 |
| X6/F16 (14-)                        | 205 |
| Z3/E36 (95-02)                      | 205 |
| Z4 Roadster/E85 (03-08)             | 206 |
| Z4 Coupe/E86 (06-08)                | 207 |
| Z4 Roadster/E89 (09-)               | 207 |
| Z8/E52 (00-03)                      | 208 |

## CHEVROLET

|                          |     |
|--------------------------|-----|
| AVEO (T200,T250) (04-11) | 208 |
| AVEO (T300) (11-)        | 209 |
| CAPTIVA (06-)            | 209 |
| CRUZE (09-)              | 210 |
| EPICA (05-10)            | 212 |
| EVANDA (05-06)           | 212 |
| IMPALA (99-05)           | 212 |
| KALOS (05-08)            | 212 |
| LACETTI (05-10)          | 212 |
| LANOS (05-10)            | 212 |
| MALIBU (V300) (12-)      | 213 |
| MATIZ (05-10)            | 213 |
| NUBIRA (05-10)           | 214 |
| ORLANDO (11-)            | 214 |
| REZZO (05-09)            | 215 |
| SPARK (05-10)            | 215 |
| SPARK (10-)              | 215 |
| TRANS SPORT (96-05)      | 215 |
| TRAX (12-)               | 216 |
| VOLT (11-)               | 216 |

## CHRYSLER

|  |     |
|--|-----|
| 300 C Limousine (04-12)                | 216 |
| 300 C Touring (04-10)                  | 216 |
| 300 M (LR) (98-04)                     | 217 |
| CONCORDE (LP41) (92-97)                | 217 |
| CONCORDE (C 41) (97-03)                | 217 |
| CROSSFIRE Coupe (03-08)                | 217 |
| CROSSFIRE Cabrio (04-08)               | 217 |
| GRAND VOYAGER (RT) (07-)               | 217 |
| NEON (PL) (94-99)                      | 217 |
| NEON II (99-06)                        | 218 |
| NEW YORKER (CH41) / LHS (CP41) (93-98) | 218 |
| PT CRUISER (00-10)                     | 218 |
| STRATUS (JA,JX) (95-01)                | 218 |
| SEBRING (JR) (01-07)                   | 218 |
| SEBRING (JS) (07-10)                   | 219 |
| SEBRING Cabriolet (JR) (01-07)         | 219 |
| SEBRING Cabriolet (JS) (07-10)         | 219 |
| VISION (XP41) (93-97)                  | 219 |
| VOYAGER (GS) (95-01)                   | 219 |
| VOYAGER (RG) (00-08)                   | 220 |

## CITROEN

|                              |     |
|------------------------------|-----|
| AX (86-98)                   | 221 |
| BERLINGO (MF) Kombi (96-08)  | 222 |
| BERLINGO (M_) Kasten (96-08) | 224 |
| BERLINGO (B9) (08-)          | 225 |
| C1 (05-14)                   | 226 |
| C1 (14-)                     | 226 |
| C2 (03-09)                   | 226 |
| C3 (02-09)                   | 227 |
| C3 PLURIEL (03-10)           | 228 |
| C3 II (09-)                  | 228 |
| C3 PICASSO (09-)             | 230 |
| C4 I Limousine (LC_) (04-11) | 231 |
| C4 I Coupe (04-10)           | 233 |
| C4 I PICASSO (07-13)         | 234 |



## CITROEN

|                                     |     |
|-------------------------------------|-----|
| C4 I GRAND PICASSO (06-13)          | 235 |
| C4 II Limousine (B7) (10-)          | 235 |
| C4 II PICASSO (13-)                 | 236 |
| C4 II GRAND PICASSO (13-)           | 238 |
| C4 AIRCROSS (12-)                   | 239 |
| C4 CACTUS (14-)                     | 239 |
| C-ELYSEE (12-)                      | 240 |
| C5 I Limousine (01-04)              | 240 |
| C5 I Kombi (01-04)                  | 241 |
| C5 II Limousine (04-08)             | 241 |
| C5 II Kombi (04-08)                 | 242 |
| C5 III Limousine (X7) (08-)         | 243 |
| C5 III Kombi (X7) (08-)             | 244 |
| C6 (05-12)                          | 246 |
| C8 (02-14)                          | 246 |
| C-CROSSER (07-13)                   | 247 |
| C-Zero (10-)                        | 247 |
| DS3 (09-)                           | 247 |
| DS3 Cabrio (13-)                    | 249 |
| DS4 (11-)                           | 250 |
| DS5 (11-)                           | 251 |
| EVASION (94-02)                     | 252 |
| JUMPER Bus (94-02)                  | 253 |
| JUMPER Kasten (94-02)               | 255 |
| JUMPER Pritsche/Fahrgestell (94-02) | 257 |
| JUMPER (02-06)                      | 258 |
| JUMPER (06-)                        | 259 |
| JUMPY Kombi (95-06)                 | 261 |
| JUMPY Kasten (95-06)                | 262 |
| JUMPY Pritsche/Fahrgestell (99-06)  | 262 |
| JUMPY (07-16)                       | 263 |
| JUMPY (K0) Kasten (16-)             | 263 |
| NEMO (08-)                          | 263 |
| SAXO (96-04)                        | 264 |
| SPACETOURER (16-)                   | 265 |
| XANTIA (X1) Limousine (93-97)       | 265 |
| XANTIA (X1) Kombi (95-97)           | 267 |
| XANTIA (X2) Limousine (98-03)       | 268 |
| XANTIA (X2) Kombi (98-03)           | 269 |
| XM (Y4) Limousine (94-00)           | 269 |
| XM (Y4) Kombi (94-00)               | 270 |
| XSARA (N1) Limousine (97-05)        | 271 |
| XSARA (N2) Kombi (97-05)            | 272 |
| XSARA (N0) Coupe (97-05)            | 274 |
| XSARA Picasso (N68) (00-10)         | 275 |
| ZX (N2) Limousine (91-97)           | 276 |
| ZX (N2) Kombi (93-98)               | 278 |

## DACIA

|                                 |     |
|---------------------------------|-----|
| DOKKER (12-)                    | 278 |
| DOKKER Express (12-)            | 279 |
| DUSTER (HS_) (10-)              | 279 |
| LODGY (JS_) (12-)               | 280 |
| LOGAN Express (FS_) (09-13)     | 281 |
| LOGAN Limousine (LS_) (04-13)   | 281 |
| LOGAN MCV Kombi (KS_) (07-13)   | 283 |
| LOGAN Pick-up (US_) (08-13)     | 284 |
| LOGAN II Limousine (LS2_) (12-) | 284 |
| LOGAN II MCV Kombi (13-)        | 285 |
| SANDERO (08-13)                 | 285 |
| SANDERO II (B52_) (12-)         | 286 |

## DAEWOO

|                       |     |
|-----------------------|-----|
| ARANOS (95-97)        | 287 |
| CIELO (94-98)         | 287 |
| ESPERO (95-99)        | 288 |
| EVANDA (02-05)        | 288 |
| GENTRA (13-)          | 288 |
| KALOS (02-05)         | 288 |
| KORANDO (KJ) (99-05)  | 288 |
| LACETTI (04-05)       | 288 |
| LANOS (97-02)         | 288 |
| LEGANZA (97-02)       | 289 |
| MAGNUS (99-04)        | 289 |
| MATIZ (98-05)         | 289 |
| MUSSO (FJ) (99-05)    | 289 |
| NEXIA / RACER (95-08) | 289 |
| NUBIRA (97-99)        | 290 |
| NUBIRA (99-05)        | 290 |
| REZZO (00-05)         | 290 |

## DAIHATSU

|                      |     |
|----------------------|-----|
| APPLAUSE I (89-97)   | 291 |
| APPLAUSE II (97-00)  | 291 |
| CHARADE (93-01)      | 291 |
| CHARADE (GB) (03-07) | 291 |
| CHARADE (11-13)      | 291 |
| COPEL (03-12)        | 292 |
| CUORE (94-99)        | 292 |
| CUORE (98-03)        | 292 |
| CUORE (03-07)        | 292 |
| CUORE (07-13)        | 292 |
| GRAN MOVE (96-02)    | 292 |
| MATERIA (06-12)      | 292 |
| MOVE (96-02)         | 293 |



**DAIHATSU**

|                     |     |
|---------------------|-----|
| ROCKY 4x4 (84-99)   | 293 |
| SIRION (98-04)      | 293 |
| SIRION (05-13)      | 293 |
| TERIOS (J1) (97-05) | 293 |
| TERIOS (J2) (05-13) | 294 |
| TREVIS (06-09)      | 294 |
| YRV (01-06)         | 294 |

**FIAT**

|                                      |     |
|--------------------------------------|-----|
| 124 Spider (16-)                     | 294 |
| 500 (07-)                            | 294 |
| 500 C Cabrio (09-)                   | 295 |
| 500 L Kombi (12-)                    | 296 |
| 500 X (14-)                          | 297 |
| ALBEA (02-12)                        | 297 |
| BARCETTA (95-04)                     | 297 |
| BRAVA (95-01)                        | 297 |
| BRAVO (95-01)                        | 298 |
| BRAVO (07-)                          | 299 |
| CINQUECENTO (92-98)                  | 300 |
| COUPE (94-00)                        | 300 |
| CROMA (05-10)                        | 300 |
| DOBLO (01-10)                        | 301 |
| DOBLO (10-)                          | 302 |
| DUCATO (94-02)                       | 303 |
| DUCATO (02-06)                       | 306 |
| DUCATO (06-)                         | 307 |
| FIORINO (93-01)                      | 308 |
| FIORINO / QUBO (08-)                 | 309 |
| FREMONT (11-15)                      | 309 |
| IDEA (04-12)                         | 310 |
| LINEA (07-11)                        | 310 |
| MAREA (96-02)                        | 311 |
| MULTIPLA (98-10)                     | 312 |
| PALIO / PALIO WEEKEND EUROPA (96-06) | 312 |
| PALIO SW / SIENA (PL) (98-06)        | 313 |
| PANDA (86-02)                        | 313 |
| PANDA (03-13)                        | 313 |
| PANDA Cross (06-11)                  | 314 |
| PANDA (12-)                          | 315 |
| PUNTO (93-00)                        | 315 |
| PUNTO (00-03)                        | 316 |
| PUNTO (03-06)                        | 316 |
| PUNTO / PUNTO EVO (09-)              | 317 |
| GRANDE PUNTO (06-11)                 | 318 |
| SCUDO (95-06)                        | 319 |
| SCUDO (07-)                          | 320 |
| SEDICI (06-)                         | 320 |
| SEICENTO (98-08)                     | 321 |
| STILO / STILO Multi Wagon (01-08)    | 321 |
| STRADA / PICK-UP (99-11)             | 322 |
| STRADA (11-)                         | 322 |
| ULYSSE (94-02)                       | 322 |
| ULYSSE (02-11)                       | 323 |

**FORD**

|   |     |
|---|-----|
| B-MAX (12-)                             | 323 |
| C-MAX I (07-10)                         | 324 |
| C-MAX II (10-)                          | 324 |
| GRAND C-MAX (10-)                       | 326 |
| CARGO (87-98)                           | 328 |
| COUGAR (98-01)                          | 328 |
| ECOSPORT II (14-)                       | 329 |
| ESCORT VII (95-00)                      | 329 |
| FIESTA IV (96-02)                       | 330 |
| FIESTA V (02-08)                        | 332 |
| FIESTA VI (08-)                         | 332 |
| FOCUS I (98-04)                         | 334 |
| FOCUS II (05-11)                        | 335 |
| FOCUS III (11-)                         | 336 |
| FOCUS C-MAX (03-07)                     | 338 |
| FUSION (02-12)                          | 339 |
| GALAXY I (95-06)                        | 339 |
| GALAXY II (06-)                         | 340 |
| KA I (96-08)                            | 341 |
| KA II (08-)                             | 342 |
| KUGA I (08-12)                          | 342 |
| KUGA II (13-)                           | 343 |
| MAVERICK (97-98)                        | 344 |
| MAVERICK (01-07)                        | 344 |
| MONDEO II (96-00)                       | 344 |
| MONDEO III (00-07)                      | 345 |
| MONDEO IV (07-14)                       | 345 |
| MONDEO V (14-)                          | 347 |
| PROBE (93-97)                           | 347 |
| PUMA (97-01)                            | 347 |
| RANGER II (10-11)                       | 348 |
| RANGER (11-)                            | 348 |
| SCORPIO / GRANADA (GB) (95-98)          | 348 |
| S-MAX (06-)                             | 349 |
| STREET KA (03-06)                       | 350 |
| TOURNEO (94-00)                         | 350 |
| TRANSIT (95-00)                         | 351 |
| TRANSIT (00-06)                         | 353 |
| TRANSIT (06-14)                         | 353 |
| TRANSIT (14-)                           | 354 |
| TRANSIT COURIER / TOURNEO COURIER (14-) | 354 |

**FORD**

|   |     |
|---|-----|
| TRANSIT CONNECT / TOURNEO CONNECT (03-13) | 354 |
| TRANSIT CONNECT / TOURNEO CONNECT (13-)   | 355 |
| TRANSIT CUSTOM / TOURNEO CUSTOM (12-)     | 356 |

**HONDA**

|                                 |     |
|---------------------------------|-----|
| ACCORD (93-98)                  | 356 |
| ACCORD (98-02)                  | 357 |
| ACCORD Coupe (98-03)            | 357 |
| ACCORD Limousine (03-08)        | 357 |
| ACCORD Kombi (03-08)            | 358 |
| ACCORD VIII Limousine (08-)     | 358 |
| ACCORD VIII Kombi (08-)         | 358 |
| CITY (08-)                      | 358 |
| CIVIC (3/4-tuerig) (95-01)      | 359 |
| CIVIC (3-tuerig) (01-05)        | 359 |
| CIVIC (4-tuerig) (01-05)        | 359 |
| CIVIC (5-tuerig) (97-01)        | 359 |
| CIVIC (5-tuerig) (01-05)        | 360 |
| CIVIC IX (5-tuerig) (12-)       | 360 |
| CIVIC Hatchback (FK/FN) (05-12) | 361 |
| CIVIC Stufenheck (FD) (05-12)   | 361 |
| CIVIC AERODECK (98-01)          | 361 |
| CIVIC COUPE (96-01)             | 362 |
| CIVIC COUPE (01-04)             | 362 |
| CR-V I (97-02)                  | 362 |
| CR-V II (02-06)                 | 362 |
| CR-V III (07-12)                | 363 |
| CR-V IV (12-)                   | 364 |
| CRX (92-98)                     | 364 |
| FR-V (05-09)                    | 364 |
| HR-V (99-05)                    | 364 |
| INSIGHT (00-06)                 | 365 |
| INSIGHT (09-13)                 | 365 |
| INTEGRA R (97-01)               | 365 |
| JAZZ (02-08)                    | 365 |
| JAZZ (08-15)                    | 365 |
| JAZZ (15-)                      | 366 |
| LEGEND (96-04)                  | 366 |
| LOGO (99-02)                    | 366 |
| NSX (01-05)                     | 366 |
| PRELUDE (96-00)                 | 366 |
| S2000 (99-04)                   | 366 |
| SHUTTLE / ODYSSEY (95-01)       | 366 |
| STREAM (01-05)                  | 367 |

**HYUNDAI**

|                            |     |
|----------------------------|-----|
| ACCENT I (94-99)           | 367 |
| ACCENT II (00-05)          | 367 |
| ACCENT III (05-10)         | 368 |
| ACCENT IV (10-)            | 368 |
| ATOS (98-08)               | 369 |
| ATOS PRIME (99-08)         | 369 |
| CENTENNIAL (99-09)         | 369 |
| COUPE (RD) (96-02)         | 369 |
| COUPE (GK) (02-09)         | 370 |
| ELANTRA (00-06)            | 370 |
| ELANTRA (06-11)            | 371 |
| ELANTRA (11-)              | 371 |
| GALLOPER (98-03)           | 372 |
| GETZ (02-09)               | 372 |
| GRANDEUR (99-05)           | 373 |
| GRANDEUR (05-10)           | 373 |
| GRANDEUR (HG) (11-)        | 373 |
| GRAND SANTA FE (13-)       | 373 |
| H-1 KASTEN (00-07)         | 374 |
| H-1 KASTEN (08-)           | 374 |
| H-1 STAREX (97-07)         | 374 |
| H-1 STAREX (07-)           | 375 |
| H 100 (93-00)              | 375 |
| HIGHWAY VAN (00-04)        | 375 |
| i10 (08-13)                | 375 |
| i10 (13-)                  | 376 |
| i20 (08-14)                | 376 |
| i20 / i20 COUPE (GB) (14-) | 376 |
| i30 (07-11)                | 377 |
| i30 (GD) (11-)             | 377 |
| i30 CW Kombi (08-12)       | 378 |
| i30 CW Kombi (12-)         | 379 |
| i40 (12-)                  | 379 |
| i40 CW Kombi (11-)         | 380 |
| ix20 (10-)                 | 380 |
| ix35 (09-)                 | 380 |
| ix55 (08-12)               | 382 |
| LANTRA/ELANTRA (95-00)     | 382 |
| MATRIX (01-10)             | 382 |
| SANTA FE I (SM) (01-06)    | 383 |
| SANTA FE II (CM) (06-12)   | 384 |
| SANTA FE III (DM) (12-)    | 385 |
| SANTAMO (98-02)            | 385 |
| SONATA (Y-3) (93-98)       | 385 |
| SONATA (EF) (98-04)        | 386 |
| SONATA (NF) (05-10)        | 386 |
| SONATA (YF) (09-)          | 387 |
| TERRACAN (01-07)           | 387 |
| TIBURON Coupe (06-08)      | 388 |
| TRAJET (00-08)             | 388 |
| TUCSON (04-10)             | 388 |

**HYUNDAI**

|                |     |
|----------------|-----|
| TUCSON (15-)   | 389 |
| VELOSTER (11-) | 389 |
| XG (98-05)     | 390 |

**INFINITI**

|                                  |     |
|----------------------------------|-----|
| EX/QX50 (J50) (08-)              | 390 |
| FX (S50) (03-08)                 | 390 |
| FX/QX70 (S51) (08-)              | 390 |
| G25/G37 (V36) (07-13)            | 390 |
| G37/Q60 Coupe (CV36) (07-15)     | 390 |
| G37/Q60 Cabriolet (HV36) (10-15) | 390 |
| M35/M45 (Y50) (05-)              | 390 |
| M/Q70 (Y51) (10-)                | 390 |
| Q50 (V37) (13-)                  | 391 |

**ISUZU**

|                     |     |
|---------------------|-----|
| D-MAX (8DH) (02-12) | 391 |
| TROOPER (91-98)     | 391 |
| TROOPER (98-04)     | 391 |

**IVECO**

|                          |     |
|--------------------------|-----|
| CAMPAGNOLA (08-10)       | 391 |
| DAILY I / GRINTA (78-99) | 391 |
| DAILY II (99-06)         | 392 |
| DAILY III (06-13)        | 392 |
| DAILY V (11-)            | 392 |
| EUROCARGO (06-)          | 393 |
| MASSIF (08-10)           | 393 |

**JAGUAR**

|                                |     |
|--------------------------------|-----|
| F-Type (X152) (12-)            | 393 |
| S-Type (CCX) (99-08)           | 393 |
| X-Type (CF1) Limousine (01-09) | 393 |
| X-Type (CF1) Kombi (03-09)     | 394 |
| XF (CC9) (08-)                 | 395 |
| XF Sportbrake (CC9) (12-)      | 395 |
| XJ (X300) (94-97)              | 396 |
| XJ (NAW,NBW) (97-03)           | 396 |
| XJ (X350,X358) (03-09)         | 396 |
| XJ (X351) (09-)                | 397 |
| XK8 Coupe (QEV) (96-05)        | 397 |
| XK8 Convertible (QDV) (96-05)  | 398 |
| XK Coupe (06-)                 | 398 |
| XK Convertible (06-)           | 398 |

**JEEP**

|                                   |     |
|-----------------------------------|-----|
| CHEROKEE (XJ) (95-01)             | 399 |
| CHEROKEE (KJ) (01-08)             | 399 |
| CHEROKEE (KK) (08-12)             | 399 |
| CHEROKEE (KL) (13-)               | 399 |
| COMMANDER (XK) (05-10)            | 399 |
| COMPASS (MK49) (06-)              | 399 |
| GRAND CHEROKEE I (ZJ) (93-99)     | 400 |
| GRAND CHEROKEE II (WJ,WG) (99-05) | 400 |
| GRAND CHEROKEE III (WH) (05-10)   | 400 |
| GRAND CHEROKEE IV (WK) (10-)      | 401 |
| PATRIOT (MK74) (07-)              | 401 |
| RENEGADE (BU) (14-)               | 401 |
| WRANGLER II (TJ) (96-07)          | 401 |
| WRANGLER III (JK) (07-)           | 402 |

**KIA**

|                                     |     |
|-------------------------------------|-----|
| BESTA (96-03)                       | 402 |
| BONGO (03-10)                       | 402 |
| CARENS I (00-02)                    | 402 |
| CARENS II (02-06)                   | 402 |
| CARENS III (06-13)                  | 402 |
| CARENS IV (13-)                     | 403 |
| CARNIVAL I (99-01)                  | 403 |
| CARNIVAL II (01-06)                 | 403 |
| CARNIVAL / GRAND CARNIVAL III (06-) | 403 |
| CEE'D Limousine (06-12)             | 404 |
| CEE'D Kombi (07-13)                 | 404 |
| CEE'D (12-)                         | 405 |
| CERATO (04-09)                      | 406 |
| CERATO (09-)                        | 406 |
| CERATO KOUP (09-)                   | 406 |
| CLARUS (96-01)                      | 406 |
| JOICE (00-03)                       | 407 |
| MAGENTIS (01-05)                    | 407 |
| MAGENTIS (05-10)                    | 407 |
| MENTOR I (GB) (96-01)               | 407 |
| MENTOR II (GB) (01-04)              | 408 |
| OPIRUS (03-10)                      | 408 |
| OPTIMA (TF) (12-15)                 | 408 |
| OPTIMA (JF) (15-)                   | 408 |
| PICANTO (BA) (04-11)                | 408 |
| PICANTO (TA) (11-)                  | 409 |
| PREGIO (97-04)                      | 409 |

**KIA**

|                         |     |
|-------------------------|-----|
| PRIDE Limousine (96-00) | 409 |
| PRIDE Kombi (99-01)     | 409 |
| PRIDE (05-11)           | 409 |
| PRO CEE'D (08-13)       | 410 |
| PRO CEE'D (13-)         | 410 |
| RETONA (99-03)          | 411 |
| RIO I (DC) (00-05)      | 411 |
| RIO II (JB) (05-11)     | 411 |
| RIO III (UB) (11-)      | 411 |
| SEDONA I (GB) (99-01)   | 412 |
| SEDONA II (GB) (01-06)  | 412 |
| SEDONA III (GB) (06-)   | 412 |
| SEPHIA I (93-98)        | 412 |
| SEPHIA I (98-01)        | 412 |
| SEPHIA II (01-04)       | 413 |
| SHUMA I (97-01)         | 413 |
| SHUMA II (01-04)        | 413 |
| SORENTO (JC) (02-09)    | 413 |
| SORENTO (XM) (09-14)    | 414 |
| SORENTO (UM) (15-)      | 414 |
| SOUL (09-14)            | 414 |
| SOUL (14-)              | 415 |
| SPORTAGE (94-03)        | 415 |
| SPORTAGE (04-10)        | 415 |
| SPORTAGE (10-15)        | 416 |
| SPORTAGE (15-)          | 417 |
| VENGA (10-)             | 417 |

**LADA**

|                               |     |
|-------------------------------|-----|
| 110 Stufenheck (2110) (95-07) | 417 |
| 111 Kombi (2111) (95-08)      | 417 |
| 112 Fließheck (2112) (95-08)  | 418 |
| KALINA (1117/1118/1119) (04-) | 418 |
| PRIORA (2170/2172) (08-)      | 418 |
| SAMARA (2108/2109) (86-99)    | 418 |
| NIVA II (2123) (02-)          | 419 |

**LANCIA**

|                                  |     |
|----------------------------------|-----|
| DEDRA (94-99)                    | 419 |
| DELTA (94-99)                    | 419 |
| DELTA / Chrysler Delta (08-)     | 420 |
| FLAVIA (12-)                     | 420 |
| KAPPA (95-01)                    | 420 |
| LYBRA (99-05)                    | 421 |
| MUSA (04-13)                     | 421 |
| PHEDRA (02-10)                   | 422 |
| THEMA (11-)                      | 422 |
| THESIS (02-07)                   | 422 |
| Y (96-03)                        | 422 |
| YPSILON (03-11)                  | 423 |
| YPSILON / Chrysler Ypsilon (11-) | 424 |
| ZETA (94-02)                     | 424 |

**LAND ROVER**

|                                     |     |
|-------------------------------------|-----|
| DEFENDER Cabrio (07-)               | 424 |
| DEFENDER Pick-up (07-)              | 424 |
| DEFENDER Pritsche/Fahrgestell (11-) | 425 |
| DEFENDER Station Wagon (07-)        | 425 |
| DISCOVERY I (89-98)                 | 425 |
| DISCOVERY II (94-04)                | 425 |
| DISCOVERY III (04-09)               | 426 |
| DISCOVERY IV (09-)                  | 426 |
| DISCOVERY SPORT (14-)               | 427 |
| FREELANDER (LN) (98-06)             | 427 |
| FREELANDER 2 (FA) (06-)             | 427 |
| RANGE ROVER II (LP) (94-02)         | 428 |
| RANGE ROVER III (LM) (02-12)        | 428 |
| RANGE ROVER IV (LG) (12-)           | 429 |
| RANGE ROVER EVOQUE (SAL) (11-)      | 429 |
| RANGE ROVER EVOQUE Cabriolet (16-)  | 430 |
| RANGE ROVER SPORT (LS) (05-13)      | 430 |
| RANGE ROVER SPORT (LW) (13-)        | 431 |

**LEXUS**

|                                   |     |
|-----------------------------------|-----|
| CT 200 (11-)                      | 431 |
| ES 300/330 (96-06)                | 431 |
| ES 350 (06-12)                    | 431 |
| ES 250/300/350 (GSV,ASV,AV) (12-) | 431 |
| GS 300 (93-97)                    | 431 |
| GS 300 (97-05)                    | 431 |
| GS 430 (00-05)                    | 431 |
| GS (GRS_ GWS_) (05-11)            | 432 |
| GS (GRL1_ GWL1_) (12-)            | 432 |
| GX 470 (J12) (01-09)              | 432 |
| GX 470 (URJ15) (09-)              | 433 |
| HS 250 (ANF) (09-)                | 433 |
| IS 200 (99-05)                    | 433 |
| IS 200/220/250/350 (05-)          | 433 |
| IS 200/250/300 (13-)              | 433 |
| LS 400 (94-00)                    | 433 |
| LS 460 (06-)                      | 433 |
| LS 600 (07-)                      | 434 |
| LX 470 (98-08)                    | 434 |

**LEXUS**

|                               |     |
|-------------------------------|-----|
| LX 570 (URJ) (07-)            | 434 |
| NX (14-)                      | 434 |
| RC (14-)                      | 434 |
| RX 300 (MCU_) (00-03)         | 434 |
| RX 300/350/400 (MCU_) (03-08) | 434 |
| RX 270/350/450 (GVL_) (09-15) | 435 |
| SC 430 (UZ240) (01-10)        | 435 |

**MAYBACH**

|                |     |
|----------------|-----|
| (W240) (02-12) | 435 |
|----------------|-----|

**MAZDA**

|   |     |
|---|-----|
| 121 (96-03)                             | 435 |
| 2 (DY) (03-07)                          | 436 |
| 2 (DE) (07-14)                          | 436 |
| 3 (BK) (03-09)                          | 437 |
| 3 (BL) (09-13)                          | 438 |
| 3 (BM) (13-)                            | 438 |
| 323 Limousine/323 C/323 F/323 S (94-98) | 439 |
| 323 Limousine/323 F/323 P/323 S (98-03) | 439 |
| 5 (CR) (05-10)                          | 439 |
| 5 (CW) (10-)                            | 440 |
| 6 Limousine (GG) (02-07)                | 440 |
| 6 Kombi (GY) (02-07)                    | 441 |
| 6 (GH) (07-12)                          | 441 |
| 626 (GE) (91-97)                        | 442 |
| 626 (GF) (97-02)                        | 442 |
| 626 Kombi (GV) (92-98)                  | 443 |
| 626 Kombi (GW) (98-02)                  | 443 |
| B2500 (02-06)                           | 443 |
| BT-50 (06-12)                           | 443 |
| CX-3 (15-)                              | 444 |
| CX-5 (11-)                              | 444 |
| CX-7 (06-13)                            | 444 |
| CX-9 (07-)                              | 444 |
| DEMIO (98-02)                           | 445 |
| E2000/E2200 Bus (87-97)                 | 445 |
| E2000/E2200 Kasten (87-97)              | 445 |
| E2000/E2200 Pritsche (87-97)            | 445 |
| MPV I (94-99)                           | 445 |
| MPV II (99-05)                          | 445 |
| MX-3 (91-98)                            | 445 |
| MX-5 (NA) (89-98)                       | 446 |
| MX-5 (NB) (98-05)                       | 446 |
| MX-5 (NC) (05-)                         | 446 |
| MX-5 (ND) (15-)                         | 446 |
| MX-6 (91-97)                            | 446 |
| PREMACY (CP) (99-05)                    | 447 |
| PREMACY (CR) (05-10)                    | 447 |
| RX-8 (03-12)                            | 447 |
| TRIBUTE (00-04)                         | 448 |
| TRIBUTE (04-08)                         | 448 |
| XEDOS 6 (92-00)                         | 448 |
| XEDOS 9 (93-02)                         | 448 |

**MERCEDES BENZ**

|  |     |
|--|-----|
| A-Klasse (W168) (97-04)                | 448 |
| A-Klasse (W169) (04-12)                | 449 |
| A-Klasse (W176) (12-)                  | 450 |
| B-Klasse (W245) (05-11)                | 451 |
| B-Klasse (W246/W242) (11-)             | 452 |
| CITAN (W415) (12-)                     | 453 |
| C-Klasse (W202) Limousine (93-00)      | 454 |
| C-Klasse (S202) Kombi (96-01)          | 455 |
| C-Klasse (W203) Limousine (00-07)      | 457 |
| C-Klasse (S203) Kombi (01-07)          | 459 |
| C-Klasse (CL203) Sportcoupe (01-08)    | 462 |
| C-Klasse (CLC203) Coupe (08-10)        | 463 |
| C-Klasse (W204) Limousine (07-14)      | 464 |
| C-Klasse (S204) Kombi (07-14)          | 468 |
| C-Klasse (C204) Coupe (11-)            | 471 |
| C-Klasse (W205) Limousine (14-)        | 472 |
| C-Klasse (S205) Kombi (14-)            | 472 |
| C-Klasse (C205) Coupe (15-)            | 473 |
| C-Klasse (A205) Cabrio (16-)           | 473 |
| CL-Klasse (C140) Coupe (96-99)         | 474 |
| CL-Klasse (C215) Coupe (99-06)         | 474 |
| CL-Klasse (C216) Coupe (06-14)         | 474 |
| CLA-Klasse (C117) Coupe (13-)          | 475 |
| CLA-Klasse (X117) Shooting Brake (15-) | 476 |
| CLK-Klasse (C208) Coupe (97-02)        | 477 |
| CLK-Klasse (A208) Cabrio (98-03)       | 478 |
| CLK-Klasse (C209) Coupe (02-09)        | 479 |
| CLK-Klasse (A209) Cabrio (03-09)       | 481 |
| CLS-Klasse (C219) Coupe (04-10)        | 482 |
| CLS-Klasse (C218) Coupe (10-)          | 483 |
| CLS-Klasse (X218) Shooting Brake (12-) | 484 |
| E-Klasse (C124) Coupe (93-97)          | 485 |
| E-Klasse (A124) Cabrio (93-98)         | 485 |
| E-Klasse (W210) Limousine (95-02)      | 485 |
| E-Klasse (S210) Kombi (96-03)          | 487 |
| E-Klasse (W211) Limousine (02-09)      | 489 |
| E-Klasse (S211) Kombi (03-09)          | 492 |
| E-Klasse (W212) Limousine (09-)        | 494 |
| E-Klasse (S212) Kombi (09-)            | 498 |

**MERCEDES BENZ**

|   |     |
|---|-----|
| E-Klasse (C207) Coupe (09-)               | 500 |
| E-Klasse (A207) Cabrio (10-)              | 502 |
| E-Klasse (W213) Limousine (16-)           | 503 |
| E-Klasse (S213) Kombi (16-)               | 504 |
| G-Klasse (W463) (90-)                     | 504 |
| G-Klasse (W463) Cabrio (90-)              | 504 |
| GL-Klasse (X164) (06-12)                  | 505 |
| GL-Klasse / GLS-Klasse (X166) (12-)       | 506 |
| GLA-Klasse (X156) (13-)                   | 506 |
| GLC-Klasse (X253) (15-)                   | 507 |
| GLC-Klasse (C253) Coupe (16-)             | 507 |
| GLE-Klasse (C292) Coupe (15-)             | 507 |
| GLK-Klasse (X204) (08-15)                 | 507 |
| M-Klasse (W163) (98-05)                   | 509 |
| M-Klasse (W164) (05-11)                   | 510 |
| M-Klasse/GLE-Klasse (W166) (11-)          | 511 |
| R-Klasse (W251,V251) (06-12)              | 512 |
| S-Klasse (W140) (93-98)                   | 513 |
| S-Klasse (W220) (98-06)                   | 514 |
| S-Klasse (W221) (06-13)                   | 515 |
| S-Klasse (W222) (13-)                     | 518 |
| S-Klasse (C217) Coupe (14-)               | 518 |
| S-Klasse (A217) Cabrio (15-)              | 518 |
| SL-Klasse (R129) (93-01)                  | 518 |
| SL-Klasse (R230) (01-11)                  | 519 |
| SL-Klasse (R231) (12-)                    | 520 |
| SLK-Klasse (R170) (96-04)                 | 521 |
| SLK-Klasse (R171) (04-11)                 | 522 |
| SLK-Klasse / SLC-Klasse (R172) (11-)      | 522 |
| SLR-Klasse (C199) Coupe (04-09)           | 523 |
| SLS AMG 63 / ROADSTER (C197) (10-14)      | 523 |
| VANEO (BM414) (02-05)                     | 523 |
| V-Klasse (BM638) (96-03)                  | 524 |
| V-Klasse (BM447) (14-)                    | 524 |
| VIANO (BM639) (03-14)                     | 525 |
| VITO (BM638) (96-03)                      | 526 |
| VITO (BM639) (03-14)                      | 526 |
| VITO (W447) (14-)                         | 527 |
| Transporter (BM 901/902) SPRINTER (95-06) | 528 |
| Transporter (BM 903/904) SPRINTER (95-06) | 529 |
| Transporter (BM 905) SPRINTER (01-06)     | 530 |
| Transporter (BM 906) SPRINTER (06-)       | 530 |
| Transporter VARIO (96-13)                 | 534 |

**MERCEDES NFZ.**

|                                   |     |
|-----------------------------------|-----|
| UNIMOG 20 (BM 405.050) (07-)      | 535 |
| UNIMOG 300-400 (BM 405.1) (00-)   | 535 |
| UNIMOG 3000-5000 (BM 437.4) (02-) | 535 |

**MG**

|                      |     |
|----------------------|-----|
| ZR (01-05)           | 535 |
| ZS (01-05)           | 536 |
| ZT Limousine (01-05) | 536 |
| ZT-T Kombi (01-05)   | 536 |
| MGF (RD) (95-02)     | 537 |
| MG TF (02-05)        | 537 |

**MINI**

|                      |     |
|----------------------|-----|
| F55 (14-)            | 537 |
| F56 (13-)            | 537 |
| F57 Cabrio (15-)     | 537 |
| R50 / R53 (00-06)    | 538 |
| R52 Cabrio (04-08)   | 538 |
| R55 Clubman (07-14)  | 539 |
| F54 Clubman (15-)    | 539 |
| R55 Clubvan (12-)    | 539 |
| R56 (06-14)          | 539 |
| R57 Cabrio (09-14)   | 540 |
| R58 Coupe (11-)      | 541 |
| R59 Roadster (12-)   | 541 |
| R60 Countryman (10-) | 541 |
| R61 Paceman (12-)    | 542 |

**MITSUBISHI**

|                                    |     |
|------------------------------------|-----|
| ASX (10-)                          | 542 |
| CARISMA (95-06)                    | 543 |
| COLT/LANCER Limousine (96-03)      | 544 |
| COLT (04-12)                       | 545 |
| COLT CZC Cabriolet (06-09)         | 545 |
| ECLIPSE II (95-99)                 | 545 |
| GALANT (96-03)                     | 546 |
| GALANT Stufenheck (03-)            | 546 |
| GALLOPER (99-03)                   | 546 |
| GRANDIS (04-10)                    | 546 |
| i (10-)                            | 547 |
| i-MiEV (09-14)                     | 547 |
| L 200 (96-06)                      | 547 |
| L 200 (06-15)                      | 547 |
| L 200 (15-)                        | 547 |
| L 300 (94-00) (Kabine und Chassis) | 547 |
| L 400 (96-05)                      | 547 |
| LANCER Evolution (99-03)           | 548 |
| LANCER Evolution (04-07)           | 548 |







### MITSUBISHI

|   |     |
|---|-----|
| LANCER Evolution (CZ4A) (07-)                 | 548 |
| LANCER Limousine (03-07)                      | 548 |
| LANCER Kombi (03-07)                          | 548 |
| LANCER Stufenheck/Sportlimousine (CY_A) (07-) | 548 |
| LANCER Sportback (CX_A) (08-)                 | 549 |
| OUTLANDER I (03-06)                           | 550 |
| OUTLANDER II (06-12)                          | 551 |
| OUTLANDER III (12-)                           | 552 |
| PAJERO (90-00)                                | 552 |
| PAJERO (00-07)                                | 553 |
| PAJERO (07-)                                  | 553 |
| PAJERO PININ / SHOGUN PININ (GB) (99-05)      | 554 |
| PAJERO SPORT / MONTERO (USA) (98-09)          | 555 |
| PAJERO SPORT (KH_) (09-)                      | 555 |
| SANTAMO (99-04)                               | 555 |
| SPACE GEAR (95-02)                            | 555 |
| SPACE RUNNER (91-99)                          | 555 |
| SPACE RUNNER (99-03)                          | 556 |
| SPACE STAR (98-06)                            | 556 |
| SPACE STAR (A05A) (12-)                       | 557 |
| SPACE WAGON (91-98)                           | 557 |
| SPACE WAGON (98-05)                           | 557 |

### NISSAN

|   |     |
|---|-----|
| 200 SX (S14) (94-99)                    | 557 |
| 350 Z (Z33) (02-09)                     | 557 |
| ALMERA (N15) (95-00)                    | 558 |
| ALMERA (N16) (00-06)                    | 558 |
| ALMERA TINO (V10M) (00-05)              | 559 |
| CABSTAR E (F23E) (92-07)                | 559 |
| CABSTAR E (F24E) (06-13)                | 559 |
| CUBE (Z12) (10-11)                      | 560 |
| GT-R (R35) (09-)                        | 560 |
| INTERSTAR (X70) (02-10)                 | 560 |
| JUKE (F15) (10-)                        | 560 |
| KUBISTAR (X76) Kombi (03-09)            | 561 |
| LEAF (EM61) (10-)                       | 562 |
| MAXIMA (A32) (94-99)                    | 562 |
| MAXIMA (CA33) (00-03)                   | 562 |
| MICRA (K11E) (92-02)                    | 562 |
| MICRA (K12E) (03-10)                    | 563 |
| MICRA C+C (CK12E) (05-10)               | 563 |
| MICRA (K13K) (10-)                      | 563 |
| MURANO (Z50) (03-08)                    | 564 |
| MURANO (Z51) (07-)                      | 564 |
| NAVARA (D40M) (05-)                     | 564 |
| NAVARA Pick-up (D23) (15-)              | 565 |
| NOTE (E11E) (06-13)                     | 565 |
| NOTE (E12E) (13-)                       | 565 |
| NP 300 (D40M) (08-)                     | 565 |
| NV 200 (M20) Kasten (10-)               | 566 |
| NV 200 EVALIA (M20) Bus (10-)           | 566 |
| NV 400 (X62) Bus (11-)                  | 566 |
| NV 400 (X62) Kasten (11-)               | 566 |
| NV 400 (X62) Pritsche/Fahrgestell (11-) | 566 |
| PATHFINDER (R50) (97-04)                | 567 |
| PATHFINDER (R51M) (05-)                 | 567 |
| PATROL GR I (Y60) (88-97)               | 567 |
| PATROL GR II (Y61) (97-10)              | 568 |
| PICK-UP (D21) (85-97)                   | 568 |
| PICK-UP (D22) (98-07)                   | 568 |
| PICK-UP (D22S) (06-)                    | 568 |
| PIXO (K10B) (09-13)                     | 568 |
| PRIMASTAR (X83) Bus (01-)               | 569 |
| PRIMASTAR (X83) Kasten/Pritsche (02-)   | 569 |
| PRIMERA (P11E) Limousine (96-02)        | 569 |
| PRIMERA (P12E) Limousine (02-08)        | 570 |
| PRIMERA (W10) Kombi (90-98)             | 570 |
| PRIMERA (W11) Kombi (98-02)             | 571 |
| PRIMERA (W12) Kombi (02-08)             | 571 |
| PULSAR (14-)                            | 571 |
| QASHQAI / QASHQAI +2 (J10,JJ10) (07-14) | 572 |
| QASHQAI (J11E) (14-)                    | 573 |
| SERENA/VANETTE CARGO (C23M/963) (92-01) | 573 |
| SUNNY (Y10) Kombi (90-00)               | 573 |
| TEANA (J31) (03-08)                     | 574 |
| TEANA (J32) (08-)                       | 574 |
| TERRANO I (WD21) (87-97)                | 574 |
| TERRANO II (R20) (93-06)                | 574 |
| TIIDA Schrägheck (C11X) (07-11)         | 574 |
| TIIDA Stufenheck (SC11X) (07-11)        | 574 |
| URVAN (E24) (87-97)                     | 575 |
| X-TRAIL (T30) (01-07)                   | 575 |
| X-TRAIL (T31) (07-14)                   | 576 |
| X-TRAIL (T32) (13-)                     | 577 |

### OPEL

|  |     |
|--|-----|
| ADAM / Vauxhall Adam (13-)             | 577 |
| AGILA / Vauxhall Agila Mk I (00-07)    | 577 |
| AGILA / Vauxhall Agila Mk II (08-)     | 578 |
| ANTARA / Vauxhall Antara (06-)         | 578 |
| AMPERA / Vauxhall Ampera (11-)         | 579 |
| ARENA / Vauxhall Arena (97-01)         | 579 |
| ASTRA F / Vauxhall Astra MKIII (91-01) | 580 |
| ASTRA F CLASSIC (98-02)                | 582 |
| ASTRA F CLASSIC Caravan (98-05)        | 582 |
| ASTRA G / Vauxhall Astra MKIV (98-05)  | 582 |



### OPEL

|   |     |
|---|-----|
| ASTRA H / GTC / Vauxhall Astra Mk V (04-10)                 | 584 |
| ASTRA H Caravan/Vau. Astra MKV Estate (04-10)               | 586 |
| ASTRA H TwinTop (06-10)                                     | 587 |
| ASTRA J / GTC / Vauxhall Astra MK VI (09-)                  | 588 |
| ASTRA J Sports Tourer/Vau.Astra Sports Tourer (10-)         | 590 |
| CALIBRA / Vauxhall Calibra (89-97)                          | 592 |
| CAMPO (97-01)   | 593 |
| CASCADA / Vauxhall Cascada (13-)                            | 593 |
| COMBO / Vauxhall Combo (01-11)                              | 593 |
| COMBO D / Vauxhall Combo D (11-)                            | 594 |
| CORSA B / Vauxhall Corsa (93-00)                            | 595 |
| CORSA C / Vauxhall Corsa MK II (00-06)                      | 596 |
| CORSA D / Vauxhall Corsa MK III (06-)                       | 597 |
| CORSA E / Vauxhall Corsa Mk IV (14-)                        | 598 |
| FRONTERA A (92-98)  | 599 |
| FRONTERA B (98-04)  | 600 |
| GT (07-09)  | 600 |
| INSIGNIA / Vauxhall Insignia (08-)                          | 600 |
| INSIGNIA Country Tourer (13-)                               | 603 |
| INSIGNIA Sports Tourer / Vauxh. Insignia SportsTourer (08-) | 604 |
| KARL / Vauxhall Viva (15-)                                  | 607 |
| MERIVA A / Vauxhall Meriva Mk I (03-10)                     | 607 |
| MERIVA B / Vauxhall Meriva Mk II (10-)                      | 608 |
| MOKKA / Vauxhall Mokka (12-)                                | 609 |
| MONTEREY (92-98)  | 610 |
| MONTEREY (98-99)  | 610 |
| MOVANO A (98-10)  | 610 |
| MOVANO B (10-)  | 611 |
| OMEGA B / Vauxhall Omega (94-03)                            | 612 |
| SIGNUM / Vauxhall Signum (03-08)                            | 612 |
| SINTRA / Vauxhall Sintra (97-99)                            | 613 |
| SPEEDSTER / Vauxhall VX220 (00-05)                          | 614 |
| TIGRA / Vauxhall Tigra (94-00)                              | 614 |
| TIGRA TWIN TOP / Vau. Tigra Twin Top (04-09)                | 614 |
| VECTRA B / Vauxhall Vectra (96-02)                          | 614 |
| VECTRA C (F68,F69)/Vau. Vectra MK II (02-08)                | 615 |
| VECTRA C Caravan (F35) / Vau. MK II (03-08)                 | 617 |
| VIVARO (01-14)  | 618 |
| VIVARO B (14-)  | 618 |
| ZAFIRA I / Vauxhall Zafira I (99-05)                        | 618 |
| ZAFIRA II / Vauxhall Zafira II (05-)                        | 619 |
| ZAFIRA III Tourer / Vauxhall Zafira III Tourer (11-)        | 620 |

### PEUGEOT

|                                     |     |
|-------------------------------------|-----|
| 106 (96-04)                         | 622 |
| 107 (05-14)                         | 623 |
| 108 (14-)                           | 624 |
| 205 (91-98)                         | 624 |
| 206 Limousine (98-09)               | 625 |
| 206 CC (00-07)                      | 627 |
| 206 SW (02-07)                      | 627 |
| 206 PLUS (09-13)                    | 628 |
| 207 Limousine (06-12)               | 629 |
| 207 CC (07-15)                      | 630 |
| 207 SW (07-13)                      | 630 |
| 208 (12-)                           | 631 |
| 301 (12-)                           | 633 |
| 306 Limousine (3/5-tuerig) (93-01)  | 633 |
| 306 Limousine (4-tuerig) (94-01)    | 635 |
| 306 Cabriolet (94-03)               | 637 |
| 306 Kombi (97-02)                   | 638 |
| 307 Limousine (00-07)               | 639 |
| 307 Break (02-08)                   | 640 |
| 307 CC (03-09)                      | 642 |
| 307 SW (02-08)                      | 643 |
| 308 Limousine (07-13)               | 644 |
| 308 SW (08-14)                      | 646 |
| 308 CC (09-15)                      | 647 |
| 308 II (T9) (13-)                   | 648 |
| 308 II SW (T9) (14-)                | 650 |
| 406 Limousine (95-04)               | 652 |
| 406 Kombi (96-04)                   | 654 |
| 406 Coupe (97-05)                   | 654 |
| 407 Limousine / SW (04-11)          | 655 |
| 407 Coupe (05-11)                   | 655 |
| 508 (10-)                           | 657 |
| 508 SW (10-)                        | 658 |
| 605 (90-99)                         | 661 |
| 607 (00-10)                         | 662 |
| 806 (94-02)                         | 663 |
| 807 (02-14)                         | 663 |
| 1007 (05-11)                        | 664 |
| 2008 (13-)                          | 665 |
| 3008 (09-)                          | 666 |
| 4007 (07-12)                        | 666 |
| 4008 (12-)                          | 667 |
| 5008 (09-)                          | 667 |
| BIPPER (08-15)                      | 668 |
| BOXER Bus (94-02)                   | 668 |
| BOXER Kasten (94-02)                | 670 |
| BOXER Pritsche/Fahrgestell (94-02)  | 672 |
| BOXER (02-06)                       | 674 |
| BOXER (06-)                         | 675 |
| EXPERT Kombi (95-06)                | 676 |
| EXPERT Kasten (95-06)               | 677 |
| EXPERT Pritsche/Fahrgestell (95-06) | 678 |
| EXPERT / Expert Tepee (07-15)       | 679 |
| EXPERT (K0) Kasten (16-)            | 679 |



### PEUGEOT

|  |     |
|--|-----|
| iON (10-)                                | 679 |
| PARTNER Kombi (96-08)                    | 679 |
| PARTNER Kasten (96-08)                   | 680 |
| PARTNER Tepee/Kasten/Pritsche (B9) (08-) | 681 |
| RCZ (10-15)                              | 682 |
| TRAVELLER (16-)                          | 683 |

### PONTIAC

|                     |     |
|---------------------|-----|
| TRANS SPORT (97-05) | 683 |
|---------------------|-----|

### PORSCHE

|                            |     |
|----------------------------|-----|
| 911 (993) (93-97)          | 683 |
| 911 TARGA (993) (95-97)    | 683 |
| 911 CABRIO (993) (94-97)   | 683 |
| 911 (996) (97-05)          | 684 |
| 911 TARGA (996) (01-05)    | 684 |
| 911 CABRIO (996) (98-05)   | 684 |
| 911 COUPE (997) (04-13)    | 685 |
| 911 CABRIO (997) (05-13)   | 686 |
| 911 TARGA (997) (06-13)    | 687 |
| 911 COUPE (991) (11-)      | 687 |
| 911 CABRIO (991) (12-)     | 688 |
| 911 TARGA (991) (14-)      | 688 |
| CARRERA GT (993) (03-07)   | 689 |
| BOXSTER (986) (96-04)      | 689 |
| BOXSTER (987) (05-11)      | 689 |
| BOXSTER (981) (12-)        | 690 |
| BOXSTER Spyder (981) (15-) | 690 |
| 718 BOXSTER (982) (16-)    | 690 |
| CAYENNE I (03-10)          | 690 |
| CAYENNE II (10-)           | 693 |
| CAYMAN (987C) (05-12)      | 695 |
| CAYMAN (981C) (13-)        | 696 |
| 718 CAYMAN (982) (16-)     | 696 |
| MACAN (13-)                | 696 |
| PANAMERA (10-)             | 697 |

### PROTON

|                           |     |
|---------------------------|-----|
| JUMBUCK Pick-up (02-)     | 698 |
| PERSONA 300 / 400 (94-00) | 698 |
| SATRIA (00-)              | 698 |
| WIRA (00-05)              | 698 |

### RENAULT

|  |     |
|--|-----|
| AVANTIME (01-03)                                   | 698 |
| CAPTUR (J87) (13-)                                 | 699 |
| CLIO I Limousine (B/C 57_) (90-98)                 | 699 |
| CLIO I Kasten (S 57_) (91-98)                      | 701 |
| CLIO II Limousine (BB_/CB_) (98-12)                | 701 |
| CLIO II Kasten (SB_) (98-12)                       | 704 |
| CLIO III (BR_/CR_) (05-12)                         | 705 |
| CLIO III Grandtour (KR_) (08-12)                   | 707 |
| CLIO IV (B98_) (12-)                               | 708 |
| CLIO IV Grandtour (K98_) (12-)                     | 708 |
| DOKKER (K67/F67) (12-)                             | 709 |
| DUSTER (HS_) (11-)                                 | 709 |
| ESPACE III (JE_) (96-02)                           | 709 |
| ESPACE IV (JK_) (02-)                              | 710 |
| ESPACE V (JR_) (15-)                               | 711 |
| EXPRESS/RAPID (F40_) (85-98)                       | 711 |
| FLUENCE (L30_) (11-13)                             | 714 |
| KADJAR (HFE) (15-)                                 | 714 |
| KANGOO I (KC_) (98-07)                             | 715 |
| KANGOO II (KW_) (08-)                              | 716 |
| KANGOO Be Bop (KW0_) (09-10)                       | 717 |
| KANGOO Express/Rapid (FC_) (98-07)                 | 717 |
| KANGOO Express/Rapid (FW_) (08-)                   | 719 |
| KOLEOS (HY0_) (08-15)                              | 720 |
| LAGUNA I Limousine (B56/556_) (93-00)              | 720 |
| LAGUNA I Grandtour (K56_) (95-00)                  | 723 |
| LAGUNA II Limousine (BG_) (01-07)                  | 725 |
| LAGUNA II Grandtour (KG_) (01-07)                  | 727 |
| LAGUNA III Limousine (BT0/1) (07-15)               | 729 |
| LAGUNA III Coupe (DT0/1) (07-15)                   | 730 |
| LAGUNA III Grandtour (KT0/1) (07-15)               | 731 |
| LATITUDE (L70_) (11-13)                            | 732 |
| LOGAN (LS_) (04-13)                                | 732 |
| LOGAN Kombi (KS_) (04-13)                          | 733 |
| LOGAN Express (07-13)                              | 733 |
| LOGAN II (L52) (13-)                               | 733 |
| LOGAN II Kombi (L52) (13-)                         | 733 |
| MASCOTT (99-04)                                    | 734 |
| MASCOTT (04-10)                                    | 735 |
| MASTER I Bus (80-98)                               | 735 |
| MASTER I Kasten (80-98)                            | 736 |
| MASTER I Pritsche/Fahrgestell (80-98)              | 736 |
| MASTER II Bus (JD/ND_) (98-06)                     | 737 |
| MASTER II Kasten (FD_) (98-06)                     | 737 |
| MASTER II Pritsche/Fahrgestell (ED/HD/UD_) (98-06) | 738 |
| MASTER II Bus (JD_) (06-10)                        | 739 |
| MASTER II Kasten (FD_) (06-10)                     | 739 |
| MASTER II Pritsche/Fahrgestell (ED/HD/UD_) (06-10) | 739 |
| MASTER III Kasten/Bus (FV/JV) (10-)                | 740 |



## RENAULT

|   |     |
|---|-----|
| MASTER III Pritsche/Fahrgestell (EV/UV) (10-)   | 741 |
| MAXITY (SHF/SHT) (06-)                          | 742 |
| MEGANE I Limousine 3/5-tuerig (BA/SA_) (96-02)  | 742 |
| MEGANE I Classic (LA_) (96-02)                  | 744 |
| MEGANE I Coach (DA_) (95-03)                    | 746 |
| MEGANE I Cabrio (EA_) (96-03)                   | 747 |
| MEGANE I Grandtour (KA_) (98-03)                | 748 |
| MEGANE II Limousine 3/5-tuerig (BM/CM_) (02-08) | 749 |
| MEGANE II Limousine 4-tuerig (LM_) (03-08)      | 751 |
| MEGANE II Coupe/Cabrio (EM_) (03-10)            | 753 |
| MEGANE II Grandtour (KM_) (03-08)               | 755 |
| MEGANE III Schrägheck (BZO_) (08-)              | 756 |
| MEGANE III CC (EZO_) (10-)                      | 758 |
| MEGANE III Coupe (DZO_) (08-)                   | 758 |
| MEGANE III Grandtour (KZ_) (08-)                | 759 |
| MEGANE IV (B9_) (15-)                           | 761 |
| MEGANE IV Grandtour (K9_) (15-)                 | 761 |
| MEGANE SCENIC (JA_) (96-99)                     | 761 |
| MODUS/GRAND MODUS (JPO_) (04-13)                | 762 |
| SAFRANE (B54_) (92-00)                          | 763 |
| SANDERO (B50_) (07-)                            | 764 |
| SANDERO II (13-)                                | 765 |
| SCENIC I (JA_) (99-03)                          | 765 |
| SCENIC II (JM_) (03-09)                         | 766 |
| SCENIC III (JZ_) (09-)                          | 768 |
| GRAND SCENIC (JM_) (04-09)                      | 769 |
| GRAND SCENIC (JZ_) (09-)                        | 770 |
| THALIA I (LB_) (98-)                            | 771 |
| THALIA II / SYMBOL (LU_) (08-)                  | 772 |
| TRAFIC I Propulsion (PXX) (89-97)               | 772 |
| TRAFIC I Kasten (TXX) (89-01)                   | 773 |
| TRAFIC I Bus (TXW) (89-01)                      | 774 |
| TRAFIC II (JL/FL/EL) (01-14)                    | 775 |
| TRAFIC III (14-)                                | 775 |
| TWINGO I Limousine (C06_) (93-07)               | 775 |
| TWINGO I Kasten (S06_) (93-07)                  | 776 |
| TWINGO II (CNO_) (07-14)                        | 776 |
| TWINGO III (14-)                                | 777 |
| VEL SATIS (BJO_) (02-09)                        | 777 |
| WIND (E4M_) (10-13)                             | 778 |
| ZOE (12-)                                       | 778 |

## ROLLS ROYCE

|               |     |
|---------------|-----|
| SILVER SERAPH | 778 |
|---------------|-----|

## ROVER

|                           |     |
|---------------------------|-----|
| 25-Serie (RF) (99-05)     | 778 |
| 45-Serie (RT) (00-05)     | 779 |
| 75-Serie (RJ/RX) (99-05)  | 779 |
| 100-Serie (XP) (90-98)    | 780 |
| 200 II-Serie (RF) (95-00) | 780 |
| 400-Serie (RT) (95-00)    | 781 |
| 600-Serie (RH) (93-99)    | 781 |
| 800-Serie (XS/RS) (86-99) | 781 |
| STREETWISE (03-05)        | 782 |

## SAAB

|                              |     |
|------------------------------|-----|
| 9-3 (YS3D) (98-02)           | 782 |
| 9-3 Limousine (YS3F) (03-12) | 782 |
| 9-3 SportCombi (05-12)       | 784 |
| 9-3 Cabriolet (YS3D) (98-03) | 786 |
| 9-3 Cabriolet (YS3F) (03-12) | 787 |
| 9-3 X (09-12)                | 788 |
| 9-5 Limousine (YS3E) (97-10) | 789 |
| 9-5 Kombi (YS3E) (98-10)     | 790 |
| 9-5 II (10-12)               | 792 |
| 900 (94-98)                  | 793 |
| 9000 (94-98)                 | 794 |

## SEAT

|                                   |     |
|-----------------------------------|-----|
| ALHAMBRA I (96-10)                | 794 |
| ALHAMBRA II (10-)                 | 796 |
| ALTEA (5P1) (04-15)               | 797 |
| ALTEA XL (5P5) (06-15)            | 799 |
| AROSA (6H) (97-05)                | 801 |
| ATECA (16-)                       | 802 |
| CORDOBA I (93-99)                 | 802 |
| CORDOBA II (6K2) (99-02)          | 805 |
| CORDOBA III (6L2) (02-09)         | 806 |
| EXEO / ST (09-13)                 | 807 |
| IBIZA II (93-99)                  | 808 |
| IBIZA III (6K1) (99-02)           | 811 |
| IBIZA IV (6L1) (02-10)            | 813 |
| IBIZA V / ST / SC (08-)           | 815 |
| INCA (6K9) (96-03)                | 818 |
| LEON I (1M1) (99-05)              | 819 |
| LEON II (1P1) (05-12)             | 822 |
| LEON III (5F) / SC / ST (12-)     | 825 |
| LEON III (5F) ST X-Perience (14-) | 829 |
| MARBELLA (87-98)                  | 829 |
| Mii (12-)                         | 829 |
| TOLEDO I (1L) (91-98)             | 830 |
| TOLEDO II (1M2) (98-04)           | 831 |



## SEAT

|                          |     |
|--------------------------|-----|
| TOLEDO III (5P2) (05-09) | 834 |
| TOLEDO IV (KG3) (12-)    | 835 |

## SKODA

|                               |     |
|-------------------------------|-----|
| CITIGO (12-)                  | 836 |
| FABIA I (6Y) (99-07)          | 836 |
| FABIA II (5J) (07-14)         | 838 |
| FABIA III (NJ) (14-)          | 840 |
| FELICIA I (791/795) (95-97)   | 841 |
| FELICIA II (6U) (98-01)       | 841 |
| FELICIA PICK-UP (797) (97-00) | 842 |
| OCTAVIA I (1U) (97-10)        | 842 |
| OCTAVIA II (1Z) (04-13)       | 844 |
| OCTAVIA III (5E) (12-)        | 847 |
| RAPID / RAPID Spaceback (12-) | 850 |
| ROOMSTER (5J) (06-15)         | 851 |
| SUPERB I (02-08)              | 853 |
| SUPERB II (08-15)             | 854 |
| SUPERB II Combi (09-15)       | 855 |
| SUPERB III (15-)              | 857 |
| SUPERB III Combi (15-)        | 858 |
| YETI (09-)                    | 859 |

## SMART

|                                |     |
|--------------------------------|-----|
| CABRIO (BM450) (00-03)         | 861 |
| CITY COUPE (BM450) (98-04)     | 862 |
| CROSSBLADE (BM450) (02-04)     | 862 |
| FORFOUR (BM454) (04-06)        | 862 |
| FORTWO CABRIO (BM450) (04-07)  | 863 |
| FORTWO COUPE (BM450) (04-07)   | 863 |
| FORTWO CABRIO (BM451) (07-)    | 863 |
| FORTWO COUPE (BM451) (07-)     | 864 |
| FORTWO (BM453) (14-)           | 865 |
| FORTWO CABRIO (BM453) (15-)    | 865 |
| FORFOUR (BM453) (14-)          | 865 |
| ROADSTER (BM452) (03-05)       | 865 |
| ROADSTER COUPE (BM452) (03-05) | 865 |

## SSANG YONG

|                             |     |
|-----------------------------|-----|
| ACTYON SPORTS Pick-up (07-) | 866 |
| KORANDO (96-99)             | 866 |
| REXTON I (02-06)            | 866 |

## SUBARU

|                           |     |
|---------------------------|-----|
| BRZ Coupe (Z10) (12-)     | 866 |
| FORESTER (97-02)          | 866 |
| FORESTER (02-08)          | 866 |
| FORESTER (08-13)          | 867 |
| FORESTER (13-)            | 867 |
| IMPREZA Limousine (93-00) | 867 |
| IMPREZA Limousine (00-05) | 868 |
| IMPREZA Limousine (05-07) | 868 |
| IMPREZA Kombi (93-00)     | 869 |
| IMPREZA Kombi (00-05)     | 869 |
| IMPREZA Kombi (05-07)     | 870 |
| IMPREZA (08-11)           | 870 |
| IMPREZA (GP) (11-)        | 870 |
| JUSTY (95-03)             | 870 |
| JUSTY (G3X) (03-07)       | 871 |
| JUSTY (07-11)             | 871 |
| LEGACY Limousine (94-99)  | 871 |
| LEGACY Kombi (94-98)      | 872 |
| LEGACY (99-03)            | 872 |
| LEGACY (03-09)            | 872 |
| LEGACY (09-)              | 872 |
| OUTBACK (00-03)           | 873 |
| OUTBACK (03-09)           | 873 |
| OUTBACK (09-)             | 873 |
| TREZIA (11-)              | 873 |
| TRIBECA (B9) (05-10)      | 874 |
| XV (12-)                  | 874 |

## SUZUKI

|                      |     |
|----------------------|-----|
| ALTO (93-02)         | 874 |
| ALTO (02-08)         | 874 |
| ALTO (09-)           | 874 |
| BALENO (95-02)       | 874 |
| CARRY (99-04)        | 875 |
| GRAND VITARA (98-05) | 875 |
| GRAND VITARA (05-15) | 875 |
| IGNIS I (00-03)      | 876 |
| IGNIS II (03-12)     | 876 |
| JIMNY (98-)          | 876 |
| KIZASHI (10-15)      | 876 |
| LIANA (01-07)        | 877 |
| SAMURAI (98-04)      | 877 |
| SPLASH (08-)         | 877 |
| SWIFT II (96-04)     | 878 |
| SWIFT III (05-10)    | 878 |
| SWIFT IV (10-)       | 879 |
| SX4 (06-15)          | 879 |



## SUZUKI

|                   |     |
|-------------------|-----|
| SX4 (13-)         | 880 |
| VITARA (89-98)    | 880 |
| VITARA (LY) (15-) | 880 |
| WAGON R+ (98-00)  | 881 |
| WAGON R+ (00-08)  | 881 |
| X-90 (95-97)      | 881 |

## TOYOTA

|  |     |
|--|-----|
| 4-RUNNER (96-99)                       | 881 |
| ALPHARD II (GGH2_, ANH2_, ATH2_) (08-) | 882 |
| AURIS (06-12)                          | 882 |
| AURIS (12-)                            | 883 |
| AURIS Touring Sports (13-)             | 883 |
| AVENSIS (97-03)                        | 884 |
| AVENSIS (03-08)                        | 885 |
| AVENSIS (09-)                          | 886 |
| AVENSIS VERSO (01-09)                  | 886 |
| AYGO (05-14)                           | 886 |
| AYGO (14-)                             | 887 |
| CAMRY (96-01)                          | 887 |
| CAMRY (01-05)                          | 887 |
| CAMRY (06-11)                          | 887 |
| CAMRY (11-)                            | 888 |
| CARINA E (92-97)                       | 888 |
| CELICA (93-99)                         | 888 |
| CELICA (99-05)                         | 888 |
| COROLLA (92-97)                        | 889 |
| COROLLA (97-02)                        | 889 |
| COROLLA (02-04)                        | 890 |
| COROLLA (04-06)                        | 890 |
| COROLLA (06-13)                        | 891 |
| COROLLA (13-)                          | 891 |
| COROLLA VERSO (02-04)                  | 891 |
| COROLLA VERSO (04-09)                  | 892 |
| FJ CRUISER (06-14)                     | 892 |
| HIACE (95-06)                          | 892 |
| HIACE (06-)                            | 893 |
| HILUX (88-97)                          | 893 |
| HILUX (97-05)                          | 893 |
| HILUX (05-)                            | 893 |
| IQ (09-)                               | 894 |
| LAND CRUISER STATION WAGON 80 (90-97)  | 894 |
| LAND CRUISER 90-95 (96-02)             | 894 |
| LAND CRUISER 100 (98-08)               | 894 |
| LAND CRUISER 120 (03-)                 | 894 |
| LAND CRUISER 150 (10-)                 | 895 |
| LAND CRUISER 200 (07-)                 | 895 |
| MR2 (89-00)                            | 895 |
| MR2 (00-07)                            | 895 |
| PASEO (95-99)                          | 896 |
| PICNIC (96-01)                         | 896 |
| PREVIA (90-00)                         | 896 |
| PREVIA (00-05)                         | 896 |
| PREVIA (05-)                           | 896 |
| PRIUS (00-03)                          | 897 |
| PRIUS (03-09)                          | 897 |
| PRIUS (09-15)                          | 897 |
| PRIUS (15-)                            | 897 |
| PRIUS PLUS (12-)                       | 897 |
| PROACE Kasten/Kombi (13-)              | 897 |
| RAV4 I (94-00)                         | 898 |
| RAV4 II (00-05)                        | 898 |
| RAV4 III (05-)                         | 898 |
| RAV4 IV (12-)                          | 899 |
| STARLET (96-99)                        | 899 |
| SUPRA (93-98)                          | 900 |
| URBAN CRUISER (09-)                    | 900 |
| VERSO (09-)                            | 900 |
| VERSO S (10-)                          | 900 |
| YARIS (99-05)                          | 900 |
| YARIS (06-11)                          | 901 |
| YARIS (11-)                            | 902 |
| YARIS VERSO (99-05)                    | 903 |

## VOLKSWAGEN

|                            |     |
|----------------------------|-----|
| AMAROK (10-)               | 903 |
| BORA (98-04)               | 904 |
| CADDY II (96-04)           | 908 |
| CADDY Pickup (97-02)       | 909 |
| CADDY III (04-15)          | 909 |
| CADDY IV (15-)             | 912 |
| CRAFTER (06-)              | 913 |
| EOS (06-)                  | 914 |
| FOX (05-11)                | 916 |
| GOLF III (92-97)           | 917 |
| GOLF III Variant (93-99)   | 919 |
| GOLF III Cabriolet (94-02) | 921 |
| GOLF IV (98-05)            | 922 |
| GOLF IV Variant (99-06)    | 925 |
| GOLF V (03-08)             | 926 |
| GOLF V Variant (07-09)     | 930 |
| GOLF VI (08-)              | 931 |
| GOLF VI Variant (09-)      | 934 |
| GOLF VI Cabriolet (11-)    | 935 |
| GOLF VII (12-)             | 937 |
| GOLF VII Variant (13-)     | 942 |
| GOLF VII Sportswan (14-)   | 945 |





## VOLKSWAGEN

|  |      |
|--|------|
| GOLF VII ALLTRACK (14-)                        | 947  |
| GOLF Plus (05-14)                              | 947  |
| JETTA V (05-10)                                | 950  |
| JETTA VI (10-)                                 | 951  |
| LT/LT 4x4 (96-06)                              | 954  |
| LUPO (98-05)                                   | 954  |
| NEW BEETLE (98-10)                             | 955  |
| NEW BEETLE Cabriolet (03-10)                   | 956  |
| BEETLE (11-)                                   | 957  |
| BEETLE Cabriolet (12-)                         | 958  |
| PASSAT (97-05)                                 | 960  |
| PASSAT Limousine (05-10)                       | 963  |
| PASSAT Variant (05-10)                         | 965  |
| PASSAT CC (08-11)                              | 967  |
| PASSAT CC (11-)                                | 968  |
| PASSAT / PASSAT VARIANT (10-14)                | 970  |
| PASSAT ALLTRACK (12-14)                        | 972  |
| PASSAT / PASSAT VARIANT (14-)                  | 972  |
| PASSAT ALLTRACK (15-)                          | 974  |
| PHAETON (02-)                                  | 975  |
| POLO III (95-01)                               | 976  |
| POLO IV (02-09)                                | 978  |
| POLO V (09-)                                   | 981  |
| POLO Classic (96-01)                           | 985  |
| POLO Variant (97-01)                           | 986  |
| SCIROCCO (08-)                                 | 987  |
| SHARAN I (95-10)                               | 989  |
| SHARAN II (10-)                                | 991  |
| TARO (89-97)                                   | 992  |
| TIGUAN (07-)                                   | 992  |
| TIGUAN (16-)                                   | 993  |
| TOUAREG I (03-10)                              | 994  |
| TOUAREG II (10-)                               | 997  |
| TOURAN I (03-15)                               | 998  |
| TOURAN II (15-)                                | 1000 |
| TRANSPORTER (T4) (90-03)                       | 1001 |
| TRANSPORTER (T5) BUS / MULTIVAN / KASTEN (03-) | 1003 |
| TRANSPORTER (T5) PRITSCHKE / FAHRGESTELL (03-) | 1007 |
| TRANSPORTER (T6) (15-)                         | 1011 |
| VENTO (92-98)                                  | 1012 |
| UP / LOAD UP (11-)                             | 1013 |

## VOLVO

|                              |      |
|------------------------------|------|
| 940 II Limousine (95-98)     | 1014 |
| 940 II Kombi (95-98)         | 1014 |
| C30 Coupe (06-12)            | 1015 |
| C70 Coupe (97-02)            | 1016 |
| C70 I Cabrio (98-06)         | 1017 |
| C70 II Cabrio (06-13)        | 1018 |
| S40 I (95-03)                | 1019 |
| S40 II (04-12)               | 1020 |
| S60 I (00-09)                | 1021 |
| S60 II (10-)                 | 1023 |
| S70 (97-00)                  | 1027 |
| S80 I (98-06)                | 1029 |
| S80 II (06-)                 | 1031 |
| S90 I (97-98)                | 1037 |
| V40 (95-04)                  | 1037 |
| V40 (12-)                    | 1038 |
| V50 (04-12)                  | 1040 |
| V60 (10-)                    | 1041 |
| V70 I (97-00)                | 1046 |
| V70 II (00-07)               | 1048 |
| V70 III (07-)                | 1050 |
| V90 I (97-98)                | 1056 |
| XC60 (08-)                   | 1056 |
| XC70 I CROSS COUNTRY (00-07) | 1058 |
| XC70 II CROSS COUNTRY (07-)  | 1059 |
| XC90 (02-14)                 | 1061 |







- D** Fahrzeugverwendungen
- EN** Applications of vehicles
- FR** Applications
- IT** Applicazioni autoveicoli
- ES** Aplicaciones
- NL** Voertuigtoepassingen
- DA** Køretøjsanvendelser
- SV** Fordonsanvändningar
- HU** Járműalkalmazások
- PT** Utilizações do veículo
- RU** Применение в автомобилях
- CZ** Použití vozidel
- PL** Zastosowania pojazdów
- EL** Χρήσεις οχημάτων
- TR** Araç kullanımları
- ZH** 汽车用户
- JA** 車両利用方法
- AR** إستعمالات العربية

# K24-F

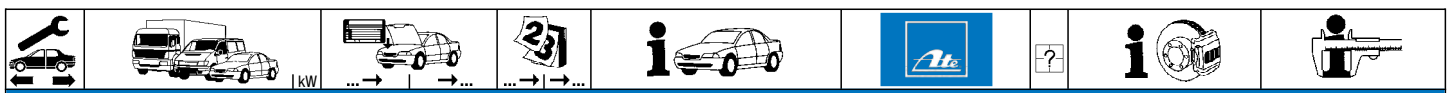

### ALFA ROMEO 145 (94-01)

|  |                  |    |       |             |                |        |                            |                         |     |
|--|------------------|----|-------|-------------|----------------|--------|----------------------------|-------------------------|-----|
|  | 1.4 i.e.         | 66 | 07.94 | 12.96       | 13.0460-2949.2 | 602949 |                            | 20833 17,0 +/WK/S       | TRW |
|  | 1.6 i.e.         | 76 | 07.94 | 12.96       | 13.0460-7068.2 | 607068 |                            | 21930 17,9 +/WK         | ATE |
|  | 1.7 i.e. 16V     |    | 07.94 | 12.96       |                |        |                            |                         |     |
|  | 2.0 TD           | 66 | 07.94 | 12.96       |                |        |                            |                         |     |
|  | 1.4 i.e. T.Spark | 76 | 01.97 | 02.01       | 13.0460-7067.2 | 607067 |                            | 21927 17,9 +/WK         | ATE |
|  | 1.6 i.e. T.Spark |    | 01.97 | 02.01       |                |        |                            |                         |     |
|  | 1.9 JTD          | 77 | 02.99 | 02.01       |                |        |                            |                         |     |
|  | 2.0 TD           | 66 | 01.97 | 02.99       |                |        |                            |                         |     |
|  | 1.8 i.e. T.Spark |    | 01.97 | 02.01       | 13.0460-7069.2 | 607069 |                            | 21636 19,3 +/WK         | ATE |
|  | 2.0 i.e. 16V     |    | 10.95 | 02.01       |                |        |                            |                         |     |
|  | 1.4 i.e.         | 66 | 07.94 | 12.96       | 24.0112-0127.1 | 412127 |                            | 258 12,0 10,2 +B        |     |
|  | 1.6 i.e.         | 76 | 07.94 | 12.96       |                |        |                            |                         |     |
|  | 2.0 TD           | 66 | 07.94 | 12.96       |                |        |                            |                         |     |
|  | 1.4 i.e. T.Spark | 76 | 01.97 | 02.01       | 24.0120-0142.1 | 420142 |                            | 258 20,0 18,2 V L +B    |     |
|  | 1.6 i.e. T.Spark |    | 01.97 | 02.01       | 24.0320-0142.1 | 520142 |                            | 258 20,0 18,2 V L +B PD |     |
|  | 1.7 i.e. 16V     |    | 07.94 | 12.96       |                |        |                            |                         |     |
|  | 1.9 JTD          | 77 | 02.99 | 02.01       |                |        |                            |                         |     |
|  | 2.0 TD           | 66 | 01.97 | 02.99       |                |        |                            |                         |     |
|  | 1.8 i.e. T.Spark |    | 01.97 | 02.01       | 24.0122-0107.1 | 422107 |                            | 284 22,0 20,2 V +B      |     |
|  | 2.0 i.e. 16V     |    | 10.95 | 02.01       |                |        |                            |                         |     |
|  | 1.4 i.e.         | 66 | 07.94 | 12.96 + ABS | 13.0460-2951.2 | 602951 | + GG-Sättel <sup>1)</sup>  | 21103 14,2 /S           | TRW |
|  | 1.4 i.e. T.Spark | 76 | 01.97 | 02.01 + ABS | 13.0460-2826.2 | 602826 | + ALU-Sättel <sup>2)</sup> | 23177 14,2 /S           | TRW |
|  | 1.6 i.e.         | 76 | 07.94 | 12.96 + ABS | 13.0460-0072.2 | 610072 | + GG-Sättel <sup>1)</sup>  | Belagsatz-Zubehör       | TRW |
|  | 1.6 i.e. T.Spark |    | 01.97 | 02.01 + ABS |                |        |                            |                         |     |
|  | 1.7 i.e. 16V     |    | 07.94 | 12.96       |                |        |                            |                         |     |
|  | 1.8 i.e. T.Spark |    | 01.97 | 02.01       |                |        |                            |                         |     |
|  | 1.9 JTD          | 77 | 02.99 | 02.01 + ABS |                |        |                            |                         |     |
|  | 2.0 i.e. 16V     | 77 | 10.95 | 02.01       |                |        |                            |                         |     |
|  | 2.0 TD           | 66 | 07.94 | 02.99 + ABS |                |        |                            |                         |     |
|  |                  |    |       |             |                |        |                            |                         |     |
|  | 1.4 i.e.         | 66 | 07.94 | 12.96 + ABS | 24.0111-0149.1 | 411149 |                            | 241 11,0 9,2            |     |
|  | 1.4 i.e. T.Spark | 76 | 01.97 | 02.01 + ABS |                |        |                            |                         |     |
|  | 1.6 i.e.         | 76 | 07.94 | 12.96 + ABS |                |        |                            |                         |     |
|  | 1.6 i.e. T.Spark |    | 01.97 | 02.01 + ABS |                |        |                            |                         |     |
|  | 1.7 i.e. 16V     |    | 07.94 | 12.96       |                |        |                            |                         |     |
|  | 1.8 i.e. T.Spark |    | 01.97 | 02.01       |                |        |                            |                         |     |
|  | 1.9 JTD          | 77 | 02.99 | 02.01 + ABS |                |        |                            |                         |     |
|  | 2.0 i.e. 16V     | 77 | 10.95 | 02.01 + ABS |                |        |                            |                         |     |
|  | 2.0 TD           | 66 | 07.94 | 02.99 + ABS |                |        |                            |                         |     |
|  |                  |    |       |             |                |        |                            |                         |     |
|  | 1.4 i.e.         | 66 | 07.94 | 12.96 - ABS | 24.0111-0119.1 | 411119 |                            | 241 11,0 9,2 +B         |     |
|  | 1.4 i.e. T.Spark | 76 | 01.97 | 02.01 - ABS |                |        |                            |                         |     |
|  | 1.6 i.e.         | 76 | 07.94 | 12.96 - ABS |                |        |                            |                         |     |
|  | 2.0 TD           | 66 | 07.94 | 12.96 - ABS |                |        |                            |                         |     |
|  | 1.4 i.e. T.Spark | 76 | 01.97 | 02.01 - ABS | 03.0137-0208.2 | 650208 |                            | 228 x 42 HEB            |     |
|  | 1.6 i.e. T.Spark |    | 01.97 | 02.01 - ABS | 03.0137-9081.2 | 669081 |                            | Bremsbacken-Zubehör     |     |
|  | 1.9 JTD          | 77 | 02.99 | 02.01 - ABS |                |        |                            |                         |     |
|  | 2.0 TD           | 66 | 01.97 | 02.99 - ABS |                |        |                            |                         |     |
|  | 1.4 i.e. T.Spark | 76 | 01.97 | 02.01 - ABS | 03.0137-0262.2 | 650262 |                            | 203 x 39                | BDX |
|  | 1.6 i.e. T.Spark |    | 01.97 | 02.01 - ABS | 03.0137-9125.2 | 669125 |                            | Bremsbacken-Zubehör     | BDX |
|  | 1.9 JTD          | 77 | 02.99 | 02.01 - ABS |                |        |                            |                         |     |
|  | 2.0 TD           | 66 | 01.97 | 02.99 - ABS |                |        |                            |                         |     |
|  | 1.4 i.e.         | 66 | 07.94 | 12.96 - ABS | 24.0222-8018.1 | 480078 |                            | 228/230 x 48            |     |
|  | 1.6 i.e.         | 76 | 07.94 | 12.96 - ABS |                |        |                            |                         |     |
|  | 2.0 TD           | 66 | 07.94 | 12.96 - ABS |                |        |                            |                         |     |
|  | 1.4 i.e. T.Spark | 76 | 01.97 | 02.01 - ABS | 24.0220-3007.1 | 480064 |                            | 203/204,7 x 48,5        |     |
|  | 1.6 i.e. T.Spark |    | 01.97 | 02.01 - ABS |                |        |                            |                         |     |
|  | 1.9 JTD          | 77 | 02.99 | 02.01 - ABS |                |        |                            |                         |     |
|  | 2.0 TD           | 66 | 01.97 | 02.99 - ABS |                |        |                            |                         |     |
|  |                  |    |       |             |                |        |                            |                         |     |
|  | 1.4 i.e.         | 66 | 07.94 | 12.96 - ABS | 03.0420-4520.3 | 684520 |                            | 20,64/228x42 Kit        |     |
|  | 1.6 i.e.         | 76 | 07.94 | 12.96 - ABS |                |        |                            |                         |     |
|  | 2.0 TD           | 66 | 07.94 | 12.96 - ABS |                |        |                            |                         |     |
|  | 1.4 i.e. T.Spark | 76 | 01.97 | 02.01 - ABS | 03.0520-6722.3 | 696722 |                            | 22,20/203x39 TopKit     | BDX |
|  | 1.6 i.e. T.Spark |    | 01.97 | 02.01 - ABS |                |        |                            |                         |     |
|  | 1.9 JTD          | 77 | 02.99 | 02.01 - ABS |                |        |                            |                         |     |
|  | 2.0 TD           | 66 | 01.97 | 02.99 - ABS |                |        |                            |                         |     |
|  |                  |    |       |             |                |        |                            |                         |     |

### ALFA ROMEO 146 (94-01)

|  |                  |    |       |       |                |        |  |                         |     |
|--|------------------|----|-------|-------|----------------|--------|--|-------------------------|-----|
|  | 1.4 i.e.         | 66 | 12.94 | 12.96 | 13.0460-2949.2 | 602949 |  | 20833 17,0 +/WK/S       | TRW |
|  | 1.6 i.e.         | 76 | 12.94 | 12.96 | 13.0460-7068.2 | 607068 |  | 21930 17,9 +/WK         | ATE |
|  | 1.7 i.e. 16V     |    | 12.94 | 12.96 |                |        |  |                         |     |
|  | 2.0 TD           | 66 | 12.94 | 12.96 |                |        |  |                         |     |
|  | 1.4 i.e. T.Spark | 76 | 01.97 | 02.01 | 13.0460-7067.2 | 607067 |  | 21927 17,9 +/WK         | ATE |
|  | 1.6 i.e. T.Spark |    | 01.97 | 02.01 |                |        |  |                         |     |
|  | 1.9 JTD          | 77 | 02.99 | 02.01 |                |        |  |                         |     |
|  | 2.0 TD           | 66 | 01.97 | 02.99 |                |        |  |                         |     |
|  | 1.8 i.e. T.Spark |    | 01.97 | 02.01 | 13.0460-7069.2 | 607069 |  | 21636 19,3 +/WK         | ATE |
|  | 2.0 i.e. 16V     |    | 10.95 | 02.01 |                |        |  |                         |     |
|  | 1.4 i.e.         | 66 | 12.94 | 12.96 | 24.0112-0127.1 | 412127 |  | 258 12,0 10,2 +B        |     |
|  | 1.6 i.e.         | 76 | 12.94 | 12.96 |                |        |  |                         |     |
|  | 2.0 TD           | 66 | 12.94 | 12.96 |                |        |  |                         |     |
|  | 1.4 i.e. T.Spark | 76 | 01.97 | 02.01 | 24.0120-0142.1 | 420142 |  | 258 20,0 18,2 V L +B    |     |
|  | 1.6 i.e. T.Spark |    | 01.97 | 02.01 | 24.0320-0142.1 | 520142 |  | 258 20,0 18,2 V L +B PD |     |
|  | 1.7 i.e. 16V     |    | 12.94 | 12.96 |                |        |  |                         |     |
|  | 1.9 JTD          | 77 | 02.99 | 02.01 |                |        |  |                         |     |
|  | 2.0 TD           | 66 | 01.97 | 02.99 |                |        |  |                         |     |
|  | 1.8 i.e. T.Spark |    | 01.97 | 02.01 | 24.0122-0107.1 | 422107 |  | 284 22,0 20,2 V +B      |     |
|  | 2.0 i.e. 16V     |    | 10.95 | 02.01 |                |        |  |                         |     |

<sup>1)</sup> + cast iron caliper / + pinza in ghisa / + étriers en fonte grise / + fundición gris-pinza

<sup>2)</sup> + aluminium calipers / + pinze in alluminio / + étriers en aluminium / + pinzas de aluminio



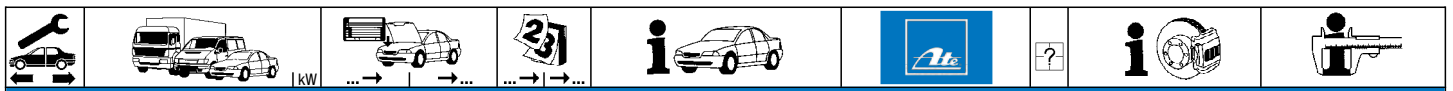

### ALFA ROMEO 146 (94-01)

















|  |                  |    |       |       |       |                |        |                            |   |     |
|--|------------------|----|-------|-------|-------|----------------|--------|----------------------------|---|-----|
|  | 1.4 i.e.         | 66 | 12.94 | 12.96 | + ABS | 13.0460-2951.2 | 602951 | + GG-Sättel <sup>1)</sup>  | 21103 14,2 /S<br>23177 14,2 /S<br>Belagsatz-Zubehör | TRW |
|  | 1.4 i.e. T.Spark | 76 | 01.97 | 02.01 | + ABS | 13.0460-2826.2 | 602826 | + ALU-Sättel <sup>2)</sup> |   | TRW |
|  | 1.6 i.e.         | 76 | 12.94 | 12.96 | + ABS | 13.0460-0072.2 | 610072 | + GG-Sättel <sup>1)</sup>  |   | TRW |
|  | 1.6 i.e. T.Spark |    | 01.97 | 02.01 | + ABS |                |        |                            |   |     |
|  | 1.7 i.e. 16V     |    | 12.94 | 12.96 |       |                |        |                            |   |     |
|  | 1.8 i.e. T.Spark |    | 01.97 | 02.01 |       |                |        |                            |   |     |
|  | 1.9 JTD          | 77 | 02.99 | 02.01 | + ABS |                |        |                            |   |     |
|  | 2.0 i.e. 16V     |    | 10.95 | 02.01 |       |                |        |                            |   |     |
|  | 2.0 TD           | 66 | 12.94 | 02.99 | + ABS |                |        |                            |   |     |
|  | 1.4 i.e.         | 66 | 12.94 | 12.96 | + ABS | 24.0111-0149.1 | 411149 |                            | 241 11,0 9,2  |     |
|  | 1.4 i.e. T.Spark | 76 | 01.97 | 02.01 | + ABS |                |        |                            |   |     |
|  | 1.6 i.e.         | 76 | 12.94 | 12.96 | + ABS |                |        |                            |   |     |
|  | 1.6 i.e. T.Spark |    | 01.97 | 02.01 | + ABS |                |        |                            |   |     |
|  | 1.7 i.e. 16V     |    | 12.94 | 12.96 |       |                |        |                            |   |     |
|  | 1.8 i.e. T.Spark |    | 01.97 | 02.01 |       |                |        |                            |   |     |
|  | 1.9 JTD          | 77 | 02.99 | 02.01 | + ABS |                |        |                            |   |     |
|  | 2.0 i.e. 16V     |    | 10.95 | 02.01 | + ABS |                |        |                            |   |     |
|  | 2.0 TD           | 66 | 12.94 | 02.99 | + ABS |                |        |                            |   |     |
|  | 2.0 i.e. 16V     |    | 10.95 | 02.01 | - ABS |                |        |                            |   |     |
|  | 1.4 i.e.         | 66 | 12.94 | 12.96 | - ABS | 03.0137-0208.2 | 650208 |                            | 228 x 42 HEB<br>Bremsbacken-Zubehör                 |     |
|  | 1.6 i.e.         | 76 | 12.94 | 12.96 | - ABS |                |        |                            |   |     |
|  | 2.0 TD           | 66 | 12.94 | 12.96 | - ABS |                |        |                            |   |     |
|  | 1.4 i.e. T.Spark | 76 | 01.97 | 02.01 | - ABS |                |        |                            |   |     |
|  | 1.6 i.e. T.Spark |    | 01.97 | 02.01 | - ABS |                |        |                            |   |     |
|  | 1.4 i.e.         | 66 | 12.94 | 12.96 | - ABS | 24.0222-8018.1 | 480078 |                            | 228/230 x 48  |     |
|  | 1.6 i.e.         | 76 | 12.94 | 12.96 | - ABS |                |        |                            |   |     |
|  | 2.0 TD           | 66 | 12.94 | 12.96 | - ABS |                |        |                            |   |     |
|  | 1.4 i.e. T.Spark | 76 | 01.97 | 02.01 | - ABS |                |        |                            |   |     |
|  | 1.6 i.e. T.Spark |    | 01.97 | 02.01 | - ABS |                |        |                            |   |     |
|  | 1.4 i.e.         | 66 | 12.94 | 12.96 | - ABS | 24.0220-3007.1 | 480064 |                            | 203/204,7 x 48,5                                    |     |
|  | 1.6 i.e.         | 76 | 12.94 | 12.96 | - ABS |                |        |                            |   |     |
|  | 2.0 TD           | 66 | 12.94 | 12.96 | - ABS |                |        |                            |   |     |
|  | 1.4 i.e. T.Spark | 76 | 01.97 | 02.01 | - ABS |                |        |                            |   |     |
|  | 1.6 i.e. T.Spark |    | 01.97 | 02.01 | - ABS |                |        |                            |   |     |
|  | 1.4 i.e.         | 66 | 12.94 | 12.96 | - ABS | 03.0420-4520.3 | 684520 |                            | 20,64/228x42 Kit                                    |     |
|  | 1.6 i.e.         | 76 | 12.94 | 12.96 | - ABS |                |        |                            |   |     |
|  | 2.0 TD           | 66 | 12.94 | 12.96 | - ABS |                |        |                            |   |     |
|  | 1.4 i.e. T.Spark | 76 | 01.97 | 02.01 | - ABS |                |        |                            |   |     |
|  | 1.6 i.e. T.Spark |    | 01.97 | 02.01 | - ABS |                |        |                            |   |     |
|  | 1.4 i.e.         | 66 | 12.94 | 12.96 | - ABS | 03.0520-6722.3 | 696722 |                            | 22,20/203x39 TopKit                                 | BDX |
|  | 1.6 i.e.         | 76 | 12.94 | 12.96 | - ABS |                |        |                            |   |     |
|  | 2.0 TD           | 66 | 12.94 | 12.96 | - ABS |                |        |                            |   |     |
|  | 1.4 i.e. T.Spark | 76 | 01.97 | 02.01 | - ABS |                |        |                            |   |     |
|  | 1.6 i.e. T.Spark |    | 01.97 | 02.01 | - ABS |                |        |                            |   |     |

### ALFA ROMEO 147 (01-10)

|                   |                   |                   |       |       |                |                |                |        |                    |                 |     |
|-------------------|-------------------|-------------------|-------|-------|----------------|----------------|----------------|--------|--------------------|-----------------|-----|
|                   | 1.6 i 16V T.Spark | 77                | 01.01 |       | VET: - 3021488 | 13.0460-7139.2 | 607139         |        | 23140 19,4 +/WK    | ATE             |     |
|                   |                   |                   |       |       |                | 13.0470-7139.2 | LD7139         |        | 23140 19,4 +/WK    | ATE             |     |
|                   | 1.6 i 16V T.Spark | 77                |       | 10.10 | VET: 3021489 - | 13.0460-7140.2 | 607140         |        | 23289 19,3 +/WK    | ATE             |     |
|                   | 1.6 i 16V T.Spark | 88                | 01.01 | 10.10 |                | 13.0470-7140.2 | LD7140         |        | 23289 19,3 +/WK    | ATE             |     |
|                   | 1.9 JTD           | 74                | 06.03 | 10.10 |                |                |                |        |                    |                 |     |
|                   | 1.9 JTD           | 81                | 11.00 | 10.10 |                |                |                |        |                    |                 |     |
|                   | 1.9 JTD           | 85                | 01.01 | 10.10 |                |                |                |        |                    |                 |     |
|                   | 1.9 JTD 16V       |                   | 11.02 | 10.10 |                |                |                |        |                    |                 |     |
|                   | 1.9 JTDM 16V      |                   | 07.05 | 10.10 |                |                |                |        |                    |                 |     |
|                   | 1.9 JTDM 8V       | 88                | 07.05 | 10.10 |                |                |                |        |                    |                 |     |
|                   | 2.0 i 16V T.Spark | 110               | 01.01 | 10.10 |                |                |                |        |                    |                 |     |
|                   | 3.2 GTA           | 184               | 02.03 | 12.03 |                | 13.0460-4985.2 | 604985         |        | 21381 18,0 +/WK    | BRE             |     |
|                   |                   |                   |       |       |                | 13.0460-0254.2 | 610254         |        | Belagsatz-Zubehör  |                 |     |
|                   | 1.6 i 16V T.Spark | 77                | 01.01 |       | VET: - 3021488 | 24.0115-0108.1 | 415108         |        | 281 15,0 13,2 +B   |                 |     |
|                   | 1.6 i 16V T.Spark | 77                |       | 10.10 | VET: 3021489 - | 24.0122-0145.1 | 422145         |        | 284 22,0 20,2 V +B |                 |     |
|                   | 1.6 i 16V T.Spark | 88                | 01.01 | 10.10 |                |                |                |        |                    |                 |     |
|                   | 1.9 JTD           | 74                | 06.03 | 10.10 |                |                |                |        |                    |                 |     |
|                   | 1.9 JTD           | 81                | 11.00 | 10.10 |                |                |                |        |                    |                 |     |
|                   | 1.9 JTD           | 85                | 01.01 | 10.10 |                |                |                |        |                    |                 |     |
|                   | 1.9 JTD 16V       |                   | 11.02 | 10.10 |                |                |                |        |                    |                 |     |
|                   | 1.9 JTDM 16V      |                   | 07.05 | 10.10 |                |                |                |        |                    |                 |     |
|                   | 1.9 JTDM 8V       | 88                | 07.05 | 10.10 |                |                |                |        |                    |                 |     |
|                   | 2.0 i 16V T.Spark | 110               | 01.01 | 10.10 |                |                |                |        |                    |                 |     |
|                   | 3.2 GTA           | 184               | 02.03 | 09.03 |                | 24.0128-0119.1 | 428119         |        | 305 28,0 26,0 V    |                 |     |
|                   | 3.2 GTA           | 184               | 10.03 | 10.10 |                | 24.0132-0129.1 | 432129         |        | 330 32,0 30,0 V L  |                 |     |
|                   |                   | 1.6 i 16V T.Spark | 77    | 01.01 | 10.10          |                | 13.0460-2867.2 | 602867 |                    | 23517 16,6 /S   | TRW |
| 1.6 i 16V T.Spark |                   | 88                | 01.01 | 10.10 |                | 13.0470-2867.2 | LD2867         |        | 23517 16,6 /S      | TRW             |     |
| 1.9 JTD           |                   | 74                | 06.03 | 10.10 |                |                |                |        |                    |                 |     |
| 1.9 JTD           |                   | 81                | 11.00 | 10.10 |                |                |                |        |                    |                 |     |
| 1.9 JTD           |                   | 85                | 01.01 | 10.10 |                |                |                |        |                    |                 |     |
| 1.9 JTD 16V       |                   |                   | 11.02 | 10.10 |                |                |                |        |                    |                 |     |
| 1.9 JTDM 16V      |                   |                   | 07.05 | 10.10 |                |                |                |        |                    |                 |     |
| 1.9 JTDM 8V       |                   | 88                | 07.05 | 10.10 |                |                |                |        |                    |                 |     |
| 2.0 i 16V T.Spark |                   | 110               | 01.01 | 10.10 |                |                |                |        |                    |                 |     |
| 3.2 GTA           |                   | 184               | 02.03 | 10.10 |                |                |                |        |                    |                 |     |
|                   |                   | 1.6 i 16V T.Spark | 77    | 01.01 | 10.10          |                | 24.0110-0209.1 | 410209 |                    | 251 10,0 9,0 +B |     |
|                   |                   | 1.6 i 16V T.Spark | 88    | 01.01 | 10.10          |                |                |        |                    |                 |     |
|                   |                   | 1.9 JTD           | 74    | 06.03 | 10.10          |                |                |        |                    |                 |     |
|                   | 1.9 JTD           | 81                | 11.00 | 10.10 |                |                |                |        |                    |                 |     |
|                   | 1.9 JTD           | 85                | 01.01 | 10.10 |                |                |                |        |                    |                 |     |
|                   | 1.9 JTD 16V       |                   | 11.02 | 10.10 |                |                |                |        |                    |                 |     |
|                   | 1.9 JTDM 16V      |                   | 07.05 | 10.10 |                |                |                |        |                    |                 |     |
| 1.9 JTDM 8V       | 88                | 07.05             | 10.10 |       |                |                |                |        |                    |                 |     |

<sup>1)</sup> + cast iron caliper / + pinza in ghisa / + étriers en fonte grise / + fundición gris-pinza

<sup>2)</sup> + aluminium calipers / + pinze in alluminio / + étriers en aluminium / + pinzas de aluminio

|     |  |  |  |  |  |  |  |  |
|--|--|--|--|--|---|--|--|--|
| <b>ALFA ROMEO 147 (01-10)</b>  |  |  |  |  |   |  |  |  |
|    | 2.0 i 16V T.Spark  | 110  | 01.01  | 10.10  | 24.0110-0209.1  | 410209   |  | 251 10,0 9,0 +B  |
|  | 3.2 GTA  | 184  | 02.03  | 10.10  | 24.0110-0283.1  | 410283   |  | 276 10,0 9,0 +B  |
| <b>ALFA ROMEO 155 (92-97)</b>  |  |  |  |  |   |  |  |  |
|    | 1.7 T.S.   |  | 04.93  | 12.97  | 13.0460-2949.2  | 602949   |  | 20833 17,0 +/WK/S TRW  |
|  | 1.8 T.S.   |  | 05.92  | 12.97  |   |  |  |  |
|  | 1.9 TD   |  | 03.93  | 12.97  |   |  |  |  |
|  | 2.0 16V Turbo Q4   |  | 11.92  | 12.97  | 13.0460-2979.2  | 602979   |  | 21147 19,0 +/WK/S TRW  |
|  | 2.5 TD   |  | 03.93  | 10.97  |   |  |  |  |
|  | 2.5 V6   |  | 05.92  | 12.97  |   |  |  |  |
|  | 2.0 T.S.   |  | 05.92  | 12.97  | 13.0460-2987.2  | 602987   |  | 23168 19,0 +/WK/S TRW  |
|    | 1.7 T.S.   |  | 04.93  | 12.97  | 24.0120-0142.1  | 420142   |  | 258 20,0 18,2 V L +B   |
|  | 1.8 T.S.   |  | 05.92  | 12.97  | 24.0320-0142.1  | 520142   |  | 258 20,0 18,2 V L +B PD  |
|  | 1.9 TD   |  | 03.93  | 12.97  | 24.0112-0127.1  | 412127   |  | 258 12,0 10,2 +B   |
|  | 2.5 TD   |  | 04.93  | 12.97  |   |  |  |  |
|  | 2.0 T.S.   |  | 11.95  | 12.97  | 24.0122-0107.1  | 422107   |  | 284 22,0 20,2 V +B   |
|  | 2.0 16V Turbo Q4   |  | 11.92  | 12.97  | 24.0122-0147.1  | 422147   |  | 284 22,0 20,2 V +B   |
|  | 2.5 TD   |  | 03.93  | 12.97  |   |  |  |  |
|  | 2.5 V6   |  | 05.92  | 12.97  |   |  |  |  |
|    | 1.7 T.S.   |  | 04.93  | 12.97  | 13.0460-2951.2  | 602951   | + GG-Sättel <sup>1)</sup>  | 21103 14,2 /S TRW  |
|  | 1.8 T.S.   |  | 05.92  | 12.97  | 13.0460-2826.2  | 602826   | + ALU-Sättel <sup>2)</sup>   | 23177 14,2 /S TRW  |
|  | 1.9 TD   |  | 03.93  | 12.97  | 13.0460-0072.2  | 610072   | + GG-Sättel <sup>1)</sup>  | Belagsatz-Zubehör TRW  |
|  | 2.0 16V Turbo Q4   |  | 11.92  | 12.97  |   |  |  |  |
|  | 2.0 T.S.   |  | 05.92  | 12.97  |   |  |  |  |
|  | 2.5 TD   |  | 03.93  | 12.97  |   |  |  |  |
|  | 2.5 V6   |  | 05.92  | 12.97  |   |  |  |  |
|    | 1.7 T.S.   |  | 04.93  | 12.97  | 24.0111-0149.1  | 411149   |  | 241 11,0 9,2   |
|  | 1.8 T.S.   |  | 05.92  | 12.97  |   |  |  |  |
|  | 1.9 TD   |  | 03.93  | 12.97  |   |  |  |  |
|  | 2.0 16V Turbo Q4   |  | 11.92  | 12.97  |   |  |  |  |
|  | 2.0 T.S.   |  | 05.92  | 12.97  |   |  |  |  |
|  | 2.5 TD   |  | 03.93  | 12.97  |   |  |  |  |
|  | 2.5 V6   |  | 05.92  | 12.97  |   |  |  |  |
| <b>ALFA ROMEO 156 (97-05)</b>  |  |  |  |  |   |  |  |  |
|   | 1.6 i 16V T.Spark  |  | 10.97  | 02.00  | 13.0460-7105.2  | 607105   |  | 23140 19,4 +/WK ATE  |
|  | 1.8 i 16V T.Spark  |  | 10.97  | 02.00  |   |  |  |  |
|  | 1.9 JTD  |  | 10.97  | 02.00  |   |  |  |  |
|  | 1.6 i 16V T.Spark  |  | 03.00  | 02.01  | 13.0460-7139.2  | 607139   |  | 23140 19,4 +/WK ATE  |
|  | 1.8 i 16V T.Spark  |  | 03.00  | 02.01  | 13.0470-7139.2  | LD7139   |  | 23140 19,4 +/WK ATE  |
|  | 1.9 JTD  |  | 03.00  | 02.01  |   |  |  |  |
|  | 2.0 16V T.Spark  |  | 10.97  | 02.00  | 13.0460-7069.2  | 607069   |  | 21636 19,3 +/WK ATE  |
|  | 2.4 JTD  | 100  | 10.97  | 02.00  |   |  |  |  |
|  | 2.5 V6 24V   |  | 10.97  | 02.00  |   |  |  |  |
|  | 1.6 i 16V T.Spark  |  | 03.01  | 07.05  | 13.0460-7140.2  | 607140   |  | 23289 19,3 +/WK ATE  |
|  | 1.8 i 16V T.Spark  |  | 03.01  | 07.05  | 13.0470-7140.2  | LD7140   |  | 23289 19,3 +/WK ATE  |
|  | 1.9 JTD  |  | 03.01  | 07.05  |   |  |  |  |
|  | 1.9 JTD 16V  | 103  | 11.02  | 07.05  |   |  |  |  |
|  | 2.0 16V T.Spark  |  | 03.00  | 07.05  |   |  |  |  |
|  | 2.0 JTS  | 122  | 03.02  | 07.05  |   |  |  |  |
|  | 2.4 JTD  | 100  | 03.00  | 10.00  |   |  |  |  |
|  | 2.4 JTD  | 103  | 10.00  | 07.05  |   |  |  |  |
|  | 2.5 V6 24V   |  | 03.00  | 07.05  |   |  |  |  |
|  | 1.9 JTD 16V  | 110  | 07.04  | 07.05  | 13.0460-4803.2  | 604803   |  | 23092 15,6 +/WK/Zub BRE  |
|  |  |  |  |  | 13.0470-4803.2  | LD4803   |  | 23092 15,6 +/WK/Zub BRE  |
|  | 2.4 JTD  | 110  | 03.02  | 07.05  | 13.0460-7180.2  | 607180   |  | 23222 19,3 +/WK ATE  |
|  | 2.4 JTD  | 129  | 10.03  | 07.05  |   |  |  |  |
|  | 3.2 GTA  | 184  | 03.02  | 07.05  | 13.0460-4985.2  | 604985   |  | 21381 18,0 +/WK BRE  |
|  |  |  |  |  | 13.0460-0254.2  | 610254   |  | Belagsatz-Zubehör  |
|  | 1.6 i 16V T.Spark  |  | 10.97  | 07.05  | 24.0115-0108.1  | 415108   |  | 281 15,0 13,2 +B   |
|  | 1.8 i 16V T.Spark  |  | 10.97  | 07.05  |   |  |  |  |
|  | 1.9 JTD  |  | 10.97  | 07.05  |   |  |  |  |
|  | 1.8 i 16V T.Spark  |  | 10.97  | 07.05  | 24.0122-0145.1  | 422145   |  | 284 22,0 20,2 V +B   |
|  | 1.9 JTD 16V  | 103  | 11.02  | 07.05  |   |  |  |  |
|  | 2.0 16V T.Spark  |  | 10.97  | 07.05  |   |  |  |  |
|  | 2.0 JTS  | 122  | 03.02  | 07.05  |   |  |  |  |
|  | 2.4 JTD  | 100  | 10.97  | 10.00  |   |  |  |  |
|  | 2.4 JTD  | 103  | 10.00  | 07.05  |   |  |  |  |
|  | 2.4 JTD  | 110  | 03.02  | 07.05  |   |  |  |  |
|  | 2.4 JTD  | 129  | 10.03  | 07.05  |   |  |  |  |
|  | 2.5 V6 24V   |  | 10.97  | 07.05  |   |  |  |  |
|  | 3.2 GTA  | 184  | 03.02  | 09.03  | 24.0128-0119.1  | 428119   |  | 305 28,0 26,0 V  |
|  | 1.9 JTD 16V  | 110  | 07.04  | 07.05  | 24.0132-0129.1  | 432129   |  | 330 32,0 30,0 V L  |
|  | 3.2 GTA  | 184  | 10.03  | 07.05  |   |  |  |  |
|  | 1.6 i 16V T.Spark  |  | 10.97  | 02.02  | 13.0460-2827.2  | 602827   |  | 21606 16,7 /S TRW  |
|  | 1.8 i 16V T.Spark  |  | 10.97  | 02.02  |   |  |  |  |
|  | 1.9 JTD  |  | 10.97  | 02.02  |   |  |  |  |
|  | 2.0 16V T.Spark  |  | 10.97  | 02.02  |   |  |  |  |
|  | 2.4 JTD  | 100  | 10.97  | 10.00  |   |  |  |  |
|  | 2.4 JTD  | 103  | 10.00  | 02.02  |   |  |  |  |
|  | 2.5 V6 24V   |  | 10.97  | 02.02  |   |  |  |  |
|  | 1.6 i 16V T.Spark  |  | 03.02  | 07.05  | 13.0460-2867.2  | 602867   |  | 23517 16,6 /S TRW  |
|  | 1.8 i 16V T.Spark  |  | 03.02  | 07.05  | 13.0470-2867.2  | LD2867   |  | 23517 16,6 /S TRW  |

<sup>1)</sup> + cast iron caliper / + pinza in ghisa / + étriers en fonte grise / + fundición gris-pinza

<sup>2)</sup> + aluminium calipers / + pinze in alluminio / + étriers en aluminium / + pinzas de aluminio





### ALFA ROMEO 156 (97-05)

|            |                   |       |       |       |                |        |  |  |                 |     |                |        |
|------------|-------------------|-------|-------|-------|----------------|--------|--|--|-----------------|-----|----------------|--------|
|            | 1.9 JTD           |       | 03.02 | 07.05 | 13.0460-2867.2 | 602867 |  |  | 23517 16,6 /S   | TRW |                |        |
|            | 1.9 JTD 16V       | 103   | 11.02 | 07.05 |                |        |  |  |                 |     | 13.0470-2867.2 | LD2867 |
|            | 1.9 JTD 16V       | 110   | 07.04 | 07.05 |                |        |  |  |                 |     |                |        |
|            | 2.0 16V T.Spark   |       | 03.02 | 07.05 |                |        |  |  |                 |     |                |        |
|            | 2.0 JTS           | 122   | 03.02 | 07.05 |                |        |  |  |                 |     |                |        |
|            | 2.4 JTD           | 103   | 03.02 | 07.05 |                |        |  |  |                 |     |                |        |
|            | 2.4 JTD           | 110   | 03.02 | 07.05 |                |        |  |  |                 |     |                |        |
|            | 2.4 JTD           | 129   | 10.03 | 07.05 |                |        |  |  |                 |     |                |        |
| 2.5 V6 24V |                   | 03.02 | 07.05 |       |                |        |  |  |                 |     |                |        |
| 3.2 GTA    | 184               | 03.02 | 07.05 |       |                |        |  |  |                 |     |                |        |
|            | 1.6 i 16V T.Spark |       | 10.97 | 02.02 | 24.0110-0209.1 | 410209 |  |  | 251 10,0 9,0 +B |     |                |        |
|            | 1.8 i 16V T.Spark |       | 10.97 | 02.02 |                |        |  |  |                 |     |                |        |
|            | 1.9 JTD           |       | 10.97 | 02.02 |                |        |  |  |                 |     |                |        |
|            | 2.0 16V T.Spark   |       | 10.97 | 02.02 |                |        |  |  |                 |     |                |        |
|            | 2.4 JTD           | 100   | 10.97 | 10.00 |                |        |  |  |                 |     |                |        |
|            | 2.4 JTD           | 103   | 10.00 | 02.02 |                |        |  |  |                 |     |                |        |
| 2.5 V6 24V |                   | 10.97 | 02.02 |       |                |        |  |  |                 |     |                |        |
|            | 1.6 i 16V T.Spark |       | 03.02 | 07.05 | 24.0110-0283.1 | 410283 |  |  | 276 10,0 9,0 +B |     |                |        |
|            | 1.8 i 16V T.Spark |       | 03.02 | 07.05 |                |        |  |  |                 |     |                |        |
|            | 1.9 JTD           |       | 03.02 | 07.05 |                |        |  |  |                 |     |                |        |
|            | 1.9 JTD 16V       | 103   | 11.02 | 07.05 |                |        |  |  |                 |     |                |        |
|            | 1.9 JTD 16V       | 110   | 07.04 | 07.05 |                |        |  |  |                 |     |                |        |
|            | 2.0 16V T.Spark   |       | 03.02 | 07.05 |                |        |  |  |                 |     |                |        |
|            | 2.0 JTS           | 122   | 03.02 | 07.05 |                |        |  |  |                 |     |                |        |
|            | 2.4 JTD           | 103   | 03.02 | 07.05 |                |        |  |  |                 |     |                |        |
|            | 2.4 JTD           | 110   | 03.02 | 07.05 |                |        |  |  |                 |     |                |        |
|            | 2.4 JTD           | 129   | 10.03 | 07.05 |                |        |  |  |                 |     |                |        |
|            | 2.5 V6 24V        |       | 03.02 | 07.05 |                |        |  |  |                 |     |                |        |
|            | 3.2 GTA           | 184   | 03.02 | 07.05 |                |        |  |  |                 |     |                |        |

### ALFA ROMEO 159 (05-11)

|                 |                 |         |       |       |                |        |  |  |                       |     |                |                |                |        |  |               |     |
|-----------------|-----------------|---------|-------|-------|----------------|--------|--|--|-----------------------|-----|----------------|----------------|----------------|--------|--|---------------|-----|
|                 | 1.8 MPI         | 103     | 03.07 | 10.11 | 13.0460-7211.2 | 607211 |  |  | 24339 20,5 +/WK       | ATE |                |                |                |        |  |               |     |
|                 | 1.9 JTDM 16V    |         | 06.05 | 10.11 |                |        |  |  |                       |     | 13.0470-7211.2 | LD7211         |                |        |  |               |     |
|                 | 1.9 JTDM 8V     |         | 06.05 | 10.11 |                |        |  |  |                       |     |                |                |                |        |  |               |     |
|                 | 1.9 JTS         | 118     | 06.05 | 10.11 |                |        |  |  |                       |     |                |                |                |        |  |               |     |
|                 | 2.2 JTS         | 136     | 06.05 | 10.11 |                |        |  |  |                       |     |                |                |                |        |  |               |     |
|                 | 2.4 JTDM 20V    | 147     | 06.05 | 12.06 |                |        |  |  |                       |     |                |                |                |        |  |               |     |
|                 | 3.2 JTS Q4      | 191     | 12.05 | 12.06 |                |        |  |  |                       |     |                |                |                |        |  |               |     |
|                 | 2.4 JTDM 20V    | 147     | 01.07 | 10.11 |                |        |  |  |                       |     |                |                |                |        |  |               |     |
|                 | 2.4 JTDM 20V    | 154     | 05.07 | 10.11 |                |        |  |  |                       |     |                |                |                |        |  |               |     |
|                 | 2.4 JTDM 20V Q4 | 154     | 05.07 | 10.11 |                |        |  |  |                       |     |                |                |                |        |  |               |     |
| 3.2 JTS         | 191             | 02.08   | 10.11 |       |                |        |  |  |                       |     |                |                |                |        |  |               |     |
| 3.2 JTS Q4      | 191             | 01.07   | 10.11 |       |                |        |  |  |                       |     |                |                |                |        |  |               |     |
|                 | 1.8 Tbi         | 147     | 05.09 | 10.11 | 13.0460-4867.2 | 604867 |  |  | 24852 16,0 +/WK       | BRE |                |                |                |        |  |               |     |
|                 | 2.0 JTDM        | 100     | 06.10 | 10.11 |                |        |  |  |                       |     | 13.0470-4867.2 | LD4867         |                |        |  |               |     |
|                 | 2.0 JTDM        | 120     | 05.09 | 10.11 |                |        |  |  |                       |     |                |                |                |        |  |               |     |
|                 | 2.0 JTDM        | 125     | 05.09 | 10.11 |                |        |  |  |                       |     |                |                |                |        |  |               |     |
|                 | 1.8 MPI         | 103     | 03.07 | 10.11 |                |        |  |  |                       |     |                |                | 24.0128-0192.1 | 428192 |  |               |     |
|                 | 1.9 JTDM 16V    |         | 06.05 | 10.11 |                |        |  |  |                       |     |                |                |                |        |  |               |     |
|                 | 1.9 JTDM 8V     |         | 06.05 | 10.11 |                |        |  |  |                       |     |                |                |                |        |  |               |     |
|                 | 1.9 JTS         | 118     | 06.05 | 10.11 |                |        |  |  |                       |     |                |                |                |        |  |               |     |
| 2.0 JTDM        | 100             | 06.10   | 10.11 |       |                |        |  |  |                       |     |                |                |                |        |  |               |     |
| 2.0 JTDM        | 120             | 05.09   | 10.11 |       |                |        |  |  |                       |     |                |                |                |        |  |               |     |
| 2.0 JTDM        | 125             | 05.09   | 10.11 |       |                |        |  |  |                       |     |                |                |                |        |  |               |     |
| 2.2 JTS         | 136             | 06.05   | 10.11 |       |                |        |  |  |                       |     |                |                |                |        |  |               |     |
|                 | 1.8 Tbi         | 147     | 05.09 | 10.11 | 24.0128-0191.1 | 428191 |  |  | 330 28,0 26,0 V +S +B |     |                |                |                |        |  |               |     |
|                 | 2.0 JTDM        | 120     | 05.09 | 10.11 |                |        |  |  |                       |     |                |                |                |        |  |               |     |
|                 | 2.0 JTDM        | 125     | 05.09 | 10.11 |                |        |  |  |                       |     |                |                |                |        |  |               |     |
|                 | 2.4 JTDM 20V    | 147     | 06.05 | 10.11 |                |        |  |  |                       |     |                |                |                |        |  |               |     |
|                 | 2.4 JTDM 20V    | 154     | 05.07 | 10.11 |                |        |  |  |                       |     |                |                |                |        |  |               |     |
|                 | 2.4 JTDM 20V Q4 | 154     | 05.07 | 10.11 |                |        |  |  |                       |     |                |                |                |        |  |               |     |
|                 | 3.2 JTS         | 191     | 02.08 | 10.11 |                |        |  |  |                       |     |                |                |                |        |  |               |     |
|                 | 3.2 JTS Q4      | 191     | 12.05 | 10.11 |                |        |  |  |                       |     |                |                |                |        |  |               |     |
|                 |                 | 1.8 MPI | 103   | 03.07 |                |        |  |  |                       |     | 10.11          | 13.0460-2707.2 | 602707         |        |  | 23760 17,7 /S | TRW |
|                 |                 | 1.8 Tbi | 147   | 05.09 |                |        |  |  |                       |     | 10.11          |                |                |        |  |               |     |
| 1.9 JTDM 16V    |                 |         | 06.05 | 10.11 |                |        |  |  |                       |     |                |                |                |        |  |               |     |
| 1.9 JTDM 8V     |                 |         | 06.05 | 10.11 |                |        |  |  |                       |     |                |                |                |        |  |               |     |
| 1.9 JTS         |                 | 118     | 06.05 | 10.11 |                |        |  |  |                       |     |                |                |                |        |  |               |     |
| 2.0 JTDM        |                 | 100     | 06.10 | 10.11 |                |        |  |  |                       |     |                |                |                |        |  |               |     |
| 2.0 JTDM        |                 | 120     | 05.09 | 10.11 |                |        |  |  |                       |     |                |                |                |        |  |               |     |
| 2.0 JTDM        |                 | 125     | 05.09 | 10.11 |                |        |  |  |                       |     |                |                |                |        |  |               |     |
| 2.2 JTS         |                 | 136     | 06.05 | 10.11 |                |        |  |  |                       |     |                |                |                |        |  |               |     |
| 2.4 JTDM 20V    |                 | 147     | 06.05 | 10.11 |                |        |  |  |                       |     |                |                |                |        |  |               |     |
| 2.4 JTDM 20V    |                 | 154     | 05.07 | 10.11 |                |        |  |  |                       |     |                |                |                |        |  |               |     |
| 2.4 JTDM 20V Q4 |                 | 154     | 05.07 | 10.11 |                |        |  |  |                       |     |                |                |                |        |  |               |     |
| 3.2 JTS         | 191             | 02.08   | 10.11 |       |                |        |  |  |                       |     |                |                |                |        |  |               |     |
| 3.2 JTS Q4      | 191             | 12.05   | 10.11 |       |                |        |  |  |                       |     |                |                |                |        |  |               |     |
|                 | 1.8 MPI         | 103     | 03.07 | 10.11 | 24.0112-0170.1 | 412170 |  |  | 278 12,0 10,0 +S +B   |     |                |                |                |        |  |               |     |
|                 | 1.9 JTDM 16V    |         | 06.05 | 10.11 |                |        |  |  |                       |     |                |                |                |        |  |               |     |
|                 | 1.9 JTDM 8V     |         | 06.05 | 10.11 |                |        |  |  |                       |     |                |                |                |        |  |               |     |
|                 | 1.9 JTS         | 118     | 06.05 | 10.11 |                |        |  |  |                       |     |                |                |                |        |  |               |     |
|                 | 2.0 JTDM        | 100     | 06.10 | 10.11 |                |        |  |  |                       |     |                |                |                |        |  |               |     |
|                 | 2.0 JTDM        | 120     | 05.09 | 10.11 |                |        |  |  |                       |     |                |                |                |        |  |               |     |
|                 | 2.0 JTDM        | 125     | 05.09 | 10.11 |                |        |  |  |                       |     |                |                |                |        |  |               |     |
|                 | 2.2 JTS         | 136     | 06.05 | 10.11 |                |        |  |  |                       |     |                |                |                |        |  |               |     |
|                 | 1.8 Tbi         | 147     | 05.09 | 10.11 | 24.0122-0233.1 | 422233 |  |  | 292 22,0 20,0 V +S +B |     |                |                |                |        |  |               |     |
|                 |                 |         |       |       |                |        |  |  |                       |     |                |                |                |        |  |               |     |

1) - sport package / - pacchetto sportivo / - version sport / - kit sportivo

2) + sports package / + pacchetto sportivo / + version sport / + kit sportivo

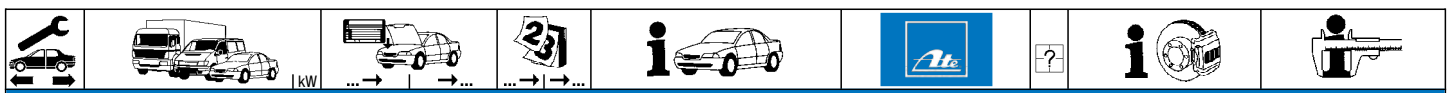

### ALFA ROMEO 159 (05-11)

|  |                 |     |  |       |       |                |        |  |                       |
|--|-----------------|-----|--|-------|-------|----------------|--------|--|-----------------------|
|  | 2.4 JTDM 20V    | 147 |  | 06.05 | 10.11 | 24.0122-0233.1 | 422233 |  | 292 22,0 20,0 V +S +B |
|  | 2.4 JTDM 20V    | 154 |  | 05.07 | 10.11 |                |        |  |                       |
|  | 2.4 JTDM 20V Q4 | 154 |  | 05.07 | 10.11 |                |        |  |                       |
|  | 3.2 JTS         | 191 |  | 02.08 | 10.11 |                |        |  |                       |
|  | 3.2 JTS Q4      | 191 |  | 12.05 | 10.11 |                |        |  |                       |

### ALFA ROMEO 164 (92-98)







|  |                   |     |  |       |       |                |        |  |                       |
|--|-------------------|-----|--|-------|-------|----------------|--------|--|-----------------------|
|  | 2.0 T.Spark       |     |  | 09.91 | 09.98 | 13.0460-2809.2 | 602809 |  | 21182 19,4 +/WK/S TRW |
|  | 2.0 Super Turbo   |     |  | 09.91 | 09.98 | 13.0460-2980.2 | 602980 |  | 21147 19,0 +/WK/S TRW |
|  | 2.0 Turbo         |     |  | 09.91 | 09.98 |                |        |  |                       |
|  | 2.5 TD            |     |  | 09.91 | 09.98 |                |        |  |                       |
|  | 3.0 i 24V Super   | 155 |  | 12.92 | 09.98 |                |        |  |                       |
|  | 3.0 i V6          | 135 |  | 09.91 | 11.92 |                |        |  |                       |
|  | 3.0 i V6          | 156 |  | 12.92 | 09.98 |                |        |  |                       |
|  | 3.0 i V6 Q.V.     | 147 |  | 09.91 | 11.92 |                |        |  |                       |
|  | 3.0 i V6 Q.V.     | 171 |  | 12.92 | 09.98 |                |        |  |                       |
|  | 3.0 i V6 Q.V. Q4  | 171 |  | 04.94 | 09.98 |                |        |  |                       |
|  | 2.0 Super T.Spark |     |  | 09.91 | 09.98 | 24.0122-0130.1 | 422130 |  | 257 22,0 20,2 V       |
|  | 2.0 T.Spark       |     |  | 09.91 | 09.98 |                |        |  |                       |
|  | 2.0 Turbo         |     |  | 09.91 | 09.98 | 24.0122-0145.1 | 422145 |  | 284 22,0 20,2 V +B    |
|  | 2.0 Super Turbo   |     |  | 09.91 | 09.98 | 24.0126-0103.1 | 426103 |  | 281 26,0 24,2 V       |
|  | 2.5 TD            |     |  | 09.91 | 09.98 |                |        |  |                       |
|  | 3.0 i 24V Super   | 155 |  | 12.92 | 09.98 |                |        |  |                       |
|  | 3.0 i V6          | 135 |  | 09.91 | 11.92 |                |        |  |                       |
|  | 3.0 i V6          | 156 |  | 12.92 | 09.98 |                |        |  |                       |
|  | 3.0 i V6 Q.V.     | 147 |  | 09.91 | 11.92 |                |        |  |                       |
|  | 3.0 i V6 Q.V.     | 171 |  | 12.92 | 09.98 |                |        |  |                       |
|  | 3.0 i V6 Q.V. Q4  | 171 |  | 04.94 | 09.98 |                |        |  |                       |
|  | 2.0 T.Spark       |     |  | 09.91 | 09.98 | 13.0460-2962.2 | 602962 |  | 20668 16,6 /S TRW     |
|  | 2.0 Turbo         |     |  | 09.91 | 09.98 | 13.0460-0072.2 | 610072 |  | Belagsatz-Zubehör TRW |
|  | 2.5 TD            |     |  | 09.91 | 09.98 |                |        |  |                       |
|  | 3.0 i 24V Super   | 155 |  | 12.92 | 09.98 |                |        |  |                       |
|  | 3.0 i V6          | 135 |  | 09.91 | 11.92 |                |        |  |                       |
|  | 3.0 i V6          | 156 |  | 12.92 | 09.98 |                |        |  |                       |
|  | 3.0 i V6 Q.V.     | 147 |  | 09.91 | 11.92 |                |        |  |                       |
|  | 3.0 i V6 Q.V.     | 171 |  | 12.92 | 09.98 |                |        |  |                       |
|  | 3.0 i V6 Q.V. Q4  | 171 |  | 04.94 | 09.98 | 13.0460-2827.2 | 602827 |  | 21606 16,7 /S TRW     |
|  | 2.0 T.Spark       |     |  | 09.91 | 09.98 | 24.0110-0190.1 | 410190 |  | 252 10,0 9,0 +B       |
|  | 2.0 Super Turbo   |     |  | 09.91 | 09.98 | 24.0110-0209.1 | 410209 |  | 251 10,0 9,0 +B       |
|  | 2.0 Turbo         |     |  | 09.91 | 09.98 |                |        |  |                       |
|  | 2.5 TD            |     |  | 09.91 | 09.98 |                |        |  |                       |
|  | 3.0 i 24V Super   | 155 |  | 12.92 | 09.98 |                |        |  |                       |
|  | 3.0 i V6          | 135 |  | 09.91 | 11.92 |                |        |  |                       |
|  | 3.0 i V6          | 156 |  | 12.92 | 09.98 |                |        |  |                       |
|  | 3.0 i V6 Q.V.     | 147 |  | 09.91 | 11.92 |                |        |  |                       |
|  | 3.0 i V6 Q.V.     | 171 |  | 12.92 | 09.98 |                |        |  |                       |

### ALFA ROMEO 166 (98-07)

|  |                   |     |  |       |       |                |        |  |                     |
|--|-------------------|-----|--|-------|-------|----------------|--------|--|---------------------|
|  | 2.0 i 16V T.Spark |     |  | 10.98 | 12.07 | 13.0460-7112.2 | 607112 |  | 21637 19,3 +/WK ATE |
|  | 2.4 JTD           | 100 |  | 10.98 | 10.00 |                |        |  |                     |
|  | 2.4 JTD           | 103 |  | 10.00 | 12.07 |                |        |  |                     |
|  | 2.4 JTD           | 110 |  | 04.02 | 12.07 |                |        |  |                     |
|  | 2.4 JTD           | 120 |  | 10.03 | 12.07 |                |        |  |                     |
|  | 2.4 JTD           | 132 |  | 07.06 | 12.07 |                |        |  |                     |
|  | 2.4 JTD           | 136 |  | 07.05 | 12.07 |                |        |  |                     |
|  | 2.0 i V6 Turbo    |     |  | 10.98 | 12.07 | 13.0460-4971.2 | 604971 |  | 23092 16,0 +/WK BRE |
|  | 2.4 JTD           | 129 |  | 10.03 | 12.07 | 13.0470-4971.2 | LD4971 |  | 23092 16,0 +/WK BRE |
|  | 2.5 i V6          |     |  | 10.98 | 12.07 |                |        |  |                     |
|  | 3.0 i V6          |     |  | 10.98 | 12.07 |                |        |  |                     |
|  | 3.2 i V6          |     |  | 10.03 | 12.07 |                |        |  |                     |
|  | 2.0 i 16V T.Spark |     |  | 10.98 | 12.07 | 24.0126-0133.1 | 426133 |  | 281 26,0 24,2 V     |
|  | 2.4 JTD           | 100 |  | 10.98 | 10.00 |                |        |  |                     |
|  | 2.4 JTD           | 103 |  | 10.00 | 12.07 |                |        |  |                     |
|  | 2.4 JTD           | 110 |  | 04.02 | 12.07 |                |        |  |                     |
|  | 2.4 JTD           | 120 |  | 10.03 | 12.07 |                |        |  |                     |
|  | 2.4 JTD           | 132 |  | 07.06 | 12.07 |                |        |  |                     |
|  | 2.4 JTD           | 136 |  | 07.05 | 12.07 |                |        |  |                     |
|  | 2.0 i V6 Turbo    |     |  | 10.98 | 12.07 | 24.0128-0118.1 | 428118 |  | 310 28,0 26,0 V     |
|  | 2.4 JTD           | 129 |  | 10.03 | 12.07 |                |        |  |                     |
|  | 2.5 i V6          |     |  | 10.98 | 12.07 |                |        |  |                     |
|  | 3.0 i V6          |     |  | 10.98 | 12.07 |                |        |  |                     |
|  | 3.2 i V6          |     |  | 10.03 | 12.07 |                |        |  |                     |
|  | 2.0 i 16V T.Spark |     |  | 10.98 | 12.07 | 13.0460-2827.2 | 602827 |  | 21606 16,7 /S TRW   |
|  | 2.0 i V6 Turbo    |     |  | 10.98 | 12.07 |                |        |  |                     |
|  | 2.4 JTD           | 100 |  | 10.98 | 10.00 |                |        |  |                     |
|  | 2.4 JTD           | 103 |  | 10.00 | 12.07 |                |        |  |                     |
|  | 2.4 JTD           | 110 |  | 04.02 | 12.07 |                |        |  |                     |
|  | 2.4 JTD           | 120 |  | 10.03 | 12.07 |                |        |  |                     |
|  | 2.4 JTD           | 129 |  | 10.03 | 12.07 |                |        |  |                     |
|  | 2.4 JTD           | 132 |  | 07.06 | 12.07 |                |        |  |                     |
|  | 2.4 JTD           | 136 |  | 07.05 | 12.07 |                |        |  |                     |
|  | 2.5 i V6          |     |  | 10.98 | 12.07 |                |        |  |                     |
|  | 3.0 i V6          |     |  | 10.98 | 12.07 |                |        |  |                     |
|  | 3.2 i V6          |     |  | 10.03 | 12.07 |                |        |  |                     |

1) - series super / - serie super / - Série super / - serie súper



| ALFA ROMEO 166 (98-07)   |                   |     |  |       |       |                                  |  |                |        |  |  |                                    |            |
|--|-------------------|-----|--|-------|-------|----------------------------------|--|----------------|--------|--|--|------------------------------------|------------|
|    | 2.0 i 16V T.Spark |     |  | 10.98 | 12.07 |                                  |  | 24.0110-0290.1 | 410290 |  | 276 10,0 9,0 +B  |                                    |            |
|  | 2.0 i V6 Turbo    |     |  | 10.98 | 12.07 |                                  |  |                |        |  |  |                                    |            |
|  | 2.4 JTD           | 100 |  | 10.98 | 10.00 |                                  |  |                |        |  |  |                                    |            |
|  | 2.4 JTD           | 103 |  | 10.00 | 12.07 |                                  |  |                |        |  |  |                                    |            |
|  | 2.4 JTD           | 110 |  | 04.02 | 12.07 |                                  |  |                |        |  |  |                                    |            |
|  | 2.4 JTD           | 120 |  | 10.03 | 12.07 |                                  |  |                |        |  |  |                                    |            |
|  | 2.4 JTD           | 129 |  | 10.03 | 12.07 |                                  |  |                |        |  |  |                                    |            |
|  | 2.4 JTD           | 132 |  | 07.06 | 12.07 |                                  |  |                |        |  |  |                                    |            |
|  | 2.4 JTD           | 136 |  | 07.05 | 12.07 |                                  |  |                |        |  |  |                                    |            |
|  | 2.5 i V6          |     |  | 10.98 | 12.07 |                                  |  |                |        |  |  |                                    |            |
|  | 3.0 i V6          |     |  | 10.98 | 12.07 |                                  |  |                |        |  |  |                                    |            |
|  | 3.2 i V6          |     |  | 10.03 | 12.07 |                                  |  |                |        |  |  |                                    |            |
| ALFA ROMEO BRERA (06-11)   |                   |     |  |       |       |                                  |  |                |        |  |  |                                    |            |
|    | 2.2 JTS           | 136 |  | 12.05 | 09.11 |                                  |  | 13.0460-7211.2 | 607211 |  | 24339 20,5 +/WK<br>24339 20,5 +/WK                                   | ATE<br>ATE                         |            |
|  | 1.8 TBi           | 147 |  | 05.09 | 09.11 |                                  |  | 13.0460-4971.2 | 604971 |  | 23092 16,0 +/WK<br>23092 16,0 +/WK                                   | BRE<br>BRE                         |            |
|  | 2.4 JTDM 20V      | 147 |  | 12.05 | 09.11 |                                  |  | 13.0470-7211.2 | LD7211 |  |  |                                    |            |
|  | 2.4 JTDM 20V      | 154 |  | 02.07 | 09.11 |                                  |  |                |        |  |  |                                    |            |
|  | 3.2 JTS           | 191 |  | 03.08 | 09.11 |                                  |  |                |        |  |  |                                    |            |
|  | 3.2 JTS Q4        | 191 |  | 12.05 | 09.11 |                                  |  |                |        |  |  |                                    |            |
|  | 2.0 JTDM          | 125 |  | 05.09 | 09.11 |                                  |  | 13.0460-4867.2 | 604867 |  | 24852 16,0 +/WK<br>24852 16,0 +/WK                                   | BRE<br>BRE                         |            |
|  | 2.0 JTDM          | 125 |  | 05.09 | 09.11 |                                  |  | 13.0470-4867.2 | LD4867 |  |  |                                    |            |
|    | 2.0 JTDM          | 125 |  | 05.09 | 09.11 |                                  |  | 24.0128-0192.1 | 428192 |  | 305 28,0 26,0 V +S +B  |                                    |            |
|  | 2.2 JTS           | 136 |  | 12.05 | 09.11 |                                  |  |                |        |  |  |                                    |            |
|  | 1.8 TBi           | 147 |  | 05.09 | 09.11 |                                  |  | 24.0128-0191.1 | 428191 |  | 330 28,0 26,0 V +S +B  |                                    |            |
|  | 2.4 JTDM 20V      | 147 |  | 12.05 | 09.11 |                                  |  |                |        |  |  |                                    |            |
|  | 2.4 JTDM 20V      | 154 |  | 02.07 | 09.11 |                                  |  |                |        |  |  |                                    |            |
|  | 3.2 JTS           | 191 |  | 03.08 | 09.11 |                                  |  |                |        |  |  |                                    |            |
|  | 3.2 JTS Q4        | 191 |  | 12.05 | 09.11 |                                  |  |                |        |  |  |                                    |            |
|    | 1.8 TBi           | 147 |  | 05.09 | 09.11 |                                  |  | 13.0460-2707.2 | 602707 |  | 23760 17,7 /S<br>23760 17,7 /S                                       | TRW<br>TRW                         |            |
|  | 2.0 JTDM          | 125 |  | 05.09 | 09.11 |                                  |  | 13.0470-2707.2 | LD2707 |  |  |                                    |            |
|  | 2.2 JTS           | 136 |  | 12.05 | 09.11 |                                  |  |                |        |  |  |                                    |            |
|  | 2.4 JTDM 20V      | 147 |  | 12.05 | 09.11 |                                  |  |                |        |  |  |                                    |            |
|  | 2.4 JTDM 20V      | 154 |  | 02.07 | 09.11 |                                  |  |                |        |  |  |                                    |            |
|  | 3.2 JTS           | 191 |  | 03.08 | 09.11 |                                  |  |                |        |  |  |                                    |            |
|  | 3.2 JTS Q4        | 191 |  | 12.05 | 09.11 |                                  |  |                |        |  |  |                                    |            |
|   | 2.0 JTDM          | 125 |  | 05.09 | 09.11 |                                  |  | 24.0112-0170.1 | 412170 |  | 278 12,0 10,0 +S +B  |                                    |            |
|  | 2.2 JTS           | 136 |  | 12.05 | 09.11 |                                  |  |                |        |  |  |                                    |            |
|  | 1.8 TBi           | 147 |  | 05.09 | 09.11 |                                  |  | 24.0122-0233.1 | 422233 |  | 292 22,0 20,0 V +S +B  |                                    |            |
|  | 2.4 JTDM 20V      | 147 |  | 12.05 | 09.11 |                                  |  |                |        |  |  |                                    |            |
|  | 2.4 JTDM 20V      | 154 |  | 02.07 | 09.11 |                                  |  |                |        |  |  |                                    |            |
|  | 3.2 JTS           | 191 |  | 03.08 | 09.11 |                                  |  |                |        |  |  |                                    |            |
|  | 3.2 JTS Q4        | 191 |  | 12.05 | 09.11 |                                  |  |                |        |  |  |                                    |            |
| ALFA ROMEO GIULIETTA (10-)   |                   |     |  |       |       |                                  |  |                |        |  |  |                                    |            |
|  | 1.4 BiFuel        | 88  |  | 12.11 |       |                                  |  | 13.0460-7273.2 | 607273 |  | - Sonderbremszange <sup>1)</sup><br>- Sonderbremszange <sup>1)</sup> | 24538 19,4 +/WK<br>24538 19,4 +/WK | ATE<br>ATE |
|  | 1.4 TB            | 88  |  | 04.10 |       |                                  |  | 13.0470-7273.2 | LD7273 |  |  |                                    |            |
|  | 1.6 JTDM          | 77  |  | 04.10 |       |                                  |  |                |        |  |  |                                    |            |
|  | 1.6 JTDM          | 88  |  | 02.15 |       |                                  |  |                |        |  |  |                                    |            |
|  | 2.0 JTDM          | 103 |  | 04.10 |       |                                  |  | 13.0460-7269.2 | 607269 |  | - Sonderbremszange <sup>1)</sup><br>- Sonderbremszange <sup>1)</sup> | 24340 19,5 +/WK<br>24340 19,5 +/WK | ATE<br>ATE |
|  | 2.0 JTDM          | 110 |  | 08.13 |       |                                  |  | 13.0470-7269.2 | LD7269 |  |  |                                    |            |
|  | 2.0 JTDM          | 125 |  | 04.10 |       |                                  |  |                |        |  |  |                                    |            |
|  | 1.4 BiFuel        | 88  |  | 12.11 | 04.12 | + Sonderbremszange <sup>2)</sup> |  | 13.0460-4854.2 | 604854 |  |  | 23756 16,3 +/WK<br>23756 16,3 +/WK | BRE<br>BRE |
|  | 1.4 TB            | 77  |  | 04.11 | 04.12 |                                  |  | 13.0470-4854.2 | LD4854 |  |  |                                    |            |
|  | 1.4 TB            | 88  |  | 04.10 | 04.12 | + Sonderbremszange <sup>2)</sup> |  |                |        |  |  |                                    |            |
|  | 1.4 TB            | 120 |  | 04.10 | 04.12 |                                  |  |                |        |  |  |                                    |            |
|  | 1.4 TB MultiAir   | 125 |  | 04.10 | 04.12 |                                  |  |                |        |  |  |                                    |            |
|  | 1.6 JTDM          | 77  |  | 04.10 | 04.12 | + Sonderbremszange <sup>2)</sup> |  |                |        |  |  |                                    |            |
|  | 1.8 TBi           | 173 |  | 04.10 | 04.12 |                                  |  |                |        |  |  |                                    |            |
|  | 2.0 JTDM          | 103 |  | 04.10 | 04.12 | + Sonderbremszange <sup>2)</sup> |  |                |        |  |  |                                    |            |
|  | 2.0 JTDM          | 125 |  | 04.10 | 04.12 | + Sonderbremszange <sup>2)</sup> |  |                |        |  |  |                                    |            |
|  | 1.4 BiFuel        | 88  |  | 05.12 |       | + Sonderbremszange <sup>2)</sup> |  | 13.0460-4971.2 | 604971 |  |  | 23092 16,0 +/WK<br>23092 16,0 +/WK | BRE<br>BRE |
|  | 1.4 TB            | 77  |  | 05.12 |       |                                  |  | 13.0470-4971.2 | LD4971 |  |  |                                    |            |
|  | 1.4 TB            | 88  |  | 05.12 |       | + Sonderbremszange <sup>2)</sup> |  |                |        |  |  |                                    |            |
|  | 1.4 TB            | 120 |  | 05.12 |       |                                  |  |                |        |  |  |                                    |            |
|  | 1.4 TB MultiAir   | 125 |  | 05.12 |       |                                  |  |                |        |  |  |                                    |            |
|  | 1.6 JTDM          | 77  |  | 05.12 |       | + Sonderbremszange <sup>2)</sup> |  |                |        |  |  |                                    |            |
|  | 1.6 JTDM          | 88  |  | 02.15 |       | + Sonderbremszange <sup>2)</sup> |  |                |        |  |  |                                    |            |
|  | 1.8 TBi           | 173 |  | 05.12 |       |                                  |  |                |        |  |  |                                    |            |
|  | 1.8 TBi           | 177 |  | 09.13 |       |                                  |  |                |        |  |  |                                    |            |
|  | 2.0 JTDM          | 103 |  | 05.12 |       | + Sonderbremszange <sup>2)</sup> |  |                |        |  |  |                                    |            |
|  | 2.0 JTDM          | 110 |  | 08.13 |       | + Sonderbremszange <sup>2)</sup> |  |                |        |  |  |                                    |            |
|  | 2.0 JTDM          | 125 |  | 05.12 |       | + Sonderbremszange <sup>2)</sup> |  |                |        |  |  |                                    |            |
|  | 2.0 JTDM          | 103 |  | 04.10 |       |                                  |  | 24.0128-0192.1 | 428192 |  | 305 28,0 26,0 V +S +B  |                                    |            |
|  | 2.0 JTDM          | 110 |  | 08.13 |       |                                  |  |                |        |  |  |                                    |            |
|  | 2.0 JTDM          | 125 |  | 04.10 |       |                                  |  |                |        |  |  |                                    |            |
|  | 1.4 TB            | 120 |  | 04.10 |       |                                  |  | 24.0128-0191.1 | 428191 |  | 330 28,0 26,0 V +S +B  |                                    |            |
|  | 1.4 TB MultiAir   | 125 |  | 04.10 |       |                                  |  |                |        |  |  |                                    |            |
|  | 1.8 TBi           | 173 |  | 04.10 |       |                                  |  |                |        |  |  |                                    |            |
|  | 1.8 TBi           | 177 |  | 09.13 |       |                                  |  |                |        |  |  |                                    |            |
|  | 1.4 BiFuel        | 88  |  | 12.11 |       |                                  |  | 24.0126-0168.1 | 426168 |  | 281 26,2 24,2 V +S +B  |                                    |            |
|  | 1.4 TB            | 77  |  | 04.11 |       |                                  |  |                |        |  |  |                                    |            |
|  | 1.4 TB            | 88  |  | 04.10 |       |                                  |  |                |        |  |  |                                    |            |
|  | 1.6 JTDM          | 77  |  | 04.10 |       |                                  |  |                |        |  |  |                                    |            |

<sup>1)</sup> - special brake caliper / - pinza freno speciale / - pince à frein spéciale / - pinza freno especial  
<sup>2)</sup> + special brake caliper / + pinza freno speciale / + pince à frein spéciale / + pinza freno especial

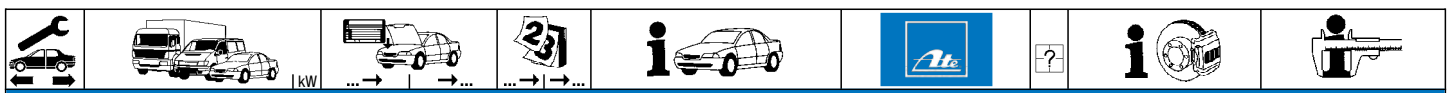

### ALFA ROMEO GIULIETTA (10-)

|  |                 |     |  |       |                                  |                |        |                                  |                          |
|--|-----------------|-----|--|-------|----------------------------------|----------------|--------|----------------------------------|--------------------------|
|  | 1.6 JTDM        | 88  |  | 02.15 |                                  | 24.0126-0168.1 | 426168 |                                  | 281 26,2 24,2 V +S +B    |
|  | 1.4 BiFuel      | 88  |  | 12.11 |                                  | 24.0711-5254.3 | 360346 | 2                                | Radsensor L=1045         |
|  | 1.4 TB          | 77  |  | 04.11 |                                  |                |        |                                  |                          |
|  | 1.4 TB          | 88  |  | 04.10 |                                  |                |        |                                  |                          |
|  | 1.4 TB          | 120 |  | 04.10 |                                  |                |        |                                  |                          |
|  | 1.4 TB MultiAir | 125 |  | 04.10 |                                  |                |        |                                  |                          |
|  | 1.6 JTDM        | 77  |  | 04.10 |                                  |                |        |                                  |                          |
|  | 1.6 JTDM        | 88  |  | 02.15 |                                  |                |        |                                  |                          |
|  | 1.8 TBi         | 173 |  | 04.10 |                                  |                |        |                                  |                          |
|  | 1.8 TBi         | 177 |  | 09.13 |                                  |                |        |                                  |                          |
|  | 2.0 JTDM        | 103 |  | 04.10 |                                  |                |        |                                  |                          |
|  | 2.0 JTDM        | 110 |  | 08.13 |                                  |                |        |                                  |                          |
|  | 2.0 JTDM        | 125 |  | 04.10 |                                  |                |        |                                  |                          |
|  | 1.4 BiFuel      | 88  |  | 12.11 |                                  | 13.0460-2767.2 | 602767 | - Sonderbremszange <sup>1)</sup> | 25156 17,4 +/WK/Zub/STRW |
|  | 1.4 TB          | 88  |  | 04.10 |                                  | 13.0470-2767.2 | LD2767 | - Sonderbremszange <sup>1)</sup> | 25156 17,4 +/WK/Zub/STRW |
|  | 1.6 JTDM        | 77  |  | 04.10 |                                  |                |        |                                  |                          |
|  | 1.6 JTDM        | 88  |  | 02.15 |                                  |                |        |                                  |                          |
|  | 2.0 JTDM        | 103 |  | 04.10 |                                  |                |        |                                  |                          |
|  | 2.0 JTDM        | 110 |  | 08.13 |                                  |                |        |                                  |                          |
|  | 2.0 JTDM        | 125 |  | 04.10 |                                  |                |        |                                  |                          |
|  | 1.4 BiFuel      | 88  |  | 12.11 | + Sonderbremszange <sup>2)</sup> | 13.0460-2768.2 | 602768 |                                  | 23811 17,7 +/WK/Zub/STRW |
|  | 1.4 TB          | 77  |  | 04.11 |                                  | 13.0470-2768.2 | LD2768 |                                  | 23811 17,7 +/WK/Zub/STRW |
|  | 1.4 TB          | 88  |  | 04.10 | + Sonderbremszange <sup>2)</sup> |                |        |                                  |                          |
|  | 1.4 TB          | 120 |  | 04.10 |                                  |                |        |                                  |                          |
|  | 1.4 TB MultiAir | 125 |  | 04.10 |                                  |                |        |                                  |                          |
|  | 1.6 JTDM        | 77  |  | 04.10 | + Sonderbremszange <sup>2)</sup> |                |        |                                  |                          |
|  | 1.6 JTDM        | 88  |  | 02.15 | + Sonderbremszange <sup>2)</sup> |                |        |                                  |                          |
|  | 1.8 TBi         | 173 |  | 04.10 |                                  |                |        |                                  |                          |
|  | 1.8 TBi         | 177 |  | 09.13 |                                  |                |        |                                  |                          |
|  | 2.0 JTDM        | 103 |  | 04.10 | + Sonderbremszange <sup>2)</sup> |                |        |                                  |                          |
|  | 2.0 JTDM        | 110 |  | 08.13 | + Sonderbremszange <sup>2)</sup> |                |        |                                  |                          |
|  | 2.0 JTDM        | 125 |  | 04.10 | + Sonderbremszange <sup>2)</sup> |                |        |                                  |                          |
|  | 1.4 BiFuel      | 88  |  | 12.11 |                                  | 24.0110-0359.1 | 410359 | - Sonderbremszange <sup>1)</sup> | 264 10,0 8,0 +S +B       |
|  | 1.4 TB          | 88  |  | 04.10 |                                  |                |        |                                  |                          |
|  | 1.6 JTDM        | 77  |  | 04.10 |                                  |                |        |                                  |                          |
|  | 1.6 JTDM        | 88  |  | 02.15 |                                  |                |        |                                  |                          |
|  | 2.0 JTDM        | 103 |  | 04.10 |                                  |                |        |                                  |                          |
|  | 2.0 JTDM        | 110 |  | 08.13 |                                  |                |        |                                  |                          |
|  | 2.0 JTDM        | 125 |  | 04.10 |                                  |                |        |                                  |                          |
|  | 1.4 BiFuel      | 88  |  | 12.11 | + Sonderbremszange <sup>2)</sup> | 24.0112-0170.1 | 412170 |                                  | 278 12,0 10,0 +S +B      |
|  | 1.4 TB          | 77  |  | 04.11 |                                  |                |        |                                  |                          |
|  | 1.4 TB          | 88  |  | 04.10 | + Sonderbremszange <sup>2)</sup> |                |        |                                  |                          |
|  | 1.4 TB          | 120 |  | 04.10 |                                  |                |        |                                  |                          |
|  | 1.4 TB MultiAir | 125 |  | 04.10 |                                  |                |        |                                  |                          |
|  | 1.6 JTDM        | 77  |  | 04.10 | + Sonderbremszange <sup>2)</sup> |                |        |                                  |                          |
|  | 1.6 JTDM        | 88  |  | 02.15 | + Sonderbremszange <sup>2)</sup> |                |        |                                  |                          |
|  | 1.8 TBi         | 173 |  | 04.10 |                                  |                |        |                                  |                          |
|  | 1.8 TBi         | 177 |  | 09.13 |                                  |                |        |                                  |                          |
|  | 2.0 JTDM        | 103 |  | 04.10 | + Sonderbremszange <sup>2)</sup> |                |        |                                  |                          |
|  | 2.0 JTDM        | 110 |  | 08.13 | + Sonderbremszange <sup>2)</sup> |                |        |                                  |                          |
|  | 2.0 JTDM        | 125 |  | 04.10 | + Sonderbremszange <sup>2)</sup> |                |        |                                  |                          |
|  | 1.4 BiFuel      | 88  |  | 12.11 |                                  | 24.0711-5255.3 | 360347 | 2                                | Radsensor L=626          |
|  | 1.4 TB          | 77  |  | 04.11 |                                  |                |        |                                  |                          |
|  | 1.4 TB          | 88  |  | 04.10 |                                  |                |        |                                  |                          |
|  | 1.4 TB          | 120 |  | 04.10 |                                  |                |        |                                  |                          |
|  | 1.4 TB MultiAir | 125 |  | 04.10 |                                  |                |        |                                  |                          |
|  | 1.6 JTDM        | 77  |  | 04.10 |                                  |                |        |                                  |                          |
|  | 1.6 JTDM        | 88  |  | 02.15 |                                  |                |        |                                  |                          |
|  | 1.8 TBi         | 173 |  | 04.10 |                                  |                |        |                                  |                          |
|  | 1.8 TBi         | 177 |  | 09.13 |                                  |                |        |                                  |                          |
|  | 2.0 JTDM        | 103 |  | 04.10 |                                  |                |        |                                  |                          |
|  | 2.0 JTDM        | 110 |  | 08.13 |                                  |                |        |                                  |                          |
|  | 2.0 JTDM        | 125 |  | 04.10 |                                  |                |        |                                  |                          |

















### ALFA ROMEO GT (04-10)

|  |          |     |         |       |       |                |        |  |                    |     |
|--|----------|-----|---------|-------|-------|----------------|--------|--|--------------------|-----|
|  | 1.8 TS   | 103 | 3286797 | 11.03 |       | 13.0460-7181.2 | 607181 |  | 21636 19,3 +/WK    | ATE |
|  | 1.9 JTD  | 110 | 3286797 | 11.03 |       | 13.0470-7181.2 | LD7181 |  | 21636 19,3 +/WK    | ATE |
|  | 2.0 JTS  | 121 | 3286797 | 11.03 |       |                |        |  |                    |     |
|  | 1.8 TS   | 103 | 3286798 |       | 07.10 | 13.0460-7140.2 | 607140 |  | 23289 19,3 +/WK    | ATE |
|  | 1.9 JTD  | 110 | 3286798 |       | 07.10 | 13.0470-7140.2 | LD7140 |  | 23289 19,3 +/WK    | ATE |
|  | 1.9 JTD  | 125 |         | 05.08 | 07.10 |                |        |  |                    |     |
|  | 2.0 JTS  | 121 | 3286798 |       | 07.10 |                |        |  |                    |     |
|  | 3.2 i V6 | 176 |         | 11.03 | 07.10 | 13.0460-4991.2 | 604991 |  | 23092 16,0 +/WK    | BRE |
|  | 1.8 TS   | 103 |         | 11.03 | 07.10 | 24.0122-0145.1 | 422145 |  | 284 22,0 20,2 V +B |     |
|  | 1.9 JTD  | 110 |         | 11.03 | 07.10 |                |        |  |                    |     |
|  | 1.9 JTD  | 125 |         | 05.08 | 07.10 |                |        |  |                    |     |
|  | 2.0 JTS  | 121 |         | 11.03 | 07.10 |                |        |  |                    |     |
|  | 3.2 i V6 | 176 |         | 11.03 | 07.10 | 24.0132-0129.1 | 432129 |  | 330 32,0 30,0 V L  |     |
|  | 1.8 TS   | 103 |         | 11.03 | 07.10 | 13.0460-2867.2 | 602867 |  | 23517 16,6 /S      | TRW |
|  | 1.9 JTD  | 110 |         | 11.03 | 07.10 | 13.0470-2867.2 | LD2867 |  | 23517 16,6 /S      | TRW |
|  | 1.9 JTD  | 125 |         | 05.08 | 07.10 |                |        |  |                    |     |
|  | 2.0 JTS  | 121 |         | 11.03 | 07.10 |                |        |  |                    |     |
|  | 3.2 i V6 | 176 |         | 11.03 | 07.10 |                |        |  |                    |     |

<sup>1)</sup> - special brake caliper / - pinza freno speciale / - pince à frein spéciale / - pinza freno especial

<sup>2)</sup> + special brake caliper / + pinza freno speciale / + pince à frein spéciale / + pinza freno especial



|     |  |  |  |  |  |  |  |  |
|--|--|--|--|--|---|--|--|--|
| <b>ALFA ROMEO GT (04-10)</b>   |  |  |  |  |   |  |  |  |
|    | 1.8 TS   | 103  |  | 11.03  | 07.10   | 24.0110-0283.1   | 410283   | 276 10,0 9,0 +B  |
|  | 1.9 JTD  | 110  |  | 11.03  | 07.10   |  |  |  |
|  | 1.9 JTD  | 125  |  | 05.08  | 07.10   |  |  |  |
|  | 2.0 JTS  | 121  |  | 11.03  | 07.10   |  |  |  |
|  | 3.2 i V6   | 176  |  | 11.03  | 07.10   |  |  |  |
| <b>ALFA ROMEO GTV (95-05)</b>  |  |  |  |  |   |  |  |  |
|    | 2.0 i 16V  |  |  | 05.95  | 06.95   | 13.0460-2987.2   | 602987   | 23168 19,0 +/WK/S TRW  |
|  | 2.0 i V6 Turbo   | 148  |  | 05.95  | 06.95   |  |  |  |
|  | 1.8 i 16V  | 106  |  | 04.98  | 12.05   | 13.0460-7069.2   | 607069   | 21636 19,3 +/WK ATE  |
|  | 2.0 i 16V  |  |  | 07.95  | 12.05   |  |  |  |
|  | 2.0 i V6 Turbo   | 148  |  | 07.95  | 12.05   |  |  |  |
|  | 2.0 JTS  | 121  |  | 04.03  | 12.05   |  |  |  |
|  | 3.0 i V6   |  |  | 10.96  | 12.05   | 13.0460-4968.2   | 604968   | 21381 18,0 +/WK BRE  |
|  | 3.2 i V6   | 176  |  | 04.03  | 12.05   |  |  |  |
|    | 1.8 i 16V  | 106  |  | 04.98  | 12.05   | 24.0122-0225.1   | 422225   | 284 22,0 20,2 V  |
|  | 2.0 i 16V  |  |  | 05.95  | 12.05   |  |  |  |
|  | 2.0 JTS  | 121  |  | 04.03  | 12.05   |  |  |  |
|  | 2.0 i V6 Turbo   | 148  |  | 05.95  | 12.05   | 24.0122-0145.1   | 422145   | 284 22,0 20,2 V +B   |
|  | 3.0 i V6   |  |  | 10.96  | 12.05   | 24.0128-0119.1   | 428119   | 305 28,0 26,0 V  |
|  | 3.2 i V6   | 176  |  | 04.03  | 12.05   |  |  |  |
|    | 1.8 i 16V  | 106  |  | 04.98  | 12.05   | 13.0460-2951.2   | 602951   | + GG-Sättel <sup>1)</sup> 21103 14,2 /S TRW  |
|  | 2.0 i 16V  |  |  | 05.95  | 12.05   | 13.0460-0072.2   | 610072   | + GG-Sättel <sup>1)</sup> Belagsatz-Zubehör TRW                                    |
|  | 2.0 i V6 Turbo   | 148  |  | 05.95  | 12.05   | 13.0460-2826.2   | 602826   | + ALU-Sättel <sup>2)</sup> 23177 14,2 /S TRW                                       |
|  | 2.0 JTS  | 121  |  | 04.03  | 12.05   |  |  |  |
|  | 3.0 i V6   |  |  | 10.96  | 12.05   |  |  |  |
|  | 3.2 i V6   | 176  |  | 04.03  | 12.05   |  |  |  |
|    | 1.8 i 16V  | 106  |  | 04.98  | 12.05   | 24.0111-0142.1   | 411142   | 241 11,0 9,2 +B  |
|  | 2.0 i 16V  |  |  | 05.95  | 12.05   |  |  |  |
|  | 2.0 i V6 Turbo   | 148  |  | 05.95  | 12.05   |  |  |  |
|  | 2.0 JTS  | 121  |  | 04.03  | 12.05   |  |  |  |
|  | 3.0 i V6   |  |  | 10.96  | 12.05   |  |  |  |
|  | 3.2 i V6   | 176  |  | 04.03  | 12.05   |  |  |  |
| <b>ALFA ROMEO MITO (08-)</b>   |  |  |  |  |   |  |  |  |
|    | 0.9  | 63   |  | 07.11  |   | 13.0460-3863.2   | 603863   | 23706 18,0 +/WK/Zub/SBOS   |
|  | 0.9  | 77   |  | 04.13  |   |  |  |  |
|  | 1.4  | 77   |  | 08.10  |   |  |  |  |
|  | 1.4 i 16V  | 51   |  | 05.11  |   | 13.0460-3826.2   | 603826   | 23706 18,0 +/WK/Zub/SBOS   |
|  | 1.4 i 16V  | 58   |  | 08.08  |   | 13.0470-3826.2   | LD3826   | 23706 18,0 +/WK/Zub/SBOS   |
|  | 1.4 i 16V  | 70   |  | 08.08  |   |  |  |  |
|  | 1.3 JTDM   | 62   |  | 01.11  |   | 13.0460-3984.2   | 603984   | 23711 19,4 +/WK/S BOS  |
|  | 1.3 JTDM   | 66   |  | 08.08  |   | 13.0470-3984.2   | LD3984   | 23711 19,4 +/WK/S BOS  |
|  | 1.3 JTDM   | 70   |  | 10.09  |   |  |  |  |
|  | 1.4  | 88   |  | 08.08  |   |  |  |  |
|  | 1.4 Bifuel   | 88   |  | 07.11  |   |  |  |  |
|  | 1.4 TB   | 99   |  | 09.09  |   |  |  |  |
|  | 1.6 JTD  | 88   |  | 08.08  |   |  |  |  |
|  | 1.6 JTDM   | 85   |  | 09.08  |   |  |  |  |
|  | 1.4 TB   | 114  |  | 08.08  |   | 13.0460-4853.2   | 604853   | 24162 15,2 +/WK BRE  |
|  | 1.4 TB   | 125  |  | 10.09  |   | 13.0470-4853.2   | LD4853   | 24162 15,2 +/WK BRE  |
|  | 1.4 Turbo  | 110  |  | 09.08  |   | 13.0460-0175.2   | 610175   | Belagsatz-Zubehör BRE  |
|  | 0.9  | 63   |  | 07.11  |   | 24.0122-0197.1   | 422197   | 258 22,0 20,2 V +B   |
|  | 0.9  | 77   |  | 04.13  |   | 24.0322-0197.1   | 522197   | 258 22,0 20,2 V +B PD  |
|  | 1.4  | 77   |  | 08.10  |   |  |  |  |
|  | 1.4 i 16V  | 51   |  | 05.11  |   |  |  |  |
|  | 1.4 i 16V  | 58   |  | 08.08  |   |  |  |  |
|  | 1.4 i 16V  | 70   |  | 08.08  |   |  |  |  |
|  | 1.3 JTDM   | 62   |  | 01.11  |   | 24.0126-0125.1   | 426125   | 281 26,0 24,2 V +B   |
|  | 1.3 JTDM   | 66   |  | 08.08  |   |  |  |  |
|  | 1.3 JTDM   | 70   |  | 10.09  |   |  |  |  |
|  | 1.4  | 88   |  | 08.08  |   |  |  |  |
|  | 1.4 Bifuel   | 88   |  | 07.11  |   |  |  |  |
|  | 1.4 TB   | 99   |  | 09.09  |   |  |  |  |
|  | 1.6 JTD  | 88   |  | 08.08  |   |  |  |  |
|  | 1.6 JTDM   | 85   |  | 09.08  |   |  |  |  |
|  | 1.4 TB   | 114  |  | 08.08  |   | 24.0128-0231.1   | 428231   | 305 28,0 26,0 V L +B   |
|  | 1.4 TB   | 125  |  | 10.09  |   |  |  |  |
|  | 1.4 Turbo  | 110  |  | 09.08  |   |  |  |  |
|  | 0.9  | 63   |  | 07.11  |   | 13.0460-3991.2   | 603991   | + Sonderbremszange <sup>3)</sup> 23714 16,6 /S BOS                                 |
|  | 0.9  | 77   |  | 04.13  |   | 13.0470-3812.2   | LD3812   | + Sonderbremszange <sup>3)</sup> 23714 17,6 /S BOS                                 |
|  | 1.3 JTDM   | 62   |  | 01.11  |   | 13.0460-3861.2   | 603861   | + Sonderbremszange <sup>3)</sup> 23714 17,6 +/WK/Zub/SBOS                          |
|  | 1.3 JTDM   | 66   |  | 08.08  |   |  |  |  |
|  | 1.3 JTDM   | 70   |  | 10.09  |   |  |  |  |
|  | 1.4  | 77   |  | 08.10  |   |  |  |  |
|  | 1.4  | 88   |  | 08.08  |   |  |  |  |
|  | 1.4 Bifuel   | 88   |  | 07.11  |   |  |  |  |
|  | 1.4 i 16V  | 51   |  | 05.11  |   |  |  |  |
|  | 1.4 i 16V  | 58   |  | 08.08  |   |  |  |  |
|  | 1.4 i 16V  | 70   |  | 08.08  |   |  |  |  |
|  | 1.4 TB   | 99   |  | 09.09  |   |  |  |  |
|  | 1.4 TB   | 114  |  | 08.08  |   |  |  |  |
|  | 1.4 TB   | 125  |  | 10.09  |   |  |  |  |
|  | 1.4 Turbo  | 110  |  | 09.08  |   |  |  |  |
|  | 1.6 JTD  | 88   |  | 08.08  |   |  |  |  |

1) + cast iron caliper / + pinza in ghisa / + étriers en fonte grise / + fundición gris-pinza  
2) + aluminium calipers / + pinze in alluminio / + étriers en aluminium / + pinzas de aluminio  
3) + special brake caliper / + pinza freno speciale / + pince à frein spéciale / + pinza freno especial

| ALFA ROMEO MITO (08-)     |                |           |       |       |       |       |  |                |                |                                  |                   |                    |             |     |  |  |  |  |  |
|---------------------------|----------------|-----------|-------|-------|-------|-------|--|----------------|----------------|----------------------------------|-------------------|--------------------|-------------|-----|--|--|--|--|--|
|                           | 1.6 JTDM       | 85        |       | 09.09 |       |       |  | 13.0460-3991.2 | 603991         | + Sonderbremszange <sup>1)</sup> | 23714             | 16,6 /S            | BOS         |     |  |  |  |  |  |
|                           |                |           |       |       |       |       |  | 13.0470-3812.2 | LD3812         | + Sonderbremszange <sup>1)</sup> | 23714             | 17,6 /S            | BOS         |     |  |  |  |  |  |
|                           |                |           |       |       |       |       |  | 13.0460-3861.2 | 603861         | + Sonderbremszange <sup>1)</sup> | 23714             | 17,6 +/WK/Zub/SBOS | BOS         |     |  |  |  |  |  |
|                           | 0.9            | 63        |       | 07.11 |       |       |  | 13.0460-2763.2 | 602763         | - Sonderbremszange <sup>2)</sup> | 25237             | 17,2 +/WK/Zub/STRW |             |     |  |  |  |  |  |
|                           | 0.9            | 77        |       | 04.13 |       |       |  |                |                |                                  |                   |                    |             |     |  |  |  |  |  |
|                           | 1.3 JTDM       | 62        |       | 01.11 |       |       |  |                |                |                                  |                   |                    |             |     |  |  |  |  |  |
|                           | 1.3 JTDM       | 66        |       | 08.08 |       |       |  |                |                |                                  |                   |                    |             |     |  |  |  |  |  |
|                           | 1.3 JTDM       | 70        |       | 10.09 |       |       |  |                |                |                                  |                   |                    |             |     |  |  |  |  |  |
|                           | 1.4            | 77        |       | 08.10 |       |       |  |                |                |                                  |                   |                    |             |     |  |  |  |  |  |
|                           | 1.4            | 88        |       | 08.08 |       |       |  |                |                |                                  |                   |                    |             |     |  |  |  |  |  |
|                           | 1.4 Bifuel     | 88        |       | 07.11 |       |       |  |                |                |                                  |                   |                    |             |     |  |  |  |  |  |
|                           | 1.4 i 16V      | 51        |       | 05.11 |       |       |  |                |                |                                  |                   |                    |             |     |  |  |  |  |  |
|                           | 1.4 i 16V      | 58        |       | 08.08 |       |       |  |                |                |                                  |                   |                    |             |     |  |  |  |  |  |
|                           | 1.4 i 16V      | 70        |       | 08.08 |       |       |  |                |                |                                  |                   |                    |             |     |  |  |  |  |  |
|                           | 1.4 TB         | 99        |       | 09.09 |       |       |  |                |                |                                  |                   |                    |             |     |  |  |  |  |  |
| 1.4 TB                    | 114            |           | 08.08 |       |       |       |  |                |                |                                  |                   |                    |             |     |  |  |  |  |  |
| 1.4 TB                    | 125            |           | 10.09 |       |       |       |  |                |                |                                  |                   |                    |             |     |  |  |  |  |  |
| 1.4 Turbo                 | 110            |           | 09.08 |       |       |       |  |                |                |                                  |                   |                    |             |     |  |  |  |  |  |
| 1.6 JTD                   | 88             |           | 08.08 |       |       |       |  |                |                |                                  |                   |                    |             |     |  |  |  |  |  |
| 1.6 JTDM                  | 85             |           | 09.09 |       |       |       |  |                |                |                                  |                   |                    |             |     |  |  |  |  |  |
|                           | 0.9            | 63        |       | 07.11 |       |       |  | 24.0110-0349.1 | 410349         |                                  | 251               | 10,0 9,0 +B        |             |     |  |  |  |  |  |
|                           | 0.9            | 77        |       | 04.13 |       |       |  | 24.0310-0349.1 | 510349         |                                  | 251               | 10,0 9,0 +B PD     |             |     |  |  |  |  |  |
|                           | 1.3 JTDM       | 62        |       | 01.11 |       |       |  |                |                |                                  |                   |                    |             |     |  |  |  |  |  |
|                           | 1.3 JTDM       | 66        |       | 08.08 |       |       |  |                |                |                                  |                   |                    |             |     |  |  |  |  |  |
|                           | 1.3 JTDM       | 70        |       | 10.09 |       |       |  |                |                |                                  |                   |                    |             |     |  |  |  |  |  |
|                           | 1.4            | 77        |       | 08.10 |       |       |  |                |                |                                  |                   |                    |             |     |  |  |  |  |  |
|                           | 1.4            | 88        |       | 08.08 |       |       |  |                |                |                                  |                   |                    |             |     |  |  |  |  |  |
|                           | 1.4 Bifuel     | 88        |       | 07.11 |       |       |  |                |                |                                  |                   |                    |             |     |  |  |  |  |  |
|                           | 1.4 i 16V      | 51        |       | 05.11 |       |       |  |                |                |                                  |                   |                    |             |     |  |  |  |  |  |
|                           | 1.4 i 16V      | 58        |       | 08.08 |       |       |  |                |                |                                  |                   |                    |             |     |  |  |  |  |  |
|                           | 1.4 i 16V      | 70        |       | 08.08 |       |       |  |                |                |                                  |                   |                    |             |     |  |  |  |  |  |
|                           | 1.4 TB         | 99        |       | 09.09 |       |       |  |                |                |                                  |                   |                    |             |     |  |  |  |  |  |
|                           | 1.4 TB         | 114       |       | 08.08 |       |       |  |                |                |                                  |                   |                    |             |     |  |  |  |  |  |
|                           | 1.4 TB         | 125       |       | 10.09 |       |       |  |                |                |                                  |                   |                    |             |     |  |  |  |  |  |
|                           | 1.4 Turbo      | 110       |       | 09.08 |       |       |  |                |                |                                  |                   |                    |             |     |  |  |  |  |  |
| 1.6 JTD                   | 88             |           | 08.08 |       |       |       |  |                |                |                                  |                   |                    |             |     |  |  |  |  |  |
| 1.6 JTDM                  | 85             |           | 09.08 |       |       |       |  |                |                |                                  |                   |                    |             |     |  |  |  |  |  |
| ALFA ROMEO SPIDER (95-05) |                |           |       |       |       |       |  |                |                |                                  |                   |                    |             |     |  |  |  |  |  |
|                           | 2.0 i 16V      | 110       |       | 05.95 | 10.95 |       |  | 13.0460-2987.2 | 602987         |                                  | 23168             | 19,0 +/WK/S        | TRW         |     |  |  |  |  |  |
|                           | 3.0 i V6       | 141       |       | 05.95 | 06.95 |       |  |                |                |                                  |                   |                    |             |     |  |  |  |  |  |
|                           | 1.8 i 16V      | 106       |       | 04.98 | 12.05 |       |  | 13.0460-7069.2 | 607069         |                                  | 21636             | 19,3 +/WK          | ATE         |     |  |  |  |  |  |
|                           | 2.0 16V        | 114       |       | 05.98 | 12.05 |       |  |                |                |                                  |                   |                    |             |     |  |  |  |  |  |
|                           | 2.0 i 16V      | 110       |       | 11.95 | 12.05 |       |  |                |                |                                  |                   |                    |             |     |  |  |  |  |  |
|                           | 2.0 i V6 Turbo | 148       |       | 05.98 | 12.05 |       |  |                |                |                                  |                   |                    |             |     |  |  |  |  |  |
|                           | 2.0 JTS        | 121       |       | 04.03 | 12.05 |       |  |                |                |                                  |                   |                    |             |     |  |  |  |  |  |
|                           | 3.0 i V6       | 141       |       | 07.95 | 12.05 |       |  | 13.0460-4968.2 | 604968         |                                  | 21381             | 18,0 +/WK          | BRE         |     |  |  |  |  |  |
|                           | 3.0 V6         | 160       |       | 10.00 | 12.05 |       |  |                |                |                                  |                   |                    |             |     |  |  |  |  |  |
|                           | 3.0 V6 24V     | 162       |       | 01.99 | 12.05 |       |  |                |                |                                  |                   |                    |             |     |  |  |  |  |  |
| 3.2 i V6                  | 176            |           | 04.03 | 12.05 |       |       |  |                |                |                                  |                   |                    |             |     |  |  |  |  |  |
|                           | 2.0 i 16V      | 110       |       | 05.95 | 10.95 |       |  | 24.0120-0159.1 | 420159         |                                  | 257               | 20,0 18,2 V        |             |     |  |  |  |  |  |
|                           | 1.8 i 16V      | 106       |       | 04.98 | 12.05 |       |  | 24.0122-0225.1 | 422225         |                                  | 284               | 22,0 20,2 V        |             |     |  |  |  |  |  |
|                           | 2.0 16V        | 114       |       | 05.98 | 12.05 |       |  |                |                |                                  |                   |                    |             |     |  |  |  |  |  |
|                           | 2.0 i 16V      | 110       |       | 11.95 | 12.05 |       |  |                |                |                                  |                   |                    |             |     |  |  |  |  |  |
|                           | 2.0 JTS        | 121       |       | 04.03 | 12.05 |       |  |                |                |                                  |                   |                    |             |     |  |  |  |  |  |
|                           | 2.0 i V6 Turbo | 148       |       | 05.98 | 12.05 |       |  | 24.0122-0145.1 | 422145         |                                  | 284               | 22,0 20,2 V +B     |             |     |  |  |  |  |  |
|                           | 3.0 i V6       | 141       |       | 05.95 | 12.05 |       |  | 24.0128-0119.1 | 428119         |                                  | 305               | 28,0 26,0 V        |             |     |  |  |  |  |  |
|                           | 3.0 V6         | 160       |       | 10.00 | 12.05 |       |  |                |                |                                  |                   |                    |             |     |  |  |  |  |  |
|                           | 3.0 V6 24V     | 162       |       | 01.99 | 12.05 |       |  |                |                |                                  |                   |                    |             |     |  |  |  |  |  |
|                           | 3.2 i V6       | 176       |       | 04.03 | 12.05 |       |  |                |                |                                  |                   |                    |             |     |  |  |  |  |  |
|                           | 1.8 i 16V      | 106       |       | 04.98 | 12.05 |       |  | 13.0460-2951.2 | 602951         | + GG-Sättel <sup>3)</sup>        | 21103             | 14,2 /S            | TRW         |     |  |  |  |  |  |
|                           | 2.0 16V        | 114       |       | 05.98 | 12.05 |       |  | 13.0460-2826.2 | 602826         | + ALLU-Sättel <sup>4)</sup>      | 23177             | 14,2 /S            | TRW         |     |  |  |  |  |  |
|                           | 2.0 i 16V      | 110       |       | 05.95 | 12.05 |       |  | 13.0460-0072.2 | 610072         | + GG-Sättel <sup>3)</sup>        | Belagsatz-Zubehör |                    | TRW         |     |  |  |  |  |  |
|                           | 2.0 i V6 Turbo | 148       |       | 05.98 | 12.05 |       |  |                |                |                                  |                   |                    |             |     |  |  |  |  |  |
|                           | 2.0 JTS        | 121       |       | 04.03 | 12.05 |       |  |                |                |                                  |                   |                    |             |     |  |  |  |  |  |
|                           | 3.0 i V6       | 141       |       | 05.95 | 12.05 |       |  |                |                |                                  |                   |                    |             |     |  |  |  |  |  |
|                           | 3.0 V6         | 160       |       | 10.00 | 12.05 |       |  |                |                |                                  |                   |                    |             |     |  |  |  |  |  |
|                           | 3.0 V6 24V     | 162       |       | 01.99 | 12.05 |       |  |                |                |                                  |                   |                    |             |     |  |  |  |  |  |
|                           | 3.2 i V6       | 176       |       | 04.03 | 12.05 |       |  |                |                |                                  |                   |                    |             |     |  |  |  |  |  |
|                           |                | 1.8 i 16V | 106   |       | 04.98 | 12.05 |  |                | 24.0111-0142.1 | 411142                           |                   | 241                | 11,0 9,2 +B |     |  |  |  |  |  |
| 2.0 16V                   |                | 114       |       | 05.98 | 12.05 |       |  |                |                |                                  |                   |                    |             |     |  |  |  |  |  |
| 2.0 i 16V                 |                | 110       |       | 05.95 | 12.05 |       |  |                |                |                                  |                   |                    |             |     |  |  |  |  |  |
| 2.0 i V6 Turbo            |                | 148       |       | 05.98 | 12.05 |       |  |                |                |                                  |                   |                    |             |     |  |  |  |  |  |
| 2.0 JTS                   |                | 121       |       | 04.03 | 12.05 |       |  |                |                |                                  |                   |                    |             |     |  |  |  |  |  |
| 3.0 i V6                  |                | 141       |       | 05.95 | 12.05 |       |  |                |                |                                  |                   |                    |             |     |  |  |  |  |  |
| 3.0 V6                    |                | 160       |       | 10.00 | 12.05 |       |  |                |                |                                  |                   |                    |             |     |  |  |  |  |  |
| 3.0 V6 24V                |                | 162       |       | 01.99 | 12.05 |       |  |                |                |                                  |                   |                    |             |     |  |  |  |  |  |
| 3.2 i V6                  |                | 176       |       | 04.03 | 12.05 |       |  |                |                |                                  |                   |                    |             |     |  |  |  |  |  |
|                           |                | 2.2 JTS   | 136   |       | 04.06 | 02.08 |  |                | 13.0460-7211.2 | 607211                           |                   | 24339              | 20,5 +/WK   | ATE |  |  |  |  |  |
|                           |                |           |       |       |       |       |  | 13.0470-7211.2 | LD7211         |                                  | 24339             | 20,5 +/WK          | ATE         |     |  |  |  |  |  |
|                           | 2.0 JTDM       | 120       |       | 04.09 | 09.11 |       |  | 13.0460-4867.2 | 604867         |                                  | 24852             | 16,0 +/WK          | BRE         |     |  |  |  |  |  |
|                           | 2.0 JTDM       | 125       |       | 05.09 | 09.11 |       |  | 13.0470-4867.2 | LD4867         |                                  | 24852             | 16,0 +/WK          | BRE         |     |  |  |  |  |  |
|                           | 2.2 JTS        | 136       |       | 03.08 | 09.11 |       |  |                |                |                                  |                   |                    |             |     |  |  |  |  |  |
|                           |                |           |       |       |       |       |  |                |                |                                  |                   |                    |             |     |  |  |  |  |  |
|                           |                |           |       |       |       |       |  |                |                |                                  |                   |                    |             |     |  |  |  |  |  |
|                           |                |           |       |       |       |       |  |                |                |                                  |                   |                    |             |     |  |  |  |  |  |
|                           |                |           |       |       |       |       |  |                |                |                                  |                   |                    |             |     |  |  |  |  |  |
|                           |                |           |       |       |       |       |  |                |                |                                  |                   |                    |             |     |  |  |  |  |  |





<sup>1)</sup> + special brake caliper / + pinza freno speciale / + pince à frein spéciale / + pinza freno especial

<sup>2)</sup> - special brake caliper / - pinza freno speciale / - pince à frein spéciale / - pinza freno especial

<sup>3)</sup> + cast iron caliper / + pinza in ghisa / + étriers en fonte grise / + fundición gris-pinza

<sup>4)</sup> + aluminium calipers / + pinza in alluminio / + étriers en aluminium / + pinzas de aluminio



| AUDI A1 / A1 Sportback (10-)   |                  |       |                 |                 |                |        |   |                            |                            |
|--|------------------|-------|-----------------|-----------------|----------------|--------|---|----------------------------|----------------------------|
|    | 1.4 TFSI         | 136   | 11.10           | PR: 1ZG         | 24.0122-0151.1 | 422151 |   |                            | 256 22,0 19,0 V L +S +B    |
|  | 1.6 TDI          | 66    | 05.10           | PR: 1ZG         | 24.0322-0151.1 | 522151 |   |                            | 256 22,0 19,0 V L +S +B PD |
|  | 1.6 TDI          | 77    | 05.10           | PR: 1ZG         |                |        |   |                            |                            |
|  | 1.6 TDI          | 85    | 11.14           | PR: 1ZG         |                |        |   |                            |                            |
|  | 1.8 TFSI         | 141   | 02.15           | PR: 1ZG         |                |        |   |                            |                            |
|  | 2.0 TDI          | 105   | 09.11           | PR: 1ZG         |                |        |   |                            |                            |
|  | 2.0 TFSI quattro | 188   | 10.12           | PR: 1ZG         |                |        |   |                            |                            |
|  | 1.0 TFSI         | 60    | 01.16           | PR: 1ZM,1ZN,1ZS | 24.0125-0123.1 | 425123 |   |                            | 310 25,0 22,0 V L +S +B    |
|  | 1.0 TFSI         | 70    | 03.15           | PR: 1ZM,1ZN,1ZS | 24.0325-0123.1 | 525123 |   |                            | 310 25,0 22,0 V L +B PD    |
|  | 1.2 TFSI         | 63    | 05.10           | PR: 1ZM,1ZN,1ZS |                |        |   |                            |                            |
| 1.4 TDI  | 66               | 11.14 | PR: 1ZM,1ZN,1ZS |                 |                |        |   |                            |                            |
| 1.4 TFSI   | 90               | 05.10 | PR: 1ZM,1ZN,1ZS |                 |                |        |   |                            |                            |
| 1.4 TFSI   | 92               | 11.14 | PR: 1ZM,1ZN,1ZS |                 |                |        |   |                            |                            |
| 1.4 TFSI   | 103              | 04.12 | PR: 1ZM,1ZN,1ZS |                 |                |        |   |                            |                            |
| 1.4 TFSI   | 110              | 11.14 | PR: 1ZM,1ZN,1ZS |                 |                |        |   |                            |                            |
| 1.4 TFSI   | 136              | 11.10 | PR: 1ZM,1ZN,1ZS |                 |                |        |   |                            |                            |
| 1.6 TDI  | 66               | 05.10 | PR: 1ZM,1ZN,1ZS |                 |                |        |   |                            |                            |
| 1.6 TDI  | 77               | 05.10 | PR: 1ZM,1ZN,1ZS |                 |                |        |   |                            |                            |
| 1.6 TDI  | 85               | 11.14 | PR: 1ZM,1ZN,1ZS |                 |                |        |   |                            |                            |
| 1.8 TFSI   | 141              | 02.15 | PR: 1ZM,1ZN,1ZS |                 |                |        |   |                            |                            |
| 2.0 TDI  | 105              | 09.11 | PR: 1ZM,1ZN,1ZS |                 |                |        |   |                            |                            |
| 2.0 TFSI quattro   | 188              | 10.12 | PR: 1ZM,1ZN,1ZS |                 |                |        |   |                            |                            |
| 1.0 TFSI   | 60               | 01.16 | PR: 1ZC         | 24.0125-0113.1  | 425113         |        |   | 288 25,0 22,0 V L +S +B    |                            |
| 1.0 TFSI   | 70               | 03.15 | PR: 1ZC         | 24.0325-0113.1  | 525113         |        |   | 288 25,0 22,0 V L +S +B PD |                            |
| 1.2 TFSI   | 63               | 05.10 | PR: 1ZC         |                 |                |        |   |                            |                            |
| 1.4 TDI  | 66               | 11.14 | PR: 1ZC         |                 |                |        |   |                            |                            |
| 1.4 TFSI   | 90               | 05.10 | PR: 1ZC         |                 |                |        |   |                            |                            |
| 1.4 TFSI   | 92               | 11.14 | PR: 1ZC         |                 |                |        |   |                            |                            |
| 1.4 TFSI   | 92               | 11.14 | PR: 1ZC         |                 |                |        |   |                            |                            |
| 1.4 TFSI   | 103              | 04.12 | PR: 1ZC         |                 |                |        |   |                            |                            |
| 1.4 TFSI   | 136              | 11.10 | PR: 1ZC         |                 |                |        |   |                            |                            |
| 1.6 TDI  | 66               | 05.10 | PR: 1ZC         |                 |                |        |   |                            |                            |
| 1.6 TDI  | 77               | 05.10 | PR: 1ZC         |                 |                |        |   |                            |                            |
| 1.6 TDI  | 85               | 11.14 | PR: 1ZC         |                 |                |        |   |                            |                            |
| 1.8 TFSI   | 141              | 02.15 | PR: 1ZC         |                 |                |        |   |                            |                            |
| 2.0 TDI  | 105              | 09.11 | PR: 1ZC         |                 |                |        |   |                            |                            |
| 2.0 TFSI quattro   | 188              | 10.12 | PR: 1ZC         |                 |                |        |   |                            |                            |
| S1   | 170              | 03.14 | PR: 1ZC         |                 |                |        |   |                            |                            |
| 1.2 TFSI   | 63               | 05.10 | PR: 1LJ         | 24.0125-0158.1  | 425158         |        |   | 312 25,0 22,0 V L +S +B    |                            |
| 1.4 TFSI   | 90               | 05.10 | PR: 1LJ         |                 |                |        |   |                            |                            |
| 1.4 TFSI   | 103              | 04.12 | PR: 1LJ         |                 |                |        |   |                            |                            |
| 1.4 TFSI   | 136              | 11.10 | PR: 1LJ         |                 |                |        |   |                            |                            |
| 1.6 TDI  | 66               | 05.10 | PR: 1LJ         |                 |                |        |   |                            |                            |
| 1.6 TDI  | 77               | 05.10 | PR: 1LJ         |                 |                |        |   |                            |                            |
| 2.0 TDI  | 105              | 09.11 | PR: 1LJ         |                 |                |        |   |                            |                            |
| 2.0 TFSI quattro   | 188              | 10.12 | PR: 1LJ         |                 |                |        |   |                            |                            |
|  | 1.0 TFSI         | 60    | 01.16           |                 | 24.0711-5273.3 | 360303 |  |                            | Radsensor                  |
|  | 1.0 TFSI         | 70    | 03.15           |                 | 24.0711-5274.3 | 360304 |  |                            | Radsensor                  |
|  | 1.2 TFSI         | 63    | 05.10           |                 |                |        |   |                            |                            |
|  | 1.4 TDI          | 66    | 11.14           |                 |                |        |   |                            |                            |
|  | 1.4 TFSI         | 90    | 05.10           |                 |                |        |   |                            |                            |
|  | 1.4 TFSI         | 92    | 11.14           |                 |                |        |   |                            |                            |
|  | 1.4 TFSI         | 103   | 04.12           |                 |                |        |   |                            |                            |
|  | 1.4 TFSI         | 110   | 11.14           |                 |                |        |   |                            |                            |
|  | 1.4 TFSI         | 136   | 11.10           |                 |                |        |   |                            |                            |
|  | 1.6 TDI          | 66    | 05.10           |                 |                |        |   |                            |                            |
| 1.6 TDI  | 77               | 05.10 |                 |                 |                |        |   |                            |                            |
| 1.6 TDI  | 85               | 11.14 |                 |                 |                |        |   |                            |                            |
| 1.8 TFSI   | 141              | 02.15 |                 |                 |                |        |   |                            |                            |
| 2.0 TDI  | 105              | 09.11 |                 |                 |                |        |   |                            |                            |
| 2.0 TFSI quattro   | 188              | 10.12 |                 |                 |                |        |   |                            |                            |
| S1   | 170              | 03.14 |                 |                 |                |        |   |                            |                            |
|  | 1.0 TFSI         | 60    | 01.16           | PR: 1KT         | 13.0460-2820.2 | 602820 |   |                            | 20961 17,6 /S TRW          |
|  | 1.0 TFSI         | 70    | 03.15           | PR: 1KT         | 13.0470-2820.2 | LD2820 |   |                            | 20961 17,6 /S TRW          |
|  | 1.2 TFSI         | 63    | 05.10           | PR: 1KT         |                |        |   |                            |                            |
|  | 1.4 TDI          | 66    | 11.14           | PR: 1KT         |                |        |   |                            |                            |
|  | 1.4 TFSI         | 90    | 05.10           | PR: 1KT         |                |        |   |                            |                            |
|  | 1.4 TFSI         | 92    | 11.14           | PR: 1KT         |                |        |   |                            |                            |
|  | 1.4 TFSI         | 103   | 04.12           | PR: 1KT         |                |        |   |                            |                            |
|  | 1.4 TFSI         | 110   | 11.14           | PR: 1KT         |                |        |   |                            |                            |
|  | 1.4 TFSI         | 136   | 11.10           | PR: 1KT         |                |        |   |                            |                            |
|  | 1.6 TDI          | 66    | 05.10           | PR: 1KT         |                |        |   |                            |                            |
| 1.6 TDI  | 77               | 05.10 | PR: 1KT         |                 |                |        |   |                            |                            |
| 1.6 TDI  | 85               | 11.14 | PR: 1KT         |                 |                |        |   |                            |                            |
| 1.8 TFSI   | 141              | 02.15 | PR: 1KT         |                 |                |        |   |                            |                            |
| 2.0 TDI  | 105              | 09.11 | PR: 1KT         |                 |                |        |   |                            |                            |
| 2.0 TFSI quattro   | 188              | 10.12 | PR: 1KT         |                 |                |        |   |                            |                            |
| 1.2 TFSI   | 63               | 05.10 | PR: 1KS         | 13.0460-3858.2  | 603858         |        |   | 24563 17,7 /Zub/S BOS      |                            |
| 1.4 TDI  | 66               | 11.14 | PR: 1KS         | 13.0470-3858.2  | LD3858         |        |   | 24563 17,7 /Zub/S BOS      |                            |
| 1.4 TFSI   | 90               | 05.10 | PR: 1KS         |                 |                |        |   |                            |                            |
| 1.4 TFSI   | 92               | 11.14 | PR: 1KS         |                 |                |        |   |                            |                            |
| 1.4 TFSI   | 103              | 04.12 | PR: 1KS         |                 |                |        |   |                            |                            |
| 1.4 TFSI   | 110              | 11.14 | PR: 1KS         |                 |                |        |   |                            |                            |
| 1.4 TFSI   | 136              | 11.10 | PR: 1KS         |                 |                |        |   |                            |                            |
| 1.6 TDI  | 66               | 05.10 | PR: 1KS         |                 |                |        |   |                            |                            |
| 1.6 TDI  | 77               | 05.10 | PR: 1KS         |                 |                |        |   |                            |                            |
| 1.6 TDI  | 85               | 11.14 | PR: 1KS         |                 |                |        |   |                            |                            |



























### AUDI A1 / A1 Sportback (10-)











|                     |                  |          |    |  |              |              |         |                       |                       |        |                                      |                                      |                             |            |
|---------------------|------------------|----------|----|--|--------------|--------------|---------|-----------------------|-----------------------|--------|--------------------------------------|--------------------------------------|-----------------------------|------------|
|                     | 2.0 TDI          | 105      |    |  | <b>09.11</b> | PR: 1KS      |         | <b>13.0460-3858.2</b> | 603858                |        |                                      |                                      | <b>24563</b> 17,7 /Zub/S    | <b>BOS</b> |
|                     | 2.0 TFSI quattro | 188      |    |  | <b>10.12</b> | PR: 1KS      |         | <b>13.0470-3858.2</b> | LD3858                |        |                                      |                                      | <b>24563</b> 17,7 /Zub/S    | <b>BOS</b> |
|                     | 1.0 TFSI         | 60       |    |  | <b>01.16</b> | PR: 1KT      |         | <b>24.0109-0123.1</b> | 409123                |        |                                      |                                      | 230 9,0 7,0 +S +B           |            |
|                     | 1.0 TFSI         | 70       |    |  | <b>03.15</b> | PR: 1KT      |         | <b>24.0309-0123.1</b> | 509123                |        |                                      |                                      | <b>230 9,0 7,0 +S +B PD</b> |            |
|                     | 1.2 TFSI         | 63       |    |  | <b>05.10</b> | PR: 1KT      |         |                       |                       |        |                                      |                                      |                             |            |
|                     | 1.4 TDI          | 66       |    |  | <b>11.14</b> | PR: 1KT      |         |                       |                       |        |                                      |                                      |                             |            |
|                     | 1.4 TFSI         | 90       |    |  | <b>05.10</b> | PR: 1KT      |         |                       |                       |        |                                      |                                      |                             |            |
|                     | 1.4 TFSI         | 92       |    |  | <b>11.14</b> | PR: 1KT      |         |                       |                       |        |                                      |                                      |                             |            |
|                     | 1.4 TFSI         | 103      |    |  | <b>04.12</b> | PR: 1KT      |         |                       |                       |        |                                      |                                      |                             |            |
|                     | 1.4 TFSI         | 110      |    |  | <b>11.14</b> | PR: 1KT      |         |                       |                       |        |                                      |                                      |                             |            |
|                     | 1.4 TFSI         | 136      |    |  | <b>11.10</b> | PR: 1KT      |         |                       |                       |        |                                      |                                      |                             |            |
|                     | 1.6 TDI          | 66       |    |  | <b>05.10</b> | PR: 1KT      |         |                       |                       |        |                                      |                                      |                             |            |
|                     | 1.6 TDI          | 77       |    |  | <b>05.10</b> | PR: 1KT      |         |                       |                       |        |                                      |                                      |                             |            |
|                     | 1.6 TDI          | 85       |    |  | <b>11.14</b> | PR: 1KT      |         |                       |                       |        |                                      |                                      |                             |            |
|                     | 1.8 TFSI         | 141      |    |  | <b>02.15</b> | PR: 1KT      |         |                       |                       |        |                                      |                                      |                             |            |
| 2.0 TDI             | 105              |          |    |  | <b>09.11</b> | PR: 1KT      |         |                       |                       |        |                                      |                                      |                             |            |
| 2.0 TFSI quattro    | 188              |          |    |  | <b>10.12</b> | PR: 1KT      |         |                       |                       |        |                                      |                                      |                             |            |
|                     | 1.2 TFSI         | 63       |    |  | <b>05.10</b> | PR: 1KS      |         | <b>24.0110-0356.1</b> | 410356                |        |                                      |                                      | 272 9,7 8,0 +S +B           |            |
|                     | 1.4 TDI          | 66       |    |  | <b>11.14</b> | PR: 1KS      |         | <b>24.0310-0356.1</b> | 510356                |        |                                      |                                      | <b>272 9,7 8,0 +S +B PD</b> |            |
|                     | 1.4 TFSI         | 90       |    |  | <b>05.10</b> | PR: 1KS      |         |                       |                       |        |                                      |                                      |                             |            |
|                     | 1.4 TFSI         | 92       |    |  | <b>11.14</b> | PR: 1KS      |         |                       |                       |        |                                      |                                      |                             |            |
|                     | 1.4 TFSI         | 103      |    |  | <b>04.12</b> | PR: 1KS      |         |                       |                       |        |                                      |                                      |                             |            |
|                     | 1.4 TFSI         | 110      |    |  | <b>11.14</b> | PR: 1KS      |         |                       |                       |        |                                      |                                      |                             |            |
|                     | 1.4 TFSI         | 136      |    |  | <b>11.10</b> | PR: 1KS      |         |                       |                       |        |                                      |                                      |                             |            |
|                     | 1.6 TDI          | 66       |    |  | <b>05.10</b> | PR: 1KS      |         |                       |                       |        |                                      |                                      |                             |            |
|                     | 1.6 TDI          | 77       |    |  | <b>05.10</b> | PR: 1KS      |         |                       |                       |        |                                      |                                      |                             |            |
|                     | 1.6 TDI          | 85       |    |  | <b>11.14</b> | PR: 1KS      |         |                       |                       |        |                                      |                                      |                             |            |
|                     | 2.0 TDI          | 105      |    |  |              | <b>09.11</b> | PR: 1KS |                       |                       |        |                                      |                                      |                             |            |
|                     | 2.0 TFSI quattro | 188      |    |  |              | <b>10.12</b> | PR: 1KS |                       |                       |        |                                      |                                      |                             |            |
|                     |                  | 1.0 TFSI | 60 |  |              | <b>01.16</b> |         |                       | <b>24.0711-6233.3</b> | 360315 |                                      | <input type="checkbox"/> PR: ON3,ON6 |                             | Radsensor  |
| 1.0 TFSI            |                  | 70       |    |  | <b>03.15</b> |              |         | <b>24.0711-6234.3</b> | 360316                |        | <input type="checkbox"/> PR: ON3,ON6 |                                      | Radsensor                   |            |
| 1.2 TFSI            |                  | 63       |    |  | <b>05.10</b> |              |         | <b>24.0711-5271.3</b> | 360301                |        | <input type="checkbox"/> PR: ON0     |                                      | Radsensor                   |            |
| 1.4 TDI             |                  | 66       |    |  | <b>11.14</b> |              |         | <b>24.0711-6336.3</b> | 360366                |        | <input type="checkbox"/> PR: ON0     |                                      | Radsensor                   |            |
| 1.4 TFSI            |                  | 90       |    |  | <b>05.10</b> |              |         |                       |                       |        |                                      |                                      |                             |            |
| 1.4 TFSI            |                  | 92       |    |  | <b>11.14</b> |              |         |                       |                       |        |                                      |                                      |                             |            |
| 1.4 TFSI            |                  | 103      |    |  | <b>04.12</b> |              |         |                       |                       |        |                                      |                                      |                             |            |
| 1.4 TFSI            |                  | 110      |    |  | <b>11.14</b> |              |         |                       |                       |        |                                      |                                      |                             |            |
| 1.4 TFSI            |                  | 136      |    |  | <b>11.10</b> |              |         |                       |                       |        |                                      |                                      |                             |            |
| 1.6 TDI             |                  | 66       |    |  | <b>05.10</b> |              |         |                       |                       |        |                                      |                                      |                             |            |
| 1.6 TDI             |                  | 77       |    |  | <b>05.10</b> |              |         |                       |                       |        |                                      |                                      |                             |            |
| 1.6 TDI             |                  | 85       |    |  | <b>11.14</b> |              |         |                       |                       |        |                                      |                                      |                             |            |
| 1.8 TFSI            |                  | 141      |    |  | <b>02.15</b> |              |         |                       |                       |        |                                      |                                      |                             |            |
| 2.0 TDI             | 105              |          |    |  | <b>09.11</b> |              |         |                       |                       |        |                                      |                                      |                             |            |
| 2.0 TFSI quattro S1 | 170              |          |    |  | <b>03.14</b> |              |         |                       |                       |        |                                      |                                      |                             |            |

### AUDI A2 (00-05)

|  |         |    |  |  |              |              |         |                       |        |  |                          |  |                                   |            |
|--|---------|----|--|--|--------------|--------------|---------|-----------------------|--------|--|--------------------------|--|-----------------------------------|------------|
|  | 1.2 TDI | 45 |  |  | <b>03.01</b> | <b>07.05</b> |         | <b>13.0460-7178.2</b> | 607178 |  |                          |  | <b>23395</b> 13,7 +/WK            | <b>VW</b>  |
|  | 1.4     | 55 |  |  | <b>06.00</b> | <b>07.05</b> |         | <b>13.0460-7117.2</b> | 607117 |  |                          |  | <b>23131</b> 19,6 +/WK            | <b>VW</b>  |
|  | 1.4 TDI | 55 |  |  | <b>06.00</b> | <b>07.05</b> |         | <b>13.0470-7117.2</b> | LD7117 |  |                          |  | <b>23131</b> 19,6 +/WK            | <b>VW</b>  |
|  | 1.4 TDI | 66 |  |  | <b>11.03</b> | <b>07.05</b> |         |                       |        |  |                          |  |                                   |            |
|  | 1.6 FSI | 81 |  |  | <b>05.02</b> | <b>07.05</b> |         |                       |        |  |                          |  |                                   |            |
|  | 1.2 TDI | 45 |  |  | <b>03.01</b> | <b>07.05</b> |         | <b>24.0115-0109.1</b> | 415109 |  |                          |  | 239 15,0 13,0 V L +B              |            |
|  | 1.4     | 55 |  |  | <b>06.00</b> | <b>07.05</b> |         | <b>24.0122-0151.1</b> | 422151 |  |                          |  | 256 22,0 19,0 V L +S +B           |            |
|  | 1.4 TDI | 55 |  |  | <b>06.00</b> | <b>07.05</b> |         | <b>24.0322-0151.1</b> | 522151 |  |                          |  | <b>256 22,0 19,0 V L +S +B PD</b> |            |
|  | 1.4 TDI | 66 |  |  | <b>11.03</b> | <b>07.05</b> |         |                       |        |  |                          |  |                                   |            |
|  | 1.6 FSI | 81 |  |  | <b>05.02</b> | <b>07.05</b> |         |                       |        |  |                          |  |                                   |            |
|  | 1.4     | 55 |  |  | <b>06.00</b> | <b>07.05</b> |         | <b>24.0711-5273.3</b> | 360303 |  | <input type="checkbox"/> |  | Radsensor                         |            |
|  | 1.4 TDI | 55 |  |  | <b>06.00</b> | <b>07.05</b> |         | <b>24.0711-5274.3</b> | 360304 |  | <input type="checkbox"/> |  | Radsensor                         |            |
|  | 1.4 TDI | 66 |  |  | <b>11.03</b> | <b>07.05</b> |         |                       |        |  |                          |  |                                   |            |
|  | 1.6 FSI | 81 |  |  | <b>05.02</b> | <b>07.05</b> |         |                       |        |  |                          |  |                                   |            |
|  | 1.4 TDI | 66 |  |  | <b>11.03</b> | <b>07.05</b> |         | <b>13.0460-2894.2</b> | 602894 |  |                          |  | <b>20961</b> 17,4 /Zub/S          | <b>TRW</b> |
|  | 1.6 FSI | 81 |  |  | <b>05.02</b> | <b>07.05</b> |         | <b>13.0470-2894.2</b> | LD2894 |  |                          |  | <b>20961</b> 17,4 /Zub/S          | <b>TRW</b> |
|  | 1.4 TDI | 66 |  |  | <b>11.03</b> | <b>07.05</b> |         | <b>13.0460-2864.2</b> | 602864 |  |                          |  | <b>20961</b> 17,4 /S              | <b>TRW</b> |
|  | 1.6 FSI | 81 |  |  | <b>05.02</b> | <b>07.05</b> |         | <b>13.0460-0072.2</b> | 610072 |  |                          |  | Belagsatz-Zubehör                 | <b>TRW</b> |
|  | 1.4 TDI | 66 |  |  | <b>11.03</b> | <b>07.05</b> |         | <b>24.0109-0123.1</b> | 409123 |  |                          |  | 230 9,0 7,0 +S +B                 |            |
|  | 1.6 FSI | 81 |  |  | <b>05.02</b> | <b>07.05</b> |         | <b>24.0309-0123.1</b> | 509123 |  |                          |  | <b>230 9,0 7,0 +S +B PD</b>       |            |
|  | 1.2 TDI | 45 |  |  | <b>03.01</b> | <b>07.05</b> |         | <b>24.0711-6049.3</b> | 360126 |  | <input type="checkbox"/> |  | Radsensor                         |            |
|  | 1.4     | 55 |  |  |              |              |         | <b>24.0711-6050.3</b> | 360127 |  | <input type="checkbox"/> |  | Radsensor                         |            |
|  | 1.4 TDI | 55 |  |  | <b>06.00</b> | <b>07.05</b> |         | <b>24.0711-6233.3</b> | 360315 |  | <input type="checkbox"/> |  | Radsensor                         |            |
|  | 1.4 TDI | 66 |  |  | <b>11.03</b> | <b>07.05</b> |         | <b>24.0711-6234.3</b> | 360316 |  | <input type="checkbox"/> |  | Radsensor                         |            |
|  | 1.6 FSI | 81 |  |  | <b>05.02</b> | <b>07.05</b> |         |                       |        |  |                          |  |                                   |            |
|  | 1.2 TDI | 45 |  |  | <b>03.01</b> | <b>07.05</b> |         | <b>03.0137-9008.2</b> | 669008 |  |                          |  | Bremsbacken-Zubehör               |            |
|  | 1.4 TDI | 55 |  |  | <b>06.00</b> | <b>07.05</b> | PR: 1KR |                       |        |  |                          |  |                                   |            |
|  | 1.4     | 55 |  |  | <b>06.00</b> | <b>07.05</b> | PR: 1KR |                       |        |  |                          |  |                                   |            |
|  | 1.4     | 55 |  |  | <b>06.00</b> | <b>07.05</b> | PR: 1KB | <b>03.0137-0268.2</b> | 650268 |  |                          |  | 200 x 40 HEB                      | <b>VW</b>  |
|  | 1.4 TDI | 55 |  |  | <b>06.00</b> | <b>07.05</b> | PR: 1KB | <b>03.0137-9168.2</b> | 669168 |  |                          |  | Bremsbacken-Zubehör               | <b>VW</b>  |
|  | 1.4     | 55 |  |  | <b>06.00</b> | <b>07.05</b> | PR: 1KB |                       |        |  |                          |  |                                   |            |
|  | 1.4 TDI | 55 |  |  | <b>06.00</b> | <b>07.05</b> | PR: 1KB |                       |        |  |                          |  |                                   |            |
|  | 1.4     | 55 |  |  | <b>06.00</b> | <b>07.05</b> | PR: 1KB | <b>24.0220-0037.1</b> | 480161 |  |                          |  | 200/201,5 x 50,5                  |            |
|  | 1.4 TDI | 55 |  |  | <b>06.00</b> | <b>07.05</b> | PR: 1KB |                       |        |  |                          |  |                                   |            |

| AUDI A2 (00-05)  |   | AUDI A3 (8L) (96-03)   |   |   |   |  |
|--|---|--|---|---|---|--|
|    | 1.4<br>1.4 TDI  | 55<br>55   | 06.00<br>07.05 PR: 1KB<br>06.00<br>07.05 PR: 1KB  | 03.0520-1517.3<br>691517  |   | 17,46/200x40 TopKit<br>VW                        |
|  | 1.4<br>1.4 TDI  | 55<br>55   | 06.00<br>07.05 PR: 1KR<br>06.00<br>07.05 PR: 1KR  | 03.0520-0415.3<br>690415  |   | 15,87/200x40 TopKit<br>VW                        |
|    | 1.6<br>1.8<br>1.8 T<br>1.8 T<br>1.8 T quattro<br>1.8 T quattro<br>1.9 TDI<br>1.9 TDI  | 75<br>92<br>110<br>132<br>110<br>132<br>66<br>81                   | 8L-X-200000 09.96<br>8L-X-200000 09.96<br>8L-X-200000 12.96<br>8L-X-200000 12.98<br>8L-X-200000 08.98<br>8L-X-200000 10.98<br>8L-X-200000 09.96<br>8L-X-200000 03.97  | PR: 1LQ,1LR,1LS<br>PR: 1LQ,1LR,1LS<br>PR: 1LQ,1LR,1LS<br>PR: 1LQ,1LR,1LS<br>PR: 1LQ,1LR,1LS<br>PR: 1LQ,1LR,1LS<br>PR: 1LQ,1LR,1LS<br>PR: 1LQ,1LR,1LS  | 13.0460-7111.2<br>607111<br>13.0470-7111.2<br>LD7111  | 23130 19,6 +<br>23130 19,6 +<br>VW<br>VW         |
|  | 1.6<br>1.8<br>1.8 T<br>1.8 T<br>1.8 T quattro<br>1.8 T quattro<br>1.9 TDI<br>1.9 TDI<br>1.9 TDI<br>1.9 TDI<br>1.9 TDI quattro       | 75<br>92<br>110<br>132<br>110<br>132<br>66<br>74<br>81<br>96<br>96 | 8L-Y-000001<br>8L-Y-000001<br>8L-Y-000001<br>8L-Y-000001<br>8L-Y-000001<br>8L-Y-000001<br>8L-Y-000001<br>8L-Y-000001<br>8L-Y-000001<br>8L-Y-000001<br>8L-Y-000001   | 06.03 PR: 1LQ,1LS<br>06.03 PR: 1LQ,1LS<br>06.03 PR: 1LQ,1LS<br>06.03 PR: 1LQ,1LS<br>06.03 PR: 1LQ,1LS<br>06.03 PR: 1LQ,1LS<br>06.01 PR: 1LQ,1LS<br>06.03 PR: 1LQ,1LS<br>06.01 PR: 1LQ,1LS<br>06.03 PR: 1LQ,1LS<br>09.00<br>06.03 PR: 1LQ,1LS  | 13.0460-7117.2<br>607117<br>13.0470-7117.2<br>LD7117  | 23131 19,6 +/WK<br>23131 19,6 +/WK<br>VW<br>VW   |
|  | 1.6<br>1.8<br>1.8 T<br>1.8 T<br>1.8 T quattro<br>1.8 T quattro<br>1.9 TDI<br>1.9 TDI<br>1.9 TDI<br>1.9 TDI<br>1.9 TDI quattro       | 75<br>92<br>110<br>132<br>110<br>132<br>66<br>74<br>81<br>96<br>96 | 09.96 06.03 PR: 12P<br>09.96 06.03 PR: 12P<br>12.96 06.03 PR: 12P<br>12.98 06.03 PR: 12P<br>08.98 06.03 PR: 12P<br>10.98 06.03 PR: 12P<br>09.96 06.01 PR: 12P<br>09.00 06.03 PR: 12P<br>03.97 06.01 PR: 12P<br>09.00 06.03 PR: 12P<br>09.00 06.03 PR: 12P   | 13.0460-7117.2<br>607117<br>13.0470-7117.2<br>LD7117  | 23131 19,6 +/WK<br>23131 19,6 +/WK<br>VW<br>VW        |  |
|  | 1.6<br>1.8<br>1.8 T<br>1.8 T<br>1.8 T quattro<br>1.8 T quattro<br>1.9 TDI<br>1.9 TDI<br>1.9 TDI<br>1.9 TDI<br>S3                    | 75<br>92<br>110<br>132<br>110<br>132<br>66<br>81                   | 8L-X-150000 09.96<br>8L-X-150000 09.96<br>8L-X-150000 12.96<br>8L-X-150000 12.98<br>8L-X-150000 08.98<br>8L-X-150000 10.98<br>8L-X-150000 09.96<br>8L-X-150000 03.97<br>8L-X-200000 08.98   | PR: 1LE,1LN,1ZD<br>PR: 1LE,1LN,1ZD<br>PR: 1LE,1LN,1ZD<br>PR: 1LE,1LN,1ZD<br>PR: 1LE,1LN,1ZD<br>PR: 1LE,1LN,1ZD<br>PR: 1LE,1LN,1ZD<br>PR: 1LE,1LN,1ZD<br>PR: 1LT   | 13.0460-7081.2<br>607081<br>13.0470-7081.2<br>LD7081  | 21911 20,3 +<br>21911 20,3 +<br>ATE<br>ATE       |
|  | 1.6<br>1.8<br>1.8 T<br>1.8 T<br>1.8 T quattro<br>1.8 T quattro<br>1.9 TDI<br>1.9 TDI<br>1.9 TDI<br>1.9 TDI<br>1.9 TDI quattro<br>S3 | 75<br>92<br>110<br>132<br>110<br>132<br>66<br>74<br>81<br>96<br>96 | 8L-Y-000001<br>8L-Y-000001<br>8L-Y-000001<br>8L-Y-000001<br>8L-Y-000001<br>8L-Y-000001<br>8L-Y-000001<br>8L-Y-000001<br>8L-Y-000001<br>8L-Y-000001<br>8L-Y-000001<br>8L-Y-000001  | 06.03 PR: 1LE,1LN,1ZD<br>06.03 PR: 1LE,1LN,1ZD<br>06.03 PR: 1LE,1LN,1ZD<br>06.03 PR: 1LE,1LN,1ZD<br>06.03 PR: 1LE,1LN,1ZD<br>06.03 PR: 1LE,1LN,1ZD<br>06.01 PR: 1LE,1LN,1ZD<br>06.03 PR: 1LE,1LN,1ZD<br>06.01 PR: 1LE,1LN,1ZD<br>06.03 PR: 1LE,1LN,1ZD<br>09.00<br>06.03 PR: 1LE,1LN,1ZD<br>06.01 PR: 1LE,1LN,1ZD<br>06.03 PR: 1LE,1LN,1ZD<br>09.00<br>06.03 PR: 1LE,1LN,1ZD<br>06.03 PR: 1LT | 13.0460-7122.2<br>607122<br>13.0470-7122.2<br>LD7122  | 23392 20,3 +/WK<br>23392 20,3 +/WK<br>ATE<br>ATE |
|  | 1.6<br>1.8<br>1.8 T<br>1.8 T<br>1.8 T quattro<br>1.8 T quattro<br>1.9 TDI<br>1.9 TDI<br>1.9 TDI<br>1.9 TDI<br>1.9 TDI quattro       | 75<br>92<br>110<br>132<br>110<br>132<br>66<br>74<br>81<br>96<br>96 | 09.96 06.03 PR: 1LQ<br>09.96 06.03 PR: 1LQ<br>12.96 06.03 PR: 1LQ<br>12.98 06.03 PR: 1LQ<br>08.98 06.03 PR: 1LQ<br>10.98 06.03 PR: 1LQ<br>09.96 06.01 PR: 1LQ<br>09.00 06.03 PR: 1LQ<br>03.97 06.01 PR: 1LQ<br>09.00 06.03 PR: 1LQ<br>09.00 06.03 PR: 1LQ   | 24.0122-0151.1<br>422151<br>24.0322-0151.1<br>522151  | 256 22,0 19,0 V L +S +B<br>256 22,0 19,0 V L +S +B PD |  |
|  | 1.6<br>1.8<br>1.8 T<br>1.8 T<br>1.8 T quattro<br>1.8 T quattro<br>1.9 TDI<br>1.9 TDI<br>1.9 TDI<br>1.9 TDI<br>1.9 TDI quattro       | 75<br>92<br>110<br>132<br>110<br>132<br>66<br>74<br>81<br>96<br>96 | 09.96 06.03 PR: 1LR,1LS,1ZP<br>09.96 06.03 PR: 1LR,1LS,1ZP<br>12.96 06.03 PR: 1LR,1LS,1ZP<br>12.98 06.03 PR: 1LR,1LS,1ZP<br>08.98 06.03 PR: 1LR,1LS,1ZP<br>10.98 06.03 PR: 1LR,1LS,1ZP<br>09.96 06.01 PR: 1LR,1LS,1ZP<br>09.00 06.03 PR: 1LR,1LS,1ZP<br>03.97 06.01 PR: 1LR,1LS,1ZP<br>09.00 06.03 PR: 1LR,1LS,1ZP<br>09.00 06.03 PR: 1LR,1LS,1ZP | 24.0122-0150.1<br>422150<br>24.0322-0150.1<br>522150  | 280 22,0 19,0 V L +S +B<br>280 22,0 19,0 V L +S +B PD |  |
|  | 1.6<br>1.8<br>1.8 T<br>1.8 T<br>1.8 T quattro<br>1.8 T quattro<br>1.9 TDI<br>1.9 TDI<br>1.9 TDI<br>1.9 TDI<br>1.9 TDI quattro       | 75<br>92<br>110<br>132<br>110<br>132<br>66<br>74<br>81<br>96<br>96 | 09.96 06.03 PR: 1LE,1LN,1ZD<br>09.96 06.03 PR: 1LE,1LN,1ZD<br>12.96 06.03 PR: 1LE,1LN,1ZD<br>12.98 06.03 PR: 1LE,1LN,1ZD<br>08.98 06.03 PR: 1LE,1LN,1ZD<br>10.98 06.03 PR: 1LE,1LN,1ZD<br>09.96 06.03 PR: 1LE,1LN,1ZD<br>03.97 06.01 PR: 1LE,1LN,1ZD<br>09.00 06.03 PR: 1LE,1LN,1ZD<br>09.00 06.03 PR: 1LE,1LN,1ZD                                | 24.0125-0113.1<br>425113<br>24.0325-0113.1<br>525113  | 288 25,0 22,0 V L +S +B<br>288 25,0 22,0 V L +S +B PD |  |



|          |                      |       |       |                         |                |        |   |                            |  |
|--|----------------------|-------|-------|-------------------------|----------------|--------|---|----------------------------|--|
| <b>AUDI A3 (8L) (96-03)</b>  |                      |       |       |                         |                |        |   |                            |  |
|    | 1.9 TDI 74           | 09.00 | 06.03 | PR: 1LE,1LN,1ZD         | 24.0125-0113.1 | 425113 |   | 288 25,0 22,0 V L +S +B    |  |
|  | 1.9 TDI 81           | 03.97 | 06.01 | PR: 1LE,1LN,1ZD         | 24.0325-0113.1 | 525113 |   | 288 25,0 22,0 V L +S +B PD |  |
|  | 1.9 TDI 96           | 09.00 | 06.03 | PR: 1LE,1LN,1ZD         |                |        |   |                            |  |
|  | 1.9 TDI quattro 96   | 09.00 | 06.03 | PR: 1LE,1LN,1ZD         |                |        |   |                            |  |
|  | S3                   | 08.98 | 06.03 | PR: 1LT                 | 24.0125-0123.1 | 425123 |   | 310 25,0 22,0 V L +S +B    |  |
|  |                      |       |       |                         | 24.0325-0123.1 | 525123 |   | 310 25,0 22,0 V L +B PD    |  |
|    | 1.6 75               | 09.96 | 06.03 |                         | 24.0711-1361.3 | 360022 |      | Radsensor                  |  |
|  | 1.8 92               | 09.96 | 06.03 |                         | 24.0711-1362.3 | 360023 |      | Radsensor                  |  |
|  | 1.8 T 110            | 12.96 | 06.03 |                         |                |        |   |                            |  |
|  | 1.8 T 132            | 12.98 | 06.03 |                         |                |        |   |                            |  |
|  | 1.8 T quattro 110    | 08.98 | 06.03 |                         |                |        |   |                            |  |
|  | 1.8 T quattro 132    | 10.98 | 06.03 |                         |                |        |   |                            |  |
|  | 1.9 TDI 66           | 09.96 | 06.01 |                         |                |        |   |                            |  |
|  | 1.9 TDI 74           | 09.00 | 06.03 |                         |                |        |   |                            |  |
|  | 1.9 TDI 81           | 03.97 | 06.01 |                         |                |        |   |                            |  |
|  | 1.9 TDI 96           | 09.00 | 06.03 |                         |                |        |   |                            |  |
|  | 1.9 TDI quattro 96   | 09.00 | 06.03 |                         |                |        |   |                            |  |
|  | S3                   | 08.98 | 06.03 |                         |                |        |   |                            |  |
|  |                      |       |       |                         |                |        |   |                            |  |
|  |                      |       |       |                         |                |        |   |                            |  |
|    | 1.6 75               | 09.96 | 06.03 | PR: 1KK,1KV,1KE         | 13.0460-2894.2 | 602894 |   | 20961 17,4 /Zub/S TRW      |  |
|  | 1.8 92               | 09.96 | 06.03 | PR: 1KK,1KV,1KE         | 13.0470-2894.2 | LD2894 |   | 20961 17,4 /Zub/S TRW      |  |
|  | 1.8 T 110            | 12.96 | 06.03 | PR: 1KK,1KV,1KE         |                |        |   |                            |  |
|  | 1.8 T 132            | 12.98 | 06.03 | PR: 1KK,1KV,1KE         |                |        |   |                            |  |
|  | 1.8 T quattro 110    | 08.98 | 06.03 | PR: 1KK,1KV,1KE         |                |        |   |                            |  |
|  | 1.8 T quattro 132    | 10.98 | 06.03 | PR: 1KK,1KV,1KE         |                |        |   |                            |  |
|  | 1.9 TDI 66           | 09.96 | 06.01 | PR: 1KK,1KV,1KE         |                |        |   |                            |  |
|  | 1.9 TDI 74           | 09.00 | 06.03 | PR: 1KK,1KV,1KE         |                |        |   |                            |  |
|  | 1.9 TDI 81           | 03.97 | 06.01 | PR: 1KK,1KV,1KE         |                |        |   |                            |  |
|  | 1.9 TDI 96           | 09.00 | 06.03 | PR: 1KK,1KV,1KE         |                |        |   |                            |  |
|  | 1.9 TDI quattro 96   | 09.00 | 06.03 | PR: 1KK,1KV,1KE         |                |        |   |                            |  |
|  | S3                   | 08.98 | 06.03 | PR: 1KF                 | 13.0460-2820.2 | 602820 |   | 20961 17,6 /S TRW          |  |
|  |                      |       |       |                         | 13.0470-2820.2 | LD2820 |   | 20961 17,6 /S TRW          |  |
|  |                      |       |       |                         |                |        |   |                            |  |
|  |                      |       |       |                         |                |        |   |                            |  |
|    | 1.6 75               | 09.96 | 06.03 | PR: 1KK,1KV             | 24.0109-0123.1 | 409123 |   | 230 9,0 7,0 +S +B          |  |
|  | 1.8 92               | 09.96 | 06.03 | PR: 1KK,1KV             | 24.0309-0123.1 | 509123 |   | 230 9,0 7,0 +S +B PD       |  |
|  | 1.8 T 110            | 12.96 | 06.03 | PR: 1KK,1KV             |                |        |   |                            |  |
|  | 1.8 T 132            | 12.98 | 06.03 | PR: 1KK,1KV             |                |        |   |                            |  |
|  | 1.9 TDI 66           | 09.96 | 06.01 | PR: 1KK,1KV             |                |        |   |                            |  |
|  | 1.9 TDI 74           | 09.00 | 06.03 | PR: 1KK,1KV             |                |        |   |                            |  |
|  | 1.9 TDI 81           | 03.97 | 06.01 | PR: 1KK,1KV             |                |        |   |                            |  |
|  | 1.9 TDI 96           | 09.00 | 06.03 | PR: 1KK,1KV             |                |        |   |                            |  |
|  | 1.8 T quattro 110    | 08.98 | 06.03 | PR: 1KE                 | 24.0109-0133.1 | 409133 |   | 239 8,9 7,0 +S +B          |  |
|  | 1.8 T quattro 132    | 10.98 | 06.03 | PR: 1KE                 | 24.0309-0133.1 | 509133 |   | 239 8,9 7,0 +S +B PD       |  |
|  | 1.9 TDI quattro 96   | 09.00 | 06.03 | PR: 1KE                 |                |        |   |                            |  |
|  | S3                   | 08.98 | 06.03 | PR: 1KF                 | 24.0122-0163.1 | 422163 |   | 256 22,0 20,0 V L +B       |  |
|  |                      |       |       |                         | 24.0322-0163.1 | 522163 |   | 256 22,0 20,0 V L +B PD    |  |
|  |                      |       |       |                         |                |        |   |                            |  |
|  |                      |       |       |                         |                |        |   |                            |  |
|    | 1.6 75               | 09.96 | 06.03 |                         | 24.0741-1107.3 | 360042 | 2  | Radsensor                  |  |
|  | 1.8 92               | 09.96 | 06.03 |                         |                |        |   |                            |  |
|  | 1.8 T 110            | 12.96 | 06.03 |                         |                |        |   |                            |  |
|  | 1.8 T 132            | 12.98 | 06.03 |                         |                |        |   |                            |  |
|  | 1.8 T quattro 110    | 08.98 | 08.00 |                         |                |        |   |                            |  |
|  | 1.8 T quattro 132    | 10.98 | 08.00 |                         |                |        |   |                            |  |
|  | 1.9 TDI 66           | 09.96 | 06.01 |                         |                |        |   |                            |  |
|  | 1.9 TDI 74           | 09.00 | 06.03 |                         |                |        |   |                            |  |
|  | 1.9 TDI 81           | 03.97 | 06.01 |                         |                |        |   |                            |  |
|  | 1.9 TDI 96           | 09.00 | 06.03 |                         |                |        |   |                            |  |
|  | S3                   | 08.98 | 08.00 |                         |                |        |   |                            |  |
|  | 1.8 T quattro 110    | 09.00 | 06.03 |                         | 24.0711-1365.3 | 360172 | 2  | Radsensor L=226            |  |
|  | 1.8 T quattro 132    | 09.00 | 06.03 |                         |                |        |   |                            |  |
|  | 1.9 TDI quattro 96   | 09.00 | 06.03 |                         |                |        |   |                            |  |
| S3   | 09.00                | 06.03 |       |                         |                |        |   |                            |  |
| <b>AUDI A3 / A3 (8P) Sportback (03-13)</b>   |                      |       |       |                         |                |        |   |                            |  |
|    | 1.2 TSI 77           | 04.10 | 08.13 | PR: 1ZF,1ZM             | 13.0460-7117.2 | 607117 |   | 23131 19,6 +/WK VW         |  |
|  | 1.4 TFSI 92          | 07.07 | 08.13 | PR: 1ZF,1ZM             | 13.0470-7117.2 | LD7117 |   | 23131 19,6 +/WK VW         |  |
|  | 1.6 75               | 05.03 | 08.13 | PR: 1ZF,1ZM             |                |        |   |                            |  |
|  | 1.6 FSI 85           | 08.03 | 08.13 | PR: 1ZF,1ZM             |                |        |   |                            |  |
|  | 1.6 TDI 66           | 05.09 | 08.13 | PR: 1ZF,1ZM             |                |        |   |                            |  |
|  | 1.6 TDI 77           | 05.09 | 08.13 | PR: 1ZF,1ZM             |                |        |   |                            |  |
|  | 1.8 TFSI 118         | 01.07 | 08.13 | PR: 1ZF,1ZM             |                |        |   |                            |  |
|  | 1.8 TFSI quattro 118 | 05.08 | 08.13 | PR: 1ZF,1ZM             |                |        |   |                            |  |
|  | 1.9 TDI 77           | 06.03 | 08.13 | PR: 1ZF,1ZM             |                |        |   |                            |  |
|  | 2.0 FSI 110          | 05.03 | 08.13 | PR: 1ZF,1ZM             |                |        |   |                            |  |
|  | 2.0 TDI 100          | 05.03 | 08.13 | PR: 1ZF,1ZM             |                |        |   |                            |  |
|  | 2.0 TDI 103          | 05.03 | 08.13 | PR: 1ZF,1ZM             |                |        |   |                            |  |
|  | 2.0 TDI 120          | 06.06 | 06.08 | PR: 1ZF,1ZM             |                |        |   |                            |  |
|  | 2.0 TDI 125          | 03.06 | 08.13 | PR: 1ZF,1ZM             |                |        |   |                            |  |
|  | 2.0 TDI quattro 100  | 05.03 | 08.13 | PR: 1ZF,1ZM             |                |        |   |                            |  |
|  | 2.0 TDI quattro 103  | 08.04 | 08.13 | PR: 1ZF,1ZM             |                |        |   |                            |  |
|  | 2.0 TDI quattro 125  | 03.06 | 08.13 | PR: 1ZF,1ZM             |                |        |   |                            |  |
|  | 2.0 TFSI 147         | 06.04 | 08.13 | PR: 1ZF,1ZM             |                |        |   |                            |  |
|  | 2.0 TFSI quattro 147 | 06.04 | 08.13 | PR: 1ZF,1ZM             |                |        |   |                            |  |
|  | 3.2 quattro 184      | 03.06 | 08.13 | PR: 1ZF,1ZM             |                |        |   |                            |  |
|  | 1.2 TSI 77           | 04.10 | 08.13 | PR: 1ZE,1ZP,1ZD,1LJ,1ZA | 13.0460-7184.2 | 607184 |   | 23587 20,6 +/WK ATE        |  |
|  | 1.4 TFSI 92          | 07.07 | 08.13 | PR: 1ZE,1ZP,1ZD,1LJ,1ZA | 13.0470-7184.2 | LD7184 |   | 23587 20,6 +/WK ATE        |  |
|  | 1.6 75               | 05.03 | 08.13 | PR: 1ZE,1ZP,1ZD,1LJ,1ZA |                |        |   |                            |  |
|  | 1.6 FSI 85           | 08.03 | 08.13 | PR: 1ZE,1ZP,1ZD,1LJ,1ZA |                |        |   |                            |  |
|  | 1.6 TDI 66           | 05.09 | 08.13 | PR: 1ZE,1ZP,1ZD,1LJ,1ZA |                |        |   |                            |  |



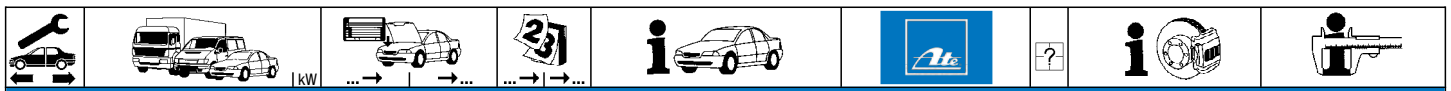







|          |                      |       |                 |                         |                |        |                         |                         |     |
|--|----------------------|-------|-----------------|-------------------------|----------------|--------|-------------------------|-------------------------|-----|
| AUDI A3 / A3 (8P) Sportback (03-13)  |                      |       |                 |                         |                |        |                         |                         |     |
|    | 1.6 TDI 77           | 05.09 | 08.13           | PR: 1ZE,1ZP,1ZD,1LJ,1ZA | 13.0460-7184.2 | 607184 |                         | 23587 20,6 +WK          | ATE |
|  | 1.8 TFSI 118         | 01.07 | 08.13           | PR: 1ZE,1ZP,1ZD,1LJ,1ZA | 13.0470-7184.2 | LD7184 |                         | 23587 20,6 +WK          | ATE |
|  | 1.8 TFSI quattro 118 | 05.08 | 08.13           | PR: 1ZE,1ZP,1ZD,1LJ,1ZA |                |        |                         |                         |     |
|  | 1.9 TDI 77           | 06.03 | 08.13           | PR: 1ZE,1ZP,1ZD,1LJ,1ZA |                |        |                         |                         |     |
|  | 2.0 FSI 110          | 05.03 | 08.13           | PR: 1ZE,1ZP,1ZD,1LJ,1ZA |                |        |                         |                         |     |
|  | 2.0 TDI 100          | 05.03 | 08.13           | PR: 1ZE,1ZP,1ZD,1LJ,1ZA |                |        |                         |                         |     |
|  | 2.0 TDI 103          | 05.03 | 08.13           | PR: 1ZE,1ZP,1ZD,1LJ,1ZA |                |        |                         |                         |     |
|  | 2.0 TDI 120          | 06.06 | 06.08           | PR: 1ZE,1ZP,1ZD,1LJ,1ZA |                |        |                         |                         |     |
|  | 2.0 TDI 125          | 03.06 | 08.13           | PR: 1ZE,1ZP,1ZD,1LJ,1ZA |                |        |                         |                         |     |
|  | 2.0 TDI quattro 100  | 05.03 | 08.13           | PR: 1ZE,1ZP,1ZD,1LJ,1ZA |                |        |                         |                         |     |
|  | 2.0 TDI quattro 103  | 08.04 | 08.13           | PR: 1ZE,1ZP,1ZD,1LJ,1ZA |                |        |                         |                         |     |
|  | 2.0 TDI quattro 125  | 03.06 | 08.13           | PR: 1ZE,1ZP,1ZD,1LJ,1ZA |                |        |                         |                         |     |
|  | 2.0 TFSI 147         | 06.04 | 08.13           | PR: 1ZE,1ZP,1ZD,1LJ,1ZA |                |        |                         |                         |     |
|  | 2.0 TFSI quattro 147 | 06.04 | 08.13           | PR: 1ZE,1ZP,1ZD,1LJ,1ZA |                |        |                         |                         |     |
|  | 3.2 quattro 184      | 03.06 | 08.13           | PR: 1ZE,1ZP,1ZD,1LJ,1ZA |                |        |                         |                         |     |
|  | 1.2 TSI 77           | 04.10 | 08.13           | PR: 1LK                 | 13.0460-7200.2 | 607200 |                         | 23801 20,3 +WK          | ATE |
|  | 1.4 TFSI 92          | 07.07 | 08.13           | PR: 1LK                 | 13.0470-7200.2 | LD7200 |                         | 23801 20,3 +WK          | ATE |
|  | 1.6 75               | 05.03 | 08.13           | PR: 1LK                 |                |        |                         |                         |     |
|  | 1.6 FSI 85           | 08.03 | 08.13           | PR: 1LK                 |                |        |                         |                         |     |
|  | 1.6 TDI 66           | 05.09 | 08.13           | PR: 1LK                 |                |        |                         |                         |     |
| 1.6 TDI 77   | 05.09                | 08.13 | PR: 1LK         |                         |                |        |                         |                         |     |
| 1.8 TFSI 118   | 01.07                | 08.13 | PR: 1LK         |                         |                |        |                         |                         |     |
| 1.8 TFSI quattro 118   | 05.08                | 08.13 | PR: 1LK         |                         |                |        |                         |                         |     |
| 1.9 TDI 77   | 06.03                | 08.13 | PR: 1LK         |                         |                |        |                         |                         |     |
| 2.0 FSI 110  | 05.03                | 08.13 | PR: 1LK         |                         |                |        |                         |                         |     |
| 2.0 TDI 100  | 05.03                | 08.13 | PR: 1LK         |                         |                |        |                         |                         |     |
| 2.0 TDI 103  | 05.03                | 08.13 | PR: 1LK         |                         |                |        |                         |                         |     |
| 2.0 TDI 120  | 06.06                | 06.08 | PR: 1LK         |                         |                |        |                         |                         |     |
| 2.0 TDI 125  | 03.06                | 08.13 | PR: 1LK         |                         |                |        |                         |                         |     |
| 2.0 TDI quattro 100  | 05.03                | 08.13 | PR: 1LK         |                         |                |        |                         |                         |     |
| 2.0 TDI quattro 103  | 08.04                | 08.13 | PR: 1LK         |                         |                |        |                         |                         |     |
| 2.0 TDI quattro 125  | 03.06                | 08.13 | PR: 1LK         |                         |                |        |                         |                         |     |
| 2.0 TFSI 147   | 06.04                | 08.13 | PR: 1LK         |                         |                |        |                         |                         |     |
| 2.0 TFSI quattro 147   | 06.04                | 08.13 | PR: 1LK         |                         |                |        |                         |                         |     |
| 3.2 quattro 184  | 03.06                | 08.13 | PR: 1LK         |                         |                |        |                         |                         |     |
| S3 188   | 07.08                | 08.13 | PR: 1ZK         | 13.0460-7227.2          | 607227         |        | 23801 20,3 +WK          | ATE                     |     |
| S3 195   | 11.06                | 08.13 | PR: 1ZK         | 13.0470-7227.2          | LD7227         |        | 23801 20,4 +WK          | ATE                     |     |
| RS 3 250   | 04.11                | 08.13 | PR: 1LG         | 13.0460-4833.2          | 604833         |        | 24098 17,1 WE           | BRE                     |     |
|  |                      |       |                 | 24.8190-0302.2          | 620302         | 1      | Warnkontakt L=367,4mm   |                         |     |
|   | 1.2 TSI 77           | 04.10 | 08.13           | PR: 1ZF,1ZM             | 24.0122-0210.1 | 422210 |                         | 280 22,0 19,0 V L +S +B |     |
|  | 1.4 TFSI 92          | 07.07 | 08.13           | PR: 1ZF,1ZM             | 24.0322-0210.1 | 522210 |                         | 280 22,0 19,0 V L +S +B | PD  |
|  | 1.6 75               | 05.03 | 08.13           | PR: 1ZF,1ZM             |                |        |                         |                         |     |
|  | 1.6 FSI 85           | 08.03 | 08.13           | PR: 1ZF,1ZM             |                |        |                         |                         |     |
|  | 1.6 TDI 66           | 05.09 | 08.13           | PR: 1ZF,1ZM             |                |        |                         |                         |     |
|  | 1.6 TDI 77           | 05.09 | 08.13           | PR: 1ZF,1ZM             |                |        |                         |                         |     |
|  | 1.8 TFSI 118         | 01.07 | 08.13           | PR: 1ZF,1ZM             |                |        |                         |                         |     |
|  | 1.8 TFSI quattro 118 | 05.08 | 08.13           | PR: 1ZF,1ZM             |                |        |                         |                         |     |
|  | 1.9 TDI 77           | 06.03 | 08.13           | PR: 1ZF,1ZM             |                |        |                         |                         |     |
|  | 2.0 FSI 110          | 05.03 | 08.13           | PR: 1ZF,1ZM             |                |        |                         |                         |     |
|  | 2.0 TDI 100          | 05.03 | 08.13           | PR: 1ZF,1ZM             |                |        |                         |                         |     |
|  | 2.0 TDI 103          | 05.03 | 08.13           | PR: 1ZF,1ZM             |                |        |                         |                         |     |
|  | 2.0 TDI 120          | 06.06 | 06.08           | PR: 1ZF,1ZM             |                |        |                         |                         |     |
|  | 2.0 TDI 125          | 03.06 | 08.13           | PR: 1ZF,1ZM             |                |        |                         |                         |     |
|  | 2.0 TDI quattro 100  | 05.03 | 08.13           | PR: 1ZF,1ZM             |                |        |                         |                         |     |
|  | 2.0 TDI quattro 103  | 08.04 | 08.13           | PR: 1ZF,1ZM             |                |        |                         |                         |     |
|  | 2.0 TDI quattro 125  | 03.06 | 08.13           | PR: 1ZF,1ZM             |                |        |                         |                         |     |
|  | 2.0 TFSI 147         | 06.04 | 08.13           | PR: 1ZF,1ZM             |                |        |                         |                         |     |
|  | 2.0 TFSI quattro 147 | 06.04 | 08.13           | PR: 1ZF,1ZM             |                |        |                         |                         |     |
|  | 3.2 quattro 184      | 03.06 | 08.13           | PR: 1ZF,1ZM             |                |        |                         |                         |     |
| 1.2 TSI 77   | 04.10                | 08.13 | PR: 1ZE,1ZP     | 24.0125-0145.1          | 425145         |        | 288 25,0 22,0 V L +S +B |                         |     |
| 1.4 TFSI 92  | 07.07                | 08.13 | PR: 1ZE,1ZP     | 24.0325-0145.1          | 525145         |        | 288 25,0 22,0 V L +S +B | PD                      |     |
| 1.6 75   | 05.03                | 08.13 | PR: 1ZE,1ZP     |                         |                |        |                         |                         |     |
| 1.6 FSI 85   | 08.03                | 08.13 | PR: 1ZE,1ZP     |                         |                |        |                         |                         |     |
| 1.6 TDI 66   | 05.09                | 08.13 | PR: 1ZE,1ZP     |                         |                |        |                         |                         |     |
| 1.6 TDI 77   | 05.09                | 08.13 | PR: 1ZE,1ZP     |                         |                |        |                         |                         |     |
| 1.8 TFSI 118   | 01.07                | 08.13 | PR: 1ZE,1ZP     |                         |                |        |                         |                         |     |
| 1.8 TFSI quattro 118   | 05.08                | 08.13 | PR: 1ZE,1ZP     |                         |                |        |                         |                         |     |
| 1.9 TDI 77   | 06.03                | 08.13 | PR: 1ZE,1ZP     |                         |                |        |                         |                         |     |
| 2.0 FSI 110  | 05.03                | 08.13 | PR: 1ZE,1ZP     |                         |                |        |                         |                         |     |
| 2.0 TDI 100  | 05.03                | 08.13 | PR: 1ZE,1ZP     |                         |                |        |                         |                         |     |
| 2.0 TDI 103  | 05.03                | 08.13 | PR: 1ZE,1ZP     |                         |                |        |                         |                         |     |
| 2.0 TDI 120  | 06.06                | 06.08 | PR: 1ZE,1ZP     |                         |                |        |                         |                         |     |
| 2.0 TDI 125  | 03.06                | 08.13 | PR: 1ZE,1ZP     |                         |                |        |                         |                         |     |
| 2.0 TDI quattro 100  | 05.03                | 08.13 | PR: 1ZE,1ZP     |                         |                |        |                         |                         |     |
| 2.0 TDI quattro 103  | 08.04                | 08.13 | PR: 1ZE,1ZP     |                         |                |        |                         |                         |     |
| 2.0 TDI quattro 125  | 03.06                | 08.13 | PR: 1ZE,1ZP     |                         |                |        |                         |                         |     |
| 2.0 TFSI 147   | 06.04                | 08.13 | PR: 1ZE,1ZP     |                         |                |        |                         |                         |     |
| 2.0 TFSI quattro 147   | 06.04                | 08.13 | PR: 1ZE,1ZP     |                         |                |        |                         |                         |     |
| 3.2 quattro 184  | 07.03                | 08.13 | PR: 1ZE,1ZP     |                         |                |        |                         |                         |     |
| 1.2 TSI 77   | 04.10                | 08.13 | PR: 1ZD,1LJ,1ZA | 24.0125-0158.1          | 425158         |        | 312 25,0 22,0 V L +S +B |                         |     |
| 1.4 TFSI 92  | 07.07                | 08.13 | PR: 1ZD,1LJ,1ZA | 24.0325-0158.1          | 525158         |        | 312 25,0 22,0 V L +S +B | PD                      |     |
| 1.6 75   | 05.03                | 08.13 | PR: 1ZD,1LJ,1ZA |                         |                |        |                         |                         |     |
| 1.6 FSI 85   | 08.03                | 08.13 | PR: 1ZD,1LJ,1ZA |                         |                |        |                         |                         |     |
| 1.6 TDI 66   | 05.09                | 08.13 | PR: 1ZD,1LJ,1ZA |                         |                |        |                         |                         |     |
| 1.6 TDI 77   | 05.09                | 08.13 | PR: 1ZD,1LJ,1ZA |                         |                |        |                         |                         |     |
| 1.8 TFSI 118   | 01.07                | 08.13 | PR: 1ZD,1LJ,1ZA |                         |                |        |                         |                         |     |
| 1.8 TFSI quattro 118   | 05.08                | 08.13 | PR: 1ZD,1LJ,1ZA |                         |                |        |                         |                         |     |





**AUDI A3 / A3 (8P) Sportback (03-13)**

|  |  |  |   |   |  |   |
|--|--|--|---|---|--|---|
|    | 1.9 TDI 77<br>2.0 FSI 110<br>2.0 TDI 100<br>2.0 TDI 103<br>2.0 TDI 120<br>2.0 TDI 125<br>2.0 TDI quattro 100<br>2.0 TDI quattro 103<br>2.0 TDI quattro 125<br>2.0 TFSI 147<br>2.0 TFSI quattro 147<br>3.2 quattro 184  |  | 06.03 08.13 PR: 1ZD,1LJ,1ZA<br>05.03 08.13 PR: 1ZD,1LJ,1ZA<br>05.03 08.13 PR: 1ZD,1LJ,1ZA<br>06.06 06.08 PR: 1ZD,1LJ,1ZA<br>03.06 08.13 PR: 1ZD,1LJ,1ZA<br>05.03 08.13 PR: 1ZD,1LJ,1ZA<br>08.04 08.13 PR: 1ZD,1LJ,1ZA<br>03.06 08.13 PR: 1ZD,1LJ,1ZA<br>06.04 08.13 PR: 1ZD,1LJ,1ZA<br>06.04 08.13 PR: 1ZD,1LJ,1ZA<br>07.03 08.13 PR: 1ZD,1LJ,1ZA   | 24.0125-0158.1 425158<br>24.0325-0158.1 525158                          |  | 312 25,0 22,0 VL +S +B<br>312 25,0 22,0 VL +S +B PD                       |
|  | 1.2 TSI 77<br>1.4 TFSI 92<br>1.6 75<br>1.6 FSI 85<br>1.6 TDI 66<br>1.6 TDI 77<br>1.8 TFSI 118<br>1.8 TFSI quattro 118<br>1.9 TDI 77<br>2.0 FSI 110<br>2.0 TDI 100<br>2.0 TDI 103<br>2.0 TDI 120<br>2.0 TDI 125<br>2.0 TDI quattro 100<br>2.0 TDI quattro 103<br>2.0 TDI quattro 125<br>2.0 TFSI 147<br>2.0 TFSI quattro 147<br>3.2 quattro 184<br>S3 188<br>S3 195             |  | 04.10 08.13 PR: 1LK<br>07.07 08.13 PR: 1LK<br>05.03 08.13 PR: 1LK<br>08.03 08.13 PR: 1LK<br>05.09 08.13 PR: 1LK<br>05.09 08.13 PR: 1LK<br>01.07 08.13 PR: 1LK<br>05.08 08.13 PR: 1LK<br>06.03 08.13 PR: 1LK<br>05.03 08.13 PR: 1LK<br>05.03 08.13 PR: 1LK<br>06.06 06.08 PR: 1LK<br>03.06 08.13 PR: 1LK<br>05.03 08.13 PR: 1LK<br>08.04 08.13 PR: 1LK<br>03.06 08.13 PR: 1LK<br>06.04 08.13 PR: 1LK<br>06.04 08.13 PR: 1LK<br>07.03 08.13 PR: 1LK<br>07.08 08.13 PR: 1ZK<br>11.06 08.13 PR: 1ZK | 24.0130-0115.1 430115<br>24.0330-0115.1 530115                          |  | 345 30,0 27,0 VL +B<br>345 30,0 27,0 VL +B PD                             |
|    | 1.2 TSI 77<br>1.4 TFSI 92<br>1.6 75<br>1.6 FSI 85<br>1.6 TDI 66<br>1.6 TDI 77<br>1.8 TFSI 118<br>1.8 TFSI quattro 118<br>1.9 TDI 77<br>2.0 FSI 110<br>2.0 TDI 100<br>2.0 TDI 103<br>2.0 TDI 120<br>2.0 TDI 125<br>2.0 TDI quattro 100<br>2.0 TDI quattro 103<br>2.0 TDI quattro 125<br>2.0 TFSI 147<br>2.0 TFSI quattro 147<br>3.2 quattro 184<br>RS 3 250<br>S3 188<br>S3 195 |  | 04.10 08.13<br>07.07 08.13<br>05.03 08.13<br>08.03 08.13<br>05.09 08.13<br>05.09 08.13<br>01.07 08.13<br>05.08 08.13<br>06.03 08.13<br>05.03 08.13<br>05.03 08.13<br>06.06 06.08<br>03.06 08.13<br>05.03 08.13<br>08.04 08.13<br>03.06 08.13<br>06.04 08.13<br>06.04 08.13<br>07.03 08.13<br>04.11 08.13<br>07.08 08.13<br>11.06 08.13  | 24.0711-5271.3 360301<br>24.0711-5272.3 360302                          | <input type="checkbox"/><br><input type="checkbox"/> | Radsensor<br>Radsensor  |
|  | 1.2 TSI 77<br>1.4 TFSI 92<br>1.6 75<br>1.6 FSI 85<br>1.6 TDI 66<br>1.6 TDI 77<br>1.8 TFSI 118<br>1.9 TDI 77<br>2.0 FSI 110<br>2.0 TDI 100<br>2.0 TDI 103<br>2.0 TDI 120<br>2.0 TDI 125<br>2.0 TDI quattro 100<br>2.0 TDI quattro 103<br>2.0 TDI quattro 125<br>2.0 TFSI 147  |  | 04.10 08.13 PR: 1KQ,1KD<br>07.07 08.13 PR: 1KQ,1KD<br>05.03 08.13 PR: 1KQ,1KD<br>08.03 08.13 PR: 1KQ,1KD<br>05.09 08.13 PR: 1KQ,1KD<br>05.09 08.13 PR: 1KQ,1KD<br>01.07 08.13 PR: 1KQ,1KD<br>06.03 08.13 PR: 1KQ,1KD<br>05.03 08.13 PR: 1KQ,1KD<br>05.03 08.13 PR: 1KQ,1KD<br>06.06 06.08 PR: 1KQ,1KD<br>03.06 08.13 PR: 1KQ,1KD<br>06.04 08.13 PR: 1KQ,1KD   | 13.0460-2820.2 602820<br>13.0470-2820.2 LD2820                          |  | 20961 17,6 /S TRW<br>20961 17,6 /S TRW                                    |
|  | 1.2 TSI 77<br>1.4 TFSI 92<br>1.6 75<br>1.6 FSI 85<br>1.6 TDI 66<br>1.6 TDI 77<br>1.8 TFSI 118<br>1.8 TFSI quattro 118<br>1.9 TDI 77<br>2.0 FSI 110<br>2.0 TDI 100<br>2.0 TDI 103<br>2.0 TDI 120<br>2.0 TDI 125<br>2.0 TDI quattro 100<br>2.0 TDI quattro 103   |  | 04.10 08.13 PR: 1KE,1KZ<br>07.07 08.13 PR: 1KE,1KZ<br>05.03 08.13 PR: 1KE,1KZ<br>08.03 08.13 PR: 1KE,1KZ<br>05.09 08.13 PR: 1KE,1KZ<br>05.09 08.13 PR: 1KE,1KZ<br>01.07 08.13 PR: 1KE,1KZ<br>05.08 08.13 PR: 1KF,1KJ,1KU<br>06.03 08.13 PR: 1KE,1KZ<br>05.03 08.13 PR: 1KE,1KZ<br>05.03 08.13 PR: 1KE,1KZ<br>06.06 06.08 PR: 1KE,1KZ<br>03.06 08.13 PR: 1KE,1KZ<br>05.03 08.13 PR: 1KF,1KJ,1KU<br>08.04 08.13 PR: 1KF,1KJ,1KU   | 13.0460-2880.2 602880<br>13.0470-2880.2 LD2880<br>13.0460-0259.2 610259 |  | 23914 17,1 /WE/Zub/S TRW<br>23914 17,1 /WE/Zub/S TRW<br>Belagsatz-Zubehör |

|          |                      |       |             |                 |                |        |                      |                        |     |
|--|----------------------|-------|-------------|-----------------|----------------|--------|----------------------|------------------------|-----|
| AUDI A3 / A3 (8P) Sportback (03-13)  |                      |       |             |                 |                |        |                      |                        |     |
|    | 2.0 TDI quattro 125  | 03.06 | 08.13       | PR: 1KF,1KJ,1KU | 13.0460-2880.2 | 602880 |                      | 23914 17,1 /WE/Zub/S   | TRW |
|  | 2.0 TFSI 147         | 06.04 | 08.13       | PR: 1KE,1KZ     | 13.0470-2880.2 | LD2880 |                      | 23914 17,1 /WE/Zub/S   | TRW |
|  | 2.0 TFSI quattro 147 | 06.04 | 08.13       | PR: 1KF,1KJ,1KU | 13.0460-0259.2 | 610259 |                      | Belagsatz-Zubehör      |     |
|  | 3.2 quattro 184      | 07.03 | 08.13       | PR: 1KF,1KJ,1KU |                |        |                      |                        |     |
|  | 3.2 quattro 184      | 07.03 | 08.13       | PR: 2EA         | 13.0460-2880.2 | 602880 |                      | 23914 17,1 /WE/Zub/S   | TRW |
|  | RS 3 250             | 04.11 | 08.13       |                 | 13.0470-2880.2 | LD2880 |                      | 23914 17,1 /WE/Zub/S   | TRW |
|  | S3 188               | 07.08 | 08.13       | PR: 1KW         | 13.0460-0035.2 | 610035 |                      | Belagsatz-Zubehör      |     |
|  | S3 195               | 11.06 | 08.13       | PR: 1KW         |                |        |                      |                        |     |
|  | 1.2 TSI 77           | 04.10 | 08.13       | PR: 1KS         | 13.0460-3858.2 | 603858 |                      | 24563 17,7 /Zub/S      | BOS |
|  | 1.4 TFSI 92          | 07.07 | 08.13       | PR: 1KS         | 13.0470-3858.2 | LD3858 |                      | 24563 17,7 /Zub/S      | BOS |
|  | 1.6 75               | 05.03 | 08.13       | PR: 1KS         |                |        |                      |                        |     |
|  | 1.6 FSI 85           | 08.03 | 08.13       | PR: 1KS         |                |        |                      |                        |     |
|  | 1.6 TDI 66           | 05.09 | 08.13       | PR: 1KS         |                |        |                      |                        |     |
|  | 1.6 TDI 77           | 05.09 | 08.13       | PR: 1KS         |                |        |                      |                        |     |
|  | 1.8 TFSI 118         | 01.07 | 08.13       | PR: 1KS         |                |        |                      |                        |     |
|  | 1.8 TFSI quattro 118 | 05.08 | 08.13       | PR: 1KS         |                |        |                      |                        |     |
|  | 1.9 TDI 77           | 06.03 | 08.13       | PR: 1KS         |                |        |                      |                        |     |
|  | 2.0 FSI 110          | 05.03 | 08.13       | PR: 1KS         |                |        |                      |                        |     |
|  | 2.0 TDI 100          | 05.03 | 08.13       | PR: 1KS         |                |        |                      |                        |     |
|  | 2.0 TDI 103          | 05.03 | 08.13       | PR: 1KS         |                |        |                      |                        |     |
|  | 2.0 TDI 120          | 06.06 | 06.08       | PR: 1KS         |                |        |                      |                        |     |
|  | 2.0 TDI 125          | 03.06 | 08.13       | PR: 1KS         |                |        |                      |                        |     |
|  | 2.0 TDI quattro 100  | 05.03 | 08.13       | PR: 1KS         |                |        |                      |                        |     |
| 2.0 TDI quattro 103  | 08.04                | 08.13 | PR: 1KS     |                 |                |        |                      |                        |     |
| 2.0 TDI quattro 125  | 03.06                | 08.13 | PR: 1KS     |                 |                |        |                      |                        |     |
| 2.0 TFSI 147   | 06.04                | 08.13 | PR: 1KS     |                 |                |        |                      |                        |     |
| 2.0 TFSI quattro 147   | 06.04                | 08.13 | PR: 1KS     |                 |                |        |                      |                        |     |
| 3.2 quattro 184  | 07.03                | 08.13 | PR: 1KS     |                 |                |        |                      |                        |     |
|    | 1.2 TSI 77           | 04.10 | 08.13       | PR: 1KQ,1KD     | 24.0110-0277.1 | 410277 |                      | 253 10,0 8,0 +S +B     |     |
|  | 1.4 TFSI 92          | 07.07 | 08.13       | PR: 1KQ,1KD     | 24.0310-0277.1 | 510277 |                      | 253 10,0 8,0 +S +B PD  |     |
|  | 1.6 75               | 05.03 | 08.13       | PR: 1KQ,1KD     |                |        |                      |                        |     |
|  | 1.6 FSI 85           | 08.03 | 08.13       | PR: 1KQ,1KD     |                |        |                      |                        |     |
|  | 1.6 TDI 66           | 05.09 | 08.13       | PR: 1KQ,1KD     |                |        |                      |                        |     |
|  | 1.6 TDI 77           | 05.09 | 08.13       | PR: 1KQ,1KD     |                |        |                      |                        |     |
|  | 1.8 TFSI 118         | 01.07 | 08.13       | PR: 1KQ,1KD     |                |        |                      |                        |     |
|  | 1.9 TDI 77           | 06.03 | 08.13       | PR: 1KQ,1KD     |                |        |                      |                        |     |
|  | 2.0 FSI 110          | 05.03 | 08.13       | PR: 1KQ,1KD     |                |        |                      |                        |     |
|  | 2.0 TDI 100          | 05.03 | 08.13       | PR: 1KQ,1KD     |                |        |                      |                        |     |
|  | 2.0 TDI 103          | 05.03 | 08.13       | PR: 1KQ,1KD     |                |        |                      |                        |     |
|  | 2.0 TDI 120          | 06.06 | 06.08       | PR: 1KQ,1KD     |                |        |                      |                        |     |
|  | 2.0 TDI 125          | 03.06 | 08.13       | PR: 1KQ,1KD     |                |        |                      |                        |     |
|  | 2.0 TFSI 147         | 06.04 | 08.13       | PR: 1KQ,1KD     |                |        |                      |                        |     |
|  | 1.2 TSI 77           | 04.10 | 08.13       | PR: 1KZ         | 24.0112-0169.1 | 412169 |                      | 282 12,0 10,0 +S +B    |     |
|  | 1.4 TFSI 92          | 07.07 | 08.13       | PR: 1KZ         | 24.0312-0169.1 | 512169 |                      | 282 12,0 10,0 +S +B PD |     |
|  | 1.6 75               | 05.03 | 08.13       | PR: 1KZ         |                |        |                      |                        |     |
|  | 1.6 FSI 85           | 08.03 | 08.13       | PR: 1KZ         |                |        |                      |                        |     |
|  | 1.6 TDI 66           | 05.09 | 08.13       | PR: 1KZ         |                |        |                      |                        |     |
|  | 1.6 TDI 77           | 05.09 | 08.13       | PR: 1KZ         |                |        |                      |                        |     |
|  | 1.8 TFSI 118         | 01.07 | 08.13       | PR: 1KZ         |                |        |                      |                        |     |
|  | 1.8 TFSI quattro 118 | 05.08 | 08.13       | PR: 1KJ         |                |        |                      |                        |     |
|  | 1.9 TDI 77           | 06.03 | 08.13       | PR: 1KZ         |                |        |                      |                        |     |
| 2.0 FSI 110  | 05.03                | 08.13 | PR: 1KZ     |                 |                |        |                      |                        |     |
| 2.0 TDI 100  | 05.03                | 08.13 | PR: 1KZ     |                 |                |        |                      |                        |     |
| 2.0 TDI 103  | 05.03                | 08.13 | PR: 1KZ     |                 |                |        |                      |                        |     |
| 2.0 TDI 120  | 06.06                | 06.08 | PR: 1KZ     |                 |                |        |                      |                        |     |
| 2.0 TDI 125  | 03.06                | 08.13 | PR: 1KZ     |                 |                |        |                      |                        |     |
| 2.0 TDI quattro 100  | 05.03                | 08.13 | PR: 1KJ,1KU |                 |                |        |                      |                        |     |
| 2.0 TDI quattro 103  | 08.04                | 08.13 | PR: 1KJ,1KU |                 |                |        |                      |                        |     |
| 2.0 TDI quattro 125  | 03.06                | 08.13 | PR: 1KJ,1KU |                 |                |        |                      |                        |     |
| 2.0 TFSI 147   | 06.04                | 08.13 | PR: 1KZ     |                 |                |        |                      |                        |     |
| 2.0 TFSI quattro 147   | 06.04                | 08.13 | PR: 1KJ,1KU |                 |                |        |                      |                        |     |
| 3.2 quattro 184  | 07.03                | 08.13 | PR: 1KJ     |                 |                |        |                      |                        |     |
| 1.2 TSI 77   | 04.10                | 08.13 | PR: 1KE     | 24.0112-0158.1  | 412158         |        | 256 12,0 10,0 +S +B  |                        |     |
| 1.4 TFSI 92  | 07.07                | 08.13 | PR: 1KE     | 24.0312-0158.1  | 512158         |        | 256 12,0 10,0 +B PD  |                        |     |
| 1.6 75   | 05.03                | 08.13 | PR: 1KE     |                 |                |        |                      |                        |     |
| 1.6 FSI 85   | 08.03                | 08.13 | PR: 1KE     |                 |                |        |                      |                        |     |
| 1.6 TDI 66   | 05.09                | 08.13 | PR: 1KE     |                 |                |        |                      |                        |     |
| 1.6 TDI 77   | 05.09                | 08.13 | PR: 1KE     |                 |                |        |                      |                        |     |
| 1.8 TFSI 118   | 01.07                | 08.13 | PR: 1KE     |                 |                |        |                      |                        |     |
| 1.9 TDI 77   | 06.03                | 08.13 | PR: 1KE     |                 |                |        |                      |                        |     |
| 2.0 FSI 110  | 05.03                | 08.13 | PR: 1KE     |                 |                |        |                      |                        |     |
| 2.0 TDI 100  | 05.03                | 08.13 | PR: 1KE     |                 |                |        |                      |                        |     |
| 2.0 TDI 103  | 05.03                | 08.13 | PR: 1KE     |                 |                |        |                      |                        |     |
| 2.0 TDI 120  | 06.06                | 06.08 | PR: 1KE     |                 |                |        |                      |                        |     |
| 2.0 TDI 125  | 03.06                | 08.13 | PR: 1KE     |                 |                |        |                      |                        |     |
| 2.0 TDI quattro 100  | 05.03                | 08.13 | PR: 1KF     |                 |                |        |                      |                        |     |
| 2.0 TDI quattro 103  | 08.04                | 08.13 | PR: 1KF     |                 |                |        |                      |                        |     |
| 2.0 TDI quattro 125  | 03.06                | 08.13 | PR: 1KF     |                 |                |        |                      |                        |     |
| 2.0 TFSI 147   | 06.04                | 08.13 | PR: 1KE     |                 |                |        |                      |                        |     |
| 2.0 TFSI quattro 147   | 06.04                | 08.13 | PR: 1KF     |                 |                |        |                      |                        |     |
| 3.2 quattro 184  | 07.03                | 08.13 | PR: 2EA     | 24.0122-0219.1  | 422219         |        | 310 22,0 20,0 VL +B  |                        |     |
| RS 3 250   | 04.11                | 08.13 |             |                 |                |        |                      |                        |     |
| S3 188   | 07.08                | 08.13 | PR: 1KW     |                 |                |        |                      |                        |     |
| S3 195   | 11.06                | 08.13 | PR: 1KW     |                 |                |        |                      |                        |     |
| 1.2 TSI 77   | 04.10                | 08.13 | PR: 1KS     | 24.0110-0356.1  | 410356         |        | 272 9,7 8,0 +S +B    |                        |     |
| 1.4 TFSI 92  | 07.07                | 08.13 | PR: 1KS     | 24.0310-0356.1  | 510356         |        | 272 9,7 8,0 +S +B PD |                        |     |

### AUDI A3 / A3 (8P) Sportback (03-13)

|                  |                  |          |       |       |         |                |                |  |   |        |  |                        |
|------------------|------------------|----------|-------|-------|---------|----------------|----------------|--|---|--------|--|------------------------|
|                  | 1.6              | 75       | 05.03 | 08.13 | PR: 1KS | 24.0110-0356.1 | 410356         |  | 272 9,7 8,0 +S +B<br>272 9,7 8,0 +S +B PD |        |  |                        |
|                  | 1.6 FSI          | 85       | 08.03 | 08.13 | PR: 1KS | 24.0310-0356.1 | 510356         |  |   |        |  |                        |
|                  | 1.6 TDI          | 66       | 05.09 | 08.13 | PR: 1KS |                |                |  |   |        |  |                        |
|                  | 1.6 TDI          | 77       | 05.09 | 08.13 | PR: 1KS |                |                |  |   |        |  |                        |
|                  | 1.8 TFSI         | 118      | 01.07 | 08.13 | PR: 1KS |                |                |  |   |        |  |                        |
|                  | 1.8 TFSI quattro | 118      | 05.08 | 08.13 | PR: 1KS |                |                |  |   |        |  |                        |
|                  | 1.9 TDI          | 77       | 06.03 | 08.13 | PR: 1KS |                |                |  |   |        |  |                        |
|                  | 2.0 FSI          | 110      | 05.03 | 08.13 | PR: 1KS |                |                |  |   |        |  |                        |
|                  | 2.0 TDI          | 100      | 05.03 | 08.13 | PR: 1KS |                |                |  |   |        |  |                        |
|                  | 2.0 TDI          | 103      | 05.03 | 08.13 | PR: 1KS |                |                |  |   |        |  |                        |
|                  | 2.0 TDI          | 120      | 06.06 | 06.08 | PR: 1KS |                |                |  |   |        |  |                        |
|                  | 2.0 TDI          | 125      | 03.06 | 08.13 | PR: 1KS |                |                |  |   |        |  |                        |
|                  | 2.0 TDI quattro  | 100      | 05.03 | 08.13 | PR: 1KS |                |                |  |   |        |  |                        |
|                  | 2.0 TDI quattro  | 103      | 08.04 | 08.13 | PR: 1KS |                |                |  |   |        |  |                        |
|                  | 2.0 TDI quattro  | 125      | 03.06 | 08.13 | PR: 1KS |                |                |  |   |        |  |                        |
|                  | 2.0 TFSI         | 147      | 06.04 | 08.13 | PR: 1KS |                |                |  |   |        |  |                        |
|                  | 2.0 TFSI quattro | 147      | 06.04 | 08.13 | PR: 1KS |                |                |  |   |        |  |                        |
|                  | 3.2 quattro      | 184      | 07.03 | 08.13 | PR: 1KS |                |                |  |   |        |  |                        |
|                  |                  | 1.2 TSI  | 77    | 04.10 | 08.13   |                | 24.0711-6231.3 |  |   | 360305 |  | Radsensor<br>Radsensor |
|                  |                  | 1.4 TFSI | 92    | 07.07 | 08.13   |                | 24.0711-6232.3 |  |   | 360306 |  |                        |
| 1.6              |                  | 75       | 05.03 | 08.13 |         |                |                |  |   |        |  |                        |
| 1.6 FSI          |                  | 85       | 08.03 | 08.13 |         |                |                |  |   |        |  |                        |
| 1.6 TDI          |                  | 66       | 05.09 | 08.13 |         |                |                |  |   |        |  |                        |
| 1.6 TDI          |                  | 77       | 05.09 | 08.13 |         |                |                |  |   |        |  |                        |
| 1.8 TFSI         |                  | 118      | 01.07 | 08.13 |         |                |                |  |   |        |  |                        |
| 1.9 TDI          |                  | 77       | 06.03 | 08.13 |         |                |                |  |   |        |  |                        |
| 2.0 FSI          |                  | 110      | 05.03 | 08.13 |         |                |                |  |   |        |  |                        |
| 2.0 TDI          |                  | 100      | 05.03 | 08.13 |         |                |                |  |   |        |  |                        |
| 2.0 TDI          |                  | 103      | 05.03 | 08.13 |         |                |                |  |   |        |  |                        |
| 2.0 TDI          |                  | 120      | 06.06 | 06.08 |         |                |                |  |   |        |  |                        |
| 2.0 TDI          |                  | 125      | 03.06 | 08.13 |         |                |                |  |   |        |  |                        |
| 2.0 TFSI         |                  | 147      | 06.04 | 08.13 |         |                |                |  |   |        |  |                        |
| 1.8 TFSI quattro |                  | 118      | 05.08 | 08.13 |         | 24.0711-5271.3 | 360301         |  |   |        |  |                        |
| 2.0 TDI quattro  |                  | 100      | 05.03 | 08.13 |         | 24.0711-5272.3 | 360302         |  |   |        |  |                        |
| 2.0 TDI quattro  |                  | 103      | 08.04 | 08.13 |         |                |                |  |   |        |  |                        |
| 2.0 TDI quattro  | 125              | 03.06    | 08.13 |       |         |                |                |  |   |        |  |                        |
| 2.0 TFSI quattro | 147              | 06.04    | 08.13 |       |         |                |                |  |   |        |  |                        |
| 3.2 quattro      | 184              | 07.03    | 08.13 |       |         |                |                |  |   |        |  |                        |
| RS 3             | 250              | 04.11    | 08.13 |       |         |                |                |  |   |        |  |                        |
| S3               | 188              | 07.08    | 08.13 |       |         |                |                |  |   |        |  |                        |
| S3               | 195              | 11.06    | 08.13 |       |         |                |                |  |   |        |  |                        |

### AUDI A3 (8P) Cabrio (08-13)

|          |          |       |       |             |                |                |   |  |   |   |
|----------|----------|-------|-------|-------------|----------------|----------------|---|--|---|---|
|          | 1.2 TSI  | 77    | 03.10 | 08.13       | PR: 1ZF        | 13.0460-7117.2 | 607117  |  | 23131 19,6 +/WK<br>23131 19,6 +/WK                    | VW<br>VW  |
|          | 1.4 TFSI | 92    | 01.11 | 08.13       | PR: 1ZF        | 13.0470-7117.2 | LD7117  |  |   |   |
|          | 1.6      | 75    | 09.08 | 08.13       | PR: 1ZF        |                |   |  |   |   |
|          | 1.6 TDI  | 77    | 05.09 | 08.13       | PR: 1ZF        |                |   |  |   |   |
|          | 1.8 TFSI | 118   | 04.08 | 08.13       | PR: 1ZF        |                |   |  |   |   |
|          | 1.9 TDI  | 77    | 04.08 | 08.13       | PR: 1ZF        |                |   |  |   |   |
|          | 2.0 TDI  | 100   | 04.08 | 08.13       | PR: 1ZF        |                |   |  |   |   |
|          | 2.0 TDI  | 103   | 04.08 | 08.13       | PR: 1ZF        |                |   |  |   |   |
|          | 2.0 TFSI | 147   | 04.08 | 08.13       | PR: 1ZF        |                |   |  |   |   |
|          | 1.2 TSI  | 77    | 03.10 | 08.13       | PR: 1LJ,1ZE    | 13.0460-7184.2 | 607184  |  |   |   |
| 1.4 TFSI | 92       | 01.11 | 08.13 | PR: 1LJ,1ZE | 13.0470-7184.2 | LD7184         |   |  |   |   |
| 1.6      | 75       | 09.08 | 08.13 | PR: 1LJ,1ZE |                |                |   |  |   |   |
| 1.6 TDI  | 77       | 05.09 | 08.13 | PR: 1LJ,1ZE |                |                |   |  |   |   |
| 1.8 TFSI | 118      | 04.08 | 08.13 | PR: 1LJ,1ZE |                |                |   |  |   |   |
| 1.9 TDI  | 77       | 04.08 | 08.13 | PR: 1LJ,1ZE |                |                |   |  |   |   |
| 2.0 TDI  | 100      | 04.08 | 08.13 | PR: 1LJ,1ZE |                |                |   |  |   |   |
| 2.0 TDI  | 103      | 04.08 | 08.13 | PR: 1LJ,1ZE |                |                |   |  |   |   |
| 2.0 TFSI | 147      | 04.08 | 08.13 | PR: 1LJ,1ZE |                |                |   |  |   |   |
|          | 1.2 TSI  | 77    | 03.10 | 08.13       | PR: 1ZE        | 24.0122-0210.1 | 422210  |  | 280 22,0 19,0 V L +S +B<br>280 22,0 19,0 V L +S +B PD |   |
|          | 1.4 TFSI | 92    | 01.11 | 08.13       | PR: 1ZF        | 24.0322-0210.1 | 522210  |  |   |   |
|          | 1.6      | 75    | 09.08 | 08.13       | PR: 1ZF        |                |   |  |   |   |
|          | 1.6 TDI  | 77    | 05.09 | 08.13       | PR: 1ZF        |                |   |  |   |   |
|          | 1.8 TFSI | 118   | 04.08 | 08.13       | PR: 1ZF        |                |   |  |   |   |
|          | 1.9 TDI  | 77    | 04.08 | 08.13       | PR: 1ZF        |                |   |  |   |   |
|          | 2.0 TDI  | 100   | 04.08 | 08.13       | PR: 1ZF        |                |   |  |   |   |
|          | 2.0 TDI  | 103   | 04.08 | 08.13       | PR: 1ZF        |                |   |  |   |   |
|          | 2.0 TFSI | 147   | 04.08 | 08.13       | PR: 1ZF        |                |   |  |   |   |
|          | 1.2 TSI  | 77    | 03.10 | 08.13       | PR: 1ZE        | 24.0125-0145.1 | 425145  |  |   | 288 25,0 22,0 V L +S +B<br>288 25,0 22,0 V L +S +B PD |
| 1.4 TFSI | 92       | 01.11 | 08.13 | PR: 1ZE     | 24.0325-0145.1 | 525145         |   |  |   |   |
| 1.6      | 75       | 09.08 | 08.13 | PR: 1ZE     |                |                |   |  |   |   |
| 1.6 TDI  | 77       | 05.09 | 08.13 | PR: 1ZE     |                |                |   |  |   |   |
| 1.8 TFSI | 118      | 04.08 | 08.13 | PR: 1ZE     |                |                |   |  |   |   |
| 1.9 TDI  | 77       | 04.08 | 08.13 | PR: 1ZE     |                |                |   |  |   |   |
| 2.0 TDI  | 100      | 04.08 | 08.13 | PR: 1ZE     |                |                |   |  |   |   |
| 2.0 TDI  | 103      | 04.08 | 08.13 | PR: 1ZE     |                |                |   |  |   |   |
| 2.0 TFSI | 147      | 04.08 | 08.13 | PR: 1ZE     |                |                |   |  |   |   |
| 1.2 TSI  | 77       | 03.10 | 08.13 | PR: 1LJ     | 24.0125-0158.1 | 425158         | 312 25,0 22,0 V L +S +B<br>312 25,0 22,0 V L +S +B PD |  |   |   |
| 1.4 TFSI | 92       | 01.11 | 08.13 | PR: 1LJ     | 24.0325-0158.1 | 525158         |   |  |   |   |
| 1.6      | 75       | 09.08 | 08.13 | PR: 1LJ     |                |                |   |  |   |   |
| 1.6 TDI  | 77       | 05.09 | 08.13 | PR: 1LJ     |                |                |   |  |   |   |
| 1.8 TFSI | 118      | 04.08 | 08.13 | PR: 1LJ     |                |                |   |  |   |   |
| 1.9 TDI  | 77       | 04.08 | 08.13 | PR: 1LJ     |                |                |   |  |   |   |
| 2.0 TDI  | 100      | 04.08 | 08.13 | PR: 1LJ     |                |                |   |  |   |   |
| 2.0 TDI  | 103      | 04.08 | 08.13 | PR: 1LJ     |                |                |   |  |   |   |

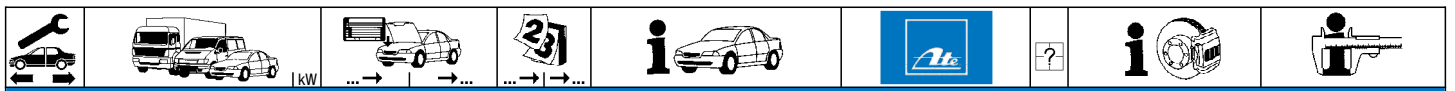

**AUDI A3 (8P) Cabrio (08-13)**

|  |          |     |  |       |       |         |                |        |  |                           |
|--|----------|-----|--|-------|-------|---------|----------------|--------|--|---------------------------|
|  | 2.0 TFSI | 147 |  | 04.08 | 08.13 | PR: 1LJ | 24.0125-0158.1 | 425158 |  | 312 25,0 22,0 VL +S +B    |
|  |          |     |  |       |       |         | 24.0325-0158.1 | 525158 |  | 312 25,0 22,0 VL +S +B PD |
|  | 1.2 TSI  | 77  |  | 03.10 | 08.13 |         | 24.0711-5271.3 | 360301 |  | Radsensor                 |
|  | 1.4 TFSI | 92  |  | 01.11 | 08.13 |         | 24.0711-5272.3 | 360302 |  | Radsensor                 |
|  | 1.6      | 75  |  | 09.08 | 08.13 |         |                |        |  |                           |
|  | 1.6 TDI  | 77  |  | 05.09 | 08.13 |         |                |        |  |                           |
|  | 1.8 TFSI | 118 |  | 04.08 | 08.13 |         |                |        |  |                           |
|  | 1.9 TDI  | 77  |  | 04.08 | 08.13 |         |                |        |  |                           |
|  | 2.0 TDI  | 100 |  | 04.08 | 08.13 |         |                |        |  |                           |
|  | 2.0 TDI  | 103 |  | 04.08 | 08.13 |         |                |        |  |                           |
|  | 2.0 TFSI | 147 |  | 04.08 | 08.13 |         |                |        |  |                           |
|  | 1.2 TSI  | 77  |  | 03.10 | 08.13 | PR: 1KD | 13.0460-2820.2 | 602820 |  | 20961 17,6 /S TRW         |
|  | 1.4 TFSI | 92  |  | 01.11 | 08.13 | PR: 1KD | 13.0470-2820.2 | LD2820 |  | 20961 17,6 /S TRW         |
|  | 1.6      | 75  |  | 09.08 | 08.13 | PR: 1KD |                |        |  |                           |
|  | 1.6 TDI  | 77  |  | 05.09 | 08.13 | PR: 1KD |                |        |  |                           |
|  | 1.8 TFSI | 118 |  | 04.08 | 08.13 | PR: 1KD |                |        |  |                           |
|  | 1.9 TDI  | 77  |  | 04.08 | 08.13 | PR: 1KD |                |        |  |                           |
|  | 2.0 TDI  | 100 |  | 04.08 | 08.13 | PR: 1KD |                |        |  |                           |
|  | 2.0 TDI  | 103 |  | 04.08 | 08.13 | PR: 1KD |                |        |  |                           |
|  | 2.0 TFSI | 147 |  | 04.08 | 08.13 | PR: 1KD |                |        |  |                           |
|  | 1.2 TSI  | 77  |  | 03.10 | 08.13 | PR: 1KZ | 13.0460-2880.2 | 602880 |  | 23914 17,1 /WE/Zub/S TRW  |
|  | 1.4 TFSI | 92  |  | 01.11 | 08.13 | PR: 1KZ | 13.0470-2880.2 | LD2880 |  | 23914 17,1 /WE/Zub/S TRW  |
|  | 1.6      | 75  |  | 09.08 | 08.13 | PR: 1KZ | 13.0460-0259.2 | 610259 |  | Belagsatz-Zubehör         |
|  | 1.6 TDI  | 77  |  | 05.09 | 08.13 | PR: 1KZ |                |        |  |                           |
|  | 1.8 TFSI | 118 |  | 04.08 | 08.13 | PR: 1KZ |                |        |  |                           |
|  | 1.9 TDI  | 77  |  | 04.08 | 08.13 | PR: 1KZ |                |        |  |                           |
|  | 2.0 TDI  | 100 |  | 04.08 | 08.13 | PR: 1KZ |                |        |  |                           |
|  | 2.0 TDI  | 103 |  | 04.08 | 08.13 | PR: 1KZ |                |        |  |                           |
|  | 2.0 TFSI | 147 |  | 04.08 | 08.13 | PR: 1KZ |                |        |  |                           |
|  | 1.2 TSI  | 77  |  | 03.10 | 08.13 | PR: 1KS | 13.0460-3858.2 | 603858 |  | 24563 17,7 /Zub/S BOS     |
|  | 1.4 TFSI | 92  |  | 01.11 | 08.13 | PR: 1KS | 13.0470-3858.2 | LD3858 |  | 24563 17,7 /Zub/S BOS     |
|  | 1.6      | 75  |  | 09.08 | 08.13 | PR: 1KS |                |        |  |                           |
|  | 1.6 TDI  | 77  |  | 05.09 | 08.13 | PR: 1KS |                |        |  |                           |
|  | 1.8 TFSI | 118 |  | 04.08 | 08.13 | PR: 1KS |                |        |  |                           |
|  | 1.9 TDI  | 77  |  | 04.08 | 08.13 | PR: 1KS |                |        |  |                           |
|  | 2.0 TDI  | 100 |  | 04.08 | 08.13 | PR: 1KS |                |        |  |                           |
|  | 2.0 TDI  | 103 |  | 04.08 | 08.13 | PR: 1KS |                |        |  |                           |
|  | 2.0 TFSI | 147 |  | 04.08 | 08.13 | PR: 1KS |                |        |  |                           |
|  | 1.2 TSI  | 77  |  | 03.10 | 08.13 | PR: 1KD | 24.0110-0277.1 | 410277 |  | 253 10,0 8,0 +S +B        |
|  | 1.4 TFSI | 92  |  | 01.11 | 08.13 | PR: 1KD | 24.0310-0277.1 | 510277 |  | 253 10,0 8,0 +S +B PD     |
|  | 1.6      | 75  |  | 09.08 | 08.13 | PR: 1KD |                |        |  |                           |
|  | 1.6 TDI  | 77  |  | 05.09 | 08.13 | PR: 1KD |                |        |  |                           |
|  | 1.8 TFSI | 118 |  | 04.08 | 08.13 | PR: 1KD |                |        |  |                           |
|  | 1.9 TDI  | 77  |  | 04.08 | 08.13 | PR: 1KD |                |        |  |                           |
|  | 2.0 TDI  | 100 |  | 04.08 | 08.13 | PR: 1KD |                |        |  |                           |
|  | 2.0 TDI  | 103 |  | 04.08 | 08.13 | PR: 1KD |                |        |  |                           |
|  | 2.0 TFSI | 147 |  | 04.08 | 08.13 | PR: 1KD |                |        |  |                           |
|  | 1.2 TSI  | 77  |  | 03.10 | 08.13 | PR: 1KZ | 24.0112-0169.1 | 412169 |  | 282 12,0 10,0 +S +B       |
|  | 1.4 TFSI | 92  |  | 01.11 | 08.13 | PR: 1KZ | 24.0312-0169.1 | 512169 |  | 282 12,0 10,0 +S +B PD    |
|  | 1.6      | 75  |  | 09.08 | 08.13 | PR: 1KZ |                |        |  |                           |
|  | 1.6 TDI  | 77  |  | 05.09 | 08.13 | PR: 1KZ |                |        |  |                           |
|  | 1.8 TFSI | 118 |  | 04.08 | 08.13 | PR: 1KZ |                |        |  |                           |
|  | 1.9 TDI  | 77  |  | 04.08 | 08.13 | PR: 1KZ |                |        |  |                           |
|  | 2.0 TDI  | 100 |  | 04.08 | 08.13 | PR: 1KZ |                |        |  |                           |
|  | 2.0 TDI  | 103 |  | 04.08 | 08.13 | PR: 1KZ |                |        |  |                           |
|  | 2.0 TFSI | 147 |  | 04.08 | 08.13 | PR: 1KZ |                |        |  |                           |
|  | 1.2 TSI  | 77  |  | 03.10 | 08.13 | PR: 1KS | 24.0110-0356.1 | 410356 |  | 272 9,7 8,0 +S +B         |
|  | 1.4 TFSI | 92  |  | 01.11 | 08.13 | PR: 1KS | 24.0310-0356.1 | 510356 |  | 272 9,7 8,0 +S +B PD      |
|  | 1.6      | 75  |  | 09.08 | 08.13 | PR: 1KS |                |        |  |                           |
|  | 1.6 TDI  | 77  |  | 05.09 | 08.13 | PR: 1KS |                |        |  |                           |
|  | 1.8 TFSI | 118 |  | 04.08 | 08.13 | PR: 1KS |                |        |  |                           |
|  | 1.9 TDI  | 77  |  | 04.08 | 08.13 | PR: 1KS |                |        |  |                           |
|  | 2.0 TDI  | 100 |  | 04.08 | 08.13 | PR: 1KS |                |        |  |                           |
|  | 2.0 TDI  | 103 |  | 04.08 | 08.13 | PR: 1KS |                |        |  |                           |
|  | 2.0 TFSI | 147 |  | 04.08 | 08.13 | PR: 1KS |                |        |  |                           |
|  | 1.2 TSI  | 77  |  | 03.10 | 08.13 |         | 24.0711-6231.3 | 360305 |  | Radsensor                 |
|  | 1.4 TFSI | 92  |  | 01.11 | 08.13 |         | 24.0711-6232.3 | 360306 |  | Radsensor                 |
|  | 1.6      | 75  |  | 09.08 | 08.13 |         |                |        |  |                           |
|  | 1.6 TDI  | 77  |  | 05.09 | 08.13 |         |                |        |  |                           |
|  | 1.8 TFSI | 118 |  | 04.08 | 08.13 |         |                |        |  |                           |
|  | 1.9 TDI  | 77  |  | 04.08 | 08.13 |         |                |        |  |                           |
|  | 2.0 TDI  | 100 |  | 04.08 | 08.13 |         |                |        |  |                           |
|  | 2.0 TDI  | 103 |  | 04.08 | 08.13 |         |                |        |  |                           |
|  | 2.0 TFSI | 147 |  | 04.08 | 08.13 |         |                |        |  |                           |

**AUDI A3 / A3 (8V) Sportback (12-)**

|  |                 |     |  |       |  |                     |                |        |   |                       |
|--|-----------------|-----|--|-------|--|---------------------|----------------|--------|---|-----------------------|
|  | 1.0 TFSI        | 85  |  | 07.16 |  | PR: 1ZA,1ZD,1ZE,1ZP | 13.0460-2785.2 | 602785 |   | 25683 20,4 +/WK/S TRW |
|  | 1.2 TFSI        | 77  |  | 02.13 |  | PR: 1ZA,1ZD,1ZE,1ZP | 13.0470-2785.2 | LD2785 |   | 25683 20,4 +/WK/S TRW |
|  | 1.2 TFSI        | 81  |  | 05.14 |  | PR: 1ZA,1ZD,1ZE,1ZP | 24.8190-0065.2 | 620065 | 1 | Warnkontakt L=172mm   |
|  | 1.4 TFSI        | 90  |  | 08.12 |  | PR: 1ZA,1ZD,1ZE,1ZP |                |        |   |                       |
|  | 1.4 TFSI        | 92  |  | 09.13 |  | PR: 1ZA,1ZD,1ZE,1ZP |                |        |   |                       |
|  | 1.4 TFSI        | 103 |  | 10.12 |  | PR: 1ZA,1ZD,1ZE,1ZP |                |        |   |                       |
|  | 1.4 TFSI        | 110 |  | 05.14 |  | PR: 1ZA,1ZD,1ZE,1ZP |                |        |   |                       |
|  | 1.4 TFSI e-tron | 110 |  | 02.14 |  | PR: 1ZA,1ZD,1ZE,1ZP |                |        |   |                       |
|  | 1.4 TFSI g-tron | 81  |  | 02.14 |  | PR: 1ZA,1ZD,1ZE,1ZP |                |        |   |                       |





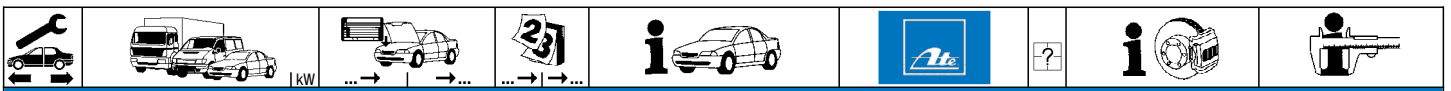

**AUDI A3 / A3 (8V) Sportback (12-)**

|                  |                  |       |             |                     |                |        |   |  |   |            |
|------------------|------------------|-------|-------------|---------------------|----------------|--------|---|--|---|------------|
|                  | 1.6 TDI          | 77    | 09.12       | PR: 1ZA,1ZD,1ZE,1ZP | 13.0460-2785.2 | 602785 | 1 |  | 25683 20,4 +/WK/S<br>25683 20,4 +/WK/S<br>Warnkontakt L=172mm | TRW<br>TRW |
|                  | 1.6 TDI          | 81    | 08.13       | PR: 1ZA,1ZD,1ZE,1ZP | 13.0470-2785.2 | LD2785 |   |  |   |            |
|                  | 1.6 TDI quattro  | 81    | 05.15       | PR: 1ZA,1ZD,1ZE,1ZP | 24.8190-0065.2 | 620065 |   |  |   |            |
|                  | 1.8 TFSI         | 132   | 08.12       | PR: 1ZA,1ZD,1ZE,1ZP |                |        |   |  |   |            |
|                  | 1.8 TFSI quattro | 132   | 08.12       | PR: 1ZA,1ZD,1ZE,1ZP |                |        |   |  |   |            |
|                  | 2.0 TDI          | 81    | 01.13       | PR: 1ZA,1ZD,1ZE,1ZP |                |        |   |  |   |            |
|                  | 2.0 TDI          | 100   | 05.13       | PR: 1ZA,1ZD,1ZE,1ZP |                |        |   |  |   |            |
|                  | 2.0 TDI          | 105   | 08.12       | PR: 1ZA,1ZD,1ZE,1ZP |                |        |   |  |   |            |
|                  | 2.0 TDI          | 110   | 08.12       | PR: 1ZA,1ZD,1ZE,1ZP |                |        |   |  |   |            |
|                  | 2.0 TDI          | 135   | 12.12       | PR: 1ZA,1ZD,1ZE,1ZP |                |        |   |  |   |            |
|                  | 2.0 TDI quattro  | 110   | 10.12       | PR: 1ZA,1ZD,1ZE,1ZP |                |        |   |  |   |            |
|                  | 2.0 TDI quattro  | 135   | 12.12       | PR: 1ZA,1ZD,1ZE,1ZP |                |        |   |  |   |            |
|                  | 2.0 TFSI         | 140   | 05.16       | PR: 1ZA,1ZD,1ZE,1ZP |                |        |   |  |   |            |
|                  | 2.0 TFSI quattro | 140   | 05.16       | PR: 1ZA,1ZD,1ZE,1ZP |                |        |   |  |   |            |
|                  | S3               | 206   | 02.13       | PR: 1LC,1LJ         | 13.0460-2764.2 | 602764 |   |  |   |            |
|                  | S3               | 210   | 05.14       | PR: 1LC,1LJ         | 13.0470-2764.2 | LD2764 |   |  |   |            |
|                  | S3               | 221   | 10.12       | PR: 1LC,1LJ         | 24.8190-0065.2 | 620065 |   |  |   |            |
|                  | S3               | 228   | 06.16       | PR: 1LC,1LJ         |                |        |   |  |   |            |
|                  | 1.2 TFSI         | 77    | 02.13       | PR: 1ZF             | 13.0460-7303.2 | 607303 |   |  |   |            |
|                  | 1.2 TFSI         | 81    | 05.14       | PR: 1ZF             | 13.0470-7303.2 | LD7303 |   |  |   |            |
| 1.4 TFSI         | 90               | 08.12 | PR: 1ZF     |                     |                |        |   |  |   |            |
| 1.4 TFSI         | 92               | 09.13 | PR: 1ZF     |                     |                |        |   |  |   |            |
| 1.4 TFSI         | 103              | 10.12 | PR: 1ZF     |                     |                |        |   |  |   |            |
| 1.4 TFSI         | 110              | 05.14 | PR: 1ZF     |                     |                |        |   |  |   |            |
| 1.4 TFSI e-tron  | 110              | 02.14 | PR: 1ZF     |                     |                |        |   |  |   |            |
| 1.4 TFSI g-tron  | 81               | 02.14 | PR: 1ZF     |                     |                |        |   |  |   |            |
| 1.6 TDI          | 77               | 09.12 | PR: 1ZF     |                     |                |        |   |  |   |            |
| 1.6 TDI          | 81               | 08.13 | PR: 1ZF     |                     |                |        |   |  |   |            |
| 1.6 TDI quattro  | 81               | 05.15 | PR: 1ZF     |                     |                |        |   |  |   |            |
| 1.8 TFSI         | 132              | 08.12 | PR: 1ZF     |                     |                |        |   |  |   |            |
| 1.8 TFSI quattro | 132              | 08.12 | PR: 1ZF     |                     |                |        |   |  |   |            |
| 2.0 TDI          | 81               | 01.13 | PR: 1ZF     |                     |                |        |   |  |   |            |
| 2.0 TDI          | 100              | 05.13 | PR: 1ZF     |                     |                |        |   |  |   |            |
| 2.0 TDI          | 105              | 08.12 | PR: 1ZF     |                     |                |        |   |  |   |            |
| 2.0 TDI          | 110              | 08.12 | PR: 1ZF     |                     |                |        |   |  |   |            |
| 2.0 TDI          | 135              | 12.12 | PR: 1ZF     |                     |                |        |   |  |   |            |
| 2.0 TDI quattro  | 110              | 10.12 | PR: 1ZF     |                     |                |        |   |  |   |            |
| 2.0 TDI quattro  | 135              | 12.12 | PR: 1ZF     |                     |                |        |   |  |   |            |
|                  | 1.0 TFSI         | 85    | 07.16       | PR: 1ZA,1ZD         | 24.0125-0158.1 | 425158 |   |  | 312 25,0 22,0 V L +S +B<br>312 25,0 22,0 V L +S +B PD         |            |
|                  | 1.2 TFSI         | 77    | 02.13       | PR: 1ZA,1ZD         | 24.0325-0158.1 | 525158 |   |  |   |            |
|                  | 1.2 TFSI         | 81    | 05.14       | PR: 1ZA,1ZD         |                |        |   |  |   |            |
|                  | 1.4 TFSI         | 90    | 08.12       | PR: 1ZA,1ZD         |                |        |   |  |   |            |
|                  | 1.4 TFSI         | 92    | 09.13       | PR: 1ZA,1ZD         |                |        |   |  |   |            |
|                  | 1.4 TFSI         | 103   | 10.12       | PR: 1ZA,1ZD         |                |        |   |  |   |            |
|                  | 1.4 TFSI         | 110   | 05.14       | PR: 1ZA,1ZD         |                |        |   |  |   |            |
|                  | 1.4 TFSI e-tron  | 110   | 02.14       | PR: 1ZA,1ZD         |                |        |   |  |   |            |
|                  | 1.4 TFSI g-tron  | 81    | 02.14       | PR: 1ZA,1ZD         |                |        |   |  |   |            |
|                  | 1.6 TDI          | 77    | 09.12       | PR: 1ZA,1ZD         |                |        |   |  |   |            |
|                  | 1.6 TDI          | 81    | 08.13       | PR: 1ZA,1ZD         |                |        |   |  |   |            |
|                  | 1.6 TDI quattro  | 81    | 05.15       | PR: 1ZA,1ZD         |                |        |   |  |   |            |
|                  | 1.8 TFSI         | 132   | 08.12       | PR: 1ZA,1ZD         |                |        |   |  |   |            |
|                  | 1.8 TFSI quattro | 132   | 08.12       | PR: 1ZA,1ZD         |                |        |   |  |   |            |
|                  | 2.0 TDI          | 81    | 01.13       | PR: 1ZA,1ZD         |                |        |   |  |   |            |
|                  | 2.0 TDI          | 100   | 05.13       | PR: 1ZA,1ZD         |                |        |   |  |   |            |
|                  | 2.0 TDI          | 105   | 08.12       | PR: 1ZA,1ZD         |                |        |   |  |   |            |
|                  | 2.0 TDI          | 110   | 08.12       | PR: 1ZA,1ZD         |                |        |   |  |   |            |
|                  | 2.0 TDI          | 135   | 12.12       | PR: 1ZA,1ZD         |                |        |   |  |   |            |
|                  | 2.0 TDI quattro  | 110   | 10.12       | PR: 1ZA,1ZD         |                |        |   |  |   |            |
| 2.0 TDI quattro  | 135              | 12.12 | PR: 1ZA,1ZD |                     |                |        |   |  |   |            |
| 2.0 TFSI         | 140              | 05.16 | PR: 1ZA,1ZD |                     |                |        |   |  |   |            |
| 2.0 TFSI quattro | 140              | 05.16 | PR: 1ZA,1ZD |                     |                |        |   |  |   |            |
| 1.2 TFSI         | 77               | 02.13 | PR: 1ZF     | 24.0124-0258.1      | 424258         |        |   |  |   |            |
| 1.2 TFSI         | 81               | 05.14 | PR: 1ZF     |                     |                |        |   |  |   |            |
| 1.4 TFSI         | 90               | 08.12 | PR: 1ZF     |                     |                |        |   |  |   |            |
| 1.4 TFSI         | 92               | 09.13 | PR: 1ZF     |                     |                |        |   |  |   |            |
| 1.4 TFSI         | 103              | 10.12 | PR: 1ZF     |                     |                |        |   |  |   |            |
| 1.4 TFSI         | 110              | 05.14 | PR: 1ZF     |                     |                |        |   |  |   |            |
| 1.4 TFSI e-tron  | 110              | 02.14 | PR: 1ZF     |                     |                |        |   |  |   |            |
| 1.4 TFSI g-tron  | 81               | 02.14 | PR: 1ZF     |                     |                |        |   |  |   |            |
| 1.6 TDI          | 77               | 09.12 | PR: 1ZF     |                     |                |        |   |  |   |            |
| 1.6 TDI          | 81               | 08.13 | PR: 1ZF     |                     |                |        |   |  |   |            |
| 1.6 TDI quattro  | 81               | 05.15 | PR: 1ZF     |                     |                |        |   |  |   |            |
| 1.8 TFSI         | 132              | 08.12 | PR: 1ZF     |                     |                |        |   |  |   |            |
| 1.8 TFSI quattro | 132              | 08.12 | PR: 1ZF     |                     |                |        |   |  |   |            |
| 2.0 TDI          | 81               | 01.13 | PR: 1ZF     |                     |                |        |   |  |   |            |
| 2.0 TDI          | 100              | 05.13 | PR: 1ZF     |                     |                |        |   |  |   |            |
| 2.0 TDI          | 105              | 08.12 | PR: 1ZF     |                     |                |        |   |  |   |            |
| 2.0 TDI          | 110              | 08.12 | PR: 1ZF     |                     |                |        |   |  |   |            |
| 2.0 TDI          | 135              | 12.12 | PR: 1ZF     |                     |                |        |   |  |   |            |
| 2.0 TDI quattro  | 110              | 10.12 | PR: 1ZF     |                     |                |        |   |  |   |            |
| 2.0 TDI quattro  | 135              | 12.12 | PR: 1ZF     |                     |                |        |   |  |   |            |
| 1.0 TFSI         | 85               | 07.16 | PR: 1ZE,1ZP | 24.0125-0145.1      | 425145         |        |   |  |   |            |
| 1.2 TFSI         | 77               | 02.13 | PR: 1ZE,1ZP | 24.0325-0145.1      | 525145         |        |   |  |   |            |
| 1.2 TFSI         | 81               | 05.14 | PR: 1ZE,1ZP |                     |                |        |   |  |   |            |
| 1.4 TFSI         | 90               | 08.12 | PR: 1ZE,1ZP |                     |                |        |   |  |   |            |
| 1.4 TFSI         | 92               | 09.13 | PR: 1ZE,1ZP |                     |                |        |   |  |   |            |
| 1.4 TFSI         | 103              | 10.12 | PR: 1ZE,1ZP |                     |                |        |   |  |   |            |

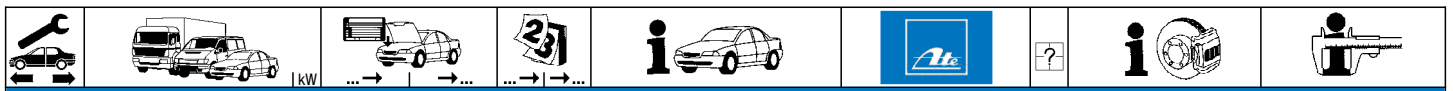

**AUDI A3 / A3 (8V) Sportback (12-)**

|                  |                  |       |                 |                |                |        |  |  |
|------------------|------------------|-------|-----------------|----------------|----------------|--------|--|--|
|                  | 1.4 TFSI         | 110   | 05.14           | PR: 1ZE,1ZP    | 24.0125-0145.1 | 425145 |  | 288 25,0 22,0 VL +S +B                                     |
|                  | 1.4 TFSI e-tron  | 110   | 02.14           | PR: 1ZE,1ZP    | 24.0325-0145.1 | 525145 |  | 288 25,0 22,0 VL +S +B PD                                  |
|                  | 1.4 TFSI g-tron  | 81    | 02.14           | PR: 1ZE,1ZP    |                |        |  |  |
|                  | 1.6 TDI          | 77    | 09.12           | PR: 1ZE,1ZP    |                |        |  |  |
|                  | 1.6 TDI          | 81    | 08.13           | PR: 1ZE,1ZP    |                |        |  |  |
|                  | 1.6 TDI quattro  | 81    | 05.15           | PR: 1ZE,1ZP    |                |        |  |  |
|                  | 1.8 TFSI         | 132   | 08.12           | PR: 1ZE,1ZP    |                |        |  |  |
|                  | 1.8 TFSI quattro | 132   | 08.12           | PR: 1ZE,1ZP    |                |        |  |  |
|                  | 2.0 TDI          | 81    | 01.13           | PR: 1ZE,1ZP    |                |        |  |  |
|                  | 2.0 TDI          | 100   | 05.13           | PR: 1ZE,1ZP    |                |        |  |  |
|                  | 2.0 TDI          | 105   | 08.12           | PR: 1ZE,1ZP    |                |        |  |  |
|                  | 2.0 TDI          | 110   | 08.12           | PR: 1ZE,1ZP    |                |        |  |  |
|                  | 2.0 TDI          | 135   | 12.12           | PR: 1ZE,1ZP    |                |        |  |  |
|                  | 2.0 TDI quattro  | 110   | 10.12           | PR: 1ZE,1ZP    |                |        |  |  |
|                  | 2.0 TDI quattro  | 135   | 12.12           | PR: 1ZE,1ZP    |                |        |  |  |
| 2.0 TFSI         | 140              | 05.16 | PR: 1ZE,1ZP     |                |                |        |  |  |
| 2.0 TFSI quattro | 140              | 05.16 | PR: 1ZE,1ZP     |                |                |        |  |  |
| S3               | 206              | 02.13 | PR: 1LC,1LJ     | 24.0130-0225.1 | 430225         |        | 340 30,0 27,0 VL +S +B                                     |  |
| S3               | 210              | 05.14 | PR: 1LC,1LJ     |                |                |        |  |  |
| S3               | 221              | 10.12 | PR: 1LC,1LJ     |                |                |        |  |  |
| S3               | 228              | 06.16 | PR: 1LC,1LJ     |                |                |        |  |  |
|                  | 1.0 TFSI         | 85    | 07.16           |                | 24.0711-5273.3 | 360303 |  | Radsensor  |
|                  | 1.2 TFSI         | 77    | 02.13           |                | 24.0711-5274.3 | 360304 |  | Radsensor  |
|                  | 1.2 TFSI         | 81    | 05.14           |                |                |        |  |  |
|                  | 1.4 TFSI         | 90    | 08.12           |                |                |        |  |  |
|                  | 1.4 TFSI         | 92    | 09.13           |                |                |        |  |  |
|                  | 1.4 TFSI         | 103   | 10.12           |                |                |        |  |  |
|                  | 1.4 TFSI         | 110   | 05.14           |                |                |        |  |  |
|                  | 1.4 TFSI e-tron  | 110   | 02.14           |                |                |        |  |  |
|                  | 1.4 TFSI g-tron  | 81    | 02.14           |                |                |        |  |  |
|                  | 1.6 TDI          | 77    | 09.12           |                |                |        |  |  |
|                  | 1.6 TDI          | 81    | 08.13           |                |                |        |  |  |
|                  | 1.6 TDI quattro  | 81    | 05.15           |                |                |        |  |  |
|                  | 1.8 TFSI         | 132   | 08.12           |                |                |        |  |  |
|                  | 1.8 TFSI quattro | 132   | 08.12           |                |                |        |  |  |
|                  | 2.0 TDI          | 81    | 01.13           |                |                |        |  |  |
|                  | 2.0 TDI          | 100   | 05.13           |                |                |        |  |  |
|                  | 2.0 TDI          | 105   | 08.12           |                |                |        |  |  |
|                  | 2.0 TDI          | 110   | 08.12           |                |                |        |  |  |
|                  | 2.0 TDI          | 135   | 12.12           |                |                |        |  |  |
|                  | 2.0 TDI quattro  | 110   | 10.12           |                |                |        |  |  |
|                  | 2.0 TDI quattro  | 135   | 12.12           |                |                |        |  |  |
|                  | 2.0 TFSI         | 140   | 05.16           |                |                |        |  |  |
| 2.0 TFSI quattro | 140              | 05.16 |                 |                |                |        |  |  |
| RS 3             | 270              | 03.15 |                 |                |                |        |  |  |
| S3               | 206              | 02.13 |                 |                |                |        |  |  |
| S3               | 210              | 05.14 |                 |                |                |        |  |  |
| S3               | 221              | 10.12 |                 |                |                |        |  |  |
| S3               | 228              | 06.16 |                 |                |                |        |  |  |
|                  | 1.0 TFSI         | 85    | 07.16           | PR: 1KE        | 13.0460-7293.2 | 607293 |  | elektrische Feststellbremse <sup>1)</sup> 25008 16,3 + ATE |
|                  | 1.2 TFSI         | 77    | 02.13           | PR: 1KE        |                |        |  |  |
|                  | 1.2 TFSI         | 81    | 05.14           | PR: 1KE        |                |        |  |  |
|                  | 1.4 TFSI         | 90    | 08.12           | PR: 1KE        |                |        |  |  |
|                  | 1.4 TFSI         | 92    | 09.13           | PR: 1KE        |                |        |  |  |
|                  | 1.4 TFSI         | 103   | 10.12           | PR: 1KE        |                |        |  |  |
|                  | 1.4 TFSI         | 110   | 05.14           | PR: 1KE        |                |        |  |  |
|                  | 1.4 TFSI e-tron  | 110   | 02.14           | PR: 1KE        |                |        |  |  |
|                  | 1.4 TFSI g-tron  | 81    | 02.14           | PR: 1KE        |                |        |  |  |
|                  | 1.6 TDI          | 77    | 09.12           | PR: 1KE        |                |        |  |  |
|                  | 1.6 TDI          | 81    | 08.13           | PR: 1KE        |                |        |  |  |
|                  | 1.6 TDI quattro  | 81    | 05.15           | PR: 1KE        |                |        |  |  |
|                  | 1.8 TFSI         | 132   | 08.12           | PR: 1KE        |                |        |  |  |
|                  | 1.8 TFSI quattro | 132   | 08.12           | PR: 1KE        |                |        |  |  |
|                  | 2.0 TDI          | 81    | 01.13           | PR: 1KE        |                |        |  |  |
|                  | 2.0 TDI          | 100   | 05.13           | PR: 1KE        |                |        |  |  |
|                  | 2.0 TDI          | 105   | 08.12           | PR: 1KE        |                |        |  |  |
|                  | 2.0 TDI          | 110   | 08.12           | PR: 1KE        |                |        |  |  |
|                  | 2.0 TDI          | 135   | 12.12           | PR: 1KE        |                |        |  |  |
|                  | 2.0 TDI quattro  | 110   | 10.12           | PR: 1KE        |                |        |  |  |
|                  | 2.0 TDI quattro  | 135   | 12.12           | PR: 1KE        |                |        |  |  |
|                  | 2.0 TFSI         | 140   | 05.16           | PR: 1KE        |                |        |  |  |
| 2.0 TFSI quattro | 140              | 05.16 | PR: 1KE         |                |                |        |  |  |
| S3               | 206              | 02.13 | PR: 1KE         |                |                |        |  |  |
| S3               | 210              | 05.14 | PR: 1KE         |                |                |        |  |  |
| S3               | 221              | 10.12 | PR: 1KE         |                |                |        |  |  |
| S3               | 228              | 06.16 | PR: 1KE         |                |                |        |  |  |
| 1.0 TFSI         | 85               | 07.16 | PR: 1KJ,1KY,2ED | 13.0460-7294.2 | 607294         |        | elektrische Feststellbremse <sup>1)</sup> 25009 16,4 + ATE |  |
| 1.2 TFSI         | 77               | 02.13 | PR: 1KJ,1KY,2ED | 13.0470-7294.2 | LD7294         |        | elektrische Feststellbremse <sup>1)</sup> 25009 16,4 + ATE |  |
| 1.2 TFSI         | 81               | 05.14 | PR: 1KJ,1KY,2ED |                |                |        |  |  |
| 1.4 TFSI         | 90               | 08.12 | PR: 1KJ,1KY,2ED |                |                |        |  |  |
| 1.4 TFSI         | 92               | 09.13 | PR: 1KJ,1KY,2ED |                |                |        |  |  |
| 1.4 TFSI         | 103              | 10.12 | PR: 1KJ,1KY,2ED |                |                |        |  |  |
| 1.4 TFSI         | 110              | 05.14 | PR: 1KJ,1KY,2ED |                |                |        |  |  |
| 1.4 TFSI e-tron  | 110              | 02.14 | PR: 1KJ,1KY,2ED |                |                |        |  |  |
| 1.4 TFSI g-tron  | 81               | 02.14 | PR: 1KJ,1KY,2ED |                |                |        |  |  |
| 1.6 TDI          | 77               | 09.12 | PR: 1KJ,1KY,2ED |                |                |        |  |  |
| 1.6 TDI          | 81               | 08.13 | PR: 1KJ,1KY,2ED |                |                |        |  |  |

<sup>1)</sup> electric parking brake / fr.di stazionamento elettrico / frein à main électrique / freno de mano eléctrico



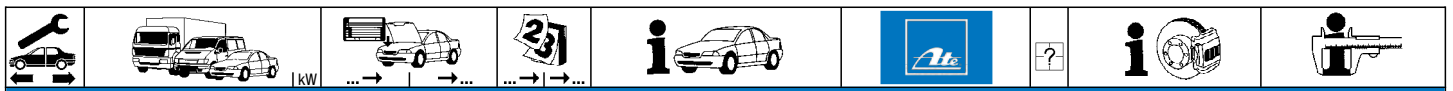

























**AUDI A3 / A3 (8V) Sportback (12-)**

|                  |                  |          |                 |                 |                |   |   |   |            |
|------------------|------------------|----------|-----------------|-----------------|----------------|---|---|---|------------|
|                  | 1.6 TDI quattro  | 81       | 05.15           | PR: 1KJ,1KY,2ED | 13.0460-7294.2 | 607294                                    | elektrische Feststellbremse <sup>1)</sup> | 25009 16,4 +<br>25009 16,4 +              | ATE<br>ATE |
|                  | 1.8 TFSI         | 132      | 08.12           | PR: 1KJ,1KY,2ED | 13.0470-7294.2 | LD7294                                    |   |   |            |
|                  | 1.8 TFSI quattro | 132      | 08.12           | PR: 1KJ,1KY,2ED |                |   |   |   |            |
|                  | 2.0 TDI          | 81       | 01.13           | PR: 1KJ,1KY,2ED |                |   |   |   |            |
|                  | 2.0 TDI          | 100      | 05.13           | PR: 1KJ,1KY,2ED |                |   |   |   |            |
|                  | 2.0 TDI          | 105      | 08.12           | PR: 1KJ,1KY,2ED |                |   |   |   |            |
|                  | 2.0 TDI          | 110      | 08.12           | PR: 1KJ,1KY,2ED |                |   |   |   |            |
|                  | 2.0 TDI          | 135      | 12.12           | PR: 1KJ,1KY,2ED |                |   |   |   |            |
|                  | 2.0 TDI quattro  | 110      | 10.12           | PR: 1KJ,1KY,2ED |                |   |   |   |            |
|                  | 2.0 TDI quattro  | 135      | 12.12           | PR: 1KJ,1KY,2ED |                |   |   |   |            |
|                  | 2.0 TFSI         | 140      | 05.16           | PR: 1KJ,1KY,2ED |                |   |   |   |            |
|                  | 2.0 TFSI quattro | 140      | 05.16           | PR: 1KJ,1KY,2ED |                |   |   |   |            |
|                  | S3               | 206      | 02.13           | PR: 1KJ,1KY,2ED |                |   |   |   |            |
| S3               | 210              | 05.14    | PR: 1KJ,1KY,2ED |                 |                |   |   |   |            |
| S3               | 221              | 10.12    | PR: 1KJ,1KY,2ED |                 |                |   |   |   |            |
| S3               | 228              | 06.16    | PR: 1KJ,1KY,2ED |                 |                |   |   |   |            |
| RS 3             | 270              | 03.15    | PR: 1KX,2EE     | 13.0460-7307.2  | 607307         | elektrische Feststellbremse <sup>1)</sup> | 25009 16,4 +/WK                           | ATE                                       |            |
|                  | 1.0 TFSI         | 85       | 07.16           | PR: 1KE         | 24.0110-0356.1 | 410356                                    | elektrische Feststellbremse <sup>1)</sup> | 272 9,7 8,0 +S +B<br>272 9,7 8,0 +S +B PD |            |
|                  | 1.2 TFSI         | 77       | 02.13           | PR: 1KE         | 24.0310-0356.1 | 510356                                    |   |   |            |
|                  | 1.2 TFSI         | 81       | 05.14           | PR: 1KE         |                |   |   |   |            |
|                  | 1.4 TFSI         | 90       | 08.12           | PR: 1KE         |                |   |   |   |            |
|                  | 1.4 TFSI         | 92       | 09.13           | PR: 1KE         |                |   |   |   |            |
|                  | 1.4 TFSI         | 103      | 10.12           | PR: 1KE         |                |   |   |   |            |
|                  | 1.4 TFSI         | 110      | 05.14           | PR: 1KE         |                |   |   |   |            |
|                  | 1.4 TFSI e-tron  | 110      | 02.14           | PR: 1KE         |                |   |   |   |            |
|                  | 1.4 TFSI g-tron  | 81       | 02.14           | PR: 1KE         |                |   |   |   |            |
|                  | 1.6 TDI          | 77       | 09.12           | PR: 1KE         |                |   |   |   |            |
|                  | 1.6 TDI          | 81       | 08.13           | PR: 1KE         |                |   |   |   |            |
|                  | 1.6 TDI quattro  | 81       | 05.15           | PR: 1KE         |                |   |   |   |            |
|                  | 1.8 TFSI         | 132      | 08.12           | PR: 1KE         |                |   |   |   |            |
|                  | 1.8 TFSI quattro | 132      | 08.12           | PR: 1KE         |                |   |   |   |            |
|                  | 2.0 TDI          | 81       | 01.13           | PR: 1KE         |                |   |   |   |            |
|                  | 2.0 TDI          | 100      | 05.13           | PR: 1KE         |                |   |   |   |            |
|                  | 2.0 TDI          | 105      | 08.12           | PR: 1KE         |                |   |   |   |            |
|                  | 2.0 TDI          | 110      | 08.12           | PR: 1KE         |                |   |   |   |            |
|                  | 2.0 TDI          | 135      | 12.12           | PR: 1KE         |                |   |   |   |            |
|                  | 2.0 TDI quattro  | 110      | 10.12           | PR: 1KE         |                |   |   |   |            |
|                  | 2.0 TDI quattro  | 135      | 12.12           | PR: 1KE         |                |   |   |   |            |
|                  | 2.0 TFSI         | 140      | 05.16           | PR: 1KE         |                |   |   |   |            |
|                  | 2.0 TFSI quattro | 140      | 05.16           | PR: 1KE         |                |   |   |   |            |
|                  | S3               | 206      | 02.13           | PR: 1KE         |                |   |   |   |            |
|                  | S3               | 210      | 05.14           | PR: 1KE         |                |   |   |   |            |
|                  | S3               | 221      | 10.12           | PR: 1KE         |                |   |   |   |            |
|                  | S3               | 228      | 06.16           | PR: 1KE         |                |   |   |   |            |
|                  |                  | 1.0 TFSI | 85              | 07.16           |                |   |   |   |            |
| 1.2 TFSI         |                  | 77       | 02.13           | PR: 1KJ,1KY     |                |   |   |   |            |
| 1.2 TFSI         |                  | 81       | 05.14           | PR: 1KJ,1KY     |                |   |   |   |            |
| 1.4 TFSI         |                  | 90       | 08.12           | PR: 1KJ,1KY     |                |   |   |   |            |
| 1.4 TFSI         |                  | 92       | 09.13           | PR: 1KJ,1KY     |                |   |   |   |            |
| 1.4 TFSI         |                  | 103      | 10.12           | PR: 1KJ,1KY     |                |   |   |   |            |
| 1.4 TFSI         |                  | 110      | 05.14           | PR: 1KJ,1KY     |                |   |   |   |            |
| 1.4 TFSI e-tron  |                  | 110      | 02.14           | PR: 1KJ,1KY     |                |   |   |   |            |
| 1.4 TFSI g-tron  |                  | 81       | 02.14           | PR: 1KJ,1KY     |                |   |   |   |            |
| 1.6 TDI          |                  | 77       | 09.12           | PR: 1KJ,1KY     |                |   |   |   |            |
| 1.6 TDI          |                  | 81       | 08.13           | PR: 1KJ,1KY     |                |   |   |   |            |
| 1.6 TDI quattro  |                  | 81       | 05.15           | PR: 1KJ,1KY     |                |   |   |   |            |
| 1.8 TFSI         |                  | 132      | 08.12           | PR: 1KJ,1KY     |                |   |   |   |            |
| 1.8 TFSI quattro |                  | 132      | 08.12           | PR: 1KJ,1KY     |                |   |   |   |            |
| 2.0 TDI          |                  | 81       | 01.13           | PR: 1KJ,1KY     |                |   |   |   |            |
| 2.0 TDI          |                  | 100      | 05.13           | PR: 1KJ,1KY     |                |   |   |   |            |
| 2.0 TDI          |                  | 105      | 08.12           | PR: 1KJ,1KY     |                |   |   |   |            |
| 2.0 TDI          |                  | 110      | 08.12           | PR: 1KJ,1KY     |                |   |   |   |            |
| 2.0 TDI          |                  | 135      | 12.12           | PR: 1KJ,1KY     |                |   |   |   |            |
| 2.0 TDI quattro  |                  | 110      | 10.12           | PR: 1KJ,1KY     |                |   |   |   |            |
| 2.0 TDI quattro  |                  | 135      | 12.12           | PR: 1KJ,1KY     |                |   |   |   |            |
| 2.0 TFSI         |                  | 140      | 05.16           | PR: 1KJ,1KY     |                |   |   |   |            |
| 2.0 TFSI quattro |                  | 140      | 05.16           | PR: 1KJ,1KY     |                |   |   |   |            |
| RS 3             |                  | 270      | 03.15           | PR: 1KX,2EE     |                |   |   |   |            |
| S3               |                  | 206      | 02.13           | PR: 1KJ,1KY     |                |   |   |   |            |
| S3               |                  | 210      | 05.14           | PR: 1KJ,1KY     |                |   |   |   |            |
| S3               |                  | 221      | 10.12           | PR: 1KJ,1KY     |                |   |   |   |            |
| S3               |                  | 228      | 06.16           | PR: 1KJ,1KY     |                |   |   |   |            |
|                  | 1.0 TFSI         | 85       | 07.16           | PR: 2ED         | 24.0112-0210.1 | 412210                                    | elektrische Feststellbremse <sup>1)</sup> | 300 12,0 10,0 +S +B                       |            |
|                  | 1.2 TFSI         | 77       | 02.13           | PR: 2ED         |                |   |   |   |            |
|                  | 1.2 TFSI         | 81       | 05.14           | PR: 2ED         |                |   |   |   |            |
|                  | 1.4 TFSI         | 90       | 08.12           | PR: 2ED         |                |   |   |   |            |
|                  | 1.4 TFSI         | 92       | 09.13           | PR: 2ED         |                |   |   |   |            |
|                  | 1.4 TFSI         | 103      | 10.12           | PR: 2ED         |                |   |   |   |            |
|                  | 1.4 TFSI         | 110      | 05.14           | PR: 2ED         |                |   |   |   |            |
|                  | 1.4 TFSI e-tron  | 110      | 02.14           | PR: 2ED         |                |   |   |   |            |
|                  | 1.4 TFSI g-tron  | 81       | 02.14           | PR: 2ED         |                |   |   |   |            |
|                  | 1.6 TDI          | 77       | 09.12           | PR: 2ED         |                |   |   |   |            |
|                  | 1.6 TDI          | 81       | 08.13           | PR: 2ED         |                |   |   |   |            |
|                  | 1.6 TDI quattro  | 81       | 05.15           | PR: 2ED         |                |   |   |   |            |
|                  | 1.8 TFSI         | 132      | 08.12           | PR: 2ED         |                |   |   |   |            |
|                  | 1.8 TFSI quattro | 132      | 08.12           | PR: 2ED         |                |   |   |   |            |
|                  | 2.0 TDI          | 81       | 01.13           | PR: 2ED         |                |   |   |   |            |

<sup>1)</sup> electric parking brake / fr.di stazionamento elettrico / frein à main électrique / freno de mano eléctrico

|     |    |  |   |    |  |  |    |  |                     |
|--|--|--|---|--|---|--|--|--|---------------------|
| <b>AUDI A3 / A3 (8V) Sportback (12-)</b>   |  |  |   |  |   |  |  |  |                     |
|    | 2.0 TDI 100<br>2.0 TDI 105<br>2.0 TDI 110<br>2.0 TDI 135<br>2.0 TDI quattro 110<br>2.0 TDI quattro 135<br>2.0 TFSI 140<br>2.0 TFSI 140<br>S3 206<br>S3 210<br>S3 221<br>S3 228   |  | 05.13<br>08.12<br>08.12<br>12.12<br>10.12<br>12.12<br>05.16<br>05.16<br>02.13<br>05.14<br>10.12<br>06.16  | PR: 2ED<br>PR: 2ED<br>PR: 2ED<br>PR: 2ED<br>PR: 2ED<br>PR: 2ED<br>PR: 2ED<br>PR: 2ED<br>PR: 2ED<br>PR: 2ED<br>PR: 2ED  | 24.0112-0210.1  | 412210   |  | elektrische Feststellbremse <sup>1)</sup>  | 300 12,0 10,0 +S +B |
|    | 1.0 TFSI 85<br>1.2 TFSI 77<br>1.2 TFSI 81<br>1.4 TFSI 90<br>1.4 TFSI 92<br>1.4 TFSI 103<br>1.4 TFSI 110<br>1.4 TFSI e-tron 110<br>1.4 TFSI g-tron 81<br>1.6 TDI 77<br>1.6 TDI 81<br>1.8 TFSI 132<br>2.0 TDI 81<br>2.0 TDI 100<br>2.0 TDI 105<br>2.0 TDI 110<br>2.0 TDI 135<br>2.0 TFSI 140 |  | 07.16<br>02.13<br>05.14<br>08.12<br>09.13<br>10.12<br>05.14<br>02.14<br>02.14<br>09.12<br>08.13<br>08.12<br>01.13<br>05.13<br>08.12<br>12.12<br>05.16 |  | 24.0711-6230.3<br>24.0711-6337.3  | 360310<br>360390   | 2  - Geschwindigkeitsregelanlage <sup>2)</sup><br>2  + Geschwindigkeitsregelanlage <sup>3)</sup>   | Radsensor<br>Radsensor   |                     |
|  | 1.0 TFSI 85<br>1.2 TFSI 77<br>1.2 TFSI 81<br>1.4 TFSI 90<br>1.4 TFSI 92<br>1.4 TFSI 103<br>1.4 TFSI 110<br>1.4 TFSI e-tron 110<br>1.4 TFSI g-tron 81<br>1.6 TDI 77<br>1.6 TDI 81<br>1.8 TFSI 132<br>2.0 TDI 81<br>2.0 TDI 100<br>2.0 TDI 105<br>2.0 TDI 110<br>2.0 TDI 135<br>2.0 TFSI 140 |  | 07.16<br>02.13<br>05.14<br>08.12<br>09.13<br>10.12<br>05.14<br>02.14<br>02.14<br>09.12<br>08.13<br>08.12<br>01.13<br>05.13<br>08.12<br>12.12<br>05.16 |  | 24.0711-6230.3<br>24.0711-6337.3  | 360310<br>360390   | 2  - Parkassistent <sup>4)</sup><br>2  + Parkassistent <sup>5)</sup>   | Radsensor<br>Radsensor   |                     |
|  | 1.6 TDI quattro 81<br>1.8 TFSI quattro 132<br>2.0 TDI quattro 110<br>2.0 TDI quattro 135<br>2.0 TFSI quattro 140<br>RS 3 270<br>S3 206<br>S3 210<br>S3 221<br>S3 228   |  | 05.15<br>08.12<br>10.12<br>12.12<br>05.16<br>03.15<br>02.13<br>05.14<br>10.12<br>06.16  |  | 24.0711-5271.3<br>24.0711-5272.3<br>24.0711-5401.3<br>24.0711-5402.3              | 360301<br>360302<br>360330<br>360331   |  - Geschwindigkeitsregelanlage <sup>2)</sup><br> - Geschwindigkeitsregelanlage <sup>2)</sup><br> + Geschwindigkeitsregelanlage <sup>3)</sup><br> + Geschwindigkeitsregelanlage <sup>3)</sup> | Radsensor<br>Radsensor<br>Radsensor<br>Radsensor                                   |                     |
|  | 1.6 TDI quattro 81<br>1.8 TFSI quattro 132<br>2.0 TDI quattro 110<br>2.0 TDI quattro 135<br>2.0 TFSI quattro 140<br>RS 3 270<br>S3 206<br>S3 210<br>S3 221<br>S3 228   |  | 05.15<br>08.12<br>10.12<br>12.12<br>05.16<br>03.15<br>02.13<br>05.14<br>10.12<br>06.16  |  | 24.0711-5271.3<br>24.0711-5272.3<br>24.0711-5401.3<br>24.0711-5402.3              | 360301<br>360302<br>360330<br>360331   |  - Parkassistent <sup>4)</sup><br> - Parkassistent <sup>4)</sup><br> + Parkassistent <sup>5)</sup><br> + Parkassistent <sup>5)</sup>   | Radsensor<br>Radsensor<br>Radsensor<br>Radsensor                                   |                     |
| <b>AUDI A3 (8V) Cabrio (13-)</b>   |  |  |   |  |   |  |  |  |                     |
|  | 1.4 TFSI 85<br>1.4 TFSI 92<br>1.4 TFSI 103<br>1.4 TFSI 110<br>1.6 TDI 81<br>1.8 TFSI 132<br>1.8 TFSI quattro 132<br>2.0 TDI 110<br>2.0 TDI 135<br>2.0 TDI quattro 110<br>2.0 TDI quattro 135<br>2.0 TFSI 140<br>2.0 TFSI quattro 140<br>2.0 TFSI quattro 162                               |  | 02.16<br>10.13<br>10.13<br>05.14<br>10.13<br>10.13<br>03.14<br>10.13<br>05.14<br>03.14<br>05.14<br>05.16<br>05.16<br>05.14                            | PR: 1ZA,1ZD,1ZE,1ZP<br>PR: 1ZA,1ZD,1ZE,1ZP<br>PR: 1ZA,1ZD,1ZE,1ZP<br>PR: 1ZA,1ZD,1ZE,1ZP<br>PR: 1ZA,1ZD,1ZE,1ZP<br>PR: 1ZA,1ZD,1ZE,1ZP<br>PR: 1ZA,1ZD,1ZE,1ZP<br>PR: 1ZA,1ZD,1ZE,1ZP<br>PR: 1ZA,1ZD,1ZE,1ZP<br>PR: 1ZA,1ZD,1ZE,1ZP<br>PR: 1ZA,1ZD,1ZE,1ZP<br>PR: 1ZA,1ZD,1ZE,1ZP<br>PR: 1ZA,1ZD,1ZE,1ZP<br>PR: 1ZA,1ZD,1ZE,1ZP | 13.0460-2785.2<br>13.0470-2785.2  | 602785<br>LD2785   |  | 25683 20,4 +/WK/S<br>25683 20,4 +/WK/S   | TRW<br>TRW          |
|  | S3 221<br>S3 228   |  | 04.14<br>07.16  | PR: 1LC,1LJ<br>PR: 1LC,1LJ   | 13.0460-2764.2<br>13.0470-2764.2  | 602764<br>LD2764   |  | 24738 20,0 +/WK/S<br>24738 20,0 +/WK/S   | TRW<br>TRW          |

<sup>1)</sup> electric parking brake / fr.di stazionamento elettrico / frein à main électrique / freno de mano eléctrico  
<sup>2)</sup> - speed control system / - impianto variatore di velocità / - régulateur de vitesse / - sistema de regulación de velocidad  
<sup>3)</sup> + speed control system / + impianto variatore di velocità / + régulateur de vitesse / + sistema de regulación de velocidad  
<sup>4)</sup> - parking assistant / - assistente di parcheggio / - assistance au stationnement / - asistente de aparcamiento  
<sup>5)</sup> + parking assistant / + assistente di parcheggio / + assistance au stationnement / + asistente de aparcamiento

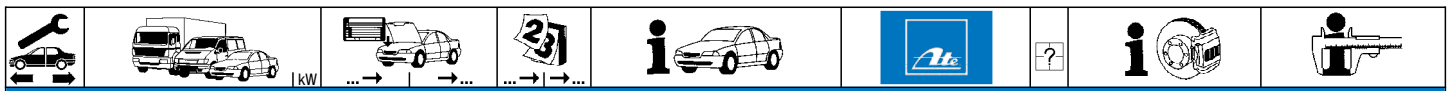

**AUDI A3 (8V) Cabrio (13-)**

|                  |                  |       |             |                                  |                                  |                  |  |   |   |                |        |  |  |                         |
|------------------|------------------|-------|-------------|----------------------------------|----------------------------------|------------------|--|---|---|----------------|--------|--|--|-------------------------|
|                  | 1.4 TFSI         | 85    | 02.16       | PR: 1ZF                          | 13.0460-7303.2<br>13.0470-7303.2 | 607303<br>LD7303 |  |   | 22035 17,5 +WK<br>22035 17,5 +WK                      | ATE<br>ATE     |        |  |  |                         |
|                  | 1.4 TFSI         | 92    | 10.13       | PR: 1ZF                          |                                  |                  |  |   |   |                |        |  |  |                         |
|                  | 1.4 TFSI         | 103   | 10.13       | PR: 1ZF                          |                                  |                  |  |   |   |                |        |  |  |                         |
|                  | 1.4 TFSI         | 110   | 05.14       | PR: 1ZF                          |                                  |                  |  |   |   |                |        |  |  |                         |
|                  | 1.6 TDI          | 81    | 10.13       | PR: 1ZF                          |                                  |                  |  |   |   |                |        |  |  |                         |
|                  | 1.8 TFSI         | 132   | 10.13       | PR: 1ZF                          |                                  |                  |  |   |   |                |        |  |  |                         |
|                  | 1.8 TFSI quattro | 132   | 03.14       | PR: 1ZF                          |                                  |                  |  |   |   |                |        |  |  |                         |
|                  | 2.0 TDI          | 110   | 10.13       | PR: 1ZF                          |                                  |                  |  |   |   |                |        |  |  |                         |
|                  | 2.0 TDI          | 135   | 05.14       | PR: 1ZF                          |                                  |                  |  |   |   |                |        |  |  |                         |
|                  | 2.0 TDI quattro  | 110   | 03.14       | PR: 1ZF                          |                                  |                  |  |   |   |                |        |  |  |                         |
|                  | 2.0 TDI quattro  | 135   | 05.14       | PR: 1ZF                          |                                  |                  |  |   |   |                |        |  |  |                         |
|                  | 2.0 TFSI         | 140   | 05.16       | PR: 1ZF                          |                                  |                  |  |   |   |                |        |  |  |                         |
| 2.0 TFSI quattro | 140              | 05.16 | PR: 1ZF     |                                  |                                  |                  |  |   |   |                |        |  |  |                         |
| 2.0 TFSI quattro | 162              | 05.14 | PR: 1ZF     |                                  |                                  |                  |  |   |   |                |        |  |  |                         |
|                  | 1.4 TFSI         | 85    | 02.16       | PR: 1ZE,1ZP                      | 24.0125-0145.1<br>24.0325-0145.1 | 425145<br>525145 |  |   | 288 25,0 22,0 V L +S +B<br>288 25,0 22,0 V L +S +B PD |                |        |  |  |                         |
|                  | 1.4 TFSI         | 92    | 10.13       | PR: 1ZE,1ZP                      |                                  |                  |  |   |   |                |        |  |  |                         |
|                  | 1.4 TFSI         | 103   | 10.13       | PR: 1ZE,1ZP                      |                                  |                  |  |   |   |                |        |  |  |                         |
|                  | 1.4 TFSI         | 110   | 05.14       | PR: 1ZE,1ZP                      |                                  |                  |  |   |   |                |        |  |  |                         |
|                  | 1.6 TDI          | 81    | 10.13       | PR: 1ZE,1ZP                      |                                  |                  |  |   |   |                |        |  |  |                         |
|                  | 1.8 TFSI         | 132   | 10.13       | PR: 1ZE,1ZP                      |                                  |                  |  |   |   |                |        |  |  |                         |
|                  | 1.8 TFSI quattro | 132   | 03.14       | PR: 1ZE,1ZP                      |                                  |                  |  |   |   |                |        |  |  |                         |
|                  | 2.0 TDI          | 110   | 10.13       | PR: 1ZE,1ZP                      |                                  |                  |  |   |   |                |        |  |  |                         |
|                  | 2.0 TDI          | 135   | 05.14       | PR: 1ZE,1ZP                      |                                  |                  |  |   |   |                |        |  |  |                         |
|                  | 2.0 TDI quattro  | 110   | 03.14       | PR: 1ZE,1ZP                      |                                  |                  |  |   |   |                |        |  |  |                         |
|                  | 2.0 TDI quattro  | 135   | 05.14       | PR: 1ZE,1ZP                      |                                  |                  |  |   |   |                |        |  |  |                         |
|                  | 2.0 TFSI         | 140   | 05.16       | PR: 1ZE,1ZP                      |                                  |                  |  |   |   |                |        |  |  |                         |
|                  | 2.0 TFSI quattro | 140   | 05.16       | PR: 1ZE,1ZP                      |                                  |                  |  |   |   |                |        |  |  |                         |
|                  | 2.0 TFSI quattro | 162   | 05.14       | PR: 1ZE,1ZP                      |                                  |                  |  |   |   |                |        |  |  |                         |
|                  | 1.4 TFSI         | 85    | 02.16       | PR: 1ZF                          |                                  |                  |  |   |   | 24.0124-0258.1 | 424258 |  |  | 276 24,0 21,0 V L +S +B |
|                  | 1.4 TFSI         | 92    | 10.13       | PR: 1ZF                          |                                  |                  |  |   |   |                |        |  |  |                         |
|                  | 1.4 TFSI         | 103   | 10.13       | PR: 1ZF                          |                                  |                  |  |   |   |                |        |  |  |                         |
|                  | 1.4 TFSI         | 110   | 05.14       | PR: 1ZF                          |                                  |                  |  |   |   |                |        |  |  |                         |
|                  | 1.6 TDI          | 81    | 10.13       | PR: 1ZF                          |                                  |                  |  |   |   |                |        |  |  |                         |
|                  | 1.8 TFSI         | 132   | 10.13       | PR: 1ZF                          |                                  |                  |  |   |   |                |        |  |  |                         |
|                  | 1.8 TFSI quattro | 132   | 03.14       | PR: 1ZF                          |                                  |                  |  |   |   |                |        |  |  |                         |
|                  | 2.0 TDI          | 110   | 10.13       | PR: 1ZF                          |                                  |                  |  |   |   |                |        |  |  |                         |
|                  | 2.0 TDI          | 135   | 05.14       | PR: 1ZF                          |                                  |                  |  |   |   |                |        |  |  |                         |
|                  | 2.0 TDI quattro  | 110   | 03.14       | PR: 1ZF                          |                                  |                  |  |   |   |                |        |  |  |                         |
| 2.0 TDI quattro  | 135              | 05.14 | PR: 1ZF     |                                  |                                  |                  |  |   |   |                |        |  |  |                         |
| 2.0 TFSI         | 140              | 05.16 | PR: 1ZF     |                                  |                                  |                  |  |   |   |                |        |  |  |                         |
| 2.0 TFSI quattro | 140              | 05.16 | PR: 1ZF     |                                  |                                  |                  |  |   |   |                |        |  |  |                         |
| 2.0 TFSI quattro | 162              | 05.14 | PR: 1ZF     |                                  |                                  |                  |  |   |   |                |        |  |  |                         |
| 1.4 TFSI         | 85               | 02.16 | PR: 1ZA,1ZD | 24.0125-0158.1<br>24.0325-0158.1 | 425158<br>525158                 |                  |  | 312 25,0 22,0 V L +S +B<br>312 25,0 22,0 V L +S +B PD |   |                |        |  |  |                         |
| 1.4 TFSI         | 92               | 10.13 | PR: 1ZA,1ZD |                                  |                                  |                  |  |   |   |                |        |  |  |                         |
| 1.4 TFSI         | 103              | 10.13 | PR: 1ZA,1ZD |                                  |                                  |                  |  |   |   |                |        |  |  |                         |
| 1.4 TFSI         | 110              | 05.14 | PR: 1ZA,1ZD |                                  |                                  |                  |  |   |   |                |        |  |  |                         |
| 1.6 TDI          | 81               | 10.13 | PR: 1ZA,1ZD |                                  |                                  |                  |  |   |   |                |        |  |  |                         |
| 1.8 TFSI         | 132              | 10.13 | PR: 1ZA,1ZD |                                  |                                  |                  |  |   |   |                |        |  |  |                         |
| 1.8 TFSI quattro | 132              | 03.14 | PR: 1ZA,1ZD |                                  |                                  |                  |  |   |   |                |        |  |  |                         |
| 2.0 TDI          | 110              | 10.13 | PR: 1ZA,1ZD |                                  |                                  |                  |  |   |   |                |        |  |  |                         |
| 2.0 TDI          | 135              | 05.14 | PR: 1ZA,1ZD |                                  |                                  |                  |  |   |   |                |        |  |  |                         |
| 2.0 TDI quattro  | 110              | 03.14 | PR: 1ZA,1ZD |                                  |                                  |                  |  |   |   |                |        |  |  |                         |
| 2.0 TDI quattro  | 135              | 05.14 | PR: 1ZA,1ZD |                                  |                                  |                  |  |   |   |                |        |  |  |                         |
| 2.0 TFSI         | 140              | 05.16 | PR: 1ZA,1ZD |                                  |                                  |                  |  |   |   |                |        |  |  |                         |
| 2.0 TFSI quattro | 140              | 05.16 | PR: 1ZA,1ZD |                                  |                                  |                  |  |   |   |                |        |  |  |                         |
| 2.0 TFSI quattro | 162              | 05.14 | PR: 1ZA,1ZD |                                  |                                  |                  |  |   |   |                |        |  |  |                         |
| S3               | 221              | 04.14 | PR: 1LC,1LJ | 24.0130-0225.1                   | 430225                           |                  |  | 340 30,0 27,0 V L +S +B                               |   |                |        |  |  |                         |
| S3               | 228              | 07.16 | PR: 1LC,1LJ |                                  |                                  |                  |  |   |   |                |        |  |  |                         |
|                  | 1.4 TFSI         | 85    | 02.16       |                                  | 24.0711-5273.3<br>24.0711-5274.3 | 360303<br>360304 |  |   | Radsensor<br>Radsensor                                |                |        |  |  |                         |
|                  | 1.4 TFSI         | 92    | 10.13       |                                  |                                  |                  |  |   |   |                |        |  |  |                         |
|                  | 1.4 TFSI         | 103   | 10.13       |                                  |                                  |                  |  |   |   |                |        |  |  |                         |
|                  | 1.4 TFSI         | 110   | 05.14       |                                  |                                  |                  |  |   |   |                |        |  |  |                         |
|                  | 1.6 TDI          | 81    | 10.13       |                                  |                                  |                  |  |   |   |                |        |  |  |                         |
|                  | 1.8 TFSI         | 132   | 10.13       |                                  |                                  |                  |  |   |   |                |        |  |  |                         |
|                  | 1.8 TFSI quattro | 132   | 03.14       |                                  |                                  |                  |  |   |   |                |        |  |  |                         |
|                  | 2.0 TDI          | 110   | 10.13       |                                  |                                  |                  |  |   |   |                |        |  |  |                         |
|                  | 2.0 TDI          | 135   | 05.14       |                                  |                                  |                  |  |   |   |                |        |  |  |                         |
|                  | 2.0 TDI quattro  | 110   | 03.14       |                                  |                                  |                  |  |   |   |                |        |  |  |                         |
|                  | 2.0 TDI quattro  | 135   | 05.14       |                                  |                                  |                  |  |   |   |                |        |  |  |                         |
|                  | 2.0 TFSI         | 140   | 05.16       |                                  |                                  |                  |  |   |   |                |        |  |  |                         |
|                  | 2.0 TFSI quattro | 140   | 05.16       |                                  |                                  |                  |  |   |   |                |        |  |  |                         |
|                  | 2.0 TFSI quattro | 162   | 05.14       |                                  |                                  |                  |  |   |   |                |        |  |  |                         |
| S3               | 221              | 04.14 |             |                                  |                                  |                  |  |   |   |                |        |  |  |                         |
| S3               | 228              | 07.16 |             |                                  |                                  |                  |  |   |   |                |        |  |  |                         |
|                  | 1.4 TFSI         | 85    | 02.16       | PR: 1KE                          | 13.0460-7293.2                   | 607293           |  |   | 25008 16,3 +  | ATE            |        |  |  |                         |
|                  | 1.4 TFSI         | 92    | 10.13       | PR: 1KE                          |                                  |                  |  |   |   |                |        |  |  |                         |
|                  | 1.4 TFSI         | 103   | 10.13       | PR: 1KE                          |                                  |                  |  |   |   |                |        |  |  |                         |
|                  | 1.4 TFSI         | 110   | 05.14       | PR: 1KE                          |                                  |                  |  |   |   |                |        |  |  |                         |
|                  | 1.6 TDI          | 81    | 10.13       | PR: 1KE                          |                                  |                  |  |   |   |                |        |  |  |                         |
|                  | 1.8 TFSI         | 132   | 10.13       | PR: 1KE                          |                                  |                  |  |   |   |                |        |  |  |                         |
|                  | 1.8 TFSI quattro | 132   | 03.14       | PR: 1KE                          |                                  |                  |  |   |   |                |        |  |  |                         |
|                  | 2.0 TDI          | 110   | 10.13       | PR: 1KE                          |                                  |                  |  |   |   |                |        |  |  |                         |
|                  | 2.0 TDI          | 135   | 05.14       | PR: 1KE                          |                                  |                  |  |   |   |                |        |  |  |                         |
|                  | 2.0 TDI quattro  | 110   | 03.14       | PR: 1KE                          |                                  |                  |  |   |   |                |        |  |  |                         |
|                  | 2.0 TDI quattro  | 135   | 05.14       | PR: 1KE                          |                                  |                  |  |   |   |                |        |  |  |                         |
|                  | 2.0 TFSI         | 140   | 05.16       | PR: 1KE                          |                                  |                  |  |   |   |                |        |  |  |                         |
| 2.0 TFSI quattro | 140              | 05.16 | PR: 1KE     |                                  |                                  |                  |  |   |   |                |        |  |  |                         |





## AUDI A3 (8V) Cabrio (13-)

|                  |                  |          |             |                |                |                |        |   |   |           |                |                |   |   |                   |                     |        |  |   |           |  |
|------------------|------------------|----------|-------------|----------------|----------------|----------------|--------|---|---|-----------|----------------|----------------|---|---|-------------------|---------------------|--------|--|---|-----------|--|
|                  | 2.0 TFSI quattro | 162      | 05.14       | PR: 1KE        | 13.0460-7293.2 | 607293         |        |   | 25008 16,3 +                                | ATE       |                |                |   |   |                   |                     |        |  |   |           |  |
|                  | S3               | 221      | 04.14       | PR: 1KE        |                |                |        |   |   |           |                |                |   |   |                   |                     |        |  |   |           |  |
|                  | S3               | 228      | 07.16       | PR: 1KE        |                |                |        |   |   |           |                |                |   |   |                   |                     |        |  |   |           |  |
|                  | 1.4 TFSI         | 85       | 02.16       | PR: 1KJ,1KY    | 13.0460-7294.2 | 607294         |        |   | 25009 16,4 +                                | ATE       |                |                |   |   |                   |                     |        |  |   |           |  |
|                  | 1.4 TFSI         | 92       | 10.13       | PR: 1KJ,1KY    |                |                |        |   |   |           |                |                |   |   |                   |                     |        |  |   |           |  |
|                  | 1.4 TFSI         | 103      | 10.13       | PR: 1KJ,1KY    | 13.0470-7294.2 | LD7294         |        |   | 25009 16,4 +                                | ATE       |                |                |   |   |                   |                     |        |  |   |           |  |
|                  | 1.4 TFSI         | 110      | 05.14       | PR: 1KJ,1KY    |                |                |        |   |   |           |                |                |   |   |                   |                     |        |  |   |           |  |
|                  | 1.6 TDI          | 81       | 10.13       | PR: 1KJ,1KY    |                |                |        |   |   |           |                |                |   |   |                   |                     |        |  |   |           |  |
|                  | 1.8 TFSI         | 132      | 10.13       | PR: 1KJ,1KY    |                |                |        |   |   |           |                |                |   |   |                   |                     |        |  |   |           |  |
|                  | 1.8 TFSI quattro | 132      | 03.14       | PR: 1KJ,1KY    |                |                |        |   |   |           |                |                |   |   |                   |                     |        |  |   |           |  |
|                  | 2.0 TDI          | 110      | 10.13       | PR: 1KJ,1KY    |                |                |        |   |   |           |                |                |   |   |                   |                     |        |  |   |           |  |
|                  | 2.0 TDI          | 135      | 05.14       | PR: 1KJ,1KY    |                |                |        |   |   |           |                |                |   |   |                   |                     |        |  |   |           |  |
|                  | 2.0 TDI quattro  | 110      | 03.14       | PR: 1KJ,1KY    |                |                |        |   |   |           |                |                |   |   |                   |                     |        |  |   |           |  |
|                  | 2.0 TDI quattro  | 135      | 05.14       | PR: 1KJ,1KY    |                |                |        |   |   |           |                |                |   |   |                   |                     |        |  |   |           |  |
|                  | 2.0 TFSI         | 140      | 05.16       | PR: 1KJ,1KY    |                |                |        |   |   |           |                |                |   |   |                   |                     |        |  |   |           |  |
| 2.0 TFSI quattro | 140              | 05.16    | PR: 1KJ,1KY |                |                |                |        |   |   |           |                |                |   |   |                   |                     |        |  |   |           |  |
| 2.0 TFSI quattro | 162              | 05.14    | PR: 1KJ,1KY |                |                |                |        |   |   |           |                |                |   |   |                   |                     |        |  |   |           |  |
| S3               | 221              | 04.14    | PR: 1KJ,1KY |                |                |                |        |   |   |           |                |                |   |   |                   |                     |        |  |   |           |  |
| S3               | 228              | 07.16    | PR: 1KJ,1KY |                |                |                |        |   |   |           |                |                |   |   |                   |                     |        |  |   |           |  |
|                  | 1.4 TFSI         | 85       | 02.16       | PR: 1KE        |                |                |        |   |   |           | 24.0110-0356.1 | 410356         |   | elektrische Feststellbremse <sup>1)</sup> | 272 9,7 8,0 +S +B | ATE                 |        |  |   |           |  |
|                  | 1.4 TFSI         | 92       | 10.13       | PR: 1KE        |                |                |        |   |   |           |                |                |   |   |                   |                     |        |  |   |           |  |
|                  | 1.4 TFSI         | 103      | 10.13       | PR: 1KE        | 24.0310-0356.1 | 510356         |        | elektrische Feststellbremse <sup>1)</sup> | 272 9,7 8,0 +S +B PD                        | ATE       |                |                |   |   |                   |                     |        |  |   |           |  |
|                  | 1.4 TFSI         | 110      | 05.14       | PR: 1KE        |                |                |        |   |   |           |                |                |   |   |                   |                     |        |  |   |           |  |
|                  | 1.6 TDI          | 81       | 10.13       | PR: 1KE        |                |                |        |   |   |           |                |                |   |   |                   |                     |        |  |   |           |  |
|                  | 1.8 TFSI         | 132      | 10.13       | PR: 1KE        |                |                |        |   |   |           |                |                |   |   |                   |                     |        |  |   |           |  |
|                  | 1.8 TFSI quattro | 132      | 03.14       | PR: 1KE        |                |                |        |   |   |           |                |                |   |   |                   |                     |        |  |   |           |  |
|                  | 2.0 TDI          | 110      | 10.13       | PR: 1KE        |                |                |        |   |   |           |                |                |   |   |                   |                     |        |  |   |           |  |
|                  | 2.0 TDI          | 135      | 05.14       | PR: 1KE        |                |                |        |   |   |           |                |                |   |   |                   |                     |        |  |   |           |  |
|                  | 2.0 TDI quattro  | 110      | 03.14       | PR: 1KE        |                |                |        |   |   |           |                |                |   |   |                   |                     |        |  |   |           |  |
|                  | 2.0 TDI quattro  | 135      | 05.14       | PR: 1KE        |                |                |        |   |   |           |                |                |   |   |                   |                     |        |  |   |           |  |
|                  | 2.0 TFSI         | 140      | 05.16       | PR: 1KE        |                |                |        |   |   |           |                |                |   |   |                   |                     |        |  |   |           |  |
|                  | 2.0 TFSI quattro | 140      | 05.16       | PR: 1KE        |                |                |        |   |   |           |                |                |   |   |                   |                     |        |  |   |           |  |
|                  | 2.0 TFSI quattro | 162      | 05.14       | PR: 1KE        |                |                |        |   |   |           |                |                |   |   |                   |                     |        |  |   |           |  |
|                  | S3               | 221      | 04.14       | PR: 1KE        |                |                |        |   |   |           |                |                |   |   |                   |                     |        |  |   |           |  |
|                  | S3               | 228      | 07.16       | PR: 1KE        |                |                |        |   |   |           |                |                |   |   |                   |                     |        |  |   |           |  |
|                  |                  | 1.4 TFSI | 85          | 02.16          |                |                |        |   |   |           | PR: 1KJ,1KY    | 24.0122-0219.1 | 422219                                      |   |                   | 310 22,0 20,0 VL +B |        |  |   |           |  |
|                  |                  | 1.4 TFSI | 92          | 10.13          |                |                |        |   |   |           | PR: 1KJ,1KY    |                |   |   |                   |                     |        |  |   |           |  |
|                  |                  | 1.4 TFSI | 103         | 10.13          |                |                |        |   |   |           | PR: 1KJ,1KY    |                |   |   |                   |                     |        |  |   |           |  |
|                  |                  | 1.4 TFSI | 110         | 05.14          |                |                |        |   |   |           | PR: 1KJ,1KY    |                |   |   |                   |                     |        |  |   |           |  |
| 1.6 TDI          |                  | 81       | 10.13       | PR: 1KJ,1KY    |                |                |        |   |   |           |                |                |   |   |                   |                     |        |  |   |           |  |
| 1.8 TFSI         |                  | 132      | 10.13       | PR: 1KJ,1KY    |                |                |        |   |   |           |                |                |   |   |                   |                     |        |  |   |           |  |
| 1.8 TFSI quattro |                  | 132      | 03.14       | PR: 1KJ,1KY    |                |                |        |   |   |           |                |                |   |   |                   |                     |        |  |   |           |  |
| 2.0 TDI          |                  | 110      | 10.13       | PR: 1KJ,1KY    |                |                |        |   |   |           |                |                |   |   |                   |                     |        |  |   |           |  |
| 2.0 TDI          |                  | 135      | 05.14       | PR: 1KJ,1KY    |                |                |        |   |   |           |                |                |   |   |                   |                     |        |  |   |           |  |
| 2.0 TDI quattro  |                  | 110      | 03.14       | PR: 1KJ,1KY    |                |                |        |   |   |           |                |                |   |   |                   |                     |        |  |   |           |  |
| 2.0 TDI quattro  |                  | 135      | 05.14       | PR: 1KJ,1KY    |                |                |        |   |   |           |                |                |   |   |                   |                     |        |  |   |           |  |
| 2.0 TFSI         |                  | 140      | 05.16       | PR: 1KJ,1KY    |                |                |        |   |   |           |                |                |   |   |                   |                     |        |  |   |           |  |
| 2.0 TFSI quattro |                  | 140      | 05.16       | PR: 1KJ,1KY    |                |                |        |   |   |           |                |                |   |   |                   |                     |        |  |   |           |  |
| 2.0 TFSI quattro |                  | 162      | 05.14       | PR: 1KJ,1KY    |                |                |        |   |   |           |                |                |   |   |                   |                     |        |  |   |           |  |
| S3               |                  | 221      | 04.14       | PR: 1KJ,1KY    |                |                |        |   |   |           |                |                |   |   |                   |                     |        |  |   |           |  |
| S3               |                  | 228      | 07.16       | PR: 1KJ,1KY    |                |                |        |   |   |           |                |                |   |   |                   |                     |        |  |   |           |  |
|                  |                  | 1.4 TFSI | 85          | 02.16          |                | 24.0711-6230.3 | 360310 | 2   | - Geschwindigkeitsregelanlage <sup>2)</sup> | Radsensor |                |                |   |   |                   |                     |        |  |   |           |  |
|                  |                  | 1.4 TFSI | 92          | 10.13          |                |                |        |   |   |           |                |                |   |   |                   |                     |        |  |   |           |  |
|                  |                  | 1.4 TFSI | 103         | 10.13          |                | 24.0711-6337.3 | 360390 | 2   | + Geschwindigkeitsregelanlage <sup>3)</sup> | Radsensor |                |                |   |   |                   |                     |        |  |   |           |  |
|                  |                  | 1.4 TFSI | 110         | 05.14          |                |                |        |   |   |           |                |                |   |   |                   |                     |        |  |   |           |  |
|                  | 1.6 TDI          | 81       | 10.13       |                |                |                |        |   |   |           |                |                |   |   |                   |                     |        |  |   |           |  |
|                  | 1.8 TFSI         | 132      | 10.13       |                |                |                |        |   |   |           |                |                |   |   |                   |                     |        |  |   |           |  |
|                  | 2.0 TDI          | 110      | 10.13       |                |                |                |        |   |   |           |                |                |   |   |                   |                     |        |  |   |           |  |
|                  | 2.0 TDI          | 135      | 05.14       |                |                |                |        |   |   |           |                |                |   |   |                   |                     |        |  |   |           |  |
|                  | 2.0 TFSI         | 140      | 05.16       |                |                |                |        |   |   |           |                |                |   |   |                   |                     |        |  |   |           |  |
|                  | 1.4 TFSI         | 85       | 02.16       |                | 24.0711-6230.3 |                |        |   |   |           |                | 360310         | 2   | - Parkassistent <sup>4)</sup>             | Radsensor         |                     |        |  |   |           |  |
|                  | 1.4 TFSI         | 92       | 10.13       |                |                |                |        |   |   |           |                |                |   |   |                   |                     |        |  |   |           |  |
|                  | 1.4 TFSI         | 103      | 10.13       |                | 24.0711-6337.3 |                |        |   |   |           |                | 360390         | 2   | + Parkassistent <sup>5)</sup>             | Radsensor         |                     |        |  |   |           |  |
|                  | 1.4 TFSI         | 110      | 05.14       |                |                |                |        |   |   |           |                |                |   |   |                   |                     |        |  |   |           |  |
|                  | 1.6 TDI          | 81       | 10.13       |                |                |                |        |   |   |           |                |                |   |   |                   |                     |        |  |   |           |  |
|                  | 1.8 TFSI         | 132      | 10.13       |                |                |                |        |   |   |           |                |                |   |   |                   |                     |        |  |   |           |  |
| 2.0 TDI          | 110              | 10.13    |             |                |                |                |        |   |   |           |                |                |   |   |                   |                     |        |  |   |           |  |
| 2.0 TDI          | 135              | 05.14    |             |                |                |                |        |   |   |           |                |                |   |   |                   |                     |        |  |   |           |  |
| 2.0 TFSI         | 140              | 05.16    |             |                |                |                |        |   |   |           |                |                |   |   |                   |                     |        |  |   |           |  |
| 1.8 TFSI quattro | 132              | 03.14    |             | 24.0711-5401.3 |                | 360330         |        | + Parkassistent <sup>5)</sup>             | Radsensor                                   |           |                |                |   |   |                   |                     |        |  |   |           |  |
| 2.0 TDI quattro  | 110              | 03.14    |             |                |                |                |        |   |   |           |                |                |   |   |                   |                     |        |  |   |           |  |
| 2.0 TDI quattro  | 135              | 05.14    |             | 24.0711-5402.3 |                | 360331         |        | + Parkassistent <sup>5)</sup>             | Radsensor                                   |           |                |                |   |   |                   |                     |        |  |   |           |  |
| 2.0 TFSI quattro | 140              | 05.16    |             |                |                |                |        |   |   |           |                |                |   |   |                   |                     |        |  |   |           |  |
| 2.0 TFSI quattro | 162              | 05.14    |             |                |                |                |        |   |   |           |                |                |   |   |                   |                     |        |  |   |           |  |
| S3               | 221              | 04.14    |             |                |                |                |        |   |   |           |                |                |   |   |                   |                     |        |  |   |           |  |
| S3               | 228              | 07.16    |             |                |                |                |        |   |   |           |                |                |   |   |                   |                     |        |  |   |           |  |
| 1.8 TFSI quattro | 132              | 03.14    |             |                |                |                |        |   |   |           | 24.0711-5401.3 |                |   |   |                   |                     | 360330 |  | + Geschwindigkeitsregelanlage <sup>3)</sup> | Radsensor |  |
| 2.0 TDI quattro  | 110              | 03.14    |             |                |                |                |        |   |   |           |                |                |   |   |                   |                     |        |  |   |           |  |
| 2.0 TDI quattro  | 135              | 05.14    |             |                | 24.0711-5271.3 |                |        |   |   |           | 360301         |                | - Geschwindigkeitsregelanlage <sup>2)</sup> | Radsensor                                 |                   |                     |        |  |   |           |  |
| 2.0 TFSI quattro | 140              | 05.16    |             |                |                |                |        |   |   |           |                |                |   |   |                   |                     |        |  |   |           |  |
| 2.0 TFSI quattro | 162              | 05.14    |             |                |                |                |        |   |   |           |                |                |   |   |                   |                     |        |  |   |           |  |
| S3               | 221              | 04.14    |             |                |                |                |        |   |   |           |                |                |   |   |                   |                     |        |  |   |           |  |
| S3               | 228              | 07.16    |             |                |                |                |        |   |   |           |                |                |   |   |                   |                     |        |  |   |           |  |
| 1.8 TFSI quattro | 132              | 03.14    |             |                |                |                |        |   |   |           |                |                |   |   |                   | 24.0711-5272.3      | 360302 |  | - Geschwindigkeitsregelanlage <sup>2)</sup> | Radsensor |  |
| 2.0 TDI quattro  | 110              | 03.14    |             |                |                |                |        |   |   |           |                |                |   |   |                   |                     |        |  |   |           |  |
| 2.0 TDI quattro  | 135              | 05.14    |             |                |                |                |        |   |   |           |                |                |   |   |                   | 24.0711-5272.3      | 360302 |  | - Geschwindigkeitsregelanlage <sup>2)</sup> | Radsensor |  |
| 2.0 TFSI quattro | 140              | 05.16    |             |                |                |                |        |   |   |           |                |                |   |   |                   |                     |        |  |   |           |  |
| 2.0 TFSI quattro | 162              | 05.14    |             |                |                |                |        |   |   |           |                |                |   |   |                   |                     |        |  |   |           |  |
| S3               | 221              | 04.14    |             |                |                |                |        |   |   |           |                |                |   |   |                   |                     |        |  |   |           |  |
| S3               | 228              | 07.16    |             |                |                |                |        |   |   |           |                |                |   |   |                   |                     |        |  |   |           |  |

<sup>1)</sup> electric parking brake / fr.di stazionamento elettrico / frein à main électrique / freno de mano eléctrico

<sup>2)</sup> - speed control system / - impianto variatore di velocità / - régulateur de vitesse / - sistema de regulación de velocidad

<sup>3)</sup> + speed control system / + impianto variatore di velocità / + régulateur de vitesse / + sistema de regulación de velocidad

<sup>4)</sup> - parking assistant / - assistente di parcheggio / - assistance au stationnement / - asistente de aparcamiento

<sup>5)</sup> + parking assistant / + assistente di parcheggio / + assistance au stationnement / + asistente de aparcamiento



**AUDI A4 (B5) (95-01)**

|                 |             |              |              |              |              |                       |                       |        |                         |                         |
|-----------------|-------------|--------------|--------------|--------------|--------------|-----------------------|-----------------------|--------|-------------------------|-------------------------|
|                 | 1.6         |              | 8D-V-169695  | <b>11.94</b> |              | <b>13.0460-2934.2</b> | 602934                |        | 20669 19,0 /S           | TRW                     |
|                 | 1.9 TDI     | 55           | 8D-V-169695  | <b>03.96</b> |              | <b>13.0460-2822.2</b> | 602822                |        | 21945 19,6 /S           | TRW                     |
|                 | 1.9 TDI     | 66           | 8D-V-169695  | <b>01.95</b> |              |                       |                       |        |                         |                         |
|                 | 1.6         |              | 8D-V-054061  | <b>11.94</b> |              | <b>13.0460-7077.2</b> | 607077                |        | 21624 20,3 +            | ATE                     |
|                 | 1.9 TDI     | 55           | 8D-V-054061  | <b>03.96</b> |              |                       |                       |        |                         |                         |
|                 | 1.9 TDI     | 66           | 8D-V-054061  | <b>01.95</b> |              |                       |                       |        |                         |                         |
|                 | 1.8         | 85           | 8D-V-054061  | <b>07.95</b> | 04.01        | <b>13.0460-7110.2</b> | 607110                |        | 23018 20,3 +/WK         | ATE                     |
|                 | 1.8         | 92           | 8D-V-054061  | <b>11.94</b> | 04.01        | <b>13.0470-7110.2</b> | LD7110                |        | 23018 20,3 +/WK         | ATE                     |
|                 | 1.8         | 95           | 8D-V-054061  | <b>01.95</b> | 04.01        | <b>13.0460-7077.2</b> | 607077                |        | 21624 20,3 +            | ATE                     |
|                 | 1.8 T       |              |              | <b>05.95</b> | 04.01        |                       |                       |        |                         |                         |
| 1.9 TDI         | 81          |              | <b>02.96</b> | 04.01        |              |                       |                       |        |                         |                         |
| 1.9 TDI         | 85          |              | <b>03.00</b> | 04.01        |              |                       |                       |        |                         |                         |
| 2.4             |             |              | <b>07.95</b> | 07.97        | + (T)        |                       |                       |        |                         |                         |
| 2.4             | 121         |              | <b>08.97</b> | 04.01        |              |                       |                       |        |                         |                         |
| 2.5 TDI         |             |              | <b>08.97</b> | 04.01        |              |                       |                       |        |                         |                         |
| 2.6             |             |              | <b>11.94</b> | 04.01        |              |                       |                       |        |                         |                         |
| 2.8             | 128         |              | <b>11.94</b> | 07.97        |              |                       |                       |        |                         |                         |
| 2.8             | 142         |              | <b>03.96</b> | 04.01        |              |                       |                       |        |                         |                         |
| 1.8 quattro     | 85          |              | 8D-V-054061  | <b>11.94</b> |              | <b>13.0460-7077.2</b> | 607077                |        | 21624 20,3 +            | ATE                     |
| 1.8 quattro     | 92          |              | 8D-V-054061  | <b>02.95</b> |              |                       |                       |        |                         |                         |
| 1.8 T quattro   | 110         |              |              | <b>02.95</b> | 01.99        |                       |                       |        |                         |                         |
| 1.8 T quattro   | 132         |              |              | <b>08.97</b> | 01.99        |                       |                       |        |                         |                         |
| 1.9 TDI quattro | 81          |              |              | <b>07.96</b> | 01.99        |                       |                       |        |                         |                         |
| 2.4 quattro     |             |              |              | <b>08.97</b> | 01.99        |                       |                       |        |                         |                         |
| 2.5 TDI quattro |             |              |              | <b>11.97</b> | 01.99        |                       |                       |        |                         |                         |
| 2.6 quattro     |             |              |              | <b>11.94</b> | 01.99        |                       |                       |        |                         |                         |
| 2.8 quattro     | 128         |              |              | <b>11.94</b> | 07.96        |                       |                       |        |                         |                         |
| 2.8 quattro     | 142         |              |              | <b>06.96</b> | 01.99        |                       |                       |        |                         |                         |
| 1.8 T quattro   | 110         |              |              | <b>02.99</b> | 04.01        | <b>13.0460-7110.2</b> | 607110                |        | 23018 20,3 +/WK         | ATE                     |
| 1.8 T quattro   | 132         |              |              | <b>02.99</b> | 04.01        | <b>13.0470-7110.2</b> | LD7110                |        | 23018 20,3 +/WK         | ATE                     |
| 1.9 TDI quattro | 81          |              |              | <b>02.99</b> | 04.01        |                       |                       |        |                         |                         |
| 1.9 TDI quattro | 85          |              |              | <b>03.00</b> | 04.01        |                       |                       |        |                         |                         |
| 2.4 quattro     |             |              |              | <b>02.99</b> | 04.01        |                       |                       |        |                         |                         |
| 2.5 TDI quattro |             |              |              | <b>02.99</b> | 04.01        |                       |                       |        |                         |                         |
| 2.6 quattro     |             |              |              | <b>02.99</b> | 04.01        |                       |                       |        |                         |                         |
| 2.8 quattro     | 142         |              |              | <b>02.99</b> | 04.01        |                       |                       |        |                         |                         |
| 1.6             |             | 8D-V-169696  |              | <b>04.01</b> |              | <b>13.0460-2837.2</b> | 602837                |        | 21945 19,6 +/WK/S       | TRW                     |
| 1.6             |             | 8D-V-054062  |              | <b>04.01</b> |              | <b>13.0470-2837.2</b> | LD2837                |        | 21945 19,6 +/WK/S       | TRW                     |
| 1.8             | 85          | 8D-V-054062  |              | <b>04.01</b> |              | <b>13.0460-2822.2</b> | 602822                |        | 21945 19,6 /S           | TRW                     |
| 1.8             | 92          | 8D-V-054062  |              | <b>04.01</b> |              |                       |                       |        |                         |                         |
| 1.8             | 95          | 8D-V-054062  |              | <b>04.01</b> |              |                       |                       |        |                         |                         |
| 1.8 quattro     | 85          | 8D-V-054062  |              | <b>04.01</b> |              |                       |                       |        |                         |                         |
| 1.8 quattro     | 92          | 8D-V-054062  |              | <b>04.01</b> |              |                       |                       |        |                         |                         |
| 1.9 TDI         | 55          | 8D-V-169696  |              | <b>04.01</b> |              |                       |                       |        |                         |                         |
| 1.9 TDI         | 55          | 8D-V-054062  |              | <b>04.01</b> |              |                       |                       |        |                         |                         |
| 1.9 TDI         | 66          | 8D-V-169696  |              | <b>04.01</b> |              |                       |                       |        |                         |                         |
| 1.9 TDI         | 66          | 8D-V-054062  |              | <b>04.01</b> |              |                       |                       |        |                         |                         |
| S4              |             | 8D-X-199 999 | <b>10.97</b> |              |              | <b>13.0460-2705.2</b> | 602705                |        | 21454 17,0 +/S          | TRW                     |
| S4              |             | 8D-X-200 001 |              | <b>04.01</b> |              | <b>13.0460-2875.2</b> | 602875                |        | 23280 17,5 +/WK         | TRW                     |
| RS 4            |             |              | <b>06.00</b> | <b>04.01</b> |              | <b>13.0460-7183.2</b> | 607183                |        | 21484 20,5 +/WE         | ATE                     |
|                 | 1.6         |              | 8D-V-169695  | <b>11.94</b> |              | <b>24.0113-0181.1</b> | 413181                |        | 280 13,0 11,0 L +B      |                         |
|                 | 1.9 TDI     | 55           | 8D-V-169695  | <b>03.96</b> |              | <b>24.0313-0181.1</b> | 513181                |        | 280 13,0 11,0 L +B PD   |                         |
|                 | 1.9 TDI     | 66           | 8D-V-169695  | <b>01.95</b> |              |                       |                       |        |                         |                         |
|                 | 1.6         |              | 8D-V-054061  | <b>11.94</b> |              | <b>24.0115-0105.1</b> | 415105                |        | 288 15,0 13,0 L +B      |                         |
|                 | 1.8         | 85           | 8D-V-054061  | <b>07.95</b> |              | <b>24.0315-0105.1</b> | 515105                |        | 288 15,0 13,0 L +B PD   |                         |
|                 | 1.8         | 92           | 8D-V-054061  | <b>11.94</b> |              |                       |                       |        |                         |                         |
|                 | 1.8         | 95           | 8D-V-054061  | <b>01.95</b> |              |                       |                       |        |                         |                         |
|                 | 1.8 quattro | 85           | 8D-V-054061  | <b>07.95</b> |              |                       |                       |        |                         |                         |
|                 | 1.8 quattro | 92           | 8D-V-054061  | <b>11.94</b> |              |                       |                       |        |                         |                         |
|                 | 1.6         |              | 8D-V-169696  |              | <b>04.01</b> |                       | <b>24.0122-0152.1</b> | 422152 |                         | 280 22,0 20,0 V L +S +B |
| 1.6             |             | 8D-V-054062  |              | <b>04.01</b> |              | <b>24.0322-0152.1</b> | 522152                |        | 280 22,0 20,0 V L +B PD |                         |
| 1.8             | 85          | 8D-V-054062  |              | <b>04.01</b> |              |                       |                       |        |                         |                         |
| 1.8             | 92          | 8D-V-054062  |              | <b>04.01</b> |              |                       |                       |        |                         |                         |
| 1.8             | 95          | 8D-V-054062  |              | <b>04.01</b> |              |                       |                       |        |                         |                         |
| 1.8 quattro     | 85          | 8D-V-054062  |              | <b>04.01</b> |              |                       |                       |        |                         |                         |
| 1.8 quattro     | 92          | 8D-V-054062  |              | <b>04.01</b> |              |                       |                       |        |                         |                         |
| 1.9 TDI         | 55          | 8D-V-169696  |              | <b>04.01</b> |              |                       |                       |        |                         |                         |
| 1.9 TDI         | 55          | 8D-V-054062  |              | <b>04.01</b> |              |                       |                       |        |                         |                         |
| 1.9 TDI         | 66          | 8D-V-169696  |              | <b>04.01</b> |              |                       |                       |        |                         |                         |
| 1.9 TDI         | 66          | 8D-V-054062  |              | <b>04.01</b> |              |                       |                       |        |                         |                         |
| 1.8 T           |             |              | <b>05.95</b> | <b>04.01</b> |              | <b>24.0125-0105.1</b> | 425105                |        | 288 25,0 23,0 V L +S +B |                         |
| 1.8 T quattro   | 110         |              | <b>02.95</b> | <b>04.01</b> |              | <b>24.0325-0105.1</b> | 525105                |        | 288 25,0 23,0 V L +B PD |                         |
| 1.8 T quattro   | 132         |              | <b>08.97</b> | <b>04.01</b> |              |                       |                       |        |                         |                         |
| 1.9 TDI         | 81          |              | <b>02.96</b> | <b>04.01</b> |              |                       |                       |        |                         |                         |
| 1.9 TDI         | 85          |              | <b>03.00</b> | <b>04.01</b> |              |                       |                       |        |                         |                         |
| 1.9 TDI quattro | 81          |              | <b>07.96</b> | <b>04.01</b> |              |                       |                       |        |                         |                         |
| 1.9 TDI quattro | 85          |              | <b>03.00</b> | <b>04.01</b> |              |                       |                       |        |                         |                         |
| 2.4             |             |              | <b>07.95</b> | 07.97        | + (T)        |                       |                       |        |                         |                         |
| 2.4             | 121         |              | <b>08.97</b> | <b>04.01</b> |              |                       |                       |        |                         |                         |
| 2.4 quattro     |             |              | <b>08.97</b> | <b>04.01</b> |              |                       |                       |        |                         |                         |
| 2.5 TDI         |             |              | <b>08.97</b> | <b>04.01</b> |              |                       |                       |        |                         |                         |
| 2.5 TDI quattro |             |              | <b>11.97</b> | <b>04.01</b> |              |                       |                       |        |                         |                         |
| 2.6             |             |              | <b>11.94</b> | <b>04.01</b> |              |                       |                       |        |                         |                         |
| 2.6 quattro     |             |              | <b>11.94</b> | <b>04.01</b> |              |                       |                       |        |                         |                         |
| 2.8             | 128         |              | <b>11.94</b> | <b>07.97</b> |              |                       |                       |        |                         |                         |

1) + (G) / + GUS States / + (G) / + Stati del GUS / + (G) / + Etats de la CEI / + (G) / + estados del GUS

2) + GUS States / + Stati del GUS / + Etats de la CEI / + estados del GUS

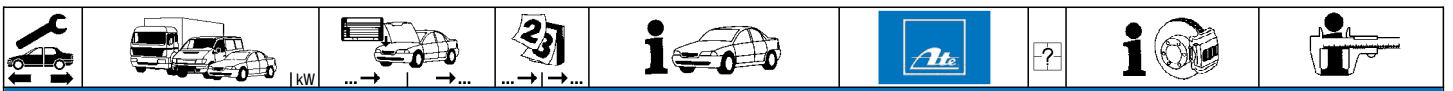

**AUDI A4 (B5) (95-01)**

|  |                 |     |             |       |       |                |        |   |                         |
|--|-----------------|-----|-------------|-------|-------|----------------|--------|---|-------------------------|
|  | 2.8             | 142 |             | 03.96 | 04.01 | 24.0125-0105.1 | 425105 |   | 288 25,0 23,0 V L +S +B |
|  | 2.8 quattro     | 128 |             | 11.94 | 07.96 | 24.0325-0105.1 | 525105 |   | 288 25,0 23,0 V L +B PD |
|  | 2.8 quattro     | 142 |             | 09.96 | 04.01 |                |        |   |                         |
|  | S4              |     |             | 10.97 | 04.01 | 24.0130-0113.1 | 430113 |   | 320 30,0 28,0 V L +S +B |
|  |                 |     |             |       |       | 24.0330-0113.1 | 530113 |   | 320 30,0 28,0 V L +B PD |
|  | 1.6             |     |             | 11.94 | 04.01 | 24.0710-5014.3 | 360369 | 2 | Radsensor               |
|  | 1.8             |     |             | 11.94 | 04.01 |                |        |   |                         |
|  | 1.8 quattro     | 85  |             | 11.94 | 04.01 |                |        |   |                         |
|  | 1.8 quattro     | 92  |             | 11.94 | 04.01 |                |        |   |                         |
|  | 1.8 T           |     |             | 05.95 | 04.01 |                |        |   |                         |
|  | 1.8 T quattro   | 110 |             | 02.95 | 04.01 |                |        |   |                         |
|  | 1.8 T quattro   | 132 |             | 08.97 | 04.01 |                |        |   |                         |
|  | 1.9 TDI         | 55  |             | 03.96 | 04.01 |                |        |   |                         |
|  | 1.9 TDI         | 66  |             | 01.95 | 04.01 |                |        |   |                         |
|  | 1.9 TDI         | 81  |             | 02.96 | 04.01 |                |        |   |                         |
|  | 1.9 TDI         | 85  |             | 03.00 | 04.01 |                |        |   |                         |
|  | 1.9 TDI quattro | 81  |             | 07.96 | 04.01 |                |        |   |                         |
|  | 1.9 TDI quattro | 85  |             | 03.00 | 04.01 |                |        |   |                         |
|  | 2.4             |     |             | 07.95 | 04.01 |                |        |   |                         |
|  | 2.4             | 121 |             | 08.97 | 04.01 |                |        |   |                         |
|  | 2.4 quattro     |     |             | 08.97 | 04.01 |                |        |   |                         |
|  | 2.5 TDI         |     |             | 08.97 | 04.01 |                |        |   |                         |
|  | 2.5 TDI quattro |     |             | 11.97 | 04.01 |                |        |   |                         |
|  | 2.6             |     |             | 11.94 | 04.01 |                |        |   |                         |
|  | 2.6 quattro     |     |             | 11.94 | 04.01 |                |        |   |                         |
|  | 2.8             | 128 |             | 11.94 | 07.97 |                |        |   |                         |
|  | 2.8             | 142 |             | 03.96 | 04.01 |                |        |   |                         |
|  | 2.8 quattro     | 128 |             | 11.94 | 07.96 |                |        |   |                         |
|  | 2.8 quattro     | 142 |             | 09.96 | 04.01 |                |        |   |                         |
|  | S4              |     |             | 10.97 | 04.01 |                |        |   |                         |
|  | 1.6             |     | 8D-V-160000 | 11.94 |       | 13.0460-3602.2 | 603602 |   | 21144 15,8 /S TRW       |
|  | 1.8             |     | 8D-V-160000 | 11.94 |       |                |        |   |                         |
|  | 1.8 quattro     | 85  |             | 11.94 | 04.01 |                |        |   |                         |
|  | 1.8 quattro     | 92  |             | 11.94 | 04.01 |                |        |   |                         |
|  | 1.8 T           |     | 8D-V-160000 | 05.95 |       |                |        |   |                         |
|  | 1.8 T quattro   | 110 |             | 02.95 | 04.01 |                |        |   |                         |
|  | 1.8 T quattro   | 132 |             | 08.97 | 04.01 |                |        |   |                         |
|  | 1.9 TDI         | 55  | 8D-V-160000 | 03.96 |       |                |        |   |                         |
|  | 1.9 TDI         | 66  | 8D-V-160000 | 01.95 |       |                |        |   |                         |
|  | 1.9 TDI         | 81  | 8D-V-160000 | 02.96 |       |                |        |   |                         |
|  | 1.9 TDI         | 85  | 8D-V-160000 | 03.00 |       |                |        |   |                         |
|  | 1.9 TDI quattro | 81  |             | 07.96 | 04.01 |                |        |   |                         |
|  | 1.9 TDI quattro | 85  |             | 03.00 | 04.01 |                |        |   |                         |
|  | 2.4             |     | 8D-V-160000 | 07.95 |       |                |        |   |                         |
|  | 2.4 quattro     |     |             | 08.97 | 04.01 |                |        |   |                         |
|  | 2.5 TDI         |     | 8D-V-160000 | 08.97 |       |                |        |   |                         |
|  | 2.5 TDI quattro |     |             | 11.97 | 04.01 |                |        |   |                         |
|  | 2.6             |     | 8D-V-160000 | 11.94 |       |                |        |   |                         |
|  | 2.6 quattro     |     |             | 11.94 | 04.01 |                |        |   |                         |
|  | 2.8             | 128 | 8D-V-160000 | 11.94 |       |                |        |   |                         |
|  | 2.8             | 142 | 8D-V-160000 | 03.96 |       |                |        |   |                         |
|  | 2.8 quattro     | 128 |             | 11.94 | 07.96 |                |        |   |                         |
|  | 2.8 quattro     | 142 |             | 09.96 | 04.01 |                |        |   |                         |
|  | 1.6             |     | 8D-V-160001 |       | 04.01 | 13.0460-2820.2 | 602820 |   | 20961 17,6 /S TRW       |
|  | 1.8             |     | 8D-V-160001 |       | 04.01 | 13.0470-2820.2 | LD2820 |   | 20961 17,6 /S TRW       |
|  | 1.8 T           |     | 8D-V-160001 |       | 04.01 | 13.0460-0072.2 | 610072 |   | Belagsatz-Zubehör TRW   |
|  | 1.9 TDI         | 55  | 8D-V-160001 |       | 04.01 |                |        |   |                         |
|  | 1.9 TDI         | 66  | 8D-V-160001 |       | 04.01 |                |        |   |                         |
|  | 1.9 TDI         | 81  | 8D-V-160001 |       | 04.01 |                |        |   |                         |
|  | 1.9 TDI         | 85  |             | 03.00 | 04.01 |                |        |   |                         |
|  | 2.4             |     | 8D-V-160001 |       | 07.97 |                |        |   |                         |
|  | 2.4             | 121 |             | 08.97 | 04.01 |                |        |   |                         |
|  | 2.5 TDI         |     |             | 08.97 | 04.01 |                |        |   |                         |
|  | 2.6             |     | 8D-V-160001 |       | 04.01 |                |        |   |                         |
|  | 2.8             | 128 | 8D-V-160001 |       | 07.97 |                |        |   |                         |
|  | 2.8             | 142 | 8D-V-160001 |       | 04.01 |                |        |   |                         |
|  | S4              |     |             | 10.97 | 04.01 |                |        |   |                         |
|  | 1.6             |     |             | 11.94 | 04.01 | 24.0110-0210.1 | 410210 |   | 245 10,0 8,0 +B         |
|  | 1.8             |     |             | 11.94 | 04.01 |                |        |   |                         |
|  | 1.8 T           |     |             | 05.95 | 04.01 |                |        |   |                         |
|  | 1.9 TDI         | 55  |             | 03.96 | 04.01 |                |        |   |                         |
|  | 1.9 TDI         | 66  |             | 01.95 | 04.01 |                |        |   |                         |
|  | 1.9 TDI         | 81  |             | 02.96 | 04.01 |                |        |   |                         |
|  | 1.9 TDI         | 85  |             | 03.00 | 04.01 |                |        |   |                         |
|  | 2.4             |     |             | 07.95 | 07.97 |                |        |   |                         |
|  | 2.4             | 121 |             | 08.97 | 04.01 |                |        |   |                         |
|  | 2.5 TDI         |     |             | 08.97 | 04.01 |                |        |   |                         |
|  | 2.6             |     |             | 11.94 | 04.01 |                |        |   |                         |
|  | 2.8             | 128 |             | 11.94 | 07.97 |                |        |   |                         |
|  | 2.8             | 142 |             | 03.96 | 04.01 |                |        |   |                         |
|  | 1.8 quattro     | 85  |             | 11.94 | 04.01 | 24.0110-0224.1 | 410224 |   | 245 10,0 8,0 +B         |
|  | 1.8 quattro     | 92  |             | 11.94 | 04.01 | 24.0310-0224.1 | 510224 |   | 245 10,0 8,0 +B PD      |
|  | 1.8 T quattro   | 110 |             | 02.95 | 04.01 |                |        |   |                         |
|  | 1.8 T quattro   | 132 |             | 08.97 | 04.01 |                |        |   |                         |
|  | 1.9 TDI quattro | 81  |             | 07.96 | 04.01 |                |        |   |                         |
|  | 1.9 TDI quattro | 85  |             | 03.00 | 04.01 |                |        |   |                         |
|  | 2.4 quattro     |     |             | 08.97 | 04.01 |                |        |   |                         |



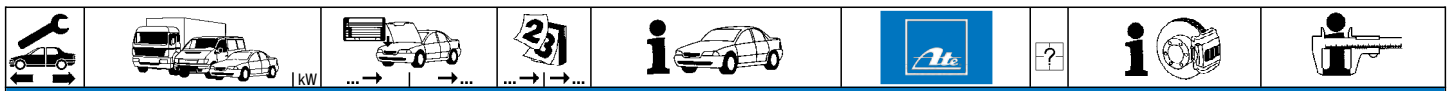

| AUDI A4 (B5) (95-01) |                 |     |  |       |       |  |                |        |  |                      |
|----------------------|-----------------|-----|--|-------|-------|--|----------------|--------|--|----------------------|
|                      | 2.5 TDI quattro |     |  | 11.97 | 04.01 |  | 24.0110-0224.1 | 410224 |  | 245 10,0 8,0 +B      |
|                      | 2.6 quattro     |     |  | 11.94 | 04.01 |  | 24.0310-0224.1 | 510224 |  | 245 10,0 8,0 +B PD   |
|                      | 2.8 quattro     | 128 |  | 11.94 | 07.96 |  |                |        |  |                      |
|                      | 2.8 quattro     | 142 |  | 06.96 | 04.01 |  |                |        |  |                      |
|                      | S4              |     |  | 10.97 | 04.01 |  | 24.0122-0221.1 | 422221 |  | 256 22,0 20,0 V L +B |









### AUDI A4 (B6/B7) (01-08)

|  |                  |     |  |       |       |                     |                |        |  |                   |     |
|--|------------------|-----|--|-------|-------|---------------------|----------------|--------|--|-------------------|-----|
|  | 1.6              | 75  |  | 12.00 | 11.08 | PR: 1LZ             | 13.0460-2837.2 | 602837 |  | 21945 19,6 +/WK/S | TRW |
|  | 1.8 T            | 110 |  | 12.00 | 11.08 | PR: 1LZ             | 13.0470-2837.2 | LD2837 |  | 21945 19,6 +/WK/S | TRW |
|  | 1.8 T            | 120 |  | 07.02 | 11.08 | PR: 1LZ             |                |        |  |                   |     |
|  | 1.8 T            | 125 |  | 07.01 | 11.08 | PR: 1LZ             |                |        |  |                   |     |
|  | 1.8 T            | 140 |  | 11.02 | 11.08 | PR: 1LZ             |                |        |  |                   |     |
|  | 1.8 T quattro    | 110 |  | 12.00 | 11.08 | PR: 1LZ             |                |        |  |                   |     |
|  | 1.8 T quattro    | 120 |  | 07.02 | 11.08 | PR: 1LZ             |                |        |  |                   |     |
|  | 1.8 T quattro    | 125 |  | 07.01 | 11.08 | PR: 1LZ             |                |        |  |                   |     |
|  | 1.8 T quattro    | 140 |  | 11.02 | 11.08 | PR: 1LZ             |                |        |  |                   |     |
|  | 1.9 TDI          | 74  |  | 04.01 | 11.08 | PR: 1LZ             |                |        |  |                   |     |
|  | 1.9 TDI          | 85  |  | 06.04 | 11.08 | PR: 1LZ             |                |        |  |                   |     |
|  | 1.9 TDI          | 96  |  | 12.00 | 11.08 | PR: 1LZ             |                |        |  |                   |     |
|  | 1.9 TDI quattro  |     |  | 12.00 | 11.08 | PR: 1LZ             |                |        |  |                   |     |
|  | 2.0              | 96  |  | 12.00 | 11.08 | PR: 1LZ             |                |        |  |                   |     |
|  | 2.0 FSI          | 110 |  | 07.02 | 11.08 | PR: 1LZ             |                |        |  |                   |     |
|  | 2.0 TDI          | 100 |  | 11.04 | 11.08 | PR: 1LZ             |                |        |  |                   |     |
|  | 2.0 TDI          | 103 |  | 11.04 | 11.08 | PR: 1LZ             |                |        |  |                   |     |
|  | 2.0 TDI          | 125 |  | 06.06 | 11.08 | PR: 1LZ             |                |        |  |                   |     |
|  | 2.0 TDI quattro  | 103 |  | 01.06 | 11.08 | PR: 1LZ             |                |        |  |                   |     |
|  | 2.0 TDI quattro  | 125 |  | 06.06 | 11.08 | PR: 1LZ             |                |        |  |                   |     |
|  | 2.0 TFSI         | 147 |  | 11.04 | 11.08 | PR: 1LZ             |                |        |  |                   |     |
|  | 2.0 TFSI         | 162 |  | 06.05 | 11.08 | PR: 1LZ             |                |        |  |                   |     |
|  | 2.0 TFSI quattro | 147 |  | 11.04 | 11.08 | PR: 1LZ             |                |        |  |                   |     |
|  | 2.0 TFSI quattro | 162 |  | 06.05 | 11.08 | PR: 1LZ             |                |        |  |                   |     |
|  | 2.4              |     |  | 09.01 | 11.08 | PR: 1LZ             |                |        |  |                   |     |
|  | 2.5 TDI          |     |  | 12.00 | 11.08 | PR: 1LZ             |                |        |  |                   |     |
|  | 2.5 TDI quattro  |     |  | 12.00 | 11.08 | PR: 1LZ             |                |        |  |                   |     |
|  | 2.7 TDI          | 120 |  | 11.05 | 11.08 | PR: 1LZ             |                |        |  |                   |     |
|  | 2.7 TDI          | 132 |  | 01.06 | 11.08 | PR: 1LZ             |                |        |  |                   |     |
|  | 3.0              |     |  | 12.00 | 11.08 | PR: 1LZ             |                |        |  |                   |     |
|  | 3.0 quattro      |     |  | 12.00 | 11.08 | PR: 1LZ             |                |        |  |                   |     |
|  | 3.0 TDI quattro  | 150 |  | 11.04 | 11.08 | PR: 1LZ             |                |        |  |                   |     |
|  | 3.0 TDI quattro  | 171 |  | 01.06 | 11.08 | PR: 1LZ             |                |        |  |                   |     |
|  | 3.2 FSI          | 188 |  | 01.05 | 11.08 | PR: 1LZ             |                |        |  |                   |     |
|  | 3.2 FSI quattro  | 188 |  | 01.05 | 11.08 | PR: 1LZ             |                |        |  |                   |     |
|  | 1.6              | 75  |  | 12.00 | 11.08 | PR: 1LB,1LE,1LF,1LT | 13.0460-7110.2 | 607110 |  | 23018 20,3 +/WK   | ATE |
|  | 1.8 T            | 110 |  | 12.00 | 11.08 | PR: 1LB,1LE,1LF,1LT | 13.0470-7110.2 | LD7110 |  | 23018 20,3 +/WK   | ATE |
|  | 1.8 T            | 120 |  | 07.02 | 11.08 | PR: 1LB,1LE,1LF,1LT |                |        |  |                   |     |
|  | 1.8 T            | 125 |  | 07.01 | 11.08 | PR: 1LB,1LE,1LF,1LT |                |        |  |                   |     |
|  | 1.8 T            | 140 |  | 11.02 | 11.08 | PR: 1LB,1LE,1LF,1LT |                |        |  |                   |     |
|  | 1.8 T quattro    | 110 |  | 12.00 | 11.08 | PR: 1LB,1LE,1LF,1LT |                |        |  |                   |     |
|  | 1.8 T quattro    | 120 |  | 07.02 | 11.08 | PR: 1LB,1LE,1LF,1LT |                |        |  |                   |     |
|  | 1.8 T quattro    | 125 |  | 07.01 | 11.08 | PR: 1LB,1LE,1LF,1LT |                |        |  |                   |     |
|  | 1.8 T quattro    | 140 |  | 11.02 | 11.08 | PR: 1LB,1LE,1LF,1LT |                |        |  |                   |     |
|  | 1.9 TDI          | 74  |  | 04.01 | 11.08 | PR: 1LB,1LE,1LF,1LT |                |        |  |                   |     |
|  | 1.9 TDI          | 85  |  | 06.04 | 11.08 | PR: 1LB,1LE,1LF,1LT |                |        |  |                   |     |
|  | 1.9 TDI          | 96  |  | 12.00 | 11.08 | PR: 1LB,1LE,1LF,1LT |                |        |  |                   |     |
|  | 1.9 TDI quattro  |     |  | 12.00 | 11.08 | PR: 1LB,1LE,1LF,1LT |                |        |  |                   |     |
|  | 2.0              | 96  |  | 12.00 | 11.08 | PR: 1LB,1LE,1LF,1LT |                |        |  |                   |     |
|  | 2.0 FSI          | 110 |  | 07.02 | 11.08 | PR: 1LB,1LE,1LF,1LT |                |        |  |                   |     |
|  | 2.0 TDI          | 100 |  | 11.04 | 11.08 | PR: 1LB,1LE,1LF,1LT |                |        |  |                   |     |
|  | 2.0 TDI          | 103 |  | 11.04 | 11.08 | PR: 1LB,1LE,1LF,1LT |                |        |  |                   |     |
|  | 2.0 TDI          | 125 |  | 06.06 | 11.08 | PR: 1LB,1LE,1LF,1LT |                |        |  |                   |     |
|  | 2.0 TDI quattro  | 103 |  | 01.06 | 11.08 | PR: 1LB,1LE,1LF,1LT |                |        |  |                   |     |
|  | 2.0 TDI quattro  | 125 |  | 06.06 | 11.08 | PR: 1LB,1LE,1LF,1LT |                |        |  |                   |     |
|  | 2.0 TFSI         | 147 |  | 11.04 | 11.08 | PR: 1LB,1LE,1LF,1LT |                |        |  |                   |     |
|  | 2.0 TFSI         | 162 |  | 06.05 | 11.08 | PR: 1LB,1LE,1LF,1LT |                |        |  |                   |     |
|  | 2.0 TFSI quattro | 147 |  | 11.04 | 11.08 | PR: 1LB,1LE,1LF,1LT |                |        |  |                   |     |
|  | 2.0 TFSI quattro | 162 |  | 06.05 | 11.08 | PR: 1LB,1LE,1LF,1LT |                |        |  |                   |     |
|  | 2.4              |     |  | 09.01 | 11.08 | PR: 1LB,1LE,1LF,1LT |                |        |  |                   |     |
|  | 2.5 TDI          |     |  | 12.00 | 11.08 | PR: 1LB,1LE,1LF,1LT |                |        |  |                   |     |
|  | 2.5 TDI quattro  |     |  | 12.00 | 11.08 | PR: 1LB,1LE,1LF,1LT |                |        |  |                   |     |
|  | 2.7 TDI          | 120 |  | 11.05 | 11.08 | PR: 1LB,1LE,1LF,1LT |                |        |  |                   |     |
|  | 2.7 TDI          | 132 |  | 01.06 | 11.08 | PR: 1LB,1LE,1LF,1LT |                |        |  |                   |     |
|  | 3.0              |     |  | 12.00 | 11.08 | PR: 1LB,1LE,1LF,1LT |                |        |  |                   |     |
|  | 3.0 quattro      |     |  | 12.00 | 11.08 | PR: 1LB,1LE,1LF,1LT |                |        |  |                   |     |
|  | 3.0 TDI quattro  | 150 |  | 11.04 | 11.08 | PR: 1LB,1LE,1LF,1LT |                |        |  |                   |     |
|  | 3.0 TDI quattro  | 171 |  | 01.06 | 11.08 | PR: 1LB,1LE,1LF,1LT |                |        |  |                   |     |
|  | 3.2 FSI          | 188 |  | 01.05 | 11.08 | PR: 1LB,1LE,1LF,1LT |                |        |  |                   |     |
|  | 3.2 FSI quattro  | 188 |  | 01.05 | 11.08 | PR: 1LB,1LE,1LF,1LT |                |        |  |                   |     |
|  | 1.6              | 75  |  | 12.00 | 11.08 | PR: 1LA,1LC         | 13.0460-7201.2 | 607201 |  | 23763 20,3 +/WK   | ATE |
|  | 1.8 T            | 110 |  | 12.00 | 11.08 | PR: 1LA,1LC         | 13.0470-7201.2 | LD7201 |  | 23763 20,3 +/WK   | ATE |
|  | 1.8 T            | 120 |  | 07.02 | 11.08 | PR: 1LA,1LC         |                |        |  |                   |     |
|  | 1.8 T            | 125 |  | 07.01 | 11.08 | PR: 1LA,1LC         |                |        |  |                   |     |
|  | 1.8 T            | 140 |  | 11.02 | 11.08 | PR: 1LA,1LC         |                |        |  |                   |     |
|  | 1.8 T quattro    | 110 |  | 12.00 | 11.08 | PR: 1LA,1LC         |                |        |  |                   |     |
|  | 1.8 T quattro    | 120 |  | 07.02 | 11.08 | PR: 1LA,1LC         |                |        |  |                   |     |
|  | 1.8 T quattro    | 125 |  | 07.01 | 11.08 | PR: 1LA,1LC         |                |        |  |                   |     |
|  | 1.8 T quattro    | 140 |  | 11.02 | 11.08 | PR: 1LA,1LC         |                |        |  |                   |     |
|  | 1.9 TDI          | 74  |  | 04.01 | 11.08 | PR: 1LA,1LC         |                |        |  |                   |     |

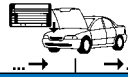
**AUDI A4 (B6/B7) (01-08)**

|                  |                  |       |       |             |                |                |        |                |  |            |
|------------------|------------------|-------|-------|-------------|----------------|----------------|--------|----------------|--|------------|
|                  | 1.9 TDI          | 85    | 06.04 | 11.08       | PR: 1LA,1LC    | 13.0460-7201.2 | 607201 |                | 23763 20,3 +WK<br>23763 20,3 +WK                   | ATE<br>ATE |
|                  | 1.9 TDI          | 96    | 12.00 | 11.08       | PR: 1LA,1LC    | 13.0470-7201.2 | LD7201 |                |  |            |
|                  | 1.9 TDI quattro  |       | 12.00 | 11.08       | PR: 1LA,1LC    |                |        |                |  |            |
|                  | 2.0              | 96    | 12.00 | 11.08       | PR: 1LA,1LC    |                |        |                |  |            |
|                  | 2.0 FSI          | 110   | 07.02 | 11.08       | PR: 1LA,1LC    |                |        |                |  |            |
|                  | 2.0 TDI          | 100   | 11.04 | 11.08       | PR: 1LA,1LC    |                |        |                |  |            |
|                  | 2.0 TDI          | 103   | 11.04 | 11.08       | PR: 1LA,1LC    |                |        |                |  |            |
|                  | 2.0 TDI          | 125   | 06.06 | 11.08       | PR: 1LA,1LC    |                |        |                |  |            |
|                  | 2.0 TDI quattro  | 103   | 01.06 | 11.08       | PR: 1LA,1LC    |                |        |                |  |            |
|                  | 2.0 TDI quattro  | 125   | 06.06 | 11.08       | PR: 1LA,1LC    |                |        |                |  |            |
|                  | 2.0 TFSI         | 147   | 11.04 | 11.08       | PR: 1LA,1LC    |                |        |                |  |            |
|                  | 2.0 TFSI         | 162   | 06.05 | 11.08       | PR: 1LA,1LC    |                |        |                |  |            |
|                  | 2.0 TFSI quattro | 147   | 11.04 | 11.08       | PR: 1LA,1LC    |                |        |                |  |            |
|                  | 2.0 TFSI quattro | 162   | 06.05 | 11.08       | PR: 1LA,1LC    |                |        |                |  |            |
|                  | 2.4              |       | 09.01 | 11.08       | PR: 1LA,1LC    |                |        |                |  |            |
|                  | 2.5 TDI          |       | 12.00 | 11.08       | PR: 1LA,1LC    |                |        |                |  |            |
|                  | 2.5 TDI quattro  |       | 12.00 | 11.08       | PR: 1LA,1LC    |                |        |                |  |            |
|                  | 2.7 TDI          | 120   | 11.05 | 11.08       | PR: 1LA,1LC    |                |        |                |  |            |
|                  | 2.7 TDI          | 132   | 01.06 | 11.08       | PR: 1LA,1LC    |                |        |                |  |            |
|                  | 3.0              |       | 12.00 | 11.08       | PR: 1LA,1LC    |                |        |                |  |            |
| 3.0 quattro      |                  | 12.00 | 11.08 | PR: 1LA,1LC |                |                |        |                |  |            |
| 3.0 TDI quattro  | 150              | 11.04 | 11.08 | PR: 1LA,1LC |                |                |        |                |  |            |
| 3.0 TDI quattro  | 171              | 01.06 | 11.08 | PR: 1LA,1LC |                |                |        |                |  |            |
| 3.2 FSI          | 188              | 01.05 | 11.08 | PR: 1LA,1LC |                |                |        |                |  |            |
| 3.2 FSI quattro  | 188              | 01.05 | 11.08 | PR: 1LA,1LC |                |                |        |                |  |            |
| S4               | 253              | 03.03 | 11.08 | PR: 1LJ     | 13.0460-7201.2 | 607201         |        | 23763 20,3 +WK | ATE  |            |
|                  | 1.6              | 75    | 12.00 | 11.08       | PR: 1LZ        | 24.0122-0152.1 | 422152 |                | 280 22,0 20,0 V L +S +B<br>280 22,0 20,0 V L +B PD |            |
|                  | 1.8 T            | 110   | 12.00 | 11.08       | PR: 1LZ        | 24.0322-0152.1 | 522152 |                |  |            |
|                  | 1.8 T            | 120   | 07.02 | 11.08       | PR: 1LZ        |                |        |                |  |            |
|                  | 1.8 T            | 125   | 07.01 | 11.08       | PR: 1LZ        |                |        |                |  |            |
|                  | 1.8 T            | 140   | 11.02 | 11.08       | PR: 1LZ        |                |        |                |  |            |
|                  | 1.8 T quattro    | 110   | 12.00 | 11.08       | PR: 1LZ        |                |        |                |  |            |
|                  | 1.8 T quattro    | 120   | 07.02 | 11.08       | PR: 1LZ        |                |        |                |  |            |
|                  | 1.8 T quattro    | 125   | 07.01 | 11.08       | PR: 1LZ        |                |        |                |  |            |
|                  | 1.8 T quattro    | 140   | 11.02 | 11.08       | PR: 1LZ        |                |        |                |  |            |
|                  | 1.9 TDI          | 74    | 04.01 | 11.08       | PR: 1LZ        |                |        |                |  |            |
|                  | 1.9 TDI          | 85    | 06.04 | 11.08       | PR: 1LZ        |                |        |                |  |            |
|                  | 1.9 TDI          | 96    | 12.00 | 11.08       | PR: 1LZ        |                |        |                |  |            |
|                  | 1.9 TDI quattro  |       | 12.00 | 11.08       | PR: 1LZ        |                |        |                |  |            |
|                  | 2.0              | 96    | 12.00 | 11.08       | PR: 1LZ        |                |        |                |  |            |
|                  | 2.0 FSI          | 110   | 07.02 | 11.08       | PR: 1LZ        |                |        |                |  |            |
|                  | 2.0 TDI          | 100   | 11.04 | 11.08       | PR: 1LZ        |                |        |                |  |            |
|                  | 2.0 TDI          | 103   | 11.04 | 11.08       | PR: 1LZ        |                |        |                |  |            |
|                  | 2.0 TDI          | 125   | 06.06 | 11.08       | PR: 1LZ        |                |        |                |  |            |
|                  | 2.0 TDI quattro  | 103   | 01.06 | 11.08       | PR: 1LZ        |                |        |                |  |            |
|                  | 2.0 TDI quattro  | 125   | 06.06 | 11.08       | PR: 1LZ        |                |        |                |  |            |
|                  | 2.0 TFSI         | 147   | 11.04 | 11.08       | PR: 1LZ        |                |        |                |  |            |
|                  | 2.0 TFSI         | 162   | 06.05 | 11.08       | PR: 1LZ        |                |        |                |  |            |
|                  | 2.0 TFSI quattro | 147   | 11.04 | 11.08       | PR: 1LZ        |                |        |                |  |            |
|                  | 2.0 TFSI quattro | 162   | 06.05 | 11.08       | PR: 1LZ        |                |        |                |  |            |
|                  | 2.4              |       | 09.01 | 11.08       | PR: 1LZ        |                |        |                |  |            |
|                  | 2.5 TDI          |       | 12.00 | 11.08       | PR: 1LZ        |                |        |                |  |            |
|                  | 2.5 TDI quattro  |       | 12.00 | 11.08       | PR: 1LZ        |                |        |                |  |            |
|                  | 2.7 TDI          | 120   | 11.05 | 11.08       | PR: 1LZ        |                |        |                |  |            |
|                  | 2.7 TDI          | 132   | 01.06 | 11.08       | PR: 1LZ        |                |        |                |  |            |
|                  | 3.0              |       | 12.00 | 11.08       | PR: 1LZ        |                |        |                |  |            |
| 3.0 quattro      |                  | 12.00 | 11.08 | PR: 1LZ     |                |                |        |                |  |            |
| 3.0 TDI quattro  | 150              | 11.04 | 11.08 | PR: 1LZ     |                |                |        |                |  |            |
| 3.0 TDI quattro  | 171              | 01.06 | 11.08 | PR: 1LZ     |                |                |        |                |  |            |
| 3.2 FSI          | 188              | 01.05 | 11.08 | PR: 1LZ     |                |                |        |                |  |            |
| 3.2 FSI quattro  | 188              | 01.05 | 11.08 | PR: 1LZ     |                |                |        |                |  |            |
|                  | 1.6              | 75    | 12.00 | 11.08       | PR: 1LB,1LE    | 24.0125-0105.1 | 425105 |                | 288 25,0 23,0 V L +S +B<br>288 25,0 23,0 V L +B PD |            |
|                  | 1.8 T            | 110   | 12.00 | 11.08       | PR: 1LB,1LE    | 24.0325-0105.1 | 525105 |                |  |            |
|                  | 1.8 T            | 120   | 07.02 | 11.08       | PR: 1LB,1LE    |                |        |                |  |            |
|                  | 1.8 T            | 125   | 07.01 | 11.08       | PR: 1LB,1LE    |                |        |                |  |            |
|                  | 1.8 T            | 140   | 11.02 | 11.08       | PR: 1LB,1LE    |                |        |                |  |            |
|                  | 1.8 T quattro    | 110   | 12.00 | 11.08       | PR: 1LB,1LE    |                |        |                |  |            |
|                  | 1.8 T quattro    | 120   | 07.02 | 11.08       | PR: 1LB,1LE    |                |        |                |  |            |
|                  | 1.8 T quattro    | 125   | 07.01 | 11.08       | PR: 1LB,1LE    |                |        |                |  |            |
|                  | 1.8 T quattro    | 140   | 11.02 | 11.08       | PR: 1LB,1LE    |                |        |                |  |            |
|                  | 1.9 TDI          | 74    | 04.01 | 11.08       | PR: 1LB,1LE    |                |        |                |  |            |
|                  | 1.9 TDI          | 85    | 06.04 | 11.08       | PR: 1LB,1LE    |                |        |                |  |            |
|                  | 1.9 TDI          | 96    | 12.00 | 11.08       | PR: 1LB,1LE    |                |        |                |  |            |
|                  | 1.9 TDI quattro  |       | 12.00 | 11.08       | PR: 1LB,1LE    |                |        |                |  |            |
|                  | 2.0              | 96    | 12.00 | 11.08       | PR: 1LB,1LE    |                |        |                |  |            |
|                  | 2.0 FSI          | 110   | 07.02 | 11.08       | PR: 1LB,1LE    |                |        |                |  |            |
|                  | 2.0 TDI          | 100   | 11.04 | 11.08       | PR: 1LB,1LE    |                |        |                |  |            |
|                  | 2.0 TDI          | 103   | 11.04 | 11.08       | PR: 1LB,1LE    |                |        |                |  |            |
|                  | 2.0 TDI          | 125   | 06.06 | 11.08       | PR: 1LB,1LE    |                |        |                |  |            |
|                  | 2.0 TDI quattro  | 103   | 01.06 | 11.08       | PR: 1LB,1LE    |                |        |                |  |            |
|                  | 2.0 TDI quattro  | 125   | 06.06 | 11.08       | PR: 1LB,1LE    |                |        |                |  |            |
| 2.0 TFSI         | 147              | 11.04 | 11.08 | PR: 1LB,1LE |                |                |        |                |  |            |
| 2.0 TFSI quattro | 147              | 11.04 | 11.08 | PR: 1LB,1LE |                |                |        |                |  |            |
| 2.4              |                  | 09.01 | 11.08 | PR: 1LB,1LE |                |                |        |                |  |            |
| 2.5 TDI          |                  | 12.00 | 11.08 | PR: 1LB,1LE |                |                |        |                |  |            |
| 2.5 TDI quattro  |                  | 12.00 | 11.08 | PR: 1LB,1LE |                |                |        |                |  |            |
| 2.7 TDI          | 120              | 11.05 | 11.08 | PR: 1LB,1LE |                |                |        |                |  |            |



| AUDI A4 (B6/B7) (01-08)  |  | PR: 1LB,1LE  |  | 24.0125-0105.1   | 425105  | 288 25,0 23,0 V L +S +B  |
|--|--|--|--|--|---|--|
|   |  |  |  |  |  |  |
|  | 2.7 TDI 132  | 01.06  | 11.08  | 24.0125-0105.1   | 425105  | 288 25,0 23,0 V L +S +B  |
|  | 2.0 TFSI 162   | 06.05  | 11.08  | 24.0325-0105.1   | 525105  | 288 25,0 23,0 V L +B PD  |
|  | 2.0 TFSI quattro 162   | 06.05  | 11.08  |  |   |  |
|  | 3.0 150  | 12.00  | 11.08  |  |   |  |
|  | 3.0 quattro 150  | 12.00  | 11.08  |  |   |  |
|  | 3.0 TDI quattro 171  | 11.04  | 11.08  |  |   |  |
|  | 3.0 TDI quattro 171  | 01.06  | 11.08  |  |   |  |
|  | 3.2 FSI 188  | 01.05  | 11.08  |  |   |  |
|  | 3.2 FSI quattro 188  | 01.05  | 11.08  |  |   |  |
|  | 1.6 75   | 12.00  | 11.08  | 24.0125-0137.1   | 425137  | 312 25,0 23,0 V L +S +B  |
|  | 1.8 T 110  | 12.00  | 11.08  | 24.0325-0137.1   | 525137  | 312 25,0 23,0 V L +B PD  |
|  | 1.8 T 120  | 07.02  | 11.08  |  |   |  |
|  | 1.8 T 125  | 07.01  | 11.08  |  |   |  |
|  | 1.8 T quattro 110  | 12.00  | 11.08  |  |   |  |
|  | 1.8 T quattro 120  | 07.02  | 11.08  |  |   |  |
|  | 1.8 T quattro 125  | 07.01  | 11.08  |  |   |  |
|  | 1.9 TDI 74   | 04.01  | 11.08  |  |   |  |
|  | 1.9 TDI 85   | 06.04  | 11.08  |  |   |  |
|  | 1.9 TDI 96   | 12.00  | 11.08  |  |   |  |
|  | 1.9 TDI quattro 96   | 12.00  | 11.08  |  |   |  |
|  | 2.0 96   | 12.00  | 11.08  |  |   |  |
|  | 2.0 FSI 110  | 07.02  | 11.08  |  |   |  |
|  | 2.0 TDI 100  | 11.04  | 11.08  |  |   |  |
|  | 2.0 TDI 103  | 11.04  | 11.08  |  |   |  |
|  | 2.0 TDI 125  | 06.06  | 11.08  |  |   |  |
|  | 2.0 TDI quattro 103  | 01.06  | 11.08  |  |   |  |
|  | 2.0 TDI quattro 125  | 06.06  | 11.08  |  |   |  |
|  | 2.4 125  | 09.01  | 11.08  |  |   |  |
|  | 2.5 TDI 120  | 12.00  | 11.08  |  |   |  |
|  | 2.5 TDI quattro 120  | 12.00  | 11.08  |  |   |  |
|  | 2.7 TDI 120  | 11.05  | 11.08  |  |   |  |
|  | 1.8 T 140  | 11.02  | 11.08  | 24.0125-0137.1   | 425137  | 312 25,0 23,0 V L +S +B  |
|  | 1.8 T quattro 140  | 11.02  | 11.08  | 24.0325-0137.1   | 525137  | 312 25,0 23,0 V L +B PD  |
|  | 2.0 TFSI 147   | 11.04  | 11.08  |  |   |  |
|  | 2.0 TFSI 162   | 06.05  | 11.08  |  |   |  |
|  | 2.0 TFSI quattro 147   | 11.04  | 11.08  |  |   |  |
|  | 2.0 TFSI quattro 162   | 06.05  | 11.08  |  |   |  |
|  | 2.7 TDI 132  | 01.06  | 11.08  |  |   |  |
|  | 3.0 150  | 12.00  | 11.08  |  |   |  |
|  | 3.0 quattro 150  | 11.04  | 11.08  |  |   |  |
|  | 3.0 TDI quattro 171  | 01.06  | 11.08  |  |   |  |
|  | 3.0 TDI quattro 171  | 01.06  | 11.08  |  |   |  |
|  | 3.2 FSI 188  | 01.05  | 11.08  |  |   |  |
|  | 3.2 FSI quattro 188  | 01.05  | 11.08  |  |   |  |
|  | 1.6 75   | 12.00  | 11.08  | 24.0130-0113.1   | 430113  | 320 30,0 28,0 V L +S +B  |
|  | 1.8 T 110  | 12.00  | 11.08  | 24.0330-0113.1   | 530113  | 320 30,0 28,0 V L +B PD  |
|  | 1.8 T 120  | 07.02  | 11.08  |  |   |  |
|  | 1.8 T 125  | 07.01  | 11.08  |  |   |  |
|  | 1.8 T 140  | 11.02  | 11.08  |  |   |  |
|  | 1.8 T quattro 110  | 12.00  | 11.08  |  |   |  |
|  | 1.8 T quattro 120  | 07.02  | 11.08  |  |   |  |
|  | 1.8 T quattro 125  | 07.01  | 11.08  |  |   |  |
|  | 1.8 T quattro 140  | 11.02  | 11.08  |  |   |  |
|  | 1.9 TDI 74   | 04.01  | 11.08  |  |   |  |
|  | 1.9 TDI 85   | 06.04  | 11.08  |  |   |  |
|  | 1.9 TDI 96   | 12.00  | 11.08  |  |   |  |
|  | 1.9 TDI quattro 96   | 12.00  | 11.08  |  |   |  |
|  | 2.0 96   | 12.00  | 11.08  |  |   |  |
|  | 2.0 FSI 110  | 07.02  | 11.08  |  |   |  |
|  | 2.0 TDI 100  | 11.04  | 11.08  |  |   |  |
|  | 2.0 TDI 103  | 11.04  | 11.08  |  |   |  |
|  | 2.0 TDI 125  | 06.06  | 11.08  |  |   |  |
|  | 2.0 TDI quattro 103  | 01.06  | 11.08  |  |   |  |
|  | 2.0 TDI quattro 125  | 06.06  | 11.08  |  |   |  |
|  | 2.0 TFSI 147   | 11.04  | 11.08  |  |   |  |
|  | 2.0 TFSI 162   | 06.05  | 11.08  |  |   |  |
|  | 2.0 TFSI quattro 147   | 11.04  | 11.08  |  |   |  |
|  | 2.0 TFSI quattro 162   | 06.05  | 11.08  |  |   |  |
|  | 2.4 125  | 09.01  | 11.08  |  |   |  |
|  | 2.5 TDI 120  | 12.00  | 11.08  |  |   |  |
|  | 2.5 TDI quattro 120  | 12.00  | 11.08  |  |   |  |
|  | 2.7 TDI 120  | 11.05  | 11.08  |  |   |  |
|  | 2.7 TDI 132  | 01.06  | 11.08  |  |   |  |
|  | 3.0 150  | 12.00  | 11.08  |  |   |  |
|  | 3.0 quattro 150  | 12.00  | 11.08  |  |   |  |
|  | 3.0 TDI quattro 171  | 11.04  | 11.08  |  |   |  |
|  | 3.0 TDI quattro 171  | 01.06  | 11.08  |  |   |  |
|  | 3.2 FSI 188  | 01.05  | 11.08  |  |   |  |
|  | 3.2 FSI quattro 188  | 01.05  | 11.08  |  |   |  |
|  | 1.6 75   | 12.00  | 11.08  | 24.0130-0185.1   | 430185  | 320 30,0 28,0 V L +B   |
|  | 1.8 T 110  | 12.00  | 11.08  |  |   |  |
|  | 1.8 T 120  | 07.02  | 11.08  |  |   |  |
|  | 1.8 T 125  | 07.01  | 11.08  |  |   |  |
|  | 1.8 T 140  | 11.02  | 11.08  |  |   |  |
|  | 1.8 T quattro 110  | 12.00  | 11.08  |  |   |  |
|  | 1.8 T quattro 120  | 07.02  | 11.08  |  |   |  |

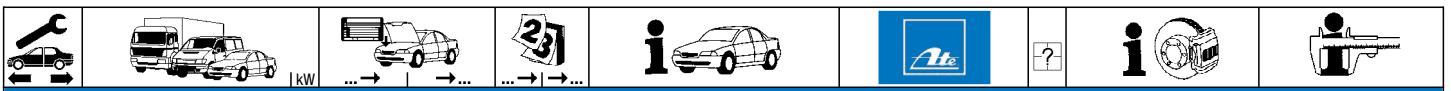

**AUDI A4 (B6/B7) (01-08)**

|  |                  |            |             |              |              |             |                       |        |  |  |                                    |
|--|------------------|------------|-------------|--------------|--------------|-------------|-----------------------|--------|--|--|------------------------------------|
|  | 1.8 T quattro    | 125        |             | <b>07.01</b> | <b>11.08</b> | PR: 1LC     | <b>24.0130-0185.1</b> | 430185 |  |  | 320 30,0 28,0 VL +B                |
|  | 1.8 T quattro    | 140        |             | <b>11.02</b> | <b>11.08</b> | PR: 1LC     |                       |        |  |  |                                    |
|  | 1.9 TDI          | 74         |             | <b>04.01</b> | <b>11.08</b> | PR: 1LC     |                       |        |  |  |                                    |
|  | 1.9 TDI          | 85         |             | <b>06.04</b> | <b>11.08</b> | PR: 1LC     |                       |        |  |  |                                    |
|  | 1.9 TDI          | 96         |             | <b>12.00</b> | <b>11.08</b> | PR: 1LC     |                       |        |  |  |                                    |
|  | 1.9 TDI quattro  |            |             | <b>12.00</b> | <b>11.08</b> | PR: 1LC     |                       |        |  |  |                                    |
|  | 2.0              | 96         |             | <b>12.00</b> | <b>11.08</b> | PR: 1LC     |                       |        |  |  |                                    |
|  | 2.0 FSI          | 110        |             | <b>07.02</b> | <b>11.08</b> | PR: 1LC     |                       |        |  |  |                                    |
|  | 2.0 TDI          | 100        |             | <b>11.04</b> | <b>11.08</b> | PR: 1LC     |                       |        |  |  |                                    |
|  | 2.0 TDI          | 103        |             | <b>11.04</b> | <b>11.08</b> | PR: 1LC     |                       |        |  |  |                                    |
|  | 2.0 TDI          | 125        |             | <b>06.06</b> | <b>11.08</b> | PR: 1LC     |                       |        |  |  |                                    |
|  | 2.0 TDI quattro  | 103        |             | <b>01.06</b> | <b>11.08</b> | PR: 1LC     |                       |        |  |  |                                    |
|  | 2.0 TDI quattro  | 125        |             | <b>06.06</b> | <b>11.08</b> | PR: 1LC     |                       |        |  |  |                                    |
|  | 2.0 TFSI         | 147        |             | <b>11.04</b> | <b>11.08</b> | PR: 1LC     |                       |        |  |  |                                    |
|  | 2.0 TFSI         | 162        |             | <b>06.05</b> | <b>11.08</b> | PR: 1LC     |                       |        |  |  |                                    |
|  | 2.0 TFSI quattro | 147        |             | <b>11.04</b> | <b>11.08</b> | PR: 1LC     |                       |        |  |  |                                    |
|  | 2.0 TFSI quattro | 162        |             | <b>06.05</b> | <b>11.08</b> | PR: 1LC     |                       |        |  |  |                                    |
|  | 2.4              |            |             | <b>09.01</b> | <b>11.08</b> | PR: 1LC     |                       |        |  |  |                                    |
|  | 2.5 TDI          |            |             | <b>12.00</b> | <b>11.08</b> | PR: 1LC     |                       |        |  |  |                                    |
|  | 2.5 TDI quattro  |            |             | <b>12.00</b> | <b>11.08</b> | PR: 1LC     |                       |        |  |  |                                    |
|  | 2.7 TDI          | 120        |             | <b>11.05</b> | <b>11.08</b> | PR: 1LC     |                       |        |  |  |                                    |
|  | 2.7 TDI          | 132        |             | <b>01.06</b> | <b>11.08</b> | PR: 1LC     |                       |        |  |  |                                    |
|  | 3.0              |            |             | <b>12.00</b> | <b>11.08</b> | PR: 1LC     |                       |        |  |  |                                    |
|  | 3.0 quattro      |            |             | <b>12.00</b> | <b>11.08</b> | PR: 1LC     |                       |        |  |  |                                    |
|  | 3.0 TDI quattro  | 150        |             | <b>11.04</b> | <b>11.08</b> | PR: 1LC     |                       |        |  |  |                                    |
|  | 3.0 TDI quattro  | 171        |             | <b>01.06</b> | <b>11.08</b> | PR: 1LC     |                       |        |  |  |                                    |
|  | 3.2 FSI          | 188        |             | <b>01.05</b> | <b>11.08</b> | PR: 1LC     |                       |        |  |  |                                    |
|  | 3.2 FSI quattro  | 188        |             | <b>01.05</b> | <b>11.08</b> | PR: 1LC     |                       |        |  |  |                                    |
|  | <b>S4</b>        | <b>253</b> |             | <b>03.03</b> | <b>11.08</b> | PR: 1LJ     | <b>24.0130-0119.1</b> | 430119 |  |  | 345 30,0 28,0 VL +B                |
|  | 1.6              | 75         | 8E-4-180000 | <b>12.00</b> |              | PR: 1KD     | <b>13.0460-2820.2</b> | 602820 |  |  | <b>20961</b> 17,6 /S <b>TRW</b>    |
|  | 1.8 T            | 110        | 8E-4-180000 | <b>12.00</b> |              | PR: 1KD     | <b>13.0470-2820.2</b> | LD2820 |  |  | <b>20961</b> 17,6 /S <b>TRW</b>    |
|  | 1.8 T            | 120        | 8E-4-180000 | <b>07.02</b> |              | PR: 1KD     | <b>13.0460-0072.2</b> | 610072 |  |  | Belagsatz-Zubehör <b>TRW</b>       |
|  | 1.8 T            | 125        | 8E-4-180000 | <b>07.01</b> |              | PR: 1KD     |                       |        |  |  |                                    |
|  | 1.8 T            | 140        | 8E-4-180000 | <b>11.02</b> |              | PR: 1KD     |                       |        |  |  |                                    |
|  | 1.8 T quattro    | 110        | 8E-4-180000 | <b>12.00</b> |              | PR: 1KD     |                       |        |  |  |                                    |
|  | 1.8 T quattro    | 120        | 8E-4-180000 | <b>07.02</b> |              | PR: 1KD     |                       |        |  |  |                                    |
|  | 1.8 T quattro    | 125        | 8E-4-180000 | <b>07.01</b> |              | PR: 1KD     |                       |        |  |  |                                    |
|  | 1.8 T quattro    | 140        | 8E-4-180000 | <b>11.02</b> |              | PR: 1KD     |                       |        |  |  |                                    |
|  | 1.9 TDI          | 74         | 8E-4-180000 | <b>04.01</b> |              | PR: 1KD     |                       |        |  |  |                                    |
|  | 1.9 TDI          | 96         | 8E-4-180000 | <b>12.00</b> |              | PR: 1KD     |                       |        |  |  |                                    |
|  | 1.9 TDI quattro  |            | 8E-4-180000 | <b>12.00</b> |              | PR: 1KD     |                       |        |  |  |                                    |
|  | 2.0              | 96         | 8E-4-180000 | <b>12.00</b> |              | PR: 1KD     |                       |        |  |  |                                    |
|  | 2.0 FSI          | 110        | 8E-4-180000 | <b>07.02</b> |              | PR: 1KD     |                       |        |  |  |                                    |
|  | 2.4              |            | 8E-4-180000 | <b>09.01</b> |              | PR: 1KD     |                       |        |  |  |                                    |
|  | 2.5 TDI          |            | 8E-4-180000 | <b>12.00</b> |              | PR: 1KD     |                       |        |  |  |                                    |
|  | 2.5 TDI quattro  |            | 8E-4-180000 | <b>12.00</b> |              | PR: 1KD     |                       |        |  |  |                                    |
|  | 1.6              | 75         | 8E-4-180000 | <b>12.00</b> |              | PR: 1KP     | <b>13.0460-2860.2</b> | 602860 |  |  | <b>23554</b> 16,3 /WE/S <b>TRW</b> |
|  | 1.8 T            | 110        | 8E-4-180000 | <b>12.00</b> |              | PR: 1KP     | <b>13.0470-2860.2</b> | LD2860 |  |  | <b>23554</b> 16,3 /WE/S <b>TRW</b> |
|  | 1.8 T            | 120        | 8E-4-180000 | <b>07.02</b> |              | PR: 1KP     | <b>13.0460-0072.2</b> | 610072 |  |  | Belagsatz-Zubehör <b>TRW</b>       |
|  | 1.8 T            | 125        | 8E-4-180000 | <b>07.01</b> |              | PR: 1KP     |                       |        |  |  |                                    |
|  | 1.8 T            | 140        | 8E-4-180000 | <b>11.02</b> |              | PR: 1KP     |                       |        |  |  |                                    |
|  | 1.8 T quattro    | 110        | 8E-4-180000 | <b>12.00</b> |              | PR: 1KP     |                       |        |  |  |                                    |
|  | 1.8 T quattro    | 120        | 8E-4-180000 | <b>07.02</b> |              | PR: 1KP     |                       |        |  |  |                                    |
|  | 1.8 T quattro    | 125        | 8E-4-180000 | <b>07.01</b> |              | PR: 1KP     |                       |        |  |  |                                    |
|  | 1.8 T quattro    | 140        | 8E-4-180000 | <b>11.02</b> |              | PR: 1KP     |                       |        |  |  |                                    |
|  | 1.9 TDI          | 74         | 8E-4-180000 | <b>04.01</b> |              | PR: 1KP     |                       |        |  |  |                                    |
|  | 1.9 TDI          | 96         | 8E-4-180000 | <b>12.00</b> |              | PR: 1KP     |                       |        |  |  |                                    |
|  | 1.9 TDI quattro  |            | 8E-4-180000 | <b>12.00</b> |              | PR: 1KP     |                       |        |  |  |                                    |
|  | 2.0              | 96         | 8E-4-180000 | <b>12.00</b> |              | PR: 1KP     |                       |        |  |  |                                    |
|  | 2.0 FSI          | 110        | 8E-4-180000 | <b>07.02</b> |              | PR: 1KP     |                       |        |  |  |                                    |
|  | 2.4              |            | 8E-4-180000 | <b>09.01</b> |              | PR: 1KP     |                       |        |  |  |                                    |
|  | 2.5 TDI          |            | 8E-4-180000 | <b>12.00</b> |              | PR: 1KP     |                       |        |  |  |                                    |
|  | 2.5 TDI quattro  |            | 8E-4-180000 | <b>12.00</b> |              | PR: 1KP     |                       |        |  |  |                                    |
|  | 1.6              | 75         | 8E-4-180001 |              | <b>11.08</b> | PR: 1KD,1KP | <b>13.0460-2886.2</b> | 602886 |  |  | <b>20961</b> 16,2 /S <b>TRW</b>    |
|  | 1.8 T            | 110        | 8E-4-180001 |              | <b>11.08</b> | PR: 1KD,1KP | <b>13.0470-2886.2</b> | LD2886 |  |  | <b>20961</b> 16,2 /S <b>TRW</b>    |
|  | 1.8 T            | 120        | 8E-4-180001 |              | <b>11.08</b> | PR: 1KD,1KP |                       |        |  |  |                                    |
|  | 1.8 T            | 125        | 8E-4-180001 |              | <b>11.08</b> | PR: 1KD,1KP |                       |        |  |  |                                    |
|  | 1.8 T            | 140        | 8E-4-180001 |              | <b>11.08</b> | PR: 1KD,1KP |                       |        |  |  |                                    |
|  | 1.8 T quattro    | 110        | 8E-4-180001 |              | <b>11.08</b> | PR: 1KD,1KP |                       |        |  |  |                                    |
|  | 1.8 T quattro    | 120        | 8E-4-180001 |              | <b>11.08</b> | PR: 1KD,1KP |                       |        |  |  |                                    |
|  | 1.8 T quattro    | 125        | 8E-4-180001 |              | <b>11.08</b> | PR: 1KD,1KP |                       |        |  |  |                                    |
|  | 1.8 T quattro    | 140        | 8E-4-180001 |              | <b>11.08</b> | PR: 1KD,1KP |                       |        |  |  |                                    |
|  | 1.9 TDI          | 74         | 8E-4-180001 |              | <b>11.08</b> | PR: 1KD,1KP |                       |        |  |  |                                    |
|  | 1.9 TDI          | 85         |             | <b>06.04</b> | <b>11.08</b> | PR: 1KD,1KP |                       |        |  |  |                                    |
|  | 1.9 TDI          | 96         | 8E-4-180001 |              | <b>11.08</b> | PR: 1KD,1KP |                       |        |  |  |                                    |
|  | 1.9 TDI quattro  |            | 8E-4-180001 |              | <b>11.08</b> | PR: 1KD,1KP |                       |        |  |  |                                    |
|  | 2.0              | 96         | 8E-4-180001 |              | <b>11.08</b> | PR: 1KD,1KP |                       |        |  |  |                                    |
|  | 2.0 FSI          | 110        | 8E-4-180001 |              | <b>11.08</b> | PR: 1KD,1KP |                       |        |  |  |                                    |
|  | 2.0 TDI          | 103        |             | <b>11.04</b> | <b>11.08</b> | PR: 1KD,1KP |                       |        |  |  |                                    |
|  | 2.0 TDI          | 125        |             | <b>06.06</b> | <b>11.08</b> | PR: 1KD,1KP |                       |        |  |  |                                    |
|  | 2.0 TDI quattro  | 103        |             | <b>01.06</b> | <b>11.08</b> | PR: 1KD,1KP |                       |        |  |  |                                    |
|  | 2.0 TDI quattro  | 125        |             | <b>06.06</b> | <b>11.08</b> | PR: 1KD,1KP |                       |        |  |  |                                    |
|  | 2.0 TFSI         | 147        |             | <b>11.04</b> | <b>11.08</b> | PR: 1KD,1KP |                       |        |  |  |                                    |
|  | 2.0 TFSI         | 162        |             | <b>06.05</b> | <b>11.08</b> | PR: 1KD,1KP |                       |        |  |  |                                    |
|  | 2.0 TFSI quattro | 147        |             | <b>11.04</b> | <b>11.08</b> | PR: 1KD,1KP |                       |        |  |  |                                    |
|  | 2.0 TFSI quattro | 162        |             | <b>06.05</b> | <b>11.08</b> | PR: 1KD,1KP |                       |        |  |  |                                    |
|  | 2.4              |            | 8E-4-180001 |              | <b>11.08</b> | PR: 1KD,1KP |                       |        |  |  |                                    |



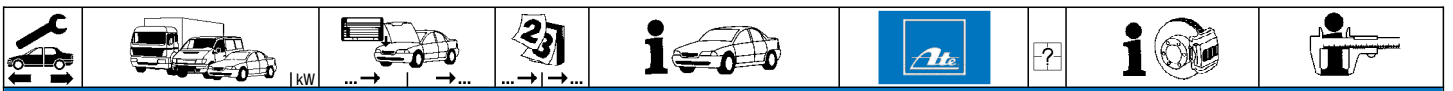

**AUDI A4 (B6/B7) (01-08)**

|                  |                  |                 |             |       |             |                |                |                |                      |                     |     |
|------------------|------------------|-----------------|-------------|-------|-------------|----------------|----------------|----------------|----------------------|---------------------|-----|
|                  | 2.5 TDI          | 8E-4-180001     |             | 11.08 | PR: 1KD,1KP | 13.0460-2886.2 | 602886         |                | 20961 16,2 /S        | TRW                 |     |
|                  | 2.5 TDI quattro  | 8E-4-180001     |             | 11.08 | PR: 1KD,1KP | 13.0470-2886.2 | LD2886         |                | 20961 16,2 /S        | TRW                 |     |
|                  | 3.0              |                 | 8E-7-300000 | 12.00 | PR: 1KD,1KP |                |                |                |                      |                     |     |
|                  | 3.0 quattro      |                 | 8E-7-300000 | 12.00 | PR: 1KD,1KP |                |                |                |                      |                     |     |
|                  | 1.6              | 75 8E-5-400001  |             | 11.08 | PR: 1KW     | 13.0460-2880.2 | 602880         |                | 23914 17,1 /WE/Zub/S | TRW                 |     |
|                  | 1.8 T            | 110 8E-5-400001 |             | 11.08 | PR: 1KW     | 13.0470-2880.2 | LD2880         |                | 23914 17,1 /WE/Zub/S | TRW                 |     |
|                  | 1.8 T            | 120 8E-5-400001 |             | 11.08 | PR: 1KW     | 13.0460-0259.2 | 610259         |                | Belagsatz-Zubehör    |                     |     |
|                  | 1.8 T            | 125 8E-5-400001 |             | 11.08 | PR: 1KW     |                |                |                |                      |                     |     |
|                  | 1.8 T            | 140 8E-5-400001 |             | 11.08 | PR: 1KW     |                |                |                |                      |                     |     |
|                  | 1.8 T quattro    | 110 8E-5-400001 |             | 11.08 | PR: 1KW     |                |                |                |                      |                     |     |
|                  | 1.8 T quattro    | 120 8E-5-400001 |             | 11.08 | PR: 1KW     |                |                |                |                      |                     |     |
|                  | 1.8 T quattro    | 125 8E-5-400001 |             | 11.08 | PR: 1KW     |                |                |                |                      |                     |     |
|                  | 1.8 T quattro    | 140 8E-5-400001 |             | 11.08 | PR: 1KW     |                |                |                |                      |                     |     |
|                  | 1.9 TDI          | 74 8E-5-400001  |             | 11.08 | PR: 1KW     |                |                |                |                      |                     |     |
|                  | 1.9 TDI          | 85 8E-5-400001  |             | 11.08 | PR: 1KW     |                |                |                |                      |                     |     |
|                  | 1.9 TDI          | 96 8E-5-400001  |             | 11.08 | PR: 1KW     |                |                |                |                      |                     |     |
|                  | 1.9 TDI quattro  | 8E-5-400001     |             | 11.08 | PR: 1KW     |                |                |                |                      |                     |     |
|                  | 2.0              | 96 8E-5-400001  |             | 11.08 | PR: 1KW     |                |                |                |                      |                     |     |
|                  | 2.0 FSI          | 110 8E-5-400001 |             | 11.08 | PR: 1KW     |                |                |                |                      |                     |     |
|                  | 2.0 TDI          | 100 8E-5-400001 |             | 11.08 | PR: 1KW     |                |                |                |                      |                     |     |
|                  | 2.0 TDI          | 103 8E-5-400001 |             | 11.08 | PR: 1KW     |                |                |                |                      |                     |     |
|                  | 2.0 TDI          | 125             |             | 06.06 | 11.08       | PR: 1KW        |                |                |                      |                     |     |
|                  | 2.0 TDI quattro  | 103             |             | 01.06 | 11.08       | PR: 1KW        |                |                |                      |                     |     |
|                  | 2.0 TDI quattro  | 125             |             | 06.06 | 11.08       | PR: 1KW        |                |                |                      |                     |     |
|                  | 2.0 TFSI         | 147 8E-5-400001 |             | 11.08 | PR: 1KW     |                |                |                |                      |                     |     |
|                  | 2.0 TFSI         | 162 8E-5-400001 |             | 11.08 | PR: 1KW     |                |                |                |                      |                     |     |
|                  | 2.0 TFSI quattro | 147 8E-5-400001 |             | 11.08 | PR: 1KW     |                |                |                |                      |                     |     |
|                  | 2.0 TFSI quattro | 162 8E-5-400001 |             | 11.08 | PR: 1KW     |                |                |                |                      |                     |     |
|                  | 2.4              | 8E-5-400001     |             | 11.08 | PR: 1KW     |                |                |                |                      |                     |     |
|                  | 2.5 TDI          | 8E-5-400001     |             | 11.08 | PR: 1KW     |                |                |                |                      |                     |     |
|                  | 2.5 TDI quattro  | 8E-5-400001     |             | 11.08 | PR: 1KW     |                |                |                |                      |                     |     |
|                  | 2.7 TDI          | 120             |             | 11.05 | 11.08       | PR: 1KW        |                |                |                      |                     |     |
|                  | 2.7 TDI          | 132             |             | 01.06 | 11.08       | PR: 1KW        |                |                |                      |                     |     |
|                  | 3.0              | 8E-5-400001     |             | 11.08 | PR: 1KW     |                |                |                |                      |                     |     |
|                  | 3.0 quattro      | 8E-5-400001     |             | 11.08 | PR: 1KW     |                |                |                |                      |                     |     |
|                  | 3.0 TDI quattro  | 150 8E-5-400001 |             | 11.08 | PR: 1KW     |                |                |                |                      |                     |     |
|                  | 3.0 TDI quattro  | 171             |             | 01.06 | 11.08       | PR: 1KW        |                |                |                      |                     |     |
|                  | 3.2 FSI          | 188 8E-5-400001 |             | 11.08 | PR: 1KW     |                |                |                |                      |                     |     |
|                  | 3.2 FSI quattro  | 188 8E-5-400001 |             | 11.08 | PR: 1KW     |                |                |                |                      |                     |     |
|                  |                  | S4              | 253         |       | 03.03       | 11.08          | 13.0460-2888.2 | 602888         |                      | 23326 17,4 /WE/S    | TRW |
|                  |                  | S4              | 253         |       | 01.05       | 11.08          | 13.0470-2888.2 | LD2888         |                      | 23326 17,4 /WE/S    | TRW |
|                  |                  | S4              | 253         |       | 01.05       | 11.08          | 13.0460-2889.2 | 602889         |                      | 23326 17,4 /WE/S    | TRW |
|                  |                  | RS 4            | 309         |       | 11.05       | 11.08          | 13.0460-0023.2 | 610023         |                      | Belagsatz-Zubehör   |     |
|                  |                  | 1.6             | 75          |       | 12.00       | 11.08          | PR: 1KD        | 24.0110-0261.1 | 410261               | 245 10,0 8,0 +S +B  |     |
| 1.8 T            |                  | 110             |             | 12.00 | 11.08       | PR: 1KD        | 24.0310-0261.1 | 510261         | 245 10,0 8,0 +B PD   |                     |     |
| 1.8 T            |                  | 120             |             | 07.02 | 11.08       | PR: 1KD        |                |                |                      |                     |     |
| 1.8 T            |                  | 125             |             | 07.01 | 11.08       | PR: 1KD        |                |                |                      |                     |     |
| 1.8 T            |                  | 140             |             | 11.02 | 11.08       | PR: 1KD        |                |                |                      |                     |     |
| 1.8 T quattro    |                  | 110             |             | 12.00 | 11.08       | PR: 1KD        |                |                |                      |                     |     |
| 1.8 T quattro    |                  | 120             |             | 07.02 | 11.08       | PR: 1KD        |                |                |                      |                     |     |
| 1.8 T quattro    |                  | 125             |             | 07.01 | 11.08       | PR: 1KD        |                |                |                      |                     |     |
| 1.8 T quattro    |                  | 140             |             | 11.02 | 11.08       | PR: 1KD        |                |                |                      |                     |     |
| 1.9 TDI          |                  | 74              |             | 04.01 | 11.08       | PR: 1KD        |                |                |                      |                     |     |
| 1.9 TDI          |                  | 85              |             | 06.04 | 11.08       | PR: 1KD        |                |                |                      |                     |     |
| 1.9 TDI          |                  | 96              |             | 12.00 | 11.08       | PR: 1KD        |                |                |                      |                     |     |
| 1.9 TDI quattro  |                  |                 |             | 12.00 | 11.08       | PR: 1KD        |                |                |                      |                     |     |
| 2.0              |                  | 96              |             | 12.00 | 11.08       | PR: 1KD        |                |                |                      |                     |     |
| 2.0 FSI          |                  | 110             |             | 07.02 | 11.08       | PR: 1KD        |                |                |                      |                     |     |
| 2.0 TDI          |                  | 100             |             | 11.04 | 11.08       | PR: 1KD        |                |                |                      |                     |     |
| 2.0 TDI          |                  | 103             |             | 11.04 | 11.08       | PR: 1KD        |                |                |                      |                     |     |
| 2.0 TDI          |                  | 125             |             | 06.06 | 11.08       | PR: 1KD        |                |                |                      |                     |     |
| 2.0 TDI quattro  |                  | 103             |             | 01.06 | 11.08       | PR: 1KD        |                |                |                      |                     |     |
| 2.0 TDI quattro  |                  | 125             |             | 06.06 | 11.08       | PR: 1KD        |                |                |                      |                     |     |
| 2.0 TFSI         |                  | 147             |             | 11.04 | 11.08       | PR: 1KD        |                |                |                      |                     |     |
| 2.0 TFSI         |                  | 162             |             | 06.05 | 11.08       | PR: 1KD        |                |                |                      |                     |     |
| 2.0 TFSI quattro |                  | 147             |             | 11.04 | 11.08       | PR: 1KD        |                |                |                      |                     |     |
| 2.0 TFSI quattro |                  | 162             |             | 06.05 | 11.08       | PR: 1KD        |                |                |                      |                     |     |
| 2.4              |                  |                 |             | 09.01 | 11.08       | PR: 1KD        |                |                |                      |                     |     |
| 2.5 TDI          |                  |                 |             | 12.00 | 11.08       | PR: 1KD        |                |                |                      |                     |     |
| 2.5 TDI quattro  |                  |                 |             | 12.00 | 11.08       | PR: 1KD        |                |                |                      |                     |     |
| 3.0 TDI quattro  |                  | 150             |             | 11.04 | 11.08       | PR: 1KD        |                |                |                      |                     |     |
| 3.2 FSI          |                  | 188             |             | 01.05 | 11.08       | PR: 1KD        |                |                |                      |                     |     |
| 3.2 FSI quattro  |                  | 188             |             | 01.05 | 11.08       | PR: 1KD        |                |                |                      |                     |     |
|                  |                  | 1.6             | 75          |       | 12.00       | 11.08          | PR: 1KP        | 24.0112-0148.1 | 412148               | 255 12,0 10,0 +B    |     |
|                  |                  | 1.8 T           | 110         |       | 12.00       | 11.08          | PR: 1KP        | 24.0312-0148.1 | 512148               | 255 12,0 10,0 +B PD |     |
|                  |                  | 1.8 T           | 120         |       | 07.02       | 11.08          | PR: 1KP        |                |                      |                     |     |
|                  |                  | 1.8 T           | 125         |       | 07.01       | 11.08          | PR: 1KP        |                |                      |                     |     |
|                  |                  | 1.8 T           | 140         |       | 11.02       | 11.08          | PR: 1KP        |                |                      |                     |     |
|                  |                  | 1.8 T quattro   | 110         |       | 12.00       | 11.08          | PR: 1KP        |                |                      |                     |     |
|                  |                  | 1.8 T quattro   | 120         |       | 07.02       | 11.08          | PR: 1KP        |                |                      |                     |     |
|                  |                  | 1.8 T quattro   | 125         |       | 07.01       | 11.08          | PR: 1KP        |                |                      |                     |     |
|                  |                  | 1.8 T quattro   | 140         |       | 11.02       | 11.08          | PR: 1KP        |                |                      |                     |     |
|                  | 1.9 TDI          | 74              |             | 04.01 | 11.08       | PR: 1KP        |                |                |                      |                     |     |
|                  | 1.9 TDI          | 85              |             | 06.04 | 11.08       | PR: 1KP        |                |                |                      |                     |     |
|                  | 1.9 TDI          | 96              |             | 12.00 | 11.08       | PR: 1KP        |                |                |                      |                     |     |

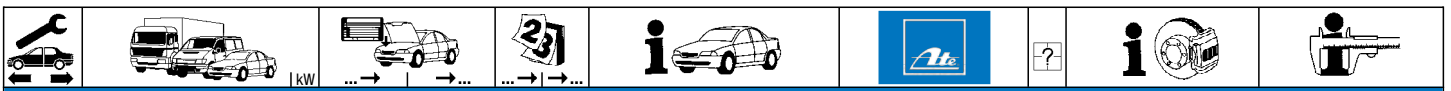

**AUDI A4 (B6/B7) (01-08)**

|  |                  |                 |       |       |             |                |        |  |                      |
|--|------------------|-----------------|-------|-------|-------------|----------------|--------|--|----------------------|
|  | 1.9 TDI quattro  |                 | 12.00 | 11.08 | PR: 1KP     | 24.0112-0148.1 | 412148 |  | 255 12,0 10,0 +B     |
|  | 2.0              | 96              | 12.00 | 11.08 | PR: 1KP     | 24.0312-0148.1 | 512148 |  | 255 12,0 10,0 +B PD  |
|  | 2.0 FSI          | 110             | 07.02 | 11.08 | PR: 1KP     |                |        |  |                      |
|  | 2.0 TDI          | 100             | 11.04 | 11.08 | PR: 1KP     |                |        |  |                      |
|  | 2.0 TDI          | 103             | 11.04 | 11.08 | PR: 1KP     |                |        |  |                      |
|  | 2.0 TDI          | 125             | 06.06 | 11.08 | PR: 1KP     |                |        |  |                      |
|  | 2.0 TDI quattro  | 103             | 01.06 | 11.08 | PR: 1KP     |                |        |  |                      |
|  | 2.0 TDI quattro  | 125             | 06.06 | 11.08 | PR: 1KP     |                |        |  |                      |
|  | 2.0 TFSI         | 147             | 11.04 | 11.08 | PR: 1KP     |                |        |  |                      |
|  | 2.0 TFSI         | 162             | 06.05 | 11.08 | PR: 1KP     |                |        |  |                      |
|  | 2.0 TFSI quattro | 147             | 11.04 | 11.08 | PR: 1KP     |                |        |  |                      |
|  | 2.0 TFSI quattro | 162             | 06.05 | 11.08 | PR: 1KP     |                |        |  |                      |
|  | 2.4              |                 | 09.01 | 11.08 | PR: 1KP     |                |        |  |                      |
|  | 2.5 TDI          |                 | 12.00 | 11.08 | PR: 1KP     |                |        |  |                      |
|  | 2.5 TDI quattro  |                 | 12.00 | 11.08 | PR: 1KP     |                |        |  |                      |
|  | 3.0              |                 | 12.00 | 11.08 | PR: 1KD,1KP |                |        |  |                      |
|  | 3.0 quattro      |                 | 12.00 | 11.08 | PR: 1KD,1KP |                |        |  |                      |
|  | 3.0 TDI quattro  | 150             | 11.04 | 11.08 | PR: 1KP     |                |        |  |                      |
|  | 3.2 FSI          | 188             | 01.05 | 11.08 | PR: 1KP     |                |        |  |                      |
|  | 3.2 FSI quattro  | 188             | 01.05 | 11.08 | PR: 1KP     |                |        |  |                      |
|  | 1.6              | 75 8E-5-400001  |       | 11.08 | PR: 1KW     | 24.0112-0166.1 | 412166 |  | 288 12,0 10,0 +B     |
|  | 1.8 T            | 110 8E-5-400001 |       | 11.08 | PR: 1KW     | 24.0312-0166.1 | 512166 |  | 288 12,0 10,0 +B PD  |
|  | 1.8 T            | 120 8E-5-400001 |       | 11.08 | PR: 1KW     |                |        |  |                      |
|  | 1.8 T            | 125 8E-5-400001 |       | 11.08 | PR: 1KW     |                |        |  |                      |
|  | 1.8 T            | 140 8E-5-400001 |       | 11.08 | PR: 1KW     |                |        |  |                      |
|  | 1.8 T quattro    | 110 8E-5-400001 |       | 11.08 | PR: 1KW     |                |        |  |                      |
|  | 1.8 T quattro    | 120 8E-5-400001 |       | 11.08 | PR: 1KW     |                |        |  |                      |
|  | 1.8 T quattro    | 125 8E-5-400001 |       | 11.08 | PR: 1KW     |                |        |  |                      |
|  | 1.8 T quattro    | 140 8E-5-400001 |       | 11.08 | PR: 1KW     |                |        |  |                      |
|  | 1.9 TDI          | 74 8E-5-400001  |       | 11.08 | PR: 1KW     |                |        |  |                      |
|  | 1.9 TDI          | 85 8E-5-400001  |       | 11.08 | PR: 1KW     |                |        |  |                      |
|  | 1.9 TDI          | 96 8E-5-400001  |       | 11.08 | PR: 1KW     |                |        |  |                      |
|  | 1.9 TDI quattro  | 8E-5-400001     |       | 11.08 | PR: 1KW     |                |        |  |                      |
|  | 2.0              | 96 8E-5-400001  |       | 11.08 | PR: 1KW     |                |        |  |                      |
|  | 2.0 FSI          | 110 8E-5-400001 |       | 11.08 | PR: 1KW     |                |        |  |                      |
|  | 2.0 TDI          | 100 8E-5-400001 |       | 11.08 | PR: 1KW     |                |        |  |                      |
|  | 2.0 TDI          | 103 8E-5-400001 |       | 11.08 | PR: 1KW     |                |        |  |                      |
|  | 2.0 TDI          | 125             | 06.06 | 11.08 | PR: 1KW     |                |        |  |                      |
|  | 2.0 TDI quattro  | 103             | 01.06 | 11.08 | PR: 1KW     |                |        |  |                      |
|  | 2.0 TDI quattro  | 125             | 06.06 | 11.08 | PR: 1KW     |                |        |  |                      |
|  | 2.0 TFSI         | 147 8E-5-400001 |       | 11.08 | PR: 1KW     |                |        |  |                      |
|  | 2.0 TFSI         | 162 8E-5-400001 |       | 11.08 | PR: 1KW     |                |        |  |                      |
|  | 2.0 TFSI quattro | 147 8E-5-400001 |       | 11.08 | PR: 1KW     |                |        |  |                      |
|  | 2.0 TFSI quattro | 162 8E-5-400001 |       | 11.08 | PR: 1KW     |                |        |  |                      |
|  | 2.4              | 8E-5-400001     |       | 11.08 | PR: 1KW     |                |        |  |                      |
|  | 2.5 TDI          | 8E-5-400001     |       | 11.08 | PR: 1KW     |                |        |  |                      |
|  | 2.5 TDI quattro  | 8E-5-400001     |       | 11.08 | PR: 1KW     |                |        |  |                      |
|  | 2.7 TDI          | 120             | 11.05 | 11.08 | PR: 1KW     |                |        |  |                      |
|  | 2.7 TDI          | 132             | 01.06 | 11.08 | PR: 1KW     |                |        |  |                      |
|  | 3.0              | 8E-5-400001     |       | 11.08 | PR: 1KW     |                |        |  |                      |
|  | 3.0 quattro      | 8E-5-400001     |       | 11.08 | PR: 1KW     |                |        |  |                      |
|  | 3.0 TDI quattro  | 150 8E-5-400001 |       | 11.08 | PR: 1KW     |                |        |  |                      |
|  | 3.0 TDI quattro  | 171             | 01.06 | 11.08 | PR: 1KW     |                |        |  |                      |
|  | 3.2 FSI          | 188 8E-5-400001 |       | 11.08 | PR: 1KW     |                |        |  |                      |
|  | 3.2 FSI quattro  | 188 8E-5-400001 |       | 11.08 | PR: 1KW     |                |        |  |                      |
|  | S4               | 253             | 03.03 | 11.08 |             | 24.0122-0220.1 | 422220 |  | 300 22,0 20,0 V L +B |

**AUDI A4 (B8) Limousine (07-)**

|  |                  |     |       |  |             |                |        |  |                 |     |
|--|------------------|-----|-------|--|-------------|----------------|--------|--|-----------------|-----|
|  | 1.8 TFSI         | 88  | 01.08 |  | PR: 1LT,1LY | 13.0460-7256.2 | 607256 |  | 24705 19,8 +/WK | ATE |
|  | 1.8 TFSI         | 118 | 11.07 |  | PR: 1LT,1LY | 13.0470-7256.2 | LD7256 |  | 24705 19,8 +/WK | ATE |
|  | 1.8 TFSI         | 125 | 01.12 |  | PR: 1LT,1LY |                |        |  |                 |     |
|  | 1.8 TFSI quattro | 118 | 09.08 |  | PR: 1LT,1LY |                |        |  |                 |     |
|  | 1.8 TFSI quattro | 125 | 01.12 |  | PR: 1LT,1LY |                |        |  |                 |     |
|  | 2.0 TDI          | 88  | 06.08 |  | PR: 1LT,1LY |                |        |  |                 |     |
|  | 2.0 TDI          | 100 | 11.07 |  | PR: 1LT,1LY |                |        |  |                 |     |
|  | 2.0 TDI          | 105 | 11.07 |  | PR: 1LT,1LY |                |        |  |                 |     |
|  | 2.0 TDI          | 110 | 05.13 |  | PR: 1LT,1LY |                |        |  |                 |     |
|  | 2.0 TDI          | 120 | 08.08 |  | PR: 1LT,1LY |                |        |  |                 |     |
|  | 2.0 TDI          | 125 | 01.08 |  | PR: 1LT,1LY |                |        |  |                 |     |
|  | 2.0 TDI          | 130 | 11.11 |  | PR: 1LT,1LY |                |        |  |                 |     |
|  | 2.0 TDI          | 140 | 09.13 |  | PR: 1LT,1LY |                |        |  |                 |     |
|  | 2.0 TDI quattro  | 110 | 05.13 |  | PR: 1LT,1LY |                |        |  |                 |     |
|  | 2.0 TDI quattro  | 125 | 01.08 |  | PR: 1LT,1LY |                |        |  |                 |     |
|  | 2.0 TDI quattro  | 130 | 11.11 |  | PR: 1LT,1LY |                |        |  |                 |     |
|  | 2.0 TDI quattro  | 140 | 09.13 |  | PR: 1LT,1LY |                |        |  |                 |     |
|  | 2.0 TFSI         | 132 | 06.08 |  | PR: 1LT,1LY |                |        |  |                 |     |
|  | 2.0 TFSI         | 155 | 06.08 |  | PR: 1LT,1LY |                |        |  |                 |     |
|  | 2.0 TFSI         | 162 | 05.13 |  | PR: 1LT,1LY |                |        |  |                 |     |
|  | 2.0 TFSI         | 165 | 05.13 |  | PR: 1LT,1LY |                |        |  |                 |     |
|  | 2.0 TFSI quattro | 132 | 11.09 |  | PR: 1LT,1LY |                |        |  |                 |     |
|  | 2.0 TFSI quattro | 155 | 06.08 |  | PR: 1LT,1LY |                |        |  |                 |     |
|  | 2.0 TFSI quattro | 162 | 05.13 |  | PR: 1LT,1LY |                |        |  |                 |     |
|  | 2.0 TFSI quattro | 165 | 05.13 |  | PR: 1LT,1LY |                |        |  |                 |     |
|  | 2.7 TDI          | 120 | 11.07 |  | PR: 1LT,1LY |                |        |  |                 |     |
|  | 2.7 TDI          | 140 | 11.07 |  | PR: 1LT,1LY |                |        |  |                 |     |
|  | 3.0 TDI          | 150 | 11.11 |  | PR: 1LT,1LY |                |        |  |                 |     |
|  | 3.0 TDI quattro  | 155 | 06.08 |  | PR: 1LT,1LY |                |        |  |                 |     |



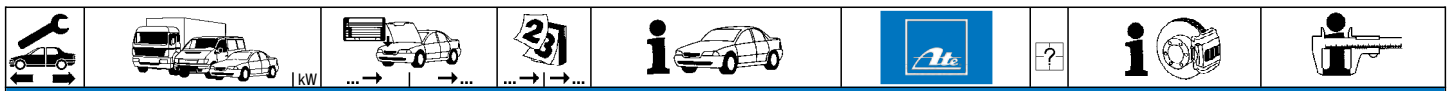

**AUDI A4 (B8) Limousine (07-)**

|                  |                  |                  |       |                 |                |                |                              |                   |                            |  |
|------------------|------------------|------------------|-------|-----------------|----------------|----------------|------------------------------|-------------------|----------------------------|--|
|                  | 3.0 TDI quattro  | 176              | 11.07 | PR: 1LT,1LY     | 13.0460-7256.2 | 607256         |                              | 24705 19,8 +/WK   | ATE                        |  |
|                  | 3.0 TDI quattro  | 180              | 11.11 | PR: 1LT,1LY     | 13.0470-7256.2 | LD7256         |                              | 24705 19,8 +/WK   | ATE                        |  |
|                  | 3.0 TFSI quattro | 200              | 02.12 | PR: 1LT,1LY     |                |                |                              |                   |                            |  |
|                  | 3.2 FSI          | 195              | 09.08 | PR: 1LT,1LY     |                |                |                              |                   |                            |  |
|                  | 3.2 FSI quattro  | 195              | 11.07 | PR: 1LT,1LY     |                |                |                              |                   |                            |  |
|                  | 1.8 TFSI         | 88               | 01.08 | PR: 1LA,1LB,1LD | 13.0460-2746.2 | 602746         | Federmaß 44 mm <sup>1)</sup> | 24743 19,2 +/WK/S | TRW                        |  |
|                  | 1.8 TFSI         | 118              | 11.07 | PR: 1LA,1LB,1LD | 13.0470-2746.2 | LD2746         | Federmaß 44 mm <sup>1)</sup> | 24743 19,2 +/WK/S | TRW                        |  |
|                  | 1.8 TFSI         | 125              | 01.12 | PR: 1LA,1LB,1LD |                |                |                              |                   |                            |  |
|                  | 1.8 TFSI quattro | 118              | 09.08 | PR: 1LA,1LB,1LD |                |                |                              |                   |                            |  |
|                  | 1.8 TFSI quattro | 125              | 01.12 | PR: 1LA,1LB,1LD |                |                |                              |                   |                            |  |
|                  | 2.0 TDI          | 88               | 06.08 | PR: 1LA,1LB,1LD |                |                |                              |                   |                            |  |
|                  | 2.0 TDI          | 100              | 11.07 | PR: 1LA,1LB,1LD |                |                |                              |                   |                            |  |
|                  | 2.0 TDI          | 105              | 11.07 | PR: 1LA,1LB,1LD |                |                |                              |                   |                            |  |
|                  | 2.0 TDI          | 110              | 05.13 | PR: 1LA,1LB,1LD |                |                |                              |                   |                            |  |
|                  | 2.0 TDI          | 120              | 08.08 | PR: 1LA,1LB,1LD |                |                |                              |                   |                            |  |
|                  | 2.0 TDI          | 125              | 01.08 | PR: 1LA,1LB,1LD |                |                |                              |                   |                            |  |
|                  | 2.0 TDI          | 130              | 11.11 | PR: 1LA,1LB,1LD |                |                |                              |                   |                            |  |
|                  | 2.0 TDI          | 140              | 09.13 | PR: 1LA,1LB,1LD |                |                |                              |                   |                            |  |
|                  | 2.0 TDI quattro  | 110              | 05.13 | PR: 1LA,1LB,1LD |                |                |                              |                   |                            |  |
|                  | 2.0 TDI quattro  | 125              | 01.08 | PR: 1LA,1LB,1LD |                |                |                              |                   |                            |  |
|                  | 2.0 TDI quattro  | 130              | 11.11 | PR: 1LA,1LB,1LD |                |                |                              |                   |                            |  |
|                  | 2.0 TDI quattro  | 140              | 09.13 | PR: 1LA,1LB,1LD |                |                |                              |                   |                            |  |
|                  | 2.0 TFSI         | 132              | 06.08 | PR: 1LA,1LB,1LD |                |                |                              |                   |                            |  |
|                  | 2.0 TFSI         | 155              | 06.08 | PR: 1LA,1LB,1LD |                |                |                              |                   |                            |  |
|                  | 2.0 TFSI         | 162              | 05.13 | PR: 1LA,1LB,1LD |                |                |                              |                   |                            |  |
|                  | 2.0 TFSI         | 165              | 05.13 | PR: 1LA,1LB,1LD |                |                |                              |                   |                            |  |
|                  | 2.0 TFSI quattro | 132              | 11.09 | PR: 1LA,1LB,1LD |                |                |                              |                   |                            |  |
|                  | 2.0 TFSI quattro | 155              | 06.08 | PR: 1LA,1LB,1LD |                |                |                              |                   |                            |  |
|                  | 2.0 TFSI quattro | 162              | 05.13 | PR: 1LA,1LB,1LD |                |                |                              |                   |                            |  |
|                  | 2.0 TFSI quattro | 165              | 05.13 | PR: 1LA,1LB,1LD |                |                |                              |                   |                            |  |
|                  | 2.7 TDI          | 120              | 11.07 | PR: 1LA,1LB,1LD |                |                |                              |                   |                            |  |
|                  | 2.7 TDI          | 140              | 11.07 | PR: 1LA,1LB,1LD |                |                |                              |                   |                            |  |
|                  | 3.0 TDI          | 150              | 11.11 | PR: 1LA,1LB,1LD |                |                |                              |                   |                            |  |
|                  | 3.0 TDI quattro  | 155              | 06.08 | PR: 1LA,1LB,1LD |                |                |                              |                   |                            |  |
|                  | 3.0 TDI quattro  | 176              | 11.07 | PR: 1LA,1LB,1LD |                |                |                              |                   |                            |  |
|                  | 3.0 TDI quattro  | 180              | 11.11 | PR: 1LA,1LB,1LD |                |                |                              |                   |                            |  |
|                  | 3.0 TFSI quattro | 200              | 02.12 | PR: 1LA,1LB,1LD |                |                |                              |                   |                            |  |
|                  | 3.2 FSI          | 195              | 09.08 | PR: 1LA,1LB,1LD |                |                |                              |                   |                            |  |
|                  | 3.2 FSI quattro  | 195              | 11.07 | PR: 1LA,1LB,1LD |                |                |                              |                   |                            |  |
|                  | S4               | 245              | 07.11 | PR: 1LJ,1ZT     | 13.0460-2746.2 | 602746         | Federmaß 44 mm <sup>1)</sup> | 24743 19,2 +/WK/S | TRW                        |  |
|                  |                  | 1.8 TFSI         | 88    | 01.08           | PR: 1LT,1LY    | 24.0125-0184.1 | 425184                       |                   | 314 25,0 23,0 V L +S +B    |  |
|                  |                  | 1.8 TFSI         | 118   | 11.07           | PR: 1LT,1LY    | 24.0325-0184.1 | 525184                       |                   | 314 25,0 23,0 V L +S +B PD |  |
|                  |                  | 1.8 TFSI         | 125   | 01.12           | PR: 1LT,1LY    |                |                              |                   |                            |  |
|                  |                  | 1.8 TFSI quattro | 118   | 09.08           | PR: 1LT,1LY    |                |                              |                   |                            |  |
| 1.8 TFSI quattro |                  | 125              | 01.12 | PR: 1LT,1LY     |                |                |                              |                   |                            |  |
| 2.0 TDI          |                  | 88               | 06.08 | PR: 1LT,1LY     |                |                |                              |                   |                            |  |
| 2.0 TDI          |                  | 100              | 11.07 | PR: 1LT,1LY     |                |                |                              |                   |                            |  |
| 2.0 TDI          |                  | 105              | 11.07 | PR: 1LT,1LY     |                |                |                              |                   |                            |  |
| 2.0 TDI          |                  | 110              | 05.13 | PR: 1LT,1LY     |                |                |                              |                   |                            |  |
| 2.0 TDI          |                  | 120              | 08.08 | PR: 1LT,1LY     |                |                |                              |                   |                            |  |
| 2.0 TDI          |                  | 125              | 01.08 | PR: 1LT,1LY     |                |                |                              |                   |                            |  |
| 2.0 TDI          |                  | 130              | 11.11 | PR: 1LT,1LY     |                |                |                              |                   |                            |  |
| 2.0 TDI          |                  | 140              | 09.13 | PR: 1LT,1LY     |                |                |                              |                   |                            |  |
| 2.0 TDI quattro  |                  | 110              | 05.13 | PR: 1LT,1LY     |                |                |                              |                   |                            |  |
| 2.0 TDI quattro  |                  | 125              | 01.08 | PR: 1LT,1LY     |                |                |                              |                   |                            |  |
| 2.0 TDI quattro  |                  | 130              | 11.11 | PR: 1LT,1LY     |                |                |                              |                   |                            |  |
| 2.0 TDI quattro  |                  | 140              | 09.13 | PR: 1LT,1LY     |                |                |                              |                   |                            |  |
| 2.0 TFSI         |                  | 132              | 06.08 | PR: 1LT,1LY     |                |                |                              |                   |                            |  |
| 2.0 TFSI         |                  | 155              | 06.08 | PR: 1LT,1LY     |                |                |                              |                   |                            |  |
| 2.0 TFSI         |                  | 162              | 05.13 | PR: 1LT,1LY     |                |                |                              |                   |                            |  |
| 2.0 TFSI         |                  | 165              | 05.13 | PR: 1LT,1LY     |                |                |                              |                   |                            |  |
| 2.0 TFSI quattro |                  | 132              | 11.09 | PR: 1LT,1LY     |                |                |                              |                   |                            |  |
| 2.0 TFSI quattro |                  | 155              | 06.08 | PR: 1LT,1LY     |                |                |                              |                   |                            |  |
| 2.0 TFSI quattro |                  | 162              | 05.13 | PR: 1LT,1LY     |                |                |                              |                   |                            |  |
| 2.0 TFSI quattro |                  | 165              | 05.13 | PR: 1LT,1LY     |                |                |                              |                   |                            |  |
| 2.7 TDI          |                  | 120              | 11.07 | PR: 1LT,1LY     |                |                |                              |                   |                            |  |
| 2.7 TDI          |                  | 140              | 11.07 | PR: 1LT,1LY     |                |                |                              |                   |                            |  |
| 3.0 TDI          |                  | 150              | 11.11 | PR: 1LT,1LY     |                |                |                              |                   |                            |  |
| 3.0 TDI quattro  |                  | 155              | 06.08 | PR: 1LT,1LY     |                |                |                              |                   |                            |  |
| 3.0 TDI quattro  |                  | 176              | 11.07 | PR: 1LT,1LY     |                |                |                              |                   |                            |  |
| 3.0 TDI quattro  |                  | 180              | 11.11 | PR: 1LT,1LY     |                |                |                              |                   |                            |  |
| 3.0 TFSI quattro |                  | 200              | 02.12 | PR: 1LT,1LY     |                |                |                              |                   |                            |  |
| 3.2 FSI          |                  | 195              | 09.08 | PR: 1LT,1LY     |                |                |                              |                   |                            |  |
| 3.2 FSI quattro  |                  | 195              | 11.07 | PR: 1LT,1LY     |                |                |                              |                   |                            |  |
|                  |                  | 1.8 TFSI         | 88    | 01.08           | 06.11          | PR: 1LA        | 24.0130-0193.1               | 430193            | 320 30,0 28,0 V L +S +B    |  |
|                  |                  | 1.8 TFSI         | 118   | 11.07           | 06.11          | PR: 1LA        | 24.0330-0193.1               | 530193            | 320 30,0 28,0 V L +S +B PD |  |
|                  |                  | 1.8 TFSI quattro | 118   | 09.08           | 06.11          | PR: 1LA        |                              |                   |                            |  |
|                  |                  | 2.0 TDI          | 88    | 06.08           | 06.11          | PR: 1LA        |                              |                   |                            |  |
|                  |                  | 2.0 TDI          | 100   | 11.07           | 06.11          | PR: 1LA        |                              |                   |                            |  |
|                  |                  | 2.0 TDI          | 105   | 11.07           | 06.11          | PR: 1LA        |                              |                   |                            |  |
|                  |                  | 2.0 TDI          | 120   | 08.08           | 06.11          | PR: 1LA        |                              |                   |                            |  |
|                  |                  | 2.0 TDI          | 125   | 01.08           | 06.11          | PR: 1LA        |                              |                   |                            |  |
|                  | 2.0 TDI quattro  | 125              | 01.08 | 06.11           | PR: 1LA        |                |                              |                   |                            |  |
|                  | 2.0 TFSI         | 132              | 06.08 | 06.11           | PR: 1LA        |                |                              |                   |                            |  |
|                  | 2.0 TFSI         | 155              | 06.08 | 06.11           | PR: 1LA        |                |                              |                   |                            |  |
|                  | 2.0 TFSI quattro | 132              | 11.09 | 06.11           | PR: 1LA        |                |                              |                   |                            |  |
| 2.0 TFSI quattro | 155              | 06.08            | 06.11 | PR: 1LA         |                |                |                              |                   |                            |  |

<sup>1)</sup> Spring dimension 44 mm / dimensioni molla 44 mm / dimension de ressort 44 mm / medida de muelle 44 mm







**AUDI A4 (B8) Limousine (07-)**

|                  |                  |                  |              |              |              |             |                       |                       |   |                                      |                        |
|------------------|------------------|------------------|--------------|--------------|--------------|-------------|-----------------------|-----------------------|---|--------------------------------------|------------------------|
|                  | 2.7 TDI          | 120              |              | <b>11.07</b> | <b>06.11</b> | PR: 1LA     | <b>24.0130-0193.1</b> | 430193                |   | 320 30,0 28,0 VL +S +B               |                        |
|                  | 2.7 TDI          | 140              |              | <b>11.07</b> | <b>06.11</b> | PR: 1LA     | <b>24.0330-0193.1</b> | 530193                |   | <b>320 30,0 28,0 VL +S +B PD</b>     |                        |
|                  | 3.0 TDI quattro  | 155              |              | <b>06.08</b> | <b>06.11</b> | PR: 1LA     |                       |                       |   |                                      |                        |
|                  | 3.0 TDI quattro  | 176              |              | <b>11.07</b> | <b>06.11</b> | PR: 1LA     |                       |                       |   |                                      |                        |
|                  | 3.2 FSI          | 195              |              | <b>09.08</b> | <b>06.11</b> | PR: 1LA     |                       |                       |   |                                      |                        |
|                  | 3.2 FSI quattro  | 195              |              | <b>11.07</b> | <b>06.11</b> | PR: 1LA     |                       |                       |   |                                      |                        |
|                  | 1.8 TFSI         | 88               |              | <b>07.11</b> |              | PR: 1LA,1LB | <b>24.0130-0221.1</b> | 430221                |   | 320 30,0 28,0 VL +S +B               |                        |
|                  | 1.8 TFSI         | 118              |              | <b>07.11</b> |              | PR: 1LA,1LB |                       |                       |   |                                      |                        |
|                  | 1.8 TFSI         | 125              |              | <b>01.12</b> |              | PR: 1LA,1LB |                       |                       |   |                                      |                        |
|                  | 1.8 TFSI quattro | 118              |              | <b>07.11</b> |              | PR: 1LA,1LB |                       |                       |   |                                      |                        |
|                  | 1.8 TFSI quattro | 125              |              | <b>01.12</b> |              | PR: 1LA,1LB |                       |                       |   |                                      |                        |
|                  | 2.0 TDI          | 88               |              | <b>07.11</b> |              | PR: 1LA,1LB |                       |                       |   |                                      |                        |
|                  | 2.0 TDI          | 100              |              | <b>07.11</b> |              | PR: 1LA,1LB |                       |                       |   |                                      |                        |
|                  | 2.0 TDI          | 105              |              | <b>07.11</b> |              | PR: 1LA,1LB |                       |                       |   |                                      |                        |
|                  | 2.0 TDI          | 110              |              | <b>05.13</b> |              | PR: 1LA,1LB |                       |                       |   |                                      |                        |
|                  | 2.0 TDI          | 120              |              | <b>07.11</b> |              | PR: 1LA,1LB |                       |                       |   |                                      |                        |
|                  | 2.0 TDI          | 125              |              | <b>07.11</b> |              | PR: 1LA,1LB |                       |                       |   |                                      |                        |
|                  | 2.0 TDI          | 130              |              | <b>11.11</b> |              | PR: 1LA,1LB |                       |                       |   |                                      |                        |
|                  | 2.0 TDI          | 140              |              | <b>09.13</b> |              | PR: 1LA,1LB |                       |                       |   |                                      |                        |
|                  | 2.0 TDI quattro  | 110              |              | <b>05.13</b> |              | PR: 1LA,1LB |                       |                       |   |                                      |                        |
|                  | 2.0 TDI quattro  | 125              |              | <b>07.11</b> |              | PR: 1LA,1LB |                       |                       |   |                                      |                        |
|                  | 2.0 TDI quattro  | 130              |              | <b>11.11</b> |              | PR: 1LA,1LB |                       |                       |   |                                      |                        |
|                  | 2.0 TDI quattro  | 140              |              | <b>09.13</b> |              | PR: 1LA,1LB |                       |                       |   |                                      |                        |
|                  | 2.0 TFSI         | 132              |              | <b>07.11</b> |              | PR: 1LA,1LB |                       |                       |   |                                      |                        |
|                  | 2.0 TFSI         | 155              |              | <b>07.11</b> |              | PR: 1LA,1LB |                       |                       |   |                                      |                        |
|                  | 2.0 TFSI         | 162              |              | <b>05.13</b> |              | PR: 1LA,1LB |                       |                       |   |                                      |                        |
|                  | 2.0 TFSI         | 165              |              | <b>05.13</b> |              | PR: 1LA,1LB |                       |                       |   |                                      |                        |
|                  | 2.0 TFSI quattro | 132              |              | <b>11.09</b> |              | PR: 1LA,1LB |                       |                       |   |                                      |                        |
|                  | 2.0 TFSI quattro | 155              |              | <b>07.11</b> |              | PR: 1LA,1LB |                       |                       |   |                                      |                        |
|                  | 2.0 TFSI quattro | 162              |              | <b>05.13</b> |              | PR: 1LA,1LB |                       |                       |   |                                      |                        |
|                  | 2.0 TFSI quattro | 165              |              | <b>05.13</b> |              | PR: 1LA,1LB |                       |                       |   |                                      |                        |
|                  | 2.7 TDI          | 120              |              | <b>07.11</b> |              | PR: 1LA,1LB |                       |                       |   |                                      |                        |
|                  | 2.7 TDI          | 140              |              | <b>07.11</b> |              | PR: 1LA,1LB |                       |                       |   |                                      |                        |
|                  | 3.0 TDI          | 150              |              | <b>11.11</b> |              | PR: 1LA,1LB |                       |                       |   |                                      |                        |
|                  | 3.0 TDI quattro  | 155              |              | <b>07.11</b> |              | PR: 1LA,1LB |                       |                       |   |                                      |                        |
|                  | 3.0 TDI quattro  | 176              |              | <b>07.11</b> |              | PR: 1LA,1LB |                       |                       |   |                                      |                        |
|                  | 3.0 TDI quattro  | 180              |              | <b>11.11</b> |              | PR: 1LA,1LB |                       |                       |   |                                      |                        |
|                  | 3.0 TFSI quattro | 200              |              | <b>02.12</b> |              | PR: 1LA,1LB |                       |                       |   |                                      |                        |
|                  | 3.2 FSI          | 195              |              | <b>07.11</b> |              | PR: 1LA,1LB |                       |                       |   |                                      |                        |
|                  | 3.2 FSI quattro  | 195              |              | <b>07.11</b> |              | PR: 1LA,1LB |                       |                       |   |                                      |                        |
|                  | S4               | 245              |              | <b>11.08</b> | <b>06.11</b> | PR: 1LJ     | <b>24.0129-0102.1</b> | 429102                |   | 345 29,5 28,0 VL +S +B               |                        |
|                  | S4               | 245              |              | <b>07.11</b> |              | PR: 1LJ,1ZT | <b>24.0130-0222.1</b> | 430222                |   | 345 30,0 28,0 VL +S +B               |                        |
|                  |                  | 1.8 TFSI         | 88           |              | <b>01.08</b> |             | PR: 1LD               | <b>24.0130-0222.1</b> | 430222                                    |                                      | 345 30,0 28,0 VL +S +B |
|                  |                  | 1.8 TFSI         | 118          |              | <b>11.07</b> |             | PR: 1LD               |                       |   |                                      |                        |
|                  |                  | 1.8 TFSI         | 125          |              | <b>01.12</b> |             | PR: 1LD               |                       |   |                                      |                        |
|                  |                  | 1.8 TFSI quattro | 118          |              | <b>09.08</b> |             | PR: 1LD               |                       |   |                                      |                        |
|                  |                  | 1.8 TFSI quattro | 125          |              | <b>01.12</b> |             | PR: 1LD               |                       |   |                                      |                        |
|                  |                  | 2.0 TDI          | 88           |              | <b>06.08</b> |             | PR: 1LD               |                       |   |                                      |                        |
| 2.0 TDI          |                  | 100              |              | <b>11.07</b> |              | PR: 1LD     |                       |                       |   |                                      |                        |
| 2.0 TDI          |                  | 105              |              | <b>11.07</b> |              | PR: 1LD     |                       |                       |   |                                      |                        |
| 2.0 TDI          |                  | 110              |              | <b>05.13</b> |              | PR: 1LD     |                       |                       |   |                                      |                        |
| 2.0 TDI          |                  | 120              |              | <b>08.08</b> |              | PR: 1LD     |                       |                       |   |                                      |                        |
| 2.0 TDI          |                  | 125              |              | <b>01.08</b> |              | PR: 1LD     |                       |                       |   |                                      |                        |
| 2.0 TDI          |                  | 130              |              | <b>11.11</b> |              | PR: 1LD     |                       |                       |   |                                      |                        |
| 2.0 TDI          |                  | 140              |              | <b>09.13</b> |              | PR: 1LD     |                       |                       |   |                                      |                        |
| 2.0 TDI quattro  |                  | 110              |              | <b>05.13</b> |              | PR: 1LD     |                       |                       |   |                                      |                        |
| 2.0 TDI quattro  |                  | 125              |              | <b>01.08</b> |              | PR: 1LD     |                       |                       |   |                                      |                        |
| 2.0 TDI quattro  |                  | 130              |              | <b>11.11</b> |              | PR: 1LD     |                       |                       |   |                                      |                        |
| 2.0 TDI quattro  |                  | 140              |              | <b>09.13</b> |              | PR: 1LD     |                       |                       |   |                                      |                        |
| 2.0 TFSI         |                  | 132              |              | <b>06.08</b> |              | PR: 1LD     |                       |                       |   |                                      |                        |
| 2.0 TFSI         |                  | 155              |              | <b>06.08</b> |              | PR: 1LD     |                       |                       |   |                                      |                        |
| 2.0 TFSI         |                  | 162              |              | <b>05.13</b> |              | PR: 1LD     |                       |                       |   |                                      |                        |
| 2.0 TFSI         |                  | 165              |              | <b>05.13</b> |              | PR: 1LD     |                       |                       |   |                                      |                        |
| 2.0 TFSI quattro |                  | 132              |              | <b>11.09</b> |              | PR: 1LD     |                       |                       |   |                                      |                        |
| 2.0 TFSI quattro |                  | 155              |              | <b>06.08</b> |              | PR: 1LD     |                       |                       |   |                                      |                        |
| 2.0 TFSI quattro |                  | 162              |              | <b>05.13</b> |              | PR: 1LD     |                       |                       |   |                                      |                        |
| 2.0 TFSI quattro |                  | 165              |              | <b>05.13</b> |              | PR: 1LD     |                       |                       |   |                                      |                        |
| 2.7 TDI          |                  | 120              |              | <b>11.07</b> |              | PR: 1LD     |                       |                       |   |                                      |                        |
| 2.7 TDI          |                  | 140              |              | <b>11.07</b> |              | PR: 1LD     |                       |                       |   |                                      |                        |
| 3.0 TDI          |                  | 150              |              | <b>11.11</b> |              | PR: 1LD     |                       |                       |   |                                      |                        |
| 3.0 TDI quattro  |                  | 155              |              | <b>06.08</b> |              | PR: 1LD     |                       |                       |   |                                      |                        |
| 3.0 TDI quattro  |                  | 176              |              | <b>11.07</b> |              | PR: 1LD     |                       |                       |   |                                      |                        |
| 3.0 TDI quattro  |                  | 180              |              | <b>11.11</b> |              | PR: 1LD     |                       |                       |   |                                      |                        |
| 3.0 TFSI quattro |                  | 200              |              | <b>02.12</b> |              | PR: 1LD     |                       |                       |   |                                      |                        |
| 3.2 FSI          |                  | 195              |              | <b>09.08</b> |              | PR: 1LD     |                       |                       |   |                                      |                        |
| 3.2 FSI quattro  |                  | 195              |              | <b>11.07</b> |              | PR: 1LD     |                       |                       |   |                                      |                        |
|                  | 1.8 TFSI         | 88               |              | <b>01.08</b> |              | PR: 1KW,2EH | <b>13.0460-2747.2</b> | 602747                | elektrische Feststellbremse <sup>1)</sup> | <b>24606</b> 17,4 +/Zub/S <b>TRW</b> |                        |
|                  | 1.8 TFSI         | 118              |              | <b>11.07</b> |              | PR: 1KW,2EH | <b>13.0470-2747.2</b> | LD2747                | elektrische Feststellbremse <sup>1)</sup> | <b>24606</b> 17,4 +/Zub/S <b>TRW</b> |                        |
|                  | 1.8 TFSI         | 125              |              | <b>01.12</b> |              | PR: 1KW,2EH |                       |                       |   |                                      |                        |
|                  | 1.8 TFSI quattro | 118              |              | <b>09.08</b> |              | PR: 1KW,2EH |                       |                       |   |                                      |                        |
|                  | 1.8 TFSI quattro | 125              |              | <b>01.12</b> |              | PR: 1KW,2EH |                       |                       |   |                                      |                        |
|                  | 2.0 TDI          | 88               |              | <b>06.08</b> |              | PR: 1KW,2EH |                       |                       |   |                                      |                        |
|                  | 2.0 TDI          | 100              |              | <b>11.07</b> |              | PR: 1KW,2EH |                       |                       |   |                                      |                        |
|                  | 2.0 TDI          | 105              |              | <b>11.07</b> |              | PR: 1KW,2EH |                       |                       |   |                                      |                        |
| 2.0 TDI          | 110              |                  | <b>05.13</b> |              | PR: 1KW,2EH  |             |                       |                       |   |                                      |                        |
| 2.0 TDI          | 120              |                  | <b>08.08</b> |              | PR: 1KW,2EH  |             |                       |                       |   |                                      |                        |

<sup>1)</sup> electric parking brake / fr.di stazionamento elettrico / frein à main électrique / freno de mano eléctrico



| AUDI A4 (B8) Limousine (07-)   |                  |       |             |                |                |   |   |                     |     |
|--|------------------|-------|-------------|----------------|----------------|---|---|---------------------|-----|
|    | 2.0 TDI          | 125   | 01.08       | PR: 1KW,2EH    | 13.0460-2747.2 | 602747                                    | elektrische Feststellbremse <sup>1)</sup> | 24606 17,4 +/Zub/S  | TRW |
|  | 2.0 TDI          | 130   | 11.11       | PR: 1KW,2EH    | 13.0470-2747.2 | LD2747                                    |   |                     |     |
|  | 2.0 TDI          | 140   | 09.13       | PR: 1KW,2EH    |                |   |   |                     |     |
|  | 2.0 TDI quattro  | 110   | 05.13       | PR: 1KW,2EH    |                |   |   |                     |     |
|  | 2.0 TDI quattro  | 125   | 01.08       | PR: 1KW,2EH    |                |   |   |                     |     |
|  | 2.0 TDI quattro  | 130   | 11.11       | PR: 1KW,2EH    |                |   |   |                     |     |
|  | 2.0 TDI quattro  | 140   | 09.13       | PR: 1KW,2EH    |                |   |   |                     |     |
|  | 2.0 TFSI         | 132   | 06.08       | PR: 1KW,2EH    |                |   |   |                     |     |
|  | 2.0 TFSI         | 155   | 06.08       | PR: 1KW,2EH    |                |   |   |                     |     |
|  | 2.0 TFSI         | 162   | 05.13       | PR: 1KW,2EH    |                |   |   |                     |     |
|  | 2.0 TFSI         | 165   | 05.13       | PR: 1KW,2EH    |                |   |   |                     |     |
|  | 2.0 TFSI quattro | 132   | 11.09       | PR: 1KW,2EH    |                |   |   |                     |     |
|  | 2.0 TFSI quattro | 155   | 06.08       | PR: 1KW,2EH    |                |   |   |                     |     |
|  | 2.0 TFSI quattro | 162   | 05.13       | PR: 1KW,2EH    |                |   |   |                     |     |
|  | 2.0 TFSI quattro | 165   | 05.13       | PR: 1KW,2EH    |                |   |   |                     |     |
|  | 2.7 TDI          | 120   | 11.07       | PR: 1KW,2EH    |                |   |   |                     |     |
|  | 2.7 TDI          | 140   | 11.07       | PR: 1KW,2EH    |                |   |   |                     |     |
|  | 3.0 TDI          | 150   | 11.11       | PR: 1KW,2EH    |                |   |   |                     |     |
|  | 3.0 TDI quattro  | 155   | 06.08       | PR: 1KW,2EH    |                |   |   |                     |     |
|  | 3.0 TDI quattro  | 176   | 11.07       | PR: 1KW,2EH    |                |   |   |                     |     |
| 3.0 TDI quattro  | 180              | 11.11 | PR: 1KW,2EH |                |                |   |   |                     |     |
| 3.0 TFSI quattro   | 200              | 02.12 | PR: 1KW,2EH |                |                |   |   |                     |     |
| 3.2 FSI  | 195              | 09.08 | PR: 1KW,2EH |                |                |   |   |                     |     |
| 3.2 FSI quattro  | 195              | 11.07 | PR: 1KW,2EH |                |                |   |   |                     |     |
| S4   | 245              | 01.08 | PR: 1KE     | 13.0460-2748.2 | 602748         | elektrische Feststellbremse <sup>1)</sup> | 24606 17,4 +/Zub/S                        | TRW                 |     |
|  |                  |       |             | 13.0470-2748.2 | LD2748         | elektrische Feststellbremse <sup>1)</sup> | 24606 17,4 +/Zub/S                        | TRW                 |     |
|  | 1.8 TFSI         | 88    | 01.08       | PR: 1KP        | 13.0460-2748.2 | 602748                                    | elektrische Feststellbremse <sup>1)</sup> | 24606 17,4 +/Zub/S  | TRW |
|  | 1.8 TFSI         | 118   | 11.07       | PR: 1KP        | 13.0470-2748.2 | LD2748                                    |   |                     |     |
|  | 1.8 TFSI         | 125   | 01.12       | PR: 1KP        |                |   |   |                     |     |
|  | 1.8 TFSI quattro | 118   | 09.08       | PR: 1KP        |                |   |   |                     |     |
|  | 1.8 TFSI quattro | 125   | 01.12       | PR: 1KP        |                |   |   |                     |     |
|  | 2.0 TDI          | 88    | 06.08       | PR: 1KP        |                |   |   |                     |     |
|  | 2.0 TDI          | 100   | 11.07       | PR: 1KP        |                |   |   |                     |     |
|  | 2.0 TDI          | 105   | 11.07       | PR: 1KP        |                |   |   |                     |     |
|  | 2.0 TDI          | 110   | 05.13       | PR: 1KP        |                |   |   |                     |     |
|  | 2.0 TDI          | 120   | 08.08       | PR: 1KP        |                |   |   |                     |     |
|  | 2.0 TDI          | 125   | 01.08       | PR: 1KP        |                |   |   |                     |     |
|  | 2.0 TDI          | 130   | 11.11       | PR: 1KP        |                |   |   |                     |     |
|  | 2.0 TDI          | 140   | 09.13       | PR: 1KP        |                |   |   |                     |     |
|  | 2.0 TDI quattro  | 110   | 05.13       | PR: 1KP        |                |   |   |                     |     |
|  | 2.0 TDI quattro  | 125   | 01.08       | PR: 1KP        |                |   |   |                     |     |
|  | 2.0 TDI quattro  | 130   | 11.11       | PR: 1KP        |                |   |   |                     |     |
|  | 2.0 TDI quattro  | 140   | 09.13       | PR: 1KP        |                |   |   |                     |     |
|  | 2.0 TFSI         | 132   | 06.08       | PR: 1KP        |                |   |   |                     |     |
|  | 2.0 TFSI         | 155   | 06.08       | PR: 1KP        |                |   |   |                     |     |
|  | 2.0 TFSI         | 162   | 05.13       | PR: 1KP        |                |   |   |                     |     |
|  | 2.0 TFSI         | 165   | 05.13       | PR: 1KP        |                |   |   |                     |     |
|  | 2.0 TFSI quattro | 132   | 11.09       | PR: 1KP        |                |   |   |                     |     |
|  | 2.0 TFSI quattro | 155   | 06.08       | PR: 1KP        |                |   |   |                     |     |
|  | 2.0 TFSI quattro | 162   | 05.13       | PR: 1KP        |                |   |   |                     |     |
|  | 2.0 TFSI quattro | 165   | 05.13       | PR: 1KP        |                |   |   |                     |     |
|  | 2.7 TDI          | 120   | 11.07       | PR: 1KP        |                |   |   |                     |     |
|  | 2.7 TDI          | 140   | 11.07       | PR: 1KP        |                |   |   |                     |     |
|  | 3.0 TDI          | 150   | 11.11       | PR: 1KP        |                |   |   |                     |     |
|  | 3.0 TDI quattro  | 155   | 06.08       | PR: 1KP        |                |   |   |                     |     |
|  | 3.0 TDI quattro  | 176   | 11.07       | PR: 1KP        |                |   |   |                     |     |
| 3.0 TDI quattro  | 180              | 11.11 | PR: 1KP     |                |                |   |   |                     |     |
| 3.0 TFSI quattro   | 200              | 02.12 | PR: 1KP     |                |                |   |   |                     |     |
| 3.2 FSI  | 195              | 09.08 | PR: 1KP     |                |                |   |   |                     |     |
| 3.2 FSI quattro  | 195              | 11.07 | PR: 1KP     |                |                |   |   |                     |     |
|  | 1.8 TFSI         | 88    | 01.08       | PR: 1KW,2EH    | 24.0112-0178.1 | 412178                                    | elektrische Feststellbremse <sup>1)</sup> | 300 12,0 10,0 +S +B | TRW |
|  | 1.8 TFSI         | 118   | 11.07       | PR: 1KW,2EH    | 24.0312-0178.1 | 512178                                    |   |                     |     |
|  | 1.8 TFSI         | 125   | 01.12       | PR: 1KW,2EH    |                |   |   |                     |     |
|  | 1.8 TFSI quattro | 118   | 09.08       | PR: 1KW,2EH    |                |   |   |                     |     |
|  | 1.8 TFSI quattro | 125   | 01.12       | PR: 1KW,2EH    |                |   |   |                     |     |
|  | 2.0 TDI          | 88    | 06.08       | PR: 1KW,2EH    |                |   |   |                     |     |
|  | 2.0 TDI          | 100   | 11.07       | PR: 1KW,2EH    |                |   |   |                     |     |
|  | 2.0 TDI          | 105   | 11.07       | PR: 1KW,2EH    |                |   |   |                     |     |
|  | 2.0 TDI          | 110   | 05.13       | PR: 1KW,2EH    |                |   |   |                     |     |
|  | 2.0 TDI          | 120   | 08.08       | PR: 1KW,2EH    |                |   |   |                     |     |
|  | 2.0 TDI          | 125   | 01.08       | PR: 1KW,2EH    |                |   |   |                     |     |
|  | 2.0 TDI          | 130   | 11.11       | PR: 1KW,2EH    |                |   |   |                     |     |
|  | 2.0 TDI          | 140   | 09.13       | PR: 1KW,2EH    |                |   |   |                     |     |
|  | 2.0 TDI quattro  | 110   | 05.13       | PR: 1KW,2EH    |                |   |   |                     |     |
|  | 2.0 TDI quattro  | 125   | 01.08       | PR: 1KW,2EH    |                |   |   |                     |     |
|  | 2.0 TDI quattro  | 130   | 11.11       | PR: 1KW,2EH    |                |   |   |                     |     |
|  | 2.0 TDI quattro  | 140   | 09.13       | PR: 1KW,2EH    |                |   |   |                     |     |
|  | 2.0 TFSI         | 132   | 06.08       | PR: 1KW,2EH    |                |   |   |                     |     |
|  | 2.0 TFSI         | 155   | 06.08       | PR: 1KW,2EH    |                |   |   |                     |     |
|  | 2.0 TFSI         | 162   | 05.13       | PR: 1KW,2EH    |                |   |   |                     |     |
| 2.0 TFSI   | 165              | 05.13 | PR: 1KW,2EH |                |                |   |   |                     |     |
| 2.0 TFSI quattro   | 132              | 11.09 | PR: 1KW,2EH |                |                |   |   |                     |     |
| 2.0 TFSI quattro   | 155              | 06.08 | PR: 1KW,2EH |                |                |   |   |                     |     |
| 2.0 TFSI quattro   | 162              | 05.13 | PR: 1KW,2EH |                |                |   |   |                     |     |
| 2.0 TFSI quattro   | 165              | 05.13 | PR: 1KW,2EH |                |                |   |   |                     |     |
| 2.7 TDI  | 120              | 11.07 | PR: 1KW,2EH |                |                |   |   |                     |     |
| 2.7 TDI  | 140              | 11.07 | PR: 1KW,2EH |                |                |   |   |                     |     |

<sup>1)</sup> electric parking brake / fr.di stazionamento elettrico / frein à main électrique / freno de mano eléctrico



### AUDI A4 (B8) Limousine (07-)

|  |                  |     |       |               |                |        |   |                         |
|--|------------------|-----|-------|---------------|----------------|--------|---|-------------------------|
|  | 3.0 TDI          | 150 | 11.11 | PR: 1KW,2EH   | 24.0112-0178.1 | 412178 | elektrische Feststellbremse <sup>1)</sup> | 300 12,0 10,0 +S +B     |
|  | 3.0 TDI quattro  | 155 | 06.08 | PR: 1KW,2EH   | 24.0312-0178.1 | 512178 | elektrische Feststellbremse <sup>1)</sup> | 300 12,0 10,0 +S +B PD  |
|  | 3.0 TDI quattro  | 176 | 11.07 | PR: 1KW,2EH   |                |        |   |                         |
|  | 3.0 TDI quattro  | 180 | 11.11 | PR: 1KW,2EH   |                |        |   |                         |
|  | 3.0 TFSI quattro | 200 | 02.12 | PR: 1KW,2EH   |                |        |   |                         |
|  | 3.2 FSI          | 195 | 09.08 | PR: 1KW,2EH   |                |        |   |                         |
|  | 3.2 FSI quattro  | 195 | 11.07 | PR: 1KW,2EH   |                |        |   |                         |
|  | S4               | 245 | 01.08 | 10.10 PR: 1KE | 24.0122-0250.1 | 422250 | elektrische Feststellbremse <sup>1)</sup> | 330 22,0 20,0 V L +S +B |
|  | 1.8 TFSI         | 88  | 01.08 | PR: 1KP       | 24.0122-0272.1 | 422272 | elektrische Feststellbremse <sup>1)</sup> | 330 21,9 20,0 V L +S +B |
|  | 1.8 TFSI         | 118 | 11.07 | PR: 1KP       |                |        |   |                         |
|  | 1.8 TFSI         | 125 | 01.12 | PR: 1KP       |                |        |   |                         |
|  | 1.8 TFSI quattro | 118 | 09.08 | PR: 1KP       |                |        |   |                         |
|  | 1.8 TFSI quattro | 125 | 01.12 | PR: 1KP       |                |        |   |                         |
|  | 2.0 TDI          | 88  | 06.08 | PR: 1KP       |                |        |   |                         |
|  | 2.0 TDI          | 100 | 11.07 | PR: 1KP       |                |        |   |                         |
|  | 2.0 TDI          | 105 | 11.07 | PR: 1KP       |                |        |   |                         |
|  | 2.0 TDI          | 110 | 05.13 | PR: 1KP       |                |        |   |                         |
|  | 2.0 TDI          | 120 | 08.08 | PR: 1KP       |                |        |   |                         |
|  | 2.0 TDI          | 125 | 01.08 | PR: 1KP       |                |        |   |                         |
|  | 2.0 TDI          | 130 | 11.11 | PR: 1KP       |                |        |   |                         |
|  | 2.0 TDI          | 140 | 09.13 | PR: 1KP       |                |        |   |                         |
|  | 2.0 TDI quattro  | 110 | 05.13 | PR: 1KP       |                |        |   |                         |
|  | 2.0 TDI quattro  | 125 | 01.08 | PR: 1KP       |                |        |   |                         |
|  | 2.0 TDI quattro  | 130 | 11.11 | PR: 1KP       |                |        |   |                         |
|  | 2.0 TDI quattro  | 140 | 09.13 | PR: 1KP       |                |        |   |                         |
|  | 2.0 TFSI         | 132 | 06.08 | PR: 1KP       |                |        |   |                         |
|  | 2.0 TFSI         | 155 | 06.08 | PR: 1KP       |                |        |   |                         |
|  | 2.0 TFSI         | 162 | 05.13 | PR: 1KP       |                |        |   |                         |
|  | 2.0 TFSI         | 165 | 05.13 | PR: 1KP       |                |        |   |                         |
|  | 2.0 TFSI quattro | 132 | 11.09 | PR: 1KP       |                |        |   |                         |
|  | 2.0 TFSI quattro | 155 | 06.08 | PR: 1KP       |                |        |   |                         |
|  | 2.0 TFSI quattro | 162 | 05.13 | PR: 1KP       |                |        |   |                         |
|  | 2.0 TFSI quattro | 165 | 05.13 | PR: 1KP       |                |        |   |                         |
|  | 2.7 TDI          | 120 | 11.07 | PR: 1KP       |                |        |   |                         |
|  | 2.7 TDI          | 140 | 11.07 | PR: 1KP       |                |        |   |                         |
|  | 3.0 TDI          | 150 | 11.11 | PR: 1KP       |                |        |   |                         |
|  | 3.0 TDI quattro  | 155 | 06.08 | PR: 1KP       |                |        |   |                         |
|  | 3.0 TDI quattro  | 176 | 11.07 | PR: 1KP       |                |        |   |                         |
|  | 3.0 TDI quattro  | 180 | 11.11 | PR: 1KP       |                |        |   |                         |
|  | 3.0 TFSI quattro | 200 | 02.12 | PR: 1KP       |                |        |   |                         |
|  | 3.2 FSI          | 195 | 09.08 | PR: 1KP       |                |        |   |                         |
|  | 3.2 FSI quattro  | 195 | 11.07 | PR: 1KP       |                |        |   |                         |
|  | S4               | 245 | 11.10 | PR: 1KE       |                |        |   |                         |



### AUDI A4 (B8) Avant (08-)

|  |                  |     |       |                 |                |        |                              |                   |     |
|--|------------------|-----|-------|-----------------|----------------|--------|------------------------------|-------------------|-----|
|  | 1.8 FSI          | 88  | 04.08 | PR: 1LT,1LY     | 13.0460-7256.2 | 607256 |                              | 24705 19,8 +/WK   | ATE |
|  | 1.8 TFSI         | 118 | 04.08 | PR: 1LT,1LY     | 13.0470-7256.2 | LD7256 |                              | 24705 19,8 +/WK   | ATE |
|  | 1.8 TFSI         | 125 | 01.12 | PR: 1LT,1LY     |                |        |                              |                   |     |
|  | 1.8 TFSI quattro | 118 | 09.08 | PR: 1LT,1LY     |                |        |                              |                   |     |
|  | 1.8 TFSI quattro | 125 | 01.12 | PR: 1LT,1LY     |                |        |                              |                   |     |
|  | 2.0 TDI          | 88  | 06.08 | PR: 1LT,1LY     |                |        |                              |                   |     |
|  | 2.0 TDI          | 100 | 04.08 | PR: 1LT,1LY     |                |        |                              |                   |     |
|  | 2.0 TDI          | 105 | 04.08 | PR: 1LT,1LY     |                |        |                              |                   |     |
|  | 2.0 TDI          | 110 | 05.13 | PR: 1LT,1LY     |                |        |                              |                   |     |
|  | 2.0 TDI          | 125 | 04.08 | PR: 1LT,1LY     |                |        |                              |                   |     |
|  | 2.0 TDI          | 130 | 11.11 | PR: 1LT,1LY     |                |        |                              |                   |     |
|  | 2.0 TDI          | 140 | 09.13 | PR: 1LT,1LY     |                |        |                              |                   |     |
|  | 2.0 TDI quattro  | 105 | 04.08 | PR: 1LT,1LY     |                |        |                              |                   |     |
|  | 2.0 TDI quattro  | 110 | 05.13 | PR: 1LT,1LY     |                |        |                              |                   |     |
|  | 2.0 TDI quattro  | 125 | 08.08 | PR: 1LT,1LY     |                |        |                              |                   |     |
|  | 2.0 TDI quattro  | 130 | 11.11 | PR: 1LT,1LY     |                |        |                              |                   |     |
|  | 2.0 TDI quattro  | 140 | 09.13 | PR: 1LT,1LY     |                |        |                              |                   |     |
|  | 2.0 TFSI         | 132 | 06.08 | PR: 1LT,1LY     |                |        |                              |                   |     |
|  | 2.0 TFSI         | 155 | 04.08 | PR: 1LT,1LY     |                |        |                              |                   |     |
|  | 2.0 TFSI         | 165 | 05.13 | PR: 1LT,1LY     |                |        |                              |                   |     |
|  | 2.0 TFSI quattro | 132 | 11.09 | PR: 1LT,1LY     |                |        |                              |                   |     |
|  | 2.0 TFSI quattro | 155 | 04.08 | PR: 1LT,1LY     |                |        |                              |                   |     |
|  | 2.0 TFSI quattro | 165 | 05.13 | PR: 1LT,1LY     |                |        |                              |                   |     |
|  | 2.7 TDI          | 120 | 06.08 | PR: 1LT,1LY     |                |        |                              |                   |     |
|  | 2.7 TDI          | 140 | 06.08 | PR: 1LT,1LY     |                |        |                              |                   |     |
|  | 3.0 TDI          | 150 | 11.11 | PR: 1LT,1LY     |                |        |                              |                   |     |
|  | 3.0 TDI quattro  | 155 | 06.08 | PR: 1LT,1LY     |                |        |                              |                   |     |
|  | 3.0 TDI quattro  | 176 | 04.08 | PR: 1LT,1LY     |                |        |                              |                   |     |
|  | 3.0 TDI quattro  | 180 | 11.11 | PR: 1LT,1LY     |                |        |                              |                   |     |
|  | 3.0 TFSI quattro | 200 | 02.12 | PR: 1LT,1LY     |                |        |                              |                   |     |
|  | 3.2 FSI          | 195 | 09.08 | PR: 1LT,1LY     |                |        |                              |                   |     |
|  | 3.2 FSI quattro  | 195 | 04.08 | PR: 1LT,1LY     |                |        |                              |                   |     |
|  | 1.8 FSI          | 88  | 04.08 | PR: 1LA,1LB,1LD | 13.0460-2746.2 | 602746 | Federmaß 44 mm <sup>2)</sup> | 24743 19,2 +/WK/S | TRW |
|  | 1.8 TFSI         | 118 | 04.08 | PR: 1LA,1LB,1LD | 13.0470-2746.2 | LD2746 | Federmaß 44 mm <sup>2)</sup> | 24743 19,2 +/WK/S | TRW |
|  | 1.8 TFSI         | 125 | 01.12 | PR: 1LA,1LB,1LD |                |        |                              |                   |     |
|  | 1.8 TFSI quattro | 118 | 09.08 | PR: 1LA,1LB,1LD |                |        |                              |                   |     |
|  | 1.8 TFSI quattro | 125 | 01.12 | PR: 1LA,1LB,1LD |                |        |                              |                   |     |
|  | 2.0 TDI          | 88  | 06.08 | PR: 1LA,1LB,1LD |                |        |                              |                   |     |
|  | 2.0 TDI          | 100 | 04.08 | PR: 1LA,1LB,1LD |                |        |                              |                   |     |
|  | 2.0 TDI          | 105 | 04.08 | PR: 1LA,1LB,1LD |                |        |                              |                   |     |
|  | 2.0 TDI          | 110 | 05.13 | PR: 1LA,1LB,1LD |                |        |                              |                   |     |
|  | 2.0 TDI          | 125 | 04.08 | PR: 1LA,1LB,1LD |                |        |                              |                   |     |

<sup>1)</sup> electric parking brake / fr.di stazionamento elettrico / frein à main électrique / freno de mano eléctrico

<sup>2)</sup> spring dimension 44 mm / dimensioni molla 44 mm / dimension de ressort 44 mm / medida de muelle 44 mm



| AUDI A4 (B8) Avant (08-)   |                  |       |                 |                 |                |   |                              |                            |     |
|--|------------------|-------|-----------------|-----------------|----------------|---|------------------------------|----------------------------|-----|
|  | 2.0 TDI          | 130   | 11.11           | PR: 1LA,1LB,1LD | 13.0460-2746.2 | 602746  | Federmaß 44 mm <sup>1)</sup> | 24743 19,2 +WK/S           | TRW |
|  | 2.0 TDI          | 140   | 09.13           | PR: 1LA,1LB,1LD | 13.0470-2746.2 | LD2746  | Federmaß 44 mm <sup>1)</sup> | 24743 19,2 +WK/S           | TRW |
|  | 2.0 TDI quattro  | 105   | 04.08           | PR: 1LA,1LB,1LD |                |   |                              |                            |     |
|  | 2.0 TDI quattro  | 110   | 05.13           | PR: 1LA,1LB,1LD |                |   |                              |                            |     |
|  | 2.0 TDI quattro  | 125   | 08.08           | PR: 1LA,1LB,1LD |                |   |                              |                            |     |
|  | 2.0 TDI quattro  | 130   | 11.11           | PR: 1LA,1LB,1LD |                |   |                              |                            |     |
|  | 2.0 TDI quattro  | 140   | 09.13           | PR: 1LA,1LB,1LD |                |   |                              |                            |     |
|  | 2.0 TFSI         | 132   | 06.08           | PR: 1LA,1LB,1LD |                |   |                              |                            |     |
|  | 2.0 TFSI         | 155   | 04.08           | PR: 1LA,1LB,1LD |                |   |                              |                            |     |
|  | 2.0 TFSI         | 165   | 05.13           | PR: 1LA,1LB,1LD |                |   |                              |                            |     |
|  | 2.0 TFSI quattro | 132   | 11.09           | PR: 1LA,1LB,1LD |                |   |                              |                            |     |
|  | 2.0 TFSI quattro | 155   | 04.08           | PR: 1LA,1LB,1LD |                |   |                              |                            |     |
|  | 2.0 TFSI quattro | 165   | 05.13           | PR: 1LA,1LB,1LD |                |   |                              |                            |     |
|  | 2.7 TDI          | 120   | 06.08           | PR: 1LA,1LB,1LD |                |   |                              |                            |     |
|  | 2.7 TDI          | 140   | 06.08           | PR: 1LA,1LB,1LD |                |   |                              |                            |     |
|  | 3.0 TDI          | 150   | 11.11           | PR: 1LA,1LB,1LD |                |   |                              |                            |     |
|  | 3.0 TDI quattro  | 155   | 06.08           | PR: 1LA,1LB,1LD |                |   |                              |                            |     |
|  | 3.0 TDI quattro  | 176   | 04.08           | PR: 1LA,1LB,1LD |                |   |                              |                            |     |
|  | 3.0 TDI quattro  | 180   | 11.11           | PR: 1LA,1LB,1LD |                |   |                              |                            |     |
|  | 3.0 TFSI quattro | 200   | 02.12           | PR: 1LA,1LB,1LD |                |   |                              |                            |     |
| 3.2 FSI  | 195              | 09.08 | PR: 1LA,1LB,1LD |                 |                |   |                              |                            |     |
| 3.2 FSI quattro  | 195              | 04.08 | PR: 1LA,1LB,1LD |                 |                |   |                              |                            |     |
| S4   | 245              | 07.11 | PR: 1LJ,1ZT     | 13.0460-2746.2  | 602746         | Federmaß 44 mm <sup>1)</sup>  | 24743 19,2 +WK/S             | TRW                        |     |
| RS 4   | 331              | 05.12 | PR: 1LW         | 24.8190-0017.2  | 620017         | 1  | Warmkontakt L=388,3mm        |                            |     |
|  | 1.8 FSI          | 88    | 04.08           | PR: 1LT,1LY     | 24.0125-0184.1 | 425184  |                              | 314 25,0 23,0 V L +S +B    |     |
|  | 1.8 TFSI         | 118   | 04.08           | PR: 1LT,1LY     | 24.0325-0184.1 | 525184  |                              | 314 25,0 23,0 V L +S +B PD |     |
|  | 1.8 TFSI         | 125   | 01.12           | PR: 1LT,1LY     |                |   |                              |                            |     |
|  | 1.8 TFSI quattro | 118   | 09.08           | PR: 1LT,1LY     |                |   |                              |                            |     |
|  | 1.8 TFSI quattro | 125   | 01.12           | PR: 1LT,1LY     |                |   |                              |                            |     |
|  | 2.0 TDI          | 88    | 06.08           | PR: 1LT,1LY     |                |   |                              |                            |     |
|  | 2.0 TDI          | 100   | 04.08           | PR: 1LT,1LY     |                |   |                              |                            |     |
|  | 2.0 TDI          | 105   | 04.08           | PR: 1LT,1LY     |                |   |                              |                            |     |
|  | 2.0 TDI          | 110   | 05.13           | PR: 1LT,1LY     |                |   |                              |                            |     |
|  | 2.0 TDI          | 125   | 04.08           | PR: 1LT,1LY     |                |   |                              |                            |     |
|  | 2.0 TDI          | 130   | 11.11           | PR: 1LT,1LY     |                |   |                              |                            |     |
|  | 2.0 TDI          | 140   | 09.13           | PR: 1LT,1LY     |                |   |                              |                            |     |
|  | 2.0 TDI quattro  | 105   | 04.08           | PR: 1LT,1LY     |                |   |                              |                            |     |
|  | 2.0 TDI quattro  | 110   | 05.13           | PR: 1LT,1LY     |                |   |                              |                            |     |
|  | 2.0 TDI quattro  | 125   | 08.08           | PR: 1LT,1LY     |                |   |                              |                            |     |
|  | 2.0 TDI quattro  | 130   | 11.11           | PR: 1LT,1LY     |                |   |                              |                            |     |
|  | 2.0 TDI quattro  | 140   | 09.13           | PR: 1LT,1LY     |                |   |                              |                            |     |
|  | 2.0 TFSI         | 132   | 06.08           | PR: 1LT,1LY     |                |   |                              |                            |     |
|  | 2.0 TFSI         | 155   | 04.08           | PR: 1LT,1LY     |                |   |                              |                            |     |
|  | 2.0 TFSI         | 165   | 05.13           | PR: 1LT,1LY     |                |   |                              |                            |     |
|  | 2.0 TFSI quattro | 132   | 11.09           | PR: 1LT,1LY     |                |   |                              |                            |     |
|  | 2.0 TFSI quattro | 155   | 04.08           | PR: 1LT,1LY     |                |   |                              |                            |     |
|  | 2.0 TFSI quattro | 165   | 05.13           | PR: 1LT,1LY     |                |   |                              |                            |     |
|  | 2.7 TDI          | 120   | 06.08           | PR: 1LT,1LY     |                |   |                              |                            |     |
|  | 2.7 TDI          | 140   | 06.08           | PR: 1LT,1LY     |                |   |                              |                            |     |
|  | 3.0 TDI          | 150   | 11.11           | PR: 1LT,1LY     |                |   |                              |                            |     |
|  | 3.0 TDI quattro  | 155   | 06.08           | PR: 1LT,1LY     |                |   |                              |                            |     |
|  | 3.0 TDI quattro  | 176   | 04.08           | PR: 1LT,1LY     |                |   |                              |                            |     |
|  | 3.0 TDI quattro  | 180   | 11.11           | PR: 1LT,1LY     |                |   |                              |                            |     |
|  | 3.0 TFSI quattro | 200   | 02.12           | PR: 1LT,1LY     |                |   |                              |                            |     |
| 3.2 FSI  | 195              | 09.08 | PR: 1LT,1LY     |                 |                |   |                              |                            |     |
| 3.2 FSI quattro  | 195              | 04.08 | PR: 1LT,1LY     |                 |                |   |                              |                            |     |
| 1.8 FSI  | 88               | 04.08 | 06.11 PR: 1LA   | 24.0130-0193.1  | 430193         |   | 320 30,0 28,0 V L +S +B      |                            |     |
| 1.8 TFSI   | 118              | 04.08 | 06.11 PR: 1LA   | 24.0330-0193.1  | 530193         |   | 320 30,0 28,0 V L +S +B PD   |                            |     |
| 1.8 TFSI quattro   | 118              | 09.08 | 06.11 PR: 1LA   |                 |                |   |                              |                            |     |
| 2.0 TDI  | 88               | 06.08 | 06.11 PR: 1LA   |                 |                |   |                              |                            |     |
| 2.0 TDI  | 100              | 04.08 | 06.11 PR: 1LA   |                 |                |   |                              |                            |     |
| 2.0 TDI  | 105              | 04.08 | 06.11 PR: 1LA   |                 |                |   |                              |                            |     |
| 2.0 TDI  | 125              | 04.08 | 06.11 PR: 1LA   |                 |                |   |                              |                            |     |
| 2.0 TDI quattro  | 105              | 04.08 | 06.11 PR: 1LA   |                 |                |   |                              |                            |     |
| 2.0 TDI quattro  | 125              | 08.08 | 06.11 PR: 1LA   |                 |                |   |                              |                            |     |
| 2.0 TFSI   | 132              | 06.08 | 06.11 PR: 1LA   |                 |                |   |                              |                            |     |
| 2.0 TFSI   | 155              | 04.08 | 06.11 PR: 1LA   |                 |                |   |                              |                            |     |
| 2.0 TFSI quattro   | 132              | 11.09 | 06.11 PR: 1LA   |                 |                |   |                              |                            |     |
| 2.0 TFSI quattro   | 155              | 04.08 | 06.11 PR: 1LA   |                 |                |   |                              |                            |     |
| 2.7 TDI  | 120              | 06.08 | 06.11 PR: 1LA   |                 |                |   |                              |                            |     |
| 2.7 TDI  | 140              | 06.08 | 06.11 PR: 1LA   |                 |                |   |                              |                            |     |
| 3.0 TDI quattro  | 155              | 06.08 | 06.11 PR: 1LA   |                 |                |   |                              |                            |     |
| 3.0 TDI quattro  | 176              | 04.08 | 06.11 PR: 1LA   |                 |                |   |                              |                            |     |
| 3.2 FSI  | 195              | 09.08 | 06.11 PR: 1LA   |                 |                |   |                              |                            |     |
| 3.2 FSI quattro  | 195              | 04.08 | 06.11 PR: 1LA   |                 |                |   |                              |                            |     |
| 1.8 FSI  | 88               | 07.11 | PR: 1LA,1LB     | 24.0130-0221.1  | 430221         |   | 320 30,0 28,0 V L +S +B      |                            |     |
| 1.8 TFSI   | 118              | 07.11 | PR: 1LA,1LB     |                 |                |   |                              |                            |     |
| 1.8 TFSI   | 125              | 01.12 | PR: 1LA,1LB     |                 |                |   |                              |                            |     |
| 1.8 TFSI quattro   | 118              | 07.11 | PR: 1LA,1LB     |                 |                |   |                              |                            |     |
| 1.8 TFSI quattro   | 125              | 01.12 | PR: 1LA,1LB     |                 |                |   |                              |                            |     |
| 2.0 TDI  | 88               | 07.11 | PR: 1LA,1LB     |                 |                |   |                              |                            |     |
| 2.0 TDI  | 100              | 07.11 | PR: 1LA,1LB     |                 |                |   |                              |                            |     |
| 2.0 TDI  | 105              | 07.11 | PR: 1LA,1LB     |                 |                |   |                              |                            |     |
| 2.0 TDI  | 110              | 05.13 | PR: 1LA,1LB     |                 |                |   |                              |                            |     |
| 2.0 TDI  | 125              | 07.11 | PR: 1LA,1LB     |                 |                |   |                              |                            |     |
| 2.0 TDI  | 130              | 11.11 | PR: 1LA,1LB     |                 |                |   |                              |                            |     |
| 2.0 TDI  | 140              | 09.13 | PR: 1LA,1LB     |                 |                |   |                              |                            |     |



<sup>1)</sup> Spring dimension 44 mm / dimensioni molla 44 mm / dimension de ressort 44 mm / medida de muelle 44 mm

**AUDI A4 (B8) Avant (08-)**

|  |                      |  |              |                      |                       |        |   |                                      |
|--|----------------------|--|--------------|----------------------|-----------------------|--------|---|--------------------------------------|
|  | 2.0 TDI quattro 105  |  | <b>07.11</b> | PR: 1LA,1LB          | <b>24.0130-0221.1</b> | 430221 |   | 320 30,0 28,0 VL +S +B               |
|  | 2.0 TDI quattro 110  |  | <b>05.13</b> | PR: 1LA,1LB          |                       |        |   |                                      |
|  | 2.0 TDI quattro 125  |  | <b>07.11</b> | PR: 1LA,1LB          |                       |        |   |                                      |
|  | 2.0 TDI quattro 130  |  | <b>11.11</b> | PR: 1LA,1LB          |                       |        |   |                                      |
|  | 2.0 TDI quattro 140  |  | <b>09.13</b> | PR: 1LA,1LB          |                       |        |   |                                      |
|  | 2.0 TFSI 132         |  | <b>07.11</b> | PR: 1LA,1LB          |                       |        |   |                                      |
|  | 2.0 TFSI 155         |  | <b>07.11</b> | PR: 1LA,1LB          |                       |        |   |                                      |
|  | 2.0 TFSI 165         |  | <b>05.13</b> | PR: 1LA,1LB          |                       |        |   |                                      |
|  | 2.0 TFSI quattro 132 |  | <b>07.11</b> | PR: 1LA,1LB          |                       |        |   |                                      |
|  | 2.0 TFSI quattro 155 |  | <b>07.11</b> | PR: 1LA,1LB          |                       |        |   |                                      |
|  | 2.0 TFSI quattro 165 |  | <b>05.13</b> | PR: 1LA,1LB          |                       |        |   |                                      |
|  | 2.7 TDI 120          |  | <b>07.11</b> | PR: 1LA,1LB          |                       |        |   |                                      |
|  | 2.7 TDI 140          |  | <b>07.11</b> | PR: 1LA,1LB          |                       |        |   |                                      |
|  | 3.0 TDI 150          |  | <b>11.11</b> | PR: 1LA,1LB          |                       |        |   |                                      |
|  | 3.0 TDI quattro 155  |  | <b>07.11</b> | PR: 1LA,1LB          |                       |        |   |                                      |
|  | 3.0 TDI quattro 176  |  | <b>07.11</b> | PR: 1LA,1LB          |                       |        |   |                                      |
|  | 3.0 TDI quattro 180  |  | <b>11.11</b> | PR: 1LA,1LB          |                       |        |   |                                      |
|  | 3.0 TFSI quattro 200 |  | <b>02.12</b> | PR: 1LA,1LB          |                       |        |   |                                      |
|  | 3.2 FSI 195          |  | <b>07.11</b> | PR: 1LA,1LB          |                       |        |   |                                      |
|  | 3.2 FSI quattro 195  |  | <b>07.11</b> | PR: 1LA,1LB          |                       |        |   |                                      |
|  | <b>S4</b> 245        |  | <b>11.08</b> | <b>06.11</b> PR: 1LJ | <b>24.0129-0102.1</b> | 429102 |   | 345 29,5 28,0 VL +S +B               |
|  | <b>S4</b> 245        |  | <b>07.11</b> | PR: 1LJ              | <b>24.0130-0222.1</b> | 430222 |   | 345 30,0 28,0 VL +S +B               |
|  | 1.8 FSI 88           |  | <b>04.08</b> | PR: 1LD              | <b>24.0130-0222.1</b> | 430222 |   | 345 30,0 28,0 VL +S +B               |
|  | 1.8 TFSI 118         |  | <b>04.08</b> | PR: 1LD              |                       |        |   |                                      |
|  | 1.8 TFSI 125         |  | <b>01.12</b> | PR: 1LD              |                       |        |   |                                      |
|  | 1.8 TFSI quattro 118 |  | <b>09.08</b> | PR: 1LD              |                       |        |   |                                      |
|  | 1.8 TFSI quattro 125 |  | <b>01.12</b> | PR: 1LD              |                       |        |   |                                      |
|  | 2.0 TDI 88           |  | <b>06.08</b> | PR: 1LD              |                       |        |   |                                      |
|  | 2.0 TDI 100          |  | <b>04.08</b> | PR: 1LD              |                       |        |   |                                      |
|  | 2.0 TDI 105          |  | <b>04.08</b> | PR: 1LD              |                       |        |   |                                      |
|  | 2.0 TDI 110          |  | <b>05.13</b> | PR: 1LD              |                       |        |   |                                      |
|  | 2.0 TDI 125          |  | <b>04.08</b> | PR: 1LD              |                       |        |   |                                      |
|  | 2.0 TDI 130          |  | <b>11.11</b> | PR: 1LD              |                       |        |   |                                      |
|  | 2.0 TDI 140          |  | <b>09.13</b> | PR: 1LD              |                       |        |   |                                      |
|  | 2.0 TDI quattro 105  |  | <b>04.08</b> | PR: 1LD              |                       |        |   |                                      |
|  | 2.0 TDI quattro 110  |  | <b>05.13</b> | PR: 1LD              |                       |        |   |                                      |
|  | 2.0 TDI quattro 125  |  | <b>08.08</b> | PR: 1LD              |                       |        |   |                                      |
|  | 2.0 TDI quattro 130  |  | <b>11.11</b> | PR: 1LD              |                       |        |   |                                      |
|  | 2.0 TDI quattro 140  |  | <b>09.13</b> | PR: 1LD              |                       |        |   |                                      |
|  | 2.0 TFSI 132         |  | <b>06.08</b> | PR: 1LD              |                       |        |   |                                      |
|  | 2.0 TFSI 155         |  | <b>04.08</b> | PR: 1LD              |                       |        |   |                                      |
|  | 2.0 TFSI 165         |  | <b>05.13</b> | PR: 1LD              |                       |        |   |                                      |
|  | 2.0 TFSI quattro 132 |  | <b>11.09</b> | PR: 1LD              |                       |        |   |                                      |
|  | 2.0 TFSI quattro 155 |  | <b>04.08</b> | PR: 1LD              |                       |        |   |                                      |
|  | 2.0 TFSI quattro 165 |  | <b>05.13</b> | PR: 1LD              |                       |        |   |                                      |
|  | 2.7 TDI 120          |  | <b>06.08</b> | PR: 1LD              |                       |        |   |                                      |
|  | 2.7 TDI 140          |  | <b>06.08</b> | PR: 1LD              |                       |        |   |                                      |
|  | 3.0 TDI 150          |  | <b>11.11</b> | PR: 1LD              |                       |        |   |                                      |
|  | 3.0 TDI quattro 155  |  | <b>06.08</b> | PR: 1LD              |                       |        |   |                                      |
|  | 3.0 TDI quattro 176  |  | <b>04.08</b> | PR: 1LD              |                       |        |   |                                      |
|  | 3.0 TDI quattro 180  |  | <b>11.11</b> | PR: 1LD              |                       |        |   |                                      |
|  | 3.0 TFSI quattro 200 |  | <b>02.12</b> | PR: 1LD              |                       |        |   |                                      |
|  | 3.2 FSI 195          |  | <b>09.08</b> | PR: 1LD              |                       |        |   |                                      |
|  | 3.2 FSI quattro 195  |  | <b>04.08</b> | PR: 1LD              |                       |        |   |                                      |
|  | <b>S4</b> 245        |  | <b>11.08</b> | PR: 1ZT              |                       |        |   |                                      |
|  | 1.8 FSI 88           |  | <b>04.08</b> | PR: 1KW,2EH          | <b>13.0460-2747.2</b> | 602747 | elektrische Feststellbremse <sup>1)</sup> | <b>24606</b> 17,4 +/Zub/S <b>TRW</b> |
|  | 1.8 TFSI 118         |  | <b>04.08</b> | PR: 1KW,2EH          | <b>13.0470-2747.2</b> | LD2747 | elektrische Feststellbremse <sup>1)</sup> | <b>24606</b> 17,4 +/Zub/S <b>TRW</b> |
|  | 1.8 TFSI 125         |  | <b>01.12</b> | PR: 1KW,2EH          |                       |        |   |                                      |
|  | 1.8 TFSI quattro 118 |  | <b>09.08</b> | PR: 1KW,2EH          |                       |        |   |                                      |
|  | 1.8 TFSI quattro 125 |  | <b>01.12</b> | PR: 1KW,2EH          |                       |        |   |                                      |
|  | 2.0 TDI 88           |  | <b>06.08</b> | PR: 1KW,2EH          |                       |        |   |                                      |
|  | 2.0 TDI 100          |  | <b>04.08</b> | PR: 1KW,2EH          |                       |        |   |                                      |
|  | 2.0 TDI 105          |  | <b>04.08</b> | PR: 1KW,2EH          |                       |        |   |                                      |
|  | 2.0 TDI 110          |  | <b>05.13</b> | PR: 1KW,2EH          |                       |        |   |                                      |
|  | 2.0 TDI 125          |  | <b>04.08</b> | PR: 1KW,2EH          |                       |        |   |                                      |
|  | 2.0 TDI 130          |  | <b>11.11</b> | PR: 1KW,2EH          |                       |        |   |                                      |
|  | 2.0 TDI 140          |  | <b>09.13</b> | PR: 1KW,2EH          |                       |        |   |                                      |
|  | 2.0 TDI quattro 105  |  | <b>04.08</b> | PR: 1KW,2EH          |                       |        |   |                                      |
|  | 2.0 TDI quattro 110  |  | <b>05.13</b> | PR: 1KW,2EH          |                       |        |   |                                      |
|  | 2.0 TDI quattro 125  |  | <b>08.08</b> | PR: 1KW,2EH          |                       |        |   |                                      |
|  | 2.0 TDI quattro 130  |  | <b>11.11</b> | PR: 1KW,2EH          |                       |        |   |                                      |
|  | 2.0 TDI quattro 140  |  | <b>09.13</b> | PR: 1KW,2EH          |                       |        |   |                                      |
|  | 2.0 TFSI 132         |  | <b>06.08</b> | PR: 1KW,2EH          |                       |        |   |                                      |
|  | 2.0 TFSI 155         |  | <b>04.08</b> | PR: 1KW,2EH          |                       |        |   |                                      |
|  | 2.0 TFSI 165         |  | <b>05.13</b> | PR: 1KW,2EH          |                       |        |   |                                      |
|  | 2.0 TFSI quattro 132 |  | <b>11.09</b> | PR: 1KW,2EH          |                       |        |   |                                      |
|  | 2.0 TFSI quattro 155 |  | <b>04.08</b> | PR: 1KW,2EH          |                       |        |   |                                      |
|  | 2.0 TFSI quattro 165 |  | <b>05.13</b> | PR: 1KW,2EH          |                       |        |   |                                      |
|  | 2.7 TDI 120          |  | <b>06.08</b> | PR: 1KW,2EH          |                       |        |   |                                      |
|  | 2.7 TDI 140          |  | <b>06.08</b> | PR: 1KW,2EH          |                       |        |   |                                      |
|  | 3.0 TDI 150          |  | <b>11.11</b> | PR: 1KW,2EH          |                       |        |   |                                      |
|  | 3.0 TDI quattro 155  |  | <b>06.08</b> | PR: 1KW,2EH          |                       |        |   |                                      |
|  | 3.0 TDI quattro 176  |  | <b>04.08</b> | PR: 1KW,2EH          |                       |        |   |                                      |
|  | 3.0 TDI quattro 180  |  | <b>11.11</b> | PR: 1KW,2EH          |                       |        |   |                                      |
|  | 3.0 TFSI quattro 200 |  | <b>02.12</b> | PR: 1KW,2EH          |                       |        |   |                                      |
|  | 3.2 FSI 195          |  | <b>09.08</b> | PR: 1KW,2EH          |                       |        |   |                                      |
|  | 3.2 FSI quattro 195  |  | <b>04.08</b> | PR: 1KW,2EH          |                       |        |   |                                      |

<sup>1)</sup> electric parking brake / fr.di stazionamento elettrico / frein à main électrique / freno de mano eléctrico



| AUDI A4 (B8) Avant (08-)   |                  |       |             |             |                |        |   |       |                     |      |
|--|------------------|-------|-------------|-------------|----------------|--------|---|-------|---------------------|------|
|  | S4               | 245   | 11.08       | PR: 1KE     | 13.0460-2748.2 | 602748 | elektrische Feststellbremse <sup>1)</sup> | 24606 | 17,4 +/Zub/S        | TRW  |
|  |                  |       |             |             | 13.0470-2748.2 | LD2748 | elektrische Feststellbremse <sup>1)</sup> | 24606 | 17,4 +/Zub/S        | TRW  |
|  | 1.8 FSI          | 88    | 04.08       | PR: 1KP     | 13.0460-2748.2 | 602748 | elektrische Feststellbremse <sup>1)</sup> | 24606 | 17,4 +/Zub/S        | TRW  |
|  | 1.8 TFSI         | 118   | 04.08       | PR: 1KP     | 13.0470-2748.2 | LD2748 | elektrische Feststellbremse <sup>1)</sup> | 24606 | 17,4 +/Zub/S        | TRW  |
|  | 1.8 TFSI         | 125   | 01.12       | PR: 1KP     |                |        |   |       |                     |      |
|  | 1.8 TFSI quattro | 118   | 09.08       | PR: 1KP     |                |        |   |       |                     |      |
|  | 1.8 TFSI quattro | 125   | 01.12       | PR: 1KP     |                |        |   |       |                     |      |
|  | 2.0 TDI          | 88    | 06.08       | PR: 1KP     |                |        |   |       |                     |      |
|  | 2.0 TDI          | 100   | 04.08       | PR: 1KP     |                |        |   |       |                     |      |
|  | 2.0 TDI          | 105   | 04.08       | PR: 1KP     |                |        |   |       |                     |      |
|  | 2.0 TDI          | 110   | 05.13       | PR: 1KP     |                |        |   |       |                     |      |
|  | 2.0 TDI          | 125   | 04.08       | PR: 1KP     |                |        |   |       |                     |      |
|  | 2.0 TDI          | 130   | 11.11       | PR: 1KP     |                |        |   |       |                     |      |
|  | 2.0 TDI          | 140   | 09.13       | PR: 1KP     |                |        |   |       |                     |      |
|  | 2.0 TDI quattro  | 105   | 04.08       | PR: 1KP     |                |        |   |       |                     |      |
|  | 2.0 TDI quattro  | 110   | 05.13       | PR: 1KP     |                |        |   |       |                     |      |
|  | 2.0 TDI quattro  | 125   | 08.08       | PR: 1KP     |                |        |   |       |                     |      |
|  | 2.0 TDI quattro  | 130   | 11.11       | PR: 1KP     |                |        |   |       |                     |      |
|  | 2.0 TDI quattro  | 140   | 09.13       | PR: 1KP     |                |        |   |       |                     |      |
|  | 2.0 TDI quattro  | 140   | 09.13       | PR: 1KP     |                |        |   |       |                     |      |
|  | 2.0 TFSI         | 132   | 06.08       | PR: 1KP     |                |        |   |       |                     |      |
|  | 2.0 TFSI         | 155   | 04.08       | PR: 1KP     |                |        |   |       |                     |      |
|  | 2.0 TFSI         | 165   | 05.13       | PR: 1KP     |                |        |   |       |                     |      |
|  | 2.0 TFSI quattro | 132   | 11.09       | PR: 1KP     |                |        |   |       |                     |      |
|  | 2.0 TFSI quattro | 155   | 04.08       | PR: 1KP     |                |        |   |       |                     |      |
|  | 2.7 TDI          | 120   | 06.08       | PR: 1KP     |                |        |   |       |                     |      |
|  | 2.7 TDI          | 140   | 06.08       | PR: 1KP     |                |        |   |       |                     |      |
|  | 3.0 TDI          | 150   | 11.11       | PR: 1KP     |                |        |   |       |                     |      |
|  | 3.0 TDI quattro  | 155   | 06.08       | PR: 1KP     |                |        |   |       |                     |      |
|  | 3.0 TDI quattro  | 176   | 04.08       | PR: 1KP     |                |        |   |       |                     |      |
|  | 3.0 TDI quattro  | 180   | 11.11       | PR: 1KP     |                |        |   |       |                     |      |
|  | 3.0 TFSI quattro | 200   | 02.12       | PR: 1KP     |                |        |   |       |                     |      |
|  | 3.2 FSI          | 195   | 09.08       | PR: 1KP     |                |        |   |       |                     |      |
|  | 3.2 FSI quattro  | 195   | 04.08       | PR: 1KP     |                |        |   |       |                     |      |
| RS 4   | 331              | 05.12 |             |             | 13.0460-2770.2 | 602770 | elektrische Feststellbremse <sup>1)</sup> | 25214 | 17,4 +/WK/Zub/STRW  | STRW |
|  |                  |       |             |             | 13.0470-2770.2 | LD2770 | elektrische Feststellbremse <sup>1)</sup> | 25214 | 17,4 +/WK/Zub/STRW  | STRW |
|  | 1.8 FSI          | 88    | 04.08       | PR: 1KW,2EH | 24.0112-0178.1 | 412178 | elektrische Feststellbremse <sup>1)</sup> | 300   | 12,0 10,0 +S +B     |      |
|  | 1.8 TFSI         | 118   | 04.08       | PR: 1KW,2EH | 24.0312-0178.1 | 512178 | elektrische Feststellbremse <sup>1)</sup> | 300   | 12,0 10,0 +S +B PD  |      |
|  | 1.8 TFSI         | 125   | 01.12       | PR: 1KW,2EH |                |        |   |       |                     |      |
|  | 1.8 TFSI quattro | 118   | 09.08       | PR: 1KW,2EH |                |        |   |       |                     |      |
|  | 1.8 TFSI quattro | 125   | 01.12       | PR: 1KW,2EH |                |        |   |       |                     |      |
|  | 2.0 TDI          | 88    | 06.08       | PR: 1KW,2EH |                |        |   |       |                     |      |
|  | 2.0 TDI          | 100   | 04.08       | PR: 1KW,2EH |                |        |   |       |                     |      |
|  | 2.0 TDI          | 105   | 04.08       | PR: 1KW,2EH |                |        |   |       |                     |      |
|  | 2.0 TDI          | 110   | 05.13       | PR: 1KW,2EH |                |        |   |       |                     |      |
|  | 2.0 TDI          | 125   | 04.08       | PR: 1KW,2EH |                |        |   |       |                     |      |
|  | 2.0 TDI          | 130   | 11.11       | PR: 1KW,2EH |                |        |   |       |                     |      |
|  | 2.0 TDI          | 140   | 09.13       | PR: 1KW,2EH |                |        |   |       |                     |      |
|  | 2.0 TDI quattro  | 105   | 04.08       | PR: 1KW,2EH |                |        |   |       |                     |      |
|  | 2.0 TDI quattro  | 110   | 05.13       | PR: 1KW,2EH |                |        |   |       |                     |      |
|  | 2.0 TDI quattro  | 125   | 08.08       | PR: 1KW,2EH |                |        |   |       |                     |      |
|  | 2.0 TDI quattro  | 130   | 11.11       | PR: 1KW,2EH |                |        |   |       |                     |      |
|  | 2.0 TDI quattro  | 140   | 09.13       | PR: 1KW,2EH |                |        |   |       |                     |      |
|  | 2.0 TFSI         | 132   | 06.08       | PR: 1KW,2EH |                |        |   |       |                     |      |
|  | 2.0 TFSI         | 155   | 04.08       | PR: 1KW,2EH |                |        |   |       |                     |      |
|  | 2.0 TFSI         | 165   | 05.13       | PR: 1KW,2EH |                |        |   |       |                     |      |
|  | 2.0 TFSI quattro | 132   | 11.09       | PR: 1KW,2EH |                |        |   |       |                     |      |
| 2.0 TFSI quattro   | 155              | 04.08 | PR: 1KW,2EH |             |                |        |   |       |                     |      |
| 2.0 TFSI quattro   | 165              | 05.13 | PR: 1KW,2EH |             |                |        |   |       |                     |      |
| 2.7 TDI  | 120              | 06.08 | PR: 1KW,2EH |             |                |        |   |       |                     |      |
| 2.7 TDI  | 140              | 06.08 | PR: 1KW,2EH |             |                |        |   |       |                     |      |
| 3.0 TDI  | 150              | 11.11 | PR: 1KW,2EH |             |                |        |   |       |                     |      |
| 3.0 TDI quattro  | 155              | 06.08 | PR: 1KW,2EH |             |                |        |   |       |                     |      |
| 3.0 TDI quattro  | 176              | 04.08 | PR: 1KW,2EH |             |                |        |   |       |                     |      |
| 3.0 TDI quattro  | 180              | 11.11 | PR: 1KW,2EH |             |                |        |   |       |                     |      |
| 3.0 TFSI quattro   | 200              | 02.12 | PR: 1KW,2EH |             |                |        |   |       |                     |      |
| 3.2 FSI  | 195              | 09.08 | PR: 1KW,2EH |             |                |        |   |       |                     |      |
| 3.2 FSI quattro  | 195              | 04.08 | PR: 1KW,2EH |             |                |        |   |       |                     |      |
| S4   | 245              | 11.08 | PR: 1KE     |             | 24.0122-0250.1 | 422250 | elektrische Feststellbremse <sup>1)</sup> | 330   | 22,0 20,0 V L +S +B |      |
| 1.8 FSI  | 88               | 04.08 | PR: 1KP     |             | 24.0122-0272.1 | 422272 | elektrische Feststellbremse <sup>1)</sup> | 330   | 21,9 20,0 V L +S +B |      |
| 1.8 TFSI   | 118              | 04.08 | PR: 1KP     |             |                |        |   |       |                     |      |
| 1.8 TFSI   | 125              | 01.12 | PR: 1KP     |             |                |        |   |       |                     |      |
| 1.8 TFSI quattro   | 118              | 09.08 | PR: 1KP     |             |                |        |   |       |                     |      |
| 1.8 TFSI quattro   | 125              | 01.12 | PR: 1KP     |             |                |        |   |       |                     |      |
| 2.0 TDI  | 88               | 06.08 | PR: 1KP     |             |                |        |   |       |                     |      |
| 2.0 TDI  | 100              | 04.08 | PR: 1KP     |             |                |        |   |       |                     |      |
| 2.0 TDI  | 105              | 04.08 | PR: 1KP     |             |                |        |   |       |                     |      |
| 2.0 TDI  | 110              | 05.13 | PR: 1KP     |             |                |        |   |       |                     |      |
| 2.0 TDI  | 125              | 04.08 | PR: 1KP     |             |                |        |   |       |                     |      |
| 2.0 TDI  | 130              | 11.11 | PR: 1KP     |             |                |        |   |       |                     |      |
| 2.0 TDI  | 140              | 09.13 | PR: 1KP     |             |                |        |   |       |                     |      |
| 2.0 TDI quattro  | 105              | 04.08 | PR: 1KP     |             |                |        |   |       |                     |      |
| 2.0 TDI quattro  | 110              | 05.13 | PR: 1KP     |             |                |        |   |       |                     |      |
| 2.0 TDI quattro  | 125              | 08.08 | PR: 1KP     |             |                |        |   |       |                     |      |
| 2.0 TDI quattro  | 130              | 11.11 | PR: 1KP     |             |                |        |   |       |                     |      |
| 2.0 TDI quattro  | 140              | 09.13 | PR: 1KP     |             |                |        |   |       |                     |      |
| 2.0 TFSI   | 132              | 06.08 | PR: 1KP     |             |                |        |   |       |                     |      |

<sup>1)</sup> electric parking brake / fr.di stazionamento elettrico / frein à main électrique / freno de mano eléctrico

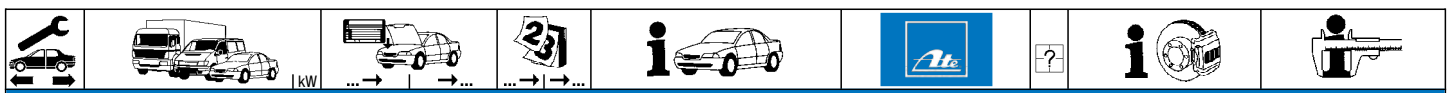

### AUDI A4 (B8) Avant (08-)

|  |                  |     |  |              |         |                       |        |  |   |                         |
|--|------------------|-----|--|--------------|---------|-----------------------|--------|--|---|-------------------------|
|  | 2.0 TFSI         | 155 |  | <b>04.08</b> | PR: 1KP | <b>24.0122-0272.1</b> | 422272 |  | elektrische Feststellbremse <sup>1)</sup> | 330 21,9 20,0 V L +S +B |
|  | 2.0 TFSI         | 165 |  | <b>05.13</b> | PR: 1KP |                       |        |  |   |                         |
|  | 2.0 TFSI quattro | 132 |  | <b>11.09</b> | PR: 1KP |                       |        |  |   |                         |
|  | 2.0 TFSI quattro | 155 |  | <b>04.08</b> | PR: 1KP |                       |        |  |   |                         |
|  | 2.0 TFSI quattro | 165 |  | <b>05.13</b> | PR: 1KP |                       |        |  |   |                         |
|  | 2.7 TDI          | 120 |  | <b>06.08</b> | PR: 1KP |                       |        |  |   |                         |
|  | 2.7 TDI          | 140 |  | <b>06.08</b> | PR: 1KP |                       |        |  |   |                         |
|  | 3.0 TDI          | 150 |  | <b>11.11</b> | PR: 1KP |                       |        |  |   |                         |
|  | 3.0 TDI quattro  | 155 |  | <b>06.08</b> | PR: 1KP |                       |        |  |   |                         |
|  | 3.0 TDI quattro  | 176 |  | <b>04.08</b> | PR: 1KP |                       |        |  |   |                         |
|  | 3.0 TDI quattro  | 180 |  | <b>11.11</b> | PR: 1KP |                       |        |  |   |                         |
|  | 3.0 TFSI quattro | 200 |  | <b>02.12</b> | PR: 1KP |                       |        |  |   |                         |
|  | 3.2 FSI          | 195 |  | <b>09.08</b> | PR: 1KP |                       |        |  |   |                         |
|  | 3.2 FSI quattro  | 195 |  | <b>04.08</b> | PR: 1KP |                       |        |  |   |                         |

### AUDI A4 Allroad (09-)

|  |                  |     |  |              |                      |                       |        |  |                              |  |                          |
|--|------------------|-----|--|--------------|----------------------|-----------------------|--------|--|------------------------------|--|--------------------------|
|  | 2.0 TDI quattro  | 105 |  | <b>09.09</b> | PR: 1LT              | <b>13.0460-7256.2</b> | 607256 |  |                              | <b>24705</b> 19,8 +/WK<br><b>24705</b> 19,8 +/WK | <b>ATE</b><br><b>ATE</b> |
|  | 2.0 TDI quattro  | 110 |  | <b>05.13</b> | PR: 1LT              | <b>13.0470-7256.2</b> | LD7256 |  |                              |  |                          |
|  | 2.0 TDI quattro  | 120 |  | <b>04.09</b> | PR: 1LT              |                       |        |  |                              |  |                          |
|  | 2.0 TDI quattro  | 125 |  | <b>02.09</b> | PR: 1LT              |                       |        |  |                              |  |                          |
|  | 2.0 TDI quattro  | 130 |  | <b>01.12</b> | PR: 1LT              |                       |        |  |                              |  |                          |
|  | 2.0 TDI quattro  | 140 |  | <b>09.13</b> | PR: 1LT              |                       |        |  |                              |  |                          |
|  | 2.0 TFSI quattro | 155 |  | <b>04.09</b> | PR: 1LT              |                       |        |  |                              |  |                          |
|  | 2.0 TFSI quattro | 162 |  | <b>05.13</b> | PR: 1LT              |                       |        |  |                              |  |                          |
|  | 2.0 TFSI quattro | 165 |  | <b>04.13</b> | PR: 1LT              |                       |        |  |                              |  |                          |
|  | 3.0 TDI quattro  | 176 |  | <b>04.09</b> | PR: 1LT              |                       |        |  |                              |  |                          |
|  | 3.0 TDI quattro  | 180 |  | <b>01.12</b> | PR: 1LT              |                       |        |  |                              |  |                          |
|  | 2.0 TDI quattro  | 105 |  | <b>09.09</b> | PR: 1LA              | <b>13.0460-2746.2</b> | 602746 |  | Federmaß 44 mm <sup>2)</sup> | <b>24743</b> 19,2 +/WK/S                         | <b>TRW</b>               |
|  | 2.0 TDI quattro  | 110 |  | <b>05.13</b> | PR: 1LA              | <b>13.0470-2746.2</b> | LD2746 |  | Federmaß 44 mm <sup>2)</sup> | <b>24743</b> 19,2 +/WK/S                         | <b>TRW</b>               |
|  | 2.0 TDI quattro  | 120 |  | <b>04.09</b> | PR: 1LA              |                       |        |  |                              |  |                          |
|  | 2.0 TDI quattro  | 125 |  | <b>02.09</b> | PR: 1LA              |                       |        |  |                              |  |                          |
|  | 2.0 TDI quattro  | 130 |  | <b>01.12</b> | PR: 1LA              |                       |        |  |                              |  |                          |
|  | 2.0 TDI quattro  | 140 |  | <b>09.13</b> | PR: 1LA              |                       |        |  |                              |  |                          |
|  | 2.0 TFSI quattro | 155 |  | <b>04.09</b> | PR: 1LA              |                       |        |  |                              |  |                          |
|  | 2.0 TFSI quattro | 162 |  | <b>05.13</b> | PR: 1LA              |                       |        |  |                              |  |                          |
|  | 2.0 TFSI quattro | 165 |  | <b>04.13</b> | PR: 1LA              |                       |        |  |                              |  |                          |
|  | 3.0 TDI quattro  | 176 |  | <b>04.09</b> | PR: 1LA              |                       |        |  |                              |  |                          |
|  | 3.0 TDI quattro  | 180 |  | <b>01.12</b> | PR: 1LA              |                       |        |  |                              |  |                          |
|  | 2.0 TDI quattro  | 105 |  | <b>09.09</b> | PR: 1LT              | <b>24.0125-0184.1</b> | 425184 |  |                              | 314 25,0 23,0 V L +S +B                          |                          |
|  | 2.0 TDI quattro  | 110 |  | <b>05.13</b> | PR: 1LT              | <b>24.0325-0184.1</b> | 525184 |  |                              | <b>314 25,0 23,0 V L +S +B PD</b>                |                          |
|  | 2.0 TDI quattro  | 120 |  | <b>04.09</b> | PR: 1LT              |                       |        |  |                              |  |                          |
|  | 2.0 TDI quattro  | 125 |  | <b>02.09</b> | PR: 1LT              |                       |        |  |                              |  |                          |
|  | 2.0 TDI quattro  | 130 |  | <b>01.12</b> | PR: 1LT              |                       |        |  |                              |  |                          |
|  | 2.0 TDI quattro  | 140 |  | <b>09.13</b> | PR: 1LT              |                       |        |  |                              |  |                          |
|  | 2.0 TFSI quattro | 155 |  | <b>04.09</b> | PR: 1LT              |                       |        |  |                              |  |                          |
|  | 2.0 TFSI quattro | 162 |  | <b>05.13</b> | PR: 1LT              |                       |        |  |                              |  |                          |
|  | 2.0 TFSI quattro | 165 |  | <b>04.13</b> | PR: 1LT              |                       |        |  |                              |  |                          |
|  | 3.0 TDI quattro  | 176 |  | <b>04.09</b> | PR: 1LT              |                       |        |  |                              |  |                          |
|  | 3.0 TDI quattro  | 180 |  | <b>01.12</b> | PR: 1LT              |                       |        |  |                              |  |                          |
|  | 2.0 TDI quattro  | 105 |  | <b>09.09</b> | <b>06.11</b> PR: 1LA | <b>24.0130-0193.1</b> | 430193 |  |                              | 320 30,0 28,0 V L +S +B                          |                          |
|  | 2.0 TDI quattro  | 120 |  | <b>04.09</b> | <b>06.11</b> PR: 1LA | <b>24.0330-0193.1</b> | 530193 |  |                              | <b>320 30,0 28,0 V L +S +B PD</b>                |                          |
|  | 2.0 TDI quattro  | 125 |  | <b>02.09</b> | <b>06.11</b> PR: 1LA |                       |        |  |                              |  |                          |
|  | 2.0 TFSI quattro | 155 |  | <b>04.09</b> | <b>06.11</b> PR: 1LA |                       |        |  |                              |  |                          |
|  | 3.0 TDI quattro  | 176 |  | <b>04.09</b> | <b>06.11</b> PR: 1LA |                       |        |  |                              |  |                          |
|  | 2.0 TDI quattro  | 105 |  | <b>07.11</b> | PR: 1LA              | <b>24.0130-0221.1</b> | 430221 |  |                              | 320 30,0 28,0 V L +S +B                          |                          |
|  | 2.0 TDI quattro  | 110 |  | <b>05.13</b> | PR: 1LA              |                       |        |  |                              |  |                          |
|  | 2.0 TDI quattro  | 120 |  | <b>07.11</b> | PR: 1LA              |                       |        |  |                              |  |                          |
|  | 2.0 TDI quattro  | 125 |  | <b>07.11</b> | PR: 1LA              |                       |        |  |                              |  |                          |
|  | 2.0 TDI quattro  | 130 |  | <b>01.12</b> | PR: 1LA              |                       |        |  |                              |  |                          |
|  | 2.0 TDI quattro  | 140 |  | <b>09.13</b> | PR: 1LA              |                       |        |  |                              |  |                          |
|  | 2.0 TFSI quattro | 155 |  | <b>07.11</b> | PR: 1LA              |                       |        |  |                              |  |                          |
|  | 2.0 TFSI quattro | 162 |  | <b>05.13</b> | PR: 1LA              |                       |        |  |                              |  |                          |
|  | 2.0 TFSI quattro | 165 |  | <b>04.13</b> | PR: 1LA              |                       |        |  |                              |  |                          |
|  | 3.0 TDI quattro  | 176 |  | <b>07.11</b> | PR: 1LA              |                       |        |  |                              |  |                          |
|  | 3.0 TDI quattro  | 180 |  | <b>01.12</b> | PR: 1LA              |                       |        |  |                              |  |                          |
|  | 2.0 TDI quattro  | 105 |  | <b>09.09</b> | PR: 1KW,GP0,GP1,GP2  | <b>13.0460-2747.2</b> | 602747 |  |                              | <b>24606</b> 17,4 +/Zub/S                        | <b>TRW</b>               |
|  | 2.0 TDI quattro  | 110 |  | <b>05.13</b> | PR: 1KW,GP0,GP1,GP2  | <b>13.0470-2747.2</b> | LD2747 |  |                              | <b>24606</b> 17,4 +/Zub/S                        | <b>TRW</b>               |
|  | 2.0 TDI quattro  | 120 |  | <b>04.09</b> | PR: 1KW,GP0,GP1,GP2  |                       |        |  |                              |  |                          |
|  | 2.0 TDI quattro  | 125 |  | <b>02.09</b> | PR: 1KW,GP0,GP1,GP2  |                       |        |  |                              |  |                          |
|  | 2.0 TDI quattro  | 130 |  | <b>01.12</b> | PR: 1KW,GP0,GP1,GP2  |                       |        |  |                              |  |                          |
|  | 2.0 TDI quattro  | 140 |  | <b>09.13</b> | PR: 1KW,GP0,GP1,GP2  |                       |        |  |                              |  |                          |
|  | 2.0 TFSI quattro | 155 |  | <b>04.09</b> | PR: 1KW,GP0,GP1,GP2  |                       |        |  |                              |  |                          |
|  | 2.0 TFSI quattro | 162 |  | <b>05.13</b> | PR: 1KW,GP0,GP1,GP2  |                       |        |  |                              |  |                          |
|  | 2.0 TFSI quattro | 165 |  | <b>04.13</b> | PR: 1KW,GP0,GP1,GP2  |                       |        |  |                              |  |                          |
|  | 3.0 TDI quattro  | 176 |  | <b>04.09</b> | PR: 1KW,GP0,GP1,GP2  |                       |        |  |                              |  |                          |
|  | 3.0 TDI quattro  | 180 |  | <b>01.12</b> | PR: 1KW,GP0,GP1,GP2  |                       |        |  |                              |  |                          |
|  | 2.0 TDI quattro  | 105 |  | <b>09.09</b> | PR: 1KW,GP0,GP1,GP2  | <b>24.0112-0178.1</b> | 412178 |  |                              | 300 12,0 10,0 +S +B                              |                          |
|  | 2.0 TDI quattro  | 110 |  | <b>05.13</b> | PR: 1KW,GP0,GP1,GP2  | <b>24.0312-0178.1</b> | 512178 |  |                              | <b>300 12,0 10,0 +S +B PD</b>                    |                          |
|  | 2.0 TDI quattro  | 120 |  | <b>04.09</b> | PR: 1KW,GP0,GP1,GP2  |                       |        |  |                              |  |                          |
|  | 2.0 TDI quattro  | 125 |  | <b>02.09</b> | PR: 1KW,GP0,GP1,GP2  |                       |        |  |                              |  |                          |
|  | 2.0 TDI quattro  | 130 |  | <b>01.12</b> | PR: 1KW,GP0,GP1,GP2  |                       |        |  |                              |  |                          |
|  | 2.0 TDI quattro  | 140 |  | <b>09.13</b> | PR: 1KW,GP0,GP1,GP2  |                       |        |  |                              |  |                          |
|  | 2.0 TFSI quattro | 155 |  | <b>04.09</b> | PR: 1KW,GP0,GP1,GP2  |                       |        |  |                              |  |                          |
|  | 2.0 TFSI quattro | 162 |  | <b>05.13</b> | PR: 1KW,GP0,GP1,GP2  |                       |        |  |                              |  |                          |
|  | 2.0 TFSI quattro | 165 |  | <b>04.13</b> | PR: 1KW,GP0,GP1,GP2  |                       |        |  |                              |  |                          |
|  | 3.0 TDI quattro  | 176 |  | <b>04.09</b> | PR: 1KW,GP0,GP1,GP2  |                       |        |  |                              |  |                          |
|  | 3.0 TDI quattro  | 180 |  | <b>01.12</b> | PR: 1KW,GP0,GP1,GP2  |                       |        |  |                              |  |                          |

<sup>1)</sup> electric parking brake / fr.dci stazionamento elettrico / frein à main électrique / freno de mano eléctrico

<sup>2)</sup> spring dimension 44 mm / dimensioni molla 44 mm / dimension de ressort 44 mm / medida de muelle 44 mm



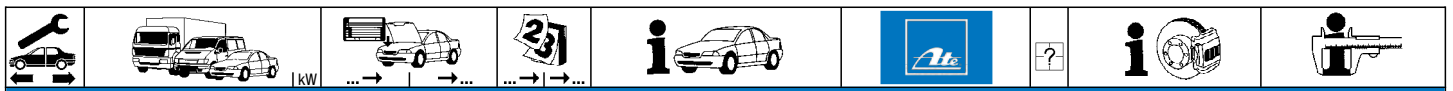

**AUDI A4 Cabrio (02-08)**

|                  |                  |     |       |       |                     |                     |                |        |  |  |                         |                         |  |
|------------------|------------------|-----|-------|-------|---------------------|---------------------|----------------|--------|--|--|-------------------------|-------------------------|--|
|                  | 1.8 T            | 120 |       | 04.02 | 11.08               | PR: 1LB,1LE,1LF,1LT | 13.0460-7110.2 | 607110 |  |  | 23018 20,3 +/WK         | ATE                     |  |
|                  | 1.8 T quattro    | 120 |       | 05.03 | 11.08               | PR: 1LB,1LE,1LF,1LT | 13.0470-7110.2 | LD7110 |  |  | 23018 20,3 +/WK         | ATE                     |  |
|                  | 2.0              | 96  |       | 05.04 | 11.08               | PR: 1LB,1LE,1LF,1LT |                |        |  |  |                         |                         |  |
|                  | 2.0 TDI          |     |       | 10.05 | 11.08               | PR: 1LB,1LE,1LF,1LT |                |        |  |  |                         |                         |  |
|                  | 2.0 TFSI         | 147 |       | 01.06 | 11.08               | PR: 1LB,1LE,1LF,1LT |                |        |  |  |                         |                         |  |
|                  | 2.0 TFSI quattro | 147 |       | 11.05 | 11.08               | PR: 1LB,1LE,1LF,1LT |                |        |  |  |                         |                         |  |
|                  | 2.4              | 120 |       | 04.02 | 11.08               | PR: 1LB,1LE,1LF,1LT |                |        |  |  |                         |                         |  |
|                  | 2.4              | 125 |       | 04.02 | 11.08               | PR: 1LB,1LE,1LF,1LT |                |        |  |  |                         |                         |  |
|                  | 2.5 TDI          | 120 |       | 08.02 | 11.08               | PR: 1LB,1LE,1LF,1LT |                |        |  |  |                         |                         |  |
|                  | 2.7 TDI          | 132 |       | 06.06 | 11.08               | PR: 1LB,1LE,1LF,1LT |                |        |  |  |                         |                         |  |
|                  | 3.0              | 162 |       | 04.02 | 11.08               | PR: 1LB,1LE,1LF,1LT |                |        |  |  |                         |                         |  |
|                  | 3.0 quattro      | 162 |       | 05.03 | 11.08               | PR: 1LB,1LE,1LF,1LT |                |        |  |  |                         |                         |  |
|                  | 3.0 TDI quattro  | 150 |       | 01.06 | 11.08               | PR: 1LB,1LE,1LF,1LT |                |        |  |  |                         |                         |  |
|                  | 3.0 TDI quattro  | 171 |       | 10.05 | 11.08               | PR: 1LB,1LE,1LF,1LT |                |        |  |  |                         |                         |  |
|                  | 3.2 FSI          | 188 |       | 10.05 | 11.08               | PR: 1LB,1LE,1LF,1LT |                |        |  |  |                         |                         |  |
| 3.2 FSI quattro  | 188              |     | 10.05 | 11.08 | PR: 1LB,1LE,1LF,1LT |                     |                |        |  |  |                         |                         |  |
| 1.8 T            | 120              |     | 04.02 | 11.08 | PR: 1LA             | 13.0460-7201.2      | 607201         |        |  |  | 23763 20,3 +/WK         | ATE                     |  |
| 1.8 T quattro    | 120              |     | 05.03 | 11.08 | PR: 1LA             | 13.0470-7201.2      | LD7201         |        |  |  | 23763 20,3 +/WK         | ATE                     |  |
| 2.0              | 96               |     | 05.04 | 11.08 | PR: 1LA             |                     |                |        |  |  |                         |                         |  |
| 2.0 TDI          |                  |     | 10.05 | 11.08 | PR: 1LA             |                     |                |        |  |  |                         |                         |  |
| 2.0 TFSI         | 147              |     | 01.06 | 11.08 | PR: 1LA             |                     |                |        |  |  |                         |                         |  |
| 2.0 TFSI quattro | 147              |     | 11.05 | 11.08 | PR: 1LA             |                     |                |        |  |  |                         |                         |  |
| 2.4              | 120              |     | 04.02 | 11.08 | PR: 1LA             |                     |                |        |  |  |                         |                         |  |
| 2.4              | 125              |     | 04.02 | 11.08 | PR: 1LA             |                     |                |        |  |  |                         |                         |  |
| 2.5 TDI          | 120              |     | 08.02 | 11.08 | PR: 1LA             |                     |                |        |  |  |                         |                         |  |
| 2.7 TDI          | 132              |     | 06.06 | 11.08 | PR: 1LA             |                     |                |        |  |  |                         |                         |  |
| 3.0              | 162              |     | 04.02 | 11.08 | PR: 1LA             |                     |                |        |  |  |                         |                         |  |
| 3.0 quattro      | 162              |     | 05.03 | 11.08 | PR: 1LA             |                     |                |        |  |  |                         |                         |  |
| 3.0 TDI quattro  | 150              |     | 01.06 | 11.08 | PR: 1LA             |                     |                |        |  |  |                         |                         |  |
| 3.0 TDI quattro  | 171              |     | 10.05 | 11.08 | PR: 1LA             |                     |                |        |  |  |                         |                         |  |
| 3.2 FSI          | 188              |     | 10.05 | 11.08 | PR: 1LA             |                     |                |        |  |  |                         |                         |  |
| 3.2 FSI quattro  | 188              |     | 10.05 | 11.08 | PR: 1LA             |                     |                |        |  |  |                         |                         |  |
| S4               | 253              |     | 02.04 | 11.08 |                     | 13.0460-7201.2      | 607201         |        |  |  | 23763 20,3 +/WK         | ATE                     |  |
| RS 4             | 309              |     | 05.06 | 11.08 | PR: 1LU             | 24.8190-0017.2      | 620017         | 2      |  |  | Warnkontakt L=388,3mm   |                         |  |
|                  | 1.8 T            | 120 |       | 04.02 | 11.08               | PR: 1LB,1LE         | 24.0125-0105.1 | 425105 |  |  | 288 25,0 23,0 V L +S +B |                         |  |
|                  | 1.8 T quattro    | 120 |       | 05.03 | 11.08               | PR: 1LB,1LE         | 24.0325-0105.1 | 525105 |  |  | 288 25,0 23,0 V L +B PD |                         |  |
|                  | 2.0              | 96  |       | 05.04 | 11.08               | PR: 1LB,1LE         |                |        |  |  |                         |                         |  |
|                  | 2.0 TDI          |     |       | 10.05 | 11.08               | PR: 1LB,1LE         |                |        |  |  |                         |                         |  |
|                  | 2.4              | 120 |       | 04.02 | 11.08               | PR: 1LB,1LE         |                |        |  |  |                         |                         |  |
|                  | 2.4              | 125 |       | 04.02 | 11.08               | PR: 1LB,1LE         |                |        |  |  |                         |                         |  |
|                  | 2.5 TDI          | 120 |       | 08.02 | 11.08               | PR: 1LB,1LE         |                |        |  |  |                         |                         |  |
|                  | 2.0 TFSI         | 147 |       | 01.06 | 11.08               | PR: 1LB,1LE         | 24.0125-0105.1 | 425105 |  |  |                         | 288 25,0 23,0 V L +S +B |  |
|                  | 2.0 TFSI quattro | 147 |       | 11.05 | 11.08               | PR: 1LB,1LE         |                |        |  |  |                         |                         |  |
|                  | 2.7 TDI          | 132 |       | 06.06 | 11.08               | PR: 1LB,1LE         |                |        |  |  |                         |                         |  |
|                  | 3.0              | 162 |       | 04.02 | 11.08               | PR: 1LB,1LE         |                |        |  |  |                         |                         |  |
|                  | 3.0 quattro      | 162 |       | 05.03 | 11.08               | PR: 1LB,1LE         |                |        |  |  |                         |                         |  |
|                  | 3.0 TDI quattro  | 150 |       | 01.06 | 11.08               | PR: 1LB,1LE         |                |        |  |  |                         |                         |  |
|                  | 3.0 TDI quattro  | 171 |       | 10.05 | 11.08               | PR: 1LB,1LE         |                |        |  |  |                         |                         |  |
|                  | 3.2 FSI          | 188 |       | 10.05 | 11.08               | PR: 1LB,1LE         |                |        |  |  |                         |                         |  |
| 3.2 FSI quattro  | 188              |     | 10.05 | 11.08 | PR: 1LB,1LE         |                     |                |        |  |  |                         |                         |  |
| 1.8 T            | 120              |     | 04.02 | 11.08 | PR: 1LF,1LT         | 24.0125-0137.1      | 425137         |        |  |  | 312 25,0 23,0 V L +S +B |                         |  |
| 1.8 T quattro    | 120              |     | 05.03 | 11.08 | PR: 1LF,1LT         | 24.0325-0137.1      | 525137         |        |  |  | 312 25,0 23,0 V L +B PD |                         |  |
| 2.0              | 96               |     | 05.04 | 11.08 | PR: 1LF,1LT         |                     |                |        |  |  |                         |                         |  |
| 2.0 TDI          |                  |     | 10.05 | 11.08 | PR: 1LF,1LT         |                     |                |        |  |  |                         |                         |  |
| 2.4              | 120              |     | 04.02 | 11.08 | PR: 1LF,1LT         |                     |                |        |  |  |                         |                         |  |
| 2.4              | 125              |     | 04.02 | 11.08 | PR: 1LF,1LT         |                     |                |        |  |  |                         |                         |  |
| 2.5 TDI          | 120              |     | 08.02 | 11.08 | PR: 1LF,1LT         |                     |                |        |  |  |                         |                         |  |
| 2.0 TFSI         | 147              |     | 01.06 | 11.08 | PR: 1LF,1LT         | 24.0125-0137.1      | 425137         |        |  |  | 312 25,0 23,0 V L +S +B |                         |  |
| 2.0 TFSI quattro | 147              |     | 11.05 | 11.08 | PR: 1LF,1LT         | 24.0325-0137.1      | 525137         |        |  |  | 312 25,0 23,0 V L +B PD |                         |  |
| 2.7 TDI          | 132              |     | 06.06 | 11.08 | PR: 1LF,1LT         |                     |                |        |  |  |                         |                         |  |
| 3.0              | 162              |     | 04.02 | 11.08 | PR: 1LF,1LT         |                     |                |        |  |  |                         |                         |  |
| 3.0 quattro      | 162              |     | 05.03 | 11.08 | PR: 1LF,1LT         |                     |                |        |  |  |                         |                         |  |
| 3.0 TDI quattro  | 150              |     | 01.06 | 11.08 | PR: 1LF,1LT         |                     |                |        |  |  |                         |                         |  |
| 3.0 TDI quattro  | 171              |     | 10.05 | 11.08 | PR: 1LF,1LT         |                     |                |        |  |  |                         |                         |  |
| 3.2 FSI          | 188              |     | 10.05 | 11.08 | PR: 1LF,1LT         |                     |                |        |  |  |                         |                         |  |
| 3.2 FSI quattro  | 188              |     | 10.05 | 11.08 | PR: 1LF,1LT         |                     |                |        |  |  |                         |                         |  |
| 1.8 T            | 120              |     | 04.02 | 11.08 | PR: 1LA             | 24.0130-0113.1      | 430113         |        |  |  | 320 30,0 28,0 V L +S +B |                         |  |
| 1.8 T quattro    | 120              |     | 05.03 | 11.08 | PR: 1LA             | 24.0330-0113.1      | 530113         |        |  |  | 320 30,0 28,0 V L +B PD |                         |  |
| 2.0              | 96               |     | 05.04 | 11.08 | PR: 1LA             |                     |                |        |  |  |                         |                         |  |
| 2.0 TDI          |                  |     | 10.05 | 11.08 | PR: 1LA             |                     |                |        |  |  |                         |                         |  |
| 2.0 TFSI         | 147              |     | 01.06 | 11.08 | PR: 1LA             |                     |                |        |  |  |                         |                         |  |
| 2.0 TFSI quattro | 147              |     | 11.05 | 11.08 | PR: 1LA             |                     |                |        |  |  |                         |                         |  |
| 2.4              | 120              |     | 04.02 | 11.08 | PR: 1LA             |                     |                |        |  |  |                         |                         |  |
| 2.4              | 125              |     | 04.02 | 11.08 | PR: 1LA             |                     |                |        |  |  |                         |                         |  |
| 2.5 TDI          | 120              |     | 08.02 | 11.08 | PR: 1LA             |                     |                |        |  |  |                         |                         |  |
| 2.7 TDI          | 132              |     | 06.06 | 11.08 | PR: 1LA             |                     |                |        |  |  |                         |                         |  |
| 3.0              | 162              |     | 04.02 | 11.08 | PR: 1LA             |                     |                |        |  |  |                         |                         |  |
| 3.0 quattro      | 162              |     | 05.03 | 11.08 | PR: 1LA             |                     |                |        |  |  |                         |                         |  |
| 3.0 TDI quattro  | 150              |     | 01.06 | 11.08 | PR: 1LA             |                     |                |        |  |  |                         |                         |  |
| 3.0 TDI quattro  | 171              |     | 10.05 | 11.08 | PR: 1LA             |                     |                |        |  |  |                         |                         |  |
| 3.2 FSI          | 188              |     | 10.05 | 11.08 | PR: 1LA             |                     |                |        |  |  |                         |                         |  |
| 3.2 FSI quattro  | 188              |     | 10.05 | 11.08 | PR: 1LA             |                     |                |        |  |  |                         |                         |  |
| S4               | 253              |     | 02.04 | 11.08 |                     | 24.0130-0119.1      | 430119         |        |  |  | 345 30,0 28,0 V L +B    |                         |  |

| AUDI A4 Cabrio (02-08) |                               |          |             |       |                     |                     |                     |                |        |   |                         |  |
|------------------------|-------------------------------|----------|-------------|-------|---------------------|---------------------|---------------------|----------------|--------|---|-------------------------|--|
|                        | 1.8 T                         | 120      |             | 04.02 | 11.08               | PR: 1KD,1KP         | 13.0460-2886.2      | 602886         |        | 20961 16,2 /S                             | TRW                     |  |
|                        | 1.8 T quattro                 | 120      |             | 05.03 | 11.08               | PR: 1KD,1KP         | 13.0470-2886.2      | LD2886         |        | 20961 16,2 /S                             | TRW                     |  |
|                        | 2.0                           | 96       |             | 05.04 | 11.08               | PR: 1KD,1KP         |                     |                |        |   |                         |  |
|                        | 2.0 TDI                       |          |             | 10.05 | 11.08               | PR: 1KD,1KP         |                     |                |        |   |                         |  |
|                        | 2.0 TFSI                      | 147      |             | 01.06 | 11.08               | PR: 1KD,1KP         |                     |                |        |   |                         |  |
|                        | 2.0 TFSI quattro              | 147      |             | 11.05 | 11.08               | PR: 1KD,1KP         |                     |                |        |   |                         |  |
|                        | 2.4                           | 120      |             | 04.02 | 12.05               | PR: 1KD,1KP         |                     |                |        |   |                         |  |
|                        | 2.4                           | 125      |             | 04.02 | 12.05               | PR: 1KD,1KP         |                     |                |        |   |                         |  |
|                        | 2.5 TDI                       | 120      |             | 08.02 | 12.05               | PR: 1KD,1KP         |                     |                |        |   |                         |  |
|                        | 3.0                           | 162      |             | 04.02 | 12.05               | PR: 1KD,1KP         |                     |                |        |   |                         |  |
| 3.0 quattro            | 162                           |          | 05.03       | 12.05 | PR: 1KD,1KP         |                     |                     |                |        |   |                         |  |
|                        | 1.8 T                         | 120      | 8E-5-400001 |       | 11.08               | PR: 1KW             | 13.0460-2880.2      | 602880         |        | 23914 17,1 /WE/Zub/S                      | TRW                     |  |
|                        | 1.8 T quattro                 | 120      | 8E-5-400001 |       | 11.08               | PR: 1KW             | 13.0470-2880.2      | LD2880         |        | 23914 17,1 /WE/Zub/S                      | TRW                     |  |
|                        | 2.0                           | 96       | 8E-5-400001 |       | 11.08               | PR: 1KW             | 13.0460-0259.2      | 610259         |        | Belagsatz-Zubehör                         |                         |  |
|                        | 2.0 TDI                       |          | 8E-5-400001 |       | 11.08               | PR: 1KW             |                     |                |        |   |                         |  |
|                        | 2.0 TFSI                      | 147      | 8E-5-400001 |       | 11.08               | PR: 1KW             |                     |                |        |   |                         |  |
|                        | 2.0 TFSI quattro              | 147      | 8E-5-400001 |       | 11.08               | PR: 1KW             |                     |                |        |   |                         |  |
|                        | 2.4                           | 120      | 8E-5-400001 |       | 11.08               | PR: 1KW             |                     |                |        |   |                         |  |
|                        | 2.4                           | 125      | 8E-5-400001 |       | 11.08               | PR: 1KW             |                     |                |        |   |                         |  |
|                        | 2.5 TDI                       | 120      | 8E-5-400001 |       | 11.08               | PR: 1KW             |                     |                |        |   |                         |  |
|                        | 2.7 TDI                       | 132      | 8E-5-400001 |       | 11.08               | PR: 1KW             |                     |                |        |   |                         |  |
|                        | 3.0                           | 162      | 8E-5-400001 |       | 11.08               | PR: 1KW             |                     |                |        |   |                         |  |
|                        | 3.0 quattro                   | 162      | 8E-5-400001 |       | 11.08               | PR: 1KW             |                     |                |        |   |                         |  |
|                        | 3.0 TDI quattro               | 150      |             | 01.06 | 11.08               | PR: 1KW             |                     |                |        |   |                         |  |
|                        | 3.0 TDI quattro               | 171      | 8E-5-400001 |       | 11.08               | PR: 1KW             |                     |                |        |   |                         |  |
|                        | 3.2 FSI                       | 188      | 8E-5-400001 |       | 11.08               | PR: 1KW             |                     |                |        |   |                         |  |
|                        | 3.2 FSI quattro               | 188      | 8E-5-400001 |       | 11.08               | PR: 1KW             |                     |                |        |   |                         |  |
|                        | S4                            | 253      |             | 02.04 | 11.08               |                     | 13.0460-2888.2      | 602888         |        | 23326 17,4 /WE/S                          | TRW                     |  |
|                        |                               |          |             |       |                     |                     | 13.0470-2888.2      | LD2888         |        | 23326 17,4 /WE/S                          | TRW                     |  |
|                        |                               |          |             |       |                     |                     | 13.0460-0023.2      | 610023         |        | Belagsatz-Zubehör                         |                         |  |
|                        | RS 4                          | 309      |             | 05.06 | 11.08               |                     | 13.0460-0023.2      | 610023         |        | Belagsatz-Zubehör                         |                         |  |
|                        | 1.8 T                         | 120      |             | 04.02 | 11.08               | PR: 1KD             | 24.0110-0261.1      | 410261         |        | 245 10,0 8,0 +S +B                        |                         |  |
|                        | 1.8 T quattro                 | 120      |             | 05.03 | 11.08               | PR: 1KD             | 24.0310-0261.1      | 510261         |        | 245 10,0 8,0 +B PD                        |                         |  |
|                        | 2.0                           | 96       |             | 05.04 | 11.08               | PR: 1KD             |                     |                |        |   |                         |  |
|                        | 2.0 TDI                       |          |             | 10.05 | 11.08               | PR: 1KD             |                     |                |        |   |                         |  |
|                        | 2.0 TFSI                      | 147      |             | 01.06 | 11.08               | PR: 1KD             |                     |                |        |   |                         |  |
|                        | 2.0 TFSI quattro              | 147      |             | 11.05 | 11.08               | PR: 1KD             |                     |                |        |   |                         |  |
|                        | 1.8 T                         | 120      |             | 04.02 | 11.08               | PR: 1KP             | 24.0112-0148.1      | 412148         |        | 255 12,0 10,0 +B                          |                         |  |
|                        | 1.8 T quattro                 | 120      |             | 05.03 | 11.08               | PR: 1KP             | 24.0312-0148.1      | 512148         |        | 255 12,0 10,0 +B PD                       |                         |  |
|                        | 2.0                           | 96       |             | 05.04 | 11.08               | PR: 1KP             |                     |                |        |   |                         |  |
|                        | 2.0 TDI                       |          |             | 10.05 | 11.08               | PR: 1KP             |                     |                |        |   |                         |  |
| 2.0 TFSI               | 147                           |          | 01.06       | 11.08 | PR: 1KP             |                     |                     |                |        |   |                         |  |
| 2.0 TFSI quattro       | 147                           |          | 11.05       | 11.08 | PR: 1KP             |                     |                     |                |        |   |                         |  |
| 2.4                    | 120                           |          | 04.02       | 11.08 |                     |                     |                     |                |        |   |                         |  |
| 2.4                    | 125                           |          | 04.02       | 11.08 |                     |                     |                     |                |        |   |                         |  |
| 2.5 TDI                | 120                           |          | 08.02       | 11.08 |                     |                     |                     |                |        |   |                         |  |
| 3.0                    | 162                           |          | 04.02       | 11.08 |                     |                     |                     |                |        |   |                         |  |
| 3.0 quattro            | 162                           |          | 05.03       | 11.08 |                     |                     |                     |                |        |   |                         |  |
|                        | 1.8 T                         | 120      | 8E-5-400001 |       | 11.08               | PR: 1KW             | 24.0112-0166.1      | 412166         |        | 288 12,0 10,0 +B                          |                         |  |
|                        | 1.8 T quattro                 | 120      | 8E-5-400001 |       | 11.08               | PR: 1KW             | 24.0312-0166.1      | 512166         |        | 288 12,0 10,0 +B PD                       |                         |  |
|                        | 2.0                           | 96       | 8E-5-400001 |       | 11.08               | PR: 1KW             |                     |                |        |   |                         |  |
|                        | 2.0 TDI                       |          | 8E-5-400001 |       | 11.08               | PR: 1KW             |                     |                |        |   |                         |  |
|                        | 2.0 TFSI                      | 147      | 8E-5-400001 |       | 11.08               | PR: 1KW             |                     |                |        |   |                         |  |
|                        | 2.0 TFSI quattro              | 147      | 8E-5-400001 |       | 11.08               | PR: 1KW             |                     |                |        |   |                         |  |
|                        | 2.4                           | 120      | 8E-5-400001 |       | 11.08               | PR: 1KW             |                     |                |        |   |                         |  |
|                        | 2.4                           | 125      | 8E-5-400001 |       | 11.08               | PR: 1KW             |                     |                |        |   |                         |  |
|                        | 2.5 TDI                       | 120      | 8E-5-400001 |       | 11.08               | PR: 1KW             |                     |                |        |   |                         |  |
|                        | 2.7 TDI                       | 132      | 8E-5-400001 |       | 11.08               | PR: 1KW             |                     |                |        |   |                         |  |
|                        | 3.0                           | 162      | 8E-5-400001 |       | 11.08               | PR: 1KW             |                     |                |        |   |                         |  |
|                        | 3.0 quattro                   | 162      | 8E-5-400001 |       | 11.08               | PR: 1KW             |                     |                |        |   |                         |  |
|                        | 3.0 TDI quattro               | 150      |             | 01.06 | 11.08               | PR: 1KW             |                     |                |        |   |                         |  |
|                        | 3.0 TDI quattro               | 171      | 8E-5-400001 |       | 11.08               | PR: 1KW             |                     |                |        |   |                         |  |
|                        | 3.2 FSI                       | 188      | 8E-5-400001 |       | 11.08               | PR: 1KW             |                     |                |        |   |                         |  |
|                        | 3.2 FSI quattro               | 188      | 8E-5-400001 |       | 11.08               | PR: 1KW             |                     |                |        |   |                         |  |
|                        | S4                            | 253      |             | 02.04 | 11.08               |                     | 24.0122-0220.1      | 422220         |        | 300 22,0 20,0 V L +B                      |                         |  |
|                        | AUDI A4 / A4 Avant (B9) (15-) |          |             |       |                     |                     |                     |                |        |   |                         |  |
|                        |                               | 1.4 TFSI | 110         |       | 08.15               |                     | PR: 1KF,1KJ,1KK,2EJ | 24.0122-0272.1 | 422272 | elektrische Feststellbremse <sup>1)</sup> | 330 21,9 20,0 V L +S +B |  |
|                        |                               | 2.0 TDI  | 90          |       | 04.16               |                     | PR: 1KF,1KJ,1KK,2EJ |                |        |   |                         |  |
| 2.0 TDI                |                               | 100      |             | 05.15 |                     | PR: 1KF,1KJ,1KK,2EJ |                     |                |        |   |                         |  |
| 2.0 TDI                |                               | 110      |             | 05.15 |                     | PR: 1KF,1KJ,1KK,2EJ |                     |                |        |   |                         |  |
| 2.0 TDI                |                               | 140      |             | 05.15 |                     | PR: 1KF,1KJ,1KK,2EJ |                     |                |        |   |                         |  |
| 2.0 TDI quattro        |                               | 140      |             | 09.15 |                     | PR: 1KF,1KJ,1KK,2EJ |                     |                |        |   |                         |  |
| 2.0 TFSI               |                               | 140      |             | 05.15 |                     | PR: 1KF,1KJ,1KK,2EJ |                     |                |        |   |                         |  |
| 2.0 TFSI               |                               | 185      |             | 05.15 |                     | PR: 1KF,1KJ,1KK,2EJ |                     |                |        |   |                         |  |
| 2.0 TFSI quattro       |                               | 185      |             | 05.15 |                     | PR: 1KF,1KJ,1KK,2EJ |                     |                |        |   |                         |  |
| 3.0 TDI                |                               | 160      |             | 09.15 |                     | PR: 1KF,1KJ,1KK,2EJ |                     |                |        |   |                         |  |
| 3.0 TDI quattro        | 160                           |          | 09.15       |       | PR: 1KF,1KJ,1KK,2EJ |                     |                     |                |        |   |                         |  |
| 3.0 TDI quattro        | 200                           |          | 05.15       |       | PR: 1KF,1KJ,1KK,2EJ |                     |                     |                |        |   |                         |  |
| S4                     | 260                           |          | 05.16       |       | PR: 1KF,1KJ,1KK,2EJ |                     |                     |                |        |   |                         |  |

<sup>1)</sup> electric parking brake / fr.di stazionamento elettrico / frein à main électrique / freno de mano eléctrico

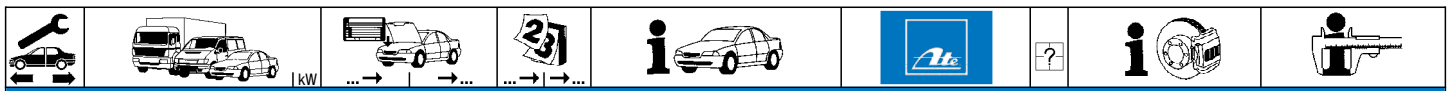

### AUDI A4 Allroad (16-)

|  |                  |     |       |                     |                |        |   |                         |
|--|------------------|-----|-------|---------------------|----------------|--------|---|-------------------------|
|  | 2.0 TDI quattro  | 120 | 05.16 | PR: 1KF,1KJ,1KK,2EJ | 24.0122-0272.1 | 422272 | elektrische Feststellbremse <sup>1)</sup> | 330 21,9 20,0 V L +S +B |
|  | 2.0 TDI quattro  | 140 | 01.16 | PR: 1KF,1KJ,1KK,2EJ |                |        |   |                         |
|  | 2.0 TFSI quattro | 183 | 05.16 | PR: 1KF,1KJ,1KK,2EJ |                |        |   |                         |
|  | 2.0 TFSI quattro | 185 | 01.16 | PR: 1KF,1KJ,1KK,2EJ |                |        |   |                         |
|  | 3.0 TDI quattro  | 160 | 01.16 | PR: 1KF,1KJ,1KK,2EJ |                |        |   |                         |
|  | 3.0 TDI quattro  | 200 | 01.16 | PR: 1KF,1KJ,1KK,2EJ |                |        |   |                         |

### AUDI A5 / A5 Sportback (07-)

|  |                  |     |       |         |                |        |                              |                   |     |
|--|------------------|-----|-------|---------|----------------|--------|------------------------------|-------------------|-----|
|  | 1.8 TFSI         | 106 | 06.14 | PR: 1LT | 13.0460-7256.2 | 607256 |                              | 24705 19,8 +/WK   | ATE |
|  | 1.8 TFSI         | 118 | 05.09 | PR: 1LT | 13.0470-7256.2 | LD7256 |                              | 24705 19,8 +/WK   | ATE |
|  | 1.8 TFSI         | 125 | 10.07 | PR: 1LT |                |        |                              |                   |     |
|  | 1.8 TFSI         | 130 | 05.15 | PR: 1LT |                |        |                              |                   |     |
|  | 2.0 TDI          | 105 | 09.09 | PR: 1LT |                |        |                              |                   |     |
|  | 2.0 TDI          | 110 | 05.13 | PR: 1LT |                |        |                              |                   |     |
|  | 2.0 TDI          | 120 | 10.08 | PR: 1LT |                |        |                              |                   |     |
|  | 2.0 TDI          | 125 | 08.08 | PR: 1LT |                |        |                              |                   |     |
|  | 2.0 TDI          | 130 | 07.11 | PR: 1LT |                |        |                              |                   |     |
|  | 2.0 TDI          | 140 | 09.13 | PR: 1LT |                |        |                              |                   |     |
|  | 2.0 TDI quattro  | 125 | 08.08 | PR: 1LT |                |        |                              |                   |     |
|  | 2.0 TDI quattro  | 130 | 12.11 | PR: 1LT |                |        |                              |                   |     |
|  | 2.0 TDI quattro  | 140 | 09.13 | PR: 1LT |                |        |                              |                   |     |
|  | 2.0 TFSI         | 132 | 11.08 | PR: 1LT |                |        |                              |                   |     |
|  | 2.0 TFSI         | 155 | 06.08 | PR: 1LT |                |        |                              |                   |     |
|  | 2.0 TFSI         | 165 | 05.13 | PR: 1LT |                |        |                              |                   |     |
|  | 2.0 TFSI         | 169 | 08.15 | PR: 1LT |                |        |                              |                   |     |
|  | 2.0 TFSI quattro | 155 | 06.08 | PR: 1LT |                |        |                              |                   |     |
|  | 2.0 TFSI quattro | 165 | 05.13 | PR: 1LT |                |        |                              |                   |     |
|  | 2.0 TFSI quattro | 169 | 08.15 | PR: 1LT |                |        |                              |                   |     |
|  | 2.7 TDI          | 120 | 09.07 | PR: 1LT |                |        |                              |                   |     |
|  | 2.7 TDI          | 140 | 05.07 | PR: 1LT |                |        |                              |                   |     |
|  | 3.0 TDI          | 150 | 07.11 | PR: 1LT |                |        |                              |                   |     |
|  | 3.0 TDI quattro  | 155 | 03.08 | PR: 1LT |                |        |                              |                   |     |
|  | 3.0 TDI quattro  | 160 | 05.15 | PR: 1LT |                |        |                              |                   |     |
|  | 3.0 TDI quattro  | 176 | 05.07 | PR: 1LT |                |        |                              |                   |     |
|  | 3.0 TDI quattro  | 180 | 07.11 | PR: 1LT |                |        |                              |                   |     |
|  | 3.0 TFSI quattro | 200 | 12.11 | PR: 1LT |                |        |                              |                   |     |
|  | 3.2 FSI          | 195 | 05.07 | PR: 1LT |                |        |                              |                   |     |
|  | 3.2 FSI quattro  | 195 | 05.07 | PR: 1LT |                |        |                              |                   |     |
|  | 1.8 TFSI         | 106 | 06.14 | PR: 1LA | 13.0460-2746.2 | 602746 | Federmaß 44 mm <sup>2)</sup> | 24743 19,2 +/WK/S | TRW |
|  | 1.8 TFSI         | 118 | 05.09 | PR: 1LA | 13.0470-2746.2 | LD2746 | Federmaß 44 mm <sup>2)</sup> | 24743 19,2 +/WK/S | TRW |
|  | 1.8 TFSI         | 125 | 10.07 | PR: 1LA |                |        |                              |                   |     |
|  | 1.8 TFSI         | 130 | 05.15 | PR: 1LA |                |        |                              |                   |     |
|  | 2.0 TDI          | 105 | 09.09 | PR: 1LA |                |        |                              |                   |     |
|  | 2.0 TDI          | 110 | 05.13 | PR: 1LA |                |        |                              |                   |     |
|  | 2.0 TDI          | 120 | 10.08 | PR: 1LA |                |        |                              |                   |     |
|  | 2.0 TDI          | 125 | 08.08 | PR: 1LA |                |        |                              |                   |     |
|  | 2.0 TDI          | 130 | 07.11 | PR: 1LA |                |        |                              |                   |     |
|  | 2.0 TDI          | 140 | 09.13 | PR: 1LA |                |        |                              |                   |     |
|  | 2.0 TDI quattro  | 125 | 08.08 | PR: 1LA |                |        |                              |                   |     |
|  | 2.0 TDI quattro  | 130 | 12.11 | PR: 1LA |                |        |                              |                   |     |
|  | 2.0 TDI quattro  | 140 | 09.13 | PR: 1LA |                |        |                              |                   |     |
|  | 2.0 TFSI         | 132 | 11.08 | PR: 1LA |                |        |                              |                   |     |
|  | 2.0 TFSI         | 155 | 06.08 | PR: 1LA |                |        |                              |                   |     |
|  | 2.0 TFSI         | 165 | 05.13 | PR: 1LA |                |        |                              |                   |     |
|  | 2.0 TFSI         | 169 | 08.15 | PR: 1LA |                |        |                              |                   |     |
|  | 2.0 TFSI quattro | 155 | 06.08 | PR: 1LA |                |        |                              |                   |     |
|  | 2.0 TFSI quattro | 165 | 05.13 | PR: 1LA |                |        |                              |                   |     |
|  | 2.0 TFSI quattro | 169 | 08.15 | PR: 1LA |                |        |                              |                   |     |
|  | 2.7 TDI          | 120 | 09.07 | PR: 1LA |                |        |                              |                   |     |
|  | 2.7 TDI          | 140 | 07.07 | PR: 1LA |                |        |                              |                   |     |
|  | 3.0 TDI          | 150 | 07.11 | PR: 1LA |                |        |                              |                   |     |
|  | 3.0 TDI quattro  | 155 | 03.08 | PR: 1LA |                |        |                              |                   |     |
|  | 3.0 TDI quattro  | 160 | 05.15 | PR: 1LA |                |        |                              |                   |     |
|  | 3.0 TDI quattro  | 176 | 07.07 | PR: 1LA |                |        |                              |                   |     |
|  | 3.0 TDI quattro  | 180 | 07.11 | PR: 1LA |                |        |                              |                   |     |
|  | 3.0 TFSI quattro | 200 | 12.11 | PR: 1LA |                |        |                              |                   |     |
|  | 3.2 FSI          | 195 | 05.07 | PR: 1LA |                |        |                              |                   |     |
|  | 3.2 FSI quattro  | 195 | 05.07 | PR: 1LA |                |        |                              |                   |     |
|  | S5               | 245 | 07.11 | PR: 1LJ | 13.0460-2746.2 | 602746 | Federmaß 44 mm <sup>2)</sup> | 24743 19,2 +/WK/S | TRW |
|  | S5               | 260 | 07.11 | PR: 1LJ |                |        |                              |                   |     |
|  | 1.8 TFSI         | 106 | 06.14 | PR: 1LD | 13.0460-2746.2 | 602746 | Federmaß 44 mm <sup>2)</sup> | 24743 19,2 +/WK/S | TRW |
|  | 1.8 TFSI         | 118 | 05.09 | PR: 1LD | 13.0470-2746.2 | LD2746 | Federmaß 44 mm <sup>2)</sup> | 24743 19,2 +/WK/S | TRW |
|  | 1.8 TFSI         | 125 | 10.07 | PR: 1LD |                |        |                              |                   |     |
|  | 1.8 TFSI         | 130 | 05.15 | PR: 1LD |                |        |                              |                   |     |
|  | 2.0 TDI          | 105 | 09.09 | PR: 1LD |                |        |                              |                   |     |
|  | 2.0 TDI          | 110 | 05.13 | PR: 1LD |                |        |                              |                   |     |
|  | 2.0 TDI          | 120 | 10.08 | PR: 1LD |                |        |                              |                   |     |
|  | 2.0 TDI          | 125 | 08.08 | PR: 1LD |                |        |                              |                   |     |
|  | 2.0 TDI          | 130 | 07.11 | PR: 1LD |                |        |                              |                   |     |
|  | 2.0 TDI          | 140 | 09.13 | PR: 1LD |                |        |                              |                   |     |
|  | 2.0 TDI quattro  | 125 | 08.08 | PR: 1LD |                |        |                              |                   |     |
|  | 2.0 TDI quattro  | 130 | 12.11 | PR: 1LD |                |        |                              |                   |     |
|  | 2.0 TDI quattro  | 140 | 09.13 | PR: 1LD |                |        |                              |                   |     |
|  | 2.0 TFSI         | 132 | 11.08 | PR: 1LD |                |        |                              |                   |     |
|  | 2.0 TFSI         | 155 | 06.08 | PR: 1LD |                |        |                              |                   |     |
|  | 2.0 TFSI         | 165 | 05.13 | PR: 1LD |                |        |                              |                   |     |
|  | 2.0 TFSI         | 169 | 08.15 | PR: 1LD |                |        |                              |                   |     |

<sup>1)</sup> electric parking brake / fr.di stazionamento elettrico / frein à main électrique / freno de mano eléctrico  
<sup>2)</sup> spring dimension 44 mm / dimensioni molla 44 mm / dimension de ressort 44 mm / medida de muelle 44 mm



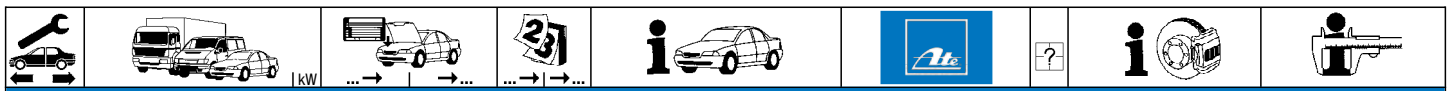

**AUDI A5 / A5 Sportback (07-)**

|                  |                  |       |             |                |                |                              |                              |                         |     |                |        |  |                         |     |
|------------------|------------------|-------|-------------|----------------|----------------|------------------------------|------------------------------|-------------------------|-----|----------------|--------|--|-------------------------|-----|
|                  | 2.0 TFSI quattro | 155   | 06.08       | PR: 1LD        | 13.0460-2746.2 | 602746                       | Federmaß 44 mm <sup>1)</sup> | 24743 19,2 +/WK/S       | TRW |                |        |  |                         |     |
|                  | 2.0 TFSI quattro | 165   | 05.13       | PR: 1LD        |                |                              |                              |                         |     |                |        |  |                         |     |
|                  | 2.0 TFSI quattro | 169   | 08.15       | PR: 1LD        |                |                              |                              |                         |     |                |        |  |                         |     |
|                  | 2.7 TDI          | 120   | 09.07       | PR: 1LD        |                |                              |                              |                         |     |                |        |  |                         |     |
|                  | 2.7 TDI          | 140   | 05.07       | PR: 1LD        |                |                              |                              |                         |     |                |        |  |                         |     |
|                  | 3.0 TDI          | 150   | 07.11       | PR: 1LD        |                |                              |                              |                         |     |                |        |  |                         |     |
|                  | 3.0 TDI quattro  | 155   | 03.08       | PR: 1LD        |                |                              |                              |                         |     |                |        |  |                         |     |
|                  | 3.0 TDI quattro  | 160   | 05.15       | PR: 1LD        |                |                              |                              |                         |     |                |        |  |                         |     |
|                  | 3.0 TDI quattro  | 176   | 05.07       | PR: 1LD        |                |                              |                              |                         |     |                |        |  |                         |     |
|                  | 3.0 TDI quattro  | 180   | 07.11       | PR: 1LD        |                |                              |                              |                         |     |                |        |  |                         |     |
| 3.0 TFSI quattro | 200              | 12.11 | PR: 1LD     |                |                |                              |                              |                         |     |                |        |  |                         |     |
| 3.2 FSI          | 195              | 05.07 | PR: 1LD     |                |                |                              |                              |                         |     |                |        |  |                         |     |
| 3.2 FSI quattro  | 195              | 05.07 | PR: 1LD     |                |                |                              |                              |                         |     |                |        |  |                         |     |
| S5               | 245              | 01.10 | PR: 1ZT,1LD | 13.0460-2746.2 | 602746         | Federmaß 44 mm <sup>1)</sup> | 24743 19,2 +/WK/S            | TRW                     |     |                |        |  |                         |     |
| S5               | 260              | 05.07 | PR: 1ZT,1LD |                |                |                              |                              |                         |     |                |        |  |                         |     |
|                  | 1.8 TFSI         | 106   | 06.14       | PR: 1LT        | 24.0125-0184.1 | 425184                       |                              | 314 25,0 23,0 V L +S +B | TRW |                |        |  |                         |     |
|                  | 1.8 TFSI         | 118   | 05.09       | PR: 1LT        |                |                              |                              |                         |     |                |        |  |                         |     |
|                  | 1.8 TFSI         | 125   | 10.07       | PR: 1LT        |                |                              |                              |                         |     |                |        |  |                         |     |
|                  | 1.8 TFSI         | 130   | 05.15       | PR: 1LT        |                |                              |                              |                         |     |                |        |  |                         |     |
|                  | 2.0 TDI          | 105   | 09.09       | PR: 1LT        |                |                              |                              |                         |     |                |        |  |                         |     |
|                  | 2.0 TDI          | 110   | 05.13       | PR: 1LT        |                |                              |                              |                         |     |                |        |  |                         |     |
|                  | 2.0 TDI          | 120   | 10.08       | PR: 1LT        |                |                              |                              |                         |     |                |        |  |                         |     |
|                  | 2.0 TDI          | 125   | 08.08       | PR: 1LT        |                |                              |                              |                         |     |                |        |  |                         |     |
|                  | 2.0 TDI          | 130   | 07.11       | PR: 1LT        |                |                              |                              |                         |     |                |        |  |                         |     |
|                  | 2.0 TDI          | 140   | 09.13       | PR: 1LT        |                |                              |                              |                         |     |                |        |  |                         |     |
|                  | 2.0 TDI quattro  | 125   | 08.08       | PR: 1LT        |                |                              |                              |                         |     |                |        |  |                         |     |
|                  | 2.0 TDI quattro  | 130   | 12.11       | PR: 1LT        |                |                              |                              |                         |     |                |        |  |                         |     |
|                  | 2.0 TDI quattro  | 140   | 09.13       | PR: 1LT        |                |                              |                              |                         |     |                |        |  |                         |     |
|                  | 2.0 TFSI         | 132   | 11.08       | PR: 1LT        |                |                              |                              |                         |     |                |        |  |                         |     |
|                  | 2.0 TFSI         | 155   | 06.08       | PR: 1LT        |                |                              |                              |                         |     |                |        |  |                         |     |
|                  | 2.0 TFSI         | 165   | 05.13       | PR: 1LT        |                |                              |                              |                         |     |                |        |  |                         |     |
|                  | 2.0 TFSI         | 169   | 08.15       | PR: 1LT        |                |                              |                              |                         |     |                |        |  |                         |     |
|                  | 2.0 TFSI quattro | 155   | 06.08       | PR: 1LT        |                |                              |                              |                         |     |                |        |  |                         |     |
|                  | 2.0 TFSI quattro | 165   | 05.13       | PR: 1LT        |                |                              |                              |                         |     |                |        |  |                         |     |
|                  | 2.0 TFSI quattro | 169   | 08.15       | PR: 1LT        |                |                              |                              |                         |     |                |        |  |                         |     |
|                  | 2.7 TDI          | 120   | 09.07       | PR: 1LT        |                |                              |                              |                         |     |                |        |  |                         |     |
|                  | 2.7 TDI          | 140   | 05.07       | PR: 1LT        |                |                              |                              |                         |     |                |        |  |                         |     |
|                  | 3.0 TDI          | 150   | 07.11       | PR: 1LT        |                |                              |                              |                         |     |                |        |  |                         |     |
|                  | 3.0 TDI quattro  | 155   | 03.08       | PR: 1LT        |                |                              |                              |                         |     |                |        |  |                         |     |
|                  | 3.0 TDI quattro  | 160   | 05.15       | PR: 1LT        |                |                              |                              |                         |     |                |        |  |                         |     |
|                  | 3.0 TDI quattro  | 176   | 05.07       | PR: 1LT        |                |                              |                              |                         |     |                |        |  |                         |     |
|                  | 3.0 TDI quattro  | 180   | 07.11       | PR: 1LT        |                |                              |                              |                         |     |                |        |  |                         |     |
|                  | 3.0 TFSI quattro | 200   | 12.11       | PR: 1LT        |                |                              |                              |                         |     |                |        |  |                         |     |
|                  | 3.2 FSI          | 195   | 05.07       | PR: 1LT        |                |                              |                              |                         |     |                |        |  |                         |     |
|                  | 3.2 FSI quattro  | 195   | 05.07       | PR: 1LT        |                |                              |                              |                         |     |                |        |  |                         |     |
|                  | 1.8 TFSI         | 118   | 05.09       | 06.11 PR: 1LA  |                |                              |                              |                         |     | 24.0130-0193.1 | 430193 |  | 320 30,0 28,0 V L +S +B | TRW |
|                  | 1.8 TFSI         | 125   | 10.07       | 06.11 PR: 1LA  |                |                              |                              |                         |     |                |        |  |                         |     |
|                  | 2.0 TDI          | 105   | 09.09       | 06.11 PR: 1LA  |                |                              |                              |                         |     |                |        |  |                         |     |
|                  | 2.0 TDI          | 120   | 10.08       | 06.11 PR: 1LA  |                |                              |                              |                         |     |                |        |  |                         |     |
|                  | 2.0 TDI          | 125   | 08.08       | 06.11 PR: 1LA  |                |                              |                              |                         |     |                |        |  |                         |     |
|                  | 2.0 TDI quattro  | 125   | 08.08       | 06.11 PR: 1LA  |                |                              |                              |                         |     |                |        |  |                         |     |
|                  | 2.0 TFSI         | 132   | 11.08       | 06.11 PR: 1LA  |                |                              |                              |                         |     |                |        |  |                         |     |
|                  | 2.0 TFSI         | 155   | 06.08       | 06.11 PR: 1LA  |                |                              |                              |                         |     |                |        |  |                         |     |
|                  | 2.0 TFSI quattro | 155   | 06.08       | 06.11 PR: 1LA  |                |                              |                              |                         |     |                |        |  |                         |     |
|                  | 2.7 TDI          | 120   | 09.07       | 06.11 PR: 1LA  |                |                              |                              |                         |     |                |        |  |                         |     |
|                  | 2.7 TDI          | 140   | 07.07       | 06.11 PR: 1LA  |                |                              |                              |                         |     |                |        |  |                         |     |
|                  | 3.0 TDI quattro  | 155   | 03.08       | 06.11 PR: 1LA  |                |                              |                              |                         |     |                |        |  |                         |     |
|                  | 3.0 TDI quattro  | 176   | 07.07       | 06.11 PR: 1LA  |                |                              |                              |                         |     |                |        |  |                         |     |
|                  | 3.2 FSI          | 195   | 05.07       | 06.11 PR: 1LA  |                |                              |                              |                         |     |                |        |  |                         |     |
|                  | 3.2 FSI quattro  | 195   | 05.07       | 06.11 PR: 1LA  |                |                              |                              |                         |     |                |        |  |                         |     |
|                  | 1.8 TFSI         | 106   | 06.14       | PR: 1LA        |                |                              |                              |                         |     | 24.0130-0221.1 | 430221 |  | 320 30,0 28,0 V L +S +B | TRW |
|                  | 1.8 TFSI         | 118   | 07.11       | PR: 1LA        |                |                              |                              |                         |     |                |        |  |                         |     |
|                  | 1.8 TFSI         | 125   | 07.11       | PR: 1LA        |                |                              |                              |                         |     |                |        |  |                         |     |
|                  | 1.8 TFSI         | 130   | 05.15       | PR: 1LA        |                |                              |                              |                         |     |                |        |  |                         |     |
| 2.0 TDI          | 105              | 07.11 | PR: 1LA     |                |                |                              |                              |                         |     |                |        |  |                         |     |
| 2.0 TDI          | 110              | 05.13 | PR: 1LA     |                |                |                              |                              |                         |     |                |        |  |                         |     |
| 2.0 TDI          | 120              | 07.11 | PR: 1LA     |                |                |                              |                              |                         |     |                |        |  |                         |     |
| 2.0 TDI          | 125              | 07.11 | PR: 1LA     |                |                |                              |                              |                         |     |                |        |  |                         |     |
| 2.0 TDI          | 130              | 07.11 | PR: 1LA     |                |                |                              |                              |                         |     |                |        |  |                         |     |
| 2.0 TDI          | 140              | 09.13 | PR: 1LA     |                |                |                              |                              |                         |     |                |        |  |                         |     |
| 2.0 TDI quattro  | 125              | 07.11 | PR: 1LA     |                |                |                              |                              |                         |     |                |        |  |                         |     |
| 2.0 TDI quattro  | 130              | 12.11 | PR: 1LA     |                |                |                              |                              |                         |     |                |        |  |                         |     |
| 2.0 TDI quattro  | 140              | 09.13 | PR: 1LA     |                |                |                              |                              |                         |     |                |        |  |                         |     |
| 2.0 TFSI         | 132              | 07.11 | PR: 1LA     |                |                |                              |                              |                         |     |                |        |  |                         |     |
| 2.0 TFSI         | 155              | 07.11 | PR: 1LA     |                |                |                              |                              |                         |     |                |        |  |                         |     |
| 2.0 TFSI         | 165              | 05.13 | PR: 1LA     |                |                |                              |                              |                         |     |                |        |  |                         |     |
| 2.0 TFSI         | 169              | 08.15 | PR: 1LA     |                |                |                              |                              |                         |     |                |        |  |                         |     |
| 2.0 TFSI quattro | 155              | 07.11 | PR: 1LA     |                |                |                              |                              |                         |     |                |        |  |                         |     |
| 2.0 TFSI quattro | 165              | 05.13 | PR: 1LA     |                |                |                              |                              |                         |     |                |        |  |                         |     |
| 2.0 TFSI quattro | 169              | 08.15 | PR: 1LA     |                |                |                              |                              |                         |     |                |        |  |                         |     |
| 2.7 TDI          | 120              | 07.11 | PR: 1LA     |                |                |                              |                              |                         |     |                |        |  |                         |     |
| 2.7 TDI          | 140              | 07.11 | PR: 1LA     |                |                |                              |                              |                         |     |                |        |  |                         |     |
| 3.0 TDI          | 150              | 07.11 | PR: 1LA     |                |                |                              |                              |                         |     |                |        |  |                         |     |
| 3.0 TDI quattro  | 155              | 07.11 | PR: 1LA     |                |                |                              |                              |                         |     |                |        |  |                         |     |
| 3.0 TDI quattro  | 160              | 05.15 | PR: 1LA     |                |                |                              |                              |                         |     |                |        |  |                         |     |
| 3.0 TDI quattro  | 176              | 07.11 | PR: 1LA     |                |                |                              |                              |                         |     |                |        |  |                         |     |
| 3.0 TDI quattro  | 180              | 07.11 | PR: 1LA     |                |                |                              |                              |                         |     |                |        |  |                         |     |

<sup>1)</sup> Spring dimension 44 mm / dimensioni molla 44 mm / dimension de ressort 44 mm / medida de muelle 44 mm



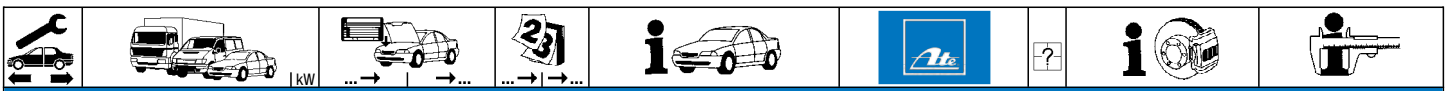

**AUDI A5 / A5 Sportback (07-)**

|                 |                  |          |             |                |                |                |                        |                        |
|-----------------|------------------|----------|-------------|----------------|----------------|----------------|------------------------|------------------------|
|                 | 3.0 TFSI quattro | 200      | 12.11       | PR: 1LA        | 24.0130-0221.1 | 430221         |                        | 320 30,0 28,0 VL +S +B |
|                 | 3.2 FSI          | 195      | 07.11       | PR: 1LA        |                |                |                        |                        |
|                 | 3.2 FSI quattro  | 195      | 07.11       | PR: 1LA        |                |                |                        |                        |
|                 | 1.8 TFSI         | 106      | 06.14       | PR: 1LJ        | 24.0129-0102.1 | 429102         |                        | 345 29,5 28,0 VL +S +B |
|                 | 1.8 TFSI         | 118      | 05.09       | PR: 1LJ        |                |                |                        |                        |
|                 | 1.8 TFSI         | 125      | 10.07       | PR: 1LJ        |                |                |                        |                        |
|                 | 1.8 TFSI         | 130      | 05.15       | PR: 1LJ        |                |                |                        |                        |
|                 | 2.0 TDI          | 105      | 09.09       | PR: 1LJ        |                |                |                        |                        |
|                 | 2.0 TDI          | 110      | 05.13       | PR: 1LJ        |                |                |                        |                        |
|                 | 2.0 TDI          | 120      | 10.08       | PR: 1LJ        |                |                |                        |                        |
|                 | 2.0 TDI          | 125      | 08.08       | PR: 1LJ        |                |                |                        |                        |
|                 | 2.0 TDI          | 130      | 07.11       | PR: 1LJ        |                |                |                        |                        |
|                 | 2.0 TDI          | 140      | 09.13       | PR: 1LJ        |                |                |                        |                        |
|                 | 2.0 TDI quattro  | 125      | 08.08       | PR: 1LJ        |                |                |                        |                        |
|                 | 2.0 TDI quattro  | 130      | 12.11       | PR: 1LJ        |                |                |                        |                        |
|                 | 2.0 TDI quattro  | 140      | 09.13       | PR: 1LJ        |                |                |                        |                        |
|                 | 2.0 TFSI         | 132      | 11.08       | PR: 1LJ        |                |                |                        |                        |
|                 | 2.0 TFSI         | 155      | 06.08       | PR: 1LJ        |                |                |                        |                        |
|                 | 2.0 TFSI         | 165      | 05.13       | PR: 1LJ        |                |                |                        |                        |
|                 | 2.0 TFSI         | 169      | 08.15       | PR: 1LJ        |                |                |                        |                        |
|                 | 2.0 TFSI quattro | 155      | 06.08       | PR: 1LJ        |                |                |                        |                        |
|                 | 2.0 TFSI quattro | 165      | 05.13       | PR: 1LJ        |                |                |                        |                        |
|                 | 2.0 TFSI quattro | 169      | 08.15       | PR: 1LJ        |                |                |                        |                        |
|                 | 2.7 TDI          | 120      | 09.07       | PR: 1LJ        |                |                |                        |                        |
|                 | 2.7 TDI          | 140      | 05.07       | PR: 1LJ        |                |                |                        |                        |
|                 | 3.0 TDI          | 150      | 07.11       | PR: 1LJ        |                |                |                        |                        |
|                 | 3.0 TDI quattro  | 155      | 03.08       | PR: 1LJ        |                |                |                        |                        |
|                 | 3.0 TDI quattro  | 160      | 05.15       | PR: 1LJ        |                |                |                        |                        |
|                 | 3.0 TDI quattro  | 176      | 05.07       | PR: 1LJ        |                |                |                        |                        |
|                 | 3.0 TDI quattro  | 180      | 07.11       | PR: 1LJ        |                |                |                        |                        |
|                 | 3.0 TFSI quattro | 200      | 12.11       | PR: 1LJ        |                |                |                        |                        |
|                 | 3.2 FSI          | 195      | 05.07       | PR: 1LJ        |                |                |                        |                        |
|                 | 3.2 FSI quattro  | 195      | 05.07       | PR: 1LJ        |                |                |                        |                        |
|                 | S5               | 245      | 01.10       | 06.11 PR: 1LJ  |                |                |                        |                        |
|                 | S5               | 260      | 05.07       | 06.11 PR: 1LJ  |                |                |                        |                        |
|                 | S5               | 245      | 07.11       | PR: 1LJ        | 24.0130-0222.1 | 430222         |                        | 345 30,0 28,0 VL +S +B |
| S5              | 260              | 07.11    | PR: 1LJ     |                |                |                |                        |                        |
| S5              | 245              | 01.10    | PR: 1ZT     | 24.0130-0222.1 | 430222         |                | 345 30,0 28,0 VL +S +B |                        |
| S5              | 260              | 05.07    | PR: 1ZT     |                |                |                |                        |                        |
|                 | 1.8 TFSI         | 106      | 06.14       | PR: 1LD        | 24.0130-0222.1 | 430222         |                        | 345 30,0 28,0 VL +S +B |
|                 | 1.8 TFSI         | 118      | 05.09       | PR: 1LD        |                |                |                        |                        |
|                 | 1.8 TFSI         | 125      | 10.07       | PR: 1LD        |                |                |                        |                        |
|                 | 1.8 TFSI         | 130      | 05.15       | PR: 1LD        |                |                |                        |                        |
|                 | 2.0 TDI          | 105      | 09.09       | PR: 1LD        |                |                |                        |                        |
|                 | 2.0 TDI          | 110      | 05.13       | PR: 1LD        |                |                |                        |                        |
|                 | 2.0 TDI          | 120      | 10.08       | PR: 1LD        |                |                |                        |                        |
|                 | 2.0 TDI          | 125      | 08.08       | PR: 1LD        |                |                |                        |                        |
|                 | 2.0 TDI          | 130      | 07.11       | PR: 1LD        |                |                |                        |                        |
|                 | 2.0 TDI          | 140      | 09.13       | PR: 1LD        |                |                |                        |                        |
|                 | 2.0 TDI quattro  | 125      | 08.08       | PR: 1LD        |                |                |                        |                        |
|                 | 2.0 TDI quattro  | 130      | 12.11       | PR: 1LD        |                |                |                        |                        |
|                 | 2.0 TDI quattro  | 140      | 09.13       | PR: 1LD        |                |                |                        |                        |
|                 | 2.0 TFSI         | 132      | 11.08       | PR: 1LD        |                |                |                        |                        |
|                 | 2.0 TFSI         | 155      | 06.08       | PR: 1LD        |                |                |                        |                        |
|                 | 2.0 TFSI         | 165      | 05.13       | PR: 1LD        |                |                |                        |                        |
|                 | 2.0 TFSI         | 169      | 08.15       | PR: 1LD        |                |                |                        |                        |
|                 | 2.0 TFSI quattro | 155      | 06.08       | PR: 1LD        |                |                |                        |                        |
|                 | 2.0 TFSI quattro | 165      | 05.13       | PR: 1LD        |                |                |                        |                        |
|                 | 2.0 TFSI quattro | 169      | 08.15       | PR: 1LD        |                |                |                        |                        |
|                 | 2.7 TDI          | 120      | 09.07       | PR: 1LD        |                |                |                        |                        |
|                 | 2.7 TDI          | 140      | 05.07       | PR: 1LD        |                |                |                        |                        |
|                 | 3.0 TDI          | 150      | 07.11       | PR: 1LD        |                |                |                        |                        |
|                 | 3.0 TDI quattro  | 155      | 03.08       | PR: 1LD        |                |                |                        |                        |
|                 | 3.0 TDI quattro  | 160      | 05.15       | PR: 1LD        |                |                |                        |                        |
|                 | 3.0 TDI quattro  | 176      | 05.07       | PR: 1LD        |                |                |                        |                        |
|                 | 3.0 TDI quattro  | 180      | 07.11       | PR: 1LD        |                |                |                        |                        |
|                 | 3.0 TFSI quattro | 200      | 12.11       | PR: 1LD        |                |                |                        |                        |
|                 | 3.2 FSI          | 195      | 05.07       | PR: 1LD        |                |                |                        |                        |
|                 | 3.2 FSI quattro  | 195      | 06.07       | PR: 1LD        |                |                |                        |                        |
|                 | S5               | 245      | 01.10       | PR: 1ZT,1LD    |                |                |                        |                        |
|                 | S5               | 260      | 05.07       | PR: 1ZT,1LD    |                |                |                        |                        |
|                 |                  | 1.8 TFSI | 106         | 06.14          | PR: 1KW,2EH    | 13.0460-2747.2 | 602747                 |                        |
| 1.8 TFSI        |                  | 118      | 05.09       | PR: 1KW,2EH    | 13.0470-2747.2 | LD2747         |                        | 24606 17,4 +/Zub/S TRW |
| 1.8 TFSI        |                  | 125      | 10.07       | PR: 1KW,2EH    |                |                |                        |                        |
| 1.8 TFSI        |                  | 130      | 05.15       | PR: 1KW,2EH    |                |                |                        |                        |
| 2.0 TDI         |                  | 105      | 09.09       | PR: 1KW,2EH    |                |                |                        |                        |
| 2.0 TDI         |                  | 110      | 05.13       | PR: 1KW,2EH    |                |                |                        |                        |
| 2.0 TDI         |                  | 120      | 10.08       | PR: 1KW,2EH    |                |                |                        |                        |
| 2.0 TDI         |                  | 125      | 08.08       | PR: 1KW,2EH    |                |                |                        |                        |
| 2.0 TDI         |                  | 130      | 07.11       | PR: 1KW,2EH    |                |                |                        |                        |
| 2.0 TDI         |                  | 140      | 09.13       | PR: 1KW,2EH    |                |                |                        |                        |
| 2.0 TDI quattro |                  | 125      | 08.08       | PR: 1KW,2EH    |                |                |                        |                        |
| 2.0 TDI quattro |                  | 130      | 12.11       | PR: 1KW,2EH    |                |                |                        |                        |
| 2.0 TDI quattro |                  | 140      | 09.13       | PR: 1KW,2EH    |                |                |                        |                        |
| 2.0 TFSI        |                  | 132      | 11.08       | PR: 1KW,2EH    |                |                |                        |                        |
| 2.0 TFSI        |                  | 155      | 06.08       | PR: 1KW,2EH    |                |                |                        |                        |
| 2.0 TFSI        | 165              | 05.13    | PR: 1KW,2EH |                |                |                |                        |                        |

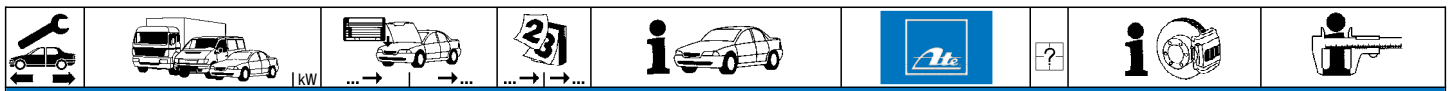

**AUDI A5 / A5 Sportback (07-)**

|                  |                  |       |               |                |                |                    |                     |                        |     |        |                    |     |
|------------------|------------------|-------|---------------|----------------|----------------|--------------------|---------------------|------------------------|-----|--------|--------------------|-----|
|                  | 2.0 TFSI         | 169   | 08.15         | PR: 1KW,2EH    | 13.0460-2747.2 | 602747             |                     | 24606 17,4 +/Zub/S     | TRW |        |                    |     |
|                  | 2.0 TFSI quattro | 155   | 06.08         | PR: 1KW,2EH    |                | LD2747             |                     |                        |     |        |                    |     |
|                  | 2.0 TFSI quattro | 165   | 05.13         | PR: 1KW,2EH    |                |                    |                     |                        |     |        |                    |     |
|                  | 2.0 TFSI quattro | 169   | 08.15         | PR: 1KW,2EH    |                |                    |                     |                        |     |        |                    |     |
|                  | 2.7 TDI          | 120   | 09.07         | PR: 1KW,2EH    |                |                    |                     |                        |     |        |                    |     |
|                  | 2.7 TDI          | 140   | 05.07         | PR: 1KW,2EH    |                |                    |                     |                        |     |        |                    |     |
|                  | 3.0 TDI          | 150   | 07.11         | PR: 1KW,2EH    |                |                    |                     |                        |     |        |                    |     |
|                  | 3.0 TDI quattro  | 155   | 03.08         | PR: 1KW,2EH    |                |                    |                     |                        |     |        |                    |     |
|                  | 3.0 TDI quattro  | 160   | 05.15         | PR: 1KW,2EH    |                |                    |                     |                        |     |        |                    |     |
|                  | 3.0 TDI quattro  | 176   | 05.07         | PR: 1KW,2EH    |                |                    |                     |                        |     |        |                    |     |
|                  | 3.0 TDI quattro  | 180   | 07.11         | PR: 1KW,2EH    |                |                    |                     |                        |     |        |                    |     |
|                  | 3.0 TFSI quattro | 200   | 12.11         | PR: 1KW,2EH    |                |                    |                     |                        |     |        |                    |     |
|                  | 3.2 FSI          | 195   | 05.07         | PR: 1KW,2EH    |                |                    |                     |                        |     |        |                    |     |
|                  | 3.2 FSI quattro  | 195   | 06.07         | PR: 1KW,2EH    |                |                    |                     |                        |     |        |                    |     |
|                  | 1.8 TFSI         | 106   | 06.14         | PR: 1KE        |                | 13.0460-2748.2     |                     |                        |     | 602748 | 24606 17,4 +/Zub/S | TRW |
|                  | 1.8 TFSI         | 118   | 05.09         | PR: 1KE        |                | 13.0470-2748.2     |                     |                        |     | LD2748 |                    |     |
|                  | 1.8 TFSI         | 125   | 10.07         | PR: 1KE        |                | 13.0460-0023.2     |                     |                        |     | 610023 |                    |     |
|                  | 1.8 TFSI         | 130   | 05.15         | PR: 1KE        |                |                    |                     |                        |     |        |                    |     |
|                  | 2.0 TDI          | 105   | 09.09         | PR: 1KE        |                |                    |                     |                        |     |        |                    |     |
| 2.0 TDI          | 110              | 05.13 | PR: 1KE       |                |                |                    |                     |                        |     |        |                    |     |
| 2.0 TDI          | 120              | 10.08 | PR: 1KE       |                |                |                    |                     |                        |     |        |                    |     |
| 2.0 TDI          | 125              | 08.08 | PR: 1KE       |                |                |                    |                     |                        |     |        |                    |     |
| 2.0 TDI          | 130              | 07.11 | PR: 1KE       |                |                |                    |                     |                        |     |        |                    |     |
| 2.0 TDI          | 140              | 09.13 | PR: 1KE       |                |                |                    |                     |                        |     |        |                    |     |
| 2.0 TDI quattro  | 125              | 08.08 | PR: 1KE       |                |                |                    |                     |                        |     |        |                    |     |
| 2.0 TDI quattro  | 130              | 12.11 | PR: 1KE       |                |                |                    |                     |                        |     |        |                    |     |
| 2.0 TDI quattro  | 140              | 09.13 | PR: 1KE       |                |                |                    |                     |                        |     |        |                    |     |
| 2.0 TFSI         | 132              | 11.08 | PR: 1KE       |                |                |                    |                     |                        |     |        |                    |     |
| 2.0 TFSI         | 155              | 06.08 | PR: 1KE       |                |                |                    |                     |                        |     |        |                    |     |
| 2.0 TFSI         | 165              | 05.13 | PR: 1KE       |                |                |                    |                     |                        |     |        |                    |     |
| 2.0 TFSI         | 169              | 08.15 | PR: 1KE       |                |                |                    |                     |                        |     |        |                    |     |
| 2.0 TFSI quattro | 155              | 06.08 | PR: 1KE       |                |                |                    |                     |                        |     |        |                    |     |
| 2.0 TFSI quattro | 165              | 05.13 | PR: 1KE       |                |                |                    |                     |                        |     |        |                    |     |
| 2.0 TFSI quattro | 169              | 08.15 | PR: 1KE       |                |                |                    |                     |                        |     |        |                    |     |
| 2.7 TDI          | 120              | 09.07 | PR: 1KE       |                |                |                    |                     |                        |     |        |                    |     |
| 2.7 TDI          | 140              | 05.07 | PR: 1KE       |                |                |                    |                     |                        |     |        |                    |     |
| 3.0 TDI          | 150              | 07.11 | PR: 1KE       |                |                |                    |                     |                        |     |        |                    |     |
| 3.0 TDI quattro  | 155              | 03.08 | PR: 1KE       |                |                |                    |                     |                        |     |        |                    |     |
| 3.0 TDI quattro  | 160              | 05.15 | PR: 1KE       |                |                |                    |                     |                        |     |        |                    |     |
| 3.0 TDI quattro  | 176              | 05.07 | PR: 1KE       |                |                |                    |                     |                        |     |        |                    |     |
| 3.0 TDI quattro  | 180              | 07.11 | PR: 1KE       |                |                |                    |                     |                        |     |        |                    |     |
| 3.0 TFSI quattro | 200              | 12.11 | PR: 1KE       |                |                |                    |                     |                        |     |        |                    |     |
| 3.2 FSI          | 195              | 05.07 | PR: 1KE       |                |                |                    |                     |                        |     |        |                    |     |
| 3.2 FSI quattro  | 195              | 05.07 | PR: 1KE       |                |                |                    |                     |                        |     |        |                    |     |
| RS 5             | 331              | 03.10 | PR: GP1       |                |                |                    |                     |                        |     |        |                    |     |
| S5               | 245              | 01.10 | 10.10 PR: 1KE |                |                |                    |                     |                        |     |        |                    |     |
| S5               | 260              | 05.07 | 10.10 PR: 1KE |                |                |                    |                     |                        |     |        |                    |     |
| 1.8 TFSI         | 106              | 06.14 | PR: 1KP       | 13.0460-2748.2 | 602748         | 24606 17,4 +/Zub/S | TRW                 |                        |     |        |                    |     |
| 1.8 TFSI         | 118              | 05.09 | PR: 1KP       | 13.0470-2748.2 | LD2748         |                    |                     |                        |     |        |                    |     |
| 1.8 TFSI         | 125              | 10.07 | PR: 1KP       |                |                |                    |                     |                        |     |        |                    |     |
| 1.8 TFSI         | 130              | 05.15 | PR: 1KP       |                |                |                    |                     |                        |     |        |                    |     |
| 2.0 TDI          | 105              | 09.09 | PR: 1KP       |                |                |                    |                     |                        |     |        |                    |     |
| 2.0 TDI          | 110              | 05.13 | PR: 1KP       |                |                |                    |                     |                        |     |        |                    |     |
| 2.0 TDI          | 120              | 10.08 | PR: 1KP       |                |                |                    |                     |                        |     |        |                    |     |
| 2.0 TDI          | 125              | 08.08 | PR: 1KP       |                |                |                    |                     |                        |     |        |                    |     |
| 2.0 TDI          | 130              | 07.11 | PR: 1KP       |                |                |                    |                     |                        |     |        |                    |     |
| 2.0 TDI          | 140              | 09.13 | PR: 1KP       |                |                |                    |                     |                        |     |        |                    |     |
| 2.0 TDI quattro  | 125              | 08.08 | PR: 1KP       |                |                |                    |                     |                        |     |        |                    |     |
| 2.0 TDI quattro  | 130              | 12.11 | PR: 1KP       |                |                |                    |                     |                        |     |        |                    |     |
| 2.0 TDI quattro  | 140              | 09.13 | PR: 1KP       |                |                |                    |                     |                        |     |        |                    |     |
| 2.0 TFSI         | 132              | 11.08 | PR: 1KP       |                |                |                    |                     |                        |     |        |                    |     |
| 2.0 TFSI         | 155              | 06.08 | PR: 1KP       |                |                |                    |                     |                        |     |        |                    |     |
| 2.0 TFSI         | 165              | 05.13 | PR: 1KP       |                |                |                    |                     |                        |     |        |                    |     |
| 2.0 TFSI         | 169              | 08.15 | PR: 1KP       |                |                |                    |                     |                        |     |        |                    |     |
| 2.0 TFSI quattro | 155              | 06.08 | PR: 1KP       |                |                |                    |                     |                        |     |        |                    |     |
| 2.0 TFSI quattro | 165              | 05.13 | PR: 1KP       |                |                |                    |                     |                        |     |        |                    |     |
| 2.0 TFSI quattro | 169              | 08.15 | PR: 1KP       |                |                |                    |                     |                        |     |        |                    |     |
| 2.7 TDI          | 120              | 09.07 | PR: 1KP       |                |                |                    |                     |                        |     |        |                    |     |
| 2.7 TDI          | 140              | 05.07 | PR: 1KP       |                |                |                    |                     |                        |     |        |                    |     |
| 3.0 TDI          | 150              | 07.11 | PR: 1KP       |                |                |                    |                     |                        |     |        |                    |     |
| 3.0 TDI quattro  | 155              | 03.08 | PR: 1KP       |                |                |                    |                     |                        |     |        |                    |     |
| 3.0 TDI quattro  | 160              | 05.15 | PR: 1KP       |                |                |                    |                     |                        |     |        |                    |     |
| 3.0 TDI quattro  | 176              | 05.07 | PR: 1KP       |                |                |                    |                     |                        |     |        |                    |     |
| 3.0 TDI quattro  | 180              | 07.11 | PR: 1KP       |                |                |                    |                     |                        |     |        |                    |     |
| 3.0 TFSI quattro | 200              | 12.11 | PR: 1KP       |                |                |                    |                     |                        |     |        |                    |     |
| 3.2 FSI          | 195              | 05.07 | PR: 1KP       |                |                |                    |                     |                        |     |        |                    |     |
| 3.2 FSI quattro  | 195              | 05.07 | PR: 1KP       |                |                |                    |                     |                        |     |        |                    |     |
| RS 5             | 331              | 03.10 | PR: 1KP       |                |                |                    |                     |                        |     |        |                    |     |
| S5               | 245              | 11.10 | PR: 1KE,1KP   |                |                |                    |                     |                        |     |        |                    |     |
| S5               | 260              | 11.10 | PR: 1KE,1KP   |                |                |                    |                     |                        |     |        |                    |     |
|                  | 1.8 TFSI         | 106   | 06.14         | PR: 1KW,2EH    | 24.0112-0178.1 | 412178             | 300 12,0 10,0 +S +B | 300 12,0 10,0 +S +B PD |     |        |                    |     |
|                  | 1.8 TFSI         | 118   | 05.09         | PR: 1KW,2EH    | 24.0312-0178.1 | 512178             |                     |                        |     |        |                    |     |
|                  | 1.8 TFSI         | 125   | 10.07         | PR: 1KW,2EH    |                |                    |                     |                        |     |        |                    |     |
|                  | 1.8 TFSI         | 130   | 05.15         | PR: 1KW,2EH    |                |                    |                     |                        |     |        |                    |     |
|                  | 2.0 TDI          | 105   | 09.09         | PR: 1KW,2EH    |                |                    |                     |                        |     |        |                    |     |
|                  | 2.0 TDI          | 110   | 05.13         | PR: 1KW,2EH    |                |                    |                     |                        |     |        |                    |     |
| 2.0 TDI          | 120              | 10.08 | PR: 1KW,2EH   |                |                |                    |                     |                        |     |        |                    |     |



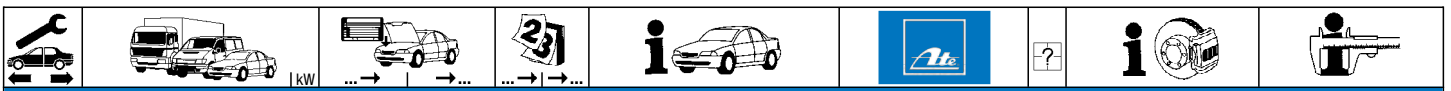

**AUDI A5 / A5 Sportback (07-)**

|  |                      |       |               |                |        |  |                         |
|--|----------------------|-------|---------------|----------------|--------|--|-------------------------|
|  | 2.0 TDI 125          | 08.08 | PR: 1KW,2EH   | 24.0112-0178.1 | 412178 |  | 300 12,0 10,0 +S +B     |
|  | 2.0 TDI 130          | 07.11 | PR: 1KW,2EH   | 24.0312-0178.1 | 512178 |  | 300 12,0 10,0 +S +B PD  |
|  | 2.0 TDI 140          | 09.13 | PR: 1KW,2EH   |                |        |  |                         |
|  | 2.0 TDI quattro 125  | 08.08 | PR: 1KW,2EH   |                |        |  |                         |
|  | 2.0 TDI quattro 130  | 12.11 | PR: 1KW,2EH   |                |        |  |                         |
|  | 2.0 TDI quattro 140  | 09.13 | PR: 1KW,2EH   |                |        |  |                         |
|  | 2.0 TFSI 132         | 11.08 | PR: 1KW,2EH   |                |        |  |                         |
|  | 2.0 TFSI 155         | 06.08 | PR: 1KW,2EH   |                |        |  |                         |
|  | 2.0 TFSI 165         | 05.13 | PR: 1KW,2EH   |                |        |  |                         |
|  | 2.0 TFSI 169         | 08.15 | PR: 1KW,2EH   |                |        |  |                         |
|  | 2.0 TFSI quattro 155 | 06.08 | PR: 1KW,2EH   |                |        |  |                         |
|  | 2.0 TFSI quattro 165 | 05.13 | PR: 1KW,2EH   |                |        |  |                         |
|  | 2.0 TFSI quattro 169 | 08.15 | PR: 1KW,2EH   |                |        |  |                         |
|  | 2.7 TDI 120          | 09.07 | PR: 1KW,2EH   |                |        |  |                         |
|  | 2.7 TDI 140          | 05.07 | PR: 1KW,2EH   |                |        |  |                         |
|  | 3.0 TDI 150          | 07.11 | PR: 1KW,2EH   |                |        |  |                         |
|  | 3.0 TDI quattro 155  | 03.08 | PR: 1KW,2EH   |                |        |  |                         |
|  | 3.0 TDI quattro 160  | 05.15 | PR: 1KW,2EH   |                |        |  |                         |
|  | 3.0 TDI quattro 176  | 05.07 | PR: 1KW,2EH   |                |        |  |                         |
|  | 3.0 TDI quattro 180  | 07.11 | PR: 1KW,2EH   |                |        |  |                         |
|  | 3.0 TFSI quattro 200 | 12.11 | PR: 1KW,2EH   |                |        |  |                         |
|  | 3.2 FSI 195          | 05.07 | PR: 1KW,2EH   |                |        |  |                         |
|  | 3.2 FSI quattro 195  | 06.07 | PR: 1KW,2EH   |                |        |  |                         |
|  | 1.8 TFSI 106         | 06.14 | PR: 1KE       | 24.0122-0250.1 | 422250 |  | 330 22,0 20,0 V L +S +B |
|  | 1.8 TFSI 118         | 05.09 | PR: 1KE       |                |        |  |                         |
|  | 1.8 TFSI 125         | 10.07 | PR: 1KE       |                |        |  |                         |
|  | 1.8 TFSI 130         | 05.15 | PR: 1KE       |                |        |  |                         |
|  | 2.0 TDI 105          | 09.09 | PR: 1KE       |                |        |  |                         |
|  | 2.0 TDI 110          | 05.13 | PR: 1KE       |                |        |  |                         |
|  | 2.0 TDI 120          | 10.08 | PR: 1KE       |                |        |  |                         |
|  | 2.0 TDI 125          | 08.08 | PR: 1KE       |                |        |  |                         |
|  | 2.0 TDI 130          | 07.11 | PR: 1KE       |                |        |  |                         |
|  | 2.0 TDI 140          | 09.13 | PR: 1KE       |                |        |  |                         |
|  | 2.0 TDI quattro 125  | 08.08 | PR: 1KE       |                |        |  |                         |
|  | 2.0 TDI quattro 130  | 12.11 | PR: 1KE       |                |        |  |                         |
|  | 2.0 TDI quattro 140  | 09.13 | PR: 1KE       |                |        |  |                         |
|  | 2.0 TFSI 132         | 11.08 | PR: 1KE       |                |        |  |                         |
|  | 2.0 TFSI 155         | 06.08 | PR: 1KE       |                |        |  |                         |
|  | 2.0 TFSI 165         | 05.13 | PR: 1KE       |                |        |  |                         |
|  | 2.0 TFSI 169         | 08.15 | PR: 1KE       |                |        |  |                         |
|  | 2.0 TFSI quattro 155 | 06.08 | PR: 1KE       |                |        |  |                         |
|  | 2.0 TFSI quattro 165 | 05.13 | PR: 1KE       |                |        |  |                         |
|  | 2.0 TFSI quattro 169 | 08.15 | PR: 1KE       |                |        |  |                         |
|  | 2.7 TDI 120          | 09.07 | PR: 1KE       |                |        |  |                         |
|  | 2.7 TDI 140          | 05.07 | PR: 1KE       |                |        |  |                         |
|  | 3.0 TDI 150          | 07.11 | PR: 1KE       |                |        |  |                         |
|  | 3.0 TDI quattro 155  | 03.08 | PR: 1KE       |                |        |  |                         |
|  | 3.0 TDI quattro 160  | 05.15 | PR: 1KE       |                |        |  |                         |
|  | 3.0 TDI quattro 176  | 05.07 | PR: 1KE       |                |        |  |                         |
|  | 3.0 TDI quattro 180  | 07.11 | PR: 1KE       |                |        |  |                         |
|  | 3.2 FSI 195          | 05.07 | PR: 1KE       |                |        |  |                         |
|  | 3.2 FSI quattro 195  | 05.07 | PR: 1KE       |                |        |  |                         |
|  | S5 245               | 01.10 | 10.10 PR: 1KE |                |        |  |                         |
|  | S5 260               | 05.07 | 10.10 PR: 1KE |                |        |  |                         |
|  | 1.8 TFSI 106         | 06.14 | PR: 1KP       | 24.0122-0272.1 | 422272 |  | 330 21,9 20,0 V L +S +B |
|  | 1.8 TFSI 118         | 05.09 | PR: 1KP       |                |        |  |                         |
|  | 1.8 TFSI 125         | 10.07 | PR: 1KP       |                |        |  |                         |
|  | 1.8 TFSI 130         | 05.15 | PR: 1KP       |                |        |  |                         |
|  | 2.0 TDI 105          | 09.09 | PR: 1KP       |                |        |  |                         |
|  | 2.0 TDI 110          | 05.13 | PR: 1KP       |                |        |  |                         |
|  | 2.0 TDI 120          | 10.08 | PR: 1KP       |                |        |  |                         |
|  | 2.0 TDI 125          | 08.08 | PR: 1KP       |                |        |  |                         |
|  | 2.0 TDI 130          | 07.11 | PR: 1KP       |                |        |  |                         |
|  | 2.0 TDI 140          | 09.13 | PR: 1KP       |                |        |  |                         |
|  | 2.0 TDI quattro 125  | 08.08 | PR: 1KP       |                |        |  |                         |
|  | 2.0 TDI quattro 130  | 12.11 | PR: 1KP       |                |        |  |                         |
|  | 2.0 TDI quattro 140  | 09.13 | PR: 1KP       |                |        |  |                         |
|  | 2.0 TFSI 132         | 11.08 | PR: 1KP       |                |        |  |                         |
|  | 2.0 TFSI 155         | 06.08 | PR: 1KP       |                |        |  |                         |
|  | 2.0 TFSI 165         | 05.13 | PR: 1KP       |                |        |  |                         |
|  | 2.0 TFSI 169         | 08.15 | PR: 1KP       |                |        |  |                         |
|  | 2.0 TFSI quattro 155 | 06.08 | PR: 1KP       |                |        |  |                         |
|  | 2.0 TFSI quattro 165 | 05.13 | PR: 1KP       |                |        |  |                         |
|  | 2.0 TFSI quattro 169 | 08.15 | PR: 1KP       |                |        |  |                         |
|  | 2.7 TDI 120          | 09.07 | PR: 1KP       |                |        |  |                         |
|  | 2.7 TDI 140          | 05.07 | PR: 1KP       |                |        |  |                         |
|  | 3.0 TDI 150          | 07.11 | PR: 1KP       |                |        |  |                         |
|  | 3.0 TDI quattro 155  | 03.08 | PR: 1KP       |                |        |  |                         |
|  | 3.0 TDI quattro 160  | 05.15 | PR: 1KP       |                |        |  |                         |
|  | 3.0 TDI quattro 176  | 05.07 | PR: 1KP       |                |        |  |                         |
|  | 3.0 TDI quattro 180  | 07.11 | PR: 1KP       |                |        |  |                         |
|  | 3.2 FSI 195          | 05.07 | PR: 1KP       |                |        |  |                         |
|  | 3.2 FSI quattro 195  | 05.07 | PR: 1KP       |                |        |  |                         |
|  | S5 245               | 11.10 | PR: 1KE,1KP   |                |        |  |                         |
|  | S5 260               | 11.10 | PR: 1KE,1KP   |                |        |  |                         |

**AUDI A5 Cabrio (09-)**

|                  |                  |       |                     |                     |                |        |                              |                              |                   |     |
|------------------|------------------|-------|---------------------|---------------------|----------------|--------|------------------------------|------------------------------|-------------------|-----|
|                  | 1.8 TFSI         | 118   | 09.09               | PR: 1LT             | 13.0460-7256.2 | 607256 |                              | 24705 19,8 +/WK              | ATE               |     |
|                  | 1.8 TFSI         | 125   | 07.11               | PR: 1LT             | 13.0470-7256.2 | LD7256 |                              | 24705 19,8 +/WK              | ATE               |     |
|                  | 1.8 TFSI         | 130   | 05.15               | PR: 1LT             |                |        |                              |                              |                   |     |
|                  | 2.0 TDI          | 105   | 11.11               | PR: 1LT             |                |        |                              |                              |                   |     |
|                  | 2.0 TDI          | 110   | 05.13               | PR: 1LT             |                |        |                              |                              |                   |     |
|                  | 2.0 TDI          | 120   | 05.09               | PR: 1LT             |                |        |                              |                              |                   |     |
|                  | 2.0 TDI          | 125   | 05.09               | PR: 1LT             |                |        |                              |                              |                   |     |
|                  | 2.0 TDI          | 130   | 07.11               | PR: 1LT             |                |        |                              |                              |                   |     |
|                  | 2.0 TDI          | 140   | 09.13               | PR: 1LT             |                |        |                              |                              |                   |     |
|                  | 2.0 TDI quattro  | 130   | 01.12               | PR: 1LT             |                |        |                              |                              |                   |     |
|                  | 2.0 TDI quattro  | 140   | 09.13               | PR: 1LT             |                |        |                              |                              |                   |     |
|                  | 2.0 TFSI         | 132   | 03.09               | PR: 1LT             |                |        |                              |                              |                   |     |
|                  | 2.0 TFSI         | 155   | 03.09               | PR: 1LT             |                |        |                              |                              |                   |     |
|                  | 2.0 TFSI         | 165   | 05.13               | PR: 1LT             |                |        |                              |                              |                   |     |
|                  | 2.0 TFSI         | 169   | 08.15               | PR: 1LT             |                |        |                              |                              |                   |     |
|                  | 2.0 TFSI quattro | 155   | 03.09               | PR: 1LT             |                |        |                              |                              |                   |     |
|                  | 2.0 TFSI quattro | 165   | 05.13               | PR: 1LT             |                |        |                              |                              |                   |     |
|                  | 2.0 TFSI quattro | 169   | 08.15               | PR: 1LT             |                |        |                              |                              |                   |     |
|                  | 2.7 TDI          | 120   | 05.09               | PR: 1LT             |                |        |                              |                              |                   |     |
|                  | 2.7 TDI          | 140   | 03.09               | PR: 1LT             |                |        |                              |                              |                   |     |
|                  | 3.0 TDI          | 150   | 07.11               | PR: 1LT             |                |        |                              |                              |                   |     |
|                  | 3.0 TDI quattro  | 160   | 05.15               | PR: 1LT             |                |        |                              |                              |                   |     |
|                  | 3.0 TDI quattro  | 176   | 03.09               | PR: 1LT             |                |        |                              |                              |                   |     |
|                  | 3.0 TDI quattro  | 180   | 07.11               | PR: 1LT             |                |        |                              |                              |                   |     |
|                  | 3.0 TFSI quattro | 200   | 11.11               | PR: 1LT             |                |        |                              |                              |                   |     |
|                  | 3.2 FSI          | 195   | 03.09               | PR: 1LT             |                |        |                              |                              |                   |     |
|                  | 3.2 FSI quattro  | 195   | 03.09               | PR: 1LT             |                |        |                              |                              |                   |     |
|                  | 1.8 TFSI         | 118   | 09.09               | PR: 1LA,1LB,1LD     | 13.0460-2746.2 | 602746 |                              | Federmaß 44 mm <sup>1)</sup> | 24743 19,2 +/WK/S | TRW |
|                  | 1.8 TFSI         | 125   | 07.11               | PR: 1LA,1LB,1LD     | 13.0470-2746.2 | LD2746 |                              | Federmaß 44 mm <sup>1)</sup> | 24743 19,2 +/WK/S | TRW |
|                  | 1.8 TFSI         | 130   | 05.15               | PR: 1LA,1LB,1LD,1LJ |                |        |                              |                              |                   |     |
|                  | 2.0 TDI          | 105   | 11.11               | PR: 1LA,1LB,1LD,1LJ |                |        |                              |                              |                   |     |
|                  | 2.0 TDI          | 110   | 05.13               | PR: 1LA,1LB,1LD     |                |        |                              |                              |                   |     |
| 2.0 TDI          | 120              | 05.09 | PR: 1LA,1LB,1LD     |                     |                |        |                              |                              |                   |     |
| 2.0 TDI          | 125              | 05.09 | PR: 1LA,1LB,1LD     |                     |                |        |                              |                              |                   |     |
| 2.0 TDI          | 130              | 07.11 | PR: 1LA,1LB,1LD     |                     |                |        |                              |                              |                   |     |
| 2.0 TDI          | 140              | 09.13 | PR: 1LA,1LB,1LD     |                     |                |        |                              |                              |                   |     |
| 2.0 TDI quattro  | 130              | 01.12 | PR: 1LA,1LB,1LD,1LJ |                     |                |        |                              |                              |                   |     |
| 2.0 TDI quattro  | 140              | 09.13 | PR: 1LA,1LB,1LD,1LJ |                     |                |        |                              |                              |                   |     |
| 2.0 TFSI         | 132              | 03.09 | PR: 1LA,1LB,1LD     |                     |                |        |                              |                              |                   |     |
| 2.0 TFSI         | 155              | 03.09 | PR: 1LA,1LB,1LD     |                     |                |        |                              |                              |                   |     |
| 2.0 TFSI         | 165              | 05.13 | PR: 1LA,1LB,1LD     |                     |                |        |                              |                              |                   |     |
| 2.0 TFSI         | 169              | 08.15 | PR: 1LA,1LB,1LD     |                     |                |        |                              |                              |                   |     |
| 2.0 TFSI quattro | 155              | 03.09 | PR: 1LA,1LB,1LD     |                     |                |        |                              |                              |                   |     |
| 2.0 TFSI quattro | 165              | 05.13 | PR: 1LA,1LB,1LD     |                     |                |        |                              |                              |                   |     |
| 2.0 TFSI quattro | 169              | 08.15 | PR: 1LA,1LB,1LD     |                     |                |        |                              |                              |                   |     |
| 2.7 TDI          | 120              | 05.09 | PR: 1LA,1LB,1LD     |                     |                |        |                              |                              |                   |     |
| 2.7 TDI          | 140              | 03.09 | PR: 1LA,1LB,1LD     |                     |                |        |                              |                              |                   |     |
| 3.0 TDI          | 150              | 07.11 | PR: 1LA,1LB,1LD     |                     |                |        |                              |                              |                   |     |
| 3.0 TDI quattro  | 160              | 05.15 | PR: 1LA,1LB,1LD,1LJ |                     |                |        |                              |                              |                   |     |
| 3.0 TDI quattro  | 176              | 03.09 | PR: 1LA,1LB,1LD     |                     |                |        |                              |                              |                   |     |
| 3.0 TDI quattro  | 180              | 07.11 | PR: 1LA,1LB,1LD     |                     |                |        |                              |                              |                   |     |
| 3.0 TFSI quattro | 200              | 11.11 | PR: 1LA,1LB,1LD,1LJ |                     |                |        |                              |                              |                   |     |
| 3.2 FSI          | 195              | 03.09 | PR: 1LA,1LB,1LD     |                     |                |        |                              |                              |                   |     |
| 3.2 FSI quattro  | 195              | 03.09 | PR: 1LA,1LB,1LD     |                     |                |        |                              |                              |                   |     |
| S5               | 245              | 04.09 | PR: 1ZT,1LD         | 13.0460-2746.2      | 602746         |        | Federmaß 44 mm <sup>1)</sup> | 24743 19,2 +/WK/S            | TRW               |     |
| S5               | 245              | 07.11 | PR: 1LJ             | 13.0460-2746.2      | 602746         |        | Federmaß 44 mm <sup>1)</sup> | 24743 19,2 +/WK/S            | TRW               |     |
| RS 5             | 331              | 02.13 | PR: 1LW             | 24.8190-0017.2      | 620017         | 1      |                              | Warnkontakt L=388,3mm        |                   |     |
|                  | 1.8 TFSI         | 118   | 09.09               | PR: 1LT             | 24.0125-0184.1 | 425184 |                              | 314 25,0 23,0 V L +S +B      |                   |     |
|                  | 1.8 TFSI         | 125   | 07.11               | PR: 1LT             | 24.0325-0184.1 | 525184 |                              | 314 25,0 23,0 V L +S +B PD   |                   |     |
|                  | 1.8 TFSI         | 130   | 05.15               | PR: 1LT             |                |        |                              |                              |                   |     |
|                  | 2.0 TDI          | 105   | 11.11               | PR: 1LT             |                |        |                              |                              |                   |     |
|                  | 2.0 TDI          | 110   | 05.13               | PR: 1LT             |                |        |                              |                              |                   |     |
|                  | 2.0 TDI          | 120   | 05.09               | PR: 1LT             |                |        |                              |                              |                   |     |
|                  | 2.0 TDI          | 125   | 05.09               | PR: 1LT             |                |        |                              |                              |                   |     |
|                  | 2.0 TDI          | 130   | 07.11               | PR: 1LT             |                |        |                              |                              |                   |     |
|                  | 2.0 TDI          | 140   | 09.13               | PR: 1LT             |                |        |                              |                              |                   |     |
|                  | 2.0 TDI quattro  | 130   | 01.12               | PR: 1LT             |                |        |                              |                              |                   |     |
|                  | 2.0 TDI quattro  | 140   | 09.13               | PR: 1LT             |                |        |                              |                              |                   |     |
|                  | 2.0 TFSI         | 132   | 03.09               | PR: 1LT             |                |        |                              |                              |                   |     |
|                  | 2.0 TFSI         | 155   | 03.09               | PR: 1LT             |                |        |                              |                              |                   |     |
|                  | 2.0 TFSI         | 165   | 05.13               | PR: 1LT             |                |        |                              |                              |                   |     |
|                  | 2.0 TFSI         | 169   | 08.15               | PR: 1LT             |                |        |                              |                              |                   |     |
|                  | 2.0 TFSI quattro | 155   | 03.09               | PR: 1LT             |                |        |                              |                              |                   |     |
|                  | 2.0 TFSI quattro | 165   | 05.13               | PR: 1LT             |                |        |                              |                              |                   |     |
|                  | 2.0 TFSI quattro | 169   | 08.15               | PR: 1LT             |                |        |                              |                              |                   |     |
|                  | 2.7 TDI          | 120   | 05.09               | PR: 1LT             |                |        |                              |                              |                   |     |
|                  | 2.7 TDI          | 140   | 03.09               | PR: 1LT             |                |        |                              |                              |                   |     |
| 3.0 TDI          | 150              | 07.11 | PR: 1LT             |                     |                |        |                              |                              |                   |     |
| 3.0 TDI quattro  | 160              | 05.15 | PR: 1LT             |                     |                |        |                              |                              |                   |     |
| 3.0 TDI quattro  | 176              | 03.09 | PR: 1LT             |                     |                |        |                              |                              |                   |     |
| 3.0 TDI quattro  | 180              | 07.11 | PR: 1LT             |                     |                |        |                              |                              |                   |     |
| 3.0 TFSI quattro | 200              | 11.11 | PR: 1LT             |                     |                |        |                              |                              |                   |     |
| 3.2 FSI          | 195              | 03.09 | PR: 1LT             |                     |                |        |                              |                              |                   |     |
| 3.2 FSI quattro  | 195              | 03.09 | PR: 1LT             |                     |                |        |                              |                              |                   |     |
| 1.8 TFSI         | 118              | 09.09 | 06.11 PR: 1LA,1LB   | 24.0130-0193.1      | 430193         |        |                              | 320 30,0 28,0 V L +S +B      |                   |     |
| 2.0 TDI          | 120              | 05.09 | 06.11 PR: 1LA,1LB   | 24.0330-0193.1      | 530193         |        |                              | 320 30,0 28,0 V L +S +B PD   |                   |     |

<sup>1)</sup> spring dimension 44 mm / dimensioni molla 44 mm / dimension de ressort 44 mm / medida de muelle 44 mm



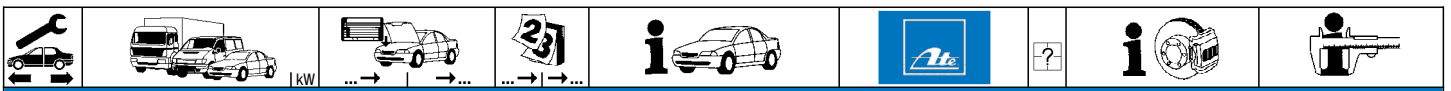



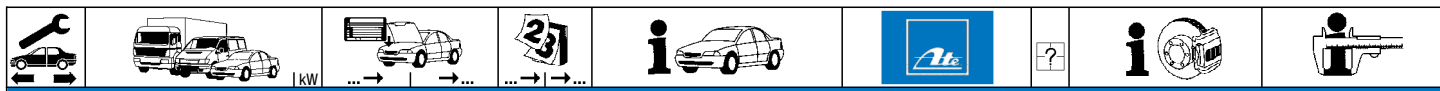

**AUDI A5 Cabrio (09-)**

|                  |                  |     |       |       |             |                |                |        |                        |                           |
|------------------|------------------|-----|-------|-------|-------------|----------------|----------------|--------|------------------------|---------------------------|
|                  | 2.0 TDI          | 125 |       | 05.09 | 06.11       | PR: 1LA,1LB    | 24.0130-0193.1 | 430193 |                        | 320 30,0 28,0 VL +S +B    |
|                  | 2.0 TFSI         | 132 |       | 03.09 | 06.11       | PR: 1LA,1LB    | 24.0330-0193.1 | 530193 |                        | 320 30,0 28,0 VL +S +B PD |
|                  | 2.0 TFSI         | 155 |       | 03.09 | 06.11       | PR: 1LA,1LB    |                |        |                        |                           |
|                  | 2.0 TFSI quattro | 155 |       | 03.09 | 06.11       | PR: 1LA,1LB    |                |        |                        |                           |
|                  | 2.7 TDI          | 120 |       | 05.09 | 06.11       | PR: 1LA,1LB    |                |        |                        |                           |
|                  | 2.7 TDI          | 140 |       | 03.09 | 06.11       | PR: 1LA,1LB    |                |        |                        |                           |
|                  | 3.0 TDI quattro  | 176 |       | 03.09 | 06.11       | PR: 1LA,1LB    |                |        |                        |                           |
|                  | 3.2 FSI          | 195 |       | 03.09 | 06.11       | PR: 1LA,1LB    |                |        |                        |                           |
|                  | 3.2 FSI quattro  | 195 |       | 03.09 | 06.11       | PR: 1LA,1LB    |                |        |                        |                           |
|                  | 1.8 TFSI         | 118 |       | 07.11 |             | PR: 1LA,1LB    | 24.0130-0221.1 | 430221 |                        | 320 30,0 28,0 VL +S +B    |
| 1.8 TFSI         | 125              |     | 07.11 |       | PR: 1LA,1LB |                |                |        |                        |                           |
| 1.8 TFSI         | 130              |     | 05.15 |       | PR: 1LA,1LB |                |                |        |                        |                           |
| 2.0 TDI          | 105              |     | 11.11 |       | PR: 1LA,1LB |                |                |        |                        |                           |
| 2.0 TDI          | 110              |     | 05.13 |       | PR: 1LA,1LB |                |                |        |                        |                           |
| 2.0 TDI          | 120              |     | 07.11 |       | PR: 1LA,1LB |                |                |        |                        |                           |
| 2.0 TDI          | 125              |     | 07.11 |       | PR: 1LA,1LB |                |                |        |                        |                           |
| 2.0 TDI          | 130              |     | 07.11 |       | PR: 1LA,1LB |                |                |        |                        |                           |
| 2.0 TDI          | 140              |     | 09.13 |       | PR: 1LA,1LB |                |                |        |                        |                           |
| 2.0 TDI quattro  | 130              |     | 01.12 |       | PR: 1LA,1LB |                |                |        |                        |                           |
| 2.0 TDI quattro  | 140              |     | 09.13 |       | PR: 1LA,1LB |                |                |        |                        |                           |
| 2.0 TFSI         | 132              |     | 07.11 |       | PR: 1LA,1LB |                |                |        |                        |                           |
| 2.0 TFSI         | 155              |     | 07.11 |       | PR: 1LA,1LB |                |                |        |                        |                           |
| 2.0 TFSI         | 165              |     | 05.13 |       | PR: 1LA,1LB |                |                |        |                        |                           |
| 2.0 TFSI         | 169              |     | 08.15 |       | PR: 1LA,1LB |                |                |        |                        |                           |
| 2.0 TFSI quattro | 155              |     | 07.11 |       | PR: 1LA,1LB |                |                |        |                        |                           |
| 2.0 TFSI quattro | 165              |     | 05.13 |       | PR: 1LA,1LB |                |                |        |                        |                           |
| 2.0 TFSI quattro | 169              |     | 08.15 |       | PR: 1LA,1LB |                |                |        |                        |                           |
| 2.7 TDI          | 120              |     | 07.11 |       | PR: 1LA,1LB |                |                |        |                        |                           |
| 2.7 TDI          | 140              |     | 07.11 |       | PR: 1LA,1LB |                |                |        |                        |                           |
| 3.0 TDI          | 150              |     | 07.11 |       | PR: 1LA,1LB |                |                |        |                        |                           |
| 3.0 TDI quattro  | 160              |     | 05.15 |       | PR: 1LA,1LB |                |                |        |                        |                           |
| 3.0 TDI quattro  | 176              |     | 07.11 |       | PR: 1LA,1LB |                |                |        |                        |                           |
| 3.0 TDI quattro  | 180              |     | 07.11 |       | PR: 1LA,1LB |                |                |        |                        |                           |
| 3.0 TFSI quattro | 200              |     | 11.11 |       | PR: 1LA,1LB |                |                |        |                        |                           |
| 3.2 FSI          | 195              |     | 07.11 |       | PR: 1LA,1LB |                |                |        |                        |                           |
| 3.2 FSI quattro  | 195              |     | 07.11 |       | PR: 1LA,1LB |                |                |        |                        |                           |
| 1.8 TFSI         | 118              |     | 09.09 |       | PR: 1LJ     | 24.0129-0102.1 | 429102         |        | 345 29,5 28,0 VL +S +B |                           |
| 1.8 TFSI         | 125              |     | 07.11 |       | PR: 1LJ     |                |                |        |                        |                           |
| 1.8 TFSI         | 130              |     | 05.15 |       | PR: 1LJ     |                |                |        |                        |                           |
| 2.0 TDI          | 110              |     | 05.13 |       | PR: 1LJ     |                |                |        |                        |                           |
| 2.0 TDI          | 120              |     | 05.09 |       | PR: 1LJ     |                |                |        |                        |                           |
| 2.0 TDI          | 125              |     | 05.09 |       | PR: 1LJ     |                |                |        |                        |                           |
| 2.0 TDI          | 130              |     | 07.11 |       | PR: 1LJ     |                |                |        |                        |                           |
| 2.0 TDI          | 140              |     | 09.13 |       | PR: 1LJ     |                |                |        |                        |                           |
| 2.0 TDI quattro  | 140              |     | 09.13 |       | PR: 1LJ     |                |                |        |                        |                           |
| 2.0 TFSI         | 132              |     | 03.09 |       | PR: 1LJ     |                |                |        |                        |                           |
| 2.0 TFSI         | 155              |     | 03.09 |       | PR: 1LJ     |                |                |        |                        |                           |
| 2.0 TFSI         | 165              |     | 05.13 |       | PR: 1LJ     |                |                |        |                        |                           |
| 2.0 TFSI         | 169              |     | 08.15 |       | PR: 1LJ     |                |                |        |                        |                           |
| 2.0 TFSI quattro | 155              |     | 03.09 |       | PR: 1LJ     |                |                |        |                        |                           |
| 2.0 TFSI quattro | 165              |     | 05.13 |       | PR: 1LJ     |                |                |        |                        |                           |
| 2.0 TFSI quattro | 169              |     | 08.15 |       | PR: 1LJ     |                |                |        |                        |                           |
| 2.7 TDI          | 120              |     | 05.09 |       | PR: 1LJ     |                |                |        |                        |                           |
| 2.7 TDI          | 140              |     | 03.09 |       | PR: 1LJ     |                |                |        |                        |                           |
| 3.0 TDI          | 150              |     | 07.11 |       | PR: 1LJ     |                |                |        |                        |                           |
| 3.0 TDI quattro  | 160              |     | 05.15 |       | PR: 1LJ     |                |                |        |                        |                           |
| 3.0 TDI quattro  | 176              |     | 03.09 |       | PR: 1LJ     |                |                |        |                        |                           |
| 3.0 TDI quattro  | 180              |     | 07.11 |       | PR: 1LJ     |                |                |        |                        |                           |
| 3.2 FSI          | 195              |     | 03.09 |       | PR: 1LJ     |                |                |        |                        |                           |
| 3.2 FSI quattro  | 195              |     | 03.09 |       | PR: 1LJ     |                |                |        |                        |                           |
| S5               | 245              |     | 04.09 | 06.11 | PR: 1LJ     |                |                |        |                        |                           |
| 1.8 TFSI         | 118              |     | 09.09 |       | PR: 1LD     | 24.0130-0222.1 | 430222         |        | 345 30,0 28,0 VL +S +B |                           |
| 1.8 TFSI         | 125              |     | 07.11 |       | PR: 1LD     |                |                |        |                        |                           |
| 1.8 TFSI         | 130              |     | 05.15 |       | PR: 1LD     |                |                |        |                        |                           |
| 2.0 TDI          | 105              |     | 11.11 |       | PR: 1LD,1LJ |                |                |        |                        |                           |
| 2.0 TDI          | 110              |     | 05.13 |       | PR: 1LD     |                |                |        |                        |                           |
| 2.0 TDI          | 120              |     | 05.09 |       | PR: 1LD     |                |                |        |                        |                           |
| 2.0 TDI          | 125              |     | 05.09 |       | PR: 1LD     |                |                |        |                        |                           |
| 2.0 TDI          | 130              |     | 07.11 |       | PR: 1LD     |                |                |        |                        |                           |
| 2.0 TDI          | 140              |     | 09.13 |       | PR: 1LD     |                |                |        |                        |                           |
| 2.0 TDI quattro  | 130              |     | 01.12 |       | PR: 1LD,1LJ |                |                |        |                        |                           |
| 2.0 TDI quattro  | 140              |     | 09.13 |       | PR: 1LD     |                |                |        |                        |                           |
| 2.0 TFSI         | 132              |     | 03.09 |       | PR: 1LD     |                |                |        |                        |                           |
| 2.0 TFSI         | 155              |     | 03.09 |       | PR: 1LD     |                |                |        |                        |                           |
| 2.0 TFSI         | 165              |     | 05.13 |       | PR: 1LD     |                |                |        |                        |                           |
| 2.0 TFSI         | 169              |     | 08.15 |       | PR: 1LD     |                |                |        |                        |                           |
| 2.0 TFSI quattro | 155              |     | 03.09 |       | PR: 1LD     |                |                |        |                        |                           |
| 2.0 TFSI quattro | 165              |     | 05.13 |       | PR: 1LD     |                |                |        |                        |                           |
| 2.0 TFSI quattro | 169              |     | 08.15 |       | PR: 1LD     |                |                |        |                        |                           |
| 2.7 TDI          | 120              |     | 05.09 |       | PR: 1LD     |                |                |        |                        |                           |
| 2.7 TDI          | 140              |     | 03.09 |       | PR: 1LD     |                |                |        |                        |                           |
| 3.0 TDI          | 150              |     | 07.11 |       | PR: 1LD     |                |                |        |                        |                           |
| 3.0 TDI quattro  | 160              |     | 05.15 |       | PR: 1LD     |                |                |        |                        |                           |
| 3.0 TDI quattro  | 176              |     | 03.09 |       | PR: 1LD     |                |                |        |                        |                           |
| 3.0 TDI quattro  | 180              |     | 07.11 |       | PR: 1LD     |                |                |        |                        |                           |
| 3.0 TFSI quattro | 200              |     | 11.11 |       | PR: 1LD,1LJ |                |                |        |                        |                           |
| 3.2 FSI          | 195              |     | 03.09 |       | PR: 1LD     |                |                |        |                        |                           |





**AUDI A5 Cabrio (09-)**

|  |  |              |                              |                            |  |                              |  |  |                                      |
|--|--|--------------|------------------------------|----------------------------|--|------------------------------|--|--|--------------------------------------|
|    | 3.2 FSI quattro<br>S5  | 195<br>245   | <b>03.09</b><br><b>07.11</b> | PR: 1LD<br>PR: 1ZT,1LD,1LJ | <b>24.0130-0222.1</b> 430222                                 |                              |  | 345 30,0 28,0 VL +S +B   |                                      |
|    | 1.8 TFSI   | 118          | <b>09.09</b>                 | PR: 1KW,2EH                | <b>13.0460-2747.2</b> 602747                                 |                              | elektrische Feststellbremse <sup>1)</sup>  | <b>24606</b> 17,4 +/Zub/S <b>TRW</b>                               |                                      |
|  | 1.8 TFSI   | 125          | <b>07.11</b>                 | PR: 1KW,2EH                | <b>13.0470-2747.2</b> LD2747                                 |                              | elektrische Feststellbremse <sup>1)</sup>  | <b>24606</b> 17,4 +/Zub/S <b>TRW</b>                               |                                      |
|  | 1.8 TFSI   | 130          | <b>05.15</b>                 | PR: 1KW,2EH                |  |                              |  |  |                                      |
|  | 2.0 TDI  | 105          | <b>11.11</b>                 | PR: 1KW,2EH                |  |                              |  |  |                                      |
|  | 2.0 TDI  | 110          | <b>05.13</b>                 | PR: 1KW,2EH                |  |                              |  |  |                                      |
|  | 2.0 TDI  | 120          | <b>05.09</b>                 | PR: 1KW,2EH                |  |                              |  |  |                                      |
|  | 2.0 TDI  | 125          | <b>05.09</b>                 | PR: 1KW,2EH                |  |                              |  |  |                                      |
|  | 2.0 TDI  | 130          | <b>07.11</b>                 | PR: 1KW,2EH                |  |                              |  |  |                                      |
|  | 2.0 TDI  | 140          | <b>09.13</b>                 | PR: 1KW,2EH                |  |                              |  |  |                                      |
|  | 2.0 TDI quattro  | 130          | <b>01.12</b>                 | PR: 1KW,2EH                |  |                              |  |  |                                      |
|  | 2.0 TDI quattro  | 140          | <b>09.13</b>                 | PR: 1KW,2EH                |  |                              |  |  |                                      |
|  | 2.0 TFSI   | 132          | <b>03.09</b>                 | PR: 1KW,2EH                |  |                              |  |  |                                      |
|  | 2.0 TFSI   | 155          | <b>03.09</b>                 | PR: 1KW,2EH                |  |                              |  |  |                                      |
|  | 2.0 TFSI   | 165          | <b>05.13</b>                 | PR: 1KW,2EH                |  |                              |  |  |                                      |
|  | 2.0 TFSI   | 169          | <b>08.15</b>                 | PR: 1KW,2EH                |  |                              |  |  |                                      |
|  | 2.0 TFSI quattro   | 155          | <b>03.09</b>                 | PR: 1KW,2EH                |  |                              |  |  |                                      |
|  | 2.0 TFSI quattro   | 165          | <b>05.13</b>                 | PR: 1KW,2EH                |  |                              |  |  |                                      |
|  | 2.0 TFSI quattro   | 169          | <b>08.15</b>                 | PR: 1KW,2EH                |  |                              |  |  |                                      |
|  | 2.7 TDI  | 120          | <b>05.09</b>                 | PR: 1KW,2EH                |  |                              |  |  |                                      |
|  | 2.7 TDI  | 140          | <b>03.09</b>                 | PR: 1KW,2EH                |  |                              |  |  |                                      |
|  | 3.0 TDI  | 150          | <b>07.11</b>                 | PR: 1KW,2EH                |  |                              |  |  |                                      |
|  | 3.0 TDI quattro  | 160          | <b>05.15</b>                 | PR: 1KW,2EH                |  |                              |  |  |                                      |
|  | 3.0 TDI quattro  | 176          | <b>03.09</b>                 | PR: 1KW,2EH                |  |                              |  |  |                                      |
|  | 3.0 TDI quattro  | 180          | <b>07.11</b>                 | PR: 1KW,2EH                |  |                              |  |  |                                      |
|  | 3.0 TFSI quattro   | 200          | <b>11.11</b>                 | PR: 1KW,2EH                |  |                              |  |  |                                      |
|  | 3.2 FSI  | 195          | <b>03.09</b>                 | PR: 1KW,2EH                |  |                              |  |  |                                      |
|  | 3.2 FSI quattro  | 195          | <b>03.09</b>                 | PR: 1KW,2EH                |  |                              |  |  |                                      |
|  |  | 1.8 TFSI     | 118                          | <b>09.09</b>               | PR: 1KE,1KP  | <b>13.0460-2748.2</b> 602748 |  | elektrische Feststellbremse <sup>1)</sup>                          | <b>24606</b> 17,4 +/Zub/S <b>TRW</b> |
|  |  | 1.8 TFSI     | 125                          | <b>07.11</b>               | PR: 1KE,1KP  | <b>13.0470-2748.2</b> LD2748 |  | elektrische Feststellbremse <sup>1)</sup>                          | <b>24606</b> 17,4 +/Zub/S <b>TRW</b> |
|  |  | 1.8 TFSI     | 130                          | <b>05.15</b>               | PR: 1KE,1KP  |                              |  |  |                                      |
|  |  | 2.0 TDI      | 105                          | <b>11.11</b>               | PR: 1KE,1KP  |                              |  |  |                                      |
|  |  | 2.0 TDI      | 110                          | <b>05.13</b>               | PR: 1KE,1KP  |                              |  |  |                                      |
|  |  | 2.0 TDI      | 120                          | <b>05.09</b>               | PR: 1KE,1KP  |                              |  |  |                                      |
|  |  | 2.0 TDI      | 125                          | <b>05.09</b>               | PR: 1KE,1KP  |                              |  |  |                                      |
|  |  | 2.0 TDI      | 130                          | <b>07.11</b>               | PR: 1KE,1KP  |                              |  |  |                                      |
| 2.0 TDI  |  | 140          | <b>09.13</b>                 | PR: 1KE,1KP                |  |                              |  |  |                                      |
| 2.0 TDI quattro  |  | 130          | <b>01.12</b>                 | PR: 1KE,1KP                |  |                              |  |  |                                      |
| 2.0 TDI quattro  |  | 140          | <b>09.13</b>                 | PR: 1KE,1KP                |  |                              |  |  |                                      |
| 2.0 TFSI   |  | 132          | <b>03.09</b>                 | PR: 1KE,1KP                |  |                              |  |  |                                      |
| 2.0 TFSI   |  | 155          | <b>03.09</b>                 | PR: 1KE,1KP                |  |                              |  |  |                                      |
| 2.0 TFSI   |  | 165          | <b>05.13</b>                 | PR: 1KE,1KP                |  |                              |  |  |                                      |
| 2.0 TFSI   |  | 169          | <b>08.15</b>                 | PR: 1KE,1KP                |  |                              |  |  |                                      |
| 2.0 TFSI quattro   |  | 155          | <b>03.09</b>                 | PR: 1KE,1KP                |  |                              |  |  |                                      |
| 2.0 TFSI quattro   |  | 165          | <b>05.13</b>                 | PR: 1KE,1KP                |  |                              |  |  |                                      |
| 2.0 TFSI quattro   |  | 169          | <b>08.15</b>                 | PR: 1KE,1KP                |  |                              |  |  |                                      |
| 2.7 TDI  |  | 120          | <b>05.09</b>                 | PR: 1KE,1KP                |  |                              |  |  |                                      |
| 2.7 TDI  |  | 140          | <b>03.09</b>                 | PR: 1KE,1KP                |  |                              |  |  |                                      |
| 3.0 TDI  |  | 150          | <b>07.11</b>                 | PR: 1KE,1KP                |  |                              |  |  |                                      |
| 3.0 TDI quattro  |  | 160          | <b>05.15</b>                 | PR: 1KE,1KP                |  |                              |  |  |                                      |
| 3.0 TDI quattro  |  | 176          | <b>03.09</b>                 | PR: 1KE,1KP                |  |                              |  |  |                                      |
| 3.0 TDI quattro  |  | 180          | <b>07.11</b>                 | PR: 1KE,1KP                |  |                              |  |  |                                      |
| 3.0 TFSI quattro   | 200  | <b>11.11</b> | PR: 1KE,1KP                  |                            |  |                              |  |  |                                      |
| 3.2 FSI  | 195  | <b>03.09</b> | PR: 1KE,1KP                  |                            |  |                              |  |  |                                      |
| 3.2 FSI quattro  | 195  | <b>03.09</b> | PR: 1KE,1KP                  |                            |  |                              |  |  |                                      |
| RS 5   | 331  | <b>02.13</b> | PR: 1KZ,2ED                  |                            | <b>13.0460-2770.2</b> 602770<br><b>13.0470-2770.2</b> LD2770 |                              | elektrische Feststellbremse <sup>1)</sup><br>elektrische Feststellbremse <sup>1)</sup> | <b>25214</b> 17,4 +/WK/Zub/STRW<br><b>25214</b> 17,4 +/WK/Zub/STRW |                                      |
|  | 1.8 TFSI   | 118          | <b>09.09</b>                 | PR: 1KW,2EH                | <b>24.0112-0178.1</b> 412178                                 |                              | elektrische Feststellbremse <sup>1)</sup>  | 300 12,0 10,0 +S +B  |                                      |
|  | 1.8 TFSI   | 125          | <b>07.11</b>                 | PR: 1KW,2EH                | <b>24.0312-0178.1</b> 512178                                 |                              | elektrische Feststellbremse <sup>1)</sup>  | <b>300 12,0 10,0 +S +B PD</b>                                      |                                      |
|  | 1.8 TFSI   | 130          | <b>05.15</b>                 | PR: 1KW,2EH                |  |                              |  |  |                                      |
|  | 2.0 TDI  | 105          | <b>11.11</b>                 | PR: 1KW,2EH                |  |                              |  |  |                                      |
|  | 2.0 TDI  | 110          | <b>05.13</b>                 | PR: 1KW,2EH                |  |                              |  |  |                                      |
|  | 2.0 TDI  | 120          | <b>05.09</b>                 | PR: 1KW,2EH                |  |                              |  |  |                                      |
|  | 2.0 TDI  | 125          | <b>05.09</b>                 | PR: 1KW,2EH                |  |                              |  |  |                                      |
|  | 2.0 TDI  | 130          | <b>07.11</b>                 | PR: 1KW,2EH                |  |                              |  |  |                                      |
|  | 2.0 TDI  | 140          | <b>09.13</b>                 | PR: 1KW,2EH                |  |                              |  |  |                                      |
|  | 2.0 TDI quattro  | 130          | <b>01.12</b>                 | PR: 1KW,2EH                |  |                              |  |  |                                      |
|  | 2.0 TDI quattro  | 140          | <b>09.13</b>                 | PR: 1KW,2EH                |  |                              |  |  |                                      |
|  | 2.0 TFSI   | 132          | <b>03.09</b>                 | PR: 1KW,2EH                |  |                              |  |  |                                      |
|  | 2.0 TFSI   | 155          | <b>03.09</b>                 | PR: 1KW,2EH                |  |                              |  |  |                                      |
|  | 2.0 TFSI   | 165          | <b>05.13</b>                 | PR: 1KW,2EH                |  |                              |  |  |                                      |
|  | 2.0 TFSI   | 169          | <b>08.15</b>                 | PR: 1KW,2EH                |  |                              |  |  |                                      |
|  | 2.0 TFSI quattro   | 155          | <b>03.09</b>                 | PR: 1KW,2EH                |  |                              |  |  |                                      |
|  | 2.0 TFSI quattro   | 165          | <b>05.13</b>                 | PR: 1KW,2EH                |  |                              |  |  |                                      |
|  | 2.0 TFSI quattro   | 169          | <b>08.15</b>                 | PR: 1KW,2EH                |  |                              |  |  |                                      |
|  | 2.7 TDI  | 120          | <b>05.09</b>                 | PR: 1KW,2EH                |  |                              |  |  |                                      |
|  | 2.7 TDI  | 140          | <b>03.09</b>                 | PR: 1KW,2EH                |  |                              |  |  |                                      |
|  | 3.0 TDI  | 150          | <b>07.11</b>                 | PR: 1KW,2EH                |  |                              |  |  |                                      |
| 3.0 TDI quattro  | 160  | <b>05.15</b> | PR: 1KW,2EH                  |                            |  |                              |  |  |                                      |
| 3.0 TDI quattro  | 176  | <b>03.09</b> | PR: 1KW,2EH                  |                            |  |                              |  |  |                                      |
| 3.0 TDI quattro  | 180  | <b>07.11</b> | PR: 1KW,2EH                  |                            |  |                              |  |  |                                      |
| 3.0 TFSI quattro   | 200  | <b>11.11</b> | PR: 1KW,2EH                  |                            |  |                              |  |  |                                      |
| 3.2 FSI  | 195  | <b>03.09</b> | PR: 1KW,2EH                  |                            |  |                              |  |  |                                      |
| 3.2 FSI quattro  | 195  | <b>03.09</b> | PR: 1KW,2EH                  |                            |  |                              |  |  |                                      |

<sup>1)</sup> electric parking brake / fr.di stazionamento elettrico / frein à main électrique / freno de mano eléctrico

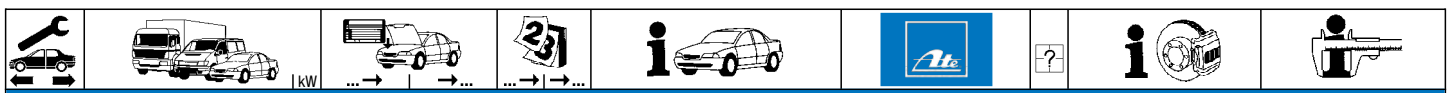







| AUDI A5 Cabrio (09-) |                  |     |       |       |         |             |                |        |   |                         |
|----------------------|------------------|-----|-------|-------|---------|-------------|----------------|--------|---|-------------------------|
|                      | 1.8 TFSI         | 118 |       | 09.09 | 10.10   | PR: 1KE     | 24.0122-0250.1 | 422250 | elektrische Feststellbremse <sup>1)</sup> | 330 22,0 20,0 V L +S +B |
|                      | 2.0 TDI          | 120 |       | 05.09 | 10.10   | PR: 1KE     |                |        |   |                         |
|                      | 2.0 TDI          | 125 |       | 05.09 | 10.10   | PR: 1KE     |                |        |   |                         |
|                      | 2.0 TFSI         | 132 |       | 03.09 | 10.10   | PR: 1KE     |                |        |   |                         |
|                      | 2.0 TFSI         | 155 |       | 03.09 | 10.10   | PR: 1KE     |                |        |   |                         |
|                      | 2.7 TDI          | 120 |       | 05.09 | 10.10   | PR: 1KE     |                |        |   |                         |
|                      | 2.7 TDI          | 140 |       | 03.09 | 10.10   | PR: 1KE     |                |        |   |                         |
|                      | 3.0 TDI quattro  | 176 |       | 03.09 | 10.10   | PR: 1KE     |                |        |   |                         |
|                      | 3.2 FSI          | 195 |       | 03.09 | 10.10   | PR: 1KE     |                |        |   |                         |
|                      | 3.2 FSI quattro  | 195 |       | 03.09 | 10.10   | PR: 1KE     |                |        |   |                         |
| S5                   | 245              |     | 04.09 | 10.10 | PR: 1KE |             |                |        |   |                         |
|                      | 1.8 TFSI         | 118 |       | 11.10 |         | PR: 1KE,1KP | 24.0122-0272.1 | 422272 | elektrische Feststellbremse <sup>1)</sup> | 330 21,9 20,0 V L +S +B |
|                      | 1.8 TFSI         | 125 |       | 07.11 |         | PR: 1KE,1KP |                |        |   |                         |
|                      | 1.8 TFSI         | 130 |       | 05.15 |         | PR: 1KE,1KP |                |        |   |                         |
|                      | 2.0 TDI          | 105 |       | 11.11 |         | PR: 1KE,1KP |                |        |   |                         |
|                      | 2.0 TDI          | 110 |       | 05.13 |         | PR: 1KE,1KP |                |        |   |                         |
|                      | 2.0 TDI          | 120 |       | 11.10 |         | PR: 1KE,1KP |                |        |   |                         |
|                      | 2.0 TDI          | 125 |       | 11.10 |         | PR: 1KE,1KP |                |        |   |                         |
|                      | 2.0 TDI          | 130 |       | 07.11 |         | PR: 1KE,1KP |                |        |   |                         |
|                      | 2.0 TDI          | 140 |       | 09.13 |         | PR: 1KE,1KP |                |        |   |                         |
|                      | 2.0 TDI quattro  | 130 |       | 01.12 |         | PR: 1KE,1KP |                |        |   |                         |
|                      | 2.0 TDI quattro  | 140 |       | 09.13 |         | PR: 1KE,1KP |                |        |   |                         |
|                      | 2.0 TFSI         | 132 |       | 11.10 |         | PR: 1KE,1KP |                |        |   |                         |
|                      | 2.0 TFSI         | 155 |       | 11.10 |         | PR: 1KE,1KP |                |        |   |                         |
|                      | 2.0 TFSI         | 165 |       | 05.13 |         | PR: 1KE,1KP |                |        |   |                         |
|                      | 2.0 TFSI         | 169 |       | 08.15 |         | PR: 1KE,1KP |                |        |   |                         |
|                      | 2.0 TFSI quattro | 155 |       | 11.10 |         | PR: 1KE,1KP |                |        |   |                         |
|                      | 2.0 TFSI quattro | 165 |       | 05.13 |         | PR: 1KE,1KP |                |        |   |                         |
|                      | 2.0 TFSI quattro | 169 |       | 08.15 |         | PR: 1KE,1KP |                |        |   |                         |
|                      | 2.7 TDI          | 120 |       | 11.10 |         | PR: 1KE,1KP |                |        |   |                         |
|                      | 2.7 TDI          | 140 |       | 11.10 |         | PR: 1KE,1KP |                |        |   |                         |
|                      | 3.0 TDI          | 150 |       | 07.11 |         | PR: 1KE,1KP |                |        |   |                         |
|                      | 3.0 TDI quattro  | 160 |       | 05.15 |         | PR: 1KE,1KP |                |        |   |                         |
|                      | 3.0 TDI quattro  | 176 |       | 11.10 |         | PR: 1KE,1KP |                |        |   |                         |
|                      | 3.0 TDI quattro  | 180 |       | 07.11 |         | PR: 1KE,1KP |                |        |   |                         |
|                      | 3.0 TFSI quattro | 200 |       | 11.11 |         | PR: 1KE,1KP |                |        |   |                         |
|                      | 3.2 FSI          | 195 |       | 11.10 |         | PR: 1KE,1KP |                |        |   |                         |
|                      | 3.2 FSI quattro  | 195 |       | 11.10 |         | PR: 1KE,1KP |                |        |   |                         |
|                      | S5               | 245 |       | 11.10 |         | PR: 1KE,1KP |                |        |   |                         |

| AUDI A6 / A6 Avant (4A/C4) (94-97) |                 |     |       |       |       |                |                |        |                   |                      |                       |                |        |  |                         |                         |
|------------------------------------|-----------------|-----|-------|-------|-------|----------------|----------------|--------|-------------------|----------------------|-----------------------|----------------|--------|--|-------------------------|-------------------------|
|                                    | 1.8             |     |       | 10.95 | 12.97 |                | 13.0460-7050.2 | 607050 |                   | 20678 19,5 +/WK      | ATE                   |                |        |  |                         |                         |
|                                    | 1.8 quattro     |     |       | 10.95 | 12.97 |                |                |        |                   |                      |                       |                |        |  |                         |                         |
|                                    | 1.9 TDI         |     |       | 06.94 | 12.97 |                |                |        |                   |                      |                       |                |        |  |                         |                         |
|                                    | 2.0             |     |       | 06.94 | 12.97 |                |                |        |                   |                      |                       |                |        |  |                         |                         |
|                                    | 2.0 16V         |     |       | 06.94 | 12.97 |                |                |        |                   |                      |                       |                |        |  |                         |                         |
|                                    | 2.0 quattro     |     |       | 06.94 | 12.97 |                |                |        |                   |                      |                       |                |        |  |                         |                         |
|                                    | 2.3             |     |       | 06.94 | 12.95 |                |                |        |                   |                      |                       |                |        |  |                         |                         |
|                                    | 2.3 quattro     |     |       | 08.94 | 12.95 |                |                |        |                   |                      |                       |                |        |  |                         |                         |
|                                    | 2.5 TDI         |     |       | 06.94 | 12.97 |                |                |        |                   |                      |                       |                |        |  |                         |                         |
|                                    | 2.5 TDI quattro |     |       | 07.95 | 12.97 |                |                |        |                   |                      |                       |                |        |  |                         |                         |
|                                    | 2.6             |     |       | 06.94 | 12.97 |                |                |        |                   |                      |                       |                |        |  |                         |                         |
|                                    | 2.6 quattro     |     |       | 06.94 | 12.97 |                |                |        |                   |                      |                       |                |        |  |                         |                         |
|                                    | 2.8             | 128 |       | 06.94 | 12.97 |                |                |        |                   |                      |                       |                |        |  |                         |                         |
|                                    | 2.8             | 142 |       | 10.95 | 12.97 |                |                |        |                   |                      |                       |                |        |  |                         |                         |
| 2.8 quattro                        |                 |     | 06.94 | 12.97 |       |                |                |        |                   |                      |                       |                |        |  |                         |                         |
| S6                                 | 169             |     | 06.94 | 12.97 |       | 13.0460-2717.2 | 602717         |        | 21452 18,5 +/WK/S | TRW                  |                       |                |        |  |                         |                         |
| S6                                 | 213             |     | 09.94 | 12.97 |       |                |                |        |                   |                      |                       |                |        |  |                         |                         |
| S6 plus                            | 235             |     | 06.96 | 12.97 |       |                |                |        |                   |                      |                       |                |        |  |                         |                         |
|                                    | 1.8             |     |       | 10.95 | 12.97 |                | 24.0115-0105.1 | 415105 |                   | 288 15,0 13,0 L +B   | 288 15,0 13,0 L +B PD |                |        |  |                         |                         |
|                                    | 1.8 quattro     |     |       | 10.95 | 12.97 |                |                |        |                   |                      |                       |                |        |  |                         |                         |
|                                    | 1.9 TDI         |     |       | 06.94 | 12.97 |                |                |        |                   |                      |                       |                |        |  |                         |                         |
|                                    | 2.0             |     |       | 06.94 | 12.97 |                |                |        |                   |                      |                       |                |        |  |                         |                         |
|                                    | 2.0 16V         |     |       | 06.94 | 12.97 |                |                |        |                   |                      |                       |                |        |  |                         |                         |
|                                    | 2.0 quattro     |     |       | 06.94 | 12.97 |                |                |        |                   |                      |                       |                |        |  |                         |                         |
|                                    | 2.3             |     |       | 06.94 | 12.95 |                |                |        |                   |                      |                       |                |        |  |                         |                         |
|                                    | 2.3 quattro     |     |       | 08.94 | 12.95 |                |                |        |                   |                      |                       |                |        |  |                         |                         |
|                                    | 2.5 TDI         | 85  |       | 06.94 | 12.97 |                |                |        |                   |                      |                       |                |        |  |                         |                         |
|                                    | 2.5 TDI         | 103 |       | 10.94 | 12.97 |                |                |        |                   |                      |                       | 24.0125-0105.1 | 425105 |  | 288 25,0 23,0 V L +S +B | 288 25,0 23,0 V L +B PD |
|                                    | 2.5 TDI quattro |     |       | 07.95 | 12.97 |                |                |        |                   |                      |                       |                |        |  |                         |                         |
|                                    | 2.6             |     |       | 06.94 | 12.97 |                |                |        |                   |                      |                       | 24.0325-0105.1 | 525105 |  |                         |                         |
|                                    | 2.6 quattro     |     |       | 06.94 | 12.97 |                |                |        |                   |                      |                       |                |        |  |                         |                         |
|                                    | 2.8             | 128 |       | 06.94 | 12.97 |                |                |        |                   |                      |                       |                |        |  |                         |                         |
| 2.8                                | 142             |     | 10.95 | 12.97 |       |                |                |        |                   |                      |                       |                |        |  |                         |                         |
| 2.8 quattro                        |                 |     | 06.94 | 12.97 |       | 24.0130-0104.1 | 430104         |        |                   | 314 30,0 28,0 V L +B |                       |                |        |  |                         |                         |
| S6                                 | 169             |     | 06.94 | 12.97 |       |                |                |        |                   |                      |                       |                |        |  |                         |                         |
| S6                                 | 213             |     | 09.94 | 12.97 |       |                |                |        |                   |                      |                       |                |        |  |                         |                         |
| S6 plus                            | 235             |     | 06.96 | 12.97 |       | 24.0130-0183.1 | 430183         |        |                   | 323 30,0 28,0 V +B   |                       |                |        |  |                         |                         |
| 1.8                                |                 |     | 10.95 | 12.97 |       |                |                |        |                   |                      |                       |                |        |  |                         |                         |
| 1.8 quattro                        |                 |     | 10.95 | 12.97 |       | 13.0460-3602.2 | 603602         |        |                   | 21144 15,8 /S        | TRW                   |                |        |  |                         |                         |
| 1.9 TDI                            |                 |     | 06.94 | 12.97 |       |                |                |        |                   |                      |                       |                |        |  |                         |                         |
| 2.0                                |                 |     | 06.94 | 12.97 |       |                |                |        |                   |                      |                       |                |        |  |                         |                         |
| 2.0 16V                            |                 |     | 06.94 | 12.97 |       |                |                |        |                   |                      |                       |                |        |  |                         |                         |
| 2.0 quattro                        |                 |     | 06.94 | 12.97 |       |                |                |        |                   |                      |                       |                |        |  |                         |                         |
| 2.3                                |                 |     | 06.94 | 12.95 |       |                |                |        |                   |                      |                       |                |        |  |                         |                         |
| 2.3 quattro                        |                 |     | 08.94 | 12.95 |       |                |                |        |                   |                      |                       |                |        |  |                         |                         |

<sup>1)</sup> electric parking brake / fr.di stazionamento elettrico / frein à main électrique / freno de mano eléctrico

| AUDI A6 / A6 Avant (4A/C4) (94-97)   |   |                   |                            |  |  |                                  |                  |  |  |  |            |
|--|---|-------------------|----------------------------|--|--|----------------------------------|------------------|--|--|--|------------|
|    | 2.5 TDI<br>2.5 TDI quattro<br>2.6<br>2.6 quattro<br>2.8<br>2.8<br>2.8 quattro<br>S6<br>S6<br>S6 plus  |                   |                            | 06.94<br>07.95<br>06.94<br>06.94<br>06.94<br>10.95<br>06.94<br>06.94<br>09.94<br>06.96   | 12.97<br>12.97<br>12.97<br>12.97<br>12.97<br>12.97<br>12.97<br>12.97<br>12.97<br>12.97   | 13.0460-3602.2                   | 603602           |  |  | 21144 15,8 /S                                      | TRW        |
|    | 1.8<br>1.8 quattro<br>1.9 TDI<br>2.0<br>2.0 16V<br>2.0 quattro<br>2.3<br>2.3 quattro<br>2.5 TDI<br>2.5 TDI quattro<br>2.6<br>2.6 quattro<br>2.8<br>2.8<br>2.8 quattro<br>S6<br>S6<br>S6 plus  |                   |                            | 10.95<br>10.95<br>06.94<br>06.94<br>06.94<br>06.94<br>06.94<br>08.94<br>06.94<br>07.95<br>06.94<br>06.94<br>06.94<br>10.95<br>10.95<br>06.94<br>09.94<br>06.96   | 12.97<br>12.97<br>12.97<br>12.97<br>12.97<br>12.97<br>12.95<br>12.95<br>12.97<br>12.97<br>12.97<br>12.97<br>12.97<br>12.97<br>12.97<br>12.97<br>12.97<br>12.97   | 24.0110-0201.1<br>24.0310-0201.1 | 410201<br>510201 |  |  | 245 10,0 8,0 +B<br>245 10,0 8,0 +B PD              |            |
|  | S6<br>S6<br>S6 plus   | 169<br>213<br>235 |                            | 06.94<br>09.94<br>06.96  | 12.97<br>12.97<br>12.97  | 24.0120-0172.1                   | 420172           |  |  | 269 19,9 18,0 V L +B                               |            |
| AUDI A6 / A6 Avant (4B/C5) (97-05)   |   |                   |                            |  |  |                                  |                  |  |  |  |            |
|    | 1.8<br>1.8 T<br>1.8 T<br>1.8 T quattro<br>1.9 TDI<br>2.0<br>2.4<br>2.4<br>2.4<br>2.4 quattro<br>2.5 TDI<br>2.5 TDI<br>2.5 TDI<br>2.5 TDI quattro<br>2.8<br>2.8 quattro<br>2.7 T<br>2.7 T quattro  |                   |                            | 04.97<br>04.97<br>12.97<br>04.97<br>04.97<br>08.01<br>07.98<br>04.97<br>04.97<br>04.97<br>04.97<br>07.02<br>02.00<br>07.97<br>04.97<br>04.97<br>03.98<br>10.97   | 01.05<br>01.05<br>01.05<br>01.05<br>01.05<br>01.05<br>01.05<br>01.05<br>01.05<br>01.05<br>01.05<br>01.05<br>01.05<br>01.05<br>01.05<br>01.05<br>01.05<br>01.05<br>01.05  | 13.0460-7110.2<br>13.0470-7110.2 | 607110<br>LD7110 |  |  | 23018 20,3 +WK<br>23018 20,3 +WK                   | ATE<br>ATE |
|  | 2.7 T<br>2.7 T quattro<br>4.2 quattro<br>S6   |                   | 4B-X-060000<br>4B-X-060000 | 03.98<br>11.98<br>09.99  | 05.01<br>05.01<br>01.05<br>01.05   | 13.0460-2701.2                   | 602701           |  |  | 21454 17,0 +WK/S                                   | TRW        |
|  | 2.7 T<br>2.7 T quattro<br>4.2 quattro<br>S6   | 110<br>132        | 4B-X-060001<br>4B-X-060001 | 05.01<br>05.01<br>11.98<br>09.99   | 01.05<br>01.05<br>01.05<br>01.05   | 13.0460-2875.2                   | 602875           |  |  | 23280 17,5 +WK                                     | TRW        |
|  | 1.8 T quattro<br>2.4 quattro<br>2.5 TDI<br>2.5 TDI<br>2.5 TDI quattro<br>2.7 T<br>2.7 T quattro<br>3.0<br>3.0 quattro   |                   |                            | 06.01<br>06.01<br>07.02<br>02.00<br>06.01<br>06.01<br>06.01<br>06.01<br>06.01  | 01.05<br>01.05<br>01.05<br>01.05<br>01.05<br>01.05<br>01.05<br>01.05<br>01.05  | 13.0460-7166.2<br>13.0470-7166.2 | 607166<br>LD7166 |  |  | 23762 20,4 +WK<br>23762 20,4 +WK                   | ATE<br>ATE |
|  | 1.8<br>1.8 T<br>1.8 T<br>1.8 T quattro<br>1.9 TDI<br>2.0<br>2.4<br>2.4<br>2.4<br>2.4 quattro<br>2.5 TDI<br>2.5 TDI<br>2.5 TDI<br>2.5 TDI quattro<br>2.8<br>2.8 quattro<br>1.8<br>1.8 T<br>1.8 T<br>1.8 T quattro<br>1.9 TDI<br>2.0<br>2.4<br>2.4<br>2.4 |                   |                            | 04.97<br>04.97<br>12.97<br>04.97<br>04.97<br>08.01<br>07.98<br>04.97<br>04.97<br>04.97<br>04.97<br>07.02<br>02.00<br>07.97<br>04.97<br>04.97<br>04.97<br>04.97<br>12.97<br>04.97<br>04.97<br>04.97<br>08.01<br>07.98<br>04.97<br>04.97 | 01.05<br>01.05<br>01.05<br>01.05<br>01.05<br>01.05<br>01.05<br>01.05<br>01.05<br>01.05<br>01.05<br>01.05<br>01.05<br>01.05<br>01.05<br>01.05<br>01.05<br>01.05<br>01.05<br>01.05<br>01.05<br>01.05<br>01.05<br>01.05<br>01.05<br>01.05 | 24.0125-0105.1<br>24.0325-0105.1 | 425105<br>525105 |  |  | 288 25,0 23,0 V L +S +B<br>288 25,0 23,0 V L +B PD |            |
|  | 1.8<br>1.8 T<br>1.8 T<br>1.8 T quattro<br>1.9 TDI<br>2.0<br>2.4<br>2.4<br>2.4   | 110<br>132        |                            | 04.97<br>04.97<br>12.97<br>04.97<br>04.97<br>08.01<br>07.98<br>04.97<br>04.97  | 01.05<br>01.05<br>01.05<br>01.05<br>01.05<br>01.05<br>01.05<br>01.05<br>01.05  | 24.0125-0137.1<br>24.0325-0137.1 | 425137<br>525137 |  |  | 312 25,0 23,0 V L +S +B<br>312 25,0 23,0 V L +B PD |            |

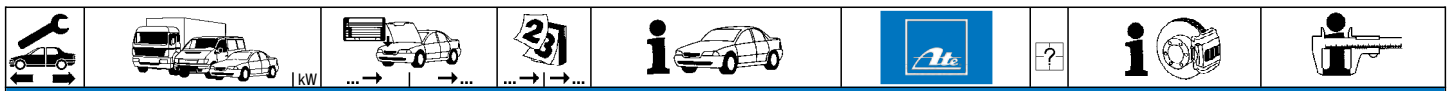

**AUDI A6 / A6 Avant (4B/C5) (97-05)**

|                  |                      |             |             |             |                |                |                |                      |                         |                   |
|------------------|----------------------|-------------|-------------|-------------|----------------|----------------|----------------|----------------------|-------------------------|-------------------|
|                  | 2.4 quattro          |             | 04.97       | 01.05       | PR: 1LF,1LT    | 24.0125-0137.1 | 425137         |                      | 312 25,0 23,0 V L +S +B |                   |
|                  | 2.5 TDI              | 110         | 04.97       | 01.05       | PR: 1LF,1LT    | 24.0325-0137.1 | 525137         |                      | 312 25,0 23,0 V L +B PD |                   |
|                  | 2.5 TDI              | 120         | 07.02       | 01.05       | PR: 1LF,1LT    |                |                |                      |                         |                   |
|                  | 2.5 TDI              | 132         | 02.00       | 01.05       | PR: 1LF,1LT    |                |                |                      |                         |                   |
|                  | 2.5 TDI quattro      |             | 07.97       | 01.05       | PR: 1LF,1LT    |                |                |                      |                         |                   |
|                  | 2.8                  |             | 04.97       | 01.05       | PR: 1LF,1LT    |                |                |                      |                         |                   |
|                  | 2.8 quattro          |             | 04.97       | 01.05       | PR: 1LF,1LT    |                |                |                      |                         |                   |
|                  | 1.8 T                | 110         | 04.97       | 01.05       | PR: 1LG,1LA    | 24.0130-0113.1 | 430113         |                      | 320 30,0 28,0 V L +S +B |                   |
|                  | 1.8 T quattro        |             | 06.01       | 01.05       | PR: 1LG,1LA    | 24.0330-0113.1 | 530113         |                      | 320 30,0 28,0 V L +B PD |                   |
|                  | 2.4 quattro          |             | 06.01       | 01.05       | PR: 1LG,1LA    |                |                |                      |                         |                   |
| 2.5 TDI          | 110                  | 04.97       | 01.05       | PR: 1LG,1LA |                |                |                |                      |                         |                   |
| 2.5 TDI          | 120                  | 07.02       | 01.05       | PR: 1LG,1LA |                |                |                |                      |                         |                   |
| 2.5 TDI          | 132                  | 02.00       | 01.05       | PR: 1LG,1LA |                |                |                |                      |                         |                   |
| 2.5 TDI quattro  |                      | 06.01       | 01.05       | PR: 1LG,1LA |                |                |                |                      |                         |                   |
| 2.7 T            |                      | 03.98       | 01.05       |             |                |                |                |                      |                         |                   |
| 2.7 T quattro    |                      | 10.97       | 01.05       |             |                |                |                |                      |                         |                   |
| 3.0              |                      | 06.01       | 01.05       |             |                |                |                |                      |                         |                   |
| 3.0 quattro      |                      | 06.01       | 01.05       |             |                |                |                |                      |                         |                   |
| 4.2 quattro      |                      | 11.98       | 01.05       |             | 24.0130-0174.1 | 430174         |                | 321 30,0 28,0 V L +B |                         |                   |
| S6               |                      | 09.99       | 01.05       |             |                |                |                |                      |                         |                   |
|                  | 1.8                  |             | 04.97       | 05.01       |                | 13.0460-2820.2 | 602820         |                      | 20961 17,6 /S TRW       |                   |
|                  | 1.8 T                | 110         | 04.97       | 05.01       |                | 13.0470-2820.2 | LD2820         |                      | 20961 17,6 /S TRW       |                   |
|                  | 1.8 T                | 132         | 12.97       | 05.01       |                | 13.0460-0072.2 | 610072         |                      | Belagsatz-Zubehör TRW   |                   |
|                  | 1.8 T quattro        |             | 04.97       | 05.01       |                |                |                |                      |                         |                   |
|                  | 1.9 TDI              |             | 04.97       | 05.01       |                |                |                |                      |                         |                   |
|                  | 2.4                  | 100         | 07.98       | 05.01       |                |                |                |                      |                         |                   |
|                  | 2.4                  | 115         | 04.97       | 05.01       |                |                |                |                      |                         |                   |
|                  | 2.4                  | 121         | 04.97       | 05.01       |                |                |                |                      |                         |                   |
|                  | 2.4 quattro          |             | 04.97       | 05.01       |                |                |                |                      |                         |                   |
|                  | 2.5 TDI              | 110         | 04.97       | 05.01       |                |                |                |                      |                         |                   |
|                  | 2.5 TDI              | 132         | 02.00       | 05.01       |                |                |                |                      |                         |                   |
|                  | 2.5 TDI quattro      |             | 07.97       | 05.01       |                |                |                |                      |                         |                   |
|                  | 2.7 T                |             | 03.98       | 05.01       |                |                |                |                      |                         |                   |
|                  | 2.7 T quattro        |             | 10.97       | 05.01       |                |                |                |                      |                         |                   |
|                  | 2.8                  |             | 04.97       | 05.01       |                |                |                |                      |                         |                   |
|                  | 2.8 quattro          |             | 04.97       | 05.01       |                |                |                |                      |                         |                   |
|                  | 4.2 quattro          |             | 11.98       | 05.01       |                |                |                |                      |                         |                   |
|                  | S6                   |             | 09.99       | 05.01       |                |                |                |                      |                         |                   |
|                  |                      | 1.8         |             | 06.01       | 01.05          |                | 13.0460-2886.2 | 602886               |                         | 20961 16,2 /S TRW |
|                  |                      | 1.8 T       | 110         | 06.01       | 01.05          |                | 13.0470-2886.2 | LD2886               |                         | 20961 16,2 /S TRW |
| 1.8 T            |                      | 132         | 06.01       | 01.05       |                |                |                |                      |                         |                   |
| 1.8 T quattro    |                      |             | 06.01       | 01.05       |                |                |                |                      |                         |                   |
| 1.9 TDI          |                      |             | 06.01       | 01.05       |                |                |                |                      |                         |                   |
| 2.0              |                      |             | 08.01       | 01.05       |                |                |                |                      |                         |                   |
| 2.4              |                      | 100         | 06.01       | 01.05       |                |                |                |                      |                         |                   |
| 2.4              |                      | 115         | 06.01       | 01.05       |                |                |                |                      |                         |                   |
| 2.4              |                      | 121         | 06.01       | 01.05       |                |                |                |                      |                         |                   |
| 2.4 quattro      |                      |             | 06.01       | 01.05       |                |                |                |                      |                         |                   |
| 2.5 TDI          |                      | 110         | 06.01       | 01.05       |                |                |                |                      |                         |                   |
| 2.5 TDI          |                      | 120         | 07.02       | 01.05       |                |                |                |                      |                         |                   |
| 2.5 TDI          |                      | 132         | 06.01       | 01.05       |                |                |                |                      |                         |                   |
| 2.5 TDI quattro  |                      |             | 06.01       | 01.05       |                |                |                |                      |                         |                   |
| 2.7 T            |                      |             | 06.01       | 01.05       |                |                |                |                      |                         |                   |
| 2.7 T quattro    |                      |             | 06.01       | 01.05       |                |                |                |                      |                         |                   |
| 2.8              |                      |             | 06.01       | 01.05       |                |                |                |                      |                         |                   |
| 2.8 quattro      |                      |             | 06.01       | 01.05       |                |                |                |                      |                         |                   |
| 3.0              |                      |             | 06.01       | 01.05       |                |                |                |                      |                         |                   |
| 3.0 quattro      |                      |             | 06.01       | 01.05       |                |                |                |                      |                         |                   |
| 4.2 quattro      |                      | 06.01       | 01.05       |             |                |                |                |                      |                         |                   |
| S6               |                      | 06.01       | 01.05       |             |                |                |                |                      |                         |                   |
| RS 6             |                      | 07.02       | 01.05       |             | 13.0460-2889.2 | 602889         |                | 23326 17,4 /WE/S TRW |                         |                   |
|                  | 1.8                  |             | 04.97       | 01.05       |                | 24.0110-0201.1 | 410201         |                      | 245 10,0 8,0 +B         |                   |
|                  | 1.8 T                | 110         | 04.97       | 01.05       |                | 24.0310-0201.1 | 510201         |                      | 245 10,0 8,0 +B PD      |                   |
|                  | 1.8 T                | 132         | 12.97       | 01.05       |                |                |                |                      |                         |                   |
|                  | 1.9 TDI              |             | 04.97       | 01.05       |                |                |                |                      |                         |                   |
|                  | 2.0                  |             | 08.01       | 01.05       |                |                |                |                      |                         |                   |
|                  | 2.4                  | 100         | 07.98       | 01.05       |                |                |                |                      |                         |                   |
|                  | 2.4                  | 115         | 04.97       | 01.05       |                |                |                |                      |                         |                   |
|                  | 2.4                  | 121         | 04.97       | 01.05       |                |                |                |                      |                         |                   |
|                  | 2.5 TDI              | 110         | 04.97       | 01.05       |                |                |                |                      |                         |                   |
|                  | 2.5 TDI              | 120         | 07.02       | 01.05       |                |                |                |                      |                         |                   |
|                  | 2.5 TDI              | 132         | 02.00       | 01.05       |                |                |                |                      |                         |                   |
|                  | 2.7 T                |             | 03.98       | 01.05       |                |                |                |                      |                         |                   |
|                  | 2.8                  |             | 04.97       | 01.05       |                |                |                |                      |                         |                   |
|                  | 3.0                  |             | 06.01       | 01.05       |                |                |                |                      |                         |                   |
|                  | 1.8 T Lim. quattro   |             | 4B-X-200000 | 04.97       |                |                | 24.0110-0258.1 | 410258               |                         | 245 10,0 8,0 +B   |
|                  | 2.4 Lim. quattro     |             | 4B-X-200000 | 04.97       |                |                |                |                      |                         |                   |
|                  | 2.5 TDI Lim. quattro |             | 4B-X-200000 | 07.97       |                |                |                |                      |                         |                   |
|                  | 2.7 T Lim. quattro   |             | 4B-X-200000 | 10.97       |                |                |                |                      |                         |                   |
| 2.8 Lim. quattro |                      | 4B-X-200000 | 04.97       |             |                |                |                |                      |                         |                   |
| 3.0 Lim. quattro |                      | 4B-X-200000 | 06.01       |             |                |                |                |                      |                         |                   |
| 1.8 T quattro    | 4B-Y-000001          |             | 01.05       | PR: ON1     |                | 24.0110-0258.1 | 410258         |                      | 245 10,0 8,0 +B         |                   |
| 2.4 quattro      | 4B-Y-000001          |             | 01.05       | PR: ON1     |                |                |                |                      |                         |                   |
| 2.5 TDI quattro  | 4B-Y-000001          |             | 01.05       | PR: ON1     |                |                |                |                      |                         |                   |
| 2.7 T quattro    | 4B-Y-000001          |             | 01.05       | PR: ON1     |                |                |                |                      |                         |                   |
| 2.8 quattro      | 4B-Y-000001          |             | 01.05       | PR: ON1     |                |                |                |                      |                         |                   |





| AUDI A6 / A6 Avant (4B/C5) (97-05) |                 |             |             |       |       |                                |                |                |                      |                 |
|------------------------------------|-----------------|-------------|-------------|-------|-------|--------------------------------|----------------|----------------|----------------------|-----------------|
|                                    | 3.0 quattro     | 4B-Y-000001 |             |       | 01.05 | PR: ON1                        |                | 24.0110-0258.1 | 410258               | 245 10,0 8,0 +B |
|                                    | 1.8 T quattro   |             | 4B-X-200000 | 04.97 |       | + Avant                        |                | 24.0110-0259.1 | 410259               | 255 10,0 8,0 +B |
|                                    | 2.4 quattro     |             | 4B-X-200000 | 04.97 |       | + Avant                        |                |                |                      |                 |
|                                    | 2.5 TDI quattro |             | 4B-X-200000 | 07.97 |       | + Avant                        |                |                |                      |                 |
|                                    | 2.7 T quattro   |             | 4B-X-200000 | 10.97 |       | + Avant                        |                |                |                      |                 |
|                                    | 2.8 quattro     |             | 4B-X-200000 | 04.97 |       | + Avant                        |                |                |                      |                 |
|                                    | 3.0 quattro     |             | 4B-X-200000 | 06.01 |       | + Avant                        |                |                |                      |                 |
| 1.8 T quattro                      | 4B-Y-000001     |             |             |       | 01.05 | PR: ON5/ - Avant <sup>1)</sup> | 24.0110-0259.1 | 410259         | 255 10,0 8,0 +B      |                 |
| 2.4 quattro                        | 4B-Y-000001     |             |             |       | 01.05 | PR: ON5/ - Avant <sup>1)</sup> |                |                |                      |                 |
| 2.5 TDI quattro                    | 4B-Y-000001     |             |             |       | 01.05 | PR: ON5/ - Avant <sup>1)</sup> |                |                |                      |                 |
| 2.7 T quattro                      | 4B-Y-000001     |             |             |       | 01.05 | PR: ON5/ - Avant <sup>1)</sup> |                |                |                      |                 |
| 2.8 quattro                        | 4B-Y-000001     |             |             |       | 01.05 | PR: ON5/ - Avant <sup>1)</sup> |                |                |                      |                 |
| 3.0 quattro                        | 4B-Y-000001     |             |             |       | 01.05 | PR: ON5/ - Avant <sup>1)</sup> |                |                |                      |                 |
| 1.8 T quattro                      |                 |             |             | 04.97 | 01.05 | PR: ON6                        | 24.0110-0260.1 | 410260         | 255 10,0 8,0 +B      |                 |
| 2.4 quattro                        |                 |             |             | 04.97 | 01.05 | PR: ON6                        | 24.0310-0260.1 | 510260         | 255 10,0 8,0 +B PD   |                 |
| 2.5 TDI quattro                    |                 |             |             | 07.97 | 01.05 | PR: ON6                        |                |                |                      |                 |
| 2.7 T quattro                      |                 |             |             | 10.97 | 01.05 | PR: ON6                        | 24.0110-0260.1 | 410260         | 255 10,0 8,0 +B      |                 |
| 2.8 quattro                        |                 |             |             | 04.97 | 01.05 | PR: ON6                        |                |                |                      |                 |
| 3.0 quattro                        |                 |             |             | 06.01 | 01.05 | PR: ON6                        |                |                |                      |                 |
| 4.2 quattro                        |                 |             |             | 11.98 | 01.05 |                                | 24.0122-0222.1 | 422222         | 269 22,0 20,0 V L +B |                 |
| S6                                 |                 |             |             | 09.99 | 01.05 |                                |                |                |                      |                 |

| AUDI A6 Allroad (00-05) |         |  |       |       |       |                |                |                      |                         |     |
|-------------------------|---------|--|-------|-------|-------|----------------|----------------|----------------------|-------------------------|-----|
|                         | 2.5 TDI |  |       | 05.00 | 07.05 | PR: 1LA        | 13.0460-7166.2 | 607166               | 23762 20,4 +/WK         | ATE |
|                         | 2.7 T   |  |       | 05.00 | 07.05 | PR: 1LA        | 13.0470-7166.2 | LD7166               | 23762 20,4 +/WK         | ATE |
|                         | 4.2     |  |       | 07.02 | 07.05 | PR: 1LA        | 13.0460-7166.2 | 607166               | 23762 20,4 +/WK         | ATE |
|                         | 2.5 TDI |  |       | 05.00 | 07.05 | PR: 1LX        | 13.0460-2875.2 | 602875               | 23280 17,5 +/WK         | TRW |
|                         | 2.7 T   |  |       | 05.00 | 07.05 | PR: 1LX        |                |                      |                         |     |
|                         | 4.2     |  |       | 07.02 | 07.05 | PR: 1LX        |                |                      |                         |     |
|                         | 2.5 TDI |  |       | 05.00 | 07.05 |                | 24.0130-0113.1 | 430113               | 320 30,0 28,0 V L +S +B |     |
|                         | 2.7 T   |  |       | 05.00 | 07.05 |                | 24.0330-0113.1 | 530113               | 320 30,0 28,0 V L +B PD |     |
|                         | 4.2     |  |       | 07.02 | 07.05 |                |                |                      |                         |     |
|                         | 2.5 TDI |  |       | 05.00 | 07.05 |                | 13.0460-2886.2 | 602886               | 20961 16,2 /S           | TRW |
|                         | 2.7 T   |  |       | 05.00 | 07.05 |                | 13.0470-2886.2 | LD2886               | 20961 16,2 /S           | TRW |
|                         | 4.2     |  |       | 07.02 | 07.05 |                |                |                      |                         |     |
|                         | 2.5 TDI |  |       | 05.00 | 07.05 |                | 24.0110-0260.1 | 410260               | 255 10,0 8,0 +B         |     |
|                         |         |  |       |       |       |                | 24.0310-0260.1 | 510260               | 255 10,0 8,0 +B PD      |     |
|                         | 2.7 T   |  |       | 05.00 | 07.05 |                | 24.0110-0260.1 | 410260               | 255 10,0 8,0 +B         |     |
| 4.2                     |         |  | 07.02 | 07.05 |       | 24.0122-0203.1 | 422203         | 269 22,0 20,0 V L +B |                         |     |

| AUDI A6 (4F2/C6) Limousine (04-11) |                 |     |  |       |       |                     |                |        |                 |     |
|------------------------------------|-----------------|-----|--|-------|-------|---------------------|----------------|--------|-----------------|-----|
|                                    | 2.0 TDI         | 100 |  | 06.05 | 03.11 | PR: 1LT             | 13.0460-7110.2 | 607110 | 23018 20,3 +/WK | ATE |
|                                    | 2.0 TDI         | 103 |  | 10.08 | 03.11 | PR: 1LT             | 13.0470-7110.2 | LD7110 | 23018 20,3 +/WK | ATE |
|                                    | 2.0 TDI         | 103 |  | 10.08 | 03.11 | PR: 1LT             |                |        |                 |     |
|                                    | 2.0 TDI         | 103 |  | 10.08 | 03.11 | PR: 1LT             |                |        |                 |     |
|                                    | 2.0 TDI         | 103 |  | 07.04 | 03.11 | PR: 1LT             |                |        |                 |     |
|                                    | 2.0 TDI         | 125 |  | 10.08 | 03.11 | PR: 1LT             |                |        |                 |     |
|                                    | 2.0 TFSI        | 125 |  | 06.05 | 03.11 | PR: 1LT             |                |        |                 |     |
|                                    | 2.4             | 130 |  | 04.04 | 03.11 | PR: 1LT             |                |        |                 |     |
|                                    | 2.4 quattro     | 130 |  | 01.05 | 03.11 | PR: 1LT             |                |        |                 |     |
|                                    | 2.7 TDI         | 120 |  | 11.04 | 03.11 | PR: 1LT             |                |        |                 |     |
|                                    | 2.7 TDI         | 132 |  | 11.04 | 03.11 | PR: 1LT             |                |        |                 |     |
|                                    | 2.7 TDI quattro | 120 |  | 06.05 | 03.11 | PR: 1LT             |                |        |                 |     |
|                                    | 2.7 TDI quattro | 132 |  | 11.04 | 03.11 | PR: 1LT             |                |        |                 |     |
|                                    | 2.7 TDI quattro | 140 |  | 10.08 | 03.11 | PR: 1LT             |                |        |                 |     |
|                                    | 2.8 FSI         | 140 |  | 10.08 | 03.11 | PR: 1LT             |                |        |                 |     |
|                                    | 2.8 FSI         | 154 |  | 11.06 | 03.11 | PR: 1LT             |                |        |                 |     |
|                                    | 2.8 FSI         | 162 |  | 10.08 | 03.11 | PR: 1LT             |                |        |                 |     |
|                                    | 2.8 FSI quattro | 140 |  | 10.08 | 03.11 | PR: 1LT             |                |        |                 |     |
|                                    | 2.8 FSI quattro | 154 |  | 04.07 | 03.11 | PR: 1LT             |                |        |                 |     |
|                                    | 2.8 FSI quattro | 162 |  | 10.08 | 03.11 | PR: 1LT             |                |        |                 |     |
|                                    | 3.0             | 160 |  | 04.04 | 03.11 | PR: 1LT             |                |        |                 |     |
|                                    | 3.0 quattro     | 160 |  | 04.04 | 03.11 | PR: 1LT             |                |        |                 |     |
|                                    | 3.0 TDI quattro | 155 |  | 04.04 | 03.11 | PR: 1LT             |                |        |                 |     |
|                                    | 3.0 TDI quattro | 165 |  | 04.04 | 03.11 | PR: 1LT             |                |        |                 |     |
|                                    | 3.0 TDI quattro | 171 |  | 06.06 | 03.11 | PR: 1LT             |                |        |                 |     |
|                                    | 3.2 FSI         | 188 |  | 04.04 | 03.11 | PR: 1LT             |                |        |                 |     |
|                                    | 3.2 FSI quattro | 188 |  | 04.04 | 03.11 | PR: 1LT             |                |        |                 |     |
|                                    | 4.2 FSI quattro | 257 |  | 06.06 | 03.11 | PR: 1LT             | 13.0460-7110.2 | 607110 | 23018 20,3 +/WK | ATE |
|                                    | 4.2 quattro     | 246 |  | 04.04 | 03.11 | PR: 1LT             |                |        |                 |     |
|                                    | 2.0 TDI         | 100 |  | 06.05 | 03.11 | PR: 1LG,1LD,1ZL,1LH | 13.0460-7201.2 | 607201 | 23763 20,3 +/WK | ATE |
|                                    | 2.0 TDI         | 103 |  | 07.04 | 03.11 | PR: 1LG,1LD,1ZL,1LH | 13.0470-7201.2 | LD7201 | 23763 20,3 +/WK | ATE |
|                                    | 2.0 TDI         | 125 |  | 10.08 | 03.11 | PR: 1LG,1ZL         |                |        |                 |     |
|                                    | 2.0 TFSI        | 125 |  | 06.05 | 03.11 | PR: 1LG,1LD,1ZL,1LH |                |        |                 |     |
|                                    | 2.4             | 130 |  | 04.04 | 03.11 | PR: 1LG,1LD,1ZL,1LH |                |        |                 |     |
|                                    | 2.4 quattro     | 130 |  | 01.05 | 03.11 | PR: 1LG,1LD,1ZL,1LH |                |        |                 |     |
|                                    | 2.7 TDI         | 120 |  | 11.04 | 03.11 | PR: 1LG,1LD,1ZL,1LH |                |        |                 |     |
|                                    | 2.7 TDI         | 132 |  | 11.04 | 03.11 | PR: 1LG,1LD,1ZL,1LH |                |        |                 |     |
|                                    | 2.7 TDI         | 140 |  | 10.08 | 03.11 | PR: 1LG,1ZL         |                |        |                 |     |
|                                    | 2.7 TDI quattro | 120 |  | 06.05 | 03.11 | PR: 1LG,1LD,1ZL,1LH |                |        |                 |     |
|                                    | 2.7 TDI quattro | 132 |  | 11.04 | 03.11 | PR: 1LG,1LD,1ZL,1LH |                |        |                 |     |
|                                    | 2.7 TDI quattro | 140 |  | 10.08 | 03.11 | PR: 1LG,1ZL         |                |        |                 |     |
|                                    | 2.8 FSI         | 140 |  | 10.08 | 03.11 | PR: 1LG,1ZL         |                |        |                 |     |
|                                    | 2.8 FSI         | 154 |  | 11.06 | 03.11 | PR: 1LG,1LD,1ZL,1LH |                |        |                 |     |
|                                    | 2.8 FSI         | 162 |  | 10.08 | 03.11 | PR: 1LG,1ZL         |                |        |                 |     |

<sup>1)</sup> PR: ON5/ - Estate / PR: ON5/ - Station Wagon / PR: ON5/ - Break / PR: ON5/ - Break





**AUDI A6 (4F2/C6) Limousine (04-11)**

|                  |                  |     |       |       |                     |                     |                |        |  |                            |     |
|------------------|------------------|-----|-------|-------|---------------------|---------------------|----------------|--------|--|----------------------------|-----|
|                  | 2.8 FSI quattro  | 140 |       | 10.08 | 03.11               | PR: 1LG,1ZL         | 13.0460-7201.2 | 607201 |  | 23763 20,3 +/WK            | ATE |
|                  | 2.8 FSI quattro  | 154 |       | 04.07 | 03.11               | PR: 1LG,1LD,1ZL,1LH | 13.0470-7201.2 | LD7201 |  | 23763 20,3 +/WK            | ATE |
|                  | 2.8 FSI quattro  | 162 |       | 10.08 | 03.11               | PR: 1LG,1ZL         |                |        |  |                            |     |
|                  | 3.0              | 160 |       | 04.04 | 03.11               | PR: 1LG,1LD,1ZL,1LH |                |        |  |                            |     |
|                  | 3.0 quattro      | 160 |       | 04.04 | 03.11               | PR: 1LG,1LD,1ZL,1LH |                |        |  |                            |     |
|                  | 3.0 TDI quattro  | 155 |       | 04.04 | 03.11               | PR: 1LG,1LD,1ZL,1LH |                |        |  |                            |     |
|                  | 3.0 TDI quattro  | 165 |       | 04.04 | 03.11               | PR: 1LG,1LD,1ZL,1LH |                |        |  |                            |     |
|                  | 3.0 TDI quattro  | 171 |       | 04.04 | 03.11               | PR: 1LG,1LD,1ZL,1LH |                |        |  |                            |     |
|                  | 3.0 TDI quattro  | 176 |       | 10.08 | 03.11               | PR: 1LG,1ZL         |                |        |  |                            |     |
|                  | 3.0 TFSI quattro |     |       | 10.08 | 03.11               | PR: 1LG,1ZL         |                |        |  |                            |     |
| 3.2 FSI          |                  |     | 04.04 | 03.11 | PR: 1LG,1LD,1ZL,1LH |                     |                |        |  |                            |     |
| 3.2 FSI quattro  | 188              |     | 04.04 | 03.11 | PR: 1LG,1LD,1ZL,1LH |                     |                |        |  |                            |     |
| 4.2 FSI quattro  | 257              |     | 06.06 | 03.11 | PR: 1LG,1LD,1ZL,1LH | 13.0460-7201.2      | 607201         |        |  | 23763 20,3 +/WK            | ATE |
| 4.2 quattro      | 246              |     | 04.04 | 03.11 | PR: 1LG,1LD,1ZL,1LH |                     |                |        |  |                            |     |
| S6               | 320              |     | 03.06 | 03.11 |                     | 13.0460-7182.2      | 607182         |        |  | 23896 20,6 +/WK            | ATE |
| RS 6             | 426              |     | 04.08 | 03.11 | PR: 1LM             | 13.0460-4864.2      | 604864         |        |  | 24455 16,8 /WK             | BRE |
|                  | 2.0 TDI          | 100 |       | 06.05 | 03.11               | PR: 1LT             | 24.0125-0149.1 | 425149 |  | 314 25,0 23,0 V L +B       |     |
|                  | 2.0 TDI          | 103 |       | 07.04 | 03.11               | PR: 1LT             | 24.0325-0149.1 | 525149 |  | 314 25,0 23,0 V L +B PD    |     |
|                  | 2.0 TDI          | 125 |       | 10.08 | 03.11               | PR: 1LT             |                |        |  |                            |     |
|                  | 2.0 TFSI         | 125 |       | 06.05 | 03.11               | PR: 1LT             |                |        |  |                            |     |
|                  | 2.4              | 130 |       | 04.04 | 03.11               | PR: 1LT             |                |        |  |                            |     |
|                  | 2.4 quattro      | 130 |       | 01.05 | 03.11               | PR: 1LT             |                |        |  |                            |     |
|                  | 2.7 TDI          | 120 |       | 11.04 | 03.11               | PR: 1LT             |                |        |  |                            |     |
|                  | 2.7 TDI          | 132 |       | 11.04 | 03.11               | PR: 1LT             |                |        |  |                            |     |
|                  | 2.7 TDI          | 140 |       | 10.08 | 03.11               | PR: 1LT             |                |        |  |                            |     |
|                  | 2.7 TDI quattro  | 120 |       | 06.05 | 03.11               | PR: 1LT             |                |        |  |                            |     |
|                  | 2.7 TDI quattro  | 132 |       | 11.04 | 03.11               | PR: 1LT             |                |        |  |                            |     |
|                  | 2.7 TDI quattro  | 140 |       | 10.08 | 03.11               | PR: 1LT             |                |        |  |                            |     |
|                  | 2.8 FSI          | 140 |       | 10.08 | 03.11               | PR: 1LT             |                |        |  |                            |     |
|                  | 2.8 FSI          | 154 |       | 11.06 | 03.11               | PR: 1LT             |                |        |  |                            |     |
|                  | 2.8 FSI          | 162 |       | 10.08 | 03.11               | PR: 1LT             |                |        |  |                            |     |
|                  | 2.8 FSI quattro  | 140 |       | 10.08 | 03.11               | PR: 1LT             |                |        |  |                            |     |
|                  | 2.8 FSI quattro  | 154 |       | 04.07 | 03.11               | PR: 1LT             |                |        |  |                            |     |
|                  | 2.8 FSI quattro  | 162 |       | 10.08 | 03.11               | PR: 1LT             |                |        |  |                            |     |
|                  | 3.0              | 160 |       | 04.04 | 03.11               | PR: 1LT             |                |        |  |                            |     |
|                  | 3.0 quattro      | 160 |       | 04.04 | 03.11               | PR: 1LT             |                |        |  |                            |     |
|                  | 3.0 TDI quattro  | 155 |       | 04.04 | 03.11               | PR: 1LT             |                |        |  |                            |     |
|                  | 3.0 TDI quattro  | 165 |       | 04.04 | 03.11               | PR: 1LT             |                |        |  |                            |     |
|                  | 3.0 TDI quattro  | 171 |       | 06.06 | 03.11               | PR: 1LT             |                |        |  |                            |     |
|                  | 3.0 TDI quattro  | 176 |       | 10.08 | 03.11               | PR: 1LT             |                |        |  |                            |     |
|                  | 3.0 TFSI quattro |     |       | 10.08 | 03.11               | PR: 1LT             |                |        |  |                            |     |
|                  | 3.2 FSI          |     |       | 04.04 | 03.11               | PR: 1LT             |                |        |  |                            |     |
|                  | 3.2 FSI quattro  | 188 |       | 04.04 | 03.11               | PR: 1LT             |                |        |  |                            |     |
| 4.2 FSI quattro  | 257              |     | 06.06 | 03.11 | PR: 1LT             |                     |                |        |  |                            |     |
| 4.2 quattro      | 246              |     | 04.04 | 03.11 | PR: 1LT             |                     |                |        |  |                            |     |
| 2.0 TDI          | 100              |     | 06.05 | 03.11 | PR: 1LG,1LD         | 24.0130-0175.1      | 430175         |        |  | 321 30,0 28,0 V L +S +B    |     |
| 2.0 TDI          | 103              |     | 07.04 | 03.11 | PR: 1LG,1LD         | 24.0330-0175.1      | 530175         |        |  | 321 30,0 28,0 V L +S +B PD |     |
| 2.0 TDI          | 125              |     | 10.08 | 03.11 | PR: 1LG             |                     |                |        |  |                            |     |
| 2.0 TFSI         | 125              |     | 06.05 | 03.11 | PR: 1LG,1LD         |                     |                |        |  |                            |     |
| 2.4              | 130              |     | 04.04 | 03.11 | PR: 1LG,1LD         |                     |                |        |  |                            |     |
| 2.4 quattro      | 130              |     | 01.05 | 03.11 | PR: 1LG,1LD         |                     |                |        |  |                            |     |
| 2.7 TDI          | 120              |     | 11.04 | 03.11 | PR: 1LG,1LD         |                     |                |        |  |                            |     |
| 2.7 TDI          | 132              |     | 11.04 | 03.11 | PR: 1LG,1LD         |                     |                |        |  |                            |     |
| 2.7 TDI          | 140              |     | 10.08 | 03.11 | PR: 1LG             |                     |                |        |  |                            |     |
| 2.7 TDI quattro  | 120              |     | 06.05 | 03.11 | PR: 1LG,1LD         |                     |                |        |  |                            |     |
| 2.7 TDI quattro  | 132              |     | 11.04 | 03.11 | PR: 1LG,1LD         |                     |                |        |  |                            |     |
| 2.7 TDI quattro  | 140              |     | 10.08 | 03.11 | PR: 1LG             |                     |                |        |  |                            |     |
| 2.8 FSI          | 140              |     | 10.08 | 03.11 | PR: 1LG             |                     |                |        |  |                            |     |
| 2.8 FSI          | 154              |     | 11.06 | 03.11 | PR: 1LG,1LD         |                     |                |        |  |                            |     |
| 2.8 FSI          | 162              |     | 10.08 | 03.11 | PR: 1LG             |                     |                |        |  |                            |     |
| 2.8 FSI quattro  | 140              |     | 10.08 | 03.11 | PR: 1LG             |                     |                |        |  |                            |     |
| 2.8 FSI quattro  | 154              |     | 04.07 | 03.11 | PR: 1LG,1LD         |                     |                |        |  |                            |     |
| 2.8 FSI quattro  | 162              |     | 10.08 | 03.11 | PR: 1LG             |                     |                |        |  |                            |     |
| 3.0              | 160              |     | 04.04 | 03.11 | PR: 1LG,1LD         |                     |                |        |  |                            |     |
| 3.0 quattro      | 160              |     | 04.04 | 03.11 | PR: 1LG,1LD         |                     |                |        |  |                            |     |
| 3.0 TDI quattro  | 155              |     | 04.04 | 03.11 | PR: 1LG,1LD         |                     |                |        |  |                            |     |
| 3.0 TDI quattro  | 165              |     | 04.04 | 03.11 | PR: 1LG,1LD         |                     |                |        |  |                            |     |
| 3.0 TDI quattro  | 171              |     | 06.06 | 03.11 | PR: 1LG,1LD         |                     |                |        |  |                            |     |
| 3.0 TDI quattro  | 176              |     | 10.08 | 03.11 | PR: 1LG             |                     |                |        |  |                            |     |
| 3.0 TFSI quattro |                  |     | 10.08 | 03.11 | PR: 1LG             |                     |                |        |  |                            |     |
| 3.2 FSI          |                  |     | 04.04 | 03.11 | PR: 1LG,1LD         |                     |                |        |  |                            |     |
| 3.2 FSI quattro  | 188              |     | 04.04 | 03.11 | PR: 1LG,1LD         |                     |                |        |  |                            |     |
| 4.2 FSI quattro  | 257              |     | 06.06 | 03.11 | PR: 1LG,1LD         |                     |                |        |  |                            |     |
| 4.2 quattro      | 246              |     | 04.04 | 03.11 | PR: 1LG,1LD         |                     |                |        |  |                            |     |
| 2.0 TDI          | 100              |     | 06.05 | 03.11 | PR: 1ZL,1LH         | 24.0130-0176.1      | 430176         |        |  | 347 30,0 28,0 V L +S +B    |     |
| 2.0 TDI          | 103              |     | 07.04 | 03.11 | PR: 1ZL,1LH         | 24.0330-0176.1      | 530176         |        |  | 347 30,0 28,0 V L +S +B PD |     |
| 2.0 TDI          | 125              |     | 10.08 | 03.11 | PR: 1ZL             |                     |                |        |  |                            |     |
| 2.0 TFSI         | 125              |     | 06.05 | 03.11 | PR: 1ZL,1LH         |                     |                |        |  |                            |     |
| 2.4              | 130              |     | 04.04 | 03.11 | PR: 1ZL,1LH         |                     |                |        |  |                            |     |
| 2.4 quattro      | 130              |     | 01.05 | 03.11 | PR: 1ZL,1LH         |                     |                |        |  |                            |     |
| 2.7 TDI          | 120              |     | 11.04 | 03.11 | PR: 1ZL,1LH         |                     |                |        |  |                            |     |
| 2.7 TDI          | 132              |     | 11.04 | 03.11 | PR: 1ZL,1LH         |                     |                |        |  |                            |     |
| 2.7 TDI          | 140              |     | 10.08 | 03.11 | PR: 1ZL             |                     |                |        |  |                            |     |
| 2.7 TDI quattro  | 120              |     | 06.05 | 03.11 | PR: 1ZL,1LH         |                     |                |        |  |                            |     |
| 2.7 TDI quattro  | 132              |     | 11.04 | 03.11 | PR: 1ZL,1LH         |                     |                |        |  |                            |     |
| 2.7 TDI quattro  | 140              |     | 10.08 | 03.11 | PR: 1ZL             |                     |                |        |  |                            |     |









**AUDI A6 (4F2/C6) Limousine (04-11)**

|  |   |  |  |   |  |   |
|--|---|--|--|---|--|---|
|  | 2.8 FSI 140<br>2.8 FSI 154<br>2.8 FSI 162<br>2.8 FSI quattro 140<br>2.8 FSI quattro 154<br>2.8 FSI quattro 162<br>3.0 160<br>3.0 quattro 160<br>3.0 TDI quattro 155<br>3.0 TDI quattro 165<br>3.0 TDI quattro 171<br>3.0 TDI quattro 176<br>3.0 TFSI quattro<br>3.2 FSI<br>3.2 FSI quattro 188<br>4.2 FSI quattro 257<br>4.2 quattro 246  |  | 10.08 03.11 PR: 1ZL<br>11.06 03.11 PR: 1ZL,1LH<br>10.08 03.11 PR: 1ZL<br>10.08 03.11 PR: 1ZL<br>04.07 03.11 PR: 1ZL,1LH<br>10.08 03.11 PR: 1ZL<br>04.04 03.11 PR: 1ZL,1LH<br>04.04 03.11 PR: 1ZL,1LH<br>04.04 03.11 PR: 1ZL,1LH<br>06.06 03.11 PR: 1ZL,1LH<br>10.08 03.11 PR: 1ZL<br>10.08 03.11 PR: 1ZL<br>04.04 03.11 PR: 1ZL,1LH<br>04.04 03.11 PR: 1ZL,1LH<br>06.06 03.11 PR: 1ZL,1LH<br>04.04 03.11 PR: 1ZL,1LH   | 24.0130-0176.1 430176<br>24.0330-0176.1 530176                          |  | 347 30,0 28,0 V L +S +B<br>347 30,0 28,0 V L +S +B PD                     |
|  | S6 320  |  | 03.06 03.11  | 24.0136-0107.1 436107   |  | 385 36,0 33,5 V L +B  |
|  | 2.0 TDI 100<br>2.0 TDI 103<br>2.0 TDI 125<br>2.0 TFSI 125<br>2.4 130<br>2.4 quattro 130<br>2.7 TDI 120<br>2.7 TDI 132<br>2.7 TDI 140<br>2.7 TDI quattro 120<br>2.7 TDI quattro 132<br>2.7 TDI quattro 140<br>2.8 FSI 140<br>2.8 FSI 154<br>2.8 FSI 162<br>2.8 FSI quattro 140<br>2.8 FSI quattro 154<br>2.8 FSI quattro 162<br>3.0 160<br>3.0 quattro 160<br>3.0 TDI quattro 155<br>3.0 TDI quattro 165<br>3.0 TDI quattro 171<br>3.0 TDI quattro 176<br>3.0 TFSI quattro<br>3.2 FSI<br>3.2 FSI quattro 188<br>4.2 FSI quattro 257<br>4.2 quattro 246 |  | 06.05 03.11 PR: 1KD,2ED<br>07.04 03.11 PR: 1KD,2ED<br>10.08 03.11 PR: 1KD<br>06.05 03.11 PR: 1KD,2ED<br>04.04 03.11 PR: 1KD,2ED<br>01.05 03.11 PR: 1KD,2ED<br>11.04 03.11 PR: 1KD,2ED<br>11.04 03.11 PR: 1KD,2ED<br>10.08 03.11 PR: 1KD<br>06.05 03.11 PR: 1KD,2ED<br>11.04 03.11 PR: 1KD,2ED<br>10.08 03.11 PR: 1KD<br>10.08 03.11 PR: 1KD<br>11.06 03.11 PR: 1KD,2ED<br>10.08 03.11 PR: 1KD<br>10.08 03.11 PR: 1KD<br>04.07 03.11 PR: 1KD,2ED<br>10.08 03.11 PR: 1KD<br>04.04 03.11 PR: 1KD,2ED<br>04.04 03.11 PR: 1KD,2ED<br>04.04 03.11 PR: 1KD,2ED<br>06.06 03.11 PR: 1KD,2ED<br>10.08 03.11 PR: 1KD<br>10.08 03.11 PR: 1KD<br>04.04 03.11 PR: 1KD,2ED<br>04.04 03.11 PR: 1KD,2ED<br>06.06 03.11 PR: 1KD,2ED<br>04.04 03.11 PR: 1KD,2ED | 13.0460-2880.2 602880<br>13.0470-2880.2 LD2880<br>13.0460-0259.2 610259 | elektrische Feststellbremse 1)<br>elektrische Feststellbremse 1) | 23914 17,1 /WE/Zub/S TRW<br>23914 17,1 /WE/Zub/S TRW<br>Belagsatz-Zubehör |
|  | 2.0 TDI 100<br>2.0 TDI 103<br>2.0 TDI 125<br>2.0 TFSI 125<br>2.4 130<br>2.4 quattro 130<br>2.7 TDI 120<br>2.7 TDI 132<br>2.7 TDI 140<br>2.7 TDI quattro 120<br>2.7 TDI quattro 132<br>2.7 TDI quattro 140<br>2.8 FSI 140<br>2.8 FSI 154<br>2.8 FSI 162<br>2.8 FSI quattro 140<br>2.8 FSI quattro 154<br>2.8 FSI quattro 162<br>3.0 160<br>3.0 quattro 160<br>3.0 TDI quattro 155<br>3.0 TDI quattro 165<br>3.0 TDI quattro 171<br>3.0 TDI quattro 176<br>3.0 TFSI quattro<br>3.2 FSI<br>3.2 FSI quattro 188<br>4.2 FSI quattro 257<br>4.2 quattro 246 |  | 06.05 03.11 PR: 1KW,2EE<br>07.04 03.11 PR: 1KW,2EE<br>10.08 03.11 PR: 1KW<br>06.05 03.11 PR: 1KW,2EE<br>04.04 03.11 PR: 1KW,2EE<br>01.05 03.11 PR: 1KW,2EE<br>11.04 03.11 PR: 1KW,2EE<br>11.04 03.11 PR: 1KW,2EE<br>10.08 03.11 PR: 1KW<br>06.05 03.11 PR: 1KW,2EE<br>11.04 03.11 PR: 1KW,2EE<br>10.08 03.11 PR: 1KW<br>10.08 03.11 PR: 1KW<br>11.06 03.11 PR: 1KW,2EE<br>10.08 03.11 PR: 1KW<br>10.08 03.11 PR: 1KW<br>04.07 03.11 PR: 1KW,2EE<br>10.08 03.11 PR: 1KW<br>04.04 03.11 PR: 1KW,2EE<br>04.04 03.11 PR: 1KW,2EE<br>04.04 03.11 PR: 1KW,2EE<br>06.06 03.11 PR: 1KW,2EE<br>10.08 03.11 PR: 1KW<br>10.08 03.11 PR: 1KW<br>04.04 03.11 PR: 1KW,2EE<br>04.04 03.11 PR: 1KW,2EE<br>06.06 03.11 PR: 1KW,2EE<br>04.04 03.11 PR: 1KW,2EE | 13.0460-2888.2 602888<br>13.0470-2888.2 LD2888<br>13.0460-0023.2 610023 | elektrische Feststellbremse 1)<br>elektrische Feststellbremse 1) | 23326 17,4 /WE/S TRW<br>23326 17,4 /WE/S TRW<br>Belagsatz-Zubehör         |
|  | 2.0 TDI 100<br>2.0 TDI 103<br>2.0 TDI 125<br>2.0 TFSI 125<br>2.4 130<br>2.4 quattro 130<br>2.7 TDI 120<br>2.7 TDI 132<br>2.7 TDI 140<br>2.7 TDI quattro 120<br>2.7 TDI quattro 132<br>2.7 TDI quattro 140<br>2.8 FSI 140<br>2.8 FSI 154<br>2.8 FSI 162<br>2.8 FSI quattro 140<br>2.8 FSI quattro 154<br>2.8 FSI quattro 162<br>3.0 160<br>3.0 quattro 160<br>3.0 TDI quattro 155<br>3.0 TDI quattro 165<br>3.0 TDI quattro 171<br>3.0 TDI quattro 176<br>3.0 TFSI quattro<br>3.2 FSI<br>3.2 FSI quattro 188<br>4.2 FSI quattro 257<br>4.2 quattro 246 |  | 06.05 03.11 PR: 1KQ<br>07.04 03.11 PR: 1KQ<br>10.08 03.11 PR: 1KQ<br>06.05 03.11 PR: 1KQ<br>04.04 03.11 PR: 1KQ<br>01.05 03.11 PR: 1KQ<br>11.04 03.11 PR: 1KQ<br>11.04 03.11 PR: 1KQ<br>10.08 03.11 PR: 1KQ<br>06.05 03.11 PR: 1KQ<br>11.04 03.11 PR: 1KQ  | 13.0460-2880.2 602880<br>13.0470-2880.2 LD2880<br>13.0460-0259.2 610259 | elektrische Feststellbremse 1)                                   | 23914 17,1 /WE/Zub/S TRW<br>23914 17,1 /WE/Zub/S TRW<br>Belagsatz-Zubehör |

1) electric parking brake / fr.di stazionamento elettrico / frein à main électrique / freno de mano eléctrico



| AUDI A6 (4F2/C6) Limousine (04-11)   |   |  |   |  |   |
|--|---|--|---|--|---|
|     | 2.7 TDI quattro 140<br>2.8 FSI 140<br>2.8 FSI 154<br>2.8 FSI 162<br>2.8 FSI quattro 140<br>2.8 FSI quattro 154<br>2.8 FSI quattro 162<br>3.0 160<br>3.0 quattro 160<br>3.0 TDI quattro 155<br>3.0 TDI quattro 165<br>3.0 TDI quattro 171<br>3.0 TDI quattro 176<br>3.0 TFSI quattro<br>3.2 FSI<br>3.2 FSI quattro 188<br>4.2 FSI quattro 257<br>4.2 quattro 246   | 10.08 03.11 PR: 1KQ<br>10.08 03.11 PR: 1KQ<br>11.06 03.11 PR: 1KQ<br>10.08 03.11 PR: 1KQ<br>10.08 03.11 PR: 1KQ<br>04.07 03.11 PR: 1KQ<br>10.08 03.11 PR: 1KQ<br>04.04 03.11 PR: 1KQ<br>04.04 03.11 PR: 1KQ<br>04.04 03.11 PR: 1KQ<br>04.04 03.11 PR: 1KQ<br>06.06 03.11 PR: 1KQ<br>10.08 03.11 PR: 1KQ<br>10.08 03.11 PR: 1KQ<br>04.04 03.11 PR: 1KQ<br>04.04 03.11 PR: 1KQ<br>06.06 03.11 PR: 1KQ<br>04.04 03.11 PR: 1KQ   | 13.0460-2880.2 602880<br>13.0470-2880.2 LD2880<br>13.0460-0259.2 610259 | elektrische Feststellbremse <sup>1)</sup>  | 23914 17,1 /WE/Zub/S TRW<br>23914 17,1 /WE/Zub/S TRW<br>Belagsatz-Zubehör |
|  | RS 6 426<br>S6 320  | 04.08 03.11<br>03.06 03.11 PR: 1KW,2EE   | 13.0460-2888.2 602888<br>13.0460-0023.2 610023                          | elektrische Feststellbremse <sup>1)</sup>  | 23326 17,4 /WE/S TRW<br>Belagsatz-Zubehör                                 |
|    | 2.0 TDI 100<br>2.0 TDI 103<br>2.0 TDI 103<br>2.0 TDI 125<br>2.0 TFSI 125<br>2.4 130<br>2.4 quattro 130<br>2.7 TDI 120<br>2.7 TDI 132<br>2.7 TDI 140<br>2.7 TDI quattro 120<br>2.7 TDI quattro 132<br>2.7 TDI quattro 140<br>2.8 FSI 140<br>2.8 FSI 154<br>2.8 FSI 162<br>2.8 FSI quattro 140<br>2.8 FSI quattro 154<br>2.8 FSI quattro 162<br>3.0 quattro 160<br>3.0 TDI quattro 155<br>3.0 TDI quattro 165<br>3.0 TDI quattro 171<br>3.0 TDI quattro 176<br>3.0 TFSI quattro<br>3.2 FSI<br>3.2 FSI quattro 188<br>4.2 FSI quattro 257<br>4.2 quattro 246 | 06.05 03.11 PR: 1KD,2ED,1KQ<br>04.04 03.11 PR: 1KD,2ED,1KQ<br>07.04 03.11 PR: 1KD,2ED,1KQ<br>10.08 03.11 PR: 1KD,1KQ<br>06.05 03.11 PR: 1KD,2ED,1KQ<br>04.04 03.11 PR: 1KD,2ED,1KQ<br>01.05 03.11 PR: 1KD,2ED,1KQ<br>11.04 03.11 PR: 1KD,2ED,1KQ<br>11.04 03.11 PR: 1KD,2ED,1KQ<br>10.08 03.11 PR: 1KD,1KQ<br>06.05 03.11 PR: 1KD,2ED,1KQ<br>11.04 03.11 PR: 1KD,2ED,1KQ<br>10.08 03.11 PR: 1KD,1KQ<br>10.08 03.11 PR: 1KD,1KQ<br>11.06 03.11 PR: 1KD,2ED,1KQ<br>10.08 03.11 PR: 1KD,1KQ<br>10.08 03.11 PR: 1KD,1KQ<br>04.07 03.11 PR: 1KD,2ED,1KQ<br>10.08 03.11 PR: 1KD,1KQ<br>04.04 03.11 PR: 1KD,2ED,1KQ<br>04.04 03.11 PR: 1KD,2ED,1KQ<br>06.06 03.11 PR: 1KD,2ED,1KQ<br>10.08 03.11 PR: 1KD,1KQ<br>10.08 03.11 PR: 1KD,1KQ<br>04.04 03.11 PR: 1KD,2ED,1KQ<br>04.04 03.11 PR: 1KD,2ED,1KQ<br>06.06 03.11 PR: 1KD,2ED,1KQ<br>04.04 03.11 PR: 1KD,1KQ<br>04.04 03.11 PR: 1KD,2ED,1KQ<br>04.04 03.11 PR: 1KD,2ED,1KQ | 24.0112-0159.1 412159<br>24.0312-0159.1 512159                          | elektrische Feststellbremse <sup>1)</sup><br>elektrische Feststellbremse <sup>1)</sup> | 302 12,0 10,0 +S +B<br>302 12,0 10,0 +B PD                                |
|  | 2.0 TDI 100<br>2.0 TDI 103<br>2.0 TDI 125<br>2.0 TFSI 125<br>2.4 130<br>2.4 quattro 130<br>2.7 TDI 120<br>2.7 TDI 132<br>2.7 TDI 140<br>2.7 TDI quattro 120<br>2.7 TDI quattro 132<br>2.7 TDI quattro 140<br>2.8 FSI 140<br>2.8 FSI 154<br>2.8 FSI 162<br>2.8 FSI quattro 140<br>2.8 FSI quattro 154<br>2.8 FSI quattro 162<br>3.0 160<br>3.0 quattro 160<br>3.0 TDI quattro 155<br>3.0 TDI quattro 165<br>3.0 TDI quattro 171<br>3.0 TDI quattro 176<br>3.0 TFSI quattro<br>3.2 FSI<br>3.2 FSI quattro 188<br>4.2 FSI quattro 257<br>4.2 quattro 246     | 06.05 03.11 PR: 1KW,2EE<br>07.04 03.11 PR: 1KW,2EE<br>10.08 03.11 PR: 1KW<br>06.05 03.11 PR: 1KW,2EE<br>04.04 03.11 PR: 1KW,2EE<br>01.05 03.11 PR: 1KW,2EE<br>11.04 03.11 PR: 1KW,2EE<br>11.04 03.11 PR: 1KW,2EE<br>10.08 03.11 PR: 1KW<br>06.05 03.11 PR: 1KW,2EE<br>11.04 03.11 PR: 1KW,2EE<br>10.08 03.11 PR: 1KW<br>10.08 03.11 PR: 1KW<br>11.06 03.11 PR: 1KW,2EE<br>10.08 03.11 PR: 1KW<br>10.08 03.11 PR: 1KW<br>04.07 03.11 PR: 1KW,2EE<br>10.08 03.11 PR: 1KW<br>04.04 03.11 PR: 1KW,2EE<br>04.04 03.11 PR: 1KW,2EE<br>04.04 03.11 PR: 1KW,2EE<br>06.06 03.11 PR: 1KW,2EE<br>10.08 03.11 PR: 1KW<br>10.08 03.11 PR: 1KW<br>04.04 03.11 PR: 1KW,2EE<br>04.04 03.11 PR: 1KW,2EE<br>06.06 03.11 PR: 1KW,2EE<br>04.04 03.11 PR: 1KW,2EE<br>04.04 03.11 PR: 1KW,2EE  | 24.0122-0223.1 422223<br>24.0322-0223.1 522223                          | elektrische Feststellbremse <sup>1)</sup><br>elektrische Feststellbremse <sup>1)</sup> | 330 22,0 20,0 V L +B<br>330 22,0 20,0 V L +B PD                           |
|  | S6 320  | 03.06 03.11 PR: 1KW,2EE  | 24.0122-0243.1 422243   | elektrische Feststellbremse <sup>1)</sup>  | 330 22,0 20,0 V L +B  |
| AUDI A6 (4F5/C6) Avant (05-11)   |   |  |   |  |   |
|  | 2.0 TDI 100<br>2.0 TDI 103<br>2.0 TDI 125<br>2.0 TFSI 125<br>2.4 130<br>2.4 quattro 130   | 06.05 08.11 PR: 1LT<br>03.05 08.11 PR: 1LT<br>10.08 08.11 PR: 1LT<br>06.05 08.11 PR: 1LT<br>03.05 08.11 PR: 1LT<br>03.05 08.11 PR: 1LT   | 13.0460-7110.2 607110<br>13.0470-7110.2 LD7110                          |  | 23018 20,3 +/WK ATE<br>23018 20,3 +/WK ATE                                |
|  |   |  |   |  |   |

<sup>1)</sup> electric parking brake / fr.di stazionamento elettrico / frein à main électrique / freno de mano eléctrico

**AUDI A6 (4F5/C6) Avant (05-11)**

|                  |                  |       |       |                     |                     |                |        |                            |                         |     |  |
|------------------|------------------|-------|-------|---------------------|---------------------|----------------|--------|----------------------------|-------------------------|-----|--|
|                  | 2.7 TDI          | 120   | 03.05 | 08.11               | PR: 1LT             | 13.0460-7110.2 | 607110 |                            | 23018 20,3 +/WK         | ATE |  |
|                  | 2.7 TDI          | 132   | 03.05 | 08.11               | PR: 1LT             | 13.0470-7110.2 | LD7110 |                            | 23018 20,3 +/WK         | ATE |  |
|                  | 2.7 TDI          | 140   | 10.08 | 08.11               | PR: 1LT             |                |        |                            |                         |     |  |
|                  | 2.7 TDI quattro  | 120   | 06.05 | 08.11               | PR: 1LT             |                |        |                            |                         |     |  |
|                  | 2.7 TDI quattro  | 132   | 03.05 | 08.11               | PR: 1LT             |                |        |                            |                         |     |  |
|                  | 2.7 TDI quattro  | 140   | 10.08 | 08.11               | PR: 1LT             |                |        |                            |                         |     |  |
|                  | 2.8 FSI          | 140   | 10.08 | 08.11               | PR: 1LT             |                |        |                            |                         |     |  |
|                  | 2.8 FSI          | 154   | 11.06 | 08.11               | PR: 1LT             |                |        |                            |                         |     |  |
|                  | 2.8 FSI          | 162   | 10.08 | 08.11               | PR: 1LT             |                |        |                            |                         |     |  |
|                  | 2.8 FSI quattro  | 140   | 10.08 | 08.11               | PR: 1LT             |                |        |                            |                         |     |  |
|                  | 2.8 FSI quattro  | 154   | 04.07 | 08.11               | PR: 1LT             |                |        |                            |                         |     |  |
|                  | 2.8 FSI quattro  | 162   | 10.08 | 08.11               | PR: 1LT             |                |        |                            |                         |     |  |
|                  | 3.0              | 160   | 03.05 | 08.11               | PR: 1LT             |                |        |                            |                         |     |  |
|                  | 3.0 quattro      | 160   | 03.05 | 08.11               | PR: 1LT             |                |        |                            |                         |     |  |
|                  | 3.0 TDI quattro  | 155   | 03.05 | 08.11               | PR: 1LT             |                |        |                            |                         |     |  |
|                  | 3.0 TDI quattro  | 165   | 03.05 | 08.11               | PR: 1LT             |                |        |                            |                         |     |  |
|                  | 3.0 TDI quattro  | 171   | 06.06 | 08.11               | PR: 1LT             |                |        |                            |                         |     |  |
|                  | 3.0 TDI quattro  | 176   | 10.08 | 08.11               | PR: 1LT             |                |        |                            |                         |     |  |
|                  | 3.0 TFSI quattro |       | 10.08 | 08.11               | PR: 1LT             |                |        |                            |                         |     |  |
|                  | 3.2 FSI          | 188   | 03.05 | 08.11               | PR: 1LT             |                |        |                            |                         |     |  |
| 3.2 FSI quattro  | 188              | 03.05 | 08.11 | PR: 1LT             |                     |                |        |                            |                         |     |  |
| 4.2 FSI quattro  | 257              | 06.06 | 08.11 | PR: 1LT             | 13.0460-7110.2      | 607110         |        | 23018 20,3 +/WK            | ATE                     |     |  |
| 4.2 quattro      | 246              | 03.05 | 08.11 | PR: 1LT             |                     |                |        |                            |                         |     |  |
|                  | 2.0 TDI          | 100   | 06.05 | 08.11               | PR: 1LG,1LD,1ZL,1LH | 13.0460-7201.2 | 607201 |                            | 23763 20,3 +/WK         | ATE |  |
|                  | 2.0 TDI          | 103   | 03.05 | 08.11               | PR: 1LG,1LD,1ZL,1LH | 13.0470-7201.2 | LD7201 |                            | 23763 20,3 +/WK         | ATE |  |
|                  | 2.0 TDI          | 125   | 10.08 | 08.11               | PR: 1LG,1ZL         |                |        |                            |                         |     |  |
|                  | 2.0 TFSI         | 125   | 06.05 | 08.11               | PR: 1LG,1LD,1ZL,1LH |                |        |                            |                         |     |  |
|                  | 2.4              | 130   | 03.05 | 08.11               | PR: 1LG,1LD,1ZL,1LH |                |        |                            |                         |     |  |
|                  | 2.4 quattro      | 130   | 03.05 | 08.11               | PR: 1LG,1LD,1ZL,1LH |                |        |                            |                         |     |  |
|                  | 2.7 TDI          | 120   | 03.05 | 08.11               | PR: 1LG,1LD,1ZL,1LH |                |        |                            |                         |     |  |
|                  | 2.7 TDI          | 132   | 03.05 | 08.11               | PR: 1LG,1LD,1ZL,1LH |                |        |                            |                         |     |  |
|                  | 2.7 TDI          | 140   | 10.08 | 08.11               | PR: 1LG,1ZL         |                |        |                            |                         |     |  |
|                  | 2.7 TDI quattro  | 120   | 06.05 | 08.11               | PR: 1LG,1LD,1ZL,1LH |                |        |                            |                         |     |  |
|                  | 2.7 TDI quattro  | 132   | 03.05 | 08.11               | PR: 1LG,1LD,1ZL,1LH |                |        |                            |                         |     |  |
|                  | 2.7 TDI quattro  | 140   | 10.08 | 08.11               | PR: 1LG,1ZL         |                |        |                            |                         |     |  |
|                  | 2.8 FSI          | 140   | 10.08 | 08.11               | PR: 1LG,1ZL         |                |        |                            |                         |     |  |
|                  | 2.8 FSI          | 154   | 11.06 | 08.11               | PR: 1LG,1LD,1ZL,1LH |                |        |                            |                         |     |  |
|                  | 2.8 FSI          | 162   | 10.08 | 08.11               | PR: 1LG,1ZL         |                |        |                            |                         |     |  |
|                  | 2.8 FSI quattro  | 140   | 10.08 | 08.11               | PR: 1LG,1ZL         |                |        |                            |                         |     |  |
|                  | 2.8 FSI quattro  | 154   | 04.07 | 08.11               | PR: 1LG,1LD,1ZL,1LH |                |        |                            |                         |     |  |
|                  | 2.8 FSI quattro  | 162   | 10.08 | 08.11               | PR: 1LG,1ZL         |                |        |                            |                         |     |  |
|                  | 3.0              | 160   | 03.05 | 08.11               | PR: 1LG,1LD,1ZL,1LH |                |        |                            |                         |     |  |
|                  | 3.0 quattro      | 160   | 03.05 | 08.11               | PR: 1LG,1LD,1ZL,1LH |                |        |                            |                         |     |  |
| 3.0 TDI quattro  | 155              | 03.05 | 08.11 | PR: 1LG,1LD,1ZL,1LH |                     |                |        |                            |                         |     |  |
| 3.0 TDI quattro  | 165              | 03.05 | 08.11 | PR: 1LG,1LD,1ZL,1LH |                     |                |        |                            |                         |     |  |
| 3.0 TDI quattro  | 171              | 06.06 | 08.11 | PR: 1LG,1LD,1ZL,1LH |                     |                |        |                            |                         |     |  |
| 3.0 TDI quattro  | 176              | 10.08 | 08.11 | PR: 1LG,1ZL         |                     |                |        |                            |                         |     |  |
| 3.0 TFSI quattro |                  | 10.08 | 08.11 | PR: 1LG,1ZL         |                     |                |        |                            |                         |     |  |
| 3.2 FSI          | 188              | 03.05 | 08.11 | PR: 1LG,1LD,1ZL,1LH |                     |                |        |                            |                         |     |  |
| 3.2 FSI quattro  | 188              | 03.05 | 08.11 | PR: 1LG,1LD,1ZL,1LH |                     |                |        |                            |                         |     |  |
| 4.2 FSI quattro  | 257              | 06.06 | 08.11 | PR: 1LG,1LD,1ZL,1LH | 13.0460-7201.2      | 607201         |        | 23763 20,3 +/WK            | ATE                     |     |  |
| 4.2 quattro      | 246              | 03.05 | 08.11 | PR: 1LG,1LD,1ZL,1LH |                     |                |        |                            |                         |     |  |
| S6               | 320              | 03.06 | 08.11 |                     | 13.0460-7182.2      | 607182         |        | 23896 20,6 +/WK            | ATE                     |     |  |
| RS 6             | 426              | 04.08 | 08.11 | PR: 1LM             | 13.0460-4864.2      | 604864         |        | 24455 16,8 /WK             | BRE                     |     |  |
|                  | 2.0 TDI          | 100   | 06.05 | 08.11               | PR: 1LT             | 24.0125-0149.1 | 425149 |                            | 314 25,0 23,0 V L +B    |     |  |
|                  | 2.0 TDI          | 103   | 03.05 | 08.11               | PR: 1LT             | 24.0325-0149.1 | 525149 |                            | 314 25,0 23,0 V L +B PD |     |  |
|                  | 2.0 TDI          | 125   | 10.08 | 08.11               | PR: 1LT             |                |        |                            |                         |     |  |
|                  | 2.0 TFSI         | 125   | 06.05 | 08.11               | PR: 1LT             |                |        |                            |                         |     |  |
|                  | 2.4              | 130   | 03.05 | 08.11               | PR: 1LT             |                |        |                            |                         |     |  |
|                  | 2.4 quattro      | 130   | 03.05 | 08.11               | PR: 1LT             |                |        |                            |                         |     |  |
|                  | 2.7 TDI          | 120   | 03.05 | 08.11               | PR: 1LT             |                |        |                            |                         |     |  |
|                  | 2.7 TDI          | 132   | 03.05 | 08.11               | PR: 1LT             |                |        |                            |                         |     |  |
|                  | 2.7 TDI          | 140   | 10.08 | 08.11               | PR: 1LT             |                |        |                            |                         |     |  |
|                  | 2.7 TDI quattro  | 120   | 06.05 | 08.11               | PR: 1LT             |                |        |                            |                         |     |  |
|                  | 2.7 TDI quattro  | 132   | 03.05 | 08.11               | PR: 1LT             |                |        |                            |                         |     |  |
|                  | 2.7 TDI quattro  | 140   | 10.08 | 08.11               | PR: 1LT             |                |        |                            |                         |     |  |
|                  | 2.8 FSI          | 140   | 10.08 | 08.11               | PR: 1LT             |                |        |                            |                         |     |  |
|                  | 2.8 FSI          | 154   | 11.06 | 08.11               | PR: 1LT             |                |        |                            |                         |     |  |
|                  | 2.8 FSI          | 162   | 10.08 | 08.11               | PR: 1LT             |                |        |                            |                         |     |  |
|                  | 2.8 FSI quattro  | 140   | 10.08 | 08.11               | PR: 1LT             |                |        |                            |                         |     |  |
|                  | 2.8 FSI quattro  | 154   | 04.07 | 08.11               | PR: 1LT             |                |        |                            |                         |     |  |
|                  | 2.8 FSI quattro  | 162   | 10.08 | 08.11               | PR: 1LT             |                |        |                            |                         |     |  |
|                  | 3.0              | 160   | 03.05 | 08.11               | PR: 1LT             |                |        |                            |                         |     |  |
|                  | 3.0 quattro      | 160   | 03.05 | 08.11               | PR: 1LT             |                |        |                            |                         |     |  |
| 3.0 TDI quattro  | 155              | 03.05 | 08.11 | PR: 1LT             |                     |                |        |                            |                         |     |  |
| 3.0 TDI quattro  | 165              | 03.05 | 08.11 | PR: 1LT             |                     |                |        |                            |                         |     |  |
| 3.0 TDI quattro  | 171              | 06.06 | 08.11 | PR: 1LT             |                     |                |        |                            |                         |     |  |
| 3.0 TDI quattro  | 176              | 10.08 | 08.11 | PR: 1LT             |                     |                |        |                            |                         |     |  |
| 3.0 TFSI quattro |                  | 10.08 | 08.11 | PR: 1LT             |                     |                |        |                            |                         |     |  |
| 3.2 FSI          | 188              | 03.05 | 08.11 | PR: 1LT             |                     |                |        |                            |                         |     |  |
| 3.2 FSI quattro  | 188              | 03.05 | 08.11 | PR: 1LT             |                     |                |        |                            |                         |     |  |
| 4.2 FSI quattro  | 257              | 06.06 | 08.11 | PR: 1LT             |                     |                |        |                            |                         |     |  |
| 4.2 quattro      | 246              | 03.05 | 08.11 | PR: 1LT             |                     |                |        |                            |                         |     |  |
| 2.0 TDI          | 100              | 06.05 | 08.11 | PR: 1LG,1LD         | 24.0130-0175.1      | 430175         |        | 321 30,0 28,0 V L +S +B    |                         |     |  |
| 2.0 TDI          | 103              | 03.05 | 08.11 | PR: 1LG,1LD         | 24.0330-0175.1      | 530175         |        | 321 30,0 28,0 V L +S +B PD |                         |     |  |
| 2.0 TDI          | 125              | 10.08 | 08.11 | PR: 1LG             |                     |                |        |                            |                         |     |  |



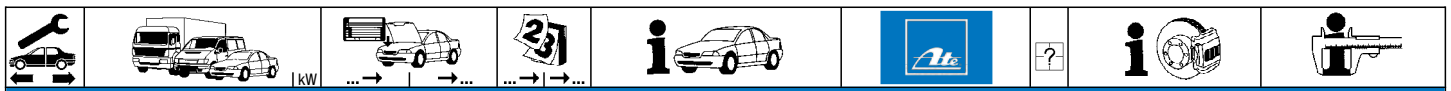

**AUDI A6 (4F5/C6) Avant (05-11)**

|                  |                  |       |       |             |                |                |                      |  |   |   |
|------------------|------------------|-------|-------|-------------|----------------|----------------|----------------------|--|---|---|
|                  | 2.0 TFSI         | 125   | 06.05 | 08.11       | PR: 1LG,1LD    | 24.0130-0175.1 | 430175               |  | 321 30,0 28,0 V L +S +B<br>321 30,0 28,0 V L +S +B PD                     |   |
|                  | 2.4              | 130   | 03.05 | 08.11       | PR: 1LG,1LD    | 24.0330-0175.1 | 530175               |  |   |   |
|                  | 2.4 quattro      | 130   | 03.05 | 08.11       | PR: 1LG,1LD    |                |                      |  |   |   |
|                  | 2.7 TDI          | 120   | 03.05 | 08.11       | PR: 1LG,1LD    |                |                      |  |   |   |
|                  | 2.7 TDI          | 132   | 03.05 | 08.11       | PR: 1LG,1LD    |                |                      |  |   |   |
|                  | 2.7 TDI          | 140   | 10.08 | 08.11       | PR: 1LG        |                |                      |  |   |   |
|                  | 2.7 TDI quattro  | 120   | 06.05 | 08.11       | PR: 1LG,1LD    |                |                      |  |   |   |
|                  | 2.7 TDI quattro  | 132   | 03.05 | 08.11       | PR: 1LG,1LD    |                |                      |  |   |   |
|                  | 2.7 TDI quattro  | 140   | 10.08 | 08.11       | PR: 1LG        |                |                      |  |   |   |
|                  | 2.8 FSI          | 140   | 10.08 | 08.11       | PR: 1LG        |                |                      |  |   |   |
|                  | 2.8 FSI          | 154   | 11.06 | 08.11       | PR: 1LG,1LD    |                |                      |  |   |   |
|                  | 2.8 FSI          | 162   | 10.08 | 08.11       | PR: 1LG        |                |                      |  |   |   |
|                  | 2.8 FSI quattro  | 140   | 10.08 | 08.11       | PR: 1LG        |                |                      |  |   |   |
|                  | 2.8 FSI quattro  | 154   | 04.07 | 08.11       | PR: 1LG,1LD    |                |                      |  |   |   |
|                  | 2.8 FSI quattro  | 162   | 10.08 | 08.11       | PR: 1LG        |                |                      |  |   |   |
|                  | 3.0              | 160   | 03.05 | 08.11       | PR: 1LG,1LD    |                |                      |  |   |   |
|                  | 3.0 quattro      | 160   | 03.05 | 08.11       | PR: 1LG,1LD    |                |                      |  |   |   |
|                  | 3.0 TDI quattro  | 155   | 03.05 | 08.11       | PR: 1LG,1LD    |                |                      |  |   |   |
|                  | 3.0 TDI quattro  | 165   | 03.05 | 08.11       | PR: 1LG,1LD    |                |                      |  |   |   |
|                  | 3.0 TDI quattro  | 171   | 06.06 | 08.11       | PR: 1LG,1LD    |                |                      |  |   |   |
|                  | 3.0 TDI quattro  | 176   | 10.08 | 08.11       | PR: 1LG        |                |                      |  |   |   |
|                  | 3.0 TFSI quattro |       | 10.08 | 08.11       | PR: 1LG        |                |                      |  |   |   |
|                  | 3.2 FSI          | 188   | 03.05 | 08.11       | PR: 1LG,1LD    |                |                      |  |   |   |
|                  | 3.2 FSI quattro  | 188   | 03.05 | 08.11       | PR: 1LG,1LD    |                |                      |  |   |   |
|                  | 4.2 FSI quattro  | 257   | 06.06 | 08.11       | PR: 1LG,1LD    |                |                      |  |   |   |
|                  | 4.2 quattro      | 246   | 03.05 | 08.11       | PR: 1LG,1LD    |                |                      |  |   |   |
|                  | 2.0 TDI          | 100   | 06.05 | 08.11       | PR: 1ZL,1LH    | 24.0130-0176.1 | 430176               |  |   | 347 30,0 28,0 V L +S +B<br>347 30,0 28,0 V L +S +B PD |
|                  | 2.0 TDI          | 103   | 03.05 | 08.11       | PR: 1ZL,1LH    | 24.0330-0176.1 | 530176               |  |   |   |
|                  | 2.0 TDI          | 125   | 10.08 | 08.11       | PR: 1ZL        |                |                      |  |   |   |
|                  | 2.0 TFSI         | 125   | 06.05 | 08.11       | PR: 1ZL,1LH    |                |                      |  |   |   |
|                  | 2.4              | 130   | 03.05 | 08.11       | PR: 1ZL,1LH    |                |                      |  |   |   |
| 2.4 quattro      | 130              | 03.05 | 08.11 | PR: 1ZL,1LH |                |                |                      |  |   |   |
| 2.7 TDI          | 120              | 03.05 | 08.11 | PR: 1ZL,1LH |                |                |                      |  |   |   |
| 2.7 TDI          | 132              | 03.05 | 08.11 | PR: 1ZL,1LH |                |                |                      |  |   |   |
| 2.7 TDI          | 140              | 10.08 | 08.11 | PR: 1ZL     |                |                |                      |  |   |   |
| 2.7 TDI quattro  | 120              | 06.05 | 08.11 | PR: 1ZL,1LH |                |                |                      |  |   |   |
| 2.7 TDI quattro  | 132              | 03.05 | 08.11 | PR: 1ZL,1LH |                |                |                      |  |   |   |
| 2.7 TDI quattro  | 140              | 10.08 | 08.11 | PR: 1ZL     |                |                |                      |  |   |   |
| 2.8 FSI          | 140              | 10.08 | 08.11 | PR: 1ZL     |                |                |                      |  |   |   |
| 2.8 FSI          | 154              | 11.06 | 08.11 | PR: 1ZL,1LH |                |                |                      |  |   |   |
| 2.8 FSI          | 162              | 10.08 | 08.11 | PR: 1ZL     |                |                |                      |  |   |   |
| 2.8 FSI quattro  | 140              | 10.08 | 08.11 | PR: 1ZL     |                |                |                      |  |   |   |
| 2.8 FSI quattro  | 154              | 04.07 | 08.11 | PR: 1ZL,1LH |                |                |                      |  |   |   |
| 2.8 FSI quattro  | 162              | 10.08 | 08.11 | PR: 1ZL     |                |                |                      |  |   |   |
| 3.0              | 160              | 03.05 | 08.11 | PR: 1ZL,1LH |                |                |                      |  |   |   |
| 3.0 quattro      | 160              | 03.05 | 08.11 | PR: 1ZL,1LH |                |                |                      |  |   |   |
| 3.0 TDI quattro  | 155              | 03.05 | 08.11 | PR: 1ZL,1LH |                |                |                      |  |   |   |
| 3.0 TDI quattro  | 165              | 03.05 | 08.11 | PR: 1ZL,1LH |                |                |                      |  |   |   |
| 3.0 TDI quattro  | 171              | 06.06 | 08.11 | PR: 1ZL,1LH |                |                |                      |  |   |   |
| 3.0 TDI quattro  | 176              | 10.08 | 08.11 | PR: 1ZL     |                |                |                      |  |   |   |
| 3.0 TFSI quattro |                  | 10.08 | 08.11 | PR: 1ZL     |                |                |                      |  |   |   |
| 3.2 FSI          | 188              | 03.05 | 08.11 | PR: 1ZL,1LH |                |                |                      |  |   |   |
| 3.2 FSI quattro  | 188              | 03.05 | 08.11 | PR: 1ZL,1LH |                |                |                      |  |   |   |
| 4.2 FSI quattro  | 257              | 06.06 | 08.11 | PR: 1ZL,1LH |                |                |                      |  |   |   |
| 4.2 quattro      | 246              | 03.05 | 08.11 | PR: 1ZL,1LH |                |                |                      |  |   |   |
| S6               | 320              | 06.05 | 08.11 |             | 24.0136-0107.1 | 436107         | 385 36,0 33,5 V L +B |  |   |   |
|                  | 2.0 TDI          | 100   | 06.05 | 08.11       | PR: 1KD,2ED    | 13.0460-2880.2 | 602880               | elektrische Feststellbremse <sup>1)</sup><br>elektrische Feststellbremse <sup>1)</sup> | 23914 17,1 /WE/Zub/S TRW<br>23914 17,1 /WE/Zub/S TRW<br>Belagsatz-Zubehör |   |
|                  | 2.0 TDI          | 103   | 03.05 | 08.11       | PR: 1KD,2ED    | 13.0470-2880.2 | LD2880               |  |   |   |
|                  | 2.0 TDI          | 125   | 10.08 | 08.11       | PR: 1KD        | 13.0460-0259.2 | 610259               |  |   |   |
|                  | 2.0 TFSI         | 125   | 06.05 | 08.11       | PR: 1KD,2ED    |                |                      |  |   |   |
|                  | 2.4              | 130   | 03.05 | 08.11       | PR: 1KD,2ED    |                |                      |  |   |   |
|                  | 2.4 quattro      | 130   | 03.05 | 08.11       | PR: 1KD,2ED    |                |                      |  |   |   |
|                  | 2.7 TDI          | 120   | 03.05 | 08.11       | PR: 1KD,2ED    |                |                      |  |   |   |
|                  | 2.7 TDI          | 132   | 03.05 | 08.11       | PR: 1KD,2ED    |                |                      |  |   |   |
|                  | 2.7 TDI          | 140   | 10.08 | 08.11       | PR: 1KD        |                |                      |  |   |   |
|                  | 2.7 TDI quattro  | 120   | 06.05 | 08.11       | PR: 1KD,2ED    |                |                      |  |   |   |
|                  | 2.7 TDI quattro  | 132   | 03.05 | 08.11       | PR: 1KD,2ED    |                |                      |  |   |   |
|                  | 2.7 TDI quattro  | 140   | 10.08 | 08.11       | PR: 1KD        |                |                      |  |   |   |
|                  | 2.8 FSI          | 140   | 10.08 | 08.11       | PR: 1KD        |                |                      |  |   |   |
|                  | 2.8 FSI          | 154   | 11.06 | 08.11       | PR: 1KD,2ED    |                |                      |  |   |   |
|                  | 2.8 FSI          | 162   | 10.08 | 08.11       | PR: 1KD        |                |                      |  |   |   |
|                  | 2.8 FSI quattro  | 140   | 10.08 | 08.11       | PR: 1KD        |                |                      |  |   |   |
|                  | 2.8 FSI quattro  | 154   | 04.07 | 08.11       | PR: 1KD,2ED    |                |                      |  |   |   |
|                  | 2.8 FSI quattro  | 162   | 10.08 | 08.11       | PR: 1KD        |                |                      |  |   |   |
|                  | 3.0              | 160   | 03.05 | 08.11       | PR: 1KD,2ED    |                |                      |  |   |   |
|                  | 3.0 quattro      | 160   | 03.05 | 08.11       | PR: 1KD,2ED    |                |                      |  |   |   |
|                  | 3.0 TDI quattro  | 155   | 03.05 | 08.11       | PR: 1KD,2ED    |                |                      |  |   |   |
|                  | 3.0 TDI quattro  | 165   | 03.05 | 08.11       | PR: 1KD,2ED    |                |                      |  |   |   |
|                  | 3.0 TDI quattro  | 171   | 06.06 | 08.11       | PR: 1KD,2ED    |                |                      |  |   |   |
|                  | 3.0 TDI quattro  | 176   | 10.08 | 08.11       | PR: 1KD        |                |                      |  |   |   |
|                  | 3.0 TFSI quattro |       | 10.08 | 08.11       | PR: 1KD        |                |                      |  |   |   |
|                  | 3.2 FSI          | 188   | 03.05 | 08.11       | PR: 1KD,2ED    |                |                      |  |   |   |
|                  | 3.2 FSI quattro  | 188   | 03.05 | 08.11       | PR: 1KD,2ED    |                |                      |  |   |   |
| 4.2 FSI quattro  | 257              | 06.06 | 08.11 | PR: 1KD,2ED |                |                |                      |  |   |   |
| 4.2 quattro      | 246              | 03.05 | 08.11 | PR: 1KD,2ED |                |                |                      |  |   |   |

<sup>1)</sup> electric parking brake / fr.di stazionamento elettrico / frein à main électrique / freno de mano eléctrico

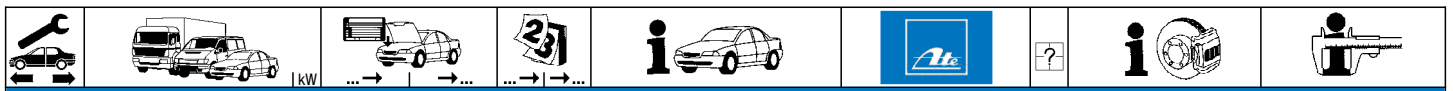

**AUDI A6 (4F5/C6) Avant (05-11)**

|                  |                  |       |       |             |                 |                |   |  |   |            |  |   |            |
|------------------|------------------|-------|-------|-------------|-----------------|----------------|---|--|---|------------|--|---|------------|
|                  | 2.0 TDI          | 100   | 06.05 | 08.11       | PR: 1KW,2EE     | 13.0460-2888.2 | 602888                                    | elektrische Feststellbremse <sup>1)</sup><br>elektrische Feststellbremse <sup>1)</sup> | 23326 17,4 /WE/S<br>23326 17,4 /WE/S<br>Belagsatz-Zubehör | TRW<br>TRW |  |   |            |
|                  | 2.0 TDI          | 103   | 03.05 | 08.11       | PR: 1KW,2EE     | 13.0470-2888.2 | LD2888                                    |  |   |            |  |   |            |
|                  | 2.0 TDI          | 125   | 10.08 | 08.11       | PR: 1KW         | 13.0460-0023.2 | 610023                                    |  |   |            |  |   |            |
|                  | 2.0 TFSI         | 125   | 06.05 | 08.11       | PR: 1KW,2EE     |                |   |  |   |            |  |   |            |
|                  | 2.4              | 130   | 03.05 | 08.11       | PR: 1KW,2EE     |                |   |  |   |            |  |   |            |
|                  | 2.4 quattro      | 130   | 03.05 | 08.11       | PR: 1KW,2EE     |                |   |  |   |            |  |   |            |
|                  | 2.7 TDI          | 120   | 03.05 | 08.11       | PR: 1KW,2EE     |                |   |  |   |            |  |   |            |
|                  | 2.7 TDI          | 132   | 03.05 | 08.11       | PR: 1KW,2EE     |                |   |  |   |            |  |   |            |
|                  | 2.7 TDI          | 140   | 10.08 | 08.11       | PR: 1KW         |                |   |  |   |            |  |   |            |
|                  | 2.7 TDI quattro  | 120   | 06.05 | 08.11       | PR: 1KW,2EE     |                |   |  |   |            |  |   |            |
|                  | 2.7 TDI quattro  | 132   | 03.05 | 08.11       | PR: 1KW,2EE     |                |   |  |   |            |  |   |            |
|                  | 2.7 TDI quattro  | 140   | 10.08 | 08.11       | PR: 1KW         |                |   |  |   |            |  |   |            |
|                  | 2.8 FSI          | 140   | 10.08 | 08.11       | PR: 1KW         |                |   |  |   |            |  |   |            |
|                  | 2.8 FSI          | 154   | 11.06 | 08.11       | PR: 1KW,2EE     |                |   |  |   |            |  |   |            |
|                  | 2.8 FSI          | 162   | 10.08 | 08.11       | PR: 1KW         |                |   |  |   |            |  |   |            |
|                  | 2.8 FSI quattro  | 140   | 10.08 | 08.11       | PR: 1KW         |                |   |  |   |            |  |   |            |
|                  | 2.8 FSI quattro  | 154   | 04.07 | 08.11       | PR: 1KW,2EE     |                |   |  |   |            |  |   |            |
|                  | 2.8 FSI quattro  | 162   | 10.08 | 08.11       | PR: 1KW         |                |   |  |   |            |  |   |            |
|                  | 3.0              | 160   | 03.05 | 08.11       | PR: 1KW,2EE     |                |   |  |   |            |  |   |            |
|                  | 3.0 quattro      | 160   | 03.05 | 08.11       | PR: 1KW,2EE     |                |   |  |   |            |  |   |            |
|                  | 3.0 TDI quattro  | 155   | 03.05 | 08.11       | PR: 1KW,2EE     |                |   |  |   |            |  |   |            |
|                  | 3.0 TDI quattro  | 165   | 03.05 | 08.11       | PR: 1KW,2EE     |                |   |  |   |            |  |   |            |
|                  | 3.0 TDI quattro  | 171   | 06.06 | 08.11       | PR: 1KW,2EE     |                |   |  |   |            |  |   |            |
|                  | 3.0 TDI quattro  | 176   | 10.08 | 08.11       | PR: 1KW         |                |   |  |   |            |  |   |            |
|                  | 3.0 TFSI quattro |       | 10.08 | 08.11       | PR: 1KW         |                |   |  |   |            |  |   |            |
|                  | 3.2 FSI          | 188   | 03.05 | 08.11       | PR: 1KW,2EE     |                |   |  |   |            |  |   |            |
|                  | 3.2 FSI quattro  | 188   | 03.05 | 08.11       | PR: 1KW,2EE     |                |   |  |   |            |  |   |            |
|                  | 4.2 FSI quattro  | 257   | 06.06 | 08.11       | PR: 1KW,2EE     |                |   |  |   |            |  |   |            |
|                  | 4.2 quattro      | 246   | 03.05 | 08.11       | PR: 1KW,2EE     |                |   |  |   |            |  |   |            |
|                  | 2.0 TDI          | 100   | 06.05 | 08.11       | PR: 1KQ         | 13.0460-2880.2 | 602880                                    |  |   |            | elektrische Feststellbremse <sup>1)</sup><br>elektrische Feststellbremse <sup>1)</sup> | 23914 17,1 /WE/Zub/S<br>23914 17,1 /WE/Zub/S<br>Belagsatz-Zubehör | TRW<br>TRW |
|                  | 2.0 TDI          | 103   | 03.05 | 08.11       | PR: 1KQ         | 13.0470-2880.2 | LD2880                                    |  |   |            |  |   |            |
|                  | 2.0 TDI          | 125   | 10.08 | 08.11       | PR: 1KQ         | 13.0460-0259.2 | 610259                                    |  |   |            |  |   |            |
|                  | 2.0 TFSI         | 125   | 06.05 | 08.11       | PR: 1KQ         |                |   |  |   |            |  |   |            |
|                  | 2.4              | 130   | 03.05 | 08.11       | PR: 1KQ         |                |   |  |   |            |  |   |            |
| 2.4 quattro      | 130              | 03.05 | 08.11 | PR: 1KQ     |                 |                |   |  |   |            |  |   |            |
| 2.7 TDI          | 120              | 03.05 | 08.11 | PR: 1KQ     |                 |                |   |  |   |            |  |   |            |
| 2.7 TDI          | 132              | 03.05 | 08.11 | PR: 1KQ     |                 |                |   |  |   |            |  |   |            |
| 2.7 TDI          | 140              | 10.08 | 08.11 | PR: 1KQ     |                 |                |   |  |   |            |  |   |            |
| 2.7 TDI quattro  | 120              | 06.05 | 08.11 | PR: 1KQ     |                 |                |   |  |   |            |  |   |            |
| 2.7 TDI quattro  | 132              | 03.05 | 08.11 | PR: 1KQ     |                 |                |   |  |   |            |  |   |            |
| 2.7 TDI quattro  | 140              | 10.08 | 08.11 | PR: 1KQ     |                 |                |   |  |   |            |  |   |            |
| 2.8 FSI          | 140              | 10.08 | 08.11 | PR: 1KQ     |                 |                |   |  |   |            |  |   |            |
| 2.8 FSI          | 154              | 11.06 | 08.11 | PR: 1KQ     |                 |                |   |  |   |            |  |   |            |
| 2.8 FSI          | 162              | 10.08 | 08.11 | PR: 1KQ     |                 |                |   |  |   |            |  |   |            |
| 2.8 FSI quattro  | 140              | 10.08 | 08.11 | PR: 1KQ     |                 |                |   |  |   |            |  |   |            |
| 2.8 FSI quattro  | 154              | 04.07 | 08.11 | PR: 1KQ     |                 |                |   |  |   |            |  |   |            |
| 2.8 FSI quattro  | 162              | 10.08 | 08.11 | PR: 1KQ     |                 |                |   |  |   |            |  |   |            |
| 3.0              | 160              | 03.05 | 08.11 | PR: 1KQ     |                 |                |   |  |   |            |  |   |            |
| 3.0 quattro      | 160              | 03.05 | 08.11 | PR: 1KQ     |                 |                |   |  |   |            |  |   |            |
| 3.0 TDI quattro  | 155              | 03.05 | 08.11 | PR: 1KQ     |                 |                |   |  |   |            |  |   |            |
| 3.0 TDI quattro  | 165              | 03.05 | 08.11 | PR: 1KQ     |                 |                |   |  |   |            |  |   |            |
| 3.0 TDI quattro  | 171              | 06.06 | 08.11 | PR: 1KQ     |                 |                |   |  |   |            |  |   |            |
| 3.0 TDI quattro  | 176              | 10.08 | 08.11 | PR: 1KQ     |                 |                |   |  |   |            |  |   |            |
| 3.0 TFSI quattro |                  | 10.08 | 08.11 | PR: 1KQ     |                 |                |   |  |   |            |  |   |            |
| 3.2 FSI          | 188              | 03.05 | 08.11 | PR: 1KQ     |                 |                |   |  |   |            |  |   |            |
| 3.2 FSI quattro  | 188              | 03.05 | 08.11 | PR: 1KQ     |                 |                |   |  |   |            |  |   |            |
| 4.2 FSI quattro  | 257              | 06.06 | 08.11 | PR: 1KQ     |                 |                |   |  |   |            |  |   |            |
| 4.2 quattro      | 246              | 03.05 | 08.11 | PR: 1KQ     |                 |                |   |  |   |            |  |   |            |
| RS 6             | 426              | 04.08 | 08.11 |             | 13.0460-2888.2  | 602888         | elektrische Feststellbremse <sup>1)</sup> | 23326 17,4 /WE/S<br>Belagsatz-Zubehör  | TRW   |            |  |   |            |
| S6               | 320              | 03.06 | 08.11 | PR: 1KW,2EE | 13.0460-0023.2  | 610023         |   |  |   |            |  |   |            |
|                  | 2.0 TDI          | 100   | 06.05 | 08.11       | PR: 1KD,2ED,1KQ | 24.0112-0159.1 | 412159                                    | elektrische Feststellbremse <sup>1)</sup><br>elektrische Feststellbremse <sup>1)</sup> | 302 12,0 10,0 +S +B<br>302 12,0 10,0 +B PD                |            |  |   |            |
|                  | 2.0 TDI          | 103   | 03.05 | 08.11       | PR: 1KD,2ED,1KQ | 24.0312-0159.1 | 512159                                    |  |   |            |  |   |            |
|                  | 2.0 TDI          | 125   | 10.08 | 08.11       | PR: 1KD,1KQ     |                |   |  |   |            |  |   |            |
|                  | 2.0 TFSI         | 125   | 06.05 | 08.11       | PR: 1KD,2ED,1KQ |                |   |  |   |            |  |   |            |
|                  | 2.4              | 130   | 03.05 | 08.11       | PR: 1KD,2ED,1KQ |                |   |  |   |            |  |   |            |
|                  | 2.4 quattro      | 130   | 03.05 | 08.11       | PR: 1KD,2ED,1KQ |                |   |  |   |            |  |   |            |
|                  | 2.7 TDI          | 120   | 03.05 | 08.11       | PR: 1KD,2ED,1KQ |                |   |  |   |            |  |   |            |
|                  | 2.7 TDI          | 132   | 03.05 | 08.11       | PR: 1KD,2ED,1KQ |                |   |  |   |            |  |   |            |
|                  | 2.7 TDI          | 140   | 10.08 | 08.11       | PR: 1KD,1KQ     |                |   |  |   |            |  |   |            |
|                  | 2.7 TDI quattro  | 120   | 06.05 | 08.11       | PR: 1KD,2ED,1KQ |                |   |  |   |            |  |   |            |
|                  | 2.7 TDI quattro  | 132   | 03.05 | 08.11       | PR: 1KD,2ED,1KQ |                |   |  |   |            |  |   |            |
|                  | 2.7 TDI quattro  | 140   | 10.08 | 08.11       | PR: 1KD,1KQ     |                |   |  |   |            |  |   |            |
|                  | 2.8 FSI          | 140   | 10.08 | 08.11       | PR: 1KD,1KQ     |                |   |  |   |            |  |   |            |
|                  | 2.8 FSI          | 154   | 11.06 | 08.11       | PR: 1KD,2ED,1KQ |                |   |  |   |            |  |   |            |
|                  | 2.8 FSI          | 162   | 10.08 | 08.11       | PR: 1KD,1KQ     |                |   |  |   |            |  |   |            |
|                  | 2.8 FSI quattro  | 140   | 10.08 | 08.11       | PR: 1KD,1KQ     |                |   |  |   |            |  |   |            |
|                  | 2.8 FSI quattro  | 154   | 04.07 | 08.11       | PR: 1KD,2ED,1KQ |                |   |  |   |            |  |   |            |
|                  | 2.8 FSI quattro  | 162   | 10.08 | 08.11       | PR: 1KD,1KQ     |                |   |  |   |            |  |   |            |
|                  | 3.0              | 160   | 03.05 | 08.11       | PR: 1KD,2ED,1KQ |                |   |  |   |            |  |   |            |
|                  | 3.0 quattro      | 160   | 03.05 | 08.11       | PR: 1KD,2ED,1KQ |                |   |  |   |            |  |   |            |
|                  | 3.0 TDI quattro  | 155   | 03.05 | 08.11       | PR: 1KD,2ED,1KQ |                |   |  |   |            |  |   |            |
|                  | 3.0 TDI quattro  | 165   | 03.05 | 08.11       | PR: 1KD,2ED,1KQ |                |   |  |   |            |  |   |            |
|                  | 3.0 TDI quattro  | 171   | 06.06 | 08.11       | PR: 1KD,2ED,1KQ |                |   |  |   |            |  |   |            |
|                  | 3.0 TDI quattro  | 176   | 10.08 | 08.11       | PR: 1KD,1KQ     |                |   |  |   |            |  |   |            |
|                  | 3.0 TFSI quattro |       | 10.08 | 08.11       | PR: 1KD,1KQ     |                |   |  |   |            |  |   |            |
|                  | 3.2 FSI          | 188   | 03.05 | 08.11       | PR: 1KD,2ED,1KQ |                |   |  |   |            |  |   |            |
|                  | 3.2 FSI quattro  | 188   | 03.05 | 08.11       | PR: 1KD,2ED,1KQ |                |   |  |   |            |  |   |            |

<sup>1)</sup> electric parking brake / fr.d. stazionamento elettrico / frein à main électrique / freno de mano eléctrico



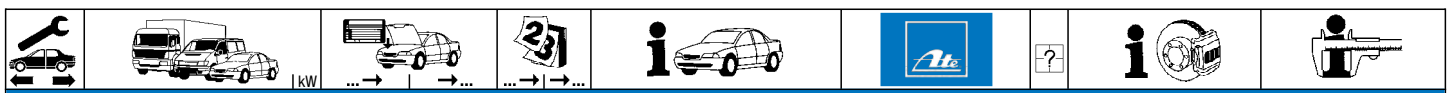

| AUDI A6 (4F5/C6) Avant (05-11) |                  |     |       |       |             |                 |                |   |   |                         |
|--------------------------------|------------------|-----|-------|-------|-------------|-----------------|----------------|---|---|-------------------------|
|                                | 4.2 FSI quattro  | 257 |       | 06.06 | 08.11       | PR: 1KD,2ED,1KQ | 24.0112-0159.1 | 412159                                    | elektrische Feststellbremse <sup>1)</sup> | 302 12,0 10,0 +S +B     |
|                                | 4.2 quattro      | 246 |       | 03.05 | 08.11       | PR: 1KD,2ED,1KQ | 24.0312-0159.1 | 512159                                    | elektrische Feststellbremse <sup>1)</sup> | 302 12,0 10,0 +B PD     |
|                                | 2.0 TDI          | 100 |       | 06.05 | 08.11       | PR: 1KW,2EE     | 24.0122-0223.1 | 422223                                    | elektrische Feststellbremse <sup>1)</sup> | 330 22,0 20,0 V L +B    |
|                                | 2.0 TDI          | 103 |       | 03.05 | 08.11       | PR: 1KW,2EE     | 24.0322-0223.1 | 522223                                    | elektrische Feststellbremse <sup>1)</sup> | 330 22,0 20,0 V L +B PD |
|                                | 2.0 TDI          | 125 |       | 10.08 | 08.11       | PR: 1KW         |                |   |   |                         |
|                                | 2.0 TFSI         | 125 |       | 06.05 | 08.11       | PR: 1KW,2EE     |                |   |   |                         |
|                                | 2.4              | 130 |       | 03.05 | 08.11       | PR: 1KW,2EE     |                |   |   |                         |
|                                | 2.4 quattro      | 130 |       | 03.05 | 08.11       | PR: 1KW,2EE     |                |   |   |                         |
|                                | 2.7 TDI          | 120 |       | 03.05 | 08.11       | PR: 1KW,2EE     |                |   |   |                         |
|                                | 2.7 TDI          | 132 |       | 03.05 | 08.11       | PR: 1KW,2EE     |                |   |   |                         |
|                                | 2.7 TDI          | 140 |       | 10.08 | 08.11       | PR: 1KW         |                |   |   |                         |
|                                | 2.7 TDI quattro  | 120 |       | 06.05 | 08.11       | PR: 1KW,2EE     |                |   |   |                         |
|                                | 2.7 TDI quattro  | 132 |       | 03.05 | 08.11       | PR: 1KW,2EE     |                |   |   |                         |
|                                | 2.7 TDI quattro  | 140 |       | 10.08 | 08.11       | PR: 1KW         |                |   |   |                         |
|                                | 2.8 FSI          | 140 |       | 10.08 | 08.11       | PR: 1KW         |                |   |   |                         |
|                                | 2.8 FSI          | 154 |       | 11.06 | 08.11       | PR: 1KW,2EE     |                |   |   |                         |
|                                | 2.8 FSI          | 162 |       | 10.08 | 08.11       | PR: 1KW         |                |   |   |                         |
|                                | 2.8 FSI quattro  | 140 |       | 10.08 | 08.11       | PR: 1KW         |                |   |   |                         |
|                                | 2.8 FSI quattro  | 154 |       | 04.07 | 08.11       | PR: 1KW,2EE     |                |   |   |                         |
|                                | 2.8 FSI quattro  | 162 |       | 10.08 | 08.11       | PR: 1KW         |                |   |   |                         |
|                                | 3.0              | 160 |       | 03.05 | 08.11       | PR: 1KW,2EE     |                |   |   |                         |
|                                | 3.0 quattro      | 160 |       | 03.05 | 08.11       | PR: 1KW,2EE     |                |   |   |                         |
|                                | 3.0 TDI quattro  | 155 |       | 03.05 | 08.11       | PR: 1KW,2EE     |                |   |   |                         |
|                                | 3.0 TDI quattro  | 165 |       | 03.05 | 08.11       | PR: 1KW,2EE     |                |   |   |                         |
|                                | 3.0 TDI quattro  | 171 |       | 06.06 | 08.11       | PR: 1KW,2EE     |                |   |   |                         |
|                                | 3.0 TDI quattro  | 176 |       | 10.08 | 08.11       | PR: 1KW         |                |   |   |                         |
|                                | 3.0 TFSI quattro |     |       | 10.08 | 08.11       | PR: 1KW         |                |   |   |                         |
|                                | 3.2 FSI          | 188 |       | 03.05 | 08.11       | PR: 1KW,2EE     |                |   |   |                         |
|                                | 3.2 FSI quattro  | 188 |       | 03.05 | 08.11       | PR: 1KW,2EE     |                |   |   |                         |
|                                | 4.2 FSI quattro  | 257 |       | 06.06 | 08.11       | PR: 1KW,2EE     |                |   |   |                         |
| 4.2 quattro                    | 246              |     | 03.05 | 08.11 | PR: 1KW,2EE |                 |                |   |   |                         |
| S6                             | 320              |     | 03.06 | 08.11 | PR: 1KW,2EE | 24.0122-0243.1  | 422243         | elektrische Feststellbremse <sup>1)</sup> | 330 22,0 20,0 V L +B                      |                         |

| AUDI A6 Allroad (06-11) |          |     |  |       |       |             |                |        |   |                            |
|-------------------------|----------|-----|--|-------|-------|-------------|----------------|--------|---|----------------------------|
|                         | 2.7 TDI  | 120 |  | 05.06 | 05.11 | PR: 1LG,1ZL | 13.0460-7201.2 | 607201 |   | 23763 20,3 +/WK ATE        |
|                         | 2.7 TDI  | 132 |  | 05.06 | 05.11 | PR: 1LG,1ZL | 13.0470-7201.2 | LD7201 |   | 23763 20,3 +/WK ATE        |
|                         | 2.7 TDI  | 140 |  | 10.08 | 05.11 | PR: 1LG,1ZL |                |        |   |                            |
|                         | 3.0 TDI  | 155 |  | 05.06 | 05.11 | PR: 1LG,1ZL |                |        |   |                            |
|                         | 3.0 TDI  | 171 |  | 05.06 | 05.11 | PR: 1LG,1ZL |                |        |   |                            |
|                         | 3.0 TDI  | 176 |  | 10.08 | 05.11 | PR: 1LG,1ZL |                |        |   |                            |
|                         | 3.0 TFSI | 213 |  | 10.08 | 05.11 | PR: 1LG,1ZL |                |        |   |                            |
|                         | 3.2 FSI  | 188 |  | 05.06 | 05.11 | PR: 1LG,1ZL |                |        |   |                            |
|                         | 4.2 FSI  | 257 |  | 05.06 | 05.11 | PR: 1LG,1ZL | 13.0460-7201.2 | 607201 |   | 23763 20,3 +/WK ATE        |
|                         | 2.7 TDI  | 120 |  | 05.06 | 05.11 | PR: 1LG     | 24.0130-0175.1 | 430175 |   | 321 30,0 28,0 V L +S +B    |
|                         | 2.7 TDI  | 132 |  | 05.06 | 05.11 | PR: 1LG     | 24.0330-0175.1 | 530175 |   | 321 30,0 28,0 V L +S +B PD |
|                         | 2.7 TDI  | 140 |  | 10.08 | 05.11 | PR: 1LG     |                |        |   |                            |
|                         | 3.0 TDI  | 155 |  | 05.06 | 05.11 | PR: 1LG     |                |        |   |                            |
|                         | 3.0 TDI  | 171 |  | 05.06 | 05.11 | PR: 1LG     |                |        |   |                            |
|                         | 3.0 TDI  | 176 |  | 10.08 | 05.11 | PR: 1LG     |                |        |   |                            |
|                         | 3.0 TFSI | 213 |  | 10.08 | 05.11 | PR: 1LG     |                |        |   |                            |
|                         | 3.2 FSI  | 188 |  | 05.06 | 05.11 | PR: 1LG     |                |        |   |                            |
|                         | 4.2 FSI  | 257 |  | 05.06 | 05.11 | PR: 1LG     |                |        |   |                            |
|                         | 2.7 TDI  | 120 |  | 05.06 | 05.11 | PR: 1ZL     | 24.0130-0176.1 | 430176 |   | 347 30,0 28,0 V L +S +B    |
|                         | 2.7 TDI  | 132 |  | 05.06 | 05.11 | PR: 1ZL     | 24.0330-0176.1 | 530176 |   | 347 30,0 28,0 V L +S +B PD |
|                         | 2.7 TDI  | 140 |  | 10.08 | 05.11 | PR: 1ZL     |                |        |   |                            |
|                         | 3.0 TDI  | 155 |  | 05.06 | 05.11 | PR: 1ZL     |                |        |   |                            |
|                         | 3.0 TDI  | 171 |  | 05.06 | 05.11 | PR: 1ZL     |                |        |   |                            |
|                         | 3.0 TDI  | 176 |  | 10.08 | 05.11 | PR: 1ZL     |                |        |   |                            |
|                         | 3.0 TFSI | 213 |  | 10.08 | 05.11 | PR: 1ZL     |                |        |   |                            |
|                         | 3.2 FSI  | 188 |  | 05.06 | 05.11 | PR: 1ZL     |                |        |   |                            |
|                         | 4.2 FSI  | 257 |  | 05.06 | 05.11 | PR: 1ZL     |                |        |   |                            |
|                         | 2.7 TDI  | 120 |  | 05.06 | 05.11 | PR: 1KD     | 13.0460-2880.2 | 602880 | elektrische Feststellbremse <sup>1)</sup> | 23914 17,1 /WE/Zub/S TRW   |
|                         | 2.7 TDI  | 132 |  | 05.06 | 05.11 | PR: 1KD     | 13.0470-2880.2 | LD2880 | elektrische Feststellbremse <sup>1)</sup> | 23914 17,1 /WE/Zub/S TRW   |
|                         | 2.7 TDI  | 140 |  | 10.08 | 05.11 | PR: 1KD     | 13.0460-0259.2 | 610259 |   | Belagsatz-Zubehör          |
|                         | 3.0 TDI  | 155 |  | 05.06 | 05.11 | PR: 1KD     |                |        |   |                            |
|                         | 3.0 TDI  | 171 |  | 05.06 | 05.11 | PR: 1KD     |                |        |   |                            |
|                         | 3.0 TDI  | 176 |  | 10.08 | 05.11 | PR: 1KD     |                |        |   |                            |
|                         | 3.0 TFSI | 213 |  | 10.08 | 05.11 | PR: 1KD     |                |        |   |                            |
|                         | 3.2 FSI  | 188 |  | 05.06 | 05.11 | PR: 1KD     |                |        |   |                            |
|                         | 4.2 FSI  | 257 |  | 05.06 | 05.11 | PR: 1KD     |                |        |   |                            |
|                         | 2.7 TDI  | 120 |  | 05.06 | 05.11 | PR: 1KW,2EE | 13.0460-2888.2 | 602888 | elektrische Feststellbremse <sup>1)</sup> | 23326 17,4 /WE/S TRW       |
|                         | 2.7 TDI  | 132 |  | 05.06 | 05.11 | PR: 1KW,2EE | 13.0470-2888.2 | LD2888 | elektrische Feststellbremse <sup>1)</sup> | 23326 17,4 /WE/S TRW       |
|                         | 2.7 TDI  | 140 |  | 10.08 | 05.11 | PR: 1KW,2EE | 13.0460-0023.2 | 610023 |   | Belagsatz-Zubehör          |
|                         | 3.0 TDI  | 155 |  | 05.06 | 05.11 | PR: 1KW,2EE |                |        |   |                            |
|                         | 3.0 TDI  | 171 |  | 05.06 | 05.11 | PR: 1KW,2EE |                |        |   |                            |
|                         | 3.0 TDI  | 176 |  | 10.08 | 05.11 | PR: 1KW,2EE |                |        |   |                            |
|                         | 3.0 TFSI | 213 |  | 10.08 | 05.11 | PR: 1KW,2EE |                |        |   |                            |
|                         | 3.2 FSI  | 188 |  | 05.06 | 05.11 | PR: 1KW,2EE |                |        |   |                            |
|                         | 4.2 FSI  | 257 |  | 05.06 | 05.11 | PR: 1KW,2EE |                |        |   |                            |
|                         | 2.7 TDI  | 120 |  | 05.06 | 05.11 | PR: 1KD     | 24.0112-0176.1 | 412176 | elektrische Feststellbremse <sup>1)</sup> | 302 12,0 10,0 L +B         |
|                         | 2.7 TDI  | 132 |  | 05.06 | 05.11 | PR: 1KD     |                |        |   |                            |
|                         | 2.7 TDI  | 140 |  | 10.08 | 05.11 | PR: 1KD     |                |        |   |                            |
|                         | 3.0 TDI  | 155 |  | 05.06 | 05.11 | PR: 1KD     |                |        |   |                            |
|                         | 3.0 TDI  | 171 |  | 05.06 | 05.11 | PR: 1KD     |                |        |   |                            |

<sup>1)</sup> electric parking brake / fr.di stazionamento elettrico / frein à main électrique / freno de mano eléctrico

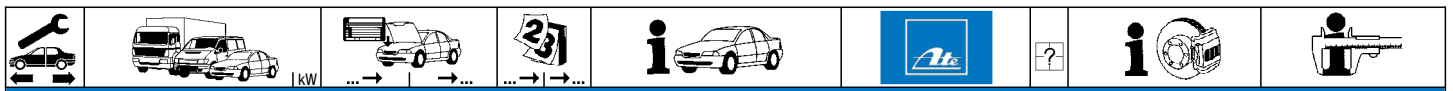

### AUDI A6 Allroad (06-11)

|  |          |     |       |       |             |                |        |  |   |                      |
|--|----------|-----|-------|-------|-------------|----------------|--------|--|---|----------------------|
|  | 3.2 FSI  | 188 | 05.06 | 05.11 | PR: 1KD     | 24.0112-0176.1 | 412176 |  | elektrische Feststellbremse <sup>1)</sup> | 302 12,0 10,0 L +B   |
|  | 4.2 FSI  | 257 | 05.06 | 05.11 | PR: 1KD     |                |        |  |   |                      |
|  | 2.7 TDI  | 120 | 05.06 | 05.11 | PR: 1KW,2EE | 24.0122-0243.1 | 422243 |  | elektrische Feststellbremse <sup>1)</sup> | 330 22,0 20,0 V L +B |
|  | 2.7 TDI  | 132 | 05.06 | 05.11 | PR: 1KW,2EE |                |        |  |   |                      |
|  | 2.7 TDI  | 140 | 10.08 | 05.11 | PR: 1KW,2EE |                |        |  |   |                      |
|  | 3.0 TDI  | 155 | 05.06 | 05.11 | PR: 1KW,2EE |                |        |  |   |                      |
|  | 3.0 TDI  | 171 | 05.06 | 05.11 | PR: 1KW,2EE |                |        |  |   |                      |
|  | 3.0 TDI  | 176 | 10.08 | 05.11 | PR: 1KW,2EE |                |        |  |   |                      |
|  | 3.0 TFSI | 213 | 10.08 | 05.11 | PR: 1KW,2EE |                |        |  |   |                      |
|  | 3.2 FSI  | 188 | 05.06 | 05.11 | PR: 1KW,2EE |                |        |  |   |                      |
|  | 4.2 FSI  | 257 | 05.06 | 05.11 | PR: 1KW,2EE |                |        |  |   |                      |

### AUDI A6 (4G2/C7) Limousine (11-)

|  |                  |     |       |  |             |                |        |   |                              |                       |     |
|--|------------------|-----|-------|--|-------------|----------------|--------|---|------------------------------|-----------------------|-----|
|  | 1.8 TFSI         | 140 | 09.14 |  | PR: 1LA,1LJ | 13.0460-2765.2 | 602765 |   | Federmaß 46 mm <sup>2)</sup> | 24743 19,2 +/-WK/S    | TRW |
|  | 2.0 TDI          | 100 | 01.12 |  | PR: 1LA,1LJ | 13.0470-2765.2 | LD2765 |   | Federmaß 46 mm <sup>2)</sup> | 24743 19,2 +/-WK/S    | TRW |
|  | 2.0 TDI          | 110 | 09.14 |  | PR: 1LA,1LJ |                |        |   |                              |                       |     |
|  | 2.0 TDI          | 120 | 04.11 |  | PR: 1LA,1LJ |                |        |   |                              |                       |     |
|  | 2.0 TDI          | 130 | 04.11 |  | PR: 1LA,1LJ |                |        |   |                              |                       |     |
|  | 2.0 TDI quattro  | 140 | 04.15 |  | PR: 1LA,1LJ |                |        |   |                              |                       |     |
|  | 2.0 TDI ultra    | 140 | 11.13 |  | PR: 1LA,1LJ |                |        |   |                              |                       |     |
|  | 2.0 TFSI         | 132 | 04.11 |  | PR: 1LA,1LJ |                |        |   |                              |                       |     |
|  | 2.0 TFSI         | 155 | 04.11 |  | PR: 1LA,1LJ |                |        |   |                              |                       |     |
|  | 2.0 TFSI         | 162 | 05.13 |  | PR: 1LA,1LJ |                |        |   |                              |                       |     |
|  | 2.0 TFSI         | 185 | 09.14 |  | PR: 1LA,1LJ |                |        |   |                              |                       |     |
|  | 2.0 TFSI hybrid  | 155 | 11.11 |  | PR: 1LA,1LJ |                |        |   |                              |                       |     |
|  | 2.0 TFSI quattro | 155 | 05.12 |  | PR: 1LA,1LJ |                |        |   |                              |                       |     |
|  | 2.0 TFSI quattro | 162 | 05.13 |  | PR: 1LA,1LJ |                |        |   |                              |                       |     |
|  | 2.0 TFSI quattro | 185 | 05.14 |  | PR: 1LA,1LJ |                |        |   |                              |                       |     |
|  | 2.8 FSI          | 150 | 04.11 |  | PR: 1LA,1LJ |                |        |   |                              |                       |     |
|  | 2.8 FSI quattro  | 150 | 04.11 |  | PR: 1LA,1LJ |                |        |   |                              |                       |     |
|  | 2.8 FSI quattro  | 162 | 09.14 |  | PR: 1LA,1LJ |                |        |   |                              |                       |     |
|  | 3.0 TDI          | 150 | 04.11 |  | PR: 1LA,1LJ |                |        |   |                              |                       |     |
|  | 3.0 TDI          | 155 | 09.14 |  | PR: 1LA,1LJ |                |        |   |                              |                       |     |
|  | 3.0 TDI          | 160 | 09.14 |  | PR: 1LA,1LJ |                |        |   |                              |                       |     |
|  | 3.0 TDI quattro  | 150 | 04.11 |  | PR: 1LA,1LJ |                |        |   |                              |                       |     |
|  | 3.0 TDI quattro  | 155 | 09.14 |  | PR: 1LA,1LJ |                |        |   |                              |                       |     |
|  | 3.0 TDI quattro  | 160 | 09.14 |  | PR: 1LA,1LJ |                |        |   |                              |                       |     |
|  | 3.0 TDI quattro  | 176 | 05.13 |  | PR: 1LA,1LJ |                |        |   |                              |                       |     |
|  | 3.0 TDI quattro  | 180 | 04.11 |  | PR: 1LA,1LJ |                |        |   |                              |                       |     |
|  | 3.0 TDI quattro  | 200 | 09.14 |  | PR: 1LA,1LJ |                |        |   |                              |                       |     |
|  | 3.0 TFSI quattro |     | 04.11 |  | PR: 1LA,1LJ |                |        |   |                              |                       |     |
|  | 3.0 TDI quattro  | 230 | 12.11 |  | PR: 1LA,1LJ | 13.0460-2765.2 | 602765 |   | Federmaß 46 mm <sup>2)</sup> | 24743 19,2 +/-WK/S    | TRW |
|  | 3.0 TDI quattro  | 235 | 09.14 |  | PR: 1LA,1LJ |                |        |   |                              |                       |     |
|  | 3.0 TDI quattro  | 240 | 09.14 |  | PR: 1LA,1LJ |                |        |   |                              |                       |     |
|  | 3.0 TFSI quattro | 245 | 09.14 |  | PR: 1LA,1LJ |                |        |   |                              |                       |     |
|  | S6               | 309 | 04.12 |  | PR: 1LA,1LJ |                |        |   |                              |                       |     |
|  | S6               | 331 | 10.14 |  | PR: 1LA,1LJ |                |        |   |                              |                       |     |
|  | 1.8 TFSI         | 140 | 09.14 |  | PR: 1LL,1ZK | 13.0460-7280.2 | 607280 |   |                              | 25158 20,3 +/-WK      | ATE |
|  | 2.0 TDI          | 100 | 01.12 |  | PR: 1LL,1ZK | 13.0470-7280.2 | LD7280 |   |                              | 25158 20,3 +/-WK      | ATE |
|  | 2.0 TDI          | 110 | 09.14 |  | PR: 1LL,1ZK | 24.8190-0301.2 | 620301 | 1 |                              | Warnkontakt L=311,6mm |     |
|  | 2.0 TDI          | 120 | 04.11 |  | PR: 1LL,1ZK |                |        |   |                              |                       |     |
|  | 2.0 TDI          | 130 | 04.11 |  | PR: 1LL,1ZK |                |        |   |                              |                       |     |
|  | 2.0 TDI quattro  | 140 | 04.15 |  | PR: 1LL,1ZK |                |        |   |                              |                       |     |
|  | 2.0 TDI ultra    | 140 | 11.13 |  | PR: 1LL,1ZK |                |        |   |                              |                       |     |
|  | 2.0 TFSI         | 132 | 04.11 |  | PR: 1LL,1ZK |                |        |   |                              |                       |     |
|  | 2.0 TFSI         | 155 | 04.11 |  | PR: 1LL,1ZK |                |        |   |                              |                       |     |
|  | 2.0 TFSI         | 162 | 05.13 |  | PR: 1LL,1ZK |                |        |   |                              |                       |     |
|  | 2.0 TFSI         | 185 | 09.14 |  | PR: 1LL,1ZK |                |        |   |                              |                       |     |
|  | 2.0 TFSI hybrid  | 155 | 11.11 |  | PR: 1LL,1ZK |                |        |   |                              |                       |     |
|  | 2.0 TFSI quattro | 155 | 05.12 |  | PR: 1LL,1ZK |                |        |   |                              |                       |     |
|  | 2.0 TFSI quattro | 162 | 05.13 |  | PR: 1LL,1ZK |                |        |   |                              |                       |     |
|  | 2.0 TFSI quattro | 185 | 05.14 |  | PR: 1LL,1ZK |                |        |   |                              |                       |     |
|  | 2.8 FSI          | 150 | 04.11 |  | PR: 1LL,1ZK |                |        |   |                              |                       |     |
|  | 2.8 FSI quattro  | 150 | 04.11 |  | PR: 1LL,1ZK |                |        |   |                              |                       |     |
|  | 2.8 FSI quattro  | 162 | 09.14 |  | PR: 1LL,1ZK |                |        |   |                              |                       |     |
|  | 3.0 TDI          | 150 | 04.11 |  | PR: 1LL,1ZK |                |        |   |                              |                       |     |
|  | 3.0 TDI          | 155 | 09.14 |  | PR: 1LL,1ZK |                |        |   |                              |                       |     |
|  | 3.0 TDI          | 160 | 09.14 |  | PR: 1LL,1ZK |                |        |   |                              |                       |     |
|  | 3.0 TDI quattro  | 150 | 04.11 |  | PR: 1LL,1ZK |                |        |   |                              |                       |     |
|  | 3.0 TDI quattro  | 155 | 09.14 |  | PR: 1LL,1ZK |                |        |   |                              |                       |     |
|  | 3.0 TDI quattro  | 160 | 09.14 |  | PR: 1LL,1ZK |                |        |   |                              |                       |     |
|  | 3.0 TDI quattro  | 176 | 05.13 |  | PR: 1LL,1ZK |                |        |   |                              |                       |     |
|  | 3.0 TDI quattro  | 180 | 04.11 |  | PR: 1LL,1ZK |                |        |   |                              |                       |     |
|  | 3.0 TDI quattro  | 200 | 09.14 |  | PR: 1LL,1ZK |                |        |   |                              |                       |     |
|  | 3.0 TFSI quattro |     | 04.11 |  | PR: 1LL,1ZK |                |        |   |                              |                       |     |
|  | 3.0 TDI quattro  | 230 | 12.11 |  | PR: 1LL,1ZK | 13.0460-7280.2 | 607280 |   |                              | 25158 20,3 +/-WK      | ATE |
|  | 3.0 TDI quattro  | 235 | 09.14 |  | PR: 1LL,1ZK | 24.8190-0301.2 | 620301 | 1 |                              | Warnkontakt L=311,6mm |     |
|  | 3.0 TDI quattro  | 240 | 09.14 |  | PR: 1LL,1ZK |                |        |   |                              |                       |     |
|  | 3.0 TFSI quattro | 245 | 09.14 |  | PR: 1LL,1ZK |                |        |   |                              |                       |     |
|  | S6               | 309 | 04.12 |  | PR: 1LL,1ZK |                |        |   |                              |                       |     |
|  | S6               | 331 | 10.14 |  | PR: 1LL,1ZK |                |        |   |                              |                       |     |
|  | 1.8 TFSI         | 140 | 09.14 |  | PR: 1LU     | 13.0460-4873.2 | 604873 |   |                              | 24847 17,0 /WE        | BRE |
|  | 2.0 TDI          | 100 | 01.12 |  | PR: 1LU     | 24.8190-0019.2 | 620019 | 2 |                              | Warnkontakt L=254mm   |     |
|  | 2.0 TDI          | 110 | 09.14 |  | PR: 1LU     |                |        |   |                              |                       |     |
|  | 2.0 TDI          | 120 | 04.11 |  | PR: 1LU     |                |        |   |                              |                       |     |
|  | 2.0 TDI          | 130 | 04.11 |  | PR: 1LU     |                |        |   |                              |                       |     |
|  | 2.0 TDI quattro  | 140 | 04.15 |  | PR: 1LU     |                |        |   |                              |                       |     |

<sup>1)</sup> electric parking brake / fr.di stazionamento elettrico / frein à main électrique / freno de mano eléctrico

<sup>2)</sup> spring dimension 46 mm / dimensioni molla 46 mm / dimension de ressort 46 mm / medida de muelle 46 mm



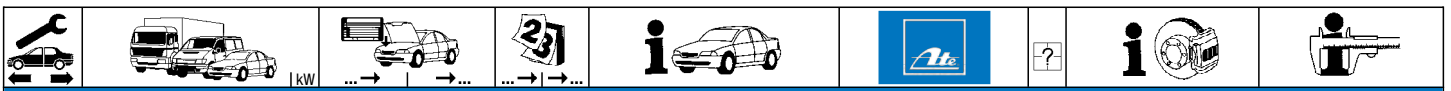

**AUDI A6 (4G2/C7) Limousine (11-)**

|                  |                  |       |         |  |                                  |                  |   |                                       |            |                |        |   |                       |  |
|------------------|------------------|-------|---------|--|----------------------------------|------------------|---|---------------------------------------|------------|----------------|--------|---|-----------------------|--|
|                  | 2.0 TDI ultra    | 140   | 11.13   | PR: 1LU  | 13.0460-4873.2<br>24.8190-0019.2 | 604873<br>620019 | 2   | 24847 17,0 /WE<br>Warnkontakt L=254mm | <b>BRE</b> |                |        |   |                       |  |
|                  | 2.0 TFSI         | 132   | 04.11   | PR: 1LU  |                                  |                  |   |                                       |            |                |        |   |                       |  |
|                  | 2.0 TFSI         | 155   | 04.11   | PR: 1LU  |                                  |                  |   |                                       |            |                |        |   |                       |  |
|                  | 2.0 TFSI         | 162   | 05.13   | PR: 1LU  |                                  |                  |   |                                       |            |                |        |   |                       |  |
|                  | 2.0 TFSI         | 185   | 09.14   | PR: 1LU  |                                  |                  |   |                                       |            |                |        |   |                       |  |
|                  | 2.0 TFSI hybrid  | 155   | 11.11   | PR: 1LU  |                                  |                  |   |                                       |            |                |        |   |                       |  |
|                  | 2.0 TFSI quattro | 155   | 05.12   | PR: 1LU  |                                  |                  |   |                                       |            |                |        |   |                       |  |
|                  | 2.0 TFSI quattro | 162   | 05.13   | PR: 1LU  |                                  |                  |   |                                       |            |                |        |   |                       |  |
|                  | 2.0 TFSI quattro | 185   | 05.14   | PR: 1LU  |                                  |                  |   |                                       |            |                |        |   |                       |  |
|                  | 2.8 FSI          | 150   | 04.11   | PR: 1LU  |                                  |                  |   |                                       |            |                |        |   |                       |  |
|                  | 2.8 FSI quattro  | 150   | 04.11   | PR: 1LU  |                                  |                  |   |                                       |            |                |        |   |                       |  |
|                  | 2.8 FSI quattro  | 162   | 09.14   | PR: 1LU  |                                  |                  |   |                                       |            |                |        |   |                       |  |
|                  | 3.0 TDI          | 150   | 04.11   | PR: 1LU  |                                  |                  |   |                                       |            |                |        |   |                       |  |
|                  | 3.0 TDI          | 155   | 09.14   | PR: 1LU  |                                  |                  |   |                                       |            |                |        |   |                       |  |
|                  | 3.0 TDI          | 160   | 09.14   | PR: 1LU  |                                  |                  |   |                                       |            |                |        |   |                       |  |
|                  | 3.0 TDI quattro  | 150   | 04.11   | PR: 1LU  |                                  |                  |   |                                       |            |                |        |   |                       |  |
|                  | 3.0 TDI quattro  | 155   | 09.14   | PR: 1LU  |                                  |                  |   |                                       |            |                |        |   |                       |  |
|                  | 3.0 TDI quattro  | 160   | 09.14   | PR: 1LU  |                                  |                  |   |                                       |            |                |        |   |                       |  |
|                  | 3.0 TDI quattro  | 176   | 05.13   | PR: 1LU  |                                  |                  |   |                                       |            |                |        |   |                       |  |
|                  | 3.0 TDI quattro  | 180   | 04.11   | PR: 1LU  |                                  |                  |   |                                       |            |                |        |   |                       |  |
|                  | 3.0 TDI quattro  | 200   | 09.14   | PR: 1LU  |                                  |                  |   |                                       |            |                |        |   |                       |  |
|                  | 3.0 TDI quattro  | 230   | 12.11   | PR: 1LU  |                                  |                  |   |                                       |            |                |        |   |                       |  |
|                  | 3.0 TDI quattro  | 235   | 09.14   | PR: 1LU  |                                  |                  |   |                                       |            |                |        |   |                       |  |
|                  | 3.0 TDI quattro  | 240   | 09.14   | PR: 1LU  |                                  |                  |   |                                       |            |                |        |   |                       |  |
|                  | 3.0 TFSI quattro |       | 04.11   | PR: 1LU  |                                  |                  |   |                                       |            |                |        |   |                       |  |
|                  | 3.0 TFSI quattro | 245   | 09.14   | PR: 1LU  |                                  |                  |   |                                       |            |                |        |   |                       |  |
|                  | S6               | 309   | 04.12   | PR: 1LU  |                                  |                  |   |                                       |            |                |        |   |                       |  |
|                  | 1.8 TFSI         | 140   | 09.14   | PR: 1LW  |                                  |                  |   |                                       |            | 24.8190-0020.2 | 620020 | 2 | Warnkontakt L=443,3mm |  |
|                  | 2.0 TDI          | 100   | 01.12   | PR: 1LW  |                                  |                  |   |                                       |            |                |        |   |                       |  |
|                  | 2.0 TDI          | 110   | 09.14   | PR: 1LW  |                                  |                  |   |                                       |            |                |        |   |                       |  |
|                  | 2.0 TDI          | 120   | 04.11   | PR: 1LW  |                                  |                  |   |                                       |            |                |        |   |                       |  |
|                  | 2.0 TDI          | 130   | 04.11   | PR: 1LW  |                                  |                  |   |                                       |            |                |        |   |                       |  |
|                  | 2.0 TDI quattro  | 140   | 04.15   | PR: 1LW  |                                  |                  |   |                                       |            |                |        |   |                       |  |
| 2.0 TDI ultra    | 140              | 11.13 | PR: 1LW |  |                                  |                  |   |                                       |            |                |        |   |                       |  |
| 2.0 TFSI         | 132              | 04.11 | PR: 1LW |  |                                  |                  |   |                                       |            |                |        |   |                       |  |
| 2.0 TFSI         | 155              | 04.11 | PR: 1LW |  |                                  |                  |   |                                       |            |                |        |   |                       |  |
| 2.0 TFSI         | 162              | 05.13 | PR: 1LW |  |                                  |                  |   |                                       |            |                |        |   |                       |  |
| 2.0 TFSI         | 185              | 09.14 | PR: 1LW |  |                                  |                  |   |                                       |            |                |        |   |                       |  |
| 2.0 TFSI hybrid  | 155              | 11.11 | PR: 1LW |  |                                  |                  |   |                                       |            |                |        |   |                       |  |
| 2.0 TFSI quattro | 155              | 05.12 | PR: 1LW |  |                                  |                  |   |                                       |            |                |        |   |                       |  |
| 2.0 TFSI quattro | 162              | 05.13 | PR: 1LW |  |                                  |                  |   |                                       |            |                |        |   |                       |  |
| 2.0 TFSI quattro | 185              | 05.14 | PR: 1LW |  |                                  |                  |   |                                       |            |                |        |   |                       |  |
| 2.8 FSI          | 150              | 04.11 | PR: 1LW |  |                                  |                  |   |                                       |            |                |        |   |                       |  |
| 2.8 FSI quattro  | 150              | 04.11 | PR: 1LW |  |                                  |                  |   |                                       |            |                |        |   |                       |  |
| 2.8 FSI quattro  | 162              | 09.14 | PR: 1LW |  |                                  |                  |   |                                       |            |                |        |   |                       |  |
| 3.0 TDI          | 150              | 04.11 | PR: 1LW |  |                                  |                  |   |                                       |            |                |        |   |                       |  |
| 3.0 TDI          | 155              | 09.14 | PR: 1LW |  |                                  |                  |   |                                       |            |                |        |   |                       |  |
| 3.0 TDI          | 160              | 09.14 | PR: 1LW |  |                                  |                  |   |                                       |            |                |        |   |                       |  |
| 3.0 TDI quattro  | 150              | 04.11 | PR: 1LW |  |                                  |                  |   |                                       |            |                |        |   |                       |  |
| 3.0 TDI quattro  | 155              | 09.14 | PR: 1LW |  |                                  |                  |   |                                       |            |                |        |   |                       |  |
| 3.0 TDI quattro  | 160              | 09.14 | PR: 1LW |  |                                  |                  |   |                                       |            |                |        |   |                       |  |
| 3.0 TDI quattro  | 176              | 05.13 | PR: 1LW |  |                                  |                  |   |                                       |            |                |        |   |                       |  |
| 3.0 TDI quattro  | 180              | 04.11 | PR: 1LW |  |                                  |                  |   |                                       |            |                |        |   |                       |  |
| 3.0 TDI quattro  | 200              | 09.14 | PR: 1LW |  |                                  |                  |   |                                       |            |                |        |   |                       |  |
| 3.0 TDI quattro  | 230              | 12.11 | PR: 1LW |  |                                  |                  |   |                                       |            |                |        |   |                       |  |
| 3.0 TDI quattro  | 235              | 09.14 | PR: 1LW |  |                                  |                  |   |                                       |            |                |        |   |                       |  |
| 3.0 TDI quattro  | 240              | 09.14 | PR: 1LW |  |                                  |                  |   |                                       |            |                |        |   |                       |  |
| 3.0 TFSI quattro |                  | 04.11 | PR: 1LW |  |                                  |                  |   |                                       |            |                |        |   |                       |  |
| 3.0 TFSI quattro | 245              | 09.14 | PR: 1LW |  |                                  |                  |   |                                       |            |                |        |   |                       |  |
| S6               | 309              | 04.12 | PR: 1LW |  |                                  |                  |   |                                       |            |                |        |   |                       |  |
| S6               | 331              | 10.14 | PR: 1LW |  |                                  |                  |   |                                       |            |                |        |   |                       |  |
| 1.8 TFSI         | 140              | 09.14 | PR: 1LF | 13.0460-7280.2<br>13.0470-7280.2<br>24.8190-0301.2 | 607280<br>LD7280<br>620301       | 1                | 25158 20,3 +/WK<br>25158 20,3 +/WK<br>Warnkontakt L=311,6mm | <b>ATE</b><br><b>ATE</b>              |            |                |        |   |                       |  |
| 2.0 TDI          | 100              | 01.12 | PR: 1LF |  |                                  |                  |   |                                       |            |                |        |   |                       |  |
| 2.0 TDI          | 110              | 09.14 | PR: 1LF |  |                                  |                  |   |                                       |            |                |        |   |                       |  |
| 2.0 TDI          | 120              | 07.11 | PR: 1LF |  |                                  |                  |   |                                       |            |                |        |   |                       |  |
| 2.0 TDI          | 130              | 07.11 | PR: 1LF |  |                                  |                  |   |                                       |            |                |        |   |                       |  |
| 2.0 TDI quattro  | 140              | 04.15 | PR: 1LF |  |                                  |                  |   |                                       |            |                |        |   |                       |  |
| 2.0 TDI ultra    | 140              | 11.13 | PR: 1LF |  |                                  |                  |   |                                       |            |                |        |   |                       |  |
| 2.0 TFSI         | 132              | 07.11 | PR: 1LF |  |                                  |                  |   |                                       |            |                |        |   |                       |  |
| 2.0 TFSI         | 155              | 07.11 | PR: 1LF |  |                                  |                  |   |                                       |            |                |        |   |                       |  |
| 2.0 TFSI         | 162              | 05.13 | PR: 1LF |  |                                  |                  |   |                                       |            |                |        |   |                       |  |
| 2.0 TFSI         | 185              | 09.14 | PR: 1LF |  |                                  |                  |   |                                       |            |                |        |   |                       |  |
| 2.0 TFSI hybrid  | 155              | 11.11 | PR: 1LF |  |                                  |                  |   |                                       |            |                |        |   |                       |  |
| 2.0 TFSI quattro | 155              | 05.12 | PR: 1LF |  |                                  |                  |   |                                       |            |                |        |   |                       |  |
| 2.0 TFSI quattro | 162              | 05.13 | PR: 1LF |  |                                  |                  |   |                                       |            |                |        |   |                       |  |
| 2.0 TFSI quattro | 185              | 05.14 | PR: 1LF |  |                                  |                  |   |                                       |            |                |        |   |                       |  |
| 2.8 FSI          | 150              | 07.11 | PR: 1LF |  |                                  |                  |   |                                       |            |                |        |   |                       |  |
| 2.8 FSI quattro  | 150              | 07.11 | PR: 1LF |  |                                  |                  |   |                                       |            |                |        |   |                       |  |
| 2.8 FSI quattro  | 162              | 09.14 | PR: 1LF |  |                                  |                  |   |                                       |            |                |        |   |                       |  |
| 3.0 TDI          | 150              | 07.11 | PR: 1LF |  |                                  |                  |   |                                       |            |                |        |   |                       |  |
| 3.0 TDI          | 155              | 09.14 | PR: 1LF |  |                                  |                  |   |                                       |            |                |        |   |                       |  |
| 3.0 TDI          | 160              | 09.14 | PR: 1LF |  |                                  |                  |   |                                       |            |                |        |   |                       |  |
| 3.0 TDI quattro  | 150              | 07.11 | PR: 1LF |  |                                  |                  |   |                                       |            |                |        |   |                       |  |
| 3.0 TDI quattro  | 155              | 09.14 | PR: 1LF |  |                                  |                  |   |                                       |            |                |        |   |                       |  |
| 3.0 TDI quattro  | 160              | 09.14 | PR: 1LF |  |                                  |                  |   |                                       |            |                |        |   |                       |  |
| 3.0 TDI quattro  | 176              | 05.13 | PR: 1LF |  |                                  |                  |   |                                       |            |                |        |   |                       |  |
| 3.0 TDI quattro  | 180              | 07.11 | PR: 1LF |  |                                  |                  |   |                                       |            |                |        |   |                       |  |



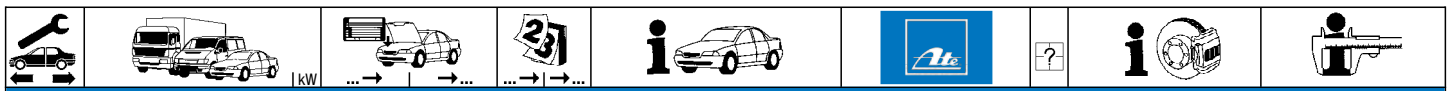

**AUDI A6 (4G2/C7) Limousine (11-)**

|                  |                  |       |         |                 |                |        |   |                         |                |                         |  |
|------------------|------------------|-------|---------|-----------------|----------------|--------|---|-------------------------|----------------|-------------------------|--|
|                  | 3.0 TDI quattro  | 200   | 09.14   | PR: 1LF         | 13.0460-7280.2 | 607280 | 1 | 25158 20,3 +WK          | ATE            |                         |  |
|                  | 3.0 TFSI quattro |       | 07.11   | PR: 1LF         | 13.0470-7280.2 | LD7280 |   |                         | 25158 20,3 +WK | ATE                     |  |
|                  | 3.0 TDI quattro  | 230   | 12.11   | PR: 1LF         | 13.0460-7280.2 | 607280 | 1 | Warnkontakt L=311,6mm   | ATE            |                         |  |
|                  | 3.0 TDI quattro  | 235   | 09.14   | PR: 1LF         | 24.8190-0301.2 | 620301 |   |                         |                |                         |  |
|                  | 3.0 TDI quattro  | 240   | 09.14   | PR: 1LF         |                |        |   |                         |                |                         |  |
|                  | 3.0 TFSI quattro | 245   | 09.14   | PR: 1LF         |                |        |   |                         |                |                         |  |
|                  | S6               | 309   | 04.12   | PR: 1LF         |                |        |   |                         |                |                         |  |
|                  | S6               | 331   | 10.14   | PR: 1LF         |                |        |   |                         |                |                         |  |
|                  | 1.8 TFSI         | 140   | 09.14   | PR: 1LA         | 24.0130-0221.1 | 430221 |   |                         |                | 320 30,0 28,0 V L +S +B |  |
|                  | 2.0 TDI          | 100   | 01.12   | PR: 1LA         |                |        |   |                         |                |                         |  |
|                  | 2.0 TDI          | 110   | 09.14   | PR: 1LA         |                |        |   |                         |                |                         |  |
|                  | 2.0 TDI          | 120   | 04.11   | PR: 1LA         |                |        |   |                         |                |                         |  |
| 2.0 TDI          | 130              | 04.11 | PR: 1LA |                 |                |        |   |                         |                |                         |  |
| 2.0 TDI quattro  | 140              | 04.15 | PR: 1LA |                 |                |        |   |                         |                |                         |  |
| 2.0 TDI ultra    | 140              | 11.13 | PR: 1LA |                 |                |        |   |                         |                |                         |  |
| 2.0 TFSI         | 132              | 04.11 | PR: 1LA |                 |                |        |   |                         |                |                         |  |
| 2.0 TFSI         | 155              | 04.11 | PR: 1LA |                 |                |        |   |                         |                |                         |  |
| 2.0 TFSI         | 162              | 05.13 | PR: 1LA |                 |                |        |   |                         |                |                         |  |
| 2.0 TFSI         | 185              | 09.14 | PR: 1LA |                 |                |        |   |                         |                |                         |  |
| 2.0 TFSI hybrid  | 155              | 11.11 | PR: 1LA |                 |                |        |   |                         |                |                         |  |
| 2.0 TFSI quattro | 155              | 05.12 | PR: 1LA |                 |                |        |   |                         |                |                         |  |
| 2.0 TFSI quattro | 162              | 05.13 | PR: 1LA |                 |                |        |   |                         |                |                         |  |
| 2.0 TFSI quattro | 185              | 05.14 | PR: 1LA |                 |                |        |   |                         |                |                         |  |
| 2.8 FSI          | 150              | 04.11 | PR: 1LA |                 |                |        |   |                         |                |                         |  |
| 2.8 FSI quattro  | 150              | 04.11 | PR: 1LA |                 |                |        |   |                         |                |                         |  |
| 2.8 FSI quattro  | 162              | 09.14 | PR: 1LA |                 |                |        |   |                         |                |                         |  |
| 3.0 TDI          | 150              | 04.11 | PR: 1LA |                 |                |        |   |                         |                |                         |  |
| 3.0 TDI          | 155              | 09.14 | PR: 1LA |                 |                |        |   |                         |                |                         |  |
| 3.0 TDI          | 160              | 09.14 | PR: 1LA |                 |                |        |   |                         |                |                         |  |
| 3.0 TDI quattro  | 150              | 04.11 | PR: 1LA |                 |                |        |   |                         |                |                         |  |
| 3.0 TDI quattro  | 155              | 09.14 | PR: 1LA |                 |                |        |   |                         |                |                         |  |
| 3.0 TDI quattro  | 160              | 09.14 | PR: 1LA |                 |                |        |   |                         |                |                         |  |
| 3.0 TDI quattro  | 176              | 05.13 | PR: 1LA |                 |                |        |   |                         |                |                         |  |
| 3.0 TDI quattro  | 180              | 04.11 | PR: 1LA |                 |                |        |   |                         |                |                         |  |
| 3.0 TDI quattro  | 200              | 09.14 | PR: 1LA |                 |                |        |   |                         |                |                         |  |
| 3.0 TDI quattro  | 230              | 12.11 | PR: 1LA |                 |                |        |   |                         |                |                         |  |
| 3.0 TDI quattro  | 235              | 09.14 | PR: 1LA |                 |                |        |   |                         |                |                         |  |
| 3.0 TDI quattro  | 240              | 09.14 | PR: 1LA |                 |                |        |   |                         |                |                         |  |
| 3.0 TFSI quattro |                  | 04.11 | PR: 1LA |                 |                |        |   |                         |                |                         |  |
| 3.0 TFSI quattro | 245              | 09.14 | PR: 1LA |                 |                |        |   |                         |                |                         |  |
| S6               | 309              | 04.12 | PR: 1LA |                 |                |        |   |                         |                |                         |  |
| S6               | 331              | 10.14 | PR: 1LA |                 |                |        |   |                         |                |                         |  |
|                  | 1.8 TFSI         | 140   | 09.14   | PR: 1LJ         | 24.0130-0222.1 | 430222 |   | 345 30,0 28,0 V L +S +B |                |                         |  |
|                  | 2.0 TDI          | 100   | 01.12   | PR: 1LJ         |                |        |   |                         |                |                         |  |
|                  | 2.0 TDI          | 110   | 09.14   | PR: 1LJ         |                |        |   |                         |                |                         |  |
|                  | 2.0 TDI          | 120   | 04.11   | PR: 1LJ         |                |        |   |                         |                |                         |  |
|                  | 2.0 TDI          | 130   | 04.11   | PR: 1LJ         |                |        |   |                         |                |                         |  |
|                  | 2.0 TDI quattro  | 140   | 04.15   | PR: 1LJ         |                |        |   |                         |                |                         |  |
|                  | 2.0 TDI ultra    | 140   | 11.13   | PR: 1LJ         |                |        |   |                         |                |                         |  |
|                  | 2.0 TFSI         | 132   | 04.11   | PR: 1LJ         |                |        |   |                         |                |                         |  |
|                  | 2.0 TFSI         | 155   | 04.11   | PR: 1LJ         |                |        |   |                         |                |                         |  |
|                  | 2.0 TFSI         | 162   | 05.13   | PR: 1LJ         |                |        |   |                         |                |                         |  |
|                  | 2.0 TFSI         | 185   | 09.14   | PR: 1LJ         |                |        |   |                         |                |                         |  |
|                  | 2.0 TFSI hybrid  | 155   | 11.11   | PR: 1LJ         |                |        |   |                         |                |                         |  |
|                  | 2.0 TFSI quattro | 155   | 05.12   | PR: 1LJ         |                |        |   |                         |                |                         |  |
|                  | 2.0 TFSI quattro | 162   | 05.13   | PR: 1LJ         |                |        |   |                         |                |                         |  |
|                  | 2.0 TFSI quattro | 185   | 05.14   | PR: 1LJ         |                |        |   |                         |                |                         |  |
|                  | 2.8 FSI          | 150   | 04.11   | PR: 1LJ         |                |        |   |                         |                |                         |  |
|                  | 2.8 FSI quattro  | 150   | 04.11   | PR: 1LJ         |                |        |   |                         |                |                         |  |
|                  | 2.8 FSI quattro  | 162   | 09.14   | PR: 1LJ         |                |        |   |                         |                |                         |  |
|                  | 3.0 TDI          | 150   | 04.11   | PR: 1LJ         |                |        |   |                         |                |                         |  |
|                  | 3.0 TDI          | 155   | 09.14   | PR: 1LJ         |                |        |   |                         |                |                         |  |
|                  | 3.0 TDI          | 160   | 09.14   | PR: 1LJ         |                |        |   |                         |                |                         |  |
|                  | 3.0 TDI quattro  | 150   | 04.11   | PR: 1LJ         |                |        |   |                         |                |                         |  |
|                  | 3.0 TDI quattro  | 155   | 09.14   | PR: 1LJ         |                |        |   |                         |                |                         |  |
|                  | 3.0 TDI quattro  | 160   | 09.14   | PR: 1LJ         |                |        |   |                         |                |                         |  |
|                  | 3.0 TDI quattro  | 176   | 05.13   | PR: 1LJ         |                |        |   |                         |                |                         |  |
|                  | 3.0 TDI quattro  | 180   | 04.11   | PR: 1LJ         |                |        |   |                         |                |                         |  |
|                  | 3.0 TDI quattro  | 200   | 09.14   | PR: 1LJ         |                |        |   |                         |                |                         |  |
|                  | 3.0 TDI quattro  | 230   | 12.11   | PR: 1LJ         |                |        |   |                         |                |                         |  |
|                  | 3.0 TDI quattro  | 235   | 09.14   | PR: 1LJ         |                |        |   |                         |                |                         |  |
|                  | 3.0 TDI quattro  | 240   | 09.14   | PR: 1LJ         |                |        |   |                         |                |                         |  |
|                  | 3.0 TFSI quattro |       | 04.11   | PR: 1LJ         |                |        |   |                         |                |                         |  |
|                  | 3.0 TFSI quattro | 245   | 09.14   | PR: 1LJ         |                |        |   |                         |                |                         |  |
|                  | S6               | 309   | 04.12   | PR: 1LJ         |                |        |   |                         |                |                         |  |
| S6               | 331              | 10.14 | PR: 1LJ |                 |                |        |   |                         |                |                         |  |
|                  | 1.8 TFSI         | 140   | 09.14   | PR: 1LL,1LF,1ZK | 24.0134-0103.1 | 434103 |   | 356 34,0 31,5 V L +S +B |                |                         |  |
|                  | 2.0 TDI          | 100   | 01.12   | PR: 1LL,1LF,1ZK |                |        |   |                         |                |                         |  |
|                  | 2.0 TDI          | 110   | 09.14   | PR: 1LL,1LF,1ZK |                |        |   |                         |                |                         |  |
|                  | 2.0 TDI          | 120   | 04.11   | PR: 1LL,1LF,1ZK |                |        |   |                         |                |                         |  |
|                  | 2.0 TDI          | 130   | 04.11   | PR: 1LL,1LF,1ZK |                |        |   |                         |                |                         |  |
|                  | 2.0 TDI quattro  | 140   | 04.15   | PR: 1LL,1LF,1ZK |                |        |   |                         |                |                         |  |
|                  | 2.0 TDI ultra    | 140   | 11.13   | PR: 1LL,1LF,1ZK |                |        |   |                         |                |                         |  |
|                  | 2.0 TFSI         | 132   | 04.11   | PR: 1LL,1LF,1ZK |                |        |   |                         |                |                         |  |
|                  | 2.0 TFSI         | 155   | 04.11   | PR: 1LL,1LF,1ZK |                |        |   |                         |                |                         |  |
|                  | 2.0 TFSI         | 162   | 05.13   | PR: 1LL,1LF,1ZK |                |        |   |                         |                |                         |  |



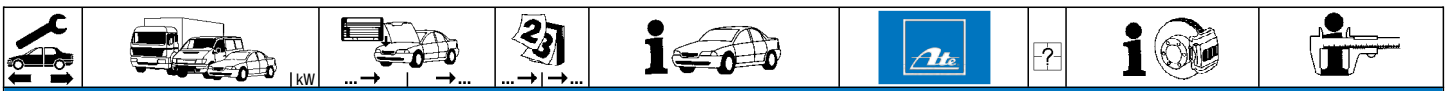

**AUDI A6 (4G2/C7) Limousine (11-)**

|                  |                  |       |                 |                 |                |        |                          |                          |        |   |                     |
|------------------|------------------|-------|-----------------|-----------------|----------------|--------|--------------------------|--------------------------|--------|---|---------------------|
|                  | 2.0 TFSI         | 185   | 09.14           | PR: 1LL,1LF,1ZK | 24.0134-0103.1 | 434103 |                          | 356 34,0 31,5 VL +S +B   |        |   |                     |
|                  | 2.0 TFSI hybrid  | 155   | 11.11           | PR: 1LL,1LF,1ZK |                |        |                          |                          |        |   |                     |
|                  | 2.0 TFSI quattro | 155   | 05.12           | PR: 1LL,1LF,1ZK |                |        |                          |                          |        |   |                     |
|                  | 2.0 TFSI quattro | 162   | 05.13           | PR: 1LL,1LF,1ZK |                |        |                          |                          |        |   |                     |
|                  | 2.0 TFSI quattro | 185   | 05.14           | PR: 1LL,1LF,1ZK |                |        |                          |                          |        |   |                     |
|                  | 2.8 FSI          | 150   | 04.11           | PR: 1LL,1LF,1ZK |                |        |                          |                          |        |   |                     |
|                  | 2.8 FSI quattro  | 150   | 04.11           | PR: 1LL,1LF,1ZK |                |        |                          |                          |        |   |                     |
|                  | 2.8 FSI quattro  | 162   | 09.14           | PR: 1LL,1LF,1ZK |                |        |                          |                          |        |   |                     |
|                  | 3.0 TDI          | 150   | 04.11           | PR: 1LL,1LF,1ZK |                |        |                          |                          |        |   |                     |
|                  | 3.0 TDI          | 155   | 09.14           | PR: 1LL,1LF,1ZK |                |        |                          |                          |        |   |                     |
|                  | 3.0 TDI          | 160   | 09.14           | PR: 1LL,1LF,1ZK |                |        |                          |                          |        |   |                     |
|                  | 3.0 TDI quattro  | 150   | 04.11           | PR: 1LL,1LF,1ZK |                |        |                          |                          |        |   |                     |
|                  | 3.0 TDI quattro  | 155   | 09.14           | PR: 1LL,1LF,1ZK |                |        |                          |                          |        |   |                     |
|                  | 3.0 TDI quattro  | 160   | 09.14           | PR: 1LL,1LF,1ZK |                |        |                          |                          |        |   |                     |
|                  | 3.0 TDI quattro  | 176   | 05.13           | PR: 1LL,1LF,1ZK |                |        |                          |                          |        |   |                     |
|                  | 3.0 TDI quattro  | 180   | 04.11           | PR: 1LL,1LF,1ZK |                |        |                          |                          |        |   |                     |
|                  | 3.0 TDI quattro  | 200   | 09.14           | PR: 1LL,1LF,1ZK |                |        |                          |                          |        |   |                     |
|                  | 3.0 TDI quattro  | 230   | 12.11           | PR: 1LL,1LF,1ZK |                |        |                          |                          |        |   |                     |
|                  | 3.0 TDI quattro  | 235   | 09.14           | PR: 1LL,1LF,1ZK |                |        |                          |                          |        |   |                     |
|                  | 3.0 TDI quattro  | 240   | 09.14           | PR: 1LL,1LF,1ZK |                |        |                          |                          |        |   |                     |
| 3.0 TFSI quattro |                  | 04.11 | PR: 1LL,1LF,1ZK |                 |                |        |                          |                          |        |   |                     |
| 3.0 TFSI quattro | 245              | 09.14 | PR: 1LL,1LF,1ZK |                 |                |        |                          |                          |        |   |                     |
| S6               | 309              | 04.12 | PR: 1LL,1LF,1ZK |                 |                |        |                          |                          |        |   |                     |
| S6               | 331              | 10.14 | PR: 1LL,1LF,1ZK |                 |                |        |                          |                          |        |   |                     |
|                  | 1.8 TFSI         | 140   | 09.14           | PR: 1KW         | 13.0460-2769.2 | 602769 |                          | 25214 17,4 +/WK/Zub/STRW |        |   |                     |
|                  | 2.0 TDI          | 100   | 01.12           | PR: 1KW         |                |        |                          |                          |        |   |                     |
|                  | 2.0 TDI          | 110   | 09.14           | PR: 1KW         |                |        |                          |                          |        |   |                     |
|                  | 2.0 TDI          | 120   | 04.11           | PR: 1KW         |                |        |                          |                          |        |   |                     |
|                  | 2.0 TDI          | 130   | 04.11           | PR: 1KW         |                |        |                          |                          |        |   |                     |
|                  | 2.0 TDI quattro  | 140   | 04.15           | PR: 1KW         |                |        |                          |                          |        |   |                     |
|                  | 2.0 TDI ultra    | 140   | 11.13           | PR: 1KW         |                |        |                          |                          |        |   |                     |
|                  | 2.0 TFSI         | 132   | 04.11           | PR: 1KW         |                |        |                          |                          |        |   |                     |
|                  | 2.0 TFSI         | 155   | 04.11           | PR: 1KW         |                |        |                          |                          |        |   |                     |
|                  | 2.0 TFSI         | 162   | 05.13           | PR: 1KW         |                |        |                          |                          |        |   |                     |
|                  | 2.0 TFSI         | 185   | 09.14           | PR: 1KW         |                |        |                          |                          |        |   |                     |
|                  | 2.0 TFSI hybrid  | 155   | 11.11           | PR: 1KW         |                |        |                          |                          |        |   |                     |
|                  | 2.0 TFSI quattro | 155   | 05.12           | PR: 1KW         |                |        |                          |                          |        |   |                     |
|                  | 2.0 TFSI quattro | 162   | 05.13           | PR: 1KW         |                |        |                          |                          |        |   |                     |
|                  | 2.0 TFSI quattro | 185   | 05.14           | PR: 1KW         |                |        |                          |                          |        |   |                     |
|                  | 2.8 FSI          | 150   | 04.11           | PR: 1KW         |                |        |                          |                          |        |   |                     |
|                  | 2.8 FSI quattro  | 150   | 04.11           | PR: 1KW         |                |        |                          |                          |        |   |                     |
|                  | 2.8 FSI quattro  | 162   | 09.14           | PR: 1KW         |                |        |                          |                          |        |   |                     |
|                  | 3.0 TDI          | 150   | 04.11           | PR: 1KW         |                |        |                          |                          |        |   |                     |
|                  | 3.0 TDI          | 155   | 09.14           | PR: 1KW         |                |        |                          |                          |        |   |                     |
|                  | 3.0 TDI          | 160   | 09.14           | PR: 1KW         |                |        |                          |                          |        |   |                     |
|                  | 3.0 TDI quattro  | 150   | 04.11           | PR: 1KW         |                |        |                          |                          |        |   |                     |
|                  | 3.0 TDI quattro  | 155   | 09.14           | PR: 1KW         |                |        |                          |                          |        |   |                     |
|                  | 3.0 TDI quattro  | 160   | 09.14           | PR: 1KW         |                |        |                          |                          |        |   |                     |
|                  | 3.0 TDI quattro  | 176   | 05.13           | PR: 1KW         |                |        |                          |                          |        |   |                     |
|                  | 3.0 TDI quattro  | 180   | 04.11           | PR: 1KW         |                |        |                          |                          |        |   |                     |
|                  | 3.0 TDI quattro  | 200   | 09.14           | PR: 1KW         |                |        |                          |                          |        |   |                     |
|                  | 3.0 TDI quattro  | 230   | 12.11           | PR: 1KW         |                |        |                          |                          |        |   |                     |
|                  | 3.0 TDI quattro  | 235   | 09.14           | PR: 1KW         |                |        |                          |                          |        |   |                     |
|                  | 3.0 TDI quattro  | 240   | 09.14           | PR: 1KW         |                |        |                          |                          |        |   |                     |
|                  | 3.0 TFSI quattro |       | 04.11           | PR: 1KW         |                |        |                          |                          |        |   |                     |
|                  | 3.0 TFSI quattro | 245   | 09.14           | PR: 1KW         |                |        |                          |                          |        |   |                     |
|                  | S6               | 309   | 04.12           | PR: 1KW         |                |        |                          |                          |        |   |                     |
|                  | S6               | 331   | 10.14           | PR: 1KW         |                |        |                          |                          |        |   |                     |
| 1.8 TFSI         | 140              | 09.14 | PR: 1KY,2EA,2EE | 13.0460-2770.2  | 602770         |        | 25214 17,4 +/WK/Zub/STRW |                          |        |   |                     |
| 2.0 TDI          | 100              | 01.12 | PR: 1KY,2EA,2EE |                 |                |        |                          |                          |        |   |                     |
| 2.0 TDI          | 110              | 09.14 | PR: 1KY,2EA,2EE |                 |                |        |                          |                          |        |   |                     |
| 2.0 TDI          | 120              | 04.11 | PR: 1KY,2EA,2EE |                 |                |        |                          |                          |        |   |                     |
| 2.0 TDI          | 130              | 04.11 | PR: 1KY,2EA,2EE |                 |                |        |                          |                          |        |   |                     |
| 2.0 TDI quattro  | 140              | 04.15 | PR: 1KY,2EA,2EE |                 |                |        |                          |                          |        |   |                     |
| 2.0 TDI ultra    | 140              | 11.13 | PR: 1KY,2EA,2EE |                 |                |        |                          |                          |        |   |                     |
| 2.0 TFSI         | 132              | 04.11 | PR: 1KY,2EA,2EE |                 |                |        |                          |                          |        |   |                     |
| 2.0 TFSI         | 155              | 04.11 | PR: 1KY,2EA,2EE |                 |                |        |                          |                          |        |   |                     |
| 2.0 TFSI         | 162              | 05.13 | PR: 1KY,2EA,2EE |                 |                |        |                          |                          |        |   |                     |
| 2.0 TFSI         | 185              | 09.14 | PR: 1KY,2EA,2EE |                 |                |        |                          |                          |        |   |                     |
| 2.0 TFSI hybrid  | 155              | 11.11 | PR: 1KY,2EA,2EE |                 |                |        |                          |                          |        |   |                     |
| 2.0 TFSI quattro | 155              | 05.12 | PR: 1KY,2EA,2EE |                 |                |        |                          |                          |        |   |                     |
| 2.0 TFSI quattro | 162              | 05.13 | PR: 1KY,2EA,2EE |                 |                |        |                          |                          |        |   |                     |
| 2.0 TFSI quattro | 185              | 05.14 | PR: 1KY,2EA,2EE |                 |                |        |                          |                          |        |   |                     |
| 2.8 FSI          | 150              | 04.11 | PR: 1KY,2EA,2EE |                 |                |        |                          |                          |        |   |                     |
| 2.8 FSI quattro  | 150              | 04.11 | PR: 1KY,2EA,2EE |                 |                |        |                          |                          |        |   |                     |
| 2.8 FSI quattro  | 162              | 09.14 | PR: 1KY,2EA,2EE |                 |                |        |                          |                          |        |   |                     |
| 3.0 TDI          | 150              | 04.11 | PR: 1KY,2EA,2EE |                 |                |        |                          |                          |        |   |                     |
| 3.0 TDI          | 155              | 09.14 | PR: 1KY,2EA,2EE |                 |                |        |                          |                          |        |   |                     |
| 3.0 TDI          | 160              | 09.14 | PR: 1KY,2EA,2EE |                 |                |        |                          |                          |        |   |                     |
| 3.0 TDI quattro  | 150              | 04.11 | PR: 1KY,2EA,2EE |                 |                |        |                          |                          |        |   |                     |
| 3.0 TDI quattro  | 155              | 09.14 | PR: 1KY,2EA,2EE |                 |                |        |                          |                          |        |   |                     |
| 3.0 TDI quattro  | 160              | 09.14 | PR: 1KY,2EA,2EE |                 |                |        |                          |                          |        |   |                     |
| 3.0 TDI quattro  | 176              | 05.13 | PR: 1KY,2EA,2EE |                 |                |        |                          |                          |        |   |                     |
| 3.0 TDI quattro  | 180              | 04.11 | PR: 1KY,2EA,2EE |                 |                |        |                          |                          |        |   |                     |
| 3.0 TDI quattro  | 200              | 09.14 | PR: 1KY,2EA,2EE |                 |                |        |                          |                          |        |   |                     |
| 3.0 TDI quattro  | 230              | 12.11 | PR: 1KY,2EA,2EE |                 |                |        |                          |                          |        |   |                     |
| 3.0 TDI quattro  | 235              | 09.14 | PR: 1KY,2EA,2EE |                 |                |        |                          |                          |        |   |                     |
|                  |                  |       |                 |                 |                |        |                          | 24.8190-0313.2           | 620313 | 1 | Warnkontakt L=217mm |

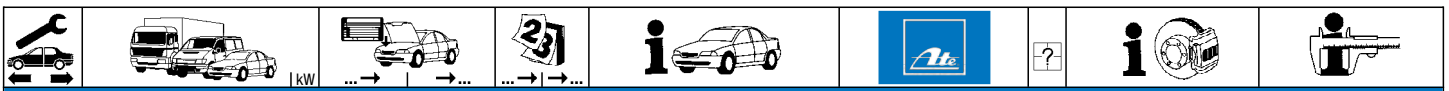

**AUDI A6 (4G2/C7) Limousine (11-)**

|  |                  |                 |       |                 |                       |                       |        |   |  |                        |
|--|------------------|-----------------|-------|-----------------|-----------------------|-----------------------|--------|---|--|------------------------|
|  | 3.0 TDI quattro  | 240             | 09.14 | PR: 1KY,2EA,2EE | <b>13.0460-2770.2</b> | 602770                |        | 25214 17,4 +/WK/Zub/STRW<br>25214 17,4 +/WK/Zub/STRW<br>Warnkontakt L=217mm |  |                        |
|  | 3.0 TFSI quattro |                 | 04.11 | PR: 1KY,2EA,2EE | <b>13.0470-2770.2</b> | LD2770                |        |   |  |                        |
|  | 3.0 TFSI quattro | 245             | 09.14 | PR: 1KY,2EA,2EE | <b>24.8190-0313.2</b> | 620313                | 1      |   |  |                        |
|  | S6               | 309             | 04.12 | PR: 1KY,2EA,2EE |                       |                       |        |   |  |                        |
|  | S6               | 331             | 10.14 | PR: 1KY,2EA,2EE |                       |                       |        |   |  |                        |
|  | 1.8 TFSI         | 140             | 09.14 | PR: 1KW         | <b>24.0112-0178.1</b> | 412178                |        | 300 12,0 10,0 +S +B<br>300 12,0 10,0 +S +B PD                               |  |                        |
|  | 2.0 TDI          | 100             | 01.12 | PR: 1KW         | <b>24.0312-0178.1</b> | 512178                |        |   |  |                        |
|  | 2.0 TDI          | 110             | 09.14 | PR: 1KW         |                       |                       |        |   |  |                        |
|  | 2.0 TDI          | 120             | 04.11 | PR: 1KW         |                       |                       |        |   |  |                        |
|  | 2.0 TDI          | 130             | 04.11 | PR: 1KW         |                       |                       |        |   |  |                        |
|  | 2.0 TDI quattro  | 140             | 04.15 | PR: 1KW         |                       |                       |        |   |  |                        |
|  | 2.0 TDI ultra    | 140             | 11.13 | PR: 1KW         |                       |                       |        |   |  |                        |
|  | 2.0 TFSI         | 132             | 04.11 | PR: 1KW         |                       |                       |        |   |  |                        |
|  | 2.0 TFSI         | 155             | 04.11 | PR: 1KW         |                       |                       |        |   |  |                        |
|  | 2.0 TFSI         | 162             | 05.13 | PR: 1KW         |                       |                       |        |   |  |                        |
|  | 2.0 TFSI         | 185             | 09.14 | PR: 1KW         |                       |                       |        |   |  |                        |
|  | 2.0 TFSI hybrid  | 155             | 11.11 | PR: 1KW         |                       |                       |        |   |  |                        |
|  | 2.0 TFSI quattro | 155             | 05.12 | PR: 1KW         |                       |                       |        |   |  |                        |
|  | 2.0 TFSI quattro | 162             | 05.13 | PR: 1KW         |                       |                       |        |   |  |                        |
|  | 2.0 TFSI quattro | 185             | 05.14 | PR: 1KW         |                       |                       |        |   |  |                        |
|  | 2.8 FSI          | 150             | 04.11 | PR: 1KW         |                       |                       |        |   |  |                        |
|  | 2.8 FSI quattro  | 150             | 04.11 | PR: 1KW         |                       |                       |        |   |  |                        |
|  | 2.8 FSI quattro  | 162             | 09.14 | PR: 1KW         |                       |                       |        |   |  |                        |
|  | 3.0 TDI          | 150             | 04.11 | PR: 1KW         |                       |                       |        |   |  |                        |
|  | 3.0 TDI          | 155             | 09.14 | PR: 1KW         |                       |                       |        |   |  |                        |
|  | 3.0 TDI          | 160             | 09.14 | PR: 1KW         |                       |                       |        |   |  |                        |
|  | 3.0 TDI quattro  | 150             | 04.11 | PR: 1KW         |                       |                       |        |   |  |                        |
|  | 3.0 TDI quattro  | 155             | 09.14 | PR: 1KW         |                       |                       |        |   |  |                        |
|  | 3.0 TDI quattro  | 160             | 09.14 | PR: 1KW         |                       |                       |        |   |  |                        |
|  | 3.0 TDI quattro  | 176             | 05.13 | PR: 1KW         |                       |                       |        |   |  |                        |
|  | 3.0 TDI quattro  | 180             | 04.11 | PR: 1KW         |                       |                       |        |   |  |                        |
|  | 3.0 TDI quattro  | 200             | 09.14 | PR: 1KW         |                       |                       |        |   |  |                        |
|  | 3.0 TDI quattro  | 230             | 12.11 | PR: 1KW         |                       |                       |        |   |  |                        |
|  | 3.0 TDI quattro  | 235             | 09.14 | PR: 1KW         |                       |                       |        |   |  |                        |
|  | 3.0 TDI quattro  | 240             | 09.14 | PR: 1KW         |                       |                       |        |   |  |                        |
|  | 3.0 TFSI quattro |                 | 04.11 | PR: 1KW         |                       |                       |        |   |  |                        |
|  | 3.0 TFSI quattro | 245             | 09.14 | PR: 1KW         |                       |                       |        |   |  |                        |
|  | S6               | 309             | 04.12 | PR: 1KW         |                       |                       |        |   |  |                        |
|  | S6               | 331             | 10.14 | PR: 1KW         |                       |                       |        |   |  |                        |
|  |                  | 1.8 TFSI        | 140   | 09.14           | PR: 2EA,2EE           | <b>24.0122-0272.1</b> | 422272 |   |  | 330 21,9 20,0 VL +S +B |
|  |                  | 2.0 TDI         | 100   | 01.12           | PR: 2EA,2EE           |                       |        |   |  |                        |
|  |                  | 2.0 TDI         | 110   | 09.14           | PR: 2EA,2EE           |                       |        |   |  |                        |
|  |                  | 2.0 TDI         | 120   | 04.11           | PR: 2EA,2EE           |                       |        |   |  |                        |
|  |                  | 2.0 TDI         | 130   | 04.11           | PR: 2EA,2EE           |                       |        |   |  |                        |
|  |                  | 2.0 TDI quattro | 140   | 04.15           | PR: 2EA,2EE           |                       |        |   |  |                        |
|  |                  | 2.0 TDI ultra   | 140   | 11.13           | PR: 2EA,2EE           |                       |        |   |  |                        |
|  |                  | 2.0 TFSI        | 132   | 04.11           | PR: 2EA,2EE           |                       |        |   |  |                        |
|  |                  | 2.0 TFSI        | 155   | 04.11           | PR: 2EA,2EE           |                       |        |   |  |                        |
|  |                  | 2.0 TFSI        | 162   | 05.13           | PR: 2EA,2EE           |                       |        |   |  |                        |
|  | 2.0 TFSI         | 185             | 09.14 | PR: 2EA,2EE     |                       |                       |        |   |  |                        |
|  | 2.0 TFSI hybrid  | 155             | 11.11 | PR: 2EA,2EE     |                       |                       |        |   |  |                        |
|  | 2.0 TFSI quattro | 155             | 05.12 | PR: 2EA,2EE     |                       |                       |        |   |  |                        |
|  | 2.0 TFSI quattro | 162             | 05.13 | PR: 2EA,2EE     |                       |                       |        |   |  |                        |
|  | 2.0 TFSI quattro | 185             | 05.14 | PR: 2EA,2EE     |                       |                       |        |   |  |                        |
|  | 2.8 FSI          | 150             | 04.11 | PR: 2EA,2EE     |                       |                       |        |   |  |                        |
|  | 2.8 FSI quattro  | 150             | 04.11 | PR: 2EA,2EE     |                       |                       |        |   |  |                        |
|  | 2.8 FSI quattro  | 162             | 09.14 | PR: 2EA,2EE     |                       |                       |        |   |  |                        |
|  | 3.0 TDI          | 150             | 04.11 | PR: 2EA,2EE     |                       |                       |        |   |  |                        |
|  | 3.0 TDI          | 155             | 09.14 | PR: 2EA,2EE     |                       |                       |        |   |  |                        |
|  | 3.0 TDI          | 160             | 09.14 | PR: 2EA,2EE     |                       |                       |        |   |  |                        |
|  | 3.0 TDI quattro  | 150             | 04.11 | PR: 2EA,2EE     |                       |                       |        |   |  |                        |
|  | 3.0 TDI quattro  | 155             | 09.14 | PR: 2EA,2EE     |                       |                       |        |   |  |                        |
|  | 3.0 TDI quattro  | 160             | 09.14 | PR: 2EA,2EE     |                       |                       |        |   |  |                        |
|  | 3.0 TDI quattro  | 176             | 05.13 | PR: 2EA,2EE     |                       |                       |        |   |  |                        |
|  | 3.0 TDI quattro  | 180             | 04.11 | PR: 2EA,2EE     |                       |                       |        |   |  |                        |
|  | 3.0 TDI quattro  | 200             | 09.14 | PR: 2EA,2EE     |                       |                       |        |   |  |                        |
|  | 3.0 TDI quattro  | 230             | 12.11 | PR: 2EA,2EE     |                       |                       |        |   |  |                        |
|  | 3.0 TDI quattro  | 235             | 09.14 | PR: 2EA,2EE     |                       |                       |        |   |  |                        |
|  | 3.0 TDI quattro  | 240             | 09.14 | PR: 2EA,2EE     |                       |                       |        |   |  |                        |
|  | 3.0 TFSI quattro |                 | 04.11 | PR: 2EA,2EE     |                       |                       |        |   |  |                        |
|  | 3.0 TFSI quattro | 245             | 09.14 | PR: 2EA,2EE     |                       |                       |        |   |  |                        |
|  | S6               | 309             | 04.12 | PR: 2EA,2EE     |                       |                       |        |   |  |                        |
|  | S6               | 331             | 10.14 | PR: 2EA,2EE     |                       |                       |        |   |  |                        |
|  | 1.8 TFSI         | 140             | 09.14 | PR: 1KY         | <b>24.0122-0273.1</b> | 422273                |        | 356 22,0 20,0 VL +S +B  |  |                        |
|  | 2.0 TDI          | 100             | 01.12 | PR: 1KY         |                       |                       |        |   |  |                        |
|  | 2.0 TDI          | 110             | 09.14 | PR: 1KY         |                       |                       |        |   |  |                        |
|  | 2.0 TDI          | 120             | 04.11 | PR: 1KY         |                       |                       |        |   |  |                        |
|  | 2.0 TDI          | 130             | 04.11 | PR: 1KY         |                       |                       |        |   |  |                        |
|  | 2.0 TDI quattro  | 140             | 04.15 | PR: 1KY         |                       |                       |        |   |  |                        |
|  | 2.0 TDI ultra    | 140             | 11.13 | PR: 1KY         |                       |                       |        |   |  |                        |
|  | 2.0 TFSI         | 132             | 04.11 | PR: 1KY         |                       |                       |        |   |  |                        |
|  | 2.0 TFSI         | 155             | 04.11 | PR: 1KY         |                       |                       |        |   |  |                        |
|  | 2.0 TFSI         | 162             | 05.13 | PR: 1KY         |                       |                       |        |   |  |                        |
|  | 2.0 TFSI         | 185             | 09.14 | PR: 1KY         |                       |                       |        |   |  |                        |
|  | 2.0 TFSI hybrid  | 155             | 11.11 | PR: 1KY         |                       |                       |        |   |  |                        |
|  | 2.0 TFSI quattro | 155             | 05.12 | PR: 1KY         |                       |                       |        |   |  |                        |
|  | 2.0 TFSI quattro | 162             | 05.13 | PR: 1KY         |                       |                       |        |   |  |                        |





**AUDI A6 (4G2/C7) Limousine (11-)**

|  |                  |     |       |         |                |        |  |                        |
|--|------------------|-----|-------|---------|----------------|--------|--|------------------------|
|  | 2.0 TFSI quattro | 185 | 05.14 | PR: 1KY | 24.0122-0273.1 | 422273 |  | 356 22,0 20,0 VL +S +B |
|  | 2.8 FSI          | 150 | 04.11 | PR: 1KY |                |        |  |                        |
|  | 2.8 FSI quattro  | 150 | 04.11 | PR: 1KY |                |        |  |                        |
|  | 2.8 FSI quattro  | 162 | 09.14 | PR: 1KY |                |        |  |                        |
|  | 3.0 TDI          | 150 | 04.11 | PR: 1KY |                |        |  |                        |
|  | 3.0 TDI          | 155 | 09.14 | PR: 1KY |                |        |  |                        |
|  | 3.0 TDI          | 160 | 09.14 | PR: 1KY |                |        |  |                        |
|  | 3.0 TDI quattro  | 150 | 04.11 | PR: 1KY |                |        |  |                        |
|  | 3.0 TDI quattro  | 155 | 09.14 | PR: 1KY |                |        |  |                        |
|  | 3.0 TDI quattro  | 160 | 09.14 | PR: 1KY |                |        |  |                        |
|  | 3.0 TDI quattro  | 176 | 05.13 | PR: 1KY |                |        |  |                        |
|  | 3.0 TDI quattro  | 180 | 04.11 | PR: 1KY |                |        |  |                        |
|  | 3.0 TDI quattro  | 200 | 09.14 | PR: 1KY |                |        |  |                        |
|  | 3.0 TDI quattro  | 230 | 12.11 | PR: 1KY |                |        |  |                        |
|  | 3.0 TDI quattro  | 235 | 09.14 | PR: 1KY |                |        |  |                        |
|  | 3.0 TDI quattro  | 240 | 09.14 | PR: 1KY |                |        |  |                        |
|  | 3.0 TFSI quattro |     | 04.11 | PR: 1KY |                |        |  |                        |
|  | 3.0 TFSI quattro | 245 | 09.14 | PR: 1KY |                |        |  |                        |
|  | S6               | 309 | 04.12 | PR: 1KY |                |        |  |                        |
|  | S6               | 331 | 10.14 | PR: 1KY |                |        |  |                        |

**AUDI A6 (4G5/C7) Avant (11-)**

|  |                  |     |       |             |                |        |                              |                       |
|--|------------------|-----|-------|-------------|----------------|--------|------------------------------|-----------------------|
|  | 1.8 TFSI         | 140 | 09.14 | PR: 1LA,1LJ | 13.0460-2765.2 | 602765 | Federmaß 46 mm <sup>1)</sup> | 24743 19,2 +/WK/S TRW |
|  | 2.0 TDI          | 100 | 01.12 | PR: 1LA,1LJ | 13.0470-2765.2 | LD2765 | Federmaß 46 mm <sup>1)</sup> | 24743 19,2 +/WK/S TRW |
|  | 2.0 TDI          | 110 | 09.14 | PR: 1LA,1LJ | 24.8190-0311.2 | 620311 |                              | Warnkontakt L=300mm   |
|  | 2.0 TDI          | 120 | 09.11 | PR: 1LA,1LJ |                |        |                              |                       |
|  | 2.0 TDI          | 130 | 09.11 | PR: 1LA,1LJ |                |        |                              |                       |
|  | 2.0 TDI quattro  | 140 | 04.15 | PR: 1LA,1LJ |                |        |                              |                       |
|  | 2.0 TDI ultra    | 140 | 11.13 | PR: 1LA,1LJ |                |        |                              |                       |
|  | 2.0 TFSI         | 132 | 06.11 | PR: 1LA,1LJ |                |        |                              |                       |
|  | 2.0 TFSI         | 185 | 09.14 | PR: 1LA,1LJ |                |        |                              |                       |
|  | 2.0 TFSI quattro | 185 | 05.15 | PR: 1LA,1LJ |                |        |                              |                       |
|  | 2.8 FSI          | 150 | 09.11 | PR: 1LA,1LJ |                |        |                              |                       |
|  | 2.8 FSI quattro  | 150 | 09.11 | PR: 1LA,1LJ |                |        |                              |                       |
|  | 2.8 FSI quattro  | 162 | 09.14 | PR: 1LA,1LJ |                |        |                              |                       |
|  | 3.0 TDI          | 150 | 09.11 | PR: 1LA,1LJ |                |        |                              |                       |
|  | 3.0 TDI          | 155 | 09.14 | PR: 1LA,1LJ |                |        |                              |                       |
|  | 3.0 TDI          | 160 | 09.14 | PR: 1LA,1LJ |                |        |                              |                       |
|  | 3.0 TDI quattro  | 150 | 09.11 | PR: 1LA,1LJ |                |        |                              |                       |
|  | 3.0 TDI quattro  | 155 | 09.14 | PR: 1LA,1LJ |                |        |                              |                       |
|  | 3.0 TDI quattro  | 160 | 09.14 | PR: 1LA,1LJ |                |        |                              |                       |
|  | 3.0 TDI quattro  | 180 | 09.11 | PR: 1LA,1LJ |                |        |                              |                       |
|  | 3.0 TDI quattro  | 200 | 09.14 | PR: 1LA,1LJ |                |        |                              |                       |
|  | 3.0 TFSI quattro |     | 09.11 | PR: 1LA,1LJ |                |        |                              |                       |
|  | 3.0 TDI quattro  | 230 | 12.11 | PR: 1LA,1LJ | 13.0460-2765.2 | 602765 | Federmaß 46 mm <sup>1)</sup> | 24743 19,2 +/WK/S TRW |
|  | 3.0 TDI quattro  | 235 | 09.14 | PR: 1LA,1LJ | 24.8190-0311.2 | 620311 |                              | Warnkontakt L=300mm   |
|  | 3.0 TDI quattro  | 240 | 09.14 | PR: 1LA,1LJ |                |        |                              |                       |
|  | 3.0 TFSI quattro | 245 | 09.14 | PR: 1LA,1LJ |                |        |                              |                       |
|  | S6               | 309 | 04.12 | PR: 1LA,1LJ |                |        |                              |                       |
|  | S6               | 331 | 09.14 | PR: 1LA,1LJ |                |        |                              |                       |
|  | 1.8 TFSI         | 140 | 09.14 | PR: 1LL,1ZK | 13.0460-7280.2 | 607280 |                              | 25158 20,3 +/WK ATE   |
|  | 2.0 TDI          | 100 | 01.12 | PR: 1LL,1ZK | 13.0470-7280.2 | LD7280 |                              | 25158 20,3 +/WK ATE   |
|  | 2.0 TDI          | 110 | 09.14 | PR: 1LL,1ZK | 24.8190-0301.2 | 620301 |                              | Warnkontakt L=311,6mm |
|  | 2.0 TDI          | 120 | 09.11 | PR: 1LL,1ZK |                |        |                              |                       |
|  | 2.0 TDI          | 130 | 09.11 | PR: 1LL,1ZK |                |        |                              |                       |
|  | 2.0 TDI quattro  | 140 | 04.15 | PR: 1LL,1ZK |                |        |                              |                       |
|  | 2.0 TDI ultra    | 140 | 11.13 | PR: 1LL,1ZK |                |        |                              |                       |
|  | 2.0 TFSI         | 132 | 06.11 | PR: 1LL,1ZK |                |        |                              |                       |
|  | 2.0 TFSI         | 185 | 09.14 | PR: 1LL,1ZK |                |        |                              |                       |
|  | 2.0 TFSI quattro | 185 | 05.15 | PR: 1LL,1ZK |                |        |                              |                       |
|  | 2.8 FSI          | 150 | 09.11 | PR: 1LL,1ZK |                |        |                              |                       |
|  | 2.8 FSI quattro  | 150 | 09.11 | PR: 1LL,1ZK |                |        |                              |                       |
|  | 2.8 FSI quattro  | 162 | 09.14 | PR: 1LL,1ZK |                |        |                              |                       |
|  | 3.0 TDI          | 150 | 09.11 | PR: 1LL,1ZK |                |        |                              |                       |
|  | 3.0 TDI          | 155 | 09.14 | PR: 1LL,1ZK |                |        |                              |                       |
|  | 3.0 TDI          | 160 | 09.14 | PR: 1LL,1ZK |                |        |                              |                       |
|  | 3.0 TDI quattro  | 150 | 09.11 | PR: 1LL,1ZK |                |        |                              |                       |
|  | 3.0 TDI quattro  | 155 | 09.14 | PR: 1LL,1ZK |                |        |                              |                       |
|  | 3.0 TDI quattro  | 160 | 09.14 | PR: 1LL,1ZK |                |        |                              |                       |
|  | 3.0 TDI quattro  | 180 | 09.11 | PR: 1LL,1ZK |                |        |                              |                       |
|  | 3.0 TDI quattro  | 200 | 09.14 | PR: 1LL,1ZK |                |        |                              |                       |
|  | 3.0 TFSI quattro |     | 09.11 | PR: 1LL,1ZK |                |        |                              |                       |
|  | 3.0 TDI quattro  | 230 | 12.11 | PR: 1LL,1ZK | 13.0460-7280.2 | 607280 |                              | 25158 20,3 +/WK ATE   |
|  | 3.0 TDI quattro  | 235 | 09.14 | PR: 1LL,1ZK | 24.8190-0301.2 | 620301 |                              | Warnkontakt L=311,6mm |
|  | 3.0 TDI quattro  | 240 | 09.14 | PR: 1LL,1ZK |                |        |                              |                       |
|  | 3.0 TFSI quattro | 245 | 09.14 | PR: 1LL,1ZK |                |        |                              |                       |
|  | S6               | 309 | 04.12 | PR: 1LL,1ZK |                |        |                              |                       |
|  | S6               | 331 | 09.14 | PR: 1LL,1ZK |                |        |                              |                       |
|  | 1.8 TFSI         | 140 | 09.14 | PR: 1LF     | 13.0460-7280.2 | 607280 |                              | 25158 20,3 +/WK ATE   |
|  | 2.0 TDI          | 100 | 01.12 | PR: 1LF     | 13.0470-7280.2 | LD7280 |                              | 25158 20,3 +/WK ATE   |
|  | 2.0 TDI          | 110 | 09.14 | PR: 1LF     | 24.8190-0301.2 | 620301 |                              | Warnkontakt L=311,6mm |
|  | 2.0 TDI          | 120 | 09.11 | PR: 1LF     |                |        |                              |                       |
|  | 2.0 TDI          | 130 | 09.11 | PR: 1LF     |                |        |                              |                       |
|  | 2.0 TDI quattro  | 140 | 04.15 | PR: 1LF     |                |        |                              |                       |
|  | 2.0 TDI ultra    | 140 | 11.13 | PR: 1LF     |                |        |                              |                       |
|  | 2.0 TFSI         | 132 | 06.11 | PR: 1LF     |                |        |                              |                       |
|  | 2.0 TFSI         | 185 | 09.14 | PR: 1LF     |                |        |                              |                       |

<sup>1)</sup> spring dimension 46 mm / dimensioni molla 46 mm / dimension de ressort 46 mm / medida de muelle 46 mm

**AUDI A6 (4G5/C7) Avant (11-)**

|                  |                  |       |         |                |                |        |  |   |            |
|------------------|------------------|-------|---------|----------------|----------------|--------|--|---|------------|
|                  | 2.0 TFSI quattro | 185   | 05.15   | PR: 1LF        | 13.0460-7280.2 | 607280 | 1  | 25158 20,3 +/WK<br>25158 20,3 +/WK<br>Warnkontakt L=311,6mm | ATE<br>ATE |
|                  | 2.8 FSI          | 150   | 09.11   | PR: 1LF        | 13.0470-7280.2 | LD7280 |  |   |            |
|                  | 2.8 FSI quattro  | 150   | 09.11   | PR: 1LF        | 24.8190-0301.2 | 620301 |  |   |            |
|                  | 2.8 FSI quattro  | 162   | 09.14   | PR: 1LF        |                |        |  |   |            |
|                  | 3.0 TDI          | 150   | 09.11   | PR: 1LF        |                |        |  |   |            |
|                  | 3.0 TDI          | 155   | 09.14   | PR: 1LF        |                |        |  |   |            |
|                  | 3.0 TDI          | 160   | 09.14   | PR: 1LF        |                |        |  |   |            |
|                  | 3.0 TDI quattro  | 150   | 09.11   | PR: 1LF        |                |        |  |   |            |
|                  | 3.0 TDI quattro  | 155   | 09.14   | PR: 1LF        |                |        |  |   |            |
|                  | 3.0 TDI quattro  | 160   | 09.14   | PR: 1LF        |                |        |  |   |            |
| 3.0 TDI quattro  | 180              | 09.11 | PR: 1LF |                |                |        |  |   |            |
| 3.0 TDI quattro  | 200              | 09.14 | PR: 1LF |                |                |        |  |   |            |
| 3.0 TFSI quattro |                  | 09.11 | PR: 1LF |                |                |        |  |   |            |
| 3.0 TDI quattro  | 230              | 12.11 | PR: 1LF | 13.0460-7280.2 | 607280         | 1      | 25158 20,3 +/WK<br>Warnkontakt L=311,6mm | ATE   |            |
| 3.0 TDI quattro  | 235              | 09.14 | PR: 1LF | 24.8190-0301.2 | 620301         |        |  |   |            |
| 3.0 TDI quattro  | 240              | 09.14 | PR: 1LF |                |                |        |  |   |            |
| 3.0 TFSI quattro | 245              | 09.14 | PR: 1LF |                |                |        |  |   |            |
| S6               | 309              | 04.12 | PR: 1LF |                |                |        |  |   |            |
| S6               | 331              | 09.14 | PR: 1LF |                |                |        |  |   |            |
| 1.8 TFSI         | 140              | 09.14 | PR: 1LU | 13.0460-4873.2 | 604873         | 2      | 24847 17,0 /WE<br>Warnkontakt L=254mm    | BRE   |            |
| 2.0 TDI          | 100              | 01.12 | PR: 1LU | 24.8190-0019.2 | 620019         |        |  |   |            |
| 2.0 TDI          | 110              | 09.14 | PR: 1LU |                |                |        |  |   |            |
| 2.0 TDI          | 120              | 09.11 | PR: 1LU |                |                |        |  |   |            |
| 2.0 TDI          | 130              | 09.11 | PR: 1LU |                |                |        |  |   |            |
| 2.0 TDI quattro  | 140              | 04.15 | PR: 1LU |                |                |        |  |   |            |
| 2.0 TDI ultra    | 140              | 11.13 | PR: 1LU |                |                |        |  |   |            |
| 2.0 TFSI         | 132              | 06.11 | PR: 1LU |                |                |        |  |   |            |
| 2.0 TFSI         | 185              | 09.14 | PR: 1LU |                |                |        |  |   |            |
| 2.0 TFSI quattro | 185              | 05.15 | PR: 1LU |                |                |        |  |   |            |
| 2.8 FSI          | 150              | 09.11 | PR: 1LU |                |                |        |  |   |            |
| 2.8 FSI quattro  | 150              | 09.11 | PR: 1LU |                |                |        |  |   |            |
| 2.8 FSI quattro  | 162              | 09.14 | PR: 1LU |                |                |        |  |   |            |
| 3.0 TDI          | 150              | 09.11 | PR: 1LU |                |                |        |  |   |            |
| 3.0 TDI          | 155              | 09.14 | PR: 1LU |                |                |        |  |   |            |
| 3.0 TDI          | 160              | 09.14 | PR: 1LU |                |                |        |  |   |            |
| 3.0 TDI quattro  | 150              | 09.11 | PR: 1LU |                |                |        |  |   |            |
| 3.0 TDI quattro  | 155              | 09.14 | PR: 1LU |                |                |        |  |   |            |
| 3.0 TDI quattro  | 160              | 09.14 | PR: 1LU |                |                |        |  |   |            |
| 3.0 TDI quattro  | 180              | 09.11 | PR: 1LU |                |                |        |  |   |            |
| 3.0 TDI quattro  | 200              | 09.14 | PR: 1LU |                |                |        |  |   |            |
| 3.0 TDI quattro  | 230              | 12.11 | PR: 1LU |                |                |        |  |   |            |
| 3.0 TDI quattro  | 235              | 09.14 | PR: 1LU |                |                |        |  |   |            |
| 3.0 TDI quattro  | 240              | 09.14 | PR: 1LU |                |                |        |  |   |            |
| 3.0 TFSI quattro | 245              | 09.11 | PR: 1LU |                |                |        |  |   |            |
| 3.0 TFSI quattro | 245              | 09.14 | PR: 1LU |                |                |        |  |   |            |
| RS 6             | 412              | 03.13 | PR: 1LU |                |                |        |  |   |            |
| S6               | 309              | 04.12 | PR: 1LU |                |                |        |  |   |            |
| S6               | 331              | 09.14 | PR: 1LU |                |                |        |  |   |            |
| 1.8 TFSI         | 140              | 09.14 | PR: 1LW | 24.8190-0020.2 | 620020         | 2      | Warnkontakt L=443,3mm                    |   |            |
| 2.0 TDI          | 100              | 01.12 | PR: 1LW |                |                |        |  |   |            |
| 2.0 TDI          | 110              | 09.14 | PR: 1LW |                |                |        |  |   |            |
| 2.0 TDI          | 120              | 09.11 | PR: 1LW |                |                |        |  |   |            |
| 2.0 TDI          | 130              | 09.11 | PR: 1LW |                |                |        |  |   |            |
| 2.0 TDI quattro  | 140              | 04.15 | PR: 1LW |                |                |        |  |   |            |
| 2.0 TDI ultra    | 140              | 11.13 | PR: 1LW |                |                |        |  |   |            |
| 2.0 TFSI         | 132              | 06.11 | PR: 1LW |                |                |        |  |   |            |
| 2.0 TFSI         | 185              | 09.14 | PR: 1LW |                |                |        |  |   |            |
| 2.0 TFSI quattro | 185              | 05.15 | PR: 1LW |                |                |        |  |   |            |
| 2.8 FSI          | 150              | 09.11 | PR: 1LW |                |                |        |  |   |            |
| 2.8 FSI quattro  | 150              | 09.11 | PR: 1LW |                |                |        |  |   |            |
| 2.8 FSI quattro  | 162              | 09.14 | PR: 1LW |                |                |        |  |   |            |
| 3.0 TDI          | 150              | 09.11 | PR: 1LW |                |                |        |  |   |            |
| 3.0 TDI          | 155              | 09.14 | PR: 1LW |                |                |        |  |   |            |
| 3.0 TDI          | 160              | 09.14 | PR: 1LW |                |                |        |  |   |            |
| 3.0 TDI quattro  | 150              | 09.11 | PR: 1LW |                |                |        |  |   |            |
| 3.0 TDI quattro  | 155              | 09.14 | PR: 1LW |                |                |        |  |   |            |
| 3.0 TDI quattro  | 160              | 09.14 | PR: 1LW |                |                |        |  |   |            |
| 3.0 TDI quattro  | 180              | 09.11 | PR: 1LW |                |                |        |  |   |            |
| 3.0 TDI quattro  | 200              | 09.14 | PR: 1LW |                |                |        |  |   |            |
| 3.0 TDI quattro  | 230              | 12.11 | PR: 1LW |                |                |        |  |   |            |
| 3.0 TDI quattro  | 235              | 09.14 | PR: 1LW |                |                |        |  |   |            |
| 3.0 TDI quattro  | 240              | 09.14 | PR: 1LW |                |                |        |  |   |            |
| 3.0 TFSI quattro | 245              | 09.11 | PR: 1LW |                |                |        |  |   |            |
| 3.0 TFSI quattro | 245              | 09.14 | PR: 1LW |                |                |        |  |   |            |
| RS 6             | 412              | 03.13 | PR: 1LW |                |                |        |  |   |            |
| S6               | 309              | 04.12 | PR: 1LW |                |                |        |  |   |            |
| S6               | 331              | 09.14 | PR: 1LW |                |                |        |  |   |            |
|                  | 1.8 TFSI         | 140   | 09.14   | PR: 1LA        | 24.0130-0221.1 | 430221 |  | 320 30,0 28,0 VL +S +B                                      |            |
|                  | 2.0 TDI          | 100   | 01.12   | PR: 1LA        |                |        |  |   |            |
|                  | 2.0 TDI          | 110   | 09.14   | PR: 1LA        |                |        |  |   |            |
|                  | 2.0 TDI          | 120   | 09.11   | PR: 1LA        |                |        |  |   |            |
|                  | 2.0 TDI          | 130   | 09.11   | PR: 1LA        |                |        |  |   |            |
|                  | 2.0 TDI quattro  | 140   | 04.15   | PR: 1LA        |                |        |  |   |            |
|                  | 2.0 TDI ultra    | 140   | 11.13   | PR: 1LA        |                |        |  |   |            |
|                  | 2.0 TFSI         | 132   | 06.11   | PR: 1LA        |                |        |  |   |            |
|                  | 2.0 TFSI         | 185   | 09.14   | PR: 1LA        |                |        |  |   |            |
|                  | 2.0 TFSI quattro | 185   | 05.15   | PR: 1LA        |                |        |  |   |            |



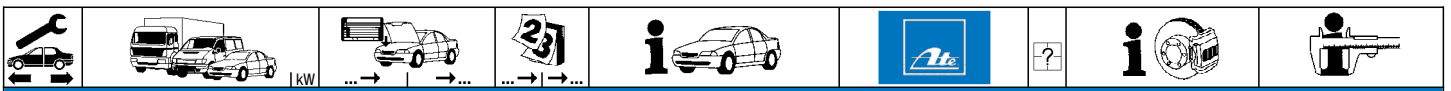

**AUDI A6 (4G5/C7) Avant (11-)**



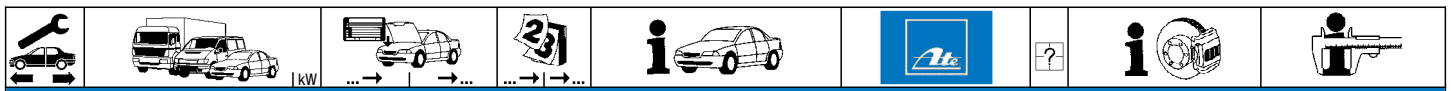











|                 |                  |     |       |                 |                 |                |        |  |                          |
|-----------------|------------------|-----|-------|-----------------|-----------------|----------------|--------|--|--------------------------|
|                 | 2.8 FSI          | 150 |       | 09.11           | PR: 1LA         | 24.0130-0221.1 | 430221 |  | 320 30,0 28,0 VL +S +B   |
|                 | 2.8 FSI quattro  | 150 |       | 09.11           | PR: 1LA         |                |        |  |                          |
|                 | 2.8 FSI quattro  | 162 |       | 09.14           | PR: 1LA         |                |        |  |                          |
|                 | 3.0 TDI          | 150 |       | 09.11           | PR: 1LA         |                |        |  |                          |
|                 | 3.0 TDI          | 155 |       | 09.14           | PR: 1LA         |                |        |  |                          |
|                 | 3.0 TDI          | 160 |       | 09.14           | PR: 1LA         |                |        |  |                          |
|                 | 3.0 TDI quattro  | 150 |       | 09.11           | PR: 1LA         |                |        |  |                          |
|                 | 3.0 TDI quattro  | 155 |       | 09.14           | PR: 1LA         |                |        |  |                          |
|                 | 3.0 TDI quattro  | 160 |       | 09.14           | PR: 1LA         |                |        |  |                          |
|                 | 3.0 TDI quattro  | 180 |       | 09.11           | PR: 1LA         |                |        |  |                          |
|                 | 3.0 TDI quattro  | 200 |       | 09.14           | PR: 1LA         |                |        |  |                          |
|                 | 3.0 TDI quattro  | 230 |       | 12.11           | PR: 1LA         |                |        |  |                          |
|                 | 3.0 TDI quattro  | 235 |       | 09.14           | PR: 1LA         |                |        |  |                          |
|                 | 3.0 TDI quattro  | 240 |       | 09.14           | PR: 1LA         |                |        |  |                          |
|                 | 3.0 TFSI quattro |     |       | 09.11           | PR: 1LA         |                |        |  |                          |
|                 | 3.0 TFSI quattro | 245 |       | 09.14           | PR: 1LA         |                |        |  |                          |
| S6              | 309              |     | 04.12 | PR: 1LA         |                 |                |        |  |                          |
| S6              | 331              |     | 09.14 | PR: 1LA         |                 |                |        |  |                          |
|                 | 1.8 TFSI         | 140 |       | 09.14           | PR: 1LJ         | 24.0130-0222.1 | 430222 |  | 345 30,0 28,0 VL +S +B   |
|                 | 2.0 TDI          | 100 |       | 01.12           | PR: 1LJ         |                |        |  |                          |
|                 | 2.0 TDI          | 110 |       | 09.14           | PR: 1LJ         |                |        |  |                          |
|                 | 2.0 TDI          | 120 |       | 09.11           | PR: 1LJ         |                |        |  |                          |
|                 | 2.0 TDI          | 130 |       | 09.11           | PR: 1LJ         |                |        |  |                          |
|                 | 2.0 TDI quattro  | 140 |       | 04.15           | PR: 1LJ         |                |        |  |                          |
|                 | 2.0 TDI ultra    | 140 |       | 11.13           | PR: 1LJ         |                |        |  |                          |
|                 | 2.0 TFSI         | 132 |       | 06.11           | PR: 1LJ         |                |        |  |                          |
|                 | 2.0 TFSI         | 185 |       | 09.14           | PR: 1LJ         |                |        |  |                          |
|                 | 2.0 TFSI quattro | 185 |       | 05.15           | PR: 1LJ         |                |        |  |                          |
|                 | 2.8 FSI          | 150 |       | 09.11           | PR: 1LJ         |                |        |  |                          |
|                 | 2.8 FSI quattro  | 150 |       | 09.11           | PR: 1LJ         |                |        |  |                          |
|                 | 2.8 FSI quattro  | 162 |       | 09.14           | PR: 1LJ         |                |        |  |                          |
|                 | 3.0 TDI          | 150 |       | 09.11           | PR: 1LJ         |                |        |  |                          |
|                 | 3.0 TDI          | 155 |       | 09.14           | PR: 1LJ         |                |        |  |                          |
|                 | 3.0 TDI          | 160 |       | 09.14           | PR: 1LJ         |                |        |  |                          |
|                 | 3.0 TDI quattro  | 150 |       | 09.11           | PR: 1LJ         |                |        |  |                          |
|                 | 3.0 TDI quattro  | 155 |       | 09.14           | PR: 1LJ         |                |        |  |                          |
|                 | 3.0 TDI quattro  | 160 |       | 09.14           | PR: 1LJ         |                |        |  |                          |
|                 | 3.0 TDI quattro  | 180 |       | 09.11           | PR: 1LJ         |                |        |  |                          |
|                 | 3.0 TDI quattro  | 200 |       | 09.14           | PR: 1LJ         |                |        |  |                          |
|                 | 3.0 TDI quattro  | 230 |       | 12.11           | PR: 1LJ         |                |        |  |                          |
|                 | 3.0 TDI quattro  | 235 |       | 09.14           | PR: 1LJ         |                |        |  |                          |
|                 | 3.0 TDI quattro  | 240 |       | 09.14           | PR: 1LJ         |                |        |  |                          |
|                 | 3.0 TFSI quattro |     |       | 09.11           | PR: 1LJ         |                |        |  |                          |
|                 | 3.0 TFSI quattro | 245 |       | 09.14           | PR: 1LJ         |                |        |  |                          |
| S6              | 309              |     | 04.12 | PR: 1LJ         |                 |                |        |  |                          |
| S6              | 331              |     | 09.14 | PR: 1LJ         |                 |                |        |  |                          |
|                 | 1.8 TFSI         | 140 |       | 09.14           | PR: 1LL,1LF,1ZK | 24.0134-0103.1 | 434103 |  | 356 34,0 31,5 VL +S +B   |
|                 | 2.0 TDI          | 100 |       | 01.12           | PR: 1LL,1LF,1ZK |                |        |  |                          |
|                 | 2.0 TDI          | 110 |       | 09.14           | PR: 1LL,1LF,1ZK |                |        |  |                          |
|                 | 2.0 TDI          | 120 |       | 09.11           | PR: 1LL,1LF,1ZK |                |        |  |                          |
|                 | 2.0 TDI          | 130 |       | 09.11           | PR: 1LL,1LF,1ZK |                |        |  |                          |
|                 | 2.0 TDI quattro  | 140 |       | 04.15           | PR: 1LL,1LF,1ZK |                |        |  |                          |
|                 | 2.0 TDI ultra    | 140 |       | 11.13           | PR: 1LL,1LF,1ZK |                |        |  |                          |
|                 | 2.0 TFSI         | 132 |       | 06.11           | PR: 1LL,1LF,1ZK |                |        |  |                          |
|                 | 2.0 TFSI         | 185 |       | 09.14           | PR: 1LL,1LF,1ZK |                |        |  |                          |
|                 | 2.0 TFSI quattro | 185 |       | 05.15           | PR: 1LL,1LF,1ZK |                |        |  |                          |
|                 | 2.8 FSI          | 150 |       | 09.11           | PR: 1LL,1LF,1ZK |                |        |  |                          |
|                 | 2.8 FSI quattro  | 150 |       | 09.11           | PR: 1LL,1LF,1ZK |                |        |  |                          |
|                 | 2.8 FSI quattro  | 162 |       | 09.14           | PR: 1LL,1LF,1ZK |                |        |  |                          |
|                 | 3.0 TDI          | 150 |       | 09.11           | PR: 1LL,1LF,1ZK |                |        |  |                          |
|                 | 3.0 TDI          | 155 |       | 09.14           | PR: 1LL,1LF,1ZK |                |        |  |                          |
|                 | 3.0 TDI          | 160 |       | 09.14           | PR: 1LL,1LF,1ZK |                |        |  |                          |
|                 | 3.0 TDI quattro  | 150 |       | 09.11           | PR: 1LL,1LF,1ZK |                |        |  |                          |
|                 | 3.0 TDI quattro  | 155 |       | 09.14           | PR: 1LL,1LF,1ZK |                |        |  |                          |
|                 | 3.0 TDI quattro  | 160 |       | 09.14           | PR: 1LL,1LF,1ZK |                |        |  |                          |
|                 | 3.0 TDI quattro  | 180 |       | 09.11           | PR: 1LL,1LF,1ZK |                |        |  |                          |
|                 | 3.0 TDI quattro  | 200 |       | 09.14           | PR: 1LL,1LF,1ZK |                |        |  |                          |
|                 | 3.0 TDI quattro  | 230 |       | 12.11           | PR: 1LL,1LF,1ZK |                |        |  |                          |
|                 | 3.0 TDI quattro  | 235 |       | 09.14           | PR: 1LL,1LF,1ZK |                |        |  |                          |
|                 | 3.0 TDI quattro  | 240 |       | 09.14           | PR: 1LL,1LF,1ZK |                |        |  |                          |
|                 | 3.0 TFSI quattro |     |       | 09.11           | PR: 1LL,1LF,1ZK |                |        |  |                          |
|                 | 3.0 TFSI quattro | 245 |       | 09.14           | PR: 1LL,1LF,1ZK |                |        |  |                          |
| S6              | 309              |     | 04.12 | PR: 1LL,1LF,1ZK |                 |                |        |  |                          |
| S6              | 331              |     | 09.14 | PR: 1LL,1LF,1ZK |                 |                |        |  |                          |
|                 | 1.8 TFSI         | 140 |       | 09.14           | PR: 1KW         | 13.0460-2769.2 | 602769 |  | 25214 17,4 +/WK/Zub/STRW |
|                 | 2.0 TDI          | 100 |       | 01.12           | PR: 1KW         |                |        |  |                          |
|                 | 2.0 TDI          | 110 |       | 09.14           | PR: 1KW         |                |        |  |                          |
|                 | 2.0 TDI          | 120 |       | 09.11           | PR: 1KW         |                |        |  |                          |
|                 | 2.0 TDI          | 130 |       | 09.11           | PR: 1KW         |                |        |  |                          |
|                 | 2.0 TDI quattro  | 140 |       | 04.15           | PR: 1KW         |                |        |  |                          |
|                 | 2.0 TDI ultra    | 140 |       | 11.13           | PR: 1KW         |                |        |  |                          |
|                 | 2.0 TFSI         | 132 |       | 06.11           | PR: 1KW         |                |        |  |                          |
|                 | 2.0 TFSI         | 185 |       | 09.14           | PR: 1KW         |                |        |  |                          |
|                 | 2.0 TFSI quattro | 185 |       | 05.15           | PR: 1KW         |                |        |  |                          |
|                 | 2.8 FSI          | 150 |       | 09.11           | PR: 1KW         |                |        |  |                          |
|                 | 2.8 FSI quattro  | 150 |       | 09.11           | PR: 1KW         |                |        |  |                          |
| 2.8 FSI quattro | 162              |     | 09.14 | PR: 1KW         |                 |                |        |  |                          |
| ↓               |                  |     |       |                 |                 |                |        |  | 25214 17,4 +/WK/Zub/STRW |
| ↓               |                  |     |       |                 |                 |                |        |  | 25214 17,4 +/WK/Zub/STRW |



**AUDI A6 (4G5/C7) Avant (11-)**



|                  |                  |       |                     |                     |                |        |                         |  |   |
|------------------|------------------|-------|---------------------|---------------------|----------------|--------|-------------------------|--|---|
|                  | 3.0 TDI          | 150   | 09.11               | PR: 1KW             | 13.0460-2769.2 | 602769 |                         | 25214 17,4 +/WK/Zub/STRW<br>25214 17,4 +/WK/Zub/STRW |   |
|                  | 3.0 TDI          | 155   | 09.14               | PR: 1KW             | 13.0470-2769.2 | LD2769 |                         |  |   |
|                  | 3.0 TDI          | 160   | 09.14               | PR: 1KW             |                |        |                         |  |   |
|                  | 3.0 TDI quattro  | 150   | 09.11               | PR: 1KW             |                |        |                         |  |   |
|                  | 3.0 TDI quattro  | 155   | 09.14               | PR: 1KW             |                |        |                         |  |   |
|                  | 3.0 TDI quattro  | 160   | 09.14               | PR: 1KW             |                |        |                         |  |   |
|                  | 3.0 TDI quattro  | 180   | 09.11               | PR: 1KW             |                |        |                         |  |   |
|                  | 3.0 TDI quattro  | 200   | 09.14               | PR: 1KW             |                |        |                         |  |   |
|                  | 3.0 TDI quattro  | 230   | 12.11               | PR: 1KW             |                |        |                         |  |   |
|                  | 3.0 TDI quattro  | 235   | 09.14               | PR: 1KW             |                |        |                         |  |   |
|                  | 3.0 TDI quattro  | 240   | 09.14               | PR: 1KW             |                |        |                         |  |   |
|                  | 3.0 TFSI quattro |       | 09.11               | PR: 1KW             |                |        |                         |  |   |
|                  | 3.0 TFSI quattro | 245   | 09.14               | PR: 1KW             |                |        |                         |  |   |
|                  | S6               | 309   | 04.12               | PR: 1KW             |                |        |                         |  |   |
|                  | S6               | 331   | 09.14               | PR: 1KW             |                |        |                         |  |   |
|                  | 1.8 TFSI         | 140   | 09.14               | PR: 1KY,2EA,2EE,2EJ | 13.0460-2770.2 | 602770 |                         |  | 25214 17,4 +/WK/Zub/STRW<br>25214 17,4 +/WK/Zub/STRW<br>Warnkontakt L=217mm |
|                  | 2.0 TDI          | 100   | 01.12               | PR: 1KY,2EA,2EE,2EJ | 13.0470-2770.2 | LD2770 |                         |  |   |
|                  | 2.0 TDI          | 110   | 09.14               | PR: 1KY,2EA,2EE,2EJ | 24.8190-0313.2 | 620313 | 1                       |  |   |
|                  | 2.0 TDI          | 120   | 09.11               | PR: 1KY,2EA,2EE,2EJ |                |        |                         |  |   |
|                  | 2.0 TDI          | 130   | 09.11               | PR: 1KY,2EA,2EE,2EJ |                |        |                         |  |   |
| 2.0 TDI quattro  | 140              | 04.15 | PR: 1KY,2EA,2EE,2EJ |                     |                |        |                         |  |   |
| 2.0 TDI ultra    | 140              | 11.13 | PR: 1KY,2EA,2EE,2EJ |                     |                |        |                         |  |   |
| 2.0 TFSI         | 132              | 06.11 | PR: 1KY,2EA,2EE,2EJ |                     |                |        |                         |  |   |
| 2.0 TFSI         | 185              | 09.14 | PR: 1KY,2EA,2EE,2EJ |                     |                |        |                         |  |   |
| 2.0 TFSI quattro | 185              | 05.15 | PR: 1KY,2EA,2EE,2EJ |                     |                |        |                         |  |   |
| 2.8 FSI          | 150              | 09.11 | PR: 1KY,2EA,2EE,2EJ |                     |                |        |                         |  |   |
| 2.8 FSI quattro  | 150              | 09.11 | PR: 1KY,2EA,2EE,2EJ |                     |                |        |                         |  |   |
| 2.8 FSI quattro  | 162              | 09.14 | PR: 1KY,2EA,2EE,2EJ |                     |                |        |                         |  |   |
| 3.0 TDI          | 150              | 09.11 | PR: 1KY,2EA,2EE,2EJ |                     |                |        |                         |  |   |
| 3.0 TDI          | 155              | 09.14 | PR: 1KY,2EA,2EE,2EJ |                     |                |        |                         |  |   |
| 3.0 TDI          | 160              | 09.14 | PR: 1KY,2EA,2EE,2EJ |                     |                |        |                         |  |   |
| 3.0 TDI quattro  | 150              | 09.11 | PR: 1KY,2EA,2EE,2EJ |                     |                |        |                         |  |   |
| 3.0 TDI quattro  | 155              | 09.14 | PR: 1KY,2EA,2EE,2EJ |                     |                |        |                         |  |   |
| 3.0 TDI quattro  | 160              | 09.14 | PR: 1KY,2EA,2EE,2EJ |                     |                |        |                         |  |   |
| 3.0 TDI quattro  | 180              | 09.11 | PR: 1KY,2EA,2EE,2EJ |                     |                |        |                         |  |   |
| 3.0 TDI quattro  | 200              | 09.14 | PR: 1KY,2EA,2EE,2EJ |                     |                |        |                         |  |   |
| 3.0 TDI quattro  | 230              | 12.11 | PR: 1KY,2EA,2EE,2EJ |                     |                |        |                         |  |   |
| 3.0 TDI quattro  | 235              | 09.14 | PR: 1KY,2EA,2EE,2EJ |                     |                |        |                         |  |   |
| 3.0 TDI quattro  | 240              | 09.14 | PR: 1KY,2EA,2EE,2EJ |                     |                |        |                         |  |   |
| 3.0 TFSI quattro |                  | 09.11 | PR: 1KY,2EA,2EE,2EJ |                     |                |        |                         |  |   |
| 3.0 TFSI quattro | 245              | 09.14 | PR: 1KY,2EA,2EE,2EJ |                     |                |        |                         |  |   |
| RS 6             | 412              | 03.13 | PR: 1KJ,1KQ         |                     |                |        |                         |  |   |
| RS 6 Performance | 445              | 11.15 | PR: 1KJ,1KQ         |                     |                |        |                         |  |   |
| S6               | 309              | 04.12 | PR: 1KY,2EA,2EE,2EJ |                     |                |        |                         |  |   |
| S6               | 331              | 09.14 | PR: 1KY,2EA,2EE,2EJ |                     |                |        |                         |  |   |
|                  | 1.8 TFSI         | 140   | 09.14               | PR: 1KW             | 24.0112-0178.1 | 412178 |                         | 300 12,0 10,0 +S +B<br>300 12,0 10,0 +S +B PD        |   |
|                  | 2.0 TDI          | 100   | 01.12               | PR: 1KW             | 24.0312-0178.1 | 512178 |                         |  |   |
|                  | 2.0 TDI          | 110   | 09.14               | PR: 1KW             |                |        |                         |  |   |
|                  | 2.0 TDI          | 120   | 09.11               | PR: 1KW             |                |        |                         |  |   |
|                  | 2.0 TDI          | 130   | 09.11               | PR: 1KW             |                |        |                         |  |   |
|                  | 2.0 TDI quattro  | 140   | 04.15               | PR: 1KW             |                |        |                         |  |   |
|                  | 2.0 TDI ultra    | 140   | 11.13               | PR: 1KW             |                |        |                         |  |   |
|                  | 2.0 TFSI         | 132   | 06.11               | PR: 1KW             |                |        |                         |  |   |
|                  | 2.0 TFSI         | 185   | 09.14               | PR: 1KW             |                |        |                         |  |   |
|                  | 2.0 TFSI quattro | 185   | 05.15               | PR: 1KW             |                |        |                         |  |   |
|                  | 2.8 FSI          | 150   | 09.11               | PR: 1KW             |                |        |                         |  |   |
|                  | 2.8 FSI quattro  | 150   | 09.11               | PR: 1KW             |                |        |                         |  |   |
|                  | 2.8 FSI quattro  | 162   | 09.14               | PR: 1KW             |                |        |                         |  |   |
|                  | 3.0 TDI          | 150   | 09.11               | PR: 1KW             |                |        |                         |  |   |
|                  | 3.0 TDI          | 155   | 09.14               | PR: 1KW             |                |        |                         |  |   |
|                  | 3.0 TDI          | 160   | 09.14               | PR: 1KW             |                |        |                         |  |   |
|                  | 3.0 TDI quattro  | 150   | 09.11               | PR: 1KW             |                |        |                         |  |   |
|                  | 3.0 TDI quattro  | 155   | 09.14               | PR: 1KW             |                |        |                         |  |   |
|                  | 3.0 TDI quattro  | 160   | 09.14               | PR: 1KW             |                |        |                         |  |   |
|                  | 3.0 TDI quattro  | 180   | 09.11               | PR: 1KW             |                |        |                         |  |   |
| 3.0 TDI quattro  | 200              | 09.14 | PR: 1KW             |                     |                |        |                         |  |   |
| 3.0 TDI quattro  | 230              | 12.11 | PR: 1KW             |                     |                |        |                         |  |   |
| 3.0 TDI quattro  | 235              | 09.14 | PR: 1KW             |                     |                |        |                         |  |   |
| 3.0 TDI quattro  | 240              | 09.14 | PR: 1KW             |                     |                |        |                         |  |   |
| 3.0 TFSI quattro |                  | 09.11 | PR: 1KW             |                     |                |        |                         |  |   |
| 3.0 TFSI quattro | 245              | 09.14 | PR: 1KW             |                     |                |        |                         |  |   |
| S6               | 309              | 04.12 | PR: 1KW             |                     |                |        |                         |  |   |
| S6               | 331              | 09.14 | PR: 1KW             |                     |                |        |                         |  |   |
| 1.8 TFSI         | 140              | 09.14 | PR: 2EA,2EE,2EJ     | 24.0122-0272.1      | 422272         |        | 330 21,9 20,0 V L +S +B |  |   |
| 2.0 TDI          | 100              | 01.12 | PR: 2EA,2EE,2EJ     |                     |                |        |                         |  |   |
| 2.0 TDI          | 110              | 09.14 | PR: 2EA,2EE,2EJ     |                     |                |        |                         |  |   |
| 2.0 TDI          | 120              | 09.11 | PR: 2EA,2EE,2EJ     |                     |                |        |                         |  |   |
| 2.0 TDI          | 130              | 09.11 | PR: 2EA,2EE,2EJ     |                     |                |        |                         |  |   |
| 2.0 TDI quattro  | 140              | 04.15 | PR: 2EA,2EE,2EJ     |                     |                |        |                         |  |   |
| 2.0 TDI ultra    | 140              | 11.13 | PR: 2EA,2EE,2EJ     |                     |                |        |                         |  |   |
| 2.0 TFSI         | 132              | 06.11 | PR: 2EA,2EE,2EJ     |                     |                |        |                         |  |   |
| 2.0 TFSI         | 185              | 09.14 | PR: 2EA,2EE,2EJ     |                     |                |        |                         |  |   |
| 2.0 TFSI quattro | 185              | 05.15 | PR: 2EA,2EE,2EJ     |                     |                |        |                         |  |   |
| 2.8 FSI          | 150              | 09.11 | PR: 2EA,2EE,2EJ     |                     |                |        |                         |  |   |
| 2.8 FSI quattro  | 150              | 09.11 | PR: 2EA,2EE,2EJ     |                     |                |        |                         |  |   |
| 2.8 FSI quattro  | 162              | 09.14 | PR: 2EA,2EE,2EJ     |                     |                |        |                         |  |   |
| 3.0 TDI          | 150              | 09.11 | PR: 2EA,2EE,2EJ     |                     |                |        |                         |  |   |



|     |    |   |  |    |   |  |  |  |  |   |            |
|--|--|---|--|--|--|--|--|--|--|---|------------|
| <b>AUDI A6 (4G5/C7) Avant (11-)</b>  |  |   |  |  |  |  |  |  |  |   |            |
|    | 3.0 TDI 155<br>3.0 TDI 160<br>3.0 TDI quattro 150<br>3.0 TDI quattro 155<br>3.0 TDI quattro 160<br>3.0 TDI quattro 180<br>3.0 TDI quattro 200<br>3.0 TDI quattro 230<br>3.0 TDI quattro 235<br>3.0 TDI quattro 240<br>3.0 TFSI quattro<br>3.0 TFSI quattro<br>S6<br>S6   | 155<br>160<br>150<br>155<br>160<br>180<br>200<br>230<br>235<br>240<br>245<br>309<br>331   |  | 09.14<br>09.14<br>09.11<br>09.14<br>09.14<br>09.11<br>12.11<br>09.14<br>09.14<br>09.14<br>09.11<br>09.14<br>04.12<br>09.14   | PR: 2EA,2EE,2EJ<br>PR: 2EA,2EE,2EJ<br>PR: 2EA,2EE,2EJ<br>PR: 2EA,2EE,2EJ<br>PR: 2EA,2EE,2EJ<br>PR: 2EA,2EE,2EJ<br>PR: 2EA,2EE,2EJ<br>PR: 2EA,2EE,2EJ<br>PR: 2EA,2EE,2EJ<br>PR: 2EA,2EE,2EJ<br>PR: 2EA,2EE,2EJ<br>PR: 2EA,2EE,2EJ<br>PR: 2EA,2EE,2EJ<br>PR: 2EA,2EE,2EJ                     | 24.0122-0272.1   | 422272   |  | 330 21,9 20,0 V L +S +B  |   |            |
|  | 1.8 TFSI<br>2.0 TDI<br>2.0 TDI<br>2.0 TDI<br>2.0 TDI<br>2.0 TDI quattro<br>2.0 TDI ultra<br>2.0 TFSI<br>2.0 TFSI<br>2.0 TFSI quattro<br>2.8 FSI<br>2.8 FSI quattro<br>2.8 FSI quattro<br>3.0 TDI<br>3.0 TDI<br>3.0 TDI<br>3.0 TDI quattro<br>3.0 TDI quattro<br>3.0 TDI quattro<br>3.0 TDI quattro<br>3.0 TDI quattro<br>3.0 TDI quattro<br>3.0 TDI quattro<br>3.0 TDI quattro<br>3.0 TFSI quattro<br>3.0 TFSI quattro<br>S6<br>S6 | 140<br>100<br>110<br>120<br>130<br>140<br>140<br>132<br>185<br>185<br>150<br>150<br>162<br>150<br>155<br>160<br>150<br>155<br>160<br>180<br>200<br>230<br>235<br>240<br>245<br>309<br>331 |  | 09.14<br>01.12<br>09.14<br>09.11<br>09.11<br>04.15<br>11.13<br>06.11<br>09.14<br>05.15<br>09.11<br>09.11<br>09.14<br>09.11<br>09.14<br>09.14<br>09.11<br>09.14<br>09.14<br>09.11<br>09.11<br>12.11<br>09.14<br>09.14<br>04.12<br>09.14 | PR: 1KY<br>PR: 1KY<br>PR: 1KY<br>PR: 1KY<br>PR: 1KY<br>PR: 1KY<br>PR: 1KY<br>PR: 1KY<br>PR: 1KY<br>PR: 1KY<br>PR: 1KY<br>PR: 1KY<br>PR: 1KY<br>PR: 1KY<br>PR: 1KY<br>PR: 1KY<br>PR: 1KY<br>PR: 1KY<br>PR: 1KY<br>PR: 1KY<br>PR: 1KY<br>PR: 1KY<br>PR: 1KY<br>PR: 1KY<br>PR: 1KY<br>PR: 1KY | 24.0122-0273.1   | 422273   |  | 356 22,0 20,0 V L +S +B  |   |            |
| <b>AUDI A6 Allroad (12-)</b>   |  |   |  |  |  |  |  |  |  |   |            |
|  | 3.0 TDI quattro<br>3.0 TDI quattro<br>3.0 TDI quattro<br>3.0 TDI quattro<br>3.0 TDI quattro<br>3.0 TDI quattro   | 140<br>150<br>155<br>160<br>180<br>200  |  | 11.15<br>01.12<br>09.14<br>09.14<br>01.12<br>09.14   | PR: 1LJ<br>PR: 1LJ<br>PR: 1LJ<br>PR: 1LJ<br>PR: 1LJ<br>PR: 1LJ   | 13.0460-2765.2<br>13.0470-2765.2<br>24.8190-0311.2                                 | 602765<br>LD2765<br>620311   | 1  | Federmaß 46 mm <sup>1)</sup><br>Federmaß 46 mm <sup>1)</sup>                           | 24743 19,2 +/WK/S<br>24743 19,2 +/WK/S<br>Warnkontakt L=300mm               | TRW<br>TRW |
|  | 3.0 TDI quattro<br>3.0 TFSI quattro<br>3.0 TFSI quattro  | 230<br>228<br>245   |  | 01.12<br>01.12<br>09.14  | PR: 1LJ<br>PR: 1LJ<br>PR: 1LJ  | 13.0460-2765.2<br>24.8190-0311.2   | 602765<br>620311   | 1  | Federmaß 46 mm <sup>1)</sup>   | 24743 19,2 +/WK/S<br>Warnkontakt L=300mm                                    | TRW        |
|  | 3.0 TDI quattro<br>3.0 TDI quattro<br>3.0 TDI quattro<br>3.0 TDI quattro<br>3.0 TDI quattro  | 140<br>150<br>155<br>160<br>180<br>200  |  | 11.15<br>01.12<br>09.14<br>09.14<br>01.12<br>09.14   | PR: 1LL,1ZK<br>PR: 1LL,1ZK<br>PR: 1LL,1ZK<br>PR: 1LL,1ZK<br>PR: 1LL,1ZK  | 13.0460-7280.2<br>13.0470-7280.2<br>24.8190-0301.2                                 | 607280<br>LD7280<br>620301   | 1  |  | 25158 20,3 +/WK<br>25158 20,3 +/WK<br>Warnkontakt L=311,6mm                 | ATE<br>ATE |
|  | 3.0 TDI quattro<br>3.0 TFSI quattro<br>3.0 TFSI quattro  | 230<br>228<br>245   |  | 01.12<br>01.12<br>09.14  | PR: 1LL,1ZK<br>PR: 1LL,1ZK<br>PR: 1LL,1ZK  | 13.0460-7280.2<br>24.8190-0301.2   | 607280<br>620301   | 1  |  | 25158 20,3 +/WK<br>Warnkontakt L=311,6mm                                    | ATE        |
|  | 3.0 TDI quattro<br>3.0 TDI quattro<br>3.0 TDI quattro<br>3.0 TDI quattro<br>3.0 TDI quattro<br>3.0 TDI quattro<br>3.0 TFSI quattro<br>3.0 TFSI quattro<br>3.0 TFSI quattro   | 140<br>150<br>155<br>160<br>180<br>230<br>228<br>245<br>245   |  | 11.15<br>01.12<br>09.14<br>09.14<br>01.12<br>01.12<br>09.14<br>09.14   | PR: 1ZK<br>PR: 1ZK<br>PR: 1ZK<br>PR: 1ZK<br>PR: 1ZK<br>PR: 1ZK<br>PR: 1ZK<br>PR: 1ZK   | 24.0134-0103.1   | 434103   |  |  | 356 34,0 31,5 V L +S +B   |            |
|  | 3.0 TDI quattro<br>3.0 TDI quattro<br>3.0 TDI quattro<br>3.0 TDI quattro<br>3.0 TDI quattro<br>3.0 TDI quattro<br>3.0 TDI quattro<br>3.0 TFSI quattro<br>3.0 TFSI quattro  | 140<br>150<br>155<br>160<br>180<br>200<br>230<br>228<br>245   |  | 11.15<br>01.12<br>09.14<br>09.14<br>01.12<br>01.12<br>09.14<br>09.14   | PR: 2EA,2EJ<br>PR: 2EA,2EJ<br>PR: 2EA,2EJ<br>PR: 2EA,2EJ<br>PR: 2EA,2EJ<br>PR: 2EA,2EJ<br>PR: 2EA,2EJ<br>PR: 2EA,2EJ<br>PR: 2EA,2EJ  | 13.0460-2770.2<br>13.0470-2770.2<br>24.8190-0313.2                                 | 602770<br>LD2770<br>620313   | 1  | elektrische Feststellbremse <sup>2)</sup><br>elektrische Feststellbremse <sup>2)</sup> | 25214 17,4 +/WK/Zub/STRW<br>25214 17,4 +/WK/Zub/STRW<br>Warnkontakt L=217mm |            |
|  | 3.0 TDI quattro<br>3.0 TDI quattro<br>3.0 TDI quattro<br>3.0 TDI quattro<br>3.0 TDI quattro  | 140<br>150<br>155<br>160<br>180<br>200  |  | 11.15<br>01.12<br>09.14<br>09.14<br>01.12<br>09.14   | PR: 2EA,2EJ<br>PR: 2EA,2EJ<br>PR: 2EA,2EJ<br>PR: 2EA,2EJ<br>PR: 2EA,2EJ  | 24.0122-0272.1   | 422272   |  | elektrische Feststellbremse <sup>2)</sup>  | 330 21,9 20,0 V L +S +B   |            |

<sup>1)</sup> spring dimension 46 mm / dimensioni molla 46 mm / dimension de ressort 46 mm / medida de muelle 46 mm

<sup>2)</sup> electric parking brake / fr.di stazionamento elettrico / frein à main électrique / freno de mano eléctrico

| AUDI A6 Allroad (12-)  |   |                 |             |                |             |   |                         |   |                         |                  |     |       |             |                |        |                              |                       |                  |     |       |             |                |        |  |                     |         |     |       |             |  |  |  |  |                 |     |       |             |  |  |  |  |         |     |       |             |  |  |  |  |         |     |       |             |  |  |  |  |         |     |       |             |  |  |  |  |                 |     |       |             |  |  |  |  |                 |     |       |             |  |  |  |  |                 |     |       |             |  |  |  |  |                 |     |       |             |  |  |  |  |                 |     |       |             |  |  |  |  |                 |     |       |             |  |  |  |  |               |     |       |             |  |  |  |  |                  |     |       |             |  |  |  |  |                 |     |       |             |                |        |                              |                       |                 |     |       |             |                |        |  |                     |                 |     |       |             |  |  |  |  |                  |     |       |             |  |  |  |  |    |     |       |             |  |  |  |  |    |     |       |             |  |  |  |  |          |     |       |             |                |        |  |                     |          |     |       |             |                |        |  |                     |                  |     |       |             |                |        |  |                       |         |     |       |             |  |  |  |  |                 |     |       |             |  |  |  |  |         |     |       |             |  |  |  |  |         |     |       |             |  |  |  |  |         |     |       |             |  |  |  |  |                 |     |       |             |  |  |  |  |                 |     |       |             |  |  |  |  |                 |     |       |             |  |  |  |  |                 |     |       |             |  |  |  |  |                 |     |       |             |  |  |  |  |                 |     |       |             |  |  |  |  |               |     |       |             |  |  |  |  |                  |     |       |             |  |  |  |  |                 |     |       |             |                |        |  |                     |                 |     |       |             |                |        |  |                       |                 |     |       |             |  |  |  |  |                  |     |       |             |  |  |  |  |    |     |       |             |  |  |  |  |    |     |       |             |  |  |  |  |          |     |       |         |                |        |  |                    |          |     |       |         |                |        |  |                     |                  |     |       |         |  |  |  |  |         |     |       |         |  |  |  |  |                 |     |       |         |  |  |  |  |         |     |       |         |  |  |  |  |         |     |       |         |  |  |  |  |         |     |       |         |  |  |  |  |                 |     |       |         |  |  |  |  |                 |     |       |         |  |  |  |  |                 |     |       |         |  |  |  |  |                 |     |       |         |  |  |  |  |                 |     |       |         |  |  |  |  |                 |     |       |         |  |  |  |  |                 |     |       |         |  |  |  |  |                 |     |       |         |  |  |  |  |                 |     |       |         |  |  |  |  |               |     |       |         |  |  |  |  |                  |     |       |         |  |  |  |  |                  |     |       |         |  |  |  |  |    |     |       |         |  |  |  |  |    |     |       |         |  |  |  |  |          |     |       |         |                |        |  |                       |          |     |       |         |  |  |  |  |                  |     |       |         |  |  |  |  |         |     |       |         |  |  |  |  |                 |     |       |         |  |  |  |  |         |     |       |         |  |  |  |  |         |     |       |         |  |  |  |  |         |     |       |         |  |  |  |  |                 |     |       |         |  |  |  |  |                 |     |       |         |  |  |  |  |                 |     |       |         |  |  |  |  |                 |     |       |         |  |  |  |  |                 |     |       |         |  |  |  |  |                 |     |       |         |  |  |  |  |                 |     |       |         |  |  |  |  |                 |     |       |         |  |  |  |  |
|--|---|-----------------|-------------|----------------|-------------|---|-------------------------|---|-------------------------|------------------|-----|-------|-------------|----------------|--------|------------------------------|-----------------------|------------------|-----|-------|-------------|----------------|--------|--|---------------------|---------|-----|-------|-------------|--|--|--|--|-----------------|-----|-------|-------------|--|--|--|--|---------|-----|-------|-------------|--|--|--|--|---------|-----|-------|-------------|--|--|--|--|---------|-----|-------|-------------|--|--|--|--|-----------------|-----|-------|-------------|--|--|--|--|-----------------|-----|-------|-------------|--|--|--|--|-----------------|-----|-------|-------------|--|--|--|--|-----------------|-----|-------|-------------|--|--|--|--|-----------------|-----|-------|-------------|--|--|--|--|-----------------|-----|-------|-------------|--|--|--|--|---------------|-----|-------|-------------|--|--|--|--|------------------|-----|-------|-------------|--|--|--|--|-----------------|-----|-------|-------------|----------------|--------|------------------------------|-----------------------|-----------------|-----|-------|-------------|----------------|--------|--|---------------------|-----------------|-----|-------|-------------|--|--|--|--|------------------|-----|-------|-------------|--|--|--|--|----|-----|-------|-------------|--|--|--|--|----|-----|-------|-------------|--|--|--|--|----------|-----|-------|-------------|----------------|--------|--|---------------------|----------|-----|-------|-------------|----------------|--------|--|---------------------|------------------|-----|-------|-------------|----------------|--------|--|-----------------------|---------|-----|-------|-------------|--|--|--|--|-----------------|-----|-------|-------------|--|--|--|--|---------|-----|-------|-------------|--|--|--|--|---------|-----|-------|-------------|--|--|--|--|---------|-----|-------|-------------|--|--|--|--|-----------------|-----|-------|-------------|--|--|--|--|-----------------|-----|-------|-------------|--|--|--|--|-----------------|-----|-------|-------------|--|--|--|--|-----------------|-----|-------|-------------|--|--|--|--|-----------------|-----|-------|-------------|--|--|--|--|-----------------|-----|-------|-------------|--|--|--|--|---------------|-----|-------|-------------|--|--|--|--|------------------|-----|-------|-------------|--|--|--|--|-----------------|-----|-------|-------------|----------------|--------|--|---------------------|-----------------|-----|-------|-------------|----------------|--------|--|-----------------------|-----------------|-----|-------|-------------|--|--|--|--|------------------|-----|-------|-------------|--|--|--|--|----|-----|-------|-------------|--|--|--|--|----|-----|-------|-------------|--|--|--|--|----------|-----|-------|---------|----------------|--------|--|--------------------|----------|-----|-------|---------|----------------|--------|--|---------------------|------------------|-----|-------|---------|--|--|--|--|---------|-----|-------|---------|--|--|--|--|-----------------|-----|-------|---------|--|--|--|--|---------|-----|-------|---------|--|--|--|--|---------|-----|-------|---------|--|--|--|--|---------|-----|-------|---------|--|--|--|--|-----------------|-----|-------|---------|--|--|--|--|-----------------|-----|-------|---------|--|--|--|--|-----------------|-----|-------|---------|--|--|--|--|-----------------|-----|-------|---------|--|--|--|--|-----------------|-----|-------|---------|--|--|--|--|-----------------|-----|-------|---------|--|--|--|--|-----------------|-----|-------|---------|--|--|--|--|-----------------|-----|-------|---------|--|--|--|--|-----------------|-----|-------|---------|--|--|--|--|---------------|-----|-------|---------|--|--|--|--|------------------|-----|-------|---------|--|--|--|--|------------------|-----|-------|---------|--|--|--|--|----|-----|-------|---------|--|--|--|--|----|-----|-------|---------|--|--|--|--|----------|-----|-------|---------|----------------|--------|--|-----------------------|----------|-----|-------|---------|--|--|--|--|------------------|-----|-------|---------|--|--|--|--|---------|-----|-------|---------|--|--|--|--|-----------------|-----|-------|---------|--|--|--|--|---------|-----|-------|---------|--|--|--|--|---------|-----|-------|---------|--|--|--|--|---------|-----|-------|---------|--|--|--|--|-----------------|-----|-------|---------|--|--|--|--|-----------------|-----|-------|---------|--|--|--|--|-----------------|-----|-------|---------|--|--|--|--|-----------------|-----|-------|---------|--|--|--|--|-----------------|-----|-------|---------|--|--|--|--|-----------------|-----|-------|---------|--|--|--|--|-----------------|-----|-------|---------|--|--|--|--|-----------------|-----|-------|---------|--|--|--|--|
|  | <table border="1"> <tr> <td>3.0 TDI quattro</td> <td>230</td> <td>01.12</td> <td>PR: 2EA,2EJ</td> <td>24.0122-0272.1</td> <td>422272</td> <td>elektrische Feststellbremse <sup>1)</sup></td> <td>330 21,9 20,0 V L +S +B</td> </tr> <tr> <td>3.0 TFSI quattro</td> <td>228</td> <td>01.12</td> <td>PR: 2EA,2EJ</td> <td></td> <td></td> <td></td> <td></td> </tr> <tr> <td>3.0 TFSI quattro</td> <td>245</td> <td>09.14</td> <td>PR: 2EA,2EJ</td> <td></td> <td></td> <td></td> <td></td> </tr> </table>  | 3.0 TDI quattro | 230         | 01.12          | PR: 2EA,2EJ | 24.0122-0272.1                            | 422272                  | elektrische Feststellbremse <sup>1)</sup> | 330 21,9 20,0 V L +S +B | 3.0 TFSI quattro | 228 | 01.12 | PR: 2EA,2EJ |                |        |                              |                       | 3.0 TFSI quattro | 245 | 09.14 | PR: 2EA,2EJ |                |        |  |                     |         |     |       |             |  |  |  |  |                 |     |       |             |  |  |  |  |         |     |       |             |  |  |  |  |         |     |       |             |  |  |  |  |         |     |       |             |  |  |  |  |                 |     |       |             |  |  |  |  |                 |     |       |             |  |  |  |  |                 |     |       |             |  |  |  |  |                 |     |       |             |  |  |  |  |                 |     |       |             |  |  |  |  |                 |     |       |             |  |  |  |  |               |     |       |             |  |  |  |  |                  |     |       |             |  |  |  |  |                 |     |       |             |                |        |                              |                       |                 |     |       |             |                |        |  |                     |                 |     |       |             |  |  |  |  |                  |     |       |             |  |  |  |  |    |     |       |             |  |  |  |  |    |     |       |             |  |  |  |  |          |     |       |             |                |        |  |                     |          |     |       |             |                |        |  |                     |                  |     |       |             |                |        |  |                       |         |     |       |             |  |  |  |  |                 |     |       |             |  |  |  |  |         |     |       |             |  |  |  |  |         |     |       |             |  |  |  |  |         |     |       |             |  |  |  |  |                 |     |       |             |  |  |  |  |                 |     |       |             |  |  |  |  |                 |     |       |             |  |  |  |  |                 |     |       |             |  |  |  |  |                 |     |       |             |  |  |  |  |                 |     |       |             |  |  |  |  |               |     |       |             |  |  |  |  |                  |     |       |             |  |  |  |  |                 |     |       |             |                |        |  |                     |                 |     |       |             |                |        |  |                       |                 |     |       |             |  |  |  |  |                  |     |       |             |  |  |  |  |    |     |       |             |  |  |  |  |    |     |       |             |  |  |  |  |          |     |       |         |                |        |  |                    |          |     |       |         |                |        |  |                     |                  |     |       |         |  |  |  |  |         |     |       |         |  |  |  |  |                 |     |       |         |  |  |  |  |         |     |       |         |  |  |  |  |         |     |       |         |  |  |  |  |         |     |       |         |  |  |  |  |                 |     |       |         |  |  |  |  |                 |     |       |         |  |  |  |  |                 |     |       |         |  |  |  |  |                 |     |       |         |  |  |  |  |                 |     |       |         |  |  |  |  |                 |     |       |         |  |  |  |  |                 |     |       |         |  |  |  |  |                 |     |       |         |  |  |  |  |                 |     |       |         |  |  |  |  |               |     |       |         |  |  |  |  |                  |     |       |         |  |  |  |  |                  |     |       |         |  |  |  |  |    |     |       |         |  |  |  |  |    |     |       |         |  |  |  |  |          |     |       |         |                |        |  |                       |          |     |       |         |  |  |  |  |                  |     |       |         |  |  |  |  |         |     |       |         |  |  |  |  |                 |     |       |         |  |  |  |  |         |     |       |         |  |  |  |  |         |     |       |         |  |  |  |  |         |     |       |         |  |  |  |  |                 |     |       |         |  |  |  |  |                 |     |       |         |  |  |  |  |                 |     |       |         |  |  |  |  |                 |     |       |         |  |  |  |  |                 |     |       |         |  |  |  |  |                 |     |       |         |  |  |  |  |                 |     |       |         |  |  |  |  |                 |     |       |         |  |  |  |  |
| 3.0 TDI quattro  | 230   | 01.12           | PR: 2EA,2EJ | 24.0122-0272.1 | 422272      | elektrische Feststellbremse <sup>1)</sup> | 330 21,9 20,0 V L +S +B |   |                         |                  |     |       |             |                |        |                              |                       |                  |     |       |             |                |        |  |                     |         |     |       |             |  |  |  |  |                 |     |       |             |  |  |  |  |         |     |       |             |  |  |  |  |         |     |       |             |  |  |  |  |         |     |       |             |  |  |  |  |                 |     |       |             |  |  |  |  |                 |     |       |             |  |  |  |  |                 |     |       |             |  |  |  |  |                 |     |       |             |  |  |  |  |                 |     |       |             |  |  |  |  |                 |     |       |             |  |  |  |  |               |     |       |             |  |  |  |  |                  |     |       |             |  |  |  |  |                 |     |       |             |                |        |                              |                       |                 |     |       |             |                |        |  |                     |                 |     |       |             |  |  |  |  |                  |     |       |             |  |  |  |  |    |     |       |             |  |  |  |  |    |     |       |             |  |  |  |  |          |     |       |             |                |        |  |                     |          |     |       |             |                |        |  |                     |                  |     |       |             |                |        |  |                       |         |     |       |             |  |  |  |  |                 |     |       |             |  |  |  |  |         |     |       |             |  |  |  |  |         |     |       |             |  |  |  |  |         |     |       |             |  |  |  |  |                 |     |       |             |  |  |  |  |                 |     |       |             |  |  |  |  |                 |     |       |             |  |  |  |  |                 |     |       |             |  |  |  |  |                 |     |       |             |  |  |  |  |                 |     |       |             |  |  |  |  |               |     |       |             |  |  |  |  |                  |     |       |             |  |  |  |  |                 |     |       |             |                |        |  |                     |                 |     |       |             |                |        |  |                       |                 |     |       |             |  |  |  |  |                  |     |       |             |  |  |  |  |    |     |       |             |  |  |  |  |    |     |       |             |  |  |  |  |          |     |       |         |                |        |  |                    |          |     |       |         |                |        |  |                     |                  |     |       |         |  |  |  |  |         |     |       |         |  |  |  |  |                 |     |       |         |  |  |  |  |         |     |       |         |  |  |  |  |         |     |       |         |  |  |  |  |         |     |       |         |  |  |  |  |                 |     |       |         |  |  |  |  |                 |     |       |         |  |  |  |  |                 |     |       |         |  |  |  |  |                 |     |       |         |  |  |  |  |                 |     |       |         |  |  |  |  |                 |     |       |         |  |  |  |  |                 |     |       |         |  |  |  |  |                 |     |       |         |  |  |  |  |                 |     |       |         |  |  |  |  |               |     |       |         |  |  |  |  |                  |     |       |         |  |  |  |  |                  |     |       |         |  |  |  |  |    |     |       |         |  |  |  |  |    |     |       |         |  |  |  |  |          |     |       |         |                |        |  |                       |          |     |       |         |  |  |  |  |                  |     |       |         |  |  |  |  |         |     |       |         |  |  |  |  |                 |     |       |         |  |  |  |  |         |     |       |         |  |  |  |  |         |     |       |         |  |  |  |  |         |     |       |         |  |  |  |  |                 |     |       |         |  |  |  |  |                 |     |       |         |  |  |  |  |                 |     |       |         |  |  |  |  |                 |     |       |         |  |  |  |  |                 |     |       |         |  |  |  |  |                 |     |       |         |  |  |  |  |                 |     |       |         |  |  |  |  |                 |     |       |         |  |  |  |  |
| 3.0 TFSI quattro   | 228   | 01.12           | PR: 2EA,2EJ |                |             |   |                         |   |                         |                  |     |       |             |                |        |                              |                       |                  |     |       |             |                |        |  |                     |         |     |       |             |  |  |  |  |                 |     |       |             |  |  |  |  |         |     |       |             |  |  |  |  |         |     |       |             |  |  |  |  |         |     |       |             |  |  |  |  |                 |     |       |             |  |  |  |  |                 |     |       |             |  |  |  |  |                 |     |       |             |  |  |  |  |                 |     |       |             |  |  |  |  |                 |     |       |             |  |  |  |  |                 |     |       |             |  |  |  |  |               |     |       |             |  |  |  |  |                  |     |       |             |  |  |  |  |                 |     |       |             |                |        |                              |                       |                 |     |       |             |                |        |  |                     |                 |     |       |             |  |  |  |  |                  |     |       |             |  |  |  |  |    |     |       |             |  |  |  |  |    |     |       |             |  |  |  |  |          |     |       |             |                |        |  |                     |          |     |       |             |                |        |  |                     |                  |     |       |             |                |        |  |                       |         |     |       |             |  |  |  |  |                 |     |       |             |  |  |  |  |         |     |       |             |  |  |  |  |         |     |       |             |  |  |  |  |         |     |       |             |  |  |  |  |                 |     |       |             |  |  |  |  |                 |     |       |             |  |  |  |  |                 |     |       |             |  |  |  |  |                 |     |       |             |  |  |  |  |                 |     |       |             |  |  |  |  |                 |     |       |             |  |  |  |  |               |     |       |             |  |  |  |  |                  |     |       |             |  |  |  |  |                 |     |       |             |                |        |  |                     |                 |     |       |             |                |        |  |                       |                 |     |       |             |  |  |  |  |                  |     |       |             |  |  |  |  |    |     |       |             |  |  |  |  |    |     |       |             |  |  |  |  |          |     |       |         |                |        |  |                    |          |     |       |         |                |        |  |                     |                  |     |       |         |  |  |  |  |         |     |       |         |  |  |  |  |                 |     |       |         |  |  |  |  |         |     |       |         |  |  |  |  |         |     |       |         |  |  |  |  |         |     |       |         |  |  |  |  |                 |     |       |         |  |  |  |  |                 |     |       |         |  |  |  |  |                 |     |       |         |  |  |  |  |                 |     |       |         |  |  |  |  |                 |     |       |         |  |  |  |  |                 |     |       |         |  |  |  |  |                 |     |       |         |  |  |  |  |                 |     |       |         |  |  |  |  |                 |     |       |         |  |  |  |  |               |     |       |         |  |  |  |  |                  |     |       |         |  |  |  |  |                  |     |       |         |  |  |  |  |    |     |       |         |  |  |  |  |    |     |       |         |  |  |  |  |          |     |       |         |                |        |  |                       |          |     |       |         |  |  |  |  |                  |     |       |         |  |  |  |  |         |     |       |         |  |  |  |  |                 |     |       |         |  |  |  |  |         |     |       |         |  |  |  |  |         |     |       |         |  |  |  |  |         |     |       |         |  |  |  |  |                 |     |       |         |  |  |  |  |                 |     |       |         |  |  |  |  |                 |     |       |         |  |  |  |  |                 |     |       |         |  |  |  |  |                 |     |       |         |  |  |  |  |                 |     |       |         |  |  |  |  |                 |     |       |         |  |  |  |  |                 |     |       |         |  |  |  |  |
| 3.0 TFSI quattro   | 245   | 09.14           | PR: 2EA,2EJ |                |             |   |                         |   |                         |                  |     |       |             |                |        |                              |                       |                  |     |       |             |                |        |  |                     |         |     |       |             |  |  |  |  |                 |     |       |             |  |  |  |  |         |     |       |             |  |  |  |  |         |     |       |             |  |  |  |  |         |     |       |             |  |  |  |  |                 |     |       |             |  |  |  |  |                 |     |       |             |  |  |  |  |                 |     |       |             |  |  |  |  |                 |     |       |             |  |  |  |  |                 |     |       |             |  |  |  |  |                 |     |       |             |  |  |  |  |               |     |       |             |  |  |  |  |                  |     |       |             |  |  |  |  |                 |     |       |             |                |        |                              |                       |                 |     |       |             |                |        |  |                     |                 |     |       |             |  |  |  |  |                  |     |       |             |  |  |  |  |    |     |       |             |  |  |  |  |    |     |       |             |  |  |  |  |          |     |       |             |                |        |  |                     |          |     |       |             |                |        |  |                     |                  |     |       |             |                |        |  |                       |         |     |       |             |  |  |  |  |                 |     |       |             |  |  |  |  |         |     |       |             |  |  |  |  |         |     |       |             |  |  |  |  |         |     |       |             |  |  |  |  |                 |     |       |             |  |  |  |  |                 |     |       |             |  |  |  |  |                 |     |       |             |  |  |  |  |                 |     |       |             |  |  |  |  |                 |     |       |             |  |  |  |  |                 |     |       |             |  |  |  |  |               |     |       |             |  |  |  |  |                  |     |       |             |  |  |  |  |                 |     |       |             |                |        |  |                     |                 |     |       |             |                |        |  |                       |                 |     |       |             |  |  |  |  |                  |     |       |             |  |  |  |  |    |     |       |             |  |  |  |  |    |     |       |             |  |  |  |  |          |     |       |         |                |        |  |                    |          |     |       |         |                |        |  |                     |                  |     |       |         |  |  |  |  |         |     |       |         |  |  |  |  |                 |     |       |         |  |  |  |  |         |     |       |         |  |  |  |  |         |     |       |         |  |  |  |  |         |     |       |         |  |  |  |  |                 |     |       |         |  |  |  |  |                 |     |       |         |  |  |  |  |                 |     |       |         |  |  |  |  |                 |     |       |         |  |  |  |  |                 |     |       |         |  |  |  |  |                 |     |       |         |  |  |  |  |                 |     |       |         |  |  |  |  |                 |     |       |         |  |  |  |  |                 |     |       |         |  |  |  |  |               |     |       |         |  |  |  |  |                  |     |       |         |  |  |  |  |                  |     |       |         |  |  |  |  |    |     |       |         |  |  |  |  |    |     |       |         |  |  |  |  |          |     |       |         |                |        |  |                       |          |     |       |         |  |  |  |  |                  |     |       |         |  |  |  |  |         |     |       |         |  |  |  |  |                 |     |       |         |  |  |  |  |         |     |       |         |  |  |  |  |         |     |       |         |  |  |  |  |         |     |       |         |  |  |  |  |                 |     |       |         |  |  |  |  |                 |     |       |         |  |  |  |  |                 |     |       |         |  |  |  |  |                 |     |       |         |  |  |  |  |                 |     |       |         |  |  |  |  |                 |     |       |         |  |  |  |  |                 |     |       |         |  |  |  |  |                 |     |       |         |  |  |  |  |
| AUDI A7 Sportback (10-)  |   |                 |             |                |             |   |                         |   |                         |                  |     |       |             |                |        |                              |                       |                  |     |       |             |                |        |  |                     |         |     |       |             |  |  |  |  |                 |     |       |             |  |  |  |  |         |     |       |             |  |  |  |  |         |     |       |             |  |  |  |  |         |     |       |             |  |  |  |  |                 |     |       |             |  |  |  |  |                 |     |       |             |  |  |  |  |                 |     |       |             |  |  |  |  |                 |     |       |             |  |  |  |  |                 |     |       |             |  |  |  |  |                 |     |       |             |  |  |  |  |               |     |       |             |  |  |  |  |                  |     |       |             |  |  |  |  |                 |     |       |             |                |        |                              |                       |                 |     |       |             |                |        |  |                     |                 |     |       |             |  |  |  |  |                  |     |       |             |  |  |  |  |    |     |       |             |  |  |  |  |    |     |       |             |  |  |  |  |          |     |       |             |                |        |  |                     |          |     |       |             |                |        |  |                     |                  |     |       |             |                |        |  |                       |         |     |       |             |  |  |  |  |                 |     |       |             |  |  |  |  |         |     |       |             |  |  |  |  |         |     |       |             |  |  |  |  |         |     |       |             |  |  |  |  |                 |     |       |             |  |  |  |  |                 |     |       |             |  |  |  |  |                 |     |       |             |  |  |  |  |                 |     |       |             |  |  |  |  |                 |     |       |             |  |  |  |  |                 |     |       |             |  |  |  |  |               |     |       |             |  |  |  |  |                  |     |       |             |  |  |  |  |                 |     |       |             |                |        |  |                     |                 |     |       |             |                |        |  |                       |                 |     |       |             |  |  |  |  |                  |     |       |             |  |  |  |  |    |     |       |             |  |  |  |  |    |     |       |             |  |  |  |  |          |     |       |         |                |        |  |                    |          |     |       |         |                |        |  |                     |                  |     |       |         |  |  |  |  |         |     |       |         |  |  |  |  |                 |     |       |         |  |  |  |  |         |     |       |         |  |  |  |  |         |     |       |         |  |  |  |  |         |     |       |         |  |  |  |  |                 |     |       |         |  |  |  |  |                 |     |       |         |  |  |  |  |                 |     |       |         |  |  |  |  |                 |     |       |         |  |  |  |  |                 |     |       |         |  |  |  |  |                 |     |       |         |  |  |  |  |                 |     |       |         |  |  |  |  |                 |     |       |         |  |  |  |  |                 |     |       |         |  |  |  |  |               |     |       |         |  |  |  |  |                  |     |       |         |  |  |  |  |                  |     |       |         |  |  |  |  |    |     |       |         |  |  |  |  |    |     |       |         |  |  |  |  |          |     |       |         |                |        |  |                       |          |     |       |         |  |  |  |  |                  |     |       |         |  |  |  |  |         |     |       |         |  |  |  |  |                 |     |       |         |  |  |  |  |         |     |       |         |  |  |  |  |         |     |       |         |  |  |  |  |         |     |       |         |  |  |  |  |                 |     |       |         |  |  |  |  |                 |     |       |         |  |  |  |  |                 |     |       |         |  |  |  |  |                 |     |       |         |  |  |  |  |                 |     |       |         |  |  |  |  |                 |     |       |         |  |  |  |  |                 |     |       |         |  |  |  |  |                 |     |       |         |  |  |  |  |
|  | <table border="1"> <tr> <td>1.8 TFSI</td> <td>140</td> <td>04.15</td> <td>PR: 1LA,1LJ</td> <td>13.0460-2765.2</td> <td>602765</td> <td>Federmaß 46 mm <sup>2)</sup></td> <td>24743 19,2 +/WK/S TRW</td> </tr> <tr> <td>2.0 TFSI</td> <td>185</td> <td>09.14</td> <td>PR: 1LA,1LJ</td> <td>13.0470-2765.2</td> <td>LD2765</td> <td>Federmaß 46 mm <sup>2)</sup></td> <td>24743 19,2 +/WK/S TRW</td> </tr> <tr> <td>2.0 TFSI quattro</td> <td>185</td> <td>05.15</td> <td>PR: 1LA,1LJ</td> <td>24.8190-0311.2</td> <td>620311</td> <td></td> <td>Warnkontakt L=300mm</td> </tr> <tr> <td>2.8 FSI</td> <td>150</td> <td>05.11</td> <td>PR: 1LA,1LJ</td> <td></td> <td></td> <td></td> <td></td> </tr> <tr> <td>2.8 FSI quattro</td> <td>150</td> <td>07.10</td> <td>PR: 1LA,1LJ</td> <td></td> <td></td> <td></td> <td></td> </tr> <tr> <td>3.0 TDI</td> <td>140</td> <td>11.15</td> <td>PR: 1LA,1LJ</td> <td></td> <td></td> <td></td> <td></td> </tr> <tr> <td>3.0 TDI</td> <td>150</td> <td>11.10</td> <td>PR: 1LA,1LJ</td> <td></td> <td></td> <td></td> <td></td> </tr> <tr> <td>3.0 TDI</td> <td>155</td> <td>11.15</td> <td>PR: 1LA,1LJ</td> <td></td> <td></td> <td></td> <td></td> </tr> <tr> <td>3.0 TDI quattro</td> <td>140</td> <td>11.15</td> <td>PR: 1LA,1LJ</td> <td></td> <td></td> <td></td> <td></td> </tr> <tr> <td>3.0 TDI quattro</td> <td>150</td> <td>07.10</td> <td>PR: 1LA,1LJ</td> <td></td> <td></td> <td></td> <td></td> </tr> <tr> <td>3.0 TDI quattro</td> <td>160</td> <td>05.14</td> <td>PR: 1LA,1LJ</td> <td></td> <td></td> <td></td> <td></td> </tr> <tr> <td>3.0 TDI quattro</td> <td>176</td> <td>05.13</td> <td>PR: 1LA,1LJ</td> <td></td> <td></td> <td></td> <td></td> </tr> <tr> <td>3.0 TDI quattro</td> <td>180</td> <td>07.10</td> <td>PR: 1LA,1LJ</td> <td></td> <td></td> <td></td> <td></td> </tr> <tr> <td>3.0 TDI quattro</td> <td>200</td> <td>05.14</td> <td>PR: 1LA,1LJ</td> <td></td> <td></td> <td></td> <td></td> </tr> <tr> <td>3.0 TDI ultra</td> <td>160</td> <td>05.14</td> <td>PR: 1LA,1LJ</td> <td></td> <td></td> <td></td> <td></td> </tr> <tr> <td>3.0 TFSI quattro</td> <td>160</td> <td>07.10</td> <td>PR: 1LA,1LJ</td> <td></td> <td></td> <td></td> <td></td> </tr> <tr> <td>3.0 TDI quattro</td> <td>230</td> <td>11.11</td> <td>PR: 1LA,1LJ</td> <td>13.0460-2765.2</td> <td>602765</td> <td>Federmaß 46 mm <sup>2)</sup></td> <td>24743 19,2 +/WK/S TRW</td> </tr> <tr> <td>3.0 TDI quattro</td> <td>235</td> <td>05.14</td> <td>PR: 1LA,1LJ</td> <td>24.8190-0311.2</td> <td>620311</td> <td></td> <td>Warnkontakt L=300mm</td> </tr> <tr> <td>3.0 TDI quattro</td> <td>240</td> <td>08.14</td> <td>PR: 1LA,1LJ</td> <td></td> <td></td> <td></td> <td></td> </tr> <tr> <td>3.0 TFSI quattro</td> <td>245</td> <td>05.14</td> <td>PR: 1LA,1LJ</td> <td></td> <td></td> <td></td> <td></td> </tr> <tr> <td>S7</td> <td>309</td> <td>10.11</td> <td>PR: 1LA,1LJ</td> <td></td> <td></td> <td></td> <td></td> </tr> <tr> <td>S7</td> <td>331</td> <td>05.14</td> <td>PR: 1LA,1LJ</td> <td></td> <td></td> <td></td> <td></td> </tr> <tr> <td>1.8 TFSI</td> <td>140</td> <td>04.15</td> <td>PR: 1LL,1LF</td> <td>13.0460-7280.2</td> <td>607280</td> <td></td> <td>25158 20,3 +/WK ATE</td> </tr> <tr> <td>2.0 TFSI</td> <td>185</td> <td>09.14</td> <td>PR: 1LL,1LF</td> <td>13.0470-7280.2</td> <td>LD7280</td> <td></td> <td>25158 20,3 +/WK ATE</td> </tr> <tr> <td>2.0 TFSI quattro</td> <td>185</td> <td>05.15</td> <td>PR: 1LL,1LF</td> <td>24.8190-0301.2</td> <td>620301</td> <td></td> <td>Warnkontakt L=311,6mm</td> </tr> <tr> <td>2.8 FSI</td> <td>150</td> <td>05.11</td> <td>PR: 1LL,1LF</td> <td></td> <td></td> <td></td> <td></td> </tr> <tr> <td>2.8 FSI quattro</td> <td>150</td> <td>07.10</td> <td>PR: 1LL,1LF</td> <td></td> <td></td> <td></td> <td></td> </tr> <tr> <td>3.0 TDI</td> <td>140</td> <td>11.15</td> <td>PR: 1LL,1LF</td> <td></td> <td></td> <td></td> <td></td> </tr> <tr> <td>3.0 TDI</td> <td>150</td> <td>11.10</td> <td>PR: 1LL,1LF</td> <td></td> <td></td> <td></td> <td></td> </tr> <tr> <td>3.0 TDI</td> <td>155</td> <td>11.15</td> <td>PR: 1LL,1LF</td> <td></td> <td></td> <td></td> <td></td> </tr> <tr> <td>3.0 TDI quattro</td> <td>140</td> <td>11.15</td> <td>PR: 1LL,1LF</td> <td></td> <td></td> <td></td> <td></td> </tr> <tr> <td>3.0 TDI quattro</td> <td>150</td> <td>07.10</td> <td>PR: 1LL,1LF</td> <td></td> <td></td> <td></td> <td></td> </tr> <tr> <td>3.0 TDI quattro</td> <td>160</td> <td>05.14</td> <td>PR: 1LL,1LF</td> <td></td> <td></td> <td></td> <td></td> </tr> <tr> <td>3.0 TDI quattro</td> <td>176</td> <td>05.13</td> <td>PR: 1LL,1LF</td> <td></td> <td></td> <td></td> <td></td> </tr> <tr> <td>3.0 TDI quattro</td> <td>180</td> <td>07.10</td> <td>PR: 1LL,1LF</td> <td></td> <td></td> <td></td> <td></td> </tr> <tr> <td>3.0 TDI quattro</td> <td>200</td> <td>05.14</td> <td>PR: 1LL,1LF</td> <td></td> <td></td> <td></td> <td></td> </tr> <tr> <td>3.0 TDI ultra</td> <td>160</td> <td>05.14</td> <td>PR: 1LL,1LF</td> <td></td> <td></td> <td></td> <td></td> </tr> <tr> <td>3.0 TFSI quattro</td> <td>160</td> <td>07.10</td> <td>PR: 1LL,1LF</td> <td></td> <td></td> <td></td> <td></td> </tr> <tr> <td>3.0 TDI quattro</td> <td>230</td> <td>11.11</td> <td>PR: 1LL,1LF</td> <td>13.0460-7280.2</td> <td>607280</td> <td></td> <td>25158 20,3 +/WK ATE</td> </tr> <tr> <td>3.0 TDI quattro</td> <td>235</td> <td>05.14</td> <td>PR: 1LL,1LF</td> <td>24.8190-0301.2</td> <td>620301</td> <td></td> <td>Warnkontakt L=311,6mm</td> </tr> <tr> <td>3.0 TDI quattro</td> <td>240</td> <td>08.14</td> <td>PR: 1LL,1LF</td> <td></td> <td></td> <td></td> <td></td> </tr> <tr> <td>3.0 TFSI quattro</td> <td>245</td> <td>05.14</td> <td>PR: 1LL,1LF</td> <td></td> <td></td> <td></td> <td></td> </tr> <tr> <td>S7</td> <td>309</td> <td>10.11</td> <td>PR: 1LL,1LF</td> <td></td> <td></td> <td></td> <td></td> </tr> <tr> <td>S7</td> <td>331</td> <td>05.14</td> <td>PR: 1LL,1LF</td> <td></td> <td></td> <td></td> <td></td> </tr> <tr> <td>1.8 TFSI</td> <td>140</td> <td>04.15</td> <td>PR: 1LU</td> <td>13.0460-4873.2</td> <td>604873</td> <td></td> <td>24847 17,0 /WE BRE</td> </tr> <tr> <td>2.0 TFSI</td> <td>185</td> <td>09.14</td> <td>PR: 1LU</td> <td>24.8190-0019.2</td> <td>620019</td> <td></td> <td>Warnkontakt L=254mm</td> </tr> <tr> <td>2.0 TFSI quattro</td> <td>185</td> <td>05.15</td> <td>PR: 1LU</td> <td></td> <td></td> <td></td> <td></td> </tr> <tr> <td>2.8 FSI</td> <td>150</td> <td>05.11</td> <td>PR: 1LU</td> <td></td> <td></td> <td></td> <td></td> </tr> <tr> <td>2.8 FSI quattro</td> <td>150</td> <td>07.10</td> <td>PR: 1LU</td> <td></td> <td></td> <td></td> <td></td> </tr> <tr> <td>3.0 TDI</td> <td>140</td> <td>11.15</td> <td>PR: 1LU</td> <td></td> <td></td> <td></td> <td></td> </tr> <tr> <td>3.0 TDI</td> <td>150</td> <td>11.10</td> <td>PR: 1LU</td> <td></td> <td></td> <td></td> <td></td> </tr> <tr> <td>3.0 TDI</td> <td>155</td> <td>11.15</td> <td>PR: 1LU</td> <td></td> <td></td> <td></td> <td></td> </tr> <tr> <td>3.0 TDI quattro</td> <td>140</td> <td>11.15</td> <td>PR: 1LU</td> <td></td> <td></td> <td></td> <td></td> </tr> <tr> <td>3.0 TDI quattro</td> <td>150</td> <td>07.10</td> <td>PR: 1LU</td> <td></td> <td></td> <td></td> <td></td> </tr> <tr> <td>3.0 TDI quattro</td> <td>160</td> <td>05.14</td> <td>PR: 1LU</td> <td></td> <td></td> <td></td> <td></td> </tr> <tr> <td>3.0 TDI quattro</td> <td>176</td> <td>05.13</td> <td>PR: 1LU</td> <td></td> <td></td> <td></td> <td></td> </tr> <tr> <td>3.0 TDI quattro</td> <td>180</td> <td>07.10</td> <td>PR: 1LU</td> <td></td> <td></td> <td></td> <td></td> </tr> <tr> <td>3.0 TDI quattro</td> <td>200</td> <td>05.14</td> <td>PR: 1LU</td> <td></td> <td></td> <td></td> <td></td> </tr> <tr> <td>3.0 TDI quattro</td> <td>230</td> <td>11.11</td> <td>PR: 1LU</td> <td></td> <td></td> <td></td> <td></td> </tr> <tr> <td>3.0 TDI quattro</td> <td>235</td> <td>05.14</td> <td>PR: 1LU</td> <td></td> <td></td> <td></td> <td></td> </tr> <tr> <td>3.0 TDI quattro</td> <td>240</td> <td>08.14</td> <td>PR: 1LU</td> <td></td> <td></td> <td></td> <td></td> </tr> <tr> <td>3.0 TDI ultra</td> <td>160</td> <td>05.14</td> <td>PR: 1LU</td> <td></td> <td></td> <td></td> <td></td> </tr> <tr> <td>3.0 TFSI quattro</td> <td>160</td> <td>07.10</td> <td>PR: 1LU</td> <td></td> <td></td> <td></td> <td></td> </tr> <tr> <td>3.0 TFSI quattro</td> <td>245</td> <td>05.14</td> <td>PR: 1LU</td> <td></td> <td></td> <td></td> <td></td> </tr> <tr> <td>S7</td> <td>309</td> <td>10.11</td> <td>PR: 1LU</td> <td></td> <td></td> <td></td> <td></td> </tr> <tr> <td>S7</td> <td>331</td> <td>05.14</td> <td>PR: 1LU</td> <td></td> <td></td> <td></td> <td></td> </tr> <tr> <td>1.8 TFSI</td> <td>140</td> <td>04.15</td> <td>PR: 1LW</td> <td>24.8190-0020.2</td> <td>620020</td> <td></td> <td>Warnkontakt L=443,3mm</td> </tr> <tr> <td>2.0 TFSI</td> <td>185</td> <td>09.14</td> <td>PR: 1LW</td> <td></td> <td></td> <td></td> <td></td> </tr> <tr> <td>2.0 TFSI quattro</td> <td>185</td> <td>05.15</td> <td>PR: 1LW</td> <td></td> <td></td> <td></td> <td></td> </tr> <tr> <td>2.8 FSI</td> <td>150</td> <td>05.11</td> <td>PR: 1LW</td> <td></td> <td></td> <td></td> <td></td> </tr> <tr> <td>2.8 FSI quattro</td> <td>150</td> <td>07.10</td> <td>PR: 1LW</td> <td></td> <td></td> <td></td> <td></td> </tr> <tr> <td>3.0 TDI</td> <td>140</td> <td>11.15</td> <td>PR: 1LW</td> <td></td> <td></td> <td></td> <td></td> </tr> <tr> <td>3.0 TDI</td> <td>150</td> <td>11.10</td> <td>PR: 1LW</td> <td></td> <td></td> <td></td> <td></td> </tr> <tr> <td>3.0 TDI</td> <td>155</td> <td>11.15</td> <td>PR: 1LW</td> <td></td> <td></td> <td></td> <td></td> </tr> <tr> <td>3.0 TDI quattro</td> <td>140</td> <td>11.15</td> <td>PR: 1LW</td> <td></td> <td></td> <td></td> <td></td> </tr> <tr> <td>3.0 TDI quattro</td> <td>150</td> <td>07.10</td> <td>PR: 1LW</td> <td></td> <td></td> <td></td> <td></td> </tr> <tr> <td>3.0 TDI quattro</td> <td>160</td> <td>05.14</td> <td>PR: 1LW</td> <td></td> <td></td> <td></td> <td></td> </tr> <tr> <td>3.0 TDI quattro</td> <td>176</td> <td>05.13</td> <td>PR: 1LW</td> <td></td> <td></td> <td></td> <td></td> </tr> <tr> <td>3.0 TDI quattro</td> <td>180</td> <td>07.10</td> <td>PR: 1LW</td> <td></td> <td></td> <td></td> <td></td> </tr> <tr> <td>3.0 TDI quattro</td> <td>200</td> <td>05.14</td> <td>PR: 1LW</td> <td></td> <td></td> <td></td> <td></td> </tr> <tr> <td>3.0 TDI quattro</td> <td>230</td> <td>11.11</td> <td>PR: 1LW</td> <td></td> <td></td> <td></td> <td></td> </tr> <tr> <td>3.0 TDI quattro</td> <td>235</td> <td>05.14</td> <td>PR: 1LW</td> <td></td> <td></td> <td></td> <td></td> </tr> </table> | 1.8 TFSI        | 140         | 04.15          | PR: 1LA,1LJ | 13.0460-2765.2                            | 602765                  | Federmaß 46 mm <sup>2)</sup>              | 24743 19,2 +/WK/S TRW   | 2.0 TFSI         | 185 | 09.14 | PR: 1LA,1LJ | 13.0470-2765.2 | LD2765 | Federmaß 46 mm <sup>2)</sup> | 24743 19,2 +/WK/S TRW | 2.0 TFSI quattro | 185 | 05.15 | PR: 1LA,1LJ | 24.8190-0311.2 | 620311 |  | Warnkontakt L=300mm | 2.8 FSI | 150 | 05.11 | PR: 1LA,1LJ |  |  |  |  | 2.8 FSI quattro | 150 | 07.10 | PR: 1LA,1LJ |  |  |  |  | 3.0 TDI | 140 | 11.15 | PR: 1LA,1LJ |  |  |  |  | 3.0 TDI | 150 | 11.10 | PR: 1LA,1LJ |  |  |  |  | 3.0 TDI | 155 | 11.15 | PR: 1LA,1LJ |  |  |  |  | 3.0 TDI quattro | 140 | 11.15 | PR: 1LA,1LJ |  |  |  |  | 3.0 TDI quattro | 150 | 07.10 | PR: 1LA,1LJ |  |  |  |  | 3.0 TDI quattro | 160 | 05.14 | PR: 1LA,1LJ |  |  |  |  | 3.0 TDI quattro | 176 | 05.13 | PR: 1LA,1LJ |  |  |  |  | 3.0 TDI quattro | 180 | 07.10 | PR: 1LA,1LJ |  |  |  |  | 3.0 TDI quattro | 200 | 05.14 | PR: 1LA,1LJ |  |  |  |  | 3.0 TDI ultra | 160 | 05.14 | PR: 1LA,1LJ |  |  |  |  | 3.0 TFSI quattro | 160 | 07.10 | PR: 1LA,1LJ |  |  |  |  | 3.0 TDI quattro | 230 | 11.11 | PR: 1LA,1LJ | 13.0460-2765.2 | 602765 | Federmaß 46 mm <sup>2)</sup> | 24743 19,2 +/WK/S TRW | 3.0 TDI quattro | 235 | 05.14 | PR: 1LA,1LJ | 24.8190-0311.2 | 620311 |  | Warnkontakt L=300mm | 3.0 TDI quattro | 240 | 08.14 | PR: 1LA,1LJ |  |  |  |  | 3.0 TFSI quattro | 245 | 05.14 | PR: 1LA,1LJ |  |  |  |  | S7 | 309 | 10.11 | PR: 1LA,1LJ |  |  |  |  | S7 | 331 | 05.14 | PR: 1LA,1LJ |  |  |  |  | 1.8 TFSI | 140 | 04.15 | PR: 1LL,1LF | 13.0460-7280.2 | 607280 |  | 25158 20,3 +/WK ATE | 2.0 TFSI | 185 | 09.14 | PR: 1LL,1LF | 13.0470-7280.2 | LD7280 |  | 25158 20,3 +/WK ATE | 2.0 TFSI quattro | 185 | 05.15 | PR: 1LL,1LF | 24.8190-0301.2 | 620301 |  | Warnkontakt L=311,6mm | 2.8 FSI | 150 | 05.11 | PR: 1LL,1LF |  |  |  |  | 2.8 FSI quattro | 150 | 07.10 | PR: 1LL,1LF |  |  |  |  | 3.0 TDI | 140 | 11.15 | PR: 1LL,1LF |  |  |  |  | 3.0 TDI | 150 | 11.10 | PR: 1LL,1LF |  |  |  |  | 3.0 TDI | 155 | 11.15 | PR: 1LL,1LF |  |  |  |  | 3.0 TDI quattro | 140 | 11.15 | PR: 1LL,1LF |  |  |  |  | 3.0 TDI quattro | 150 | 07.10 | PR: 1LL,1LF |  |  |  |  | 3.0 TDI quattro | 160 | 05.14 | PR: 1LL,1LF |  |  |  |  | 3.0 TDI quattro | 176 | 05.13 | PR: 1LL,1LF |  |  |  |  | 3.0 TDI quattro | 180 | 07.10 | PR: 1LL,1LF |  |  |  |  | 3.0 TDI quattro | 200 | 05.14 | PR: 1LL,1LF |  |  |  |  | 3.0 TDI ultra | 160 | 05.14 | PR: 1LL,1LF |  |  |  |  | 3.0 TFSI quattro | 160 | 07.10 | PR: 1LL,1LF |  |  |  |  | 3.0 TDI quattro | 230 | 11.11 | PR: 1LL,1LF | 13.0460-7280.2 | 607280 |  | 25158 20,3 +/WK ATE | 3.0 TDI quattro | 235 | 05.14 | PR: 1LL,1LF | 24.8190-0301.2 | 620301 |  | Warnkontakt L=311,6mm | 3.0 TDI quattro | 240 | 08.14 | PR: 1LL,1LF |  |  |  |  | 3.0 TFSI quattro | 245 | 05.14 | PR: 1LL,1LF |  |  |  |  | S7 | 309 | 10.11 | PR: 1LL,1LF |  |  |  |  | S7 | 331 | 05.14 | PR: 1LL,1LF |  |  |  |  | 1.8 TFSI | 140 | 04.15 | PR: 1LU | 13.0460-4873.2 | 604873 |  | 24847 17,0 /WE BRE | 2.0 TFSI | 185 | 09.14 | PR: 1LU | 24.8190-0019.2 | 620019 |  | Warnkontakt L=254mm | 2.0 TFSI quattro | 185 | 05.15 | PR: 1LU |  |  |  |  | 2.8 FSI | 150 | 05.11 | PR: 1LU |  |  |  |  | 2.8 FSI quattro | 150 | 07.10 | PR: 1LU |  |  |  |  | 3.0 TDI | 140 | 11.15 | PR: 1LU |  |  |  |  | 3.0 TDI | 150 | 11.10 | PR: 1LU |  |  |  |  | 3.0 TDI | 155 | 11.15 | PR: 1LU |  |  |  |  | 3.0 TDI quattro | 140 | 11.15 | PR: 1LU |  |  |  |  | 3.0 TDI quattro | 150 | 07.10 | PR: 1LU |  |  |  |  | 3.0 TDI quattro | 160 | 05.14 | PR: 1LU |  |  |  |  | 3.0 TDI quattro | 176 | 05.13 | PR: 1LU |  |  |  |  | 3.0 TDI quattro | 180 | 07.10 | PR: 1LU |  |  |  |  | 3.0 TDI quattro | 200 | 05.14 | PR: 1LU |  |  |  |  | 3.0 TDI quattro | 230 | 11.11 | PR: 1LU |  |  |  |  | 3.0 TDI quattro | 235 | 05.14 | PR: 1LU |  |  |  |  | 3.0 TDI quattro | 240 | 08.14 | PR: 1LU |  |  |  |  | 3.0 TDI ultra | 160 | 05.14 | PR: 1LU |  |  |  |  | 3.0 TFSI quattro | 160 | 07.10 | PR: 1LU |  |  |  |  | 3.0 TFSI quattro | 245 | 05.14 | PR: 1LU |  |  |  |  | S7 | 309 | 10.11 | PR: 1LU |  |  |  |  | S7 | 331 | 05.14 | PR: 1LU |  |  |  |  | 1.8 TFSI | 140 | 04.15 | PR: 1LW | 24.8190-0020.2 | 620020 |  | Warnkontakt L=443,3mm | 2.0 TFSI | 185 | 09.14 | PR: 1LW |  |  |  |  | 2.0 TFSI quattro | 185 | 05.15 | PR: 1LW |  |  |  |  | 2.8 FSI | 150 | 05.11 | PR: 1LW |  |  |  |  | 2.8 FSI quattro | 150 | 07.10 | PR: 1LW |  |  |  |  | 3.0 TDI | 140 | 11.15 | PR: 1LW |  |  |  |  | 3.0 TDI | 150 | 11.10 | PR: 1LW |  |  |  |  | 3.0 TDI | 155 | 11.15 | PR: 1LW |  |  |  |  | 3.0 TDI quattro | 140 | 11.15 | PR: 1LW |  |  |  |  | 3.0 TDI quattro | 150 | 07.10 | PR: 1LW |  |  |  |  | 3.0 TDI quattro | 160 | 05.14 | PR: 1LW |  |  |  |  | 3.0 TDI quattro | 176 | 05.13 | PR: 1LW |  |  |  |  | 3.0 TDI quattro | 180 | 07.10 | PR: 1LW |  |  |  |  | 3.0 TDI quattro | 200 | 05.14 | PR: 1LW |  |  |  |  | 3.0 TDI quattro | 230 | 11.11 | PR: 1LW |  |  |  |  | 3.0 TDI quattro | 235 | 05.14 | PR: 1LW |  |  |  |  |
| 1.8 TFSI   | 140   | 04.15           | PR: 1LA,1LJ | 13.0460-2765.2 | 602765      | Federmaß 46 mm <sup>2)</sup>              | 24743 19,2 +/WK/S TRW   |   |                         |                  |     |       |             |                |        |                              |                       |                  |     |       |             |                |        |  |                     |         |     |       |             |  |  |  |  |                 |     |       |             |  |  |  |  |         |     |       |             |  |  |  |  |         |     |       |             |  |  |  |  |         |     |       |             |  |  |  |  |                 |     |       |             |  |  |  |  |                 |     |       |             |  |  |  |  |                 |     |       |             |  |  |  |  |                 |     |       |             |  |  |  |  |                 |     |       |             |  |  |  |  |                 |     |       |             |  |  |  |  |               |     |       |             |  |  |  |  |                  |     |       |             |  |  |  |  |                 |     |       |             |                |        |                              |                       |                 |     |       |             |                |        |  |                     |                 |     |       |             |  |  |  |  |                  |     |       |             |  |  |  |  |    |     |       |             |  |  |  |  |    |     |       |             |  |  |  |  |          |     |       |             |                |        |  |                     |          |     |       |             |                |        |  |                     |                  |     |       |             |                |        |  |                       |         |     |       |             |  |  |  |  |                 |     |       |             |  |  |  |  |         |     |       |             |  |  |  |  |         |     |       |             |  |  |  |  |         |     |       |             |  |  |  |  |                 |     |       |             |  |  |  |  |                 |     |       |             |  |  |  |  |                 |     |       |             |  |  |  |  |                 |     |       |             |  |  |  |  |                 |     |       |             |  |  |  |  |                 |     |       |             |  |  |  |  |               |     |       |             |  |  |  |  |                  |     |       |             |  |  |  |  |                 |     |       |             |                |        |  |                     |                 |     |       |             |                |        |  |                       |                 |     |       |             |  |  |  |  |                  |     |       |             |  |  |  |  |    |     |       |             |  |  |  |  |    |     |       |             |  |  |  |  |          |     |       |         |                |        |  |                    |          |     |       |         |                |        |  |                     |                  |     |       |         |  |  |  |  |         |     |       |         |  |  |  |  |                 |     |       |         |  |  |  |  |         |     |       |         |  |  |  |  |         |     |       |         |  |  |  |  |         |     |       |         |  |  |  |  |                 |     |       |         |  |  |  |  |                 |     |       |         |  |  |  |  |                 |     |       |         |  |  |  |  |                 |     |       |         |  |  |  |  |                 |     |       |         |  |  |  |  |                 |     |       |         |  |  |  |  |                 |     |       |         |  |  |  |  |                 |     |       |         |  |  |  |  |                 |     |       |         |  |  |  |  |               |     |       |         |  |  |  |  |                  |     |       |         |  |  |  |  |                  |     |       |         |  |  |  |  |    |     |       |         |  |  |  |  |    |     |       |         |  |  |  |  |          |     |       |         |                |        |  |                       |          |     |       |         |  |  |  |  |                  |     |       |         |  |  |  |  |         |     |       |         |  |  |  |  |                 |     |       |         |  |  |  |  |         |     |       |         |  |  |  |  |         |     |       |         |  |  |  |  |         |     |       |         |  |  |  |  |                 |     |       |         |  |  |  |  |                 |     |       |         |  |  |  |  |                 |     |       |         |  |  |  |  |                 |     |       |         |  |  |  |  |                 |     |       |         |  |  |  |  |                 |     |       |         |  |  |  |  |                 |     |       |         |  |  |  |  |                 |     |       |         |  |  |  |  |
| 2.0 TFSI   | 185   | 09.14           | PR: 1LA,1LJ | 13.0470-2765.2 | LD2765      | Federmaß 46 mm <sup>2)</sup>              | 24743 19,2 +/WK/S TRW   |   |                         |                  |     |       |             |                |        |                              |                       |                  |     |       |             |                |        |  |                     |         |     |       |             |  |  |  |  |                 |     |       |             |  |  |  |  |         |     |       |             |  |  |  |  |         |     |       |             |  |  |  |  |         |     |       |             |  |  |  |  |                 |     |       |             |  |  |  |  |                 |     |       |             |  |  |  |  |                 |     |       |             |  |  |  |  |                 |     |       |             |  |  |  |  |                 |     |       |             |  |  |  |  |                 |     |       |             |  |  |  |  |               |     |       |             |  |  |  |  |                  |     |       |             |  |  |  |  |                 |     |       |             |                |        |                              |                       |                 |     |       |             |                |        |  |                     |                 |     |       |             |  |  |  |  |                  |     |       |             |  |  |  |  |    |     |       |             |  |  |  |  |    |     |       |             |  |  |  |  |          |     |       |             |                |        |  |                     |          |     |       |             |                |        |  |                     |                  |     |       |             |                |        |  |                       |         |     |       |             |  |  |  |  |                 |     |       |             |  |  |  |  |         |     |       |             |  |  |  |  |         |     |       |             |  |  |  |  |         |     |       |             |  |  |  |  |                 |     |       |             |  |  |  |  |                 |     |       |             |  |  |  |  |                 |     |       |             |  |  |  |  |                 |     |       |             |  |  |  |  |                 |     |       |             |  |  |  |  |                 |     |       |             |  |  |  |  |               |     |       |             |  |  |  |  |                  |     |       |             |  |  |  |  |                 |     |       |             |                |        |  |                     |                 |     |       |             |                |        |  |                       |                 |     |       |             |  |  |  |  |                  |     |       |             |  |  |  |  |    |     |       |             |  |  |  |  |    |     |       |             |  |  |  |  |          |     |       |         |                |        |  |                    |          |     |       |         |                |        |  |                     |                  |     |       |         |  |  |  |  |         |     |       |         |  |  |  |  |                 |     |       |         |  |  |  |  |         |     |       |         |  |  |  |  |         |     |       |         |  |  |  |  |         |     |       |         |  |  |  |  |                 |     |       |         |  |  |  |  |                 |     |       |         |  |  |  |  |                 |     |       |         |  |  |  |  |                 |     |       |         |  |  |  |  |                 |     |       |         |  |  |  |  |                 |     |       |         |  |  |  |  |                 |     |       |         |  |  |  |  |                 |     |       |         |  |  |  |  |                 |     |       |         |  |  |  |  |               |     |       |         |  |  |  |  |                  |     |       |         |  |  |  |  |                  |     |       |         |  |  |  |  |    |     |       |         |  |  |  |  |    |     |       |         |  |  |  |  |          |     |       |         |                |        |  |                       |          |     |       |         |  |  |  |  |                  |     |       |         |  |  |  |  |         |     |       |         |  |  |  |  |                 |     |       |         |  |  |  |  |         |     |       |         |  |  |  |  |         |     |       |         |  |  |  |  |         |     |       |         |  |  |  |  |                 |     |       |         |  |  |  |  |                 |     |       |         |  |  |  |  |                 |     |       |         |  |  |  |  |                 |     |       |         |  |  |  |  |                 |     |       |         |  |  |  |  |                 |     |       |         |  |  |  |  |                 |     |       |         |  |  |  |  |                 |     |       |         |  |  |  |  |
| 2.0 TFSI quattro   | 185   | 05.15           | PR: 1LA,1LJ | 24.8190-0311.2 | 620311      |   | Warnkontakt L=300mm     |   |                         |                  |     |       |             |                |        |                              |                       |                  |     |       |             |                |        |  |                     |         |     |       |             |  |  |  |  |                 |     |       |             |  |  |  |  |         |     |       |             |  |  |  |  |         |     |       |             |  |  |  |  |         |     |       |             |  |  |  |  |                 |     |       |             |  |  |  |  |                 |     |       |             |  |  |  |  |                 |     |       |             |  |  |  |  |                 |     |       |             |  |  |  |  |                 |     |       |             |  |  |  |  |                 |     |       |             |  |  |  |  |               |     |       |             |  |  |  |  |                  |     |       |             |  |  |  |  |                 |     |       |             |                |        |                              |                       |                 |     |       |             |                |        |  |                     |                 |     |       |             |  |  |  |  |                  |     |       |             |  |  |  |  |    |     |       |             |  |  |  |  |    |     |       |             |  |  |  |  |          |     |       |             |                |        |  |                     |          |     |       |             |                |        |  |                     |                  |     |       |             |                |        |  |                       |         |     |       |             |  |  |  |  |                 |     |       |             |  |  |  |  |         |     |       |             |  |  |  |  |         |     |       |             |  |  |  |  |         |     |       |             |  |  |  |  |                 |     |       |             |  |  |  |  |                 |     |       |             |  |  |  |  |                 |     |       |             |  |  |  |  |                 |     |       |             |  |  |  |  |                 |     |       |             |  |  |  |  |                 |     |       |             |  |  |  |  |               |     |       |             |  |  |  |  |                  |     |       |             |  |  |  |  |                 |     |       |             |                |        |  |                     |                 |     |       |             |                |        |  |                       |                 |     |       |             |  |  |  |  |                  |     |       |             |  |  |  |  |    |     |       |             |  |  |  |  |    |     |       |             |  |  |  |  |          |     |       |         |                |        |  |                    |          |     |       |         |                |        |  |                     |                  |     |       |         |  |  |  |  |         |     |       |         |  |  |  |  |                 |     |       |         |  |  |  |  |         |     |       |         |  |  |  |  |         |     |       |         |  |  |  |  |         |     |       |         |  |  |  |  |                 |     |       |         |  |  |  |  |                 |     |       |         |  |  |  |  |                 |     |       |         |  |  |  |  |                 |     |       |         |  |  |  |  |                 |     |       |         |  |  |  |  |                 |     |       |         |  |  |  |  |                 |     |       |         |  |  |  |  |                 |     |       |         |  |  |  |  |                 |     |       |         |  |  |  |  |               |     |       |         |  |  |  |  |                  |     |       |         |  |  |  |  |                  |     |       |         |  |  |  |  |    |     |       |         |  |  |  |  |    |     |       |         |  |  |  |  |          |     |       |         |                |        |  |                       |          |     |       |         |  |  |  |  |                  |     |       |         |  |  |  |  |         |     |       |         |  |  |  |  |                 |     |       |         |  |  |  |  |         |     |       |         |  |  |  |  |         |     |       |         |  |  |  |  |         |     |       |         |  |  |  |  |                 |     |       |         |  |  |  |  |                 |     |       |         |  |  |  |  |                 |     |       |         |  |  |  |  |                 |     |       |         |  |  |  |  |                 |     |       |         |  |  |  |  |                 |     |       |         |  |  |  |  |                 |     |       |         |  |  |  |  |                 |     |       |         |  |  |  |  |
| 2.8 FSI  | 150   | 05.11           | PR: 1LA,1LJ |                |             |   |                         |   |                         |                  |     |       |             |                |        |                              |                       |                  |     |       |             |                |        |  |                     |         |     |       |             |  |  |  |  |                 |     |       |             |  |  |  |  |         |     |       |             |  |  |  |  |         |     |       |             |  |  |  |  |         |     |       |             |  |  |  |  |                 |     |       |             |  |  |  |  |                 |     |       |             |  |  |  |  |                 |     |       |             |  |  |  |  |                 |     |       |             |  |  |  |  |                 |     |       |             |  |  |  |  |                 |     |       |             |  |  |  |  |               |     |       |             |  |  |  |  |                  |     |       |             |  |  |  |  |                 |     |       |             |                |        |                              |                       |                 |     |       |             |                |        |  |                     |                 |     |       |             |  |  |  |  |                  |     |       |             |  |  |  |  |    |     |       |             |  |  |  |  |    |     |       |             |  |  |  |  |          |     |       |             |                |        |  |                     |          |     |       |             |                |        |  |                     |                  |     |       |             |                |        |  |                       |         |     |       |             |  |  |  |  |                 |     |       |             |  |  |  |  |         |     |       |             |  |  |  |  |         |     |       |             |  |  |  |  |         |     |       |             |  |  |  |  |                 |     |       |             |  |  |  |  |                 |     |       |             |  |  |  |  |                 |     |       |             |  |  |  |  |                 |     |       |             |  |  |  |  |                 |     |       |             |  |  |  |  |                 |     |       |             |  |  |  |  |               |     |       |             |  |  |  |  |                  |     |       |             |  |  |  |  |                 |     |       |             |                |        |  |                     |                 |     |       |             |                |        |  |                       |                 |     |       |             |  |  |  |  |                  |     |       |             |  |  |  |  |    |     |       |             |  |  |  |  |    |     |       |             |  |  |  |  |          |     |       |         |                |        |  |                    |          |     |       |         |                |        |  |                     |                  |     |       |         |  |  |  |  |         |     |       |         |  |  |  |  |                 |     |       |         |  |  |  |  |         |     |       |         |  |  |  |  |         |     |       |         |  |  |  |  |         |     |       |         |  |  |  |  |                 |     |       |         |  |  |  |  |                 |     |       |         |  |  |  |  |                 |     |       |         |  |  |  |  |                 |     |       |         |  |  |  |  |                 |     |       |         |  |  |  |  |                 |     |       |         |  |  |  |  |                 |     |       |         |  |  |  |  |                 |     |       |         |  |  |  |  |                 |     |       |         |  |  |  |  |               |     |       |         |  |  |  |  |                  |     |       |         |  |  |  |  |                  |     |       |         |  |  |  |  |    |     |       |         |  |  |  |  |    |     |       |         |  |  |  |  |          |     |       |         |                |        |  |                       |          |     |       |         |  |  |  |  |                  |     |       |         |  |  |  |  |         |     |       |         |  |  |  |  |                 |     |       |         |  |  |  |  |         |     |       |         |  |  |  |  |         |     |       |         |  |  |  |  |         |     |       |         |  |  |  |  |                 |     |       |         |  |  |  |  |                 |     |       |         |  |  |  |  |                 |     |       |         |  |  |  |  |                 |     |       |         |  |  |  |  |                 |     |       |         |  |  |  |  |                 |     |       |         |  |  |  |  |                 |     |       |         |  |  |  |  |                 |     |       |         |  |  |  |  |
| 2.8 FSI quattro  | 150   | 07.10           | PR: 1LA,1LJ |                |             |   |                         |   |                         |                  |     |       |             |                |        |                              |                       |                  |     |       |             |                |        |  |                     |         |     |       |             |  |  |  |  |                 |     |       |             |  |  |  |  |         |     |       |             |  |  |  |  |         |     |       |             |  |  |  |  |         |     |       |             |  |  |  |  |                 |     |       |             |  |  |  |  |                 |     |       |             |  |  |  |  |                 |     |       |             |  |  |  |  |                 |     |       |             |  |  |  |  |                 |     |       |             |  |  |  |  |                 |     |       |             |  |  |  |  |               |     |       |             |  |  |  |  |                  |     |       |             |  |  |  |  |                 |     |       |             |                |        |                              |                       |                 |     |       |             |                |        |  |                     |                 |     |       |             |  |  |  |  |                  |     |       |             |  |  |  |  |    |     |       |             |  |  |  |  |    |     |       |             |  |  |  |  |          |     |       |             |                |        |  |                     |          |     |       |             |                |        |  |                     |                  |     |       |             |                |        |  |                       |         |     |       |             |  |  |  |  |                 |     |       |             |  |  |  |  |         |     |       |             |  |  |  |  |         |     |       |             |  |  |  |  |         |     |       |             |  |  |  |  |                 |     |       |             |  |  |  |  |                 |     |       |             |  |  |  |  |                 |     |       |             |  |  |  |  |                 |     |       |             |  |  |  |  |                 |     |       |             |  |  |  |  |                 |     |       |             |  |  |  |  |               |     |       |             |  |  |  |  |                  |     |       |             |  |  |  |  |                 |     |       |             |                |        |  |                     |                 |     |       |             |                |        |  |                       |                 |     |       |             |  |  |  |  |                  |     |       |             |  |  |  |  |    |     |       |             |  |  |  |  |    |     |       |             |  |  |  |  |          |     |       |         |                |        |  |                    |          |     |       |         |                |        |  |                     |                  |     |       |         |  |  |  |  |         |     |       |         |  |  |  |  |                 |     |       |         |  |  |  |  |         |     |       |         |  |  |  |  |         |     |       |         |  |  |  |  |         |     |       |         |  |  |  |  |                 |     |       |         |  |  |  |  |                 |     |       |         |  |  |  |  |                 |     |       |         |  |  |  |  |                 |     |       |         |  |  |  |  |                 |     |       |         |  |  |  |  |                 |     |       |         |  |  |  |  |                 |     |       |         |  |  |  |  |                 |     |       |         |  |  |  |  |                 |     |       |         |  |  |  |  |               |     |       |         |  |  |  |  |                  |     |       |         |  |  |  |  |                  |     |       |         |  |  |  |  |    |     |       |         |  |  |  |  |    |     |       |         |  |  |  |  |          |     |       |         |                |        |  |                       |          |     |       |         |  |  |  |  |                  |     |       |         |  |  |  |  |         |     |       |         |  |  |  |  |                 |     |       |         |  |  |  |  |         |     |       |         |  |  |  |  |         |     |       |         |  |  |  |  |         |     |       |         |  |  |  |  |                 |     |       |         |  |  |  |  |                 |     |       |         |  |  |  |  |                 |     |       |         |  |  |  |  |                 |     |       |         |  |  |  |  |                 |     |       |         |  |  |  |  |                 |     |       |         |  |  |  |  |                 |     |       |         |  |  |  |  |                 |     |       |         |  |  |  |  |
| 3.0 TDI  | 140   | 11.15           | PR: 1LA,1LJ |                |             |   |                         |   |                         |                  |     |       |             |                |        |                              |                       |                  |     |       |             |                |        |  |                     |         |     |       |             |  |  |  |  |                 |     |       |             |  |  |  |  |         |     |       |             |  |  |  |  |         |     |       |             |  |  |  |  |         |     |       |             |  |  |  |  |                 |     |       |             |  |  |  |  |                 |     |       |             |  |  |  |  |                 |     |       |             |  |  |  |  |                 |     |       |             |  |  |  |  |                 |     |       |             |  |  |  |  |                 |     |       |             |  |  |  |  |               |     |       |             |  |  |  |  |                  |     |       |             |  |  |  |  |                 |     |       |             |                |        |                              |                       |                 |     |       |             |                |        |  |                     |                 |     |       |             |  |  |  |  |                  |     |       |             |  |  |  |  |    |     |       |             |  |  |  |  |    |     |       |             |  |  |  |  |          |     |       |             |                |        |  |                     |          |     |       |             |                |        |  |                     |                  |     |       |             |                |        |  |                       |         |     |       |             |  |  |  |  |                 |     |       |             |  |  |  |  |         |     |       |             |  |  |  |  |         |     |       |             |  |  |  |  |         |     |       |             |  |  |  |  |                 |     |       |             |  |  |  |  |                 |     |       |             |  |  |  |  |                 |     |       |             |  |  |  |  |                 |     |       |             |  |  |  |  |                 |     |       |             |  |  |  |  |                 |     |       |             |  |  |  |  |               |     |       |             |  |  |  |  |                  |     |       |             |  |  |  |  |                 |     |       |             |                |        |  |                     |                 |     |       |             |                |        |  |                       |                 |     |       |             |  |  |  |  |                  |     |       |             |  |  |  |  |    |     |       |             |  |  |  |  |    |     |       |             |  |  |  |  |          |     |       |         |                |        |  |                    |          |     |       |         |                |        |  |                     |                  |     |       |         |  |  |  |  |         |     |       |         |  |  |  |  |                 |     |       |         |  |  |  |  |         |     |       |         |  |  |  |  |         |     |       |         |  |  |  |  |         |     |       |         |  |  |  |  |                 |     |       |         |  |  |  |  |                 |     |       |         |  |  |  |  |                 |     |       |         |  |  |  |  |                 |     |       |         |  |  |  |  |                 |     |       |         |  |  |  |  |                 |     |       |         |  |  |  |  |                 |     |       |         |  |  |  |  |                 |     |       |         |  |  |  |  |                 |     |       |         |  |  |  |  |               |     |       |         |  |  |  |  |                  |     |       |         |  |  |  |  |                  |     |       |         |  |  |  |  |    |     |       |         |  |  |  |  |    |     |       |         |  |  |  |  |          |     |       |         |                |        |  |                       |          |     |       |         |  |  |  |  |                  |     |       |         |  |  |  |  |         |     |       |         |  |  |  |  |                 |     |       |         |  |  |  |  |         |     |       |         |  |  |  |  |         |     |       |         |  |  |  |  |         |     |       |         |  |  |  |  |                 |     |       |         |  |  |  |  |                 |     |       |         |  |  |  |  |                 |     |       |         |  |  |  |  |                 |     |       |         |  |  |  |  |                 |     |       |         |  |  |  |  |                 |     |       |         |  |  |  |  |                 |     |       |         |  |  |  |  |                 |     |       |         |  |  |  |  |
| 3.0 TDI  | 150   | 11.10           | PR: 1LA,1LJ |                |             |   |                         |   |                         |                  |     |       |             |                |        |                              |                       |                  |     |       |             |                |        |  |                     |         |     |       |             |  |  |  |  |                 |     |       |             |  |  |  |  |         |     |       |             |  |  |  |  |         |     |       |             |  |  |  |  |         |     |       |             |  |  |  |  |                 |     |       |             |  |  |  |  |                 |     |       |             |  |  |  |  |                 |     |       |             |  |  |  |  |                 |     |       |             |  |  |  |  |                 |     |       |             |  |  |  |  |                 |     |       |             |  |  |  |  |               |     |       |             |  |  |  |  |                  |     |       |             |  |  |  |  |                 |     |       |             |                |        |                              |                       |                 |     |       |             |                |        |  |                     |                 |     |       |             |  |  |  |  |                  |     |       |             |  |  |  |  |    |     |       |             |  |  |  |  |    |     |       |             |  |  |  |  |          |     |       |             |                |        |  |                     |          |     |       |             |                |        |  |                     |                  |     |       |             |                |        |  |                       |         |     |       |             |  |  |  |  |                 |     |       |             |  |  |  |  |         |     |       |             |  |  |  |  |         |     |       |             |  |  |  |  |         |     |       |             |  |  |  |  |                 |     |       |             |  |  |  |  |                 |     |       |             |  |  |  |  |                 |     |       |             |  |  |  |  |                 |     |       |             |  |  |  |  |                 |     |       |             |  |  |  |  |                 |     |       |             |  |  |  |  |               |     |       |             |  |  |  |  |                  |     |       |             |  |  |  |  |                 |     |       |             |                |        |  |                     |                 |     |       |             |                |        |  |                       |                 |     |       |             |  |  |  |  |                  |     |       |             |  |  |  |  |    |     |       |             |  |  |  |  |    |     |       |             |  |  |  |  |          |     |       |         |                |        |  |                    |          |     |       |         |                |        |  |                     |                  |     |       |         |  |  |  |  |         |     |       |         |  |  |  |  |                 |     |       |         |  |  |  |  |         |     |       |         |  |  |  |  |         |     |       |         |  |  |  |  |         |     |       |         |  |  |  |  |                 |     |       |         |  |  |  |  |                 |     |       |         |  |  |  |  |                 |     |       |         |  |  |  |  |                 |     |       |         |  |  |  |  |                 |     |       |         |  |  |  |  |                 |     |       |         |  |  |  |  |                 |     |       |         |  |  |  |  |                 |     |       |         |  |  |  |  |                 |     |       |         |  |  |  |  |               |     |       |         |  |  |  |  |                  |     |       |         |  |  |  |  |                  |     |       |         |  |  |  |  |    |     |       |         |  |  |  |  |    |     |       |         |  |  |  |  |          |     |       |         |                |        |  |                       |          |     |       |         |  |  |  |  |                  |     |       |         |  |  |  |  |         |     |       |         |  |  |  |  |                 |     |       |         |  |  |  |  |         |     |       |         |  |  |  |  |         |     |       |         |  |  |  |  |         |     |       |         |  |  |  |  |                 |     |       |         |  |  |  |  |                 |     |       |         |  |  |  |  |                 |     |       |         |  |  |  |  |                 |     |       |         |  |  |  |  |                 |     |       |         |  |  |  |  |                 |     |       |         |  |  |  |  |                 |     |       |         |  |  |  |  |                 |     |       |         |  |  |  |  |
| 3.0 TDI  | 155   | 11.15           | PR: 1LA,1LJ |                |             |   |                         |   |                         |                  |     |       |             |                |        |                              |                       |                  |     |       |             |                |        |  |                     |         |     |       |             |  |  |  |  |                 |     |       |             |  |  |  |  |         |     |       |             |  |  |  |  |         |     |       |             |  |  |  |  |         |     |       |             |  |  |  |  |                 |     |       |             |  |  |  |  |                 |     |       |             |  |  |  |  |                 |     |       |             |  |  |  |  |                 |     |       |             |  |  |  |  |                 |     |       |             |  |  |  |  |                 |     |       |             |  |  |  |  |               |     |       |             |  |  |  |  |                  |     |       |             |  |  |  |  |                 |     |       |             |                |        |                              |                       |                 |     |       |             |                |        |  |                     |                 |     |       |             |  |  |  |  |                  |     |       |             |  |  |  |  |    |     |       |             |  |  |  |  |    |     |       |             |  |  |  |  |          |     |       |             |                |        |  |                     |          |     |       |             |                |        |  |                     |                  |     |       |             |                |        |  |                       |         |     |       |             |  |  |  |  |                 |     |       |             |  |  |  |  |         |     |       |             |  |  |  |  |         |     |       |             |  |  |  |  |         |     |       |             |  |  |  |  |                 |     |       |             |  |  |  |  |                 |     |       |             |  |  |  |  |                 |     |       |             |  |  |  |  |                 |     |       |             |  |  |  |  |                 |     |       |             |  |  |  |  |                 |     |       |             |  |  |  |  |               |     |       |             |  |  |  |  |                  |     |       |             |  |  |  |  |                 |     |       |             |                |        |  |                     |                 |     |       |             |                |        |  |                       |                 |     |       |             |  |  |  |  |                  |     |       |             |  |  |  |  |    |     |       |             |  |  |  |  |    |     |       |             |  |  |  |  |          |     |       |         |                |        |  |                    |          |     |       |         |                |        |  |                     |                  |     |       |         |  |  |  |  |         |     |       |         |  |  |  |  |                 |     |       |         |  |  |  |  |         |     |       |         |  |  |  |  |         |     |       |         |  |  |  |  |         |     |       |         |  |  |  |  |                 |     |       |         |  |  |  |  |                 |     |       |         |  |  |  |  |                 |     |       |         |  |  |  |  |                 |     |       |         |  |  |  |  |                 |     |       |         |  |  |  |  |                 |     |       |         |  |  |  |  |                 |     |       |         |  |  |  |  |                 |     |       |         |  |  |  |  |                 |     |       |         |  |  |  |  |               |     |       |         |  |  |  |  |                  |     |       |         |  |  |  |  |                  |     |       |         |  |  |  |  |    |     |       |         |  |  |  |  |    |     |       |         |  |  |  |  |          |     |       |         |                |        |  |                       |          |     |       |         |  |  |  |  |                  |     |       |         |  |  |  |  |         |     |       |         |  |  |  |  |                 |     |       |         |  |  |  |  |         |     |       |         |  |  |  |  |         |     |       |         |  |  |  |  |         |     |       |         |  |  |  |  |                 |     |       |         |  |  |  |  |                 |     |       |         |  |  |  |  |                 |     |       |         |  |  |  |  |                 |     |       |         |  |  |  |  |                 |     |       |         |  |  |  |  |                 |     |       |         |  |  |  |  |                 |     |       |         |  |  |  |  |                 |     |       |         |  |  |  |  |
| 3.0 TDI quattro  | 140   | 11.15           | PR: 1LA,1LJ |                |             |   |                         |   |                         |                  |     |       |             |                |        |                              |                       |                  |     |       |             |                |        |  |                     |         |     |       |             |  |  |  |  |                 |     |       |             |  |  |  |  |         |     |       |             |  |  |  |  |         |     |       |             |  |  |  |  |         |     |       |             |  |  |  |  |                 |     |       |             |  |  |  |  |                 |     |       |             |  |  |  |  |                 |     |       |             |  |  |  |  |                 |     |       |             |  |  |  |  |                 |     |       |             |  |  |  |  |                 |     |       |             |  |  |  |  |               |     |       |             |  |  |  |  |                  |     |       |             |  |  |  |  |                 |     |       |             |                |        |                              |                       |                 |     |       |             |                |        |  |                     |                 |     |       |             |  |  |  |  |                  |     |       |             |  |  |  |  |    |     |       |             |  |  |  |  |    |     |       |             |  |  |  |  |          |     |       |             |                |        |  |                     |          |     |       |             |                |        |  |                     |                  |     |       |             |                |        |  |                       |         |     |       |             |  |  |  |  |                 |     |       |             |  |  |  |  |         |     |       |             |  |  |  |  |         |     |       |             |  |  |  |  |         |     |       |             |  |  |  |  |                 |     |       |             |  |  |  |  |                 |     |       |             |  |  |  |  |                 |     |       |             |  |  |  |  |                 |     |       |             |  |  |  |  |                 |     |       |             |  |  |  |  |                 |     |       |             |  |  |  |  |               |     |       |             |  |  |  |  |                  |     |       |             |  |  |  |  |                 |     |       |             |                |        |  |                     |                 |     |       |             |                |        |  |                       |                 |     |       |             |  |  |  |  |                  |     |       |             |  |  |  |  |    |     |       |             |  |  |  |  |    |     |       |             |  |  |  |  |          |     |       |         |                |        |  |                    |          |     |       |         |                |        |  |                     |                  |     |       |         |  |  |  |  |         |     |       |         |  |  |  |  |                 |     |       |         |  |  |  |  |         |     |       |         |  |  |  |  |         |     |       |         |  |  |  |  |         |     |       |         |  |  |  |  |                 |     |       |         |  |  |  |  |                 |     |       |         |  |  |  |  |                 |     |       |         |  |  |  |  |                 |     |       |         |  |  |  |  |                 |     |       |         |  |  |  |  |                 |     |       |         |  |  |  |  |                 |     |       |         |  |  |  |  |                 |     |       |         |  |  |  |  |                 |     |       |         |  |  |  |  |               |     |       |         |  |  |  |  |                  |     |       |         |  |  |  |  |                  |     |       |         |  |  |  |  |    |     |       |         |  |  |  |  |    |     |       |         |  |  |  |  |          |     |       |         |                |        |  |                       |          |     |       |         |  |  |  |  |                  |     |       |         |  |  |  |  |         |     |       |         |  |  |  |  |                 |     |       |         |  |  |  |  |         |     |       |         |  |  |  |  |         |     |       |         |  |  |  |  |         |     |       |         |  |  |  |  |                 |     |       |         |  |  |  |  |                 |     |       |         |  |  |  |  |                 |     |       |         |  |  |  |  |                 |     |       |         |  |  |  |  |                 |     |       |         |  |  |  |  |                 |     |       |         |  |  |  |  |                 |     |       |         |  |  |  |  |                 |     |       |         |  |  |  |  |
| 3.0 TDI quattro  | 150   | 07.10           | PR: 1LA,1LJ |                |             |   |                         |   |                         |                  |     |       |             |                |        |                              |                       |                  |     |       |             |                |        |  |                     |         |     |       |             |  |  |  |  |                 |     |       |             |  |  |  |  |         |     |       |             |  |  |  |  |         |     |       |             |  |  |  |  |         |     |       |             |  |  |  |  |                 |     |       |             |  |  |  |  |                 |     |       |             |  |  |  |  |                 |     |       |             |  |  |  |  |                 |     |       |             |  |  |  |  |                 |     |       |             |  |  |  |  |                 |     |       |             |  |  |  |  |               |     |       |             |  |  |  |  |                  |     |       |             |  |  |  |  |                 |     |       |             |                |        |                              |                       |                 |     |       |             |                |        |  |                     |                 |     |       |             |  |  |  |  |                  |     |       |             |  |  |  |  |    |     |       |             |  |  |  |  |    |     |       |             |  |  |  |  |          |     |       |             |                |        |  |                     |          |     |       |             |                |        |  |                     |                  |     |       |             |                |        |  |                       |         |     |       |             |  |  |  |  |                 |     |       |             |  |  |  |  |         |     |       |             |  |  |  |  |         |     |       |             |  |  |  |  |         |     |       |             |  |  |  |  |                 |     |       |             |  |  |  |  |                 |     |       |             |  |  |  |  |                 |     |       |             |  |  |  |  |                 |     |       |             |  |  |  |  |                 |     |       |             |  |  |  |  |                 |     |       |             |  |  |  |  |               |     |       |             |  |  |  |  |                  |     |       |             |  |  |  |  |                 |     |       |             |                |        |  |                     |                 |     |       |             |                |        |  |                       |                 |     |       |             |  |  |  |  |                  |     |       |             |  |  |  |  |    |     |       |             |  |  |  |  |    |     |       |             |  |  |  |  |          |     |       |         |                |        |  |                    |          |     |       |         |                |        |  |                     |                  |     |       |         |  |  |  |  |         |     |       |         |  |  |  |  |                 |     |       |         |  |  |  |  |         |     |       |         |  |  |  |  |         |     |       |         |  |  |  |  |         |     |       |         |  |  |  |  |                 |     |       |         |  |  |  |  |                 |     |       |         |  |  |  |  |                 |     |       |         |  |  |  |  |                 |     |       |         |  |  |  |  |                 |     |       |         |  |  |  |  |                 |     |       |         |  |  |  |  |                 |     |       |         |  |  |  |  |                 |     |       |         |  |  |  |  |                 |     |       |         |  |  |  |  |               |     |       |         |  |  |  |  |                  |     |       |         |  |  |  |  |                  |     |       |         |  |  |  |  |    |     |       |         |  |  |  |  |    |     |       |         |  |  |  |  |          |     |       |         |                |        |  |                       |          |     |       |         |  |  |  |  |                  |     |       |         |  |  |  |  |         |     |       |         |  |  |  |  |                 |     |       |         |  |  |  |  |         |     |       |         |  |  |  |  |         |     |       |         |  |  |  |  |         |     |       |         |  |  |  |  |                 |     |       |         |  |  |  |  |                 |     |       |         |  |  |  |  |                 |     |       |         |  |  |  |  |                 |     |       |         |  |  |  |  |                 |     |       |         |  |  |  |  |                 |     |       |         |  |  |  |  |                 |     |       |         |  |  |  |  |                 |     |       |         |  |  |  |  |
| 3.0 TDI quattro  | 160   | 05.14           | PR: 1LA,1LJ |                |             |   |                         |   |                         |                  |     |       |             |                |        |                              |                       |                  |     |       |             |                |        |  |                     |         |     |       |             |  |  |  |  |                 |     |       |             |  |  |  |  |         |     |       |             |  |  |  |  |         |     |       |             |  |  |  |  |         |     |       |             |  |  |  |  |                 |     |       |             |  |  |  |  |                 |     |       |             |  |  |  |  |                 |     |       |             |  |  |  |  |                 |     |       |             |  |  |  |  |                 |     |       |             |  |  |  |  |                 |     |       |             |  |  |  |  |               |     |       |             |  |  |  |  |                  |     |       |             |  |  |  |  |                 |     |       |             |                |        |                              |                       |                 |     |       |             |                |        |  |                     |                 |     |       |             |  |  |  |  |                  |     |       |             |  |  |  |  |    |     |       |             |  |  |  |  |    |     |       |             |  |  |  |  |          |     |       |             |                |        |  |                     |          |     |       |             |                |        |  |                     |                  |     |       |             |                |        |  |                       |         |     |       |             |  |  |  |  |                 |     |       |             |  |  |  |  |         |     |       |             |  |  |  |  |         |     |       |             |  |  |  |  |         |     |       |             |  |  |  |  |                 |     |       |             |  |  |  |  |                 |     |       |             |  |  |  |  |                 |     |       |             |  |  |  |  |                 |     |       |             |  |  |  |  |                 |     |       |             |  |  |  |  |                 |     |       |             |  |  |  |  |               |     |       |             |  |  |  |  |                  |     |       |             |  |  |  |  |                 |     |       |             |                |        |  |                     |                 |     |       |             |                |        |  |                       |                 |     |       |             |  |  |  |  |                  |     |       |             |  |  |  |  |    |     |       |             |  |  |  |  |    |     |       |             |  |  |  |  |          |     |       |         |                |        |  |                    |          |     |       |         |                |        |  |                     |                  |     |       |         |  |  |  |  |         |     |       |         |  |  |  |  |                 |     |       |         |  |  |  |  |         |     |       |         |  |  |  |  |         |     |       |         |  |  |  |  |         |     |       |         |  |  |  |  |                 |     |       |         |  |  |  |  |                 |     |       |         |  |  |  |  |                 |     |       |         |  |  |  |  |                 |     |       |         |  |  |  |  |                 |     |       |         |  |  |  |  |                 |     |       |         |  |  |  |  |                 |     |       |         |  |  |  |  |                 |     |       |         |  |  |  |  |                 |     |       |         |  |  |  |  |               |     |       |         |  |  |  |  |                  |     |       |         |  |  |  |  |                  |     |       |         |  |  |  |  |    |     |       |         |  |  |  |  |    |     |       |         |  |  |  |  |          |     |       |         |                |        |  |                       |          |     |       |         |  |  |  |  |                  |     |       |         |  |  |  |  |         |     |       |         |  |  |  |  |                 |     |       |         |  |  |  |  |         |     |       |         |  |  |  |  |         |     |       |         |  |  |  |  |         |     |       |         |  |  |  |  |                 |     |       |         |  |  |  |  |                 |     |       |         |  |  |  |  |                 |     |       |         |  |  |  |  |                 |     |       |         |  |  |  |  |                 |     |       |         |  |  |  |  |                 |     |       |         |  |  |  |  |                 |     |       |         |  |  |  |  |                 |     |       |         |  |  |  |  |
| 3.0 TDI quattro  | 176   | 05.13           | PR: 1LA,1LJ |                |             |   |                         |   |                         |                  |     |       |             |                |        |                              |                       |                  |     |       |             |                |        |  |                     |         |     |       |             |  |  |  |  |                 |     |       |             |  |  |  |  |         |     |       |             |  |  |  |  |         |     |       |             |  |  |  |  |         |     |       |             |  |  |  |  |                 |     |       |             |  |  |  |  |                 |     |       |             |  |  |  |  |                 |     |       |             |  |  |  |  |                 |     |       |             |  |  |  |  |                 |     |       |             |  |  |  |  |                 |     |       |             |  |  |  |  |               |     |       |             |  |  |  |  |                  |     |       |             |  |  |  |  |                 |     |       |             |                |        |                              |                       |                 |     |       |             |                |        |  |                     |                 |     |       |             |  |  |  |  |                  |     |       |             |  |  |  |  |    |     |       |             |  |  |  |  |    |     |       |             |  |  |  |  |          |     |       |             |                |        |  |                     |          |     |       |             |                |        |  |                     |                  |     |       |             |                |        |  |                       |         |     |       |             |  |  |  |  |                 |     |       |             |  |  |  |  |         |     |       |             |  |  |  |  |         |     |       |             |  |  |  |  |         |     |       |             |  |  |  |  |                 |     |       |             |  |  |  |  |                 |     |       |             |  |  |  |  |                 |     |       |             |  |  |  |  |                 |     |       |             |  |  |  |  |                 |     |       |             |  |  |  |  |                 |     |       |             |  |  |  |  |               |     |       |             |  |  |  |  |                  |     |       |             |  |  |  |  |                 |     |       |             |                |        |  |                     |                 |     |       |             |                |        |  |                       |                 |     |       |             |  |  |  |  |                  |     |       |             |  |  |  |  |    |     |       |             |  |  |  |  |    |     |       |             |  |  |  |  |          |     |       |         |                |        |  |                    |          |     |       |         |                |        |  |                     |                  |     |       |         |  |  |  |  |         |     |       |         |  |  |  |  |                 |     |       |         |  |  |  |  |         |     |       |         |  |  |  |  |         |     |       |         |  |  |  |  |         |     |       |         |  |  |  |  |                 |     |       |         |  |  |  |  |                 |     |       |         |  |  |  |  |                 |     |       |         |  |  |  |  |                 |     |       |         |  |  |  |  |                 |     |       |         |  |  |  |  |                 |     |       |         |  |  |  |  |                 |     |       |         |  |  |  |  |                 |     |       |         |  |  |  |  |                 |     |       |         |  |  |  |  |               |     |       |         |  |  |  |  |                  |     |       |         |  |  |  |  |                  |     |       |         |  |  |  |  |    |     |       |         |  |  |  |  |    |     |       |         |  |  |  |  |          |     |       |         |                |        |  |                       |          |     |       |         |  |  |  |  |                  |     |       |         |  |  |  |  |         |     |       |         |  |  |  |  |                 |     |       |         |  |  |  |  |         |     |       |         |  |  |  |  |         |     |       |         |  |  |  |  |         |     |       |         |  |  |  |  |                 |     |       |         |  |  |  |  |                 |     |       |         |  |  |  |  |                 |     |       |         |  |  |  |  |                 |     |       |         |  |  |  |  |                 |     |       |         |  |  |  |  |                 |     |       |         |  |  |  |  |                 |     |       |         |  |  |  |  |                 |     |       |         |  |  |  |  |
| 3.0 TDI quattro  | 180   | 07.10           | PR: 1LA,1LJ |                |             |   |                         |   |                         |                  |     |       |             |                |        |                              |                       |                  |     |       |             |                |        |  |                     |         |     |       |             |  |  |  |  |                 |     |       |             |  |  |  |  |         |     |       |             |  |  |  |  |         |     |       |             |  |  |  |  |         |     |       |             |  |  |  |  |                 |     |       |             |  |  |  |  |                 |     |       |             |  |  |  |  |                 |     |       |             |  |  |  |  |                 |     |       |             |  |  |  |  |                 |     |       |             |  |  |  |  |                 |     |       |             |  |  |  |  |               |     |       |             |  |  |  |  |                  |     |       |             |  |  |  |  |                 |     |       |             |                |        |                              |                       |                 |     |       |             |                |        |  |                     |                 |     |       |             |  |  |  |  |                  |     |       |             |  |  |  |  |    |     |       |             |  |  |  |  |    |     |       |             |  |  |  |  |          |     |       |             |                |        |  |                     |          |     |       |             |                |        |  |                     |                  |     |       |             |                |        |  |                       |         |     |       |             |  |  |  |  |                 |     |       |             |  |  |  |  |         |     |       |             |  |  |  |  |         |     |       |             |  |  |  |  |         |     |       |             |  |  |  |  |                 |     |       |             |  |  |  |  |                 |     |       |             |  |  |  |  |                 |     |       |             |  |  |  |  |                 |     |       |             |  |  |  |  |                 |     |       |             |  |  |  |  |                 |     |       |             |  |  |  |  |               |     |       |             |  |  |  |  |                  |     |       |             |  |  |  |  |                 |     |       |             |                |        |  |                     |                 |     |       |             |                |        |  |                       |                 |     |       |             |  |  |  |  |                  |     |       |             |  |  |  |  |    |     |       |             |  |  |  |  |    |     |       |             |  |  |  |  |          |     |       |         |                |        |  |                    |          |     |       |         |                |        |  |                     |                  |     |       |         |  |  |  |  |         |     |       |         |  |  |  |  |                 |     |       |         |  |  |  |  |         |     |       |         |  |  |  |  |         |     |       |         |  |  |  |  |         |     |       |         |  |  |  |  |                 |     |       |         |  |  |  |  |                 |     |       |         |  |  |  |  |                 |     |       |         |  |  |  |  |                 |     |       |         |  |  |  |  |                 |     |       |         |  |  |  |  |                 |     |       |         |  |  |  |  |                 |     |       |         |  |  |  |  |                 |     |       |         |  |  |  |  |                 |     |       |         |  |  |  |  |               |     |       |         |  |  |  |  |                  |     |       |         |  |  |  |  |                  |     |       |         |  |  |  |  |    |     |       |         |  |  |  |  |    |     |       |         |  |  |  |  |          |     |       |         |                |        |  |                       |          |     |       |         |  |  |  |  |                  |     |       |         |  |  |  |  |         |     |       |         |  |  |  |  |                 |     |       |         |  |  |  |  |         |     |       |         |  |  |  |  |         |     |       |         |  |  |  |  |         |     |       |         |  |  |  |  |                 |     |       |         |  |  |  |  |                 |     |       |         |  |  |  |  |                 |     |       |         |  |  |  |  |                 |     |       |         |  |  |  |  |                 |     |       |         |  |  |  |  |                 |     |       |         |  |  |  |  |                 |     |       |         |  |  |  |  |                 |     |       |         |  |  |  |  |
| 3.0 TDI quattro  | 200   | 05.14           | PR: 1LA,1LJ |                |             |   |                         |   |                         |                  |     |       |             |                |        |                              |                       |                  |     |       |             |                |        |  |                     |         |     |       |             |  |  |  |  |                 |     |       |             |  |  |  |  |         |     |       |             |  |  |  |  |         |     |       |             |  |  |  |  |         |     |       |             |  |  |  |  |                 |     |       |             |  |  |  |  |                 |     |       |             |  |  |  |  |                 |     |       |             |  |  |  |  |                 |     |       |             |  |  |  |  |                 |     |       |             |  |  |  |  |                 |     |       |             |  |  |  |  |               |     |       |             |  |  |  |  |                  |     |       |             |  |  |  |  |                 |     |       |             |                |        |                              |                       |                 |     |       |             |                |        |  |                     |                 |     |       |             |  |  |  |  |                  |     |       |             |  |  |  |  |    |     |       |             |  |  |  |  |    |     |       |             |  |  |  |  |          |     |       |             |                |        |  |                     |          |     |       |             |                |        |  |                     |                  |     |       |             |                |        |  |                       |         |     |       |             |  |  |  |  |                 |     |       |             |  |  |  |  |         |     |       |             |  |  |  |  |         |     |       |             |  |  |  |  |         |     |       |             |  |  |  |  |                 |     |       |             |  |  |  |  |                 |     |       |             |  |  |  |  |                 |     |       |             |  |  |  |  |                 |     |       |             |  |  |  |  |                 |     |       |             |  |  |  |  |                 |     |       |             |  |  |  |  |               |     |       |             |  |  |  |  |                  |     |       |             |  |  |  |  |                 |     |       |             |                |        |  |                     |                 |     |       |             |                |        |  |                       |                 |     |       |             |  |  |  |  |                  |     |       |             |  |  |  |  |    |     |       |             |  |  |  |  |    |     |       |             |  |  |  |  |          |     |       |         |                |        |  |                    |          |     |       |         |                |        |  |                     |                  |     |       |         |  |  |  |  |         |     |       |         |  |  |  |  |                 |     |       |         |  |  |  |  |         |     |       |         |  |  |  |  |         |     |       |         |  |  |  |  |         |     |       |         |  |  |  |  |                 |     |       |         |  |  |  |  |                 |     |       |         |  |  |  |  |                 |     |       |         |  |  |  |  |                 |     |       |         |  |  |  |  |                 |     |       |         |  |  |  |  |                 |     |       |         |  |  |  |  |                 |     |       |         |  |  |  |  |                 |     |       |         |  |  |  |  |                 |     |       |         |  |  |  |  |               |     |       |         |  |  |  |  |                  |     |       |         |  |  |  |  |                  |     |       |         |  |  |  |  |    |     |       |         |  |  |  |  |    |     |       |         |  |  |  |  |          |     |       |         |                |        |  |                       |          |     |       |         |  |  |  |  |                  |     |       |         |  |  |  |  |         |     |       |         |  |  |  |  |                 |     |       |         |  |  |  |  |         |     |       |         |  |  |  |  |         |     |       |         |  |  |  |  |         |     |       |         |  |  |  |  |                 |     |       |         |  |  |  |  |                 |     |       |         |  |  |  |  |                 |     |       |         |  |  |  |  |                 |     |       |         |  |  |  |  |                 |     |       |         |  |  |  |  |                 |     |       |         |  |  |  |  |                 |     |       |         |  |  |  |  |                 |     |       |         |  |  |  |  |
| 3.0 TDI ultra  | 160   | 05.14           | PR: 1LA,1LJ |                |             |   |                         |   |                         |                  |     |       |             |                |        |                              |                       |                  |     |       |             |                |        |  |                     |         |     |       |             |  |  |  |  |                 |     |       |             |  |  |  |  |         |     |       |             |  |  |  |  |         |     |       |             |  |  |  |  |         |     |       |             |  |  |  |  |                 |     |       |             |  |  |  |  |                 |     |       |             |  |  |  |  |                 |     |       |             |  |  |  |  |                 |     |       |             |  |  |  |  |                 |     |       |             |  |  |  |  |                 |     |       |             |  |  |  |  |               |     |       |             |  |  |  |  |                  |     |       |             |  |  |  |  |                 |     |       |             |                |        |                              |                       |                 |     |       |             |                |        |  |                     |                 |     |       |             |  |  |  |  |                  |     |       |             |  |  |  |  |    |     |       |             |  |  |  |  |    |     |       |             |  |  |  |  |          |     |       |             |                |        |  |                     |          |     |       |             |                |        |  |                     |                  |     |       |             |                |        |  |                       |         |     |       |             |  |  |  |  |                 |     |       |             |  |  |  |  |         |     |       |             |  |  |  |  |         |     |       |             |  |  |  |  |         |     |       |             |  |  |  |  |                 |     |       |             |  |  |  |  |                 |     |       |             |  |  |  |  |                 |     |       |             |  |  |  |  |                 |     |       |             |  |  |  |  |                 |     |       |             |  |  |  |  |                 |     |       |             |  |  |  |  |               |     |       |             |  |  |  |  |                  |     |       |             |  |  |  |  |                 |     |       |             |                |        |  |                     |                 |     |       |             |                |        |  |                       |                 |     |       |             |  |  |  |  |                  |     |       |             |  |  |  |  |    |     |       |             |  |  |  |  |    |     |       |             |  |  |  |  |          |     |       |         |                |        |  |                    |          |     |       |         |                |        |  |                     |                  |     |       |         |  |  |  |  |         |     |       |         |  |  |  |  |                 |     |       |         |  |  |  |  |         |     |       |         |  |  |  |  |         |     |       |         |  |  |  |  |         |     |       |         |  |  |  |  |                 |     |       |         |  |  |  |  |                 |     |       |         |  |  |  |  |                 |     |       |         |  |  |  |  |                 |     |       |         |  |  |  |  |                 |     |       |         |  |  |  |  |                 |     |       |         |  |  |  |  |                 |     |       |         |  |  |  |  |                 |     |       |         |  |  |  |  |                 |     |       |         |  |  |  |  |               |     |       |         |  |  |  |  |                  |     |       |         |  |  |  |  |                  |     |       |         |  |  |  |  |    |     |       |         |  |  |  |  |    |     |       |         |  |  |  |  |          |     |       |         |                |        |  |                       |          |     |       |         |  |  |  |  |                  |     |       |         |  |  |  |  |         |     |       |         |  |  |  |  |                 |     |       |         |  |  |  |  |         |     |       |         |  |  |  |  |         |     |       |         |  |  |  |  |         |     |       |         |  |  |  |  |                 |     |       |         |  |  |  |  |                 |     |       |         |  |  |  |  |                 |     |       |         |  |  |  |  |                 |     |       |         |  |  |  |  |                 |     |       |         |  |  |  |  |                 |     |       |         |  |  |  |  |                 |     |       |         |  |  |  |  |                 |     |       |         |  |  |  |  |
| 3.0 TFSI quattro   | 160   | 07.10           | PR: 1LA,1LJ |                |             |   |                         |   |                         |                  |     |       |             |                |        |                              |                       |                  |     |       |             |                |        |  |                     |         |     |       |             |  |  |  |  |                 |     |       |             |  |  |  |  |         |     |       |             |  |  |  |  |         |     |       |             |  |  |  |  |         |     |       |             |  |  |  |  |                 |     |       |             |  |  |  |  |                 |     |       |             |  |  |  |  |                 |     |       |             |  |  |  |  |                 |     |       |             |  |  |  |  |                 |     |       |             |  |  |  |  |                 |     |       |             |  |  |  |  |               |     |       |             |  |  |  |  |                  |     |       |             |  |  |  |  |                 |     |       |             |                |        |                              |                       |                 |     |       |             |                |        |  |                     |                 |     |       |             |  |  |  |  |                  |     |       |             |  |  |  |  |    |     |       |             |  |  |  |  |    |     |       |             |  |  |  |  |          |     |       |             |                |        |  |                     |          |     |       |             |                |        |  |                     |                  |     |       |             |                |        |  |                       |         |     |       |             |  |  |  |  |                 |     |       |             |  |  |  |  |         |     |       |             |  |  |  |  |         |     |       |             |  |  |  |  |         |     |       |             |  |  |  |  |                 |     |       |             |  |  |  |  |                 |     |       |             |  |  |  |  |                 |     |       |             |  |  |  |  |                 |     |       |             |  |  |  |  |                 |     |       |             |  |  |  |  |                 |     |       |             |  |  |  |  |               |     |       |             |  |  |  |  |                  |     |       |             |  |  |  |  |                 |     |       |             |                |        |  |                     |                 |     |       |             |                |        |  |                       |                 |     |       |             |  |  |  |  |                  |     |       |             |  |  |  |  |    |     |       |             |  |  |  |  |    |     |       |             |  |  |  |  |          |     |       |         |                |        |  |                    |          |     |       |         |                |        |  |                     |                  |     |       |         |  |  |  |  |         |     |       |         |  |  |  |  |                 |     |       |         |  |  |  |  |         |     |       |         |  |  |  |  |         |     |       |         |  |  |  |  |         |     |       |         |  |  |  |  |                 |     |       |         |  |  |  |  |                 |     |       |         |  |  |  |  |                 |     |       |         |  |  |  |  |                 |     |       |         |  |  |  |  |                 |     |       |         |  |  |  |  |                 |     |       |         |  |  |  |  |                 |     |       |         |  |  |  |  |                 |     |       |         |  |  |  |  |                 |     |       |         |  |  |  |  |               |     |       |         |  |  |  |  |                  |     |       |         |  |  |  |  |                  |     |       |         |  |  |  |  |    |     |       |         |  |  |  |  |    |     |       |         |  |  |  |  |          |     |       |         |                |        |  |                       |          |     |       |         |  |  |  |  |                  |     |       |         |  |  |  |  |         |     |       |         |  |  |  |  |                 |     |       |         |  |  |  |  |         |     |       |         |  |  |  |  |         |     |       |         |  |  |  |  |         |     |       |         |  |  |  |  |                 |     |       |         |  |  |  |  |                 |     |       |         |  |  |  |  |                 |     |       |         |  |  |  |  |                 |     |       |         |  |  |  |  |                 |     |       |         |  |  |  |  |                 |     |       |         |  |  |  |  |                 |     |       |         |  |  |  |  |                 |     |       |         |  |  |  |  |
| 3.0 TDI quattro  | 230   | 11.11           | PR: 1LA,1LJ | 13.0460-2765.2 | 602765      | Federmaß 46 mm <sup>2)</sup>              | 24743 19,2 +/WK/S TRW   |   |                         |                  |     |       |             |                |        |                              |                       |                  |     |       |             |                |        |  |                     |         |     |       |             |  |  |  |  |                 |     |       |             |  |  |  |  |         |     |       |             |  |  |  |  |         |     |       |             |  |  |  |  |         |     |       |             |  |  |  |  |                 |     |       |             |  |  |  |  |                 |     |       |             |  |  |  |  |                 |     |       |             |  |  |  |  |                 |     |       |             |  |  |  |  |                 |     |       |             |  |  |  |  |                 |     |       |             |  |  |  |  |               |     |       |             |  |  |  |  |                  |     |       |             |  |  |  |  |                 |     |       |             |                |        |                              |                       |                 |     |       |             |                |        |  |                     |                 |     |       |             |  |  |  |  |                  |     |       |             |  |  |  |  |    |     |       |             |  |  |  |  |    |     |       |             |  |  |  |  |          |     |       |             |                |        |  |                     |          |     |       |             |                |        |  |                     |                  |     |       |             |                |        |  |                       |         |     |       |             |  |  |  |  |                 |     |       |             |  |  |  |  |         |     |       |             |  |  |  |  |         |     |       |             |  |  |  |  |         |     |       |             |  |  |  |  |                 |     |       |             |  |  |  |  |                 |     |       |             |  |  |  |  |                 |     |       |             |  |  |  |  |                 |     |       |             |  |  |  |  |                 |     |       |             |  |  |  |  |                 |     |       |             |  |  |  |  |               |     |       |             |  |  |  |  |                  |     |       |             |  |  |  |  |                 |     |       |             |                |        |  |                     |                 |     |       |             |                |        |  |                       |                 |     |       |             |  |  |  |  |                  |     |       |             |  |  |  |  |    |     |       |             |  |  |  |  |    |     |       |             |  |  |  |  |          |     |       |         |                |        |  |                    |          |     |       |         |                |        |  |                     |                  |     |       |         |  |  |  |  |         |     |       |         |  |  |  |  |                 |     |       |         |  |  |  |  |         |     |       |         |  |  |  |  |         |     |       |         |  |  |  |  |         |     |       |         |  |  |  |  |                 |     |       |         |  |  |  |  |                 |     |       |         |  |  |  |  |                 |     |       |         |  |  |  |  |                 |     |       |         |  |  |  |  |                 |     |       |         |  |  |  |  |                 |     |       |         |  |  |  |  |                 |     |       |         |  |  |  |  |                 |     |       |         |  |  |  |  |                 |     |       |         |  |  |  |  |               |     |       |         |  |  |  |  |                  |     |       |         |  |  |  |  |                  |     |       |         |  |  |  |  |    |     |       |         |  |  |  |  |    |     |       |         |  |  |  |  |          |     |       |         |                |        |  |                       |          |     |       |         |  |  |  |  |                  |     |       |         |  |  |  |  |         |     |       |         |  |  |  |  |                 |     |       |         |  |  |  |  |         |     |       |         |  |  |  |  |         |     |       |         |  |  |  |  |         |     |       |         |  |  |  |  |                 |     |       |         |  |  |  |  |                 |     |       |         |  |  |  |  |                 |     |       |         |  |  |  |  |                 |     |       |         |  |  |  |  |                 |     |       |         |  |  |  |  |                 |     |       |         |  |  |  |  |                 |     |       |         |  |  |  |  |                 |     |       |         |  |  |  |  |
| 3.0 TDI quattro  | 235   | 05.14           | PR: 1LA,1LJ | 24.8190-0311.2 | 620311      |   | Warnkontakt L=300mm     |   |                         |                  |     |       |             |                |        |                              |                       |                  |     |       |             |                |        |  |                     |         |     |       |             |  |  |  |  |                 |     |       |             |  |  |  |  |         |     |       |             |  |  |  |  |         |     |       |             |  |  |  |  |         |     |       |             |  |  |  |  |                 |     |       |             |  |  |  |  |                 |     |       |             |  |  |  |  |                 |     |       |             |  |  |  |  |                 |     |       |             |  |  |  |  |                 |     |       |             |  |  |  |  |                 |     |       |             |  |  |  |  |               |     |       |             |  |  |  |  |                  |     |       |             |  |  |  |  |                 |     |       |             |                |        |                              |                       |                 |     |       |             |                |        |  |                     |                 |     |       |             |  |  |  |  |                  |     |       |             |  |  |  |  |    |     |       |             |  |  |  |  |    |     |       |             |  |  |  |  |          |     |       |             |                |        |  |                     |          |     |       |             |                |        |  |                     |                  |     |       |             |                |        |  |                       |         |     |       |             |  |  |  |  |                 |     |       |             |  |  |  |  |         |     |       |             |  |  |  |  |         |     |       |             |  |  |  |  |         |     |       |             |  |  |  |  |                 |     |       |             |  |  |  |  |                 |     |       |             |  |  |  |  |                 |     |       |             |  |  |  |  |                 |     |       |             |  |  |  |  |                 |     |       |             |  |  |  |  |                 |     |       |             |  |  |  |  |               |     |       |             |  |  |  |  |                  |     |       |             |  |  |  |  |                 |     |       |             |                |        |  |                     |                 |     |       |             |                |        |  |                       |                 |     |       |             |  |  |  |  |                  |     |       |             |  |  |  |  |    |     |       |             |  |  |  |  |    |     |       |             |  |  |  |  |          |     |       |         |                |        |  |                    |          |     |       |         |                |        |  |                     |                  |     |       |         |  |  |  |  |         |     |       |         |  |  |  |  |                 |     |       |         |  |  |  |  |         |     |       |         |  |  |  |  |         |     |       |         |  |  |  |  |         |     |       |         |  |  |  |  |                 |     |       |         |  |  |  |  |                 |     |       |         |  |  |  |  |                 |     |       |         |  |  |  |  |                 |     |       |         |  |  |  |  |                 |     |       |         |  |  |  |  |                 |     |       |         |  |  |  |  |                 |     |       |         |  |  |  |  |                 |     |       |         |  |  |  |  |                 |     |       |         |  |  |  |  |               |     |       |         |  |  |  |  |                  |     |       |         |  |  |  |  |                  |     |       |         |  |  |  |  |    |     |       |         |  |  |  |  |    |     |       |         |  |  |  |  |          |     |       |         |                |        |  |                       |          |     |       |         |  |  |  |  |                  |     |       |         |  |  |  |  |         |     |       |         |  |  |  |  |                 |     |       |         |  |  |  |  |         |     |       |         |  |  |  |  |         |     |       |         |  |  |  |  |         |     |       |         |  |  |  |  |                 |     |       |         |  |  |  |  |                 |     |       |         |  |  |  |  |                 |     |       |         |  |  |  |  |                 |     |       |         |  |  |  |  |                 |     |       |         |  |  |  |  |                 |     |       |         |  |  |  |  |                 |     |       |         |  |  |  |  |                 |     |       |         |  |  |  |  |
| 3.0 TDI quattro  | 240   | 08.14           | PR: 1LA,1LJ |                |             |   |                         |   |                         |                  |     |       |             |                |        |                              |                       |                  |     |       |             |                |        |  |                     |         |     |       |             |  |  |  |  |                 |     |       |             |  |  |  |  |         |     |       |             |  |  |  |  |         |     |       |             |  |  |  |  |         |     |       |             |  |  |  |  |                 |     |       |             |  |  |  |  |                 |     |       |             |  |  |  |  |                 |     |       |             |  |  |  |  |                 |     |       |             |  |  |  |  |                 |     |       |             |  |  |  |  |                 |     |       |             |  |  |  |  |               |     |       |             |  |  |  |  |                  |     |       |             |  |  |  |  |                 |     |       |             |                |        |                              |                       |                 |     |       |             |                |        |  |                     |                 |     |       |             |  |  |  |  |                  |     |       |             |  |  |  |  |    |     |       |             |  |  |  |  |    |     |       |             |  |  |  |  |          |     |       |             |                |        |  |                     |          |     |       |             |                |        |  |                     |                  |     |       |             |                |        |  |                       |         |     |       |             |  |  |  |  |                 |     |       |             |  |  |  |  |         |     |       |             |  |  |  |  |         |     |       |             |  |  |  |  |         |     |       |             |  |  |  |  |                 |     |       |             |  |  |  |  |                 |     |       |             |  |  |  |  |                 |     |       |             |  |  |  |  |                 |     |       |             |  |  |  |  |                 |     |       |             |  |  |  |  |                 |     |       |             |  |  |  |  |               |     |       |             |  |  |  |  |                  |     |       |             |  |  |  |  |                 |     |       |             |                |        |  |                     |                 |     |       |             |                |        |  |                       |                 |     |       |             |  |  |  |  |                  |     |       |             |  |  |  |  |    |     |       |             |  |  |  |  |    |     |       |             |  |  |  |  |          |     |       |         |                |        |  |                    |          |     |       |         |                |        |  |                     |                  |     |       |         |  |  |  |  |         |     |       |         |  |  |  |  |                 |     |       |         |  |  |  |  |         |     |       |         |  |  |  |  |         |     |       |         |  |  |  |  |         |     |       |         |  |  |  |  |                 |     |       |         |  |  |  |  |                 |     |       |         |  |  |  |  |                 |     |       |         |  |  |  |  |                 |     |       |         |  |  |  |  |                 |     |       |         |  |  |  |  |                 |     |       |         |  |  |  |  |                 |     |       |         |  |  |  |  |                 |     |       |         |  |  |  |  |                 |     |       |         |  |  |  |  |               |     |       |         |  |  |  |  |                  |     |       |         |  |  |  |  |                  |     |       |         |  |  |  |  |    |     |       |         |  |  |  |  |    |     |       |         |  |  |  |  |          |     |       |         |                |        |  |                       |          |     |       |         |  |  |  |  |                  |     |       |         |  |  |  |  |         |     |       |         |  |  |  |  |                 |     |       |         |  |  |  |  |         |     |       |         |  |  |  |  |         |     |       |         |  |  |  |  |         |     |       |         |  |  |  |  |                 |     |       |         |  |  |  |  |                 |     |       |         |  |  |  |  |                 |     |       |         |  |  |  |  |                 |     |       |         |  |  |  |  |                 |     |       |         |  |  |  |  |                 |     |       |         |  |  |  |  |                 |     |       |         |  |  |  |  |                 |     |       |         |  |  |  |  |
| 3.0 TFSI quattro   | 245   | 05.14           | PR: 1LA,1LJ |                |             |   |                         |   |                         |                  |     |       |             |                |        |                              |                       |                  |     |       |             |                |        |  |                     |         |     |       |             |  |  |  |  |                 |     |       |             |  |  |  |  |         |     |       |             |  |  |  |  |         |     |       |             |  |  |  |  |         |     |       |             |  |  |  |  |                 |     |       |             |  |  |  |  |                 |     |       |             |  |  |  |  |                 |     |       |             |  |  |  |  |                 |     |       |             |  |  |  |  |                 |     |       |             |  |  |  |  |                 |     |       |             |  |  |  |  |               |     |       |             |  |  |  |  |                  |     |       |             |  |  |  |  |                 |     |       |             |                |        |                              |                       |                 |     |       |             |                |        |  |                     |                 |     |       |             |  |  |  |  |                  |     |       |             |  |  |  |  |    |     |       |             |  |  |  |  |    |     |       |             |  |  |  |  |          |     |       |             |                |        |  |                     |          |     |       |             |                |        |  |                     |                  |     |       |             |                |        |  |                       |         |     |       |             |  |  |  |  |                 |     |       |             |  |  |  |  |         |     |       |             |  |  |  |  |         |     |       |             |  |  |  |  |         |     |       |             |  |  |  |  |                 |     |       |             |  |  |  |  |                 |     |       |             |  |  |  |  |                 |     |       |             |  |  |  |  |                 |     |       |             |  |  |  |  |                 |     |       |             |  |  |  |  |                 |     |       |             |  |  |  |  |               |     |       |             |  |  |  |  |                  |     |       |             |  |  |  |  |                 |     |       |             |                |        |  |                     |                 |     |       |             |                |        |  |                       |                 |     |       |             |  |  |  |  |                  |     |       |             |  |  |  |  |    |     |       |             |  |  |  |  |    |     |       |             |  |  |  |  |          |     |       |         |                |        |  |                    |          |     |       |         |                |        |  |                     |                  |     |       |         |  |  |  |  |         |     |       |         |  |  |  |  |                 |     |       |         |  |  |  |  |         |     |       |         |  |  |  |  |         |     |       |         |  |  |  |  |         |     |       |         |  |  |  |  |                 |     |       |         |  |  |  |  |                 |     |       |         |  |  |  |  |                 |     |       |         |  |  |  |  |                 |     |       |         |  |  |  |  |                 |     |       |         |  |  |  |  |                 |     |       |         |  |  |  |  |                 |     |       |         |  |  |  |  |                 |     |       |         |  |  |  |  |                 |     |       |         |  |  |  |  |               |     |       |         |  |  |  |  |                  |     |       |         |  |  |  |  |                  |     |       |         |  |  |  |  |    |     |       |         |  |  |  |  |    |     |       |         |  |  |  |  |          |     |       |         |                |        |  |                       |          |     |       |         |  |  |  |  |                  |     |       |         |  |  |  |  |         |     |       |         |  |  |  |  |                 |     |       |         |  |  |  |  |         |     |       |         |  |  |  |  |         |     |       |         |  |  |  |  |         |     |       |         |  |  |  |  |                 |     |       |         |  |  |  |  |                 |     |       |         |  |  |  |  |                 |     |       |         |  |  |  |  |                 |     |       |         |  |  |  |  |                 |     |       |         |  |  |  |  |                 |     |       |         |  |  |  |  |                 |     |       |         |  |  |  |  |                 |     |       |         |  |  |  |  |
| S7   | 309   | 10.11           | PR: 1LA,1LJ |                |             |   |                         |   |                         |                  |     |       |             |                |        |                              |                       |                  |     |       |             |                |        |  |                     |         |     |       |             |  |  |  |  |                 |     |       |             |  |  |  |  |         |     |       |             |  |  |  |  |         |     |       |             |  |  |  |  |         |     |       |             |  |  |  |  |                 |     |       |             |  |  |  |  |                 |     |       |             |  |  |  |  |                 |     |       |             |  |  |  |  |                 |     |       |             |  |  |  |  |                 |     |       |             |  |  |  |  |                 |     |       |             |  |  |  |  |               |     |       |             |  |  |  |  |                  |     |       |             |  |  |  |  |                 |     |       |             |                |        |                              |                       |                 |     |       |             |                |        |  |                     |                 |     |       |             |  |  |  |  |                  |     |       |             |  |  |  |  |    |     |       |             |  |  |  |  |    |     |       |             |  |  |  |  |          |     |       |             |                |        |  |                     |          |     |       |             |                |        |  |                     |                  |     |       |             |                |        |  |                       |         |     |       |             |  |  |  |  |                 |     |       |             |  |  |  |  |         |     |       |             |  |  |  |  |         |     |       |             |  |  |  |  |         |     |       |             |  |  |  |  |                 |     |       |             |  |  |  |  |                 |     |       |             |  |  |  |  |                 |     |       |             |  |  |  |  |                 |     |       |             |  |  |  |  |                 |     |       |             |  |  |  |  |                 |     |       |             |  |  |  |  |               |     |       |             |  |  |  |  |                  |     |       |             |  |  |  |  |                 |     |       |             |                |        |  |                     |                 |     |       |             |                |        |  |                       |                 |     |       |             |  |  |  |  |                  |     |       |             |  |  |  |  |    |     |       |             |  |  |  |  |    |     |       |             |  |  |  |  |          |     |       |         |                |        |  |                    |          |     |       |         |                |        |  |                     |                  |     |       |         |  |  |  |  |         |     |       |         |  |  |  |  |                 |     |       |         |  |  |  |  |         |     |       |         |  |  |  |  |         |     |       |         |  |  |  |  |         |     |       |         |  |  |  |  |                 |     |       |         |  |  |  |  |                 |     |       |         |  |  |  |  |                 |     |       |         |  |  |  |  |                 |     |       |         |  |  |  |  |                 |     |       |         |  |  |  |  |                 |     |       |         |  |  |  |  |                 |     |       |         |  |  |  |  |                 |     |       |         |  |  |  |  |                 |     |       |         |  |  |  |  |               |     |       |         |  |  |  |  |                  |     |       |         |  |  |  |  |                  |     |       |         |  |  |  |  |    |     |       |         |  |  |  |  |    |     |       |         |  |  |  |  |          |     |       |         |                |        |  |                       |          |     |       |         |  |  |  |  |                  |     |       |         |  |  |  |  |         |     |       |         |  |  |  |  |                 |     |       |         |  |  |  |  |         |     |       |         |  |  |  |  |         |     |       |         |  |  |  |  |         |     |       |         |  |  |  |  |                 |     |       |         |  |  |  |  |                 |     |       |         |  |  |  |  |                 |     |       |         |  |  |  |  |                 |     |       |         |  |  |  |  |                 |     |       |         |  |  |  |  |                 |     |       |         |  |  |  |  |                 |     |       |         |  |  |  |  |                 |     |       |         |  |  |  |  |
| S7   | 331   | 05.14           | PR: 1LA,1LJ |                |             |   |                         |   |                         |                  |     |       |             |                |        |                              |                       |                  |     |       |             |                |        |  |                     |         |     |       |             |  |  |  |  |                 |     |       |             |  |  |  |  |         |     |       |             |  |  |  |  |         |     |       |             |  |  |  |  |         |     |       |             |  |  |  |  |                 |     |       |             |  |  |  |  |                 |     |       |             |  |  |  |  |                 |     |       |             |  |  |  |  |                 |     |       |             |  |  |  |  |                 |     |       |             |  |  |  |  |                 |     |       |             |  |  |  |  |               |     |       |             |  |  |  |  |                  |     |       |             |  |  |  |  |                 |     |       |             |                |        |                              |                       |                 |     |       |             |                |        |  |                     |                 |     |       |             |  |  |  |  |                  |     |       |             |  |  |  |  |    |     |       |             |  |  |  |  |    |     |       |             |  |  |  |  |          |     |       |             |                |        |  |                     |          |     |       |             |                |        |  |                     |                  |     |       |             |                |        |  |                       |         |     |       |             |  |  |  |  |                 |     |       |             |  |  |  |  |         |     |       |             |  |  |  |  |         |     |       |             |  |  |  |  |         |     |       |             |  |  |  |  |                 |     |       |             |  |  |  |  |                 |     |       |             |  |  |  |  |                 |     |       |             |  |  |  |  |                 |     |       |             |  |  |  |  |                 |     |       |             |  |  |  |  |                 |     |       |             |  |  |  |  |               |     |       |             |  |  |  |  |                  |     |       |             |  |  |  |  |                 |     |       |             |                |        |  |                     |                 |     |       |             |                |        |  |                       |                 |     |       |             |  |  |  |  |                  |     |       |             |  |  |  |  |    |     |       |             |  |  |  |  |    |     |       |             |  |  |  |  |          |     |       |         |                |        |  |                    |          |     |       |         |                |        |  |                     |                  |     |       |         |  |  |  |  |         |     |       |         |  |  |  |  |                 |     |       |         |  |  |  |  |         |     |       |         |  |  |  |  |         |     |       |         |  |  |  |  |         |     |       |         |  |  |  |  |                 |     |       |         |  |  |  |  |                 |     |       |         |  |  |  |  |                 |     |       |         |  |  |  |  |                 |     |       |         |  |  |  |  |                 |     |       |         |  |  |  |  |                 |     |       |         |  |  |  |  |                 |     |       |         |  |  |  |  |                 |     |       |         |  |  |  |  |                 |     |       |         |  |  |  |  |               |     |       |         |  |  |  |  |                  |     |       |         |  |  |  |  |                  |     |       |         |  |  |  |  |    |     |       |         |  |  |  |  |    |     |       |         |  |  |  |  |          |     |       |         |                |        |  |                       |          |     |       |         |  |  |  |  |                  |     |       |         |  |  |  |  |         |     |       |         |  |  |  |  |                 |     |       |         |  |  |  |  |         |     |       |         |  |  |  |  |         |     |       |         |  |  |  |  |         |     |       |         |  |  |  |  |                 |     |       |         |  |  |  |  |                 |     |       |         |  |  |  |  |                 |     |       |         |  |  |  |  |                 |     |       |         |  |  |  |  |                 |     |       |         |  |  |  |  |                 |     |       |         |  |  |  |  |                 |     |       |         |  |  |  |  |                 |     |       |         |  |  |  |  |
| 1.8 TFSI   | 140   | 04.15           | PR: 1LL,1LF | 13.0460-7280.2 | 607280      |   | 25158 20,3 +/WK ATE     |   |                         |                  |     |       |             |                |        |                              |                       |                  |     |       |             |                |        |  |                     |         |     |       |             |  |  |  |  |                 |     |       |             |  |  |  |  |         |     |       |             |  |  |  |  |         |     |       |             |  |  |  |  |         |     |       |             |  |  |  |  |                 |     |       |             |  |  |  |  |                 |     |       |             |  |  |  |  |                 |     |       |             |  |  |  |  |                 |     |       |             |  |  |  |  |                 |     |       |             |  |  |  |  |                 |     |       |             |  |  |  |  |               |     |       |             |  |  |  |  |                  |     |       |             |  |  |  |  |                 |     |       |             |                |        |                              |                       |                 |     |       |             |                |        |  |                     |                 |     |       |             |  |  |  |  |                  |     |       |             |  |  |  |  |    |     |       |             |  |  |  |  |    |     |       |             |  |  |  |  |          |     |       |             |                |        |  |                     |          |     |       |             |                |        |  |                     |                  |     |       |             |                |        |  |                       |         |     |       |             |  |  |  |  |                 |     |       |             |  |  |  |  |         |     |       |             |  |  |  |  |         |     |       |             |  |  |  |  |         |     |       |             |  |  |  |  |                 |     |       |             |  |  |  |  |                 |     |       |             |  |  |  |  |                 |     |       |             |  |  |  |  |                 |     |       |             |  |  |  |  |                 |     |       |             |  |  |  |  |                 |     |       |             |  |  |  |  |               |     |       |             |  |  |  |  |                  |     |       |             |  |  |  |  |                 |     |       |             |                |        |  |                     |                 |     |       |             |                |        |  |                       |                 |     |       |             |  |  |  |  |                  |     |       |             |  |  |  |  |    |     |       |             |  |  |  |  |    |     |       |             |  |  |  |  |          |     |       |         |                |        |  |                    |          |     |       |         |                |        |  |                     |                  |     |       |         |  |  |  |  |         |     |       |         |  |  |  |  |                 |     |       |         |  |  |  |  |         |     |       |         |  |  |  |  |         |     |       |         |  |  |  |  |         |     |       |         |  |  |  |  |                 |     |       |         |  |  |  |  |                 |     |       |         |  |  |  |  |                 |     |       |         |  |  |  |  |                 |     |       |         |  |  |  |  |                 |     |       |         |  |  |  |  |                 |     |       |         |  |  |  |  |                 |     |       |         |  |  |  |  |                 |     |       |         |  |  |  |  |                 |     |       |         |  |  |  |  |               |     |       |         |  |  |  |  |                  |     |       |         |  |  |  |  |                  |     |       |         |  |  |  |  |    |     |       |         |  |  |  |  |    |     |       |         |  |  |  |  |          |     |       |         |                |        |  |                       |          |     |       |         |  |  |  |  |                  |     |       |         |  |  |  |  |         |     |       |         |  |  |  |  |                 |     |       |         |  |  |  |  |         |     |       |         |  |  |  |  |         |     |       |         |  |  |  |  |         |     |       |         |  |  |  |  |                 |     |       |         |  |  |  |  |                 |     |       |         |  |  |  |  |                 |     |       |         |  |  |  |  |                 |     |       |         |  |  |  |  |                 |     |       |         |  |  |  |  |                 |     |       |         |  |  |  |  |                 |     |       |         |  |  |  |  |                 |     |       |         |  |  |  |  |
| 2.0 TFSI   | 185   | 09.14           | PR: 1LL,1LF | 13.0470-7280.2 | LD7280      |   | 25158 20,3 +/WK ATE     |   |                         |                  |     |       |             |                |        |                              |                       |                  |     |       |             |                |        |  |                     |         |     |       |             |  |  |  |  |                 |     |       |             |  |  |  |  |         |     |       |             |  |  |  |  |         |     |       |             |  |  |  |  |         |     |       |             |  |  |  |  |                 |     |       |             |  |  |  |  |                 |     |       |             |  |  |  |  |                 |     |       |             |  |  |  |  |                 |     |       |             |  |  |  |  |                 |     |       |             |  |  |  |  |                 |     |       |             |  |  |  |  |               |     |       |             |  |  |  |  |                  |     |       |             |  |  |  |  |                 |     |       |             |                |        |                              |                       |                 |     |       |             |                |        |  |                     |                 |     |       |             |  |  |  |  |                  |     |       |             |  |  |  |  |    |     |       |             |  |  |  |  |    |     |       |             |  |  |  |  |          |     |       |             |                |        |  |                     |          |     |       |             |                |        |  |                     |                  |     |       |             |                |        |  |                       |         |     |       |             |  |  |  |  |                 |     |       |             |  |  |  |  |         |     |       |             |  |  |  |  |         |     |       |             |  |  |  |  |         |     |       |             |  |  |  |  |                 |     |       |             |  |  |  |  |                 |     |       |             |  |  |  |  |                 |     |       |             |  |  |  |  |                 |     |       |             |  |  |  |  |                 |     |       |             |  |  |  |  |                 |     |       |             |  |  |  |  |               |     |       |             |  |  |  |  |                  |     |       |             |  |  |  |  |                 |     |       |             |                |        |  |                     |                 |     |       |             |                |        |  |                       |                 |     |       |             |  |  |  |  |                  |     |       |             |  |  |  |  |    |     |       |             |  |  |  |  |    |     |       |             |  |  |  |  |          |     |       |         |                |        |  |                    |          |     |       |         |                |        |  |                     |                  |     |       |         |  |  |  |  |         |     |       |         |  |  |  |  |                 |     |       |         |  |  |  |  |         |     |       |         |  |  |  |  |         |     |       |         |  |  |  |  |         |     |       |         |  |  |  |  |                 |     |       |         |  |  |  |  |                 |     |       |         |  |  |  |  |                 |     |       |         |  |  |  |  |                 |     |       |         |  |  |  |  |                 |     |       |         |  |  |  |  |                 |     |       |         |  |  |  |  |                 |     |       |         |  |  |  |  |                 |     |       |         |  |  |  |  |                 |     |       |         |  |  |  |  |               |     |       |         |  |  |  |  |                  |     |       |         |  |  |  |  |                  |     |       |         |  |  |  |  |    |     |       |         |  |  |  |  |    |     |       |         |  |  |  |  |          |     |       |         |                |        |  |                       |          |     |       |         |  |  |  |  |                  |     |       |         |  |  |  |  |         |     |       |         |  |  |  |  |                 |     |       |         |  |  |  |  |         |     |       |         |  |  |  |  |         |     |       |         |  |  |  |  |         |     |       |         |  |  |  |  |                 |     |       |         |  |  |  |  |                 |     |       |         |  |  |  |  |                 |     |       |         |  |  |  |  |                 |     |       |         |  |  |  |  |                 |     |       |         |  |  |  |  |                 |     |       |         |  |  |  |  |                 |     |       |         |  |  |  |  |                 |     |       |         |  |  |  |  |
| 2.0 TFSI quattro   | 185   | 05.15           | PR: 1LL,1LF | 24.8190-0301.2 | 620301      |   | Warnkontakt L=311,6mm   |   |                         |                  |     |       |             |                |        |                              |                       |                  |     |       |             |                |        |  |                     |         |     |       |             |  |  |  |  |                 |     |       |             |  |  |  |  |         |     |       |             |  |  |  |  |         |     |       |             |  |  |  |  |         |     |       |             |  |  |  |  |                 |     |       |             |  |  |  |  |                 |     |       |             |  |  |  |  |                 |     |       |             |  |  |  |  |                 |     |       |             |  |  |  |  |                 |     |       |             |  |  |  |  |                 |     |       |             |  |  |  |  |               |     |       |             |  |  |  |  |                  |     |       |             |  |  |  |  |                 |     |       |             |                |        |                              |                       |                 |     |       |             |                |        |  |                     |                 |     |       |             |  |  |  |  |                  |     |       |             |  |  |  |  |    |     |       |             |  |  |  |  |    |     |       |             |  |  |  |  |          |     |       |             |                |        |  |                     |          |     |       |             |                |        |  |                     |                  |     |       |             |                |        |  |                       |         |     |       |             |  |  |  |  |                 |     |       |             |  |  |  |  |         |     |       |             |  |  |  |  |         |     |       |             |  |  |  |  |         |     |       |             |  |  |  |  |                 |     |       |             |  |  |  |  |                 |     |       |             |  |  |  |  |                 |     |       |             |  |  |  |  |                 |     |       |             |  |  |  |  |                 |     |       |             |  |  |  |  |                 |     |       |             |  |  |  |  |               |     |       |             |  |  |  |  |                  |     |       |             |  |  |  |  |                 |     |       |             |                |        |  |                     |                 |     |       |             |                |        |  |                       |                 |     |       |             |  |  |  |  |                  |     |       |             |  |  |  |  |    |     |       |             |  |  |  |  |    |     |       |             |  |  |  |  |          |     |       |         |                |        |  |                    |          |     |       |         |                |        |  |                     |                  |     |       |         |  |  |  |  |         |     |       |         |  |  |  |  |                 |     |       |         |  |  |  |  |         |     |       |         |  |  |  |  |         |     |       |         |  |  |  |  |         |     |       |         |  |  |  |  |                 |     |       |         |  |  |  |  |                 |     |       |         |  |  |  |  |                 |     |       |         |  |  |  |  |                 |     |       |         |  |  |  |  |                 |     |       |         |  |  |  |  |                 |     |       |         |  |  |  |  |                 |     |       |         |  |  |  |  |                 |     |       |         |  |  |  |  |                 |     |       |         |  |  |  |  |               |     |       |         |  |  |  |  |                  |     |       |         |  |  |  |  |                  |     |       |         |  |  |  |  |    |     |       |         |  |  |  |  |    |     |       |         |  |  |  |  |          |     |       |         |                |        |  |                       |          |     |       |         |  |  |  |  |                  |     |       |         |  |  |  |  |         |     |       |         |  |  |  |  |                 |     |       |         |  |  |  |  |         |     |       |         |  |  |  |  |         |     |       |         |  |  |  |  |         |     |       |         |  |  |  |  |                 |     |       |         |  |  |  |  |                 |     |       |         |  |  |  |  |                 |     |       |         |  |  |  |  |                 |     |       |         |  |  |  |  |                 |     |       |         |  |  |  |  |                 |     |       |         |  |  |  |  |                 |     |       |         |  |  |  |  |                 |     |       |         |  |  |  |  |
| 2.8 FSI  | 150   | 05.11           | PR: 1LL,1LF |                |             |   |                         |   |                         |                  |     |       |             |                |        |                              |                       |                  |     |       |             |                |        |  |                     |         |     |       |             |  |  |  |  |                 |     |       |             |  |  |  |  |         |     |       |             |  |  |  |  |         |     |       |             |  |  |  |  |         |     |       |             |  |  |  |  |                 |     |       |             |  |  |  |  |                 |     |       |             |  |  |  |  |                 |     |       |             |  |  |  |  |                 |     |       |             |  |  |  |  |                 |     |       |             |  |  |  |  |                 |     |       |             |  |  |  |  |               |     |       |             |  |  |  |  |                  |     |       |             |  |  |  |  |                 |     |       |             |                |        |                              |                       |                 |     |       |             |                |        |  |                     |                 |     |       |             |  |  |  |  |                  |     |       |             |  |  |  |  |    |     |       |             |  |  |  |  |    |     |       |             |  |  |  |  |          |     |       |             |                |        |  |                     |          |     |       |             |                |        |  |                     |                  |     |       |             |                |        |  |                       |         |     |       |             |  |  |  |  |                 |     |       |             |  |  |  |  |         |     |       |             |  |  |  |  |         |     |       |             |  |  |  |  |         |     |       |             |  |  |  |  |                 |     |       |             |  |  |  |  |                 |     |       |             |  |  |  |  |                 |     |       |             |  |  |  |  |                 |     |       |             |  |  |  |  |                 |     |       |             |  |  |  |  |                 |     |       |             |  |  |  |  |               |     |       |             |  |  |  |  |                  |     |       |             |  |  |  |  |                 |     |       |             |                |        |  |                     |                 |     |       |             |                |        |  |                       |                 |     |       |             |  |  |  |  |                  |     |       |             |  |  |  |  |    |     |       |             |  |  |  |  |    |     |       |             |  |  |  |  |          |     |       |         |                |        |  |                    |          |     |       |         |                |        |  |                     |                  |     |       |         |  |  |  |  |         |     |       |         |  |  |  |  |                 |     |       |         |  |  |  |  |         |     |       |         |  |  |  |  |         |     |       |         |  |  |  |  |         |     |       |         |  |  |  |  |                 |     |       |         |  |  |  |  |                 |     |       |         |  |  |  |  |                 |     |       |         |  |  |  |  |                 |     |       |         |  |  |  |  |                 |     |       |         |  |  |  |  |                 |     |       |         |  |  |  |  |                 |     |       |         |  |  |  |  |                 |     |       |         |  |  |  |  |                 |     |       |         |  |  |  |  |               |     |       |         |  |  |  |  |                  |     |       |         |  |  |  |  |                  |     |       |         |  |  |  |  |    |     |       |         |  |  |  |  |    |     |       |         |  |  |  |  |          |     |       |         |                |        |  |                       |          |     |       |         |  |  |  |  |                  |     |       |         |  |  |  |  |         |     |       |         |  |  |  |  |                 |     |       |         |  |  |  |  |         |     |       |         |  |  |  |  |         |     |       |         |  |  |  |  |         |     |       |         |  |  |  |  |                 |     |       |         |  |  |  |  |                 |     |       |         |  |  |  |  |                 |     |       |         |  |  |  |  |                 |     |       |         |  |  |  |  |                 |     |       |         |  |  |  |  |                 |     |       |         |  |  |  |  |                 |     |       |         |  |  |  |  |                 |     |       |         |  |  |  |  |
| 2.8 FSI quattro  | 150   | 07.10           | PR: 1LL,1LF |                |             |   |                         |   |                         |                  |     |       |             |                |        |                              |                       |                  |     |       |             |                |        |  |                     |         |     |       |             |  |  |  |  |                 |     |       |             |  |  |  |  |         |     |       |             |  |  |  |  |         |     |       |             |  |  |  |  |         |     |       |             |  |  |  |  |                 |     |       |             |  |  |  |  |                 |     |       |             |  |  |  |  |                 |     |       |             |  |  |  |  |                 |     |       |             |  |  |  |  |                 |     |       |             |  |  |  |  |                 |     |       |             |  |  |  |  |               |     |       |             |  |  |  |  |                  |     |       |             |  |  |  |  |                 |     |       |             |                |        |                              |                       |                 |     |       |             |                |        |  |                     |                 |     |       |             |  |  |  |  |                  |     |       |             |  |  |  |  |    |     |       |             |  |  |  |  |    |     |       |             |  |  |  |  |          |     |       |             |                |        |  |                     |          |     |       |             |                |        |  |                     |                  |     |       |             |                |        |  |                       |         |     |       |             |  |  |  |  |                 |     |       |             |  |  |  |  |         |     |       |             |  |  |  |  |         |     |       |             |  |  |  |  |         |     |       |             |  |  |  |  |                 |     |       |             |  |  |  |  |                 |     |       |             |  |  |  |  |                 |     |       |             |  |  |  |  |                 |     |       |             |  |  |  |  |                 |     |       |             |  |  |  |  |                 |     |       |             |  |  |  |  |               |     |       |             |  |  |  |  |                  |     |       |             |  |  |  |  |                 |     |       |             |                |        |  |                     |                 |     |       |             |                |        |  |                       |                 |     |       |             |  |  |  |  |                  |     |       |             |  |  |  |  |    |     |       |             |  |  |  |  |    |     |       |             |  |  |  |  |          |     |       |         |                |        |  |                    |          |     |       |         |                |        |  |                     |                  |     |       |         |  |  |  |  |         |     |       |         |  |  |  |  |                 |     |       |         |  |  |  |  |         |     |       |         |  |  |  |  |         |     |       |         |  |  |  |  |         |     |       |         |  |  |  |  |                 |     |       |         |  |  |  |  |                 |     |       |         |  |  |  |  |                 |     |       |         |  |  |  |  |                 |     |       |         |  |  |  |  |                 |     |       |         |  |  |  |  |                 |     |       |         |  |  |  |  |                 |     |       |         |  |  |  |  |                 |     |       |         |  |  |  |  |                 |     |       |         |  |  |  |  |               |     |       |         |  |  |  |  |                  |     |       |         |  |  |  |  |                  |     |       |         |  |  |  |  |    |     |       |         |  |  |  |  |    |     |       |         |  |  |  |  |          |     |       |         |                |        |  |                       |          |     |       |         |  |  |  |  |                  |     |       |         |  |  |  |  |         |     |       |         |  |  |  |  |                 |     |       |         |  |  |  |  |         |     |       |         |  |  |  |  |         |     |       |         |  |  |  |  |         |     |       |         |  |  |  |  |                 |     |       |         |  |  |  |  |                 |     |       |         |  |  |  |  |                 |     |       |         |  |  |  |  |                 |     |       |         |  |  |  |  |                 |     |       |         |  |  |  |  |                 |     |       |         |  |  |  |  |                 |     |       |         |  |  |  |  |                 |     |       |         |  |  |  |  |
| 3.0 TDI  | 140   | 11.15           | PR: 1LL,1LF |                |             |   |                         |   |                         |                  |     |       |             |                |        |                              |                       |                  |     |       |             |                |        |  |                     |         |     |       |             |  |  |  |  |                 |     |       |             |  |  |  |  |         |     |       |             |  |  |  |  |         |     |       |             |  |  |  |  |         |     |       |             |  |  |  |  |                 |     |       |             |  |  |  |  |                 |     |       |             |  |  |  |  |                 |     |       |             |  |  |  |  |                 |     |       |             |  |  |  |  |                 |     |       |             |  |  |  |  |                 |     |       |             |  |  |  |  |               |     |       |             |  |  |  |  |                  |     |       |             |  |  |  |  |                 |     |       |             |                |        |                              |                       |                 |     |       |             |                |        |  |                     |                 |     |       |             |  |  |  |  |                  |     |       |             |  |  |  |  |    |     |       |             |  |  |  |  |    |     |       |             |  |  |  |  |          |     |       |             |                |        |  |                     |          |     |       |             |                |        |  |                     |                  |     |       |             |                |        |  |                       |         |     |       |             |  |  |  |  |                 |     |       |             |  |  |  |  |         |     |       |             |  |  |  |  |         |     |       |             |  |  |  |  |         |     |       |             |  |  |  |  |                 |     |       |             |  |  |  |  |                 |     |       |             |  |  |  |  |                 |     |       |             |  |  |  |  |                 |     |       |             |  |  |  |  |                 |     |       |             |  |  |  |  |                 |     |       |             |  |  |  |  |               |     |       |             |  |  |  |  |                  |     |       |             |  |  |  |  |                 |     |       |             |                |        |  |                     |                 |     |       |             |                |        |  |                       |                 |     |       |             |  |  |  |  |                  |     |       |             |  |  |  |  |    |     |       |             |  |  |  |  |    |     |       |             |  |  |  |  |          |     |       |         |                |        |  |                    |          |     |       |         |                |        |  |                     |                  |     |       |         |  |  |  |  |         |     |       |         |  |  |  |  |                 |     |       |         |  |  |  |  |         |     |       |         |  |  |  |  |         |     |       |         |  |  |  |  |         |     |       |         |  |  |  |  |                 |     |       |         |  |  |  |  |                 |     |       |         |  |  |  |  |                 |     |       |         |  |  |  |  |                 |     |       |         |  |  |  |  |                 |     |       |         |  |  |  |  |                 |     |       |         |  |  |  |  |                 |     |       |         |  |  |  |  |                 |     |       |         |  |  |  |  |                 |     |       |         |  |  |  |  |               |     |       |         |  |  |  |  |                  |     |       |         |  |  |  |  |                  |     |       |         |  |  |  |  |    |     |       |         |  |  |  |  |    |     |       |         |  |  |  |  |          |     |       |         |                |        |  |                       |          |     |       |         |  |  |  |  |                  |     |       |         |  |  |  |  |         |     |       |         |  |  |  |  |                 |     |       |         |  |  |  |  |         |     |       |         |  |  |  |  |         |     |       |         |  |  |  |  |         |     |       |         |  |  |  |  |                 |     |       |         |  |  |  |  |                 |     |       |         |  |  |  |  |                 |     |       |         |  |  |  |  |                 |     |       |         |  |  |  |  |                 |     |       |         |  |  |  |  |                 |     |       |         |  |  |  |  |                 |     |       |         |  |  |  |  |                 |     |       |         |  |  |  |  |
| 3.0 TDI  | 150   | 11.10           | PR: 1LL,1LF |                |             |   |                         |   |                         |                  |     |       |             |                |        |                              |                       |                  |     |       |             |                |        |  |                     |         |     |       |             |  |  |  |  |                 |     |       |             |  |  |  |  |         |     |       |             |  |  |  |  |         |     |       |             |  |  |  |  |         |     |       |             |  |  |  |  |                 |     |       |             |  |  |  |  |                 |     |       |             |  |  |  |  |                 |     |       |             |  |  |  |  |                 |     |       |             |  |  |  |  |                 |     |       |             |  |  |  |  |                 |     |       |             |  |  |  |  |               |     |       |             |  |  |  |  |                  |     |       |             |  |  |  |  |                 |     |       |             |                |        |                              |                       |                 |     |       |             |                |        |  |                     |                 |     |       |             |  |  |  |  |                  |     |       |             |  |  |  |  |    |     |       |             |  |  |  |  |    |     |       |             |  |  |  |  |          |     |       |             |                |        |  |                     |          |     |       |             |                |        |  |                     |                  |     |       |             |                |        |  |                       |         |     |       |             |  |  |  |  |                 |     |       |             |  |  |  |  |         |     |       |             |  |  |  |  |         |     |       |             |  |  |  |  |         |     |       |             |  |  |  |  |                 |     |       |             |  |  |  |  |                 |     |       |             |  |  |  |  |                 |     |       |             |  |  |  |  |                 |     |       |             |  |  |  |  |                 |     |       |             |  |  |  |  |                 |     |       |             |  |  |  |  |               |     |       |             |  |  |  |  |                  |     |       |             |  |  |  |  |                 |     |       |             |                |        |  |                     |                 |     |       |             |                |        |  |                       |                 |     |       |             |  |  |  |  |                  |     |       |             |  |  |  |  |    |     |       |             |  |  |  |  |    |     |       |             |  |  |  |  |          |     |       |         |                |        |  |                    |          |     |       |         |                |        |  |                     |                  |     |       |         |  |  |  |  |         |     |       |         |  |  |  |  |                 |     |       |         |  |  |  |  |         |     |       |         |  |  |  |  |         |     |       |         |  |  |  |  |         |     |       |         |  |  |  |  |                 |     |       |         |  |  |  |  |                 |     |       |         |  |  |  |  |                 |     |       |         |  |  |  |  |                 |     |       |         |  |  |  |  |                 |     |       |         |  |  |  |  |                 |     |       |         |  |  |  |  |                 |     |       |         |  |  |  |  |                 |     |       |         |  |  |  |  |                 |     |       |         |  |  |  |  |               |     |       |         |  |  |  |  |                  |     |       |         |  |  |  |  |                  |     |       |         |  |  |  |  |    |     |       |         |  |  |  |  |    |     |       |         |  |  |  |  |          |     |       |         |                |        |  |                       |          |     |       |         |  |  |  |  |                  |     |       |         |  |  |  |  |         |     |       |         |  |  |  |  |                 |     |       |         |  |  |  |  |         |     |       |         |  |  |  |  |         |     |       |         |  |  |  |  |         |     |       |         |  |  |  |  |                 |     |       |         |  |  |  |  |                 |     |       |         |  |  |  |  |                 |     |       |         |  |  |  |  |                 |     |       |         |  |  |  |  |                 |     |       |         |  |  |  |  |                 |     |       |         |  |  |  |  |                 |     |       |         |  |  |  |  |                 |     |       |         |  |  |  |  |
| 3.0 TDI  | 155   | 11.15           | PR: 1LL,1LF |                |             |   |                         |   |                         |                  |     |       |             |                |        |                              |                       |                  |     |       |             |                |        |  |                     |         |     |       |             |  |  |  |  |                 |     |       |             |  |  |  |  |         |     |       |             |  |  |  |  |         |     |       |             |  |  |  |  |         |     |       |             |  |  |  |  |                 |     |       |             |  |  |  |  |                 |     |       |             |  |  |  |  |                 |     |       |             |  |  |  |  |                 |     |       |             |  |  |  |  |                 |     |       |             |  |  |  |  |                 |     |       |             |  |  |  |  |               |     |       |             |  |  |  |  |                  |     |       |             |  |  |  |  |                 |     |       |             |                |        |                              |                       |                 |     |       |             |                |        |  |                     |                 |     |       |             |  |  |  |  |                  |     |       |             |  |  |  |  |    |     |       |             |  |  |  |  |    |     |       |             |  |  |  |  |          |     |       |             |                |        |  |                     |          |     |       |             |                |        |  |                     |                  |     |       |             |                |        |  |                       |         |     |       |             |  |  |  |  |                 |     |       |             |  |  |  |  |         |     |       |             |  |  |  |  |         |     |       |             |  |  |  |  |         |     |       |             |  |  |  |  |                 |     |       |             |  |  |  |  |                 |     |       |             |  |  |  |  |                 |     |       |             |  |  |  |  |                 |     |       |             |  |  |  |  |                 |     |       |             |  |  |  |  |                 |     |       |             |  |  |  |  |               |     |       |             |  |  |  |  |                  |     |       |             |  |  |  |  |                 |     |       |             |                |        |  |                     |                 |     |       |             |                |        |  |                       |                 |     |       |             |  |  |  |  |                  |     |       |             |  |  |  |  |    |     |       |             |  |  |  |  |    |     |       |             |  |  |  |  |          |     |       |         |                |        |  |                    |          |     |       |         |                |        |  |                     |                  |     |       |         |  |  |  |  |         |     |       |         |  |  |  |  |                 |     |       |         |  |  |  |  |         |     |       |         |  |  |  |  |         |     |       |         |  |  |  |  |         |     |       |         |  |  |  |  |                 |     |       |         |  |  |  |  |                 |     |       |         |  |  |  |  |                 |     |       |         |  |  |  |  |                 |     |       |         |  |  |  |  |                 |     |       |         |  |  |  |  |                 |     |       |         |  |  |  |  |                 |     |       |         |  |  |  |  |                 |     |       |         |  |  |  |  |                 |     |       |         |  |  |  |  |               |     |       |         |  |  |  |  |                  |     |       |         |  |  |  |  |                  |     |       |         |  |  |  |  |    |     |       |         |  |  |  |  |    |     |       |         |  |  |  |  |          |     |       |         |                |        |  |                       |          |     |       |         |  |  |  |  |                  |     |       |         |  |  |  |  |         |     |       |         |  |  |  |  |                 |     |       |         |  |  |  |  |         |     |       |         |  |  |  |  |         |     |       |         |  |  |  |  |         |     |       |         |  |  |  |  |                 |     |       |         |  |  |  |  |                 |     |       |         |  |  |  |  |                 |     |       |         |  |  |  |  |                 |     |       |         |  |  |  |  |                 |     |       |         |  |  |  |  |                 |     |       |         |  |  |  |  |                 |     |       |         |  |  |  |  |                 |     |       |         |  |  |  |  |
| 3.0 TDI quattro  | 140   | 11.15           | PR: 1LL,1LF |                |             |   |                         |   |                         |                  |     |       |             |                |        |                              |                       |                  |     |       |             |                |        |  |                     |         |     |       |             |  |  |  |  |                 |     |       |             |  |  |  |  |         |     |       |             |  |  |  |  |         |     |       |             |  |  |  |  |         |     |       |             |  |  |  |  |                 |     |       |             |  |  |  |  |                 |     |       |             |  |  |  |  |                 |     |       |             |  |  |  |  |                 |     |       |             |  |  |  |  |                 |     |       |             |  |  |  |  |                 |     |       |             |  |  |  |  |               |     |       |             |  |  |  |  |                  |     |       |             |  |  |  |  |                 |     |       |             |                |        |                              |                       |                 |     |       |             |                |        |  |                     |                 |     |       |             |  |  |  |  |                  |     |       |             |  |  |  |  |    |     |       |             |  |  |  |  |    |     |       |             |  |  |  |  |          |     |       |             |                |        |  |                     |          |     |       |             |                |        |  |                     |                  |     |       |             |                |        |  |                       |         |     |       |             |  |  |  |  |                 |     |       |             |  |  |  |  |         |     |       |             |  |  |  |  |         |     |       |             |  |  |  |  |         |     |       |             |  |  |  |  |                 |     |       |             |  |  |  |  |                 |     |       |             |  |  |  |  |                 |     |       |             |  |  |  |  |                 |     |       |             |  |  |  |  |                 |     |       |             |  |  |  |  |                 |     |       |             |  |  |  |  |               |     |       |             |  |  |  |  |                  |     |       |             |  |  |  |  |                 |     |       |             |                |        |  |                     |                 |     |       |             |                |        |  |                       |                 |     |       |             |  |  |  |  |                  |     |       |             |  |  |  |  |    |     |       |             |  |  |  |  |    |     |       |             |  |  |  |  |          |     |       |         |                |        |  |                    |          |     |       |         |                |        |  |                     |                  |     |       |         |  |  |  |  |         |     |       |         |  |  |  |  |                 |     |       |         |  |  |  |  |         |     |       |         |  |  |  |  |         |     |       |         |  |  |  |  |         |     |       |         |  |  |  |  |                 |     |       |         |  |  |  |  |                 |     |       |         |  |  |  |  |                 |     |       |         |  |  |  |  |                 |     |       |         |  |  |  |  |                 |     |       |         |  |  |  |  |                 |     |       |         |  |  |  |  |                 |     |       |         |  |  |  |  |                 |     |       |         |  |  |  |  |                 |     |       |         |  |  |  |  |               |     |       |         |  |  |  |  |                  |     |       |         |  |  |  |  |                  |     |       |         |  |  |  |  |    |     |       |         |  |  |  |  |    |     |       |         |  |  |  |  |          |     |       |         |                |        |  |                       |          |     |       |         |  |  |  |  |                  |     |       |         |  |  |  |  |         |     |       |         |  |  |  |  |                 |     |       |         |  |  |  |  |         |     |       |         |  |  |  |  |         |     |       |         |  |  |  |  |         |     |       |         |  |  |  |  |                 |     |       |         |  |  |  |  |                 |     |       |         |  |  |  |  |                 |     |       |         |  |  |  |  |                 |     |       |         |  |  |  |  |                 |     |       |         |  |  |  |  |                 |     |       |         |  |  |  |  |                 |     |       |         |  |  |  |  |                 |     |       |         |  |  |  |  |
| 3.0 TDI quattro  | 150   | 07.10           | PR: 1LL,1LF |                |             |   |                         |   |                         |                  |     |       |             |                |        |                              |                       |                  |     |       |             |                |        |  |                     |         |     |       |             |  |  |  |  |                 |     |       |             |  |  |  |  |         |     |       |             |  |  |  |  |         |     |       |             |  |  |  |  |         |     |       |             |  |  |  |  |                 |     |       |             |  |  |  |  |                 |     |       |             |  |  |  |  |                 |     |       |             |  |  |  |  |                 |     |       |             |  |  |  |  |                 |     |       |             |  |  |  |  |                 |     |       |             |  |  |  |  |               |     |       |             |  |  |  |  |                  |     |       |             |  |  |  |  |                 |     |       |             |                |        |                              |                       |                 |     |       |             |                |        |  |                     |                 |     |       |             |  |  |  |  |                  |     |       |             |  |  |  |  |    |     |       |             |  |  |  |  |    |     |       |             |  |  |  |  |          |     |       |             |                |        |  |                     |          |     |       |             |                |        |  |                     |                  |     |       |             |                |        |  |                       |         |     |       |             |  |  |  |  |                 |     |       |             |  |  |  |  |         |     |       |             |  |  |  |  |         |     |       |             |  |  |  |  |         |     |       |             |  |  |  |  |                 |     |       |             |  |  |  |  |                 |     |       |             |  |  |  |  |                 |     |       |             |  |  |  |  |                 |     |       |             |  |  |  |  |                 |     |       |             |  |  |  |  |                 |     |       |             |  |  |  |  |               |     |       |             |  |  |  |  |                  |     |       |             |  |  |  |  |                 |     |       |             |                |        |  |                     |                 |     |       |             |                |        |  |                       |                 |     |       |             |  |  |  |  |                  |     |       |             |  |  |  |  |    |     |       |             |  |  |  |  |    |     |       |             |  |  |  |  |          |     |       |         |                |        |  |                    |          |     |       |         |                |        |  |                     |                  |     |       |         |  |  |  |  |         |     |       |         |  |  |  |  |                 |     |       |         |  |  |  |  |         |     |       |         |  |  |  |  |         |     |       |         |  |  |  |  |         |     |       |         |  |  |  |  |                 |     |       |         |  |  |  |  |                 |     |       |         |  |  |  |  |                 |     |       |         |  |  |  |  |                 |     |       |         |  |  |  |  |                 |     |       |         |  |  |  |  |                 |     |       |         |  |  |  |  |                 |     |       |         |  |  |  |  |                 |     |       |         |  |  |  |  |                 |     |       |         |  |  |  |  |               |     |       |         |  |  |  |  |                  |     |       |         |  |  |  |  |                  |     |       |         |  |  |  |  |    |     |       |         |  |  |  |  |    |     |       |         |  |  |  |  |          |     |       |         |                |        |  |                       |          |     |       |         |  |  |  |  |                  |     |       |         |  |  |  |  |         |     |       |         |  |  |  |  |                 |     |       |         |  |  |  |  |         |     |       |         |  |  |  |  |         |     |       |         |  |  |  |  |         |     |       |         |  |  |  |  |                 |     |       |         |  |  |  |  |                 |     |       |         |  |  |  |  |                 |     |       |         |  |  |  |  |                 |     |       |         |  |  |  |  |                 |     |       |         |  |  |  |  |                 |     |       |         |  |  |  |  |                 |     |       |         |  |  |  |  |                 |     |       |         |  |  |  |  |
| 3.0 TDI quattro  | 160   | 05.14           | PR: 1LL,1LF |                |             |   |                         |   |                         |                  |     |       |             |                |        |                              |                       |                  |     |       |             |                |        |  |                     |         |     |       |             |  |  |  |  |                 |     |       |             |  |  |  |  |         |     |       |             |  |  |  |  |         |     |       |             |  |  |  |  |         |     |       |             |  |  |  |  |                 |     |       |             |  |  |  |  |                 |     |       |             |  |  |  |  |                 |     |       |             |  |  |  |  |                 |     |       |             |  |  |  |  |                 |     |       |             |  |  |  |  |                 |     |       |             |  |  |  |  |               |     |       |             |  |  |  |  |                  |     |       |             |  |  |  |  |                 |     |       |             |                |        |                              |                       |                 |     |       |             |                |        |  |                     |                 |     |       |             |  |  |  |  |                  |     |       |             |  |  |  |  |    |     |       |             |  |  |  |  |    |     |       |             |  |  |  |  |          |     |       |             |                |        |  |                     |          |     |       |             |                |        |  |                     |                  |     |       |             |                |        |  |                       |         |     |       |             |  |  |  |  |                 |     |       |             |  |  |  |  |         |     |       |             |  |  |  |  |         |     |       |             |  |  |  |  |         |     |       |             |  |  |  |  |                 |     |       |             |  |  |  |  |                 |     |       |             |  |  |  |  |                 |     |       |             |  |  |  |  |                 |     |       |             |  |  |  |  |                 |     |       |             |  |  |  |  |                 |     |       |             |  |  |  |  |               |     |       |             |  |  |  |  |                  |     |       |             |  |  |  |  |                 |     |       |             |                |        |  |                     |                 |     |       |             |                |        |  |                       |                 |     |       |             |  |  |  |  |                  |     |       |             |  |  |  |  |    |     |       |             |  |  |  |  |    |     |       |             |  |  |  |  |          |     |       |         |                |        |  |                    |          |     |       |         |                |        |  |                     |                  |     |       |         |  |  |  |  |         |     |       |         |  |  |  |  |                 |     |       |         |  |  |  |  |         |     |       |         |  |  |  |  |         |     |       |         |  |  |  |  |         |     |       |         |  |  |  |  |                 |     |       |         |  |  |  |  |                 |     |       |         |  |  |  |  |                 |     |       |         |  |  |  |  |                 |     |       |         |  |  |  |  |                 |     |       |         |  |  |  |  |                 |     |       |         |  |  |  |  |                 |     |       |         |  |  |  |  |                 |     |       |         |  |  |  |  |                 |     |       |         |  |  |  |  |               |     |       |         |  |  |  |  |                  |     |       |         |  |  |  |  |                  |     |       |         |  |  |  |  |    |     |       |         |  |  |  |  |    |     |       |         |  |  |  |  |          |     |       |         |                |        |  |                       |          |     |       |         |  |  |  |  |                  |     |       |         |  |  |  |  |         |     |       |         |  |  |  |  |                 |     |       |         |  |  |  |  |         |     |       |         |  |  |  |  |         |     |       |         |  |  |  |  |         |     |       |         |  |  |  |  |                 |     |       |         |  |  |  |  |                 |     |       |         |  |  |  |  |                 |     |       |         |  |  |  |  |                 |     |       |         |  |  |  |  |                 |     |       |         |  |  |  |  |                 |     |       |         |  |  |  |  |                 |     |       |         |  |  |  |  |                 |     |       |         |  |  |  |  |
| 3.0 TDI quattro  | 176   | 05.13           | PR: 1LL,1LF |                |             |   |                         |   |                         |                  |     |       |             |                |        |                              |                       |                  |     |       |             |                |        |  |                     |         |     |       |             |  |  |  |  |                 |     |       |             |  |  |  |  |         |     |       |             |  |  |  |  |         |     |       |             |  |  |  |  |         |     |       |             |  |  |  |  |                 |     |       |             |  |  |  |  |                 |     |       |             |  |  |  |  |                 |     |       |             |  |  |  |  |                 |     |       |             |  |  |  |  |                 |     |       |             |  |  |  |  |                 |     |       |             |  |  |  |  |               |     |       |             |  |  |  |  |                  |     |       |             |  |  |  |  |                 |     |       |             |                |        |                              |                       |                 |     |       |             |                |        |  |                     |                 |     |       |             |  |  |  |  |                  |     |       |             |  |  |  |  |    |     |       |             |  |  |  |  |    |     |       |             |  |  |  |  |          |     |       |             |                |        |  |                     |          |     |       |             |                |        |  |                     |                  |     |       |             |                |        |  |                       |         |     |       |             |  |  |  |  |                 |     |       |             |  |  |  |  |         |     |       |             |  |  |  |  |         |     |       |             |  |  |  |  |         |     |       |             |  |  |  |  |                 |     |       |             |  |  |  |  |                 |     |       |             |  |  |  |  |                 |     |       |             |  |  |  |  |                 |     |       |             |  |  |  |  |                 |     |       |             |  |  |  |  |                 |     |       |             |  |  |  |  |               |     |       |             |  |  |  |  |                  |     |       |             |  |  |  |  |                 |     |       |             |                |        |  |                     |                 |     |       |             |                |        |  |                       |                 |     |       |             |  |  |  |  |                  |     |       |             |  |  |  |  |    |     |       |             |  |  |  |  |    |     |       |             |  |  |  |  |          |     |       |         |                |        |  |                    |          |     |       |         |                |        |  |                     |                  |     |       |         |  |  |  |  |         |     |       |         |  |  |  |  |                 |     |       |         |  |  |  |  |         |     |       |         |  |  |  |  |         |     |       |         |  |  |  |  |         |     |       |         |  |  |  |  |                 |     |       |         |  |  |  |  |                 |     |       |         |  |  |  |  |                 |     |       |         |  |  |  |  |                 |     |       |         |  |  |  |  |                 |     |       |         |  |  |  |  |                 |     |       |         |  |  |  |  |                 |     |       |         |  |  |  |  |                 |     |       |         |  |  |  |  |                 |     |       |         |  |  |  |  |               |     |       |         |  |  |  |  |                  |     |       |         |  |  |  |  |                  |     |       |         |  |  |  |  |    |     |       |         |  |  |  |  |    |     |       |         |  |  |  |  |          |     |       |         |                |        |  |                       |          |     |       |         |  |  |  |  |                  |     |       |         |  |  |  |  |         |     |       |         |  |  |  |  |                 |     |       |         |  |  |  |  |         |     |       |         |  |  |  |  |         |     |       |         |  |  |  |  |         |     |       |         |  |  |  |  |                 |     |       |         |  |  |  |  |                 |     |       |         |  |  |  |  |                 |     |       |         |  |  |  |  |                 |     |       |         |  |  |  |  |                 |     |       |         |  |  |  |  |                 |     |       |         |  |  |  |  |                 |     |       |         |  |  |  |  |                 |     |       |         |  |  |  |  |
| 3.0 TDI quattro  | 180   | 07.10           | PR: 1LL,1LF |                |             |   |                         |   |                         |                  |     |       |             |                |        |                              |                       |                  |     |       |             |                |        |  |                     |         |     |       |             |  |  |  |  |                 |     |       |             |  |  |  |  |         |     |       |             |  |  |  |  |         |     |       |             |  |  |  |  |         |     |       |             |  |  |  |  |                 |     |       |             |  |  |  |  |                 |     |       |             |  |  |  |  |                 |     |       |             |  |  |  |  |                 |     |       |             |  |  |  |  |                 |     |       |             |  |  |  |  |                 |     |       |             |  |  |  |  |               |     |       |             |  |  |  |  |                  |     |       |             |  |  |  |  |                 |     |       |             |                |        |                              |                       |                 |     |       |             |                |        |  |                     |                 |     |       |             |  |  |  |  |                  |     |       |             |  |  |  |  |    |     |       |             |  |  |  |  |    |     |       |             |  |  |  |  |          |     |       |             |                |        |  |                     |          |     |       |             |                |        |  |                     |                  |     |       |             |                |        |  |                       |         |     |       |             |  |  |  |  |                 |     |       |             |  |  |  |  |         |     |       |             |  |  |  |  |         |     |       |             |  |  |  |  |         |     |       |             |  |  |  |  |                 |     |       |             |  |  |  |  |                 |     |       |             |  |  |  |  |                 |     |       |             |  |  |  |  |                 |     |       |             |  |  |  |  |                 |     |       |             |  |  |  |  |                 |     |       |             |  |  |  |  |               |     |       |             |  |  |  |  |                  |     |       |             |  |  |  |  |                 |     |       |             |                |        |  |                     |                 |     |       |             |                |        |  |                       |                 |     |       |             |  |  |  |  |                  |     |       |             |  |  |  |  |    |     |       |             |  |  |  |  |    |     |       |             |  |  |  |  |          |     |       |         |                |        |  |                    |          |     |       |         |                |        |  |                     |                  |     |       |         |  |  |  |  |         |     |       |         |  |  |  |  |                 |     |       |         |  |  |  |  |         |     |       |         |  |  |  |  |         |     |       |         |  |  |  |  |         |     |       |         |  |  |  |  |                 |     |       |         |  |  |  |  |                 |     |       |         |  |  |  |  |                 |     |       |         |  |  |  |  |                 |     |       |         |  |  |  |  |                 |     |       |         |  |  |  |  |                 |     |       |         |  |  |  |  |                 |     |       |         |  |  |  |  |                 |     |       |         |  |  |  |  |                 |     |       |         |  |  |  |  |               |     |       |         |  |  |  |  |                  |     |       |         |  |  |  |  |                  |     |       |         |  |  |  |  |    |     |       |         |  |  |  |  |    |     |       |         |  |  |  |  |          |     |       |         |                |        |  |                       |          |     |       |         |  |  |  |  |                  |     |       |         |  |  |  |  |         |     |       |         |  |  |  |  |                 |     |       |         |  |  |  |  |         |     |       |         |  |  |  |  |         |     |       |         |  |  |  |  |         |     |       |         |  |  |  |  |                 |     |       |         |  |  |  |  |                 |     |       |         |  |  |  |  |                 |     |       |         |  |  |  |  |                 |     |       |         |  |  |  |  |                 |     |       |         |  |  |  |  |                 |     |       |         |  |  |  |  |                 |     |       |         |  |  |  |  |                 |     |       |         |  |  |  |  |
| 3.0 TDI quattro  | 200   | 05.14           | PR: 1LL,1LF |                |             |   |                         |   |                         |                  |     |       |             |                |        |                              |                       |                  |     |       |             |                |        |  |                     |         |     |       |             |  |  |  |  |                 |     |       |             |  |  |  |  |         |     |       |             |  |  |  |  |         |     |       |             |  |  |  |  |         |     |       |             |  |  |  |  |                 |     |       |             |  |  |  |  |                 |     |       |             |  |  |  |  |                 |     |       |             |  |  |  |  |                 |     |       |             |  |  |  |  |                 |     |       |             |  |  |  |  |                 |     |       |             |  |  |  |  |               |     |       |             |  |  |  |  |                  |     |       |             |  |  |  |  |                 |     |       |             |                |        |                              |                       |                 |     |       |             |                |        |  |                     |                 |     |       |             |  |  |  |  |                  |     |       |             |  |  |  |  |    |     |       |             |  |  |  |  |    |     |       |             |  |  |  |  |          |     |       |             |                |        |  |                     |          |     |       |             |                |        |  |                     |                  |     |       |             |                |        |  |                       |         |     |       |             |  |  |  |  |                 |     |       |             |  |  |  |  |         |     |       |             |  |  |  |  |         |     |       |             |  |  |  |  |         |     |       |             |  |  |  |  |                 |     |       |             |  |  |  |  |                 |     |       |             |  |  |  |  |                 |     |       |             |  |  |  |  |                 |     |       |             |  |  |  |  |                 |     |       |             |  |  |  |  |                 |     |       |             |  |  |  |  |               |     |       |             |  |  |  |  |                  |     |       |             |  |  |  |  |                 |     |       |             |                |        |  |                     |                 |     |       |             |                |        |  |                       |                 |     |       |             |  |  |  |  |                  |     |       |             |  |  |  |  |    |     |       |             |  |  |  |  |    |     |       |             |  |  |  |  |          |     |       |         |                |        |  |                    |          |     |       |         |                |        |  |                     |                  |     |       |         |  |  |  |  |         |     |       |         |  |  |  |  |                 |     |       |         |  |  |  |  |         |     |       |         |  |  |  |  |         |     |       |         |  |  |  |  |         |     |       |         |  |  |  |  |                 |     |       |         |  |  |  |  |                 |     |       |         |  |  |  |  |                 |     |       |         |  |  |  |  |                 |     |       |         |  |  |  |  |                 |     |       |         |  |  |  |  |                 |     |       |         |  |  |  |  |                 |     |       |         |  |  |  |  |                 |     |       |         |  |  |  |  |                 |     |       |         |  |  |  |  |               |     |       |         |  |  |  |  |                  |     |       |         |  |  |  |  |                  |     |       |         |  |  |  |  |    |     |       |         |  |  |  |  |    |     |       |         |  |  |  |  |          |     |       |         |                |        |  |                       |          |     |       |         |  |  |  |  |                  |     |       |         |  |  |  |  |         |     |       |         |  |  |  |  |                 |     |       |         |  |  |  |  |         |     |       |         |  |  |  |  |         |     |       |         |  |  |  |  |         |     |       |         |  |  |  |  |                 |     |       |         |  |  |  |  |                 |     |       |         |  |  |  |  |                 |     |       |         |  |  |  |  |                 |     |       |         |  |  |  |  |                 |     |       |         |  |  |  |  |                 |     |       |         |  |  |  |  |                 |     |       |         |  |  |  |  |                 |     |       |         |  |  |  |  |
| 3.0 TDI ultra  | 160   | 05.14           | PR: 1LL,1LF |                |             |   |                         |   |                         |                  |     |       |             |                |        |                              |                       |                  |     |       |             |                |        |  |                     |         |     |       |             |  |  |  |  |                 |     |       |             |  |  |  |  |         |     |       |             |  |  |  |  |         |     |       |             |  |  |  |  |         |     |       |             |  |  |  |  |                 |     |       |             |  |  |  |  |                 |     |       |             |  |  |  |  |                 |     |       |             |  |  |  |  |                 |     |       |             |  |  |  |  |                 |     |       |             |  |  |  |  |                 |     |       |             |  |  |  |  |               |     |       |             |  |  |  |  |                  |     |       |             |  |  |  |  |                 |     |       |             |                |        |                              |                       |                 |     |       |             |                |        |  |                     |                 |     |       |             |  |  |  |  |                  |     |       |             |  |  |  |  |    |     |       |             |  |  |  |  |    |     |       |             |  |  |  |  |          |     |       |             |                |        |  |                     |          |     |       |             |                |        |  |                     |                  |     |       |             |                |        |  |                       |         |     |       |             |  |  |  |  |                 |     |       |             |  |  |  |  |         |     |       |             |  |  |  |  |         |     |       |             |  |  |  |  |         |     |       |             |  |  |  |  |                 |     |       |             |  |  |  |  |                 |     |       |             |  |  |  |  |                 |     |       |             |  |  |  |  |                 |     |       |             |  |  |  |  |                 |     |       |             |  |  |  |  |                 |     |       |             |  |  |  |  |               |     |       |             |  |  |  |  |                  |     |       |             |  |  |  |  |                 |     |       |             |                |        |  |                     |                 |     |       |             |                |        |  |                       |                 |     |       |             |  |  |  |  |                  |     |       |             |  |  |  |  |    |     |       |             |  |  |  |  |    |     |       |             |  |  |  |  |          |     |       |         |                |        |  |                    |          |     |       |         |                |        |  |                     |                  |     |       |         |  |  |  |  |         |     |       |         |  |  |  |  |                 |     |       |         |  |  |  |  |         |     |       |         |  |  |  |  |         |     |       |         |  |  |  |  |         |     |       |         |  |  |  |  |                 |     |       |         |  |  |  |  |                 |     |       |         |  |  |  |  |                 |     |       |         |  |  |  |  |                 |     |       |         |  |  |  |  |                 |     |       |         |  |  |  |  |                 |     |       |         |  |  |  |  |                 |     |       |         |  |  |  |  |                 |     |       |         |  |  |  |  |                 |     |       |         |  |  |  |  |               |     |       |         |  |  |  |  |                  |     |       |         |  |  |  |  |                  |     |       |         |  |  |  |  |    |     |       |         |  |  |  |  |    |     |       |         |  |  |  |  |          |     |       |         |                |        |  |                       |          |     |       |         |  |  |  |  |                  |     |       |         |  |  |  |  |         |     |       |         |  |  |  |  |                 |     |       |         |  |  |  |  |         |     |       |         |  |  |  |  |         |     |       |         |  |  |  |  |         |     |       |         |  |  |  |  |                 |     |       |         |  |  |  |  |                 |     |       |         |  |  |  |  |                 |     |       |         |  |  |  |  |                 |     |       |         |  |  |  |  |                 |     |       |         |  |  |  |  |                 |     |       |         |  |  |  |  |                 |     |       |         |  |  |  |  |                 |     |       |         |  |  |  |  |
| 3.0 TFSI quattro   | 160   | 07.10           | PR: 1LL,1LF |                |             |   |                         |   |                         |                  |     |       |             |                |        |                              |                       |                  |     |       |             |                |        |  |                     |         |     |       |             |  |  |  |  |                 |     |       |             |  |  |  |  |         |     |       |             |  |  |  |  |         |     |       |             |  |  |  |  |         |     |       |             |  |  |  |  |                 |     |       |             |  |  |  |  |                 |     |       |             |  |  |  |  |                 |     |       |             |  |  |  |  |                 |     |       |             |  |  |  |  |                 |     |       |             |  |  |  |  |                 |     |       |             |  |  |  |  |               |     |       |             |  |  |  |  |                  |     |       |             |  |  |  |  |                 |     |       |             |                |        |                              |                       |                 |     |       |             |                |        |  |                     |                 |     |       |             |  |  |  |  |                  |     |       |             |  |  |  |  |    |     |       |             |  |  |  |  |    |     |       |             |  |  |  |  |          |     |       |             |                |        |  |                     |          |     |       |             |                |        |  |                     |                  |     |       |             |                |        |  |                       |         |     |       |             |  |  |  |  |                 |     |       |             |  |  |  |  |         |     |       |             |  |  |  |  |         |     |       |             |  |  |  |  |         |     |       |             |  |  |  |  |                 |     |       |             |  |  |  |  |                 |     |       |             |  |  |  |  |                 |     |       |             |  |  |  |  |                 |     |       |             |  |  |  |  |                 |     |       |             |  |  |  |  |                 |     |       |             |  |  |  |  |               |     |       |             |  |  |  |  |                  |     |       |             |  |  |  |  |                 |     |       |             |                |        |  |                     |                 |     |       |             |                |        |  |                       |                 |     |       |             |  |  |  |  |                  |     |       |             |  |  |  |  |    |     |       |             |  |  |  |  |    |     |       |             |  |  |  |  |          |     |       |         |                |        |  |                    |          |     |       |         |                |        |  |                     |                  |     |       |         |  |  |  |  |         |     |       |         |  |  |  |  |                 |     |       |         |  |  |  |  |         |     |       |         |  |  |  |  |         |     |       |         |  |  |  |  |         |     |       |         |  |  |  |  |                 |     |       |         |  |  |  |  |                 |     |       |         |  |  |  |  |                 |     |       |         |  |  |  |  |                 |     |       |         |  |  |  |  |                 |     |       |         |  |  |  |  |                 |     |       |         |  |  |  |  |                 |     |       |         |  |  |  |  |                 |     |       |         |  |  |  |  |                 |     |       |         |  |  |  |  |               |     |       |         |  |  |  |  |                  |     |       |         |  |  |  |  |                  |     |       |         |  |  |  |  |    |     |       |         |  |  |  |  |    |     |       |         |  |  |  |  |          |     |       |         |                |        |  |                       |          |     |       |         |  |  |  |  |                  |     |       |         |  |  |  |  |         |     |       |         |  |  |  |  |                 |     |       |         |  |  |  |  |         |     |       |         |  |  |  |  |         |     |       |         |  |  |  |  |         |     |       |         |  |  |  |  |                 |     |       |         |  |  |  |  |                 |     |       |         |  |  |  |  |                 |     |       |         |  |  |  |  |                 |     |       |         |  |  |  |  |                 |     |       |         |  |  |  |  |                 |     |       |         |  |  |  |  |                 |     |       |         |  |  |  |  |                 |     |       |         |  |  |  |  |
| 3.0 TDI quattro  | 230   | 11.11           | PR: 1LL,1LF | 13.0460-7280.2 | 607280      |   | 25158 20,3 +/WK ATE     |   |                         |                  |     |       |             |                |        |                              |                       |                  |     |       |             |                |        |  |                     |         |     |       |             |  |  |  |  |                 |     |       |             |  |  |  |  |         |     |       |             |  |  |  |  |         |     |       |             |  |  |  |  |         |     |       |             |  |  |  |  |                 |     |       |             |  |  |  |  |                 |     |       |             |  |  |  |  |                 |     |       |             |  |  |  |  |                 |     |       |             |  |  |  |  |                 |     |       |             |  |  |  |  |                 |     |       |             |  |  |  |  |               |     |       |             |  |  |  |  |                  |     |       |             |  |  |  |  |                 |     |       |             |                |        |                              |                       |                 |     |       |             |                |        |  |                     |                 |     |       |             |  |  |  |  |                  |     |       |             |  |  |  |  |    |     |       |             |  |  |  |  |    |     |       |             |  |  |  |  |          |     |       |             |                |        |  |                     |          |     |       |             |                |        |  |                     |                  |     |       |             |                |        |  |                       |         |     |       |             |  |  |  |  |                 |     |       |             |  |  |  |  |         |     |       |             |  |  |  |  |         |     |       |             |  |  |  |  |         |     |       |             |  |  |  |  |                 |     |       |             |  |  |  |  |                 |     |       |             |  |  |  |  |                 |     |       |             |  |  |  |  |                 |     |       |             |  |  |  |  |                 |     |       |             |  |  |  |  |                 |     |       |             |  |  |  |  |               |     |       |             |  |  |  |  |                  |     |       |             |  |  |  |  |                 |     |       |             |                |        |  |                     |                 |     |       |             |                |        |  |                       |                 |     |       |             |  |  |  |  |                  |     |       |             |  |  |  |  |    |     |       |             |  |  |  |  |    |     |       |             |  |  |  |  |          |     |       |         |                |        |  |                    |          |     |       |         |                |        |  |                     |                  |     |       |         |  |  |  |  |         |     |       |         |  |  |  |  |                 |     |       |         |  |  |  |  |         |     |       |         |  |  |  |  |         |     |       |         |  |  |  |  |         |     |       |         |  |  |  |  |                 |     |       |         |  |  |  |  |                 |     |       |         |  |  |  |  |                 |     |       |         |  |  |  |  |                 |     |       |         |  |  |  |  |                 |     |       |         |  |  |  |  |                 |     |       |         |  |  |  |  |                 |     |       |         |  |  |  |  |                 |     |       |         |  |  |  |  |                 |     |       |         |  |  |  |  |               |     |       |         |  |  |  |  |                  |     |       |         |  |  |  |  |                  |     |       |         |  |  |  |  |    |     |       |         |  |  |  |  |    |     |       |         |  |  |  |  |          |     |       |         |                |        |  |                       |          |     |       |         |  |  |  |  |                  |     |       |         |  |  |  |  |         |     |       |         |  |  |  |  |                 |     |       |         |  |  |  |  |         |     |       |         |  |  |  |  |         |     |       |         |  |  |  |  |         |     |       |         |  |  |  |  |                 |     |       |         |  |  |  |  |                 |     |       |         |  |  |  |  |                 |     |       |         |  |  |  |  |                 |     |       |         |  |  |  |  |                 |     |       |         |  |  |  |  |                 |     |       |         |  |  |  |  |                 |     |       |         |  |  |  |  |                 |     |       |         |  |  |  |  |
| 3.0 TDI quattro  | 235   | 05.14           | PR: 1LL,1LF | 24.8190-0301.2 | 620301      |   | Warnkontakt L=311,6mm   |   |                         |                  |     |       |             |                |        |                              |                       |                  |     |       |             |                |        |  |                     |         |     |       |             |  |  |  |  |                 |     |       |             |  |  |  |  |         |     |       |             |  |  |  |  |         |     |       |             |  |  |  |  |         |     |       |             |  |  |  |  |                 |     |       |             |  |  |  |  |                 |     |       |             |  |  |  |  |                 |     |       |             |  |  |  |  |                 |     |       |             |  |  |  |  |                 |     |       |             |  |  |  |  |                 |     |       |             |  |  |  |  |               |     |       |             |  |  |  |  |                  |     |       |             |  |  |  |  |                 |     |       |             |                |        |                              |                       |                 |     |       |             |                |        |  |                     |                 |     |       |             |  |  |  |  |                  |     |       |             |  |  |  |  |    |     |       |             |  |  |  |  |    |     |       |             |  |  |  |  |          |     |       |             |                |        |  |                     |          |     |       |             |                |        |  |                     |                  |     |       |             |                |        |  |                       |         |     |       |             |  |  |  |  |                 |     |       |             |  |  |  |  |         |     |       |             |  |  |  |  |         |     |       |             |  |  |  |  |         |     |       |             |  |  |  |  |                 |     |       |             |  |  |  |  |                 |     |       |             |  |  |  |  |                 |     |       |             |  |  |  |  |                 |     |       |             |  |  |  |  |                 |     |       |             |  |  |  |  |                 |     |       |             |  |  |  |  |               |     |       |             |  |  |  |  |                  |     |       |             |  |  |  |  |                 |     |       |             |                |        |  |                     |                 |     |       |             |                |        |  |                       |                 |     |       |             |  |  |  |  |                  |     |       |             |  |  |  |  |    |     |       |             |  |  |  |  |    |     |       |             |  |  |  |  |          |     |       |         |                |        |  |                    |          |     |       |         |                |        |  |                     |                  |     |       |         |  |  |  |  |         |     |       |         |  |  |  |  |                 |     |       |         |  |  |  |  |         |     |       |         |  |  |  |  |         |     |       |         |  |  |  |  |         |     |       |         |  |  |  |  |                 |     |       |         |  |  |  |  |                 |     |       |         |  |  |  |  |                 |     |       |         |  |  |  |  |                 |     |       |         |  |  |  |  |                 |     |       |         |  |  |  |  |                 |     |       |         |  |  |  |  |                 |     |       |         |  |  |  |  |                 |     |       |         |  |  |  |  |                 |     |       |         |  |  |  |  |               |     |       |         |  |  |  |  |                  |     |       |         |  |  |  |  |                  |     |       |         |  |  |  |  |    |     |       |         |  |  |  |  |    |     |       |         |  |  |  |  |          |     |       |         |                |        |  |                       |          |     |       |         |  |  |  |  |                  |     |       |         |  |  |  |  |         |     |       |         |  |  |  |  |                 |     |       |         |  |  |  |  |         |     |       |         |  |  |  |  |         |     |       |         |  |  |  |  |         |     |       |         |  |  |  |  |                 |     |       |         |  |  |  |  |                 |     |       |         |  |  |  |  |                 |     |       |         |  |  |  |  |                 |     |       |         |  |  |  |  |                 |     |       |         |  |  |  |  |                 |     |       |         |  |  |  |  |                 |     |       |         |  |  |  |  |                 |     |       |         |  |  |  |  |
| 3.0 TDI quattro  | 240   | 08.14           | PR: 1LL,1LF |                |             |   |                         |   |                         |                  |     |       |             |                |        |                              |                       |                  |     |       |             |                |        |  |                     |         |     |       |             |  |  |  |  |                 |     |       |             |  |  |  |  |         |     |       |             |  |  |  |  |         |     |       |             |  |  |  |  |         |     |       |             |  |  |  |  |                 |     |       |             |  |  |  |  |                 |     |       |             |  |  |  |  |                 |     |       |             |  |  |  |  |                 |     |       |             |  |  |  |  |                 |     |       |             |  |  |  |  |                 |     |       |             |  |  |  |  |               |     |       |             |  |  |  |  |                  |     |       |             |  |  |  |  |                 |     |       |             |                |        |                              |                       |                 |     |       |             |                |        |  |                     |                 |     |       |             |  |  |  |  |                  |     |       |             |  |  |  |  |    |     |       |             |  |  |  |  |    |     |       |             |  |  |  |  |          |     |       |             |                |        |  |                     |          |     |       |             |                |        |  |                     |                  |     |       |             |                |        |  |                       |         |     |       |             |  |  |  |  |                 |     |       |             |  |  |  |  |         |     |       |             |  |  |  |  |         |     |       |             |  |  |  |  |         |     |       |             |  |  |  |  |                 |     |       |             |  |  |  |  |                 |     |       |             |  |  |  |  |                 |     |       |             |  |  |  |  |                 |     |       |             |  |  |  |  |                 |     |       |             |  |  |  |  |                 |     |       |             |  |  |  |  |               |     |       |             |  |  |  |  |                  |     |       |             |  |  |  |  |                 |     |       |             |                |        |  |                     |                 |     |       |             |                |        |  |                       |                 |     |       |             |  |  |  |  |                  |     |       |             |  |  |  |  |    |     |       |             |  |  |  |  |    |     |       |             |  |  |  |  |          |     |       |         |                |        |  |                    |          |     |       |         |                |        |  |                     |                  |     |       |         |  |  |  |  |         |     |       |         |  |  |  |  |                 |     |       |         |  |  |  |  |         |     |       |         |  |  |  |  |         |     |       |         |  |  |  |  |         |     |       |         |  |  |  |  |                 |     |       |         |  |  |  |  |                 |     |       |         |  |  |  |  |                 |     |       |         |  |  |  |  |                 |     |       |         |  |  |  |  |                 |     |       |         |  |  |  |  |                 |     |       |         |  |  |  |  |                 |     |       |         |  |  |  |  |                 |     |       |         |  |  |  |  |                 |     |       |         |  |  |  |  |               |     |       |         |  |  |  |  |                  |     |       |         |  |  |  |  |                  |     |       |         |  |  |  |  |    |     |       |         |  |  |  |  |    |     |       |         |  |  |  |  |          |     |       |         |                |        |  |                       |          |     |       |         |  |  |  |  |                  |     |       |         |  |  |  |  |         |     |       |         |  |  |  |  |                 |     |       |         |  |  |  |  |         |     |       |         |  |  |  |  |         |     |       |         |  |  |  |  |         |     |       |         |  |  |  |  |                 |     |       |         |  |  |  |  |                 |     |       |         |  |  |  |  |                 |     |       |         |  |  |  |  |                 |     |       |         |  |  |  |  |                 |     |       |         |  |  |  |  |                 |     |       |         |  |  |  |  |                 |     |       |         |  |  |  |  |                 |     |       |         |  |  |  |  |
| 3.0 TFSI quattro   | 245   | 05.14           | PR: 1LL,1LF |                |             |   |                         |   |                         |                  |     |       |             |                |        |                              |                       |                  |     |       |             |                |        |  |                     |         |     |       |             |  |  |  |  |                 |     |       |             |  |  |  |  |         |     |       |             |  |  |  |  |         |     |       |             |  |  |  |  |         |     |       |             |  |  |  |  |                 |     |       |             |  |  |  |  |                 |     |       |             |  |  |  |  |                 |     |       |             |  |  |  |  |                 |     |       |             |  |  |  |  |                 |     |       |             |  |  |  |  |                 |     |       |             |  |  |  |  |               |     |       |             |  |  |  |  |                  |     |       |             |  |  |  |  |                 |     |       |             |                |        |                              |                       |                 |     |       |             |                |        |  |                     |                 |     |       |             |  |  |  |  |                  |     |       |             |  |  |  |  |    |     |       |             |  |  |  |  |    |     |       |             |  |  |  |  |          |     |       |             |                |        |  |                     |          |     |       |             |                |        |  |                     |                  |     |       |             |                |        |  |                       |         |     |       |             |  |  |  |  |                 |     |       |             |  |  |  |  |         |     |       |             |  |  |  |  |         |     |       |             |  |  |  |  |         |     |       |             |  |  |  |  |                 |     |       |             |  |  |  |  |                 |     |       |             |  |  |  |  |                 |     |       |             |  |  |  |  |                 |     |       |             |  |  |  |  |                 |     |       |             |  |  |  |  |                 |     |       |             |  |  |  |  |               |     |       |             |  |  |  |  |                  |     |       |             |  |  |  |  |                 |     |       |             |                |        |  |                     |                 |     |       |             |                |        |  |                       |                 |     |       |             |  |  |  |  |                  |     |       |             |  |  |  |  |    |     |       |             |  |  |  |  |    |     |       |             |  |  |  |  |          |     |       |         |                |        |  |                    |          |     |       |         |                |        |  |                     |                  |     |       |         |  |  |  |  |         |     |       |         |  |  |  |  |                 |     |       |         |  |  |  |  |         |     |       |         |  |  |  |  |         |     |       |         |  |  |  |  |         |     |       |         |  |  |  |  |                 |     |       |         |  |  |  |  |                 |     |       |         |  |  |  |  |                 |     |       |         |  |  |  |  |                 |     |       |         |  |  |  |  |                 |     |       |         |  |  |  |  |                 |     |       |         |  |  |  |  |                 |     |       |         |  |  |  |  |                 |     |       |         |  |  |  |  |                 |     |       |         |  |  |  |  |               |     |       |         |  |  |  |  |                  |     |       |         |  |  |  |  |                  |     |       |         |  |  |  |  |    |     |       |         |  |  |  |  |    |     |       |         |  |  |  |  |          |     |       |         |                |        |  |                       |          |     |       |         |  |  |  |  |                  |     |       |         |  |  |  |  |         |     |       |         |  |  |  |  |                 |     |       |         |  |  |  |  |         |     |       |         |  |  |  |  |         |     |       |         |  |  |  |  |         |     |       |         |  |  |  |  |                 |     |       |         |  |  |  |  |                 |     |       |         |  |  |  |  |                 |     |       |         |  |  |  |  |                 |     |       |         |  |  |  |  |                 |     |       |         |  |  |  |  |                 |     |       |         |  |  |  |  |                 |     |       |         |  |  |  |  |                 |     |       |         |  |  |  |  |
| S7   | 309   | 10.11           | PR: 1LL,1LF |                |             |   |                         |   |                         |                  |     |       |             |                |        |                              |                       |                  |     |       |             |                |        |  |                     |         |     |       |             |  |  |  |  |                 |     |       |             |  |  |  |  |         |     |       |             |  |  |  |  |         |     |       |             |  |  |  |  |         |     |       |             |  |  |  |  |                 |     |       |             |  |  |  |  |                 |     |       |             |  |  |  |  |                 |     |       |             |  |  |  |  |                 |     |       |             |  |  |  |  |                 |     |       |             |  |  |  |  |                 |     |       |             |  |  |  |  |               |     |       |             |  |  |  |  |                  |     |       |             |  |  |  |  |                 |     |       |             |                |        |                              |                       |                 |     |       |             |                |        |  |                     |                 |     |       |             |  |  |  |  |                  |     |       |             |  |  |  |  |    |     |       |             |  |  |  |  |    |     |       |             |  |  |  |  |          |     |       |             |                |        |  |                     |          |     |       |             |                |        |  |                     |                  |     |       |             |                |        |  |                       |         |     |       |             |  |  |  |  |                 |     |       |             |  |  |  |  |         |     |       |             |  |  |  |  |         |     |       |             |  |  |  |  |         |     |       |             |  |  |  |  |                 |     |       |             |  |  |  |  |                 |     |       |             |  |  |  |  |                 |     |       |             |  |  |  |  |                 |     |       |             |  |  |  |  |                 |     |       |             |  |  |  |  |                 |     |       |             |  |  |  |  |               |     |       |             |  |  |  |  |                  |     |       |             |  |  |  |  |                 |     |       |             |                |        |  |                     |                 |     |       |             |                |        |  |                       |                 |     |       |             |  |  |  |  |                  |     |       |             |  |  |  |  |    |     |       |             |  |  |  |  |    |     |       |             |  |  |  |  |          |     |       |         |                |        |  |                    |          |     |       |         |                |        |  |                     |                  |     |       |         |  |  |  |  |         |     |       |         |  |  |  |  |                 |     |       |         |  |  |  |  |         |     |       |         |  |  |  |  |         |     |       |         |  |  |  |  |         |     |       |         |  |  |  |  |                 |     |       |         |  |  |  |  |                 |     |       |         |  |  |  |  |                 |     |       |         |  |  |  |  |                 |     |       |         |  |  |  |  |                 |     |       |         |  |  |  |  |                 |     |       |         |  |  |  |  |                 |     |       |         |  |  |  |  |                 |     |       |         |  |  |  |  |                 |     |       |         |  |  |  |  |               |     |       |         |  |  |  |  |                  |     |       |         |  |  |  |  |                  |     |       |         |  |  |  |  |    |     |       |         |  |  |  |  |    |     |       |         |  |  |  |  |          |     |       |         |                |        |  |                       |          |     |       |         |  |  |  |  |                  |     |       |         |  |  |  |  |         |     |       |         |  |  |  |  |                 |     |       |         |  |  |  |  |         |     |       |         |  |  |  |  |         |     |       |         |  |  |  |  |         |     |       |         |  |  |  |  |                 |     |       |         |  |  |  |  |                 |     |       |         |  |  |  |  |                 |     |       |         |  |  |  |  |                 |     |       |         |  |  |  |  |                 |     |       |         |  |  |  |  |                 |     |       |         |  |  |  |  |                 |     |       |         |  |  |  |  |                 |     |       |         |  |  |  |  |
| S7   | 331   | 05.14           | PR: 1LL,1LF |                |             |   |                         |   |                         |                  |     |       |             |                |        |                              |                       |                  |     |       |             |                |        |  |                     |         |     |       |             |  |  |  |  |                 |     |       |             |  |  |  |  |         |     |       |             |  |  |  |  |         |     |       |             |  |  |  |  |         |     |       |             |  |  |  |  |                 |     |       |             |  |  |  |  |                 |     |       |             |  |  |  |  |                 |     |       |             |  |  |  |  |                 |     |       |             |  |  |  |  |                 |     |       |             |  |  |  |  |                 |     |       |             |  |  |  |  |               |     |       |             |  |  |  |  |                  |     |       |             |  |  |  |  |                 |     |       |             |                |        |                              |                       |                 |     |       |             |                |        |  |                     |                 |     |       |             |  |  |  |  |                  |     |       |             |  |  |  |  |    |     |       |             |  |  |  |  |    |     |       |             |  |  |  |  |          |     |       |             |                |        |  |                     |          |     |       |             |                |        |  |                     |                  |     |       |             |                |        |  |                       |         |     |       |             |  |  |  |  |                 |     |       |             |  |  |  |  |         |     |       |             |  |  |  |  |         |     |       |             |  |  |  |  |         |     |       |             |  |  |  |  |                 |     |       |             |  |  |  |  |                 |     |       |             |  |  |  |  |                 |     |       |             |  |  |  |  |                 |     |       |             |  |  |  |  |                 |     |       |             |  |  |  |  |                 |     |       |             |  |  |  |  |               |     |       |             |  |  |  |  |                  |     |       |             |  |  |  |  |                 |     |       |             |                |        |  |                     |                 |     |       |             |                |        |  |                       |                 |     |       |             |  |  |  |  |                  |     |       |             |  |  |  |  |    |     |       |             |  |  |  |  |    |     |       |             |  |  |  |  |          |     |       |         |                |        |  |                    |          |     |       |         |                |        |  |                     |                  |     |       |         |  |  |  |  |         |     |       |         |  |  |  |  |                 |     |       |         |  |  |  |  |         |     |       |         |  |  |  |  |         |     |       |         |  |  |  |  |         |     |       |         |  |  |  |  |                 |     |       |         |  |  |  |  |                 |     |       |         |  |  |  |  |                 |     |       |         |  |  |  |  |                 |     |       |         |  |  |  |  |                 |     |       |         |  |  |  |  |                 |     |       |         |  |  |  |  |                 |     |       |         |  |  |  |  |                 |     |       |         |  |  |  |  |                 |     |       |         |  |  |  |  |               |     |       |         |  |  |  |  |                  |     |       |         |  |  |  |  |                  |     |       |         |  |  |  |  |    |     |       |         |  |  |  |  |    |     |       |         |  |  |  |  |          |     |       |         |                |        |  |                       |          |     |       |         |  |  |  |  |                  |     |       |         |  |  |  |  |         |     |       |         |  |  |  |  |                 |     |       |         |  |  |  |  |         |     |       |         |  |  |  |  |         |     |       |         |  |  |  |  |         |     |       |         |  |  |  |  |                 |     |       |         |  |  |  |  |                 |     |       |         |  |  |  |  |                 |     |       |         |  |  |  |  |                 |     |       |         |  |  |  |  |                 |     |       |         |  |  |  |  |                 |     |       |         |  |  |  |  |                 |     |       |         |  |  |  |  |                 |     |       |         |  |  |  |  |
| 1.8 TFSI   | 140   | 04.15           | PR: 1LU     | 13.0460-4873.2 | 604873      |   | 24847 17,0 /WE BRE      |   |                         |                  |     |       |             |                |        |                              |                       |                  |     |       |             |                |        |  |                     |         |     |       |             |  |  |  |  |                 |     |       |             |  |  |  |  |         |     |       |             |  |  |  |  |         |     |       |             |  |  |  |  |         |     |       |             |  |  |  |  |                 |     |       |             |  |  |  |  |                 |     |       |             |  |  |  |  |                 |     |       |             |  |  |  |  |                 |     |       |             |  |  |  |  |                 |     |       |             |  |  |  |  |                 |     |       |             |  |  |  |  |               |     |       |             |  |  |  |  |                  |     |       |             |  |  |  |  |                 |     |       |             |                |        |                              |                       |                 |     |       |             |                |        |  |                     |                 |     |       |             |  |  |  |  |                  |     |       |             |  |  |  |  |    |     |       |             |  |  |  |  |    |     |       |             |  |  |  |  |          |     |       |             |                |        |  |                     |          |     |       |             |                |        |  |                     |                  |     |       |             |                |        |  |                       |         |     |       |             |  |  |  |  |                 |     |       |             |  |  |  |  |         |     |       |             |  |  |  |  |         |     |       |             |  |  |  |  |         |     |       |             |  |  |  |  |                 |     |       |             |  |  |  |  |                 |     |       |             |  |  |  |  |                 |     |       |             |  |  |  |  |                 |     |       |             |  |  |  |  |                 |     |       |             |  |  |  |  |                 |     |       |             |  |  |  |  |               |     |       |             |  |  |  |  |                  |     |       |             |  |  |  |  |                 |     |       |             |                |        |  |                     |                 |     |       |             |                |        |  |                       |                 |     |       |             |  |  |  |  |                  |     |       |             |  |  |  |  |    |     |       |             |  |  |  |  |    |     |       |             |  |  |  |  |          |     |       |         |                |        |  |                    |          |     |       |         |                |        |  |                     |                  |     |       |         |  |  |  |  |         |     |       |         |  |  |  |  |                 |     |       |         |  |  |  |  |         |     |       |         |  |  |  |  |         |     |       |         |  |  |  |  |         |     |       |         |  |  |  |  |                 |     |       |         |  |  |  |  |                 |     |       |         |  |  |  |  |                 |     |       |         |  |  |  |  |                 |     |       |         |  |  |  |  |                 |     |       |         |  |  |  |  |                 |     |       |         |  |  |  |  |                 |     |       |         |  |  |  |  |                 |     |       |         |  |  |  |  |                 |     |       |         |  |  |  |  |               |     |       |         |  |  |  |  |                  |     |       |         |  |  |  |  |                  |     |       |         |  |  |  |  |    |     |       |         |  |  |  |  |    |     |       |         |  |  |  |  |          |     |       |         |                |        |  |                       |          |     |       |         |  |  |  |  |                  |     |       |         |  |  |  |  |         |     |       |         |  |  |  |  |                 |     |       |         |  |  |  |  |         |     |       |         |  |  |  |  |         |     |       |         |  |  |  |  |         |     |       |         |  |  |  |  |                 |     |       |         |  |  |  |  |                 |     |       |         |  |  |  |  |                 |     |       |         |  |  |  |  |                 |     |       |         |  |  |  |  |                 |     |       |         |  |  |  |  |                 |     |       |         |  |  |  |  |                 |     |       |         |  |  |  |  |                 |     |       |         |  |  |  |  |
| 2.0 TFSI   | 185   | 09.14           | PR: 1LU     | 24.8190-0019.2 | 620019      |   | Warnkontakt L=254mm     |   |                         |                  |     |       |             |                |        |                              |                       |                  |     |       |             |                |        |  |                     |         |     |       |             |  |  |  |  |                 |     |       |             |  |  |  |  |         |     |       |             |  |  |  |  |         |     |       |             |  |  |  |  |         |     |       |             |  |  |  |  |                 |     |       |             |  |  |  |  |                 |     |       |             |  |  |  |  |                 |     |       |             |  |  |  |  |                 |     |       |             |  |  |  |  |                 |     |       |             |  |  |  |  |                 |     |       |             |  |  |  |  |               |     |       |             |  |  |  |  |                  |     |       |             |  |  |  |  |                 |     |       |             |                |        |                              |                       |                 |     |       |             |                |        |  |                     |                 |     |       |             |  |  |  |  |                  |     |       |             |  |  |  |  |    |     |       |             |  |  |  |  |    |     |       |             |  |  |  |  |          |     |       |             |                |        |  |                     |          |     |       |             |                |        |  |                     |                  |     |       |             |                |        |  |                       |         |     |       |             |  |  |  |  |                 |     |       |             |  |  |  |  |         |     |       |             |  |  |  |  |         |     |       |             |  |  |  |  |         |     |       |             |  |  |  |  |                 |     |       |             |  |  |  |  |                 |     |       |             |  |  |  |  |                 |     |       |             |  |  |  |  |                 |     |       |             |  |  |  |  |                 |     |       |             |  |  |  |  |                 |     |       |             |  |  |  |  |               |     |       |             |  |  |  |  |                  |     |       |             |  |  |  |  |                 |     |       |             |                |        |  |                     |                 |     |       |             |                |        |  |                       |                 |     |       |             |  |  |  |  |                  |     |       |             |  |  |  |  |    |     |       |             |  |  |  |  |    |     |       |             |  |  |  |  |          |     |       |         |                |        |  |                    |          |     |       |         |                |        |  |                     |                  |     |       |         |  |  |  |  |         |     |       |         |  |  |  |  |                 |     |       |         |  |  |  |  |         |     |       |         |  |  |  |  |         |     |       |         |  |  |  |  |         |     |       |         |  |  |  |  |                 |     |       |         |  |  |  |  |                 |     |       |         |  |  |  |  |                 |     |       |         |  |  |  |  |                 |     |       |         |  |  |  |  |                 |     |       |         |  |  |  |  |                 |     |       |         |  |  |  |  |                 |     |       |         |  |  |  |  |                 |     |       |         |  |  |  |  |                 |     |       |         |  |  |  |  |               |     |       |         |  |  |  |  |                  |     |       |         |  |  |  |  |                  |     |       |         |  |  |  |  |    |     |       |         |  |  |  |  |    |     |       |         |  |  |  |  |          |     |       |         |                |        |  |                       |          |     |       |         |  |  |  |  |                  |     |       |         |  |  |  |  |         |     |       |         |  |  |  |  |                 |     |       |         |  |  |  |  |         |     |       |         |  |  |  |  |         |     |       |         |  |  |  |  |         |     |       |         |  |  |  |  |                 |     |       |         |  |  |  |  |                 |     |       |         |  |  |  |  |                 |     |       |         |  |  |  |  |                 |     |       |         |  |  |  |  |                 |     |       |         |  |  |  |  |                 |     |       |         |  |  |  |  |                 |     |       |         |  |  |  |  |                 |     |       |         |  |  |  |  |
| 2.0 TFSI quattro   | 185   | 05.15           | PR: 1LU     |                |             |   |                         |   |                         |                  |     |       |             |                |        |                              |                       |                  |     |       |             |                |        |  |                     |         |     |       |             |  |  |  |  |                 |     |       |             |  |  |  |  |         |     |       |             |  |  |  |  |         |     |       |             |  |  |  |  |         |     |       |             |  |  |  |  |                 |     |       |             |  |  |  |  |                 |     |       |             |  |  |  |  |                 |     |       |             |  |  |  |  |                 |     |       |             |  |  |  |  |                 |     |       |             |  |  |  |  |                 |     |       |             |  |  |  |  |               |     |       |             |  |  |  |  |                  |     |       |             |  |  |  |  |                 |     |       |             |                |        |                              |                       |                 |     |       |             |                |        |  |                     |                 |     |       |             |  |  |  |  |                  |     |       |             |  |  |  |  |    |     |       |             |  |  |  |  |    |     |       |             |  |  |  |  |          |     |       |             |                |        |  |                     |          |     |       |             |                |        |  |                     |                  |     |       |             |                |        |  |                       |         |     |       |             |  |  |  |  |                 |     |       |             |  |  |  |  |         |     |       |             |  |  |  |  |         |     |       |             |  |  |  |  |         |     |       |             |  |  |  |  |                 |     |       |             |  |  |  |  |                 |     |       |             |  |  |  |  |                 |     |       |             |  |  |  |  |                 |     |       |             |  |  |  |  |                 |     |       |             |  |  |  |  |                 |     |       |             |  |  |  |  |               |     |       |             |  |  |  |  |                  |     |       |             |  |  |  |  |                 |     |       |             |                |        |  |                     |                 |     |       |             |                |        |  |                       |                 |     |       |             |  |  |  |  |                  |     |       |             |  |  |  |  |    |     |       |             |  |  |  |  |    |     |       |             |  |  |  |  |          |     |       |         |                |        |  |                    |          |     |       |         |                |        |  |                     |                  |     |       |         |  |  |  |  |         |     |       |         |  |  |  |  |                 |     |       |         |  |  |  |  |         |     |       |         |  |  |  |  |         |     |       |         |  |  |  |  |         |     |       |         |  |  |  |  |                 |     |       |         |  |  |  |  |                 |     |       |         |  |  |  |  |                 |     |       |         |  |  |  |  |                 |     |       |         |  |  |  |  |                 |     |       |         |  |  |  |  |                 |     |       |         |  |  |  |  |                 |     |       |         |  |  |  |  |                 |     |       |         |  |  |  |  |                 |     |       |         |  |  |  |  |               |     |       |         |  |  |  |  |                  |     |       |         |  |  |  |  |                  |     |       |         |  |  |  |  |    |     |       |         |  |  |  |  |    |     |       |         |  |  |  |  |          |     |       |         |                |        |  |                       |          |     |       |         |  |  |  |  |                  |     |       |         |  |  |  |  |         |     |       |         |  |  |  |  |                 |     |       |         |  |  |  |  |         |     |       |         |  |  |  |  |         |     |       |         |  |  |  |  |         |     |       |         |  |  |  |  |                 |     |       |         |  |  |  |  |                 |     |       |         |  |  |  |  |                 |     |       |         |  |  |  |  |                 |     |       |         |  |  |  |  |                 |     |       |         |  |  |  |  |                 |     |       |         |  |  |  |  |                 |     |       |         |  |  |  |  |                 |     |       |         |  |  |  |  |
| 2.8 FSI  | 150   | 05.11           | PR: 1LU     |                |             |   |                         |   |                         |                  |     |       |             |                |        |                              |                       |                  |     |       |             |                |        |  |                     |         |     |       |             |  |  |  |  |                 |     |       |             |  |  |  |  |         |     |       |             |  |  |  |  |         |     |       |             |  |  |  |  |         |     |       |             |  |  |  |  |                 |     |       |             |  |  |  |  |                 |     |       |             |  |  |  |  |                 |     |       |             |  |  |  |  |                 |     |       |             |  |  |  |  |                 |     |       |             |  |  |  |  |                 |     |       |             |  |  |  |  |               |     |       |             |  |  |  |  |                  |     |       |             |  |  |  |  |                 |     |       |             |                |        |                              |                       |                 |     |       |             |                |        |  |                     |                 |     |       |             |  |  |  |  |                  |     |       |             |  |  |  |  |    |     |       |             |  |  |  |  |    |     |       |             |  |  |  |  |          |     |       |             |                |        |  |                     |          |     |       |             |                |        |  |                     |                  |     |       |             |                |        |  |                       |         |     |       |             |  |  |  |  |                 |     |       |             |  |  |  |  |         |     |       |             |  |  |  |  |         |     |       |             |  |  |  |  |         |     |       |             |  |  |  |  |                 |     |       |             |  |  |  |  |                 |     |       |             |  |  |  |  |                 |     |       |             |  |  |  |  |                 |     |       |             |  |  |  |  |                 |     |       |             |  |  |  |  |                 |     |       |             |  |  |  |  |               |     |       |             |  |  |  |  |                  |     |       |             |  |  |  |  |                 |     |       |             |                |        |  |                     |                 |     |       |             |                |        |  |                       |                 |     |       |             |  |  |  |  |                  |     |       |             |  |  |  |  |    |     |       |             |  |  |  |  |    |     |       |             |  |  |  |  |          |     |       |         |                |        |  |                    |          |     |       |         |                |        |  |                     |                  |     |       |         |  |  |  |  |         |     |       |         |  |  |  |  |                 |     |       |         |  |  |  |  |         |     |       |         |  |  |  |  |         |     |       |         |  |  |  |  |         |     |       |         |  |  |  |  |                 |     |       |         |  |  |  |  |                 |     |       |         |  |  |  |  |                 |     |       |         |  |  |  |  |                 |     |       |         |  |  |  |  |                 |     |       |         |  |  |  |  |                 |     |       |         |  |  |  |  |                 |     |       |         |  |  |  |  |                 |     |       |         |  |  |  |  |                 |     |       |         |  |  |  |  |               |     |       |         |  |  |  |  |                  |     |       |         |  |  |  |  |                  |     |       |         |  |  |  |  |    |     |       |         |  |  |  |  |    |     |       |         |  |  |  |  |          |     |       |         |                |        |  |                       |          |     |       |         |  |  |  |  |                  |     |       |         |  |  |  |  |         |     |       |         |  |  |  |  |                 |     |       |         |  |  |  |  |         |     |       |         |  |  |  |  |         |     |       |         |  |  |  |  |         |     |       |         |  |  |  |  |                 |     |       |         |  |  |  |  |                 |     |       |         |  |  |  |  |                 |     |       |         |  |  |  |  |                 |     |       |         |  |  |  |  |                 |     |       |         |  |  |  |  |                 |     |       |         |  |  |  |  |                 |     |       |         |  |  |  |  |                 |     |       |         |  |  |  |  |
| 2.8 FSI quattro  | 150   | 07.10           | PR: 1LU     |                |             |   |                         |   |                         |                  |     |       |             |                |        |                              |                       |                  |     |       |             |                |        |  |                     |         |     |       |             |  |  |  |  |                 |     |       |             |  |  |  |  |         |     |       |             |  |  |  |  |         |     |       |             |  |  |  |  |         |     |       |             |  |  |  |  |                 |     |       |             |  |  |  |  |                 |     |       |             |  |  |  |  |                 |     |       |             |  |  |  |  |                 |     |       |             |  |  |  |  |                 |     |       |             |  |  |  |  |                 |     |       |             |  |  |  |  |               |     |       |             |  |  |  |  |                  |     |       |             |  |  |  |  |                 |     |       |             |                |        |                              |                       |                 |     |       |             |                |        |  |                     |                 |     |       |             |  |  |  |  |                  |     |       |             |  |  |  |  |    |     |       |             |  |  |  |  |    |     |       |             |  |  |  |  |          |     |       |             |                |        |  |                     |          |     |       |             |                |        |  |                     |                  |     |       |             |                |        |  |                       |         |     |       |             |  |  |  |  |                 |     |       |             |  |  |  |  |         |     |       |             |  |  |  |  |         |     |       |             |  |  |  |  |         |     |       |             |  |  |  |  |                 |     |       |             |  |  |  |  |                 |     |       |             |  |  |  |  |                 |     |       |             |  |  |  |  |                 |     |       |             |  |  |  |  |                 |     |       |             |  |  |  |  |                 |     |       |             |  |  |  |  |               |     |       |             |  |  |  |  |                  |     |       |             |  |  |  |  |                 |     |       |             |                |        |  |                     |                 |     |       |             |                |        |  |                       |                 |     |       |             |  |  |  |  |                  |     |       |             |  |  |  |  |    |     |       |             |  |  |  |  |    |     |       |             |  |  |  |  |          |     |       |         |                |        |  |                    |          |     |       |         |                |        |  |                     |                  |     |       |         |  |  |  |  |         |     |       |         |  |  |  |  |                 |     |       |         |  |  |  |  |         |     |       |         |  |  |  |  |         |     |       |         |  |  |  |  |         |     |       |         |  |  |  |  |                 |     |       |         |  |  |  |  |                 |     |       |         |  |  |  |  |                 |     |       |         |  |  |  |  |                 |     |       |         |  |  |  |  |                 |     |       |         |  |  |  |  |                 |     |       |         |  |  |  |  |                 |     |       |         |  |  |  |  |                 |     |       |         |  |  |  |  |                 |     |       |         |  |  |  |  |               |     |       |         |  |  |  |  |                  |     |       |         |  |  |  |  |                  |     |       |         |  |  |  |  |    |     |       |         |  |  |  |  |    |     |       |         |  |  |  |  |          |     |       |         |                |        |  |                       |          |     |       |         |  |  |  |  |                  |     |       |         |  |  |  |  |         |     |       |         |  |  |  |  |                 |     |       |         |  |  |  |  |         |     |       |         |  |  |  |  |         |     |       |         |  |  |  |  |         |     |       |         |  |  |  |  |                 |     |       |         |  |  |  |  |                 |     |       |         |  |  |  |  |                 |     |       |         |  |  |  |  |                 |     |       |         |  |  |  |  |                 |     |       |         |  |  |  |  |                 |     |       |         |  |  |  |  |                 |     |       |         |  |  |  |  |                 |     |       |         |  |  |  |  |
| 3.0 TDI  | 140   | 11.15           | PR: 1LU     |                |             |   |                         |   |                         |                  |     |       |             |                |        |                              |                       |                  |     |       |             |                |        |  |                     |         |     |       |             |  |  |  |  |                 |     |       |             |  |  |  |  |         |     |       |             |  |  |  |  |         |     |       |             |  |  |  |  |         |     |       |             |  |  |  |  |                 |     |       |             |  |  |  |  |                 |     |       |             |  |  |  |  |                 |     |       |             |  |  |  |  |                 |     |       |             |  |  |  |  |                 |     |       |             |  |  |  |  |                 |     |       |             |  |  |  |  |               |     |       |             |  |  |  |  |                  |     |       |             |  |  |  |  |                 |     |       |             |                |        |                              |                       |                 |     |       |             |                |        |  |                     |                 |     |       |             |  |  |  |  |                  |     |       |             |  |  |  |  |    |     |       |             |  |  |  |  |    |     |       |             |  |  |  |  |          |     |       |             |                |        |  |                     |          |     |       |             |                |        |  |                     |                  |     |       |             |                |        |  |                       |         |     |       |             |  |  |  |  |                 |     |       |             |  |  |  |  |         |     |       |             |  |  |  |  |         |     |       |             |  |  |  |  |         |     |       |             |  |  |  |  |                 |     |       |             |  |  |  |  |                 |     |       |             |  |  |  |  |                 |     |       |             |  |  |  |  |                 |     |       |             |  |  |  |  |                 |     |       |             |  |  |  |  |                 |     |       |             |  |  |  |  |               |     |       |             |  |  |  |  |                  |     |       |             |  |  |  |  |                 |     |       |             |                |        |  |                     |                 |     |       |             |                |        |  |                       |                 |     |       |             |  |  |  |  |                  |     |       |             |  |  |  |  |    |     |       |             |  |  |  |  |    |     |       |             |  |  |  |  |          |     |       |         |                |        |  |                    |          |     |       |         |                |        |  |                     |                  |     |       |         |  |  |  |  |         |     |       |         |  |  |  |  |                 |     |       |         |  |  |  |  |         |     |       |         |  |  |  |  |         |     |       |         |  |  |  |  |         |     |       |         |  |  |  |  |                 |     |       |         |  |  |  |  |                 |     |       |         |  |  |  |  |                 |     |       |         |  |  |  |  |                 |     |       |         |  |  |  |  |                 |     |       |         |  |  |  |  |                 |     |       |         |  |  |  |  |                 |     |       |         |  |  |  |  |                 |     |       |         |  |  |  |  |                 |     |       |         |  |  |  |  |               |     |       |         |  |  |  |  |                  |     |       |         |  |  |  |  |                  |     |       |         |  |  |  |  |    |     |       |         |  |  |  |  |    |     |       |         |  |  |  |  |          |     |       |         |                |        |  |                       |          |     |       |         |  |  |  |  |                  |     |       |         |  |  |  |  |         |     |       |         |  |  |  |  |                 |     |       |         |  |  |  |  |         |     |       |         |  |  |  |  |         |     |       |         |  |  |  |  |         |     |       |         |  |  |  |  |                 |     |       |         |  |  |  |  |                 |     |       |         |  |  |  |  |                 |     |       |         |  |  |  |  |                 |     |       |         |  |  |  |  |                 |     |       |         |  |  |  |  |                 |     |       |         |  |  |  |  |                 |     |       |         |  |  |  |  |                 |     |       |         |  |  |  |  |
| 3.0 TDI  | 150   | 11.10           | PR: 1LU     |                |             |   |                         |   |                         |                  |     |       |             |                |        |                              |                       |                  |     |       |             |                |        |  |                     |         |     |       |             |  |  |  |  |                 |     |       |             |  |  |  |  |         |     |       |             |  |  |  |  |         |     |       |             |  |  |  |  |         |     |       |             |  |  |  |  |                 |     |       |             |  |  |  |  |                 |     |       |             |  |  |  |  |                 |     |       |             |  |  |  |  |                 |     |       |             |  |  |  |  |                 |     |       |             |  |  |  |  |                 |     |       |             |  |  |  |  |               |     |       |             |  |  |  |  |                  |     |       |             |  |  |  |  |                 |     |       |             |                |        |                              |                       |                 |     |       |             |                |        |  |                     |                 |     |       |             |  |  |  |  |                  |     |       |             |  |  |  |  |    |     |       |             |  |  |  |  |    |     |       |             |  |  |  |  |          |     |       |             |                |        |  |                     |          |     |       |             |                |        |  |                     |                  |     |       |             |                |        |  |                       |         |     |       |             |  |  |  |  |                 |     |       |             |  |  |  |  |         |     |       |             |  |  |  |  |         |     |       |             |  |  |  |  |         |     |       |             |  |  |  |  |                 |     |       |             |  |  |  |  |                 |     |       |             |  |  |  |  |                 |     |       |             |  |  |  |  |                 |     |       |             |  |  |  |  |                 |     |       |             |  |  |  |  |                 |     |       |             |  |  |  |  |               |     |       |             |  |  |  |  |                  |     |       |             |  |  |  |  |                 |     |       |             |                |        |  |                     |                 |     |       |             |                |        |  |                       |                 |     |       |             |  |  |  |  |                  |     |       |             |  |  |  |  |    |     |       |             |  |  |  |  |    |     |       |             |  |  |  |  |          |     |       |         |                |        |  |                    |          |     |       |         |                |        |  |                     |                  |     |       |         |  |  |  |  |         |     |       |         |  |  |  |  |                 |     |       |         |  |  |  |  |         |     |       |         |  |  |  |  |         |     |       |         |  |  |  |  |         |     |       |         |  |  |  |  |                 |     |       |         |  |  |  |  |                 |     |       |         |  |  |  |  |                 |     |       |         |  |  |  |  |                 |     |       |         |  |  |  |  |                 |     |       |         |  |  |  |  |                 |     |       |         |  |  |  |  |                 |     |       |         |  |  |  |  |                 |     |       |         |  |  |  |  |                 |     |       |         |  |  |  |  |               |     |       |         |  |  |  |  |                  |     |       |         |  |  |  |  |                  |     |       |         |  |  |  |  |    |     |       |         |  |  |  |  |    |     |       |         |  |  |  |  |          |     |       |         |                |        |  |                       |          |     |       |         |  |  |  |  |                  |     |       |         |  |  |  |  |         |     |       |         |  |  |  |  |                 |     |       |         |  |  |  |  |         |     |       |         |  |  |  |  |         |     |       |         |  |  |  |  |         |     |       |         |  |  |  |  |                 |     |       |         |  |  |  |  |                 |     |       |         |  |  |  |  |                 |     |       |         |  |  |  |  |                 |     |       |         |  |  |  |  |                 |     |       |         |  |  |  |  |                 |     |       |         |  |  |  |  |                 |     |       |         |  |  |  |  |                 |     |       |         |  |  |  |  |
| 3.0 TDI  | 155   | 11.15           | PR: 1LU     |                |             |   |                         |   |                         |                  |     |       |             |                |        |                              |                       |                  |     |       |             |                |        |  |                     |         |     |       |             |  |  |  |  |                 |     |       |             |  |  |  |  |         |     |       |             |  |  |  |  |         |     |       |             |  |  |  |  |         |     |       |             |  |  |  |  |                 |     |       |             |  |  |  |  |                 |     |       |             |  |  |  |  |                 |     |       |             |  |  |  |  |                 |     |       |             |  |  |  |  |                 |     |       |             |  |  |  |  |                 |     |       |             |  |  |  |  |               |     |       |             |  |  |  |  |                  |     |       |             |  |  |  |  |                 |     |       |             |                |        |                              |                       |                 |     |       |             |                |        |  |                     |                 |     |       |             |  |  |  |  |                  |     |       |             |  |  |  |  |    |     |       |             |  |  |  |  |    |     |       |             |  |  |  |  |          |     |       |             |                |        |  |                     |          |     |       |             |                |        |  |                     |                  |     |       |             |                |        |  |                       |         |     |       |             |  |  |  |  |                 |     |       |             |  |  |  |  |         |     |       |             |  |  |  |  |         |     |       |             |  |  |  |  |         |     |       |             |  |  |  |  |                 |     |       |             |  |  |  |  |                 |     |       |             |  |  |  |  |                 |     |       |             |  |  |  |  |                 |     |       |             |  |  |  |  |                 |     |       |             |  |  |  |  |                 |     |       |             |  |  |  |  |               |     |       |             |  |  |  |  |                  |     |       |             |  |  |  |  |                 |     |       |             |                |        |  |                     |                 |     |       |             |                |        |  |                       |                 |     |       |             |  |  |  |  |                  |     |       |             |  |  |  |  |    |     |       |             |  |  |  |  |    |     |       |             |  |  |  |  |          |     |       |         |                |        |  |                    |          |     |       |         |                |        |  |                     |                  |     |       |         |  |  |  |  |         |     |       |         |  |  |  |  |                 |     |       |         |  |  |  |  |         |     |       |         |  |  |  |  |         |     |       |         |  |  |  |  |         |     |       |         |  |  |  |  |                 |     |       |         |  |  |  |  |                 |     |       |         |  |  |  |  |                 |     |       |         |  |  |  |  |                 |     |       |         |  |  |  |  |                 |     |       |         |  |  |  |  |                 |     |       |         |  |  |  |  |                 |     |       |         |  |  |  |  |                 |     |       |         |  |  |  |  |                 |     |       |         |  |  |  |  |               |     |       |         |  |  |  |  |                  |     |       |         |  |  |  |  |                  |     |       |         |  |  |  |  |    |     |       |         |  |  |  |  |    |     |       |         |  |  |  |  |          |     |       |         |                |        |  |                       |          |     |       |         |  |  |  |  |                  |     |       |         |  |  |  |  |         |     |       |         |  |  |  |  |                 |     |       |         |  |  |  |  |         |     |       |         |  |  |  |  |         |     |       |         |  |  |  |  |         |     |       |         |  |  |  |  |                 |     |       |         |  |  |  |  |                 |     |       |         |  |  |  |  |                 |     |       |         |  |  |  |  |                 |     |       |         |  |  |  |  |                 |     |       |         |  |  |  |  |                 |     |       |         |  |  |  |  |                 |     |       |         |  |  |  |  |                 |     |       |         |  |  |  |  |
| 3.0 TDI quattro  | 140   | 11.15           | PR: 1LU     |                |             |   |                         |   |                         |                  |     |       |             |                |        |                              |                       |                  |     |       |             |                |        |  |                     |         |     |       |             |  |  |  |  |                 |     |       |             |  |  |  |  |         |     |       |             |  |  |  |  |         |     |       |             |  |  |  |  |         |     |       |             |  |  |  |  |                 |     |       |             |  |  |  |  |                 |     |       |             |  |  |  |  |                 |     |       |             |  |  |  |  |                 |     |       |             |  |  |  |  |                 |     |       |             |  |  |  |  |                 |     |       |             |  |  |  |  |               |     |       |             |  |  |  |  |                  |     |       |             |  |  |  |  |                 |     |       |             |                |        |                              |                       |                 |     |       |             |                |        |  |                     |                 |     |       |             |  |  |  |  |                  |     |       |             |  |  |  |  |    |     |       |             |  |  |  |  |    |     |       |             |  |  |  |  |          |     |       |             |                |        |  |                     |          |     |       |             |                |        |  |                     |                  |     |       |             |                |        |  |                       |         |     |       |             |  |  |  |  |                 |     |       |             |  |  |  |  |         |     |       |             |  |  |  |  |         |     |       |             |  |  |  |  |         |     |       |             |  |  |  |  |                 |     |       |             |  |  |  |  |                 |     |       |             |  |  |  |  |                 |     |       |             |  |  |  |  |                 |     |       |             |  |  |  |  |                 |     |       |             |  |  |  |  |                 |     |       |             |  |  |  |  |               |     |       |             |  |  |  |  |                  |     |       |             |  |  |  |  |                 |     |       |             |                |        |  |                     |                 |     |       |             |                |        |  |                       |                 |     |       |             |  |  |  |  |                  |     |       |             |  |  |  |  |    |     |       |             |  |  |  |  |    |     |       |             |  |  |  |  |          |     |       |         |                |        |  |                    |          |     |       |         |                |        |  |                     |                  |     |       |         |  |  |  |  |         |     |       |         |  |  |  |  |                 |     |       |         |  |  |  |  |         |     |       |         |  |  |  |  |         |     |       |         |  |  |  |  |         |     |       |         |  |  |  |  |                 |     |       |         |  |  |  |  |                 |     |       |         |  |  |  |  |                 |     |       |         |  |  |  |  |                 |     |       |         |  |  |  |  |                 |     |       |         |  |  |  |  |                 |     |       |         |  |  |  |  |                 |     |       |         |  |  |  |  |                 |     |       |         |  |  |  |  |                 |     |       |         |  |  |  |  |               |     |       |         |  |  |  |  |                  |     |       |         |  |  |  |  |                  |     |       |         |  |  |  |  |    |     |       |         |  |  |  |  |    |     |       |         |  |  |  |  |          |     |       |         |                |        |  |                       |          |     |       |         |  |  |  |  |                  |     |       |         |  |  |  |  |         |     |       |         |  |  |  |  |                 |     |       |         |  |  |  |  |         |     |       |         |  |  |  |  |         |     |       |         |  |  |  |  |         |     |       |         |  |  |  |  |                 |     |       |         |  |  |  |  |                 |     |       |         |  |  |  |  |                 |     |       |         |  |  |  |  |                 |     |       |         |  |  |  |  |                 |     |       |         |  |  |  |  |                 |     |       |         |  |  |  |  |                 |     |       |         |  |  |  |  |                 |     |       |         |  |  |  |  |
| 3.0 TDI quattro  | 150   | 07.10           | PR: 1LU     |                |             |   |                         |   |                         |                  |     |       |             |                |        |                              |                       |                  |     |       |             |                |        |  |                     |         |     |       |             |  |  |  |  |                 |     |       |             |  |  |  |  |         |     |       |             |  |  |  |  |         |     |       |             |  |  |  |  |         |     |       |             |  |  |  |  |                 |     |       |             |  |  |  |  |                 |     |       |             |  |  |  |  |                 |     |       |             |  |  |  |  |                 |     |       |             |  |  |  |  |                 |     |       |             |  |  |  |  |                 |     |       |             |  |  |  |  |               |     |       |             |  |  |  |  |                  |     |       |             |  |  |  |  |                 |     |       |             |                |        |                              |                       |                 |     |       |             |                |        |  |                     |                 |     |       |             |  |  |  |  |                  |     |       |             |  |  |  |  |    |     |       |             |  |  |  |  |    |     |       |             |  |  |  |  |          |     |       |             |                |        |  |                     |          |     |       |             |                |        |  |                     |                  |     |       |             |                |        |  |                       |         |     |       |             |  |  |  |  |                 |     |       |             |  |  |  |  |         |     |       |             |  |  |  |  |         |     |       |             |  |  |  |  |         |     |       |             |  |  |  |  |                 |     |       |             |  |  |  |  |                 |     |       |             |  |  |  |  |                 |     |       |             |  |  |  |  |                 |     |       |             |  |  |  |  |                 |     |       |             |  |  |  |  |                 |     |       |             |  |  |  |  |               |     |       |             |  |  |  |  |                  |     |       |             |  |  |  |  |                 |     |       |             |                |        |  |                     |                 |     |       |             |                |        |  |                       |                 |     |       |             |  |  |  |  |                  |     |       |             |  |  |  |  |    |     |       |             |  |  |  |  |    |     |       |             |  |  |  |  |          |     |       |         |                |        |  |                    |          |     |       |         |                |        |  |                     |                  |     |       |         |  |  |  |  |         |     |       |         |  |  |  |  |                 |     |       |         |  |  |  |  |         |     |       |         |  |  |  |  |         |     |       |         |  |  |  |  |         |     |       |         |  |  |  |  |                 |     |       |         |  |  |  |  |                 |     |       |         |  |  |  |  |                 |     |       |         |  |  |  |  |                 |     |       |         |  |  |  |  |                 |     |       |         |  |  |  |  |                 |     |       |         |  |  |  |  |                 |     |       |         |  |  |  |  |                 |     |       |         |  |  |  |  |                 |     |       |         |  |  |  |  |               |     |       |         |  |  |  |  |                  |     |       |         |  |  |  |  |                  |     |       |         |  |  |  |  |    |     |       |         |  |  |  |  |    |     |       |         |  |  |  |  |          |     |       |         |                |        |  |                       |          |     |       |         |  |  |  |  |                  |     |       |         |  |  |  |  |         |     |       |         |  |  |  |  |                 |     |       |         |  |  |  |  |         |     |       |         |  |  |  |  |         |     |       |         |  |  |  |  |         |     |       |         |  |  |  |  |                 |     |       |         |  |  |  |  |                 |     |       |         |  |  |  |  |                 |     |       |         |  |  |  |  |                 |     |       |         |  |  |  |  |                 |     |       |         |  |  |  |  |                 |     |       |         |  |  |  |  |                 |     |       |         |  |  |  |  |                 |     |       |         |  |  |  |  |
| 3.0 TDI quattro  | 160   | 05.14           | PR: 1LU     |                |             |   |                         |   |                         |                  |     |       |             |                |        |                              |                       |                  |     |       |             |                |        |  |                     |         |     |       |             |  |  |  |  |                 |     |       |             |  |  |  |  |         |     |       |             |  |  |  |  |         |     |       |             |  |  |  |  |         |     |       |             |  |  |  |  |                 |     |       |             |  |  |  |  |                 |     |       |             |  |  |  |  |                 |     |       |             |  |  |  |  |                 |     |       |             |  |  |  |  |                 |     |       |             |  |  |  |  |                 |     |       |             |  |  |  |  |               |     |       |             |  |  |  |  |                  |     |       |             |  |  |  |  |                 |     |       |             |                |        |                              |                       |                 |     |       |             |                |        |  |                     |                 |     |       |             |  |  |  |  |                  |     |       |             |  |  |  |  |    |     |       |             |  |  |  |  |    |     |       |             |  |  |  |  |          |     |       |             |                |        |  |                     |          |     |       |             |                |        |  |                     |                  |     |       |             |                |        |  |                       |         |     |       |             |  |  |  |  |                 |     |       |             |  |  |  |  |         |     |       |             |  |  |  |  |         |     |       |             |  |  |  |  |         |     |       |             |  |  |  |  |                 |     |       |             |  |  |  |  |                 |     |       |             |  |  |  |  |                 |     |       |             |  |  |  |  |                 |     |       |             |  |  |  |  |                 |     |       |             |  |  |  |  |                 |     |       |             |  |  |  |  |               |     |       |             |  |  |  |  |                  |     |       |             |  |  |  |  |                 |     |       |             |                |        |  |                     |                 |     |       |             |                |        |  |                       |                 |     |       |             |  |  |  |  |                  |     |       |             |  |  |  |  |    |     |       |             |  |  |  |  |    |     |       |             |  |  |  |  |          |     |       |         |                |        |  |                    |          |     |       |         |                |        |  |                     |                  |     |       |         |  |  |  |  |         |     |       |         |  |  |  |  |                 |     |       |         |  |  |  |  |         |     |       |         |  |  |  |  |         |     |       |         |  |  |  |  |         |     |       |         |  |  |  |  |                 |     |       |         |  |  |  |  |                 |     |       |         |  |  |  |  |                 |     |       |         |  |  |  |  |                 |     |       |         |  |  |  |  |                 |     |       |         |  |  |  |  |                 |     |       |         |  |  |  |  |                 |     |       |         |  |  |  |  |                 |     |       |         |  |  |  |  |                 |     |       |         |  |  |  |  |               |     |       |         |  |  |  |  |                  |     |       |         |  |  |  |  |                  |     |       |         |  |  |  |  |    |     |       |         |  |  |  |  |    |     |       |         |  |  |  |  |          |     |       |         |                |        |  |                       |          |     |       |         |  |  |  |  |                  |     |       |         |  |  |  |  |         |     |       |         |  |  |  |  |                 |     |       |         |  |  |  |  |         |     |       |         |  |  |  |  |         |     |       |         |  |  |  |  |         |     |       |         |  |  |  |  |                 |     |       |         |  |  |  |  |                 |     |       |         |  |  |  |  |                 |     |       |         |  |  |  |  |                 |     |       |         |  |  |  |  |                 |     |       |         |  |  |  |  |                 |     |       |         |  |  |  |  |                 |     |       |         |  |  |  |  |                 |     |       |         |  |  |  |  |
| 3.0 TDI quattro  | 176   | 05.13           | PR: 1LU     |                |             |   |                         |   |                         |                  |     |       |             |                |        |                              |                       |                  |     |       |             |                |        |  |                     |         |     |       |             |  |  |  |  |                 |     |       |             |  |  |  |  |         |     |       |             |  |  |  |  |         |     |       |             |  |  |  |  |         |     |       |             |  |  |  |  |                 |     |       |             |  |  |  |  |                 |     |       |             |  |  |  |  |                 |     |       |             |  |  |  |  |                 |     |       |             |  |  |  |  |                 |     |       |             |  |  |  |  |                 |     |       |             |  |  |  |  |               |     |       |             |  |  |  |  |                  |     |       |             |  |  |  |  |                 |     |       |             |                |        |                              |                       |                 |     |       |             |                |        |  |                     |                 |     |       |             |  |  |  |  |                  |     |       |             |  |  |  |  |    |     |       |             |  |  |  |  |    |     |       |             |  |  |  |  |          |     |       |             |                |        |  |                     |          |     |       |             |                |        |  |                     |                  |     |       |             |                |        |  |                       |         |     |       |             |  |  |  |  |                 |     |       |             |  |  |  |  |         |     |       |             |  |  |  |  |         |     |       |             |  |  |  |  |         |     |       |             |  |  |  |  |                 |     |       |             |  |  |  |  |                 |     |       |             |  |  |  |  |                 |     |       |             |  |  |  |  |                 |     |       |             |  |  |  |  |                 |     |       |             |  |  |  |  |                 |     |       |             |  |  |  |  |               |     |       |             |  |  |  |  |                  |     |       |             |  |  |  |  |                 |     |       |             |                |        |  |                     |                 |     |       |             |                |        |  |                       |                 |     |       |             |  |  |  |  |                  |     |       |             |  |  |  |  |    |     |       |             |  |  |  |  |    |     |       |             |  |  |  |  |          |     |       |         |                |        |  |                    |          |     |       |         |                |        |  |                     |                  |     |       |         |  |  |  |  |         |     |       |         |  |  |  |  |                 |     |       |         |  |  |  |  |         |     |       |         |  |  |  |  |         |     |       |         |  |  |  |  |         |     |       |         |  |  |  |  |                 |     |       |         |  |  |  |  |                 |     |       |         |  |  |  |  |                 |     |       |         |  |  |  |  |                 |     |       |         |  |  |  |  |                 |     |       |         |  |  |  |  |                 |     |       |         |  |  |  |  |                 |     |       |         |  |  |  |  |                 |     |       |         |  |  |  |  |                 |     |       |         |  |  |  |  |               |     |       |         |  |  |  |  |                  |     |       |         |  |  |  |  |                  |     |       |         |  |  |  |  |    |     |       |         |  |  |  |  |    |     |       |         |  |  |  |  |          |     |       |         |                |        |  |                       |          |     |       |         |  |  |  |  |                  |     |       |         |  |  |  |  |         |     |       |         |  |  |  |  |                 |     |       |         |  |  |  |  |         |     |       |         |  |  |  |  |         |     |       |         |  |  |  |  |         |     |       |         |  |  |  |  |                 |     |       |         |  |  |  |  |                 |     |       |         |  |  |  |  |                 |     |       |         |  |  |  |  |                 |     |       |         |  |  |  |  |                 |     |       |         |  |  |  |  |                 |     |       |         |  |  |  |  |                 |     |       |         |  |  |  |  |                 |     |       |         |  |  |  |  |
| 3.0 TDI quattro  | 180   | 07.10           | PR: 1LU     |                |             |   |                         |   |                         |                  |     |       |             |                |        |                              |                       |                  |     |       |             |                |        |  |                     |         |     |       |             |  |  |  |  |                 |     |       |             |  |  |  |  |         |     |       |             |  |  |  |  |         |     |       |             |  |  |  |  |         |     |       |             |  |  |  |  |                 |     |       |             |  |  |  |  |                 |     |       |             |  |  |  |  |                 |     |       |             |  |  |  |  |                 |     |       |             |  |  |  |  |                 |     |       |             |  |  |  |  |                 |     |       |             |  |  |  |  |               |     |       |             |  |  |  |  |                  |     |       |             |  |  |  |  |                 |     |       |             |                |        |                              |                       |                 |     |       |             |                |        |  |                     |                 |     |       |             |  |  |  |  |                  |     |       |             |  |  |  |  |    |     |       |             |  |  |  |  |    |     |       |             |  |  |  |  |          |     |       |             |                |        |  |                     |          |     |       |             |                |        |  |                     |                  |     |       |             |                |        |  |                       |         |     |       |             |  |  |  |  |                 |     |       |             |  |  |  |  |         |     |       |             |  |  |  |  |         |     |       |             |  |  |  |  |         |     |       |             |  |  |  |  |                 |     |       |             |  |  |  |  |                 |     |       |             |  |  |  |  |                 |     |       |             |  |  |  |  |                 |     |       |             |  |  |  |  |                 |     |       |             |  |  |  |  |                 |     |       |             |  |  |  |  |               |     |       |             |  |  |  |  |                  |     |       |             |  |  |  |  |                 |     |       |             |                |        |  |                     |                 |     |       |             |                |        |  |                       |                 |     |       |             |  |  |  |  |                  |     |       |             |  |  |  |  |    |     |       |             |  |  |  |  |    |     |       |             |  |  |  |  |          |     |       |         |                |        |  |                    |          |     |       |         |                |        |  |                     |                  |     |       |         |  |  |  |  |         |     |       |         |  |  |  |  |                 |     |       |         |  |  |  |  |         |     |       |         |  |  |  |  |         |     |       |         |  |  |  |  |         |     |       |         |  |  |  |  |                 |     |       |         |  |  |  |  |                 |     |       |         |  |  |  |  |                 |     |       |         |  |  |  |  |                 |     |       |         |  |  |  |  |                 |     |       |         |  |  |  |  |                 |     |       |         |  |  |  |  |                 |     |       |         |  |  |  |  |                 |     |       |         |  |  |  |  |                 |     |       |         |  |  |  |  |               |     |       |         |  |  |  |  |                  |     |       |         |  |  |  |  |                  |     |       |         |  |  |  |  |    |     |       |         |  |  |  |  |    |     |       |         |  |  |  |  |          |     |       |         |                |        |  |                       |          |     |       |         |  |  |  |  |                  |     |       |         |  |  |  |  |         |     |       |         |  |  |  |  |                 |     |       |         |  |  |  |  |         |     |       |         |  |  |  |  |         |     |       |         |  |  |  |  |         |     |       |         |  |  |  |  |                 |     |       |         |  |  |  |  |                 |     |       |         |  |  |  |  |                 |     |       |         |  |  |  |  |                 |     |       |         |  |  |  |  |                 |     |       |         |  |  |  |  |                 |     |       |         |  |  |  |  |                 |     |       |         |  |  |  |  |                 |     |       |         |  |  |  |  |
| 3.0 TDI quattro  | 200   | 05.14           | PR: 1LU     |                |             |   |                         |   |                         |                  |     |       |             |                |        |                              |                       |                  |     |       |             |                |        |  |                     |         |     |       |             |  |  |  |  |                 |     |       |             |  |  |  |  |         |     |       |             |  |  |  |  |         |     |       |             |  |  |  |  |         |     |       |             |  |  |  |  |                 |     |       |             |  |  |  |  |                 |     |       |             |  |  |  |  |                 |     |       |             |  |  |  |  |                 |     |       |             |  |  |  |  |                 |     |       |             |  |  |  |  |                 |     |       |             |  |  |  |  |               |     |       |             |  |  |  |  |                  |     |       |             |  |  |  |  |                 |     |       |             |                |        |                              |                       |                 |     |       |             |                |        |  |                     |                 |     |       |             |  |  |  |  |                  |     |       |             |  |  |  |  |    |     |       |             |  |  |  |  |    |     |       |             |  |  |  |  |          |     |       |             |                |        |  |                     |          |     |       |             |                |        |  |                     |                  |     |       |             |                |        |  |                       |         |     |       |             |  |  |  |  |                 |     |       |             |  |  |  |  |         |     |       |             |  |  |  |  |         |     |       |             |  |  |  |  |         |     |       |             |  |  |  |  |                 |     |       |             |  |  |  |  |                 |     |       |             |  |  |  |  |                 |     |       |             |  |  |  |  |                 |     |       |             |  |  |  |  |                 |     |       |             |  |  |  |  |                 |     |       |             |  |  |  |  |               |     |       |             |  |  |  |  |                  |     |       |             |  |  |  |  |                 |     |       |             |                |        |  |                     |                 |     |       |             |                |        |  |                       |                 |     |       |             |  |  |  |  |                  |     |       |             |  |  |  |  |    |     |       |             |  |  |  |  |    |     |       |             |  |  |  |  |          |     |       |         |                |        |  |                    |          |     |       |         |                |        |  |                     |                  |     |       |         |  |  |  |  |         |     |       |         |  |  |  |  |                 |     |       |         |  |  |  |  |         |     |       |         |  |  |  |  |         |     |       |         |  |  |  |  |         |     |       |         |  |  |  |  |                 |     |       |         |  |  |  |  |                 |     |       |         |  |  |  |  |                 |     |       |         |  |  |  |  |                 |     |       |         |  |  |  |  |                 |     |       |         |  |  |  |  |                 |     |       |         |  |  |  |  |                 |     |       |         |  |  |  |  |                 |     |       |         |  |  |  |  |                 |     |       |         |  |  |  |  |               |     |       |         |  |  |  |  |                  |     |       |         |  |  |  |  |                  |     |       |         |  |  |  |  |    |     |       |         |  |  |  |  |    |     |       |         |  |  |  |  |          |     |       |         |                |        |  |                       |          |     |       |         |  |  |  |  |                  |     |       |         |  |  |  |  |         |     |       |         |  |  |  |  |                 |     |       |         |  |  |  |  |         |     |       |         |  |  |  |  |         |     |       |         |  |  |  |  |         |     |       |         |  |  |  |  |                 |     |       |         |  |  |  |  |                 |     |       |         |  |  |  |  |                 |     |       |         |  |  |  |  |                 |     |       |         |  |  |  |  |                 |     |       |         |  |  |  |  |                 |     |       |         |  |  |  |  |                 |     |       |         |  |  |  |  |                 |     |       |         |  |  |  |  |
| 3.0 TDI quattro  | 230   | 11.11           | PR: 1LU     |                |             |   |                         |   |                         |                  |     |       |             |                |        |                              |                       |                  |     |       |             |                |        |  |                     |         |     |       |             |  |  |  |  |                 |     |       |             |  |  |  |  |         |     |       |             |  |  |  |  |         |     |       |             |  |  |  |  |         |     |       |             |  |  |  |  |                 |     |       |             |  |  |  |  |                 |     |       |             |  |  |  |  |                 |     |       |             |  |  |  |  |                 |     |       |             |  |  |  |  |                 |     |       |             |  |  |  |  |                 |     |       |             |  |  |  |  |               |     |       |             |  |  |  |  |                  |     |       |             |  |  |  |  |                 |     |       |             |                |        |                              |                       |                 |     |       |             |                |        |  |                     |                 |     |       |             |  |  |  |  |                  |     |       |             |  |  |  |  |    |     |       |             |  |  |  |  |    |     |       |             |  |  |  |  |          |     |       |             |                |        |  |                     |          |     |       |             |                |        |  |                     |                  |     |       |             |                |        |  |                       |         |     |       |             |  |  |  |  |                 |     |       |             |  |  |  |  |         |     |       |             |  |  |  |  |         |     |       |             |  |  |  |  |         |     |       |             |  |  |  |  |                 |     |       |             |  |  |  |  |                 |     |       |             |  |  |  |  |                 |     |       |             |  |  |  |  |                 |     |       |             |  |  |  |  |                 |     |       |             |  |  |  |  |                 |     |       |             |  |  |  |  |               |     |       |             |  |  |  |  |                  |     |       |             |  |  |  |  |                 |     |       |             |                |        |  |                     |                 |     |       |             |                |        |  |                       |                 |     |       |             |  |  |  |  |                  |     |       |             |  |  |  |  |    |     |       |             |  |  |  |  |    |     |       |             |  |  |  |  |          |     |       |         |                |        |  |                    |          |     |       |         |                |        |  |                     |                  |     |       |         |  |  |  |  |         |     |       |         |  |  |  |  |                 |     |       |         |  |  |  |  |         |     |       |         |  |  |  |  |         |     |       |         |  |  |  |  |         |     |       |         |  |  |  |  |                 |     |       |         |  |  |  |  |                 |     |       |         |  |  |  |  |                 |     |       |         |  |  |  |  |                 |     |       |         |  |  |  |  |                 |     |       |         |  |  |  |  |                 |     |       |         |  |  |  |  |                 |     |       |         |  |  |  |  |                 |     |       |         |  |  |  |  |                 |     |       |         |  |  |  |  |               |     |       |         |  |  |  |  |                  |     |       |         |  |  |  |  |                  |     |       |         |  |  |  |  |    |     |       |         |  |  |  |  |    |     |       |         |  |  |  |  |          |     |       |         |                |        |  |                       |          |     |       |         |  |  |  |  |                  |     |       |         |  |  |  |  |         |     |       |         |  |  |  |  |                 |     |       |         |  |  |  |  |         |     |       |         |  |  |  |  |         |     |       |         |  |  |  |  |         |     |       |         |  |  |  |  |                 |     |       |         |  |  |  |  |                 |     |       |         |  |  |  |  |                 |     |       |         |  |  |  |  |                 |     |       |         |  |  |  |  |                 |     |       |         |  |  |  |  |                 |     |       |         |  |  |  |  |                 |     |       |         |  |  |  |  |                 |     |       |         |  |  |  |  |
| 3.0 TDI quattro  | 235   | 05.14           | PR: 1LU     |                |             |   |                         |   |                         |                  |     |       |             |                |        |                              |                       |                  |     |       |             |                |        |  |                     |         |     |       |             |  |  |  |  |                 |     |       |             |  |  |  |  |         |     |       |             |  |  |  |  |         |     |       |             |  |  |  |  |         |     |       |             |  |  |  |  |                 |     |       |             |  |  |  |  |                 |     |       |             |  |  |  |  |                 |     |       |             |  |  |  |  |                 |     |       |             |  |  |  |  |                 |     |       |             |  |  |  |  |                 |     |       |             |  |  |  |  |               |     |       |             |  |  |  |  |                  |     |       |             |  |  |  |  |                 |     |       |             |                |        |                              |                       |                 |     |       |             |                |        |  |                     |                 |     |       |             |  |  |  |  |                  |     |       |             |  |  |  |  |    |     |       |             |  |  |  |  |    |     |       |             |  |  |  |  |          |     |       |             |                |        |  |                     |          |     |       |             |                |        |  |                     |                  |     |       |             |                |        |  |                       |         |     |       |             |  |  |  |  |                 |     |       |             |  |  |  |  |         |     |       |             |  |  |  |  |         |     |       |             |  |  |  |  |         |     |       |             |  |  |  |  |                 |     |       |             |  |  |  |  |                 |     |       |             |  |  |  |  |                 |     |       |             |  |  |  |  |                 |     |       |             |  |  |  |  |                 |     |       |             |  |  |  |  |                 |     |       |             |  |  |  |  |               |     |       |             |  |  |  |  |                  |     |       |             |  |  |  |  |                 |     |       |             |                |        |  |                     |                 |     |       |             |                |        |  |                       |                 |     |       |             |  |  |  |  |                  |     |       |             |  |  |  |  |    |     |       |             |  |  |  |  |    |     |       |             |  |  |  |  |          |     |       |         |                |        |  |                    |          |     |       |         |                |        |  |                     |                  |     |       |         |  |  |  |  |         |     |       |         |  |  |  |  |                 |     |       |         |  |  |  |  |         |     |       |         |  |  |  |  |         |     |       |         |  |  |  |  |         |     |       |         |  |  |  |  |                 |     |       |         |  |  |  |  |                 |     |       |         |  |  |  |  |                 |     |       |         |  |  |  |  |                 |     |       |         |  |  |  |  |                 |     |       |         |  |  |  |  |                 |     |       |         |  |  |  |  |                 |     |       |         |  |  |  |  |                 |     |       |         |  |  |  |  |                 |     |       |         |  |  |  |  |               |     |       |         |  |  |  |  |                  |     |       |         |  |  |  |  |                  |     |       |         |  |  |  |  |    |     |       |         |  |  |  |  |    |     |       |         |  |  |  |  |          |     |       |         |                |        |  |                       |          |     |       |         |  |  |  |  |                  |     |       |         |  |  |  |  |         |     |       |         |  |  |  |  |                 |     |       |         |  |  |  |  |         |     |       |         |  |  |  |  |         |     |       |         |  |  |  |  |         |     |       |         |  |  |  |  |                 |     |       |         |  |  |  |  |                 |     |       |         |  |  |  |  |                 |     |       |         |  |  |  |  |                 |     |       |         |  |  |  |  |                 |     |       |         |  |  |  |  |                 |     |       |         |  |  |  |  |                 |     |       |         |  |  |  |  |                 |     |       |         |  |  |  |  |
| 3.0 TDI quattro  | 240   | 08.14           | PR: 1LU     |                |             |   |                         |   |                         |                  |     |       |             |                |        |                              |                       |                  |     |       |             |                |        |  |                     |         |     |       |             |  |  |  |  |                 |     |       |             |  |  |  |  |         |     |       |             |  |  |  |  |         |     |       |             |  |  |  |  |         |     |       |             |  |  |  |  |                 |     |       |             |  |  |  |  |                 |     |       |             |  |  |  |  |                 |     |       |             |  |  |  |  |                 |     |       |             |  |  |  |  |                 |     |       |             |  |  |  |  |                 |     |       |             |  |  |  |  |               |     |       |             |  |  |  |  |                  |     |       |             |  |  |  |  |                 |     |       |             |                |        |                              |                       |                 |     |       |             |                |        |  |                     |                 |     |       |             |  |  |  |  |                  |     |       |             |  |  |  |  |    |     |       |             |  |  |  |  |    |     |       |             |  |  |  |  |          |     |       |             |                |        |  |                     |          |     |       |             |                |        |  |                     |                  |     |       |             |                |        |  |                       |         |     |       |             |  |  |  |  |                 |     |       |             |  |  |  |  |         |     |       |             |  |  |  |  |         |     |       |             |  |  |  |  |         |     |       |             |  |  |  |  |                 |     |       |             |  |  |  |  |                 |     |       |             |  |  |  |  |                 |     |       |             |  |  |  |  |                 |     |       |             |  |  |  |  |                 |     |       |             |  |  |  |  |                 |     |       |             |  |  |  |  |               |     |       |             |  |  |  |  |                  |     |       |             |  |  |  |  |                 |     |       |             |                |        |  |                     |                 |     |       |             |                |        |  |                       |                 |     |       |             |  |  |  |  |                  |     |       |             |  |  |  |  |    |     |       |             |  |  |  |  |    |     |       |             |  |  |  |  |          |     |       |         |                |        |  |                    |          |     |       |         |                |        |  |                     |                  |     |       |         |  |  |  |  |         |     |       |         |  |  |  |  |                 |     |       |         |  |  |  |  |         |     |       |         |  |  |  |  |         |     |       |         |  |  |  |  |         |     |       |         |  |  |  |  |                 |     |       |         |  |  |  |  |                 |     |       |         |  |  |  |  |                 |     |       |         |  |  |  |  |                 |     |       |         |  |  |  |  |                 |     |       |         |  |  |  |  |                 |     |       |         |  |  |  |  |                 |     |       |         |  |  |  |  |                 |     |       |         |  |  |  |  |                 |     |       |         |  |  |  |  |               |     |       |         |  |  |  |  |                  |     |       |         |  |  |  |  |                  |     |       |         |  |  |  |  |    |     |       |         |  |  |  |  |    |     |       |         |  |  |  |  |          |     |       |         |                |        |  |                       |          |     |       |         |  |  |  |  |                  |     |       |         |  |  |  |  |         |     |       |         |  |  |  |  |                 |     |       |         |  |  |  |  |         |     |       |         |  |  |  |  |         |     |       |         |  |  |  |  |         |     |       |         |  |  |  |  |                 |     |       |         |  |  |  |  |                 |     |       |         |  |  |  |  |                 |     |       |         |  |  |  |  |                 |     |       |         |  |  |  |  |                 |     |       |         |  |  |  |  |                 |     |       |         |  |  |  |  |                 |     |       |         |  |  |  |  |                 |     |       |         |  |  |  |  |
| 3.0 TDI ultra  | 160   | 05.14           | PR: 1LU     |                |             |   |                         |   |                         |                  |     |       |             |                |        |                              |                       |                  |     |       |             |                |        |  |                     |         |     |       |             |  |  |  |  |                 |     |       |             |  |  |  |  |         |     |       |             |  |  |  |  |         |     |       |             |  |  |  |  |         |     |       |             |  |  |  |  |                 |     |       |             |  |  |  |  |                 |     |       |             |  |  |  |  |                 |     |       |             |  |  |  |  |                 |     |       |             |  |  |  |  |                 |     |       |             |  |  |  |  |                 |     |       |             |  |  |  |  |               |     |       |             |  |  |  |  |                  |     |       |             |  |  |  |  |                 |     |       |             |                |        |                              |                       |                 |     |       |             |                |        |  |                     |                 |     |       |             |  |  |  |  |                  |     |       |             |  |  |  |  |    |     |       |             |  |  |  |  |    |     |       |             |  |  |  |  |          |     |       |             |                |        |  |                     |          |     |       |             |                |        |  |                     |                  |     |       |             |                |        |  |                       |         |     |       |             |  |  |  |  |                 |     |       |             |  |  |  |  |         |     |       |             |  |  |  |  |         |     |       |             |  |  |  |  |         |     |       |             |  |  |  |  |                 |     |       |             |  |  |  |  |                 |     |       |             |  |  |  |  |                 |     |       |             |  |  |  |  |                 |     |       |             |  |  |  |  |                 |     |       |             |  |  |  |  |                 |     |       |             |  |  |  |  |               |     |       |             |  |  |  |  |                  |     |       |             |  |  |  |  |                 |     |       |             |                |        |  |                     |                 |     |       |             |                |        |  |                       |                 |     |       |             |  |  |  |  |                  |     |       |             |  |  |  |  |    |     |       |             |  |  |  |  |    |     |       |             |  |  |  |  |          |     |       |         |                |        |  |                    |          |     |       |         |                |        |  |                     |                  |     |       |         |  |  |  |  |         |     |       |         |  |  |  |  |                 |     |       |         |  |  |  |  |         |     |       |         |  |  |  |  |         |     |       |         |  |  |  |  |         |     |       |         |  |  |  |  |                 |     |       |         |  |  |  |  |                 |     |       |         |  |  |  |  |                 |     |       |         |  |  |  |  |                 |     |       |         |  |  |  |  |                 |     |       |         |  |  |  |  |                 |     |       |         |  |  |  |  |                 |     |       |         |  |  |  |  |                 |     |       |         |  |  |  |  |                 |     |       |         |  |  |  |  |               |     |       |         |  |  |  |  |                  |     |       |         |  |  |  |  |                  |     |       |         |  |  |  |  |    |     |       |         |  |  |  |  |    |     |       |         |  |  |  |  |          |     |       |         |                |        |  |                       |          |     |       |         |  |  |  |  |                  |     |       |         |  |  |  |  |         |     |       |         |  |  |  |  |                 |     |       |         |  |  |  |  |         |     |       |         |  |  |  |  |         |     |       |         |  |  |  |  |         |     |       |         |  |  |  |  |                 |     |       |         |  |  |  |  |                 |     |       |         |  |  |  |  |                 |     |       |         |  |  |  |  |                 |     |       |         |  |  |  |  |                 |     |       |         |  |  |  |  |                 |     |       |         |  |  |  |  |                 |     |       |         |  |  |  |  |                 |     |       |         |  |  |  |  |
| 3.0 TFSI quattro   | 160   | 07.10           | PR: 1LU     |                |             |   |                         |   |                         |                  |     |       |             |                |        |                              |                       |                  |     |       |             |                |        |  |                     |         |     |       |             |  |  |  |  |                 |     |       |             |  |  |  |  |         |     |       |             |  |  |  |  |         |     |       |             |  |  |  |  |         |     |       |             |  |  |  |  |                 |     |       |             |  |  |  |  |                 |     |       |             |  |  |  |  |                 |     |       |             |  |  |  |  |                 |     |       |             |  |  |  |  |                 |     |       |             |  |  |  |  |                 |     |       |             |  |  |  |  |               |     |       |             |  |  |  |  |                  |     |       |             |  |  |  |  |                 |     |       |             |                |        |                              |                       |                 |     |       |             |                |        |  |                     |                 |     |       |             |  |  |  |  |                  |     |       |             |  |  |  |  |    |     |       |             |  |  |  |  |    |     |       |             |  |  |  |  |          |     |       |             |                |        |  |                     |          |     |       |             |                |        |  |                     |                  |     |       |             |                |        |  |                       |         |     |       |             |  |  |  |  |                 |     |       |             |  |  |  |  |         |     |       |             |  |  |  |  |         |     |       |             |  |  |  |  |         |     |       |             |  |  |  |  |                 |     |       |             |  |  |  |  |                 |     |       |             |  |  |  |  |                 |     |       |             |  |  |  |  |                 |     |       |             |  |  |  |  |                 |     |       |             |  |  |  |  |                 |     |       |             |  |  |  |  |               |     |       |             |  |  |  |  |                  |     |       |             |  |  |  |  |                 |     |       |             |                |        |  |                     |                 |     |       |             |                |        |  |                       |                 |     |       |             |  |  |  |  |                  |     |       |             |  |  |  |  |    |     |       |             |  |  |  |  |    |     |       |             |  |  |  |  |          |     |       |         |                |        |  |                    |          |     |       |         |                |        |  |                     |                  |     |       |         |  |  |  |  |         |     |       |         |  |  |  |  |                 |     |       |         |  |  |  |  |         |     |       |         |  |  |  |  |         |     |       |         |  |  |  |  |         |     |       |         |  |  |  |  |                 |     |       |         |  |  |  |  |                 |     |       |         |  |  |  |  |                 |     |       |         |  |  |  |  |                 |     |       |         |  |  |  |  |                 |     |       |         |  |  |  |  |                 |     |       |         |  |  |  |  |                 |     |       |         |  |  |  |  |                 |     |       |         |  |  |  |  |                 |     |       |         |  |  |  |  |               |     |       |         |  |  |  |  |                  |     |       |         |  |  |  |  |                  |     |       |         |  |  |  |  |    |     |       |         |  |  |  |  |    |     |       |         |  |  |  |  |          |     |       |         |                |        |  |                       |          |     |       |         |  |  |  |  |                  |     |       |         |  |  |  |  |         |     |       |         |  |  |  |  |                 |     |       |         |  |  |  |  |         |     |       |         |  |  |  |  |         |     |       |         |  |  |  |  |         |     |       |         |  |  |  |  |                 |     |       |         |  |  |  |  |                 |     |       |         |  |  |  |  |                 |     |       |         |  |  |  |  |                 |     |       |         |  |  |  |  |                 |     |       |         |  |  |  |  |                 |     |       |         |  |  |  |  |                 |     |       |         |  |  |  |  |                 |     |       |         |  |  |  |  |
| 3.0 TFSI quattro   | 245   | 05.14           | PR: 1LU     |                |             |   |                         |   |                         |                  |     |       |             |                |        |                              |                       |                  |     |       |             |                |        |  |                     |         |     |       |             |  |  |  |  |                 |     |       |             |  |  |  |  |         |     |       |             |  |  |  |  |         |     |       |             |  |  |  |  |         |     |       |             |  |  |  |  |                 |     |       |             |  |  |  |  |                 |     |       |             |  |  |  |  |                 |     |       |             |  |  |  |  |                 |     |       |             |  |  |  |  |                 |     |       |             |  |  |  |  |                 |     |       |             |  |  |  |  |               |     |       |             |  |  |  |  |                  |     |       |             |  |  |  |  |                 |     |       |             |                |        |                              |                       |                 |     |       |             |                |        |  |                     |                 |     |       |             |  |  |  |  |                  |     |       |             |  |  |  |  |    |     |       |             |  |  |  |  |    |     |       |             |  |  |  |  |          |     |       |             |                |        |  |                     |          |     |       |             |                |        |  |                     |                  |     |       |             |                |        |  |                       |         |     |       |             |  |  |  |  |                 |     |       |             |  |  |  |  |         |     |       |             |  |  |  |  |         |     |       |             |  |  |  |  |         |     |       |             |  |  |  |  |                 |     |       |             |  |  |  |  |                 |     |       |             |  |  |  |  |                 |     |       |             |  |  |  |  |                 |     |       |             |  |  |  |  |                 |     |       |             |  |  |  |  |                 |     |       |             |  |  |  |  |               |     |       |             |  |  |  |  |                  |     |       |             |  |  |  |  |                 |     |       |             |                |        |  |                     |                 |     |       |             |                |        |  |                       |                 |     |       |             |  |  |  |  |                  |     |       |             |  |  |  |  |    |     |       |             |  |  |  |  |    |     |       |             |  |  |  |  |          |     |       |         |                |        |  |                    |          |     |       |         |                |        |  |                     |                  |     |       |         |  |  |  |  |         |     |       |         |  |  |  |  |                 |     |       |         |  |  |  |  |         |     |       |         |  |  |  |  |         |     |       |         |  |  |  |  |         |     |       |         |  |  |  |  |                 |     |       |         |  |  |  |  |                 |     |       |         |  |  |  |  |                 |     |       |         |  |  |  |  |                 |     |       |         |  |  |  |  |                 |     |       |         |  |  |  |  |                 |     |       |         |  |  |  |  |                 |     |       |         |  |  |  |  |                 |     |       |         |  |  |  |  |                 |     |       |         |  |  |  |  |               |     |       |         |  |  |  |  |                  |     |       |         |  |  |  |  |                  |     |       |         |  |  |  |  |    |     |       |         |  |  |  |  |    |     |       |         |  |  |  |  |          |     |       |         |                |        |  |                       |          |     |       |         |  |  |  |  |                  |     |       |         |  |  |  |  |         |     |       |         |  |  |  |  |                 |     |       |         |  |  |  |  |         |     |       |         |  |  |  |  |         |     |       |         |  |  |  |  |         |     |       |         |  |  |  |  |                 |     |       |         |  |  |  |  |                 |     |       |         |  |  |  |  |                 |     |       |         |  |  |  |  |                 |     |       |         |  |  |  |  |                 |     |       |         |  |  |  |  |                 |     |       |         |  |  |  |  |                 |     |       |         |  |  |  |  |                 |     |       |         |  |  |  |  |
| S7   | 309   | 10.11           | PR: 1LU     |                |             |   |                         |   |                         |                  |     |       |             |                |        |                              |                       |                  |     |       |             |                |        |  |                     |         |     |       |             |  |  |  |  |                 |     |       |             |  |  |  |  |         |     |       |             |  |  |  |  |         |     |       |             |  |  |  |  |         |     |       |             |  |  |  |  |                 |     |       |             |  |  |  |  |                 |     |       |             |  |  |  |  |                 |     |       |             |  |  |  |  |                 |     |       |             |  |  |  |  |                 |     |       |             |  |  |  |  |                 |     |       |             |  |  |  |  |               |     |       |             |  |  |  |  |                  |     |       |             |  |  |  |  |                 |     |       |             |                |        |                              |                       |                 |     |       |             |                |        |  |                     |                 |     |       |             |  |  |  |  |                  |     |       |             |  |  |  |  |    |     |       |             |  |  |  |  |    |     |       |             |  |  |  |  |          |     |       |             |                |        |  |                     |          |     |       |             |                |        |  |                     |                  |     |       |             |                |        |  |                       |         |     |       |             |  |  |  |  |                 |     |       |             |  |  |  |  |         |     |       |             |  |  |  |  |         |     |       |             |  |  |  |  |         |     |       |             |  |  |  |  |                 |     |       |             |  |  |  |  |                 |     |       |             |  |  |  |  |                 |     |       |             |  |  |  |  |                 |     |       |             |  |  |  |  |                 |     |       |             |  |  |  |  |                 |     |       |             |  |  |  |  |               |     |       |             |  |  |  |  |                  |     |       |             |  |  |  |  |                 |     |       |             |                |        |  |                     |                 |     |       |             |                |        |  |                       |                 |     |       |             |  |  |  |  |                  |     |       |             |  |  |  |  |    |     |       |             |  |  |  |  |    |     |       |             |  |  |  |  |          |     |       |         |                |        |  |                    |          |     |       |         |                |        |  |                     |                  |     |       |         |  |  |  |  |         |     |       |         |  |  |  |  |                 |     |       |         |  |  |  |  |         |     |       |         |  |  |  |  |         |     |       |         |  |  |  |  |         |     |       |         |  |  |  |  |                 |     |       |         |  |  |  |  |                 |     |       |         |  |  |  |  |                 |     |       |         |  |  |  |  |                 |     |       |         |  |  |  |  |                 |     |       |         |  |  |  |  |                 |     |       |         |  |  |  |  |                 |     |       |         |  |  |  |  |                 |     |       |         |  |  |  |  |                 |     |       |         |  |  |  |  |               |     |       |         |  |  |  |  |                  |     |       |         |  |  |  |  |                  |     |       |         |  |  |  |  |    |     |       |         |  |  |  |  |    |     |       |         |  |  |  |  |          |     |       |         |                |        |  |                       |          |     |       |         |  |  |  |  |                  |     |       |         |  |  |  |  |         |     |       |         |  |  |  |  |                 |     |       |         |  |  |  |  |         |     |       |         |  |  |  |  |         |     |       |         |  |  |  |  |         |     |       |         |  |  |  |  |                 |     |       |         |  |  |  |  |                 |     |       |         |  |  |  |  |                 |     |       |         |  |  |  |  |                 |     |       |         |  |  |  |  |                 |     |       |         |  |  |  |  |                 |     |       |         |  |  |  |  |                 |     |       |         |  |  |  |  |                 |     |       |         |  |  |  |  |
| S7   | 331   | 05.14           | PR: 1LU     |                |             |   |                         |   |                         |                  |     |       |             |                |        |                              |                       |                  |     |       |             |                |        |  |                     |         |     |       |             |  |  |  |  |                 |     |       |             |  |  |  |  |         |     |       |             |  |  |  |  |         |     |       |             |  |  |  |  |         |     |       |             |  |  |  |  |                 |     |       |             |  |  |  |  |                 |     |       |             |  |  |  |  |                 |     |       |             |  |  |  |  |                 |     |       |             |  |  |  |  |                 |     |       |             |  |  |  |  |                 |     |       |             |  |  |  |  |               |     |       |             |  |  |  |  |                  |     |       |             |  |  |  |  |                 |     |       |             |                |        |                              |                       |                 |     |       |             |                |        |  |                     |                 |     |       |             |  |  |  |  |                  |     |       |             |  |  |  |  |    |     |       |             |  |  |  |  |    |     |       |             |  |  |  |  |          |     |       |             |                |        |  |                     |          |     |       |             |                |        |  |                     |                  |     |       |             |                |        |  |                       |         |     |       |             |  |  |  |  |                 |     |       |             |  |  |  |  |         |     |       |             |  |  |  |  |         |     |       |             |  |  |  |  |         |     |       |             |  |  |  |  |                 |     |       |             |  |  |  |  |                 |     |       |             |  |  |  |  |                 |     |       |             |  |  |  |  |                 |     |       |             |  |  |  |  |                 |     |       |             |  |  |  |  |                 |     |       |             |  |  |  |  |               |     |       |             |  |  |  |  |                  |     |       |             |  |  |  |  |                 |     |       |             |                |        |  |                     |                 |     |       |             |                |        |  |                       |                 |     |       |             |  |  |  |  |                  |     |       |             |  |  |  |  |    |     |       |             |  |  |  |  |    |     |       |             |  |  |  |  |          |     |       |         |                |        |  |                    |          |     |       |         |                |        |  |                     |                  |     |       |         |  |  |  |  |         |     |       |         |  |  |  |  |                 |     |       |         |  |  |  |  |         |     |       |         |  |  |  |  |         |     |       |         |  |  |  |  |         |     |       |         |  |  |  |  |                 |     |       |         |  |  |  |  |                 |     |       |         |  |  |  |  |                 |     |       |         |  |  |  |  |                 |     |       |         |  |  |  |  |                 |     |       |         |  |  |  |  |                 |     |       |         |  |  |  |  |                 |     |       |         |  |  |  |  |                 |     |       |         |  |  |  |  |                 |     |       |         |  |  |  |  |               |     |       |         |  |  |  |  |                  |     |       |         |  |  |  |  |                  |     |       |         |  |  |  |  |    |     |       |         |  |  |  |  |    |     |       |         |  |  |  |  |          |     |       |         |                |        |  |                       |          |     |       |         |  |  |  |  |                  |     |       |         |  |  |  |  |         |     |       |         |  |  |  |  |                 |     |       |         |  |  |  |  |         |     |       |         |  |  |  |  |         |     |       |         |  |  |  |  |         |     |       |         |  |  |  |  |                 |     |       |         |  |  |  |  |                 |     |       |         |  |  |  |  |                 |     |       |         |  |  |  |  |                 |     |       |         |  |  |  |  |                 |     |       |         |  |  |  |  |                 |     |       |         |  |  |  |  |                 |     |       |         |  |  |  |  |                 |     |       |         |  |  |  |  |
| 1.8 TFSI   | 140   | 04.15           | PR: 1LW     | 24.8190-0020.2 | 620020      |   | Warnkontakt L=443,3mm   |   |                         |                  |     |       |             |                |        |                              |                       |                  |     |       |             |                |        |  |                     |         |     |       |             |  |  |  |  |                 |     |       |             |  |  |  |  |         |     |       |             |  |  |  |  |         |     |       |             |  |  |  |  |         |     |       |             |  |  |  |  |                 |     |       |             |  |  |  |  |                 |     |       |             |  |  |  |  |                 |     |       |             |  |  |  |  |                 |     |       |             |  |  |  |  |                 |     |       |             |  |  |  |  |                 |     |       |             |  |  |  |  |               |     |       |             |  |  |  |  |                  |     |       |             |  |  |  |  |                 |     |       |             |                |        |                              |                       |                 |     |       |             |                |        |  |                     |                 |     |       |             |  |  |  |  |                  |     |       |             |  |  |  |  |    |     |       |             |  |  |  |  |    |     |       |             |  |  |  |  |          |     |       |             |                |        |  |                     |          |     |       |             |                |        |  |                     |                  |     |       |             |                |        |  |                       |         |     |       |             |  |  |  |  |                 |     |       |             |  |  |  |  |         |     |       |             |  |  |  |  |         |     |       |             |  |  |  |  |         |     |       |             |  |  |  |  |                 |     |       |             |  |  |  |  |                 |     |       |             |  |  |  |  |                 |     |       |             |  |  |  |  |                 |     |       |             |  |  |  |  |                 |     |       |             |  |  |  |  |                 |     |       |             |  |  |  |  |               |     |       |             |  |  |  |  |                  |     |       |             |  |  |  |  |                 |     |       |             |                |        |  |                     |                 |     |       |             |                |        |  |                       |                 |     |       |             |  |  |  |  |                  |     |       |             |  |  |  |  |    |     |       |             |  |  |  |  |    |     |       |             |  |  |  |  |          |     |       |         |                |        |  |                    |          |     |       |         |                |        |  |                     |                  |     |       |         |  |  |  |  |         |     |       |         |  |  |  |  |                 |     |       |         |  |  |  |  |         |     |       |         |  |  |  |  |         |     |       |         |  |  |  |  |         |     |       |         |  |  |  |  |                 |     |       |         |  |  |  |  |                 |     |       |         |  |  |  |  |                 |     |       |         |  |  |  |  |                 |     |       |         |  |  |  |  |                 |     |       |         |  |  |  |  |                 |     |       |         |  |  |  |  |                 |     |       |         |  |  |  |  |                 |     |       |         |  |  |  |  |                 |     |       |         |  |  |  |  |               |     |       |         |  |  |  |  |                  |     |       |         |  |  |  |  |                  |     |       |         |  |  |  |  |    |     |       |         |  |  |  |  |    |     |       |         |  |  |  |  |          |     |       |         |                |        |  |                       |          |     |       |         |  |  |  |  |                  |     |       |         |  |  |  |  |         |     |       |         |  |  |  |  |                 |     |       |         |  |  |  |  |         |     |       |         |  |  |  |  |         |     |       |         |  |  |  |  |         |     |       |         |  |  |  |  |                 |     |       |         |  |  |  |  |                 |     |       |         |  |  |  |  |                 |     |       |         |  |  |  |  |                 |     |       |         |  |  |  |  |                 |     |       |         |  |  |  |  |                 |     |       |         |  |  |  |  |                 |     |       |         |  |  |  |  |                 |     |       |         |  |  |  |  |
| 2.0 TFSI   | 185   | 09.14           | PR: 1LW     |                |             |   |                         |   |                         |                  |     |       |             |                |        |                              |                       |                  |     |       |             |                |        |  |                     |         |     |       |             |  |  |  |  |                 |     |       |             |  |  |  |  |         |     |       |             |  |  |  |  |         |     |       |             |  |  |  |  |         |     |       |             |  |  |  |  |                 |     |       |             |  |  |  |  |                 |     |       |             |  |  |  |  |                 |     |       |             |  |  |  |  |                 |     |       |             |  |  |  |  |                 |     |       |             |  |  |  |  |                 |     |       |             |  |  |  |  |               |     |       |             |  |  |  |  |                  |     |       |             |  |  |  |  |                 |     |       |             |                |        |                              |                       |                 |     |       |             |                |        |  |                     |                 |     |       |             |  |  |  |  |                  |     |       |             |  |  |  |  |    |     |       |             |  |  |  |  |    |     |       |             |  |  |  |  |          |     |       |             |                |        |  |                     |          |     |       |             |                |        |  |                     |                  |     |       |             |                |        |  |                       |         |     |       |             |  |  |  |  |                 |     |       |             |  |  |  |  |         |     |       |             |  |  |  |  |         |     |       |             |  |  |  |  |         |     |       |             |  |  |  |  |                 |     |       |             |  |  |  |  |                 |     |       |             |  |  |  |  |                 |     |       |             |  |  |  |  |                 |     |       |             |  |  |  |  |                 |     |       |             |  |  |  |  |                 |     |       |             |  |  |  |  |               |     |       |             |  |  |  |  |                  |     |       |             |  |  |  |  |                 |     |       |             |                |        |  |                     |                 |     |       |             |                |        |  |                       |                 |     |       |             |  |  |  |  |                  |     |       |             |  |  |  |  |    |     |       |             |  |  |  |  |    |     |       |             |  |  |  |  |          |     |       |         |                |        |  |                    |          |     |       |         |                |        |  |                     |                  |     |       |         |  |  |  |  |         |     |       |         |  |  |  |  |                 |     |       |         |  |  |  |  |         |     |       |         |  |  |  |  |         |     |       |         |  |  |  |  |         |     |       |         |  |  |  |  |                 |     |       |         |  |  |  |  |                 |     |       |         |  |  |  |  |                 |     |       |         |  |  |  |  |                 |     |       |         |  |  |  |  |                 |     |       |         |  |  |  |  |                 |     |       |         |  |  |  |  |                 |     |       |         |  |  |  |  |                 |     |       |         |  |  |  |  |                 |     |       |         |  |  |  |  |               |     |       |         |  |  |  |  |                  |     |       |         |  |  |  |  |                  |     |       |         |  |  |  |  |    |     |       |         |  |  |  |  |    |     |       |         |  |  |  |  |          |     |       |         |                |        |  |                       |          |     |       |         |  |  |  |  |                  |     |       |         |  |  |  |  |         |     |       |         |  |  |  |  |                 |     |       |         |  |  |  |  |         |     |       |         |  |  |  |  |         |     |       |         |  |  |  |  |         |     |       |         |  |  |  |  |                 |     |       |         |  |  |  |  |                 |     |       |         |  |  |  |  |                 |     |       |         |  |  |  |  |                 |     |       |         |  |  |  |  |                 |     |       |         |  |  |  |  |                 |     |       |         |  |  |  |  |                 |     |       |         |  |  |  |  |                 |     |       |         |  |  |  |  |
| 2.0 TFSI quattro   | 185   | 05.15           | PR: 1LW     |                |             |   |                         |   |                         |                  |     |       |             |                |        |                              |                       |                  |     |       |             |                |        |  |                     |         |     |       |             |  |  |  |  |                 |     |       |             |  |  |  |  |         |     |       |             |  |  |  |  |         |     |       |             |  |  |  |  |         |     |       |             |  |  |  |  |                 |     |       |             |  |  |  |  |                 |     |       |             |  |  |  |  |                 |     |       |             |  |  |  |  |                 |     |       |             |  |  |  |  |                 |     |       |             |  |  |  |  |                 |     |       |             |  |  |  |  |               |     |       |             |  |  |  |  |                  |     |       |             |  |  |  |  |                 |     |       |             |                |        |                              |                       |                 |     |       |             |                |        |  |                     |                 |     |       |             |  |  |  |  |                  |     |       |             |  |  |  |  |    |     |       |             |  |  |  |  |    |     |       |             |  |  |  |  |          |     |       |             |                |        |  |                     |          |     |       |             |                |        |  |                     |                  |     |       |             |                |        |  |                       |         |     |       |             |  |  |  |  |                 |     |       |             |  |  |  |  |         |     |       |             |  |  |  |  |         |     |       |             |  |  |  |  |         |     |       |             |  |  |  |  |                 |     |       |             |  |  |  |  |                 |     |       |             |  |  |  |  |                 |     |       |             |  |  |  |  |                 |     |       |             |  |  |  |  |                 |     |       |             |  |  |  |  |                 |     |       |             |  |  |  |  |               |     |       |             |  |  |  |  |                  |     |       |             |  |  |  |  |                 |     |       |             |                |        |  |                     |                 |     |       |             |                |        |  |                       |                 |     |       |             |  |  |  |  |                  |     |       |             |  |  |  |  |    |     |       |             |  |  |  |  |    |     |       |             |  |  |  |  |          |     |       |         |                |        |  |                    |          |     |       |         |                |        |  |                     |                  |     |       |         |  |  |  |  |         |     |       |         |  |  |  |  |                 |     |       |         |  |  |  |  |         |     |       |         |  |  |  |  |         |     |       |         |  |  |  |  |         |     |       |         |  |  |  |  |                 |     |       |         |  |  |  |  |                 |     |       |         |  |  |  |  |                 |     |       |         |  |  |  |  |                 |     |       |         |  |  |  |  |                 |     |       |         |  |  |  |  |                 |     |       |         |  |  |  |  |                 |     |       |         |  |  |  |  |                 |     |       |         |  |  |  |  |                 |     |       |         |  |  |  |  |               |     |       |         |  |  |  |  |                  |     |       |         |  |  |  |  |                  |     |       |         |  |  |  |  |    |     |       |         |  |  |  |  |    |     |       |         |  |  |  |  |          |     |       |         |                |        |  |                       |          |     |       |         |  |  |  |  |                  |     |       |         |  |  |  |  |         |     |       |         |  |  |  |  |                 |     |       |         |  |  |  |  |         |     |       |         |  |  |  |  |         |     |       |         |  |  |  |  |         |     |       |         |  |  |  |  |                 |     |       |         |  |  |  |  |                 |     |       |         |  |  |  |  |                 |     |       |         |  |  |  |  |                 |     |       |         |  |  |  |  |                 |     |       |         |  |  |  |  |                 |     |       |         |  |  |  |  |                 |     |       |         |  |  |  |  |                 |     |       |         |  |  |  |  |
| 2.8 FSI  | 150   | 05.11           | PR: 1LW     |                |             |   |                         |   |                         |                  |     |       |             |                |        |                              |                       |                  |     |       |             |                |        |  |                     |         |     |       |             |  |  |  |  |                 |     |       |             |  |  |  |  |         |     |       |             |  |  |  |  |         |     |       |             |  |  |  |  |         |     |       |             |  |  |  |  |                 |     |       |             |  |  |  |  |                 |     |       |             |  |  |  |  |                 |     |       |             |  |  |  |  |                 |     |       |             |  |  |  |  |                 |     |       |             |  |  |  |  |                 |     |       |             |  |  |  |  |               |     |       |             |  |  |  |  |                  |     |       |             |  |  |  |  |                 |     |       |             |                |        |                              |                       |                 |     |       |             |                |        |  |                     |                 |     |       |             |  |  |  |  |                  |     |       |             |  |  |  |  |    |     |       |             |  |  |  |  |    |     |       |             |  |  |  |  |          |     |       |             |                |        |  |                     |          |     |       |             |                |        |  |                     |                  |     |       |             |                |        |  |                       |         |     |       |             |  |  |  |  |                 |     |       |             |  |  |  |  |         |     |       |             |  |  |  |  |         |     |       |             |  |  |  |  |         |     |       |             |  |  |  |  |                 |     |       |             |  |  |  |  |                 |     |       |             |  |  |  |  |                 |     |       |             |  |  |  |  |                 |     |       |             |  |  |  |  |                 |     |       |             |  |  |  |  |                 |     |       |             |  |  |  |  |               |     |       |             |  |  |  |  |                  |     |       |             |  |  |  |  |                 |     |       |             |                |        |  |                     |                 |     |       |             |                |        |  |                       |                 |     |       |             |  |  |  |  |                  |     |       |             |  |  |  |  |    |     |       |             |  |  |  |  |    |     |       |             |  |  |  |  |          |     |       |         |                |        |  |                    |          |     |       |         |                |        |  |                     |                  |     |       |         |  |  |  |  |         |     |       |         |  |  |  |  |                 |     |       |         |  |  |  |  |         |     |       |         |  |  |  |  |         |     |       |         |  |  |  |  |         |     |       |         |  |  |  |  |                 |     |       |         |  |  |  |  |                 |     |       |         |  |  |  |  |                 |     |       |         |  |  |  |  |                 |     |       |         |  |  |  |  |                 |     |       |         |  |  |  |  |                 |     |       |         |  |  |  |  |                 |     |       |         |  |  |  |  |                 |     |       |         |  |  |  |  |                 |     |       |         |  |  |  |  |               |     |       |         |  |  |  |  |                  |     |       |         |  |  |  |  |                  |     |       |         |  |  |  |  |    |     |       |         |  |  |  |  |    |     |       |         |  |  |  |  |          |     |       |         |                |        |  |                       |          |     |       |         |  |  |  |  |                  |     |       |         |  |  |  |  |         |     |       |         |  |  |  |  |                 |     |       |         |  |  |  |  |         |     |       |         |  |  |  |  |         |     |       |         |  |  |  |  |         |     |       |         |  |  |  |  |                 |     |       |         |  |  |  |  |                 |     |       |         |  |  |  |  |                 |     |       |         |  |  |  |  |                 |     |       |         |  |  |  |  |                 |     |       |         |  |  |  |  |                 |     |       |         |  |  |  |  |                 |     |       |         |  |  |  |  |                 |     |       |         |  |  |  |  |
| 2.8 FSI quattro  | 150   | 07.10           | PR: 1LW     |                |             |   |                         |   |                         |                  |     |       |             |                |        |                              |                       |                  |     |       |             |                |        |  |                     |         |     |       |             |  |  |  |  |                 |     |       |             |  |  |  |  |         |     |       |             |  |  |  |  |         |     |       |             |  |  |  |  |         |     |       |             |  |  |  |  |                 |     |       |             |  |  |  |  |                 |     |       |             |  |  |  |  |                 |     |       |             |  |  |  |  |                 |     |       |             |  |  |  |  |                 |     |       |             |  |  |  |  |                 |     |       |             |  |  |  |  |               |     |       |             |  |  |  |  |                  |     |       |             |  |  |  |  |                 |     |       |             |                |        |                              |                       |                 |     |       |             |                |        |  |                     |                 |     |       |             |  |  |  |  |                  |     |       |             |  |  |  |  |    |     |       |             |  |  |  |  |    |     |       |             |  |  |  |  |          |     |       |             |                |        |  |                     |          |     |       |             |                |        |  |                     |                  |     |       |             |                |        |  |                       |         |     |       |             |  |  |  |  |                 |     |       |             |  |  |  |  |         |     |       |             |  |  |  |  |         |     |       |             |  |  |  |  |         |     |       |             |  |  |  |  |                 |     |       |             |  |  |  |  |                 |     |       |             |  |  |  |  |                 |     |       |             |  |  |  |  |                 |     |       |             |  |  |  |  |                 |     |       |             |  |  |  |  |                 |     |       |             |  |  |  |  |               |     |       |             |  |  |  |  |                  |     |       |             |  |  |  |  |                 |     |       |             |                |        |  |                     |                 |     |       |             |                |        |  |                       |                 |     |       |             |  |  |  |  |                  |     |       |             |  |  |  |  |    |     |       |             |  |  |  |  |    |     |       |             |  |  |  |  |          |     |       |         |                |        |  |                    |          |     |       |         |                |        |  |                     |                  |     |       |         |  |  |  |  |         |     |       |         |  |  |  |  |                 |     |       |         |  |  |  |  |         |     |       |         |  |  |  |  |         |     |       |         |  |  |  |  |         |     |       |         |  |  |  |  |                 |     |       |         |  |  |  |  |                 |     |       |         |  |  |  |  |                 |     |       |         |  |  |  |  |                 |     |       |         |  |  |  |  |                 |     |       |         |  |  |  |  |                 |     |       |         |  |  |  |  |                 |     |       |         |  |  |  |  |                 |     |       |         |  |  |  |  |                 |     |       |         |  |  |  |  |               |     |       |         |  |  |  |  |                  |     |       |         |  |  |  |  |                  |     |       |         |  |  |  |  |    |     |       |         |  |  |  |  |    |     |       |         |  |  |  |  |          |     |       |         |                |        |  |                       |          |     |       |         |  |  |  |  |                  |     |       |         |  |  |  |  |         |     |       |         |  |  |  |  |                 |     |       |         |  |  |  |  |         |     |       |         |  |  |  |  |         |     |       |         |  |  |  |  |         |     |       |         |  |  |  |  |                 |     |       |         |  |  |  |  |                 |     |       |         |  |  |  |  |                 |     |       |         |  |  |  |  |                 |     |       |         |  |  |  |  |                 |     |       |         |  |  |  |  |                 |     |       |         |  |  |  |  |                 |     |       |         |  |  |  |  |                 |     |       |         |  |  |  |  |
| 3.0 TDI  | 140   | 11.15           | PR: 1LW     |                |             |   |                         |   |                         |                  |     |       |             |                |        |                              |                       |                  |     |       |             |                |        |  |                     |         |     |       |             |  |  |  |  |                 |     |       |             |  |  |  |  |         |     |       |             |  |  |  |  |         |     |       |             |  |  |  |  |         |     |       |             |  |  |  |  |                 |     |       |             |  |  |  |  |                 |     |       |             |  |  |  |  |                 |     |       |             |  |  |  |  |                 |     |       |             |  |  |  |  |                 |     |       |             |  |  |  |  |                 |     |       |             |  |  |  |  |               |     |       |             |  |  |  |  |                  |     |       |             |  |  |  |  |                 |     |       |             |                |        |                              |                       |                 |     |       |             |                |        |  |                     |                 |     |       |             |  |  |  |  |                  |     |       |             |  |  |  |  |    |     |       |             |  |  |  |  |    |     |       |             |  |  |  |  |          |     |       |             |                |        |  |                     |          |     |       |             |                |        |  |                     |                  |     |       |             |                |        |  |                       |         |     |       |             |  |  |  |  |                 |     |       |             |  |  |  |  |         |     |       |             |  |  |  |  |         |     |       |             |  |  |  |  |         |     |       |             |  |  |  |  |                 |     |       |             |  |  |  |  |                 |     |       |             |  |  |  |  |                 |     |       |             |  |  |  |  |                 |     |       |             |  |  |  |  |                 |     |       |             |  |  |  |  |                 |     |       |             |  |  |  |  |               |     |       |             |  |  |  |  |                  |     |       |             |  |  |  |  |                 |     |       |             |                |        |  |                     |                 |     |       |             |                |        |  |                       |                 |     |       |             |  |  |  |  |                  |     |       |             |  |  |  |  |    |     |       |             |  |  |  |  |    |     |       |             |  |  |  |  |          |     |       |         |                |        |  |                    |          |     |       |         |                |        |  |                     |                  |     |       |         |  |  |  |  |         |     |       |         |  |  |  |  |                 |     |       |         |  |  |  |  |         |     |       |         |  |  |  |  |         |     |       |         |  |  |  |  |         |     |       |         |  |  |  |  |                 |     |       |         |  |  |  |  |                 |     |       |         |  |  |  |  |                 |     |       |         |  |  |  |  |                 |     |       |         |  |  |  |  |                 |     |       |         |  |  |  |  |                 |     |       |         |  |  |  |  |                 |     |       |         |  |  |  |  |                 |     |       |         |  |  |  |  |                 |     |       |         |  |  |  |  |               |     |       |         |  |  |  |  |                  |     |       |         |  |  |  |  |                  |     |       |         |  |  |  |  |    |     |       |         |  |  |  |  |    |     |       |         |  |  |  |  |          |     |       |         |                |        |  |                       |          |     |       |         |  |  |  |  |                  |     |       |         |  |  |  |  |         |     |       |         |  |  |  |  |                 |     |       |         |  |  |  |  |         |     |       |         |  |  |  |  |         |     |       |         |  |  |  |  |         |     |       |         |  |  |  |  |                 |     |       |         |  |  |  |  |                 |     |       |         |  |  |  |  |                 |     |       |         |  |  |  |  |                 |     |       |         |  |  |  |  |                 |     |       |         |  |  |  |  |                 |     |       |         |  |  |  |  |                 |     |       |         |  |  |  |  |                 |     |       |         |  |  |  |  |
| 3.0 TDI  | 150   | 11.10           | PR: 1LW     |                |             |   |                         |   |                         |                  |     |       |             |                |        |                              |                       |                  |     |       |             |                |        |  |                     |         |     |       |             |  |  |  |  |                 |     |       |             |  |  |  |  |         |     |       |             |  |  |  |  |         |     |       |             |  |  |  |  |         |     |       |             |  |  |  |  |                 |     |       |             |  |  |  |  |                 |     |       |             |  |  |  |  |                 |     |       |             |  |  |  |  |                 |     |       |             |  |  |  |  |                 |     |       |             |  |  |  |  |                 |     |       |             |  |  |  |  |               |     |       |             |  |  |  |  |                  |     |       |             |  |  |  |  |                 |     |       |             |                |        |                              |                       |                 |     |       |             |                |        |  |                     |                 |     |       |             |  |  |  |  |                  |     |       |             |  |  |  |  |    |     |       |             |  |  |  |  |    |     |       |             |  |  |  |  |          |     |       |             |                |        |  |                     |          |     |       |             |                |        |  |                     |                  |     |       |             |                |        |  |                       |         |     |       |             |  |  |  |  |                 |     |       |             |  |  |  |  |         |     |       |             |  |  |  |  |         |     |       |             |  |  |  |  |         |     |       |             |  |  |  |  |                 |     |       |             |  |  |  |  |                 |     |       |             |  |  |  |  |                 |     |       |             |  |  |  |  |                 |     |       |             |  |  |  |  |                 |     |       |             |  |  |  |  |                 |     |       |             |  |  |  |  |               |     |       |             |  |  |  |  |                  |     |       |             |  |  |  |  |                 |     |       |             |                |        |  |                     |                 |     |       |             |                |        |  |                       |                 |     |       |             |  |  |  |  |                  |     |       |             |  |  |  |  |    |     |       |             |  |  |  |  |    |     |       |             |  |  |  |  |          |     |       |         |                |        |  |                    |          |     |       |         |                |        |  |                     |                  |     |       |         |  |  |  |  |         |     |       |         |  |  |  |  |                 |     |       |         |  |  |  |  |         |     |       |         |  |  |  |  |         |     |       |         |  |  |  |  |         |     |       |         |  |  |  |  |                 |     |       |         |  |  |  |  |                 |     |       |         |  |  |  |  |                 |     |       |         |  |  |  |  |                 |     |       |         |  |  |  |  |                 |     |       |         |  |  |  |  |                 |     |       |         |  |  |  |  |                 |     |       |         |  |  |  |  |                 |     |       |         |  |  |  |  |                 |     |       |         |  |  |  |  |               |     |       |         |  |  |  |  |                  |     |       |         |  |  |  |  |                  |     |       |         |  |  |  |  |    |     |       |         |  |  |  |  |    |     |       |         |  |  |  |  |          |     |       |         |                |        |  |                       |          |     |       |         |  |  |  |  |                  |     |       |         |  |  |  |  |         |     |       |         |  |  |  |  |                 |     |       |         |  |  |  |  |         |     |       |         |  |  |  |  |         |     |       |         |  |  |  |  |         |     |       |         |  |  |  |  |                 |     |       |         |  |  |  |  |                 |     |       |         |  |  |  |  |                 |     |       |         |  |  |  |  |                 |     |       |         |  |  |  |  |                 |     |       |         |  |  |  |  |                 |     |       |         |  |  |  |  |                 |     |       |         |  |  |  |  |                 |     |       |         |  |  |  |  |
| 3.0 TDI  | 155   | 11.15           | PR: 1LW     |                |             |   |                         |   |                         |                  |     |       |             |                |        |                              |                       |                  |     |       |             |                |        |  |                     |         |     |       |             |  |  |  |  |                 |     |       |             |  |  |  |  |         |     |       |             |  |  |  |  |         |     |       |             |  |  |  |  |         |     |       |             |  |  |  |  |                 |     |       |             |  |  |  |  |                 |     |       |             |  |  |  |  |                 |     |       |             |  |  |  |  |                 |     |       |             |  |  |  |  |                 |     |       |             |  |  |  |  |                 |     |       |             |  |  |  |  |               |     |       |             |  |  |  |  |                  |     |       |             |  |  |  |  |                 |     |       |             |                |        |                              |                       |                 |     |       |             |                |        |  |                     |                 |     |       |             |  |  |  |  |                  |     |       |             |  |  |  |  |    |     |       |             |  |  |  |  |    |     |       |             |  |  |  |  |          |     |       |             |                |        |  |                     |          |     |       |             |                |        |  |                     |                  |     |       |             |                |        |  |                       |         |     |       |             |  |  |  |  |                 |     |       |             |  |  |  |  |         |     |       |             |  |  |  |  |         |     |       |             |  |  |  |  |         |     |       |             |  |  |  |  |                 |     |       |             |  |  |  |  |                 |     |       |             |  |  |  |  |                 |     |       |             |  |  |  |  |                 |     |       |             |  |  |  |  |                 |     |       |             |  |  |  |  |                 |     |       |             |  |  |  |  |               |     |       |             |  |  |  |  |                  |     |       |             |  |  |  |  |                 |     |       |             |                |        |  |                     |                 |     |       |             |                |        |  |                       |                 |     |       |             |  |  |  |  |                  |     |       |             |  |  |  |  |    |     |       |             |  |  |  |  |    |     |       |             |  |  |  |  |          |     |       |         |                |        |  |                    |          |     |       |         |                |        |  |                     |                  |     |       |         |  |  |  |  |         |     |       |         |  |  |  |  |                 |     |       |         |  |  |  |  |         |     |       |         |  |  |  |  |         |     |       |         |  |  |  |  |         |     |       |         |  |  |  |  |                 |     |       |         |  |  |  |  |                 |     |       |         |  |  |  |  |                 |     |       |         |  |  |  |  |                 |     |       |         |  |  |  |  |                 |     |       |         |  |  |  |  |                 |     |       |         |  |  |  |  |                 |     |       |         |  |  |  |  |                 |     |       |         |  |  |  |  |                 |     |       |         |  |  |  |  |               |     |       |         |  |  |  |  |                  |     |       |         |  |  |  |  |                  |     |       |         |  |  |  |  |    |     |       |         |  |  |  |  |    |     |       |         |  |  |  |  |          |     |       |         |                |        |  |                       |          |     |       |         |  |  |  |  |                  |     |       |         |  |  |  |  |         |     |       |         |  |  |  |  |                 |     |       |         |  |  |  |  |         |     |       |         |  |  |  |  |         |     |       |         |  |  |  |  |         |     |       |         |  |  |  |  |                 |     |       |         |  |  |  |  |                 |     |       |         |  |  |  |  |                 |     |       |         |  |  |  |  |                 |     |       |         |  |  |  |  |                 |     |       |         |  |  |  |  |                 |     |       |         |  |  |  |  |                 |     |       |         |  |  |  |  |                 |     |       |         |  |  |  |  |
| 3.0 TDI quattro  | 140   | 11.15           | PR: 1LW     |                |             |   |                         |   |                         |                  |     |       |             |                |        |                              |                       |                  |     |       |             |                |        |  |                     |         |     |       |             |  |  |  |  |                 |     |       |             |  |  |  |  |         |     |       |             |  |  |  |  |         |     |       |             |  |  |  |  |         |     |       |             |  |  |  |  |                 |     |       |             |  |  |  |  |                 |     |       |             |  |  |  |  |                 |     |       |             |  |  |  |  |                 |     |       |             |  |  |  |  |                 |     |       |             |  |  |  |  |                 |     |       |             |  |  |  |  |               |     |       |             |  |  |  |  |                  |     |       |             |  |  |  |  |                 |     |       |             |                |        |                              |                       |                 |     |       |             |                |        |  |                     |                 |     |       |             |  |  |  |  |                  |     |       |             |  |  |  |  |    |     |       |             |  |  |  |  |    |     |       |             |  |  |  |  |          |     |       |             |                |        |  |                     |          |     |       |             |                |        |  |                     |                  |     |       |             |                |        |  |                       |         |     |       |             |  |  |  |  |                 |     |       |             |  |  |  |  |         |     |       |             |  |  |  |  |         |     |       |             |  |  |  |  |         |     |       |             |  |  |  |  |                 |     |       |             |  |  |  |  |                 |     |       |             |  |  |  |  |                 |     |       |             |  |  |  |  |                 |     |       |             |  |  |  |  |                 |     |       |             |  |  |  |  |                 |     |       |             |  |  |  |  |               |     |       |             |  |  |  |  |                  |     |       |             |  |  |  |  |                 |     |       |             |                |        |  |                     |                 |     |       |             |                |        |  |                       |                 |     |       |             |  |  |  |  |                  |     |       |             |  |  |  |  |    |     |       |             |  |  |  |  |    |     |       |             |  |  |  |  |          |     |       |         |                |        |  |                    |          |     |       |         |                |        |  |                     |                  |     |       |         |  |  |  |  |         |     |       |         |  |  |  |  |                 |     |       |         |  |  |  |  |         |     |       |         |  |  |  |  |         |     |       |         |  |  |  |  |         |     |       |         |  |  |  |  |                 |     |       |         |  |  |  |  |                 |     |       |         |  |  |  |  |                 |     |       |         |  |  |  |  |                 |     |       |         |  |  |  |  |                 |     |       |         |  |  |  |  |                 |     |       |         |  |  |  |  |                 |     |       |         |  |  |  |  |                 |     |       |         |  |  |  |  |                 |     |       |         |  |  |  |  |               |     |       |         |  |  |  |  |                  |     |       |         |  |  |  |  |                  |     |       |         |  |  |  |  |    |     |       |         |  |  |  |  |    |     |       |         |  |  |  |  |          |     |       |         |                |        |  |                       |          |     |       |         |  |  |  |  |                  |     |       |         |  |  |  |  |         |     |       |         |  |  |  |  |                 |     |       |         |  |  |  |  |         |     |       |         |  |  |  |  |         |     |       |         |  |  |  |  |         |     |       |         |  |  |  |  |                 |     |       |         |  |  |  |  |                 |     |       |         |  |  |  |  |                 |     |       |         |  |  |  |  |                 |     |       |         |  |  |  |  |                 |     |       |         |  |  |  |  |                 |     |       |         |  |  |  |  |                 |     |       |         |  |  |  |  |                 |     |       |         |  |  |  |  |
| 3.0 TDI quattro  | 150   | 07.10           | PR: 1LW     |                |             |   |                         |   |                         |                  |     |       |             |                |        |                              |                       |                  |     |       |             |                |        |  |                     |         |     |       |             |  |  |  |  |                 |     |       |             |  |  |  |  |         |     |       |             |  |  |  |  |         |     |       |             |  |  |  |  |         |     |       |             |  |  |  |  |                 |     |       |             |  |  |  |  |                 |     |       |             |  |  |  |  |                 |     |       |             |  |  |  |  |                 |     |       |             |  |  |  |  |                 |     |       |             |  |  |  |  |                 |     |       |             |  |  |  |  |               |     |       |             |  |  |  |  |                  |     |       |             |  |  |  |  |                 |     |       |             |                |        |                              |                       |                 |     |       |             |                |        |  |                     |                 |     |       |             |  |  |  |  |                  |     |       |             |  |  |  |  |    |     |       |             |  |  |  |  |    |     |       |             |  |  |  |  |          |     |       |             |                |        |  |                     |          |     |       |             |                |        |  |                     |                  |     |       |             |                |        |  |                       |         |     |       |             |  |  |  |  |                 |     |       |             |  |  |  |  |         |     |       |             |  |  |  |  |         |     |       |             |  |  |  |  |         |     |       |             |  |  |  |  |                 |     |       |             |  |  |  |  |                 |     |       |             |  |  |  |  |                 |     |       |             |  |  |  |  |                 |     |       |             |  |  |  |  |                 |     |       |             |  |  |  |  |                 |     |       |             |  |  |  |  |               |     |       |             |  |  |  |  |                  |     |       |             |  |  |  |  |                 |     |       |             |                |        |  |                     |                 |     |       |             |                |        |  |                       |                 |     |       |             |  |  |  |  |                  |     |       |             |  |  |  |  |    |     |       |             |  |  |  |  |    |     |       |             |  |  |  |  |          |     |       |         |                |        |  |                    |          |     |       |         |                |        |  |                     |                  |     |       |         |  |  |  |  |         |     |       |         |  |  |  |  |                 |     |       |         |  |  |  |  |         |     |       |         |  |  |  |  |         |     |       |         |  |  |  |  |         |     |       |         |  |  |  |  |                 |     |       |         |  |  |  |  |                 |     |       |         |  |  |  |  |                 |     |       |         |  |  |  |  |                 |     |       |         |  |  |  |  |                 |     |       |         |  |  |  |  |                 |     |       |         |  |  |  |  |                 |     |       |         |  |  |  |  |                 |     |       |         |  |  |  |  |                 |     |       |         |  |  |  |  |               |     |       |         |  |  |  |  |                  |     |       |         |  |  |  |  |                  |     |       |         |  |  |  |  |    |     |       |         |  |  |  |  |    |     |       |         |  |  |  |  |          |     |       |         |                |        |  |                       |          |     |       |         |  |  |  |  |                  |     |       |         |  |  |  |  |         |     |       |         |  |  |  |  |                 |     |       |         |  |  |  |  |         |     |       |         |  |  |  |  |         |     |       |         |  |  |  |  |         |     |       |         |  |  |  |  |                 |     |       |         |  |  |  |  |                 |     |       |         |  |  |  |  |                 |     |       |         |  |  |  |  |                 |     |       |         |  |  |  |  |                 |     |       |         |  |  |  |  |                 |     |       |         |  |  |  |  |                 |     |       |         |  |  |  |  |                 |     |       |         |  |  |  |  |
| 3.0 TDI quattro  | 160   | 05.14           | PR: 1LW     |                |             |   |                         |   |                         |                  |     |       |             |                |        |                              |                       |                  |     |       |             |                |        |  |                     |         |     |       |             |  |  |  |  |                 |     |       |             |  |  |  |  |         |     |       |             |  |  |  |  |         |     |       |             |  |  |  |  |         |     |       |             |  |  |  |  |                 |     |       |             |  |  |  |  |                 |     |       |             |  |  |  |  |                 |     |       |             |  |  |  |  |                 |     |       |             |  |  |  |  |                 |     |       |             |  |  |  |  |                 |     |       |             |  |  |  |  |               |     |       |             |  |  |  |  |                  |     |       |             |  |  |  |  |                 |     |       |             |                |        |                              |                       |                 |     |       |             |                |        |  |                     |                 |     |       |             |  |  |  |  |                  |     |       |             |  |  |  |  |    |     |       |             |  |  |  |  |    |     |       |             |  |  |  |  |          |     |       |             |                |        |  |                     |          |     |       |             |                |        |  |                     |                  |     |       |             |                |        |  |                       |         |     |       |             |  |  |  |  |                 |     |       |             |  |  |  |  |         |     |       |             |  |  |  |  |         |     |       |             |  |  |  |  |         |     |       |             |  |  |  |  |                 |     |       |             |  |  |  |  |                 |     |       |             |  |  |  |  |                 |     |       |             |  |  |  |  |                 |     |       |             |  |  |  |  |                 |     |       |             |  |  |  |  |                 |     |       |             |  |  |  |  |               |     |       |             |  |  |  |  |                  |     |       |             |  |  |  |  |                 |     |       |             |                |        |  |                     |                 |     |       |             |                |        |  |                       |                 |     |       |             |  |  |  |  |                  |     |       |             |  |  |  |  |    |     |       |             |  |  |  |  |    |     |       |             |  |  |  |  |          |     |       |         |                |        |  |                    |          |     |       |         |                |        |  |                     |                  |     |       |         |  |  |  |  |         |     |       |         |  |  |  |  |                 |     |       |         |  |  |  |  |         |     |       |         |  |  |  |  |         |     |       |         |  |  |  |  |         |     |       |         |  |  |  |  |                 |     |       |         |  |  |  |  |                 |     |       |         |  |  |  |  |                 |     |       |         |  |  |  |  |                 |     |       |         |  |  |  |  |                 |     |       |         |  |  |  |  |                 |     |       |         |  |  |  |  |                 |     |       |         |  |  |  |  |                 |     |       |         |  |  |  |  |                 |     |       |         |  |  |  |  |               |     |       |         |  |  |  |  |                  |     |       |         |  |  |  |  |                  |     |       |         |  |  |  |  |    |     |       |         |  |  |  |  |    |     |       |         |  |  |  |  |          |     |       |         |                |        |  |                       |          |     |       |         |  |  |  |  |                  |     |       |         |  |  |  |  |         |     |       |         |  |  |  |  |                 |     |       |         |  |  |  |  |         |     |       |         |  |  |  |  |         |     |       |         |  |  |  |  |         |     |       |         |  |  |  |  |                 |     |       |         |  |  |  |  |                 |     |       |         |  |  |  |  |                 |     |       |         |  |  |  |  |                 |     |       |         |  |  |  |  |                 |     |       |         |  |  |  |  |                 |     |       |         |  |  |  |  |                 |     |       |         |  |  |  |  |                 |     |       |         |  |  |  |  |
| 3.0 TDI quattro  | 176   | 05.13           | PR: 1LW     |                |             |   |                         |   |                         |                  |     |       |             |                |        |                              |                       |                  |     |       |             |                |        |  |                     |         |     |       |             |  |  |  |  |                 |     |       |             |  |  |  |  |         |     |       |             |  |  |  |  |         |     |       |             |  |  |  |  |         |     |       |             |  |  |  |  |                 |     |       |             |  |  |  |  |                 |     |       |             |  |  |  |  |                 |     |       |             |  |  |  |  |                 |     |       |             |  |  |  |  |                 |     |       |             |  |  |  |  |                 |     |       |             |  |  |  |  |               |     |       |             |  |  |  |  |                  |     |       |             |  |  |  |  |                 |     |       |             |                |        |                              |                       |                 |     |       |             |                |        |  |                     |                 |     |       |             |  |  |  |  |                  |     |       |             |  |  |  |  |    |     |       |             |  |  |  |  |    |     |       |             |  |  |  |  |          |     |       |             |                |        |  |                     |          |     |       |             |                |        |  |                     |                  |     |       |             |                |        |  |                       |         |     |       |             |  |  |  |  |                 |     |       |             |  |  |  |  |         |     |       |             |  |  |  |  |         |     |       |             |  |  |  |  |         |     |       |             |  |  |  |  |                 |     |       |             |  |  |  |  |                 |     |       |             |  |  |  |  |                 |     |       |             |  |  |  |  |                 |     |       |             |  |  |  |  |                 |     |       |             |  |  |  |  |                 |     |       |             |  |  |  |  |               |     |       |             |  |  |  |  |                  |     |       |             |  |  |  |  |                 |     |       |             |                |        |  |                     |                 |     |       |             |                |        |  |                       |                 |     |       |             |  |  |  |  |                  |     |       |             |  |  |  |  |    |     |       |             |  |  |  |  |    |     |       |             |  |  |  |  |          |     |       |         |                |        |  |                    |          |     |       |         |                |        |  |                     |                  |     |       |         |  |  |  |  |         |     |       |         |  |  |  |  |                 |     |       |         |  |  |  |  |         |     |       |         |  |  |  |  |         |     |       |         |  |  |  |  |         |     |       |         |  |  |  |  |                 |     |       |         |  |  |  |  |                 |     |       |         |  |  |  |  |                 |     |       |         |  |  |  |  |                 |     |       |         |  |  |  |  |                 |     |       |         |  |  |  |  |                 |     |       |         |  |  |  |  |                 |     |       |         |  |  |  |  |                 |     |       |         |  |  |  |  |                 |     |       |         |  |  |  |  |               |     |       |         |  |  |  |  |                  |     |       |         |  |  |  |  |                  |     |       |         |  |  |  |  |    |     |       |         |  |  |  |  |    |     |       |         |  |  |  |  |          |     |       |         |                |        |  |                       |          |     |       |         |  |  |  |  |                  |     |       |         |  |  |  |  |         |     |       |         |  |  |  |  |                 |     |       |         |  |  |  |  |         |     |       |         |  |  |  |  |         |     |       |         |  |  |  |  |         |     |       |         |  |  |  |  |                 |     |       |         |  |  |  |  |                 |     |       |         |  |  |  |  |                 |     |       |         |  |  |  |  |                 |     |       |         |  |  |  |  |                 |     |       |         |  |  |  |  |                 |     |       |         |  |  |  |  |                 |     |       |         |  |  |  |  |                 |     |       |         |  |  |  |  |
| 3.0 TDI quattro  | 180   | 07.10           | PR: 1LW     |                |             |   |                         |   |                         |                  |     |       |             |                |        |                              |                       |                  |     |       |             |                |        |  |                     |         |     |       |             |  |  |  |  |                 |     |       |             |  |  |  |  |         |     |       |             |  |  |  |  |         |     |       |             |  |  |  |  |         |     |       |             |  |  |  |  |                 |     |       |             |  |  |  |  |                 |     |       |             |  |  |  |  |                 |     |       |             |  |  |  |  |                 |     |       |             |  |  |  |  |                 |     |       |             |  |  |  |  |                 |     |       |             |  |  |  |  |               |     |       |             |  |  |  |  |                  |     |       |             |  |  |  |  |                 |     |       |             |                |        |                              |                       |                 |     |       |             |                |        |  |                     |                 |     |       |             |  |  |  |  |                  |     |       |             |  |  |  |  |    |     |       |             |  |  |  |  |    |     |       |             |  |  |  |  |          |     |       |             |                |        |  |                     |          |     |       |             |                |        |  |                     |                  |     |       |             |                |        |  |                       |         |     |       |             |  |  |  |  |                 |     |       |             |  |  |  |  |         |     |       |             |  |  |  |  |         |     |       |             |  |  |  |  |         |     |       |             |  |  |  |  |                 |     |       |             |  |  |  |  |                 |     |       |             |  |  |  |  |                 |     |       |             |  |  |  |  |                 |     |       |             |  |  |  |  |                 |     |       |             |  |  |  |  |                 |     |       |             |  |  |  |  |               |     |       |             |  |  |  |  |                  |     |       |             |  |  |  |  |                 |     |       |             |                |        |  |                     |                 |     |       |             |                |        |  |                       |                 |     |       |             |  |  |  |  |                  |     |       |             |  |  |  |  |    |     |       |             |  |  |  |  |    |     |       |             |  |  |  |  |          |     |       |         |                |        |  |                    |          |     |       |         |                |        |  |                     |                  |     |       |         |  |  |  |  |         |     |       |         |  |  |  |  |                 |     |       |         |  |  |  |  |         |     |       |         |  |  |  |  |         |     |       |         |  |  |  |  |         |     |       |         |  |  |  |  |                 |     |       |         |  |  |  |  |                 |     |       |         |  |  |  |  |                 |     |       |         |  |  |  |  |                 |     |       |         |  |  |  |  |                 |     |       |         |  |  |  |  |                 |     |       |         |  |  |  |  |                 |     |       |         |  |  |  |  |                 |     |       |         |  |  |  |  |                 |     |       |         |  |  |  |  |               |     |       |         |  |  |  |  |                  |     |       |         |  |  |  |  |                  |     |       |         |  |  |  |  |    |     |       |         |  |  |  |  |    |     |       |         |  |  |  |  |          |     |       |         |                |        |  |                       |          |     |       |         |  |  |  |  |                  |     |       |         |  |  |  |  |         |     |       |         |  |  |  |  |                 |     |       |         |  |  |  |  |         |     |       |         |  |  |  |  |         |     |       |         |  |  |  |  |         |     |       |         |  |  |  |  |                 |     |       |         |  |  |  |  |                 |     |       |         |  |  |  |  |                 |     |       |         |  |  |  |  |                 |     |       |         |  |  |  |  |                 |     |       |         |  |  |  |  |                 |     |       |         |  |  |  |  |                 |     |       |         |  |  |  |  |                 |     |       |         |  |  |  |  |
| 3.0 TDI quattro  | 200   | 05.14           | PR: 1LW     |                |             |   |                         |   |                         |                  |     |       |             |                |        |                              |                       |                  |     |       |             |                |        |  |                     |         |     |       |             |  |  |  |  |                 |     |       |             |  |  |  |  |         |     |       |             |  |  |  |  |         |     |       |             |  |  |  |  |         |     |       |             |  |  |  |  |                 |     |       |             |  |  |  |  |                 |     |       |             |  |  |  |  |                 |     |       |             |  |  |  |  |                 |     |       |             |  |  |  |  |                 |     |       |             |  |  |  |  |                 |     |       |             |  |  |  |  |               |     |       |             |  |  |  |  |                  |     |       |             |  |  |  |  |                 |     |       |             |                |        |                              |                       |                 |     |       |             |                |        |  |                     |                 |     |       |             |  |  |  |  |                  |     |       |             |  |  |  |  |    |     |       |             |  |  |  |  |    |     |       |             |  |  |  |  |          |     |       |             |                |        |  |                     |          |     |       |             |                |        |  |                     |                  |     |       |             |                |        |  |                       |         |     |       |             |  |  |  |  |                 |     |       |             |  |  |  |  |         |     |       |             |  |  |  |  |         |     |       |             |  |  |  |  |         |     |       |             |  |  |  |  |                 |     |       |             |  |  |  |  |                 |     |       |             |  |  |  |  |                 |     |       |             |  |  |  |  |                 |     |       |             |  |  |  |  |                 |     |       |             |  |  |  |  |                 |     |       |             |  |  |  |  |               |     |       |             |  |  |  |  |                  |     |       |             |  |  |  |  |                 |     |       |             |                |        |  |                     |                 |     |       |             |                |        |  |                       |                 |     |       |             |  |  |  |  |                  |     |       |             |  |  |  |  |    |     |       |             |  |  |  |  |    |     |       |             |  |  |  |  |          |     |       |         |                |        |  |                    |          |     |       |         |                |        |  |                     |                  |     |       |         |  |  |  |  |         |     |       |         |  |  |  |  |                 |     |       |         |  |  |  |  |         |     |       |         |  |  |  |  |         |     |       |         |  |  |  |  |         |     |       |         |  |  |  |  |                 |     |       |         |  |  |  |  |                 |     |       |         |  |  |  |  |                 |     |       |         |  |  |  |  |                 |     |       |         |  |  |  |  |                 |     |       |         |  |  |  |  |                 |     |       |         |  |  |  |  |                 |     |       |         |  |  |  |  |                 |     |       |         |  |  |  |  |                 |     |       |         |  |  |  |  |               |     |       |         |  |  |  |  |                  |     |       |         |  |  |  |  |                  |     |       |         |  |  |  |  |    |     |       |         |  |  |  |  |    |     |       |         |  |  |  |  |          |     |       |         |                |        |  |                       |          |     |       |         |  |  |  |  |                  |     |       |         |  |  |  |  |         |     |       |         |  |  |  |  |                 |     |       |         |  |  |  |  |         |     |       |         |  |  |  |  |         |     |       |         |  |  |  |  |         |     |       |         |  |  |  |  |                 |     |       |         |  |  |  |  |                 |     |       |         |  |  |  |  |                 |     |       |         |  |  |  |  |                 |     |       |         |  |  |  |  |                 |     |       |         |  |  |  |  |                 |     |       |         |  |  |  |  |                 |     |       |         |  |  |  |  |                 |     |       |         |  |  |  |  |
| 3.0 TDI quattro  | 230   | 11.11           | PR: 1LW     |                |             |   |                         |   |                         |                  |     |       |             |                |        |                              |                       |                  |     |       |             |                |        |  |                     |         |     |       |             |  |  |  |  |                 |     |       |             |  |  |  |  |         |     |       |             |  |  |  |  |         |     |       |             |  |  |  |  |         |     |       |             |  |  |  |  |                 |     |       |             |  |  |  |  |                 |     |       |             |  |  |  |  |                 |     |       |             |  |  |  |  |                 |     |       |             |  |  |  |  |                 |     |       |             |  |  |  |  |                 |     |       |             |  |  |  |  |               |     |       |             |  |  |  |  |                  |     |       |             |  |  |  |  |                 |     |       |             |                |        |                              |                       |                 |     |       |             |                |        |  |                     |                 |     |       |             |  |  |  |  |                  |     |       |             |  |  |  |  |    |     |       |             |  |  |  |  |    |     |       |             |  |  |  |  |          |     |       |             |                |        |  |                     |          |     |       |             |                |        |  |                     |                  |     |       |             |                |        |  |                       |         |     |       |             |  |  |  |  |                 |     |       |             |  |  |  |  |         |     |       |             |  |  |  |  |         |     |       |             |  |  |  |  |         |     |       |             |  |  |  |  |                 |     |       |             |  |  |  |  |                 |     |       |             |  |  |  |  |                 |     |       |             |  |  |  |  |                 |     |       |             |  |  |  |  |                 |     |       |             |  |  |  |  |                 |     |       |             |  |  |  |  |               |     |       |             |  |  |  |  |                  |     |       |             |  |  |  |  |                 |     |       |             |                |        |  |                     |                 |     |       |             |                |        |  |                       |                 |     |       |             |  |  |  |  |                  |     |       |             |  |  |  |  |    |     |       |             |  |  |  |  |    |     |       |             |  |  |  |  |          |     |       |         |                |        |  |                    |          |     |       |         |                |        |  |                     |                  |     |       |         |  |  |  |  |         |     |       |         |  |  |  |  |                 |     |       |         |  |  |  |  |         |     |       |         |  |  |  |  |         |     |       |         |  |  |  |  |         |     |       |         |  |  |  |  |                 |     |       |         |  |  |  |  |                 |     |       |         |  |  |  |  |                 |     |       |         |  |  |  |  |                 |     |       |         |  |  |  |  |                 |     |       |         |  |  |  |  |                 |     |       |         |  |  |  |  |                 |     |       |         |  |  |  |  |                 |     |       |         |  |  |  |  |                 |     |       |         |  |  |  |  |               |     |       |         |  |  |  |  |                  |     |       |         |  |  |  |  |                  |     |       |         |  |  |  |  |    |     |       |         |  |  |  |  |    |     |       |         |  |  |  |  |          |     |       |         |                |        |  |                       |          |     |       |         |  |  |  |  |                  |     |       |         |  |  |  |  |         |     |       |         |  |  |  |  |                 |     |       |         |  |  |  |  |         |     |       |         |  |  |  |  |         |     |       |         |  |  |  |  |         |     |       |         |  |  |  |  |                 |     |       |         |  |  |  |  |                 |     |       |         |  |  |  |  |                 |     |       |         |  |  |  |  |                 |     |       |         |  |  |  |  |                 |     |       |         |  |  |  |  |                 |     |       |         |  |  |  |  |                 |     |       |         |  |  |  |  |                 |     |       |         |  |  |  |  |
| 3.0 TDI quattro  | 235   | 05.14           | PR: 1LW     |                |             |   |                         |   |                         |                  |     |       |             |                |        |                              |                       |                  |     |       |             |                |        |  |                     |         |     |       |             |  |  |  |  |                 |     |       |             |  |  |  |  |         |     |       |             |  |  |  |  |         |     |       |             |  |  |  |  |         |     |       |             |  |  |  |  |                 |     |       |             |  |  |  |  |                 |     |       |             |  |  |  |  |                 |     |       |             |  |  |  |  |                 |     |       |             |  |  |  |  |                 |     |       |             |  |  |  |  |                 |     |       |             |  |  |  |  |               |     |       |             |  |  |  |  |                  |     |       |             |  |  |  |  |                 |     |       |             |                |        |                              |                       |                 |     |       |             |                |        |  |                     |                 |     |       |             |  |  |  |  |                  |     |       |             |  |  |  |  |    |     |       |             |  |  |  |  |    |     |       |             |  |  |  |  |          |     |       |             |                |        |  |                     |          |     |       |             |                |        |  |                     |                  |     |       |             |                |        |  |                       |         |     |       |             |  |  |  |  |                 |     |       |             |  |  |  |  |         |     |       |             |  |  |  |  |         |     |       |             |  |  |  |  |         |     |       |             |  |  |  |  |                 |     |       |             |  |  |  |  |                 |     |       |             |  |  |  |  |                 |     |       |             |  |  |  |  |                 |     |       |             |  |  |  |  |                 |     |       |             |  |  |  |  |                 |     |       |             |  |  |  |  |               |     |       |             |  |  |  |  |                  |     |       |             |  |  |  |  |                 |     |       |             |                |        |  |                     |                 |     |       |             |                |        |  |                       |                 |     |       |             |  |  |  |  |                  |     |       |             |  |  |  |  |    |     |       |             |  |  |  |  |    |     |       |             |  |  |  |  |          |     |       |         |                |        |  |                    |          |     |       |         |                |        |  |                     |                  |     |       |         |  |  |  |  |         |     |       |         |  |  |  |  |                 |     |       |         |  |  |  |  |         |     |       |         |  |  |  |  |         |     |       |         |  |  |  |  |         |     |       |         |  |  |  |  |                 |     |       |         |  |  |  |  |                 |     |       |         |  |  |  |  |                 |     |       |         |  |  |  |  |                 |     |       |         |  |  |  |  |                 |     |       |         |  |  |  |  |                 |     |       |         |  |  |  |  |                 |     |       |         |  |  |  |  |                 |     |       |         |  |  |  |  |                 |     |       |         |  |  |  |  |               |     |       |         |  |  |  |  |                  |     |       |         |  |  |  |  |                  |     |       |         |  |  |  |  |    |     |       |         |  |  |  |  |    |     |       |         |  |  |  |  |          |     |       |         |                |        |  |                       |          |     |       |         |  |  |  |  |                  |     |       |         |  |  |  |  |         |     |       |         |  |  |  |  |                 |     |       |         |  |  |  |  |         |     |       |         |  |  |  |  |         |     |       |         |  |  |  |  |         |     |       |         |  |  |  |  |                 |     |       |         |  |  |  |  |                 |     |       |         |  |  |  |  |                 |     |       |         |  |  |  |  |                 |     |       |         |  |  |  |  |                 |     |       |         |  |  |  |  |                 |     |       |         |  |  |  |  |                 |     |       |         |  |  |  |  |                 |     |       |         |  |  |  |  |

<sup>1)</sup> electric parking brake / fr.di stazionamento elettrico / frein à main électrique / freno de mano eléctrico

<sup>2)</sup> spring dimension 46 mm / dimensioni molla 46 mm / dimension de ressort 46 mm / medida de muelle 46 mm

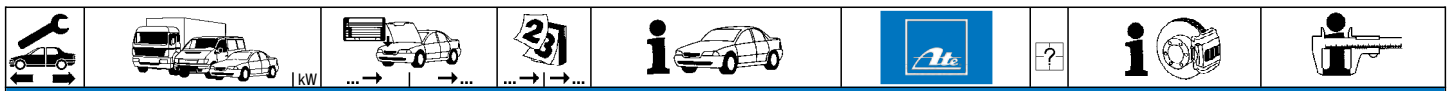





**AUDI A7 Sportback (10-)**

|                  |                  |       |             |             |                |        |   |                         |                |        |   |   |
|------------------|------------------|-------|-------------|-------------|----------------|--------|---|-------------------------|----------------|--------|---|---|
|                  | 3.0 TDI quattro  | 240   | 08.14       | PR: 1LW     | 24.8190-0020.2 | 620020 | 2 | Warnkontakt L=443,3mm   |                |        |   |   |
|                  | 3.0 TDI ultra    | 160   | 05.14       | PR: 1LW     |                |        |   |                         |                |        |   |   |
|                  | 3.0 TFSI quattro |       | 07.10       | PR: 1LW     |                |        |   |                         |                |        |   |   |
|                  | 3.0 TFSI quattro | 245   | 05.14       | PR: 1LW     |                |        |   |                         |                |        |   |   |
|                  | S7               | 309   | 10.11       | PR: 1LW     |                |        |   |                         |                |        |   |   |
|                  | S7               | 331   | 05.14       | PR: 1LW     |                |        |   |                         |                |        |   |   |
|                  | 1.8 TFSI         | 140   | 04.15       | PR: 1LP     |                |        |   |                         | 13.0460-4879.2 | 604879 | 1 | 25643 16,8 /WE BRE<br>25643 17,0 /WE BRE<br>Warnkontakt L=332mm |
|                  | 2.0 TFSI         | 185   | 09.14       | PR: 1LP     |                |        |   |                         |                |        |   |   |
|                  | 2.0 TFSI quattro | 185   | 05.15       | PR: 1LP     |                |        |   |                         |                |        |   |   |
|                  | 2.8 FSI          | 150   | 05.14       | PR: 1LP     |                |        |   |                         |                |        |   |   |
|                  | 2.8 FSI quattro  | 150   | 05.14       | PR: 1LP     |                |        |   |                         |                |        |   |   |
|                  | 3.0 TDI          | 140   | 11.15       | PR: 1LP     |                |        |   |                         |                |        |   |   |
|                  | 3.0 TDI          | 150   | 05.14       | PR: 1LP     |                |        |   |                         |                |        |   |   |
|                  | 3.0 TDI          | 155   | 11.15       | PR: 1LP     |                |        |   |                         |                |        |   |   |
|                  | 3.0 TDI quattro  | 140   | 11.15       | PR: 1LP     |                |        |   |                         |                |        |   |   |
|                  | 3.0 TDI quattro  | 150   | 05.14       | PR: 1LP     |                |        |   |                         |                |        |   |   |
|                  | 3.0 TDI quattro  | 160   | 05.14       | PR: 1LP     |                |        |   |                         |                |        |   |   |
|                  | 3.0 TDI quattro  | 176   | 05.14       | PR: 1LP     |                |        |   |                         |                |        |   |   |
|                  | 3.0 TDI quattro  | 180   | 05.14       | PR: 1LP     |                |        |   |                         |                |        |   |   |
|                  | 3.0 TDI quattro  | 200   | 05.14       | PR: 1LP     |                |        |   |                         |                |        |   |   |
| 3.0 TDI quattro  | 230              | 05.14 | PR: 1LP     |             |                |        |   |                         |                |        |   |   |
| 3.0 TDI quattro  | 235              | 05.14 | PR: 1LP     |             |                |        |   |                         |                |        |   |   |
| 3.0 TDI quattro  | 240              | 08.14 | PR: 1LP     |             |                |        |   |                         |                |        |   |   |
| 3.0 TDI ultra    | 160              | 05.14 | PR: 1LP     |             |                |        |   |                         |                |        |   |   |
| 3.0 TFSI quattro |                  | 05.14 | PR: 1LP     |             |                |        |   |                         |                |        |   |   |
| 3.0 TFSI quattro | 245              | 05.14 | PR: 1LP     |             |                |        |   |                         |                |        |   |   |
| S7               | 309              | 05.14 | PR: 1LP     |             |                |        |   |                         |                |        |   |   |
| S7               | 331              | 05.14 | PR: 1LP     |             |                |        |   |                         |                |        |   |   |
|                  | 1.8 TFSI         | 140   | 04.15       | PR: 1LA     | 24.0130-0221.1 | 430221 |   | 320 30,0 28,0 V L +S +B |                |        |   |   |
|                  | 2.0 TFSI         | 185   | 09.14       | PR: 1LA     |                |        |   |                         |                |        |   |   |
|                  | 2.0 TFSI quattro | 185   | 05.15       | PR: 1LA     |                |        |   |                         |                |        |   |   |
|                  | 2.8 FSI          | 150   | 05.11       | PR: 1LA     |                |        |   |                         |                |        |   |   |
|                  | 2.8 FSI quattro  | 150   | 07.10       | PR: 1LA     |                |        |   |                         |                |        |   |   |
|                  | 3.0 TDI          | 140   | 11.15       | PR: 1LA     |                |        |   |                         |                |        |   |   |
|                  | 3.0 TDI          | 150   | 11.10       | PR: 1LA     |                |        |   |                         |                |        |   |   |
|                  | 3.0 TDI          | 155   | 11.15       | PR: 1LA     |                |        |   |                         |                |        |   |   |
|                  | 3.0 TDI quattro  | 140   | 11.15       | PR: 1LA     |                |        |   |                         |                |        |   |   |
|                  | 3.0 TDI quattro  | 150   | 07.10       | PR: 1LA     |                |        |   |                         |                |        |   |   |
|                  | 3.0 TDI quattro  | 160   | 05.14       | PR: 1LA     |                |        |   |                         |                |        |   |   |
|                  | 3.0 TDI quattro  | 176   | 05.13       | PR: 1LA     |                |        |   |                         |                |        |   |   |
|                  | 3.0 TDI quattro  | 180   | 07.10       | PR: 1LA     |                |        |   |                         |                |        |   |   |
|                  | 3.0 TDI quattro  | 200   | 05.14       | PR: 1LA     |                |        |   |                         |                |        |   |   |
|                  | 3.0 TDI quattro  | 230   | 11.11       | PR: 1LA     |                |        |   |                         |                |        |   |   |
|                  | 3.0 TDI quattro  | 235   | 05.14       | PR: 1LA     |                |        |   |                         |                |        |   |   |
|                  | 3.0 TDI quattro  | 240   | 08.14       | PR: 1LA     |                |        |   |                         |                |        |   |   |
|                  | 3.0 TDI ultra    | 160   | 05.14       | PR: 1LA     |                |        |   |                         |                |        |   |   |
|                  | 3.0 TFSI quattro |       | 07.10       | PR: 1LA     |                |        |   |                         |                |        |   |   |
|                  | 3.0 TFSI quattro | 245   | 05.14       | PR: 1LA     |                |        |   |                         |                |        |   |   |
| S7               | 309              | 10.11 | PR: 1LA     |             |                |        |   |                         |                |        |   |   |
| S7               | 331              | 05.14 | PR: 1LA     |             |                |        |   |                         |                |        |   |   |
|                  | 1.8 TFSI         | 140   | 04.15       | PR: 1LJ,1LP | 24.0130-0222.1 | 430222 |   | 345 30,0 28,0 V L +S +B |                |        |   |   |
|                  | 2.0 TFSI         | 185   | 09.14       | PR: 1LJ,1LP |                |        |   |                         |                |        |   |   |
|                  | 2.0 TFSI quattro | 185   | 05.15       | PR: 1LJ,1LP |                |        |   |                         |                |        |   |   |
|                  | 2.8 FSI          | 150   | 05.11       | PR: 1LJ,1LP |                |        |   |                         |                |        |   |   |
|                  | 2.8 FSI quattro  | 150   | 07.10       | PR: 1LJ,1LP |                |        |   |                         |                |        |   |   |
|                  | 3.0 TDI          | 140   | 11.15       | PR: 1LJ,1LP |                |        |   |                         |                |        |   |   |
|                  | 3.0 TDI          | 150   | 11.10       | PR: 1LJ,1LP |                |        |   |                         |                |        |   |   |
|                  | 3.0 TDI          | 155   | 11.15       | PR: 1LJ,1LP |                |        |   |                         |                |        |   |   |
|                  | 3.0 TDI quattro  | 140   | 11.15       | PR: 1LJ,1LP |                |        |   |                         |                |        |   |   |
|                  | 3.0 TDI quattro  | 150   | 07.10       | PR: 1LJ,1LP |                |        |   |                         |                |        |   |   |
|                  | 3.0 TDI quattro  | 160   | 05.14       | PR: 1LJ,1LP |                |        |   |                         |                |        |   |   |
|                  | 3.0 TDI quattro  | 176   | 05.13       | PR: 1LJ,1LP |                |        |   |                         |                |        |   |   |
|                  | 3.0 TDI quattro  | 180   | 07.10       | PR: 1LJ,1LP |                |        |   |                         |                |        |   |   |
|                  | 3.0 TDI quattro  | 200   | 05.14       | PR: 1LJ,1LP |                |        |   |                         |                |        |   |   |
|                  | 3.0 TDI quattro  | 230   | 11.11       | PR: 1LJ,1LP |                |        |   |                         |                |        |   |   |
|                  | 3.0 TDI quattro  | 235   | 05.14       | PR: 1LJ,1LP |                |        |   |                         |                |        |   |   |
|                  | 3.0 TDI quattro  | 240   | 08.14       | PR: 1LJ,1LP |                |        |   |                         |                |        |   |   |
|                  | 3.0 TDI ultra    | 160   | 05.14       | PR: 1LJ,1LP |                |        |   |                         |                |        |   |   |
|                  | 3.0 TFSI quattro |       | 07.10       | PR: 1LJ,1LP |                |        |   |                         |                |        |   |   |
|                  | 3.0 TFSI quattro | 245   | 05.14       | PR: 1LJ,1LP |                |        |   |                         |                |        |   |   |
| S7               | 309              | 10.11 | PR: 1LJ,1LP |             |                |        |   |                         |                |        |   |   |
| S7               | 331              | 05.14 | PR: 1LJ,1LP |             |                |        |   |                         |                |        |   |   |
|                  | 1.8 TFSI         | 140   | 04.15       | PR: 1LL,1LF | 24.0134-0103.1 | 434103 |   | 356 34,0 31,5 V L +S +B |                |        |   |   |
|                  | 2.0 TFSI         | 185   | 09.14       | PR: 1LL,1LF |                |        |   |                         |                |        |   |   |
|                  | 2.0 TFSI quattro | 185   | 05.15       | PR: 1LL,1LF |                |        |   |                         |                |        |   |   |
|                  | 2.8 FSI          | 150   | 05.11       | PR: 1LL,1LF |                |        |   |                         |                |        |   |   |
|                  | 2.8 FSI quattro  | 150   | 07.10       | PR: 1LL,1LF |                |        |   |                         |                |        |   |   |
|                  | 3.0 TDI          | 140   | 11.15       | PR: 1LL,1LF |                |        |   |                         |                |        |   |   |
|                  | 3.0 TDI          | 150   | 11.10       | PR: 1LL,1LF |                |        |   |                         |                |        |   |   |
|                  | 3.0 TDI          | 155   | 11.15       | PR: 1LL,1LF |                |        |   |                         |                |        |   |   |
|                  | 3.0 TDI quattro  | 140   | 11.15       | PR: 1LL,1LF |                |        |   |                         |                |        |   |   |
|                  | 3.0 TDI quattro  | 150   | 07.10       | PR: 1LL,1LF |                |        |   |                         |                |        |   |   |
|                  | 3.0 TDI quattro  | 160   | 05.14       | PR: 1LL,1LF |                |        |   |                         |                |        |   |   |
|                  | 3.0 TDI quattro  | 176   | 05.13       | PR: 1LL,1LF |                |        |   |                         |                |        |   |   |
|                  | 3.0 TDI quattro  | 180   | 07.10       | PR: 1LL,1LF |                |        |   |                         |                |        |   |   |
|                  | 3.0 TDI quattro  | 200   | 05.14       | PR: 1LL,1LF |                |        |   |                         |                |        |   |   |
|                  | 3.0 TDI quattro  | 230   | 11.11       | PR: 1LL,1LF |                |        |   |                         |                |        |   |   |





AUDI A7 Sportback (10-)

|  |  |   |   |   |  |                            |   |  |   |
|--|--|---|---|---|--|----------------------------|---|--|---|
|    | 3.0 TDI quattro<br>240<br>3.0 TDI ultra<br>160<br>3.0 TFSI quattro<br>245<br>3.0 TFSI quattro<br>309<br>S7<br>331  | 235<br>240<br>160<br>245<br>309<br>331  | 05.14<br>08.14<br>05.14<br>07.10<br>05.14<br>10.11<br>05.14   | PR: 1LL,1LF<br>PR: 1LL,1LF<br>PR: 1LL,1LF<br>PR: 1LL,1LF<br>PR: 1LL,1LF<br>PR: 1LL,1LF<br>PR: 1LL,1LF   | 24.0134-0103.1                                     | 434103                     |   | 356 34,0 31,5 VL +S +B   |   |
|    | 1.8 TFSI<br>140<br>2.0 TFSI<br>185<br>2.0 TFSI quattro<br>185<br>2.8 FSI<br>150<br>2.8 FSI quattro<br>150<br>3.0 TDI<br>140<br>3.0 TDI<br>150<br>3.0 TDI<br>155<br>3.0 TDI quattro<br>140<br>3.0 TDI quattro<br>150<br>3.0 TDI quattro<br>160<br>3.0 TDI quattro<br>176<br>3.0 TDI quattro<br>180<br>3.0 TDI quattro<br>200<br>3.0 TDI quattro<br>230<br>3.0 TDI quattro<br>235<br>3.0 TDI quattro<br>240<br>3.0 TDI ultra<br>160<br>3.0 TFSI quattro<br>245<br>3.0 TFSI quattro<br>309<br>S7<br>331                             | 140<br>185<br>185<br>150<br>150<br>140<br>150<br>155<br>140<br>150<br>160<br>176<br>180<br>200<br>230<br>235<br>240<br>160<br>245<br>309<br>331               | 04.15<br>09.14<br>05.15<br>05.11<br>07.10<br>11.15<br>11.10<br>11.15<br>11.15<br>07.10<br>05.14<br>05.13<br>07.10<br>05.14<br>11.11<br>05.14<br>08.14<br>05.14<br>07.10<br>05.14<br>10.11<br>05.14          | PR: 1KW<br>PR: 1KW<br>PR: 1KW<br>PR: 1KW<br>PR: 1KW<br>PR: 1KW<br>PR: 1KW<br>PR: 1KW<br>PR: 1KW<br>PR: 1KW<br>PR: 1KW<br>PR: 1KW<br>PR: 1KW<br>PR: 1KW<br>PR: 1KW<br>PR: 1KW<br>PR: 1KW<br>PR: 1KW<br>PR: 1KW<br>PR: 1KW<br>PR: 1KW<br>PR: 1KW<br>PR: 1KW<br>PR: 1KW<br>PR: 1KW   | 13.0460-2769.2<br>13.0470-2769.2<br>24.8190-0313.2 | 602769<br>LD2769<br>620313 | 1 | elektrische Feststellbremse <sup>1)</sup><br>elektrische Feststellbremse <sup>1)</sup> | 25214 17,4 +WK/Zub/STRW<br>25214 17,4 +WK/Zub/STRW<br>Warnkontakt L=217mm |
|  | 1.8 TFSI<br>140<br>2.0 TFSI<br>185<br>2.0 TFSI quattro<br>185<br>2.8 FSI<br>150<br>2.8 FSI quattro<br>150<br>3.0 TDI<br>140<br>3.0 TDI<br>150<br>3.0 TDI<br>155<br>3.0 TDI quattro<br>140<br>3.0 TDI quattro<br>150<br>3.0 TDI quattro<br>160<br>3.0 TDI quattro<br>176<br>3.0 TDI quattro<br>180<br>3.0 TDI quattro<br>200<br>3.0 TDI quattro<br>230<br>3.0 TDI quattro<br>235<br>3.0 TDI quattro<br>240<br>3.0 TDI ultra<br>160<br>3.0 TFSI quattro<br>245<br>3.0 TFSI quattro<br>412<br>RS 7<br>445<br>S7<br>309<br>S7<br>331 | 140<br>185<br>185<br>150<br>150<br>140<br>150<br>155<br>140<br>150<br>160<br>176<br>180<br>200<br>230<br>235<br>240<br>160<br>245<br>412<br>445<br>309<br>331 | 04.15<br>09.14<br>05.15<br>05.11<br>07.10<br>11.15<br>11.10<br>11.15<br>11.15<br>07.10<br>05.14<br>05.13<br>07.10<br>05.14<br>11.11<br>08.14<br>05.14<br>07.10<br>05.14<br>10.13<br>11.15<br>10.11<br>05.14 | PR: 1KY,2EA,2EE,2EJ<br>PR: 1KY,2EA,2EE,2EJ<br>PR: 1KY,2EA,2EE,2EJ<br>PR: 1KY,2EA,2EE,2EJ<br>PR: 1KY,2EA,2EE,2EJ<br>PR: 1KY,2EA,2EE,2EJ<br>PR: 1KY,2EA,2EE,2EJ<br>PR: 1KY,2EA,2EE,2EJ<br>PR: 1KY,2EA,2EE,2EJ<br>PR: 1KY,2EA,2EE,2EJ<br>PR: 1KY,2EA,2EE,2EJ<br>PR: 1KY,2EA,2EE,2EJ<br>PR: 1KY,2EA,2EE,2EJ<br>PR: 1KY,2EA,2EE,2EJ<br>PR: 1KY,2EA,2EE,2EJ<br>PR: 1KY,2EA,2EE,2EJ<br>PR: 1KY,2EA,2EE,2EJ<br>PR: 1KJ<br>PR: 1KJ<br>PR: 1KY,2EA,2EE,2EJ<br>PR: 1KY,2EA,2EE,2EJ | 13.0460-2770.2<br>13.0470-2770.2<br>24.8190-0313.2 | 602770<br>LD2770<br>620313 | 1 | elektrische Feststellbremse <sup>1)</sup><br>elektrische Feststellbremse <sup>1)</sup> | 25214 17,4 +WK/Zub/STRW<br>25214 17,4 +WK/Zub/STRW<br>Warnkontakt L=217mm |
|  | 1.8 TFSI<br>140<br>2.0 TFSI<br>185<br>2.0 TFSI quattro<br>185<br>2.8 FSI<br>150<br>2.8 FSI quattro<br>150<br>3.0 TDI<br>140<br>3.0 TDI<br>150<br>3.0 TDI<br>155<br>3.0 TDI quattro<br>140<br>3.0 TDI quattro<br>150<br>3.0 TDI quattro<br>160<br>3.0 TDI quattro<br>176<br>3.0 TDI quattro<br>180<br>3.0 TDI quattro<br>200<br>3.0 TDI quattro<br>230<br>3.0 TDI quattro<br>235<br>3.0 TDI quattro<br>240<br>3.0 TDI ultra<br>160<br>3.0 TFSI quattro<br>245<br>3.0 TFSI quattro<br>309<br>S7<br>331                             | 140<br>185<br>185<br>150<br>150<br>140<br>150<br>155<br>140<br>150<br>160<br>176<br>180<br>200<br>230<br>235<br>240<br>160<br>245<br>309<br>331               | 04.15<br>09.14<br>05.15<br>05.11<br>07.10<br>11.15<br>11.10<br>11.15<br>11.15<br>07.10<br>05.14<br>05.13<br>07.10<br>05.14<br>11.11<br>08.14<br>05.14<br>07.10<br>05.14<br>10.11<br>05.14                   | PR: 1KW<br>PR: 1KW<br>PR: 1KW<br>PR: 1KW<br>PR: 1KW<br>PR: 1KW<br>PR: 1KW<br>PR: 1KW<br>PR: 1KW<br>PR: 1KW<br>PR: 1KW<br>PR: 1KW<br>PR: 1KW<br>PR: 1KW<br>PR: 1KW<br>PR: 1KW<br>PR: 1KW<br>PR: 1KW<br>PR: 1KW<br>PR: 1KW  | 24.0112-0178.1<br>24.0312-0178.1                   | 412178<br>512178           |   | elektrische Feststellbremse <sup>1)</sup><br>elektrische Feststellbremse <sup>1)</sup> | 300 12,0 10,0 +S +B<br>300 12,0 10,0 +S +B PD                             |
|  | 1.8 TFSI<br>140<br>2.0 TFSI<br>185<br>2.0 TFSI quattro<br>185<br>2.8 FSI<br>150<br>2.8 FSI quattro<br>150<br>3.0 TDI<br>140<br>3.0 TDI<br>150<br>3.0 TDI<br>155<br>3.0 TDI quattro<br>140<br>3.0 TDI quattro<br>150<br>3.0 TDI quattro<br>160<br>3.0 TDI quattro<br>176<br>3.0 TDI quattro<br>180<br>3.0 TDI quattro<br>200<br>3.0 TDI quattro<br>230<br>3.0 TDI quattro<br>235<br>3.0 TDI quattro<br>240<br>3.0 TDI ultra<br>160<br>3.0 TFSI quattro<br>245<br>3.0 TFSI quattro<br>309<br>S7<br>331                             | 140<br>185<br>185<br>150<br>150<br>140<br>150<br>155<br>140<br>150<br>160<br>176<br>180<br>200<br>230<br>235<br>240<br>160<br>245<br>309<br>331               | 04.15<br>09.14<br>05.15<br>05.11<br>07.10<br>11.15<br>11.10<br>11.15<br>11.15<br>07.10<br>05.14<br>05.13<br>07.10<br>05.14<br>11.11<br>08.14<br>05.14<br>07.10<br>05.14<br>10.11<br>05.14                   | PR: 2EA,2EE,2EJ<br>PR: 2EA,2EE,2EJ<br>PR: 2EA,2EE,2EJ<br>PR: 2EA,2EE,2EJ<br>PR: 2EA,2EE,2EJ<br>PR: 2EA,2EE,2EJ<br>PR: 2EA,2EE,2EJ<br>PR: 2EA,2EE,2EJ<br>PR: 2EA,2EE,2EJ<br>PR: 2EA,2EE,2EJ<br>PR: 2EA,2EE,2EJ<br>PR: 2EA,2EE,2EJ<br>PR: 2EA,2EE,2EJ<br>PR: 2EA,2EE,2EJ<br>PR: 2EA,2EE,2EJ<br>PR: 2EA,2EE,2EJ<br>PR: 2EA,2EE,2EJ<br>PR: 2EA,2EE,2EJ  | 24.0122-0272.1                                     | 422272                     |   | elektrische Feststellbremse <sup>1)</sup>  | 330 21,9 20,0 VL +S +B  |

<sup>1)</sup> electric parking brake / fr/di stazionamento elettrico / frein à main électrique / freno de mano eléctrico





### AUDI A7 Sportback (10-)

|    |                  |       |         |                 |                |        |   |                         |
|----|------------------|-------|---------|-----------------|----------------|--------|---|-------------------------|
|    | 3.0 TDI quattro  | 180   | 07.10   | PR: 2EA,2EE,2EJ | 24.0122-0272.1 | 422272 | elektrische Feststellbremse <sup>1)</sup> | 330 21,9 20,0 V L +S +B |
|    | 3.0 TDI quattro  | 200   | 05.14   | PR: 2EA,2EE,2EJ |                |        |   |                         |
|    | 3.0 TDI quattro  | 230   | 11.11   | PR: 2EA,2EE,2EJ |                |        |   |                         |
|    | 3.0 TDI quattro  | 235   | 05.14   | PR: 2EA,2EE,2EJ |                |        |   |                         |
|    | 3.0 TDI quattro  | 240   | 08.14   | PR: 2EA,2EE,2EJ |                |        |   |                         |
|    | 3.0 TDI ultra    | 160   | 05.14   | PR: 2EA,2EE,2EJ |                |        |   |                         |
|    | 3.0 TFSI quattro |       | 07.10   | PR: 2EA,2EE,2EJ |                |        |   |                         |
|    | 3.0 TFSI quattro | 245   | 05.14   | PR: 2EA,2EE,2EJ |                |        |   |                         |
|    | S7               | 309   | 10.11   | PR: 2EA,2EE,2EJ |                |        |   |                         |
|    | S7               | 331   | 05.14   | PR: 2EA,2EE,2EJ |                |        |   |                         |
|    | 1.8 TFSI         | 140   | 04.15   | PR: 1KY         | 24.0122-0273.1 | 422273 | elektrische Feststellbremse <sup>1)</sup> | 356 22,0 20,0 V L +S +B |
|    | 2.0 TFSI         | 185   | 09.14   | PR: 1KY         |                |        |   |                         |
|    | 2.0 TFSI quattro | 185   | 05.15   | PR: 1KY         |                |        |   |                         |
|    | 2.8 FSI          | 150   | 05.11   | PR: 1KY         |                |        |   |                         |
|    | 2.8 FSI quattro  | 150   | 07.10   | PR: 1KY         |                |        |   |                         |
|    | 3.0 TDI          | 140   | 11.15   | PR: 1KY         |                |        |   |                         |
|    | 3.0 TDI          | 150   | 11.10   | PR: 1KY         |                |        |   |                         |
|    | 3.0 TDI          | 155   | 11.15   | PR: 1KY         |                |        |   |                         |
|    | 3.0 TDI quattro  | 140   | 11.15   | PR: 1KY         |                |        |   |                         |
|    | 3.0 TDI quattro  | 150   | 07.10   | PR: 1KY         |                |        |   |                         |
|    | 3.0 TDI quattro  | 160   | 05.14   | PR: 1KY         |                |        |   |                         |
|    | 3.0 TDI quattro  | 176   | 05.13   | PR: 1KY         |                |        |   |                         |
|    | 3.0 TDI quattro  | 180   | 07.10   | PR: 1KY         |                |        |   |                         |
|    | 3.0 TDI quattro  | 200   | 05.14   | PR: 1KY         |                |        |   |                         |
|    | 3.0 TDI quattro  | 230   | 11.11   | PR: 1KY         |                |        |   |                         |
|    | 3.0 TDI quattro  | 235   | 05.14   | PR: 1KY         |                |        |   |                         |
|    | 3.0 TDI quattro  | 240   | 08.14   | PR: 1KY         |                |        |   |                         |
|    | 3.0 TDI ultra    | 160   | 05.14   | PR: 1KY         |                |        |   |                         |
|    | 3.0 TFSI quattro |       | 07.10   | PR: 1KY         |                |        |   |                         |
|    | 3.0 TFSI quattro | 245   | 05.14   | PR: 1KY         |                |        |   |                         |
| S7 | 309              | 10.11 | PR: 1KY |                 |                |        |   |                         |
| S7 | 331              | 05.14 | PR: 1KY |                 |                |        |   |                         |

### AUDI A8 (94-02)

|             |                 |       |       |                                 |                |        |  |                      |     |                                 |                |        |                      |                   |
|-------------|-----------------|-------|-------|---------------------------------|----------------|--------|--|----------------------|-----|---------------------------------|----------------|--------|----------------------|-------------------|
|             | 2.5 TDI         |       | 06.97 | 09.98                           | 13.0460-2700.2 | 602700 |  | 21452 18,5 +/WK/S    | TRW |                                 |                |        |                      |                   |
|             | 2.5 TDI quattro |       | 06.97 | 09.98                           |                |        |  |                      |     | - Sonderfahrzeuge <sup>2)</sup> |                |        |                      |                   |
|             | 2.8             | 120   | 07.95 | 03.96                           |                |        |  |                      |     |                                 |                |        |                      |                   |
|             | 2.8             | 128   | 06.94 | 03.96                           |                |        |  |                      |     |                                 |                |        |                      |                   |
|             | 2.8 30V         | 142   | 04.96 | 09.98                           |                |        |  |                      |     |                                 |                |        |                      |                   |
|             | 2.8 30V quattro | 142   | 04.96 | 09.98                           |                |        |  |                      |     | - Sonderfahrzeuge <sup>2)</sup> |                |        |                      |                   |
|             | 2.8 quattro     | 120   | 07.95 | 03.96                           |                |        |  |                      |     | - Sonderfahrzeuge <sup>2)</sup> |                |        |                      |                   |
|             | 2.8 quattro     | 128   | 06.94 | 03.96                           |                |        |  |                      |     | - Sonderfahrzeuge <sup>2)</sup> |                |        |                      |                   |
|             | 3.7             |       | 07.95 | 09.98                           |                |        |  |                      |     |                                 |                |        |                      |                   |
|             | 3.7 quattro     |       | 10.95 | 09.98                           |                |        |  |                      |     | - Sonderfahrzeuge <sup>2)</sup> |                |        |                      |                   |
| 4.2 quattro |                 | 06.94 | 09.98 | - Sonderfahrzeuge <sup>2)</sup> |                |        |  |                      |     |                                 |                |        |                      |                   |
|             | 2.5 TDI         |       | 10.98 | 09.02                           | 13.0460-2876.2 | 602876 |  | 23119 17,5 +/WK      | TRW |                                 |                |        |                      |                   |
|             | 2.5 TDI quattro |       | 10.98 | 09.02                           |                |        |  |                      |     |                                 |                |        |                      |                   |
|             | 2.8 30V         | 142   | 10.98 | 09.02                           |                |        |  |                      |     |                                 |                |        |                      |                   |
|             | 2.8 30V quattro | 142   | 10.98 | 09.02                           |                |        |  |                      |     |                                 |                |        |                      |                   |
|             | 3.3 TDI quattro |       | 12.99 | 09.02                           |                |        |  |                      |     |                                 |                |        |                      |                   |
|             | 3.7             |       | 10.98 | 09.02                           |                |        |  |                      |     |                                 |                |        |                      |                   |
|             | 3.7 quattro     |       | 10.98 | 09.02                           |                |        |  |                      |     |                                 |                |        |                      |                   |
|             | 4.2 quattro     |       | 10.98 | 09.02                           |                |        |  |                      |     |                                 |                |        |                      |                   |
|             | 6.0 W12 quattro |       | 01.01 | 09.02                           |                |        |  |                      |     | 13.0460-7183.2                  | 607183         |        | 21484 20,5 +/WE      | ATE               |
|             | S8              |       | 06.96 | 04.99                           |                |        |  |                      |     | - Sonderfahrzeuge <sup>2)</sup> | 13.0460-2717.2 | 602717 |                      | 21452 18,5 +/WK/S |
| S8          |                 | 05.99 | 09.02 | - Sonderfahrzeuge <sup>2)</sup> | 13.0460-4802.2 | 604802 |  | 23773 17,5 +/WK      | BRE |                                 |                |        |                      |                   |
|             | 2.5 TDI         |       | 06.97 | 09.98                           | 24.0130-0104.1 | 430104 |  | 314 30,0 28,0 V L +B |     |                                 |                |        |                      |                   |
|             | 2.5 TDI quattro |       | 06.97 | 09.98                           |                |        |  |                      |     |                                 |                |        |                      |                   |
|             | 2.8             | 120   | 07.95 | 03.96                           |                |        |  |                      |     |                                 |                |        |                      |                   |
|             | 2.8             | 128   | 06.94 | 03.96                           |                |        |  |                      |     |                                 |                |        |                      |                   |
|             | 2.8 30V         | 142   | 04.96 | 09.98                           |                |        |  |                      |     |                                 |                |        |                      |                   |
|             | 2.8 30V quattro | 142   | 04.96 | 09.98                           |                |        |  |                      |     |                                 |                |        |                      |                   |
|             | 2.8 quattro     | 120   | 07.95 | 03.96                           |                |        |  |                      |     |                                 |                |        |                      |                   |
|             | 2.8 quattro     | 128   | 06.94 | 03.96                           |                |        |  |                      |     |                                 |                |        |                      |                   |
|             | 3.7             |       | 07.95 | 09.98                           |                |        |  |                      |     |                                 |                |        |                      |                   |
|             | 3.7 quattro     |       | 10.95 | 09.98                           |                |        |  |                      |     |                                 |                |        |                      |                   |
| 4.2 quattro |                 | 06.94 | 09.98 |                                 |                |        |  |                      |     |                                 |                |        |                      |                   |
|             | 2.5 TDI         |       | 10.98 | 09.02                           | 24.0130-0183.1 | 430183 |  | 323 30,0 28,0 V L +B |     |                                 |                |        |                      |                   |
|             | 2.5 TDI quattro |       | 10.98 | 09.02                           |                |        |  |                      |     |                                 |                |        |                      |                   |
|             | 2.8 30V         | 142   | 10.98 | 09.02                           |                |        |  |                      |     |                                 |                |        |                      |                   |
|             | 2.8 30V quattro | 142   | 10.98 | 09.02                           |                |        |  |                      |     |                                 |                |        |                      |                   |
|             | 3.3 TDI quattro |       | 12.99 | 09.02                           |                |        |  |                      |     |                                 |                |        |                      |                   |
|             | 3.7             |       | 10.98 | 09.02                           |                |        |  |                      |     |                                 |                |        |                      |                   |
|             | 3.7 quattro     |       | 10.98 | 09.02                           |                |        |  |                      |     |                                 |                |        |                      |                   |
|             | 4.2 quattro     |       | 10.98 | 09.02                           |                |        |  |                      |     |                                 |                |        |                      |                   |
|             | S8              |       | 06.96 | 04.99                           |                |        |  |                      |     |                                 |                |        |                      |                   |
|             | S8              |       | 05.99 | 09.02                           |                |        |  |                      |     | 24.0130-0177.1                  | 430177         |        | 345 30,0 28,0 V L +B |                   |
|             | 2.5 TDI         |       | 06.97 | 09.98                           | 13.0460-3602.2 | 603602 |  | 21144 15,8 /S        | TRW |                                 |                |        |                      |                   |
|             | 2.5 TDI quattro |       | 06.97 | 09.98                           |                |        |  |                      |     |                                 |                |        |                      |                   |
|             | 2.8             | 120   | 07.95 | 03.96                           |                |        |  |                      |     |                                 |                |        |                      |                   |
|             | 2.8             | 128   | 06.94 | 03.96                           |                |        |  |                      |     |                                 |                |        |                      |                   |
|             | 2.8 30V         | 142   | 04.96 | 09.98                           |                |        |  |                      |     |                                 |                |        |                      |                   |
|             | 2.8 30V quattro | 142   | 04.96 | 09.98                           |                |        |  |                      |     |                                 |                |        |                      |                   |
|             | 2.8 quattro     | 120   | 07.95 | 03.96                           |                |        |  |                      |     |                                 |                |        |                      |                   |
|             | 2.8 quattro     | 128   | 06.94 | 03.96                           |                |        |  |                      |     |                                 |                |        |                      |                   |
|             | 3.7             |       | 07.95 | 09.98                           |                |        |  |                      |     |                                 |                |        |                      |                   |
|             | ↓               |       |       |                                 |                |        |  |                      |     |                                 |                |        |                      |                   |

<sup>1)</sup> electric parking brake / fr.di stazionamento elettrico / frein à main électrique / freno de mano eléctrico

<sup>2)</sup> - special vehicles / - veicoli speciali / - véhicules spécial / - vehículo especial

| AUDI A8 (94-02) |                 |                 |             |       |                 |                      |                      |                |        |                         |                            |     |
|-----------------|-----------------|-----------------|-------------|-------|-----------------|----------------------|----------------------|----------------|--------|-------------------------|----------------------------|-----|
|                 | 3.7 quattro     |                 |             | 10.95 | 09.98           |                      |                      | 13.0460-3602.2 | 603602 |                         | 21144 15,8 /S              | TRW |
|                 | 4.2 quattro     |                 |             | 06.94 | 09.98           |                      |                      |                |        |                         |                            |     |
|                 | S8              |                 |             | 06.96 | 09.98           |                      |                      |                |        |                         |                            |     |
|                 | 2.5 TDI         |                 |             | 10.98 | 09.02           |                      |                      | 13.0460-2820.2 | 602820 |                         | 20961 17,6 /S              | TRW |
|                 | 2.5 TDI quattro |                 |             | 10.98 | 09.02           |                      | - Sonderfahrzeuge 1) | 13.0470-2820.2 | LD2820 |                         | 20961 17,6 /S              | TRW |
|                 | 2.8 30V         | 142             |             | 10.98 | 09.02           |                      | - Sonderfahrzeuge 1) | 13.0460-0072.2 | 610072 |                         | Belagsatz-Zubehör          | TRW |
|                 | 2.8 30V quattro | 142             |             | 10.98 | 09.02           |                      |                      |                |        |                         |                            |     |
|                 | 3.3 TDI quattro |                 |             | 12.99 | 09.02           |                      | - Sonderfahrzeuge 1) |                |        |                         |                            |     |
|                 | 3.7             |                 |             | 10.98 | 09.02           |                      | - Sonderfahrzeuge 1) |                |        |                         |                            |     |
|                 | 3.7 quattro     |                 |             | 10.98 | 09.02           |                      | - Sonderfahrzeuge 1) |                |        |                         |                            |     |
| 4.2 quattro     |                 |                 | 10.98       | 09.02 |                 | - Sonderfahrzeuge 1) |                      |                |        |                         |                            |     |
| 6.0 W12 quattro |                 |                 | 01.01       | 09.02 |                 | - Sonderfahrzeuge 1) |                      |                |        |                         |                            |     |
| S8              |                 |                 | 10.98       | 09.02 |                 | - Sonderfahrzeuge 1) |                      |                |        |                         |                            |     |
|                 | 2.5 TDI         |                 |             | 06.97 | 09.98           |                      |                      | 24.0110-0116.1 | 410116 |                         | 245 9,9 8,0 +B             |     |
|                 | 2.5 TDI quattro |                 |             | 06.97 | 09.98           |                      | - Sonderfahrzeuge 1) |                |        |                         |                            |     |
|                 | 2.8             | 120             |             | 07.95 | 03.96           |                      |                      |                |        |                         |                            |     |
|                 | 2.8             | 128             |             | 06.94 | 03.96           |                      |                      |                |        |                         |                            |     |
|                 | 2.8 quattro     | 120             |             | 07.95 | 03.96           |                      | - Sonderfahrzeuge 1) |                |        |                         |                            |     |
|                 | 2.8 quattro     | 128             |             | 06.94 | 03.96           |                      | - Sonderfahrzeuge 1) |                |        |                         |                            |     |
|                 | 2.8 30V         | 142             |             | 10.98 | 09.02           |                      |                      | 24.0120-0137.1 | 420137 |                         | 269 19,9 18,0 V +B         |     |
|                 | 2.8 30V quattro | 142             |             | 04.96 | 09.98           |                      | - Sonderfahrzeuge 1) |                |        |                         |                            |     |
|                 | 3.7             |                 |             | 10.98 | 09.02           |                      |                      |                |        |                         |                            |     |
|                 | 3.7 quattro     |                 |             | 10.95 | 09.98           |                      | - Sonderfahrzeuge 1) |                |        |                         |                            |     |
|                 | 4.2 quattro     |                 |             | 06.94 | 09.98           |                      | - Sonderfahrzeuge 1) |                |        |                         |                            |     |
|                 | S8              |                 |             | 06.96 | 09.98           |                      | - Sonderfahrzeuge 1) |                |        |                         |                            |     |
|                 | 2.5 TDI         |                 |             | 10.98 | 09.02           |                      |                      | 24.0122-0198.1 | 422198 |                         | 269 21,9 20,0 V L +B       |     |
|                 | 2.5 TDI quattro |                 |             | 10.98 | 09.02           |                      | - Sonderfahrzeuge 1) |                |        |                         |                            |     |
|                 | 2.8 30V         | 142             |             | 10.98 | 09.02           |                      |                      |                |        |                         |                            |     |
|                 | 2.8 30V quattro | 142             |             | 10.98 | 09.02           |                      | - Sonderfahrzeuge 1) |                |        |                         |                            |     |
|                 | 3.3 TDI quattro |                 |             | 12.99 | 09.02           |                      | - Sonderfahrzeuge 1) |                |        |                         |                            |     |
|                 | 3.7             |                 |             | 10.98 | 09.02           |                      |                      |                |        |                         |                            |     |
|                 | 3.7 quattro     |                 |             | 10.98 | 09.02           |                      | - Sonderfahrzeuge 1) |                |        |                         |                            |     |
|                 | 4.2 quattro     |                 |             | 10.98 | 09.02           |                      | - Sonderfahrzeuge 1) |                |        |                         |                            |     |
| 6.0 W12 quattro |                 |                 | 01.01       | 09.02 |                 | - Sonderfahrzeuge 1) | 24.0122-0152.1       | 422152         |        | 280 22,0 20,0 V L +S +B |                            |     |
| S8              |                 |                 | 10.98       | 09.02 |                 |                      |                      |                |        |                         |                            |     |
| AUDI A8 (03-09) |                 |                 |             |       |                 |                      |                      |                |        |                         |                            |     |
|                 | 2.8 FSI         | 154             |             | 08.07 | 10.09           | PR: 1LG              |                      | 13.0460-7201.2 | 607201 |                         | 23763 20,3 +WK             | ATE |
|                 | 3.0             |                 |             | 07.03 | 10.09           | PR: 1LG              |                      | 13.0470-7201.2 | LD7201 |                         | 23763 20,3 +WK             | ATE |
|                 | 3.0 TDI quattro |                 |             | 11.03 | 10.09           | PR: 1LG              |                      |                |        |                         |                            |     |
|                 | 3.2 FSI         | 191             |             | 06.05 | 10.09           | PR: 1LG              |                      |                |        |                         |                            |     |
|                 | 3.2 FSI quattro | 191             |             | 06.05 | 10.09           | PR: 1LG              |                      |                |        |                         |                            |     |
|                 | 3.7 quattro     |                 |             | 11.02 | 10.09           | PR: 1LG              |                      |                |        |                         |                            |     |
|                 | 4.0 TDI quattro |                 |             | 03.03 | 10.09           | PR: 1LG              |                      | 13.0460-7201.2 | 607201 |                         | 23763 20,3 +WK             | ATE |
|                 | 4.2 FSI quattro | 257             |             | 06.06 | 10.09           | PR: 1LG              |                      |                |        |                         |                            |     |
|                 | 4.2 quattro     |                 |             | 11.02 | 10.09           | PR: 1LG              |                      |                |        |                         |                            |     |
|                 | 4.2 TDI quattro |                 |             | 07.05 | 10.09           | PR: 1LG              |                      |                |        |                         |                            |     |
|                 | 6.0 W12 quattro |                 |             | 02.04 | 10.09           | PR: 1LG              |                      |                |        |                         |                            |     |
|                 | 2.8 FSI         | 154             |             | 08.07 | 10.09           | PR: 1LJ,1LL,1LM      |                      | 13.0460-7182.2 | 607182 |                         | 23896 20,6 +WK             | ATE |
|                 | 3.0             |                 |             | 07.03 | 10.09           | PR: 1LJ,1LL,1LM      |                      |                |        |                         |                            |     |
|                 | 3.0 TDI quattro |                 |             | 11.03 | 10.09           | PR: 1LJ,1LL,1LM      |                      |                |        |                         |                            |     |
|                 | 3.2 FSI         | 191             |             | 06.05 | 10.09           | PR: 1LJ,1LL,1LM      |                      |                |        |                         |                            |     |
|                 | 3.2 FSI quattro | 191             |             | 06.05 | 10.09           | PR: 1LJ,1LL,1LM      |                      |                |        |                         |                            |     |
|                 | 3.7 quattro     |                 |             | 11.02 | 10.09           | PR: 1LJ,1LL,1LM      |                      |                |        |                         |                            |     |
|                 | 4.0 TDI quattro |                 |             | 03.03 | 10.09           | PR: 1LJ,1LL,1LM      |                      |                |        |                         |                            |     |
|                 | 4.2 FSI quattro | 257             |             | 06.06 | 10.09           | PR: 1LJ,1LL,1LM      |                      |                |        |                         |                            |     |
| 4.2 quattro     |                 |                 | 11.02       | 10.09 | PR: 1LJ,1LL,1LM |                      |                      |                |        |                         |                            |     |
| 4.2 TDI quattro |                 |                 | 07.05       | 10.09 | PR: 1LJ,1LL,1LM |                      |                      |                |        |                         |                            |     |
| 6.0 W12 quattro |                 |                 | 02.04       | 10.09 | PR: 1LJ,1LL,1LM |                      |                      |                |        |                         |                            |     |
| S8              | 331             |                 | 06.06       | 10.09 | PR: 1LJ,1LL,1LM |                      |                      |                |        |                         |                            |     |
|                 | 3.0             |                 | 4E-5-003250 | 07.03 |                 | PR: 1LG              |                      | 24.0130-0183.1 | 430183 |                         | 323 30,0 28,0 V +B         |     |
|                 | 3.0 TDI quattro |                 | 4E-5-003250 | 11.03 |                 | PR: 1LG              |                      |                |        |                         |                            |     |
|                 | 3.2 FSI         | 191             | 4E-5-003250 | 06.05 |                 | PR: 1LG              |                      |                |        |                         |                            |     |
|                 | 3.2 FSI quattro | 191             | 4E-5-003250 | 06.05 |                 | PR: 1LG              |                      |                |        |                         |                            |     |
|                 | 3.7 quattro     |                 | 4E-5-003250 | 11.02 |                 | PR: 1LG              |                      |                |        |                         |                            |     |
|                 | 4.0 TDI quattro |                 | 4E-5-003250 | 03.03 |                 | PR: 1LG              |                      |                |        |                         |                            |     |
|                 | 4.2 FSI quattro | 257             | 4E-5-003250 | 06.06 |                 | PR: 1LG              |                      |                |        |                         |                            |     |
|                 | 4.2 quattro     |                 | 4E-5-003250 | 11.02 |                 | PR: 1LG              |                      |                |        |                         |                            |     |
|                 | 4.2 TDI quattro |                 | 4E-5-003250 | 07.05 |                 | PR: 1LG              |                      |                |        |                         |                            |     |
|                 | 6.0 W12 quattro |                 | 4E-5-003250 | 02.04 |                 | PR: 1LG              |                      |                |        |                         |                            |     |
|                 | 2.8 FSI         | 154             |             | 08.07 | 10.09           | PR: 1LG              |                      | 24.0130-0175.1 | 430175 |                         | 321 30,0 28,0 V L +S +B    |     |
|                 | 3.0             | 4E-5-003251     |             | 10.09 | 10.09           | PR: 1LG              |                      | 24.0330-0175.1 | 530175 |                         | 321 30,0 28,0 V L +S +B PD |     |
|                 | 3.0 TDI quattro | 4E-5-003251     |             | 10.09 | 10.09           | PR: 1LG              |                      |                |        |                         |                            |     |
|                 | 3.2 FSI         | 191 4E-5-003251 |             | 10.09 | 10.09           | PR: 1LG              |                      |                |        |                         |                            |     |
|                 | 3.2 FSI quattro | 191 4E-5-003251 |             | 10.09 | 10.09           | PR: 1LG              |                      |                |        |                         |                            |     |
|                 | 3.7 quattro     | 4E-5-003251     |             | 10.09 | 10.09           | PR: 1LG              |                      |                |        |                         |                            |     |
|                 | 4.0 TDI quattro | 4E-5-003251     |             | 10.09 | 10.09           | PR: 1LG              |                      |                |        |                         |                            |     |
|                 | 4.2 FSI quattro | 257 4E-5-003251 |             | 10.09 | 10.09           | PR: 1LG              |                      |                |        |                         |                            |     |
|                 | 4.2 quattro     | 4E-5-003251     |             | 10.09 | 10.09           | PR: 1LG              |                      |                |        |                         |                            |     |
| 4.2 TDI quattro | 4E-5-003251     |                 | 10.09       | 10.09 | PR: 1LG         |                      |                      |                |        |                         |                            |     |
| 6.0 W12 quattro | 4E-5-003251     |                 | 10.09       | 10.09 | PR: 1LG         |                      |                      |                |        |                         |                            |     |
| 2.8 FSI         | 154             |                 | 08.07       | 10.09 | PR: 1LL,1LM     |                      | 24.0134-0100.1       | 434100         |        | 360 34,0 31,0 V L +B    |                            |     |
| 3.0             |                 |                 | 07.03       | 10.09 | PR: 1LL,1LM     |                      |                      |                |        |                         |                            |     |
| 3.0 TDI quattro |                 |                 | 11.03       | 10.09 | PR: 1LL,1LM     |                      |                      |                |        |                         |                            |     |
| 3.2 FSI         | 191             |                 | 06.05       | 10.09 | PR: 1LL,1LM     |                      |                      |                |        |                         |                            |     |
| 3.2 FSI quattro | 191             |                 | 06.05       | 10.09 | PR: 1LL,1LM     |                      |                      |                |        |                         |                            |     |

1) - special vehicles / - veicoli speciali / - vehicule special / - vehiculo especial

















| AUDI A8 (03-09) |   |                                 |  |  |  |                                  |                  |  |                                       |     |
|-----------------|---|---------------------------------|--|--|--|----------------------------------|------------------|--|---------------------------------------|-----|
|                 | 3.7 quattro<br>4.0 TDI quattro<br>4.2 FSI quattro<br>4.2 quattro<br>4.2 TDI quattro<br>6.0 W12 quattro  | 257                             | 11.02<br>03.03<br>06.06<br>11.02<br>07.05<br>02.04   | 10.09<br>10.09<br>10.09<br>10.09<br>10.09<br>10.09   | PR: 1LL,1LM<br>PR: 1LL,1LM<br>PR: 1LL,1LM<br>PR: 1LL,1LM<br>PR: 1LL,1LM<br>PR: 1LL,1LM   | 24.0134-0100.1                   | 434100           |  | 360 34,0 31,0 V L +B                  |     |
|                 | 2.8 FSI<br>3.0<br>3.0 TDI quattro<br>3.2 FSI<br>3.2 FSI quattro<br>3.7 quattro<br>4.0 TDI quattro<br>4.2 FSI quattro<br>4.2 quattro<br>4.2 TDI quattro<br>6.0 W12 quattro<br>S8 | 154<br>191<br>191<br>257<br>331 | 08.07<br>07.03<br>11.03<br>06.05<br>06.05<br>11.02<br>03.03<br>06.06<br>11.02<br>07.05<br>02.04<br>06.06 | 10.09<br>10.09<br>10.09<br>10.09<br>10.09<br>10.09<br>10.09<br>10.09<br>10.09<br>10.09<br>10.09<br>10.09 | PR: 1LJ<br>PR: 1LJ<br>PR: 1LJ<br>PR: 1LJ<br>PR: 1LJ<br>PR: 1LJ<br>PR: 1LJ<br>PR: 1LJ<br>PR: 1LJ<br>PR: 1LJ<br>PR: 1LJ<br>10.09   | 24.0136-0103.1                   | 436103           |  | 385 36,0 33,5 V L +B                  |     |
|                 | 2.8 FSI<br>3.0<br>3.0 TDI quattro<br>3.2 FSI<br>3.2 FSI quattro<br>3.7 quattro<br>4.0 TDI quattro<br>4.2 FSI quattro<br>4.2 quattro<br>4.2 TDI quattro<br>6.0 W12 quattro<br>S8 | 154<br>191<br>191<br>257<br>331 | 08.07<br>07.03<br>11.03<br>06.05<br>06.05<br>11.02<br>03.03<br>06.06<br>11.02<br>07.05<br>02.04<br>06.06 | 10.09<br>10.09<br>10.09<br>10.09<br>10.09<br>10.09<br>10.09<br>10.09<br>10.09<br>10.09<br>10.09<br>10.09 | PR: 1KE,1KW,1KY,1KZ<br>PR: 1KE,1KW,1KY,1KZ<br>PR: 1KE,1KW,1KY,1KZ<br>PR: 1KE,1KW,1KY,1KZ<br>PR: 1KE,1KW,1KY,1KZ<br>PR: 1KE,1KW,1KY,1KZ<br>PR: 1KE,1KW,1KY,1KZ<br>PR: 1KE,1KW,1KY,1KZ<br>PR: 1KE,1KW,1KY,1KZ<br>PR: 1KE,1KW,1KY,1KZ<br>PR: 1KE,1KW,1KY,1KZ<br>PR: 1KE,1KW,1KY,1KZ | 13.0460-2889.2<br>13.0460-0023.2 | 602889<br>610023 | elektrische Feststellbremse <sup>1)</sup><br>elektrische Feststellbremse <sup>1)</sup> | 23326 17,4 /WE/S<br>Belagsatz-Zubehör | TRW |
|                 | 2.8 FSI<br>3.0<br>3.0 TDI quattro<br>3.2 FSI<br>3.2 FSI quattro<br>3.7 quattro<br>4.0 TDI quattro<br>4.2 FSI quattro<br>4.2 quattro<br>4.2 TDI quattro<br>6.0 W12 quattro<br>S8 | 154<br>191<br>191<br>257<br>331 | 08.07<br>07.03<br>11.03<br>06.05<br>06.05<br>11.02<br>03.03<br>06.06<br>11.02<br>07.05<br>02.04<br>06.06 | 10.09<br>10.09<br>10.09<br>10.09<br>10.09<br>10.09<br>10.09<br>10.09<br>10.09<br>10.09<br>10.09<br>10.09 | PR: 1KE<br>PR: 1KE<br>PR: 1KE<br>PR: 1KE<br>PR: 1KE<br>PR: 1KE<br>PR: 1KE<br>PR: 1KE<br>PR: 1KE<br>PR: 1KE<br>PR: 1KE<br>PR: 1KE   | 24.0122-0202.1                   | 422202           | elektrische Feststellbremse <sup>1)</sup>  | 280 22,0 20,0 V L +B                  |     |
|                 | 2.8 FSI<br>3.0<br>3.0 TDI quattro<br>3.2 FSI<br>3.2 FSI quattro<br>3.7 quattro<br>4.0 TDI quattro<br>4.2 FSI quattro<br>4.2 quattro<br>4.2 TDI quattro<br>6.0 W12 quattro<br>S8 | 154<br>191<br>191<br>257<br>331 | 08.07<br>07.03<br>11.03<br>06.05<br>06.05<br>11.02<br>03.03<br>06.06<br>11.02<br>07.05<br>02.04<br>06.06 | 10.09<br>10.09<br>10.09<br>10.09<br>10.09<br>10.09<br>10.09<br>10.09<br>10.09<br>10.09<br>10.09<br>10.09 | PR: 1KW<br>PR: 1KW<br>PR: 1KW<br>PR: 1KW<br>PR: 1KW<br>PR: 1KW<br>PR: 1KW<br>PR: 1KW<br>PR: 1KW<br>PR: 1KW<br>PR: 1KW<br>PR: 1KW   | 24.0122-0212.1                   | 422212           | elektrische Feststellbremse <sup>1)</sup>  | 310 22,0 20,0 V L +B                  |     |
|                 | 2.8 FSI<br>3.0<br>3.0 TDI quattro<br>3.2 FSI<br>3.2 FSI quattro<br>3.7 quattro<br>4.0 TDI quattro<br>4.2 FSI quattro<br>4.2 quattro<br>4.2 TDI quattro<br>6.0 W12 quattro<br>S8 | 154<br>191<br>191<br>257<br>331 | 08.07<br>07.03<br>11.03<br>06.05<br>06.05<br>11.02<br>03.03<br>06.06<br>11.02<br>07.05<br>02.04<br>06.06 | 10.09<br>10.09<br>10.09<br>10.09<br>10.09<br>10.09<br>10.09<br>10.09<br>10.09<br>10.09<br>10.09<br>10.09 | PR: 1KY,1KZ<br>PR: 1KY,1KZ<br>PR: 1KY,1KZ<br>PR: 1KY,1KZ<br>PR: 1KY,1KZ<br>PR: 1KY,1KZ<br>PR: 1KY,1KZ<br>PR: 1KY,1KZ<br>PR: 1KY,1KZ<br>PR: 1KY,1KZ<br>PR: 1KY,1KZ<br>PR: 1KY,1KZ   | 24.0122-0214.1                   | 422214           | elektrische Feststellbremse <sup>1)</sup>  | 335 22,0 20,0 V L +B                  |     |

**AUDI A8 (09-)**

|  |  |  |  |                |  |  |                            |   |   |            |
|--|--|--|--|----------------|--|--|----------------------------|---|---|------------|
|  | 4.2 FSI quattro<br>4.2 TDI quattro   | 273<br>258                             | 11.09<br>11.09   | 06.10<br>06.10 | PR: 1LL<br>PR: 1LL   | 13.0460-7280.2<br>24.8190-0303.2                   | 607280<br>620303           | 2 | 25158 20,3 +/WK<br>Warnkontakt L=296,6mm                    | ATE        |
|  | 2.0 TFSI hybrid<br>3.0 TDI<br>3.0 TDI quattro<br>3.0 TDI quattro   | 155<br>150<br>190                      | 05.12<br>09.11<br>07.10<br>09.13                                     |                | PR: 1LL<br>PR: 1LL<br>PR: 1LL<br>PR: 1LL   | 13.0460-7280.2<br>13.0470-7280.2<br>24.8190-0301.2 | 607280<br>LD7280<br>620301 | 2 | 25158 20,3 +/WK<br>25158 20,3 +/WK<br>Warnkontakt L=311,6mm | ATE<br>ATE |
|  | 3.0 TFSI quattro<br>4.0 TFSI quattro<br>4.0 TFSI quattro<br>4.2 FSI quattro<br>4.2 TDI quattro<br>4.2 TDI quattro<br>6.3 W12 quattro<br>S8 | 309<br>320<br>273<br>258<br>283<br>368 | 07.10<br>03.12<br>09.13<br>07.10<br>07.10<br>09.13<br>01.11<br>04.12 |                | PR: 1LL<br>PR: 1LL<br>PR: 1LL<br>PR: 1LL<br>PR: 1LL<br>PR: 1LL<br>PR: 1LL<br>PR: 1LL | 13.0460-7280.2<br>24.8190-0301.2                   | 607280<br>620301           | 2 | 25158 20,3 +/WK<br>Warnkontakt L=311,6mm                    | ATE        |
|  | 4.2 FSI quattro<br>4.2 TDI quattro   | 273<br>258                             | 11.09<br>11.09   | 06.10<br>06.10 | PR: 1LJ<br>PR: 1LJ   | 13.0460-7281.2<br>24.8190-0303.2                   | 607281<br>620303           | 2 | 25160 20,3 +/WK<br>Warnkontakt L=296,6mm                    | ATE        |

<sup>1)</sup> electric parking brake / fr.di stazionamento elettrico / frein à main électrique / freno de mano eléctrico





















|     |    kW |  |  |  |  |  |  |  |  |
|--|---|--|--|--|---|--|--|--|--|
| <b>AUDI A8 (09-)</b>   |   |  |  |  |   |  |  |  |  |
|    | 2.0 TFSI hybrid   | 155  | 05.12  | PR: 1LJ  | 13.0460-7281.2  | 607281   | 2  | 25160 20,3 +/WK<br>25160 20,3 +/WK<br>Warnkontakt L=311,6mm                        | ATE<br>ATE   |
|  | 3.0 TDI   | 150  | 09.11  | PR: 1LJ  | 13.0470-7281.2  | LD7281   |  |  |  |
|  | 3.0 TDI quattro   |  | 07.10  | PR: 1LJ  | 24.8190-0301.2  | 620301   |  |  |  |
|  | 3.0 TDI quattro   | 190  | 09.13  | PR: 1LJ  |   |  |  |  |  |
|  | 3.0 TFSI quattro  |  | 07.10  | PR: 1LJ  | 13.0460-7281.2  | 607281   |  |  |  |
|  | 4.0 TFSI quattro  | 309  | 03.12  | PR: 1LJ  | 24.8190-0301.2  | 620301   |  |  |  |
|  | 4.0 TFSI quattro  | 320  | 09.13  | PR: 1LJ  |   |  |  |  |  |
|  | 4.2 FSI quattro   | 273  | 07.10  | PR: 1LJ  |   |  |  |  |  |
|  | 4.2 TDI quattro   | 258  | 07.10  | PR: 1LJ  |   |  |  |  |  |
|  | 4.2 TDI quattro   | 283  | 09.13  | PR: 1LJ  |   |  |  |  |  |
|  | 6.3 W12 quattro   | 368  | 01.11  | PR: 1LJ  |   |  |  |  |  |
|  | S8  |  | 04.12  | PR: 1LJ  |   |  |  |  |  |
|  | 2.0 TFSI hybrid   | 155  | 05.12  | PR: 1LX,1LN  | 13.0460-4873.2  | 604873   | 2  | 24847 17,0 /WE<br>Warnkontakt L=254mm  | BRE  |
|  | 3.0 TDI   | 150  | 09.11  | PR: 1LX,1LN  | 24.8190-0019.2  | 620019   |  |  |  |
|  | 3.0 TDI quattro   |  | 07.10  | PR: 1LX,1LN  |   |  |  |  |  |
|  | 3.0 TDI quattro   | 190  | 09.13  | PR: 1LX,1LN  |   |  |  |  |  |
|  | 3.0 TFSI quattro  |  | 07.10  | PR: 1LX,1LN  |   |  |  |  |  |
|  | 4.0 TFSI quattro  | 309  | 03.12  | PR: 1LX,1LN  |   |  |  |  |  |
|  | 4.0 TFSI quattro  | 320  | 09.13  | PR: 1LX,1LN  |   |  |  |  |  |
|  | 4.2 FSI quattro   | 273  | 11.09  | PR: 1LX,1LN  |   |  |  |  |  |
|  | 4.2 TDI quattro   | 258  | 11.09  | PR: 1LX,1LN  |   |  |  |  |  |
|  | 4.2 TDI quattro   | 283  | 09.13  | PR: 1LX,1LN  |   |  |  |  |  |
|  | 6.3 W12 quattro   | 368  | 01.11  | PR: 1LX,1LN  |   |  |  |  |  |
|  | S8  |  | 04.12  | PR: 1LX,1LN  |   |  |  |  |  |
|    | 2.0 TFSI hybrid   | 155  | 05.12  | PR: 1LL  | 24.0134-0103.1  | 434103   |  | 356 34,0 31,5 V L +S +B  |  |
|  | 3.0 TDI   | 150  | 09.11  | PR: 1LL  |   |  |  |  |  |
|  | 3.0 TDI quattro   |  | 07.10  | PR: 1LL  |   |  |  |  |  |
|  | 3.0 TDI quattro   | 190  | 09.13  | PR: 1LL  |   |  |  |  |  |
|  | 3.0 TFSI quattro  |  | 07.10  | PR: 1LL  |   |  |  |  |  |
|  | 4.0 TFSI quattro  | 309  | 03.12  | PR: 1LL  |   |  |  |  |  |
|  | 4.0 TFSI quattro  | 320  | 09.13  | PR: 1LL  |   |  |  |  |  |
|  | 4.2 FSI quattro   | 273  | 11.09  | PR: 1LL  |   |  |  |  |  |
|  | 4.2 TDI quattro   | 258  | 11.09  | PR: 1LL  |   |  |  |  |  |
|  | 4.2 TDI quattro   | 283  | 09.13  | PR: 1LL  |   |  |  |  |  |
|  | 6.3 W12 quattro   | 368  | 01.11  | PR: 1LL  |   |  |  |  |  |
|  | S8  |  | 04.12  | PR: 1LL  |   |  |  |  |  |
|  | 2.0 TFSI hybrid   | 155  | 05.12  | PR: 1KW,1KY,1KZ  | 13.0460-2773.2  | 602773   |  | 25214 17,4 +/WK/Zub/STRW<br>25214 17,4 +/WK/Zub/STRW                               | elektrische Feststellbremse <sup>1)</sup><br>elektrische Feststellbremse <sup>1)</sup> |
|  | 3.0 TDI   | 150  | 09.11  | PR: 1KW,1KY,1KZ  | 13.0470-2773.2  | LD2773   |  |  |  |
|  | 3.0 TDI quattro   |  | 07.10  | PR: 1KW,1KY,1KZ  |   |  |  |  |  |
|  | 3.0 TDI quattro   | 190  | 09.13  | PR: 1KW,1KY,1KZ  |   |  |  |  |  |
|  | 3.0 TFSI quattro  |  | 07.10  | PR: 1KW,1KY,1KZ  |   |  |  |  |  |
|  | 4.0 TFSI quattro  | 309  | 03.12  | PR: 1KW,1KY,1KZ  |   |  |  |  |  |
|  | 4.0 TFSI quattro  | 320  | 09.13  | PR: 1KW,1KY,1KZ  |   |  |  |  |  |
|  | 4.2 FSI quattro   | 273  | 11.09  | PR: 1KW,1KY,1KZ  |   |  |  |  |  |
|  | 4.2 TDI quattro   | 258  | 11.09  | PR: 1KW,1KY,1KZ  |   |  |  |  |  |
|  | 4.2 TDI quattro   | 283  | 09.13  | PR: 1KW,1KY,1KZ  |   |  |  |  |  |
|  | 6.3 W12 quattro   | 368  | 01.11  | PR: 1KW,1KY,1KZ  |   |  |  |  |  |
|  | S8  |  | 04.12  | PR: 1KW,1KY,1KZ  |   |  |  |  |  |
|  | 2.0 TFSI hybrid   | 155  | 05.12  | PR: 1KW  | 24.0122-0272.1  | 422272   |  | 330 21,9 20,0 V L +S +B  | elektrische Feststellbremse <sup>1)</sup>  |
|  | 3.0 TDI   | 150  | 09.11  | PR: 1KW  |   |  |  |  |  |
|  | 3.0 TDI quattro   |  | 07.10  | PR: 1KW  |   |  |  |  |  |
|  | 3.0 TDI quattro   | 190  | 09.13  | PR: 1KW  |   |  |  |  |  |
|  | 3.0 TDI quattro   | 190  | 09.13  | PR: 1KW  |   |  |  |  |  |
|  | 3.0 TFSI quattro  |  | 07.10  | PR: 1KW  |   |  |  |  |  |
|  | 4.0 TFSI quattro  | 309  | 03.12  | PR: 1KW  |   |  |  |  |  |
|  | 4.0 TFSI quattro  | 320  | 09.13  | PR: 1KW  |   |  |  |  |  |
|  | 4.2 FSI quattro   | 273  | 11.09  | PR: 1KW  |   |  |  |  |  |
|  | 4.2 TDI quattro   | 258  | 11.09  | PR: 1KW  |   |  |  |  |  |
|  | 4.2 TDI quattro   | 283  | 09.13  | PR: 1KW  |   |  |  |  |  |
|  | 6.3 W12 quattro   | 368  | 01.11  | PR: 1KW  |   |  |  |  |  |
| S8   |   | 04.12  | PR: 1KW  |  |   |  |  |  |  |
|  | 2.0 TFSI hybrid   | 155  | 05.12  | PR: 1KY,1KZ  | 24.0122-0273.1  | 422273   |  | 356 22,0 20,0 V L +S +B  | elektrische Feststellbremse <sup>1)</sup>  |
|  | 3.0 TDI   | 150  | 09.11  | PR: 1KY,1KZ  |   |  |  |  |  |
|  | 3.0 TDI quattro   |  | 07.10  | PR: 1KY,1KZ  |   |  |  |  |  |
|  | 3.0 TDI quattro   | 190  | 09.13  | PR: 1KY,1KZ  |   |  |  |  |  |
|  | 3.0 TFSI quattro  |  | 07.10  | PR: 1KY,1KZ  |   |  |  |  |  |
|  | 4.0 TFSI quattro  | 309  | 03.12  | PR: 1KY,1KZ  |   |  |  |  |  |
|  | 4.0 TFSI quattro  | 320  | 09.13  | PR: 1KY,1KZ  |   |  |  |  |  |
|  | 4.2 FSI quattro   | 273  | 11.09  | PR: 1KY,1KZ  |   |  |  |  |  |
|  | 4.2 TDI quattro   | 258  | 11.09  | PR: 1KY,1KZ  |   |  |  |  |  |
|  | 4.2 TDI quattro   | 283  | 09.13  | PR: 1KY,1KZ  |   |  |  |  |  |
|  | 6.3 W12 quattro   | 368  | 01.11  | PR: 1KY,1KZ  |   |  |  |  |  |
|  | S8  |  | 04.12  | PR: 1KY,1KZ  |   |  |  |  |  |

<sup>1)</sup> electric parking brake / fr.dl stazionamento elettrico / frein à main électrique / freno de mano eléctrico



| <b>AUDI CABRIO (91-00)</b> |                  |     |             |             |       |             |             |                |        |   |  |  |  |                |                     |  |  |  |     |  |
|----------------------------|------------------|-----|-------------|-------------|-------|-------------|-------------|----------------|--------|---|--|--|--|----------------|---------------------|--|--|--|-----|--|
|                            | 1.8              |     |             | 04.97       | 08.00 |             |             | 13.0460-2934.2 | 602934 |   |  |  |  | 20669          | 19,0 /S             |  |  |  | TRW |  |
|                            | 1.9 TDI          |     |             | 07.95       | 08.00 |             |             |                |        |   |  |  |  |                |                     |  |  |  |     |  |
|                            | 2.0              | 85  |             | 01.93       | 07.98 |             |             |                |        |   |  |  |  |                |                     |  |  |  |     |  |
|                            | 2.0              | 103 |             | 05.95       | 07.96 |             | + ①         |                |        |   |  |  |  |                |                     |  |  |  |     |  |
|                            | 2.3              |     |             | 07.91       | 06.94 |             |             |                |        |   |  |  |  |                |                     |  |  |  |     |  |
|                            | 2.6              |     |             | 01.94       | 08.00 |             |             |                |        |   |  |  |  |                |                     |  |  |  |     |  |
| 2.8                        |                  |     | 11.92       | 08.00       |       |             |             | 13.0460-2963.2 | 602963 |   |  |  |  | 21138          | 18,8 +/WK/S         |  |  |  | TRW |  |
|                            | 2.3              |     |             | 8G-N-025000 | 07.91 |             |             | 24.0122-0108.1 | 422108 |   |  |  |  | 256            | 22,0 20,0 V L +B    |  |  |  |     |  |
|                            | 1.8              |     |             |             | 04.97 | 08.00       |             |                |        |   |  |  |  | 280            | 22,0 20,0 V L +B    |  |  |  |     |  |
|                            | 1.9 TDI          |     |             |             | 07.95 | 08.00       |             |                |        |   |  |  |  |                |                     |  |  |  |     |  |
|                            | 2.0              | 85  |             | 01.93       | 07.98 |             |             |                |        |   |  |  |  |                |                     |  |  |  |     |  |
|                            | 2.0              | 103 |             | 05.95       | 07.96 |             | + ①         |                |        |   |  |  |  |                |                     |  |  |  |     |  |
|                            | 2.3              |     | 8G-P-000001 | 07.91       | 06.94 |             |             |                |        |   |  |  |  |                |                     |  |  |  |     |  |
| 2.6                        |                  |     | 01.94       | 08.00       |       |             |             |                |        |   |  |  |  |                |                     |  |  |  |     |  |
| 2.8                        |                  |     | 11.92       | 08.00       |       |             |             | 24.0125-0106.1 | 425106 |   |  |  |  | 276            | 25,0 23,0 V L +B    |  |  |  |     |  |
|                            | 1.8              |     |             |             | 04.97 | 08.00       |             |                |        |   |  |  |  | 13.0460-3602.2 | 603602              |  |  |  |     |  |
|                            | 1.9 TDI          |     |             |             | 07.95 | 08.00       |             |                |        |   |  |  |  |                |                     |  |  |  |     |  |
|                            | 2.0              | 85  |             | 01.93       | 07.98 |             |             |                |        |   |  |  |  |                |                     |  |  |  |     |  |
|                            | 2.0              | 103 |             | 05.95       | 07.96 |             | + ①         |                |        |   |  |  |  |                |                     |  |  |  |     |  |
|                            | 2.3              |     |             | 07.91       | 06.94 |             |             |                |        |   |  |  |  |                |                     |  |  |  |     |  |
|                            | 2.6              |     |             | 01.94       | 08.00 |             |             |                |        |   |  |  |  |                |                     |  |  |  |     |  |
| 2.8                        |                  |     | 11.92       | 08.00       |       |             |             |                |        |   |  |  |  |                |                     |  |  |  |     |  |
|                            | 1.8              |     |             |             | 04.97 | 08.00       |             |                |        |   |  |  |  | 24.0110-0178.1 | 410178              |  |  |  |     |  |
|                            | 1.9 TDI          |     |             |             | 07.95 | 08.00       |             |                |        |   |  |  |  |                |                     |  |  |  |     |  |
|                            | 2.0              | 85  |             | 01.93       | 07.98 |             |             |                |        |   |  |  |  |                |                     |  |  |  |     |  |
|                            | 2.0              | 103 |             | 05.95       | 07.96 |             | + ①         |                |        |   |  |  |  |                |                     |  |  |  |     |  |
|                            | 2.3              |     |             | 07.91       | 06.94 |             |             |                |        |   |  |  |  |                |                     |  |  |  |     |  |
|                            | 2.6              |     |             | 01.94       | 08.00 |             |             |                |        |   |  |  |  |                |                     |  |  |  |     |  |
| 2.8                        |                  |     | 11.92       | 08.00       |       |             |             |                |        |   |  |  |  |                |                     |  |  |  |     |  |
| <b>AUDI Q2 (16-)</b>       |                  |     |             |             |       |             |             |                |        |   |  |  |  |                |                     |  |  |  |     |  |
|                            | 1.0 TFSI         | 85  |             |             | 09.16 |             | PR: 1ZA,1ZD | 13.0460-2785.2 | 602785 |   |  |  |  | 25683          | 20,4 +/WK/S         |  |  |  | TRW |  |
|                            | 1.4 TFSI         | 110 |             |             | 09.16 |             | PR: 1ZA,1ZD | 13.0470-2785.2 | LD2785 |   |  |  |  | 25683          | 20,4 +/WK/S         |  |  |  | TRW |  |
|                            | 1.4 TFSI quattro | 110 |             |             | 09.16 |             | PR: 1ZA,1ZD | 24.8190-0065.2 | 620065 | 1 |  |  |  |                |                     |  |  |  |     |  |
|                            | 1.6 TDI          | 85  |             |             | 09.16 |             | PR: 1ZA,1ZD |                |        |   |  |  |  |                |                     |  |  |  |     |  |
|                            | 2.0 TDI          | 110 |             |             | 09.16 |             | PR: 1ZA,1ZD |                |        |   |  |  |  |                |                     |  |  |  |     |  |
|                            | 2.0 TDI quattro  | 110 |             |             | 09.16 |             | PR: 1ZA,1ZD |                |        |   |  |  |  |                |                     |  |  |  |     |  |
|                            | 2.0 TDI quattro  | 140 |             |             | 09.16 |             | PR: 1ZA,1ZD |                |        |   |  |  |  |                |                     |  |  |  |     |  |
| 2.0 TFSI quattro           | 140              |     |             | 09.16       |       | PR: 1ZA,1ZD |             |                |        |   |  |  |  |                |                     |  |  |  |     |  |
|                            | 1.0 TFSI         | 85  |             |             | 09.16 |             | PR: 1ZA,1ZD | 24.0125-0158.1 | 425158 |   |  |  |  | 312            | 25,0 22,0 V L +S +B |  |  |  |     |  |
|                            | 1.4 TFSI         | 110 |             |             | 09.16 |             | PR: 1ZA,1ZD | 24.8190-0065.2 | 620065 | 1 |  |  |  |                |                     |  |  |  |     |  |
|                            | 1.4 TFSI quattro | 110 |             |             | 09.16 |             | PR: 1ZA,1ZD |                |        |   |  |  |  |                |                     |  |  |  |     |  |
|                            | 1.6 TDI          | 85  |             |             | 09.16 |             | PR: 1ZA,1ZD |                |        |   |  |  |  |                |                     |  |  |  |     |  |
|                            | 2.0 TDI          | 110 |             |             | 09.16 |             | PR: 1ZA,1ZD |                |        |   |  |  |  |                |                     |  |  |  |     |  |
|                            | 2.0 TDI quattro  | 110 |             |             | 09.16 |             | PR: 1ZA,1ZD |                |        |   |  |  |  |                |                     |  |  |  |     |  |
|                            | 2.0 TDI quattro  | 140 |             |             | 09.16 |             | PR: 1ZA,1ZD |                |        |   |  |  |  |                |                     |  |  |  |     |  |
| 2.0 TFSI quattro           | 140              |     |             | 09.16       |       | PR: 1ZA,1ZD |             |                |        |   |  |  |  |                |                     |  |  |  |     |  |
|                            | 1.0 TFSI         | 85  |             |             | 09.16 |             |             | 24.0711-5273.3 | 360303 |   |  |  |  |                |                     |  |  |  |     |  |
|                            | 1.4 TFSI         | 110 |             |             | 09.16 |             |             | 24.0711-5274.3 | 360304 |   |  |  |  |                |                     |  |  |  |     |  |
|                            | 1.4 TFSI quattro | 110 |             |             | 09.16 |             |             |                |        |   |  |  |  |                |                     |  |  |  |     |  |
|                            | 1.6 TDI          | 85  |             |             | 09.16 |             |             |                |        |   |  |  |  |                |                     |  |  |  |     |  |
|                            | 2.0 TDI          | 110 |             |             | 09.16 |             |             |                |        |   |  |  |  |                |                     |  |  |  |     |  |
|                            | 2.0 TDI quattro  | 110 |             |             | 09.16 |             |             |                |        |   |  |  |  |                |                     |  |  |  |     |  |
|                            | 2.0 TDI quattro  | 140 |             |             | 09.16 |             |             |                |        |   |  |  |  |                |                     |  |  |  |     |  |
| 2.0 TFSI quattro           | 140              |     |             | 09.16       |       |             |             |                |        |   |  |  |  |                |                     |  |  |  |     |  |
|                            | 1.0 TFSI         | 85  |             |             | 09.16 |             | PR: 1KE     | 13.0460-7293.2 | 607293 |   |  |  |  |                |                     |  |  |  |     |  |
|                            | 1.4 TFSI         | 110 |             |             | 09.16 |             | PR: 1KE     |                |        |   |  |  |  |                |                     |  |  |  |     |  |
|                            | 1.4 TFSI quattro | 110 |             |             | 09.16 |             | PR: 1KE     |                |        |   |  |  |  |                |                     |  |  |  |     |  |
|                            | 1.6 TDI          | 85  |             |             | 09.16 |             | PR: 1KE     |                |        |   |  |  |  |                |                     |  |  |  |     |  |
|                            | 2.0 TDI          | 110 |             |             | 09.16 |             | PR: 1KE     |                |        |   |  |  |  |                |                     |  |  |  |     |  |
|                            | 2.0 TDI quattro  | 110 |             |             | 09.16 |             | PR: 1KE     |                |        |   |  |  |  |                |                     |  |  |  |     |  |
|                            | 2.0 TDI quattro  | 140 |             |             | 09.16 |             | PR: 1KE     |                |        |   |  |  |  |                |                     |  |  |  |     |  |
| 2.0 TFSI quattro           | 140              |     |             | 09.16       |       | PR: 1KE     |             |                |        |   |  |  |  |                |                     |  |  |  |     |  |
|                            | 1.0 TFSI         | 85  |             |             | 09.16 |             | PR: 1KE     | 24.0110-0356.1 | 410356 |   |  |  |  |                |                     |  |  |  |     |  |
|                            | 1.4 TFSI         | 110 |             |             | 09.16 |             | PR: 1KE     |                |        |   |  |  |  |                |                     |  |  |  |     |  |
|                            | 1.4 TFSI quattro | 110 |             |             | 09.16 |             | PR: 1KE     |                |        |   |  |  |  |                |                     |  |  |  |     |  |
|                            | 1.6 TDI          | 85  |             |             | 09.16 |             | PR: 1KE     |                |        |   |  |  |  |                |                     |  |  |  |     |  |
|                            | 2.0 TDI          | 110 |             |             | 09.16 |             | PR: 1KE     |                |        |   |  |  |  |                |                     |  |  |  |     |  |
|                            | 2.0 TDI quattro  | 110 |             |             | 09.16 |             | PR: 1KE     |                |        |   |  |  |  |                |                     |  |  |  |     |  |
|                            | 2.0 TDI quattro  | 140 |             |             | 09.16 |             | PR: 1KE     |                |        |   |  |  |  |                |                     |  |  |  |     |  |
| 2.0 TFSI quattro           | 140              |     |             | 09.16       |       | PR: 1KE     |             |                |        |   |  |  |  |                |                     |  |  |  |     |  |
|                            | 1.0 TFSI         | 85  |             |             | 09.16 |             |             | 24.0711-6337.3 | 360390 | 2 |  |  |  |                |                     |  |  |  |     |  |
|                            | 1.4 TFSI         | 110 |             |             | 09.16 |             |             |                |        |   |  |  |  |                |                     |  |  |  |     |  |
|                            | 1.6 TDI          | 85  |             |             | 09.16 |             |             |                |        |   |  |  |  |                |                     |  |  |  |     |  |
|                            | 2.0 TDI          | 110 |             |             | 09.16 |             |             |                |        |   |  |  |  |                |                     |  |  |  |     |  |
|                            | 1.4 TFSI quattro | 110 |             |             | 09.16 |             |             | 24.0711-5401.3 | 360330 |   |  |  |  |                |                     |  |  |  |     |  |
|                            | 2.0 TDI quattro  | 110 |             |             | 09.16 |             |             | 24.0711-5402.3 | 360331 |   |  |  |  |                |                     |  |  |  |     |  |
|                            | 2.0 TDI quattro  | 140 |             |             | 09.16 |             |             |                |        |   |  |  |  |                |                     |  |  |  |     |  |
| 2.0 TFSI quattro           | 140              |     |             | 09.16       |       |             |             |                |        |   |  |  |  |                |                     |  |  |  |     |  |
| <b>AUDI Q3 (11-)</b>       |                  |     |             |             |       |             |             |                |        |   |  |  |  |                |                     |  |  |  |     |  |
|                            | 1.4 TFSI         | 92  |             |             | 07.16 |             | PR: 1LJ,1ZD | 13.0460-7242.2 | 607242 |   |  |  |  | 24332          | 19,8 +/WK           |  |  |  | ATE |  |
|                            | 1.4 TFSI         | 110 |             |             | 09.13 |             | PR: 1LJ,1ZD | 13.0470-7242.2 | LD7242 |   |  |  |  | 24332          | 19,8 +/WK           |  |  |  | ATE |  |
|                            | 2.0 TDI          | 88  |             |             | 03.15 |             | PR: 1LJ,1ZD |                |        |   |  |  |  |                |                     |  |  |  |     |  |
|                            | 2.0 TDI          | 103 |             |             | 06.11 |             | PR: 1LJ,1ZD |                |        |   |  |  |  |                |                     |  |  |  |     |  |
| ↓                          | ↓                |     |             |             |       |             |             |                |        |   |  |  |  |                |                     |  |  |  |     |  |





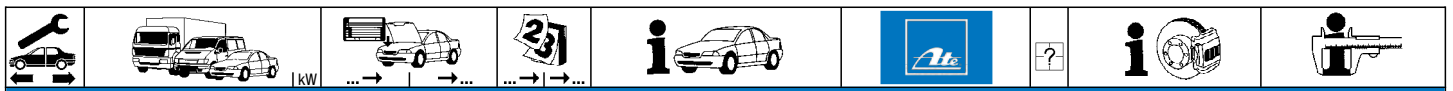

1) electric parking brake / fr.di stazionamento elettrico / frein à main électrique / freno de mano eléctrico

|     |   |   |    |  |   |  |      |  |            |
|--|---|---|--|--|--|--|--|--|------------|
| <b>AUDI Q3 (11-)</b>   |   |   |  |  |  |  |  |  |            |
|    | 2.0 TDI 110<br>2.0 TDI 130<br>2.0 TDI 135<br>2.0 TDI quattro 103<br>2.0 TDI quattro 110<br>2.0 TDI quattro 130<br>2.0 TDI quattro 135<br>2.0 TFSI 132<br>2.0 TFSI quattro 125<br>2.0 TFSI quattro 132<br>2.0 TFSI quattro 155<br>2.0 TFSI quattro 162   | 11.14<br>05.13<br>05.15<br>01.12<br>11.14<br>06.11<br>11.14<br>05.15<br>06.11<br>11.14<br>06.11<br>11.14  | PR: 1LJ,1ZD<br>PR: 1LJ,1ZD<br>PR: 1LJ,1ZD<br>PR: 1LJ,1ZD<br>PR: 1LJ,1ZD<br>PR: 1LJ,1ZD<br>PR: 1LJ,1ZD<br>PR: 1LJ,1ZD<br>PR: 1LJ,1ZD<br>PR: 1LJ,1ZD<br>PR: 1LJ,1ZD<br>PR: 1LJ,1ZD   | 13.0460-7242.2 607242<br>13.0470-7242.2 LD7242                                   |  |  |  | 24332 19,8 +/WK<br>24332 19,8 +/WK   | ATE<br>ATE |
|    | 1.4 TFSI 92<br>1.4 TFSI 110<br>2.0 TDI 88<br>2.0 TDI 103<br>2.0 TDI 110<br>2.0 TDI 130<br>2.0 TDI 135<br>2.0 TDI quattro 103<br>2.0 TDI quattro 110<br>2.0 TDI quattro 130<br>2.0 TDI quattro 135<br>2.0 TFSI 132<br>2.0 TFSI quattro 125<br>2.0 TFSI quattro 132<br>2.0 TFSI quattro 155<br>2.0 TFSI quattro 162   | 07.16<br>09.13<br>03.15<br>06.11<br>11.14<br>05.13<br>05.15<br>01.12<br>11.14<br>06.11<br>11.14<br>05.15<br>06.11<br>11.14<br>06.11<br>11.14                            | PR: 1LJ,1ZD<br>PR: 1LJ,1ZD<br>PR: 1LJ,1ZD<br>PR: 1LJ,1ZD<br>PR: 1LJ,1ZD<br>PR: 1LJ,1ZD<br>PR: 1LJ,1ZD<br>PR: 1LJ,1ZD<br>PR: 1LJ,1ZD<br>PR: 1LJ,1ZD<br>PR: 1LJ,1ZD<br>PR: 1LJ,1ZD<br>PR: 1LJ,1ZD<br>PR: 1LJ,1ZD<br>PR: 1LJ,1ZD<br>PR: 1LJ,1ZD | 24.0125-0158.1 425158<br>24.0325-0158.1 525158                                   |  |  | 312 25,0 22,0 V L +S +B<br>312 25,0 22,0 V L +S +B PD                                  |  |            |
|    | 1.4 TFSI 92<br>1.4 TFSI 110<br>2.0 TDI 88<br>2.0 TDI 103<br>2.0 TDI 110<br>2.0 TDI 130<br>2.0 TDI 135<br>2.0 TDI quattro 103<br>2.0 TDI quattro 110<br>2.0 TDI quattro 130<br>2.0 TDI quattro 135<br>2.0 TFSI 132<br>2.0 TFSI quattro 125<br>2.0 TFSI quattro 132<br>2.0 TFSI quattro 155<br>2.0 TFSI quattro 162<br>RS 2.5 228<br>RS 2.5 250<br>RS 2.5 performance 270 | 07.16<br>09.13<br>03.15<br>06.11<br>11.14<br>05.13<br>05.15<br>01.12<br>11.14<br>06.11<br>11.14<br>05.15<br>06.11<br>11.14<br>06.11<br>11.14<br>09.13<br>03.15<br>01.15 |  | 24.0711-5271.3 360301<br>24.0711-5272.3 360302                                   | <br>     |  | Radsensor<br>Radsensor   |  |            |
|  | 1.4 TFSI 110<br>2.0 TDI 103<br>2.0 TDI 130<br>2.0 TDI quattro 103<br>2.0 TDI quattro 130<br>2.0 TFSI quattro 125<br>2.0 TFSI quattro 155  | 09.13<br>06.11<br>05.13<br>01.12<br>06.11<br>06.11<br>06.11   | PR: 1KU<br>PR: 1KU<br>PR: 1KU<br>PR: 1KU<br>PR: 1KU<br>PR: 1KU<br>PR: 1KU  | 13.0460-2880.2 602880<br>13.0470-2880.2 LD2880                                   |  |  | elektrische Feststellbremse <sup>1)</sup><br>elektrische Feststellbremse <sup>1)</sup> | 23914 17,1 /WE/Zub/S TRW<br>23914 17,1 /WE/Zub/S TRW                               |            |
|  | 1.4 TFSI 110<br>2.0 TDI 103<br>2.0 TDI 130<br>2.0 TDI quattro 103<br>2.0 TDI quattro 130<br>2.0 TFSI quattro 125<br>2.0 TFSI quattro 155  | 09.13<br>06.11<br>05.13<br>01.12<br>06.11<br>06.11<br>06.11   | PR: 1KU<br>PR: 1KU<br>PR: 1KU<br>PR: 1KU<br>PR: 1KU<br>PR: 1KU<br>PR: 1KU  | 24.0112-0169.1 412169<br>24.0312-0169.1 512169                                   |  |  | elektrische Feststellbremse <sup>1)</sup><br>elektrische Feststellbremse <sup>1)</sup> | 282 12,0 10,0 +S +B<br>282 12,0 10,0 +S +B PD                                      |            |
|  | 1.4 TFSI 92<br>2.0 TDI 88<br>2.0 TDI 110<br>2.0 TDI 135<br>2.0 TDI quattro 110<br>2.0 TDI quattro 135<br>2.0 TFSI 132<br>2.0 TFSI quattro 132<br>2.0 TFSI quattro 162   | 07.16<br>03.15<br>11.14<br>05.15<br>11.14<br>11.14<br>05.15<br>11.14<br>11.14   | PR: 1KU<br>PR: 1KU<br>PR: 1KU<br>PR: 1KU<br>PR: 1KU<br>PR: 1KU<br>PR: 1KU<br>PR: 1KU   | 24.0112-0210.1 412210  |  |  | elektrische Feststellbremse <sup>1)</sup>  | 300 12,0 10,0 +S +B  |            |
|  | RS 2.5 228<br>RS 2.5 250<br>RS 2.5 performance 270  | 09.13<br>03.15<br>01.15   | PR: 2EA,2EJ<br>PR: 2EA,2EJ<br>PR: 2EA,2EJ  | 24.0122-0219.1 422219  |  |  | elektrische Feststellbremse <sup>1)</sup>  | 310 22,0 20,0 V L +B   |            |
|  | 1.4 TFSI 110<br>2.0 TDI 88<br>2.0 TDI 103<br>2.0 TDI 110<br>2.0 TDI 130<br>2.0 TDI 135<br>2.0 TFSI 132  | 09.13<br>03.15<br>06.11<br>11.14<br>05.13<br>05.15<br>05.15   | PR: 7X0,7X1,7X4,7X8<br>PR: 7X0,7X1,7X4,7X8<br>PR: 7X0,7X1,7X4,7X8<br>PR: 7X0,7X1,7X4,7X8<br>PR: 7X0,7X1,7X4,7X8<br>PR: 7X0,7X1,7X4,7X8<br>PR: 7X0,7X1,7X4,7X8  | 24.0711-6231.3 360305<br>24.0711-6232.3 360306                                   | <br> |  | Radsensor<br>Radsensor   |  |            |
|  | 1.4 TFSI 92<br>1.4 TFSI 110<br>2.0 TDI 88<br>2.0 TDI 103<br>2.0 TDI 110<br>2.0 TDI 130  | 07.16<br>09.13<br>03.15<br>06.11<br>11.14<br>05.13  | PR: 7X5,8A3<br>PR: 7X5,8A3<br>PR: 7X5,8A3<br>PR: 7X5,8A3<br>PR: 7X5,8A3  | 24.0711-6335.3 360365<br>24.0711-6336.3 360366                                   | <br> |  | Radsensor<br>Radsensor   |  |            |





<sup>1)</sup> electric parking brake / fr.di stazionamento elettrico / frein à main électrique / freno de mano eléctrico



### AUDI Q3 (11-)

|  |                    |     |       |                     |                |        |   |  |           |
|--|--------------------|-----|-------|---------------------|----------------|--------|---|--|-----------|
|  | 2.0 TDI            | 135 | 05.15 | PR: 7X5,8A3         | 24.0711-6335.3 | 360365 |  |  | Radsensor |
|  | 2.0 TFSI           | 132 | 05.15 | PR: 7X5,8A3         | 24.0711-6336.3 | 360366 |  |  | Radsensor |
|  | 2.0 TDI quattro    | 103 | 01.12 | PR: 7X0,7X1,7X4,7X8 | 24.0711-5271.3 | 360301 |  |  | Radsensor |
|  | 2.0 TDI quattro    | 110 | 11.14 | PR: 7X0,7X1,7X4,7X8 | 24.0711-5272.3 | 360302 |  |  | Radsensor |
|  | 2.0 TDI quattro    | 130 | 06.11 | PR: 7X0,7X1,7X4,7X8 |                |        |   |  |           |
|  | 2.0 TDI quattro    | 135 | 11.14 | PR: 7X0,7X1,7X4,7X8 |                |        |   |  |           |
|  | 2.0 TFSI quattro   | 125 | 06.11 | PR: 7X0,7X1,7X4,7X8 |                |        |   |  |           |
|  | 2.0 TFSI quattro   | 132 | 11.14 | PR: 7X0,7X1,7X4,7X8 |                |        |   |  |           |
|  | 2.0 TFSI quattro   | 155 | 06.11 | PR: 7X0,7X1,7X4,7X8 |                |        |   |  |           |
|  | 2.0 TFSI quattro   | 162 | 11.14 | PR: 7X0,7X1,7X4,7X8 |                |        |   |  |           |
|  | RS 2.5             | 228 | 09.13 |                     |                |        |   |  |           |
|  | RS 2.5             | 250 | 03.15 |                     |                |        |   |  |           |
|  | RS 2.5 performance | 270 | 01.15 |                     |                |        |   |  |           |
|  | 2.0 TDI quattro    | 103 | 01.12 | PR: 7X5,8A3         | 24.0711-5401.3 | 360330 |  |  | Radsensor |
|  | 2.0 TDI quattro    | 110 | 11.14 | PR: 7X5,8A3         | 24.0711-5402.3 | 360331 |  |  | Radsensor |
|  | 2.0 TDI quattro    | 130 | 06.11 | PR: 7X5,8A3         |                |        |   |  |           |
|  | 2.0 TDI quattro    | 135 | 11.14 | PR: 7X5,8A3         |                |        |   |  |           |
|  | 2.0 TFSI quattro   | 125 | 06.11 | PR: 7X5,8A3         |                |        |   |  |           |
|  | 2.0 TFSI quattro   | 132 | 11.14 | PR: 7X5,8A3         |                |        |   |  |           |
|  | 2.0 TFSI quattro   | 155 | 06.11 | PR: 7X5,8A3         |                |        |   |  |           |
|  | 2.0 TFSI quattro   | 162 | 11.14 | PR: 7X5,8A3         |                |        |   |  |           |

### AUDI Q5 (08-)

|  |                       |     |       |                     |                |        |   |                     |     |
|--|-----------------------|-----|-------|---------------------|----------------|--------|---|---------------------|-----|
|  | 2.0 TDI               | 100 | 08.09 | PR: 1LA,1ZB,1ZT     | 13.0460-2765.2 | 602765 | Federmaß 46 mm <sup>1)</sup>  | 24743 19,2 +/-WK/S  | TRW |
|  | 2.0 TDI               | 105 | 08.09 | PR: 1LA,1ZB,1ZT     | 13.0470-2765.2 | LD2765 | Federmaß 46 mm <sup>1)</sup>  | 24743 19,2 +/-WK/S  | TRW |
|  | 2.0 TDI               | 110 | 05.13 | PR: 1LA,1ZB,1ZT     | 24.8190-0311.2 | 620311 |    | Warnkontakt L=300mm |     |
|  | 2.0 TDI               | 140 | 09.15 | PR: 1LA,1ZB,1ZT     |                |        |   |                     |     |
|  | 2.0 TDI quattro       | 100 | 08.09 | PR: 1LA,1ZB,1ZT     |                |        |   |                     |     |
|  | 2.0 TDI quattro       | 105 | 08.09 | PR: 1LA,1ZB,1ZT     |                |        |   |                     |     |
|  | 2.0 TDI quattro       | 110 | 05.13 | PR: 1LA,1ZB,1ZT     |                |        |   |                     |     |
|  | 2.0 TDI quattro       | 120 | 03.09 | PR: 1LA,1ZB,1ZT     |                |        |   |                     |     |
|  | 2.0 TDI quattro       | 125 | 03.09 | PR: 1LA,1ZB,1ZT     |                |        |   |                     |     |
|  | 2.0 TDI quattro       | 130 | 09.12 | PR: 1LA,1ZB,1ZT     |                |        |   |                     |     |
|  | 2.0 TFSI hybr.quattro | 155 | 06.11 | PR: 1LA,1ZB,1ZT     |                |        |   |                     |     |
|  | 2.0 TFSI quattro      | 132 | 08.09 | PR: 1LA,1ZB,1ZT     |                |        |   |                     |     |
|  | 2.0 TFSI quattro      | 155 | 03.09 | PR: 1LA,1ZB,1ZT     |                |        |   |                     |     |
|  | 2.0 TFSI quattro      | 162 | 05.13 | PR: 1LA,1ZB,1ZT     |                |        |   |                     |     |
|  | 2.0 TFSI quattro      | 165 | 09.12 | PR: 1LA,1ZB,1ZT     |                |        |   |                     |     |
|  | 2.0 TFSI quattro      | 169 | 08.15 | PR: 1LA,1ZB,1ZT     |                |        |   |                     |     |
|  | 3.0 TDI quattro       | 155 | 03.09 | PR: 1LA,1ZB,1ZT     |                |        |   |                     |     |
|  | 3.0 TDI quattro       | 176 | 03.09 | PR: 1LA,1ZB,1ZT     |                |        |   |                     |     |
|  | 3.0 TDI quattro       | 180 | 09.12 | PR: 1LA,1ZB,1ZT     |                |        |   |                     |     |
|  | 3.0 TDI quattro       | 190 | 11.13 | PR: 1LA,1ZB,1ZT     |                |        |   |                     |     |
|  | 3.0 TFSI quattro      | 200 | 09.12 | PR: 1LA,1ZB,1ZT     |                |        |   |                     |     |
|  | 3.2 FSI quattro       | 199 | 03.09 | PR: 1LA,1ZB,1ZT     |                |        |   |                     |     |
|  | 2.0 TDI               | 100 | 08.09 | PR: 1LJ             | 13.0460-2765.2 | 602765 | Federmaß 46 mm <sup>1)</sup>  | 24743 19,2 +/-WK/S  | TRW |
|  | 2.0 TDI               | 105 | 08.09 | PR: 1LJ             | 13.0470-2765.2 | LD2765 | Federmaß 46 mm <sup>1)</sup>  | 24743 19,2 +/-WK/S  | TRW |
|  | 2.0 TDI               | 110 | 05.13 | PR: 1LJ             |                |        |   |                     |     |
|  | 2.0 TDI               | 140 | 09.15 | PR: 1LJ             |                |        |   |                     |     |
|  | 2.0 TDI quattro       | 100 | 08.09 | PR: 1LJ             |                |        |   |                     |     |
|  | 2.0 TDI quattro       | 105 | 08.09 | PR: 1LJ             |                |        |   |                     |     |
|  | 2.0 TDI quattro       | 110 | 05.13 | PR: 1LJ             |                |        |   |                     |     |
|  | 2.0 TDI quattro       | 120 | 11.08 | PR: 1LJ             |                |        |   |                     |     |
|  | 2.0 TDI quattro       | 125 | 11.08 | PR: 1LJ             |                |        |   |                     |     |
|  | 2.0 TDI quattro       | 130 | 09.12 | PR: 1LJ             |                |        |   |                     |     |
|  | 2.0 TFSI hybr.quattro | 155 | 06.11 | PR: 1LJ             |                |        |   |                     |     |
|  | 2.0 TFSI quattro      | 132 | 08.09 | PR: 1LJ             |                |        |   |                     |     |
|  | 2.0 TFSI quattro      | 155 | 11.08 | PR: 1LJ             |                |        |   |                     |     |
|  | 2.0 TFSI quattro      | 162 | 05.13 | PR: 1LJ             |                |        |   |                     |     |
|  | 2.0 TFSI quattro      | 165 | 09.12 | PR: 1LJ             |                |        |   |                     |     |
|  | 2.0 TFSI quattro      | 169 | 08.15 | PR: 1LJ             |                |        |   |                     |     |
|  | 3.0 TDI quattro       | 155 | 11.08 | PR: 1LJ             |                |        |   |                     |     |
|  | 3.0 TDI quattro       | 176 | 11.08 | PR: 1LJ             |                |        |   |                     |     |
|  | 3.0 TDI quattro       | 180 | 09.12 | PR: 1LJ             |                |        |   |                     |     |
|  | 3.0 TDI quattro       | 190 | 11.13 | PR: 1LJ             |                |        |   |                     |     |
|  | 3.0 TFSI quattro      | 200 | 09.12 | PR: 1LJ             |                |        |   |                     |     |
|  | 3.2 FSI quattro       | 199 | 11.08 | PR: 1LJ             |                |        |   |                     |     |
|  | 2.0 TDI               | 100 | 08.09 | PR: 1LB,1LC,1LE,1LP | 13.0460-4879.2 | 604879 |  | 25643 16,8 /WE      | BRE |
|  | 2.0 TDI               | 105 | 08.09 | PR: 1LB,1LC,1LE,1LP | 13.0470-4879.2 | LD4879 |  | 25643 17,0 /WE      | BRE |
|  | 2.0 TDI               | 110 | 05.13 | PR: 1LB,1LC,1LE,1LP | 24.8190-0068.2 | 620068 |  | Warnkontakt L=332mm |     |
|  | 2.0 TDI               | 140 | 09.15 | PR: 1LB,1LC,1LE,1LP |                |        |   |                     |     |
|  | 2.0 TDI quattro       | 100 | 08.09 | PR: 1LB,1LC,1LE,1LP |                |        |   |                     |     |
|  | 2.0 TDI quattro       | 105 | 08.09 | PR: 1LB,1LC,1LE,1LP |                |        |   |                     |     |
|  | 2.0 TDI quattro       | 110 | 05.13 | PR: 1LB,1LC,1LE,1LP |                |        |   |                     |     |
|  | 2.0 TDI quattro       | 120 | 03.09 | PR: 1LB,1LC,1LE,1LP |                |        |   |                     |     |
|  | 2.0 TDI quattro       | 125 | 03.09 | PR: 1LB,1LC,1LE,1LP |                |        |   |                     |     |
|  | 2.0 TDI quattro       | 130 | 09.12 | PR: 1LB,1LC,1LE,1LP |                |        |   |                     |     |
|  | 2.0 TFSI hybr.quattro | 155 | 06.11 | PR: 1LB,1LC,1LE,1LP |                |        |   |                     |     |
|  | 2.0 TFSI quattro      | 132 | 08.09 | PR: 1LB,1LC,1LE,1LP |                |        |   |                     |     |
|  | 2.0 TFSI quattro      | 155 | 03.09 | PR: 1LB,1LC,1LE,1LP |                |        |   |                     |     |
|  | 2.0 TFSI quattro      | 162 | 05.13 | PR: 1LB,1LC,1LE,1LP |                |        |   |                     |     |
|  | 2.0 TFSI quattro      | 165 | 09.12 | PR: 1LB,1LC,1LE,1LP |                |        |   |                     |     |
|  | 2.0 TFSI quattro      | 169 | 08.15 | PR: 1LB,1LC,1LE,1LP |                |        |   |                     |     |
|  | 3.0 TDI quattro       | 155 | 03.09 | PR: 1LB,1LC,1LE,1LP |                |        |   |                     |     |
|  | 3.0 TDI quattro       | 176 | 03.09 | PR: 1LB,1LC,1LE,1LP |                |        |   |                     |     |
|  | 3.0 TDI quattro       | 180 | 09.12 | PR: 1LB,1LC,1LE,1LP |                |        |   |                     |     |
|  | 3.0 TDI quattro       | 190 | 11.13 | PR: 1LB,1LC,1LE,1LP |                |        |   |                     |     |

<sup>1)</sup> spring dimension 46 mm / dimensioni molla 46 mm / dimension de ressort 46 mm / medida de muelle 46 mm

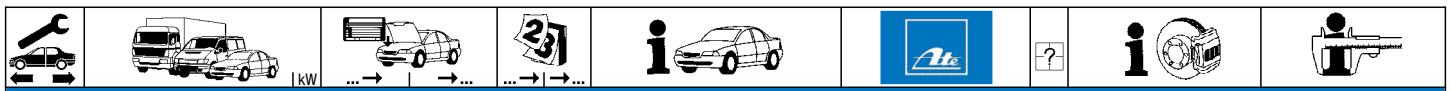

**AUDI Q5 (08-)**

|                       |                       |     |       |                 |                     |                |        |   |   |            |
|-----------------------|-----------------------|-----|-------|-----------------|---------------------|----------------|--------|---|---|------------|
|                       | 3.0 TFSI quattro      | 200 |       | 09.12           | PR: 1LB,1LC,1LE,1LP | 13.0460-4879.2 | 604879 | 1 | 25643 16,8 /WE<br>25643 17,0 /WE<br>Warnkontakt L=332mm | BRE<br>BRE |
|                       | 3.2 FSI quattro       | 199 |       | 03.09           | PR: 1LB,1LC,1LE,1LP | 13.0470-4879.2 | LD4879 |   |   |            |
|                       |                       |     |       |                 |                     | 24.8190-0068.2 | 620068 |   |   |            |
|                       | SQ5 TDI quattro       |     |       | 04.15           | PR: 1LV,1ZK         | 13.0460-7281.2 | 607281 | 1 | 25160 20,3 +/WK<br>Warnkontakt L=311,6mm                | ATE        |
|                       | SQ5 TDI quattro       | 230 |       | 12.12           | PR: 1LV,1ZK         | 24.8190-0301.2 | 620301 |   |   |            |
|                       | SQ5 TFSI quattro      | 260 |       | 05.13           | PR: 1LV,1ZK         |                |        |   |   |            |
|                       | 2.0 TDI               | 100 |       | 08.09           | PR: 1LA             | 24.0130-0193.1 | 430193 |   | 320 30,0 28,0 V L +S +B<br>320 30,0 28,0 V L +S +B PD   |            |
|                       | 2.0 TDI               | 105 |       | 08.09           | PR: 1LA             | 24.0330-0193.1 | 530193 |   |   |            |
|                       | 2.0 TDI quattro       | 100 |       | 08.09           | PR: 1LA             |                |        |   |   |            |
|                       | 2.0 TDI quattro       | 105 |       | 08.09           | PR: 1LA             |                |        |   |   |            |
|                       | 2.0 TDI quattro       | 120 |       | 03.09           | PR: 1LA             |                |        |   |   |            |
|                       | 2.0 TDI quattro       | 125 |       | 03.09           | PR: 1LA             |                |        |   |   |            |
|                       | 2.0 TFSI hybr.quattro | 155 |       | 06.11           | PR: 1LA             |                |        |   |   |            |
|                       | 2.0 TFSI quattro      | 132 |       | 08.09           | PR: 1LA             |                |        |   |   |            |
|                       | 2.0 TFSI quattro      | 155 |       | 03.09           | PR: 1LA             |                |        |   |   |            |
|                       | 3.0 TDI quattro       | 155 |       | 03.09           | PR: 1LA             |                |        |   |   |            |
|                       | 3.0 TDI quattro       | 176 |       | 03.09           | PR: 1LA             |                |        |   |   |            |
|                       | 3.2 FSI quattro       | 199 |       | 03.09           | PR: 1LA             |                |        |   |   |            |
|                       | 2.0 TDI               | 100 |       | 07.11           | PR: 1LA             | 24.0130-0221.1 | 430221 |   |   |            |
|                       | 2.0 TDI               | 105 |       | 07.11           | PR: 1LA             |                |        |   |   |            |
|                       | 2.0 TDI               | 110 |       | 05.13           | PR: 1LA             |                |        |   |   |            |
|                       | 2.0 TDI               | 140 |       | 09.15           | PR: 1LA             |                |        |   |   |            |
|                       | 2.0 TDI quattro       | 100 |       | 07.11           | PR: 1LA             |                |        |   |   |            |
|                       | 2.0 TDI quattro       | 105 |       | 07.11           | PR: 1LA             |                |        |   |   |            |
|                       | 2.0 TDI quattro       | 110 |       | 05.13           | PR: 1LA             |                |        |   |   |            |
|                       | 2.0 TDI quattro       | 120 |       | 07.11           | PR: 1LA             |                |        |   |   |            |
|                       | 2.0 TDI quattro       | 125 |       | 07.11           | PR: 1LA             |                |        |   |   |            |
|                       | 2.0 TDI quattro       | 130 |       | 09.12           | PR: 1LA             |                |        |   |   |            |
|                       | 2.0 TFSI hybr.quattro | 155 |       | 07.11           | PR: 1LA             |                |        |   |   |            |
|                       | 2.0 TFSI quattro      | 132 |       | 07.11           | PR: 1LA             |                |        |   |   |            |
| 2.0 TFSI quattro      | 155                   |     | 07.11 | PR: 1LA         |                     |                |        |   |   |            |
| 2.0 TFSI quattro      | 162                   |     | 05.13 | PR: 1LA         |                     |                |        |   |   |            |
| 2.0 TFSI quattro      | 165                   |     | 09.12 | PR: 1LA         |                     |                |        |   |   |            |
| 2.0 TFSI quattro      | 169                   |     | 08.15 | PR: 1LA         |                     |                |        |   |   |            |
| 3.0 TDI quattro       | 155                   |     | 07.11 | PR: 1LA         |                     |                |        |   |   |            |
| 3.0 TDI quattro       | 176                   |     | 07.11 | PR: 1LA         |                     |                |        |   |   |            |
| 3.0 TDI quattro       | 180                   |     | 09.12 | PR: 1LA         |                     |                |        |   |   |            |
| 3.0 TDI quattro       | 190                   |     | 11.13 | PR: 1LA         |                     |                |        |   |   |            |
| 3.0 TFSI quattro      | 200                   |     | 09.12 | PR: 1LA         |                     |                |        |   |   |            |
| 3.2 FSI quattro       | 199                   |     | 07.11 | PR: 1LA         |                     |                |        |   |   |            |
| 2.0 TDI               | 100                   |     | 08.09 | PR: 1LJ         | 24.0129-0102.1      | 429102         |        |   |   |            |
| 2.0 TDI               | 105                   |     | 08.09 | PR: 1LJ         |                     |                |        |   |   |            |
| 2.0 TDI quattro       | 100                   |     | 08.09 | PR: 1LJ         |                     |                |        |   |   |            |
| 2.0 TDI quattro       | 105                   |     | 08.09 | PR: 1LJ         |                     |                |        |   |   |            |
| 2.0 TDI quattro       | 120                   |     | 03.09 | PR: 1LJ         |                     |                |        |   |   |            |
| 2.0 TDI quattro       | 125                   |     | 03.09 | PR: 1LJ         |                     |                |        |   |   |            |
| 2.0 TFSI hybr.quattro | 155                   |     | 06.11 | PR: 1LJ         |                     |                |        |   |   |            |
| 2.0 TFSI quattro      | 132                   |     | 08.09 | PR: 1LJ         |                     |                |        |   |   |            |
| 2.0 TFSI quattro      | 155                   |     | 03.09 | PR: 1LJ         |                     |                |        |   |   |            |
| 3.0 TDI quattro       | 155                   |     | 03.09 | PR: 1LJ         |                     |                |        |   |   |            |
| 3.0 TDI quattro       | 176                   |     | 03.09 | PR: 1LJ         |                     |                |        |   |   |            |
| 3.2 FSI quattro       | 199                   |     | 03.09 | PR: 1LJ         |                     |                |        |   |   |            |
| 2.0 TDI               | 100                   |     | 07.11 | PR: 1LJ         | 24.0130-0222.1      | 430222         |        |   |   |            |
| 2.0 TDI               | 105                   |     | 07.11 | PR: 1LJ         |                     |                |        |   |   |            |
| 2.0 TDI               | 110                   |     | 05.13 | PR: 1LJ         |                     |                |        |   |   |            |
| 2.0 TDI               | 140                   |     | 09.15 | PR: 1LJ         |                     |                |        |   |   |            |
| 2.0 TDI quattro       | 100                   |     | 08.09 | PR: 1LJ         |                     |                |        |   |   |            |
| 2.0 TDI quattro       | 105                   |     | 08.09 | PR: 1LJ         |                     |                |        |   |   |            |
| 2.0 TDI quattro       | 110                   |     | 05.13 | PR: 1LJ         |                     |                |        |   |   |            |
| 2.0 TDI quattro       | 120                   |     | 07.11 | PR: 1LJ         |                     |                |        |   |   |            |
| 2.0 TDI quattro       | 125                   |     | 07.11 | PR: 1LJ         |                     |                |        |   |   |            |
| 2.0 TDI quattro       | 130                   |     | 09.12 | PR: 1LJ         |                     |                |        |   |   |            |
| 2.0 TFSI hybr.quattro | 155                   |     | 07.11 | PR: 1LJ         |                     |                |        |   |   |            |
| 2.0 TFSI quattro      | 132                   |     | 07.11 | PR: 1LJ         |                     |                |        |   |   |            |
| 2.0 TFSI quattro      | 155                   |     | 07.11 | PR: 1LJ         |                     |                |        |   |   |            |
| 2.0 TFSI quattro      | 162                   |     | 05.13 | PR: 1LJ         |                     |                |        |   |   |            |
| 2.0 TFSI quattro      | 165                   |     | 09.12 | PR: 1LJ         |                     |                |        |   |   |            |
| 2.0 TFSI quattro      | 169                   |     | 08.15 | PR: 1LJ         |                     |                |        |   |   |            |
| 3.0 TDI quattro       | 155                   |     | 07.11 | PR: 1LJ         |                     |                |        |   |   |            |
| 3.0 TDI quattro       | 176                   |     | 07.11 | PR: 1LJ         |                     |                |        |   |   |            |
| 3.0 TDI quattro       | 180                   |     | 09.12 | PR: 1LJ         |                     |                |        |   |   |            |
| 3.0 TDI quattro       | 190                   |     | 11.13 | PR: 1LJ         |                     |                |        |   |   |            |
| 3.0 TFSI quattro      | 200                   |     | 09.12 | PR: 1LJ         |                     |                |        |   |   |            |
| 3.2 FSI quattro       | 199                   |     | 07.11 | PR: 1LJ         |                     |                |        |   |   |            |
| 2.0 TDI               | 100                   |     | 08.09 | PR: 1LE,1LP,1ZT | 24.0130-0222.1      | 430222         |        |   |   |            |
| 2.0 TDI               | 105                   |     | 08.09 | PR: 1LE,1LP,1ZT |                     |                |        |   |   |            |
| 2.0 TDI               | 110                   |     | 05.13 | PR: 1LE,1LP,1ZT |                     |                |        |   |   |            |
| 2.0 TDI               | 140                   |     | 09.15 | PR: 1LE,1LP,1ZT |                     |                |        |   |   |            |
| 2.0 TDI quattro       | 100                   |     | 08.09 | PR: 1LE,1LP,1ZT |                     |                |        |   |   |            |
| 2.0 TDI quattro       | 105                   |     | 08.09 | PR: 1LE,1LP,1ZT |                     |                |        |   |   |            |
| 2.0 TDI quattro       | 110                   |     | 05.13 | PR: 1LE,1LP,1ZT |                     |                |        |   |   |            |
| 2.0 TDI quattro       | 120                   |     | 03.09 | PR: 1LE,1LP,1ZT |                     |                |        |   |   |            |
| 2.0 TDI quattro       | 125                   |     | 03.09 | PR: 1LE,1LP,1ZT |                     |                |        |   |   |            |
| 2.0 TDI quattro       | 130                   |     | 09.12 | PR: 1LE,1LP,1ZT |                     |                |        |   |   |            |
| 2.0 TFSI hybr.quattro | 155                   |     | 06.11 | PR: 1LE,1LP,1ZT |                     |                |        |   |   |            |
| 2.0 TFSI quattro      | 132                   |     | 08.09 | PR: 1LE,1LP,1ZT |                     |                |        |   |   |            |
| 2.0 TFSI quattro      | 155                   |     | 03.09 | PR: 1LE,1LP,1ZT |                     |                |        |   |   |            |



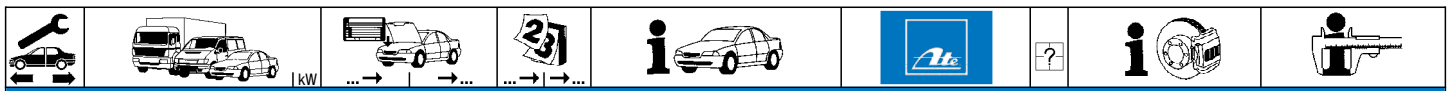

**AUDI Q5 (08-)**

|                       |                       |     |       |             |                 |                |        |   |                         |     |                |        |   |                    |     |
|-----------------------|-----------------------|-----|-------|-------------|-----------------|----------------|--------|---|-------------------------|-----|----------------|--------|---|--------------------|-----|
|                       | 2.0 TFSI quattro      | 162 |       | 05.13       | PR: 1LE,1LP,1ZT | 24.0130-0222.1 | 430222 |   | 345 30,0 28,0 V L +S +B |     |                |        |   |                    |     |
|                       | 2.0 TFSI quattro      | 165 |       | 09.12       | PR: 1LE,1LP,1ZT |                |        |   |                         |     |                |        |   |                    |     |
|                       | 2.0 TFSI quattro      | 169 |       | 08.15       | PR: 1LE,1LP,1ZT |                |        |   |                         |     |                |        |   |                    |     |
|                       | 3.0 TDI quattro       | 155 |       | 03.09       | PR: 1LE,1LP,1ZT |                |        |   |                         |     |                |        |   |                    |     |
|                       | 3.0 TDI quattro       | 176 |       | 03.09       | PR: 1LE,1LP,1ZT |                |        |   |                         |     |                |        |   |                    |     |
|                       | 3.0 TDI quattro       | 180 |       | 09.12       | PR: 1LE,1LP,1ZT |                |        |   |                         |     |                |        |   |                    |     |
|                       | 3.0 TDI quattro       | 190 |       | 11.13       | PR: 1LE,1LP,1ZT |                |        |   |                         |     |                |        |   |                    |     |
|                       | 3.0 TFSI quattro      | 200 |       | 09.12       | PR: 1LE,1LP,1ZT |                |        |   |                         |     |                |        |   |                    |     |
|                       | 3.2 FSI quattro       | 199 |       | 03.09       | PR: 1LE,1LP,1ZT |                |        |   |                         |     |                |        |   |                    |     |
|                       | 2.0 TDI               | 100 |       | 08.09       | PR: 1ZB         |                |        |   |                         |     |                |        |   |                    |     |
|                       | 2.0 TDI               | 105 |       | 08.09       | PR: 1ZB         |                |        |   |                         |     |                |        |   |                    |     |
|                       | 2.0 TDI               | 110 |       | 05.13       | PR: 1ZB         |                |        |   |                         |     |                |        |   |                    |     |
|                       | 2.0 TDI               | 140 |       | 09.15       | PR: 1ZB         |                |        |   |                         |     |                |        |   |                    |     |
|                       | 2.0 TDI quattro       | 100 |       | 08.09       | PR: 1ZB         |                |        |   |                         |     |                |        |   |                    |     |
|                       | 2.0 TDI quattro       | 105 |       | 08.09       | PR: 1ZB         |                |        |   |                         |     |                |        |   |                    |     |
| 2.0 TDI quattro       | 110                   |     | 05.13 | PR: 1ZB     |                 |                |        |   |                         |     |                |        |   |                    |     |
| 2.0 TDI quattro       | 120                   |     | 03.09 | PR: 1ZB     |                 |                |        |   |                         |     |                |        |   |                    |     |
| 2.0 TDI quattro       | 125                   |     | 03.09 | PR: 1ZB     |                 |                |        |   |                         |     |                |        |   |                    |     |
| 2.0 TDI quattro       | 130                   |     | 09.12 | PR: 1ZB     |                 |                |        |   |                         |     |                |        |   |                    |     |
| 2.0 TFSI hybr.quattro | 155                   |     | 06.11 | PR: 1ZB     |                 |                |        |   |                         |     |                |        |   |                    |     |
| 2.0 TFSI quattro      | 132                   |     | 08.09 | PR: 1ZB     |                 |                |        |   |                         |     |                |        |   |                    |     |
| 2.0 TFSI quattro      | 155                   |     | 03.09 | PR: 1ZB     |                 |                |        |   |                         |     |                |        |   |                    |     |
| 2.0 TFSI quattro      | 162                   |     | 05.13 | PR: 1ZB     |                 |                |        |   |                         |     |                |        |   |                    |     |
| 2.0 TFSI quattro      | 165                   |     | 09.12 | PR: 1ZB     |                 |                |        |   |                         |     |                |        |   |                    |     |
| 2.0 TFSI quattro      | 169                   |     | 08.15 | PR: 1ZB     |                 |                |        |   |                         |     |                |        |   |                    |     |
| 3.0 TDI quattro       | 155                   |     | 03.09 | PR: 1ZB     |                 |                |        |   |                         |     |                |        |   |                    |     |
| 3.0 TDI quattro       | 176                   |     | 03.09 | PR: 1ZB     |                 |                |        |   |                         |     |                |        |   |                    |     |
| 3.0 TDI quattro       | 180                   |     | 09.12 | PR: 1ZB     |                 |                |        |   |                         |     |                |        |   |                    |     |
| 3.0 TDI quattro       | 190                   |     | 11.13 | PR: 1ZB     |                 |                |        |   |                         |     |                |        |   |                    |     |
| 3.0 TFSI quattro      | 200                   |     | 09.12 | PR: 1ZB     |                 |                |        |   |                         |     |                |        |   |                    |     |
| 3.2 FSI quattro       | 199                   |     | 03.09 | PR: 1ZB     |                 |                |        |   |                         |     |                |        |   |                    |     |
|                       | 2.0 TDI               | 100 |       | 08.09       | PR: 1KW,2EK     | 13.0460-2747.2 | 602747 | elektrische Feststellbremse <sup>1)</sup> | 24606 17,4 +/Zub/S      | TRW |                |        |   |                    |     |
|                       | 2.0 TDI               | 105 |       | 08.09       | PR: 1KW,2EK     |                |        |   |                         |     |                |        |   |                    |     |
|                       | 2.0 TDI               | 110 |       | 05.13       | PR: 1KW,2EK     |                |        |   |                         |     |                |        |   |                    |     |
|                       | 2.0 TDI               | 140 |       | 09.15       | PR: 1KW,2EK     |                |        |   |                         |     |                |        |   |                    |     |
|                       | 2.0 TDI quattro       | 100 |       | 08.09       | PR: 1KW,2EK     |                |        |   |                         |     |                |        |   |                    |     |
|                       | 2.0 TDI quattro       | 105 |       | 08.09       | PR: 1KW,2EK     |                |        |   |                         |     |                |        |   |                    |     |
|                       | 2.0 TDI quattro       | 110 |       | 05.13       | PR: 1KW,2EK     |                |        |   |                         |     |                |        |   |                    |     |
|                       | 2.0 TDI quattro       | 120 |       | 03.09       | PR: 1KW,2EK     |                |        |   |                         |     |                |        |   |                    |     |
|                       | 2.0 TDI quattro       | 125 |       | 03.09       | PR: 1KW,2EK     |                |        |   |                         |     |                |        |   |                    |     |
|                       | 2.0 TDI quattro       | 130 |       | 09.12       | PR: 1KW,2EK     |                |        |   |                         |     |                |        |   |                    |     |
|                       | 2.0 TFSI hybr.quattro | 155 |       | 06.11       | PR: 1KW,2EK     |                |        |   |                         |     |                |        |   |                    |     |
|                       | 2.0 TFSI quattro      | 132 |       | 08.09       | PR: 1KW,2EK     |                |        |   |                         |     |                |        |   |                    |     |
|                       | 2.0 TFSI quattro      | 155 |       | 03.09       | PR: 1KW,2EK     |                |        |   |                         |     |                |        |   |                    |     |
|                       | 2.0 TFSI quattro      | 162 |       | 05.13       | PR: 1KW,2EK     |                |        |   |                         |     |                |        |   |                    |     |
|                       | 2.0 TFSI quattro      | 165 |       | 09.12       | PR: 1KW,2EK     |                |        |   |                         |     |                |        |   |                    |     |
|                       | 2.0 TFSI quattro      | 169 |       | 08.15       | PR: 1KW,2EK     |                |        |   |                         |     |                |        |   |                    |     |
|                       | 3.0 TDI quattro       | 155 |       | 03.09       | PR: 1KW,2EK     |                |        |   |                         |     |                |        |   |                    |     |
|                       | 3.0 TDI quattro       | 176 |       | 03.09       | PR: 1KW,2EK     |                |        |   |                         |     |                |        |   |                    |     |
|                       | 3.0 TDI quattro       | 180 |       | 09.12       | PR: 1KW,2EK     |                |        |   |                         |     |                |        |   |                    |     |
|                       | 3.0 TDI quattro       | 190 |       | 11.13       | PR: 1KW,2EK     |                |        |   |                         |     |                |        |   |                    |     |
|                       | 3.0 TFSI quattro      | 200 |       | 09.12       | PR: 1KW,2EK     |                |        |   |                         |     |                |        |   |                    |     |
|                       | 3.2 FSI quattro       | 199 |       | 03.09       | PR: 1KW,2EK     |                |        |   |                         |     |                |        |   |                    |     |
|                       | 2.0 TDI               | 100 |       | 08.09       | PR: 1KE,2EL     |                |        |   |                         |     | 13.0460-2748.2 | 602748 | elektrische Feststellbremse <sup>1)</sup> | 24606 17,4 +/Zub/S | TRW |
|                       | 2.0 TDI               | 105 |       | 08.09       | PR: 1KE,2EL     |                |        |   |                         |     |                |        |   |                    |     |
|                       | 2.0 TDI               | 110 |       | 05.13       | PR: 1KE,2EL     |                |        |   |                         |     |                |        |   |                    |     |
| 2.0 TDI               | 140                   |     | 09.15 | PR: 1KE,2EL |                 |                |        |   |                         |     |                |        |   |                    |     |
| 2.0 TDI quattro       | 100                   |     | 08.09 | PR: 1KE,2EL |                 |                |        |   |                         |     |                |        |   |                    |     |
| 2.0 TDI quattro       | 105                   |     | 08.09 | PR: 1KE,2EL |                 |                |        |   |                         |     |                |        |   |                    |     |
| 2.0 TDI quattro       | 110                   |     | 05.13 | PR: 1KE,2EL |                 |                |        |   |                         |     |                |        |   |                    |     |
| 2.0 TDI quattro       | 120                   |     | 03.09 | PR: 1KE,2EL |                 |                |        |   |                         |     |                |        |   |                    |     |
| 2.0 TDI quattro       | 125                   |     | 03.09 | PR: 1KE,2EL |                 |                |        |   |                         |     |                |        |   |                    |     |
| 2.0 TDI quattro       | 130                   |     | 09.12 | PR: 1KE,2EL |                 |                |        |   |                         |     |                |        |   |                    |     |
| 2.0 TFSI hybr.quattro | 155                   |     | 06.11 | PR: 1KE,2EL |                 |                |        |   |                         |     |                |        |   |                    |     |
| 2.0 TFSI quattro      | 132                   |     | 08.09 | PR: 1KE,2EL |                 |                |        |   |                         |     |                |        |   |                    |     |
| 2.0 TFSI quattro      | 155                   |     | 03.09 | PR: 1KE,2EL |                 |                |        |   |                         |     |                |        |   |                    |     |
| 2.0 TFSI quattro      | 162                   |     | 05.13 | PR: 1KE,2EL |                 |                |        |   |                         |     |                |        |   |                    |     |
| 2.0 TFSI quattro      | 165                   |     | 09.12 | PR: 1KE,2EL |                 |                |        |   |                         |     |                |        |   |                    |     |
| 2.0 TFSI quattro      | 169                   |     | 08.15 | PR: 1KE,2EL |                 |                |        |   |                         |     |                |        |   |                    |     |
| 3.0 TDI quattro       | 155                   |     | 03.09 | PR: 1KE,2EL |                 |                |        |   |                         |     |                |        |   |                    |     |
| 3.0 TDI quattro       | 176                   |     | 03.09 | PR: 1KE,2EL |                 |                |        |   |                         |     |                |        |   |                    |     |
| 3.0 TDI quattro       | 180                   |     | 09.12 | PR: 1KE,2EL |                 |                |        |   |                         |     |                |        |   |                    |     |
| 3.0 TDI quattro       | 190                   |     | 11.13 | PR: 1KE,2EL |                 |                |        |   |                         |     |                |        |   |                    |     |
| 3.0 TFSI quattro      | 200                   |     | 09.12 | PR: 1KE,2EL |                 |                |        |   |                         |     |                |        |   |                    |     |
| 3.2 FSI quattro       | 199                   |     | 03.09 | PR: 1KE,2EL |                 |                |        |   |                         |     |                |        |   |                    |     |
| SQ5 TDI quattro       | 230                   |     | 04.15 | PR: 1KF,2EJ |                 |                |        |   |                         |     |                |        |   |                    |     |
| SQ5 TDI quattro       | 230                   |     | 12.12 | PR: 1KF,2EJ |                 |                |        |   |                         |     |                |        |   |                    |     |
| SQ5 TFSI quattro      | 260                   |     | 05.13 | PR: 1KF,2EJ |                 |                |        |   |                         |     |                |        |   |                    |     |
|                       | 2.0 TDI               | 100 |       | 08.09       | PR: 1KW,2EK     | 24.0112-0178.1 | 412178 | elektrische Feststellbremse <sup>1)</sup> | 300 12,0 10,0 +S +B     |     |                |        |   |                    |     |
|                       | 2.0 TDI               | 105 |       | 08.09       | PR: 1KW,2EK     |                |        |   |                         |     |                |        |   |                    |     |
|                       | 2.0 TDI               | 110 |       | 05.13       | PR: 1KW,2EK     |                |        |   |                         |     |                |        |   |                    |     |
|                       | 2.0 TDI               | 140 |       | 09.15       | PR: 1KW,2EK     |                |        |   |                         |     |                |        |   |                    |     |
|                       | 2.0 TDI quattro       | 100 |       | 08.09       | PR: 1KW,2EK     |                |        |   |                         |     |                |        |   |                    |     |
|                       | 2.0 TDI quattro       | 105 |       | 08.09       | PR: 1KW,2EK     |                |        |   |                         |     |                |        |   |                    |     |
|                       | 2.0 TDI quattro       | 110 |       | 05.13       | PR: 1KW,2EK     |                |        |   |                         |     |                |        |   |                    |     |
|                       | 2.0 TDI quattro       | 120 |       | 03.09       | PR: 1KW,2EK     |                |        |   |                         |     |                |        |   |                    |     |
|                       | 2.0 TDI quattro       | 125 |       | 03.09       | PR: 1KW,2EK     |                |        |   |                         |     |                |        |   |                    |     |
|                       | 2.0 TDI quattro       | 125 |       | 03.09       | PR: 1KW,2EK     |                |        |   |                         |     |                |        |   |                    |     |

<sup>1)</sup> electric parking brake / fr/di stazionamento elettrico / frein à main électrique / freno de mano eléctrico





| AUDI Q5 (08-)         |                       |       |               |                |                |        |   |   |                         |
|-----------------------|-----------------------|-------|---------------|----------------|----------------|--------|---|---|-------------------------|
|                       | 2.0 TDI quattro       | 130   | 09.12         | PR: 1KW,2EK    | 24.0112-0178.1 | 412178 |   | elektrische Feststellbremse <sup>1)</sup> | 300 12,0 10,0 +S +B     |
|                       | 2.0 TFSI hybr.quattro | 155   | 06.11         | PR: 1KW,2EK    | 24.0312-0178.1 | 512178 |   | elektrische Feststellbremse <sup>1)</sup> | 300 12,0 10,0 +S +B PD  |
|                       | 2.0 TFSI quattro      | 132   | 08.09         | PR: 1KW,2EK    |                |        |   |   |                         |
|                       | 2.0 TFSI quattro      | 155   | 03.09         | PR: 1KW,2EK    |                |        |   |   |                         |
|                       | 2.0 TFSI quattro      | 162   | 05.13         | PR: 1KW,2EK    |                |        |   |   |                         |
|                       | 2.0 TFSI quattro      | 165   | 09.12         | PR: 1KW,2EK    |                |        |   |   |                         |
|                       | 2.0 TFSI quattro      | 169   | 08.15         | PR: 1KW,2EK    |                |        |   |   |                         |
|                       | 3.0 TDI quattro       | 155   | 03.09         | PR: 1KW,2EK    |                |        |   |   |                         |
|                       | 3.0 TDI quattro       | 176   | 03.09         | PR: 1KW,2EK    |                |        |   |   |                         |
|                       | 3.0 TDI quattro       | 180   | 09.12         | PR: 1KW,2EK    |                |        |   |   |                         |
|                       | 3.0 TDI quattro       | 190   | 11.13         | PR: 1KW,2EK    |                |        |   |   |                         |
|                       | 3.0 TFSI quattro      | 200   | 09.12         | PR: 1KW,2EK    |                |        |   |   |                         |
|                       | 3.2 FSI quattro       | 199   | 03.09         | PR: 1KW,2EK    |                |        |   |   |                         |
|                       | 2.0 TDI               | 100   | 08.09         | 10.10 PR: 1KE  | 24.0122-0250.1 | 422250 |   | elektrische Feststellbremse <sup>1)</sup> | 330 22,0 20,0 V L +S +B |
|                       | 2.0 TDI               | 105   | 08.09         | 10.10 PR: 1KE  |                |        |   |   |                         |
|                       | 2.0 TDI quattro       | 100   | 08.09         | 10.10 PR: 1KE  |                |        |   |   |                         |
|                       | 2.0 TDI quattro       | 105   | 08.09         | 10.10 PR: 1KE  |                |        |   |   |                         |
|                       | 2.0 TDI quattro       | 120   | 03.09         | 10.10 PR: 1KE  |                |        |   |   |                         |
|                       | 2.0 TDI quattro       | 125   | 03.09         | 10.10 PR: 1KE  |                |        |   |   |                         |
| 2.0 TFSI quattro      | 132                   | 08.09 | 10.10 PR: 1KE |                |                |        |   |   |                         |
| 2.0 TFSI quattro      | 155                   | 03.09 | 10.10 PR: 1KE |                |                |        |   |   |                         |
| 3.0 TDI quattro       | 155                   | 03.09 | 10.10 PR: 1KE |                |                |        |   |   |                         |
| 3.0 TDI quattro       | 176                   | 03.09 | 10.10 PR: 1KE |                |                |        |   |   |                         |
| 3.2 FSI quattro       | 199                   | 03.09 | 10.10 PR: 1KE |                |                |        |   |   |                         |
| 2.0 TDI               | 100                   | 11.10 | PR: 1KE,2EL   | 24.0122-0272.1 | 422272         |        | elektrische Feststellbremse <sup>1)</sup> | 330 21,9 20,0 V L +S +B                   |                         |
| 2.0 TDI               | 105                   | 11.10 | PR: 1KE,2EL   |                |                |        |   |   |                         |
| 2.0 TDI               | 110                   | 05.13 | PR: 1KE,2EL   |                |                |        |   |   |                         |
| 2.0 TDI               | 140                   | 09.15 | PR: 1KE,2EL   |                |                |        |   |   |                         |
| 2.0 TDI quattro       | 100                   | 11.10 | PR: 1KE,2EL   |                |                |        |   |   |                         |
| 2.0 TDI quattro       | 105                   | 11.10 | PR: 1KE,2EL   |                |                |        |   |   |                         |
| 2.0 TDI quattro       | 110                   | 05.13 | PR: 1KE,2EL   |                |                |        |   |   |                         |
| 2.0 TDI quattro       | 120                   | 11.10 | PR: 1KE,2EL   |                |                |        |   |   |                         |
| 2.0 TDI quattro       | 125                   | 11.10 | PR: 1KE,2EL   |                |                |        |   |   |                         |
| 2.0 TDI quattro       | 130                   | 09.12 | PR: 1KE,2EL   |                |                |        |   |   |                         |
| 2.0 TFSI hybr.quattro | 155                   | 06.11 | PR: 1KE,2EL   |                |                |        |   |   |                         |
| 2.0 TFSI quattro      | 132                   | 11.10 | PR: 1KE,2EL   |                |                |        |   |   |                         |
| 2.0 TFSI quattro      | 155                   | 11.10 | PR: 1KE,2EL   |                |                |        |   |   |                         |
| 2.0 TFSI quattro      | 162                   | 05.13 | PR: 1KE,2EL   |                |                |        |   |   |                         |
| 2.0 TFSI quattro      | 165                   | 09.12 | PR: 1KE,2EL   |                |                |        |   |   |                         |
| 2.0 TFSI quattro      | 169                   | 08.15 | PR: 1KE,2EL   |                |                |        |   |   |                         |
| 3.0 TDI quattro       | 155                   | 11.10 | PR: 1KE,2EL   |                |                |        |   |   |                         |
| 3.0 TDI quattro       | 176                   | 11.10 | PR: 1KE,2EL   |                |                |        |   |   |                         |
| 3.0 TDI quattro       | 180                   | 09.12 | PR: 1KE,2EL   |                |                |        |   |   |                         |
| 3.0 TDI quattro       | 190                   | 11.13 | PR: 1KE,2EL   |                |                |        |   |   |                         |
| 3.0 TFSI quattro      | 200                   | 09.12 | PR: 1KE,2EL   |                |                |        |   |   |                         |
| 3.2 FSI quattro       | 199                   | 11.10 | PR: 1KE,2EL   |                |                |        |   |   |                         |
| SQ5 TDI quattro       | 230                   | 04.15 | PR: 1KF,2EJ   |                |                |        |   |   |                         |
| SQ5 TDI quattro       | 230                   | 12.12 | PR: 1KF,2EJ   |                |                |        |   |   |                         |
| SQ5 TFSI quattro      | 260                   | 05.13 | PR: 1KF,2EJ   |                |                |        |   |   |                         |

| AUDI Q7 (06-15) |          |       |         |                |                |        |   |                       |                       |
|-----------------|----------|-------|---------|----------------|----------------|--------|---|-----------------------|-----------------------|
|                 | 3.0 TDI  | 150   | 05.10   | PR: 1LF        | 13.0460-4993.2 | 604993 |   |                       | 23693 16,6 /WE BRE    |
|                 | 3.0 TDI  | 155   | 03.06   | PR: 1LF        | 13.0470-4993.2 | LD4993 |   |                       | 23693 16,6 /WE BRE    |
|                 | 3.0 TDI  | 165   | 06.09   | PR: 1LF        | 24.8190-0929.2 | 620929 | 2 |                       | Warnkontakt L=417,4mm |
|                 | 3.0 TDI  | 171   | 03.06   | PR: 1LF        |                |        |   |                       |                       |
|                 | 3.0 TDI  | 176   | 11.07   | PR: 1LF        |                |        |   |                       |                       |
|                 | 3.0 TDI  | 180   | 05.11   | PR: 1LF        |                |        |   |                       |                       |
|                 | 3.0 TDI  | 200   | 03.15   | PR: 1LF        |                |        |   |                       |                       |
|                 | 3.0 TFSI | 200   | 05.10   | PR: 1LF        |                |        |   |                       |                       |
|                 | 3.6 FSI  | 206   | 08.06   | PR: 1LF        |                |        |   |                       |                       |
|                 | 3.0 TFSI | 245   | 05.10   | PR: 1LF        | 13.0460-4993.2 | 604993 |   |                       | 23693 16,6 /WE BRE    |
|                 | 4.2 FSI  | 257   | 03.06   | PR: 1LF        | 24.8190-0929.2 | 620929 | 2 |                       | Warnkontakt L=417,4mm |
|                 | 4.2 TDI  | 240   | 03.07   | PR: 1LF        |                |        |   |                       |                       |
|                 | 6.0 TDI  | 368   | 09.08   | PR: 1LF        |                |        |   |                       |                       |
| 3.0 TDI         | 150      | 05.10 | PR: 1LW | 24.8190-0011.2 | 620011         | 2      |   | Warnkontakt L=362,5mm |                       |
| 3.0 TDI         | 155      | 03.06 | PR: 1LW |                |                |        |   |                       |                       |
| 3.0 TDI         | 165      | 06.09 | PR: 1LW |                |                |        |   |                       |                       |
| 3.0 TDI         | 171      | 03.06 | PR: 1LW |                |                |        |   |                       |                       |
| 3.0 TDI         | 176      | 11.07 | PR: 1LW |                |                |        |   |                       |                       |
| 3.0 TDI         | 180      | 05.11 | PR: 1LW |                |                |        |   |                       |                       |
| 3.0 TDI         | 200      | 03.15 | PR: 1LW |                |                |        |   |                       |                       |
| 3.0 TFSI        | 200      | 05.10 | PR: 1LW |                |                |        |   |                       |                       |
| 3.0 TFSI        | 245      | 05.10 | PR: 1LW |                |                |        |   |                       |                       |
| 3.6 FSI         | 206      | 08.06 | PR: 1LW |                |                |        |   |                       |                       |
| 4.2 FSI         | 257      | 03.06 | PR: 1LW |                |                |        |   |                       |                       |
| 4.2 TDI         | 240      | 03.07 | PR: 1LW |                |                |        |   |                       |                       |
| 6.0 TDI         | 368      | 09.08 | PR: 1LW |                |                |        |   |                       |                       |
|                 | 3.0 TDI  | 150   | 05.10   | PR: 1LF        | 24.0134-0123.1 | 434123 |   |                       | 350 34,0 32,0 V L +B  |
|                 | 3.0 TDI  | 155   | 03.06   | PR: 1LF        | 24.0134-0124.1 | 434124 |   |                       | 350 34,0 32,0 V L +B  |
|                 | 3.0 TDI  | 165   | 06.09   | PR: 1LF        |                |        |   |                       |                       |
|                 | 3.0 TDI  | 171   | 03.06   | PR: 1LF        |                |        |   |                       |                       |
|                 | 3.0 TDI  | 176   | 11.07   | PR: 1LF        |                |        |   |                       |                       |
|                 | 3.0 TDI  | 180   | 05.11   | PR: 1LF        |                |        |   |                       |                       |
|                 | 3.0 TDI  | 200   | 03.15   | PR: 1LF        |                |        |   |                       |                       |
| 3.0 TFSI        | 200      | 05.10 | PR: 1LF |                |                |        |   |                       |                       |
| 3.0 TFSI        | 245      | 05.10 | PR: 1LF |                |                |        |   |                       |                       |
| 3.6 FSI         | 206      | 08.06 | PR: 1LF |                |                |        |   |                       |                       |

<sup>1)</sup> electric parking brake / fr.di stazionamento elettrico / frein à main électrique / freno de mano eléctrico



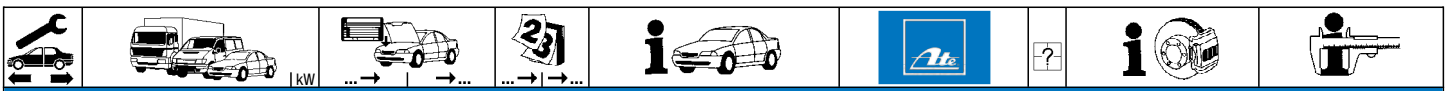

















**AUDI Q7 (06-15)**

|  |  |   |   |  |  |                            |   |   |
|--|--|---|---|--|--|----------------------------|---|---|
|  | 4.2 FSI<br>4.2 TDI<br>6.0 TDI  | 257<br>240<br>368   | 03.06<br>03.07<br>09.08   | PR: 1LF<br>PR: 1LF<br>PR: 1LF  | 24.0134-0123.1<br>24.0134-0124.1                   | 434123<br>434124           |   | 350 34,0 32,0 V L +B<br>350 34,0 32,0 V L +B              |
|  | 3.0 TDI<br>3.0 TDI<br>3.0 TDI<br>3.0 TDI<br>3.0 TDI<br>3.0 TFSI<br>3.0 TFSI<br>3.6 FSI<br>4.2 FSI<br>4.2 TDI<br>6.0 TDI            | 150<br>155<br>165<br>171<br>176<br>200<br>245<br>206<br>257<br>240<br>368               | 05.10<br>03.06<br>06.09<br>03.06<br>11.07<br>05.10<br>05.10<br>08.06<br>03.06<br>03.07<br>09.08                   | 05.10<br>05.10<br>05.10<br>05.10<br>05.10<br>05.10<br>05.10<br>05.10<br>05.10<br>05.10   | 24.0711-5401.3<br>24.0711-5402.3                   | 360330<br>360331           |   | Radsensor<br>Radsensor                                    |
|  | 3.0 TDI<br>3.0 TDI<br>3.0 TDI<br>3.0 TDI<br>3.0 TDI<br>3.0 TDI<br>3.0 TFSI<br>3.0 TFSI<br>3.6 FSI<br>4.2 FSI<br>4.2 TDI<br>6.0 TDI | 150<br>155<br>165<br>171<br>176<br>180<br>200<br>200<br>245<br>206<br>257<br>240        | 06.10<br>06.10<br>06.10<br>06.10<br>05.11<br>03.15<br>06.10<br>06.10<br>06.10<br>06.10<br>06.10                   |  | 24.0711-5403.3                                     | 360361                     | 2 | Radsensor   |
|  | 3.0 TDI<br>3.0 TDI<br>3.0 TDI<br>3.0 TDI<br>3.0 TDI<br>3.0 TDI<br>3.0 TFSI<br>3.0 TFSI<br>3.6 FSI<br>4.2 FSI<br>4.2 TDI<br>6.0 TDI | 150<br>155<br>165<br>171<br>176<br>180<br>200<br>200<br>245<br>206<br>257<br>240<br>368 | 05.10<br>03.06<br>06.09<br>03.06<br>11.07<br>05.11<br>03.15<br>05.10<br>05.10<br>08.06<br>03.06<br>03.07<br>09.08 | PR: 1KF,2EA<br>PR: 1KF,2EA<br>PR: 1KF,2EA<br>PR: 1KF,2EA<br>PR: 1KF,2EA<br>PR: 1KF,2EA<br>PR: 1KF,2EA<br>PR: 1KF,2EA<br>PR: 1KF,2EA<br>PR: 1KF,2EA<br>PR: 1KF,2EA<br>PR: 1KF,2EA | 13.0460-4976.2<br>13.0470-4976.2<br>24.8190-0930.2 | 604976<br>LD4976<br>620930 | 2 | 23694 16,7 /WE<br>23694 16,7 /WE<br>Warnkontakt L=252,4mm |
|  | 3.0 TDI<br>3.0 TDI<br>3.0 TDI<br>3.0 TDI<br>3.0 TDI<br>3.0 TDI<br>3.0 TFSI<br>3.0 TFSI<br>3.6 FSI<br>4.2 FSI<br>4.2 TDI<br>6.0 TDI | 150<br>155<br>165<br>171<br>176<br>180<br>200<br>200<br>245<br>206<br>257<br>240<br>368 | 05.10<br>03.06<br>06.09<br>03.06<br>11.07<br>05.11<br>03.15<br>05.10<br>05.10<br>08.06<br>03.06<br>03.07<br>09.08 | PR: 1KD<br>PR: 1KD<br>PR: 1KD<br>PR: 1KD<br>PR: 1KD<br>PR: 1KD<br>PR: 1KD<br>PR: 1KD<br>PR: 1KD<br>PR: 1KD<br>PR: 1KD<br>PR: 1KD   | 13.0460-4850.2<br>13.0470-4850.2<br>24.8190-0937.2 | 604850<br>LD4850<br>620937 | 2 | 24296 15,5 /WE<br>24296 15,5 /WE<br>Warnkontakt L=247,4mm |
|  | 3.0 TDI<br>3.0 TDI<br>3.0 TDI<br>3.0 TDI<br>3.0 TDI<br>3.0 TDI<br>3.0 TFSI<br>3.0 TFSI<br>3.6 FSI<br>4.2 FSI<br>4.2 TDI<br>6.0 TDI | 150<br>155<br>165<br>171<br>176<br>180<br>200<br>200<br>245<br>206<br>257<br>240<br>368 | 05.10<br>03.06<br>06.09<br>03.06<br>11.07<br>05.11<br>03.15<br>05.10<br>05.10<br>08.06<br>03.06<br>03.07<br>09.08 | PR: 2EF<br>PR: 2EF<br>PR: 2EF<br>PR: 2EF<br>PR: 2EF<br>PR: 2EF<br>PR: 2EF<br>PR: 2EF<br>PR: 2EF<br>PR: 2EF<br>PR: 2EF<br>PR: 2EF   | 24.8190-0012.2                                     | 620012                     | 2 | Warnkontakt L=272,4mm                                     |
|  | 3.0 TDI<br>3.0 TDI<br>3.0 TDI<br>3.0 TDI<br>3.0 TDI<br>3.0 TDI<br>3.0 TFSI<br>3.0 TFSI<br>3.6 FSI<br>4.2 FSI<br>4.2 TDI<br>6.0 TDI | 150<br>155<br>165<br>171<br>176<br>180<br>200<br>200<br>245<br>206<br>257<br>240<br>368 | 05.10<br>03.06<br>06.09<br>03.06<br>11.07<br>05.11<br>03.15<br>05.10<br>05.10<br>08.06<br>03.06<br>03.07<br>09.08 | PR: 1KF<br>PR: 1KF<br>PR: 1KF<br>PR: 1KF<br>PR: 1KF<br>PR: 1KF<br>PR: 1KF<br>PR: 1KF<br>PR: 1KF<br>PR: 1KF<br>PR: 1KF<br>PR: 1KF   | 24.0128-0149.1                                     | 428149                     |   | 330 28,0 26,0 V L +S +B                                   |
|  | 3.0 TDI<br>3.0 TDI<br>3.0 TDI<br>3.0 TDI<br>3.0 TDI<br>3.0 TDI<br>3.0 TFSI<br>3.0 TFSI   | 150<br>155<br>165<br>171<br>176<br>180<br>200<br>200                                    | 05.10<br>03.06<br>06.09<br>03.06<br>11.07<br>05.11<br>03.15<br>05.10  | PR: 1KD,2EA<br>PR: 1KD,2EA<br>PR: 1KD,2EA<br>PR: 1KD,2EA<br>PR: 1KD,2EA<br>PR: 1KD,2EA<br>PR: 1KD,2EA<br>PR: 1KD,2EA   | 24.0128-0169.1                                     | 428169                     |   | 358 28,0 26,0 V L +B                                      |



|     |   |         |                                      |    |  |  |    |  |
|--|---|---|--|--|---|--|--|--|
| <b>AUDI Q7 (06-15)</b>   |   |   |  |  |   |  |  |  |
|    | 3.0 TFSI 245<br>3.6 FSI 206<br>4.2 FSI 257<br>4.2 TDI 240<br>6.0 TDI 368  | 245<br>206<br>257<br>240<br>368   | 05.10<br>08.06<br>03.06<br>03.07<br>09.08  | PR: 1KD,2EA<br>PR: 1KD,2EA<br>PR: 1KD,2EA<br>PR: 1KD,2EA<br>PR: 1KD,2EA  | 24.0128-0169.1  | 428169   |  | 358 28,0 26,0 V L +B   |
|    | 3.0 TDI 150<br>3.0 TDI 155<br>3.0 TDI 165<br>3.0 TDI 171<br>3.0 TDI 176<br>3.0 TDI 180<br>3.0 TDI 200<br>3.0 TFSI 200<br>3.0 TFSI 245<br>3.6 FSI 206<br>4.2 FSI 257<br>4.2 TDI 240<br>6.0 TDI 368 | 150<br>155<br>165<br>171<br>176<br>180<br>200<br>200<br>245<br>206<br>257<br>240<br>368 | 05.10<br>03.06<br>06.09<br>03.06<br>11.07<br>05.11<br>03.15<br>05.10<br>08.06<br>03.06<br>03.07<br>09.08             |  | 24.0711-5401.3<br>24.0711-5402.3  | 360330<br>360331   | <input type="checkbox"/><br><input type="checkbox"/>   | Radsensor<br>Radsensor   |
|    | 3.0 TDI 150<br>3.0 TDI 155<br>3.0 TDI 165<br>3.0 TDI 171<br>3.0 TDI 176<br>3.0 TDI 180<br>3.0 TDI 200<br>3.0 TFSI 200<br>3.0 TFSI 245<br>3.6 FSI 206<br>4.2 FSI 257<br>4.2 TDI 240<br>6.0 TDI 368 | 150<br>155<br>165<br>171<br>176<br>180<br>200<br>200<br>245<br>206<br>257<br>240<br>368 | 05.10<br>03.06<br>06.09<br>03.06<br>11.07<br>05.11<br>03.15<br>05.10<br>08.06<br>03.06<br>03.07<br>09.08             | PR: 1KF,2EA,1KD,2EF<br>PR: 1KF,2EA,1KD,2EF<br>PR: 1KF,2EA,1KD,2EF<br>PR: 1KF,2EA,1KD,2EF<br>PR: 1KF,2EA,1KD,2EF<br>PR: 1KF,2EA,1KD,2EF<br>PR: 1KF,2EA,1KD,2EF<br>PR: 1KF,2EA,1KD,2EF<br>PR: 1KF,2EA,1KD,2EF<br>PR: 1KF,2EA,1KD,2EF<br>PR: 1KF,2EA,1KD,2EF<br>PR: 1KF,2EA,1KD,2EF | 03.0137-0451.2<br>03.0137-9288.2<br>03.0137-9700.2<br>03.0137-9702.2              | 650451<br>669288<br>669700<br>669702   |  | 210 x 30<br>Bremsbacken-Zubehör<br>Bremsbacken-Zubehör<br>Spreizschloß Satz        |
| <b>AUDI Q7 (15-)</b>   |   |   |  |  |   |  |  |  |
|    | 2.0 TFSI 185<br>3.0 TDI 160<br>3.0 TDI 183<br>3.0 TDI 200<br>3.0 TFSI 245<br>SQ7 TDI 320  | 185<br>160<br>183<br>200<br>245<br>320  | 08.15<br>05.15<br>06.15<br>06.15<br>06.15<br>04.16   | PR: 2ED,2EE<br>PR: 2ED,2EE<br>PR: 2ED,2EE<br>PR: 2ED,2EE<br>PR: 2ED,2EE<br>PR: 2ED,2EE   | 24.0122-0272.1  | 422272   | elektrische Feststellbremse <sup>1)</sup>  | 330 21,9 20,0 V L +S +B  |
| <b>AUDI R8 / R8 Spyder (07-15)</b>   |   |   |  |  |   |  |  |  |
|  | 4.2 FSI quattro 309<br>4.2 FSI quattro 316<br>5.2 FSI quattro 386<br>5.2 FSI quattro 419<br>5.2 FSI quattro GT 412  | 309<br>316<br>386<br>419<br>412   | 04.07<br>07.10<br>04.09<br>07.12<br>10.09  | PR: 1LE,1LW<br>PR: 1LE,1LW<br>PR: 1LE,1LW<br>PR: 1LE,1LW<br>PR: 1LE,1LW  | 24.8190-0017.2  | 620017   | 1  | Warnkontakt L=388,3mm  |
| <b>AUDI TT Coupe (98-06)</b>   |   |   |  |  |   |  |  |  |
|  | 1.8 T 110<br>1.8 T 120<br>1.8 T 132<br>1.8 T 140<br>1.8 T quattro 132<br>1.8 T quattro 140<br>1.8 T quattro 165<br>1.8 T quattro 176  | 110<br>120<br>132<br>140<br>132<br>140<br>165<br>176                                    | 09.02 06.06<br>09.05 06.06<br>10.98 06.06<br>09.05 06.06<br>10.98 06.06<br>09.05 06.06<br>10.98 06.06<br>03.05 06.06 | PR: 1LD,1LT,1LV<br>PR: 1LD,1LT,1LV<br>PR: 1LD,1LT,1LV<br>PR: 1LD,1LT,1LV<br>PR: 1LD,1LT,1LV<br>PR: 1LD,1LT,1LV<br>PR: 1LD,1LT,1LV<br>PR: 1LD,1LT,1LV   | 13.0460-7081.2<br>13.0470-7081.2<br>13.0460-7122.2<br>13.0470-7122.2              | 607081<br>LD7081<br>607122<br>LD7122   |  | 21911 20,3 +<br>21911 20,3 +<br>23392 20,3 +/WK<br>23392 20,3 +/WK                 |
|  | 1.8 T 110<br>1.8 T 120<br>1.8 T 132<br>1.8 T 140<br>1.8 T quattro 132<br>1.8 T quattro 140<br>1.8 T quattro 165<br>1.8 T quattro 176<br>3.2 quattro 184   | 110<br>120<br>132<br>140<br>132<br>140<br>165<br>176<br>184                             | 09.02 06.06<br>09.05 06.06<br>10.98 06.06<br>09.05 06.06<br>10.98 06.06<br>09.05 06.06<br>10.98 06.06<br>03.05 06.06 | PR: 1LV<br>PR: 1LV<br>PR: 1LV<br>PR: 1LV<br>PR: 1LV<br>PR: 1LV<br>PR: 1LV<br>PR: 1LV   | 13.0460-7122.2<br>13.0470-7122.2  | 607122<br>LD7122   |  | 23392 20,3 +/WK<br>23392 20,3 +/WK   |
|  | 1.8 T 110<br>1.8 T 120<br>1.8 T 132<br>1.8 T 140<br>1.8 T quattro 132<br>1.8 T quattro 140<br>1.8 T quattro 165<br>1.8 T quattro 176<br>3.2 quattro 184   | 110<br>120<br>132<br>140<br>132<br>140<br>165<br>176<br>184                             | 09.02 06.06<br>09.05 06.06<br>10.98 06.06<br>09.05 06.06<br>10.98 06.06<br>09.05 06.06<br>10.98 06.06<br>03.05 06.06 | PR: 1LD,1LT,1LV<br>PR: 1LD,1LT,1LV<br>PR: 1LD,1LT,1LV<br>PR: 1LD,1LT,1LV<br>PR: 1LD,1LT,1LV<br>PR: 1LD,1LT,1LV<br>PR: 1LD,1LT,1LV<br>PR: 1LD,1LT,1LV   | 24.0125-0123.1<br>24.0325-0123.1  | 425123<br>525123   |  | 310 25,0 22,0 V L +S +B<br>310 25,0 22,0 V L +B PD                                 |
|  | 1.8 T 110<br>1.8 T 120<br>1.8 T 132<br>1.8 T 140<br>1.8 T quattro 132<br>1.8 T quattro 140<br>1.8 T quattro 165<br>1.8 T quattro 176<br>3.2 quattro 184   | 110<br>120<br>132<br>140<br>132<br>140<br>165<br>176<br>184                             | 09.02 06.06<br>09.05 06.06<br>10.98 06.06<br>09.05 06.06<br>10.98 06.06<br>09.05 06.06<br>10.98 06.06<br>03.05 06.06 | PR: 1LD,1LT,1LV<br>PR: 1LD,1LT,1LV<br>PR: 1LD,1LT,1LV<br>PR: 1LD,1LT,1LV<br>PR: 1LD,1LT,1LV<br>PR: 1LD,1LT,1LV<br>PR: 1LD,1LT,1LV<br>PR: 1LD,1LT,1LV   | 24.0132-0166.2<br>24.0132-0165.2  | 432166<br>432165   | <input type="checkbox"/> zweiteilige Bremsscheibe <sup>2)</sup><br><input type="checkbox"/> zweiteilige Bremsscheibe <sup>2)</sup> | 334 32,0 30,0 V L +B<br>334 32,0 30,0 V L +B                                       |
|  | 1.8 T 110<br>1.8 T 120<br>1.8 T 132<br>1.8 T 140<br>1.8 T quattro 132<br>1.8 T quattro 140<br>1.8 T quattro 165<br>1.8 T quattro 176<br>3.2 quattro 184   | 110<br>120<br>132<br>140<br>132<br>140<br>165<br>176<br>184                             | 09.02 06.06<br>09.05 06.06<br>10.98 06.06<br>09.05 06.06<br>10.98 06.06<br>09.05 06.06<br>10.98 06.06<br>03.05 06.06 | PR: 1LD,1LT,1LV<br>PR: 1LD,1LT,1LV<br>PR: 1LD,1LT,1LV<br>PR: 1LD,1LT,1LV<br>PR: 1LD,1LT,1LV<br>PR: 1LD,1LT,1LV<br>PR: 1LD,1LT,1LV<br>PR: 1LD,1LT,1LV   | 24.0711-1361.3<br>24.0711-1362.3  | 360022<br>360023   | <input type="checkbox"/><br><input type="checkbox"/>   | Radsensor<br>Radsensor   |

<sup>1)</sup> electric parking brake / fr.di stazionamento elettrico / frein à main électrique / freno de mano eléctrico  
<sup>2)</sup> two-piece brake disc / disco frenante in due parti / disque d.fr.en deux parties / disco de fr.de dos piezas



























**AUDI TT Coupe (98-06)**

|               |               |     |              |              |              |                       |                       |        |   |   |     |
|---------------|---------------|-----|--------------|--------------|--------------|-----------------------|-----------------------|--------|---|---|-----|
|               | 1.8 T         | 110 |              | <b>09.02</b> | <b>06.06</b> | PR: 1KE,1KK,2EK       | <b>13.0460-2894.2</b> | 602894 |   | 20961 17,4 /Zub/S<br>Belagsatz-Zubehör    | TRW |
|               | 1.8 T         | 120 |              | <b>09.05</b> | <b>06.06</b> | PR: 1KE,1KK,2EK       | <b>13.0470-2894.2</b> | LD2894 |   |   | TRW |
|               | 1.8 T         | 132 |              | <b>10.98</b> | <b>06.06</b> | PR: 1KE,1KK,2EK       | <b>13.0460-0072.2</b> | 610072 |   |   | TRW |
|               | 1.8 T         | 140 |              | <b>09.05</b> | <b>06.06</b> | PR: 1KE,1KK,2EK       |                       |        |   |   |     |
|               | 1.8 T quattro | 132 |              | <b>10.98</b> | <b>06.06</b> | PR: 1KE,1KK           |                       |        |   |   |     |
|               | 1.8 T quattro | 140 |              | <b>09.05</b> | <b>06.06</b> | PR: 1KE,1KK           |                       |        |   |   |     |
|               | 1.8 T quattro | 165 |              | <b>10.98</b> | <b>06.06</b> | PR: 1KE,1KK           |                       |        |   |   |     |
|               | 1.8 T quattro | 176 |              | <b>03.05</b> | <b>06.06</b> | PR: 1KE,1KK           |                       |        |   |   |     |
| 3.2 quattro   | 184           |     | <b>04.03</b> | <b>06.06</b> | PR: 1KE,1KK  |                       |                       |        |   |   |     |
| 1.8 T quattro | 132           |     | <b>10.98</b> | <b>06.06</b> | PR: 1KF,2EH  | <b>13.0460-2820.2</b> | 602820                |        | 20961 17,6 /S<br>20961 17,6 /S                  | TRW                                       |     |
|               | 140           |     | <b>09.05</b> | <b>06.06</b> | PR: 1KF,2EH  | <b>13.0470-2820.2</b> | LD2820                |        |   | TRW                                       |     |
|               | 165           |     | <b>10.98</b> | <b>06.06</b> | PR: 1KF,2EH  |                       |                       |        |   |   |     |
|               | 176           |     | <b>03.05</b> | <b>06.06</b> | PR: 1KF,2EH  |                       |                       |        |   |   |     |
|               | 184           |     | <b>04.03</b> | <b>06.06</b> | PR: 1KF,2EH  |                       |                       |        |   |   |     |
|               |               |     |              |              |              |                       |                       |        |   |   |     |
|               | 1.8 T         | 110 |              | <b>09.02</b> | <b>06.06</b> | PR: 1KK,2EK           | <b>24.0109-0123.1</b> | 409123 |   | 230 9,0 7,0 +S +B<br>230 9,0 7,0 +S +B PD |     |
|               | 1.8 T         | 120 |              | <b>09.05</b> | <b>06.06</b> | PR: 1KK,2EK           | <b>24.0309-0123.1</b> | 509123 |   |   |     |
|               | 1.8 T         | 132 |              | <b>10.98</b> | <b>06.06</b> | PR: 1KK,2EK           |                       |        |   |   |     |
|               | 1.8 T         | 140 |              | <b>09.05</b> | <b>06.06</b> | PR: 1KK,2EK           |                       |        |   |   |     |
| 1.8 T quattro | 132           |     | <b>10.98</b> | <b>06.06</b> | PR: 1KE      | <b>24.0109-0133.1</b> | 409133                |        | 239 8,9 7,0 +S +B<br>239 8,9 7,0 +S +B PD       |   |     |
|               | 140           |     | <b>09.05</b> | <b>06.06</b> | PR: 1KE      | <b>24.0309-0133.1</b> | 509133                |        |   |   |     |
|               | 165           |     | <b>10.98</b> | <b>06.06</b> | PR: 1KE      |                       |                       |        |   |   |     |
|               | 176           |     | <b>03.05</b> | <b>06.06</b> | PR: 1KE      |                       |                       |        |   |   |     |
|               | 184           |     | <b>04.03</b> | <b>06.06</b> | PR: 1KE      |                       |                       |        |   |   |     |
| 1.8 T quattro | 132           |     | <b>10.98</b> | <b>06.06</b> | PR: 1KF,2EH  | <b>24.0122-0163.1</b> | 422163                |        | 256 22,0 20,0 V L +B<br>256 22,0 20,0 V L +B PD |   |     |
|               | 140           |     | <b>09.05</b> | <b>06.06</b> | PR: 1KF,2EH  | <b>24.0322-0163.1</b> | 522163                |        |   |   |     |
|               | 165           |     | <b>10.98</b> | <b>06.06</b> | PR: 1KF,2EH  |                       |                       |        |   |   |     |
|               | 176           |     | <b>03.05</b> | <b>06.06</b> | PR: 1KF,2EH  |                       |                       |        |   |   |     |
|               | 184           |     | <b>04.03</b> | <b>06.06</b> | PR: 1KF,2EH  |                       |                       |        |   |   |     |
|               | 1.8 T         | 110 |              | <b>09.02</b> | <b>06.06</b> |                       | <b>24.0741-1107.3</b> | 360042 | 2   | Radsensor                                 |     |
|               | 1.8 T         | 120 |              | <b>09.05</b> | <b>06.06</b> |                       |                       |        |   |   |     |
|               | 1.8 T         | 132 |              | <b>10.98</b> | <b>06.06</b> |                       |                       |        |   |   |     |
|               | 1.8 T         | 140 |              | <b>09.05</b> | <b>06.06</b> |                       |                       |        |   |   |     |
| 1.8 T quattro | 132           |     | <b>10.98</b> | <b>06.06</b> |              | <b>24.0711-1365.3</b> | 360172                | 2      | Radsensor L=226                                 |   |     |
|               | 140           |     | <b>09.05</b> | <b>06.06</b> |              |                       |                       |        |   |   |     |
|               | 165           |     | <b>10.98</b> | <b>06.06</b> |              |                       |                       |        |   |   |     |
|               | 176           |     | <b>03.05</b> | <b>06.06</b> |              |                       |                       |        |   |   |     |
| 3.2 quattro   | 184           |     | <b>04.03</b> | <b>06.06</b> |              |                       |                       |        |   |   |     |

















**AUDI TT Roadster (99-06)**













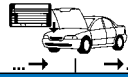





|               |               |             |              |              |                     |                       |                       |  |  |  |               |     |
|---------------|---------------|-------------|--------------|--------------|---------------------|-----------------------|-----------------------|--|--|--|---------------|-----|
|               | 1.8 T         | 110         |              | <b>01.01</b> | <b>06.06</b>        | PR: 1LD,1LT,1LV       | <b>13.0460-7081.2</b> | 607081   |  | 21911 20,3 +<br>21911 20,3 +<br>23392 20,3 +/WK<br>23392 20,3 +/WK | ATE           |     |
|               | 1.8 T         | 120         |              | <b>09.05</b> | <b>06.06</b>        | PR: 1LD,1LT,1LV       | <b>13.0470-7081.2</b> | LD7081   |  |  | ATE           |     |
|               | 1.8 T         | 132         |              | <b>04.99</b> | <b>06.06</b>        | PR: 1LD,1LT,1LV       | <b>13.0460-7122.2</b> | 607122   |  |  | ATE           |     |
|               | 1.8 T         | 140         |              | <b>09.05</b> | <b>06.06</b>        | PR: 1LD,1LT,1LV       | <b>13.0470-7122.2</b> | LD7122   |  |  | ATE           |     |
|               | 1.8 T quattro | 132         |              | <b>02.00</b> | <b>06.06</b>        | PR: 1LD,1LT,1LV       |                       |  |  |  |               |     |
|               | 1.8 T quattro | 140         |              | <b>09.05</b> | <b>06.06</b>        | PR: 1LD,1LT,1LV       |                       |  |  |  |               |     |
|               | 1.8 T quattro | 165         |              | <b>10.99</b> | <b>06.06</b>        | PR: 1LD,1LT,1LV       |                       |  |  |  |               |     |
| 1.8 T         | 110           |             | <b>01.01</b> | <b>06.06</b> | PR: 1LV             | <b>13.0460-7183.2</b> | 607183                |  |  | 21484 20,5 +/WE  | ATE           |     |
|               | 1.8 T         | 120         | <b>09.05</b> | <b>06.06</b> | PR: 1LV             |                       |                       |  |  |  |               |     |
|               | 1.8 T         | 132         | <b>04.99</b> | <b>06.06</b> | PR: 1LV             |                       |                       |  |  |  |               |     |
|               | 1.8 T         | 140         | <b>09.05</b> | <b>06.06</b> | PR: 1LV             |                       |                       |  |  |  |               |     |
|               | 1.8 T quattro | 132         | <b>02.00</b> | <b>06.06</b> | PR: 1LV             |                       |                       |  |  |  |               |     |
|               | 1.8 T quattro | 140         | <b>09.05</b> | <b>06.06</b> | PR: 1LV             |                       |                       |  |  |  |               |     |
| 3.2 quattro   | 184           |             | <b>04.03</b> | <b>06.06</b> |                     |                       |                       |  |  |  |               |     |
|               | 1.8 T         | 110         |              | <b>01.01</b> | <b>06.06</b>        | PR: 1LD,1LT,1LV       | <b>24.0125-0123.1</b> | 425123   |  | 310 25,0 22,0 V L +S +B<br>310 25,0 22,0 V L +B PD                 |               |     |
|               | 1.8 T         | 120         |              | <b>09.05</b> | <b>06.06</b>        | PR: 1LD,1LT,1LV       | <b>24.0325-0123.1</b> | 525123   |  |  |               |     |
|               | 1.8 T         | 132         |              | <b>04.99</b> | <b>06.06</b>        | PR: 1LD,1LT,1LV       |                       |  |  |  |               |     |
|               | 1.8 T         | 140         |              | <b>09.05</b> | <b>06.06</b>        | PR: 1LD,1LT,1LV       |                       |  |  |  |               |     |
|               | 1.8 T quattro | 132         |              | <b>02.00</b> | <b>06.06</b>        | PR: 1LD,1LT,1LV       |                       |  |  |  |               |     |
|               | 1.8 T quattro | 140         |              | <b>09.05</b> | <b>06.06</b>        | PR: 1LD,1LT,1LV       |                       |  |  |  |               |     |
|               | 1.8 T quattro | 165         |              | <b>10.99</b> | <b>06.06</b>        | PR: 1LD,1LT,1LV       |                       |  |  |  |               |     |
| 3.2 quattro   | 184           |             | <b>04.03</b> | <b>06.06</b> |                     | <b>24.0132-0166.2</b> | 432166                | ☐ zweiteilige Bremsscheibe <sup>1)</sup><br>☐ zweiteilige Bremsscheibe <sup>1)</sup> | 334 32,0 30,0 V L +B<br>334 32,0 30,0 V L +B |  |               |     |
|               |               |             |              |              |                     | <b>24.0132-0165.2</b> | 432165                |  |  |  |               |     |
|               |               |             |              |              |                     |                       |                       |  |  |  |               |     |
|               |               |             |              |              |                     |                       |                       |  |  |  |               |     |
|               | 1.8 T         | 110         |              | <b>01.01</b> | <b>06.06</b>        |                       | <b>24.0711-1361.3</b> | 360022   | ☐<br>☐<br>☐                                  | Radsensor<br>Radsensor   |               |     |
|               | 1.8 T         | 120         |              | <b>09.05</b> | <b>06.06</b>        |                       | <b>24.0711-1362.3</b> | 360023   |  |  |               |     |
|               | 1.8 T         | 132         |              | <b>04.99</b> | <b>06.06</b>        |                       |                       |  |  |  |               |     |
|               | 1.8 T         | 140         |              | <b>09.05</b> | <b>06.06</b>        |                       |                       |  |  |  |               |     |
|               | 1.8 T quattro | 132         |              | <b>02.00</b> | <b>06.06</b>        |                       |                       |  |  |  |               |     |
|               | 1.8 T quattro | 140         |              | <b>09.05</b> | <b>06.06</b>        |                       |                       |  |  |  |               |     |
|               | 1.8 T quattro | 165         |              | <b>10.99</b> | <b>06.06</b>        |                       |                       |  |  |  |               |     |
| 3.2 quattro   | 184           |             | <b>04.03</b> | <b>06.06</b> |                     |                       |                       |  |  |  |               |     |
|               | 1.8 T         | 110         | 8N5-011 000  | <b>01.01</b> | <b>06.06</b>        | PR: 1KE,1KF,1KK,2EH   | <b>13.0460-2894.2</b> | 602894   |  | 20961 17,4 /Zub/S<br>20961 17,4 /Zub/S<br>Belagsatz-Zubehör        | TRW           |     |
|               | 1.8 T         | 120         | 8N5-011 000  | <b>09.05</b> | <b>06.06</b>        | PR: 1KE,1KF,1KK,2EH   | <b>13.0470-2894.2</b> | LD2894   |  |  | TRW           |     |
|               | 1.8 T         | 132         | 8N5-011 000  | <b>04.99</b> | <b>06.06</b>        | PR: 1KE,1KF,1KK,2EH   | <b>13.0460-0072.2</b> | 610072   |  |  | TRW           |     |
|               | 1.8 T         | 140         | 8N5-011 000  | <b>09.05</b> | <b>06.06</b>        | PR: 1KE,1KF,1KK,2EH   |                       |  |  |  |               |     |
|               | 1.8 T quattro | 132         | 8N5-011 000  | <b>02.00</b> | <b>06.06</b>        | PR: 1KE,1KF,1KK,2EH   |                       |  |  |  |               |     |
|               | 1.8 T quattro | 140         | 8N5-011 000  | <b>09.05</b> | <b>06.06</b>        | PR: 1KE,1KF,1KK,2EH   |                       |  |  |  |               |     |
|               | 1.8 T quattro | 165         | 8N5-011 000  | <b>10.99</b> | <b>06.06</b>        | PR: 1KE,1KF,1KK,2EH   |                       |  |  |  |               |     |
|               | 1.8 T quattro | 184         | 8N5-011 000  | <b>04.03</b> | <b>06.06</b>        | PR: 1KE,1KF,1KK,2EH   |                       |  |  |  |               |     |
|               | 1.8 T         | 110         | 8N5-011 001  |              | <b>06.06</b>        | PR: 1KE,1KF,1KK,2EH   | <b>13.0460-2886.2</b> | 602886   |  |  | 20961 16,2 /S | TRW |
|               | 1.8 T         | 120         | 8N5-011 001  |              | <b>06.06</b>        | PR: 1KE,1KF,1KK,2EH   | <b>13.0470-2886.2</b> | LD2886   |  |  | 20961 16,2 /S | TRW |
| 1.8 T         | 132           | 8N5-011 001 |              | <b>06.06</b> | PR: 1KE,1KF,1KK,2EH | <b>13.0460-0072.2</b> | 610072                |  | Belagsatz-Zubehör                            | TRW  |               |     |
| 1.8 T         | 140           | 8N5-011 001 |              | <b>06.06</b> | PR: 1KE,1KF,1KK,2EH |                       |                       |  |  |  |               |     |
| 1.8 T quattro | 132           | 8N5-011 001 |              | <b>06.06</b> | PR: 1KE,1KF,1KK,2EH |                       |                       |  |  |  |               |     |
| 1.8 T quattro | 140           | 8N5-011 001 |              | <b>06.06</b> | PR: 1KE,1KF,1KK,2EH |                       |                       |  |  |  |               |     |

<sup>1)</sup> two-piece brake disc / disco frenante in due parti / disque d.fr.en deux parties / disco de fr.de dos piezas

|     |  |  |  |  |  |  |  |  |                            |                       |
|--|--|--|--|--|---|--|--|--|----------------------------|-----------------------|
| <b>AUDI TT Roadster (99-06)</b>  |  |  |  |  |   |  |  |  |                            |                       |
|    | 1.8 T quattro  | 165  | 8N5-011 001  |  | 06.06   | PR: 1KE,1KF,1KK,2EH  | 13.0460-2886.2   | 602886   | 20961 16,2 /S              | TRW                   |
|  | 3.2 quattro  | 184  | 8N5-011 001  |  | 06.06   | PR: 1KE,1KF,1KK,2EH  | 13.0470-2886.2   | LD2886   | 20961 16,2 /S              | TRW                   |
|  |  |  |  |  |   |  | 13.0460-0072.2   | 610072   | Belagsatz-Zubehör          | TRW                   |
|  | 1.8 T  | 110  |  | 01.01  | 06.06   | PR: 2EK  | 13.0460-2894.2   | 602894   | 20961 17,4 /Zub/S          | TRW                   |
|  | 1.8 T  | 120  |  | 09.05  | 06.06   | PR: 2EK  | 13.0470-2894.2   | LD2894   | 20961 17,4 /Zub/S          | TRW                   |
|  | 1.8 T  | 132  |  | 04.99  | 06.06   | PR: 2EK  |  |  |                            |                       |
|  | 1.8 T  | 140  |  | 09.05  | 06.06   | PR: 2EK  |  |  |                            |                       |
|    | 1.8 T  | 110  |  | 01.01  | 06.06   | PR: 1KK,2EK  | 24.0109-0123.1   | 409123   | 230 9,0 7,0 +S +B          |                       |
|  | 1.8 T  | 120  |  | 09.05  | 06.06   | PR: 1KK,2EK  | 24.0309-0123.1   | 509123   | 230 9,0 7,0 +S +B PD       |                       |
|  | 1.8 T  | 132  |  | 04.99  | 06.06   | PR: 1KK,2EK  |  |  |                            |                       |
|  | 1.8 T  | 140  |  | 09.05  | 06.06   | PR: 1KK,2EK  |  |  |                            |                       |
|    | 1.8 T quattro  | 132  |  | 02.00  | 06.06   | PR: 1KE  | 24.0109-0133.1   | 409133   | 239 8,9 7,0 +S +B          |                       |
|  | 1.8 T quattro  | 140  |  | 09.05  | 06.06   | PR: 1KE  | 24.0309-0133.1   | 509133   | 239 8,9 7,0 +S +B PD       |                       |
|  | 1.8 T quattro  | 165  |  | 10.99  | 06.06   | PR: 1KE  |  |  |                            |                       |
|  | 3.2 quattro  | 184  |  | 04.03  | 06.06   | PR: 1KE  |  |  |                            |                       |
|    | 1.8 T quattro  | 132  |  | 02.00  | 06.06   | PR: 1KF,2EH  | 24.0122-0163.1   | 422163   | 256 22,0 20,0 V L +B       |                       |
|  | 1.8 T quattro  | 140  |  | 09.05  | 06.06   | PR: 1KF,2EH  | 24.0322-0163.1   | 522163   | 256 22,0 20,0 V L +B PD    |                       |
|  | 1.8 T quattro  | 165  |  | 10.99  | 06.06   | PR: 1KF,2EH  |  |  |                            |                       |
|  | 3.2 quattro  | 184  |  | 04.03  | 06.06   | PR: 1KF,2EH  |  |  |                            |                       |
|    | 1.8 T  | 110  |  | 01.01  | 06.06   |  | 24.0741-1107.3   | 360042   | 2                          | Radsensor             |
|  | 1.8 T  | 120  |  | 09.05  | 06.06   |  |  |  |                            |                       |
|  | 1.8 T  | 132  |  | 04.99  | 06.06   |  |  |  |                            |                       |
|  | 1.8 T  | 140  |  | 09.05  | 06.06   |  |  |  |                            |                       |
|    | 1.8 T quattro  | 132  |  | 02.00  | 06.06   |  | 24.0711-1365.3   | 360172   | 2                          | Radsensor L=226       |
|  | 1.8 T quattro  | 140  |  | 09.05  | 06.06   |  |  |  |                            |                       |
|  | 1.8 T quattro  | 165  |  | 10.99  | 06.06   |  |  |  |                            |                       |
|  | 3.2 quattro  | 184  |  | 04.03  | 06.06   |  |  |  |                            |                       |
| <b>AUDI TT Coupe (06-14)</b>   |  |  |  |  |   |  |  |  |                            |                       |
|    | 1.8 TFSI   | 118  |  | 06.08  | 06.14   | PR: 1LJ,1LL  | 13.0460-7226.2   | 607226   | 23587 20,4 +/WK            | ATE                   |
|  | 2.0 quattro  | 195  |  | 05.08  | 06.14   | PR: 1LJ,1LL  | 13.0470-7226.2   | LD7226   | 23587 20,4 +/WK            | ATE                   |
|  | 2.0 TDI quattro  | 125  |  | 06.08  | 06.14   | PR: 1LJ,1LL  |  |  |                            |                       |
|  | 2.0 TFSI   | 147  |  | 07.06  | 06.14   | PR: 1LJ,1LL  |  |  |                            |                       |
|  | 2.0 TFSI   | 155  |  | 05.10  | 06.14   | PR: 1LJ,1LL  |  |  |                            |                       |
|  | 2.0 TFSI quattro   | 147  |  | 05.08  | 06.14   | PR: 1LJ,1LL  |  |  |                            |                       |
|  | 2.0 TFSI quattro   | 155  |  | 05.10  | 06.14   | PR: 1LJ,1LL  |  |  |                            |                       |
|  | 3.2 quattro  | 184  |  | 07.06  | 06.14   | PR: 1LJ,1LL  |  |  |                            |                       |
|    | 1.8 TFSI   | 118  |  | 06.08  | 06.14   | PR: 1LK,1LM,1LN  | 13.0460-7227.2   | 607227   | 23801 20,3 +/WK            | ATE                   |
|  | 2.0 quattro  | 195  |  | 05.08  | 06.14   | PR: 1LK,1LM,1LN  | 13.0470-7227.2   | LD7227   | 23801 20,4 +/WK            | ATE                   |
|  | 2.0 TDI quattro  | 125  |  | 06.08  | 06.14   | PR: 1LK,1LM,1LN  |  |  |                            |                       |
|  | 2.0 TFSI   | 147  |  | 07.06  | 06.14   | PR: 1LK,1LM,1LN  |  |  |                            |                       |
|  | 2.0 TFSI   | 155  |  | 05.10  | 06.14   | PR: 1LK,1LM,1LN  |  |  |                            |                       |
|  | 2.0 TFSI quattro   | 147  |  | 05.08  | 06.14   | PR: 1LK,1LM,1LN  |  |  |                            |                       |
|  | 2.0 TFSI quattro   | 155  |  | 05.10  | 06.14   | PR: 1LK,1LM,1LN  |  |  |                            |                       |
|  | 3.2 quattro  | 184  |  | 07.06  | 06.14   | PR: 1LK,1LM,1LN  |  |  |                            |                       |
|  | TTS 2.0 TFSI   | 200  |  | 05.08  | 06.14   | PR: 1LN  |  |  |                            |                       |
|  | RS 2.5 TFSI  | 250  |  | 05.09  | 06.14   | PR: 1LA  | 13.0460-4833.2   | 604833   | 24098 17,1 /WE             | BRE                   |
|  | RS 2.5 TFSI plus   | 265  |  | 05.11  | 06.14   | PR: 1LA  | 24.8190-0302.2   | 620302   | 1                          | Warnkontakt L=367,4mm |
|  | 1.8 TFSI   | 118  |  | 06.08  | 06.14   | PR: 1LJ,1LL  | 24.0125-0158.1   | 425158   | 312 25,0 22,0 V L +S +B    |                       |
|  | 2.0 quattro  | 195  |  | 05.08  | 06.14   | PR: 1LJ,1LL  | 24.0325-0158.1   | 525158   | 312 25,0 22,0 V L +S +B PD |                       |
|  | 2.0 TDI quattro  | 125  |  | 06.08  | 06.14   | PR: 1LJ,1LL  |  |  |                            |                       |
|  | 2.0 TFSI   | 147  |  | 07.06  | 06.14   | PR: 1LJ,1LL  |  |  |                            |                       |
|  | 2.0 TFSI   | 155  |  | 05.10  | 06.14   | PR: 1LJ,1LL  |  |  |                            |                       |
|  | 2.0 TFSI quattro   | 147  |  | 05.08  | 06.14   | PR: 1LJ,1LL  |  |  |                            |                       |
|  | 2.0 TFSI quattro   | 155  |  | 05.10  | 06.14   | PR: 1LJ,1LL  |  |  |                            |                       |
|  | 3.2 quattro  | 184  |  | 07.06  | 06.14   | PR: 1LJ,1LL  |  |  |                            |                       |
|  | 1.8 TFSI   | 118  |  | 06.08  | 06.14   | PR: 1LK,1LM  | 24.0130-0187.1   | 430187   | 340 30,0 28,0 V L +S +B    |                       |
|  | 2.0 quattro  | 195  |  | 05.08  | 06.14   | PR: 1LK,1LM  |  |  |                            |                       |
|  | 2.0 TDI quattro  | 125  |  | 06.08  | 06.14   | PR: 1LK,1LM  |  |  |                            |                       |
|  | 2.0 TFSI   | 147  |  | 07.06  | 06.14   | PR: 1LK,1LM  |  |  |                            |                       |
|  | 2.0 TFSI   | 155  |  | 05.10  | 06.14   | PR: 1LK,1LM  |  |  |                            |                       |
|  | 2.0 TFSI quattro   | 147  |  | 05.08  | 06.14   | PR: 1LK,1LM  |  |  |                            |                       |
|  | 2.0 TFSI quattro   | 155  |  | 05.10  | 06.14   | PR: 1LK,1LM  |  |  |                            |                       |
|  | 3.2 quattro  | 184  |  | 07.06  | 06.14   | PR: 1LK,1LM  |  |  |                            |                       |
|  | TTS 2.0 TFSI   | 200  |  | 05.08  | 06.14   | PR: 1LN  | 24.0130-0219.1   | 430219   | 340 30,0 28,0 V L +S +B    |                       |
|  | 1.8 TFSI   | 118  |  | 06.08  | 06.14   |  | 24.0711-5271.3   | 360301   |                            | Radsensor             |
|  | 2.0 quattro  | 195  |  | 05.08  | 06.14   |  | 24.0711-5272.3   | 360302   |                            | Radsensor             |
|  | 2.0 TDI quattro  | 125  |  | 06.08  | 06.14   |  |  |  |                            |                       |
|  | 2.0 TFSI   | 147  |  | 07.06  | 06.14   |  |  |  |                            |                       |
|  | 2.0 TFSI   | 155  |  | 05.10  | 06.14   |  |  |  |                            |                       |
|  | 2.0 TFSI quattro   | 147  |  | 05.08  | 06.14   |  |  |  |                            |                       |
|  | 2.0 TFSI quattro   | 155  |  | 05.10  | 06.14   |  |  |  |                            |                       |
|  | 3.2 quattro  | 184  |  | 07.06  | 06.14   |  |  |  |                            |                       |
|  | RS 2.5 TFSI  | 250  |  | 05.09  | 06.14   |  |  |  |                            |                       |
| RS 2.5 TFSI plus   | 265  |  | 05.11  | 06.14  |   |  |  |  |                            |                       |
| TTS 2.0 TFSI   | 200  |  | 05.08  | 06.14  |   |  |  |  |                            |                       |
|  | 1.8 TFSI   | 118  |  | 06.08  | 06.14   | PR: 1KJ,2EE  | 13.0460-2880.2   | 602880   | 23914 17,1 /WE/Zub/S       | TRW                   |
|  | 2.0 quattro  | 195  |  | 05.08  | 06.14   | PR: 1KJ,2EE  | 13.0470-2880.2   | LD2880   | 23914 17,1 /WE/Zub/S       | TRW                   |
|  | 2.0 TDI quattro  | 125  |  | 06.08  | 06.14   | PR: 1KJ,2EE  | 13.0460-0259.2   | 610259   | Belagsatz-Zubehör          |                       |
|  | 2.0 TFSI   | 147  |  | 07.06  | 06.14   | PR: 1KJ,2EE  |  |  |                            |                       |
|  | 2.0 TFSI   | 155  |  | 05.10  | 06.14   | PR: 1KJ,2EE  |  |  |                            |                       |
|  | 2.0 TFSI quattro   | 147  |  | 05.08  | 06.14   | PR: 1KJ,2EE  |  |  |                            |                       |
|  | 2.0 TFSI quattro   | 155  |  | 05.10  | 06.14   | PR: 1KJ,2EE  |  |  |                            |                       |
|  | 3.2 quattro  | 184  |  | 07.06  | 06.14   | PR: 1KJ,2EE  |  |  |                            |                       |



|     |   |   |   |    |   |    |    |   |
|--|---|---|---|--|--|--|--|---|
| <b>AUDI TT Coupe (06-14)</b>   |   |   |   |  |  |  |  |   |
|    | RS 2.5 TFSI<br>RS 2.5 TFSI plus<br>TTS 2.0 TFSI   | 250<br>265<br>200   | 05.09<br>05.11<br>05.08   | 06.14<br>06.14<br>06.14 PR: 2ED,2EG  | 13.0460-2887.2<br>13.0470-2887.2<br>13.0470-2887.2 LD2887  | 602887<br>602887   |  | 23914 17,1 /WE/Zub/S TRW<br>23914 17,1 /WE/Zub/S TRW<br>23914 17,1 /WE/Zub/S TRW  |
|    | 1.8 TFSI<br>2.0 quattro<br>2.0 TDI quattro<br>2.0 TFSI<br>2.0 TFSI<br>2.0 TFSI quattro<br>2.0 TFSI quattro<br>3.2 quattro<br>RS 2.5 TFSI<br>RS 2.5 TFSI plus<br>TTS 2.0 TFSI  | 118<br>195<br>125<br>147<br>155<br>147<br>155<br>184<br>250<br>265<br>200   | 06.08<br>05.08<br>06.08<br>07.06<br>05.10<br>05.08<br>05.10<br>07.06<br>05.09<br>05.11<br>05.08   | 06.14<br>06.14<br>06.14<br>06.14<br>06.14<br>06.14<br>06.14<br>06.14<br>06.14<br>06.14<br>06.14<br>06.14 PR: 2ED,2EG   | 24.0112-0175.1<br>24.0112-0175.1<br>24.0112-0175.1<br>24.0112-0175.1<br>24.0112-0175.1<br>24.0112-0175.1<br>24.0112-0175.1<br>24.0112-0175.1<br>24.0122-0242.1<br>24.0122-0242.1<br>24.0122-0242.1   | 412175<br>412175<br>412175<br>412175<br>412175<br>412175<br>412175<br>412175<br>422242<br>422242<br>422242   |  | 286 12,0 10,0 +S +B<br>310 22,0 20,0 V L +S +B  |
|    | 1.8 TFSI<br>2.0 TFSI<br>2.0 TFSI<br>2.0 quattro<br>2.0 TDI quattro<br>2.0 TFSI quattro<br>2.0 TFSI quattro<br>3.2 quattro<br>RS 2.5 TFSI<br>RS 2.5 TFSI plus<br>TTS 2.0 TFSI  | 118<br>147<br>155<br>195<br>125<br>147<br>155<br>184<br>250<br>265<br>200   | 06.08<br>07.06<br>05.10<br>05.08<br>06.08<br>05.08<br>05.10<br>07.06<br>05.09<br>05.11<br>05.08   | 06.14<br>06.14<br>06.14<br>06.14<br>06.14<br>06.14<br>06.14<br>06.14<br>06.14<br>06.14<br>06.14<br>06.14 PR: 2ED,2EG   | 24.0711-6231.3<br>24.0711-6232.3<br>24.0711-6232.3<br>24.0711-5271.3<br>24.0711-5272.3<br>24.0711-5272.3<br>24.0711-5272.3<br>24.0711-5272.3<br>24.0711-5272.3<br>24.0711-5272.3<br>24.0711-5272.3   | 360305<br>360306<br>360306<br>360301<br>360302<br>360302<br>360302<br>360302<br>360302<br>360302<br>360302   | <input type="checkbox"/><br><input type="checkbox"/><br><input type="checkbox"/><br><input type="checkbox"/><br><input type="checkbox"/><br><input type="checkbox"/><br><input type="checkbox"/><br><input type="checkbox"/><br><input type="checkbox"/><br><input type="checkbox"/><br><input type="checkbox"/> | Radsensor<br>Radsensor<br>Radsensor<br>Radsensor  |
| <b>AUDI TT Roadster (07-14)</b>  |   |   |   |  |  |  |  |   |
|    | 1.8 TFSI<br>2.0 quattro<br>2.0 TDI quattro<br>2.0 TFSI<br>2.0 TFSI<br>2.0 TFSI quattro<br>2.0 TFSI quattro<br>3.2 quattro<br>1.8 TFSI<br>2.0 quattro<br>2.0 TDI quattro<br>2.0 TFSI<br>2.0 TFSI<br>2.0 TFSI quattro<br>2.0 TFSI quattro<br>3.2 quattro<br>TTS 2.0 TFSI<br>RS 2.5 TFSI<br>RS 2.5 TFSI plus | 118<br>195<br>125<br>147<br>155<br>147<br>155<br>184<br>118<br>195<br>125<br>147<br>155<br>147<br>155<br>184<br>200<br>250<br>265 | 06.08<br>05.08<br>06.08<br>02.07<br>05.10<br>05.08<br>05.10<br>02.07<br>06.08<br>05.08<br>06.08<br>02.07<br>05.10<br>05.08<br>05.10<br>02.07<br>05.08<br>05.09<br>02.12 | 06.14<br>06.14<br>06.14<br>06.14<br>06.14<br>06.14<br>06.14<br>06.14<br>06.14 PR: 1LJ,1LL<br>06.14 PR: 1LJ,1LL<br>06.14 PR: 1LJ,1LL<br>06.14 PR: 1LJ,1LL<br>06.14 PR: 1LJ,1LL<br>06.14 PR: 1LJ,1LL<br>06.14 PR: 1LJ,1LL<br>06.14 PR: 1LJ,1LL<br>06.14 PR: 1LJ,1LL<br>06.14 PR: 1LJ,1LL<br>06.14 PR: 1LJ,1LL<br>06.14 PR: 1LJ,1LL<br>06.14 PR: 1LJ,1LL<br>06.14 PR: 1LJ,1LL<br>06.14 PR: 1LJ,1LL<br>06.14 PR: 1LJ,1LL<br>06.14 PR: 1LA<br>06.14 PR: 1LA                                   | 13.0460-7226.2<br>13.0470-7226.2<br>13.0460-7227.2<br>13.0470-7227.2<br>13.0460-7227.2<br>13.0470-7227.2<br>13.0460-7227.2<br>13.0470-7227.2<br>13.0460-4833.2<br>24.8190-0302.2   | 607226<br>LD7226<br>607227<br>LD7227<br>604833<br>620302   |  | 23587 20,4 +/WK ATE<br>23587 20,4 +/WK ATE<br>23801 20,3 +/WK ATE<br>23801 20,4 +/WK ATE<br>24098 17,1 /WE BRE<br>Warnkontakt L=367,4mm |
|  | 1.8 TFSI<br>2.0 quattro<br>2.0 TDI quattro<br>2.0 TFSI<br>2.0 TFSI<br>2.0 TFSI quattro<br>2.0 TFSI quattro<br>3.2 quattro<br>RS 2.5 TFSI<br>1.8 TFSI<br>2.0 quattro<br>2.0 TDI quattro<br>2.0 TFSI<br>2.0 TFSI<br>2.0 TFSI quattro<br>2.0 TFSI quattro<br>3.2 quattro<br>RS 2.5 TFSI<br>TTS 2.0 TFSI      | 118<br>195<br>125<br>147<br>155<br>147<br>155<br>184<br>250<br>118<br>195<br>125<br>147<br>155<br>147<br>155<br>184<br>250<br>200 | 06.08<br>05.08<br>06.08<br>02.07<br>05.10<br>05.08<br>05.10<br>02.07<br>05.09<br>06.08<br>05.08<br>06.08<br>02.07<br>05.10<br>05.08<br>05.10<br>02.07<br>05.09<br>05.08 | 06.14<br>06.14<br>06.14<br>06.14<br>06.14<br>06.14<br>06.14<br>06.14<br>06.14<br>06.14 PR: 1LJ,1LL<br>06.14 PR: 1LJ,1LL<br>06.14 PR: 1LJ,1LL<br>06.14 PR: 1LJ,1LL<br>06.14 PR: 1LJ,1LL<br>06.14 PR: 1LJ,1LL<br>06.14 PR: 1LJ,1LL<br>06.14 PR: 1LJ,1LL<br>06.14 PR: 1LJ,1LL<br>06.14 PR: 1LJ,1LL<br>06.14 PR: 1LJ,1LL<br>06.14 PR: 1LJ,1LL<br>06.14 PR: 1LJ,1LL<br>06.14 PR: 1LJ,1LL<br>06.14 PR: 1LJ,1LL<br>06.14 PR: 1LJ,1LL<br>06.14 PR: 1LJ,1LL<br>06.14 PR: 1LJ,1LL<br>06.14 PR: 1LN | 24.0125-0158.1<br>24.0325-0158.1<br>24.0125-0158.1<br>24.0325-0158.1<br>24.0125-0158.1<br>24.0325-0158.1<br>24.0125-0158.1<br>24.0325-0158.1<br>24.0125-0158.1<br>24.0325-0158.1<br>24.0125-0158.1<br>24.0325-0158.1<br>24.0125-0158.1<br>24.0325-0158.1<br>24.0125-0158.1<br>24.0325-0158.1<br>24.0125-0158.1<br>24.0325-0158.1<br>24.0125-0158.1<br>24.0325-0158.1 | 425158<br>525158<br>425158<br>525158<br>425158<br>525158<br>425158<br>525158<br>425158<br>525158<br>425158<br>525158<br>425158<br>525158<br>425158<br>525158<br>425158<br>525158<br>425158<br>525158 |  | 312 25,0 22,0 V L +S +B<br>312 25,0 22,0 V L +S +B PD<br>340 30,0 28,0 V L +S +B<br>340 30,0 28,0 V L +S +B                             |
|  | 1.8 TFSI<br>2.0 quattro<br>2.0 TDI quattro<br>2.0 TFSI<br>2.0 TFSI<br>2.0 TFSI quattro<br>2.0 TFSI quattro<br>3.2 quattro<br>RS 2.5 TFSI<br>RS 2.5 TFSI plus<br>TTS 2.0 TFSI  | 118<br>195<br>125<br>147<br>155<br>147<br>155<br>184<br>250<br>265<br>200   | 06.08<br>05.08<br>06.08<br>02.07<br>05.10<br>05.08<br>05.10<br>02.07<br>05.09<br>02.12<br>05.08   | 06.14<br>06.14<br>06.14<br>06.14<br>06.14<br>06.14<br>06.14<br>06.14<br>06.14<br>06.14<br>06.14<br>06.14 PR: 1LJ,1LL   | 24.0711-5271.3<br>24.0711-5272.3<br>24.0711-5272.3<br>24.0711-5272.3<br>24.0711-5272.3<br>24.0711-5272.3<br>24.0711-5272.3<br>24.0711-5272.3<br>24.0711-5272.3<br>24.0711-5272.3<br>24.0711-5272.3   | 360301<br>360302<br>360302<br>360302<br>360302<br>360302<br>360302<br>360302<br>360302<br>360302<br>360302   | <input type="checkbox"/><br><input type="checkbox"/><br><input type="checkbox"/><br><input type="checkbox"/><br><input type="checkbox"/><br><input type="checkbox"/><br><input type="checkbox"/><br><input type="checkbox"/><br><input type="checkbox"/><br><input type="checkbox"/><br><input type="checkbox"/> | Radsensor<br>Radsensor  |
|  | 1.8 TFSI<br>2.0 quattro<br>2.0 TDI quattro<br>2.0 TFSI<br>2.0 TFSI<br>2.0 TFSI quattro<br>2.0 TFSI quattro<br>3.2 quattro   | 118<br>195<br>125<br>147<br>155<br>147<br>155<br>184  | 06.08<br>05.08<br>06.08<br>02.07<br>05.10<br>05.08<br>05.10<br>02.07  | 06.14<br>06.14<br>06.14<br>06.14<br>06.14<br>06.14<br>06.14<br>06.14 PR: 1KJ,2EE   | 13.0460-2880.2<br>13.0470-2880.2<br>13.0460-2880.2<br>13.0460-0259.2   | 602880<br>LD2880<br>610259   |  | 23914 17,1 /WE/Zub/S TRW<br>23914 17,1 /WE/Zub/S TRW<br>Belagsatz-Zubehör   |



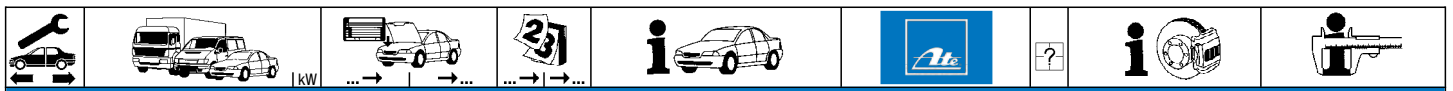



















|     |    |  |                 |   |   |                            |                            |  |
|--|--|--|---|---|--|--|--|--|
| <b>AUDI TT Roadster (07-14)</b>  |  |  |   |   |  |  |  |  |
|    | RS 2.5 TFSI<br>RS 2.5 TFSI plus<br>TTS 2.0 TFSI  | 250<br>265<br>200  | 05.09<br>02.12<br>05.08   | 06.14<br>06.14<br>06.14   | PR: 2ED,2EG  | 13.0460-2887.2<br>602887<br>13.0460-2887.2<br>602887<br>13.0470-2887.2<br>LD2887                             |  | 23914 17,1 /WE/Zub/S TRW<br>23914 17,1 /WE/Zub/S TRW<br>23914 17,1 /WE/Zub/S TRW   |
|    | 1.8 TFSI<br>2.0 quattro<br>2.0 TDI quattro<br>2.0 TFSI<br>2.0 TFSI<br>2.0 TFSI quattro<br>2.0 TFSI quattro<br>3.2 quattro<br>RS 2.5 TFSI<br>RS 2.5 TFSI plus<br>TTS 2.0 TFSI | 118<br>195<br>125<br>147<br>155<br>147<br>155<br>184<br>250<br>265<br>200        | 06.08<br>05.08<br>06.08<br>02.07<br>05.10<br>05.08<br>05.10<br>02.07<br>05.09<br>02.12<br>05.08 | 06.14<br>06.14<br>06.14<br>06.14<br>06.14<br>06.14<br>06.14<br>06.14<br>06.14<br>06.14<br>06.14                                   | PR: 1KZ,2ED<br>PR: 1KJ,2EE<br>PR: 1KJ,2EE<br>PR: 1KZ,2ED<br>PR: 1KZ,2ED<br>PR: 1KJ,2EE<br>PR: 1KJ,2EE<br>PR: 1KJ,2EE<br>PR: 1KJ,2EE<br>PR: 2ED,2EG | 24.0112-0175.1<br>412175<br>24.0122-0242.1<br>422242   |  | 286 12,0 10,0 +S +B<br>310 22,0 20,0 V L +S +B                                     |
|    | 1.8 TFSI<br>2.0 TFSI<br>2.0 TFSI<br>2.0 quattro<br>2.0 TDI quattro<br>2.0 TFSI quattro<br>2.0 TFSI quattro<br>3.2 quattro<br>RS 2.5 TFSI<br>RS 2.5 TFSI plus<br>TTS 2.0 TFSI | 118<br>147<br>155<br>195<br>125<br>147<br>155<br>184<br>250<br>265<br>200        | 06.08<br>02.07<br>05.10<br>05.08<br>06.08<br>05.08<br>05.10<br>02.07<br>05.09<br>02.12<br>05.08 | 06.14<br>06.14<br>06.14<br>06.14<br>06.14<br>06.14<br>06.14<br>06.14<br>06.14<br>06.14<br>06.14                                   |  | 24.0711-6231.3<br>360305<br>24.0711-6232.3<br>360306<br>24.0711-5271.3<br>360301<br>24.0711-5272.3<br>360302 | <input type="checkbox"/><br><input type="checkbox"/><br><input type="checkbox"/><br><input type="checkbox"/> | Radsensor<br>Radsensor<br>Radsensor<br>Radsensor                                   |
| <b>AUDI TT (14-)</b>   |  |  |   |   |  |  |  |  |
|    | 1.8 TFSI<br>2.0 TDI<br>2.0 TDI quattro<br>2.0 TFSI<br>2.0 TFSI quattro<br>2.0 TFSI quattro<br>TTS 2.0 quattro<br>TTS 2.0 quattro   | 132<br>135<br>135<br>169<br>169<br>215<br>210<br>228                             | 07.15<br>07.14<br>07.14<br>07.14<br>07.14<br>07.15<br>02.15<br>07.14                            | PR: 1LJ,1ZD<br>PR: 1LJ,1ZD<br>PR: 1LJ,1ZD<br>PR: 1LJ,1ZD<br>PR: 1LJ,1ZD<br>PR: 1LJ,1ZD<br>PR: 1LJ,1ZD                             | 13.0460-2785.2<br>602785<br>13.0470-2785.2<br>LD2785<br>24.8190-0065.2<br>620065   | 1  |  | 25683 20,4 +/WK/S TRW<br>25683 20,4 +/WK/S TRW<br>Warnkontakt L=172mm              |
|   | 1.8 TFSI<br>2.0 TDI<br>2.0 TDI quattro<br>2.0 TFSI<br>2.0 TFSI quattro<br>2.0 TFSI quattro<br>TTS 2.0 quattro<br>TTS 2.0 quattro   | 132<br>135<br>135<br>169<br>169<br>215<br>210<br>228                             | 07.15<br>07.14<br>07.14<br>07.14<br>07.14<br>07.15<br>02.15<br>07.14                            | PR: 1LJ,1ZD<br>PR: 1LJ,1ZD<br>PR: 1LJ,1ZD<br>PR: 1LJ,1ZD<br>PR: 1LJ,1ZD<br>PR: 1LJ,1ZD<br>PR: 1LJ,1ZD                             | 24.0125-0158.1<br>425158<br>24.0325-0158.1<br>525158   |  |  | 312 25,0 22,0 V L +S +B<br>312 25,0 22,0 V L +S +B PD                              |
|  | 1.8 TFSI<br>2.0 TDI<br>2.0 TDI quattro<br>2.0 TFSI<br>2.0 TFSI quattro<br>2.0 TFSI quattro<br>TTS 2.0 quattro<br>TTS 2.0 quattro   | 132<br>135<br>135<br>169<br>169<br>215<br>210<br>228                             | 07.15<br>07.14<br>07.14<br>07.14<br>07.14<br>07.15<br>02.15<br>07.14                            | PR: 1LK,1LH<br>PR: 1LK,1LH<br>PR: 1LK,1LH<br>PR: 1LK,1LH<br>PR: 1LK,1LH<br>PR: 1LK,1LH<br>PR: 1LK,1LH                             | 24.0130-0225.1<br>430225   |  |  | 340 30,0 27,0 V L +S +B  |
|  | 1.8 TFSI<br>2.0 TDI<br>2.0 TDI quattro<br>2.0 TFSI<br>2.0 TFSI quattro<br>2.0 TFSI quattro<br>TTS 2.0 quattro<br>TTS 2.0 quattro   | 132<br>135<br>135<br>169<br>169<br>215<br>210<br>228                             | 07.15<br>07.14<br>07.14<br>07.14<br>07.14<br>07.15<br>02.15<br>07.14                            |   | 24.0711-5273.3<br>360303<br>24.0711-5274.3<br>360304   | <input type="checkbox"/><br><input type="checkbox"/>   |  | Radsensor<br>Radsensor   |
|  | 1.8 TFSI<br>2.0 TDI<br>2.0 TDI quattro<br>2.0 TFSI<br>2.0 TFSI quattro<br>2.0 TFSI quattro<br>TTS 2.0 quattro<br>TTS 2.0 quattro   | 132<br>135<br>135<br>169<br>169<br>215<br>210<br>228                             | 07.15<br>07.14<br>07.14<br>07.14<br>07.14<br>07.15<br>02.15<br>07.14                            | PR: 1KZ<br>PR: 1KZ<br>PR: 1KZ<br>PR: 1KZ<br>PR: 1KZ<br>PR: 1KZ<br>PR: 1KZ   | 13.0460-7293.2<br>607293   |  |  | 25008 16,3 + ATE   |
|  | 1.8 TFSI<br>2.0 TDI<br>2.0 TDI quattro<br>2.0 TFSI<br>2.0 TFSI quattro<br>2.0 TFSI quattro<br>TTS 2.0 quattro<br>TTS 2.0 quattro   | 132<br>135<br>135<br>169<br>169<br>215<br>210<br>228                             | 07.15<br>07.14<br>07.14<br>07.14<br>07.14<br>07.15<br>02.15<br>07.14                            | PR: 2ED,2EG,2EK<br>PR: 2ED,2EG,2EK<br>PR: 2ED,2EG,2EK<br>PR: 2ED,2EG,2EK<br>PR: 2ED,2EG,2EK<br>PR: 2ED,2EG,2EK<br>PR: 2ED,2EG,2EK | 13.0460-7294.2<br>607294<br>13.0470-7294.2<br>LD7294   |  |  | 25009 16,4 + ATE<br>25009 16,4 + ATE   |
|  | 1.8 TFSI<br>2.0 TDI<br>2.0 TDI quattro<br>2.0 TFSI<br>2.0 TFSI quattro<br>2.0 TFSI quattro<br>TTS 2.0 quattro<br>TTS 2.0 quattro   | 132<br>135<br>135<br>169<br>169<br>215<br>210<br>228                             | 07.15<br>07.14<br>07.14<br>07.14<br>07.14<br>07.15<br>02.15<br>07.14                            | PR: 1KZ<br>PR: 1KZ<br>PR: 1KZ<br>PR: 1KZ<br>PR: 1KZ<br>PR: 1KZ<br>PR: 1KZ   | 24.0110-0356.1<br>410356<br>24.0310-0356.1<br>510356   |  |  | 272 9,7 8,0 +S +B<br>272 9,7 8,0 +S +B PD  |



| AUDI TT (14-)                           |                  |     |       |                               |                               |                |        |   |                     |                          |
|---|------------------|-----|-------|-------------------------------|-------------------------------|----------------|--------|---|---------------------|--------------------------|
|   | 1.8 TFSI         | 132 |       | 07.15                         | PR: 2EG,2EK                   | 24.0122-0219.1 | 422219 |   |                     | 310 22,0 20,0 V L +B     |
|   | 2.0 TDI          | 135 |       | 07.14                         | PR: 2EG,2EK                   |                |        |   |                     |                          |
|   | 2.0 TDI quattro  | 135 |       | 07.14                         | PR: 2EG,2EK                   |                |        |   |                     |                          |
|   | 2.0 TFSI         | 169 |       | 07.14                         | PR: 2EG,2EK                   |                |        |   |                     |                          |
|   | 2.0 TFSI quattro | 169 |       | 07.14                         | PR: 2EG,2EK                   |                |        |   |                     |                          |
|   | 2.0 TFSI quattro | 215 |       | 07.15                         | PR: 2EG,2EK                   |                |        |   |                     |                          |
|   | TTS 2.0 quattro  | 210 |       | 02.15                         | PR: 2EG,2EK                   |                |        |   |                     |                          |
|   | TTS 2.0 quattro  | 228 |       | 07.14                         | PR: 2EG,2EK                   |                |        |   |                     |                          |
|   | 1.8 TFSI         | 132 |       | 07.15                         | PR: 2ED                       | 24.0112-0210.1 | 412210 |   |                     | 300 12,0 10,0 +S +B      |
|   | 2.0 TDI          | 135 |       | 07.14                         | PR: 2ED                       |                |        |   |                     |                          |
|   | 2.0 TDI quattro  | 135 |       | 07.14                         | PR: 2ED                       |                |        |   |                     |                          |
|   | 2.0 TFSI         | 169 |       | 07.14                         | PR: 2ED                       |                |        |   |                     |                          |
|   | 2.0 TFSI quattro | 169 |       | 07.14                         | PR: 2ED                       |                |        |   |                     |                          |
|   | 2.0 TFSI quattro | 215 |       | 07.15                         | PR: 2ED                       |                |        |   |                     |                          |
|   | TTS 2.0 quattro  | 210 |       | 02.15                         | PR: 2ED                       |                |        |   |                     |                          |
|   | TTS 2.0 quattro  | 228 |       | 07.14                         | PR: 2ED                       |                |        |   |                     |                          |
|   | 1.8 TFSI         | 132 |       | 07.15                         |                               | 24.0711-6337.3 | 360390 | 2 |                     | Radsensor                |
|   | 2.0 TDI          | 135 |       | 07.14                         |                               |                |        |   |                     |                          |
|   | 2.0 TFSI         | 169 |       | 07.14                         |                               |                |        |   |                     |                          |
|   | 2.0 TDI quattro  | 135 |       | 07.14                         |                               | 24.0711-5401.3 | 360330 |   |                     | Radsensor                |
|   | 2.0 TFSI quattro | 169 |       | 07.14                         |                               | 24.0711-5402.3 | 360331 |   |                     | Radsensor                |
|   | 2.0 TFSI quattro | 215 |       | 07.15                         |                               |                |        |   |                     |                          |
|   | TTS 2.0 quattro  | 210 |       | 02.15                         |                               |                |        |   |                     |                          |
|   | TTS 2.0 quattro  | 228 |       | 07.14                         |                               |                |        |   |                     |                          |
| BENTLEY ARNAGE                          |                  |     |       |                               |                               |                |        |   |                     |                          |
|   | 4.4 V8           |     |       | 04.98                         |                               | 13.0460-7183.2 | 607183 |   |                     | 21484 20,5 +/WE ATE      |
|   | 6.8 V8           |     |       | 09.99                         |                               |                |        |   |                     |                          |
| BENTLEY AZURE                           |                  |     |       |                               |                               |                |        |   |                     |                          |
|   | 6.75 V8          |     |       | 08.99                         |                               | 13.0460-7183.2 | 607183 |   |                     | 21484 20,5 +/WE ATE      |
| BENTLEY CONTINENTAL                     |                  |     |       |                               |                               |                |        |   |                     |                          |
|   | 6.0              |     |       | 06.03                         |                               | 13.0460-7183.2 | 607183 |   |                     | 21484 20,5 +/WE ATE      |
|   | 6.75 V8          |     |       | 08.99                         |                               |                |        |   |                     |                          |
|   | 6.0              |     |       | 06.03                         |                               | 13.0460-2888.2 | 602888 |   |                     | 23326 17,4 /WE/S TRW     |
|   | 6.75 V8          |     |       | 08.99                         |                               |                |        |   |                     |                          |
| BMW 1er Reihe/E81/E87 Limousine (04-11) |                  |     |       |                               |                               |                |        |   |                     |                          |
|   | 120 d            | 120 |       | 09.04                         | 02.07 + 5 türig <sup>1)</sup> | 13.0460-7215.2 | 607215 |   | - Performance Parts | 23935 17,8 +/WE ATE      |
|   | 120 i            | 110 |       | 09.04                         | 12.05 + 5 türig <sup>1)</sup> | 13.0470-7215.2 | LD7215 |   | - Performance Parts | 23935 17,8 +/WE ATE      |
|   |                  |     |       |                               |                               | 24.8190-0264.2 | 620264 | 1 |                     | Warnkontakt L=630mm      |
|   | 116 d            | 85  |       | 03.09                         | 02.10                         | 13.0460-2710.2 | 602710 |   | - Performance Parts | 23915 17,6 +/WE/Zub/STRW |
|   | 116 i            | 85  |       | 09.04                         | 08.07                         | 13.0470-2710.2 | LD2710 |   | - Performance Parts | 23915 17,6 +/WE/Zub/STRW |
|   | 116 i            | 90  |       | 09.07                         | 12.08                         | 24.8190-0264.2 | 620264 | 1 |                     | Warnkontakt L=630mm      |
|   | 116 i            | 90  |       | 01.09                         | 02.10                         |                |        |   |                     |                          |
|   | 118 d            | 90  |       | 09.04                         | 03.07                         |                |        |   |                     |                          |
|   | 118 d            | 105 |       | 04.07                         | 02.10                         |                |        |   |                     |                          |
|   | 118 i            | 95  |       | 09.04                         | 03.07                         |                |        |   |                     |                          |
|   | 118 i            | 105 |       | 04.07                         | 02.10                         |                |        |   |                     |                          |
| 120 i                                   | 110              |     | 01.06 | 03.07 + 5 türig <sup>1)</sup> |                               |                |        |   |                     |                          |
|   | 116 d            | 66  |       | 01.11                         | 12.11                         | 13.0460-2710.2 | 602710 |   | - Performance Parts | 23915 17,6 +/WE/Zub/STRW |
|   | 116 d            | 85  |       | 03.10                         | 05.11                         | 13.0470-2710.2 | LD2710 |   | - Performance Parts | 23915 17,6 +/WE/Zub/STRW |
|   | 116 i            | 90  |       | 03.10                         | 05.11                         | 24.8190-0284.2 | 620284 | 1 |                     | Warnkontakt L=650mm      |
|   | 118 d            | 105 |       | 03.10                         | 05.11                         |                |        |   |                     |                          |
| 118 i                                   | 105              |     | 03.10 | 05.11                         |                               |                |        |   |                     |                          |
|   | 120 d            | 120 |       | 09.04                         | 02.07 + 3 türig <sup>2)</sup> | 13.0460-7216.2 | 607216 |   | - Performance Parts | 23794 20,3 +/WE ATE      |
|   | 120 d            | 130 |       | 03.07                         | 02.10                         | 13.0470-7216.2 | LD7216 |   | - Performance Parts | 23794 20,3 +/WE ATE      |
|   | 120 i            | 110 |       | 09.04                         | 03.07 + 3 türig <sup>2)</sup> | 24.8190-0264.2 | 620264 | 1 |                     | Warnkontakt L=630mm      |
|   | 120 i            | 125 |       | 04.07                         | 02.10                         |                |        |   |                     |                          |
|   | 120 d            | 130 |       | 03.10                         | 05.11                         | 13.0460-7216.2 | 607216 |   | - Performance Parts | 23794 20,3 +/WE ATE      |
|   | 120 i            | 125 |       | 03.10                         | 05.11                         | 13.0470-7216.2 | LD7216 |   | - Performance Parts | 23794 20,3 +/WE ATE      |
|   |                  |     |       |                               |                               | 24.8190-0284.2 | 620284 | 1 |                     | Warnkontakt L=650mm      |
|   | 123 d            | 150 |       | 10.07                         | 02.10                         | 13.0460-7223.2 | 607223 |   | - Performance Parts | 24536 20,3 +/WE ATE      |
|   | 130 i            | 190 |       | 03.05                         | 02.10                         | 13.0470-7223.2 | LD7223 |   | - Performance Parts | 24536 20,3 +/WE ATE      |
|   | 130 i            | 195 |       | 09.05                         | 02.10                         | 24.8190-0267.2 | 620267 | 1 |                     | Warnkontakt L=679mm      |
|   | 123 d            | 150 |       | 03.10                         | 05.11                         | 13.0460-7223.2 | 607223 |   | - Performance Parts | 24536 20,3 +/WE ATE      |
|   | 130 i            | 190 |       | 03.10                         | 05.11                         | 13.0470-7223.2 | LD7223 |   | - Performance Parts | 24536 20,3 +/WE ATE      |
|   | 130 i            | 195 |       | 03.10                         | 05.11                         | 24.8190-0287.2 | 620287 | 1 |                     | Warnkontakt L=723mm      |
|   | 116 d            | 66  |       | 01.11                         | 12.11                         | 13.0460-4848.2 | 604848 |   | + Performance Parts | 24316 16,9 /WE BRE       |
|   | 116 d            | 85  |       | 03.09                         | 05.11                         | 24.8190-0267.2 | 620267 | 1 | + Performance Parts | Warnkontakt L=679mm      |
|   | 116 i            | 85  |       | 09.04                         | 08.07                         |                |        |   |                     |                          |
|   | 116 i            | 90  |       | 09.07                         | 12.08                         |                |        |   |                     |                          |
|   | 116 i            | 90  |       | 01.09                         | 05.11                         |                |        |   |                     |                          |
|   | 118 d            | 90  |       | 09.04                         | 03.07                         |                |        |   |                     |                          |
|   | 118 d            | 105 |       | 04.07                         | 05.11                         |                |        |   |                     |                          |
|   | 118 i            | 95  |       | 09.04                         | 03.07                         |                |        |   |                     |                          |
|   | 118 i            | 105 |       | 04.07                         | 05.11                         |                |        |   |                     |                          |
|   | 120 d            | 120 |       | 09.04                         | 02.07                         |                |        |   |                     |                          |
|   | 120 d            | 130 |       | 03.07                         | 05.11                         |                |        |   |                     |                          |

<sup>1)</sup> + 5 door / + 5 porte / + 5 portes / + 5 puertas

<sup>2)</sup> + 3 door / + 3 porte / + 3 portes / + 3 puertas

|     |    |   |  |    |  |  |  |   |   |
|--|--|---|--|--|---|--|--|---|---|
| <b>BMW 1er Reihe/E81/E87 Limousine (04-11)</b>                                     |  |   |  |  |   |  |  |   |   |
|    | 120 i<br>120 i<br>123 d<br>130 i<br>130 i  | 110<br>125<br>150<br>190<br>195   |  | 09.04 03.07<br>04.07 05.11<br>10.07 05.11<br>03.05 05.11<br>09.05 05.11  |   | 13.0460-4848.2<br>24.8190-0267.2   | 604848<br>620267   | 1<br>+ Performance Parts<br>+ Performance Parts   | 24316 16,9 /WE<br>Warnkontakt L=679mm<br><b>BRE</b>                   |
|    | 116 d<br>116 d<br>116 i<br>116 i<br>116 i<br>118 d<br>118 i<br>118 d<br>118 d<br>118 i<br>118 i<br>120 d<br>120 i<br>120 d<br>120 i<br>123 d<br>130 i<br>130 i | 66<br>85<br>85<br>90<br>90<br>90<br>95<br>90<br>105<br>95<br>105<br>120<br>110<br>120<br>125<br>150<br>190<br>195         |  | 01.11 12.11<br>03.09 05.11<br>09.04 08.07<br>09.07 12.08<br>01.09 05.11<br>09.04 03.07 + 5 türig <sup>1)</sup><br>09.04 03.07 + 5 türig <sup>1)</sup><br>09.04 03.07 + 3 türig <sup>2)</sup><br>04.07 05.11<br>09.04 03.07 + 3 türig <sup>2)</sup><br>04.07 05.11<br>09.04 02.07 + 5 türig <sup>1)</sup><br>09.04 03.07 + 5 türig <sup>1)</sup><br>09.04 02.07 + 3 türig <sup>2)</sup><br>03.07 05.11<br>09.04 03.07 + 3 türig <sup>2)</sup><br>04.07 05.11<br>10.07 05.11<br>03.05 05.11<br>09.05 05.11 |   | 24.0122-0239.1<br>24.0322-0239.1   | 422239<br>522239   | - Performance Parts<br>- Performance Parts  | 284 22,0 20,4 V L +S +B<br><b>284 22,0 19,6 V L +S +B PD</b>          |
|    | 116 d<br>116 d<br>116 i<br>116 i<br>116 i<br>118 d<br>118 d<br>118 i<br>118 i<br>120 d<br>120 d<br>123 d<br>120 i<br>125<br>130 i<br>130 i                     | 66<br>85<br>85<br>90<br>90<br>90<br>105<br>95<br>105<br>120<br>130<br>150<br>110<br>125<br>190<br>195                     |  | 01.11 12.11<br>03.09 05.11<br>09.04 08.07<br>09.07 12.08<br>01.09 05.11<br>09.04 03.07<br>04.07 05.11<br>09.04 03.07<br>04.07 05.11<br>09.04 02.07<br>03.07 05.11<br>10.07 05.11<br>09.04 03.07<br>04.07 05.11<br>03.05 05.11<br>09.05 05.11   |   | 24.0711-6198.3   | 360199   | 2 <br>2 <br>2  | Radsensor L=660<br><br>Radsensor L=660<br>Radsensor L=660             |
|  | 116 d<br>116 i<br>116 i<br>116 i<br>118 d<br>118 i<br>118 i<br>120 i<br>120 i<br>116 d<br>116 d<br>116 i<br>118 i<br>118 d<br>120 d<br>130 i<br>130 i          | 85<br>85<br>90<br>90<br>90<br>95<br>105<br>110<br>125<br>66<br>85<br>90<br>105<br>125<br>90<br>105<br>130<br>190<br>195   |  | 03.09 02.10<br>09.04 08.07<br>09.07 12.08<br>01.09 02.10<br>09.04 03.07 + 5 türig <sup>1)</sup><br>09.04 03.07<br>04.07 02.10<br>09.04 03.07<br>04.07 02.10<br>01.11 12.11<br>03.10 05.11<br>03.10 05.11<br>03.10 05.11<br>09.04 03.07 + 3 türig <sup>2)</sup><br>04.07 02.10<br>09.04 02.07<br>03.07 02.10<br>10.07 02.10<br>03.05 02.10<br>09.05 02.10<br>03.10 05.11<br>03.10 05.11<br>24.8190-0285.2<br>620285   |   | 13.0460-2713.2<br>13.0470-2713.2<br>24.8190-0265.2                                 | 602713<br>LD2713<br>620265   | 1<br>- Performance Parts<br>- Performance Parts   | 23623 17,4 +/WE/Zub/STRW<br>Warnkontakt L=1086mm                      |
|  | 116 d<br>116 d<br>116 i<br>116 i<br>116 i<br>118 d<br>118 i<br>118 d<br>118 d<br>120 d<br>120 d<br>118 i<br>118 i<br>120 i<br>120 i<br>123 d<br>130 i<br>130 i | 66<br>85<br>85<br>90<br>90<br>90<br>95<br>90<br>105<br>130<br>130<br>150<br>190<br>195<br>105<br>130<br>150<br>190<br>195 |  | 01.11 12.11<br>03.09 05.11<br>09.04 08.07<br>09.07 12.08<br>01.09 05.11<br>09.04 03.07 + 5 türig <sup>1)</sup><br>09.04 03.07 + 5 türig <sup>1)</sup><br>09.04 03.07 + 3 türig <sup>2)</sup><br>04.07 05.11<br>09.04 02.07<br>03.07 05.11<br>03.10 05.11<br>03.10 05.11<br>24.8190-0285.2<br>620285  |   | 13.0460-2713.2<br>13.0470-2713.2<br>24.8190-0285.2                                 | 602713<br>LD2713<br>620285   | 1<br>- Performance Parts<br>- Performance Parts   | 23623 17,4 +/WE/Zub/STRW<br>Warnkontakt L=1107mm                      |
|  | 116 d<br>116 d<br>116 i<br>116 i<br>116 i<br>118 d<br>118 i<br>118 d<br>118 d<br>120 d<br>120 d<br>118 i<br>118 i<br>120 i<br>120 i<br>123 d<br>130 i<br>130 i | 66<br>85<br>85<br>90<br>90<br>90<br>95<br>90<br>105<br>130<br>130<br>150<br>190<br>195<br>105<br>130<br>150<br>190<br>195 |  | 01.11 12.11<br>03.09 05.11<br>09.04 08.07<br>09.07 12.08<br>01.09 05.11<br>09.04 03.07 + 5 türig <sup>1)</sup><br>09.04 03.07 + 5 türig <sup>1)</sup><br>09.04 03.07 + 3 türig <sup>2)</sup><br>04.07 05.11<br>09.04 02.07<br>03.07 05.11<br>03.10 05.11<br>03.10 05.11<br>24.8190-0285.2<br>620285  |   | 24.0110-0314.1<br>24.0310-0314.1   | 410314<br>510314   | - Performance Parts<br>- Performance Parts  | 280 10,0 8,4 L +S +B<br><b>280 10,0 7,6 L +B PD</b>                   |
|  | 118 d<br>118 d<br>120 d<br>120 d<br>118 i<br>118 i<br>120 i<br>120 i<br>123 d<br>130 i<br>130 i  | 90<br>105<br>120<br>130<br>150<br>190<br>195<br>105<br>130<br>150<br>190<br>195   |  | 09.04 03.07 + 3 türig <sup>2)</sup><br>04.07 02.10<br>09.04 02.07<br>03.07 02.10<br>10.07 02.10<br>03.05 02.10<br>09.05 02.10<br>03.10 05.11<br>03.10 05.11<br>24.8190-0285.2<br>620285  |   | 13.0460-7217.2<br>13.0470-7217.2<br>24.8190-0265.2                                 | 607217<br>LD7217<br>620265   | 1<br>- Performance Parts<br>- Performance Parts   | 23926 17,3 +/WE<br><b>23926 17,3 +/WE ATE</b><br>Warnkontakt L=1086mm |
|  | 118 d<br>120 d<br>120 d<br>118 i<br>118 i<br>120 i<br>120 i<br>123 d<br>130 i<br>130 i   | 105<br>130<br>150<br>190<br>195<br>105<br>130<br>150<br>190<br>195  |  | 03.10 05.11<br>03.10 05.11<br>03.10 05.11<br>03.10 05.11<br>03.10 05.11<br>03.10 05.11<br>03.10 05.11<br>03.10 05.11<br>24.8190-0285.2<br>620285   |   | 13.0460-7217.2<br>13.0470-7217.2<br>24.8190-0285.2                                 | 607217<br>LD7217<br>620285   | 1<br>- Performance Parts<br>- Performance Parts   | 23926 17,3 +/WE<br><b>23926 17,3 +/WE ATE</b><br>Warnkontakt L=1107mm |
|  | 116 d<br>116 d<br>116 i<br>116 i<br>116 i<br>118 d<br>118 i<br>118 d<br>118 d<br>120 d<br>120 d<br>118 i<br>118 i<br>120 i<br>120 i<br>123 d<br>130 i<br>130 i | 66<br>85<br>85<br>90<br>90<br>90<br>95<br>90<br>105<br>130<br>130<br>150<br>190<br>195<br>105<br>130<br>150<br>190<br>195 |  | 01.11 12.11<br>03.09 05.11<br>09.04 08.07<br>09.07 12.08<br>01.09 05.11<br>09.04 03.07 + 5 türig <sup>1)</sup><br>09.04 03.07 + 5 türig <sup>1)</sup><br>09.04 03.07 + 3 türig <sup>2)</sup><br>04.07 05.11<br>09.04 02.07<br>03.07 05.11<br>03.10 05.11<br>03.10 05.11<br>24.8190-0285.2<br>620285  |   | 24.0120-0195.1<br>24.0320-0195.1   | 420195<br>520195   | - Performance Parts<br>- Performance Parts  | 300 20,0 18,4 V L +S +B<br><b>300 20,0 18,4 V L +S +B PD</b>          |
|  | 118 i<br>118 i<br>120 i<br>120 i<br>123 d<br>130 i<br>130 i  | 95<br>105<br>110<br>125<br>150<br>190<br>195  |  | 09.04 03.07 + 3 türig <sup>2)</sup><br>04.07 05.11<br>09.04 03.07<br>04.07 05.11   |   | 24.0110-0315.1<br>24.0310-0315.1   | 410315<br>510315   | - Performance Parts<br>- Performance Parts  | 296 10,4 8,9 L +S +B<br><b>296 10,4 8,9 L +S +B PD</b>                |
|  | 123 d<br>130 i<br>130 i  | 150<br>190<br>195   |  | 04.07 05.11<br>03.05 05.11<br>09.05 05.11  |   | 24.0120-0204.1<br>24.0320-0204.1   | 420204<br>520204   | - Performance Parts<br>- Performance Parts  | 300 20,0 18,4 V L +S +B<br><b>300 20,0 18,4 V L +S +B PD</b>          |

1) + 5 door / + 5 porte / + 5 portes / + 5 puertas  
2) + 3 door / + 3 porte / + 3 portes / + 3 puertas  
3) - active steering / - sterzo attivo / - direction active / - dirección activa  
4) + active steering / + sterzo attivo / + direction active / + dirección activa



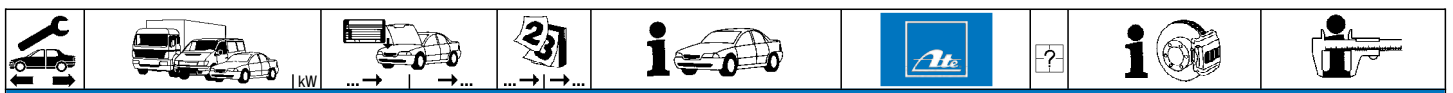

### BMW 1er Reihe/E81/E87 Limousine (04-11)

|  |       |     |       |       |                |        |   |  |   |
|--|-------|-----|-------|-------|----------------|--------|---|--|---|
|  | 116 d | 66  | 01.11 | 12.11 | 24.0711-6158.3 | 360192 | 2 |  | Radsensor L=954   |
|  | 116 d | 85  | 03.09 | 05.11 |                |        |   |  |   |
|  | 116 i | 85  | 09.04 | 08.07 |                |        |   |  |   |
|  | 116 i | 90  | 09.07 | 12.08 |                |        |   |  |   |
|  | 116 i | 90  | 01.09 | 05.11 |                |        |   |  |   |
|  | 118 d | 90  | 09.04 | 03.07 |                |        |   |  |   |
|  | 118 d | 105 | 04.07 | 05.11 |                |        |   |  |   |
|  | 118 i | 95  | 09.04 | 03.07 |                |        |   |  |   |
|  | 118 i | 105 | 04.07 | 05.11 |                |        |   |  |   |
|  | 120 d | 120 | 09.04 | 02.07 |                |        |   |  |   |
|  | 120 d | 130 | 03.07 | 05.11 |                |        |   |  |   |
|  | 120 i | 110 | 09.04 | 03.07 |                |        |   |  |   |
|  | 120 i | 125 | 04.07 | 05.11 |                |        |   |  |   |
|  | 116 d | 66  | 01.11 | 12.11 | 03.0137-0379.2 | 650379 |   |  | 161 x 20<br>Bremsbacken-Zubehör<br>Bremsbacken-Zubehör<br>Spreizschloß Satz |
|  | 116 d | 85  | 03.09 | 05.11 |                |        |   |  |   |
|  | 116 i | 85  | 09.04 | 08.07 |                |        |   |  |   |
|  | 116 i | 90  | 09.07 | 12.08 |                |        |   |  |   |
|  | 116 i | 90  | 01.09 | 05.11 |                |        |   |  |   |
|  | 118 d | 90  | 09.04 | 03.07 |                |        |   |  |   |
|  | 118 d | 105 | 04.07 | 05.11 |                |        |   |  |   |
|  | 118 i | 95  | 09.04 | 03.07 |                |        |   |  |   |
|  | 118 i | 105 | 04.07 | 05.11 |                |        |   |  |   |
|  | 120 d | 120 | 09.04 | 02.07 |                |        |   |  |   |
|  | 120 d | 130 | 03.07 | 05.11 |                |        |   |  |   |
|  | 120 i | 110 | 09.04 | 03.07 |                |        |   |  |   |
|  | 120 i | 125 | 04.07 | 05.11 |                |        |   |  |   |
|  | 123 d | 150 | 10.07 | 05.11 | 03.0137-0305.2 | 650305 |   |  | 185 x 20<br>Bremsbacken-Zubehör<br>Bremsbacken-Zubehör<br>Spreizschloß Satz |
|  | 130 i | 190 | 03.05 | 05.11 |                |        |   |  |   |
|  | 130 i | 195 | 09.05 | 05.11 |                |        |   |  |   |
|  | 130 i | 190 | 03.05 | 05.11 |                |        |   |  |   |
|  | 130 i | 195 | 09.05 | 05.11 |                |        |   |  |   |
|  | 130 i | 190 | 03.05 | 05.11 |                |        |   |  |   |
|  | 130 i | 195 | 09.05 | 05.11 |                |        |   |  |   |
|  | 130 i | 190 | 03.05 | 05.11 |                |        |   |  |   |
|  | 130 i | 195 | 09.05 | 05.11 |                |        |   |  |   |
|  | 130 i | 190 | 03.05 | 05.11 |                |        |   |  |   |
|  | 130 i | 195 | 09.05 | 05.11 |                |        |   |  |   |
|  | 130 i | 190 | 03.05 | 05.11 |                |        |   |  |   |
|  | 130 i | 195 | 09.05 | 05.11 |                |        |   |  |   |

### BMW 1er Reihe/E82 Coupe (07-13)

|       |       |       |       |       |                |        |   |                     |   |
|-------|-------|-------|-------|-------|----------------|--------|---|---------------------|---|
|       | 118 d | 105   | 09.09 | 02.10 | 13.0460-2710.2 | 602710 | 1 | - Performance Parts | 23915 17,6 +/WE/Zub/STRW<br>Warnkontakt L=630mm       |
|       | 118 d | 105   | 03.10 | 10.13 |                |        |   |                     |   |
|       | 120 d | 130   | 10.07 | 02.10 |                |        |   |                     |   |
|       | 120 i | 115   | 09.09 | 02.10 |                |        |   |                     |   |
|       | 120 i | 125   | 09.09 | 02.10 |                |        |   |                     |   |
|       | 125 i | 160   | 03.08 | 02.10 |                |        |   |                     |   |
|       | 120 d | 130   | 03.10 | 10.13 |                |        |   |                     |   |
|       | 120 i | 115   | 03.10 | 10.13 |                |        |   |                     |   |
|       | 120 i | 125   | 03.10 | 10.13 |                |        |   |                     |   |
|       | 125 i | 160   | 03.10 | 10.13 |                |        |   |                     |   |
|       | 123 d | 150   | 10.07 | 02.10 |                |        |   |                     |   |
|       | 123 d | 150   | 03.10 | 10.13 |                |        |   |                     |   |
|       |       | 135 i | 225   | 10.07 |                |        |   |                     |   |
| 135 i |       | 225   | 03.10 | 10.13 |                |        |   |                     |   |
| M     |       | 250   | 05.11 | 10.13 |                |        |   |                     |   |
| 118 d |       | 105   | 09.09 | 10.13 |                |        |   |                     |   |
| 120 d |       | 130   | 10.07 | 10.13 |                |        |   |                     |   |
| 120 i |       | 115   | 09.09 | 10.13 |                |        |   |                     |   |
| 120 i |       | 125   | 09.09 | 10.13 |                |        |   |                     |   |
| 123 d |       | 150   | 10.07 | 10.13 |                |        |   |                     |   |
| 125 i |       | 160   | 03.08 | 10.13 |                |        |   |                     |   |
| 118 d |       | 105   | 09.09 | 10.13 |                |        |   |                     |   |
| 120 d |       | 130   | 10.07 | 10.13 |                |        |   |                     |   |
| 120 i |       | 115   | 09.09 | 10.13 |                |        |   |                     |   |
| 120 i |       | 125   | 09.09 | 10.13 |                |        |   |                     |   |
|       | 123 d | 150   | 10.07 | 10.13 | 24.0122-0238.1 | 422238 | 1 | - Performance Parts | 292 22,0 20,4 V L +S +B<br>292 22,0 19,6 V L +S +B PD |
|       | 120 d | 130   | 10.07 | 10.13 |                |        |   |                     |   |
|       | 120 i | 115   | 09.09 | 10.13 |                |        |   |                     |   |
|       | 120 i | 125   | 09.09 | 10.13 |                |        |   |                     |   |
|       | 125 i | 160   | 03.08 | 10.13 |                |        |   |                     |   |
|       | 123 d | 150   | 10.07 | 10.13 |                |        |   |                     |   |
|       | 135 i | 225   | 10.07 | 10.13 |                |        |   |                     |   |
|       | M     | 250   | 05.11 | 10.13 |                |        |   |                     |   |
|       | 118 d | 105   | 09.09 | 10.13 |                |        |   |                     |   |
|       | 120 i | 115   | 09.09 | 10.13 |                |        |   |                     |   |
|       | 120 i | 125   | 09.09 | 10.13 |                |        |   |                     |   |
|       | 120 i | 125   | 09.09 | 10.13 |                |        |   |                     |   |
|       | 120 i | 125   | 09.09 | 10.13 |                |        |   |                     |   |
| 120 i | 125   | 09.09 | 10.13 |       |                |        |   |                     |   |

1) - active steering / - sterzo attivo / - direction active / - dirección activa  
2) + active steering / + sterzo attivo / + direction active / + dirección activa





### BMW 1er Reihe/E82 Coupe (07-13)

















|       |       |     |       |       |                |                |        |                      |                              |                         |
|-------|-------|-----|-------|-------|----------------|----------------|--------|----------------------|------------------------------|-------------------------|
|       | 120 d | 130 |       | 10.07 | 10.13          | 24.0711-6198.3 | 360199 | 2                    | - Aktivlenkung <sup>1)</sup> | Radsensor L=660         |
|       | 123 d | 150 |       | 10.07 | 10.13          | 24.0711-6197.3 | 360141 | 2                    | + Aktivlenkung <sup>2)</sup> | Radsensor L=660         |
|       | 125 i | 160 |       | 03.08 | 10.13          | 24.0711-6197.3 | 360141 | 2                    |                              | Radsensor L=660         |
|       | 135 i | 225 |       | 10.07 | 10.13          |                |        |                      |                              |                         |
|       | M     | 250 |       | 05.11 | 10.13          | 24.0711-6209.3 | 360352 | 2                    |                              | Radsensor L=700         |
|       | 118 d | 105 |       | 09.09 | 02.10          | 13.0460-7217.2 | 607217 | 1                    | - Performance Parts          | 23926 17,3 +/WE ATE     |
|       | 120 d | 130 |       | 10.07 | 02.10          | 13.0470-7217.2 | LD7217 |                      | - Performance Parts          | 23926 17,3 +/WE ATE     |
|       | 120 i | 115 |       | 09.09 | 02.10          | 24.8190-0265.2 | 620265 |                      | Warmkontakt L=1086mm         |                         |
|       | 120 i | 125 |       | 09.09 | 02.10          |                |        |                      |                              |                         |
|       | 123 d | 150 |       | 10.07 | 02.10          |                |        |                      |                              |                         |
|       | 125 i | 160 |       | 03.08 | 02.10          |                |        |                      |                              |                         |
|       | 118 d | 105 |       | 03.10 | 10.13          | 13.0460-7217.2 | 607217 | 1                    | - Performance Parts          | 23926 17,3 +/WE ATE     |
|       | 120 d | 130 |       | 03.10 | 10.13          | 13.0470-7217.2 | LD7217 |                      | - Performance Parts          | 23926 17,3 +/WE ATE     |
|       | 120 i | 115 |       | 03.10 | 10.13          | 24.8190-0285.2 | 620285 |                      | Warmkontakt L=1107mm         |                         |
|       | 120 i | 125 |       | 03.10 | 10.13          |                |        |                      |                              |                         |
|       | 123 d | 150 |       | 03.10 | 10.13          |                |        |                      |                              |                         |
|       | 125 i | 160 |       | 03.10 | 10.13          |                |        |                      |                              |                         |
| 135 i | 225   |     | 10.07 | 02.10 | 13.0460-4849.2 | 604849         | 1      |                      | 24315 16,2 /WE BRE           |                         |
|       |       |     |       |       | 24.8190-0265.2 | 620265         |        | Warmkontakt L=1086mm |                              |                         |
| 135 i | 225   |     | 03.10 | 10.13 | 13.0460-4849.2 | 604849         | 1      |                      | 24315 16,2 /WE BRE           |                         |
|       |       |     |       |       | 24.8190-0285.2 | 620285         |        | Warmkontakt L=1107mm |                              |                         |
| M     | 250   |     | 05.11 | 10.13 | 13.0460-7169.2 | 607169         | 1      |                      | 23309 17,3 +/WE ATE          |                         |
|       |       |     |       |       | 13.0470-7169.2 | LD7169         |        | 23309 17,3 +/WE ATE  |                              |                         |
|       |       |     |       |       | 24.8190-0265.2 | 620265         | 1      |                      | Warmkontakt L=1086mm         |                         |
|       | 118 d | 105 |       | 09.09 | 10.13          | 24.0120-0214.1 | 420214 | 1                    | - Performance Parts          | 300 20,0 18,4 V L +S +B |
|       | 120 d | 130 |       | 10.07 | 10.13          |                |        |                      |                              |                         |
|       | 120 i | 115 |       | 09.09 | 10.13          |                |        |                      |                              |                         |
|       | 120 i | 125 |       | 09.09 | 10.13          |                |        |                      |                              |                         |
|       | 125 i | 160 |       | 03.08 | 10.13          |                |        |                      |                              |                         |
|       | 123 d | 150 |       | 10.07 | 10.13          | 24.0120-0215.1 | 420215 |                      | - Performance Parts          | 300 20,0 18,4 V L +S +B |
|       | 135 i | 225 |       | 10.07 | 10.13          | 24.0122-0257.1 | 422257 |                      | 324 22,0 20,4 V L +S +B      |                         |
| M     | 250   |     | 05.11 | 10.13 | 24.0124-0231.2 | 424231         | 1      |                      | 350 24,0 22,4 V L +S +B      |                         |
|       |       |     |       |       | 24.0124-0232.2 | 424232         |        |                      | 350 24,0 22,4 V L +S +B      |                         |
|       | 118 d | 105 |       | 09.09 | 10.13          | 24.0711-6158.3 | 360192 | 2                    |                              | Radsensor L=954         |
|       | 120 i | 115 |       | 09.09 | 10.13          |                |        |                      |                              |                         |
|       | 120 i | 125 |       | 09.09 | 10.13          |                |        |                      |                              |                         |
|       | 120 d | 130 |       | 10.07 | 10.13          | 24.0711-6158.3 | 360192 | 2                    | - Aktivlenkung <sup>1)</sup> | Radsensor L=954         |
|       |       |     |       |       |                | 24.0711-6418.3 | 360407 | 2                    | + Aktivlenkung <sup>2)</sup> | Radsensor L=954         |
|       | 125 i | 160 |       | 03.08 | 10.13          | 24.0711-6418.3 | 360407 | 2                    |                              | Radsensor L=954         |
|       | 123 d | 150 |       | 10.07 | 10.13          | 24.0711-5169.3 | 360266 | 2                    | - Aktivlenkung <sup>1)</sup> | Radsensor L=959         |
|       |       |     |       |       | 24.0711-5191.3 | 360118         | 2      |                      | + Aktivlenkung <sup>2)</sup> | Radsensor L=959         |
| 135 i | 225   |     | 10.07 | 10.13 | 24.0711-5191.3 | 360118         | 2      |                      | Radsensor L=959              |                         |
| M     | 250   |     | 05.11 | 10.13 |                |                |        |                      |                              |                         |
|       | 118 d | 105 |       | 09.09 | 10.13          | 03.0137-0379.2 | 650379 | 1                    |                              | 161 x 20                |
|       | 120 d | 130 |       | 10.07 | 10.13          | 03.0137-9265.2 | 669265 |                      | Bremsbacken-Zubehör          |                         |
|       | 120 i | 115 |       | 09.09 | 10.13          | 03.0137-9701.2 | 669701 |                      | Bremsbacken-Zubehör          |                         |
|       | 120 i | 125 |       | 09.09 | 10.13          | 03.0137-9702.2 | 669702 |                      | Speisenschloß Satz           |                         |
|       | 125 i | 160 |       | 03.08 | 10.13          |                |        |                      |                              |                         |
|       | 123 d | 150 |       | 10.07 | 10.13          | 03.0137-0305.2 | 650305 |                      |                              | 185 x 20                |
|       | 135 i | 225 |       | 10.07 | 10.13          | 03.0137-9062.2 | 669062 |                      | Bremsbacken-Zubehör          |                         |
| M     | 250   |     | 05.11 | 10.13 | 03.0137-9700.2 | 669700         |        | Bremsbacken-Zubehör  |                              |                         |

### BMW 1er Reihe/E88 Cabrio (08-13)













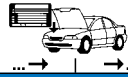





|       |       |     |       |       |                |                |        |                     |                     |                          |                     |
|-------|-------|-----|-------|-------|----------------|----------------|--------|---------------------|---------------------|--------------------------|---------------------|
|       | 118 d | 105 |       | 09.08 | 02.10          | 13.0460-2710.2 | 602710 | 1                   | - Performance Parts | 23915 17,6 +/WE/Zub/STRW |                     |
|       | 118 i | 105 |       | 03.08 | 02.10          | 13.0470-2710.2 | LD2710 |                     | - Performance Parts | 23915 17,6 +/WE/Zub/STRW |                     |
|       |       |     |       |       |                | 24.8190-0264.2 | 620264 | 1                   |                     | Warmkontakt L=630mm      |                     |
|       | 118 d | 105 |       | 03.10 | 10.13          | 13.0460-2710.2 | 602710 | 1                   | - Performance Parts | 23915 17,6 +/WE/Zub/STRW |                     |
|       | 118 i | 105 |       | 03.10 | 10.13          | 13.0470-2710.2 | LD2710 |                     | - Performance Parts | 23915 17,6 +/WE/Zub/STRW |                     |
|       |       |     |       |       |                | 24.8190-0284.2 | 620284 |                     | 1                   |                          | Warmkontakt L=650mm |
|       | 120 d | 130 |       | 03.08 | 02.10          | 13.0460-7216.2 | 607216 |                     | 1                   | - Performance Parts      | 23794 20,3 +/WE ATE |
|       | 120 d | 145 |       | 03.08 | 02.10          | 13.0470-7216.2 | LD7216 |                     |                     | - Performance Parts      | 23794 20,3 +/WE ATE |
|       | 120 i | 115 |       | 03.08 | 02.10          | 24.8190-0264.2 | 620264 |                     |                     | 1                        |                     |
|       | 120 i | 125 |       | 03.08 | 02.10          |                |        |                     |                     |                          |                     |
|       | 125 i | 160 |       | 03.08 | 02.10          |                |        |                     |                     |                          |                     |
|       | 128 i | 171 |       | 03.08 | 02.10          |                |        |                     |                     |                          |                     |
|       | 120 d | 130 |       | 03.10 | 10.13          | 13.0460-7216.2 | 607216 | 1                   | - Performance Parts | 23794 20,3 +/WE ATE      |                     |
|       | 120 d | 145 |       | 03.10 | 10.13          | 13.0470-7216.2 | LD7216 |                     | - Performance Parts | 23794 20,3 +/WE ATE      |                     |
|       | 120 i | 115 |       | 03.10 | 10.13          | 24.8190-0284.2 | 620284 |                     | 1                   |                          | Warmkontakt L=650mm |
| 120 i | 125   |     | 03.10 | 10.13 |                |                |        |                     |                     |                          |                     |
| 125 i | 160   |     | 03.10 | 10.13 |                |                |        |                     |                     |                          |                     |
| 128 i | 171   |     | 03.10 | 10.13 |                |                |        |                     |                     |                          |                     |
| 123 d | 150   |     | 09.08 | 02.10 | 13.0460-7223.2 | 607223         | 1      | - Performance Parts | 24536 20,3 +/WE ATE |                          |                     |
|       |       |     |       |       | 13.0470-7223.2 | LD7223         |        | - Performance Parts | 24536 20,3 +/WE ATE |                          |                     |
|       |       |     |       |       | 24.8190-0267.2 | 620267         | 1      |                     | Warmkontakt L=679mm |                          |                     |
| 123 d | 150   |     | 03.10 | 10.13 | 13.0460-7223.2 | 607223         | 1      | - Performance Parts | 24536 20,3 +/WE ATE |                          |                     |
|       |       |     |       |       | 13.0470-7223.2 | LD7223         |        | - Performance Parts | 24536 20,3 +/WE ATE |                          |                     |
|       |       |     |       |       | 24.8190-0287.2 | 620287         | 1      |                     | Warmkontakt L=723mm |                          |                     |
| 135 i | 225   |     | 03.08 | 02.10 | 13.0460-4848.2 | 604848         | 1      |                     | 24316 16,9 /WE BRE  |                          |                     |
| 135 i | 240   |     | 03.08 | 02.10 | 13.0460-0238.2 | 610238         |        |                     | Belagsatz-Zubehör   |                          |                     |
|       |       |     |       |       | 24.8190-0267.2 | 620267         | 1      |                     | Warmkontakt L=679mm |                          |                     |
| 135 i | 225   |     | 03.10 | 10.13 | 13.0460-4848.2 | 604848         | 1      |                     | 24316 16,9 /WE BRE  |                          |                     |
| 135 i | 240   |     | 03.10 | 10.13 | 13.0460-0238.2 | 610238         |        |                     | Belagsatz-Zubehör   |                          |                     |
|       |       |     |       |       | 24.8190-0288.2 | 620288         | 1      |                     | Warmkontakt L=698mm |                          |                     |

<sup>1)</sup> - active steering / - sterzo attivo / - direction active / - dirección activa  
<sup>2)</sup> + active steering / + sterzo attivo / + direction active / + dirección activa















|     |  |  |  |  |  |  |  |  |   |            |                              |
|--|--|--|--|--|---|--|--|--|---|------------|------------------------------|
| <b>BMW 1er Reihe/E88 Cabrio (08-13)</b>  |  |  |  |  |   |  |  |  |   |            |                              |
|    | 118 d  | 105  | 09.08  | 10.13  | 13.0460-4848.2  | 604848   | 1  | + Performance Parts  | 24316 16,9 /WE<br>Warnkontakt L=679mm                                       | <b>BRE</b> |                              |
|  | 118 i  | 105  | 03.08  | 10.13  | 24.8190-0267.2  | 620267   |  | + Performance Parts  |   |            |                              |
|  | 120 d  | 130  | 03.08  | 10.13  |   |  |  |  |   |            |                              |
|  | 120 d  | 145  | 03.08  | 10.13  |   |  |  |  |   |            |                              |
|  | 120 i  | 115  | 03.08  | 10.13  |   |  |  |  |   |            |                              |
|  | 120 i  | 125  | 03.08  | 10.13  |   |  |  |  |   |            |                              |
|  | 125 i  | 160  | 09.08  | 10.13  |   |  |  |  |   |            |                              |
|    | 118 d  | 105  | 09.08  | 10.13  | 24.0122-0238.1  | 422238   |  | - Performance Parts  | 292 22,0 20,4 V L +S +B<br>292 22,0 19,6 V L +S +B PD                       |            |                              |
|  | 118 i  | 105  | 03.08  | 10.13  | 24.0322-0238.1  | 522238   |  | - Performance Parts  |   |            |                              |
|  | 120 d  | 130  | 03.08  | 10.13  | 24.0124-0197.1  | 424197   |  | - Performance Parts  |   |            |                              |
|  | 120 d  | 145  | 03.08  | 10.13  | 24.0324-0197.1  | 524197   |  | - Performance Parts  |   |            |                              |
|  | 120 i  | 115  | 03.08  | 10.13  |   |  |  |  |   |            |                              |
|  | 120 i  | 125  | 03.08  | 10.13  |   |  |  |  |   |            |                              |
|  | 125 i  | 160  | 03.08  | 10.13  |   |  |  |  |   |            |                              |
|  | 128 i  | 171  | 03.08  | 10.13  |   |  |  |  |   |            |                              |
|  | 123 d  | 150  | 09.08  | 10.13  | 24.0124-0200.1  | 424200   |  | - Performance Parts  |   |            |                              |
|  |  |  |  |  | 24.0324-0200.1  | 524200   |  | - Performance Parts  |   |            |                              |
| 135 i  | 225  | 03.08  | 10.13  | 24.0126-0152.2   | 426152  |  |  | 338 25,9 24,4 V L +S +B  |   |            |                              |
|  | 240  | 03.08  | 10.13  |  |   |  |  |  |   |            |                              |
|    | 118 d  | 105  | 09.08  | 10.13  | 24.0711-6198.3  | 360199   | 2  |  | Radsensor L=660   |            |                              |
|  | 118 i  | 105  | 03.08  | 10.13  |   |  |  |  |   |            |                              |
|  | 120 d  | 130  | 03.08  | 10.13  | 24.0711-6198.3  | 360199   |  |  |   |            | - Aktivlenkung <sup>1)</sup> |
|  | 120 d  | 145  | 03.08  | 10.13  | 24.0711-6197.3  | 360141   |  |  |   |            | + Aktivlenkung <sup>2)</sup> |
|  | 120 i  | 115  | 03.08  | 10.13  |   |  |  |  |   |            |                              |
|  | 120 i  | 125  | 03.08  | 10.13  |   |  |  |  |   |            |                              |
|  | 123 d  | 150  | 09.08  | 10.13  |   |  |  |  |   |            |                              |
|  | 125 i  | 160  | 03.08  | 10.13  | 24.0711-6197.3  | 360141   |  |  |   |            |                              |
| 128 i  | 171  | 03.08  | 10.13  |  |   |  |  |  |   |            |                              |
|    | 118 d  | 105  | 09.08  | 02.10  | 13.0460-7217.2  | 607217   | 1  | - Performance Parts  | 23926 17,3 +/WE<br>Warnkontakt L=1086mm                                     | <b>ATE</b> |                              |
|  | 118 i  | 105  | 03.08  | 02.10  | 13.0470-7217.2  | LD7217   |  | - Performance Parts  |   |            |                              |
|  | 120 d  | 130  | 03.08  | 02.10  | 24.8190-0265.2  | 620265   |  |  |   |            |                              |
|  | 120 d  | 145  | 03.08  | 02.10  |   |  |  |  |   |            |                              |
|  | 120 i  | 115  | 03.08  | 02.10  |   |  |  |  |   |            |                              |
|  | 120 i  | 125  | 03.08  | 02.10  |   |  |  |  |   |            |                              |
|  | 123 d  | 150  | 09.08  | 02.10  |   |  |  |  |   |            |                              |
|  | 125 i  | 160  | 03.08  | 02.10  |   |  |  |  |   |            |                              |
|  | 128 i  | 171  | 03.08  | 02.10  |   |  |  |  |   |            |                              |
|  | 118 d  | 105  | 03.10  | 10.13  | 13.0460-7217.2  | 607217   |  | - Performance Parts  |   |            |                              |
|  | 118 i  | 105  | 03.10  | 10.13  | 13.0470-7217.2  | LD7217   |  | - Performance Parts  |   |            |                              |
|  | 120 d  | 130  | 03.10  | 10.13  | 24.8190-0285.2  | 620285   |  |  |   |            |                              |
|  | 120 d  | 145  | 03.08  | 10.13  |   |  |  |  |   |            |                              |
| 120 i  | 115  | 03.10  | 10.13  |  |   |  |  |  |   |            |                              |
| 120 i  | 125  | 03.10  | 10.13  |  |   |  |  |  |   |            |                              |
| 123 d  | 150  | 03.10  | 10.13  |  |   |  |  |  |   |            |                              |
| 125 i  | 160  | 03.10  | 10.13  |  |   |  |  |  |   |            |                              |
| 128 i  | 171  | 03.10  | 10.13  |  |   |  |  |  |   |            |                              |
| 135 i  | 225  | 03.08  | 02.10  | 13.0460-4849.2   | 604849  |  |  | 24315 16,2 /WE   | <b>BRE</b>  |            |                              |
| 135 i  | 240  | 03.08  | 02.10  | 24.8190-0265.2   | 620265  | 1  |  | Warnkontakt L=1086mm   |   |            |                              |
| 135 i  | 225  | 03.10  | 10.13  | 13.0460-4849.2   | 604849  |  |  | 24315 16,2 /WE   | <b>BRE</b>  |            |                              |
| 135 i  | 240  | 03.10  | 10.13  | 24.8190-0285.2   | 620285  | 1  |  | Warnkontakt L=1107mm   |   |            |                              |
|  | 118 d  | 105  | 09.08  | 10.13  | 24.0120-0214.1  | 420214   |  | - Performance Parts  | 300 20,0 18,4 V L +S +B   |            |                              |
|  | 118 i  | 105  | 03.08  | 10.13  |   |  |  |  |   |            |                              |
|  | 120 d  | 130  | 03.08  | 10.13  |   |  |  |  |   |            |                              |
|  | 120 d  | 145  | 03.08  | 10.13  |   |  |  |  |   |            |                              |
|  | 120 i  | 115  | 03.08  | 10.13  |   |  |  |  |   |            |                              |
|  | 120 i  | 125  | 03.08  | 10.13  |   |  |  |  |   |            |                              |
|  | 125 i  | 160  | 03.08  | 10.13  |   |  |  |  |   |            |                              |
|  | 128 i  | 171  | 03.08  | 10.13  |   |  |  |  |   |            |                              |
|  | 123 d  | 150  | 09.08  | 10.13  | 24.0120-0215.1  | 420215   |  | - Performance Parts  |   |            |                              |
|  | 135 i  | 225  | 03.08  | 10.13  | 24.0122-0257.1  | 422257   |  |  |   |            |                              |
| 135 i  | 240  | 03.08  | 10.13  |  |   |  |  |  |   |            |                              |
|  | 118 d  | 105  | 09.08  | 10.13  | 24.0711-6158.3  | 360192   | 2  |  | Radsensor L=954   |            |                              |
|  | 118 i  | 105  | 03.08  | 10.13  |   |  |  |  |   |            |                              |
|  | 120 d  | 130  | 03.08  | 10.13  | 24.0711-6158.3  | 360192   |  |  |   |            | - Aktivlenkung <sup>1)</sup> |
|  | 120 d  | 145  | 03.08  | 10.13  | 24.0711-6418.3  | 360407   |  |  |   |            | + Aktivlenkung <sup>2)</sup> |
|  | 120 i  | 115  | 03.08  | 10.13  |   |  |  |  |   |            |                              |
|  | 120 i  | 125  | 03.08  | 10.13  |   |  |  |  |   |            |                              |
|  | 123 d  | 150  | 09.08  | 10.13  | 24.0711-5169.3  | 360266   |  |  |   |            | - Aktivlenkung <sup>1)</sup> |
|  |  |  |  |  | 24.0711-5191.3  | 360118   |  |  |   |            | + Aktivlenkung <sup>2)</sup> |
| 125 i  | 160  | 03.08  | 10.13  | 24.0711-6418.3   | 360407  |  |  | Radsensor L=954  |   |            |                              |
| 128 i  | 171  | 03.08  | 10.13  |  |   |  |  |  |   |            |                              |
| 135 i  | 225  | 03.08  | 10.13  | 24.0711-5191.3   | 360118  | 2  |  | Radsensor L=959  |   |            |                              |
| 135 i  | 240  | 03.08  | 10.13  |  |   |  |  |  |   |            |                              |
|  | 118 d  | 105  | 09.08  | 10.13  | 03.0137-0379.2  | 650379   |  |  | 161 x 20<br>Bremsbacken-Zubehör<br>Bremsbacken-Zubehör<br>Spreizschloß Satz |            |                              |
|  | 118 i  | 105  | 03.08  | 10.13  | 03.0137-9265.2  | 669265   |  |  |   |            |                              |
|  | 120 d  | 130  | 03.08  | 10.13  | 03.0137-9701.2  | 669701   |  |  |   |            |                              |
|  | 120 d  | 145  | 03.08  | 10.13  | 03.0137-9702.2  | 669702   |  |  |   |            |                              |
|  | 120 i  | 115  | 03.08  | 10.13  |   |  |  |  |   |            |                              |
|  | 120 i  | 125  | 03.08  | 10.13  |   |  |  |  |   |            |                              |
|  | 125 i  | 160  | 03.08  | 10.13  |   |  |  |  |   |            |                              |
|  | 128 i  | 171  | 03.08  | 10.13  |   |  |  |  |   |            |                              |

1) - active steering / - sterzo attivo / - direction active / - dirección activa  
2) + active steering / + sterzo attivo / + direction active / + dirección activa

|     |    |    |   |  |  |  |    |    |
|--|--|--|---|--|---|--|--|--|
| <b>BMW 1er Reihe/E88 Cabrio (08-13)</b>  |  |  |   |  |   |  |  |  |
|    | 123 d<br>135 i<br>135 i  | 150<br>225<br>240  | 09.08<br>03.08<br>03.08   | 10.13<br>10.13<br>10.13  | 03.0137-0305.2<br>03.0137-9062.2<br>03.0137-9700.2<br>03.0137-9702.2              | 650305<br>669062<br>669700<br>669702   |  | 185 x 20<br>Bremsbacken-Zubehör<br>Bremsbacken-Zubehör<br>Spreizschloß Satz  |
| <b>BMW 1er Reihe/F20/F21 Limousine (11-)</b>                                       |  |  |   |  |   |  |  |  |
|    | 114 d<br>114 i<br>116 d<br>116 d ed<br>116 i<br>118 d  | 70<br>75<br>85<br>85<br>100<br>105   | 10.12<br>09.12<br>06.11<br>03.12<br>06.11<br>06.11  |  | 13.0460-3865.2<br>13.0470-3865.2<br>24.8190-0006.2                                | 603865<br>LD3865<br>620006   | 1   | 25014 18,2 +/WE BOS<br>25014 18,2 +/WE BOS<br>Warnkontakt L=675mm  |
|  | 116 d<br>116 i<br>118 d<br>118 d xDrive<br>118 i   | 85<br>80<br>110<br>110<br>100  | 03.15<br>03.15<br>03.15<br>03.15<br>03.15   |  | 13.0460-3865.2<br>13.0470-3865.2<br>13.0460-4875.2<br>24.8190-0006.2              | 603865<br>LD3865<br>604875<br>620006   | 1  | - M Sportbremse <sup>1)</sup><br>- M Sportbremse <sup>1)</sup><br>+ M Sportbremse <sup>2)</sup><br>25014 18,2 +/WE BOS<br>25014 18,2 +/WE BOS<br>25028 18,0 /WE BRE<br>Warnkontakt L=675mm         |
|  | 118 i<br>120 d<br>120 d  | 125<br>120<br>135  | 06.11<br>06.11<br>06.11   |  | 13.0460-3866.2<br>13.0470-3866.2<br>24.8190-0006.2                                | 603866<br>LD3866<br>620006   | 1   | 25506 18,2 +/WE BOS<br>25506 18,2 +/WE BOS<br>Warnkontakt L=675mm  |
|  | 125 d<br>125 d<br>125 i<br>125 i   | 160<br>165<br>160<br>165   | 03.12<br>03.15<br>03.12<br>09.15  |  | 13.0460-3857.2<br>13.0470-3857.2<br>13.0460-4875.2<br>24.8190-0006.2              | 603857<br>LD3857<br>604875<br>620006   | 1   | - M Sportbremse <sup>1)</sup><br>- M Sportbremse <sup>1)</sup><br>+ M Sportbremse <sup>2)</sup><br>25199 19,6 +/WE BOS<br>25199 19,6 +/WE BOS<br>25028 18,0 /WE BRE<br>Warnkontakt L=675mm         |
|  | M 135 i<br>M 135 i<br>M 135 i xDrive<br>M 135 i xDrive<br>M 140 i<br>M 140 i xDrive  | 235<br>240<br>235<br>240<br>250<br>250   | 09.12<br>03.15<br>07.12<br>03.15<br>09.15<br>09.15  |  | 13.0460-4875.2<br>24.8190-0006.2  | 604875<br>620006   | 1  | 25028 18,0 /WE BRE<br>Warnkontakt L=675mm  |
|  | 118 d xDrive<br>120 d<br>120 d xDrive<br>120 d xDrive<br>120 i<br>120 i  | 105<br>140<br>135<br>140<br>130<br>135   | 05.13<br>03.15<br>07.12<br>03.15<br>03.15<br>09.15  |  | 13.0460-3866.2<br>13.0470-3866.2<br>13.0460-4875.2<br>24.8190-0006.2              | 603866<br>LD3866<br>604875<br>620006   | 1   | - M Sportbremse <sup>1)</sup><br>- M Sportbremse <sup>1)</sup><br>+ M Sportbremse <sup>2)</sup><br>25506 18,2 +/WE BOS<br>25506 18,2 +/WE BOS<br>25028 18,0 /WE BRE<br>Warnkontakt L=675mm         |
|    | 114 d<br>114 i<br>116 d<br>116 i<br>118 d<br>118 d xDrive<br>118 i   | 70<br>75<br>85<br>80<br>110<br>110<br>100  | 10.12<br>09.12<br>03.15<br>03.15<br>03.15<br>03.15<br>03.15   |  | 24.0122-0239.1<br>24.0130-0233.2<br>24.0322-0239.1                                | 422239<br>430233<br>522239   |  | - M Sportbremse <sup>1)</sup><br>+ M Sportbremse / zweiteil.Br. <sup>3)</sup><br>+ M Sportbremse <sup>2)</sup><br>284 22,0 20,4 V L +S +B<br>340 30,0 28,4 V L +S +B<br>284 22,0 19,6 V L +S +B PD |
|  | 116 d<br>116 d ed<br>116 i<br>118 d  | 85<br>85<br>100<br>105   | 06.11<br>03.12<br>06.11<br>06.11  |  | 24.0122-0239.1<br>24.0322-0239.1  | 422239<br>522239   |  | 284 22,0 20,4 V L +S +B<br>284 22,0 19,6 V L +S +B PD  |
|  | 118 i<br>120 d<br>120 d  | 125<br>120<br>135  | 06.11<br>06.11<br>06.11   |  | 24.0122-0278.1  | 422278   |  | 300 22,0 20,4 V L +S +B  |
|  | 125 d<br>125 d<br>125 i<br>125 i   | 160<br>165<br>160<br>165   | 03.12<br>03.15<br>03.12<br>09.15  |  | 24.0124-0203.1<br>24.0324-0203.1<br>24.0130-0233.2                                | 424203<br>524203<br>430233   |  | - M Sportbremse <sup>1)</sup><br>- M Sportbremse <sup>1)</sup><br>+ M Sportbremse / zweiteil.Br. <sup>3)</sup><br>312 23,9 22,4 V L +S +B<br>312 23,9 22,4 V L +S +B PD<br>340 30,0 28,4 V L +S +B |
|  | M 135 i<br>M 135 i<br>M 135 i xDrive<br>M 135 i xDrive<br>M 140 i<br>M 140 i xDrive  | 235<br>240<br>235<br>240<br>250<br>250   | 09.12<br>03.15<br>07.12<br>03.15<br>09.15<br>09.15  |  | 24.0130-0233.2  | 430233   |  | zweiteilige Bremsscheibe <sup>4)</sup><br>340 30,0 28,4 V L +S +B  |
|  | 118 d xDrive<br>120 d<br>120 d xDrive<br>120 d xDrive<br>120 i<br>120 i  | 105<br>140<br>135<br>140<br>130<br>135   | 05.13<br>03.15<br>07.12<br>03.15<br>03.15<br>09.15  |  | 24.0122-0278.1<br>24.0130-0233.2  | 422278<br>430233   |  | - M Sportbremse <sup>1)</sup><br>+ M Sportbremse / zweiteil.Br. <sup>3)</sup><br>300 22,0 20,4 V L +S +B<br>340 30,0 28,4 V L +S +B  |
|  | 114 d<br>114 i<br>116 d<br>116 d<br>116 d ed<br>116 i<br>116 i<br>118 d<br>118 d<br>118 i<br>118 i<br>120 d<br>120 d<br>120 d<br>120 i<br>120 i<br>120 i<br>125 d<br>125 d<br>125 i<br>125 i | 70<br>75<br>85<br>85<br>85<br>80<br>100<br>105<br>110<br>100<br>125<br>120<br>140<br>130<br>135<br>135<br>160<br>165<br>160<br>165 | 10.12<br>09.12<br>06.11<br>03.15<br>03.12<br>03.15<br>06.11<br>06.11<br>03.15<br>03.15<br>06.11<br>06.11<br>03.15<br>03.15<br>09.15<br>03.12<br>03.15<br>03.12<br>09.15 |  | 24.0711-6281.3<br>24.0711-6282.3  | 360386<br>360387   | 2 <br>2  | - Start/Stop /- Parkassistent <sup>5)</sup><br>+ Start/Stop /+ Parkassistent <sup>6)</sup><br>Radsensor L=540<br>Radsensor L=540   |

1) - M sport brake / - M freno sportivo / - M frein de sport / - M freno deportiva  
2) + M sport brake / + M freno sportivo / + M frein de sport / + M freno deportiva  
3) + M sport brake / two-p. disc / + M freno sport / deux part.disc / + M frein de sport / d. parti. disque / + M freno sport / deux parties disc  
4) two-piece brake disc / disco frenante in due parti / disque d.fr.en deux parties / disco de fr.de dos piezas  
5) -idling/stop/-parking assist. / -start/stop/-assist.parcheggio / -marche/arrêt/-assist.stationnem. / -arramque/paro/-assist.aparcamiento  
6) +idling/stop/+parking assist. / +start/stop/+assist.parcheggio / +marche/arrêt/+assist.stationnem. / +arramque/paro/+assist.aparcamiento

|     |  |  |  |  |  |  |  |  |
|--|--|--|--|--|---|--|--|--|
| <b>BMW 1er Reihe/F20/F21 Limousine (11-)</b>                                       |  |  |  |  |   |  |  |  |
|    | M 135 i  | 235  | 09.12  | 24.0711-6281.3   | 360386  | 2  | - Start/Stop / - Parkassistent <sup>1)</sup>                                       | Radsensor L=540  |
|  | M 135 i  | 240  | 03.15  | 24.0711-6282.3   | 360387  | 2  | + Start/Stop / + Parkassistent <sup>2)</sup>                                       | Radsensor L=540  |
|  | M 140 i  | 250  | 09.15  |  |   |  |  |  |
|  | M 140 i xDrive   | 250  | 09.15  |  |   |  |  |  |
|  | 118 d xDrive   | 105  | 05.13  | 24.0711-6299.3   | 360388  | 2  | - Parkassistent <sup>3)</sup>  | Radsensor L=746  |
|  | 118 d xDrive   | 110  | 03.15  | 24.0711-6300.3   | 360389  | 2  | + Parkassistent <sup>4)</sup>  | Radsensor L=746  |
|  | 120 d xDrive   | 135  | 07.12  |  |   |  |  |  |
|  | 120 d xDrive   | 140  | 03.15  |  |   |  |  |  |
|  | M 135 i xDrive   | 235  | 07.12  |  |   |  |  |  |
|  | M 135 i xDrive   | 240  | 03.15  |  |   |  |  |  |
|    | 116 d  | 85   | 06.11  | 13.0460-3859.2   | 603859  |  |  | 25307 17,5 +/WE BOS  |
|  | 116 d ed   | 85   | 03.12  | 13.0470-3859.2   | LD3859  |  |  | 25307 17,5 +/WE BOS  |
|  | 116 i  | 100  | 06.11  | 24.8190-0007.2   | 620007  | 1  |  | Warnkontakt L=1045mm   |
|  | 118 d  | 105  | 06.11  |  |   |  |  |  |
|  | 118 i  | 125  | 06.11  |  |   |  |  |  |
|  | 120 d  | 120  | 06.11  |  |   |  |  |  |
|  | 120 d  | 135  | 06.11  |  |   |  |  |  |
|  | 114 d  | 70   | 10.12  | 13.0460-3859.2   | 603859  |  | - M Sportbremse <sup>5)</sup>  | 25307 17,5 +/WE BOS  |
|  | 114 i  | 75   | 09.12  | 13.0470-3859.2   | LD3859  |  | - M Sportbremse <sup>5)</sup>  | 25307 17,5 +/WE BOS  |
|  | 116 d  | 85   | 03.15  | 13.0460-4874.2   | 604874  |  | + M Sportbremse <sup>6)</sup>  | 25029 16,7 /WE/Zub BRE   |
|  | 116 i  | 80   | 03.15  | 24.8190-0007.2   | 620007  | 1  |  | Warnkontakt L=1045mm   |
|  | 116 i  | 80   | 03.15  |  |   |  |  |  |
|  | 118 d  | 110  | 03.15  |  |   |  |  |  |
|  | 118 d xDrive   | 105  | 05.13  |  |   |  |  |  |
|  | 118 d xDrive   | 110  | 03.15  |  |   |  |  |  |
|  | 118 i  | 100  | 03.15  |  |   |  |  |  |
|  | 120 d  | 140  | 03.15  |  |   |  |  |  |
|  | 120 d xDrive   | 135  | 07.12  |  |   |  |  |  |
|  | 120 d xDrive   | 140  | 03.15  |  |   |  |  |  |
|  | 120 i  | 130  | 03.15  |  |   |  |  |  |
| 120 i  | 135  | 09.15  |  |  |   |  |  |  |
| 125 d  | 160  | 03.12  |  |  |   |  |  |  |
| 125 d  | 165  | 03.15  |  |  |   |  |  |  |
| 125 i  | 160  | 03.12  |  |  |   |  |  |  |
| 125 i  | 165  | 09.15  |  |  |   |  |  |  |
| M 135 i  | 235  | 09.12  | 13.0460-4874.2   | 604874   |   |  | 25029 16,7 /WE/Zub BRE   |  |
| M 135 i  | 240  | 03.15  | 24.8190-0007.2   | 620007   | 1   |  | Warnkontakt L=1045mm   |  |
| M 135 i xDrive   | 235  | 07.12  |  |  |   |  |  |  |
| M 135 i xDrive   | 240  | 03.15  |  |  |   |  |  |  |
| M 140 i  | 250  | 09.15  |  |  |   |  |  |  |
| M 140 i xDrive   | 250  | 09.15  |  |  |   |  |  |  |
|  | 114 d  | 70   | 10.12  | 24.0111-0175.1   | 411175  |  | - M Sportbremse <sup>5)</sup>  | 290 11,0 9,4 L +S +B   |
|  | 114 i  | 75   | 09.12  | 24.0124-0250.2   | 424250  |  | + M Sportbremse / zweiteil.Br. <sup>7)</sup>                                       | 345 24,0 22,4 V L +S +B  |
|  | 116 d  | 85   | 03.15  |  |   |  |  |  |
|  | 116 i  | 80   | 03.15  |  |   |  |  |  |
|  | 118 d  | 110  | 03.15  |  |   |  |  |  |
|  | 118 d xDrive   | 105  | 05.13  |  |   |  |  |  |
|  | 118 d xDrive   | 110  | 03.15  |  |   |  |  |  |
|  | 118 i  | 100  | 03.15  |  |   |  |  |  |
|  | 120 i  | 130  | 03.15  |  |   |  |  |  |
|  | 120 i  | 135  | 09.15  |  |   |  |  |  |
|  | 116 d  | 85   | 06.11  | 24.0111-0175.1   | 411175  |  |  | 290 11,0 9,4 L +S +B   |
|  | 116 d ed   | 85   | 03.12  |  |   |  |  |  |
|  | 116 i  | 100  | 06.11  |  |   |  |  |  |
|  | 118 d  | 105  | 06.11  |  |   |  |  |  |
|  | 118 i  | 125  | 06.11  |  |   |  |  |  |
| 120 d  | 120  | 06.11  | 24.0120-0237.1   | 420237   |   |  | 300 20,0 18,4 V L +S +B  |  |
| 120 d  | 135  | 06.11  |  |  |   |  |  |  |
| 125 d  | 160  | 03.12  | 24.0120-0237.1   | 420237   |   | - M Sportbremse <sup>5)</sup>  | 300 20,0 18,4 V L +S +B  |  |
| 125 d  | 165  | 03.15  |  |  |   |  |  |  |
| 125 i  | 160  | 03.12  |  |  |   |  |  |  |
| 125 i  | 165  | 09.15  |  |  |   |  |  |  |
| 120 d  | 140  | 03.15  | 24.0120-0237.1   | 420237   |   | - M Sportbremse <sup>5)</sup>  | 300 20,0 18,4 V L +S +B  |  |
| 120 d xDrive   | 135  | 07.12  | 24.0124-0250.2   | 424250   |   | + M Sportbremse / zweiteil.Br. <sup>7)</sup>                                       | 345 24,0 22,4 V L +S +B  |  |
| 120 d xDrive   | 140  | 03.15  |  |  |   |  |  |  |
| M 135 i  | 235  | 09.12  | 24.0124-0250.2   | 424250   |   | zweiteilige Bremsscheibe <sup>8)</sup>   | 345 24,0 22,4 V L +S +B  |  |
| M 135 i  | 240  | 03.15  |  |  |   |  |  |  |
| M 135 i xDrive   | 235  | 07.12  |  |  |   |  |  |  |
| M 135 i xDrive   | 240  | 03.15  |  |  |   |  |  |  |
| M 140 i  | 250  | 09.15  |  |  |   |  |  |  |
| M 140 i xDrive   | 250  | 09.15  |  |  |   |  |  |  |
|  | 114 d  | 70   | 10.12  | 24.0711-5347.3   | 360374  | 2  |  | Radsensor L=802  |
|  | 114 i  | 75   | 09.12  |  |   |  |  |  |
|  | 116 d  | 85   | 06.11  |  |   |  |  |  |
|  | 116 d  | 85   | 03.15  |  |   |  |  |  |
|  | 116 d ed   | 85   | 03.12  |  |   |  |  |  |
|  | 116 i  | 80   | 03.15  |  |   |  |  |  |
|  | 116 i  | 100  | 06.11  |  |   |  |  |  |
|  | 118 d  | 105  | 06.11  |  |   |  |  |  |
|  | 118 d  | 110  | 03.15  |  |   |  |  |  |
|  | 118 d xDrive   | 105  | 05.13  |  |   |  |  |  |
|  | 118 d xDrive   | 110  | 03.15  |  |   |  |  |  |
|  | 118 i  | 100  | 03.15  |  |   |  |  |  |
| 118 i  | 125  | 06.11  |  |  |   |  |  |  |
| 120 d  | 120  | 06.11  |  |  |   |  |  |  |
| 120 d  | 135  | 06.11  |  |  |   |  |  |  |

<sup>1)</sup> - idling/stop/-parking assist. / -start/stop/-assist.parcheggio / -marche/arrêt/-assist.stationnem. / -arramque/paro/-assist.aparcamiento  
<sup>2)</sup> + idling/stop/+parking assist. / +start/stop/+assist.parcheggio / +marche/arrêt/+assist.stationnem. / +arramque/paro/+assist.aparcamiento  
<sup>3)</sup> - parking assistant / - assistente di parcheggio / - assistance au stationnement / - asistente de aparcamiento  
<sup>4)</sup> + parking assistant / + assistente di parcheggio / + assistance au stationnement / + asistente de aparcamiento  
<sup>5)</sup> - M sport brake / - M freno sportivo / - M frein de sport / - M freno deportiva  
<sup>6)</sup> + M sport brake / + M freno sportivo / + M frein de sport / + M freno deportiva  
<sup>7)</sup> + M sport brake / two-p. disc / + M freno sport / deux part.disc / + M frein de sport / d. parti. disque / + M freno sport / deux parties disc  
<sup>8)</sup> two-piece brake disc / disco frenante in due parti / disque d.fr.en deux parties / disco de fr.de dos piezas



### BMW 1er Reihe/F20/F21 Limousine (11-)

|  |                |     |       |                |        |   |  |                     |
|--|----------------|-----|-------|----------------|--------|---|--|---------------------|
|  | 120 d          | 140 | 03.15 | 24.0711-5347.3 | 360374 | 2 |  | Radsensor L=802     |
|  | 120 d xDrive   | 135 | 07.12 |                |        |   |  |                     |
|  | 120 d xDrive   | 140 | 03.15 |                |        |   |  |                     |
|  | 120 i          | 130 | 03.15 |                |        |   |  |                     |
|  | 120 i          | 135 | 09.15 |                |        |   |  |                     |
|  | 125 d          | 160 | 03.12 |                |        |   |  |                     |
|  | 125 d          | 165 | 03.15 |                |        |   |  |                     |
|  | 125 i          | 160 | 03.12 |                |        |   |  |                     |
|  | 125 i          | 165 | 09.15 |                |        |   |  |                     |
|  | M 135 i        | 235 | 09.12 |                |        |   |  |                     |
|  | M 135 i        | 240 | 03.15 |                |        |   |  |                     |
|  | M 135 i xDrive | 235 | 07.12 |                |        |   |  |                     |
|  | M 135 i xDrive | 240 | 03.15 |                |        |   |  |                     |
|  | M 140 i        | 250 | 09.15 |                |        |   |  |                     |
|  | M 140 i xDrive | 250 | 09.15 |                |        |   |  |                     |
|  | 114 d          | 70  | 10.12 | 03.0137-0379.2 | 650379 |   |  | 161 x 20            |
|  | 114 i          | 75  | 09.12 | 03.0137-9265.2 | 669265 |   |  | Bremsbacken-Zubehör |
|  | 116 d          | 85  | 06.11 | 03.0137-9701.2 | 669701 |   |  | Bremsbacken-Zubehör |
|  | 116 d          | 85  | 03.15 | 03.0137-9702.2 | 669702 |   |  | Spreizschloß Satz   |
|  | 116 d ed       | 85  | 03.12 |                |        |   |  |                     |
|  | 116 i          | 80  | 03.15 |                |        |   |  |                     |
|  | 116 i          | 100 | 06.11 |                |        |   |  |                     |
|  | 118 d          | 105 | 06.11 |                |        |   |  |                     |
|  | 118 d          | 110 | 03.15 |                |        |   |  |                     |
|  | 118 d xDrive   | 105 | 05.13 |                |        |   |  |                     |
|  | 118 d xDrive   | 110 | 03.15 |                |        |   |  |                     |
|  | 118 i          | 100 | 03.15 |                |        |   |  |                     |
|  | 118 i          | 125 | 06.11 |                |        |   |  |                     |
|  | 120 d          | 120 | 06.11 |                |        |   |  |                     |
|  | 120 d          | 135 | 06.11 |                |        |   |  |                     |
|  | 120 d          | 140 | 03.15 |                |        |   |  |                     |
|  | 120 d xDrive   | 135 | 07.12 |                |        |   |  |                     |
|  | 120 d xDrive   | 140 | 03.15 |                |        |   |  |                     |
|  | 120 i          | 130 | 03.15 |                |        |   |  |                     |
|  | 120 i          | 135 | 09.15 |                |        |   |  |                     |
|  | 125 d          | 160 | 03.12 |                |        |   |  |                     |
|  | 125 d          | 165 | 03.15 |                |        |   |  |                     |
|  | 125 i          | 160 | 03.12 |                |        |   |  |                     |
|  | 125 i          | 165 | 09.15 |                |        |   |  |                     |
|  | M 135 i        | 235 | 09.12 |                |        |   |  |                     |
|  | M 135 i        | 240 | 03.15 |                |        |   |  |                     |
|  | M 135 i xDrive | 235 | 07.12 |                |        |   |  |                     |
|  | M 135 i xDrive | 240 | 03.15 |                |        |   |  |                     |
|  | M 140 i        | 250 | 09.15 |                |        |   |  |                     |
|  | M 140 i xDrive | 250 | 09.15 |                |        |   |  |                     |

### BMW 2er Reihe/F22 Coupe (13-)

|  |                |     |       |                |        |   |  |                            |     |
|--|----------------|-----|-------|----------------|--------|---|--|----------------------------|-----|
|  | 218 d          | 100 | 07.15 | 13.0460-3865.2 | 603865 |   | - M Sportbremse <sup>1)</sup>                | 25014 18,2 +/WE            | BOS |
|  | 218 d          | 105 | 10.13 | 13.0470-3865.2 | LD3865 |   | - M Sportbremse <sup>1)</sup>                | 25014 18,2 +/WE            | BOS |
|  | 218 d          | 110 | 07.15 | 13.0460-4875.2 | 604875 |   | + M Sportbremse <sup>2)</sup>                | 25028 18,0 /WE             | BRE |
|  | 218 i          | 100 | 03.15 | 24.8190-0006.2 | 620006 | 1 |  | Warnkontakt L=675mm        |     |
|  | 220 d          | 120 | 11.14 | 13.0460-3857.2 | 603857 |   | - M Sportbremse <sup>1)</sup>                | 25199 19,6 +/WE            | BOS |
|  | 220 d          | 135 | 10.13 | 13.0470-3857.2 | LD3857 |   | - M Sportbremse <sup>1)</sup>                | 25199 19,6 +/WE            | BOS |
|  | 220 d          | 140 | 11.14 | 13.0460-4875.2 | 604875 |   | + M Sportbremse <sup>2)</sup>                | 25028 18,0 /WE             | BRE |
|  | 220 d xDrive   | 120 | 03.15 | 24.8190-0006.2 | 620006 | 1 |  | Warnkontakt L=675mm        |     |
|  | 220 d xDrive   | 140 | 03.15 |                |        |   |  |                            |     |
|  | 220 i          | 135 | 10.13 |                |        |   |  |                            |     |
|  | 225 d          | 160 | 10.13 |                |        |   |  |                            |     |
|  | 225 d          | 165 | 07.14 |                |        |   |  |                            |     |
|  | 228 i          | 180 | 07.14 | 13.0460-3857.2 | 603857 |   | - M Sportbremse <sup>1)</sup>                | 25199 19,6 +/WE            | BOS |
|  | 230 i          | 185 | 09.15 | 13.0470-3857.2 | LD3857 |   | - M Sportbremse <sup>1)</sup>                | 25199 19,6 +/WE            | BOS |
|  |                |     |       | 13.0460-4875.2 | 604875 |   | + M Sportbremse <sup>2)</sup>                | 25028 18,0 /WE             | BRE |
|  |                |     |       | 24.8190-0006.2 | 620006 | 1 |  | Warnkontakt L=675mm        |     |
|  | M 235 i        | 240 | 10.13 | 13.0460-4875.2 | 604875 |   |  | 25028 18,0 /WE             | BRE |
|  | M 235 i xDrive | 240 | 07.14 | 24.8190-0006.2 | 620006 | 1 |  | Warnkontakt L=675mm        |     |
|  | M 240 i        | 250 | 09.15 |                |        |   |  |                            |     |
|  | M 240 i xDrive | 250 | 09.15 |                |        |   |  |                            |     |
|  | M2             | 272 | 11.15 | 24.8190-0006.2 | 620006 | 1 |  | Warnkontakt L=675mm        |     |
|  | 218 d          | 100 | 07.15 | 24.0122-0239.1 | 422239 |   | - M Sportbremse <sup>1)</sup>                | 284 22,0 20,4 V L +S +B    |     |
|  | 218 d          | 105 | 10.13 | 24.0322-0239.1 | 522239 |   | - M Sportbremse <sup>1)</sup>                | 284 22,0 19,6 V L +S +B PD |     |
|  | 218 d          | 110 | 07.15 | 24.0130-0233.2 | 430233 |   | + M Sportbremse / zweiteil.Br. <sup>3)</sup> | 340 30,0 28,4 V L +S +B    |     |
|  | 218 i          | 100 | 03.15 |                |        |   |  |                            |     |
|  | 220 d          | 120 | 11.14 | 24.0124-0203.1 | 424203 |   | - M Sportbremse <sup>1)</sup>                | 312 23,9 22,4 V L +S +B    |     |
|  | 220 d          | 135 | 10.13 | 24.0324-0203.1 | 524203 |   | - M Sportbremse <sup>1)</sup>                | 312 23,9 22,4 V L +S +B PD |     |
|  | 220 d          | 140 | 11.14 | 24.0130-0233.2 | 430233 |   | + M Sportbremse / zweiteil.Br. <sup>3)</sup> | 340 30,0 28,4 V L +S +B    |     |
|  | 220 d xDrive   | 120 | 03.15 |                |        |   |  |                            |     |
|  | 220 d xDrive   | 140 | 03.15 |                |        |   |  |                            |     |
|  | 220 i          | 135 | 10.13 |                |        |   |  |                            |     |
|  | 225 d          | 160 | 10.13 |                |        |   |  |                            |     |
|  | 225 d          | 165 | 07.14 |                |        |   |  |                            |     |
|  | 228 i          | 180 | 07.14 | 24.0130-0233.2 | 430233 |   | + M Sportbremse / zweiteil.Br. <sup>3)</sup> | 340 30,0 28,4 V L +S +B    |     |
|  | 230 i          | 185 | 09.15 |                |        |   |  |                            |     |
|  | M 235 i        | 240 | 10.13 | 24.0130-0233.2 | 430233 |   | zweiteilige Bremsscheibe <sup>4)</sup>       | 340 30,0 28,4 V L +S +B    |     |
|  | M 235 i xDrive | 240 | 07.14 |                |        |   |  |                            |     |
|  | M 240 i        | 250 | 09.15 |                |        |   |  |                            |     |
|  | M 240 i xDrive | 250 | 09.15 |                |        |   |  |                            |     |

<sup>1)</sup> - M sport brake / - M freno sportivo / - M frein de sport / - M freno deportiva



















<sup>2)</sup> + M sport brake / + M freno sportivo / + M frein de sport / + M freno deportiva

<sup>3)</sup> + M sport brake / two-p. disc / + M freno sport / deux part.disc / + M frein de sport / d. parti. disque / + M freno sport / deux parties disc













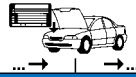











<sup>4)</sup> two-piece brake disc / disco frenante en due parti / disque d.fr.en deux parties / disco de fr.de dos piezas





|     |    |  |  |  |  |  |  |  |   |  |   |   |   |  |                 |   |
|--|--|--|--|--|---|--|--|--|---|--|---|---|---|--|-----------------|---|
| <b>BMW 2er Reihe/F22 Coupe (13-)</b>   |  |  |  |  |   |  |  |  |   |  |   |   |   |  |                 |   |
|    | 218 d  | 100  | 07.15  |  | 24.0711-6281.3  | 360386   | 2  | - Parkassistent <sup>1)</sup>  | Radsensor L=540   |  |   |   |   |  |                 |   |
|  | 218 d  | 105  | 10.13  |  | 24.0711-6282.3  | 360387   | 2  | + Parkassistent <sup>2)</sup>  | Radsensor L=540   |  |   |   |   |  |                 |   |
|  | 218 d  | 110  | 07.15  |  |   |  |  |  |   |  |   |   |   |  |                 |   |
|  | 218 i  | 100  | 03.15  |  |   |  |  |  |   |  |   |   |   |  |                 |   |
|  | 220 d  | 120  | 11.14  |  |   |  |  |  |   |  |   |   |   |  |                 |   |
|  | 220 d  | 135  | 10.13  |  |   |  |  |  |   |  |   |   |   |  |                 |   |
|  | 220 d  | 140  | 11.14  |  |   |  |  |  |   |  |   |   |   |  |                 |   |
|  | 220 i  | 135  | 10.13  |  |   |  |  |  |   |  |   |   |   |  |                 |   |
|  | 225 d  | 160  | 10.13  |  |   |  |  |  |   |  |   |   |   |  |                 |   |
|  | 225 d  | 165  | 07.14  |  |   |  |  |  |   |  |   |   |   |  |                 |   |
|  | 228 i  | 180  | 07.14  |  |   |  |  |  |   |  |   |   |   |  |                 |   |
|  | 230 i  | 185  | 09.15  |  |   |  |  |  |   |  |   |   |   |  |                 |   |
|  | M 235 i  | 240  | 10.13  |  |   |  |  |  |   |  |   |   |   |  |                 |   |
|  | M 240 i  | 250  | 09.15  |  |   |  |  |  |   |  |   |   |   |  |                 |   |
|    | 220 d xDrive   | 120  | 03.15  |  | 24.0711-6299.3  | 360388   | 2  | - Parkassistent <sup>1)</sup>  | Radsensor L=746   |  |   |   |   |  |                 |   |
|  | 220 d xDrive   | 140  | 03.15  |  | 24.0711-6300.3  | 360389   | 2  | + Parkassistent <sup>2)</sup>  | Radsensor L=746   |  |   |   |   |  |                 |   |
|  | M 235 i xDrive   | 240  | 07.14  |  |   |  |  |  |   |  |   |   |   |  |                 |   |
|  | M 240 i xDrive   | 250  | 09.15  |  |   |  |  |  |   |  |   |   |   |  |                 |   |
|  | M2   | 272  | 11.15  |  | 24.0711-6282.3  | 360387   | 2  |  | Radsensor L=540   |  |   |   |   |  |                 |   |
|  |   | 218 d  | 100  | 07.15  |   | 13.0460-3859.2   | 603859   | 1  | - M Sportbremse <sup>3)</sup><br>- M Sportbremse <sup>3)</sup><br>+ M Sportbremse <sup>4)</sup> | 25307 17,5 +/WE BOS<br>25307 17,5 +/WE BOS<br>25029 16,7 /WE/Zub BRE<br>Warnkontakt L=1045mm |   |   |   |  |                 |   |
|  |  | 218 d  | 105  | 10.13  |   | 13.0470-3859.2   | LD3859   |  |   |  |   |   |   |  |                 |   |
|  |  | 218 d  | 110  | 07.15  |   | 13.0460-4874.2   | 604874   |  |   |  |   |   |   |  |                 |   |
|  |  | 218 i  | 100  | 03.15  |   | 24.8190-0007.2   | 620007   |  |   |  |   |   |   |  |                 |   |
|  |  | 220 d  | 120  | 11.14  |   |  |  |  |   |  |   |   |   |  |                 |   |
|  |  | 220 d  | 135  | 10.13  |   |  |  |  |   |  |   |   |   |  |                 |   |
|  |  | 220 d  | 140  | 11.14  |   |  |  |  |   |  |   |   |   |  |                 |   |
|  |  | 220 d xDrive   | 120  | 03.15  |   |  |  |  |   |  |   |   |   |  |                 |   |
|  |  | 220 d xDrive   | 140  | 03.15  |   |  |  |  |   |  |   |   |   |  |                 |   |
| 220 i  |  | 135  | 10.13  |  |   |  |  |  |   |  |   |   |   |  |                 |   |
| 225 d  |  | 160  | 10.13  |  |   |  |  |  |   |  |   |   |   |  |                 |   |
| 225 d  |  | 165  | 07.14  |  |   |  |  |  |   |  |   |   |   |  |                 |   |
| 228 i  |  | 180  | 07.14  |  |   |  |  |  |   |  |   |   |   |  |                 |   |
| 230 i  |  | 185  | 09.15  |  |   |  |  |  |   |  |   |   |   |  |                 |   |
|  | M 235 i  | 240  | 10.13  |  | 13.0460-4874.2  | 604874   | 1  |  | 25029 16,7 /WE/Zub BRE<br>Warnkontakt L=1045mm  |  |   |   |   |  |                 |   |
|  | M 235 i xDrive   | 240  | 07.14  |  | 24.8190-0007.2  | 620007   |  |  |   |  |   |   |   |  |                 |   |
|  | M 240 i  | 250  | 09.15  |  |   |  |  |  |   |  |   |   |   |  |                 |   |
|  | M 240 i xDrive   | 250  | 09.15  |  |   |  |  |  |   |  |   |   |   |  |                 |   |
|  | M2   | 272  | 11.15  |  | 24.8190-0007.2  | 620007   |  |  |   | 1  |   | Warnkontakt L=1045mm  |   |  |                 |   |
|  |  | 218 d  | 100  | 07.15  |   | 24.0111-0175.1   |  |  |   | 411175   | 1   | - M Sportbremse <sup>3)</sup><br>+ M Sportbremse / zweiteil.Br. <sup>5)</sup> | 290 11,0 9,4 L +S +B<br>345 24,0 22,4 V L +S +B |  |                 |   |
|  |  | 218 d  | 105  | 10.13  |   | 24.0124-0250.2   |  |  |   | 424250   |   |   |   |  |                 |   |
|  |  | 218 d  | 110  | 07.15  |   |  |  |  |   |  |   |   |   |  |                 |   |
|  |  | 218 i  | 100  | 03.15  |   |  |  |  |   |  |   |   |   |  |                 |   |
|  |  | 220 d  | 120  | 11.14  |   | 24.0120-0237.1   |  |  |   | 420237   |   |   |   |  |                 |   |
|  |  | 220 d  | 135  | 10.13  |   | 24.0124-0250.2   |  |  |   | 424250   |   |   |   |  |                 |   |
|  |  | 220 d  | 140  | 11.14  |   |  |  |  |   |  |   |   |   |  |                 |   |
|  |  | 220 d xDrive   | 120  | 03.15  |   |  |  |  |   |  |   |   |   |  |                 |   |
|  |  | 220 d xDrive   | 140  | 03.15  |   |  |  |  |   |  |   |   |   |  |                 |   |
| 220 i  |  | 135  | 10.13  |  |   |  |  |  |   |  |   |   |   |  |                 |   |
| 225 d  |  | 160  | 10.13  |  |   |  |  |  |   |  |   |   |   |  |                 |   |
| 225 d  |  | 165  | 07.14  |  |   |  |  |  |   |  |   |   |   |  |                 |   |
| 228 i  |  | 180  | 07.14  |  |   |  |  |  |   |  |   |   |   |  |                 |   |
| 230 i  |  | 185  | 09.15  |  |   |  |  |  |   |  |   |   |   |  |                 |   |
|  | M 235 i  | 240  | 10.13  |  | 24.0124-0250.2  | 424250   | 1  | zweiteilige Bremsscheibe <sup>6)</sup>   | 345 24,0 22,4 V L +S +B   |  |   |   |   |  |                 |   |
|  | M 235 i xDrive   | 240  | 07.14  |  |   |  |  |  |   |  |   |   |   |  |                 |   |
|  | M 240 i  | 250  | 09.15  |  |   |  |  |  |   |  |   |   |   |  |                 |   |
|  | M 240 i xDrive   | 250  | 09.15  |  |   |  |  |  |   |  |   |   |   |  |                 |   |
|  |  | 218 d  | 100  | 07.15  |   | 24.0711-5347.3   |  |  |   | 360374   | 2   |   | Radsensor L=802                                 |  |                 |   |
|  |  | 218 d  | 105  | 10.13  |   |  |  |  |   |  |   |   |   |  |                 |   |
|  |  | 218 d  | 110  | 07.15  |   |  |  |  |   |  |   |   |   |  |                 |   |
|  |  | 218 i  | 100  | 03.15  |   |  |  |  |   |  |   |   |   |  |                 |   |
|  |  | 220 d  | 120  | 11.14  |   |  |  |  |   |  |   |   |   |  |                 |   |
|  |  | 220 d  | 135  | 10.13  |   |  |  |  |   |  |   |   |   |  |                 |   |
|  |  | 220 d  | 140  | 11.14  |   |  |  |  |   |  |   |   |   |  |                 |   |
|  |  | 220 d xDrive   | 120  | 03.15  |   |  |  |  |   |  |   |   |   |  |                 |   |
|  |  | 220 d xDrive   | 140  | 03.15  |   |  |  |  |   |  |   |   |   |  |                 |   |
|  |  | 220 i  | 135  | 10.13  |   |  |  |  |   |  |   |   |   |  |                 |   |
| 225 d  |  | 160  | 10.13  |  |   |  |  |  |   |  |   |   |   |  |                 |   |
| 225 d  |  | 165  | 07.14  |  |   |  |  |  |   |  |   |   |   |  |                 |   |
| 228 i  |  | 180  | 07.14  |  |   |  |  |  |   |  |   |   |   |  |                 |   |
| 230 i  |  | 185  | 09.15  |  |   |  |  |  |   |  |   |   |   |  |                 |   |
| M 235 i  | 240  | 10.13  |  |  |   |  |  |  |   |  |   |   |   |  |                 |   |
| M 240 i  | 250  | 09.15  |  |  |   |  |  |  |   |  |   |   |   |  |                 |   |
|  | M 235 i xDrive   | 240  | 07.14  |  | 24.0711-5347.3  | 360374   | 2  | - Geschwindigkeitsregelanlage <sup>7)</sup>  | Radsensor L=802   |  |   |   |   |  |                 |   |
|  | M 240 i xDrive   | 250  | 09.15  |  | 24.0711-5359.3  | 360375   |  |  |   | 2  | + Geschwindigkeitsregelanlage <sup>8)</sup> | Radsensor L=802   |   |  |                 |   |
|  | M2   | 272  | 11.15  |  | 24.0711-5359.3  | 360375   |  |  |   |  |   |   | 2   |  | Radsensor L=802 |   |
|  |  | 218 d  | 100  | 07.15  |   | 03.0137-0379.2   |  |  |   |  |   |   | 650379  |  |                 | 161 x 20<br>Bremsbacken-Zubehör<br>Bremsbacken-Zubehör<br>Spreizschloß Satz |
|  |  | 218 d  | 105  | 10.13  |   | 03.0137-9265.2   |  |  |   |  |   |   | 669265  |  |                 |   |
|  |  | 218 d  | 110  | 07.15  |   | 03.0137-9701.2   |  |  |   |  |   |   | 669701  |  |                 |   |
|  |  | 218 i  | 100  | 03.15  |   | 03.0137-9702.2   |  |  |   |  |   |   | 669702  |  |                 |   |
|  |  | 220 d  | 120  | 11.14  |   |  |  |  |   |  |   |   |   |  |                 |   |
|  |  | 220 d  | 135  | 10.13  |   |  |  |  |   |  |   |   |   |  |                 |   |
|  |  | 220 d  | 140  | 11.14  |   |  |  |  |   |  |   |   |   |  |                 |   |
|  |  | 220 d xDrive   | 120  | 03.15  |   |  |  |  |   |  |   |   |   |  |                 |   |
|  |  | 220 d xDrive   | 140  | 03.15  |   |  |  |  |   |  |   |   |   |  |                 |   |
|  |  | 220 i  | 135  | 10.13  |   |  |  |  |   |  |   |   |   |  |                 |   |

<sup>1)</sup> - parking assistant / - assistente di parcheggio / - assistance au stationnement / - asistente de aparcamiento  
<sup>2)</sup> + parking assistant / + assistente di parcheggio / + assistance au stationnement / + asistente de aparcamiento  
<sup>3)</sup> - M sport brake / - M freno sportivo / - M frein de sport / - M freno deportiva  
<sup>4)</sup> + M sport brake / + M freno sportivo / + M frein de sport / + M freno deportiva  
<sup>5)</sup> + M sport brake / two-p. disc / + M freno sport / deux part.disc / + M frein de sport / d. parti. disque / + M freno sport / deux parties disc  
<sup>6)</sup> two-piece brake disc / disco frenante in due parti / disque d.fr.en deux parties / disco de fr.de dos piezas  
<sup>7)</sup> - speed control system / - impianto variatore di velocità / - régulateur de vitesse / - sistema de regulación de velocidad  
<sup>8)</sup> + speed control system / + impianto variatore di velocità / + régulateur de vitesse / + sistema de regulación de velocidad

|     |  |  |  |  |  |  |       |       |  |                   |  |
|--|--|--|--|--|---|--|---|---|--|-------------------|--|
| <b>BMW 2er Reihe/F22 Coupe (13-)</b>   |  |  |  |  |   |  |   |   |  |                   |  |
|    | 225 d  | 160  | 10.13  |  | 03.0137-0379.2  | 650379   |   | 161 x 20<br>Bremsbacken-Zubehör<br>Bremsbacken-Zubehör<br>Spreizschloß Satz             |  |                   |  |
|  | 225 d  | 165  | 07.14  |  | 03.0137-9265.2  | 669265   |   |   |  |                   |  |
|  | 228 i  | 180  | 07.14  |  | 03.0137-9701.2  | 669701   |   |   |  |                   |  |
|  | 230 i  | 185  | 09.15  |  | 03.0137-9702.2  | 669702   |   |   |  |                   |  |
|  | M 235 i  | 240  | 10.13  |  |   |  |   |   |  |                   |  |
|  | M 235 i xDrive   | 240  | 07.14  |  |   |  |   |   |  |                   |  |
|  | M 240 i  | 250  | 09.15  |  |   |  |   |   |  |                   |  |
|  | M 240 i xDrive   | 250  | 09.15  |  |   |  |   |   |  |                   |  |
|  | M2   | 272  | 11.15  |  | 03.0137-0305.2  | 650305   |   | 185 x 20<br>Bremsbacken-Zubehör<br>Bremsbacken-Zubehör<br>Spreizschloß Satz             |  |                   |  |
|  |  |  |  |  | 03.0137-9062.2  | 669062   |   |   |  |                   |  |
|  |  |  |  |  | 03.0137-9700.2  | 669700   |   |   |  |                   |  |
|  |  |  |  |  | 03.0137-9702.2  | 669702   |   |   |  |                   |  |
| <b>BMW 2er Reihe/F23 Cabrio (14-)</b>  |  |  |  |  |   |  |   |   |  |                   |  |
|    | 218 d  | 100  | 07.15  |  | 13.0460-3865.2  | 603865   | - M Sportbremse <sup>1)</sup>   | 25014 18,2 +/WE<br>25014 18,2 +/WE<br>25028 18,0 /WE<br>Warnkontakt L=675mm             | BOS<br>BOS<br>BRE  |                   |  |
|  | 218 d  | 110  | 07.15  |  | 13.0470-3865.2  | LD3865   | - M Sportbremse <sup>1)</sup>   |   |  |                   |  |
|  | 218 i  | 100  | 03.15  |  | 13.0460-4875.2  | 604875   | + M Sportbremse <sup>2)</sup>   |   |  |                   |  |
|  |  |  |  |  | 24.8190-0006.2  | 620006   | 1    |   |  |                   |  |
|  |  | 220 d  | 120  | 11.14  |   | 13.0460-4875.2   | 604875  | + M Sportbremse <sup>2)</sup>   | 25028 18,0 /WE<br>25199 19,6 +/WE<br>25199 19,6 +/WE<br>Warnkontakt L=675mm      | BRE<br>BOS<br>BOS |  |
|  |  | 220 d  | 140  | 11.14  |   | 13.0460-3857.2   | 603857  | - M Sportbremse <sup>1)</sup>   |  |                   |  |
|  |  | 220 i  | 135  | 11.14  |   | 13.0470-3857.2   | LD3857  | - M Sportbremse <sup>1)</sup>   |  |                   |  |
|  |  | 225 d  | 165  | 07.15  |   | 24.8190-0006.2   | 620006  | 1    |  |                   |  |
|  |  | 228 i  | 180  | 11.14  |   |  |   |   |  |                   |  |
|  |  | 230 i  | 185  | 09.15  |   |  |   |   |  |                   |  |
|  |  | 228 i xDrive   | 180  | 11.14  |   | 13.0460-4875.2   | 604875  | + M Sportbremse <sup>2)</sup>   | 25028 18,0 /WE<br>Warnkontakt L=675mm  | BRE               |  |
|  |  |  |  |  |   | 24.8190-0006.2   | 620006  | 1    |  |                   |  |
|  |  | M 235 i  | 240  | 11.14  |   | 13.0460-4875.2   | 604875  |   | 25028 18,0 /WE<br>Warnkontakt L=675mm  | BRE               |  |
|  |  | M 235 i xDrive   | 240  | 07.15  |   | 24.8190-0006.2   | 620006  | 1    |  |                   |  |
|  | M 240 i  | 250  | 09.15  |  |   |  |   |   |  |                   |  |
|  | M 240 i xDrive   | 250  | 09.15  |  |   |  |   |   |  |                   |  |
|    | 218 d  | 100  | 07.15  |  | 24.0122-0239.1  | 422239   | - M Sportbremse <sup>1)</sup>   | 284 22,0 20,4 V L +S +B<br>284 22,0 19,6 V L +S +B PD<br>340 30,0 28,4 V L +S +B        | PD   |                   |  |
|  | 218 d  | 110  | 07.15  |  | 24.0322-0239.1  | 522239   | - M Sportbremse <sup>1)</sup>   |   |  |                   |  |
|  | 218 i  | 100  | 03.15  |  | 24.0130-0233.2  | 430233   | + M Sportbremse <sup>2)</sup>   |   |  |                   |  |
|  |  |  |  |  |   |  |   |   |  |                   |  |
|  |  | 220 d  | 120  | 11.14  |   | 24.0124-0203.1   | 424203  | - M Sportbremse <sup>1)</sup>   | 312 23,9 22,4 V L +S +B<br>312 23,9 22,4 V L +S +B PD<br>340 30,0 28,4 V L +S +B | PD                |  |
|  |  | 220 d  | 140  | 11.14  |   | 24.0324-0203.1   | 524203  | - M Sportbremse <sup>1)</sup>   |  |                   |  |
|  |  | 220 i  | 135  | 11.14  |   | 24.0130-0233.2   | 430233  | + M Sportbremse <sup>2)</sup>   |  |                   |  |
|  |  | 225 d  | 165  | 07.15  |   |  |   |   |  |                   |  |
|  |  | 228 i xDrive   | 180  | 11.14  |   |  |   |   |  |                   |  |
|  |  | 228 i  | 180  | 11.14  |   | 24.0130-0233.2   | 430233  | + M Sportbremse <sup>2)</sup>   | 340 30,0 28,4 V L +S +B  |                   |  |
|  |  | 230 i  | 185  | 09.15  |   |  |   |   |  |                   |  |
|  |  | M 235 i  | 240  | 11.14  |   | 24.0130-0233.2   | 430233  |   | 340 30,0 28,4 V L +S +B  |                   |  |
|  |  | M 235 i xDrive   | 240  | 07.15  |   |  |   |   |  |                   |  |
|  |  | M 240 i  | 250  | 09.15  |   |  |   |   |  |                   |  |
|  | M 240 i xDrive   | 250  | 09.15  |  |   |  |   |   |  |                   |  |
|  | 218 d  | 100  | 07.15  |  | 24.0711-6281.3  | 360386   | 2  | Radsensor L=540   |  |                   |  |
|  | 218 d  | 110  | 07.15  |  |   |  |   |   |  |                   |  |
|  | 218 i  | 100  | 03.15  |  |   |  |   |   |  |                   |  |
|  | 220 d  | 120  | 11.14  |  |   |  |   |   |  |                   |  |
|  | 220 d  | 140  | 11.14  |  |   |  |   |   |  |                   |  |
|  | 220 i  | 135  | 11.14  |  |   |  |   |   |  |                   |  |
|  | 225 d  | 165  | 07.15  |  |   |  |   |   |  |                   |  |
|  | 228 i  | 180  | 11.14  |  |   |  |   |   |  |                   |  |
|  | 230 i  | 185  | 09.15  |  |   |  |   |   |  |                   |  |
|  | M 235 i  | 240  | 11.14  |  |   |  |   |   |  |                   |  |
|  | M 240 i  | 250  | 09.15  |  |   |  |   |   |  |                   |  |
|  | 228 i xDrive   | 180  | 11.14  |  | 24.0711-6299.3  | 360388   | 2  |   |  | Radsensor L=746   |  |
|  | M 235 i xDrive   | 240  | 07.15  |  |   |  |   |   |  |                   |  |
|  | M 240 i xDrive   | 250  | 09.15  |  |   |  |   |   |  |                   |  |
|  |  |  |  |  |   |  |   |   |  |                   |  |
|  | 218 d  | 100  | 07.15  |  | 13.0460-3859.2  | 603859   | - M Sportbremse <sup>1)</sup>   | 25307 17,5 +/WE<br>25307 17,5 +/WE<br>25029 16,7 /WE/Zub<br>Warnkontakt L=1045mm        | BOS<br>BOS<br>BRE  |                   |  |
|  | 218 d  | 110  | 07.15  |  | 13.0470-3859.2  | LD3859   | - M Sportbremse <sup>1)</sup>   |   |  |                   |  |
|  | 218 i  | 100  | 03.15  |  | 13.0460-4874.2  | 604874   | + M Sportbremse <sup>2)</sup>   |   |  |                   |  |
|  |  |  |  |  | 24.8190-0007.2  | 620007   | 1  |   |  |                   |  |
|  |  | 220 d  | 120  | 07.15  |   |  |   |   |  |                   |  |
|  |  | 220 d  | 140  | 11.14  |   |  |   |   |  |                   |  |
|  |  | 220 i  | 135  | 11.14  |   |  |   |   |  |                   |  |
|  |  | 225 d  | 165  | 07.15  |   |  |   |   |  |                   |  |
|  |  | 228 i  | 180  | 11.14  |   |  |   |   |  |                   |  |
|  |  | 228 i xDrive   | 180  | 11.14  |   |  |   |   |  |                   |  |
|  |  | 230 i  | 185  | 09.15  |   | 13.0460-4874.2   | 604874  | + M Sportbremse <sup>2)</sup>   | 25029 16,7 /WE/Zub<br>Warnkontakt L=1045mm                                       | BRE               |  |
|  |  |  |  |  |   | 24.8190-0007.2   | 620007  | 1  |  |                   |  |
|  |  | M 235 i  | 240  | 11.14  |   | 13.0460-4874.2   | 604874  |   | 25029 16,7 /WE/Zub<br>Warnkontakt L=1045mm                                       | BRE               |  |
|  |  | M 235 i xDrive   | 240  | 07.15  |   | 24.8190-0007.2   | 620007  | 1  |  |                   |  |
|  | M 240 i  | 250  | 09.15  |  |   |  |   |   |  |                   |  |
|  | M 240 i xDrive   | 250  | 09.15  |  |   |  |   |   |  |                   |  |
|  | 218 d  | 100  | 07.15  |  | 24.0111-0175.1  | 411175   | - M Sportbremse <sup>1)</sup>   | 290 11,0 9,4 L +S +B<br>345 24,0 22,4 V L +S +B   |  |                   |  |
|  | 218 d  | 110  | 07.15  |  | 24.0124-0250.2  | 424250   | + M Sportbremse <sup>2)</sup>   |   |  |                   |  |
|  | 218 i  | 100  | 03.15  |  |   |  |   |   |  |                   |  |
|  |  |  |  |  |   |  |   |   |  |                   |  |
|  |  | 220 d  | 120  | 11.14  |   | 24.0120-0237.1   | 420237  | - M Sportbremse <sup>1)</sup>   | 300 20,0 18,4 V L +S +B<br>345 24,0 22,4 V L +S +B                               |                   |  |
|  |  | 220 d  | 140  | 11.14  |   | 24.0124-0250.2   | 424250  | + M Sportbremse <sup>2)</sup>   |  |                   |  |
|  |  | 220 i  | 135  | 11.14  |   |  |   |   |  |                   |  |
|  |  | 225 d  | 165  | 07.15  |   |  |   |   |  |                   |  |
|  |  | 228 i  | 180  | 11.14  |   |  |   |   |  |                   |  |
|  |  | 228 i xDrive   | 180  | 11.14  |   |  |   |   |  |                   |  |
|  |  | 230 i  | 185  | 09.15  |   |  |   |   |  |                   |  |
|  |  | M 235 i  | 240  | 11.14  |   | 24.0124-0250.2   | 424250  |   | 345 24,0 22,4 V L +S +B  |                   |  |
|  |  | M 235 i xDrive   | 240  | 07.15  |   |  |   |   |  |                   |  |
|  |  | M 240 i  | 250  | 09.15  |   |  |   |   |  |                   |  |
|  | M 240 i  | 250  | 09.15  |  |   |  |   |   |  |                   |  |

1) - M sport brake / - M freno sportivo / - M frein de sport / - M freno deportiva  
2) + M sport brake / + M freno sportivo / + M frein de sport / + M freno deportiva



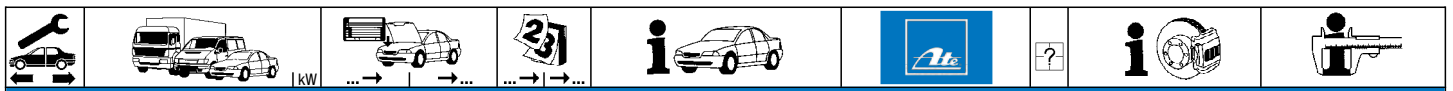

**BMW 2er Reihe/F23 Cabrio (14-)**

|  |                |     |  |       |  |                |        |   |                                 |
|--|----------------|-----|--|-------|--|----------------|--------|---|---------------------------------|
|  | M 240 i xDrive | 250 |  | 09.15 |  | 24.0124-0250.2 | 424250 |   | 345 24,0 22,4 VL +S +B          |
|  | 218 d          | 100 |  | 07.15 |  | 24.0711-5347.3 | 360374 | 2 | Radsensor L=802                 |
|  | 218 d          | 110 |  | 07.15 |  |                |        |   |                                 |
|  | 218 i          | 100 |  | 03.15 |  |                |        |   |                                 |
|  | 220 d          | 120 |  | 11.14 |  |                |        |   |                                 |
|  | 220 d          | 140 |  | 11.14 |  |                |        |   |                                 |
|  | 220 i          | 135 |  | 11.14 |  |                |        |   |                                 |
|  | 225 d          | 165 |  | 07.15 |  |                |        |   |                                 |
|  | 228 i          | 180 |  | 11.14 |  |                |        |   |                                 |
|  | 228 i xDrive   | 180 |  | 11.14 |  |                |        |   |                                 |
|  | 230 i          | 185 |  | 09.15 |  |                |        |   |                                 |
|  | M 235 i        | 240 |  | 11.14 |  |                |        |   |                                 |
|  | M 235 i xDrive | 240 |  | 07.15 |  |                |        |   |                                 |
|  | M 240 i        | 250 |  | 09.15 |  |                |        |   |                                 |
|  | M 240 i xDrive | 250 |  | 09.15 |  |                |        |   |                                 |
|  | 218 d          | 100 |  | 07.15 |  | 03.0137-0379.2 | 650379 |   | 161 x 20<br>Bremsbacken-Zubehör |
|  | 218 d          | 110 |  | 07.15 |  | 03.0137-9265.2 | 669265 |   | Bremsbacken-Zubehör             |
|  | 218 i          | 100 |  | 03.15 |  | 03.0137-9701.2 | 669701 |   | Spreizschloß Satz               |
|  | 220 d          | 120 |  | 11.14 |  | 03.0137-9702.2 | 669702 |   |                                 |
|  | 220 d          | 140 |  | 11.14 |  |                |        |   |                                 |
|  | 220 i          | 135 |  | 11.14 |  |                |        |   |                                 |
|  | 225 d          | 165 |  | 07.15 |  |                |        |   |                                 |
|  | 228 i          | 180 |  | 11.14 |  |                |        |   |                                 |
|  | 228 i xDrive   | 180 |  | 11.14 |  |                |        |   |                                 |
|  | 230 i          | 185 |  | 09.15 |  |                |        |   |                                 |
|  | M 235 i        | 240 |  | 11.14 |  |                |        |   |                                 |
|  | M 235 i xDrive | 240 |  | 07.15 |  |                |        |   |                                 |
|  | M 240 i        | 250 |  | 09.15 |  |                |        |   |                                 |
|  | M 240 i xDrive | 250 |  | 09.15 |  |                |        |   |                                 |















**BMW 2er Reihe/F45 Active Tourer (14-)**

|  |               |     |  |       |  |                |        |   |                        |
|--|---------------|-----|--|-------|--|----------------|--------|---|------------------------|
|  | 214 d         | 70  |  | 03.15 |  | 24.0122-0292.1 | 422292 |   | 280 22,0 20,4 VL +S +B |
|  | 216 i         | 75  |  | 11.15 |  |                |        |   |                        |
|  | 220 d         | 120 |  | 11.14 |  | 24.0124-0260.1 | 424260 |   | 307 24,0 22,4 VL +B    |
|  | 220 d         | 140 |  | 10.14 |  |                |        |   |                        |
|  | 220 d xDrive  | 120 |  | 11.14 |  |                |        |   |                        |
|  | 220 d xDrive  | 140 |  | 10.14 |  |                |        |   |                        |
|  | 220 i         | 120 |  | 11.14 |  |                |        |   |                        |
|  | 220 i         | 141 |  | 10.14 |  |                |        |   |                        |
|  | 225 i         | 170 |  | 10.14 |  | 24.0124-0259.1 | 424259 |   | 330 24,0 22,4 VL +S +B |
|  | 225 i xDrive  | 170 |  | 10.14 |  |                |        |   |                        |
|  | 225 xe xDrive | 100 |  | 03.16 |  |                |        |   |                        |
|  | 225 xe xDrive | 165 |  | 03.16 |  |                |        |   |                        |
|  | 214 d         | 70  |  | 03.15 |  | 24.8190-0942.2 | 620942 | 1 | Warnkontakt L=641mm    |
|  | 216 d         | 85  |  | 10.14 |  |                |        |   |                        |
|  | 216 i         | 75  |  | 11.15 |  |                |        |   |                        |
|  | 218 d         | 100 |  | 09.14 |  |                |        |   |                        |
|  | 218 d         | 110 |  | 10.14 |  |                |        |   |                        |
|  | 218 d xDrive  | 100 |  | 11.15 |  |                |        |   |                        |
|  | 218 d xDrive  | 110 |  | 11.15 |  |                |        |   |                        |
|  | 218 i         | 100 |  | 10.14 |  |                |        |   |                        |
|  | 220 d         | 120 |  | 11.14 |  |                |        |   |                        |
|  | 220 d         | 140 |  | 10.14 |  |                |        |   |                        |
|  | 220 d xDrive  | 120 |  | 11.14 |  |                |        |   |                        |
|  | 220 d xDrive  | 140 |  | 10.14 |  |                |        |   |                        |
|  | 220 i         | 120 |  | 11.14 |  |                |        |   |                        |
|  | 220 i         | 141 |  | 10.14 |  |                |        |   |                        |
|  | 225 i         | 170 |  | 10.14 |  |                |        |   |                        |
|  | 225 i xDrive  | 170 |  | 10.14 |  |                |        |   |                        |
|  | 225 xe xDrive | 100 |  | 03.16 |  |                |        |   |                        |
|  | 225 xe xDrive | 165 |  | 03.16 |  |                |        |   |                        |

**BMW 2er Reihe/F46 Gran Tourer (15-)**

|  |              |     |  |       |  |                |        |   |                        |
|--|--------------|-----|--|-------|--|----------------|--------|---|------------------------|
|  | 218 d        | 100 |  | 03.15 |  | 24.0124-0260.1 | 424260 |   | 307 24,0 22,4 VL +B    |
|  | 218 d        | 110 |  | 03.15 |  |                |        |   |                        |
|  | 218 d xDrive | 100 |  | 03.15 |  |                |        |   |                        |
|  | 218 d xDrive | 110 |  | 03.15 |  |                |        |   |                        |
|  | 218 i        | 100 |  | 03.15 |  |                |        |   |                        |
|  | 220 d        | 120 |  | 07.15 |  | 24.0124-0259.1 | 424259 |   | 330 24,0 22,4 VL +S +B |
|  | 220 d        | 140 |  | 07.15 |  |                |        |   |                        |
|  | 220 d xDrive | 120 |  | 03.15 |  |                |        |   |                        |
|  | 220 d xDrive | 140 |  | 03.15 |  |                |        |   |                        |
|  | 220 i        | 120 |  | 03.15 |  |                |        |   |                        |
|  | 220 i        | 141 |  | 03.15 |  |                |        |   |                        |
|  | 214 d        | 70  |  | 03.15 |  | 24.8190-0942.2 | 620942 | 1 | Warnkontakt L=641mm    |
|  | 216 d        | 85  |  | 03.15 |  |                |        |   |                        |
|  | 216 i        | 75  |  | 07.15 |  |                |        |   |                        |
|  | 218 d        | 100 |  | 03.15 |  |                |        |   |                        |
|  | 218 d        | 110 |  | 03.15 |  |                |        |   |                        |
|  | 218 d xDrive | 100 |  | 03.15 |  |                |        |   |                        |
|  | 218 d xDrive | 110 |  | 03.15 |  |                |        |   |                        |
|  | 218 i        | 100 |  | 03.15 |  |                |        |   |                        |
|  | 220 d        | 120 |  | 07.15 |  |                |        |   |                        |
|  | 220 d        | 140 |  | 07.15 |  |                |        |   |                        |



|     |   |                     |    |   |  |  |                            |                        |
|--|---|---|--|---|---|--|--|--|
| <b>BMW 2er Reihe/F46 Gran Tourer (15-)</b>   |   |   |  |   |   |  |  |  |
|    | 220 d xDrive<br>220 d xDrive<br>220 i<br>220 i  | 120<br>140<br>120<br>141  | 03.15<br>03.15<br>03.15<br>03.15   |   | 24.8190-0942.2  | 620942   | 1  | Warnkontakt L=641mm  |
| <b>BMW 3er Reihe/E36 Limousine (90-98)</b>   |   |   |  |   |   |  |  |  |
|    | 316 i<br>316 i<br>318 i<br>318 i<br>318 is<br>318 is<br>318 tds<br>320 i<br>323 i<br>325 i<br>325 td<br>325 tds<br>328 i                              | 73<br>75<br>83<br>85<br>103<br>103<br>66<br>110<br>125<br>141<br>85<br>105<br>142                   | 09.90<br>09.90<br>12.90<br>10.93<br>03.93<br>09.95<br>01.95<br>09.90<br>03.95<br>09.90<br>09.91<br>05.93<br>01.95                            | 09.93<br>02.98<br>10.93<br>02.98<br>02.98<br>02.98<br>02.98<br>02.98<br>02.98<br>09.95<br>02.98<br>02.98  | 13.0460-5405.2<br>13.0470-5405.2<br>24.8190-0207.2                                | 605405<br>LD5405<br>620207   | 1  | 21643 17,8 +/-WE ATE<br>21643 17,8 +/-WE ATE<br>Warnkontakt L=786mm                                      |
|  | M3 3.0<br>M3 3.2  | 210<br>236  | 08.94<br>09.95   | 09.95<br>02.98  | 13.0460-7185.2<br>24.8190-0210.2  | 607185<br>620210   | 1  | 21064 20,3 +/-WE ATE<br>Warnkontakt L=810mm  |
|    | 316 i<br>316 i<br>318 i<br>318 i<br>318 tds<br>318 i<br>318 i<br>318 is<br>318 is<br>318 tds<br>320 i<br>323 i<br>325 i<br>325 td<br>325 tds<br>328 i | 73<br>75<br>83<br>85<br>66<br>83<br>85<br>103<br>103<br>66<br>110<br>125<br>141<br>85<br>105<br>142 | 09.90<br>09.90<br>12.90<br>10.93<br>01.95<br>12.90<br>10.93<br>03.93<br>09.95<br>01.95<br>09.90<br>03.95<br>09.90<br>09.91<br>05.93<br>01.95 | 09.93<br>02.98<br>10.93<br>02.98<br>02.98<br>+ erhöhte Zuladung <sup>1)</sup><br>+ erhöhte Zuladung <sup>1)</sup><br>+ erhöhte Zuladung <sup>1)</sup><br>+ erhöhte Zuladung <sup>2)</sup><br>+ erhöhte Zuladung <sup>2)</sup><br>+ erhöhte Zuladung <sup>2)</sup><br>+ erhöhte Zuladung <sup>2)</sup><br>+ erhöhte Zuladung <sup>2)</sup><br>+ erhöhte Zuladung <sup>2)</sup><br>+ erhöhte Zuladung <sup>2)</sup><br>+ erhöhte Zuladung <sup>2)</sup><br>+ erhöhte Zuladung <sup>2)</sup><br>+ erhöhte Zuladung <sup>2)</sup><br>+ erhöhte Zuladung <sup>2)</sup> | 24.0112-0126.1<br>24.0312-0126.1<br>24.0122-0115.1<br>24.0322-0115.1              | 412126<br>512126<br>422115<br>522115   |  | 286 12,0 10,4 +S +B<br>286 12,0 9,6 +S +B PD<br>286 22,0 20,4 V L +S +B<br>286 22,0 19,6 V L +S +B PD    |
|  | M3 3.0<br>M3 3.2  | 210<br>236  | 08.94<br>09.95   | 09.95<br>02.98  | 24.0128-0198.1<br>24.0128-0199.1<br>24.0328-0198.1<br>24.0328-0199.1              | 428198<br>428199<br>528198<br>528199   | <input type="checkbox"/><br><input type="checkbox"/><br><input type="checkbox"/><br><input type="checkbox"/> | 315 28,0 26,4 V L +S +B<br>315 28,0 26,4 V L +S +B<br>315 28,0 26,4 V L +S +B<br>315 28,0 26,4 V L +S +B |
|  | M3 3.2  | 236   | 09.95  | 02.98   | 24.0128-0204.2<br>24.0128-0205.2  | 428204<br>428205   | <input type="checkbox"/><br><input type="checkbox"/>   | 315 28,0 26,4 V L +S +B<br>315 28,0 26,4 V L +S +B   |
|  | 316 i<br>316 i<br>318 i<br>318 i<br>318 is<br>318 is<br>318 tds<br>320 i<br>323 i<br>325 i<br>325 td<br>325 tds<br>328 i<br>M3 3.0<br>M3 3.2          | 73<br>75<br>83<br>85<br>103<br>103<br>66<br>110<br>125<br>141<br>85<br>105<br>142<br>210<br>236     | 09.90<br>07.93<br>12.90<br>10.93<br>03.93<br>09.95<br>01.95<br>09.90<br>03.95<br>09.90<br>09.91<br>05.93<br>01.95<br>08.94<br>09.95          | 09.93<br>02.98<br>10.93<br>02.98<br>02.98<br>02.98<br>02.98<br>02.98<br>02.98<br>09.95<br>02.98<br>02.98<br>02.98<br>09.95<br>02.98   | 24.0741-1103.3  | 360161   | 2 <input type="checkbox"/>   | Radsensor L=560  |
|  | 316 i<br>316 i<br>318 i<br>318 i<br>318 is<br>318 is<br>318 tds<br>320 i<br>323 i<br>325 i<br>325 td<br>325 tds<br>328 i<br>M3 3.0<br>M3 3.2          | 73<br>75<br>83<br>85<br>103<br>103<br>66<br>110<br>125<br>141<br>85<br>105<br>142<br>210<br>236     | 09.90<br>09.90<br>12.90<br>10.93<br>03.93<br>09.95<br>01.95<br>09.90<br>03.95<br>09.90<br>09.91<br>05.93<br>01.95<br>08.94<br>09.95          | 09.93<br>02.98<br>10.93<br>02.98<br>02.98<br>02.98<br>+ ABS<br>+ ABS<br>+ ABS<br>+ ABS<br>+ ABS<br>+ ABS<br>+ ABS<br>+ ABS<br>09.95<br>02.98  | 13.0460-3605.2<br>13.0470-3605.2<br>24.8190-0206.2                                | 603605<br>LD3605<br>620206   | 1  | 20180 17,3 +/-WE ATE<br>20180 17,3 +/-WE ATE<br>Warnkontakt L=790mm                                      |
|  | M3 3.0<br>M3 3.2  | 210<br>236  | 08.94<br>09.95   | 09.95<br>02.98  | 13.0460-3803.2<br>24.8190-0206.2  | 603803<br>620206   | 1  | 20995 17,3 +/-WE ATE<br>Warnkontakt L=790mm  |
|  | 316 i<br>316 i<br>318 i<br>318 i<br>318 is<br>318 is<br>318 tds<br>320 i<br>323 i<br>325 i<br>325 td<br>325 tds<br>323 i<br>328 i                     | 73<br>75<br>83<br>85<br>103<br>103<br>66<br>110<br>125<br>141<br>85<br>105<br>125<br>142            | 09.90<br>09.90<br>12.90<br>10.93<br>03.93<br>09.95<br>01.95<br>09.90<br>03.95<br>09.90<br>09.91<br>05.93<br>03.95<br>01.95                   | 09.93<br>02.98<br>10.93<br>02.98<br>02.98<br>02.98<br>+ ABS<br>+ ABS<br>+ ABS<br>+ ABS<br>+ ABS<br>+ ABS<br>+ ABS<br>+ ABS<br>02.98   | 24.0110-0202.1<br>24.0310-0202.1  | 410202<br>510202   |  | 280 10,0 8,4 L +S +B<br>280 10,0 7,6 L +S +B PD<br>276 19,0 17,4 V L +S +B<br>276 19,0 16,6 V L +S +B PD |

1) - increased payload / - carico utile maggiorato / - charge utile augmentée / - incremento de carga  
2) + increased payload / + carico utile maggiorato / + charge utile augmentée / + incremento de carga  
3) two-piece brake disc / disco frenante in due parti / disque d.fr.en deux parties / disco de fr.de dos piezas



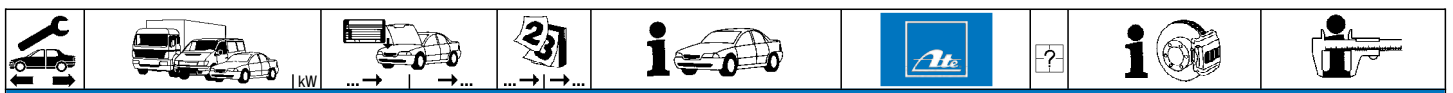

### BMW 3er Reihe/E36 Limousine (90-98)

|  |  |   |  |   |  |                                  |                  |   |  |  |
|--|--|---|--|---|--|----------------------------------|------------------|---|--|--|
|  | M3 3.0<br>M3 3.2   | 210<br>236  |  | 08.94<br>09.95  | 09.95<br>02.98   | 24.0120-0189.1<br>24.0120-0190.1 | 420189<br>420190 |   |  | 312 20,0 18,4 V L +S +B<br>312 20,0 18,4 V L +S +B |
|  | 316 i<br>316 i<br>318 i<br>318 i<br>318 is<br>318 is<br>318 tds<br>320 i<br>323 i<br>325 i<br>325 td<br>325 tds<br>328 i<br>M3 3.0<br>M3 3.2 | 73<br>75<br>83<br>85<br>103<br>103<br>66<br>110<br>125<br>141<br>85<br>105<br>142<br>210<br>236 |  | 09.90<br>07.93<br>12.90<br>10.93<br>03.93<br>09.95<br>01.95<br>09.90<br>03.95<br>09.90<br>09.91<br>05.93<br>01.95<br>08.94<br>09.95 | 09.93<br>02.98<br>10.93<br>02.98<br>02.98<br>02.98<br>02.98<br>02.98<br>02.98<br>09.95<br>02.98<br>02.98<br>02.98<br>02.98 | 24.0751-1122.3                   | 360068           | 2 |  | Radsensor L=780                                    |
|  | 316 i<br>316 i<br>318 i<br>318 i<br>318 tds  | 73<br>75<br>83<br>85<br>66  |  | 09.90<br>09.90<br>12.90<br>10.93<br>01.95   | 09.93<br>02.98<br>10.93<br>02.98<br>02.98  | 03.0137-0247.2<br>03.0137-9147.2 | 650247<br>669147 |   |  | 229 x 42 HEB<br>Bremsbacken-Zubehör                |
|  | 316 i<br>316 i<br>318 i<br>318 i<br>318 tds  | 73<br>75<br>83<br>85<br>66  |  | 09.90<br>09.90<br>12.90<br>10.93<br>01.95   | 09.93<br>02.98<br>10.93<br>02.98<br>02.98  | 24.0222-8013.1                   | 480030           |   |  | 229/229,5 x 47                                     |
|  | 316 i<br>316 i<br>318 i<br>318 i<br>318 tds  | 73<br>75<br>83<br>85<br>66  |  | 09.90<br>09.90<br>12.90<br>10.93<br>01.95   | 09.93<br>02.98<br>09.93<br>02.98<br>02.98  | 03.0420-1223.3<br>03.0520-1223.3 | 681223<br>691223 |   |  | 23,81/229x42 Kit<br>23,81/229x42 TopKit            |
|  | 316 i<br>316 i<br>318 i<br>318 i<br>318 is<br>318 is<br>318 tds<br>320 i<br>323 i<br>325 i<br>325 td<br>325 tds<br>328 i<br>M3 3.0<br>M3 3.2 | 73<br>75<br>83<br>85<br>103<br>103<br>66<br>110<br>125<br>141<br>85<br>105<br>142<br>210<br>236 |  | 09.90<br>07.93<br>12.90<br>10.93<br>03.93<br>09.95<br>01.95<br>09.90<br>03.95<br>09.90<br>09.91<br>05.93<br>01.95<br>08.94<br>09.95 | 09.93<br>02.98<br>10.93<br>02.98<br>02.98<br>02.98<br>02.98<br>02.98<br>02.98<br>09.95<br>02.98<br>02.98<br>02.98<br>02.98 | 03.0137-0248.2<br>03.0137-9148.2 | 650248<br>669148 |   |  | 161 x 25<br>Bremsbacken-Zubehör                    |
|  | M3 3.0<br>M3 3.2   | 210<br>236  |  | 08.94<br>09.95  | 09.95<br>02.98   | 03.0137-0150.2<br>03.0137-9148.2 | 650150<br>669148 |   |  | 180 x 25<br>Bremsbacken-Zubehör                    |





























### BMW 3er Reihe/E36 Touring (95-99)

|  |   |  |  |   |   |  |                            |   |  |   |
|--|---|--|--|---|---|--|----------------------------|---|--|---|
|  | 316 i<br>318 i<br>318 tds<br>320 i<br>323 i<br>325 tds<br>328 i | 75<br>85<br>66<br>110<br>125<br>105<br>142 |  | 01.96<br>07.95<br>01.95<br>01.95<br>09.95<br>01.95<br>01.95 | 10.99<br>10.99<br>10.99<br>10.99<br>10.99<br>10.99<br>10.99 | 13.0460-5405.2<br>13.0470-5405.2<br>24.8190-0207.2 | 605405<br>LD5405<br>620207 | 1 |  | 21643 17,8 +/WE<br>21643 17,8 +/WE<br>Warnkontakt L=786mm |
|  | 316 i<br>318 i<br>318 tds                                       | 75<br>85<br>66                             |  | 01.96<br>07.95<br>01.95                                     | 10.99<br>10.99<br>10.99                                     | 24.0112-0126.1<br>24.0312-0126.1                   | 412126<br>512126           |   |  | 286 12,0 10,4 +S +B<br>286 12,0 9,6 +S +B PD              |
|  | 316 i<br>318 i<br>318 tds<br>320 i<br>323 i<br>325 tds<br>328 i | 75<br>85<br>66<br>110<br>125<br>105<br>142 |  | 01.96<br>07.95<br>01.95<br>01.95<br>09.95<br>01.95<br>01.95 | 10.99<br>10.99<br>10.99<br>10.99<br>10.99<br>10.99<br>10.99 | 24.0122-0115.1<br>24.0322-0115.1                   | 422115<br>522115           |   |  | 286 22,0 20,4 V L +S +B<br>286 22,0 19,6 V L +S +B PD     |
|  | 316 i<br>318 i<br>318 tds<br>320 i<br>323 i<br>325 tds<br>328 i | 75<br>85<br>66<br>110<br>125<br>105<br>142 |  | 01.96<br>07.95<br>01.95<br>01.95<br>09.95<br>01.95<br>01.95 | 10.99<br>10.99<br>10.99<br>10.99<br>10.99<br>10.99<br>10.99 | 24.0741-1103.3                                     | 360161                     | 2 |  | Radsensor L=560   |
|  | 316 i<br>318 i<br>318 tds<br>320 i<br>323 i<br>325 tds<br>328 i | 75<br>85<br>66<br>110<br>125<br>105<br>142 |  | 01.96<br>07.95<br>01.95<br>01.95<br>09.95<br>01.95<br>01.95 | 10.99<br>10.99<br>10.99<br>10.99<br>10.99<br>10.99<br>10.99 | 13.0460-3605.2<br>13.0470-3605.2<br>24.8190-0206.2 | 603605<br>LD3605<br>620206 | 1 |  | 20180 17,3 +/WE<br>20180 17,3 +/WE<br>Warnkontakt L=790mm |
|  | 316 i<br>318 i<br>318 tds<br>320 i<br>325 tds                   | 75<br>85<br>66<br>110<br>105               |  | 01.96<br>07.95<br>01.95<br>01.95<br>01.95                   | 10.99<br>10.99<br>10.99<br>10.99<br>10.99                   | 24.0110-0202.1<br>24.0310-0202.1                   | 410202<br>510202           |   |  | 280 10,0 8,4 L +S +B<br>280 10,0 7,6 L +S +B PD           |

1) - increased payload / - carico utile maggiorato / - charge utile augmentée / - incremento de carga





















2) + increased payload / + carico utile maggiorato / + charge utile augmentée / + incremento de carga



|     |  |  |  |  |  |  |  |   |
|--|--|--|--|--|---|--|--|---|
| <b>BMW 3er Reihe/E36 Touring (95-99)</b>   |  |  |  |  |   |  |  |   |
|    | 323 i<br>328 i   | 125<br>142   |  | 09.95<br>01.95   | 10.99<br>10.99  | 24.0119-0107.1<br>24.0319-0107.1   | 419107<br>519107   | 276 19,0 17,4 V L +S +B<br><b>276 19,0 16,6 V L +S +B PD</b>  |
|    | 316 i<br>318 i<br>318 tds<br>320 i<br>323 i<br>325 tds<br>328 i                  | 75<br>85<br>66<br>110<br>125<br>105<br>142                                       |  | 01.96<br>07.95<br>01.95<br>01.95<br>09.95<br>01.95<br>01.95                      | 10.99<br>10.99<br>10.99<br>10.99<br>10.99<br>10.99<br>10.99                       | 24.0751-1122.3   | 360068   | 2 <br>Radsensor L=780  |
|    | 316 i<br>318 i<br>318 tds<br>320 i<br>323 i<br>325 tds<br>328 i                  | 75<br>85<br>66<br>110<br>125<br>105<br>142                                       |  | 01.96<br>07.95<br>01.95<br>01.95<br>09.95<br>01.95<br>01.95                      | 10.99<br>10.99<br>10.99<br>10.99<br>10.99<br>10.99<br>10.99                       | 03.0137-0248.2<br>03.0137-9148.2   | 650248<br>669148   | 161 x 25<br>Bremsbacken-Zubehör   |
| <b>BMW 3er Reihe/E36 Coupe (92-99)</b>   |  |  |  |  |   |  |  |   |
|    | 316 i<br>318 is<br>318 is<br>320 i<br>323 i<br>325 i<br>328 i                    | 75<br>103<br>103<br>110<br>125<br>141<br>142                                     |  | 09.93<br>03.92<br>09.95<br>03.92<br>03.95<br>03.92<br>01.95                      | 04.99<br>10.95<br>04.99<br>04.99<br>04.99<br>04.99<br>04.99                       | 13.0460-5405.2<br>13.0470-5405.2<br>24.8190-0207.2                                 | 605405<br>LD5405<br>620207   | 1<br>21643 17,8 +/WE<br>21643 17,8 +/WE<br>Warnkontakt L=786mm<br><b>ATE</b>  |
|  | M3 3.0<br>M3 3.0<br>M3 3.2   | 210<br>217<br>236  |  | 10.92<br>01.95<br>10.95  | 01.95<br>10.95<br>04.99   | 13.0460-7185.2<br>24.8190-0210.2   | 607185<br>620210   | 1<br>21064 20,3 +/WE<br>Warnkontakt L=810mm<br><b>ATE</b>   |
|    | 316 i<br>318 is<br>318 is<br>320 i<br>323 i<br>325 i<br>328 i                    | 75<br>103<br>103<br>110<br>125<br>141<br>142                                     |  | 03.93<br>03.92<br>09.95<br>03.92<br>03.95<br>03.92<br>01.95                      | 04.99<br>10.95<br>04.99<br>04.99<br>04.99<br>04.99<br>04.99                       | 24.0112-0126.1<br>24.0312-0126.1   | 412126<br>512126   | 286 12,0 10,4 +S +B<br><b>286 12,0 9,6 +S +B PD</b>   |
|  | M3 3.0<br>M3 3.0   | 210<br>217   |  | 10.92<br>01.95   | 01.95<br>10.95  | 24.0128-0198.1<br>24.0128-0199.1<br>24.0328-0198.1<br>24.0328-0199.1               | 428198<br>428199<br>528198<br>528199   | <br><br><br><br>315 28,0 26,4 V L +S +B<br>315 28,0 26,4 V L +S +B<br>315 28,0 26,4 V L +S +B<br>315 28,0 26,4 V L +S +B |
|  | M3 3.2   | 236  |  | 10.95  | 04.99   | 24.0128-0204.2<br>24.0128-0205.2   | 428204<br>428205   |  zweiteilige Bremsscheibe <sup>1)</sup><br> zweiteilige Bremsscheibe <sup>1)</sup><br>315 28,0 26,4 V L +S +B<br>315 28,0 26,4 V L +S +B  |
|  | 316 i<br>318 is<br>318 is<br>320 i<br>323 i<br>325 i<br>328 i                    | 75<br>103<br>103<br>110<br>125<br>141<br>142                                     |  | 09.93<br>03.92<br>09.95<br>03.92<br>03.95<br>03.92<br>01.95                      | 04.99<br>10.95<br>04.99<br>04.99<br>04.99<br>04.99<br>04.99                       | 24.0741-1103.3   | 360161   | 2 <br>Radsensor L=560  |
|  | M3 3.0<br>M3 3.0<br>M3 3.2   | 210<br>217<br>236  |  | 10.92<br>01.95<br>10.95  | 01.95<br>10.95<br>04.99   | 13.0460-3605.2<br>13.0470-3605.2<br>24.8190-0206.2                                 | 603605<br>LD3605<br>620206   | 1<br>20180 17,3 +/WE<br>20180 17,3 +/WE<br>Warnkontakt L=790mm<br><b>ATE</b>  |
|  | M3 3.0<br>M3 3.0<br>M3 3.2   | 210<br>217<br>236  |  | 10.92<br>01.95<br>10.95  | 01.95<br>10.95<br>04.99   | 13.0460-3803.2<br>24.8190-0206.2   | 603803<br>620206   | 1<br>20995 17,3 +/WE<br>Warnkontakt L=790mm<br><b>ATE</b>   |
|  | 316 i<br>318 is<br>318 is<br>320 i<br>325 i                                      | 75<br>103<br>103<br>110<br>141   |  | 09.93<br>03.92<br>09.95<br>03.92<br>03.92  | 04.99<br>10.95<br>04.99<br>04.99<br>04.99   | 24.0110-0202.1<br>24.0310-0202.1   | 410202<br>510202   | 280 10,0 8,4 L +S +B<br><b>280 10,0 7,6 L +S +B PD</b>  |
|  | 323 i<br>328 i   | 125<br>142   |  | 03.95<br>01.95   | 04.99<br>04.99  | 24.0119-0107.1<br>24.0319-0107.1   | 419107<br>519107   | 276 19,0 17,4 V L +S +B<br><b>276 19,0 16,6 V L +S +B PD</b>  |
|  | M3 3.0<br>M3 3.0<br>M3 3.2   | 210<br>217<br>236  |  | 10.92<br>01.95<br>10.95  | 01.95<br>10.95<br>04.99   | 24.0120-0189.1<br>24.0120-0190.1   | 420189<br>420190   | <br><br>312 20,0 18,4 V L +S +B<br>312 20,0 18,4 V L +S +B  |
|  | 316 i<br>318 is<br>318 is<br>320 i<br>323 i<br>325 i<br>328 i                    | 75<br>103<br>103<br>110<br>125<br>141<br>142                                     |  | 09.93<br>03.92<br>09.95<br>03.92<br>03.95<br>03.92<br>01.95                      | 04.99<br>10.95<br>04.99<br>04.99<br>04.99<br>04.99<br>04.99                       | 24.0751-1122.3   | 360068   | 2 <br>Radsensor L=780  |
|  | M3 3.0<br>M3 3.0<br>M3 3.2   | 210<br>217<br>236  |  | 10.92<br>01.95<br>10.95  | 01.95<br>10.95<br>04.99   |  |  |   |

<sup>1)</sup> two-piece brake disc / disco frenante in due parti / disque d.fr.en deux parties / disco de fr.de dos piezas



|     |  |  |  |  |  |  |  |  |   |
|--|--|--|--|--|---|--|--|--|---|
| <b>BMW 3er Reihe/E36 Coupe (92-99)</b>   |  |  |  |  |   |  |  |  |   |
|    | 316 i  | 75   |  | 09.93  | 04.99   |  | 03.0137-0247.2<br>03.0137-9147.2   | 650247<br>669147   | 229 x 42 HEB<br>Bremsbacken-Zubehör                         |
|    | 316 i  | 75   |  | 09.93  | 04.99   |  | 24.0222-8013.1   | 480030   | 229/229,5 x 47  |
|    | 316 i  | 75   |  | 09.93  | 04.99   |  | 03.0420-1223.3<br>03.0520-1223.3   | 681223<br>691223   | 23,81/229x42 Kit<br>23,81/229x42 TopKit                     |
|    | 316 i  | 75   |  | 09.93  | 04.99   |  | 03.0137-0248.2<br>03.0137-9148.2   | 650248<br>669148   | 161 x 25<br>Bremsbacken-Zubehör                             |
|  | 318 is   | 103  |  | 03.92  | 10.95   |  |  |  |   |
|  | 318 is   | 103  |  | 09.95  | 04.99   |  |  |  |   |
|  | 320 i  | 110  |  | 03.92  | 04.99   |  |  |  |   |
|  | 323 i  | 125  |  | 03.95  | 04.99   |  |  |  |   |
|  | 325 i  | 141  |  | 03.92  | 04.99   |  |  |  |   |
|  | 328 i  | 142  |  | 01.95  | 04.99   |  |  |  |   |
|  | M3 3.0   | 210  |  | 10.92  | 01.95   |  | 03.0137-0150.2   | 650150   | 180 x 25<br>Bremsbacken-Zubehör                             |
|  | M3 3.0   | 217  |  | 01.95  | 10.95   |  | 03.0137-9062.2   | 669062   |   |
|  | M3 3.2   | 236  |  | 10.95  | 04.99   |  |  |  |   |
| <b>BMW 3er Reihe/E36 Cabrio (93-99)</b>  |  |  |  |  |   |  |  |  |   |
|    | 318 i  | 85   |  | 01.94  | 04.99   |  | 13.0460-5405.2   | 605405   | 21643 17,8 +/-WE<br>21643 17,8 +/-WE<br>Warnkontakt L=786mm |
|  | 320 i  | 110  |  | 12.93  | 04.99   |  | 13.0470-5405.2   | LD5405   |   |
|  | 323 i  | 125  |  | 06.95  | 04.99   |  | 24.8190-0207.2   | 620207   |   |
|  | 325 i  | 141  |  | 03.93  | 04.99   |  |  |  |   |
|  | 328 i  | 142  |  | 03.95  | 04.99   |  |  |  |   |
|  | M3 3.0   | 210  |  | 01.94  | 04.99   |  | 13.0460-7185.2   | 607185   | 21064 20,3 +/-WE<br>Warnkontakt L=810mm                     |
|  | M3 3.2   | 236  |  | 10.95  | 04.99   |  | 24.8190-0210.2   | 620210   |   |
|    | 318 i  | 85   |  | 01.94  | 04.99   |  | 24.0112-0126.1   | 412126   | 286 12,0 10,4 +S +B   |
|  | 320 i  | 110  |  | 12.93  | 04.99   | + Motorcode M50 1)   | 24.0312-0126.1   | 512126   | 286 12,0 9,6 +S +B PD                                       |
|  | 320 i  | 110  |  | 12.93  | 04.99   | + Motorcode M52 2)   | 24.0122-0115.1   | 422115   | 286 22,0 20,4 V L +S +B                                     |
|  | 323 i  | 125  |  | 06.95  | 04.99   |  | 24.0322-0115.1   | 522115   | 286 22,0 19,6 V L +S +B PD                                  |
|  | 325 i  | 141  |  | 03.93  | 04.99   |  |  |  |   |
|  | 328 i  | 142  |  | 03.95  | 04.99   |  |  |  |   |
|  | M3 3.0   | 210  |  | 01.94  | 04.99   |  | 24.0128-0198.1   | 428198   | 315 28,0 26,4 V L +S +B                                     |
|  |  |  |  |  |   |  | 24.0328-0198.1   | 528198   | 315 28,0 26,4 V L +S +B                                     |
|  |  |  |  |  |   |  | 24.0128-0199.1   | 428199   | 315 28,0 26,4 V L +S +B                                     |
|  |  |  |  |  |   |  | 24.0328-0199.1   | 528199   | 315 28,0 26,4 V L +S +B                                     |
|  | M3 3.2   | 236  |  | 10.95  | 04.99   |  | 24.0128-0204.2   | 428204   | 315 28,0 26,4 V L +S +B                                     |
|  |  |  |  |  |   |  | 24.0128-0205.2   | 428205   | 315 28,0 26,4 V L +S +B                                     |
|  | 318 i  | 85   |  | 01.94  | 04.99   |  | 24.0741-1103.3   | 360161   | 2<br>Radsensor L=560  |
|  | 320 i  | 110  |  | 12.93  | 04.99   |  |  |  |   |
|  | 323 i  | 125  |  | 06.95  | 04.99   |  |  |  |   |
|  | 325 i  | 141  |  | 03.93  | 04.99   |  |  |  |   |
|  | 328 i  | 142  |  | 03.95  | 04.99   |  |  |  |   |
|  | M3 3.0   | 210  |  | 01.94  | 04.99   |  |  |  |   |
|  | M3 3.2   | 236  |  | 10.95  | 04.99   |  |  |  |   |
|  | 318 i  | 85   |  | 01.94  | 04.99   |  | 13.0460-3605.2   | 603605   | 20180 17,3 +/-WE<br>20180 17,3 +/-WE<br>Warnkontakt L=790mm |
|  | 320 i  | 110  |  | 12.93  | 04.99   |  | 13.0470-3605.2   | LD3605   |   |
|  | 323 i  | 125  |  | 06.95  | 04.99   |  | 24.8190-0206.2   | 620206   |   |
|  | 325 i  | 141  |  | 03.93  | 04.99   |  |  |  |   |
|  | 328 i  | 142  |  | 03.95  | 04.99   |  |  |  |   |
|  | M3 3.0   | 210  |  | 01.94  | 04.99   |  | 13.0460-3803.2   | 603803   | 20995 17,3 +/-WE<br>Warnkontakt L=790mm                     |
|  | M3 3.2   | 236  |  | 10.95  | 04.99   |  | 24.8190-0206.2   | 620206   |   |
|  | 318 i  | 85   |  | 01.94  | 04.99   |  | 24.0110-0202.1   | 410202   | 280 10,0 8,4 L +S +B  |
|  | 320 i  | 110  |  | 12.93  | 04.99   |  | 24.0310-0202.1   | 510202   | 280 10,0 7,6 L +S +B PD                                     |
|  | 325 i  | 141  |  | 03.93  | 04.99   |  |  |  |   |
|  | 323 i  | 125  |  | 06.95  | 04.99   |  | 24.0119-0107.1   | 419107   | 276 19,0 17,4 V L +S +B                                     |
|  | 328 i  | 142  |  | 03.95  | 04.99   |  | 24.0319-0107.1   | 519107   | 276 19,0 16,6 V L +S +B PD                                  |
|  | M3 3.0   | 210  |  | 01.94  | 04.99   |  | 24.0120-0189.1   | 420189   | 312 20,0 18,4 V L +S +B                                     |
|  | M3 3.2   | 236  |  | 10.95  | 04.99   |  | 24.0120-0190.1   | 420190   | 312 20,0 18,4 V L +S +B                                     |
|  | 318 i  | 85   |  | 01.94  | 04.99   |  | 24.0751-1122.3   | 360068   | 2<br>Radsensor L=780  |
|  | 320 i  | 110  |  | 12.93  | 04.99   |  |  |  |   |
|  | 323 i  | 125  |  | 06.95  | 04.99   |  |  |  |   |
|  | 325 i  | 141  |  | 03.93  | 04.99   |  |  |  |   |
|  | 328 i  | 142  |  | 03.95  | 04.99   |  |  |  |   |
|  | M3 3.0   | 210  |  | 01.94  | 04.99   |  |  |  |   |
|  | M3 3.2   | 236  |  | 10.95  | 04.99   |  |  |  |   |
|  | 318 i  | 85   |  | 01.94  | 04.99   |  | 03.0137-0248.2<br>03.0137-9148.2   | 650248<br>669148   | 161 x 25<br>Bremsbacken-Zubehör                             |
|  | 320 i  | 110  |  | 12.93  | 04.99   |  |  |  |   |
|  | 323 i  | 125  |  | 06.95  | 04.99   |  |  |  |   |
|  | 325 i  | 141  |  | 03.93  | 04.99   |  |  |  |   |
|  | 328 i  | 142  |  | 03.95  | 04.99   |  |  |  |   |
|  | M3 3.0   | 210  |  | 01.94  | 04.99   |  | 03.0137-0150.2   | 650150   | 180 x 25<br>Bremsbacken-Zubehör                             |
|  | M3 3.2   | 236  |  | 10.95  | 04.99   |  | 03.0137-9062.2   | 669062   |   |
| <b>BMW 3er Reihe/E36 Compact (94-00)</b>   |  |  |  |  |   |  |  |  |   |
|  | 316 g  | 75   |  | 03.94  | 08.00   |  | 13.0460-5405.2   | 605405   | 21643 17,8 +/-WE<br>21643 17,8 +/-WE<br>Warnkontakt L=786mm |
|  | 316 i 1.6  | 75   |  | 03.94  | 08.00   |  | 13.0470-5405.2   | LD5405   |   |
|  | 316 i 1.9  | 77   |  | 12.98  | 08.00   |  | 24.8190-0207.2   | 620207   |   |
|  | 318 tds  | 66   |  | 01.95  | 08.00   |  |  |  |   |
|  | 318 ti   | 103  |  | 07.95  | 08.00   |  |  |  |   |
|  | 318 ti   | 103  |  | 11.94  | 08.00   |  |  |  |   |
|  | 323 ti   | 125  |  | 08.97  | 08.00   |  |  |  |   |

1) + engine code M50 / + codice motore M50 / + moteur code M50 / + motor code M50  
2) + engine code M52 / + codice motore M52 / + moteur code M52 / + motor code M52  
3) two-piece brake disc / disco frenante in due parti / disque d.fr.en deux parties / disco de fr.de dos piezas



### BMW 3er Reihe/E36 Compact (94-00)

|  |           |     |  |       |       |                               |                |        |   |  |                            |
|--|-----------|-----|--|-------|-------|-------------------------------|----------------|--------|---|--|----------------------------|
|  | 316 g     | 75  |  | 03.94 | 08.00 |                               | 24.0112-0126.1 | 412126 |   |  | 286 12,0 10,4 +S +B        |
|  | 316 i 1.6 | 75  |  | 03.94 | 08.00 |                               | 24.0312-0126.1 | 512126 |   |  | 286 12,0 9,6 +S +B PD      |
|  | 316 i 1.9 | 77  |  | 12.98 | 08.00 |                               |                |        |   |  |                            |
|  | 318 tds   | 66  |  | 01.95 | 08.00 |                               |                |        |   |  |                            |
|  | 318 ti    | 103 |  | 07.95 | 04.98 | + Motorcode M44 <sup>1)</sup> |                |        |   |  |                            |
|  | 318 ti    | 103 |  | 11.94 | 08.00 | + Motorcode M42 <sup>2)</sup> |                |        |   |  |                            |
|  | 318 ti    | 103 |  | 05.98 | 08.00 | + Motorcode M44 <sup>1)</sup> | 24.0122-0115.1 | 422115 |   |  | 286 22,0 20,4 V L +S +B    |
|  | 323 ti    | 125 |  | 08.97 | 08.00 |                               | 24.0322-0115.1 | 522115 |   |  | 286 22,0 19,6 V L +S +B PD |
|  | 316 g     | 75  |  | 03.94 | 08.00 |                               | 24.0741-1103.3 | 360161 | 2 |  | Radsensor L=560            |
|  | 316 i 1.6 | 75  |  | 03.94 | 08.00 |                               |                |        |   |  |                            |
|  | 316 i 1.9 | 77  |  | 12.98 | 08.00 |                               |                |        |   |  |                            |
|  | 318 tds   | 66  |  | 01.95 | 08.00 |                               |                |        |   |  |                            |
|  | 318 ti    | 103 |  | 07.95 | 08.00 |                               |                |        |   |  |                            |
|  | 318 ti    | 103 |  | 11.94 | 08.00 |                               |                |        |   |  |                            |
|  | 323 ti    | 125 |  | 08.97 | 08.00 |                               |                |        |   |  |                            |
|  | 316 g     | 75  |  | 03.94 | 08.00 |                               | 13.0460-3605.2 | 603605 |   |  | 20180 17,3 +/WE ATE        |
|  | 316 i 1.6 | 75  |  | 03.94 | 08.00 |                               | 13.0470-3605.2 | LD3605 | 1 |  | 20180 17,3 +/WE ATE        |
|  | 316 i 1.9 | 77  |  | 12.98 | 08.00 |                               | 24.8190-0211.2 | 620211 |   |  | Warnkontakt L=840mm        |
|  | 318 tds   | 66  |  | 01.95 | 08.00 |                               |                |        |   |  |                            |
|  | 318 ti    | 103 |  | 07.95 | 08.00 |                               |                |        |   |  |                            |
|  | 318 ti    | 103 |  | 11.94 | 08.00 |                               |                |        |   |  |                            |
|  | 323 ti    | 125 |  | 08.97 | 08.00 |                               |                |        |   |  |                            |
|  | 316 g     | 75  |  | 03.94 | 08.00 |                               | 24.0110-0211.1 | 410211 |   |  | 272 10,0 8,4 L +S +B       |
|  | 316 i 1.6 | 75  |  | 03.94 | 08.00 |                               |                |        |   |  |                            |
|  | 316 i 1.9 | 77  |  | 12.98 | 08.00 |                               |                |        |   |  |                            |
|  | 318 tds   | 66  |  | 01.95 | 08.00 |                               |                |        |   |  |                            |
|  | 318 ti    | 103 |  | 07.95 | 08.00 |                               |                |        |   |  |                            |
|  | 318 ti    | 103 |  | 11.94 | 08.00 |                               |                |        |   |  |                            |
|  | 323 ti    | 125 |  | 08.97 | 08.00 |                               |                |        |   |  |                            |
|  | 316 g     | 75  |  | 03.94 | 08.00 |                               | 03.0137-0247.2 | 650247 |   |  | 229 x 42 HEB               |
|  | 316 i 1.6 | 75  |  | 03.94 | 08.00 |                               | 03.0137-9147.2 | 669147 |   |  | Bremsbacken-Zubehör        |
|  | 318 tds   | 66  |  | 01.95 | 08.00 |                               |                |        |   |  |                            |
|  | 316 g     | 75  |  | 03.94 | 08.00 |                               | 24.0222-8013.1 | 480030 |   |  | 229/229,5 x 47             |
|  | 316 i 1.6 | 75  |  | 03.94 | 08.00 |                               |                |        |   |  |                            |
|  | 318 tds   | 66  |  | 01.95 | 08.00 |                               |                |        |   |  |                            |
|  | 316 g     | 75  |  | 03.94 | 08.00 |                               | 03.0420-5322.3 | 685322 |   |  | 22,20/229x42 Kit           |
|  | 316 i 1.6 | 75  |  | 03.94 | 08.00 |                               | 03.0520-5322.3 | 695322 |   |  | 22,20/229x42 TopKit        |
|  | 318 tds   | 66  |  | 01.95 | 08.00 |                               |                |        |   |  |                            |
|  | 316 g     | 75  |  | 03.94 | 08.00 |                               | 03.0137-0248.2 | 650248 |   |  | 161 x 25                   |
|  | 316 i 1.6 | 75  |  | 03.94 | 08.00 |                               | 03.0137-9148.2 | 669148 |   |  | Bremsbacken-Zubehör        |
|  | 316 i 1.9 | 77  |  | 12.98 | 08.00 |                               |                |        |   |  |                            |
|  | 318 tds   | 66  |  | 01.95 | 08.00 |                               |                |        |   |  |                            |
|  | 318 ti    | 103 |  | 07.95 | 08.00 |                               |                |        |   |  |                            |
|  | 318 ti    | 103 |  | 11.94 | 08.00 |                               |                |        |   |  |                            |
|  | 323 ti    | 125 |  | 08.97 | 08.00 |                               |                |        |   |  |                            |

### BMW 3er Reihe/E46 Limousine (98-05)

|        |           |     |       |       |                                  |                                  |                |        |   |                     |                            |
|--------|-----------|-----|-------|-------|----------------------------------|----------------------------------|----------------|--------|---|---------------------|----------------------------|
|        | 316 i     | 85  |       | 02.02 | 02.05                            |                                  | 13.0460-5405.2 | 605405 |   |                     | 21643 17,8 +/WE ATE        |
|        | 316 i 1.6 | 77  |       | 04.00 | 02.05                            |                                  | 13.0470-5405.2 | LD5405 |   |                     | 21643 17,8 +/WE ATE        |
|        | 316 i 1.9 | 77  |       | 09.98 | 02.05                            |                                  | 24.8190-0220.2 | 620220 | 1 |                     | Warnkontakt L=601mm        |
|        | 318 d     | 85  |       | 09.01 | 02.05                            |                                  |                |        |   |                     |                            |
|        | 318 i     | 87  |       | 02.98 | 02.05                            |                                  |                |        |   |                     |                            |
|        | 318 i     | 105 |       | 09.01 | 02.05                            |                                  |                |        |   |                     |                            |
|        | 320 d     | 95  |       | 02.98 | 02.05                            |                                  |                |        |   |                     |                            |
|        | 320 d     | 100 |       | 04.98 | 02.05                            |                                  |                |        |   |                     |                            |
|        | 320 d     | 110 |       | 09.01 | 02.05                            |                                  |                |        |   |                     |                            |
|        | 320 i     | 110 |       | 03.98 | 02.05                            |                                  |                |        |   |                     |                            |
|        | 320 i     | 125 |       | 09.00 | 02.05                            |                                  |                |        |   |                     |                            |
|        | 323 i     | 125 |       | 03.98 | 02.05                            |                                  |                |        |   |                     |                            |
|        | 325 i     | 141 |       | 09.00 | 02.05                            | - erhöhte Zuladung <sup>3)</sup> |                |        |   |                     |                            |
|        | 328 i     | 142 |       | 02.98 | 02.05                            |                                  |                |        |   |                     |                            |
|        | 325 i     | 141 |       | 09.00 | 02.05                            | + erhöhte Zuladung <sup>4)</sup> | 13.0460-7155.2 | 607155 |   |                     | 23183 20,3 +/WE ATE        |
|        |           |     |       |       |                                  |                                  | 13.0470-7155.2 | LD7155 |   |                     | 23183 20,3 +/WE ATE        |
|        |           |     |       |       |                                  |                                  | 24.8190-0220.2 | 620220 | 1 |                     | Warnkontakt L=601mm        |
| 325 xi | 141       |     | 09.00 | 02.05 | - erhöhte Zuladung <sup>3)</sup> | 13.0460-5405.2                   | 605405         |        |   | 21643 17,8 +/WE ATE |                            |
|        |           |     |       |       |                                  | 13.0470-5405.2                   | LD5405         |        |   | 21643 17,8 +/WE ATE |                            |
|        |           |     |       |       |                                  | 24.8190-0227.2                   | 620227         | 1      |   | Warnkontakt L=651mm |                            |
| 325 xi | 141       |     | 09.00 | 02.05 | + erhöhte Zuladung <sup>4)</sup> | 13.0460-7155.2                   | 607155         |        |   | 23183 20,3 +/WE ATE |                            |
| 330 d  | 135       |     | 10.99 | 02.05 |                                  | 13.0470-7155.2                   | LD7155         |        |   | 23183 20,3 +/WE ATE |                            |
| 330 d  | 150       |     | 03.03 | 02.05 |                                  |                                  |                |        |   |                     |                            |
| 330 i  | 170       |     | 06.00 | 02.05 |                                  |                                  |                |        |   |                     |                            |
| 330 xd | 135       |     | 06.00 | 02.05 |                                  |                                  |                |        |   |                     |                            |
| 330 xd | 150       |     | 03.03 | 02.05 |                                  |                                  |                |        |   |                     |                            |
| 330 xi | 170       |     | 06.00 | 02.05 |                                  |                                  |                |        |   |                     |                            |
|        | 316 i     | 85  |       | 02.02 | 02.05                            |                                  | 24.0122-0115.1 | 422115 |   |                     | 286 22,0 20,4 V L +S +B    |
|        | 316 i 1.6 | 77  |       | 04.00 | 02.05                            |                                  | 24.0322-0115.1 | 522115 |   |                     | 286 22,0 19,6 V L +S +B PD |
|        | 316 i 1.9 | 77  |       | 09.98 | 02.05                            |                                  |                |        |   |                     |                            |
|        | 318 d     | 85  |       | 09.01 | 02.05                            |                                  |                |        |   |                     |                            |
|        | 318 i     | 87  |       | 02.98 | 02.05                            |                                  |                |        |   |                     |                            |
|        | 318 i     | 105 |       | 09.01 | 02.05                            | - erhöhte Zuladung <sup>3)</sup> |                |        |   |                     |                            |
|        | 320 d     | 95  |       | 02.98 | 02.05                            |                                  |                |        |   |                     |                            |
|        | 320 d     | 100 |       | 04.98 | 02.05                            |                                  |                |        |   |                     |                            |
|        | 320 i     | 110 |       | 03.98 | 02.05                            | - erhöhte Zuladung <sup>3)</sup> |                |        |   |                     |                            |
| 320 i  | 125       |     | 09.00 | 02.05 | - erhöhte Zuladung <sup>3)</sup> |                                  |                |        |   |                     |                            |
| 323 i  | 125       |     | 03.98 | 02.05 | - erhöhte Zuladung <sup>3)</sup> |                                  |                |        |   |                     |                            |

















<sup>1)</sup> + engine code M44 / + codice motore M44 / + moteur code M44 / + motor code M44

<sup>2)</sup> + engine code M42 / + codice motore M42 / + moteur code M42 / + motor code M42

<sup>3)</sup> - increased payload / - carico utile maggiorato / - charge utile augmentée / - incremento de carga

















<sup>4)</sup> + increased payload / + carico utile maggiorato / + charge utile augmentée / + incremento de carga



|     |  |  |  |  |  |  |  |  |   |  |                 |   |
|--|--|--|--|--|---|--|--|--|---|--|-----------------|---|
| <b>BMW 3er Reihe/E46 Limousine (98-05)</b>   |  |  |  |  |   |  |  |  |   |  |                 |   |
|    | 318 i  | 105  |  | 09.01  | 02.05   | + erhöhte Zuladung <sup>1)</sup>   | 24.0122-0160.1   | 422160   | 300 22,0 20,4 V L +S +B<br>300 22,0 19,6 V L +S +B PD                                 |  |                 |   |
|  | 320 d  | 110  |  | 09.01  | 02.05   |  | 24.0322-0160.1   | 522160   |   |  |                 |   |
|  | 320 i  | 110  |  | 03.98  | 02.05   | + erhöhte Zuladung <sup>1)</sup>   |  |  |   |  |                 |   |
|  | 320 i  | 125  |  | 09.00  | 02.05   | + erhöhte Zuladung <sup>1)</sup>   |  |  |   |  |                 |   |
|  | 323 i  | 125  |  | 03.98  | 02.05   | + erhöhte Zuladung <sup>1)</sup>   |  |  |   |  |                 |   |
|  | 325 i  | 141  |  | 09.00  | 02.05   | - erhöhte Zuladung <sup>2)</sup>   |  |  |   |  |                 |   |
|  | 325 xi   | 141  |  | 09.00  | 02.05   | - erhöhte Zuladung <sup>2)</sup>   |  |  |   |  |                 |   |
|  | 328 i  | 142  |  | 02.98  | 02.05   |  |  |  |   |  |                 |   |
|  | 325 i  | 141  |  | 09.00  | 02.05   | + erhöhte Zuladung <sup>1)</sup>   | 24.0125-0138.1   | 425138   |   | 325 24,9 23,4 V L +S +B<br>325 24,9 22,5 V L +S +B PD  |                 |   |
|  | 325 xi   | 141  |  | 09.00  | 02.05   | + erhöhte Zuladung <sup>1)</sup>   | 24.0325-0138.1   | 525138   |   |  |                 |   |
|  | 330 d  | 135  |  | 10.90  | 02.05   |  |  |  |   |  |                 |   |
|  | 330 d  | 150  |  | 03.03  | 02.05   |  |  |  |   |  |                 |   |
|  | 330 i  | 170  |  | 06.00  | 02.05   |  |  |  |   |  |                 |   |
|  | 330 xd   | 135  |  | 06.00  | 02.05   |  |  |  |   |  |                 |   |
| 330 xd   | 150  |  | 03.03  | 02.05  |   |  |  |  |   |  |                 |   |
| 330 xi   | 170  |  | 06.00  | 02.05  |   |  |  |  |   |  |                 |   |
|    | 316 i 1.6  | 77   |  | 04.00  | 09.01   | - DSC  | 24.0710-2020.1   | 360227   | 2  |  | Radsensor L=580 |   |
|  | 316 i 1.9  | 77   |  | 09.98  | 09.01   | - DSC  |  |  |   |  |                 |   |
|  | 318 i  | 87   |  | 02.98  | 02.05   | - DSC  |  |  |   |  |                 |   |
|  | 320 d  | 95   |  | 02.98  | 02.05   | - DSC  |  |  |   |  |                 |   |
|  | 320 d  | 100  |  | 04.98  | 02.05   | - DSC  |  |  |   |  |                 |   |
|  | 320 i  | 110  |  | 03.98  | 02.05   |  |  |  |   |  |                 |   |
|  | 320 i  | 125  |  | 09.00  | 09.01   | - DSC  |  |  |   |  |                 |   |
|  | 323 i  | 125  |  | 03.98  | 02.05   |  |  |  |   |  |                 |   |
|  | 325 i  | 141  |  | 09.00  | 09.01   | - DSC  |  |  |   |  |                 |   |
|  | 328 i  | 142  |  | 02.98  | 02.05   |  |  |  |   |  |                 |   |
|  | 316 i  | 85   |  | 02.02  | 02.05   |  | 24.0711-5277.3   | 360322   |   | <br> |                 | Radsensor L=565<br>Radsensor L=565              |
|  | 316 i 1.6  | 77   |  | 09.00  | 03.03   | + DSC  | 24.0711-5278.3   | 360323   |   |  |                 |   |
|  | 316 i 1.6  | 77   |  | 10.01  | 02.05   | - DSC  |  |  |   |  |                 |   |
|  | 316 i 1.9  | 77   |  | 09.00  | 03.03   | + DSC  |  |  |   |  |                 |   |
| 316 i 1.9  | 77   |  | 10.01  | 02.05  | - DSC   |  |  |  |   |  |                 |   |
| 318 d  | 85   |  | 09.01  | 02.05  |   |  |  |  |   |  |                 |   |
| 318 i  | 87   |  | 09.00  | 03.03  | + DSC   |  |  |  |   |  |                 |   |
| 318 i  | 105  |  | 09.01  | 02.05  |   |  |  |  |   |  |                 |   |
| 320 d  | 95   |  | 09.00  | 03.03  | + DSC   |  |  |  |   |  |                 |   |
| 320 d  | 100  |  | 09.00  | 03.03  | + DSC   |  |  |  |   |  |                 |   |
| 320 d  | 110  |  | 09.01  | 02.05  |   |  |  |  |   |  |                 |   |
| 320 i  | 125  |  | 09.00  | 03.03  | + DSC   |  |  |  |   |  |                 |   |
| 320 i  | 125  |  | 10.01  | 02.05  | - DSC   |  |  |  |   |  |                 |   |
| 325 i  | 141  |  | 09.00  | 02.05  | + DSC   |  |  |  |   |  |                 |   |
| 325 i  | 141  |  | 10.01  | 02.05  | - DSC   |  |  |  |   |  |                 |   |
| 330 d  | 135  |  | 10.99  | 02.05  |   |  |  |  |   |  |                 |   |
| 330 d  | 150  |  | 03.03  | 02.05  |   |  |  |  |   |  |                 |   |
| 330 i  | 170  |  | 06.00  | 02.05  |   |  |  |  |   |  |                 |   |
|  | 316 i  | 85   |  | 02.02  | 02.05   |  | 13.0460-3605.2   | 603605   | 1   | 20180 17,3 +/WE ATE<br>20180 17,3 +/WE ATE<br>Warnkontakt L=1338mm   |                 |   |
|  | 316 i 1.6  | 77   |  | 04.00  | 02.05   |  | 13.0470-3605.2   | LD3605   |   |  |                 |   |
|  | 316 i 1.9  | 77   |  | 09.98  | 02.05   |  | 24.8190-0221.2   | 620221   |   |  |                 |   |
|  | 318 d  | 85   |  | 09.01  | 02.05   |  |  |  |   |  |                 |   |
|  | 318 i  | 87   |  | 02.98  | 02.05   |  |  |  |   |  |                 |   |
|  | 318 i  | 105  |  | 09.01  | 02.05   |  |  |  |   |  |                 |   |
|  | 320 d  | 95   |  | 02.98  | 02.05   |  |  |  |   |  |                 |   |
|  | 320 d  | 100  |  | 04.98  | 02.05   |  |  |  |   |  |                 |   |
|  | 320 d  | 110  |  | 09.01  | 02.05   |  |  |  |   |  |                 |   |
|  | 320 i  | 110  |  | 03.98  | 02.05   |  |  |  |   |  |                 |   |
|  | 320 i  | 125  |  | 09.00  | 02.05   |  |  |  |   |  |                 |   |
|  | 323 i  | 125  |  | 03.98  | 02.05   |  |  |  |   |  |                 |   |
|  | 325 i  | 141  |  | 09.00  | 02.05   | - erhöhte Zuladung <sup>2)</sup>   |  |  |   |  |                 |   |
|  | 325 xi   | 141  |  | 09.00  | 02.05   | - erhöhte Zuladung <sup>2)</sup>   |  |  |   |  |                 |   |
| 328 i  | 142  |  | 02.98  | 02.05  |   |  |  |  |   |  |                 |   |
| 325 i  | 141  |  | 09.00  | 02.05  | + erhöhte Zuladung <sup>1)</sup>  | 13.0460-7079.2   | 607079   | 1  | 21487 17,3 +/WE ATE<br>21487 17,3 +/WE ATE<br>Warnkontakt L=1338mm                    |  |                 |   |
| 325 xi   | 141  |  | 09.00  | 02.05  | + erhöhte Zuladung <sup>1)</sup>  | 13.0470-7079.2   | LD7079   |  |   |  |                 |   |
| 330 d  | 135  |  | 10.99  | 02.05  |   | 24.8190-0221.2   | 620221   |  |   |  |                 |   |
| 330 d  | 150  |  | 03.03  | 02.05  |   |  |  |  |   |  |                 |   |
| 330 i  | 170  |  | 06.00  | 02.05  |   |  |  |  |   |  |                 |   |
| 330 xd   | 135  |  | 06.00  | 02.05  |   |  |  |  |   |  |                 |   |
| 330 xd   | 150  |  | 03.03  | 02.05  |   |  |  |  |   |  |                 |   |
| 330 xi   | 170  |  | 06.00  | 02.05  |   |  |  |  |   |  |                 |   |
|  | 316 i  | 85   |  | 02.02  | 02.05   | - erhöhte Zuladung <sup>2)</sup>   | 24.0110-0202.1   |  |   | 410202   |                 | 280 10,0 8,4 L +S +B<br>280 10,0 7,6 L +S +B PD |
|  | 316 i 1.6  | 77   |  | 04.00  | 02.05   |  | 24.0310-0202.1   |  |   | 510202   |                 |   |
|  | 316 i 1.9  | 77   |  | 09.98  | 02.05   | - erhöhte Zuladung <sup>2)</sup>   |  |  |   |  |                 |   |
|  | 318 i  | 87   |  | 02.98  | 02.05   | - erhöhte Zuladung <sup>2)</sup>   |  |  |   |  |                 |   |
|  | 316 i  | 85   |  | 02.02  | 02.05   | + erhöhte Zuladung <sup>1)</sup>   | 24.0119-0107.1   | 419107   | 276 19,0 17,4 V L +S +B<br>276 19,0 16,6 V L +S +B PD                                 |  |                 |   |
|  | 316 i 1.9  | 77   |  | 09.98  | 02.05   | + erhöhte Zuladung <sup>1)</sup>   | 24.0319-0107.1   | 519107   |   |  |                 |   |
|  | 318 d  | 85   |  | 09.01  | 02.05   |  |  |  |   |  |                 |   |
|  | 318 i  | 87   |  | 02.98  | 02.05   | + erhöhte Zuladung <sup>1)</sup>   |  |  |   |  |                 |   |
|  | 318 i  | 105  |  | 09.01  | 02.05   | - erhöhte Zuladung <sup>2)</sup>   |  |  |   |  |                 |   |
|  | 320 d  | 95   |  | 02.98  | 02.05   |  |  |  |   |  |                 |   |
|  | 320 d  | 100  |  | 04.98  | 02.05   |  |  |  |   |  |                 |   |
|  | 320 i  | 110  |  | 03.98  | 02.05   | - erhöhte Zuladung <sup>2)</sup>   |  |  |   |  |                 |   |
|  | 320 i  | 125  |  | 09.00  | 02.05   | - erhöhte Zuladung <sup>2)</sup>   |  |  |   |  |                 |   |
|  | 323 i  | 125  |  | 03.98  | 02.05   | - erhöhte Zuladung <sup>2)</sup>   |  |  |   |  |                 |   |
| 318 i  | 105  |  | 09.01  | 02.05  | + erhöhte Zuladung <sup>1)</sup>  | 24.0119-0108.1   | 419108   | 294 18,9 17,4 V L +S +B<br>294 18,9 17,4 V L +S +B PD                              |   |  |                 |   |
| 320 d  | 110  |  | 09.01  | 02.05  |   | 24.0319-0108.1   | 519108   |  |   |  |                 |   |
| 320 i  | 110  |  | 03.98  | 02.05  | + erhöhte Zuladung <sup>1)</sup>  |  |  |  |   |  |                 |   |
| 320 i  | 125  |  | 09.00  | 02.05  | + erhöhte Zuladung <sup>1)</sup>  |  |  |  |   |  |                 |   |
| 323 i  | 125  |  | 03.98  | 02.05  | + erhöhte Zuladung <sup>1)</sup>  |  |  |  |   |  |                 |   |

<sup>1)</sup> + increased payload / + carico utile maggiorato / + charge utile augmentée / + incremento de carga





















<sup>2)</sup> - increased payload / - carico utile maggiorato / - charge utile augmentée / - incremento de carga

|  |           |  |       |  |       |  |                |  |   |     |  |  |  |  |  |  |                                   |                                   |
|--|-----------|---|-------|--|-------|--|----------------|--|---|---|--|---|--|--|--|--|-----------------------------------|-----------------------------------|
| <b>BMW 3er Reihe/E46 Limousine (98-05)</b>   |           |   |       |  |       |  |                |  |   |   |  |   |  |  |  |  |                                   |                                   |
|    | 325 i     | 141   |       | 09.00  | 02.05 | - erhöhte Zuladung <sup>1)</sup>   | 24.0119-0108.1 | 419108   |   |   |  |   |  |  |  |  | 294 18,9 17,4 V L +S +B           |                                   |
|  | 328 i     | 142   |       | 02.98  | 02.05 |  | 24.0319-0108.1 | 519108   |   |   |  |   |  |  |  |  | <b>294 18,9 17,4 V L +S +B PD</b> |                                   |
|  | 325 xi    | 141   |       | 09.00  | 02.05 | - erhöhte Zuladung <sup>1)</sup>   | 24.0119-0113.1 | 419113   |   |   |  |   |  |  |  |  | 294 19,0 17,4 V L +S +B           |                                   |
|  | 325 xi    | 141   |       | 09.00  | 02.05 | + erhöhte Zuladung <sup>2)</sup>   | 24.0122-0209.1 | 422209   |   |   |  |   |  |  |  |  | 320 22,0 20,4 V L +S +B           |                                   |
|  | 330 d     | 135   |       | 10.99  | 02.05 |  | 24.0322-0209.1 | 522209   |   |   |  |   |  |  |  |  | <b>320 22,0 20,4 V L +S +B PD</b> |                                   |
|  | 330 d     | 150   |       | 03.03  | 02.05 |  |                |  |   |   |  |   |  |  |  |  |                                   |                                   |
|  | 330 i     | 170   |       | 06.00  | 02.05 |  |                |  |   |   |  |   |  |  |  |  |                                   |                                   |
|  | 330 xd    | 135   |       | 06.00  | 02.05 |  |                |  |   |   |  |   |  |  |  |  |                                   |                                   |
| 330 xd   | 150       |   | 03.03 | 02.05  |       |  |                |  |   |   |  |   |  |  |  |  |                                   |                                   |
| 330 xi   | 170       |   | 06.00 | 02.05  |       |  |                |  |   |   |  |   |  |  |  |  |                                   |                                   |
|    | 316 i 1.6 | 77  |       | 04.00  | 09.01 | - DSC  | 24.0751-1179.3 | 360169   | 2   |  |  |   |  |  |  |  | Radsensor L=981                   |                                   |
|  | 316 i 1.9 | 77  |       | 09.98  | 09.01 | - DSC  |                |  |   |   |  |   |  |  |  |  |                                   |                                   |
|  | 318 i     | 87  |       | 02.98  | 02.05 | - DSC  |                |  |   |   |  |   |  |  |  |  |                                   |                                   |
|  | 320 d     | 95  |       | 02.98  | 02.05 | - DSC  |                |  |   |   |  |   |  |  |  |  |                                   |                                   |
|  | 320 d     | 100   |       | 04.98  | 02.05 | - DSC  |                |  |   |   |  |   |  |  |  |  |                                   |                                   |
|  | 320 i     | 110   |       | 03.98  | 02.05 |  |                |  |   |   |  |   |  |  |  |  |                                   |                                   |
|  | 320 i     | 125   |       | 09.00  | 09.01 | - DSC  |                |  |   |   |  |   |  |  |  |  |                                   |                                   |
|  | 323 i     | 125   |       | 03.98  | 02.05 |  |                |  |   |   |  |   |  |  |  |  |                                   |                                   |
|  | 325 i     | 141   |       | 09.00  | 09.01 | - DSC  |                |  |   |   |  |   |  |  |  |  |                                   |                                   |
|  | 328 i     | 142   |       | 02.98  | 02.05 |  |                |  |   |   |  |   |  |  |  |  |                                   |                                   |
|  | 316 i     | 85  |       | 02.02  | 02.05 |  | 24.0711-6041.3 | 360124   | 2   |  |  |   |  |  |  |  | Radsensor L=981                   |                                   |
|  | 316 i 1.6 | 77  |       | 09.00  | 03.03 | + DSC  |                |  |   |   |  |   |  |  |  |  |                                   |                                   |
|  | 316 i 1.6 | 77  |       | 10.01  | 02.05 | - DSC  |                |  |   |   |  |   |  |  |  |  |                                   |                                   |
|  | 316 i 1.9 | 77  |       | 09.00  | 03.03 | + DSC  |                |  |   |   |  |   |  |  |  |  |                                   |                                   |
|  | 316 i 1.9 | 77  |       | 10.01  | 02.05 | - DSC  |                |  |   |   |  |   |  |  |  |  |                                   |                                   |
| 318 d  | 85        |   | 09.01 | 02.05  |       |  |                |  |   |   |  |   |  |  |  |  |                                   |                                   |
| 318 i  | 87        |   | 09.00 | 03.03  | + DSC |  |                |  |   |   |  |   |  |  |  |  |                                   |                                   |
| 318 i  | 105       |   | 09.01 | 02.05  |       |  |                |  |   |   |  |   |  |  |  |  |                                   |                                   |
| 320 d  | 95        |   | 09.00 | 03.03  | + DSC |  |                |  |   |   |  |   |  |  |  |  |                                   |                                   |
| 320 d  | 100       |   | 09.00 | 03.03  | + DSC |  |                |  |   |   |  |   |  |  |  |  |                                   |                                   |
| 320 d  | 110       |   | 09.01 | 02.05  |       |  |                |  |   |   |  |   |  |  |  |  |                                   |                                   |
| 320 i  | 125       |   | 09.00 | 03.03  | + DSC |  |                |  |   |   |  |   |  |  |  |  |                                   |                                   |
| 320 i  | 125       |   | 10.01 | 02.05  | - DSC |  |                |  |   |   |  |   |  |  |  |  |                                   |                                   |
| 325 i  | 141       |   | 09.00 | 02.05  | + DSC |  |                |  |   |   |  |   |  |  |  |  |                                   |                                   |
| 325 i  | 141       |   | 10.01 | 02.05  | - DSC |  |                |  |   |   |  |   |  |  |  |  |                                   |                                   |
| 330 d  | 135       |   | 10.99 | 02.05  |       | 24.0751-1183.3   | 360298         | 2  |  | - DSC   |  |   |  |  |  |  | Radsensor L=981                   |                                   |
| 330 d  | 150       |   | 03.03 | 02.05  |       | 24.0711-6042.3   | 360125         | 2  |  | + DSC   |  |   |  |  |  |  | Radsensor L=981                   |                                   |
| 330 i  | 170       |   | 06.00 | 02.05  |       |  |                |  |   |   |  |   |  |  |  |  |                                   |                                   |
|   | 316 i     | 85  |       | 02.02  | 02.05 |  | 03.0137-0379.2 | 650379   |   |   |  |   |  |  |  |  |                                   | 161 x 20<br>Bremsbacken-Zubehör   |
|  | 316 i 1.6 | 77  |       | 04.00  | 02.05 |  | 03.0137-9265.2 | 669265   |   |   |  |   |  |  |  |  |                                   | Bremsbacken-Zubehör               |
|  | 316 i 1.9 | 77  |       | 09.98  | 02.05 |  | 03.0137-9701.2 | 669701   |   |   |  |   |  |  |  |  |                                   | Spreizschloß Satz                 |
|  | 318 d     | 85  |       | 09.01  | 02.05 |  | 03.0137-9702.2 | 669702   |   |   |  |   |  |  |  |  |                                   |                                   |
|  | 318 i     | 87  |       | 02.98  | 02.05 |  |                |  |   |   |  |   |  |  |  |  |                                   |                                   |
|  | 318 i     | 105   |       | 09.01  | 02.05 |  |                |  |   |   |  |   |  |  |  |  |                                   |                                   |
|  | 320 d     | 95  |       | 02.98  | 02.05 |  |                |  |   |   |  |   |  |  |  |  |                                   |                                   |
|  | 320 d     | 100   |       | 04.98  | 02.05 |  |                |  |   |   |  |   |  |  |  |  |                                   |                                   |
|  | 320 d     | 110   |       | 09.01  | 02.05 |  |                |  |   |   |  |   |  |  |  |  |                                   |                                   |
|  | 320 i     | 110   |       | 03.98  | 02.05 |  |                |  |   |   |  |   |  |  |  |  |                                   |                                   |
|  | 320 i     | 125   |       | 09.00  | 02.05 |  |                |  |   |   |  |   |  |  |  |  |                                   |                                   |
|  | 323 i     | 125   |       | 03.98  | 02.05 |  |                |  |   |   |  |   |  |  |  |  |                                   |                                   |
|  | 325 i     | 141   |       | 09.00  | 02.05 |  |                |  |   |   |  |   |  |  |  |  |                                   |                                   |
|  | 328 i     | 142   |       | 02.98  | 02.05 |  |                |  |   |   |  |   |  |  |  |  |                                   |                                   |
|  | 325 xi    | 141   |       | 09.00  | 02.05 |  | 03.0137-0305.2 | 650305   |   |   |  |   |  |  |  |  |                                   | 185 x 20<br>Bremsbacken-Zubehör   |
| 330 d  | 135       |   | 10.99 | 02.05  |       | 03.0137-9062.2   | 669062         |  |   |   |  |   |  |  |  |  | Bremsbacken-Zubehör               |                                   |
| 330 d  | 150       |   | 03.03 | 02.05  |       | 03.0137-9700.2   | 669700         |  |   |   |  |   |  |  |  |  | Spreizschloß Satz                 |                                   |
| 330 i  | 170       |   | 06.00 | 02.05  |       | 03.0137-9702.2   | 669702         |  |   |   |  |   |  |  |  |  |                                   |                                   |
| 330 xd   | 135       |   | 06.00 | 02.05  |       |  |                |  |   |   |  |   |  |  |  |  |                                   |                                   |
| 330 xd   | 150       |   | 03.03 | 02.05  |       |  |                |  |   |   |  |   |  |  |  |  |                                   |                                   |
| 330 xi   | 170       |   | 06.00 | 02.05  |       |  |                |  |   |   |  |   |  |  |  |  |                                   |                                   |
| <b>BMW 3er Reihe/E46 Touring (99-05)</b>   |           |   |       |  |       |  |                |  |   |   |  |   |  |  |  |  |                                   |                                   |
|  | 316 i     | 85  |       | 03.02  | 02.05 |  | 13.0460-5405.2 | 605405   |   |   |  |   |  |  |  |  |                                   | 21643 17,8 +/WE ATE               |
|  | 318 d     | 85  |       | 03.02  | 02.05 |  | 13.0470-5405.2 | LD5405   |   |   |  |   |  |  |  |  |                                   | 21643 17,8 +/WE ATE               |
|  | 318 i     | 87  |       | 10.99  | 02.05 |  | 24.8190-0220.2 | 620220   | 1   |   |  |   |  |  |  |  |                                   | Warnkontakt L=601mm               |
|  | 318 i     | 105   |       | 09.01  | 02.05 |  |                |  |   |   |  |   |  |  |  |  |                                   |                                   |
|  | 320 d     | 100   |       | 03.00  | 02.05 |  |                |  |   |   |  |   |  |  |  |  |                                   |                                   |
|  | 320 d     | 110   |       | 09.01  | 02.05 |  |                |  |   |   |  |   |  |  |  |  |                                   |                                   |
|  | 320 i     | 110   |       | 10.99  | 02.05 |  |                |  |   |   |  |   |  |  |  |  |                                   |                                   |
|  | 320 i     | 125   |       | 09.00  | 02.05 |  |                |  |   |   |  |   |  |  |  |  |                                   |                                   |
|  | 325 i     | 141   |       | 09.00  | 02.05 |  |                |  |   |   |  |   |  |  |  |  |                                   |                                   |
|  | 328 i     | 142   |       | 10.99  | 02.05 |  |                |  |   |   |  |   |  |  |  |  |                                   |                                   |
| 325 xi   | 141       |   | 09.00 | 02.05  |       | 13.0460-5405.2   | 605405         |  |   |   |  |   |  |  |  |  |                                   | 21643 17,8 +/WE ATE               |
|  |           |   |       |  |       | 13.0470-5405.2   | LD5405         |  |   |   |  |   |  |  |  |  |                                   | 21643 17,8 +/WE ATE               |
|  |           |   |       |  |       | 24.8190-0227.2   | 620227         | 1  |   |   |  |   |  |  |  |  |                                   | Warnkontakt L=651mm               |
| 330 d  | 135       |   | 10.99 | 02.05  |       | 13.0460-7155.2   | 607155         |  |   |   |  |   |  |  |  |  |                                   | 23183 20,3 +/WE ATE               |
| 330 d  | 150       |   | 03.03 | 02.05  |       | 13.0470-7155.2   | LD7155         |  |   |   |  |   |  |  |  |  |                                   | 23183 20,3 +/WE ATE               |
| 330 i  | 170       |   | 06.00 | 02.05  |       | 24.8190-0227.2   | 620227         | 1  |   |   |  |   |  |  |  |  |                                   | Warnkontakt L=651mm               |
| 330 xd   | 135       |   | 06.00 | 02.05  |       |  |                |  |   |   |  |   |  |  |  |  |                                   |                                   |
| 330 xd   | 150       |   | 03.03 | 02.05  |       |  |                |  |   |   |  |   |  |  |  |  |                                   |                                   |
| 330 xi   | 170       |   | 06.00 | 02.05  |       |  |                |  |   |   |  |   |  |  |  |  |                                   |                                   |
|  | 316 i     | 85  |       | 03.02  | 02.05 |  | 24.0122-0115.1 | 422115   |   |   |  |   |  |  |  |  |                                   | 286 22,0 20,4 V L +S +B           |
|  | 318 d     | 85  |       | 03.02  | 02.05 | - erhöhte Zuladung <sup>1)</sup>   | 24.0322-0115.1 | 522115   |   |   |  |   |  |  |  |  |                                   | <b>286 22,0 19,6 V L +S +B PD</b> |
|  | 318 i     | 87  |       | 10.99  | 02.05 |  |                |  |   |   |  |   |  |  |  |  |                                   |                                   |
|  | 318 i     | 105   |       | 09.01  | 02.05 |  |                |  |   |   |  |   |  |  |  |  |                                   |                                   |
|  | 320 d     | 100   |       | 03.00  | 02.05 |  |                |  |   |   |  |   |  |  |  |  |                                   |                                   |
|  | 320 i     | 110   |       | 10.99  | 02.05 |  |                |  |   |   |  |   |  |  |  |  |                                   |                                   |















<sup>1)</sup> - increased payload / - carico utile maggiorato / - charge utile augmentée / - incremento de carga

<sup>2)</sup> + increased payload / + carico utile maggiorato / + charge utile augmentée / + incremento de carga

















|     |  |  |  |  |  |  |  |       |   |                            |
|--|--|--|--|--|---|--|--|---|---|----------------------------|
| <b>BMW 3er Reihe/E46 Touring (99-05)</b>   |  |  |  |  |   |  |  |   |   |                            |
|    | 318 d  | 85   |  | 03.02  | 02.05   | + erhöhte Zuladung <sup>1)</sup>   | 24.0122-0160.1   | 422160  |   | 300 22,0 20,4 V L +S +B    |
|  | 320 d  | 110  |  | 09.01  | 02.05   |  | 24.0322-0160.1   | 522160  |   | 300 22,0 19,6 V L +S +B PD |
|  | 320 i  | 125  |  | 09.00  | 02.05   |  |  |   |   |                            |
|  | 325 i  | 141  |  | 09.00  | 02.05   |  |  |   |   |                            |
|  | 325 xi   | 141  |  | 09.00  | 02.05   |  |  |   |   |                            |
|  | 328 i  | 142  |  | 10.99  | 02.05   |  |  |   |   |                            |
|  | 330 d  | 135  |  | 10.99  | 02.05   |  | 24.0125-0138.1   | 425138  |   | 325 24,9 23,4 V L +S +B    |
|  | 330 d  | 150  |  | 03.03  | 02.05   |  | 24.0325-0138.1   | 525138  |   | 325 24,9 22,5 V L +S +B PD |
|  | 330 i  | 170  |  | 06.00  | 02.05   |  |  |   |   |                            |
|  | 330 xd   | 135  |  | 06.00  | 02.05   |  |  |   |   |                            |
| 330 xd   | 150  |  | 03.03  | 02.05  |   |  |  |   |   |                            |
| 330 xi   | 170  |  | 06.00  | 02.05  |   |  |  |   |   |                            |
|    | 318 i  | 87   |  | 10.99  | 02.05   | - DSC  | 24.0710-2020.1   | 360227  | 2    | Radsensor L=580            |
|  | 320 d  | 100  |  | 03.00  | 02.05   | - DSC  |  |   |   |                            |
|  | 320 i  | 110  |  | 10.99  | 02.05   |  |  |   |   |                            |
|  | 320 i  | 125  |  | 09.00  | 08.01   | - DSC  |  |   |   |                            |
|  | 325 i  | 141  |  | 09.00  | 08.01   | - DSC  |  |   |   |                            |
|  | 328 i  | 142  |  | 10.99  | 02.05   |  |  |   |   |                            |
|  | 330 d  | 135  |  | 10.99  | 08.01   | - DSC  |  |   |   |                            |
|  | 316 i  | 85   |  | 03.02  | 02.05   |  | 24.0711-5277.3   | 360322  |      | Radsensor L=565            |
|  | 318 d  | 85   |  | 03.02  | 02.05   |  | 24.0711-5278.3   | 360323  |      | Radsensor L=565            |
|  | 318 i  | 87   |  | 10.99  | 02.05   | + DSC  |  |   |   |                            |
| 318 i  | 105  |  | 09.01  | 02.05  |   |  |  |   |   |                            |
| 320 d  | 100  |  | 09.00  | 03.03  | + DSC   |  |  |   |   |                            |
| 320 d  | 110  |  | 09.01  | 02.05  |   |  |  |   |   |                            |
| 320 i  | 125  |  | 09.00  | 02.05  | + DSC   |  |  |   |   |                            |
| 320 i  | 125  |  | 09.01  | 02.05  | - DSC   |  |  |   |   |                            |
| 325 i  | 141  |  | 09.00  | 03.03  | + DSC   |  |  |   |   |                            |
| 325 i  | 141  |  | 09.01  | 02.05  | - DSC   |  |  |   |   |                            |
| 330 d  | 135  |  | 09.00  | 03.03  | + DSC   |  |  |   |   |                            |
| 330 d  | 135  |  | 09.01  | 02.05  | - DSC   |  |  |   |   |                            |
| 330 d  | 150  |  | 03.03  | 02.05  |   |  |  |   |   |                            |
| 330 i  | 170  |  | 06.00  | 02.05  |   |  |  |   |   |                            |
|    | 316 i  | 85   |  | 03.02  | 02.05   |  | 13.0460-3605.2   | 603605  |   | 20180 17,3 +/WE ATE        |
|  | 318 d  | 85   |  | 03.02  | 02.05   |  | 13.0470-3605.2   | LD3605  |   | 20180 17,3 +/WE ATE        |
|  | 318 i  | 87   |  | 10.99  | 02.05   |  | 24.8190-0221.2   | 620221  | 1   | Warnkontakt L=1338mm       |
|  | 318 i  | 105  |  | 09.01  | 02.05   |  |  |   |   |                            |
|  | 320 d  | 100  |  | 03.00  | 02.05   |  |  |   |   |                            |
|  | 320 d  | 110  |  | 09.01  | 02.05   |  |  |   |   |                            |
|  | 320 i  | 110  |  | 10.99  | 02.05   |  |  |   |   |                            |
|  | 320 i  | 125  |  | 09.00  | 02.05   |  |  |   |   |                            |
|  | 325 i  | 141  |  | 09.00  | 02.05   |  |  |   |   |                            |
|  | 325 i  | 141  |  | 09.00  | 02.05   |  |  |   |   |                            |
|  | 328 i  | 142  |  | 10.99  | 02.05   |  |  |   |   |                            |
|  | 330 d  | 135  |  | 10.99  | 02.05   |  | 13.0460-7079.2   | 607079  |   | 21487 17,3 +/WE ATE        |
|  | 330 d  | 150  |  | 03.03  | 02.05   |  | 13.0470-7079.2   | LD7079  |   | 21487 17,3 +/WE ATE        |
|  | 330 i  | 170  |  | 06.00  | 02.05   |  | 24.8190-0221.2   | 620221  | 1   | Warnkontakt L=1338mm       |
| 330 xd   | 135  |  | 06.00  | 02.05  |   |  |  |   |   |                            |
| 330 xd   | 150  |  | 03.03  | 02.05  |   |  |  |   |   |                            |
| 330 xi   | 170  |  | 06.00  | 02.05  |   |  |  |   |   |                            |
|  | 316 i  | 85   |  | 03.02  | 02.05   |  | 24.0119-0107.1   | 419107  |   | 276 19,0 17,4 V L +S +B    |
|  | 318 d  | 85   |  | 03.02  | 02.05   | - erhöhte Zuladung <sup>2)</sup>   | 24.0319-0107.1   | 519107  |   | 276 19,0 16,6 V L +S +B PD |
|  | 318 i  | 87   |  | 10.99  | 02.05   |  |  |   |   |                            |
|  | 318 i  | 105  |  | 09.01  | 02.05   |  |  |   |   |                            |
|  | 320 d  | 100  |  | 03.00  | 02.05   |  |  |   |   |                            |
|  | 320 i  | 110  |  | 10.99  | 02.05   |  |  |   |   |                            |
|  | 318 d  | 85   |  | 03.02  | 02.05   | + erhöhte Zuladung <sup>1)</sup>   | 24.0119-0108.1   | 419108  |   | 294 18,9 17,4 V L +S +B    |
|  | 320 d  | 110  |  | 09.01  | 02.05   |  | 24.0319-0108.1   | 519108  |   | 294 18,9 17,4 V L +S +B PD |
|  | 320 i  | 125  |  | 09.00  | 02.05   |  |  |   |   |                            |
|  | 325 i  | 141  |  | 09.00  | 02.05   |  |  |   |   |                            |
| 328 i  | 142  |  | 10.99  | 02.05  |   |  |  |   |   |                            |
| 325 xi   | 141  |  | 09.00  | 02.05  |   | 24.0119-0113.1   | 419113   |   | 294 19,0 17,4 V L +S +B   |                            |
| 330 d  | 135  |  | 10.99  | 02.05  |   | 24.0122-0209.1   | 422209   |   | 320 22,0 20,4 V L +S +B   |                            |
| 330 d  | 150  |  | 03.03  | 02.05  |   | 24.0322-0209.1   | 522209   |   | 320 22,0 20,4 V L +S +B PD  |                            |
| 330 i  | 170  |  | 06.00  | 02.05  |   |  |  |   |   |                            |
| 330 xd   | 135  |  | 06.00  | 02.05  |   |  |  |   |   |                            |
| 330 xd   | 150  |  | 03.03  | 02.05  |   |  |  |   |   |                            |
| 330 xi   | 170  |  | 06.00  | 02.05  |   |  |  |   |   |                            |
|  | 318 i  | 87   |  | 10.99  | 02.05   | - DSC  | 24.0751-1179.3   | 360169  | 2  | Radsensor L=981            |
|  | 320 d  | 100  |  | 03.00  | 02.05   | - DSC  |  |   |   |                            |
|  | 320 i  | 110  |  | 10.99  | 02.05   |  |  |   |   |                            |
|  | 320 i  | 125  |  | 09.00  | 08.01   | - DSC  |  |   |   |                            |
|  | 328 i  | 142  |  | 10.99  | 02.05   |  |  |   |   |                            |
|  | 316 i  | 85   |  | 03.02  | 02.05   |  | 24.0711-6041.3   | 360124  | 2  | Radsensor L=981            |
|  | 318 d  | 85   |  | 03.02  | 02.05   |  |  |   |   |                            |
|  | 318 i  | 87   |  | 09.00  | 03.03   | + DSC  |  |   |   |                            |
|  | 318 i  | 105  |  | 09.01  | 02.05   |  |  |   |   |                            |
|  | 320 d  | 100  |  | 09.00  | 03.03   | + DSC  |  |   |   |                            |
| 320 d  | 110  |  | 09.01  | 02.05  |   |  |  |   |   |                            |
| 320 i  | 125  |  | 09.00  | 02.05  | + DSC   |  |  |   |   |                            |
| 320 i  | 125  |  | 09.01  | 02.05  | - DSC   |  |  |   |   |                            |
| 325 i  | 141  |  | 09.00  | 03.03  | + DSC   |  |  |   |   |                            |
| 325 i  | 141  |  | 09.01  | 02.05  | - DSC   |  |  |   |   |                            |
| 330 i  | 170  |  | 09.00  | 02.05  | + Automatikgetriebe <sup>3)</sup>   |  |  |   |   |                            |
| 330 d  | 135  |  | 10.99  | 08.00  |   | 24.0751-1183.3   | 360298   | 2  | Radsensor L=981   |                            |

1) + increased payload / + carico utile maggiorato / + charge utile augmentée / + incremento de carga  
2) - increased payload / - carico utile maggiorato / - charge utile augmentée / - incremento de carga  
3) + autom.transmission / + scatola cambio automatico / + transmission automatique / + cambio automático



















|     |  |  |  |  |  |  |  |  |                            |
|--|--|--|--|--|---|--|--|--|----------------------------|
| <b>BMW 3er Reihe/E46 Touring (99-05)</b>   |  |  |  |  |   |  |  |  |                            |
|    | 330 i  | 170  | 06.00  | 08.01  | + Schaltgetriebe <sup>1)</sup>  | 24.0751-1183.3   | 360298   | 2  | Radsensor L=981            |
|  | 330 d  | 135  | 09.00  | 02.05  |   | 24.0711-6042.3   | 360125   | 2  | Radsensor L=981            |
|  | 330 d  | 150  | 03.03  | 02.05  |   |  |  |  |                            |
|  | 330 i  | 170  | 09.01  | 02.05  | + Schaltgetriebe <sup>1)</sup>  |  |  |  |                            |
|    | 316 i  | 85   | 03.02  | 02.05  |   | 03.0137-0379.2   | 650379   |  | 161 x 20                   |
|  | 318 d  | 85   | 03.02  | 02.05  |   | 03.0137-9265.2   | 669265   |  | Bremsbacken-Zubehör        |
|  | 318 i  | 87   | 10.99  | 02.05  |   | 03.0137-9701.2   | 669701   |  | Bremsbacken-Zubehör        |
|  | 318 i  | 105  | 09.01  | 02.05  |   | 03.0137-9702.2   | 669702   |  | Spreizschloß Satz          |
|  | 320 d  | 100  | 03.00  | 02.05  |   |  |  |  |                            |
|  | 320 d  | 110  | 09.01  | 02.05  |   |  |  |  |                            |
|  | 320 i  | 110  | 10.99  | 02.05  |   |  |  |  |                            |
|  | 320 i  | 125  | 09.00  | 02.05  |   |  |  |  |                            |
|  | 325 i  | 141  | 09.00  | 02.05  |   |  |  |  |                            |
|  | 328 i  | 142  | 10.99  | 02.05  |   |  |  |  |                            |
|  | 325 xi   | 141  | 09.00  | 02.05  |   | 03.0137-0305.2   | 650305   |  | 185 x 20                   |
|  | 330 d  | 135  | 10.99  | 02.05  |   | 03.0137-9062.2   | 669062   |  | Bremsbacken-Zubehör        |
|  | 330 d  | 150  | 03.03  | 02.05  |   | 03.0137-9700.2   | 669700   |  | Bremsbacken-Zubehör        |
|  | 330 i  | 170  | 06.00  | 02.05  |   | 03.0137-9702.2   | 669702   |  | Spreizschloß Satz          |
|  | 330 xd   | 135  | 06.00  | 02.05  |   |  |  |  |                            |
|  | 330 xd   | 150  | 03.03  | 02.05  |   |  |  |  |                            |
|  | 330 xi   | 170  | 06.00  | 02.05  |   |  |  |  |                            |
| <b>BMW 3er Reihe/E46 Coupe (99-06)</b>   |  |  |  |  |   |  |  |  |                            |
|    | 316 Ci   | 77   | 04.00  | 09.06  |   | 13.0460-5405.2   | 605405   | 1  | 21643 17,8 +/WE ATE        |
|  | 316 Ci   | 85   | 06.02  | 09.06  |   | 13.0470-5405.2   | LD7155   |  | 21643 17,8 +/WE ATE        |
|  | 318 Ci   | 87   | 11.99  | 09.01  |   | 24.8190-0220.2   | 620220   |  | Warnkontakt L=601mm        |
|  | 318 Ci   | 105  | 09.01  | 09.06  |   |  |  |  |                            |
|  | 318 Ci   | 110  | 03.05  | 09.06  |   |  |  |  |                            |
|  | 320 Cd   | 110  | 11.03  | 09.06  |   |  |  |  |                            |
|  | 320 Ci   | 110  | 08.99  | 09.00  |   |  |  |  |                            |
|  | 320 Ci   | 125  | 09.00  | 09.06  |   |  |  |  |                            |
|  | 323 Ci   | 125  | 04.99  | 09.00  |   |  |  |  |                            |
|  | 325 Ci   | 141  | 09.00  | 09.06  |   |  |  |  |                            |
|  | 328 Ci   | 142  | 04.99  | 06.00  |   |  |  |  |                            |
|  | 330 Cd   | 150  | 03.03  | 09.06  |   | 13.0460-7155.2   | 607155   |  | 23183 20,3 +/WE ATE        |
|  | 330 Ci   | 170  | 06.00  | 09.06  |   | 13.0470-7155.2   | LD7155   |  | 23183 20,3 +/WE ATE        |
|  | 330 xi   | 170  | 06.00  | 09.06  |   | 24.8190-0227.2   | 620227   | 1  | Warnkontakt L=651mm        |
|  | M3   | 252  | 06.00  | 09.06  |   | 13.0460-7185.2   | 607185   |  | 21064 20,3 +/WE ATE        |
|  | M3 CSL   | 265  | 06.03  | 09.06  |   | 24.8190-0227.2   | 620227   | 1  | Warnkontakt L=651mm        |
|   | 316 Ci   | 77   | 04.00  | 09.06  |   | 24.0122-0115.1   | 422115   |  | 286 22,0 20,4 V L +S +B    |
|  | 316 Ci   | 85   | 06.02  | 09.06  |   | 24.0322-0115.1   | 522115   |  | 286 22,0 19,6 V L +S +B PD |
|  | 318 Ci   | 87   | 11.99  | 09.01  |   |  |  |  |                            |
|  | 318 Ci   | 105  | 09.01  | 09.06  |   |  |  |  |                            |
|  | 318 Ci   | 110  | 03.05  | 09.06  |   |  |  |  |                            |
|  | 320 Ci   | 110  | 08.99  | 09.00  |   |  |  |  |                            |
|  | 320 Ci   | 125  | 09.00  | 09.06  |   |  |  |  |                            |
|  | 323 Ci   | 125  | 04.99  | 09.00  |   |  |  |  |                            |
|  | 320 Cd   | 110  | 11.03  | 09.06  |   | 24.0122-0160.1   | 422160   |  | 300 22,0 20,4 V L +S +B    |
|  | 325 Ci   | 141  | 09.00  | 09.06  |   | 24.0322-0160.1   | 522160   |  | 300 22,0 19,6 V L +S +B PD |
|  | 328 Ci   | 142  | 04.99  | 06.00  |   |  |  |  |                            |
|  | 330 Cd   | 150  | 03.03  | 09.06  |   | 24.0125-0138.1   | 425138   |  | 325 24,9 23,4 V L +S +B    |
|  | 330 Ci   | 170  | 06.00  | 09.06  |   | 24.0325-0138.1   | 525138   |  | 325 24,9 22,5 V L +S +B PD |
|  | 330 xi   | 170  | 06.00  | 09.06  |   |  |  |  |                            |
|  | M3   | 252  | 06.00  | 09.06  |   | 24.0128-0206.2   | 428206   | <input type="checkbox"/> - Competition Paket <sup>2)</sup>                         | 325 28,0 26,4 V L +S +B    |
|  |  |  |  |  |   | 24.0128-0207.2   | 428207   | <input type="checkbox"/> - Competition Paket <sup>2)</sup>                         | 325 28,0 26,4 V L +S +B    |
|  |  |  |  |  |   | 24.0128-0208.2   | 428208   | <input type="checkbox"/> + Competition Paket <sup>3)</sup>                         | 345 28,0 26,4 V L +S +B    |
|  |  |  |  |  |   | 24.0128-0209.2   | 428209   | <input type="checkbox"/> + Competition Paket <sup>3)</sup>                         | 345 28,0 26,4 V L +S +B    |
|  | M3 CSL   | 265  | 06.03  | 09.06  |   | 24.0128-0208.2   | 428208   | <input type="checkbox"/> zweiteilige Bremsscheibe <sup>4)</sup>                    | 345 28,0 26,4 V L +S +B    |
|  |  |  |  |  |   | 24.0128-0209.2   | 428209   | <input type="checkbox"/> zweiteilige Bremsscheibe <sup>4)</sup>                    | 345 28,0 26,4 V L +S +B    |
|  | 316 Ci   | 77   | 04.00  | 09.06  |   | 24.0711-5277.3   | 360322   | <input type="checkbox"/> + DSC   | Radsensor L=565            |
|  | 318 Ci   | 87   | 11.99  | 09.01  |   | 24.0711-5278.3   | 360323   | <input type="checkbox"/> + DSC   | Radsensor L=565            |
|  | 320 Ci   | 110  | 08.99  | 09.00  |   |  |  |  |                            |
|  | 320 Ci   | 125  | 09.00  | 09.06  |   |  |  |  |                            |
|  | 323 Ci   | 125  | 04.99  | 09.00  |   |  |  |  |                            |
|  | 325 Ci   | 141  | 09.00  | 09.06  |   |  |  |  |                            |
|  | 330 Ci   | 170  | 09.00  | 09.06  |   |  |  |  |                            |
|  | 330 xi   | 170  | 09.00  | 09.06  |   |  |  |  |                            |
|  | 316 Ci   | 77   | 09.01  | 09.06  |   | 24.0711-5277.3   | 360322   | <input type="checkbox"/> - DSC   | Radsensor L=565            |
|  | 320 Ci   | 125  | 09.01  | 09.06  |   | 24.0711-5278.3   | 360323   | <input type="checkbox"/> - DSC   | Radsensor L=565            |
|  | 325 Ci   | 141  | 09.01  | 09.06  |   |  |  |  |                            |
|  | 316 Ci   | 85   | 06.02  | 09.06  |   | 24.0711-5277.3   | 360322   | <input type="checkbox"/>   | Radsensor L=565            |
|  | 318 Ci   | 105  | 09.01  | 09.06  |   | 24.0711-5278.3   | 360323   | <input type="checkbox"/>   | Radsensor L=565            |
|  | 318 Ci   | 110  | 03.05  | 09.06  |   |  |  |  |                            |
|  | 320 Cd   | 110  | 11.03  | 09.06  |   |  |  |  |                            |
|  | 330 Cd   | 150  | 03.03  | 09.06  |   |  |  |  |                            |
|  | 330 Ci   | 170  | 09.01  | 09.06  | - DSC   |  |  |  |                            |
|  | M3   | 252  | 09.02  | 09.06  |   |  |  |  |                            |
|  | M3 CSL   | 265  | 06.03  | 09.06  |   |  |  |  |                            |
|  | 316 Ci   | 77   | 04.00  | 09.06  |   | 13.0460-3605.2   | 603605   | 1  | 20180 17,3 +/WE ATE        |
|  | 316 Ci   | 85   | 06.02  | 09.06  |   | 13.0470-3605.2   | LD3605   |  | 20180 17,3 +/WE ATE        |
|  | 318 Ci   | 87   | 11.99  | 09.01  |   | 24.8190-0221.2   | 620221   |  | Warnkontakt L=1338mm       |
|  | 318 Ci   | 105  | 09.01  | 09.06  |   |  |  |  |                            |
|  | 318 Ci   | 110  | 03.05  | 09.06  |   |  |  |  |                            |
|  | 320 Cd   | 110  | 11.03  | 09.06  |   |  |  |  |                            |
|  | 320 Ci   | 110  | 08.99  | 09.00  |   |  |  |  |                            |

1) + manual transmission / + scatola cambio velocità / + transmission mécanique / + cambio de velocidad  
2) - Competition package / - pacco Competition / - version Competition / - paquete Competition  
3) + Competition package / + pacco Competition / + version Competition / + paquete Competition  
4) two-piece brake disc / disco frenante in due parti / disque d.fr.en deux parties / disco de fr.de dos piezas



|     |  |  |  |  |  |  |  |  |   |                 |   |   |            |
|--|--|--|--|--|---|--|--|--|---|-----------------|---|---|------------|
| <b>BMW 3er Reihe/E46 Coupe (99-06)</b>   |  |  |  |  |   |  |  |  |   |                 |   |   |            |
|    | 320 Ci   | 125  |  | 09.00  | 09.06   | 13.0460-3605.2   | 603605   | 1  | 20180 17,3 +/WE<br>20180 17,3 +/WE<br>Warnkontakt L=1338mm                  | ATE<br>ATE      |   |   |            |
|  | 323 Ci   | 125  |  | 04.99  | 09.00   | 13.0470-3605.2   | LD3605   |  |   |                 |   |   |            |
|  | 325 Ci   | 141  |  | 09.00  | 09.06   | 24.8190-0221.2   | 620221   |  |   |                 |   |   |            |
|  | 328 Ci   | 142  |  | 04.99  | 06.00   |  |  |  |   |                 |   |   |            |
|  | 330 Cd   | 150  |  | 03.03  | 09.06   | 13.0460-7079.2   | 607079   |  |   |                 |   |   |            |
|  | 330 Ci   | 170  |  | 06.00  | 09.06   | 13.0470-7079.2   | LD7079   |  |   |                 |   |   |            |
|  | 330 xi   | 170  |  | 06.00  | 09.06   | 24.8190-0221.2   | 620221   |  |   |                 |   |   |            |
|  | M3   | 252  |  | 06.00  | 09.06   | 13.0460-7079.2   | 607079   |  |   |                 |   |   |            |
|  | M3 CSL   | 265  |  | 06.03  | 09.06   | 13.0470-7079.2   | LD7079   |  |   |                 |   |   |            |
|  |  |  |  |  |   | 24.8190-0228.2   | 620228   |  |   |                 |   |   |            |
|    | 316 Ci   | 77   |  | 04.00  | 09.06   | 24.0110-0202.1   | 410202   | 1  | 280 10,0 8,4 L +S +B<br>280 10,0 7,6 L +S +B PD                             | ATE<br>ATE      |   |   |            |
|  | 316 Ci   | 85   |  | 06.02  | 09.06   | 24.0310-0202.1   | 510202   |  |   |                 |   |   |            |
|  | 318 Ci   | 87   |  | 11.99  | 09.01   |  |  |  |   |                 |   |   |            |
|  | 318 Ci   | 105  |  | 09.01  | 09.06   | 24.0119-0107.1   | 419107   |  |   |                 |   |   |            |
|  | 318 Ci   | 110  |  | 03.05  | 09.06   | 24.0319-0107.1   | 519107   |  |   |                 |   |   |            |
|  | 320 Ci   | 110  |  | 08.99  | 09.00   |  |  |  |   |                 |   |   |            |
|  | 320 Ci   | 125  |  | 09.00  | 09.06   |  |  |  |   |                 |   |   |            |
|  | 323 Ci   | 125  |  | 04.99  | 09.00   |  |  |  |   |                 |   |   |            |
|  | 320 Cd   | 110  |  | 11.03  | 09.06   | 24.0119-0108.1   | 419108   |  |   |                 |   |   |            |
|  | 325 Ci   | 141  |  | 09.00  | 09.06   | 24.0319-0108.1   | 519108   |  |   |                 |   |   |            |
| 328 Ci   | 142  |  | 04.99  | 06.00  |   |  |  |  |   |                 |   |   |            |
| 330 Cd   | 150  |  | 03.03  | 09.06  | 24.0122-0209.1  | 422209   | 1  | 276 19,0 17,4 V L +S +B<br>276 19,0 16,6 V L +S +B PD                              | ATE<br>ATE  |                 |   |   |            |
| 330 Ci   | 170  |  | 06.00  | 09.06  | 24.0322-0209.1  | 522209   |  |  |   |                 |   |   |            |
| 330 xi   | 170  |  | 06.00  | 09.06  |   |  |  |  |   |                 |   |   |            |
| M3   | 252  |  | 06.00  | 09.06  | 24.0120-0221.2  | 420221   |  |  |   |                 |   |   |            |
| M3 CSL   | 265  |  | 06.03  | 09.06  | 24.0120-0222.2  | 420222   |  |  |   |                 |   |   |            |
|  |  |  |  |  |   |  |  |  |   |                 |   |   |            |
|  |  |  |  |  |   |  |  |  |   |                 |   |   |            |
|  |  |  |  |  |   |  |  |  |   |                 |   |   |            |
|  |  |  |  |  |   |  |  |  |   |                 |   |   |            |
|  |  |  |  |  |   |  |  |  |   |                 |   |   |            |
|    | 316 Ci   | 77   |  | 04.00  | 08.00   | 24.0751-1179.3   | 360169   | 2  | ☐ + DSC   | Radsensor L=981 |   |   |            |
|  | 318 Ci   | 87   |  | 11.99  | 08.00   |  |  |  |   |                 |   |   |            |
|  | 316 Ci   | 77   |  | 09.00  | 09.06   | 24.0711-6041.3   | 360124   |  |   |                 |   |   |            |
|  | 318 Ci   | 87   |  | 09.00  | 09.01   |  |  |  |   |                 |   |   |            |
|  | 320 Ci   | 125  |  | 09.00  | 09.06   |  |  |  |   |                 |   |   |            |
|  | 325 Ci   | 141  |  | 09.00  | 09.06   |  |  |  |   |                 |   |   |            |
|  | 316 Ci   | 77   |  | 04.00  | 08.00   | 24.0751-1179.3   | 360169   |  |   |                 |   |   |            |
|  | 318 Ci   | 87   |  | 11.99  | 08.01   |  |  |  |   |                 |   |   |            |
|  | 320 Ci   | 110  |  | 08.99  | 09.00   |  |  |  |   |                 |   |   |            |
|  | 320 Ci   | 125  |  | 09.00  | 08.01   |  |  |  |   |                 |   |   |            |
| 323 Ci   | 125  |  | 04.99  | 09.00  |   |  |  |  |   |                 |   |   |            |
| 325 Ci   | 141  |  | 09.00  | 08.01  |   |  |  |  |   |                 |   |   |            |
| 328 Ci   | 142  |  | 04.99  | 06.00  |   |  |  |  |   |                 |   |   |            |
| 330 Ci   | 170  |  | 06.00  | 08.01  |   |  |  |  |   |                 |   |   |            |
| 330 xi   | 170  |  | 06.00  | 08.01  |   |  |  |  |   |                 |   |   |            |
| M3   | 252  |  | 06.00  | 08.02  |   |  |  |  |   |                 |   |   |            |
| 316 Ci   | 77   |  | 09.01  | 09.06  | 24.0711-6041.3  | 360124   | 2  | ☐ - DSC  | Radsensor L=981   |                 |   |   |            |
| 318 Ci   | 87   |  | 09.00  | 09.01  |   |  |  |  |   |                 |   |   |            |
| 320 Ci   | 125  |  | 09.01  | 09.06  |   |  |  |  |   |                 |   |   |            |
| 325 Ci   | 141  |  | 09.01  | 09.06  |   |  |  |  |   |                 |   |   |            |
| 316 Ci   | 85   |  | 06.02  | 09.06  | 24.0711-6041.3  | 360124   |  |  |   |                 |   |   |            |
| 318 Ci   | 105  |  | 09.01  | 09.06  |   |  |  |  |   |                 |   |   |            |
| 318 Ci   | 110  |  | 03.05  | 09.06  |   |  |  |  |   |                 |   |   |            |
| 320 Cd   | 110  |  | 11.03  | 09.06  |   |  |  |  |   |                 |   |   |            |
| M3   | 252  |  | 09.02  | 09.06  |   |  |  |  |   |                 |   |   |            |
| M3 CSL   | 265  |  | 06.03  | 09.06  |   |  |  |  |   |                 |   |   |            |
| 330 Cd   | 150  |  | 03.03  | 09.06  | 24.0711-6042.3  | 360125   |  |  |   |                 |   |   |            |
| 330 Ci   | 170  |  | 06.00  | 09.06  |   |  |  |  |   |                 |   |   |            |
| 330 Ci   | 170  |  | 09.01  | 09.06  |   |  |  |  |   |                 |   |   |            |
| 330 xi   | 170  |  | 06.00  | 09.06  |   |  |  |  |   |                 |   |   |            |
| 330 xi   | 170  |  | 09.01  | 09.06  |   |  |  |  |   |                 |   |   |            |
|  | 316 Ci   | 77   |  | 04.00  | 09.06   | 03.0137-0379.2   | 650379   | 1  | 161 x 20<br>Bremsbacken-Zubehör<br>Bremsbacken-Zubehör<br>Spreizschloß Satz | ATE<br>ATE      |   |   |            |
|  | 316 Ci   | 85   |  | 06.02  | 09.06   | 03.0137-9265.2   | 669265   |  |   |                 |   |   |            |
|  | 318 Ci   | 87   |  | 11.99  | 09.01   | 03.0137-9701.2   | 669701   |  |   |                 |   |   |            |
|  | 318 Ci   | 105  |  | 09.01  | 09.06   | 03.0137-9702.2   | 669702   |  |   |                 |   |   |            |
|  | 318 Ci   | 110  |  | 03.05  | 09.06   |  |  |  |   |                 |   |   |            |
|  | 320 Cd   | 110  |  | 11.03  | 09.06   |  |  |  |   |                 |   |   |            |
|  | 320 Ci   | 110  |  | 08.99  | 09.00   |  |  |  |   |                 |   |   |            |
|  | 320 Ci   | 125  |  | 09.00  | 09.06   |  |  |  |   |                 |   |   |            |
|  | 323 Ci   | 125  |  | 04.99  | 09.00   |  |  |  |   |                 |   |   |            |
|  | 325 Ci   | 141  |  | 09.00  | 09.06   |  |  |  |   |                 |   |   |            |
| 328 Ci   | 142  |  | 04.99  | 06.00  |   |  |  |  |   |                 |   |   |            |
| 330 Cd   | 150  |  | 03.03  | 09.06  | 03.0137-0305.2  | 650305   | 1  | 185 x 20<br>Bremsbacken-Zubehör<br>Bremsbacken-Zubehör<br>Spreizschloß Satz        | ATE<br>ATE  |                 |   |   |            |
| 330 Ci   | 170  |  | 06.00  | 09.06  | 03.0137-9062.2  | 669062   |  |  |   |                 |   |   |            |
| 330 xi   | 170  |  | 06.00  | 09.06  | 03.0137-9700.2  | 669700   |  |  |   |                 |   |   |            |
|  |  |  |  |  | 03.0137-9702.2  | 669702   |  |  |   |                 |   |   |            |
| M3   | 252  |  | 06.00  | 09.06  | 03.0137-0419.2  | 650419   |  |  |   |                 |   |   |            |
| M3 CSL   | 265  |  | 06.03  | 09.06  |   |  |  |  |   |                 |   |   |            |
| <b>BMW 3er Reihe/E46 Cabrio (00-06)</b>  |  |  |  |  |   |  |  |  |   |                 |   |   |            |
|  | 318 Ci   | 105  |  | 09.01  | 09.06   | 13.0460-5405.2   |  |  |   | 605405          | 1 | 21643 17,8 +/WE<br>21643 17,8 +/WE<br>Warnkontakt L=601mm | ATE<br>ATE |
|  | 318 Ci   | 110  |  | 02.05  | 09.06   | 13.0470-5405.2   |  |  |   | LD5405          |   |   |            |
|  | 320 Cd   | 110  |  | 02.05  | 09.06   | 24.8190-0220.2   |  |  |   | 620220          |   |   |            |
|  | 320 Ci   | 125  |  | 09.00  | 09.06   |  |  |  |   |                 |   |   |            |
|  | 323 Ci   | 125  |  | 04.00  | 09.00   |  |  |  |   |                 |   |   |            |
|  | 325 Ci   | 141  |  | 09.00  | 09.06   |  |  |  |   |                 |   |   |            |
|  | 330 Cd   | 150  |  | 08.05  | 09.06   | 13.0460-7155.2   | 607155   |  |   |                 |   |   |            |
|  | 330 Ci   | 170  |  | 06.00  | 09.06   | 13.0470-7155.2   | LD7155   |  |   |                 |   |   |            |
|  |  |  |  |  |   | 24.8190-0227.2   | 620227   |  |   |                 |   |   |            |
|  |  |  |  |  |   |  |  |  |   |                 |   |   |            |

1) two-piece brake disc / disco frenante in due parti / disque d.fr.en deux parties / disco de fr.de dos piezas

|     |  |  |  |  |  |  |  |  |  |                    |
|--|--|--|--|--|---|--|--|--|--|--------------------|
| <b>BMW 3er Reihe/E46 Cabrio (00-06)</b>  |  |  |  |  |   |  |  |  |  |                    |
|    | M3 3.2   | 252  |  | 04.01  | 09.06   |  | 13.0460-7185.2 607185<br>24.8190-0227.2 620227                                     | 1  | 21064 20,3 +WE ATE<br>Warnkontakt L=651mm          |                    |
|    | 318 Ci   | 105  |  | 09.01  | 09.06   |  | 24.0122-0115.1 422115  |  | 286 22,0 20,4 V L +S +B                            |                    |
|  | 318 Ci   | 110  |  | 02.05  | 09.06   |  | 24.0322-0115.1 522115  |  | 286 22,0 19,6 V L +S +B PD                         |                    |
|  | 320 Cd   | 110  |  | 02.05  | 09.06   |  | 24.0122-0160.1 422160  |  | 300 22,0 20,4 V L +S +B                            |                    |
|  | 320 Ci   | 125  |  | 09.00  | 09.06   |  | 24.0322-0160.1 522160  |  | 300 22,0 19,6 V L +S +B PD                         |                    |
|  | 323 Ci   | 125  |  | 04.00  | 09.00   |  |  |  |  |                    |
|  | 325 Ci   | 141  |  | 09.00  | 09.06   |  |  |  |  |                    |
|  | 330 Cd   | 150  |  | 08.05  | 09.06   |  | 24.0125-0138.1 425138  |  | 325 24,9 23,4 V L +S +B                            |                    |
|  | 330 Ci   | 170  |  | 06.00  | 09.06   |  | 24.0325-0138.1 525138  |  | 325 24,9 22,5 V L +S +B PD                         |                    |
|    | M3 3.2   | 252  |  | 04.01  | 09.06   |  | 24.0128-0206.2 428206<br>24.0128-0207.2 428207                                     | 2  | 325 28,0 26,4 V L +S +B<br>325 28,0 26,4 V L +S +B |                    |
|  | 320 Ci   | 125  |  | 09.00  | 08.01   |  | 24.0710-2020.1 360227  | 2  | Radsensor L=580                                    |                    |
|    | 323 Ci   | 125  |  | 04.00  | 09.00   |  |  |  |  |                    |
|  | 325 Ci   | 141  |  | 09.00  | 08.01   |  |  |  |  |                    |
|  | 330 Ci   | 170  |  | 06.00  | 08.00   |  |  |  |  |                    |
|  | M3 3.2   | 252  |  | 04.01  | 08.02   |  |  |  |  |                    |
|  | 318 Ci   | 105  |  | 09.01  | 09.06   |  | 24.0711-5277.3 360322  | 2  | Radsensor L=565                                    |                    |
|  | 318 Ci   | 110  |  | 02.05  | 09.06   |  | 24.0711-5278.3 360323  | 2  | Radsensor L=565                                    |                    |
|  | 320 Cd   | 110  |  | 02.05  | 09.06   |  |  |  |  |                    |
|  | 320 Ci   | 125  |  | 09.01  | 09.06   |  |  |  |  |                    |
|  | 325 Ci   | 141  |  | 09.01  | 09.06   |  |  |  |  |                    |
|  | 330 Cd   | 150  |  | 08.05  | 09.06   |  |  |  |  |                    |
|  | 330 Ci   | 170  |  | 09.00  | 09.06   |  |  |  |  |                    |
|  | M3 3.2   | 252  |  | 09.02  | 09.06   |  |  |  |  |                    |
|  |  | 318 Ci   | 105  |  | 09.01   | 09.06  |  | 13.0460-3605.2 603605  | 1  | 20180 17,3 +WE ATE |
|  |  | 318 Ci   | 110  |  | 02.05   | 09.06  |  | 13.0470-3605.2 LD3605  |  | 20180 17,3 +WE ATE |
| 320 Cd   |  | 110  |  | 02.05  | 09.06   |  | 24.8190-0221.2 620221  |  | Warnkontakt L=1338mm                               |                    |
| 320 Ci   |  | 125  |  | 09.00  | 09.06   |  |  |  |  |                    |
| 323 Ci   |  | 125  |  | 04.00  | 09.00   |  |  |  |  |                    |
| 325 Ci   |  | 141  |  | 09.00  | 09.06   |  |  |  |  |                    |
| 330 Cd   |  | 150  |  | 08.05  | 09.06   |  | 13.0460-7079.2 607079  |  | 21487 17,3 +WE ATE                                 |                    |
| 330 Ci   |  | 170  |  | 06.00  | 09.06   |  | 13.0470-7079.2 LD7079  |  | 21487 17,3 +WE ATE                                 |                    |
| M3 3.2   |  | 252  |  | 04.01  | 09.06   |  | 24.8190-0221.2 620221  | 1  | Warnkontakt L=1338mm                               |                    |
|  |  |  |  |  |   |  | 13.0460-7079.2 607079  |  | 21487 17,3 +WE ATE                                 |                    |
|   | 318 Ci   | 105  |  | 09.01  | 09.06   |  | 24.0119-0107.1 419107  |  | 276 19,0 17,4 V L +S +B                            |                    |
|  | 318 Ci   | 110  |  | 02.05  | 09.06   |  | 24.0319-0107.1 519107  |  | 276 19,0 16,6 V L +S +B PD                         |                    |
|  | 320 Cd   | 110  |  | 02.05  | 09.06   |  | 24.0119-0108.1 419108  |  | 294 18,9 17,4 V L +S +B                            |                    |
|  | 320 Ci   | 125  |  | 09.00  | 09.06   |  | 24.0319-0108.1 519108  |  | 294 18,9 17,4 V L +S +B PD                         |                    |
|  | 323 Ci   | 125  |  | 04.00  | 09.00   |  |  |  |  |                    |
|  | 325 Ci   | 141  |  | 09.00  | 09.06   |  |  |  |  |                    |
|  | 330 Cd   | 150  |  | 08.05  | 09.06   |  | 24.0122-0209.1 422209  |  | 320 22,0 20,4 V L +S +B                            |                    |
|  | 330 Ci   | 170  |  | 06.00  | 09.06   |  | 24.0322-0209.1 522209  |  | 320 22,0 20,4 V L +S +B PD                         |                    |
|  | M3 3.2   | 252  |  | 04.01  | 09.06   |  | 24.0120-0221.2 420221  | 2  | 328 20,0 18,4 V L +S +B                            |                    |
|  |  |  |  |  |   |  | 24.0120-0222.2 420222  | 2  | 328 20,0 18,4 V L +S +B                            |                    |
|  | 320 Ci   | 125  |  | 09.00  | 08.01   |  | 24.0751-1179.3 360169  | 2  | Radsensor L=981                                    |                    |
|  | 323 Ci   | 125  |  | 04.00  | 09.00   |  |  |  |  |                    |
|  | 325 Ci   | 141  |  | 09.00  | 08.01   |  |  |  |  |                    |
|  | 330 Ci   | 170  |  | 06.00  | 08.00   |  |  |  |  |                    |
|  | M3 3.2   | 252  |  | 04.01  | 08.02   |  |  |  |  |                    |
|  | 318 Ci   | 105  |  | 09.01  | 09.06   |  | 24.0711-6041.3 360124  | 2  | Radsensor L=981                                    |                    |
|  | 318 Ci   | 110  |  | 02.05  | 09.06   |  |  |  |  |                    |
|  | 320 Cd   | 110  |  | 02.05  | 09.06   |  |  |  |  |                    |
|  | 320 Ci   | 125  |  | 09.01  | 09.06   |  |  |  |  |                    |
|  | 325 Ci   | 141  |  | 09.01  | 09.06   |  |  |  |  |                    |
|  | 330 Ci   | 170  |  | 09.00  | 09.06 + Automatikgetriebe 1)  |  |  |  |  |                    |
|  | M3 3.2   | 252  |  | 09.02  | 09.06   |  |  |  |  |                    |
|  | 330 Cd   | 150  |  | 08.05  | 09.06   |  | 24.0711-6042.3 360125  | 2  | Radsensor L=981                                    |                    |
|  | 330 Ci   | 170  |  | 09.00  | 09.06 + Schaltgetriebe 2)   |  |  |  |  |                    |
|  | 318 Ci   | 105  |  | 09.01  | 09.06   |  | 03.0137-0379.2 650379  |  | 161 x 20   |                    |
|  | 318 Ci   | 110  |  | 02.05  | 09.06   |  | 03.0137-9265.2 669265  |  | Bremsbacken-Zubehör                                |                    |
|  | 320 Cd   | 110  |  | 02.05  | 09.06   |  | 03.0137-9701.2 669701  |  | Bremsbacken-Zubehör                                |                    |
|  | 320 Ci   | 125  |  | 09.00  | 09.06   |  | 03.0137-9702.2 669702  |  | Spreizschloß Satz                                  |                    |
|  | 323 Ci   | 125  |  | 04.00  | 09.00   |  |  |  |  |                    |
|  | 325 Ci   | 141  |  | 09.00  | 09.06   |  |  |  |  |                    |
|  | 330 Cd   | 150  |  | 08.05  | 09.06   |  | 03.0137-0305.2 650305  |  | 185 x 20   |                    |
|  | 330 Ci   | 170  |  | 06.00  | 09.06   |  | 03.0137-9062.2 669062  |  | Bremsbacken-Zubehör                                |                    |
|  | M3 3.2   | 252  |  | 04.01  | 09.06   |  | 03.0137-9700.2 669700  |  | Bremsbacken-Zubehör                                |                    |
|  |  |  |  |  |   |  | 03.0137-9702.2 669702  |  | Spreizschloß Satz                                  |                    |
| <b>BMW 3er Reihe/E46 Compact (01-05)</b>   |  |  |  |  |   |  |  |  |  |                    |
|  | 316 ti   | 77   |  | 06.02  | 02.05   |  | 13.0460-5405.2 605405  | 1  | 21643 17,8 +WE ATE                                 |                    |
|  | 316 ti   | 85   |  | 06.01  | 02.05   |  | 13.0470-5405.2 LD5405  |  | 21643 17,8 +WE ATE                                 |                    |
|  | 318 td   | 85   |  | 03.03  | 02.05   |  | 24.8190-0220.2 620220  |  | Warnkontakt L=601mm                                |                    |
|  | 318 ti   | 105  |  | 09.01  | 02.05   |  |  |  |  |                    |
|  | 320 td   | 110  |  | 09.01  | 02.05   |  |  |  |  |                    |
|  | 325 ti   | 141  |  | 06.01  | 02.05   |  |  |  |  |                    |
|  |  |  |  |  |   |  |  |  |  |                    |

1) + autom.transmission / + scatola cambio automatico / + transmission automatique / + cambio automático

2) + manual transmission / + scatola cambio velocità / + transmission mécanique / + cambio de velocidad

| BMW 3er Reihe/E46 Compact (01-05) |        |     |  |       |       |                                  |                |        |   |  |  |                            |
|-----------------------------------|--------|-----|--|-------|-------|----------------------------------|----------------|--------|---|--|--|----------------------------|
|                                   | 316 ti | 77  |  | 06.02 | 02.05 |                                  | 24.0122-0115.1 | 422115 |   |  |  | 286 22,0 20,4 V L +S +B    |
|                                   | 316 ti | 85  |  | 06.01 | 02.05 |                                  | 24.0322-0115.1 | 522115 |   |  |  | 286 22,0 19,6 V L +S +B PD |
|                                   | 318 td | 85  |  | 03.03 | 02.05 |                                  |                |        |   |  |  |                            |
|                                   | 318 ti | 105 |  | 09.01 | 02.05 |                                  |                |        |   |  |  |                            |
|                                   | 320 td | 110 |  | 09.01 | 02.05 |                                  | 24.0122-0160.1 | 422160 |   |  |  | 300 22,0 20,4 V L +S +B    |
|                                   | 325 ti | 141 |  | 06.01 | 02.05 |                                  | 24.0322-0160.1 | 522160 |   |  |  | 300 22,0 19,6 V L +S +B PD |
|                                   | 316 ti | 85  |  | 06.01 | 08.01 | - DSC                            | 24.0710-2020.1 | 360227 | 2 |  |  | Radsensor L=580            |
|                                   | 325 ti | 141 |  | 06.01 | 08.01 | - DSC                            |                |        |   |  |  |                            |
|                                   | 316 ti | 77  |  | 06.02 | 02.05 |                                  | 24.0711-5277.3 | 360322 |   |  |  | Radsensor L=565            |
|                                   | 316 ti | 85  |  | 06.01 | 03.03 | + DSC                            | 24.0711-5278.3 | 360323 |   |  |  | Radsensor L=565            |
|                                   | 316 ti | 85  |  | 09.01 | 02.05 | - DSC                            |                |        |   |  |  |                            |
|                                   | 318 td | 85  |  | 03.03 | 02.05 |                                  |                |        |   |  |  |                            |
|                                   | 318 ti | 105 |  | 09.01 | 02.05 |                                  |                |        |   |  |  |                            |
|                                   | 320 td | 110 |  | 09.01 | 02.05 |                                  |                |        |   |  |  |                            |
|                                   | 325 ti | 141 |  | 06.01 | 02.05 | + DSC                            |                |        |   |  |  |                            |
|                                   | 325 ti | 141 |  | 09.01 | 02.05 | - DSC                            |                |        |   |  |  |                            |
|                                   | 316 ti | 77  |  | 06.02 | 02.05 |                                  | 13.0460-3605.2 | 603605 |   |  |  | 20180 17,3 +/WE ATE        |
|                                   | 316 ti | 85  |  | 06.01 | 02.05 |                                  | 13.0470-3605.2 | LD3605 |   |  |  | 20180 17,3 +/WE ATE        |
|                                   | 318 td | 85  |  | 03.03 | 02.05 |                                  | 24.8190-0221.2 | 620221 | 1 |  |  | Warnkontakt L=1338mm       |
|                                   | 318 ti | 105 |  | 09.01 | 02.05 |                                  |                |        |   |  |  |                            |
|                                   | 320 td | 110 |  | 09.01 | 02.05 |                                  |                |        |   |  |  |                            |
|                                   | 325 ti | 141 |  | 06.01 | 02.05 |                                  |                |        |   |  |  |                            |
|                                   | 316 ti | 77  |  | 06.02 | 02.05 |                                  | 24.0110-0202.1 | 410202 |   |  |  | 280 10,0 8,4 L +S +B       |
|                                   | 316 ti | 85  |  | 06.01 | 02.05 | - erhöhte Zuladung <sup>1)</sup> | 24.0310-0202.1 | 510202 |   |  |  | 280 10,0 7,6 L +S +B PD    |
|                                   | 316 ti | 85  |  | 06.01 | 02.05 | + erhöhte Zuladung <sup>2)</sup> | 24.0119-0107.1 | 419107 |   |  |  | 276 19,0 17,4 V L +S +B    |
|                                   | 318 td | 85  |  | 03.03 | 02.05 |                                  | 24.0319-0107.1 | 519107 |   |  |  | 276 19,0 16,6 V L +S +B PD |
|                                   | 318 ti | 105 |  | 09.01 | 02.05 |                                  |                |        |   |  |  |                            |
|                                   | 320 td | 110 |  | 09.01 | 02.05 |                                  | 24.0119-0108.1 | 419108 |   |  |  | 294 18,9 17,4 V L +S +B    |
|                                   | 325 ti | 141 |  | 06.01 | 02.05 |                                  | 24.0319-0108.1 | 519108 |   |  |  | 294 18,9 17,4 V L +S +B PD |
|                                   | 316 ti | 85  |  | 06.01 | 08.01 | - DSC                            | 24.0751-1179.3 | 360169 | 2 |  |  | Radsensor L=981            |
|                                   | 325 ti | 141 |  | 06.01 | 08.01 | - DSC                            |                |        |   |  |  |                            |
|                                   | 316 ti | 77  |  | 06.02 | 02.05 |                                  | 24.0711-6041.3 | 360124 | 2 |  |  | Radsensor L=981            |
|                                   | 316 ti | 85  |  | 06.01 | 03.03 | + DSC                            |                |        |   |  |  |                            |
|                                   | 316 ti | 85  |  | 09.01 | 02.05 | - DSC                            |                |        |   |  |  |                            |
|                                   | 318 td | 85  |  | 03.03 | 02.05 |                                  |                |        |   |  |  |                            |
|                                   | 318 ti | 105 |  | 09.01 | 02.05 |                                  |                |        |   |  |  |                            |
|                                   | 320 td | 110 |  | 09.01 | 02.05 |                                  |                |        |   |  |  |                            |
|                                   | 325 ti | 141 |  | 06.01 | 02.05 | + DSC                            |                |        |   |  |  |                            |
|                                   | 325 ti | 141 |  | 09.01 | 02.05 | - DSC                            |                |        |   |  |  |                            |
|                                   | 316 ti | 77  |  | 06.02 | 02.05 |                                  | 03.0137-0379.2 | 650379 |   |  |  | 161 x 20                   |
|                                   | 316 ti | 85  |  | 06.01 | 02.05 |                                  | 03.0137-9265.2 | 669265 |   |  |  | Bremsbacken-Zubehör        |
|                                   | 318 td | 85  |  | 03.03 | 02.05 |                                  | 03.0137-9701.2 | 669701 |   |  |  | Bremsbacken-Zubehör        |
|                                   | 318 ti | 105 |  | 09.01 | 02.05 |                                  | 03.0137-9702.2 | 669702 |   |  |  | Spreizschloß Satz          |
|                                   | 320 td | 110 |  | 09.01 | 02.05 |                                  |                |        |   |  |  |                            |
|                                   | 325 ti | 141 |  | 06.01 | 02.05 |                                  |                |        |   |  |  |                            |
|                                   | 325 ti | 141 |  | 06.01 | 02.05 |                                  |                |        |   |  |  |                            |

### BMW 3er Reihe/E90 Limousine (05-12)

|  |        |     |  |       |       |  |                |        |   |  |  |                     |
|--|--------|-----|--|-------|-------|--|----------------|--------|---|--|--|---------------------|
|  | 316 i  | 85  |  | 01.05 | 08.07 |  | 13.0460-7215.2 | 607215 |   |  |  | 23935 17,8 +/WE ATE |
|  | 318 d  | 90  |  | 09.05 | 08.07 | - erhöhte Zuladung <sup>1)</sup>                   | 13.0470-7215.2 | LD7215 |   |  |  | 23935 17,8 +/WE ATE |
|  | 318 i  | 95  |  | 09.05 | 08.07 | - erhöhte Zuladung/ + Motorcode N46 <sup>3)</sup>  | 24.8190-0264.2 | 620264 | 1 |  |  | Warnkontakt L=630mm |
|  | 320 i  | 110 |  | 12.04 | 08.07 | - erhöhte Zuladung/ + Motorcode N46 <sup>3)</sup>  |                |        |   |  |  |                     |
|  | 316 d  | 85  |  | 07.09 | 02.10 |  | 13.0460-7216.2 | 607216 |   |  |  | 23794 20,3 +/WE ATE |
|  | 316 i  | 90  |  | 09.07 | 02.10 |  | 13.0470-7216.2 | LD7216 |   |  |  | 23794 20,3 +/WE ATE |
|  | 318 d  | 90  |  | 09.07 | 02.10 |  | 24.8190-0264.2 | 620264 | 1 |  |  | Warnkontakt L=630mm |
|  | 318 d  | 90  |  | 09.05 | 08.07 | + erhöhte Zuladung <sup>2)</sup>                   |                |        |   |  |  |                     |
|  | 318 i  | 95  |  | 03.07 | 08.07 | - erhöhte Zuladung/ + Motorcode N46N <sup>4)</sup> |                |        |   |  |  |                     |
|  | 318 i  | 95  |  | 09.05 | 08.07 | + erhöhte Zuladung/ + Motorcode N46 <sup>5)</sup>  |                |        |   |  |  |                     |
|  | 318 i  | 105 |  | 09.07 | 02.10 |  |                |        |   |  |  |                     |
|  | 320 i  | 110 |  | 03.07 | 08.07 | - erhöhte Zuladung/ + Motorcode N46N <sup>4)</sup> |                |        |   |  |  |                     |
|  | 320 i  | 110 |  | 12.04 | 08.07 | + erhöhte Zuladung/ + Motorcode N46 <sup>5)</sup>  |                |        |   |  |  |                     |
|  | 320 i  | 125 |  | 09.07 | 02.10 | - erhöhte Zuladung <sup>1)</sup>                   |                |        |   |  |  |                     |
|  | 320 si | 127 |  | 06.06 | 02.10 |  |                |        |   |  |  |                     |
|  | 325 d  | 145 |  | 09.06 | 02.10 | - Behörde <sup>6)</sup>                            |                |        |   |  |  |                     |
|  | 325 i  | 160 |  | 12.04 | 08.07 | - erhöhte Zuladung/ + Motorcode N52 <sup>7)</sup>  |                |        |   |  |  |                     |
|  | 316 d  | 85  |  | 03.10 | 03.12 |  | 13.0460-7216.2 | 607216 |   |  |  | 23794 20,3 +/WE ATE |
|  | 316 i  | 90  |  | 03.10 | 03.12 |  | 13.0470-7216.2 | LD7216 |   |  |  | 23794 20,3 +/WE ATE |
|  | 318 d  | 105 |  | 03.10 | 03.12 |  | 24.8190-0284.2 | 620284 | 1 |  |  | Warnkontakt L=650mm |
|  | 318 i  | 105 |  | 03.10 | 03.12 |  |                |        |   |  |  |                     |
|  | 320 i  | 125 |  | 03.10 | 03.12 | - erhöhte Zuladung <sup>1)</sup>                   |                |        |   |  |  |                     |
|  | 320 si | 127 |  | 03.10 | 03.12 |  |                |        |   |  |  |                     |
|  | 325 d  | 145 |  | 03.10 | 03.12 | - Behörde <sup>6)</sup>                            |                |        |   |  |  |                     |
|  | 330 i  | 190 |  | 12.04 | 08.07 | + Motorcode N52N <sup>8)</sup>                     | 13.0460-7216.2 | 607216 |   |  |  | 23794 20,3 +/WE ATE |
|  | 330 i  | 190 |  | 12.04 | 08.07 | - erhöhte Zuladung/ + Motorcode N52 <sup>7)</sup>  | 13.0470-7216.2 | LD7216 |   |  |  | 23794 20,3 +/WE ATE |
|  |        |     |  |       |       |  | 24.8190-0264.2 | 620264 | 1 |  |  | Warnkontakt L=630mm |
|  |        |     |  |       |       |  | 24.8190-0284.2 | 620284 | 1 |  |  | Warnkontakt L=650mm |
|  | 318 i  | 95  |  | 03.07 | 08.07 | + erhöhte Zuladung/ + Motorcode N46N <sup>9)</sup> | 13.0460-7238.2 | 607238 |   |  |  | 23313 20,3 +/WE ATE |
|  |        |     |  |       |       |  | 13.0470-7238.2 | LD7238 |   |  |  | 23313 20,3 +/WE ATE |
|  |        |     |  |       |       |  | 24.8190-0264.2 | 620264 | 1 |  |  | Warnkontakt L=630mm |
|  |        |     |  |       |       |  | 24.8190-0284.2 | 620284 | 1 |  |  | Warnkontakt L=650mm |
|  | 320 d  | 110 |  | 09.05 | 02.10 | + Behörde <sup>10)</sup>                           | 13.0460-7216.2 | 607216 |   |  |  | 23794 20,3 +/WE ATE |
|  | 320 d  | 120 |  | 12.04 | 03.12 | + Behörde <sup>10)</sup>                           | 13.0470-7216.2 | LD7216 |   |  |  | 23794 20,3 +/WE ATE |
|  | 320 d  | 130 |  | 09.07 | 02.10 | + Behörde <sup>10)</sup>                           | 24.8190-0267.2 | 620267 | 1 |  |  | Warnkontakt L=679mm |
|  | 320 xd |     |  | 09.07 | 02.10 | + Behörde <sup>10)</sup>                           |                |        |   |  |  |                     |
|  | 325 i  | 160 |  | 12.04 | 02.10 | + erhöhte Zuladung <sup>2)</sup>                   |                |        |   |  |  |                     |

<sup>1)</sup> - increased payload / - carico utile maggiorato / - charge utile augmentée / - incremento de carga  
<sup>2)</sup> + increased payload / + carico utile maggiorato / + charge utile augmentée / + incremento de carga  
<sup>3)</sup> - increased payload/+engine co.N46 / - carico utile maggior./+codic.mot.N46 / - charge utile augmentée/+moteur co.N46 / - incremento de carga/+motor co.N46  
<sup>4)</sup> - increased payload/+engine co.N46N / - carico utile maggior./+codic.mot.N46N / - charge utile augmentée/+moteur co.N46N / - incremento de carga/+motor co.N46N  
<sup>5)</sup> + increased payload/+engine co.N46 / + carico utile maggior./+codic.mot.N46 / + charge utile augmentée/+moteur co.N46 / + incremento de carga/+motor co.N46

<sup>6)</sup> - authority cars / - enti statali / - véhicule communal / - vehiculos oficiales  
<sup>7)</sup> - increased payload/+engine co.N52 / - carico utile maggior./+codic.mot.N52 / - charge utile augmentée/+moteur co.N52 / - incremento de carga/+motor co.N52  
<sup>8)</sup> + engine code N52N / + codice motore N52N / + moteur code N52N / + motor code N52N  
<sup>9)</sup> + increased payload/+engine co.N46N / + carico utile maggior./+codic.mot.N46N / + charge utile augmentée/+moteur co.N46N / + incremento de carga/+motor co.N46N  
<sup>10)</sup> + authority cars / + enti statali / + véhicule communal / + vehiculos oficiales



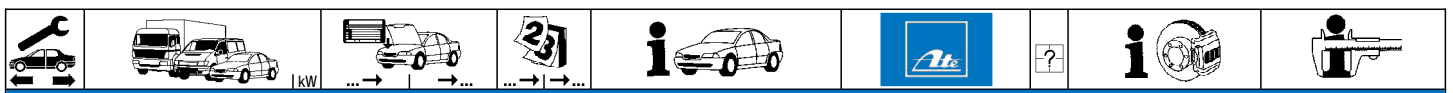

**BMW 3er Reihe/E90 Limousine (05-12)**

|  |        |     |  |       |       |   |                |        |   |                     |     |
|--|--------|-----|--|-------|-------|---|----------------|--------|---|---------------------|-----|
|  | 320 d  | 110 |  | 03.10 | 03.12 | + Behörde <sup>1)</sup>                             | 13.0460-7216.2 | 607216 |   | 23794 20,3 +/WE     | ATE |
|  | 320 d  | 130 |  | 03.10 | 03.12 | + Behörde <sup>1)</sup>                             | 13.0470-7216.2 | LD7216 |   | 23794 20,3 +/WE     | ATE |
|  | 320 xd |     |  | 03.10 | 03.12 | + Behörde <sup>1)</sup>                             | 24.8190-0287.2 | 620287 | 1 | Warnkontakt L=723mm |     |
|  | 325 i  | 160 |  | 03.10 | 03.12 | + erhöhte Zuladung <sup>2)</sup>                    |                |        |   |                     |     |
|  | 330 d  | 170 |  | 09.05 | 03.12 | - erhöhte Zuladung <sup>3)</sup>                    | 13.0460-7216.2 | 607216 |   | 23794 20,3 +/WE     | ATE |
|  | 330 d  | 180 |  | 09.08 | 03.12 | - erhöhte Zuladung <sup>3)</sup>                    | 13.0470-7216.2 | LD7216 |   | 23794 20,3 +/WE     | ATE |
|  | 330 i  | 190 |  | 12.04 | 08.07 | + erhöhte Zuladung/ + Motorcode N52 <sup>4)</sup>   | 24.8190-0267.2 | 620267 | 1 | Warnkontakt L=679mm |     |
|  |        |     |  |       |       |   | 24.8190-0287.2 | 620287 | 1 | Warnkontakt L=723mm |     |
|  | 320 d  | 110 |  | 09.05 | 02.10 | - Behörde <sup>5)</sup>                             | 13.0460-7238.2 | 607238 |   | 23313 20,3 +/WE     | ATE |
|  | 320 d  | 120 |  | 12.04 | 02.10 | - Behörde <sup>5)</sup>                             | 13.0470-7238.2 | LD7238 |   | 23313 20,3 +/WE     | ATE |
|  | 320 d  | 130 |  | 09.07 | 02.10 | - Behörde <sup>5)</sup>                             | 24.8190-0267.2 | 620267 | 1 | Warnkontakt L=679mm |     |
|  | 320 i  | 110 |  | 03.07 | 08.07 | + erhöhte Zuladung/ + Motorcode N46N <sup>6)</sup>  |                |        |   |                     |     |
|  | 320 i  | 125 |  | 09.07 | 02.10 | + erhöhte Zuladung <sup>2)</sup>                    |                |        |   |                     |     |
|  | 320 xd |     |  | 09.07 | 02.10 | - Behörde <sup>5)</sup>                             |                |        |   |                     |     |
|  | 325 i  | 160 |  | 09.07 | 02.10 | - erhöhte Zuladung/ + Motorcode N53 <sup>7)</sup>   |                |        |   |                     |     |
|  | 325 i  | 160 |  | 12.04 | 08.07 | - erhöhte Zuladung/ + Motorcode N52N <sup>8)</sup>  |                |        |   |                     |     |
|  | 320 d  | 110 |  | 03.10 | 03.12 | - Behörde <sup>5)</sup>                             | 13.0460-7238.2 | 607238 |   | 23313 20,3 +/WE     | ATE |
|  | 320 d  | 120 |  | 03.10 | 03.12 | - Behörde <sup>5)</sup>                             | 13.0470-7238.2 | LD7238 |   | 23313 20,3 +/WE     | ATE |
|  | 320 d  | 130 |  | 03.10 | 03.12 | - Behörde <sup>5)</sup>                             | 24.8190-0287.2 | 620287 | 1 | Warnkontakt L=723mm |     |
|  | 320 i  | 125 |  | 03.10 | 03.12 | + erhöhte Zuladung <sup>2)</sup>                    |                |        |   |                     |     |
|  | 320 xd |     |  | 03.10 | 03.12 | - Behörde <sup>5)</sup>                             |                |        |   |                     |     |
|  | 325 i  | 160 |  | 03.10 | 03.12 | - erhöhte Zuladung/ + Motorcode N53 <sup>7)</sup>   |                |        |   |                     |     |
|  | 325 i  | 160 |  | 03.10 | 03.12 | - erhöhte Zuladung/ + Motorcode N52N <sup>8)</sup>  |                |        |   |                     |     |
|  | 325 xi | 160 |  | 09.07 | 02.10 | + erhöhte Zuladung/ + Motorcode N53 <sup>9)</sup>   | 13.0460-7216.2 | 607216 |   | 23794 20,3 +/WE     | ATE |
|  | 325 xi | 160 |  | 01.05 | 08.07 | + erhöhte Zuladung/ + Motorcode N52N <sup>10)</sup> | 13.0470-7216.2 | LD7216 |   | 23794 20,3 +/WE     | ATE |
|  | 325 xi | 160 |  | 01.05 | 08.07 | + Motorcode N52 <sup>11)</sup>                      | 24.8190-0266.2 | 620266 | 1 | Warnkontakt L=840mm |     |
|  | 325 xi | 160 |  | 03.10 | 03.12 | + erhöhte Zuladung/ + Motorcode N53 <sup>9)</sup>   | 13.0460-7216.2 | 607216 |   | 23794 20,3 +/WE     | ATE |
|  |        |     |  |       |       |   | 13.0470-7216.2 | LD7216 |   | 23794 20,3 +/WE     | ATE |
|  |        |     |  |       |       |   | 24.8190-0286.2 | 620286 | 1 | Warnkontakt L=867mm |     |
|  | 330 xd | 170 |  | 09.05 | 08.07 |   | 13.0460-7216.2 | 607216 |   | 23794 20,3 +/WE     | ATE |
|  | 330 xd | 180 |  | 01.09 | 02.10 | - erhöhte Zuladung <sup>3)</sup>                    | 13.0470-7216.2 | LD7216 |   | 23794 20,3 +/WE     | ATE |
|  | 330 xi | 190 |  | 01.05 | 08.07 |   | 24.8190-0266.2 | 620266 | 1 | Warnkontakt L=840mm |     |
|  | 330 xi | 200 |  | 09.07 | 02.10 | - erhöhte Zuladung <sup>3)</sup>                    |                |        |   |                     |     |
|  | 330 xd | 180 |  | 03.10 | 03.12 | - erhöhte Zuladung <sup>3)</sup>                    | 13.0460-7216.2 | 607216 |   | 23794 20,3 +/WE     | ATE |
|  | 330 xi | 200 |  | 03.10 | 03.12 | - erhöhte Zuladung <sup>3)</sup>                    | 13.0470-7216.2 | LD7216 |   | 23794 20,3 +/WE     | ATE |
|  |        |     |  |       |       |   | 24.8190-0286.2 | 620286 | 1 | Warnkontakt L=867mm |     |
|  | 325 xi | 160 |  | 09.07 | 02.10 | + erhöhte Zuladung/ + Motorcode N53 <sup>9)</sup>   | 13.0460-7238.2 | 607238 |   | 23313 20,3 +/WE     | ATE |
|  | 325 xi | 160 |  | 01.05 | 08.07 | - erhöhte Zuladung/ + Motorcode N52N <sup>8)</sup>  | 13.0470-7238.2 | LD7238 |   | 23313 20,3 +/WE     | ATE |
|  |        |     |  |       |       |   | 24.8190-0266.2 | 620266 | 1 | Warnkontakt L=840mm |     |
|  | 325 xi | 160 |  | 03.10 | 03.12 | + erhöhte Zuladung/ + Motorcode N53 <sup>9)</sup>   | 13.0460-7238.2 | 607238 |   | 23313 20,3 +/WE     | ATE |
|  |        |     |  |       |       |   | 13.0470-7238.2 | LD7238 |   | 23313 20,3 +/WE     | ATE |
|  |        |     |  |       |       |   | 24.8190-0286.2 | 620286 | 1 | Warnkontakt L=867mm |     |
|  | 330 xd | 170 |  | 09.07 | 02.10 |   | 13.0460-7237.2 | 607237 |   | 24161 20,3 +/WE     | ATE |
|  | 330 xd | 180 |  | 01.09 | 02.10 | + erhöhte Zuladung <sup>2)</sup>                    | 13.0470-7237.2 | LD7237 |   | 24161 20,3 +/WE     | ATE |
|  | 330 xd | 180 |  | 01.09 | 02.10 |   | 13.0460-7238.2 | 607238 |   | 23313 20,3 +/WE     | ATE |
|  | 330 xi | 200 |  | 09.07 | 02.10 | + erhöhte Zuladung <sup>2)</sup>                    | 13.0470-7238.2 | LD7238 |   | 23313 20,3 +/WE     | ATE |
|  |        |     |  |       |       |   | 24.8190-0266.2 | 620266 | 1 | Warnkontakt L=840mm |     |
|  | 330 xd | 170 |  | 03.10 | 03.12 | + erhöhte Zuladung <sup>2)</sup>                    | 13.0460-7237.2 | 607237 |   | 24161 20,3 +/WE     | ATE |
|  | 330 xd | 180 |  | 03.10 | 03.12 | + erhöhte Zuladung <sup>2)</sup>                    | 13.0470-7237.2 | LD7237 |   | 24161 20,3 +/WE     | ATE |
|  | 330 xi | 200 |  | 03.10 | 03.12 | + erhöhte Zuladung <sup>2)</sup>                    | 13.0460-7238.2 | 607238 |   | 23313 20,3 +/WE     | ATE |
|  |        |     |  |       |       |   | 13.0470-7238.2 | LD7238 |   | 23313 20,3 +/WE     | ATE |
|  |        |     |  |       |       |   | 24.8190-0286.2 | 620286 | 1 | Warnkontakt L=867mm |     |
|  | 335 d  | 210 |  | 09.06 | 03.12 |   | 13.0460-7237.2 | 607237 |   | 24161 20,3 +/WE     | ATE |
|  | 335 i  | 225 |  | 09.06 | 03.12 |   | 13.0470-7237.2 | LD7237 |   | 24161 20,3 +/WE     | ATE |
|  |        |     |  |       |       |   | 13.0460-7238.2 | 607238 |   | 23313 20,3 +/WE     | ATE |
|  |        |     |  |       |       |   | 13.0470-7238.2 | LD7238 |   | 23313 20,3 +/WE     | ATE |
|  |        |     |  |       |       |   | 24.8190-0267.2 | 620267 | 1 | Warnkontakt L=679mm |     |
|  | 325 d  | 145 |  | 09.06 | 02.10 | + Behörde <sup>1)</sup>                             | 13.0460-7237.2 | 607237 |   | 24161 20,3 +/WE     | ATE |
|  |        |     |  |       |       |   | 13.0470-7237.2 | LD7237 |   | 24161 20,3 +/WE     | ATE |
|  |        |     |  |       |       |   | 13.0460-7238.2 | 607238 |   | 23313 20,3 +/WE     | ATE |
|  |        |     |  |       |       |   | 13.0470-7238.2 | LD7238 |   | 23313 20,3 +/WE     | ATE |
|  |        |     |  |       |       |   | 24.8190-0267.2 | 620267 | 1 | Warnkontakt L=679mm |     |
|  | 325 d  | 145 |  | 03.10 | 03.12 | + Behörde <sup>1)</sup>                             | 13.0460-7237.2 | 607237 |   | 24161 20,3 +/WE     | ATE |
|  |        |     |  |       |       |   | 13.0470-7237.2 | LD7237 |   | 24161 20,3 +/WE     | ATE |
|  |        |     |  |       |       |   | 13.0460-7238.2 | 607238 |   | 23313 20,3 +/WE     | ATE |
|  |        |     |  |       |       |   | 13.0470-7238.2 | LD7238 |   | 23313 20,3 +/WE     | ATE |
|  |        |     |  |       |       |   | 24.8190-0287.2 | 620287 | 1 | Warnkontakt L=723mm |     |
|  | 330 d  | 170 |  | 09.05 | 02.10 | + erhöhte Zuladung <sup>2)</sup>                    | 13.0460-7237.2 | 607237 |   | 24161 20,3 +/WE     | ATE |
|  | 330 d  | 180 |  | 09.08 | 02.10 | + erhöhte Zuladung <sup>2)</sup>                    | 13.0470-7237.2 | LD7237 |   | 24161 20,3 +/WE     | ATE |
|  | 330 i  | 200 |  | 09.07 | 02.10 |   | 13.0460-7238.2 | 607238 |   | 23313 20,3 +/WE     | ATE |
|  | 335 xi | 225 |  | 03.07 | 02.10 |   | 13.0470-7238.2 | LD7238 |   | 23313 20,3 +/WE     | ATE |
|  |        |     |  |       |       |   | 24.8190-0267.2 | 620267 | 1 | Warnkontakt L=679mm |     |
|  | 330 d  | 170 |  | 03.10 | 03.12 | + erhöhte Zuladung <sup>2)</sup>                    | 13.0460-7237.2 | 607237 |   | 24161 20,3 +/WE     | ATE |
|  | 330 d  | 180 |  | 03.10 | 03.12 | + erhöhte Zuladung <sup>2)</sup>                    | 13.0470-7237.2 | LD7237 |   | 24161 20,3 +/WE     | ATE |
|  | 330 i  | 200 |  | 03.10 | 03.12 |   | 13.0460-7238.2 | 607238 |   | 23313 20,3 +/WE     | ATE |
|  | 335 xi | 225 |  | 03.10 | 03.12 |   | 13.0470-7238.2 | LD7238 |   | 23313 20,3 +/WE     | ATE |
|  |        |     |  |       |       |   | 24.8190-0287.2 | 620287 | 1 | Warnkontakt L=723mm |     |
|  | M3     | 309 |  | 12.07 | 03.12 |   | 13.0460-7167.2 | 607167 | 1 | 23312 20,3 +/WE     | ATE |
|  |        |     |  |       |       |   | 24.8190-0271.2 | 620271 | 1 | Warnkontakt L=659mm |     |
|  |        |     |  |       |       |   | 24.8190-0272.2 | 620272 | 1 | Warnkontakt L=672mm |     |
|  | 316 d  | 85  |  | 07.09 | 03.12 |   | 13.0460-4848.2 | 604848 |   | 24316 16,9 /WE      | BRE |
|  | 316 i  | 85  |  | 01.05 | 08.07 |   | 24.8190-0267.2 | 620267 | 1 | Warnkontakt L=679mm |     |
|  | 316 i  | 90  |  | 09.07 | 03.12 |   |                |        |   |                     |     |
|  | 318 d  |     |  | 09.07 | 03.12 |   |                |        |   |                     |     |
|  | 318 d  | 90  |  | 09.05 | 08.07 |   |                |        |   |                     |     |
|  | 318 i  | 95  |  | 09.05 | 08.07 |   |                |        |   |                     |     |
|  | 318 i  | 105 |  | 09.07 | 03.12 |   |                |        |   |                     |     |

1) + authority cars / + enti statali / + véhicule communal / + vehiculos oficiales  
 2) + increased payload / + carico utile maggiorato / + charge utile augmentée / + incremento de carga  
 3) - increased payload / - carico utile maggiorato / - charge utile augmentée / - incremento de carga  
 4) + increased payload/+engine co.N52 / + carico utile maggior./+codic.mot.N52 / + charge utile augmentée/+moteur co.N52 / + incremento de carga/+motor co.N52  
 5) - authority cars / - enti statali / - véhicule communal / - vehiculos oficiales  
 6) + increased payload/+engine co.N46N / + carico utile maggior./+codic.mot.N46N / + charge utile augmentée/+moteur co.N46N / + incremento de carga/+motor co.N46N

7) - increased payload/+engine co.N53 / - carico utile maggior./+codic.mot.N53 / - charge utile augmentée/+moteur co.N53 / - incremento de carga/+motor co.N53  
 8) - increased payload/+engine co.N52N / - carico utile maggior./+codic.mot.N52N / - charge utile augmentée/+moteur co.N52N / - incremento de carga/+motor co.N52N  
 9) + increased payload/+engine co.N53 / + carico utile maggior./+codic.mot.N53 / + charge utile augmentée/+moteur co.N53 / + incremento de carga/+motor co.N53  
 10) + increased payload/+engine co.N52N / + carico utile maggior./+codic.mot.N52N / + charge utile augmentée/+moteur co.N52N / + incremento de carga/+motor co.N52N  
 11) + engine code N52 / + codic motore N52 / + moteur code N52 / + motor code N52



**BMW 3er Reihe/E90 Limousine (05-12)**

|  |        |     |  |       |       |   |                |        |   |  |                            |            |
|--|--------|-----|--|-------|-------|---|----------------|--------|---|--|----------------------------|------------|
|  | 320 d  | 110 |  | 09.05 | 03.12 |   | 13.0460-4848.2 | 604848 |   | + Performance Parts  | 24316 16,9 /WE             | <b>BRE</b> |
|  | 320 d  | 120 |  | 12.04 | 03.12 |   | 24.8190-0267.2 | 620267 | 1 | + Performance Parts  | Warnkontakt L=679mm        |            |
|  | 320 d  | 130 |  | 09.07 | 03.12 |   |                |        |   |  |                            |            |
|  | 320 i  | 110 |  | 12.04 | 08.07 |   |                |        |   |  |                            |            |
|  | 320 i  | 125 |  | 09.07 | 03.12 |   |                |        |   |  |                            |            |
|  | 320 si | 127 |  | 06.06 | 03.12 |   |                |        |   |  |                            |            |
|  | 320 xd |     |  | 09.07 | 03.12 |   |                |        |   |  |                            |            |
|  | 325 d  | 145 |  | 09.06 | 03.12 |   |                |        |   |  |                            |            |
|  | 325 i  | 160 |  | 12.04 | 03.12 |   |                |        |   |  |                            |            |
|  | 325 xi | 160 |  | 01.05 | 03.12 |   |                |        |   |  |                            |            |
|  | 330 d  | 170 |  | 09.05 | 03.12 |   |                |        |   |  |                            |            |
|  | 330 d  | 180 |  | 09.08 | 03.12 |   |                |        |   |  |                            |            |
|  | 330 i  | 190 |  | 12.04 | 08.07 |   |                |        |   |  |                            |            |
|  | 330 i  | 200 |  | 09.07 | 03.12 |   |                |        |   |  |                            |            |
|  | 330 xd | 170 |  | 09.05 | 03.12 |   |                |        |   |  |                            |            |
|  | 330 xd | 180 |  | 01.09 | 03.12 |   |                |        |   |  |                            |            |
|  | 330 xi | 190 |  | 01.05 | 08.07 |   |                |        |   |  |                            |            |
|  | 330 xi | 200 |  | 09.07 | 03.12 |   |                |        |   |  |                            |            |
|  | 316 i  | 85  |  | 01.05 | 08.07 |   | 24.0122-0238.1 | 422238 |   |  | 292 22,0 20,4 V L +S +B    |            |
|  | 318 d  | 90  |  | 09.05 | 08.07 | - erhöhte Zuladung <sup>1)</sup>                    | 24.0322-0238.1 | 522238 |   |  | 292 22,0 19,6 V L +S +B PD |            |
|  | 318 i  | 95  |  | 09.05 | 08.07 | - erhöhte Zuladung/ + Motorcode N46 <sup>2)</sup>   |                |        |   |  |                            |            |
|  | 320 i  | 110 |  | 12.04 | 08.07 | - erhöhte Zuladung/ + Motorcode N46 <sup>2)</sup>   |                |        |   |  |                            |            |
|  | 316 d  | 85  |  | 07.09 | 03.12 |   | 24.0124-0197.1 | 424197 |   |  | 300 24,0 22,4 V L +S +B    |            |
|  | 316 i  | 90  |  | 09.07 | 03.12 |   | 24.0324-0197.1 | 524197 |   |  | 300 24,0 21,6 V L +S +B PD |            |
|  | 318 d  |     |  | 09.07 | 03.12 |   |                |        |   |  |                            |            |
|  | 318 d  | 90  |  | 09.05 | 08.07 | + erhöhte Zuladung <sup>3)</sup>                    |                |        |   |  |                            |            |
|  | 318 i  | 95  |  | 03.07 | 08.07 | - erhöhte Zuladung/ + Motorcode N46N <sup>4)</sup>  |                |        |   |  |                            |            |
|  | 318 i  | 95  |  | 09.05 | 08.07 | + erhöhte Zuladung/ + Motorcode N46 <sup>5)</sup>   |                |        |   |  |                            |            |
|  | 318 i  | 105 |  | 09.07 | 03.12 |   |                |        |   |  |                            |            |
|  | 320 d  | 110 |  | 09.05 | 03.12 | - Behörde <sup>6)</sup>                             |                |        |   |  |                            |            |
|  | 320 d  | 120 |  | 12.04 | 03.12 | - Behörde <sup>6)</sup>                             |                |        |   |  |                            |            |
|  | 320 i  | 110 |  | 03.07 | 08.07 | - erhöhte Zuladung/ + Motorcode N46N <sup>4)</sup>  |                |        |   |  |                            |            |
|  | 320 i  | 110 |  | 12.04 | 08.07 | + erhöhte Zuladung/ + Motorcode N46 <sup>5)</sup>   |                |        |   |  |                            |            |
|  | 320 i  | 125 |  | 09.07 | 03.12 | - erhöhte Zuladung <sup>1)</sup>                    |                |        |   |  |                            |            |
|  | 320 si | 127 |  | 06.06 | 03.12 |   |                |        |   |  |                            |            |
|  | 325 i  | 160 |  | 12.04 | 08.07 | - erhöhte Zuladung/ + Motorcode N52 <sup>7)</sup>   |                |        |   |  |                            |            |
|  | 325 xi | 160 |  | 01.05 | 08.07 | - erhöhte Zuladung/ + Motorcode N52 <sup>7)</sup>   |                |        |   |  |                            |            |
|  | 318 i  | 95  |  | 03.07 | 08.07 | + erhöhte Zuladung/ + Motorcode N46N <sup>8)</sup>  | 24.0124-0203.1 | 424203 |   |  | 312 23,9 22,4 V L +S +B    |            |
|  | 320 d  | 120 |  | 09.07 | 03.12 | - Behörde <sup>6)</sup>                             | 24.0324-0203.1 | 524203 |   |  | 312 23,9 22,4 V L +S +B PD |            |
|  | 320 d  | 130 |  | 09.07 | 03.12 | - Behörde <sup>6)</sup>                             |                |        |   |  |                            |            |
|  | 320 i  | 110 |  | 03.07 | 08.07 | + erhöhte Zuladung/ + Motorcode N46N <sup>8)</sup>  |                |        |   |  |                            |            |
|  | 320 i  | 125 |  | 09.07 | 03.12 | + erhöhte Zuladung <sup>3)</sup>                    |                |        |   |  |                            |            |
|  | 320 xd |     |  | 09.07 | 03.12 | - Behörde <sup>6)</sup>                             |                |        |   |  |                            |            |
|  | 325 i  | 160 |  | 09.07 | 03.12 | - erhöhte Zuladung/ + Motorcode N53 <sup>9)</sup>   |                |        |   |  |                            |            |
|  | 325 i  | 160 |  | 12.04 | 08.07 | - erhöhte Zuladung/ + Motorcode N52N <sup>10)</sup> |                |        |   |  |                            |            |
|  | 325 xi | 160 |  | 09.07 | 03.12 | - erhöhte Zuladung/ + Motorcode N53 <sup>9)</sup>   |                |        |   |  |                            |            |
|  | 325 xi | 160 |  | 01.05 | 08.07 | - erhöhte Zuladung/ + Motorcode N52N <sup>10)</sup> |                |        |   |  |                            |            |
|  | 320 d  | 110 |  | 09.05 | 03.12 | + Behörde <sup>11)</sup>                            | 24.0124-0200.1 | 424200 |   |  | 330 24,0 22,4 V L +S +B    |            |
|  | 320 d  | 120 |  | 12.04 | 03.12 | + Behörde <sup>11)</sup>                            | 24.0324-0200.1 | 524200 |   |  | 330 24,0 21,6 V L +S +B PD |            |
|  | 320 d  | 130 |  | 09.07 | 03.12 | + Behörde <sup>11)</sup>                            |                |        |   |  |                            |            |
|  | 320 xd |     |  | 09.07 | 03.12 | + Behörde <sup>11)</sup>                            |                |        |   |  |                            |            |
|  | 325 d  | 145 |  | 09.06 | 03.12 | - Behörde <sup>6)</sup>                             |                |        |   |  |                            |            |
|  | 325 i  | 160 |  | 12.04 | 03.12 | + erhöhte Zuladung <sup>3)</sup>                    |                |        |   |  |                            |            |
|  | 325 xi | 160 |  | 01.05 | 03.12 | + erhöhte Zuladung <sup>3)</sup>                    |                |        |   |  |                            |            |
|  | 330 d  | 170 |  | 10.09 | 03.12 | - erhöhte Zuladung <sup>1)</sup>                    |                |        |   |  |                            |            |
|  | 330 d  | 180 |  | 10.09 | 03.12 | - erhöhte Zuladung <sup>1)</sup>                    |                |        |   |  |                            |            |
|  | 330 i  | 190 |  | 12.04 | 08.07 |   |                |        |   |  |                            |            |
|  | 330 xd | 170 |  | 09.05 | 08.07 |   |                |        |   |  |                            |            |
|  | 330 xd | 180 |  | 01.09 | 03.12 | - erhöhte Zuladung <sup>1)</sup>                    |                |        |   |  |                            |            |
|  | 330 xi | 190 |  | 01.05 | 08.07 |   |                |        |   |  |                            |            |
|  | 330 xi | 200 |  | 09.07 | 03.12 | - erhöhte Zuladung <sup>1)</sup>                    |                |        |   |  |                            |            |
|  | 325 d  | 145 |  | 09.06 | 03.12 | + Behörde <sup>11)</sup>                            | 24.0130-0192.1 | 430192 |   |  | 348 30,0 28,4 V L +S +B    |            |
|  | 330 d  | 170 |  | 09.05 | 03.12 | + erhöhte Zuladung <sup>3)</sup>                    |                |        |   |  |                            |            |
|  | 330 d  | 170 |  | 09.07 | 09.09 | - erhöhte Zuladung <sup>1)</sup>                    |                |        |   |  |                            |            |
|  | 330 d  | 180 |  | 09.08 | 03.12 | + erhöhte Zuladung <sup>3)</sup>                    |                |        |   |  |                            |            |
|  | 330 d  | 180 |  | 09.08 | 09.09 | - erhöhte Zuladung <sup>1)</sup>                    |                |        |   |  |                            |            |
|  | 330 i  | 200 |  | 09.07 | 03.12 |   |                |        |   |  |                            |            |
|  | 330 xd | 170 |  | 09.07 | 03.12 | - erhöhte Zuladung <sup>1)</sup>                    |                |        |   |  |                            |            |
|  | 330 xd | 180 |  | 01.09 | 03.12 | + erhöhte Zuladung <sup>3)</sup>                    |                |        |   |  |                            |            |
|  | 330 xi | 200 |  | 09.07 | 03.12 | + erhöhte Zuladung <sup>3)</sup>                    |                |        |   |  |                            |            |
|  | 335 d  | 210 |  | 09.06 | 03.12 |   |                |        |   |  |                            |            |
|  | 335 i  | 225 |  | 09.06 | 03.12 |   |                |        |   |  |                            |            |
|  | 335 xi | 225 |  | 03.07 | 03.12 |   |                |        |   |  |                            |            |
|  | M3     | 309 |  | 12.07 | 03.12 |   | 24.0130-0214.2 | 430214 |   | <input type="checkbox"/> zweiteilige Bremsscheibe <sup>12)</sup> | 360 30,0 28,4 V L +S +B    |            |
|  |        |     |  |       |       |   | 24.0130-0213.2 | 430213 |   | <input type="checkbox"/> zweiteilige Bremsscheibe <sup>12)</sup> | 360 30,0 28,4 V L +S +B    |            |
|  | 316 d  | 85  |  | 07.09 | 03.12 |   | 24.0711-6198.3 | 360199 | 2 | <input type="checkbox"/>   | Radsensor L=660            |            |
|  | 316 i  | 85  |  | 01.05 | 08.07 |   |                |        |   |  |                            |            |
|  | 316 i  | 90  |  | 09.07 | 03.12 |   |                |        |   |  |                            |            |
|  | 318 d  |     |  | 09.07 | 03.12 |   |                |        |   |  |                            |            |
|  | 318 d  | 90  |  | 09.05 | 08.07 |   |                |        |   |  |                            |            |
|  | 318 i  | 95  |  | 09.05 | 08.07 |   |                |        |   |  |                            |            |
|  | 318 i  | 105 |  | 09.07 | 03.12 |   |                |        |   |  |                            |            |
|  | 320 si | 127 |  | 06.06 | 03.12 |   |                |        |   |  |                            |            |
|  | 320 d  | 110 |  | 09.05 | 03.12 |   | 24.0711-6198.3 | 360199 | 2 | <input type="checkbox"/> - Aktivlenkung <sup>13)</sup>           | Radsensor L=660            |            |
|  | 320 d  | 120 |  | 12.04 | 03.12 |   | 24.0711-6197.3 | 360141 | 2 | <input type="checkbox"/> + Aktivlenkung <sup>14)</sup>           | Radsensor L=660            |            |
|  | 320 d  | 130 |  | 09.07 | 03.12 |   |                |        |   |  |                            |            |

<sup>1)</sup> - increased payload / - carico utile maggiorato / - charge utile augmentée / - incremento de carga

<sup>2)</sup> - increased payl./+engine co.N46 / - carico utile maggior./+codic.mot.N46 / - charge utile augmentée/+moteur co.N46 / - incremento de carga/+motor co.N46

<sup>3)</sup> + increased payload / + carico utile maggiorato / + charge utile augmentée / + incremento de carga

<sup>4)</sup> - increased payl./+engine co.N46N / - carico utile maggior./+codic.mot.N46N / - charge utile augmentée/+moteur co.N46N / - incremento de carga/+motor co.N46N

<sup>5)</sup> + increased payl./+engine co.N46 / + carico utile maggior./+codic.mot.N46 / + charge utile augmentée/+moteur co.N46 / + incremento de carga/+motor co.N46

<sup>6)</sup> - authority cars / - enti statali / - véhicule communal / - vehiculos oficiales













<sup>7)</sup> - increased payl./+engine co.N52 / - carico utile maggior./+codic.mot.N52 / - charge utile augmentée/+moteur co.N52 / - incremento de carga/+motor co.N52

<sup>8)</sup> + increased payl./+engine co.N46N / + carico utile maggior./+codic.mot.N46N / + charge utile augmentée/+moteur co.N46N / + incremento de carga/+motor co.N46N

<sup>9)</sup> - increased payl./+engine co.N53 / - carico utile maggior./+codic.mot.N53 / - charge utile augmentée/+moteur co.N53 / - incremento de carga/+motor co.N53

<sup>10)</sup> - increased payl./+engine co.N52N / - carico utile maggior./+codic.mot.N52N / - charge utile augmentée/+moteur co.N52N / - incremento de carga/+motor co.N52N

<sup>11)</sup> + authority cars / + enti statali / + véhicule communal / + vehiculos oficiales

|     |  |  |  |  |  |  |  |  |                          |
|--|--|--|--|--|---|--|--|--|--------------------------|
| <b>BMW 3er Reihe/E90 Limousine (05-12)</b>   |  |  |  |  |   |  |  |  |                          |
|    | 320 i  | 110  |  | 12.04 08.07  | 24.0711-6198.3  | 360199   | 2  | - Aktivlenkung <sup>1)</sup>   | Radsensor L=660          |
|  | 320 i  | 125  |  | 09.07 03.12  | 24.0711-6197.3  | 360141   | 2  | + Aktivlenkung <sup>2)</sup>   | Radsensor L=660          |
|  | 325 i  | 160  |  | 12.04 08.07  |   |  |  |  |                          |
|  | 325 d  | 145  |  | 09.06 03.12  | 24.0711-6197.3  | 360141   | 2  |  | Radsensor L=660          |
|  | 325 i  | 160  |  | 09.07 03.12  |   |  |  |  |                          |
|  | 330 d  | 170  |  | 09.05 03.12  |   |  |  |  |                          |
|  | 330 d  | 180  |  | 09.08 03.12  |   |  |  |  |                          |
|  | 330 i  | 190  |  | 12.04 08.07  |   |  |  |  |                          |
|  | 330 i  | 200  |  | 09.07 03.12  |   |  |  |  |                          |
|  | 335 d  | 210  |  | 09.06 03.12  |   |  |  |  |                          |
| 335 i  | 225  |  | 09.06 03.12  |  |   |  |  |  |                          |
| M3   | 309  |  | 12.07 03.12  | 24.0711-6209.3   | 360352  | 2  |  | Radsensor L=700  |                          |
|    | 316 d  | 85   |  | 07.09 02.10  | 13.0460-2713.2  | 602713   |  |  | 23623 17,4 +/WE/Zub/STRW |
|  | 316 i  | 85   |  | 01.05 08.07  | 13.0470-2713.2  | LD2713   |  |  | 23623 17,4 +/WE/Zub/STRW |
|  | 316 i  | 90   |  | 09.07 02.10  | 24.8190-0265.2  | 620265   | 1  |  | Warnkontakt L=1086mm     |
|  | 318 d  | 90   |  | 09.05 08.07  |   |  |  | - erhöhte Zuladung <sup>3)</sup>   |                          |
|  | 318 i  | 95   |  | 09.05 08.07  |   |  |  | - erhöhte Zuladung/ + Motorcode N46 <sup>4)</sup>                                  |                          |
|  | 320 i  | 110  |  | 12.04 08.07  |   |  |  | - erhöhte Zuladung/ + Motorcode N46 <sup>4)</sup>                                  |                          |
|  | 316 d  | 85   |  | 03.10 03.12  | 13.0460-2713.2  | 602713   |  |  | 23623 17,4 +/WE/Zub/STRW |
|  | 316 i  | 90   |  | 03.10 03.12  | 13.0470-2713.2  | LD2713   |  |  | 23623 17,4 +/WE/Zub/STRW |
|  |  |  |  |  | 24.8190-0285.2  | 620285   | 1  |  | Warnkontakt L=1107mm     |
|  |  |  |  |  |   |  |  |  |                          |
|  | 318 d  | 90   |  | 09.07 02.10  | 13.0460-7217.2  | 607217   |  |  | 23926 17,3 +/WE          |
|  | 318 d  | 95   |  | 09.05 08.07  | 13.0470-7217.2  | LD7217   |  | + erhöhte Zuladung <sup>5)</sup>   | ATE                      |
|  | 318 i  | 95   |  | 03.07 08.07  | 24.8190-0265.2  | 620265   | 1  | + Motorcode N46N <sup>6)</sup>   | ATE                      |
|  | 318 i  | 95   |  | 09.05 08.07  |   |  |  | + erhöhte Zuladung/ + Motorcode N46 <sup>7)</sup>                                  |                          |
|  | 318 i  | 105  |  | 09.07 02.10  |   |  |  |  |                          |
|  | 320 d  | 110  |  | 09.05 02.10  |   |  |  | - Behörde <sup>8)</sup>  |                          |
|  | 320 d  | 120  |  | 12.04 03.12  |   |  |  |  |                          |
|  | 320 d  | 130  |  | 09.07 02.10  |   |  |  | - Behörde <sup>8)</sup>  |                          |
|  | 320 i  | 110  |  | 03.07 08.07  |   |  |  | + Motorcode N46N <sup>6)</sup>   |                          |
|  | 320 i  | 110  |  | 12.04 08.07  |   |  |  | + erhöhte Zuladung/ + Motorcode N46 <sup>7)</sup>                                  |                          |
| 320 i  | 125  |  | 09.07 02.10  |  |   |  |  |  |                          |
| 320 si   | 127  |  | 06.06 02.10  |  |   |  |  |  |                          |
| 320 xd   | 160  |  | 09.07 02.10  |  |   |  | - Behörde <sup>8)</sup>  |  |                          |
| 325 i  | 160  |  | 12.04 02.10  |  |   |  | - erhöhte Zuladung <sup>3)</sup>   |  |                          |
| 325 xi   | 160  |  | 01.05 02.10  |  |   |  | - erhöhte Zuladung <sup>3)</sup>   |  |                          |
|  | 318 d  | 105  |  | 03.10 03.12  | 13.0460-7217.2  | 607217   |  |  | 23926 17,3 +/WE          |
|  | 318 i  | 110  |  | 03.10 03.12  | 13.0470-7217.2  | LD7217   |  |  | ATE                      |
|  | 320 d  | 110  |  | 03.10 03.12  | 24.8190-0285.2  | 620285   | 1  | - Behörde <sup>8)</sup>  | Warnkontakt L=1107mm     |
|  | 320 d  | 130  |  | 03.10 03.12  |   |  |  | - Behörde <sup>8)</sup>  |                          |
|  | 320 i  | 125  |  | 03.10 03.12  |   |  |  |  |                          |
|  | 320 si   | 127  |  | 03.10 03.12  |   |  |  |  |                          |
|  | 320 xd   | 160  |  | 03.10 03.12  |   |  |  | - Behörde <sup>8)</sup>  |                          |
|  | 325 i  | 160  |  | 03.10 03.12  |   |  |  | - erhöhte Zuladung <sup>3)</sup>   |                          |
|  | 325 xi   | 160  |  | 03.10 03.12  |   |  |  | - erhöhte Zuladung <sup>3)</sup>   |                          |
|  |  |  |  |  |   |  |  |  |                          |
|  | 320 d  | 110  |  | 09.05 02.10  | 13.0460-7225.2  | 607225   |  | + Behörde <sup>9)</sup>  | 23550 17,3 +/WE          |
|  | 320 d  | 130  |  | 09.07 02.10  | 13.0470-7225.2  | LD7225   |  | + Behörde <sup>9)</sup>  | ATE                      |
|  | 320 xd   | 160  |  | 09.07 02.10  | 24.8190-0265.2  | 620265   | 1  | + Behörde <sup>9)</sup>  | ATE                      |
|  | 325 d  | 145  |  | 09.06 02.10  |   |  |  |  | Warnkontakt L=1086mm     |
|  | 325 i  | 160  |  | 12.04 02.10  |   |  |  | + erhöhte Zuladung <sup>5)</sup>   |                          |
|  | 325 xi   | 160  |  | 01.05 02.10  |   |  |  | + erhöhte Zuladung <sup>5)</sup>   |                          |
|  | 330 d  | 170  |  | 09.05 02.10  |   |  |  |  |                          |
|  | 330 d  | 180  |  | 09.08 02.10  |   |  |  |  |                          |
|  | 330 i  | 190  |  | 12.04 08.07  |   |  |  |  |                          |
|  | 330 i  | 200  |  | 09.07 02.10  |   |  |  |  |                          |
| 330 xd   | 170  |  | 09.05 02.10  |  |   |  |  |  |                          |
| 330 xd   | 180  |  | 01.09 02.10  |  |   |  |  |  |                          |
| 330 xi   | 190  |  | 01.05 08.07  |  |   |  |  |  |                          |
| 330 xi   | 200  |  | 09.07 02.10  |  |   |  |  |  |                          |
| 335 d  | 210  |  | 09.06 02.10  |  |   |  |  |  |                          |
| 335 i  | 225  |  | 09.06 02.10  |  |   |  |  |  |                          |
| 335 xi   | 225  |  | 03.07 02.10  |  |   |  |  |  |                          |
|  | 320 d  | 110  |  | 03.10 03.12  | 13.0460-7225.2  | 607225   |  | + Behörde <sup>9)</sup>  | 23550 17,3 +/WE          |
|  | 320 d  | 130  |  | 03.10 03.12  | 13.0470-7225.2  | LD7225   |  | + Behörde <sup>9)</sup>  | ATE                      |
|  | 320 xd   | 160  |  | 03.10 03.12  | 24.8190-0285.2  | 620285   | 1  | + Behörde <sup>9)</sup>  | ATE                      |
|  | 325 d  | 145  |  | 03.10 03.12  |   |  |  |  | Warnkontakt L=1107mm     |
|  | 325 i  | 160  |  | 03.10 03.12  |   |  |  | + erhöhte Zuladung <sup>5)</sup>   |                          |
|  | 325 xi   | 160  |  | 03.10 03.12  |   |  |  | + erhöhte Zuladung <sup>5)</sup>   |                          |
|  | 330 d  | 170  |  | 03.10 03.12  |   |  |  |  |                          |
|  | 330 d  | 180  |  | 03.10 03.12  |   |  |  |  |                          |
|  | 330 i  | 200  |  | 03.10 03.12  |   |  |  |  |                          |
|  | 330 xd   | 170  |  | 03.10 03.12  |   |  |  |  |                          |
| 330 xd   | 180  |  | 03.10 03.12  |  |   |  |  |  |                          |
| 330 xi   | 200  |  | 03.10 03.12  |  |   |  |  |  |                          |
| 335 d  | 210  |  | 03.10 03.12  |  |   |  |  |  |                          |
| 335 i  | 225  |  | 03.10 03.12  |  |   |  |  |  |                          |
| 335 xi   | 225  |  | 03.10 03.12  |  |   |  |  |  |                          |
|  | M3   | 309  |  | 12.07 02.10  | 13.0460-7169.2  | 607169   |  |  | 23309 17,3 +/WE          |
|  |  |  |  |  | 13.0470-7169.2  | LD7169   |  |  | ATE                      |
|  |  |  |  |  | 24.8190-0265.2  | 620265   | 1  |  | Warnkontakt L=1086mm     |
|  | M3   | 309  |  | 03.10 03.12  | 13.0460-7169.2  | 607169   |  |  | 23309 17,3 +/WE          |
|  |  |  |  |  | 13.0470-7169.2  | LD7169   |  |  | ATE                      |
|  |  |  |  |  | 24.8190-0285.2  | 620285   | 1  |  | Warnkontakt L=1107mm     |
|  | 316 d  | 85   |  | 07.09 03.12  | 24.0110-0315.1  | 410315   |  |  | 296 10,4 8,9 L +S +B     |
|  | 316 i  | 85   |  | 01.05 08.07  | 24.0310-0315.1  | 510315   |  |  | 296 10,4 8,9 L +S +B PD  |
|  | 316 i  | 90   |  | 09.07 03.12  |   |  |  |  |                          |

<sup>1)</sup> - active steering / - sterzo attivo / - direction active / - dirección activa

<sup>2)</sup> + active steering / + sterzo attivo / + direction active / + dirección activa

<sup>3)</sup> - increased payload / - carico utile maggiorato / - charge utile augmentée / - incremento de carga

<sup>4)</sup> - increased payload/+engine co.N46 / - carico utile maggior./+codic.mot.N46 / - charge utile augmentée/+moteur co.

N46 / - incremento de carga/+motor co.N46

<sup>5)</sup> + increased payload / + carico utile maggiorato / + charge utile augmentée / + incremento de carga

<sup>6)</sup> + engine code N46N / + codice motore N46N / + moteur code N46N / + motor code N46N

<sup>7)</sup> + increased payload/+engine co.N46 / + carico utile maggior./+codic.mot.N46 / + charge utile augmentée/+moteur co.

N46 / + incremento de carga/+motor co.N46

<sup>8)</sup> - authority cars / - enti statali / - véhicule communal / - vehiculos oficiales

<sup>9)</sup> + authority cars / + enti statali / + véhicule communal / + vehiculos oficiales



**BMW 3er Reihe/E90 Limousine (05-12)**

|        |        |       |       |                                  |   |                |  |                                  |   |   |
|--------|--------|-------|-------|----------------------------------|---|----------------|--|----------------------------------|---|---|
|        | 318 d  | 90    | 09.05 | 08.07                            | - erhöhte Zuladung <sup>1)</sup>                  | 24.0110-0315.1 | 410315                                 |                                  | 296 10,4 8,9 L +S +B<br><b>296 10,4 8,9 L +S +B PD</b>                      |   |
|        | 318 i  | 95    | 09.05 | 08.07                            | - erhöhte Zuladung/ + Motorcode N46 <sup>2)</sup> | 24.0310-0315.1 | 510315                                 |                                  |   |   |
|        | 320 i  | 110   | 12.04 | 08.07                            | - erhöhte Zuladung/ + Motorcode N46 <sup>2)</sup> |                |  |                                  |   |   |
|        | 318 d  | 90    | 09.07 | 03.12                            |   | 24.0120-0195.1 | 420195                                 |                                  |   | 300 20,0 18,4 V L +S +B<br><b>300 20,0 18,4 V L +S +B PD</b>                |
|        | 318 d  | 90    | 09.05 | 08.07                            | + erhöhte Zuladung <sup>3)</sup>                  | 24.0320-0195.1 | 520195                                 |                                  |   |   |
|        | 318 i  | 95    | 03.07 | 08.07                            | + Motorcode N46N <sup>4)</sup>                    |                |  |                                  |   |   |
|        | 318 i  | 95    | 09.05 | 08.07                            | + erhöhte Zuladung/ + Motorcode N46 <sup>5)</sup> |                |  |                                  |   |   |
|        | 318 i  | 105   | 09.07 | 03.12                            |   |                |  |                                  |   |   |
|        | 320 d  | 110   | 09.05 | 03.12                            | - Behörde <sup>6)</sup>                           |                |  |                                  |   |   |
|        | 320 d  | 120   | 12.04 | 03.12                            |   |                |  |                                  |   |   |
|        | 320 d  | 130   | 09.07 | 03.12                            | - Behörde <sup>6)</sup>                           |                |  |                                  |   |   |
|        | 320 i  | 110   | 03.07 | 08.07                            | + Motorcode N46N <sup>4)</sup>                    |                |  |                                  |   |   |
|        | 320 i  | 110   | 12.04 | 08.07                            | + erhöhte Zuladung/ + Motorcode N46 <sup>5)</sup> |                |  |                                  |   |   |
|        | 320 i  | 125   | 09.07 | 03.12                            |   |                |  |                                  |   |   |
|        | 325 i  | 160   | 12.04 | 03.12                            | - erhöhte Zuladung <sup>1)</sup>                  |                |  |                                  |   |   |
|        | 320 si | 127   | 06.06 | 03.12                            |   | 24.0120-0204.1 | 420204                                 |                                  |   | 300 20,0 18,4 V L +S +B<br><b>300 20,0 18,4 V L +S +B PD</b>                |
|        | 320 xd | 160   | 09.07 | 03.12                            | - Behörde <sup>6)</sup>                           | 24.0320-0204.1 | 520204                                 |                                  |   |   |
|        | 325 xi | 160   | 01.05 | 03.12                            | - erhöhte Zuladung <sup>1)</sup>                  |                |  |                                  |   |   |
|        | 320 d  | 110   | 09.05 | 03.12                            | + Behörde <sup>7)</sup>                           | 24.0122-0236.1 | 422236                                 |                                  |   | 336 22,0 20,4 V L +S +B<br><b>336 22,0 20,4 V L +S +B PD</b>                |
|        | 320 d  | 130   | 09.07 | 03.12                            | + Behörde <sup>7)</sup>                           | 24.0322-0236.1 | 522236                                 |                                  |   |   |
| 320 xd | 160    | 09.07 | 03.12 | + Behörde <sup>7)</sup>          |   |                |  |                                  |   |   |
| 325 d  | 145    | 09.06 | 03.12 |                                  |   |                |  |                                  |   |   |
| 325 i  | 160    | 12.04 | 03.12 | + erhöhte Zuladung <sup>3)</sup> |   |                |  |                                  |   |   |
| 325 xi | 160    | 01.05 | 03.12 | + erhöhte Zuladung <sup>3)</sup> |   |                |  |                                  |   |   |
| 330 d  | 170    | 09.05 | 03.12 |                                  |   |                |  |                                  |   |   |
| 330 d  | 180    | 09.08 | 03.12 |                                  |   |                |  |                                  |   |   |
| 330 i  | 190    | 12.04 | 08.07 |                                  |   |                |  |                                  |   |   |
| 330 i  | 200    | 09.07 | 03.12 |                                  |   |                |  |                                  |   |   |
| 330 xd | 170    | 09.05 | 03.12 |                                  |   |                |  |                                  |   |   |
| 330 xd | 180    | 01.09 | 03.12 |                                  |   |                |  |                                  |   |   |
| 330 xi | 190    | 07.05 | 08.07 |                                  |   |                |  |                                  |   |   |
| 330 xi | 200    | 09.07 | 03.12 |                                  |   |                |  |                                  |   |   |
| 335 d  | 210    | 09.06 | 03.12 |                                  |   |                |  |                                  |   |   |
| 335 i  | 225    | 09.06 | 03.12 |                                  |   |                |  |                                  |   |   |
| 335 xi | 225    | 03.07 | 03.12 |                                  |   |                |  |                                  |   |   |
| M3     | 309    | 12.07 | 03.12 |                                  | 24.0124-0231.2                                    | 424231         | zweiteilige Bremsscheibe <sup>8)</sup> | 350 24,0 22,4 V L +S +B          |   |   |
|        |        |       |       |                                  | 24.0124-0232.2                                    | 424232         | zweiteilige Bremsscheibe <sup>8)</sup> | 350 24,0 22,4 V L +S +B          |   |   |
|        | 316 d  | 85    | 07.09 | 03.12                            |   | 24.0711-6158.3 | 360192                                 | 2                                | Radsensor L=954   |   |
|        | 316 i  | 85    | 01.05 | 08.07                            |   |                |  |                                  |   |   |
|        | 316 i  | 90    | 09.07 | 03.12                            |   |                |  |                                  |   |   |
|        | 318 d  | 90    | 09.07 | 03.12                            | - erhöhte Zuladung <sup>1)</sup>                  |                |  |                                  |   |   |
|        | 318 d  | 90    | 09.05 | 08.07                            |   |                |  |                                  |   |   |
|        | 318 i  | 95    | 09.05 | 08.07                            | - erhöhte Zuladung <sup>1)</sup>                  |                |  |                                  |   |   |
|        | 318 i  | 105   | 09.07 | 03.12                            | - erhöhte Zuladung <sup>1)</sup>                  |                |  |                                  |   |   |
|        | 320 d  | 110   | 09.05 | 03.12                            |   | 24.0711-6158.3 | 360192                                 | 2  - Aktivlenkung <sup>9)</sup>  |   | Radsensor L=954   |
|        | 320 d  | 120   | 12.04 | 03.12                            |   | 24.0711-6418.3 | 360407                                 | 2  + Aktivlenkung <sup>10)</sup> |   | Radsensor L=954   |
|        | 320 d  | 130   | 09.07 | 03.12                            |   |                |  |                                  |   |   |
|        | 320 i  | 110   | 12.04 | 08.07                            | - erhöhte Zuladung <sup>1)</sup>                  |                |  |                                  |   |   |
|        | 320 i  | 125   | 09.07 | 03.12                            |   |                |  |                                  |   |   |
|        | 325 i  | 160   | 12.04 | 03.12                            | - erhöhte Zuladung <sup>1)</sup>                  |                |  |                                  |   |   |
|        | 318 d  | 95    | 09.07 | 03.12                            | + erhöhte Zuladung <sup>3)</sup>                  | 24.0711-5169.3 | 360266                                 | 2                                |   | Radsensor L=959   |
|        | 318 i  | 95    | 09.05 | 08.07                            | + erhöhte Zuladung <sup>3)</sup>                  |                |  |                                  |   |   |
|        | 318 i  | 105   | 09.07 | 03.12                            | + erhöhte Zuladung <sup>3)</sup>                  |                |  |                                  |   |   |
|        | 320 i  | 110   | 12.04 | 08.07                            | + erhöhte Zuladung <sup>3)</sup>                  |                |  |                                  |   |   |
|        | 320 si | 127   | 06.06 | 03.12                            |   |                |  |                                  |   |   |
|        | 325 d  | 145   | 09.06 | 03.12                            |   | 24.0711-5191.3 | 360118                                 | 2                                |   | Radsensor L=959   |
|        | 325 i  | 160   | 12.04 | 03.12                            | + erhöhte Zuladung <sup>3)</sup>                  |                |  |                                  |   |   |
| 330 d  | 170    | 09.05 | 03.12 |                                  |   |                |  |                                  |   |   |
| 330 d  | 180    | 09.08 | 03.12 |                                  |   |                |  |                                  |   |   |
| 330 i  | 190    | 12.04 | 08.07 |                                  |   |                |  |                                  |   |   |
| 330 i  | 200    | 09.07 | 03.12 |                                  |   |                |  |                                  |   |   |
| 335 d  | 210    | 09.06 | 03.12 |                                  |   |                |  |                                  |   |   |
| 335 i  | 225    | 09.06 | 03.12 |                                  |   |                |  |                                  |   |   |
| M3     | 309    | 12.07 | 03.12 |                                  |   |                |  |                                  |   |   |
|        | 316 d  | 85    | 07.09 | 03.12                            |   | 03.0137-0379.2 | 650379                                 |                                  | 161 x 20<br>Bremsbacken-Zubehör<br>Bremsbacken-Zubehör<br>Spreizschloß Satz |   |
|        | 316 i  | 85    | 01.05 | 08.07                            |   | 03.0137-9265.2 | 669265                                 |                                  |   |   |
|        | 316 i  | 90    | 09.07 | 03.12                            |   | 03.0137-9701.2 | 669701                                 |                                  |   |   |
|        | 318 d  | 90    | 09.07 | 03.12                            |   | 03.0137-9702.2 | 669702                                 |                                  |   |   |
|        | 318 d  | 90    | 09.05 | 08.07                            |   |                |  |                                  |   |   |
|        | 318 i  | 95    | 09.05 | 08.07                            |   |                |  |                                  |   |   |
|        | 318 i  | 105   | 09.07 | 03.12                            |   |                |  |                                  |   |   |
|        | 320 d  | 110   | 09.05 | 03.12                            | - Behörde <sup>6)</sup>                           |                |  |                                  |   |   |
|        | 320 d  | 120   | 12.04 | 03.12                            |   |                |  |                                  |   |   |
|        | 320 d  | 130   | 09.07 | 03.12                            | - Behörde <sup>6)</sup>                           |                |  |                                  |   |   |
|        | 320 i  | 110   | 12.04 | 08.07                            |   |                |  |                                  |   |   |
|        | 320 i  | 125   | 09.07 | 03.12                            |   |                |  |                                  |   |   |
|        | 325 i  | 160   | 12.04 | 03.12                            | - erhöhte Zuladung <sup>1)</sup>                  |                |  |                                  |   |   |
|        | 320 d  | 110   | 09.05 | 03.12                            | + Behörde <sup>7)</sup>                           | 03.0137-0305.2 | 650305                                 |                                  |   | 185 x 20<br>Bremsbacken-Zubehör<br>Bremsbacken-Zubehör<br>Spreizschloß Satz |
|        | 320 d  | 130   | 09.07 | 03.12                            | + Behörde <sup>7)</sup>                           | 03.0137-9062.2 | 669062                                 |                                  |   |   |
|        | 320 si | 127   | 06.06 | 03.12                            |   | 03.0137-9700.2 | 669700                                 |                                  |   |   |
|        | 320 xd | 160   | 09.07 | 03.12                            |   | 03.0137-9702.2 | 669702                                 |                                  |   |   |
|        | 325 d  | 145   | 09.06 | 03.12                            |   |                |  |                                  |   |   |
|        | 325 i  | 160   | 12.04 | 03.12                            | + erhöhte Zuladung <sup>3)</sup>                  |                |  |                                  |   |   |
|        | 325 xi | 160   | 01.05 | 03.12                            |   |                |  |                                  |   |   |
| 330 d  | 170    | 09.05 | 03.12 |                                  |   |                |  |                                  |   |   |
| 330 d  | 180    | 09.08 | 03.12 |                                  |   |                |  |                                  |   |   |

1) - increased payload / - carico utile maggiorato / - charge utile augmentée / - incremento de carga  
 2) - increased payload/+engine co.N46 / - carico utile maggior./+codic.mot.N46 / - charge utile augmentée/+moteur co. N46 / - incremento de carga/+motor co.N46  
 3) + increased payload / + carico utile maggiorato / + charge utile augmentée / + incremento de carga  
 4) + engine code N46N / + codice motore N46N / + moteur code N46N / + motor code N46N  
 5) + increased payload/+engine co.N46 / + carico utile maggior./+codic.mot.N46 / + charge utile augmentée/+moteur co. N46 / + incremento de carga/+motor co.N46  
 6) - authority cars / - enti statali / - véhicule communal / - vehiculos oficiales

7) + authority cars / + enti statali / + véhicule communal / + vehiculos oficiales  
 8) two-piece brake disc / disco frenante in due parti / disque d.fren deux parties / disco de fr.de dos piezas  
 9) - active steering / - sterzo attivo / - direction active / - dirección activa  
 10) + active steering / + sterzo attivo / + direction active / + dirección activa





| BMW 3er Reihe/E90 Limousine (05-12) |        |     |  |       |       |  |                |        |  |   |
|-------------------------------------|--------|-----|--|-------|-------|--|----------------|--------|--|---|
|                                     | 330 i  | 190 |  | 12.04 | 08.07 |  | 03.0137-0305.2 | 650305 |  | 185 x 20<br>Bremsbacken-Zubehör<br>Bremsbacken-Zubehör<br>Spreizschloß Satz |
|                                     | 330 i  | 200 |  | 09.07 | 03.12 |  | 03.0137-9062.2 | 669062 |  |   |
|                                     | 330 xd | 170 |  | 09.05 | 03.12 |  | 03.0137-9700.2 | 669700 |  |   |
|                                     | 330 xd | 180 |  | 01.09 | 03.12 |  | 03.0137-9702.2 | 669702 |  |   |
|                                     | 330 xi | 190 |  | 01.05 | 08.07 |  |                |        |  |   |
|                                     | 330 xi | 200 |  | 09.07 | 03.12 |  |                |        |  |   |
|                                     | 335 d  | 210 |  | 09.06 | 03.12 |  |                |        |  |   |
|                                     | 335 i  | 225 |  | 09.06 | 03.12 |  |                |        |  |   |
|                                     | 335 xi | 225 |  | 03.07 | 03.12 |  |                |        |  |   |
|                                     | M3     | 309 |  | 12.07 | 03.12 |  |                |        |  |   |

| BMW 3er Reihe/E91 Touring (05-12) |        |     |  |       |       |  |                |        |   |   |
|-----------------------------------|--------|-----|--|-------|-------|--|----------------|--------|---|---|
|                                   | 316 d  | 85  |  | 09.09 | 02.10 |  | 13.0460-7216.2 | 607216 |   | 23794 20,3 +/WE<br>23794 20,3 +/WE<br>Warnkontakt L=630mm |
|                                   | 316i   | 90  |  | 09.07 | 02.10 |  | 13.0470-7216.2 | LD7216 |   |   |
|                                   | 318 d  | 90  |  | 09.05 | 08.07 |  | 24.8190-0264.2 | 620264 | 1 |   |
|                                   | 318 i  | 95  |  | 01.06 | 08.07 | + Motorcode N46 <sup>1)</sup>                          |                |        |   |   |
|                                   | 318 i  | 100 |  | 03.08 | 02.10 | - erhöhte Zuladung <sup>2)</sup>                       |                |        |   |   |
|                                   | 318 i  | 105 |  | 03.08 | 02.10 | - erhöhte Zuladung <sup>2)</sup>                       |                |        |   |   |
|                                   | 320 d  | 120 |  | 06.05 | 08.07 |  |                |        |   |   |
|                                   | 320 i  | 110 |  | 06.05 | 08.07 | + Motorcode N46N <sup>3)</sup>                         |                |        |   |   |
|                                   | 320 i  | 110 |  | 06.05 | 05.12 | + Motorcode N46 <sup>1)</sup>                          |                |        |   |   |
|                                   | 325 d  | 145 |  | 09.06 | 02.10 | - Behörde <sup>4)</sup>                                |                |        |   |   |
|                                   | 325 i  | 160 |  | 06.05 | 08.07 | + Motorcode N52 <sup>5)</sup>                          |                |        |   |   |
|                                   | 316 d  | 85  |  | 03.10 | 05.12 |  | 13.0460-7216.2 | 607216 |   | 23794 20,3 +/WE<br>23794 20,3 +/WE<br>Warnkontakt L=650mm |
|                                   | 316i   | 90  |  | 03.10 | 05.12 |  | 13.0470-7216.2 | LD7216 |   |   |
|                                   | 318 i  | 100 |  | 03.10 | 05.12 | - erhöhte Zuladung <sup>2)</sup>                       | 24.8190-0284.2 | 620284 | 1 |   |
|                                   | 318 i  | 105 |  | 03.10 | 05.12 | - erhöhte Zuladung <sup>2)</sup>                       |                |        |   |   |
|                                   | 325 d  | 145 |  | 03.10 | 05.12 | - Behörde <sup>4)</sup>                                |                |        |   |   |
|                                   | 330 d  | 170 |  | 06.05 | 08.07 |  | 13.0460-7216.2 | 607216 |   |   |
|                                   | 330 i  | 190 |  | 06.05 | 08.07 |  | 13.0470-7216.2 | LD7216 |   |   |
|                                   |        |     |  |       |       |  | 24.8190-0264.2 | 620264 | 1 |   |
|                                   |        |     |  |       |       |  | 24.8190-0284.2 | 620284 | 1 |   |
|                                   |        |     |  |       |       |  |                |        |   |   |
|                                   | 318 d  | 105 |  | 09.07 | 02.10 |  | 13.0460-7238.2 | 607238 |   | 23313 20,3 +/WE<br>23313 20,3 +/WE<br>Warnkontakt L=679mm |
|                                   | 318 i  | 95  |  | 03.07 | 08.07 | + Motorcode N46N <sup>3)</sup>                         | 13.0470-7238.2 | LD7238 |   |   |
|                                   | 318 i  | 100 |  | 09.07 | 02.10 | + erhöhte Zuladung <sup>6)</sup>                       | 24.8190-0267.2 | 620267 | 1 |   |
|                                   | 318 i  | 100 |  | 09.07 | 02.08 | - erhöhte Zuladung <sup>2)</sup>                       |                |        |   |   |
|                                   | 318 i  | 105 |  | 09.07 | 02.10 | + erhöhte Zuladung <sup>6)</sup>                       |                |        |   |   |
|                                   | 318 i  | 105 |  | 09.07 | 02.08 | - erhöhte Zuladung <sup>2)</sup>                       |                |        |   |   |
|                                   | 320 d  | 120 |  | 09.07 | 02.10 | - Behörde <sup>4)</sup>                                |                |        |   |   |
|                                   | 320 d  | 110 |  | 09.07 | 02.10 | - Behörde <sup>4)</sup>                                |                |        |   |   |
|                                   | 320 i  | 110 |  | 09.07 | 05.12 | + Motorcode N46N <sup>3)</sup>                         |                |        |   |   |
|                                   | 320 i  | 125 |  | 09.07 | 02.10 |  |                |        |   |   |
|                                   | 320 xd | 130 |  | 09.07 | 02.10 | - Behörde <sup>4)</sup>                                |                |        |   |   |
|                                   | 323 i  | 130 |  | 09.06 | 05.12 |  |                |        |   |   |
|                                   | 325 i  | 160 |  | 03.07 | 02.10 | - erhöhte Zuladung/ + Motorcode N52N/N53 <sup>7)</sup> |                |        |   |   |
|                                   | 318 d  | 105 |  | 03.10 | 05.12 |  | 13.0460-7238.2 | 607238 |   | 23313 20,3 +/WE<br>23313 20,3 +/WE<br>Warnkontakt L=723mm |
|                                   | 318 i  | 100 |  | 03.10 | 05.12 | + erhöhte Zuladung <sup>6)</sup>                       | 13.0470-7238.2 | LD7238 |   |   |
|                                   | 318 i  | 105 |  | 03.10 | 05.12 | + erhöhte Zuladung <sup>6)</sup>                       | 24.8190-0287.2 | 620287 | 1 |   |
|                                   | 320 d  | 120 |  | 03.10 | 05.12 | - Behörde <sup>4)</sup>                                |                |        |   |   |
|                                   | 320 d  | 120 |  | 03.10 | 05.12 | - Behörde <sup>4)</sup>                                |                |        |   |   |
|                                   | 320 i  | 125 |  | 03.10 | 05.12 |  |                |        |   |   |
|                                   | 320 xd | 130 |  | 03.10 | 05.12 | - Behörde <sup>4)</sup>                                |                |        |   |   |
|                                   | 325 i  | 155 |  | 01.12 | 05.12 | - erhöhte Zuladung <sup>2)</sup>                       |                |        |   |   |
|                                   | 325 i  | 160 |  | 03.10 | 05.12 | - erhöhte Zuladung/ + Motorcode N52N/N53 <sup>7)</sup> |                |        |   |   |
|                                   | 325 i  | 160 |  | 03.07 | 08.07 | + erhöhte Zuladung/ + Motorcode N52N <sup>8)</sup>     | 13.0460-7216.2 | 607216 |   |   |
|                                   | 325 xi | 160 |  | 06.05 | 08.07 | + erhöhte Zuladung/ + Motorcode N52N <sup>8)</sup>     | 13.0470-7216.2 | LD7216 |   |   |
|                                   | 325 xi | 160 |  | 06.05 | 02.10 | + Motorcode N52N/N53 <sup>9)</sup>                     | 24.8190-0266.2 | 620266 | 1 |   |
|                                   | 325 xi | 160 |  | 03.10 | 05.12 | + Motorcode N52N/N53 <sup>9)</sup>                     | 13.0460-7216.2 | 607216 |   |   |
|                                   |        |     |  |       |       |  | 13.0470-7216.2 | LD7216 |   |   |
|                                   |        |     |  |       |       |  | 24.8190-0286.2 | 620286 | 1 |   |
|                                   | 330 xd | 190 |  | 06.05 | 08.07 |  | 13.0460-7216.2 | 607216 |   |   |
|                                   | 330 xi | 190 |  | 06.05 | 08.07 |  | 13.0470-7216.2 | LD7216 |   |   |
|                                   |        |     |  |       |       |  | 24.8190-0266.2 | 620266 | 1 |   |
|                                   | 325 xi | 160 |  | 06.05 | 02.10 | - erhöhte Zuladung/ + Motorcode N52N <sup>10)</sup>    | 13.0460-7238.2 | 607238 |   |   |
|                                   |        |     |  |       |       |  | 13.0470-7238.2 | LD7238 |   |   |
|                                   |        |     |  |       |       |  | 24.8190-0266.2 | 620266 | 1 |   |
|                                   | 325 xi | 160 |  | 03.10 | 05.12 | - erhöhte Zuladung/ + Motorcode N52N <sup>10)</sup>    | 13.0460-7238.2 | 607238 |   |   |
|                                   |        |     |  |       |       |  | 13.0470-7238.2 | LD7238 |   |   |
|                                   |        |     |  |       |       |  | 24.8190-0286.2 | 620286 | 1 |   |
|                                   | 320 d  | 120 |  | 09.07 | 02.10 | + Behörde <sup>11)</sup>                               | 13.0460-7216.2 | 607216 |   |   |
|                                   | 320 d  | 130 |  | 09.07 | 02.10 | + Behörde <sup>11)</sup>                               | 13.0470-7216.2 | LD7216 |   |   |
|                                   | 320 xd | 130 |  | 09.07 | 02.10 | + Behörde <sup>11)</sup>                               | 24.8190-0267.2 | 620267 | 1 |   |
|                                   | 325 i  | 160 |  | 09.07 | 02.10 | + erhöhte Zuladung/ + Motorcode N53 <sup>12)</sup>     |                |        |   |   |
|                                   | 320 d  | 120 |  | 03.10 | 05.12 | + Behörde <sup>11)</sup>                               | 13.0460-7216.2 | 607216 |   |   |
|                                   | 320 d  | 130 |  | 03.10 | 05.12 | + Behörde <sup>11)</sup>                               | 13.0470-7216.2 | LD7216 |   |   |
|                                   | 320 xd | 130 |  | 03.10 | 05.12 | + Behörde <sup>11)</sup>                               | 24.8190-0287.2 | 620287 | 1 |   |
|                                   | 325 i  | 155 |  | 01.12 | 05.12 | + erhöhte Zuladung <sup>6)</sup>                       |                |        |   |   |
|                                   | 325 i  | 160 |  | 03.10 | 05.12 | + erhöhte Zuladung/ + Motorcode N53 <sup>12)</sup>     |                |        |   |   |
|                                   | 330 xd | 200 |  | 09.07 | 02.10 |  | 13.0460-7237.2 | 607237 |   |   |
|                                   | 330 xi | 200 |  | 09.07 | 02.10 |  | 13.0470-7237.2 | LD7237 |   |   |
|                                   |        |     |  |       |       |  | 13.0460-7238.2 | 607238 |   |   |
|                                   |        |     |  |       |       |  | 13.0470-7238.2 | LD7238 |   |   |
|                                   |        |     |  |       |       |  | 24.8190-0266.2 | 620266 | 1 |   |

1) + engine code N46 / + codice motore N46 / + moteur code N46 / + motor code N46  
2) - increased payload / - carico utile maggiorato / - charge utile augmentée / - incremento de carga  
3) + engine code N46N / + codice motore N46N / + moteur code N46N / + motor code N46N  
4) - authority cars / - enti statali / - véhicules communal / - vehículos oficiales  
5) + engine code N52 / + codice motore N52 / + moteur code N52 / + motor code N52  
6) + increased payload / + carico utile maggiorato / + charge utile augmentée / + incremento de carga  
7) - increased payload / + eng.co.N52N/N53 / - caric.utili.magg./+codic.mot.N52N/N53 / - charge utile augment./+moteur N52N/N53 / - incremento de carga/+motor co.N52N/N53  
8) + increased payload/+engine co.N52N / + carico utile maggior./+codic.mot.N52N / + charge utile augmentée/+moteur co.N52N / + incremento de carga/+motor co.N52N  
9) + engine code N52N/N53 / + codice motore N52N/N53 / + moteur code N52N/N53 / + motor code N52N/N53  
10) - increased payload/+engine co.N52N / - carico utile maggior./+codic.mot.N52N / - charge utile augmentée/+moteur co.N52N / - incremento de carga/+motor co.N52N  
11) + authority cars / + enti statali / + véhicules communal / + vehículos oficiales  
12) + increased payload/+engine co.N53 / + carico utile maggior./+codic.mot.N53 / + charge utile augmentée/+moteur co.N53 / + incremento de carga/+motor co.N53





**BMW 3er Reihe/E91 Touring (05-12)**

|        |        |       |       |  |   |                |                |        |                            |                            |     |
|--------|--------|-------|-------|--|---|----------------|----------------|--------|----------------------------|----------------------------|-----|
|        | 330 xd | 200   |       | 03.10  | 05.12   |                | 13.0460-7237.2 | 607237 |                            | 24161 20,3 +/WE            | ATE |
|        | 330 xi |       |       | 03.10  | 05.12   |                | 13.0470-7237.2 | LD7237 |                            | 24161 20,3 +/WE            | ATE |
|        |        |       |       |  |   |                | 13.0460-7238.2 | 607238 |                            | 23313 20,3 +/WE            | ATE |
|        |        |       |       |  |   |                | 13.0470-7238.2 | LD7238 |                            | 23313 20,3 +/WE            | ATE |
|        |        |       |       |  |   |                | 24.8190-0266.2 | 620286 | 1                          | Warnkontakt L=867mm        |     |
|        | 335 d  | 210   |       | 09.06  | 05.12   |                | 13.0460-7237.2 | 607237 |                            | 24161 20,3 +/WE            | ATE |
|        | 335 i  | 225   |       | 09.06  | 05.12   |                | 13.0470-7237.2 | LD7237 |                            | 24161 20,3 +/WE            | ATE |
|        |        |       |       |  |   |                | 13.0460-7238.2 | 607238 |                            | 23313 20,3 +/WE            | ATE |
|        |        |       |       |  |   |                | 13.0470-7238.2 | LD7238 |                            | 23313 20,3 +/WE            | ATE |
|        |        |       |       |  |   |                | 24.8190-0267.2 | 620267 | 1                          | Warnkontakt L=679mm        |     |
| 325 d  | 145    |       | 09.06 | 02.10  | + Behörde <sup>1)</sup>                           | 13.0460-7237.2 | 607237         |        | 24161 20,3 +/WE            | ATE                        |     |
|        |        |       |       |  |   | 13.0470-7237.2 | LD7237         |        | 24161 20,3 +/WE            | ATE                        |     |
|        |        |       |       |  |   | 13.0460-7238.2 | 607238         |        | 23313 20,3 +/WE            | ATE                        |     |
|        |        |       |       |  |   | 13.0470-7238.2 | LD7238         |        | 23313 20,3 +/WE            | ATE                        |     |
|        |        |       |       |  |   | 24.8190-0267.2 | 620267         | 1      | Warnkontakt L=679mm        |                            |     |
| 325 d  | 145    |       | 03.10 | 05.12  | + Behörde <sup>1)</sup>                           | 13.0460-7237.2 | 607237         |        | 24161 20,3 +/WE            | ATE                        |     |
|        |        |       |       |  |   | 13.0470-7237.2 | LD7237         |        | 24161 20,3 +/WE            | ATE                        |     |
|        |        |       |       |  |   | 13.0460-7238.2 | 607238         |        | 23313 20,3 +/WE            | ATE                        |     |
|        |        |       |       |  |   | 13.0470-7238.2 | LD7238         |        | 23313 20,3 +/WE            | ATE                        |     |
|        |        |       |       |  |   | 24.8190-0287.2 | 620287         | 1      | Warnkontakt L=723mm        |                            |     |
| 330 d  | 170    |       | 09.07 | 02.10  |   | 13.0460-7237.2 | 607237         |        | 24161 20,3 +/WE            | ATE                        |     |
| 330 d  | 180    |       | 09.08 | 02.10  |   | 13.0470-7237.2 | LD7237         |        | 24161 20,3 +/WE            | ATE                        |     |
| 330 i  | 200    |       | 09.07 | 02.10  |   | 13.0460-7238.2 | 607238         |        | 23313 20,3 +/WE            | ATE                        |     |
| 335 xi | 225    |       | 03.07 | 02.10  |   | 13.0470-7238.2 | LD7238         |        | 23313 20,3 +/WE            | ATE                        |     |
|        |        |       |       |  |   | 24.8190-0267.2 | 620267         | 1      | Warnkontakt L=679mm        |                            |     |
| 330 d  | 170    |       | 03.10 | 05.12  |   | 13.0460-7237.2 | 607237         |        | 24161 20,3 +/WE            | ATE                        |     |
| 330 d  | 180    |       | 03.10 | 05.12  |   | 13.0470-7237.2 | LD7237         |        | 24161 20,3 +/WE            | ATE                        |     |
| 330 i  | 200    |       | 03.10 | 05.12  |   | 13.0460-7238.2 | 607238         |        | 23313 20,3 +/WE            | ATE                        |     |
| 335 xi | 225    |       | 03.10 | 05.12  |   | 13.0470-7238.2 | LD7238         |        | 23313 20,3 +/WE            | ATE                        |     |
|        |        |       |       |  |   | 24.8190-0287.2 | 620287         | 1      | Warnkontakt L=723mm        |                            |     |
| 316 d  | 85     |       | 09.09 | 05.12  |   | 13.0460-4848.2 | 604848         |        | 24316 16,9 /WE             | BRE                        |     |
| 316i   | 90     |       | 09.07 | 05.12  |   | 24.8190-0267.2 | 620267         | 1      | + Performance Parts        |                            |     |
| 318 d  | 90     |       | 09.05 | 08.07  |   |                |                |        | + Performance Parts        |                            |     |
| 318 d  | 105    |       | 09.07 | 05.12  |   |                |                |        |                            |                            |     |
| 318 i  | 95     |       | 01.06 | 08.07  |   |                |                |        |                            |                            |     |
| 318 i  | 100    |       | 09.07 | 05.12  |   |                |                |        |                            |                            |     |
| 318 i  | 105    |       | 09.07 | 05.12  |   |                |                |        |                            |                            |     |
| 320 d  | 120    |       | 09.07 | 05.12  |   |                |                |        |                            |                            |     |
| 320 d  | 120    |       | 06.05 | 08.07  |   |                |                |        |                            |                            |     |
| 320 i  | 110    |       | 06.05 | 08.07  |   |                |                |        |                            |                            |     |
| 320 i  | 125    |       | 09.07 | 05.12  |   |                |                |        |                            |                            |     |
| 320 xd | 130    |       | 09.07 | 05.12  |   |                |                |        |                            |                            |     |
| 325 d  | 145    |       | 09.06 | 05.12  |   |                |                |        |                            |                            |     |
| 325 i  | 155    |       | 01.12 | 05.12  |   |                |                |        |                            |                            |     |
| 325 i  | 160    |       | 06.05 | 05.12  |   |                |                |        |                            |                            |     |
| 325 xi | 160    |       | 06.05 | 05.12  |   |                |                |        |                            |                            |     |
| 330 d  | 170    |       | 06.05 | 05.12  |   |                |                |        |                            |                            |     |
| 330 d  | 180    |       | 09.08 | 05.12  |   |                |                |        |                            |                            |     |
| 330 i  | 190    |       | 06.05 | 08.07  |   |                |                |        |                            |                            |     |
| 330 i  | 200    |       | 09.07 | 05.12  |   |                |                |        |                            |                            |     |
| 330 xd |        |       | 06.05 | 05.12  |   |                |                |        |                            |                            |     |
| 330 xi | 190    |       | 06.05 | 08.07  |   |                |                |        |                            |                            |     |
| 330 xi | 200    |       | 09.07 | 05.12  |   |                |                |        |                            |                            |     |
|        | 316 d  | 85    | 09.09 | 05.12  |   | 24.0124-0197.1 | 424197         |        |                            | 300 24,0 22,4 V L +S +B    |     |
|        | 316i   | 90    | 09.07 | 05.12  |   | 24.0324-0197.1 | 524197         |        |                            | 300 24,0 21,6 V L +S +B PD |     |
|        | 318 d  | 90    | 09.05 | 08.07  |   |                |                |        |                            |                            |     |
|        | 318 i  | 95    | 01.06 | 08.07  | + Motorcode N46 <sup>2)</sup>                     |                |                |        |                            |                            |     |
|        | 318 i  | 100   | 03.08 | 05.12  | - erhöhte Zuladung <sup>3)</sup>                  |                |                |        |                            |                            |     |
|        | 318 i  | 105   | 03.08 | 05.12  | - erhöhte Zuladung <sup>3)</sup>                  |                |                |        |                            |                            |     |
|        | 320 d  | 120   | 06.05 | 08.07  | - Behörde <sup>4)</sup>                           |                |                |        |                            |                            |     |
|        | 320 i  | 110   | 06.05 | 08.07  | + Motorcode N46 <sup>2)</sup>                     |                |                |        |                            |                            |     |
|        | 325 i  | 160   | 06.05 | 08.07  | - erhöhte Zuladung/ + Motorcode N52 <sup>5)</sup> |                |                |        |                            |                            |     |
|        | 318 d  | 105   | 09.07 | 05.12  |   | 24.0124-0203.1 | 424203         |        |                            | 312 23,9 22,4 V L +S +B    |     |
|        | 318 i  | 95    | 03.07 | 08.07  | + Motorcode N46N <sup>6)</sup>                    | 24.0324-0203.1 | 524203         |        |                            | 312 23,9 22,4 V L +S +B PD |     |
|        | 318 i  | 100   | 09.07 | 05.12  | + erhöhte Zuladung <sup>7)</sup>                  |                |                |        |                            |                            |     |
|        | 318 i  | 100   | 09.07 | 02.08  | - erhöhte Zuladung <sup>3)</sup>                  |                |                |        |                            |                            |     |
|        | 318 i  | 105   | 09.07 | 05.12  | + erhöhte Zuladung <sup>7)</sup>                  |                |                |        |                            |                            |     |
|        | 318 i  | 105   | 09.07 | 02.08  | - erhöhte Zuladung <sup>3)</sup>                  |                |                |        |                            |                            |     |
|        | 320 d  | 120   | 09.07 | 05.12  | - Behörde <sup>4)</sup>                           |                |                |        |                            |                            |     |
|        | 320 d  | 120   | 09.07 | 05.12  | - Behörde <sup>4)</sup>                           |                |                |        |                            |                            |     |
|        | 320 i  | 110   | 09.07 | 05.12  | + Motorcode N46N <sup>6)</sup>                    |                |                |        |                            |                            |     |
|        | 320 i  | 125   | 09.07 | 05.12  |   |                |                |        |                            |                            |     |
|        | 320 xd | 130   | 09.07 | 05.12  | - Behörde <sup>4)</sup>                           |                |                |        |                            |                            |     |
| 323 i  | 130    | 09.06 | 05.12 |  |   |                |                |        |                            |                            |     |
| 325 i  | 155    | 01.12 | 05.12 | - erhöhte Zuladung <sup>3)</sup>                       |   |                |                |        |                            |                            |     |
| 325 i  | 160    | 03.07 | 05.12 | - erhöhte Zuladung/ + Motorcode N52N/N53 <sup>8)</sup> |   |                |                |        |                            |                            |     |
| 325 xi | 160    | 06.05 | 08.07 | - erhöhte Zuladung/ + Motorcode N52N <sup>9)</sup>     |   |                |                |        |                            |                            |     |
| 320 d  | 120    | 09.07 | 05.12 | + Behörde <sup>1)</sup>                                | 24.0124-0200.1                                    | 424200         |                |        | 330 24,0 22,4 V L +S +B    |                            |     |
| 320 d  | 120    | 06.05 | 05.12 | + Behörde <sup>1)</sup>                                | 24.0324-0200.1                                    | 524200         |                |        | 330 24,0 21,6 V L +S +B PD |                            |     |
| 320 xd | 130    | 09.07 | 05.12 | + Behörde <sup>1)</sup>                                |   |                |                |        |                            |                            |     |
| 325 d  | 145    | 09.06 | 05.12 | - Behörde <sup>4)</sup>                                |   |                |                |        |                            |                            |     |
| 325 i  | 155    | 01.12 | 05.12 | + erhöhte Zuladung <sup>7)</sup>                       |   |                |                |        |                            |                            |     |
| 325 i  | 160    | 06.05 | 05.12 | + erhöhte Zuladung <sup>7)</sup>                       |   |                |                |        |                            |                            |     |
| 325 xi | 160    | 06.05 | 08.07 | + erhöhte Zuladung/ + Motorcode N52N <sup>10)</sup>    |   |                |                |        |                            |                            |     |
| 325 xi | 160    | 06.05 | 05.12 | + Motorcode N52N/N53 <sup>11)</sup>                    |   |                |                |        |                            |                            |     |
| 330 d  | 170    | 06.05 | 08.07 | + erhöhte Zuladung <sup>7)</sup>                       |   |                |                |        |                            |                            |     |
| 330 d  | 170    | 06.05 | 05.12 | - erhöhte Zuladung <sup>3)</sup>                       |   |                |                |        |                            |                            |     |

1) + authority cars / + enti statali / + véhicule communal / + vehiculos oficiales  
 2) + engine code N46 / + codice motore N46 / + moteur code N46 / + motor code N46  
 3) - increased payload / - carico utile maggiorato / - charge utile augmentée / - incremento de carga  
 4) - authority cars / - enti statali / - véhicule communal / - vehiculos oficiales  
 5) - increased payload / + engine co.N52 / - carico utile maggior./ + codic.mot.N52 / - charge utile augmentée/ +moteur co. N52 / - incremento de carga/ +motor co.N52  
 6) + engine code N46N / + codice motore N46N / + moteur code N46N / + motor code N46N  
 7) + increased payload / + carico utile maggiorato / + charge utile augmentée / + incremento de carga

8) - increased payload / + engine co.N52N/N53 / - caric.utili.magg./ + codic.mot.N52N/N53 / - charge utile augment./ +moteur N52N/N53 / - incremento de carga/ +motor co.N52N/N53  
 9) - increased payload / + engine co.N52N / - carico utile maggior./ + codic.mot.N52N / - charge utile augmentée/ +moteur co.N52N / - incremento de carga/ +motor co.N52N  
 10) + increased payload / + engine co.N52N / + carico utile maggior./ + codic.mot.N52N / + charge utile augmentée/ +moteur co.N52N / + incremento de carga/ +motor co.N52N  
 11) + engine code N52N/N53 / + codice motore N52N/N53 / + moteur code N52N/N53 / + motor code N52N/N53

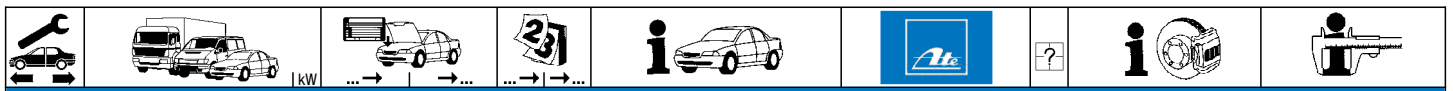

**BMW 3er Reihe/E91 Touring (05-12)**

|        |        |     |       |       |  |  |                |        |   |  |  |                         |
|--------|--------|-----|-------|-------|--|--|----------------|--------|---|--|--|-------------------------|
|        | 330 d  | 180 |       | 09.09 | 05.12  | - erhöhte Zuladung <sup>1)</sup>                   | 24.0124-0200.1 | 424200 |   |  | 330 24,0 22,4 V L +S +B<br>330 24,0 21,6 V L +S +B PD              |                         |
|        | 330 i  | 190 |       | 06.05 | 08.07  |  | 24.0324-0200.1 | 524200 |   |  |  |                         |
|        | 330 xd |     |       | 06.05 | 08.07  | + erhöhte Zuladung <sup>2)</sup>                   |                |        |   |  |  |                         |
|        | 330 xd |     |       | 06.05 | 05.12  | - erhöhte Zuladung <sup>1)</sup>                   |                |        |   |  |  |                         |
|        | 330 xi | 190 |       | 06.05 | 08.07  |  |                |        |   |  |  |                         |
|        | 330 xi | 200 |       | 09.07 | 05.12  |  |                |        |   |  |  |                         |
|        | 325 d  | 145 |       | 09.06 | 05.12  | + Behörde <sup>3)</sup>                            | 24.0130-0192.1 | 430192 |   |  |  | 348 30,0 28,4 V L +S +B |
|        | 330 d  | 170 |       | 09.07 | 05.12  | + erhöhte Zuladung <sup>2)</sup>                   |                |        |   |  |  |                         |
|        | 330 d  | 180 |       | 09.08 | 05.12  | + erhöhte Zuladung <sup>2)</sup>                   |                |        |   |  |  |                         |
|        | 330 d  | 180 |       | 09.08 | 08.09  | - erhöhte Zuladung <sup>1)</sup>                   |                |        |   |  |  |                         |
| 330 i  | 200    |     | 09.07 | 05.12 |  |  |                |        |   |  |  |                         |
| 330 xd |        |     | 09.07 | 05.12 | + erhöhte Zuladung <sup>2)</sup>                   |  |                |        |   |  |  |                         |
| 335 d  | 210    |     | 09.06 | 05.12 |  |  |                |        |   |  |  |                         |
| 335 i  | 225    |     | 09.06 | 05.12 |  |  |                |        |   |  |  |                         |
| 335 xi | 225    |     | 03.07 | 05.12 |  |  |                |        |   |  |  |                         |
|        | 316 d  | 85  |       | 09.09 | 05.12  |  | 24.0711-6198.3 | 360199 | 2 |  | Radsensor L=660  |                         |
|        | 316i   | 90  |       | 09.07 | 05.12  |  |                |        |   |  |  |                         |
|        | 318 d  | 90  |       | 09.05 | 08.07  |  |                |        |   |  |  |                         |
|        | 318 d  | 105 |       | 09.07 | 05.12  |  |                |        |   |  |  |                         |
|        | 318 i  | 95  |       | 01.06 | 08.07  |  |                |        |   |  |  |                         |
|        | 318 i  | 100 |       | 09.07 | 05.12  |  |                |        |   |  |  |                         |
|        | 318 i  | 105 |       | 09.07 | 05.12  |  |                |        |   |  |  |                         |
|        | 320 d  |     |       | 09.07 | 05.12  |  |                |        |   |  |  |                         |
|        | 320 d  | 120 |       | 06.05 | 08.07  |  |                |        |   |  |  |                         |
|        | 320 i  | 110 |       | 06.05 | 08.07  |  |                |        |   |  |  |                         |
| 320 i  | 125    |     | 09.07 | 05.12 |  |  |                |        |   |  |  |                         |
|        | 323 i  | 130 |       | 09.06 | 05.12  |  | 24.0711-6197.3 | 360141 | 2 |  | Radsensor L=660  |                         |
|        | 325 d  | 145 |       | 09.06 | 05.12  |  |                |        |   |  |  |                         |
|        | 325 i  | 155 |       | 01.12 | 05.12  |  |                |        |   |  |  |                         |
|        | 325 i  | 160 |       | 06.05 | 05.12  |  |                |        |   |  |  |                         |
|        | 330 d  | 170 |       | 06.05 | 05.12  |  |                |        |   |  |  |                         |
|        | 330 d  | 180 |       | 09.08 | 05.12  |  |                |        |   |  |  |                         |
|        | 330 i  | 190 |       | 06.05 | 08.07  |  |                |        |   |  |  |                         |
|        | 330 i  | 200 |       | 09.07 | 05.12  |  |                |        |   |  |  |                         |
|        | 335 d  | 210 |       | 09.06 | 05.12  |  |                |        |   |  |  |                         |
|        | 335 i  | 225 |       | 09.06 | 05.12  |  |                |        |   |  |  |                         |
|        | 316 d  | 85  |       | 09.09 | 02.10  |  | 13.0460-7217.2 | 607217 |   |  | 23926 17,3 +/WE ATE<br>23926 17,3 +/WE ATE<br>Warnkontakt L=1086mm |                         |
|        | 316i   | 90  |       | 09.07 | 02.10  |  | 13.0470-7217.2 | LD7217 |   |  |  |                         |
|        | 318 d  | 90  |       | 09.05 | 08.07  |  | 24.8190-0265.2 | 620265 | 1 |  |  |                         |
|        | 318 d  | 105 |       | 09.07 | 02.10  |  |                |        |   |  |  |                         |
|        | 318 i  | 95  |       | 01.06 | 08.07  |  |                |        |   |  |  |                         |
|        | 318 i  | 100 |       | 09.07 | 02.10  |  |                |        |   |  |  |                         |
|        | 318 i  | 105 |       | 09.07 | 02.10  |  |                |        |   |  |  |                         |
|        | 320 d  |     |       | 09.07 | 02.10  | - Behörde <sup>4)</sup>                            |                |        |   |  |  |                         |
|        | 320 d  | 120 |       | 06.05 | 02.10  | - Behörde <sup>4)</sup>                            |                |        |   |  |  |                         |
|        | 320 i  | 110 |       | 06.05 | 08.07  |  |                |        |   |  |  |                         |
| 320 i  | 125    |     | 09.07 | 02.10 |  |  |                |        |   |  |  |                         |
| 320 xd | 130    |     | 09.07 | 02.10 | - Behörde <sup>4)</sup>                            |  |                |        |   |  |  |                         |
| 323 i  | 130    |     | 09.06 | 05.12 |  |  |                |        |   |  |  |                         |
| 325 i  | 160    |     | 06.05 | 02.10 | - erhöhte Zuladung <sup>1)</sup>                   |  |                |        |   |  |  |                         |
| 325 xi | 160    |     | 06.05 | 08.07 | - erhöhte Zuladung/ + Motorcode N52N <sup>5)</sup> |  |                |        |   |  |  |                         |
|        | 316 d  | 85  |       | 03.10 | 05.12  |  | 13.0460-7217.2 | 607217 |   |  | 23926 17,3 +/WE ATE<br>23926 17,3 +/WE ATE<br>Warnkontakt L=1107mm |                         |
|        | 316i   | 90  |       | 03.10 | 05.12  |  | 13.0470-7217.2 | LD7217 |   |  |  |                         |
|        | 318 d  | 105 |       | 03.10 | 05.12  |  | 24.8190-0285.2 | 620285 | 1 |  |  |                         |
|        | 318 i  | 100 |       | 03.10 | 05.12  |  |                |        |   |  |  |                         |
|        | 318 i  | 105 |       | 03.10 | 05.12  |  |                |        |   |  |  |                         |
|        | 320 d  |     |       | 03.10 | 05.12  | - Behörde <sup>4)</sup>                            |                |        |   |  |  |                         |
|        | 320 d  | 120 |       | 03.10 | 05.12  | - Behörde <sup>4)</sup>                            |                |        |   |  |  |                         |
|        | 320 i  | 125 |       | 03.10 | 05.12  |  |                |        |   |  |  |                         |
|        | 320 xd | 130 |       | 03.10 | 05.12  | - Behörde <sup>4)</sup>                            |                |        |   |  |  |                         |
|        | 325 i  | 155 |       | 01.12 | 05.12  | - erhöhte Zuladung <sup>1)</sup>                   |                |        |   |  |  |                         |
| 325 i  | 160    |     | 03.10 | 05.12 | - erhöhte Zuladung <sup>1)</sup>                   |  |                |        |   |  |  |                         |
|        | 320 d  |     |       | 09.07 | 02.10  | + Behörde <sup>3)</sup>                            | 13.0460-7225.2 | 607225 |   |  | 23550 17,3 +/WE ATE<br>23550 17,3 +/WE ATE<br>Warnkontakt L=1086mm |                         |
|        | 320 d  | 120 |       | 06.05 | 02.10  | + Behörde <sup>3)</sup>                            | 13.0470-7225.2 | LD7225 |   |  |  |                         |
|        | 320 xd | 130 |       | 09.07 | 02.10  | + Behörde <sup>3)</sup>                            | 24.8190-0265.2 | 620265 | 1 |  |  |                         |
|        | 325 d  | 145 |       | 09.06 | 02.10  |  |                |        |   |  |  |                         |
|        | 325 i  | 160 |       | 06.05 | 02.10  | + erhöhte Zuladung <sup>2)</sup>                   |                |        |   |  |  |                         |
|        | 325 xi | 160 |       | 06.05 | 08.07  | + erhöhte Zuladung/ + Motorcode N52N <sup>6)</sup> |                |        |   |  |  |                         |
|        | 325 xi | 160 |       | 06.05 | 02.10  | + Motorcode N52N/N53 <sup>7)</sup>                 |                |        |   |  |  |                         |
|        | 330 d  | 170 |       | 06.05 | 02.10  |  |                |        |   |  |  |                         |
|        | 330 d  | 180 |       | 09.08 | 02.10  |  |                |        |   |  |  |                         |
|        | 330 i  | 190 |       | 06.05 | 08.07  |  |                |        |   |  |  |                         |
| 330 i  | 200    |     | 09.07 | 02.10 |  |  |                |        |   |  |  |                         |
| 330 xd |        |     | 06.05 | 02.10 |  |  |                |        |   |  |  |                         |
| 330 xi | 190    |     | 06.05 | 08.07 |  |  |                |        |   |  |  |                         |
| 330 xi | 200    |     | 09.07 | 02.10 |  |  |                |        |   |  |  |                         |
| 335 d  | 210    |     | 09.06 | 02.10 |  |  |                |        |   |  |  |                         |
| 335 i  | 225    |     | 09.06 | 02.10 |  |  |                |        |   |  |  |                         |
| 335 xi | 225    |     | 03.07 | 02.10 |  |  |                |        |   |  |  |                         |
|        | 320 d  |     |       | 03.10 | 05.12  | + Behörde <sup>3)</sup>                            | 13.0460-7225.2 | 607225 |   |  | 23550 17,3 +/WE ATE<br>23550 17,3 +/WE ATE<br>Warnkontakt L=1107mm |                         |
|        | 320 d  | 120 |       | 03.10 | 05.12  | + Behörde <sup>3)</sup>                            | 13.0470-7225.2 | LD7225 |   |  |  |                         |
|        | 320 xd | 130 |       | 03.10 | 05.12  | + Behörde <sup>3)</sup>                            | 24.8190-0285.2 | 620285 | 1 |  |  |                         |
|        | 325 d  | 145 |       | 03.10 | 05.12  |  |                |        |   |  |  |                         |
|        | 325 i  | 155 |       | 01.12 | 05.12  | + erhöhte Zuladung <sup>2)</sup>                   |                |        |   |  |  |                         |
|        | 325 xi | 160 |       | 03.10 | 05.12  | + erhöhte Zuladung <sup>2)</sup>                   |                |        |   |  |  |                         |
| 325 xi | 160    |     | 03.10 | 05.12 | + Motorcode N52N/N53 <sup>7)</sup>                 |  |                |        |   |  |  |                         |

1) - increased payload / - carico utile maggiorato / - charge utile augmentée / - incremento de carga  
2) + increased payload / + carico utile maggiorato / + charge utile augmentée / + incremento de carga  
3) + authority cars / + enti statali / + véhicule communal / + vehiculos oficiales  
4) - authority cars / - enti statali / - véhicule communal / - vehiculos oficiales  
5) - increased payl./+engine co.N52N / - carico utile maggior./+codic.mot.N52N / - charge utile augmentée/+moteur co.N52N / - incremento de carga/+motor co.N52N  
6) + increased payl./+engine co.N52N / + carico utile maggior./+codic.mot.N52N / + charge utile augmentée/+moteur co.N52N / + incremento de carga/+motor co.N52N  
7) + engine code N52N/N53 / + codice motore N52N/N53 / + moteur code N52N/N53 / + motor code N52N/N53



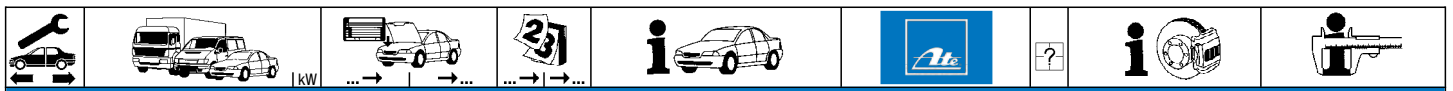

**BMW 3er Reihe/E91 Touring (05-12)**

|        |        |     |       |       |   |   |                |        |   |   |  |            |   |  |   |  |
|--------|--------|-----|-------|-------|---|---|----------------|--------|---|---|--|------------|---|--|---|--|
|        | 330 d  | 170 |       | 03.10 | 05.12                                   |   | 13.0460-7225.2 | 607225 | 1 |   | 23550 17,3 +WE<br>23550 17,3 +WE<br>Warnkontakt L=1107mm | ATE<br>ATE |   |  |   |  |
|        | 330 d  | 180 |       | 03.10 | 05.12                                   |   | 13.0470-7225.2 | LD7225 |   |   |  |            |   |  |   |  |
|        | 330 i  | 200 |       | 03.10 | 05.12                                   |   | 24.8190-0285.2 | 620285 |   |   |  |            |   |  |   |  |
|        | 330 xd |     |       | 03.10 | 05.12                                   |   |                |        |   |   |  |            |   |  |   |  |
|        | 330 xi | 200 |       | 03.10 | 05.12                                   |   |                |        |   |   |  |            |   |  |   |  |
|        | 335 d  | 210 |       | 03.10 | 05.12                                   |   |                |        |   |   |  |            |   |  |   |  |
|        | 335 i  | 225 |       | 03.10 | 05.12                                   |   |                |        |   |   |  |            |   |  |   |  |
| 335 xi | 225    |     | 03.10 | 05.12 |   |   |                |        |   |   |  |            |   |  |   |  |
|        | 316i   | 90  |       | 09.07 | 09.09                                   |   | 24.0120-0204.1 | 420204 |   |   | 300 20,0 18,4 V L +S +B<br>300 20,0 18,4 V L +S +B PD    |            |   |  |   |  |
|        | 318 d  | 90  |       | 09.05 | 08.07                                   |   | 24.0320-0204.1 | 520204 |   |   |  |            |   |  |   |  |
|        | 318 d  | 105 |       | 09.07 | 09.09                                   |   |                |        |   |   |  |            |   |  |   |  |
|        | 318 i  | 95  |       | 01.06 | 08.07                                   |   |                |        |   |   |  |            |   |  |   |  |
|        | 318 i  | 100 |       | 09.07 | 09.09                                   |   |                |        |   |   |  |            |   |  |   |  |
|        | 318 i  | 105 |       | 09.07 | 09.09                                   |   |                |        |   |   |  |            |   |  |   |  |
|        | 320 d  | 120 |       | 09.07 | 09.09                                   | - Behörde 1)                            |                |        |   |   |  |            |   |  |   |  |
|        | 320 d  | 110 |       | 06.05 | 08.07                                   | - Behörde 1)                            |                |        |   |   |  |            |   |  |   |  |
|        | 320 i  | 110 |       | 06.05 | 08.07                                   |   |                |        |   |   |  |            |   |  |   |  |
|        | 320 i  | 125 |       | 09.07 | 09.09                                   |   |                |        |   |   |  |            |   |  |   |  |
|        | 320 xd | 130 |       | 09.07 | 05.12                                   | - Behörde 1)                            |                |        |   |   |  |            |   |  |   |  |
|        | 323 i  | 130 |       | 09.06 | 05.12                                   |   |                |        |   |   |  |            |   |  |   |  |
|        | 325 i  | 155 |       | 01.12 | 05.12                                   | - erhöhte Zuladung 2)                   |                |        |   |   |  |            |   |  |   |  |
|        | 325 i  | 160 |       | 06.05 | 09.09                                   | - erhöhte Zuladung 2)                   |                |        |   |   |  |            |   |  |   |  |
|        | 325 xi | 160 |       | 06.05 | 05.12                                   | - erhöhte Zuladung/ + Motorcode N52N 3) |                |        |   |   |  |            |   |  |   |  |
|        | 316 d  | 85  |       | 09.09 | 05.12                                   |   | 24.0120-0195.1 | 420195 |   |   |  |            |   |  | 300 20,0 18,4 V L +S +B<br>300 20,0 18,4 V L +S +B PD |  |
|        | 316i   | 90  |       | 10.09 | 05.12                                   |   | 24.0320-0195.1 | 520195 |   |   |  |            |   |  |   |  |
|        | 318 d  | 105 |       | 10.09 | 05.12                                   |   |                |        |   |   |  |            |   |  |   |  |
|        | 318 i  | 100 |       | 10.09 | 05.12                                   |   |                |        |   |   |  |            |   |  |   |  |
| 318 i  | 105    |     | 10.09 | 05.12 |   |   |                |        |   |   |  |            |   |  |   |  |
| 320 d  | 120    |     | 10.09 | 05.12 | - Behörde 1)                            |   |                |        |   |   |  |            |   |  |   |  |
| 320 i  | 125    |     | 10.09 | 05.12 |   |   |                |        |   |   |  |            |   |  |   |  |
| 325 i  | 160    |     | 10.09 | 05.12 | - erhöhte Zuladung 2)                   |   |                |        |   |   |  |            |   |  |   |  |
| 320 d  | 120    |     | 09.07 | 05.12 | + Behörde 4)                            | 24.0122-0236.1                          | 422236         |        |   |   |  |            |   |  |   |  |
| 320 d  | 120    |     | 06.05 | 08.07 | + Behörde 4)                            | 24.0322-0236.1                          | 522236         |        |   |   |  |            |   |  |   |  |
| 320 xd | 130    |     | 09.07 | 05.12 | + Behörde 4)                            |   |                |        |   |   |  |            |   |  |   |  |
| 325 d  | 145    |     | 09.06 | 05.12 |   |   |                |        |   |   |  |            |   |  |   |  |
| 325 i  | 155    |     | 01.12 | 05.12 | + erhöhte Zuladung 5)                   |   |                |        |   |   |  |            |   |  |   |  |
| 325 i  | 160    |     | 06.05 | 05.12 | + erhöhte Zuladung 5)                   |   |                |        |   |   |  |            |   |  |   |  |
| 325 xi | 160    |     | 06.05 | 05.12 | + erhöhte Zuladung/ + Motorcode N52N 6) |   |                |        |   |   |  |            |   |  |   |  |
| 325 xi | 160    |     | 06.05 | 05.12 | + Motorcode N52N/N53 7)                 |   |                |        |   |   |  |            |   |  |   |  |
| 330 d  | 170    |     | 06.05 | 05.12 |   |   |                |        |   |   |  |            |   |  |   |  |
| 330 d  | 180    |     | 09.08 | 05.12 |   |   |                |        |   |   |  |            |   |  |   |  |
| 330 i  | 190    |     | 06.05 | 08.07 |   |   |                |        |   |   |  |            |   |  |   |  |
| 330 i  | 200    |     | 09.07 | 05.12 |   |   |                |        |   |   |  |            |   |  |   |  |
| 330 xd | 190    |     | 06.05 | 05.12 |   |   |                |        |   |   |  |            |   |  |   |  |
| 330 xi | 190    |     | 06.05 | 08.07 |   |   |                |        |   |   |  |            |   |  |   |  |
| 330 xi | 200    |     | 09.07 | 05.12 |   |   |                |        |   |   |  |            |   |  |   |  |
| 335 d  | 210    |     | 09.06 | 05.12 |   |   |                |        |   |   |  |            |   |  |   |  |
| 335 i  | 225    |     | 09.06 | 05.12 |   |   |                |        |   |   |  |            |   |  |   |  |
| 335 xi | 225    |     | 03.07 | 05.12 |   |   |                |        |   |   |  |            |   |  |   |  |
|        | 316 d  | 85  |       | 09.09 | 05.12                                   |   | 24.0711-6158.3 | 360192 | 2 |   | Radsensor L=954  |            |   |  |   |  |
|        | 316i   | 90  |       | 09.09 | 05.12                                   |   |                |        |   |   |  |            |   |  |   |  |
|        | 316i   | 90  |       | 09.07 | 08.09                                   |   | 24.0711-5169.3 | 360266 |   |   |  |            |   |  |   |  |
|        | 318 d  | 90  |       | 09.05 | 08.07                                   |   |                |        |   |   |  |            |   |  |   |  |
|        | 318 d  | 105 |       | 09.07 | 05.12                                   |   |                |        |   |   |  |            |   |  |   |  |
|        | 318 i  | 95  |       | 01.06 | 08.07                                   |   |                |        |   |   |  |            |   |  |   |  |
|        | 318 i  | 100 |       | 09.07 | 05.12                                   |   |                |        |   |   |  |            |   |  |   |  |
|        | 318 i  | 105 |       | 09.07 | 05.12                                   |   |                |        |   |   |  |            |   |  |   |  |
|        | 320 d  | 120 |       | 09.07 | 05.12                                   |   |                |        |   |   |  |            |   |  |   |  |
|        | 320 d  | 110 |       | 06.05 | 08.07                                   |   |                |        |   |   |  |            |   |  |   |  |
|        | 320 i  | 110 |       | 06.05 | 08.07                                   |   |                |        |   |   |  |            |   |  |   |  |
|        | 320 i  | 125 |       | 09.07 | 05.12                                   |   |                |        |   |   |  |            |   |  |   |  |
|        | 323 i  | 130 |       | 09.06 | 05.12                                   |   | 24.0711-5191.3 | 360118 |   |   |  |            | 2 |  | Radsensor L=959                                       |  |
| 325 d  | 145    |     | 09.06 | 05.12 |   |   |                |        |   |   |  |            |   |  |   |  |
| 325 i  | 155    |     | 01.12 | 05.12 |   |   |                |        |   |   |  |            |   |  |   |  |
| 325 i  | 160    |     | 06.05 | 05.12 |   |   |                |        |   |   |  |            |   |  |   |  |
| 330 d  | 170    |     | 06.05 | 05.12 |   |   |                |        |   |   |  |            |   |  |   |  |
| 330 d  | 180    |     | 09.08 | 05.12 |   |   |                |        |   |   |  |            |   |  |   |  |
| 330 i  | 190    |     | 06.05 | 08.07 |   |   |                |        |   |   |  |            |   |  |   |  |
| 330 i  | 200    |     | 09.07 | 05.12 |   |   |                |        |   |   |  |            |   |  |   |  |
| 335 d  | 210    |     | 09.06 | 05.12 |   |   |                |        |   |   |  |            |   |  |   |  |
| 335 i  | 225    |     | 09.06 | 05.12 |   |   |                |        |   |   |  |            |   |  |   |  |
| 316 d  | 85     |     | 09.09 | 05.12 | + erhöhte Zuladung 5)                   | 03.0137-0305.2                          | 650305         |        |   | 185 x 20<br>Bremsbacken-Zubehör<br>Bremsbacken-Zubehör<br>Spreizschloß Satz |  |            |   |  |   |  |
| 316i   | 90     |     | 09.07 | 09.09 |   | 03.0137-9062.2                          | 669062         |        |   |   |  |            |   |  |   |  |
| 318 d  | 90     |     | 09.05 | 05.12 |   | 03.0137-9700.2                          | 669700         |        |   |   |  |            |   |  |   |  |
| 318 d  | 105    |     | 09.07 | 09.09 |   | 03.0137-9702.2                          | 669702         |        |   |   |  |            |   |  |   |  |
| 318 i  | 95     |     | 01.06 | 09.09 |   |   |                |        |   |   |  |            |   |  |   |  |
| 318 i  | 100    |     | 09.07 | 09.09 |   |   |                |        |   |   |  |            |   |  |   |  |
| 318 i  | 105    |     | 09.07 | 09.09 |   |   |                |        |   |   |  |            |   |  |   |  |
| 320 d  | 120    |     | 09.07 | 09.09 | - erhöhte Zuladung 2)                   |   |                |        |   |   |  |            |   |  |   |  |
| 320 d  | 120    |     | 09.07 | 05.12 | + erhöhte Zuladung 5)                   |   |                |        |   |   |  |            |   |  |   |  |
| 320 i  | 110    |     | 06.05 | 05.12 |   |   |                |        |   |   |  |            |   |  |   |  |
| 320 i  | 110    |     | 06.05 | 09.09 |   |   |                |        |   |   |  |            |   |  |   |  |
| 320 i  | 125    |     | 09.07 | 09.09 |   |   |                |        |   |   |  |            |   |  |   |  |
| 320 xd | 130    |     | 06.05 | 05.12 |   |   |                |        |   |   |  |            |   |  |   |  |
| 320 xd | 130    |     | 09.07 | 05.12 |   |   |                |        |   |   |  |            |   |  |   |  |
| 323 i  | 130    |     | 09.06 | 05.12 |   |   |                |        |   |   |  |            |   |  |   |  |

1) - authority cars / - enti statali / - véhicule communal / - vehiculos oficiales

2) - increased payload / - carico utile maggiorato / - charge utile augmentée / - incremento de carga

3) - increased payload/+engine co.N52N / - carico utile maggior./+codic.mot.N52N / - charge utile augmentée/+moteur co.N52N / - incremento de carga/+motor co.N52N

4) + authority cars / + enti statali / + véhicule communal / + vehiculos oficiales

5) + increased payload / + carico utile maggiorato / + charge utile augmentée / + incremento de carga

6) + increased payload/+engine co.N52N / + carico utile maggior./+codic.mot.N52N / + charge utile augmentée/+moteur co.N52N / + incremento de carga/+motor co.N52N

7) + engine code N52N/N53 / + codice motore N52N/N53 / + moteur code N52N/N53 / + motor code N52N/N53

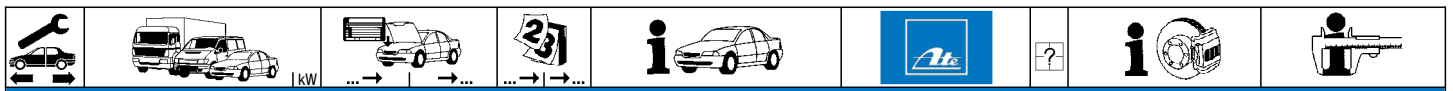

### BMW 3er Reihe/E91 Touring (05-12)

|       |        |     |       |       |                                  |                                  |                |                              |   |   |   |
|-------|--------|-----|-------|-------|----------------------------------|----------------------------------|----------------|------------------------------|---|---|---|
|       | 325 d  | 145 |       | 09.06 | 05.12                            |                                  | 03.0137-0305.2 | 650305                       |   | 185 x 20<br>Bremsbacken-Zubehör<br>Bremsbacken-Zubehör<br>Spreizschloß Satz |   |
|       | 325 i  | 155 |       | 01.12 | 05.12                            |                                  | 03.0137-9062.2 | 669062                       |   |   |   |
|       | 325 i  | 160 |       | 06.05 | 05.12                            |                                  | 03.0137-9700.2 | 669700                       |   |   |   |
|       | 325 xi | 160 |       | 06.05 | 05.12                            |                                  | 03.0137-9702.2 | 669702                       |   |   |   |
|       | 330 d  | 170 |       | 06.05 | 05.12                            |                                  |                |                              |   |   |   |
|       | 330 d  | 180 |       | 09.08 | 05.12                            |                                  |                |                              |   |   |   |
|       | 330 i  | 190 |       | 06.05 | 05.12                            |                                  |                |                              |   |   |   |
|       | 330 i  | 200 |       | 09.07 | 05.12                            |                                  |                |                              |   |   |   |
|       | 330 xd |     |       | 06.05 | 05.12                            |                                  |                |                              |   |   |   |
|       | 330 xi | 190 |       | 06.05 | 05.12                            |                                  |                |                              |   |   |   |
|       | 330 xi | 200 |       | 09.07 | 05.12                            |                                  |                |                              |   |   |   |
|       | 335 d  | 210 |       | 09.06 | 05.12                            |                                  |                |                              |   |   |   |
|       | 335 i  | 225 |       | 09.06 | 05.12                            |                                  |                |                              |   |   |   |
|       | 335 xi | 225 |       | 03.07 | 05.12                            |                                  |                |                              |   |   |   |
|       | 316 d  | 85  |       | 10.09 | 05.12                            | - erhöhte Zuladung <sup>1)</sup> | 03.0137-0379.2 | 650379                       |   |   | 161 x 20<br>Bremsbacken-Zubehör<br>Bremsbacken-Zubehör<br>Spreizschloß Satz |
|       | 316 i  | 90  |       | 10.09 | 05.12                            |                                  | 03.0137-9062.2 | 669062                       |   |   |   |
|       | 318 d  | 105 |       | 10.09 | 05.12                            |                                  | 03.0137-9701.2 | 669701                       |   |   |   |
|       | 318 i  | 95  |       | 10.09 | 05.12                            |                                  | 03.0137-9702.2 | 669702                       |   |   |   |
|       | 318 i  | 100 |       | 10.09 | 05.12                            |                                  |                |                              |   |   |   |
|       | 318 i  | 105 |       | 10.09 | 05.12                            |                                  |                |                              |   |   |   |
| 320 d |        |     | 10.09 | 05.12 | - erhöhte Zuladung <sup>1)</sup> |                                  |                |                              |   |   |   |
| 320 i | 110    |     | 10.09 | 05.12 |                                  |                                  |                |                              |   |   |   |
| 320 i | 125    |     | 10.09 | 05.12 |                                  | 03.0137-0379.2                   | 650379         | - Aktivlenkung <sup>2)</sup> | 161 x 20<br>185 x 20<br>Bremsbacken-Zubehör<br>Bremsbacken-Zubehör<br>Spreizschloß Satz |   |   |
|       |        |     |       |       |                                  | 03.0137-0305.2                   | 650305         | + Aktivlenkung <sup>3)</sup> |   |   |   |
|       |        |     |       |       |                                  | 03.0137-9062.2                   | 669062         | + Aktivlenkung <sup>3)</sup> |   |   |   |
|       |        |     |       |       |                                  | 03.0137-9700.2                   | 669700         | - Aktivlenkung <sup>2)</sup> |   |   |   |
|       |        |     |       |       |                                  | 03.0137-9701.2                   | 669701         |                              |   |   |   |

### BMW 3er Reihe/E92 Coupe (06-13)

|        |       |     |       |       |  |  |                |        |   |   |   |   |     |   |     |   |     |   |   |     |
|--------|-------|-----|-------|-------|--|--|----------------|--------|---|---|---|---|-----|---|-----|---|-----|---|---|-----|
|        | 316 i | 90  |       | 09.07 | 02.10  |  | 13.0460-7216.2 | 607216 |   | 23794 20,3 +/WE<br>23794 20,3 +/WE<br>Warnkontakt L=630mm | ATE   |   |     |   |     |   |     |   |   |     |
|        | 320 i |     |       | 03.07 | 02.10  |  | 13.0470-7216.2 | LD7216 |   |   |   |   |     |   |     |   |     |   |   |     |
|        | 325 d |     |       | 03.07 | 02.10  |  | 24.8190-0264.2 | 620264 | 1   |   |   |   |     |   |     |   |     |   |   |     |
|        | 325 i | 160 |       | 09.06 | 02.10  | + Motorcode N53 <sup>4)</sup>                    |                |        |   |   |   |   |     |   |     |   |     |   |   |     |
|        | 325 i | 160 |       | 09.06 | 08.07  | + Motorcode N52N <sup>5)</sup>                   |                |        |   |   |   |   |     |   |     |   |     |   |   |     |
|        | 330 i |     |       | 09.06 | 02.10  | + Motorcode N52N <sup>5)</sup>                   |                |        |   |   |   |   |     |   |     |   |     |   |   |     |
|        | 316 i | 90  |       | 03.10 | 06.13  |  | 13.0460-7216.2 | 607216 |   |   |   | 23794 20,3 +/WE<br>23794 20,3 +/WE<br>Warnkontakt L=650mm                                       | ATE |   |     |   |     |   |   |     |
|        | 318 i | 105 |       | 03.10 | 06.13  |  | 13.0470-7216.2 | LD7216 |   |   |   |   |     |   |     |   |     |   |   |     |
|        | 320 i |     |       | 03.10 | 06.13  |  | 24.8190-0284.2 | 620284 | 1   |   |   |   |     |   |     |   |     |   |   |     |
|        | 325 d |     |       | 03.10 | 06.13  |  |                |        |   |   |   |   |     |   |     |   |     |   |   |     |
|        | 325 i | 160 |       | 03.10 | 06.13  | + Motorcode N53 <sup>4)</sup>                    |                |        |   |   |   |   |     |   |     |   |     |   |   |     |
|        | 330 i |     |       | 03.10 | 06.13  | + Motorcode N52N <sup>5)</sup>                   |                |        |   |   |   |   |     |   |     |   |     |   |   |     |
|        | 330 d |     |       | 09.09 | 02.10  | - erhöhte Zuladung <sup>1)</sup>                 | 13.0460-7216.2 | 607216 |   |   |   |   |     | 23794 20,3 +/WE<br>23794 20,3 +/WE<br>Warnkontakt L=679mm | ATE |   |     |   |   |     |
|        | 330 i |     |       | 09.09 | 02.10  | - erhöhte Zuladung/+ Motorcode N53 <sup>6)</sup> | 13.0470-7216.2 | LD7216 |   |   |   |   |     |   |     |   |     |   |   |     |
|        |       |     |       |       |  |  | 24.8190-0267.2 | 620267 | 1   |   |   |   |     |   |     |   |     |   |   |     |
|        | 330 d |     |       | 03.10 | 06.13  | - erhöhte Zuladung <sup>1)</sup>                 | 13.0460-7216.2 | 607216 |   |   |   |   |     |   |     | 23794 20,3 +/WE<br>23794 20,3 +/WE<br>Warnkontakt L=723mm | ATE |   |   |     |
|        | 330 i |     |       | 03.10 | 06.13  | - erhöhte Zuladung/+ Motorcode N53 <sup>6)</sup> | 13.0470-7216.2 | LD7216 |   |   |   |   |     |   |     |   |     |   |   |     |
|        |       |     |       |       |  |  | 24.8190-0287.2 | 620287 | 1   |   |   |   |     |   |     |   |     |   |   |     |
|        | 320 d |     |       | 03.07 | 02.10  |  | 13.0460-7238.2 | 607238 |   |   |   |   |     |   |     |   |     | 23313 20,3 +/WE<br>23313 20,3 +/WE<br>Warnkontakt L=679mm | ATE   |     |
|        | 323 i |     |       | 09.07 | 02.10  |  | 13.0470-7238.2 | LD7238 |   |   |   |   |     |   |     |   |     |   |   |     |
| 325 i  | 160   |     | 09.07 | 02.10 | + Motorcode N52N <sup>5)</sup>                   | 24.8190-0267.2                                   | 620267         | 1      |   |   |   |   |     |   |     |   |     |   |   |     |
| 320 d  |       |     | 03.10 | 06.13 |  | 13.0460-7238.2                                   | 607238         |        | 24161 20,3 +/WE<br>24161 20,3 +/WE<br>23313 20,3 +/WE<br>23313 20,3 +/WE<br>Warnkontakt L=679mm | ATE   |   |   |     |   |     |   |     |   |   |     |
| 323 i  |       |     | 03.10 | 06.13 |  | 13.0470-7238.2                                   | LD7238         |        |   |   |   |   |     |   |     |   |     |   |   |     |
| 325 i  | 160   |     | 03.10 | 06.13 | + Motorcode N52N <sup>5)</sup>                   | 24.8190-0287.2                                   | 620287         | 1      |   |   |   |   |     |   |     |   |     |   |   |     |
| 330 d  |       |     | 09.09 | 02.10 | + erhöhte Zuladung <sup>7)</sup>                 | 13.0460-7237.2                                   | 607237         |        |   |   | 24161 20,3 +/WE<br>24161 20,3 +/WE<br>23313 20,3 +/WE<br>23313 20,3 +/WE<br>Warnkontakt L=679mm |   |     |   |     |   |     |   |   | ATE |
| 330 d  |       |     | 09.06 | 08.09 |  | 13.0470-7237.2                                   | LD7237         |        |   |   |   |   |     |   |     |   |     |   |   |     |
| 330 i  |       |     | 09.09 | 02.10 | + erhöhte Zuladung/+ Motorcode N53 <sup>8)</sup> | 13.0460-7238.2                                   | 607238         |        |   |   |   |   |     |   |     |   |     |   |   |     |
| 330 i  |       |     | 09.06 | 08.09 | + Motorcode N53 <sup>4)</sup>                    | 13.0470-7238.2                                   | LD7238         |        |   |   |   |   |     |   |     |   |     |   |   |     |
| 335 d  | 210   |     | 09.06 | 02.10 |  | 24.8190-0267.2                                   | 620267         | 1      |   |   |   |   |     |   |     |   |     |   |   |     |
| 335 i  | 225   |     | 09.06 | 02.10 |  |  |                |        |   |   |   |   |     |   |     |   |     |   |   |     |
| 330 d  |       |     | 03.10 | 06.13 | + erhöhte Zuladung <sup>7)</sup>                 | 13.0460-7237.2                                   | 607237         |        |   |   |   | 24161 20,3 +/WE<br>24161 20,3 +/WE<br>23313 20,3 +/WE<br>23313 20,3 +/WE<br>Warnkontakt L=723mm | ATE |   |     |   |     |   |   |     |
| 330 i  |       |     | 03.10 | 06.13 | + erhöhte Zuladung/+ Motorcode N53 <sup>8)</sup> | 13.0470-7237.2                                   | LD7237         |        |   |   |   |   |     |   |     |   |     |   |   |     |
| 335 d  | 210   |     | 03.10 | 06.13 |  | 13.0460-7238.2                                   | 607238         |        |   |   |   |   |     |   |     |   |     |   |   |     |
| 335 i  | 225   |     | 03.10 | 06.13 |  | 13.0470-7238.2                                   | LD7238         |        |   |   |   |   |     |   |     |   |     |   |   |     |
|        |       |     |       |       |  | 24.8190-0287.2                                   | 620287         | 1      |   |   |   |   |     |   |     |   |     |   |   |     |
| 325 xi | 160   |     | 09.06 | 08.07 |  | 13.0460-7216.2                                   | 607216         |        |   |   |   |   |     | 23794 20,3 +/WE<br>23794 20,3 +/WE<br>Warnkontakt L=840mm | ATE |   |     |   |   |     |
| 330 xd |       |     | 09.09 | 02.10 | - erhöhte Zuladung <sup>1)</sup>                 | 13.0470-7216.2                                   | LD7216         |        |   |   |   |   |     |   |     |   |     |   |   |     |
| 330 xi |       |     | 09.06 | 02.10 |  | 24.8190-0266.2                                   | 620266         | 1      |   |   |   |   |     |   |     |   |     |   |   |     |
| 330 xd |       |     | 03.10 | 06.13 | - erhöhte Zuladung <sup>1)</sup>                 | 13.0460-7216.2                                   | 607216         |        |   |   |   |   |     |   |     | 23794 20,3 +/WE<br>23794 20,3 +/WE<br>Warnkontakt L=867mm | ATE |   |   |     |
| 330 xi |       |     | 03.10 | 06.13 |  | 13.0470-7216.2                                   | LD7216         |        |   |   |   |   |     |   |     |   |     |   |   |     |
|        |       |     |       |       |  | 24.8190-0286.2                                   | 620286         | 1      |   |   |   |   |     |   |     |   |     |   |   |     |
| 320 xd |       |     | 03.07 | 02.10 |  | 13.0460-7238.2                                   | 607238         |        | 23313 20,3 +/WE<br>23313 20,3 +/WE<br>Warnkontakt L=840mm                                       | ATE   |   |   |     |   |     |   |     |   |   |     |
| 325 xi | 160   |     | 09.07 | 02.10 |  | 13.0470-7238.2                                   | LD7238         |        |   |   |   |   |     |   |     |   |     |   |   |     |
|        |       |     |       |       |  | 24.8190-0266.2                                   | 620266         | 1      |   |   |   |   |     |   |     |   |     |   |   |     |
| 320 xd |       |     | 03.10 | 06.13 |  | 13.0460-7238.2                                   | 607238         |        |   |   | 23313 20,3 +/WE<br>23313 20,3 +/WE<br>Warnkontakt L=867mm                                       |   |     |   |     |   |     | ATE   |   |     |
| 325 xi | 160   |     | 03.10 | 06.13 |  | 13.0470-7238.2                                   | LD7238         |        |   |   |   |   |     |   |     |   |     |   |   |     |
|        |       |     |       |       |  | 24.8190-0286.2                                   | 620286         | 1      |   |   |   |   |     |   |     |   |     |   |   |     |
| 330 xd |       |     | 09.09 | 02.10 | + erhöhte Zuladung <sup>7)</sup>                 | 13.0460-7237.2                                   | 607237         |        |   |   |   |   |     |   |     |   |     |   | 24161 20,3 +/WE<br>24161 20,3 +/WE<br>23313 20,3 +/WE<br>23313 20,3 +/WE<br>Warnkontakt L=840mm | ATE |
| 330 xd |       |     | 09.06 | 08.09 |  | 13.0470-7237.2                                   | LD7237         |        |   |   |   |   |     |   |     |   |     |   |   |     |
| 335 xi | 225   |     | 09.07 | 02.10 |  | 13.0460-7238.2                                   | 607238         |        |   |   |   |   |     |   |     |   |     |   |   |     |
|        |       |     |       |       |  | 13.0470-7238.2                                   | LD7238         |        |   |   |   |   |     |   |     |   |     |   |   |     |
|        |       |     |       |       |  | 24.8190-0266.2                                   | 620266         | 1      |   |   |   |   |     |   |     |   |     |   |   |     |

<sup>1)</sup> - increased payload / - carico utile maggiorato / - charge utile augmentée / - incremento de carga  
<sup>2)</sup> - active steering / - sterzo attivo / - direction active / - dirección activa  
<sup>3)</sup> + active steering / + sterzo attivo / + direction active / + dirección activa  
<sup>4)</sup> + engine code N53 / + codice motore N53 / + moteur code N53 / + motor code N53  
<sup>5)</sup> + engine code N52N / + codice motore N52N / + moteur code N52N / + motor code N52N  
<sup>6)</sup> - increased payload/+engine co.N53 / - carico utile maggior./+codic.mot.N53 / - charge utile augmentée/+ moteur co.N53 / - incremento de carga/+motor co.N53  
<sup>7)</sup> + increased payload / + carico utile maggiorato / + charge utile augmentée / + incremento de carga  
<sup>8)</sup> + increased payload/+engine co.N53 / + carico utile maggior./+codic.mot.N53 / + charge utile augmentée/+moteur co.N53 / + incremento de carga/+motor co.N53



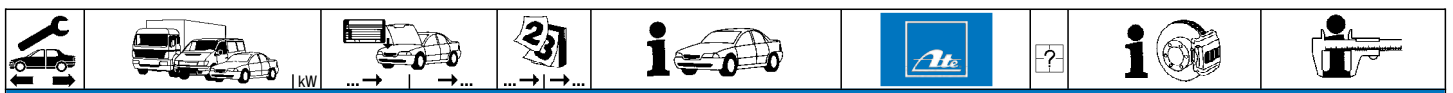

















**BMW 3er Reihe/E92 Coupe (06-13)**

|  |        |     |       |       |  |                |        |   |  |   |                          |
|--|--------|-----|-------|-------|--|----------------|--------|---|--|---|--------------------------|
|  | 330 xd | 225 | 03.10 | 06.13 | + erhöhte Zuladung <sup>1)</sup>                 | 13.0460-7237.2 | 607237 | 1 |  | 24161 20,3 +/WE<br>24161 20,3 +/WE<br>23313 20,3 +/WE<br>23313 20,3 +/WE<br>Warnkontakt L=867mm | ATE<br>ATE<br>ATE<br>ATE |
|  | 335 xi |     |       |       |  | 13.0470-7237.2 | LD7237 |   |  |   |                          |
|  | M3     |     | 03.07 | 06.13 |  | 13.0460-7167.2 | 607167 |   |  | 23312 20,3 +/WE<br>Warnkontakt L=659mm<br>Warnkontakt L=672mm                                   | ATE                      |
|  | 316 i  | 90  | 09.07 | 06.13 |  | 13.0460-4848.2 | 604848 | 1 | + Performance Pack<br>+ Performance Pack   | 24316 16,9 /WE<br>Warnkontakt L=679mm   | BRE                      |
|  | 318 i  | 105 | 03.10 | 06.13 |  | 24.8190-0267.2 | 620267 |   |  |   |                          |
|  | 320 d  |     | 03.07 | 06.13 |  |                |        |   |  |   |                          |
|  | 320 i  |     | 03.07 | 06.13 |  |                |        |   |  |   |                          |
|  | 320 xd |     | 03.07 | 06.13 |  |                |        |   |  |   |                          |
|  | 323 i  |     | 09.06 | 06.13 |  |                |        |   |  |   |                          |
|  | 325 d  |     | 03.07 | 06.13 |  |                |        |   |  |   |                          |
|  | 325 i  | 160 | 09.06 | 06.13 |  |                |        |   |  |   |                          |
|  | 325 xi | 160 | 09.06 | 06.13 |  |                |        |   |  |   |                          |
|  | 330 d  |     | 09.06 | 06.13 |  |                |        |   |  |   |                          |
|  | 330 i  |     | 09.06 | 06.13 |  |                |        |   |  |   |                          |
|  | 330 xd |     | 09.06 | 06.13 |  |                |        |   |  |   |                          |
|  | 330 xi |     | 09.06 | 06.13 |  |                |        |   |  |   |                          |
|  | 316 i  | 90  | 09.07 | 06.13 |  | 24.0124-0197.1 | 424197 |   |  | 300 24,0 22,4 V L +S +B<br>300 24,0 21,6 V L +S +B PD   |                          |
|  | 318 i  | 105 | 03.10 | 06.13 |  | 24.0324-0197.1 | 524197 |   |  |   |                          |
|  | 320 i  |     | 03.07 | 06.13 |  |                |        |   |  |   |                          |
|  | 323 i  |     | 09.06 | 08.07 |  |                |        |   |  |   |                          |
|  | 320 d  |     | 03.07 | 06.13 |  | 24.0124-0203.1 | 424203 |   |  | 312 23,9 22,4 V L +S +B<br>312 23,9 22,4 V L +S +B PD   |                          |
|  | 320 xd |     | 03.07 | 06.13 |  | 24.0324-0203.1 | 524203 |   |  |   |                          |
|  | 323 i  |     | 09.07 | 06.13 |  |                |        |   |  |   |                          |
|  | 325 i  | 160 | 09.07 | 06.13 | + Motorcode N52N <sup>2)</sup>                   |                |        |   |  |   |                          |
|  | 325 i  | 160 | 09.07 | 06.13 | + Motorcode N52N <sup>2)</sup>                   |                |        |   |  |   |                          |
|  | 325 d  |     | 03.07 | 06.13 |  | 24.0124-0200.1 | 424200 |   |  | 330 24,0 22,4 V L +S +B<br>330 24,0 21,6 V L +S +B PD   |                          |
|  | 325 i  | 160 | 09.06 | 08.07 | + Motorcode N52N <sup>2)</sup>                   | 24.0324-0200.1 | 524200 |   |  |   |                          |
|  | 325 i  | 160 | 09.06 | 06.13 | + Motorcode N53 <sup>3)</sup>                    |                |        |   |  |   |                          |
|  | 325 xi | 160 | 09.06 | 08.07 | + Motorcode N52N <sup>2)</sup>                   |                |        |   |  |   |                          |
|  | 325 xi | 160 | 09.06 | 06.13 | + Motorcode N53 <sup>3)</sup>                    |                |        |   |  |   |                          |
|  | 330 d  |     | 09.09 | 06.13 | - erhöhte Zuladung <sup>4)</sup>                 |                |        |   |  |   |                          |
|  | 330 i  |     | 09.09 | 06.13 | - erhöhte Zuladung/+ Motorcode N53 <sup>5)</sup> |                |        |   |  |   |                          |
|  | 330 i  |     | 09.06 | 06.13 | + Motorcode N52N <sup>2)</sup>                   |                |        |   |  |   |                          |
|  | 330 xd |     | 09.09 | 06.13 | - erhöhte Zuladung <sup>4)</sup>                 |                |        |   |  |   |                          |
|  | 330 xi |     | 09.06 | 06.13 |  |                |        |   |  |   |                          |
|  | 330 d  |     | 09.09 | 06.13 | + erhöhte Zuladung <sup>1)</sup>                 | 24.0130-0192.1 | 430192 |   |  | 348 30,0 28,4 V L +S +B   |                          |
|  | 330 d  |     | 09.06 | 08.09 |  |                |        |   |  |   |                          |
|  | 330 i  |     | 09.09 | 06.13 | + erhöhte Zuladung/+ Motorcode N53 <sup>6)</sup> |                |        |   |  |   |                          |
|  | 330 i  |     | 09.06 | 08.09 | + Motorcode N53 <sup>3)</sup>                    |                |        |   |  |   |                          |
|  | 330 xd |     | 09.09 | 06.13 | + erhöhte Zuladung <sup>1)</sup>                 |                |        |   |  |   |                          |
|  | 330 xd |     | 09.06 | 08.09 |  |                |        |   |  |   |                          |
|  | 335 d  | 210 | 09.06 | 06.13 |  |                |        |   |  |   |                          |
|  | 335 i  | 225 | 09.06 | 06.13 |  |                |        |   |  |   |                          |
|  | 335 xi | 225 | 09.07 | 06.13 |  |                |        |   |  |   |                          |
|  | M3     |     | 03.07 | 06.13 |  | 24.0130-0214.2 | 430214 |   | zweiteilige Bremsscheibe <sup>7)</sup><br>zweiteilige Bremsscheibe <sup>7)</sup> | 360 30,0 28,4 V L +S +B<br>360 30,0 28,4 V L +S +B  |                          |
|  |        |     |       |       |  | 24.0130-0213.2 | 430213 |   |  |   |                          |
|  | 316 i  | 90  | 09.07 | 06.13 |  | 24.0711-6198.3 | 360199 | 2 |  | Radsensor L=660   |                          |
|  | 318 i  | 105 | 03.10 | 06.13 |  |                |        |   |  |   |                          |
|  | 320 d  |     | 03.07 | 06.13 |  |                |        |   |  |   |                          |
|  | 320 i  |     | 03.07 | 06.13 |  |                |        |   |  |   |                          |
|  | 323 i  |     | 09.06 | 06.13 |  | 24.0711-6197.3 | 360141 | 2 |  | Radsensor L=660   |                          |
|  | 325 d  |     | 03.07 | 06.13 |  |                |        |   |  |   |                          |
|  | 325 i  | 160 | 09.06 | 06.13 |  |                |        |   |  |   |                          |
|  | 330 d  |     | 09.06 | 06.13 |  |                |        |   |  |   |                          |
|  | 330 i  |     | 09.06 | 06.13 |  |                |        |   |  |   |                          |
|  | 335 d  | 210 | 09.06 | 06.13 |  |                |        |   |  |   |                          |
|  | 335 i  | 225 | 09.06 | 06.13 |  |                |        |   |  |   |                          |
|  | M3     |     | 03.07 | 06.13 |  | 24.0711-6209.3 | 360352 | 2 |  | Radsensor L=700   |                          |
|  | 316 i  | 90  | 09.07 | 02.10 |  | 13.0460-2713.2 | 602713 | 1 |  | 23623 17,4 +/WE/Zub/STRW<br>23623 17,4 +/WE/Zub/STRW<br>Warnkontakt L=1086mm                    |                          |
|  |        |     |       |       |  | 13.0470-2713.2 | LD2713 |   |  |   |                          |
|  | 316 i  | 90  | 03.10 | 06.13 |  | 24.8190-0265.2 | 620265 |   |  |   |                          |
|  | 316 i  | 90  | 03.10 | 06.13 |  | 13.0460-2713.2 | 602713 | 1 |  | 23623 17,4 +/WE/Zub/STRW<br>23623 17,4 +/WE/Zub/STRW<br>Warnkontakt L=1107mm                    |                          |
|  |        |     |       |       |  | 13.0470-2713.2 | LD2713 |   |  |   |                          |
|  |        |     |       |       |  | 24.8190-0285.2 | 620285 |   |  |   |                          |
|  | 320 d  |     | 03.07 | 02.10 |  | 13.0460-7217.2 | 607217 | 1 |  | 23926 17,3 +/WE<br>23926 17,3 +/WE<br>Warnkontakt L=1086mm                                      | ATE<br>ATE               |
|  | 320 i  |     | 03.07 | 02.10 |  | 13.0470-7217.2 | LD7217 |   |  |   |                          |
|  | 320 xd |     | 03.07 | 02.10 |  | 24.8190-0265.2 | 620265 |   |  |   |                          |
|  | 323 i  |     | 09.06 | 02.10 |  |                |        |   |  |   |                          |
|  | 325 i  | 160 | 09.06 | 02.10 |  |                |        |   |  |   |                          |
|  | 325 xi | 160 | 09.06 | 02.10 |  |                |        |   |  |   |                          |
|  | 318 i  | 105 | 03.10 | 06.13 |  | 13.0460-7217.2 | 607217 | 1 |  | 23926 17,3 +/WE<br>23926 17,3 +/WE<br>Warnkontakt L=1107mm                                      | ATE<br>ATE               |
|  | 320 d  |     | 03.10 | 06.13 |  | 13.0470-7217.2 | LD7217 |   |  |   |                          |
|  | 320 i  |     | 03.10 | 06.13 |  | 24.8190-0285.2 | 620285 |   |  |   |                          |
|  | 320 xd |     | 03.10 | 06.13 |  |                |        |   |  |   |                          |
|  | 323 i  |     | 03.10 | 06.13 |  |                |        |   |  |   |                          |
|  | 325 i  | 160 | 03.10 | 06.13 |  |                |        |   |  |   |                          |
|  | 325 xi | 160 | 03.10 | 06.13 |  |                |        |   |  |   |                          |
|  | 325 d  |     | 03.07 | 02.10 |  | 13.0460-7225.2 | 607225 | 1 |  | 23550 17,3 +/WE<br>23550 17,3 +/WE<br>Warnkontakt L=1086mm                                      | ATE<br>ATE               |
|  | 330 d  |     | 09.06 | 02.10 |  | 13.0470-7225.2 | LD7225 |   |  |   |                          |
|  | 330 i  |     | 09.06 | 02.10 |  | 24.8190-0265.2 | 620265 |   |  |   |                          |

<sup>1)</sup> + increased payload / + carico utile maggiorato / + charge utile augmentée / + incremento de carga  
<sup>2)</sup> + engine code N52N / + codice motore N52N / + moteur code N52N / + motor code N52N  
<sup>3)</sup> + engine code N53 / + codice motore N53 / + moteur code N53 / + motor code N53  
<sup>4)</sup> - increased payload / - carico utile maggiorato / - charge utile augmentée / - incremento de carga  
<sup>5)</sup> - increased payload/+engine co.N53 / - carico utile maggior./+codic.mot.N53 / - charge utile augmentée/+ moteur co.N53 / - incremento de carga/+motor co.N53  
<sup>6)</sup> + increased payload/+engine co.N53 / + carico utile maggior./+codic.mot.N53 / + charge utile augmentée/+moteur co.N53 / + incremento de carga/+motor co.N53  
<sup>7)</sup> two-piece brake disc / disco frenante in due parti / disque d.fr.en deux parties / disco de fr.de dos piezas



|     |    |  |  |  |  |  |    |     |                 |
|--|--|--|--|--|---|--|--|---|-----------------|
| <b>BMW 3er Reihe/E92 Coupe (06-13)</b>   |  |  |  |  |   |  |  |   |                 |
|    | 330 xd   |  | 09.06  | 02.10  | 13.0460-7225.2  | 607225   |  | 23550 17,3 +/WE   | ATE             |
|  | 330 xi   |  | 09.06  | 02.10  | 13.0470-7225.2  | LD7225   |  | 23550 17,3 +/WE   | ATE             |
|  | 335 d  | 210  | 09.06  | 02.10  | 24.8190-0265.2  | 620265   | 1  | Warnkontakt L=1086mm  |                 |
|  | 335 i  | 225  | 09.06  | 02.10  |   |  |  |   |                 |
|  | 335 xi   | 225  | 09.07  | 02.10  |   |  |  |   |                 |
|  | 325 d  |  | 03.10  | 06.13  | 13.0460-7225.2  | 607225   |  | 23550 17,3 +/WE   | ATE             |
|  | 330 d  |  | 03.10  | 06.13  | 13.0470-7225.2  | LD7225   |  | 23550 17,3 +/WE   | ATE             |
|  | 330 i  |  | 03.10  | 06.13  | 24.8190-0285.2  | 620285   | 1  | Warnkontakt L=1107mm  |                 |
|  | 330 xd   |  | 03.10  | 06.13  |   |  |  |   |                 |
|  | 330 xi   |  | 03.10  | 06.13  |   |  |  |   |                 |
| 335 d  | 210  | 03.10  | 06.13  |  |   |  |  |   |                 |
| 335 i  | 225  | 03.10  | 06.13  |  |   |  |  |   |                 |
| 335 xi   | 225  | 03.10  | 06.13  |  |   |  |  |   |                 |
| M3   |  | 03.07  | 02.10  | 13.0460-7169.2   | 607169  |  | 23309 17,3 +/WE  | ATE   |                 |
|  |  |  |  | 13.0470-7169.2   | LD7169  |  | 23309 17,3 +/WE  | ATE   |                 |
|  |  |  |  | 24.8190-0265.2   | 620265  | 1  | Warnkontakt L=1086mm   |   |                 |
| M3   |  | 03.10  | 06.13  | 13.0460-7169.2   | 607169  |  | 23309 17,3 +/WE  | ATE   |                 |
|  |  |  |  | 13.0470-7169.2   | LD7169  |  | 23309 17,3 +/WE  | ATE   |                 |
|  |  |  |  | 24.8190-0285.2   | 620285  | 1  | Warnkontakt L=1107mm   |   |                 |
|    | 316 i  | 90   | 09.07  | 06.13  | 24.0110-0315.1  | 410315   |  | 296 10,4 8,9 L +S +B  |                 |
|  |  |  |  |  | 24.0310-0315.1  | 510315   |  | 296 10,4 8,9 L +S +B PD   |                 |
|  | 318 i  | 105  | 03.10  | 06.13  | 24.0120-0195.1  | 420195   |  | 300 20,0 18,4 V L +S +B   |                 |
|  | 320 d  |  | 03.07  | 06.13  | 24.0320-0195.1  | 520195   |  | 300 20,0 18,4 V L +S +B PD  |                 |
|  | 320 i  |  | 03.07  | 06.13  |   |  |  |   |                 |
|  | 323 i  |  | 09.06  | 06.13  |   |  |  |   |                 |
|  | 325 i  | 160  | 09.06  | 06.13  |   |  |  |   |                 |
|  | 320 xd   |  | 03.07  | 06.13  | 24.0120-0204.1  | 420204   |  | 300 20,0 18,4 V L +S +B   |                 |
|  | 325 xi   | 160  | 09.06  | 06.13  | 24.0320-0204.1  | 520204   |  | 300 20,0 18,4 V L +S +B PD  |                 |
|  | 325 d  |  | 03.07  | 06.13  | 24.0122-0236.1  | 422236   |  | 336 22,0 20,4 V L +S +B   |                 |
|  | 330 d  |  | 09.06  | 06.13  | 24.0322-0236.1  | 522236   |  | 336 22,0 20,4 V L +S +B PD  |                 |
|  | 330 i  |  | 09.06  | 06.13  |   |  |  |   |                 |
|  | 330 xd   |  | 09.06  | 06.13  |   |  |  |   |                 |
|  | 330 xi   |  | 09.06  | 06.13  |   |  |  |   |                 |
|  | 335 d  | 210  | 09.06  | 06.13  |   |  |  |   |                 |
| 335 i  | 225  | 09.06  | 06.13  |  |   |  |  |   |                 |
| 335 xi   | 225  | 09.07  | 06.13  |  |   |  |  |   |                 |
| M3   |  | 03.07  | 06.13  | 24.0124-0231.2   | 424231  |  | 350 24,0 22,4 V L +S +B  |   |                 |
|  |  |  |  | 24.0124-0232.2   | 424232  |  | 350 24,0 22,4 V L +S +B  |   |                 |
|   | 316 i  | 90   | 09.07  | 06.13  | 24.0711-6158.3  | 360192   | 2  |   | Radsensor L=954 |
|  | 318 i  | 105  | 03.10  | 06.13  |   |  |  |   |                 |
|  | 320 d  |  | 03.07  | 06.13  | - Aktivlenkung <sup>2)</sup>  |  |  |   |                 |
|  | 320 i  |  | 03.07  | 06.13  | - Aktivlenkung <sup>2)</sup>  |  |  |   |                 |
|  | 320 d  |  | 03.07  | 06.13  | + Aktivlenkung <sup>3)</sup>  | 24.0711-6418.3   | 360407   | 2  | Radsensor L=954 |
|  | 323 i  |  | 09.06  | 06.13  |   |  |  |   |                 |
|  | 325 i  | 160  | 09.06  | 06.13  |   |  |  |   |                 |
|  | 320 i  |  | 03.07  | 06.13  | + Aktivlenkung <sup>3)</sup>  | 24.0711-5191.3   | 360118   | 2  | Radsensor L=959 |
|  | 325 d  |  | 03.07  | 06.13  |   |  |  |   |                 |
|  | 330 d  |  | 09.06  | 06.13  |   |  |  |   |                 |
|  | 330 i  |  | 09.06  | 06.13  |   |  |  |   |                 |
|  | 335 d  | 210  | 09.06  | 06.13  |   |  |  |   |                 |
|  | 335 i  | 225  | 09.06  | 06.13  |   |  |  |   |                 |
|  | M3   |  | 03.07  | 06.13  |   |  |  |   |                 |
|  |  | 316 i  | 90   | 09.07  | 06.13   | 03.0137-0379.2   | 650379   |   | 161 x 20        |
| 318 i  |  | 105  | 03.10  | 06.13  | 03.0137-9265.2  | 669265   |  | Bremsbacken-Zubehör   |                 |
| 320 d  |  |  | 03.07  | 06.13  | 03.0137-9701.2  | 669701   |  | Bremsbacken-Zubehör   |                 |
| 320 i  |  |  | 03.07  | 06.13  | 03.0137-9702.2  | 669702   |  | Spreizschloß Satz   |                 |
| 323 i  |  |  | 09.06  | 06.13  |   |  |  |   |                 |
| 325 i  |  | 160  | 09.06  | 06.13  |   |  |  |   |                 |
| 320 xd   |  |  | 03.07  | 06.13  | 03.0137-0305.2  | 650305   |  | 185 x 20  |                 |
| 325 d  |  |  | 03.07  | 06.13  | 03.0137-9062.2  | 669062   |  | Bremsbacken-Zubehör   |                 |
| 325 xi   |  | 160  | 09.06  | 06.13  | 03.0137-9700.2  | 669700   |  | Bremsbacken-Zubehör   |                 |
| 330 d  |  |  | 09.06  | 06.13  | 03.0137-9702.2  | 669702   |  | Spreizschloß Satz   |                 |
| 330 i  |  |  | 09.06  | 06.13  |   |  |  |   |                 |
| 330 xd   |  |  | 09.06  | 06.13  |   |  |  |   |                 |
| 330 xi   |  |  | 09.06  | 06.13  |   |  |  |   |                 |
| 335 d  |  | 210  | 09.06  | 06.13  |   |  |  |   |                 |
| 335 i  |  | 225  | 09.06  | 06.13  |   |  |  |   |                 |
| 335 xi   | 225  | 09.07  | 06.13  |  |   |  |  |   |                 |
| M3   |  | 03.07  | 06.13  |  |   |  |  |   |                 |
| <b>BMW 3er Reihe/E93 Cabrio (07-13)</b>  |  |  |  |  |   |  |  |   |                 |
|  | 320 d  | 120  | 01.08  | 02.10  | 13.0460-7238.2  | 607238   |  | 23313 20,3 +/WE   | ATE             |
|  | 320 d  | 130  | 03.08  | 02.10  | 13.0470-7238.2  | LD7238   |  | 23313 20,3 +/WE   | ATE             |
|  | 320 d  | 135  | 01.10  | 02.10  | 24.8190-0267.2  | 620267   | 1  | Warnkontakt L=679mm   |                 |
|  | 320 i  |  | 03.07  | 02.08  |   |  |  |   |                 |
|  | 323 i  | 130  | 03.07  | 02.10  |   |  |  |   |                 |
|  | 325 i  | 160  | 03.07  | 02.10  | + Motorcode N52N <sup>4)</sup>  |  |  |   |                 |
|  | 320 d  | 120  | 03.10  | 11.13  | 13.0460-7238.2  | 607238   |  | 23313 20,3 +/WE   | ATE             |
|  | 320 d  | 130  | 03.10  | 11.13  | 13.0470-7238.2  | LD7238   |  | 23313 20,3 +/WE   | ATE             |
|  | 320 d  | 135  | 03.10  | 11.13  | 24.8190-0287.2  | 620287   | 1  | Warnkontakt L=723mm   |                 |
|  | 323 i  | 130  | 03.10  | 11.13  |   |  |  |   |                 |
|  | 325 i  | 160  | 03.10  | 11.13  | + Motorcode N52N <sup>4)</sup>  |  |  |   |                 |
|  | 320 i  |  | 03.08  | 02.10  | 13.0460-7216.2  | 607216   |  | 23794 20,3 +/WE   | ATE             |
|  | 325 d  | 145  | 09.07  | 02.10  | 13.0470-7216.2  | LD7216   |  | 23794 20,3 +/WE   | ATE             |
|  | 325 i  | 160  | 03.07  | 02.10  | 24.8190-0264.2  | 620264   | 1  | Warnkontakt L=630mm   |                 |
|  |  |  |  |  | + Motorcode N53 <sup>5)</sup>   |  |  |   |                 |

<sup>1)</sup> two-piece brake disc / disco frenante in due parti / disque d.fr.en deux parties / disco de fr.de dos piezas

<sup>2)</sup> - active steering / - sterzo attivo / - direction active / - dirección activa

<sup>3)</sup> + active steering / + sterzo attivo / + direction active / + dirección activa

<sup>4)</sup> + engine code N52N / + codice motore N52N / + moteur code N52N / + motor code N52N

<sup>5)</sup> + engine code N53 / + codice motore N53 / + moteur code N53 / + motor code N53



**BMW 3er Reihe/E93 Cabrio (07-13)**

|  |       |     |  |       |       |  |                |        |   |                             |                            |     |
|--|-------|-----|--|-------|-------|--|----------------|--------|---|-----------------------------|----------------------------|-----|
|  | 330 i | 200 |  | 03.07 | 02.10 | + Motorcode N52N 1)                    | 13.0460-7216.2 | 607216 |   |                             | 23794 20,3 +/WE            | ATE |
|  |       |     |  |       |       |  | 13.0470-7216.2 | LD7216 |   |                             | 23794 20,3 +/WE            | ATE |
|  |       |     |  |       |       |  | 24.8190-0264.2 | 620264 | 1 |                             | Warnkontakt L=630mm        |     |
|  | 318 i | 105 |  | 03.10 | 11.13 |  | 13.0460-7216.2 | 607216 |   |                             | 23794 20,3 +/WE            | ATE |
|  | 320 i |     |  | 03.10 | 11.13 |  | 13.0470-7216.2 | LD7216 |   |                             | 23794 20,3 +/WE            | ATE |
|  | 325 d | 145 |  | 03.10 | 11.13 |  | 24.8190-0284.2 | 620284 | 1 |                             | Warnkontakt L=650mm        |     |
|  | 325 d | 150 |  | 03.10 | 11.13 |  |                |        |   |                             |                            |     |
|  | 325 i | 160 |  | 03.10 | 11.13 | + Motorcode N53 2)                     |                |        |   |                             |                            |     |
|  | 330 i | 200 |  | 03.10 | 11.13 | + Motorcode N52N 1)                    |                |        |   |                             |                            |     |
|  | 330 d | 170 |  | 09.09 | 02.10 | - erhöhte Zuladung 3)                  | 13.0460-7216.2 | 607216 |   |                             | 23794 20,3 +/WE            | ATE |
|  | 330 d | 180 |  | 09.09 | 02.10 |  | 13.0470-7216.2 | LD7216 |   |                             | 23794 20,3 +/WE            | ATE |
|  | 330 i | 200 |  | 09.09 | 02.10 | - erhöhte Zuladung 3)                  | 24.8190-0267.2 | 620267 | 1 |                             | Warnkontakt L=679mm        |     |
|  | 330 d | 170 |  | 03.10 | 11.13 | - erhöhte Zuladung 3)                  | 13.0460-7216.2 | 607216 |   |                             | 23794 20,3 +/WE            | ATE |
|  | 330 d | 180 |  | 03.10 | 11.13 |  | 13.0470-7216.2 | LD7216 |   |                             | 23794 20,3 +/WE            | ATE |
|  | 330 i | 200 |  | 03.10 | 11.13 | - erhöhte Zuladung/ + Motorcode N53 4) | 24.8190-0287.2 | 620287 | 1 |                             | Warnkontakt L=723mm        |     |
|  | 330 i | 200 |  | 03.07 | 08.09 | + Motorcode N53 2)                     | 13.0460-7237.2 | 607237 |   |                             | 24161 20,3 +/WE            | ATE |
|  |       |     |  |       |       |  | 13.0470-7237.2 | LD7237 |   |                             | 24161 20,3 +/WE            | ATE |
|  |       |     |  |       |       |  | 13.0460-7238.2 | 607238 |   |                             | 23313 20,3 +/WE            | ATE |
|  |       |     |  |       |       |  | 13.0470-7238.2 | LD7238 |   |                             | 23313 20,3 +/WE            | ATE |
|  |       |     |  |       |       |  | 24.8190-0267.2 | 620267 | 1 |                             | Warnkontakt L=679mm        |     |
|  | 330 d | 170 |  | 09.09 | 02.10 | + erhöhte Zuladung 5)                  | 13.0460-7237.2 | 607237 |   |                             | 24161 20,3 +/WE            | ATE |
|  | 330 d | 170 |  | 03.07 | 08.09 |  | 13.0470-7237.2 | LD7237 |   |                             | 24161 20,3 +/WE            | ATE |
|  | 330 d | 180 |  | 01.09 | 08.09 |  | 13.0460-7238.2 | 607238 |   |                             | 23313 20,3 +/WE            | ATE |
|  | 330 i | 200 |  | 09.09 | 02.10 | + erhöhte Zuladung/ + Motorcode N53 6) | 13.0470-7238.2 | LD7238 |   |                             | 23313 20,3 +/WE            | ATE |
|  | 335 i | 225 |  | 03.07 | 02.10 |  | 24.8190-0267.2 | 620267 | 1 |                             | Warnkontakt L=679mm        |     |
|  | 330 d | 170 |  | 03.10 | 11.13 | + erhöhte Zuladung 5)                  | 13.0460-7237.2 | 607237 |   |                             | 24161 20,3 +/WE            | ATE |
|  | 330 i | 200 |  | 03.10 | 11.13 | + erhöhte Zuladung/ + Motorcode N53 6) | 13.0470-7237.2 | LD7237 |   |                             | 24161 20,3 +/WE            | ATE |
|  | 335 i | 225 |  | 03.10 | 11.13 |  | 13.0460-7238.2 | 607238 |   |                             | 23313 20,3 +/WE            | ATE |
|  |       |     |  |       |       |  | 13.0470-7238.2 | LD7238 |   |                             | 23313 20,3 +/WE            | ATE |
|  |       |     |  |       |       |  | 24.8190-0287.2 | 620287 | 1 |                             | Warnkontakt L=723mm        |     |
|  | M3    | 309 |  | 03.08 | 11.13 |  | 13.0460-7167.2 | 607167 | 1 |                             | 23312 20,3 +/WE            | ATE |
|  |       |     |  |       |       |  | 24.8190-0271.2 | 620271 | 1 |                             | Warnkontakt L=659mm        |     |
|  |       |     |  |       |       |  | 24.8190-0272.2 | 620272 | 1 |                             | Warnkontakt L=672mm        |     |
|  | 318 i | 105 |  | 03.10 | 11.13 |  | 13.0460-4848.2 | 604848 | 1 | + Performance Parts         | 24316 16,9 /WE             | BRE |
|  | 320 d | 120 |  | 01.08 | 11.13 |  | 24.8190-0267.2 | 620267 | 1 | + Performance Parts         | Warnkontakt L=679mm        |     |
|  | 320 d | 130 |  | 03.08 | 11.13 |  |                |        |   |                             |                            |     |
|  | 320 d | 135 |  | 01.10 | 11.13 |  |                |        |   |                             |                            |     |
|  | 320 i |     |  | 03.07 | 11.13 |  |                |        |   |                             |                            |     |
|  | 323 i | 130 |  | 03.07 | 11.13 |  |                |        |   |                             |                            |     |
|  | 325 d | 145 |  | 09.07 | 11.13 |  |                |        |   |                             |                            |     |
|  | 325 d | 150 |  | 03.10 | 11.13 |  |                |        |   |                             |                            |     |
|  | 325 i | 160 |  | 03.07 | 11.13 |  |                |        |   |                             |                            |     |
|  | 330 d | 170 |  | 03.07 | 11.13 |  |                |        |   |                             |                            |     |
|  | 330 d | 180 |  | 01.09 | 11.13 |  |                |        |   |                             |                            |     |
|  | 330 i | 200 |  | 03.07 | 11.13 |  |                |        |   |                             |                            |     |
|  | 330 i | 200 |  | 03.07 | 11.13 |  |                |        |   |                             |                            |     |
|  | 320 d | 120 |  | 01.08 | 11.13 |  | 24.0124-0203.1 | 424203 |   |                             | 312 23,9 22,4 V L +S +B    |     |
|  | 320 d | 130 |  | 03.08 | 11.13 |  | 24.0324-0203.1 | 524203 |   |                             | 312 23,9 22,4 V L +S +B PD |     |
|  | 320 d | 135 |  | 01.10 | 11.13 |  |                |        |   |                             |                            |     |
|  | 320 i |     |  | 03.07 | 02.08 |  |                |        |   |                             |                            |     |
|  | 323 i | 130 |  | 03.07 | 11.13 |  |                |        |   |                             |                            |     |
|  | 325 i | 160 |  | 03.07 | 11.13 | + Motorcode N52N 1)                    |                |        |   |                             |                            |     |
|  | 318 i | 105 |  | 03.10 | 11.13 |  | 24.0124-0197.1 | 424197 |   |                             | 300 24,0 22,4 V L +S +B    |     |
|  | 320 i |     |  | 03.08 | 11.13 |  | 24.0324-0197.1 | 524197 |   |                             | 300 24,0 21,6 V L +S +B PD |     |
|  | 325 d | 145 |  | 09.07 | 11.13 |  | 24.0124-0200.1 | 424200 |   |                             | 330 24,0 22,4 V L +S +B    |     |
|  | 325 d | 150 |  | 03.10 | 11.13 |  | 24.0324-0200.1 | 524200 |   |                             | 330 24,0 21,6 V L +S +B PD |     |
|  | 325 i | 160 |  | 03.07 | 11.13 | + Motorcode N53 2)                     |                |        |   |                             |                            |     |
|  | 330 d | 170 |  | 09.09 | 11.13 | - erhöhte Zuladung 3)                  |                |        |   |                             |                            |     |
|  | 330 d | 180 |  | 09.09 | 11.13 | - erhöhte Zuladung 3)                  |                |        |   |                             |                            |     |
|  | 330 i | 200 |  | 09.09 | 11.13 | - erhöhte Zuladung/ + Motorcode N53 4) |                |        |   |                             |                            |     |
|  | 330 i | 200 |  | 03.07 | 11.13 | + Motorcode N52N 1)                    |                |        |   |                             |                            |     |
|  | 330 d | 170 |  | 09.09 | 11.13 | + erhöhte Zuladung 5)                  | 24.0130-0192.1 | 430192 |   |                             | 348 30,0 28,4 V L +S +B    |     |
|  | 330 d | 170 |  | 03.07 | 08.09 |  |                |        |   |                             |                            |     |
|  | 330 d | 180 |  | 09.09 | 11.13 | + erhöhte Zuladung 5)                  |                |        |   |                             |                            |     |
|  | 330 d | 180 |  | 01.09 | 08.09 |  |                |        |   |                             |                            |     |
|  | 330 i | 200 |  | 09.09 | 11.13 | + erhöhte Zuladung/ + Motorcode N53 6) |                |        |   |                             |                            |     |
|  | 330 i | 200 |  | 03.07 | 08.09 | + Motorcode N53 2)                     |                |        |   |                             |                            |     |
|  | 335 i | 225 |  | 03.07 | 11.13 |  |                |        |   |                             |                            |     |
|  | M3    | 309 |  | 03.08 | 11.13 |  | 24.0130-0214.2 | 430214 |   | zweiteilige Bremsscheibe 7) | 360 30,0 28,4 V L +S +B    |     |
|  |       |     |  |       |       |  | 24.0130-0213.2 | 430213 |   | zweiteilige Bremsscheibe 7) | 360 30,0 28,4 V L +S +B    |     |
|  | 318 i | 105 |  | 03.10 | 11.13 |  | 24.0711-6198.3 | 360199 | 2 |                             | Radsensor L=660            |     |
|  | 323 i | 130 |  | 03.07 | 11.13 |  | 24.0711-6197.3 | 360141 | 2 |                             | Radsensor L=660            |     |
|  | 325 d | 145 |  | 09.07 | 11.13 |  |                |        |   |                             |                            |     |
|  | 325 d | 150 |  | 03.10 | 11.13 |  |                |        |   |                             |                            |     |
|  | 325 i | 160 |  | 03.07 | 11.13 |  |                |        |   |                             |                            |     |
|  | 330 d | 170 |  | 03.07 | 11.13 |  |                |        |   |                             |                            |     |
|  | 330 d | 180 |  | 01.09 | 11.13 |  |                |        |   |                             |                            |     |
|  | 330 i | 200 |  | 03.07 | 11.13 |  |                |        |   |                             |                            |     |
|  | 335 i | 225 |  | 03.07 | 11.13 |  |                |        |   |                             |                            |     |
|  | 320 d | 120 |  | 01.08 | 11.13 |  | 24.0711-6198.3 | 360199 | 2 | - Aktivlenkung 8)           | Radsensor L=660            |     |
|  | 320 d | 130 |  | 03.08 | 11.13 |  | 24.0711-6197.3 | 360141 | 2 | + Aktivlenkung 9)           | Radsensor L=660            |     |
|  | 320 d | 135 |  | 01.10 | 11.13 |  |                |        |   |                             |                            |     |
|  | 320 i |     |  | 03.07 | 11.13 |  |                |        |   |                             |                            |     |
|  | M3    | 309 |  | 03.08 | 11.13 |  | 24.0711-6209.3 | 360352 | 2 |                             | Radsensor L=700            |     |

1) + engine code N52N / + codice motore N52N / + moteur code N52N / + motor code N52N

2) + engine code N53 / + codice motore N53 / + moteur code N53 / + motor code N53

3) - increased payload / - carico utile maggiorato / - charge utile augmentée / - incremento de carga

4) - increased payl./+engine co.N53 / - carico utile maggior./+codic.mot.N53 / - charge utile augmentée/+ moteur co.

N53 / - incremento de carga/+motor co.N53

5) + increased payload / + carico utile maggiorato / + charge utile augmentée / + incremento de carga























6) + increased payl./+engine co.N53 / + carico utile maggior./+codic.mot.N53 / + charge utile augmentée/+moteur co.

N53 / + incremento de carga/+motor co.N53

7) two-piece brake disc / disco frenante in due parti / disque d.fr.en deux parties / disco de fr.de dos piezas

8) - active steering / - sterzo attivo / - direction active / - dirección activa

9) + active steering / + sterzo attivo / + direction active / + dirección activa

|     |  |  |  |  |  |  |  |       |   |  |
|--|--|--|--|--|---|--|--|---|---|--|
| <b>BMW 3er Reihe/E93 Cabrio (07-13)</b>  |  |  |  |  |   |  |  |   |   |  |
|    | 320 d  | 120  |  | 01.08  | 02.10   |  | 13.0460-7217.2   | 607217  | 23926 17,3 +/WE<br>23926 17,3 +/WE<br>Warnkontakt L=1086mm<br><b>ATE</b><br><b>ATE</b>  |  |
|  | 320 d  | 130  |  | 03.08  | 02.10   |  | 13.0470-7217.2   | LD7217  |   |  |
|  | 320 d  | 135  |  | 01.10  | 02.10   |  | 24.8190-0265.2   | 620265  |   |  |
|  | 320 i  |  |  | 03.07  | 02.10   |  |  |   |   |  |
|  | 323 i  | 130  |  | 03.07  | 02.10   |  |  |   |   |  |
|  | 325 i  | 160  |  | 03.07  | 02.10   |  |  |   |   |  |
|  | 318 i  | 105  |  | 03.10  | 11.13   |  | 13.0460-7217.2   | 607217  |   | 23926 17,3 +/WE<br>23926 17,3 +/WE<br>Warnkontakt L=1107mm<br><b>ATE</b><br><b>ATE</b>   |
|  | 320 d  | 120  |  | 03.10  | 11.13   |  | 13.0470-7217.2   | LD7217  |   |  |
|  | 320 d  | 130  |  | 03.10  | 11.13   |  | 24.8190-0285.2   | 620285  |   |  |
|  | 320 d  | 135  |  | 03.10  | 11.13   |  |  |   |   |  |
| 320 i  |  |  | 03.10  | 11.13  |   |  |  |   |   |  |
| 325 i  | 160  |  | 03.10  | 11.13  |   |  |  |   |   |  |
| 325 d  | 145  |  | 09.07  | 02.10  |   | 13.0460-7225.2   | 607225   | 23550 17,3 +/WE<br>23550 17,3 +/WE<br>Warnkontakt L=1086mm<br><b>ATE</b><br><b>ATE</b>  |   |  |
| 330 d  | 170  |  | 03.07  | 02.10  |   | 13.0470-7225.2   | LD7225   |   |   |  |
| 330 d  | 180  |  | 01.09  | 02.10  |   | 24.8190-0265.2   | 620265   |   |   |  |
| 330 i  | 200  |  | 03.07  | 02.10  |   |  |  |   |   |  |
| 335 i  | 225  |  | 03.07  | 02.10  |   |  |  |   |   |  |
| 325 d  | 145  |  | 03.10  | 11.13  |   | 13.0460-7225.2   | 607225   | 23550 17,3 +/WE<br>23550 17,3 +/WE<br>Warnkontakt L=1107mm<br><b>ATE</b><br><b>ATE</b>  |   |  |
| 325 d  | 150  |  | 03.10  | 11.13  |   | 13.0470-7225.2   | LD7225   |   |   |  |
| 330 d  | 170  |  | 03.10  | 11.13  |   | 24.8190-0285.2   | 620285   |   |   |  |
| 330 d  | 180  |  | 01.09  | 11.13  |   |  |  |   |   |  |
| 330 i  | 200  |  | 03.10  | 11.13  |   |  |  |   |   |  |
| 335 i  | 225  |  | 03.10  | 11.13  |   |  |  |   |   |  |
| M3   | 309  |  | 03.08  | 02.10  |   | 24.8190-0265.2   | 620265   | 1   | Warnkontakt L=1086mm  |  |
| M3   | 309  |  | 03.10  | 11.13  |   | 24.8190-0285.2   | 620285   | 1   | Warnkontakt L=1107mm  |  |
|    | 320 d  | 120  |  | 01.08  | 11.13   |  | 24.0120-0204.1   | 420204  | 300 20,0 18,4 V L +S +B<br>300 20,0 18,4 V L +S +B PD                                   |  |
|  | 320 d  | 130  |  | 03.08  | 11.13   |  | 24.0320-0204.1   | 520204  |   |  |
|  | 320 d  | 135  |  | 01.10  | 11.13   |  |  |   |   |  |
|  | 320 i  |  |  | 03.07  | 08.09   |  |  |   |   |  |
|  | 323 i  | 130  |  | 03.07  | 11.13   |  |  |   |   |  |
|  | 325 i  | 160  |  | 03.07  | 11.13   |  |  |   |   |  |
|  | 318 i  | 105  |  | 03.10  | 11.13   |  | 24.0120-0195.1   | 420195  |   | 300 20,0 18,4 V L +S +B<br>300 20,0 18,4 V L +S +B PD  |
|  | 320 i  |  |  | 09.09  | 11.13   |  | 24.0320-0195.1   | 520195  |   |  |
|  | 325 d  | 145  |  | 09.07  | 11.13   |  | 24.0122-0236.1   | 422236  |   | 336 22,0 20,4 V L +S +B<br>336 22,0 20,4 V L +S +B PD  |
|  | 325 d  | 150  |  | 03.10  | 11.13   |  | 24.0322-0236.1   | 522236  |   |  |
| 330 d  | 170  |  | 03.07  | 11.13  |   |  |  |   |   |  |
| 330 d  | 180  |  | 01.09  | 11.13  |   |  |  |   |   |  |
| 330 i  | 200  |  | 03.07  | 11.13  |   |  |  |   |   |  |
| 335 i  | 225  |  | 03.07  | 11.13  |   |  |  |   |   |  |
| M3   | 309  |  | 03.08  | 11.13  |   | 24.0124-0231.2   | 424231   | 2  | zweiteilige Bremsscheibe <sup>1)</sup><br>350 24,0 22,4 V L +S +B                       |  |
|  |  |  |  |  |   | 24.0124-0232.2   | 424232   | 2  | zweiteilige Bremsscheibe <sup>1)</sup><br>350 24,0 22,4 V L +S +B                       |  |
|  | 318 i  | 105  |  | 03.10  | 11.13   |  | 24.0711-6158.3   | 360192  | 2  | Radsensor L=954  |
|  | 320 i  |  |  | 09.09  | 11.13   |  |  |   |   |  |
|  | 320 i  |  |  | 03.07  | 08.09   |  | 24.0711-5169.3   | 360266  | 2  | Radsensor L=959  |
|  | 320 d  | 120  |  | 01.08  | 11.13   |  | 24.0711-5169.3   | 360266  | 2  | - Aktivlenkung <sup>2)</sup><br>Radsensor L=959  |
|  | 320 d  | 130  |  | 03.08  | 11.13   |  | 24.0711-5191.3   | 360118  | 2  | + Aktivlenkung <sup>3)</sup><br>Radsensor L=959  |
|  | 320 d  | 135  |  | 01.10  | 11.13   |  |  |   |   |  |
|  | 323 i  | 130  |  | 03.07  | 11.13   |  | 24.0711-5191.3   | 360118  | 2  | Radsensor L=959  |
|  | 325 d  | 145  |  | 09.07  | 11.13   |  |  |   |   |  |
|  | 325 d  | 150  |  | 03.10  | 11.13   |  |  |   |   |  |
|  | 325 i  | 160  |  | 03.07  | 11.13   |  |  |   |   |  |
| 330 d  | 170  |  | 03.07  | 11.13  |   |  |  |   |   |  |
| 330 d  | 180  |  | 01.09  | 11.13  |   |  |  |   |   |  |
| 330 i  | 200  |  | 03.07  | 11.13  |   |  |  |   |   |  |
| 335 i  | 225  |  | 03.07  | 11.13  |   |  |  |   |   |  |
| M3   | 309  |  | 03.08  | 11.13  |   |  |  |   |   |  |
|  | 318 i  | 105  |  | 03.10  | 11.13   |  | 03.0137-0379.2   | 650379  |   | 161 x 20<br>Bremsbacken-Zubehör  |
|  | 320 i  |  |  | 09.09  | 11.13   |  | 03.0137-9265.2   | 669265  |   | Bremsbacken-Zubehör  |
|  | 320 d  | 120  |  | 01.08  | 11.13   |  | 03.0137-9701.2   | 669701  |   | Spreizschloß Satz  |
|  | 320 d  | 130  |  | 03.08  | 11.13   |  | 03.0137-9702.2   | 669702  |   |  |
|  | 320 d  | 135  |  | 01.10  | 11.13   |  |  |   |   |  |
|  | 320 i  |  |  | 03.07  | 08.09   |  |  |   |   |  |
|  | 323 i  | 130  |  | 03.07  | 11.13   |  |  |   |   |  |
|  | 325 d  | 145  |  | 09.07  | 11.13   |  |  |   |   |  |
|  | 325 d  | 150  |  | 03.10  | 11.13   |  |  |   |   |  |
|  | 325 i  | 160  |  | 03.07  | 11.13   |  |  |   |   |  |
|  | 330 d  | 170  |  | 03.07  | 11.13   |  |  |   |   |  |
|  | 330 d  | 180  |  | 01.09  | 11.13   |  |  |   |   |  |
| 330 i  | 200  |  | 03.07  | 11.13  |   |  |  |   |   |  |
| 335 i  | 225  |  | 03.07  | 11.13  |   |  |  |   |   |  |
| M3   | 309  |  | 03.08  | 11.13  |   |  |  |   |   |  |
| <b>BMW 3er Reihe/F30 Limousine (11-)</b>   |  |  |  |  |   |  |  |   |   |  |
|  | 316 d  | 85   |  | 02.12  |   |  | 13.0460-3866.2   | 603866  | 1  | - M Sportbremse <sup>4)</sup><br>- M Sportbremse <sup>4)</sup><br>+ M Sportbremse <sup>5)</sup><br>25506 18,2 +/WE<br>25506 18,2 +/WE<br>25028 18,0 /WE<br>Warnkontakt L=675mm<br><b>BOS</b><br><b>BOS</b><br><b>BRE</b> |
|  | 316 i  | 100  |  | 11.12  |   |  | 13.0470-3866.2   | LD3866  |   |  |
|  | 318 d  | 105  |  | 02.12  |   |  | 13.0460-4875.2   | 604875  |   |  |
|  | 318 d  | 110  |  | 07.15  |   |  | 24.8190-0006.2   | 620006  |   |  |
|  | 318 d xDrive   | 105  |  | 05.13  |   |  |  |   |   |  |
|  | 318 d xDrive   | 110  |  | 07.15  |   |  |  |   |   |  |
|  | 318 i  | 100  |  | 07.15  |   |  |  |   |   |  |
|  | 320 d  | 120  |  | 02.12  |   |  |  |   |   |  |
|  | 320 d  | 140  |  | 07.15  |   |  |  |   |   |  |
|  | 320 d xDrive   | 140  |  | 07.15  |   |  |  |   |   |  |

<sup>1)</sup> two-piece brake disc / disco frenante in due parti / disque d.fr.en deux parties / disco de fr.de dos piezas

<sup>2)</sup> - active steering / - sterzo attivo / - direction active / - dirección activa

<sup>3)</sup> + active steering / + sterzo attivo / + direction active / + dirección activa

<sup>4)</sup> - M sport brake / - M freno sportivo / - M frein de sport / - M freno deportiva













<sup>5)</sup> + M sport brake / + M freno sportivo / + M frein de sport / + M freno deportiva



**BMW 3er Reihe/F30 Limousine (11-)**

|                |              |     |       |       |                |                |        |  |  |                            |     |  |
|----------------|--------------|-----|-------|-------|----------------|----------------|--------|--|--|----------------------------|-----|--|
|                | 320 i        | 135 |       | 02.12 |                | 13.0460-3866.2 | 603866 |  | - M Sportbremse <sup>1)</sup>                | 25506 18,2 +/WE            | BOS |  |
|                | 320 i xDrive | 135 |       | 02.12 |                | 13.0470-3866.2 | LD3866 |  | - M Sportbremse <sup>1)</sup>                | 25506 18,2 +/WE            | BOS |  |
|                |              |     |       |       |                | 13.0460-4875.2 | 604875 |  | + M Sportbremse <sup>2)</sup>                | 25028 18,0 /WE             | BRE |  |
|                |              |     |       |       |                | 24.8190-0006.2 | 620006 | 1  |  | Warnkontakt L=675mm        |     |  |
|                | 320 i ed     | 125 |       | 11.12 |                | 13.0460-3866.2 | 603866 |  |  | 25506 18,2 +/WE            | BOS |  |
|                |              |     |       |       |                | 13.0470-3866.2 | LD3866 |  |  | 25506 18,2 +/WE            | BOS |  |
|                |              |     |       |       |                | 24.8190-0006.2 | 620006 | 1  |  | Warnkontakt L=675mm        |     |  |
|                | 320 d        | 135 |       | 02.12 |                | 13.0460-3857.2 | 603857 |  | - M Sportbremse <sup>1)</sup>                | 25199 19,6 +/WE            | BOS |  |
|                | 320 d xDrive | 135 |       | 02.12 |                | 13.0470-3857.2 | LD3857 |  | - M Sportbremse <sup>1)</sup>                | 25199 19,6 +/WE            | BOS |  |
|                | 328 i        | 180 |       | 02.12 |                | 13.0460-4875.2 | 604875 |  | + M Sportbremse <sup>2)</sup>                | 25028 18,0 /WE             | BRE |  |
|                |              |     |       |       |                | 24.8190-0006.2 | 620006 | 1  |  | Warnkontakt L=675mm        |     |  |
|                | 330 i        | 185 |       | 07.15 |                | 13.0460-3857.2 | 603857 |  | - M Sportbremse <sup>1)</sup>                | 25199 19,6 +/WE            | BOS |  |
|                | 330 i xDrive | 185 |       | 07.15 |                | 13.0470-3857.2 | LD3857 |  | - M Sportbremse <sup>1)</sup>                | 25199 19,6 +/WE            | BOS |  |
|                |              |     |       |       |                | 24.8190-0006.2 | 620006 | 1  |  | Warnkontakt L=675mm        |     |  |
|                | 340 i        | 240 |       | 07.15 |                | 13.0460-4875.2 | 604875 |  | - M Sportbremse <sup>1)</sup>                | 25028 18,0 /WE             | BRE |  |
| 340 i xDrive   | 240          |     | 07.15 |       | 24.8190-0006.2 | 620006         | 1      |  | Warnkontakt L=675mm                          |                            |     |  |
| 325 d          | 160          |     | 04.13 |       | 13.0460-3857.2 | 603857         |        | - M Sportbremse <sup>1)</sup>                | 25199 19,6 +/WE                              | BOS                        |     |  |
| 325 d          | 165          |     | 03.16 |       | 13.0470-3857.2 | LD3857         |        | - M Sportbremse <sup>1)</sup>                | 25199 19,6 +/WE                              | BOS                        |     |  |
| 328 i xDrive   | 180          |     | 02.12 |       | 13.0460-4875.2 | 604875         |        | + M Sportbremse <sup>2)</sup>                | 25028 18,0 /WE                               | BRE                        |     |  |
| 330 d          | 190          |     | 07.12 |       | 24.8190-0006.2 | 620006         | 1      |  | Warnkontakt L=675mm                          |                            |     |  |
| 330 d          | 210          |     | 09.15 |       |                |                |        |  |  |                            |     |  |
| 330 d xDrive   | 190          |     | 03.13 |       |                |                |        |  |  |                            |     |  |
| 330 d xDrive   | 210          |     | 09.15 |       |                |                |        |  |  |                            |     |  |
| 330 e          |              |     | 01.16 |       | 13.0460-3857.2 | 603857         |        | - M Sportbremse <sup>1)</sup>                | 25199 19,6 +/WE                              | BOS                        |     |  |
|                |              |     |       |       | 13.0470-3857.2 | LD3857         |        | - M Sportbremse <sup>1)</sup>                | 25199 19,6 +/WE                              | BOS                        |     |  |
|                |              |     |       |       | 24.8190-0006.2 | 620006         | 1      |  | Warnkontakt L=675mm                          |                            |     |  |
| 335 d xDrive   | 230          |     | 07.13 |       | 13.0460-4875.2 | 604875         |        |  | 25028 18,0 /WE                               | BRE                        |     |  |
| 335 i          | 225          |     | 02.12 |       | 24.8190-0006.2 | 620006         | 1      |  | Warnkontakt L=675mm                          |                            |     |  |
| 335 i          | 250          |     | 07.13 |       |                |                |        |  |  |                            |     |  |
| 335 i xDrive   | 225          |     | 02.12 |       |                |                |        |  |  |                            |     |  |
| ActiveHybrid 3 | 250          |     | 07.12 |       |                |                |        |  |  |                            |     |  |
| M3             | 317          |     | 01.14 |       | 24.8190-0006.2 | 620006         | 1      |  | Warnkontakt L=675mm                          |                            |     |  |
| M3             | 331          |     | 03.16 |       |                |                |        |  |  |                            |     |  |
|                | 316 d        | 85  |       | 02.12 |                | 24.0122-0278.1 | 422278 |  | - M Sportbremse <sup>1)</sup>                | 300 22,0 20,4 V L +S +B    |     |  |
|                | 316 i        | 100 |       | 11.12 |                | 24.0130-0233.2 | 430233 |  | + M Sportbremse / zweiteil.Br. <sup>3)</sup> | 340 30,0 28,4 V L +S +B    |     |  |
|                | 318 d        | 105 |       | 02.12 |                |                |        |  |  |                            |     |  |
|                | 318 d        | 110 |       | 07.15 |                |                |        |  |  |                            |     |  |
|                | 318 d xDrive | 105 |       | 05.13 |                |                |        |  |  |                            |     |  |
|                | 318 d xDrive | 110 |       | 07.15 |                |                |        |  |  |                            |     |  |
|                | 318 i        | 100 |       | 07.15 |                |                |        |  |  |                            |     |  |
|                | 320 d        | 120 |       | 02.12 |                |                |        |  |  |                            |     |  |
|                | 320 d        | 140 |       | 07.15 |                |                |        |  |  |                            |     |  |
|                | 320 d xDrive | 140 |       | 07.15 |                |                |        |  |  |                            |     |  |
|                | 320 i        | 135 |       | 02.12 |                |                |        |  |  |                            |     |  |
|                | 320 i xDrive | 135 |       | 02.12 |                |                |        |  |  |                            |     |  |
|                | 320 i ed     | 125 |       | 11.12 |                | 24.0122-0278.1 | 422278 |  |  | 300 22,0 20,4 V L +S +B    |     |  |
|                | 320 d        | 135 |       | 02.12 |                | 24.0124-0203.1 | 424203 |  | - M Sportbremse <sup>1)</sup>                | 312 23,9 22,4 V L +S +B    |     |  |
|                | 320 d xDrive | 135 |       | 02.12 |                | 24.0324-0203.1 | 524203 |  | - M Sportbremse <sup>1)</sup>                | 312 23,9 22,4 V L +S +B PD |     |  |
|                | 330 e        |     |       | 01.16 |                | 24.0130-0233.2 | 430233 |  | + M Sportbremse / zweiteil.Br. <sup>3)</sup> | 340 30,0 28,4 V L +S +B    |     |  |
|                | 325 d        | 160 |       | 04.13 |                | 24.0130-0234.2 | 430234 |  | + M Sportbremse / zweiteil.Br. <sup>3)</sup> | 370 30,0 28,4 V L +S +B    |     |  |
|                | 325 d        | 165 |       | 03.16 |                |                |        |  |  |                            |     |  |
|                | 328 i        | 180 |       | 02.12 |                |                |        |  |  |                            |     |  |
|                | 328 i xDrive | 180 |       | 02.12 |                |                |        |  |  |                            |     |  |
|                | 330 d        | 190 |       | 07.12 |                |                |        |  |  |                            |     |  |
|                | 330 d        | 210 |       | 09.15 |                |                |        |  |  |                            |     |  |
|                | 330 d xDrive | 190 |       | 03.13 |                |                |        |  |  |                            |     |  |
|                | 330 d xDrive | 210 |       | 09.15 |                |                |        |  |  |                            |     |  |
|                | 330 i        | 185 |       | 07.15 |                |                |        |  |  |                            |     |  |
| 330 i xDrive   | 185          |     | 07.15 |       |                |                |        |  |  |                            |     |  |
| 335 d xDrive   | 230          |     | 07.13 |       | 24.0130-0233.2 | 430233         |        | - M Sportbremse / zweiteil.Br. <sup>4)</sup> | 340 30,0 28,4 V L +S +B                      |                            |     |  |
| 335 i          | 225          |     | 02.12 |       | 24.0130-0234.2 | 430234         |        | + M Sportbremse / zweiteil.Br. <sup>3)</sup> | 370 30,0 28,4 V L +S +B                      |                            |     |  |
| 335 i          | 250          |     | 07.13 |       |                |                |        |  |  |                            |     |  |
| 335 i xDrive   | 225          |     | 02.12 |       |                |                |        |  |  |                            |     |  |
| 340 i          | 240          |     | 07.15 |       |                |                |        |  |  |                            |     |  |
| 340 i xDrive   | 240          |     | 07.15 |       |                |                |        |  |  |                            |     |  |
| ActiveHybrid 3 | 250          |     | 07.12 |       |                |                |        |  |  |                            |     |  |
|                | 316 d        | 85  |       | 02.12 |                | 24.0711-6281.3 | 360386 | 2  | - Start/Stop /- Parkassistent <sup>5)</sup>  | Radsensor L=540            |     |  |
|                | 316 i        | 100 |       | 11.12 |                | 24.0711-6282.3 | 360387 | 2  | + Start/Stop /+ Parkassistent <sup>6)</sup>  | Radsensor L=540            |     |  |
|                | 318 d        | 105 |       | 02.12 |                |                |        |  |  |                            |     |  |
|                | 318 d        | 110 |       | 07.15 |                |                |        |  |  |                            |     |  |
|                | 318 i        | 100 |       | 07.15 |                |                |        |  |  |                            |     |  |
|                | 320 d        | 120 |       | 02.12 |                |                |        |  |  |                            |     |  |
|                | 320 d        | 135 |       | 02.12 |                |                |        |  |  |                            |     |  |
|                | 320 d        | 140 |       | 07.15 |                |                |        |  |  |                            |     |  |
|                | 320 i        | 135 |       | 02.12 |                |                |        |  |  |                            |     |  |
|                | 320 i ed     | 125 |       | 11.12 |                |                |        |  |  |                            |     |  |
|                | 325 d        | 160 |       | 04.13 |                |                |        |  |  |                            |     |  |
|                | 325 d        | 165 |       | 03.16 |                |                |        |  |  |                            |     |  |
|                | 328 i        | 180 |       | 02.12 |                |                |        |  |  |                            |     |  |
|                | 330 d        | 190 |       | 07.12 |                |                |        |  |  |                            |     |  |
|                | 330 d        | 210 |       | 09.15 |                |                |        |  |  |                            |     |  |
|                | 330 e        |     |       | 01.16 |                |                |        |  |  |                            |     |  |
|                | 330 i        | 185 |       | 07.15 |                |                |        |  |  |                            |     |  |
|                | 335 i        | 225 |       | 02.12 |                |                |        |  |  |                            |     |  |
| 335 i          | 250          |     | 07.13 |       |                |                |        |  |  |                            |     |  |



















<sup>1)</sup> - M sport brake / - M freno sportivo / - M frein de sport / - M freno deportiva  
<sup>2)</sup> + M sport brake / + M freno sportivo / + M frein de sport / + M freno deportiva  
<sup>3)</sup> + M sport brake / two-p. disc / + M freno sport / deux part.disc / + M frein de sport / d. parti. disque / + M freno sport / deux parties disc  
<sup>4)</sup> - M sport brake / two-p. disc / - M freno sport / deux part.disc / - M frein de sport / d. parti. disque / - M freno sport / deux parties disc  
<sup>5)</sup> -idling/stop/-parking assist. / -start/stop/-assist.parcheggio / -marche/arrêt/-assist.stationnem. / -arranque/paro/-assist.aparcamiento  
<sup>6)</sup> +idling/stop/+parking assist. / +start/stop/+assist.parcheggio / +marche/arrêt/+assist.stationnem. / +arranque/paro/+assist.aparcamiento

|     |  |  |  |  |  |  |  |  |  |                         |
|--|--|--|--|--|---|--|--|--|--|-------------------------|
| <b>BMW 3er Reihe/F30 Limousine (11-)</b>   |  |  |  |  |   |  |  |  |  |                         |
|    | 340 i  | 240  | 07.15  |  | 24.0711-6281.3  | 360386   | 2  | - Start/Stop /- Parkassistent <sup>1)</sup>  | Radsensor L=540                              |                         |
|  | ActiveHybrid 3   | 250  | 07.12  |  | 24.0711-6282.3  | 360387   | 2  | + Start/Stop /+ Parkassistent <sup>2)</sup>  | Radsensor L=540                              |                         |
|  | 318 d xDrive   | 105  | 05.13  |  | 24.0711-6299.3  | 360388   | 2  | - Start/Stop /- Parkassistent <sup>1)</sup>  | Radsensor L=746                              |                         |
|  | 318 d xDrive   | 110  | 07.15  |  | 24.0711-6300.3  | 360389   | 2  | + Start/Stop /+ Parkassistent <sup>2)</sup>  | Radsensor L=746                              |                         |
|  | 320 d xDrive   | 135  | 02.12  |  |   |  |  |  |  |                         |
|  | 320 d xDrive   | 140  | 07.15  |  |   |  |  |  |  |                         |
|  | 320 i xDrive   | 135  | 02.12  |  |   |  |  |  |  |                         |
|  | 328 i xDrive   | 180  | 02.12  |  |   |  |  |  |  |                         |
|  | 330 d xDrive   | 190  | 03.13  |  |   |  |  |  |  |                         |
|  | 330 d xDrive   | 210  | 09.15  |  |   |  |  |  |  |                         |
|  | 330 i xDrive   | 185  | 07.15  |  |   |  |  |  |  |                         |
|  | 335 d xDrive   | 230  | 07.13  |  |   |  |  |  |  |                         |
|  | 335 i xDrive   | 225  | 02.12  |  |   |  |  |  |  |                         |
| 340 i xDrive   | 240  | 07.15  |  |  |   |  |  |  |  |                         |
| M3   | 317  | 01.14  |  |  | 24.0711-6282.3  | 360387   | 2  |  | Radsensor L=540                              |                         |
| M3   | 331  | 03.16  |  |  |   |  |  |  |  |                         |
|    | 316 d  | 85   | 02.12  |  | 13.0460-3859.2  | 603859   |  | - M Sportbremse <sup>3)</sup>  | 25307 17,5 +/WE BOS                          |                         |
|  | 316 i  | 100  | 11.12  |  | 13.0470-3859.2  | LD3859   |  | - M Sportbremse <sup>3)</sup>  | 25307 17,5 +/WE BOS                          |                         |
|  | 318 d  | 105  | 02.12  |  | 13.0460-4874.2  | 604874   |  | + M Sportbremse <sup>4)</sup>  | 25029 16,7 /WE/Zub BRE                       |                         |
|  | 318 d  | 110  | 07.15  |  | 24.8190-0007.2  | 620007   | 1  |  | Warnkontakt L=1045mm                         |                         |
|  | 318 d xDrive   | 105  | 05.13  |  |   |  |  |  |  |                         |
|  | 318 d xDrive   | 110  | 07.15  |  |   |  |  |  |  |                         |
|  | 318 i  | 100  | 07.15  |  |   |  |  |  |  |                         |
|  | 320 d  | 120  | 02.12  |  |   |  |  |  |  |                         |
|  | 320 d  | 135  | 02.12  |  |   |  |  |  |  |                         |
|  | 320 d  | 140  | 07.15  |  |   |  |  |  |  |                         |
|  | 320 d xDrive   | 135  | 02.12  |  |   |  |  |  |  |                         |
|  | 320 d xDrive   | 140  | 07.15  |  |   |  |  |  |  |                         |
|  | 320 i  | 135  | 02.12  |  |   |  |  |  |  |                         |
|  | 320 i xDrive   | 135  | 02.12  |  |   |  |  |  |  |                         |
|  | 325 d  | 160  | 04.13  |  |   |  |  |  |  |                         |
|  | 325 d  | 165  | 03.16  |  |   |  |  |  |  |                         |
|  | 328 i  | 180  | 02.12  |  |   |  |  |  |  |                         |
|  | 328 i xDrive   | 180  | 02.12  |  |   |  |  |  |  |                         |
|  | 330 e  |  | 01.16  |  |   | 13.0460-3859.2   | 603859   |  | - M Sportbremse <sup>3)</sup>                | 25307 17,5 +/WE BOS     |
|  | 330 i  | 185  | 07.15  |  |   | 13.0470-3859.2   | LD3859   |  | - M Sportbremse <sup>3)</sup>                | 25307 17,5 +/WE BOS     |
|  | 330 i xDrive   | 185  | 07.15  |  |   | 24.8190-0007.2   | 620007   | 1  |  | Warnkontakt L=1045mm    |
|  | 320 i ed   | 125  | 11.12  |  |   | 13.0460-3859.2   | 603859   |  |  | 25307 17,5 +/WE BOS     |
|  |  |  |  |  |   | 13.0470-3859.2   | LD3859   |  |  | 25307 17,5 +/WE BOS     |
|  |  |  |  |  |   | 24.8190-0007.2   | 620007   | 1  |  | Warnkontakt L=1045mm    |
|  | 330 d  | 190  | 07.12  |  |   | 13.0460-4874.2   | 604874   |  | + M Sportbremse <sup>4)</sup>                | 25029 16,7 /WE/Zub BRE  |
|  | 330 d  | 210  | 09.15  |  |   | 24.8190-0007.2   | 620007   | 1  |  | Warnkontakt L=1045mm    |
|  | 330 d xDrive   | 190  | 03.13  |  |   |  |  |  |  |                         |
| 330 d xDrive   | 210  | 09.15  |  |  |   |  |  |  |  |                         |
| 335 d xDrive   | 230  | 07.13  |  |  |   |  |  |  |  |                         |
| 335 i  | 225  | 02.12  |  |  |   |  |  |  |  |                         |
| 335 i  | 250  | 07.13  |  |  |   |  |  |  |  |                         |
| 335 i xDrive   | 225  | 02.12  |  |  |   |  |  |  |  |                         |
| ActiveHybrid 3   | 250  | 07.12  |  |  |   |  |  |  |  |                         |
| 340 i  | 240  | 07.15  |  |  | 24.8190-0007.2  | 620007   | 1  |  | Warnkontakt L=1045mm                         |                         |
| 340 i xDrive   | 240  | 07.15  |  |  |   |  |  |  |  |                         |
| M3   | 317  | 01.14  |  |  | 24.8190-0007.2  | 620007   | 1  |  | Warnkontakt L=1045mm                         |                         |
| M3   | 331  | 03.16  |  |  |   |  |  |  |  |                         |
|  | 316 d  | 85   | 02.12  |  | 24.0120-0237.1  | 420237   |  | - M Sportbremse <sup>3)</sup>  | 300 20,0 18,4 V L +S +B                      |                         |
|  | 316 i  | 100  | 11.12  |  | 24.0124-0250.2  | 424250   |  | + M Sportbremse / zweiteil.Br. <sup>5)</sup>                                       | 345 24,0 22,4 V L +S +B                      |                         |
|  | 318 d  | 105  | 02.12  |  |   |  |  |  |  |                         |
|  | 318 d  | 110  | 07.15  |  |   |  |  |  |  |                         |
|  | 318 i  | 100  | 07.15  |  |   |  |  |  |  |                         |
|  | 320 d  | 120  | 02.12  |  |   |  |  |  |  |                         |
|  | 320 d  | 135  | 02.12  |  |   |  |  |  |  |                         |
|  | 320 d  | 140  | 07.15  |  |   |  |  |  |  |                         |
|  | 320 i  | 135  | 02.12  |  |   |  |  |  |  |                         |
|  | 325 d  | 160  | 04.13  |  |   |  |  |  |  |                         |
|  | 325 d  | 165  | 03.16  |  |   |  |  |  |  |                         |
|  | 320 i ed   | 125  | 11.12  |  |   | 24.0120-0237.1   | 420237   |  |  | 300 20,0 18,4 V L +S +B |
|  | 318 d xDrive   | 105  | 05.13  |  |   | 24.0120-0240.1   | 420240   |  | - M Sportbremse <sup>3)</sup>                | 300 20,0 18,4 V L +S +B |
|  | 318 d xDrive   | 110  | 07.15  |  |   | 24.0124-0251.2   | 424251   |  | + M Sportbremse / zweiteil.Br. <sup>5)</sup> | 345 24,0 22,4 V L +S +B |
|  | 320 d xDrive   | 135  | 02.12  |  |   |  |  |  |  |                         |
|  | 320 d xDrive   | 140  | 07.15  |  |   |  |  |  |  |                         |
|  | 320 i xDrive   | 135  | 02.12  |  |   |  |  |  |  |                         |
|  | 328 i  | 180  | 02.12  |  |   |  |  |  |  |                         |
|  | 328 i xDrive   | 180  | 02.12  |  |   |  |  |  |  |                         |
|  | 330 e  |  | 01.16  |  |   |  |  |  |  |                         |
|  | 330 i  | 185  | 07.15  |  |   |  |  |  |  |                         |
|  | 330 i xDrive   | 185  | 07.15  |  |   |  |  |  |  |                         |
|  | 330 d  | 190  | 07.12  |  |   | 24.0120-0243.1   | 420243   |  | - M Sportbremse <sup>3)</sup>                | 330 20,0 18,4 V L +S +B |
|  | 330 d  | 210  | 09.15  |  |   | 24.0124-0251.2   | 424251   |  | + M Sportbremse / zweiteil.Br. <sup>5)</sup> | 345 24,0 22,4 V L +S +B |
|  | 330 d xDrive   | 190  | 03.13  |  |   |  |  |  |  |                         |
|  | 330 d xDrive   | 210  | 09.15  |  |   |  |  |  |  |                         |
|  | 335 d xDrive   | 230  | 07.13  |  |   |  |  |  |  |                         |
| 335 i  | 225  | 02.12  |  |  |   |  |  |  |  |                         |
| 335 i  | 250  | 07.13  |  |  |   |  |  |  |  |                         |
| 335 i xDrive   | 225  | 02.12  |  |  |   |  |  |  |  |                         |
| 340 i  | 240  | 07.15  |  |  |   |  |  |  |  |                         |
| 340 i xDrive   | 240  | 07.15  |  |  |   |  |  |  |  |                         |

<sup>1)</sup> - idling/stop/-parking assist. / -start/stop/-assist.parcheggio / -marche/arrêt/-assist.stationnem. / -arramque/paro/-assist.aparcamiento  
<sup>2)</sup> +idling/stop/+parking assist. / +start/stop/+assist.parcheggio / +marche/arrêt/+assist.stationnem. / +arramque/paro/+assist.aparcamiento  
<sup>3)</sup> - M sport brake / - M freno sportivo / - M frein de sport / - M freno deportiva  
<sup>4)</sup> + M sport brake / + M freno sportivo / + M frein de sport / + M freno deportiva  
<sup>5)</sup> + M sport brake / two-p. disc / + M freno sport / deux part.disc / + M frein de sport / d. parti. disque / + M freno sport / deux parties disc





|     |   |    |   |  |  |  |    |  |
|--|---|--|---|--|---|--|--|--|
| <b>BMW 3er Reihe/F30 Limousine (11-)</b>   |   |  |   |  |   |  |  |  |
|    | ActiveHybrid 3  | 250  | 07.12   |  | 24.0120-0243.1<br>24.0124-0251.2  | 420243<br>424251   | - M Sportbremse <sup>1)</sup><br>+ M Sportbremse / zweiteil.Br. <sup>2)</sup>  | 330 20,0 18,4 V L +S +B<br>345 24,0 22,4 V L +S +B                                 |
|    | 316 d<br>316 i<br>318 d<br>318 d<br>318 d xDrive<br>318 d xDrive<br>318 i<br>320 d<br>320 d<br>320 d<br>320 d xDrive<br>320 d xDrive<br>320 i<br>320 i ed<br>320 i xDrive<br>325 d<br>325 d<br>328 i<br>328 i xDrive<br>330 d<br>330 d<br>330 d xDrive<br>330 d xDrive<br>330 e<br>330 i<br>330 i xDrive<br>335 d xDrive<br>335 i<br>335 i<br>335 i xDrive<br>340 i<br>340 i xDrive | 85<br>100<br>105<br>110<br>105<br>110<br>100<br>120<br>135<br>140<br>135<br>140<br>135<br>125<br>135<br>160<br>165<br>180<br>180<br>190<br>210<br>190<br>210<br>185<br>185<br>230<br>225<br>250<br>225<br>240<br>240 | 02.12<br>11.12<br>02.12<br>07.15<br>05.13<br>07.15<br>02.12<br>02.12<br>07.15<br>02.12<br>07.15<br>02.12<br>11.12<br>02.12<br>04.13<br>03.16<br>02.12<br>02.12<br>07.12<br>09.15<br>03.13<br>09.15<br>01.16<br>07.15<br>07.15<br>07.13<br>02.12<br>07.13<br>02.12<br>07.15<br>07.15 |  | 24.0711-5347.3<br>24.0711-5359.3  | 360374<br>360375   | 2  - Geschwindigkeitsregelanlage <sup>3)</sup><br>2  + Geschwindigkeitsregelanlage <sup>4)</sup> | Radsensor L=802<br>Radsensor L=802   |
|  | ActiveHybrid 3  | 250  | 07.12   |  | 24.0711-5347.3  | 360374   | 2   | Radsensor L=802  |
|    | 316 d<br>316 i<br>318 d<br>318 d<br>318 i<br>320 d<br>320 d<br>320 d<br>320 i<br>320 i ed<br>325 d<br>325 d<br>328 i  | 85<br>100<br>105<br>110<br>100<br>120<br>135<br>140<br>135<br>125<br>160<br>165<br>180   | 02.12<br>11.12<br>02.12<br>07.15<br>07.15<br>02.12<br>02.12<br>07.15<br>02.12<br>11.12<br>04.13<br>03.16<br>02.12   |  | 03.0137-0379.2<br>03.0137-9265.2<br>03.0137-9701.2<br>03.0137-9702.2              | 650379<br>669265<br>669701<br>669702   |  | 161 x 20<br>Bremsbacken-Zubehör<br>Bremsbacken-Zubehör<br>Spreizschloß Satz        |
|  | 328 i   | 180  | 02.12   | + Motorcode N26 <sup>5)</sup>  | 03.0137-0379.2<br>03.0137-9062.2<br>03.0137-9701.2<br>03.0137-9702.2              | 650379<br>669062<br>669701<br>669702   |  | 161 x 20<br>Bremsbacken-Zubehör<br>Bremsbacken-Zubehör<br>Spreizschloß Satz        |
|  | 318 d xDrive<br>318 d xDrive<br>320 d xDrive<br>320 d xDrive<br>320 i xDrive<br>328 i<br>328 i xDrive<br>330 d<br>330 d<br>330 d xDrive<br>330 d xDrive<br>330 e<br>330 i<br>330 i xDrive<br>335 d xDrive<br>335 i<br>335 i<br>335 i xDrive<br>340 i<br>340 i xDrive<br>ActiveHybrid 3<br>M3<br>M3  | 105<br>110<br>135<br>140<br>135<br>180<br>180<br>190<br>210<br>190<br>210<br>185<br>185<br>230<br>225<br>250<br>225<br>240<br>240<br>250<br>317<br>331   | 05.13<br>07.15<br>02.12<br>07.15<br>02.12<br>02.12<br>02.12<br>07.12<br>09.15<br>03.13<br>09.15<br>01.16<br>07.15<br>07.15<br>07.13<br>02.12<br>02.12<br>07.15<br>07.15<br>07.12<br>01.14<br>03.16  | + Motorcode N20 <sup>6)</sup>  | 03.0137-0305.2<br>03.0137-9062.2<br>03.0137-9700.2<br>03.0137-9702.2              | 650305<br>669062<br>669700<br>669702   |  | 185 x 20<br>Bremsbacken-Zubehör<br>Bremsbacken-Zubehör<br>Spreizschloß Satz        |
| <b>BMW 3er Reihe/F31 Touring (12-)</b>   |   |  |   |  |   |  |  |  |
|  | 316 d<br>316 i<br>318 d<br>318 d<br>318 d xDrive<br>318 d xDrive<br>318 i<br>320 d<br>320 d<br>320 d xDrive   | 85<br>100<br>105<br>110<br>105<br>110<br>100<br>135<br>140<br>135  | 05.12<br>03.13<br>05.12<br>07.15<br>05.13<br>07.15<br>07.15<br>05.12<br>07.15<br>03.13  |  | 13.0460-4875.2<br>24.8190-0006.2  | 604875<br>620006   | 1  + M Sportbremse <sup>7)</sup>  | 25028 18,0 /WE<br>Warnkontakt L=675mm  |
|  |   |  |   |  |   |  |  | <b>BRE</b>   |

1) - M sport brake / - M freno sportivo / - M frein de sport / - M freno deportiva  
2) + M sport brake / two-p. disc / + M freno sport / deux part.disc / + M frein de sport / d. parti. disque / + M freno sport / deux parties disc  
3) - speed control system / - impianto variatore di velocità / - régulateur de vitesse / - sistema de regulación de velocidad  
4) + speed control system / + impianto variatore di velocità / + régulateur de vitesse / + sistema de regulación de velocidad  
5) + engine code N26 / + codice motore N26 / + moteur code N26 / + motor code N26  
6) + engine code N20 / + codice motore N20 / + moteur code N20 / + motor code N20  
7) + M sport brake / + M freno sportivo / + M frein de sport / + M freno deportiva

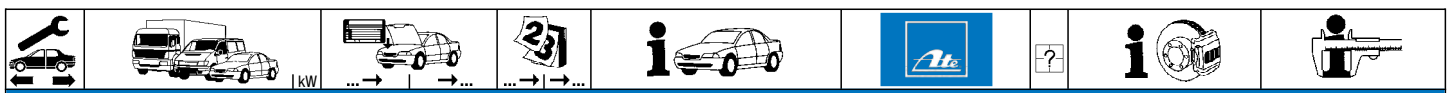

**BMW 3er Reihe/F31 Touring (12-)**

|              |              |       |       |                |                |        |  |  |                            |     |
|--------------|--------------|-------|-------|----------------|----------------|--------|--|--|----------------------------|-----|
|              | 320 d xDrive | 140   | 07.15 |                | 13.0460-4875.2 | 604875 |  | + M Sportbremse <sup>1)</sup>                | 25028 18,0 /WE             | BRE |
|              | 320 i        | 135   | 05.12 |                | 24.8190-0006.2 | 620006 | 1  |  | Warnkontakt L=675mm        |     |
|              | 320 i xDrive | 135   | 03.13 |                |                |        |  |  |                            |     |
|              | 325 d        | 160   | 04.13 |                | 13.0460-3857.2 | 603857 |  | - M Sportbremse <sup>2)</sup>                | 25199 19,6 +/WE            | BOS |
|              | 325 d        | 165   | 03.16 |                | 13.0470-3857.2 | LD3857 |  | - M Sportbremse <sup>2)</sup>                | 25199 19,6 +/WE            | BOS |
|              | 328 i        | 180   | 05.12 |                | 13.0460-4875.2 | 604875 |  | + M Sportbremse <sup>1)</sup>                | 25028 18,0 /WE             | BRE |
|              | 328 i xDrive | 180   | 03.13 |                | 24.8190-0006.2 | 620006 | 1  |  | Warnkontakt L=675mm        |     |
|              | 330 d        | 190   | 05.12 |                |                |        |  |  |                            |     |
|              | 330 d        | 210   | 09.15 |                |                |        |  |  |                            |     |
|              | 330 d xDrive | 190   | 03.13 |                |                |        |  |  |                            |     |
|              | 330 d xDrive | 210   | 09.15 |                |                |        |  |  |                            |     |
|              | 330 i        | 185   | 07.15 |                | 13.0460-3857.2 | 603857 |  | - M Sportbremse <sup>2)</sup>                | 25199 19,6 +/WE            | BOS |
|              | 330 i xDrive | 185   | 07.15 |                | 13.0470-3857.2 | LD3857 |  | - M Sportbremse <sup>2)</sup>                | 25199 19,6 +/WE            | BOS |
|              | 340 i        | 240   | 07.15 |                | 13.0460-4875.2 | 604875 |  | - M Sportbremse <sup>2)</sup>                | 25028 18,0 /WE             | BRE |
|              | 340 i xDrive | 240   | 07.15 |                | 24.8190-0006.2 | 620006 | 1  |  | Warnkontakt L=675mm        |     |
|              | 316 d        | 85    | 05.12 |                | 13.0460-3866.2 | 603866 |  | - M Sportbremse <sup>2)</sup>                | 25506 18,2 +/WE            | BOS |
|              | 316 i        | 100   | 03.13 |                | 13.0470-3866.2 | LD3866 |  | - M Sportbremse <sup>2)</sup>                | 25506 18,2 +/WE            | BOS |
|              | 318 d        | 105   | 05.12 |                | 24.8190-0006.2 | 620006 | 1  |  | Warnkontakt L=675mm        |     |
| 318 d        | 110          | 07.15 |       |                |                |        |  |  |                            |     |
| 318 d xDrive | 105          | 05.13 |       |                |                |        |  |  |                            |     |
| 318 d xDrive | 110          | 07.15 |       |                |                |        |  |  |                            |     |
| 318 i        | 100          | 07.15 |       |                |                |        |  |  |                            |     |
| 320 i        | 135          | 05.12 |       |                |                |        |  |  |                            |     |
| 320 i xDrive | 135          | 03.13 |       |                |                |        |  |  |                            |     |
| 320 d        | 120          | 05.12 |       | 13.0460-3866.2 | 603866         |        | - Start/Stop-Anlage <sup>3)</sup>            | 25506 18,2 +/WE                              | BOS                        |     |
|              |              |       |       | 13.0470-3866.2 | LD3866         |        | - Start/Stop-Anlage <sup>3)</sup>            | 25506 18,2 +/WE                              | BOS                        |     |
|              |              |       |       | 13.0460-3857.2 | 603857         |        | + Start/Stop-Anlage <sup>4)</sup>            | 25199 19,6 +/WE                              | BOS                        |     |
|              |              |       |       | 13.0470-3857.2 | LD3857         |        | + Start/Stop-Anlage <sup>4)</sup>            | 25199 19,6 +/WE                              | BOS                        |     |
|              |              |       |       | 24.8190-0006.2 | 620006         | 1      |  | Warnkontakt L=675mm                          |                            |     |
| 320 d        | 135          | 05.12 |       | 13.0460-3857.2 | 603857         |        | - M Sportbremse <sup>2)</sup>                | 25199 19,6 +/WE                              | BOS                        |     |
| 320 d        | 140          | 07.15 |       | 13.0470-3857.2 | LD3857         |        | - M Sportbremse <sup>2)</sup>                | 25199 19,6 +/WE                              | BOS                        |     |
| 320 d xDrive | 135          | 03.13 |       | 24.8190-0006.2 | 620006         | 1      |  | Warnkontakt L=675mm                          |                            |     |
| 320 d xDrive | 140          | 07.15 |       |                |                |        |  |  |                            |     |
| 320 d        | 135          | 05.12 |       | 13.0460-4875.2 | 604875         |        | + verstärkte Bremsanlage <sup>5)</sup>       | 25028 18,0 /WE                               | BRE                        |     |
| 320 d        | 140          | 07.15 |       | 24.8190-0006.2 | 620006         | 1      |  | Warnkontakt L=675mm                          |                            |     |
| 320 d xDrive | 135          | 03.13 |       |                |                |        |  |  |                            |     |
| 320 d xDrive | 140          | 07.15 |       |                |                |        |  |  |                            |     |
| 325 d        | 160          | 04.13 |       |                |                |        |  |  |                            |     |
| 325 d        | 165          | 03.16 |       |                |                |        |  |  |                            |     |
| 335 d xDrive | 230          | 11.13 |       |                |                |        |  |  |                            |     |
| 335 i        | 225          | 03.13 |       | 13.0460-4875.2 | 604875         |        |  | 25028 18,0 /WE                               | BRE                        |     |
| 335 i xDrive | 225          | 03.13 |       | 24.8190-0006.2 | 620006         | 1      |  | Warnkontakt L=675mm                          |                            |     |
|              | 316 d        | 85    | 05.12 |                | 24.0122-0278.1 | 422278 |  | - M Sportbremse <sup>2)</sup>                | 300 22,0 20,4 V L +S +B    |     |
|              | 316 i        | 100   | 03.13 |                |                |        |  |  |                            |     |
|              | 318 d        | 105   | 05.12 |                |                |        |  |  |                            |     |
|              | 318 d        | 110   | 07.15 |                |                |        |  |  |                            |     |
|              | 318 d xDrive | 105   | 05.13 |                |                |        |  |  |                            |     |
|              | 318 d xDrive | 110   | 07.15 |                |                |        |  |  |                            |     |
|              | 318 i        | 100   | 07.15 |                |                |        |  |  |                            |     |
|              | 320 d        | 120   | 05.12 |                | 24.0122-0278.1 | 422278 |  | - Start/Stop-Anlage <sup>3)</sup>            | 300 22,0 20,4 V L +S +B    |     |
|              |              |       |       |                | 24.0124-0203.1 | 424203 |  | + Start/Stop-Anlage <sup>4)</sup>            | 312 23,9 22,4 V L +S +B    |     |
|              |              |       |       |                | 24.0324-0203.1 | 524203 |  | + Start/Stop-Anlage <sup>4)</sup>            | 312 23,9 22,4 V L +S +B PD |     |
|              | 320 d        | 135   | 05.12 |                | 24.0124-0203.1 | 424203 |  | - M Sportbremse <sup>2)</sup>                | 312 23,9 22,4 V L +S +B    |     |
|              | 320 d        | 140   | 07.15 |                | 24.0324-0203.1 | 524203 |  | - M Sportbremse <sup>2)</sup>                | 312 23,9 22,4 V L +S +B PD |     |
|              | 320 d xDrive | 135   | 03.13 |                |                |        |  |  |                            |     |
|              | 320 d xDrive | 140   | 07.15 |                |                |        |  |  |                            |     |
|              | 320 i        | 135   | 05.12 |                |                |        |  |  |                            |     |
|              | 320 i xDrive | 135   | 03.13 |                |                |        |  |  |                            |     |
|              | 316 d        | 85    | 05.12 |                | 24.0130-0233.2 | 430233 |  | + M Sportbremse / zweiteil.Br. <sup>6)</sup> | 340 30,0 28,4 V L +S +B    |     |
|              | 316 i        | 100   | 03.13 |                |                |        |  |  |                            |     |
|              | 318 d        | 105   | 05.12 |                |                |        |  |  |                            |     |
|              | 318 d        | 110   | 07.15 |                |                |        |  |  |                            |     |
|              | 318 d xDrive | 105   | 05.13 |                |                |        |  |  |                            |     |
|              | 318 d xDrive | 110   | 07.15 |                |                |        |  |  |                            |     |
|              | 318 i        | 100   | 07.15 |                |                |        |  |  |                            |     |
|              | 320 d        | 135   | 05.12 |                |                |        |  |  |                            |     |
|              | 320 d        | 140   | 07.15 |                |                |        |  |  |                            |     |
|              | 320 d xDrive | 135   | 03.13 |                |                |        |  |  |                            |     |
|              | 320 d xDrive | 140   | 07.15 |                |                |        |  |  |                            |     |
|              | 320 i        | 135   | 05.12 |                |                |        |  |  |                            |     |
|              | 320 i xDrive | 135   | 03.13 |                |                |        |  |  |                            |     |
|              | 328 i xDrive | 180   | 03.13 |                |                |        |  |  |                            |     |
|              | 325 d        | 160   | 04.13 |                | 24.0130-0234.2 | 430234 |  | + M Sportbremse / zweiteil.Br. <sup>6)</sup> | 370 30,0 28,4 V L +S +B    |     |
|              | 325 d        | 165   | 03.16 |                | 24.0130-0233.2 | 430233 |  | + verst.Bremsanl./zweiteil.Br. <sup>7)</sup> | 340 30,0 28,4 V L +S +B    |     |
|              | 328 i        | 180   | 05.12 |                |                |        |  |  |                            |     |
|              | 328 i xDrive | 180   | 03.13 |                |                |        |  |  |                            |     |
|              | 330 d        | 190   | 05.12 |                |                |        |  |  |                            |     |
|              | 330 d        | 210   | 09.15 |                |                |        |  |  |                            |     |
| 330 d xDrive | 190          | 03.13 |       |                |                |        |  |  |                            |     |
| 330 d xDrive | 210          | 09.15 |       |                |                |        |  |  |                            |     |
| 330 i        | 185          | 07.15 |       | 24.0130-0234.2 | 430234         |        | + M Sportbremse / zweiteil.Br. <sup>6)</sup> | 370 30,0 28,4 V L +S +B                      |                            |     |
| 330 i xDrive | 185          | 07.15 |       |                |                |        |  |  |                            |     |
| 330 d        | 190          | 05.12 |       | 24.0130-0234.2 | 430234         |        | + M Sportbremse / zweiteil.Br. <sup>6)</sup> | 370 30,0 28,4 V L +S +B                      |                            |     |
| 330 d xDrive | 190          | 03.13 |       |                |                |        |  |  |                            |     |

<sup>1)</sup> + M sport brake / + M freno sportivo / + M frein de sport / + M freno deportiva

<sup>2)</sup> - M sport brake / - M freno sportivo / - M frein de sport / - M freno deportiva

<sup>3)</sup> - idling stop system / - dispositivo start/stop / - unité marche/arrêt / - unidad arranque/paro

<sup>4)</sup> + idling stop system / + dispositivo start/stop / + unité marche/arrêt / + unidad arranque/paro

<sup>5)</sup> + heavy duty br.system / + sistema fr.rinforzato / + système de fr.renforcé / + sistema de fr.reforzado

<sup>6)</sup> + M sport brake / two-p. disc / + M freno sport / deux part.disc / + M frein de sport / d. parti. disque / + M freno sport / deux parties disc

<sup>7)</sup> + heavyduty brake/2-piece disc / + sistema fr.rinforzato/disco in 2 parti / + système de fr.renforcé/disque en 2 part. / + sistema de fr.reforzado/disco de 2 piezas



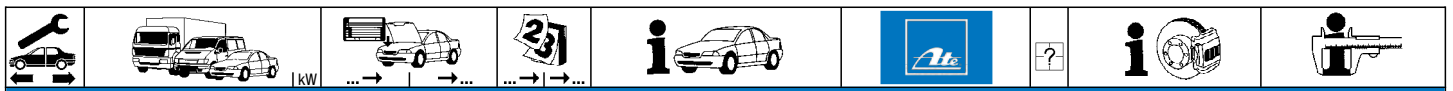

**BMW 3er Reihe/F31 Touring (12-)**

|              |              |       |                |                |                    |                                     |                         |
|--------------|--------------|-------|----------------|----------------|--------------------|-------------------------------------|-------------------------|
|              | 335 d xDrive | 230   | 11.13          | 24.0130-0234.2 | 430234             | + M Sportbremse / zweiteil.Br. 1)   | 370 30,0 28,4 V L +S +B |
|              | 335 i        | 225   | 05.12          |                |                    |                                     |                         |
|              | 335 i xDrive | 225   | 03.13          |                |                    |                                     |                         |
|              | 340 i        | 240   | 07.15          |                |                    |                                     |                         |
|              | 340 i xDrive | 240   | 07.15          |                |                    |                                     |                         |
|              | 320 d        | 135   | 05.12          | 24.0130-0233.2 | 430233             | + verst.Bremsanl./zweiteil.Br. 2)   | 340 30,0 28,4 V L +S +B |
|              | 320 d        | 140   | 07.15          |                |                    |                                     |                         |
|              | 320 d xDrive | 135   | 03.13          |                |                    |                                     |                         |
|              | 320 d xDrive | 140   | 07.15          |                |                    |                                     |                         |
|              | 325 d        | 160   | 04.13          |                |                    |                                     |                         |
|              | 325 d        | 165   | 03.16          |                |                    |                                     |                         |
|              | 335 d xDrive | 230   | 11.13          | 24.0130-0233.2 | 430233             | - M Sportbremse / zweiteil.Br. 3)   | 340 30,0 28,4 V L +S +B |
|              | 335 i        | 225   | 03.13          |                |                    |                                     |                         |
|              | 335 i xDrive | 225   | 03.13          |                |                    |                                     |                         |
|              | 340 i        | 240   | 07.15          |                |                    |                                     |                         |
| 340 i xDrive | 240          | 07.15 |                |                |                    |                                     |                         |
|              | 316 d        | 85    | 05.12          | 24.0711-6281.3 | 360386             | 2  - Start/Stop /- Parkassistent 4) | Radsensor L=540         |
|              | 316 i        | 100   | 03.13          | 24.0711-6282.3 | 360387             | 2  + Start/Stop /+ Parkassistent 5) | Radsensor L=540         |
|              | 318 d        | 105   | 05.12          |                |                    |                                     |                         |
|              | 318 d        | 110   | 07.15          |                |                    |                                     |                         |
|              | 318 i        | 100   | 07.15          |                |                    |                                     |                         |
|              | 320 d        | 120   | 05.12          |                |                    |                                     |                         |
|              | 320 d        | 135   | 05.12          |                |                    |                                     |                         |
|              | 320 d        | 140   | 07.15          |                |                    |                                     |                         |
|              | 320 i        | 135   | 05.12          |                |                    |                                     |                         |
|              | 325 d        | 160   | 04.13          |                |                    |                                     |                         |
|              | 325 d        | 165   | 03.16          |                |                    |                                     |                         |
|              | 328 i        | 180   | 05.12          |                |                    |                                     |                         |
|              | 330 d        | 190   | 05.12          |                |                    |                                     |                         |
|              | 330 d        | 210   | 09.15          |                |                    |                                     |                         |
|              | 330 i        | 185   | 07.15          |                |                    |                                     |                         |
|              | 335 i        | 225   | 03.13          |                |                    |                                     |                         |
|              | 340 i        | 240   | 07.15          |                |                    |                                     |                         |
|              | 318 d xDrive | 105   | 05.13          | 24.0711-6299.3 | 360388             | 2  - Start/Stop /- Parkassistent 4) | Radsensor L=746         |
|              | 318 d xDrive | 110   | 07.15          | 24.0711-6300.3 | 360389             | 2  + Start/Stop /+ Parkassistent 5) | Radsensor L=746         |
|              | 320 d xDrive | 135   | 03.13          |                |                    |                                     |                         |
| 320 d xDrive | 140          | 07.15 |                |                |                    |                                     |                         |
| 320 i xDrive | 135          | 03.13 |                |                |                    |                                     |                         |
| 328 i xDrive | 180          | 03.13 |                |                |                    |                                     |                         |
| 330 d xDrive | 190          | 03.13 |                |                |                    |                                     |                         |
| 330 d xDrive | 210          | 09.15 |                |                |                    |                                     |                         |
| 330 i xDrive | 185          | 07.15 |                |                |                    |                                     |                         |
| 335 d xDrive | 230          | 11.13 |                |                |                    |                                     |                         |
| 335 i xDrive | 225          | 03.13 |                |                |                    |                                     |                         |
| 340 i xDrive | 240          | 07.15 |                |                |                    |                                     |                         |
|              | 316 d        | 85    | 05.12          | 13.0460-4874.2 | 604874             | + M Sportbremse 6)                  | 25029 16,7 /WE/Zub BOS  |
|              | 316 i        | 100   | 03.13          | 24.8190-0007.2 | 620007             | 1                                   | Warnkontakt L=1045mm    |
|              | 318 d        | 105   | 05.12          |                |                    |                                     |                         |
|              | 318 d        | 110   | 07.15          |                |                    |                                     |                         |
|              | 318 d xDrive | 105   | 05.13          |                |                    |                                     |                         |
|              | 318 d xDrive | 110   | 07.15          |                |                    |                                     |                         |
|              | 320 d        | 135   | 05.12          |                |                    |                                     |                         |
|              | 320 d        | 140   | 07.15          |                |                    |                                     |                         |
|              | 320 d xDrive | 135   | 03.13          |                |                    |                                     |                         |
|              | 320 d xDrive | 140   | 07.15          |                |                    |                                     |                         |
|              | 320 i        | 135   | 05.12          |                |                    |                                     |                         |
|              | 320 i xDrive | 135   | 03.13          |                |                    |                                     |                         |
|              | 325 d        | 160   | 04.13          |                |                    |                                     |                         |
|              | 325 d        | 165   | 03.16          |                |                    |                                     |                         |
|              | 328 i        | 180   | 05.12          |                |                    |                                     |                         |
|              | 328 i xDrive | 180   | 03.13          |                |                    |                                     |                         |
|              | 330 d        | 190   | 05.12          |                |                    |                                     |                         |
|              | 330 d        | 210   | 09.15          |                |                    |                                     |                         |
|              | 330 d xDrive | 190   | 03.13          |                |                    |                                     |                         |
|              | 330 d xDrive | 210   | 09.15          |                |                    |                                     |                         |
| 335 d xDrive | 230          | 11.13 |                |                |                    |                                     |                         |
| 335 i        | 225          | 03.13 |                |                |                    |                                     |                         |
| 335 i xDrive | 225          | 03.13 |                |                |                    |                                     |                         |
| 316 d        | 85           | 05.12 | 13.0460-3859.2 | 603859         | - M Sportbremse 7) | 25307 17,5 +/WE BOS                 |                         |
| 316 i        | 100          | 03.13 | 13.0470-3859.2 | LD3859         | - M Sportbremse 7) | 25307 17,5 +/WE BOS                 |                         |
| 318 d        | 105          | 05.12 | 24.8190-0007.2 | 620007         | 1                  | Warnkontakt L=1045mm                |                         |
| 318 d        | 110          | 07.15 |                |                |                    |                                     |                         |
| 318 d xDrive | 105          | 05.13 |                |                |                    |                                     |                         |
| 318 d xDrive | 110          | 07.15 |                |                |                    |                                     |                         |
| 318 i        | 100          | 07.15 |                |                |                    |                                     |                         |
| 320 d        | 135          | 05.12 |                |                |                    |                                     |                         |
| 320 d        | 140          | 07.15 |                |                |                    |                                     |                         |
| 320 d xDrive | 135          | 03.13 |                |                |                    |                                     |                         |
| 320 d xDrive | 140          | 07.15 |                |                |                    |                                     |                         |
| 320 i        | 135          | 05.12 |                |                |                    |                                     |                         |
| 320 i xDrive | 135          | 03.13 |                |                |                    |                                     |                         |
| 325 d        | 160          | 04.13 |                |                |                    |                                     |                         |
| 325 d        | 165          | 03.16 |                |                |                    |                                     |                         |
| 328 i        | 180          | 05.12 |                |                |                    |                                     |                         |
| 328 i xDrive | 180          | 03.13 |                |                |                    |                                     |                         |
| 330 i        | 185          | 07.15 |                |                |                    |                                     |                         |
| 330 i xDrive | 185          | 07.15 |                |                |                    |                                     |                         |

1) + M sport brake / two-p. disc / + M freno sport / deux part.disc / + M frein de sport / d. parti. disque / + M freno sport / deux parties disc  
2) + heavyduty brake/2-piece disc / + sistema fr.rinforzato/disco in 2 parti / + système de fr.renforcé/disque en 2 part. / + sistema de fr.reforzado/disco de 2 piezas  
3) - M sport brake / two-p. disc / - M freno sport / deux part.disc / - M frein de sport / d. parti. disque / - M freno sport / deux parties disc  
4) - idling/stop/-parking assist. / -start/stop/-assist.parcheggio / -marche/arrêt/-assist.stationnem. / -arramque/paro/-assist.aparcamiento  
5) +idling/stop/+parking assist. / +start/stop/+assist.parcheggio / +marche/arrêt/+assist.stationnem. / +arramque/paro/+assist.aparcamiento  
6) + M sport brake / + M freno sportivo / + M frein de sport / + M freno deportiva  
7) - M sport brake / - M freno sportivo / - M frein de sport / - M freno deportiva

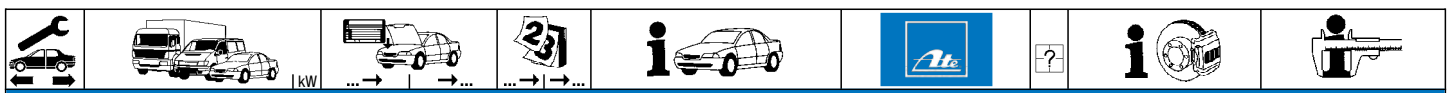

**BMW 3er Reihe/F31 Touring (12-)**

|              |              |       |                |                |        |  |  |                         |
|--------------|--------------|-------|----------------|----------------|--------|--|--|-------------------------|
|              | 320 d        | 120   | 05.12          | 13.0460-3859.2 | 603859 |  | 25307 17,5 +WE                               | BOS                     |
|              |              |       |                | 13.0470-3859.2 | LD3859 |  | 25307 17,5 +WE                               | BOS                     |
|              |              |       |                | 24.8190-0007.2 | 620007 | 1                                      | Warnkontakt L=1045mm                         |                         |
|              | 320 d        | 135   | 05.12          | 24.8190-0007.2 | 620007 | 1                                      | Warnkontakt L=1045mm                         |                         |
|              | 320 d xDrive | 135   | 03.13          |                |        |  |  |                         |
|              | 325 d        | 160   | 04.13          |                |        |  |  |                         |
|              | 325 d        | 165   | 03.16          |                |        |  |  |                         |
|              | 330 d        | 190   | 05.12          | 24.8190-0007.2 | 620007 | 1                                      | Warnkontakt L=1045mm                         |                         |
|              | 330 d        | 210   | 09.15          |                |        |  |  |                         |
|              | 330 d xDrive | 190   | 03.13          |                |        |  |  |                         |
|              | 330 d xDrive | 210   | 09.15          |                |        |  |  |                         |
|              | 335 d xDrive | 230   | 11.13          |                |        |  |  |                         |
|              | 335 i        | 225   | 03.13          |                |        |  |  |                         |
|              | 335 i xDrive | 225   | 03.13          |                |        |  |  |                         |
|              | 340 i        | 240   | 07.15          |                |        |  |  |                         |
| 340 i xDrive | 240          | 07.15 |                |                |        |  |  |                         |
| 318 i        | 100          | 07.15 | 24.8190-0007.2 | 620007         | 1      | Warnkontakt L=1045mm                   |  |                         |
| 330 i        | 185          | 07.15 |                |                |        |  |  |                         |
| 330 i xDrive | 185          | 07.15 |                |                |        |  |  |                         |
| 340 i        | 240          | 07.15 |                |                |        |  |  |                         |
| 340 i xDrive | 240          | 07.15 |                |                |        |  |  |                         |
|              | 316 d        | 85    | 05.12          | 24.0120-0237.1 | 420237 |  | - M Sportbremse <sup>1)</sup>                | 300 20,0 18,4 V L +S +B |
|              | 316 i        | 100   | 03.13          |                |        |  |  |                         |
|              | 318 d        | 105   | 05.12          |                |        |  |  |                         |
|              | 320 i        | 135   | 05.12          |                |        |  |  |                         |
|              | 316 d        | 85    | 05.12          | 24.0124-0250.2 | 424250 |  | + M Sportbremse / zweiteil.Br. <sup>2)</sup> | 345 24,0 22,4 V L +S +B |
|              | 316 i        | 100   | 03.13          |                |        |  |  |                         |
|              | 318 d        | 105   | 05.12          |                |        |  |  |                         |
|              | 320 i        | 135   | 05.12          |                |        |  |  |                         |
|              | 325 d        | 160   | 04.13          |                |        |  |  |                         |
|              | 325 d        | 165   | 03.16          |                |        |  |  |                         |
|              | 318 d        | 110   | 07.15          | 24.0124-0251.2 | 424251 |  | + M Sportbremse / zweiteil.Br. <sup>2)</sup> | 345 24,0 22,4 V L +S +B |
|              | 318 d xDrive | 105   | 05.13          |                |        |  |  |                         |
|              | 318 d xDrive | 110   | 07.15          |                |        |  |  |                         |
|              | 318 i        | 100   | 07.15          |                |        |  |  |                         |
|              | 320 d        | 135   | 05.12          |                |        |  |  |                         |
|              | 320 d        | 140   | 07.15          |                |        |  |  |                         |
|              | 320 d xDrive | 135   | 03.13          |                |        |  |  |                         |
|              | 320 d xDrive | 140   | 07.15          |                |        |  |  |                         |
|              | 320 i xDrive | 135   | 03.13          |                |        |  |  |                         |
|              | 328 i        | 180   | 05.12          |                |        |  |  |                         |
|              | 328 i xDrive | 180   | 03.13          |                |        |  |  |                         |
|              | 330 d        | 190   | 05.12          |                |        |  |  |                         |
|              | 330 d        | 210   | 09.15          |                |        |  |  |                         |
|              | 330 d xDrive | 190   | 03.13          |                |        |  |  |                         |
|              | 330 d xDrive | 210   | 09.15          |                |        |  |  |                         |
|              | 330 i        | 185   | 07.15          |                |        |  |  |                         |
|              | 330 i xDrive | 185   | 07.15          |                |        |  |  |                         |
|              | 335 d xDrive | 230   | 11.13          |                |        |  |  |                         |
|              | 335 i        | 225   | 03.13          |                |        |  |  |                         |
|              | 335 i xDrive | 225   | 03.13          |                |        |  |  |                         |
|              | 340 i        | 240   | 07.15          |                |        |  |  |                         |
|              | 340 i xDrive | 240   | 07.15          |                |        |  |  |                         |
|              | 318 d xDrive | 105   | 05.13          | 24.0120-0240.1 | 420240 |  | - M Sportbremse <sup>1)</sup>                | 300 20,0 18,4 V L +S +B |
|              | 318 i        | 100   | 07.15          |                |        |  |  |                         |
|              | 320 d        | 135   | 05.12          |                |        |  |  |                         |
|              | 320 d        | 140   | 07.15          |                |        |  |  |                         |
|              | 320 d xDrive | 135   | 03.13          |                |        |  |  |                         |
|              | 320 d xDrive | 140   | 07.15          |                |        |  |  |                         |
|              | 320 i xDrive | 135   | 03.13          |                |        |  |  |                         |
|              | 328 i        | 180   | 05.12          |                |        |  |  |                         |
|              | 328 i xDrive | 180   | 03.13          |                |        |  |  |                         |
|              | 330 i        | 185   | 07.15          |                |        |  |  |                         |
|              | 330 i xDrive | 185   | 07.15          |                |        |  |  |                         |
|              | 325 d        | 160   | 04.13          | 24.0120-0243.1 | 420243 |  | - M Sportbremse <sup>1)</sup>                | 330 20,0 18,4 V L +S +B |
|              | 325 d        | 165   | 03.16          |                |        |  |  |                         |
| 330 d        | 190          | 05.12 |                |                |        |  |  |                         |
| 330 d        | 210          | 09.15 |                |                |        |  |  |                         |
| 330 d xDrive | 190          | 03.13 |                |                |        |  |  |                         |
| 330 d xDrive | 210          | 09.15 |                |                |        |  |  |                         |
| 335 d xDrive | 230          | 11.13 |                |                |        |  |  |                         |
| 335 i        | 225          | 03.13 |                |                |        |  |  |                         |
| 335 i xDrive | 225          | 03.13 |                |                |        |  |  |                         |
| 340 i        | 240          | 07.15 |                |                |        |  |  |                         |
| 340 i xDrive | 240          | 07.15 |                |                |        |  |  |                         |
| 320 d        | 120          | 05.12 | 24.0120-0240.1 | 420240         |        |  | 300 20,0 18,4 V L +S +B                      |                         |
| 320 d        | 135          | 05.12 | 24.0120-0243.1 | 420243         |        | + verstärkte Bremsanlage <sup>3)</sup> | 330 20,0 18,4 V L +S +B                      |                         |
| 320 d        | 140          | 07.15 |                |                |        |  |  |                         |
| 320 d xDrive | 135          | 03.13 |                |                |        |  |  |                         |
| 320 d xDrive | 140          | 07.15 |                |                |        |  |  |                         |
| 325 d        | 160          | 04.13 |                |                |        |  |  |                         |
| 325 d        | 165          | 03.16 |                |                |        |  |  |                         |

<sup>1)</sup> - M sport brake / - M freno sportivo / - M frein de sport / - M freno deportiva

<sup>2)</sup> + M sport brake / two-p. disc / + M freno sport / deux part.disc / + M frein de sport / d. parti. disque / + M freno sport / deux parties disc

<sup>3)</sup> + heavy duty br.system / + sistema fr.rinforzato / + système de fr.renforcé / + sistema de fr.reforzado



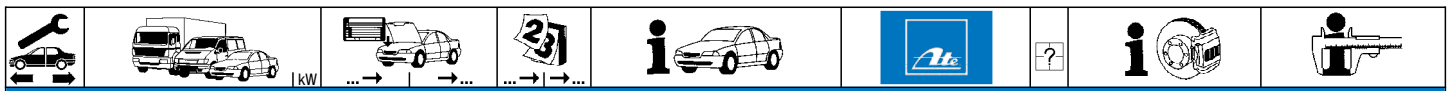

### BMW 3er Reihe/F31 Touring (12-)













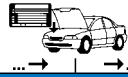





|              |              |       |       |                |        |   |                                  |                                 |
|--------------|--------------|-------|-------|----------------|--------|---|----------------------------------|---------------------------------|
|              | 316 d        | 85    | 05.12 | 24.0711-5347.3 | 360374 | 2 | - Geschwindigkeitsregelanlage 1) | Radsensor L=802                 |
|              | 316 i        | 100   | 03.13 | 24.0711-5359.3 | 360375 | 2 | + Geschwindigkeitsregelanlage 2) | Radsensor L=802                 |
|              | 318 d        | 105   | 05.12 |                |        |   |                                  |                                 |
|              | 318 d        | 110   | 07.15 |                |        |   |                                  |                                 |
|              | 318 d xDrive | 105   | 05.13 |                |        |   |                                  |                                 |
|              | 318 d xDrive | 110   | 07.15 |                |        |   |                                  |                                 |
|              | 318 i        | 100   | 07.15 |                |        |   |                                  |                                 |
|              | 320 d        | 120   | 05.12 |                |        |   |                                  |                                 |
|              | 320 d        | 135   | 05.12 |                |        |   |                                  |                                 |
|              | 320 d        | 140   | 07.15 |                |        |   |                                  |                                 |
|              | 320 d xDrive | 135   | 03.13 |                |        |   |                                  |                                 |
|              | 320 d xDrive | 140   | 07.15 |                |        |   |                                  |                                 |
|              | 320 i        | 135   | 05.12 |                |        |   |                                  |                                 |
|              | 320 i xDrive | 135   | 03.13 |                |        |   |                                  |                                 |
|              | 325 d        | 160   | 04.13 |                |        |   |                                  |                                 |
|              | 325 d        | 165   | 03.16 |                |        |   |                                  |                                 |
|              | 328 i        | 180   | 05.12 |                |        |   |                                  |                                 |
|              | 328 i xDrive | 180   | 03.13 |                |        |   |                                  |                                 |
|              | 330 d        | 190   | 05.12 |                |        |   |                                  |                                 |
|              | 330 d        | 210   | 09.15 |                |        |   |                                  |                                 |
| 330 d xDrive | 190          | 03.13 |       |                |        |   |                                  |                                 |
| 330 d xDrive | 210          | 09.15 |       |                |        |   |                                  |                                 |
| 330 i        | 185          | 07.15 |       |                |        |   |                                  |                                 |
| 330 i xDrive | 185          | 07.15 |       |                |        |   |                                  |                                 |
| 335 d xDrive | 230          | 11.13 |       |                |        |   |                                  |                                 |
| 335 i        | 225          | 03.13 |       |                |        |   |                                  |                                 |
| 335 i xDrive | 225          | 03.13 |       |                |        |   |                                  |                                 |
| 340 i        | 240          | 07.15 |       |                |        |   |                                  |                                 |
| 340 i xDrive | 240          | 07.15 |       |                |        |   |                                  |                                 |
|              | 316 d        | 85    | 05.12 | 03.0137-0379.2 | 650379 |   |                                  | 161 x 20<br>Bremsbacken-Zubehör |
|              | 316 i        | 100   | 03.13 | 03.0137-9265.2 | 669265 |   |                                  | Bremsbacken-Zubehör             |
|              | 318 d        | 105   | 05.12 | 03.0137-9701.2 | 669701 |   |                                  | Spreizschloß Satz               |
|              | 320 i        | 135   | 05.12 | 03.0137-9702.2 | 669702 |   |                                  |                                 |
|              | 318 d        | 110   | 07.15 | 03.0137-0305.2 | 650305 |   |                                  | 185 x 20<br>Bremsbacken-Zubehör |
|              | 318 d xDrive | 105   | 05.13 | 03.0137-9062.2 | 669062 |   |                                  | Bremsbacken-Zubehör             |
|              | 318 d xDrive | 110   | 07.15 | 03.0137-9700.2 | 669700 |   |                                  | Spreizschloß Satz               |
|              | 318 i        | 100   | 07.15 | 03.0137-9702.2 | 669702 |   |                                  |                                 |
|              | 320 d        | 120   | 05.12 |                |        |   |                                  |                                 |
|              | 320 d        | 135   | 05.12 |                |        |   |                                  |                                 |
|              | 320 d        | 140   | 07.15 |                |        |   |                                  |                                 |
|              | 320 d xDrive | 135   | 03.13 |                |        |   |                                  |                                 |
|              | 320 d xDrive | 140   | 07.15 |                |        |   |                                  |                                 |
|              | 320 i xDrive | 135   | 03.13 |                |        |   |                                  |                                 |
|              | 325 d        | 160   | 04.13 |                |        |   |                                  |                                 |
|              | 325 d        | 165   | 03.16 |                |        |   |                                  |                                 |
|              | 328 i        | 180   | 05.12 |                |        |   |                                  |                                 |
|              | 328 i xDrive | 180   | 03.13 |                |        |   |                                  |                                 |
|              | 330 d        | 190   | 05.12 |                |        |   |                                  |                                 |
|              | 330 d        | 210   | 09.15 |                |        |   |                                  |                                 |
| 330 d xDrive | 190          | 03.13 |       |                |        |   |                                  |                                 |
| 330 d xDrive | 210          | 09.15 |       |                |        |   |                                  |                                 |
| 330 i        | 185          | 07.15 |       |                |        |   |                                  |                                 |
| 330 i xDrive | 185          | 07.15 |       |                |        |   |                                  |                                 |
| 335 d xDrive | 230          | 11.13 |       |                |        |   |                                  |                                 |
| 335 i        | 225          | 03.13 |       |                |        |   |                                  |                                 |
| 335 i xDrive | 225          | 03.13 |       |                |        |   |                                  |                                 |
| 340 i        | 240          | 07.15 |       |                |        |   |                                  |                                 |
| 340 i xDrive | 240          | 07.15 |       |                |        |   |                                  |                                 |

### BMW 3er Reihe/F34 GT (13-)

|              |              |       |                |                |        |                    |                     |                     |     |
|--------------|--------------|-------|----------------|----------------|--------|--------------------|---------------------|---------------------|-----|
|              | 318 d        | 105   | 03.13          | 13.0460-3866.2 | 603866 |                    | - M Sportbremse 3)  | 25506 18,2 +/WE     | BOS |
|              | 318 d        | 110   | 07.15          | 13.0470-3866.2 | LD3866 |                    | - M Sportbremse 3)  | 25506 18,2 +/WE     | BOS |
|              | 320 i        | 135   | 03.13          | 13.0460-4875.2 | 604875 |                    | + M Sportbremse 4)  | 25028 18,0 /WE      | BRE |
|              | 320 i xDrive | 135   | 03.13          | 24.8190-0006.2 | 620006 | 1                  |                     | Warnkontakt L=675mm |     |
|              | 320 d        | 135   | 03.13          | 13.0460-3857.2 | 603857 |                    | - M Sportbremse 3)  | 25199 19,6 +/WE     | BOS |
|              | 320 d        | 140   | 07.15          | 13.0470-3857.2 | LD3857 |                    | - M Sportbremse 3)  | 25199 19,6 +/WE     | BOS |
|              | 320 d xDrive | 135   | 03.13          | 13.0460-4875.2 | 604875 |                    | + M Sportbremse 4)  | 25028 18,0 /WE      | BRE |
|              | 320 d xDrive | 140   | 07.15          | 24.8190-0006.2 | 620006 | 1                  |                     | Warnkontakt L=675mm |     |
|              | 325 d        | 160   | 03.13          | 13.0460-3857.2 | 603857 |                    | - M Sportbremse 3)  | 25199 19,6 +/WE     | BOS |
|              | 328 i        | 180   | 03.13          | 13.0470-3857.2 | LD3857 |                    | - M Sportbremse 3)  | 25199 19,6 +/WE     | BOS |
|              | 328 i xDrive | 180   | 03.13          | 13.0460-4875.2 | 604875 |                    | + M Sportbremse 4)  | 25028 18,0 /WE      | BRE |
|              | 330 d        | 190   | 03.14          | 24.8190-0006.2 | 620006 | 1                  |                     | Warnkontakt L=675mm |     |
|              | 330 d        | 210   | 09.15          |                |        |                    |                     |                     |     |
|              | 330 d xDrive | 190   | 03.14          |                |        |                    |                     |                     |     |
|              | 330 d xDrive | 210   | 09.15          |                |        |                    |                     |                     |     |
|              | 335 d xDrive | 230   | 03.14          | 13.0460-4875.2 | 604875 |                    |                     | 25028 18,0 /WE      | BRE |
|              | 335 i        | 225   | 03.13          | 24.8190-0006.2 | 620006 | 1                  |                     | Warnkontakt L=675mm |     |
|              | 335 i xDrive | 225   | 03.13          |                |        |                    |                     |                     |     |
|              | 320 d xDrive | 135   | 10.15          | 13.0460-3857.2 | 603857 |                    | - M Sportbremse 3)  | 25199 19,6 +/WE     | BOS |
|              | 325 d        | 165   | 07.16          | 13.0470-3857.2 | LD3857 |                    | - M Sportbremse 3)  | 25199 19,6 +/WE     | BOS |
| 330 i        | 185          | 10.15 | 13.0460-4875.2 | 604875         |        | + M Sportbremse 4) | 25028 18,0 /WE      | BRE                 |     |
|              |              |       | 24.8190-0006.2 | 620006         | 1      |                    | Warnkontakt L=675mm |                     |     |
| 340 i        | 240          | 10.15 | 13.0460-4875.2 | 604875         |        |                    | 25028 18,0 /WE      | BRE                 |     |
| 340 i xDrive | 240          | 10.15 | 24.8190-0006.2 | 620006         | 1      |                    | Warnkontakt L=675mm |                     |     |

1) - speed control system / - impianto variatore di velocità / - régulateur de vitesse / - sistema de regulación de velocidad  
 2) + speed control system / + impianto variatore di velocità / + régulateur de vitesse / + sistema de regulación de velocidad  
 3) - M sport brake / - M freno sportivo / - M frein de sport / - M freno deportiva  
 4) + M sport brake / + M freno sportivo / + M frein de sport / + M freno deportiva



|     |  |  |  |  |  |  |   |  |
|--|--|--|--|--|---|--|---|--|
| <b>BMW 3er Reihe/F34 GT (13-)</b>  |  |  |  |  |   |  |   |  |
|    | 318 d  | 105  | 03.13  |  | 24.0122-0278.1  | 422278   | - M Sportbremse <sup>1)</sup>   | 300 22,0 20,4 V L +S +B  |
|  | 318 d  | 110  | 07.15  |  | 24.0130-0233.2  | 430233   | + M Sportbremse / zweiteil.Br. <sup>2)</sup>  | 340 30,0 28,4 V L +S +B  |
|  | 320 i  | 135  | 03.13  |  |   |  |   |  |
|  | 320 i xDrive   | 135  | 03.13  |  |   |  |   |  |
|  | 320 d  | 135  | 03.13  |  | 24.0124-0203.1  | 424203   | - M Sportbremse <sup>1)</sup>   | 312 23,9 22,4 V L +S +B  |
|  | 320 d  | 140  | 07.15  |  | 24.0324-0203.1  | 524203   | - M Sportbremse <sup>1)</sup>   | <b>312 23,9 22,4 V L +S +B PD</b>  |
|  | 320 d xDrive   | 135  | 03.13  |  | 24.0130-0233.2  | 430233   | + M Sportbremse / zweiteil.Br. <sup>2)</sup>  | 340 30,0 28,4 V L +S +B  |
|  | 320 d xDrive   | 140  | 07.15  |  |   |  |   |  |
|  | 325 d  | 160  | 03.13  |  | 24.0130-0234.2  | 430234   | + M Sportbremse / zweiteil.Br. <sup>2)</sup>  | 370 30,0 28,4 V L +S +B  |
|  | 325 d  | 165  | 07.16  |  |   |  |   |  |
|  | 328 i  | 180  | 03.13  |  |   |  |   |  |
|  | 328 i xDrive   | 180  | 03.13  |  |   |  |   |  |
|  | 330 d  | 190  | 03.14  |  |   |  |   |  |
|  | 330 d  | 210  | 09.15  |  |   |  |   |  |
| 330 d xDrive   | 190  | 03.14  |  |  |   |  |   |  |
| 330 d xDrive   | 210  | 09.15  |  |  |   |  |   |  |
| 330 i  | 185  | 10.15  |  |  |   |  |   |  |
| 330 i xDrive   | 185  | 10.15  |  |  |   |  |   |  |
| 335 i  | 225  | 03.13  |  | 24.0130-0233.2   | 430233  | - M Sportbremse / zweiteil.Br. <sup>3)</sup>                                       | 340 30,0 28,4 V L +S +B   |  |
| 335 i xDrive   | 225  | 03.13  |  | 24.0130-0234.2   | 430234  | + M Sportbremse / zweiteil.Br. <sup>2)</sup>                                       | 370 30,0 28,4 V L +S +B   |  |
| 340 i  | 240  | 10.15  |  |  |   |  |   |  |
| 340 i xDrive   | 240  | 10.15  |  |  |   |  |   |  |
| 335 d xDrive   | 230  | 03.14  |  | 24.0130-0234.2   | 430234  | + M Sportbremse / zweiteil.Br. <sup>2)</sup>                                       | 370 30,0 28,4 V L +S +B   |  |
|    | 320 d xDrive   | 135  | 03.13  |  | 24.0711-6299.3  | 360388   | 2  - Start/Stop /- Parkassistent <sup>4)</sup>   | Radsensor L=746  |
|  | 320 d xDrive   | 140  | 07.15  |  | 24.0711-6300.3  | 360389   | 2  + Start/Stop /+ Parkassistent <sup>5)</sup>   | Radsensor L=746  |
|  | 320 i xDrive   | 135  | 03.13  |  |   |  |   |  |
|  | 328 i xDrive   | 180  | 03.13  |  |   |  |   |  |
|  | 330 d xDrive   | 190  | 03.14  |  |   |  |   |  |
|  | 330 d xDrive   | 210  | 09.15  |  |   |  |   |  |
|  | 330 i xDrive   | 185  | 10.15  |  |   |  |   |  |
|  | 335 d xDrive   | 230  | 03.14  |  |   |  |   |  |
|  | 335 i xDrive   | 225  | 03.13  |  |   |  |   |  |
|  | 340 i xDrive   | 240  | 10.15  |  |   |  |   |  |
|  |  | 318 d  | 105  | 03.13  |   | 13.0460-3859.2   | 603859  | - M Sportbremse <sup>1)</sup>  |
| 318 d  |  | 110  | 07.15  |  | 13.0470-3859.2  | LD3859   | - M Sportbremse <sup>1)</sup>   | <b>25307</b> 17,5 +/WE <b>BOS</b>  |
| 320 d  |  | 135  | 03.13  |  | 13.0460-4874.2  | 604874   | + M Sportbremse <sup>6)</sup>   | <b>25029</b> 16,7 /WE/Zub <b>BRE</b>   |
| 320 d  |  | 140  | 07.15  |  | 24.8190-0007.2  | 620007   |   | Warnkontakt L=1045mm   |
| 320 d xDrive   |  | 135  | 03.13  |  |   |  |   |  |
| 320 d xDrive   |  | 140  | 07.15  |  |   |  |   |  |
| 320 i  |  | 135  | 03.13  |  |   |  |   |  |
| 320 i xDrive   |  | 135  | 03.13  |  |   |  |   |  |
| 325 d  |  | 160  | 03.13  |  |   |  |   |  |
| 325 d  |  | 165  | 07.16  |  |   |  |   |  |
| 328 i  |  | 180  | 03.13  |  |   |  |   |  |
| 328 i xDrive   |  | 180  | 03.13  |  |   |  |   |  |
| 330 d  |  | 190  | 03.14  |  | 13.0460-4874.2  | 604874   | + M Sportbremse <sup>6)</sup>   | <b>25029</b> 16,7 /WE/Zub <b>BRE</b>   |
| 330 d  |  | 210  | 09.15  |  | 24.8190-0007.2  | 620007   |   | Warnkontakt L=1045mm   |
| 330 d xDrive   | 190  | 03.14  |  |  |   |  |   |  |
| 330 d xDrive   | 210  | 09.15  |  |  |   |  |   |  |
| 335 d xDrive   | 230  | 03.14  |  |  |   |  |   |  |
| 335 i  | 225  | 03.13  |  |  |   |  |   |  |
| 335 i xDrive   | 225  | 03.13  |  |  |   |  |   |  |
| 340 i  | 240  | 10.15  |  |  |   |  |   |  |
| 340 i xDrive   | 240  | 10.15  |  |  |   |  |   |  |
|  | 318 d  | 105  | 03.13  |  | 24.0120-0240.1  | 420240   | - M Sportbremse <sup>1)</sup>   | 300 20,0 18,4 V L +S +B  |
|  | 318 d  | 110  | 07.15  |  | 24.0124-0251.2  | 424251   | + M Sportbremse / zweiteil.Br. <sup>2)</sup>  | 345 24,0 22,4 V L +S +B  |
|  | 320 d  | 135  | 03.13  |  |   |  |   |  |
|  | 320 d  | 140  | 07.15  |  |   |  |   |  |
|  | 320 d xDrive   | 135  | 03.13  |  |   |  |   |  |
|  | 320 d xDrive   | 140  | 07.15  |  |   |  |   |  |
|  | 320 i  | 135  | 03.13  |  |   |  |   |  |
|  | 320 i xDrive   | 135  | 03.13  |  |   |  |   |  |
|  | 325 d  | 165  | 07.16  |  |   |  |   |  |
|  | 328 i  | 180  | 03.13  |  |   |  |   |  |
|  | 328 i xDrive   | 180  | 03.13  |  |   |  |   |  |
|  | 330 i  | 185  | 10.15  |  |   |  |   |  |
|  | 330 i xDrive   | 185  | 10.15  |  |   |  |   |  |
|  | 325 d  | 160  | 03.13  |  | 24.0120-0237.1  | 420237   | - M Sportbremse <sup>1)</sup>   | 300 20,0 18,4 V L +S +B  |
|  |  |  |  | 24.0124-0250.2   | 424250  | + M Sportbremse / zweiteil.Br. <sup>2)</sup>                                       | 345 24,0 22,4 V L +S +B   |  |
|  |  |  |  | 24.0120-0243.1   | 420243  | + verstärkte Bremsanlage <sup>7)</sup>   | 330 20,0 18,4 V L +S +B   |  |
| 330 d  | 190  | 03.14  |  | 24.0120-0243.1   | 420243  | - M Sportbremse <sup>1)</sup>  | 330 20,0 18,4 V L +S +B   |  |
| 330 d  | 210  | 09.15  |  | 24.0124-0251.2   | 424251  | + M Sportbremse / zweiteil.Br. <sup>2)</sup>                                       | 345 24,0 22,4 V L +S +B   |  |
| 330 d xDrive   | 190  | 03.14  |  |  |   |  |   |  |
| 330 d xDrive   | 210  | 09.15  |  |  |   |  |   |  |
| 335 d xDrive   | 230  | 03.14  |  |  |   |  |   |  |
| 335 i  | 225  | 03.13  |  |  |   |  |   |  |
| 335 i xDrive   | 225  | 03.13  |  |  |   |  |   |  |
| 340 i  | 240  | 10.15  |  |  |   |  |   |  |
| 340 i xDrive   | 240  | 10.15  |  |  |   |  |   |  |
|  | 318 d  | 105  | 03.13  |  | 24.0711-5347.3  | 360374   | 2  - Geschwindigkeitsregelanlage <sup>8)</sup> | Radsensor L=802  |
|  | 318 d  | 110  | 07.15  |  | 24.0711-5359.3  | 360375   | 2  + Geschwindigkeitsregelanlage <sup>9)</sup> | Radsensor L=802  |
|  | 320 d  | 135  | 03.13  |  |   |  |   |  |
|  | 320 d  | 140  | 07.15  |  |   |  |   |  |
|  | 320 d xDrive   | 135  | 03.13  |  |   |  |   |  |
|  | 320 d xDrive   | 140  | 07.15  |  |   |  |   |  |
| 320 i  | 135  | 03.13  |  |  |   |  |   |  |

<sup>1)</sup> - M sport brake / - M freno sportivo / - M frein de sport / - M freno deportiva

<sup>2)</sup> + M sport brake / two-p. disc / + M freno sport / deux part.disc / + M frein de sport / d. parti. disque / + M freno sport / deux parties disc

<sup>3)</sup> - M sport brake / two-p. disc / - M freno sport / deux part.disc / - M frein de sport / d. parti. disque / - M freno sport / deux parties disc

<sup>4)</sup> - idling/stop/-parking assist. / -start/stop/-assist.parcheggio / -marche/arrêt/-assist.stationnem. / -arranque/paro/-assist.aparcamiento

<sup>5)</sup> + idling/stop/+parking assist. / +start/stop/+assist.parcheggio / +marche/arrêt/+assist.stationnem. / +arranque/paro/+assist.aparcamiento

<sup>6)</sup> + M sport brake / + M freno sportivo / + M frein de sport / + M freno deportiva

<sup>7)</sup> + heavy duty br.system / + sistema fr.rinforzato / + système de fr.renforcé / + sistema de fr.reforzado

<sup>8)</sup> - speed control system / - impianto variatore di velocità / - régulateur de vitesse / - sistema de regulación de velocidad

<sup>9)</sup> + speed control system / + impianto variatore di velocità / + régulateur de vitesse / + sistema de regulación de velocidad



### BMW 3er Reihe/F34 GT (13-)

|              |              |       |       |  |                |        |   |                                  |                     |
|--------------|--------------|-------|-------|--|----------------|--------|---|----------------------------------|---------------------|
|              | 320 i xDrive | 135   | 03.13 |  | 24.0711-5347.3 | 360374 | 2 | - Geschwindigkeitsregelanlage 1) | Radsensor L=802     |
|              | 325 d        | 160   | 03.13 |  | 24.0711-5359.3 | 360375 | 2 | + Geschwindigkeitsregelanlage 2) | Radsensor L=802     |
|              | 325 d        | 165   | 07.16 |  |                |        |   |                                  |                     |
|              | 328 i        | 180   | 03.13 |  |                |        |   |                                  |                     |
|              | 328 i xDrive | 180   | 03.13 |  |                |        |   |                                  |                     |
|              | 330 d        | 190   | 03.14 |  |                |        |   |                                  |                     |
|              | 330 d        | 210   | 09.15 |  |                |        |   |                                  |                     |
|              | 330 d xDrive | 190   | 03.14 |  |                |        |   |                                  |                     |
|              | 330 d xDrive | 210   | 09.15 |  |                |        |   |                                  |                     |
|              | 330 i        | 185   | 10.15 |  |                |        |   |                                  |                     |
|              | 330 i xDrive | 185   | 10.15 |  |                |        |   |                                  |                     |
|              | 335 d xDrive | 230   | 03.14 |  |                |        |   |                                  |                     |
|              | 335 i        | 225   | 03.13 |  |                |        |   |                                  |                     |
|              | 335 i xDrive | 225   | 03.13 |  |                |        |   |                                  |                     |
|              | 340 i        | 240   | 10.15 |  |                |        |   |                                  |                     |
| 340 i xDrive | 240          | 10.15 |       |  |                |        |   |                                  |                     |
|              | 318 d        | 105   | 03.13 |  | 03.0137-0305.2 | 650305 |   |                                  | 185 x 20            |
|              | 318 d        | 110   | 07.15 |  | 03.0137-9062.2 | 669062 |   |                                  | Bremsbacken-Zubehör |
|              | 320 d        | 135   | 03.13 |  | 03.0137-9700.2 | 669700 |   |                                  | Bremsbacken-Zubehör |
|              | 320 d        | 140   | 07.15 |  | 03.0137-9702.2 | 669702 |   |                                  | Spreizschloß Satz   |
|              | 320 d xDrive | 135   | 03.13 |  |                |        |   |                                  |                     |
|              | 320 d xDrive | 140   | 07.15 |  |                |        |   |                                  |                     |
|              | 320 i        | 135   | 03.13 |  |                |        |   |                                  |                     |
|              | 320 i xDrive | 135   | 03.13 |  |                |        |   |                                  |                     |
|              | 325 d        | 160   | 03.13 |  |                |        |   |                                  |                     |
|              | 325 d        | 165   | 07.16 |  |                |        |   |                                  |                     |
|              | 328 i        | 180   | 03.13 |  |                |        |   |                                  |                     |
|              | 328 i xDrive | 180   | 03.13 |  |                |        |   |                                  |                     |
|              | 330 d        | 190   | 03.14 |  |                |        |   |                                  |                     |
|              | 330 d        | 210   | 09.15 |  |                |        |   |                                  |                     |
|              | 330 d xDrive | 190   | 03.14 |  |                |        |   |                                  |                     |
|              | 330 d xDrive | 210   | 09.15 |  |                |        |   |                                  |                     |
|              | 330 i        | 185   | 10.15 |  |                |        |   |                                  |                     |
|              | 330 i xDrive | 185   | 10.15 |  |                |        |   |                                  |                     |
|              | 335 d xDrive | 230   | 03.14 |  |                |        |   |                                  |                     |
|              | 335 i        | 225   | 03.13 |  |                |        |   |                                  |                     |
| 335 i xDrive | 225          | 03.13 |       |  |                |        |   |                                  |                     |
| 340 i        | 240          | 10.15 |       |  |                |        |   |                                  |                     |
| 340 i xDrive | 240          | 10.15 |       |  |                |        |   |                                  |                     |

### BMW 4er Reihe/F32 Coupe (13-)

|              |              |       |                    |                    |                |        |   |                     |                     |     |
|--------------|--------------|-------|--------------------|--------------------|----------------|--------|---|---------------------|---------------------|-----|
|              | 420 d        | 135   | 07.13              | - M Sportbremse 3) | 13.0460-3857.2 | 603857 |   |                     | 25199 19,6 +/WE     | BOS |
|              | 420 d        | 140   | 03.15              | - M Sportbremse 3) | 13.0470-3857.2 | LD3857 |   |                     | 25199 19,6 +/WE     | BOS |
|              | 420 d xDrive | 135   | 07.13              | - M Sportbremse 3) | 24.8190-0006.2 | 620006 | 1 | ☐                   | Warnkontakt L=675mm |     |
|              | 420 d xDrive | 140   | 03.15              | - M Sportbremse 3) |                |        |   |                     |                     |     |
|              | 425 d        | 160   | 03.14              | - M Sportbremse 3) |                |        |   |                     |                     |     |
|              | 425 d        | 165   | 03.16              | - M Sportbremse 3) |                |        |   |                     |                     |     |
|              | 428 i        | 180   | 07.13              | - M Sportbremse 3) |                |        |   |                     |                     |     |
|              | 428 i xDrive | 180   | 07.13              | - M Sportbremse 3) |                |        |   |                     |                     |     |
|              | 430 d        | 190   | 07.13              | - M Sportbremse 3) |                |        |   |                     |                     |     |
|              | 430 d xDrive | 190   | 03.14              | - M Sportbremse 3) |                |        |   |                     |                     |     |
|              | 430 i        | 185   | 03.16              | - M Sportbremse 3) |                |        |   |                     |                     |     |
|              | 430 i xDrive | 185   | 03.16              | - M Sportbremse 3) |                |        |   |                     |                     |     |
|              | 418 d        | 110   | 03.15              | - M Sportbremse 3) | 13.0460-3866.2 | 603866 |   |                     | 25506 18,2 +/WE     | BOS |
|              | 418 i        | 100   | 02.16              | - M Sportbremse 3) | 13.0470-3866.2 | LD3866 |   |                     | 25506 18,2 +/WE     | BOS |
|              | 420 i        | 135   | 02.16              | - M Sportbremse 3) | 24.8190-0006.2 | 620006 | 1 | ☐                   | Warnkontakt L=675mm |     |
| 420 i        | 135          | 07.13 | - M Sportbremse 3) |                    |                |        |   |                     |                     |     |
| 420 i xDrive | 135          | 02.16 | - M Sportbremse 3) |                    |                |        |   |                     |                     |     |
| 420 i xDrive | 135          | 07.13 | - M Sportbremse 3) |                    |                |        |   |                     |                     |     |
| 418 d        | 110          | 03.15 | + M Sportbremse 4) | 13.0460-4875.2     | 604875         |        |   | 25028 18,0 /WE      | BRE                 |     |
| 420 d        | 135          | 07.13 | + M Sportbremse 4) | 24.8190-0006.2     | 620006         | 1      | ☐ | Warnkontakt L=675mm |                     |     |
| 420 d        | 140          | 03.15 | + M Sportbremse 4) |                    |                |        |   |                     |                     |     |
| 420 d xDrive | 135          | 07.13 | + M Sportbremse 4) |                    |                |        |   |                     |                     |     |
| 420 d xDrive | 140          | 03.15 | + M Sportbremse 4) |                    |                |        |   |                     |                     |     |
| 420 i        | 135          | 02.16 | + M Sportbremse 4) |                    |                |        |   |                     |                     |     |
| 420 i        | 135          | 07.13 | + M Sportbremse 4) |                    |                |        |   |                     |                     |     |
| 420 i xDrive | 135          | 02.16 | + M Sportbremse 4) |                    |                |        |   |                     |                     |     |
| 420 i xDrive | 135          | 07.13 | + M Sportbremse 4) |                    |                |        |   |                     |                     |     |
| 435 d xDrive | 230          | 07.13 | - M Sportbremse 3) |                    |                |        |   |                     |                     |     |
| 435 i        | 225          | 07.13 | - M Sportbremse 3) |                    |                |        |   |                     |                     |     |
| 435 i xDrive | 225          | 07.13 | - M Sportbremse 3) |                    |                |        |   |                     |                     |     |
| 425 d        | 160          | 03.14 | + M Sportbremse 4) | 13.0460-4875.2     | 604875         |        |   | 25028 18,0 /WE      | BRE                 |     |
| 428 i        | 180          | 07.13 | + M Sportbremse 4) | 24.8190-0006.2     | 620006         | 1      | ☐ | Warnkontakt L=675mm |                     |     |
| 428 i xDrive | 180          | 07.13 | + M Sportbremse 4) |                    |                |        |   |                     |                     |     |
| 430 d        | 190          | 07.13 | + M Sportbremse 4) |                    |                |        |   |                     |                     |     |
| 430 d xDrive | 190          | 03.14 | + M Sportbremse 4) |                    |                |        |   |                     |                     |     |
| 435 d xDrive | 230          | 07.13 | + M Sportbremse 4) |                    |                |        |   |                     |                     |     |
| 435 i        | 225          | 07.13 | + M Sportbremse 4) |                    |                |        |   |                     |                     |     |
| 435 i xDrive | 225          | 07.13 | + M Sportbremse 4) |                    |                |        |   |                     |                     |     |
| 425 d        | 165          | 03.16 | + M Sportbremse 4) | 13.0460-4875.2     | 604875         |        |   | 25028 18,0 /WE      | BRE                 |     |
| 430 i        | 185          | 03.16 | + M Sportbremse 4) | 24.8190-0006.2     | 620006         | 1      | ☐ | Warnkontakt L=675mm |                     |     |
| 430 i xDrive | 185          | 03.16 | + M Sportbremse 4) |                    |                |        |   |                     |                     |     |
| 440 i        | 240          | 03.16 | + M Sportbremse 4) |                    |                |        |   |                     |                     |     |
| 440 i xDrive | 240          | 03.16 | + M Sportbremse 4) |                    |                |        |   |                     |                     |     |
| 418 i        | 100          | 02.16 | + M Sportbremse 4) | 24.8190-0006.2     | 620006         | 1      | ☐ | Warnkontakt L=675mm |                     |     |
| 440 i        | 240          | 03.16 | - M Sportbremse 3) |                    |                |        |   |                     |                     |     |
| 440 i xDrive | 240          | 03.16 | - M Sportbremse 3) |                    |                |        |   |                     |                     |     |

1) - speed control system / - impianto variatore di velocità / - régulateur de vitesse / - sistema de regulación de velocidad  
 2) + speed control system / + impianto variatore di velocità / + régulateur de vitesse / + sistema de regulación de velocidad  
 3) - M sport brake / - M freno sportivo / - M frein de sport / - M freno deportiva  
 4) + M sport brake / + M freno sportivo / + M frein de sport / + M freno deportiva



**BMW 4er Reihe/F32 Coupe (13-)**

|  |  |  |  |  |  |                            |        |  |  |
|--|--|--|--|--|--|----------------------------|--------|--|--|
|  | M4<br>M4<br>M4 GTS   | 317<br>331<br>368  | 03.14<br>03.16<br>03.16  |  | 24.8190-0006.2                                     | 620006                     | 1      |  | Warnkontakt L=675mm  |
|  | 420 d<br>420 d<br>420 d xDrive<br>420 d xDrive   | 135<br>140<br>135<br>140   | 07.13<br>03.15<br>07.13<br>03.15   | - M Sportbremse <sup>1)</sup><br>+ M Sportbremse <sup>1)</sup><br>- M Sportbremse <sup>1)</sup><br>- M Sportbremse <sup>1)</sup>   | 24.0124-0203.1<br>24.0324-0203.1                   | 424203<br>524203           |        |  | 312 23,9 22,4 V L +S +B<br>312 23,9 22,4 V L +S +B PD              |
|  | 418 d<br>418 i<br>420 i<br>420 i<br>420 i xDrive<br>420 i xDrive   | 110<br>100<br>135<br>135<br>135<br>135   | 03.15<br>02.16<br>02.16<br>07.13<br>02.16<br>07.13   | - M Sportbremse <sup>1)</sup><br>+ M Sportbremse <sup>1)</sup><br>- M Sportbremse <sup>1)</sup><br>- M Sportbremse <sup>1)</sup><br>- M Sportbremse <sup>1)</sup><br>- M Sportbremse <sup>1)</sup>   | 24.0122-0278.1                                     | 422278                     |        |  | 300 22,0 20,4 V L +S +B  |
|  | 418 d<br>418 i<br>420 d<br>420 d<br>420 d xDrive<br>420 d xDrive<br>420 i<br>420 i<br>420 i xDrive<br>420 i xDrive<br>435 d xDrive<br>435 i<br>435 i xDrive<br>440 i<br>440 i xDrive   | 110<br>100<br>135<br>140<br>135<br>140<br>135<br>135<br>135<br>135<br>230<br>225<br>225<br>240<br>240        | 03.15<br>02.16<br>07.13<br>03.15<br>07.13<br>03.15<br>02.16<br>07.13<br>02.16<br>07.13<br>07.13<br>07.13<br>07.13<br>03.16<br>03.16          | + M Sportbremse <sup>2)</sup><br>+ M Sportbremse <sup>2)</sup><br>+ M Sportbremse <sup>2)</sup><br>+ M Sportbremse <sup>2)</sup><br>+ M Sportbremse <sup>2)</sup><br>+ M Sportbremse <sup>2)</sup><br>+ M Sportbremse <sup>2)</sup><br>+ M Sportbremse <sup>2)</sup><br>+ M Sportbremse <sup>2)</sup><br>+ M Sportbremse <sup>2)</sup><br>- M Sportbremse <sup>1)</sup><br>- M Sportbremse <sup>1)</sup><br>- M Sportbremse <sup>1)</sup><br>- M Sportbremse <sup>1)</sup><br>- M Sportbremse <sup>1)</sup>                                  | 24.0130-0233.2                                     | 430233                     |        | zweiteilige Bremsscheibe <sup>3)</sup>   | 340 30,0 28,4 V L +S +B  |
|  | 425 d<br>425 d<br>428 i<br>428 i xDrive<br>430 d<br>430 d xDrive<br>430 i<br>430 i xDrive<br>435 d xDrive<br>440 i<br>440 i xDrive<br>435 i<br>435 i xDrive                            | 160<br>165<br>180<br>180<br>190<br>190<br>185<br>185<br>230<br>240<br>240<br>225<br>225                      | 03.14<br>03.16<br>07.13<br>07.13<br>07.13<br>03.14<br>03.16<br>03.16<br>07.13<br>03.16<br>03.16<br>07.13<br>07.13                            | + M Sportbremse <sup>2)</sup><br>+ M Sportbremse <sup>2)</sup><br>+ M Sportbremse <sup>2)</sup><br>+ M Sportbremse <sup>2)</sup><br>+ M Sportbremse <sup>2)</sup><br>+ M Sportbremse <sup>2)</sup><br>+ M Sportbremse <sup>2)</sup><br>+ M Sportbremse <sup>2)</sup><br>+ M Sportbremse <sup>2)</sup><br>+ M Sportbremse <sup>2)</sup><br>+ M Sportbremse <sup>2)</sup><br>+ M Sportbremse <sup>2)</sup><br>+ M Sportbremse <sup>2)</sup>  | 24.0130-0234.2                                     | 430234                     |        | zweiteilige Bremsscheibe <sup>3)</sup>   | 370 30,0 28,4 V L +S +B  |
|  | 418 d<br>418 i<br>420 d<br>420 d<br>420 i<br>420 i<br>425 d<br>425 d<br>428 i<br>430 d<br>430 i<br>435 i<br>440 i  | 110<br>100<br>135<br>140<br>135<br>135<br>160<br>165<br>180<br>190<br>185<br>225<br>240                      | 03.15<br>02.16<br>07.13<br>03.15<br>02.16<br>07.13<br>03.14<br>03.16<br>07.13<br>07.13<br>03.16<br>07.13<br>03.16                            |  | 24.0711-6281.3<br>24.0711-6282.3                   | 360386<br>360387           | 2<br>2 | - Start/Stop /- Parkassistent <sup>4)</sup><br>+ Start/Stop /+ Parkassistent <sup>5)</sup> | Radsensor L=540<br>Radsensor L=540                                 |
|  | 420 d xDrive<br>420 d xDrive<br>420 i xDrive<br>420 i xDrive<br>428 i xDrive<br>430 d xDrive<br>430 i xDrive<br>435 d xDrive<br>435 i xDrive<br>440 i xDrive                           | 135<br>140<br>135<br>135<br>180<br>190<br>185<br>230<br>225<br>240   | 07.13<br>03.15<br>02.16<br>07.13<br>07.13<br>03.14<br>03.16<br>07.13<br>07.13<br>03.16   |  | 24.0711-6299.3<br>24.0711-6300.3                   | 360388<br>360389           | 2<br>2 | - Start/Stop /- Parkassistent <sup>4)</sup><br>+ Start/Stop /+ Parkassistent <sup>5)</sup> | Radsensor L=746<br>Radsensor L=746                                 |
|  | M4<br>M4<br>M4 GTS   | 317<br>331<br>368  | 03.14<br>03.16<br>03.16  |  | 24.0711-6282.3                                     | 360387                     | 2      |  | Radsensor L=540  |
|  | 418 d<br>418 i<br>420 d<br>420 d<br>420 d xDrive<br>420 d xDrive<br>420 i<br>420 i<br>420 i xDrive<br>420 i xDrive<br>425 d<br>425 d<br>428 i<br>428 i xDrive<br>430 i<br>430 i xDrive | 110<br>100<br>135<br>140<br>135<br>140<br>135<br>135<br>135<br>135<br>160<br>165<br>180<br>180<br>185<br>185 | 03.15<br>02.16<br>07.13<br>03.15<br>07.13<br>03.15<br>02.16<br>07.13<br>02.16<br>07.13<br>03.14<br>03.16<br>07.13<br>07.13<br>03.16<br>03.16 | - M Sportbremse <sup>1)</sup><br>- M Sportbremse <sup>1)</sup><br>- M Sportbremse <sup>1)</sup><br>- M Sportbremse <sup>1)</sup><br>- M Sportbremse <sup>1)</sup><br>- M Sportbremse <sup>1)</sup><br>- M Sportbremse <sup>1)</sup><br>- M Sportbremse <sup>1)</sup><br>- M Sportbremse <sup>1)</sup><br>- M Sportbremse <sup>1)</sup><br>- M Sportbremse <sup>1)</sup><br>- M Sportbremse <sup>1)</sup><br>- M Sportbremse <sup>1)</sup><br>- M Sportbremse <sup>1)</sup><br>- M Sportbremse <sup>1)</sup><br>- M Sportbremse <sup>1)</sup> | 13.0460-3859.2<br>13.0470-3859.2<br>24.8190-0007.2 | 603859<br>LD3859<br>620007 | 1      |  | 25307 17,5 +/WE BOS<br>25307 17,5 +/WE BOS<br>Warnkontakt L=1045mm |
|  | 430 d<br>430 d xDrive<br>435 d xDrive  | 190<br>190<br>230  | 07.13<br>03.14<br>07.13  | - M Sportbremse <sup>1)</sup><br>- M Sportbremse <sup>1)</sup><br>- M Sportbremse <sup>1)</sup>  | 24.8190-0007.2                                     | 620007                     | 1      |  | Warnkontakt L=1045mm   |

1) - M sport brake / - M freno sportivo / - M frein de sport / - M freno deportiva  
 2) + M sport brake / + M freno sportivo / + M frein de sport / + M freno deportiva  
 3) two-piece brake disc / disco frenante in due parti / disque d.fr.en deux parties / disco de fr.de dos piezas  
 4) -idling/stop/-parking assist. / -start/stop/-assist.parcheggio / -marche/arrêt/-assist.stationnem. / -arranque/paro/-assist.aparcamiento  
 5) +idling/stop/+parking assist. / +start/stop/+assist.parcheggio / +marche/arrêt/+assist.stationnem. / +arranque/paro/+assist.aparcamiento

























**BMW 4er Reihe/F32 Coupe (13-)**

|  |              |     |       |                               |                |        |   |   |                         |
|--|--------------|-----|-------|-------------------------------|----------------|--------|---|---|-------------------------|
|  | 435 i        | 225 | 07.13 | - M Sportbremse <sup>1)</sup> | 24.8190-0007.2 | 620007 | 1 |   | Warnkontakt L=1045mm    |
|  | 435 i xDrive | 225 | 07.13 | - M Sportbremse <sup>1)</sup> |                |        |   |   |                         |
|  | 440 i        | 240 | 03.16 | - M Sportbremse <sup>1)</sup> |                |        |   |   |                         |
|  | 440 i xDrive | 240 | 03.16 | - M Sportbremse <sup>1)</sup> |                |        |   |   |                         |
|  | 418 d        | 110 | 03.15 | + M Sportbremse <sup>2)</sup> | 13.0460-4874.2 | 604874 |   |   | 25029 16,7 / WE/Zub BRE |
|  | 420 d        | 135 | 07.13 | + M Sportbremse <sup>2)</sup> | 24.8190-0007.2 | 620007 | 1 |   | Warnkontakt L=1045mm    |
|  | 420 d        | 140 | 03.15 | + M Sportbremse <sup>2)</sup> |                |        |   |   |                         |
|  | 420 d xDrive | 135 | 07.13 | + M Sportbremse <sup>2)</sup> |                |        |   |   |                         |
|  | 420 d xDrive | 140 | 03.15 | + M Sportbremse <sup>2)</sup> |                |        |   |   |                         |
|  | 420 i        | 135 | 02.16 | + M Sportbremse <sup>2)</sup> |                |        |   |   |                         |
|  | 420 i        | 135 | 07.13 | + M Sportbremse <sup>2)</sup> |                |        |   |   |                         |
|  | 420 i xDrive | 135 | 02.16 | + M Sportbremse <sup>2)</sup> |                |        |   |   |                         |
|  | 420 i xDrive | 135 | 07.13 | + M Sportbremse <sup>2)</sup> |                |        |   |   |                         |
|  | 425 d        | 160 | 03.14 | + M Sportbremse <sup>2)</sup> |                |        |   |   |                         |
|  | 428 i        | 180 | 07.13 | + M Sportbremse <sup>2)</sup> |                |        |   |   |                         |
|  | 428 i xDrive | 180 | 07.13 | + M Sportbremse <sup>2)</sup> |                |        |   |   |                         |
|  | 430 d        | 190 | 07.13 | + M Sportbremse <sup>2)</sup> |                |        |   |   |                         |
|  | 430 d xDrive | 190 | 03.14 | + M Sportbremse <sup>2)</sup> |                |        |   |   |                         |
|  | 430 i        | 185 | 03.16 | + M Sportbremse <sup>2)</sup> |                |        |   |   |                         |
|  | 430 i xDrive | 185 | 03.16 | + M Sportbremse <sup>2)</sup> |                |        |   |   |                         |
|  | 435 d xDrive | 230 | 07.13 | + M Sportbremse <sup>2)</sup> |                |        |   |   |                         |
|  | 435 i        | 225 | 07.13 | + M Sportbremse <sup>2)</sup> |                |        |   |   |                         |
|  | 435 i xDrive | 225 | 07.13 | + M Sportbremse <sup>2)</sup> |                |        |   |   |                         |
|  | M4           | 317 | 03.14 |                               | 24.8190-0007.2 | 620007 | 1 |   | Warnkontakt L=1045mm    |
|  | M4           | 331 | 03.16 |                               |                |        |   |   |                         |
|  | M4 GTS       | 368 | 03.16 |                               |                |        |   |   |                         |
|  | 418 i        | 100 | 02.16 | + M Sportbremse <sup>2)</sup> | 24.8190-0007.2 | 620007 | 1 |   | Warnkontakt L=1045mm    |
|  | 425 d        | 165 | 03.16 | + M Sportbremse <sup>2)</sup> |                |        |   |   |                         |
|  | 440 i        | 240 | 03.16 | + M Sportbremse <sup>2)</sup> |                |        |   |   |                         |
|  | 440 i xDrive | 240 | 03.16 | + M Sportbremse <sup>2)</sup> |                |        |   |   |                         |
|  | 418 d        | 110 | 03.15 | - M Sportbremse <sup>1)</sup> | 24.0120-0237.1 | 420237 |   |   | 300 20,0 18,4 V L +S +B |
|  | 420 d        | 135 | 07.13 | - M Sportbremse <sup>1)</sup> |                |        |   |   |                         |
|  | 420 i        | 135 | 07.13 | - M Sportbremse <sup>1)</sup> |                |        |   |   |                         |
|  | 425 d        | 160 | 03.14 | - M Sportbremse <sup>1)</sup> |                |        |   |   |                         |
|  | 418 i        | 100 | 02.16 | - M Sportbremse <sup>1)</sup> | 24.0120-0240.1 | 420240 |   |   | 300 20,0 18,4 V L +S +B |
|  | 420 d xDrive | 135 | 07.13 | - M Sportbremse <sup>1)</sup> |                |        |   |   |                         |
|  | 420 d xDrive | 140 | 03.15 | - M Sportbremse <sup>1)</sup> |                |        |   |   |                         |
|  | 420 i        | 135 | 02.16 | - M Sportbremse <sup>1)</sup> |                |        |   |   |                         |
|  | 420 i xDrive | 135 | 02.16 | - M Sportbremse <sup>1)</sup> |                |        |   |   |                         |
|  | 420 i xDrive | 135 | 07.13 | - M Sportbremse <sup>1)</sup> |                |        |   |   |                         |
|  | 425 d        | 165 | 03.16 | - M Sportbremse <sup>1)</sup> |                |        |   |   |                         |
|  | 428 i        | 180 | 07.13 | - M Sportbremse <sup>1)</sup> |                |        |   |   |                         |
|  | 428 i xDrive | 180 | 07.13 | - M Sportbremse <sup>1)</sup> |                |        |   |   |                         |
|  | 430 i        | 185 | 03.16 | - M Sportbremse <sup>1)</sup> |                |        |   |   |                         |
|  | 430 i xDrive | 185 | 03.16 | - M Sportbremse <sup>1)</sup> |                |        |   |   |                         |
|  | 430 d        | 190 | 07.13 | - M Sportbremse <sup>1)</sup> | 24.0120-0243.1 | 420243 |   |   | 330 20,0 18,4 V L +S +B |
|  | 430 d xDrive | 190 | 03.14 | - M Sportbremse <sup>1)</sup> |                |        |   |   |                         |
|  | 435 d xDrive | 230 | 07.13 | - M Sportbremse <sup>1)</sup> |                |        |   |   |                         |
|  | 435 i        | 225 | 07.13 | - M Sportbremse <sup>1)</sup> |                |        |   |   |                         |
|  | 435 i xDrive | 225 | 07.13 | - M Sportbremse <sup>1)</sup> |                |        |   |   |                         |
|  | 440 i        | 240 | 03.16 | - M Sportbremse <sup>1)</sup> |                |        |   |   |                         |
|  | 440 i xDrive | 240 | 03.16 | - M Sportbremse <sup>1)</sup> |                |        |   |   |                         |
|  | 418 d        | 110 | 03.15 | + M Sportbremse <sup>2)</sup> | 24.0124-0250.2 | 424250 |   | zweitellige Bremsscheibe <sup>3)</sup>      | 345 24,0 22,4 V L +S +B |
|  | 420 d        | 135 | 07.13 | + M Sportbremse <sup>2)</sup> |                |        |   |   |                         |
|  | 420 d        | 140 | 03.15 | + M Sportbremse <sup>2)</sup> |                |        |   |   |                         |
|  | 420 i        | 135 | 07.13 | + M Sportbremse <sup>2)</sup> |                |        |   |   |                         |
|  | 425 d        | 160 | 03.14 | + M Sportbremse <sup>2)</sup> |                |        |   |   |                         |
|  | 418 i        | 100 | 02.16 | + M Sportbremse <sup>2)</sup> | 24.0124-0251.2 | 424251 |   | zweitellige Bremsscheibe <sup>3)</sup>      | 345 24,0 22,4 V L +S +B |
|  | 420 d xDrive | 135 | 07.13 | + M Sportbremse <sup>2)</sup> |                |        |   |   |                         |
|  | 420 d xDrive | 140 | 03.15 | + M Sportbremse <sup>2)</sup> |                |        |   |   |                         |
|  | 420 i        | 135 | 02.16 | + M Sportbremse <sup>2)</sup> |                |        |   |   |                         |
|  | 420 i xDrive | 135 | 02.16 | + M Sportbremse <sup>2)</sup> |                |        |   |   |                         |
|  | 420 i xDrive | 135 | 07.13 | + M Sportbremse <sup>2)</sup> |                |        |   |   |                         |
|  | 425 d        | 165 | 03.16 | + M Sportbremse <sup>2)</sup> |                |        |   |   |                         |
|  | 428 i        | 180 | 07.13 | + M Sportbremse <sup>2)</sup> |                |        |   |   |                         |
|  | 428 i xDrive | 180 | 07.13 | + M Sportbremse <sup>2)</sup> |                |        |   |   |                         |
|  | 430 d        | 190 | 07.13 | + M Sportbremse <sup>2)</sup> |                |        |   |   |                         |
|  | 430 d xDrive | 190 | 03.14 | + M Sportbremse <sup>2)</sup> |                |        |   |   |                         |
|  | 430 i        | 185 | 03.16 | + M Sportbremse <sup>2)</sup> |                |        |   |   |                         |
|  | 430 i xDrive | 185 | 03.16 | + M Sportbremse <sup>2)</sup> |                |        |   |   |                         |
|  | 435 d xDrive | 230 | 07.13 | + M Sportbremse <sup>2)</sup> |                |        |   |   |                         |
|  | 435 i        | 225 | 07.13 | + M Sportbremse <sup>2)</sup> |                |        |   |   |                         |
|  | 435 i xDrive | 225 | 07.13 | + M Sportbremse <sup>2)</sup> |                |        |   |   |                         |
|  | 440 i        | 240 | 03.16 | + M Sportbremse <sup>2)</sup> |                |        |   |   |                         |
|  | 440 i xDrive | 240 | 03.16 | + M Sportbremse <sup>2)</sup> |                |        |   |   |                         |
|  | 418 d        | 110 | 03.15 |                               | 24.0711-5347.3 | 360374 | 2 | - Geschwindigkeitsregelanlage <sup>4)</sup> | Radsensor L=802         |
|  | 418 i        | 100 | 02.16 |                               | 24.0711-5359.3 | 360375 | 2 | + Geschwindigkeitsregelanlage <sup>5)</sup> | Radsensor L=802         |
|  | 420 d        | 135 | 07.13 |                               |                |        |   |   |                         |
|  | 420 d        | 140 | 03.15 |                               |                |        |   |   |                         |
|  | 420 d xDrive | 135 | 07.13 |                               |                |        |   |   |                         |
|  | 420 d xDrive | 140 | 03.15 |                               |                |        |   |   |                         |
|  | 420 i        | 135 | 02.16 |                               |                |        |   |   |                         |
|  | 420 i        | 135 | 07.13 |                               |                |        |   |   |                         |
|  | 420 i xDrive | 135 | 02.16 |                               |                |        |   |   |                         |
|  | 420 i xDrive | 135 | 07.13 |                               |                |        |   |   |                         |
|  | 425 d        | 160 | 03.14 |                               |                |        |   |   |                         |

1) - M sport brake / - M freno sportivo / - M frein de sport / - M freno deportiva  
 2) + M sport brake / + M freno sportivo / + M frein de sport / + M freno deportiva  
 3) two-piece brake disc / disco frenante in due parti / disque d.fr.en deux parties / disco de fr.de dos piezas  
 4) - speed control system / - impianto variatore di velocità / - régulateur de vitesse / - sistema de regulación de velocidad  
 5) + speed control system / + impianto variatore di velocità / + régulateur de vitesse / + sistema de regulación de velocidad





|     |  |  |  |  |  |  |     |   |  |  |
|--|--|--|--|--|---|--|---|---|--|--|
| <b>BMW 4er Reihe/F33 Cabrio (14-)</b>  |  |  |  |  |   |  |   |   |  |  |
|    | 420 d  | 135  |  | 10.13  |   | 24.0711-6281.3   | 360386  | 2  - Start/Stop-Anlage <sup>1)</sup>   | Radsensor L=540<br>Radsensor L=540   |  |
|  | 420 d  | 140  |  | 07.15  |   | 24.0711-6282.3   | 360387  | 2  + Start/Stop-Anlage <sup>2)</sup>   |  |  |
|  | 420 i  | 135  |  | 02.16  |   |  |   |   |  |  |
|  | 420 i  | 135  |  | 07.14  |   |  |   |   |  |  |
|  | 425 d  | 160  |  | 07.14  |   |  |   |   |  |  |
|  | 425 d  | 165  |  | 03.16  |   |  |   |   |  |  |
|  | 428 i  | 180  |  | 10.13  |   |  |   |   |  |  |
|  | 430 d  | 190  |  | 07.14  |   |  |   |   |  |  |
|  | 430 i  | 185  |  | 03.16  |   |  |   |   |  |  |
|  | 435 i  | 225  |  | 10.13  |   |  |   |   |  |  |
|  | 440 i  | 240  |  | 03.16  |   |  |   |   |  |  |
|  | 428 i xDrive   | 180  |  | 10.13  |   | 24.0711-6299.3   | 360388  | 2  - Start/Stop-Anlage <sup>1)</sup>   |  | Radsensor L=746<br>Radsensor L=746                 |
|  | 430 i xDrive   | 185  |  | 03.16  |   | 24.0711-6300.3   | 360389  | 2  + Start/Stop-Anlage <sup>2)</sup>   |  |  |
|  | 435 d xDrive   | 230  |  | 07.14  |   |  |   |   |  |  |
| 435 i xDrive   | 225  |  | 10.13  |  |   |  |   |   |  |  |
| 440 i xDrive   | 240  |  | 03.16  |  |   |  |   |   |  |  |
| M4   | 317  |  | 07.14  |  | 24.0711-6282.3  | 360387   | 2  | Radsensor L=540   |  |  |
| M4   | 331  |  | 03.16  |  |   |  |   |   |  |  |
|    | 420 d  | 135  |  | 10.13  |   | 13.0460-3859.2   | 603859  | - M Sportbremse <sup>3)</sup>   | 25307 17,5 +/WE BOS<br>25307 17,5 +/WE BOS<br>25029 16,7 /WE/Zub BRE<br>Warnkontakt L=1045mm |  |
|  | 420 d  | 140  |  | 07.15  |   | 13.0470-3859.2   | LD3859  | - M Sportbremse <sup>3)</sup>   |  |  |
|  | 420 i  | 135  |  | 02.16  |   | 13.0460-4874.2   | 604874  | + M Sportbremse <sup>4)</sup>   |  |  |
|  | 420 i  | 135  |  | 07.14  |   | 24.8190-0007.2   | 620007  | 1   |  |  |
|  | 425 d  | 160  |  | 07.14  |   |  |   |   |  |  |
|  | 428 i  | 180  |  | 10.13  |   |  |   |   |  |  |
|  | 428 i xDrive   | 180  |  | 10.13  |   |  |   |   |  |  |
|  | 430 i  | 185  |  | 03.16  |   |  |   |   |  |  |
|  | 430 i xDrive   | 185  |  | 03.16  |   |  |   |   |  |  |
|  | 430 d  | 190  |  | 07.14  |   | 13.0460-4874.2   | 604874  | + M Sportbremse <sup>4)</sup>   |  | 25029 16,7 /WE/Zub BRE<br>Warnkontakt L=1045mm     |
|  | 435 d xDrive   | 230  |  | 07.14  |   | 24.8190-0007.2   | 620007  | 1   |  |  |
|  | 435 i  | 225  |  | 10.13  |   |  |   |   |  |  |
|  | 435 i xDrive   | 225  |  | 10.13  |   |  |   |   |  |  |
|  | 440 i  | 240  |  | 03.16  |   | 24.8190-0007.2   | 620007  | 1   |  | Warnkontakt L=1045mm                               |
| 440 i xDrive   | 240  |  | 03.16  |  |   |  |   |   |  |  |
| M4   | 317  |  | 07.14  |  | 24.8190-0007.2  | 620007   | 1   | Warnkontakt L=1045mm  |  |  |
| M4   | 331  |  | 03.16  |  |   |  |   |   |  |  |
| 425 d  | 165  |  | 03.16  |  | 13.0460-3859.2  | 603859   | - M Sportbremse <sup>3)</sup>   | 25307 17,5 +/WE BOS<br>25307 17,5 +/WE BOS<br>Warnkontakt L=1045mm  |  |  |
|  |  |  |  |  | 13.0470-3859.2  | LD3859   | - M Sportbremse <sup>3)</sup>   |   |  |  |
|  |  |  |  |  | 24.8190-0007.2  | 620007   | 1   |   |  |  |
|   | 420 d  | 135  |  | 10.13  |   | 24.0120-0240.1   | 420240  | - M Sportbremse <sup>3)</sup>   | 300 20,0 18,4 V L +S +B<br>345 24,0 22,4 V L +S +B   |  |
|  | 420 d  | 140  |  | 07.15  |   | 24.0124-0251.2   | 424251  | + M Sportbremse / zweiteil.Br. <sup>5)</sup>  |  |  |
|  | 420 i  | 135  |  | 02.16  |   |  |   |   |  |  |
|  | 420 i  | 135  |  | 07.14  |   |  |   |   |  |  |
|  | 425 d  | 160  |  | 07.14  |   |  |   |   |  |  |
|  | 425 d  | 165  |  | 03.16  |   |  |   |   |  |  |
|  | 428 i  | 180  |  | 10.13  |   |  |   |   |  |  |
|  | 428 i xDrive   | 180  |  | 10.13  |   |  |   |   |  |  |
|  | 430 i  | 185  |  | 03.16  |   |  |   |   |  |  |
|  | 430 i xDrive   | 185  |  | 03.16  |   |  |   |   |  |  |
|  | 430 d  | 190  |  | 07.14  |   | 24.0120-0243.1   | 420243  | - M Sportbremse <sup>3)</sup>   |  | 330 20,0 18,4 V L +S +B<br>345 24,0 22,4 V L +S +B |
|  | 435 d xDrive   | 230  |  | 07.14  |   | 24.0124-0251.2   | 424251  | + M Sportbremse / zweiteil.Br. <sup>5)</sup>  |  |  |
|  | 435 i  | 225  |  | 10.13  |   |  |   |   |  |  |
|  | 435 i xDrive   | 225  |  | 10.13  |   |  |   |   |  |  |
| 440 i  | 240  |  | 03.16  |  |   |  |   |   |  |  |
| 440 i xDrive   | 240  |  | 03.16  |  |   |  |   |   |  |  |
|  | 420 d  | 135  |  | 10.13  |   | 24.0711-5347.3   | 360374  | 2  - Start/Stop-Anlage <sup>1)</sup> | Radsensor L=802<br>Radsensor L=802   |  |
|  | 420 d  | 140  |  | 07.15  |   | 24.0711-5359.3   | 360375  | 2  + Start/Stop-Anlage <sup>2)</sup> |  |  |
|  | 420 i  | 135  |  | 02.16  |   |  |   |   |  |  |
|  | 420 i  | 135  |  | 07.14  |   |  |   |   |  |  |
|  | 425 d  | 160  |  | 07.14  |   |  |   |   |  |  |
|  | 425 d  | 165  |  | 03.16  |   |  |   |   |  |  |
|  | 428 i  | 180  |  | 10.13  |   |  |   |   |  |  |
|  | 428 i xDrive   | 180  |  | 10.13  |   |  |   |   |  |  |
|  | 430 d  | 190  |  | 07.14  |   |  |   |   |  |  |
|  | 430 i  | 185  |  | 03.16  |   |  |   |   |  |  |
|  | 430 i xDrive   | 185  |  | 03.16  |   |  |   |   |  |  |
|  | 435 d xDrive   | 230  |  | 07.14  |   |  |   |   |  |  |
|  | 435 i  | 225  |  | 10.13  |   |  |   |   |  |  |
|  | 435 i xDrive   | 225  |  | 10.13  |   |  |   |   |  |  |
| 440 i  | 240  |  | 03.16  |  |   |  |   |   |  |  |
| 440 i xDrive   | 240  |  | 03.16  |  |   |  |   |   |  |  |
|  | 420 d  | 135  |  | 10.13  |   | 03.0137-0379.2   | 650379  |   | 161 x 20<br>Bremsbacken-Zubehör<br>Bremsbacken-Zubehör<br>Spreizschloß Satz                  |  |
|  |  |  |  |  |   | 03.0137-9265.2   | 669265  |   |  |  |
|  |  |  |  |  |   | 03.0137-9701.2   | 669701  |   |  |  |
|  |  |  |  |  |   | 03.0137-9702.2   | 669702  |   |  |  |
|  | 420 d  | 140  |  | 07.15  |   | 03.0137-0305.2   | 650305  |   | 185 x 20<br>Bremsbacken-Zubehör<br>Bremsbacken-Zubehör<br>Spreizschloß Satz                  |  |
|  | 420 i  | 135  |  | 02.16  |   | 03.0137-9062.2   | 669062  |   |  |  |
|  | 420 i  | 135  |  | 07.14  |   | 03.0137-9700.2   | 669700  |   |  |  |
|  | 425 d  | 160  |  | 07.14  |   | 03.0137-9702.2   | 669702  |   |  |  |
|  | 425 d  | 165  |  | 03.16  |   |  |   |   |  |  |
|  | 428 i  | 180  |  | 10.13  |   |  |   |   |  |  |
|  | 428 i xDrive   | 180  |  | 10.13  |   |  |   |   |  |  |
|  | 430 d  | 190  |  | 07.14  |   |  |   |   |  |  |
|  | 430 i  | 185  |  | 03.16  |   |  |   |   |  |  |
|  | 430 i xDrive   | 185  |  | 03.16  |   |  |   |   |  |  |
| 435 d xDrive   | 230  |  | 07.14  |  |   |  |   |   |  |  |
| 435 i  | 225  |  | 10.13  |  |   |  |   |   |  |  |

<sup>1)</sup> - idling stop system / - dispositivo start/stop / - unité marche/arrêt / - unidad arranque/paro  
<sup>2)</sup> + idling stop system / + dispositivo start/stop / + unité marche/arrêt / + unidad arranque/paro  
<sup>3)</sup> - M sport brake / - M freno sportivo / - M frein de sport / - M freno deportiva  
<sup>4)</sup> + M sport brake / + M freno sportivo / + M frein de sport / + M freno deportiva  
<sup>5)</sup> + M sport brake / two-p. disc / + M freno sport / deux part.disc / + M frein de sport / d. parti. disque / + M freno sport / deux parties disc

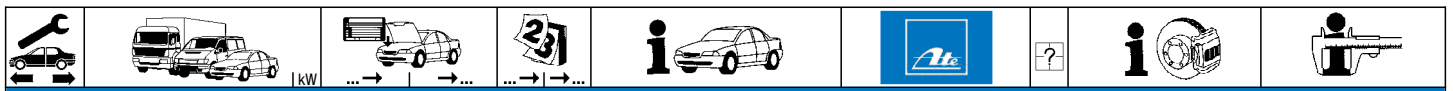

**BMW 4er Reihe/F33 Cabrio (14-)**

|  |              |     |  |       |  |                |        |  |                     |
|--|--------------|-----|--|-------|--|----------------|--------|--|---------------------|
|  | 435 i xDrive | 225 |  | 10.13 |  | 03.0137-0305.2 | 650305 |  | 185 x 20            |
|  | 440 i        | 240 |  | 03.16 |  | 03.0137-9062.2 | 669062 |  | Bremsbacken-Zubehör |
|  | 440 i xDrive | 240 |  | 03.16 |  | 03.0137-9700.2 | 669700 |  | Bremsbacken-Zubehör |
|  | M4           | 317 |  | 07.14 |  | 03.0137-9702.2 | 669702 |  | Spreizschloß Satz   |
|  | M4           | 331 |  | 03.16 |  |                |        |  |                     |

**BMW 4er Reihe/F36 Gran Coupe (14-)**

|              |              |     |       |                                 |                                 |                |        |                         |                            |     |
|--------------|--------------|-----|-------|---------------------------------|---------------------------------|----------------|--------|-------------------------|----------------------------|-----|
|              | 418 d        | 105 |       | 03.14                           | - M Sportbremse <sup>1)</sup>   | 13.0460-3866.2 | 603866 |                         | 25506 18,2 +/WE            | BOS |
|              | 418 d        | 110 |       | 07.15                           | - M Sportbremse <sup>1)</sup>   | 13.0470-3866.2 | LD3866 |                         | 25506 18,2 +/WE            | BOS |
|              | 418 i        | 100 |       | 07.15                           | - M Sportbremse <sup>1)</sup>   | 24.8190-0006.2 | 620006 | 1                       | Warnkontakt L=675mm        |     |
|              | 420 i        | 135 |       | 02.16                           | - M Sportbremse/+ Motorcode B48 |                |        |                         |                            |     |
|              | 420 i xDrive | 135 |       | 02.16                           | - M Sportbremse <sup>1)</sup>   |                |        |                         |                            |     |
|              | 420 i xDrive | 135 |       | 07.14                           | - M Sportbremse <sup>1)</sup>   |                |        |                         |                            |     |
|              | 420 d        | 135 |       | 03.14                           | - M Sportbremse <sup>1)</sup>   | 13.0460-3857.2 | 603857 |                         | 25199 19,6 +/WE            | BOS |
|              | 420 d        | 140 |       | 03.15                           | - M Sportbremse <sup>1)</sup>   | 13.0470-3857.2 | LD3857 |                         | 25199 19,6 +/WE            | BOS |
|              | 420 d xDrive | 135 |       | 03.14                           | - M Sportbremse <sup>1)</sup>   | 24.8190-0006.2 | 620006 | 1                       | Warnkontakt L=675mm        |     |
|              | 420 d xDrive | 140 |       | 03.15                           | - M Sportbremse <sup>1)</sup>   |                |        |                         |                            |     |
| 420 i        | 135          |     | 03.14 | - M Sportbremse <sup>1)</sup>   |                                 |                |        |                         |                            |     |
| 425 d        | 165          |     | 03.16 | - M Sportbremse <sup>1)</sup>   |                                 |                |        |                         |                            |     |
| 428 i        | 180          |     | 03.14 | - M Sportbremse <sup>1)</sup>   |                                 |                |        |                         |                            |     |
| 428 i xDrive | 180          |     | 03.14 | - M Sportbremse <sup>1)</sup>   |                                 |                |        |                         |                            |     |
| 430 d        | 190          |     | 07.14 | - M Sportbremse <sup>1)</sup>   |                                 |                |        |                         |                            |     |
| 430 d xDrive | 190          |     | 07.14 | - M Sportbremse <sup>1)</sup>   |                                 |                |        |                         |                            |     |
| 430 i        | 185          |     | 03.16 | - M Sportbremse <sup>1)</sup>   |                                 |                |        |                         |                            |     |
| 430 i xDrive | 185          |     | 03.16 | - M Sportbremse <sup>1)</sup>   |                                 |                |        |                         |                            |     |
| 420 i        | 135          |     | 02.16 | + M Sportbremse/+ Motorcode B48 | 24.8190-0006.2                  | 620006         | 1      | Warnkontakt L=675mm     |                            |     |
| 420 i xDrive | 135          |     | 02.16 | + M Sportbremse/+ Motorcode B48 |                                 |                |        |                         |                            |     |
| 440 i        | 240          |     | 03.16 | - M Sportbremse <sup>1)</sup>   |                                 |                |        |                         |                            |     |
| 440 i xDrive | 240          |     | 03.16 | - M Sportbremse <sup>1)</sup>   |                                 |                |        |                         |                            |     |
| 418 d        | 105          |     | 03.14 | + M Sportbremse <sup>2)</sup>   | 13.0460-4875.2                  | 604875         |        | 25028 18,0 /WE          | BRE                        |     |
| 418 d        | 110          |     | 07.15 | + M Sportbremse <sup>2)</sup>   | 24.8190-0006.2                  | 620006         | 1      | Warnkontakt L=675mm     |                            |     |
| 418 i        | 100          |     | 07.15 | + M Sportbremse <sup>2)</sup>   |                                 |                |        |                         |                            |     |
| 420 d        | 135          |     | 03.14 | + M Sportbremse <sup>2)</sup>   |                                 |                |        |                         |                            |     |
| 420 d        | 140          |     | 03.15 | + M Sportbremse <sup>2)</sup>   |                                 |                |        |                         |                            |     |
| 420 d xDrive | 135          |     | 03.14 | + M Sportbremse <sup>2)</sup>   |                                 |                |        |                         |                            |     |
| 420 d xDrive | 140          |     | 03.15 | + M Sportbremse <sup>2)</sup>   |                                 |                |        |                         |                            |     |
| 420 i        | 135          |     | 03.14 | + M Sportbremse <sup>2)</sup>   |                                 |                |        |                         |                            |     |
| 420 i xDrive | 135          |     | 07.14 | + M Sportbremse <sup>2)</sup>   |                                 |                |        |                         |                            |     |
| 435 d xDrive | 230          |     | 07.14 | - M Sportbremse <sup>1)</sup>   |                                 |                |        |                         |                            |     |
| 435 i        | 225          |     | 03.14 | - M Sportbremse <sup>1)</sup>   |                                 |                |        |                         |                            |     |
| 435 i xDrive | 225          |     | 07.14 | - M Sportbremse <sup>1)</sup>   |                                 |                |        |                         |                            |     |
| 428 i        | 180          |     | 03.14 | + M Sportbremse <sup>2)</sup>   | 13.0460-4875.2                  | 604875         |        | 25028 18,0 /WE          | BRE                        |     |
| 428 i xDrive | 180          |     | 03.14 | + M Sportbremse <sup>2)</sup>   | 24.8190-0006.2                  | 620006         | 1      | Warnkontakt L=675mm     |                            |     |
| 430 d        | 190          |     | 07.14 | + M Sportbremse <sup>2)</sup>   |                                 |                |        |                         |                            |     |
| 430 d xDrive | 190          |     | 07.14 | + M Sportbremse <sup>2)</sup>   |                                 |                |        |                         |                            |     |
| 435 d xDrive | 230          |     | 07.14 | + M Sportbremse <sup>2)</sup>   |                                 |                |        |                         |                            |     |
| 435 i        | 225          |     | 03.14 | + M Sportbremse <sup>2)</sup>   |                                 |                |        |                         |                            |     |
| 435 i xDrive | 225          |     | 07.14 | + M Sportbremse <sup>2)</sup>   |                                 |                |        |                         |                            |     |
| 425 d        | 165          |     | 03.16 | + M Sportbremse <sup>2)</sup>   | 13.0460-4875.2                  | 604875         |        | 25028 18,0 /WE          | BRE                        |     |
| 430 i        | 185          |     | 03.16 | + M Sportbremse <sup>2)</sup>   | 24.8190-0006.2                  | 620006         | 1      | Warnkontakt L=675mm     |                            |     |
| 430 i xDrive | 185          |     | 03.16 | + M Sportbremse <sup>2)</sup>   |                                 |                |        |                         |                            |     |
| 440 i        | 240          |     | 03.16 | + M Sportbremse <sup>2)</sup>   |                                 |                |        |                         |                            |     |
| 440 i xDrive | 240          |     | 03.16 | + M Sportbremse <sup>2)</sup>   |                                 |                |        |                         |                            |     |
|              | 418 d        | 105 |       | 03.14                           | - M Sportbremse <sup>1)</sup>   | 24.0122-0278.1 | 422278 |                         | 300 22,0 20,4 V L +S +B    |     |
|              | 418 d        | 110 |       | 07.15                           | - M Sportbremse <sup>1)</sup>   |                |        |                         |                            |     |
|              | 418 i        | 100 |       | 07.15                           | - M Sportbremse <sup>1)</sup>   |                |        |                         |                            |     |
|              | 420 d        | 135 |       | 03.14                           | - M Sportbremse <sup>1)</sup>   |                |        |                         |                            |     |
|              | 420 i        | 135 |       | 02.16                           | - M Sportbremse <sup>1)</sup>   |                |        |                         |                            |     |
|              | 420 i        | 135 |       | 03.14                           | - M Sportbremse <sup>1)</sup>   |                |        |                         |                            |     |
|              | 420 i xDrive | 135 |       | 02.16                           | - M Sportbremse <sup>1)</sup>   |                |        |                         |                            |     |
|              | 420 i xDrive | 135 |       | 07.14                           | - M Sportbremse <sup>1)</sup>   |                |        |                         |                            |     |
|              | 420 d        | 140 |       | 03.15                           | - M Sportbremse <sup>1)</sup>   | 24.0124-0203.1 | 424203 |                         | 312 23,9 22,4 V L +S +B    |     |
|              | 420 d xDrive | 135 |       | 03.14                           | - M Sportbremse <sup>1)</sup>   | 24.0324-0203.1 | 524203 |                         | 312 23,9 22,4 V L +S +B PD |     |
| 420 d xDrive | 140          |     | 03.15 | - M Sportbremse <sup>1)</sup>   |                                 |                |        |                         |                            |     |
| 418 d        | 105          |     | 03.14 | + M Sportbremse <sup>2)</sup>   | 24.0130-0233.2                  | 430233         |        | 340 30,0 28,4 V L +S +B |                            |     |
| 418 d        | 110          |     | 07.15 | + M Sportbremse <sup>2)</sup>   |                                 |                |        |                         |                            |     |
| 418 i        | 100          |     | 07.15 | + M Sportbremse <sup>2)</sup>   |                                 |                |        |                         |                            |     |
| 420 d        | 135          |     | 03.14 | + M Sportbremse <sup>2)</sup>   |                                 |                |        |                         |                            |     |
| 420 d        | 140          |     | 03.15 | + M Sportbremse <sup>2)</sup>   |                                 |                |        |                         |                            |     |
| 420 d xDrive | 135          |     | 03.14 | + M Sportbremse <sup>2)</sup>   |                                 |                |        |                         |                            |     |
| 420 d xDrive | 140          |     | 03.15 | + M Sportbremse <sup>2)</sup>   |                                 |                |        |                         |                            |     |
| 420 i        | 135          |     | 02.16 | + M Sportbremse <sup>2)</sup>   |                                 |                |        |                         |                            |     |
| 420 i        | 135          |     | 03.14 | + M Sportbremse <sup>2)</sup>   |                                 |                |        |                         |                            |     |
| 420 i xDrive | 135          |     | 02.16 | + M Sportbremse <sup>2)</sup>   |                                 |                |        |                         |                            |     |
| 420 i xDrive | 135          |     | 07.14 | + M Sportbremse <sup>2)</sup>   |                                 |                |        |                         |                            |     |
| 435 d xDrive | 230          |     | 07.14 | - M Sportbremse <sup>1)</sup>   |                                 |                |        |                         |                            |     |
| 435 i        | 225          |     | 03.14 | - M Sportbremse <sup>1)</sup>   |                                 |                |        |                         |                            |     |
| 435 i xDrive | 225          |     | 07.14 | - M Sportbremse <sup>1)</sup>   |                                 |                |        |                         |                            |     |
| 440 i        | 240          |     | 03.16 | - M Sportbremse <sup>1)</sup>   |                                 |                |        |                         |                            |     |
| 440 i xDrive | 240          |     | 03.16 | - M Sportbremse <sup>1)</sup>   |                                 |                |        |                         |                            |     |
| 425 d        | 165          |     | 03.16 | + M Sportbremse <sup>2)</sup>   | 24.0130-0234.2                  | 430234         |        | 370 30,0 28,4 V L +S +B |                            |     |
| 428 i        | 180          |     | 03.14 | + M Sportbremse <sup>2)</sup>   |                                 |                |        |                         |                            |     |
| 428 i xDrive | 180          |     | 03.14 | + M Sportbremse <sup>2)</sup>   |                                 |                |        |                         |                            |     |
| 430 d        | 190          |     | 07.14 | + M Sportbremse <sup>2)</sup>   |                                 |                |        |                         |                            |     |
| 430 d xDrive | 190          |     | 07.14 | + M Sportbremse <sup>2)</sup>   |                                 |                |        |                         |                            |     |
| 430 i        | 185          |     | 03.16 | + M Sportbremse <sup>2)</sup>   |                                 |                |        |                         |                            |     |

<sup>1)</sup> - M sport brake / - M freno sportivo / - M frein de sport / - M freno deportiva  
<sup>2)</sup> + M sport brake / + M freno sportivo / + M frein de sport / + M freno deportiva



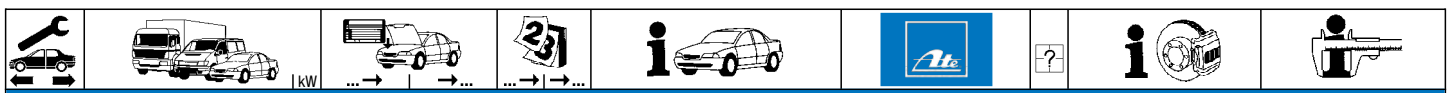

**BMW 4er Reihe/F36 Gran Coupe (14-)**

|  |  |  |  |  |  |                            |  |  |
|--|--|--|--|--|--|----------------------------|--|--|
|  | 430 i xDrive<br>435 d xDrive<br>435 i<br>435 i xDrive<br>440 i<br>440 i xDrive   | 185<br>230<br>225<br>225<br>240<br>240   | 03.16<br>07.14<br>03.14<br>07.14<br>03.16<br>03.16   | + M Sportbremse <sup>1)</sup><br>+ M Sportbremse <sup>1)</sup><br>+ M Sportbremse <sup>1)</sup><br>+ M Sportbremse <sup>1)</sup><br>+ M Sportbremse <sup>1)</sup><br>+ M Sportbremse <sup>1)</sup>   | 24.0130-0234.2<br>430234                           |                            |  | 370 30,0 28,4 VL +S +B   |
|  | 418 d<br>418 d<br>418 i<br>420 d<br>420 d<br>420 i<br>420 i<br>425 d<br>428 i<br>430 i<br>435 i<br>440 i   | 105<br>110<br>100<br>135<br>140<br>135<br>135<br>165<br>180<br>185<br>225<br>240                             | 03.14<br>07.15<br>07.15<br>03.14<br>03.15<br>02.16<br>03.14<br>03.16<br>03.14<br>03.16<br>03.14<br>03.16                                     |  | 24.0711-6281.3<br>24.0711-6282.3                   | 360386<br>360387           | 2  - Start/Stop-Anlage/-Einparkhilfe <sup>2)</sup><br>2  + Start/Stop-Anlage/+Einparkhilfe <sup>3)</sup> | Radsensor L=540<br>Radsensor L=540                                 |
|  | 420 d xDrive<br>420 d xDrive<br>420 i xDrive<br>420 i xDrive<br>428 i xDrive<br>430 d xDrive<br>430 i xDrive<br>435 d xDrive<br>435 i xDrive<br>440 i xDrive   | 135<br>140<br>135<br>135<br>180<br>190<br>185<br>230<br>225<br>240   | 03.14<br>03.15<br>02.16<br>07.14<br>03.14<br>07.14<br>03.16<br>07.14<br>07.14<br>03.16   |  | 24.0711-6299.3<br>24.0711-6300.3                   | 360388<br>360389           | 2  - Start/Stop-Anlage/-Einparkhilfe <sup>2)</sup><br>2  + Start/Stop-Anlage/+Einparkhilfe <sup>3)</sup> | Radsensor L=746<br>Radsensor L=746                                 |
|  | 418 d<br>418 d<br>418 i<br>420 d<br>420 d<br>420 d xDrive<br>420 d xDrive<br>420 i<br>420 i<br>420 i xDrive<br>420 i xDrive<br>425 d<br>428 i<br>428 i xDrive<br>430 i<br>430 i xDrive               | 105<br>110<br>100<br>135<br>140<br>135<br>140<br>135<br>135<br>135<br>135<br>165<br>180<br>180<br>185<br>185 | 03.14<br>07.15<br>07.15<br>03.14<br>03.15<br>03.14<br>03.15<br>02.16<br>03.14<br>02.16<br>07.14<br>03.16<br>03.14<br>03.14<br>03.16<br>03.16 | - M Sportbremse <sup>4)</sup><br>- M Sportbremse <sup>4)</sup><br>- M Sportbremse <sup>4)</sup><br>- M Sportbremse <sup>4)</sup><br>- M Sportbremse <sup>4)</sup><br>- M Sportbremse <sup>4)</sup><br>- M Sportbremse <sup>4)</sup><br>- M Sportbremse <sup>4)</sup><br>- M Sportbremse <sup>4)</sup><br>- M Sportbremse <sup>4)</sup><br>- M Sportbremse <sup>4)</sup><br>- M Sportbremse <sup>4)</sup><br>- M Sportbremse <sup>4)</sup><br>- M Sportbremse <sup>4)</sup><br>- M Sportbremse <sup>4)</sup><br>- M Sportbremse <sup>4)</sup> | 13.0460-3859.2<br>13.0470-3859.2<br>24.8190-0007.2 | 603859<br>LD3859<br>620007 | 1  | 25307 17,5 +/WE BOS<br>25307 17,5 +/WE BOS<br>Warnkontakt L=1045mm |
|  | 430 d<br>430 d xDrive<br>435 d xDrive<br>435 i<br>435 i xDrive<br>440 i<br>440 i xDrive  | 190<br>190<br>230<br>225<br>225<br>240<br>240  | 07.14<br>07.14<br>07.14<br>03.14<br>07.14<br>03.16<br>03.16  | - M Sportbremse <sup>4)</sup><br>- M Sportbremse <sup>4)</sup><br>- M Sportbremse <sup>4)</sup><br>- M Sportbremse <sup>4)</sup><br>- M Sportbremse <sup>4)</sup><br>- M Sportbremse <sup>4)</sup><br>- M Sportbremse <sup>4)</sup>  | 24.8190-0007.2                                     | 620007                     | 1  | Warnkontakt L=1045mm   |
|  | 418 d<br>420 d<br>420 d<br>420 d xDrive<br>420 d xDrive<br>420 i<br>420 i xDrive<br>428 i<br>428 i xDrive<br>430 d<br>430 d xDrive<br>430 i<br>430 i xDrive<br>435 d xDrive<br>435 i<br>435 i xDrive | 105<br>135<br>140<br>135<br>140<br>135<br>135<br>180<br>180<br>190<br>190<br>185<br>185<br>230<br>225<br>225 | 03.14<br>03.14<br>03.15<br>03.14<br>03.15<br>03.14<br>07.14<br>03.14<br>03.14<br>07.14<br>07.14<br>03.16<br>03.16<br>07.14<br>03.14<br>07.14 | + M Sportbremse <sup>1)</sup><br>+ M Sportbremse <sup>1)</sup><br>+ M Sportbremse <sup>1)</sup><br>+ M Sportbremse <sup>1)</sup><br>+ M Sportbremse <sup>1)</sup><br>+ M Sportbremse <sup>1)</sup><br>+ M Sportbremse <sup>1)</sup><br>+ M Sportbremse <sup>1)</sup><br>+ M Sportbremse <sup>1)</sup><br>+ M Sportbremse <sup>1)</sup><br>+ M Sportbremse <sup>1)</sup><br>+ M Sportbremse <sup>1)</sup><br>+ M Sportbremse <sup>1)</sup><br>+ M Sportbremse <sup>1)</sup><br>+ M Sportbremse <sup>1)</sup><br>+ M Sportbremse <sup>1)</sup> | 13.0460-4874.2<br>24.8190-0007.2                   | 604874<br>620007           | 1  | 25029 16,7 /WE/Zub BRE<br>Warnkontakt L=1045mm                     |
|  | 418 d<br>418 i<br>420 i<br>420 i xDrive<br>425 d<br>440 i<br>440 i xDrive  | 110<br>100<br>135<br>135<br>165<br>240<br>240  | 07.15<br>07.15<br>02.16<br>02.16<br>03.16<br>03.16<br>03.16  | + M Sportbremse <sup>1)</sup><br>+ M Sportbremse <sup>1)</sup><br>+ M Sportbremse/+ Motorcode B48<br>+ M Sportbremse/+ Motorcode B48<br>+ M Sportbremse <sup>1)</sup><br>+ M Sportbremse <sup>1)</sup><br>+ M Sportbremse <sup>1)</sup>  | 24.8190-0007.2                                     | 620007                     | 1  | Warnkontakt L=1045mm   |
|  | 418 d<br>420 d   | 105<br>135   | 03.14<br>03.14   | - M Sportbremse <sup>4)</sup><br>- M Sportbremse <sup>4)</sup>   | 24.0120-0237.1                                     | 420237                     |  | 300 20,0 18,4 VL +S +B   |
|  | 418 d<br>418 i<br>420 d<br>420 d xDrive<br>420 i<br>420 i<br>420 i xDrive<br>420 i xDrive<br>425 d   | 110<br>100<br>140<br>135<br>140<br>135<br>135<br>135<br>165  | 07.15<br>07.15<br>03.15<br>03.14<br>03.15<br>02.16<br>03.14<br>02.16<br>03.16  | - M Sportbremse <sup>4)</sup><br>- M Sportbremse <sup>4)</sup><br>- M Sportbremse <sup>4)</sup><br>- M Sportbremse <sup>4)</sup><br>- M Sportbremse <sup>4)</sup><br>- M Sportbremse <sup>4)</sup><br>- M Sportbremse <sup>4)</sup><br>- M Sportbremse <sup>4)</sup><br>- M Sportbremse <sup>4)</sup>  | 24.0120-0240.1                                     | 420240                     |  | 300 20,0 18,4 VL +S +B   |

<sup>1)</sup> + M sport brake / + M freno sportivo / + M frein de sport / + M freno deportiva

<sup>2)</sup> - idling stop system/- parking aid / - disposit.start/stop/- aiuto parcheggio / - unité marche/arrêt /-aide au stationnem. / - unidad arranque/paro/- ayuda estacionam.

<sup>3)</sup> + idling stop system/+ parking aid / + dispositivo start/stop/+aiuto parcheggio / + unité marche/arrêt/+aide stationnem. / + unidad arranque/paro/+ayuda estacionam.

<sup>4)</sup> - M sport brake / - M freno sportivo / - M frein de sport / - M freno deportiva

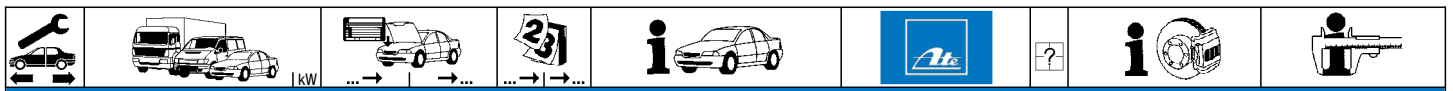

**BMW 4er Reihe/F36 Gran Coupe (14-)**

|              |              |       |                               |                               |                |        |  |                                 |
|--------------|--------------|-------|-------------------------------|-------------------------------|----------------|--------|--|---------------------------------|
|              | 428 i        | 180   | 03.14                         | - M Sportbremse <sup>1)</sup> | 24.0120-0240.1 | 420240 |  | 300 20,0 18,4 VL +S +B          |
|              | 428 i xDrive | 180   | 03.14                         | - M Sportbremse <sup>1)</sup> |                |        |  |                                 |
|              | 430 i        | 185   | 03.16                         | - M Sportbremse <sup>1)</sup> |                |        |  |                                 |
|              | 430 i xDrive | 185   | 03.16                         | - M Sportbremse <sup>1)</sup> |                |        |  |                                 |
|              | 430 d        | 190   | 07.14                         | - M Sportbremse <sup>1)</sup> | 24.0120-0243.1 | 420243 |  | 330 20,0 18,4 VL +S +B          |
|              | 430 d xDrive | 190   | 07.14                         | - M Sportbremse <sup>1)</sup> |                |        |  |                                 |
|              | 435 d xDrive | 230   | 07.14                         | - M Sportbremse <sup>1)</sup> |                |        |  |                                 |
|              | 435 i        | 225   | 03.14                         | - M Sportbremse <sup>1)</sup> |                |        |  |                                 |
|              | 435 i xDrive | 225   | 07.14                         | - M Sportbremse <sup>1)</sup> |                |        |  |                                 |
|              | 440 i        | 240   | 03.16                         | - M Sportbremse <sup>1)</sup> |                |        |  |                                 |
|              | 440 i xDrive | 240   | 03.16                         | - M Sportbremse <sup>1)</sup> |                |        |  |                                 |
|              | 418 d        | 105   | 03.14                         | + M Sportbremse <sup>2)</sup> | 24.0124-0250.2 | 424250 | zweiteilige Bremsscheibe <sup>3)</sup>             | 345 24,0 22,4 VL +S +B          |
|              | 420 d        | 135   | 03.14                         | + M Sportbremse <sup>2)</sup> |                |        |  |                                 |
|              | 418 d        | 110   | 07.15                         | + M Sportbremse <sup>2)</sup> | 24.0124-0251.2 | 424251 | zweiteilige Bremsscheibe <sup>3)</sup>             | 345 24,0 22,4 VL +S +B          |
| 418 i        | 100          | 07.15 | + M Sportbremse <sup>2)</sup> |                               |                |        |  |                                 |
| 420 d        | 140          | 03.15 | + M Sportbremse <sup>2)</sup> |                               |                |        |  |                                 |
| 420 d xDrive | 135          | 03.14 | + M Sportbremse <sup>2)</sup> |                               |                |        |  |                                 |
| 420 d xDrive | 140          | 03.15 | + M Sportbremse <sup>2)</sup> |                               |                |        |  |                                 |
| 420 i        | 135          | 02.16 | + M Sportbremse <sup>2)</sup> |                               |                |        |  |                                 |
| 420 i        | 135          | 03.14 | + M Sportbremse <sup>2)</sup> |                               |                |        |  |                                 |
| 420 i xDrive | 135          | 02.16 | + M Sportbremse <sup>2)</sup> |                               |                |        |  |                                 |
| 420 i xDrive | 135          | 07.14 | + M Sportbremse <sup>2)</sup> |                               |                |        |  |                                 |
| 425 d        | 165          | 03.16 | + M Sportbremse <sup>2)</sup> |                               |                |        |  |                                 |
| 428 i        | 180          | 03.14 | + M Sportbremse <sup>2)</sup> |                               |                |        |  |                                 |
| 428 i xDrive | 180          | 03.14 | + M Sportbremse <sup>2)</sup> |                               |                |        |  |                                 |
| 430 d        | 190          | 07.14 | + M Sportbremse <sup>2)</sup> |                               |                |        |  |                                 |
| 430 d xDrive | 190          | 07.14 | + M Sportbremse <sup>2)</sup> |                               |                |        |  |                                 |
| 430 i        | 185          | 03.16 | + M Sportbremse <sup>2)</sup> |                               |                |        |  |                                 |
| 430 i xDrive | 185          | 03.16 | + M Sportbremse <sup>2)</sup> |                               |                |        |  |                                 |
| 435 d xDrive | 230          | 07.14 | + M Sportbremse <sup>2)</sup> |                               |                |        |  |                                 |
| 435 i        | 225          | 03.14 | + M Sportbremse <sup>2)</sup> |                               |                |        |  |                                 |
| 435 i xDrive | 225          | 07.14 | + M Sportbremse <sup>2)</sup> |                               |                |        |  |                                 |
| 440 i        | 240          | 03.16 | + M Sportbremse <sup>2)</sup> |                               |                |        |  |                                 |
| 440 i xDrive | 240          | 03.16 | + M Sportbremse <sup>2)</sup> |                               |                |        |  |                                 |
|              | 418 d        | 105   | 03.14                         |                               | 24.0711-5347.3 | 360374 | 2  - Start/Stop-Anlage/-Einparkhilfe <sup>4)</sup> | Radsensor L=802                 |
|              | 418 d        | 110   | 07.15                         |                               | 24.0711-5359.3 | 360375 | 2  + Start/Stop-Anlage/+Einparkhilfe <sup>5)</sup> | Radsensor L=802                 |
|              | 418 i        | 100   | 07.15                         |                               |                |        |  |                                 |
|              | 420 d        | 135   | 03.14                         |                               |                |        |  |                                 |
|              | 420 d        | 140   | 03.15                         |                               |                |        |  |                                 |
|              | 420 d xDrive | 135   | 03.14                         |                               |                |        |  |                                 |
|              | 420 d xDrive | 140   | 03.15                         |                               |                |        |  |                                 |
|              | 420 i        | 135   | 02.16                         |                               |                |        |  |                                 |
|              | 420 i        | 135   | 03.14                         |                               |                |        |  |                                 |
|              | 420 i xDrive | 135   | 02.16                         |                               |                |        |  |                                 |
|              | 420 i xDrive | 135   | 07.14                         |                               |                |        |  |                                 |
|              | 425 d        | 165   | 03.16                         |                               |                |        |  |                                 |
|              | 428 i        | 180   | 03.14                         |                               |                |        |  |                                 |
|              | 428 i xDrive | 180   | 03.14                         |                               |                |        |  |                                 |
| 430 d        | 190          | 07.14 |                               |                               |                |        |  |                                 |
| 430 d xDrive | 190          | 07.14 |                               |                               |                |        |  |                                 |
| 430 i        | 185          | 03.16 |                               |                               |                |        |  |                                 |
| 430 i xDrive | 185          | 03.16 |                               |                               |                |        |  |                                 |
| 435 d xDrive | 230          | 07.14 |                               |                               |                |        |  |                                 |
| 435 i        | 225          | 03.14 |                               |                               |                |        |  |                                 |
| 435 i xDrive | 225          | 07.14 |                               |                               |                |        |  |                                 |
| 440 i        | 240          | 03.16 |                               |                               |                |        |  |                                 |
| 440 i xDrive | 240          | 03.16 |                               |                               |                |        |  |                                 |
|              | 418 d        | 105   | 03.14                         |                               | 03.0137-0379.2 | 650379 |  | 161 x 20<br>Bremsbacken-Zubehör |
|              | 420 d        | 135   | 03.14                         |                               | 03.0137-9265.2 | 669265 |  | Bremsbacken-Zubehör             |
|              |              |       |                               |                               | 03.0137-9701.2 | 669701 |  | Spreizschloß Satz               |
|              |              |       |                               |                               | 03.0137-9702.2 | 669702 |  |                                 |
|              | 418 d        | 110   | 07.15                         |                               | 03.0137-0305.2 | 650305 |  | 185 x 20<br>Bremsbacken-Zubehör |
|              | 418 i        | 100   | 07.15                         |                               | 03.0137-9062.2 | 669062 |  | Bremsbacken-Zubehör             |
|              | 420 d        | 140   | 03.15                         |                               | 03.0137-9700.2 | 669700 |  | Spreizschloß Satz               |
|              | 420 d xDrive | 135   | 03.14                         |                               | 03.0137-9702.2 | 669702 |  |                                 |
|              | 420 d xDrive | 140   | 03.15                         |                               |                |        |  |                                 |
|              | 420 i        | 135   | 02.16                         |                               |                |        |  |                                 |
|              | 420 i        | 135   | 03.14                         |                               |                |        |  |                                 |
|              | 420 i xDrive | 135   | 02.16                         |                               |                |        |  |                                 |
|              | 420 i xDrive | 135   | 07.14                         |                               |                |        |  |                                 |
|              | 425 d        | 165   | 03.16                         |                               |                |        |  |                                 |
| 428 i        | 180          | 03.14 |                               |                               |                |        |  |                                 |
| 428 i xDrive | 180          | 03.14 |                               |                               |                |        |  |                                 |
| 430 d        | 190          | 07.14 |                               |                               |                |        |  |                                 |
| 430 d xDrive | 190          | 07.14 |                               |                               |                |        |  |                                 |
| 430 i        | 185          | 03.16 |                               |                               |                |        |  |                                 |
| 430 i xDrive | 185          | 03.16 |                               |                               |                |        |  |                                 |
| 435 d xDrive | 230          | 07.14 |                               |                               |                |        |  |                                 |
| 435 i        | 225          | 03.14 |                               |                               |                |        |  |                                 |
| 435 i xDrive | 225          | 07.14 |                               |                               |                |        |  |                                 |
| 440 i        | 240          | 03.16 |                               |                               |                |        |  |                                 |
| 440 i xDrive | 240          | 03.16 |                               |                               |                |        |  |                                 |

<sup>1)</sup> - M sport brake / - M freno sportivo / - M frein de sport / - M freno deportiva

<sup>2)</sup> + M sport brake / + M freno sportivo / + M frein de sport / + M freno deportiva

<sup>3)</sup> two-piece brake disc / disco frenante in due parti / disque d.fr.en deux parties / disco de fr.de dos piezas

<sup>4)</sup> - idling stop system/- parking aid / - disposit.start/stop/- aiuto parcheggio / - unité marche/arrêt /-aide au stationnem. / - unidad arranque/paro/- ayuda estacionam.

<sup>5)</sup> + idling stop system/+ parking aid / + dispositivo start/stop/+aiuto parcheggio / + unité marche/arrêt/+aide stationnem. / + unidad arranque/paro/+ayuda estacionam.

















| BMW 5er Reihe/E39 (96-03) |                 |     |  |       |       |                         |  |                |        |   |  |  |   |
|---------------------------|-----------------|-----|--|-------|-------|-------------------------|--|----------------|--------|---|--|--|---|
|                           | 520 d           | 100 |  | 04.00 | 07.03 | - Behörde <sup>1)</sup> |  | 13.0460-7089.2 | 607089 |   |  |  |   |
|                           | 520 d Touring   | 100 |  | 04.00 | 07.03 | - Behörde <sup>1)</sup> |  | 13.0470-7089.2 | LD7089 |   |  |  | 21677 20,3 +WE ATE                              |
|                           | 520 i           |     |  | 03.96 | 07.03 | - Behörde <sup>1)</sup> |  | 24.8190-0219.2 | 620219 | 1 |  |  | 21677 20,3 +WE ATE                              |
|                           | 520 i Touring   |     |  | 05.97 | 07.03 | - Behörde <sup>1)</sup> |  |                |        |   |  |  | Warnkontakt L=764mm                             |
|                           | 523 i           | 125 |  | 12.95 | 09.00 |                         |  |                |        |   |  |  |   |
|                           | 523 i Touring   | 125 |  | 05.97 | 09.00 |                         |  |                |        |   |  |  |   |
|                           | 525 d           | 120 |  | 04.00 | 07.03 | - Behörde <sup>1)</sup> |  |                |        |   |  |  |   |
|                           | 525 d Touring   | 120 |  | 04.00 | 07.03 | - Behörde <sup>1)</sup> |  |                |        |   |  |  |   |
|                           | 525 i           | 141 |  | 10.00 | 07.03 | - Behörde <sup>1)</sup> |  |                |        |   |  |  |   |
|                           | 525 i Touring   | 141 |  | 10.00 | 07.03 | - Behörde <sup>1)</sup> |  |                |        |   |  |  |   |
|                           | 525 td          | 85  |  | 01.97 | 09.00 |                         |  |                |        |   |  |  |   |
|                           | 525 tds         | 105 |  | 02.96 | 09.00 |                         |  |                |        |   |  |  |   |
|                           | 525 tds Touring | 105 |  | 06.98 | 09.00 |                         |  |                |        |   |  |  |   |
|                           | 528 i           | 142 |  | 12.95 | 09.00 |                         |  |                |        |   |  |  |   |
|                           | 528 i Touring   | 142 |  | 05.97 | 09.00 |                         |  |                |        |   |  |  |   |
|                           | 530 d           |     |  | 09.98 | 09.00 |                         |  |                |        |   |  |  |   |
|                           | 530 d Touring   |     |  | 09.98 | 09.00 |                         |  |                |        |   |  |  |   |
|                           | 535 i           |     |  | 05.96 | 08.97 |                         |  | 13.0460-7089.2 | 607089 |   |  |  | 21677 20,3 +WE ATE                              |
|                           |                 |     |  |       |       |                         |  | 24.8190-0219.2 | 620219 | 1 |  |  | Warnkontakt L=764mm                             |
|                           | 520 d           | 100 |  | 04.00 | 07.03 | + Behörde <sup>2)</sup> |  | 13.0460-7078.2 | 607078 |   |  |  | 21486 19,3 +WE ATE                              |
|                           | 520 d Touring   | 100 |  | 04.00 | 07.03 | + Behörde <sup>2)</sup> |  | 13.0470-7078.2 | LD7078 |   |  |  | 21486 19,3 +WE ATE                              |
|                           | 520 i           |     |  | 03.96 | 07.03 | + Behörde <sup>2)</sup> |  | 24.8190-0219.2 | 620219 | 1 |  |  | Warnkontakt L=764mm                             |
|                           | 520 i Touring   |     |  | 05.97 | 07.03 | + Behörde <sup>2)</sup> |  |                |        |   |  |  |   |
|                           | 525 d           | 120 |  | 04.00 | 07.03 | + Behörde <sup>2)</sup> |  |                |        |   |  |  |   |
|                           | 525 d Touring   | 120 |  | 04.00 | 07.03 | + Behörde <sup>2)</sup> |  |                |        |   |  |  |   |
|                           | 525 i           | 141 |  | 10.00 | 07.03 | + Behörde <sup>2)</sup> |  |                |        |   |  |  |   |
|                           | 525 i Touring   | 141 |  | 10.00 | 07.03 | + Behörde <sup>2)</sup> |  |                |        |   |  |  |   |
|                           | 530 d           |     |  | 10.00 | 07.03 |                         |  |                |        |   |  |  |   |
|                           | 530 d Touring   |     |  | 10.00 | 07.03 |                         |  |                |        |   |  |  |   |
|                           | 530 i           | 170 |  | 10.00 | 07.03 |                         |  |                |        |   |  |  |   |
|                           | 530 i Touring   | 170 |  | 10.00 | 07.03 |                         |  |                |        |   |  |  |   |
|                           | 540 i           | 210 |  | 05.96 | 07.03 |                         |  |                |        |   |  |  |   |
|                           | 540 i Touring   | 210 |  | 05.97 | 07.03 |                         |  |                |        |   |  |  |   |
|                           | 535 i           |     |  | 09.97 | 07.03 |                         |  | 13.0460-7078.2 | 607078 |   |  |  | 21486 19,3 +WE ATE                              |
|                           |                 |     |  |       |       |                         |  | 24.8190-0219.2 | 620219 | 1 |  |  | Warnkontakt L=764mm                             |
|                           | M5              | 294 |  | 10.98 | 07.03 | - (USA)                 |  | 13.0460-7078.2 | 607078 |   |  |  | 21486 19,3 +WE ATE                              |
|                           |                 |     |  |       |       |                         |  | 24.8190-0219.2 | 620219 | 1 |  |  | Warnkontakt L=764mm                             |
|                           | 520 d           | 100 |  | 04.00 | 07.03 | - Behörde <sup>1)</sup> |  | 24.0122-0159.1 | 422159 |   |  |  | 296 22,0 20,4 V L +S +B                         |
|                           | 520 d Touring   | 100 |  | 04.00 | 07.03 | - Behörde <sup>1)</sup> |  | 24.0322-0159.1 | 522159 |   |  |  | 296 22,0 19,6 V L +S +B PD                      |
|                           | 520 i           |     |  | 03.96 | 07.03 | - Behörde <sup>1)</sup> |  |                |        |   |  |  |   |
|                           | 520 i Touring   |     |  | 05.97 | 07.03 | - Behörde <sup>1)</sup> |  |                |        |   |  |  |   |
|                           | 523 i           | 125 |  | 12.95 | 09.00 |                         |  |                |        |   |  |  |   |
|                           | 523 i Touring   | 125 |  | 05.97 | 09.00 |                         |  |                |        |   |  |  |   |
|                           | 525 d           | 120 |  | 04.00 | 07.03 | - Behörde <sup>1)</sup> |  |                |        |   |  |  |   |
|                           | 525 d Touring   | 120 |  | 04.00 | 07.03 | - Behörde <sup>1)</sup> |  |                |        |   |  |  |   |
|                           | 525 i           | 141 |  | 10.00 | 07.03 | - Behörde <sup>1)</sup> |  |                |        |   |  |  |   |
|                           | 525 i Touring   | 141 |  | 10.00 | 07.03 | - Behörde <sup>1)</sup> |  |                |        |   |  |  |   |
|                           | 525 td          | 85  |  | 01.97 | 09.00 |                         |  |                |        |   |  |  |   |
|                           | 525 tds         | 105 |  | 02.96 | 09.00 |                         |  |                |        |   |  |  |   |
|                           | 525 tds Touring | 105 |  | 06.98 | 09.00 |                         |  |                |        |   |  |  |   |
|                           | 528 i           | 142 |  | 12.95 | 09.00 |                         |  |                |        |   |  |  |   |
|                           | 528 i Touring   | 142 |  | 05.97 | 09.00 |                         |  |                |        |   |  |  |   |
|                           | 530 d           |     |  | 09.98 | 09.00 |                         |  |                |        |   |  |  |   |
|                           | 530 d Touring   |     |  | 09.98 | 09.00 |                         |  |                |        |   |  |  |   |
|                           | 535 i           |     |  | 05.96 | 08.97 |                         |  |                |        |   |  |  |   |
|                           | 535 i           |     |  | 09.97 | 02.00 |                         |  | 24.0130-0101.1 | 430101 |   |  |  | 324 30,0 28,4 V L +S +B                         |
|                           | 540 i           | 210 |  | 05.96 | 02.00 |                         |  |                |        |   |  |  |   |
|                           | 540 i Touring   | 210 |  | 05.97 | 02.00 |                         |  |                |        |   |  |  |   |
|                           | 520 d           | 100 |  | 04.00 | 07.03 | + Behörde <sup>2)</sup> |  | 24.0130-0107.1 | 430107 |   |  |  | 324 29,9 28,4 V L +S +B                         |
|                           | 520 d Touring   | 100 |  | 04.00 | 07.03 | + Behörde <sup>2)</sup> |  | 24.0330-0107.1 | 530107 |   |  |  | 324 29,9 27,6 V L +S +B PD                      |
|                           | 520 i           |     |  | 03.96 | 07.03 | + Behörde <sup>2)</sup> |  |                |        |   |  |  |   |
|                           | 520 i Touring   |     |  | 05.97 | 07.03 | + Behörde <sup>2)</sup> |  |                |        |   |  |  |   |
|                           | 525 d           | 120 |  | 04.00 | 07.03 | + Behörde <sup>2)</sup> |  |                |        |   |  |  |   |
|                           | 525 d Touring   | 120 |  | 04.00 | 07.03 | + Behörde <sup>2)</sup> |  |                |        |   |  |  |   |
|                           | 525 i           | 141 |  | 10.00 | 07.03 | + Behörde <sup>2)</sup> |  |                |        |   |  |  |   |
|                           | 525 i Touring   | 141 |  | 10.00 | 07.03 | + Behörde <sup>2)</sup> |  |                |        |   |  |  |   |
|                           | 530 d           |     |  | 10.00 | 07.03 |                         |  |                |        |   |  |  |   |
|                           | 530 d Touring   |     |  | 10.00 | 07.03 |                         |  |                |        |   |  |  |   |
|                           | 530 i           | 170 |  | 10.00 | 07.03 |                         |  |                |        |   |  |  |   |
|                           | 530 i Touring   | 170 |  | 10.00 | 07.03 |                         |  |                |        |   |  |  |   |
|                           | 535 i           |     |  | 03.00 | 07.03 |                         |  |                |        |   |  |  |   |
|                           | 540 i           | 210 |  | 03.00 | 07.03 |                         |  |                |        |   |  |  |   |
|                           | 540 i Touring   | 210 |  | 03.00 | 07.03 |                         |  |                |        |   |  |  |   |
|                           | M5              | 294 |  | 10.98 | 07.03 | - (USA)                 |  | 24.0132-0161.2 | 432161 |   |  |  | 345 32,0 30,4 V L +S +B                         |
|                           |                 |     |  |       |       |                         |  | 24.0132-0162.2 | 432162 |   |  |  | 345 32,0 30,4 V L +S +B                         |
|                           |                 |     |  |       |       |                         |  |                |        |   |  |  | zweiteilige Bremsscheibe/ mit ABE <sup>3)</sup> |
|                           |                 |     |  |       |       |                         |  |                |        |   |  |  | zweiteilige Bremsscheibe/ mit ABE <sup>3)</sup> |
|                           | 520 i           |     |  | 03.96 | 08.98 |                         |  | 24.0710-2001.1 | 360208 | 2 |  |  | Radsensor L=635                                 |
|                           | 520 i Touring   |     |  | 05.97 | 08.98 |                         |  |                |        |   |  |  |   |
|                           | 523 i           | 125 |  | 12.95 | 08.98 |                         |  |                |        |   |  |  |   |
|                           | 523 i Touring   | 125 |  | 05.97 | 08.98 |                         |  |                |        |   |  |  |   |
|                           | 525 td          | 85  |  | 01.97 | 08.98 |                         |  |                |        |   |  |  |   |
|                           | 525 tds         | 105 |  | 02.96 | 08.98 |                         |  |                |        |   |  |  |   |
|                           | 525 tds Touring | 105 |  | 06.98 | 08.98 |                         |  |                |        |   |  |  |   |
|                           | 528 i           | 142 |  | 12.95 | 08.98 |                         |  |                |        |   |  |  |   |
|                           | 528 i Touring   | 142 |  | 05.97 | 08.98 |                         |  |                |        |   |  |  |   |
|                           | 535 i           |     |  | 05.96 | 08.98 |                         |  |                |        |   |  |  |   |
|                           | 540 i           | 210 |  | 05.96 | 08.98 |                         |  |                |        |   |  |  |   |

<sup>1)</sup> - authority cars / - enti statali / - véhicule communal / - vehiculos oficiales

<sup>2)</sup> + authority cars / + enti statali / + véhicule communal / + vehiculos oficiales

<sup>3)</sup> two-piece brake disc/ with ABE / disco frenante in due parti/ con ABE / disque d.fr.en deux parties/ avec ABE / disco de fr.de dos piezas/ con ABE



|     |  |  |  |  |  |  |  |  |
|--|--|--|--|--|---|--|--|--|
| <b>BMW 5er Reihe/E39 (96-03)</b>   |  |  |  |  |   |  |  |  |
|    | 540 i Touring  | 210  | 05.97  | 08.98  | 24.0710-2001.1  | 360208   | 2  | Radsensor L=635  |
|  | 520 d  | 100  | 04.00  | 07.03  | 24.0710-2002.1  | 360209   | 2  | Radsensor L=661  |
|  | 520 i  |  | 09.98  | 07.03  |   |  |  |  |
|  | 523 i  | 125  | 09.98  | 09.00  |   |  |  |  |
|  | 525 d  | 120  | 04.00  | 07.03  |   |  |  |  |
|  | 525 i  | 141  | 10.00  | 07.03  |   |  |  |  |
|  | 525 td   | 85   | 09.98  | 09.00  |   |  |  |  |
|  | 525 tds  | 105  | 09.98  | 09.00  |   |  |  |  |
|  | 528 i  | 142  | 09.98  | 09.00  |   |  |  |  |
|  | 530 d  |  | 09.98  | 07.03  |   |  |  |  |
|  | 530 i  | 170  | 10.00  | 07.03  |   |  |  |  |
|  | 535 i  |  | 09.98  | 07.03  |   |  |  |  |
|  | 540 i  | 210  | 09.98  | 07.03  |   |  |  |  |
|  | M5   | 294  | 10.98  | 07.03  |   |  |  |  |
|  | 520 d Touring  | 100  | 04.00  | 07.03  | 24.0710-2002.1  | 360209   | 2  | Radsensor L=661  |
|  | 520 i Touring  |  | 09.98  | 07.03  |   |  |  |  |
|  | 523 i Touring  | 125  | 09.98  | 09.00  |   |  |  |  |
|  | 525 d Touring  | 120  | 04.00  | 07.03  |   |  |  |  |
|  | 525 i Touring  | 141  | 10.00  | 07.03  |   |  |  |  |
| 525 tds Touring  | 105  | 09.98  | 09.00  |  |   |  |  |  |
| 528 i Touring  | 142  | 09.98  | 09.00  |  |   |  |  |  |
| 530 d Touring  |  | 09.98  | 07.03  |  |   |  |  |  |
| 530 i Touring  | 170  | 10.00  | 07.03  |  |   |  |  |  |
| 540 i Touring  | 210  | 09.98  | 07.03  |  |   |  |  |  |
|    | 520 d  | 100  | 04.00  | 07.03  | 13.0460-7090.2  | 607090   |  | 21691 17,3 +/WE ATE  |
|  | 520 i  |  | 03.96  | 07.03  | 13.0470-7090.2  | LD7090   |  | 21691 17,3 +/WE ATE  |
|  | 523 i  | 125  | 12.95  | 09.00  | 24.8190-0218.2  | 620218   | 1  | Warnkontakt L=545mm  |
|  | 525 d  | 120  | 04.00  | 07.03  |   |  |  |  |
|  | 525 i  | 141  | 10.00  | 07.03  |   |  |  |  |
|  | 525 td   | 85   | 01.97  | 09.00  |   |  |  |  |
|  | 525 tds  | 105  | 02.96  | 09.00  |   |  |  |  |
|  | 528 i  | 142  | 12.95  | 09.00  |   |  |  |  |
|  | 530 d  |  | 09.98  | 07.03  |   |  |  |  |
|  | 530 i  | 170  | 10.00  | 07.03  |   |  |  |  |
|  | 535 i  |  | 05.96  | 07.03  |   |  |  |  |
|  | 540 i  | 210  | 05.96  | 07.03  |   |  |  |  |
|  | 520 d Touring  | 100  | 04.00  | 07.03  | 13.0460-7090.2  | 607090   |  | 21691 17,3 +/WE ATE  |
|  | 520 i Touring  |  | 05.97  | 07.03  | 13.0470-7090.2  | LD7090   |  | 21691 17,3 +/WE ATE  |
|  | 523 i Touring  | 125  | 05.97  | 09.00  | 24.8190-0222.2  | 620222   | 1  | Warnkontakt L=1090mm   |
|  | 525 d Touring  | 120  | 04.00  | 07.03  |   |  |  |  |
|  | 525 i Touring  | 141  | 10.00  | 07.03  |   |  |  |  |
|  | 525 tds Touring  | 105  | 06.98  | 09.00  |   |  |  |  |
|  | 528 i Touring  | 142  | 05.97  | 09.00  |   |  |  |  |
| 530 d Touring  |  | 09.98  | 07.03  |  |   |  |  |  |
| 530 i Touring  | 170  | 10.00  | 07.03  |  |   |  |  |  |
| 540 i Touring  | 210  | 05.97  | 07.03  |  |   |  |  |  |
| M5   | 294  | 10.98  | 07.03  | 13.0460-7079.2   | 607079  |  | 21487 17,3 +/WE ATE  |  |
|  | 520 d  | 100  | 04.00  | 07.03  | - Behörde <sup>1)</sup>   | 24.0110-0227.1   | 410227   | 298 10,0 8,4 L +S +B   |
|  | 520 i  |  | 03.96  | 07.03  | - Behörde <sup>1)</sup>   | 24.0310-0227.1   | 510227   | 298 10,0 7,6 L +S +B PD  |
|  | 523 i  | 125  | 12.95  | 08.98  | - Behörde <sup>1)</sup>   |  |  |  |
|  | 525 td   | 85   | 01.97  | 09.00  | - Behörde <sup>1)</sup>   |  |  |  |
|  | 525 tds  | 105  | 02.96  | 09.00  | - Behörde <sup>1)</sup>   |  |  |  |
|  | 520 d  | 100  | 04.00  | 07.03  | + Behörde <sup>2)</sup>   | 24.0120-0154.1   | 420154   | 298 20,0 18,4 V L +S +B  |
|  | 520 d Touring  | 100  | 04.00  | 07.03  | + Behörde <sup>2)</sup>   | 24.0320-0154.1   | 520154   | 298 20,0 17,6 V L +S +B PD   |
|  | 520 i  |  | 03.96  | 07.03  | + Behörde <sup>2)</sup>   |  |  |  |
|  | 520 i Touring  |  | 05.97  | 07.03  |   |  |  |  |
|  | 523 i  | 125  | 09.98  | 09.00  |   |  |  |  |
|  | 523 i  | 125  | 12.95  | 08.98  | + Behörde <sup>2)</sup>   |  |  |  |
|  | 523 i Touring  | 125  | 05.97  | 09.00  |   |  |  |  |
|  | 525 d  | 120  | 04.00  | 07.03  |   |  |  |  |
|  | 525 d Touring  | 120  | 04.00  | 07.03  |   |  |  |  |
|  | 525 i  | 141  | 10.00  | 07.03  |   |  |  |  |
|  | 525 i Touring  | 141  | 10.00  | 07.03  |   |  |  |  |
|  | 525 td   | 85   | 01.97  | 09.00  | + Behörde <sup>2)</sup>   |  |  |  |
|  | 525 tds  | 105  | 02.96  | 09.00  | + Behörde <sup>2)</sup>   |  |  |  |
|  | 525 tds Touring  | 105  | 06.98  | 09.00  |   |  |  |  |
| 528 i  | 142  | 12.95  | 09.00  |  |   |  |  |  |
| 528 i Touring  | 142  | 05.97  | 09.00  |  |   |  |  |  |
| 530 d  |  | 09.98  | 07.03  |  |   |  |  |  |
| 530 d Touring  |  | 09.98  | 07.03  |  |   |  |  |  |
| 530 i  | 170  | 10.00  | 07.03  |  |   |  |  |  |
| 530 i Touring  | 170  | 10.00  | 07.03  |  |   |  |  |  |
| 535 i  |  | 05.96  | 07.03  |  |   |  |  |  |
| 540 i  | 210  | 05.96  | 07.03  |  |   |  |  |  |
| 540 i Touring  | 210  | 05.97  | 07.03  |  |   |  |  |  |
|  | 520 i  |  | 03.96  | 08.98  | 24.0710-2007.1  | 360214   | 2  | Radsensor L=830  |
|  | 523 i  | 125  | 12.95  | 08.98  |   |  |  |  |
|  | 525 td   | 85   | 01.97  | 08.98  |   |  |  |  |
|  | 525 tds  | 105  | 02.96  | 08.98  |   |  |  |  |
|  | 528 i  | 142  | 12.95  | 08.98  |   |  |  |  |
|  | 535 i  |  | 05.96  | 08.98  |   |  |  |  |
| 540 i  | 210  | 05.96  | 08.98  |  |   |  |  |  |
|  | 520 d  | 100  | 04.00  | 07.03  | 24.0710-2009.1  | 360216   | 2  | Radsensor L=859  |
|  | 520 i  |  | 09.98  | 07.03  |   |  |  |  |
|  | 523 i  | 125  | 09.98  | 09.00  |   |  |  |  |
|  | 525 d  | 120  | 04.00  | 07.03  |   |  |  |  |

1) - authority cars / - enti statali / - véhicule communal / - vehiculos oficiales  
2) + authority cars / + enti statali / + véhicule communal / + vehiculos oficiales





### BMW 5er Reihe/E39 (96-03)

|                 |                 |     |       |       |       |                |                |        |   |                     |                     |
|-----------------|-----------------|-----|-------|-------|-------|----------------|----------------|--------|---|---------------------|---------------------|
|                 | 525 i           | 141 |       | 10.00 | 07.03 |                | 24.0710-2009.1 | 360216 | 2 |                     | Radsensor L=859     |
|                 | 525 td          | 85  |       | 09.98 | 09.00 |                |                |        |   |                     |                     |
|                 | 525 tds         | 105 |       | 09.98 | 09.00 |                |                |        |   |                     |                     |
|                 | 528 i           | 142 |       | 09.98 | 09.00 |                |                |        |   |                     |                     |
|                 | 530 d           |     |       | 09.98 | 07.03 |                |                |        |   |                     |                     |
|                 | 530 i           | 170 |       | 10.00 | 07.03 |                |                |        |   |                     |                     |
|                 | 535 i           |     |       | 09.98 | 07.03 |                |                |        |   |                     |                     |
|                 | 540 i           | 210 |       | 09.98 | 07.03 |                |                |        |   |                     |                     |
|                 | M5              | 294 |       | 10.98 | 07.03 |                |                |        |   |                     |                     |
|                 | 520 i Touring   |     |       | 05.97 | 08.98 |                | 24.0710-2004.1 | 360211 | 2 |                     | Radsensor L=970     |
|                 | 523 i Touring   | 125 |       | 05.97 | 08.98 |                |                |        |   |                     |                     |
|                 | 525 tds Touring | 105 |       | 06.98 | 08.98 |                |                |        |   |                     |                     |
|                 | 528 i Touring   | 142 |       | 05.97 | 08.98 |                |                |        |   |                     |                     |
| 540 i Touring   | 210             |     | 05.97 | 08.98 |       |                |                |        |   |                     |                     |
| 520 d Touring   | 100             |     | 04.00 | 07.03 |       | 24.0710-2010.1 | 360217         | 2      |   | Radsensor L=999     |                     |
| 520 i Touring   |                 |     | 09.98 | 07.03 |       |                |                |        |   |                     |                     |
| 523 i Touring   | 125             |     | 09.98 | 09.00 |       |                |                |        |   |                     |                     |
| 525 d Touring   | 120             |     | 04.00 | 07.03 |       |                |                |        |   |                     |                     |
| 525 i Touring   | 141             |     | 10.00 | 07.03 |       |                |                |        |   |                     |                     |
| 525 tds Touring | 105             |     | 09.98 | 09.00 |       |                |                |        |   |                     |                     |
| 528 i Touring   | 142             |     | 09.98 | 09.00 |       |                |                |        |   |                     |                     |
| 530 d Touring   |                 |     | 09.98 | 07.03 |       |                |                |        |   |                     |                     |
| 530 i Touring   | 170             |     | 10.00 | 07.03 |       |                |                |        |   |                     |                     |
| 540 i Touring   | 210             |     | 09.98 | 07.03 |       |                |                |        |   |                     |                     |
|                 | 520 d           | 100 |       | 04.00 | 07.03 |                | 03.0137-0305.2 | 650305 |   |                     | 185 x 20            |
|                 | 520 d Touring   | 100 |       | 04.00 | 07.03 |                | 03.0137-9062.2 | 669062 |   |                     | Bremsbacken-Zubehör |
|                 | 520 i           |     |       | 03.96 | 07.03 |                | 03.0137-9700.2 | 669700 |   |                     | Bremsbacken-Zubehör |
|                 | 520 i Touring   |     |       | 05.97 | 07.03 |                | 03.0137-9702.2 | 669702 |   |                     | Spreizschloß Satz   |
|                 | 523 i           | 125 |       | 12.95 | 09.00 |                |                |        |   |                     |                     |
|                 | 523 i Touring   | 125 |       | 05.97 | 09.00 |                |                |        |   |                     |                     |
|                 | 525 d           | 120 |       | 04.00 | 07.03 |                |                |        |   |                     |                     |
|                 | 525 d Touring   | 120 |       | 04.00 | 07.03 |                |                |        |   |                     |                     |
|                 | 525 i           | 141 |       | 10.00 | 07.03 |                |                |        |   |                     |                     |
|                 | 525 i Touring   | 141 |       | 10.00 | 07.03 |                |                |        |   |                     |                     |
|                 | 525 td          | 85  |       | 01.97 | 09.00 |                |                |        |   |                     |                     |
|                 | 525 tds         | 105 |       | 02.96 | 09.00 |                |                |        |   |                     |                     |
|                 | 525 tds Touring | 105 |       | 06.98 | 09.00 |                |                |        |   |                     |                     |
|                 | 528 i           | 142 |       | 12.95 | 09.00 |                |                |        |   |                     |                     |
|                 | 528 i Touring   | 142 |       | 05.97 | 09.00 |                |                |        |   |                     |                     |
|                 | 530 d           |     |       | 09.98 | 07.03 |                |                |        |   |                     |                     |
|                 | 530 d Touring   |     |       | 09.98 | 07.03 |                |                |        |   |                     |                     |
|                 | 530 i           | 170 |       | 10.00 | 07.03 |                |                |        |   |                     |                     |
|                 | 530 i Touring   | 170 |       | 10.00 | 07.03 |                |                |        |   |                     |                     |
|                 | 535 i           |     |       | 05.96 | 07.03 |                |                |        |   |                     |                     |
|                 | 540 i           | 210 |       | 05.96 | 07.03 |                |                |        |   |                     |                     |
|                 | 540 i Touring   | 210 |       | 05.97 | 07.03 |                |                |        |   |                     |                     |
|                 | M5              | 294 |       | 10.98 | 07.03 |                | 03.0137-0419.2 | 650419 |   |                     | 185 x 30            |
|                 |                 |     |       |       |       | 03.0137-9288.2 | 669288         |        |   | Bremsbacken-Zubehör |                     |

### BMW 5er Reihe/E60 Limousine (03-10)

|        |       |     |       |       |       |                                |                |        |   |                     |                     |     |
|--------|-------|-----|-------|-------|-------|--------------------------------|----------------|--------|---|---------------------|---------------------|-----|
|        | 520 d | 120 |       | 07.05 | 02.10 | - Behörde 1)                   | 13.0460-7176.2 | 607176 |   |                     | 23794 20,3 +/WE     | ATE |
|        | 520 i | 125 |       | 07.03 | 03.05 | + Schaltgetriebe 2)            | 13.0470-7176.2 | LD7176 |   |                     | 23794 20,3 +/WE     | ATE |
|        | 523 i | 130 |       | 07.05 | 03.07 | - Behörde 1)                   | 24.8190-0273.2 | 620273 | 1 |                     | Warnkontakt L=662mm |     |
|        | 523 i | 140 |       | 03.07 | 02.10 | - Behörde/ + Motorcode N52N 3) |                |        |   |                     |                     |     |
|        | 525 d | 130 |       | 10.03 | 03.07 | - Behörde 1)                   |                |        |   |                     |                     |     |
|        | 525 i | 141 |       | 07.03 | 06.05 | - Behörde 1)                   |                |        |   |                     |                     |     |
|        | 525 i | 160 |       | 03.07 | 02.10 | - Behörde/ + Motorcode N52N 3) |                |        |   |                     |                     |     |
|        | 520 d | 120 |       | 07.05 | 02.10 | + Behörde 4)                   | 13.0460-7167.2 | 607167 |   |                     | 23312 20,3 +/WE     | ATE |
|        | 520 d | 130 |       | 09.07 | 02.10 |                                | 13.0470-7167.2 | LD7167 |   |                     | 23312 20,3 +/WE     | ATE |
|        | 520 i | 125 |       | 07.03 | 03.05 | + Automatikgetriebe 5)         | 13.0460-7296.2 | 607296 |   |                     | 23312 20,3 +/WE     | ATE |
|        | 523 i | 130 |       | 07.05 | 03.07 | + Behörde 4)                   | 13.0470-7296.2 | LD7296 |   |                     | 23312 20,3 +/WE     | ATE |
|        | 523 i | 140 |       | 03.07 | 02.10 | + Motorcode N53 6)             | 24.8190-0273.2 | 620273 | 1 |                     | Warnkontakt L=662mm |     |
|        | 523 i | 140 |       | 03.07 | 02.10 | + Behörde/ + Motorcode N52N 7) |                |        |   |                     |                     |     |
|        | 525 d | 130 |       | 10.03 | 03.07 | + Behörde 4)                   |                |        |   |                     |                     |     |
|        | 525 d | 145 |       | 03.07 | 02.10 |                                |                |        |   |                     |                     |     |
|        | 525 i | 141 |       | 07.03 | 06.05 | + Behörde 4)                   |                |        |   |                     |                     |     |
|        | 525 i | 160 |       | 03.07 | 02.10 | + Motorcode N53 6)             |                |        |   |                     |                     |     |
|        | 525 i | 160 |       | 03.07 | 02.10 | + Behörde/ + Motorcode N52N 7) |                |        |   |                     |                     |     |
|        | 525 i | 160 |       | 07.05 | 03.07 |                                |                |        |   |                     |                     |     |
| 525 xd | 145   |     | 03.07 | 02.10 |       |                                |                |        |   |                     |                     |     |
| 525 xi | 160   |     | 07.05 | 02.10 |       |                                |                |        |   |                     |                     |     |
| 530 d  | 160   |     | 07.03 | 08.05 |       |                                |                |        |   |                     |                     |     |
| 530 d  | 170   |     | 07.03 | 03.07 |       |                                |                |        |   |                     |                     |     |
| 530 d  | 173   |     | 03.07 | 02.10 |       |                                |                |        |   |                     |                     |     |
| 530 i  | 170   |     | 07.03 | 03.05 |       |                                |                |        |   |                     |                     |     |
| 530 i  | 190   |     | 07.05 | 03.07 |       |                                |                |        |   |                     |                     |     |
| 530 i  | 200   |     | 01.07 | 02.10 |       |                                |                |        |   |                     |                     |     |
| 530 xd | 170   |     | 07.05 | 03.07 |       |                                |                |        |   |                     |                     |     |
| 530 xd | 173   |     | 03.07 | 02.10 |       |                                |                |        |   |                     |                     |     |
| 530 xi | 190   |     | 07.05 | 03.07 |       |                                |                |        |   |                     |                     |     |
| 530 xi | 200   |     | 03.07 | 02.10 |       |                                |                |        |   |                     |                     |     |
| 530 d  | 160   |     | 07.03 | 08.05 |       | 13.0460-7167.2                 | 607167         |        |   | 23312 20,3 +/WE     | ATE                 |     |
| 530 d  | 170   |     | 07.03 | 03.07 |       | 13.0470-7167.2                 | LD7167         |        |   | 23312 20,3 +/WE     | ATE                 |     |
| 530 d  | 173   |     | 03.07 | 02.10 |       | 13.0460-7296.2                 | 607296         |        |   | 23312 20,3 +/WE     | ATE                 |     |
| 530 i  | 170   |     | 07.03 | 03.05 |       | 13.0470-7296.2                 | LD7296         |        |   | 23312 20,3 +/WE     | ATE                 |     |
| 530 i  | 190   |     | 07.05 | 03.07 |       | 24.8190-0273.2                 | 620273         | 1      |   | Warnkontakt L=662mm |                     |     |
| 530 i  | 200   |     | 01.07 | 02.10 |       |                                |                |        |   |                     |                     |     |

1) - authority cars / - enti statali / - véhicule communal / - vehiculos oficiales

2) + manual transmission / + scatola cambio velocità / + transmission mécanique / + cambio de velocidad



















3) - authority cars/+engine co. N52N / - enti statali/+codice mot.N52N / - véhicule communal/+moteur co.N52N / - vehiculos oficiales/+motor co.N52N

4) + authority cars / + enti statali / + véhicule communal / + vehiculos oficiales

5) + autom.transmission / + scatola cambio automatico / + transmission automatique / + cambio automático

6) + engine code N53 / + codice motore N53 / + moteur code N53 / + motor code N53

7) + authority cars/+engine no.N52N / + enti statali/+codice mot.N52N / + véhicule communal/+moteur co.N52N / + vehiculos oficiales/+motor co.N52N

|     |  |  |  |  |  |  |     |   |                         |     |
|--|--|--|--|--|---|--|---|---|-------------------------|-----|
| <b>BMW 5er Reihe/E60 Limousine (03-10)</b>   |  |  |  |  |   |  |   |   |                         |     |
|    | 530 xd   | 170  |  | 07.05  | 03.07   | 13.0460-7167.2   | 607167  |   | 23312 20,3 +/WE         | ATE |
|  | 530 xd   | 173  |  | 03.07  | 02.10   | 13.0470-7167.2   | LD7167  |   | 23312 20,3 +/WE         | ATE |
|  | 530 xi   | 190  |  | 07.05  | 03.07   | 13.0460-7296.2   | 607296  |   | 23312 20,3 +/WE         | ATE |
|  | 530 xi   | 200  |  | 03.07  | 02.10   | 13.0470-7296.2   | LD7296  |   | 23312 20,3 +/WE         | ATE |
|  |  |  |  |  |   | 24.8190-0273.2   | 620273  | 1    | Warnkontakt L=662mm     |     |
|  | 540 i  | 225  |  | 03.07  | 02.10   | 13.0460-7167.2   | 607167  |   | 23312 20,3 +/WE         | ATE |
|  | 540 i  | 225  |  | 07.05  | 03.07   | 13.0470-7167.2   | LD7167  |   | 23312 20,3 +/WE         | ATE |
|  |  |  |  |  |   | 13.0460-7296.2   | 607296  |   | 23312 20,3 +/WE         | ATE |
|  |  |  |  |  |   | 13.0470-7296.2   | LD7296  |   | 23312 20,3 +/WE         | ATE |
|  |  |  |  |  |   | 24.8190-0273.2   | 620273  | 1    | Warnkontakt L=662mm     |     |
| 545 i  | 245  |  | 07.03  | 08.05  | 13.0460-7167.2  | 607167   |   | 23312 20,3 +/WE   | ATE                     |     |
| 550 i  | 270  |  | 03.07  | 02.10  | 13.0460-7296.2  | 607296   |   | 23312 20,3 +/WE   | ATE                     |     |
|  |  |  |  |  | 24.8190-0273.2  | 620273   | 1   | Warnkontakt L=662mm   |                         |     |
| 535 d  | 200  |  | 09.04  | 03.07  | 13.0460-7210.2  | 607210   |   | 23791 20,8 +/WE   | ATE                     |     |
| 535 d  | 210  |  | 03.07  | 02.10  | 13.0470-7210.2  | LD7210   |   | 23791 20,8 +/WE   | ATE                     |     |
| 540 i  | 225  |  | 03.07  | 02.10  | 24.8190-0273.2  | 620273   | 1  | Warnkontakt L=662mm   |                         |     |
| 550 i  | 270  |  | 03.07  | 02.10  | 13.0460-7210.2  | 607210   |   | 23791 20,8 +/WE   | ATE                     |     |
| 550 i  | 270  |  | 07.05  | 03.07  | 24.8190-0273.2  | 620273   | 1  | Warnkontakt L=662mm   |                         |     |
| M5   | 373  |  | 09.04  | 02.10  |   |  |   |   |                         |     |
|    | 520 d  | 120  |  | 07.05  | 02.10   | 24.0124-0181.1   | 424181  |   | 310 24,0 22,4 V L +S +B |     |
|  | 520 i  | 125  |  | 07.03  | 03.05   | 24.0324-0181.1   | 524181  |   | 310 24,0 21,6 V L +S +B | PD  |
|  | 523 i  | 130  |  | 07.05  | 03.07   |  |   |   |                         |     |
|  | 523 i  | 140  |  | 03.07  | 02.10   |  |   |   |                         |     |
|  | 525 d  | 130  |  | 10.03  | 03.07   |  |   |   |                         |     |
|  | 525 i  | 141  |  | 07.03  | 06.05   |  |   |   |                         |     |
|  | 525 i  | 160  |  | 03.07  | 02.10   |  |   |   |                         |     |
|  | 520 d  | 120  |  | 07.05  | 02.10   | 24.0130-0173.1   | 430173  |   | 324 30,0 28,4 V L +S +B |     |
|  | 520 d  | 130  |  | 09.07  | 02.10   | 24.0330-0173.1   | 530173  |   | 324 30,0 27,6 V L +S +B | PD  |
|  | 520 i  | 125  |  | 07.03  | 03.05   |  |   |   |                         |     |
| 523 i  | 130  |  | 07.05  | 03.07  |   |  |   |   |                         |     |
| 523 i  | 140  |  | 03.07  | 02.10  |   |  |   |   |                         |     |
| 523 i  | 140  |  | 03.07  | 02.10  |   |  |   |   |                         |     |
| 525 d  | 130  |  | 10.03  | 03.07  |   |  |   |   |                         |     |
| 525 d  | 145  |  | 03.07  | 02.10  |   |  |   |   |                         |     |
| 525 i  | 141  |  | 07.03  | 06.05  |   |  |   |   |                         |     |
| 525 i  | 160  |  | 03.07  | 02.10  |   |  |   |   |                         |     |
| 525 i  | 160  |  | 07.05  | 03.07  |   |  |   |   |                         |     |
| 525 xd   | 145  |  | 03.07  | 02.10  |   |  |   |   |                         |     |
| 525 xi   | 160  |  | 07.05  | 02.10  |   |  |   |   |                         |     |
| 530 d  | 160  |  | 07.03  | 08.05  |   |  |   |   |                         |     |
| 530 d  | 170  |  | 07.03  | 03.07  |   |  |   |   |                         |     |
| 530 d  | 173  |  | 03.07  | 02.10  |   |  |   |   |                         |     |
| 530 i  | 170  |  | 07.03  | 03.05  |   |  |   |   |                         |     |
| 530 i  | 190  |  | 07.05  | 03.07  |   |  |   |   |                         |     |
| 530 i  | 200  |  | 01.07  | 02.10  |   |  |   |   |                         |     |
| 530 xd   | 170  |  | 07.05  | 03.07  |   |  |   |   |                         |     |
| 530 xd   | 173  |  | 03.07  | 02.10  |   |  |   |   |                         |     |
| 530 xi   | 190  |  | 07.05  | 03.07  |   |  |   |   |                         |     |
| 530 xi   | 200  |  | 03.07  | 02.10  |   |  |   |   |                         |     |
| 525 d  | 145  |  | 03.07  | 02.10  | 24.0130-0186.2  | 430186   |   | zweiteilige Bremsscheibe <sup>11)</sup>   | 348 30,0 28,4 V L +S +B |     |
| 525 i  | 160  |  | 03.07  | 02.10  |   |  |   |   |                         |     |
| 530 d  | 160  |  | 07.03  | 08.05  |   |  |   |   |                         |     |
| 530 d  | 170  |  | 07.03  | 03.07  |   |  |   |   |                         |     |
| 530 d  | 173  |  | 03.07  | 02.10  |   |  |   |   |                         |     |
| 530 i  | 190  |  | 07.05  | 03.07  |   |  |   |   |                         |     |
| 530 i  | 200  |  | 01.07  | 02.10  |   |  |   |   |                         |     |
| 530 i  | 200  |  | 01.07  | 02.10  |   |  |   |   |                         |     |
| 540 i  | 225  |  | 03.07  | 02.10  |   |  |   |   |                         |     |
| 540 i  | 225  |  | 07.05  | 03.07  |   |  |   |   |                         |     |
| 545 i  | 245  |  | 07.03  | 08.05  |   |  |   |   |                         |     |
| 550 i  | 270  |  | 03.07  | 02.10  |   |  |   |   |                         |     |
| 535 d  | 200  |  | 09.04  | 03.07  | 24.0136-0106.2  | 436106   |   | zweiteilige Bremsscheibe <sup>11)</sup>   | 348 36,0 34,4 V L +S +B |     |
| 550 i  | 270  |  | 07.05  | 03.07  |   |  |   |   |                         |     |
| 535 d  | 210  |  | 03.07  | 02.10  | 24.0136-0106.2  | 436106   |   | zweiteilige Bremsscheibe <sup>11)</sup>   | 348 36,0 34,4 V L +S +B |     |
| 540 i  | 225  |  | 03.07  | 02.10  |   |  |   |   |                         |     |
| 550 i  | 270  |  | 03.07  | 02.10  |   |  |   |   |                         |     |
| M5   | 373  |  | 09.04  | 02.10  | 24.0136-0117.2  | 436117   |   |  zweiteilige Bremsscheibe <sup>11)</sup> | 374 36,0 34,4 V L +S +B |     |
|  |  |  |  |  | 24.0136-0116.2  | 436116   |   |  zweiteilige Bremsscheibe <sup>11)</sup> | 374 36,0 34,4 V L +S +B |     |
|  | M5   | 373  |  | 09.04  | 02.10   | 24.0711-6238.3   | 360284  | 2                                        | Radsensor L=577         |     |
|  | 520 d  | 120  |  | 07.05  | 02.10   | 13.0460-7174.2   | 607174  |   | 23732 17,3 +/WE         | ATE |
|  | 520 d  | 130  |  | 09.07  | 02.10   | 13.0470-7174.2   | LD7174  |   | 23732 17,3 +/WE         | ATE |
|  | 520 i  | 125  |  | 07.03  | 03.05   | 24.8190-0274.2   | 620274  | 1   | Warnkontakt L=664mm     |     |
|  | 523 i  | 130  |  | 07.05  | 03.07   |  |   |   |                         |     |
|  | 523 i  | 140  |  | 03.07  | 02.10   |  |   |   |                         |     |
|  | 525 d  | 130  |  | 10.03  | 03.07   |  |   |   |                         |     |
|  | 525 d  | 145  |  | 03.07  | 02.10   |  |   |   |                         |     |
|  | 525 i  | 141  |  | 07.03  | 06.05   |  |   |   |                         |     |
|  | 525 i  | 160  |  | 03.07  | 02.10   |  |   |   |                         |     |
| 525 i  | 160  |  | 03.07  | 02.10  |   |  |   |   |                         |     |
| 525 i  | 160  |  | 07.05  | 03.07  |   |  |   |   |                         |     |
| 525 xd   | 145  |  | 03.07  | 02.10  |   |  |   |   |                         |     |
| 525 xi   | 160  |  | 07.05  | 02.10  |   |  |   |   |                         |     |
| 530 d  | 160  |  | 07.03  | 08.05  |   |  |   |   |                         |     |

1) - increased payload / - carico utile maggiorato / - charge utile augmentée / - incremento de carga  
2) - increased payload / + carico utile maggiorato / + charge utile augmentée / + incremento de carga  
3) - authority cars / - enti statali / - véhicule communal / - vehículos oficiales  
4) - manual transmission / + scatola cambio velocità / + transmission mécanique / + cambio de velocidad  
5) - authority cars/+engine co. N52N / - enti statali/+codice mot.N52N / - véhicule communal/+moteur co.N52N / - vehículos oficiales/+motor co.N52N  
6) - authority cars / + enti statali / + véhicule communal / + vehículos oficiales  
7) - autom.transmission / + scatola cambio automatico / + transmission automatique / + cambio automático

8) + engine code N53 / + codice motore N53 / + moteur code N53 / + motor code N53  
9) + authority cars/+engine no.N52N / + enti statali/+codice mot.N52N / + véhicule communal/+moteur co.N52N / + vehículos oficiales/+motor co.N52N  
10) - authority cars/+engine co.N53 / - enti statali/+codice mot.N53 / - véhicule communal/+moteur co.N53 / - vehículos oficiales/+motor co.N53  
11) two-piece brake disc / disco frenante in due parti / disque d.fr.en deux parties / disco de fr.de dos piezas  
12) + authority cars/+engine no.N53 / + enti statali/+codice mot.N53 / + véhicule communal/+moteur co.N53 / + vehículos oficiales/+motor co.N53  
13) + engine code N52N / + codice motore N52N / + moteur code N52N / + motor code N52N



**BMW 5er Reihe/E60 Limousine (03-10)**

|       |        |       |       |   |   |                |        |   |  |   |  |
|-------|--------|-------|-------|---|---|----------------|--------|---|--|---|--|
|       | 530 d  | 170   | 07.03 | 03.07                                     | - Behörde <sup>1)</sup>                   | 13.0460-7174.2 | 607174 | 1 |  | 23732 17,3 +/WE<br>23732 17,3 +/WE<br>Warnkontakt L=664mm | ATE<br>ATE   |
|       | 530 d  | 173   | 03.07 | 02.10                                     | - Behörde <sup>1)</sup>                   | 13.0470-7174.2 | LD7174 |   |  |   |  |
|       | 530 i  | 170   | 07.03 | 03.05                                     |   | 24.8190-0274.2 | 620274 |   |  |   |  |
|       | 530 i  | 190   | 07.05 | 03.07                                     | - Behörde <sup>1)</sup>                   |                |        |   |  |   |  |
|       | 530 i  | 200   | 01.07 | 02.10                                     | - Behörde/ + Motorcode N52N <sup>2)</sup> |                |        |   |  |   |  |
|       | 530 xd | 170   | 07.05 | 03.07                                     |   |                |        |   |  |   |  |
|       | 530 xd | 173   | 03.07 | 02.10                                     |   |                |        |   |  |   |  |
|       | 530 xi | 190   | 07.05 | 03.07                                     |   |                |        |   |  |   |  |
|       | 530 xi | 200   | 03.07 | 02.10                                     |   |                |        |   |  |   |  |
|       | 525 d  | 145   | 03.07 | 02.10                                     | + Behörde <sup>3)</sup>                   | 13.0460-7169.2 | 607169 |   |  |   |  |
|       | 525 i  | 160   | 03.07 | 02.10                                     | + Behörde/ + Motorcode N53 <sup>4)</sup>  | 13.0470-7169.2 | LD7169 |   |  |   |  |
|       | 530 d  | 160   | 07.03 | 08.05                                     | + Behörde <sup>3)</sup>                   | 24.8190-0274.2 | 620274 |   |  |   |  |
|       | 530 d  | 170   | 07.03 | 03.07                                     | + Behörde <sup>3)</sup>                   |                |        |   |  |   |  |
|       | 530 d  | 173   | 03.07 | 02.10                                     | + Behörde <sup>3)</sup>                   |                |        |   |  |   |  |
| 530 i | 190    | 07.05 | 03.07 | + Behörde <sup>3)</sup>                   |   |                |        |   |  |   |  |
| 530 i | 200    | 01.07 | 02.10 | + Motorcode N53 <sup>5)</sup>             |   |                |        |   |  |   |  |
| 530 i | 200    | 01.07 | 02.10 | + Behörde/ + Motorcode N52N <sup>6)</sup> |   |                |        |   |  |   |  |
| 535 d | 200    | 09.04 | 03.07 |   |   |                |        |   |  |   |  |
| 535 d | 210    | 03.07 | 02.10 |   |   |                |        |   |  |   |  |
| 540 i | 225    | 07.05 | 02.10 |   |   |                |        |   |  |   |  |
| 545 i | 245    | 07.03 | 08.05 |   |   |                |        |   |  |   |  |
| 550 i | 270    | 07.05 | 02.10 |   |   |                |        |   |  |   |  |
| M5    | 373    | 09.04 | 02.10 |   |   |                |        |   |  |   |  |
|       | 520 d  | 120   | 07.05 | 02.10                                     |   | 24.0120-0183.1 | 420183 |   |  | 320 20,0 18,4 V L +S +B<br>320 20,0 18,4 V L +S +B PD     |  |
|       | 520 d  | 130   | 09.07 | 02.10                                     |   | 24.0320-0183.1 | 520183 |   |  |   |  |
|       | 520 i  | 125   | 07.03 | 03.05                                     |   |                |        |   |  |   |  |
|       | 523 i  | 130   | 07.05 | 03.07                                     |   |                |        |   |  |   |  |
|       | 523 i  | 140   | 03.07 | 02.10                                     |   |                |        |   |  |   |  |
|       | 525 d  | 130   | 10.03 | 03.07                                     |   |                |        |   |  |   |  |
|       | 525 d  | 145   | 03.07 | 02.10                                     | - Behörde <sup>1)</sup>                   |                |        |   |  |   |  |
|       | 525 i  | 141   | 07.03 | 06.05                                     |   |                |        |   |  |   |  |
|       | 525 i  | 160   | 03.07 | 02.10                                     | - Behörde/ + Motorcode N53 <sup>7)</sup>  |                |        |   |  |   |  |
|       | 525 i  | 160   | 03.07 | 02.10                                     | + Motorcode N52N <sup>8)</sup>            |                |        |   |  |   |  |
|       | 525 i  | 160   | 07.05 | 03.07                                     |   |                |        |   |  |   |  |
|       | 530 d  | 160   | 07.03 | 08.05                                     | - Behörde <sup>1)</sup>                   |                |        |   |  |   |  |
|       | 530 d  | 170   | 07.03 | 03.07                                     | - Behörde <sup>1)</sup>                   |                |        |   |  |   |  |
|       | 530 d  | 173   | 03.07 | 02.10                                     | - Behörde <sup>1)</sup>                   |                |        |   |  |   |  |
|       | 530 i  | 170   | 07.03 | 03.05                                     |   |                |        |   |  |   |  |
|       | 530 i  | 190   | 07.05 | 03.07                                     | - Behörde <sup>1)</sup>                   |                |        |   |  |   |  |
|       | 530 i  | 200   | 01.07 | 02.10                                     | - Behörde/ + Motorcode N52N <sup>2)</sup> |                |        |   |  |   |  |
|       | 525 xd | 145   | 03.07 | 02.10                                     |   | 24.0120-0213.1 | 420213 |   |  |   |  |
|       | 525 xi | 160   | 07.05 | 02.10                                     |   | 24.0320-0213.1 | 520213 |   |  |   |  |
|       | 530 xd | 170   | 07.05 | 03.07                                     |   |                |        |   |  |   |  |
|       | 530 xd | 173   | 03.07 | 02.10                                     |   |                |        |   |  |   |  |
|       | 530 xi | 190   | 07.05 | 03.07                                     |   |                |        |   |  |   |  |
|       | 530 xi | 200   | 03.07 | 02.10                                     |   |                |        |   |  |   |  |
|       | 525 d  | 145   | 03.07 | 02.10                                     | + Behörde <sup>3)</sup>                   | 24.0124-0201.2 | 424201 |   |  |   |  |
| 525 i | 160    | 03.07 | 02.10 | + Behörde/ + Motorcode N53 <sup>4)</sup>  |   |                |        |   |  |   |  |
| 530 d | 160    | 07.03 | 08.05 | + Behörde <sup>3)</sup>                   |   |                |        |   |  |   |  |
| 530 d | 170    | 07.03 | 03.07 | + Behörde <sup>3)</sup>                   |   |                |        |   |  |   |  |
| 530 d | 173    | 03.07 | 02.10 | + Behörde <sup>3)</sup>                   |   |                |        |   |  |   |  |
| 530 i | 190    | 07.05 | 03.07 | + Behörde <sup>3)</sup>                   |   |                |        |   |  |   |  |
| 530 i | 200    | 01.07 | 02.10 | + Motorcode N53 <sup>5)</sup>             |   |                |        |   |  |   |  |
| 530 i | 200    | 01.07 | 02.10 | + Behörde/ + Motorcode N52N <sup>6)</sup> |   |                |        |   |  |   |  |
| 535 d | 200    | 09.04 | 03.07 |   |   |                |        |   |  |   |  |
| 535 d | 210    | 03.07 | 02.10 |   |   |                |        |   |  |   |  |
| 540 i | 225    | 07.05 | 02.10 |   |   |                |        |   |  |   |  |
| 545 i | 245    | 07.03 | 08.05 |   |   |                |        |   |  |   |  |
| 550 i | 270    | 07.05 | 02.10 |   |   |                |        |   |  |   |  |
| M5    | 373    | 07.03 | 02.10 |   | 24.0124-0235.2                            | 424235         |        |   |  |   |  |
|       |        |       |       |   | 24.0124-0234.2                            | 424234         |        |   |  |   |  |
|       | M5     | 373   | 09.04 | 02.10                                     |   | 24.0711-5162.3 | 360170 | 2 |  | zweiteilige Bremsscheibe <sup>9)</sup>                    | 370 24,0 22,4 V L +S +B<br>370 24,0 22,4 V L +S +B |
|       |        |       |       |   |   |                |        |   |  | zweiteilige Bremsscheibe <sup>9)</sup>                    |  |
|       | M5     | 373   | 09.04 | 02.10                                     |   | 24.0711-5162.3 | 360170 | 2 |  | zweiteilige Bremsscheibe <sup>9)</sup>                    | Radsensor L=719                                    |
|       | 520 d  | 120   | 07.05 | 02.10                                     |   | 03.0137-0419.2 | 650419 |   |  | 185 x 30<br>Bremsbacken-Zubehör                           |  |
|       | 520 d  | 130   | 09.07 | 02.10                                     |   | 03.0137-9288.2 | 669288 |   |  |   |  |
|       | 520 i  | 125   | 07.03 | 03.05                                     |   |                |        |   |  |   |  |
|       | 523 i  | 130   | 07.05 | 03.07                                     |   |                |        |   |  |   |  |
|       | 523 i  | 140   | 03.07 | 02.10                                     |   |                |        |   |  |   |  |
|       | 525 d  | 130   | 10.03 | 03.07                                     |   |                |        |   |  |   |  |
|       | 525 d  | 145   | 03.07 | 02.10                                     |   |                |        |   |  |   |  |
|       | 525 i  | 141   | 07.03 | 06.05                                     |   |                |        |   |  |   |  |
|       | 525 i  | 160   | 07.05 | 02.10                                     |   |                |        |   |  |   |  |
|       | 525 xd | 145   | 03.07 | 02.10                                     |   |                |        |   |  |   |  |
|       | 525 xi | 160   | 07.05 | 02.10                                     |   |                |        |   |  |   |  |
|       | 530 d  | 160   | 07.03 | 08.05                                     |   |                |        |   |  |   |  |
|       | 530 d  | 170   | 07.03 | 03.07                                     |   |                |        |   |  |   |  |
|       | 530 d  | 173   | 03.07 | 02.10                                     |   |                |        |   |  |   |  |
|       | 530 i  | 170   | 07.03 | 03.05                                     |   |                |        |   |  |   |  |
|       | 530 i  | 190   | 07.05 | 03.07                                     |   |                |        |   |  |   |  |
|       | 530 i  | 200   | 01.07 | 02.10                                     |   |                |        |   |  |   |  |
|       | 530 xd | 170   | 07.05 | 03.07                                     |   |                |        |   |  |   |  |
|       | 530 xd | 173   | 03.07 | 02.10                                     |   |                |        |   |  |   |  |
|       | 530 xi | 190   | 07.05 | 03.07                                     |   |                |        |   |  |   |  |
|       | 530 xi | 200   | 03.07 | 02.10                                     |   |                |        |   |  |   |  |
|       | 535 d  | 200   | 09.04 | 03.07                                     |   |                |        |   |  |   |  |

1) - authority cars / - enti statali / - véhicule communal / - vehiculos oficiales  
2) - authority cars/+engine co.N52N / - enti statali/+codice mot.N52N / - véhicule communal/+moteur co.N52N / - vehiculos oficiales/+motor co.N52N  
3) + authority cars / + enti statali / + véhicule communal / + vehiculos oficiales  
4) + authority cars/+engine no.N53 / + enti statali/+codice mot.N53 / + véhicule communal/+moteur co.N53 / + vehiculos oficiales/+motor co.N53  
5) + engine code N53 / + codice motore N53 / + moteur code N53 / + motor code N53  
6) + authority cars/+engine no.N52N / + enti statali/+codice mot.N52N / + véhicule communal/+moteur co.N52N / + vehiculos oficiales/+motor co.N52N

7) - authority cars/+engine co.N53 / - enti statali/+codice mot.N53 / - véhicule communal/+moteur co.N53 / - vehiculos oficiales/+motor co.N53  
8) + engine code N52N / + codice motore N52N / + moteur code N52N / + motor code N52N  
9) two-piece brake disc / disco frenante in due parti / disque d.fr.en deux parties / disco de fr.de dos piezas



### BMW 5er Reihe/E60 Limousine (03-10)

|  |       |     |  |       |       |  |                |        |  |  |                     |
|--|-------|-----|--|-------|-------|--|----------------|--------|--|--|---------------------|
|  | 535 d | 210 |  | 03.07 | 02.10 |  | 03.0137-0419.2 | 650419 |  |  | 185 x 30            |
|  | 540 i | 225 |  | 07.05 | 02.10 |  | 03.0137-9288.2 | 669288 |  |  | Bremsbacken-Zubehör |
|  | 545 i | 245 |  | 07.03 | 08.05 |  |                |        |  |  |                     |
|  | 550 i | 270 |  | 07.05 | 02.10 |  |                |        |  |  |                     |
|  | M5    | 373 |  | 09.04 | 02.10 |  |                |        |  |  |                     |

### BMW 5er Reihe/E61 Touring (04-10)

|  |        |     |  |       |       |   |                |        |   |  |                            |     |
|--|--------|-----|--|-------|-------|---|----------------|--------|---|--|----------------------------|-----|
|  | 520 d  | 110 |  | 09.05 | 05.10 | - Behörde <sup>1)</sup>                   | 13.0460-7176.2 | 607176 |   |  | 23794 20,3 +/WE            | ATE |
|  | 520 d  | 120 |  | 07.05 | 05.10 | - Behörde <sup>1)</sup>                   | 13.0470-7176.2 | LD7176 |   |  | 23794 20,3 +/WE            | ATE |
|  | 520 i  | 125 |  | 06.04 | 05.10 | - Behörde <sup>1)</sup>                   | 24.8190-0273.2 | 620273 | 1 |  | Warnkontakt L=662mm        |     |
|  | 523 i  | 130 |  | 07.05 | 03.07 | - Behörde <sup>1)</sup>                   |                |        |   |  |                            |     |
|  | 523 i  | 140 |  | 03.07 | 05.10 | - Behörde/ + Motorcode N52N <sup>2)</sup> |                |        |   |  |                            |     |
|  | 525 d  | 120 |  | 12.04 | 05.10 |   |                |        |   |  |                            |     |
|  | 525 d  | 130 |  | 05.04 | 03.07 | - Behörde <sup>1)</sup>                   |                |        |   |  |                            |     |
|  | 525 i  | 141 |  | 05.04 | 03.05 | - Behörde <sup>1)</sup>                   |                |        |   |  |                            |     |
|  | 525 i  | 160 |  | 03.07 | 05.10 | - Behörde/ + Motorcode N52N <sup>2)</sup> |                |        |   |  |                            |     |
|  | 520 d  | 110 |  | 09.05 | 05.10 | + Behörde <sup>3)</sup>                   | 13.0460-7167.2 | 607167 |   |  | 23312 20,3 +/WE            | ATE |
|  | 520 d  | 120 |  | 07.05 | 05.10 | + Behörde <sup>3)</sup>                   | 13.0470-7167.2 | LD7167 |   |  | 23312 20,3 +/WE            | ATE |
|  | 520 d  | 130 |  | 09.07 | 05.10 |   | 13.0460-7296.2 | 607296 |   |  | 23312 20,3 +/WE            | ATE |
|  | 520 i  | 125 |  | 06.04 | 05.10 | + Behörde <sup>3)</sup>                   | 13.0470-7296.2 | LD7296 |   |  | 23312 20,3 +/WE            | ATE |
|  | 523 i  | 130 |  | 07.05 | 03.07 | + Behörde <sup>3)</sup>                   | 24.8190-0273.2 | 620273 | 1 |  | Warnkontakt L=662mm        |     |
|  | 523 i  | 140 |  | 03.07 | 05.10 | + Motorcode N53 <sup>4)</sup>             |                |        |   |  |                            |     |
|  | 523 i  | 140 |  | 03.07 | 05.10 | + Behörde/ + Motorcode N52N <sup>5)</sup> |                |        |   |  |                            |     |
|  | 525 d  | 120 |  | 12.04 | 05.10 |   |                |        |   |  |                            |     |
|  | 525 d  | 130 |  | 05.04 | 03.07 | + Behörde <sup>3)</sup>                   |                |        |   |  |                            |     |
|  | 525 d  | 145 |  | 03.07 | 05.10 |   |                |        |   |  |                            |     |
|  | 525 i  | 141 |  | 05.04 | 03.05 | + Behörde <sup>3)</sup>                   |                |        |   |  |                            |     |
|  | 525 i  | 160 |  | 03.07 | 05.10 | + Motorcode N53 <sup>4)</sup>             |                |        |   |  |                            |     |
|  | 525 i  | 160 |  | 03.07 | 05.10 | + Behörde/ + Motorcode N52N <sup>5)</sup> |                |        |   |  |                            |     |
|  | 525 i  | 160 |  | 07.05 | 03.07 |   |                |        |   |  |                            |     |
|  | 525 xd | 145 |  | 03.07 | 05.10 |   |                |        |   |  |                            |     |
|  | 525 xi | 160 |  | 07.05 | 05.10 |   |                |        |   |  |                            |     |
|  | 530 d  | 160 |  | 05.04 | 08.05 |   |                |        |   |  |                            |     |
|  | 530 d  | 170 |  | 07.05 | 05.10 |   |                |        |   |  |                            |     |
|  | 530 d  | 173 |  | 03.07 | 05.10 |   |                |        |   |  |                            |     |
|  | 530 i  | 190 |  | 07.05 | 03.07 |   |                |        |   |  |                            |     |
|  | 530 i  | 200 |  | 03.07 | 05.10 |   |                |        |   |  |                            |     |
|  | 530 xd | 170 |  | 07.05 | 03.07 |   |                |        |   |  |                            |     |
|  | 530 xd | 173 |  | 03.07 | 05.10 |   |                |        |   |  |                            |     |
|  | 530 xi | 190 |  | 07.05 | 03.07 |   |                |        |   |  |                            |     |
|  | 530 xi | 200 |  | 03.07 | 05.10 |   |                |        |   |  |                            |     |
|  | 545 i  | 245 |  | 05.04 | 08.05 |   | 13.0460-7167.2 | 607167 |   |  | 23312 20,3 +/WE            | ATE |
|  | 550 i  | 270 |  | 03.07 | 05.10 | + <sup>6)</sup>                           | 13.0460-7296.2 | 607296 |   |  | 23312 20,3 +/WE            | ATE |
|  |        |     |  |       |       |   | 24.8190-0273.2 | 620273 | 1 |  | Warnkontakt L=662mm        |     |
|  | 535 d  | 200 |  | 09.04 | 03.07 |   | 13.0460-7210.2 | 607210 |   |  | 23791 20,8 +/WE            | ATE |
|  | 535 d  | 210 |  | 03.07 | 05.10 |   | 13.0470-7210.2 | LD7210 |   |  | 23791 20,8 +/WE            | ATE |
|  |        |     |  |       |       |   | 24.8190-0273.2 | 620273 | 1 |  | Warnkontakt L=662mm        |     |
|  | 550 i  | 270 |  | 03.07 | 05.10 | - <sup>6)</sup>                           | 13.0460-7210.2 | 607210 |   |  | 23791 20,8 +/WE            | ATE |
|  | 550 i  | 270 |  | 07.05 | 03.07 |   | 24.8190-0273.2 | 620273 | 1 |  | Warnkontakt L=662mm        |     |
|  | M5     | 373 |  | 02.07 | 05.10 |   | 13.0460-7210.2 | 607210 |   |  | 23791 20,8 +/WE            | ATE |
|  |        |     |  |       |       |   | 24.8190-0273.2 | 620273 | 1 |  | Warnkontakt L=662mm        |     |
|  |        |     |  |       |       |   | 24.8190-0276.2 | 620276 | 1 |  | Warnkontakt L=674mm        |     |
|  | 520 d  | 110 |  | 09.05 | 05.10 | - Behörde <sup>1)</sup>                   | 24.0124-0181.1 | 424181 |   |  | 310 24,0 22,4 V L +S +B    |     |
|  | 520 d  | 110 |  | 09.05 | 05.10 | - Behörde <sup>1)</sup>                   | 24.0324-0181.1 | 524181 |   |  | 310 24,0 21,6 V L +S +B PD |     |
|  | 520 d  | 120 |  | 07.05 | 05.10 | - Behörde <sup>1)</sup>                   |                |        |   |  |                            |     |
|  | 520 i  | 125 |  | 06.04 | 05.10 | - Behörde <sup>1)</sup>                   |                |        |   |  |                            |     |
|  | 523 i  | 130 |  | 07.05 | 03.07 | - Behörde <sup>1)</sup>                   |                |        |   |  |                            |     |
|  | 523 i  | 140 |  | 03.07 | 05.10 | - Behörde/ + Motorcode N52N <sup>2)</sup> |                |        |   |  |                            |     |
|  | 525 d  | 120 |  | 12.04 | 05.10 |   |                |        |   |  |                            |     |
|  | 525 d  | 130 |  | 05.04 | 03.07 | - Behörde <sup>1)</sup>                   |                |        |   |  |                            |     |
|  | 525 i  | 141 |  | 05.04 | 03.05 | - Behörde <sup>1)</sup>                   |                |        |   |  |                            |     |
|  | 525 i  | 160 |  | 03.07 | 05.10 | - Behörde/ + Motorcode N52N <sup>2)</sup> |                |        |   |  |                            |     |
|  | 520 d  | 110 |  | 09.09 | 05.10 | + Behörde <sup>3)</sup>                   | 24.0130-0173.1 | 430173 |   |  | 324 30,0 28,4 V L +S +B    |     |
|  | 520 d  | 120 |  | 07.05 | 05.10 | + Behörde <sup>3)</sup>                   | 24.0330-0173.1 | 530173 |   |  | 324 30,0 27,6 V L +S +B PD |     |
|  | 520 d  | 130 |  | 09.07 | 05.10 |   |                |        |   |  |                            |     |
|  | 520 i  | 125 |  | 06.04 | 05.10 | + Behörde <sup>3)</sup>                   |                |        |   |  |                            |     |
|  | 523 i  | 130 |  | 07.05 | 03.07 | + Behörde <sup>3)</sup>                   |                |        |   |  |                            |     |
|  | 523 i  | 140 |  | 03.07 | 05.10 | + Motorcode N53 <sup>4)</sup>             |                |        |   |  |                            |     |
|  | 523 i  | 140 |  | 03.07 | 05.10 | + Behörde/ + Motorcode N52N <sup>5)</sup> |                |        |   |  |                            |     |
|  | 525 d  | 120 |  | 12.04 | 05.10 |   |                |        |   |  |                            |     |
|  | 525 d  | 130 |  | 05.04 | 03.07 | + Behörde <sup>3)</sup>                   |                |        |   |  |                            |     |
|  | 525 d  | 145 |  | 03.07 | 05.10 | - Behörde <sup>1)</sup>                   |                |        |   |  |                            |     |
|  | 525 i  | 141 |  | 05.04 | 03.05 | + Behörde <sup>3)</sup>                   |                |        |   |  |                            |     |
|  | 525 i  | 160 |  | 03.07 | 05.10 | - Behörde/ + Motorcode N53 <sup>6)</sup>  |                |        |   |  |                            |     |
|  | 525 i  | 160 |  | 03.07 | 05.10 | + Behörde/ + Motorcode N52N <sup>5)</sup> |                |        |   |  |                            |     |
|  | 525 i  | 160 |  | 07.05 | 03.07 |   |                |        |   |  |                            |     |
|  | 525 xd | 145 |  | 03.07 | 05.10 |   |                |        |   |  |                            |     |
|  | 525 xi | 160 |  | 07.05 | 05.10 |   |                |        |   |  |                            |     |
|  | 530 d  | 160 |  | 05.04 | 08.05 | - Behörde <sup>1)</sup>                   |                |        |   |  |                            |     |
|  | 530 d  | 170 |  | 07.05 | 05.10 | - Behörde <sup>1)</sup>                   |                |        |   |  |                            |     |
|  | 530 d  | 173 |  | 03.07 | 05.10 | - Behörde <sup>1)</sup>                   |                |        |   |  |                            |     |
|  | 530 i  | 190 |  | 07.05 | 03.07 |   |                |        |   |  |                            |     |
|  | 530 i  | 200 |  | 03.07 | 05.10 | - Behörde/ + Motorcode N52N <sup>2)</sup> |                |        |   |  |                            |     |
|  | 530 xd | 170 |  | 07.05 | 03.07 |   |                |        |   |  |                            |     |
|  | 530 xd | 173 |  | 03.07 | 05.10 |   |                |        |   |  |                            |     |
|  | 530 xi | 190 |  | 07.05 | 03.07 |   |                |        |   |  |                            |     |
|  | 530 xi | 200 |  | 03.07 | 05.10 |   |                |        |   |  |                            |     |

<sup>1)</sup> - authority cars / - enti statale / - véhicule communal / - vehiculos oficiales

<sup>2)</sup> - authority cars/+engine co. N52N / - enti statale/+codice mot.N52N / - véhicule communal/+moteur co.N52N / - vehiculos oficiales/+motor co.N52N

<sup>3)</sup> + authority cars / + enti statale / + véhicule communal / + vehiculos oficiales

<sup>4)</sup> + engine code N53 / + codice motore N53 / + moteur code N53 / + motor code N53

<sup>5)</sup> + authority cars/+engine no.N52N / + enti statale/+codice mot.N52N / + véhicule communal/+moteur co.N52N / + vehiculos oficiales/+motor co.N52N

<sup>6)</sup> - authority cars/+engine co.N53 / - enti statale/+codice mot.N53 / - véhicule communal/+moteur co.N53 / - vehiculos oficiales/+motor co.N53





















**BMW 5er Reihe/E61 Touring (04-10)**

|        |        |     |       |       |   |   |                |        |  |   |   |                |        |  |  |                         |
|--------|--------|-----|-------|-------|---|---|----------------|--------|--|---|---|----------------|--------|--|--|-------------------------|
|        | 525 d  | 145 |       | 03.07 | 05.10                                     | + Behörde <sup>1)</sup>                   | 24.0130-0186.2 | 430186 |  | zweitellige Bremsscheibe <sup>2)</sup>                    | 348 30,0 28,4 V L +S +B                                   |                |        |  |  |                         |
|        | 525 i  | 160 |       | 03.07 | 05.10                                     | + Behörde/ + Motorcode N53 <sup>3)</sup>  |                |        |  |   |   |                |        |  |  |                         |
|        | 530 d  | 160 |       | 05.04 | 08.05                                     | + Behörde <sup>1)</sup>                   |                |        |  |   |   |                |        |  |  |                         |
|        | 530 d  | 170 |       | 07.05 | 05.10                                     | + Behörde <sup>1)</sup>                   |                |        |  |   |   |                |        |  |  |                         |
|        | 530 d  | 173 |       | 03.07 | 05.10                                     | + Behörde <sup>1)</sup>                   |                |        |  |   |   |                |        |  |  |                         |
|        | 530 i  | 200 |       | 03.07 | 05.10                                     | + Motorcode N53 <sup>4)</sup>             |                |        |  |   |   |                |        |  |  |                         |
|        | 530 i  | 200 |       | 03.07 | 05.10                                     | + Behörde/ + Motorcode N52N <sup>5)</sup> |                |        |  |   |   |                |        |  |  |                         |
|        | 545 i  | 245 |       | 05.04 | 08.05                                     |   |                |        |  |   |   |                |        |  |  |                         |
|        | 550 i  | 270 |       | 03.07 | 05.10                                     | +   |                |        |  |   |   |                |        |  |  |                         |
|        | 535 d  | 200 |       | 09.04 | 03.07                                     |   |                |        |  |   |   | 24.0136-0106.2 | 436106 |  | zweitellige Bremsscheibe <sup>2)</sup> | 348 36,0 34,4 V L +S +B |
| 550 i  | 270    |     | 07.05 | 03.07 |   | 24.0136-0106.2                            | 436106         |        | zweitellige Bremsscheibe <sup>2)</sup> | 348 36,0 34,4 V L +S +B                                   |   |                |        |  |  |                         |
| 535 d  | 210    |     | 03.07 | 05.10 |   | 24.0136-0117.2                            | 436117         |        | zweitellige Bremsscheibe <sup>2)</sup> | 374 36,0 34,4 V L +S +B                                   |   |                |        |  |  |                         |
| 550 i  | 270    |     | 03.07 | 05.10 | -   | 24.0136-0116.2                            | 436116         |        | zweitellige Bremsscheibe <sup>2)</sup> | 374 36,0 34,4 V L +S +B                                   |   |                |        |  |  |                         |
| M5     | 373    |     | 02.07 | 05.10 |   | 24.0136-0117.2                            | 436117         |        | zweitellige Bremsscheibe <sup>2)</sup> | 374 36,0 34,4 V L +S +B                                   |   |                |        |  |  |                         |
|        |        |     |       |       |   | 24.0136-0116.2                            | 436116         |        | zweitellige Bremsscheibe <sup>2)</sup> | 374 36,0 34,4 V L +S +B                                   |   |                |        |  |  |                         |
|        | M5     | 373 |       | 02.07 | 05.10                                     |   | 24.0711-6238.3 | 360284 | 2                                      |   | Radsensor L=577   |                |        |  |  |                         |
|        | 520 d  | 110 |       | 09.05 | 05.10                                     |   | 13.0460-7174.2 | 607174 | 1                                      |   | 23309 17,3 +/WE<br>23732 17,3 +/WE<br>Warnkontakt L=872mm |                |        |  |  |                         |
|        | 520 d  | 120 |       | 07.05 | 05.10                                     |   |                |        |  |   |   |                |        |  |  |                         |
|        | 520 d  | 130 |       | 09.07 | 05.10                                     |   |                |        |  |   |   |                |        |  |  |                         |
|        | 520 i  | 125 |       | 06.04 | 05.10                                     |   |                |        |  |   |   |                |        |  |  |                         |
|        | 523 i  | 130 |       | 07.05 | 03.07                                     |   |                |        |  |   |   |                |        |  |  |                         |
|        | 523 i  | 140 |       | 03.07 | 05.10                                     |   |                |        |  |   |   |                |        |  |  |                         |
|        | 525 d  | 120 |       | 12.04 | 05.10                                     |   |                |        |  |   |   |                |        |  |  |                         |
|        | 525 d  | 130 |       | 05.04 | 03.07                                     |   |                |        |  |   |   |                |        |  |  |                         |
|        | 525 d  | 145 |       | 03.07 | 05.10                                     | - Behörde <sup>6)</sup>                   |                |        |  |   |   |                |        |  |  |                         |
|        | 525 i  | 141 |       | 05.04 | 03.05                                     |   |                |        |  |   |   |                |        |  |  |                         |
|        | 525 i  | 160 |       | 03.07 | 05.10                                     | - Behörde/ + Motorcode N53 <sup>7)</sup>  |                |        |  |   |   |                |        |  |  |                         |
|        | 525 i  | 160 |       | 03.07 | 05.10                                     | + Motorcode N52N <sup>8)</sup>            |                |        |  |   |   |                |        |  |  |                         |
|        | 525 i  | 160 |       | 07.05 | 03.07                                     |   |                |        |  |   |   |                |        |  |  |                         |
|        | 525 xd | 145 |       | 03.07 | 05.10                                     |   |                |        |  |   |   |                |        |  |  |                         |
|        | 525 xi | 160 |       | 07.05 | 05.10                                     |   |                |        |  |   |   |                |        |  |  |                         |
|        | 530 d  | 160 |       | 05.04 | 08.05                                     |   |                |        |  |   |   |                |        |  |  |                         |
|        | 530 d  | 170 |       | 07.05 | 05.10                                     | - Behörde <sup>6)</sup>                   |                |        |  |   |   |                |        |  |  |                         |
|        | 530 d  | 173 |       | 03.07 | 05.10                                     | - Behörde <sup>6)</sup>                   |                |        |  |   |   |                |        |  |  |                         |
|        | 530 i  | 190 |       | 07.05 | 03.07                                     |   |                |        |  |   |   |                |        |  |  |                         |
|        | 530 i  | 200 |       | 03.07 | 05.10                                     | - Behörde/ + Motorcode N52N <sup>9)</sup> |                |        |  |   |   |                |        |  |  |                         |
| 530 xd | 170    |     | 07.05 | 03.07 |   |   |                |        |  |   |   |                |        |  |  |                         |
| 530 xd | 173    |     | 03.07 | 05.10 |   |   |                |        |  |   |   |                |        |  |  |                         |
| 530 xi | 190    |     | 07.05 | 03.07 |   |   |                |        |  |   |   |                |        |  |  |                         |
| 530 xi | 200    |     | 03.07 | 05.10 |   |   |                |        |  |   |   |                |        |  |  |                         |
| 525 d  | 145    |     | 03.07 | 05.10 | + Behörde <sup>1)</sup>                   | 13.0460-7169.2                            | 607169         | 1      |  | 23309 17,3 +/WE<br>23309 17,3 +/WE<br>Warnkontakt L=872mm |   |                |        |  |  |                         |
| 525 i  | 160    |     | 03.07 | 05.10 | + Behörde/ + Motorcode N53 <sup>3)</sup>  |   |                |        |  |   |   |                |        |  |  |                         |
| 530 d  | 170    |     | 07.05 | 05.10 | + Behörde <sup>1)</sup>                   |   |                |        |  |   |   |                |        |  |  |                         |
| 530 d  | 173    |     | 03.07 | 05.10 | + Behörde <sup>1)</sup>                   |   |                |        |  |   |   |                |        |  |  |                         |
| 530 i  | 200    |     | 03.07 | 05.10 | + Motorcode N53 <sup>4)</sup>             |   |                |        |  |   |   |                |        |  |  |                         |
| 530 i  | 200    |     | 03.07 | 05.10 | + Behörde/ + Motorcode N52N <sup>5)</sup> |   |                |        |  |   |   |                |        |  |  |                         |
| 535 d  | 200    |     | 09.04 | 03.07 |   |   |                |        |  |   |   |                |        |  |  |                         |
| 535 d  | 210    |     | 03.07 | 05.10 |   |   |                |        |  |   |   |                |        |  |  |                         |
| 545 i  | 245    |     | 05.04 | 08.05 |   |   |                |        |  |   |   |                |        |  |  |                         |
| 550 i  | 270    |     | 07.05 | 05.10 |   |   |                |        |  |   |   |                |        |  |  |                         |
| M5     | 373    |     | 02.07 | 05.10 |   | 13.0460-7169.2                            | 607169         |        |  | 23309 17,3 +/WE   |   |                |        |  |  |                         |
|        |        |     |       |       |   | 13.0470-7169.2                            | LD7169         |        |  | 23309 17,3 +/WE   |   |                |        |  |  |                         |
|        |        |     |       |       |   | 24.8190-0279.2                            | 620279         |        | 1                                      | Warnkontakt L=992mm                                       |   |                |        |  |  |                         |
|        | 520 d  | 110 |       | 09.05 | 05.10                                     |   | 24.0120-0183.1 | 420183 |  |   | 320 20,0 18,4 V L +S +B<br>320 20,0 18,4 V L +S +B PD     |                |        |  |  |                         |
|        | 520 d  | 120 |       | 07.05 | 05.10                                     |   |                |        |  |   |   |                |        |  |  |                         |
|        | 520 d  | 130 |       | 09.07 | 05.10                                     |   |                |        |  |   |   |                |        |  |  |                         |
|        | 520 i  | 125 |       | 06.04 | 05.10                                     |   |                |        |  |   |   |                |        |  |  |                         |
|        | 523 i  | 130 |       | 07.05 | 03.07                                     |   |                |        |  |   |   |                |        |  |  |                         |
|        | 523 i  | 140 |       | 03.07 | 05.10                                     |   |                |        |  |   |   |                |        |  |  |                         |
|        | 525 d  | 120 |       | 12.04 | 05.10                                     |   |                |        |  |   |   |                |        |  |  |                         |
|        | 525 d  | 130 |       | 05.04 | 03.07                                     |   |                |        |  |   |   |                |        |  |  |                         |
|        | 525 d  | 145 |       | 03.07 | 05.10                                     | - Behörde <sup>6)</sup>                   |                |        |  |   |   |                |        |  |  |                         |
|        | 525 i  | 141 |       | 05.04 | 03.05                                     |   |                |        |  |   |   |                |        |  |  |                         |
|        | 525 i  | 160 |       | 03.07 | 05.10                                     | - Behörde/ + Motorcode N53 <sup>7)</sup>  |                |        |  |   |   |                |        |  |  |                         |
|        | 525 i  | 160 |       | 03.07 | 05.10                                     | + Motorcode N52N <sup>8)</sup>            |                |        |  |   |   |                |        |  |  |                         |
|        | 525 i  | 160 |       | 07.05 | 03.07                                     |   |                |        |  |   |   |                |        |  |  |                         |
|        | 530 d  | 160 |       | 05.04 | 08.05                                     | - Behörde <sup>6)</sup>                   |                |        |  |   |   |                |        |  |  |                         |
|        | 530 d  | 170 |       | 07.05 | 05.10                                     | - Behörde <sup>6)</sup>                   |                |        |  |   |   |                |        |  |  |                         |
|        | 530 d  | 173 |       | 03.07 | 05.10                                     | - Behörde <sup>6)</sup>                   |                |        |  |   |   |                |        |  |  |                         |
|        | 530 i  | 190 |       | 07.05 | 03.07                                     |   |                |        |  |   |   |                |        |  |  |                         |
|        | 530 i  | 200 |       | 03.07 | 05.10                                     | - Behörde/ + Motorcode N52N <sup>9)</sup> |                |        |  |   |   |                |        |  |  |                         |
|        | 525 d  | 145 |       | 03.07 | 05.10                                     | + Behörde <sup>1)</sup>                   |                |        |  |   |   | 24.0124-0201.2 | 424201 |  |  | 345 24,0 22,4 V L +S +B |
|        | 525 i  | 160 |       | 03.07 | 05.10                                     | + Behörde/ + Motorcode N53 <sup>3)</sup>  |                |        |  |   |   |                |        |  |  |                         |
| 530 d  | 160    |     | 05.04 | 08.05 | + Behörde <sup>1)</sup>                   |   |                |        |  |   |   |                |        |  |  |                         |
| 530 d  | 170    |     | 07.05 | 05.10 | + Behörde <sup>1)</sup>                   |   |                |        |  |   |   |                |        |  |  |                         |
| 530 d  | 173    |     | 03.07 | 05.10 | + Behörde <sup>1)</sup>                   |   |                |        |  |   |   |                |        |  |  |                         |
| 530 i  | 200    |     | 03.07 | 05.10 | + Motorcode N53 <sup>4)</sup>             |   |                |        |  |   |   |                |        |  |  |                         |
| 530 i  | 200    |     | 03.07 | 05.10 | + Behörde/ + Motorcode N52N <sup>5)</sup> |   |                |        |  |   |   |                |        |  |  |                         |
| 535 d  | 200    |     | 09.04 | 03.07 |   |   |                |        |  |   |   |                |        |  |  |                         |
| 535 d  | 210    |     | 03.07 | 05.10 |   |   |                |        |  |   |   |                |        |  |  |                         |
| 545 i  | 245    |     | 05.04 | 08.05 |   |   |                |        |  |   |   |                |        |  |  |                         |
| 550 i  | 270    |     | 07.05 | 05.10 |   |   |                |        |  |   |   |                |        |  |  |                         |
| 525 xd | 145    |     | 03.07 | 05.10 |   | 24.0120-0213.1                            | 420213         |        |  | 320 20,0 18,4 V L +S +B                                   |   |                |        |  |  |                         |
| 525 xi | 160    |     | 07.05 | 05.10 |   |   |                |        |  |   | 24.0320-0213.1  | 520213         |        |  | 320 20,0 18,4 V L +S +B PD             |                         |

1) + authority cars / + enti statali / + véhicule communal / + vehiculos oficiales  
2) two-piece brake disc / disco frenante in due parti / disque d.fr.en deux parties / disco de fr.de dos piezas  
3) + authority cars/+engine no.N53 / + enti statali/+codice mot.N53 / + véhicule communal/+moteur co.N53 / + vehiculos oficiales/+motor co.N53  
4) + engine code N53 / + codice motore N53 / + moteur code N53 / + motor code N53  
5) + authority cars/+engine no.N52N / + enti statali/+codice mot.N52N / + véhicule communal/+moteur co.N52N / + vehiculos oficiales/+motor co.N52N  
6) - authority cars / - enti statali / - véhicule communal / - vehiculos oficiales

7) - authority cars/+engine co.N53 / - enti statali/+codice mot.N53 / - véhicule communal/+moteur co.N53 / - vehiculos oficiales/+motor co.N53  
8) + engine code N52N / + codice motore N52N / + moteur code N52N / + motor code N52N  
9) - authority cars/+engine co. N52N / - enti statali/+codice mot.N52N / - véhicule communal/+moteur co.N52N / - vehiculos oficiales/+motor co.N52N



















|   |  |  |  |  |  |  |  |  |
|--|--|--|--|--|---|--|--|--|
| <b>BMW 5er Reihe/E61 Touring (04-10)</b>   |  |  |  |  |   |  |  |  |
|  | 530 xd   | 170  | 07.05  | 03.07  | 24.0120-0213.1  | 420213   |  | 320 20,0 18,4 V L +S +B  |
|  | 530 xd   | 173  | 03.07  | 05.10  | 24.0320-0213.1  | 520213   |  | 320 20,0 18,4 V L +S +B PD   |
|  | 530 xi   | 190  | 07.05  | 03.07  |   |  |  |  |
|  | 530 xi   | 200  | 03.07  | 05.10  |   |  |  |  |
|  | M5   | 373  | 02.07  | 05.10  | 24.0124-0235.2  | 424235   | <input type="checkbox"/> zweiteilige Bremsscheibe <sup>1)</sup>                    | 370 24,0 22,4 V L +S +B  |
|  |  |  |  |  | 24.0124-0234.2  | 424234   | <input type="checkbox"/> zweiteilige Bremsscheibe <sup>1)</sup>                    | 370 24,0 22,4 V L +S +B  |
|  | M5   | 373  | 02.07  | 05.10  | 24.0711-5211.3  | 360273   | 2 <input type="checkbox"/>   | Radsensor L=937  |
|  |  |  |  |  |   |  |  |  |
|  | 520 d  | 110  | 09.05  | 05.10  | 03.0137-0419.2  | 650419   |  | 185 x 30   |
|  | 520 d  | 120  | 07.05  | 05.10  | 03.0137-9288.2  | 669288   |  | Bremsbacken-Zubehör  |
|  | 520 d  | 130  | 09.07  | 05.10  |   |  |  |  |
|  | 520 i  | 125  | 06.04  | 05.10  |   |  |  |  |
|  | 523 i  | 130  | 07.05  | 03.07  |   |  |  |  |
|  | 523 i  | 140  | 03.07  | 05.10  |   |  |  |  |
|  | 525 d  | 120  | 12.04  | 05.10  |   |  |  |  |
|  | 525 d  | 130  | 05.04  | 03.07  |   |  |  |  |
|  | 525 d  | 145  | 03.07  | 05.10  |   |  |  |  |
|  | 525 i  | 141  | 05.04  | 03.05  |   |  |  |  |
|  | 525 i  | 160  | 07.05  | 05.10  |   |  |  |  |
|  | 525 xd   | 145  | 03.07  | 05.10  |   |  |  |  |
|  | 525 xi   | 160  | 07.05  | 05.10  |   |  |  |  |
|  | 530 d  | 160  | 05.04  | 08.05  |   |  |  |  |
|  | 530 d  | 170  | 07.05  | 05.10  |   |  |  |  |
|  | 530 d  | 173  | 03.07  | 05.10  |   |  |  |  |
|  | 530 i  | 190  | 07.05  | 03.07  |   |  |  |  |
|  | 530 i  | 200  | 03.07  | 05.10  |   |  |  |  |
|  | 530 xd   | 170  | 07.05  | 03.07  |   |  |  |  |
|  | 530 xd   | 173  | 03.07  | 05.10  |   |  |  |  |
|  | 530 xi   | 190  | 07.05  | 03.07  |   |  |  |  |
|  | 530 xi   | 200  | 03.07  | 05.10  |   |  |  |  |
|  | 535 d  | 200  | 09.04  | 03.07  |   |  |  |  |
|  | 535 d  | 210  | 03.07  | 05.10  |   |  |  |  |
|  | 545 i  | 245  | 05.04  | 08.05  |   |  |  |  |
|  | 550 i  | 270  | 07.05  | 05.10  |   |  |  |  |
|  | M5   | 373  | 02.07  | 05.10  |   |  |  |  |

| <b>BMW 5er Reihe/F10 Limousine (10-)</b>  |              |       |                                   |                                   |                |        |                            |  |
|---|--------------|-------|-----------------------------------|-----------------------------------|----------------|--------|----------------------------|--|
|  | 518 d        | 105   | 01.13                             |                                   | 13.0460-7268.2 | 607268 |                            | 24697 19,3 +/WE ATE  |
|   | 518 d        | 110   | 07.14                             |                                   | 13.0470-7268.2 | LD7268 |                            | 24697 19,3 +/WE ATE  |
|   | 520 d        | 135   | 03.10                             |                                   | 24.8190-0298.2 | 620298 | 1 <input type="checkbox"/> | Warnkontakt L=1087mm   |
|   | 520 d        | 140   | 07.14                             |                                   |                |        |                            |  |
|   | 520 d xDrive | 135   | 02.13                             |                                   |                |        |                            |  |
|   | 520 d xDrive | 140   | 07.14                             |                                   |                |        |                            |  |
|   | 520 i        | 120   | 09.11                             |                                   |                |        |                            |  |
|   | 520 i        | 135   | 09.11                             |                                   |                |        |                            |  |
|   | 523 i        | 150   | 03.10                             |                                   |                |        |                            |  |
|   | 525 d        | 150   | 03.10                             | - verstärkte Bremse <sup>2)</sup> | 13.0460-7275.2 | 607275 | 1 <input type="checkbox"/> | 24688 19,2 +/WE ATE<br>Warnkontakt L=1087mm                        |
|   | 525 d        | 160   | 09.11                             | - verstärkte Bremse <sup>2)</sup> | 13.0470-7275.2 | LD7275 |                            |  |
|   | 525 d xDrive | 160   | 09.11                             | - verstärkte Bremse <sup>2)</sup> | 24.8190-0298.2 | 620298 |                            |  |
|   | 528 i        | 180   | 09.11                             | - verstärkte Bremse <sup>2)</sup> |                |        |                            |  |
|   | 528 i        | 190   | 03.10                             | - verstärkte Bremse <sup>2)</sup> |                |        |                            |  |
|   | 528 i xDrive | 180   | 09.11                             | - verstärkte Bremse <sup>2)</sup> |                |        |                            |  |
|   | 530 d        | 180   | 03.10                             | - verstärkte Bremse <sup>2)</sup> |                |        |                            |  |
|   | 530 d        | 190   | 09.11                             | - verstärkte Bremse <sup>2)</sup> |                |        |                            |  |
|   | 530 d        | 210   | 10.15                             | - verstärkte Bremse <sup>2)</sup> |                |        |                            |  |
|   | 530 d xDrive | 190   | 03.11                             | - verstärkte Bremse <sup>2)</sup> |                |        |                            |  |
| 530 d xDrive  | 210          | 10.15 | - verstärkte Bremse <sup>2)</sup> |                                   |                |        |                            |  |
| 530 i   | 200          | 09.11 | - verstärkte Bremse <sup>2)</sup> |                                   |                |        |                            |  |
|   | 525 d        | 150   | 03.10                             | + verstärkte Bremse <sup>3)</sup> | 13.0460-7267.2 | 607267 | 1 <input type="checkbox"/> | 25045 19,5 +/WE ATE<br>25045 19,5 +/WE ATE<br>Warnkontakt L=1087mm |
|   | 525 d        | 160   | 09.11                             | + verstärkte Bremse <sup>3)</sup> | 13.0470-7267.2 | LD7267 |                            |  |
|   | 525 d xDrive | 160   | 09.11                             | + verstärkte Bremse <sup>3)</sup> | 24.8190-0298.2 | 620298 |                            |  |
|   | 528 i        | 180   | 09.11                             | + verstärkte Bremse <sup>3)</sup> |                |        |                            |  |
|   | 528 i        | 190   | 03.10                             | + verstärkte Bremse <sup>3)</sup> |                |        |                            |  |
|   | 528 i xDrive | 180   | 09.11                             | + verstärkte Bremse <sup>3)</sup> |                |        |                            |  |
|   | 530 d        | 180   | 03.10                             | + verstärkte Bremse <sup>3)</sup> |                |        |                            |  |
|   | 530 d        | 190   | 09.11                             | + verstärkte Bremse <sup>3)</sup> |                |        |                            |  |
|   | 530 d        | 210   | 10.15                             | + verstärkte Bremse <sup>3)</sup> |                |        |                            |  |
|   | 530 d xDrive | 190   | 03.11                             | + verstärkte Bremse <sup>3)</sup> |                |        |                            |  |
| 530 d xDrive  | 210          | 10.15 | + verstärkte Bremse <sup>3)</sup> |                                   |                |        |                            |  |
| 530 i   | 200          | 09.11 | + verstärkte Bremse <sup>3)</sup> |                                   |                |        |                            |  |
| 535 d   | 220          | 09.10 |                                   |                                   |                |        |                            |  |
| 535 i   | 225          | 03.10 |                                   |                                   |                |        |                            |  |
| 535 i xDrive  | 225          | 03.11 |                                   |                                   |                |        |                            |  |
|   | 535 d        | 230   | 09.11                             |                                   | 13.0460-7267.2 | 607267 | 1 <input type="checkbox"/> | 25045 19,5 +/WE ATE<br>Warnkontakt L=1087mm                        |
|   | 535 d xDrive | 230   | 09.11                             |                                   | 24.8190-0298.2 | 620298 |                            |  |
|   | 550 i        | 300   | 03.10                             |                                   |                |        |                            |  |
|   | 550 i        | 330   | 05.13                             |                                   |                |        |                            |  |
|   | 550 i xDrive | 300   | 09.10                             |                                   |                |        |                            |  |
|   | 550 i xDrive | 330   | 05.13                             |                                   |                |        |                            |  |
| Active Hybrid 5   | 250          | 09.11 |                                   |                                   |                |        |                            |  |
| M 550 d xDrive  | 280          | 03.12 |                                   |                                   |                |        |                            |  |
| M5  | 412          | 09.11 |                                   |                                   | 24.8190-0298.2 | 620298 | 1 <input type="checkbox"/> | Warnkontakt L=1087mm   |
| M5 Competition  | 423          | 01.14 |                                   |                                   |                |        |                            |  |

<sup>1)</sup> two-piece brake disc / disco frenante in due parti / disque d.fr.en deux parties / disco de fr.de dos piezas

<sup>2)</sup> - heavy duty brake / - freno rinforzato / - frein renforcé / - freno reforzado

<sup>3)</sup> + heavy duty brake / + freno rinforzato / + frein renforcé / + freno reforzado

|     |  |  |  |  |  |  |     |  |                          |
|--|--|--|--|--|---|--|---|--|--------------------------|
| <b>BMW 5er Reihe/F10 Limousine (10-)</b>   |  |  |  |  |   |  |   |  |                          |
|    | 518 d  | 105  | 01.13  |  | 24.0124-0239.2  | 424239   |   | zweiteilige Bremsscheibe <sup>1)</sup>   | 330 24,0 22,4 V L +S +B  |
|  | 518 d  | 110  | 07.14  |  |   |  |   |  |                          |
|  | 520 d  | 135  | 03.10  |  |   |  |   |  |                          |
|  | 520 d  | 140  | 07.14  |  |   |  |   |  |                          |
|  | 520 d xDrive   | 135  | 02.13  |  |   |  |   |  |                          |
|  | 520 d xDrive   | 140  | 07.14  |  |   |  |   |  |                          |
|  | 520 i  | 120  | 09.11  |  |   |  |   |  |                          |
|  | 520 i  | 135  | 09.11  |  |   |  |   |  |                          |
|  | 523 i  | 150  | 03.10  |  |   |  |   |  |                          |
|  | 530 i  | 200  | 09.11  |  |   |  |   |  |                          |
|  | 525 d  | 150  | 03.10  | - verstärkte Bremse <sup>2)</sup>  | 24.0130-0218.2  | 430218   |   | zweiteilige Bremsscheibe <sup>1)</sup>   | 348 30,0 28,4 V L +S +B  |
|  | 525 d  | 160  | 09.11  | - verstärkte Bremse <sup>2)</sup>  |   |  |   |  |                          |
|  | 525 d xDrive   | 160  | 09.11  | - verstärkte Bremse <sup>2)</sup>  |   |  |   |  |                          |
|  | 528 i  | 180  | 09.11  | - verstärkte Bremse <sup>2)</sup>  |   |  |   |  |                          |
|  | 528 i  | 190  | 03.10  | - verstärkte Bremse <sup>2)</sup>  |   |  |   |  |                          |
|  | 528 i xDrive   | 180  | 09.11  | - verstärkte Bremse <sup>2)</sup>  |   |  |   |  |                          |
|  | 530 d  | 180  | 03.10  | - verstärkte Bremse <sup>2)</sup>  |   |  |   |  |                          |
|  | 530 d  | 190  | 09.11  | - verstärkte Bremse <sup>2)</sup>  |   |  |   |  |                          |
|  | 530 d  | 210  | 10.15  | - verstärkte Bremse <sup>2)</sup>  |   |  |   |  |                          |
|  | 530 d xDrive   | 190  | 03.11  | - verstärkte Bremse <sup>2)</sup>  |   |  |   |  |                          |
|  | 530 d xDrive   | 210  | 10.15  | - verstärkte Bremse <sup>2)</sup>  |   |  |   |  |                          |
|  | 530 i  | 200  | 09.11  | - verstärkte Bremse <sup>2)</sup>  |   |  |   |  |                          |
|  | 525 d  | 150  | 03.10  | + verstärkte Bremse <sup>3)</sup>  | 24.0136-0115.2  | 436115   |    | zweiteilige Bremsscheibe <sup>1)</sup>   | 348 36,0 34,4 V L +S +B  |
|  | 525 d  | 160  | 09.11  | + verstärkte Bremse <sup>3)</sup>  | 24.0136-0114.2  | 436114   |    | zweiteilige Bremsscheibe <sup>1)</sup>   | 348 36,0 34,4 V L +S +B  |
|  | 525 d xDrive   | 160  | 09.11  | + verstärkte Bremse <sup>3)</sup>  |   |  |   |  |                          |
|  | 528 i  | 180  | 09.11  | + verstärkte Bremse <sup>3)</sup>  |   |  |   |  |                          |
|  | 528 i  | 190  | 03.10  | + verstärkte Bremse <sup>3)</sup>  |   |  |   |  |                          |
|  | 528 i xDrive   | 180  | 09.11  | + verstärkte Bremse <sup>3)</sup>  |   |  |   |  |                          |
|  | 530 d  | 180  | 03.10  | + verstärkte Bremse <sup>3)</sup>  |   |  |   |  |                          |
|  | 530 d  | 190  | 09.11  | + verstärkte Bremse <sup>3)</sup>  |   |  |   |  |                          |
|  | 530 d  | 210  | 10.15  | + verstärkte Bremse <sup>3)</sup>  |   |  |   |  |                          |
|  | 530 d xDrive   | 190  | 03.11  | + verstärkte Bremse <sup>3)</sup>  |   |  |   |  |                          |
|  | 530 d xDrive   | 210  | 10.15  | + verstärkte Bremse <sup>3)</sup>  |   |  |   |  |                          |
|  | 530 i  | 200  | 09.11  | + verstärkte Bremse <sup>3)</sup>  |   |  |   |  |                          |
|  | 535 d  | 220  | 09.10  |  |   |  |   |  |                          |
|  | 535 d  | 230  | 09.11  |  |   |  |   |  |                          |
|  | 535 d xDrive   | 230  | 09.11  |  |   |  |   |  |                          |
|  | 535 i  | 225  | 03.10  |  |   |  |   |  |                          |
|  | 535 i xDrive   | 225  | 03.11  |  |   |  |   |  |                          |
|  | Active Hybrid 5  | 250  | 09.11  |  |   |  |   |  |                          |
|  | 550 i  | 300  | 03.10  |  | 24.0136-0119.2  | 436119   |   | zweiteilige Bremsscheibe <sup>1)</sup>   | 374 36,0 34,4 V L +S +B  |
|  | 550 i  | 330  | 05.13  |  | 24.0136-0118.2  | 436118   |  | zweiteilige Bremsscheibe <sup>1)</sup>   | 374 36,0 34,4 V L +S +B  |
|  | 550 i xDrive   | 300  | 09.10  |  |   |  |   |  |                          |
|  | 550 i xDrive   | 330  | 05.13  |  |   |  |   |  |                          |
|  | M 550 d xDrive   | 280  | 03.12  |  |   |  |   |  |                          |
|  | M5   | 412  | 09.11  |  | 24.0136-0126.2  | 436126   |  | zweiteilige Bremsscheibe <sup>1)</sup>   | 400 36,0 34,4 V L +S +B  |
|  | M5 Competition   | 423  | 01.14  |  | 24.0136-0125.2  | 436125   |  | zweiteilige Bremsscheibe <sup>1)</sup>   | 400 36,0 34,4 V L +S +B  |
|  | 518 d  | 105  | 01.13  |  | 13.0460-2760.2  | 602760   |   |  | 24561 17,7 +/WE/Zub/STRW |
|  | 518 d  | 110  | 07.14  |  | 13.0470-2760.2  | LD2760   |   |  | 24561 17,7 +/WE/Zub/STRW |
|  | 520 d  | 135  | 03.10  |  | 24.8190-0312.2  | 620312   | 1   |  | Warnkontakt L=915mm      |
|  | 520 d  | 140  | 07.14  |  |   |  |   |  |                          |
|  | 520 d xDrive   | 135  | 02.13  |  |   |  |   |  |                          |
|  | 520 d xDrive   | 140  | 07.14  |  |   |  |   |  |                          |
|  | 520 i  | 120  | 09.11  |  |   |  |   |  |                          |
|  | 520 i  | 135  | 09.11  |  |   |  |   |  |                          |
|  | 523 i  | 150  | 03.10  |  |   |  |   |  |                          |
|  | 525 d  | 150  | 03.10  |  |   |  |   |  |                          |
|  | 525 d  | 160  | 09.11  |  |   |  |   |  |                          |
|  | 525 d xDrive   | 160  | 09.11  |  |   |  |   |  |                          |
|  | 528 i  | 180  | 09.11  |  |   |  |   |  |                          |
|  | 528 i  | 190  | 03.10  |  |   |  |   |  |                          |
|  | 528 i xDrive   | 180  | 09.11  |  |   |  |   |  |                          |
|  | 530 i  | 200  | 09.11  |  |   |  |   |  |                          |
|  | 525 d  | 150  | 03.10  |  | 13.0460-2716.2  | 602716   |   | elektrische Feststellbremse <sup>4)</sup>  | 24703 17,8 +/WE/Zub/STRW |
|  | 530 d  | 180  | 03.10  |  | 13.0470-2716.2  | LD2716   |   | elektrische Feststellbremse <sup>4)</sup>  | 24703 17,8 +/WE/Zub/STRW |
|  | 530 d  | 190  | 09.11  |  | 24.8190-0312.2  | 620312   | 1   |  | Warnkontakt L=915mm      |
|  | 530 d  | 210  | 10.15  |  |   |  |   |  |                          |
|  | 530 d xDrive   | 190  | 03.11  |  |   |  |   |  |                          |
|  | 530 d xDrive   | 210  | 10.15  |  |   |  |   |  |                          |
|  | 535 d  | 220  | 09.10  |  |   |  |   |  |                          |
|  | 535 d  | 230  | 09.11  |  |   |  |   |  |                          |
|  | 535 d xDrive   | 230  | 09.11  |  |   |  |   |  |                          |
|  | 535 i  | 225  | 03.10  |  |   |  |   |  |                          |
|  | 535 i xDrive   | 225  | 03.11  |  |   |  |   |  |                          |
|  | 550 i  | 300  | 03.10  |  |   |  |   |  |                          |
|  | 550 i  | 330  | 05.13  |  |   |  |   |  |                          |
|  | 550 i xDrive   | 300  | 09.10  |  |   |  |   |  |                          |
|  | 550 i xDrive   | 330  | 05.13  |  |   |  |   |  |                          |
|  | Active Hybrid 5  | 250  | 09.11  |  |   |  |   |  |                          |
|  | M 550 d xDrive   | 280  | 03.12  |  |   |  |   |  |                          |
|  | M5   | 412  | 09.11  |  | 13.0460-2716.2  | 602716   |   | elektrische Feststellbremse <sup>4)</sup>  | 24703 17,8 +/WE/Zub/STRW |
|  | M5 Competition   | 423  | 01.14  |  | 13.0470-2716.2  | LD2716   |   | elektrische Feststellbremse <sup>4)</sup>  | 24703 17,8 +/WE/Zub/STRW |
|  |  |  |  |  | 24.8190-0008.2  | 620008   | 1   |  | Warnkontakt L=1000mm     |
|  | 518 d  | 105  | 01.13  |  | 24.0120-0229.2  | 420229   |   | zweiteilige Bremsscheibe <sup>1)</sup>   | 330 20,0 18,4 V L +S +B  |
|  | 518 d  | 110  | 07.14  |  |   |  |   |  |                          |
|  | 520 d  | 135  | 03.10  |  |   |  |   |  |                          |

<sup>1)</sup> two-piece brake disc / disco frenante in due parti / disque d.fr.en deux parties / disco de fr.de dos piezas

<sup>2)</sup> - heavy duty brake / - freno rinforzato / - frein renforcé / - freno reforzado

<sup>3)</sup> + heavy duty brake / + freno rinforzato / + frein renforcé / + freno reforzado

<sup>4)</sup> electric parking brake / fr.di stazionamento elettrico / frein à main électrique / freno de mano eléctrico

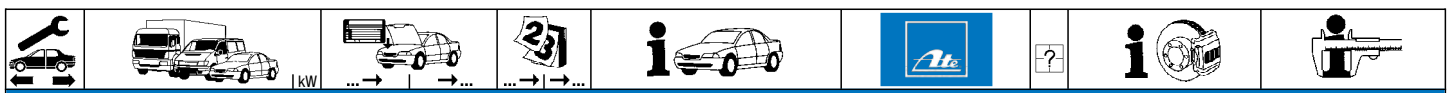

### BMW 5er Reihe/F10 Limousine (10-)

|  |                 |     |       |  |                |        |  |  |                         |
|--|-----------------|-----|-------|--|----------------|--------|--|--|-------------------------|
|  | 520 d           | 140 | 07.14 |  | 24.0120-0229.2 | 420229 |  | zweiteilige Bremsscheibe <sup>1)</sup> | 330 20,0 18,4 V L +S +B |
|  | 520 d xDrive    | 135 | 02.13 |  |                |        |  |  |                         |
|  | 520 d xDrive    | 140 | 07.14 |  |                |        |  |  |                         |
|  | 520 i           | 120 | 09.11 |  |                |        |  |  |                         |
|  | 520 i           | 135 | 09.11 |  |                |        |  |  |                         |
|  | 523 i           | 150 | 03.10 |  |                |        |  |  |                         |
|  | 525 d           | 150 | 03.10 |  |                |        |  |  |                         |
|  | 525 d           | 160 | 09.11 |  |                |        |  |  |                         |
|  | 525 d xDrive    | 160 | 09.11 |  |                |        |  |  |                         |
|  | 528 i           | 180 | 09.11 |  |                |        |  |  |                         |
|  | 528 i           | 190 | 03.10 |  |                |        |  |  |                         |
|  | 528 i xDrive    | 180 | 09.11 |  |                |        |  |  |                         |
|  | 530 d           | 180 | 03.10 |  |                |        |  |  |                         |
|  | 530 i           | 200 | 09.11 |  |                |        |  |  |                         |
|  | 530 d           | 190 | 09.11 |  | 24.0124-0233.2 | 424233 |  | zweiteilige Bremsscheibe <sup>1)</sup> | 345 24,0 22,4 V L +S +B |
|  | 530 d           | 210 | 10.15 |  |                |        |  |  |                         |
|  | 530 d xDrive    | 190 | 03.11 |  |                |        |  |  |                         |
|  | 530 d xDrive    | 210 | 10.15 |  |                |        |  |  |                         |
|  | 535 d           | 220 | 09.10 |  |                |        |  |  |                         |
|  | 535 d           | 230 | 09.11 |  |                |        |  |  |                         |
|  | 535 d xDrive    | 230 | 09.11 |  |                |        |  |  |                         |
|  | 535 i           | 225 | 03.10 |  |                |        |  |  |                         |
|  | 535 i xDrive    | 225 | 03.11 |  |                |        |  |  |                         |
|  | 550 i           | 300 | 03.10 |  |                |        |  |  |                         |
|  | 550 i           | 330 | 05.13 |  |                |        |  |  |                         |
|  | 550 i xDrive    | 300 | 09.10 |  |                |        |  |  |                         |
|  | 550 i xDrive    | 330 | 05.13 |  |                |        |  |  |                         |
|  | Active Hybrid 5 | 250 | 09.11 |  |                |        |  |  |                         |
|  | M 550 d xDrive  | 280 | 03.12 |  |                |        |  |  |                         |

### BMW 5er Reihe/F11 Touring (10-)

|  |                |     |       |                                   |                |        |   |  |                         |     |
|--|----------------|-----|-------|-----------------------------------|----------------|--------|---|--|-------------------------|-----|
|  | 518 d          | 105 | 01.13 | - verstärkte Bremse <sup>2)</sup> | 13.0460-7268.2 | 607268 |   |  | 24697 19,3 +/WE         | ATE |
|  | 518 d          | 110 | 05.14 | - verstärkte Bremse <sup>2)</sup> | 13.0470-7268.2 | LD7268 |   |  | 24697 19,3 +/WE         | ATE |
|  | 520 d          | 135 | 09.10 | - verstärkte Bremse <sup>2)</sup> | 24.8190-0298.2 | 620298 | 1 |  | Warnkontakt L=1087mm    |     |
|  | 520 d          | 140 | 05.14 | - verstärkte Bremse <sup>2)</sup> |                |        |   |  |                         |     |
|  | 520 d xDrive   | 135 | 02.13 | - verstärkte Bremse <sup>2)</sup> |                |        |   |  |                         |     |
|  | 520 d xDrive   | 140 | 05.14 | - verstärkte Bremse <sup>2)</sup> |                |        |   |  |                         |     |
|  | 520 i          | 135 | 09.11 | - verstärkte Bremse <sup>2)</sup> |                |        |   |  |                         |     |
|  | 523 i          | 150 | 09.10 |                                   |                |        |   |  |                         |     |
|  | 518 d          | 105 | 01.13 | + verstärkte Bremse <sup>3)</sup> | 13.0460-7275.2 | 607275 |   |  | 24688 19,2 +/WE         | ATE |
|  | 518 d          | 110 | 05.14 | + verstärkte Bremse <sup>3)</sup> | 13.0470-7275.2 | LD7275 |   |  | 24688 19,2 +/WE         | ATE |
|  | 520 d          | 135 | 09.10 | + verstärkte Bremse <sup>3)</sup> | 24.8190-0298.2 | 620298 | 1 |  | Warnkontakt L=1087mm    |     |
|  | 520 d xDrive   | 135 | 02.13 | + verstärkte Bremse <sup>3)</sup> |                |        |   |  |                         |     |
|  | 525 d          | 150 | 09.10 |                                   |                |        |   |  |                         |     |
|  | 525 d          | 160 | 09.11 | - verstärkte Bremse <sup>2)</sup> |                |        |   |  |                         |     |
|  | 525 d xDrive   | 160 | 09.11 | - verstärkte Bremse <sup>2)</sup> |                |        |   |  |                         |     |
|  | 528 i          | 180 | 09.11 |                                   |                |        |   |  |                         |     |
|  | 528 i          | 190 | 09.10 |                                   |                |        |   |  |                         |     |
|  | 528 i xDrive   | 180 | 09.11 |                                   |                |        |   |  |                         |     |
|  | 530 d          | 180 | 09.10 |                                   |                |        |   |  |                         |     |
|  | 530 d          | 190 | 09.11 | - verstärkte Bremse <sup>2)</sup> |                |        |   |  |                         |     |
|  | 530 d          | 210 | 10.15 | - verstärkte Bremse <sup>2)</sup> |                |        |   |  |                         |     |
|  | 530 d xDrive   | 190 | 03.11 | - verstärkte Bremse <sup>2)</sup> |                |        |   |  |                         |     |
|  | 530 d xDrive   | 210 | 10.15 | - verstärkte Bremse <sup>2)</sup> |                |        |   |  |                         |     |
|  | 530 i          | 200 | 09.11 |                                   |                |        |   |  |                         |     |
|  | 520 d          | 140 | 05.14 | + verstärkte Bremse <sup>3)</sup> | 13.0460-7267.2 | 607267 |   |  | 25045 19,5 +/WE         | ATE |
|  | 520 d xDrive   | 140 | 05.14 | + verstärkte Bremse <sup>3)</sup> | 13.0470-7267.2 | LD7267 |   |  | 25045 19,5 +/WE         | ATE |
|  | 525 d          | 160 | 09.11 | + verstärkte Bremse <sup>3)</sup> | 24.8190-0298.2 | 620298 | 1 |  | Warnkontakt L=1087mm    |     |
|  | 525 d xDrive   | 160 | 09.11 | + verstärkte Bremse <sup>3)</sup> |                |        |   |  |                         |     |
|  | 530 d          | 190 | 09.11 | + verstärkte Bremse <sup>3)</sup> |                |        |   |  |                         |     |
|  | 530 d          | 210 | 10.15 | + verstärkte Bremse <sup>3)</sup> |                |        |   |  |                         |     |
|  | 530 d xDrive   | 190 | 03.11 | + verstärkte Bremse <sup>3)</sup> |                |        |   |  |                         |     |
|  | 530 d xDrive   | 210 | 10.15 | + verstärkte Bremse <sup>3)</sup> |                |        |   |  |                         |     |
|  | 535 d          | 220 | 09.10 |                                   |                |        |   |  |                         |     |
|  | 535 i          | 225 | 09.10 |                                   |                |        |   |  |                         |     |
|  | 535 i          | 240 | 10.15 |                                   |                |        |   |  |                         |     |
|  | 535 i xDrive   | 225 | 09.11 |                                   |                |        |   |  |                         |     |
|  | 535 i xDrive   | 240 | 10.15 |                                   |                |        |   |  |                         |     |
|  | 535 d          | 230 | 09.11 |                                   | 13.0460-7267.2 | 607267 |   |  | 25045 19,5 +/WE         | ATE |
|  | 535 d xDrive   | 230 | 09.11 |                                   | 24.8190-0298.2 | 620298 | 1 |  | Warnkontakt L=1087mm    |     |
|  | 550 i          | 300 | 09.11 |                                   |                |        |   |  |                         |     |
|  | 550 i          | 330 | 05.13 |                                   |                |        |   |  |                         |     |
|  | M 550 d xDrive | 280 | 03.12 |                                   |                |        |   |  |                         |     |
|  | 518 d          | 105 | 01.13 | - verstärkte Bremse <sup>2)</sup> | 24.0124-0239.2 | 424239 |   | zweiteilige Bremsscheibe <sup>1)</sup> | 330 24,0 22,4 V L +S +B |     |
|  | 518 d          | 110 | 05.14 | - verstärkte Bremse <sup>2)</sup> |                |        |   |  |                         |     |
|  | 520 d          | 135 | 09.10 | - verstärkte Bremse <sup>2)</sup> |                |        |   |  |                         |     |
|  | 520 d          | 140 | 05.14 | - verstärkte Bremse <sup>2)</sup> |                |        |   |  |                         |     |
|  | 520 d xDrive   | 135 | 02.13 | - verstärkte Bremse <sup>2)</sup> |                |        |   |  |                         |     |
|  | 520 d xDrive   | 140 | 05.14 | - verstärkte Bremse <sup>2)</sup> |                |        |   |  |                         |     |
|  | 520 i          | 135 | 09.11 |                                   |                |        |   |  |                         |     |
|  | 523 i          | 150 | 09.10 |                                   |                |        |   |  |                         |     |
|  | 518 d          | 105 | 01.13 | + verstärkte Bremse <sup>3)</sup> | 24.0130-0218.2 | 430218 |   | zweiteilige Bremsscheibe <sup>1)</sup> | 348 30,0 28,4 V L +S +B |     |
|  | 518 d          | 110 | 05.14 | + verstärkte Bremse <sup>3)</sup> |                |        |   |  |                         |     |
|  | 520 d          | 135 | 09.10 | + verstärkte Bremse <sup>3)</sup> |                |        |   |  |                         |     |
|  | 520 d xDrive   | 135 | 02.13 | + verstärkte Bremse <sup>3)</sup> |                |        |   |  |                         |     |
|  | 525 d          | 150 | 09.10 |                                   |                |        |   |  |                         |     |
|  | 525 d          | 160 | 09.11 | - verstärkte Bremse <sup>2)</sup> |                |        |   |  |                         |     |

<sup>1)</sup> two-piece brake disc / disco frenante in due parti / disque d.fr.en deux parties / disco de fr.de dos piezas

<sup>2)</sup> - heavy duty brake / - freno rinforzato / - frein renforcé / - freno reforzado

<sup>3)</sup> + heavy duty brake / + freno rinforzato / + frein renforcé / + freno reforzado



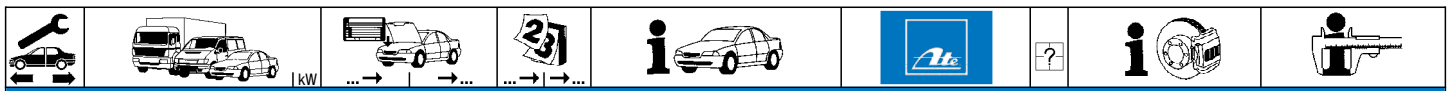

**BMW 5er Reihe/F11 Touring (10-)**

|                |                |       |                                   |                                   |                                   |                |  |   |
|----------------|----------------|-------|-----------------------------------|-----------------------------------|-----------------------------------|----------------|--|---|
|                | 525 d xDrive   | 160   | 09.11                             | - verstärkte Bremse <sup>1)</sup> | 24.0130-0218.2                    | 430218         | zweiteilige Bremsscheibe <sup>2)</sup> | 348 30,0 28,4 V L +S +B                         |
|                | 528 i          | 180   | 09.11                             |                                   |                                   |                |  |   |
|                | 528 i          | 190   | 09.10                             |                                   |                                   |                |  |   |
|                | 528 i xDrive   | 180   | 09.11                             |                                   |                                   |                |  |   |
|                | 530 d          | 180   | 09.10                             |                                   |                                   |                |  |   |
|                | 530 d          | 190   | 09.11                             | - verstärkte Bremse <sup>1)</sup> |                                   |                |  |   |
|                | 530 d          | 210   | 10.15                             | - verstärkte Bremse <sup>1)</sup> |                                   |                |  |   |
|                | 530 d xDrive   | 190   | 03.11                             | - verstärkte Bremse <sup>1)</sup> |                                   |                |  |   |
|                | 530 d xDrive   | 210   | 10.15                             | - verstärkte Bremse <sup>1)</sup> |                                   |                |  |   |
|                | 530 i          | 200   | 09.11                             |                                   |                                   |                |  |   |
|                | 520 d          | 140   | 05.14                             | + verstärkte Bremse <sup>3)</sup> | 24.0136-0115.2                    | 436115         | zweiteilige Bremsscheibe <sup>2)</sup> | 348 36,0 34,4 V L +S +B                         |
|                | 520 d xDrive   | 140   | 05.14                             | + verstärkte Bremse <sup>3)</sup> | 24.0136-0114.2                    | 436114         | zweiteilige Bremsscheibe <sup>2)</sup> | 348 36,0 34,4 V L +S +B                         |
|                | 525 d          | 160   | 09.11                             | + verstärkte Bremse <sup>3)</sup> |                                   |                |  |   |
|                | 525 d xDrive   | 160   | 09.11                             | + verstärkte Bremse <sup>3)</sup> |                                   |                |  |   |
|                | 530 d          | 190   | 09.11                             | + verstärkte Bremse <sup>3)</sup> |                                   |                |  |   |
|                | 530 d          | 210   | 10.15                             | + verstärkte Bremse <sup>3)</sup> |                                   |                |  |   |
|                | 530 d xDrive   | 190   | 03.11                             | + verstärkte Bremse <sup>3)</sup> |                                   |                |  |   |
|                | 530 d xDrive   | 210   | 10.15                             | + verstärkte Bremse <sup>3)</sup> |                                   |                |  |   |
|                | 535 d          | 220   | 09.10                             |                                   |                                   |                |  |   |
|                | 535 d          | 230   | 09.11                             |                                   |                                   |                |  |   |
|                | 535 d xDrive   | 230   | 09.11                             |                                   |                                   |                |  |   |
|                | 535 i          | 225   | 09.10                             |                                   |                                   |                |  |   |
|                | 535 i          | 240   | 10.15                             |                                   |                                   |                |  |   |
|                | 535 i xDrive   | 225   | 09.11                             |                                   |                                   |                |  |   |
| 535 i xDrive   | 240            | 10.15 |                                   |                                   |                                   |                |  |   |
|                | 550 i          | 300   | 09.11                             |                                   | 24.0136-0119.2                    | 436119         | zweiteilige Bremsscheibe <sup>2)</sup> | 374 36,0 34,4 V L +S +B                         |
|                | 550 i          | 330   | 05.13                             |                                   | 24.0136-0118.2                    | 436118         | zweiteilige Bremsscheibe <sup>2)</sup> | 374 36,0 34,4 V L +S +B                         |
|                | M 550 d xDrive | 280   | 03.12                             |                                   |                                   |                |  |   |
|                | 518 d          | 105   | 01.13                             | - verstärkte Bremse <sup>1)</sup> | 13.0460-2760.2                    | 602760         | 1                                      | 24561 17,7 +WE/Zub/STRW<br>Warnkontakt L=1110mm |
|                | 518 d          | 110   | 05.14                             | - verstärkte Bremse <sup>1)</sup> | 13.0470-2760.2                    | LD2760         |  |   |
|                | 520 d          | 135   | 09.10                             | - verstärkte Bremse <sup>1)</sup> | 24.8190-0308.2                    | 620308         |  |   |
|                | 520 d          | 140   | 05.14                             | - verstärkte Bremse <sup>1)</sup> |                                   |                |  |   |
|                | 520 d xDrive   | 135   | 02.13                             | - verstärkte Bremse <sup>1)</sup> |                                   |                |  |   |
|                | 520 d xDrive   | 140   | 05.14                             | - verstärkte Bremse <sup>1)</sup> |                                   |                |  |   |
|                | 520 i          | 135   | 09.11                             |                                   |                                   |                |  |   |
|                | 523 i          | 150   | 09.10                             |                                   |                                   |                |  |   |
|                | 525 d          | 150   | 09.10                             | - verstärkte Bremse <sup>1)</sup> |                                   |                |  |   |
|                | 525 d          | 160   | 09.11                             | - verstärkte Bremse <sup>1)</sup> |                                   |                |  |   |
|                | 525 d xDrive   | 160   | 09.11                             | - verstärkte Bremse <sup>1)</sup> |                                   |                |  |   |
|                | 528 i          | 180   | 09.11                             |                                   |                                   |                |  |   |
|                | 528 i          | 190   | 09.10                             |                                   |                                   |                |  |   |
|                | 528 i xDrive   | 180   | 09.11                             |                                   |                                   |                |  |   |
|                | 530 d          | 180   | 09.10                             | - verstärkte Bremse <sup>1)</sup> |                                   |                |  |   |
|                | 530 d          | 190   | 09.11                             | - verstärkte Bremse <sup>1)</sup> |                                   |                |  |   |
|                | 530 d          | 210   | 10.15                             | - verstärkte Bremse <sup>1)</sup> |                                   |                |  |   |
|                | 530 d xDrive   | 190   | 03.11                             | - verstärkte Bremse <sup>1)</sup> |                                   |                |  |   |
|                | 530 i          | 200   | 09.11                             |                                   |                                   |                |  |   |
|                |                | 518 d | 105                               | 01.13                             | + verstärkte Bremse <sup>3)</sup> | 13.0460-2716.2 |  |   |
| 518 d          |                | 110   | 05.14                             | + verstärkte Bremse <sup>3)</sup> | 13.0470-2716.2                    | LD2716         |  |   |
| 520 d          |                | 135   | 09.10                             | + verstärkte Bremse <sup>3)</sup> | 24.8190-0308.2                    | 620308         |  |   |
| 520 d          |                | 140   | 05.14                             | + verstärkte Bremse <sup>3)</sup> |                                   |                |  |   |
| 520 d xDrive   |                | 135   | 02.13                             | + verstärkte Bremse <sup>3)</sup> |                                   |                |  |   |
| 520 d xDrive   |                | 140   | 05.14                             | + verstärkte Bremse <sup>3)</sup> |                                   |                |  |   |
| 525 d          |                | 160   | 09.11                             | + verstärkte Bremse <sup>3)</sup> |                                   |                |  |   |
| 525 d xDrive   |                | 160   | 09.11                             | + verstärkte Bremse <sup>3)</sup> |                                   |                |  |   |
| 530 d          |                | 180   | 09.10                             | + verstärkte Bremse <sup>3)</sup> |                                   |                |  |   |
| 530 d          |                | 190   | 09.11                             | + verstärkte Bremse <sup>3)</sup> |                                   |                |  |   |
| 530 d          |                | 210   | 10.15                             | + verstärkte Bremse <sup>3)</sup> |                                   |                |  |   |
| 530 d xDrive   |                | 190   | 03.11                             | + verstärkte Bremse <sup>3)</sup> |                                   |                |  |   |
| 530 d xDrive   |                | 210   | 10.15                             | + verstärkte Bremse <sup>3)</sup> |                                   |                |  |   |
| 535 d          |                | 220   | 09.10                             |                                   |                                   |                |  |   |
| 535 d          |                | 230   | 09.11                             |                                   |                                   |                |  |   |
| 535 d xDrive   |                | 230   | 09.11                             |                                   |                                   |                |  |   |
| 535 i          |                | 225   | 09.10                             |                                   |                                   |                |  |   |
| 535 i          |                | 240   | 10.15                             |                                   |                                   |                |  |   |
| 535 i xDrive   |                | 225   | 09.11                             |                                   |                                   |                |  |   |
| 535 i xDrive   |                | 240   | 10.15                             |                                   |                                   |                |  |   |
| 550 i          | 300            | 09.11 |                                   |                                   |                                   |                |  |   |
| 550 i          | 330            | 05.13 |                                   |                                   |                                   |                |  |   |
| M 550 d xDrive | 280            | 03.12 |                                   |                                   |                                   |                |  |   |
|                | 518 d          | 105   | 01.13                             | - verstärkte Bremse <sup>1)</sup> | 24.0120-0229.2                    | 420229         | zweiteilige Bremsscheibe <sup>2)</sup> | 330 20,0 18,4 V L +S +B                         |
|                | 518 d          | 110   | 05.14                             | - verstärkte Bremse <sup>1)</sup> |                                   |                |  |   |
|                | 520 d          | 135   | 09.10                             | - verstärkte Bremse <sup>1)</sup> |                                   |                |  |   |
|                | 520 d          | 140   | 05.14                             | - verstärkte Bremse <sup>1)</sup> |                                   |                |  |   |
|                | 520 d xDrive   | 135   | 02.13                             | - verstärkte Bremse <sup>1)</sup> |                                   |                |  |   |
|                | 520 d xDrive   | 140   | 05.14                             | - verstärkte Bremse <sup>1)</sup> |                                   |                |  |   |
|                | 520 i          | 135   | 09.11                             |                                   |                                   |                |  |   |
|                | 523 i          | 150   | 09.10                             |                                   |                                   |                |  |   |
|                | 525 d          | 150   | 09.10                             |                                   |                                   |                |  |   |
|                | 525 d          | 160   | 09.11                             | - verstärkte Bremse <sup>1)</sup> |                                   |                |  |   |
|                | 525 d xDrive   | 160   | 09.11                             | - verstärkte Bremse <sup>1)</sup> |                                   |                |  |   |
|                | 528 i          | 180   | 09.11                             |                                   |                                   |                |  |   |
|                | 528 i          | 190   | 09.10                             |                                   |                                   |                |  |   |
|                | 528 i xDrive   | 180   | 09.11                             |                                   |                                   |                |  |   |
|                | 530 d          | 180   | 09.10                             |                                   |                                   |                |  |   |
|                | 530 d          | 190   | 09.11                             | - verstärkte Bremse <sup>1)</sup> |                                   |                |  |   |
| 530 d          | 210            | 10.15 | - verstärkte Bremse <sup>1)</sup> |                                   |                                   |                |  |   |

<sup>1)</sup> - heavy duty brake / - freno rinforzato / - frein renforcé / - freno reforzado

<sup>2)</sup> two-piece brake disc / disco frenante in due parti / disque d.fr.en deux parties / disco de fr.de dos piezas

<sup>3)</sup> + heavy duty brake / + freno rinforzato / + frein renforcé / + freno reforzado





### BMW 5er Reihe/F11 Touring (10-)

|  |                |     |  |       |  |                |        |  |  |                         |
|--|----------------|-----|--|-------|--|----------------|--------|--|--|-------------------------|
|  | 530 i          | 200 |  | 09.11 |  | 24.0120-0229.2 | 420229 |  | zweiteilige Bremsscheibe <sup>1)</sup> | 330 20,0 18,4 V L +S +B |
|  | 518 d          | 105 |  | 01.13 |  | 24.0124-0233.2 | 424233 |  | zweiteilige Bremsscheibe <sup>1)</sup> | 345 24,0 22,4 V L +S +B |
|  | 518 d          | 110 |  | 05.14 |  |                |        |  |  |                         |
|  | 520 d          | 135 |  | 09.10 |  |                |        |  |  |                         |
|  | 520 d          | 140 |  | 05.14 |  |                |        |  |  |                         |
|  | 520 d xDrive   | 135 |  | 02.13 |  |                |        |  |  |                         |
|  | 520 d xDrive   | 140 |  | 05.14 |  |                |        |  |  |                         |
|  | 525 d          | 160 |  | 09.11 |  |                |        |  |  |                         |
|  | 525 d xDrive   | 160 |  | 09.11 |  |                |        |  |  |                         |
|  | 530 d          | 190 |  | 09.11 |  |                |        |  |  |                         |
|  | 530 d          | 210 |  | 10.15 |  |                |        |  |  |                         |
|  | 530 d xDrive   | 190 |  | 03.11 |  |                |        |  |  |                         |
|  | 530 d xDrive   | 210 |  | 10.15 |  |                |        |  |  |                         |
|  | 535 d          | 220 |  | 09.10 |  |                |        |  |  |                         |
|  | 535 d          | 230 |  | 09.11 |  |                |        |  |  |                         |
|  | 535 d xDrive   | 230 |  | 09.11 |  |                |        |  |  |                         |
|  | 535 i          | 225 |  | 09.10 |  |                |        |  |  |                         |
|  | 535 i          | 240 |  | 10.15 |  |                |        |  |  |                         |
|  | 535 i xDrive   | 225 |  | 09.11 |  |                |        |  |  |                         |
|  | 535 i xDrive   | 240 |  | 10.15 |  |                |        |  |  |                         |
|  | 550 i          | 300 |  | 09.11 |  |                |        |  |  |                         |
|  | 550 i          | 330 |  | 05.13 |  |                |        |  |  |                         |
|  | M 550 d xDrive | 280 |  | 03.12 |  |                |        |  |  |                         |

### BMW 5er Reihe/F07 GT GRAN TURISMO (09-)

|  |              |     |  |       |       |                |        |   |  |                         |
|--|--------------|-----|--|-------|-------|----------------|--------|---|--|-------------------------|
|  | 520 d        | 135 |  | 10.11 |       | 13.0460-7267.2 | 607267 |   |  | 25045 19,5 +/WE ATE     |
|  | 530 d        | 155 |  | 07.10 |       | 13.0470-7267.2 | LD7267 |   |  | 25045 19,5 +/WE ATE     |
|  | 530 d        | 180 |  | 10.09 |       | 24.8190-0298.2 | 620298 | 1 |  | Warnkontakt L=1087mm    |
|  | 530 d        | 190 |  | 10.09 |       |                |        |   |  |                         |
|  | 530 d xDrive | 180 |  | 09.10 |       |                |        |   |  |                         |
|  | 530 d xDrive | 190 |  | 10.09 |       |                |        |   |  |                         |
|  | 535 d        | 220 |  | 03.10 |       |                |        |   |  |                         |
|  | 535 d xDrive | 220 |  | 09.10 |       |                |        |   |  |                         |
|  | 535 i        | 225 |  | 10.09 |       |                |        |   |  |                         |
|  | 535 i xDrive | 225 |  | 09.10 |       |                |        |   |  |                         |
|  | 535 d        | 230 |  | 02.12 |       | 13.0460-7267.2 | 607267 |   |  | 25045 19,5 +/WE ATE     |
|  | 535 d xDrive | 230 |  | 02.12 |       | 24.8190-0298.2 | 620298 | 1 |  | Warnkontakt L=1087mm    |
|  | 550 i        | 300 |  | 10.09 | 02.10 | 13.0460-7261.2 | 607261 |   |  | 24436 19,7 +/WE ATE     |
|  |              |     |  |       |       | 24.8190-0260.2 | 620260 | 1 |  | Warnkontakt L=1060mm    |
|  | 550 i        | 300 |  | 03.10 |       | 13.0460-7261.2 | 607261 |   |  | 24436 19,7 +/WE ATE     |
|  | 550 i        | 330 |  | 05.12 |       | 24.8190-0298.2 | 620298 | 1 |  | Warnkontakt L=1087mm    |
|  | 550 i xDrive | 300 |  | 09.10 |       |                |        |   |  |                         |
|  | 550 i xDrive | 330 |  | 05.12 |       |                |        |   |  |                         |
|  | 520 d        | 135 |  | 10.11 |       | 24.0136-0115.2 | 436115 |   | zweiteilige Bremsscheibe <sup>1)</sup> | 348 36,0 34,4 V L +S +B |
|  | 530 d        | 155 |  | 07.10 |       | 24.0136-0114.2 | 436114 |   | zweiteilige Bremsscheibe <sup>1)</sup> | 348 36,0 34,4 V L +S +B |
|  | 530 d        | 180 |  | 10.09 |       |                |        |   |  |                         |
|  | 530 d        | 190 |  | 10.09 |       |                |        |   |  |                         |
|  | 530 d xDrive | 180 |  | 09.10 |       |                |        |   |  |                         |
|  | 530 d xDrive | 190 |  | 10.09 |       |                |        |   |  |                         |
|  | 535 d        | 220 |  | 03.10 |       |                |        |   |  |                         |
|  | 535 d        | 230 |  | 02.12 |       |                |        |   |  |                         |
|  | 535 d xDrive | 220 |  | 09.10 |       |                |        |   |  |                         |
|  | 535 d xDrive | 230 |  | 02.12 |       |                |        |   |  |                         |
|  | 535 i        | 225 |  | 10.09 |       |                |        |   |  |                         |
|  | 535 i xDrive | 225 |  | 09.10 |       |                |        |   |  |                         |
|  | 550 i        | 300 |  | 10.09 |       | 24.0136-0121.2 | 436121 |   | zweiteilige Bremsscheibe <sup>1)</sup> | 374 36,0 34,4 V L +S +B |
|  | 550 i        | 330 |  | 05.12 |       | 24.0136-0120.2 | 436120 |   | zweiteilige Bremsscheibe <sup>1)</sup> | 374 36,0 34,4 V L +S +B |
|  | 550 i xDrive | 300 |  | 09.10 |       |                |        |   |  |                         |
|  | 550 i xDrive | 330 |  | 05.12 |       |                |        |   |  |                         |
|  | 550 i xDrive | 300 |  | 09.10 |       |                |        |   |  |                         |
|  | 550 i xDrive | 330 |  | 05.12 |       |                |        |   |  |                         |
|  | 550 i xDrive | 300 |  | 09.10 |       | 24.0136-0119.2 | 436119 |   | zweiteilige Bremsscheibe <sup>1)</sup> | 374 36,0 34,4 V L +S +B |
|  | 550 i xDrive | 330 |  | 05.12 |       | 24.0136-0118.2 | 436118 |   | zweiteilige Bremsscheibe <sup>1)</sup> | 374 36,0 34,4 V L +S +B |
|  | 550 i        | 300 |  | 10.09 |       |                |        |   |  |                         |
|  | 550 i        | 330 |  | 05.12 |       |                |        |   |  |                         |
|  | 550 i xDrive | 300 |  | 09.10 |       |                |        |   |  |                         |
|  | 550 i xDrive | 330 |  | 05.12 |       |                |        |   |  |                         |
|  | 520 d        | 135 |  | 10.11 |       | 24.0124-0233.2 | 424233 |   | zweiteilige Bremsscheibe <sup>1)</sup> | 345 24,0 22,4 V L +S +B |
|  | 530 d        | 155 |  | 07.10 |       |                |        |   |  |                         |
|  | 530 d        | 180 |  | 10.09 |       |                |        |   |  |                         |
|  | 530 d        | 190 |  | 10.09 |       |                |        |   |  |                         |
|  | 530 d xDrive | 180 |  | 09.10 |       |                |        |   |  |                         |
|  | 530 d xDrive | 190 |  | 10.09 |       |                |        |   |  |                         |
|  | 535 d        | 220 |  | 03.10 |       |                |        |   |  |                         |
|  | 535 d        | 230 |  | 02.12 |       |                |        |   |  |                         |
|  | 535 d xDrive | 220 |  | 09.10 |       |                |        |   |  |                         |
|  | 535 d xDrive | 230 |  | 02.12 |       |                |        |   |  |                         |
|  | 535 i        | 225 |  | 10.09 |       |                |        |   |  |                         |
|  | 535 i xDrive | 225 |  | 09.10 |       |                |        |   |  |                         |
|  | 550 i        | 300 |  | 10.09 |       |                |        |   |  |                         |
|  | 550 i        | 330 |  | 05.12 |       |                |        |   |  |                         |
|  | 550 i xDrive | 300 |  | 09.10 |       |                |        |   |  |                         |
|  | 550 i xDrive | 330 |  | 05.12 |       |                |        |   |  |                         |

<sup>1)</sup> two-piece brake disc / disco frenante in due parti / disque d.fr.en deux parties / disco de fr.de dos piezas

<sup>2)</sup> + heavy duty brake / + freno rinforzato / + frein renforcé / + freno reforzado

<sup>3)</sup> - heavy duty brake / - freno rinforzato / - frein renforcé / - freno reforzado





### BMW 5er Reihe/F07 GT GRAN TURISMO (09-)

|              |              |     |       |       |  |  |                |        |  |  |                                 |
|--------------|--------------|-----|-------|-------|--|--|----------------|--------|--|--|---------------------------------|
|              | 535 d xDrive | 230 |       | 02.12 |  |  | 24.0124-0233.2 | 424233 |  | zweiteilige Bremsscheibe <sup>1)</sup> | 345 24,0 22,4 V L +S +B         |
|              | 535 i        | 225 |       | 10.09 |  |  |                |        |  |  |                                 |
|              | 535 i xDrive | 225 |       | 09.10 |  |  |                |        |  |  |                                 |
|              | 550 i        | 300 |       | 10.09 |  |  | 24.0124-0241.1 | 424241 |  |  | 370 23,9 22,4 V L +S +B         |
|              | 550 i        | 330 |       | 05.12 |  |  |                |        |  |  |                                 |
|              | 550 i xDrive | 300 |       | 09.10 |  |  |                |        |  |  |                                 |
|              | 550 i xDrive | 330 |       | 05.12 |  |  |                |        |  |  |                                 |
|              | 520 d        | 135 |       | 10.11 |  |  | 03.0137-0419.2 | 650419 |  |  | 185 x 30<br>Bremsbacken-Zubehör |
|              | 530 d        | 155 |       | 07.10 |  |  | 03.0137-9288.2 | 669288 |  |  |                                 |
|              | 530 d        | 180 |       | 10.09 |  |  |                |        |  |  |                                 |
|              | 530 d        | 190 |       | 10.09 |  |  |                |        |  |  |                                 |
|              | 530 d xDrive | 180 |       | 09.10 |  |  |                |        |  |  |                                 |
|              | 530 d xDrive | 190 |       | 10.09 |  |  |                |        |  |  |                                 |
|              | 535 d        | 220 |       | 03.10 |  |  |                |        |  |  |                                 |
|              | 535 d        | 230 |       | 02.12 |  |  |                |        |  |  |                                 |
|              | 535 d xDrive | 220 |       | 09.10 |  |  |                |        |  |  |                                 |
|              | 535 d xDrive | 230 |       | 02.12 |  |  |                |        |  |  |                                 |
|              | 535 i        | 225 |       | 10.09 |  |  |                |        |  |  |                                 |
|              | 535 i xDrive | 225 |       | 09.10 |  |  |                |        |  |  |                                 |
|              | 550 i        | 300 |       | 10.09 |  |  |                |        |  |  |                                 |
|              | 550 i        | 330 |       | 05.12 |  |  |                |        |  |  |                                 |
|              | 550 i xDrive | 300 |       | 09.10 |  |  |                |        |  |  |                                 |
| 550 i xDrive | 330          |     | 05.12 |       |  |  |                |        |  |  |                                 |

















### BMW 6er Reihe/E63 Coupe (04-11)

|        |        |     |       |       |       |                |                |        |   |  |                                 |     |
|--------|--------|-----|-------|-------|-------|----------------|----------------|--------|---|--|---------------------------------|-----|
|        | 630 i  | 190 |       | 07.04 | 08.07 |                | 13.0460-7167.2 | 607167 |   |  | 23312 20,3 +/WE                 | ATE |
|        | 630 i  | 200 |       | 09.07 | 05.11 |                | 13.0470-7167.2 | LD7167 |   |  | 23312 20,3 +/WE                 | ATE |
|        |        |     |       |       |       |                | 13.0460-7296.2 | 607296 |   |  | 23312 20,3 +/WE                 | ATE |
|        |        |     |       |       |       |                | 13.0470-7296.2 | LD7296 |   |  | 23312 20,3 +/WE                 | ATE |
|        |        |     |       |       |       |                | 24.8190-0273.2 | 620273 | 1 |  | Warnkontakt L=662mm             |     |
|        | 645 Ci | 245 |       | 12.03 | 08.07 |                | 13.0460-7167.2 | 607167 | 1 |  | 23312 20,3 +/WE                 | ATE |
|        |        |     |       |       |       |                | 24.8190-0273.2 | 620273 |   |  | Warnkontakt L=662mm             |     |
|        | 635 d  | 210 |       | 09.07 | 05.11 |                | 13.0460-7210.2 | 607210 |   |  | 23791 20,8 +/WE                 | ATE |
|        |        |     |       |       |       |                | 13.0470-7210.2 | LD7210 |   |  | 23791 20,8 +/WE                 | ATE |
|        |        |     |       |       |       |                | 24.8190-0273.2 | 620273 | 1 |  | Warnkontakt L=662mm             |     |
|        | 650 i  | 270 |       | 07.05 | 05.11 |                | 13.0460-7210.2 | 607210 |   |  | 23791 20,8 +/WE                 | ATE |
|        |        |     |       |       |       |                | 24.8190-0273.2 | 620273 | 1 |  | Warnkontakt L=662mm             |     |
|        | M6     | 373 |       | 06.05 | 05.11 |                | 13.0460-7210.2 | 607210 |   |  | 23791 20,8 +/WE                 | ATE |
|        |        |     |       |       |       |                | 24.8190-0273.2 | 620273 | 1 |  | Warnkontakt L=662mm             |     |
|        |        |     |       |       |       |                | 24.8190-0276.2 | 620276 | 1 |  | Warnkontakt L=674mm             |     |
|        | 630 i  | 190 |       | 07.04 | 08.07 |                | 24.0130-0173.1 | 430173 |   |  | 324 30,0 28,4 V L +S +B         | PD  |
|        |        |     |       |       |       |                | 24.0330-0173.1 | 530173 |   |  | 324 30,0 27,6 V L +S +B         | PD  |
|        | 630 i  | 200 |       | 09.07 | 05.11 |                | 24.0130-0186.2 | 430186 |   | zweiteilige Bremsscheibe <sup>1)</sup> | 348 30,0 28,4 V L +S +B         |     |
|        | 645 Ci | 245 |       | 12.03 | 08.07 |                |                |        |   |  |                                 |     |
|        | 635 d  | 210 |       | 09.07 | 05.11 |                | 24.0136-0106.2 | 436106 |   | zweiteilige Bremsscheibe <sup>1)</sup> | 348 36,0 34,4 V L +S +B         |     |
| 650 i  | 270    |     | 07.05 | 05.11 |       |                |                |        |   |  |                                 |     |
|        | M6     | 373 |       | 06.05 | 05.11 |                | 24.0136-0117.2 | 436117 |   | zweiteilige Bremsscheibe <sup>1)</sup> | 374 36,0 34,4 V L +S +B         |     |
|        |        |     |       |       |       |                | 24.0136-0116.2 | 436116 |   | zweiteilige Bremsscheibe <sup>1)</sup> | 374 36,0 34,4 V L +S +B         |     |
|        | M6     | 373 |       | 06.05 | 05.11 |                | 24.0711-6238.3 | 360284 | 2 |  | Radensensor L=577               |     |
|        | 630 i  | 190 |       | 07.04 | 08.07 |                | 13.0460-7174.2 | 607174 |   |  | 23732 17,3 +/WE                 | ATE |
|        |        |     |       |       |       |                | 13.0470-7174.2 | LD7174 |   |  | 23732 17,3 +/WE                 | ATE |
|        |        |     |       |       |       |                | 24.8190-0274.2 | 620274 | 1 |  | Warnkontakt L=664mm             |     |
|        | 630 i  | 200 |       | 09.07 | 05.11 |                | 13.0460-7169.2 | 607169 |   |  | 23309 17,3 +/WE                 | ATE |
|        | 635 d  | 210 |       | 09.07 | 05.11 |                | 13.0470-7169.2 | LD7169 |   |  | 23309 17,3 +/WE                 | ATE |
| 645 Ci | 245    |     | 12.03 | 08.07 |       | 24.8190-0274.2 | 620274         | 1      |   | Warnkontakt L=664mm                    |                                 |     |
| 650 i  | 270    |     | 07.05 | 05.11 |       |                |                |        |   |  |                                 |     |
|        | M6     | 373 |       | 06.05 | 05.11 |                | 24.8190-0274.2 | 620274 | 1 |  | Warnkontakt L=664mm             |     |
|        | 630 i  | 190 |       | 07.04 | 08.07 |                | 24.0120-0183.1 | 420183 |   |  | 320 20,0 18,4 V L +S +B         | PD  |
|        |        |     |       |       |       |                | 24.0320-0183.1 | 520183 |   |  | 320 20,0 18,4 V L +S +B         | PD  |
|        | 630 i  | 200 |       | 09.07 | 05.11 |                | 24.0124-0201.2 | 424201 |   | zweiteilige Bremsscheibe <sup>1)</sup> | 345 24,0 22,4 V L +S +B         |     |
|        | 635 d  | 210 |       | 09.07 | 05.11 |                |                |        |   |  |                                 |     |
|        | 645 Ci | 245 |       | 12.03 | 08.07 |                |                |        |   |  |                                 |     |
| 650 i  | 270    |     | 07.05 | 05.11 |       |                |                |        |   |  |                                 |     |
|        | M6     | 373 |       | 06.05 | 05.11 |                | 24.0124-0235.2 | 424235 |   | zweiteilige Bremsscheibe <sup>1)</sup> | 370 24,0 22,4 V L +S +B         |     |
|        |        |     |       |       |       |                | 24.0124-0234.2 | 424234 |   | zweiteilige Bremsscheibe <sup>1)</sup> | 370 24,0 22,4 V L +S +B         |     |
|        | M6     | 373 |       | 06.05 | 05.11 |                | 24.0711-5162.3 | 360170 | 2 |  | Radensensor L=719               |     |
|        | 630 i  | 190 |       | 07.04 | 08.07 |                | 03.0137-0419.2 | 650419 |   |  | 185 x 30<br>Bremsbacken-Zubehör |     |
|        | 630 i  | 200 |       | 09.07 | 05.11 |                | 03.0137-9288.2 | 669288 |   |  |                                 |     |
|        | 635 d  | 210 |       | 09.07 | 05.11 |                |                |        |   |  |                                 |     |
|        | 645 Ci | 245 |       | 12.03 | 08.07 |                |                |        |   |  |                                 |     |
|        | 650 i  | 270 |       | 07.05 | 05.11 |                |                |        |   |  |                                 |     |
|        | M6     | 373 |       | 06.05 | 05.11 |                |                |        |   |  |                                 |     |

### BMW 6er Reihe/E64 Cabrio (04-11)

|  |        |     |  |       |       |  |                |        |   |  |                     |     |
|--|--------|-----|--|-------|-------|--|----------------|--------|---|--|---------------------|-----|
|  | 630 i  | 190 |  | 07.04 | 08.07 |  | 13.0460-7167.2 | 607167 |   |  | 23312 20,3 +/WE     | ATE |
|  | 630 i  | 200 |  | 09.07 | 02.11 |  | 13.0470-7167.2 | LD7167 |   |  | 23312 20,3 +/WE     | ATE |
|  |        |     |  |       |       |  | 13.0460-7296.2 | 607296 |   |  | 23312 20,3 +/WE     | ATE |
|  |        |     |  |       |       |  | 13.0470-7296.2 | LD7296 |   |  | 23312 20,3 +/WE     | ATE |
|  |        |     |  |       |       |  | 24.8190-0273.2 | 620273 | 1 |  | Warnkontakt L=662mm |     |
|  | 645 Ci | 245 |  | 04.04 | 08.07 |  | 13.0460-7167.2 | 607167 |   |  | 23312 20,3 +/WE     | ATE |
|  |        |     |  |       |       |  | 24.8190-0273.2 | 620273 | 1 |  | Warnkontakt L=662mm |     |

<sup>1)</sup> two-piece brake disc / disco frenante in due parti / disque d.fr.en deux parties / disco de fr.de dos piezas

|     |  |  |  |  |  |  |      |                                |
|--|--|--|--|--|---|--|--|--|
| <b>BMW 6er Reihe/E64 Cabrio (04-11)</b>  |  |  |  |  |   |  |  |  |
|    | 635 d  | 210  |  | 09.07  | 02.11   |  | 13.0460-7210.2 607210<br>13.0470-7210.2 LD7210<br>24.8190-0273.2 620273                | 23791 20,8 +/WE ATE<br>23791 20,8 +/WE ATE<br>Warnkontakt L=662mm  |
|  | 650 i  | 270  |  | 07.05  | 02.11   |  | 13.0460-7210.2 607210<br>24.8190-0273.2 620273   | 23791 20,8 +/WE ATE<br>Warnkontakt L=662mm   |
|  | M6   | 373  |  | 07.06  | 02.11   |  | 13.0460-7210.2 607210<br>24.8190-0273.2 620273<br>24.8190-0276.2 620276                | 23791 20,8 +/WE ATE<br>Warnkontakt L=662mm<br>Warnkontakt L=674mm  |
|    | 630 i  | 190  |  | 07.04  | 08.07   |  | 24.0130-0173.1 430173<br>24.0330-0173.1 530173   | 324 30,0 28,4 V L +S +B<br>324 30,0 27,6 V L +S +B PD  |
|  | 630 i<br>645 Ci  | 200<br>245   |  | 09.07<br>04.04   | 02.11<br>08.07  |  | 24.0130-0186.2 430186  | zweiteilige Bremsscheibe 1)<br>348 30,0 28,4 V L +S +B   |
|  | 635 d<br>650 i   | 210<br>270   |  | 09.07<br>07.05   | 02.11<br>02.11  |  | 24.0136-0106.2 436106  | zweiteilige Bremsscheibe 1)<br>348 36,0 34,4 V L +S +B   |
|  | M6   | 373  |  | 07.06  | 02.11   |  | 24.0136-0117.2 436117<br>24.0136-0116.2 436116   | zweiteilige Bremsscheibe 1)<br>zweiteilige Bremsscheibe 1)<br>374 36,0 34,4 V L +S +B<br>374 36,0 34,4 V L +S +B |
|  | M6   | 373  |  | 07.06  | 02.11   |  | 24.0711-6238.3 360284  | 2<br>Radsensor L=577   |
|    | 630 i  | 190  |  | 07.04  | 08.07   |  | 13.0460-7174.2 607174<br>13.0470-7174.2 LD7174<br>24.8190-0274.2 620274                | 23732 17,3 +/WE ATE<br>23732 17,3 +/WE ATE<br>Warnkontakt L=664mm  |
|  | 630 i<br>635 d<br>645 Ci<br>650 i  | 200<br>210<br>245<br>270   |  | 09.07<br>09.07<br>04.04<br>07.05   | 02.11<br>02.11<br>08.07<br>02.11  |  | 13.0460-7169.2 607169<br>13.0470-7169.2 LD7169<br>24.8190-0274.2 620274                | 23309 17,3 +/WE ATE<br>23309 17,3 +/WE ATE<br>Warnkontakt L=664mm  |
|  | M6   | 373  |  | 07.06  | 02.11   |  | 24.8190-0274.2 620274  | Warnkontakt L=664mm  |
|  | 630 i  | 190  |  | 07.04  | 08.07   |  | 24.0120-0183.1 420183<br>24.0320-0183.1 520183   | 320 20,0 18,4 V L +S +B<br>320 20,0 18,4 V L +S +B PD  |
|  | 630 i<br>635 d<br>645 Ci<br>650 i  | 200<br>210<br>245<br>270   |  | 09.07<br>09.07<br>04.04<br>07.05   | 02.11<br>02.11<br>08.07<br>02.11  |  | 24.0124-0201.2 424201  | zweiteilige Bremsscheibe 1)<br>345 24,0 22,4 V L +S +B   |
|  | M6   | 373  |  | 07.06  | 02.11   |  | 24.0124-0235.2 424235<br>24.0124-0234.2 424234   | zweiteilige Bremsscheibe 1)<br>zweiteilige Bremsscheibe 1)<br>370 24,0 22,4 V L +S +B<br>370 24,0 22,4 V L +S +B |
| M6   | 373  |  | 07.06  | 02.11  |   | 24.0711-5162.3 360170  | 2<br>Radsensor L=719   |  |
|  | 630 i  | 190  |  | 07.04  | 08.07   |  | 03.0137-0419.2 650419  | 185 x 30<br>Bremsbacken-Zubehör  |
|  | 630 i  | 200  |  | 09.07  | 02.11   |  | 03.0137-9288.2 669288  |  |
|  | 635 d  | 210  |  | 09.07  | 02.11   |  |  |  |
|  | 645 Ci   | 245  |  | 04.04  | 08.07   |  |  |  |
|  | 650 i  | 270  |  | 07.05  | 02.11   |  |  |  |
| <b>BMW 6er Reihe/F12 Cabrio (11-)</b>  |  |  |  |  |   |  |  |  |
|  | 640 d  | 230  |  | 06.11  |   |  | 13.0460-7267.2 607267<br>24.8190-0298.2 620298   | 25045 19,5 +/WE ATE<br>Warnkontakt L=1087mm  |
|  | 640 d xDrive   | 230  |  | 03.12  |   |  |  |  |
|  | 640 i  | 235  |  | 03.11  |   |  |  |  |
|  | 640 i xDrive   | 235  |  | 01.13  |   |  |  |  |
|  | 650 i  | 300  |  | 03.11  |   |  |  |  |
|  | 650 i  | 330  |  | 10.11  |   |  |  |  |
|  | 650 i xDrive   | 300  |  | 06.11  |   |  |  |  |
|  | 650 i xDrive   | 330  |  | 09.12  |   |  |  |  |
|  | M6   | 412  |  | 06.12  |   |  | 24.8190-0298.2 620298  | 1<br>Warnkontakt L=1087mm  |
| M6   | 441  |  | 07.15  |  |   |  |  |  |
| M6 Competition   | 423  |  | 02.14  |  |   |  |  |  |
|  | 640 d  | 230  |  | 06.11  |   |  | 24.0136-0115.2 436115  | zweiteilige Bremsscheibe 1)<br>348 36,0 34,4 V L +S +B   |
|  | 640 d xDrive   | 230  |  | 03.12  |   |  | 24.0136-0114.2 436114  | zweiteilige Bremsscheibe 1)<br>348 36,0 34,4 V L +S +B   |
|  | 640 i  | 235  |  | 03.11  |   |  |  |  |
|  | 640 i xDrive   | 235  |  | 01.13  |   |  |  |  |
|  | 650 i  | 300  |  | 03.11  |   |  | 24.0136-0119.2 436119  | zweiteilige Bremsscheibe 1)<br>374 36,0 34,4 V L +S +B   |
|  | 650 i  | 330  |  | 10.11  |   |  | 24.0136-0118.2 436118  | zweiteilige Bremsscheibe 1)<br>374 36,0 34,4 V L +S +B   |
| 650 i xDrive   | 300  |  | 06.11  |  |   |  |  |  |
| 650 i xDrive   | 330  |  | 09.12  |  |   |  |  |  |
| M6   | 412  |  | 06.12  |  |   | 24.0136-0126.2 436126  | zweiteilige Bremsscheibe 1)<br>- M Carbon Keramik Bremse 2)<br>400 36,0 34,4 V L +S +B |  |
| M6   | 441  |  | 07.15  |  |   | 24.0136-0125.2 436125  | - M Carbon Keramik Bremse 2)<br>400 36,0 34,4 V L +S +B                                |  |
| M6 Competition   | 423  |  | 02.14  |  |   |  |  |  |
|  | 640 d  | 230  |  | 06.11  |   |  | 13.0460-2716.2 602716  | 24703 17,8 +/WE/Zub/STRW   |
|  | 640 d xDrive   | 230  |  | 03.12  |   |  | 13.0470-2716.2 LD2716  | 24703 17,8 +/WE/Zub/STRW   |
|  | 640 i  | 235  |  | 03.11  |   |  | 24.8190-0312.2 620312  | Warnkontakt L=915mm  |
|  | 640 i xDrive   | 235  |  | 01.13  |   |  |  |  |
|  | 650 i  | 300  |  | 03.11  |   |  |  |  |
|  | 650 i  | 330  |  | 10.11  |   |  |  |  |
|  | 650 i xDrive   | 300  |  | 06.11  |   |  |  |  |
|  | 650 i xDrive   | 330  |  | 09.12  |   |  |  |  |
|  | M6   | 412  |  | 06.12  |   |  | 13.0460-2716.2 602716  | - M Carbon Keramik Bremse 2)<br>24703 17,8 +/WE/Zub/STRW   |
| M6   | 441  |  | 07.15  |  |   | 13.0470-2716.2 LD2716  | - M Carbon Keramik Bremse 2)<br>24703 17,8 +/WE/Zub/STRW                               |  |
| M6 Competition   | 423  |  | 02.14  |  |   | 24.8190-0008.2 620008  | Warnkontakt L=1000mm   |  |
|  | 640 d  | 230  |  | 06.11  |   |  | 24.0124-0233.2 424233  | zweiteilige Bremsscheibe 1)<br>345 24,0 22,4 V L +S +B   |
|  | 640 d xDrive   | 230  |  | 03.12  |   |  |  |  |
|  | 640 i  | 235  |  | 03.11  |   |  |  |  |
|  | 640 i xDrive   | 235  |  | 01.13  |   |  |  |  |
|  | 650 i  | 300  |  | 03.11  |   |  |  |  |
|  | 650 i  | 330  |  | 10.11  |   |  |  |  |

1) two-piece brake disc / disco frenante in due parti / disque d.fr.en deux parties / disco de fr.de dos piezas

2) - M Carbon ceramic brake / - M Carbon freno in ceramica / - M Carbon frein de céramique / - M Carbon freno de cerámica



### BMW 6er Reihe/F12 Cabrio (11-)

|  |                              |            |                |  |                |        |  |  |                         |
|--|------------------------------|------------|----------------|--|----------------|--------|--|--|-------------------------|
|  | 650 i xDrive<br>650 i xDrive | 300<br>330 | 06.11<br>09.12 |  | 24.0124-0233.2 | 424233 |  | zweiteilige Bremsscheibe <sup>1)</sup> | 345 24,0 22,4 V L +S +B |
|--|------------------------------|------------|----------------|--|----------------|--------|--|--|-------------------------|

### BMW 6er Reihe/F13 Coupe (11-)

|  |  |  |  |  |  |                            |   |  |  |  |
|--|--|--|--|--|--|----------------------------|---|--|--|--|
|  | 640 d<br>640 d xDrive<br>640 i<br>640 i xDrive<br>650 i<br>650 i<br>650 i xDrive<br>650 i xDrive | 230<br>230<br>235<br>235<br>300<br>330<br>300<br>330 | 06.11<br>03.12<br>06.11<br>01.13<br>06.11<br>09.12<br>06.11<br>09.12 |  | 13.0460-7267.2<br>24.8190-0298.2                   | 607267<br>620298           | 1 |  | 25045 19,5 +/-WE<br>Warnkontakt L=1087mm   | <b>ATE</b>   |
|  | M6<br>M6<br>M6 Competition<br>640 d<br>640 d xDrive<br>640 i<br>640 i xDrive                     | 412<br>441<br>423<br>230<br>230<br>235<br>235        | 06.12<br>07.15<br>02.14<br>06.11<br>03.12<br>06.11<br>01.13          |  | 24.8190-0298.2                                     | 620298                     | 1 |  | Warnkontakt L=1087mm   |  |
|  | 640 d<br>640 d xDrive<br>640 i<br>640 i xDrive   | 230<br>230<br>235<br>235                             | 06.11<br>03.12<br>06.11<br>01.13                                     |  | 24.0136-0115.2<br>24.0136-0114.2                   | 436115<br>436114           |   |  | zweiteilige Bremsscheibe <sup>1)</sup><br>zweiteilige Bremsscheibe <sup>1)</sup>   | 348 36,0 34,4 V L +S +B<br>348 36,0 34,4 V L +S +B                             |
|  | 650 i<br>650 i<br>650 i xDrive<br>650 i xDrive   | 300<br>330<br>300<br>330                             | 06.11<br>09.12<br>06.11<br>09.12                                     |  | 24.0136-0119.2<br>24.0136-0118.2                   | 436119<br>436118           |   |  | zweiteilige Bremsscheibe <sup>1)</sup><br>zweiteilige Bremsscheibe <sup>1)</sup>   | 374 36,0 34,4 V L +S +B<br>374 36,0 34,4 V L +S +B                             |
|  | M6<br>M6<br>M6 Competition   | 412<br>441<br>423                                    | 06.12<br>07.15<br>02.14  |  | 24.0136-0126.2<br>24.0136-0125.2                   | 436126<br>436125           |   |  | - M Carbon Keramik Bremse <sup>2)</sup><br>- M Carbon Keramik Bremse <sup>2)</sup> | 400 36,0 34,4 V L +S +B<br>400 36,0 34,4 V L +S +B                             |
|  | 640 d<br>640 d xDrive<br>640 i<br>640 i xDrive<br>650 i<br>650 i<br>650 i xDrive<br>650 i xDrive | 230<br>230<br>235<br>235<br>300<br>330<br>300<br>330 | 06.11<br>03.12<br>06.11<br>01.13<br>06.11<br>09.12<br>06.11<br>09.12 |  | 13.0460-2716.2<br>13.0470-2716.2<br>24.8190-0312.2 | 602716<br>LD2716<br>620312 | 1 |  | 24703 17,8 +/-WE/Zub/STRW<br>24703 17,8 +/-WE/Zub/STRW<br>Warnkontakt L=915mm      |  |
|  | M6<br>M6<br>M6 Competition   | 412<br>441<br>423                                    | 06.12<br>07.15<br>02.14  |  | 13.0460-2716.2<br>13.0470-2716.2<br>24.8190-0008.2 | 602716<br>LD2716<br>620008 | 1 |  | - M Carbon Keramik Bremse <sup>2)</sup><br>- M Carbon Keramik Bremse <sup>2)</sup> | 24703 17,8 +/-WE/Zub/STRW<br>24703 17,8 +/-WE/Zub/STRW<br>Warnkontakt L=1000mm |
|  | 640 d<br>640 d xDrive<br>640 i<br>640 i xDrive<br>650 i<br>650 i<br>650 i xDrive<br>650 i xDrive | 230<br>230<br>235<br>235<br>300<br>330<br>300<br>330 | 06.11<br>03.12<br>06.11<br>01.13<br>06.11<br>09.12<br>06.11<br>09.12 |  | 24.0124-0233.2                                     | 424233                     |   |  | zweiteilige Bremsscheibe <sup>1)</sup>   | 345 24,0 22,4 V L +S +B  |

### BMW 6er Reihe/F06 Gran Coupe (11-)

|  |  |   |   |  |  |                            |   |  |  |  |
|--|--|---|---|--|--|----------------------------|---|--|--|--|
|  | 640 d<br>640 d xDrive<br>640 i<br>640 i xDrive<br>650 i<br>650 i xDrive      | 230<br>230<br>235<br>235<br>330<br>330        | 09.11<br>01.13<br>03.12<br>01.13<br>11.11<br>11.11          |  | 13.0460-7267.2<br>24.8190-0298.2                   | 607267<br>620298           | 1 |  | 25045 19,5 +/-WE<br>Warnkontakt L=1087mm   | <b>ATE</b>   |
|  | M6<br>M6<br>M6 Competition<br>640 d<br>640 d xDrive<br>640 i<br>640 i xDrive | 412<br>441<br>423<br>230<br>230<br>235<br>235 | 12.12<br>07.15<br>02.14<br>09.11<br>01.13<br>03.12<br>01.13 |  | 24.8190-0298.2                                     | 620298                     | 1 |  | Warnkontakt L=1087mm   |  |
|  | 650 i<br>650 i xDrive  | 330<br>330                                    | 11.11<br>11.11  |  | 24.0136-0115.2<br>24.0136-0114.2                   | 436115<br>436114           |   |  | zweiteilige Bremsscheibe <sup>1)</sup><br>zweiteilige Bremsscheibe <sup>1)</sup>   | 348 36,0 34,4 V L +S +B<br>348 36,0 34,4 V L +S +B                             |
|  | M6<br>M6<br>M6 Competition   | 412<br>441<br>423                             | 12.12<br>07.15<br>02.14                                     |  | 24.0136-0119.2<br>24.0136-0118.2                   | 436119<br>436118           |   |  | zweiteilige Bremsscheibe <sup>1)</sup><br>zweiteilige Bremsscheibe <sup>1)</sup>   | 374 36,0 34,4 V L +S +B<br>374 36,0 34,4 V L +S +B                             |
|  | 640 d<br>640 d xDrive<br>640 i<br>640 i xDrive<br>650 i<br>650 i xDrive      | 230<br>230<br>235<br>235<br>330<br>330        | 09.11<br>01.13<br>03.12<br>01.13<br>11.11<br>11.11          |  | 24.0136-0126.2<br>24.0136-0125.2                   | 436126<br>436125           |   |  | - M Carbon Keramik Bremse <sup>2)</sup><br>- M Carbon Keramik Bremse <sup>2)</sup> | 400 36,0 34,4 V L +S +B<br>400 36,0 34,4 V L +S +B                             |
|  | 640 d<br>640 d xDrive<br>640 i<br>640 i xDrive<br>650 i<br>650 i xDrive      | 230<br>230<br>235<br>235<br>330<br>330        | 09.11<br>01.13<br>03.12<br>01.13<br>11.11<br>11.11          |  | 13.0460-2716.2<br>13.0470-2716.2<br>24.8190-0312.2 | 602716<br>LD2716<br>620312 | 1 |  | 24703 17,8 +/-WE/Zub/STRW<br>24703 17,8 +/-WE/Zub/STRW<br>Warnkontakt L=915mm      |  |
|  | M6<br>M6<br>M6 Competition   | 412<br>441<br>423                             | 12.12<br>07.15<br>02.14                                     |  | 13.0460-2716.2<br>13.0470-2716.2<br>24.8190-0008.2 | 602716<br>LD2716<br>620008 | 1 |  | - M Carbon Keramik Bremse <sup>2)</sup><br>- M Carbon Keramik Bremse <sup>2)</sup> | 24703 17,8 +/-WE/Zub/STRW<br>24703 17,8 +/-WE/Zub/STRW<br>Warnkontakt L=1000mm |
|  | 640 d<br>640 d xDrive<br>640 i<br>640 i xDrive<br>650 i<br>650 i xDrive      | 230<br>230<br>235<br>235<br>330<br>330        | 09.11<br>01.13<br>03.12<br>01.13<br>11.11<br>11.11          |  | 24.0124-0233.2                                     | 424233                     |   |  |  | 345 24,0 22,4 V L +S +B  |

<sup>1)</sup> two-piece brake disc / disco frenante in due parti / disque d.fr.en deux parties / disco de fr.de dos piezas  
<sup>2)</sup> - M Carbon ceramic brake / - M Carbon freno in ceramica / - M Carbon frein de céramique / - M Carbon freno de cerámica

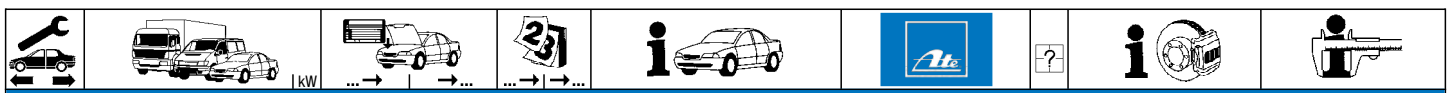





**BMW 7er Reihe/E38 (93-01)**



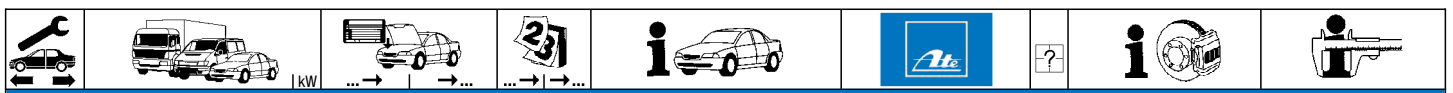

|        |         |     |       |       |                |                |        |   |  |  |     |
|--------|---------|-----|-------|-------|----------------|----------------|--------|---|--|--|-----|
|        | 725 tds | 105 |       | 05.96 | 11.01          | 13.0460-4965.2 | 604965 | 1 |  | 21471 18,0 /WE<br>Belagsatz-Zubehör<br>Warnkontakt L=569mm | BRE |
|        | 728 i   | 142 |       | 07.95 | 11.01          | 13.0460-0267.2 | 610267 |   |  |  |     |
|        | 728 iL  | 142 |       | 01.96 | 11.01          | 24.8190-0208.2 | 620208 |   |  |  |     |
|        | 730 d   |     |       | 09.98 | 11.01          |                |        |   |  |  |     |
|        | 730 i   |     |       | 07.93 | 11.01          |                |        |   |  |  |     |
|        | 730 iL  |     |       | 05.94 | 11.01          |                |        |   |  |  |     |
|        | 735 i   | 173 |       | 01.96 | 11.01          |                |        |   |  |  |     |
|        | 735 iL  | 173 |       | 01.96 | 11.01          |                |        |   |  |  |     |
|        | 740 i   | 210 |       | 07.93 | 11.01          | 13.0460-7078.2 | 607078 |   |  |  |     |
|        | 740 iL  | 210 |       | 05.94 | 11.01          | 13.0470-7078.2 | LD7078 |   |  |  |     |
|        |         |     |       |       | 24.8190-0208.2 | 620208         |        |   | 21486 19,3 +/WE<br>Warnkontakt L=578mm | ATE  |     |
|        | 750 i   | 240 |       | 11.93 | 08.98          | 13.0460-7183.2 | 607183 |   |  | 21484 20,5 +/WE<br>Warnkontakt L=578mm                     | ATE |
|        | 750 iL  | 240 |       | 01.94 | 08.98          | 24.8190-0232.2 | 620232 | 1 |  |  |     |
|        | 740 d   | 180 |       | 05.99 | 11.01          | 13.0460-7183.2 | 607183 |   |  | 21484 20,5 +/WE<br>Warnkontakt L=585mm                     | ATE |
|        | 750 i   | 240 |       | 09.98 | 11.01          | 24.8190-0234.2 | 620234 | 1 |  |  |     |
|        | 750 iL  | 240 |       | 09.98 | 11.01          |                |        |   |  |  |     |
|        | 725 tds | 105 |       | 05.96 | 11.01          | 24.0128-0105.1 | 428105 |   |  | 316 28,0 26,4 V L +S +B                                    |     |
|        | 728 i   | 142 |       | 07.95 | 11.01          |                |        |   |  |  |     |
|        | 728 iL  | 142 |       | 01.96 | 11.01          |                |        |   |  |  |     |
|        | 730 d   |     |       | 09.98 | 11.01          |                |        |   |  |  |     |
|        | 730 i   |     |       | 07.93 | 11.01          |                |        |   |  |  |     |
|        | 730 iL  |     |       | 05.94 | 11.01          |                |        |   |  |  |     |
|        | 735 i   | 173 |       | 01.96 | 11.01          |                |        |   |  |  |     |
|        | 735 iL  | 173 |       | 01.96 | 11.01          |                |        |   |  |  |     |
|        | 740 i   | 210 |       | 07.93 | 11.01          | 24.0130-0101.1 | 430101 |   |  | 324 30,0 28,4 V L +S +B                                    |     |
|        | 740 iL  | 210 |       | 05.94 | 11.01          |                |        |   |  |  |     |
|        | 740 d   | 180 |       | 05.99 | 11.01          | 24.0132-0113.1 | 432113 |   |  | 334 31,9 30,4 V L +S +B                                    |     |
|        | 750 i   | 240 |       | 11.93 | 11.01          |                |        |   |  |  |     |
|        | 750 iL  | 240 |       | 01.94 | 11.01          |                |        |   |  |  |     |
|        | 725 tds | 105 |       | 05.96 | 08.98          | 24.0710-2005.1 | 360212 | 2 |  | Radsensor L=607  |     |
|        | 728 i   | 142 |       | 07.95 | 08.98          |                |        |   |  |  |     |
|        | 728 iL  | 142 |       | 01.96 | 08.98          |                |        |   |  |  |     |
|        | 730 i   |     |       | 07.93 | 08.98          |                |        |   |  |  |     |
|        | 730 iL  |     |       | 05.94 | 08.98          |                |        |   |  |  |     |
|        | 735 i   | 173 |       | 01.96 | 08.98          |                |        |   |  |  |     |
|        | 735 iL  | 173 |       | 01.96 | 08.98          |                |        |   |  |  |     |
|        | 740 i   | 210 |       | 07.93 | 08.98          |                |        |   |  |  |     |
|        | 740 iL  | 210 |       | 05.94 | 08.98          |                |        |   |  |  |     |
|        | 750 i   | 240 |       | 11.93 | 08.98          |                |        |   |  |  |     |
| 750 iL | 240     |     | 01.94 | 08.98 |                |                |        |   |  |  |     |
|        | 725 tds | 105 |       | 09.98 | 11.01          | 24.0710-2008.1 | 360215 | 2 |  | Radsensor L=610  |     |
|        | 728 i   | 142 |       | 09.98 | 11.01          |                |        |   |  |  |     |
|        | 728 iL  | 142 |       | 09.98 | 11.01          |                |        |   |  |  |     |
|        | 730 d   |     |       | 09.98 | 11.01          |                |        |   |  |  |     |
|        | 730 i   |     |       | 09.98 | 11.01          |                |        |   |  |  |     |
|        | 730 iL  |     |       | 09.98 | 11.01          |                |        |   |  |  |     |
|        | 735 i   | 173 |       | 09.98 | 11.01          |                |        |   |  |  |     |
|        | 735 iL  | 173 |       | 09.98 | 11.01          |                |        |   |  |  |     |
|        | 740 d   | 180 |       | 05.99 | 11.01          |                |        |   |  |  |     |
|        | 740 i   | 210 |       | 09.98 | 11.01          |                |        |   |  |  |     |
| 740 iL | 210     |     | 09.98 | 11.01 |                |                |        |   |  |  |     |
| 750 i  | 240     |     | 09.98 | 11.01 |                |                |        |   |  |  |     |
| 750 iL | 240     |     | 09.98 | 11.01 |                |                |        |   |  |  |     |
|        | 725 tds | 105 |       | 05.96 | 11.01          | 13.0460-7079.2 | 607079 | 1 |  | 21487 17,3 +/WE<br>Warnkontakt L=620mm                     | ATE |
|        | 728 i   | 142 |       | 07.95 | 11.01          | 13.0470-7079.2 | LD7079 |   |  |  |     |
|        | 728 iL  | 142 |       | 01.96 | 11.01          | 24.8190-0209.2 | 620209 |   |  |  |     |
|        | 730 d   |     |       | 09.98 | 11.01          |                |        |   |  |  |     |
|        | 730 i   |     |       | 07.93 | 11.01          |                |        |   |  |  |     |
|        | 730 iL  |     |       | 05.94 | 11.01          |                |        |   |  |  |     |
|        | 735 i   | 173 |       | 01.96 | 11.01          |                |        |   |  |  |     |
|        | 735 iL  | 173 |       | 01.96 | 11.01          |                |        |   |  |  |     |
|        | 740 d   | 180 |       | 05.99 | 11.01          |                |        |   |  |  |     |
|        | 740 i   | 210 |       | 07.93 | 11.01          |                |        |   |  |  |     |
| 740 iL | 210     |     | 05.94 | 11.01 |                |                |        |   |  |  |     |
| 750 i  | 240     |     | 11.93 | 11.01 |                |                |        |   |  |  |     |
| 750 iL | 240     |     | 01.94 | 11.01 |                |                |        |   |  |  |     |
|        | 725 tds | 105 |       | 05.96 | 11.01          | 24.0112-0132.1 | 412132 |   |  | 324 12,0 10,4 L +S +B                                      |     |
|        | 728 i   | 142 |       | 07.95 | 11.01          |                |        |   |  |  |     |
|        | 728 iL  | 142 |       | 01.96 | 11.01          |                |        |   |  |  |     |
|        | 730 d   |     |       | 09.98 | 11.01          |                |        |   |  |  |     |
|        | 730 i   |     |       | 07.93 | 11.01          |                |        |   |  |  |     |
|        | 730 iL  |     |       | 05.94 | 11.01          |                |        |   |  |  |     |
|        | 735 i   | 173 |       | 01.96 | 11.01          |                |        |   |  |  |     |
|        | 735 iL  | 173 |       | 01.96 | 11.01          |                |        |   |  |  |     |
|        | 740 i   | 210 |       | 07.93 | 11.01          |                |        |   |  |  |     |
|        | 740 iL  | 210 |       | 05.94 | 11.01          |                |        |   |  |  |     |
|        | 740 d   | 180 |       | 05.99 | 11.01          | 24.0120-0182.1 | 420182 |   |  | 328 20,0 18,4 V L +S +B                                    |     |
|        | 750 i   | 240 |       | 11.93 | 11.01          |                |        |   |  |  |     |
|        | 750 iL  | 240 |       | 01.94 | 11.01          |                |        |   |  |  |     |
|        | 725 tds | 105 |       | 05.96 | 08.98          | 24.0710-2006.1 | 360213 | 2 |  | Radsensor L=1000   |     |
|        | 728 i   | 142 |       | 07.95 | 08.98          |                |        |   |  |  |     |
|        | 728 iL  | 142 |       | 01.96 | 08.98          |                |        |   |  |  |     |
|        | 730 i   |     |       | 07.93 | 08.98          |                |        |   |  |  |     |
|        | 730 iL  |     |       | 05.94 | 08.98          |                |        |   |  |  |     |
|        | 735 i   | 173 |       | 01.96 | 08.98          |                |        |   |  |  |     |
| ↓      | ↓       |     |       |       |                |                |        |   |  |  |     |

































| BMW 7er Reihe/E38 (93-01)  |         |     |  |       |       |                |        |   |   |                  |
|--|---------|-----|--|-------|-------|----------------|--------|---|---|------------------|
|  | 735 iL  | 173 |  | 01.96 | 08.98 | 24.0710-2006.1 | 360213 | 2 |  | Radsensor L=1000 |
|  | 740 i   | 210 |  | 07.93 | 08.98 |                |        |   |   |                  |
|  | 740 iL  | 210 |  | 05.94 | 08.98 |                |        |   |   |                  |
|  | 750 i   | 240 |  | 11.93 | 08.98 |                |        |   |   |                  |
|  | 750 iL  | 240 |  | 01.94 | 08.98 |                |        |   |   |                  |
|  | 725 tds | 105 |  | 09.98 | 11.01 | 24.0710-2003.1 | 360210 | 2 |  | Radsensor L=1029 |
|  | 728 i   | 142 |  | 09.98 | 11.01 |                |        |   |   |                  |
|  | 728 iL  | 142 |  | 09.98 | 11.01 |                |        |   |   |                  |
|  | 730 d   |     |  | 09.98 | 11.01 |                |        |   |   |                  |
|  | 730 i   |     |  | 09.98 | 11.01 |                |        |   |   |                  |
|  | 730 iL  |     |  | 09.98 | 11.01 |                |        |   |   |                  |
|  | 735 i   | 173 |  | 09.98 | 11.01 |                |        |   |   |                  |
|  | 735 iL  | 173 |  | 09.98 | 11.01 |                |        |   |   |                  |
|  | 740 d   | 180 |  | 05.99 | 11.01 |                |        |   |   |                  |
|  | 740 i   | 210 |  | 09.98 | 11.01 |                |        |   |   |                  |
|  | 740 iL  | 210 |  | 09.98 | 11.01 |                |        |   |   |                  |
|  | 750 i   | 240 |  | 09.98 | 11.01 |                |        |   |   |                  |
|  | 750 iL  | 240 |  | 09.98 | 11.01 |                |        |   |   |                  |

| BMW 7er Reihe/E65/E66 (02-08)  |          |     |  |       |       |                |        |   |  |                        |
|--|----------|-----|--|-------|-------|----------------|--------|---|--|------------------------|
|    | 730 d    | 160 |  | 09.02 | 08.08 | 13.0460-7167.2 | 607167 |   |  | 23312 20,3 +/WE ATE    |
|  | 730 d,Ld | 170 |  | 03.05 | 08.08 | 13.0470-7167.2 | LD7167 |   |  | 23312 20,3 +/WE ATE    |
|  | 730 i,Li | 170 |  | 03.03 | 08.08 | 24.8190-0230.2 | 620230 | 1 |  | Warnkontakt L=814mm    |
|  | 730 i,Li | 190 |  | 07.05 | 08.08 |                |        |   |  |                        |
|  | 735 i,Li | 200 |  | 11.01 | 08.08 | 13.0460-7167.2 | 607167 |   |  | 23312 20,3 +/WE ATE    |
|  | 740 d    | 190 |  | 09.02 | 08.08 | 24.8190-0230.2 | 620230 | 1 |  | Warnkontakt L=814mm    |
|  | 740 i,Li | 225 |  | 03.05 | 08.08 |                |        |   |  |                        |
|  | 745 i,Li | 245 |  | 11.01 | 08.08 |                |        |   |  |                        |
|  | 750 i,Li | 270 |  | 03.05 | 08.08 |                |        |   |  | - Europa <sup>1)</sup> |
|  | 760 i,Li | 327 |  | 03.03 | 08.08 |                |        |   |  | - Europa <sup>1)</sup> |
|  | 745 d    |     |  | 03.05 | 08.08 | 13.0460-7210.2 | 607210 |   |  | 23791 20,8 +/WE ATE    |
|  | 750 i,Li | 270 |  | 03.05 | 08.08 | 24.8190-0230.2 | 620230 | 1 |  | Warnkontakt L=814mm    |
|  | 760 i,Li | 327 |  | 03.03 | 08.08 |                |        |   |  | + Europa <sup>2)</sup> |
|  | 730 d    | 160 |  | 09.02 | 02.05 | 24.0130-0117.1 | 430117 |   |  | 324 30,0 28,4 V L +B   |
|  | 730 i,Li | 170 |  | 03.03 | 08.08 |                |        |   |  |                        |
|  | 730 i,Li | 190 |  | 07.05 | 08.08 |                |        |   |  |                        |
|  | 735 i,Li | 200 |  | 11.01 | 08.08 |                |        |   |  |                        |
|  | 730 d,Ld | 170 |  | 03.05 | 08.08 | 24.0130-0118.1 | 430118 |   |  | 348 30,0 28,4 V L +B   |
|  | 740 d    | 190 |  | 09.02 | 08.08 |                |        |   |  |                        |
|  | 740 i,Li | 225 |  | 03.05 | 08.08 |                |        |   |  |                        |
|  | 745 i,Li | 245 |  | 11.01 | 08.08 |                |        |   |  |                        |
|  | 750 i,Li | 270 |  | 03.05 | 08.08 |                |        |   |  | - Europa <sup>1)</sup> |
|  | 760 i,Li | 327 |  | 03.03 | 08.08 |                |        |   |  | - Europa <sup>1)</sup> |
|  | 745 d    |     |  | 03.05 | 08.08 | 24.0136-0101.1 | 436101 |   |  | 374 36,0 34,4 V L +B   |
|  | 760 i,Li | 327 |  | 03.03 | 08.08 |                |        |   |  | + Europa <sup>2)</sup> |
|  | 750 i,Li | 270 |  | 03.05 | 08.08 | 24.0136-0110.1 | 436110 |   |  | 348 35,9 34,4 V L +B   |
|  | 730 d    | 160 |  | 09.02 | 02.05 | 13.0460-7168.2 | 607168 |   |  | 23447 17,3 +/WE ATE    |
|  | 730 i,Li | 170 |  | 03.03 | 08.08 | 13.0470-7168.2 | LD7168 |   |  | 23447 17,3 +/WE ATE    |
|  | 730 i,Li | 190 |  | 07.05 | 08.08 | 24.8190-0231.2 | 620231 | 1 |  | Warnkontakt L=830mm    |
|  | 735 i,Li | 200 |  | 11.01 | 08.08 |                |        |   |  |                        |
|  | 730 d,Ld | 170 |  | 03.05 | 08.08 | 13.0460-7169.2 | 607169 |   |  | 23309 17,3 +/WE ATE    |
|  | 740 d    | 190 |  | 09.02 | 08.08 | 13.0470-7169.2 | LD7169 |   |  | 23309 17,3 +/WE ATE    |
|  | 740 i,Li | 225 |  | 03.05 | 08.08 | 24.8190-0231.2 | 620231 | 1 |  | Warnkontakt L=830mm    |
|  | 745 d    |     |  | 03.05 | 08.08 |                |        |   |  |                        |
|  | 745 i,Li | 245 |  | 11.01 | 08.08 |                |        |   |  |                        |
|  | 750 i,Li | 270 |  | 03.05 | 08.08 |                |        |   |  |                        |
|  | 760 i,Li | 327 |  | 03.03 | 08.08 |                |        |   |  |                        |
|  | 730 d    | 160 |  | 09.02 | 02.05 | 24.0120-0178.1 | 420178 |   |  | 324 20,0 18,4 V L +B   |
|  | 730 i,Li | 170 |  | 03.03 | 08.08 |                |        |   |  |                        |
|  | 735 i,Li | 200 |  | 11.01 | 08.08 |                |        |   |  |                        |
|  | 730 i,Li | 190 |  | 07.05 | 08.08 | 24.0120-0217.1 | 420217 |   |  | 324 20,0 18,4 V L +B   |
|  | 740 d    | 190 |  | 09.02 | 08.08 | 24.0124-0177.1 | 424177 |   |  | 345 24,0 22,4 V L +B   |
|  | 745 i,Li | 245 |  | 11.01 | 08.08 |                |        |   |  |                        |
|  | 760 i,Li | 327 |  | 03.03 | 03.05 |                |        |   |  | - Europa <sup>1)</sup> |
|  | 760 i,Li | 327 |  | 03.03 | 03.05 | 24.0124-0186.1 | 424186 |   |  | + Europa <sup>2)</sup> |
|  | 730 d,Ld | 170 |  | 03.05 | 08.08 | 24.0124-0213.1 | 424213 |   |  | 370 24,0 22,4 V L      |
|  | 740 i,Li | 225 |  | 03.05 | 08.08 |                |        |   |  | 345 24,0 22,4 V L +B   |
|  | 750 i,Li | 270 |  | 03.05 | 08.08 |                |        |   |  |                        |
|  | 760 i,Li | 327 |  | 04.05 | 08.08 |                |        |   |  | - Europa <sup>1)</sup> |
|  | 745 d    |     |  | 03.05 | 08.08 | 24.0124-0214.1 | 424214 |   |  | 370 24,0 22,4 V L +B   |
|  | 760 i,Li | 327 |  | 04.05 | 08.08 |                |        |   |  | + Europa <sup>2)</sup> |



















1) - Europe / - Europa / - Europe / - Europa  
 2) + Europe / + Europa / + Europe / + Europa

|     |  |  |  |  |  |  |    |  |
|--|--|--|--|--|---|--|--|--|
| <b>BMW 7er Reihe/E65/E66 (02-08)</b>   |  |  |  |  |   |  |  |  |
|    | 730 d  | 160  | 09.02  | 08.08  | 03.0137-0419.2  | 650419   |  | 185 x 30   |
|  | 730 d,Ld   | 170  | 03.05  | 08.08  | 03.0137-9288.2  | 669288   |  | Bremsbacken-Zubehör  |
|  | 730 i,Li   | 170  | 03.03  | 08.08  |   |  |  |  |
|  | 730 i,Li   | 190  | 07.05  | 08.08  |   |  |  |  |
|  | 735 i,Li   | 200  | 11.01  | 08.08  |   |  |  |  |
|  | 740 d  | 190  | 09.02  | 08.08  |   |  |  |  |
|  | 740 i,Li   | 225  | 03.05  | 08.08  |   |  |  |  |
|  | 745 d  |  | 03.05  | 08.08  |   |  |  |  |
|  | 745 i,Li   | 245  | 11.01  | 08.08  |   |  |  |  |
|  | 750 i,Li   | 270  | 03.05  | 08.08  |   |  |  |  |
|  | 760 i,Li   | 327  | 03.03  | 08.08  |   |  |  |  |
| <b>BMW 7er Reihe/F01/F02/F03/F04 (08-15)</b>                                       |  |  |  |  |   |  |  |  |
|    | 730 d  | 180  | 09.08  | 02.10  | 13.0460-7267.2  | 607267   |  | 25045 19,5 +/WE ATE  |
|  | 730 i  | 190  | 09.08  | 02.10  | 13.0470-7267.2  | LD7267   |  | 25045 19,5 +/WE ATE  |
|  | 740 d  | 225  | 09.09  | 02.10  | 24.8190-0260.2  | 620260   | 1   | Warnkontakt L=1060mm   |
|  | 740 i  | 240  | 09.08  | 02.10  | 13.0460-7267.2  | 607267   |  | 25045 19,5 +/WE ATE  |
|  | 750 i  | 300  | 09.08  | 02.10  | 24.8190-0260.2  | 620260   | 1   | Warnkontakt L=1060mm   |
|  | 750 i xDrive   | 300  | 09.09  | 02.10  |   |  |  |  |
|  | 730 d  | 180  | 03.10  |  | 13.0460-7267.2  | 607267   |  | 25045 19,5 +/WE ATE  |
|  | 730 d  | 190  | 06.12  |  | 13.0470-7267.2  | LD7267   |  | 25045 19,5 +/WE ATE  |
|  | 730 d xDrive   | 190  | 06.12  |  | 24.8190-0298.2  | 620298   | 1   | Warnkontakt L=1087mm   |
|  | 730 i  | 190  | 03.10  |  |   |  |  |  |
|  | 740 d  | 225  | 03.10  |  |   |  |  |  |
|  | 740 d xDrive   | 225  | 09.10  |  |   |  |  |  |
|  | 740 d  | 230  | 06.12  |  | 13.0460-7267.2  | 607267   |  | 25045 19,5 +/WE ATE  |
|  | 740 d xDrive   | 230  | 06.12  |  | 24.8190-0298.2  | 620298   | 1   | Warnkontakt L=1087mm   |
|  | 740 i  | 235  | 06.12  |  |   |  |  |  |
|  | 740 i  | 240  | 03.10  |  |   |  |  |  |
|  | 740 i,Li xDrive  | 235  | 07.12  |  |   |  |  |  |
|  | 750 i  | 300  | 03.10  |  |   |  |  |  |
|  | 750 i  | 330  | 06.12  |  |   |  |  |  |
|  | 750 i xDrive   | 300  | 03.10  |  |   |  |  |  |
|  | 750 i xDrive   | 330  | 10.12  |  |   |  |  |  |
|  | ActiveHybrid 7   | 260  | 06.12  |  |   |  |  |  |
|  | ActiveHybrid 7   | 342  | 03.10  |  |   |  |  |  |
|  | 750 d xDrive   | 280  | 06.12  |  | 13.0460-7261.2  | 607261   |  | 24436 19,7 +/WE ATE  |
|  | 750 i  | 300  | 09.08  |  | 24.8190-0298.2  | 620298   | 1   | Warnkontakt L=1087mm   |
|  | 750 i  | 330  | 06.12  |  |   |  |  |  |
|  | 750 i xDrive   | 300  | 09.09  |  |   |  |  |  |
|  | 750 i xDrive   | 330  | 10.12  |  |   |  |  |  |
|  | 760 i  | 400  | 09.09  |  |   |  |  |  |
|  | ActiveHybrid 7   | 342  | 03.10  |  |   |  |  |  |
|  | 730 d  | 180  | 09.08  |  | 24.0136-0115.2  | 436115   |  zweiteilige Bremsscheibe <sup>3)</sup> | 348 36,0 34,4 V L +S +B  |
|  | 730 d  | 190  | 06.12  |  | 24.0136-0114.2  | 436114   |  zweiteilige Bremsscheibe <sup>3)</sup> | 348 36,0 34,4 V L +S +B  |
|  | 730 d xDrive   | 190  | 06.12  |  |   |  |  |  |
|  | 730 i  | 190  | 09.08  |  |   |  |  |  |
|  | 740 d  | 225  | 09.09  |  |   |  |  |  |
|  | 740 d  | 230  | 06.12  |  |   |  |  |  |
|  | 740 d xDrive   | 225  | 09.10  |  |   |  |  |  |
|  | 740 d xDrive   | 230  | 06.12  |  |   |  |  |  |
|  | 740 i  | 235  | 06.12  |  |   |  |  |  |
|  | 740 i,Li xDrive  | 235  | 07.12  |  |   |  |  |  |
|  | ActiveHybrid 7   | 260  | 06.12  |  |   |  |  |  |
|  | 740 i  | 240  | 09.08  |  | 24.0136-0119.2  | 436119   |  zweiteilige Bremsscheibe <sup>3)</sup> | 374 36,0 34,4 V L +S +B  |
|  | 750 i  | 300  | 09.08  |  | 24.0136-0118.2  | 436118   |  zweiteilige Bremsscheibe <sup>3)</sup> | 374 36,0 34,4 V L +S +B  |
|  | 750 i  | 330  | 06.12  |  |   |  |  |  |
|  | 750 i xDrive   | 300  | 09.09  |  |   |  |  |  |
|  | 750 i xDrive   | 330  | 10.12  |  |   |  |  |  |
|  | ActiveHybrid 7   | 342  | 03.10  |  |   |  |  |  |
|  | 750 d xDrive   | 280  | 06.12  |  | 24.0136-0121.2  | 436121   |  zweiteilige Bremsscheibe <sup>3)</sup> | 374 36,0 34,4 V L +S +B  |
|  | 750 i  | 300  | 09.08  |  | 24.0136-0120.2  | 436120   |  zweiteilige Bremsscheibe <sup>3)</sup> | 374 36,0 34,4 V L +S +B  |
|  | 750 i  | 330  | 06.12  |  |   |  |  |  |
|  | 750 i xDrive   | 300  | 09.09  |  |   |  |  |  |
|  | 750 i xDrive   | 330  | 10.12  |  |   |  |  |  |
|  | 760 i  | 400  | 09.09  |  |   |  |  |  |
|  | ActiveHybrid 7   | 342  | 03.10  |  |   |  |  |  |
|  | 730 d  | 180  | 09.08  | 02.10  | 13.0460-7274.2  | 607274   |  | 23731 17,3 +/WE ATE  |
|  | 730 i  | 190  | 09.08  | 02.10  | 24.8190-0261.2  | 620261   | 1                                       | Warnkontakt L=1045mm   |
|  | 740 d  | 225  | 09.09  | 02.10  |   |  |  |  |
|  | 740 i  | 240  | 09.08  | 02.10  |   |  |  |  |
|  | 750 i  | 300  | 09.08  | 02.10  |   |  |  |  |
|  | 750 i xDrive   | 300  | 09.09  | 02.10  |   |  |  |  |
|  | 760 i  | 400  | 09.09  | 02.10  |   |  |  |  |
|  | 730 d  | 180  | 03.10  |  | 13.0460-7274.2  | 607274   |  | 23731 17,3 +/WE ATE  |
|  | 730 d  | 190  | 06.12  |  | 24.8190-0299.2  | 620299   | 1                                       | Warnkontakt L=1065mm   |
|  | 730 d xDrive   | 190  | 06.12  |  |   |  |  |  |
|  | 730 i  | 190  | 03.10  |  |   |  |  |  |
|  | 740 d  | 225  | 03.10  |  |   |  |  |  |
|  | 740 d  | 230  | 06.12  |  |   |  |  |  |
|  | 740 d xDrive   | 225  | 09.10  |  |   |  |  |  |
|  | 740 d xDrive   | 230  | 06.12  |  |   |  |  |  |
|  | 740 i  | 235  | 06.12  |  |   |  |  |  |
|  | 740 i  | 240  | 03.10  |  |   |  |  |  |
|  | 740 i,Li xDrive  | 235  | 07.12  |  |   |  |  |  |
|  | 750 d xDrive   | 280  | 06.12  |  |   |  |  |  |











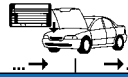

<sup>1)</sup> - heavy duty brake / - freno rinforzato / - frein renforcé / - freno reforzado















<sup>2)</sup> + heavy duty brake / + freno rinforzato / + frein renforcé / + freno reforzado

<sup>3)</sup> two-piece brake disc / disco frenante en due parti / disque d.fr.en deux parties / disco de fr.de dos piezas

|     |    |   |  |   |  |  |  |  |   |                                 |
|--|--|---|--|---|---|--|--|--|---|---------------------------------|
| <b>BMW 7er Reihe/F01/F02/F03/F04 (08-15)</b>                                       |  |   |  |   |   |  |  |  |   |                                 |
|    | 750 i<br>750 i<br>750 i xDrive<br>750 i xDrive<br>760 i<br>ActiveHybrid 7<br>ActiveHybrid 7  | 300<br>330<br>300<br>330<br>400<br>260<br>342   |  | 03.10<br>06.12<br>03.10<br>10.12<br>03.10<br>06.12<br>03.10   |   | 13.0460-7274.2<br>24.8190-0299.2   | 607274<br>620299   | 1  | 23731 17,3 +WE<br>Warnkontakt L=1065mm                  | ATE                             |
|    | 730 d<br>730 d<br>730 d xDrive<br>730 i<br>740 d<br>740 d<br>740 d xDrive<br>740 d xDrive<br>740 i<br>740 i<br>740 i, Li xDrive<br>ActiveHybrid 7  | 180<br>190<br>190<br>190<br>225<br>230<br>225<br>230<br>235<br>240<br>235<br>260  |  | 09.08<br>06.12<br>06.12<br>09.08<br>09.09<br>06.12<br>09.10<br>06.12<br>06.12<br>09.08<br>07.12<br>06.12  |   | 24.0124-0233.2   | 424233   |  | zweiteilige Bremsscheibe 1)                             | 345 24,0 22,4 V L +S +B         |
|  | 750 d xDrive<br>750 i<br>750 i<br>750 i xDrive<br>750 i xDrive<br>760 i<br>ActiveHybrid 7  | 280<br>300<br>330<br>300<br>330<br>400<br>342   |  | 06.12<br>09.08<br>06.12<br>09.09<br>10.12<br>09.09<br>03.10   |   | 24.0124-0241.1   | 424241   |  |   | 370 23,9 22,4 V L +S +B         |
|    | 730 d<br>730 d<br>730 d xDrive<br>730 i<br>740 d<br>740 d<br>740 d xDrive<br>740 d xDrive<br>740 i<br>740 i<br>740 i, Li xDrive<br>750 d xDrive<br>750 i<br>750 i<br>750 i xDrive<br>750 i xDrive<br>760 i<br>ActiveHybrid 7<br>ActiveHybrid 7 | 180<br>190<br>190<br>190<br>225<br>230<br>225<br>230<br>235<br>240<br>235<br>280<br>300<br>330<br>300<br>330<br>400<br>260<br>342 |  | 09.08<br>06.12<br>06.12<br>09.08<br>09.09<br>06.12<br>09.10<br>06.12<br>06.12<br>09.08<br>07.12<br>06.12<br>09.08<br>06.12<br>09.09<br>10.12<br>09.09<br>06.12<br>03.10 |   | 03.0137-0419.2<br>03.0137-9288.2   | 650419<br>669288   |  |   | 185 x 30<br>Bremsbacken-Zubehör |
| <b>BMW 8er Reihe/E31 (90-99)</b>   |  |   |  |   |   |  |  |  |   |                                 |
|  | 850 i/Ci   | 220   |  | 04.90 08.91   |   | 13.0460-7147.2<br>24.8190-0214.2   | 607147<br>620214   | 1  | 21284 19,1 +WE<br>Warnkontakt L=235mm                   | ATE                             |
|  | 840 i<br>850 i/Ci  | 210<br>220  |  | 02.93 02.94<br>09.91 10.94  |   | 13.0460-7147.2<br>24.8190-0223.2   | 607147<br>620223   | 1  | 21284 19,1 +WE<br>Warnkontakt L=261mm                   | ATE                             |
|  | 840 Ci<br>840 i<br>850 Ci  | 210<br>210<br>240   |  | 01.96 08.99<br>03.94 02.96<br>09.94 12.99   |   | 13.0460-0267.2<br>24.8190-0223.2   | 610267<br>620223   | 1  | Belagsatz-Zubehör<br>Warnkontakt L=261mm                |                                 |
|  | 850 CSi  | 280   |  | 09.92 10.96   |   | 13.0460-9037.2<br>24.8190-0223.2   | 609037<br>620223   | 1  | 20309 17,9 /WE<br>Warnkontakt L=261mm                   | ATE                             |
|  | 840 i<br>850 i/Ci  | 210<br>220  |  | 02.93 02.94<br>04.90 10.94  |   | 24.0130-0101.1   | 430101   |  | 324 30,0 28,4 V L +S +B                                 |                                 |
|  | 850 i/Ci   | 220   |  | 04.90 08.91   |   | 24.8190-0214.2   | 620214   | 1  | Warnkontakt L=235mm                                     |                                 |
|  | 840 Ci<br>840 i<br>850 Ci<br>850 i/Ci<br>850 CSi   | 210<br>210<br>240<br>220<br>280   |  | 01.96 08.99<br>02.93 02.96<br>09.94 12.99<br>04.90 10.94<br>09.92 10.96   |   | 24.0112-0132.1   | 412132   |  | 324 12,0 10,4 L +S +B                                   |                                 |
|  | 840 Ci<br>840 i<br>850 Ci<br>850 CSi<br>850 i/Ci   | 210<br>210<br>240<br>280<br>220   |  | 01.96 08.99<br>02.93 02.96<br>09.94 12.99<br>09.92 10.96<br>04.90 10.94   |   | 03.0137-0150.2<br>03.0137-9062.2   | 650150<br>669062   |  | 180 x 25<br>Bremsbacken-Zubehör                         |                                 |
| <b>BMW i8/I12 (14-)</b>  |  |   |  |   |   |  |  |  |   |                                 |
|  | 1.5 Hybrid   |   |  | 03.14   |   | 13.0460-2760.2<br>13.0470-2760.2   | 602760<br>LD2760   |  | 24561 17,7 +WE/Zub/STRW<br>24561 17,7 +WE/Zub/STRW      |                                 |
| <b>BMW X1/E84 (09-)</b>  |  |   |  |   |   |  |  |  |   |                                 |
|  | sDrive 18 d<br>sDrive 20 d   | 105<br>130  |  | 10.09 02.10<br>10.09 02.10  |   | 13.0460-7238.2<br>13.0470-7238.2<br>24.8190-0283.2                                 | 607238<br>LD7238<br>620283   | 1  | 23313 20,3 +WE<br>23313 20,3 +WE<br>Warnkontakt L=632mm | ATE<br>ATE                      |
|  | xDrive 18 d<br>xDrive 20 d   | 105<br>130  |  | 10.09 02.10<br>10.09 02.10  |   | 13.0460-7238.2<br>13.0470-7238.2<br>24.8190-0266.2                                 | 607238<br>LD7238<br>620266   | 1  | 23313 20,3 +WE<br>23313 20,3 +WE<br>Warnkontakt L=840mm | ATE<br>ATE                      |

1) two-piece brake disc / disco frenante in due parti / disque d.fr.en deux parties / disco de fr.de dos piezas

|     |  |  |  |  |  |  |   |  |   |
|--|--|--|--|--|---|--|---|--|---|
| <b>BMW X1/E84 (09-)</b>  |  |  |  |  |   |  |   |  |   |
|    | xDrive 23 d  | 150  |  | 10.09  | 02.10   |  | 13.0460-7216.2 607216<br>13.0470-7216.2 LD7216<br>24.8190-0266.2 620266   | 1  | 23794 20,3 +/WE ATE<br>23794 20,3 +/WE ATE<br>Warnkontakt L=840mm   |
|  | sDrive 16 d  | 85   |  | 07.12  |   |  | 13.0460-7238.2 607238<br>13.0470-7238.2 LD7238  |  | 23313 20,3 +/WE ATE<br>23313 20,3 +/WE ATE<br>Warnkontakt L=676mm   |
|  | sDrive 16 i  | 105  |  | 03.13  |   |  |   |  |   |
|  | sDrive 18 d  | 105  |  | 03.10  |   |  | 24.8190-0297.2 620297   | 1  |   |
|  | sDrive 18 i  | 110  |  | 03.10  |   |  |   |  |   |
|  | sDrive 20 d  | 130  |  | 03.10  |   |  |   |  |   |
|  | sDrive 20 d ed   | 135  |  | 07.12  |   |  |   |  |   |
|  | sDrive 20 i  | 120  |  | 03.10  |   |  |   |  |   |
|  | sDrive 20 i  | 135  |  | 09.11  |   |  |   |  |   |
|  | xDrive 18 d  | 105  |  | 03.10  |   |  | 13.0460-7238.2 607238<br>13.0470-7238.2 LD7238  | 1  | 23313 20,3 +/WE ATE<br>23313 20,3 +/WE ATE<br>Warnkontakt L=867mm   |
|  | xDrive 20 d  | 130  |  | 03.10  |   |  |   |  |   |
|  | xDrive 20 d  | 135  |  | 07.12  |   |  | 24.8190-0286.2 620286   |  |   |
|  | xDrive 20 i  | 135  |  | 09.11  |   |  |   |  |   |
|  | xDrive 23 d  | 150  |  | 03.12  |   |  |   |  |   |
|  | xDrive 25 d  | 160  |  | 07.12  |   |  |   |  |   |
|  | xDrive 25 i  | 160  |  | 03.12  |   |  |   |  |   |
|  | xDrive 28 i  | 180  |  | 03.12  |   |  |   |  |   |
|  | xDrive 23 d  | 150  |  | 03.10  | 02.12   |  | 13.0460-7216.2 607216<br>13.0470-7216.2 LD7216  | 1  | 23794 20,3 +/WE ATE<br>23794 20,3 +/WE ATE<br>Warnkontakt L=867mm   |
|  | xDrive 25 i  | 160  |  | 03.10  | 02.12   |  |   |  |   |
|  | xDrive 28 i  | 180  |  | 04.11  | 02.12   |  | 24.8190-0286.2 620286   |  |   |
|  | xDrive 28 i  | 190  |  | 10.09  | 02.10   |  | 13.0460-7237.2 607237<br>13.0470-7237.2 LD7237<br>13.0460-7238.2 607238<br>13.0470-7238.2 LD7238<br>24.8190-0266.2 620266 | 1  | 24161 20,3 +/WE ATE<br>24161 20,3 +/WE ATE<br>23313 20,3 +/WE ATE<br>23313 20,3 +/WE ATE<br>Warnkontakt L=840mm |
|  | xDrive 28 i  | 190  |  | 03.10  |   |  | 13.0460-7237.2 607237<br>13.0470-7237.2 LD7237<br>13.0460-7238.2 607238<br>13.0470-7238.2 LD7238<br>24.8190-0286.2 620286 | 1  | 24161 20,3 +/WE ATE<br>24161 20,3 +/WE ATE<br>23313 20,3 +/WE ATE<br>23313 20,3 +/WE ATE<br>Warnkontakt L=867mm |
|    | sDrive 16 d  | 85   |  | 07.12  |   |  | 24.0124-0203.1 424203<br>24.0324-0203.1 524203  |  | 312 23,9 22,4 V L +S +B<br>312 23,9 22,4 V L +S +B PD   |
|  | sDrive 16 i  | 105  |  | 03.13  |   |  |   |  |   |
|  | sDrive 18 d  | 105  |  | 10.09  |   |  |   |  |   |
|  | sDrive 18 i  | 110  |  | 10.09  |   |  |   |  |   |
|  | sDrive 20 d  | 130  |  | 10.09  |   |  |   |  |   |
|  | sDrive 20 d ed   | 135  |  | 07.12  |   |  |   |  |   |
|  | sDrive 20 i  | 120  |  | 03.10  |   |  |   |  |   |
|  | sDrive 20 i  | 135  |  | 09.11  |   |  |   |  |   |
|  | xDrive 18 d  | 105  |  | 10.09  |   |  |   |  |   |
|  | xDrive 20 d  | 130  |  | 10.09  |   |  |   |  |   |
|  | xDrive 20 d  | 135  |  | 07.12  |   |  |   |  |   |
|  | xDrive 20 i  | 135  |  | 09.11  |   |  |   |  |   |
|  | xDrive 23 d  | 150  |  | 03.12  |   |  |   |  |   |
|  | xDrive 25 d  | 160  |  | 07.12  |   |  |   |  |   |
|  | xDrive 25 i  | 160  |  | 03.12  |   |  |   |  |   |
|  | xDrive 28 i  | 180  |  | 03.12  |   |  |   |  |   |
|  | xDrive 23 d  | 150  |  | 10.09  | 02.12   |  | 24.0124-0200.1 424200<br>24.0324-0200.1 524200  |  | 330 24,0 22,4 V L +S +B<br>330 24,0 21,6 V L +S +B PD   |
|  | xDrive 25 i  | 160  |  | 03.10  | 02.12   |  |   |  |   |
|  | xDrive 28 i  | 180  |  | 04.11  | 02.12   |  |   |  |   |
|  | xDrive 28 i  | 190  |  | 10.09  |   |  | 24.0130-0192.1 430192   |  | 348 30,0 28,4 V L +S +B   |
|  | sDrive 18 d  | 105  |  | 10.09  | 02.10   |  | 13.0460-7217.2 607217<br>13.0470-7217.2 LD7217  | 1  | 23926 17,3 +/WE ATE<br>23926 17,3 +/WE ATE<br>Warnkontakt L=1120mm  |
|  | sDrive 20 d  | 130  |  | 10.09  | 02.10   |  |   |  |   |
|  | xDrive 18 d  | 105  |  | 10.09  | 02.10   |  | 24.8190-0282.2 620282   |  |   |
|  | xDrive 20 d  | 130  |  | 10.09  | 02.10   |  |   |  |   |
|  | xDrive 23 d  | 150  |  | 10.09  | 02.10   |  |   |  |   |
|  | sDrive 16 d  | 85   |  | 07.12  |   |  | 13.0460-7217.2 607217<br>13.0470-7217.2 LD7217  | 1  | 23926 17,3 +/WE ATE<br>23926 17,3 +/WE ATE<br>Warnkontakt L=1141mm  |
|  | sDrive 16 i  | 105  |  | 03.13  |   |  |   |  |   |
|  | sDrive 18 d  | 105  |  | 03.10  |   |  | 24.8190-0296.2 620296   |  |   |
|  | sDrive 18 i  | 110  |  | 03.10  |   |  |   |  |   |
|  | sDrive 20 d  | 130  |  | 03.10  |   |  |   |  |   |
|  | sDrive 20 d ed   | 135  |  | 07.12  |   |  |   |  |   |
|  | sDrive 20 i  | 120  |  | 03.10  |   |  |   |  |   |
|  | sDrive 20 i  | 135  |  | 09.11  |   |  |   |  |   |
|  | xDrive 18 d  | 105  |  | 03.10  |   |  |   |  |   |
|  | xDrive 20 d  | 130  |  | 03.10  |   |  |   |  |   |
|  | xDrive 20 d  | 135  |  | 07.12  |   |  |   |  |   |
|  | xDrive 20 i  | 135  |  | 09.11  |   |  |   |  |   |
|  | xDrive 23 d  | 150  |  | 03.10  |   |  |   |  |   |
|  | xDrive 25 d  | 160  |  | 07.12  |   |  |   |  |   |
|  | xDrive 25 i  | 160  |  | 03.10  |   |  |   |  |   |
|  | xDrive 28 i  | 180  |  | 04.11  |   |  |   |  |   |
|  | xDrive 28 i  | 190  |  | 10.09  | 02.10   |  | 13.0460-7225.2 607225<br>13.0470-7225.2 LD7225<br>24.8190-0282.2 620282   | 1  | 23550 17,3 +/WE ATE<br>23550 17,3 +/WE ATE<br>Warnkontakt L=1120mm  |
|  | xDrive 28 i  | 190  |  | 03.10  |   |  | 13.0460-7225.2 607225<br>13.0470-7225.2 LD7225<br>24.8190-0296.2 620296   | 1  | 23550 17,3 +/WE ATE<br>23550 17,3 +/WE ATE<br>Warnkontakt L=1141mm  |
|  | sDrive 16 d  | 85   |  | 07.12  |   |  | 24.0120-0204.1 420204<br>24.0320-0204.1 520204  |  | 300 20,0 18,4 V L +S +B<br>300 20,0 18,4 V L +S +B PD   |
|  | sDrive 16 i  | 105  |  | 03.13  |   |  |   |  |   |
|  | sDrive 18 d  | 105  |  | 10.09  |   |  |   |  |   |
|  | sDrive 18 i  | 110  |  | 03.10  |   |  |   |  |   |
|  | sDrive 20 d  | 130  |  | 10.09  |   |  |   |  |   |
|  | sDrive 20 d ed   | 135  |  | 07.12  |   |  |   |  |   |
|  | sDrive 20 i  | 120  |  | 03.10  |   |  |   |  |   |

|     |  |  |  |  |  |  |  |  |     |
|--|--|--|--|--|---|--|--|--|-----|
| <b>BMW X1/E84 (09-)</b>  |  |  |  |  |   |  |  |  |     |
|    | sDrive 20 i  | 135  |  | 09.11  | 24.0120-0204.1  | 420204   |  | 300 20,0 18,4 V L +S +B  |     |
|  | xDrive 18 d  | 105  |  | 10.09  | 24.0320-0204.1  | 520204   |  | 300 20,0 18,4 V L +S +B PD   |     |
|  | xDrive 20 d  | 130  |  | 10.09  |   |  |  |  |     |
|  | xDrive 20 d  | 135  |  | 07.12  |   |  |  |  |     |
|  | xDrive 20 i  | 135  |  | 09.11  |   |  |  |  |     |
|  | xDrive 23 d  | 150  |  | 10.09  |   |  |  |  |     |
|  | xDrive 25 d  | 160  |  | 07.12  |   |  |  |  |     |
|  | xDrive 25 i  | 160  |  | 03.10  |   |  |  |  |     |
|  | xDrive 28 i  | 180  |  | 04.11  |   |  |  |  |     |
|  | xDrive 28 i  | 190  |  | 10.09  | 24.0122-0236.1  | 422236   |  | 336 22,0 20,4 V L +S +B  |     |
|  |  |  |  |  | 24.0322-0236.1  | 522236   |  | 336 22,0 20,4 V L +S +B PD   |     |
|    | sDrive 16 d  | 85   |  | 07.12  | 03.0137-0305.2  | 650305   |  | 185 x 20   |     |
|  | sDrive 16 i  | 105  |  | 03.13  | 03.0137-9062.2  | 669062   |  | Bremsbacken-Zubehör  |     |
|  | sDrive 18 d  | 105  |  | 10.09  | 03.0137-9700.2  | 669700   |  | Bremsbacken-Zubehör  |     |
|  | sDrive 18 i  | 110  |  | 03.10  | 03.0137-9702.2  | 669702   |  | Spreizschloß Satz  |     |
|  | sDrive 20 d  | 130  |  | 10.09  |   |  |  |  |     |
|  | sDrive 20 d  | 135  |  | 07.12  |   |  |  |  |     |
|  | sDrive 20 d ed   | 120  |  | 03.10  |   |  |  |  |     |
|  | sDrive 20 i  | 135  |  | 09.11  |   |  |  |  |     |
|  | xDrive 18 d  | 105  |  | 10.09  |   |  |  |  |     |
|  | xDrive 20 d  | 130  |  | 10.09  |   |  |  |  |     |
|  | xDrive 20 d  | 135  |  | 07.12  |   |  |  |  |     |
|  | xDrive 20 i  | 135  |  | 09.11  |   |  |  |  |     |
|  | xDrive 23 d  | 150  |  | 10.09  |   |  |  |  |     |
|  | xDrive 25 d  | 160  |  | 07.12  |   |  |  |  |     |
|  | xDrive 25 i  | 160  |  | 03.10  |   |  |  |  |     |
|  | xDrive 28 i  | 180  |  | 04.11  |   |  |  |  |     |
|  | xDrive 28 i  | 190  |  | 10.09  |   |  |  |  |     |
|  | <b>BMW X1/F48 (15-)</b>  |  |  |  |   |  |  |  |     |
|    | sDrive 16d   | 85   |  | 09.15  | 24.0124-0260.1  | 424260   |  | 307 24,0 22,4 V L +B   |     |
|  | sDrive 18d   | 100  |  | 09.15  |   |  |  |  |     |
|  | sDrive 18d   | 110  |  | 09.15  |   |  |  |  |     |
|  | sDrive 18i   | 100  |  | 09.15  |   |  |  |  |     |
|  | xDrive 18d   |  |  | 09.15  |   |  |  |  |     |
|  | sDrive 20d   | 120  |  | 11.15  | 24.0124-0259.1  | 424259   |  | 330 24,0 22,4 V L +S +B  |     |
|  | sDrive 20d   | 140  |  | 11.15  |   |  |  |  |     |
|  | sDrive 20i   | 141  |  | 09.15  |   |  |  |  |     |
|  | xDrive 20d   | 120  |  | 11.15  |   |  |  |  |     |
|  | xDrive 20d   | 140  |  | 09.15  |   |  |  |  |     |
|  | xDrive 20i   | 141  |  | 09.15  |   |  |  |  |     |
|  | xDrive 25d   | 170  |  | 09.15  |   |  |  |  |     |
|  | xDrive 25i   | 170  |  | 09.15  |   |  |  |  |     |
|  | sDrive 16d   | 85   |  | 09.15  | 24.8190-0942.2  | 620942   | 1  | elektrische Feststellbremse <sup>1)</sup>  |     |
|  | sDrive 18d   | 100  |  | 09.15  |   |  |  | Warnkontakt L=641mm  |     |
|  | sDrive 18d   | 110  |  | 09.15  |   |  |  |  |     |
|  | sDrive 18i   | 100  |  | 09.15  |   |  |  |  |     |
|  | sDrive 20d   | 120  |  | 11.15  |   |  |  |  |     |
|  | sDrive 20d   | 140  |  | 11.15  |   |  |  |  |     |
|  | sDrive 20i   | 141  |  | 09.15  |   |  |  |  |     |
|  | xDrive 18d   | 120  |  | 09.15  |   |  |  |  |     |
|  | xDrive 20d   | 120  |  | 11.15  |   |  |  |  |     |
|  | xDrive 20d   | 140  |  | 09.15  |   |  |  |  |     |
|  | xDrive 20i   | 141  |  | 09.15  |   |  |  |  |     |
|  | xDrive 25d   | 170  |  | 09.15  |   |  |  |  |     |
| xDrive 25i   | 170  |  | 09.15  |  |   |  |  |  |     |
| <b>BMW X3/E83 (03-10)</b>  |  |  |  |  |   |  |  |  |     |
|  | 2.0 d  | 110  |  | 08.04  | 08.10   | 13.0460-7155.2   | 607155   | 23183 20,3 +/WE  | ATE |
|  | 2.0 d  | 130  |  | 09.07  | 08.10   | 13.0470-7155.2   | LD7155   | 23183 20,3 +/WE  | ATE |
|  | 2.0 i  | 110  |  | 07.05  | 08.10   | 24.8190-0240.2   | 620240   | Warnkontakt L=735mm  |     |
|  | 2.5 i  | 141  |  | 03.04  | 08.06   |  |  |  |     |
|  | 2.5 si   | 160  |  | 09.06  | 08.10   |  |  |  |     |
|  | 3.0 d  | 150  |  | 10.03  | 08.06   |  |  |  |     |
|  | 3.0 d  | 160  |  | 01.04  | 08.10   |  |  |  |     |
|  | 3.0 i  | 170  |  | 10.03  | 08.06   |  |  |  |     |
|  | 3.0 si   | 200  |  | 09.06  | 08.10   |  |  |  |     |
|  | xDrive 18 d  | 105  |  | 09.08  | 08.10   |  |  |  |     |
|  | xDrive 20 d  | 120  |  | 09.08  | 08.10   |  |  |  |     |
|  | xDrive 20 d  | 130  |  | 09.08  | 08.10   |  |  |  |     |
|  | xDrive 20 i  | 110  |  | 09.08  | 08.10   |  |  |  |     |
|  | xDrive 25 i  | 160  |  | 09.08  | 08.10   |  |  |  |     |
|  | xDrive 30 d  | 155  |  | 09.08  | 08.10   |  |  |  |     |
|  | xDrive 30 d  | 160  |  | 09.08  | 08.10   |  |  |  |     |
|  | xDrive 30 i  | 200  |  | 09.08  | 08.10   |  |  |  |     |
|  | 3.0 sd   | 210  |  | 09.06  | 08.10   | 13.0460-7078.2   | 607078   | 21486 19,3 +/WE  | ATE |
|  | xDrive 35 d  | 210  |  | 09.08  | 08.10   | 24.8190-0254.2   | 620254   | Warnkontakt L=745mm  |     |
|  | 2.0 d  | 110  |  | 08.04  | 08.10   | 24.0125-0160.1   | 425160   | 325 25,0 23,4 V L +S +B  |     |
|  | 2.0 d  | 130  |  | 09.07  | 08.10   | 24.0325-0160.1   | 525160   | 325 25,0 22,6 V L +S +B PD   |     |
|  | 2.0 i  | 110  |  | 07.05  | 08.10   |  |  |  |     |
|  | 2.5 i  | 141  |  | 03.04  | 08.06   |  |  |  |     |
|  | 2.5 si   | 160  |  | 09.06  | 08.10   |  |  |  |     |
|  | 3.0 d  | 150  |  | 10.03  | 08.06   |  |  |  |     |
|  | 3.0 d  | 160  |  | 01.04  | 08.10   |  |  |  |     |
|  | 3.0 i  | 170  |  | 10.03  | 08.06   |  |  |  |     |
|  | 3.0 si   | 200  |  | 09.06  | 08.10   |  |  |  |     |
|  | xDrive 18 d  | 105  |  | 09.08  | 08.10   |  |  |  |     |
| ↓  |  |  |  |  |   |  |  |  |     |

<sup>1)</sup> electric parking brake / fr.di stazionamento elettrico / frein à main électrique / freno de mano eléctrico





























**BMW X3/E83 (03-10)**

|  |  |   |  |  |  |   |  |  |
|--|--|---|--|--|--|---|--|--|
|  | xDrive 20 d<br>xDrive 20 d<br>xDrive 20 i<br>xDrive 25 i<br>xDrive 30 d<br>xDrive 30 d<br>xDrive 30 i  | 120<br>130<br>110<br>160<br>155<br>160<br>200   |  | 09.08 08.10<br>09.08 08.10<br>09.08 08.10<br>09.08 08.10<br>09.08 08.10<br>09.08 08.10<br>09.08 08.10  |  | 24.0125-0160.1 425160<br>24.0325-0160.1 525160                            |  | 325 25,0 23,4 V L +S +B<br>325 25,0 22,6 V L +S +B PD              |
|  | 3.0 sd<br>xDrive 35 d  | 210<br>210  |  | 09.06 08.10<br>09.08 08.10   |  | 24.0130-0109.1 430109<br>24.0330-0109.1 530109                            |  | 332 29,9 28,4 V L +S +B<br>332 29,9 27,6 V L +S +B PD              |
|  | 2.0 d<br>2.0 d<br>2.0 i<br>2.5 i<br>2.5 si<br>3.0 d<br>3.0 d<br>3.0 i<br>3.0 sd<br>3.0 si<br>xDrive 18 d<br>xDrive 20 d<br>xDrive 20 d<br>xDrive 20 i<br>xDrive 25 i<br>xDrive 30 d<br>xDrive 30 d<br>xDrive 30 i<br>xDrive 35 d | 110<br>130<br>110<br>141<br>160<br>150<br>160<br>170<br>210<br>200<br>105<br>120<br>130<br>110<br>160<br>155<br>160<br>200<br>210 |  | 08.04 08.10<br>09.07 08.10<br>07.05 08.10<br>03.04 08.06<br>09.06 08.10<br>10.03 08.06<br>01.04 08.10<br>10.03 08.06<br>09.06 08.10<br>09.06 08.10<br>09.08 08.10<br>09.08 08.10<br>09.08 08.10<br>09.08 08.10<br>09.08 08.10<br>09.08 08.10<br>09.08 08.10<br>09.08 08.10 |  | 13.0460-7079.2 607079<br>13.0470-7079.2 LD7079<br>24.8190-0241.2 620241 1 |  | 21487 17,3 +/WE ATE<br>21487 17,3 +/WE ATE<br>Warnkontakt L=1055mm |
|  | 2.0 d<br>2.0 d<br>2.0 i<br>2.5 i<br>2.5 si<br>3.0 d<br>3.0 d<br>3.0 i<br>3.0 sd<br>3.0 si<br>xDrive 18 d<br>xDrive 20 d<br>xDrive 20 d<br>xDrive 20 i<br>xDrive 25 i<br>xDrive 30 d<br>xDrive 30 d<br>xDrive 30 i<br>xDrive 35 d | 110<br>130<br>110<br>141<br>160<br>150<br>160<br>170<br>210<br>200<br>105<br>120<br>130<br>110<br>160<br>155<br>160<br>200<br>210 |  | 08.04 08.10<br>09.07 08.10<br>07.05 08.10<br>03.04 08.06<br>09.06 08.10<br>10.03 08.06<br>01.04 08.10<br>10.03 08.06<br>09.06 08.10<br>09.06 08.10<br>09.08 08.10<br>09.08 08.10<br>09.08 08.10<br>09.08 08.10<br>09.08 08.10<br>09.08 08.10<br>09.08 08.10<br>09.08 08.10 |  | 24.0122-0224.1 422224<br>24.0322-0224.1 522224                            |  | 320 22,0 20,4 V L +S +B<br>320 22,0 20,4 V L +S +B PD              |
|  | 2.0 d<br>2.0 d<br>2.0 i<br>2.5 i<br>2.5 si<br>3.0 d<br>3.0 d<br>3.0 i<br>3.0 sd<br>3.0 si<br>xDrive 18 d<br>xDrive 20 d<br>xDrive 20 d<br>xDrive 20 i<br>xDrive 25 i<br>xDrive 30 d<br>xDrive 30 d<br>xDrive 30 i<br>xDrive 35 d | 110<br>130<br>110<br>141<br>160<br>150<br>160<br>170<br>210<br>200<br>105<br>120<br>130<br>110<br>160<br>155<br>160<br>200<br>210 |  | 08.04 08.10<br>09.07 08.10<br>07.05 08.10<br>03.04 08.06<br>09.06 08.10<br>10.03 08.06<br>01.04 08.10<br>10.03 08.06<br>09.06 08.10<br>09.06 08.10<br>09.08 08.10<br>09.08 08.10<br>09.08 08.10<br>09.08 08.10<br>09.08 08.10<br>09.08 08.10<br>09.08 08.10<br>09.08 08.10 |  | 03.0137-0419.2 650419<br>03.0137-9288.2 669288                            |  | 185 x 30<br>Bremsbacken-Zubehör                                    |

**BMW X3/F25 (10-)**

|  |   |   |  |  |  |   |  |   |
|--|---|---|--|--|--|---|--|---|
|  | sDrive 18 d<br>sDrive 18 d<br>sDrive 18 d<br>sDrive 18 i<br>sDrive 20 i<br>xDrive 20 d<br>xDrive 20 d<br>xDrive 20 d<br>xDrive 20 d<br>xDrive 20 i<br>xDrive 28 i<br>xDrive 28 i<br>xDrive 30 d<br>xDrive 35 i<br>xDrive 35 d | 100<br>105<br>110<br>125<br>135<br>120<br>135<br>140<br>135<br>135<br>180<br>190<br>190<br>225<br>230 |  | 08.11<br>08.11<br>02.14<br>02.14<br>02.14<br>09.10<br>09.10<br>02.14<br>09.11<br>03.12<br>09.10<br>03.11<br>09.10<br>09.11 |  | 13.0460-3857.2 603857<br>13.0470-3857.2 LD3857<br>24.8190-0309.2 620309 1 |  | 25199 19,6 +/WE BOS<br>25199 19,6 +/WE BOS<br>Warnkontakt L=954mm |
|  | sDrive 18 d<br>sDrive 18 d<br>sDrive 18 d<br>sDrive 18 i  | 100<br>105<br>110<br>125  |  | 08.11<br>08.11<br>02.14<br>02.14   |  | 24.0128-0254.1 428254<br>24.0328-0254.1 528254                            |  | 328 28,0 26,4 V L +S +B<br>328 28,0 26,4 V L +S +B PD             |



|     |    |                |  |    |  |  |  |  |   |  |   |
|--|--|--|--|--|---|--|--|--|---|--|---|
| <b>BMW X3/F25 (10-)</b>  |  |  |  |  |   |  |  |  |   |  |   |
|    | sDrive 20 i<br>xDrive 20 d<br>xDrive 20 d<br>xDrive 20 d<br>xDrive 20 i<br>xDrive 28 i<br>xDrive 28 i<br>xDrive 30 d<br>xDrive 35 d<br>xDrive 35 i   | 135<br>120<br>135<br>140<br>135<br>180<br>190<br>190<br>230<br>225                             |  | 02.14<br>09.10<br>09.10<br>02.14<br>09.11<br>03.12<br>09.10<br>03.11<br>09.11<br>09.10                                     |   |  | 24.0128-0254.1<br>24.0328-0254.1   | 428254<br>528254   | 328 28,0 26,4 V L +S +B<br>328 28,0 26,4 V L +S +B PD                                   |  |   |
|    | sDrive 18 d<br>sDrive 18 d<br>sDrive 18 d<br>sDrive 18 i<br>sDrive 20 i<br>xDrive 20 d<br>xDrive 20 d<br>xDrive 20 d<br>xDrive 20 i<br>xDrive 28 i<br>xDrive 28 i<br>xDrive 30 d<br>xDrive 35 d<br>xDrive 35 i | 100<br>105<br>110<br>125<br>135<br>120<br>135<br>140<br>135<br>180<br>190<br>190<br>230<br>225 |  | 08.11<br>08.11<br>02.14<br>02.14<br>02.14<br>09.10<br>09.10<br>02.14<br>09.11<br>03.12<br>09.10<br>03.11<br>09.11<br>09.10 |   |  | 24.0711-6350.3   | 360391   | 2    | Radsensor L=1021   |   |
|    | sDrive 18 d<br>sDrive 18 d<br>sDrive 18 d<br>sDrive 18 i<br>sDrive 20 i<br>xDrive 20 d<br>xDrive 20 d<br>xDrive 20 d<br>xDrive 20 i<br>xDrive 28 i<br>xDrive 28 i<br>xDrive 30 d<br>xDrive 35 d<br>xDrive 35 i | 100<br>105<br>110<br>125<br>135<br>120<br>135<br>140<br>135<br>180<br>190<br>190<br>230<br>225 |  | 08.11<br>08.11<br>02.14<br>02.14<br>02.14<br>09.10<br>09.10<br>02.14<br>09.11<br>03.12<br>09.10<br>03.11<br>09.11<br>09.10 |   |  | 13.0460-2760.2<br>13.0470-2760.2<br>24.8190-0310.2                                 | 602760<br>LD2760<br>620310   | 1   | 24561 17,7 +/WE/Zub/STRW<br>24561 17,7 +/WE/Zub/STRW<br>Warnkontakt L=1243mm           |   |
|   | sDrive 18 d<br>sDrive 18 d<br>sDrive 18 d<br>sDrive 18 i<br>sDrive 20 i<br>xDrive 20 d<br>xDrive 20 d<br>xDrive 20 d<br>xDrive 20 i<br>xDrive 28 i<br>xDrive 28 i<br>xDrive 30 d<br>xDrive 35 d<br>xDrive 35 i | 100<br>105<br>110<br>125<br>135<br>120<br>135<br>140<br>135<br>180<br>190<br>190<br>230<br>225 |  | 08.11<br>08.11<br>02.14<br>02.14<br>02.14<br>09.10<br>09.10<br>02.14<br>09.11<br>03.12<br>09.10<br>03.11<br>09.11<br>09.10 |   |  | 24.0120-0234.1<br>24.0320-0234.1   | 420234<br>520234   |   | elektrische Feststellbremse <sup>1)</sup><br>elektrische Feststellbremse <sup>1)</sup> | 330 20,0 18,4 V L +S +B<br>330 20,0 18,4 V L +S +B PD |
|  | sDrive 18 d<br>sDrive 18 d<br>sDrive 18 d<br>sDrive 18 i<br>sDrive 20 i<br>xDrive 20 d<br>xDrive 20 d<br>xDrive 20 d<br>xDrive 20 i<br>xDrive 28 i<br>xDrive 28 i<br>xDrive 30 d<br>xDrive 35 d<br>xDrive 35 i | 100<br>105<br>110<br>125<br>135<br>120<br>135<br>140<br>135<br>180<br>190<br>190<br>230<br>225 |  | 08.11<br>08.11<br>02.14<br>02.14<br>02.14<br>09.10<br>09.10<br>02.14<br>09.11<br>03.12<br>09.10<br>03.11<br>09.11<br>09.10 |   |  | 24.0711-5414.3   | 360383   | 2  | Radsensor L=612  |   |
| <b>BMW X4/F26 (14-)</b>  |  |  |  |  |   |  |  |  |   |  |   |
|  | xDrive 20 d<br>xDrive 20 i<br>xDrive 28 i<br>xDrive 30 d<br>xDrive 35 i<br>xDrive 35 d   | 140<br>135<br>180<br>190<br>225<br>230   |  | 04.14<br>04.14<br>04.14<br>04.14<br>04.14<br>04.14   |   |  | 13.0460-3857.2<br>13.0470-3857.2<br>24.8190-0309.2                                 | 603857<br>LD3857<br>620309   | 1  | 25199 19,6 +/WE BOS<br>25199 19,6 +/WE BOS<br>Warnkontakt L=954mm                      |   |
|  | M 40 i   | 265  |  | 12.15  |   |  | 24.8190-0309.2   | 620309   | 1  | Warnkontakt L=954mm  |   |
|  | xDrive 20 d<br>xDrive 20 i<br>xDrive 28 i<br>xDrive 30 d<br>xDrive 35 d<br>xDrive 35 i   | 140<br>135<br>180<br>190<br>230<br>225   |  | 04.14<br>04.14<br>04.14<br>04.14<br>04.14<br>04.14   |   |  | 24.0128-0254.1<br>24.0328-0254.1   | 428254<br>528254   |   | 328 28,0 26,4 V L +S +B<br>328 28,0 26,4 V L +S +B PD                                  |   |
|  | M 40 i<br>xDrive 20 d<br>xDrive 20 i<br>xDrive 28 i  | 265<br>140<br>135<br>180   |  | 12.15<br>04.14<br>04.14<br>04.14   |   |  | 24.0711-6350.3   | 360391   | 2  | Radsensor L=1021   |   |
|  |   |  |  |  |   |  |  |  |   |  |   |

<sup>1)</sup> electric parking brake / fr.di stazionamento elettrico / frein à main électrique / freno de mano eléctrico



### BMW X4/F26 (14-)

|             |             |     |       |       |  |  |                |        |   |                            |                          |
|-------------|-------------|-----|-------|-------|--|--|----------------|--------|---|----------------------------|--------------------------|
|             | xDrive 30 d | 190 |       | 04.14 |  |  | 24.0711-6350.3 | 360391 | 2 |                            | Radsensor L=1021         |
|             | xDrive 35 d | 230 |       | 04.14 |  |  |                |        |   |                            |                          |
|             | xDrive 35 i | 225 |       | 04.14 |  |  |                |        |   |                            |                          |
|             | xDrive 20 d | 140 |       | 04.14 |  |  | 13.0460-2760.2 | 602760 | 1 |                            | 24561 17,7 +/WE/Zub/STRW |
|             | xDrive 20 i | 135 |       | 04.14 |  |  | 13.0470-2760.2 | LD2760 |   | 24561 17,7 +/WE/Zub/STRW   |                          |
|             | xDrive 28 i | 180 |       | 04.14 |  |  | 24.8190-0310.2 | 620310 |   | Warnkontakt L=1243mm       |                          |
|             | xDrive 30 d | 190 |       | 04.14 |  |  |                |        |   |                            |                          |
|             | xDrive 35 i | 225 |       | 04.14 |  |  |                |        |   |                            |                          |
|             | xDrive 35 d | 230 |       | 04.14 |  |  | 13.0460-2760.2 | 602760 |   | 24561 17,7 +/WE/Zub/STRW   |                          |
|             | M 40 i      | 265 |       | 12.15 |  |  | 24.8190-0310.2 | 620310 | 1 |                            | Warnkontakt L=1243mm     |
|             | M 40 i      | 265 |       | 12.15 |  |  | 24.0120-0234.1 | 420234 | 1 |                            | 330 20,0 18,4 V L +S +B  |
|             | xDrive 20 d | 140 |       | 04.14 |  |  | 24.0320-0234.1 | 520234 |   | 330 20,0 18,4 V L +S +B PD |                          |
|             | xDrive 20 i | 135 |       | 04.14 |  |  |                |        |   |                            |                          |
|             | xDrive 28 i | 180 |       | 04.14 |  |  |                |        |   |                            |                          |
|             | xDrive 30 d | 190 |       | 04.14 |  |  |                |        |   |                            |                          |
|             | xDrive 35 d | 230 |       | 04.14 |  |  |                |        |   |                            |                          |
| xDrive 35 i | 225         |     | 04.14 |       |  |  |                |        |   |                            |                          |
|             | M 40 i      | 265 |       | 12.15 |  |  | 24.0711-5414.3 | 360383 | 2 |                            | Radsensor L=612          |
|             | xDrive 20 d | 140 |       | 04.14 |  |  |                |        |   |                            |                          |
|             | xDrive 20 i | 135 |       | 04.14 |  |  |                |        |   |                            |                          |
|             | xDrive 28 i | 180 |       | 04.14 |  |  |                |        |   |                            |                          |
|             | xDrive 30 d | 190 |       | 04.14 |  |  |                |        |   |                            |                          |
|             | xDrive 35 d | 230 |       | 04.14 |  |  |                |        |   |                            |                          |
|             | xDrive 35 i | 225 |       | 04.14 |  |  |                |        |   |                            |                          |

### BMW X5/E53 (00-07)

















|        |        |     |       |       |                                 |                                 |                |                      |   |                      |                            |                         |
|--------|--------|-----|-------|-------|---------------------------------|---------------------------------|----------------|----------------------|---|----------------------|----------------------------|-------------------------|
|        | 3.0 d  | 135 |       | 05.01 | 09.03                           |                                 | 13.0460-7078.2 | 607078               | 1 |                      | 21486 19,3 +/WE            | ATE                     |
|        | 3.0 d  | 160 |       | 10.03 | 12.06                           |                                 | 13.0470-7078.2 | LD7078               |   | 21486 19,3 +/WE      | ATE                        |                         |
|        | 3.0 i  | 170 |       | 04.00 | 12.06                           |                                 | 13.0460-7078.2 | 607078               |   | 21486 19,3 +/WE      | ATE                        |                         |
|        | 4.4 i  | 210 |       | 04.00 | 09.03                           |                                 | 24.8190-0225.2 | 620225               |   | Warnkontakt L=794mm  |                            |                         |
|        | 4.4 i  | 235 |       | 10.03 | 12.06                           | - Sonderfahrzeuge <sup>1)</sup> |                |                      |   |                      |                            |                         |
|        | 4.4 i  | 235 |       | 10.03 | 12.06                           | + Sonderfahrzeuge <sup>2)</sup> | 13.0460-7170.2 | 607170               | 1 |                      | 23448 20,8 +/WE            | ATE                     |
|        | 4.6 iS | 255 |       | 12.01 | 09.03                           |                                 | 24.8190-0225.2 | 620225               |   | Warnkontakt L=794mm  |                            |                         |
|        | 4.8 iS | 265 |       | 03.04 | 12.06                           |                                 |                |                      |   |                      |                            |                         |
|        | 3.0 d  | 135 |       | 05.01 | 09.03                           |                                 | 24.0130-0109.1 | 430109               |   | 1                    |                            | 332 29,9 28,4 V L +S +B |
|        | 3.0 d  | 160 |       | 10.03 | 12.06                           |                                 | 24.0330-0109.1 | 530109               |   |                      | 332 29,9 27,6 V L +S +B PD |                         |
| 3.0 i  | 170    |     | 04.00 | 12.06 |                                 |                                 |                |                      |   |                      |                            |                         |
| 4.4 i  | 210    |     | 04.00 | 09.03 | - Sonderfahrzeuge <sup>1)</sup> |                                 |                |                      |   |                      |                            |                         |
| 4.4 i  | 235    |     | 10.03 | 12.06 | + Sonderfahrzeuge <sup>2)</sup> | 24.0136-0104.1                  | 436104         | 356 36,0 34,4 V L +B |   |                      |                            |                         |
|        | 3.0 d  | 135 |       | 05.01 | 09.03                           |                                 | 24.0710-2011.1 | 360218               | 2 |                      | Radsensor L=640            |                         |
|        | 3.0 i  | 170 |       | 04.00 | 09.03                           |                                 |                |                      |   |                      |                            |                         |
|        | 4.4 i  | 210 |       | 04.00 | 09.03                           |                                 |                |                      |   |                      |                            |                         |
|        | 4.6 iS | 255 |       | 12.01 | 09.03                           |                                 |                |                      |   |                      |                            |                         |
|        | 3.0 d  | 135 |       | 05.01 | 09.03                           |                                 | 13.0460-7079.2 | 607079               | 1 |                      | 21487 17,3 +/WE            | ATE                     |
|        | 3.0 d  | 160 |       | 10.03 | 12.06                           |                                 | 13.0470-7079.2 | LD7079               |   | 21487 17,3 +/WE      | ATE                        |                         |
|        | 3.0 i  | 170 |       | 04.00 | 12.06                           |                                 | 24.8190-0226.2 | 620226               |   | Warnkontakt L=712mm  |                            |                         |
|        | 4.4 i  | 210 |       | 04.00 | 09.03                           |                                 | 13.0460-7079.2 | 607079               |   | 21487 17,3 +/WE      | ATE                        |                         |
|        | 4.8 iS | 265 |       | 03.04 | 12.06                           |                                 | 24.8190-0226.2 | 620226               |   | Warnkontakt L=712mm  |                            |                         |
|        | 3.0 d  | 135 |       | 05.01 | 09.03                           |                                 | 24.0112-0152.1 | 412152               | 1 |                      | 324 12,0 10,4 L +B         |                         |
|        | 3.0 d  | 160 |       | 10.03 | 12.06                           |                                 | 24.0312-0152.1 | 512152               |   | 324 12,0 9,6 L +B PD |                            |                         |
|        | 3.0 i  | 170 |       | 04.00 | 12.06                           |                                 |                |                      |   |                      |                            |                         |
|        | 4.4 i  | 210 |       | 04.00 | 09.03                           |                                 | 24.0120-0191.1 | 420191               |   | 324 20,0 18,4 V L +B |                            |                         |
|        | 4.4 i  | 235 |       | 10.03 | 12.06                           |                                 |                |                      |   |                      |                            |                         |
|        | 4.6 iS | 255 |       | 12.01 | 09.03                           |                                 |                |                      |   |                      |                            |                         |
|        | 4.8 iS | 265 |       | 03.04 | 12.06                           |                                 |                |                      |   |                      |                            |                         |
|        | 3.0 d  | 135 |       | 05.01 | 09.03                           |                                 | 24.0710-2012.1 | 360219               | 2 |                      | Radsensor L=655            |                         |
|        | 3.0 i  | 170 |       | 04.00 | 09.03                           |                                 |                |                      |   |                      |                            |                         |
|        | 4.4 i  | 210 |       | 04.00 | 09.03                           |                                 |                |                      |   |                      |                            |                         |
| 4.6 iS | 255    |     | 12.01 | 09.03 |                                 |                                 |                |                      |   |                      |                            |                         |
|        |        |     | 03.04 | 12.06 |                                 |                                 |                |                      |   |                      |                            |                         |
|        | 3.0 d  | 135 |       | 05.01 | 09.03                           |                                 | 03.0137-0419.2 | 650419               | 1 |                      | 185 x 30                   |                         |
|        | 3.0 d  | 160 |       | 10.03 | 12.06                           |                                 | 03.0137-9288.2 | 669288               |   | Bremsbacken-Zubehör  |                            |                         |
|        | 3.0 i  | 170 |       | 04.00 | 12.06                           |                                 |                |                      |   |                      |                            |                         |
|        | 4.4 i  | 210 |       | 04.00 | 09.03                           |                                 |                |                      |   |                      |                            |                         |
|        | 4.4 i  | 235 |       | 10.03 | 12.06                           |                                 |                |                      |   |                      |                            |                         |
|        | 4.6 iS | 255 |       | 12.01 | 09.03                           |                                 |                |                      |   |                      |                            |                         |
|        | 4.8 iS | 265 |       | 03.04 | 12.06                           |                                 |                |                      |   |                      |                            |                         |
|        |        |     |       |       |                                 |                                 |                |                      |   |                      |                            |                         |

### BMW X5/E70 (07-13)



















|  |             |     |  |       |               |  |                |        |   |                     |                     |                 |     |
|--|-------------|-----|--|-------|---------------|--|----------------|--------|---|---------------------|---------------------|-----------------|-----|
|  | 3.0 d       | 173 |  | 01.07 | 07.13         |  | 13.0460-7231.2 | 607231 | 1 |                     | 24170 20,2 +/WE     | ATE             |     |
|  | 3.0 sd      | 210 |  | 10.08 | 07.13         |  | 13.0470-7231.2 | LD7231 |   | 24170 20,2 +/WE     | ATE                 |                 |     |
|  | 3.0 si      | 200 |  | 01.07 | 07.13         |  | 24.8190-0268.2 | 620268 |   | Warnkontakt L=905mm |                     |                 |     |
|  | xDrive 30 i | 200 |  | 09.08 | 07.13         |  |                |        |   |                     |                     |                 |     |
|  | xDrive 35 d | 210 |  | 09.08 | 07.13         |  |                |        |   |                     |                     |                 |     |
|  | 4.8 i       | 261 |  | 01.07 | 07.13 + (USA) |  | 13.0460-7231.2 | 607231 |   | 1                   |                     | 24170 20,2 +/WE | ATE |
|  | xDrive 48 i | 261 |  | 09.08 | 02.10 + (USA) |  | 24.8190-0268.2 | 620268 |   |                     | Warnkontakt L=905mm |                 |     |

<sup>1)</sup> - special vehicles / - veicoli speciali / - vehicule special / - vehiculo especial  
<sup>2)</sup> + special vehicles / + veiculo speciale / + vehicule special / + vehiculo especial





































|     |  |  |  |  |  |  |  |     |   |            |
|--|--|--|--|--|---|--|--|---|---|------------|
| <b>BMW X5/E70 (07-13)</b>  |  |  |  |  |   |  |  |   |   |            |
|    | xDrive 30 d  | 173  |  | 09.08  | 07.13   | 13.0460-7231.2   | 607231   | 1  | 24170 20,2 +/-WE<br>24170 20,2 +/-WE<br>Warnkontakt L=938mm | ATE<br>ATE |
|  | xDrive 30 d  | 180  |  | 09.10  | 07.13   | 13.0470-7231.2   | LD7231   |   |   |            |
|  | xDrive 30 i  | 200  |  | 03.10  | 07.13   | 24.8190-0289.2   | 620289   |   |   |            |
|  | xDrive 35 i  | 225  |  | 09.10  | 07.13   |  |  |   |   |            |
|  | xDrive 40 d  | 225  |  | 09.10  | 07.13   |  |  |   |   |            |
|  | xDrive 48 i  | 261  |  | 03.10  | 07.13   | + (USA)<br>13.0460-7231.2  | 607231   |   |   |            |
|  |  |  |  |  |   | 24.8190-0289.2   | 620289   |   |   |            |
|  | 3.0 sd   | 210  |  | 09.07  | 09.08   | 13.0460-7239.2   | 607239   |   |   |            |
|  |  |  |  |  |   | 13.0470-7239.2   | LD7239   |   |   |            |
|  |  |  |  |  |   | 24.8190-0270.2   | 620270   |   |   |            |
|  | 4.8 i  | 261  |  | 01.07  | 07.13   | - (USA)<br>13.0460-7239.2  | 607239   |   |   |            |
|  | xDrive 48 i  | 261  |  | 09.08  | 02.10   | - (USA)<br>24.8190-0270.2  | 620270   |   |   |            |
|  | xDrive 48 i  | 261  |  | 03.10  | 07.13   | - (USA)<br>13.0460-7239.2  | 607239   |   |   |            |
|  |  |  |  |  |   | 24.8190-0291.2   | 620291   |   |   |            |
| M 50 d   | 280  |  | 06.12  | 07.13  | 13.0460-7261.2  | 607261   |  |   |   |            |
| xDrive 50 i  | 300  |  | 03.10  | 07.13  | - gepanzerte Fahrzeuge <sup>1)</sup><br>24.8190-0071.2                            | 620071   |  |   |   |            |
| xDrive 50 i  | 300  |  | 03.10  | 07.13  | + gepanzerte Fahrzeuge <sup>2)</sup><br>24.8190-0291.2                            | 620291   |  |   |   |            |
| M  | 408  |  | 09.09  | 02.10  | 24.8190-0281.2  | 620281   |  |   |   |            |
| M  | 408  |  | 03.10  | 07.13  | 24.8190-0291.2  | 620291   |  |   |   |            |
|    | 3.0 si   | 200  |  | 01.07  | 07.13   | 24.0130-0200.1   | 430200   |   | 332 29,9 28,4 V L +S +B                                     |            |
|  | xDrive 30 d  | 173  |  | 09.08  | 07.13   |  |  |   |   |            |
|  | xDrive 30 d  | 180  |  | 09.10  | 07.13   |  |  |   |   |            |
|  | xDrive 30 i  | 200  |  | 09.08  | 07.13   |  |  |   |   |            |
|  | 3.0 d  | 173  |  | 01.07  | 07.13   | 24.0130-0199.1   | 430199   |   |   |            |
|  | 3.0 sd   | 210  |  | 10.08  | 07.13   |  |  |   |   |            |
|  | 4.8 i  | 261  |  | 01.07  | 07.13   | + (USA)  |  |   |   |            |
|  | xDrive 35 d  | 210  |  | 09.08  | 07.13   |  |  |   |   |            |
|  | xDrive 35 i  | 225  |  | 09.10  | 07.13   |  |  |   |   |            |
|  | xDrive 40 d  | 225  |  | 09.10  | 07.13   |  |  |   |   |            |
|  | xDrive 48 i  | 261  |  | 09.08  | 07.13   | + (USA)  |  |   |   |            |
|  | 3.0 sd   | 210  |  | 09.07  | 09.08   | 24.0136-0109.1   | 436109   |   |   |            |
|  | 4.8 i  | 261  |  | 01.07  | 07.13   | - (USA)  |  |   |   |            |
|  | xDrive 48 i  | 261  |  | 09.08  | 07.13   | - (USA)  |  |   |   |            |
| xDrive 50 i  | 300  |  | 03.10  | 07.13  | + gepanzerte Fahrzeuge <sup>2)</sup>  |  |  |   |   |            |
| M 50 d   | 280  |  | 06.12  | 07.13  | 24.0136-0113.2  | 436113   |  |   |   |            |
| xDrive 50 i  | 300  |  | 03.10  | 07.13  | - gepanzerte Fahrzeuge <sup>1)</sup><br>24.0136-0112.2                            | 436112   |  |   |   |            |
|   | 3.0 d  | 173  |  | 01.07  | 07.13   | 24.0710-5017.3   | 360408   | 2  | Radsensor L=565   |            |
|  | 3.0 sd   | 210  |  | 09.07  | 09.08   |  |  |   |   |            |
|  | 3.0 si   | 200  |  | 01.07  | 07.13   |  |  |   |   |            |
|  | 4.8 i  | 261  |  | 01.07  | 07.13   |  |  |   |   |            |
|  | M  | 408  |  | 09.09  | 07.13   |  |  |   |   |            |
|  | M 50 d   | 280  |  | 06.12  | 07.13   |  |  |   |   |            |
|  | xDrive 30 d  | 173  |  | 09.08  | 07.13   |  |  |   |   |            |
|  | xDrive 30 d  | 180  |  | 09.10  | 07.13   |  |  |   |   |            |
|  | xDrive 30 i  | 200  |  | 09.08  | 07.13   |  |  |   |   |            |
|  | xDrive 35 d  | 210  |  | 09.08  | 07.13   |  |  |   |   |            |
|  | xDrive 35 i  | 225  |  | 09.10  | 07.13   |  |  |   |   |            |
|  | xDrive 40 d  | 225  |  | 09.10  | 07.13   |  |  |   |   |            |
|  | xDrive 48 i  | 261  |  | 09.08  | 07.13   |  |  |   |   |            |
|  | xDrive 50 i  | 300  |  | 03.10  | 07.13   |  |  |   |   |            |
|  | 3.0 d  | 173  |  | 01.07  | 02.10   | 13.0460-7232.2   | 607232   | 1   | 23447 17,3 +/-WE<br>23447 17,3 +/-WE<br>Warnkontakt L=965mm | ATE<br>ATE |
|  | 3.0 sd   | 210  |  | 10.09  | 02.10   | 13.0470-7232.2   | LD7232   |   |   |            |
|  | 3.0 si   | 200  |  | 01.07  | 02.10   | 24.8190-0269.2   | 620269   |   |   |            |
|  | xDrive 30 d  | 173  |  | 09.08  | 02.10   |  |  |   |   |            |
|  | xDrive 30 i  | 200  |  | 09.08  | 02.10   |  |  |   |   |            |
|  | xDrive 35 d  | 210  |  | 09.08  | 02.10   |  |  |   |   |            |
|  | 3.0 d  | 173  |  | 03.10  | 07.13   | 13.0460-7232.2   | 607232   |   |   |            |
|  | 3.0 sd   | 210  |  | 03.10  | 07.13   | 13.0470-7232.2   | LD7232   |   |   |            |
|  | 3.0 si   | 200  |  | 03.10  | 07.13   | 24.8190-0290.2   | 620290   |   |   |            |
|  | xDrive 30 d  | 173  |  | 03.10  | 07.13   | 24.8190-0028.2   | 620028   |   |   |            |
|  | xDrive 30 d  | 180  |  | 09.10  | 07.13   |  |  |   |   |            |
|  | xDrive 30 i  | 200  |  | 03.10  | 07.13   |  |  |   |   |            |
|  | xDrive 35 d  | 210  |  | 03.10  | 07.13   |  |  |   |   |            |
|  | xDrive 35 i  | 225  |  | 09.10  | 07.13   |  |  |   |   |            |
| xDrive 40 d  | 225  |  | 09.10  | 07.13  |   |  |  |   |   |            |
| 3.0 sd   | 210  |  | 09.07  | 09.09  | 13.0460-7169.2  | 607169   |  |   |   |            |
| 4.8 i  | 261  |  | 01.07  | 02.10  | 13.0470-7169.2  | LD7169   |  |   |   |            |
| xDrive 48 i  | 261  |  | 09.08  | 02.10  | 24.8190-0269.2  | 620269   |  |   |   |            |
| 4.8 i  | 261  |  | 03.10  | 07.13  | 13.0460-7169.2  | 607169   |  |   |   |            |
| xDrive 48 i  | 261  |  | 03.10  | 07.13  | 13.0470-7169.2  | LD7169   |  |   |   |            |
|  |  |  |  |  | 24.8190-0290.2  | 620290   |  |   |   |            |
|  |  |  |  |  | 24.8190-0028.2  | 620028   |  |   |   |            |
| M 50 d   | 280  |  | 06.12  | 07.13  | 13.0460-7169.2  | 607169   |  |   |   |            |
| xDrive 50 i  | 300  |  | 03.10  | 07.13  | 13.0470-7169.2  | LD7169   |  |   |   |            |
|  |  |  |  |  | 24.8190-0290.2  | 620290   |  |   |   |            |
|  |  |  |  |  | 24.8190-0028.2  | 620028   |  |   |   |            |
| M  | 408  |  | 09.09  | 02.10  | 24.8190-0269.2  | 620269   |  |   |   |            |
| M  | 408  |  | 03.10  | 07.13  | 24.8190-0290.2  | 620290   |  |   |   |            |
|  |  |  |  |  | 24.8190-0028.2  | 620028   |  |   |   |            |
|  | 3.0 d  | 173  |  | 01.07  | 07.13   | 24.0120-0206.1   | 420206   |   | 320 19,9 18,4 V L +S +B                                     |            |
|  | 3.0 sd   | 210  |  | 10.09  | 07.13   |  |  |   |   |            |
|  | 3.0 si   | 200  |  | 01.07  | 07.13   |  |  |   |   |            |
|  | xDrive 30 d  | 173  |  | 09.08  | 07.13   |  |  |   |   |            |
|  | xDrive 30 d  | 180  |  | 09.10  | 07.13   |  |  |   |   |            |





























<sup>1)</sup> - armoured vehicles / - veicoli blindati / - véhicule blindé / - vehículo blindado  
<sup>2)</sup> + armoured vehicles / + veicoli blindati / + véhicule blindé / + vehículo blindado

|     |  |  |  |  |  |  |  |  |                         |
|--|--|--|--|--|---|--|--|--|-------------------------|
| <b>BMW X5/E70 (07-13)</b>  |  |  |  |  |   |  |  |  |                         |
|    | xDrive 30 i  | 200  |  | 09.08  | 07.13   | 24.0120-0206.1   | 420206   |  | 320 19,9 18,4 V L +S +B |
|  | xDrive 35 d  | 210  |  | 09.08  | 07.13   |  |  |  |                         |
|  | xDrive 35 i  | 225  |  | 09.10  | 07.13   |  |  |  |                         |
|  | xDrive 40 d  | 225  |  | 09.10  | 07.13   |  |  |  |                         |
|  | 3.0 sd   | 210  |  | 09.07  | 09.09   | 24.0124-0216.1   | 424216   |  | 345 24,0 22,4 V L +S +B |
|  | 4.8 i  | 261  |  | 01.07  | 07.13   |  |  |  |                         |
|  | M 50 d   | 280  |  | 06.12  | 07.13   |  |  |  |                         |
|  | xDrive 48 i  | 261  |  | 09.08  | 07.13   |  |  |  |                         |
| xDrive 50 i  | 300  |  | 03.10  | 07.13  |   |  |  |  |                         |
|    | 3.0 d  | 173  |  | 01.07  | 07.13   | 24.0710-5018.3   | 360409   | 2  | Radsensor L=985         |
|  | 3.0 sd   | 210  |  | 09.07  | 09.08   |  |  |  |                         |
|  | 3.0 si   | 200  |  | 01.07  | 07.13   |  |  |  |                         |
|  | 4.8 i  | 261  |  | 01.07  | 07.13   |  |  |  |                         |
|  | M  | 408  |  | 09.09  | 07.13   |  |  |  |                         |
|  | M 50 d   | 280  |  | 06.12  | 07.13   |  |  |  |                         |
|  | xDrive 30 d  | 173  |  | 09.08  | 07.13   |  |  |  |                         |
|  | xDrive 30 d  | 180  |  | 09.10  | 07.13   |  |  |  |                         |
|  | xDrive 30 i  | 200  |  | 09.08  | 07.13   |  |  |  |                         |
|  | xDrive 35 d  | 210  |  | 09.08  | 07.13   |  |  |  |                         |
|  | xDrive 35 i  | 225  |  | 09.10  | 07.13   |  |  |  |                         |
|  | xDrive 40 d  | 225  |  | 09.10  | 07.13   |  |  |  |                         |
|  | xDrive 48 i  | 261  |  | 09.08  | 07.13   |  |  |  |                         |
|  | xDrive 50 i  | 300  |  | 03.10  | 07.13   |  |  |  |                         |
|    | 3.0 d  | 173  |  | 01.07  | 07.13   | 03.0137-0419.2   | 650419   |  | 185 x 30                |
|  | 3.0 sd   | 210  |  | 09.07  | 09.08   | 03.0137-9288.2   | 669288   |  | Bremsbacken-Zubehör     |
|  | 3.0 si   | 200  |  | 01.07  | 07.13   |  |  |  |                         |
|  | 4.8 i  | 261  |  | 01.07  | 07.13   |  |  |  |                         |
|  | M  | 408  |  | 09.09  | 07.13   |  |  |  |                         |
|  | M 50 d   | 280  |  | 06.12  | 07.13   |  |  |  |                         |
|  | xDrive 30 d  | 173  |  | 08.09  | 07.13   |  |  |  |                         |
|  | xDrive 30 d  | 180  |  | 09.10  | 07.13   |  |  |  |                         |
|  | xDrive 30 i  | 200  |  | 08.09  | 07.13   |  |  |  |                         |
|  | xDrive 35 d  | 210  |  | 08.09  | 07.13   |  |  |  |                         |
|  | xDrive 35 i  | 225  |  | 09.10  | 07.13   |  |  |  |                         |
|  | xDrive 40 d  | 225  |  | 09.10  | 07.13   |  |  |  |                         |
|  | xDrive 48 i  | 261  |  | 08.09  | 07.13   |  |  |  |                         |
|  | xDrive 50 i  | 300  |  | 03.10  | 07.13   |  |  |  |                         |
| <b>BMW X5/F15 (13-)</b>  |  |  |  |  |   |  |  |  |                         |
|   | sDrive 25 d  | 160  |  | 08.13  |   | 13.0460-7231.2   | 607231   |  | 24170 20,2 +/WE         |
|  | sDrive 25 d  | 170  |  | 07.15  |   | 13.0470-7231.2   | LD7231   |  | ATE                     |
|  | xDrive 25 d  | 160  |  | 08.13  |   | 24.8190-0289.2   | 620289   | 1  | Warnkontakt L=938mm     |
|  | xDrive 25 d  | 170  |  | 07.15  |   |  |  |  |                         |
|  | xDrive 30 d  | 190  |  | 08.13  |   |  |  |  |                         |
|  | xDrive 35 i  | 225  |  | 08.13  |   |  |  |  |                         |
|  | M 50 d   | 280  |  | 08.13  |   | 13.0460-7261.2   | 607261   |  | 24436 19,7 +/WE         |
|  | xDrive 50 i  | 330  |  | 08.13  |   | 24.8190-0071.2   | 620071   | 1  | Warnkontakt L=945mm     |
|  | xDrive 40 d  | 230  |  | 08.13  |   | 13.0460-7231.2   | 607231   |  | 24170 20,2 +/WE         |
|  | xDrive 40 e  | 180  |  | 09.15  |   | 24.8190-0289.2   | 620289   | 1  | Warnkontakt L=938mm     |
| xDrive 40 e  | 230  |  | 09.15  |  |   |  |  |  |                         |
| M  | 423  |  | 12.14  |  | 24.8190-0291.2  | 620291   | 1  | Warnkontakt L=974mm  |                         |
|  | sDrive 25 d  | 160  |  | 08.13  |   | 24.0130-0200.1   | 430200   |  | 332 29,9 28,4 V L +S +B |
|  | sDrive 25 d  | 170  |  | 07.15  |   |  |  |  |                         |
|  | xDrive 25 d  | 160  |  | 08.13  |   |  |  |  |                         |
|  | xDrive 25 d  | 170  |  | 07.15  |   |  |  |  |                         |
|  | xDrive 30 d  | 190  |  | 08.13  |   |  |  |  |                         |
|  | xDrive 35 i  | 225  |  | 08.13  |   | 24.0130-0199.1   | 430199   |  | 348 29,9 28,4 V L +S +B |
|  | xDrive 40 d  | 230  |  | 08.13  |   |  |  |  |                         |
|  | xDrive 40 e  | 180  |  | 09.15  |   |  |  |  |                         |
|  | xDrive 40 e  | 230  |  | 09.15  |   |  |  |  |                         |
|  | M 50 d   | 280  |  | 08.13  |   | 24.0136-0113.2   | 436113   |  | 385 36,0 34,4 V L +S +B |
| xDrive 50 i  | 330  |  | 08.13  |  | 24.0136-0112.2  | 436112   |  | 385 36,0 34,4 V L +S +B  |                         |
|  | M  | 423  |  | 12.14  |   | 24.0710-5017.3   | 360408   | 2  | Radsensor L=565         |
|  | M 50 d   | 280  |  | 08.13  |   |  |  |  |                         |
|  | sDrive 25 d  | 160  |  | 08.13  |   |  |  |  |                         |
|  | sDrive 25 d  | 170  |  | 07.15  |   |  |  |  |                         |
|  | xDrive 25 d  | 160  |  | 08.13  |   |  |  |  |                         |
|  | xDrive 25 d  | 170  |  | 07.15  |   |  |  |  |                         |
|  | xDrive 30 d  | 190  |  | 08.13  |   |  |  |  |                         |
|  | xDrive 35 i  | 225  |  | 08.13  |   |  |  |  |                         |
|  | xDrive 40 d  | 230  |  | 08.13  |   |  |  |  |                         |
|  | xDrive 40 e  | 180  |  | 09.15  |   |  |  |  |                         |
|  | xDrive 40 e  | 230  |  | 09.15  |   |  |  |  |                         |
| xDrive 50 i  | 330  |  | 08.13  |  |   |  |  |  |                         |
|  | sDrive 25 d  | 160  |  | 08.13  |   | 13.0460-7232.2   | 607232   |  | 23447 17,3 +/WE         |
|  | sDrive 25 d  | 170  |  | 07.15  |   | 13.0470-7232.2   | LD7232   |  | ATE                     |
|  | xDrive 25 d  | 160  |  | 08.13  |   | 24.8190-0028.2   | 620028   | 1  | Warnkontakt L=977mm     |
|  | xDrive 25 d  | 170  |  | 07.15  |   |  |  |  |                         |
|  | xDrive 30 d  | 190  |  | 08.13  |   |  |  |  |                         |
|  | xDrive 40 e  | 180  |  | 09.15  |   |  |  |  |                         |
|  | xDrive 40 e  | 230  |  | 09.15  |   |  |  |  |                         |
|  | M 50 d   | 280  |  | 08.13  |   | 13.0460-7169.2   | 607169   |  | 23309 17,3 +/WE         |
|  | xDrive 35 i  | 225  |  | 08.13  |   | 13.0470-7169.2   | LD7169   |  | ATE                     |
|  | xDrive 40 d  | 230  |  | 08.13  |   | 24.8190-0028.2   | 620028   | 1  | Warnkontakt L=977mm     |





























|     |  |  |  |  |  |  |  |  |   |                         |
|--|--|--|--|--|---|--|--|--|---|-------------------------|
| <b>BMW X5/F15 (13-)</b>  |  |  |  |  |   |  |  |  |   |                         |
|    | xDrive 50 i  | 330  |  | 08.13  |   | 13.0460-7169.2<br>24.8190-0028.2   | 607169<br>620028   | 1  | 23309 17,3 +/WE<br>Warnkontakt L=977mm  | ATE                     |
|  | M  | 423  |  | 12.14  |   | 13.0460-7260.2<br>24.8190-0290.2   | 607260<br>620290   | 1  | 24458 17,3 +/WE<br>Warnkontakt L=1002mm | ATE                     |
|    | sDrive 25 d  | 160  |  | 08.13  |   |  |  |  |   |                         |
|  | sDrive 25 d  | 170  |  | 07.15  |   |  |  |  |   |                         |
|  | xDrive 25 d  | 160  |  | 08.13  |   |  |  |  |   |                         |
|  | xDrive 25 d  | 170  |  | 07.15  |   |  |  |  |   |                         |
|  | xDrive 30 d  | 190  |  | 08.13  |   |  |  |  |   |                         |
|  | xDrive 40 e  | 180  |  | 09.15  |   |  |  |  |   |                         |
|  | xDrive 40 e  | 230  |  | 09.15  |   |  |  |  |   |                         |
|  | M 50 d   | 280  |  | 08.13  |   | 24.0124-0216.1   | 424216   |  | 345 24,0 22,4 V L +S +B                 |                         |
|  | xDrive 35 i  | 225  |  | 08.13  |   |  |  |  |   |                         |
|  | xDrive 40 d  | 230  |  | 08.13  |   |  |  |  |   |                         |
|  | xDrive 50 i  | 330  |  | 08.13  |   |  |  |  |   |                         |
|    | M  | 423  |  | 12.14  |   | 24.0710-5018.3   | 360409   | 2  | Radsensor L=985                         |                         |
|  | M 50 d   | 280  |  | 08.13  |   |  |  |  |   |                         |
|  | sDrive 25 d  | 160  |  | 08.13  |   |  |  |  |   |                         |
|  | sDrive 25 d  | 170  |  | 07.15  |   |  |  |  |   |                         |
|  | xDrive 25 d  | 160  |  | 08.13  |   |  |  |  |   |                         |
|  | xDrive 25 d  | 170  |  | 07.15  |   |  |  |  |   |                         |
|  | xDrive 30 d  | 190  |  | 08.13  |   |  |  |  |   |                         |
|  | xDrive 35 i  | 225  |  | 08.13  |   |  |  |  |   |                         |
|  | xDrive 40 d  | 230  |  | 08.13  |   |  |  |  |   |                         |
|  | xDrive 40 e  | 180  |  | 09.15  |   |  |  |  |   |                         |
|  | xDrive 40 e  | 230  |  | 09.15  |   |  |  |  |   |                         |
|  | xDrive 50 i  | 330  |  | 08.13  |   |  |  |  |   |                         |
|    | M  | 423  |  | 12.14  |   | 03.0137-0419.2   | 650419   |  | 185 x 30                                |                         |
|  | M 50 d   | 280  |  | 08.13  |   | 03.0137-9288.2   | 669288   |  | Bremsbacken-Zubehör                     |                         |
|  | sDrive 25 d  | 160  |  | 08.13  |   | 03.0137-9700.2   | 669700   |  | Bremsbacken-Zubehör                     |                         |
|  | sDrive 25 d  | 170  |  | 07.15  |   | 03.0137-9702.2   | 669702   |  | Spreizschloß Satz                       |                         |
|  | xDrive 25 d  | 160  |  | 08.13  |   |  |  |  |   |                         |
|  | xDrive 25 d  | 170  |  | 07.15  |   |  |  |  |   |                         |
|  | xDrive 30 d  | 190  |  | 08.13  |   |  |  |  |   |                         |
|  | xDrive 35 i  | 225  |  | 08.13  |   |  |  |  |   |                         |
|  | xDrive 40 d  | 230  |  | 08.13  |   |  |  |  |   |                         |
|  | xDrive 40 e  | 180  |  | 09.15  |   |  |  |  |   |                         |
|  | xDrive 40 e  | 230  |  | 09.15  |   |  |  |  |   |                         |
|  | xDrive 50 i  | 330  |  | 08.13  |   |  |  |  |   |                         |
| <b>BMW X6/E71/E72 (08-14)</b>  |  |  |  |  |   |  |  |  |   |                         |
|  | 30 d   | 173  |  | 05.08  | 10.08   | 13.0460-7239.2   | 607239   |  | 24172 19,0 +/WE                         | ATE                     |
|  | 35 d   | 210  |  | 01.08  | 10.08   | 13.0470-7239.2   | LD7239   |  | 24172 19,0 +/WE                         | ATE                     |
|  | 35 i   | 225  |  | 01.08  | 10.08   | 24.8190-0270.2   | 620270   | 1  | Warnkontakt L=898mm                     |                         |
|  | xDrive 30 d  |  |  | 09.08  | 10.08   |  |  |  |   |                         |
|  | xDrive 35 d  | 210  |  | 09.08  | 10.08   |  |  |  |   |                         |
|  | xDrive 35 i  | 225  |  | 09.08  | 10.08   |  |  |  |   |                         |
|  | 30 d   | 173  |  | 11.08  | 02.10   | 13.0460-7231.2   | 607231   |  | 24170 20,2 +/WE                         | ATE                     |
|  | 35 d   | 210  |  | 11.08  | 02.10   | 13.0470-7231.2   | LD7231   |  | 24170 20,2 +/WE                         | ATE                     |
|  | 35 i   | 225  |  | 11.08  | 02.10   | 24.8190-0268.2   | 620268   | 1  | Warnkontakt L=905mm                     |                         |
|  | xDrive 30 d  |  |  | 11.08  | 02.10   |  |  |  |   |                         |
|  | xDrive 35 d  | 210  |  | 11.08  | 02.10   |  |  |  |   |                         |
|  | xDrive 35 i  | 225  |  | 11.08  | 02.10   |  |  |  |   |                         |
|  | 30 d   | 173  |  | 03.10  | 07.14   | 13.0460-7231.2   | 607231   |  | 24170 20,2 +/WE                         | ATE                     |
|  | 35 d   | 210  |  | 03.10  | 07.14   | 13.0470-7231.2   | LD7231   |  | 24170 20,2 +/WE                         | ATE                     |
|  | 35 i   | 225  |  | 03.10  | 07.14   | 24.8190-0289.2   | 620289   | 1  | Warnkontakt L=938mm                     |                         |
|  | xDrive 30 d  |  |  | 03.10  | 07.14   |  |  |  |   |                         |
|  | xDrive 30 d  | 180  |  | 09.10  | 07.14   |  |  |  |   |                         |
|  | xDrive 35 d  | 210  |  | 03.10  | 07.14   |  |  |  |   |                         |
|  | xDrive 35 i  | 225  |  | 03.10  | 07.14   |  |  |  |   |                         |
|  | xDrive 40 d  | 225  |  | 10.10  | 07.14   |  |  |  |   |                         |
|  | 50 i   | 300  |  | 05.08  | 02.10   | 13.0460-7261.2   | 607261   |  | 24436 19,7 +/WE                         | ATE                     |
|  | xDrive 50 i  | 300  |  | 09.08  | 02.10   | 24.8190-0280.2   | 620280   | 1  | Warnkontakt L=930mm                     |                         |
|  | 50 i   | 300  |  | 03.10  | 07.14   | 13.0460-7261.2   | 607261   |  | 24436 19,7 +/WE                         | ATE                     |
|  | ActiveHybrid   | 357  |  | 10.10  | 07.14   | 24.8190-0071.2   | 620071   | 1  | Warnkontakt L=945mm                     |                         |
|  | M 50 d   | 280  |  | 06.12  | 07.14   |  |  |  |   |                         |
|  | xDrive 50 i  | 300  |  | 03.10  | 07.14   |  |  |  |   |                         |
|  | M  | 408  |  | 09.09  | 02.10   | 24.8190-0281.2   | 620281   | 1  | Warnkontakt L=962mm                     |                         |
|  | M  | 408  |  | 03.10  | 07.14   | 24.8190-0291.2   | 620291   | 1  | Warnkontakt L=974mm                     |                         |
|  | 35 d   | 210  |  | 01.08  | 10.08   | 24.0136-0109.1   | 436109   |  | 365 36,0 34,4 V L +S +B                 |                         |
|  | 35 i   | 225  |  | 01.08  | 10.08   |  |  |  |   |                         |
|  | xDrive 35 d  | 210  |  | 09.08  | 10.08   |  |  |  |   |                         |
|  | xDrive 35 i  | 225  |  | 09.08  | 10.08   |  |  |  |   |                         |
|  | 30 d   | 173  |  | 05.08  | 07.14   | 24.0130-0199.1   | 430199   |  | 348 29,9 28,4 V L +S +B                 |                         |
|  | 35 d   | 210  |  | 11.08  | 07.14   |  |  |  |   |                         |
|  | 35 i   | 225  |  | 11.08  | 07.14   |  |  |  |   |                         |
|  | xDrive 30 d  |  |  | 09.08  | 07.14   |  |  |  |   |                         |
|  | xDrive 30 d  | 180  |  | 09.10  | 07.14   | + Motorcode M57  |  |  |   |                         |
|  | xDrive 35 d  | 210  |  | 11.08  | 07.14   |  |  |  |   |                         |
|  | xDrive 35 i  | 225  |  | 11.08  | 07.14   |  |  |  |   |                         |
|  | xDrive 40 d  | 225  |  | 10.10  | 07.14   |  |  |  |   |                         |
|  | xDrive 30 d  | 180  |  | 09.10  | 07.14   | + Motorcode N57  | 24.0130-0200.1   | 430200   |   | 332 29,9 28,4 V L +S +B |
|  | 50 i   | 300  |  | 05.08  | 07.14   | 24.0136-0113.2   | 436113   |  | 385 36,0 34,4 V L +S +B                 |                         |
|  | ActiveHybrid   | 357  |  | 10.10  | 07.14   | 24.0136-0112.2   | 436112   |  | 385 36,0 34,4 V L +S +B                 |                         |
|  | M 50 d   | 280  |  | 06.12  | 07.14   |  |  |  |   |                         |

|     |  |  |  |  |  |  |  |    |  |
|--|--|--|--|--|---|--|--|--|--|
| <b>BMW X6/E71/E72 (08-14)</b>  |  |  |  |  |   |  |  |  |  |
|    | xDrive 50 i  | 300  |  | 09.08  | 07.14   | 24.0136-0113.2   | 436113   | <br> | 385 36,0 34,4 V L +S +B<br>385 36,0 34,4 V L +S +B |
|    | 30 d   | 173  |  | 05.08  | 07.14   | 24.0710-5017.3   | 360408   | 2   | Radsensor L=565                                    |
|  | 35 d   | 210  |  | 01.08  | 07.14   |  |  |  |  |
|  | 35 i   | 225  |  | 01.08  | 07.14   |  |  |  |  |
|  | 50 i   | 300  |  | 05.08  | 07.14   |  |  |  |  |
|  | ActiveHybrid   | 357  |  | 10.09  | 07.14   |  |  |  |  |
|  | M  | 408  |  | 09.09  | 07.14   |  |  |  |  |
|  | M 50 d   | 280  |  | 06.12  | 07.14   |  |  |  |  |
|  | xDrive 30 d  |  |  | 09.08  | 07.14   |  |  |  |  |
|  | xDrive 30 d  | 180  |  | 09.10  | 07.14   |  |  |  |  |
|  | xDrive 35 d  | 210  |  | 09.08  | 07.14   |  |  |  |  |
|  | xDrive 35 i  | 225  |  | 09.08  | 07.14   |  |  |  |  |
|  | xDrive 40 d  | 225  |  | 10.10  | 07.14   |  |  |  |  |
|  | xDrive 50 i  | 300  |  | 09.08  | 07.14   |  |  |  |  |
|    | 35 d   | 210  |  | 01.08  | 09.09   | 13.0460-7169.2   | 607169   |  | 23309 17,3 +/WE ATE                                |
|  | 35 i   | 225  |  | 01.08  | 09.09   | 13.0470-7169.2   | LD7169   |  | 23309 17,3 +/WE ATE                                |
|  | 50 i   | 300  |  | 10.09  | 02.10   | 24.8190-0269.2   | 620269   | 1  | Warnkontakt L=965mm                                |
|  | xDrive 35 d  | 210  |  | 09.08  | 09.09   |  |  |  |  |
|  | xDrive 35 i  | 225  |  | 09.08  | 09.09   |  |  |  |  |
|  | xDrive 50 i  | 300  |  | 10.09  | 02.10   |  |  |  |  |
|  | 50 i   | 300  |  | 03.10  | 07.14   | 13.0460-7169.2   | 607169   |  | 23309 17,3 +/WE ATE                                |
|  | ActiveHybrid   | 357  |  | 10.10  | 07.14   | 13.0470-7169.2   | LD7169   |  | 23309 17,3 +/WE ATE                                |
|  | M 50 d   | 280  |  | 06.12  | 07.14   | 24.8190-0290.2   | 620290   | 1  | Warnkontakt L=1002mm                               |
|  | xDrive 50 i  | 300  |  | 03.10  | 07.14   | 24.8190-0028.2   | 620028   | 1  | Warnkontakt L=977mm                                |
|  | 30 d   | 173  |  | 09.08  | 02.10   | 13.0460-7232.2   | 607232   |  | 23447 17,3 +/WE ATE                                |
|  | 35 d   | 210  |  | 10.09  | 02.10   | 13.0470-7232.2   | LD7232   |  | 23447 17,3 +/WE ATE                                |
|  | 35 i   | 225  |  | 10.09  | 02.10   | 24.8190-0269.2   | 620269   | 1  | Warnkontakt L=965mm                                |
|  | xDrive 30 d  |  |  | 09.08  | 02.10   |  |  |  |  |
|  | xDrive 35 d  | 210  |  | 10.09  | 02.10   |  |  |  |  |
|  | xDrive 35 i  | 225  |  | 10.09  | 02.10   |  |  |  |  |
|  | 30 d   | 173  |  | 03.10  | 07.14   | 13.0460-7232.2   | 607232   |  | 23447 17,3 +/WE ATE                                |
|  | 35 d   | 210  |  | 03.10  | 07.14   | 13.0470-7232.2   | LD7232   |  | 23447 17,3 +/WE ATE                                |
|  | 35 i   | 225  |  | 03.10  | 07.14   | 24.8190-0290.2   | 620290   | 1  | Warnkontakt L=1002mm                               |
|  | xDrive 30 d  |  |  | 03.10  | 07.14   | 24.8190-0028.2   | 620028   | 1  | Warnkontakt L=977mm                                |
|  | xDrive 30 d  | 180  |  | 09.10  | 07.14   |  |  |  |  |
|  | xDrive 35 d  | 210  |  | 03.10  | 07.14   |  |  |  |  |
|  | xDrive 35 i  | 225  |  | 03.10  | 07.14   |  |  |  |  |
|  | xDrive 40 d  | 225  |  | 10.10  | 07.14   |  |  |  |  |
|  | 50 i   | 300  |  | 05.08  | 09.09   | 13.0460-7260.2   | 607260   |  | 24458 17,3 +/WE ATE                                |
|  | xDrive 50 i  | 300  |  | 09.08  | 09.09   | 24.8190-0269.2   | 620269   | 1  | Warnkontakt L=965mm                                |
|  | M  | 408  |  | 09.09  | 02.10   | 24.8190-0269.2   | 620269   | 1  | Warnkontakt L=965mm                                |
|  | M  | 408  |  | 03.10  | 07.14   | 24.8190-0290.2   | 620290   | 1  | Warnkontakt L=1002mm                               |
|  |  |  |  |  |   | 24.8190-0028.2   | 620028   | 1  | Warnkontakt L=977mm                                |
|  | 30 d   | 173  |  | 05.08  | 07.14   | 24.0120-0206.1   | 420206   |  | 320 19,9 18,4 V L +S +B                            |
|  | 35 d   | 210  |  | 10.09  | 07.14   |  |  |  |  |
|  | 35 i   | 225  |  | 10.09  | 07.14   |  |  |  |  |
|  | xDrive 30 d  |  |  | 09.08  | 07.14   |  |  |  |  |
|  | xDrive 30 d  | 180  |  | 09.10  | 07.14   |  |  |  |  |
|  | xDrive 35 d  | 210  |  | 10.09  | 07.14   |  |  |  |  |
|  | xDrive 35 i  | 225  |  | 10.09  | 07.14   |  |  |  |  |
|  | xDrive 40 d  | 225  |  | 10.10  | 07.14   |  |  |  |  |
|  | 50 i   | 300  |  | 11.08  | 09.09   | 24.0124-0219.2   | 424219   |  | 385 24,0 22,4 V L +S +B                            |
|  | xDrive 50 i  | 300  |  | 11.08  | 09.09   |  |  |  |  |
|  | 35 d   | 210  |  | 01.08  | 09.09   | 24.0124-0216.1   | 424216   |  | 345 24,0 22,4 V L +S +B                            |
|  | 35 i   | 225  |  | 01.08  | 09.09   |  |  |  |  |
|  | 50 i   | 300  |  | 10.09  | 07.14   |  |  |  |  |
|  | ActiveHybrid   | 357  |  | 10.10  | 07.14   |  |  |  |  |
|  | M 50 d   | 280  |  | 06.12  | 07.14   |  |  |  |  |
|  | xDrive 35 d  | 210  |  | 09.08  | 09.09   |  |  |  |  |
|  | xDrive 35 i  | 225  |  | 11.08  | 09.09   |  |  |  |  |
|  | xDrive 50 i  | 300  |  | 10.09  | 07.14   |  |  |  |  |
|  | 30 d   | 173  |  | 05.08  | 07.14   | 24.0710-5018.3   | 360409   | 2   | Radsensor L=985                                    |
|  | 35 d   | 210  |  | 01.08  | 07.14   |  |  |  |  |
|  | 35 i   | 225  |  | 01.08  | 07.14   |  |  |  |  |
|  | 50 i   | 300  |  | 05.08  | 07.14   |  |  |  |  |
|  | ActiveHybrid   | 357  |  | 10.10  | 07.14   |  |  |  |  |
|  | M  | 408  |  | 09.09  | 07.14   |  |  |  |  |
|  | M 50 d   | 280  |  | 06.12  | 07.14   |  |  |  |  |
|  | xDrive 30 d  |  |  | 09.08  | 07.14   |  |  |  |  |
|  | xDrive 30 d  | 180  |  | 09.10  | 07.14   |  |  |  |  |
|  | xDrive 35 d  | 210  |  | 09.08  | 07.14   |  |  |  |  |
|  | xDrive 35 i  | 225  |  | 09.08  | 07.14   |  |  |  |  |
|  | xDrive 40 d  | 225  |  | 10.10  | 07.14   |  |  |  |  |
|  | xDrive 50 i  | 300  |  | 09.08  | 07.14   |  |  |  |  |
|  | 30 d   | 173  |  | 05.08  | 07.14   | 03.0137-0419.2   | 650419   |  | 185 x 30   |
|  | 35 d   | 210  |  | 01.08  | 07.14   | 03.0137-9288.2   | 669288   |  | Bremsbacken-Zubehör                                |
|  | 35 i   | 225  |  | 01.08  | 07.14   |  |  |  |  |
|  | 50 i   | 300  |  | 05.08  | 07.14   |  |  |  |  |
|  | ActiveHybrid   | 357  |  | 10.10  | 07.14   |  |  |  |  |
|  | M  | 408  |  | 09.09  | 07.14   |  |  |  |  |
|  | M 50 d   | 280  |  | 06.12  | 07.14   |  |  |  |  |
|  | xDrive 30 d  |  |  | 09.08  | 07.14   |  |  |  |  |
|  | xDrive 30 d  | 180  |  | 09.10  | 07.14   |  |  |  |  |
| ↓  | ↓  |  |  |  |   |  |  |  |  |

|     |        |  |  |                                      |  |  |    |                              |
|--|--|--|--|--|---|--|--|--|
| <b>BMW X6/E71/E72 (08-14)</b>  |  |  |  |  |   |  |  |  |
|    | xDrive 35 d<br>xDrive 35 i<br>xDrive 40 d<br>xDrive 50 i                               | 210<br>225<br>225<br>300   |  | 09.08 07.14<br>09.08 07.14<br>10.10 07.14<br>09.08 07.14   | 03.0137-0419.2<br>03.0137-9288.2  | 650419<br>669288   |  | 185 x 30<br>Bremsbacken-Zubehör  |
| <b>BMW X6/F16 (14-)</b>  |  |  |  |  |   |  |  |  |
|    | xDrive 30 d<br>xDrive 30 d<br>xDrive 35 i<br>xDrive 40 d                               | 155<br>190<br>225<br>230   |  | 08.14<br>08.14<br>12.14<br>08.14   | 13.0460-7231.2<br>13.0470-7231.2<br>24.8190-0289.2                                | 607231<br>LD7231<br>620289   | 1   | 24170 20,2 +/-WE ATE<br>24170 20,2 +/-WE ATE<br>Warnkontakt L=938mm  |
|  | M 50 d<br>xDrive 50 i<br>M   | 280<br>330<br>423  |  | 08.14<br>08.14<br>12.14  | 13.0460-7261.2<br>24.8190-0071.2<br>24.8190-0291.2                                | 607261<br>620071<br>620291   | 1   | 24436 19,7 +/-WE ATE<br>Warnkontakt L=945mm<br>Warnkontakt L=974mm   |
|    | xDrive 30 d<br>xDrive 30 d<br>xDrive 35 i<br>xDrive 40 d                               | 155<br>190<br>225<br>230   |  | 08.14<br>08.14<br>12.14<br>08.14   | 24.0130-0199.1  | 430199   |  | 332 29,9 28,4 V L +S +B<br>348 29,9 28,4 V L +S +B   |
|  | M 50 d<br>xDrive 50 i  | 280<br>330   |  | 08.14<br>08.14   | 24.0136-0113.2<br>24.0136-0112.2  | 436113<br>436112   | <br> | 385 36,0 34,4 V L +S +B<br>385 36,0 34,4 V L +S +B   |
|    | M<br>M 50 d<br>xDrive 30 d<br>xDrive 30 d<br>xDrive 35 i<br>xDrive 40 d<br>xDrive 50 i | 423<br>280<br>155<br>190<br>225<br>230<br>330                                    |  | 12.14<br>08.14<br>08.14<br>08.14<br>12.14<br>08.14<br>08.14  | 24.0710-5017.3  | 360408   | 2   | Radsensor L=565  |
|    | xDrive 30 d<br>xDrive 30 d   | 155<br>190   |  | 08.14<br>08.14   | 13.0460-7232.2<br>13.0470-7232.2<br>24.8190-0028.2                                | 607232<br>LD7232<br>620028   | 1  | 23447 17,3 +/-WE ATE<br>23447 17,3 +/-WE ATE<br>Warnkontakt L=977mm  |
|  | M 50 d<br>xDrive 35 i<br>xDrive 40 d<br>xDrive 50 i<br>M                               | 280<br>225<br>230<br>330<br>423  |  | 08.14<br>12.14<br>08.14<br>08.14<br>12.14  | 13.0460-7169.2<br>13.0470-7169.2<br>24.8190-0028.2                                | 607169<br>LD7169<br>620028   | 1  | 23309 17,3 +/-WE ATE<br>23309 17,3 +/-WE ATE<br>Warnkontakt L=977mm  |
|  | M 50 d<br>xDrive 50 i  | 280<br>330   |  | 08.14<br>08.14   | 13.0460-7260.2<br>24.8190-0290.2  | 607260<br>620290   | 1  | 24458 17,3 +/-WE ATE<br>Warnkontakt L=1002mm   |
|   | xDrive 30 d<br>xDrive 30 d   | 155<br>190   |  | 08.14<br>08.14   | 24.0120-0206.1  | 420206   |  | 320 19,9 18,4 V L +S +B  |
|  | M 50 d<br>xDrive 35 i<br>xDrive 40 d<br>xDrive 50 i                                    | 280<br>225<br>230<br>330   |  | 08.14<br>12.14<br>08.14<br>08.14   | 24.0124-0216.1  | 424216   |  | 345 24,0 22,4 V L +S +B  |
|  | M<br>M 50 d<br>xDrive 30 d<br>xDrive 30 d<br>xDrive 35 i<br>xDrive 40 d<br>xDrive 50 i | 423<br>280<br>155<br>190<br>225<br>230<br>330                                    |  | 12.14<br>08.14<br>08.14<br>08.14<br>12.14<br>08.14<br>08.14  | 24.0710-5018.3  | 360409   | 2   | Radsensor L=985  |
|  | M<br>M 50 d<br>xDrive 30 d<br>xDrive 30 d<br>xDrive 35 i<br>xDrive 40 d<br>xDrive 50 i | 423<br>280<br>155<br>190<br>225<br>230<br>330                                    |  | 12.14<br>08.14<br>08.14<br>08.14<br>12.14<br>08.14<br>08.14  | 03.0137-0419.2<br>03.0137-9288.2<br>03.0137-9702.2<br>03.0137-9700.2              | 650419<br>669288<br>669702<br>669700   |  | 185 x 30<br>Bremsbacken-Zubehör<br>Spreizschloß Satz<br>Bremsbacken-Zubehör                                    |
| <b>BMW Z3/E36 (95-02)</b>  |  |  |  |  |   |  |  |  |
|  | 1.8<br>1.9<br>2.0<br>2.2<br>2.8 Coupe<br>2.8 Roadster<br>3.0 Coupe<br>3.0 Roadster     | 85<br><br>110<br>125<br>141<br>141<br>170<br>170                                 |  | 10.95 10.98<br>10.95 12.02<br>04.99 08.00<br>10.00 12.02<br>07.97 06.00<br>05.97 06.00<br>06.00 12.02<br>06.00 12.02 | 13.0460-5405.2<br>13.0470-5405.2<br>24.8190-0207.2                                | 605405<br>LD5405<br>620207   | 1  | 21643 17,8 +/-WE ATE<br>21643 17,8 +/-WE ATE<br>Warnkontakt L=786mm  |
|  | M Coupe<br>M Roadster  | <br><br>110<br>125   |  | 02.98 12.02<br>03.97 12.02   | 13.0460-6033.2<br>24.8190-0210.2  | 606033<br>620210   | 1  | 20968 20,3 +/-WE ATE<br>Warnkontakt L=810mm  |
|  | 1.8<br>1.9<br>2.0<br>2.2<br>2.8 Coupe<br>2.8 Roadster                                  | 85<br><br>110<br>125<br>141<br>141   |  | 10.95 10.98<br>10.95 12.02<br>04.99 08.00<br>10.00 12.02<br>07.97 06.00<br>05.97 06.00                               | 24.0112-0126.1<br>24.0312-0126.1  | 412126<br>512126   |  | 286 12,0 10,4 +S +B<br>286 12,0 9,6 +S +B PD   |
|  | 3.0 Coupe<br>3.0 Roadster<br>M Coupe<br>M Roadster                                     | 170<br>170<br><br><br>110<br>125   |  | 06.00 12.02<br>06.00 12.02<br>02.98 12.02<br>03.97 12.02   | 24.0122-0115.1<br>24.0322-0115.1<br>24.0128-0160.1<br>24.0322-0160.1              | 422115<br>522115<br>422160<br>522160   |  | 286 22,0 20,4 V L +S +B<br>286 22,0 19,6 V L +S +B PD<br>300 22,0 20,4 V L +S +B<br>300 22,0 19,6 V L +S +B PD |
|  | 1.8<br>1.9<br>2.0<br>2.8 Coupe<br>2.8 Roadster<br>3.0 Coupe                            | 85<br><br>110<br>141<br>141<br>170   |  | 10.95 10.98<br>10.95 08.00<br>04.99 08.00<br>07.97 06.00<br>05.97 06.00<br>06.00 08.00                               | 24.0741-1103.3  | 360161   | 2   | Radsensor L=560  |
|  |     |  |  |  |   |  |  |  |

1) two-piece brake disc / disco frenante in due parti / disque d.fr.en deux parties / disco de fr.de dos piezas

|     |    |  |  |  |  |  |  |    |  |
|--|--|--|--|--|---|--|--|--|--|
| <b>BMW Z3/E36 (95-02)</b>  |  |  |  |  |   |  |  |  |  |
|    | 3.0 Roadster<br>M Coupe<br>M Roadster  | 170  |  | 06.00<br>02.98<br>03.97  | 08.00<br>08.00<br>08.00   | 24.0741-1103.3   | 360161   | 2   | Radsensor L=560  |
|  | 1.9<br>2.2<br>3.0 Coupe<br>3.0 Roadster<br>M Coupe<br>M Roadster                   | 125<br>170<br>170  |  | 09.00<br>10.00<br>09.00<br>09.00<br>09.00  | 12.02<br>12.02<br>12.02<br>12.02<br>12.02   | 24.0741-1103.3   | 360161   | 2  - DSC  | Radsensor L=560  |
|    | 1.8<br>1.9<br>2.0<br>2.2<br>2.8 Coupe<br>2.8 Roadster<br>3.0 Coupe<br>3.0 Roadster | 85<br>110<br>125<br>141<br>141<br>170<br>170                                     |  | 10.95<br>10.95<br>04.99<br>10.00<br>07.97<br>05.97<br>06.00<br>06.00             | 10.98<br>12.02<br>08.00<br>12.02<br>06.00<br>06.00<br>12.02                       | 13.0460-3605.2<br>13.0470-3605.2<br>24.8190-0211.2                                 | 603605<br>LD3605<br>620211   | 1  | 20180 17,3 +/WE<br>20180 17,3 +/WE<br>Warnkontakt L=840mm  |
|  | M Coupe<br>M Roadster  |  |  | 02.98<br>03.97   | 12.02<br>12.02  | 13.0460-3803.2<br>24.8190-0211.2   | 603803<br>620211   | 1  | 20995 17,3 +/WE<br>Warnkontakt L=840mm   |
|    | 1.8<br>1.9<br>2.0<br>2.2<br>2.8 Coupe<br>2.8 Roadster<br>3.0 Coupe<br>3.0 Roadster | 85<br>110<br>125<br>141<br>141<br>170<br>170                                     |  | 10.95<br>10.95<br>04.99<br>10.00<br>07.97<br>05.97<br>06.00<br>06.00             | 10.98<br>12.02<br>08.00<br>12.02<br>06.00<br>06.00<br>12.02                       | 24.0110-0273.1   | 410273   |  | 272 10,0 8,4 L +S +B   |
|  | M Coupe<br>M Roadster  |  |  | 02.98<br>03.97   | 12.02<br>12.02  | 24.0120-0189.1<br>24.0120-0190.1   | 420189<br>420190   | <br>   | 312 20,0 18,4 V L +S +B<br>312 20,0 18,4 V L +S +B   |
|    | 1.8<br>1.9<br>2.0<br>2.2<br>2.8 Coupe<br>2.8 Roadster<br>3.0 Coupe<br>3.0 Roadster | 85<br>110<br>125<br>141<br>141<br>170<br>170                                     |  | 10.95<br>10.95<br>04.99<br>10.00<br>07.97<br>05.97<br>06.00<br>06.00             | 10.98<br>12.02<br>08.00<br>12.02<br>06.00<br>06.00<br>12.02                       | 03.0137-0248.2<br>03.0137-9148.2   | 650248<br>669148   |  | 161 x 25<br>Bremsbacken-Zubehör  |
|  | M Coupe<br>M Roadster  |  |  | 02.98<br>03.97   | 12.02<br>12.02  | 03.0137-0150.2<br>03.0137-9062.2   | 650150<br>669062   |  | 180 x 25<br>Bremsbacken-Zubehör  |
| <b>BMW Z4 Roadster/E85 (03-08)</b>   |  |  |  |  |   |  |  |  |  |
|  | 2.0 i<br>2.2 i<br>2.5 i<br>2.5 i<br>2.5 si<br>3.0 i                                | 110<br>125<br>130<br>141<br>160<br>170   |  | 04.05<br>10.03<br>01.06<br>12.02<br>01.06<br>12.02                               | 12.08<br>12.08<br>12.08<br>12.08<br>12.08<br>12.08                                | 13.0460-5405.2<br>13.0470-5405.2<br>24.8190-0220.2                                 | 605405<br>LD5405<br>620220   | 1  | 21643 17,8 +/WE<br>21643 17,8 +/WE<br>Warnkontakt L=601mm  |
|  | 3.0 si   | 195  |  | 01.06  | 12.08   | 13.0460-7155.2<br>13.0470-7155.2<br>24.8190-0244.2                                 | 607155<br>LD7155<br>620244   | 1  | 23183 20,3 +/WE<br>23183 20,3 +/WE<br>Warnkontakt L=611mm  |
|  | M  | 252  |  | 01.06  | 12.08   | 13.0460-7185.2<br>24.8190-0244.2   | 607185<br>620244   | 1  | 21064 20,3 +/WE<br>Warnkontakt L=611mm   |
|  | 2.0 i<br>2.2 i<br>2.5 i<br>2.5 i   | 110<br>125<br>130<br>141   |  | 04.05<br>10.03<br>01.06<br>12.02   | 12.08<br>12.08<br>12.08<br>12.08  | 24.0122-0115.1<br>24.0322-0115.1   | 422115<br>522115   |  | 286 22,0 20,4 V L +S +B<br>286 22,0 19,6 V L +S +B PD  |
|  | 2.5 si<br>3.0 i<br>3.0 si  | 160<br>170<br>195  |  | 01.06<br>12.02<br>01.06  | 12.08<br>12.08<br>12.08   | 24.0122-0160.1<br>24.0322-0160.1<br>24.0125-0138.1                                 | 422160<br>522160<br>425138   |  | 300 22,0 20,4 V L +S +B<br>300 22,0 19,6 V L +S +B PD<br>325 24,9 23,4 V L +S +B<br>325 24,9 22,5 V L +S +B PD |
|  | M  | 252  |  | 01.06  | 12.08   | 24.0128-0208.2<br>24.0128-0209.2   | 428208<br>428209   |  zweiteilige Bremsscheibe/ mit ABE 1)<br> zweiteilige Bremsscheibe/ mit ABE 1) | 345 28,0 26,4 V L +S +B<br>345 28,0 26,4 V L +S +B   |
|  | 2.0 i<br>2.2 i<br>2.5 i<br>2.5 i<br>2.5 si<br>3.0 i<br>3.0 si                      | 110<br>125<br>130<br>141<br>160<br>170<br>195                                    |  | 04.05<br>10.03<br>01.06<br>12.02<br>01.06<br>12.02<br>01.06                      | 12.08<br>12.08<br>12.08<br>12.08<br>12.08<br>12.08<br>12.08                       | 24.0711-5277.3<br>24.0711-5278.3   | 360322<br>360323   | <br>   | Radsensor L=565<br>Radsensor L=565   |
|  | M  | 252  |  | 01.06  | 12.08   | 13.0460-7079.2<br>13.0470-7079.2<br>24.8190-0245.2                                 | 607079<br>LD7079<br>620245   | 1  | 21487 17,3 +/WE<br>21487 17,3 +/WE<br>Warnkontakt L=1163mm   |
|  | 2.0 i<br>2.2 i<br>2.5 i<br>2.5 i   | 110<br>125<br>130<br>141   |  | 04.05<br>10.03<br>01.06<br>12.02   | 12.08<br>12.08<br>12.08<br>12.08  | 24.0110-0287.1   | 410287   |  | 280 10,0 8,4 L +S +B   |
|  | 2.5 si   | 160  |  | 01.06  | 12.08   | 24.0119-0112.1   | 419112   |  | 294 19,0 17,4 V L +S +B  |

1) two-piece brake disc/ with ABE / disco frenante en due parti/ con ABE / disque d.fren deux parties/ avec ABE / disco de fr.de dos piezas/ con ABE

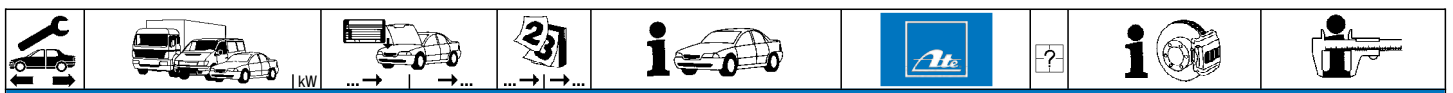

| BMW Z4 Roadster/E85 (03-08) |        |     |  |       |       |  |                |        |   |   |
|-----------------------------|--------|-----|--|-------|-------|--|----------------|--------|---|---|
|                             | 3.0 i  | 170 |  | 12.02 | 12.08 |  | 24.0119-0112.1 | 419112 |   | 294 19,0 17,4 V L +S +B   |
|                             | 3.0 si | 195 |  | 01.06 | 12.08 |  |                |        |   |   |
|                             | M      | 252 |  | 01.06 | 12.08 |  | 24.0120-0221.2 | 420221 | <input type="checkbox"/> zweiteilige Bremsscheibe <sup>1)</sup> | 328 20,0 18,4 V L +S +B   |
|                             |        |     |  |       |       |  | 24.0120-0222.2 | 420222 | <input type="checkbox"/> zweiteilige Bremsscheibe <sup>1)</sup> | 328 20,0 18,4 V L +S +B   |
|                             | 2.0 i  | 110 |  | 04.05 | 12.08 |  | 24.0711-6094.3 | 360179 | 2 <input type="checkbox"/>                                      | Radsensor L=806   |
|                             | 2.2 i  | 125 |  | 10.03 | 12.08 |  |                |        |   |   |
|                             | 2.5 i  | 130 |  | 01.06 | 12.08 |  |                |        |   |   |
|                             | 2.5 i  | 141 |  | 12.02 | 12.08 |  |                |        |   |   |
|                             | 2.5 si | 160 |  | 01.06 | 12.08 |  |                |        |   |   |
|                             | 3.0 i  | 170 |  | 12.02 | 12.08 |  |                |        |   |   |
|                             | 3.0 si | 195 |  | 01.06 | 12.08 |  |                |        |   |   |
|                             | M      | 252 |  | 01.06 | 12.08 |  |                |        |   |   |
|                             | 2.0 i  | 110 |  | 04.05 | 12.08 |  | 03.0137-0379.2 | 650379 |   | 161 x 20<br>Bremsbacken-Zubehör<br>Bremsbacken-Zubehör<br>Spreizschloß Satz |
|                             | 2.2 i  | 125 |  | 10.03 | 12.08 |  |                |        |   |   |
|                             | 2.5 i  | 130 |  | 01.06 | 12.08 |  |                |        |   |   |
|                             | 2.5 i  | 141 |  | 12.02 | 12.08 |  |                |        |   |   |
|                             | 2.5 si | 160 |  | 01.06 | 12.08 |  |                |        |   |   |
|                             | 3.0 i  | 170 |  | 12.02 | 12.08 |  |                |        |   |   |
|                             | 3.0 si | 195 |  | 01.06 | 12.08 |  |                |        |   |   |
|                             | M      | 252 |  | 01.06 | 12.08 |  |                |        |   |   |
|                             |        |     |  |       |       |  | 03.0137-0419.2 | 650419 |   | 185 x 30  |
|                             |        |     |  |       |       |  | 03.0137-9288.2 | 669288 |   | Bremsbacken-Zubehör   |























| BMW Z4 Coupe/E86 (06-08) |        |     |  |       |       |  |                |        |  |                            |
|--------------------------|--------|-----|--|-------|-------|--|----------------|--------|--|----------------------------|
|                          | 3.0 si | 195 |  | 03.06 | 09.08 |  | 13.0460-7155.2 | 607155 |  | 23183 20,3 +/WE            |
|                          |        |     |  |       |       |  | 13.0470-7155.2 | LD7155 |  | 23183 20,3 +/WE            |
|                          | M      | 252 |  | 03.06 | 09.08 |  | 24.8190-0244.2 | 620244 | 1  | Warnkontakt L=611mm        |
|                          |        |     |  |       |       |  |                |        |  | 21064 20,3 +/WE            |
|                          | 3.0 si | 195 |  | 03.06 | 09.08 |  | 24.0125-0138.1 | 425138 |  | 325 24,9 23,4 V L +S +B    |
|                          |        |     |  |       |       |  | 24.0325-0138.1 | 525138 |  | 325 24,9 22,5 V L +S +B PD |
|                          | M      | 252 |  | 03.06 | 09.08 |  | 24.0128-0208.2 | 428208 | <input type="checkbox"/> zweiteilige Bremsscheibe/ mit ABE <sup>2)</sup> | 345 28,0 26,4 V L +S +B    |
|                          |        |     |  |       |       |  | 24.0128-0209.2 | 428209 | <input type="checkbox"/> zweiteilige Bremsscheibe/ mit ABE <sup>2)</sup> | 345 28,0 26,4 V L +S +B    |
|                          | 3.0 si | 195 |  | 03.06 | 09.08 |  | 24.0711-5277.3 | 360322 | <input type="checkbox"/>   | Radsensor L=565            |
|                          | M      | 252 |  | 03.06 | 09.08 |  | 24.0711-5278.3 | 360323 | <input type="checkbox"/>   | Radsensor L=565            |
|                          | 3.0 si | 195 |  | 03.06 | 09.08 |  | 13.0460-3605.2 | 603605 |  | 20180 17,3 +/WE            |
|                          |        |     |  |       |       |  | 13.0470-3605.2 | LD3605 |  | 20180 17,3 +/WE            |
|                          | M      | 252 |  | 03.06 | 09.08 |  | 24.8190-0229.2 | 620229 | 1  | Warnkontakt L=1143mm       |
|                          |        |     |  |       |       |  |                |        |  | 21487 17,3 +/WE            |
|                          | 3.0 si | 195 |  | 03.06 | 09.08 |  | 13.0460-7079.2 | 607079 |  | 21487 17,3 +/WE            |
|                          |        |     |  |       |       |  | 13.0470-7079.2 | LD7079 |  | 21487 17,3 +/WE            |
|                          | M      | 252 |  | 03.06 | 09.08 |  | 24.8190-0245.2 | 620245 | 1  | Warnkontakt L=1163mm       |
|                          |        |     |  |       |       |  |                |        |  | 294 19,0 17,4 V L +S +B    |
|                          | 3.0 si | 195 |  | 03.06 | 09.08 |  | 24.0119-0112.1 | 419112 |  | 328 20,0 18,4 V L +S +B    |
|                          |        |     |  |       |       |  | 24.0120-0221.2 | 420221 | <input type="checkbox"/> zweiteilige Bremsscheibe <sup>1)</sup>          | 328 20,0 18,4 V L +S +B    |
|                          | M      | 252 |  | 03.06 | 09.08 |  | 24.0120-0222.2 | 420222 | <input type="checkbox"/> zweiteilige Bremsscheibe <sup>1)</sup>          | 328 20,0 18,4 V L +S +B    |
|                          |        |     |  |       |       |  |                |        |  | 328 20,0 18,4 V L +S +B    |
|                          | 3.0 si | 195 |  | 03.06 | 09.08 |  | 24.0711-6094.3 | 360179 | 2 <input type="checkbox"/>   | Radsensor L=806            |
|                          | M      | 252 |  | 03.06 | 09.08 |  |                |        |  |                            |
|                          | 3.0 si | 195 |  | 03.06 | 09.08 |  | 03.0137-0379.2 | 650379 |  | 161 x 20                   |
|                          |        |     |  |       |       |  | 03.0137-9265.2 | 669265 |  | Bremsbacken-Zubehör        |
|                          |        |     |  |       |       |  | 03.0137-9701.2 | 669701 |  | Bremsbacken-Zubehör        |
|                          |        |     |  |       |       |  | 03.0137-9702.2 | 669702 |  | Spreizschloß Satz          |
|                          | M      | 252 |  | 03.06 | 09.08 |  | 03.0137-0419.2 | 650419 |  | 185 x 30                   |
|                          |        |     |  |       |       |  | 03.0137-9288.2 | 669288 |  | Bremsbacken-Zubehör        |

| BMW Z4 Roadster/E89 (09-) |             |     |  |       |       |  |                |        |   |                            |
|---------------------------|-------------|-----|--|-------|-------|--|----------------|--------|---|----------------------------|
|                           | sDrive 23i  | 150 |  | 01.09 | 02.10 |  | 13.0460-7216.2 | 607216 |   | 23794 20,3 +/WE            |
|                           |             |     |  |       |       |  | 13.0470-7216.2 | LD7216 |   | 23794 20,3 +/WE            |
|                           | M           | 252 |  | 01.09 | 02.10 |  | 24.8190-0263.2 | 620263 | 1   | Warnkontakt L=969mm        |
|                           |             |     |  |       |       |  |                |        |   | 24161 20,3 +/WE            |
|                           | sDrive 18i  | 115 |  | 03.13 |       |  | 13.0460-7216.2 | 607216 |   | 23794 20,3 +/WE            |
|                           | sDrive 20i  | 135 |  | 09.11 |       |  | 13.0470-7216.2 | LD7216 |   | 23794 20,3 +/WE            |
|                           | sDrive 23i  | 150 |  | 03.10 |       |  | 24.8190-0295.2 | 620295 | 1   | Warnkontakt L=1013mm       |
|                           | sDrive 28i  | 180 |  | 09.11 |       |  |                |        |   |                            |
|                           | sDrive 30i  | 190 |  | 03.10 |       |  |                |        |   |                            |
|                           | sDrive 30i  | 190 |  | 01.09 | 02.10 |  | 13.0460-7216.2 | 607216 |   | 23794 20,3 +/WE            |
|                           |             |     |  |       |       |  | 13.0470-7216.2 | LD7216 |   | 23794 20,3 +/WE            |
|                           | M           | 252 |  | 01.09 | 02.10 |  | 24.8190-0263.2 | 620263 | 1   | Warnkontakt L=969mm        |
|                           |             |     |  |       |       |  |                |        |   | 24161 20,3 +/WE            |
|                           | sDrive 35i  | 225 |  | 01.09 | 02.10 |  | 13.0460-7237.2 | 607237 |   | 23313 20,3 +/WE            |
|                           |             |     |  |       |       |  | 13.0460-7238.2 | 607238 |   | 23313 20,3 +/WE            |
|                           |             |     |  |       |       |  | 13.0470-7238.2 | LD7238 |   | 23313 20,3 +/WE            |
|                           |             |     |  |       |       |  | 24.8190-0263.2 | 620263 | 1   | Warnkontakt L=969mm        |
|                           | sDrive 35i  | 225 |  | 03.10 |       |  | 13.0460-7237.2 | 607237 |   | 24161 20,3 +/WE            |
|                           | sDrive 35is | 250 |  | 09.10 |       |  | 13.0460-7238.2 | 607238 |   | 23313 20,3 +/WE            |
|                           |             |     |  |       |       |  | 24.8190-0295.2 | 620295 | 1   | Warnkontakt L=1013mm       |
|                           |             |     |  |       |       |  |                |        |   |                            |
|                           | sDrive 18i  | 115 |  | 03.13 |       |  | 24.0124-0197.1 | 424197 |   | 300 24,0 22,4 V L +S +B    |
|                           | sDrive 20i  | 135 |  | 09.11 |       |  | 24.0324-0197.1 | 524197 |   | 300 24,0 21,6 V L +S +B PD |
|                           | sDrive 23i  | 150 |  | 01.09 |       |  |                |        |   |                            |
|                           | sDrive 28i  | 180 |  | 09.11 |       |  | 24.0124-0242.2 | 424242 | <input type="checkbox"/> zweiteilige Bremsscheibe <sup>1)</sup> | 330 24,0 22,4 V L +S +B    |
|                           | sDrive 30i  | 190 |  | 01.09 |       |  |                |        |   |                            |
|                           |             |     |  |       |       |  |                |        |   |                            |
|                           | sDrive 35i  | 225 |  | 01.09 |       |  | 24.0130-0216.2 | 430216 | <input type="checkbox"/> zweiteilige Bremsscheibe <sup>1)</sup> | 348 30,0 28,4 V L +S +B    |
|                           | sDrive 35is | 250 |  | 09.10 |       |  |                |        |   |                            |
|                           | sDrive 23i  | 150 |  | 01.09 | 02.10 |  | 13.0460-2759.2 | 602759 |   | 24559 17,8 +/WE/Zub./STRW  |
|                           | sDrive 30i  | 190 |  | 01.09 | 02.10 |  | 24.8190-0262.2 | 620262 | 1   | Warnkontakt L=1338mm       |

<sup>1)</sup> two-piece brake disc / disco frenante in due parti / disque d.fr.en deux parties / disco de fr.de dos piezas



















<sup>2)</sup> two-piece brake disc/ with ABE / disco frenante in due parti/ con ABE / disque d.fr.en deux parties/ avec ABE / disco de fr.de dos piezas/ con ABE



|     |    |  |  |    |  |  |  |     |  |
|--|--|--|--|--|---|--|--|---|--|
| <b>BMW Z4 Roadster/E89 (09-)</b>   |  |  |  |  |   |  |  |   |  |
|    | sDrive 18i<br>sDrive 20i<br>sDrive 23i<br>sDrive 28i<br>sDrive 30i   | 115<br>135<br>150<br>180<br>190  |  | 03.13<br>09.11<br>03.10<br>09.11<br>03.10  |   | 13.0460-2759.2<br>24.8190-0294.2   | 602759<br>620294   | 1   | 24559 17,8 +/WE/Zub/STRW<br>Warnkontakt L=1361mm   |
|  | sDrive 35i   | 225  |  | 01.09<br>02.10   |   | 13.0460-2760.2<br>13.0470-2760.2<br>24.8190-0262.2                                 | 602760<br>LD2760<br>620262   | 1   | 24561 17,7 +/WE/Zub/STRW<br>24561 17,7 +/WE/Zub/STRW<br>Warnkontakt L=1338mm                               |
|  | sDrive 35i<br>sDrive 35is  | 225<br>250   |  | 03.10<br>09.10   |   | 13.0460-2760.2<br>13.0470-2760.2<br>24.8190-0294.2                                 | 602760<br>LD2760<br>620294   | 1   | 24561 17,7 +/WE/Zub/STRW<br>24561 17,7 +/WE/Zub/STRW<br>Warnkontakt L=1361mm                               |
|    | sDrive 18i<br>sDrive 20i<br>sDrive 23i<br>sDrive 28i<br>sDrive 30i   | 115<br>135<br>150<br>180<br>190  |  | 03.13<br>09.11<br>01.09<br>09.11<br>01.09  |   | 24.0120-0226.1   | 420226   |   | 300 20,0 18,4 V L +S +B  |
|  | sDrive 35i<br>sDrive 35is  | 225<br>250   |  | 01.09<br>09.10   |   | 24.0120-0228.1   | 420228   |   | 324 20,0 18,4 V L +S +B  |
| <b>BMW Z8/E52 (00-03)</b>  |  |  |  |  |   |  |  |   |  |
|    | 4.9  | 294  |  | 06.00<br>08.03   |   | 13.0460-7183.2<br>24.8190-0233.2   | 607183<br>620233   | 1   | 21484 20,5 +/WE<br>Warnkontakt L=758mm<br><b>ATE</b>   |
|    | 4.9  | 294  |  | 06.00<br>08.03   |   | 24.0132-0160.1   | 432160   |   | 334 31,9 30,4 V L +S +B  |
|    | 4.9  | 294  |  | 06.00<br>08.03   |   | 13.0460-7079.2<br>24.8190-0218.2   | 607079<br>620218   | 1   | 21487 17,3 +/WE<br>Warnkontakt L=545mm<br><b>ATE</b>   |
|    | 4.9  | 294  |  | 06.00<br>08.03   |   | 24.0120-0182.1   | 420182   |   | 328 20,0 18,4 V L +S +B  |
|    | 4.9  | 294  |  | 06.00<br>08.03   |   | 24.0710-2003.1   | 360210   | 2  | Radsensor L=1029   |
|    | 4.9  | 294  |  | 06.00<br>08.03   |   | 03.0137-0150.2<br>03.0137-9062.2   | 650150<br>669062   |   | 180 x 25<br>Bremsbacken-Zubehör  |
| <b>CHEVROLET AVEO (T200,T250) (04-11)</b>  |  |  |  |  |   |  |  |   |  |
|  | 1.2 i<br>1.2 i<br>1.2 i<br>1.2 i<br>1.2 LPG<br>1.4 CNG<br>1.4 i 16V<br>1.4 i 16V<br>1.5 i<br>1.6 i 16V<br>1.6 i 16V<br>1.6 i 16V | 53<br>55<br>56<br>62<br>62<br>69<br>69<br>74<br>62<br>75<br>76<br>77             |  | 03.06<br>07.11<br>01.08<br>07.11<br>03.06<br>07.11<br>01.08<br>07.11<br>04.08<br>07.11<br>01.10<br>07.11<br>03.06<br>07.11<br>01.08<br>07.11<br>05.05<br>07.11<br>03.06<br>07.11<br>05.05<br>07.11<br>12.04<br>07.11 |   | 13.0460-5899.2   | 605899   |   | 23974 17,6<br><b>AKE</b>   |
|  | 1.2 i<br>1.2 i<br>1.2 i<br>1.2 i<br>1.2 LPG<br>1.4 CNG<br>1.4 i 16V<br>1.4 i 16V<br>1.5 i<br>1.6 i 16V<br>1.6 i 16V<br>1.6 i 16V | 53<br>55<br>56<br>62<br>62<br>69<br>69<br>74<br>62<br>75<br>76<br>77             |  | 03.06<br>07.11<br>01.08<br>07.11<br>03.06<br>07.11<br>01.08<br>07.11<br>04.08<br>07.11<br>01.10<br>07.11<br>03.06<br>07.11<br>01.08<br>07.11<br>05.05<br>07.11<br>03.06<br>07.11<br>05.05<br>07.11<br>12.04<br>07.11 |   | 24.0120-0115.1<br>24.0120-0227.1   | 420115<br>420227   |   | Naben D=60 <sup>1)</sup><br>Naben D=59 <sup>2)</sup><br>236 20,0 17,0 V L +S +B<br>236 20,0 18,0 V L +S +B |
|  | 1.2 i<br>1.2 i<br>1.2 i<br>1.2 i<br>1.2 LPG<br>1.4 CNG<br>1.4 i 16V<br>1.4 i 16V<br>1.5 i<br>1.6 i 16V<br>1.6 i 16V<br>1.6 i 16V | 53<br>55<br>56<br>62<br>62<br>69<br>69<br>74<br>62<br>75<br>76<br>77             |  | 03.06<br>07.11<br>01.08<br>07.11<br>03.06<br>07.11<br>01.08<br>07.11<br>04.08<br>07.11<br>01.10<br>07.11<br>03.06<br>07.11<br>01.08<br>07.11<br>05.05<br>07.11<br>03.06<br>07.11<br>05.05<br>07.11<br>12.04<br>07.11 |   | 03.0137-0472.2<br>03.0137-9167.2   | 650472<br>669167   |   | 200 x 36 HEB<br>Bremsbacken-Zubehör  |
|  | 1.2 i<br>1.2 i<br>1.2 i<br>1.2 i<br>1.2 LPG<br>1.4 CNG<br>1.4 i 16V<br>1.4 i 16V<br>1.5 i  | 53<br>55<br>56<br>62<br>62<br>69<br>69<br>74<br>62                               |  | 03.06<br>07.11<br>01.08<br>07.11<br>03.06<br>07.11<br>01.10<br>07.11<br>03.06<br>07.11<br>01.08<br>07.11<br>05.05<br>07.11   |   | 03.0520-6619.3   | 696619   |   | 19,05/200x36 TopKit  |

<sup>1)</sup> hub diameter=60 / diametro mozzo=60 / diamètre du moyeu=60 / diámetro del buje=60

<sup>2)</sup> hub diameter=59 / diametro mozzo=59 / diamètre du moyeu=59 / diámetro del buje=59

|     |    |   |   |  |  |  |  |  |
|--|--|---|---|--|---|--|--|--|
| <b>CHEVROLET AVEO (T200,T250) (04-11)</b>  |  |   |   |  |   |  |  |  |
|    | 1.6 i 16V<br>1.6 i 16V<br>1.6 i 16V  | 75<br>76<br>77  | 03.06<br>05.05<br>12.04   | 07.11<br>07.11<br>07.11  | 03.0520-6619.3  | 696619   |  | 19,05/200x36 TopKit  |
| <b>CHEVROLET AVEO (T300) (11-)</b>   |  |   |   |  |   |  |  |  |
|    | 1.2 16V<br>1.2 16V<br>1.2 LPG<br>1.3 D<br>1.3 D<br>1.4 16V<br>1.4 16V<br>1.6 16V<br>1.6 16V<br>1.6 16V<br>1.4 Turbo  | 51<br>63<br>63<br>55<br>70<br>74<br>76<br>85<br>88<br>89<br>103   | 03.11<br>03.11<br>11.12<br>07.11<br>07.11<br>03.11<br>12.12<br>03.11<br>06.11<br>12.12<br>08.13   |  | 13.0460-7262.2<br>13.0470-7262.2  | 607262<br>LD7262   | + 15" Rad 1)<br>+ 15" Rad 1)   | 25031 19,1 +/WK/Zub<br>25031 19,1 +/WK/Zub<br><b>ATE</b>                           |
|    | 1.2 16V<br>1.2 16V<br>1.2 LPG<br>1.3 D<br>1.3 D<br>1.4 16V<br>1.4 16V<br>1.6 16V<br>1.6 16V<br>1.6 16V<br>1.4 Turbo  | 51<br>63<br>63<br>55<br>70<br>74<br>76<br>85<br>88<br>89<br>103   | 03.11<br>03.11<br>11.12<br>07.11<br>07.11<br>03.11<br>12.12<br>03.11<br>06.11<br>12.12<br>08.13   |  | 24.0126-0165.1<br>24.0326-0165.1  | 426165<br>526165   | + 15" Rad 1)<br>+ 15" Rad 1)   | 25031 19,1 +/WK/Zub<br>25031 19,1 +/WK/Zub<br><b>ATE</b>                           |
|    | 1.4 Turbo  | 103   | 08.13   |  | 13.0460-7264.2<br>13.0470-7264.2  | 607264<br>LD7264   |  | 25096 17,0 +/WK/Zub<br>25096 17,0 +/WK/Zub<br><b>ATE</b>                           |
|    | 1.4 Turbo  | 103   | 08.13   |  | 24.0112-0188.1<br>24.0312-0188.1  | 412188<br>512188   |  | 268 12,0 10,0 +S +B<br>268 12,0 10,0 +S +B PD                                      |
| <b>CHEVROLET CAPTIVA (06-)</b>   |  |   |   |  |   |  |  |  |
|   | 2.0 VCDi<br>2.0 VCDi 4WD<br>2.0 VDCi<br>2.0 VDCi 4WD<br>2.2 VCDi<br>2.2 VCDi 4WD<br>2.2 VCDi 4WD<br>2.4<br>2.4<br>2.4<br>2.4<br>2.4 4WD<br>2.4 4WD<br>2.4 4WD<br>2.4 4WD<br>2.4 Flex<br>2.4 LPG<br>2.4 LPG 4WD<br>3.0 4WD<br>3.0 Flex<br>3.0 Flex AWD<br>3.2 4WD | 110<br>110<br>93<br>93<br>120<br>120<br>135<br>100<br>103<br>123<br>136<br>100<br>103<br>123<br>136<br>100<br>100<br>190<br>197<br>197<br>169 | 09.07<br>10.06<br>10.06<br>10.06<br>03.11<br>03.11<br>03.11<br>06.06<br>12.06<br>03.11<br>01.11<br>06.06<br>12.06<br>03.11<br>01.11<br>01.07<br>01.07<br>01.10<br>01.11<br>01.11<br>06.06 |  | 13.0460-5785.2  | 605785   |  | 24510 17,0 +/WK  |
|  | 2.0 VCDi<br>2.0 VCDi 4WD<br>2.0 VDCi<br>2.0 VDCi 4WD<br>2.2 VCDi<br>2.2 VCDi 4WD<br>2.2 VCDi 4WD<br>2.4<br>2.4<br>2.4<br>2.4<br>2.4 4WD<br>2.4 4WD<br>2.4 4WD<br>2.4 4WD<br>2.4 Flex<br>2.4 LPG<br>2.4 LPG 4WD<br>3.0 4WD<br>3.0 Flex<br>3.0 Flex AWD<br>3.2 4WD | 110<br>110<br>93<br>93<br>120<br>120<br>135<br>100<br>103<br>123<br>136<br>100<br>103<br>123<br>136<br>100<br>100<br>190<br>197<br>197<br>169 | 09.07<br>10.06<br>10.06<br>10.06<br>03.11<br>03.11<br>03.11<br>06.06<br>12.06<br>03.11<br>01.11<br>06.06<br>12.06<br>03.11<br>01.11<br>01.07<br>01.07<br>01.10<br>01.11<br>01.11<br>06.06 |  | 24.0129-0101.1  | 429101   |  | 296 29,0 27,5 V L +B   |
|  | 2.0 VCDi<br>2.0 VCDi 4WD<br>2.0 VDCi<br>2.0 VDCi 4WD<br>2.2 VCDi<br>2.2 VCDi 4WD<br>2.2 VCDi 4WD   | 110<br>110<br>93<br>93<br>120<br>120<br>135   | 09.07<br>10.06<br>10.06<br>10.06<br>03.11<br>03.11<br>03.11   |  | 13.0460-5788.2<br>13.0460-0135.2  | 605788<br>610135   |  | 24498 14,7 +/WK/Zub<br>Belagsatz-Zubehör   |
|  |   |   |   |  |   |  |  |  |

1) + 15" wheel / + ruota 15" / + roue 15" / + rueda 15"

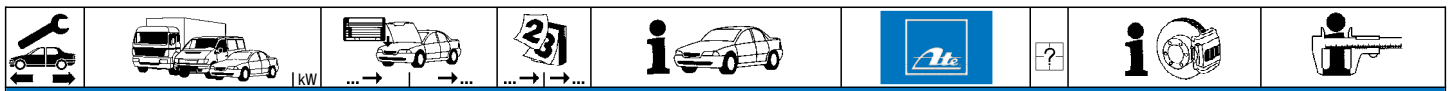

**CHEVROLET CAPTIVA (06-)**

|              |              |          |       |       |                |                |  |  |
|--------------|--------------|----------|-------|-------|----------------|----------------|--|--|
|              | 2.4          | 100      | 06.06 |       | 13.0460-5788.2 | 605788         |  | 24498 14,7 +/WK/Zub<br>Belagsatz-Zubehör |
|              | 2.4          | 103      | 12.06 |       | 13.0460-0135.2 | 610135         |  |  |
|              | 2.4          | 123      | 03.11 |       |                |                |  |  |
|              | 2.4          | 136      | 01.11 |       |                |                |  |  |
|              | 2.4 4WD      | 100      | 06.06 |       |                |                |  |  |
|              | 2.4 4WD      | 103      | 12.06 |       |                |                |  |  |
|              | 2.4 4WD      | 123      | 03.11 |       |                |                |  |  |
|              | 2.4 Flex     | 136      | 01.11 |       |                |                |  |  |
|              | 2.4 LPG      | 100      | 01.07 |       |                |                |  |  |
|              | 2.4 LPG 4WD  | 100      | 01.07 |       |                |                |  |  |
|              | 3.0 4WD      | 190      | 01.10 |       |                |                |  |  |
|              | 3.0 Flex     | 197      | 01.11 |       |                |                |  |  |
|              | 3.0 Flex AWD | 197      | 01.11 |       |                |                |  |  |
|              | 3.2 4WD      | 169      | 06.06 |       |                |                |  |  |
|              |              | 2.0 VCDi | 110   | 09.07 |                | 24.0120-0209.1 |  |  |
| 2.0 VCDi 4WD |              | 110      | 10.06 |       |                |                |  |  |
| 2.0 VDCi     |              | 93       | 10.06 |       |                |                |  |  |
| 2.0 VDCi 4WD |              | 93       | 10.06 |       |                |                |  |  |
| 2.2 VCDi     |              | 120      | 03.11 |       |                |                |  |  |
| 2.2 VCDi 4WD |              | 120      | 03.11 |       |                |                |  |  |
| 2.2 VCDi 4WD |              | 135      | 03.11 |       |                |                |  |  |
| 2.4          |              | 100      | 06.06 |       |                |                |  |  |
| 2.4          |              | 103      | 12.06 |       |                |                |  |  |
| 2.4          |              | 123      | 03.11 |       |                |                |  |  |
| 2.4          |              | 136      | 01.11 |       |                |                |  |  |
| 2.4 4WD      |              | 100      | 06.06 |       |                |                |  |  |
| 2.4 4WD      |              | 103      | 12.06 |       |                |                |  |  |
| 2.4 4WD      |              | 123      | 03.11 |       |                |                |  |  |
| 2.4 Flex     |              | 136      | 01.11 |       |                |                |  |  |
| 2.4 LPG      | 100          | 01.07    |       |       |                |                |  |  |
| 2.4 LPG 4WD  | 100          | 01.07    |       |       |                |                |  |  |
| 3.0 4WD      | 190          | 01.10    |       |       |                |                |  |  |
| 3.0 Flex     | 197          | 01.11    |       |       |                |                |  |  |
| 3.0 Flex AWD | 197          | 01.11    |       |       |                |                |  |  |
| 3.2 4WD      | 169          | 06.06    |       |       |                |                |  |  |
|              | 2.0 VCDi     | 110      | 09.07 |       | 03.0137-3011.2 | 653011         |  | 188 x 26                                 |
|              | 2.0 VCDi 4WD | 110      | 10.06 |       |                |                |  |  |
|              | 2.0 VDCi     | 93       | 10.06 |       |                |                |  |  |
|              | 2.0 VDCi 4WD | 93       | 10.06 |       |                |                |  |  |
|              | 2.2 VCDi     | 120      | 03.11 |       |                |                |  |  |
|              | 2.2 VCDi 4WD | 120      | 03.11 |       |                |                |  |  |
|              | 2.2 VCDi 4WD | 135      | 03.11 |       |                |                |  |  |
|              | 2.4          | 100      | 06.06 |       |                |                |  |  |
|              | 2.4          | 103      | 12.06 |       |                |                |  |  |
|              | 2.4          | 123      | 03.11 |       |                |                |  |  |
|              | 2.4          | 136      | 01.11 |       |                |                |  |  |
|              | 2.4 4WD      | 100      | 06.06 |       |                |                |  |  |
|              | 2.4 4WD      | 103      | 12.06 |       |                |                |  |  |
|              | 2.4 4WD      | 123      | 03.11 |       |                |                |  |  |
|              | 2.4 Flex     | 136      | 01.11 |       |                |                |  |  |
| 2.4 LPG      | 100          | 01.07    |       |       |                |                |  |  |
| 2.4 LPG 4WD  | 100          | 01.07    |       |       |                |                |  |  |
| 3.0 4WD      | 190          | 01.10    |       |       |                |                |  |  |
| 3.0 Flex     | 197          | 01.11    |       |       |                |                |  |  |
| 3.0 Flex AWD | 197          | 01.11    |       |       |                |                |  |  |
| 3.2 4WD      | 169          | 06.06    |       |       |                |                |  |  |

**CHEVROLET CRUZE (09-)**

|             |             |       |   |   |                |        |  |  |  |  |
|-------------|-------------|-------|---|---|----------------|--------|--|--|--|--|
|             | 1.4 16V     |       | 08.12                                       | + Bremsscheibendurchm. 276 mm <sup>1)</sup> | 13.0460-7262.2 | 607262 |  | 25031 19,1 +/WK/Zub<br>25031 19,1 +/WK/Zub ATE |  |  |
|             | 1.6 16V     | 80    | 05.09                                       | + Bremsscheibendurchm. 276 mm <sup>1)</sup> | 13.0470-7262.2 | LD7262 |  |  |  |  |
|             | 1.6 16V     | 83    | 05.09                                       | + Bremsscheibendurchm. 276 mm <sup>1)</sup> |                |        |  |  |  |  |
|             | 1.6 16V     | 91    | 05.09                                       | + Bremsscheibendurchm. 276 mm <sup>1)</sup> |                |        |  |  |  |  |
|             | 1.7 D       | 96    | 01.12                                       | + Bremsscheibendurchm. 276 mm <sup>1)</sup> |                |        |  |  |  |  |
|             | 1.8 16V     | 103   | 11.09                                       | + Bremsscheibendurchm. 276 mm <sup>1)</sup> |                |        |  |  |  |  |
|             | 1.8 16V     | 104   | 05.09                                       | + Bremsscheibendurchm. 276 mm <sup>1)</sup> |                |        |  |  |  |  |
|             | 1.8 16V LPG | 104   | 06.11                                       | + Bremsscheibendurchm. 276 mm <sup>1)</sup> |                |        |  |  |  |  |
|             | 1.8 Flex    | 106   | 01.11                                       | + Bremsscheibendurchm. 276 mm <sup>1)</sup> |                |        |  |  |  |  |
|             | 2.0 CDI     | 90    | 05.09                                       | + Bremsscheibendurchm. 276 mm <sup>1)</sup> |                |        |  |  |  |  |
|             | 2.0 CDI     | 92    | 05.09                                       | + Bremsscheibendurchm. 276 mm <sup>1)</sup> |                |        |  |  |  |  |
|             | 2.0 CDI     | 110   | 05.09                                       | + Bremsscheibendurchm. 276 mm <sup>1)</sup> |                |        |  |  |  |  |
|             | 2.0 CDI     | 120   | 08.10                                       | + Bremsscheibendurchm. 276 mm <sup>1)</sup> |                |        |  |  |  |  |
|             | 1.4 16V     |       | 08.12                                       | + Bremsscheibendurchm. 300 mm <sup>2)</sup> | 13.0460-7263.2 | 607263 |  |  |  | 24034 19,1 +/WK/Zub<br>24034 19,1 +/WK/Zub ATE |
|             | 1.6 16V     | 80    | 05.09                                       | + Bremsscheibendurchm. 300 mm <sup>2)</sup> | 13.0470-7263.2 | LD7263 |  |  |  |  |
| 1.6 16V     | 83          | 05.09 | + Bremsscheibendurchm. 300 mm <sup>2)</sup> |   |                |        |  |  |  |  |
| 1.6 16V     | 91          | 05.09 | + Bremsscheibendurchm. 300 mm <sup>2)</sup> |   |                |        |  |  |  |  |
| 1.7 D       | 96          | 01.12 | + Bremsscheibendurchm. 300 mm <sup>2)</sup> |   |                |        |  |  |  |  |
| 1.8 16V     | 103         | 11.09 | + Bremsscheibendurchm. 300 mm <sup>2)</sup> |   |                |        |  |  |  |  |
| 1.8 16V     | 104         | 05.09 | + Bremsscheibendurchm. 300 mm <sup>2)</sup> |   |                |        |  |  |  |  |
| 1.8 16V LPG | 104         | 06.11 | + Bremsscheibendurchm. 300 mm <sup>2)</sup> |   |                |        |  |  |  |  |
| 1.8 Flex    | 106         | 01.11 | + Bremsscheibendurchm. 300 mm <sup>2)</sup> |   |                |        |  |  |  |  |
| 2.0 CDI     | 90          | 05.09 | + Bremsscheibendurchm. 300 mm <sup>2)</sup> |   |                |        |  |  |  |  |
| 2.0 CDI     | 92          | 05.09 | + Bremsscheibendurchm. 300 mm <sup>2)</sup> |   |                |        |  |  |  |  |
| 2.0 CDI     | 110         | 05.09 | + Bremsscheibendurchm. 300 mm <sup>2)</sup> |   |                |        |  |  |  |  |
| 2.0 CDI     | 120         | 08.10 | + Bremsscheibendurchm. 300 mm <sup>2)</sup> |   |                |        |  |  |  |  |

<sup>1)</sup> + brake disc diameter 276 mm / + disco fr.diam. 276mm / + disques fr.diam. 276mm / + disco fr.díam. 276mm

<sup>2)</sup> + brake disc diameter 300mm / + diametro dischi freno 300mm / + diamètre disques frein 300mm / + diámetro disco freno 300mm

































**CHEVROLET CRUZE (09-)**

|          |             |     |       |   |   |                |        |   |   |
|----------|-------------|-----|-------|---|---|----------------|--------|---|---|
|          | 1.4 16V     |     |       | 08.12                                       | + Bremsscheibendurchm. 276 mm <sup>1)</sup> | 24.0126-0165.1 | 426165 |   | 276 26,0 23,0 V +S +B<br>276 26,0 23,0 V +S +B PD     |
|          | 1.6 16V     | 80  |       | 05.09                                       | + Bremsscheibendurchm. 276 mm <sup>1)</sup> | 24.0326-0165.1 | 526165 |   |   |
|          | 1.6 16V     | 83  |       | 05.09                                       | + Bremsscheibendurchm. 276 mm <sup>1)</sup> |                |        |   |   |
|          | 1.6 16V     | 91  |       | 05.09                                       | + Bremsscheibendurchm. 276 mm <sup>1)</sup> |                |        |   |   |
|          | 1.7 D       | 96  |       | 01.12                                       | + Bremsscheibendurchm. 276 mm <sup>1)</sup> |                |        |   |   |
|          | 1.8 16V     | 103 |       | 11.09                                       | + Bremsscheibendurchm. 276 mm <sup>1)</sup> |                |        |   |   |
|          | 1.8 16V     | 104 |       | 05.09                                       | + Bremsscheibendurchm. 276 mm <sup>1)</sup> |                |        |   |   |
|          | 1.8 16V LPG | 104 |       | 06.11                                       | + Bremsscheibendurchm. 276 mm <sup>1)</sup> |                |        |   |   |
|          | 1.8 Flex    | 106 |       | 01.11                                       | + Bremsscheibendurchm. 276 mm <sup>1)</sup> |                |        |   |   |
|          | 2.0 CDI     | 90  |       | 05.09                                       | + Bremsscheibendurchm. 276 mm <sup>1)</sup> |                |        |   |   |
|          | 2.0 CDI     | 92  |       | 05.09                                       | + Bremsscheibendurchm. 276 mm <sup>1)</sup> |                |        |   |   |
| 2.0 CDI  | 110         |     | 05.09 | + Bremsscheibendurchm. 276 mm <sup>1)</sup> |   |                |        |   |   |
| 2.0 CDI  | 120         |     | 08.10 | + Bremsscheibendurchm. 276 mm <sup>1)</sup> |   |                |        |   |   |
|          | 1.4 16V     |     |       | 08.12                                       | + Bremsscheibendurchm. 300 mm <sup>2)</sup> | 24.0126-0166.1 | 426166 |   | 300 26,0 23,0 V L +S +B<br>300 26,0 23,0 V L +S +B PD |
|          | 1.6 16V     | 80  |       | 05.09                                       | + Bremsscheibendurchm. 300 mm <sup>2)</sup> | 24.0326-0166.1 | 526166 |   |   |
|          | 1.6 16V     | 83  |       | 05.09                                       | + Bremsscheibendurchm. 300 mm <sup>2)</sup> |                |        |   |   |
|          | 1.6 16V     | 91  |       | 05.09                                       | + Bremsscheibendurchm. 300 mm <sup>2)</sup> |                |        |   |   |
|          | 1.7 D       | 96  |       | 01.12                                       | + Bremsscheibendurchm. 300 mm <sup>2)</sup> |                |        |   |   |
|          | 1.8 16V     | 103 |       | 11.09                                       | + Bremsscheibendurchm. 300 mm <sup>2)</sup> |                |        |   |   |
|          | 1.8 16V     | 104 |       | 05.09                                       | + Bremsscheibendurchm. 300 mm <sup>2)</sup> |                |        |   |   |
|          | 1.8 16V LPG | 104 |       | 06.11                                       | + Bremsscheibendurchm. 300 mm <sup>2)</sup> |                |        |   |   |
|          | 1.8 Flex    | 106 |       | 01.11                                       | + Bremsscheibendurchm. 300 mm <sup>2)</sup> |                |        |   |   |
|          | 2.0 CDI     | 90  |       | 05.09                                       | + Bremsscheibendurchm. 300 mm <sup>2)</sup> |                |        |   |   |
|          | 2.0 CDI     | 92  |       | 05.09                                       | + Bremsscheibendurchm. 300 mm <sup>2)</sup> |                |        |   |   |
| 2.0 CDI  | 110         |     | 05.09 | + Bremsscheibendurchm. 300 mm <sup>2)</sup> |   |                |        |   |   |
| 2.0 CDI  | 120         |     | 08.10 | + Bremsscheibendurchm. 300 mm <sup>2)</sup> |   |                |        |   |   |
|          | 1.4 16V     |     |       | 08.12                                       |   | 24.0711-5348.3 | 360351 | 2 | Radsensor L=800                                       |
|          | 1.6 16V     | 80  |       | 05.09                                       |   |                |        |   |   |
|          | 1.6 16V     | 83  |       | 05.09                                       |   |                |        |   |   |
|          | 1.6 16V     | 91  |       | 05.09                                       |   |                |        |   |   |
|          | 1.7 D       | 96  |       | 01.12                                       |   |                |        |   |   |
|          | 1.8 16V     | 103 |       | 11.09                                       |   |                |        |   |   |
|          | 1.8 16V     | 104 |       | 05.09                                       |   |                |        |   |   |
|          | 1.8 16V LPG | 104 |       | 06.11                                       |   |                |        |   |   |
|          | 1.8 Flex    | 106 |       | 01.11                                       |   |                |        |   |   |
|          | 2.0 CDI     | 90  |       | 05.09                                       |   |                |        |   |   |
|          | 2.0 CDI     | 92  |       | 05.09                                       |   |                |        |   |   |
| 2.0 CDI  | 110         |     | 05.09 |   |   |                |        |   |   |
| 2.0 CDI  | 120         |     | 08.10 |   |   |                |        |   |   |
|          | 1.4 16V     |     |       | 08.12                                       |   | 13.0460-7264.2 | 607264 |   | 25096 17,0 +WK/Zub ATE<br>25096 17,0 +WK/Zub ATE      |
|          | 1.6 16V     | 80  |       | 05.09                                       |   | 13.0470-7264.2 | LD7264 |   |   |
|          | 1.6 16V     | 83  |       | 05.09                                       |   |                |        |   |   |
|          | 1.6 16V     | 91  |       | 05.09                                       |   |                |        |   |   |
|          | 1.7 D       | 96  |       | 01.12                                       |   |                |        |   |   |
|          | 1.8 16V     | 103 |       | 11.09                                       |   |                |        |   |   |
|          | 1.8 16V     | 104 |       | 05.09                                       |   |                |        |   |   |
|          | 1.8 16V LPG | 104 |       | 06.11                                       |   |                |        |   |   |
|          | 1.8 Flex    | 106 |       | 01.11                                       |   |                |        |   |   |
|          | 2.0 CDI     | 90  |       | 05.09                                       |   |                |        |   |   |
|          | 2.0 CDI     | 92  |       | 05.09                                       |   |                |        |   |   |
| 2.0 CDI  | 110         |     | 05.09 |   |   |                |        |   |   |
| 2.0 CDI  | 120         |     | 08.10 |   |   |                |        |   |   |
|          | 1.4 16V     |     |       | 08.12                                       | + Bremsscheibendurchm. 268 mm <sup>3)</sup> | 24.0112-0188.1 | 412188 |   | 268 12,0 10,0 +S +B<br>268 12,0 10,0 +S +B PD         |
|          | 1.6 16V     | 80  |       | 05.09                                       | + Bremsscheibendurchm. 268 mm <sup>3)</sup> | 24.0312-0188.1 | 512188 |   |   |
|          | 1.6 16V     | 83  |       | 05.09                                       | + Bremsscheibendurchm. 268 mm <sup>3)</sup> |                |        |   |   |
|          | 1.6 16V     | 91  |       | 05.09                                       | + Bremsscheibendurchm. 268 mm <sup>3)</sup> |                |        |   |   |
|          | 1.7 D       | 96  |       | 01.12                                       | + Bremsscheibendurchm. 268 mm <sup>3)</sup> |                |        |   |   |
|          | 1.8 16V     | 103 |       | 11.09                                       | + Bremsscheibendurchm. 268 mm <sup>3)</sup> |                |        |   |   |
|          | 1.8 16V     | 104 |       | 05.09                                       | + Bremsscheibendurchm. 268 mm <sup>3)</sup> |                |        |   |   |
|          | 1.8 16V LPG | 104 |       | 06.11                                       | + Bremsscheibendurchm. 268 mm <sup>3)</sup> |                |        |   |   |
|          | 1.8 Flex    | 106 |       | 01.11                                       | + Bremsscheibendurchm. 268 mm <sup>3)</sup> |                |        |   |   |
|          | 2.0 CDI     | 90  |       | 05.09                                       | + Bremsscheibendurchm. 268 mm <sup>3)</sup> |                |        |   |   |
|          | 2.0 CDI     | 92  |       | 05.09                                       | + Bremsscheibendurchm. 268 mm <sup>3)</sup> |                |        |   |   |
| 2.0 CDI  | 110         |     | 05.09 | + Bremsscheibendurchm. 268 mm <sup>3)</sup> |   |                |        |   |   |
| 2.0 CDI  | 120         |     | 08.10 | + Bremsscheibendurchm. 268 mm <sup>3)</sup> |   |                |        |   |   |
|          | 1.4 16V     |     |       | 08.12                                       | + Bremsscheibendurchm. 292mm <sup>4)</sup>  | 24.0112-0189.1 | 412189 |   | 292 12,0 10,0 +S +B<br>292 12,0 10,0 +S +B PD         |
|          | 1.6 16V     | 80  |       | 05.09                                       | + Bremsscheibendurchm. 292mm <sup>4)</sup>  | 24.0312-0189.1 | 512189 |   |   |
|          | 1.6 16V     | 83  |       | 05.09                                       | + Bremsscheibendurchm. 292mm <sup>4)</sup>  |                |        |   |   |
|          | 1.6 16V     | 91  |       | 05.09                                       | + Bremsscheibendurchm. 292mm <sup>4)</sup>  |                |        |   |   |
|          | 1.7 D       | 96  |       | 01.12                                       | + Bremsscheibendurchm. 292mm <sup>4)</sup>  |                |        |   |   |
|          | 1.8 16V     | 103 |       | 11.09                                       | + Bremsscheibendurchm. 292mm <sup>4)</sup>  |                |        |   |   |
|          | 1.8 16V     | 104 |       | 05.09                                       | + Bremsscheibendurchm. 292mm <sup>4)</sup>  |                |        |   |   |
|          | 1.8 16V LPG | 104 |       | 06.11                                       | + Bremsscheibendurchm. 292mm <sup>4)</sup>  |                |        |   |   |
|          | 1.8 Flex    | 106 |       | 01.11                                       | + Bremsscheibendurchm. 292mm <sup>4)</sup>  |                |        |   |   |
|          | 2.0 CDI     | 90  |       | 05.09                                       | + Bremsscheibendurchm. 292mm <sup>4)</sup>  |                |        |   |   |
|          | 2.0 CDI     | 92  |       | 05.09                                       | + Bremsscheibendurchm. 292mm <sup>4)</sup>  |                |        |   |   |
| 2.0 CDI  | 110         |     | 05.09 | + Bremsscheibendurchm. 292mm <sup>4)</sup>  |   |                |        |   |   |
| 2.0 CDI  | 120         |     | 08.10 | + Bremsscheibendurchm. 292mm <sup>4)</sup>  |   |                |        |   |   |
|          | 1.4 16V     |     |       | 08.12                                       |   | 24.0711-5366.3 | 360355 | 2 | Radsensor L=574                                       |
|          | 1.6 16V     | 80  |       | 05.09                                       |   |                |        |   |   |
|          | 1.6 16V     | 83  |       | 05.09                                       |   |                |        |   |   |
|          | 1.6 16V     | 91  |       | 05.09                                       |   |                |        |   |   |
|          | 1.7 D       | 96  |       | 01.12                                       |   |                |        |   |   |
|          | 1.8 16V     | 103 |       | 11.09                                       |   |                |        |   |   |
|          | 1.8 16V     | 104 |       | 05.09                                       |   |                |        |   |   |
|          | 1.8 16V LPG | 104 |       | 06.11                                       |   |                |        |   |   |
| 1.8 Flex | 106         |     | 01.11 |   |   |                |        |   |   |





















1) + brake disc diameter 276 mm / + disco fr.diam. 276mm / + disques fr.diam. 276mm / + disco fr.diam. 276mm  
 2) + brake disc diameter 300mm / + diametro dischi freno 300mm / + diamètre disques frein 300mm / + diametro disco freno 300mm  
 3) + brake disc diameter 268 mm / + disco fr.diam. 268mm / + disques fr.diam. 268mm / + disco fr.diam. 268mm  
 4) + brake disc diameter 292mm / + diametro dischi freno 292mm / + diamètre disques frein 292mm / + diametro disco freno 292mm

|     |                |  |  |  |  |  |  |  |
|--|--|--|--|--|---|--|--|--|
| <b>CHEVROLET CRUZE (09-)</b>   |  |  |  |  |   |  |  |  |
|    | 2.0 CDI<br>2.0 CDI<br>2.0 CDI<br>2.0 CDI   | 90<br>92<br>110<br>120   | 05.09<br>05.09<br>05.09<br>08.10   |  | 24.0711-5366.3  | 360355   | 2  | Radsensor L=574  |
| <b>CHEVROLET EPICA (05-10)</b>   |  |  |  |  |   |  |  |  |
|    | 2.0 i 16V<br>2.0 i 16V   | 94<br>98   | 01.05<br>01.05   | 12.06<br>12.06   | 13.0460-5859.2<br>13.0460-0140.2  | 605859<br>610140   |  | 23234 16,9 +/WK<br>Belagsatz-Zubehör   |
|    | 1.8 i 16V<br>2.0 D<br>2.0 i 16V<br>2.0 i 16V<br>2.0 i 16V<br>2.0 i 16V<br>2.0 i V6<br>2.5 i V6 | 90<br>110<br>85<br>94<br>96<br>98<br>105<br>115                                  | 01.06<br>01.07<br>08.06<br>01.05<br>08.06<br>01.05<br>06.06<br>06.06             | 12.06<br>12.10<br>12.10<br>12.06<br>12.10<br>12.06<br>12.10<br>12.10             | 24.0124-0237.1  | 424237   |  | 278 24,0 22,0 V +B   |
| <b>CHEVROLET EVANDA (05-06)</b>  |  |  |  |  |   |  |  |  |
|    | 2.0 i 16V  | 96   | 03.05  | 12.06  | 13.0460-5859.2<br>13.0460-0140.2  | 605859<br>610140   |  | 23234 16,9 +/WK<br>Belagsatz-Zubehör   |
|    | 2.0 i 16V  | 96   | 03.05  | 12.06  | 24.0124-0199.1  | 424199   |  | 256 24,0 21,0 V +S +B  |
| <b>CHEVROLET IMPALA (99-05)</b>  |  |  |  |  |   |  |  |  |
|    | 3.4 V6<br>3.8 V6<br>3.8 V6   | 134<br>149<br>179  | 01.99<br>01.99<br>06.03  | 05.05<br>05.05<br>05.05  | 13.0460-8002.2  | 608002   |  | 23358 18,0 +/WK  |
| <b>CHEVROLET KALOS (05-08)</b>   |  |  |  |  |   |  |  |  |
|    | 1.2 i<br>1.4 i<br>1.4 i 16V  | 53<br>61<br>69   | 03.05<br>03.05<br>03.05  | 05.08<br>05.08<br>05.08  | 13.0460-5899.2  | 605899   |  | 23974 17,6   |
|    | 1.2 i<br>1.4 i<br>1.4 i 16V  | 53<br>61<br>69   | 03.05<br>03.05<br>03.05  | 05.08<br>05.08<br>05.08  | 24.0120-0115.1<br>24.0320-0115.1<br>24.0120-0227.1                                | 420115<br>520115<br>420227   | Naben D=60 <sup>1)</sup><br>Naben D=60 <sup>1)</sup><br>Naben D=59 <sup>2)</sup>   | 236 20,0 17,0 V L +S +B<br>236 20,0 17,0 V L +S +B PD<br>236 20,0 18,0 V L +S +B   |
|   | 1.2 i<br>1.4 i<br>1.4 i 16V  | 53<br>61<br>69   | 03.05<br>03.05<br>03.05  | 05.08<br>05.08<br>05.08  | 03.0137-0472.2<br>03.0137-9167.2  | 650472<br>669167   |  | 200 x 36 HEB<br>Bremsbacken-Zubehör  |
|  | 1.2 i<br>1.4 i<br>1.4 i 16V  | 53<br>61<br>69   | 03.05<br>03.05<br>03.05  | 05.08<br>05.08<br>05.08  | 03.0520-6619.3  | 696619   |  | 19,05/200x36 TopKit  |
| <b>CHEVROLET LACETTI (05-10)</b>   |  |  |  |  |   |  |  |  |
|  | 1.4 i 16V<br>1.6 i 16V<br>1.8 i 16V<br>1.8 i 16V<br>2.0 TDCi                                   | 70<br>80<br>89<br>90<br>89   | 03.05<br>03.05<br>08.05<br>03.05<br>01.07  | 12.10<br>12.10<br>12.10<br>12.10<br>12.10  | 13.0460-5863.2  | 605863   |  | 23234 16,8 +/WK  |
|  | 1.4 i 16V<br>1.6 i 16V<br>1.8 i 16V<br>1.8 i 16V<br>2.0 TDCi                                   | 70<br>80<br>89<br>90<br>89   | 03.05<br>03.05<br>08.05<br>03.05<br>01.07  | 12.10<br>12.10<br>12.10<br>12.10<br>12.10  | 24.0124-0199.1  | 424199   |  | 256 24,0 21,0 V +S +B  |
|  | 1.4 i 16V<br>1.6 i 16V<br>1.8 i 16V<br>1.8 i 16V   | 70<br>80<br>89<br>90   | 03.05<br>03.05<br>08.05<br>03.05   | 12.06<br>12.06<br>12.06<br>12.06   | 13.0460-5739.2  | 605739   |  | 24071 14,6   |
|  | 1.4 i 16V<br>1.6 i 16V<br>1.8 i 16V<br>1.8 i 16V<br>2.0 TDCi                                   | 70<br>80<br>89<br>90<br>89   | 03.05<br>03.05<br>08.05<br>03.05<br>01.07  | 12.10<br>12.10<br>12.10<br>12.10<br>12.10  | 24.0110-0340.1  | 410340   |  | 258 10,5 8,0 +S +B   |
| <b>CHEVROLET LANOS (05-10)</b>   |  |  |  |  |   |  |  |  |
|  | 1.4<br>1.5<br>1.6 i 16V  | 55<br>63<br>78   | 11.05<br>11.05<br>11.05  | 12.10<br>12.10<br>12.10  | 13.0460-7051.2  | 607051   |  | 20547 16,5 +/WE  |
|  | 1.4<br>1.5<br>1.6 i 16V  | 55<br>63<br>78   | 11.05<br>11.05<br>11.05  | 12.10<br>12.10<br>12.10  | 13.0460-7052.2  | 607052   |  | 21190 17,5 +/WE  |
|  | 1.4<br>1.5<br>1.6 i 16V  | 55<br>63<br>78   | 11.05<br>11.05<br>11.05  | 12.10<br>12.10<br>12.10  | 24.0120-0115.1  | 420115   |  | 236 20,0 17,0 V L +S +B  |
|  | 1.4<br>1.5<br>1.6 i 16V  | 55<br>63<br>78   | 11.05<br>11.05<br>11.05  | 12.10<br>12.10<br>12.10  | 24.0124-0115.1  | 424115   |  | 256 24,0 21,0 V L +S +B  |
|  | 1.4<br>1.5<br>1.6 i 16V  | 55<br>63<br>78   | 11.05<br>11.05<br>11.05  | 12.10<br>12.10<br>12.10  | 03.0137-0267.2  | 650267   |  | 200 x 46 HEB   |
|  | 1.4<br>1.5<br>1.6 i 16V  | 55<br>63<br>78   | 11.05<br>11.05<br>11.05  | 12.10<br>12.10<br>12.10  | 24.0220-0036.1<br>24.0220-0001.2  | 480149<br>480013   | - ABS<br>+ ABS   | 200/201 x 52,5<br>200/201 x 53,5   |

<sup>1)</sup> hub diameter=60 / diametro mozzo=60 / diamètre du moyeu=60 / diámetro del buje=60

<sup>2)</sup> hub diameter=59 / diametro mozzo=59 / diamètre du moyeu=59 / diámetro del buje=59



|     |  |  |  |  |  |  |  |     |                         |     |
|--|--|--|--|--|---|--|--|---|-------------------------|-----|
| <b>CHEVROLET MALIBU (V300) (12-)</b>   |  |  |  |  |   |  |  |   |                         |     |
|    | 2.0 16V  | 104  |  | 02.12  | + 16" Rad <sup>1)</sup>   | 13.0460-5611.2   | 605611   |   | 24415 19,1 +/WK/Zub     | MAN |
|  | 2.0 16V  | 108  |  | 12.12  | + 16" Rad <sup>1)</sup>   | 13.0470-5611.2   | LD5611   |   | 24415 19,1 +/WK/Zub     | MAN |
|  | 2.0 LPG  | 101  |  | 02.12  | + 16" Rad <sup>1)</sup>   |  |  |   |                         |     |
|  | 2.0 VDCi   | 118  |  | 04.12  | + 16" Rad <sup>1)</sup>   |  |  |   |                         |     |
|  | 2.4 16V  | 123  |  | 01.12  | + 16" Rad <sup>1)</sup>   |  |  |   |                         |     |
|  | 2.4 16V  | 125  |  | 01.12  | + 16" Rad <sup>1)</sup>   |  |  |   |                         |     |
|  | 2.4 16V  | 137  |  | 01.12  | + 16" Rad <sup>1)</sup>   |  |  |   |                         |     |
|  | 2.0 16V  | 104  |  | 02.12  | + 17" Rad <sup>2)</sup>   | 13.0460-5612.2   | 605612   |   | 24412 19,0 +/WK/Zub     | MAN |
|  | 2.0 16V  | 108  |  | 12.12  | + 17" Rad <sup>2)</sup>   | 13.0470-5612.2   | LD5612   |   | 24412 19,0 +/WK/Zub     | MAN |
|  | 2.0 LPG  | 101  |  | 02.12  | + 17" Rad <sup>2)</sup>   |  |  |   |                         |     |
|  | 2.0 VDCi   | 118  |  | 04.12  | + 17" Rad <sup>2)</sup>   |  |  |   |                         |     |
|  | 2.4 16V  | 123  |  | 01.12  | + 17" Rad <sup>2)</sup>   |  |  |   |                         |     |
| 2.4 16V  | 125  |  | 01.12  | + 17" Rad <sup>2)</sup>  |   |  |  |   |                         |     |
| 2.4 16V  | 137  |  | 01.12  | + 17" Rad <sup>2)</sup>  |   |  |  |   |                         |     |
|    | 2.0 16V  | 104  |  | 02.12  | + 16" Rad <sup>1)</sup>   | 24.0130-0207.1   | 430207   |   | 296 30,0 27,0 V L +S +B |     |
|  | 2.0 16V  | 108  |  | 12.12  | + 16" Rad <sup>1)</sup>   | 24.0330-0207.1   | 530207   |   | 296 30,0 27,0 V L +S +B | PD  |
|  | 2.0 LPG  | 101  |  | 02.12  | + 16" Rad <sup>1)</sup>   |  |  |   |                         |     |
|  | 2.0 VDCi   | 118  |  | 04.12  | + 16" Rad <sup>1)</sup>   |  |  |   |                         |     |
|  | 2.4 16V  | 123  |  | 01.12  | + 16" Rad <sup>1)</sup>   |  |  |   |                         |     |
|  | 2.4 16V  | 125  |  | 01.12  | + 16" Rad <sup>1)</sup>   |  |  |   |                         |     |
|  | 2.4 16V  | 137  |  | 01.12  | + 16" Rad <sup>1)</sup>   |  |  |   |                         |     |
|  | 2.0 16V  | 104  |  | 02.12  | + 17" Rad <sup>2)</sup>   | 24.0130-0209.1   | 430209   |   | 321 30,0 27,0 V L +S +B |     |
|  | 2.0 16V  | 108  |  | 12.12  | + 17" Rad <sup>2)</sup>   | 24.0330-0209.1   | 530209   |   | 321 30,0 27,0 V L +S +B | PD  |
|  | 2.0 LPG  | 101  |  | 02.12  | + 17" Rad <sup>2)</sup>   |  |  |   |                         |     |
|  | 2.0 VDCi   | 118  |  | 04.12  | + 17" Rad <sup>2)</sup>   |  |  |   |                         |     |
|  | 2.4 16V  | 123  |  | 01.12  | + 17" Rad <sup>2)</sup>   |  |  |   |                         |     |
| 2.4 16V  | 125  |  | 01.12  | + 17" Rad <sup>2)</sup>  |   |  |  |   |                         |     |
| 2.4 16V  | 137  |  | 01.12  | + 17" Rad <sup>2)</sup>  |   |  |  |   |                         |     |
|    | 2.0 16V  | 104  |  | 02.12  |   | 24.0710-5015.3   | 360403   | 2  | Radsensor L=740         |     |
|  | 2.0 16V  | 108  |  | 12.12  |   |  |  |   |                         |     |
|  | 2.0 LPG  | 101  |  | 02.12  |   |  |  |   |                         |     |
|  | 2.0 VDCi   | 118  |  | 04.12  |   |  |  |   |                         |     |
|  | 2.4 16V  | 123  |  | 01.12  |   |  |  |   |                         |     |
|  | 2.4 16V  | 137  |  | 01.12  |   |  |  |   |                         |     |
|    | 2.0 16V  | 104  |  | 02.12  | + 16" Rad <sup>1)</sup>   | 24.0112-0202.1   | 412202   |   | 292 12,0 10,5 +B        |     |
|  | 2.0 16V  | 108  |  | 12.12  | + 16" Rad <sup>1)</sup>   |  |  |   |                         |     |
|  | 2.0 LPG  | 101  |  | 02.12  | + 16" Rad <sup>1)</sup>   |  |  |   |                         |     |
|  | 2.0 VDCi   | 118  |  | 04.12  | + 16" Rad <sup>1)</sup>   |  |  |   |                         |     |
|  | 2.4 16V  | 123  |  | 01.12  | + 16" Rad <sup>1)</sup>   |  |  |   |                         |     |
|  | 2.4 16V  | 125  |  | 01.12  | + 16" Rad <sup>1)</sup>   |  |  |   |                         |     |
|  | 2.4 16V  | 137  |  | 01.12  | + 16" Rad <sup>1)</sup>   |  |  |   |                         |     |
|  | 2.0 16V  | 104  |  | 02.12  | + 17" Rad <sup>2)</sup>   | 24.0123-0114.1   | 423114   |   | 315 22,9 21,5 V +S +B   |     |
|  | 2.0 16V  | 108  |  | 12.12  | + 17" Rad <sup>2)</sup>   | 24.0323-0114.1   | 523114   |   | 315 22,9 21,5 V +S +B   | PD  |
|  | 2.0 LPG  | 101  |  | 02.12  | + 17" Rad <sup>2)</sup>   |  |  |   |                         |     |
|  | 2.0 VDCi   | 118  |  | 04.12  | + 17" Rad <sup>2)</sup>   |  |  |   |                         |     |
|  | 2.4 16V  | 123  |  | 01.12  | + 17" Rad <sup>2)</sup>   |  |  |   |                         |     |
| 2.4 16V  | 125  |  | 01.12  | + 17" Rad <sup>2)</sup>  |   |  |  |   |                         |     |
| 2.4 16V  | 137  |  | 01.12  | + 17" Rad <sup>2)</sup>  |   |  |  |   |                         |     |
|  | 2.0 16V  | 104  |  | 02.12  | + Niveauregulierung <sup>3)</sup>   | 24.0711-5395.3   | 360381   |  | Radsensor L=1417        |     |
|  | 2.0 16V  | 108  |  | 12.12  | + Niveauregulierung <sup>3)</sup>   | 24.0711-5396.3   | 360382   |  | Radsensor L=1674        |     |
|  | 2.0 LPG  | 101  |  | 02.12  | + Niveauregulierung <sup>3)</sup>   |  |  |   |                         |     |
|  | 2.0 VDCi   | 118  |  | 04.12  | + Niveauregulierung <sup>3)</sup>   |  |  |   |                         |     |
|  | 2.4 16V  | 123  |  | 01.12  | + Niveauregulierung <sup>3)</sup>   |  |  |   |                         |     |
|  | 2.4 16V  | 137  |  | 01.12  | + Niveauregulierung <sup>3)</sup>   |  |  |   |                         |     |
| <b>CHEVROLET MATIZ (05-10)</b>   |  |  |  |  |   |  |  |   |                         |     |
|  | 0.8  | 38   |  | 03.05  | 12.10   | 13.0460-5996.2   | 605996   |   | 23241 16,1              |     |
|  | 0.8 LPG  | 38   |  | 03.05  | 12.10   | 13.0460-0252.2   | 610252   |   | Belagsatz-Zubehör       |     |
|  | 1.0  | 47   |  | 03.05  | 12.10   |  |  |   |                         |     |
|  | 1.0  | 48   |  | 01.07  | 12.10   |  |  |   |                         |     |
|  | 1.0  | 49   |  | 03.05  | 12.10   |  |  |   |                         |     |
|  | 1.0 LPG  | 44   |  | 01.07  | 12.10   |  |  |   |                         |     |
|  | 1.0 LPG  | 49   |  | 03.05  | 12.10   |  |  |   |                         |     |
|  | 0.8  | 38   |  | 03.05  | 12.10   | 24.0113-0195.1   | 413195   |   | 236 12,6 9,7 +B         |     |
|  | 0.8 LPG  | 38   |  | 03.05  | 12.10   |  |  |   |                         |     |
|  | 1.0  | 47   |  | 03.05  | 12.10   |  |  |   |                         |     |
|  | 1.0  | 48   |  | 01.07  | 12.10   |  |  |   |                         |     |
|  | 1.0  | 49   |  | 03.05  | 12.10   |  |  |   |                         |     |
|  | 1.0 LPG  | 44   |  | 01.07  | 12.10   |  |  |   |                         |     |
|  | 1.0 LPG  | 49   |  | 03.05  | 12.10   |  |  |   |                         |     |
|  | 0.8  | 38   |  | 03.05  | 12.10   | 03.0137-0363.2   | 650363   |   | 180 x 31 HEB            |     |
|  | 0.8 LPG  | 38   |  | 03.05  | 12.10   | 03.0137-9260.2   | 669260   |   | Bremsbacken-Zubehör     |     |
|  | 1.0  | 47   |  | 03.05  | 12.10   |  |  |   |                         |     |
|  | 1.0  | 48   |  | 01.07  | 12.10   |  |  |   |                         |     |
|  | 1.0  | 49   |  | 03.05  | 12.10   |  |  |   |                         |     |
|  | 1.0 LPG  | 44   |  | 01.07  | 12.10   |  |  |   |                         |     |
|  | 1.0 LPG  | 49   |  | 03.05  | 12.10   |  |  |   |                         |     |
|  | 0.8  | 38   |  | 03.05  | 12.10   | 24.0218-0035.1   | 480146   | ohne Sensorring <sup>4)</sup>   | 180/182 x 40            |     |
|  | 0.8 LPG  | 38   |  | 03.05  | 12.10   |  |  |   |                         |     |
|  | 1.0  | 47   |  | 03.05  | 12.10   |  |  |   |                         |     |
|  | 1.0  | 48   |  | 01.07  | 12.10   |  |  |   |                         |     |
|  | 1.0  | 49   |  | 03.05  | 12.10   |  |  |   |                         |     |
|  | 1.0 LPG  | 44   |  | 01.07  | 12.10   |  |  |   |                         |     |
|  | 1.0 LPG  | 49   |  | 03.05  | 12.10   |  |  |   |                         |     |
| ↓  |  |  |  |  |   |  |  |   |                         |     |

<sup>1)</sup> + 16" wheel / + ruota 16" / + roue 16" / + rueda 16"

<sup>2)</sup> + 17" wheel / + ruota 17" / + roue 17" / + rueda 17"

<sup>3)</sup> + suspension level control / + correttore assetto / + correcteur d'assiette / + regulación altura suspensión

<sup>4)</sup> without sensor ring / senza sensori / sans secours ABS / sin anillo sensor ABS

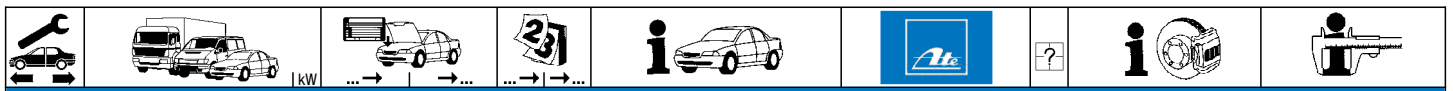

### CHEVROLET MATIZ (05-10)

|  |         |    |  |       |       |                |        |  |                     |
|--|---------|----|--|-------|-------|----------------|--------|--|---------------------|
|  | 0.8     | 38 |  | 03.05 | 12.10 | 03.0520-4017.3 | 694017 |  | 17,46/180x31 TopKit |
|  | 0.8 LPG | 38 |  | 03.05 | 12.10 |                |        |  |                     |
|  | 1.0     | 47 |  | 03.05 | 12.10 |                |        |  |                     |
|  | 1.0     | 48 |  | 01.07 | 12.10 |                |        |  |                     |
|  | 1.0     | 49 |  | 03.05 | 12.10 |                |        |  |                     |
|  | 1.0 LPG | 44 |  | 01.07 | 12.10 |                |        |  |                     |
|  | 1.0 LPG | 49 |  | 03.05 | 12.10 |                |        |  |                     |

























### CHEVROLET NUBIRA (05-10)

























|  |           |    |        |       |       |                |        |  |                       |     |
|--|-----------|----|--------|-------|-------|----------------|--------|--|-----------------------|-----|
|  | 1.4 i 16V | 69 | 695960 | 01.05 |       | 13.0460-5859.2 | 605859 |  | 23234 16,9 +/WK       | AKE |
|  | 1.4 i 16V | 70 | 695960 | 01.06 |       | 13.0460-0140.2 | 610140 |  | Belagsatz-Zubehör     | AKE |
|  | 1.5 i 16V | 78 | 695960 | 01.05 |       |                |        |  |                       |     |
|  | 1.6 i 16V | 76 | 695960 | 01.10 |       |                |        |  |                       |     |
|  | 1.6 i 16V | 80 | 695960 | 03.05 |       |                |        |  |                       |     |
|  | 1.8 i 16V | 89 | 695960 | 08.05 |       |                |        |  |                       |     |
|  | 1.8 i 16V | 90 | 695960 | 03.05 |       |                |        |  |                       |     |
|  | 2.0 i 16V | 88 | 695960 | 01.05 |       |                |        |  |                       |     |
|  | 2.0 TCDi  | 89 | 695960 | 01.05 |       |                |        |  |                       |     |
|  | 1.4 i 16V | 69 | 695961 |       | 12.10 | 13.0460-5863.2 | 605863 |  | 23234 16,8 +/WK       | AKE |
|  | 1.4 i 16V | 70 | 695961 |       | 12.10 |                |        |  |                       |     |
|  | 1.5 i 16V | 78 | 695961 |       | 12.10 |                |        |  |                       |     |
|  | 1.6 i 16V | 76 | 695961 |       | 12.10 |                |        |  |                       |     |
|  | 1.6 i 16V | 80 | 695961 |       | 12.10 |                |        |  |                       |     |
|  | 1.8 i 16V | 89 | 695961 |       | 12.10 |                |        |  |                       |     |
|  | 1.8 i 16V | 90 | 695961 |       | 12.10 |                |        |  |                       |     |
|  | 2.0 i 16V | 88 | 695961 |       | 12.10 |                |        |  |                       |     |
|  | 2.0 TCDi  | 89 | 695961 |       | 12.10 |                |        |  |                       |     |
|  | 1.4 i 16V | 69 |        | 01.05 | 12.10 | 24.0124-0199.1 | 424199 |  | 256 24,0 21,0 V +S +B |     |
|  | 1.4 i 16V | 70 |        | 01.06 | 12.10 |                |        |  |                       |     |
|  | 1.5 i 16V | 78 |        | 01.05 | 12.10 |                |        |  |                       |     |
|  | 1.6 i 16V | 76 |        | 01.10 | 12.10 |                |        |  |                       |     |
|  | 1.6 i 16V | 80 |        | 03.05 | 12.10 |                |        |  |                       |     |
|  | 1.8 i 16V | 89 |        | 08.05 | 12.10 |                |        |  |                       |     |
|  | 1.8 i 16V | 90 |        | 03.05 | 12.10 |                |        |  |                       |     |
|  | 2.0 i 16V | 88 |        | 01.05 | 12.10 |                |        |  |                       |     |
|  | 2.0 TCDi  | 89 |        | 01.05 | 12.10 |                |        |  |                       |     |
|  | 1.4 i 16V | 69 |        | 01.05 | 12.06 | 13.0460-5739.2 | 605739 |  | 24071 14,6            | SUM |
|  | 1.4 i 16V | 70 |        | 01.06 | 12.06 |                |        |  |                       |     |
|  | 1.5 i 16V | 78 |        | 01.05 | 12.06 |                |        |  |                       |     |
|  | 1.6 i 16V | 80 |        | 03.05 | 12.06 |                |        |  |                       |     |
|  | 1.8 i 16V | 89 |        | 08.05 | 12.06 |                |        |  |                       |     |
|  | 1.8 i 16V | 90 |        | 03.05 | 12.06 |                |        |  |                       |     |
|  | 2.0 i 16V | 88 |        | 01.05 | 12.06 |                |        |  |                       |     |
|  | 2.0 TCDi  | 89 |        | 01.05 | 12.06 |                |        |  |                       |     |
|  | 1.4 i 16V | 69 |        | 01.05 | 12.10 | 24.0110-0340.1 | 410340 |  | 258 10,5 8,0 +S +B    |     |
|  | 1.4 i 16V | 70 |        | 01.06 | 12.10 |                |        |  |                       |     |
|  | 1.5 i 16V | 78 |        | 01.05 | 12.10 |                |        |  |                       |     |
|  | 1.6 i 16V | 76 |        | 01.10 | 12.10 |                |        |  |                       |     |
|  | 1.6 i 16V | 80 |        | 03.05 | 12.10 |                |        |  |                       |     |
|  | 1.8 i 16V | 89 |        | 08.05 | 12.10 |                |        |  |                       |     |
|  | 1.8 i 16V | 90 |        | 03.05 | 12.10 |                |        |  |                       |     |
|  | 2.0 i 16V | 88 |        | 01.05 | 12.10 |                |        |  |                       |     |
|  | 2.0 TCDi  | 89 |        | 01.05 | 12.10 |                |        |  |                       |     |
|  | 1.4 i 16V | 69 |        | 01.05 | 12.10 | 03.0137-0267.2 | 650267 |  | 200 x 46 HEB          |     |
|  | 1.4 i 16V | 70 |        | 01.06 | 12.10 |                |        |  |                       |     |
|  | 1.5 i 16V | 78 |        | 01.05 | 12.10 |                |        |  |                       |     |
|  | 1.6 i 16V | 76 |        | 01.10 | 12.10 |                |        |  |                       |     |
|  | 1.6 i 16V | 80 |        | 03.05 | 12.10 |                |        |  |                       |     |
|  | 1.8 i 16V | 89 |        | 08.05 | 12.10 |                |        |  |                       |     |
|  | 1.8 i 16V | 90 |        | 03.05 | 12.10 |                |        |  |                       |     |
|  | 2.0 i 16V | 88 |        | 01.05 | 12.10 |                |        |  |                       |     |
|  | 2.0 TCDi  | 89 |        | 01.05 | 12.10 |                |        |  |                       |     |
|  | 1.4 i 16V | 69 |        | 01.05 | 12.10 | 24.0220-0001.2 | 480013 |  | 200/201 x 53,5        |     |
|  | 1.4 i 16V | 70 |        | 01.06 | 12.10 |                |        |  |                       |     |
|  | 1.5 i 16V | 78 |        | 01.05 | 12.10 |                |        |  |                       |     |
|  | 1.6 i 16V | 76 |        | 01.10 | 12.10 |                |        |  |                       |     |
|  | 1.6 i 16V | 80 |        | 03.05 | 12.10 |                |        |  |                       |     |
|  | 1.8 i 16V | 89 |        | 08.05 | 12.10 |                |        |  |                       |     |
|  | 1.8 i 16V | 90 |        | 03.05 | 12.10 |                |        |  |                       |     |
|  | 2.0 i 16V | 88 |        | 01.05 | 12.10 |                |        |  |                       |     |
|  | 2.0 TCDi  | 89 |        | 01.05 | 12.10 |                |        |  |                       |     |

### CHEVROLET ORLANDO (11-)































|  |         |     |  |       |  |                |        |  |                            |     |
|--|---------|-----|--|-------|--|----------------|--------|--|----------------------------|-----|
|  | 1.4 16V | 103 |  | 06.12 |  | 13.0460-7263.2 | 607263 |  | 24034 19,1 +/WK/Zub        |     |
|  | 1.8 16V | 104 |  | 02.11 |  | 13.0470-7263.2 | LD7263 |  | 24034 19,1 +/WK/Zub        | ATE |
|  | 1.8 LPG | 104 |  | 06.11 |  |                |        |  |                            |     |
|  | 2.0 D   | 96  |  | 02.11 |  |                |        |  |                            |     |
|  | 2.0 D   | 120 |  | 02.11 |  |                |        |  |                            |     |
|  | 2.0 LPG | 103 |  | 02.12 |  |                |        |  |                            |     |
|  | 1.4 16V | 103 |  | 06.12 |  | 24.0126-0166.1 | 426166 |  | 300 26,0 23,0 V L +S +B    |     |
|  | 1.8 16V | 104 |  | 02.11 |  | 24.0326-0166.1 | 526166 |  | 300 26,0 23,0 V L +S +B PD |     |
|  | 1.8 LPG | 104 |  | 06.11 |  |                |        |  |                            |     |
|  | 2.0 D   | 96  |  | 02.11 |  |                |        |  |                            |     |
|  | 2.0 D   | 120 |  | 02.11 |  |                |        |  |                            |     |
|  | 2.0 LPG | 103 |  | 02.12 |  |                |        |  |                            |     |



|     |  |  |  |        |  |  |  |     |   |
|--|--|--|--|--|---|--|--|---|---|
| <b>CHEVROLET ORLANDO (11-)</b>   |  |  |  |  |   |  |  |   |   |
|    | 1.4 16V<br>1.8 16V<br>1.8 LPG<br>2.0 D<br>2.0 D<br>2.0 LPG                       | 103<br>104<br>104<br>96<br>120<br>103  |  | 06.12<br>02.11<br>06.11<br>02.11<br>02.11<br>02.12                                     |   | 24.0711-5348.3   | 360351   | 2  | Radsensor L=800                               |
|    | 1.4 16V<br>1.8 16V<br>1.8 LPG<br>2.0 D<br>2.0 D<br>2.0 LPG                       | 103<br>104<br>104<br>96<br>120<br>103  |  | 06.12<br>02.11<br>06.11<br>02.11<br>02.11<br>02.12                                     |   | 13.0460-7264.2<br>13.0470-7264.2   | 607264<br>LD7264   |   | 25096 17,0 +/WK/Zub<br>25096 17,0 +/WK/Zub    |
|    | 1.4 16V<br>1.8 16V<br>1.8 LPG<br>2.0 D<br>2.0 D<br>2.0 LPG                       | 103<br>104<br>104<br>96<br>120<br>103  |  | 06.12<br>02.11<br>06.11<br>02.11<br>02.11<br>02.12                                     |   | 24.0112-0189.1<br>24.0312-0189.1   | 412189<br>512189   |   | 292 12,0 10,0 +S +B<br>292 12,0 10,0 +S +B PD |
| <b>CHEVROLET REZZO (05-09)</b>   |  |  |  |  |   |  |  |   |   |
|    | 1.6 i 16V<br>1.6 i 16V<br>2.0 i 16V<br>2.0 i 16V                                 | 77 826909<br>79 826909<br>89 826909<br>90 826909                                 |  | 05.09<br>05.09<br>05.09<br>05.09   |   | 13.0460-5859.2<br>13.0460-0140.2   | 605859<br>610140   |   | 23234 16,9 +/WK<br>Belagsatz-Zubehör          |
|    | 1.6 i 16V<br>1.6 i 16V<br>2.0 i 16V<br>2.0 i 16V                                 | 77<br>79<br>89<br>90   |  | 03.05 05.09<br>08.05 05.09<br>03.05 05.09<br>08.05 05.09                               |   | 24.0124-0199.1   | 424199   |   | 256 24,0 21,0 V +S +B                         |
| <b>CHEVROLET SPARK (05-10)</b>   |  |  |  |  |   |  |  |   |   |
|    | 0.8<br>1.0 LPG<br>1.0 SX<br>1.0 SX<br>1.0 SX                                     | 37<br>46<br>44<br>46<br>49   |  | 05.05 02.10<br>05.05 02.10<br>06.09 02.10<br>05.05 02.10<br>05.05 02.10                |   | 13.0460-5996.2   | 605996   |   | 23241 16,1                                    |
|    | 0.8<br>1.0 LPG<br>1.0 SX<br>1.0 SX<br>1.0 SX                                     | 37<br>46<br>44<br>46<br>49   |  | 05.05 02.10<br>05.05 02.10<br>06.09 02.10<br>05.05 02.10<br>05.05 02.10                |   | 24.0113-0195.1   | 413195   |   | 236 12,6 9,7 +B                               |
|  | 0.8<br>1.0 LPG<br>1.0 SX<br>1.0 SX<br>1.0 SX                                     | 37<br>46<br>44<br>46<br>49   |  | 05.05 02.10<br>05.05 02.10<br>06.09 02.10<br>05.05 02.10<br>05.05 02.10                |   | 03.0137-0363.2<br>03.0137-9260.2   | 650363<br>669260   |   | 180 x 31 HEB<br>Bremsbacken-Zubehör           |
|  | 0.8<br>1.0 LPG<br>1.0 SX<br>1.0 SX<br>1.0 SX                                     | 37<br>46<br>44<br>46<br>49   |  | 05.05 02.10<br>05.05 02.10<br>06.09 02.10<br>05.05 02.10<br>05.05 02.10                |   | 03.0520-4017.3   | 694017   |   | 17,46/180x31 TopKit                           |
| <b>CHEVROLET SPARK (10-)</b>   |  |  |  |  |   |  |  |   |   |
|  | 1.0<br>1.0 16V<br>1.2 16V<br>1.2 16V<br>1.2 LPG<br>1.2 LPG                       | 50<br>50<br>60<br>61<br>59<br>60   |  | 03.10<br>03.10<br>03.10<br>01.11<br>01.11<br>03.10                                     |   | 13.0460-5642.2   | 605642   |   | 25268 17,8 +/WK                               |
|  | 1.0<br>1.0 16V<br>1.2 16V<br>1.2 16V<br>1.2 LPG<br>1.2 LPG                       | 50<br>50<br>60<br>61<br>59<br>60   |  | 03.10<br>03.10<br>03.10<br>01.11<br>01.11<br>03.10                                     |   | 24.0120-0227.1   | 420227   |   | 236 20,0 18,0 V L +S +B                       |
|  | 1.0<br>1.0 16V<br>1.2 16V<br>1.2 16V<br>1.2 LPG<br>1.2 LPG                       | 50<br>50<br>60<br>61<br>59<br>60   |  | 03.10<br>03.10<br>03.10<br>01.11<br>01.11<br>03.10                                     |   | 03.0137-0472.2<br>03.0137-9314.2   | 650472<br>669314   |   | 200 x 36 HEB<br>Bremsbacken-Zubehör           |
|  | 1.0<br>1.0 16V<br>1.2 16V<br>1.2 16V<br>1.2 LPG<br>1.2 LPG                       | 50<br>50<br>60<br>61<br>59<br>60   |  | 03.10 03.12<br>03.10 03.12<br>03.10 03.12<br>01.11 03.12<br>01.11 03.12<br>03.10 03.12 |   | 03.0520-6619.3   | 696619   |   | 19,05/200x36 TopKit                           |
| <b>CHEVROLET TRANS SPORT (96-05)</b>   |  |  |  |  |   |  |  |   |   |
|  | 3.4 V6<br>3.4 V6<br>3.4 V6 AWD   | 137<br>138<br>138  |  | 11.96 09.05<br>10.00 09.05<br>10.01 09.05  |   | 13.0460-8002.2   | 608002   |   | 23358 18,0 +/WK                               |
|  | 3.4 V6<br>3.4 V6<br>3.4 V6 AWD   | 137<br>138<br>138  |  | 11.96 09.05<br>10.00 09.05<br>10.01 09.05  |   | 24.0132-0110.1   | 432110   |   | 278 32,2 30,7 V                               |





















|     |         |  |  |  |  |  |       |   |
|--|---|--|--|--|---|--|---|---|
| <b>CHEVROLET TRANS SPORT (96-05)</b>   |   |  |  |  |   |  |   |   |
|    | 3.4 V6<br>3.4 V6<br>3.4 V6 AWD  | 137<br>138<br>138  | 11.96<br>10.00<br>10.01  | 09.05<br>09.05<br>09.05  | 24.0111-0133.1  | 411133   |   | 278 11,0 9,0 +B   |
| <b>CHEVROLET TRAX (12-)</b>  |   |  |  |  |   |  |   |   |
|    | 1.4<br>1.4 AWD<br>1.4 LPG<br>1.6<br>1.6 AWD<br>1.7 TD<br>1.7 TD AWD<br>1.8<br>1.8 AWD   | 103<br>103<br>103<br>85<br>85<br>96<br>96<br>103<br>103                          | 12.12<br>12.12<br>04.13<br>12.12<br>12.12<br>12.12<br>12.12<br>03.13<br>03.13    |  | 13.0460-7263.2<br>13.0470-7263.2  | 607263<br>LD7263   |   | 24034 19,1 +/WK/Zub<br>24034 19,1 +/WK/Zub ATE  |
|    | 1.4<br>1.4 AWD<br>1.4 LPG<br>1.6<br>1.6 AWD<br>1.7 TD<br>1.7 TD AWD<br>1.8<br>1.8 AWD   | 103<br>103<br>103<br>85<br>85<br>96<br>96<br>103<br>103                          | 12.12<br>12.12<br>04.13<br>12.12<br>12.12<br>12.12<br>12.12<br>03.13<br>03.13    |  | 24.0126-0182.1  | 426182   |   | 300 26,0 23,0 V L +S +B   |
|    | 1.4<br>1.4 AWD<br>1.4 LPG<br>1.6<br>1.6 AWD<br>1.7 TD<br>1.7 TD AWD<br>1.8<br>1.8 AWD   | 103<br>103<br>103<br>85<br>85<br>96<br>96<br>103<br>103                          | 12.12<br>12.12<br>04.13<br>12.12<br>12.12<br>12.12<br>12.12<br>03.13<br>03.13    |  | 13.0460-7264.2<br>13.0470-7264.2  | 607264<br>LD7264   |   | 25096 17,0 +/WK/Zub ATE<br>25096 17,0 +/WK/Zub ATE  |
|    | 1.4<br>1.4 AWD<br>1.4 LPG<br>1.6<br>1.6 AWD<br>1.7 TD<br>1.7 TD AWD<br>1.8<br>1.8 AWD   | 103<br>103<br>103<br>85<br>85<br>96<br>96<br>103<br>103                          | 12.12<br>12.12<br>04.13<br>12.12<br>12.12<br>12.12<br>12.12<br>03.13<br>03.13    |  | 24.0112-0188.1<br>24.0312-0188.1  | 412188<br>512188   |   | 268 12,0 10,0 +S +B<br>268 12,0 10,0 +S +B PD   |
| <b>CHEVROLET VOLT (11-)</b>  |   |  |  |  |   |  |   |   |
|  | EV 150  | 111  | 11.11  |  | 13.0460-7263.2<br>13.0470-7263.2  | 607263<br>LD7263   |   | 24034 19,1 +/WK/Zub<br>24034 19,1 +/WK/Zub ATE  |
|  | EV 150  | 111  | 11.11  |  | 24.0126-0166.1<br>24.0326-0166.1  | 426166<br>526166   |   | 300 26,0 23,0 V L +S +B<br>300 26,0 23,0 V L +S +B PD   |
|  | EV 150  | 111  | 11.11  |  | 24.0711-5348.3  | 360351   | 2  | Radsensor L=800   |
|  | EV 150  | 111  | 11.11  |  | 13.0460-7264.2<br>13.0470-7264.2  | 607264<br>LD7264   |   | elektrische Feststellbremse <sup>1)</sup><br>elektrische Feststellbremse <sup>1)</sup> 25096 17,0 +/WK/Zub ATE<br>25096 17,0 +/WK/Zub ATE |
|  | EV 150  | 111  | 11.11  |  | 24.0112-0189.1<br>24.0312-0189.1  | 412189<br>512189   |   | elektrische Feststellbremse <sup>1)</sup><br>elektrische Feststellbremse <sup>1)</sup> 292 12,0 10,0 +S +B<br>292 12,0 10,0 +S +B PD      |
|  | EV 150  | 111  | 11.11  |  | 24.0711-5366.3  | 360355   | 2  | Radsensor L=574   |
| <b>CHRYSLER 300 C Limousine (04-12)</b>  |   |  |  |  |   |  |   |   |
|  | 2.7 V6<br>2.7 V6<br>3.0 CRD<br>3.0 V6 CRD<br>3.5 V6<br>5.7 SRT8<br>5.7 V8<br>6.1 SRT8   | 130<br>142<br>160<br>155<br>183<br>250<br>256<br>317                             | 01.07<br>09.04<br>09.05<br>11.10<br>09.04<br>09.04<br>12.09<br>06.05             | 11.12<br>11.12<br>11.12<br>11.12<br>11.12<br>11.12<br>11.12<br>11.12             | 03.0137-4014.2<br>03.0137-9269.2  | 654014<br>669269   |   | 183 x 31 /Zub<br>Bremsbacken-Zubehör  |
| <b>CHRYSLER 300 C Touring (04-10)</b>  |   |  |  |  |   |  |   |   |
|  | 2.7 V6<br>2.7 V6<br>3.0 CRD<br>3.5 V6<br>3.5 V6 AWD<br>5.7 V8<br>5.7 V8 AWD<br>6.1 SRT8 | 130<br>142<br>160<br>183<br>183<br>250<br>250<br>317                             | 01.07<br>09.04<br>09.05<br>09.04<br>09.04<br>09.04<br>04.05<br>06.05             | 12.10<br>12.10<br>12.10<br>12.10<br>12.10<br>12.10<br>12.10<br>12.10             | 03.0137-4014.2<br>03.0137-9269.2  | 654014<br>669269   |   | 183 x 31 /Zub<br>Bremsbacken-Zubehör  |

<sup>1)</sup> electric parking brake / fr.di stazionamento elettrico / frein à main électrique / freno de mano eléctrico

|     |    kW |  |  |  |  |  |  |  |                                    |            |
|--|---|--|--|--|---|--|--|--|------------------------------------|------------|
| <b>CHRYSLER 300 M (LR) (98-04)</b>   |   |  |  |  |   |  |  |  |                                    |            |
|    | 2.7 V6<br>2.7 V6<br>3.5 V6<br>3.5 V6  | 149<br>150<br>185<br>187   |  | 11.98<br>08.00<br>08.00<br>07.98   | 08.00<br>09.04<br>09.04<br>08.00  | 13.0460-8003.2   | 608003   |  | 23043 16,0 +                       |            |
|    | 2.7 V6<br>2.7 V6<br>3.5 V6<br>3.5 V6  | 149<br>150<br>185<br>187   |  | 11.98<br>08.00<br>08.00<br>07.98   | 08.00<br>09.04<br>09.04<br>08.00  | 13.0460-8010.2   | 608010   |  | 23561 18,1 +                       |            |
| <b>CHRYSLER CONCORDE (LP41) (92-97)</b>  |   |  |  |  |   |  |  |  |                                    |            |
|    | 3.3 V6  | 120  |  | 01.95  | 09.97   | 13.0460-8003.2   | 608003   |  | 23043 16,0 +                       |            |
| <b>CHRYSLER CONCORDE (C_41) (97-03)</b>  |   |  |  |  |   |  |  |  |                                    |            |
|    | 2.7 V6<br>3.5 V6<br>3.5 V6 Supercharged   | 149<br>174<br>186  |  | 10.97<br>10.97<br>10.97  | 09.03<br>09.03<br>09.03   | 13.0460-8003.2   | 608003   |  | 23043 16,0 +                       |            |
|    | 2.7 V6<br>3.5 V6<br>3.5 V6 Supercharged   | 149<br>174<br>186  |  | 10.97<br>10.97<br>10.97  | 09.03<br>09.03<br>09.03   | 13.0460-8010.2   | 608010   |  | 23561 18,1 +                       |            |
| <b>CHRYSLER CROSSFIRE Coupe (03-08)</b>  |   |  |  |  |   |  |  |  |                                    |            |
|    | 3.2 V6  | 160  |  | 07.03  | 01.08   | 13.0460-7087.2<br>13.0470-7087.2   | 607087<br>LD7087   |  | 21670 19,4 +/WE<br>21670 19,4 +/WE | ATE<br>ATE |
|  | 3.2 SRT-6   | 246  |  | 09.04  | 08.06   | 13.0460-7183.2   | 607183   |  | 21484 20,5 +/WE                    | ATE        |
|    | 3.2 V6  | 160  |  | 07.03  | 01.08   | 24.0128-0106.1   | 428106   |  | 300 28,0 25,4 V L +S +B            |            |
|  | 3.2 SRT-6   | 246  |  | 09.04  | 08.06   | 24.0132-0159.1   | 432159   |  | 330 32,0 29,4 V L +B               |            |
|    | 3.2 V6  | 160  |  | 07.03  | 01.08   | 13.0460-4064.2<br>13.0470-4064.2   | 604064<br>LD4064   |  | 21919 15,3 /Zub<br>21919 15,3 /Zub | ATE<br>ATE |
|  | 3.2 SRT-6   | 246  |  | 09.04  | 08.06   | 13.0460-4047.2<br>13.0470-4047.2   | 604047<br>LD4047   |  | 21305 15,7 /WE<br>21305 15,7 /WE   | ATE<br>ATE |
|    | 3.2 V6  | 160  |  | 07.03  | 01.08   | 24.0109-0114.1   | 409114   |  | 278 9,0 7,3 +S +B                  |            |
|  | 3.2 SRT-6   | 246  |  | 09.04  | 08.06   | 24.0122-0228.1   | 422228   |  | 300 22,0 19,4 V L +B               |            |
|    | 3.2 SRT-6<br>3.2 V6   | 246<br>160   |  | 09.04<br>07.03   | 08.06<br>01.08  | 03.0137-4013.2   | 654013   |  | 164 x 20 /Zub                      |            |
| <b>CHRYSLER CROSSFIRE Cabrio (04-08)</b>   |   |  |  |  |   |  |  |  |                                    |            |
|  | 3.2 V6  | 160  |  | 05.04  | 01.08   | 13.0460-7087.2<br>13.0470-7087.2   | 607087<br>LD7087   |  | 21670 19,4 +/WE<br>21670 19,4 +/WE | ATE<br>ATE |
|  | 3.2 SRT-6   | 246  |  | 09.04  | 08.06   | 13.0460-7183.2   | 607183   |  | 21484 20,5 +/WE                    | ATE        |
|  | 3.2 V6  | 160  |  | 05.04  | 01.08   | 24.0128-0106.1   | 428106   |  | 300 28,0 25,4 V L +S +B            |            |
|  | 3.2 SRT-6   | 246  |  | 09.04  | 08.06   | 24.0132-0159.1   | 432159   |  | 330 32,0 29,4 V L +B               |            |
|  | 3.2 V6  | 160  |  | 05.04  | 01.08   | 13.0460-4064.2<br>13.0470-4064.2   | 604064<br>LD4064   |  | 21919 15,3 /Zub<br>21919 15,3 /Zub | ATE<br>ATE |
|  | 3.2 SRT-6   | 246  |  | 09.04  | 08.06   | 13.0460-4047.2<br>13.0470-4047.2   | 604047<br>LD4047   |  | 21305 15,7 /WE<br>21305 15,7 /WE   | ATE<br>ATE |
|  | 3.2 V6  | 160  |  | 05.04  | 01.08   | 24.0109-0114.1   | 409114   |  | 278 9,0 7,3 +S +B                  |            |
|  | 3.2 SRT-6   | 246  |  | 09.04  | 08.06   | 24.0122-0228.1   | 422228   |  | 300 22,0 19,4 V L +B               |            |
|  | 3.2 SRT-6<br>3.2 V6   | 246<br>160   |  | 09.04<br>05.04   | 08.06<br>01.08  | 03.0137-4013.2   | 654013   |  | 164 x 20 /Zub                      |            |
| <b>CHRYSLER GRAND VOYAGER (RT) (07-)</b>   |   |  |  |  |   |  |  |  |                                    |            |
|  | 2.8 CRDi<br>3.3 V6<br>3.8 V6  | 120<br>125<br>142  |  | 10.07<br>01.08<br>10.07  | + ABS<br>+ ABS<br>+ ABS   | 13.0460-2766.2   | 602766   |  | 24604 18,7 +/WK/Zub                | BOS        |
|  | 2.8 CRDi<br>3.3 V6<br>3.8 V6  | 120<br>125<br>142  |  | 10.07<br>01.08<br>10.07  | + ABS<br>+ ABS<br>+ ABS   | 24.0128-0263.1   | 428263   |  | 302 28,0 26,4 V L +B               |            |
|  | 2.8 CRDi<br>3.3 V6<br>3.8 V6  | 120<br>125<br>142  |  | 10.07<br>01.08<br>10.07  |   | 13.0460-2771.2   | 602771   |  | 24822 15,7 +/WK/Zub                | TRW        |
| <b>CHRYSLER NEON (PL) (94-99)</b>  |   |  |  |  |   |  |  |  |                                    |            |
|  | 1.8 16V<br>2.0 16V<br>2.0 16V<br>2.0 16V  | 85<br>98<br>107<br>109   |  | 09.97<br>01.95<br>06.94<br>04.96   | 08.99<br>08.99<br>08.99<br>08.99  | 13.0460-8003.2   | 608003   | für 5-Loch-Felge <sup>1)</sup>   | 23043 16,0 +                       |            |
|  | 1.8 16V<br>2.0 16V<br>2.0 16V<br>2.0 16V  | 85<br>98<br>107<br>109   |  | 09.97<br>01.95<br>06.94<br>04.96   | 08.99<br>08.99<br>08.99<br>08.99  | 13.0460-8010.2   | 608010   | für 5-Loch-Felge <sup>1)</sup>   | 23561 18,1 +                       |            |
|  | 1.8 16V<br>2.0 16V<br>2.0 16V<br>2.0 16V  | 85<br>98<br>107<br>109   |  | 09.97<br>01.95<br>06.94<br>04.96   | 08.99<br>08.99<br>08.99<br>08.99  | 24.0109-0146.1   | 409146   | für 5-Loch-Felge <sup>1)</sup>   | 270 9,0 7,3 +B                     |            |

<sup>1)</sup> for 5 bore wheel rim / per cerchione a 5 fori / pour jante à 5 trous / para Llantas de 5 taladros



|     |                      |  |  |  |    |  |  |  |
|--|--|--|--|--|---|--|--|--|
| <b>CHRYSLER NEON II (99-06)</b>  |  |  |  |  |   |  |  |  |
|    | 1.6 16V<br>1.8<br>2.0 16V<br>2.0 16V R/T   | 85<br>91<br>97<br>98<br>110  |  | 11.01<br>01.00<br>10.02<br>08.99<br>10.01  | 12.06<br>12.06<br>12.06<br>12.06<br>12.06   |  | 13.0460-8003.2<br>608003   | 23043 16,0 +   |
|    | 1.6 16V<br>1.8<br>2.0 16V<br>2.0 16V<br>2.0 16V R/T  | 85<br>91<br>97<br>98<br>110  |  | 11.01<br>01.00<br>10.02<br>08.99<br>10.01  | 12.06 + ABS<br>12.06<br>12.06<br>12.06<br>12.06                                     |  | 13.0460-8010.2<br>608010   | 23561 18,1 +   |
|    | 1.6 16V<br>1.8<br>2.0 16V<br>2.0 16V<br>2.0 16V R/T  | 85<br>91<br>97<br>98<br>110  |  | 11.01<br>01.00<br>10.02<br>08.99<br>10.01  | 12.06 + ABS<br>12.06<br>12.06<br>12.06<br>12.06                                     |  | 24.0109-0146.1<br>409146   | 270 9,0 7,3 +B   |
| <b>CHRYSLER NEW YORKER (CH41) / LHS (CP41) (93-98)</b>                             |  |  |  |  |   |  |  |  |
|    | 3.5 i 24V  | 155  |  | 01.95<br>09.98   |   |  | 13.0460-8003.2<br>608003   | 23043 16,0 +   |
| <b>CHRYSLER PT CRUISER (00-10)</b>   |  |  |  |  |   |  |  |  |
|    | 1.6 16V<br>2.0 16V<br>2.0 16V<br>2.2 CRD<br>2.2 CRD<br>2.4 16V<br>2.4 16V<br>2.4 16V<br>2.4 GT Turbo | 85<br>100<br>104<br>89<br>110<br>105<br>110<br>169<br>164                        |  | 11.01<br>10.04<br>06.00<br>03.02<br>08.05<br>03.04<br>06.00<br>09.04<br>08.03    | 09.10<br>09.10<br>09.10<br>09.10<br>09.10<br>09.10<br>09.10<br>09.10<br>09.10       |  | 13.0460-2959.2<br>602959<br>13.0460-0134.2<br>610134                               | 23532 20,1 +/WK/S<br>Belagsatz-Zubehör<br>TRW<br>TRW                               |
|    | 1.6 16V<br>2.0 16V<br>2.0 16V<br>2.2 CRD<br>2.2 CRD<br>2.4 16V<br>2.4 16V<br>2.4 16V<br>2.4 GT Turbo | 85<br>100<br>104<br>89<br>110<br>105<br>110<br>169<br>164                        |  | 11.01<br>10.04<br>06.00<br>03.02<br>08.05<br>03.04<br>06.00<br>09.04<br>08.03    | 09.10<br>09.10<br>09.10<br>09.10<br>09.10<br>09.10<br>09.10<br>09.10<br>09.10       |  | 24.0123-0107.1<br>423107   | 280 23,0 21,4 V L +B   |
|  | 1.6 16V<br>2.0 16V<br>2.0 16V<br>2.2 CRD<br>2.2 CRD<br>2.4 16V<br>2.4 16V<br>2.4 16V<br>2.4 GT Turbo | 85<br>100<br>104<br>89<br>110<br>105<br>110<br>169<br>164                        |  | 11.01<br>10.04<br>06.00<br>03.02<br>08.05<br>03.04<br>06.00<br>09.04<br>08.03    | 09.10 + ABS<br>09.10<br>09.10<br>09.10<br>09.10<br>09.10<br>09.10<br>09.10<br>09.10 |  | 13.0460-8010.2<br>608010   | 23561 18,1 +   |
|  | 1.6 16V<br>2.0 16V<br>2.0 16V<br>2.2 CRD<br>2.2 CRD<br>2.4 16V<br>2.4 16V<br>2.4 16V<br>2.4 GT Turbo | 85<br>100<br>104<br>89<br>110<br>105<br>110<br>169<br>164                        |  | 11.01<br>10.04<br>06.00<br>03.02<br>08.05<br>03.04<br>06.00<br>09.04<br>08.03    | 09.10 + ABS<br>09.10<br>09.10<br>09.10<br>09.10<br>09.10<br>09.10<br>09.10<br>09.10 |  | 24.0109-0146.1<br>409146   | 270 9,0 7,3 +B   |
|  | 1.6 16V<br>2.0 16V<br>2.0 16V<br>2.2 CRD<br>2.2 CRD<br>2.4 16V<br>2.4 16V<br>2.4 16V<br>2.4 GT Turbo | 85<br>100<br>104<br>89<br>110<br>105<br>110<br>169<br>164                        |  | 11.01<br>10.04<br>06.00<br>03.02<br>08.05<br>03.04<br>06.00<br>09.04<br>08.03    | 09.10 + ABS<br>09.10<br>09.10<br>09.10<br>09.10<br>09.10<br>09.10<br>09.10<br>09.10 |  | 03.0137-3018.2<br>653018   | 172 x 22   |
| <b>CHRYSLER STRATUS (JA,JX) (95-01)</b>  |  |  |  |  |   |  |  |  |
|  | 2.5 LX V6<br>2.5 V6  | 120<br>125   |  | 12.95<br>12.95   | 04.01<br>04.01  |  | 13.0460-8010.2<br>608010   | 23561 18,1 +   |
| <b>CHRYSLER SEBRING (JR) (01-07)</b>   |  |  |  |  |   |  |  |  |
|  | 2.0 16V<br>2.4 16V<br>2.4 16V<br>2.4 16V Turbo<br>2.7 V6   | 104<br>105<br>112<br>164<br>149  |  | 04.01<br>04.01<br>04.01<br>09.01<br>04.01  | 06.07<br>06.07<br>06.07<br>06.07<br>06.07   |  | 13.0460-5980.2<br>605980<br>13.0460-8010.2<br>608010                               | 21706 15,5 +/WK<br>AKE   |
|  | 2.0 16V<br>2.4 16V<br>2.4 16V<br>2.4 16V Turbo<br>2.7 V6   | 104<br>105<br>112<br>164<br>149  |  | 04.01<br>04.01<br>04.01<br>09.01<br>04.01  | 06.07<br>06.07<br>06.07<br>06.07<br>06.07   |  | 03.0137-3018.2<br>653018   | 172 x 22   |



| CHRYSLER SEBRING (JS) (07-10)           |   |  |  |   |   |  |                |        |                         |                     |
|---|---|--|--|---|---|--|----------------|--------|-------------------------|---------------------|
|   | 2.0 CRD<br>2.0 VVT<br>2.4 VVT<br>2.7 VVT<br>2.7 VVT<br>3.5 V6 AWD   | 103<br>115<br>125<br>137<br>141<br>175                                 |  | 07.07<br>07.07<br>07.07<br>07.07<br>07.07<br>11.07  | 12.10<br>12.10<br>12.10<br>12.10<br>12.10<br>12.10  |  | 13.0460-5760.2 | 605760 |                         | 23584 16,4 /WK AKE  |
|   | 2.0 CRD<br>2.0 VVT<br>2.4 VVT<br>2.7 VVT<br>2.7 VVT<br>3.5 V6 AWD   | 103<br>115<br>125<br>137<br>141<br>175                                 |  | 07.07<br>07.07<br>07.07<br>07.07<br>07.07<br>11.07  | 12.10<br>12.10<br>12.10<br>12.10<br>12.10<br>12.10  |  | 24.0126-0170.1 | 426170 |                         | 294 26,0 24,4 V +B  |
|   | 2.0 CRD<br>2.0 VVT<br>2.4 VVT<br>2.7 VVT<br>2.7 VVT<br>3.5 V6 AWD   | 103<br>115<br>125<br>137<br>141<br>175                                 |  | 07.07<br>07.07<br>07.07<br>07.07<br>07.07<br>11.07  | 12.10<br>12.10<br>12.10<br>12.10<br>12.10<br>12.10  |  | 13.0460-5735.2 | 605735 | + ABS                   | 24014 16,0 +/WK AKE |
|   | 2.0 CRD<br>2.0 VVT<br>2.4 VVT<br>2.7 VVT<br>2.7 VVT<br>3.5 V6 AWD   | 103<br>115<br>125<br>137<br>141<br>175                                 |  | 07.07<br>07.07<br>07.07<br>07.07<br>07.07<br>11.07  | 12.10<br>12.10<br>12.10<br>12.10<br>12.10<br>12.10  |  | 24.0110-0363.1 | 410363 | + ABS                   | 262 10,0 8,4 +B     |
|   | 2.0 CRD<br>2.0 VVT<br>2.4 VVT<br>2.7 VVT<br>2.7 VVT<br>3.5 V6 AWD   | 103<br>115<br>125<br>137<br>141<br>175                                 |  | 07.07<br>07.07<br>07.07<br>07.07<br>07.07<br>11.07  | 12.10<br>12.10<br>12.10<br>12.10<br>12.10<br>12.10  |  | 03.0137-3023.2 | 653023 | + ABS                   | 170 x 32            |
| CHRYSLER SEBRING Cabriolet (JR) (01-07) |   |  |  |   |   |  |                |        |                         |                     |
|   | 2.0 16V<br>2.4 16V<br>2.4 16V Turbo<br>2.7 V6   | 104<br>112<br>164<br>149   |  | 04.01<br>04.01<br>09.01<br>04.01  | 06.07<br>06.07<br>06.07<br>06.07  |  | 13.0460-8010.2 | 608010 |                         | 23561 18,1 +        |
|   | 2.0 16V<br>2.4 16V<br>2.4 16V Turbo<br>2.7 V6   | 104<br>112<br>164<br>149   |  | 04.01<br>04.01<br>09.01<br>04.01  | 06.07<br>06.07<br>06.07<br>06.07  |  | 03.0137-3018.2 | 653018 |                         | 172 x 22            |
| CHRYSLER SEBRING Cabriolet (JS) (07-10) |   |  |  |   |   |  |                |        |                         |                     |
|   | 2.0 CRD<br>2.4 VVT<br>2.7 VVT<br>2.7 VVT  | 103<br>125<br>137<br>141   |  | 07.07<br>07.07<br>07.07<br>07.07  | 12.10<br>12.10<br>12.10<br>12.10  |  | 13.0460-5760.2 | 605760 |                         | 23584 16,4 /WK AKE  |
|   | 2.0 CRD<br>2.4 VVT<br>2.7 VVT<br>2.7 VVT  | 103<br>125<br>137<br>141   |  | 07.07<br>07.07<br>07.07<br>07.07  | 12.10<br>12.10<br>12.10<br>12.10  |  | 24.0126-0170.1 | 426170 |                         | 294 26,0 24,4 V +B  |
|   | 2.0 CRD<br>2.4 VVT<br>2.7 VVT<br>2.7 VVT  | 103<br>125<br>137<br>141   |  | 07.07<br>07.07<br>07.07<br>07.07  | 12.10<br>12.10<br>12.10<br>12.10  |  | 13.0460-5855.2 | 605855 | + ABS                   | 23582 16,0 +        |
|   | 2.0 CRD<br>2.4 VVT<br>2.7 VVT<br>2.7 VVT  | 103<br>125<br>137<br>141   |  | 07.07<br>07.07<br>07.07<br>07.07  | 12.10<br>12.10<br>12.10<br>12.10  |  | 24.0110-0361.1 | 410361 | + ABS                   | 302 10,0 8,4 +B     |
|   | 2.0 CRD<br>2.4 VVT<br>2.7 VVT<br>2.7 VVT  | 103<br>125<br>137<br>141   |  | 07.07<br>07.07<br>07.07<br>07.07  | 12.10<br>12.10<br>12.10<br>12.10  |  | 03.0137-3023.2 | 653023 | + ABS                   | 170 x 32            |
| CHRYSLER VISION (XP41) (93-97)          |   |  |  |   |   |  |                |        |                         |                     |
|   | 3.5 TSi   | 155  |  | 01.95   | 12.97   |  | 13.0460-8003.2 | 608003 |                         | 23043 16,0 +        |
| CHRYSLER VOYAGER (GS) (95-01)           |   |  |  |   |   |  |                |        |                         |                     |
|   | 2.0 i<br>2.4 AWD<br>2.4 i<br>2.5 TD<br>2.5 TDiC AWD<br>3.0<br>3.3 i<br>3.3 i<br>3.8 i<br>3.8 i AWD<br>3.8 i AWD | 98<br>111<br>111<br>85<br>85<br>112<br>116<br>134<br>121<br>122<br>131 |  | 01.95<br>02.97<br>01.95<br>01.95<br>10.95<br>01.95<br>01.95<br>01.95<br>01.95<br>01.95<br>01.95 | 03.01<br>03.01<br>03.01<br>03.01<br>03.01<br>03.01<br>03.01<br>03.01<br>03.01<br>03.01<br>03.01 |  | 13.0460-8003.2 | 608003 |                         | 23043 16,0 +        |
|   | 2.0 i<br>2.4 AWD<br>2.4 i<br>2.5 TD<br>2.5 TDiC AWD<br>3.0  | 98<br>111<br>111<br>85<br>85<br>112                                    |  | 01.95<br>02.97<br>01.95<br>01.95<br>10.95<br>01.95  | 03.01<br>03.01<br>03.01<br>03.01<br>03.01<br>03.01  |  | 24.0124-0178.1 | 424178 | + 15" Rad <sup>1)</sup> | 283 24,0 22,4 V +B  |

<sup>1)</sup> + 15" wheel / + ruota 15" / + roue 15" / + rueda 15"



### CHRYSLER VOYAGER (GS) (95-01)

|  |   |  |   |   |                |        |                         |                    |
|--|---|--|---|---|----------------|--------|-------------------------|--------------------|
|  | 3.3 i<br>3.3 i<br>3.8 i<br>3.8 i AWD<br>3.8 i AWD   | 116<br>134<br>121<br>122<br>131  | 01.95<br>01.95<br>01.95<br>01.95<br>01.95   | 03.01<br>03.01<br>03.01<br>03.01<br>03.01   | 24.0124-0178.1 | 424178 | + 15" Rad <sup>1)</sup> | 283 24,0 22,4 V +B |
|  | 2.0 i<br>2.4 i<br>2.5 TD<br>2.5 TDiC AWD<br>3.0<br>3.3 i<br>3.3 i<br>3.8 i<br>3.8 i AWD<br>3.8 i AWD            | 98<br>111<br>85<br>85<br>112<br>116<br>134<br>121<br>122<br>131        | 01.95<br>01.95<br>01.95<br>10.95<br>01.95<br>01.95<br>01.95<br>01.95<br>01.95<br>01.95          | 09.96<br>09.96<br>09.96<br>09.96<br>09.96<br>09.96<br>09.96<br>09.96<br>09.96<br>09.96          | 13.0460-8010.2 | 608010 | + ABS                   | 23561 18,1 +       |
|  | 2.0 i<br>2.4 AWD<br>2.4 i<br>2.5 TD<br>2.5 TDiC AWD<br>3.0<br>3.3 i<br>3.3 i<br>3.8 i<br>3.8 i AWD<br>3.8 i AWD | 98<br>111<br>111<br>85<br>85<br>112<br>116<br>134<br>121<br>122<br>131 | 01.95<br>02.97<br>01.95<br>01.95<br>10.95<br>01.95<br>01.95<br>01.95<br>01.95<br>01.95<br>01.95 | 03.01<br>03.01<br>03.01<br>03.01<br>03.01<br>03.01<br>03.01<br>03.01<br>03.01<br>03.01<br>03.01 | 24.0113-0196.1 | 413196 | + ABS                   | 290 12,5 11,3 +B   |
|  | 3.8 i AWD   | 131  | 01.95   | 03.01   | 03.0137-3037.2 | 653037 |                         | 180 x 30           |











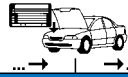

### CHRYSLER VOYAGER (RG) (00-08)

















|  |  |   |  |  |                                  |                  |  |   |
|--|--|---|--|--|----------------------------------|------------------|--|---|
|  | 2.4 16V<br>2.5 CRD<br>2.5 CRD<br>2.8 CRD<br>3.3 V6<br>3.3 V6<br>3.3 V6 AWD<br>3.3 V6 Flex-Fuel<br>3.8 V6<br>3.8 V6 AWD | 108<br>88<br>105<br>110<br>128<br>134<br>128<br>128<br>160<br>160 | 02.00<br>08.05<br>02.00<br>06.04<br>02.00<br>09.03<br>02.00<br>02.00<br>02.00<br>02.00 | 12.08<br>12.08<br>12.08<br>12.08<br>12.08<br>12.08<br>12.08<br>12.08<br>12.08<br>12.08 | 13.0460-2899.2                   | 602899           | + 15" Rad <sup>1)</sup>                            | 23638 18,3 +/WK TRW                     |
|  | 2.4 16V<br>2.5 CRD<br>2.5 CRD<br>2.8 CRD<br>3.3 V6<br>3.3 V6<br>3.3 V6 AWD<br>3.3 V6 Flex-Fuel<br>3.8 V6<br>3.8 V6 AWD | 108<br>88<br>105<br>110<br>128<br>134<br>128<br>128<br>160<br>160 | 02.00<br>08.05<br>02.00<br>06.04<br>02.00<br>09.03<br>02.00<br>02.00<br>02.00<br>02.00 | 12.08<br>12.08<br>12.08<br>12.08<br>12.08<br>12.08<br>12.08<br>12.08<br>12.08<br>12.08 | 13.0460-7207.2                   | 607207           | + 16" Rad <sup>2)</sup>                            | 23807 18,6 + ATE                        |
|  | 2.4 16V<br>2.5 CRD<br>2.5 CRD<br>2.8 CRD<br>3.3 V6<br>3.3 V6<br>3.3 V6 AWD<br>3.3 V6 Flex-Fuel<br>3.8 V6<br>3.8 V6 AWD | 108<br>88<br>105<br>110<br>128<br>134<br>128<br>128<br>160<br>160 | 02.00<br>08.05<br>02.00<br>06.04<br>02.00<br>09.03<br>02.00<br>02.00<br>02.00<br>02.00 | 12.08<br>12.08<br>12.08<br>12.08<br>12.08<br>12.08<br>12.08<br>12.08<br>12.08<br>12.08 | 24.0128-0148.1<br>24.0128-0147.1 | 428148<br>428147 | + 15" Rad <sup>1)</sup><br>+ 16" Rad <sup>2)</sup> | 281 28,0 25,3 V<br>302 28,0 26,5 V L +B |
|  | 2.4 16V<br>2.5 CRD<br>2.5 CRD<br>2.8 CRD<br>3.3 V6<br>3.3 V6<br>3.3 V6 AWD<br>3.3 V6 Flex-Fuel<br>3.8 V6<br>3.8 V6 AWD | 108<br>88<br>105<br>110<br>128<br>134<br>128<br>128<br>160<br>160 | 02.00<br>08.05<br>02.00<br>06.04<br>02.00<br>09.03<br>02.00<br>02.00<br>02.00<br>02.00 | 12.08<br>12.08<br>12.08<br>12.08<br>12.08<br>12.08<br>12.08<br>12.08<br>12.08<br>12.08 | 13.0460-8008.2                   | 608008           |  | 24036 16,7 +/WK                         |
|  | 2.4 16V<br>2.5 CRD<br>2.5 CRD<br>2.8 CRD<br>3.3 V6<br>3.3 V6<br>3.3 V6 AWD<br>3.3 V6 Flex-Fuel<br>3.8 V6<br>3.8 V6 AWD | 108<br>88<br>105<br>110<br>128<br>134<br>128<br>128<br>160<br>160 | 02.00<br>08.05<br>02.00<br>06.04<br>02.00<br>09.03<br>02.00<br>02.00<br>02.00<br>02.00 | 12.08<br>12.08<br>12.08<br>12.08<br>12.08<br>12.08<br>12.08<br>12.08<br>12.08<br>12.08 | 24.0113-0196.1                   | 413196           |  | 290 12,5 11,3 +B                        |
|  | 2.4 16V<br>2.5 CRD<br>2.5 CRD<br>2.8 CRD<br>3.3 V6   | 108<br>88<br>105<br>110<br>128                                    | 02.00<br>08.05<br>02.00<br>06.04<br>02.00  | 12.08<br>12.08<br>12.08<br>12.08<br>12.08  | 03.0137-3037.2                   | 653037           |  | 180 x 30                                |

<sup>1)</sup> + 15" wheel / + ruota 15" / + roue 15" / + rueda 15"

<sup>2)</sup> + 16" wheel / + ruota 16" / + roue 16" / + rueda 16"



|     |   |   |    |   |    |  |  |  |            |
|--|---|---|--|---|---|--|--|--|------------|
| <b>CHRYSLER VOYAGER (RG) (00-08)</b>   |   |   |  |   |   |  |  |  |            |
|    | 3.3 V6<br>3.3 V6 AWD<br>3.3 V6 Flex-Fuel<br>3.8 V6<br>3.8 V6 AWD  | 134<br>128<br>128<br>160<br>160   |  | 09.03<br>02.00<br>02.00<br>02.00<br>02.00   | 12.08<br>12.08<br>12.08<br>12.08<br>12.08   | 03.0137-3037.2   | 653037   | 180 x 30   |            |
| <b>CITROEN AX (86-98)</b>  |   |   |  |   |   |  |  |  |            |
|    | 10<br>10<br>10 E<br>11<br>11<br>13 Sport<br>14<br>14<br>14<br>14<br>14<br>14 D<br>14 GT   | 32<br>33<br>30<br>40<br>44<br>44<br>49<br>51<br>55<br>61<br>62  | ORGA 05089<br>ORGA 05089<br>ORGA 05089<br>ORGA 05089<br>ORGA 05089<br>ORGA 05089<br>ORGA 05089<br>ORGA 05089<br>ORGA 05089<br>ORGA 05089<br>ORGA 05089 | 09.86<br>07.86<br>12.86<br>12.86<br>10.89<br>04.87<br>12.86<br>06.88<br>01.89<br>03.89<br>01.88<br>09.88<br>01.88                   | 12.88   | 13.0460-4041.2<br>13.0460-0424.2   | 604041<br>610424   | 21179 16,8 +/WK<br>Belagsatz-Zubehör   | ATE<br>ATE |
|  | 10<br>10<br>10<br>11<br>14<br>14<br>14 D<br>14 GT   | 32 ORGA 05090<br>33 ORGA 05090<br>37<br>44 ORGA 05090<br>51 ORGA 05090<br>55 ORGA 05090<br>61 ORGA 05090<br>62 ORGA 05090 | ORGA 05277<br>ORGA 05277<br>ORGA 05277<br>ORGA 05277   | 06.92<br>12.98<br>12.98<br>12.97  | 07.92   | 13.0460-4042.2<br>13.0460-0424.2   | 604042<br>610424   | 21191 16,8 +/WK<br>Belagsatz-Zubehör   | ATE<br>ATE |
|  | 1.4 Allure<br>14<br>14<br>14<br>14 4x4<br>14 D<br>14 GT<br>15 D<br>14 GTI   | 48<br>51 ORGA 05278<br>55 ORGA 05278<br>61 ORGA 05278<br>55<br>59   | ORGA 05278<br>ORGA 05278<br>ORGA 05278<br>ORGA 05278   | 08.92<br>04.94<br>12.91<br>12.96<br>12.92<br>08.91<br>12.96<br>12.97<br>12.91<br>12.98<br>08.94                                     | 04.94<br>12.91<br>12.96<br>12.92<br>12.96<br>12.97<br>12.98<br>12.97  | 13.0460-3952.2<br>13.0460-0403.2   | 603952<br>610403   | 20905 18,0 +/WK<br>Belagsatz-Zubehör   | BDX<br>BDX |
|  | Electric<br>Electric  | 25<br>28  |  | 04.93<br>11.96  | 10.96<br>04.97  | 13.0460-2825.2<br>13.0460-0060.2   | 602825<br>610060   | 21614 17,7 +/WK<br>Belagsatz-Zubehör   | TRW<br>TRW |
|  | 10<br>10<br>10<br>10 E<br>11<br>11<br>11<br>14<br>14<br>14<br>14<br>14 D<br>Electric<br>Electric                                | 32<br>33<br>37<br>30<br>40<br>44<br>44<br>49<br>51<br>55<br>61<br>25<br>28  | ORGA 05277<br>ORGA 05277<br>ORGA 05277<br>ORGA 05277   | 09.86<br>07.86<br>07.92<br>12.86<br>12.86<br>10.89<br>12.86<br>06.88<br>01.89<br>03.89<br>01.88<br>09.88<br>04.93<br>11.96          | 06.92<br>12.98<br>12.98<br>12.88<br>12.88<br>06.90<br>12.97<br>12.88<br>12.89   | 24.0108-0107.1   | 408107   | 238 8,0 6,0 +S +B  |            |
|  | 1.4 Allure<br>14<br>14<br>14<br>14 4x4<br>14 D<br>14 GT<br>15 D   | 48<br>51 ORGA 05278<br>55 ORGA 05278<br>61 ORGA 05278<br>55<br>59   | ORGA 05278<br>ORGA 05278<br>ORGA 05278<br>ORGA 05278   | 08.92<br>04.94<br>12.91<br>12.96<br>12.92<br>08.91<br>12.96<br>12.97<br>12.91<br>12.98<br>08.94                                     | 04.94<br>12.91<br>12.96<br>12.92<br>12.96<br>12.97  | 24.0110-0208.1   | 410208   | 247 10,0 9,0   |            |
|  | 13 Sport<br>14 GT<br>14 GT  | 62<br>62 ORGA 05090   | ORGA 05089<br>ORGA 05089   | 04.87<br>01.88  | 12.92   | 24.0110-0197.1<br>24.0110-0198.1   | 410197<br>410198   | 238 10,0 9,0   |            |
|  | 14 GTI  | 62  | ORGA 05090   | 06.91   | 12.96   | 24.0120-0132.1<br>24.0320-0132.1   | 420132<br>520132   | 247 20,4 18,5 V +S +B<br>247 20,4 18,5 V +S +B PD                                  |            |
|  | 1.4 Allure<br>10<br>10<br>10<br>10 E<br>11<br>11<br>13 Sport<br>14<br>14<br>14<br>14 D<br>14 GT<br>15 D<br>Electric<br>Electric | 48<br>32<br>33<br>37<br>30<br>40<br>44<br>44<br>49<br>51<br>55<br>61<br>25<br>28  |  | 08.92<br>09.86<br>07.86<br>07.92<br>12.86<br>12.86<br>10.89<br>04.87<br>12.86<br>06.88<br>09.88<br>01.88<br>08.94<br>04.93<br>11.96 | 04.94<br>06.92<br>12.98<br>12.98<br>12.88<br>06.90<br>12.97<br>12.88<br>12.88<br>12.89<br>12.97<br>12.92<br>12.92<br>10.96<br>04.97 | 03.0137-0195.2<br>03.0137-9079.2   | 650195<br>669079   | 164 x 32 AUT<br>Bremsbacken-Zubehör  |            |
|  | 14<br>14<br>14  | 51<br>55<br>61  |  | 01.89<br>03.89<br>01.88   | 12.91<br>12.96<br>12.92   | 03.0137-0196.2<br>03.0137-9055.2   | 650196<br>669055   | 180 x 32 AUT<br>Bremsbacken-Zubehör  | BDX<br>BDX |

|     |    |                          |    |   |    |  |  |   |  |  |
|--|--|--|--|---|---|--|--|---|--|--|
| <b>CITROEN AX (86-98)</b>  |  |  |  |   |   |  |  |   |  |  |
|    | 14 GT<br>14 GTI<br>14 4x4  | 59   |  | 12.91<br>06.91  | 12.98<br>12.96  | 03.0137-0196.2<br>03.0137-9055.2   | 650196<br>669055   | 180 x 32 AUT<br>Bremsbacken-Zubehör   | <b>BDX</b><br><b>BDX</b>                                       |  |
|    | 1.4 Allure<br>10<br>10<br>10<br>10 E<br>11<br>11<br>13 Sport<br>14<br>14<br>14 D<br>14 GT<br>15 D<br>Electric<br>Electric  | 48<br>32<br>33<br>37<br>30<br>40<br>44<br>44<br>49<br>62<br>25<br>28                                     |  | 08.92<br>09.86<br>07.86<br>07.92<br>12.86<br>12.86<br>10.89<br>04.87<br>12.86<br>06.88<br>09.88<br>01.88<br>08.94<br>04.93<br>11.96                                     | 04.94<br>06.92<br>12.98<br>12.98<br>12.88<br>06.90<br>12.97<br>12.88<br>12.88<br>12.89<br>12.97<br>12.92<br>12.97<br>10.96<br>04.97                                     | 24.0216-5001.1<br>24.0216-5701.2   | 480001<br>480212   | ohne Sensorring <sup>1)</sup>   | 165/166 x 38,5 - Lager<br>165/166 x 38,5 + Lager               |  |
|    | 14<br>14<br>14<br>14 GT<br>14 GTI  | 51<br>55<br>61<br>59   |  | 01.89<br>03.89<br>01.88<br>12.91<br>06.91   | 12.91<br>12.96<br>12.92<br>12.98<br>12.96   | 24.0218-0020.1<br>24.0218-0720.2   | 480074<br>480205   | 180/181 x 46 - Lager<br>180/181 x 46 + Lager  |  |  |
|    | 1.4 Allure<br>10<br>10<br>10<br>10 E<br>11<br>11<br>13 Sport<br>14<br>14<br>14<br>14<br>14 D<br>14 GT<br>14 GT<br>15 D   | 48<br>32<br>33<br>37<br>30<br>40<br>44<br>44<br>49<br>51<br>61<br>59<br>62                               |  | 08.92<br>09.86<br>07.86<br>07.92<br>12.86<br>12.86<br>10.89<br>04.87<br>12.86<br>06.88<br>01.89<br>01.88<br>09.88<br>12.91<br>01.88<br>08.94                            | 04.94<br>06.92<br>12.98<br>12.98<br>12.88<br>06.90<br>12.97<br>12.88<br>12.88<br>12.89<br>12.91<br>12.92<br>12.97<br>12.98<br>12.92                                     | 03.0420-0519.3<br>03.0520-0519.3<br>03.0520-0719.3                                 | 680519<br>690519<br>690719   | für Radzylinder mit Regler <sup>2)</sup><br>für Radzylinder mit Regler <sup>2)</sup><br>für Radzylinder ohne Regler <sup>3)</sup> | 19,05/164x32 Kit<br>19,05/164x32 TopKit<br>19,05/164x32 TopKit | <b>BDX</b><br><b>BDX</b><br><b>BDX</b> |
| <b>CITROEN BERLINGO (MF) Kombi (96-08)</b>   |  |  |  |   |   |  |  |   |  |  |
|  | 1.1 i<br>1.1 i<br>1.4 GNC<br>1.4 GNC<br>1.4 Hybrid<br>1.4 Hybrid<br>1.4 i<br>1.4 i<br>1.6 16V<br>1.8 D<br>1.8 i<br>1.9 D<br>1.9 D<br>2.0 HDi<br>Electric<br>Electric                                       | 44<br>44<br>48<br>48<br>54<br>54<br>55<br>55<br>80<br>43<br>66<br>50<br>51<br>66<br>16<br>27             | ORGA 09428<br>ORGA 09127<br>ORGA 09428<br>ORGA 09127<br>ORGA 09428<br>ORGA 09127<br>ORGA 09428<br>ORGA 09127<br>ORGA 09127<br>ORGA 09127<br>ORGA 09127<br>ORGA 09127<br>ORGA 09127<br>ORGA 09127   | 07.96<br>07.96<br>11.02<br>11.02<br>05.05<br>05.05<br>07.96<br>07.96<br>10.00<br>07.98<br>05.97<br>07.96<br>07.98<br>12.99<br>01.00<br>11.02                            | 03.08<br>03.08<br>03.08<br>03.08<br>03.08<br>03.08<br>03.08<br>03.08<br>03.08<br>03.08<br>03.08<br>03.08<br>03.08<br>03.08<br>03.08<br>03.08                            | 13.0460-2829.2   | 602829   | 23124 19,0 +/WK/S   | <b>TRW</b>   |  |
|  | 1.1 i<br>1.1 i<br>1.4<br>1.4 Bivalent<br>1.4 GNC<br>1.4 GNC<br>1.4 Hybrid<br>1.4 Hybrid<br>1.4 i<br>1.4 i<br>1.6 16V<br>1.6 HDi<br>1.6 HDi 75<br>1.6 HDi 90<br>1.8 D<br>1.8 i<br>1.9 D<br>1.9 D<br>2.0 HDi | 44<br>44<br>53<br>48<br>48<br>54<br>54<br>55<br>55<br>80<br>80<br>55<br>66<br>43<br>66<br>50<br>51<br>66 | ORGA 09429<br>ORGA 09128<br>ORGA 09429<br>ORGA 09128<br>ORGA 09429<br>ORGA 09128<br>ORGA 09429<br>ORGA 09128<br>ORGA 09429<br>ORGA 09128<br>ORGA 09128<br>ORGA 09128<br>ORGA 09128<br>ORGA 09128<br>ORGA 09128<br>ORGA 09128<br>ORGA 09128<br>ORGA 09128 | 07.96<br>07.96<br>11.02<br>11.02<br>03.08<br>03.08<br>03.08<br>03.08<br>03.08<br>03.08<br>03.08<br>03.08<br>03.08<br>03.08<br>03.08<br>03.08<br>03.08<br>03.08<br>03.08 | 03.08<br>03.08<br>03.08<br>03.08<br>03.08<br>03.08<br>03.08<br>03.08<br>03.08<br>03.08<br>03.08<br>03.08<br>03.08<br>03.08<br>03.08<br>03.08<br>03.08<br>03.08<br>03.08 | 13.0460-3994.2<br>13.0470-3994.2   | 603994<br>LD3994   | 23599 19,0 /Zub/S<br>23599 19,0 /Zub/S  | <b>BOS</b><br><b>BOS</b>                                       |  |
|  | 1.6 16V<br>1.6 HDi<br>1.6 HDi 90<br>2.0 HDi  | 80<br>80<br>66<br>66   | ORGA 09128<br>ORGA 09128<br>ORGA 09128<br>ORGA 09128   | 08.05<br>07.05<br>07.05   | 03.08<br>03.08<br>03.08<br>03.08  | 13.0460-3811.2   | 603811   | 23708 19,2 /S   | <b>BOS</b>   |  |
|  | 1.1 i<br>1.4 GNC<br>1.4 Hybrid<br>1.4 i<br>Electric  | 44<br>48<br>54<br>55<br>16   | ORGA 09428<br>ORGA 09428<br>ORGA 09428<br>ORGA 09428   | 07.96<br>11.02<br>05.05<br>07.96<br>01.00   | 03.08<br>03.08<br>03.08<br>03.08  | 24.0113-0184.1<br>24.0313-0184.1   | 413184<br>513184   | 266 13,0 11,0 +S +B<br>266 13,0 11,0 +S +B PD   |  |  |

<sup>1)</sup> without sensor ring / senza sensori / sans secours ABS / sin anillo sensor ABS

<sup>2)</sup> for WC with regulator / per CR con regolatore / pour CR avec régulateur / para CR con regulador

















<sup>3)</sup> for WC without regulator / per CR senza regolatore / pour CR sans régulateur / para CR sin regulador





**CITROEN BERLINGO (MF) Kombi (96-08)**

|   |              |    |            |       |       |       |                |        |  |                          |
|---|--------------|----|------------|-------|-------|-------|----------------|--------|--|--------------------------|
|   | Electric     | 27 |            | 11.02 | 03.08 |       | 24.0113-0184.1 | 413184 |  | 266 13,0 11,0 +S +B      |
|   |              |    |            |       |       |       | 24.0313-0184.1 | 513184 |  | 266 13,0 11,0 +S +B PD   |
|   | 1.1 i        | 44 | ORGA 09127 | 07.96 |       |       | 24.0120-0133.1 | 420133 |  | 266 20,5 18,5 V +S +B    |
|   | 1.4 GNC      | 48 | ORGA 09127 | 11.02 |       |       | 24.0320-0133.1 | 520133 |  | 266 20,5 18,5 V +S +B PD |
|   | 1.4 Hybrid   | 54 | ORGA 09127 | 05.05 |       |       |                |        |  |                          |
|   | 1.4 i        | 55 | ORGA 09127 | 07.96 |       |       |                |        |  |                          |
|   | 1.6 16V      | 80 | ORGA 09127 | 10.00 |       |       |                |        |  |                          |
|   | 1.8 D        | 43 | ORGA 09127 | 07.98 |       |       |                |        |  |                          |
|   | 1.8 i        | 66 | ORGA 09127 | 05.97 |       |       |                |        |  |                          |
|   | 1.9 D        | 50 | ORGA 09127 | 07.96 |       |       |                |        |  |                          |
|   | 1.9 D        | 51 | ORGA 09127 | 07.98 |       |       |                |        |  |                          |
|   | 2.0 HDi      | 66 | ORGA 09127 | 12.99 |       |       |                |        |  |                          |
|   | 1.1 i        | 44 | ORGA 09429 |       | 03.08 |       | 24.0122-0194.1 | 422194 |  | 266 22,0 20,0 V +S +B    |
|   | 1.1 i        | 44 | ORGA 09128 |       | 03.08 |       |                |        |  |                          |
|   | 1.4          | 53 |            | 11.02 | 03.08 |       |                |        |  |                          |
|   | 1.4 Bivalent |    |            | 11.02 | 03.08 |       |                |        |  |                          |
|   | 1.4 GNC      | 48 | ORGA 09429 |       | 03.08 |       |                |        |  |                          |
|   | 1.4 GNC      | 48 | ORGA 09128 |       | 03.08 |       |                |        |  |                          |
|   | 1.4 Hybrid   | 54 | ORGA 09429 |       | 03.08 |       |                |        |  |                          |
|   | 1.4 Hybrid   | 54 | ORGA 09128 |       | 03.08 |       |                |        |  |                          |
|   | 1.4 i        | 55 | ORGA 09429 |       | 03.08 |       |                |        |  |                          |
|   | 1.4 i        | 55 | ORGA 09128 |       | 03.08 |       |                |        |  |                          |
|   | 1.6 16V      | 80 | ORGA 09128 |       | 03.08 | - ESP |                |        |  |                          |
|   | 1.6 HDi      | 80 |            | 08.05 | 03.08 | - ESP |                |        |  |                          |
|   | 1.6 HDi 75   | 55 |            | 07.05 | 03.08 |       |                |        |  |                          |
|   | 1.6 HDi 90   | 66 |            | 07.05 | 03.08 | - ESP |                |        |  |                          |
|   | 1.8 D        | 43 | ORGA 09128 |       | 03.08 |       |                |        |  |                          |
|   | 1.8 i        | 66 | ORGA 09128 |       | 03.08 |       |                |        |  |                          |
|   | 1.9 D        | 50 | ORGA 09128 |       | 03.08 |       |                |        |  |                          |
|   | 1.9 D        | 51 | ORGA 09128 |       | 03.08 |       |                |        |  |                          |
|   | 2.0 HDi      | 66 | ORGA 09128 |       | 03.08 | - ESP |                |        |  |                          |
|   | 1.6 16V      | 80 | ORGA 09128 |       | 03.08 | + ESP | 24.0126-0120.1 | 426120 |  | 283 26,0 24,0 V +S +B    |
|   | 1.6 HDi      | 80 |            | 08.05 | 03.08 | + ESP | 24.0326-0120.1 | 526120 |  | 283 26,0 24,0 V +S +B PD |
|   | 1.6 HDi 90   | 66 |            | 07.05 | 03.08 | + ESP |                |        |  |                          |
|   | 2.0 HDi      | 66 | ORGA 09128 |       | 03.08 | + ESP |                |        |  |                          |
|   | 1.6 16V      | 80 |            | 10.00 | 03.08 | + ESP | 13.0460-2823.2 | 602823 |  | 23554 17,2 /S TRW        |
|   | 1.6 HDi      | 80 |            | 08.05 | 03.08 | + ESP | 13.0470-2823.2 | LD2823 |  | 23554 17,2 /S TRW        |
|   | 1.6 HDi 90   | 66 |            | 07.05 | 03.08 | + ESP |                |        |  |                          |
|   | 2.0 HDi      | 66 |            | 12.99 | 03.08 | + ESP |                |        |  |                          |
|   | 1.6 16V      | 80 |            | 10.00 | 03.08 | + ESP | 24.0109-0137.1 | 409137 |  | 247 9,0 8,0 +S +B        |
|   | 1.6 HDi      | 80 |            | 08.05 | 03.08 | + ESP |                |        |  |                          |
|   | 1.6 HDi 90   | 66 |            | 07.05 | 03.08 | + ESP |                |        |  |                          |
|   | 2.0 HDi      | 66 |            | 12.99 | 03.08 | + ESP |                |        |  |                          |
|   | 1.1 i        | 44 |            | 07.96 | 03.08 |       | 03.0137-0341.2 | 650341 |  | 229 x 42 HEB TRW         |
|   | 1.4          | 53 |            | 11.02 | 03.08 |       | 03.0137-9220.2 | 669220 |  | Bremsbacken-Zubehör TRW  |
|   | 1.4 Bivalent |    |            | 11.02 | 03.08 |       |                |        |  |                          |
|   | 1.4 GNC      | 48 |            | 11.02 | 03.08 |       |                |        |  |                          |
|   | 1.4 Hybrid   | 54 |            | 05.05 | 03.08 |       |                |        |  |                          |
|   | 1.4 i        | 55 |            | 07.96 | 03.08 |       |                |        |  |                          |
|   | 1.6 16V      | 80 |            | 10.00 | 03.08 | - ESP |                |        |  |                          |
|   | 1.6 HDi      | 80 |            | 08.05 | 03.08 | - ESP |                |        |  |                          |
|   | 1.6 HDi 75   | 55 |            | 07.05 | 03.08 |       |                |        |  |                          |
|   | 1.6 HDi 90   | 66 |            | 07.05 | 03.08 | - ESP |                |        |  |                          |
|   | 1.8 D        | 43 |            | 07.98 | 03.08 |       |                |        |  |                          |
|   | 1.8 i        | 66 |            | 05.97 | 03.08 |       |                |        |  |                          |
|   | 1.9 D        | 50 |            | 07.96 | 03.08 |       |                |        |  |                          |
|   | 1.9 D        | 51 |            | 07.98 | 03.08 |       |                |        |  |                          |
|   | 2.0 HDi      | 66 |            | 12.99 | 03.08 | - ESP |                |        |  |                          |
|   | Electric     | 16 |            | 01.00 | 03.08 |       |                |        |  |                          |
|   | Electric     | 27 |            | 11.02 | 03.08 |       |                |        |  |                          |
|   | 1.1 i        | 44 |            | 07.96 | 03.08 |       | 24.0222-8017.1 | 480071 |  | 229/230 x 50,8           |
|   | 1.4          | 53 |            | 11.02 | 03.08 |       |                |        |  |                          |
|   | 1.4 Bivalent |    |            | 11.02 | 03.08 |       |                |        |  |                          |
|   | 1.4 GNC      | 48 |            | 11.02 | 03.08 |       |                |        |  |                          |
|   | 1.4 Hybrid   | 54 |            | 05.05 | 03.08 |       |                |        |  |                          |
|   | 1.4 i        | 55 |            | 07.96 | 03.08 |       |                |        |  |                          |
|   | 1.6 16V      | 80 |            | 10.00 | 03.08 | - ESP |                |        |  |                          |
|   | 1.6 HDi      | 80 |            | 08.05 | 03.08 | - ESP |                |        |  |                          |
|   | 1.6 HDi 75   | 55 |            | 07.05 | 03.08 |       |                |        |  |                          |
|   | 1.6 HDi 90   | 66 |            | 07.05 | 03.08 | - ESP |                |        |  |                          |
|   | 1.8 D        | 43 |            | 07.98 | 03.08 |       |                |        |  |                          |
|   | 1.8 i        | 66 |            | 05.97 | 03.08 |       |                |        |  |                          |
|   | 1.9 D        | 50 |            | 07.96 | 03.08 |       |                |        |  |                          |
|   | 1.9 D        | 51 |            | 07.98 | 03.08 |       |                |        |  |                          |
|   | 2.0 HDi      | 66 |            | 12.99 | 03.08 | - ESP |                |        |  |                          |
|   | Electric     | 16 |            | 01.00 | 03.08 |       |                |        |  |                          |
|   | Electric     | 27 |            | 11.02 | 03.08 |       |                |        |  |                          |
|   | 1.1 i        | 44 | ORGA 08000 | 07.96 |       |       | 03.0520-6322.3 | 696322 |  | 22,20/229x42 TopKit TRW  |
|   | 1.4 GNC      | 48 | ORGA 08000 | 11.02 |       |       |                |        |  |                          |
|   | 1.4 Hybrid   | 54 | ORGA 08000 | 05.05 |       |       |                |        |  |                          |
|   | 1.4 i        | 55 | ORGA 08000 | 07.96 |       |       |                |        |  |                          |
|   | 1.8 D        | 43 | ORGA 08000 | 07.98 |       |       |                |        |  |                          |
|   | 1.8 i        | 66 | ORGA 08000 | 05.97 |       |       |                |        |  |                          |
|   | 1.9 D        | 50 | ORGA 08000 | 07.96 |       |       |                |        |  |                          |
|   | 1.9 D        | 51 | ORGA 08000 | 07.98 |       |       |                |        |  |                          |
| ↓ | 1.1 i        | 44 | ORGA 08001 |       | 03.08 |       | 03.0520-6322.3 | 696322 |  | 22,20/229x42 TopKit TRW  |

|     |  |  |  |  |  |  |  |  |                          |
|--|--|--|--|--|---|--|--|--|--------------------------|
| <b>CITROEN BERLINGO (MF) Kombi (96-08)</b>   |  |  |  |  |   |  |  |  |                          |
|    | 1.4  | 53   |  | 11.02  | 03.08   |  | 03.0520-6322.3   | 696322   | 22,20/229x42 TopKit TRW  |
|  | 1.4 Bivalent   |  |  | 11.02  | 03.08   |  |  |  |                          |
|  | 1.4 GNC  | 48 ORGA 08001  |  |  | 03.08   |  |  |  |                          |
|  | 1.4 Hybrid   | 54 ORGA 08001  |  |  | 03.08   |  |  |  |                          |
|  | 1.4 i  | 55 ORGA 08001  |  |  | 03.08   |  |  |  |                          |
|  | 1.6 16V  | 80   |  | 10.00  | 03.08   | - ESP  |  |  |                          |
|  | 1.6 HDi  | 80   |  | 08.05  | 03.08   | - ESP  |  |  |                          |
|  | 1.6 HDi 75   | 55   |  | 07.05  | 03.08   |  |  |  |                          |
|  | 1.6 HDi 90   | 66   |  | 07.05  | 03.08   | - ESP  |  |  |                          |
|  | 1.8 D  | 43 ORGA 08001  |  |  | 03.08   |  |  |  |                          |
|  | 1.8 i  | 66 ORGA 08001  |  |  | 03.08   |  |  |  |                          |
|  | 1.9 D  | 50 ORGA 08001  |  |  | 03.08   |  |  |  |                          |
|  | 1.9 D  | 51 ORGA 08001  |  |  | 03.08   |  |  |  |                          |
|  | 2.0 HDi  | 66   |  | 12.99  | 03.08   | - ESP  |  |  |                          |
|  | Electric   | 16   |  | 01.00  | 03.08   |  |  |  |                          |
|  | Electric   | 27   |  | 11.02  | 03.08   |  |  |  |                          |
| <b>CITROEN BERLINGO (M_) Kasten (96-08)</b>  |  |  |  |  |   |  |  |  |                          |
|    | 1.1 i  | 44   | ORGA 09428   | 07.96  |   |  | 13.0460-2829.2   | 602829   | 23124 19,0 +/-WK/S TRW   |
|  | 1.1 i  | 44   | ORGA 09127   | 07.96  |   |  |  |  |                          |
|  | 1.4 i  | 55   | ORGA 09428   | 07.96  |   |  |  |  |                          |
|  | 1.4 i  | 55   | ORGA 09127   | 07.96  |   |  |  |  |                          |
|  | 1.6 16V  |  | ORGA 09127   | 10.00  |   |  |  |  |                          |
|  | 1.8 D  | 43   | ORGA 09127   | 07.96  |   |  |  |  |                          |
|  | 1.8 i  | 66   | ORGA 09127   | 08.99  |   |  |  |  |                          |
|  | 1.9 D  | 51   | ORGA 09127   | 07.96  |   |  |  |  |                          |
|  | 2.0 HDi 90   | 66   | ORGA 09127   | 12.99  |   |  |  |  |                          |
|  | Electric   | 27   |  | 11.04  | 03.08   |  |  |  |                          |
|  | 1.1 i  | 44   | ORGA 09429   |  | 03.08   |  | 13.0460-3994.2   | 603994   | 23599 19,0 /Zub/S BOS    |
|  | 1.1 i  | 44   | ORGA 09128   |  | 03.08   |  | 13.0470-3994.2   | LD3994   | 23599 19,0 /Zub/S BOS    |
|  | 1.4  | 48   |  | 11.02  | 03.08   |  |  |  |                          |
|  | 1.4 Bivalent   | 55   |  | 11.02  | 03.08   |  |  |  |                          |
|  | 1.4 i  | 55 ORGA 09429  |  |  | 03.08   |  |  |  |                          |
|  | 1.4 i  | 55 ORGA 09128  |  |  | 03.08   |  |  |  |                          |
|  | 1.6 16V  |  | ORGA 09128   |  | 03.08   |  |  |  |                          |
|  | 1.6 HDi 75   | 55   |  | 07.05  | 03.08   |  |  |  |                          |
|  | 1.6 HDi 90   | 66   |  | 07.05  | 03.08   |  |  |  |                          |
|  | 1.8 D  | 43 ORGA 09128  |  |  | 03.08   |  |  |  |                          |
|  | 1.8 i  | 66 ORGA 09128  |  |  | 03.08   |  |  |  |                          |
|  | 1.9 D  | 51 ORGA 09128  |  |  | 03.08   |  |  |  |                          |
|  | 2.0 HDi 90   | 66 ORGA 09128  |  |  | 03.08   |  |  |  |                          |
|  | 1.1 i  | 44   | ORGA 09428   | 07.96  |   |  | 24.0113-0184.1   | 413184   | 266 13,0 11,0 +S +B      |
|  | 1.4 i  | 55   | ORGA 09428   | 07.96  |   |  | 24.0313-0184.1   | 513184   | 266 13,0 11,0 +S +B PD   |
|  | Electric   | 27   |  | 11.04  | 03.08   |  |  |  |                          |
|  | 1.1 i  | 44   | ORGA 09127   | 07.96  |   |  | 24.0120-0133.1   | 420133   | 266 20,5 18,5 V +S +B    |
|  | 1.4 i  | 55   | ORGA 09127   | 07.96  |   |  | 24.0320-0133.1   | 520133   | 266 20,5 18,5 V +S +B PD |
|  | 1.6 16V  |  | ORGA 09127   | 10.00  |   |  |  |  |                          |
|  | 1.8 D  | 43   | ORGA 09127   | 07.96  |   |  |  |  |                          |
|  | 1.8 i  | 66   | ORGA 09127   | 08.99  |   |  |  |  |                          |
|  | 1.9 D  | 51   | ORGA 09127   | 07.96  |   |  |  |  |                          |
|  | 2.0 HDi 90   | 66   | ORGA 09127   | 12.99  |   |  |  |  |                          |
|  | 1.1 i  | 44   | ORGA 09429   |  | 03.08   |  | 24.0122-0194.1   | 422194   | 266 22,0 20,0 V +S +B    |
|  | 1.1 i  | 44   | ORGA 09128   |  | 03.08   |  |  |  |                          |
|  | 1.4  | 48   |  | 11.02  | 03.08   |  |  |  |                          |
|  | 1.4 Bivalent   | 55   |  | 11.02  | 03.08   |  |  |  |                          |
|  | 1.4 i  | 55 ORGA 09429  |  |  | 03.08   |  |  |  |                          |
|  | 1.4 i  | 55 ORGA 09128  |  |  | 03.08   |  |  |  |                          |
|  | 1.6 16V  |  | ORGA 09128   |  | 03.08   |  |  |  |                          |
|  | 1.6 HDi 75   | 55   |  | 07.05  | 03.08   |  |  |  |                          |
|  | 1.6 HDi 90   | 66   |  | 07.05  | 03.08   |  |  |  |                          |
|  | 1.8 D  | 43 ORGA 09128  |  |  | 03.08   |  |  |  |                          |
|  | 1.8 i  | 66 ORGA 09128  |  |  | 03.08   |  |  |  |                          |
|  | 1.9 D  | 51 ORGA 09128  |  |  | 03.08   |  |  |  |                          |
|  | 2.0 HDi 90   | 66 ORGA 09128  |  |  | 03.08   |  |  |  |                          |
|  | 2.0 HDi 90   | 66   |  | 12.99  | 03.08   | + ESP  | 13.0460-2823.2   | 602823   | 23554 17,2 /S TRW        |
|  |  |  |  |  |   |  | 13.0470-2823.2   | LD2823   | 23554 17,2 /S TRW        |
|  | 2.0 HDi 90   | 66   |  | 12.99  | 03.08   | + ESP  | 24.0109-0137.1   | 409137   | 247 9,0 8,0 +S +B        |
|  | 1.1 i  | 44   |  | 07.96  | 03.08   |  | 03.0137-0341.2   | 650341   | 229 x 42 HEB TRW         |
|  | 1.4  | 48   |  | 11.02  | 03.08   |  | 03.0137-9220.2   | 669220   | Bremsbacken-Zubehör TRW  |
|  | 1.4 Bivalent   | 55   |  | 11.02  | 03.08   |  |  |  |                          |
|  | 1.4 i  | 55   |  | 07.96  | 03.08   |  |  |  |                          |
|  | 1.6 16V  |  |  | 10.00  | 03.08   |  |  |  |                          |
|  | 1.6 HDi 75   | 55   |  | 07.05  | 03.08   |  |  |  |                          |
|  | 1.6 HDi 90   | 66   |  | 07.05  | 03.08   |  |  |  |                          |
|  | 1.8 D  | 43   |  | 07.96  | 03.08   |  |  |  |                          |
|  | 1.8 i  | 66   |  | 08.99  | 03.08   |  |  |  |                          |
|  | 1.9 D  | 51   |  | 07.96  | 03.08   |  |  |  |                          |
|  | 2.0 HDi 90   | 66   |  | 12.99  | 03.08   | - ESP  |  |  |                          |
|  | Electric   | 27   |  | 07.03  | 03.08   |  |  |  |                          |
|  | 1.1 i  | 44   |  | 07.96  | 03.08   |  | 24.0222-8017.1   | 480071   | 229/230 x 50,8           |
|  | 1.4  | 48   |  | 11.02  | 03.08   |  |  |  |                          |
|  | 1.4 Bivalent   | 55   |  | 11.02  | 03.08   |  |  |  |                          |
|  | 1.4 i  | 55   |  | 07.96  | 03.08   |  |  |  |                          |

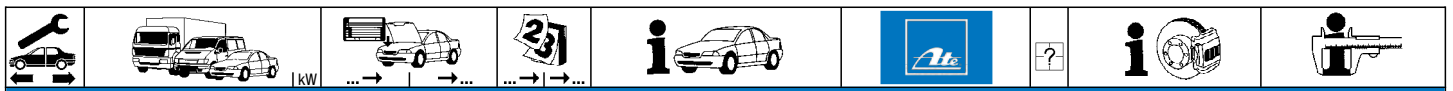











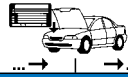















**CITROEN BERLINGO (M\_) Kasten (96-08)**

|          |              |    |            |       |       |                |        |  |                         |       |
|----------|--------------|----|------------|-------|-------|----------------|--------|--|-------------------------|-------|
|          | 1.6 16V      | 55 |            | 10.00 | 03.08 | 24.0222-8017.1 | 480071 |  | 229/230 x 50,8          |       |
|          | 1.6 HDi 75   | 66 |            | 07.05 | 03.08 |                |        |  |                         |       |
|          | 1.6 HDi 90   | 66 |            | 07.05 | 03.08 |                |        |  |                         |       |
|          | 1.8 D        | 43 |            | 07.96 | 03.08 |                |        |  |                         |       |
|          | 1.8 i        | 66 |            | 08.99 | 03.08 |                |        |  |                         |       |
|          | 1.9 D        | 51 |            | 07.96 | 03.08 |                |        |  |                         |       |
|          | 2.0 HDi 90   | 66 |            | 12.99 | 03.08 |                |        |  |                         | - ESP |
|          | Electric     | 27 |            | 07.03 | 03.08 |                |        |  |                         |       |
|          | 1.1 i        | 44 | ORGA 08000 | 07.96 |       | 03.0520-6322.3 | 696322 |  | 22,20/229x42 TopKit TRW |       |
|          | 1.4 i        | 55 | ORGA 08000 | 07.96 |       |                |        |  |                         |       |
|          | 1.8 D        | 43 | ORGA 08000 | 07.96 |       |                |        |  |                         |       |
|          | 1.8 i        | 66 | ORGA 08000 | 08.99 |       |                |        |  |                         |       |
|          | 1.9 D        | 51 | ORGA 08000 | 07.96 |       |                |        |  |                         |       |
|          | 1.1 i        | 44 | ORGA 08001 |       | 03.08 | 03.0520-6322.3 | 696322 |  | 22,20/229x42 TopKit TRW |       |
|          | 1.4          | 48 | ORGA 08001 |       | 03.08 |                |        |  |                         |       |
|          | 1.4 Bivalent | 55 |            | 11.02 | 03.08 |                |        |  |                         |       |
|          | 1.4 i        | 55 | ORGA 08001 |       | 03.08 |                |        |  |                         |       |
|          | 1.6 16V      |    |            | 10.00 | 03.08 |                |        |  |                         |       |
|          | 1.6 HDi 75   | 55 |            | 07.05 | 03.08 |                |        |  |                         |       |
|          | 1.6 HDi 90   | 66 |            | 07.05 | 03.08 |                |        |  |                         |       |
|          | 1.8 D        | 43 | ORGA 08001 |       | 03.08 |                |        |  |                         |       |
|          | 1.8 i        | 66 | ORGA 08001 |       | 03.08 |                |        |  |                         |       |
|          | 1.9 D        | 51 | ORGA 08001 |       | 03.08 |                |        |  |                         |       |
|          | 2.0 HDi 90   | 66 |            | 12.99 | 03.08 |                |        |  |                         | - ESP |
| Electric | 27           |    | 07.03      | 03.08 |       |                |        |  |                         |       |

**CITROEN BERLINGO (B9) (08-)**

|            |                  |    |       |       |  |                |        |  |   |            |
|------------|------------------|----|-------|-------|--|----------------|--------|--|---|------------|
|            | 1.2 PureTech 110 | 81 |       | 02.16 |  | 13.0460-7229.2 | 607229 |  | 24538 18,5 +<br>24538 18,5 +                      | ATE<br>ATE |
|            | 1.6 BlueHDi 100  | 73 |       | 12.14 |  |                |        |  |   |            |
|            | 1.6 BlueHDi 120  | 88 |       | 12.14 |  |                |        |  |   |            |
|            | 1.6 BlueHDi 75   | 55 |       | 04.15 |  |                |        |  |   |            |
|            | 1.6 HDi 110      | 80 |       | 04.08 |  |                |        |  |   |            |
|            | 1.6 HDi 110      | 82 |       | 07.10 |  |                |        |  |   |            |
|            | 1.6 HDi 115      | 84 |       | 07.10 |  |                |        |  |   |            |
|            | 1.6 HDi 75       | 55 |       | 04.08 |  |                |        |  |   |            |
|            | 1.6 HDi 90       | 66 |       | 04.08 |  |                |        |  |   |            |
|            | 1.6 HDi 90       | 68 |       | 07.10 |  |                |        |  |   |            |
|            | 1.6 HDi 92       | 68 |       | 07.10 |  |                |        |  |   |            |
|            | 1.6 i 16V        | 66 |       | 04.08 |  |                |        |  |   |            |
|            | 1.6 i 16V        | 80 |       | 04.08 |  |                |        |  |   |            |
|            | 1.6 VTi 120      | 88 |       | 11.09 |  |                |        |  |   |            |
|            | 1.6 VTi 95       | 72 |       | 07.10 |  |                |        |  |   |            |
| Electric   |                  |    | 02.13 |       |  |                |        |  |   |            |
|            | 1.2 PureTech 110 | 81 |       | 02.16 |  | 24.0126-0120.1 | 426120 |  | 283 26,0 24,0 V +S +B<br>283 26,0 24,0 V +S +B PD |            |
|            | 1.6 BlueHDi 100  | 73 |       | 12.14 |  |                |        |  |   |            |
|            | 1.6 BlueHDi 120  | 88 |       | 12.14 |  |                |        |  |   |            |
|            | 1.6 BlueHDi 75   | 55 |       | 04.15 |  |                |        |  |   |            |
|            | 1.6 HDi 110      | 80 |       | 04.08 |  |                |        |  |   |            |
|            | 1.6 HDi 110      | 82 |       | 07.10 |  |                |        |  |   |            |
|            | 1.6 HDi 115      | 84 |       | 07.10 |  |                |        |  |   |            |
|            | 1.6 HDi 75       | 55 |       | 04.08 |  |                |        |  |   |            |
|            | 1.6 HDi 90       | 66 |       | 04.08 |  |                |        |  |   |            |
|            | 1.6 HDi 90       | 68 |       | 07.10 |  |                |        |  |   |            |
|            | 1.6 HDi 92       | 68 |       | 07.10 |  |                |        |  |   |            |
|            | 1.6 i 16V        | 66 |       | 04.08 |  |                |        |  |   |            |
|            | 1.6 i 16V        | 80 |       | 04.08 |  |                |        |  |   |            |
|            | 1.6 VTi 120      | 88 |       | 11.09 |  |                |        |  |   |            |
|            | 1.6 VTi 95       | 72 |       | 07.10 |  |                |        |  |   |            |
| Electric   |                  |    | 02.13 |       |  |                |        |  |   |            |
|            | 1.2 PureTech 110 | 81 |       | 02.16 |  | 13.0460-2745.2 | 602745 |  | 24765 16,5 /Zub/S                                 | TRW        |
|            | 1.6 BlueHDi 100  | 73 |       | 12.14 |  |                |        |  |   |            |
|            | 1.6 BlueHDi 120  | 88 |       | 12.14 |  |                |        |  |   |            |
|            | 1.6 BlueHDi 75   | 55 |       | 04.15 |  |                |        |  |   |            |
|            | 1.6 HDi 110      | 80 |       | 04.08 |  |                |        |  |   |            |
|            | 1.6 HDi 110      | 82 |       | 07.10 |  |                |        |  |   |            |
|            | 1.6 HDi 115      | 84 |       | 07.10 |  |                |        |  |   |            |
|            | 1.6 HDi 75       | 55 |       | 04.08 |  |                |        |  |   |            |
|            | 1.6 HDi 90       | 66 |       | 04.08 |  |                |        |  |   |            |
|            | 1.6 HDi 90       | 68 |       | 07.10 |  |                |        |  |   |            |
|            | 1.6 HDi 92       | 68 |       | 07.10 |  |                |        |  |   |            |
|            | 1.6 i 16V        | 66 |       | 04.08 |  |                |        |  |   |            |
|            | 1.6 i 16V        | 80 |       | 04.08 |  |                |        |  |   |            |
|            | 1.6 VTi 120      | 88 |       | 11.09 |  |                |        |  |   |            |
|            | 1.6 VTi 95       | 72 |       | 07.10 |  |                |        |  |   |            |
| Electric   |                  |    | 02.13 |       |  |                |        |  |   |            |
|            | 1.2 PureTech 110 | 81 |       | 02.16 |  | 24.0112-0194.2 | 412194 |  | 268 12,0 10,0 +B                                  |            |
|            | 1.6 BlueHDi 100  | 73 |       | 12.14 |  |                |        |  |   |            |
|            | 1.6 BlueHDi 120  | 88 |       | 12.14 |  |                |        |  |   |            |
|            | 1.6 BlueHDi 75   | 55 |       | 04.15 |  |                |        |  |   |            |
|            | 1.6 HDi 110      | 80 |       | 04.08 |  |                |        |  |   |            |
|            | 1.6 HDi 110      | 82 |       | 07.10 |  |                |        |  |   |            |
|            | 1.6 HDi 115      | 84 |       | 07.10 |  |                |        |  |   |            |
|            | 1.6 HDi 75       | 55 |       | 04.08 |  |                |        |  |   |            |
|            | 1.6 HDi 90       | 66 |       | 04.08 |  |                |        |  |   |            |
|            | 1.6 HDi 90       | 68 |       | 07.10 |  |                |        |  |   |            |
| 1.6 HDi 92 | 68               |    | 07.10 |       |  |                |        |  |   |            |
| 1.6 i 16V  | 66               |    | 04.08 |       |  |                |        |  |   |            |

|     |  |  |  |  |   |  |  |                           |
|--|--|--|--|--|--|--|--|---|
| <b>CITROEN BERLINGO (B9) (08-)</b>   |  |  |  |  |  |  |  |   |
|    | 1.6 i 16V<br>1.6 VTi 120<br>1.6 VTi 95<br>Electric                               | 80<br>88<br>72   |  | 04.08<br>11.09<br>07.10<br>02.13   |  | 24.0112-0194.2   | 412194   | 268 12,0 10,0 +B  |
| <b>CITROEN C1 (05-14)</b>  |  |  |  |  |  |  |  |   |
|    | 1.0<br>1.4 HDi   | 50<br>40   |  | 06.05<br>06.05   | 04.14<br>12.08   | 13.0460-3829.2   | 603829   | 23959 17,0 /Zub/S BOS   |
|    | 1.0<br>1.4 HDi   | 50<br>40   |  | 06.05<br>06.05   | 04.14<br>12.08   | 24.0120-0180.1   | 420180   | 247 20,0 18,0 V +S +B   |
|    | 1.0<br>1.4 HDi   | 50<br>40   |  | 06.05<br>06.05   | 04.14<br>12.08   | 03.0137-0466.2<br>03.0137-9287.2   | 650466<br>669287   | 200 x 32 HEB BOS<br>Bremsbacken-Zubehör BOS   |
|    | 1.0<br>1.4 HDi   | 50<br>40   |  | 06.05<br>06.05   | 04.14<br>12.08   | 24.0220-0046.1   | 480193   | 200/201 x 44  |
|    | 1.0<br>1.4 HDi   | 50<br>40   |  | 06.05<br>06.05   | 04.14<br>12.08   | 03.0520-4117.3   | 694117   | 17,46/200x32 TopKit BOS   |
| <b>CITROEN C1 (14-)</b>  |  |  |  |  |  |  |  |   |
|    | 1.0 VTi 68<br>1.2 VTi 82   | 51<br>60   |  | 04.14<br>04.14   |  | 13.0460-3829.2   | 603829   | 23959 17,0 /Zub/S BOS   |
|    | 1.0 VTi 68<br>1.2 VTi 82   | 51<br>60   |  | 04.14<br>04.14   |  | 24.0120-0180.1   | 420180   | 247 20,0 18,0 V +S +B   |
|    | 1.0 VTi 68<br>1.2 VTi 82   | 51<br>60   |  | 04.14<br>04.14   |  | 03.0137-0466.2<br>03.0137-9287.2   | 650466<br>669287   | 200 x 32 HEB BOS<br>Bremsbacken-Zubehör BOS   |
|    | 1.0 VTi 68<br>1.2 VTi 82   | 51<br>60   |  | 04.14<br>04.14   |  | 24.0220-0046.1   | 480193   | 200/201 x 44  |
| <b>CITROEN C2 (03-09)</b>  |  |  |  |  |  |  |  |   |
|   | 1.1 i<br>1.4 16V<br>1.4 HDi<br>1.4 i   | 44<br>65<br>50   |  | 09.03<br>06.06<br>09.03<br>09.03   | 12.09 - belüftete Scheiben <sup>1)</sup><br>12.09 - belüftete Scheiben <sup>1)</sup><br>12.09 - belüftete Scheiben <sup>1)</sup><br>12.09 - belüftete Scheiben <sup>1)</sup>   | 13.0460-2871.2<br>13.0460-0146.2   | 602871<br>610146   | 23407 19,0 /S TRW<br>Belagsatz-Zubehör TRW  |
|  | 1.4 16V<br>1.4 HDi<br>1.4 HDi<br>1.4 i<br>1.6 16V<br>1.6 16V                     | 65<br>50<br>50<br>80<br>80   | ORGA 10800<br>ORGA 10800   | 06.06<br>09.03<br>09.03<br>09.03   | 12.09 + belüftete Scheiben <sup>2)</sup><br>+ bel.Scheiben /+16"Rad <sup>3)</sup><br>12.09 + belüftete Scheiben/ - 16"-Rad <sup>4)</sup><br>12.09 + belüftete Scheiben <sup>2)</sup><br>+ 16" Rad <sup>5)</sup><br>12.09 - 16" Rad <sup>6)</sup> | 13.0460-2881.2   | 602881   | 23409 19,3 /S TRW   |
|  | 1.4 HDi<br>1.6 16V<br>1.6 HDi<br>1.6 VTS   | 50<br>80<br>80<br>90   | ORGA 10801<br>ORGA 10801   | 12.09<br>12.09<br>09.05<br>01.05   | + bel.Scheiben /+16"Rad <sup>3)</sup><br>+ 16" Rad <sup>5)</sup>   | 13.0460-3994.2<br>13.0470-3994.2   | 603994<br>LD3994   | 23599 19,0 /Zub/S BOS<br>23599 19,0 /Zub/S BOS  |
|  | 1.1 i<br>1.4 HDi<br>1.4 i  | 44<br>50   |  | 09.03<br>09.03<br>09.03  | 12.09<br>12.09<br>12.09  | 24.0113-0184.1<br>24.0313-0184.1   | 413184<br>513184   | 266 13,0 11,0 +S +B<br>266 13,0 11,0 +S +B PD   |
|  | 1.4 16V<br>1.4 HDi<br>1.4 i<br>1.6 16V<br>1.6 HDi<br>1.6 VTS                     | 65<br>50<br>80<br>80<br>90   |  | 06.06<br>09.03<br>09.03<br>09.03<br>09.05<br>01.05                               | 12.09<br>12.09<br>12.09<br>12.09<br>12.09<br>12.09   | 24.0122-0194.1   | 422194   | 266 22,0 20,0 V +S +B   |
|  | 1.1 i<br>1.4 16V<br>1.4 HDi<br>1.4 i<br>1.6 16V<br>1.6 HDi<br>1.6 VTS            | 44<br>65<br>50<br>80<br>80<br>90   |  | 09.03<br>06.06<br>09.03<br>09.03<br>09.05<br>01.05                               | 12.09<br>12.09<br>12.09<br>12.09<br>12.09<br>12.09   | 24.0711-5124.3   | 360066   | 2 <br>Radsensor L=1120 |
|  | 1.4 16V<br>1.4 HDi<br>1.4 i<br>1.6 16V<br>1.6 HDi<br>1.6 VTS                     | 65<br>50<br>80<br>80<br>90   |  | 06.06<br>09.03<br>09.03<br>09.05<br>01.05  | 12.09<br>12.09<br>12.09<br>12.09<br>12.09  | 13.0460-2823.2<br>13.0470-2823.2<br>13.0460-0072.2                                 | 602823<br>LD2823<br>610072   | 23554 17,2 /S TRW<br>23554 17,2 /S TRW<br>Belagsatz-Zubehör TRW   |
|  | 1.4 16V<br>1.4 HDi<br>1.4 i<br>1.6 16V<br>1.6 HDi<br>1.6 VTS                     | 65<br>50<br>80<br>80<br>90   |  | 06.06<br>09.03<br>09.03<br>09.05<br>01.05  | 12.09<br>12.09<br>12.09<br>12.09<br>12.09  | 24.0109-0137.1   | 409137   | 247 9,0 8,0 +S +B   |
|  | 1.1 i<br>1.4 16V<br>1.4 HDi<br>1.4 i<br>1.6 16V                                  | 44<br>65<br>50<br>80   |  | 09.03<br>06.06<br>09.03<br>09.03<br>09.03  | 12.09<br>12.09<br>12.09<br>12.09<br>12.09  | 24.0711-5093.3   | 360063   | 2 <br>Radsensor L=757  |

<sup>1)</sup> - ventilated discs / - dischi ventilati / - disques ventilés / - disco ventilado























<sup>2)</sup> + ventilated discs / + dischi ventilati / + disques ventilés / + disco ventilado

<sup>3)</sup> + ventilated discs/+ 16 wheel / + dischi ventilati/+ ruota 16" / + disques ventilés/+ roue 16" / + disco ventilado/+ rueda 16

<sup>4)</sup> + ventilated discs/- 16 wheel / + dischi ventilati/ - ruota 16" / + disques ventilés/- roue 16" / + disco ventilado/- rueda 16

<sup>5)</sup> + 16" wheel / + ruota 16" / + roue 16" / + rueda 16"

<sup>6)</sup> - 16" wheel / - ruota 16" / - roue 16" / - rueda 16"

|     |                                        |  |  |  |  |  |  |       |   |
|--|--|--|--|--|---|--|--|---|---|
| <b>CITROEN C2 (03-09)</b>  |  |  |  |  |   |  |  |   |   |
|    | 1.6 HDi<br>1.6 VTS   | 80<br>90   |  | 09.05<br>01.05   | 12.09<br>12.09  | 24.0711-5093.3   | 360063   | 2    | Radsensor L=757   |
|    | 1.1 i<br>1.4 16V<br>1.4 HDi<br>1.4 i   | 44<br>65<br>50   |  | 09.03<br>06.06<br>09.03<br>09.03   | 12.09<br>12.09<br>12.09<br>12.09  | 03.0137-0426.2<br>03.0137-0439.2<br>03.0137-9267.2                                 | 650426<br>650439<br>669267   |   | 203 x 38 HEB TRW<br>203 x 39 HEB TRW<br>Bremsbacken-Zubehör TRW |
|    | 1.1 i<br>1.4 16V<br>1.4 HDi<br>1.4 i   | 44<br>65<br>50   |  | 09.03<br>06.06<br>09.03<br>09.03   | 12.09<br>12.09<br>12.09<br>12.09  | 24.0220-3029.1<br>24.0220-3729.2   | 480179<br>480217   | ohne Sensorring <sup>1)</sup><br>mit Sensorring <sup>2)</sup>                           | 203/204,5 x 42 - Lager<br>203/204,5 x 42 + Lager                |
|    | 1.1 i<br>1.4 16V<br>1.4 HDi<br>1.4 i   | 44<br>65<br>50   |  | 09.03<br>06.06<br>09.03<br>09.03   | 12.09<br>12.09<br>12.09<br>12.09  | 03.0520-6119.3   | 696119   |   | 19,05/203x38 TopKit TRW   |
|  | 1.1 i<br>1.4 16V<br>1.4 HDi<br>1.4 i   | 44<br>65<br>50   |  | 09.03<br>06.06<br>09.03<br>09.03   | 12.09<br>12.09<br>12.09<br>12.09  | 03.0520-8520.3<br>03.0520-7620.3   | 698520<br>697620   |   | 20,64/203x39 TopKit BOS<br>20,64/203x38 TopKit TRW              |
| <b>CITROEN C3 (02-09)</b>  |  |  |  |  |   |  |  |   |   |
|    | 1.1 i<br>1.4 bivalent<br>1.4 HDi<br>1.4 i  | 44<br>54<br>54   |  | 02.02<br>09.05<br>02.02<br>02.02   | 08.09<br>08.09<br>08.09<br>08.09  | 13.0460-2871.2<br>13.0460-0146.2   | 602871<br>610146   |   | 23407 19,0 /S TRW<br>Belagsatz-Zubehör TRW                      |
|  | 1.4 16V<br>1.4 16V HDi 90<br>1.6 16V<br>1.6 16V HDi 110<br>1.6 16V HDi 90  | 65<br>66<br>80<br>80<br>66   |  | 12.03<br>02.02<br>02.02<br>09.05<br>10.05  | 08.09<br>08.09<br>08.09 + Schaltgetriebe <sup>4)</sup><br>08.09<br>08.09          | 13.0460-2881.2   | 602881   | - 16" Rad <sup>3)</sup>   | 23409 19,3 /S TRW   |
|  | 1.6 16V<br>1.6 16V HDi 110   | 80<br>80   | ORGA 10800   | 02.02<br>09.05   |   | 13.0460-3811.2   | 603811   | + Automatikgetriebe <sup>5)</sup>   | 23708 19,2 /S BOS   |
|  | 1.6 16V<br>1.6 16V HDi 110   | 80<br>80   | ORGA 10800   | 02.02<br>08.09   |   | 13.0460-3966.2<br>13.0470-3966.2   | 603966<br>LD3966   | + Automatikgetriebe <sup>5)</sup>   | 23600 19,4 /Zub/S BOS<br>23600 19,4 /Zub/S BOS                  |
|  | 1.4 16V<br>1.6 16V<br>1.6 16V HDi 110<br>1.6 16V HDi 90  | 65<br>80<br>80<br>66   |  | 12.03<br>02.02<br>09.05<br>10.05   | 08.09<br>08.09<br>08.09 + Schaltgetriebe <sup>4)</sup><br>08.09                   | 13.0460-3994.2<br>13.0470-3994.2   | 603994<br>LD3994   | + 16" Rad <sup>6)</sup>   | 23599 19,0 /Zub/S BOS<br>23599 19,0 /Zub/S BOS                  |
|   | 1.1 i<br>1.4 bivalent<br>1.4 HDi<br>1.4 i  | 44<br>54<br>54   |  | 02.02<br>09.05<br>02.02<br>02.02   | 08.09<br>08.09<br>08.09<br>08.09  | 24.0113-0184.1<br>24.0313-0184.1   | 413184<br>513184   |   | 266 13,0 11,0 +S +B<br>266 13,0 11,0 +S +B PD                   |
|  | 1.4 16V<br>1.4 16V HDi 90<br>1.6 16V<br>1.6 16V HDi 110<br>1.6 16V HDi 90  | 65<br>66<br>80<br>80<br>66   |  | 12.03<br>02.02<br>02.02<br>09.05<br>10.05  | 08.09<br>08.09<br>08.09 + Schaltgetriebe <sup>4)</sup><br>08.09<br>08.09          | 24.0122-0194.1   | 422194   |   | 266 22,0 20,0 V +S +B   |
|  | 1.6 16V HDi 110  | 80   |  | 09.05  | 08.09   | 24.0126-0120.1<br>24.0326-0120.1   | 426120<br>526120   |   | 283 26,0 24,0 V +S +B<br>283 26,0 24,0 V +S +B PD               |
|  | 1.6 16V  | 80   |  | 02.02  | 08.09   | 24.0126-0120.1   | 426120   | + Automatikgetriebe <sup>5)</sup>   | 283 26,0 24,0 V +S +B   |
|  | 1.1 i<br>1.4 16V<br>1.4 16V HDi 90<br>1.4 bivalent<br>1.4 HDi<br>1.4 i<br>1.6 16V<br>1.6 16V HDi 110<br>1.6 16V HDi 90 | 44<br>65<br>66<br>54<br>54<br>54<br>80<br>80<br>66                               |  | 02.02<br>12.03<br>02.02<br>09.05<br>02.02<br>02.02<br>02.02<br>09.05<br>10.05    | 08.09<br>08.09<br>08.09<br>08.09<br>08.09<br>08.09<br>08.09<br>08.09<br>08.09     | 24.0711-5124.3   | 360066   | 2  | Radsensor L=1120  |
|  | 1.4 16V HDi 90<br>1.6 16V<br>1.6 16V HDi 110<br>1.6 16V HDi 90   | 66<br>80<br>80<br>66   |  | 02.02<br>02.02<br>09.05<br>10.05   | 08.09<br>08.09<br>08.09<br>08.09  | 13.0460-2823.2<br>13.0470-2823.2<br>13.0460-0072.2                                 | 602823<br>LD2823<br>610072   |   | 23554 17,2 /S TRW<br>23554 17,2 /S TRW<br>Belagsatz-Zubehör TRW |
|  | 1.4 16V HDi 90<br>1.6 16V<br>1.6 16V HDi 110<br>1.6 16V HDi 90   | 66<br>80<br>80<br>66   |  | 02.02<br>02.02<br>09.05<br>10.05   | 08.09<br>08.09<br>08.09<br>08.09  | 24.0109-0137.1   | 409137   |   | 247 9,0 8,0 +S +B   |
|  | 1.1 i<br>1.4 16V<br>1.4 16V HDi 90<br>1.4 bivalent<br>1.4 HDi<br>1.4 i<br>1.6 16V<br>1.6 16V HDi 110<br>1.6 16V HDi 90 | 44<br>65<br>66<br>54<br>54<br>54<br>80<br>80<br>66                               |  | 02.02<br>12.03<br>02.02<br>09.05<br>02.02<br>02.02<br>02.02<br>09.05<br>10.05    | 08.09<br>08.09<br>08.09<br>08.09<br>08.09<br>08.09<br>08.09<br>08.09<br>08.09     | 24.0711-5093.3   | 360063   | 2  | Radsensor L=757   |
|  | 1.1 i<br>1.4 16V<br>1.4 16V HDi 90<br>1.4 bivalent<br>1.4 HDi<br>1.4 i<br>1.6 16V HDi 90                               | 44<br>65<br>66<br>54<br>54<br>54<br>66   |  | 02.02<br>12.03<br>02.02<br>09.05<br>02.02<br>02.02<br>10.05                      | 08.09<br>08.09<br>08.09<br>08.09<br>08.09<br>08.09<br>08.09                       | 03.0137-0426.2<br>03.0137-9267.2   | 650426<br>669267   |   | 203 x 38 HEB TRW<br>Bremsbacken-Zubehör TRW                     |

<sup>1)</sup> without sensor ring / senza sensori / sans secours ABS / sin anillo sensor ABS

<sup>2)</sup> with sensor ring / con sensori / avec secours ABS / con anillo sensor ABS

























<sup>3)</sup> - 16" wheel / - ruota 16" / - roue 16" / - rueda 16"

<sup>4)</sup> + manual transmission / + scatola cambio velocità / + transmission mécanique / + cambio de velocidad

<sup>5)</sup> + autom.transmission / + scatola cambio automatico / + transmission automatique / + cambio automático

<sup>6)</sup> + 16" wheel / + ruota 16" / + roue 16" / + rueda 16"





















|     |    |  |                                   |     |  |  |       |  |
|--|--|--|---|---|---|--|---|--|
| <b>CITROEN C3 (02-09)</b>  |  |  |   |   |   |  |   |  |
|    | 1.1 i<br>1.4 16V<br>1.4 16V HDi 90<br>1.4 bivalent<br>1.4 HDi<br>1.4 i<br>1.6 16V HDi 90   | 44<br>65<br>66<br>54<br>54<br>66   | 02.02<br>12.03<br>02.02<br>09.05<br>02.02<br>02.02<br>10.05   | 08.09 + ABS<br>08.09<br>08.09<br>08.09 + ABS<br>08.09 + ABS<br>08.09 + ABS<br>08.09 | 03.0137-0439.2<br>03.0137-9281.2  | 650439<br>669281   |   | 203 x 39 HEB<br>Bremsbacken-Zubehör  |
|    | 1.1 i<br>1.4 16V<br>1.4 16V HDi 90<br>1.4 bivalent<br>1.4 HDi<br>1.4 i<br>1.6 16V HDi 90   | 44<br>65<br>66<br>54<br>54<br>66   | 02.02<br>12.03<br>02.02<br>09.05<br>02.02<br>02.02<br>10.05   | 08.09<br>08.09<br>08.09<br>08.09<br>08.09<br>08.09<br>08.09                         | 24.0220-3029.1<br>24.0220-3729.2  | 480179<br>480217   | ohne Sensorring <sup>1)</sup><br>mit Sensorring <sup>2)</sup>                           | 203/204,5 x 42 - Lager<br>203/204,5 x 42 + Lager                                   |
|    | 1.1 i<br>1.4 bivalent<br>1.4 HDi<br>1.4 i  | 44<br>54<br>54<br>54   | 02.02<br>09.05<br>02.02<br>02.02  | 08.09 - ABS<br>08.09 - ABS<br>08.09 - ABS<br>08.09 - ABS                            | 03.0520-6119.3  | 696119   |   | 19,05/203x38 TopKit TRW  |
|  | 1.1 i<br>1.4 16V<br>1.4 16V HDi 90<br>1.4 bivalent<br>1.4 HDi<br>1.4 i<br>1.6 16V HDi 90   | 44<br>65<br>66<br>54<br>54<br>66   | 02.02<br>12.03<br>02.02<br>09.05<br>02.02<br>02.02<br>10.05   | 08.09 + ABS<br>08.09<br>08.09<br>08.09 + ABS<br>08.09 + ABS<br>08.09 + ABS<br>08.09 | 03.0520-8520.3<br>03.0520-7620.3  | 698520<br>697620   |   | 20,64/203x39 TopKit BOS<br>20,64/203x38 TopKit TRW                                 |
| <b>CITROEN C3 PLURIEL (03-10)</b>  |  |  |   |   |   |  |   |  |
|    | 1.4 HDi<br>1.4 Hybrid<br>1.4 i<br>1.6 16V  | 50<br>54<br>54<br>80   | 04.04<br>05.05<br>05.03<br>05.03  | 07.10<br>07.10<br>07.10<br>07.10  | 13.0460-2881.2  | 602881   |   | 23409 19,3 /S TRW  |
|    | 1.4 HDi<br>1.4 Hybrid<br>1.4 i<br>1.6 16V  | 50<br>54<br>54<br>80   | 04.04<br>05.05<br>05.03<br>05.03  | 07.10<br>07.10<br>07.10<br>07.10  | 24.0122-0194.1  | 422194   |   | 266 22,0 20,0 V +S +B  |
|    | 1.4 HDi<br>1.4 Hybrid<br>1.4 i<br>1.6 16V  | 50<br>54<br>54<br>80   | 04.04<br>05.05<br>05.03<br>05.03  | 07.10<br>07.10<br>07.10<br>07.10  | 24.0711-5124.3  | 360066   | 2    | Radsensor L=1120   |
|  | 1.6 16V  | 80   | 05.03   | 07.10   | 13.0460-2823.2<br>13.0470-2823.2<br>13.0460-0072.2                                | 602823<br>LD2823<br>610072   |   | 23554 17,2 /S TRW<br>23554 17,2 /S TRW<br>Belagsatz-Zubehör TRW                    |
|  | 1.6 16V  | 80   | 05.03   | 07.10   | 24.0109-0137.1  | 409137   |   | 247 9,0 8,0 +S +B  |
|  | 1.4 HDi<br>1.4 Hybrid<br>1.4 i<br>1.6 16V  | 50<br>54<br>54<br>80   | 04.04<br>05.05<br>05.03<br>05.03  | 07.10<br>07.10<br>07.10<br>07.10  | 24.0711-5093.3  | 360063   | 2  | Radsensor L=757  |
|  | 1.4 HDi<br>1.4 Hybrid<br>1.4 i   | 50<br>54<br>54   | 04.04<br>05.05<br>05.03   | 07.10<br>07.10<br>07.10   | 03.0137-0426.2<br>03.0137-9267.2  | 650426<br>669267   |   | 203 x 38 HEB TRW<br>Bremsbacken-Zubehör TRW  |
|  | 1.4 HDi<br>1.4 Hybrid<br>1.4 i   | 50<br>54<br>54   | 04.04<br>05.05<br>05.03   | 07.10 + ABS<br>07.10 + ABS<br>07.10 + ABS   | 03.0137-0439.2<br>03.0137-9281.2  | 650439<br>669281   |   | 203 x 39 HEB<br>Bremsbacken-Zubehör  |
|  | 1.4 HDi<br>1.4 Hybrid<br>1.4 i   | 50<br>54<br>54   | 04.04<br>05.05<br>05.03   | 07.10<br>07.10<br>07.10   | 24.0220-3029.1<br>24.0220-3729.2  | 480179<br>480217   | ohne Sensorring <sup>1)</sup><br>mit Sensorring <sup>2)</sup>                           | 203/204,5 x 42 - Lager<br>203/204,5 x 42 + Lager                                   |
|  | 1.4 HDi<br>1.4 Hybrid<br>1.4 i   | 50<br>54<br>54   | 04.04<br>05.05<br>05.03   | 07.10 - ABS<br>07.10 - ABS<br>07.10 - ABS   | 03.0520-6119.3  | 696119   |   | 19,05/203x38 TopKit TRW  |
|  | 1.4 HDi<br>1.4 Hybrid<br>1.4 i   | 50<br>54<br>54   | 04.04<br>05.05<br>05.03   | 07.10 + ABS<br>07.10 + ABS<br>07.10 + ABS   | 03.0520-8520.3<br>03.0520-7620.3  | 698520<br>697620   |   | 20,64/203x39 TopKit BOS<br>20,64/203x38 TopKit TRW                                 |
| <b>CITROEN C3 II (09-)</b>   |  |  |   |   |   |  |   |  |
|  | 1.0 VTI 68<br>1.1<br>1.2 VTI 110<br>1.2 VTI 82<br>1.4<br>1.4 Flex<br>1.4 HDi 70<br>1.4 LPG<br>1.4 VTI 95<br>1.6 BlueHDi 100<br>1.6 BlueHDi 75<br>1.6 HDi<br>1.6 HDi 90 | 50<br>44<br>81<br>60<br>54<br>58<br>50<br>70<br>73<br>55<br>68<br>66             | 10.12<br>09.09<br>10.14<br>10.12<br>09.09<br>11.09<br>11.09<br>06.13<br>09.09<br>07.14<br>04.15<br>11.09<br>09.09 |   | + Bremsscheibendurchm. 266 mm <sup>3)</sup>                                       | 13.0460-3994.2<br>13.0470-3994.2   | 603994<br>LD3994  | 23599 19,0 /Zub/S BOS<br>23599 19,0 /Zub/S BOS                                     |
|  | 1.2 VTI 110<br>1.4 LPG<br>1.6 BlueHDi 100<br>1.6 BlueHDi 75<br>1.6 Flex<br>1.6 HDi 110   | 81<br>70<br>73<br>55<br>81<br>82   | 10.14<br>06.13<br>07.14<br>04.15<br>11.09<br>09.09  |   | + Bremsscheibendurchm. 283 mm <sup>4)</sup>                                       | 13.0460-3855.2   | 603855  | 24883 18,0 +/Zub/S BOS   |

<sup>1)</sup> without sensor ring / senza sensori / sans secours ABS / sin anillo sensor ABS

<sup>2)</sup> with sensor ring / con sensori / avec secours ABS / con anillo sensor ABS

<sup>3)</sup> + brake disc diameter 266 mm / + disco fr.diam. 266mm / + disques fr.diam. 266mm / + disco fr.diam. 266mm

<sup>4)</sup> + brake disc diameter 283 mm / + disco fr.diam. 283mm / + disques fr.diam. 283mm / + disco fr.diam. 283mm

|     |   |              |    |   |  |  |       |  |
|--|---|--|--|---|---|--|---|--|
| <b>CITROEN C3 II (09-)</b>   |   |  |  |   |   |  |   |  |
|    | 1.6 HDi 115<br>1.6 VTi 120  | 84<br>88   |  | 09.12<br>09.09  |   | 13.0460-3855.2<br>603855   |   | 24883 18,0 +/-Zub/S <b>BOS</b>   |
|    | 1.0 VTi 68<br>1.1<br>1.2 VTi 110<br>1.2 VTi 82<br>1.4<br>1.4 Flex<br>1.4 HDi 70<br>1.4 LPG<br>1.4 VTi 95<br>1.6 BlueHDi 100<br>1.6 BlueHDi 75<br>1.6 HDi<br>1.6 HDi 90  | 50<br>44<br>81<br>60<br>54<br>58<br>50<br>70<br>73<br>55<br>68<br>66                         |  | 10.12<br>09.09<br>10.14<br>10.12<br>09.09<br>11.09<br>11.09<br>06.13<br>09.09<br>07.14<br>04.15<br>11.09<br>09.09                                     |   | 24.0122-0194.1<br>422194   |   | 266 22,0 20,0 V +S +B  |
|  | 1.2 VTi 110<br>1.4 LPG<br>1.6 BlueHDi 100<br>1.6 BlueHDi 75<br>1.6 Flex<br>1.6 HDi 110<br>1.6 HDi 115<br>1.6 VTi 120  | 81<br>70<br>73<br>55<br>81<br>82<br>84<br>88   |  | 10.14<br>06.13<br>07.14<br>04.15<br>11.09<br>09.09<br>09.12<br>09.09  |   | 24.0126-0120.1 426120<br>24.0326-0120.1 526120                                     |   | 283 26,0 24,0 V +S +B<br>283 26,0 24,0 V +S +B <b>PD</b>                           |
|    | 1.0 VTi 68<br>1.1<br>1.2 VTi 110<br>1.2 VTi 82<br>1.4<br>1.4 Flex<br>1.4 HDi 70<br>1.4 LPG<br>1.4 VTi 95<br>1.6 BlueHDi 100<br>1.6 BlueHDi 75<br>1.6 Flex<br>1.6 HDi<br>1.6 HDi 110<br>1.6 HDi 115<br>1.6 HDi 90<br>1.6 VTi 120 | 50<br>44<br>81<br>60<br>54<br>58<br>50<br>70<br>73<br>55<br>81<br>68<br>82<br>84<br>66<br>88 |  | 10.12<br>09.09<br>10.14<br>10.12<br>09.09<br>11.09<br>11.09<br>06.13<br>09.09<br>07.14<br>04.15<br>11.09<br>11.09<br>09.09<br>09.12<br>09.09<br>09.09 |   | 24.0711-5256.3 360320  | 2    | Radsensor L=1029   |
|  | 1.2 VTi 110<br>1.4 LPG<br>1.6 BlueHDi 100<br>1.6 BlueHDi 75<br>1.6 HDi 110<br>1.6 HDi 115<br>1.6 VTi 120  | 81<br>70<br>73<br>55<br>82<br>84<br>88   |  | 10.14<br>06.13<br>07.14<br>04.15<br>09.09<br>09.12<br>09.09   |   | 13.0460-2740.2 602740<br>13.0470-2740.2 LD2740                                     |   | 23554 17,2 /Zub/S <b>TRW</b><br>23554 17,2 /Zub/S <b>TRW</b>                       |
|  | 1.2 VTi 110<br>1.4 LPG<br>1.6 BlueHDi 100<br>1.6 BlueHDi 75<br>1.6 HDi 110<br>1.6 HDi 115<br>1.6 VTi 120  | 81<br>70<br>73<br>55<br>82<br>84<br>88   |  | 10.14<br>06.13<br>07.14<br>04.15<br>09.09<br>09.12<br>09.09   |   | 24.0109-0100.2 409100  |   | 249 9,0 7,0 +B   |
|  | 1.0 VTi 68<br>1.1<br>1.2 VTi 82<br>1.4<br>1.4 Flex<br>1.4 HDi 70<br>1.4 VTi 95<br>1.6 Flex<br>1.6 HDi<br>1.6 HDi 110<br>1.6 HDi 115<br>1.6 HDi 90<br>1.6 VTi 120  | 50<br>44<br>60<br>54<br>58<br>50<br>81<br>68<br>82<br>84<br>66<br>88                         | ORGA 13341<br>ORGA 13341<br>ORGA 13341<br>ORGA 13341<br>ORGA 13341<br>ORGA 13341<br>ORGA 13341<br>ORGA 13341<br>ORGA 13341<br>ORGA 13341<br>ORGA 13341<br>ORGA 13341 | 10.12<br>09.09<br>10.12<br>09.09<br>11.09<br>11.09<br>09.09<br>11.09<br>11.09<br>09.09<br>09.12<br>09.09<br>09.09                                     |   | 24.0711-5257.3 360321  | 2  | Radsensor L=694  |
|  | 1.0 VTi 68<br>1.1<br>1.2 VTi 110<br>1.2 VTi 82<br>1.4<br>1.4 Flex<br>1.4 HDi 70<br>1.4 LPG<br>1.6 BlueHDi 100<br>1.6 BlueHDi 75<br>1.6 HDi<br>1.6 HDi 90  | 50<br>44<br>81<br>60<br>54<br>58<br>50<br>70<br>73<br>55<br>68<br>66                         |  | 10.12<br>09.09<br>10.14<br>10.12<br>09.09<br>11.09<br>11.09<br>06.13<br>07.14<br>04.15<br>11.09<br>09.09  |   | 03.0137-0504.2 650504<br>03.0137-9281.2 669281                                     |   | 203 x 39 HEB <b>BOS</b><br>Bremsbacken-Zubehör                                     |
|  | 1.2 VTi 110<br>1.4 LPG<br>1.4 VTi 95<br>1.6 BlueHDi 100<br>1.6 BlueHDi 75   | 81<br>70<br>73<br>55   |  | 10.14<br>06.13<br>09.09<br>07.14<br>04.15   |   | 03.0137-0491.2 650491<br>03.0137-9228.2 669228                                     |   | 228 x 42 HEB <b>BOS</b><br>Bremsbacken-Zubehör <b>BDX</b>                          |



**CITROEN C3 II (09-)**

|  |                 |    |  |       |  |                |        |  |                     |     |
|--|-----------------|----|--|-------|--|----------------|--------|--|---------------------|-----|
|  | 1.0 VTI 68      | 50 |  | 10.12 |  | 03.0520-9620.3 | 699620 |  | 20,64/203x39 TopKit | BOS |
|  | 1.1             | 44 |  | 09.09 |  |                |        |  |                     |     |
|  | 1.2 VTI 110     | 81 |  | 10.14 |  |                |        |  |                     |     |
|  | 1.2 VTI 82      | 60 |  | 10.12 |  |                |        |  |                     |     |
|  | 1.4             | 54 |  | 09.09 |  |                |        |  |                     |     |
|  | 1.4 Flex        | 58 |  | 11.09 |  |                |        |  |                     |     |
|  | 1.4 HDi 70      | 50 |  | 11.09 |  |                |        |  |                     |     |
|  | 1.4 LPG         | 70 |  | 06.13 |  |                |        |  |                     |     |
|  | 1.6 BlueHDi 100 | 73 |  | 07.14 |  |                |        |  |                     |     |
|  | 1.6 BlueHDi 75  | 55 |  | 04.15 |  |                |        |  |                     |     |
|  | 1.6 HDi         | 68 |  | 11.09 |  |                |        |  |                     |     |
|  | 1.6 HDi 90      | 66 |  | 09.09 |  |                |        |  |                     |     |
|  | 1.2 VTI 110     | 81 |  | 10.14 |  | 03.0520-9420.3 | 699420 |  | 20,64/228x42 TopKit | BOS |
|  | 1.4 LPG         | 70 |  | 06.13 |  |                |        |  |                     |     |
|  | 1.4 VTI 95      | 70 |  | 09.09 |  |                |        |  |                     |     |
|  | 1.6 BlueHDi 100 | 73 |  | 07.14 |  |                |        |  |                     |     |
|  | 1.6 BlueHDi 75  | 55 |  | 04.15 |  |                |        |  |                     |     |

**CITROEN C3 PICASSO (09-)**

|             |                 |                 |       |   |   |                |                |        |                          |                   |     |
|-------------|-----------------|-----------------|-------|---|---|----------------|----------------|--------|--------------------------|-------------------|-----|
|             | 1.2 THP 110     | 81              |       | 01.15                                       | + Bremsscheibendurchm. 266 mm <sup>1)</sup> | 13.0460-3994.2 | 603994         |        | 23599 19,0 /Zub/S        | BOS               |     |
|             | 1.4 VTI 95      | 70              |       | 02.09                                       | + Bremsscheibendurchm. 266 mm <sup>1)</sup> | 13.0470-3994.2 | LD3994         |        | 23599 19,0 /Zub/S        | BOS               |     |
|             | 1.4 VTI 95 LPG  | 70              |       | 01.12                                       | + Bremsscheibendurchm. 266 mm <sup>1)</sup> |                |                |        |                          |                   |     |
|             | 1.6 BlueHDi 100 | 73              |       | 01.15                                       | + Bremsscheibendurchm. 266 mm <sup>1)</sup> |                |                |        |                          |                   |     |
|             | 1.6 Flex        | 78              |       | 11.09                                       | + Bremsscheibendurchm. 266 mm <sup>1)</sup> |                |                |        |                          |                   |     |
|             | 1.6 HDi         | 80              |       | 02.09                                       | + Bremsscheibendurchm. 266 mm <sup>1)</sup> |                |                |        |                          |                   |     |
|             | 1.6 HDi 110     | 82              |       | 05.10                                       | + Bremsscheibendurchm. 266 mm <sup>1)</sup> |                |                |        |                          |                   |     |
|             | 1.6 HDi 115     | 84              |       | 11.12                                       | + Bremsscheibendurchm. 266 mm <sup>1)</sup> |                |                |        |                          |                   |     |
|             | 1.6 HDi 90      | 66              |       | 02.09                                       | + Bremsscheibendurchm. 266 mm <sup>1)</sup> |                |                |        |                          |                   |     |
|             | 1.6 HDi 90      | 68              |       | 07.10                                       | + Bremsscheibendurchm. 266 mm <sup>1)</sup> |                |                |        |                          |                   |     |
|             | 1.6 VTI 120     | 88              |       | 02.09                                       | + Bremsscheibendurchm. 266 mm <sup>1)</sup> |                |                |        |                          |                   |     |
|             | 1.2 THP 110     | 81              |       | 01.15                                       | + Bremsscheibendurchm. 283 mm <sup>2)</sup> | 13.0460-3855.2 | 603855         |        | 24883 18,0 +/Zub/S       | BOS               |     |
|             | 1.4 VTI 95      | 70              |       | 02.09                                       | + Bremsscheibendurchm. 283 mm <sup>2)</sup> |                |                |        |                          |                   |     |
|             | 1.4 VTI 95 LPG  | 70              |       | 01.12                                       | + Bremsscheibendurchm. 283 mm <sup>2)</sup> |                |                |        |                          |                   |     |
|             | 1.6 BlueHDi 100 | 73              |       | 01.15                                       | + Bremsscheibendurchm. 283 mm <sup>2)</sup> |                |                |        |                          |                   |     |
|             | 1.6 Flex        | 78              |       | 11.09                                       | + Bremsscheibendurchm. 283 mm <sup>2)</sup> |                |                |        |                          |                   |     |
|             | 1.6 HDi         | 80              |       | 02.09                                       | + Bremsscheibendurchm. 283 mm <sup>2)</sup> |                |                |        |                          |                   |     |
|             | 1.6 HDi 110     | 82              |       | 02.09                                       | + Bremsscheibendurchm. 283 mm <sup>2)</sup> |                |                |        |                          |                   |     |
| 1.6 HDi 115 | 84              |                 | 11.12 | + Bremsscheibendurchm. 283 mm <sup>2)</sup> |   |                |                |        |                          |                   |     |
| 1.6 HDi 90  | 66              |                 | 02.09 | + Bremsscheibendurchm. 283 mm <sup>2)</sup> |   |                |                |        |                          |                   |     |
| 1.6 HDi 90  | 68              |                 | 07.10 | + Bremsscheibendurchm. 283 mm <sup>2)</sup> |   |                |                |        |                          |                   |     |
| 1.6 VTI 120 | 88              |                 | 02.09 | + Bremsscheibendurchm. 283 mm <sup>2)</sup> |   |                |                |        |                          |                   |     |
|             | 1.2 THP 110     | 81              |       | 01.15                                       |   | 24.0122-0194.1 | 422194         |        | 266 22,0 20,0 V +S +B    |                   |     |
|             | 1.4 VTI 95      | 70              |       | 02.09                                       |   |                |                |        |                          |                   |     |
|             | 1.4 VTI 95 LPG  | 70              |       | 01.12                                       |   |                |                |        |                          |                   |     |
|             | 1.6 BlueHDi 100 | 73              |       | 01.15                                       |   |                |                |        |                          |                   |     |
|             | 1.6 Flex        | 78              |       | 11.09                                       |   |                |                |        |                          |                   |     |
|             | 1.6 HDi         | 80              |       | 02.09                                       |   |                |                |        |                          |                   |     |
|             | 1.6 HDi 110     | 82              |       | 05.10                                       |   |                |                |        |                          |                   |     |
|             | 1.6 HDi 115     | 84              |       | 11.12                                       |   |                |                |        |                          |                   |     |
|             | 1.6 HDi 90      | 66              |       | 02.09                                       |   |                |                |        |                          |                   |     |
|             | 1.6 HDi 90      | 68              |       | 07.10                                       |   |                |                |        |                          |                   |     |
|             | 1.6 VTI 120     | 88              |       | 02.09                                       |   |                |                |        |                          |                   |     |
|             | 1.2 THP 110     | 81              |       | 01.15                                       |   | 24.0126-0120.1 | 426120         |        | 283 26,0 24,0 V +S +B    |                   |     |
|             | 1.4 VTI 95      | 70              |       | 02.09                                       |   | 24.0326-0120.1 | 526120         |        | 283 26,0 24,0 V +S +B PD |                   |     |
|             | 1.4 VTI 95 LPG  | 70              |       | 01.12                                       |   |                |                |        |                          |                   |     |
|             | 1.6 BlueHDi 100 | 73              |       | 01.15                                       |   |                |                |        |                          |                   |     |
|             | 1.6 Flex        | 78              |       | 11.09                                       |   |                |                |        |                          |                   |     |
|             | 1.6 HDi         | 80              |       | 02.09                                       |   |                |                |        |                          |                   |     |
|             | 1.6 HDi 110     | 82              |       | 05.10                                       |   |                |                |        |                          |                   |     |
| 1.6 HDi 115 | 84              |                 | 11.12 |   |   |                |                |        |                          |                   |     |
| 1.6 HDi 90  | 66              |                 | 02.09 |   |   |                |                |        |                          |                   |     |
| 1.6 HDi 90  | 68              |                 | 07.10 |   |   |                |                |        |                          |                   |     |
| 1.6 VTI 120 | 88              |                 | 02.09 |   |   |                |                |        |                          |                   |     |
|             | 1.2 THP 110     | 81              |       | 01.15                                       |   | 24.0711-5256.3 | 360320         | 2      | Radsensor L=1029         |                   |     |
|             | 1.4 VTI 95      | 70              |       | 02.09                                       |   |                |                |        |                          |                   |     |
|             | 1.4 VTI 95 LPG  | 70              |       | 01.12                                       |   |                |                |        |                          |                   |     |
|             | 1.6 BlueHDi 100 | 73              |       | 01.15                                       |   |                |                |        |                          |                   |     |
|             | 1.6 Flex        | 78              |       | 11.09                                       |   |                |                |        |                          |                   |     |
|             | 1.6 HDi         | 80              |       | 02.09                                       |   |                |                |        |                          |                   |     |
|             | 1.6 HDi 110     | 82              |       | 05.10                                       |   |                |                |        |                          |                   |     |
|             | 1.6 HDi 115     | 84              |       | 11.12                                       |   |                |                |        |                          |                   |     |
|             | 1.6 HDi 90      | 66              |       | 02.09                                       |   |                |                |        |                          |                   |     |
|             | 1.6 HDi 90      | 68              |       | 07.10                                       |   |                |                |        |                          |                   |     |
|             | 1.6 VTI 120     | 88              |       | 02.09                                       |   |                |                |        |                          |                   |     |
|             |                 | 1.2 THP 110     | 81    |   | 01.15                                       |                | 13.0460-2740.2 | 602740 |                          | 23554 17,2 /Zub/S | TRW |
|             |                 | 1.4 VTI 95      | 70    |   | 02.09                                       |                | 13.0470-2740.2 | LD2740 |                          | 23554 17,2 /Zub/S | TRW |
|             |                 | 1.4 VTI 95 LPG  | 70    |   | 01.12                                       |                |                |        |                          |                   |     |
|             |                 | 1.6 BlueHDi 100 | 73    |   | 01.15                                       |                |                |        |                          |                   |     |
|             |                 | 1.6 Flex        | 78    |   | 11.09                                       |                |                |        |                          |                   |     |
|             |                 | 1.6 HDi         | 80    |   | 02.09                                       |                |                |        |                          |                   |     |
|             |                 | 1.6 HDi 110     | 82    |   | 05.10                                       |                |                |        |                          |                   |     |
| 1.6 HDi 115 |                 | 84              |       | 11.12                                       |   |                |                |        |                          |                   |     |
| 1.6 HDi 90  |                 | 66              |       | 02.09                                       |   |                |                |        |                          |                   |     |
| 1.6 HDi 90  |                 | 68              |       | 07.10                                       |   |                |                |        |                          |                   |     |
| 1.6 VTI 120 |                 | 88              |       | 02.09                                       |   |                |                |        |                          |                   |     |

<sup>1)</sup> + brake disc diameter 266 mm / + disco fr.diam. 266mm / + disques fr.diam. 266mm / + disco fr.diam. 266mm

<sup>2)</sup> + brake disc diameter 283 mm / + disco fr.diam. 283mm / + disques fr.diam. 283mm / + disco fr.diam. 283mm



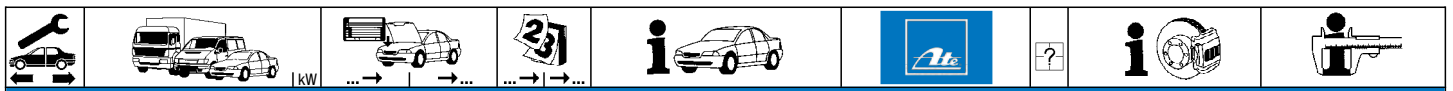

**CITROEN C3 PICASSO (09-)**

|  |                 |    |  |       |  |                |        |  |                |
|--|-----------------|----|--|-------|--|----------------|--------|--|----------------|
|  | 1.2 THP 110     | 81 |  | 01.15 |  | 24.0109-0100.2 | 409100 |  | 249 9,0 7,0 +B |
|  | 1.4 VTi 95      | 70 |  | 02.09 |  |                |        |  |                |
|  | 1.4 VTi 95 LPG  | 70 |  | 01.12 |  |                |        |  |                |
|  | 1.6 BlueHdi 100 | 73 |  | 01.15 |  |                |        |  |                |
|  | 1.6 Flex        | 78 |  | 11.09 |  |                |        |  |                |
|  | 1.6 HDi         | 80 |  | 02.09 |  |                |        |  |                |
|  | 1.6 HDi 110     | 82 |  | 05.10 |  |                |        |  |                |
|  | 1.6 HDi 115     | 84 |  | 11.12 |  |                |        |  |                |
|  | 1.6 HDi 90      | 66 |  | 02.09 |  |                |        |  |                |
|  | 1.6 HDi 90      | 68 |  | 07.10 |  |                |        |  |                |
|  | 1.6 VTi 120     | 88 |  | 02.09 |  |                |        |  |                |

**CITROEN C4 I Limousine (LC ) (04-11)**

|  |              |                |            |       |                                  |                |        |   |                          |                 |
|--|--------------|----------------|------------|-------|----------------------------------|----------------|--------|---|--------------------------|-----------------|
|  | 1.4 16V      | 65 ORGA 10551  |            | 07.11 | + ESP                            | 13.0460-3994.2 | 603994 |   | 23599 19,0 /Zub/S        | BOS             |
|  | 1.4 16V      | 65             |            | 10.04 | 07.11 - ESP                      | 13.0470-3994.2 | LD3994 |   | 23599 19,0 /Zub/S        | BOS             |
|  | 1.6 16V      | 80 ORGA 10551  |            | 07.11 | + ESP/ + Schaltgetriebe 1)       |                |        |   |                          |                 |
|  | 1.6 16V      | 80             |            | 10.04 | 07.11 - ESP/ + Schaltgetriebe 2) |                |        |   |                          |                 |
|  | 1.6 16V Flex | 80 ORGA 10551  |            | 07.11 | + ESP/ + Schaltgetriebe 1)       |                |        |   |                          |                 |
|  | 1.6 16V Flex | 80             |            | 09.07 | 07.11 - ESP/ + Schaltgetriebe 2) |                |        |   |                          |                 |
|  | 1.6 HDi      | 66 ORGA 10551  |            | 07.11 | + ESP                            |                |        |   |                          |                 |
|  | 1.6 HDi      | 66             |            | 10.04 | 07.11 - ESP                      |                |        |   |                          |                 |
|  | 1.6 VTi      | 88             |            | 07.08 | 07.11 + Schaltgetriebe 3)        |                |        |   |                          |                 |
|  | 1.4 16V      | 65             | ORGA 10550 | 10.04 | + ESP                            | 13.0460-3966.2 | 603966 |   | 23600 19,4 /Zub/S        | BOS             |
|  | 1.6 16V      | 80             | ORGA 10550 | 10.04 | + ESP/ + Schaltgetriebe 1)       | 13.0470-3966.2 | LD3966 |   | 23600 19,4 /Zub/S        | BOS             |
|  | 1.6 16V      | 80             |            | 07.06 | 07.11                            |                |        |   |                          |                 |
|  | 1.6 16V      | 80             |            | 10.04 | 07.11 + Automatikgetriebe 4)     |                |        |   |                          |                 |
|  | 1.6 16V Flex | 80             | ORGA 10550 | 09.07 | + ESP/ + Schaltgetriebe 1)       |                |        |   |                          |                 |
|  | 1.6 HDi      | 66             | ORGA 10550 | 10.04 | + ESP                            |                |        |   |                          |                 |
|  | 1.6 HDi      | 80             |            | 07.06 | 07.11                            |                |        |   |                          |                 |
|  | 1.6 HDi      | 80             |            | 10.04 | 07.11 + ESP                      |                |        |   |                          |                 |
|  | 1.6 THP 140  | 103            |            | 07.08 | 07.11                            |                |        |   |                          |                 |
|  | 1.6 THP 150  | 110            |            | 07.08 | 07.11                            |                |        |   |                          |                 |
|  | 1.6 VTi      | 88             |            | 07.08 | 07.11 + Automatikgetriebe 4)     |                |        |   |                          |                 |
|  | 2.0 16V      | 100            |            | 10.04 | 07.11                            |                |        |   |                          |                 |
|  | 2.0 16V      | 103            |            | 07.06 | 07.11                            |                |        |   |                          |                 |
|  | 2.0 16V      | 103            |            | 10.04 | 07.11                            |                |        |   |                          |                 |
|  | 2.0 16V      | 130            |            | 11.04 | 07.11                            | 13.0460-7202.2 | 607202 |   | 23589 19,1 +             | ATE             |
|  | 2.0 HDi      | 103            |            | 07.08 | 07.11                            | 13.0470-7202.2 | LD7202 |   | 23589 19,1 +             | ATE             |
|  | 2.0 HDi 135  | 100            |            | 10.04 | 07.11                            |                |        |   |                          |                 |
|  | 1.4 16V      | 65 ORGA 10551  |            | 07.11 | + ESP                            | 24.0122-0194.1 | 422194 |   | 266 22,0 20,0 V +S +B    |                 |
|  | 1.4 16V      | 65             |            | 10.04 | 07.11 - ESP                      |                |        |   |                          |                 |
|  | 1.6 16V      | 80 ORGA 10551  |            | 07.11 | + ESP/ + Schaltgetriebe 1)       |                |        |   |                          |                 |
|  | 1.6 16V      | 80             |            | 10.04 | 07.11 - ESP                      |                |        |   |                          |                 |
|  | 1.6 16V Flex | 80 ORGA 10551  |            | 07.11 | + ESP/ + Schaltgetriebe 1)       |                |        |   |                          |                 |
|  | 1.6 16V Flex | 80             |            | 09.07 | 07.11 - ESP                      |                |        |   |                          |                 |
|  | 1.6 HDi      | 66 ORGA 10551  |            | 07.11 | + ESP                            |                |        |   |                          |                 |
|  | 1.6 HDi      | 66             |            | 10.04 | 07.11 - ESP                      |                |        |   |                          |                 |
|  | 1.6 VTi      | 88             |            | 07.08 | 07.11 + Schaltgetriebe 3)        |                |        |   |                          |                 |
|  | 1.4 16V      | 65             | ORGA 10550 | 10.04 | + ESP                            | 24.0126-0120.1 | 426120 |   | 283 26,0 24,0 V +S +B    |                 |
|  | 1.6 16V      | 80             | ORGA 10550 | 10.04 | + ESP/ + Schaltgetriebe 1)       | 24.0326-0120.1 | 526120 |   | 283 26,0 24,0 V +S +B PD |                 |
|  | 1.6 16V      | 80             |            | 07.06 | 07.11                            |                |        |   |                          |                 |
|  | 1.6 16V      | 80             |            | 10.04 | 07.11 + Automatikgetriebe 4)     |                |        |   |                          |                 |
|  | 1.6 16V Flex | 80             | ORGA 10550 | 09.07 | + ESP/ + Schaltgetriebe 1)       |                |        |   |                          |                 |
|  | 1.6 HDi      | 66             | ORGA 10550 | 10.04 | + ESP                            |                |        |   |                          |                 |
|  | 1.6 HDi      | 80             |            | 07.06 | 07.11                            |                |        |   |                          |                 |
|  | 1.6 HDi      | 80             |            | 10.04 | 07.11 + ESP                      |                |        |   |                          |                 |
|  | 1.6 THP 140  | 103            |            | 07.08 | 07.11 + ESP                      |                |        |   |                          |                 |
|  | 1.6 THP 150  | 110            |            | 07.08 | 07.11 + ESP                      |                |        |   |                          |                 |
|  | 1.6 VTi      | 88             |            | 07.08 | 07.11 + Automatikgetriebe 4)     |                |        |   |                          |                 |
|  | 2.0 16V      | 100            |            | 10.04 | 07.11                            |                |        |   |                          |                 |
|  | 2.0 16V      | 103            |            | 07.06 | 07.11                            |                |        |   |                          |                 |
|  | 2.0 16V      | 103            |            | 10.04 | 07.11                            |                |        |   |                          |                 |
|  | 2.0 16V      | 130            | ORGA 11500 | 11.04 |                                  | 24.0126-0140.1 | 426140 |   | 302 26,0 24,0 V +S +B    |                 |
|  | 2.0 HDi      | 103            | ORGA 11500 | 07.08 |                                  |                |        |   |                          |                 |
|  | 2.0 HDi 135  | 100            | ORGA 11500 | 10.04 |                                  |                |        |   |                          |                 |
|  | 2.0 16V      | 130 ORGA 11501 |            | 07.11 |                                  | 24.0126-0159.1 | 426159 |   | 302 26,0 24,0 V +S +B    |                 |
|  | 2.0 HDi      | 103 ORGA 11501 |            | 07.11 |                                  |                |        |   |                          |                 |
|  | 2.0 HDi 135  | 100 ORGA 11501 |            | 07.11 |                                  |                |        |   |                          |                 |
|  | 1.4 16V      | 65             |            | 10.04 | 07.11                            | 24.0710-2017.1 | 360224 | 2 | + ABS (Bosch) 8.0        | Radsensor L=675 |
|  | 1.6 16V      | 80             |            | 07.06 | 07.11                            | 24.0711-5325.3 | 360350 | 2 | + ABS (Bosch) 8.1        | Radsensor L=680 |
|  | 1.6 16V      | 80             |            | 10.04 | 07.11                            |                |        |   |                          |                 |
|  | 1.6 16V Flex | 80             |            | 09.07 | 07.11                            |                |        |   |                          |                 |
|  | 1.6 HDi      | 66             |            | 10.04 | 07.11                            |                |        |   |                          |                 |
|  | 1.6 HDi      | 80             |            | 07.06 | 07.11                            |                |        |   |                          |                 |
|  | 1.6 HDi      | 80             |            | 10.04 | 07.11                            |                |        |   |                          |                 |
|  | 1.6 THP 140  | 103            |            | 07.08 | 07.11                            |                |        |   |                          |                 |
|  | 1.6 THP 150  | 110            |            | 07.08 | 07.11                            |                |        |   |                          |                 |
|  | 1.6 VTi      | 88             |            | 07.08 | 07.11                            |                |        |   |                          |                 |
|  | 2.0 16V      | 100            |            | 10.04 | 07.11                            |                |        |   |                          |                 |
|  | 2.0 16V      | 103            |            | 07.06 | 07.11                            |                |        |   |                          |                 |
|  | 2.0 16V      | 103            |            | 10.04 | 07.11                            |                |        |   |                          |                 |
|  | 2.0 16V      | 130            |            | 11.04 | 07.11                            |                |        |   |                          |                 |
|  | 2.0 HDi      | 81             |            | 04.07 | 07.08                            |                |        |   |                          |                 |
|  | 2.0 HDi      | 103            |            | 07.08 | 07.11                            |                |        |   |                          |                 |
|  | 2.0 HDi 135  | 100            |            | 10.04 | 07.11                            |                |        |   |                          |                 |

1) + ESP/ + manual transm. / + ESP/+ scatola cambio velocità / + ESP/ + transmission mécanique / + ESP/ + cambio de velocidad  
 2) - ESP/ + manual transm. / - ESP/+ scatola cambio velocità / - ESP/ + transmission mécanique / - ESP/ + cambio de velocidad  
 3) + manual transmission / + scatola cambio velocità / + transmission mécanique / + cambio de velocidad  
 4) + autom.transmission / + scatola cambio automatico / + transmission automatique / + cambio automático

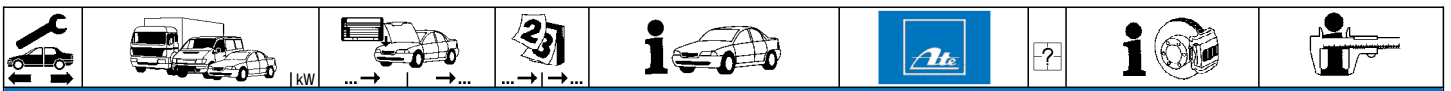

**CITROEN C4 I Limousine (LC ) (04-11)**

|             |              |            |            |            |       |                |        |                                   |                   |     |
|-------------|--------------|------------|------------|------------|-------|----------------|--------|-----------------------------------|-------------------|-----|
|             | 1.4 16V      | 65         | ORGA 11584 | 10.04      |       | 13.0460-2823.2 | 602823 |                                   | 23554 17,2 /S     | TRW |
|             | 1.6 16V      | 80         | ORGA 11584 | 07.06      |       | 13.0470-2823.2 | LD2823 |                                   | 23554 17,2 /S     | TRW |
|             | 1.6 16V      | 80         | ORGA 11584 | 10.04      |       | 13.0460-0072.2 | 610072 |                                   | Belagsatz-Zubehör | TRW |
|             | 1.6 16V Flex | 80         | ORGA 11584 | 09.07      |       |                |        |                                   |                   |     |
|             | 1.6 HDi      | 66         | ORGA 11584 | 10.04      |       |                |        |                                   |                   |     |
|             | 1.6 HDi      | 80         | ORGA 11584 | 07.06      |       |                |        |                                   |                   |     |
|             | 1.6 HDi      | 80         | ORGA 11584 | 10.04      |       |                |        |                                   |                   |     |
|             | 1.6 THP 140  | 103        | ORGA 11584 | 07.08      |       |                |        |                                   |                   |     |
|             | 1.6 THP 150  | 110        | ORGA 11584 | 07.08      |       |                |        |                                   |                   |     |
|             | 1.6 VTi      | 88         | ORGA 11584 | 07.08      |       |                |        |                                   |                   |     |
|             | 2.0 16V      | 100        | ORGA 11584 | 10.04      |       |                |        |                                   |                   |     |
|             | 2.0 16V      | 103        | ORGA 11584 | 07.06      |       |                |        |                                   |                   |     |
|             | 2.0 16V      | 103        | ORGA 11584 | 10.04      |       |                |        |                                   |                   |     |
|             | 2.0 16V      | 130        | ORGA 11584 | 11.04      |       |                |        |                                   |                   |     |
|             | 2.0 HDi      | 81         |            | 04.07      | 07.08 |                |        |                                   |                   |     |
| 2.0 HDi     | 103          | ORGA 11584 | 07.08      |            |       |                |        |                                   |                   |     |
| 2.0 HDi 135 | 100          | ORGA 11584 | 10.04      |            |       |                |        |                                   |                   |     |
|             | 1.4 16V      | 65         | ORGA 11431 | ORGA 12333 |       | 13.0460-2740.2 | 602740 |                                   | 23554 17,2 /Zub/S | TRW |
|             | 1.6 16V      | 80         | ORGA 11431 | ORGA 12333 |       | 13.0470-2740.2 | LD2740 |                                   | 23554 17,2 /Zub/S | TRW |
|             | 1.6 16V      | 80         | ORGA 11431 | ORGA 12333 |       |                |        |                                   |                   |     |
|             | 1.6 16V Flex | 80         | ORGA 11431 | ORGA 12333 |       |                |        |                                   |                   |     |
|             | 1.6 HDi      | 66         | ORGA 11431 | ORGA 12333 |       |                |        |                                   |                   |     |
|             | 1.6 HDi      | 80         | ORGA 11431 | ORGA 12333 |       |                |        |                                   |                   |     |
|             | 1.6 HDi      | 80         | ORGA 11431 | ORGA 12333 |       |                |        |                                   |                   |     |
|             | 1.6 THP 140  | 103        | ORGA 11431 | ORGA 12333 |       |                |        |                                   |                   |     |
|             | 1.6 THP 150  | 110        | ORGA 11431 | ORGA 12333 |       |                |        |                                   |                   |     |
|             | 1.6 VTi      | 88         | ORGA 11431 | ORGA 12333 |       |                |        |                                   |                   |     |
|             | 2.0 16V      | 100        | ORGA 11431 | ORGA 12333 |       |                |        |                                   |                   |     |
|             | 2.0 16V      | 103        | ORGA 11431 | ORGA 12333 |       |                |        |                                   |                   |     |
|             | 2.0 16V      | 103        | ORGA 11431 | ORGA 12333 |       |                |        |                                   |                   |     |
|             | 2.0 16V      | 130        | ORGA 11431 | ORGA 12333 |       |                |        |                                   |                   |     |
|             | 2.0 HDi      | 103        | ORGA 11431 | ORGA 12333 |       |                |        |                                   |                   |     |
| 2.0 HDi 135 | 100          | ORGA 11431 | ORGA 12333 |            |       |                |        |                                   |                   |     |
|             | 1.4 16V      | 65         | ORGA 12334 |            | 07.11 | 13.0460-2823.2 | 602823 |                                   | 23554 17,2 /S     | TRW |
|             | 1.6 16V      | 80         | ORGA 12334 |            | 07.11 | 13.0470-2823.2 | LD2823 |                                   | 23554 17,2 /S     | TRW |
|             | 1.6 16V      | 80         | ORGA 12334 |            | 07.11 | 13.0460-0072.2 | 610072 |                                   | Belagsatz-Zubehör | TRW |
|             | 1.6 16V Flex | 80         | ORGA 12334 |            | 07.11 |                |        |                                   |                   |     |
|             | 1.6 HDi      | 66         | ORGA 12334 |            | 07.11 |                |        |                                   |                   |     |
|             | 1.6 HDi      | 80         | ORGA 12334 |            | 07.11 |                |        |                                   |                   |     |
|             | 1.6 HDi      | 80         | ORGA 12334 |            | 07.11 |                |        |                                   |                   |     |
|             | 1.6 THP 140  | 103        | ORGA 12334 |            | 07.11 |                |        |                                   |                   |     |
|             | 1.6 THP 150  | 110        | ORGA 12334 |            | 07.11 |                |        |                                   |                   |     |
|             | 1.6 VTi      | 88         | ORGA 12334 |            | 07.11 |                |        |                                   |                   |     |
|             | 2.0 16V      | 100        | ORGA 12334 |            | 07.11 |                |        |                                   |                   |     |
|             | 2.0 16V      | 103        | ORGA 12334 |            | 07.11 |                |        |                                   |                   |     |
|             | 2.0 16V      | 103        | ORGA 12334 |            | 07.11 |                |        |                                   |                   |     |
|             | 2.0 16V      | 130        | ORGA 12334 |            | 07.11 |                |        |                                   |                   |     |
|             | 2.0 HDi      | 103        | ORGA 12334 |            | 07.11 |                |        |                                   |                   |     |
| 2.0 HDi 135 | 100          | ORGA 12334 |            | 07.11      |       |                |        |                                   |                   |     |
|             | 1.4 16V      | 65         | ORGA 12056 | 10.04      |       | 13.0460-3813.2 | 603813 |                                   | 24150 17,6 /S     | BOS |
|             | 1.6 16V      | 80         | ORGA 12056 | 07.06      |       | 13.0470-3813.2 | LD3813 |                                   | 24150 17,6 /Zub/S | BOS |
|             | 1.6 16V      | 80         | ORGA 12056 | 10.04      |       |                |        |                                   |                   |     |
|             | 1.6 16V Flex | 80         | ORGA 12056 | 09.07      |       |                |        |                                   |                   |     |
|             | 1.6 HDi      | 66         | ORGA 12056 | 10.04      |       |                |        |                                   |                   |     |
|             | 1.6 HDi      | 80         | ORGA 12056 | 07.06      |       |                |        |                                   |                   |     |
|             | 1.6 HDi      | 80         | ORGA 12056 | 10.04      |       |                |        |                                   |                   |     |
|             | 1.6 THP 140  | 103        | ORGA 12056 | 07.08      |       |                |        |                                   |                   |     |
|             | 1.6 THP 150  | 110        | ORGA 12056 | 07.08      |       |                |        |                                   |                   |     |
|             | 1.6 VTi      | 88         | ORGA 12056 | 07.08      |       |                |        |                                   |                   |     |
|             | 2.0 16V      | 100        | ORGA 12056 | 10.04      |       |                |        |                                   |                   |     |
|             | 2.0 16V      | 103        | ORGA 12056 | 07.06      |       |                |        |                                   |                   |     |
|             | 2.0 16V      | 103        | ORGA 12056 | 10.04      |       |                |        |                                   |                   |     |
|             | 2.0 16V      | 130        | ORGA 12056 | 11.04      |       |                |        |                                   |                   |     |
|             | 2.0 HDi      | 103        | ORGA 12056 | 07.08      |       |                |        |                                   |                   |     |
| 2.0 HDi 135 | 100          | ORGA 12056 | 10.04      |            |       |                |        |                                   |                   |     |
|             | 1.4 16V      | 65         |            | 10.04      | 07.11 | 24.0109-0100.2 | 409100 | + Achszapfen D=30mm <sup>1)</sup> | 249 9,0 7,0 +B    |     |
|             | 1.6 16V      | 80         |            | 07.06      | 07.11 | 24.0109-0150.2 | 409150 | + Achszapfen D=25mm <sup>2)</sup> | 249 9,0 8,0 +B    |     |
|             | 1.6 16V      | 80         |            | 10.04      | 07.11 |                |        |                                   |                   |     |
|             | 1.6 16V Flex | 80         |            | 09.07      | 07.11 |                |        |                                   |                   |     |
|             | 1.6 HDi      | 66         |            | 10.04      | 07.11 |                |        |                                   |                   |     |
|             | 1.6 HDi      | 80         |            | 07.06      | 07.11 |                |        |                                   |                   |     |
|             | 1.6 HDi      | 80         |            | 10.04      | 07.11 |                |        |                                   |                   |     |
|             | 1.6 THP 140  | 103        |            | 07.08      | 07.11 |                |        |                                   |                   |     |
|             | 1.6 THP 150  | 110        |            | 07.08      | 07.11 |                |        |                                   |                   |     |
|             | 1.6 VTi      | 88         |            | 07.08      | 07.11 |                |        |                                   |                   |     |
|             | 2.0 16V      | 100        |            | 10.04      | 07.11 |                |        |                                   |                   |     |
|             | 2.0 16V      | 103        |            | 07.06      | 07.11 |                |        |                                   |                   |     |
|             | 2.0 16V      | 103        |            | 10.04      | 07.11 |                |        |                                   |                   |     |
|             | 2.0 16V      | 130        |            | 11.04      | 07.11 |                |        |                                   |                   |     |
|             | 2.0 HDi      | 103        |            | 07.08      | 07.11 |                |        |                                   |                   |     |
| 2.0 HDi 135 | 100          |            | 10.04      | 07.11      |       |                |        |                                   |                   |     |
|             | 1.4 16V      | 65         |            | 10.04      | 07.11 | 24.0109-0137.1 | 409137 |                                   | 247 9,0 8,0 +S +B |     |
|             | 1.6 16V      | 80         |            | 07.06      | 07.11 |                |        |                                   |                   |     |
|             | 1.6 16V      | 80         |            | 10.04      | 07.11 |                |        |                                   |                   |     |
|             | 1.6 16V Flex | 80         |            | 09.07      | 07.11 |                |        |                                   |                   |     |
|             | 1.6 HDi      | 66         |            | 10.04      | 07.11 |                |        |                                   |                   |     |
|             | 1.6 HDi      | 80         |            | 07.06      | 07.11 |                |        |                                   |                   |     |

1) + axle stub D=30mm / + fusello D=30mm / + bout d'essieu D=30mm / + muñón del eje D=30mm

2) + axle stub D=25mm / + fusello D=25mm / + bout d'essieu D=25mm / + muñón del eje D=25mm





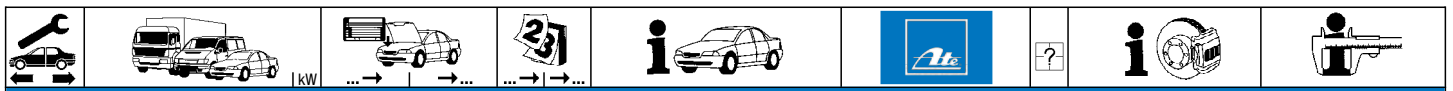

**CITROEN C4 I Limousine (LC ) (04-11)**

|  |             |     |  |       |       |                |        |  |                   |
|--|-------------|-----|--|-------|-------|----------------|--------|--|-------------------|
|  | 1.6 HDi     | 80  |  | 10.04 | 07.11 | 24.0109-0137.1 | 409137 |  | 247 9,0 8,0 +S +B |
|  | 1.6 THP 140 | 103 |  | 07.08 | 07.11 |                |        |  |                   |
|  | 1.6 THP 150 | 110 |  | 07.08 | 07.11 |                |        |  |                   |
|  | 1.6 VTi     | 88  |  | 07.08 | 07.11 |                |        |  |                   |
|  | 2.0 16V     | 100 |  | 10.04 | 07.11 |                |        |  |                   |
|  | 2.0 16V     | 103 |  | 07.06 | 07.11 |                |        |  |                   |
|  | 2.0 16V     | 103 |  | 10.04 | 07.11 |                |        |  |                   |
|  | 2.0 16V     | 130 |  | 11.04 | 07.11 |                |        |  |                   |
|  | 2.0 HDi     | 81  |  | 04.07 | 07.08 |                |        |  |                   |
|  | 2.0 HDi     | 103 |  | 07.08 | 07.11 |                |        |  |                   |
|  | 2.0 HDi 135 | 100 |  | 10.04 | 07.11 |                |        |  |                   |

**CITROEN C4 I Coupe (04-10)**

|  |             |                |            |       |                                  |                |        |  |                          |     |
|--|-------------|----------------|------------|-------|----------------------------------|----------------|--------|--|--------------------------|-----|
|  | 1.4 16V     | 65 ORGA 10551  |            |       | 07.10 + ESP                      | 13.0460-3994.2 | 603994 |  | 23599 19,0 /Zub/S        | BOS |
|  | 1.4 16V     | 65             |            | 10.04 | 07.10 - ESP                      | 13.0470-3994.2 | LD3994 |  | 23599 19,0 /Zub/S        | BOS |
|  | 1.6 16V     | 80 ORGA 10551  |            |       | 07.10 + ESP/ + Schaltgetriebe 1) |                |        |  |                          |     |
|  | 1.6 16V     | 80             |            | 10.04 | 07.10 - ESP/ + Schaltgetriebe 2) |                |        |  |                          |     |
|  | 1.6 HDi 90  | 66 ORGA 10551  |            |       | 07.10 + ESP                      |                |        |  |                          |     |
|  | 1.6 HDi 90  | 66             |            | 10.04 | 07.10 - ESP                      |                |        |  |                          |     |
|  | 1.6 VTi 120 | 88             |            | 07.08 | 07.10 + Schaltgetriebe 3)        |                |        |  |                          |     |
|  | 1.4 16V     | 65             | ORGA 10550 | 10.04 | + ESP                            | 13.0460-3966.2 | 603966 |  | 23600 19,4 /Zub/S        | BOS |
|  | 1.6 16V     | 80             | ORGA 10550 | 10.04 | + ESP/ + Schaltgetriebe 1)       | 13.0470-3966.2 | LD3966 |  | 23600 19,4 /Zub/S        | BOS |
|  | 1.6 16V     | 80             |            | 10.04 | 07.10 + Automatikgetriebe 4)     |                |        |  |                          |     |
|  | 1.6 HDi 110 | 80             |            | 10.04 | 07.10 + ESP                      |                |        |  |                          |     |
|  | 1.6 HDi 90  | 66             | ORGA 10550 | 10.04 | + ESP                            |                |        |  |                          |     |
|  | 1.6 THP 150 | 110            |            | 07.08 | 07.10 + ESP                      |                |        |  |                          |     |
|  | 1.6 VTi 120 | 88             |            | 07.08 | 07.10 + Automatikgetriebe 4)     |                |        |  |                          |     |
|  | 2.0 16V     | 100            |            | 10.04 | 07.10                            |                |        |  |                          |     |
|  | 2.0 16V     | 103            |            | 12.05 | 07.10                            |                |        |  |                          |     |
|  | 2.0 16V     | 130            |            | 10.04 | 07.10                            | 13.0460-7202.2 | 607202 |  | 23589 19,1 +             | ATE |
|  | 2.0 HDi     | 103            |            | 07.08 | 07.10                            | 13.0470-7202.2 | LD7202 |  | 23589 19,1 +             | ATE |
|  | 2.0 HDi 135 | 100            |            | 10.04 | 07.10                            |                |        |  |                          |     |
|  | 1.4 16V     | 65 ORGA 10551  |            |       | 07.10 + ESP                      | 24.0122-0194.1 | 422194 |  | 266 22,0 20,0 V +S +B    |     |
|  | 1.4 16V     | 65             |            | 10.04 | 07.10 - ESP                      |                |        |  |                          |     |
|  | 1.6 16V     | 80 ORGA 10551  |            |       | 07.10 + ESP/ + Schaltgetriebe 1) |                |        |  |                          |     |
|  | 1.6 16V     | 80             |            | 10.04 | 07.10 - ESP/ + Schaltgetriebe 2) |                |        |  |                          |     |
|  | 1.6 HDi 90  | 66 ORGA 10551  |            |       | 07.10 + ESP                      |                |        |  |                          |     |
|  | 1.6 HDi 90  | 66             |            | 10.04 | 07.10 - ESP                      |                |        |  |                          |     |
|  | 1.6 VTi 120 | 88             |            | 07.08 | 07.10 + Schaltgetriebe 3)        |                |        |  |                          |     |
|  | 1.4 16V     | 65             | ORGA 10550 | 10.04 | + ESP                            | 24.0126-0120.1 | 426120 |  | 283 26,0 24,0 V +S +B    |     |
|  | 1.6 16V     | 80             | ORGA 10550 | 10.04 | + ESP/ + Schaltgetriebe 1)       | 24.0326-0120.1 | 526120 |  | 283 26,0 24,0 V +S +B PD |     |
|  | 1.6 16V     | 80             |            | 10.04 | 07.10 + Automatikgetriebe 4)     |                |        |  |                          |     |
|  | 1.6 HDi 110 | 80             | ORGA 10550 | 10.04 | + ESP                            |                |        |  |                          |     |
|  | 1.6 HDi 90  | 66             | ORGA 10550 | 10.04 | + ESP                            |                |        |  |                          |     |
|  | 1.6 THP 150 | 110            | ORGA 10550 | 07.08 | + ESP                            |                |        |  |                          |     |
|  | 1.6 VTi 120 | 88             | ORGA 10550 | 07.08 | + Automatikgetriebe 4)           |                |        |  |                          |     |
|  | 2.0 16V     | 100            |            | 10.04 | 07.10                            |                |        |  |                          |     |
|  | 2.0 16V     | 103            |            | 12.05 | 07.10                            |                |        |  |                          |     |
|  | 2.0 16V     | 130            | ORGA 11500 | 10.04 |                                  | 24.0126-0140.1 | 426140 |  | 302 26,0 24,0 V +S +B    |     |
|  | 2.0 HDi     | 103            | ORGA 11500 | 07.08 |                                  |                |        |  |                          |     |
|  | 2.0 HDi 135 | 100            | ORGA 11500 | 10.04 |                                  |                |        |  |                          |     |
|  | 2.0 16V     | 130 ORGA 11501 |            |       | 07.10                            | 24.0126-0159.1 | 426159 |  | 302 26,0 24,0 V +S +B    |     |
|  | 2.0 HDi     | 103 ORGA 11501 |            |       | 07.10                            |                |        |  |                          |     |
|  | 2.0 HDi 135 | 100 ORGA 11501 |            |       | 07.10                            |                |        |  |                          |     |
|  | 1.4 16V     | 65             |            | 10.04 | 07.10                            | 24.0710-2017.1 | 360224 | 2 <input type="checkbox"/> + ABS (Bosch) 8.0 | Radsensor L=675          |     |
|  | 1.6 16V     | 80             |            | 10.04 | 07.10                            | 24.0711-5325.3 | 360350 | 2 <input type="checkbox"/> + ABS (Bosch) 8.1 | Radsensor L=680          |     |
|  | 1.6 HDi 110 | 80             |            | 10.04 | 07.10                            |                |        |  |                          |     |
|  | 1.6 HDi 90  | 66             |            | 10.04 | 07.10                            |                |        |  |                          |     |
|  | 1.6 THP 150 | 110            |            | 07.08 | 07.10                            |                |        |  |                          |     |
|  | 1.6 VTi 120 | 88             |            | 07.08 | 07.10                            |                |        |  |                          |     |
|  | 2.0 16V     | 100            |            | 10.04 | 07.10                            |                |        |  |                          |     |
|  | 2.0 16V     | 103            |            | 12.05 | 07.10                            |                |        |  |                          |     |
|  | 2.0 16V     | 130            |            | 10.04 | 07.10                            |                |        |  |                          |     |
|  | 2.0 HDi     | 103            |            | 07.08 | 07.10                            |                |        |  |                          |     |
|  | 2.0 HDi 135 | 100            |            | 10.04 | 07.10                            |                |        |  |                          |     |
|  | 1.4 16V     | 65             | ORGA 11584 | 10.04 |                                  | 13.0460-2823.2 | 602823 |  | 23554 17,2 /S            | TRW |
|  | 1.6 16V     | 80             | ORGA 11584 | 10.04 |                                  | 13.0470-2823.2 | LD2823 |  | 23554 17,2 /S            | TRW |
|  | 1.6 HDi 110 | 80             | ORGA 11584 | 10.04 |                                  | 13.0460-0072.2 | 610072 |  | Belagsatz-Zubehör        | TRW |
|  | 1.6 HDi 90  | 66             | ORGA 11584 | 10.04 |                                  |                |        |  |                          |     |
|  | 1.6 THP 150 | 110            | ORGA 11584 | 07.08 |                                  |                |        |  |                          |     |
|  | 1.6 VTi 120 | 88             | ORGA 11584 | 07.08 |                                  |                |        |  |                          |     |
|  | 2.0 16V     | 100            | ORGA 11584 | 10.04 |                                  |                |        |  |                          |     |
|  | 2.0 16V     | 103            | ORGA 11584 | 12.05 |                                  |                |        |  |                          |     |
|  | 2.0 16V     | 130            | ORGA 11584 | 10.04 |                                  |                |        |  |                          |     |
|  | 2.0 HDi     | 103            | ORGA 11584 | 07.08 |                                  |                |        |  |                          |     |
|  | 2.0 HDi 135 | 100            | ORGA 11584 | 10.04 |                                  |                |        |  |                          |     |
|  | 1.4 16V     | 65 ORGA 11431  | ORGA 12333 |       |                                  | 13.0460-2740.2 | 602740 |  | 23554 17,2 /Zub/S        | TRW |
|  | 1.6 16V     | 80 ORGA 11431  | ORGA 12333 |       |                                  | 13.0470-2740.2 | LD2740 |  | 23554 17,2 /Zub/S        | TRW |
|  | 1.6 HDi 110 | 80 ORGA 11431  | ORGA 12333 |       |                                  |                |        |  |                          |     |
|  | 1.6 HDi 90  | 66 ORGA 11431  | ORGA 12333 |       |                                  |                |        |  |                          |     |
|  | 1.6 THP 150 | 110 ORGA 11431 | ORGA 12333 |       |                                  |                |        |  |                          |     |
|  | 1.6 VTi 120 | 88 ORGA 11431  | ORGA 12333 |       |                                  |                |        |  |                          |     |
|  | 2.0 16V     | 100 ORGA 11431 | ORGA 12333 |       |                                  |                |        |  |                          |     |
|  | 2.0 16V     | 103 ORGA 11431 | ORGA 12333 |       |                                  |                |        |  |                          |     |
|  | 2.0 16V     | 130 ORGA 11431 | ORGA 12333 |       |                                  |                |        |  |                          |     |
|  | 2.0 HDi     | 103 ORGA 11431 | ORGA 12333 |       |                                  |                |        |  |                          |     |

1) + ESP/ + manual transm. / + ESP/+ scatola cambio velocità / + ESP/ + transmission mécanique / + ESP/ + cambio de velocidad  
 2) - ESP/ + manual transm. / - ESP/+ scatola cambio velocità / - ESP/ + transmission mécanique / - ESP/ + cambio de velocidad  
 3) + manual transmission / + scatola cambio velocità / + transmission mécanique / + cambio de velocidad  
 4) + autom.transmission / + scatola cambio automatico / + transmission automatique / + cambio automático



### CITROEN C4 I Coupe (04-10)

|             |             |     |            |            |       |       |       |  |  |                |                |        |                                   |                   |                   |     |
|-------------|-------------|-----|------------|------------|-------|-------|-------|--|--|----------------|----------------|--------|-----------------------------------|-------------------|-------------------|-----|
|             | 2.0 HDi 135 | 100 | ORGA 11431 | ORGA 12333 |       |       |       |  |  | 13.0460-2740.2 | 602740         |        |                                   | 23554 17,2 /Zub/S | TRW               |     |
|             |             |     |            |            |       |       |       |  |  | 13.0470-2740.2 | LD2740         |        |                                   | 23554 17,2 /Zub/S | TRW               |     |
|             | 1.4 16V     | 65  | ORGA 12334 |            |       | 07.10 |       |  |  | 13.0460-2823.2 | 602823         |        |                                   | 23554 17,2 /S     | TRW               |     |
|             | 1.6 16V     | 80  | ORGA 12334 |            |       | 07.10 |       |  |  | 13.0470-2823.2 | LD2823         |        |                                   | 23554 17,2 /S     | TRW               |     |
|             | 1.6 HDi 110 | 80  | ORGA 12334 |            |       | 07.10 |       |  |  | 13.0460-0072.2 | 610072         |        |                                   | Belagsatz-Zubehör | TRW               |     |
|             | 1.6 HDi 90  | 66  | ORGA 12334 |            |       | 07.10 |       |  |  |                |                |        |                                   |                   |                   |     |
|             | 1.6 THP 150 | 110 | ORGA 12334 |            |       | 07.10 |       |  |  |                |                |        |                                   |                   |                   |     |
|             | 1.6 VTi 120 | 88  | ORGA 12334 |            |       | 07.10 |       |  |  |                |                |        |                                   |                   |                   |     |
|             | 2.0 16V     | 100 | ORGA 12334 |            |       | 07.10 |       |  |  |                |                |        |                                   |                   |                   |     |
|             | 2.0 16V     | 103 | ORGA 12334 |            |       | 07.10 |       |  |  |                |                |        |                                   |                   |                   |     |
|             | 2.0 16V     | 130 | ORGA 12334 |            |       | 07.10 |       |  |  |                |                |        |                                   |                   |                   |     |
|             | 2.0 HDi     | 103 | ORGA 12334 |            |       | 07.10 |       |  |  |                |                |        |                                   |                   |                   |     |
|             | 2.0 HDi 135 | 100 | ORGA 12334 |            |       | 07.10 |       |  |  |                |                |        |                                   |                   |                   |     |
|             | 1.4 16V     | 65  |            | ORGA 12056 |       | 10.04 |       |  |  |                | 13.0460-3813.2 | 603813 |                                   |                   | 24150 17,6 /S     | BOS |
|             | 1.6 16V     | 80  |            | ORGA 12056 |       | 10.04 |       |  |  |                | 13.0470-3813.2 | LD3813 |                                   |                   | 24150 17,6 /Zub/S | BOS |
|             | 1.6 HDi 110 | 80  |            | ORGA 12056 |       | 10.04 |       |  |  |                |                |        |                                   |                   |                   |     |
|             | 1.6 HDi 90  | 66  |            | ORGA 12056 |       | 10.04 |       |  |  |                |                |        |                                   |                   |                   |     |
|             | 1.6 THP 150 | 110 |            | ORGA 12056 |       | 07.08 |       |  |  |                |                |        |                                   |                   |                   |     |
|             | 1.6 VTi 120 | 88  |            | ORGA 12056 |       | 07.08 |       |  |  |                |                |        |                                   |                   |                   |     |
| 2.0 16V     | 100         |     | ORGA 12056 |            | 10.04 |       |       |  |  |                |                |        |                                   |                   |                   |     |
| 2.0 16V     | 103         |     | ORGA 12056 |            | 12.05 |       |       |  |  |                |                |        |                                   |                   |                   |     |
| 2.0 16V     | 130         |     | ORGA 12056 |            | 10.04 |       |       |  |  |                |                |        |                                   |                   |                   |     |
| 2.0 HDi     | 103         |     | ORGA 12056 |            | 07.08 |       |       |  |  |                |                |        |                                   |                   |                   |     |
| 2.0 HDi 135 | 100         |     | ORGA 12056 |            | 10.04 |       |       |  |  |                |                |        |                                   |                   |                   |     |
|             | 1.4 16V     | 65  |            |            | 10.04 | 07.10 |       |  |  | 24.0109-0100.2 | 409100         |        | + Achszapfen D=30mm <sup>1)</sup> | 249 9,0 7,0 +B    |                   |     |
|             | 1.6 16V     | 80  |            |            | 10.04 | 07.10 |       |  |  | 24.0109-0150.2 | 409150         |        | + Achszapfen D=25mm <sup>2)</sup> | 249 9,0 8,0 +B    |                   |     |
|             | 1.6 HDi 110 | 80  |            |            | 10.04 | 07.10 |       |  |  |                |                |        |                                   |                   |                   |     |
|             | 1.6 HDi 90  | 66  |            |            | 10.04 | 07.10 |       |  |  |                |                |        |                                   |                   |                   |     |
|             | 1.6 THP 150 | 110 |            |            | 07.08 | 07.10 |       |  |  |                |                |        |                                   |                   |                   |     |
|             | 1.6 VTi 120 | 88  |            |            | 07.08 | 07.10 |       |  |  |                |                |        |                                   |                   |                   |     |
|             | 2.0 16V     | 100 |            |            | 10.04 | 07.10 |       |  |  |                |                |        |                                   |                   |                   |     |
|             | 2.0 16V     | 103 |            |            | 12.05 | 07.10 |       |  |  |                |                |        |                                   |                   |                   |     |
|             | 2.0 16V     | 130 |            |            | 10.04 | 07.10 |       |  |  |                |                |        |                                   |                   |                   |     |
|             | 2.0 HDi     | 103 |            |            | 07.08 | 07.10 |       |  |  |                |                |        |                                   |                   |                   |     |
|             | 2.0 HDi 135 | 100 |            |            | 10.04 | 07.10 |       |  |  |                |                |        |                                   |                   |                   |     |
|             | 1.4 16V     | 65  |            |            |       | 10.04 | 07.10 |  |  |                | 24.0109-0137.1 | 409137 |                                   |                   | 247 9,0 8,0 +S +B |     |
|             | 1.6 16V     | 80  |            |            |       | 10.04 | 07.10 |  |  |                |                |        |                                   |                   |                   |     |
|             | 1.6 HDi 110 | 80  |            |            |       | 10.04 | 07.10 |  |  |                |                |        |                                   |                   |                   |     |
|             | 1.6 HDi 90  | 66  |            |            |       | 10.04 | 07.10 |  |  |                |                |        |                                   |                   |                   |     |
|             | 1.6 THP 150 | 110 |            |            |       | 07.08 | 07.10 |  |  |                |                |        |                                   |                   |                   |     |
|             | 1.6 VTi 120 | 88  |            |            |       | 07.08 | 07.10 |  |  |                |                |        |                                   |                   |                   |     |
|             | 2.0 16V     | 100 |            |            |       | 10.04 | 07.10 |  |  |                |                |        |                                   |                   |                   |     |
|             | 2.0 16V     | 103 |            |            |       | 12.05 | 07.10 |  |  |                |                |        |                                   |                   |                   |     |
| 2.0 16V     | 130         |     |            |            | 10.04 | 07.10 |       |  |  |                |                |        |                                   |                   |                   |     |
| 2.0 HDi     | 103         |     |            |            | 07.08 | 07.10 |       |  |  |                |                |        |                                   |                   |                   |     |
| 2.0 HDi 135 | 100         |     |            |            | 10.04 | 07.10 |       |  |  |                |                |        |                                   |                   |                   |     |

















### CITROEN C4 I PICASSO (07-13)

|             |               |     |  |       |       |       |  |  |  |                |        |  |  |                          |     |
|-------------|---------------|-----|--|-------|-------|-------|--|--|--|----------------|--------|--|--|--------------------------|-----|
|             | 1.6 e-HDi 110 | 82  |  |       | 11.10 | 07.13 |  |  |  | 13.0460-7229.2 | 607229 |  |  | 24538 18,5 +             | ATE |
|             | 1.6 HDi       | 80  |  |       | 02.07 | 07.13 |  |  |  | 13.0470-7229.2 | LD7229 |  |  | 24538 18,5 +             | ATE |
|             | 1.6 HDi 110   | 82  |  |       | 11.10 | 07.13 |  |  |  |                |        |  |  |                          |     |
|             | 1.6 VTi 120   | 88  |  |       | 07.08 | 07.13 |  |  |  |                |        |  |  |                          |     |
|             | 1.8 i 16V     | 92  |  |       | 02.07 | 07.13 |  |  |  |                |        |  |  |                          |     |
|             | 1.6 16V       | 110 |  |       | 07.08 | 07.13 |  |  |  | 13.0460-7230.2 | 607230 |  |  | 24557 19,4 +             | ATE |
|             | 1.6 THP 140   | 103 |  |       | 07.08 | 07.13 |  |  |  | 13.0470-7230.2 | LD7230 |  |  | 24557 19,4 +             | ATE |
|             | 1.6 THP 150   | 110 |  |       | 10.08 | 07.13 |  |  |  |                |        |  |  |                          |     |
|             | 1.6 THP 155   | 115 |  |       | 11.10 | 07.13 |  |  |  |                |        |  |  |                          |     |
|             | 2.0 HDi 138   | 100 |  |       | 02.07 | 07.13 |  |  |  |                |        |  |  |                          |     |
| 2.0 HDi 150 | 110           |     |  | 07.09 | 07.13 |       |  |  |  |                |        |  |  |                          |     |
| 2.0 HDi 165 | 120           |     |  | 11.10 | 07.13 |       |  |  |  |                |        |  |  |                          |     |
| 2.0 i 16V   | 103           |     |  | 02.07 | 07.13 |       |  |  |  |                |        |  |  |                          |     |
|             | 1.6 e-HDi 110 | 82  |  |       | 11.10 | 07.13 |  |  |  | 24.0126-0120.1 | 426120 |  |  | 283 26,0 24,0 V +S +B    |     |
|             | 1.6 HDi       | 80  |  |       | 02.07 | 07.13 |  |  |  | 24.0326-0120.1 | 526120 |  |  | 283 26,0 24,0 V +S +B PD |     |
|             | 1.6 HDi 110   | 82  |  |       | 11.10 | 07.13 |  |  |  |                |        |  |  |                          |     |
|             | 1.6 VTi 120   | 88  |  |       | 07.08 | 07.13 |  |  |  |                |        |  |  |                          |     |
|             | 1.8 i 16V     | 92  |  |       | 02.07 | 07.13 |  |  |  |                |        |  |  |                          |     |
|             | 1.6 16V       | 110 |  |       | 07.08 | 07.13 |  |  |  | 24.0126-0140.1 | 426140 |  |  | 302 26,0 24,0 V +S +B    |     |
|             | 1.6 THP 140   | 103 |  |       | 07.08 | 07.13 |  |  |  |                |        |  |  |                          |     |
|             | 1.6 THP 150   | 110 |  |       | 10.08 | 07.13 |  |  |  |                |        |  |  |                          |     |
|             | 1.6 THP 155   | 115 |  |       | 11.10 | 07.13 |  |  |  |                |        |  |  |                          |     |
|             | 2.0 HDi 138   | 100 |  |       | 02.07 | 07.13 |  |  |  |                |        |  |  |                          |     |
| 2.0 HDi 150 | 110           |     |  | 07.09 | 07.13 |       |  |  |  |                |        |  |  |                          |     |
| 2.0 HDi 165 | 120           |     |  | 11.10 | 07.13 |       |  |  |  |                |        |  |  |                          |     |
| 2.0 i 16V   | 103           |     |  | 02.07 | 07.13 |       |  |  |  |                |        |  |  |                          |     |
|             | 1.6 16V       | 110 |  |       | 07.08 | 07.13 |  |  |  | 13.0460-3836.2 | 603836 |  |  | 24540 16,3 /Zub/S        | BOS |
|             | 1.6 e-HDi 110 | 82  |  |       | 11.10 | 07.13 |  |  |  | 13.0470-3836.2 | LD3836 |  |  | 24540 16,3 /Zub/S        | BOS |
|             | 1.6 HDi       | 80  |  |       | 02.07 | 07.13 |  |  |  |                |        |  |  |                          |     |
|             | 1.6 HDi 110   | 82  |  |       | 11.10 | 07.13 |  |  |  |                |        |  |  |                          |     |
|             | 1.6 THP 140   | 103 |  |       | 07.08 | 07.13 |  |  |  |                |        |  |  |                          |     |
|             | 1.6 THP 150   | 110 |  |       | 10.08 | 07.13 |  |  |  |                |        |  |  |                          |     |
|             | 1.6 THP 155   | 115 |  |       | 11.10 | 07.13 |  |  |  |                |        |  |  |                          |     |
|             | 1.6 VTi 120   | 88  |  |       | 07.08 | 07.13 |  |  |  |                |        |  |  |                          |     |
|             | 1.8 i 16V     | 92  |  |       | 02.07 | 07.13 |  |  |  |                |        |  |  |                          |     |
|             | 2.0 HDi 138   | 100 |  |       | 02.07 | 07.13 |  |  |  |                |        |  |  |                          |     |
| 2.0 HDi 150 | 110           |     |  | 07.09 | 07.13 |       |  |  |  |                |        |  |  |                          |     |
| 2.0 HDi 165 | 120           |     |  | 11.10 | 07.13 |       |  |  |  |                |        |  |  |                          |     |

<sup>1)</sup> + axle stub D=30mm / + fusello D=30mm / + bout d'essieu D=30mm / + muñón del eje D=30mm















<sup>2)</sup> + axle stub D=25mm / + fusello D=25mm / + bout d'essieu D=25mm / + muñón del eje D=25mm



|     |  |  |  |  |  |  |  |  |  |  |   |            |
|--|--|--|--|--|---|--|--|--|--|--|---|------------|
| <b>CITROEN C4 I PICASSO (07-13)</b>  |  |  |  |  |   |  |  |  |  |  |   |            |
|    | 2.0 i 16V  | 103  |  | 02.07  | 07.13   |  |  |  | 13.0460-3836.2 603836<br>13.0470-3836.2 LD3836 |  | 24540 16,3 /Zub/S<br>24540 16,3 /Zub/S            | BOS<br>BOS |
|    | 1.6 16V  | 110  |  | 07.08  | 07.13   |  |  |  | 24.0112-0194.2 412194                          |  | 268 12,0 10,0 +B                                  |            |
|  | 1.6 e-HDi 110  | 82   |  | 11.10  | 07.13   |  |  |  |  |  |   |            |
|  | 1.6 HDi  | 80   |  | 02.07  | 07.13   |  |  |  |  |  |   |            |
|  | 1.6 HDi 110  | 82   |  | 11.10  | 07.13   |  |  |  |  |  |   |            |
|  | 1.6 THP 140  | 103  |  | 07.08  | 07.13   |  |  |  |  |  |   |            |
|  | 1.6 THP 150  | 110  |  | 10.08  | 07.13   |  |  |  |  |  |   |            |
|  | 1.6 THP 155  | 115  |  | 11.10  | 07.13   |  |  |  |  |  |   |            |
|  | 1.6 VTi 120  | 88   |  | 07.08  | 07.13   |  |  |  |  |  |   |            |
|  | 1.8 i 16V  | 92   |  | 02.07  | 07.13   |  |  |  |  |  |   |            |
|  | 2.0 HDi 138  | 100  |  | 02.07  | 07.13   |  |  |  |  |  |   |            |
|  | 2.0 HDi 150  | 110  |  | 07.09  | 07.13   |  |  |  |  |  |   |            |
|  | 2.0 HDi 165  | 120  |  | 11.10  | 07.13   |  |  |  |  |  |   |            |
|  | 2.0 i 16V  | 103  |  | 02.07  | 07.13   |  |  |  |  |  |   |            |
| <b>CITROEN C4 I GRAND PICASSO (06-13)</b>  |  |  |  |  |   |  |  |  |  |  |   |            |
|    | 1.6 e-HDi 110  | 82   |  | 11.10  | 07.13   |  |  |  | 13.0460-7229.2 607229<br>13.0470-7229.2 LD7229 |  | 24538 18,5 +<br>24538 18,5 +                      | ATE<br>ATE |
|  | 1.6 HDi  | 80   |  | 10.06  | 07.13   |  |  |  |  |  |   |            |
|  | 1.6 HDi 110  | 82   |  | 09.10  | 07.13   |  |  |  |  |  |   |            |
|  | 1.6 VTi 120  | 88   |  | 07.08  | 07.13   |  |  |  |  |  |   |            |
|  | 1.8 i 16V  | 92   |  | 10.06  | 07.13   |  |  |  |  |  |   |            |
|  | 1.6 16V  | 103  |  | 07.08  | 07.13   |  |  |  | 13.0460-7230.2 607230<br>13.0470-7230.2 LD7230 |  | 24557 19,4 +<br>24557 19,4 +                      | ATE<br>ATE |
|  | 1.6 16V  | 110  |  | 10.08  | 07.13   |  |  |  |  |  |   |            |
|  | 1.6 THP 155  | 115  |  | 11.10  | 07.13   |  |  |  |  |  |   |            |
|  | 2.0 HDi 135  | 100  |  | 10.06  | 07.13   |  |  |  |  |  |   |            |
|  | 2.0 HDi 150  | 110  |  | 07.09  | 07.13   |  |  |  |  |  |   |            |
|  | 2.0 HDi 165  | 120  |  | 11.10  | 07.13   |  |  |  |  |  |   |            |
|  | 2.0 i 16V  | 103  |  | 10.06  | 07.13   |  |  |  |  |  |   |            |
|    | 1.6 e-HDi 110  | 82   |  | 11.10  | 07.13   |  |  |  | 24.0126-0120.1 426120<br>24.0326-0120.1 526120 |  | 283 26,0 24,0 V +S +B<br>283 26,0 24,0 V +S +B PD |            |
|  | 1.6 HDi  | 80   |  | 10.06  | 07.13   |  |  |  |  |  |   |            |
|  | 1.6 HDi 110  | 82   |  | 09.10  | 07.13   |  |  |  |  |  |   |            |
|  | 1.6 VTi 120  | 88   |  | 07.08  | 07.13   |  |  |  |  |  |   |            |
|  | 1.8 i 16V  | 92   |  | 10.06  | 07.13   |  |  |  |  |  |   |            |
|  | 1.6 16V  | 103  |  | 07.08  | 07.13   |  |  |  | 24.0126-0140.1 426140                          |  | 302 26,0 24,0 V +S +B                             |            |
|  | 1.6 16V  | 110  |  | 10.08  | 07.13   |  |  |  |  |  |   |            |
|  | 1.6 THP 155  | 115  |  | 11.10  | 07.13   |  |  |  |  |  |   |            |
|  | 2.0 HDi 135  | 100  |  | 10.06  | 07.13   |  |  |  |  |  |   |            |
|  | 2.0 HDi 150  | 110  |  | 07.09  | 07.13   |  |  |  |  |  |   |            |
|  | 2.0 HDi 165  | 120  |  | 11.10  | 07.13   |  |  |  |  |  |   |            |
|  | 2.0 i 16V  | 103  |  | 10.06  | 07.13   |  |  |  |  |  |   |            |
|  | 1.6 16V  | 103  |  | 07.08  | 07.13   |  |  |  | 13.0460-3836.2 603836<br>13.0470-3836.2 LD3836 |  | 24540 16,3 /Zub/S<br>24540 16,3 /Zub/S            | BOS<br>BOS |
|  | 1.6 16V  | 110  |  | 10.08  | 07.13   |  |  |  |  |  |   |            |
|  | 1.6 e-HDi 110  | 82   |  | 11.10  | 07.13   |  |  |  |  |  |   |            |
|  | 1.6 HDi  | 80   |  | 10.06  | 07.13   |  |  |  |  |  |   |            |
|  | 1.6 HDi 110  | 82   |  | 09.10  | 07.13   |  |  |  |  |  |   |            |
|  | 1.6 THP 155  | 115  |  | 11.10  | 07.13   |  |  |  |  |  |   |            |
|  | 1.6 VTi 120  | 88   |  | 07.08  | 07.13   |  |  |  |  |  |   |            |
|  | 1.8 i 16V  | 92   |  | 10.06  | 07.13   |  |  |  |  |  |   |            |
|  | 2.0 HDi 135  | 100  |  | 10.06  | 07.13   |  |  |  |  |  |   |            |
|  | 2.0 HDi 150  | 110  |  | 07.09  | 07.13   |  |  |  |  |  |   |            |
|  | 2.0 HDi 165  | 120  |  | 11.10  | 07.13   |  |  |  |  |  |   |            |
|  | 2.0 i 16V  | 103  |  | 10.06  | 07.13   |  |  |  |  |  |   |            |
|  | 1.6 16V  | 103  |  | 07.08  | 07.13   |  |  |  | 24.0112-0194.2 412194                          |  | 268 12,0 10,0 +B                                  |            |
|  | 1.6 16V  | 110  |  | 10.08  | 07.13   |  |  |  |  |  |   |            |
|  | 1.6 e-HDi 110  | 82   |  | 11.10  | 07.13   |  |  |  |  |  |   |            |
|  | 1.6 HDi  | 80   |  | 10.06  | 07.13   |  |  |  |  |  |   |            |
|  | 1.6 HDi 110  | 82   |  | 09.10  | 07.13   |  |  |  |  |  |   |            |
|  | 1.6 THP 155  | 115  |  | 11.10  | 07.13   |  |  |  |  |  |   |            |
|  | 1.6 VTi 120  | 88   |  | 07.08  | 07.13   |  |  |  |  |  |   |            |
|  | 1.8 i 16V  | 92   |  | 10.06  | 07.13   |  |  |  |  |  |   |            |
|  | 2.0 HDi 135  | 100  |  | 10.06  | 07.13   |  |  |  |  |  |   |            |
|  | 2.0 HDi 150  | 110  |  | 07.09  | 07.13   |  |  |  |  |  |   |            |
|  | 2.0 HDi 165  | 120  |  | 11.10  | 07.13   |  |  |  |  |  |   |            |
|  | 2.0 i 16V  | 103  |  | 10.06  | 07.13   |  |  |  |  |  |   |            |
| <b>CITROEN C4 II Limousine (B7) (10-)</b>  |  |  |  |  |   |  |  |  |  |  |   |            |
|  | 1.2 THP  | 96   |  | 04.14  |   |  |  |  | 13.0460-7229.2 607229<br>13.0470-7229.2 LD7229 |  | 24538 18,5 +<br>24538 18,5 +                      | ATE<br>ATE |
|  | 1.6 BlueHDi 100  | 73   |  | 07.14  |   |  |  |  |  |  |   |            |
|  | 1.6 BlueHDi 115  | 85   |  | 08.14  |   |  |  |  |  |  |   |            |
|  | 1.6 BlueHDi 120  | 88   |  | 02.15  |   |  |  |  |  |  |   |            |
|  | 1.6 Flex   | 81   |  | 11.09  |   |  |  |  |  |  |   |            |
|  | 1.6 HDi 110  | 82   |  | 11.09  |   |  |  |  |  |  |   |            |
|  | 1.6 HDi 115  | 84   |  | 07.12  |   |  |  |  |  |  |   |            |
|  | 1.6 HDi 90   | 68   |  | 11.09  |   |  |  |  |  |  |   |            |
|  | 1.6 VTi 120  | 88   |  | 11.09  |   |  |  |  |  |  |   |            |
|  | 1.6 VTi 120 LPG  | 88   |  | 09.11  |   |  |  |  |  |  |   |            |
|  | 2.0 Flex   | 103  |  | 11.09  |   |  |  |  |  |  |   |            |
|  | 1.6 THP 155  | 115  |  | 11.09  |   |  |  |  | 13.0460-7230.2 607230<br>13.0470-7230.2 LD7230 |  | 24557 19,4 +<br>24557 19,4 +                      | ATE<br>ATE |
|  | 2.0 HDi 150  | 110  |  | 11.09  |   |  |  |  |  |  |   |            |
|  | 1.2 THP 110  | 81   |  | 02.15  |   |  |  |  | 24.0122-0194.1 422194                          |  | 266 22,0 20,0 V +S +B                             |            |
|  | 1.4 VTi 95   | 70   |  | 11.09  |   |  |  |  |  |  |   |            |
|  | 1.6 HDi 90   | 68   |  | 11.09  |   |  |  |  |  |  |   |            |
|  | 1.2 THP  | 96   |  | 04.14  |   |  |  |  | 24.0126-0120.1 426120<br>24.0326-0120.1 526120 |  | 283 26,0 24,0 V +S +B<br>283 26,0 24,0 V +S +B PD |            |
|  | 1.6 BlueHDi 100  | 73   |  | 07.14  |   |  |  |  |  |  |   |            |

1) + electric parking brake / + freno a mano elettrico / + frein à main électrique / + freno de mano eléctrico

2) - electric parking brake / - freno a mano elettrico / - frein à main électrique / - freno de mano eléctrico

|     |  |  |  |  |  |  |     |  |
|--|--|--|--|--|---|--|---|--|
| <b>CITROEN C4 II Limousine (B7) (10-)</b>  |  |  |  |  |   |  |   |  |
|    | 1.6 BlueHdi 115  | 85   | 08.14  |  | 24.0126-0120.1  | 426120   |   | 283 26,0 24,0 V +S +B  |
|  | 1.6 BlueHdi 120  | 88   | 02.15  |  | 24.0326-0120.1  | 526120   |   | 283 26,0 24,0 V +S +B PD   |
|  | 1.6 Flex   | 81   | 11.09  |  |   |  |   |  |
|  | 1.6 HDi 110  | 82   | 11.09  |  |   |  |   |  |
|  | 1.6 HDi 115  | 84   | 07.12  |  |   |  |   |  |
|  | 1.6 HDi 90   | 68   | 11.09  | + elektrische Feststellbremse 1)   |   |  |   |  |
|  | 1.6 VTi 120  | 88   | 11.09  |  |   |  |   |  |
|  | 1.6 VTi 120 LPG  | 88   | 09.11  |  |   |  |   |  |
|  | 2.0 Flex   | 103  | 11.09  |  |   |  |   |  |
|  | 1.6 THP 155  | 115  | 11.09  |  | 24.0126-0159.1  | 426159   |   | 302 26,0 24,0 V +S +B  |
|  | 2.0 HDi 150  | 110  | 11.09  |  |   |  |   |  |
|    | 1.2 THP  | 96   | 04.14  |  | 24.0711-5325.3  | 360350   | 2  | Radsensor L=680  |
|  | 1.2 THP 110  | 81   | 02.15  |  |   |  |   |  |
|  | 1.4 VTi 95   | 70   | 11.09  |  |   |  |   |  |
|  | 1.6 BlueHdi 100  | 73   | 07.14  |  |   |  |   |  |
|  | 1.6 BlueHdi 115  | 85   | 08.14  |  |   |  |   |  |
|  | 1.6 BlueHdi 120  | 88   | 02.15  |  |   |  |   |  |
|  | 1.6 Flex   | 81   | 11.09  |  |   |  |   |  |
|  | 1.6 HDi 110  | 82   | 11.09  |  |   |  |   |  |
|  | 1.6 HDi 115  | 84   | 07.12  |  |   |  |   |  |
|  | 1.6 HDi 90   | 68   | 11.09  |  |   |  |   |  |
|  | 1.6 THP 155  | 115  | 11.09  |  |   |  |   |  |
|  | 1.6 VTi 120  | 88   | 11.09  |  |   |  |   |  |
|  | 1.6 VTi 120 LPG  | 88   | 09.11  |  |   |  |   |  |
|  | 2.0 Flex   | 103  | 11.09  |  |   |  |   |  |
|  | 2.0 HDi 150  | 110  | 11.09  |  |   |  |   |  |
|    | 1.2 THP  | 96   | 04.14  | - elektrische Feststellbremse 2)   | 13.0460-2775.2  | 602775   |   | 23554 17,2 +/-Zub/S TRW  |
|  | 1.2 THP 110  | 81   | 02.15  | - elektrische Feststellbremse 2)   |   |  |   |  |
|  | 1.4 VTi 95   | 70   | 11.09  | - elektrische Feststellbremse 2)   |   |  |   |  |
|  | 1.6 BlueHdi 100  | 73   | 07.14  | - elektrische Feststellbremse 2)   |   |  |   |  |
|  | 1.6 BlueHdi 120  | 88   | 02.15  | - elektrische Feststellbremse 2)   |   |  |   |  |
|  | 1.6 Flex   | 81   | 11.09  | - elektrische Feststellbremse 2)   |   |  |   |  |
|  | 1.6 HDi 110  | 82   | 11.09  | - elektrische Feststellbremse 2)   |   |  |   |  |
|  | 1.6 HDi 115  | 84   | 07.12  | - elektrische Feststellbremse 2)   |   |  |   |  |
|  | 1.6 HDi 90   | 68   | 11.09  | - elektrische Feststellbremse 2)   |   |  |   |  |
|  | 1.6 VTi 120  | 88   | 11.09  | - elektrische Feststellbremse 2)   |   |  |   |  |
|  | 1.6 VTi 120 LPG  | 88   | 09.11  | - elektrische Feststellbremse 2)   |   |  |   |  |
|  | 2.0 Flex   | 103  | 11.09  | - elektrische Feststellbremse 2)   |   |  |   |  |
|  | 1.2 THP  | 96   | 04.14  | + elektrische Feststellbremse 1)   | 13.0460-2761.2  | 602761   |   | 24922 17,5 /Zub/S TRW  |
|  | 1.2 THP 110  | 81   | 02.15  | + elektrische Feststellbremse 1)   |   |  |   |  |
|  | 1.4 VTi 95   | 70   | 11.09  | + elektrische Feststellbremse 1)   |   |  |   |  |
|  | 1.6 BlueHdi 100  | 73   | 07.14  | + elektrische Feststellbremse 1)   |   |  |   |  |
|  | 1.6 BlueHdi 115  | 85   | 08.14  |  |   |  |   |  |
|  | 1.6 BlueHdi 120  | 88   | 02.15  | + elektrische Feststellbremse 1)   |   |  |   |  |
|  | 1.6 Flex   | 81   | 11.09  | + elektrische Feststellbremse 1)   |   |  |   |  |
|  | 1.6 HDi 110  | 82   | 11.09  | + elektrische Feststellbremse 1)   |   |  |   |  |
|  | 1.6 HDi 115  | 84   | 07.12  | + elektrische Feststellbremse 1)   |   |  |   |  |
|  | 1.6 HDi 90   | 68   | 11.09  | + elektrische Feststellbremse 1)   |   |  |   |  |
|  | 1.6 THP 155  | 115  | 11.09  |  |   |  |   |  |
|  | 1.6 VTi 120  | 88   | 11.09  | + elektrische Feststellbremse 1)   |   |  |   |  |
|  | 1.6 VTi 120 LPG  | 88   | 09.11  | + elektrische Feststellbremse 1)   |   |  |   |  |
|  | 2.0 Flex   | 103  | 11.09  | + elektrische Feststellbremse 1)   |   |  |   |  |
|  | 2.0 HDi 150  | 110  | 11.09  | + elektrische Feststellbremse 1)   |   |  |   |  |
|  | 1.2 THP  | 96   | 04.14  | - elektrische Feststellbremse 2)   | 24.0109-0171.2  | 409171   |   | 249 9,0 8,0 +B   |
|  | 1.2 THP 110  | 81   | 02.15  | - elektrische Feststellbremse 2)   |   |  |   |  |
|  | 1.4 VTi 95   | 70   | 11.09  | - elektrische Feststellbremse 2)   |   |  |   |  |
|  | 1.6 BlueHdi 100  | 73   | 07.14  | - elektrische Feststellbremse 2)   |   |  |   |  |
|  | 1.6 BlueHdi 120  | 88   | 02.15  | - elektrische Feststellbremse 2)   |   |  |   |  |
|  | 1.6 Flex   | 81   | 11.09  | - elektrische Feststellbremse 2)   |   |  |   |  |
|  | 1.6 HDi 110  | 82   | 11.09  | - elektrische Feststellbremse 2)   |   |  |   |  |
|  | 1.6 HDi 115  | 84   | 07.12  | - elektrische Feststellbremse 2)   |   |  |   |  |
|  | 1.6 HDi 90   | 68   | 11.09  | - elektrische Feststellbremse 2)   |   |  |   |  |
|  | 1.6 VTi 120  | 88   | 11.09  | - elektrische Feststellbremse 2)   |   |  |   |  |
|  | 1.6 VTi 120 LPG  | 88   | 09.11  | - elektrische Feststellbremse 2)   |   |  |   |  |
|  | 2.0 Flex   | 103  | 11.09  | - elektrische Feststellbremse 2)   |   |  |   |  |
|  | 1.2 THP  | 96   | 04.14  | + elektrische Feststellbremse 1)   | 24.0112-0194.2  | 412194   | - 19" Rad 3)  | 268 12,0 10,0 +B   |
|  | 1.2 THP 110  | 81   | 02.15  | + elektrische Feststellbremse 1)   | 24.0112-0198.1  | 412198   | + 19" Rad 4)  | 290 12,0 10,0 +S +B  |
|  | 1.4 VTi 95   | 70   | 11.09  | + elektrische Feststellbremse 1)   |   |  |   |  |
|  | 1.6 BlueHdi 100  | 73   | 07.14  | + elektrische Feststellbremse 1)   |   |  |   |  |
|  | 1.6 BlueHdi 115  | 85   | 08.14  |  |   |  |   |  |
|  | 1.6 BlueHdi 120  | 88   | 02.15  | + elektrische Feststellbremse 1)   |   |  |   |  |
|  | 1.6 Flex   | 81   | 11.09  | + elektrische Feststellbremse 1)   |   |  |   |  |
|  | 1.6 HDi 110  | 82   | 11.09  | + elektrische Feststellbremse 1)   |   |  |   |  |
|  | 1.6 HDi 115  | 84   | 07.12  | + elektrische Feststellbremse 1)   |   |  |   |  |
|  | 1.6 HDi 90   | 68   | 11.09  | + elektrische Feststellbremse 1)   |   |  |   |  |
|  | 1.6 THP 155  | 115  | 11.09  |  |   |  |   |  |
|  | 1.6 VTi 120  | 88   | 11.09  | + elektrische Feststellbremse 1)   |   |  |   |  |
|  | 1.6 VTi 120 LPG  | 88   | 09.11  | + elektrische Feststellbremse 1)   |   |  |   |  |
|  | 2.0 Flex   | 103  | 11.09  | + elektrische Feststellbremse 1)   |   |  |   |  |
|  | 2.0 HDi 150  | 110  | 11.09  | + elektrische Feststellbremse 1)   |   |  |   |  |
| <b>CITROEN C4 II PICASSO (13-)</b>   |  |  |  |  |   |  |   |  |
|  | 1.2 THP 110  | 81   | 04.16  | + Bremsscheibendurchm. 283 mm 5)   | 13.0460-7305.2  | 607305   |   | 25836 17,0 +/-WE ATE   |
|  | 1.2 THP 130  | 96   | 04.14  | + Bremsscheibendurchm. 283 mm 5)   | 13.0470-7305.2  | LD7305   |   | 25836 17,0 +/-WE ATE   |
|  | 1.6 BlueHdi 100  | 73   | 12.14  | + Bremsscheibendurchm. 283 mm 5)   |   |  |   |  |
|  | 1.6 BlueHdi 120  | 88   | 07.14  | + Bremsscheibendurchm. 283 mm 5)   |   |  |   |  |
|  | 1.6 HDi 115  | 84   | 06.13  | + Bremsscheibendurchm. 283 mm 5)   |   |  |   |  |

1) + electric parking brake / + freno a mano elettrico / + frein à main électrique / + freno de mano eléctrico

2) - electric parking brake / - freno a mano elettrico / - frein à main électrique / - freno de mano eléctrico

3) - 19" wheel / - ruota 19" / - roue 19" / - rueda 19"

4) + 19" wheel / + ruota 19" / + roue 19" / + rueda 19"

5) + brake disc diameter 283 mm / + disco fr.diam. 283mm / + disques fr.diam. 283mm / + disco fr.diam. 283mm

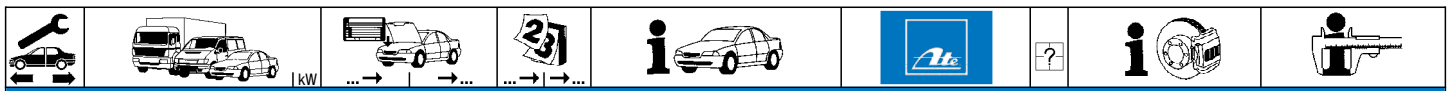

**CITROEN C4 II PICASSO (13-)**

|  |                       |     |       |   |                |        |   |                         |     |  |
|--|-----------------------|-----|-------|---|----------------|--------|---|-------------------------|-----|--|
|  | 1.6 HDi 90            | 68  | 06.13 | + Bremsscheibendurchm. 283 mm <sup>1)</sup> | 13.0460-7305.2 | 607305 |   | 25836 17,0 +/WE         | ATE |  |
|  | 1.6 THP 150           | 110 | 09.14 | + Bremsscheibendurchm. 283 mm <sup>1)</sup> | 13.0470-7305.2 | LD7305 |   | 25836 17,0 +/WE         | ATE |  |
|  | 1.6 THP 155           | 115 | 06.13 | + Bremsscheibendurchm. 283 mm <sup>1)</sup> |                |        |   |                         |     |  |
|  | 1.6 THP 165           | 121 | 07.14 | + Bremsscheibendurchm. 283 mm <sup>1)</sup> |                |        |   |                         |     |  |
|  | 1.6 VTi 120           | 88  | 06.13 | + Bremsscheibendurchm. 283 mm <sup>1)</sup> |                |        |   |                         |     |  |
|  | 2.0 BlueHDi 135       | 100 | 09.13 | + Bremsscheibendurchm. 283 mm <sup>1)</sup> |                |        |   |                         |     |  |
|  | 2.0 BlueHDi 135 Hybr. | 100 | 09.13 | + Bremsscheibendurchm. 283 mm <sup>1)</sup> |                |        |   |                         |     |  |
|  | 2.0 HDi 150           | 110 | 09.13 | + Bremsscheibendurchm. 283 mm <sup>1)</sup> |                |        |   |                         |     |  |
|  |                       |     |       |   |                |        |   |                         |     |  |
|  | 1.2 THP 110           | 81  | 04.16 | + Bremsscheibendurchm. 304 mm <sup>2)</sup> | 13.0460-7300.2 | 607300 |   | 25833 17,3 +/WE         | ATE |  |
|  | 1.2 THP 130           | 96  | 04.14 | + Bremsscheibendurchm. 304 mm <sup>2)</sup> | 13.0470-7300.2 | LD7300 |   | 25702 18,2 +            | ATE |  |
|  | 1.6 BlueHDi 100       | 73  | 12.14 | + Bremsscheibendurchm. 304 mm <sup>2)</sup> |                |        |   |                         |     |  |
|  | 1.6 BlueHDi 120       | 88  | 07.14 | + Bremsscheibendurchm. 304 mm <sup>2)</sup> |                |        |   |                         |     |  |
|  | 1.6 HDi 115           | 84  | 06.13 | + Bremsscheibendurchm. 304 mm <sup>2)</sup> |                |        |   |                         |     |  |
|  | 1.6 HDi 90            | 68  | 06.13 | + Bremsscheibendurchm. 304 mm <sup>2)</sup> |                |        |   |                         |     |  |
|  | 1.6 THP 150           | 110 | 09.14 | + Bremsscheibendurchm. 304 mm <sup>2)</sup> |                |        |   |                         |     |  |
|  | 1.6 THP 155           | 115 | 06.13 | + Bremsscheibendurchm. 304 mm <sup>2)</sup> |                |        |   |                         |     |  |
|  | 1.6 THP 165           | 121 | 07.14 | + Bremsscheibendurchm. 304 mm <sup>2)</sup> |                |        |   |                         |     |  |
|  | 1.6 VTi 120           | 88  | 06.13 | + Bremsscheibendurchm. 304 mm <sup>2)</sup> |                |        |   |                         |     |  |
|  | 2.0 BlueHDi 135       | 100 | 09.13 | + Bremsscheibendurchm. 304 mm <sup>2)</sup> |                |        |   |                         |     |  |
|  | 2.0 BlueHDi 135 Hybr. | 100 | 09.13 | + Bremsscheibendurchm. 304 mm <sup>2)</sup> |                |        |   |                         |     |  |
|  | 2.0 HDi 150           | 110 | 09.13 | + Bremsscheibendurchm. 304 mm <sup>2)</sup> |                |        |   |                         |     |  |
|  |                       |     |       |   |                |        |   |                         |     |  |
|  |                       |     |       |   |                |        |   |                         |     |  |
|  | 1.2 THP 110           | 81  | 04.16 |   | 24.0126-0183.1 | 426183 |   | 283 26,0 24,0 V L +S +B |     |  |
|  | 1.2 THP 130           | 96  | 04.14 |   | 24.0128-0269.1 | 428269 |   | 304 28,0 26,0 V L +S +B |     |  |
|  | 1.6 BlueHDi 100       | 73  | 12.14 |   |                |        |   |                         |     |  |
|  | 1.6 BlueHDi 120       | 88  | 07.14 |   |                |        |   |                         |     |  |
|  | 1.6 HDi 115           | 84  | 06.13 |   |                |        |   |                         |     |  |
|  | 1.6 HDi 90            | 68  | 06.13 |   |                |        |   |                         |     |  |
|  | 1.6 THP 150           | 110 | 09.14 |   |                |        |   |                         |     |  |
|  | 1.6 THP 155           | 115 | 06.13 |   |                |        |   |                         |     |  |
|  | 1.6 THP 165           | 121 | 07.14 |   |                |        |   |                         |     |  |
|  | 1.6 VTi 120           | 88  | 06.13 |   |                |        |   |                         |     |  |
|  | 2.0 BlueHDi 135       | 100 | 09.13 |   |                |        |   |                         |     |  |
|  | 2.0 BlueHDi 135 Hybr. | 100 | 09.13 |   |                |        |   |                         |     |  |
|  | 2.0 HDi 150           | 110 | 09.13 |   |                |        |   |                         |     |  |
|  |                       |     |       |   |                |        |   |                         |     |  |
|  |                       |     |       |   |                |        |   |                         |     |  |
|  | 1.2 THP 110           | 81  | 04.16 |   | 24.0711-5379.3 | 360422 | 2 | Radsensor L=877         |     |  |
|  | 1.2 THP 130           | 96  | 04.14 |   |                |        |   |                         |     |  |
|  | 1.6 BlueHDi 100       | 73  | 12.14 |   |                |        |   |                         |     |  |
|  | 1.6 BlueHDi 120       | 88  | 07.14 |   |                |        |   |                         |     |  |
|  | 1.6 HDi 115           | 84  | 06.13 |   |                |        |   |                         |     |  |
|  | 1.6 HDi 90            | 68  | 06.13 |   |                |        |   |                         |     |  |
|  | 1.6 THP 150           | 110 | 09.14 |   |                |        |   |                         |     |  |
|  | 1.6 THP 155           | 115 | 06.13 |   |                |        |   |                         |     |  |
|  | 1.6 THP 165           | 121 | 07.14 |   |                |        |   |                         |     |  |
|  | 1.6 VTi 120           | 88  | 06.13 |   |                |        |   |                         |     |  |
|  | 2.0 BlueHDi 135       | 100 | 09.13 |   |                |        |   |                         |     |  |
|  | 2.0 BlueHDi 135 Hybr. | 100 | 09.13 |   |                |        |   |                         |     |  |
|  | 2.0 HDi 150           | 110 | 09.13 |   |                |        |   |                         |     |  |
|  |                       |     |       |   |                |        |   |                         |     |  |
|  |                       |     |       |   |                |        |   |                         |     |  |
|  | 1.2 THP 110           | 81  | 04.16 | + Bremsscheibendurchm. 268 mm <sup>3)</sup> | 13.0460-3871.2 | 603871 |   | 25839 17,8 +/Zub/S      | BOS |  |
|  | 1.2 THP 130           | 96  | 04.14 | + Bremsscheibendurchm. 268 mm <sup>3)</sup> | 13.0470-3871.2 | LD3871 |   | 25839 17,8 +/Zub/S      | BOS |  |
|  | 1.6 BlueHDi 100       | 73  | 12.14 | + Bremsscheibendurchm. 268 mm <sup>3)</sup> |                |        |   |                         |     |  |
|  | 1.6 BlueHDi 120       | 88  | 07.14 | + Bremsscheibendurchm. 268 mm <sup>3)</sup> |                |        |   |                         |     |  |
|  | 1.6 HDi 115           | 84  | 06.13 | + Bremsscheibendurchm. 268 mm <sup>3)</sup> |                |        |   |                         |     |  |
|  | 1.6 HDi 90            | 68  | 06.13 | + Bremsscheibendurchm. 268 mm <sup>3)</sup> |                |        |   |                         |     |  |
|  | 1.6 THP 150           | 110 | 09.14 | + Bremsscheibendurchm. 268 mm <sup>3)</sup> |                |        |   |                         |     |  |
|  | 1.6 THP 155           | 115 | 06.13 | + Bremsscheibendurchm. 268 mm <sup>3)</sup> |                |        |   |                         |     |  |
|  | 1.6 THP 165           | 121 | 07.14 | + Bremsscheibendurchm. 268 mm <sup>3)</sup> |                |        |   |                         |     |  |
|  | 1.6 VTi 120           | 88  | 06.13 | + Bremsscheibendurchm. 268 mm <sup>3)</sup> |                |        |   |                         |     |  |
|  | 2.0 BlueHDi 135       | 100 | 09.13 | + Bremsscheibendurchm. 268 mm <sup>3)</sup> |                |        |   |                         |     |  |
|  | 2.0 BlueHDi 135 Hybr. | 100 | 09.13 | + Bremsscheibendurchm. 268 mm <sup>3)</sup> |                |        |   |                         |     |  |
|  | 2.0 HDi 150           | 110 | 09.13 | + Bremsscheibendurchm. 268 mm <sup>3)</sup> |                |        |   |                         |     |  |
|  |                       |     |       |   |                |        |   |                         |     |  |
|  |                       |     |       |   |                |        |   |                         |     |  |
|  | 1.2 THP 110           | 81  | 04.16 | + Bremsscheibendurchm. 290 mm <sup>4)</sup> | 13.0460-3872.2 | 603872 |   | 25827 17,7 +/Zub/S      | BOS |  |
|  | 1.2 THP 130           | 96  | 04.14 | + Bremsscheibendurchm. 290 mm <sup>4)</sup> | 13.0470-3872.2 | LD3872 |   | 25827 17,7 +/Zub/S      | BOS |  |
|  | 1.6 BlueHDi 100       | 73  | 12.14 | + Bremsscheibendurchm. 290 mm <sup>4)</sup> |                |        |   |                         |     |  |
|  | 1.6 BlueHDi 120       | 88  | 07.14 | + Bremsscheibendurchm. 290 mm <sup>4)</sup> |                |        |   |                         |     |  |
|  | 1.6 HDi 115           | 84  | 06.13 | + Bremsscheibendurchm. 290 mm <sup>4)</sup> |                |        |   |                         |     |  |
|  | 1.6 HDi 90            | 68  | 06.13 | + Bremsscheibendurchm. 290 mm <sup>4)</sup> |                |        |   |                         |     |  |
|  | 1.6 THP 150           | 110 | 09.14 | + Bremsscheibendurchm. 290 mm <sup>4)</sup> |                |        |   |                         |     |  |
|  | 1.6 THP 155           | 115 | 06.13 | + Bremsscheibendurchm. 290 mm <sup>4)</sup> |                |        |   |                         |     |  |
|  | 1.6 THP 165           | 121 | 07.14 | + Bremsscheibendurchm. 290 mm <sup>4)</sup> |                |        |   |                         |     |  |
|  | 1.6 VTi 120           | 88  | 06.13 | + Bremsscheibendurchm. 290 mm <sup>4)</sup> |                |        |   |                         |     |  |
|  | 2.0 BlueHDi 135       | 100 | 09.13 | + Bremsscheibendurchm. 290 mm <sup>4)</sup> |                |        |   |                         |     |  |
|  | 2.0 BlueHDi 135 Hybr. | 100 | 09.13 | + Bremsscheibendurchm. 290 mm <sup>4)</sup> |                |        |   |                         |     |  |
|  | 2.0 HDi 150           | 110 | 09.13 | + Bremsscheibendurchm. 290 mm <sup>4)</sup> |                |        |   |                         |     |  |
|  |                       |     |       |   |                |        |   |                         |     |  |
|  |                       |     |       |   |                |        |   |                         |     |  |
|  | 1.2 THP 110           | 81  | 04.16 |   | 24.0112-0211.1 | 412211 |   | 268 12,0 10,0 +S +B     |     |  |
|  | 1.2 THP 130           | 96  | 04.14 |   | 24.0112-0212.1 | 412212 |   | 290 12,0 10,0 +S +B     |     |  |
|  | 1.6 BlueHDi 100       | 73  | 12.14 |   |                |        |   |                         |     |  |
|  | 1.6 BlueHDi 120       | 88  | 07.14 |   |                |        |   |                         |     |  |
|  | 1.6 HDi 115           | 84  | 06.13 |   |                |        |   |                         |     |  |
|  | 1.6 HDi 90            | 68  | 06.13 |   |                |        |   |                         |     |  |
|  | 1.6 THP 150           | 110 | 09.14 |   |                |        |   |                         |     |  |
|  | 1.6 THP 155           | 115 | 06.13 |   |                |        |   |                         |     |  |
|  | 1.6 THP 165           | 121 | 07.14 |   |                |        |   |                         |     |  |
|  | 1.6 VTi 120           | 88  | 06.13 |   |                |        |   |                         |     |  |
|  | 2.0 BlueHDi 135       | 100 | 09.13 |   |                |        |   |                         |     |  |
|  | 2.0 BlueHDi 135 Hybr. | 100 | 09.13 |   |                |        |   |                         |     |  |
|  | 2.0 HDi 150           | 110 | 09.13 |   |                |        |   |                         |     |  |
|  |                       |     |       |   |                |        |   |                         |     |  |
|  |                       |     |       |   |                |        |   |                         |     |  |

1) + brake disc diameter 283 mm / + disco fr.diam. 283mm / + disques fr.diam. 283mm / + disco fr.diam. 283mm  
 2) + brake disc diameter 304 mm / + disco fr.diam. 304mm / + disques fr.diam. 304mm / + disco fr.diam. 304mm  
 3) + brake disc diameter 268 mm / + disco fr.diam. 268mm / + disques fr.diam. 268mm / + disco fr.diam. 268mm  
 4) + brake disc diameter 290mm / + diametro dischi freno 290mm / + diamètre disques frein 290mm / + diametro disco freno 290mm





**CITROEN C4 II PICASSO (13-)**

|                       |                 |       |       |  |                |        |   |                               |           |
|-----------------------|-----------------|-------|-------|--|----------------|--------|---|-------------------------------|-----------|
|                       | 1.2 THP 110     | 81    | 04.16 |  | 24.0711-6342.3 | 360443 | 2 | - Parkassistent <sup>1)</sup> | Radsensor |
|                       | 1.2 THP 130     | 96    | 04.14 |  | 24.0711-6343.3 | 360444 | 2 | + Parkassistent <sup>2)</sup> | Radsensor |
|                       | 1.6 BlueHdi 100 | 73    | 12.14 |  |                |        |   |                               |           |
|                       | 1.6 BlueHdi 120 | 88    | 07.14 |  |                |        |   |                               |           |
|                       | 1.6 Hdi 115     | 84    | 06.13 |  |                |        |   |                               |           |
|                       | 1.6 Hdi 90      | 68    | 06.13 |  |                |        |   |                               |           |
|                       | 1.6 THP 150     | 110   | 09.14 |  |                |        |   |                               |           |
|                       | 1.6 THP 155     | 115   | 06.13 |  |                |        |   |                               |           |
|                       | 1.6 THP 165     | 121   | 07.14 |  |                |        |   |                               |           |
|                       | 1.6 VTi 120     | 88    | 06.13 |  |                |        |   |                               |           |
|                       | 2.0 BlueHdi 135 | 100   | 09.13 |  |                |        |   |                               |           |
| 2.0 BlueHdi 135 Hybr. | 100             | 09.13 |       |  |                |        |   |                               |           |
| 2.0 Hdi 150           | 110             | 09.13 |       |  |                |        |   |                               |           |

**CITROEN C4 II GRAND PICASSO (13-)**

|             |                       |       |   |   |                |        |   |  |                         |     |
|-------------|-----------------------|-------|---|---|----------------|--------|---|--|-------------------------|-----|
|             | 1.2 THP 130           | 96    | 04.14                                       | + Bremsscheibendurchm. 283 mm <sup>3)</sup> | 13.0460-7305.2 | 607305 |   |  | 25836 17,0 +/WE         | ATE |
|             | 1.6 BlueHdi 100       | 73    | 01.15                                       | + Bremsscheibendurchm. 283 mm <sup>3)</sup> | 13.0470-7305.2 | LD7305 |   |  | 25836 17,0 +/WE         | ATE |
|             | 1.6 BlueHdi 120       | 88    | 07.14                                       | + Bremsscheibendurchm. 283 mm <sup>3)</sup> |                |        |   |  |                         |     |
|             | 1.6 Hdi 115           | 84    | 08.13                                       | + Bremsscheibendurchm. 283 mm <sup>3)</sup> |                |        |   |  |                         |     |
|             | 1.6 Hdi 90            | 68    | 08.13                                       | + Bremsscheibendurchm. 283 mm <sup>3)</sup> |                |        |   |  |                         |     |
|             | 1.6 THP 150           | 110   | 09.14                                       | + Bremsscheibendurchm. 283 mm <sup>3)</sup> |                |        |   |  |                         |     |
|             | 1.6 THP 155           | 115   | 08.13                                       | + Bremsscheibendurchm. 283 mm <sup>3)</sup> |                |        |   |  |                         |     |
|             | 1.6 THP 165           | 121   | 07.14                                       | + Bremsscheibendurchm. 283 mm <sup>3)</sup> |                |        |   |  |                         |     |
|             | 1.6 VTi 120           | 88    | 08.13                                       | + Bremsscheibendurchm. 283 mm <sup>3)</sup> |                |        |   |  |                         |     |
|             | 2.0 BlueHdi 135       | 100   | 09.13                                       | + Bremsscheibendurchm. 283 mm <sup>3)</sup> |                |        |   |  |                         |     |
|             | 2.0 BlueHdi 135 Hybr. | 100   | 09.13                                       | + Bremsscheibendurchm. 283 mm <sup>3)</sup> |                |        |   |  |                         |     |
| 2.0 Hdi 150 | 110                   | 09.13 | + Bremsscheibendurchm. 283 mm <sup>3)</sup> |   |                |        |   |  |                         |     |
|             | 1.2 THP 130           | 96    | 04.14                                       | + Bremsscheibendurchm. 304 mm <sup>4)</sup> | 13.0460-7300.2 | 607300 |   |  | 25833 17,3 +/WE         | ATE |
|             | 1.6 BlueHdi 100       | 73    | 01.15                                       | + Bremsscheibendurchm. 304 mm <sup>4)</sup> | 13.0470-7300.2 | LD7300 |   |  | 25702 18,2 +            | ATE |
|             | 1.6 BlueHdi 120       | 88    | 07.14                                       | + Bremsscheibendurchm. 304 mm <sup>4)</sup> |                |        |   |  |                         |     |
|             | 1.6 Hdi 115           | 84    | 08.13                                       | + Bremsscheibendurchm. 304 mm <sup>4)</sup> |                |        |   |  |                         |     |
|             | 1.6 Hdi 90            | 68    | 08.13                                       | + Bremsscheibendurchm. 304 mm <sup>4)</sup> |                |        |   |  |                         |     |
|             | 1.6 THP 150           | 110   | 09.14                                       | + Bremsscheibendurchm. 304 mm <sup>4)</sup> |                |        |   |  |                         |     |
|             | 1.6 THP 155           | 115   | 08.13                                       | + Bremsscheibendurchm. 304 mm <sup>4)</sup> |                |        |   |  |                         |     |
|             | 1.6 THP 165           | 121   | 07.14                                       | + Bremsscheibendurchm. 304 mm <sup>4)</sup> |                |        |   |  |                         |     |
|             | 1.6 VTi 120           | 88    | 08.13                                       | + Bremsscheibendurchm. 304 mm <sup>4)</sup> |                |        |   |  |                         |     |
|             | 2.0 BlueHdi 135       | 100   | 09.13                                       | + Bremsscheibendurchm. 304 mm <sup>4)</sup> |                |        |   |  |                         |     |
|             | 2.0 BlueHdi 135 Hybr. | 100   | 09.13                                       | + Bremsscheibendurchm. 304 mm <sup>4)</sup> |                |        |   |  |                         |     |
| 2.0 Hdi 150 | 110                   | 09.13 | + Bremsscheibendurchm. 304 mm <sup>4)</sup> |   |                |        |   |  |                         |     |
|             | 1.2 THP 130           | 96    | 04.14                                       |   | 24.0126-0183.1 | 426183 |   |  | 283 26,0 24,0 V L +S +B |     |
|             | 1.6 BlueHdi 100       | 73    | 01.15                                       |   | 24.0128-0269.1 | 428269 |   |  | 304 28,0 26,0 V L +S +B |     |
|             | 1.6 BlueHdi 120       | 88    | 07.14                                       |   |                |        |   |  |                         |     |
|             | 1.6 Hdi 115           | 84    | 08.13                                       |   |                |        |   |  |                         |     |
|             | 1.6 Hdi 90            | 68    | 08.13                                       |   |                |        |   |  |                         |     |
|             | 1.6 THP 150           | 110   | 09.14                                       |   |                |        |   |  |                         |     |
|             | 1.6 THP 155           | 115   | 08.13                                       |   |                |        |   |  |                         |     |
|             | 1.6 THP 165           | 121   | 07.14                                       |   |                |        |   |  |                         |     |
|             | 1.6 VTi 120           | 88    | 08.13                                       |   |                |        |   |  |                         |     |
|             | 2.0 BlueHdi 135       | 100   | 09.13                                       |   |                |        |   |  |                         |     |
|             | 2.0 BlueHdi 135 Hybr. | 100   | 09.13                                       |   |                |        |   |  |                         |     |
| 2.0 Hdi 150 | 110                   | 09.13 |   |   |                |        |   |  |                         |     |
|             | 1.2 THP 130           | 96    | 04.14                                       |   | 24.0711-5379.3 | 360422 | 2 |  | Radsensor L=877         |     |
|             | 1.6 BlueHdi 100       | 73    | 01.15                                       |   |                |        |   |  |                         |     |
|             | 1.6 BlueHdi 120       | 88    | 07.14                                       |   |                |        |   |  |                         |     |
|             | 1.6 Hdi 115           | 84    | 08.13                                       |   |                |        |   |  |                         |     |
|             | 1.6 Hdi 90            | 68    | 08.13                                       |   |                |        |   |  |                         |     |
|             | 1.6 THP 150           | 110   | 09.14                                       |   |                |        |   |  |                         |     |
|             | 1.6 THP 155           | 115   | 08.13                                       |   |                |        |   |  |                         |     |
|             | 1.6 THP 165           | 121   | 07.14                                       |   |                |        |   |  |                         |     |
|             | 1.6 VTi 120           | 88    | 08.13                                       |   |                |        |   |  |                         |     |
|             | 2.0 BlueHdi 135       | 100   | 09.13                                       |   |                |        |   |  |                         |     |
|             | 2.0 BlueHdi 135 Hybr. | 100   | 09.13                                       |   |                |        |   |  |                         |     |
| 2.0 Hdi 150 | 110                   | 09.13 |   |   |                |        |   |  |                         |     |
|             | 1.2 THP 130           | 96    | 04.14                                       | + Bremsscheibendurchm. 268 mm <sup>5)</sup> | 13.0460-3871.2 | 603871 |   |  | 25839 17,8 +/Zub/S      | BOS |
|             | 1.6 BlueHdi 100       | 73    | 01.15                                       | + Bremsscheibendurchm. 268 mm <sup>5)</sup> | 13.0470-3871.2 | LD3871 |   |  | 25839 17,8 +/Zub/S      | BOS |
|             | 1.6 BlueHdi 120       | 88    | 07.14                                       | + Bremsscheibendurchm. 268 mm <sup>5)</sup> |                |        |   |  |                         |     |
|             | 1.6 Hdi 115           | 84    | 08.13                                       | + Bremsscheibendurchm. 268 mm <sup>5)</sup> |                |        |   |  |                         |     |
|             | 1.6 Hdi 90            | 68    | 08.13                                       | + Bremsscheibendurchm. 268 mm <sup>5)</sup> |                |        |   |  |                         |     |
|             | 1.6 THP 150           | 110   | 09.14                                       | + Bremsscheibendurchm. 268 mm <sup>5)</sup> |                |        |   |  |                         |     |
|             | 1.6 THP 155           | 115   | 08.13                                       | + Bremsscheibendurchm. 268 mm <sup>5)</sup> |                |        |   |  |                         |     |
|             | 1.6 THP 165           | 121   | 07.14                                       | + Bremsscheibendurchm. 268 mm <sup>5)</sup> |                |        |   |  |                         |     |
|             | 1.6 VTi 120           | 88    | 08.13                                       | + Bremsscheibendurchm. 268 mm <sup>5)</sup> |                |        |   |  |                         |     |
|             | 2.0 BlueHdi 135       | 100   | 09.13                                       | + Bremsscheibendurchm. 268 mm <sup>5)</sup> |                |        |   |  |                         |     |
|             | 2.0 BlueHdi 135 Hybr. | 100   | 09.13                                       | + Bremsscheibendurchm. 268 mm <sup>5)</sup> |                |        |   |  |                         |     |
| 2.0 Hdi 150 | 110                   | 09.13 | + Bremsscheibendurchm. 268 mm <sup>5)</sup> |   |                |        |   |  |                         |     |
|             | 1.2 THP 130           | 96    | 04.14                                       | + Bremsscheibendurchm. 290 mm <sup>6)</sup> | 13.0460-3872.2 | 603872 |   |  | 25827 17,7 +/Zub/S      | BOS |
|             | 1.6 BlueHdi 100       | 73    | 01.15                                       | + Bremsscheibendurchm. 290 mm <sup>6)</sup> | 13.0470-3872.2 | LD3872 |   |  | 25827 17,7 +/Zub/S      | BOS |
|             | 1.6 BlueHdi 120       | 88    | 07.14                                       | + Bremsscheibendurchm. 290 mm <sup>6)</sup> |                |        |   |  |                         |     |
|             | 1.6 Hdi 115           | 84    | 08.13                                       | + Bremsscheibendurchm. 290 mm <sup>6)</sup> |                |        |   |  |                         |     |
|             | 1.6 Hdi 90            | 68    | 08.13                                       | + Bremsscheibendurchm. 290 mm <sup>6)</sup> |                |        |   |  |                         |     |
|             | 1.6 THP 150           | 110   | 09.14                                       | + Bremsscheibendurchm. 290 mm <sup>6)</sup> |                |        |   |  |                         |     |
|             | 1.6 THP 155           | 115   | 08.13                                       | + Bremsscheibendurchm. 290 mm <sup>6)</sup> |                |        |   |  |                         |     |
|             | 1.6 THP 165           | 121   | 07.14                                       | + Bremsscheibendurchm. 290 mm <sup>6)</sup> |                |        |   |  |                         |     |
|             | 1.6 VTi 120           | 88    | 08.13                                       | + Bremsscheibendurchm. 290 mm <sup>6)</sup> |                |        |   |  |                         |     |
|             | 2.0 BlueHdi 135       | 100   | 09.13                                       | + Bremsscheibendurchm. 290 mm <sup>6)</sup> |                |        |   |  |                         |     |
|             | 2.0 BlueHdi 135 Hybr. | 100   | 09.13                                       | + Bremsscheibendurchm. 290 mm <sup>6)</sup> |                |        |   |  |                         |     |
| 2.0 Hdi 150 | 110                   | 09.13 | + Bremsscheibendurchm. 290 mm <sup>6)</sup> |   |                |        |   |  |                         |     |

<sup>1)</sup> - parking assistant / - assistente di parcheggio / - assistance au stationnement / - asistente de aparcamiento  
<sup>2)</sup> + parking assistant / + assistente di parcheggio / + assistance au stationnement / + asistente de aparcamiento  
<sup>3)</sup> + brake disc diameter 283 mm / + disco fr.diam. 283mm / + disques fr.diam. 283mm / + disco fr.diam. 283mm  
<sup>4)</sup> + brake disc diameter 304 mm / + disco fr.diam. 304mm / + disques fr.diam. 304mm / + disco fr.diam. 304mm  
<sup>5)</sup> + brake disc diameter 268 mm / + disco fr.diam. 268mm / + disques fr.diam. 268mm / + disco fr.diam. 268mm  
<sup>6)</sup> + brake disc diameter 290mm / + diametro dischi freno 290mm / + diamètre disques frein 290mm / + diametro disco freno 290mm





### CITROEN C4 II GRAND PICASSO (13-)

|                       |                 |       |       |  |                |        |   |                               |                     |
|-----------------------|-----------------|-------|-------|--|----------------|--------|---|-------------------------------|---------------------|
|                       | 1.2 THP 130     | 96    | 04.14 |  | 24.0112-0211.1 | 412211 |   |                               | 268 12,0 10,0 +S +B |
|                       | 1.6 BlueHDi 100 | 73    | 01.15 |  | 24.0112-0212.1 | 412212 |   |                               | 290 12,0 10,0 +S +B |
|                       | 1.6 BlueHDi 120 | 88    | 07.14 |  |                |        |   |                               |                     |
|                       | 1.6 HDi 115     | 84    | 08.13 |  |                |        |   |                               |                     |
|                       | 1.6 HDi 90      | 68    | 08.13 |  |                |        |   |                               |                     |
|                       | 1.6 THP 150     | 110   | 09.14 |  |                |        |   |                               |                     |
|                       | 1.6 THP 155     | 115   | 08.13 |  |                |        |   |                               |                     |
|                       | 1.6 THP 165     | 121   | 07.14 |  |                |        |   |                               |                     |
|                       | 1.6 VTi 120     | 88    | 08.13 |  |                |        |   |                               |                     |
|                       | 2.0 BlueHDi 135 | 100   | 09.13 |  |                |        |   |                               |                     |
| 2.0 BlueHDi 135 Hybr. | 100             | 09.13 |       |  |                |        |   |                               |                     |
| 2.0 HDi 150           | 110             | 09.13 |       |  |                |        |   |                               |                     |
|                       | 1.2 THP 130     | 96    | 04.14 |  | 24.0711-6342.3 | 360443 | 2 | - Parkassistent <sup>1)</sup> | Radsensor           |
|                       | 1.6 BlueHDi 100 | 73    | 01.15 |  | 24.0711-6343.3 | 360444 | 2 | + Parkassistent <sup>2)</sup> | Radsensor           |
|                       | 1.6 BlueHDi 120 | 88    | 07.14 |  |                |        |   |                               |                     |
|                       | 1.6 HDi 115     | 84    | 08.13 |  |                |        |   |                               |                     |
|                       | 1.6 HDi 90      | 68    | 08.13 |  |                |        |   |                               |                     |
|                       | 1.6 THP 150     | 110   | 09.14 |  |                |        |   |                               |                     |
|                       | 1.6 THP 155     | 115   | 08.13 |  |                |        |   |                               |                     |
|                       | 1.6 THP 165     | 121   | 07.14 |  |                |        |   |                               |                     |
|                       | 1.6 VTi 120     | 88    | 08.13 |  |                |        |   |                               |                     |
|                       | 2.0 BlueHDi 135 | 100   | 09.13 |  |                |        |   |                               |                     |
| 2.0 BlueHDi 135 Hybr. | 100             | 09.13 |       |  |                |        |   |                               |                     |
| 2.0 HDi 150           | 110             | 09.13 |       |  |                |        |   |                               |                     |





























### CITROEN C4 AIRCROSS (12-)

|  |                 |     |       |  |                |        |  |  |                    |     |
|--|-----------------|-----|-------|--|----------------|--------|--|--|--------------------|-----|
|  | 1.6 16V 2WD     | 86  | 04.12 |  | 13.0460-5760.2 | 605760 |  |  | 23584 16,4 /WK     | AKE |
|  | 1.6 HDi 115 2WD | 84  | 04.12 |  |                |        |  |  |                    |     |
|  | 1.6 HDi 115 4WD | 84  | 05.12 |  |                |        |  |  |                    |     |
|  | 1.8 HDi 150 2WD | 110 | 04.12 |  |                |        |  |  |                    |     |
|  | 1.8 HDi 150 4WD | 110 | 04.12 |  |                |        |  |  |                    |     |
|  | 1.6 16V 2WD     | 86  | 04.12 |  | 24.0126-0170.1 | 426170 |  |  | 294 26,0 24,4 V +B |     |
|  | 1.6 HDi 115 2WD | 84  | 04.12 |  |                |        |  |  |                    |     |
|  | 1.6 HDi 115 4WD | 84  | 05.12 |  |                |        |  |  |                    |     |
|  | 1.8 HDi 150 2WD | 110 | 04.12 |  |                |        |  |  |                    |     |
|  | 1.8 HDi 150 4WD | 110 | 04.12 |  |                |        |  |  |                    |     |
|  | 1.6 16V 2WD     | 86  | 04.12 |  | 13.0460-5855.2 | 605855 |  |  | 23582 16,0 +       |     |
|  | 1.6 HDi 115 2WD | 84  | 04.12 |  |                |        |  |  |                    |     |
|  | 1.6 HDi 115 4WD | 84  | 05.12 |  |                |        |  |  |                    |     |
|  | 1.8 HDi 150 2WD | 110 | 04.12 |  |                |        |  |  |                    |     |
|  | 1.8 HDi 150 4WD | 110 | 04.12 |  |                |        |  |  |                    |     |
|  | 1.6 16V 2WD     | 86  | 04.12 |  | 24.0110-0360.1 | 410360 |  |  | 302 10,0 8,4 +B    |     |
|  | 1.6 HDi 115 2WD | 84  | 04.12 |  |                |        |  |  |                    |     |
|  | 1.6 HDi 115 4WD | 84  | 05.12 |  |                |        |  |  |                    |     |
|  | 1.8 HDi 150 2WD | 110 | 04.12 |  |                |        |  |  |                    |     |
|  | 1.8 HDi 150 4WD | 110 | 04.12 |  |                |        |  |  |                    |     |
|  | 1.6 16V 2WD     | 86  | 04.12 |  | 03.0137-3023.2 | 653023 |  |  | 170 x 32           |     |
|  | 1.6 HDi 115 2WD | 84  | 04.12 |  |                |        |  |  |                    |     |
|  | 1.6 HDi 115 4WD | 84  | 05.12 |  |                |        |  |  |                    |     |
|  | 1.8 HDi 150 2WD | 110 | 04.12 |  |                |        |  |  |                    |     |
|  | 1.8 HDi 150 4WD | 110 | 04.12 |  |                |        |  |  |                    |     |

### CITROEN C4 CACTUS (14-)

|  |              |    |       |                                    |                |        |   |  |                        |     |
|--|--------------|----|-------|------------------------------------|----------------|--------|---|--|------------------------|-----|
|  | 1.2 THP 110  | 81 | 09.14 | - belüftete Scheiben <sup>3)</sup> | 13.0460-3867.2 | 603867 |   |  | 25250 18,9 +/Zub/S     | MAN |
|  | 1.2 VTi 75   | 55 | 05.14 | - belüftete Scheiben <sup>3)</sup> |                |        |   |  |                        |     |
|  | 1.2 VTi 82   | 60 | 05.14 | - belüftete Scheiben <sup>3)</sup> |                |        |   |  |                        |     |
|  | 1.6 e-HDi 92 | 68 | 05.14 | - belüftete Scheiben <sup>3)</sup> |                |        |   |  |                        |     |
|  | 1.6 HDi 100  | 73 | 09.14 | - belüftete Scheiben <sup>3)</sup> |                |        |   |  |                        |     |
|  | 1.2 THP 110  | 81 | 09.14 | + belüftete Scheiben <sup>4)</sup> | 13.0460-3994.2 | 603994 |   |  | 23599 19,0 /Zub/S      | BOS |
|  | 1.2 VTi 75   | 55 | 05.14 | + belüftete Scheiben <sup>4)</sup> | 13.0470-3994.2 | LD3994 |   |  | 23599 19,0 /Zub/S      | BOS |
|  | 1.2 VTi 82   | 60 | 05.14 | + belüftete Scheiben <sup>4)</sup> |                |        |   |  |                        |     |
|  | 1.6 e-HDi 92 | 68 | 05.14 | + belüftete Scheiben <sup>4)</sup> |                |        |   |  |                        |     |
|  | 1.6 HDi 100  | 73 | 09.14 | + belüftete Scheiben <sup>4)</sup> |                |        |   |  |                        |     |
|  | 1.2 THP 110  | 81 | 09.14 | - belüftete Scheiben <sup>3)</sup> | 24.0113-0184.1 | 413184 |   |  | 266 13,0 11,0 +S +B    |     |
|  | 1.2 VTi 75   | 55 | 05.14 | - belüftete Scheiben <sup>3)</sup> | 24.0313-0184.1 | 513184 |   |  | 266 13,0 11,0 +S +B PD |     |
|  | 1.2 VTi 82   | 60 | 05.14 | - belüftete Scheiben <sup>3)</sup> |                |        |   |  |                        |     |
|  | 1.6 e-HDi 92 | 68 | 05.14 | - belüftete Scheiben <sup>3)</sup> |                |        |   |  |                        |     |
|  | 1.6 HDi 100  | 73 | 09.14 | - belüftete Scheiben <sup>3)</sup> |                |        |   |  |                        |     |
|  | 1.2 THP 110  | 81 | 09.14 | + belüftete Scheiben <sup>4)</sup> | 24.0122-0194.1 | 422194 |   |  | 266 22,0 20,0 V +S +B  |     |
|  | 1.2 VTi 75   | 55 | 05.14 | + belüftete Scheiben <sup>4)</sup> |                |        |   |  |                        |     |
|  | 1.2 VTi 82   | 60 | 05.14 | + belüftete Scheiben <sup>4)</sup> |                |        |   |  |                        |     |
|  | 1.6 e-HDi 92 | 68 | 05.14 | + belüftete Scheiben <sup>4)</sup> |                |        |   |  |                        |     |
|  | 1.6 HDi 100  | 73 | 09.14 | + belüftete Scheiben <sup>4)</sup> |                |        |   |  |                        |     |
|  | 1.2 THP 110  | 81 | 09.14 |                                    | 24.0711-5256.3 | 360320 | 2 |  | Radsensor L=1029       |     |
|  | 1.2 VTi 75   | 55 | 05.14 |                                    |                |        |   |  |                        |     |
|  | 1.2 VTi 82   | 60 | 05.14 |                                    |                |        |   |  |                        |     |
|  | 1.6 e-HDi 92 | 68 | 05.14 |                                    |                |        |   |  |                        |     |
|  | 1.6 HDi 100  | 73 | 09.14 |                                    |                |        |   |  |                        |     |
|  | 1.2 THP 110  | 81 | 09.14 |                                    | 13.0460-2740.2 | 602740 |   |  | 23554 17,2 /Zub/S      | TRW |
|  | 1.2 VTi 75   | 55 | 05.14 |                                    | 13.0470-2740.2 | LD2740 |   |  | 23554 17,2 /Zub/S      | TRW |
|  | 1.2 VTi 82   | 60 | 05.14 |                                    |                |        |   |  |                        |     |
|  | 1.6 e-HDi 92 | 68 | 05.14 |                                    |                |        |   |  |                        |     |
|  | 1.6 HDi 100  | 73 | 09.14 |                                    |                |        |   |  |                        |     |

1) - parking assistant / - assistente di parcheggio / - assistance au stationnement / - asistente de aparcamiento  
2) + parking assistant / + assistente di parcheggio / + assistance au stationnement / + asistente de aparcamiento  
3) - ventilated discs / - dischi ventilati / - disques ventilés / - disco ventilado  
4) + ventilated discs / + dischi ventilati / + disques ventilés / + disco ventilado

|     |  |  |  |        |  |  |  |    |
|--|--|--|--|--|---|--|--|--|
| <b>CITROEN C4 CACTUS (14-)</b>   |  |  |  |  |   |  |  |  |
|    | 1.2 THP 110<br>1.2 VTi 75<br>1.2 VTi 82<br>1.6 e-HDi 92<br>1.6 HDi 100           | 81<br>55<br>60<br>68<br>73   |  | 09.14<br>05.14<br>05.14<br>05.14<br>09.14  |   | 24.0109-0100.2   | 409100   | 249 9,0 7,0 +B   |
|    | 1.2 THP 110<br>1.2 VTi 75<br>1.2 VTi 82<br>1.6 e-HDi 92<br>1.6 HDi 100           | 81<br>55<br>60<br>68<br>73   |  | 09.14<br>05.14<br>05.14<br>05.14<br>09.14  |   | 03.0137-0504.2<br>03.0137-9281.2   | 650504<br>669281   | 203 x 39 HEB BOS<br>Bremsbacken-Zubehör  |
|    | 1.2 THP 110<br>1.2 VTi 75<br>1.2 VTi 82<br>1.6 e-HDi 92<br>1.6 HDi 100           | 81<br>55<br>60<br>68<br>73   |  | 09.14<br>05.14<br>05.14<br>05.14<br>09.14  |   | 03.0520-9620.3   | 699620   | 20,64/203x39 TopKit BOS  |
| <b>CITROEN C-ELYSEE (12-)</b>  |  |  |  |  |   |  |  |  |
|    | 1.2 VTi 72<br>1.2 VTi 82<br>1.6 BlueHDi 100<br>1.6 HDi 92<br>1.6 VTi 115         | 53<br>60<br>73<br>68<br>85   |  | 11.12<br>12.14<br>11.14<br>11.12<br>11.12  |   | 13.0460-3867.2<br>13.0460-3994.2<br>13.0470-3994.2                                 | 603867<br>603994<br>LD3994   | - belüftete Scheiben <sup>1)</sup><br>+ belüftete Scheiben <sup>2)</sup><br>+ belüftete Scheiben <sup>2)</sup><br>25250 18,9 +/Zub/S MAN<br>23599 19,0 /Zub/S BOS<br>23599 19,0 /Zub/S BOS |
|    | 1.2 VTi 72<br>1.2 VTi 82<br>1.6 BlueHDi 100<br>1.6 HDi 92<br>1.6 VTi 115         | 53<br>60<br>73<br>68<br>85   |  | 11.12<br>12.14<br>11.14<br>11.12<br>11.12  |   | 24.0113-0184.1<br>24.0313-0184.1<br>24.0122-0194.1                                 | 413184<br>513184<br>422194   | 266 13,0 11,0 +S +B<br>266 13,0 11,0 +S +B PD<br>266 22,0 20,0 V +S +B   |
|    | 1.2 VTi 72<br>1.2 VTi 82<br>1.6 BlueHDi 100<br>1.6 HDi 92<br>1.6 VTi 115         | 53<br>60<br>73<br>68<br>85   |  | 11.12<br>12.14<br>11.14<br>11.12<br>11.12  |   | 24.0711-5256.3   | 360320   | 2 <br>Radsensor L=1029  |
|    | 1.2 VTi 72<br>1.2 VTi 82<br>1.6 BlueHDi 100<br>1.6 HDi 92<br>1.6 VTi 115         | 53<br>60<br>73<br>68<br>85   |  | 11.12<br>12.14<br>11.14<br>11.12<br>11.12  |   | 03.0137-0504.2   | 650504   | + ABS<br>203 x 39 HEB BOS  |
|   | 1.2 VTi 72<br>1.2 VTi 82<br>1.6 BlueHDi 100<br>1.6 HDi 92<br>1.6 VTi 115         | 53<br>60<br>73<br>68<br>85   |  | 11.12<br>12.14<br>11.14<br>11.12<br>11.12  |   | 03.0520-9720.3   | 699720   | + ABS<br>20,64/203x39 TopKit BOS   |
| <b>CITROEN C5 I Limousine (01-04)</b>  |  |  |  |  |   |  |  |  |
|  | 1.8 16V<br>2.0 16V<br>2.0 16V<br>2.0 HDi 110<br>2.0 HDi 90                       | 85<br>100<br>103<br>80<br>66   |  | 03.01 08.04<br>03.01 08.04<br>03.01 08.04<br>03.01 08.04<br>03.01 08.04                |   | 13.0460-3996.2<br>13.0460-3997.2   | 603996<br>603997   | 23276 17,2 /WK/S BOS<br>23277 17,7 /WK/S BOS   |
|  | 2.2 HDi<br>3.0 V6  | 98<br>152  |  | 03.01 08.04<br>03.01 08.04   |   | 13.0460-3998.2   | 603998   | 23273 17,8 /WK/S BOS   |
|  | 1.8 16V<br>2.0 16V<br>2.0 16V<br>2.0 HDi 110<br>2.0 HDi 90                       | 85<br>100<br>103<br>80<br>66   |  | 03.01 08.04<br>03.01 08.04<br>03.01 08.04<br>03.01 08.04<br>03.01 08.04                |   | 24.0122-0194.1<br>24.0126-0120.1<br>24.0326-0120.1                                 | 422194<br>426120<br>526120   | 266 22,0 20,0 V +S +B<br>283 26,0 24,0 V +S +B<br>283 26,0 24,0 V +S +B PD   |
|  | 2.2 HDi<br>3.0 V6  | 98<br>152  |  | 03.01 08.04<br>03.01 08.04   |   | 24.0128-0128.1   | 428128   | 288 28,0 26,0 V +S +B  |
|  | 1.8 16V<br>2.0 16V<br>2.0 16V<br>2.0 HDi 110<br>2.0 HDi 90                       | 85<br>100<br>103<br>80<br>66   |  | 03.01 08.04<br>03.01 08.04<br>03.01 08.04<br>03.01 08.04<br>03.01 08.04                |   | 24.0711-5101.3   | 360084   | 2 <br>Radsensor L=1270  |
|  | 2.2 HDi<br>3.0 V6  | 98<br>152  |  | 03.01 08.04<br>03.01 08.04   |   | 13.0460-4921.2   | 604921   | 23305 15,2 CIT   |
|  | 1.8 16V<br>2.0 16V<br>2.0 16V<br>2.0 HDi 110<br>2.0 HDi 90                       | 85<br>100<br>103<br>80<br>66   |  | 03.01 08.04<br>03.01 08.04<br>03.01 08.04<br>03.01 08.04<br>03.01 08.04                |   | 24.0114-0112.1   | 414112   | 276 14,0 12,0 +S +B  |
|  | 2.2 HDi<br>3.0 V6  | 98<br>152  |  | 03.01 08.04<br>03.01 08.04   |   | 24.0711-6074.3   | 360280   | 2 <br>Radsensor L=1767  |
|  | 1.8 16V<br>2.0 16V<br>2.0 16V<br>2.0 HDi 110<br>2.0 HDi 90<br>2.2 HDi            | 85<br>100<br>103<br>80<br>66<br>98   |  | 03.01 08.04<br>03.01 08.04<br>03.01 08.04<br>03.01 08.04<br>03.01 08.04<br>03.01 08.04 |   | ORGA 09491<br>ORGA 09491<br>ORGA 09491<br>ORGA 09491<br>ORGA 09491<br>ORGA 09491   |  |  |

1) - ventilated discs / - dischi ventilati / - disques ventilés / - disco ventilado  
2) + ventilated discs / + dischi ventilati / + disques ventilés / + disco ventilado



### CITROEN C5 I Limousine (01-04)























|  |             |                |            |       |       |                |        |   |  |                  |
|--|-------------|----------------|------------|-------|-------|----------------|--------|---|--|------------------|
|  | 3.0 V6      | 152            | ORGA 09491 | 03.01 |       | 24.0711-6074.3 | 360280 | 2 |  | Radsensor L=1767 |
|  | 1.8 16V     | 85 ORGA 09492  |            |       | 08.04 | 24.0711-6108.3 | 360131 | 2 |  | Radsensor L=1670 |
|  | 2.0 16V     | 100 ORGA 09492 |            |       | 08.04 |                |        |   |  |                  |
|  | 2.0 16V     | 103 ORGA 09492 |            |       | 08.04 |                |        |   |  |                  |
|  | 2.0 HDi 110 | 80 ORGA 09492  |            |       | 08.04 |                |        |   |  |                  |
|  | 2.0 HDi 90  | 66 ORGA 09492  |            |       | 08.04 |                |        |   |  |                  |
|  | 2.2 HDi     | 98 ORGA 09492  |            |       | 08.04 |                |        |   |  |                  |
|  | 3.0 V6      | 152 ORGA 09492 |            |       | 08.04 |                |        |   |  |                  |

### CITROEN C5 I Kombi (01-04)



















|  |                 |                |            |       |       |                |        |   |  |                          |
|--|-----------------|----------------|------------|-------|-------|----------------|--------|---|--|--------------------------|
|  | 1.8 16V         | 85             |            | 06.01 | 08.04 | 13.0460-3997.2 | 603997 |   |  | 23277 17,7 /WK/S BOS     |
|  | 2.0 16V         | 100            |            | 06.01 | 08.04 |                |        |   |  |                          |
|  | 2.0 16V         | 103            |            | 06.01 | 08.04 |                |        |   |  |                          |
|  | 2.0 HDi 110     | 80             |            | 06.01 | 08.04 |                |        |   |  |                          |
|  | 2.0 HDi 90      | 66             |            | 06.01 | 08.04 |                |        |   |  |                          |
|  | 2.2 HDi         | 98             |            | 06.01 | 08.04 | 13.0460-3998.2 | 603998 |   |  | 23273 17,8 /WK/S BOS     |
|  | 3.0 V6          | 152            |            | 06.01 | 08.04 |                |        |   |  |                          |
|  | 3.0 V6 Carlsson | 173            |            | 09.03 | 08.04 |                |        |   |  |                          |
|  | 1.8 16V         | 85             |            | 06.01 | 08.04 | 24.0126-0120.1 | 426120 |   |  | 283 26,0 24,0 V +S +B    |
|  | 2.0 16V         | 100            |            | 06.01 | 08.04 | 24.0326-0120.1 | 526120 |   |  | 283 26,0 24,0 V +S +B PD |
|  | 2.0 16V         | 103            |            | 06.01 | 08.04 |                |        |   |  |                          |
|  | 2.0 HDi 110     | 80             |            | 06.01 | 08.04 |                |        |   |  |                          |
|  | 2.0 HDi 90      | 66             |            | 06.01 | 08.04 |                |        |   |  |                          |
|  | 2.2 HDi         | 98             |            | 06.01 | 08.04 | 24.0128-0128.1 | 428128 |   |  | 288 28,0 26,0 V +S +B    |
|  | 3.0 V6          | 152            |            | 06.01 | 08.04 |                |        |   |  |                          |
|  | 3.0 V6 Carlsson | 173            |            | 09.03 | 08.04 |                |        |   |  |                          |
|  | 1.8 16V         | 85             |            | 06.01 | 08.04 | 24.0711-5101.3 | 360084 | 2 |  | Radsensor L=1270         |
|  | 2.0 16V         | 100            |            | 06.01 | 08.04 |                |        |   |  |                          |
|  | 2.0 16V         | 103            |            | 06.01 | 08.04 |                |        |   |  |                          |
|  | 2.0 HDi 110     | 80             |            | 06.01 | 08.04 |                |        |   |  |                          |
|  | 2.0 HDi 90      | 66             |            | 06.01 | 08.04 |                |        |   |  |                          |
|  | 2.2 HDi         | 98             |            | 06.01 | 08.04 |                |        |   |  |                          |
|  | 3.0 V6          | 152            |            | 06.01 | 08.04 |                |        |   |  |                          |
|  | 3.0 V6 Carlsson | 173            |            | 09.03 | 08.04 |                |        |   |  |                          |
|  | 1.8 16V         | 85             |            | 06.01 | 08.04 | 13.0460-4921.2 | 604921 |   |  | 23305 15,2 CIT           |
|  | 2.0 16V         | 100            |            | 06.01 | 08.04 |                |        |   |  |                          |
|  | 2.0 16V         | 103            |            | 06.01 | 08.04 |                |        |   |  |                          |
|  | 2.0 HDi 110     | 80             |            | 06.01 | 08.04 |                |        |   |  |                          |
|  | 2.0 HDi 90      | 66             |            | 06.01 | 08.04 |                |        |   |  |                          |
|  | 2.2 HDi         | 98             |            | 06.01 | 08.04 |                |        |   |  |                          |
|  | 3.0 V6          | 152            |            | 06.01 | 08.04 |                |        |   |  |                          |
|  | 3.0 V6 Carlsson | 173            |            | 09.03 | 08.04 |                |        |   |  |                          |
|  | 1.8 16V         | 85             |            | 06.01 | 08.04 | 24.0114-0112.1 | 414112 |   |  | 276 14,0 12,0 +S +B      |
|  | 2.0 16V         | 100            |            | 06.01 | 08.04 |                |        |   |  |                          |
|  | 2.0 16V         | 103            |            | 06.01 | 08.04 |                |        |   |  |                          |
|  | 2.0 HDi 110     | 80             |            | 06.01 | 08.04 |                |        |   |  |                          |
|  | 2.0 HDi 90      | 66             |            | 06.01 | 08.04 |                |        |   |  |                          |
|  | 2.2 HDi         | 98             |            | 06.01 | 08.04 |                |        |   |  |                          |
|  | 3.0 V6          | 152            |            | 06.01 | 08.04 |                |        |   |  |                          |
|  | 3.0 V6 Carlsson | 173            |            | 09.03 | 08.04 |                |        |   |  |                          |
|  | 1.8 16V         | 85             | ORGA 09491 | 06.01 |       | 24.0711-6074.3 | 360280 | 2 |  | Radsensor L=1767         |
|  | 2.0 16V         | 100            | ORGA 09491 | 06.01 |       |                |        |   |  |                          |
|  | 2.0 16V         | 103            | ORGA 09491 | 06.01 |       |                |        |   |  |                          |
|  | 2.0 HDi 110     | 80             | ORGA 09491 | 06.01 |       |                |        |   |  |                          |
|  | 2.0 HDi 90      | 66             | ORGA 09491 | 06.01 |       |                |        |   |  |                          |
|  | 2.2 HDi         | 98             | ORGA 09491 | 06.01 |       |                |        |   |  |                          |
|  | 3.0 V6          | 152            | ORGA 09491 | 06.01 |       |                |        |   |  |                          |
|  | 3.0 V6 Carlsson | 173            | ORGA 09491 | 09.03 |       |                |        |   |  |                          |
|  | 1.8 16V         | 85 ORGA 09492  |            |       | 08.04 | 24.0711-6108.3 | 360131 | 2 |  | Radsensor L=1670         |
|  | 2.0 16V         | 100 ORGA 09492 |            |       | 08.04 |                |        |   |  |                          |
|  | 2.0 16V         | 103 ORGA 09492 |            |       | 08.04 |                |        |   |  |                          |
|  | 2.0 HDi 110     | 80 ORGA 09492  |            |       | 08.04 |                |        |   |  |                          |
|  | 2.0 HDi 90      | 66 ORGA 09492  |            |       | 08.04 |                |        |   |  |                          |
|  | 2.2 HDi         | 98 ORGA 09492  |            |       | 08.04 |                |        |   |  |                          |
|  | 3.0 V6          | 152 ORGA 09492 |            |       | 08.04 |                |        |   |  |                          |
|  | 3.0 V6 Carlsson | 173 ORGA 09492 |            |       | 08.04 |                |        |   |  |                          |

### CITROEN C5 II Limousine (04-08)















|  |              |     |  |       |       |                |        |  |  |                          |
|--|--------------|-----|--|-------|-------|----------------|--------|--|--|--------------------------|
|  | 1.8 16V      | 85  |  | 09.04 | 01.08 | 13.0460-3996.2 | 603996 |  |  | 23276 17,2 /WK/S BOS     |
|  | 1.8 16V      | 92  |  | 09.05 | 01.08 |                |        |  |  |                          |
|  | 1.6 HDi      | 80  |  | 09.04 | 01.08 | 13.0460-3997.2 | 603997 |  |  | 23277 17,7 /WK/S BOS     |
|  | 2.0 16V      | 103 |  | 09.04 | 01.08 |                |        |  |  |                          |
|  | 2.0 HDi      | 100 |  | 09.04 | 01.08 | 13.0460-3998.2 | 603998 |  |  | 23273 17,8 /WK/S BOS     |
|  | 2.2 HDi      | 98  |  | 09.04 | 01.08 |                |        |  |  |                          |
|  | 2.2 HDi      | 120 |  | 05.06 | 01.08 |                |        |  |  |                          |
|  | 2.2 HDi      | 125 |  | 04.06 | 01.08 |                |        |  |  |                          |
|  | 3.0 Carlsson | 173 |  | 09.04 | 01.08 |                |        |  |  |                          |
|  | 3.0 V6       |     |  | 09.04 | 01.08 |                |        |  |  |                          |
|  | 1.8 16V      | 85  |  | 09.04 | 01.08 | 24.0122-0194.1 | 422194 |  |  | 266 22,0 20,0 V +S +B    |
|  | 1.8 16V      | 92  |  | 09.05 | 01.08 |                |        |  |  |                          |
|  | 1.6 HDi      | 80  |  | 09.04 | 01.08 | 24.0126-0120.1 | 426120 |  |  | 283 26,0 24,0 V +S +B    |
|  | 2.0 16V      | 103 |  | 09.04 | 01.08 | 24.0326-0120.1 | 526120 |  |  | 283 26,0 24,0 V +S +B PD |
|  | 2.0 HDi      | 100 |  | 09.04 | 01.08 | 24.0128-0128.1 | 428128 |  |  | 288 28,0 26,0 V +S +B    |
|  | 2.2 HDi      | 98  |  | 09.04 | 01.08 |                |        |  |  |                          |
|  | 2.2 HDi      | 120 |  | 05.06 | 01.08 |                |        |  |  |                          |

|     |                     |  |  |        |  |  |  |                        |
|--|---|--|--|--|---|--|--|--|
| <b>CITROEN C5 II Limousine (04-08)</b>   |   |  |  |  |   |  |  |  |
|    | 2.2 HDi<br>3.0 Carlsson<br>3.0 V6   | 125<br>173   |  | 04.06<br>09.04<br>09.04  | 01.08<br>01.08<br>01.08   | 24.0128-0128.1   | 428128   | 288 28,0 26,0 V +S +B  |
|    | 1.6 HDi<br>1.8 16V<br>1.8 16V<br>2.0 16V<br>2.0 HDi<br>2.2 HDi<br>2.2 HDi<br>3.0 Carlsson<br>3.0 V6 | 80<br>85<br>92<br>103<br>100<br>98<br>120<br>125<br>173                          |  | 09.04<br>09.04<br>09.05<br>09.04<br>09.04<br>09.04<br>05.06<br>04.06<br>09.04<br>09.04 | 01.08<br>01.08<br>01.08<br>01.08<br>01.08<br>01.08<br>01.08<br>01.08<br>01.08     | 24.0711-5101.3   | 360084   | 2  Radsensor L=1270   |
|    | 1.6 HDi<br>1.8 16V<br>1.8 16V<br>2.0 16V<br>2.0 HDi<br>2.2 HDi<br>2.2 HDi<br>3.0 Carlsson<br>3.0 V6 | 80<br>85<br>92<br>103<br>100<br>98<br>120<br>125<br>173                          |  | 09.04<br>09.04<br>09.05<br>09.04<br>09.04<br>09.04<br>05.06<br>04.06<br>09.04<br>09.04 | 01.08<br>01.08<br>01.08<br>01.08<br>01.08<br>01.08<br>01.08<br>01.08<br>01.08     | 13.0460-4921.2   | 604921   | 23305 15,2 CIT   |
|    | 1.6 HDi<br>1.8 16V<br>1.8 16V<br>2.0 16V<br>2.0 HDi<br>2.2 HDi<br>2.2 HDi<br>3.0 Carlsson<br>3.0 V6 | 80<br>85<br>92<br>103<br>100<br>98<br>120<br>125<br>173                          |  | 09.04<br>09.04<br>09.05<br>09.04<br>09.04<br>09.04<br>05.06<br>04.06<br>09.04<br>09.04 | 01.08<br>01.08<br>01.08<br>01.08<br>01.08<br>01.08<br>01.08<br>01.08<br>01.08     | 24.0114-0112.1   | 414112   | 276 14,0 12,0 +S +B  |
|    | 1.6 HDi<br>1.8 16V<br>1.8 16V<br>2.0 16V<br>2.0 HDi<br>2.2 HDi<br>2.2 HDi<br>3.0 Carlsson<br>3.0 V6 | 80<br>85<br>92<br>103<br>100<br>98<br>120<br>125<br>173                          |  | 09.04<br>09.04<br>09.05<br>09.04<br>09.04<br>09.04<br>05.06<br>04.06<br>09.04<br>09.04 | 01.08<br>01.08<br>01.08<br>01.08<br>01.08<br>01.08<br>01.08<br>01.08<br>01.08     | 24.0711-6108.3   | 360131   | 2  Radsensor L=1670   |
| <b>CITROEN C5 II Kombi (04-08)</b>   |   |  |  |  |   |  |  |  |
|  | 1.6 HDi<br>1.8 16V<br>1.8 16V<br>2.0 16V  | 80<br>85<br>92<br>103  |  | 09.04<br>09.04<br>09.05<br>09.04   | 01.08<br>01.08<br>01.08<br>01.08  | 13.0460-3997.2   | 603997   | 23277 17,7 /WK/S BOS   |
|  | 2.0 HDi<br>2.2 HDi<br>2.2 HDi<br>3.0 V6   | 100<br>98<br>120<br>125  |  | 09.04<br>09.04<br>05.06<br>04.06<br>09.04  | 01.08<br>01.08<br>01.08<br>01.08<br>01.08   | 13.0460-3998.2   | 603998   | 23273 17,8 /WK/S BOS   |
|  | 1.6 HDi<br>1.8 16V<br>1.8 16V<br>2.0 16V  | 80<br>85<br>92<br>103  |  | 09.04<br>09.04<br>09.05<br>09.04   | 01.08<br>01.08<br>01.08<br>01.08  | 24.0126-0120.1<br>24.0326-0120.1   | 426120<br>526120   | 283 26,0 24,0 V +S +B<br>283 26,0 24,0 V +S +B PD  |
|  | 2.0 HDi<br>2.2 HDi<br>2.2 HDi<br>3.0 V6   | 100<br>98<br>120<br>125  |  | 09.04<br>09.04<br>05.06<br>04.06<br>09.04  | 01.08<br>01.08<br>01.08<br>01.08<br>01.08   | 24.0128-0128.1   | 428128   | 288 28,0 26,0 V +S +B  |
|  | 1.6 HDi<br>1.8 16V<br>1.8 16V<br>2.0 16V<br>2.0 HDi<br>2.2 HDi<br>2.2 HDi<br>3.0 V6                 | 80<br>85<br>92<br>103<br>100<br>98<br>120<br>125                                 |  | 09.04<br>09.04<br>09.05<br>09.04<br>09.04<br>09.04<br>05.06<br>04.05<br>09.04          | 01.08<br>01.08<br>01.08<br>01.08<br>01.08<br>01.08<br>01.08<br>01.08<br>01.08     | 24.0711-5101.3   | 360084   | 2  Radsensor L=1270 |
|  | 1.6 HDi<br>1.8 16V<br>1.8 16V<br>2.0 16V<br>2.0 HDi<br>2.2 HDi<br>2.2 HDi<br>3.0 V6                 | 80<br>85<br>92<br>103<br>100<br>98<br>120<br>125                                 |  | 09.04<br>09.04<br>09.05<br>09.04<br>09.04<br>09.04<br>05.06<br>04.06<br>09.04          | 01.08<br>01.08<br>01.08<br>01.08<br>01.08<br>01.08<br>01.08<br>01.08<br>01.08     | 13.0460-4921.2   | 604921   | 23305 15,2 CIT   |
|  | 1.6 HDi<br>1.8 16V<br>1.8 16V<br>2.0 16V<br>2.0 HDi   | 80<br>85<br>92<br>103<br>100   |  | 09.04<br>09.04<br>09.05<br>09.04<br>09.04  | 01.08<br>01.08<br>01.08<br>01.08<br>01.08   | 24.0114-0112.1   | 414112   | 276 14,0 12,0 +S +B  |
| ↓  | ↓   |  |  |  |   |  |  |  |



|     |  |  |  |  |  |  |  |       |                          |
|--|--|--|--|--|---|--|--|---|--------------------------|
| <b>CITROEN C5 II Kombi (04-08)</b>   |  |  |  |  |   |  |  |   |                          |
|    | 2.2 HDi  | 98   |  | 09.04  | 01.08   | 24.0114-0112.1   | 414112   |   | 276 14,0 12,0 +S +B      |
|  | 2.2 HDi  | 120  |  | 05.06  | 01.08   |  |  |   |                          |
|  | 2.2 HDi  | 125  |  | 04.06  | 01.08   |  |  |   |                          |
|  | 3.0 V6   |  |  | 09.04  | 01.08   |  |  |   |                          |
|    | 1.6 HDi  | 80   |  | 09.04  | 01.08   | 24.0711-6108.3   | 360131   | 2    | Radsensor L=1670         |
|  | 1.8 16V  | 85   |  | 09.04  | 01.08   |  |  |   |                          |
|  | 1.8 16V  | 92   |  | 09.05  | 01.08   |  |  |   |                          |
|  | 2.0 16V  | 103  |  | 09.04  | 01.08   |  |  |   |                          |
|  | 2.0 HDi  | 100  |  | 09.04  | 01.08   |  |  |   |                          |
|  | 2.2 HDi  | 98   |  | 09.04  | 01.08   |  |  |   |                          |
|  | 2.2 HDi  | 120  |  | 05.06  | 01.08   |  |  |   |                          |
|  | 2.2 HDi  | 125  |  | 04.06  | 01.08   |  |  |   |                          |
|  | 3.0 V6   |  |  | 09.04  | 01.08   |  |  |   |                          |
| <b>CITROEN C5 III Limousine (X7) (08-)</b>   |  |  |  |  |   |  |  |   |                          |
|    | 1.6 HDi  | 80   |  | 02.08  |   | 13.0460-7252.2   | 607252   |   | 24332 18,3 +/WK ATE      |
|  | 1.6 HDi 110  | 82   | ORGA 12774   | 07.10  |   | 13.0470-7252.2   | LD7252   |   | 24332 18,3 +/WK ATE      |
|  | 1.6 THP 155  | 115  | ORGA 12774   | 04.09  |   |  |  |   |                          |
|  | 1.6 VTI 120  | 88   | ORGA 12774   | 07.10  |   |  |  |   |                          |
|  | 1.8 16V  | 92   |  | 02.08  |   |  |  |   |                          |
|  | 2.0 16V  | 103  |  | 02.08  |   |  |  |   |                          |
|  | 2.0 16V BioFlex  | 103  |  | 02.08  |   |  |  |   |                          |
|  | 2.0 HDi  | 100  | ORGA 12774   | 02.08  |   |  |  |   |                          |
|  | 2.0 HDi 140  | 103  | ORGA 12774   | 11.08  |   |  |  |   |                          |
|  | 2.0 HDi 165  | 120  | ORGA 12774   | 04.09  |   |  |  |   |                          |
|  | 1.6 HDi 110  | 82   | ORGA 12775   |  | 01.12   | 13.0460-7252.2   | 607252   |   | 24332 18,3 +/WK ATE      |
|  | 1.6 HDi 115  | 84   |  |  |   | 13.0470-7252.2   | LD7252   |   | 24332 18,3 +/WK ATE      |
|  | 1.6 THP 155  | 115  | ORGA 12775   |  |   |  |  |   |                          |
|  | 1.6 VTI 120  | 88   | ORGA 12775   |  |   |  |  |   |                          |
|  | 2.0 BlueHDi 150  | 110  |  | 05.15  |   |  |  |   |                          |
|  | 2.0 HDi  | 100  | ORGA 12775   |  |   |  |  |   |                          |
|  | 2.0 HDi 140  | 103  | ORGA 12775   |  |   |  |  |   |                          |
|  | 2.0 HDi 165  | 120  | ORGA 12775   |  |   |  |  |   |                          |
|  | 2.2 HDi  | 125  |  | 02.08  |   | 13.0460-2892.2   | 602892   |   | 24133 18,6 +/WK/Zub/STRW |
|  | 2.7 HDi  | 150  |  | 02.08  |   | 13.0470-2892.2   | LD2892   |   | 24133 18,6 +/WK/Zub/STRW |
|  | 3.0  | 152  |  | 02.08  |   |  |  |   |                          |
|  | 3.0 V6   | 155  |  | 02.08  |   |  |  |   |                          |
|  | 2.0 HDi 180  | 133  |  | 03.15  |   | 13.0460-7279.2   | 607279   |   | 25069 17,3 +/WK ATE      |
|  | 2.2 HDi 200  | 150  |  | 07.10  |   |  |  |   |                          |
|  | 3.0 HDi 240  | 177  |  | 04.09  |   |  |  |   |                          |
|  | 1.6 HDi  | 80   |  | 02.08  |   | 24.0128-0216.1   | 428216   |   | 304 28,0 26,0 V +S +B    |
|  | 1.6 HDi 110  | 82   |  | 07.10  |   |  |  |   |                          |
|  | 1.6 HDi 115  | 84   |  | 01.12  |   |  |  |   |                          |
|  | 1.6 THP 155  | 115  |  | 04.09  |   |  |  |   |                          |
|  | 1.6 VTI 120  | 88   |  | 07.10  |   |  |  |   |                          |
|  | 1.8 16V  | 92   |  | 02.08  |   |  |  |   |                          |
|  | 2.0 16V  | 103  |  | 02.08  |   |  |  |   |                          |
|  | 2.0 16V BioFlex  | 103  |  | 02.08  |   |  |  |   |                          |
|  | 2.0 BlueHDi 150  | 110  |  | 05.15  |   |  |  |   |                          |
|  | 2.0 HDi  | 100  |  | 02.08  |   |  |  |   |                          |
|  | 2.0 HDi 140  | 103  |  | 11.08  |   |  |  |   |                          |
|  | 2.0 HDi 165  | 120  |  | 04.09  |   |  |  |   |                          |
|  | 2.0 HDi  | 100  |  | 02.08  |   | 24.0130-0206.1   | 430206   |   | 330 30,0 28,0 V L +S +B  |
|  | 2.2 HDi  | 125  |  | 02.08  |   |  |  |   |                          |
|  | 2.7 HDi  | 150  |  | 02.08  |   |  |  |   |                          |
|  | 3.0  | 152  |  | 02.08  |   |  |  |   |                          |
|  | 3.0 V6   | 155  |  | 02.08  |   |  |  |   |                          |
|  | 2.0 HDi 180  | 133  |  | 03.15  |   | 24.0130-0227.1   | 430227   |   | 340 30,0 28,0 V L +S +B  |
|  | 2.2 HDi 200  | 150  |  | 07.10  |   |  |  |   |                          |
|  | 3.0 HDi 240  | 177  |  | 04.09  |   |  |  |   |                          |
|  | 1.6 HDi  | 80   | ORGA 11683   |  | 07.10   | 24.0711-5215.3   | 360317   | 2  | Radsensor L=1259         |
|  | 1.6 HDi 110  | 82   |  |  | 01.12   | 24.0711-5345.3   | 360372   | 2  | Radsensor L=1259         |
|  | 1.6 HDi 115  | 84   |  |  | 04.09   |  |  |   |                          |
|  | 1.6 THP 155  | 115  |  |  | 07.10   |  |  |   |                          |
|  | 1.6 VTI 120  | 88   |  |  |   |  |  |   |                          |
|  | 1.8 16V  | 92   | ORGA 11683   |  |   |  |  |   |                          |
|  | 2.0 16V  | 103  | ORGA 11683   |  |   |  |  |   |                          |
|  | 2.0 16V BioFlex  | 103  | ORGA 11683   |  |   |  |  |   |                          |
|  | 2.0 BlueHDi 150  | 110  |  | 05.15  |   |  |  |   |                          |
|  | 2.0 HDi  | 100  | ORGA 11683   |  |   |  |  |   |                          |
|  | 2.0 HDi 140  | 103  | ORGA 11683   |  |   |  |  |   |                          |
|  | 2.0 HDi 165  | 120  |  | 04.09  |   |  |  |   |                          |
|  | 2.0 HDi 180  | 133  |  | 03.15  |   |  |  |   |                          |
|  | 2.2 HDi  | 125  | ORGA 11683   |  |   |  |  |   |                          |
|  | 2.2 HDi 200  | 150  |  | 07.10  |   |  |  |   |                          |
|  | 2.7 HDi  | 150  | ORGA 11683   |  |   |  |  |   |                          |
|  | 3.0  | 152  | ORGA 11683   |  |   |  |  |   |                          |
|  | 3.0 HDi 240  | 177  |  | 04.09  |   |  |  |   |                          |
|  | 3.0 V6   | 155  | ORGA 11683   |  |   |  |  |   |                          |
|  | 1.6 HDi  | 80   |  | 02.08  |   | 13.0460-2893.2   | 602893   |   | 24135 17,7 /S TRW        |
|  | 1.6 HDi 110  | 82   |  | 07.10  |   | 13.0470-2893.2   | LD2893   |   | 24135 17,7 /S TRW        |
|  | 1.6 HDi 115  | 84   |  | 01.12  |   |  |  |   |                          |
|  | 1.6 THP 155  | 115  |  | 04.09  |   |  |  |   |                          |
|  | 1.6 VTI 120  | 88   |  | 07.10  |   |  |  |   |                          |
|  | 1.8 16V  | 92   |  | 02.08  |   |  |  |   |                          |
|  | 2.0 16V  | 103  |  | 02.08  |   |  |  |   |                          |
|  |  |  |  |  |   |  |  |   |                          |

1) - electric parking brake / - freno a mano elettrico / - frein à main électrique / - freno de mano eléctrico

|     |  |  |  |  |  |  |  |       |                  |                     |     |
|--|--|--|--|--|---|--|--|---|------------------|---------------------|-----|
| <b>CITROEN C5 III Limousine (X7) (08-)</b>   |  |  |  |  |   |  |  |   |                  |                     |     |
|    | 2.0 16V BioFlex  | 103  |  | 02.08  | - elektrische Feststellbremse <sup>1)</sup>                                       | 13.0460-2893.2   | 602893   |   | 24135 17,7 /S    | TRW                 |     |
|  | 2.0 BlueHdi 150  | 110  |  | 05.15  | - elektrische Feststellbremse <sup>1)</sup>                                       | 13.0470-2893.2   | LD2893   |   | 24135 17,7 /S    | TRW                 |     |
|  | 2.0 HDi  | 100  |  | 02.08  | - elektrische Feststellbremse <sup>1)</sup>                                       |  |  |   |                  |                     |     |
|  | 2.0 HDi 140  | 103  |  | 11.08  | - elektrische Feststellbremse <sup>1)</sup>                                       |  |  |   |                  |                     |     |
|  | 2.0 HDi 165  | 120  |  | 04.09  | - elektrische Feststellbremse <sup>1)</sup>                                       |  |  |   |                  |                     |     |
|  | 2.0 HDi 180  | 133  |  | 03.15  | - elektrische Feststellbremse <sup>1)</sup>                                       |  |  |   |                  |                     |     |
|  | 2.2 HDi  | 125  |  | 02.08  | - elektrische Feststellbremse <sup>1)</sup>                                       |  |  |   |                  |                     |     |
|  | 2.2 HDi 200  | 150  |  | 07.10  | - elektrische Feststellbremse <sup>1)</sup>                                       |  |  |   |                  |                     |     |
|  | 2.7 HDi  | 150  |  | 02.08  | - elektrische Feststellbremse <sup>1)</sup>                                       |  |  |   |                  |                     |     |
|  | 3.0  | 152  |  | 02.08  | - elektrische Feststellbremse <sup>1)</sup>                                       |  |  |   |                  |                     |     |
|  | 3.0 HDi 240  | 177  |  | 04.09  | - elektrische Feststellbremse <sup>1)</sup>                                       |  |  |   |                  |                     |     |
|  | 3.0 V6   | 155  |  | 02.08  | - elektrische Feststellbremse <sup>1)</sup>                                       |  |  |   |                  |                     |     |
|  | 1.6 HDi  | 80   |  | 02.08  | + elektrische Feststellbremse <sup>2)</sup>                                       | 13.0460-7253.2   | 607253   |   |                  | 24137 15,8 +        | ATE |
|  | 1.6 HDi 110  | 82   |  | 07.10  | + elektrische Feststellbremse <sup>2)</sup>                                       |  |  |   |                  |                     |     |
|  | 1.6 HDi 115  | 84   |  | 01.12  | + elektrische Feststellbremse <sup>2)</sup>                                       |  |  |   |                  |                     |     |
|  | 1.6 THP 155  | 115  |  | 04.09  | + elektrische Feststellbremse <sup>2)</sup>                                       |  |  |   |                  |                     |     |
|  | 1.6 VTI 120  | 88   |  | 07.10  | + elektrische Feststellbremse <sup>2)</sup>                                       |  |  |   |                  |                     |     |
|  | 1.8 16V  | 92   |  | 02.08  | + elektrische Feststellbremse <sup>2)</sup>                                       |  |  |   |                  |                     |     |
|  | 2.0 16V  | 103  |  | 02.08  | + elektrische Feststellbremse <sup>2)</sup>                                       |  |  |   |                  |                     |     |
|  | 2.0 16V BioFlex  | 103  |  | 02.08  | + elektrische Feststellbremse <sup>2)</sup>                                       |  |  |   |                  |                     |     |
|  | 2.0 BlueHdi 150  | 110  |  | 05.15  | + elektrische Feststellbremse <sup>2)</sup>                                       |  |  |   |                  |                     |     |
|  | 2.0 HDi  | 100  |  | 02.08  | + elektrische Feststellbremse <sup>2)</sup>                                       |  |  |   |                  |                     |     |
|  | 2.0 HDi 140  | 103  |  | 11.08  | + elektrische Feststellbremse <sup>2)</sup>                                       |  |  |   |                  |                     |     |
|  | 2.0 HDi 165  | 120  |  | 04.09  | + elektrische Feststellbremse <sup>2)</sup>                                       |  |  |   |                  |                     |     |
|  | 2.0 HDi 180  | 133  |  | 03.15  | + elektrische Feststellbremse <sup>2)</sup>                                       |  |  |   |                  |                     |     |
|  | 2.2 HDi  | 125  |  | 02.08  | + elektrische Feststellbremse <sup>2)</sup>                                       |  |  |   |                  |                     |     |
|  | 2.2 HDi 200  | 150  |  | 07.10  | + elektrische Feststellbremse <sup>2)</sup>                                       |  |  |   |                  |                     |     |
|  | 2.7 HDi  | 150  |  | 02.08  | + elektrische Feststellbremse <sup>2)</sup>                                       |  |  |   |                  |                     |     |
|  | 3.0  | 152  |  | 02.08  | + elektrische Feststellbremse <sup>2)</sup>                                       |  |  |   |                  |                     |     |
|  | 3.0 HDi 240  | 177  |  | 04.09  | + elektrische Feststellbremse <sup>2)</sup>                                       |  |  |   |                  |                     |     |
|  | 3.0 V6   | 155  |  | 02.08  | + elektrische Feststellbremse <sup>2)</sup>                                       |  |  |   |                  |                     |     |
|  |  | 1.6 HDi  | 80   |  | 02.08   |  | 24.0112-0162.1   | 412162  |                  | 290 12,0 10,0 +S +B |     |
|  |  | 1.6 HDi 110  | 82   |  | 07.10   |  |  |   |                  |                     |     |
|  |  | 1.6 HDi 115  | 84   |  | 01.12   |  |  |   |                  |                     |     |
| 1.6 THP 155  |  | 115  |  | 04.09  |   |  |  |   |                  |                     |     |
| 1.6 VTI 120  |  | 88   |  | 07.10  |   |  |  |   |                  |                     |     |
| 1.8 16V  |  | 92   |  | 02.08  |   |  |  |   |                  |                     |     |
| 2.0 16V  |  | 103  |  | 02.08  |   |  |  |   |                  |                     |     |
| 2.0 16V BioFlex  |  | 103  |  | 02.08  |   |  |  |   |                  |                     |     |
| 2.0 BlueHdi 150  |  | 110  |  | 05.15  |   |  |  |   |                  |                     |     |
| 2.0 HDi  |  | 100  |  | 02.08  |   |  |  |   |                  |                     |     |
| 2.0 HDi 140  |  | 103  |  | 11.08  |   |  |  |   |                  |                     |     |
| 2.0 HDi 165  |  | 120  |  | 04.09  |   |  |  |   |                  |                     |     |
| 2.0 HDi 180  |  | 133  |  | 03.15  |   |  |  |   |                  |                     |     |
| 2.2 HDi  |  | 125  |  | 02.08  |   |  |  |   |                  |                     |     |
| 2.2 HDi 200  |  | 150  |  | 07.10  |   |  |  |   |                  |                     |     |
| 2.7 HDi  |  | 150  |  | 02.08  |   |  |  |   |                  |                     |     |
| 3.0  | 152  |  | 02.08  |  |   |  |  |   |                  |                     |     |
| 3.0 HDi 240  | 177  |  | 04.09  |  |   |  |  |   |                  |                     |     |
| 3.0 V6   | 155  |  | 02.08  |  |   |  |  |   |                  |                     |     |
|  | 1.6 HDi  | 80   | ORGA 11683   |  |   | 24.0711-5216.3   | 360318   | 2  | Radsensor L=1762 |                     |     |
|  | 1.6 HDi 110  | 82   |  | 07.10  |   |  |  |   |                  |                     |     |
|  | 1.6 HDi 115  | 84   |  | 01.12  |   |  |  |   |                  |                     |     |
|  | 1.6 THP 155  | 115  |  | 04.09  |   |  |  |   |                  |                     |     |
|  | 1.6 VTI 120  | 88   |  | 07.10  |   |  |  |   |                  |                     |     |
|  | 1.8 16V  | 92   | ORGA 11683   |  |   |  |  |   |                  |                     |     |
|  | 2.0 16V  | 103  | ORGA 11683   |  |   |  |  |   |                  |                     |     |
|  | 2.0 16V BioFlex  | 103  | ORGA 11683   |  |   |  |  |   |                  |                     |     |
|  | 2.0 BlueHdi 150  | 110  |  | 05.15  |   |  |  |   |                  |                     |     |
|  | 2.0 HDi  | 100  | ORGA 11683   |  |   |  |  |   |                  |                     |     |
|  | 2.0 HDi 140  | 103  | ORGA 11683   |  |   |  |  |   |                  |                     |     |
|  | 2.0 HDi 165  | 120  | ORGA 11683   |  |   |  |  |   |                  |                     |     |
|  | 2.0 HDi 180  | 133  |  | 03.15  |   |  |  |   |                  |                     |     |
| 2.2 HDi  | 125  | ORGA 11683   |  |  |   |  |  |   |                  |                     |     |
| 2.2 HDi 200  | 150  |  | 07.10  |  |   |  |  |   |                  |                     |     |
| 2.7 HDi  | 150  |  | 04.09  |  |   |  |  |   |                  |                     |     |
| 3.0  | 152  | ORGA 11683   |  |  |   |  |  |   |                  |                     |     |
| 3.0 HDi 240  | 177  |  | 04.09  |  |   |  |  |   |                  |                     |     |
| 3.0 V6   | 155  | ORGA 11683   |  |  |   |  |  |   |                  |                     |     |
| <b>CITROEN C5 III Kombi (X7) (08-)</b>   |  |  |  |  |   |  |  |   |                  |                     |     |
|  | 1.6 HDi  | 80   |  | 02.08  |   | 13.0460-7252.2   | 607252   |   | 24332 18,3 +/WK  | ATE                 |     |
|  | 1.6 HDi 110  | 82   | ORGA 12774   | 07.10  |   | 13.0470-7252.2   | LD7252   |   | 24332 18,3 +/WK  | ATE                 |     |
|  | 1.6 HDi 115  | 84   | ORGA 12774   | 01.12  |   |  |  |   |                  |                     |     |
|  | 1.6 THP 155  | 115  | ORGA 12774   | 04.09  |   |  |  |   |                  |                     |     |
|  | 1.6 VTI 120  | 88   | ORGA 12774   | 07.10  |   |  |  |   |                  |                     |     |
|  | 1.8 16V  | 92   |  | 02.08  |   |  |  |   |                  |                     |     |
|  | 2.0 16V  | 103  |  | 02.08  |   |  |  |   |                  |                     |     |
|  | 2.0 16V BioFlex  | 103  |  | 02.08  |   |  |  |   |                  |                     |     |
|  | 2.0 HDi  | 100  | ORGA 12774   | 02.08  |   |  |  |   |                  |                     |     |
|  | 2.0 HDi 140  | 103  | ORGA 12774   | 11.08  |   |  |  |   |                  |                     |     |
|  | 2.0 HDi 140  | 103  | ORGA 12774   | 11.08  |   |  |  |   |                  |                     |     |
|  | 2.0 HDi 150  | 110  | ORGA 12774   | 04.09  |   |  |  |   |                  |                     |     |
|  | 2.0 HDi 165  | 120  | ORGA 12774   | 04.09  |   |  |  |   |                  |                     |     |
| 1.6 HDi 110  | 82   | ORGA 12775   |  |  |   | 13.0460-7252.2   | 607252   |   | 24332 18,3 +/WK  | ATE                 |     |
| 1.6 HDi 115  | 84   | ORGA 12775   |  |  |   | 13.0470-7252.2   | LD7252   |   | 24332 18,3 +/WK  | ATE                 |     |
| 1.6 THP 155  | 115  | ORGA 12775   |  |  |   |  |  |   |                  |                     |     |



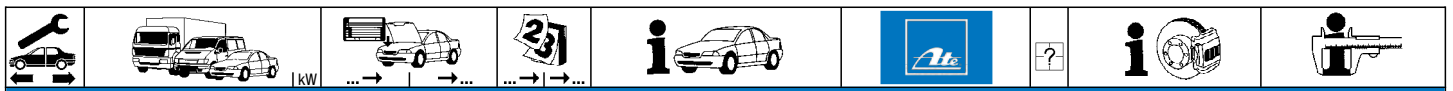





















<sup>1)</sup> - electric parking brake / - freno a mano elettrico / - frein à main électrique / - freno de mano eléctrico  
<sup>2)</sup> + electric parking brake / + freno a mano elettrico / + frein à main électrique / + freno de mano eléctrico



**CITROEN C5 III Kombi (X7) (08-)**

|                 |                 |                |  |       |       |                |        |   |                          |     |  |
|-----------------|-----------------|----------------|--|-------|-------|----------------|--------|---|--------------------------|-----|--|
|                 | 1.6 VTI 120     | 88 ORGA 12775  |  |       |       | 13.0460-7252.2 | 607252 |   | 24332 18,3 +/WK          | ATE |  |
|                 | 2.0 HDi         | 100 ORGA 12775 |  |       |       | 13.0470-7252.2 | LD7252 |   | 24332 18,3 +/WK          | ATE |  |
|                 | 2.0 HDi 140     | 103 ORGA 12775 |  |       |       |                |        |   |                          |     |  |
|                 | 2.0 HDi 140     | 103 ORGA 12775 |  |       |       |                |        |   |                          |     |  |
|                 | 2.0 HDi 150     | 110 ORGA 12775 |  |       |       |                |        |   |                          |     |  |
|                 | 2.0 HDi 165     | 120 ORGA 12775 |  |       |       |                |        |   |                          |     |  |
|                 | 2.2 HDi         | 125            |  |       | 02.08 |                |        |   |                          |     |  |
|                 | 2.7 HDi         | 150            |  |       | 02.08 | 13.0460-2892.2 | 602892 |   | 24133 18,6 +/WK/Zub/STRW | TRW |  |
|                 | 3.0             | 152            |  |       | 02.08 | 13.0470-2892.2 | LD2892 |   | 24133 18,6 +/WK/Zub/STRW | TRW |  |
|                 | 3.0 V6          | 155            |  |       | 02.08 |                |        |   |                          |     |  |
|                 | 2.0 HDi 180     | 133            |  |       | 03.15 | 13.0460-7279.2 | 607279 |   | 25069 17,3 +/WK          | ATE |  |
|                 | 2.2 HDi 200     | 150            |  |       | 07.10 |                |        |   |                          |     |  |
|                 | 3.0 HDi 240     | 177            |  |       | 04.09 |                |        |   |                          |     |  |
|                 | 1.6 HDi         | 80             |  |       | 02.08 | 24.0128-0216.1 | 428216 |   | 304 28,0 26,0 V +S +B    |     |  |
|                 | 1.6 HDi 110     | 82             |  |       | 07.10 |                |        |   |                          |     |  |
|                 | 1.6 HDi 115     | 84             |  |       | 01.12 |                |        |   |                          |     |  |
|                 | 1.6 THP 155     | 115            |  |       | 04.09 |                |        |   |                          |     |  |
|                 | 1.6 VTI 120     | 88             |  |       | 07.10 |                |        |   |                          |     |  |
|                 | 1.8 16V         | 92             |  |       | 02.08 |                |        |   |                          |     |  |
|                 | 2.0 16V         | 103            |  |       | 02.08 |                |        |   |                          |     |  |
|                 | 2.0 16V BioFlex | 103            |  |       | 02.08 |                |        |   |                          |     |  |
|                 | 2.0 HDi         | 100            |  |       | 02.08 |                |        |   |                          |     |  |
|                 | 2.0 HDi 140     | 103            |  |       | 11.08 |                |        |   |                          |     |  |
|                 | 2.0 HDi 150     | 110            |  |       | 04.09 |                |        |   |                          |     |  |
|                 | 2.0 HDi 165     | 120            |  |       | 04.09 | 24.0128-0269.1 | 428269 |   | 304 28,0 26,0 V L +S +B  |     |  |
|                 | 2.2 HDi         | 125            |  |       | 02.08 | 24.0130-0206.1 | 430206 |   | 330 30,0 28,0 V L +S +B  |     |  |
|                 | 2.7 HDi         | 150            |  |       | 02.08 |                |        |   |                          |     |  |
|                 | 3.0             | 152            |  |       | 02.08 |                |        |   |                          |     |  |
|                 | 3.0 V6          | 155            |  |       | 02.08 |                |        |   |                          |     |  |
|                 | 2.0 HDi 180     | 133            |  |       | 03.15 | 24.0130-0227.1 | 430227 |   | 340 30,0 28,0 V L +S +B  |     |  |
|                 | 2.2 HDi 200     | 150            |  |       | 07.10 |                |        |   |                          |     |  |
|                 | 3.0 HDi 240     | 177            |  |       | 04.09 |                |        |   |                          |     |  |
|                 | 1.6 HDi         | 80 ORGA 11683  |  |       |       | 24.0711-5215.3 | 360317 | 2 | Radsensor L=1259         |     |  |
|                 | 1.6 HDi 110     | 82 ORGA 11683  |  |       |       | 24.0711-5345.3 | 360372 | 2 | Radsensor L=1259         |     |  |
|                 | 1.6 HDi 115     | 84 ORGA 11683  |  |       |       |                |        |   |                          |     |  |
|                 | 1.6 THP 155     | 115 ORGA 11683 |  |       |       |                |        |   |                          |     |  |
|                 | 1.6 VTI 120     | 88 ORGA 11683  |  |       |       |                |        |   |                          |     |  |
|                 | 1.8 16V         | 92 ORGA 11683  |  |       |       |                |        |   |                          |     |  |
|                 | 2.0 16V         | 103 ORGA 11683 |  |       |       |                |        |   |                          |     |  |
|                 | 2.0 16V BioFlex | 103 ORGA 11683 |  |       |       |                |        |   |                          |     |  |
|                 | 2.0 HDi         | 100 ORGA 11683 |  |       |       |                |        |   |                          |     |  |
|                 | 2.0 HDi 140     | 103 ORGA 11683 |  |       |       |                |        |   |                          |     |  |
|                 | 2.0 HDi 150     | 110 ORGA 11683 |  |       |       |                |        |   |                          |     |  |
|                 | 2.0 HDi 165     | 120 ORGA 11683 |  |       |       |                |        |   |                          |     |  |
|                 | 2.0 HDi 180     | 133            |  |       | 03.15 |                |        |   |                          |     |  |
|                 | 2.2 HDi         | 125 ORGA 11683 |  |       |       |                |        |   |                          |     |  |
|                 | 2.2 HDi 200     | 150 ORGA 11683 |  |       |       |                |        |   |                          |     |  |
|                 | 2.7 HDi         | 150 ORGA 11683 |  |       |       |                |        |   |                          |     |  |
|                 | 3.0             | 152 ORGA 11683 |  |       |       |                |        |   |                          |     |  |
|                 | 3.0 HDi 240     | 177 ORGA 11683 |  |       |       |                |        |   |                          |     |  |
|                 | 3.0 V6          | 155 ORGA 11683 |  |       |       |                |        |   |                          |     |  |
|                 | 1.6 HDi         | 80             |  |       | 02.08 | 13.0460-2893.2 | 602893 |   | 24135 17,7 /S            | TRW |  |
|                 | 1.6 HDi 110     | 82             |  |       | 07.10 | 13.0470-2893.2 | LD2893 |   | 24135 17,7 /S            | TRW |  |
|                 | 1.6 HDi 115     | 84             |  |       | 01.12 |                |        |   |                          |     |  |
|                 | 1.6 THP 155     | 115            |  |       | 04.09 |                |        |   |                          |     |  |
|                 | 1.6 VTI 120     | 88             |  |       | 07.10 |                |        |   |                          |     |  |
|                 | 1.8 16V         | 92             |  |       | 02.08 |                |        |   |                          |     |  |
|                 | 2.0 16V         | 103            |  |       | 02.08 |                |        |   |                          |     |  |
|                 | 2.0 16V BioFlex | 103            |  |       | 02.08 |                |        |   |                          |     |  |
|                 | 2.0 HDi         | 100            |  |       | 02.08 |                |        |   |                          |     |  |
|                 | 2.0 HDi 140     | 103            |  |       | 11.08 |                |        |   |                          |     |  |
|                 | 2.0 HDi 150     | 110            |  |       | 04.09 |                |        |   |                          |     |  |
|                 | 2.0 HDi 165     | 120            |  |       | 04.09 |                |        |   |                          |     |  |
|                 | 2.0 HDi 180     | 133            |  |       | 03.15 |                |        |   |                          |     |  |
|                 | 2.2 HDi         | 125            |  |       | 02.08 |                |        |   |                          |     |  |
|                 | 2.2 HDi 200     | 150            |  |       | 07.10 |                |        |   |                          |     |  |
|                 | 2.7 HDi         | 150            |  |       | 02.08 |                |        |   |                          |     |  |
|                 | 3.0             | 152            |  |       | 02.08 |                |        |   |                          |     |  |
|                 | 3.0 HDi 240     | 177            |  |       | 04.09 |                |        |   |                          |     |  |
|                 | 3.0 V6          | 155            |  |       | 02.08 |                |        |   |                          |     |  |
|                 | 1.6 HDi         | 80             |  |       | 02.08 | 13.0460-7253.2 | 607253 |   | 24137 15,8 +             | ATE |  |
|                 | 1.6 HDi 110     | 82             |  |       | 07.10 |                |        |   |                          |     |  |
|                 | 1.6 HDi 115     | 84             |  |       | 01.12 |                |        |   |                          |     |  |
|                 | 1.6 THP 155     | 115            |  |       | 04.09 |                |        |   |                          |     |  |
|                 | 1.6 VTI 120     | 88             |  |       | 07.10 |                |        |   |                          |     |  |
|                 | 1.8 16V         | 92             |  |       | 02.08 |                |        |   |                          |     |  |
|                 | 2.0 16V         | 103            |  |       | 02.08 |                |        |   |                          |     |  |
|                 | 2.0 16V BioFlex | 103            |  |       | 02.08 |                |        |   |                          |     |  |
|                 | 2.0 HDi         | 100            |  |       | 02.08 |                |        |   |                          |     |  |
|                 | 2.0 HDi 140     | 103            |  |       | 11.08 |                |        |   |                          |     |  |
| 2.0 HDi 150     | 110             |                |  | 04.09 |       |                |        |   |                          |     |  |
|                 | 2.0 HDi 165     | 120            |  |       | 04.09 |                |        |   |                          |     |  |
|                 | 2.0 HDi 180     | 133            |  |       | 03.15 |                |        |   |                          |     |  |
|                 | 2.2 HDi         | 125            |  |       | 02.08 |                |        |   |                          |     |  |
|                 | 2.2 HDi 200     | 150            |  |       | 07.10 |                |        |   |                          |     |  |
|                 | 2.7 HDi         | 150            |  |       | 02.08 |                |        |   |                          |     |  |
|                 | 3.0             | 152            |  |       | 02.08 |                |        |   |                          |     |  |
|                 | 3.0 HDi 240     | 177            |  |       | 04.09 |                |        |   |                          |     |  |
|                 | 3.0 V6          | 155            |  |       | 02.08 |                |        |   |                          |     |  |
|                 | 1.6 HDi         | 80             |  |       | 02.08 |                |        |   |                          |     |  |
|                 | 1.6 HDi 110     | 82             |  |       | 07.10 |                |        |   |                          |     |  |
| 1.6 HDi 115     | 84              |                |  | 01.12 |       |                |        |   |                          |     |  |
| 1.6 THP 155     | 115             |                |  | 04.09 |       |                |        |   |                          |     |  |
| 1.6 VTI 120     | 88              |                |  | 07.10 |       |                |        |   |                          |     |  |
| 1.8 16V         | 92              |                |  | 02.08 |       |                |        |   |                          |     |  |
| 2.0 16V         | 103             |                |  | 02.08 |       |                |        |   |                          |     |  |
| 2.0 16V BioFlex | 103             |                |  | 02.08 |       |                |        |   |                          |     |  |
| 2.0 HDi         | 100             |                |  | 02.08 |       |                |        |   |                          |     |  |
| 2.0 HDi 140     | 103             |                |  | 11.08 |       |                |        |   |                          |     |  |
| 2.0 HDi 150     | 110             |                |  | 04.09 |       |                |        |   |                          |     |  |
| 2.0 HDi 165     | 120             |                |  | 04.09 |       |                |        |   |                          |     |  |
| 2.0 HDi 180     | 133             |                |  | 03.15 |       |                |        |   |                          |     |  |
| 2.2 HDi         | 125             |                |  | 02.08 |       |                |        |   |                          |     |  |
| 2.2 HDi 200     | 150             |                |  | 07.10 |       |                |        |   |                          |     |  |
| 2.7 HDi         | 150             |                |  | 02.08 |       |                |        |   |                          |     |  |
| 3.0             | 152             |                |  | 02.08 |       |                |        |   |                          |     |  |
| 3.0 HDi 240     | 177             |                |  | 04.09 |       |                |        |   |                          |     |  |
| 3.0 V6          | 155             |                |  | 02.08 |       |                |        |   |                          |     |  |

1) - electric parking brake / - freno a mano elettrico / - frein à main électrique / - freno de mano eléctrico  
 2) + electric parking brake / + freno a mano elettrico / + frein à main électrique / + freno de mano eléctrico

|     |    |    |   |   |  |  |    |  |
|--|--|--|---|---|---|--|--|--|
| <b>CITROEN C5 III Kombi (X7) (08-)</b>   |  |  |   |   |   |  |  |  |
|    | 3.0<br>3.0 HDi 240<br>3.0 V6   | 152<br>177<br>155  | 02.08<br>04.09<br>02.08   | + elektrische Feststellbremse <sup>1)</sup><br>+ elektrische Feststellbremse <sup>1)</sup><br>+ elektrische Feststellbremse <sup>1)</sup> | 13.0460-7253.2  | 607253   |  | 24137 15,8 + ATE   |
|    | 1.6 HDi<br>1.6 HDi 110<br>1.6 HDi 115<br>1.6 THP 155<br>1.6 VTI 120<br>1.8 16V<br>2.0 16V<br>2.0 16V BioFlex<br>2.0 HDi<br>2.0 HDi 140<br>2.0 HDi 150<br>2.0 HDi 165<br>2.0 HDi 180<br>2.2 HDi<br>2.2 HDi 200<br>2.7 HDi<br>3.0<br>3.0 HDi 240<br>3.0 V6 | 80<br>82<br>84<br>115<br>88<br>92<br>103<br>103<br>100<br>103<br>110<br>120<br>133<br>125<br>150<br>150<br>152<br>177<br>155   | 02.08<br>07.10<br>01.12<br>04.09<br>07.10<br>02.08<br>02.08<br>02.08<br>02.08<br>11.08<br>04.09<br>04.09<br>03.15<br>02.08<br>07.10<br>02.08<br>02.08<br>04.09<br>02.08 |   | 24.0112-0162.1  | 412162   |  | 290 12,0 10,0 +S +B  |
|    | 1.6 HDi<br>1.6 HDi 110<br>1.6 HDi 115<br>1.6 THP 155<br>1.6 VTI 120<br>1.8 16V<br>2.0 16V<br>2.0 16V BioFlex<br>2.0 HDi<br>2.0 HDi 140<br>2.0 HDi 150<br>2.0 HDi 165<br>2.0 HDi 180<br>2.2 HDi<br>2.2 HDi 200<br>2.7 HDi<br>3.0<br>3.0 HDi 240<br>3.0 V6 | 80 ORGA 11683<br>82 ORGA 11683<br>84 ORGA 11683<br>115 ORGA 11683<br>88 ORGA 11683<br>92 ORGA 11683<br>103 ORGA 11683<br>103 ORGA 11683<br>100 ORGA 11683<br>103 ORGA 11683<br>110 ORGA 11683<br>120 ORGA 11683<br>133<br>125 ORGA 11683<br>150 ORGA 11683<br>150 ORGA 11683<br>152 ORGA 11683<br>177 ORGA 11683<br>155 ORGA 11683 | 03.15   |   | 24.0711-5216.3  | 360318   | 2   | Radsensor L=1762   |
| <b>CITROEN C6 (05-12)</b>  |  |  |   |   |   |  |  |  |
|  | 2.2 HDi<br>2.7 HDi<br>3.0 V6<br>3.0 HDi  | 125<br>150<br>155<br>177   | 06.06<br>09.05<br>09.05<br>07.09  | 12.12<br>12.12<br>12.12<br>12.12  | 13.0460-2892.2<br>13.0470-2892.2  | 602892<br>LD2892   |  | 24133 18,6 +/WK/Zub/STRW<br>24133 18,6 +/WK/Zub/STRW<br>25069 17,3 +/WK ATE        |
|  | 2.2 HDi<br>2.7 HDi<br>3.0 V6<br>2.2 HDi<br>2.7 HDi<br>3.0 V6<br>3.0 HDi  | 125<br>150<br>155<br>125 ORGA 11194<br>150 ORGA 11194<br>155 ORGA 11194<br>177   | ORGA 11193<br>ORGA 11193<br>ORGA 11193<br>06.06<br>09.05<br>09.05<br>07.09  | 12.12<br>12.12<br>12.12<br>12.12  | 24.0130-0181.1<br>24.0130-0206.1<br>24.0130-0227.1                                | 430181<br>430206<br>430227   |  | 330 30,0 28,0 V +S +B<br>330 30,0 28,0 V L +S +B<br>340 30,0 28,0 V L +S +B        |
|  | 2.2 HDi<br>2.7 HDi<br>3.0 HDi<br>3.0 V6<br>2.2 HDi<br>2.7 HDi<br>3.0 HDi<br>3.0 V6   | 125<br>150<br>177<br>155<br>125 ORGA 11683<br>150 ORGA 11683<br>177 ORGA 11683<br>155 ORGA 11683   | ORGA 11283<br>ORGA 11283<br>ORGA 11283<br>ORGA 11283<br>06.06<br>09.05<br>07.09<br>09.05  | 12.12<br>12.12<br>12.12<br>12.12  | 24.0710-2018.1<br>24.0711-5215.3<br>24.0711-5345.3                                | 360225<br>360317<br>360372   | 2 <br>2  | Radsensor L=1259<br>Radsensor L=1259<br>Radsensor L=1259                           |
|  | 2.2 HDi<br>2.7 HDi<br>3.0 HDi<br>3.0 V6  | 125<br>150<br>177<br>155   | 06.06<br>09.05<br>07.09<br>09.05  | 12.12<br>12.12<br>12.12<br>12.12  | 13.0460-2706.2  | 602706   |  | 24462 16,7 /S TRW  |
|  | 2.2 HDi<br>2.7 HDi<br>3.0 HDi<br>3.0 V6  | 125<br>150<br>177<br>155   | 06.06<br>09.05<br>07.09<br>09.05  | 12.12<br>12.12<br>12.12<br>12.12  | 24.0122-0255.1  | 422255   |  | 302 22,0 20,0 V  |
|  | 2.2 HDi<br>2.7 HDi<br>3.0 HDi<br>3.0 V6<br>2.2 HDi<br>2.7 HDi<br>3.0 HDi<br>3.0 V6   | 125<br>150<br>177<br>155<br>125 ORGA 11683<br>150 ORGA 11683<br>177 ORGA 11683<br>155 ORGA 11683   | ORGA 11283<br>ORGA 11283<br>ORGA 11283<br>ORGA 11283<br>06.06<br>09.05<br>07.09<br>09.05  | 12.12<br>12.12<br>12.12<br>12.12  | 24.0710-2019.1<br>24.0711-5216.3  | 360226<br>360318   | 2 <br>2  | Radsensor L=1762<br>Radsensor L=1762   |
| <b>CITROEN C8 (02-14)</b>  |  |  |   |   |   |  |  |  |
|  | 2.0 16V<br>2.0 16V<br>2.0 HDi<br>2.0 HDi<br>2.0 HDi 135  | 100<br>103<br>79<br>88<br>100  | 07.02<br>09.05<br>07.02<br>02.07<br>03.06   | 07.14<br>07.14<br>07.14<br>07.14<br>07.14   | 13.0460-2863.2  | 602863   |  | 20261 19,0 +/WK/S TRW  |

<sup>1)</sup> + electric parking brake / + freno a mano elettrico / + frein à main électrique / + freno de mano eléctrico



| CITROEN C8 (02-14)        |                 |         |     |       |       |                |                |        |                       |                  |
|---------------------------|-----------------|---------|-----|-------|-------|----------------|----------------|--------|-----------------------|------------------|
|                           | 2.2 16V         | 116     |     | 07.02 | 07.14 | 13.0460-2863.2 | 602863         |        | 20261 19,0 +/WK/S     | TRW              |
|                           | 2.2 HDi         | 94      |     | 07.02 | 07.14 |                |                |        |                       |                  |
|                           | 2.0 HDi 165     | 120     |     | 03.06 | 07.14 | 13.0460-2752.2 | 602752         |        | 24839 19,4 +/WK/S     | TRW              |
|                           | 2.2 HDi         | 125     |     | 06.06 | 07.14 |                |                |        |                       |                  |
|                           | 3.0 V6          | 150     |     | 07.02 | 07.14 | 13.0460-4995.2 | 604995         |        | 23575 15,6 +/WK       | BRE              |
|                           | 2.0 16V         | 100     |     | 07.02 | 07.14 | 24.0128-0136.1 | 428136         |        | 285 28,0 26,0 V +B    |                  |
|                           | 2.0 16V         | 103     |     | 09.05 | 07.14 | 24.0328-0136.1 | 528136         |        | 285 28,0 26,0 V +B PD |                  |
|                           | 2.0 HDi         | 79      |     | 07.02 | 07.14 |                |                |        |                       |                  |
|                           | 2.0 HDi         | 88      |     | 02.07 | 07.14 |                |                |        |                       |                  |
|                           | 2.0 HDi 135     | 100     |     | 03.06 | 07.14 |                |                |        |                       |                  |
|                           | 2.2 16V         | 116     |     | 07.02 | 07.14 |                |                |        |                       |                  |
|                           | 2.2 HDi         | 94      |     | 07.02 | 07.14 |                |                |        |                       |                  |
|                           | 3.0 V6          | 150     |     | 07.02 | 07.14 | 24.0132-0126.1 | 432126         |        | 310 32,0 30,0 V       |                  |
|                           | 2.0 HDi 165     | 120     |     | 03.06 | 07.14 | 24.0132-0126.1 | 432126         |        | 310 32,0 30,0 V       |                  |
|                           | 2.2 HDi         | 125     |     | 06.06 | 07.14 |                |                |        |                       |                  |
|                           | 2.0 16V         | 100     |     | 07.02 | 07.14 | 13.0460-2819.2 | 602819         |        | 20961 17,6 /S         | TRW              |
|                           | 2.0 16V         | 103     |     | 09.05 | 07.14 | 13.0460-0072.2 | 610072         |        | Belagsatz-Zubehör     | TRW              |
|                           | 2.0 HDi         | 79      |     | 07.02 | 07.14 |                |                |        |                       |                  |
|                           | 2.0 HDi         | 88      |     | 02.07 | 07.14 |                |                |        |                       |                  |
|                           | 2.0 HDi 135     | 100     |     | 03.06 | 07.14 |                |                |        |                       |                  |
|                           | 2.0 HDi 165     | 120     |     | 03.06 | 07.14 |                |                |        |                       |                  |
|                           | 2.2 16V         | 116     |     | 07.02 | 07.14 |                |                |        |                       |                  |
|                           | 2.2 HDi         | 94      |     | 07.02 | 07.14 |                |                |        |                       |                  |
|                           | 2.2 HDi         | 125     |     | 06.06 | 07.14 |                |                |        |                       |                  |
|                           | 3.0 V6          | 150     |     | 07.02 | 07.14 |                |                |        |                       |                  |
|                           |                 | 2.0 16V | 100 |       | 07.02 | 07.14          | 24.0112-0156.1 | 412156 |                       | 272 12,0 10,0 +B |
| 2.0 16V                   |                 | 103     |     | 09.05 | 07.14 |                |                |        |                       |                  |
| 2.0 HDi                   |                 | 79      |     | 07.02 | 07.14 |                |                |        |                       |                  |
| 2.0 HDi                   |                 | 88      |     | 02.07 | 07.14 |                |                |        |                       |                  |
| 2.0 HDi 135               |                 | 100     |     | 03.06 | 07.14 |                |                |        |                       |                  |
| 2.0 HDi 165               |                 | 120     |     | 03.06 | 07.14 |                |                |        |                       |                  |
| 2.2 16V                   |                 | 116     |     | 07.02 | 07.14 |                |                |        |                       |                  |
| 2.2 HDi                   |                 | 94      |     | 07.02 | 07.14 |                |                |        |                       |                  |
| 2.2 HDi                   |                 | 125     |     | 06.06 | 07.14 |                |                |        |                       |                  |
| 3.0 V6                    |                 | 150     |     | 07.02 | 07.14 |                |                |        |                       |                  |
|                           | 2.0 16V         | 100     |     | 07.02 | 07.14 | 24.0711-6066.3 | 360130         | 2      | Radsensor L=955       |                  |
|                           | 2.0 16V         | 103     |     | 09.05 | 07.14 |                |                |        |                       |                  |
|                           | 2.0 HDi         | 79      |     | 07.02 | 07.14 |                |                |        |                       |                  |
|                           | 2.0 HDi         | 88      |     | 02.07 | 07.14 |                |                |        |                       |                  |
|                           | 2.0 HDi 135     | 100     |     | 03.06 | 07.14 |                |                |        |                       |                  |
|                           | 2.0 HDi 165     | 120     |     | 03.06 | 07.14 |                |                |        |                       |                  |
|                           | 2.2 16V         | 116     |     | 07.02 | 07.14 |                |                |        |                       |                  |
|                           | 2.2 HDi         | 94      |     | 07.02 | 07.14 |                |                |        |                       |                  |
|                           | 2.2 HDi         | 125     |     | 06.06 | 07.14 |                |                |        |                       |                  |
|                           | 3.0 V6          | 150     |     | 07.02 | 07.14 |                |                |        |                       |                  |
| CITROEN C-CROSSER (07-13) |                 |         |     |       |       |                |                |        |                       |                  |
|                           | 2.0 2WD         | 108     |     | 11.10 | 01.13 | 13.0460-5958.2 | 605958         |        | 21363 15,8 +/WK       | AKE              |
|                           | 2.0 4WD         | 108     |     | 11.10 | 01.13 | 13.0460-0235.2 | 610235         |        | Belagsatz-Zubehör     |                  |
|                           | 2.2 HDi         | 115     |     | 02.07 | 01.13 |                |                |        |                       |                  |
|                           | 2.4             | 125     |     | 08.08 | 01.13 |                |                |        |                       |                  |
|                           | 2.0 2WD         | 108     |     | 11.10 | 01.13 | 24.0124-0215.1 | 424215         |        | 294 24,0 22,4 V +B    |                  |
|                           | 2.0 4WD         | 108     |     | 11.10 | 01.13 |                |                |        |                       |                  |
|                           | 2.2 HDi         | 115     |     | 02.07 | 01.13 |                |                |        |                       |                  |
|                           | 2.4             | 125     |     | 08.08 | 01.13 |                |                |        |                       |                  |
|                           | 2.0 2WD         | 108     |     | 11.10 | 01.13 | 13.0460-5855.2 | 605855         |        | 23582 16,0 +          |                  |
|                           | 2.0 4WD         | 108     |     | 11.10 | 01.13 | 13.0460-0137.2 | 610137         |        | Belagsatz-Zubehör     |                  |
|                           | 2.2 HDi         | 115     |     | 02.07 | 01.13 |                |                |        |                       |                  |
|                           | 2.4             | 125     |     | 08.08 | 01.13 |                |                |        |                       |                  |
|                           | 2.2 HDi         | 115     |     | 02.07 | 01.13 | 24.0110-0330.1 | 410330         |        | 302 10,0 8,4 +B       |                  |
|                           | 2.4             | 125     |     | 08.08 | 01.13 |                |                |        |                       |                  |
|                           | 2.0 2WD         | 108     |     | 11.10 | 01.13 | 24.0110-0360.1 | 410360         |        | 302 10,0 8,4 +B       |                  |
|                           | 2.0 4WD         | 108     |     | 11.10 | 01.13 |                |                |        |                       |                  |
|                           | 2.2 HDi         | 115     |     | 02.07 | 01.13 | 03.0137-3015.2 | 653015         |        | 190 x 32              |                  |
|                           | 2.4             | 125     |     | 08.08 | 01.13 | 03.0137-9307.2 | 669307         |        | Bremsbacken-Zubehör   |                  |
|                           | 2.0 2WD         | 108     |     | 11.10 | 01.13 | 03.0137-3023.2 | 653023         |        | 170 x 32              |                  |
|                           | 2.0 4WD         | 108     |     | 11.10 | 01.13 | 03.0137-9307.2 | 669307         |        | Bremsbacken-Zubehör   |                  |
| CITROEN C-Zero (10-)      |                 |         |     |       |       |                |                |        |                       |                  |
|                           | C-Zero          | 35      |     | 10.10 |       | 13.0460-5621.2 | 605621         |        | 24423 14,6 /Zub       |                  |
|                           | C-Zero          | 47      |     | 10.10 |       |                |                |        |                       |                  |
|                           | C-Zero          | 49      |     | 10.14 |       |                |                |        |                       |                  |
|                           | C-Zero          | 35      |     | 10.10 |       | 24.0117-0110.1 | 417110         |        | 257 17,0 15,0 +B      |                  |
|                           | C-Zero          | 47      |     | 10.10 |       |                |                |        |                       |                  |
|                           | C-Zero          | 49      |     | 10.14 |       |                |                |        |                       |                  |
| CITROEN DS3 (09-)         |                 |         |     |       |       |                |                |        |                       |                  |
|                           | 1.2 THP 130     | 96      |     | 09.15 |       | 13.0460-3994.2 | 603994         |        | 23599 19,0 /Zub/S     | BOS              |
|                           | 1.2 VTi 110     | 81      |     | 10.14 |       | 13.0470-3994.2 | LD3994         |        | 23599 19,0 /Zub/S     | BOS              |
|                           | 1.2 VTi 82      | 60      |     | 10.12 |       |                |                |        |                       |                  |
|                           | 1.4 HDi 70      | 50      |     | 04.10 |       |                |                |        |                       |                  |
|                           | 1.4 VTi 95      | 70      |     | 04.10 |       |                |                |        |                       |                  |
|                           | 1.6 BlueHDi 100 | 73      |     | 07.14 |       |                |                |        |                       |                  |
|                           | 1.6 BlueHDi 75  | 55      |     | 03.15 |       |                |                |        |                       |                  |
|                           | 1.6 HDi 110     | 82      |     | 11.09 |       |                |                |        |                       |                  |
|                           |                 |         |     |       |       |                |                |        |                       |                  |
|                           |                 |         |     |       |       |                |                |        |                       |                  |
|                           |                 |         |     |       |       |                |                |        |                       |                  |
|                           |                 |         |     |       |       |                |                |        |                       |                  |
|                           |                 |         |     |       |       |                |                |        |                       |                  |
|                           |                 |         |     |       |       |                |                |        |                       |                  |
|                           |                 |         |     |       |       |                |                |        |                       |                  |
|                           |                 |         |     |       |       |                |                |        |                       |                  |

1) + brake disc diameter 266 mm / + disco fr.diam. 266mm / + disques fr.diam. 266mm / + disco fr.diam. 266mm





**CITROEN DS3 (09-)**

|                 |                 |             |              |   |   |                       |                       |        |                                 |                  |
|-----------------|-----------------|-------------|--------------|---|---|-----------------------|-----------------------|--------|---------------------------------|------------------|
|                 | 1.6 HDi 90      | 68          |              | <b>11.09</b>                                | + Bremsscheibendurchm. 266 mm <sup>1)</sup> | <b>13.0460-3994.2</b> | 603994                |        | 23599 19,0 /Zub/S               | <b>BOS</b>       |
|                 | 1.6 THP 163     | 121         |              | <b>10.14</b>                                |   | <b>13.0470-3994.2</b> | LD3994                |        | 23599 19,0 /Zub/S               |                  |
|                 | 1.6 THP 208     | 153         |              | <b>09.15</b>                                | + Bremsscheibendurchm. 266 mm <sup>1)</sup> |                       |                       |        |                                 |                  |
|                 | 1.2 THP 130     | 96          |              | <b>09.15</b>                                | + Bremsscheibendurchm. 283 mm <sup>2)</sup> | <b>13.0460-3855.2</b> | 603855                |        | 24883 18,0 +/Zub/S              | <b>BOS</b>       |
|                 | 1.2 VTi 110     | 81          |              | <b>10.14</b>                                | + Bremsscheibendurchm. 283 mm <sup>2)</sup> |                       |                       |        |                                 |                  |
|                 | 1.6 BlueHDi 100 | 73          |              | <b>07.14</b>                                | + Bremsscheibendurchm. 283 mm <sup>2)</sup> |                       |                       |        |                                 |                  |
|                 | 1.6 BlueHDi 120 | 88          |              | <b>10.13</b>                                |   |                       |                       |        |                                 |                  |
|                 | 1.6 BlueHDi 75  | 55          |              | <b>03.15</b>                                | + Bremsscheibendurchm. 283 mm <sup>2)</sup> |                       |                       |        |                                 |                  |
|                 | 1.6 HDi 110     | 82          |              | <b>11.09</b>                                | + Bremsscheibendurchm. 283 mm <sup>2)</sup> |                       |                       |        |                                 |                  |
|                 | 1.6 HDi 115     | 84          |              | <b>08.12</b>                                |   |                       |                       |        |                                 |                  |
|                 | 1.6 HDi 115     | 85          |              | <b>10.13</b>                                |   |                       |                       |        |                                 |                  |
|                 | 1.6 THP 150     | 115         |              | <b>04.10</b>                                |   |                       |                       |        |                                 |                  |
| 1.6 THP 163     | 121             |             | <b>10.14</b> | + Bremsscheibendurchm. 283 mm <sup>2)</sup> |   |                       |                       |        |                                 |                  |
| 1.6 THP 208     | 153             |             | <b>09.15</b> | + Bremsscheibendurchm. 283 mm <sup>2)</sup> |   |                       |                       |        |                                 |                  |
| 1.6 VTi 120     | 88              |             | <b>04.10</b> |   |   |                       |                       |        |                                 |                  |
|                 | 1.2 THP 130     | 96          |              | <b>09.15</b>                                |   | <b>24.0122-0194.1</b> | 422194                |        | 266 22,0 20,0 V +S +B           |                  |
|                 | 1.2 VTi 110     | 81          |              | <b>10.14</b>                                |   |                       |                       |        |                                 |                  |
|                 | 1.2 VTi 82      | 60          |              | <b>10.12</b>                                |   |                       |                       |        |                                 |                  |
|                 | 1.4 HDi 70      | 50          |              | <b>04.10</b>                                |   |                       |                       |        |                                 |                  |
|                 | 1.4 VTi 95      | 70          |              | <b>04.10</b>                                |   |                       |                       |        |                                 |                  |
|                 | 1.6 BlueHDi 100 | 73          |              | <b>07.14</b>                                |   |                       |                       |        |                                 |                  |
|                 | 1.6 BlueHDi 75  | 55          |              | <b>03.15</b>                                |   |                       |                       |        |                                 |                  |
|                 | 1.6 HDi 110     | 82          |              | <b>11.09</b>                                |   |                       |                       |        |                                 |                  |
|                 | 1.6 HDi 90      | 68          |              | <b>11.09</b>                                |   |                       |                       |        |                                 |                  |
|                 | 1.6 THP 163     | 121         |              | <b>10.14</b>                                |   |                       |                       |        |                                 |                  |
|                 | 1.6 THP 208     | 153         |              | <b>09.15</b>                                |   |                       |                       |        |                                 |                  |
|                 | 1.2 THP 130     | 96          |              | <b>09.15</b>                                |   | <b>24.0126-0120.1</b> | 426120                |        | 283 26,0 24,0 V +S +B           |                  |
|                 | 1.2 VTi 110     | 81          |              | <b>10.14</b>                                |   | <b>24.0326-0120.1</b> | 526120                |        | <b>283 26,0 24,0 V +S +B PD</b> |                  |
|                 | 1.6 BlueHDi 100 | 73          |              | <b>07.14</b>                                |   |                       |                       |        |                                 |                  |
|                 | 1.6 BlueHDi 120 | 88          |              | <b>10.13</b>                                |   |                       |                       |        |                                 |                  |
|                 | 1.6 BlueHDi 75  | 55          |              | <b>03.15</b>                                |   |                       |                       |        |                                 |                  |
|                 | 1.6 HDi 110     | 82          |              | <b>11.09</b>                                |   |                       |                       |        |                                 |                  |
|                 | 1.6 HDi 115     | 84          |              | <b>08.12</b>                                |   |                       |                       |        |                                 |                  |
|                 | 1.6 HDi 115     | 85          |              | <b>10.13</b>                                |   |                       |                       |        |                                 |                  |
|                 | 1.6 THP 150     | 115         |              | <b>04.10</b>                                |   |                       |                       |        |                                 |                  |
|                 | 1.6 THP 163     | 121         |              | <b>10.14</b>                                |   |                       |                       |        |                                 |                  |
|                 | 1.6 THP 208     | 153         |              | <b>09.15</b>                                |   |                       |                       |        |                                 |                  |
|                 | 1.6 VTi 120     | 88          |              | <b>04.10</b>                                |   |                       |                       |        |                                 |                  |
|                 |                 | 1.2 THP 130 | 96           |   | <b>09.15</b>                                |                       | <b>24.0711-5256.3</b> | 360320 | 2                               | Radsensor L=1029 |
| 1.2 VTi 110     |                 | 81          |              | <b>10.14</b>                                |   |                       |                       |        |                                 |                  |
| 1.2 VTi 82      |                 | 60          |              | <b>10.12</b>                                |   |                       |                       |        |                                 |                  |
| 1.4 HDi 70      |                 | 50          |              | <b>04.10</b>                                |   |                       |                       |        |                                 |                  |
| 1.4 VTi 95      |                 | 70          |              | <b>04.10</b>                                |   |                       |                       |        |                                 |                  |
| 1.6 BlueHDi 100 |                 | 73          |              | <b>07.14</b>                                |   |                       |                       |        |                                 |                  |
| 1.6 BlueHDi 120 |                 | 88          |              | <b>10.13</b>                                |   |                       |                       |        |                                 |                  |
| 1.6 BlueHDi 75  |                 | 55          |              | <b>03.15</b>                                |   |                       |                       |        |                                 |                  |
| 1.6 HDi 110     |                 | 82          |              | <b>11.09</b>                                |   |                       |                       |        |                                 |                  |
| 1.6 HDi 115     |                 | 84          |              | <b>08.12</b>                                |   |                       |                       |        |                                 |                  |
| 1.6 HDi 115     |                 | 85          |              | <b>10.13</b>                                |   |                       |                       |        |                                 |                  |
| 1.6 HDi 90      |                 | 68          |              | <b>11.09</b>                                |   |                       |                       |        |                                 |                  |
| 1.6 Racing      |                 |             |              | <b>02.11</b>                                |   |                       |                       |        |                                 |                  |
| 1.6 THP 150     |                 | 115         |              | <b>04.10</b>                                |   |                       |                       |        |                                 |                  |
| 1.6 THP 163     |                 | 121         |              | <b>10.14</b>                                |   |                       |                       |        |                                 |                  |
| 1.6 THP 208     |                 | 153         |              | <b>09.15</b>                                |   |                       |                       |        |                                 |                  |
| 1.6 VTi 120     |                 | 88          |              | <b>04.10</b>                                |   |                       |                       |        |                                 |                  |
|                 | 1.2 THP 130     | 96          |              | <b>09.15</b>                                |   | <b>13.0460-2740.2</b> | 602740                |        | 23554 17,2 /Zub/S               | <b>TRW</b>       |
|                 | 1.2 VTi 110     | 81          |              | <b>10.14</b>                                |   | <b>13.0470-2740.2</b> | LD2740                |        | 23554 17,2 /Zub/S               |                  |
|                 | 1.6 BlueHDi 100 | 73          |              | <b>07.14</b>                                |   |                       |                       |        |                                 |                  |
|                 | 1.6 BlueHDi 120 | 88          |              | <b>10.13</b>                                |   |                       |                       |        |                                 |                  |
|                 | 1.6 BlueHDi 75  | 55          |              | <b>03.15</b>                                |   |                       |                       |        |                                 |                  |
|                 | 1.6 HDi 110     | 82          |              | <b>11.09</b>                                |   |                       |                       |        |                                 |                  |
|                 | 1.6 HDi 115     | 84          |              | <b>08.12</b>                                |   |                       |                       |        |                                 |                  |
|                 | 1.6 HDi 115     | 85          |              | <b>10.13</b>                                |   |                       |                       |        |                                 |                  |
|                 | 1.6 Racing      |             |              | <b>02.11</b>                                |   |                       |                       |        |                                 |                  |
|                 | 1.6 THP 150     | 115         |              | <b>04.10</b>                                |   |                       |                       |        |                                 |                  |
|                 | 1.6 THP 163     | 121         |              | <b>10.14</b>                                |   |                       |                       |        |                                 |                  |
|                 | 1.6 THP 208     | 153         |              | <b>09.15</b>                                |   |                       |                       |        |                                 |                  |
| 1.6 VTi 120     | 88              |             | <b>04.10</b> |   |   |                       |                       |        |                                 |                  |
|                 | 1.2 THP 130     | 96          |              | <b>09.15</b>                                |   | <b>24.0109-0100.2</b> | 409100                |        | 249 9,0 7,0 +B                  |                  |
|                 | 1.2 VTi 110     | 81          |              | <b>10.14</b>                                |   |                       |                       |        |                                 |                  |
|                 | 1.6 BlueHDi 100 | 73          |              | <b>07.14</b>                                |   |                       |                       |        |                                 |                  |
|                 | 1.6 BlueHDi 120 | 88          |              | <b>10.13</b>                                |   |                       |                       |        |                                 |                  |
|                 | 1.6 BlueHDi 75  | 55          |              | <b>03.15</b>                                |   |                       |                       |        |                                 |                  |
|                 | 1.6 HDi 110     | 82          |              | <b>11.09</b>                                |   |                       |                       |        |                                 |                  |
|                 | 1.6 HDi 115     | 84          |              | <b>08.12</b>                                |   |                       |                       |        |                                 |                  |
|                 | 1.6 HDi 115     | 85          |              | <b>10.13</b>                                |   |                       |                       |        |                                 |                  |
|                 | 1.6 Racing      |             |              | <b>02.11</b>                                |   |                       |                       |        |                                 |                  |
|                 | 1.6 THP 150     | 115         |              | <b>04.10</b>                                |   |                       |                       |        |                                 |                  |
|                 | 1.6 THP 163     | 121         |              | <b>10.14</b>                                |   |                       |                       |        |                                 |                  |
|                 | 1.6 THP 208     | 153         |              | <b>09.15</b>                                |   |                       |                       |        |                                 |                  |
| 1.6 VTi 120     | 88              |             | <b>04.10</b> |   |   |                       |                       |        |                                 |                  |
|                 | 1.2 VTi 82      | 60          | ORGA 13341   | <b>10.12</b>                                |   | <b>24.0711-5257.3</b> | 360321                | 2      | Radsensor L=694                 |                  |
|                 | 1.4 HDi 70      | 50          | ORGA 13341   | <b>04.10</b>                                |   |                       |                       |        |                                 |                  |
|                 | 1.4 VTi 95      | 70          | ORGA 13341   | <b>04.10</b>                                |   |                       |                       |        |                                 |                  |
|                 | 1.6 HDi 110     | 82          | ORGA 13341   | <b>11.09</b>                                |   |                       |                       |        |                                 |                  |
|                 | 1.6 HDi 115     | 84          | ORGA 13341   | <b>08.12</b>                                |   |                       |                       |        |                                 |                  |

<sup>1)</sup> + brake disc diameter 266 mm / + disco fr.diam. 266mm / + disques fr.diam. 266mm / + disco fr.diám. 266mm

<sup>2)</sup> + brake disc diameter 283 mm / + disco fr.diam. 283mm / + disques fr.diam. 283mm / + disco fr.diám. 283mm





























| CITROEN DS3 (09-) |                 |     |  |            |       |  |                |        |   |                         |
|-------------------|-----------------|-----|--|------------|-------|--|----------------|--------|---|-------------------------|
|                   | 1.6 HDi 90      | 68  |  | ORGA 13341 | 11.09 |  | 24.0711-5257.3 | 360321 | 2 | Radsensor L=694         |
|                   | 1.6 Racing      |     |  | ORGA 13341 | 02.11 |  |                |        |   |                         |
|                   | 1.6 THP 150     | 115 |  | ORGA 13341 | 04.10 |  |                |        |   |                         |
|                   | 1.6 VTi 120     | 88  |  | ORGA 13341 | 04.10 |  |                |        |   |                         |
|                   | 1.2 THP 130     | 96  |  |            | 09.15 |  | 03.0137-0491.2 | 650491 |   | 228 x 42 HEB BOS        |
|                   | 1.2 VTi 110     | 81  |  |            | 10.14 |  | 03.0137-9228.2 | 669228 |   | Bremsbacken-Zubehör BDX |
|                   | 1.4 VTi 95      | 70  |  |            | 04.10 |  |                |        |   |                         |
|                   | 1.6 BlueHDi 75  | 55  |  |            | 03.15 |  |                |        |   |                         |
|                   | 1.2 THP 130     | 96  |  |            | 09.15 |  | 03.0137-0504.2 | 650504 |   | 203 x 39 HEB BOS        |
|                   | 1.2 VTi 110     | 81  |  |            | 10.14 |  | 03.0137-9281.2 | 669281 |   | Bremsbacken-Zubehör     |
|                   | 1.2 VTi 82      | 60  |  |            | 10.12 |  |                |        |   |                         |
|                   | 1.4 HDi 70      | 50  |  |            | 04.10 |  |                |        |   |                         |
|                   | 1.6 BlueHDi 100 | 73  |  |            | 07.14 |  |                |        |   |                         |
|                   | 1.6 BlueHDi 75  | 55  |  |            | 03.15 |  |                |        |   |                         |
|                   | 1.6 HDi 90      | 68  |  |            | 11.09 |  |                |        |   |                         |
|                   | 1.2 THP 130     | 96  |  |            | 09.15 |  | 03.0520-9420.3 | 699420 |   | 20,64/228x42 TopKit BOS |
|                   | 1.2 VTi 110     | 81  |  |            | 10.14 |  |                |        |   |                         |
|                   | 1.4 VTi 95      | 70  |  |            | 04.10 |  |                |        |   |                         |
|                   | 1.6 BlueHDi 75  | 55  |  |            | 03.15 |  |                |        |   |                         |
|                   | 1.2 THP 130     | 96  |  |            | 09.15 |  | 03.0520-9620.3 | 699620 |   | 20,64/203x39 TopKit BOS |
|                   | 1.2 VTi 110     | 81  |  |            | 10.14 |  |                |        |   |                         |
|                   | 1.2 VTi 82      | 60  |  |            | 10.12 |  |                |        |   |                         |
|                   | 1.4 HDi 70      | 50  |  |            | 04.10 |  |                |        |   |                         |
|                   | 1.6 BlueHDi 100 | 73  |  |            | 07.14 |  |                |        |   |                         |
|                   | 1.6 BlueHDi 75  | 55  |  |            | 03.15 |  |                |        |   |                         |
|                   | 1.6 HDi 90      | 68  |  |            | 11.09 |  |                |        |   |                         |

| CITROEN DS3 Cabrio (13-) |                 |     |  |  |       |   |                |        |   |                          |
|--------------------------|-----------------|-----|--|--|-------|---|----------------|--------|---|--------------------------|
|                          | 1.2 THP 130     | 96  |  |  | 09.15 | + Bremsscheibendurchm. 266 mm <sup>1)</sup> | 13.0460-3994.2 | 603994 |   | 23599 19,0 /Zub/S BOS    |
|                          | 1.2 VTi 110     | 81  |  |  | 10.14 | + Bremsscheibendurchm. 266 mm <sup>1)</sup> | 13.0470-3994.2 | LD3994 |   | 23599 19,0 /Zub/S BOS    |
|                          | 1.2 VTi 82      | 60  |  |  | 03.13 |   |                |        |   |                          |
|                          | 1.6 BlueHDi 100 | 73  |  |  | 07.14 | + Bremsscheibendurchm. 266 mm <sup>1)</sup> |                |        |   |                          |
|                          | 1.6 BlueHDi 115 | 85  |  |  | 10.13 | + Bremsscheibendurchm. 266 mm <sup>1)</sup> |                |        |   |                          |
|                          | 1.6 e-HDi 90    | 68  |  |  | 03.13 |   |                |        |   |                          |
|                          | 1.6 THP 163     | 121 |  |  | 10.14 | + Bremsscheibendurchm. 266 mm <sup>1)</sup> |                |        |   |                          |
|                          | 1.6 THP 208     | 153 |  |  | 09.15 | + Bremsscheibendurchm. 266 mm <sup>1)</sup> |                |        |   |                          |
|                          | 1.2 THP 130     | 96  |  |  | 09.15 | + Bremsscheibendurchm. 283 mm <sup>2)</sup> | 13.0460-3855.2 | 603855 |   | 24883 18,0 +/Zub/S BOS   |
|                          | 1.2 VTi 110     | 81  |  |  | 10.14 | + Bremsscheibendurchm. 283 mm <sup>2)</sup> |                |        |   |                          |
|                          | 1.6 BlueHDi 100 | 73  |  |  | 07.14 | + Bremsscheibendurchm. 283 mm <sup>2)</sup> |                |        |   |                          |
|                          | 1.6 BlueHDi 115 | 85  |  |  | 10.13 | + Bremsscheibendurchm. 283 mm <sup>2)</sup> |                |        |   |                          |
|                          | 1.6 BlueHDi 120 | 88  |  |  | 07.14 |   |                |        |   |                          |
|                          | 1.6 THP 155     | 115 |  |  | 03.13 |   |                |        |   |                          |
|                          | 1.6 THP 163     | 121 |  |  | 10.14 | + Bremsscheibendurchm. 283 mm <sup>2)</sup> |                |        |   |                          |
|                          | 1.6 THP 208     | 153 |  |  | 09.15 | + Bremsscheibendurchm. 283 mm <sup>2)</sup> |                |        |   |                          |
|                          | 1.6 VTi 120     | 88  |  |  | 03.13 |   |                |        |   |                          |
|                          | 1.2 THP 130     | 96  |  |  | 09.15 |   | 24.0122-0194.1 | 422194 |   | 266 22,0 20,0 V +S +B    |
|                          | 1.2 VTi 110     | 81  |  |  | 10.14 |   |                |        |   |                          |
|                          | 1.2 VTi 82      | 60  |  |  | 03.13 |   |                |        |   |                          |
|                          | 1.6 BlueHDi 100 | 73  |  |  | 07.14 |   |                |        |   |                          |
|                          | 1.6 BlueHDi 115 | 85  |  |  | 10.13 |   |                |        |   |                          |
|                          | 1.6 e-HDi 90    | 68  |  |  | 03.13 |   |                |        |   |                          |
|                          | 1.6 THP 163     | 121 |  |  | 10.14 |   |                |        |   |                          |
|                          | 1.6 THP 208     | 153 |  |  | 09.15 |   |                |        |   |                          |
|                          | 1.6 VTi 120     | 88  |  |  | 03.13 |   |                |        |   |                          |
|                          | 1.2 THP 130     | 96  |  |  | 09.15 |   | 24.0126-0120.1 | 426120 |   | 283 26,0 24,0 V +S +B    |
|                          | 1.2 VTi 110     | 81  |  |  | 10.14 |   | 24.0326-0120.1 | 526120 |   | 283 26,0 24,0 V +S +B PD |
|                          | 1.6 BlueHDi 100 | 73  |  |  | 07.14 |   |                |        |   |                          |
|                          | 1.6 BlueHDi 115 | 85  |  |  | 10.13 |   |                |        |   |                          |
|                          | 1.6 BlueHDi 120 | 88  |  |  | 07.14 |   |                |        |   |                          |
|                          | 1.6 THP 155     | 115 |  |  | 03.13 |   |                |        |   |                          |
|                          | 1.6 THP 163     | 121 |  |  | 10.14 |   |                |        |   |                          |
|                          | 1.6 THP 208     | 153 |  |  | 09.15 |   |                |        |   |                          |
|                          | 1.6 VTi 120     | 88  |  |  | 03.13 |   |                |        |   |                          |
|                          | 1.2 THP 130     | 96  |  |  | 09.15 |   | 24.0711-5256.3 | 360320 | 2 | Radsensor L=1029         |
|                          | 1.2 VTi 110     | 81  |  |  | 10.14 |   |                |        |   |                          |
|                          | 1.2 VTi 82      | 60  |  |  | 03.13 |   |                |        |   |                          |
|                          | 1.6 BlueHDi 100 | 73  |  |  | 07.14 |   |                |        |   |                          |
|                          | 1.6 BlueHDi 115 | 85  |  |  | 10.13 |   |                |        |   |                          |
|                          | 1.6 BlueHDi 120 | 88  |  |  | 07.14 |   |                |        |   |                          |
|                          | 1.6 e-HDi 90    | 68  |  |  | 03.13 |   |                |        |   |                          |
|                          | 1.6 Racing      | 152 |  |  | 03.14 |   |                |        |   |                          |
|                          | 1.6 THP 155     | 115 |  |  | 03.13 |   |                |        |   |                          |
|                          | 1.6 THP 163     | 121 |  |  | 10.14 |   |                |        |   |                          |
|                          | 1.6 THP 208     | 153 |  |  | 09.15 |   |                |        |   |                          |
|                          | 1.6 VTi 120     | 88  |  |  | 03.13 |   |                |        |   |                          |
|                          | 1.2 THP 130     | 96  |  |  | 09.15 |   | 13.0460-2740.2 | 602740 |   | 23554 17,2 /Zub/S TRW    |
|                          | 1.2 VTi 110     | 81  |  |  | 10.14 |   | 13.0470-2740.2 | LD2740 |   | 23554 17,2 /Zub/S TRW    |
|                          | 1.6 BlueHDi 100 | 73  |  |  | 07.14 |   |                |        |   |                          |
|                          | 1.6 BlueHDi 115 | 85  |  |  | 10.13 |   |                |        |   |                          |
|                          | 1.6 BlueHDi 120 | 88  |  |  | 07.14 |   |                |        |   |                          |
|                          | 1.6 Racing      | 152 |  |  | 03.14 |   |                |        |   |                          |
|                          | 1.6 THP 155     | 115 |  |  | 03.13 |   |                |        |   |                          |
|                          | 1.6 THP 163     | 121 |  |  | 10.14 |   |                |        |   |                          |
|                          | 1.6 THP 208     | 153 |  |  | 09.15 |   |                |        |   |                          |
|                          | 1.6 VTi 120     | 88  |  |  | 03.13 |   |                |        |   |                          |

<sup>1)</sup> + brake disc diameter 266 mm / + disco fr.diam. 266mm / + disques fr.diam. 266mm / + disco fr.díam. 266mm

<sup>2)</sup> + brake disc diameter 283 mm / + disco fr.diam. 283mm / + disques fr.diam. 283mm / + disco fr.díam. 283mm

|     |    |                      |  |    |  |  |  |                          |
|--|--|--|--|--|---|--|--|--|
| <b>CITROEN DS3 Cabrio (13-)</b>  |  |  |  |  |   |  |  |  |
|    | 1.2 THP 130<br>1.2 VTI 110<br>1.6 BlueHDi 100<br>1.6 BlueHDi 115<br>1.6 BlueHDi 120<br>1.6 Racing<br>1.6 THP 155<br>1.6 THP 163<br>1.6 THP 208<br>1.6 VTI 120  | 96<br>81<br>73<br>85<br>88<br>152<br>115<br>121<br>153<br>88   |  | 09.15<br>10.14<br>07.14<br>10.13<br>07.14<br>03.14<br>03.13<br>10.14<br>09.15<br>03.13   |   | 24.0109-0100.2   | 409100   | 249 9,0 7,0 +B   |
|    | 1.2 VTI 82<br>1.6 e-HDi 90<br>1.6 THP 155<br>1.6 VTI 120   | 60<br>68<br>115<br>88  | ORGA 13341<br>ORGA 13341<br>ORGA 13341<br>ORGA 13341                             | 03.13<br>03.13<br>03.13<br>03.13   |   | 24.0711-5257.3   | 360321   | 2 <br>Radsensor L=694   |
|    | 1.2 THP 130<br>1.2 VTI 82<br>1.6 BlueHDi 100<br>1.6 BlueHDi 115<br>1.6 e-HDi 90  | 96<br>60<br>73<br>85<br>68   |  | 09.15<br>03.13<br>07.14<br>10.13<br>03.13  |   | 03.0137-0504.2<br>03.0137-9281.2   | 650504<br>669281   | 203 x 39 HEB <b>BOS</b><br>Bremsbacken-Zubehör   |
|    | 1.2 THP 130<br>1.6 BlueHDi 115   | 96<br>85   |  | 09.15<br>10.13   |   | 03.0137-0491.2<br>03.0137-9228.2   | 650491<br>669228   | 228 x 42 HEB <b>BOS</b><br>Bremsbacken-Zubehör <b>BDX</b>  |
|    | 1.2 THP 130<br>1.2 VTI 82<br>1.6 BlueHDi 100<br>1.6 BlueHDi 115<br>1.6 e-HDi 90  | 96<br>60<br>73<br>85<br>68   |  | 09.15<br>03.13<br>07.14<br>10.13<br>03.13  |   | 03.0520-9620.3   | 699620   | 20,64/203x39 TopKit <b>BOS</b>   |
|    | 1.2 THP 130<br>1.6 BlueHDi 115   | 96<br>85   |  | 09.15<br>10.13   |   | 03.0520-9420.3   | 699420   | 20,64/228x42 TopKit <b>BOS</b>   |
| <b>CITROEN DS4 (11-)</b>   |  |  |  |  |   |  |  |  |
|    | 1.2<br>1.6 BlueHDi 115<br>1.6 BlueHDi 120<br>1.6 e-HDi 110<br>1.6 HDi 110<br>1.6 HDi 115<br>1.6 HDi 90<br>1.6 THP 155<br>1.6 VTI 120<br>2.0 HDi 165  | 96<br>85<br>88<br>81<br>82<br>84<br>68<br>115<br>88<br>120   |  | 07.14<br>08.14<br>07.14<br>04.11<br>04.11<br>08.12<br>05.11<br>04.11<br>04.11<br>04.11   |   | 13.0460-7229.2<br>13.0470-7229.2   | 607229<br>LD7229   | 24538 18,5 + <b>ATE</b><br>24538 18,5 + <b>ATE</b>   |
|  | 1.6 THP 200<br>1.6 THP 210   | 147<br>155   |  | 04.11<br>07.15   |   | 13.0460-7279.2   | 607279   | 25069 17,3 +/WK <b>ATE</b>   |
|  | 1.6 THP 163<br>2.0 BlueHDi 150<br>2.0 BlueHDi 150 Hybr.<br>2.0 BlueHDi 180<br>2.0 HDi 135  | 110<br>110<br>133<br>100   |  | 04.12<br>07.14<br>07.14<br>07.14<br>09.11  | - 19" Rad 1)<br>- 19" Rad 1)  | 13.0460-7230.2<br>13.0470-7230.2   | 607230<br>LD7230   | 24557 19,4 + <b>ATE</b><br>24557 19,4 + <b>ATE</b>   |
|  | 2.0 BlueHDi 180<br>2.0 HDi 135   | 133<br>100   |  | 07.14<br>09.11   | + 19" Rad 2)<br>+ 19" Rad 2)  | 13.0460-7279.2   | 607279   | 25069 17,3 +/WK <b>ATE</b>   |
|  | 1.2<br>1.6 BlueHDi 115<br>1.6 BlueHDi 120<br>1.6 e-HDi 110<br>1.6 HDi 110<br>1.6 HDi 115<br>1.6 HDi 90<br>1.6 THP 155<br>1.6 VTI 120<br>2.0 HDi 165  | 96<br>85<br>88<br>81<br>82<br>84<br>68<br>115<br>88<br>120   |  | 07.14<br>08.14<br>07.14<br>04.11<br>04.11<br>08.12<br>05.11<br>04.11<br>04.11<br>04.11   |   | 24.0126-0120.1<br>24.0326-0120.1   | 426120<br>526120   | 283 26,0 24,0 V +S +B<br>283 26,0 24,0 V +S +B PD  |
|  | 1.6 THP 200<br>1.6 THP 210<br>2.0 BlueHDi 180<br>2.0 HDi 135   | 147<br>155<br>133<br>100   |  | 04.11<br>07.15<br>07.14<br>09.11   | + 19" Rad 2)<br>+ 19" Rad 2)  | 24.0130-0230.1   | 430230   | 340 30,0 28,0 V L +S +B  |
|  | 1.6 THP 163<br>2.0 BlueHDi 150<br>2.0 BlueHDi 150 Hybr.<br>2.0 BlueHDi 180<br>2.0 HDi 135  | 110<br>110<br>133<br>100   |  | 04.12<br>07.14<br>07.14<br>07.14<br>09.11  | - 19" Rad 1)<br>- 19" Rad 1)  | 24.0126-0159.1   | 426159   | 302 26,0 24,0 V +S +B  |
|  | 1.2<br>1.6 BlueHDi 115<br>1.6 BlueHDi 120<br>1.6 e-HDi 110<br>1.6 HDi 110<br>1.6 HDi 115<br>1.6 HDi 90<br>1.6 THP 155<br>1.6 THP 163<br>1.6 THP 200<br>1.6 THP 210<br>1.6 VTI 120<br>2.0 BlueHDi 150<br>2.0 BlueHDi 150 Hybr.<br>2.0 BlueHDi 180<br>2.0 HDi 135<br>2.0 HDi 165 | 96<br>85<br>88<br>81<br>82<br>84<br>68<br>115<br>147<br>155<br>88<br>110<br>110<br>133<br>100<br>120 |  | 07.14<br>08.14<br>07.14<br>04.11<br>04.11<br>08.12<br>05.11<br>04.11<br>04.12<br>04.11<br>07.15<br>04.11<br>07.14<br>07.14<br>09.11<br>04.11 |   | 24.0711-5325.3   | 360350   | 2 <br>Radsensor L=680 |

1) - 19" wheel / - ruota 19" / - roue 19" / - rueda 19"  
2) + 19" wheel / + ruota 19" / + roue 19" / + rueda 19"



### CITROEN DS4 (11-)

|                       |                 |     |       |   |   |                |        |  |                     |     |
|-----------------------|-----------------|-----|-------|---|---|----------------|--------|--|---------------------|-----|
|                       | 1.6 e-HDi 110   | 81  |       | 04.11                                       | - elektrische Feststellbremse <sup>1)</sup> | 13.0460-2775.2 | 602775 |  | 23554 17,2 +/-Zub/S | TRW |
|                       | 1.6 HDi 110     | 82  |       | 04.11                                       | - elektrische Feststellbremse <sup>1)</sup> |                |        |  |                     |     |
|                       | 1.6 HDi 115     | 84  |       | 08.12                                       | - elektrische Feststellbremse <sup>1)</sup> |                |        |  |                     |     |
|                       | 1.6 HDi 90      | 68  |       | 05.11                                       | - elektrische Feststellbremse <sup>1)</sup> |                |        |  |                     |     |
|                       | 1.6 THP 155     | 115 |       | 04.11                                       | - elektrische Feststellbremse <sup>1)</sup> |                |        |  |                     |     |
|                       | 1.6 THP 163     |     |       | 04.12                                       | - elektrische Feststellbremse <sup>1)</sup> |                |        |  |                     |     |
|                       | 1.6 THP 200     | 147 |       | 04.11                                       | - elektrische Feststellbremse <sup>1)</sup> |                |        |  |                     |     |
|                       | 1.6 THP 210     | 155 |       | 07.15                                       | - elektrische Feststellbremse <sup>1)</sup> |                |        |  |                     |     |
|                       | 1.6 VTi 120     | 88  |       | 04.11                                       | - elektrische Feststellbremse <sup>1)</sup> |                |        |  |                     |     |
|                       | 2.0 BlueHDi 180 | 133 |       | 07.14                                       | - elektrische Feststellbremse <sup>1)</sup> |                |        |  |                     |     |
|                       | 2.0 HDi 135     | 100 |       | 09.11                                       | - elektrische Feststellbremse <sup>1)</sup> |                |        |  |                     |     |
|                       | 2.0 HDi 165     | 120 |       | 04.11                                       | - elektrische Feststellbremse <sup>1)</sup> |                |        |  |                     |     |
|                       | 1.2             | 96  |       | 07.14                                       |   |                |        |  |                     |     |
|                       | 1.6 BlueHDi 115 | 85  |       | 08.14                                       |   |                |        |  |                     |     |
|                       | 1.6 BlueHDi 120 | 88  |       | 07.14                                       |   |                |        |  |                     |     |
|                       | 1.6 e-HDi 110   | 81  |       | 04.11                                       | + elektrische Feststellbremse <sup>2)</sup> |                |        |  |                     |     |
|                       | 1.6 HDi 110     | 82  |       | 04.11                                       | + elektrische Feststellbremse <sup>2)</sup> |                |        |  |                     |     |
|                       | 1.6 HDi 115     | 84  |       | 08.12                                       | + elektrische Feststellbremse <sup>2)</sup> |                |        |  |                     |     |
| 1.6 HDi 90            | 68              |     | 05.11 | + elektrische Feststellbremse <sup>2)</sup> |   |                |        |  |                     |     |
| 1.6 THP 155           | 115             |     | 04.11 | + elektrische Feststellbremse <sup>2)</sup> |   |                |        |  |                     |     |
| 1.6 THP 163           |                 |     | 04.12 | + elektrische Feststellbremse <sup>2)</sup> |   |                |        |  |                     |     |
| 1.6 THP 200           | 147             |     | 04.11 | + elektrische Feststellbremse <sup>2)</sup> |   |                |        |  |                     |     |
| 1.6 THP 210           | 155             |     | 07.15 | + elektrische Feststellbremse <sup>2)</sup> |   |                |        |  |                     |     |
| 1.6 VTi 120           | 88              |     | 04.11 | + elektrische Feststellbremse <sup>2)</sup> |   |                |        |  |                     |     |
| 2.0 BlueHDi 150       | 110             |     | 07.14 |   |   |                |        |  |                     |     |
| 2.0 BlueHDi 150 Hybr. | 110             |     | 07.14 |   |   |                |        |  |                     |     |
| 2.0 BlueHDi 180       | 133             |     | 07.14 | + elektrische Feststellbremse <sup>2)</sup> |   |                |        |  |                     |     |
| 2.0 HDi 135           | 100             |     | 09.11 | + elektrische Feststellbremse <sup>2)</sup> |   |                |        |  |                     |     |
| 2.0 HDi 165           | 120             |     | 04.11 | + elektrische Feststellbremse <sup>2)</sup> |   |                |        |  |                     |     |
|                       | 1.6 e-HDi 110   | 81  |       | 04.11                                       | - elektrische Feststellbremse <sup>1)</sup> | 24.0109-0171.2 | 409171 |  | 249 9,0 8,0 +B      |     |
|                       | 1.6 HDi 110     | 82  |       | 04.11                                       | - elektrische Feststellbremse <sup>1)</sup> |                |        |  |                     |     |
|                       | 1.6 HDi 115     | 84  |       | 08.12                                       | - elektrische Feststellbremse <sup>1)</sup> |                |        |  |                     |     |
|                       | 1.6 HDi 90      | 68  |       | 05.11                                       | - elektrische Feststellbremse <sup>1)</sup> |                |        |  |                     |     |
|                       | 1.6 THP 163     |     |       | 04.12                                       | - elektrische Feststellbremse <sup>1)</sup> |                |        |  |                     |     |
|                       | 1.6 THP 200     | 147 |       | 04.11                                       | - elektrische Feststellbremse <sup>1)</sup> |                |        |  |                     |     |
|                       | 1.6 THP 210     | 155 |       | 07.15                                       | - elektrische Feststellbremse <sup>1)</sup> |                |        |  |                     |     |
|                       | 1.6 VTi 120     | 88  |       | 04.11                                       | - elektrische Feststellbremse <sup>1)</sup> |                |        |  |                     |     |
|                       | 2.0 BlueHDi 180 | 133 |       | 07.14                                       | - elektrische Feststellbremse <sup>1)</sup> |                |        |  |                     |     |
|                       | 2.0 HDi 135     | 100 |       | 09.11                                       | - elektrische Feststellbremse <sup>1)</sup> |                |        |  |                     |     |
|                       | 1.2             | 96  |       | 07.14                                       |   |                |        |  |                     |     |
|                       | 1.6 BlueHDi 115 | 85  |       | 08.14                                       |   |                |        |  |                     |     |
|                       | 1.6 BlueHDi 120 | 88  |       | 07.14                                       |   |                |        |  |                     |     |
|                       | 1.6 e-HDi 110   | 81  |       | 04.11                                       | + elektrische Feststellbremse <sup>2)</sup> |                |        |  |                     |     |
|                       | 1.6 HDi 110     | 82  |       | 04.11                                       | + elektrische Feststellbremse <sup>2)</sup> |                |        |  |                     |     |
|                       | 1.6 HDi 115     | 84  |       | 08.12                                       | + elektrische Feststellbremse <sup>2)</sup> |                |        |  |                     |     |
|                       | 1.6 HDi 90      | 68  |       | 05.11                                       | + elektrische Feststellbremse <sup>2)</sup> |                |        |  |                     |     |
|                       | 1.6 THP 155     | 115 |       | 04.11                                       | + elektrische Feststellbremse <sup>2)</sup> |                |        |  |                     |     |
| 1.6 THP 163           |                 |     | 04.12 | + elektrische Feststellbremse <sup>2)</sup> |   |                |        |  |                     |     |
| 1.6 THP 200           | 147             |     | 04.11 | + elektrische Feststellbremse <sup>2)</sup> |   |                |        |  |                     |     |
| 1.6 THP 210           | 155             |     | 07.15 | + elektrische Feststellbremse <sup>2)</sup> |   |                |        |  |                     |     |
| 1.6 VTi 120           | 88              |     | 04.11 | + elektrische Feststellbremse <sup>2)</sup> |   |                |        |  |                     |     |
| 2.0 BlueHDi 150       | 110             |     | 07.14 |   |   |                |        |  |                     |     |
| 2.0 BlueHDi 150 Hybr. | 110             |     | 07.14 |   |   |                |        |  |                     |     |
| 2.0 BlueHDi 180       | 133             |     | 07.14 |   |   |                |        |  |                     |     |
| 2.0 HDi 135           | 100             |     | 09.11 | + elektrische Feststellbremse <sup>2)</sup> |   |                |        |  |                     |     |
| 2.0 HDi 165           | 120             |     | 04.11 | + elektrische Feststellbremse <sup>2)</sup> |   |                |        |  |                     |     |

### CITROEN DS5 (11-)

|             |                      |            |            |       |                |                |                          |                          |                  |     |
|-------------|----------------------|------------|------------|-------|----------------|----------------|--------------------------|--------------------------|------------------|-----|
|             | 1.6 HDi 110          | 82         | ORGA 13342 | 11.11 |                | 13.0460-7230.2 | 607230                   | Naben D=82 <sup>5)</sup> | 24557 19,4 +     | ATE |
|             | 1.6 HDi 115          | 84         | ORGA 13342 | 08.12 |                |                |                          |                          |                  |     |
|             | 1.6 THP 155          | 115        |            | 11.11 |                |                |                          |                          |                  |     |
|             | 1.6 THP 165          | 121        |            | 01.12 |                |                |                          |                          |                  |     |
|             | 1.6 THP 200          | 147        |            | 11.11 |                |                |                          |                          |                  |     |
|             | 1.6 THP 210          | 155        |            | 11.14 |                |                |                          |                          |                  |     |
|             | 2.0 HDi 135          | 100        |            | 11.11 |                |                |                          |                          |                  |     |
|             | 2.0 HDi 135 Hybrid4  | 100        |            | 12.11 |                |                |                          |                          |                  |     |
|             | 2.0 HDi 150          | 110        |            | 07.14 |                |                |                          |                          |                  |     |
|             | 2.0 HDi 165          | 120        |            | 11.11 |                |                |                          |                          |                  |     |
|             | 2.0 HDi 165 Hybr.4x4 | 120        |            | 12.11 |                |                |                          |                          |                  |     |
|             | 2.0 HDi 180          | 133        |            | 08.13 |                |                |                          |                          |                  |     |
|             | 2.0 HDi Hybrid4      | 147        |            | 11.11 |                |                |                          |                          |                  |     |
|             | 1.6 HDi 110          | 82         | ORGA 13343 |       |                |                |                          |                          |                  |     |
| 1.6 HDi 115 | 84                   | ORGA 13343 |            |       | 13.0470-7229.2 | LD7229         | Naben D=82 <sup>5)</sup> | 24538 18,5 +             | ATE              |     |
| 1.6 HDi 120 |                      |            | 11.13      |       |                |                |                          |                          |                  |     |
|             | 1.6 HDi 110          | 82         |            | 11.11 |                | 13.0460-7279.2 | 607279                   | Naben D=83 <sup>6)</sup> | 25069 17,3 +/-WK | ATE |
|             | 1.6 HDi 115          | 84         |            | 08.12 |                |                |                          |                          |                  |     |
|             | 1.6 THP 155          | 115        |            | 11.11 |                |                |                          |                          |                  |     |
|             | 1.6 THP 165          | 121        |            | 01.12 |                |                |                          |                          |                  |     |
|             | 1.6 THP 200          | 147        |            | 11.11 |                |                |                          |                          |                  |     |
|             | 1.6 THP 210          | 155        |            | 11.14 |                |                |                          |                          |                  |     |
|             | 2.0 HDi 135          | 100        |            | 11.11 |                |                |                          |                          |                  |     |
|             | 2.0 HDi 135 Hybrid4  | 100        |            | 12.11 |                |                |                          |                          |                  |     |
|             | 2.0 HDi 150          | 110        |            | 07.14 |                |                |                          |                          |                  |     |
|             | 2.0 HDi 165          | 120        |            | 11.11 |                |                |                          |                          |                  |     |
|             | 2.0 HDi 165 Hybr.4x4 | 120        |            | 12.11 |                |                |                          |                          |                  |     |
|             | 2.0 HDi 180          | 133        |            | 08.13 |                |                |                          |                          |                  |     |
|             | 2.0 HDi Hybrid4      | 147        |            | 11.11 |                |                |                          |                          |                  |     |

<sup>1)</sup> - electric parking brake / - freno a mano elettrico / - frein à main électrique / - freno de mano eléctrico  
<sup>2)</sup> + electric parking brake / + freno a mano elettrico / + frein à main électrique / + freno de mano eléctrico  
<sup>3)</sup> - 19" wheel / - ruota 19" / - roue 19" / - rueda 19"  
<sup>4)</sup> + 19" wheel / + ruota 19" / + roue 19" / + rueda 19"  
<sup>5)</sup> hub diameter=82 / diametro mozzo=82 / diamètre du moyeu=82 / diametro del buje=82  
<sup>6)</sup> hub diameter=83 / diametro mozzo=83 / diamètre du moyeu=83 / diametro del buje=83



### CITROEN DS5 (11-)

|                      |                      |             |            |       |                |        |                          |                         |
|----------------------|----------------------|-------------|------------|-------|----------------|--------|--------------------------|-------------------------|
|                      | 1.6 HDi 110          | 82          | ORGA 13342 | 11.11 | 24.0126-0159.1 | 426159 | Naben D=82 <sup>1)</sup> | 302 26,0 24,0 V +S +B   |
|                      | 1.6 HDi 115          | 84          |            | 08.12 |                |        |                          |                         |
|                      | 1.6 THP 155          | 115         |            | 11.11 |                |        |                          |                         |
|                      | 1.6 THP 165          | 121         |            | 01.12 |                |        |                          |                         |
|                      | 1.6 THP 200          | 147         |            | 11.11 |                |        |                          |                         |
|                      | 2.0 HDi 135          | 100         |            | 11.11 |                |        |                          |                         |
|                      | 2.0 HDi 135 Hybrid4  | 100         |            | 12.11 |                |        |                          |                         |
|                      | 2.0 HDi 150          | 110         |            | 07.14 |                |        |                          |                         |
|                      | 2.0 HDi 165          | 120         |            | 11.11 |                |        |                          |                         |
|                      | 2.0 HDi 165 Hybr.4x4 | 120         |            | 12.11 |                |        |                          |                         |
| 2.0 HDi 180          | 133                  | 08.13       |            |       |                |        |                          |                         |
| 2.0 HDi Hybrid4      | 147                  | 11.11       |            |       |                |        |                          |                         |
|                      | 1.6 HDi 110          | 82          | ORGA 13343 | 11.11 | 24.0126-0120.1 | 426120 |                          | 283 26,0 24,0 V +S +B   |
|                      | 1.6 HDi 115          | 84          |            | 08.12 |                |        |                          |                         |
|                      | 1.6 HDi 120          |             |            | 11.13 |                |        |                          |                         |
|                      | 1.6 THP 210          | 155         |            | 11.14 |                |        |                          |                         |
|                      | 1.6 HDi 110          | 82          |            | 11.11 | 24.0130-0230.1 | 430230 | Naben D=83 <sup>2)</sup> | 340 30,0 28,0 V L +S +B |
|                      | 1.6 HDi 115          | 84          |            | 08.12 |                |        |                          |                         |
|                      | 1.6 THP 155          | 115         |            | 11.11 |                |        |                          |                         |
|                      | 1.6 THP 165          | 121         |            | 01.12 |                |        |                          |                         |
|                      | 1.6 THP 200          | 147         |            | 11.11 |                |        |                          |                         |
|                      | 1.6 THP 210          | 155         |            | 11.14 |                |        |                          |                         |
|                      | 2.0 HDi 135          | 100         |            | 11.11 |                |        |                          |                         |
|                      | 2.0 HDi 135 Hybrid4  | 100         |            | 12.11 |                |        |                          |                         |
|                      | 2.0 HDi 150          | 110         |            | 07.14 |                |        |                          |                         |
|                      | 2.0 HDi 165          | 120         |            | 11.11 |                |        |                          |                         |
|                      | 2.0 HDi 165 Hybr.4x4 | 120         |            | 12.11 |                |        |                          |                         |
|                      | 2.0 HDi 180          | 133         |            | 08.13 |                |        |                          |                         |
|                      | 2.0 HDi Hybrid4      | 147         |            | 11.11 |                |        |                          |                         |
|                      |                      | 1.6 HDi 110 |            | 82    |                |        |                          |                         |
| 1.6 HDi 115          |                      | 84          | 08.12      |       |                |        |                          |                         |
| 1.6 HDi 120          |                      |             | 11.13      |       |                |        |                          |                         |
| 1.6 THP 155          |                      | 115         | 11.11      |       |                |        |                          |                         |
| 1.6 THP 165          |                      | 121         | 01.12      |       |                |        |                          |                         |
| 1.6 THP 200          |                      | 147         | 11.11      |       |                |        |                          |                         |
| 1.6 THP 210          |                      | 155         | 11.14      |       |                |        |                          |                         |
| 2.0 HDi 135          |                      | 100         | 11.11      |       |                |        |                          |                         |
| 2.0 HDi 135 Hybrid4  |                      | 100         | 12.11      |       |                |        |                          |                         |
| 2.0 HDi 150          |                      | 110         | 07.14      |       |                |        |                          |                         |
| 2.0 HDi 165          |                      | 120         | 11.11      |       |                |        |                          |                         |
| 2.0 HDi 165 Hybr.4x4 |                      | 120         | 12.11      |       |                |        |                          |                         |
| 2.0 HDi 180          |                      | 133         | 08.13      |       |                |        |                          |                         |
| 2.0 HDi Hybrid4      |                      | 147         | 11.11      |       |                |        |                          |                         |
|                      | 1.6 HDi 110          | 82          |            | 11.11 | 13.0460-2761.2 | 602761 |                          | 24922 17,5 /Zub/S TRW   |
|                      | 1.6 HDi 115          | 84          |            | 08.12 |                |        |                          |                         |
|                      | 1.6 HDi 120          |             |            | 11.13 |                |        |                          |                         |
|                      | 1.6 THP 155          | 115         |            | 11.11 |                |        |                          |                         |
|                      | 1.6 THP 165          | 121         |            | 01.12 |                |        |                          |                         |
|                      | 1.6 THP 200          | 147         |            | 11.11 |                |        |                          |                         |
|                      | 1.6 THP 210          | 155         |            | 11.14 |                |        |                          |                         |
|                      | 2.0 HDi 135          | 100         |            | 11.11 |                |        |                          |                         |
|                      | 2.0 HDi 135 Hybrid4  | 100         |            | 12.11 |                |        |                          |                         |
|                      | 2.0 HDi 150          | 110         |            | 07.14 |                |        |                          |                         |
|                      | 2.0 HDi 165          | 120         |            | 11.11 |                |        |                          |                         |
|                      | 2.0 HDi 165 Hybr.4x4 | 120         |            | 12.11 |                |        |                          |                         |
|                      | 2.0 HDi 180          | 133         |            | 08.13 |                |        |                          |                         |
|                      | 2.0 HDi Hybrid4      | 147         |            | 11.11 |                |        |                          |                         |
|                      | 1.6 HDi 110          | 82          |            | 11.11 | 24.0112-0194.2 | 412194 |                          | 268 12,0 10,0 +B        |
|                      | 1.6 HDi 115          | 84          |            | 08.12 |                |        |                          |                         |
|                      | 1.6 HDi 120          |             |            | 11.13 |                |        |                          |                         |
|                      | 1.6 THP 155          | 115         |            | 11.11 |                |        |                          |                         |
|                      | 1.6 THP 165          | 121         |            | 01.12 |                |        |                          |                         |
|                      | 2.0 HDi 135          | 100         |            | 11.11 |                |        |                          |                         |
|                      | 2.0 HDi 150          | 110         |            | 07.14 |                |        |                          |                         |
|                      | 2.0 HDi 165          | 120         |            | 11.11 |                |        |                          |                         |
|                      | 2.0 HDi 180          | 133         |            | 08.13 |                |        |                          |                         |
|                      | 1.6 THP 200          | 147         |            | 11.11 |                |        |                          |                         |
| 1.6 THP 210          | 155                  | 11.14       |            |       |                |        |                          |                         |
| 2.0 HDi 135 Hybrid4  | 100                  | 12.11       |            |       |                |        |                          |                         |
| 2.0 HDi 165 Hybr.4x4 | 120                  | 12.11       |            |       |                |        |                          |                         |
| 2.0 HDi 180          | 133                  | 08.13       |            |       |                |        |                          |                         |
| 2.0 HDi Hybrid4      | 147                  | 11.11       |            |       |                |        |                          |                         |

### CITROEN EVASION (94-02)

|  |           |    |  |       |       |                |        |                        |
|--|-----------|----|--|-------|-------|----------------|--------|------------------------|
|  | 1.8       | 73 |  | 05.97 | 07.02 | 13.0460-3957.2 | 603957 | 23042 19,0 /WK/Zub BDX |
|  | 1.8       | 76 |  | 02.96 | 12.96 |                |        |                        |
|  | 1.9 i     |    |  | 10.95 | 12.98 | 13.0460-2978.2 | 602978 | 21801 19,0 +/WK/S TRW  |
|  | 1.9 TD    |    |  | 02.95 | 07.02 |                |        |                        |
|  | 2.0 16V   |    |  | 12.98 | 07.02 |                |        |                        |
|  | 2.0 HDi   |    |  | 08.99 | 07.02 |                |        |                        |
|  | 2.0 i     |    |  | 06.94 | 07.02 |                |        |                        |
|  | 2.0 Turbo |    |  | 06.94 | 07.02 |                |        |                        |
|  | 2.1 TD    |    |  | 05.96 | 07.02 |                |        |                        |
|  | 1.8       | 73 |  | 05.97 | 07.02 | 24.0120-0155.1 | 420155 | 258 20,0 18,2 V L +B   |
|  | 1.8       | 76 |  | 02.96 | 12.96 |                |        |                        |
|  | 1.9 i     |    |  | 10.95 | 12.98 | 24.0126-0104.1 | 426104 | 281 26,0 24,2 V +B     |
|  | 1.9 TD    |    |  | 02.95 | 07.02 |                |        |                        |

<sup>1)</sup> hub diameter=82 / diametro mozzo=82 / diamètre du moyeu=82 / diámetro del buje=82

<sup>2)</sup> hub diameter=83 / diametro mozzo=83 / diamètre du moyeu=83 / diámetro del buje=83





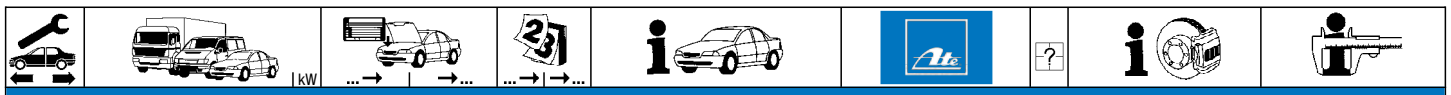











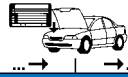



**CITROEN EVASION (94-02)**

|  |   |          |  |   |  |  |                                      |  |  |
|--|---|----------|--|---|--|--|--------------------------------------|--|--|
|  | 2.0 16V<br>2.0 HDi<br>2.0 i<br>2.0 Turbo<br>2.1 TD                                  |          |  | 12.98 07.02<br>08.99 07.02<br>06.94 07.02<br>06.94 07.02<br>05.96 07.02   |  | 24.0126-0104.1   | 426104                               |  | 281 26,0 24,2 V +B   |
|  | 1.8<br>1.8<br>1.9 i<br>1.9 TD<br>2.0 16V<br>2.0 HDi<br>2.0 i<br>2.0 Turbo<br>2.1 TD | 73<br>76 |  | 05.97 07.02 + ABS<br>02.96 12.96 + ABS<br>10.95 12.98 + ABS<br>02.95 07.02 + ABS<br>12.98 07.02<br>08.99 07.02 + ABS<br>06.94 07.02 + ABS<br>06.94 07.02<br>05.96 07.02 |  | 13.0460-7061.2   | 607061                               |  | 21275 17,0 +/WK ATE  |
|  | 1.8<br>1.8<br>1.9 i<br>1.9 TD<br>2.0 16V<br>2.0 HDi<br>2.0 i<br>2.0 Turbo<br>2.1 TD | 73<br>76 |  | 05.97 07.02 + ABS<br>02.96 12.96 + ABS<br>10.95 12.98 + ABS<br>02.95 07.02 + ABS<br>12.98 07.02<br>08.99 07.02 + ABS<br>06.94 07.02 + ABS<br>06.94 07.02<br>05.96 07.02 |  | 24.0110-0218.1   | 410218                               |  | 295 10,0 8,0 +B  |
|  | 1.8<br>1.8<br>1.9 i<br>1.9 TD<br>2.0 HDi<br>2.0 i                                   | 73<br>76 |  | 05.97 07.02 - ABS<br>02.96 12.96 - ABS<br>10.95 12.98 - ABS<br>02.95 07.02 - ABS<br>08.99 07.02 - ABS<br>06.94 07.02 - ABS  |  | 03.0137-0314.2<br>03.0137-9208.2                                     | 650314<br>669208                     |  | 255 x 61<br>Bremsbacken-Zubehör  |
|  | 1.8<br>1.8<br>1.9 i<br>1.9 TD<br>2.0 HDi<br>2.0 i                                   | 73<br>76 |  | 05.97 07.02 - ABS<br>02.96 12.96 - ABS<br>10.95 12.98 - ABS<br>02.95 07.02 - ABS<br>08.99 07.02 - ABS<br>06.94 07.02 - ABS  |  | 24.0225-5003.1   | 480066                               |  | 255/256 x 67   |
|  | 1.8<br>1.8<br>1.9 i<br>1.9 TD<br>2.0 HDi<br>2.0 i                                   | 73<br>76 |  | 05.97 07.02 - ABS<br>02.96 12.96 - ABS<br>10.95 12.98 - ABS<br>02.95 07.02 - ABS<br>08.99 07.02 - ABS<br>06.94 07.02 - ABS  |  | 03.0520-2619.3   | 692619                               |  | 19,05/255x61 TopKit BDX  |
|  | 1.8<br>1.8<br>1.9 TD<br>2.0 16V<br>2.0 HDi<br>2.0 i<br>2.0 Turbo<br>2.1 TD          | 73<br>76 |  | 05.97 07.02<br>02.96 12.96<br>02.95 07.02<br>12.98 07.02<br>08.99 07.02<br>06.94 07.02<br>06.94 07.02<br>05.96 07.02  |  | 03.0137-4018.2<br>03.0137-9249.2<br>03.0137-9700.2<br>03.0137-9702.2 | 654018<br>669249<br>669700<br>669702 |  | 180 x 30 /Zub<br>Bremsbacken-Zubehör<br>Bremsbacken-Zubehör<br>Spreizschloß Satz |

**CITROEN JUMPER Bus (94-02)**

|  |  |   |            |   |  |                |        |  |                         |
|--|--|---|------------|---|--|----------------|--------|--|-------------------------|
|  | 1.9 D (10)<br>1.9 TD (10/14)<br>1.9 TD (10/14)<br>2.0 i (10/14)<br>2.5 D (14)<br>2.5 TD (14)<br>2.5 TDi (14)<br>2.8 D (14)                 | 51<br>66<br>68<br>80<br>63<br>76<br>79<br>64            |            | 01.99 12.99<br>08.94 12.99<br>02.94 12.99<br>02.94 12.99<br>08.94 12.99<br>08.94 12.99<br>12.96 12.99<br>01.99                |  | 13.0460-2976.2 | 602976 |  | 21797 19,7 +/WK/S TRW   |
|  | 1.9 D (10)<br>1.9 TD (10/14)<br>1.9 TD (10/14)<br>2.0 i (10/14)<br>2.5 D (14)<br>2.5 TD (14)<br>2.5 TDi (14)<br>2.8 D (14)<br>2.8 HDi (14) | 51<br>66<br>68<br>80<br>63<br>76<br>79<br>64<br>94      | S 16206253 | 01.00 10.01<br>01.00 10.01<br>01.00 10.01<br>01.00 10.01<br>01.00 10.01<br>01.00 10.01<br>01.00 11.00<br>01.99<br>09.00 10.01 |  | 13.0460-2850.2 | 602850 |  | 23602 19,7 +/WK/S TRW   |
|  | 1.9 D (10)<br>1.9 TD (10/14)<br>1.9 TD (10/14)<br>2.0 i (10/14)<br>2.5 D (14)<br>2.5 TD (14)<br>2.8 D (14)<br>2.8 HDi (14)                 | 51<br>66<br>68<br>80<br>63<br>76<br>64 S 16204256<br>94 |            | 11.01 03.02<br>11.01 03.02<br>11.01 03.02<br>11.01 03.02<br>11.01 03.02<br>11.01 03.02<br>02.02<br>11.01 03.02                |  | 13.0460-4978.2 | 604978 |  | 23917 19,3 +/WK/Zub BRE |
|  | 2.0 i (18)<br>2.5 D (18)<br>2.5 TD (18)<br>2.5 TDi (18)<br>2.8 D (18)  | 80<br>63<br>76<br>79<br>64                              | S 16205352 | 02.94 12.99<br>08.94 12.99<br>08.94 12.99<br>12.96 12.99<br>01.99   |  | 13.0460-2977.2 | 602977 |  | 21799 19,7 +/WK/S TRW   |
|  | 2.0 i (18)<br>2.5 D (18)<br>2.5 TD (18)<br>2.5 TDi (18)<br>2.8 D (18)  | 80<br>63<br>76<br>79<br>64                              | S 16205352 | 01.00 10.01<br>01.00 10.01<br>01.00 10.01<br>01.00 11.00<br>01.99   |  | 13.0460-2852.2 | 602852 |  | 23603 19,7 +/WK/S TRW   |

|     |  |  |  |  |  |  |  |  |                      |                     |
|--|--|--|--|--|---|--|--|--|----------------------|---------------------|
| <b>CITROEN JUMPER Bus (94-02)</b>  |  |  |  |  |   |  |  |  |                      |                     |
|    | 2.8 HDi (18)   | 94   |  | 09.00  | 10.01   |  | 13.0460-2852.2   | 602852   | 23603 19,7 +/-WK/S   | TRW                 |
|  | 2.0 i (18)   | 80   |  | 11.01  | 03.02   |  | 13.0460-4979.2   | 604979   | 23919 19,3 +/-WK/Zub | BRE                 |
|  | 2.5 D (18)   | 63   |  | 11.01  | 03.02   |  |  |  |                      |                     |
|  | 2.5 TD (18)  | 76   |  | 11.01  | 03.02   |  |  |  |                      |                     |
|  | 2.8 D (18)   | 64   | S 16194400   |  | 02.02   |  |  |  |                      |                     |
|  | 2.8 HDi (18)   | 94   |  | 11.01  | 03.02   |  |  |  |                      |                     |
|    | 1.9 D (10)   | 51   |  | 01.99  | 10.01   |  | 24.0118-0108.1   | 418108   | 280 18,0 15,9 +B     |                     |
|  | 1.9 TD (10/14)   | 66   |  | 08.94  | 10.01   |  |  |  |                      |                     |
|  | 1.9 TD (10/14)   | 68   |  | 02.94  | 10.01   |  |  |  |                      |                     |
|  | 2.0 i (10/14)  | 80   |  | 02.94  | 10.01   |  |  |  |                      |                     |
|  | 2.5 D (14)   | 63   |  | 08.94  | 10.01   |  |  |  |                      |                     |
|  | 2.5 TD (14)  | 76   | S 16206253   |  | 01.99   |  |  |  |                      |                     |
|  | 2.8 D (14)   | 64   |  | 01.99  | 10.01   |  |  |  |                      |                     |
|  | 1.9 D (10)   | 51   |  | 11.01  | 03.02   |  | 24.0124-0127.1   | 424127   | 280 24,0 21,9 V +B   |                     |
|  | 1.9 TD (10/14)   | 66   |  | 11.01  | 03.02   |  |  |  |                      |                     |
|  | 1.9 TD (10/14)   | 68   |  | 11.01  | 03.02   |  |  |  |                      |                     |
|  | 2.0 i (10/14)  | 80   |  | 11.01  | 03.02   |  |  |  |                      |                     |
|  | 2.5 D (14)   | 63   |  | 11.01  | 03.02   |  |  |  |                      |                     |
|  | 2.5 TD (14)  | 76   |  | 08.94  | 03.02   |  |  |  |                      |                     |
|  | 2.5 TDi (14)   | 79   |  | 12.96  | 11.00   |  |  |  |                      |                     |
|  | 2.8 D (14)   | 64   |  | 01.99  | 02.02   |  |  |  |                      |                     |
|  | 2.8 HDi (14)   | 94   |  | 09.00  | 03.02   |  |  |  |                      |                     |
|  | 2.0 i (18)   | 80   |  | 02.94  | 03.02   |  | 24.0124-0138.1   | 424138   | 300 24,0 21,9 V +B   |                     |
|  | 2.5 D (18)   | 63   |  | 08.94  | 03.02   |  |  |  |                      |                     |
|  | 2.5 TD (18)  | 76   |  | 08.94  | 03.02   |  |  |  |                      |                     |
|  | 2.5 TDi (18)   | 79   |  | 12.96  | 11.00   |  |  |  |                      |                     |
|  | 2.8 D (18)   | 64   |  | 01.99  | 02.02   |  |  |  |                      |                     |
|  | 2.8 HDi (18)   | 94   |  | 09.00  | 03.02   |  |  |  |                      |                     |
|    | 1.9 D (10)   | 51   |  | 11.01  | 03.02   |  | 13.0460-4980.2   | 604980   | 23921 20,3 /Zub      | BRE                 |
|  | 1.9 TD (10/14)   | 66   |  | 11.01  | 03.02   |  |  |  |                      |                     |
|  | 1.9 TD (10/14)   | 68   |  | 11.01  | 03.02   |  |  |  |                      |                     |
|  | 2.0 i (10/14/18)   | 80   |  | 11.01  | 03.02   |  |  |  |                      |                     |
|  | 2.5 D (14/18)  | 63   |  | 11.01  | 03.02   |  |  |  |                      |                     |
|  | 2.5 TD (14/18)   | 76   |  | 11.01  | 03.02   |  |  |  |                      |                     |
|  | 2.8 D (14/18)  | 64   | S 16194400   |  | 02.02   |  |  |  |                      |                     |
|  | 2.8 HDi (14/18)  | 94   |  | 11.01  | 03.02   |  |  |  |                      |                     |
|    | 1.9 D (10)   | 51   |  | 11.01  | 03.02   |  | 24.0116-0124.1   | 416124   | 280 16,0 14,2 +B     |                     |
|  | 1.9 TD (10/14)   | 66   |  | 11.01  | 03.02   |  |  |  |                      |                     |
|  | 1.9 TD (10/14)   | 68   |  | 11.01  | 03.02   |  |  |  |                      |                     |
|  | 2.0 i (10/14)  | 80   |  | 11.01  | 03.02   |  |  |  |                      |                     |
|  | 2.5 D (14)   | 63   |  | 11.01  | 03.02   |  |  |  |                      |                     |
|  | 2.5 TD (14)  | 76   |  | 11.01  | 03.02   |  |  |  |                      |                     |
|  | 2.8 D (14)   | 64   | S 16194400   |  | 02.02   |  |  |  |                      |                     |
|  | 2.8 HDi (14)   | 94   |  | 11.01  | 03.02   |  |  |  |                      |                     |
|  | 2.0 i (18)   | 80   |  | 11.01  | 03.02   |  | 24.0116-0125.1   | 416125   | 280 16,0 14,2 +B     |                     |
|  | 2.5 D (18)   | 63   |  | 11.01  | 03.02   |  |  |  |                      |                     |
|  | 2.5 TD (18)  | 76   |  | 11.01  | 03.02   |  |  |  |                      |                     |
|  | 2.8 D (18)   | 64   | S 16194400   |  | 02.02   |  |  |  |                      |                     |
|  | 2.8 HDi (18)   | 94   |  | 11.01  | 03.02   |  |  |  |                      |                     |
|  | 1.9 D (10)   | 51   |  | 01.99  | 10.01   |  | 03.0137-0332.2   | 650333   | - Wohnmobil          | 254 x 57 HEB        |
|  | 1.9 TD (10/14)   | 66   |  | 08.94  | 10.01   |  | 03.0137-9219.2   | 669219   |                      | Bremsbacken-Zubehör |
|  | 1.9 TD (10/14)   | 68   |  | 02.94  | 10.01   |  |  |  |                      | TRW                 |
|  | 2.0 i (10/14)  | 80   |  | 02.94  | 10.01   |  |  |  |                      |                     |
|  | 2.5 D (14)   | 63   |  | 08.94  | 10.01   |  |  |  |                      |                     |
|  | 2.5 TD (14)  | 76   |  | 08.94  | 10.01   |  |  |  |                      |                     |
|  | 2.5 TDi (14)   | 79   |  | 12.96  | 11.00   |  |  |  |                      |                     |
|  | 2.8 D (14)   | 64   | S 16206253   | 01.99  |   |  |  |  |                      |                     |
|  | 2.8 HDi (14)   | 94   |  | 09.00  | 10.01   |  |  |  |                      |                     |
|  | 1.9 D (10)   | 51   |  | 11.01  | 03.02   |  | 03.0137-0432.2   | 650432   | - Quick Fit          | 254 x 57 HEB        |
|  | 1.9 TD (10/14)   | 66   |  | 11.01  | 03.02   |  | 03.0137-9285.2   | 669285   |                      | Bremsbacken-Zubehör |
|  | 1.9 TD (10/14)   | 68   |  | 11.01  | 03.02   |  |  |  |                      | AP                  |
|  | 2.0 i (10/14)  | 80   |  | 11.01  | 03.02   |  |  |  |                      |                     |
|  | 2.5 D (14)   | 63   |  | 11.01  | 03.02   |  |  |  |                      |                     |
|  | 2.5 TD (14)  | 76   |  | 11.01  | 03.02   |  |  |  |                      |                     |
|  | 2.8 D (14)   | 64   | S 16204256   |  | 02.02   |  |  |  |                      |                     |
|  | 2.8 HDi (14)   | 94   |  | 11.01  | 03.02   |  |  |  |                      |                     |
|  | 2.0 i (18)   | 80   |  | 02.94  | 10.01   |  | 03.0137-0334.2   | 650334   | - Wohnmobil          | 254 x 57 HEB        |
|  | 2.5 D (18)   | 63   |  | 08.94  | 10.01   |  | 03.0137-9219.2   | 669219   |                      | Bremsbacken-Zubehör |
|  | 2.5 TD (18)  | 76   |  | 08.94  | 10.01   |  |  |  |                      | TRW                 |
|  | 2.5 TDi (18)   | 79   |  | 12.96  | 11.00   |  |  |  |                      |                     |
|  | 2.8 D (18)   | 64   | S 16209999   | 01.99  |   |  |  |  |                      |                     |
|  | 2.8 HDi (18)   | 94   |  | 09.00  | 10.01   |  |  |  |                      |                     |
|  | 1.9 D (10)   | 51   |  | 01.99  | 03.02   |  | 24.0225-4002.1   | 480048   | 254/255,6 x 63,5     |                     |
|  | 1.9 TD (10/14)   | 66   |  | 08.94  | 03.02   |  |  |  |                      |                     |
|  | 1.9 TD (10/14)   | 68   |  | 02.94  | 03.02   |  |  |  |                      |                     |
|  | 2.0 i (10/14)  | 80   |  | 02.94  | 03.02   |  |  |  |                      |                     |
|  | 2.5 D (14)   | 63   |  | 08.94  | 03.02   |  |  |  |                      |                     |
|  | 2.5 TD (14)  | 76   |  | 08.94  | 03.02   |  |  |  |                      |                     |
|  | 2.5 TDi (14)   | 79   |  | 12.96  | 11.00   |  |  |  |                      |                     |
|  | 2.8 D (14)   | 64   |  | 01.99  | 02.02   |  |  |  |                      |                     |
|  | 2.8 HDi (14)   | 94   |  | 09.00  | 03.02   |  |  |  |                      |                     |
|  | 2.0 i (18)   | 80   |  | 02.94  | 10.01   |  | 24.0225-4005.1   | 480070   | 254/255,6 x 64,5     |                     |
|  | 2.5 D (18)   | 63   |  | 08.94  | 10.01   |  |  |  |                      |                     |
|  | 2.5 TD (18)  | 76   |  | 08.94  | 10.01   |  |  |  |                      |                     |
|  | 2.5 TDi (18)   | 79   |  | 12.96  | 11.00   |  |  |  |                      |                     |
|  | 2.8 D (18)   | 64   | S 16209999   | 01.99  |   |  |  |  |                      |                     |



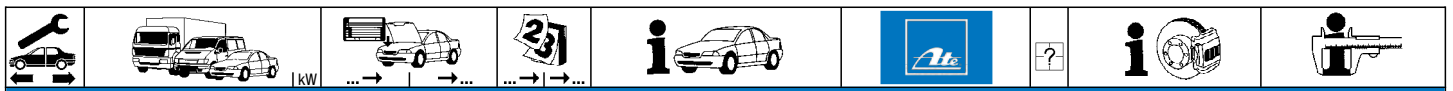

**CITROEN JUMPER Bus (94-02)**

|  |                |    |  |       |       |  |                |        |  |             |                         |
|--|----------------|----|--|-------|-------|--|----------------|--------|--|-------------|-------------------------|
|  | 2.8 HDi (18)   | 94 |  | 09.00 | 10.01 |  | 24.0225-4005.1 | 480070 |  |             | 254/255,6 x 64,5        |
|  | 1.9 D (10)     | 51 |  | 01.99 | 10.01 |  | 03.0520-0925.3 | 690925 |  | - Wohnmobil | 25,40/254x57 TopKit TRW |
|  | 1.9 TD (10/14) | 66 |  | 08.94 | 10.01 |  |                |        |  |             |                         |
|  | 1.9 TD (10/14) | 68 |  | 02.94 | 10.01 |  |                |        |  |             |                         |
|  | 2.0 i (10/14)  | 80 |  | 02.94 | 10.01 |  |                |        |  |             |                         |
|  | 2.5 D (14)     | 63 |  | 08.94 | 10.01 |  |                |        |  |             |                         |
|  | 2.5 TD (14)    | 76 |  | 08.94 | 10.01 |  | 03.0520-0226.3 | 690226 |  | - Wohnmobil | 26,99/254x57 TopKit TRW |
|  | 2.5 TDi (14)   | 79 |  | 12.96 | 11.00 |  |                |        |  |             |                         |
|  | 2.8 HDi (14)   | 94 |  | 09.00 | 10.01 |  |                |        |  |             |                         |
|  | 1.9 D (10)     | 51 |  | 11.01 | 03.02 |  | 03.0520-0326.3 | 690326 |  | + Quick Fit | 26,99/254x57 TopKit AP  |
|  | 1.9 TD (10/14) | 66 |  | 11.01 | 03.02 |  |                |        |  |             |                         |
|  | 1.9 TD (10/14) | 68 |  | 11.01 | 03.02 |  |                |        |  |             |                         |
|  | 2.0 i (10/14)  | 80 |  | 11.01 | 03.02 |  |                |        |  |             |                         |
|  | 2.5 D (14)     | 63 |  | 11.01 | 03.02 |  |                |        |  |             |                         |
|  | 2.5 TD (14)    | 76 |  | 11.01 | 03.02 |  |                |        |  |             |                         |
|  | 2.8 HDi (14)   | 94 |  | 11.01 | 03.02 |  |                |        |  |             |                         |
|  | 2.0 i (18)     | 80 |  | 02.94 | 10.01 |  | 03.0520-0728.3 | 690728 |  | - Wohnmobil | 28,57/254x57 TopKit TRW |
|  | 2.5 D (18)     | 63 |  | 08.94 | 10.01 |  |                |        |  |             |                         |
|  | 2.5 TD (18)    | 76 |  | 08.94 | 10.01 |  |                |        |  |             |                         |
|  | 2.5 TDi (18)   | 79 |  | 12.96 | 11.00 |  |                |        |  |             |                         |
|  | 2.8 HDi (18)   | 94 |  | 09.00 | 10.01 |  |                |        |  |             |                         |

**CITROEN JUMPER Kasten (94-02)**

|  |                 |    |            |       |       |  |                |        |  |  |                         |
|--|-----------------|----|------------|-------|-------|--|----------------|--------|--|--|-------------------------|
|  | 1.9 D (10)      | 50 |            | 07.99 | 12.99 |  | 13.0460-2976.2 | 602976 |  |  | 21797 19,7 +/WK/S TRW   |
|  | 1.9 D (10)      | 51 |            | 02.94 | 12.99 |  |                |        |  |  |                         |
|  | 1.9 TD (10/14)  | 66 |            | 03.94 | 12.99 |  |                |        |  |  |                         |
|  | 1.9 TD (10/14)  | 68 |            | 03.94 | 12.99 |  |                |        |  |  |                         |
|  | 2.0 i (10/14)   | 80 |            | 03.94 | 12.99 |  |                |        |  |  |                         |
|  | 2.5 D (14)      | 63 |            | 03.94 | 12.99 |  |                |        |  |  |                         |
|  | 2.5 TD (14)     | 76 |            | 03.94 | 12.99 |  |                |        |  |  |                         |
|  | 2.5 TDi (14)    | 79 |            | 12.96 | 12.99 |  |                |        |  |  |                         |
|  | 2.8 D (14)      | 64 | S 16206253 | 01.99 |       |  |                |        |  |  |                         |
|  | 1.9 D (10)      | 50 |            | 01.00 | 10.01 |  | 13.0460-2850.2 | 602850 |  |  | 23602 19,7 +/WK/S TRW   |
|  | 1.9 D (10)      | 51 |            | 01.00 | 10.01 |  |                |        |  |  |                         |
|  | 1.9 TD (10/14)  | 66 |            | 01.00 | 10.01 |  |                |        |  |  |                         |
|  | 1.9 TD (10/14)  | 68 |            | 01.00 | 10.01 |  |                |        |  |  |                         |
|  | 2.0 i (10/14)   | 80 |            | 01.00 | 10.01 |  |                |        |  |  |                         |
|  | 2.5 D (14)      | 63 |            | 01.00 | 10.01 |  |                |        |  |  |                         |
|  | 2.5 TD (14)     | 76 |            | 01.00 | 10.01 |  |                |        |  |  |                         |
|  | 2.5 TDi (14)    | 79 |            | 01.00 | 11.00 |  |                |        |  |  |                         |
|  | 2.8 HDi (14)    | 94 |            | 09.00 | 10.01 |  |                |        |  |  |                         |
|  | 1.9 D (10)      | 50 |            | 11.01 | 03.02 |  | 13.0460-4978.2 | 604978 |  |  | 23917 19,3 +/WK/Zub BRE |
|  | 1.9 D (10)      | 51 |            | 11.01 | 03.02 |  |                |        |  |  |                         |
|  | 1.9 TD (10/14)  | 66 |            | 11.01 | 03.02 |  |                |        |  |  |                         |
|  | 1.9 TD (10/14)  | 68 |            | 11.01 | 03.02 |  |                |        |  |  |                         |
|  | 2.0 HDi (10/14) | 62 |            | 11.01 | 03.02 |  |                |        |  |  |                         |
|  | 2.0 i (10/14)   | 80 |            | 11.01 | 03.02 |  |                |        |  |  |                         |
|  | 2.5 D (14)      | 63 |            | 11.01 | 03.02 |  |                |        |  |  |                         |
|  | 2.5 TD (14)     | 76 |            | 11.01 | 03.02 |  |                |        |  |  |                         |
|  | 2.8 D (14)      | 64 | S 16204256 |       | 02.02 |  |                |        |  |  |                         |
|  | 2.8 HDi (14)    | 94 |            | 11.01 | 03.02 |  |                |        |  |  |                         |
|  | 2.0 i (18)      | 80 |            | 03.94 | 12.99 |  | 13.0460-2977.2 | 602977 |  |  | 21799 19,7 +/WK/S TRW   |
|  | 2.5 D (18)      | 63 |            | 03.94 | 12.99 |  |                |        |  |  |                         |
|  | 2.5 TD (18)     | 76 |            | 03.94 | 12.99 |  |                |        |  |  |                         |
|  | 2.5 TDi (18)    | 79 |            | 12.96 | 12.99 |  |                |        |  |  |                         |
|  | 2.8 D (18)      | 64 | S 16205352 | 01.99 |       |  |                |        |  |  |                         |
|  | 2.0 i (18)      | 80 |            | 01.00 | 10.01 |  | 13.0460-2852.2 | 602852 |  |  | 23603 19,7 +/WK/S TRW   |
|  | 2.5 D (18)      | 63 |            | 01.00 | 10.01 |  |                |        |  |  |                         |
|  | 2.5 TD (18)     | 76 |            | 01.00 | 10.01 |  |                |        |  |  |                         |
|  | 2.5 TDi (18)    | 79 |            | 01.00 | 11.00 |  |                |        |  |  |                         |
|  | 2.8 HDi (18)    | 94 |            | 09.00 | 10.01 |  |                |        |  |  |                         |
|  | 2.0 HDi (18)    | 62 |            | 11.01 | 03.02 |  | 13.0460-4979.2 | 604979 |  |  | 23919 19,3 +/WK/Zub BRE |
|  | 2.0 i (18)      | 80 |            | 11.01 | 03.02 |  |                |        |  |  |                         |
|  | 2.5 D (18)      | 63 |            | 11.01 | 03.02 |  |                |        |  |  |                         |
|  | 2.5 TD (18)     | 76 |            | 11.01 | 03.02 |  |                |        |  |  |                         |
|  | 2.8 D (18)      | 64 | S 16194400 |       | 02.02 |  |                |        |  |  |                         |
|  | 2.8 HDi (18)    | 94 |            | 11.01 | 03.02 |  |                |        |  |  |                         |
|  | 1.9 D (10)      | 50 |            | 07.99 | 10.01 |  | 24.0118-0108.1 | 418108 |  |  | 280 18,0 15,9 +B        |
|  | 1.9 D (10)      | 51 |            | 02.94 | 10.01 |  |                |        |  |  |                         |
|  | 1.9 TD (10/14)  | 66 |            | 03.94 | 10.01 |  |                |        |  |  |                         |
|  | 1.9 TD (10/14)  | 68 |            | 03.94 | 10.01 |  |                |        |  |  |                         |
|  | 2.0 i (10/14)   | 80 |            | 03.94 | 10.01 |  |                |        |  |  |                         |
|  | 2.5 D (14)      | 63 |            | 03.94 | 10.01 |  |                |        |  |  |                         |
|  | 2.8 D (14)      | 64 | S 16206253 | 01.99 |       |  |                |        |  |  |                         |
|  | 1.9 D (10)      | 50 |            | 11.01 | 03.02 |  | 24.0124-0127.1 | 424127 |  |  | 280 24,0 21,9 V +B      |
|  | 1.9 D (10)      | 51 |            | 11.01 | 03.02 |  |                |        |  |  |                         |
|  | 1.9 TD (10/14)  | 66 |            | 11.01 | 03.02 |  |                |        |  |  |                         |
|  | 1.9 TD (10/14)  | 68 |            | 11.01 | 03.02 |  |                |        |  |  |                         |
|  | 2.0 HDi (10/14) | 62 |            | 11.01 | 03.02 |  |                |        |  |  |                         |
|  | 2.0 i (10/14)   | 80 |            | 11.01 | 03.02 |  |                |        |  |  |                         |
|  | 2.5 D (14)      | 63 |            | 11.01 | 03.02 |  |                |        |  |  |                         |
|  | 2.5 TD (14)     | 76 |            | 03.94 | 03.02 |  |                |        |  |  |                         |
|  | 2.5 TDi (14)    | 79 |            | 12.96 | 11.00 |  |                |        |  |  |                         |
|  | 2.8 D (14)      | 64 |            | 01.99 | 02.02 |  |                |        |  |  |                         |

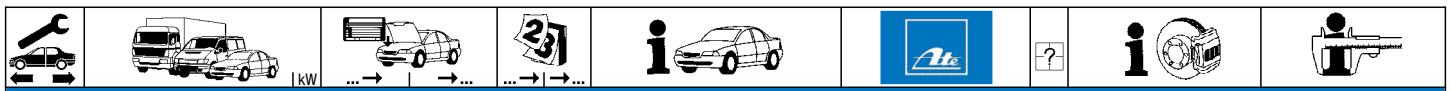

**CITROEN JUMPER Kasten (94-02)**

|  |                    |    |            |       |       |                |        |             |                                |
|--|--------------------|----|------------|-------|-------|----------------|--------|-------------|--------------------------------|
|  | 2.8 HDi (14)       | 94 |            | 09.00 | 03.02 | 24.0124-0127.1 | 424127 |             | 280 24,0 21,9 V +B             |
|  | 2.0 HDi (18)       | 62 |            | 11.01 | 03.02 | 24.0124-0138.1 | 424138 |             | 300 24,0 21,9 V +B             |
|  | 2.0 i (18)         | 80 |            | 11.01 | 03.02 |                |        |             |                                |
|  | 2.5 D (18)         | 63 |            | 11.01 | 03.02 |                |        |             |                                |
|  | 2.5 TD (18)        | 76 |            | 03.94 | 03.02 |                |        |             |                                |
|  | 2.5 TDi (18)       | 79 |            | 12.96 | 11.00 |                |        |             |                                |
|  | 2.8 D (18)         | 64 |            | 01.99 | 02.02 |                |        |             |                                |
|  | 2.8 HDi (18)       | 94 |            | 09.00 | 03.02 |                |        |             |                                |
|  | 1.9 D (10)         | 50 |            | 11.01 | 03.02 | 13.0460-4980.2 | 604980 |             | 23921 20,3 /Zub <b>BRE</b>     |
|  | 1.9 D (10)         | 51 |            | 11.01 | 03.02 |                |        |             |                                |
|  | 1.9 TD (10/14)     | 66 |            | 11.01 | 03.02 |                |        |             |                                |
|  | 1.9 TD (10/14)     | 68 |            | 11.01 | 03.02 |                |        |             |                                |
|  | 2.0 HDi (10/14/18) | 62 |            | 11.01 | 03.02 |                |        |             |                                |
|  | 2.0 i (10/14/18)   | 80 |            | 11.01 | 03.02 |                |        |             |                                |
|  | 2.5 D (14/18)      | 63 |            | 11.01 | 03.02 |                |        |             |                                |
|  | 2.5 TD (14/18)     | 76 |            | 11.01 | 03.02 |                |        |             |                                |
|  | 2.8 D (14/18)      | 64 | S 16194400 | 02.02 | 02.02 |                |        |             |                                |
|  | 2.8 HDi (14/18)    | 94 |            | 11.01 | 03.02 |                |        |             |                                |
|  | 1.9 D (10)         | 50 |            | 11.01 | 03.02 | 24.0116-0124.1 | 416124 |             | 280 16,0 14,2 +B               |
|  | 1.9 D (10)         | 51 |            | 11.01 | 03.02 |                |        |             |                                |
|  | 1.9 TD (10/14)     | 66 |            | 11.01 | 03.02 |                |        |             |                                |
|  | 1.9 TD (10/14)     | 68 |            | 11.01 | 03.02 |                |        |             |                                |
|  | 2.0 HDi (10/14)    | 62 |            | 11.01 | 03.02 |                |        |             |                                |
|  | 2.0 i (10/14)      | 80 |            | 11.01 | 03.02 |                |        |             |                                |
|  | 2.5 D (14)         | 63 |            | 11.01 | 03.02 |                |        |             |                                |
|  | 2.5 TD (14)        | 76 |            | 11.01 | 03.02 |                |        |             |                                |
|  | 2.8 D (14)         | 64 | S 16194400 | 02.02 | 02.02 |                |        |             |                                |
|  | 2.8 HDi (14)       | 94 |            | 11.01 | 03.02 |                |        |             |                                |
|  | 2.0 HDi (18)       | 62 |            | 11.01 | 03.02 | 24.0116-0125.1 | 416125 |             | 280 16,0 14,2 +B               |
|  | 2.0 i (18)         | 80 |            | 11.01 | 03.02 |                |        |             |                                |
|  | 2.5 D (18)         | 63 |            | 11.01 | 03.02 |                |        |             |                                |
|  | 2.5 TD (18)        | 76 |            | 11.01 | 03.02 |                |        |             |                                |
|  | 2.8 D (18)         | 64 | S 16194400 | 02.02 | 02.02 |                |        |             |                                |
|  | 2.8 HDi (18)       | 94 |            | 11.01 | 03.02 |                |        |             |                                |
|  | 1.9 D (10)         | 50 |            | 07.99 | 10.01 | 03.0137-0333.2 | 650333 | - Wohnmobil | 254 x 57 HEB <b>TRW</b>        |
|  | 1.9 D (10)         | 51 |            | 02.94 | 10.01 | 03.0137-9219.2 | 669219 |             | Bremsbacken-Zubehör <b>TRW</b> |
|  | 1.9 TD (10/14)     | 66 |            | 03.94 | 10.01 |                |        |             |                                |
|  | 1.9 TD (10/14)     | 68 |            | 03.94 | 10.01 |                |        |             |                                |
|  | 2.0 i (10/14)      | 80 |            | 03.94 | 10.01 |                |        |             |                                |
|  | 2.5 D (14)         | 63 |            | 03.94 | 10.01 |                |        |             |                                |
|  | 2.5 TD (14)        | 76 |            | 03.94 | 10.01 |                |        |             |                                |
|  | 2.5 TDi (14)       | 79 |            | 12.96 | 11.00 |                |        |             |                                |
|  | 2.8 D (14)         | 64 | S 16206253 | 01.99 | 01.99 |                |        |             |                                |
|  | 2.8 HDi (14)       | 94 |            | 09.00 | 10.01 |                |        |             |                                |
|  | 1.9 D (10)         | 50 |            | 11.01 | 03.02 | 03.0137-0432.2 | 650432 | - Quick Fit | 254 x 57 HEB <b>AP</b>         |
|  | 1.9 D (10)         | 51 |            | 11.01 | 03.02 | 03.0137-9285.2 | 669285 |             | Bremsbacken-Zubehör <b>AP</b>  |
|  | 1.9 TD (10/14)     | 66 |            | 11.01 | 03.02 |                |        |             |                                |
|  | 1.9 TD (10/14)     | 68 |            | 11.01 | 03.02 |                |        |             |                                |
|  | 2.0 HDi (10/14)    | 62 |            | 11.01 | 03.02 |                |        |             |                                |
|  | 2.0 i (10/14)      | 80 |            | 11.01 | 03.02 |                |        |             |                                |
|  | 2.5 D (14)         | 63 |            | 11.01 | 03.02 |                |        |             |                                |
|  | 2.5 TD (14)        | 76 |            | 11.01 | 03.02 |                |        |             |                                |
|  | 2.8 D (14)         | 64 | S 16204256 | 02.02 | 02.02 |                |        |             |                                |
|  | 2.8 HDi (14)       | 94 |            | 11.01 | 03.02 |                |        |             |                                |
|  | 2.0 i (18)         | 80 |            | 03.94 | 10.01 | 03.0137-0334.2 | 650334 | - Wohnmobil | 254 x 57 HEB <b>TRW</b>        |
|  | 2.5 D (18)         | 63 |            | 03.94 | 10.01 | 03.0137-9219.2 | 669219 |             | Bremsbacken-Zubehör <b>TRW</b> |
|  | 2.5 TD (18)        | 76 |            | 03.94 | 10.01 |                |        |             |                                |
|  | 2.5 TDi (18)       | 79 |            | 03.94 | 11.00 |                |        |             |                                |
|  | 2.8 D (18)         | 64 | S 16209999 | 01.99 | 01.99 |                |        |             |                                |
|  | 2.8 HDi (18)       | 94 |            | 09.00 | 10.01 |                |        |             |                                |
|  | 1.9 D (10)         | 50 |            | 07.99 | 03.02 | 24.0225-4002.1 | 480048 |             | 254/255,6 x 63,5               |
|  | 1.9 D (10)         | 51 |            | 02.94 | 03.02 |                |        |             |                                |
|  | 1.9 TD (10/14)     | 66 |            | 03.94 | 03.02 |                |        |             |                                |
|  | 1.9 TD (10/14)     | 68 |            | 03.94 | 03.02 |                |        |             |                                |
|  | 2.0 HDi (10/14)    | 62 |            | 11.01 | 03.02 |                |        |             |                                |
|  | 2.0 i (10/14)      | 80 |            | 03.94 | 03.02 |                |        |             |                                |
|  | 2.5 D (14)         | 63 |            | 03.94 | 03.02 |                |        |             |                                |
|  | 2.5 TD (14)        | 76 |            | 03.94 | 03.02 |                |        |             |                                |
|  | 2.5 TDi (14)       | 79 |            | 12.96 | 11.00 |                |        |             |                                |
|  | 2.8 D (14)         | 64 | S 16206253 | 01.99 | 01.99 |                |        |             |                                |
|  | 2.8 HDi (14)       | 94 |            | 09.00 | 03.02 |                |        |             |                                |
|  | 2.0 i (18)         | 80 |            | 03.94 | 10.01 | 24.0225-4005.1 | 480070 |             | 254/255,6 x 64,5               |
|  | 2.5 D (18)         | 63 |            | 03.94 | 10.01 |                |        |             |                                |
|  | 2.5 TD (18)        | 76 |            | 03.94 | 10.01 |                |        |             |                                |
|  | 2.5 TDi (18)       | 79 |            | 12.96 | 11.00 |                |        |             |                                |
|  | 2.8 D (18)         | 64 | S 16209999 | 01.99 | 01.99 |                |        |             |                                |
|  | 2.8 HDi (18)       | 94 |            | 09.00 | 10.01 |                |        |             |                                |
|  | 1.9 D (10)         | 50 |            | 07.99 | 10.01 | 03.0520-0925.3 | 690925 | - Wohnmobil | 25,40/254x57 TopKit <b>TRW</b> |
|  | 1.9 D (10)         | 51 |            | 02.94 | 10.01 |                |        |             |                                |
|  | 1.9 TD (10/14)     | 66 |            | 03.94 | 10.01 |                |        |             |                                |
|  | 1.9 TD (10/14)     | 68 |            | 03.94 | 10.01 |                |        |             |                                |
|  | 2.0 i (10/14)      | 80 |            | 03.94 | 10.01 |                |        |             |                                |
|  | 2.5 D (14)         | 63 |            | 03.94 | 10.01 |                |        |             |                                |
|  | 2.5 TD (14)        | 76 |            | 03.94 | 10.01 |                |        |             |                                |
|  | 2.5 TDi (14)       | 79 |            | 12.96 | 11.00 | 03.0520-0226.3 | 690226 | - Wohnmobil | 26,99/254x57 TopKit <b>TRW</b> |
|  | 2.8 HDi (14)       | 94 |            | 09.00 | 10.01 |                |        |             |                                |



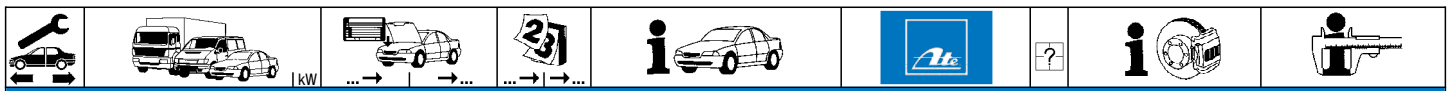

**CITROEN JUMPER Kasten (94-02)**

|              |                 |    |       |       |       |                |        |             |                     |    |
|--------------|-----------------|----|-------|-------|-------|----------------|--------|-------------|---------------------|----|
|              | 1.9 D (10)      | 50 |       | 11.01 | 03.02 | 03.0520-0326.3 | 690326 | + Quick Fit | 26,99/254x57 TopKit | AP |
|              | 1.9 D (10)      | 51 |       | 11.01 | 03.02 |                |        |             |                     |    |
|              | 1.9 TD (10/14)  | 66 |       | 11.01 | 03.02 |                |        |             |                     |    |
|              | 1.9 TD (10/14)  | 68 |       | 11.01 | 03.02 |                |        |             |                     |    |
|              | 2.0 HDi (10/14) | 62 |       | 11.01 | 03.02 |                |        |             |                     |    |
|              | 2.0 i (10/14)   | 80 |       | 11.01 | 03.02 |                |        |             |                     |    |
|              | 2.5 D (14)      | 63 |       | 11.01 | 03.02 |                |        |             |                     |    |
|              | 2.5 TD (14)     | 76 |       | 11.01 | 03.02 |                |        |             |                     |    |
|              | 2.8 HDi (14)    | 94 |       | 11.01 | 03.02 |                |        |             |                     |    |
|              | 2.0 i (18)      | 80 |       | 03.94 | 10.01 |                |        |             |                     |    |
| 2.5 D (18)   | 63              |    | 03.94 | 10.01 |       |                |        |             |                     |    |
| 2.5 TD (18)  | 76              |    | 03.94 | 10.01 |       |                |        |             |                     |    |
| 2.5 TDi (18) | 79              |    | 12.96 | 11.00 |       |                |        |             |                     |    |
| 2.8 HDi (18) | 94              |    | 09.00 | 10.01 |       |                |        |             |                     |    |

**CITROEN JUMPER Pritsche/Fahrgestell (94-02)**

|                |                  |            |            |       |                |                |        |                     |                   |     |                |        |  |                    |     |
|----------------|------------------|------------|------------|-------|----------------|----------------|--------|---------------------|-------------------|-----|----------------|--------|--|--------------------|-----|
|                | 1.9 TD (10/14)   | 66         |            | 03.94 | 12.99          | 13.0460-2976.2 | 602976 |                     | 21797 19,7 +/WK/S | TRW |                |        |  |                    |     |
|                | 1.9 TD (10/14)   | 68         |            | 03.94 | 12.99          |                |        |                     |                   |     |                |        |  |                    |     |
|                | 2.0 i (10/14)    | 80         |            | 03.94 | 12.99          |                |        |                     |                   |     |                |        |  |                    |     |
|                | 2.5 D (14)       | 63         |            | 03.94 | 12.99          |                |        |                     |                   |     |                |        |  |                    |     |
|                | 2.5 TD (14)      | 76         |            | 03.94 | 12.99          |                |        |                     |                   |     |                |        |  |                    |     |
|                | 2.5 TDi (14)     | 79         |            | 12.96 | 12.99          |                |        |                     |                   |     |                |        |  |                    |     |
|                | 2.8 D (14)       | 64         | S 16206253 | 01.99 |                |                |        |                     |                   |     |                |        |  |                    |     |
|                | 1.9 TD (10/14)   | 66         |            | 01.00 | 10.01          |                |        |                     |                   |     | 13.0460-2850.2 | 602850 |  | 23602 19,7 +/WK/S  | TRW |
|                | 1.9 TD (10/14)   | 68         |            | 01.00 | 10.01          |                |        |                     |                   |     |                |        |  |                    |     |
|                | 2.0 i (10/14)    | 80         |            | 01.00 | 10.01          |                |        |                     |                   |     |                |        |  |                    |     |
| 2.5 D (14)     | 63               |            | 01.00      | 10.01 |                |                |        |                     |                   |     |                |        |  |                    |     |
| 2.5 TD (14)    | 76               |            | 01.00      | 10.01 |                |                |        |                     |                   |     |                |        |  |                    |     |
| 2.5 TDi (14)   | 79               |            | 01.00      | 10.01 |                |                |        |                     |                   |     |                |        |  |                    |     |
| 2.8 HDi (14)   | 94               |            | 09.00      | 10.01 |                |                |        |                     |                   |     |                |        |  |                    |     |
| 1.9 TD (10/14) | 66               |            | 11.01      | 03.02 | 13.0460-4978.2 | 604978         |        | 23917 19,3 +/WK/Zub | BRE               |     |                |        |  |                    |     |
| 1.9 TD (10/14) | 68               |            | 11.01      | 03.02 |                |                |        |                     |                   |     |                |        |  |                    |     |
| 2.0 i (10/14)  | 80               |            | 11.01      | 03.02 |                |                |        |                     |                   |     |                |        |  |                    |     |
| 2.5 D (14)     | 63               |            | 11.01      | 03.02 |                |                |        |                     |                   |     |                |        |  |                    |     |
| 2.5 TD (14)    | 76               |            | 11.01      | 03.02 |                |                |        |                     |                   |     |                |        |  |                    |     |
| 2.5 TDi (14)   | 79               |            | 11.01      | 03.02 |                |                |        |                     |                   |     |                |        |  |                    |     |
| 2.8 D (14)     | 64               | S 16204256 | 02.02      |       |                |                |        |                     |                   |     |                |        |  |                    |     |
| 2.8 HDi (14)   | 94               |            | 11.01      | 03.02 |                |                |        |                     |                   |     |                |        |  |                    |     |
| 2.0 i (18)     | 80               |            | 03.94      | 12.99 | 13.0460-2977.2 | 602977         |        | 21799 19,7 +/WK/S   | TRW               |     |                |        |  |                    |     |
| 2.5 D (18)     | 63               |            | 03.94      | 12.99 |                |                |        |                     |                   |     |                |        |  |                    |     |
| 2.5 TD (18)    | 76               |            | 03.94      | 12.99 |                |                |        |                     |                   |     |                |        |  |                    |     |
| 2.5 TDi (18)   | 79               |            | 12.96      | 12.99 |                |                |        |                     |                   |     |                |        |  |                    |     |
| 2.8 D (18)     | 64               | S 16205352 | 01.99      |       |                |                |        |                     |                   |     |                |        |  |                    |     |
| 2.0 i (18)     | 80               |            | 01.00      | 10.01 | 13.0460-2852.2 | 602852         |        | 23603 19,7 +/WK/S   | TRW               |     |                |        |  |                    |     |
| 2.5 D (18)     | 63               |            | 01.00      | 10.01 |                |                |        |                     |                   |     |                |        |  |                    |     |
| 2.5 TD (18)    | 76               |            | 01.00      | 10.01 |                |                |        |                     |                   |     |                |        |  |                    |     |
| 2.5 TDi (18)   | 79               |            | 01.00      | 10.01 |                |                |        |                     |                   |     |                |        |  |                    |     |
| 2.8 D (18)     | 64               | S 16205352 | 01.99      |       |                |                |        |                     |                   |     |                |        |  |                    |     |
| 2.8 HDi (18)   | 94               |            | 09.00      | 10.01 |                |                |        |                     |                   |     |                |        |  |                    |     |
| 2.0 i (18)     | 80               |            | 11.01      | 03.02 | 13.0460-4979.2 | 604979         |        | 23919 19,3 +/WK/Zub | BRE               |     |                |        |  |                    |     |
| 2.5 D (18)     | 63               |            | 11.01      | 03.02 |                |                |        |                     |                   |     |                |        |  |                    |     |
| 2.5 TD (18)    | 76               |            | 11.01      | 03.02 |                |                |        |                     |                   |     |                |        |  |                    |     |
| 2.5 TDi (18)   | 79               |            | 11.01      | 03.02 |                |                |        |                     |                   |     |                |        |  |                    |     |
| 2.8 D (18)     | 64               | S 16194400 | 02.02      |       |                |                |        |                     |                   |     |                |        |  |                    |     |
| 2.8 HDi (18)   | 94               |            | 11.01      | 03.02 |                |                |        |                     |                   |     |                |        |  |                    |     |
|                | 1.9 TD (10/14)   | 66         |            | 03.94 | 10.01          | 24.0118-0108.1 | 418108 |                     | 280 18,0 15,9 +B  |     |                |        |  |                    |     |
|                | 1.9 TD (10/14)   | 68         |            | 03.94 | 10.01          |                |        |                     |                   |     |                |        |  |                    |     |
|                | 2.0 i (10/14)    | 80         |            | 03.94 | 10.01          |                |        |                     |                   |     |                |        |  |                    |     |
|                | 2.5 D (14)       | 63         |            | 03.94 | 10.01          |                |        |                     |                   |     |                |        |  |                    |     |
|                | 2.8 D (14)       | 64         | S 16206253 | 01.99 |                |                |        |                     |                   |     |                |        |  |                    |     |
|                | 1.9 TD (10/14)   | 66         |            | 11.01 | 03.02          |                |        |                     |                   |     | 24.0124-0127.1 | 424127 |  | 280 24,0 21,9 V +B |     |
|                | 1.9 TD (10/14)   | 68         |            | 11.01 | 03.02          |                |        |                     |                   |     |                |        |  |                    |     |
|                | 2.0 i (10/14)    | 80         |            | 11.01 | 03.02          |                |        |                     |                   |     |                |        |  |                    |     |
|                | 2.5 D (14)       | 63         |            | 11.01 | 03.02          |                |        |                     |                   |     |                |        |  |                    |     |
|                | 2.5 TD (14)      | 76         |            | 03.94 | 03.02          |                |        |                     |                   |     |                |        |  |                    |     |
| 2.5 TDi (14)   | 79               |            | 12.96      | 03.02 |                |                |        |                     |                   |     |                |        |  |                    |     |
| 2.8 D (14)     | 64               | S 16204256 | 02.02      |       |                |                |        |                     |                   |     |                |        |  |                    |     |
| 2.8 HDi (14)   | 94               |            | 09.00      | 03.02 |                |                |        |                     |                   |     |                |        |  |                    |     |
| 2.0 i (18)     | 80               |            | 03.94      | 03.02 | 24.0124-0138.1 | 424138         |        | 300 24,0 21,9 V +B  |                   |     |                |        |  |                    |     |
| 2.5 D (18)     | 63               |            | 03.94      | 03.02 |                |                |        |                     |                   |     |                |        |  |                    |     |
| 2.5 TD (18)    | 76               |            | 03.94      | 03.02 |                |                |        |                     |                   |     |                |        |  |                    |     |
| 2.5 TDi (18)   | 79               |            | 12.96      | 03.02 |                |                |        |                     |                   |     |                |        |  |                    |     |
| 2.8 D (18)     | 64               |            | 01.99      | 02.02 |                |                |        |                     |                   |     |                |        |  |                    |     |
| 2.8 HDi (18)   | 94               |            | 09.00      | 03.02 |                |                |        |                     |                   |     |                |        |  |                    |     |
|                | 1.9 TD (10/14)   | 66         |            | 11.01 | 03.02          | 13.0460-4980.2 | 604980 |                     | 23921 20,3 /Zub   | BRE |                |        |  |                    |     |
|                | 1.9 TD (10/14)   | 68         |            | 11.01 | 03.02          |                |        |                     |                   |     |                |        |  |                    |     |
|                | 2.0 i (10/14/18) | 80         |            | 11.01 | 03.02          |                |        |                     |                   |     |                |        |  |                    |     |
|                | 2.5 D (14/18)    | 63         |            | 11.01 | 03.02          |                |        |                     |                   |     |                |        |  |                    |     |
|                | 2.5 TD (14/18)   | 76         |            | 11.01 | 03.02          |                |        |                     |                   |     |                |        |  |                    |     |
|                | 2.5 TDi (14/18)  | 79         |            | 11.01 | 03.02          |                |        |                     |                   |     |                |        |  |                    |     |
|                | 2.8 D (14/18)    | 64         | S 16194400 | 02.02 |                |                |        |                     |                   |     |                |        |  |                    |     |
|                | 2.8 HDi (14/18)  | 94         |            | 11.01 | 03.02          |                |        |                     |                   |     |                |        |  |                    |     |





**CITROEN JUMPER Pritsche/Fahrgestell (94-02)**

|                |                |            |            |       |                |                |        |             |                                     |                                     |                |                |             |                     |                  |                                     |          |
|----------------|----------------|------------|------------|-------|----------------|----------------|--------|-------------|-------------------------------------|-------------------------------------|----------------|----------------|-------------|---------------------|------------------|-------------------------------------|----------|
|                | 1.9 TD (10/14) | 66         |            | 11.01 | 03.02          | 24.0116-0124.1 | 416124 |             |                                     | 280 16,0 14,2 +B                    |                |                |             |                     |                  |                                     |          |
|                | 1.9 TD (10/14) | 68         |            | 11.01 | 03.02          |                |        |             |                                     |                                     |                |                |             |                     |                  |                                     |          |
|                | 2.0 i (10/14)  | 80         |            | 11.01 | 03.02          | 24.0116-0125.1 | 416125 |             |                                     | 280 16,0 14,2 +B                    |                |                |             |                     |                  |                                     |          |
|                | 2.5 D (14)     | 63         |            | 11.01 | 03.02          |                |        |             |                                     |                                     |                |                |             |                     |                  |                                     |          |
|                | 2.5 TD (14)    | 76         |            | 11.01 | 03.02          |                |        |             |                                     |                                     |                |                |             |                     |                  |                                     |          |
|                | 2.5 TDi (14)   | 79         |            | 11.01 | 03.02          |                |        |             |                                     |                                     |                |                |             |                     |                  |                                     |          |
|                | 2.8 D (14)     | 64         | S 16194400 | 02.02 | 02.02          |                |        |             |                                     |                                     |                |                |             |                     |                  |                                     |          |
|                | 2.8 HDi (14)   | 94         |            | 11.01 | 03.02          |                |        |             |                                     |                                     |                |                |             |                     |                  |                                     |          |
|                | 2.0 i (18)     | 80         |            | 11.01 | 03.02          |                |        |             |                                     |                                     |                |                |             |                     |                  |                                     |          |
|                | 2.5 D (18)     | 63         |            | 11.01 | 03.02          |                |        |             |                                     |                                     |                |                |             |                     |                  |                                     |          |
|                | 2.5 TD (18)    | 76         |            | 11.01 | 03.02          |                |        |             |                                     |                                     |                |                |             |                     |                  |                                     |          |
|                | 2.5 TDi (18)   | 79         |            | 11.01 | 03.02          |                |        |             |                                     |                                     |                |                |             |                     |                  |                                     |          |
| 2.8 D (18)     | 64             | S 16194400 | 02.02      | 02.02 |                |                |        |             |                                     |                                     |                |                |             |                     |                  |                                     |          |
| 2.8 HDi (18)   | 94             |            | 11.01      | 03.02 |                |                |        |             |                                     |                                     |                |                |             |                     |                  |                                     |          |
|                | 1.9 TD (10/14) | 66         |            | 03.94 | 10.01          | 03.0137-0333.2 | 650333 |             | - Wohnmobil                         | 254 x 57 HEB<br>Bremsbacken-Zubehör | TRW            |                |             |                     |                  |                                     |          |
|                | 1.9 TD (10/14) | 68         |            | 03.94 | 10.01          |                |        |             |                                     |                                     |                |                |             |                     |                  |                                     |          |
|                | 2.0 i (10/14)  | 80         |            | 03.94 | 10.01          |                |        |             |                                     |                                     |                |                |             |                     |                  |                                     |          |
|                | 2.5 D (14)     | 63         |            | 03.94 | 10.01          |                |        |             |                                     |                                     |                |                |             |                     |                  |                                     |          |
|                | 2.5 TD (14)    | 76         |            | 03.94 | 10.01          |                |        |             |                                     |                                     |                |                |             |                     |                  |                                     |          |
|                | 2.5 TDi (14)   | 79         |            | 12.96 | 10.01          |                |        |             |                                     |                                     |                |                |             |                     |                  |                                     |          |
|                | 2.8 D (14)     | 64         | S 16206253 | 01.99 | 10.01          |                |        |             |                                     |                                     |                |                |             |                     |                  |                                     |          |
|                | 2.8 HDi (14)   | 94         |            | 09.00 | 10.01          |                |        |             |                                     |                                     |                |                |             |                     |                  |                                     |          |
|                | 1.9 TD (10/14) | 66         |            | 11.01 | 03.02          |                |        |             |                                     |                                     |                | 03.0137-0432.2 | 650432      |                     | - Quick Fit      | 254 x 57 HEB<br>Bremsbacken-Zubehör | AP<br>AP |
|                | 1.9 TD (10/14) | 68         |            | 11.01 | 03.02          |                |        |             |                                     |                                     |                |                |             |                     |                  |                                     |          |
| 2.0 i (10/14)  | 80             |            | 11.01      | 03.02 |                |                |        |             |                                     |                                     |                |                |             |                     |                  |                                     |          |
| 2.5 D (14)     | 63             |            | 11.01      | 03.02 |                |                |        |             |                                     |                                     |                |                |             |                     |                  |                                     |          |
| 2.5 TD (14)    | 76             |            | 11.01      | 03.02 |                |                |        |             |                                     |                                     |                |                |             |                     |                  |                                     |          |
| 2.5 TDi (14)   | 79             |            | 11.01      | 03.02 |                |                |        |             |                                     |                                     |                |                |             |                     |                  |                                     |          |
| 2.8 D (14)     | 64             | S 16204256 | 02.02      | 02.02 |                |                |        |             |                                     |                                     |                |                |             |                     |                  |                                     |          |
| 2.8 HDi (14)   | 94             |            | 11.01      | 03.02 |                |                |        |             |                                     |                                     |                |                |             |                     |                  |                                     |          |
| 2.0 i (18)     | 80             |            | 03.94      | 10.01 | 03.0137-0334.2 | 650334         |        | - Wohnmobil | 254 x 57 HEB<br>Bremsbacken-Zubehör | TRW<br>TRW                          |                |                |             |                     |                  |                                     |          |
| 2.5 D (18)     | 63             |            | 03.94      | 10.01 |                |                |        |             |                                     |                                     |                |                |             |                     |                  |                                     |          |
| 2.5 TD (18)    | 76             |            | 03.94      | 10.01 |                |                |        |             |                                     |                                     |                |                |             |                     |                  |                                     |          |
| 2.5 TDi (18)   | 79             |            | 12.96      | 10.01 |                |                |        |             |                                     |                                     |                |                |             |                     |                  |                                     |          |
| 2.8 D (18)     | 64             | S 16209999 | 01.99      | 10.01 |                |                |        |             |                                     |                                     |                |                |             |                     |                  |                                     |          |
| 2.8 HDi (18)   | 94             |            | 09.00      | 10.01 |                |                |        |             |                                     |                                     |                |                |             |                     |                  |                                     |          |
| 1.9 TD (10/14) | 66             |            | 03.94      | 03.02 |                |                |        |             |                                     |                                     | 24.0225-4002.1 | 480048         |             |                     | 254/255,6 x 63,5 |                                     |          |
| 1.9 TD (10/14) | 68             |            | 03.94      | 03.02 |                |                |        |             |                                     |                                     |                |                |             |                     |                  |                                     |          |
| 2.0 i (10/14)  | 80             |            | 03.94      | 03.02 |                |                |        |             |                                     |                                     |                |                |             |                     |                  |                                     |          |
| 2.5 D (14)     | 63             |            | 03.94      | 03.02 |                |                |        |             |                                     |                                     |                |                |             |                     |                  |                                     |          |
| 2.5 TD (14)    | 76             |            | 03.94      | 03.02 |                |                |        |             |                                     |                                     |                |                |             |                     |                  |                                     |          |
| 2.5 TDi (14)   | 79             |            | 12.96      | 03.02 |                |                |        |             |                                     |                                     |                |                |             |                     |                  |                                     |          |
| 2.8 D (14)     | 64             |            | 01.99      | 02.02 |                |                |        |             |                                     |                                     |                |                |             |                     |                  |                                     |          |
| 2.8 HDi (14)   | 94             |            | 09.00      | 03.02 |                |                |        |             |                                     |                                     |                |                |             |                     |                  |                                     |          |
| 2.0 i (18)     | 80             |            | 03.94      | 10.01 | 24.0225-4005.1 | 480070         |        |             | 254/255,6 x 64,5                    |                                     |                |                |             |                     |                  |                                     |          |
| 2.5 D (18)     | 63             |            | 03.94      | 10.01 |                |                |        |             |                                     |                                     |                |                |             |                     |                  |                                     |          |
| 2.5 TD (18)    | 76             |            | 03.94      | 10.01 |                |                |        |             |                                     |                                     |                |                |             |                     |                  |                                     |          |
| 2.5 TDi (18)   | 79             |            | 12.96      | 10.01 |                |                |        |             |                                     |                                     |                |                |             |                     |                  |                                     |          |
| 2.8 D (18)     | 64             | S 16209999 | 01.99      | 10.01 |                |                |        |             |                                     |                                     |                |                |             |                     |                  |                                     |          |
| 2.8 HDi (18)   | 94             |            | 09.00      | 10.01 |                |                |        |             |                                     |                                     |                |                |             |                     |                  |                                     |          |
| 1.9 TD (10/14) | 66             |            | 03.94      | 10.01 |                |                |        |             |                                     | 03.0520-0925.3                      | 690925         |                | - Wohnmobil | 25,40/254x57 TopKit | TRW              |                                     |          |
| 1.9 TD (10/14) | 68             |            | 03.94      | 10.01 |                |                |        |             |                                     |                                     |                |                |             |                     |                  |                                     |          |
| 2.0 i (10/14)  | 80             |            | 03.94      | 10.01 |                |                |        |             |                                     |                                     |                |                |             |                     |                  |                                     |          |
| 2.5 D (14)     | 63             |            | 03.94      | 10.01 |                |                |        |             |                                     |                                     |                |                |             |                     |                  |                                     |          |
| 2.5 TD (14)    | 76             |            | 03.94      | 10.01 |                |                |        |             |                                     |                                     |                |                |             |                     |                  |                                     |          |
| 2.5 TDi (14)   | 79             |            | 12.96      | 10.01 |                |                |        |             |                                     |                                     |                |                |             |                     |                  |                                     |          |
| 2.8 HDi (14)   | 94             |            | 09.00      | 10.01 |                |                |        |             |                                     |                                     |                |                |             |                     |                  |                                     |          |
| 1.9 TD (10/14) | 66             |            | 11.01      | 03.02 | 03.0520-0326.3 | 690326         |        | + Quick Fit | 26,99/254x57 TopKit                 |                                     |                |                |             |                     |                  | AP                                  |          |
| 1.9 TD (10/14) | 68             |            | 11.01      | 03.02 |                |                |        |             |                                     |                                     |                |                |             |                     |                  |                                     |          |
| 2.0 i (10/14)  | 80             |            | 11.01      | 03.02 |                |                |        |             |                                     |                                     |                |                |             |                     |                  |                                     |          |
| 2.5 D (14)     | 63             |            | 11.01      | 03.02 |                |                |        |             |                                     |                                     |                |                |             |                     |                  |                                     |          |
| 2.5 TD (14)    | 76             |            | 11.01      | 03.02 |                |                |        |             |                                     |                                     |                |                |             |                     |                  |                                     |          |
| 2.5 TDi (14)   | 79             |            | 11.01      | 03.02 |                |                |        |             |                                     |                                     |                |                |             |                     |                  |                                     |          |
| 2.8 HDi (14)   | 94             |            | 11.01      | 03.02 |                |                |        |             |                                     |                                     |                |                |             |                     |                  |                                     |          |
| 2.0 i (18)     | 80             |            | 03.94      | 10.01 |                |                |        |             |                                     | 03.0520-0728.3                      | 690728         |                | - Wohnmobil | 28,57/254x57 TopKit | TRW              |                                     |          |
| 2.5 D (18)     | 63             |            | 03.94      | 10.01 |                |                |        |             |                                     |                                     |                |                |             |                     |                  |                                     |          |
| 2.5 TD (18)    | 76             |            | 03.94      | 10.01 |                |                |        |             |                                     |                                     |                |                |             |                     |                  |                                     |          |
| 2.5 TDi (18)   | 79             |            | 12.96      | 10.01 |                |                |        |             |                                     |                                     |                |                |             |                     |                  |                                     |          |
| 2.8 HDi (18)   | 94             |            | 09.00      | 10.01 |                |                |        |             |                                     |                                     |                |                |             |                     |                  |                                     |          |

**CITROEN JUMPER (02-06)**

|  |                       |    |  |       |       |                |        |  |  |                    |     |
|--|-----------------------|----|--|-------|-------|----------------|--------|--|--|--------------------|-----|
|  | 2.0 HDi (10/14)       | 62 |  | 04.02 | 03.06 | 13.0460-4978.2 | 604978 |  |  | 23917 19,3 +WK/Zub | BRE |
|  | 2.0 i (10/14)         | 81 |  | 04.02 | 03.06 |                |        |  |  |                    |     |
|  | 2.2 HDi (10/14)       | 74 |  | 04.02 | 03.06 |                |        |  |  |                    |     |
|  | 2.8 HDi (10/14)       |    |  | 04.02 | 03.06 |                |        |  |  |                    |     |
|  | 2.8 HDi 4x4(10/14/18) |    |  | 04.02 | 03.06 |                |        |  |  |                    |     |
|  | 2.0 HDi (18)          | 62 |  | 04.02 | 03.06 | 13.0460-4979.2 | 604979 |  |  | 23919 19,3 +WK/Zub | BRE |
|  | 2.0 i (18)            | 81 |  | 04.02 | 03.06 |                |        |  |  |                    |     |
|  | 2.2 HDi (18)          | 74 |  | 04.02 | 03.06 |                |        |  |  |                    |     |
|  | 2.8 HDi (18)          |    |  | 04.02 | 03.06 |                |        |  |  |                    |     |
|  | 2.8 HDi 4x4(10/14/18) |    |  | 04.02 | 03.06 |                |        |  |  |                    |     |
|  | 2.0 HDi (10/14)       | 62 |  | 04.02 | 03.06 | 24.0124-0127.1 | 424127 |  |  | 280 24,0 21,9 V +B |     |
|  | 2.0 i (10/14)         | 81 |  | 04.02 | 03.06 |                |        |  |  |                    |     |
|  | 2.2 HDi (10/14)       | 74 |  | 04.02 | 03.06 |                |        |  |  |                    |     |
|  | 2.8 HDi (10/14)       |    |  | 04.02 | 03.06 |                |        |  |  |                    |     |

<sup>1)</sup> payload 1000 KG / 1400 KG / carico utile 1000 KG / 1400 KG / charge utile 1000 KG / 1400 KG / carga útil 1000 KG / 1400 KG

<sup>2)</sup> payload 1800 KG / carico utile 1800 KG / charge utile 1800 KG / carga útil 1800 KG





**CITROEN JUMPER (02-06)**

|  |                       |    |       |       |  |                |        |                            |                        |
|--|-----------------------|----|-------|-------|--|----------------|--------|----------------------------|------------------------|
|  | 2.8 HDi 4x4(10/14/18) |    | 04.02 | 03.06 | Nutzlast 1000 KG / 1400 KG <sup>1)</sup> | 24.0124-0127.1 | 424127 |                            | 280 24,0 21,9 V +B     |
|  | 2.0 HDi (18)          | 62 | 04.02 | 03.06 |  | 24.0124-0138.1 | 424138 |                            | 300 24,0 21,9 V +B     |
|  | 2.0 i (18)            | 81 | 04.02 | 03.06 |  |                |        |                            |                        |
|  | 2.2 HDi (18)          | 74 | 04.02 | 03.06 |  |                |        |                            |                        |
|  | 2.8 HDi (18)          |    | 04.02 | 03.06 |  |                |        |                            |                        |
|  | 2.8 HDi 4x4(10/14/18) |    | 04.02 | 03.06 | Nutzlast 1800 KG <sup>2)</sup>           |                |        |                            |                        |
|  | 2.0 HDi (10/14/18)    | 62 | 04.02 | 03.06 |  | 13.0460-4980.2 | 604980 |                            | 23921 20,3 /Zub BRE    |
|  | 2.0 i (10/14/18)      | 81 | 04.02 | 03.06 |  |                |        |                            |                        |
|  | 2.2 HDi (10/14/18)    | 74 | 04.02 | 03.06 |  |                |        |                            |                        |
|  | 2.8 HDi (10/14/18)    |    | 04.02 | 03.06 |  |                |        |                            |                        |
|  | 2.8 HDi 4x4(10/14/18) |    | 04.02 | 03.06 |  |                |        |                            |                        |
|  | 2.0 HDi (10/14)       | 62 | 04.02 | 03.06 |  | 24.0116-0124.1 | 416124 |                            | 280 16,0 14,2 +B       |
|  | 2.0 i (10/14)         | 81 | 04.02 | 03.06 |  |                |        |                            |                        |
|  | 2.2 HDi (10/14)       | 74 | 04.02 | 03.06 |  |                |        |                            |                        |
|  | 2.8 HDi (10/14)       |    | 04.02 | 03.06 |  |                |        |                            |                        |
|  | 2.8 HDi 4x4(10/14/18) |    | 04.02 | 03.06 | Nutzlast 1000 KG / 1400 KG <sup>1)</sup> |                |        |                            |                        |
|  | 2.0 HDi (18)          | 62 | 04.02 | 03.06 |  | 24.0116-0125.1 | 416125 |                            | 280 16,0 14,2 +B       |
|  | 2.0 i (18)            | 81 | 04.02 | 03.06 |  |                |        |                            |                        |
|  | 2.2 HDi (18)          | 74 | 04.02 | 03.06 |  |                |        |                            |                        |
|  | 2.8 HDi (18)          |    | 04.02 | 03.06 |  |                |        |                            |                        |
|  | 2.8 HDi 4x4(10/14/18) |    | 04.02 | 03.06 | Nutzlast 1800 KG <sup>2)</sup>           |                |        |                            |                        |
|  | 2.0 HDi (10/14)       | 62 | 04.02 | 03.06 |  | 03.0137-0432.2 | 650432 | - Quick Fit                | 254 x 57 HEB AP        |
|  | 2.0 i (10/14)         | 81 | 04.02 | 03.06 |  | 03.0137-9285.2 | 669285 |                            | Bremsbacken-Zubehör AP |
|  | 2.2 HDi (10/14)       | 74 | 04.02 | 03.06 |  |                |        |                            |                        |
|  | 2.8 HDi (10/14)       |    | 04.02 | 03.06 |  |                |        |                            |                        |
|  | 2.8 HDi 4x4(10/14/18) |    | 04.02 | 03.06 |  |                |        |                            |                        |
|  | 2.0 HDi (10/14)       | 62 | 04.02 | 03.06 |  | 24.0225-4002.1 | 480048 |                            | 254/255,6 x 63,5       |
|  | 2.0 i (10/14)         | 81 | 04.02 | 03.06 |  |                |        |                            |                        |
|  | 2.2 HDi (10/14)       | 74 | 04.02 | 03.06 |  |                |        |                            |                        |
|  | 2.8 HDi (10/14)       |    | 04.02 | 03.06 |  |                |        |                            |                        |
|  | 2.8 HDi 4x4(10/14/18) |    | 04.02 | 03.06 |  |                |        |                            |                        |
|  | 2.0 HDi (10/14)       | 62 | 04.02 | 03.06 |  | 03.0520-0326.3 | 690326 | + Quick Fit                | 26,99/254x57 TopKit AP |
|  | 2.0 i (10/14)         | 81 | 04.02 | 03.06 |  |                |        |                            |                        |
|  | 2.2 HDi (10/14)       | 74 | 04.02 | 03.06 |  |                |        |                            |                        |
|  | 2.8 HDi (10/14)       |    | 04.02 | 03.06 |  |                |        |                            |                        |
|  | 2.8 HDi 4x4(10/14/18) |    | 04.02 | 03.06 |  |                |        |                            |                        |
|  | 2.0 Bifuel            | 81 | 02.03 | 03.06 |  | 03.0137-4002.2 | 654002 | - Stützlager <sup>3)</sup> | 172 x 42 /Zub          |
|  | 2.0 HDi (10/14/18)    | 62 | 04.02 | 03.06 |  |                |        |                            |                        |
|  | 2.0 i (10/14/18)      | 81 | 04.02 | 03.06 |  |                |        |                            |                        |
|  | 2.2 HDi (10/14/18)    | 74 | 04.02 | 03.06 |  |                |        |                            |                        |
|  | 2.8 HDi (10/14/18)    |    | 04.02 | 03.06 |  |                |        |                            |                        |
|  | 2.8 HDi 4x4(10/14/18) |    | 04.02 | 03.06 |  |                |        |                            |                        |

**CITROEN JUMPER (06-)**

|  |                 |     |       |  |                                   |                |        |  |                         |
|--|-----------------|-----|-------|--|-----------------------------------|----------------|--------|--|-------------------------|
|  | 2.0 BlueHDI 110 | 81  | 07.15 |  | Nutzlast 120/140 <sup>4)</sup>    | 13.0460-4807.2 | 604807 |  | 24468 19,1 +/WK/Zub BRE |
|  | 2.0 BlueHDI 130 | 96  | 07.15 |  | Nutzlast 120/140 <sup>4)</sup>    |                |        |  |                         |
|  | 2.0 BlueHDI 160 | 120 | 07.15 |  | Nutzlast 120/140 <sup>4)</sup>    |                |        |  |                         |
|  | 2.2 HDi 100     | 74  | 04.06 |  | Nutzlast 120/140 <sup>4)</sup>    |                |        |  |                         |
|  | 2.2 HDi 110     | 81  | 07.11 |  | Nutzlast 120/140 <sup>4)</sup>    |                |        |  |                         |
|  | 2.2 HDi 120     | 88  | 04.06 |  | Nutzlast 120/140 <sup>4)</sup>    |                |        |  |                         |
|  | 2.2 HDi 130     | 96  | 07.11 |  | Nutzlast 120/140 <sup>4)</sup>    |                |        |  |                         |
|  | 2.2 HDi 150     | 110 | 07.11 |  | Nutzlast 120/140 <sup>4)</sup>    |                |        |  |                         |
|  | 3.0 HDi 145     | 107 | 07.10 |  | Nutzlast 120/140 <sup>4)</sup>    |                |        |  |                         |
|  | 3.0 HDi 155     | 115 | 07.10 |  | Nutzlast 120/140 <sup>4)</sup>    |                |        |  |                         |
|  | 3.0 HDi 160     | 116 | 09.06 |  | Nutzlast 120/140 <sup>4)</sup>    |                |        |  |                         |
|  | 3.0 HDi 180     | 130 | 07.11 |  | Nutzlast 120/140 <sup>4)</sup>    |                |        |  |                         |
|  | 2.2 HDi 100     | 74  | 04.06 |  | Nutzlast leicht 16Q <sup>5)</sup> | 13.0460-4809.2 | 604809 |  | 24468 19,1 +/WK/Zub BRE |
|  | 2.2 HDi 110     | 81  | 07.11 |  | Nutzlast leicht 16Q <sup>5)</sup> |                |        |  |                         |
|  | 2.2 HDi 120     | 88  | 04.06 |  | Nutzlast leicht 16Q <sup>5)</sup> |                |        |  |                         |
|  | 2.2 HDi 130     | 96  | 07.11 |  | Nutzlast leicht 16Q <sup>5)</sup> |                |        |  |                         |
|  | 2.2 HDi 150     | 110 | 07.11 |  | Nutzlast leicht 16Q <sup>5)</sup> |                |        |  |                         |
|  | 3.0 HDi 145     | 107 | 07.10 |  | Nutzlast leicht 16Q <sup>5)</sup> |                |        |  |                         |
|  | 3.0 HDi 155     | 115 | 07.10 |  | Nutzlast leicht 16Q <sup>5)</sup> |                |        |  |                         |
|  | 3.0 HDi 160     | 116 | 09.06 |  | Nutzlast leicht 16Q <sup>5)</sup> |                |        |  |                         |
|  | 3.0 HDi 180     | 130 | 07.11 |  | Nutzlast leicht 16Q <sup>5)</sup> |                |        |  |                         |
|  | 2.0 BlueHDI 110 | 81  | 07.15 |  | Nutzlast leicht 16Q <sup>5)</sup> | 13.0460-4809.2 | 604809 |  | 24468 19,1 +/WK/Zub BRE |
|  | 2.0 BlueHDI 130 | 96  | 07.15 |  | Nutzlast leicht 16Q <sup>5)</sup> |                |        |  |                         |
|  | 2.0 BlueHDI 160 | 120 | 07.15 |  | Nutzlast leicht 16Q <sup>5)</sup> |                |        |  |                         |
|  | 2.2 HDi 100     | 74  | 04.06 |  | Nutzlast schwer 16Q <sup>6)</sup> | 13.0460-4810.2 | 604810 |  | 24466 19,1 +/WK/Zub BRE |
|  | 2.2 HDi 110     | 81  | 07.11 |  | Nutzlast schwer 16Q <sup>6)</sup> |                |        |  |                         |
|  | 2.2 HDi 120     | 88  | 04.06 |  | Nutzlast schwer 16Q <sup>6)</sup> |                |        |  |                         |
|  | 2.2 HDi 130     | 96  | 07.11 |  | Nutzlast schwer 16Q <sup>6)</sup> |                |        |  |                         |
|  | 2.2 HDi 150     | 110 | 07.11 |  | Nutzlast schwer 16Q <sup>6)</sup> |                |        |  |                         |
|  | 3.0 HDi 145     | 107 | 07.10 |  | Nutzlast schwer 16Q <sup>6)</sup> |                |        |  |                         |
|  | 3.0 HDi 155     | 115 | 07.10 |  | Nutzlast schwer 16Q <sup>6)</sup> |                |        |  |                         |
|  | 3.0 HDi 160     | 116 | 09.06 |  | Nutzlast schwer 16Q <sup>6)</sup> |                |        |  |                         |
|  | 3.0 HDi 180     | 130 | 07.11 |  | Nutzlast schwer 16Q <sup>6)</sup> |                |        |  |                         |
|  | 2.0 BlueHDI 110 | 81  | 07.15 |  | Nutzlast schwer 16Q <sup>6)</sup> | 13.0460-4811.2 | 604811 |  | 24466 19,1 +/WK/Zub BRE |
|  | 2.0 BlueHDI 110 | 81  | 07.15 |  | Nutzlast 20Q <sup>7)</sup>        |                |        |  |                         |
|  | 2.0 BlueHDI 130 | 96  | 07.15 |  | Nutzlast schwer 16Q <sup>6)</sup> |                |        |  |                         |
|  | 2.0 BlueHDI 130 | 96  | 07.15 |  | Nutzlast 20Q <sup>7)</sup>        |                |        |  |                         |
|  | 2.0 BlueHDI 160 | 120 | 07.15 |  | Nutzlast schwer 16Q <sup>6)</sup> |                |        |  |                         |
|  | 2.0 BlueHDI 160 | 120 | 07.15 |  | Nutzlast 20Q <sup>7)</sup>        |                |        |  |                         |
|  | 2.2 HDi 100     | 74  | 04.06 |  | Nutzlast 20Q <sup>7)</sup>        |                |        |  |                         |
|  | 2.2 HDi 110     | 81  | 07.11 |  | Nutzlast 20Q <sup>7)</sup>        |                |        |  |                         |

<sup>1)</sup> payload 1000 KG / 1400 KG / carico utile 1000 KG / 1400 KG / charge utile 1000 KG / 1400 KG / carga útil 1000 KG / 1400 KG

<sup>2)</sup> payload 1800 KG / carico utile 1800 KG / charge utile 1800 KG / carga útil 1800 KG

<sup>3)</sup> - support bearing / - cuscinetto di spinta / - palier d'appui / - soporte de apoyo

<sup>4)</sup> payload 120/140 / carico utile 120/140 / charge utile 120/140 / carga útil 120/140

<sup>5)</sup> light payload 16Q / carico utile leggero 16Q / charge utile légère 16Q / carga útil ligera 16Q

<sup>6)</sup> heavy payload 16Q / carico utile pesante 16Q / charge utile lourde 16Q / carga útil pesada 16Q

<sup>7)</sup> payload 20Q / carico utile 20Q / charge utile 20Q / carga útil 20Q



**CITROEN JUMPER (06-)**

|  |  |  |  |  |                          |  |                           |
|--|--|--|--|--|--------------------------|--|---------------------------|
|  | 2.2 HDi 120<br>2.2 HDi 130<br>2.2 HDi 150<br>3.0 HDi 145<br>3.0 HDi 155<br>3.0 HDi 160<br>3.0 HDi 180  | 88<br>96<br>110<br>107<br>115<br>116<br>130                                | 04.06<br>07.11<br>07.11<br>07.10<br>07.10<br>09.06<br>07.11  | Nutzlast 200 <sup>1)</sup><br>Nutzlast 200 <sup>1)</sup><br>Nutzlast 200 <sup>1)</sup><br>Nutzlast 200 <sup>1)</sup><br>Nutzlast 200 <sup>1)</sup><br>Nutzlast 200 <sup>1)</sup><br>Nutzlast 200 <sup>1)</sup>   | 13.0460-4811.2<br>604811 |  | 24466 19,1 +WK/Zub<br>BRE |
|  | 2.0 BlueHDI 110<br>2.0 BlueHDI 130<br>2.0 BlueHDI 160<br>2.2 HDi 100<br>2.2 HDi 110<br>2.2 HDi 120<br>2.2 HDi 130<br>2.2 HDi 150<br>3.0 HDi 145<br>3.0 HDi 155<br>3.0 HDi 160<br>3.0 HDi 180 | 81<br>96<br>120<br>74<br>81<br>88<br>96<br>110<br>107<br>115<br>116<br>130 | 07.15<br>07.15<br>07.15<br>04.06<br>07.11<br>04.06<br>07.11<br>07.11<br>07.10<br>07.10<br>09.06<br>07.11 | Nutzlast leicht 120<br>Nutzlast leicht 120<br>Nutzlast leicht 120<br>Nutzlast 120/140 <sup>2)</sup><br>Nutzlast 120/140 <sup>2)</sup><br>Nutzlast 120/140 <sup>2)</sup><br>Nutzlast 120/140 <sup>2)</sup><br>Nutzlast 120/140 <sup>2)</sup><br>Nutzlast 120/140 <sup>2)</sup><br>Nutzlast 120/140 <sup>2)</sup><br>Nutzlast 120/140 <sup>2)</sup><br>Nutzlast 120/140 <sup>2)</sup>  | 24.0124-0127.1<br>424127 |  | 280 24,0 21,9 V +B        |
|  | 2.2 HDi 100<br>2.2 HDi 110<br>2.2 HDi 120<br>2.2 HDi 130<br>2.2 HDi 150<br>3.0 HDi 145<br>3.0 HDi 155<br>3.0 HDi 160<br>3.0 HDi 180  | 74<br>81<br>88<br>96<br>110<br>107<br>115<br>116<br>130                    | 04.06<br>07.11<br>04.06<br>07.11<br>07.11<br>07.10<br>07.10<br>09.06<br>07.11                            | Nutzlast leicht 160 <sup>3)</sup><br>Nutzlast leicht 160 <sup>3)</sup><br>Nutzlast leicht 160 <sup>3)</sup><br>Nutzlast leicht 160 <sup>3)</sup><br>Nutzlast leicht 160 <sup>3)</sup><br>Nutzlast leicht 160 <sup>3)</sup><br>Nutzlast leicht 160 <sup>3)</sup><br>Nutzlast leicht 160 <sup>3)</sup><br>Nutzlast leicht 160 <sup>3)</sup>  | 24.0128-0213.1<br>428213 |  | 280 28,0 25,9 V +B        |
|  | 2.2 HDi 100<br>2.2 HDi 110<br>2.2 HDi 120<br>2.2 HDi 130<br>2.2 HDi 150<br>3.0 HDi 145<br>3.0 HDi 155<br>3.0 HDi 160<br>3.0 HDi 180  | 74<br>81<br>88<br>96<br>110<br>107<br>115<br>116<br>130                    | 04.06<br>07.11<br>04.06<br>07.11<br>07.11<br>07.10<br>07.10<br>09.06<br>07.11                            | Nutzlast schwer 160 <sup>4)</sup><br>Nutzlast schwer 160 <sup>4)</sup><br>Nutzlast schwer 160 <sup>4)</sup><br>Nutzlast schwer 160 <sup>4)</sup><br>Nutzlast schwer 160 <sup>4)</sup><br>Nutzlast schwer 160 <sup>4)</sup><br>Nutzlast schwer 160 <sup>4)</sup><br>Nutzlast schwer 160 <sup>4)</sup><br>Nutzlast schwer 160 <sup>4)</sup>  | 24.0124-0138.1<br>424138 |  | 300 24,0 21,9 V +B        |
|  | 2.2 HDi 100<br>2.2 HDi 110<br>2.2 HDi 120<br>2.2 HDi 130<br>2.2 HDi 150<br>3.0 HDi 145<br>3.0 HDi 155<br>3.0 HDi 160<br>3.0 HDi 180  | 74<br>81<br>88<br>96<br>110<br>107<br>115<br>116<br>130                    | 04.06<br>07.11<br>04.06<br>07.11<br>07.11<br>07.10<br>07.10<br>09.06<br>07.11                            | Nutzlast 200 <sup>1)</sup><br>Nutzlast 200 <sup>1)</sup><br>Nutzlast 200 <sup>1)</sup><br>Nutzlast 200 <sup>1)</sup><br>Nutzlast 200 <sup>1)</sup><br>Nutzlast 200 <sup>1)</sup><br>Nutzlast 200 <sup>1)</sup><br>Nutzlast 200 <sup>1)</sup><br>Nutzlast 200 <sup>1)</sup>   | 24.0132-0131.1<br>432131 |  | 300 32,0 29,9 V +B        |
|  | 2.2 HDi 100<br>2.2 HDi 110<br>2.2 HDi 120<br>2.2 HDi 130<br>2.2 HDi 150<br>3.0 HDi 145<br>3.0 HDi 155<br>3.0 HDi 160<br>3.0 HDi 180  | 74<br>81<br>88<br>96<br>110<br>107<br>115<br>116<br>130                    | 04.06<br>07.11<br>04.06<br>07.11<br>07.11<br>07.10<br>07.10<br>09.06<br>07.11                            |  | 13.0460-4812.2<br>604812 |  | 24465 19,2 /Zub/S<br>BRE  |
|  | 2.0 BlueHDI 110<br>2.0 BlueHDI 130<br>2.0 BlueHDI 160<br>2.2 HDi 100<br>2.2 HDi 110<br>2.2 HDi 120<br>2.2 HDi 130<br>2.2 HDi 150<br>3.0 HDi 145<br>3.0 HDi 155<br>3.0 HDi 160<br>3.0 HDi 180 | 81<br>96<br>120<br>74<br>81<br>88<br>96<br>110<br>107<br>115<br>116<br>130 | 07.15<br>07.15<br>07.15<br>04.06<br>07.11<br>04.06<br>07.11<br>07.11<br>07.10<br>07.10<br>09.06<br>07.11 | Nutzlast 120/140+ leicht 160 <sup>5)</sup><br>Nutzlast 120/140+ leicht 160 <sup>5)</sup><br>Nutzlast 120/140+ leicht 160 <sup>5)</sup><br>Nutzlast 120/140+ leicht 160 <sup>5)</sup><br>Nutzlast 120/140+ leicht 160 <sup>5)</sup><br>Nutzlast 120/140+ leicht 160 <sup>5)</sup><br>Nutzlast 120/140+ leicht 160 <sup>5)</sup><br>Nutzlast 120/140+ leicht 160 <sup>5)</sup><br>Nutzlast 120/140+ leicht 160 <sup>5)</sup><br>Nutzlast 120/140+ leicht 160 <sup>5)</sup><br>Nutzlast 120/140+ leicht 160 <sup>5)</sup><br>Nutzlast 120/140+ leicht 160 <sup>5)</sup> | 24.0116-0124.1<br>416124 |  | 280 16,0 14,2 +B          |
|  | 2.0 BlueHDI 110<br>2.0 BlueHDI 130<br>2.0 BlueHDI 160<br>2.2 HDi 100<br>2.2 HDi 110<br>2.2 HDi 120<br>2.2 HDi 130<br>2.2 HDi 150<br>3.0 HDi 145<br>3.0 HDi 155<br>3.0 HDi 160<br>3.0 HDi 180 | 81<br>96<br>120<br>74<br>81<br>88<br>96<br>110<br>107<br>115<br>116<br>130 | 07.15<br>07.15<br>07.15<br>04.06<br>07.11<br>04.06<br>07.11<br>07.11<br>07.10<br>07.10<br>09.06<br>07.11 | Nutzlast schwer 160 <sup>4)</sup><br>Nutzlast schwer 160 <sup>4)</sup><br>Nutzlast schwer 160 <sup>4)</sup><br>Nutzlast schwer 160 <sup>4)</sup><br>Nutzlast schwer 160 <sup>4)</sup><br>Nutzlast schwer 160 <sup>4)</sup><br>Nutzlast schwer 160 <sup>4)</sup><br>Nutzlast schwer 160 <sup>4)</sup><br>Nutzlast schwer 160 <sup>4)</sup><br>Nutzlast schwer 160 <sup>4)</sup><br>Nutzlast schwer 160 <sup>4)</sup><br>Nutzlast schwer 160 <sup>4)</sup>   | 24.0116-0125.1<br>416125 |  | 280 16,0 14,2 +B          |
|  | 2.2 HDi 100<br>2.2 HDi 110<br>2.2 HDi 120<br>2.2 HDi 130<br>2.2 HDi 150<br>3.0 HDi 145<br>3.0 HDi 155<br>3.0 HDi 160<br>3.0 HDi 180  | 74<br>81<br>88<br>96<br>110<br>107<br>115<br>116<br>130                    | 04.06<br>07.11<br>04.06<br>07.11<br>07.11<br>07.10<br>07.10<br>09.06<br>07.11                            | Nutzlast 200 <sup>1)</sup><br>Nutzlast 200 <sup>1)</sup><br>Nutzlast 200 <sup>1)</sup><br>Nutzlast 200 <sup>1)</sup><br>Nutzlast 200 <sup>1)</sup><br>Nutzlast 200 <sup>1)</sup><br>Nutzlast 200 <sup>1)</sup><br>Nutzlast 200 <sup>1)</sup><br>Nutzlast 200 <sup>1)</sup>   | 24.0116-0123.1<br>416123 |  | 300 16,0 14,2 +B          |

<sup>1)</sup> payload 200 / carico utile 200 / charge utile 200 / carga útil 200  
<sup>2)</sup> payload 120/140 / carico utile 120/140 / charge utile 120/140 / carga útil 120/140  
<sup>3)</sup> light payload 160 / carico utile leggero 160 / charge utile légère 160 / carga útil ligera 160  
<sup>4)</sup> heavy payload 160 / carico utile pesante 160 / charge utile lourde 160 / carga útil pesada 160  
<sup>5)</sup> payload 120/140+ light 160 / carico utile 120/140+ leggero 160 / charge utile 120/140+ légère 160 / carga útil 120/140+ ligera 160





### CITROEN JUMPER (06-)

|  |                 |     |  |              |                            |                       |        |  |                  |
|--|-----------------|-----|--|--------------|----------------------------|-----------------------|--------|--|------------------|
|  | 3.0 HDi 160     | 116 |  | <b>09.06</b> | Nutzlast 20Q <sup>1)</sup> | <b>24.0116-0123.1</b> | 416123 |  | 300 16,0 14,2 +B |
|  | 3.0 HDi 180     | 130 |  | <b>07.11</b> | Nutzlast 20Q <sup>1)</sup> |                       |        |  |                  |
|  | 2.0 BlueHDi 110 | 81  |  | <b>07.15</b> |                            | <b>03.0137-4004.2</b> | 654004 |  | 172 x 42 /Zub    |
|  | 2.0 BlueHDi 130 | 96  |  | <b>07.15</b> |                            |                       |        |  |                  |
|  | 2.0 BlueHDi 160 | 120 |  | <b>07.15</b> |                            |                       |        |  |                  |
|  | 2.2 HDi 100     | 74  |  | <b>04.06</b> |                            |                       |        |  |                  |
|  | 2.2 HDi 110     | 81  |  | <b>07.11</b> |                            |                       |        |  |                  |
|  | 2.2 HDi 120     | 88  |  | <b>04.06</b> |                            |                       |        |  |                  |
|  | 2.2 HDi 130     | 96  |  | <b>07.11</b> |                            |                       |        |  |                  |
|  | 2.2 HDi 150     | 110 |  | <b>07.11</b> |                            |                       |        |  |                  |
|  | 3.0 HDi 145     | 107 |  | <b>07.10</b> |                            |                       |        |  |                  |
|  | 3.0 HDi 155     | 115 |  | <b>07.10</b> |                            |                       |        |  |                  |
|  | 3.0 HDi 160     | 116 |  | <b>09.06</b> |                            |                       |        |  |                  |
|  | 3.0 HDi 180     | 130 |  | <b>07.11</b> |                            |                       |        |  |                  |

### CITROEN JUMPY Kombi (95-06)

|  |         |     |            |              |              |                       |        |  |                                       |
|--|---------|-----|------------|--------------|--------------|-----------------------|--------|--|---------------------------------------|
|  | 1.6     |     | ORGA 09792 | <b>10.95</b> |              | <b>13.0460-2978.2</b> | 602978 |  | <b>21801</b> 19,0 +/WK/S <b>TRW</b>   |
|  | 1.9 D   | 51  | ORGA 09155 | <b>10.95</b> |              |                       |        |  |                                       |
|  | 1.9 TD  | 66  | ORGA 09792 | <b>10.95</b> |              |                       |        |  |                                       |
|  | 1.9 TD  | 68  | ORGA 09792 | <b>04.96</b> |              |                       |        |  |                                       |
|  | 2.0 16V | 100 | ORGA 09792 | <b>04.00</b> |              |                       |        |  |                                       |
|  | 2.0 16V | 102 | ORGA 09792 | <b>03.00</b> |              |                       |        |  |                                       |
|  | 2.0 HDi | 69  | ORGA 09792 | <b>10.99</b> |              |                       |        |  |                                       |
|  | 2.0 HDi | 80  | ORGA 09792 | <b>03.00</b> |              |                       |        |  |                                       |
|  | 1.6     |     | ORGA 09155 | <b>10.95</b> |              | <b>13.0460-3957.2</b> | 603957 |  | <b>23042</b> 19,0 /WK/Zub <b>BDX</b>  |
|  | 1.9 D   | 51  | ORGA 09156 | <b>12.06</b> |              |                       |        |  |                                       |
|  | 1.6     |     | ORGA 09793 | <b>12.06</b> |              | <b>13.0460-2863.2</b> | 602863 |  | <b>20261</b> 19,0 +/WK/S <b>TRW</b>   |
|  | 1.9 TD  | 66  | ORGA 09793 | <b>12.06</b> |              |                       |        |  |                                       |
|  | 2.0 16V | 100 | ORGA 09793 | <b>12.06</b> |              |                       |        |  |                                       |
|  | 2.0 16V | 102 | ORGA 09793 | <b>12.06</b> |              |                       |        |  |                                       |
|  | 2.0 HDi | 69  | ORGA 09793 | <b>12.06</b> |              |                       |        |  |                                       |
|  | 2.0 HDi | 80  | ORGA 09793 | <b>12.06</b> |              |                       |        |  |                                       |
|  | 1.6     |     | ORGA 09155 | <b>10.95</b> |              | <b>24.0120-0155.1</b> | 420155 |  | 258 20,0 18,2 V L +B                  |
|  | 1.9 D   | 51  | ORGA 09155 | <b>10.95</b> |              |                       |        |  |                                       |
|  | 1.9 TD  | 66  | ORGA 09155 | <b>10.95</b> |              |                       |        |  |                                       |
|  | 1.9 TD  | 68  | ORGA 09155 | <b>04.96</b> |              |                       |        |  |                                       |
|  | 2.0 16V | 100 | ORGA 09155 | <b>04.00</b> |              |                       |        |  |                                       |
|  | 2.0 16V | 102 | ORGA 09155 | <b>03.00</b> |              |                       |        |  |                                       |
|  | 2.0 HDi | 69  | ORGA 09155 | <b>10.99</b> |              |                       |        |  |                                       |
|  | 2.0 HDi | 80  | ORGA 09155 | <b>03.00</b> |              |                       |        |  |                                       |
|  | 1.6     |     | ORGA 09792 | <b>10.95</b> |              | <b>24.0126-0104.1</b> | 426104 |  | 281 26,0 24,2 V +B                    |
|  | 1.9 D   | 51  | ORGA 09792 | <b>10.95</b> |              |                       |        |  |                                       |
|  | 1.9 TD  | 66  | ORGA 09792 | <b>10.95</b> |              |                       |        |  |                                       |
|  | 1.9 TD  | 68  | ORGA 09792 | <b>04.96</b> |              |                       |        |  |                                       |
|  | 2.0 16V | 100 | ORGA 09792 | <b>04.00</b> |              |                       |        |  |                                       |
|  | 2.0 16V | 102 | ORGA 09792 | <b>03.00</b> |              |                       |        |  |                                       |
|  | 2.0 HDi | 69  | ORGA 09792 | <b>10.99</b> |              |                       |        |  |                                       |
|  | 2.0 HDi | 80  | ORGA 09792 | <b>03.00</b> |              |                       |        |  |                                       |
|  | 1.6     |     | ORGA 09793 | <b>12.06</b> |              | <b>24.0128-0136.1</b> | 428136 |  | 285 28,0 26,0 V +B                    |
|  | 1.9 D   | 51  | ORGA 09793 | <b>12.06</b> |              | <b>24.0328-0136.1</b> | 528136 |  | <b>285 28,0 26,0 V +B PD</b>          |
|  | 1.9 TD  | 66  | ORGA 09793 | <b>12.06</b> |              |                       |        |  |                                       |
|  | 1.9 TD  | 68  | ORGA 09793 | <b>12.06</b> |              |                       |        |  |                                       |
|  | 2.0 16V | 100 | ORGA 09793 | <b>12.06</b> |              |                       |        |  |                                       |
|  | 2.0 16V | 102 | ORGA 09793 | <b>12.06</b> |              |                       |        |  |                                       |
|  | 2.0 HDi | 69  | ORGA 09793 | <b>12.06</b> |              |                       |        |  |                                       |
|  | 2.0 HDi | 80  | ORGA 09793 | <b>12.06</b> |              |                       |        |  |                                       |
|  | 1.6     |     |            | <b>10.95</b> | <b>12.06</b> | <b>03.0137-0314.2</b> | 650314 |  | 255 x 61                              |
|  | 1.9 D   | 51  |            | <b>10.95</b> | <b>12.06</b> | <b>03.0137-9208.2</b> | 669208 |  | Bremsbacken-Zubehör                   |
|  | 1.9 TD  | 66  |            | <b>10.95</b> | <b>12.06</b> |                       |        |  |                                       |
|  | 1.9 TD  | 68  |            | <b>04.96</b> | <b>12.06</b> |                       |        |  |                                       |
|  | 2.0 16V | 100 |            | <b>04.00</b> | <b>12.06</b> |                       |        |  |                                       |
|  | 2.0 16V | 102 |            | <b>03.00</b> | <b>12.06</b> |                       |        |  |                                       |
|  | 2.0 HDi | 69  |            | <b>10.99</b> | <b>12.06</b> |                       |        |  |                                       |
|  | 2.0 HDi | 80  |            | <b>03.00</b> | <b>12.06</b> |                       |        |  |                                       |
|  | 1.6     |     |            | <b>10.95</b> | <b>12.06</b> | <b>24.0225-5003.1</b> | 480066 |  | 255/256 x 67                          |
|  | 1.9 D   | 51  |            | <b>10.95</b> | <b>12.06</b> |                       |        |  |                                       |
|  | 1.9 TD  | 66  |            | <b>10.95</b> | <b>12.06</b> |                       |        |  |                                       |
|  | 1.9 TD  | 68  |            | <b>04.96</b> | <b>12.06</b> |                       |        |  |                                       |
|  | 2.0 16V | 100 |            | <b>04.00</b> | <b>12.06</b> |                       |        |  |                                       |
|  | 2.0 16V | 102 |            | <b>03.00</b> | <b>12.06</b> |                       |        |  |                                       |
|  | 2.0 HDi | 69  |            | <b>10.99</b> | <b>12.06</b> |                       |        |  |                                       |
|  | 2.0 HDi | 80  |            | <b>03.00</b> | <b>12.06</b> |                       |        |  |                                       |
|  | 1.6     |     |            | <b>10.95</b> | <b>12.06</b> | <b>03.0520-2619.3</b> | 692619 |  | <b>19,05/255x61 TopKit</b> <b>BDX</b> |
|  | 1.9 D   | 51  |            | <b>10.95</b> | <b>12.06</b> |                       |        |  |                                       |
|  | 1.9 TD  | 66  |            | <b>10.95</b> | <b>12.06</b> |                       |        |  |                                       |
|  | 1.9 TD  | 68  |            | <b>04.96</b> | <b>12.06</b> |                       |        |  |                                       |
|  | 2.0 16V | 100 |            | <b>04.00</b> | <b>12.06</b> |                       |        |  |                                       |
|  | 2.0 16V | 102 |            | <b>03.00</b> | <b>12.06</b> |                       |        |  |                                       |
|  | 2.0 HDi | 69  |            | <b>10.99</b> | <b>12.06</b> |                       |        |  |                                       |
|  | 2.0 HDi | 80  |            | <b>03.00</b> | <b>12.06</b> |                       |        |  |                                       |

<sup>1)</sup> payload 20Q / carico utile 20Q / charge utile 20Q / carga útil 20Q



**CITROEN JUMPY Kasten (95-06)**

|            |             |            |              |                      |                          |                       |        |  |                              |            |
|------------|-------------|------------|--------------|----------------------|--------------------------|-----------------------|--------|--|------------------------------|------------|
|            | 1.6         |            | ORGA 09792   | <b>10.95</b>         | + 0,8/0,9 t              | <b>13.0460-3957.2</b> | 603957 |  | 23042 19,0 /WK/Zub           | <b>BDX</b> |
|            | 1.9 D       | 51         | ORGA 09155   | <b>10.95</b>         | + 0,8/0,9 t              | <b>13.0460-2978.2</b> | 602978 |  | 21801 19,0 +/WK/S            | <b>TRW</b> |
|            | 1.9 D 70    | 51         | ORGA 09155   | <b>04.98</b>         | + 0,8/0,9 t              |                       |        |  |                              |            |
|            | 1.9 TD      | 66         | ORGA 09155   | <b>10.95</b>         | + 0,8/0,9 t              |                       |        |  |                              |            |
|            | 2.0 16V     |            | ORGA 09792   | <b>03.00</b>         | + 0,8/0,9 t              |                       |        |  |                              |            |
|            | 2.0 HDi 110 | 80         | ORGA 09792   | <b>01.02</b>         | + 0,8/0,9 t              |                       |        |  |                              |            |
|            | 2.0 HDi 95  | 69         | ORGA 09792   | <b>10.99</b>         | + 0,8/0,9 t              |                       |        |  |                              |            |
|            | 1.9 D       | 51         | ORGA 09156   |                      | <b>12.06</b> + 0,8/0,9 t | <b>13.0460-3957.2</b> | 603957 |  | 23042 19,0 /WK/Zub           | <b>BDX</b> |
|            | 1.9 D 70    | 51         | ORGA 09156   |                      | <b>12.06</b> + 0,8/0,9 t |                       |        |  |                              |            |
|            | 1.9 TD      | 66         | ORGA 09156   |                      | <b>12.06</b> + 0,8/0,9 t |                       |        |  |                              |            |
|            | 1.6         |            | ORGA 09793   |                      | <b>12.06</b> + 0,8/0,9 t | <b>13.0460-2863.2</b> | 602863 |  | 20261 19,0 +/WK/S            | <b>TRW</b> |
|            | 2.0 16V     |            | ORGA 09793   |                      | <b>12.06</b> + 0,8/0,9 t |                       |        |  |                              |            |
|            | 2.0 HDi 110 | 80         | ORGA 09793   |                      | <b>12.06</b> + 0,8/0,9 t |                       |        |  |                              |            |
|            | 2.0 HDi 95  | 69         | ORGA 09793   |                      | <b>12.06</b> + 0,8/0,9 t |                       |        |  |                              |            |
|            | 1.6         |            | ORGA 09155   | <b>10.95</b>         | + 0,8 t                  | <b>24.0120-0155.1</b> | 420155 |  | 258 20,0 18,2 V L +B         |            |
|            | 1.9 D 70    | 51         | ORGA 09155   | <b>04.98</b>         | + 0,8 t                  |                       |        |  |                              |            |
|            | 1.9 TD      | 66         | ORGA 09155   | <b>10.95</b>         | + 0,8 t                  |                       |        |  |                              |            |
|            | 2.0 16V     |            | ORGA 09155   | <b>03.00</b>         | + 0,8 t                  |                       |        |  |                              |            |
|            | 2.0 HDi 110 | 80         | ORGA 09155   | <b>01.02</b>         | + 0,8 t                  |                       |        |  |                              |            |
|            | 2.0 HDi 95  | 69         | ORGA 09155   | <b>10.99</b>         | + 0,8 t                  |                       |        |  |                              |            |
|            | 1.6         |            | ORGA 09792   | <b>10.95</b>         | + 0,9 t                  | <b>24.0126-0104.1</b> | 426104 |  | 281 26,0 24,2 V +B           |            |
|            | 1.6         |            | ORGA 09792   |                      | + 0,8 t                  |                       |        |  |                              |            |
|            | 1.9 D 70    | 51         | ORGA 09792   | <b>04.98</b>         | + 0,9 t                  |                       |        |  |                              |            |
|            | 1.9 D 70    | 51         | ORGA 09156   |                      | + 0,8 t                  |                       |        |  |                              |            |
|            | 1.9 TD      | 66         | ORGA 09792   | <b>10.95</b>         | + 0,9 t                  |                       |        |  |                              |            |
|            | 1.9 TD      | 66         | ORGA 09156   |                      | + 0,8 t                  |                       |        |  |                              |            |
|            | 2.0 16V     |            | ORGA 09792   |                      | + 0,9 t                  |                       |        |  |                              |            |
|            | 2.0 16V     |            | ORGA 09156   |                      | + 0,8 t                  |                       |        |  |                              |            |
|            | 2.0 HDi 110 | 80         | ORGA 09792   | <b>01.02</b>         | + 0,9 t                  |                       |        |  |                              |            |
|            | 2.0 HDi 110 | 80         | ORGA 09156   |                      | + 0,8 t                  |                       |        |  |                              |            |
| 2.0 HDi 95 | 69          | ORGA 09792 | <b>10.99</b> | + 0,9 t              |                          |                       |        |  |                              |            |
| 2.0 HDi 95 | 69          | ORGA 09156 |              | + 0,8 t              |                          |                       |        |  |                              |            |
|            | 1.6         |            | ORGA 09793   |                      | <b>12.06</b> + 0,9 t     | <b>24.0128-0136.1</b> | 428136 |  | 285 28,0 26,0 V +B           |            |
|            | 1.6         |            | ORGA 09793   |                      | <b>12.06</b> + 0,8 t     | <b>24.0328-0136.1</b> | 528136 |  | <b>285 28,0 26,0 V +B PD</b> |            |
|            | 1.9 D 70    | 51         | ORGA 09793   |                      | <b>12.06</b> + 0,9 t     |                       |        |  |                              |            |
|            | 1.9 D 70    | 51         | ORGA 09793   |                      | <b>12.06</b> + 0,8 t     |                       |        |  |                              |            |
|            | 1.9 TD      | 66         | ORGA 09793   |                      | <b>12.06</b> + 0,9 t     |                       |        |  |                              |            |
|            | 1.9 TD      | 66         | ORGA 09793   |                      | <b>12.06</b> + 0,8 t     |                       |        |  |                              |            |
|            | 2.0 16V     |            | ORGA 09793   |                      | <b>12.06</b> + 0,9 t     |                       |        |  |                              |            |
|            | 2.0 16V     |            | ORGA 09793   |                      | <b>12.06</b> + 0,8 t     |                       |        |  |                              |            |
|            | 2.0 HDi 110 | 80         | ORGA 09793   |                      | <b>12.06</b> + 0,9 t     |                       |        |  |                              |            |
|            | 2.0 HDi 110 | 80         | ORGA 09793   |                      | <b>12.06</b> + 0,8 t     |                       |        |  |                              |            |
| 2.0 HDi 95 | 69          | ORGA 09793 |              | <b>12.06</b> + 0,9 t |                          |                       |        |  |                              |            |
| 2.0 HDi 95 | 69          | ORGA 09793 |              | <b>12.06</b> + 0,8 t |                          |                       |        |  |                              |            |
|            | 1.6         |            |              | <b>10.95</b>         | <b>12.06</b>             | <b>03.0137-0314.2</b> | 650314 |  | 255 x 61                     |            |
|            | 1.9 D       | 51         |              | <b>10.95</b>         | <b>12.06</b>             | <b>03.0137-9208.2</b> | 669208 |  | Bremsbacken-Zubehör          |            |
|            | 1.9 D 70    | 51         |              | <b>04.98</b>         | <b>12.06</b>             |                       |        |  |                              |            |
|            | 1.9 TD      | 66         |              | <b>10.95</b>         | <b>12.06</b>             |                       |        |  |                              |            |
|            | 2.0 16V     |            |              | <b>03.00</b>         | <b>12.06</b>             |                       |        |  |                              |            |
|            | 2.0 HDi 110 | 80         |              | <b>01.02</b>         | <b>12.06</b>             |                       |        |  |                              |            |
|            | 2.0 HDi 95  | 69         |              | <b>10.99</b>         | <b>12.06</b>             |                       |        |  |                              |            |
|            | 1.6         |            |              | <b>10.95</b>         | <b>12.06</b>             | <b>24.0225-5003.1</b> | 480066 |  | 255/256 x 67                 |            |
|            | 1.9 D       | 51         |              | <b>10.95</b>         | <b>12.06</b>             |                       |        |  |                              |            |
|            | 1.9 D 70    | 51         |              | <b>04.98</b>         | <b>12.06</b>             |                       |        |  |                              |            |
|            | 1.9 TD      | 66         |              | <b>10.95</b>         | <b>12.06</b>             |                       |        |  |                              |            |
|            | 2.0 16V     |            |              | <b>03.00</b>         | <b>12.06</b>             |                       |        |  |                              |            |
|            | 2.0 HDi 110 | 80         |              | <b>01.02</b>         | <b>12.06</b>             |                       |        |  |                              |            |
|            | 2.0 HDi 95  | 69         |              | <b>10.99</b>         | <b>12.06</b>             |                       |        |  |                              |            |
|            | 1.6         |            |              | <b>10.95</b>         | <b>12.06</b>             | <b>03.0520-2619.3</b> | 692619 |  | 19,05/255x61 TopKit          | <b>BDX</b> |
|            | 1.9 D       | 51         |              | <b>10.95</b>         | <b>12.06</b>             |                       |        |  |                              |            |
|            | 1.9 D 70    | 51         |              | <b>04.98</b>         | <b>12.06</b>             |                       |        |  |                              |            |
|            | 1.9 TD      | 66         |              | <b>10.95</b>         | <b>12.06</b>             |                       |        |  |                              |            |
|            | 2.0 16V     |            |              | <b>03.00</b>         | <b>12.06</b>             |                       |        |  |                              |            |
|            | 2.0 HDi 110 | 80         |              | <b>01.02</b>         | <b>12.06</b>             |                       |        |  |                              |            |
|            | 2.0 HDi 95  | 69         |              | <b>10.99</b>         | <b>12.06</b>             |                       |        |  |                              |            |

**CITROEN JUMPY Pritsche/Fahrgestell (99-06)**

|  |         |     |            |              |              |                       |        |  |                              |            |
|--|---------|-----|------------|--------------|--------------|-----------------------|--------|--|------------------------------|------------|
|  | 1.9 TD  | 68  | ORGA 09792 | <b>10.99</b> |              | <b>13.0460-2978.2</b> | 602978 |  | 21801 19,0 +/WK/S            | <b>TRW</b> |
|  | 2.0 HDi | 69  | ORGA 09792 | <b>10.99</b> |              |                       |        |  |                              |            |
|  | 1.9 TD  | 68  | ORGA 09793 |              | <b>12.06</b> | <b>13.0460-2863.2</b> | 602863 |  | 20261 19,0 +/WK/S            | <b>TRW</b> |
|  | 2.0     | 100 |            | <b>12.03</b> | <b>10.06</b> |                       |        |  |                              |            |
|  | 2.0 HDi | 69  | ORGA 09793 |              | <b>12.06</b> |                       |        |  |                              |            |
|  | 2.0 HDi | 80  |            | <b>12.03</b> | <b>10.06</b> |                       |        |  |                              |            |
|  | 1.9 TD  | 68  | ORGA 09792 | <b>10.99</b> |              | <b>24.0126-0104.1</b> | 426104 |  | 281 26,0 24,2 V +B           |            |
|  | 2.0 HDi | 69  | ORGA 09792 | <b>10.99</b> |              |                       |        |  |                              |            |
|  | 1.9 TD  | 68  | ORGA 09793 |              | <b>12.06</b> | <b>24.0128-0136.1</b> | 428136 |  | 285 28,0 26,0 V +B           |            |
|  | 2.0     | 100 |            | <b>12.03</b> | <b>10.06</b> | <b>24.0328-0136.1</b> | 528136 |  | <b>285 28,0 26,0 V +B PD</b> |            |
|  | 2.0 HDi | 69  | ORGA 09793 |              | <b>12.06</b> |                       |        |  |                              |            |
|  | 2.0 HDi | 80  |            | <b>12.03</b> | <b>10.06</b> |                       |        |  |                              |            |
|  | 1.9 TD  | 68  |            | <b>10.99</b> | <b>12.06</b> | <b>03.0137-0314.2</b> | 650314 |  | 255 x 61                     |            |
|  | 2.0     | 100 |            | <b>12.03</b> | <b>10.06</b> | <b>03.0137-9208.2</b> | 669208 |  | Bremsbacken-Zubehör          |            |
|  | 2.0 HDi | 69  |            | <b>10.99</b> | <b>12.06</b> |                       |        |  |                              |            |
|  | 2.0 HDi | 80  |            | <b>12.03</b> | <b>10.06</b> |                       |        |  |                              |            |







### CITROEN JUMPY Pritsche/Fahrgestell (99-06)

|  |                                     |                       |  |                                  |                                  |                |        |  |  |                         |
|--|-------------------------------------|-----------------------|--|----------------------------------|----------------------------------|----------------|--------|--|--|-------------------------|
|  | 1.9 TD<br>2.0<br>2.0 HDi<br>2.0 HDi | 68<br>100<br>69<br>80 |  | 10.99<br>12.03<br>10.99<br>12.03 | 12.06<br>10.06<br>12.06<br>10.06 | 24.0225-5003.1 | 480066 |  |  | 255/256 x 67            |
|  | 1.9 TD<br>2.0<br>2.0 HDi<br>2.0 HDi | 68<br>100<br>69<br>80 |  | 10.99<br>12.03<br>10.99<br>12.03 | 12.06<br>10.06<br>12.06<br>10.06 | 03.0520-2619.3 | 692619 |  |  | 19,05/255x61 TopKit BDX |

### CITROEN JUMPY (07-16)

|  |  |   |  |  |   |                                  |                  |  |             |  |
|--|--|---|--|--|---|----------------------------------|------------------|--|-------------|--|
|  | 1.6 HDi 90<br>2.0 HDi 120<br>2.0 HDi 120 4x4<br>2.0 HDi 125<br>2.0 HDi 140<br>2.0 HDi 165<br>2.0 HDi 95<br>2.0 i               | 66<br>88<br>88<br>94<br>100<br>120<br>72<br>103       |  | 01.07<br>01.07<br>01.10<br>07.11<br>01.07<br>07.10<br>07.11<br>01.07 |   | 13.0460-2738.2                   | 602738           |  |             | 24595 18,5 +/-WK/Zub/STRW                      |
|  | 1.6 HDi 90<br>1.6 HDi 90<br>2.0 HDi 120<br>2.0 HDi 120 4x4<br>2.0 HDi 125<br>2.0 HDi 140<br>2.0 HDi 165<br>2.0 HDi 95<br>2.0 i | 66<br>66<br>88<br>88<br>94<br>100<br>120<br>72<br>103 |  | 01.07<br>01.07<br>01.10<br>07.11<br>01.07<br>07.10<br>07.11<br>01.07 | + HA-Trommelbremse <sup>1)</sup><br>+ HA-Scheibenbremse <sup>2)</sup> | 24.0128-0214.1<br>24.0128-0216.1 | 428214<br>428216 |  |             | 280 28,0 26,0 V +S +B<br>304 28,0 26,0 V +S +B |
|  | 1.6 HDi 90<br>2.0 HDi 120<br>2.0 HDi 120 4x4<br>2.0 HDi 125<br>2.0 HDi 140<br>2.0 HDi 165<br>2.0 HDi 95<br>2.0 i               | 66<br>88<br>88<br>94<br>100<br>120<br>72<br>103       |  | 01.07<br>01.07<br>01.10<br>07.11<br>01.07<br>07.10<br>07.11<br>01.07 |   | 13.0460-2739.2                   | 602739           |  |             | 24578 16,5 /Zub/S TRW                          |
|  | 1.6 HDi 90<br>2.0 HDi 120<br>2.0 HDi 120 4x4<br>2.0 HDi 125<br>2.0 HDi 140<br>2.0 HDi 165<br>2.0 HDi 95<br>2.0 i               | 66<br>88<br>88<br>94<br>100<br>120<br>72<br>103       |  | 01.07<br>01.07<br>01.10<br>07.11<br>01.07<br>07.10<br>07.11<br>01.07 |   | 24.0114-0116.1                   | 414116           |  |             | 290 14,0 12,0 +S +B                            |
|  | 1.6 HDi 90   | 66  |  | 01.07  |   | 03.0137-0334.2<br>03.0137-9219.2 | 650334<br>669219 |  | - Wohnmobil | 254 x 57 HEB<br>Bremsbacken-Zubehör TRW        |
|  | 1.6 HDi 90   | 66  |  | 01.07  |   | 24.0225-4021.1                   | 480311           |  |             | 254/256,2 x 68                                 |
|  | 1.6 HDi 90   | 66  |  | 01.07  |   | 03.0520-7122.3                   | 697122           |  | - Wohnmobil | 22,20/254x57 TopKit TRW                        |

### CITROEN JUMPY (K0) Kasten (16-)

|  |  |                              |  |   |  |                |        |  |  |                     |
|--|--|------------------------------|--|---|--|----------------|--------|--|--|---------------------|
|  | 1.6 BlueHDi 115<br>1.6 BlueHDi 95<br>2.0 BlueHDi 120<br>2.0 BlueHDi 150<br>2.0 BlueHDi 180 | 85<br>70<br>90<br>110<br>130 |  | 04.16<br>04.16<br>04.16<br>04.16<br>04.16 |  | 24.0112-0212.1 | 412212 |  |  | 290 12,0 10,0 +S +B |
|--|--|------------------------------|--|---|--|----------------|--------|--|--|---------------------|

### CITROEN NEMO (08-)

|  |   |                            |  |   |  |  |                            |  |  |   |
|--|---|----------------------------|--|---|--|--|----------------------------|--|--|---|
|  | 1.4 HDi<br>1.4 i  | 50<br>54                   |  | 02.08<br>02.08                            |  | 13.0460-3818.2                                     | 603818                     |  |  | 23706 18,1 +/-WK/S BOS  |
|  | 1.3 HDi 75<br>1.3 HDi 80                                | 55<br>59                   |  | 10.10<br>10.15                            |  | 13.0460-3863.2                                     | 603863                     |  |  | 23706 18,0 +/-WK/Zub/SBOS   |
|  | 1.4 HDi<br>1.3 HDi 75<br>1.3 HDi 80<br>1.4 HDi<br>1.4 i | 50<br>55<br>59<br>50<br>54 |  | 02.08<br>10.10<br>10.15<br>02.08<br>02.08 | + automatisiertes Schaltgetriebe <sup>3)</sup><br><br>+ Schaltgetriebe <sup>4)</sup> | 24.0122-0147.1<br>24.0122-0197.1<br>24.0322-0197.1 | 422147<br>422197<br>522197 |  |  | 284 22,0 20,2 V +B<br>258 22,0 20,2 V +B<br>258 22,0 20,2 V +B PD |
|  | 1.4 HDi<br>1.4 i  | 50<br>54                   |  | 10.10<br>02.08                            |  | 03.0137-0479.2<br>03.0137-9310.2                   | 650479<br>669310           |  |  | 203 x 38 HEB<br>Bremsbacken-Zubehör AP                            |
|  | 1.3 HDi 75<br>1.3 HDi 80<br>1.4 HDi                     | 55<br>59<br>50             |  | 10.10<br>10.15<br>02.08                   | 09.10  | 03.0137-0493.2<br>03.0137-9309.2                   | 650493<br>669309           |  |  | 228 x 42 HEB<br>Bremsbacken-Zubehör AP                            |
|  | 1.4 i<br>1.3 HDi 75<br>1.3 HDi 80<br>1.4 HDi            | 54<br>55<br>59<br>50       |  | 02.08<br>10.10<br>10.15<br>02.08          |  | 24.0220-2001.1<br>24.0222-8038.1                   | 480307<br>480316           |  |  | 203/204,7 x 48,5<br>228/230 x 48                                  |
|  | 1.4 HDi<br>1.4 i  | 50<br>54                   |  | 10.10<br>02.08                            |  | 03.0520-9220.3                                     | 699220                     |  |  | 20,64/203x38 TopKit AP  |

1) + RA drum brake / + P freno a tamburo / + frein à tambour essieu AR / + ET-tambores de freno  
2) + RA disc brake / + P disco freno / + frein à disque essieu AR / + ET-disco de freno  
3) + autom.manual transmission / + scatola camb.velocità autom. / + transm.mécanique autom. / + cambio de velocidad autom.  
4) + manual transmission / + scatola cambio velocità / + transmission mécanique / + cambio de velocidad

**CITROEN SAXO (96-04)**

|             |             |           |            |            |       |                |                |                              |                                |                          |                   |  |
|-------------|-------------|-----------|------------|------------|-------|----------------|----------------|------------------------------|--------------------------------|--------------------------|-------------------|--|
|             | 1.0 i       |           |            | 02.96      | 03.04 | 13.0460-4066.2 | 604066         |                              | für 3-Loch-Felge <sup>1)</sup> | 21857 17,7               | ATE               |  |
|             | 1.1 X/SX    |           |            | 02.96      | 03.04 | 13.0460-3962.2 | 603962         |                              | für 4-Loch-Felge <sup>2)</sup> | 20905 18,0 +/WE          | BDX               |  |
|             | Electric    | 20        |            | 11.96      | 06.03 | 13.0460-0424.2 | 610424         |                              |                                | Belagsatz-Zubehör        | ATE               |  |
|             | 1.4 i VTS   | 55        |            | 02.96      | 03.04 | 13.0460-3962.2 | 603962         |                              |                                | 20905 18,0 +/WE          | BDX               |  |
|             | 1.5 D       |           |            | 04.96      | 03.04 |                |                |                              |                                |                          |                   |  |
|             | 1.5 D       | 43        |            | 07.01      | 04.04 |                |                |                              |                                |                          |                   |  |
|             | 1.4 i VTS   | 55        |            | 05.96      | 03.04 | 13.0460-7088.2 | 607088         |                              |                                | 21827 17,3 +             | ATE               |  |
|             | 1.6         | 66        |            | 02.96      | 06.03 |                |                |                              |                                |                          |                   |  |
|             | 1.6         | 74        |            | 02.01      | 04.04 |                |                |                              |                                |                          |                   |  |
|             | 1.6         | 88        |            | 02.96      | 04.04 |                |                |                              |                                |                          |                   |  |
| 1.6 16V VTS | 87          |           | 07.96      | 03.04      |       |                |                |                              |                                |                          |                   |  |
| 1.6 i       | 65          |           | 02.96      | 03.04      |       |                |                |                              |                                |                          |                   |  |
| 1.6 i VTS   | 72          |           | 09.00      | 03.04      |       |                |                |                              |                                |                          |                   |  |
| Electric    | 20          |           | 11.96      | 06.03      |       |                |                | + 4-Loch Felge <sup>3)</sup> |                                |                          |                   |  |
|             | 1.0 i       |           |            | 02.96      | 03.04 | 24.0108-0107.1 | 408107         |                              | für 3-Loch-Felge <sup>1)</sup> | 238 8,0 6,0 +S +B        |                   |  |
|             | 1.1 X/SX    |           |            | 02.96      | 03.04 | 24.0110-0187.1 | 410187         |                              | für 4-Loch-Felge <sup>2)</sup> | 247 10,0 9,0 +S +B       |                   |  |
|             | Electric    | 20        |            | 11.96      | 06.03 |                |                |                              |                                |                          |                   |  |
|             | 1.4 i VTS   | 55        |            | 02.96      | 03.04 | 24.0110-0187.1 | 410187         |                              |                                | 247 10,0 9,0 +S +B       |                   |  |
|             | 1.5 D       |           |            | 04.96      | 03.04 |                |                |                              |                                |                          |                   |  |
|             | 1.5 D       | 43        |            | 07.01      | 04.04 |                |                |                              |                                |                          |                   |  |
|             | 1.4 i VTS   | 55        |            | 05.96      | 03.04 | 24.0120-0132.1 | 420132         |                              |                                | 247 20,4 18,5 V +S +B    |                   |  |
|             | Electric    | 20        |            | 11.96      | 06.03 |                |                |                              | + 4-Loch Felge <sup>3)</sup>   |                          |                   |  |
|             | 1.6         | 66        |            | 02.96      | 06.03 | 24.0120-0132.1 | 420132         |                              |                                | 247 20,4 18,5 V +S +B    |                   |  |
|             | 1.6         | 74        |            | 02.01      | 04.04 | 24.0320-0132.1 | 520132         |                              |                                | 247 20,4 18,5 V +S +B PD |                   |  |
| 1.6         | 88          |           | 02.96      | 04.04      |       |                |                |                              |                                |                          |                   |  |
| 1.6 16V VTS | 87          |           | 07.96      | 03.04      |       |                |                |                              |                                |                          |                   |  |
| 1.6 i       | 65          |           | 02.96      | 03.04      |       |                |                |                              |                                |                          |                   |  |
| 1.6 i VTS   | 72          |           | 09.00      | 03.04      |       |                |                |                              |                                |                          |                   |  |
|             | 1.0 i       |           |            | 02.96      | 03.04 | 24.0751-1128.3 | 360094         | 2                            |                                | Radsensor L=515          |                   |  |
|             | 1.1 X/SX    |           |            | 02.96      | 03.04 |                |                |                              |                                |                          |                   |  |
|             | 1.4 i VTS   | 55        |            | 02.96      | 03.04 |                |                |                              |                                |                          |                   |  |
|             | 1.5 D       |           |            | 04.96      | 03.04 |                |                |                              |                                |                          |                   |  |
|             | 1.5 D       | 43        |            | 07.01      | 04.04 |                |                |                              |                                |                          |                   |  |
|             | 1.6         | 66        |            | 02.96      | 06.03 |                |                |                              |                                |                          |                   |  |
|             | 1.6         | 74        |            | 02.01      | 04.04 |                |                |                              |                                |                          |                   |  |
|             | 1.6         | 88        |            | 02.96      | 04.04 |                |                |                              |                                |                          |                   |  |
|             | 1.6 16V VTS | 87        |            | 07.96      | 03.04 |                |                |                              |                                |                          |                   |  |
|             | 1.6 i       | 65        |            | 02.96      | 03.04 |                |                |                              |                                |                          |                   |  |
| 1.6 i VTS   | 72          |           | 09.00      | 03.04      |       |                |                |                              |                                |                          |                   |  |
| Electric    | 20          |           | 11.96      | 06.03      |       |                |                |                              |                                |                          |                   |  |
|             | 1.6         | 66        |            | 02.96      | 06.03 | 13.0460-3823.2 | 603823         |                              |                                | 20974 11,0               | BOS               |  |
|             | 1.6         | 74        |            | 02.01      | 04.04 | 13.0460-0435.2 | 610435         |                              |                                | Belagsatz-Zubehör        | BDX               |  |
|             | 1.6         | 88        |            | 02.96      | 04.04 |                |                |                              |                                |                          |                   |  |
|             | 1.6 16V VTS | 87        |            | 07.96      | 03.04 |                |                |                              |                                |                          |                   |  |
|             | 1.6 i VTR   | 65        |            | 02.96      | 03.04 |                |                |                              |                                |                          |                   |  |
|             | 1.6 i VTS   | 72        |            | 09.00      | 03.04 |                |                |                              |                                |                          |                   |  |
|             | Electric    | 20        |            | 11.96      | 06.03 |                |                |                              |                                |                          |                   |  |
|             |             | 1.6       | 66         |            | 02.96 | 06.03          | 24.0108-0106.1 | 408106                       |                                |                          | 247 8,0 6,0 +S +B |  |
|             |             | 1.6       | 74         |            | 02.01 | 04.04          |                |                              |                                |                          |                   |  |
|             |             | 1.6       | 88         |            | 02.96 | 04.04          |                |                              |                                |                          |                   |  |
| 1.6 16V VTS |             | 87        |            | 07.96      | 03.04 |                |                |                              |                                |                          |                   |  |
| 1.6 i VTR   |             | 65        |            | 02.96      | 03.04 |                |                |                              |                                |                          |                   |  |
| 1.6 i VTS   |             | 72        |            | 09.00      | 03.04 |                |                |                              |                                |                          |                   |  |
| Electric    |             | 20        |            | 11.96      | 06.03 |                |                |                              |                                |                          |                   |  |
|             |             | 1.0 i     |            | ORGA 08028 | 02.96 |                | 24.0721-1187.3 | 360090                       | 2                              |                          | Radsensor L=715   |  |
|             |             | 1.1 X/SX  |            | ORGA 08028 | 02.96 |                |                |                              |                                |                          |                   |  |
|             |             | 1.4 i VTS | 55         | ORGA 08028 | 02.96 |                |                |                              |                                |                          |                   |  |
|             | 1.5 D       |           | ORGA 08028 | 04.96      |       |                |                |                              |                                |                          |                   |  |
|             | 1.5 D       | 43        | ORGA 08028 | 07.01      |       |                |                |                              |                                |                          |                   |  |
|             | 1.6         | 66        | ORGA 08028 | 02.96      |       |                |                |                              |                                |                          |                   |  |
|             | 1.6 i       | 65        | ORGA 08028 | 02.96      |       |                |                |                              |                                |                          |                   |  |
|             | Electric    | 20        | ORGA 08028 | 11.96      |       |                |                |                              |                                |                          |                   |  |
|             |             |           |            |            |       |                |                |                              |                                |                          |                   |  |
|             |             |           |            |            |       |                |                |                              |                                |                          |                   |  |
|             | 1.0 i       |           | ORGA 08029 |            | 03.04 | 24.0721-1199.3 | 360292         | 2                            |                                | Radsensor L=715          |                   |  |
|             | 1.1 X/SX    |           | ORGA 08029 |            | 03.04 |                |                |                              |                                |                          |                   |  |
|             | 1.4 i VTS   | 55        | ORGA 08029 |            | 03.04 |                |                |                              |                                |                          |                   |  |
|             | 1.5 D       |           | ORGA 08029 |            | 03.04 |                |                |                              |                                |                          |                   |  |
|             | 1.5 D       | 43        | ORGA 08029 |            | 04.04 |                |                |                              |                                |                          |                   |  |
|             | 1.6         | 66        | ORGA 08029 |            | 06.03 |                |                |                              |                                |                          |                   |  |
|             | 1.6 i       | 65        | ORGA 08029 |            | 03.04 |                |                |                              |                                |                          |                   |  |
|             | Electric    | 20        | ORGA 08029 |            | 06.03 |                |                |                              |                                |                          |                   |  |
|             |             |           |            |            |       |                |                |                              |                                |                          |                   |  |
|             |             |           |            |            |       |                |                |                              |                                |                          |                   |  |
|             | 1.6         | 66        | ORGA 08028 | 02.96      |       | 24.0751-1132.3 | 360294         | 2                            |                                | Radsensor L=740          |                   |  |
|             | 1.6         | 88        | ORGA 08028 | 02.96      |       |                |                |                              |                                |                          |                   |  |
|             | 1.6 16V VTS | 87        | ORGA 08028 | 07.96      |       |                |                |                              |                                |                          |                   |  |
|             | 1.6 i       | 65        | ORGA 08028 | 02.96      |       |                |                |                              |                                |                          |                   |  |
|             | Electric    | 20        | ORGA 08028 | 11.96      |       |                |                |                              |                                |                          |                   |  |
|             |             |           |            |            |       |                |                |                              |                                |                          |                   |  |
|             |             |           |            |            |       |                |                |                              |                                |                          |                   |  |
|             |             |           |            |            |       |                |                |                              |                                |                          |                   |  |
|             |             |           |            |            |       |                |                |                              |                                |                          |                   |  |
|             |             |           |            |            |       |                |                |                              |                                |                          |                   |  |
|             | 1.6         | 66        | ORGA 08029 |            | 06.03 | 24.0751-1190.3 | 360299         | 2                            |                                | Radsensor L=740          |                   |  |
|             | 1.6         | 74        |            | 02.01      | 04.04 |                |                |                              |                                |                          |                   |  |
|             | 1.6         | 88        | ORGA 08029 |            | 04.04 |                |                |                              |                                |                          |                   |  |
|             | 1.6 16V VTS | 87        | ORGA 08029 |            | 03.04 |                |                |                              |                                |                          |                   |  |
|             | 1.6 i       | 65        | ORGA 08029 |            | 03.04 |                |                |                              |                                |                          |                   |  |
|             | 1.6 i VTS   | 72        |            | 09.00      | 03.04 |                |                |                              |                                |                          |                   |  |
|             | Electric    | 20        | ORGA 08029 |            | 06.03 |                |                |                              |                                |                          |                   |  |
|             |             |           |            |            |       |                |                |                              |                                |                          |                   |  |
|             |             |           |            |            |       |                |                |                              |                                |                          |                   |  |
|             |             |           |            |            |       |                |                |                              |                                |                          |                   |  |





<sup>1)</sup> for 3 bore wheel rim / per cerchione a 3 fori / pour jante à 3 trous / para Liantas de 3 taladros

<sup>2)</sup> for 4 bore wheel rim / per cerchione a 4 fori / pour jante à 4 trous / para Liantas de 4 taladros

<sup>3)</sup> + 4 bore wheel rim / + cerchione a 4 fori / + jante à 4 trous / + Liantas de 4 taladros

<sup>4)</sup> + RA drum brake / + P freno a tamburo / + frein à tambour essieu AR / + ET-tambores de freno

<sup>5)</sup> + RA disc brake / + P disco freno / + frein à disque essieu AR / + ET-disco de freno

| CITROEN SAXO (96-04)   |                  | CITROEN SPACETOURER (16-) |            | CITROEN XANTIA (X1) Limousine (93-97) |                       |  |  |  |  |
|--|------------------|---------------------------|------------|---------------------------------------|-----------------------|--|--|--|--|
|    | 1.0 i            |                           |            | 02.96                                 | 03.04 - ABS           | 03.0137-0195.2 650195<br>03.0137-0196.2 650196<br>03.0137-9079.2 669079<br>03.0137-9055.2 669055 | für 3-Loch-Felge <sup>1)</sup><br>für 4-Loch-Felge <sup>2)</sup><br>für 3-Loch-Felge <sup>1)</sup><br>für 4-Loch-Felge <sup>2)</sup>                           | 164 x 32 AUT<br>180 x 32 AUT<br>Bremsbacken-Zubehör<br>Bremsbacken-Zubehör                       | <b>BDX</b><br><br><b>BDX</b>                         |
|  | 1.1 X/SX         |                           |            | 02.96                                 | 03.04 - ABS           |  |  |  |  |
|  | Electric         | 20                        |            | 11.96                                 | 06.03 - ABS           |  |  |  |  |
|  | 1.4 i VTS        | 55                        |            | 02.96                                 | 03.04 - ABS           |  |  |  |  |
|  | 1.5 D            | 43                        |            | 04.96                                 | 03.04 - ABS           |  |  |  |  |
|  | 1.5 D            | 43                        |            | 07.01                                 | 04.04 - ABS           |  |  |  |  |
|  | 1.6              | 66                        |            | 02.96                                 | 06.03 - ABS           |  |  |  |  |
|  | 1.6 i SX/VTL/VSX | 65                        |            | 02.96                                 | 03.04 - ABS           |  |  |  |  |
|  | 1.0 i            |                           |            | 02.96                                 | 03.04 + ABS           |  |  |  |  |
|  | 1.1 X/SX         |                           |            | 02.96                                 | 03.04 + ABS           |  |  |  |  |
| 1.4 i VTS  | 55               |                           | 02.96      | 03.04 + ABS                           |                       |  |  |  |  |
| 1.5 D  | 43               |                           | 04.96      | 03.04 + ABS                           |                       |  |  |  |  |
| 1.5 D  | 43               |                           | 07.01      | 04.04 + ABS                           |                       |  |  |  |  |
| 1.6  | 66               |                           | 02.96      | 06.03 + ABS                           |                       |  |  |  |  |
| 1.6 i SX/VTL/VSX   | 65               |                           | 02.96      | 03.04 + ABS                           |                       |  |  |  |  |
| Electric   | 20               |                           | 11.96      | 06.03 + ABS                           |                       |  |  |  |  |
|    | 1.0 i            |                           |            | 02.96                                 | 03.04 - ABS           | 24.0216-5001.1 480001<br>24.0216-5701.2 480212<br>24.0218-0020.1 480074<br>24.0218-0720.2 480205 | für 3-Loch-Felge/- Sensorring <sup>3)</sup><br>für 3-Loch-Felge/- Sensorring <sup>3)</sup><br>für 4-Loch-Felge <sup>2)</sup><br>für 4-Loch-Felge <sup>2)</sup> | 165/166 x 38,5 - Lager<br>165/166 x 38,5 + Lager<br>180/181 x 46 - Lager<br>180/181 x 46 + Lager | <b>TRW</b><br><br><b>TRW</b>                         |
|  | 1.1 X/SX         |                           |            | 02.96                                 | 03.04 - ABS           |  |  |  |  |
|  | Electric         | 20                        |            | 11.96                                 | 06.03 - ABS           |  |  |  |  |
|  | 1.4 i VTS        | 55                        |            | 02.96                                 | 03.04 - ABS           |  |  |  |  |
|  | 1.5 D            | 43                        |            | 04.96                                 | 03.04 - ABS           |  |  |  |  |
|  | 1.5 D            | 43                        |            | 07.01                                 | 04.04 - ABS           |  |  |  |  |
|  | 1.6              | 66                        |            | 02.96                                 | 06.03 - ABS           |  |  |  |  |
|  | 1.6 i SX/VTL/VSX | 65                        |            | 02.96                                 | 03.04 - ABS           |  |  |  |  |
|  | 1.0 i            |                           |            | 02.96                                 | 03.04 + ABS           |  |  |  |  |
|  | 1.1 X/SX         |                           |            | 02.96                                 | 03.04 + ABS           |  |  |  |  |
| 1.4 i VTS  | 55               |                           | 02.96      | 03.04 + ABS                           |                       |  |  |  |  |
| 1.5 D  | 43               |                           | 04.96      | 03.04 + ABS                           |                       |  |  |  |  |
| 1.5 D  | 43               |                           | 07.01      | 04.04 + ABS                           |                       |  |  |  |  |
| 1.6  | 66               |                           | 02.96      | 06.03 + ABS                           |                       |  |  |  |  |
| 1.6 i SX/VTL/VSX   | 65               |                           | 02.96      | 03.04 + ABS                           |                       |  |  |  |  |
| Electric   | 20               |                           | 11.96      | 06.03 + ABS                           |                       |  |  |  |  |
|    | 1.0 i            |                           |            | 02.96                                 | 03.04 - ABS           | 03.0420-0519.3 680519<br>03.0520-0519.3 690519<br>03.0420-1619.3 681619<br>03.0520-1619.3 691619 | für 3-Loch-Felge <sup>1)</sup><br>für 3-Loch-Felge <sup>1)</sup><br>für 4-Loch-Felge <sup>2)</sup><br>für 4-Loch-Felge <sup>2)</sup>                           | 19,05/164x32 Kit<br>19,05/164x32 TopKit<br>19,05/180x32 Kit<br>19,05/180x32 TopKit               | <b>BDX</b><br><b>BDX</b><br><b>BDX</b><br><b>BDX</b> |
|  | 1.1 X/SX         |                           |            | 02.96                                 | 03.04 - ABS           |  |  |  |  |
|  | Electric         | 20                        |            | 11.96                                 | 06.03 - ABS           |  |  |  |  |
|  | 1.4 i VTS        | 55                        |            | 02.96                                 | 03.04 - ABS           |  |  |  |  |
|  | 1.5 D            | 43                        |            | 04.96                                 | 03.04 - ABS           |  |  |  |  |
|  | 1.5 D            | 43                        |            | 07.01                                 | 04.04 - ABS           |  |  |  |  |
|  | 1.6              | 66                        |            | 02.96                                 | 06.03 - ABS           |  |  |  |  |
|  | 1.6 i SX/VTL/VSX | 65                        |            | 02.96                                 | 03.04 - ABS           |  |  |  |  |
|  | 1.0 i            |                           | ORGA 08095 | 02.96                                 | + ABS                 |  |  |  |  |
|  | 1.1 X/SX         |                           | ORGA 08095 | 02.96                                 | + ABS                 |  |  |  |  |
| 1.4 i VTS  | 55               | ORGA 08095                | 02.96      | + ABS                                 |                       |  |  |  |  |
| 1.5 D  | 43               | ORGA 08095                | 04.96      | + ABS                                 |                       |  |  |  |  |
| 1.5 D  | 43               | ORGA 08095                | 07.01      | + ABS                                 |                       |  |  |  |  |
| 1.6  | 66               | ORGA 08095                | 02.96      | + ABS                                 |                       |  |  |  |  |
| 1.6 i SX/VTL/VSX   | 65               | ORGA 08095                | 02.96      | + ABS                                 |                       |  |  |  |  |
| Electric   | 20               | ORGA 08095                | 11.96      | + ABS                                 |                       |  |  |  |  |
| 1.0 i  |                  | ORGA 08096                |            | 03.04 + ABS                           |                       |  |  |  |  |
| 1.1 X/SX   |                  | ORGA 08096                |            | 03.04 + ABS                           |                       |  |  |  |  |
| 1.4 i VTS  | 55               | ORGA 08096                |            | 03.04 + ABS                           |                       |  |  |  |  |
| 1.5 D  | 43               | ORGA 08096                |            | 03.04 + ABS                           |                       |  |  |  |  |
| 1.5 D  | 43               | ORGA 08096                |            | 04.04 + ABS                           |                       |  |  |  |  |
| 1.6  | 66               | ORGA 08096                |            | 06.03 + ABS                           |                       |  |  |  |  |
| 1.6 i SX/VTL/VSX   | 65               | ORGA 08096                |            | 03.04 + ABS                           |                       |  |  |  |  |
| Electric   | 20               | ORGA 08096                |            | 06.03 + ABS                           |                       |  |  |  |  |
|  | 1.6 BlueHDi 115  | 85                        |            | 04.16                                 |                       | 24.0112-0212.1 412212  |  | 290 12,0 10,0 +S +B  |  |
|  | 1.6 BlueHDi 95   | 70                        |            | 04.16                                 |                       |  |  |  |  |
|  | 2.0 BlueHDi 150  | 110                       |            | 04.16                                 |                       |  |  |  |  |
|  | 2.0 BlueHDi 180  | 130                       |            | 04.16                                 |                       |  |  |  |  |
|  |                  |                           |            |                                       |                       |  |  |  |  |
|  | 1.6 i            | 65                        |            | 03.93                                 | 12.97                 | 13.0460-3956.2 603956  |  | 21631 17,0 /WK   | <b>BDX</b>   |
|  | 1.8 16V          | 81                        |            | 06.95                                 | 12.97                 |  |  |  |  |
|  | 1.8 i            | 66                        |            | 04.97                                 | 12.97                 |  |  |  |  |
|  | 1.8 i            | 74                        |            | 03.93                                 | 12.97                 |  |  |  |  |
|  | 1.9 D            | 50                        |            | 06.94                                 | 12.97                 |  |  |  |  |
|  | 1.9 D            | 51                        |            | 06.94                                 | 12.97                 |  |  |  |  |
|  | 1.9 SD           | 55                        |            | 02.96                                 | 12.97                 |  |  |  |  |
|  | 1.9 TD           | 66                        |            | 10.94                                 | 12.97                 |  |  |  |  |
|  | 2.0              | 95                        |            | 03.93                                 | 05.95                 |  |  |  |  |
|  | 2.0 16V          | 97                        |            | 06.95                                 | 12.97                 |  |  |  |  |
|  | 2.0 16V          | 110                       |            | 06.94                                 | 12.97                 |  |  |  |  |
|  | 2.0 16V          | 112                       |            | 03.93                                 | 12.97                 |  |  |  |  |
|  | 2.0 i            | 89                        |            | 03.93                                 | 12.97                 |  |  |  |  |
|  | 2.0 Turbo        | 108                       |            | 06.95                                 | 12.97                 |  |  |  |  |
|  | 2.1 TD           | 80                        |            | 06.95                                 | 12.97                 |  |  |  |  |
|  | 3.0 V6           | 140                       |            | 01.97                                 | 12.97                 |  |  |  |  |
|  |                  |                           |            |                                       |                       |  |  |  |  |
|  |                  |                           |            |                                       | 13.0460-3986.2 603986 |  | 23135 18,0 +/WK/S  | <b>BOS</b>   |  |

<sup>1)</sup> for 3 bore wheel rim / per cerchione a 3 fori / pour jante à 3 trous / para Llantas de 3 taladros  
<sup>2)</sup> for 4 bore wheel rim / per cerchione a 4 fori / pour jante à 4 trous / para Llantas de 4 taladros  
<sup>3)</sup> f.3 bore wheel rim/-sensorring / p.cerchione a 3 fori/- sensore / p.jant.à 3 trous/- secours ABS / Llant.3 tala./-anillo sens.ABS  
<sup>4)</sup> + cast iron / + ghisa / + fonte grise / + fundición de gris

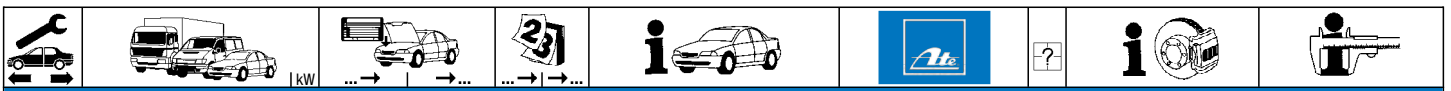

**CITROEN XANTIA (X1) Limousine (93-97)**

|           |         |            |            |       |                |                |        |                          |                          |  |
|-----------|---------|------------|------------|-------|----------------|----------------|--------|--------------------------|--------------------------|--|
|           | 1.6 i   | 65         |            | 03.93 | 12.97          | 24.0120-0133.1 | 420133 |                          | 266 20,5 18,5 V +S +B    |  |
|           | 1.8 16V | 81         |            | 06.95 | 12.97          | 24.0320-0133.1 | 520133 |                          | 266 20,5 18,5 V +S +B PD |  |
|           | 1.8 i   | 66         |            | 04.97 | 12.97          |                |        |                          |                          |  |
|           | 1.8 i   | 74         |            | 03.93 | 12.97          |                |        |                          |                          |  |
|           | 1.9 D   | 50         |            | 06.94 | 12.97          |                |        |                          |                          |  |
|           | 1.9 D   | 51         |            | 06.94 | 12.97          |                |        |                          |                          |  |
|           | 1.9 SD  | 55         |            | 02.96 | 12.97          |                |        |                          |                          |  |
|           | 1.9 TD  | 66         | ORGA 07568 |       | 12.97          |                |        |                          |                          |  |
|           | 2.0 i   | 89         |            | 03.93 | 12.97          |                |        |                          |                          |  |
|           | 1.9 TD  | 66         | ORGA 07567 | 10.94 |                | 24.0122-0142.1 | 422142 |                          | 283 22,0 20,0 V L +B     |  |
| 2.0       | 95      |            | 03.93      | 05.95 |                |                |        |                          |                          |  |
| 2.0 16V   | 97      |            | 06.95      | 12.97 |                |                |        |                          |                          |  |
| 2.0 16V   | 110     |            | 06.94      | 12.97 |                |                |        |                          |                          |  |
| 2.0 16V   | 112     |            | 03.93      | 12.97 |                |                |        |                          |                          |  |
| 2.0 Turbo | 108     |            | 06.95      | 12.97 | 24.0126-0106.1 | 426106         |        | 283 26,0 24,2 V +S +B    |                          |  |
| 2.1 TD    | 80      |            | 06.95      | 12.97 | 24.0326-0106.1 | 526106         |        | 283 26,0 24,2 V +S +B PD |                          |  |
| 3.0 V6    | 140     |            | 01.97      | 12.97 | 24.0128-0128.1 | 428128         |        | 288 28,0 26,0 V +S +B    |                          |  |
|           | 1.6 i   | 65         | ORGA 06443 | 03.93 |                | 24.0731-1133.3 | 360156 | 2                        | Radsensor L=950          |  |
|           | 1.8 i   | 74         | ORGA 06443 | 03.93 |                |                |        |                          |                          |  |
|           | 1.9 D   | 50         | ORGA 06443 | 06.94 |                |                |        |                          |                          |  |
|           | 1.9 D   | 51         | ORGA 06443 | 06.94 |                |                |        |                          |                          |  |
|           | 1.9 TD  | 66         | ORGA 06443 | 10.94 |                |                |        |                          |                          |  |
|           | 2.0 16V | 110        | ORGA 06443 | 06.94 |                |                |        |                          |                          |  |
|           | 2.0 16V | 112        | ORGA 06443 | 03.93 |                |                |        |                          |                          |  |
|           | 2.0 i   | 89         | ORGA 06443 | 03.93 |                |                |        |                          |                          |  |
|           | 1.6 i   | 65         | ORGA 06444 |       | 12.97          | 24.0751-1136.3 | 360059 | 2                        | Radsensor L=950          |  |
|           | 1.8 16V | 81         |            | 06.95 | 12.97          |                |        |                          |                          |  |
| 1.8 i     | 66      |            | 04.97      | 12.97 |                |                |        |                          |                          |  |
| 1.8 i     | 74      | ORGA 06444 |            | 12.97 |                |                |        |                          |                          |  |
| 1.9 D     | 50      | ORGA 06444 |            | 12.97 |                |                |        |                          |                          |  |
| 1.9 D     | 51      | ORGA 06444 |            | 12.97 |                |                |        |                          |                          |  |
| 1.9 SD    | 55      |            | 02.96      | 12.97 |                |                |        |                          |                          |  |
| 1.9 TD    | 66      | ORGA 06444 |            | 12.97 |                |                |        |                          |                          |  |
| 2.0       | 95      |            | 03.93      | 05.95 |                |                |        |                          |                          |  |
| 2.0 16V   | 97      |            | 06.95      | 12.97 |                |                |        |                          |                          |  |
| 2.0 16V   | 110     | ORGA 06444 |            | 12.97 |                |                |        |                          |                          |  |
| 2.0 16V   | 112     | ORGA 06444 |            | 12.97 |                |                |        |                          |                          |  |
| 2.0 i     | 89      | ORGA 06444 |            | 12.97 |                |                |        |                          |                          |  |
| 2.0 Turbo | 108     |            | 06.95      | 12.97 |                |                |        |                          |                          |  |
| 2.1 TD    | 80      |            | 06.95      | 12.97 |                |                |        |                          |                          |  |
| 3.0 V6    | 140     |            | 01.97      | 12.97 |                |                |        |                          |                          |  |
|           | 1.6 i   | 65         |            | 03.93 | 12.97          | 13.0460-4956.2 | 604956 |                          | 20162 15,4 CIT           |  |
|           | 1.8 16V | 81         |            | 06.95 | 12.97          | 13.0460-0437.2 | 610437 |                          | Belagsatz-Zubehör CIT    |  |
|           | 1.8 i   | 66         |            | 04.97 | 12.97          |                |        |                          |                          |  |
|           | 1.8 i   | 74         |            | 03.93 | 12.97          |                |        |                          |                          |  |
|           | 1.9 D   | 50         |            | 06.94 | 12.97          |                |        |                          |                          |  |
|           | 1.9 D   | 51         |            | 06.94 | 12.97          |                |        |                          |                          |  |
|           | 1.9 SD  | 55         |            | 02.96 | 12.97          |                |        |                          |                          |  |
|           | 1.9 TD  | 66         |            | 10.94 | 12.97          |                |        |                          |                          |  |
|           | 2.0     | 95         |            | 03.93 | 05.95          |                |        |                          |                          |  |
|           | 2.0 16V | 97         |            | 06.95 | 12.97          |                |        |                          |                          |  |
| 2.0 16V   | 110     |            | 06.94      | 12.97 |                |                |        |                          |                          |  |
| 2.0 16V   | 112     |            | 03.93      | 12.97 |                |                |        |                          |                          |  |
| 2.0 i     | 89      |            | 03.93      | 12.97 |                |                |        |                          |                          |  |
| 2.0 Turbo | 108     |            | 06.95      | 12.97 |                |                |        |                          |                          |  |
| 2.1 TD    | 80      |            | 06.95      | 12.97 |                |                |        |                          |                          |  |
| 3.0 V6    | 140     |            | 01.97      | 12.97 |                |                |        |                          |                          |  |
|           | 1.6 i   | 65         |            | 03.93 | 12.97          | 24.0109-0122.1 | 409122 |                          | 224 9,0 7,0 +B           |  |
|           | 1.8 16V | 81         |            | 06.95 | 12.97          |                |        |                          |                          |  |
|           | 1.8 i   | 66         |            | 04.97 | 12.97          |                |        |                          |                          |  |
|           | 1.8 i   | 74         |            | 03.93 | 12.97          |                |        |                          |                          |  |
|           | 1.9 D   | 50         |            | 06.94 | 12.97          |                |        |                          |                          |  |
|           | 1.9 D   | 51         |            | 06.94 | 12.97          |                |        |                          |                          |  |
|           | 1.9 SD  | 55         |            | 02.96 | 12.97          |                |        |                          |                          |  |
|           | 1.9 TD  | 66         |            | 10.94 | 12.97          |                |        |                          |                          |  |
|           | 2.0     | 95         |            | 03.93 | 05.95          |                |        |                          |                          |  |
|           | 2.0 16V | 97         |            | 06.95 | 12.97          |                |        |                          |                          |  |
| 2.0 16V   | 110     |            | 06.94      | 12.97 |                |                |        |                          |                          |  |
| 2.0 16V   | 112     |            | 03.93      | 12.97 |                |                |        |                          |                          |  |
| 2.0 i     | 89      |            | 03.93      | 12.97 |                |                |        |                          |                          |  |
| 2.0 Turbo | 108     |            | 06.95      | 12.97 |                |                |        |                          |                          |  |
| 2.1 TD    | 80      |            | 06.95      | 12.97 |                |                |        |                          |                          |  |
| 3.0 V6    | 140     |            | 01.97      | 12.97 |                |                |        |                          |                          |  |
|           | 1.6 i   | 65         | ORGA 07631 | 03.93 |                | 24.0721-1185.3 | 360058 | 2                        | Radsensor L=765          |  |
|           | 1.8 16V | 81         | ORGA 07631 | 06.95 |                |                |        |                          |                          |  |
|           | 1.8 i   | 66         | ORGA 07631 | 04.97 |                |                |        |                          |                          |  |
|           | 1.8 i   | 74         | ORGA 07631 | 03.93 |                |                |        |                          |                          |  |
|           | 1.9 D   | 50         | ORGA 07631 | 06.94 |                |                |        |                          |                          |  |
|           | 1.9 D   | 51         | ORGA 07631 | 06.94 |                |                |        |                          |                          |  |
|           | 1.9 SD  | 55         | ORGA 07631 | 02.96 |                |                |        |                          |                          |  |
|           | 1.9 TD  | 66         | ORGA 07631 | 10.94 |                |                |        |                          |                          |  |
|           | 2.0     | 95         | ORGA 07631 | 03.93 |                |                |        |                          |                          |  |
|           | 2.0 16V | 97         | ORGA 07631 | 06.95 |                |                |        |                          |                          |  |
| 2.0 16V   | 110     | ORGA 07631 | 06.94      |       |                |                |        |                          |                          |  |
| 2.0 16V   | 112     | ORGA 07631 | 03.93      |       |                |                |        |                          |                          |  |
| 2.0 i     | 89      | ORGA 07631 | 03.93      |       |                |                |        |                          |                          |  |



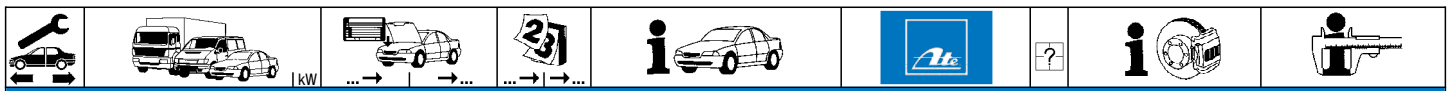











### CITROEN XANTIA (X1) Limousine (93-97)

|           |           |            |            |       |       |                |        |   |  |                 |
|-----------|-----------|------------|------------|-------|-------|----------------|--------|---|--|-----------------|
|           | 2.0 Turbo | 108        | ORGA 07631 | 06.95 |       | 24.0721-1185.3 | 360058 | 2 |  | Radsensor L=765 |
|           | 2.1 TD    | 80         | ORGA 07631 | 06.95 |       |                |        |   |  |                 |
|           | 1.6 i     | 65         | ORGA 07632 |       | 12.97 | 24.0741-1114.3 | 360067 | 2 |  | Radsensor L=780 |
|           | 1.8 16V   | 81         | ORGA 07632 |       | 12.97 |                |        |   |  |                 |
|           | 1.8 i     | 66         | ORGA 07632 |       | 12.97 |                |        |   |  |                 |
|           | 1.8 i     | 74         | ORGA 07632 |       | 12.97 |                |        |   |  |                 |
|           | 1.9 D     | 50         | ORGA 07632 |       | 12.97 |                |        |   |  |                 |
|           | 1.9 D     | 51         | ORGA 07632 |       | 12.97 |                |        |   |  |                 |
|           | 1.9 SD    | 55         | ORGA 07632 |       | 12.97 |                |        |   |  |                 |
|           | 1.9 TD    | 66         | ORGA 07632 |       | 12.97 |                |        |   |  |                 |
|           | 2.0       | 95         | ORGA 07632 |       | 05.95 |                |        |   |  |                 |
|           | 2.0 16V   | 97         | ORGA 07632 |       | 12.97 |                |        |   |  |                 |
|           | 2.0 16V   | 110        | ORGA 07632 |       | 12.97 |                |        |   |  |                 |
|           | 2.0 16V   | 112        | ORGA 07632 |       | 12.97 |                |        |   |  |                 |
|           | 2.0 i     | 89         | ORGA 07632 |       | 12.97 |                |        |   |  |                 |
| 2.0 Turbo | 108       | ORGA 07632 |            | 12.97 |       |                |        |   |  |                 |
| 2.1 TD    | 80        | ORGA 07632 |            | 12.97 |       |                |        |   |  |                 |
| 3.0 V6    | 140       |            |            | 01.97 | 12.97 |                |        |   |  |                 |

### CITROEN XANTIA (X1) Kombi (95-97)









|           |           |            |            |            |       |                |                |        |   |                          |                          |     |
|-----------|-----------|------------|------------|------------|-------|----------------|----------------|--------|---|--------------------------|--------------------------|-----|
|           | 1.8 16V   | 81         |            | 06.95      | 12.97 | 13.0460-3956.2 | 603956         |        |   | 21631 17,0 /WK           | BDX                      |     |
|           | 1.8 i     | 66         |            | 04.97      | 12.97 |                |                |        |   |                          |                          |     |
|           | 1.8 i     | 74         | ORGA 07483 |            | 12.97 | + ABS          |                |        |   |                          |                          |     |
|           | 1.8 i     | 74         |            | 06.95      | 12.97 | - ABS          |                |        |   |                          |                          |     |
|           | 1.8 i     | 74         |            | 06.95      | 12.97 | + ABS          |                |        |   |                          |                          |     |
|           | 1.9 SD    | 55         | ORGA 07482 | 06.95      | 12.97 | 13.0460-3972.2 | 603972         |        |   | 21632 16,0 /WK           | BDX                      |     |
|           | 1.9 TD    | 66         |            | 06.95      | 12.97 |                |                |        |   |                          |                          |     |
|           | 2.0 16V   | 97         |            | 06.95      | 12.97 |                |                |        |   |                          |                          |     |
|           | 2.0 i     | 89         |            | 06.95      | 12.97 |                |                |        |   |                          |                          |     |
|           | 2.0 Turbo | 108        |            | 06.95      | 12.97 |                |                |        |   |                          |                          |     |
|           | 2.1 TD    | 80         |            | 06.96      | 12.97 |                |                |        |   |                          |                          |     |
|           |           | 1.8 16V    | 81         | ORGA 07483 | 06.95 | 12.97          | 24.0120-0133.1 | 420133 |   |                          | 266 20,5 18,5 V +S +B    |     |
|           |           | 1.8 16V    | 81         |            | 06.95 | 12.97          | 24.0320-0133.1 | 520133 |   |                          | 266 20,5 18,5 V +S +B PD |     |
|           |           | 1.8 i      | 66         |            | 04.97 | 12.97          |                |        |   |                          |                          |     |
|           |           | 1.8 i      | 74         | ORGA 07483 |       | 12.97          | + ABS          |        |   |                          |                          |     |
| 1.8 i     |           | 74         |            | 06.95      | 12.97 | - ABS          |                |        |   |                          |                          |     |
|           | 1.8 16V   | 81         | ORGA 07482 | 06.95      | 12.97 | 24.0122-0142.1 | 422142         |        |   | 283 22,0 20,0 V L +B     |                          |     |
|           | 1.8 i     | 74         | ORGA 07482 | 06.95      | 12.97 | + ABS          |                |        |   |                          |                          |     |
|           | 1.9 SD    | 55         |            | 04.97      | 12.97 | + ABS          |                |        |   |                          |                          |     |
|           | 1.9 TD    | 66         |            | 06.95      | 12.97 |                |                |        |   |                          |                          |     |
|           | 2.0 16V   | 97         |            | 06.95      | 12.97 |                |                |        |   |                          |                          |     |
|           | 2.0 i     | 89         |            | 06.95      | 12.97 |                |                |        |   |                          |                          |     |
|           | 2.0 Turbo | 108        |            | 06.95      | 12.97 | 24.0126-0106.1 | 426106         |        |   | 283 26,0 24,2 V +S +B    |                          |     |
|           | 2.1 TD    | 80         |            | 06.96      | 12.97 | 24.0326-0106.1 | 526106         |        |   | 283 26,0 24,2 V +S +B PD |                          |     |
|           | 1.8 16V   | 81         |            | 06.95      | 12.97 | 24.0751-1136.3 | 360059         | 2      |   | Radsensor L=950          |                          |     |
|           | 1.8 i     | 66         |            | 04.97      | 12.97 |                |                |        |   |                          |                          |     |
|           | 1.8 i     | 74         |            | 06.95      | 12.97 |                |                |        |   |                          |                          |     |
|           | 1.9 SD    | 55         |            | 04.97      | 12.97 |                |                |        |   |                          |                          |     |
|           | 1.9 TD    | 66         |            | 06.95      | 12.97 |                |                |        |   |                          |                          |     |
|           | 2.0 16V   | 97         |            | 06.95      | 12.97 |                |                |        |   |                          |                          |     |
|           | 2.0 i     | 89         |            | 06.95      | 12.97 |                |                |        |   |                          |                          |     |
|           | 2.0 Turbo | 108        |            | 06.95      | 12.97 |                |                |        |   |                          |                          |     |
|           | 2.1 TD    | 80         |            | 06.96      | 12.97 |                |                |        |   |                          |                          |     |
|           |           | 1.8 16V    | 81         |            | 06.95 | 12.97          | 13.0460-4911.2 | 604911 |   |                          | 20389 15,4               | CIT |
| 1.8 i     |           | 66         |            | 04.97      | 12.97 | 13.0460-0264.2 | 610264         |        |   | Belagsatz-Zubehör        |                          |     |
| 1.8 i     |           | 74         |            | 06.95      | 12.97 |                |                |        |   |                          |                          |     |
| 1.9 SD    |           | 55         |            | 04.97      | 12.97 |                |                |        |   |                          |                          |     |
| 1.9 TD    |           | 66         |            | 06.95      | 12.97 |                |                |        |   |                          |                          |     |
| 2.0 16V   |           | 97         |            | 06.95      | 12.97 |                |                |        |   |                          |                          |     |
| 2.0 i     |           | 89         |            | 06.95      | 12.97 |                |                |        |   |                          |                          |     |
| 2.0 Turbo |           | 108        |            | 06.95      | 12.97 |                |                |        |   |                          |                          |     |
| 2.1 TD    |           | 80         |            | 06.96      | 12.97 |                |                |        |   |                          |                          |     |
|           |           | 1.8 16V    | 81         |            | 06.95 | 12.97          | 24.0112-0143.1 | 412143 |   |                          | 251 12,0 10,8            |     |
|           | 1.8 i     | 66         |            | 04.97      | 12.97 |                |                |        |   |                          |                          |     |
|           | 1.8 i     | 74         |            | 06.95      | 12.97 |                |                |        |   |                          |                          |     |
|           | 1.9 SD    | 55         |            | 04.97      | 12.97 |                |                |        |   |                          |                          |     |
|           | 1.9 TD    | 66         |            | 06.95      | 12.97 |                |                |        |   |                          |                          |     |
|           | 2.0 16V   | 97         |            | 06.95      | 12.97 |                |                |        |   |                          |                          |     |
|           | 2.0 i     | 89         |            | 06.95      | 12.97 |                |                |        |   |                          |                          |     |
|           | 2.0 Turbo | 108        |            | 06.95      | 12.97 |                |                |        |   |                          |                          |     |
|           | 2.1 TD    | 80         |            | 06.96      | 12.97 |                |                |        |   |                          |                          |     |
|           |           | 1.8 16V    | 81         | ORGA 07631 | 06.95 | 12.97          | 24.0721-1185.3 | 360058 | 2 |                          | Radsensor L=765          |     |
| 1.8 i     |           | 66         | ORGA 07631 | 04.97      | 12.97 |                |                |        |   |                          |                          |     |
| 1.8 i     |           | 74         | ORGA 07631 | 06.95      | 12.97 |                |                |        |   |                          |                          |     |
| 1.9 SD    |           | 55         | ORGA 07631 | 04.97      | 12.97 |                |                |        |   |                          |                          |     |
| 1.9 TD    |           | 66         | ORGA 07631 | 06.95      | 12.97 |                |                |        |   |                          |                          |     |
| 2.0 16V   |           | 97         | ORGA 07631 | 06.95      | 12.97 |                |                |        |   |                          |                          |     |
| 2.0 i     |           | 89         | ORGA 07631 | 06.95      | 12.97 |                |                |        |   |                          |                          |     |
| 2.0 Turbo |           | 108        | ORGA 07631 | 06.95      | 12.97 |                |                |        |   |                          |                          |     |
| 2.1 TD    |           | 80         | ORGA 07631 | 06.96      | 12.97 |                |                |        |   |                          |                          |     |
|           |           | 1.8 16V    | 81         | ORGA 07632 |       | 12.97          | 24.0741-1114.3 | 360067 | 2 |                          | Radsensor L=780          |     |
|           | 1.8 i     | 66         | ORGA 07632 |            | 12.97 |                |                |        |   |                          |                          |     |
|           | 1.8 i     | 74         | ORGA 07632 |            | 12.97 |                |                |        |   |                          |                          |     |
|           | 1.9 SD    | 55         | ORGA 07632 |            | 12.97 |                |                |        |   |                          |                          |     |
|           | 1.9 TD    | 66         | ORGA 07632 |            | 12.97 |                |                |        |   |                          |                          |     |
| 2.0 16V   | 97        | ORGA 07632 |            | 12.97      |       |                |                |        |   |                          |                          |     |



| CITROEN XANTIA (X1) Kombi (95-97)  |  |   |  |  |  |                                   |                                  |                  |   |   |
|--|--|---|--|--|--|-----------------------------------|----------------------------------|------------------|---|---|
|    | 2.0 i<br>2.0 Turbo<br>2.1 TD   | 89<br>108<br>80   | ORGA 07632<br>ORGA 07632<br>ORGA 07632               |  | 12.97<br>12.97<br>12.97  |                                   | 24.0741-1114.3                   | 360067           | 2    | Radsensor L=780                                   |
| CITROEN XANTIA (X2) Limousine (98-03)  |  |   |  |  |  |                                   |                                  |                  |   |   |
|    | 1.6 i SX<br>1.8 16V<br>1.8 i<br>1.9 SD<br>1.9 TD<br>2.0 HDi 90   | 65<br>81<br>66<br>55<br>66<br>66  |  |  | 01.98 03.01<br>01.98 09.01<br>01.98 09.01<br>01.98 09.01<br>01.98 09.01<br>03.99 04.03   |                                   | 13.0460-3956.2                   | 603956           |   | 21631 17,0 /WK BDX                                |
|  | 2.0 16V<br>2.0 i   | 97<br>89  |  |  | 01.98 09.01<br>01.98 09.01   |                                   | 13.0460-3972.2                   | 603972           |   | 21632 16,0 /WK BDX                                |
|  | 2.0 16V ACTIVA<br>2.0 Turbo<br>2.1 TD  | 97<br>108<br>80   | ORGA 08000<br>ORGA 08000<br>ORGA 08000               |  | 01.98<br>01.98<br>01.98  |                                   | 13.0460-3973.2                   | 603973           |   | 23146 17,0 /WK BDX                                |
|  | 1.9 TD<br>2.0 16V ACTIVA<br>2.0 HDi 110<br>2.0 Turbo<br>2.1 TD<br>3.0 V6   | 66<br>97<br>109<br>108<br>80<br>140                                     | ORGA 08001<br>ORGA 08001<br>ORGA 08001<br>ORGA 08001 |  | 01.98 09.01<br>02.99 09.01<br>02.99 09.01<br>02.99 09.01<br>01.98 09.01  | + Automatikgetriebe <sup>2)</sup> | 13.0460-3986.2                   | 603986           |   | 23135 18,0 +/WK/S BOS                             |
|    | 1.6 i SX<br>1.8 16V<br>1.8 i<br>1.9 SD<br>1.9 TD<br>2.0 HDi 90   | 65<br>81<br>66<br>55<br>66<br>66  |  |  | 01.98 03.01<br>01.98 09.01<br>01.98 09.01<br>01.98 09.01<br>01.98 09.01<br>03.99 04.03   |                                   | 24.0120-0133.1                   | 420133           |   | 266 20,5 18,5 V +S +B                             |
|  | 2.0 16V<br>2.0 i   | 97<br>89  |  |  | 01.98 09.01<br>01.98 09.01   |                                   | 24.0122-0142.1                   | 422142           |   | 283 22,0 20,0 V L +B                              |
|  | 2.0 16V ACTIVA<br>2.0 Turbo<br>2.1 TD  | 97<br>108<br>80   | ORGA 08000<br>ORGA 08000<br>ORGA 08000               |  | 01.98<br>01.98<br>01.98  |                                   | 24.0126-0106.1<br>24.0326-0106.1 | 426106<br>526106 |   | 283 26,0 24,2 V +S +B<br>283 26,0 24,2 V +S +B PD |
|  | 1.9 TD<br>2.0 16V ACTIVA<br>2.0 HDi 110<br>2.0 Turbo<br>2.1 TD<br>3.0 V6   | 66<br>97<br>109<br>108<br>80<br>140                                     | ORGA 08001<br>ORGA 08001<br>ORGA 08001<br>ORGA 08001 |  | 01.98 09.01<br>02.99 09.01<br>02.99 09.01<br>02.99 09.01<br>01.98 09.01  | + Automatikgetriebe <sup>2)</sup> | 24.0128-0128.1                   | 428128           |   | 288 28,0 26,0 V +S +B                             |
|  | 1.6 i SX<br>1.8 16V<br>1.8 i<br>1.9 SD<br>1.9 TD<br>2.0 16V<br>2.0 HDi 110<br>2.0 HDi 90<br>2.0 i<br>2.0 Turbo<br>2.1 TD<br>3.0 V6 | 65<br>81<br>66<br>55<br>66<br>97<br>109<br>66<br>89<br>108<br>80<br>140 |  |  | 01.98 03.01<br>01.98 09.01<br>01.98 09.01<br>01.98 09.01<br>01.98 09.01<br>02.99 09.01<br>02.99 09.01<br>03.99 09.01<br>01.98 09.01<br>01.98 09.01<br>01.98 02.99<br>01.98 09.01 |                                   | 24.0751-1187.3                   | 360069           | 2  | Radsensor L=965                                   |
|  | 1.6 i SX<br>1.8 16V<br>1.8 i<br>1.9 SD<br>1.9 TD<br>2.0 16V<br>2.0 HDi 110<br>2.0 HDi 90<br>2.0 i<br>2.0 Turbo<br>2.1 TD<br>3.0 V6 | 65<br>81<br>66<br>55<br>66<br>97<br>109<br>66<br>89<br>108<br>80<br>140 |  |  | 01.98 03.01<br>01.98 09.01<br>01.98 09.01<br>01.98 09.01<br>01.98 09.01<br>02.99 09.01<br>02.99 09.01<br>03.99 09.01<br>01.98 09.01<br>01.98 09.01<br>01.98 02.99<br>01.98 09.01 |                                   | 13.0460-4956.2<br>13.0460-0437.2 | 604956<br>610437 |   | 20162 15,4<br>Belagsatz-Zubehör<br>CIT<br>CIT     |
|  | 1.6 i SX<br>1.8 16V<br>1.8 i<br>1.9 SD<br>1.9 TD<br>2.0 16V<br>2.0 HDi 110<br>2.0 HDi 90<br>2.0 i<br>2.0 Turbo<br>2.1 TD<br>3.0 V6 | 65<br>81<br>66<br>55<br>66<br>97<br>109<br>66<br>89<br>108<br>80<br>140 |  |  | 01.98 03.01<br>01.98 09.01<br>01.98 09.01<br>01.98 09.01<br>01.98 09.01<br>02.99 09.01<br>02.99 09.01<br>03.99 09.01<br>01.98 09.01<br>01.98 09.01<br>01.98 02.99<br>01.98 09.01 |                                   | 24.0109-0122.1                   | 409122           |   | 224 9,0 7,0 +B                                    |
|  | 1.6 i SX<br>1.8 16V<br>1.8 i<br>1.9 SD<br>1.9 TD<br>2.0 16V<br>2.0 HDi 110<br>2.0 HDi 90<br>2.0 i<br>2.0 Turbo                     | 65<br>81<br>66<br>55<br>66<br>97<br>109<br>66<br>89<br>108              |  |  | 01.98 03.01<br>01.98 09.01<br>01.98 09.01<br>01.98 09.01<br>01.98 09.01<br>02.99 09.01<br>02.99 09.01<br>03.99 09.01<br>01.98 09.01<br>01.98 09.01                               |                                   | 24.0741-1114.3                   | 360067           | 2  | Radsensor L=780                                   |

1) + manual transmission / + scatola cambio velocità / + transmission mécanique / + cambio de velocidad  
2) + autom.transmission / + scatola cambio automatico / + transmission automatique / + cambio automático



| CITROEN XANTIA (X2) Limousine (98-03)  |   |   |                          |  |  |                                  |                  |   |                        |   |
|--|---|---|--------------------------|--|--|----------------------------------|------------------|---|------------------------|---|
|    | 2.1 TD<br>3.0 V6  | 80<br>140                                       |                          | 01.98<br>01.98   | 02.99<br>09.01   | 24.0741-1114.3                   | 360067           | 2 |                        | Radsensor L=780                                   |
| CITROEN XANTIA (X2) Kombi (98-03)  |   |   |                          |  |  |                                  |                  |   |                        |   |
|    | 1.8 16V<br>1.8 i  | 81<br>66  |                          | 01.98<br>01.98   | 09.01<br>09.01   | 13.0460-3956.2                   | 603956           |   |                        | 21631 17,0 /WK BDX                                |
|  | 1.9 SD<br>1.9 TD<br>2.0 16V<br>2.0 HDi 90<br>2.0 i  | 55<br>66<br>97<br>66<br>89                      |                          | 01.98<br>01.98<br>01.98<br>03.99<br>01.98                            | 09.01<br>09.01<br>09.01<br>04.03<br>09.01                            | 13.0460-3972.2                   | 603972           |   | + Schaltgetriebe 1)    | 21632 16,0 /WK BDX                                |
|  | 2.0 Turbo<br>2.1 TD   | 108<br>80                                       | ORGA 08000<br>ORGA 08000 | 01.98<br>01.98   |  | 13.0460-3973.2                   | 603973           |   |                        | 23146 17,0 /WK BDX                                |
|  | 1.9 TD<br>2.0 HDi 110<br>2.0 Turbo<br>2.1 TD<br>3.0 V6                                    | 66<br>109<br>108<br>80<br>140                   | ORGA 08001<br>ORGA 08001 | 01.98<br>02.99<br>01.98<br>02.99<br>01.98                            | 09.01<br>09.01<br>09.01<br>02.99<br>09.01                            | 13.0460-3986.2                   | 603986           |   | + Automatikgetriebe 2) | 23135 18,0 +/-WK/S BOS                            |
|    | 1.8 16V<br>1.8 i  | 81<br>66  |                          | 01.98<br>01.98   | 09.01<br>09.01   | 24.0120-0133.1<br>24.0320-0133.1 | 420133<br>520133 |   |                        | 266 20,5 18,5 V +S +B<br>266 20,5 18,5 V +S +B PD |
|  | 1.9 SD<br>1.9 TD<br>2.0 16V<br>2.0 HDi 90<br>2.0 i  | 55<br>66<br>97<br>66<br>89                      |                          | 01.98<br>01.98<br>01.98<br>03.99<br>01.98                            | 09.01<br>09.01<br>09.01<br>04.03<br>09.01                            | 24.0122-0142.1                   | 422142           |   | + Schaltgetriebe 1)    | 283 22,0 20,0 V L +B                              |
|  | 2.0 Turbo<br>2.1 TD   | 108<br>80                                       | ORGA 08000<br>ORGA 08000 | 01.98<br>01.98   |  | 24.0126-0106.1<br>24.0326-0106.1 | 426106<br>526106 |   |                        | 283 26,0 24,2 V +S +B<br>283 26,0 24,2 V +S +B PD |
|  | 1.9 TD<br>2.0 HDi 110<br>2.0 Turbo<br>2.1 TD<br>3.0 V6                                    | 66<br>109<br>108<br>80<br>140                   | ORGA 08001<br>ORGA 08001 | 01.98<br>02.99<br>01.98<br>02.99<br>01.98                            | 09.01<br>09.01<br>09.01<br>02.99<br>09.01                            | 24.0128-0128.1                   | 428128           |   | + Automatikgetriebe 2) | 288 28,0 26,0 V +S +B                             |
|    | 1.8 16V<br>1.8 i  | 81<br>66  |                          | 01.98<br>01.98   | 09.01<br>09.01   | 24.0751-1187.3                   | 360069           | 2 |                        | Radsensor L=965                                   |
|  | 1.9 SD<br>1.9 TD<br>2.0 16V<br>2.0 HDi 110<br>2.0 HDi 90<br>2.0 i                         | 55<br>66<br>97<br>109<br>66<br>89               |                          | 01.98<br>01.98<br>01.98<br>02.99<br>03.99<br>01.98                   | 09.01<br>09.01<br>09.01<br>09.01<br>09.01<br>09.01                   |                                  |                  |   |                        |   |
|  | 2.0 Turbo<br>2.1 TD<br>3.0 V6   | 108<br>80<br>140                                |                          | 01.98<br>01.98<br>01.98  | 09.01<br>02.99<br>09.01  |                                  |                  |   |                        |   |
|  | 1.8 16V<br>1.8 i  | 81<br>66  |                          | 01.98<br>01.98   | 09.01<br>09.01   | 13.0460-4911.2<br>13.0460-0264.2 | 604911<br>610264 |   |                        | 20389 15,4<br>Belagsatz-Zubehör CIT               |
|  | 1.9 SD<br>1.9 TD<br>2.0 16V<br>2.0 HDi 110<br>2.0 HDi 90<br>2.0 Turbo<br>2.1 TD<br>3.0 V6 | 55<br>66<br>97<br>109<br>66<br>108<br>80<br>140 |                          | 01.98<br>01.98<br>01.98<br>02.99<br>03.99<br>01.98<br>01.98<br>01.98 | 09.01<br>09.01<br>09.01<br>09.01<br>09.01<br>09.01<br>02.99<br>09.01 |                                  |                  |   |                        |   |
|  | 2.0 i   | 89  |                          | 01.98  | 09.01  | 13.0460-4956.2<br>13.0460-0437.2 | 604956<br>610437 |   |                        | 20162 15,4<br>Belagsatz-Zubehör CIT<br>CIT        |
|  | 1.8 16V<br>1.8 i  | 81<br>66  |                          | 01.98<br>01.98   | 09.01<br>09.01   | 24.0112-0143.1                   | 412143           |   |                        | 251 12,0 10,8                                     |
|  | 1.9 SD<br>1.9 TD<br>2.0 16V<br>2.0 HDi 110<br>2.0 HDi 90<br>2.0 Turbo<br>2.1 TD<br>3.0 V6 | 55<br>66<br>97<br>109<br>66<br>108<br>80<br>140 |                          | 01.98<br>01.98<br>01.98<br>02.99<br>03.99<br>01.98<br>01.98<br>01.98 | 09.01<br>09.01<br>09.01<br>09.01<br>09.01<br>09.01<br>02.99<br>09.01 |                                  |                  |   |                        |   |
|  | 2.0 i   | 89  |                          | 01.98  | 09.01  | 24.0109-0122.1                   | 409122           |   |                        | 224 9,0 7,0 +B                                    |
|  | 1.8 16V<br>1.8 i  | 81<br>66  |                          | 01.98<br>01.98   | 09.01<br>09.01   | 24.0741-1114.3                   | 360067           | 2 |                        | Radsensor L=780                                   |
|  | 1.9 SD<br>1.9 TD<br>2.0 16V<br>2.0 HDi 110<br>2.0 HDi 90<br>2.0 i                         | 55<br>66<br>97<br>109<br>66<br>89               |                          | 01.98<br>01.98<br>01.98<br>02.99<br>03.99<br>01.98                   | 09.01<br>09.01<br>09.01<br>09.01<br>09.01<br>09.01                   |                                  |                  |   |                        |   |
|  | 2.0 Turbo<br>2.1 TD<br>3.0 V6   | 108<br>80<br>140                                |                          | 01.98<br>01.98<br>01.98  | 09.01<br>02.99<br>09.01  |                                  |                  |   |                        |   |
| CITROEN XM (Y4) Limousine (94-00)  |   |   |                          |  |  |                                  |                  |   |                        |   |
|  | 2.0 16V<br>2.0 Turbo  | 97<br>108                                       |                          | 05.94<br>05.94   | 10.00<br>10.00   | 13.0460-3947.2                   | 603947           |   |                        | 21505 17,0 +/-WK BDX                              |
|  | 2.1 D12<br>2.1 TD<br>2.5 TD   | 60<br>80<br>95                                  | ORGA 07475               | 03.96<br>05.94<br>05.94  | 08.96<br>10.00<br>10.00  |                                  |                  |   |                        |   |

1) + manual transmission / + scatola cambio velocità / + transmission mécanique / + cambio de velocidad  
2) + autom.transmission / + scatola cambio automatico / + transmission automatique / + cambio automático



**CITROEN XM (Y4) Limousine (94-00)**

|         |           |            |            |       |                |                |        |     |             |               |                  |
|---------|-----------|------------|------------|-------|----------------|----------------|--------|-----|-------------|---------------|------------------|
|         | 3.0 24V   | 147        |            | 05.94 | 10.00          | 13.0460-3947.2 | 603947 |     | 21505       | 17,0 +/WK     | BDX              |
|         | 3.0 V6    | 123        |            | 05.94 | 10.00          |                |        |     |             |               |                  |
|         | 2.5 TD    | 95         | ORGA 07476 |       | 10.00          | 13.0460-3986.2 | 603986 |     | 23135       | 18,0 +/WK/S   | BOS              |
|         | 3.0 V6    | 140        |            | 04.97 | 10.00          |                |        |     |             |               |                  |
|         | 2.0 16V   | 97         |            | 05.94 | 10.00          | 24.0126-0100.1 | 426100 |     | 283         | 26,0 24,0 V L |                  |
|         | 2.0 Turbo | 108        |            | 05.94 | 10.00          |                |        |     |             |               |                  |
|         | 2.1 D12   | 60         |            | 03.96 | 08.96          |                |        |     |             |               |                  |
|         | 2.1 TD    | 80         |            | 05.94 | 10.00          |                |        |     |             |               |                  |
|         | 2.5 TD    | 95         | ORGA 07475 | 05.94 | 10.00          |                |        |     |             |               |                  |
|         | 3.0 24V   | 147        |            | 05.94 | 10.00          |                |        |     |             |               |                  |
|         | 3.0 V6    | 123        |            | 05.94 | 10.00          |                |        |     |             |               |                  |
| 2.5 TD  | 95        | ORGA 07476 |            | 10.00 | 24.0128-0178.1 | 428178         |        | 288 | 28,0 26,0 V |               |                  |
| 3.0 V6  | 140       |            | 04.97      | 10.00 |                |                |        |     |             |               |                  |
|         | 2.0 16V   | 97         |            | 05.94 | 10.00          | 24.0751-1118.3 | 360168 | 2   |             |               | Radsensor L=1300 |
|         | 2.0 Turbo | 108        |            | 05.94 | 10.00          |                |        |     |             |               |                  |
|         | 2.1 D12   | 60         |            | 03.96 | 08.96          |                |        |     |             |               |                  |
|         | 2.1 TD    | 80         |            | 05.94 | 10.00          |                |        |     |             |               |                  |
|         | 2.5 TD    | 95         |            | 05.94 | 10.00          |                |        |     |             |               |                  |
|         | 3.0 24V   | 147        |            | 05.94 | 10.00          |                |        |     |             |               |                  |
|         | 3.0 V6    | 123        |            | 05.94 | 10.00          |                |        |     |             |               |                  |
| 3.0 V6  | 140       |            | 04.97      | 10.00 |                |                |        |     |             |               |                  |
|         | 2.0 16V   | 97         |            | 05.94 | 10.00          | 13.0460-4956.2 | 604956 |     | 20162       | 15,4          | CIT              |
|         | 2.0 Turbo | 108        |            | 05.94 | 10.00          |                |        |     |             |               |                  |
|         | 2.1 D12   | 60         |            | 03.96 | 08.96          |                |        |     |             |               |                  |
|         | 2.1 TD    | 80         |            | 05.94 | 10.00          |                |        |     |             |               |                  |
|         | 2.5 TD    | 95         |            | 05.94 | 10.00          |                |        |     |             |               |                  |
|         | 3.0 24V   | 147        |            | 05.94 | 10.00          |                |        |     |             |               |                  |
|         | 3.0 V6    | 123        |            | 05.94 | 10.00          |                |        |     |             |               |                  |
| 3.0 V6  | 140       |            | 04.97      | 10.00 | 13.0460-0437.2 | 610437         |        |     |             | CIT           |                  |
| 2.0 16V | 97        |            | 05.94      | 10.00 |                |                |        |     |             |               |                  |
|         | 2.0 Turbo | 108        |            | 05.94 | 10.00          | 24.0109-0121.2 | 409121 |     | 224         | 9,0 8,0       |                  |
|         | 2.1 D12   | 60         |            | 03.96 | 08.96          |                |        |     |             |               |                  |
|         | 2.1 TD    | 80         |            | 05.94 | 10.00          |                |        |     |             |               |                  |
|         | 2.5 TD    | 95         |            | 05.94 | 10.00          |                |        |     |             |               |                  |
|         | 3.0 24V   | 147        |            | 05.94 | 10.00          |                |        |     |             |               |                  |
|         | 3.0 V6    | 123        |            | 05.94 | 10.00          |                |        |     |             |               |                  |
|         | 3.0 V6    | 140        |            | 04.97 | 10.00          |                |        |     |             |               |                  |
|         | 2.0 16V   | 97         | ORGA 07289 | 05.94 | 10.00          | 24.0711-1631.3 | 360264 | 2   |             |               | Radsensor L=832  |
|         | 2.0 Turbo | 108        | ORGA 07289 | 05.94 | 10.00          |                |        |     |             |               |                  |
|         | 2.1 D12   | 60         |            | 03.96 | 08.96          |                |        |     |             |               |                  |
|         | 2.1 TD    | 80         | ORGA 07289 | 05.94 | 10.00          |                |        |     |             |               |                  |
|         | 2.5 TD    | 95         | ORGA 07289 | 05.94 | 10.00          |                |        |     |             |               |                  |
|         | 3.0 24V   | 147        | ORGA 07289 | 05.94 | 10.00          |                |        |     |             |               |                  |
|         | 3.0 V6    | 123        | ORGA 07289 | 05.94 | 10.00          |                |        |     |             |               |                  |

**CITROEN XM (Y4) Kombi (94-00)**

|         |           |            |            |       |                |                |        |     |             |               |                  |
|---------|-----------|------------|------------|-------|----------------|----------------|--------|-----|-------------|---------------|------------------|
|         | 2.0 16V   | 97         |            | 05.94 | 10.00          | 13.0460-3947.2 | 603947 |     | 21505       | 17,0 +/WK     | BDX              |
|         | 2.0 Turbo | 108        |            | 05.94 | 10.00          |                |        |     |             |               |                  |
|         | 2.1 D     | 60         |            | 07.94 | 06.96          | 13.0460-3986.2 | 603986 |     | 23135       | 18,0 +/WK/S   | BOS              |
|         | 2.1 TD    | 80         |            | 05.94 | 10.00          |                |        |     |             |               |                  |
|         | 2.5 TD    | 95         | ORGA 07475 | 05.94 | 10.00          | 24.0126-0100.1 | 426100 |     | 283         | 26,0 24,0 V L |                  |
|         | 3.0 V6    | 123        |            | 05.94 | 10.00          |                |        |     |             |               |                  |
|         | 2.0 16V   | 97         |            | 05.94 | 10.00          |                |        |     |             |               |                  |
|         | 2.0 Turbo | 108        |            | 05.94 | 10.00          |                |        |     |             |               |                  |
|         | 2.1 D     | 60         |            | 07.94 | 06.96          |                |        |     |             |               |                  |
|         | 2.1 TD    | 80         |            | 05.94 | 10.00          |                |        |     |             |               |                  |
|         | 2.5 TD    | 95         | ORGA 07475 | 05.94 | 10.00          |                |        |     |             |               |                  |
| 3.0 V6  | 123       |            | 05.94      | 10.00 |                |                |        |     |             |               |                  |
| 2.5 TD  | 95        | ORGA 07476 |            | 10.00 | 24.0128-0178.1 | 428178         |        | 288 | 28,0 26,0 V |               |                  |
| 3.0 V6  | 140       |            | 04.97      | 10.00 |                |                |        |     |             |               |                  |
|         | 2.0 16V   | 97         |            | 05.94 | 10.00          | 24.0751-1118.3 | 360168 | 2   |             |               | Radsensor L=1300 |
|         | 2.0 Turbo | 108        |            | 05.94 | 10.00          |                |        |     |             |               |                  |
|         | 2.1 D     | 60         |            | 07.94 | 06.96          |                |        |     |             |               |                  |
|         | 2.1 TD    | 80         |            | 05.94 | 10.00          |                |        |     |             |               |                  |
|         | 2.5 TD    | 95         |            | 05.94 | 10.00          |                |        |     |             |               |                  |
|         | 3.0 V6    | 123        |            | 05.94 | 10.00          |                |        |     |             |               |                  |
|         | 3.0 V6    | 140        |            | 04.97 | 10.00          |                |        |     |             |               |                  |
|         | 2.0 16V   | 97         |            | 05.94 | 10.00          | 13.0460-4911.2 | 604911 |     | 20389       | 15,4          | CIT              |
|         | 2.0 Turbo | 108        |            | 05.94 | 10.00          |                |        |     |             |               |                  |
|         | 2.1 D     | 60         |            | 07.94 | 06.96          |                |        |     |             |               |                  |
|         | 2.1 TD    | 80         |            | 05.94 | 10.00          |                |        |     |             |               |                  |
|         | 2.5 TD    | 95         |            | 05.94 | 10.00          |                |        |     |             |               |                  |
|         | 3.0 V6    | 123        |            | 05.94 | 10.00          |                |        |     |             |               |                  |
|         | 3.0 V6    | 140        |            | 04.97 | 10.00          |                |        |     |             |               |                  |
| 2.0 16V | 97        |            | 05.94      | 10.00 |                |                |        |     |             |               |                  |
|         | 2.0 Turbo | 108        |            | 05.94 | 10.00          | 24.0112-0136.2 | 412136 |     | 251         | 12,0 10,8     |                  |
|         | 2.1 D     | 60         |            | 07.94 | 06.96          |                |        |     |             |               |                  |
|         | 2.1 TD    | 80         |            | 05.94 | 10.00          |                |        |     |             |               |                  |
|         | 2.5 TD    | 95         |            | 05.94 | 10.00          |                |        |     |             |               |                  |
|         | 3.0 V6    | 123        |            | 05.94 | 10.00          |                |        |     |             |               |                  |
|         | 3.0 V6    | 140        |            | 04.97 | 10.00          |                |        |     |             |               |                  |





### CITROEN XM (Y4) Kombi (94-00)

|  |           |     |            |       |  |                |        |   |  |                 |
|--|-----------|-----|------------|-------|--|----------------|--------|---|--|-----------------|
|  | 2.0 16V   | 97  | ORGA 07289 | 05.94 |  | 24.0711-1631.3 | 360264 | 2 |  | Radsensor L=832 |
|  | 2.0 Turbo | 108 | ORGA 07289 | 05.94 |  |                |        |   |  |                 |
|  | 2.1 D     | 60  | ORGA 07289 | 07.94 |  |                |        |   |  |                 |
|  | 2.1 TD    | 80  | ORGA 07289 | 05.94 |  |                |        |   |  |                 |
|  | 2.5 TD    | 95  | ORGA 07289 | 05.94 |  |                |        |   |  |                 |
|  | 3.0 V6    | 123 | ORGA 07289 | 05.94 |  |                |        |   |  |                 |

### CITROEN XSARA (N1) Limousine (97-05)

|  |             |     |            |       |       |        |  |                |        |  |              |                      |     |
|--|-------------|-----|------------|-------|-------|--------|--|----------------|--------|--|--------------|----------------------|-----|
|  | 1.4 i       | 55  |            | 04.97 | 08.00 | - ABS  |  | 13.0460-3977.2 | 603977 |  | 21980        | 18,0 +/WE/S          | BOS |
|  | 1.5 D       | 42  |            | 04.97 | 08.00 | - ABS  |  |                |        |  |              |                      |     |
|  | 1.4 i       | 55  |            | 04.97 | 08.00 | + ABS  |  | 13.0460-7088.2 | 607088 |  | 21827        | 17,3 +               | ATE |
|  | 1.5 D       | 42  |            | 04.97 | 08.00 | + ABS  |  |                |        |  |              |                      |     |
|  | 1.6 i       | 65  |            | 04.97 | 08.00 |        |  |                |        |  |              |                      |     |
|  | 1.8 D       | 43  |            | 04.97 | 08.00 |        |  |                |        |  |              |                      |     |
|  | 1.8 i       | 66  |            | 04.97 | 08.00 |        |  |                |        |  |              |                      |     |
|  | 1.8 i       | 74  |            | 04.97 | 08.00 | - (BR) |  |                |        |  |              |                      |     |
|  | 1.8 TD      | 66  |            | 10.97 | 08.00 |        |  |                |        |  |              |                      |     |
|  | 1.9 D       | 50  |            | 04.97 | 08.00 |        |  |                |        |  |              |                      |     |
|  | 1.9 D       | 51  |            | 07.98 | 08.00 |        |  |                |        |  |              |                      |     |
|  | 1.9 SD      | 55  |            | 01.98 | 08.00 |        |  |                |        |  |              |                      |     |
|  | 1.9 TD      | 66  |            | 04.97 | 08.00 |        |  |                |        |  |              |                      |     |
|  | 1.8 16V     | 81  |            | 04.97 | 08.00 |        |  | 13.0460-3978.2 | 603978 |  | 23332        | 18,0 +/Zub/S         | BOS |
|  | 1.8 i       | 74  |            | 04.97 | 08.00 | + (BR) |  | 13.0460-2829.2 | 602829 |  | 23124        | 19,0 +/WK/S          | TRW |
|  | 2.0 16V     | 97  |            | 07.98 | 08.00 |        |  |                |        |  |              |                      |     |
|  | 2.0 HDi 90  | 66  |            | 02.99 | 08.00 |        |  |                |        |  |              |                      |     |
|  | 1.4 HDi 70  | 50  |            | 01.03 | 03.05 |        |  | 13.0460-3994.2 | 603994 |  | 23599        | 19,0 /Zub/S          | BOS |
|  | 1.4 i       | 55  |            | 09.00 | 03.05 |        |  | 13.0470-3994.2 | LD3994 |  | 23599        | 19,0 /Zub/S          | BOS |
|  | 1.6 16V     | 80  |            | 09.00 | 03.05 |        |  |                |        |  |              |                      |     |
|  | 1.9 D       | 51  |            | 09.00 | 03.05 |        |  |                |        |  |              |                      |     |
|  | 2.0 HDi 90  | 66  |            | 09.00 | 03.05 |        |  |                |        |  |              |                      |     |
|  | 2.0 16V     | 100 | ORGA 09184 | 09.00 |       |        |  | 13.0460-2817.2 | 602817 |  | 21674        | 19,0 +/WK/S          | TRW |
|  | 2.0 16V     | 120 | ORGA 09184 | 04.97 |       |        |  |                |        |  |              |                      |     |
|  | 2.0 HDi 110 | 80  | ORGA 09184 | 05.01 |       |        |  |                |        |  |              |                      |     |
|  | 2.0 16V     | 100 | ORGA 09185 |       | 03.05 |        |  | 13.0460-3966.2 | 603966 |  | 23600        | 19,4 /Zub/S          | BOS |
|  | 2.0 16V     | 120 | ORGA 09185 |       | 03.05 |        |  | 13.0470-3966.2 | LD3966 |  | 23600        | 19,4 /Zub/S          | BOS |
|  | 2.0 HDi 110 | 80  | ORGA 09185 |       | 03.05 |        |  |                |        |  |              |                      |     |
|  | 1.4 i       | 55  |            | 04.97 | 08.00 | - ABS  |  | 24.0113-0185.1 | 413185 |  | 248          | 13,0 11,0 +S +B      |     |
|  | 1.5 D       | 42  |            | 04.97 | 08.00 | - ABS  |  | 24.0313-0185.1 | 513185 |  | 248          | 13,0 11,0 +S +B PD   |     |
|  | 1.4 i       | 55  |            | 04.97 | 08.00 | + ABS  |  | 24.0120-0132.1 | 420132 |  | 247          | 20,4 18,5 V +S +B    |     |
|  | 1.5 D       | 42  |            | 04.97 | 08.00 | + ABS  |  | 24.0320-0132.1 | 520132 |  | 247          | 20,4 18,5 V +S +B PD |     |
|  | 1.6 i       | 65  |            | 04.97 | 08.00 |        |  |                |        |  |              |                      |     |
|  | 1.8 D       | 43  |            | 04.97 | 08.00 |        |  |                |        |  |              |                      |     |
|  | 1.8 i       | 66  |            | 04.97 | 08.00 |        |  |                |        |  |              |                      |     |
|  | 1.8 i       | 74  |            | 04.97 | 08.00 | - (BR) |  |                |        |  |              |                      |     |
|  | 1.8 TD      | 66  |            | 10.97 | 08.00 |        |  |                |        |  |              |                      |     |
|  | 1.9 D       | 50  |            | 04.97 | 08.00 |        |  |                |        |  |              |                      |     |
|  | 1.9 D       | 51  |            | 07.98 | 08.00 |        |  |                |        |  |              |                      |     |
|  | 1.9 SD      | 55  |            | 01.98 | 08.00 |        |  |                |        |  |              |                      |     |
|  | 1.9 TD      | 66  |            | 04.97 | 08.00 |        |  |                |        |  |              |                      |     |
|  | 1.8 16V     | 81  |            | 04.97 | 08.00 |        |  | 24.0120-0133.1 | 420133 |  | 266          | 20,5 18,5 V +S +B    |     |
|  | 1.8 i       | 74  |            | 04.97 | 08.00 | + (BR) |  | 24.0320-0133.1 | 520133 |  | 266          | 20,5 18,5 V +S +B PD |     |
|  | 2.0 16V     | 97  |            | 07.98 | 08.00 |        |  |                |        |  |              |                      |     |
|  | 2.0 HDi 90  | 66  |            | 02.99 | 08.00 |        |  |                |        |  |              |                      |     |
|  | 1.4 HDi 70  | 50  |            | 01.03 | 03.05 |        |  | 24.0122-0194.1 | 422194 |  | 266          | 22,0 20,0 V +S +B    |     |
|  | 1.4 i       | 55  |            | 09.00 | 03.05 |        |  |                |        |  |              |                      |     |
|  | 1.6 16V     | 80  |            | 09.00 | 03.05 |        |  |                |        |  |              |                      |     |
|  | 1.9 D       | 51  |            | 09.00 | 03.05 |        |  |                |        |  |              |                      |     |
|  | 2.0 HDi 90  | 66  |            | 09.00 | 03.05 |        |  |                |        |  |              |                      |     |
|  | 2.0 16V     | 100 | ORGA 09184 | 09.00 |       |        |  | 24.0122-0142.1 | 422142 |  | 283          | 22,0 20,0 V L +B     |     |
|  | 2.0 16V     | 120 | ORGA 09184 | 04.97 |       |        |  |                |        |  |              |                      |     |
|  | 2.0 HDi 110 | 80  | ORGA 09184 | 05.01 |       |        |  |                |        |  |              |                      |     |
|  | 2.0 16V     | 100 | ORGA 09185 |       | 03.05 |        |  | 24.0126-0120.1 | 426120 |  | 283          | 26,0 24,0 V +S +B    |     |
|  | 2.0 16V     | 120 | ORGA 09185 |       | 03.05 |        |  | 24.0326-0120.1 | 526120 |  | 283          | 26,0 24,0 V +S +B PD |     |
|  | 2.0 HDi 110 | 80  | ORGA 09185 |       | 03.05 |        |  |                |        |  |              |                      |     |
|  | 1.6 16V     | 80  |            | 09.00 | 03.05 |        |  | 13.0460-3823.2 | 603823 |  | 20974        | 11,0                 | BOS |
|  | 1.8 16V     | 81  |            | 04.97 | 09.00 |        |  | 13.0460-0435.2 | 610435 |  |              | Belagsatz-Zubehör    | BDX |
|  | 1.8 i       | 74  |            | 04.97 | 09.00 | + (BR) |  |                |        |  |              |                      |     |
|  | 2.0 16V     | 97  |            | 07.98 | 09.00 |        |  |                |        |  |              |                      |     |
|  | 2.0 16V     | 100 |            | 09.00 | 03.05 |        |  |                |        |  |              |                      |     |
|  | 2.0 16V     | 120 |            | 04.97 | 09.00 |        |  |                |        |  |              |                      |     |
|  | 2.0 HDi 110 | 80  |            | 05.01 | 03.05 |        |  |                |        |  |              |                      |     |
|  | 2.0 HDi 90  | 66  |            | 02.99 | 03.05 |        |  |                |        |  |              |                      |     |
|  | 1.6 16V     | 80  |            | 09.00 | 03.05 |        |  | 24.0108-0106.1 | 408106 |  | 247          | 8,0 6,0 +S +B        |     |
|  | 1.8 16V     | 81  |            | 04.97 | 08.00 |        |  |                |        |  |              |                      |     |
|  | 1.8 i       | 74  |            | 04.97 | 08.00 | + (BR) |  |                |        |  |              |                      |     |
|  | 2.0 16V     | 97  |            | 07.98 | 08.00 |        |  |                |        |  |              |                      |     |
|  | 2.0 16V     | 100 |            | 09.00 | 03.05 |        |  |                |        |  |              |                      |     |
|  | 2.0 16V     | 120 |            | 04.97 | 08.00 |        |  |                |        |  |              |                      |     |
|  | 2.0 HDi 110 | 80  |            | 05.01 | 03.05 |        |  |                |        |  |              |                      |     |
|  | 2.0 HDi 90  | 66  |            | 02.99 | 03.05 |        |  |                |        |  |              |                      |     |
|  | 1.4 i       | 55  |            | 04.97 | 08.00 | - ABS  |  | 03.0137-0261.2 | 650261 |  | 180 x 32     |                      | BDX |
|  | 1.5 D       | 42  |            | 04.97 | 08.00 | - ABS  |  | 03.0137-0197.2 | 650197 |  | 180 x 32 HEB |                      | TRW |
|  | 1.6 i       | 65  |            | 04.97 | 08.00 | - ABS  |  | 03.0137-9086.2 | 669086 |  |              | Bremsbacken-Zubehör  | BDX |
|  | 1.8 D       | 43  |            | 04.97 | 08.00 | - ABS  |  | 03.0137-9175.2 | 669175 |  |              | Bremsbacken-Zubehör  | TRW |
|  | 1.8 i       | 66  |            | 04.97 | 08.00 | - ABS  |  |                |        |  |              |                      |     |



**CITROEN XSARA (N1) Limousine (97-05)**

|            |            |            |            |       |                       |                       |                |                |        |                        |                        |            |
|------------|------------|------------|------------|-------|-----------------------|-----------------------|----------------|----------------|--------|------------------------|------------------------|------------|
|            | 1.8 i      | 74         |            | 04.97 | 08.00                 | - ABS/ - <sup>®</sup> | 03.0137-0261.2 | 650261         |        | 180 x 32               | <b>BDX</b>             |            |
|            | 1.8 TD     | 66         |            | 10.97 | 08.00                 | - ABS                 | 03.0137-0197.2 | 650197         |        | 180 x 32 HEB           | <b>TRW</b>             |            |
|            | 1.9 D      | 50         |            | 04.97 | 08.00                 | - ABS                 | 03.0137-9086.2 | 669086         |        | Bremsbacken-Zubehör    | <b>BDX</b>             |            |
|            | 1.9 D      | 51         |            | 07.98 | 08.00                 | - ABS                 | 03.0137-9175.2 | 669175         |        | Bremsbacken-Zubehör    | <b>TRW</b>             |            |
|            | 1.4 HDi 70 | 50         |            | 01.03 | 03.05                 |                       | 03.0137-0312.2 | 650312         |        | 203 x 38 HEB           | <b>TRW</b>             |            |
|            | 1.4 i      | 55         |            | 09.00 | 03.05                 |                       | 03.0137-9158.2 | 669158         |        | Bremsbacken-Zubehör    | <b>TRW</b>             |            |
|            | 1.4 i      | 55         |            | 04.97 | 08.00                 | + ABS                 |                |                |        |                        |                        |            |
|            | 1.5 D      | 42         |            | 04.97 | 08.00                 | + ABS                 |                |                |        |                        |                        |            |
|            | 1.6 i      | 65         |            | 04.97 | 08.00                 | + ABS                 |                |                |        |                        |                        |            |
|            | 1.8 D      | 43         |            | 04.97 | 08.00                 | + ABS                 |                |                |        |                        |                        |            |
|            | 1.8 i      | 66         |            | 04.97 | 08.00                 | + ABS                 |                |                |        |                        |                        |            |
|            | 1.8 i      | 74         |            | 04.97 | 08.00                 | + ABS/ - <sup>®</sup> |                |                |        |                        |                        |            |
|            | 1.8 TD     | 66         |            | 10.97 | 08.00                 | + ABS                 |                |                |        |                        |                        |            |
|            | 1.9 D      | 50         |            | 04.97 | 08.00                 | + ABS                 |                |                |        |                        |                        |            |
|            | 1.9 D      | 51         |            | 09.00 | 03.05                 |                       |                |                |        |                        |                        |            |
|            | 1.9 D      | 51         |            | 07.98 | 08.00                 | + ABS                 |                |                |        |                        |                        |            |
|            | 1.9 SD     | 55         |            | 01.98 | 08.00                 |                       |                |                |        |                        |                        |            |
|            | 1.9 TD     | 66         |            | 04.97 | 08.00                 |                       |                |                |        |                        |                        |            |
|            |            | 1.4 i      | 55         |       | 04.97                 | 08.00                 | - ABS          | 24.0218-0016.1 | 480011 |                        | 180/181 x 44,5 - Lager |            |
| 1.5 D      |            | 42         |            | 04.97 | 08.00                 | - ABS                 | 24.0218-0716.2 | 480203         |        | 180/181 x 44,5 + Lager |                        |            |
| 1.6 i      |            | 65         |            | 04.97 | 08.00                 | - ABS                 |                |                |        |                        |                        |            |
| 1.8 D      |            | 43         |            | 04.97 | 08.00                 | - ABS                 |                |                |        |                        |                        |            |
| 1.8 i      |            | 66         |            | 04.97 | 08.00                 | - ABS                 |                |                |        |                        |                        |            |
| 1.8 i      |            | 74         |            | 04.97 | 08.00                 | - ABS/ - <sup>®</sup> |                |                |        |                        |                        |            |
| 1.8 TD     |            | 66         |            | 10.97 | 08.00                 | - ABS                 |                |                |        |                        |                        |            |
| 1.9 D      |            | 50         |            | 04.97 | 08.00                 | - ABS                 |                |                |        |                        |                        |            |
| 1.9 D      |            | 51         |            | 07.98 | 08.00                 | - ABS                 |                |                |        |                        |                        |            |
| 1.4 HDi 70 |            | 50         |            | 01.03 | 03.05                 |                       | 24.0220-3014.1 | 480090         |        | 203/204,4 x 46,5       |                        |            |
| 1.4 i      |            | 55         |            | 09.00 | 03.05                 |                       |                |                |        |                        |                        |            |
| 1.4 i      |            | 55         |            | 04.97 | 08.00                 | + ABS                 |                |                |        |                        |                        |            |
| 1.5 D      |            | 42         |            | 04.97 | 08.00                 | + ABS                 |                |                |        |                        |                        |            |
| 1.6 i      |            | 65         |            | 04.97 | 08.00                 | + ABS                 |                |                |        |                        |                        |            |
| 1.8 D      |            | 43         |            | 04.97 | 08.00                 | + ABS                 |                |                |        |                        |                        |            |
| 1.8 i      |            | 66         |            | 04.97 | 08.00                 | + ABS                 |                |                |        |                        |                        |            |
| 1.8 i      |            | 74         |            | 04.97 | 08.00                 | + ABS/ - <sup>®</sup> |                |                |        |                        |                        |            |
| 1.8 TD     |            | 66         |            | 10.97 | 08.00                 | + ABS                 |                |                |        |                        |                        |            |
| 1.9 D      |            | 50         |            | 04.97 | 08.00                 | + ABS                 |                |                |        |                        |                        |            |
| 1.9 D      | 51         |            | 09.00      | 03.05 |                       |                       |                |                |        |                        |                        |            |
| 1.9 D      | 51         |            | 07.98      | 08.00 | + ABS                 |                       |                |                |        |                        |                        |            |
| 1.9 SD     | 55         |            | 01.98      | 08.00 |                       |                       |                |                |        |                        |                        |            |
| 1.9 TD     | 66         |            | 04.97      | 08.00 |                       |                       |                |                |        |                        |                        |            |
|            | 1.4 i      | 55         |            | 04.97 | 08.00                 | - ABS                 | 03.0520-2620.3 | 692620         |        | 20,64/180x32 TopKit    | <b>BDX</b>             |            |
|            | 1.5 D      | 42         |            | 04.97 | 08.00                 | - ABS                 | 03.0520-2520.3 | 692520         |        | 20,64/180x32 TopKit    | <b>TRW</b>             |            |
|            | 1.6 i      | 65         |            | 04.97 | 08.00                 | - ABS                 |                |                |        |                        |                        |            |
|            | 1.8 D      | 43         |            | 04.97 | 08.00                 | - ABS                 |                |                |        |                        |                        |            |
|            | 1.8 i      | 66         |            | 04.97 | 08.00                 | - ABS                 |                |                |        |                        |                        |            |
|            | 1.8 i      | 74         |            | 04.97 | 08.00                 | - ABS/ - <sup>®</sup> |                |                |        |                        |                        |            |
|            | 1.8 TD     | 66         |            | 10.97 | 08.00                 | - ABS                 |                |                |        |                        |                        |            |
|            | 1.9 D      | 50         |            | 04.97 | 08.00                 | - ABS                 |                |                |        |                        |                        |            |
|            | 1.9 D      | 51         |            | 07.98 | 08.00                 | - ABS                 |                |                |        |                        |                        |            |
|            | 1.9 SD     | 55         |            | 01.98 | 08.00                 | - ABS                 |                |                |        |                        |                        |            |
|            | 1.9 TD     | 66         |            | 04.97 | 08.00                 | - ABS                 |                |                |        |                        |                        |            |
|            | 1.4 i      | 55         | ORGA 08210 | 04.97 |                       | + ABS                 | 03.0520-5720.3 | 695720         |        | + GG <sup>1)</sup>     | 20,64/203x39 TopKit    | <b>TRW</b> |
|            | 1.5 D      | 42         | ORGA 08210 | 04.97 |                       | + ABS                 |                |                |        |                        |                        |            |
|            | 1.6 i      | 65         | ORGA 08210 | 04.97 |                       | + ABS                 |                |                |        |                        |                        |            |
|            | 1.8 D      | 43         | ORGA 08210 | 04.97 |                       | + ABS                 |                |                |        |                        |                        |            |
|            | 1.8 i      | 66         | ORGA 08210 | 04.97 |                       | + ABS                 |                |                |        |                        |                        |            |
|            | 1.8 i      | 74         | ORGA 08210 | 04.97 | 08.00                 | + ABS/ - <sup>®</sup> |                |                |        |                        |                        |            |
|            | 1.8 TD     | 66         | ORGA 08210 | 10.97 |                       | + ABS                 |                |                |        |                        |                        |            |
|            | 1.9 D      | 50         | ORGA 08210 | 04.97 |                       | + ABS                 |                |                |        |                        |                        |            |
| 1.9 D      | 51         | ORGA 08210 | 07.98      |       | + ABS                 |                       |                |                |        |                        |                        |            |
| 1.9 SD     | 55         | ORGA 08210 | 01.98      |       |                       |                       |                |                |        |                        |                        |            |
| 1.9 TD     | 66         | ORGA 08210 | 04.97      |       | + ABS                 |                       |                |                |        |                        |                        |            |
| 1.9 TD     | 66         | ORGA 08210 | 04.97      | 08.00 | - ABS                 |                       |                |                |        |                        |                        |            |
| 1.4 i      | 55         | ORGA 08211 |            |       | 08.00                 | + ABS                 | 03.0520-6420.3 | 696420         |        | 20,64/203x39 TopKit    | <b>TRW</b>             |            |
| 1.5 D      | 42         | ORGA 08211 |            |       | 08.00                 | + ABS                 |                |                |        |                        |                        |            |
| 1.6 i      | 65         | ORGA 08211 |            |       | 08.00                 | + ABS                 |                |                |        |                        |                        |            |
| 1.8 D      | 43         | ORGA 08211 |            |       | 08.00                 | + ABS                 |                |                |        |                        |                        |            |
| 1.8 i      | 66         | ORGA 08211 |            |       | 08.00                 | + ABS                 |                |                |        |                        |                        |            |
| 1.8 i      | 74         |            | 04.97      |       | + ABS/ - <sup>®</sup> |                       |                |                |        |                        |                        |            |
| 1.8 TD     | 66         | ORGA 08211 |            |       | 08.00                 | + ABS                 |                |                |        |                        |                        |            |
| 1.9 D      | 50         | ORGA 08211 |            |       | 08.00                 | + ABS                 |                |                |        |                        |                        |            |
| 1.9 D      | 51         | ORGA 08211 |            |       | 08.00                 | + ABS                 |                |                |        |                        |                        |            |
| 1.9 SD     | 55         | ORGA 08211 |            |       | 08.00                 |                       |                |                |        |                        |                        |            |
| 1.9 TD     | 66         | ORGA 08211 |            |       | 08.00                 | + ABS                 |                |                |        |                        |                        |            |

















**CITROEN XSARA (N2) Kombi (97-05)**

|       |         |    |       |       |       |       |                |        |  |                    |            |
|-------|---------|----|-------|-------|-------|-------|----------------|--------|--|--------------------|------------|
|       | 1.4 i   | 55 |       | 10.97 | 08.00 | - ABS | 13.0460-7088.2 | 607088 |  | 21827 17,3 +       | <b>ATE</b> |
|       | 1.5 D   | 42 |       | 10.97 | 08.00 | - ABS |                |        |  |                    |            |
|       | 1.6 i   | 65 |       | 10.97 | 08.00 | - ABS |                |        |  |                    |            |
|       | 1.8 D   | 43 |       | 10.97 | 08.00 | - ABS |                |        |  |                    |            |
|       | 1.9 D   | 50 |       | 10.97 | 08.00 | - ABS |                |        |  |                    |            |
|       | 1.9 D   | 51 |       | 07.98 | 08.00 | - ABS |                |        |  |                    |            |
|       | 1.4 i   | 55 |       | 10.97 | 08.00 | + ABS | 13.0460-3978.2 | 603978 |  | 23332 18,0 +/Zub/S | <b>BOS</b> |
|       | 1.5 D   | 42 |       | 10.97 | 08.00 | + ABS | 13.0460-2829.2 | 602829 |  | 23124 19,0 +/WK/S  | <b>TRW</b> |
|       | 1.6 i   | 65 |       | 10.97 | 08.00 | + ABS |                |        |  |                    |            |
|       | 1.8 16V | 81 |       | 10.97 | 08.00 |       |                |        |  |                    |            |
| 1.8 D | 43      |    | 10.97 | 08.00 | + ABS |       |                |        |  |                    |            |

<sup>1)</sup> + cast iron / + ghisa / + fonte grise / + fundición de gris





|     |  |  |  |  |  |  |  |  |                          |     |
|--|--|--|--|--|---|--|--|--|--------------------------|-----|
| <b>CITROEN XSARA (N2) Kombi (97-05)</b>  |  |  |  |  |   |  |  |  |                          |     |
|    | 1.8 i  | 66   |  | 10.97  | 08.00   | 13.0460-3978.2   | 603978   |  | 23332 18,0 +/Zub/S       | BOS |
|  | 1.8 i  | 74   |  | 10.97  | 08.00   | 13.0460-2829.2   | 602829   |  | 23124 19,0 +/WK/S        | TRW |
|  | 1.9 D  | 50   |  | 10.97  | 08.00   |  |  |  |                          |     |
|  | 1.9 D  | 51   |  | 07.98  | 08.00   |  |  |  |                          |     |
|  | 1.9 SD   | 55   |  | 01.98  | 08.00   |  |  |  |                          |     |
|  | 1.9 TD   | 66   |  | 10.97  | 08.00   |  |  |  |                          |     |
|  | 2.0 16V  | 97   |  | 07.98  | 08.00   |  |  |  |                          |     |
|  | 2.0 HDi 90   | 66   |  | 09.98  | 08.00   |  |  |  |                          |     |
|  | 1.4 HDi 70   | 50   |  | 01.03  | 08.05   | 13.0460-3994.2   | 603994   |  | 23599 19,0 /Zub/S        | BOS |
|  | 1.4 i  | 55   |  | 09.00  | 08.05   | 13.0470-3994.2   | LD3994   |  | 23599 19,0 /Zub/S        | BOS |
| 1.6 16V  | 80   |  | 09.00  | 08.05  |   |  |  |  |                          |     |
| 1.9 D  | 51   |  | 09.00  | 08.05  |   |  |  |  |                          |     |
| 2.0 HDi 90   | 66   |  | 09.00  | 08.05  |   |  |  |  |                          |     |
| 2.0 16V  | 100  | ORGA 09184   | 09.00  |  | 13.0460-2817.2  | 602817   |  | 21674 19,0 +/WK/S  | TRW                      |     |
| 2.0 HDi 110  | 80   | ORGA 09184   | 05.01  |  |   |  |  |  |                          |     |
| 2.0 16V  | 100  | ORGA 09185   |  | 08.05  | 13.0460-3966.2  | 603966   |  | 23600 19,4 /Zub/S  | BOS                      |     |
| 2.0 HDi 110  | 80   | ORGA 09185   |  | 08.05  | 13.0470-3966.2  | LD3966   |  | 23600 19,4 /Zub/S  | BOS                      |     |
|    | 1.4 i  | 55   |  | 10.97  | 08.00   | 24.0120-0132.1   | 420132   |  | 247 20,4 18,5 V +S +B    |     |
|  | 1.5 D  | 42   |  | 10.97  | 08.00   | 24.0320-0132.1   | 520132   |  | 247 20,4 18,5 V +S +B PD |     |
|  | 1.6 i  | 65   |  | 10.97  | 08.00   | 24.0124-0127.1   | 424127   |  | 280 24,0 21,9 V +B       |     |
|  | 1.8 D  | 43   |  | 10.97  | 08.00   |  |  |  |                          |     |
|  | 1.9 D  | 50   |  | 10.97  | 08.00   |  |  |  |                          |     |
|  | 1.9 D  | 51   |  | 07.98  | 08.00   |  |  |  |                          |     |
|  | 1.4 i  | 55   |  | 10.97  | 08.00   | 24.0120-0133.1   | 420133   |  | 266 20,5 18,5 V +S +B    |     |
|  | 1.5 D  | 42   |  | 10.97  | 08.00   | 24.0320-0133.1   | 520133   |  | 266 20,5 18,5 V +S +B PD |     |
|  | 1.6 i  | 65   |  | 10.97  | 08.00   |  |  |  |                          |     |
|  | 1.8 16V  | 81   |  | 10.97  | 08.00   |  |  |  |                          |     |
| 1.8 D  | 43   |  | 10.97  | 08.00  |   |  |  |  |                          |     |
| 1.8 i  | 66   |  | 10.97  | 08.00  |   |  |  |  |                          |     |
| 1.8 i  | 74   |  | 10.97  | 08.00  |   |  |  |  |                          |     |
| 1.9 D  | 50   |  | 10.97  | 08.00  |   |  |  |  |                          |     |
| 1.9 D  | 51   |  | 07.98  | 08.00  |   |  |  |  |                          |     |
| 1.9 SD   | 55   |  | 01.98  | 08.00  |   |  |  |  |                          |     |
| 1.9 TD   | 66   |  | 10.97  | 08.00  |   |  |  |  |                          |     |
| 2.0 16V  | 97   |  | 07.98  | 08.00  |   |  |  |  |                          |     |
| 2.0 HDi 90   | 66   |  | 09.98  | 08.00  |   |  |  |  |                          |     |
| 1.4 HDi 70   | 50   |  | 01.03  | 08.05  | 24.0122-0194.1  | 422194   |  | 266 22,0 20,0 V +S +B  |                          |     |
| 1.4 i  | 55   |  | 09.00  | 08.05  |   |  |  |  |                          |     |
| 1.6 16V  | 80   |  | 09.00  | 08.05  |   |  |  |  |                          |     |
| 1.9 D  | 51   |  | 09.00  | 08.05  |   |  |  |  |                          |     |
| 2.0 HDi 90   | 66   |  | 09.00  | 08.05  |   |  |  |  |                          |     |
| 2.0 16V  | 100  | ORGA 09184   | 09.00  |  | 24.0122-0142.1  | 422142   |  | 283 22,0 20,0 V L +B   |                          |     |
| 2.0 HDi 110  | 80   | ORGA 09184   | 05.01  |  |   |  |  |  |                          |     |
| 2.0 16V  | 100  | ORGA 09185   |  | 08.05  | 24.0126-0120.1  | 426120   |  | 283 26,0 24,0 V +S +B  |                          |     |
| 2.0 HDi 110  | 80   | ORGA 09185   |  | 08.05  | 24.0326-0120.1  | 526120   |  | 283 26,0 24,0 V +S +B PD   |                          |     |
|  | 1.6 16V  | 80   |  | 09.00  | 08.05   | 13.0460-3823.2   | 603823   |  | 20974 11,0               | BOS |
|  | 1.8 16V  | 81   |  | 10.97  | 08.00   | 13.0460-0435.2   | 610435   |  | Belagsatz-Zubehör        | BDX |
|  | 1.8 i  | 74   |  | 10.97  | 08.00   |  |  |  |                          |     |
|  | 2.0 16V  | 97   |  | 07.98  | 08.00   |  |  |  |                          |     |
|  | 2.0 16V  | 100  |  | 09.00  | 08.05   |  |  |  |                          |     |
|  | 2.0 HDi 110  | 80   |  | 05.01  | 08.05   |  |  |  |                          |     |
|  | 2.0 HDi 90   | 66   |  | 09.98  | 08.05   |  |  |  |                          |     |
|  | 1.6 16V  | 80   |  | 09.00  | 08.05   | 24.0108-0106.1   | 408106   |  | 247 8,0 6,0 +S +B        |     |
|  | 1.8 16V  | 81   |  | 10.97  | 08.00   |  |  |  |                          |     |
|  | 1.8 i  | 74   |  | 10.97  | 08.00   |  |  |  |                          |     |
|  | 2.0 16V  | 97   |  | 07.98  | 08.00   |  |  |  |                          |     |
|  | 2.0 16V  | 100  |  | 09.00  | 08.05   |  |  |  |                          |     |
|  | 2.0 HDi 110  | 80   |  | 05.01  | 08.05   |  |  |  |                          |     |
| 2.0 HDi 90   | 66   |  | 09.98  | 08.05  |   |  |  |  |                          |     |
|  | 1.4 HDi 70   | 50   |  | 01.03  | 08.05   | 03.0137-0370.2   | 650370   |  | 229 x 42 HEB             | BDX |
|  | 1.4 i  | 55   |  | 10.97  | 08.05   | 03.0137-9228.2   | 669228   |  | Bremsbacken-Zubehör      | BDX |
|  | 1.5 D  | 42   |  | 10.97  | 08.00   |  |  |  |                          |     |
|  | 1.6 i  | 65   |  | 10.97  | 08.00   |  |  |  |                          |     |
|  | 1.8 D  | 43   |  | 10.97  | 08.00   |  |  |  |                          |     |
|  | 1.8 i  | 66   |  | 10.97  | 08.00   |  |  |  |                          |     |
|  | 1.8 i  | 74   |  | 10.97  | 08.00   |  |  |  |                          |     |
|  | 1.9 D  | 50   |  | 10.97  | 08.00   |  |  |  |                          |     |
|  | 1.9 D  | 51   |  | 07.98  | 08.05   |  |  |  |                          |     |
|  | 1.9 SD   | 55   |  | 01.98  | 08.00   |  |  |  |                          |     |
| 1.9 TD   | 66   |  | 10.97  | 08.00  |   |  |  |  |                          |     |
|  | 1.4 HDi 70   | 50   |  | 01.03  | 08.05   | 24.0222-8017.1   | 480071   |  | 229/230 x 50,8           |     |
|  | 1.4 i  | 55   |  | 10.97  | 08.05   |  |  |  |                          |     |
|  | 1.5 D  | 42   |  | 10.97  | 08.00   |  |  |  |                          |     |
|  | 1.6 i  | 65   |  | 10.97  | 08.00   |  |  |  |                          |     |
|  | 1.8 D  | 43   |  | 10.97  | 08.00   |  |  |  |                          |     |
|  | 1.8 i  | 66   |  | 10.97  | 08.00   |  |  |  |                          |     |
|  | 1.8 i  | 74   |  | 10.97  | 08.00   |  |  |  |                          |     |
|  | 1.9 D  | 50   |  | 10.97  | 08.00   |  |  |  |                          |     |
|  | 1.9 D  | 51   |  | 07.98  | 08.05   |  |  |  |                          |     |
|  | 1.9 SD   | 55   |  | 01.98  | 08.00   |  |  |  |                          |     |
| 1.9 TD   | 66   |  | 10.97  | 08.00  |   |  |  |  |                          |     |
|  | 1.4 i  | 55   |  | 10.97  | 08.00   | 03.0520-6720.3   | 696720   |  | 20,64/229x42 TopKit      | BDX |
|  | 1.5 D  | 42   |  | 10.97  | 08.00   |  |  |  |                          |     |
|  | 1.6 i  | 65   |  | 10.97  | 08.00   |  |  |  |                          |     |
|  | 1.8 D  | 43   |  | 10.97  | 08.00   |  |  |  |                          |     |

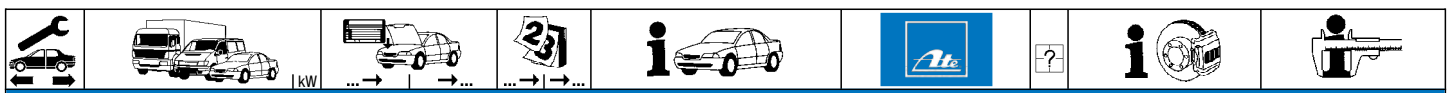

**CITROEN XSARA (N2) Kombi (97-05)**

|        |            |    |       |       |       |        |                |        |  |                     |     |
|--------|------------|----|-------|-------|-------|--------|----------------|--------|--|---------------------|-----|
|        | 1.9 D      | 50 |       | 10.97 | 08.00 | - ABS  | 03.0520-6720.3 | 696720 |  | 20,64/229x42 TopKit | BDX |
|        | 1.9 D      | 51 |       | 07.98 | 08.00 | - ABS  |                |        |  |                     |     |
|        | 1.4 HDi 70 | 50 |       | 01.03 | 08.05 |        | 03.0520-5822.3 | 695822 |  | 22,20/229x42 TopKit | BDX |
|        | 1.4 i      | 55 |       | 09.00 | 08.05 |        |                |        |  |                     |     |
|        | 1.4 i      | 55 |       | 10.97 | 08.00 | + ABS  |                |        |  |                     |     |
|        | 1.5 D      | 42 |       | 10.97 | 08.00 | + ABS  |                |        |  |                     |     |
|        | 1.6 i      | 65 |       | 10.97 | 08.00 | + ABS  |                |        |  |                     |     |
|        | 1.8 D      | 43 |       | 10.97 | 08.00 | + ABS  |                |        |  |                     |     |
|        | 1.8 i      | 66 |       | 10.97 | 08.00 |        |                |        |  |                     |     |
|        | 1.8 i      | 74 |       | 10.97 | 08.00 | - (BR) |                |        |  |                     |     |
|        | 1.9 D      | 50 |       | 10.97 | 08.00 | + ABS  |                |        |  |                     |     |
| 1.9 D  | 51         |    | 09.00 | 08.05 |       |        |                |        |  |                     |     |
| 1.9 D  | 51         |    | 07.98 | 08.00 | + ABS |        |                |        |  |                     |     |
| 1.9 SD | 55         |    | 01.98 | 08.00 |       |        |                |        |  |                     |     |
| 1.9 TD | 66         |    | 10.97 | 08.00 |       |        |                |        |  |                     |     |

**CITROEN XSARA (N0) Coupe (97-05)**

|             |             |            |       |       |       |                |                |        |                          |                          |     |
|-------------|-------------|------------|-------|-------|-------|----------------|----------------|--------|--------------------------|--------------------------|-----|
|             | 1.4 i       | 55         |       | 02.98 | 08.00 | - ABS          | 13.0460-3977.2 | 603977 |                          | 21980 18,0 +/WE/S        | BOS |
|             | 1.4 i       | 55         |       | 02.98 | 08.00 | + ABS          | 13.0460-7088.2 | 607088 |                          | 21827 17,3 +             | ATE |
|             | 1.6 i       | 65         |       | 02.98 | 08.00 |                |                |        |                          |                          |     |
|             | 1.8 i       | 66         |       | 02.98 | 08.00 |                |                |        |                          |                          |     |
|             | 1.8 i       | 74         |       | 04.97 | 08.00 | - (BR)         |                |        |                          |                          |     |
|             | 1.9 D       | 50         |       | 02.98 | 08.00 |                |                |        |                          |                          |     |
|             | 1.9 D       | 51         |       | 02.98 | 08.00 |                |                |        |                          |                          |     |
|             | 1.9 TD      | 66         |       | 02.98 | 08.00 |                |                |        |                          |                          |     |
|             | 1.8 16V     | 81         |       | 02.98 | 08.00 |                | 13.0460-3978.2 | 603978 |                          | 23332 18,0 +/Zub/S       | BOS |
|             | 1.8 i       | 74         |       | 04.97 | 08.00 | + (BR)         | 13.0460-2829.2 | 602829 |                          | 23124 19,0 +/WK/S        | TRW |
|             | 2.0 HDi 90  | 66         |       | 02.99 | 08.00 |                |                |        |                          |                          |     |
| 1.4 HDi 70  | 50          |            | 01.03 | 03.05 |       | 13.0460-3994.2 | 603994         |        | 23599 19,0 /Zub/S        | BOS                      |     |
| 1.4 i       | 55          |            | 09.00 | 03.05 |       | 13.0470-3994.2 | LD3994         |        | 23599 19,0 /Zub/S        | BOS                      |     |
| 1.6 16V     | 80          |            | 09.00 | 03.05 |       |                |                |        |                          |                          |     |
| 1.9 D       | 51          |            | 09.00 | 03.05 |       |                |                |        |                          |                          |     |
| 2.0 HDi 90  | 66          |            | 09.00 | 03.05 |       |                |                |        |                          |                          |     |
| 2.0         | 97          | ORGA 09184 | 08.98 |       |       | 13.0460-2817.2 | 602817         |        | 21674 19,0 +/WK/S        | TRW                      |     |
| 2.0 16V     | 100         | ORGA 09184 | 09.00 |       |       |                |                |        |                          |                          |     |
| 2.0 16V     | 120         | ORGA 09184 | 02.98 |       |       |                |                |        |                          |                          |     |
| 2.0 HDi 110 | 80          | ORGA 09184 | 05.01 |       |       |                |                |        |                          |                          |     |
| 2.0         | 97          | ORGA 09185 | 08.00 |       |       | 13.0460-3966.2 | 603966         |        | 23600 19,4 /Zub/S        | BOS                      |     |
| 2.0 16V     | 100         | ORGA 09185 | 03.05 |       |       | 13.0470-3966.2 | LD3966         |        | 23600 19,4 /Zub/S        | BOS                      |     |
| 2.0 16V     | 120         | ORGA 09185 | 03.05 |       |       |                |                |        |                          |                          |     |
| 2.0 HDi 110 | 80          | ORGA 09185 | 03.05 |       |       |                |                |        |                          |                          |     |
|             | 1.4 i       | 55         |       | 02.98 | 08.00 | - ABS          | 24.0113-0185.1 | 413185 |                          | 248 13,0 11,0 +S +B      |     |
|             | 1.4 i       | 55         |       | 02.98 | 08.00 | + ABS          | 24.0313-0185.1 | 513185 |                          | 248 13,0 11,0 +S +B PD   |     |
|             | 1.4 i       | 55         |       | 02.98 | 08.00 | + ABS          | 24.0120-0132.1 | 420132 |                          | 247 20,4 18,5 V +S +B    |     |
|             | 1.6 i       | 65         |       | 02.98 | 08.00 |                | 24.0320-0132.1 | 520132 |                          | 247 20,4 18,5 V +S +B PD |     |
|             | 1.8 i       | 66         |       | 02.98 | 08.00 |                |                |        |                          |                          |     |
|             | 1.8 i       | 74         |       | 04.97 | 08.00 | - (BR)         |                |        |                          |                          |     |
|             | 1.9 D       | 50         |       | 02.98 | 08.00 |                |                |        |                          |                          |     |
|             | 1.9 D       | 51         |       | 02.98 | 08.00 |                |                |        |                          |                          |     |
|             | 1.9 TD      | 66         |       | 02.98 | 08.00 |                |                |        |                          |                          |     |
|             | 1.8 16V     | 81         |       | 02.98 | 08.00 |                | 24.0120-0133.1 | 420133 |                          | 266 20,5 18,5 V +S +B    |     |
|             | 1.8 i       | 74         |       | 04.97 | 08.00 | + (BR)         | 24.0320-0133.1 | 520133 |                          | 266 20,5 18,5 V +S +B PD |     |
| 2.0 HDi 90  | 66          |            | 02.99 | 08.00 |       |                |                |        |                          |                          |     |
| 1.4 HDi 70  | 50          |            | 01.03 | 03.05 |       | 24.0122-0194.1 | 422194         |        | 266 22,0 20,0 V +S +B    |                          |     |
| 1.4 i       | 55          |            | 09.00 | 03.05 |       |                |                |        |                          |                          |     |
| 1.6 16V     | 80          |            | 09.00 | 03.05 |       |                |                |        |                          |                          |     |
| 1.9 D       | 51          |            | 09.00 | 03.05 |       |                |                |        |                          |                          |     |
| 2.0 HDi 90  | 66          |            | 09.00 | 03.05 |       |                |                |        |                          |                          |     |
| 2.0         | 97          | ORGA 09184 | 08.98 |       |       | 24.0122-0142.1 | 422142         |        | 283 22,0 20,0 V L +B     |                          |     |
| 2.0 16V     | 100         | ORGA 09184 | 09.00 |       |       |                |                |        |                          |                          |     |
| 2.0 16V     | 120         | ORGA 09184 | 02.98 |       |       |                |                |        |                          |                          |     |
| 2.0 HDi 110 | 80          | ORGA 09184 | 05.01 |       |       |                |                |        |                          |                          |     |
| 2.0         | 97          | ORGA 09185 | 08.00 |       |       | 24.0126-0120.1 | 426120         |        | 283 26,0 24,0 V +S +B    |                          |     |
| 2.0 16V     | 100         | ORGA 09185 | 03.05 |       |       | 24.0326-0120.1 | 526120         |        | 283 26,0 24,0 V +S +B PD |                          |     |
| 2.0 16V     | 120         | ORGA 09185 | 03.05 |       |       |                |                |        |                          |                          |     |
| 2.0 HDi 110 | 80          | ORGA 09185 | 03.05 |       |       |                |                |        |                          |                          |     |
|             | 1.6 16V     | 80         |       | 09.00 | 03.05 |                | 13.0460-3823.2 | 603823 |                          | 20974 11,0               | BOS |
|             | 1.8 16V     | 81         |       | 02.98 | 08.00 |                | 13.0460-0435.2 | 610435 |                          | Belagsatz-Zubehör        | BDX |
|             | 1.8 i       | 74         |       | 04.97 | 08.00 | + (BR)         |                |        |                          |                          |     |
|             | 2.0         | 97         |       | 08.98 | 08.00 |                |                |        |                          |                          |     |
|             | 2.0 16V     | 100        |       | 09.00 | 03.05 |                |                |        |                          |                          |     |
|             | 2.0 16V     | 120        |       | 02.98 | 03.05 |                |                |        |                          |                          |     |
|             | 2.0 HDi 110 | 80         |       | 05.01 | 03.05 |                |                |        |                          |                          |     |
|             | 2.0 HDi 90  | 66         |       | 02.99 | 03.05 |                |                |        |                          |                          |     |
|             | 1.6 16V     | 80         |       | 09.00 | 03.05 |                | 24.0108-0106.1 | 408106 |                          | 247 8,0 6,0 +S +B        |     |
|             | 1.8 16V     | 81         |       | 02.98 | 08.00 |                |                |        |                          |                          |     |
|             | 1.8 i       | 74         |       | 04.97 | 08.00 | + (BR)         |                |        |                          |                          |     |
|             | 2.0         | 97         |       | 08.98 | 08.00 |                |                |        |                          |                          |     |
|             | 2.0 16V     | 100        |       | 09.00 | 03.05 |                |                |        |                          |                          |     |
|             | 2.0 16V     | 120        |       | 02.98 | 03.05 |                |                |        |                          |                          |     |
|             | 2.0 HDi 110 | 80         |       | 05.01 | 03.05 |                |                |        |                          |                          |     |
| 2.0 HDi 90  | 66          |            | 02.99 | 03.05 |       |                |                |        |                          |                          |     |



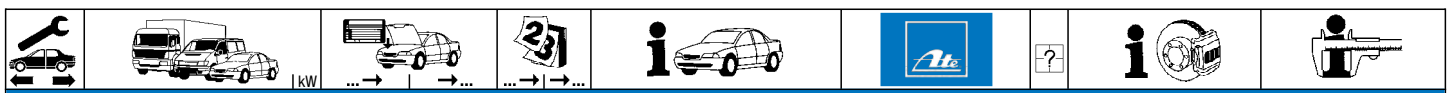

**CITROEN XSARA (N0) Coupe (97-05)**

|        |            |            |            |       |                          |                          |                |        |                     |                        |            |
|--------|------------|------------|------------|-------|--------------------------|--------------------------|----------------|--------|---------------------|------------------------|------------|
|        | 1.4 i      | 55         |            | 02.98 | 08.00                    | - ABS                    | 03.0137-0261.2 | 650261 |                     | 180 x 32               | <b>BDX</b> |
|        | 1.6 i      | 65         |            | 02.98 | 08.00                    | - ABS                    | 03.0137-0197.2 | 650197 |                     | 180 x 32 HEB           | <b>TRW</b> |
|        | 1.8 i      | 66         |            | 02.98 | 08.00                    | - ABS                    | 03.0137-9086.2 | 669086 |                     | Bremsbacken-Zubehör    | <b>BDX</b> |
|        | 1.8 i      | 74         |            | 04.97 | 08.00                    | - ABS/ - <sup>(BR)</sup> | 03.0137-9175.2 | 669175 |                     | Bremsbacken-Zubehör    | <b>TRW</b> |
|        | 1.9 D      | 50         |            | 02.98 | 08.00                    | - ABS                    |                |        |                     |                        |            |
|        | 1.9 D      | 51         |            | 02.99 | 08.00                    | - ABS                    |                |        |                     |                        |            |
|        | 1.4 HDi 70 | 50         |            | 01.03 | 03.05                    |                          | 03.0137-0312.2 | 650312 |                     | 203 x 38 HEB           | <b>TRW</b> |
|        | 1.4 i      | 55         |            | 09.00 | 03.05                    |                          | 03.0137-9158.2 | 669158 |                     | Bremsbacken-Zubehör    | <b>TRW</b> |
|        | 1.4 i      | 55         |            | 02.98 | 08.00                    | + ABS                    |                |        |                     |                        |            |
|        | 1.6 i      | 65         |            | 02.98 | 08.00                    | + ABS                    |                |        |                     |                        |            |
| 1.8 i  | 66         |            | 02.98      | 08.00 | + ABS                    |                          |                |        |                     |                        |            |
| 1.8 i  | 74         |            | 04.97      | 08.00 | + ABS/ - <sup>(BR)</sup> |                          |                |        |                     |                        |            |
| 1.9 D  | 50         |            | 02.98      | 08.00 | + ABS                    |                          |                |        |                     |                        |            |
| 1.9 D  | 51         |            | 09.00      | 03.05 |                          |                          |                |        |                     |                        |            |
| 1.9 D  | 51         |            | 02.99      | 08.00 | + ABS                    |                          |                |        |                     |                        |            |
| 1.9 TD | 66         |            | 02.98      | 08.00 |                          |                          |                |        |                     |                        |            |
|        | 1.4 i      | 55         |            | 02.98 | 08.00                    | - ABS                    | 24.0218-0016.1 | 480011 |                     | 180/181 x 44,5 - Lager |            |
|        | 1.6 i      | 65         |            | 02.98 | 08.00                    | - ABS                    | 24.0218-0716.2 | 480203 |                     | 180/181 x 44,5 + Lager |            |
|        | 1.8 i      | 66         |            | 02.98 | 08.00                    | - ABS                    |                |        |                     |                        |            |
|        | 1.8 i      | 74         |            | 04.97 | 08.00                    | - ABS/ - <sup>(BR)</sup> |                |        |                     |                        |            |
|        | 1.9 D      | 50         |            | 02.98 | 08.00                    | - ABS                    |                |        |                     |                        |            |
|        | 1.9 D      | 51         |            | 02.99 | 08.00                    | - ABS                    |                |        |                     |                        |            |
|        | 1.4 HDi 70 | 50         |            | 01.03 | 03.05                    |                          | 24.0220-3014.1 | 480090 |                     | 203/204,4 x 46,5       |            |
|        | 1.4 i      | 55         |            | 09.00 | 03.05                    |                          |                |        |                     |                        |            |
|        | 1.4 i      | 55         |            | 02.98 | 08.00                    | + ABS                    |                |        |                     |                        |            |
|        | 1.6 i      | 65         |            | 02.98 | 08.00                    | + ABS                    |                |        |                     |                        |            |
| 1.8 i  | 66         |            | 02.98      | 08.00 | + ABS                    |                          |                |        |                     |                        |            |
| 1.8 i  | 74         |            | 04.97      | 08.00 | + ABS/ - <sup>(BR)</sup> |                          |                |        |                     |                        |            |
| 1.9 D  | 50         |            | 02.98      | 08.00 | + ABS                    |                          |                |        |                     |                        |            |
| 1.9 D  | 51         |            | 09.00      | 03.05 |                          |                          |                |        |                     |                        |            |
| 1.9 D  | 51         |            | 02.99      | 08.00 | + ABS                    |                          |                |        |                     |                        |            |
| 1.9 TD | 66         |            | 02.98      | 08.00 |                          |                          |                |        |                     |                        |            |
|        | 1.4 i      | 55         |            | 02.98 | 08.00                    | - ABS                    | 03.0520-2620.3 | 692620 |                     | 20,64/180x32 TopKit    | <b>BDX</b> |
|        | 1.6 i      | 65         |            | 02.98 | 08.00                    | - ABS                    | 03.0520-2520.3 | 692520 |                     | 20,64/180x32 TopKit    | <b>TRW</b> |
|        | 1.8 i      | 66         |            | 02.98 | 08.00                    | - ABS                    |                |        |                     |                        |            |
|        | 1.8 i      | 74         |            | 04.97 | 08.00                    | - ABS/ - <sup>(BR)</sup> |                |        |                     |                        |            |
|        | 1.9 D      | 50         |            | 02.98 | 08.00                    | - ABS                    |                |        |                     |                        |            |
|        | 1.9 D      | 51         |            | 02.99 | 08.00                    | - ABS                    |                |        |                     |                        |            |
|        | 1.4 i      | 55         | ORGA 08210 | 02.98 | 08.00                    | + ABS                    | 03.0520-5720.3 | 695720 | + GG <sup>1)</sup>  | 20,64/203x39 TopKit    | <b>TRW</b> |
|        | 1.6 i      | 65         | ORGA 08210 | 02.98 | 08.00                    | + ABS                    |                |        |                     |                        |            |
|        | 1.8 i      | 66         | ORGA 08210 | 02.98 | 08.00                    | + ABS                    |                |        |                     |                        |            |
|        | 1.8 i      | 74         |            | 04.97 | 08.00                    | + ABS/ - <sup>(BR)</sup> |                |        |                     |                        |            |
| 1.9 TD | 66         |            | 02.98      | 08.00 | - ABS                    |                          |                |        |                     |                        |            |
| 1.4 i  | 55         | ORGA 08211 |            | 08.00 | + ABS                    | 03.0520-6420.3           | 696420         |        | 20,64/203x39 TopKit | <b>TRW</b>             |            |
| 1.6 i  | 65         | ORGA 08211 |            | 08.00 | + ABS                    |                          |                |        |                     |                        |            |
| 1.8 i  | 66         | ORGA 08211 |            | 08.00 | + ABS                    |                          |                |        |                     |                        |            |
| 1.8 i  | 74         |            | 04.97      | 08.00 | + ABS/ - <sup>(BR)</sup> |                          |                |        |                     |                        |            |
| 1.9 D  | 50         |            | 02.98      | 08.00 | + ABS                    |                          |                |        |                     |                        |            |
| 1.9 D  | 51         |            | 02.99      | 08.00 | + ABS                    |                          |                |        |                     |                        |            |
| 1.9 TD | 66         |            | 02.98      | 08.00 | + ABS                    |                          |                |        |                     |                        |            |

**CITROEN XSARA Picasso (N68) (00-10)**

|             |             |     |       |       |                                       |                |                |        |                    |                          |            |
|-------------|-------------|-----|-------|-------|---------------------------------------|----------------|----------------|--------|--------------------|--------------------------|------------|
|             | 1.6         | 65  |       | 06.00 | 03.10                                 |                | 13.0460-2862.2 | 602862 |                    | 23346 19,0 /WE/S         | <b>TRW</b> |
|             | 1.6         | 67  |       | 06.02 | 03.10                                 |                |                |        |                    |                          |            |
|             | 1.6         | 70  |       | 09.00 | 03.10                                 |                |                |        |                    |                          |            |
|             | 1.6 16V     |     |       | 09.05 | 03.10                                 |                |                |        |                    |                          |            |
|             | 1.6 HDi 110 | 80  |       | 05.04 | 03.10                                 |                |                |        |                    |                          |            |
|             | 1.6 HDi 90  | 66  |       | 09.05 | 03.10                                 |                |                |        |                    |                          |            |
|             | 1.8 16V     | 85  |       | 02.00 | 03.10                                 |                |                |        |                    |                          |            |
|             | 2.0 16V     | 100 |       | 01.03 | 03.10                                 |                |                |        |                    |                          |            |
|             | 2.0 HDi     |     |       | 06.00 | 03.10                                 |                |                |        |                    |                          |            |
|             | 1.6         | 65  |       | 06.00 | 03.10                                 | - ESP          | 13.0460-3994.2 | 603994 |                    | 23599 19,0 /Zub/S        | <b>BOS</b> |
| 1.6         | 67          |     | 06.02 | 03.10 | - ESP                                 | 13.0470-3994.2 | LD3994         |        | 23599 19,0 /Zub/S  | <b>BOS</b>               |            |
| 1.6         | 70          |     | 09.00 | 03.10 | - ESP                                 |                |                |        |                    |                          |            |
| 1.6 16V     |             |     | 09.05 | 03.10 | - ESP                                 |                |                |        |                    |                          |            |
| 1.6 HDi 110 | 80          |     | 05.04 | 03.10 | - ESP                                 |                |                |        |                    |                          |            |
| 1.6 HDi 90  | 66          |     | 09.05 | 03.10 | - ESP                                 |                |                |        |                    |                          |            |
| 1.8 16V     | 85          |     | 02.00 | 03.10 | - ESP                                 |                |                |        |                    |                          |            |
| 2.0 16V     | 100         |     | 01.03 | 03.10 | - ESP/ + Schaltgetriebe <sup>2)</sup> |                |                |        |                    |                          |            |
| 2.0 HDi     |             |     | 06.00 | 03.10 | - ESP                                 |                |                |        |                    |                          |            |
| 1.6         | 65          |     | 06.00 | 03.10 | + ESP                                 | 13.0460-3811.2 | 603811         |        | 23708 19,2 /S      | <b>BOS</b>               |            |
| 1.6         | 67          |     | 06.02 | 03.10 | + ESP                                 |                |                |        |                    |                          |            |
| 1.6         | 70          |     | 09.00 | 03.10 | + ESP                                 |                |                |        |                    |                          |            |
| 1.6 16V     |             |     | 09.05 | 03.10 | + ESP                                 |                |                |        |                    |                          |            |
| 1.6 HDi 110 | 80          |     | 05.04 | 03.10 | + ESP                                 |                |                |        |                    |                          |            |
| 1.6 HDi 90  | 66          |     | 09.05 | 03.10 | + ESP                                 |                |                |        |                    |                          |            |
| 1.8 16V     | 85          |     | 02.00 | 03.10 | + ESP                                 |                |                |        |                    |                          |            |
| 2.0 16V     | 100         |     | 01.03 | 03.10 | + ESP/ + Schaltgetriebe <sup>3)</sup> |                |                |        |                    |                          |            |
| 2.0 16V     | 100         |     | 01.03 | 03.10 | + Automatikgetriebe <sup>4)</sup>     |                |                |        |                    |                          |            |
| 2.0 HDi     |             |     | 06.00 | 03.10 | + ESP                                 |                |                |        |                    |                          |            |
|             | 1.6         | 65  |       | 06.00 | 03.10                                 |                | 24.0120-0133.1 | 420133 | nur für TRW-Sättel | 266 20,5 18,5 V +S +B    |            |
|             | 1.6         | 67  |       | 06.02 | 03.10                                 |                | 24.0320-0133.1 | 520133 | nur für TRW-Sättel | 266 20,5 18,5 V +S +B PD |            |
|             | 1.6         | 70  |       | 09.00 | 03.10                                 |                |                |        |                    |                          |            |
|             | 1.6 16V     |     |       | 09.05 | 03.10                                 |                |                |        |                    |                          |            |
|             | 1.6 HDi 110 | 80  |       | 05.04 | 03.10                                 |                |                |        |                    |                          |            |
|             | 1.6 HDi 90  | 66  |       | 09.05 | 03.10                                 |                |                |        |                    |                          |            |

<sup>1)</sup> + cast iron / + ghisa / + fonte grise / + fundición de gris

<sup>2)</sup> - ESP/ + manual transm. / - ESP/+ scatola cambio velocità / - ESP/ + transmission mécanique / - ESP/ + cambio de velocidad

<sup>3)</sup> + ESP/ + manual transm. / + ESP/+ scatola cambio velocità / + ESP/ + transmission mécanique / + ESP/ + cambio de velocidad

<sup>4)</sup> + autom.transmission / + scatola cambio automatico / + transmission automatique / + cambio automático

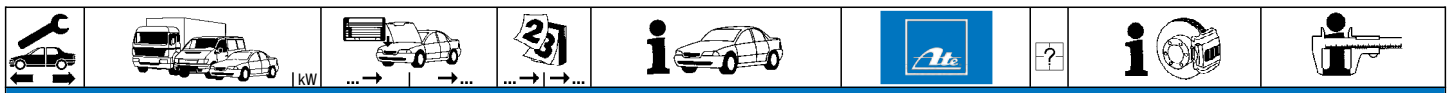

### CITROEN XSARA Picasso (N68) (00-10)

|         |             |     |       |       |       |                                       |                |                    |                          |
|---------|-------------|-----|-------|-------|-------|---------------------------------------|----------------|--------------------|--------------------------|
|         | 1.8 16V     | 85  |       | 02.00 | 03.10 | 24.0120-0133.1                        | 420133         | nur für TRW-Sättel | 266 20,5 18,5 V +S +B    |
|         | 2.0 HDi     |     |       | 06.00 | 03.10 | 24.0320-0133.1                        | 520133         | nur für TRW-Sättel | 266 20,5 18,5 V +S +B PD |
|         | 1.6         | 65  |       | 06.00 | 03.10 | - ESP                                 | 24.0122-0194.1 | 422194             | 266 22,0 20,0 V +S +B    |
|         | 1.6         | 67  |       | 06.02 | 03.10 | - ESP                                 |                |                    |                          |
|         | 1.6         | 70  |       | 09.00 | 03.10 | - ESP                                 |                |                    |                          |
|         | 1.6 16V     |     |       | 09.05 | 03.10 | - ESP                                 |                |                    |                          |
|         | 1.6 HDi 110 | 80  |       | 05.04 | 03.10 | - ESP                                 |                |                    |                          |
|         | 1.6 HDi 90  | 66  |       | 09.05 | 03.10 | - ESP                                 |                |                    |                          |
|         | 1.8 16V     | 85  |       | 02.00 | 03.10 | - ESP                                 |                |                    |                          |
|         | 2.0 16V     | 100 |       | 01.03 | 03.10 | - ESP/ + Schaltgetriebe <sup>1)</sup> |                |                    |                          |
| 2.0 HDi |             |     | 06.00 | 03.10 | - ESP |                                       |                |                    |                          |
|         | 1.6         | 65  |       | 06.00 | 03.10 | + ESP                                 | 24.0126-0120.1 | 426120             | 283 26,0 24,0 V +S +B    |
|         | 1.6         | 67  |       | 06.02 | 03.10 | + ESP                                 | 24.0326-0120.1 | 526120             | 283 26,0 24,0 V +S +B PD |
|         | 1.6         | 70  |       | 09.00 | 03.10 | + ESP                                 |                |                    |                          |
|         | 1.6 16V     |     |       | 09.05 | 03.10 | + ESP                                 |                |                    |                          |
|         | 1.6 HDi 110 | 80  |       | 05.04 | 03.10 | + ESP                                 |                |                    |                          |
|         | 1.6 HDi 90  | 66  |       | 09.05 | 03.10 | + ESP                                 |                |                    |                          |
|         | 1.8 16V     | 85  |       | 02.00 | 03.10 | + ESP                                 |                |                    |                          |
|         | 2.0 16V     | 100 |       | 01.03 | 03.10 | + ESP/ + Schaltgetriebe <sup>2)</sup> |                |                    |                          |
|         | 2.0 16V     | 100 |       | 01.03 | 03.10 | + Automatikgetriebe <sup>3)</sup>     |                |                    |                          |
|         | 2.0 HDi     |     |       | 06.00 | 03.10 | + ESP                                 |                |                    |                          |
|         | 1.6 16V     |     |       | 09.05 | 03.10 |                                       | 13.0460-2823.2 | 602823             | 23554 17,2 /S TRW        |
|         | 1.6 HDi 110 | 80  |       | 05.04 | 03.10 |                                       | 13.0470-2823.2 | LD2823             | 23554 17,2 /S TRW        |
|         | 1.6 HDi 90  | 66  |       | 09.05 | 03.10 |                                       |                |                    |                          |
|         | 1.8 16V     | 85  |       | 02.00 | 03.10 |                                       |                |                    |                          |
|         | 2.0 16V     | 100 |       | 01.03 | 03.10 |                                       |                |                    |                          |
| 2.0 HDi |             |     | 06.00 | 03.10 |       |                                       |                |                    |                          |
|         | 1.6 16V     |     |       | 09.05 | 03.10 |                                       | 24.0109-0137.1 | 409137             | 247 9,0 8,0 +S +B        |
|         | 1.6 HDi 110 | 80  |       | 05.04 | 03.10 |                                       |                |                    |                          |
|         | 1.6 HDi 90  | 66  |       | 09.05 | 03.10 |                                       |                |                    |                          |
|         | 1.8 16V     | 85  |       | 02.00 | 03.10 |                                       |                |                    |                          |
|         | 2.0 16V     | 100 |       | 01.03 | 03.10 |                                       |                |                    |                          |
| 2.0 HDi |             |     | 06.00 | 03.10 |       |                                       |                |                    |                          |
|         | 1.6         | 65  |       | 06.00 | 03.10 |                                       | 03.0137-0341.2 | 650341             | 229 x 42 HEB TRW         |
|         | 1.6         | 67  |       | 06.02 | 03.10 |                                       | 03.0137-9220.2 | 669220             | Bremsbacken-Zubehör TRW  |
|         | 1.6         | 70  |       | 09.00 | 03.10 |                                       |                |                    |                          |
|         | 1.8 16V     | 85  |       | 02.00 | 03.10 |                                       |                |                    |                          |
| 2.0 HDi |             |     | 06.00 | 03.10 |       |                                       |                |                    |                          |
|         | 1.6         | 65  |       | 06.00 | 03.10 |                                       | 24.0222-8017.1 | 480071             | 229/230 x 50,8           |
|         | 1.6         | 67  |       | 06.02 | 03.10 |                                       |                |                    |                          |
|         | 1.6         | 70  |       | 09.00 | 03.10 |                                       |                |                    |                          |
|         | 1.8 16V     | 85  |       | 02.00 | 03.10 |                                       |                |                    |                          |
|         | 2.0 HDi     |     |       | 06.00 | 03.10 |                                       |                |                    |                          |
|         | 1.6         | 65  |       | 06.00 | 03.10 |                                       | 03.0520-6322.3 | 696322             | 22,20/229x42 TopKit TRW  |
|         | 1.6         | 67  |       | 06.02 | 03.10 |                                       |                |                    |                          |
|         | 1.6         | 70  |       | 09.00 | 03.10 |                                       |                |                    |                          |
|         | 1.8 16V     | 85  |       | 02.00 | 03.10 |                                       |                |                    |                          |
|         | 2.0 HDi     |     |       | 06.00 | 03.10 |                                       |                |                    |                          |

### CITROEN ZX (N2) Limousine (91-97)















|        |         |     |            |       |       |                |        |  |                          |
|--------|---------|-----|------------|-------|-------|----------------|--------|--|--------------------------|
|        | 1.1     | 40  |            | 03.91 | 08.93 | 13.0460-3952.2 | 603952 |  | 20905 18,0 +/WK BDX      |
|        | 1.1     | 44  |            | 03.91 | 06.97 | 13.0460-0403.2 | 610403 |  | Belagsatz-Zubehör BDX    |
|        | 1.4     | 55  |            | 03.91 | 06.97 |                |        |  |                          |
|        | 1.4 i   | 55  |            | 03.91 | 06.97 |                |        |  |                          |
|        | 1.6 i   | 65  |            | 03.91 | 06.97 |                |        |  |                          |
|        | 1.9 TD  | 66  |            | 07.92 | 06.97 |                |        |  |                          |
|        | 1.6 i   | 65  |            | 03.91 | 06.97 | 13.0460-2981.2 | 602981 |  | 21460 18,0 +/WK/S TRW    |
|        | 1.8 16V | 81  |            | 01.96 | 06.97 |                |        |  |                          |
|        | 1.8 i   | 74  |            | 07.92 | 06.97 |                |        |  |                          |
|        | 1.9     | 96  |            | 03.91 | 06.97 |                |        |  |                          |
| 1.9 i  | 88      |     | 03.91      | 06.97 |       |                |        |  |                          |
| 1.9 TD | 66      |     | 07.92      | 06.97 |       |                |        |  |                          |
| 2.0 i  | 89      |     | 07.92      | 06.97 |       |                |        |  |                          |
|        | 1.8 D   | 44  |            | 06.93 | 06.97 | 13.0460-3952.2 | 603952 |  | 20905 18,0 +/WK BDX      |
|        | 1.9 D   | 47  |            | 03.91 | 06.97 |                |        |  |                          |
|        | 1.9 D   | 50  |            | 06.94 | 06.97 |                |        |  |                          |
|        | 1.8 D   | 44  | ORGA 06049 | 06.93 |       | 13.0460-2825.2 | 602825 |  | 21614 17,7 +/WK TRW      |
|        | 1.9 D   | 47  | ORGA 06049 | 03.91 |       | 13.0460-0060.2 | 610060 |  | Belagsatz-Zubehör TRW    |
|        | 2.0     | 122 |            | 09.96 | 10.97 | 13.0460-2817.2 | 602817 |  | 21674 19,0 +/WK/S TRW    |
|        | 2.0 16V | 120 |            | 05.96 | 06.97 |                |        |  |                          |
|        | 1.1     | 40  |            | 03.91 | 08.93 | 24.0110-0187.1 | 410187 |  | 247 10,0 9,0 +S +B       |
|        | 1.1     | 44  |            | 03.91 | 06.97 |                |        |  |                          |
|        | 1.4     | 55  |            | 03.91 | 06.97 |                |        |  |                          |
| 1.4 i  | 55      |     | 03.91      | 06.97 |       |                |        |  |                          |
| 1.9 TD | 66      |     | 07.92      | 06.97 |       |                |        |  |                          |
|        | 1.6 i   | 65  |            | 03.91 | 06.97 | 24.0120-0132.1 | 420132 |  | 247 20,4 18,5 V +S +B    |
|        | 1.8 16V | 81  |            | 01.96 | 06.97 | 24.0320-0132.1 | 520132 |  | 247 20,4 18,5 V +S +B PD |
|        | 1.8 i   | 74  |            | 07.92 | 06.97 |                |        |  |                          |
|        | 1.9     | 96  |            | 03.91 | 06.97 |                |        |  |                          |
|        | 1.9 i   | 88  |            | 03.91 | 06.97 |                |        |  |                          |
|        | 1.9 TD  | 66  |            | 07.92 | 06.97 |                |        |  |                          |
|        | 2.0 i   | 89  |            | 07.92 | 06.97 |                |        |  |                          |
|        | 1.8 D   | 44  |            | 06.93 | 06.97 | 24.0110-0187.1 | 410187 |  | 247 10,0 9,0 +S +B       |
|        | 1.9 D   | 47  |            | 03.91 | 06.97 |                |        |  |                          |
|        | 1.9 D   | 50  |            | 06.94 | 06.97 |                |        |  |                          |

<sup>1)</sup> - ESP/ + manual transm. / - ESP/+ scatola cambio velocità / - ESP/ + transmission mécanique / - ESP/ + cambio de velocidad

<sup>2)</sup> + ESP/ + manual transm. / + ESP/+ scatola cambio velocità / + ESP/ + transmission mécanique / + ESP/ + cambio de velocidad

<sup>3)</sup> + autom.transmission / + scatola cambio automatico / + transmission automatique / + cambio automático



|     |    |   |                |   |   |  |  |                  |
|--|--|---|--|---|--|--|--|--|
| <b>CITROEN ZX (N2) Limousine (91-97)</b>   |  |   |  |   |  |  |  |  |
|    | 2.0<br>2.0 16V<br>2.0 16V<br>2.0 16V   | 122<br>110<br>112<br>114  |  | 09.96<br>06.94<br>07.92<br>07.92  | 10.97<br>10.97<br>10.94<br>10.97   | 24.0120-0133.1<br>24.0320-0133.1   | 420133<br>520133   | 266 20,5 18,5 V +S +B<br>266 20,5 18,5 V +S +B PD  |
|  | 2.0<br>2.0 16V   | 122<br>120  |  | 09.96<br>05.96  | 10.97<br>06.97   | 24.0122-0142.1   | 422142   | 283 22,0 20,0 V L +B   |
|    | 1.6 i<br>1.8 16V<br>1.8 D<br>1.8 i<br>1.9<br>1.9 D<br>1.9 D<br>1.9 i<br>1.9 TD<br>2.0 i  | 65<br>81<br>44<br>74<br>96<br>47<br>50<br>88<br>66<br>89  |  | 03.91<br>01.96<br>06.93<br>07.92<br>03.91<br>03.91<br>06.94<br>03.91<br>07.92<br>07.92  | 06.97<br>06.97<br>06.97<br>06.97<br>06.97<br>06.97<br>06.97<br>06.97<br>06.97<br>06.97   | 13.0460-3823.2<br>13.0460-0435.2   | 603823<br>610435   | 20974 11,0<br>Belagsatz-Zubehör<br>BDX   |
|  | 2.0<br>2.0 16V<br>2.0 16V<br>2.0 16V<br>2.0 16V  | 122<br>110<br>112<br>114<br>120   |  | 09.96<br>06.94<br>07.92<br>07.92<br>05.96   | 10.97<br>06.97<br>10.94<br>10.97<br>06.97  | 13.0460-3954.2<br>13.0460-0435.2   | 603954<br>610435   | 20973 11,0 +<br>Belagsatz-Zubehör<br>BDX<br>BDX  |
|    | 1.6 i<br>1.8 16V<br>1.8 D<br>1.8 i<br>1.9<br>1.9 D<br>1.9 D<br>1.9 i<br>1.9 TD<br>2.0<br>2.0 16V<br>2.0 16V<br>2.0 16V<br>2.0 16V<br>2.0 i | 65<br>81<br>44<br>74<br>96<br>47<br>50<br>88<br>66<br>122<br>110<br>112<br>114<br>120<br>89   |  | 03.91<br>01.96<br>06.93<br>07.92<br>03.91<br>03.91<br>06.94<br>03.91<br>07.92<br>09.96<br>06.94<br>07.92<br>07.92<br>05.96<br>07.92 | 06.97<br>06.97<br>06.97<br>06.97<br>06.97<br>06.97<br>06.97<br>06.97<br>06.97<br>10.97<br>06.97<br>10.94<br>10.97<br>06.97<br>06.97                | 24.0108-0106.1   | 408106   | 247 8,0 6,0 +S +B  |
|    | 1.1<br>1.1<br>1.4<br>1.4 i<br>1.6 i<br>1.8 D<br>1.8 i<br>1.9 D<br>1.9 D<br>1.9 TD  | 40<br>44<br>55<br>55<br>65<br>44<br>74<br>47<br>50<br>66  |  | 03.91<br>03.91<br>03.91<br>03.91<br>03.91<br>06.93<br>07.92<br>03.91<br>06.94<br>07.92  | 08.93 - ABS<br>06.97 - ABS<br>06.97 - ABS<br>06.97 - ABS<br>06.97 - ABS<br>06.97 - ABS<br>06.97 - ABS<br>06.97 - ABS<br>06.97 - ABS<br>06.97 - ABS | 03.0137-0261.2<br>03.0137-0197.2<br>03.0137-9086.2<br>03.0137-9175.2               | 650261<br>650197<br>669086<br>669175   | 180 x 32<br>180 x 32 HEB<br>Bremsbacken-Zubehör<br>Bremsbacken-Zubehör<br>BDX<br>TRW<br>BDX<br>TRW |
|  | 1.1<br>1.4<br>1.4 i<br>1.6 i<br>1.8 16V<br>1.8 D<br>1.8 i<br>1.9 D<br>1.9 D<br>1.9 TD  | 44 ORGA 06749<br>55 ORGA 06749<br>55 ORGA 06749<br>65 ORGA 06749<br>81<br>44 ORGA 06749<br>74 ORGA 06749<br>47 ORGA 06749<br>50 ORGA 06749<br>66 ORGA 06749 |  | 06.97<br>06.97<br>06.97<br>06.97<br>01.96<br>06.97<br>06.97<br>06.97<br>06.97<br>06.97<br>06.97                                     | + ABS<br>+ ABS<br>+ ABS<br>+ ABS<br>+ ABS<br>+ ABS<br>+ ABS<br>+ ABS<br>+ ABS<br>+ ABS   | 03.0137-0312.2<br>03.0137-9158.2   | 650312<br>669158   | 203 x 38 HEB<br>Bremsbacken-Zubehör<br>TRW<br>TRW  |
|  | 1.1<br>1.1<br>1.4<br>1.4 i<br>1.6 i<br>1.8 D<br>1.8 i<br>1.9 D<br>1.9 D<br>1.9 TD  | 40<br>44<br>55<br>55<br>65<br>44<br>74<br>50<br>66  |  | 03.91<br>03.91<br>03.91<br>03.91<br>03.91<br>06.93<br>07.92<br>03.91<br>06.94<br>07.92  | 08.93 - ABS<br>06.97 - ABS<br>06.97 - ABS<br>06.97 - ABS<br>06.97 - ABS<br>06.97 - ABS<br>06.97 - ABS<br>06.97 - ABS<br>06.97 - ABS<br>06.97 - ABS | 24.0218-0016.1<br>24.0218-0716.2   | 480011<br>480203   | 180/181 x 44,5 - Lager<br>180/181 x 44,5 + Lager   |
|  | 1.1<br>1.4<br>1.4 i<br>1.6 i<br>1.8 16V<br>1.8 D<br>1.8 i<br>1.9 D<br>1.9 D<br>1.9 TD  | 44 ORGA 06749<br>55 ORGA 06749<br>55 ORGA 06749<br>65 ORGA 06749<br>81<br>44 ORGA 06749<br>74 ORGA 06749<br>47 ORGA 06749<br>50 ORGA 06749<br>66 ORGA 06749 |  | 06.97<br>06.97<br>06.97<br>06.97<br>01.96<br>06.97<br>06.97<br>06.97<br>06.97<br>06.97  | + ABS<br>+ ABS<br>+ ABS<br>+ ABS<br>+ ABS<br>+ ABS<br>+ ABS<br>+ ABS<br>+ ABS<br>+ ABS   | 24.0220-3014.1   | 480090   | 203/204,4 x 46,5   |
|  | 1.1<br>1.1<br>1.4<br>1.4 i<br>1.6 i<br>1.9 D<br>1.9 D  | 40<br>44<br>55<br>55<br>65<br>47<br>50  | ORGA 05718<br>ORGA 05718<br>ORGA 05718<br>ORGA 05718<br>ORGA 05718<br>ORGA 05718<br>ORGA 05718 | 03.91<br>03.91<br>03.91<br>03.91<br>03.91<br>03.91<br>06.94   | - ABS<br>- ABS<br>- ABS<br>- ABS<br>- ABS<br>- ABS<br>- ABS  | 03.0420-1620.3<br>03.0520-1820.3   | 681620<br>691820   | 20,64/180x32 Kit<br>20,64/180x32 TopKit<br>BDX<br>TRW  |
|  | 1.1<br>1.1<br>1.4  | 40 ORGA 05719<br>44 ORGA 05719<br>55 ORGA 05719   |  | 08.93<br>06.97<br>06.97   | - ABS<br>- ABS<br>- ABS  | 03.0520-2620.3<br>03.0520-2520.3   | 692620<br>692520   | 20,64/180x32 TopKit<br>20,64/180x32 TopKit<br>BDX<br>TRW   |





### CITROEN ZX (N2) Limousine (91-97)

|  |         |               |       |       |       |                |        |         |                     |     |
|--|---------|---------------|-------|-------|-------|----------------|--------|---------|---------------------|-----|
|  | 1.4 i   | 55 ORGA 05719 |       | 06.97 | - ABS | 03.0520-2620.3 | 692620 |         | 20,64/180x32 TopKit | BDX |
|  | 1.6 i   | 65 ORGA 05719 |       | 06.97 | + ABS | 03.0520-2520.3 | 692520 |         | 20,64/180x32 TopKit | TRW |
|  | 1.9 D   | 47 ORGA 05719 |       | 06.97 | - ABS |                |        |         |                     |     |
|  | 1.9 D   | 50 ORGA 05719 |       | 06.97 | - ABS |                |        |         |                     |     |
|  | 1.9 TD  | 66            | 07.92 | 06.97 | - ABS |                |        |         |                     |     |
|  | 1.1     | 44 ORGA 06749 |       | 06.97 | + ABS | 03.0520-5720.3 | 695720 | + GG 1) | 20,64/203x39 TopKit | TRW |
|  | 1.4     | 55 ORGA 06749 |       | 06.97 | + ABS |                |        |         |                     |     |
|  | 1.4 i   | 55 ORGA 06749 |       | 06.97 | + ABS |                |        |         |                     |     |
|  | 1.6 i   | 65 ORGA 06749 |       | 06.97 | + ABS |                |        |         |                     |     |
|  | 1.8 16V | 81            | 01.96 | 06.97 | + ABS |                |        |         |                     |     |
|  | 1.8 D   | 44 ORGA 06749 |       | 06.97 | + ABS |                |        |         |                     |     |
|  | 1.8 i   | 74 ORGA 06749 |       | 06.97 | + ABS |                |        |         |                     |     |
|  | 1.9 D   | 47 ORGA 06749 |       | 06.97 | + ABS |                |        |         |                     |     |
|  | 1.9 D   | 50 ORGA 06749 |       | 06.97 | + ABS |                |        |         |                     |     |
|  | 1.9 TD  | 66 ORGA 06749 |       | 06.97 | + ABS |                |        |         |                     |     |

### CITROEN ZX (N2) Kombi (93-98)























|  |         |    |       |       |  |                |        |  |                          |     |
|--|---------|----|-------|-------|--|----------------|--------|--|--------------------------|-----|
|  | 1.4 i   | 55 | 10.93 | 10.97 |  | 13.0460-3952.2 | 603952 |  | 20905 18,0 +/WK          | BDX |
|  | 1.6 i   | 65 | 10.93 | 10.97 |  | 13.0460-0403.2 | 610403 |  | Belagsatz-Zubehör        | BDX |
|  | 1.6 i   | 65 | 10.93 | 10.97 |  | 13.0460-2981.2 | 602981 |  | 21460 18,0 +/WK/S        | TRW |
|  | 1.8 16V | 81 | 01.96 | 02.98 |  |                |        |  |                          |     |
|  | 1.8 D   | 44 | 10.93 | 10.97 |  |                |        |  |                          |     |
|  | 1.8 i   | 74 | 10.93 | 10.97 |  |                |        |  |                          |     |
|  | 1.9 D   | 47 | 10.93 | 10.97 |  |                |        |  |                          |     |
|  | 1.9 D   | 50 | 06.94 | 10.97 |  |                |        |  |                          |     |
|  | 1.9 TD  | 66 | 10.93 | 10.97 |  |                |        |  |                          |     |
|  | 1.4 i   | 55 | 10.93 | 10.97 |  | 24.0110-0187.1 | 410187 |  | 247 10,0 9,0 +S +B       |     |
|  | 1.6 i   | 65 | 10.93 | 10.97 |  | 24.0120-0132.1 | 420132 |  | 247 20,4 18,5 V +S +B    |     |
|  | 1.8 16V | 81 | 01.96 | 02.98 |  | 24.0320-0132.1 | 520132 |  | 247 20,4 18,5 V +S +B PD |     |
|  | 1.8 D   | 44 | 10.93 | 10.97 |  |                |        |  |                          |     |
|  | 1.8 i   | 74 | 10.93 | 10.97 |  |                |        |  |                          |     |
|  | 1.9 D   | 47 | 10.93 | 10.97 |  |                |        |  |                          |     |
|  | 1.9 D   | 50 | 06.94 | 10.97 |  |                |        |  |                          |     |
|  | 1.9 TD  | 66 | 10.93 | 10.97 |  |                |        |  |                          |     |
|  | 1.6 i   | 65 | 10.93 | 10.97 |  | 13.0460-3823.2 | 603823 |  | 20974 11,0               | BOS |
|  | 1.8 16V | 81 | 01.96 | 02.98 |  | 13.0460-0435.2 | 610435 |  | Belagsatz-Zubehör        | BDX |
|  | 1.8 D   | 44 | 10.93 | 10.97 |  |                |        |  |                          |     |
|  | 1.8 i   | 74 | 10.93 | 10.97 |  |                |        |  |                          |     |
|  | 1.9 D   | 47 | 10.93 | 10.97 |  |                |        |  |                          |     |
|  | 1.9 D   | 50 | 06.94 | 10.97 |  |                |        |  |                          |     |
|  | 1.9 TD  | 66 | 10.93 | 10.97 |  |                |        |  |                          |     |
|  | 1.6 i   | 65 | 10.93 | 10.97 |  | 24.0108-0106.1 | 408106 |  | 247 8,0 6,0 +S +B        |     |
|  | 1.8 16V | 81 | 01.96 | 02.98 |  |                |        |  |                          |     |
|  | 1.8 D   | 44 | 10.93 | 10.97 |  |                |        |  |                          |     |
|  | 1.8 i   | 74 | 10.93 | 10.97 |  |                |        |  |                          |     |
|  | 1.9 D   | 47 | 10.93 | 10.97 |  |                |        |  |                          |     |
|  | 1.9 D   | 50 | 06.94 | 10.97 |  |                |        |  |                          |     |
|  | 1.9 TD  | 66 | 10.93 | 10.97 |  |                |        |  |                          |     |
|  | 1.4 i   | 55 | 10.93 | 10.97 |  | 03.0137-0370.2 | 650370 |  | 229 x 42 HEB             | BDX |
|  | 1.6 i   | 65 | 10.93 | 10.97 |  | 03.0137-9228.2 | 669228 |  | Bremsbacken-Zubehör      | BDX |
|  | 1.8 16V | 81 | 01.96 | 02.98 |  |                |        |  |                          |     |
|  | 1.8 D   | 44 | 10.93 | 10.97 |  |                |        |  |                          |     |
|  | 1.8 i   | 74 | 10.93 | 10.97 |  |                |        |  |                          |     |
|  | 1.9 D   | 47 | 10.93 | 10.97 |  |                |        |  |                          |     |
|  | 1.9 D   | 50 | 06.94 | 10.97 |  |                |        |  |                          |     |
|  | 1.9 TD  | 66 | 10.93 | 10.97 |  |                |        |  |                          |     |
|  | 1.4 i   | 55 | 10.93 | 10.97 |  | 24.0222-8017.1 | 480071 |  | 229/230 x 50,8           |     |
|  | 1.6 i   | 65 | 10.93 | 10.97 |  |                |        |  |                          |     |
|  | 1.8 16V | 81 | 01.96 | 02.98 |  |                |        |  |                          |     |
|  | 1.8 D   | 44 | 10.93 | 10.97 |  |                |        |  |                          |     |
|  | 1.8 i   | 74 | 10.93 | 10.97 |  |                |        |  |                          |     |
|  | 1.9 D   | 47 | 10.93 | 10.97 |  |                |        |  |                          |     |
|  | 1.9 D   | 50 | 06.94 | 10.97 |  |                |        |  |                          |     |
|  | 1.9 TD  | 66 | 10.93 | 10.97 |  |                |        |  |                          |     |
|  | 1.4 i   | 55 | 10.93 | 10.97 |  | 03.0520-3220.3 | 693220 |  | 20,64/229x42 TopKit      | BDX |
|  | 1.6 i   | 65 | 10.93 | 10.97 |  |                |        |  |                          |     |
|  | 1.8 16V | 81 | 01.96 | 02.98 |  |                |        |  |                          |     |
|  | 1.8 D   | 44 | 10.93 | 10.97 |  |                |        |  |                          |     |
|  | 1.8 i   | 74 | 10.93 | 10.97 |  |                |        |  |                          |     |
|  | 1.9 D   | 47 | 10.93 | 10.97 |  |                |        |  |                          |     |
|  | 1.9 D   | 50 | 06.94 | 10.97 |  |                |        |  |                          |     |
|  | 1.9 TD  | 66 | 10.93 | 10.97 |  |                |        |  |                          |     |

### DACIA DOKKER (12-)

|  |             |    |       |  |       |                |        |  |                   |     |
|--|-------------|----|-------|--|-------|----------------|--------|--|-------------------|-----|
|  | 1.5 dCi 75  | 55 | 11.12 |  | - ESP | 13.0460-2709.2 | 602709 |  | 23973 17,4 /Zub/S | TRW |
|  | 1.5 dCi 90  | 66 | 11.12 |  | - ESP | 13.0470-2709.2 | LD2709 |  | 23973 17,4 /Zub/S | TRW |
|  | 1.6         | 61 | 11.12 |  | - ESP |                |        |  |                   |     |
|  | 1.6         | 75 | 04.15 |  | - ESP |                |        |  |                   |     |
|  | 1.6 LPG     | 75 | 04.15 |  | - ESP |                |        |  |                   |     |
|  | 1.2 TCe 115 | 85 | 11.12 |  |       | 13.0460-7266.2 | 607266 |  | 24538 17,9 +      | ATE |
|  | 1.5 dCi 75  | 55 | 11.12 |  | + ESP | 13.0470-7266.2 | LD7266 |  | 24538 17,9 +      | ATE |
|  | 1.5 dCi 90  | 66 | 11.12 |  | + ESP |                |        |  |                   |     |
|  | 1.6         | 61 | 11.12 |  | + ESP |                |        |  |                   |     |
|  | 1.6         | 75 | 04.15 |  | + ESP |                |        |  |                   |     |
|  | 1.6 LPG     | 75 | 04.15 |  | + ESP |                |        |  |                   |     |

1) + cast iron / + ghisa / + fonte grise / + fundición de gris



|     |  |  |  |  |  |  |  |       |                                |
|--|--|--|--|--|---|--|--|---|--------------------------------|
| <b>DACIA DOKKER (12-)</b>  |  |  |  |  |   |  |  |   |                                |
|    | 1.5 dCi 75   | 55   |  | 11.12  | - ESP   | 24.0122-0270.1   | 422270   | - erhöhte Zuladung <sup>1)</sup>  | 258 22,0 19,8 V L +S +B        |
|  | 1.5 dCi 90   | 66   |  | 11.12  | - ESP   | 24.0124-0253.1   | 424253   | + erhöhte Zuladung <sup>2)</sup>  | 280 24,0 21,8 V L +S +B        |
|  | 1.6  | 61   |  | 11.12  | - ESP   |  |  |   |                                |
|  | 1.6  | 75   |  | 04.15  | - ESP   |  |  |   |                                |
|  | 1.6 LPG  | 75   |  | 04.15  | - ESP   |  |  |   |                                |
|  | 1.2 TCe 115  | 85   |  | 11.12  |   | 24.0124-0253.1   | 424253   |   | 280 24,0 21,8 V L +S +B        |
|  | 1.5 dCi 75   | 55   |  | 11.12  | + ESP   |  |  |   |                                |
|  | 1.5 dCi 90   | 66   |  | 11.12  | + ESP   |  |  |   |                                |
|  | 1.6  | 61   |  | 11.12  | + ESP   |  |  |   |                                |
|  | 1.6  | 75   |  | 04.15  | + ESP   |  |  |   |                                |
| 1.6 LPG  | 75   |  | 04.15  | + ESP  |   |  |  |   |                                |
|    | 1.2 TCe 115  | 85   |  | 11.12  |   | 24.0711-5369.3   | 360378   | 2    | Radsensor L=619                |
|  | 1.5 dCi 75   | 55   |  | 11.12  |   |  |  |   |                                |
|  | 1.5 dCi 90   | 66   |  | 11.12  |   |  |  |   |                                |
|  | 1.6  | 61   |  | 11.12  |   |  |  |   |                                |
|  | 1.6  | 75   |  | 04.15  |   |  |  |   |                                |
| 1.6 LPG  | 75   |  | 04.15  |  |   |  |  |   |                                |
|    | 1.2 TCe 115  | 85   |  | 11.12  |   | 03.0137-0496.2   | 650496   |   | 228 x 42 HEB <b>BDX</b>        |
|  | 1.5 dCi 75   | 55   |  | 11.12  |   | 03.0137-9228.2   | 669228   |   | Bremsbacken-Zubehör <b>BDX</b> |
|  | 1.5 dCi 90   | 66   |  | 11.12  |   |  |  |   |                                |
|  | 1.6  | 61   |  | 11.12  |   |  |  |   |                                |
|  | 1.6  | 75   |  | 04.15  |   |  |  |   |                                |
| 1.6 LPG  | 75   |  | 04.15  |  |   |  |  |   |                                |
|    | 1.2 TCe 115  | 85   |  | 11.12  |   | 03.0520-7222.3   | 697222   |   | 22,20/228x42 TopKit            |
|  | 1.5 dCi 75   | 55   |  | 11.12  |   |  |  |   |                                |
|  | 1.5 dCi 90   | 66   |  | 11.12  |   |  |  |   |                                |
|  | 1.6  | 61   |  | 11.12  |   |  |  |   |                                |
|  | 1.6  | 75   |  | 04.15  |   |  |  |   |                                |
| 1.6 LPG  | 75   |  | 04.15  |  |   |  |  |   |                                |
| <b>DACIA DOKKER Express (12-)</b>  |  |  |  |  |   |  |  |   |                                |
|    | 1.5 dCi  | 55   |  | 12.12  | - ESP   | 13.0460-2709.2   | 602709   | - erhöhte Zuladung <sup>1)</sup>  | 23973 17,4 /Zub/S <b>TRW</b>   |
|  | 1.5 dCi  | 66   |  | 12.12  | - ESP   | 13.0470-2709.2   | LD2709   | - erhöhte Zuladung <sup>1)</sup>  | 23973 17,4 /Zub/S <b>TRW</b>   |
|  | 1.6  | 61   |  | 12.12  | - ESP   |  |  |   |                                |
|  | 1.6  | 75   |  | 04.15  | - ESP   |  |  |   |                                |
|  | 1.6 LPG  | 75   |  | 04.15  | - ESP   |  |  |   |                                |
|  | 1.5 dCi  | 55   |  | 12.12  | - ESP   | 13.0460-7266.2   | 607266   | + erhöhte Zuladung <sup>2)</sup>  | 24538 17,9 + <b>ATE</b>        |
|  | 1.5 dCi  | 66   |  | 12.12  | - ESP   | 13.0470-7266.2   | LD7266   | + erhöhte Zuladung <sup>2)</sup>  | 24538 17,9 + <b>ATE</b>        |
|  | 1.6  | 61   |  | 12.12  | - ESP   |  |  |   |                                |
|  | 1.6  | 75   |  | 04.15  | - ESP   |  |  |   |                                |
|  | 1.6 LPG  | 75   |  | 04.15  | - ESP   |  |  |   |                                |
|   | 1.2 TCe 115  | 85   |  | 12.12  | - ESP   | 13.0460-7266.2   | 607266   |   | 24538 17,9 + <b>ATE</b>        |
|  | 1.5 dCi  | 55   |  | 12.12  | + ESP   | 13.0470-7266.2   | LD7266   |   | 24538 17,9 + <b>ATE</b>        |
|  | 1.5 dCi  | 66   |  | 12.12  | + ESP   |  |  |   |                                |
|  | 1.6  | 61   |  | 12.12  | + ESP   |  |  |   |                                |
|  | 1.6  | 75   |  | 04.15  | + ESP   |  |  |   |                                |
| 1.6 LPG  | 75   |  | 04.15  | + ESP  |   |  |  |   |                                |
|  | 1.5 dCi  | 55   |  | 12.12  | - ESP   | 24.0122-0270.1   | 422270   | - erhöhte Zuladung <sup>1)</sup>  | 258 22,0 19,8 V L +S +B        |
|  | 1.5 dCi  | 66   |  | 12.12  | - ESP   | 24.0124-0253.1   | 424253   | + erhöhte Zuladung <sup>2)</sup>  | 280 24,0 21,8 V L +S +B        |
|  | 1.6  | 61   |  | 12.12  | - ESP   |  |  |   |                                |
|  | 1.6  | 75   |  | 04.15  | - ESP   |  |  |   |                                |
|  | 1.6 LPG  | 75   |  | 04.15  | - ESP   |  |  |   |                                |
|  | 1.2 TCe 115  | 85   |  | 12.12  |   | 24.0124-0253.1   | 424253   |   | 280 24,0 21,8 V L +S +B        |
|  | 1.5 dCi  | 55   |  | 12.12  | + ESP   |  |  |   |                                |
|  | 1.5 dCi  | 66   |  | 12.12  | + ESP   |  |  |   |                                |
|  | 1.6  | 61   |  | 12.12  | + ESP   |  |  |   |                                |
|  | 1.6  | 75   |  | 04.15  | + ESP   |  |  |   |                                |
| 1.6 LPG  | 75   |  | 04.15  | + ESP  |   |  |  |   |                                |
|  | 1.2 TCe 115  | 85   |  | 12.12  |   | 24.0711-5369.3   | 360378   | 2  | Radsensor L=619                |
|  | 1.5 dCi  | 55   |  | 12.12  |   |  |  |   |                                |
|  | 1.5 dCi  | 66   |  | 12.12  |   |  |  |   |                                |
|  | 1.6  | 61   |  | 12.12  |   |  |  |   |                                |
|  | 1.6  | 75   |  | 04.15  |   |  |  |   |                                |
| 1.6 LPG  | 75   |  | 04.15  |  |   |  |  |   |                                |
|  | 1.2 TCe 115  | 85   |  | 12.12  |   | 03.0137-0496.2   | 650496   |   | 228 x 42 HEB <b>BDX</b>        |
|  | 1.5 dCi  | 55   |  | 12.12  |   | 03.0137-9228.2   | 669228   |   | Bremsbacken-Zubehör <b>BDX</b> |
|  | 1.5 dCi  | 66   |  | 12.12  |   |  |  |   |                                |
|  | 1.6  | 61   |  | 12.12  |   |  |  |   |                                |
|  | 1.6  | 75   |  | 04.15  |   |  |  |   |                                |
| 1.6 LPG  | 75   |  | 04.15  |  |   |  |  |   |                                |
|  | 1.2 TCe 115  | 85   |  | 12.12  |   | 03.0520-7222.3   | 697222   |   | 22,20/228x42 TopKit            |
|  | 1.5 dCi  | 55   |  | 12.12  |   |  |  |   |                                |
|  | 1.5 dCi  | 66   |  | 12.12  |   |  |  |   |                                |
|  | 1.6  | 61   |  | 12.12  |   |  |  |   |                                |
|  | 1.6  | 75   |  | 04.15  |   |  |  |   |                                |
| 1.6 LPG  | 75   |  | 04.15  |  |   |  |  |   |                                |
| <b>DACIA DUSTER (HS_) (10-)</b>  |  |  |  |  |   |  |  |   |                                |
|  | 1.5 dCi  | 63   |  | 04.10  | - ABS   | 13.0460-2709.2   | 602709   |   | 23973 17,4 /Zub/S <b>TRW</b>   |
|  | 1.5 dCi  | 66   |  | 10.10  | - ABS   | 13.0470-2709.2   | LD2709   |   | 23973 17,4 /Zub/S <b>TRW</b>   |
|  | 1.5 dCi  | 79   |  | 06.10  | - ABS   |  |  |   |                                |
|  | 1.5 dCi  | 80   |  | 09.13  | - ABS   |  |  |   |                                |
|  | 1.6 16V  | 77   |  | 04.10  | - ESP   |  |  |   |                                |
|  | 1.6 16V 4x4  | 77   |  | 06.10  | - ESP   |  |  |   |                                |
|  | 1.6 16V Flexifuel  | 77   |  | 04.11  | - ESP   |  |  |   |                                |
| 1.6 16V LPG  | 77   |  | 04.11  | - ESP  |   |  |  |   |                                |

1) - increased payload / - carico utile maggiorato / - charge utile augmentée / - incremento de carga  
2) + increased payload / + carico utile maggiorato / + charge utile augmentée / + incremento de carga



### DACIA DUSTER (HS\_) (10-)

|                   |                   |         |       |       |                |                |        |                         |                         |
|-------------------|-------------------|---------|-------|-------|----------------|----------------|--------|-------------------------|-------------------------|
|                   | 1.6 SCe 115       | 84      | 06.15 | - ESP | 13.0460-2709.2 | 602709         |        | 23973 17,4 /Zub/S       | TRW                     |
|                   | 1.6 SCe 115 4x4   | 84      | 06.15 | - ESP | 13.0470-2709.2 | LD2709         |        | 23973 17,4 /Zub/S       | TRW                     |
|                   | 1.2 TCe 125       | 92      | 09.13 |       | 13.0460-7266.2 | 607266         |        | 24538 17,9 +            | ATE                     |
|                   | 1.2 TCe 125 4x4   | 92      | 06.15 |       | 13.0470-7266.2 | LD7266         |        | 24538 17,9 +            | ATE                     |
|                   | 1.5 dCi           | 63      | 04.10 | + ABS |                |                |        |                         |                         |
|                   | 1.5 dCi           | 66      | 10.10 | + ABS |                |                |        |                         |                         |
|                   | 1.5 dCi           | 79      | 06.10 | + ABS |                |                |        |                         |                         |
|                   | 1.5 dCi           | 80      | 09.13 | + ABS |                |                |        |                         |                         |
|                   | 1.5 dCi 4x4       | 66      | 10.10 |       |                |                |        |                         |                         |
|                   | 1.5 dCi 4x4       | 79      | 06.10 |       |                |                |        |                         |                         |
|                   | 1.5 dCi 4x4       | 80      | 08.13 |       |                |                |        |                         |                         |
|                   | 1.5 dCi 4x4       | 81      | 10.10 |       |                |                |        |                         |                         |
|                   | 1.6 16V           | 77      | 04.10 | + ESP |                |                |        |                         |                         |
|                   | 1.6 16V 4x4       | 77      | 06.10 | + ESP |                |                |        |                         |                         |
|                   | 1.6 16V Flexifuel | 77      | 04.11 | + ESP |                |                |        |                         |                         |
|                   | 1.6 16V LPG       | 77      | 04.11 | + ESP |                |                |        |                         |                         |
|                   | 1.6 SCe 115       | 84      | 06.15 | + ESP |                |                |        |                         |                         |
|                   | 1.6 SCe 115 4x4   | 84      | 06.15 | + ESP |                |                |        |                         |                         |
|                   |                   | 1.5 dCi | 63    | 04.10 | - ABS          | 24.0123-0119.1 | 423119 |                         | 269 22,5 19,8 V L +S +B |
| 1.5 dCi           |                   | 66      | 10.10 | - ABS |                |                |        |                         |                         |
| 1.5 dCi           |                   | 79      | 06.10 | - ABS |                |                |        |                         |                         |
| 1.5 dCi           |                   | 80      | 09.13 | - ABS |                |                |        |                         |                         |
| 1.6 16V           |                   | 77      | 04.10 | - ESP |                |                |        |                         |                         |
| 1.6 16V 4x4       |                   | 77      | 06.10 | - ESP |                |                |        |                         |                         |
| 1.6 16V Flexifuel |                   | 77      | 04.11 | - ESP |                |                |        |                         |                         |
| 1.6 16V LPG       |                   | 77      | 04.11 | - ESP |                |                |        |                         |                         |
| 1.6 SCe 115       |                   | 84      | 06.15 | - ESP |                |                |        |                         |                         |
| 1.6 SCe 115 4x4   |                   | 84      | 06.15 | - ESP |                |                |        |                         |                         |
| 1.2 TCe 125       |                   | 92      | 09.13 |       | 24.0124-0221.1 | 424221         |        | 280 24,0 21,8 V L +S +B |                         |
| 1.2 TCe 125 4x4   |                   | 92      | 06.15 |       |                |                |        |                         |                         |
| 1.5 dCi           |                   | 63      | 04.10 | + ABS |                |                |        |                         |                         |
| 1.5 dCi           | 66                | 10.10   | + ABS |       |                |                |        |                         |                         |
| 1.5 dCi           | 79                | 06.10   | + ABS |       |                |                |        |                         |                         |
| 1.5 dCi           | 80                | 09.13   | + ABS |       |                |                |        |                         |                         |
| 1.5 dCi 4x4       | 66                | 10.10   |       |       |                |                |        |                         |                         |
| 1.5 dCi 4x4       | 79                | 06.10   |       |       |                |                |        |                         |                         |
| 1.5 dCi 4x4       | 80                | 08.13   |       |       |                |                |        |                         |                         |
| 1.5 dCi 4x4       | 81                | 10.10   |       |       |                |                |        |                         |                         |
| 1.6 16V           | 77                | 04.10   | + ESP |       |                |                |        |                         |                         |
| 1.6 16V 4x4       | 77                | 06.10   | + ESP |       |                |                |        |                         |                         |
| 1.6 16V Flexifuel | 77                | 04.11   | + ESP |       |                |                |        |                         |                         |
| 1.6 16V LPG       | 77                | 04.11   | + ESP |       |                |                |        |                         |                         |
| 1.6 SCe 115       | 84                | 06.15   | + ESP |       |                |                |        |                         |                         |
| 1.6 SCe 115 4x4   | 84                | 06.15   | + ESP |       |                |                |        |                         |                         |
|                   | 1.2 TCe 125       | 92      | 09.13 |       | 03.0137-0496.2 | 650496         |        | 228 x 42 HEB            | BDX                     |
|                   | 1.5 dCi           | 63      | 04.10 |       | 03.0137-9228.2 | 669228         |        | Bremsbacken-Zubehör     | BDX                     |
|                   | 1.5 dCi           | 66      | 10.10 |       |                |                |        |                         |                         |
|                   | 1.5 dCi           | 79      | 06.10 |       |                |                |        |                         |                         |
|                   | 1.5 dCi           | 80      | 09.13 |       |                |                |        |                         |                         |
|                   | 1.6 16V           | 77      | 04.10 |       |                |                |        |                         |                         |
|                   | 1.6 16V Flexifuel | 77      | 04.11 |       |                |                |        |                         |                         |
|                   | 1.6 16V LPG       | 77      | 04.11 |       |                |                |        |                         |                         |
|                   | 1.6 SCe 115       | 84      | 06.15 |       |                |                |        |                         |                         |
|                   | 1.2 TCe 125 4x4   | 92      | 06.15 |       | 03.0137-9312.2 | 669312         |        | Bremsbacken-Zubehör     |                         |
| 1.5 dCi 4x4       | 66                | 10.10   |       |       |                |                |        |                         |                         |
| 1.5 dCi 4x4       | 79                | 06.10   |       |       |                |                |        |                         |                         |
| 1.5 dCi 4x4       | 80                | 08.13   |       |       |                |                |        |                         |                         |
| 1.5 dCi 4x4       | 81                | 10.10   |       |       |                |                |        |                         |                         |
| 1.6 16V 4x4       | 77                | 06.10   |       |       |                |                |        |                         |                         |
| 1.6 SCe 115 4x4   | 84                | 06.15   |       |       |                |                |        |                         |                         |
|                   | 1.2 TCe 125       | 92      | 09.13 |       | 03.0520-7919.3 | 697919         |        | 19,05/228x42 TopKit     |                         |
|                   | 1.5 dCi           | 63      | 04.10 |       |                |                |        |                         |                         |
|                   | 1.5 dCi           | 66      | 10.10 |       |                |                |        |                         |                         |
|                   | 1.5 dCi           | 79      | 06.10 |       |                |                |        |                         |                         |
|                   | 1.5 dCi           | 80      | 09.13 |       |                |                |        |                         |                         |
|                   | 1.5 dCi 4x4       | 80      | 08.13 |       |                |                |        |                         |                         |
|                   | 1.6 16V           | 77      | 04.10 |       |                |                |        |                         |                         |
|                   | 1.6 16V Flexifuel | 77      | 04.11 |       |                |                |        |                         |                         |
|                   | 1.6 16V LPG       | 77      | 04.11 |       |                |                |        |                         |                         |
|                   | 1.6 SCe 115       | 84      | 06.15 |       |                |                |        |                         |                         |

### DACIA LODGY (JS\_) (12-)

|   |             |    |       |       |                |        |  |                         |     |
|---|-------------|----|-------|-------|----------------|--------|--|-------------------------|-----|
|   | 1.5 dCi     | 66 | 03.12 | - ESP | 13.0460-2709.2 | 602709 |  | 23973 17,4 /Zub/S       | TRW |
|   | 1.6         | 61 | 03.12 | - ESP | 13.0470-2709.2 | LD2709 |  | 23973 17,4 /Zub/S       | TRW |
|   | 1.6 LPG     | 75 | 04.15 |       |                |        |  |                         |     |
|   | 1.2 TCe     | 85 | 03.12 |       | 13.0460-7266.2 | 607266 |  | 24538 17,9 +            | ATE |
|   | 1.5 dCi     | 66 | 03.12 | + ESP | 13.0470-7266.2 | LD7266 |  | 24538 17,9 +            | ATE |
|   | 1.5 dCi     | 66 | 03.12 | + ESP |                |        |  |                         |     |
|   | 1.6         | 61 | 03.12 | + ESP |                |        |  |                         |     |
|   | 1.6 LPG     | 75 | 04.15 |       | 13.0460-2709.2 | 602709 |  | 23973 17,4 /Zub/S       | TRW |
|   | 1.6 SCe 115 | 75 | 06.15 |       | 13.0470-2709.2 | LD2709 |  | 23973 17,4 /Zub/S       | TRW |
|   | 1.2 TCe     | 85 | 03.12 | + ESP | 24.0122-0270.1 | 422270 |  | 258 22,0 19,8 V L +S +B |     |
|   | 1.5 dCi     | 66 | 03.12 | + ESP |                |        |  |                         |     |
|   | 1.5 dCi     | 66 | 03.12 | + ESP |                |        |  |                         |     |
|   | 1.6         | 61 | 03.12 | + ESP |                |        |  |                         |     |
| ↓ | 1.2 TCe     | 85 | 03.12 |       | 24.0124-0253.1 | 424253 |  | 280 24,0 21,8 V L +S +B |     |





### DACIA LODGY (JS\_) (12-)













|  |             |    |       |       |                |        |   |  |                         |
|--|-------------|----|-------|-------|----------------|--------|---|--|-------------------------|
|  | 1.5 dCi     | 66 | 03.12 | - ESP | 24.0124-0253.1 | 424253 |   |  | 280 24,0 21,8 V L +S +B |
|  | 1.5 dCi     | 66 | 03.12 | - ESP |                |        |   |  |                         |
|  | 1.6         | 61 | 03.12 | - ESP |                |        |   |  |                         |
|  | 1.6 LPG     | 75 | 04.15 |       |                |        |   |  |                         |
|  | 1.6 SCe 115 | 75 | 06.15 |       |                |        |   |  |                         |
|  | 1.2 TCe     | 85 | 03.12 |       | 24.0711-5369.3 | 360378 | 2 |  | Radsensor L=619         |
|  | 1.5 dCi     | 66 | 03.12 |       |                |        |   |  |                         |
|  | 1.5 dCi     | 61 | 03.12 |       |                |        |   |  |                         |
|  | 1.6         | 61 | 03.12 |       |                |        |   |  |                         |
|  | 1.6 LPG     | 75 | 04.15 |       |                |        |   |  |                         |
|  | 1.6 SCe 115 | 75 | 06.15 |       | 24.0711-5369.3 | 360378 | 2 |  | Radsensor L=619         |
|  | 1.2 TCe     | 85 | 03.12 |       |                |        |   |  |                         |
|  | 1.5 dCi     | 66 | 03.12 |       |                |        |   |  |                         |
|  | 1.5 dCi     | 61 | 03.12 |       |                |        |   |  |                         |
|  | 1.6         | 61 | 03.12 |       |                |        |   |  |                         |
|  | 1.6 LPG     | 75 | 04.15 |       | 03.0137-0496.2 | 650496 |   |  | 228 x 42 HEB <b>BDX</b> |
|  | 1.6 SCe 115 | 75 | 06.15 |       |                |        |   |  |                         |
|  | 1.5 dCi     | 66 | 03.12 |       |                |        |   |  |                         |
|  | 1.6         | 61 | 03.12 |       |                |        |   |  |                         |
|  | 1.6 LPG     | 75 | 04.15 |       |                |        |   |  |                         |
|  | 1.6 SCe 115 | 75 | 06.15 |       | 03.0520-7222.3 | 697222 |   |  | 22,20/228x42 TopKit     |
|  | 1.2 TCe     | 85 | 03.12 |       |                |        |   |  |                         |
|  | 1.5 dCi     | 66 | 03.12 |       |                |        |   |  |                         |
|  | 1.6         | 61 | 03.12 |       |                |        |   |  |                         |
|  | 1.6 LPG     | 75 | 04.15 |       |                |        |   |  |                         |

### DACIA LOGAN Express (FS\_) (09-13)

|  |            |    |       |       |                |        |  |  |                              |
|--|------------|----|-------|-------|----------------|--------|--|--|------------------------------|
|  | 1.4        | 55 | 03.09 | 06.13 | 13.0460-2709.2 | 602709 |  |  | 23973 17,4 /Zub/S <b>TRW</b> |
|  | 1.5 dCi    | 50 | 03.09 | 06.13 |                |        |  |  |                              |
|  | 1.5 dCi    | 55 | 05.10 | 06.13 |                |        |  |  |                              |
|  | 1.5 dCi    | 63 | 03.09 | 06.13 |                |        |  |  |                              |
|  | 1.5 dCi    | 65 | 05.10 | 06.13 |                |        |  |  |                              |
|  | 1.6        | 64 | 03.09 | 06.13 |                |        |  |  |                              |
|  | 1.6 MPI 85 | 62 | 05.10 | 06.13 |                |        |  |  |                              |
|  | 1.4        | 55 | 03.09 | 06.13 | 24.0122-0216.1 | 422216 |  |  | 260 22,0 19,8 V L +S +B      |
|  | 1.5 dCi    | 50 | 03.09 | 06.13 |                |        |  |  |                              |
|  | 1.5 dCi    | 55 | 05.10 | 06.13 |                |        |  |  |                              |
|  | 1.5 dCi    | 63 | 03.09 | 06.13 |                |        |  |  |                              |
|  | 1.5 dCi    | 65 | 05.10 | 06.13 |                |        |  |  |                              |
|  | 1.6        | 64 | 03.09 | 06.13 |                |        |  |  |                              |
|  | 1.6 MPI 85 | 62 | 05.10 | 06.13 |                |        |  |  |                              |
|  | 1.4        | 55 | 03.09 | 06.13 | 03.0137-0496.2 | 650496 |  |  | 228 x 42 HEB <b>BDX</b>      |
|  | 1.5 dCi    | 50 | 03.09 | 06.13 |                |        |  |  |                              |
|  | 1.5 dCi    | 55 | 05.10 | 06.13 |                |        |  |  |                              |
|  | 1.5 dCi    | 63 | 03.09 | 06.13 |                |        |  |  |                              |
|  | 1.5 dCi    | 65 | 05.10 | 06.13 |                |        |  |  |                              |
|  | 1.6        | 64 | 03.09 | 06.13 |                |        |  |  |                              |
|  | 1.6 MPI 85 | 62 | 05.10 | 06.13 |                |        |  |  |                              |
|  | 1.4        | 55 | 03.09 | 06.13 | 03.0520-7222.3 | 697222 |  |  | 22,20/228x42 TopKit          |
|  | 1.5 dCi    | 50 | 03.09 | 06.13 |                |        |  |  |                              |
|  | 1.5 dCi    | 55 | 05.10 | 06.13 |                |        |  |  |                              |
|  | 1.5 dCi    | 63 | 03.09 | 06.13 |                |        |  |  |                              |
|  | 1.5 dCi    | 65 | 05.10 | 06.13 |                |        |  |  |                              |
|  | 1.6        | 64 | 03.09 | 06.13 |                |        |  |  |                              |
|  | 1.6 MPI 85 | 62 | 05.10 | 06.13 |                |        |  |  |                              |

### DACIA LOGAN Limousine (LS\_) (04-13)

|                   |                   |         |       |       |                |                |        |  |                             |
|-------------------|-------------------|---------|-------|-------|----------------|----------------|--------|--|-----------------------------|
|                   | 1.2 16V           | 55      | 02.06 | 04.13 | 13.0460-2834.2 | 602834         |        |  | 21463 18,0 /WK/S <b>TRW</b> |
|                   | 1.4               | 55      | 09.04 | 04.13 |                |                |        |  |                             |
|                   | 1.4 MPI LPG       | 55      | 02.06 | 04.13 |                |                |        |  |                             |
|                   | 1.5 dCi           | 48      | 09.05 | 04.13 |                |                |        |  |                             |
|                   | 1.5 dCi           | 50      | 01.06 | 04.13 |                |                |        |  |                             |
|                   | 1.5 dCi           | 55      | 05.10 | 04.13 |                |                |        |  |                             |
|                   | 1.5 dCi           | 63      | 09.07 | 04.13 |                |                |        |  |                             |
|                   | 1.5 dCi           | 65      | 05.10 | 04.13 |                |                |        |  |                             |
|                   | 1.6 16V           | 64      | 09.04 | 04.13 |                |                |        |  |                             |
|                   | 1.6 16V           | 77      | 02.06 | 04.13 |                |                |        |  |                             |
|                   | 1.6 16V Flexifuel | 77      | 01.11 | 04.13 |                |                |        |  |                             |
|                   | 1.6 Bifuel        | 62      | 05.10 | 04.13 |                |                |        |  |                             |
|                   | 1.6 MPI 85        | 62      | 05.10 | 04.13 |                |                |        |  |                             |
|                   |                   | 1.2 16V | 55    | 02.06 |                |                |        |  |                             |
| 1.4               |                   | 55      | 09.04 | 04.13 |                |                |        |  |                             |
| 1.4 MPI LPG       |                   | 55      | 02.06 | 04.13 |                |                |        |  |                             |
| 1.5 dCi           |                   | 48      | 09.05 | 04.13 |                |                |        |  |                             |
| 1.5 dCi           |                   | 50      | 01.06 | 04.13 |                |                |        |  |                             |
| 1.5 dCi           |                   | 55      | 05.10 | 04.13 |                |                |        |  |                             |
| 1.5 dCi           |                   | 63      | 09.07 | 04.13 |                |                |        |  |                             |
| 1.5 dCi           |                   | 65      | 05.10 | 04.13 |                |                |        |  |                             |
| 1.6 16V           |                   | 64      | 09.04 | 04.13 |                |                |        |  |                             |
| 1.6 16V           |                   | 77      | 02.06 | 04.13 |                |                |        |  |                             |
| 1.6 16V Flexifuel |                   | 77      | 01.11 | 04.13 |                |                |        |  |                             |
| 1.6 Bifuel        |                   | 62      | 05.10 | 04.13 |                |                |        |  |                             |
| 1.6 MPI 85        |                   | 62      | 05.10 | 04.13 |                |                |        |  |                             |
|                   |                   | 1.2 16V | 55    | 02.06 | 04.13          | 24.0112-0171.1 | 412171 |  |                             |
|                   | 1.4               | 55      | 09.04 | 04.13 |                |                |        |  |                             |
|                   | 1.4 MPI LPG       | 55      | 02.06 | 04.13 |                |                |        |  |                             |
|                   | 1.5 dCi           | 48      | 09.05 | 04.13 |                |                |        |  |                             |
|                   | 1.5 dCi           | 50      | 01.06 | 04.13 |                |                |        |  |                             |

|     |  |  |  |  |  |  |  |  |                |        |  |
|--|--|--|--|--|---|--|--|--|----------------|--------|--|
| <b>DACIA LOGAN Limousine (LS_) (04-13)</b>   |  |  |  |  |   |  |  |  |                |        |  |
|    | 1.5 dCi  | 55   | 05.10  | 04.13  | + ABS   | 24.0112-0171.1   | 412171   | 259 12,0 10,6 +S +B  |                |        |  |
|  | 1.5 dCi  | 63   | 09.07  | 04.13  | + ABS   |  |  |  |                |        |  |
|  | 1.5 dCi  | 65   | 05.10  | 04.13  | + ABS   |  |  |  |                |        |  |
|  | 1.6 16V  | 64   | 09.04  | 04.13  | + ABS   |  |  |  |                |        |  |
|  | 1.6 16V  | 77   | 02.06  | 04.13  | + ABS   |  |  |  |                |        |  |
|  | 1.6 16V Flexifuel  | 77   | 01.11  | 04.13  | + ABS   |  |  |  |                |        |  |
|  | 1.6 Bifuel   | 62   | 05.10  | 04.13  | + ABS   |  |  |  |                |        |  |
|  | 1.6 MPI 85   | 62   | 05.10  | 04.13  | + ABS   |  |  |  |                |        |  |
|  | 1.2 16V  | 55   | 02.06  | 04.13  |   |  |  |  | 24.0121-0106.1 | 421106 | 259 20,6 17,7 V +S +B  |
|  | 1.4  | 55   | 09.04  | 04.13  |   |  |  |  |                |        |  |
|  | 1.4 MPI LPG  | 55   | 02.06  | 04.13  |   |  |  |  |                |        |  |
|  | 1.5 dCi  | 48   | 09.05  | 04.13  |   |  |  |  |                |        |  |
|  | 1.5 dCi  | 50   | 01.06  | 04.13  |   |  |  |  |                |        |  |
|  | 1.5 dCi  | 55   | 05.10  | 04.13  |   |  |  |  |                |        |  |
|  | 1.5 dCi  | 63   | 09.07  | 04.13  |   |  |  |  |                |        |  |
|  | 1.5 dCi  | 65   | 05.10  | 04.13  |   |  |  |  |                |        |  |
|  | 1.6 16V  | 64   | 09.04  | 04.13  |   |  |  |  |                |        |  |
|  | 1.6 16V  | 77   | 02.06  | 04.13  |   |  |  |  |                |        |  |
|  | 1.6 16V Flexifuel  | 77   | 01.11  | 04.13  |   |  |  |  |                |        |  |
| 1.6 Bifuel   | 62   | 05.10  | 04.13  |  |   |  |  |  |                |        |  |
| 1.6 MPI 85   | 62   | 05.10  | 04.13  |  |   |  |  |  |                |        |  |
|    | 1.2 16V  | 55   | 02.06  | 04.13  | - ABS   | 03.0137-0358.2   | 650358   | 180 x 42 HEB<br>Bremsbacken-Zubehör  |                |        |  |
|  | 1.4  | 55   | 09.04  | 04.13  | - ABS   |  |  |  |                |        |  |
|  | 1.4 MPI LPG  | 55   | 02.06  | 04.13  | - ABS   |  |  |  |                |        |  |
|  | 1.5 dCi  | 48   | 09.05  | 04.13  | - ABS   |  |  |  |                |        |  |
|  | 1.5 dCi  | 50   | 01.06  | 04.13  | - ABS   |  |  |  |                |        |  |
|  | 1.5 dCi  | 55   | 05.10  | 04.13  | - ABS   |  |  |  |                |        |  |
|  | 1.5 dCi  | 63   | 09.07  | 04.13  | - ABS   |  |  |  |                |        |  |
|  | 1.5 dCi  | 65   | 05.10  | 04.13  | - ABS   |  |  |  |                |        |  |
|  | 1.6 16V  | 64   | 12.08  | 04.13  | - ABS   |  |  |  |                |        |  |
|  | 1.6 16V  | 77   | 12.08  | 04.13  | - ABS   |  |  |  |                |        |  |
|  | 1.6 16V Flexifuel  | 77   | 01.11  | 04.13  | - ABS   |  |  |  |                |        |  |
|  | 1.6 Bifuel   | 62   | 05.10  | 04.13  | - ABS   |  |  |  |                |        |  |
|  | 1.6 MPI 85   | 62   | 05.10  | 04.13  | - ABS   |  |  |  |                |        |  |
|  | 1.2 16V  | 55   | 02.06  | 04.13  | + ABS   |  |  |  | 03.0137-0423.2 | 650423 | 203 x 39 HEB<br>Bremsbacken-Zubehör  |
|  | 1.4  | 55   | 09.04  | 04.13  | + ABS   |  |  |  |                |        |  |
|  | 1.4 MPI LPG  | 55   | 02.06  | 04.13  | + ABS   |  |  |  |                |        |  |
|  | 1.5 dCi  | 48   | 09.05  | 04.13  | + ABS   |  |  |  |                |        |  |
|  | 1.5 dCi  | 50   | 01.06  | 04.13  | + ABS   |  |  |  |                |        |  |
|  | 1.5 dCi  | 55   | 05.10  | 04.13  | + ABS   |  |  |  |                |        |  |
| 1.5 dCi  | 63   | 09.07  | 04.13  | + ABS  |   |  |  |  |                |        |  |
| 1.5 dCi  | 65   | 05.10  | 04.13  | + ABS  |   |  |  |  |                |        |  |
| 1.6 16V  | 64   | 09.04  | 04.13  | + ABS  |   |  |  |  |                |        |  |
| 1.6 16V  | 77   | 02.06  | 04.13  | + ABS  |   |  |  |  |                |        |  |
| 1.6 16V Flexifuel  | 77   | 01.11  | 04.13  | + ABS  |   |  |  |  |                |        |  |
| 1.6 Bifuel   | 62   | 05.10  | 04.13  | + ABS  |   |  |  |  |                |        |  |
| 1.6 MPI 85   | 62   | 05.10  | 04.13  | + ABS  |   |  |  |  |                |        |  |
| 1.2 16V  | 55   | 02.06  | 04.13  | + ABS  | 03.0137-0312.2  | 650312   | 203 x 38 HEB<br>Bremsbacken-Zubehör  |  |                |        |  |
| 1.4  | 55   | 09.04  | 04.13  | + ABS  |   |  |  |  |                |        |  |
| 1.4 MPI LPG  | 55   | 02.06  | 04.13  | + ABS  |   |  |  |  |                |        |  |
| 1.5 dCi  | 48   | 09.05  | 04.13  | + ABS  |   |  |  |  |                |        |  |
| 1.5 dCi  | 50   | 01.06  | 04.13  | + ABS  |   |  |  |  |                |        |  |
| 1.5 dCi  | 55   | 05.10  | 04.13  | + ABS  |   |  |  |  |                |        |  |
| 1.5 dCi  | 63   | 09.07  | 04.13  | + ABS  |   |  |  |  |                |        |  |
| 1.5 dCi  | 65   | 05.10  | 04.13  | + ABS  |   |  |  |  |                |        |  |
| 1.6 16V  | 64   | 09.04  | 04.13  | + ABS  |   |  |  |  |                |        |  |
| 1.6 16V  | 77   | 02.06  | 04.13  | + ABS  |   |  |  |  |                |        |  |
| 1.6 16V Flexifuel  | 77   | 01.11  | 04.13  | + ABS  |   |  |  |  |                |        |  |
| 1.6 Bifuel   | 62   | 05.10  | 04.13  | + ABS  |   |  |  |  |                |        |  |
| 1.6 MPI 85   | 62   | 05.10  | 04.13  | + ABS  |   |  |  |  |                |        |  |
|  | 1.4 MPI LPG  | 55   | 02.06  | 04.13  |   |  |  |  | 24.0218-0032.1 | 480118 | + Trommeldurchmesser 180 mm <sup>1)</sup><br>- ABS<br>+ ABS/ ohne Sensorring <sup>2)</sup> |
|  | 1.5 dCi  | 48   | 09.05  | 04.13  |   |  |  |  |                |        |  |
|  | 1.5 dCi  | 50   | 01.06  | 04.13  |   |  |  |  |                |        |  |
|  | 1.5 dCi  | 63   | 09.07  | 04.13  |   |  |  |  |                |        |  |
|  | 1.5 dCi  | 65   | 05.10  | 04.13  |   |  |  |  |                |        |  |
|  | 1.6 16V  | 64   | 09.04  | 04.13  |   |  |  |  |                |        |  |
|  | 1.6 16V  | 77   | 02.06  | 04.13  |   |  |  |  |                |        |  |
|  | 1.6 Bifuel   | 62   | 05.10  | 04.13  |   |  |  |  |                |        |  |
|  | 1.6 MPI 85   | 62   | 05.10  | 04.13  |   |  |  |  |                |        |  |
|  | 1.4 MPI LPG  | 55   | 02.06  | 04.13  |   | 24.0218-0732.2   | 480207   | - ABS<br>+ ABS   |                |        |  |
| 1.5 dCi  | 48   | 09.05  | 04.13  |  |   |  |  |  |                |        |  |
| 1.5 dCi  | 50   | 01.06  | 04.13  |  |   |  |  |  |                |        |  |
| 1.5 dCi  | 63   | 09.07  | 04.13  |  |   |  |  |  |                |        |  |
| 1.5 dCi  | 65   | 05.10  | 04.13  |  |   |  |  |  |                |        |  |
| 1.6 16V  | 64   | 09.04  | 04.13  |  |   |  |  |  |                |        |  |
| 1.6 16V  | 77   | 02.06  | 04.13  |  |   |  |  |  |                |        |  |
| 1.6 Bifuel   | 62   | 05.10  | 04.13  |  |   |  |  |  |                |        |  |
| 1.6 MPI 85   | 62   | 05.10  | 04.13  |  |   |  |  |  |                |        |  |
|  | 1.2 16V  | 55   | 02.06  | 04.13  | - ABS   |  |  |  | 03.0520-4719.3 | 694719 | 19,05/180x42 TopKit  |
|  | 1.4  | 55   | 09.04  | 04.13  | - ABS   |  |  |  |                |        |  |
|  | 1.4 MPI LPG  | 55   | 02.06  | 04.13  | - ABS   |  |  |  |                |        |  |
|  | 1.5 dCi  | 48   | 09.05  | 04.13  | - ABS   |  |  |  |                |        |  |
|  | 1.5 dCi  | 50   | 01.06  | 04.13  | - ABS   |  |  |  |                |        |  |
|  | 1.5 dCi  | 55   | 05.10  | 04.13  | - ABS   |  |  |  |                |        |  |
|  | 1.5 dCi  | 63   | 09.07  | 04.13  | - ABS   |  |  |  |                |        |  |
|  | 1.5 dCi  | 65   | 05.10  | 04.13  | - ABS   |  |  |  |                |        |  |
|  | 1.6 16V  | 64   | 09.04  | 04.13  | - ABS   |  |  |  |                |        |  |
|  | 1.6 16V  | 77   | 02.06  | 04.13  | - ABS   |  |  |  |                |        |  |

1) + drum diameter 180 mm / + tamburi diametro 180 mm / + tambour diamètre 180 mm / + tambores diámetro 180 mm

2) + ABS/ without sensor ring / + ABS/ senza sensore / + ABS/ sans secours ABS / + ABS/ sin anillo sensor ABS



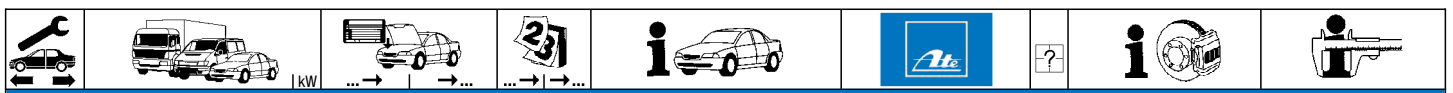

### DACIA LOGAN Limousine (LS\_) (04-13)























|            |                   |    |       |       |       |       |                |        |  |                     |     |
|------------|-------------------|----|-------|-------|-------|-------|----------------|--------|--|---------------------|-----|
|            | 1.6 16V Flexifuel | 77 |       | 01.11 | 04.13 | - ABS | 03.0520-4719.3 | 694719 |  | 19,05/180x42 TopKit | BDX |
|            | 1.6 Bifuel        | 62 |       | 05.10 | 04.13 | - ABS |                |        |  |                     |     |
|            | 1.6 MPI 85        | 62 |       | 05.10 | 04.13 | - ABS |                |        |  |                     |     |
|            | 1.2 16V           | 55 |       | 02.06 | 04.13 | + ABS | 03.0520-3817.3 | 693817 |  | 17,46/203x39 TopKit | BOS |
|            | 1.4               | 55 |       | 09.04 | 04.13 | + ABS |                |        |  |                     |     |
|            | 1.4 MPI LPG       | 55 |       | 02.06 | 04.13 | + ABS |                |        |  |                     |     |
|            | 1.5 dCi           | 48 |       | 09.05 | 04.13 | + ABS |                |        |  |                     |     |
|            | 1.5 dCi           | 50 |       | 01.06 | 04.13 | + ABS |                |        |  |                     |     |
|            | 1.5 dCi           | 55 |       | 05.10 | 04.13 | + ABS |                |        |  |                     |     |
|            | 1.5 dCi           | 63 |       | 09.07 | 04.13 | + ABS |                |        |  |                     |     |
|            | 1.5 dCi           | 65 |       | 05.10 | 04.13 | + ABS |                |        |  |                     |     |
|            | 1.6 16V           | 64 |       | 09.04 | 04.13 | + ABS |                |        |  |                     |     |
|            | 1.6 16V           | 77 |       | 02.06 | 04.13 | + ABS |                |        |  |                     |     |
|            | 1.6 16V Flexifuel | 77 |       | 01.11 | 04.13 | + ABS |                |        |  |                     |     |
|            | 1.6 MPI 85        | 62 |       | 05.10 | 04.13 | + ABS |                |        |  |                     |     |
|            | 1.2 16V           | 55 |       | 02.06 | 04.13 | + ABS | 03.0520-3517.3 | 693517 |  | 17,78/203x39 TopKit | TRW |
|            | 1.4               | 55 |       | 09.04 | 04.13 | + ABS |                |        |  |                     |     |
|            | 1.4 MPI LPG       | 55 |       | 02.06 | 04.13 | + ABS |                |        |  |                     |     |
|            | 1.5 dCi           | 48 |       | 09.05 | 04.13 | + ABS |                |        |  |                     |     |
| 1.5 dCi    | 50                |    | 01.06 | 04.13 | + ABS |       |                |        |  |                     |     |
| 1.5 dCi    | 63                |    | 09.07 | 04.13 | + ABS |       |                |        |  |                     |     |
| 1.5 dCi    | 65                |    | 05.10 | 04.13 | + ABS |       |                |        |  |                     |     |
| 1.6 16V    | 64                |    | 09.04 | 04.13 | + ABS |       |                |        |  |                     |     |
| 1.6 16V    | 77                |    | 02.06 | 04.13 | + ABS |       |                |        |  |                     |     |
| 1.6 Bifuel | 62                |    | 05.10 | 04.13 | + ABS |       |                |        |  |                     |     |
| 1.6 MPI 85 | 62                |    | 05.10 | 04.13 | + ABS |       |                |        |  |                     |     |

















### DACIA LOGAN MCV Kombi (KS\_) (07-13)













|                   |                   |    |       |       |   |   |                |        |  |                       |     |                |        |                   |                         |  |
|-------------------|-------------------|----|-------|-------|---|---|----------------|--------|--|-----------------------|-----|----------------|--------|-------------------|-------------------------|--|
|                   | 1.4               | 55 |       | 02.07 | 04.13                                       | + Bremsscheibendurchm. 259 mm <sup>1)</sup> | 13.0460-2834.2 | 602834 |  | 21463 18,0 /WK/S      | TRW |                |        |                   |                         |  |
|                   | 1.5 dCi           | 50 |       | 02.07 | 04.13                                       | + Bremsscheibendurchm. 259 mm <sup>1)</sup> |                |        |  |                       |     |                |        |                   |                         |  |
|                   | 1.5 dCi           | 55 |       | 05.10 | 04.13                                       | + Bremsscheibendurchm. 259 mm <sup>1)</sup> |                |        |  |                       |     |                |        |                   |                         |  |
|                   | 1.5 dCi           | 63 |       | 09.07 | 04.13                                       | + Bremsscheibendurchm. 259 mm <sup>1)</sup> |                |        |  |                       |     |                |        |                   |                         |  |
|                   | 1.5 dCi           | 65 |       | 05.10 | 04.13                                       | + Bremsscheibendurchm. 259 mm <sup>1)</sup> |                |        |  |                       |     |                |        |                   |                         |  |
|                   | 1.6               | 64 |       | 02.07 | 04.13                                       | + Bremsscheibendurchm. 259 mm <sup>1)</sup> |                |        |  |                       |     |                |        |                   |                         |  |
|                   | 1.4               | 55 |       | 02.07 | 04.13                                       | + Bremsscheibendurchm. 260 mm <sup>2)</sup> | 13.0460-7270.2 | 607270 |  | 24673 17,5 +          | ATE |                |        |                   |                         |  |
|                   | 1.5 dCi           | 50 |       | 02.07 | 11.08                                       | + Bremsscheibendurchm. 260 mm <sup>2)</sup> |                |        |  |                       |     |                |        |                   |                         |  |
|                   | 1.5 dCi           | 63 |       | 09.07 | 11.08                                       | + Bremsscheibendurchm. 260 mm <sup>2)</sup> |                |        |  |                       |     |                |        |                   |                         |  |
|                   | 1.6               | 64 |       | 02.07 | 11.08                                       | + Bremsscheibendurchm. 260 mm <sup>2)</sup> |                |        |  |                       |     |                |        |                   |                         |  |
| 1.6 16V           | 77                |    | 02.07 | 04.13 | + Bremsscheibendurchm. 260 mm <sup>2)</sup> |   |                |        |  |                       |     |                |        |                   |                         |  |
| 1.6 16V Flexifuel | 77                |    | 11.09 | 04.13 | + Bremsscheibendurchm. 260 mm <sup>2)</sup> |   |                |        |  |                       |     |                |        |                   |                         |  |
| 1.6 Bifuel        | 64                |    | 11.08 | 04.13 | + Bremsscheibendurchm. 260 mm <sup>2)</sup> |   |                |        |  |                       |     |                |        |                   |                         |  |
| 1.6 MPI 85        | 62                |    | 05.10 | 04.13 | + Bremsscheibendurchm. 260 mm <sup>2)</sup> |   |                |        |  |                       |     |                |        |                   |                         |  |
| 1.4               | 55                |    | 02.07 | 04.13 | + Bremsscheibendurchm. 260 mm <sup>2)</sup> | 13.0460-2709.2                              |                |        |  |                       |     | 602709         |        | 23973 17,4 /Zub/S | TRW                     |  |
| 1.5 dCi           | 50                |    | 12.08 | 04.13 | + Bremsscheibendurchm. 260 mm <sup>2)</sup> |   |                |        |  |                       |     |                |        |                   |                         |  |
| 1.5 dCi           | 55                |    | 05.10 | 04.13 | + Bremsscheibendurchm. 260 mm <sup>2)</sup> |   |                |        |  |                       |     |                |        |                   |                         |  |
| 1.5 dCi           | 63                |    | 12.08 | 04.13 | + Bremsscheibendurchm. 260 mm <sup>2)</sup> |   |                |        |  |                       |     |                |        |                   |                         |  |
| 1.5 dCi           | 65                |    | 05.10 | 04.13 | + Bremsscheibendurchm. 260 mm <sup>2)</sup> |   |                |        |  |                       |     |                |        |                   |                         |  |
| 1.6               | 64                |    | 12.08 | 04.13 | + Bremsscheibendurchm. 260 mm <sup>2)</sup> |   |                |        |  |                       |     |                |        |                   |                         |  |
| 1.6 16V           | 77                |    | 02.07 | 04.13 | + Bremsscheibendurchm. 260 mm <sup>2)</sup> |   |                |        |  |                       |     |                |        |                   |                         |  |
| 1.6 16V Flexifuel | 77                |    | 11.09 | 04.13 | + Bremsscheibendurchm. 260 mm <sup>2)</sup> |   |                |        |  |                       |     |                |        |                   |                         |  |
| 1.6 Bifuel        | 64                |    | 11.08 | 04.13 | + Bremsscheibendurchm. 260 mm <sup>2)</sup> |   |                |        |  |                       |     |                |        |                   |                         |  |
| 1.6 MPI 85        | 62                |    | 11.08 | 04.13 | + Bremsscheibendurchm. 260 mm <sup>2)</sup> |   |                |        |  |                       |     |                |        |                   |                         |  |
|                   | 1.4               | 55 |       | 02.07 | 04.13                                       |   | 24.0121-0106.1 | 421106 |  | 259 20,6 17,7 V +S +B |     |                |        |                   |                         |  |
|                   | 1.5 dCi           | 50 |       | 02.07 | 04.13                                       |   |                |        |  |                       |     |                |        |                   |                         |  |
|                   | 1.5 dCi           | 55 |       | 05.10 | 04.13                                       |   |                |        |  |                       |     |                |        |                   |                         |  |
|                   | 1.5 dCi           | 63 |       | 09.07 | 04.13                                       |   |                |        |  |                       |     |                |        |                   |                         |  |
|                   | 1.5 dCi           | 65 |       | 05.10 | 04.13                                       |   |                |        |  |                       |     |                |        |                   |                         |  |
|                   | 1.6               | 64 |       | 02.07 | 04.13                                       |   |                |        |  |                       |     |                |        |                   |                         |  |
|                   | 1.6 Bifuel        | 64 |       | 11.08 | 04.13                                       |   |                |        |  |                       |     |                |        |                   |                         |  |
|                   | 1.6 MPI 85        | 62 |       | 05.10 | 04.13                                       |   |                |        |  |                       |     |                |        |                   |                         |  |
|                   | 1.4               | 55 |       | 02.07 | 04.13                                       |   |                |        |  |                       |     | 24.0122-0216.1 | 422216 |                   | 260 22,0 19,8 V L +S +B |  |
|                   | 1.5 dCi           | 50 |       | 02.07 | 04.13                                       |   |                |        |  |                       |     |                |        |                   |                         |  |
| 1.5 dCi           | 55                |    | 05.10 | 04.13 |   |   |                |        |  |                       |     |                |        |                   |                         |  |
| 1.5 dCi           | 63                |    | 09.07 | 04.13 |   |   |                |        |  |                       |     |                |        |                   |                         |  |
| 1.5 dCi           | 65                |    | 05.10 | 04.13 |   |   |                |        |  |                       |     |                |        |                   |                         |  |
| 1.6               | 64                |    | 02.07 | 04.13 |   |   |                |        |  |                       |     |                |        |                   |                         |  |
| 1.6 16V           | 77                |    | 02.07 | 04.13 |   |   |                |        |  |                       |     |                |        |                   |                         |  |
| 1.6 16V Flexifuel | 77                |    | 11.09 | 04.13 |   |   |                |        |  |                       |     |                |        |                   |                         |  |
| 1.6 Bifuel        | 64                |    | 11.08 | 04.13 |   |   |                |        |  |                       |     |                |        |                   |                         |  |
| 1.6 MPI 85        | 62                |    | 05.10 | 04.13 |   |   |                |        |  |                       |     |                |        |                   |                         |  |
|                   | 1.4               | 55 |       | 02.07 | 04.13                                       |   | 03.0137-0496.2 | 650496 |  | 228 x 42 HEB          | BDX |                |        |                   |                         |  |
|                   | 1.5 dCi           | 50 |       | 02.07 | 04.13                                       |   |                |        |  |                       |     |                |        |                   |                         |  |
|                   | 1.5 dCi           | 55 |       | 05.10 | 04.13                                       |   |                |        |  |                       |     |                |        |                   |                         |  |
|                   | 1.5 dCi           | 63 |       | 09.07 | 04.13                                       |   |                |        |  |                       |     |                |        |                   |                         |  |
|                   | 1.5 dCi           | 65 |       | 05.10 | 04.13                                       |   |                |        |  |                       |     |                |        |                   |                         |  |
|                   | 1.6               | 64 |       | 02.07 | 04.13                                       |   |                |        |  |                       |     |                |        |                   |                         |  |
|                   | 1.6 16V           | 77 |       | 02.07 | 04.13                                       |   |                |        |  |                       |     |                |        |                   |                         |  |
|                   | 1.6 16V Flexifuel | 77 |       | 11.09 | 04.13                                       |   |                |        |  |                       |     |                |        |                   |                         |  |
|                   | 1.6 Bifuel        | 64 |       | 11.08 | 04.13                                       |   |                |        |  |                       |     |                |        |                   |                         |  |
|                   | 1.6 MPI 85        | 62 |       | 05.10 | 04.13                                       |   |                |        |  |                       |     |                |        |                   |                         |  |
|                   | 1.4               | 55 |       | 02.07 | 04.13                                       |   | 03.0137-9228.2 | 669228 |  | 203 x 39 HEB          | BDX |                |        |                   |                         |  |
|                   | 1.5 dCi           | 50 |       | 02.07 | 04.13                                       |   |                |        |  |                       |     |                |        |                   |                         |  |
|                   | 1.5 dCi           | 55 |       | 05.10 | 04.13                                       |   |                |        |  |                       |     |                |        |                   |                         |  |
|                   | 1.5 dCi           | 63 |       | 09.07 | 04.13                                       |   |                |        |  |                       |     |                |        |                   |                         |  |
|                   | 1.5 dCi           | 65 |       | 05.10 | 04.13                                       |   |                |        |  |                       |     |                |        |                   |                         |  |
|                   | 1.6               | 64 |       | 02.07 | 04.13                                       |   |                |        |  |                       |     |                |        |                   |                         |  |
|                   | 1.6 16V           | 77 |       | 02.07 | 04.13                                       |   |                |        |  |                       |     |                |        |                   |                         |  |
|                   | 1.6 16V Flexifuel | 77 |       | 11.09 | 04.13                                       |   |                |        |  |                       |     |                |        |                   |                         |  |
|                   | 1.6 Bifuel        | 64 |       | 11.08 | 04.13                                       |   |                |        |  |                       |     |                |        |                   |                         |  |
|                   | 1.6 MPI 85        | 62 |       | 05.10 | 04.13                                       |   |                |        |  |                       |     |                |        |                   |                         |  |
|                   | 1.4               | 55 |       | 02.07 | 04.13                                       | + ABS                                       | 03.0520-7222.3 | 697222 |  | 22,20/228x42 TopKit   | BOS |                |        |                   |                         |  |
|                   | 1.5 dCi           | 50 |       | 04.08 | 04.13                                       | + ABS                                       |                |        |  |                       |     |                |        |                   |                         |  |
|                   | 1.5 dCi           | 55 |       | 05.10 | 04.13                                       | + ABS                                       |                |        |  |                       |     |                |        |                   |                         |  |
|                   | 1.5 dCi           | 63 |       | 09.07 | 04.13                                       | + ABS                                       |                |        |  |                       |     |                |        |                   |                         |  |
|                   | 1.5 dCi           | 65 |       | 05.10 | 04.13                                       | + ABS                                       |                |        |  |                       |     |                |        |                   |                         |  |
|                   | 1.6               | 64 |       | 02.07 | 04.13                                       | + ABS                                       |                |        |  |                       |     |                |        |                   |                         |  |
|                   | 1.6 16V           | 77 |       | 02.07 | 04.13                                       | + ABS                                       |                |        |  |                       |     |                |        |                   |                         |  |
|                   | 1.6 16V Flexifuel | 77 |       | 11.09 | 04.13                                       | + ABS                                       |                |        |  |                       |     |                |        |                   |                         |  |
|                   | 1.6 Bifuel        | 64 |       | 11.08 | 04.13                                       | + ABS                                       |                |        |  |                       |     |                |        |                   |                         |  |
|                   | 1.6 MPI 85        | 62 |       | 05.10 | 04.13                                       | + ABS                                       |                |        |  |                       |     |                |        |                   |                         |  |

<sup>1)</sup> + brake disc diameter 259mm / + diametro dischi freno 259mm / + diamètre disques frein 259mm / + diámetro disco freno 259mm

<sup>2)</sup> + brake disc diameter 260mm / + diametro dischi freno 260mm / + diamètre disques frein 260mm / + diámetro disco freno 260mm

|     |                         |  |  |  |  |  |       |  |
|--|---|--|--|--|---|--|---|--|
| <b>DACIA LOGAN MCV Kombi (KS_) (07-13)</b>   |   |  |  |  |   |  |   |  |
|    | 1.6 16V<br>1.6 16V Flexifuel<br>1.6 Bifuel  | 77<br>77<br>64   | 02.07<br>11.09<br>11.08  | 04.13 + ABS<br>04.13 + ABS<br>04.13 + ABS  | 03.0520-7222.3<br>03.0520-7919.3  | 697222<br>697919   |   | 22,20/228x42 TopKit<br>19,05/228x42 TopKit   |
| <b>DACIA LOGAN Pick-up (US_) (08-13)</b>   |   |  |  |  |   |  |   |  |
|    | 1.5 dCi<br>1.5 dCi<br>1.6   | 50<br>63<br>64   | 03.08<br>03.08<br>03.08  | 11.08<br>11.08<br>11.08  | 13.0460-7270.2  | 607270   |   | 24673 17,5 + ATE   |
|  | 1.4<br>1.5 dCi<br>1.5 dCi<br>1.5 dCi<br>1.5 dCi<br>1.6<br>1.6 Bifuel<br>1.6 MPI 85                      | 55<br>50<br>55<br>63<br>65<br>64<br>62<br>62                                     | 01.09<br>12.08<br>05.10<br>12.08<br>05.10<br>12.08<br>05.10<br>05.10             | 06.13<br>06.13<br>06.13<br>06.13<br>06.13<br>06.13<br>06.13<br>06.13             | 13.0460-2709.2<br>13.0470-2709.2  | 602709<br>LD2709   |   | 23973 17,4 /Zub/S<br>23973 17,4 /Zub/S TRW<br>TRW                                  |
|    | 1.4<br>1.5 dCi<br>1.5 dCi<br>1.5 dCi<br>1.5 dCi<br>1.6<br>1.6 Bifuel<br>1.6 MPI 85                      | 55<br>50<br>55<br>63<br>65<br>64<br>62<br>62                                     | 01.09<br>03.08<br>05.10<br>03.08<br>05.10<br>03.08<br>05.10<br>05.10             | 06.13<br>06.13<br>06.13<br>06.13<br>06.13<br>06.13<br>06.13<br>06.13             | 24.0122-0216.1  | 422216   |   | 260 22,0 19,8 V L +S +B  |
|    | 1.4<br>1.5 dCi<br>1.5 dCi<br>1.5 dCi<br>1.5 dCi<br>1.6<br>1.6 Bifuel<br>1.6 MPI 85                      | 55<br>50<br>55<br>63<br>65<br>64<br>62<br>62                                     | 01.09<br>03.08<br>05.10<br>03.08<br>05.10<br>03.08<br>05.10<br>05.10             | 06.13<br>06.13<br>06.13<br>06.13<br>06.13<br>06.13<br>06.13<br>06.13             | 03.0137-0496.2<br>03.0137-9228.2  | 650496<br>669228   |   | 228 x 42 HEB<br>Bremsbacken-Zubehör BDX<br>BDX                                     |
|    | 1.4<br>1.5 dCi<br>1.5 dCi<br>1.5 dCi<br>1.5 dCi<br>1.6<br>1.6 Bifuel<br>1.6 MPI 85                      | 55<br>50<br>55<br>63<br>65<br>64<br>62<br>62                                     | 01.09<br>03.08<br>05.10<br>03.08<br>05.10<br>03.08<br>05.10<br>05.10             | 06.13<br>06.13<br>06.13<br>06.13<br>06.13<br>06.13<br>06.13<br>06.13             | 03.0520-7222.3  | 697222   |   | 22,20/228x42 TopKit  |
| <b>DACIA LOGAN II Limousine (L52_) (12-)</b>                                       |   |  |  |  |   |  |   |  |
|  | 0.9 TCe 90<br>1.2 16V 75<br>1.2 16V LPG<br>1.5 dCi 75<br>1.5 DCi 85<br>1.5 dCi 90<br>1.6 16V<br>1.6 16V | 66<br>55<br>55<br>55<br>63<br>66<br>75<br>77                                     | 11.12<br>11.12<br>11.12<br>11.12<br>01.13<br>11.12<br>04.15<br>01.13             |  | 13.0460-7298.2  | 607298   |   | 25702 18,2 + ATE   |
|  | 1.2 16V 75<br>1.2 16V LPG<br>0.9 TCe 90<br>1.5 dCi 75<br>1.5 DCi 85<br>1.5 dCi 90<br>1.6 16V<br>1.6 16V | 55<br>55<br>66<br>55<br>63<br>66<br>75<br>77                                     | 11.12<br>11.12<br>11.12<br>11.12<br>01.13<br>11.12<br>04.15<br>01.13             |  | 24.0112-0171.1<br>24.0122-0289.1  | 412171<br>422289   |   | 259 12,0 10,6 +S +B<br>258 22,0 19,8 V L +S +B                                     |
|  | 0.9 TCe 90<br>1.2 16V 75<br>1.2 16V LPG<br>1.5 dCi 75<br>1.5 DCi 85<br>1.5 dCi 90<br>1.6 16V<br>1.6 16V | 66<br>55<br>55<br>55<br>63<br>66<br>75<br>77                                     | 11.12<br>11.12<br>11.12<br>11.12<br>01.13<br>11.12<br>04.15<br>01.13             |  | 24.0711-5369.3  | 360378   | 2  | Radsensor L=619  |
|  | 0.9 TCe 90<br>1.2 16V 75<br>1.2 16V LPG<br>1.5 dCi 75<br>1.5 DCi 85<br>1.5 dCi 90<br>1.6 16V<br>1.6 16V | 66<br>55<br>55<br>55<br>63<br>66<br>75<br>77                                     | 11.12<br>11.12<br>11.12<br>11.12<br>01.13<br>11.12<br>04.15<br>01.13             |  | 03.0137-0423.2<br>03.0137-0532.2<br>03.0137-9274.2                                | 650423<br>650532<br>669274   |   | 203 x 39 HEB<br>203 x 39 HEB<br>Bremsbacken-Zubehör BOS<br>BOS<br>BOS              |
|  | 1.5 DCi 85<br>1.6 16V<br>1.6 16V  | 63<br>75<br>77   | 01.13<br>04.15<br>01.13  |  | 03.0137-0496.2<br>03.0137-9228.2  | 650496<br>669228   |   | 228 x 42 HEB<br>Bremsbacken-Zubehör BDX<br>BDX                                     |
|  | 0.9 TCe 90<br>1.2 16V 75<br>1.2 16V LPG<br>1.5 dCi 75<br>1.5 dCi 90                                     | 66<br>55<br>55<br>55<br>66   | 11.12<br>11.12<br>11.12<br>11.12<br>11.12  |  | 03.0520-3817.3<br>03.0520-5017.3  | 693817<br>695017   |   | 17,46/203x39 TopKit BOS<br>17,46/203x39 TopKit BOS                                 |
|  | 0.9 TCe 90<br>1.2 16V 75<br>1.5 dCi 75  | 66<br>55<br>55   | 11.12<br>11.12<br>11.12  |  | 03.0520-7919.3  | 697919   | + ABS   | 19,05/228x42 TopKit  |
|  |                      |  |  |  |   |  |   |  |























|     |   |  |   |  |  |  |     |  |
|--|---|--|---|--|---|--|---|--|
| <b>DACIA LOGAN II Limousine (L52_) (12-)</b>                                       |   |  |   |  |   |  |   |  |
|    | 1.5 dCi 85<br>1.5 dCi 90<br>1.6 16V<br>1.6 16V  | 63<br>66<br>75<br>77   | 01.13<br>11.12<br>04.15<br>01.13  |  | 03.0520-7919.3  | 697919   | + ABS   | 19,05/228x42 TopKit  |
| <b>DACIA LOGAN II MCV Kombi (13-)</b>  |   |  |   |  |   |  |   |  |
|    | 0.9 TCe 90<br>0.9 TCe 90 LPG<br>1.2 16V<br>1.2 16V LPG<br>1.5 dCi 75<br>1.5 dCi 85<br>1.5 dCi 90                            | 66<br>66<br>55<br>55<br>55<br>63<br>66   | 02.13<br>09.15<br>02.13<br>02.13<br>02.13<br>02.13<br>02.13   |  | 13.0460-7298.2  | 607298   |   | 25702 18,2 + ATE   |
|    | 0.9 TCe 90<br>0.9 TCe 90 LPG<br>1.2 16V<br>1.2 16V LPG<br>1.5 dCi 75<br>1.5 dCi 85<br>1.5 dCi 90                            | 66<br>66<br>55<br>55<br>55<br>63<br>66   | 02.13<br>09.15<br>02.13<br>02.13<br>02.13<br>02.13<br>02.13   |  | 24.0122-0289.1  | 422289   |   | 258 22,0 19,8 V L +S +B  |
|    | 0.9 TCe 90<br>0.9 TCe 90 LPG<br>1.2 16V<br>1.2 16V LPG<br>1.5 dCi 75<br>1.5 dCi 85<br>1.5 dCi 90                            | 66<br>66<br>55<br>55<br>55<br>63<br>66   | 02.13<br>09.15<br>02.13<br>02.13<br>02.13<br>02.13<br>02.13   |  | 24.0711-5369.3  | 360378   | 2  | Radsensor L=619  |
|    | 0.9 TCe 90<br>1.2 16V<br>1.2 16V LPG<br>1.5 dCi 75<br>1.5 dCi 85<br>1.5 dCi 90  | 66<br>55<br>55<br>55<br>63<br>66   | 02.13<br>02.13<br>02.13<br>02.13<br>02.13<br>02.13  |  | 03.0137-0423.2<br>03.0137-0532.2<br>03.0137-9274.2                                | 650423<br>650532<br>669274   |   | 203 x 39 HEB BOS<br>203 x 39 HEB BOS<br>Bremsbacken-Zubehör BOS                    |
|  | 0.9 TCe 90<br>0.9 TCe 90 LPG<br>1.2 16V<br>1.2 16V LPG<br>1.5 dCi 75<br>1.5 dCi 85<br>1.5 dCi 90                            | 66<br>66<br>55<br>55<br>55<br>63<br>66   | 02.13<br>09.15<br>02.13<br>02.13<br>02.13<br>02.13<br>02.13   |  | 03.0137-0496.2  | 650496   |   | 228 x 42 HEB BDX   |
| <b>DACIA SANDERO (08-13)</b>   |   |  |   |  |   |  |   |  |
|  | 1.2 16V<br>1.2 16V Bifuel<br>1.4<br>1.4 MPI LPG<br>1.5 dCi<br>1.5 dCi<br>1.5 dCi<br>1.6<br>1.6 16V<br>1.6 LPG<br>1.6 MPI 85 | 55<br>55<br>55<br>53<br>50<br>55<br>65<br>64<br>77<br>62<br>62                   | 11.08 02.13<br>11.08 02.13<br>06.08 02.13<br>01.09 02.13<br>11.08 02.13<br>05.10 02.13<br>05.10 02.13<br>06.08 02.13<br>01.11 02.13<br>05.10 10.12<br>05.10 02.13 |  | 13.0460-2834.2  | 602834   |   | 21463 18,0 /WK/S TRW   |
|  | 1.5 dCi   | 63   | 11.08 02.13   |  | 13.0460-7270.2  | 607270   |   | 24673 17,5 + ATE   |
|  | 1.2 16V<br>1.2 16V Bifuel<br>1.4<br>1.4 MPI LPG<br>1.5 dCi<br>1.5 dCi<br>1.5 dCi<br>1.6<br>1.6 16V<br>1.6 LPG<br>1.6 MPI 85 | 55<br>55<br>55<br>53<br>50<br>55<br>65<br>64<br>77<br>62<br>62                   | 11.08 02.13<br>11.08 02.13<br>06.08 02.13<br>01.09 02.13<br>11.08 02.13<br>05.10 02.13<br>05.10 02.13<br>06.08 02.13<br>01.11 02.13<br>05.10 10.12<br>05.10 02.13 |  | 24.0112-0116.1  | 412116   | Bremsscheibe 238 mm x 12 mm   | 238 12,0 10,5 +S +B  |
|  | 1.2 16V<br>1.2 16V Bifuel<br>1.4<br>1.4 MPI LPG<br>1.5 dCi<br>1.5 dCi<br>1.5 dCi<br>1.6<br>1.6 16V<br>1.6 LPG<br>1.6 MPI 85 | 55<br>55<br>55<br>53<br>50<br>55<br>65<br>64<br>77<br>62<br>62                   | 11.08 02.13<br>11.08 02.13<br>06.08 02.13<br>01.09 02.13<br>11.08 02.13<br>05.10 02.13<br>05.10 02.13<br>06.08 02.13<br>01.11 02.13<br>05.10 10.12<br>05.10 02.13 |  | 24.0112-0171.1  | 412171   | Bremsscheibe 259 mm x 12 mm   | 259 12,0 10,6 +S +B  |
|  | 1.2 16V<br>1.2 16V Bifuel<br>1.4<br>1.4 MPI LPG<br>1.5 dCi<br>1.5 dCi<br>1.5 dCi<br>1.6<br>1.6 16V<br>1.6 LPG<br>1.6 MPI 85 | 55<br>55<br>55<br>53<br>50<br>55<br>65<br>64<br>77<br>62<br>62                   | 02.09 02.13<br>11.08 02.13<br>06.08 02.13<br>01.09 02.13<br>11.08 02.13<br>05.10 02.13<br>05.10 02.13<br>06.08 02.13<br>01.11 02.13<br>05.10 10.12                |  | 24.0121-0106.1  | 421106   | Bremsscheibe 259 mm x 20,6 mm   | 259 20,6 17,7 V +S +B  |

|     |  |  |  |  |  |  |  |  |
|--|--|--|--|--|---|--|--|--|
| <b>DACIA SANDERO (08-13)</b>   |  |  |  |  |   |  |  |  |
|    | 1.6 MPI 85   | 62   | 05.10  | 02.13  | 24.0121-0106.1  | 421106   | Bremsscheibe 259 mm x 20,6 mm  | 259 20,6 17,7 V +S +B  |
|  | 1.5 dCi  | 63   | 11.08  | 02.13  | 24.0122-0216.1  | 422216   |  | 260 22,0 19,8 V L +S +B  |
|    | 1.2 16V  | 55   | 11.08  | 02.13  | 03.0137-0358.2  | 650358   | + 7" Bremse <sup>1)</sup>  | 180 x 42 HEB <b>BDX</b>  |
|  | 1.2 16V Bifuel   | 55   | 11.08  | 02.13  | 03.0137-9088.2  | 669088   |  | Bremsbacken-Zubehör <b>BDX</b>   |
|  | 1.4  | 55   | 06.08  | 02.13  |   |  |  |  |
|  | 1.4 MPI LPG  | 53   | 01.09  | 02.13  |   |  |  |  |
|  | 1.5 dCi  | 50   | 11.08  | 02.13  |   |  |  |  |
|  | 1.5 dCi  | 55   | 05.10  | 02.13  |   |  |  |  |
|  | 1.5 dCi  | 63   | 11.08  | 02.13  |   |  |  |  |
|  | 1.5 dCi  | 65   | 05.10  | 02.13  |   |  |  |  |
|  | 1.6  | 64   | 06.08  | 02.13  |   |  |  |  |
|  | 1.6 LPG  | 62   | 05.10  | 10.12  |   |  |  |  |
|  | 1.6 MPI 85   | 62   | 05.10  | 02.13  |   |  |  |  |
|  | 1.2 16V  | 55   | 11.08  | 02.13  | 03.0137-0423.2  | 650423   | + 8" Bremse <sup>2)</sup>  | 203 x 39 HEB <b>BOS</b>  |
|  | 1.2 16V Bifuel   | 55   | 11.08  | 02.13  | 03.0137-0532.2  | 650532   |  | 203 x 39 HEB <b>BOS</b>  |
|  | 1.4  | 55   | 06.08  | 02.13  | 03.0137-9274.2  | 669274   |  | Bremsbacken-Zubehör <b>BOS</b>   |
|  | 1.4 MPI LPG  | 53   | 01.09  | 02.13  |   |  |  |  |
|  | 1.5 dCi  | 50   | 11.08  | 02.13  |   |  |  |  |
|  | 1.5 dCi  | 55   | 05.10  | 02.13  |   |  |  |  |
|  | 1.5 dCi  | 65   | 05.10  | 02.13  |   |  |  |  |
|  | 1.6  | 64   | 06.08  | 02.13  |   |  |  |  |
|  | 1.6 16V  | 77   | 01.11  | 02.13  |   |  |  |  |
|  | 1.6 LPG  | 62   | 05.10  | 10.12  |   |  |  |  |
|  | 1.6 MPI 85   | 62   | 05.10  | 02.13  |   |  |  |  |
|  | 1.2 16V  | 55   | 11.08  | 02.13  | 03.0137-0312.2  | 650312   | + 8" Bremse <sup>2)</sup>  | 203 x 38 HEB <b>TRW</b>  |
|  | 1.2 16V Bifuel   | 55   | 11.08  | 02.13  |   |  |  |  |
|  | 1.4  | 55   | 06.08  | 02.13  |   |  |  |  |
|  | 1.4 MPI LPG  | 53   | 01.09  | 02.13  |   |  |  |  |
|  | 1.5 dCi  | 50   | 11.08  | 02.13  |   |  |  |  |
|  | 1.5 dCi  | 55   | 05.10  | 02.13  |   |  |  |  |
|  | 1.5 dCi  | 65   | 05.10  | 02.13  |   |  |  |  |
|  | 1.6  | 64   | 06.08  | 02.13  |   |  |  |  |
|  | 1.6 16V  | 77   | 01.11  | 02.13  |   |  |  |  |
|  | 1.6 MPI 85   | 62   | 05.10  | 02.13  |   |  |  |  |
|  | 1.5 dCi  | 63   | 11.08  | 02.13  | 03.0137-0496.2  | 650496   | + 9" Bremse <sup>3)</sup>  | 228 x 42 HEB <b>BDX</b>  |
|  |  |  |  |  | 03.0137-9228.2  | 669228   |  | Bremsbacken-Zubehör <b>BDX</b>   |
|   | 1.5 dCi  | 63   | 11.08  | 02.13  | 03.0520-7222.3  | 697222   | + 9" Bremse <sup>3)</sup>  | 22,20/228x42 TopKit  |
|  | 1.2 16V  | 55   | 11.08  | 02.13  | 03.0520-3817.3  | 693817   | + 8" Bremse <sup>2)</sup>  | 17,46/203x39 TopKit <b>BOS</b>   |
|  | 1.2 16V Bifuel   | 55   | 11.08  | 02.13  | 03.0520-5017.3  | 695017   |  | 17,46/203x39 TopKit <b>BOS</b>   |
|  | 1.4  | 55   | 06.08  | 02.13  |   |  |  |  |
|  | 1.4 MPI LPG  | 53   | 01.09  | 02.13  |   |  |  |  |
|  | 1.5 dCi  | 50   | 11.08  | 02.13  |   |  |  |  |
|  | 1.5 dCi  | 55   | 05.10  | 02.13  |   |  |  |  |
|  | 1.5 dCi  | 63   | 11.08  | 02.13  |   |  |  |  |
|  | 1.5 dCi  | 65   | 05.10  | 02.13  |   |  |  |  |
|  | 1.6  | 64   | 06.08  | 02.13  |   |  |  |  |
|  | 1.6 16V  | 77   | 01.11  | 02.13  |   |  |  |  |
|  | 1.6 MPI 85   | 62   | 05.10  | 02.13  |   |  |  |  |
|  | 1.2 16V  | 55   | 11.08  | 02.13  | 03.0520-3517.3  | 693517   | + 8" Bremse <sup>2)</sup>  | 17,78/203x39 TopKit <b>TRW</b>   |
|  | 1.2 16V Bifuel   | 55   | 11.08  | 02.13  |   |  |  |  |
|  | 1.4  | 55   | 06.08  | 02.13  |   |  |  |  |
|  | 1.4 MPI LPG  | 53   | 01.09  | 02.13  |   |  |  |  |
|  | 1.5 dCi  | 50   | 11.08  | 02.13  |   |  |  |  |
|  | 1.5 dCi  | 55   | 05.10  | 02.13  |   |  |  |  |
|  | 1.5 dCi  | 63   | 11.08  | 02.13  |   |  |  |  |
|  | 1.5 dCi  | 65   | 05.10  | 02.13  |   |  |  |  |
|  | 1.6  | 64   | 06.08  | 02.13  |   |  |  |  |
|  | 1.6 16V  | 77   | 01.11  | 02.13  |   |  |  |  |
|  | 1.6 MPI 85   | 62   | 05.10  | 02.13  |   |  |  |  |
|  | 1.2 16V  | 55   | 11.08  | 02.13  | 03.0520-4719.3  | 694719   | + 7" Bremse <sup>1)</sup>  | 19,05/180x42 TopKit <b>BDX</b>   |
|  | 1.2 16V Bifuel   | 55   | 11.08  | 02.13  |   |  |  |  |
|  | 1.4  | 55   | 06.08  | 02.13  |   |  |  |  |
|  | 1.4 MPI LPG  | 53   | 01.09  | 02.13  |   |  |  |  |
|  | 1.5 dCi  | 50   | 11.08  | 02.13  |   |  |  |  |
|  | 1.5 dCi  | 55   | 05.10  | 02.13  |   |  |  |  |
|  | 1.5 dCi  | 63   | 11.08  | 02.13  |   |  |  |  |
|  | 1.5 dCi  | 65   | 05.10  | 02.13  |   |  |  |  |
|  | 1.6  | 64   | 06.08  | 02.13  |   |  |  |  |
|  | 1.6 16V  | 77   | 01.11  | 02.13  |   |  |  |  |
|  | 1.6 MPI 85   | 62   | 05.10  | 02.13  |   |  |  |  |
| <b>DACIA SANDERO II (B52_) (12-)</b>   |  |  |  |  |   |  |  |  |
|  | 0.9 TCe 90   | 66   | 11.12  |  | 13.0460-7298.2  | 607298   |  | 25702 18,2 + <b>ATE</b>  |
|  | 0.9 TCe 90 LPG   | 66   | 09.15  |  |   |  |  |  |
|  | 1.2 16V  | 55   | 11.12  |  |   |  |  |  |
|  | 1.2 16V LPG  | 53   | 11.12  |  |   |  |  |  |
|  | 1.5 dCi 75   | 55   | 11.12  |  |   |  |  |  |
|  | 1.5 dCi 85   | 63   | 01.13  |  |   |  |  |  |
|  | 1.5 dCi 90   | 66   | 11.12  |  |   |  |  |  |
|  | 1.6  | 61   | 11.12  |  |   |  |  |  |
|  | 1.6 16V  | 75   | 04.15  |  |   |  |  |  |
|  | 1.6 16V  | 77   | 01.13  |  |   |  |  |  |































<sup>1)</sup> + 7" brake / + freno de 7 / + frein de 7" / + freno de 7































<sup>2)</sup> + 8" brake / + servofreno da 8" / + frein de 8" / + freno de 8"

<sup>3)</sup> + 9" brake / + servofreno da 9" / + frein de 9" / + freno de 9"



























|     |  |  |  |  |  |  |  |     |                                |
|--|--|--|--|--|---|--|--|---|--------------------------------|
| <b>DACIA SANDERO II (B52_) (12-)</b>   |  |  |  |  |   |  |  |   |                                |
|    | 1.2 16V  | 55   |  | 11.12  |   | 24.0112-0171.1   | 412171   |   | 259 12,0 10,6 +S +B            |
|  | 1.2 16V LPG  | 53   |  | 11.12  |   |  |  |   |                                |
|  | 0.9 TCe 90   | 66   |  | 11.12  |   | 24.0122-0289.1   | 422289   |   | 258 22,0 19,8 V L +S +B        |
|  | 0.9 TCe 90 LPG   | 66   |  | 09.15  |   |  |  |   |                                |
|  | 1.5 dCi 75   | 55   |  | 11.12  |   |  |  |   |                                |
|  | 1.5 dCi 85   | 63   |  | 01.13  |   |  |  |   |                                |
|  | 1.5 dCi 90   | 66   |  | 11.12  |   |  |  |   |                                |
|  | 1.6  | 61   |  | 11.12  |   |  |  |   |                                |
| 1.6 16V  | 75   |  | 04.15  |  |   |  |  |   |                                |
| 1.6 16V  | 77   |  | 01.13  |  |   |  |  |   |                                |
|    | 0.9 TCe 90   | 66   |  | 11.12  |   | 24.0711-5369.3   | 360378   | 2  | Radsensor L=619                |
|  | 0.9 TCe 90 LPG   | 66   |  | 09.15  |   |  |  |   |                                |
|  | 1.2 16V  | 55   |  | 11.12  |   |  |  |   |                                |
|  | 1.2 16V LPG  | 53   |  | 11.12  |   |  |  |   |                                |
|  | 1.5 dCi 75   | 55   |  | 11.12  |   |  |  |   |                                |
|  | 1.5 dCi 85   | 63   |  | 01.13  |   |  |  |   |                                |
|  | 1.5 dCi 90   | 66   |  | 11.12  |   |  |  |   |                                |
|  | 1.6  | 61   |  | 11.12  |   |  |  |   |                                |
| 1.6 16V  | 75   |  | 04.15  |  |   |  |  |   |                                |
| 1.6 16V  | 77   |  | 01.13  |  |   |  |  |   |                                |
|    | 0.9 TCe 90   | 66   |  | 11.12  |   | 03.0137-0423.2   | 650423   |   | 203 x 39 HEB <b>BOS</b>        |
|  | 0.9 TCe 90 LPG   | 66   |  | 09.15  |   | 03.0137-0532.2   | 650532   |   | 203 x 39 HEB <b>BOS</b>        |
|  | 1.2 16V  | 55   |  | 11.12  |   | 03.0137-9274.2   | 669274   |   | Bremsbacken-Zubehör <b>BOS</b> |
|  | 1.2 16V LPG  | 53   |  | 11.12  |   |  |  |   |                                |
|  | 1.5 dCi 75   | 55   |  | 11.12  |   |  |  |   |                                |
|  | 1.5 dCi 85   | 63   |  | 01.13  |   |  |  |   |                                |
|  | 1.5 dCi 90   | 66   |  | 11.12  |   |  |  |   |                                |
|  | 1.6  | 61   |  | 11.12  |   |  |  |   |                                |
|  | 1.6 16V  | 75   |  | 04.15  |   |  |  |   |                                |
|  | 1.6 16V  | 77   |  | 01.13  |   |  |  |   |                                |
|    | 0.9 TCe 90   | 66   |  | 11.12  |   | 03.0137-0496.2   | 650496   |   | 228 x 42 HEB <b>BDX</b>        |
|  | 0.9 TCe 90 LPG   | 66   |  | 09.15  |   | 03.0137-9228.2   | 669228   |   | Bremsbacken-Zubehör <b>BDX</b> |
|  | 1.2 16V  | 55   |  | 11.12  |   |  |  |   |                                |
|  | 1.2 16V LPG  | 53   |  | 11.12  |   |  |  |   |                                |
|  | 1.5 dCi 75   | 55   |  | 11.12  |   |  |  |   |                                |
|  | 1.5 dCi 85   | 63   |  | 01.13  |   |  |  |   |                                |
|  | 1.5 dCi 90   | 66   |  | 11.12  |   |  |  |   |                                |
|  | 1.6  | 61   |  | 11.12  |   |  |  |   |                                |
|  | 1.6 16V  | 75   |  | 04.15  |   |  |  |   |                                |
|  | 1.6 16V  | 77   |  | 01.13  |   |  |  |   |                                |
|  | 0.9 TCe 90   | 66   |  | 11.12  |   | 03.0520-3817.3   | 693817   |   | 17,46/203x39 TopKit <b>BOS</b> |
|  | 0.9 TCe 90 LPG   | 66   |  | 09.15  |   | 03.0520-5017.3   | 695017   |   | 17,46/203x39 TopKit <b>BOS</b> |
|  | 1.2 16V  | 55   |  | 11.12  |   |  |  |   |                                |
|  | 1.2 16V LPG  | 53   |  | 11.12  |   |  |  |   |                                |
|  | 1.5 dCi 75   | 55   |  | 11.12  |   |  |  |   |                                |
|  | 1.5 dCi 85   | 63   |  | 01.13  |   |  |  |   |                                |
|  | 1.5 dCi 90   | 66   |  | 11.12  |   |  |  |   |                                |
|  | 1.6  | 61   |  | 11.12  |   |  |  |   |                                |
|  | 1.6 16V  | 75   |  | 04.15  |   |  |  |   |                                |
|  | 1.6 16V  | 77   |  | 01.13  |   |  |  |   |                                |
|  | 0.9 TCe 90   | 66   |  | 11.12  |   | 03.0520-7919.3   | 697919   |   | 19,05/228x42 TopKit            |
|  | 0.9 TCe 90 LPG   | 66   |  | 09.15  |   |  |  |   |                                |
|  | 1.2 16V  | 55   |  | 11.12  |   |  |  |   |                                |
|  | 1.2 16V LPG  | 53   |  | 11.12  |   |  |  |   |                                |
|  | 1.5 dCi 75   | 55   |  | 11.12  |   |  |  |   |                                |
|  | 1.5 dCi 85   | 63   |  | 01.13  |   |  |  |   |                                |
|  | 1.5 dCi 90   | 66   |  | 11.12  |   |  |  |   |                                |
|  | 1.6  | 61   |  | 11.12  |   |  |  |   |                                |
|  | 1.6 16V  | 75   |  | 04.15  |   |  |  |   |                                |
|  | 1.6 16V  | 77   |  | 01.13  |   |  |  |   |                                |
| <b>DAEWOO ARANOS (95-97)</b>   |  |  |  |  |   |  |  |   |                                |
|  | 1.5  | 66   |  | 01.95  | 11.97   | 13.0460-7052.2   | 607052   |   | 21190 17,5 +/WE <b>ATE</b>     |
|  | 1.8  | 70   |  | 01.95  | 11.97   |  |  |   |                                |
|  | 2.0  | 77   |  | 01.95  | 11.97   |  |  |   |                                |
|  | 1.5  | 66   |  | 01.95  | 11.97   | 24.0124-0115.1   | 424115   |   | 256 24,0 21,0 V L +S +B        |
|  | 1.8  | 70   |  | 01.95  | 11.97   |  |  |   |                                |
|  | 2.0  | 77   |  | 01.95  | 11.97   |  |  |   |                                |
|  | 1.5  | 66   |  | 01.95  | 11.97   | 03.0137-0267.2   | 650267   |   | 200 x 46 HEB                   |
|  | 1.8  | 70   |  | 01.95  | 11.97   | 03.0137-9167.2   | 669167   |   | Bremsbacken-Zubehör            |
|  | 2.0  | 77   |  | 01.95  | 11.97   |  |  |   |                                |
|  | 1.5  | 66   |  | 01.95  | 11.97   | 24.0220-0036.1   | 480149   |   | 200/201 x 52,5                 |
|  | 1.8  | 70   |  | 01.95  | 11.97   |  |  |   |                                |
|  | 2.0  | 77   |  | 01.95  | 11.97   |  |  |   |                                |
| <b>DAEWOO CIELO (94-98)</b>  |  |  |  |  |   |  |  |   |                                |
|  | 1.5  | 66   |  | 06.94  | 07.98   | 13.0460-7052.2   | 607052   |   | 21190 17,5 +/WE <b>ATE</b>     |
|  | 1.5  | 66   |  | 06.94  | 07.98   | 24.0124-0115.1   | 424115   |   | 256 24,0 21,0 V L +S +B        |
|  | 1.5  | 66   |  | 06.94  | 07.98   | 03.0137-0267.2   | 650267   |   | 200 x 46 HEB                   |
|  |  |  |  |  |   |  |  | Bremsbacken-Zubehör   |                                |
|  |  |  |  |  |   |  |  |   |                                |



































|     |  |  |  |  |  |  |  |  |   |
|--|--|--|--|--|---|--|--|--|---|
| <b>DAEWOO CIELO (94-98)</b>  |  |  |  |  |   |  |  |  |   |
|    | 1.5  | 66   |  | 06.94  | 07.98   |  | 24.0220-0001.2   | 480013   | 200/201 x 53,5  |
| <b>DAEWOO ESPERO (95-99)</b>   |  |  |  |  |   |  |  |  |   |
|    | 1.5 i<br>1.8 i<br>2.0 i  |  |  | 02.95<br>02.95<br>02.95  | 06.99<br>06.99<br>06.99   |  | 13.0460-7052.2   | 607052   | 21190 17,5 +/-WE ATE                                  |
|    | 1.5 i<br>1.8 i<br>2.0 i  |  |  | 02.95<br>02.95<br>02.95  | 06.99<br>06.99<br>06.99   |  | 24.0124-0115.1<br>24.0324-0115.1   | 424115<br>524115   | 256 24,0 21,0 V L +S +B<br>256 24,0 21,0 V L +S +B PD |
|    | 1.5 i<br>1.8 i<br>2.0 i  |  |  | 02.95<br>02.95<br>02.95  | 06.99<br>06.99<br>06.99   |  | 03.0137-0267.2<br>03.0137-9167.2   | 650267<br>669167   | 200 x 46 HEB<br>Bremsbacken-Zubehör                   |
|    | 1.5 i<br>1.8 i<br>2.0 i  |  |  | 02.95<br>02.95<br>02.95  | 06.99<br>06.99<br>06.99   |  | 24.0220-0001.2   | 480013   | 200/201 x 53,5  |
|    | 1.5 i<br>1.8 i<br>2.0 i  |  |  | 02.95<br>02.95<br>02.95  | 06.99<br>06.99<br>06.99   |  | 03.0520-4019.3   | 694019   | 19,05/200x46 TopKit DEL                               |
| <b>DAEWOO EVANDA (02-05)</b>   |  |  |  |  |   |  |  |  |   |
|    | 2.0 i 16V  | 96   |  | 08.02  | 02.05   |  | 13.0460-5859.2<br>13.0460-0140.2   | 605859<br>610140   | 23234 16,9 +/-WK AKE<br>Belagsatz-Zubehör AKE         |
|    | 2.0 i 16V  | 96   |  | 08.02  | 02.05   |  | 24.0124-0199.1   | 424199   | 256 24,0 21,0 V +S +B                                 |
| <b>DAEWOO GENTRA (13-)</b>   |  |  |  |  |   |  |  |  |   |
|    | 1.5  | 79   |  | 06.13  |   |  | 13.0460-5863.2<br>13.0460-5859.2   | 605863<br>605859   | 23234 16,8 +/-WK AKE<br>23234 16,9 +/-WK AKE          |
|    | 1.5  | 79   |  | 06.13  |   |  | 24.0110-0340.1   | 410340   | 258 10,5 8,0 +S +B                                    |
| <b>DAEWOO KALOS (02-05)</b>  |  |  |  |  |   |  |  |  |   |
|  | 1.2 i<br>1.4 i<br>1.4 i 16V  | 53<br>61<br>69   |  | 04.03<br>09.02<br>04.03  | 02.05<br>02.05<br>02.05   |  | 13.0460-5899.2   | 605899   | 23974 17,6 AKE  |
|  | 1.2 i<br>1.4 i<br>1.4 i 16V  | 53<br>61<br>69   |  | 04.03<br>09.02<br>04.03  | 02.05<br>02.05<br>02.05   |  | 24.0120-0115.1<br>24.0320-0115.1   | 420115<br>520115   | 236 20,0 17,0 V L +S +B<br>236 20,0 17,0 V L +S +B PD |
|  | 1.2 i<br>1.4 i<br>1.4 i 16V  | 53<br>61<br>69   |  | 04.03<br>09.02<br>04.03  | 02.05<br>02.05<br>02.05   |  | 03.0137-0472.2<br>03.0137-9167.2   | 650472<br>669167   | 200 x 36 HEB<br>Bremsbacken-Zubehör                   |
|  | 1.2 i<br>1.4 i<br>1.4 i 16V  | 53<br>61<br>69   |  | 04.03<br>09.02<br>04.03  | 02.05<br>02.05<br>02.05   |  | 03.0520-6619.3   | 696619   | 19,05/200x36 TopKit                                   |
| <b>DAEWOO KORANDO (KJ) (99-05)</b>   |  |  |  |  |   |  |  |  |   |
|  | 2.0 16V<br>2.3 16V<br>2.9 D<br>2.9 TD<br>3.2 V6 4x4                              | 94<br>105<br>72<br>88<br>156   |  | 01.99<br>01.99<br>01.99<br>01.99<br>01.99  | 11.05<br>11.05<br>11.05<br>11.05<br>11.05   |  | 24.0110-0352.1   | 410352   | 299 10,4 8,5 L +B                                     |
| <b>DAEWOO LACETTI (04-05)</b>  |  |  |  |  |   |  |  |  |   |
|  | 1.4 i 16V<br>1.6 i 16V<br>1.8 i 16V  | 70<br>80<br>90   |  | 02.04<br>02.04<br>02.04  | 02.05<br>02.05<br>02.05   |  | 13.0460-5863.2   | 605863   | 23234 16,8 +/-WK AKE                                  |
|  | 1.4 i 16V<br>1.6 i 16V<br>1.8 i 16V  | 70<br>80<br>90   |  | 02.04<br>02.04<br>02.04  | 02.05<br>02.05<br>02.05   |  | 24.0124-0199.1   | 424199   | 256 24,0 21,0 V +S +B                                 |
|  | 1.4 i 16V<br>1.6 i 16V<br>1.8 i 16V  | 70<br>80<br>90   |  | 02.04<br>02.04<br>02.04  | 02.05<br>02.05<br>02.05   |  | 13.0460-5739.2   | 605739   | 24071 14,6 SUM  |
|  | 1.4 i 16V<br>1.6 i 16V<br>1.8 i 16V  | 70<br>80<br>90   |  | 02.04<br>02.04<br>02.04  | 02.05<br>02.05<br>02.05   |  | 24.0110-0340.1   | 410340   | 258 10,5 8,0 +S +B                                    |
| <b>DAEWOO LANOS (97-02)</b>  |  |  |  |  |   |  |  |  |   |
|  | 1.4 i<br>1.5 i   | 55   | 447433<br>447433   | 05.97<br>05.97   |   |  | 13.0460-7051.2   | 607051   | 20547 16,5 +/-WE ATE                                  |
|  | 1.4 i<br>1.5 i   | 55<br>447434   | 447434<br>447434   |  | 12.02<br>12.02  |  | 13.0460-5996.2   | 605996   | 23241 16,1  |
|  | 1.6 i 16V<br>1.6 i 16V   | 78<br>447434   | 447433   | 05.97  |   |  | 13.0460-7052.2   | 607052   | 21190 17,5 +/-WE ATE                                  |
|  | 1.6 i 16V  | 78   | 447434   |  | 12.02   |  | 13.0460-5994.2<br>13.0460-0140.2   | 605994<br>610140   | 23234 16,8 AKE<br>Belagsatz-Zubehör AKE               |
|  | 1.4 i<br>1.5 i   | 55   |  | 05.97<br>05.97   | 12.02<br>12.02  |  | 24.0120-0115.1<br>24.0320-0115.1   | 420115<br>520115   | 236 20,0 17,0 V L +S +B<br>236 20,0 17,0 V L +S +B PD |























|     |  |  |  |  |  |  |                |                              |
|--|--|--|--|--|---|--|--|--|
| <b>DAEWOO LANOS (97-02)</b>  |  |  |  |  |   |  |  |  |
|    | 1.6 i 16V  | 78   |  | 05.97  | 12.02   |  | 24.0124-0115.1 424115<br>24.0324-0115.1 524115   | 256 24,0 21,0 V L +S +B<br>256 24,0 21,0 V L +S +B PD  |
|    | 1.4 i<br>1.5 i<br>1.6 i 16V  | 55<br>78   |  | 05.97<br>05.97<br>05.97  | 12.02<br>12.02<br>12.02   |  | 03.0137-0267.2 650267<br>03.0137-9167.2 669167   | 200 x 46 HEB<br>Bremsbacken-Zubehör  |
|    | 1.4 i<br>1.5 i<br>1.6 i 16V  | 55<br>78   |  | 05.97<br>05.97<br>05.97  | 12.02 - ABS<br>12.02 - ABS<br>12.02 - ABS   |  | 24.0220-0036.1 480149  | 200/201 x 52,5   |
|    | 1.4 i<br>1.5 i<br>1.6 i 16V  | 55<br>78   |  | 05.97<br>05.97<br>05.97  | 12.02 + ABS<br>12.02 + ABS<br>12.02 + ABS   |  | 24.0220-0001.2 480013  | 200/201 x 53,5   |
|    | 1.4 i<br>1.5 i   | 55   | 447433<br>447433   | 05.97<br>05.97   |   |  | 03.0520-3717.3 693717  | 17,46/200x46 TopKit  |
|    | 1.4 i<br>1.5 i<br>1.6 i 16V  | 55<br>78   | 447434<br>447434<br>447433   |  | 12.02<br>12.02<br>05.97   |  | 03.0520-4019.3 694019  | 19,05/200x46 TopKit DEL  |
|    | 1.6 i 16V  | 78   | 447434   |  | 12.02   |  | 03.0520-8320.3 698320  | 20,64/200x46 TopKit TRW  |
| <b>DAEWOO LEGANZA (97-02)</b>  |  |  |  |  |   |  |  |  |
|    | 2.0<br>2.0 i 16V<br>2.0 i 16V<br>2.2 i 16V                                       | 85<br>93<br>98<br>100  |  | 06.97<br>07.00<br>06.97<br>04.99   | 12.02<br>12.02<br>12.02<br>12.02  |  | 13.0460-5859.2 605859<br>13.0460-0140.2 610140   | 23234 16,9 +WK AKE<br>Belagsatz-Zubehör AKE  |
|    | 2.0<br>2.0 i 16V<br>2.0 i 16V<br>2.2 i 16V                                       | 85<br>93<br>98<br>100  |  | 06.97<br>07.00<br>06.97<br>04.99   | 12.02<br>12.02<br>12.02<br>12.02  |  | 24.0124-0723.1 424723  | 256 24,0 21,0 V  |
|    | 2.0<br>2.0 i 16V<br>2.0 i 16V<br>2.2 i 16V                                       | 85<br>93<br>98<br>100  |  | 06.97<br>07.00<br>06.97<br>04.99   | 12.02<br>12.02<br>12.02<br>12.02  |  | 13.0460-5993.2 605993  | 23237 14,5 TRW   |
|   | 2.0<br>2.0 i 16V<br>2.0 i 16V<br>2.2 i 16V                                       | 85<br>93<br>98<br>100  |  | 06.97<br>07.00<br>06.97<br>04.99   | 12.02<br>12.02<br>12.02<br>12.02  |  | 24.0110-0282.1 410282  | 258 10,3 8,0   |
| <b>DAEWOO MAGNUS (99-04)</b>   |  |  |  |  |   |  |  |  |
|  | 2.0  | 96   |  | 07.99  | 12.04   |  | 13.0460-5859.2 605859<br>13.0460-0140.2 610140   | 23234 16,9 +WK AKE<br>Belagsatz-Zubehör AKE  |
|  | 2.0  | 96   |  | 07.99  | 12.04   |  | 24.0124-0199.1 424199  | 256 24,0 21,0 V +S +B  |
| <b>DAEWOO MATIZ (98-05)</b>  |  |  |  |  |   |  |  |  |
|  | 0.8 (KLA4)<br>1.0 (KLA0)   | 38<br>47   |  | 07.98<br>01.03   | 02.05<br>02.05  |  | 13.0460-5996.2 605996<br>13.0460-0252.2 610252   | 23241 16,1<br>Belagsatz-Zubehör  |
|  | 0.8 (KLA4)<br>1.0 (KLA0)   | 38<br>47   |  | 07.98<br>01.03   | 02.05<br>02.05  |  | 24.0113-0195.1 413195  | 236 12,6 9,7 +B  |
|  | 0.8 (KLA4)<br>1.0 (KLA0)   | 38<br>47   |  | 07.98<br>01.03   | 02.05<br>02.05  |  | 03.0137-0363.2 650363<br>03.0137-9260.2 669260   | 180 x 31 HEB<br>Bremsbacken-Zubehör  |
|  | 0.8 (KLA4)<br>1.0 (KLA0)   | 38<br>47   |  | 07.98<br>01.03   | 02.05<br>02.05  |  | 24.0218-0035.1 480146  | ohne Sensorring <sup>1)</sup><br>180/182 x 40  |
|  | 0.8 (KLA4)<br>1.0 (KLA0)   | 38<br>47   |  | 07.98<br>01.03   | 02.05<br>02.05  |  | 03.0520-4017.3 694017  | 17,46/180x31 TopKit  |
| <b>DAEWOO MUSSO (FJ) (99-05)</b>   |  |  |  |  |   |  |  |  |
|  | 2.2 TD<br>2.3 16V<br>2.9 TD 4x4<br>3.2 V6 4x4                                    | 74<br>103<br>88<br>162   |  | 09.99<br>01.99<br>01.99<br>01.99   | 11.05<br>11.05<br>11.05<br>11.05  |  | 24.0110-0352.1 410352  | 299 10,4 8,5 L +B  |
| <b>DAEWOO NEXIA / RACER (95-08)</b>  |  |  |  |  |   |  |  |  |
|  | 1.5 i<br>1.5 i 16V<br>1.8 i  |  |  | 02.95<br>02.95<br>10.95  | 08.97<br>08.97<br>06.08   |  | 13.0460-7051.2 607051<br>13.0460-7052.2 607052   | 20547 16,5 +WE ATE<br>21190 17,5 +WE ATE   |
|  | 1.5 i<br>1.5 i 16V<br>1.8 i  |  |  | 02.95<br>02.95<br>10.95  | 08.97<br>08.97<br>06.08   |  | 24.0120-0115.1 420115<br>24.0320-0115.1 520115<br>24.0124-0115.1 424115<br>24.0324-0115.1 524115 | 236 20,0 17,0 V L +S +B<br>236 20,0 17,0 V L +S +B PD<br>256 24,0 21,0 V L +S +B<br>256 24,0 21,0 V L +S +B PD |
|  | 1.5 i<br>1.5 i 16V<br>1.8 i  |  |  | 02.95<br>02.95<br>10.95  | 08.97<br>08.97<br>06.08   |  | 03.0137-0267.2 650267<br>03.0137-9167.2 669167   | 200 x 46 HEB<br>Bremsbacken-Zubehör  |
|  | 1.5 i<br>1.5 i 16V<br>1.8 i  |  |  | 02.95<br>02.95<br>10.95  | 08.97<br>08.97<br>06.08   |  | 24.0220-0001.2 480013  | 200/201 x 53,5   |

<sup>1)</sup> without sensor ring / senza sensori / sans secours ABS / sin anillo sensor ABS

|     |  |  |  |  |  |  |  |  |                         |
|--|--|--|--|--|---|--|--|--|-------------------------|
| <b>DAEWOO NEXIA / RACER (95-08)</b>  |  |  |  |  |   |  |  |  |                         |
|    | 1.5 i  |  |  | 02.95  | 08.97   |  | 03.0520-3717.3   | 693717   | 17,46/200x46 TopKit     |
|  | 1.5 i 16V  | 66   |  | 02.95  | 08.97   |  | 03.0520-4019.3   | 694019   | 19,05/200x46 TopKit DEL |
|  | 1.8 i  | 74   |  | 10.95  | 06.08   |  |  |  |                         |
| <b>DAEWOO NUBIRA (97-99)</b>   |  |  |  |  |   |  |  |  |                         |
|    | 1.6 i 16V  | 78   |  | 06.97  | 05.99   |  | 13.0460-5994.2   | 605994   | 23234 16,8 AKE          |
|  | 1.6 i 16V Kombi  | 78   |  | 06.97  | 05.99   |  | 13.0460-0140.2   | 610140   | Belagsatz-Zubehör AKE   |
|  | 2.0 i 16V  | 98   |  | 06.97  | 05.99   |  |  |  |                         |
|  | 2.0 i 16V Kombi  | 98   |  | 06.97  | 05.99   |  |  |  |                         |
|    | 1.6 i 16V  | 78   |  | 06.97  | 05.99   |  | 24.0124-0163.1   | 424163   | 256 24,0 22,0 V +S      |
|  | 1.6 i 16V Kombi  | 78   |  | 06.97  | 05.99   |  |  |  |                         |
|  | 2.0 i 16V  | 98   |  | 06.97  | 05.99   |  |  |  |                         |
|  | 2.0 i 16V Kombi  | 98   |  | 06.97  | 05.99   |  |  |  |                         |
|    | 2.0 i 16V  | 98   |  | 06.97  | 05.99   |  | 13.0460-5993.2   | 605993   | 23237 14,5 TRW          |
|  | 2.0 i 16V Kombi  | 98   |  | 06.97  | 05.99   |  |  |  |                         |
|    | 2.0 i 16V  | 98   |  | 06.97  | 05.99   |  | 24.0110-0714.1   | 410714   | 258 10,3 8,0            |
|  | 2.0 i 16V Kombi  | 98   |  | 06.97  | 05.99   |  |  |  |                         |
|    | 1.6 i 16V  | 78   |  | 06.97  | 05.99   |  | 03.0137-0267.2   | 650267   | 200 x 46 HEB            |
|  | 1.6 i 16V Kombi  | 78   |  | 06.97  | 05.99   |  | 03.0137-9167.2   | 669167   | Bremsbacken-Zubehör     |
|    | 1.6 i 16V  | 78   |  | 06.97  | 05.99   |  | 24.0220-0001.2   | 480013   | 200/201 x 53,5          |
|  | 1.6 i 16V Kombi  | 78   |  | 06.97  | 05.99   |  |  |  |                         |
|    | 1.6 i 16V  | 78   |  | 06.97  | 05.99   |  | 03.0520-8320.3   | 698320   | 20,64/200x46 TopKit TRW |
|  | 1.6 i 16V Kombi  | 78   |  | 06.97  | 05.99   |  |  |  |                         |
| <b>DAEWOO NUBIRA (99-05)</b>   |  |  |  |  |   |  |  |  |                         |
|    | 1.4 i 16V  | 69   | 695960   | 10.03  |   |  | 13.0460-5859.2   | 605859   | 23234 16,9 +/-WK AKE    |
|  | 1.6 i 16V  | 76   |  | 07.00  | 02.05   |  | 13.0460-0140.2   | 610140   | Belagsatz-Zubehör AKE   |
|  | 1.6 i 16V  | 78   | 695960   | 06.99  |   |  |  |  |                         |
|  | 1.6 i 16V  | 80   | 695960   | 08.03  |   |  |  |  |                         |
|  | 1.8 i 16V  | 90   | 695960   | 08.03  |   |  |  |  |                         |
|  | 2.0 i 16V  | 98   | 695960   | 06.99  |   |  |  |  |                         |
|  | 1.4 i 16V  | 69   | 695961   | 12.04  |   |  | 13.0460-5863.2   | 605863   | 23234 16,8 +/-WK AKE    |
|  | 1.6 i 16V  | 78   | 695961   | 02.05  |   |  |  |  |                         |
|  | 1.6 i 16V  | 80   | 695961   | 02.05  |   |  |  |  |                         |
|  | 1.8 i 16V  | 90   | 695961   | 02.05  |   |  |  |  |                         |
|  | 2.0 i 16V  | 98   | 695961   | 02.05  |   |  |  |  |                         |
|  | 1.6 i 16V  | 76   |  | 07.00  | 02.05   |  | 24.0124-0163.1   | 424163   | 256 24,0 22,0 V +S      |
|  | 1.6 i 16V  | 78   |  | 06.99  | 02.05   |  |  |  |                         |
|  | 2.0 i 16V  | 98   |  | 06.99  | 02.05   |  |  |  |                         |
|  | 1.4 i 16V  | 69   |  | 10.03  | 12.04   |  | 24.0124-0199.1   | 424199   | 256 24,0 21,0 V +S +B   |
|  | 1.6 i 16V  | 80   |  | 08.03  | 02.05   |  |  |  |                         |
|  | 1.8 i 16V  | 90   |  | 08.03  | 02.05   |  |  |  |                         |
|  | 1.6 i 16V  | 76   |  | 07.00  | 02.05   | + ABS  | 13.0460-5993.2   | 605993   | 23237 14,5 TRW          |
|  | 1.6 i 16V  | 78   |  | 06.99  | 02.05   | + ABS  |  |  |                         |
|  | 2.0 i 16V  | 98   |  | 06.99  | 02.05   |  |  |  |                         |
|  | 1.4 i 16V  | 69   |  | 10.03  | 12.04   |  | 13.0460-5739.2   | 605739   | 24071 14,6 SUM          |
|  | 1.6 i 16V  | 80   |  | 08.03  | 02.05   |  |  |  |                         |
|  | 1.8 i 16V  | 90   |  | 08.03  | 02.05   |  |  |  |                         |
|  | 1.6 i 16V  | 76   |  | 07.00  | 02.05   | + ABS  | 24.0110-0714.1   | 410714   | 258 10,3 8,0            |
|  | 1.6 i 16V  | 78   |  | 06.99  | 02.05   | + ABS  |  |  |                         |
|  | 2.0 i 16V  | 98   |  | 06.99  | 02.05   |  |  |  |                         |
|  | 1.4 i 16V  | 69   |  | 10.03  | 12.04   |  | 24.0110-0340.1   | 410340   | 258 10,5 8,0 +S +B      |
|  | 1.6 i 16V  | 80   |  | 08.03  | 02.05   |  |  |  |                         |
|  | 1.8 i 16V  | 90   |  | 08.03  | 02.05   |  |  |  |                         |
|  | 1.6 i 16V  | 76   |  | 07.00  | 02.05   | - ABS  | 03.0137-0267.2   | 650267   | 200 x 46 HEB            |
|  | 1.6 i 16V  | 78   |  | 06.99  | 02.05   | - ABS  | 03.0137-9167.2   | 669167   | Bremsbacken-Zubehör     |
|  | 1.6 i 16V  | 76   |  | 07.00  | 02.05   | - ABS  | 24.0220-0001.2   | 480013   | 200/201 x 53,5          |
|  | 1.6 i 16V  | 78   |  | 06.99  | 02.05   | - ABS  |  |  |                         |
|  | 1.6 i 16V  | 76   |  | 07.00  | 02.05   | - ABS  | 03.0520-8320.3   | 698320   | 20,64/200x46 TopKit TRW |
|  | 1.6 i 16V  | 78   |  | 06.99  | 02.05   | - ABS  |  |  |                         |
| <b>DAEWOO REZZO (00-05)</b>  |  |  |  |  |   |  |  |  |                         |
|  | 1.6 i 16V  | 77   | 826909   | 02.05  |   |  | 13.0460-5859.2   | 605859   | 23234 16,9 +/-WK AKE    |
|  | 1.8 i  | 66   | 826909   | 02.05  |   |  | 13.0460-0140.2   | 610140   | Belagsatz-Zubehör AKE   |
|  | 1.8 i  | 72   | 826909   | 02.05  |   |  |  |  |                         |
|  | 1.8 i  | 74   | 826909   | 02.05  |   |  |  |  |                         |
|  | 2.0 i 16V  | 89   | 826909   | 02.05  |   |  |  |  |                         |
|  | 2.0 i 16V  | 94   | 826909   | 02.05  |   |  |  |  |                         |
|  | 1.6 i 16V  | 77   |  | 09.00  | 02.05   |  | 24.0124-0199.1   | 424199   | 256 24,0 21,0 V +S +B   |
|  | 1.8 i  | 66   |  | 09.00  | 02.05   |  |  |  |                         |
|  | 1.8 i  | 72   |  | 09.00  | 02.05   |  |  |  |                         |
|  | 1.8 i  | 74   |  | 09.00  | 02.05   |  |  |  |                         |
|  | 2.0 i 16V  | 89   |  | 09.00  | 02.05   |  |  |  |                         |
|  | 2.0 i 16V  | 94   |  | 09.00  | 02.05   |  |  |  |                         |

|          |  |                                  |  |  |  |  |                                  |                  |  |                               |  |
|--|--|----------------------------------|--|--|--|--|----------------------------------|------------------|--|-------------------------------|--|
| <b>DAIHATSU APPLAUSE I (89-97)</b>   |  |                                  |  |  |  |  |                                  |                  |  |                               |  |
|    | 1.6 16V (A101)<br>1.6 16V 4WD (A111)   |                                  |  | 06.89<br>06.89                                     | 07.97<br>07.97   |  | 24.0118-0126.1                   | 418126           |  |                               | 235 18,0 17,0 V                                |
|    | 1.6 16V (A101)   |                                  |  | 06.89  | 07.97 + ABS  |  | 13.0460-5972.2                   | 605972           |  |                               | 21559 11,5                                     |
|    | 1.6 16V (A101)<br>1.6 16V 4WD (A111)   |                                  |  | 06.89<br>06.89                                     | 07.97<br>07.97 - ABS   |  | 03.0137-0315.2<br>03.0137-9271.2 | 650315<br>669271 |  |                               | 200 x 32<br>Bremsbacken-Zubehör                |
| <b>DAIHATSU APPLAUSE II (97-00)</b>  |  |                                  |  |  |  |  |                                  |                  |  |                               |  |
|    | 1.6 i 16V (A101)   | 73                               |  | 07.97  | 05.00  |  | 24.0118-0126.1                   | 418126           |  |                               | 235 18,0 17,0 V                                |
|    | 1.6 i 16V (A101)   | 73                               |  | 07.97  | 05.00  |  | 03.0137-0315.2<br>03.0137-9271.2 | 650315<br>669271 |  |                               | 200 x 32<br>Bremsbacken-Zubehör                |
| <b>DAIHATSU CHARADE (93-01)</b>  |  |                                  |  |  |  |  |                                  |                  |  |                               |  |
|    | 1.3 16V (G200)<br>1.3 16V (G200)<br>1.3 16V (G204)<br>1.5 16V (G203)<br>1.5 16V (G203)<br>1.6 GTi (G201) | 55<br>62<br>44<br>55<br>66<br>77 |  | 05.96<br>01.93<br>09.96<br>10.94<br>08.94<br>03.93 | 11.99<br>04.01<br>04.01<br>11.99<br>11.99<br>03.96                                     |  | 13.0460-5898.2                   | 605898           |  |                               | 21952 15,0 +/WK                                |
|    | 1.3 16V (G200)<br>1.3 16V (G200)<br>1.3 16V (G204)   | 55<br>62<br>44                   |  | 05.96<br>01.93<br>09.96                            | 11.99<br>04.01<br>04.01  |  | 24.0111-0139.1                   | 411139           |  |                               | 234 11,0 10,0                                  |
|    | 1.5 16V (G203)<br>1.5 16V (G203)<br>1.6 GTi (G201)   | 55<br>66<br>77                   |  | 10.94<br>08.94<br>03.93                            | 11.99<br>11.99<br>03.96  |  | 24.0118-0126.1                   | 418126           |  |                               | 235 18,0 17,0 V                                |
|    | 1.3 16V (G200)<br>1.3 16V (G200)<br>1.3 16V (G204)<br>1.5 16V (G203)<br>1.5 16V (G203)<br>1.6 GTi (G201) | 55<br>62<br>44<br>55<br>66<br>77 |  | 05.96<br>01.93<br>09.96<br>10.94<br>08.94<br>03.93 | 11.99 + ABS<br>04.01 + ABS<br>04.01 + ABS<br>11.99 + ABS<br>11.99 + ABS<br>03.96 + ABS |  | 13.0460-5824.2                   | 605824           |  |                               | 20008 13,0 AKE                                 |
|   | 1.3 16V (G200)<br>1.3 16V (G200)<br>1.3 16V (G204)<br>1.5 16V (G203)<br>1.5 16V (G203)                   | 55<br>62<br>44<br>55<br>66       |  | 05.96<br>01.93<br>09.96<br>10.94<br>08.94          | 11.99 - ABS<br>04.01 - ABS<br>04.01 - ABS<br>11.99 - ABS<br>11.99 - ABS                |  | 03.0137-0186.2<br>03.0137-9126.2 | 650186<br>669126 |  |                               | 180 x 28<br>Bremsbacken-Zubehör                |
| <b>DAIHATSU CHARADE (GB) (03-07)</b>   |  |                                  |  |  |  |  |                                  |                  |  |                               |  |
|    | 1.0 i (L251)<br>1.0 i (L251)   | 43<br>43                         |  | 05.03<br>12.04                                     | 08.07 - belüftete Scheiben <sup>1)</sup><br>08.07 + belüftete Scheiben <sup>2)</sup>   |  | 13.0460-5709.2<br>13.0460-5613.2 | 605709<br>605613 |  |                               | 24229 14,8 +/WK/Zub AKE<br>25262 15,0 +/WK/Zub |
|    | 1.0 i (L251)<br>1.0 i (L251)   | 43<br>43                         |  | 05.03<br>12.04                                     | 08.07 - belüftete Scheiben <sup>1)</sup><br>08.07 + belüftete Scheiben <sup>2)</sup>   |  | 24.0111-0159.1<br>24.0116-0120.1 | 411159<br>416120 |  |                               | 211 11,0 10,0 +B<br>234 16,0 15,0 V +B         |
|    | 1.0 i (L251)   | 43                               |  | 09.03  | 08.07  |  | 03.0137-0475.2                   | 650475           |  |                               | 165 x 26                                       |
|    | 1.0 i (L251)   | 43                               |  | 05.03  | 08.07 - ABS  |  | 24.0216-5004.2                   | 480183           |  | ohne Sensorring <sup>3)</sup> | 165/166 x 33,5                                 |
| <b>DAIHATSU CHARADE (11-13)</b>  |  |                                  |  |  |  |  |                                  |                  |  |                               |  |
|    | 1.33 16V   | 73                               |  | 05.11  | 01.13  |  | 13.0460-7213.2                   | 607213           |  |                               | 24022 17,8 +/WK ATE                            |
|    | 1.33 16V   | 73                               |  | 05.11  | 01.13  |  | 24.0122-0240.1                   | 422240           |  |                               | 258 22,0 20,0 V +B                             |
|    | 1.33 16V   | 73                               |  | 05.11  | 01.13  |  | 24.0710-5002.3<br>24.0710-5001.3 | 360314<br>360313 | <br> |                               | Radsensor<br>Radsensor                         |
|    | 1.33 16V   | 73                               |  | 05.11  | 01.13  |  | 13.0460-7214.2                   | 607214           |  |                               | 24574 15,0 +/WK ATE                            |
|    | 1.33 16V   | 73                               |  | 05.11  | 01.13  |  | 24.0109-0142.1                   | 409142           |  |                               | 278 9,0 7,0 +B                                 |
|    | 1.33 16V   | 73                               |  | 05.11  | 01.13  |  | 24.0711-6169.3                   | 360283           | 2   |                               | Radsensor                                      |
|    | 1.33 16V   | 73                               |  | 05.11  | 01.13  |  | 03.0137-0502.2<br>03.0137-9280.2 | 650502<br>669280 |  |                               | 203 x 38 HEB<br>Bremsbacken-Zubehör            |

1) - ventilated discs / - dischi ventilati / - disques ventilés / - disco ventilado  
2) + ventilated discs / + dischi ventilati / + disques ventilés / + disco ventilado  
3) without sensor ring / senza sensori / sans secours ABS / sin anillo sensor ABS

|     |  |  |  |  |  |  |  |                                  |
|--|--|--|--|--|---|--|--|--|
| <b>DAIHATSU COPEN (03-12)</b>  |  |  |  |  |   |  |  |  |
|    | 0.7 16V<br>0.7 16V<br>1.3 16V  | 47<br>50<br>64   |  | 01.06<br>01.06<br>03.06  | 07.12<br>07.12<br>07.12   |  | 13.0460-5887.2<br>605887   | 23507 15,2 +WK<br><b>SUM</b>   |
|    | 0.7 16V<br>0.7 16V<br>1.3 16V  | 47<br>50<br>64   |  | 09.03<br>09.03<br>03.06  | 07.12<br>07.12<br>07.12   |  | 24.0117-0107.1<br>417107   | 246 17,0 16,0 V +B   |
|    | 0.7 16V<br>0.7 16V<br>1.3 16V  | 47<br>50<br>64   |  | 09.03<br>09.03<br>03.06  | 09.05<br>09.05<br>07.12   |  | 03.0137-0406.2<br>650406   | 180 x 38   |
|    | 0.7 16V<br>0.7 16V   | 47<br>50   |  | 10.05<br>10.05   | 07.12<br>07.12  |  | 03.0137-0406.2<br>650406   | 180 x 38   |
| <b>DAIHATSU CUORE (94-99)</b>  |  |  |  |  |   |  |  |  |
|    | 0.7 4WD (L501)<br>0.8 (L501)<br>0.8 (L501)                                       | 48<br>31<br>32   |  | 10.97<br>11.96<br>08.94  | 05.99<br>10.98<br>10.96   |  | 24.0110-0235.1<br>410235   | 211 10,0 9,0   |
|    | 0.7 4WD (L501)<br>0.8 (L501)<br>0.8 (L501)                                       | 48<br>31<br>32   |  | 10.97<br>11.96<br>08.94  | 05.99<br>10.98<br>10.96   |  | 03.0137-0404.2<br>650404   | 165 x 28   |
| <b>DAIHATSU CUORE (98-03)</b>  |  |  |  |  |   |  |  |  |
|    | 1.0 (L701)<br>1.0 i (L701)   | 40<br>41   |  | 11.98<br>10.98   | 09.00<br>05.03  |  | 24.0111-0159.1<br>411159   | 211 11,0 10,0 +B   |
|    | 1.0 (L701)<br>1.0 (L701)<br>1.0 i (L701)   | 40<br>40<br>41   |  | 11.98<br>10.99<br>10.98  | 09.99<br>09.00<br>05.03   | - ABS<br>- ABS<br>- ABS  | 03.0137-0404.2<br>650404<br>03.0137-0417.2<br>650417                               | 165 x 28<br>165 x 28   |
|    | 1.0 (L701)<br>1.0 i (L701)   | 40<br>41   |  | 10.99<br>10.98   | 09.00<br>05.03  | + ABS<br>+ ABS   | 03.0137-0406.2<br>650406   | 180 x 38   |
|    | 1.0 (L701)<br>1.0 i (L701)   | 40<br>41   |  | 11.98<br>10.98   | 09.00<br>05.03  | - ABS<br>- ABS   | 24.0216-5004.2<br>480183   | ohne Sensorring <sup>1)</sup><br>165/166 x 33,5  |
| <b>DAIHATSU CUORE (03-07)</b>  |  |  |  |  |   |  |  |  |
|    | 1.0 i (L251)<br>1.0 i (L251)   | 43<br>43   |  | 05.03<br>12.04   | 08.07<br>08.07  | - belüftete Scheiben <sup>2)</sup><br>+ belüftete Scheiben <sup>3)</sup>           | 13.0460-5709.2<br>605709<br>13.0460-5613.2<br>605613                               | 24229 14,8 +WK/Zub<br><b>AKE</b><br>25262 15,0 +WK/Zub   |
|   | 1.0 i (L251)<br>1.0 i (L251)   | 43<br>43   |  | 05.03<br>12.04   | 08.07<br>08.07  | - belüftete Scheiben <sup>2)</sup><br>+ belüftete Scheiben <sup>3)</sup>           | 24.0111-0159.1<br>411159<br>24.0116-0120.1<br>416120                               | 211 11,0 10,0 +B<br>234 16,0 15,0 V +B   |
|  | 1.0 i (L251)   | 43   |  | 09.03  | 08.07   |  | 03.0137-0475.2<br>650475   | 165 x 26   |
|  | 1.0 i (L251)   | 43   |  | 05.03  | 08.07   | - ABS  | 24.0216-5004.2<br>480183   | ohne Sensorring <sup>1)</sup><br>165/166 x 33,5  |
| <b>DAIHATSU CUORE (07-13)</b>  |  |  |  |  |   |  |  |  |
|  | 1.0 DVVT (L276)<br>1.0 DVVT (L276)   | 51<br>51   |  | 09.07<br>09.07   | 01.13<br>01.13  | + 13" Rad <sup>4)</sup><br>+ 14" Rad <sup>5)</sup>                                 | 13.0460-5613.2<br>605613<br>13.0460-5887.2<br>605887                               | - belüftete Scheiben <sup>2)</sup><br>+ belüftete Scheiben <sup>3)</sup><br><b>SUM</b>                             |
|  | 1.0 DVVT (L276)<br>1.0 DVVT (L276)   | 51<br>51   |  | 09.07<br>09.07   | 01.13<br>01.13  | + 13" Rad <sup>4)</sup><br>+ 14" Rad <sup>5)</sup>                                 | 24.0111-0159.1<br>411159<br>24.0116-0130.1<br>416130                               | - belüftete Scheiben <sup>2)</sup><br>+ belüftete Scheiben <sup>3)</sup><br>211 11,0 10,0 +B<br>234 16,0 15,0 V +B |
|  | 1.0 DVVT (L276)  | 51   |  | 09.07  | 01.13   | + 14" Rad <sup>5)</sup>  | 24.0117-0107.1<br>417107   | 246 17,0 16,0 V +B   |
|  | 1.0 DVVT (L276)<br>1.0 DVVT (L276)   | 51<br>51   |  | 09.07<br>09.07   | 01.13<br>01.13  | - ESP<br>+ ESP   | 03.0137-0475.2<br>650475<br>03.0137-0489.2<br>650489                               | 165 x 26<br>180 x 28   |
| <b>DAIHATSU GRAN MOVE (96-02)</b>  |  |  |  |  |   |  |  |  |
|  | 1.5 16V<br>1.5 GLX<br>1.5 GX<br>1.6 16V<br>1.6 16V<br>1.6 GLX<br>1.6 GX          | 66<br>71<br>55<br>67<br>70<br>77<br>67   |  | 10.96<br>10.96<br>10.96<br>06.98<br>06.98<br>06.98<br>06.98                      | 08.98<br>08.98<br>08.98<br>07.02<br>07.02<br>07.02<br>07.02                       |  | 13.0460-5898.2<br>605898   | 21952 15,0 +WK   |
|  | 1.5 16V<br>1.5 GLX<br>1.5 GX   | 66<br>71<br>55   |  | 10.96<br>10.96<br>10.96  | 08.98<br>08.98<br>08.98   |  | 24.0118-0126.1<br>418126   | 235 18,0 17,0 V  |
|  | 1.5 16V<br>1.5 GLX<br>1.5 GX<br>1.6 16V<br>1.6 16V<br>1.6 GLX<br>1.6 GX          | 66<br>71<br>55<br>67<br>70<br>77<br>67   |  | 10.96<br>10.96<br>10.96<br>06.98<br>06.98<br>06.98<br>06.98                      | 08.98<br>08.98<br>08.98<br>07.02<br>07.02<br>07.02<br>07.02                       | + ABS<br>+ ABS<br>+ ABS<br>+ ABS<br>+ ABS<br>+ ABS<br>+ ABS                        | 13.0460-5824.2<br>605824   | 20008 13,0<br><b>AKE</b>   |
| <b>DAIHATSU MATERIA (06-12)</b>  |  |  |  |  |   |  |  |  |
|  | 1.3 DVVT<br>1.5 DVVT<br>1.5 DVVT 4WD   | 67<br>76<br>76   |  | 10.06<br>10.06<br>10.06  | 07.12<br>07.12<br>07.12   |  | 13.0460-5794.2<br>605794   | 24283 15,5 +WK/Zub/STRW  |

<sup>1)</sup> without sensor ring / senza sensori / sans secours ABS / sin anillo sensor ABS





























<sup>2)</sup> - ventilated discs / - dischi ventilati / - disques ventilés / - disco ventilado

<sup>3)</sup> + ventilated discs / + dischi ventilati / + disques ventilés / + disco ventilado

<sup>4)</sup> + 13" wheel / + ruota 13" / + roue 13" / + rueda 13"

<sup>5)</sup> + 14" wheel / + ruota 14" / + roue 14" / + rueda 14"































|     |                                  |  |  |  |                                     |  |  |  |
|--|--|--|--|--|--|--|--|--|
| <b>DAIHATSU MATERIA (06-12)</b>  |  |  |  |  |  |  |  |  |
|    | 1.3 DVVT<br>1.5 DVVT<br>1.5 DVVT 4WD   | 67<br>76<br>76   |  | 10.06<br>10.06<br>10.06  | 07.12<br>07.12<br>07.12  | 24.0122-0263.1   | 422263   | 254 22,0 20,0 V +B   |
|    | 1.3 DVVT<br>1.5 DVVT   | 67<br>76   |  | 10.06<br>10.06   | 07.12<br>07.12   | 03.0137-0489.2   | 650489   | 180 x 28   |
| <b>DAIHATSU MOVE (96-02)</b>   |  |  |  |  |  |  |  |  |
|    | 0.8 (L601)<br>1.0 i (L901)   | 31<br>41   |  | 10.96<br>10.98   | 09.98<br>11.00   | 13.0460-5710.2   | 605710   | 23783 14,0 <b>AKE</b>  |
|    | 0.8 (L601)<br>1.0 i (L901)   | 31<br>41   |  | 10.96<br>10.98   | 09.98<br>11.00   | 24.0116-0118.1   | 416118   | 234 16,0 14,0 V  |
|    | 0.8 (L601)<br>1.0 i (L901)<br>1.0 i (L901)   | 31<br>41<br>41   |  | 05.98<br>10.98<br>10.99  | 09.98<br>09.99 - ABS<br>11.00 - ABS  | 03.0137-0404.2   | 650404   | 165 x 28   |
|    | 1.0 i (L901)<br>1.0 i (L901)   | 41<br>41   |  | 09.99<br>10.98   | 11.00 + ABS<br>11.00 - ABS   | 03.0137-0417.2   | 650417   | 165 x 28   |
|    | 1.0 i (L901)   | 41   |  | 09.99  | 11.00 + ABS  | 03.0137-0406.2   | 650406   | 180 x 38   |
|    | 1.0 i (L901)   | 41   |  | 10.98  | 11.00 - ABS  | 24.0216-5004.2   | 480183   | 165/166 x 33,5<br>ohne Sensorring <sup>1)</sup>                                    |
| <b>DAIHATSU ROCKY 4x4 (84-99)</b>  |  |  |  |  |  |  |  |  |
|    | 2.0<br>2.8 D<br>2.8 TD   |  |  | 04.84<br>04.84<br>04.84  | 09.89<br>09.89<br>09.89  | 13.0460-5816.2   | 605816   | 21243 14,0   |
|    | 2.8 TD   |  |  | 04.84  | 12.99  | 24.0118-0121.1   | 418121   | 277 18,0 17,0 V  |
|    | 2.0<br>2.8 D<br>2.8 TD   |  |  | 04.84<br>04.84<br>04.84  | 04.93<br>12.99<br>12.99  | 03.0137-0316.2   | 650316   | 254 x 45   |
| <b>DAIHATSU SIRION (98-04)</b>   |  |  |  |  |  |  |  |  |
|  | 1.0 i (M100)<br>1.0 i (M100)<br>1.0 i 4WD (M110)<br>1.0 i 4WD (M110)<br>1.3 i 16V (M101)<br>1.3 i 16V 4WD (M111) | 41<br>43<br>41<br>43<br>75<br>75   |  | 04.98<br>09.00<br>04.98<br>09.00<br>08.00<br>08.00                               | 08.00<br>12.04<br>08.00<br>12.04<br>12.04<br>12.04   | 13.0460-5852.2   | 605852   | 23497 15,0 +/WK/Zub  |
|  | 1.0 i (M100)<br>1.0 i (M100)<br>1.0 i 4WD (M110)<br>1.0 i 4WD (M110)<br>1.3 i 16V (M101)<br>1.3 i 16V 4WD (M111) | 41<br>43<br>41<br>43<br>75<br>75   |  | 04.98<br>09.00<br>04.98<br>09.00<br>08.00<br>08.00                               | 08.00<br>12.04<br>08.00<br>12.04<br>12.04<br>12.04   | 24.0116-0120.1   | 416120   | 234 16,0 15,0 V +B   |
|  | 1.0 i (M100)<br>1.0 i (M100)<br>1.3 i 16V (M101)   | 41<br>43<br>75   |  | 09.99<br>09.00<br>08.00  | 08.00<br>12.04<br>12.04  | 03.0137-0406.2   | 650406   | 180 x 38   |
| <b>DAIHATSU SIRION (05-13)</b>   |  |  |  |  |  |  |  |  |
|  | 1.0 DVVT<br>1.0 DVVT 4WD   | 51<br>51   |  | 01.05<br>04.05   | 01.13 + 13" Rad <sup>2)</sup><br>01.13 + 13" Rad <sup>2)</sup>   | 13.0460-5613.2   | 605613   | 25262 15,0 +/WK/Zub  |
|  | 1.0 DVVT<br>1.0 DVVT 4WD<br>1.3 DVVT<br>1.3 DVVT<br>1.3 DVVT 4WD<br>1.3 DVVT 4WD<br>1.5 DVVT<br>1.5 DVVT 4WD     | 51<br>51<br>64<br>67<br>64<br>67<br>76<br>76                                     |  | 07.07<br>07.07<br>07.07<br>03.08<br>04.05<br>03.08<br>03.08<br>05.06             | 01.13 + 14" Rad <sup>3)</sup><br>01.13 + 14" Rad <sup>3)</sup><br>01.13<br>01.13<br>01.13<br>01.13<br>01.13<br>10.08 | 13.0460-5794.2<br>13.0460-5887.2   | 605794<br>605887   | 24283 15,5 +/WK/Zub/STRW<br>23507 15,2 +/WK <b>SUM</b>                             |
|  | 1.0 DVVT<br>1.0 DVVT 4WD<br>1.3 DVVT 4WD   | 51<br>51<br>64   |  | 01.05<br>04.05<br>04.05  | 01.13 + 13" Rad <sup>2)</sup><br>01.13 + 13" Rad <sup>2)</sup><br>12.06  | 24.0116-0130.1   | 416130   | 234 16,0 15,0 V +B   |
|  | 1.0 DVVT<br>1.0 DVVT 4WD<br>1.3 DVVT<br>1.3 DVVT<br>1.3 DVVT 4WD<br>1.3 DVVT 4WD<br>1.5 DVVT<br>1.5 DVVT 4WD     | 51<br>51<br>64<br>67<br>64<br>67<br>76<br>76                                     |  | 01.05<br>04.05<br>01.05<br>03.08<br>01.07<br>03.08<br>03.08<br>05.06             | 01.13 + 14" Rad <sup>3)</sup><br>01.13 + 14" Rad <sup>3)</sup><br>01.13<br>01.13<br>01.13<br>01.13<br>01.13<br>10.08 | 24.0117-0107.1<br>24.0122-0263.1   | 417107<br>422263   | 246 17,0 16,0 V +B<br>254 22,0 20,0 V +B   |
|  | 1.0 DVVT<br>1.0 DVVT 4WD<br>1.3 DVVT<br>1.3 DVVT<br>1.5 DVVT   | 51<br>51<br>64<br>67<br>76   |  | 01.05<br>04.05<br>01.05<br>03.08<br>03.08  | 01.13<br>01.13<br>01.13<br>01.13<br>01.13  | 03.0137-0489.2   | 650489   | 180 x 28   |
| <b>DAIHATSU TERIOS (J1) (97-05)</b>  |  |  |  |  |  |  |  |  |
|  | 1.3 16V<br>1.3 16V 4WD<br>1.3 16V 4WD<br>1.3 DVVT FWD<br>1.3 DVVT Turbo 4WD                                      | 63<br>61<br>63<br>63<br>103  |  | 09.01<br>10.97<br>10.00<br>10.02<br>10.02  | 10.05<br>09.00<br>10.05<br>10.05<br>10.05  | 13.0460-5713.2   | 605713   | 21650 15,5 /WK/Zub <b>SUM</b>  |

<sup>1)</sup> without sensor ring / senza sensori / sans secours ABS / sin anillo sensor ABS

<sup>2)</sup> + 13" wheel / + ruota 13" / + roue 13" / + rueda 13"

<sup>3)</sup> + 14" wheel / + ruota 14" / + roue 14" / + rueda 14"

|     |  |  |  |  |  |  |  |  |
|--|--|--|--|--|---|--|--|--|
| <b>DAIHATSU TERIOS (J1) (97-05)</b>  |  |  |  |  |   |  |  |  |
|    | 1.3 16V<br>1.3 16V 4WD<br>1.3 16V 4WD<br>1.3 DVVT FWD<br>1.3 DVVT Turbo 4WD      | 63<br>61<br>63<br>63<br>103  |  | 09.01<br>10.97<br>10.00<br>10.02<br>10.02  | 10.05<br>09.00<br>10.05<br>10.05<br>10.05   | 24.0116-0117.1   | 416117   | 273 16,0 15,0 +B   |
|    | 1.3 16V<br>1.3 16V 4WD<br>1.3 DVVT FWD<br>1.3 DVVT Turbo 4WD                     | 63<br>63<br>63<br>103  |  | 09.01<br>10.00<br>10.02<br>10.02   | 10.05<br>10.05<br>10.05<br>10.05  | 03.0137-0398.2   | 650398   | 229 x 42   |
|    | 1.3 16V<br>1.3 16V 4WD<br>1.3 16V 4WD<br>1.3 DVVT FWD<br>1.3 DVVT Turbo 4WD      | 63<br>61<br>63<br>63<br>103  |  | 09.01<br>10.97<br>10.00<br>10.02<br>10.02  | 10.05 - ABS<br>09.00 - ABS<br>10.05 - ABS<br>10.05 - ABS<br>10.05 - ABS           | 24.0222-8036.1   | 480196   | 229/230,6 x 58   |
|    | 1.3 16V<br>1.3 16V 4WD<br>1.3 16V 4WD<br>1.3 DVVT FWD<br>1.3 DVVT Turbo 4WD      | 63<br>61<br>63<br>63<br>103  |  | 09.01<br>10.97<br>10.00<br>10.02<br>10.02  | 10.05 + ABS<br>09.00 + ABS<br>10.05 + ABS<br>10.05 + ABS<br>10.05 + ABS           | 24.0222-8034.1   | 480187   | 229/230,6 x 58   |
| <b>DAIHATSU TERIOS (J2) (05-13)</b>  |  |  |  |  |   |  |  |  |
|    | 1.3 DVVT<br>1.3 DVVT 4x4<br>1.5 16V<br>1.5 16V 4x4<br>1.5 DVVT<br>1.5 DVVT 4x4   | 63<br>63<br>77<br>77<br>75<br>75   |  | 11.05<br>11.05<br>11.05<br>05.06<br>09.10<br>09.10                               | 01.13<br>01.13<br>01.13<br>01.13<br>01.13<br>01.13                                | 13.0460-5713.2   | 605713   | 21650 15,5 /WK/Zub <b>SUM</b>  |
|    | 1.3 DVVT<br>1.3 DVVT 4x4<br>1.5 16V<br>1.5 16V 4x4<br>1.5 DVVT<br>1.5 DVVT 4x4   | 63<br>63<br>77<br>77<br>75<br>75   |  | 11.05<br>11.05<br>11.05<br>05.06<br>09.10<br>09.10                               | 01.13<br>01.13<br>01.13<br>01.13<br>01.13<br>01.13                                | 24.0116-0117.1   | 416117   | 273 16,0 15,0 +B   |
|    | 1.3 DVVT<br>1.3 DVVT 4x4<br>1.5 16V<br>1.5 16V 4x4<br>1.5 DVVT<br>1.5 DVVT 4x4   | 63<br>63<br>77<br>77<br>75<br>75   |  | 11.05<br>11.05<br>11.05<br>05.06<br>09.10<br>09.10                               | 01.13<br>01.13<br>01.13<br>01.13<br>01.13<br>01.13                                | 03.0137-0492.2   | 650492   | 228 x 42   |
|  | 1.3 DVVT<br>1.3 DVVT 4x4<br>1.5 16V<br>1.5 16V 4x4<br>1.5 DVVT<br>1.5 DVVT 4x4   | 63<br>63<br>77<br>77<br>75<br>75   |  | 11.05<br>11.05<br>11.05<br>05.06<br>09.10<br>09.10                               | 01.13<br>01.13<br>01.13<br>01.13<br>01.13<br>01.13                                | 24.0222-8036.1   | 480196   | 229/230,6 x 58   |
| <b>DAIHATSU TREVIS (06-09)</b>   |  |  |  |  |   |  |  |  |
|  | 1.0 i 12V (L651)<br>1.0 i 12V (L651)   | 43<br>43   |  | 06.06<br>06.06   | 09.09 + 13" Rad 1)<br>09.09 + 14" Rad 2)  | 13.0460-5613.2   | 605613   | 25262 15,0 +/WK/Zub  |
|  | 1.0 i 12V (L651)<br>1.0 i 12V (L651)   | 43<br>43   |  | 06.06<br>06.06   | 09.09 + 13" Rad 1)<br>09.09 + 14" Rad 2)  | 24.0116-0130.1   | 416130   | 234 16,0 15,0 V +B   |
|  | 1.0 i 12V (L651)   | 43   |  | 06.06  | 09.09   | 24.0111-0159.1   | 411159   | 211 11,0 10,0 +B   |
|  | 1.0 i 12V (L651)   | 43   |  | 06.06  | 09.09   | 03.0137-0494.2   | 650494   | 165 x 28   |
| <b>DAIHATSU YRV (01-06)</b>  |  |  |  |  |   |  |  |  |
|  | 1.0 i (M200)<br>1.3 i 16V (M201)<br>1.3 i 16V 4WD (M211)                         | 43<br>64<br>64   |  | 01.01<br>01.01<br>01.01  | 08.06<br>08.06<br>08.06   | 13.0460-5852.2   | 605852   | 23497 15,0 +/WK/Zub  |
|  | 1.0 i (M200)<br>1.3 i 16V (M201)<br>1.3 i 16V 4WD (M211)<br>1.3 i 16V GTI (M202) | 43<br>64<br>64<br>95   |  | 01.01<br>01.01<br>01.01<br>07.02   | 08.06<br>08.06<br>08.06<br>08.06  | 24.0116-0120.1   | 416120   | 234 16,0 15,0 V +B   |
|  | 1.0 i (M200)<br>1.3 i 16V (M201)<br>1.3 i 16V GTI (M202)                         | 43<br>64<br>95   |  | 01.01<br>01.01<br>07.02  | 08.06<br>08.06<br>08.06   | 03.0137-0406.2   | 650406   | 180 x 38   |
| <b>FIAT 124 Spider (16-)</b>   |  |  |  |  |   |  |  |  |
|  | 1.4<br>1.4 Abarth  | 103<br>125   |  | 03.16<br>03.16   |   | 13.0460-5762.2   | 605762   | 24298 14,0 +/WK/Zub  |
| <b>FIAT 500 (07-)</b>  |  |  |  |  |   |  |  |  |
|  | 0.9<br>0.9<br>0.9  | 48<br>63<br>77   |  | 09.12<br>07.10<br>12.13  |   | 13.0460-7288.2<br>13.0470-7288.2   | 607288<br>LD7288   | 25429 17,5 +/WK <b>ATE</b><br>25429 17,5 +/WK <b>ATE</b>                           |
|  | 1.2 i<br>1.2 LPG   | 51<br>51   |  | 07.07<br>12.10   | 04.13<br>04.13  | 13.0460-3838.2<br>13.0470-3838.2   | 603838<br>LD3838   | 21436 17,0 /WK/Zub <b>BOS</b><br>21436 17,0 /WK/Zub <b>BOS</b>                     |
|  | 1.2 i<br>1.2 LPG   | 51<br>51   |  | 05.13<br>05.13   |   | 13.0460-3838.2<br>13.0470-3838.2   | 603838<br>LD3838   | 21436 17,0 /WK/Zub <b>BOS</b><br>21436 17,0 /WK/Zub <b>BOS</b>                     |
|  | 1.3 D Multijet   | 55   |  | 07.07  |   | 13.0460-3846.2<br>13.0470-3846.2   | 603846<br>LD3846   | 24072 17,9 +/WK/Zub/SBOS<br>24072 17,9 +/WK/Zub/SBOS                               |

1) + 13" wheel / + ruota 13" / + roue 13" / + rueda 13"

2) + 14" wheel / + ruota 14" / + roue 14" / + rueda 14"

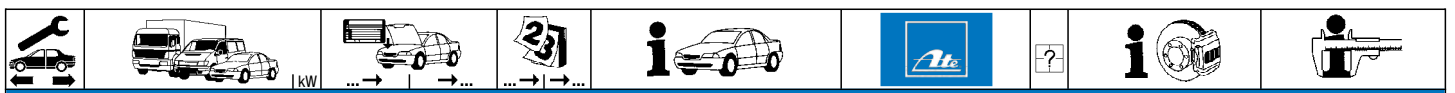























| FIAT 500 (07-)          |                       |     |  |       |       |                |        |   |                                 |                          |
|-------------------------|-----------------------|-----|--|-------|-------|----------------|--------|---|---------------------------------|--------------------------|
|                         | 1.3 D Multijet        | 70  |  | 12.09 |       | 13.0460-3818.2 | 603818 |   | 23706 18,1 +/WK/S               | BOS                      |
|                         | 1.4 i 16V             | 74  |  | 07.07 |       | 13.0460-3826.2 | 603826 |   | 23706 18,0 +/WK/Zub/SBOS        |                          |
|                         |                       |     |  |       |       | 13.0470-3826.2 | LD3826 |   | 23706 18,0 +/WK/Zub/SBOS        |                          |
|                         |                       |     |  |       |       | 13.0460-3863.2 | 603863 |   | 23706 18,0 +/WK/Zub/SBOS        |                          |
|                         | 1.4 i 16V             | 74  |  | 07.07 |       | 13.0460-3850.2 | 603850 |   | 23707 18,0 /Zub/S               | BOS                      |
|                         | 1.4 Abarth            | 99  |  | 07.08 |       | 13.0460-3827.2 | 603827 |   | für Fzg. mit 1 WK <sup>2)</sup> | 23709 19,6 +/WK/Zub/SBOS |
|                         | 1.4 Abarth            | 103 |  | 05.10 |       | 13.0470-3827.2 | LD3827 |   | für Fzg. mit 1 WK <sup>2)</sup> | 23709 19,6 +/WK/Zub/SBOS |
|                         | 1.4 Abarth            | 118 |  | 08.08 |       | 13.0460-3864.2 | 603864 |   | für Fzg. mit 2 WK <sup>3)</sup> | 23709 19,6 +/WK/Zub/SBOS |
|                         |                       |     |  |       |       |                |        |   |                                 |                          |
|                         | 0.9                   | 48  |  | 09.12 |       | 24.0112-0127.1 | 412127 |   |                                 | 258 12,0 10,2 +B         |
|                         | 0.9                   | 63  |  | 07.10 |       |                |        |   |                                 |                          |
|                         | 0.9                   | 77  |  | 12.13 |       |                |        |   |                                 |                          |
|                         | 1.2 i                 | 51  |  | 07.07 |       | 24.0111-0119.1 | 411119 |   |                                 | 241 11,0 9,2 +B          |
|                         | 1.2 LPG               | 51  |  | 12.10 |       |                |        |   |                                 |                          |
|                         | 1.3 D Multijet        | 55  |  | 07.07 |       | 24.0120-0184.1 | 420184 |   |                                 | 241 20,0 18,2 V +B       |
|                         | 1.3 D Multijet        | 70  |  | 12.09 |       | 24.0122-0197.1 | 422197 |   |                                 | 258 22,0 20,2 V +B       |
|                         | 1.4 i 16V             | 74  |  | 07.07 |       | 24.0322-0197.1 | 522197 |   |                                 | 258 22,0 20,2 V +B PD    |
|                         | 1.4 Abarth            | 99  |  | 07.08 |       | 24.0122-0147.1 | 422147 |   | - Kit ESSEESSE                  | 284 22,0 20,2 V +B       |
|                         | 1.4 Abarth            | 103 |  | 05.10 |       | 24.0122-0283.1 | 422283 |   | + Kit ESSEESSE                  | 284 22,0 20,2 V +B       |
|                         | 0.9                   | 48  |  | 09.12 |       | 24.0711-5221.3 | 360242 | 2 |                                 | Radsensor L=1080         |
|                         | 0.9                   | 63  |  | 07.10 |       |                |        |   |                                 |                          |
|                         | 0.9                   | 77  |  | 12.13 |       |                |        |   |                                 |                          |
|                         | 1.2 i                 | 51  |  | 07.07 |       |                |        |   |                                 |                          |
|                         | 1.2 LPG               | 51  |  | 10.10 |       |                |        |   |                                 |                          |
|                         | 1.3 D Multijet        | 55  |  | 07.07 |       |                |        |   |                                 |                          |
|                         | 1.3 D Multijet        | 70  |  | 12.09 |       |                |        |   |                                 |                          |
|                         | 1.4 Abarth            | 99  |  | 07.08 |       |                |        |   |                                 |                          |
|                         | 1.4 Abarth            | 103 |  | 05.10 |       |                |        |   |                                 |                          |
|                         | 1.4 Abarth            | 118 |  | 08.08 |       |                |        |   |                                 |                          |
|                         | 1.4 Abarth Assetto C. | 139 |  | 08.08 |       |                |        |   |                                 |                          |
|                         | 1.4 Abarth Tributo F. | 132 |  | 08.08 |       |                |        |   |                                 |                          |
|                         | 1.4 i 16V             | 74  |  | 07.07 |       |                |        |   |                                 |                          |
|                         | 1.4 Abarth            | 99  |  | 07.08 |       | 13.0460-2879.2 | 602879 |   |                                 | 23601 13,7 /S            |
|                         | 1.4 Abarth            | 103 |  | 05.10 |       | 13.0470-2879.2 | LD2879 |   |                                 | 23601 13,7 /S            |
|                         | 1.4 Abarth            | 118 |  | 08.08 |       |                |        |   |                                 |                          |
|                         | 1.4 Abarth Assetto C. | 139 |  | 08.08 |       |                |        |   |                                 |                          |
|                         | 1.4 Abarth Tributo F. | 132 |  | 08.08 |       |                |        |   |                                 |                          |
|                         | 1.4 i 16V             | 74  |  | 07.07 |       | 24.0111-0119.1 | 411119 |   |                                 | 241 11,0 9,2 +B          |
|                         | 1.4 Abarth            | 99  |  | 07.08 |       | 24.0111-0119.1 | 411119 |   | - Kit ESSEESSE                  | 241 11,0 9,2 +B          |
|                         | 1.4 Abarth            | 103 |  | 05.10 |       |                |        |   |                                 |                          |
|                         | 0.9                   | 48  |  | 09.12 |       | 24.0711-5220.3 | 360274 | 2 |                                 | Radsensor L=706          |
|                         | 0.9                   | 63  |  | 07.10 |       |                |        |   |                                 |                          |
|                         | 0.9                   | 77  |  | 12.13 |       |                |        |   |                                 |                          |
|                         | 1.2 i                 | 51  |  | 07.07 |       |                |        |   |                                 |                          |
|                         | 1.2 LPG               | 51  |  | 12.10 |       |                |        |   |                                 |                          |
|                         | 1.3 D Multijet        | 55  |  | 07.07 |       |                |        |   |                                 |                          |
|                         | 1.3 D Multijet        | 70  |  | 12.09 |       |                |        |   |                                 |                          |
|                         | 1.4 Abarth            | 99  |  | 07.08 |       |                |        |   |                                 |                          |
|                         | 1.4 Abarth            | 103 |  | 05.10 |       |                |        |   |                                 |                          |
|                         | 1.4 Abarth            | 118 |  | 08.08 |       |                |        |   |                                 |                          |
|                         | 1.4 Abarth Assetto C. | 139 |  | 08.08 |       |                |        |   |                                 |                          |
|                         | 1.4 Abarth Tributo F. | 132 |  | 08.08 |       |                |        |   |                                 |                          |
|                         | 1.4 i 16V             | 74  |  | 07.07 |       |                |        |   |                                 |                          |
|                         | 1.2 i                 | 51  |  | 07.07 | 05.10 | 03.0137-0462.2 | 650462 |   |                                 | 180 x 32 HEB             |
|                         | 1.3 D Multijet        | 55  |  | 07.07 | 05.10 | 03.0137-9303.2 | 669303 |   |                                 | Bremsbacken-Zubehör      |
|                         | 1.3 D Multijet        | 70  |  | 12.09 | 05.10 |                |        |   |                                 | BDX                      |
|                         | 0.9                   | 48  |  | 09.12 |       | 03.0137-0506.2 | 650506 |   |                                 | 180 x 32 HEB             |
|                         | 0.9                   | 63  |  | 07.10 |       | 03.0137-9247.2 | 669247 |   |                                 | Bremsbacken-Zubehör      |
|                         | 0.9                   | 77  |  | 12.13 |       |                |        |   |                                 | AP                       |
|                         | 1.2 i                 | 51  |  | 06.10 |       |                |        |   |                                 | AP                       |
|                         | 1.2 LPG               | 51  |  | 12.10 |       |                |        |   |                                 |                          |
|                         | 1.3 D Multijet        | 55  |  | 06.10 |       |                |        |   |                                 |                          |
|                         | 1.3 D Multijet        | 70  |  | 06.10 |       |                |        |   |                                 |                          |
|                         | 0.9                   | 48  |  | 09.12 |       | 24.0218-0011.1 | 480006 |   |                                 | 180/181,4 x 40           |
|                         | 0.9                   | 63  |  | 07.10 |       |                |        |   |                                 |                          |
|                         | 0.9                   | 77  |  | 12.13 |       |                |        |   |                                 |                          |
|                         | 1.2 i                 | 51  |  | 07.07 |       |                |        |   |                                 |                          |
|                         | 1.3 D Multijet        | 55  |  | 07.07 |       |                |        |   |                                 |                          |
|                         | 1.2 i                 | 51  |  | 07.07 | 05.10 | 03.0520-8220.3 | 698220 |   |                                 | 20,64/180x32 TopKit      |
|                         | 1.3 D Multijet        | 55  |  | 07.07 | 05.10 |                |        |   |                                 |                          |
|                         | 1.3 D Multijet        | 70  |  | 12.09 | 05.10 |                |        |   |                                 |                          |
| FIAT 500 C Cabrio (09-) |                       |     |  |       |       |                |        |   |                                 |                          |
|                         | 0.9                   | 63  |  | 09.09 |       | 13.0460-7288.2 | 607288 |   |                                 | 25429 17,5 +/WK          |
|                         | 0.9                   | 77  |  | 12.13 |       | 13.0470-7288.2 | LD7288 |   |                                 | ATE                      |
|                         | 1.2                   | 51  |  | 09.09 |       | 13.0460-3846.2 | 603846 |   |                                 | 24072 17,9 +/WK/Zub/SBOS |
|                         | 1.3 D Multijet        | 55  |  | 09.09 |       | 13.0470-3846.2 | LD3846 |   |                                 | 24072 17,9 +/WK/Zub/SBOS |
|                         | 1.3 D Multijet        | 70  |  | 09.09 |       | 13.0460-3818.2 | 603818 |   |                                 | 23706 18,1 +/WK/S        |
|                         |                       |     |  |       |       |                |        |   |                                 | BOS                      |

<sup>1)</sup> + sports package / + pacchetto sportivo / + version sport / + kit deportivo

<sup>2)</sup> for vehicle with 1 WK / per autovetture con 1 RU / pour véhicule avec 1 TU / para vehículo con 1 CD



























<sup>3)</sup> for vehicles + 2 warn.contacts / per veicoli + 2 contatti d'allarme / pour véhic.+ 2 contacts d'alerte / para vehic.+ 2 contact.alarma

|     |  |  |  |  |  |  |  |  |   |                          |
|--|--|--|--|--|---|--|--|--|---|--------------------------|
| <b>FIAT 500 C Cabrio (09-)</b>   |  |  |  |  |   |  |  |  |   |                          |
|    | 1.4  | 74   |  | 09.09  |   |  |  | 13.0460-3826.2 603826<br>13.0470-3826.2 LD3826<br>13.0460-3863.2 603863            | 23706 18,0 +/WK/Zub/SBOS<br>23706 18,0 +/WK/Zub/SBOS<br>23706 18,0 +/WK/Zub/SBOS    |                          |
|  | 1.4 Abarth   | 99   |  | 01.11  |   |  |  | 13.0460-3827.2 603827  | für Fzg. mit 1 WK <sup>1)</sup>   | 23709 19,6 +/WK/Zub/SBOS |
|  | 1.4 Abarth   | 118  |  | 05.11  |   |  |  | 13.0470-3827.2 LD3827  | für Fzg. mit 1 WK <sup>1)</sup>   | 23709 19,6 +/WK/Zub/SBOS |
|  | 1.4 Abarth   | 132  |  | 09.09  |   |  |  | 13.0460-3864.2 603864  | für Fzg. mit 2 WK <sup>2)</sup>   | 23709 19,6 +/WK/Zub/SBOS |
|    | 0.9  | 63   |  | 09.09  |   |  |  | 24.0112-0127.1 412127  |   | 258 12,0 10,2 +B         |
|  | 0.9  | 77   |  | 12.13  |   |  |  |  |   |                          |
|  | 1.2  | 51   |  | 09.09  |   |  |  | 24.0120-0184.1 420184  |   | 241 20,0 18,2 V +B       |
|  | 1.3 D Multijet   | 55   |  | 09.09  |   |  |  |  |   |                          |
|  | 1.3 D Multijet   | 70   |  | 09.09  |   |  |  | 24.0122-0197.1 422197  |   | 258 22,0 20,2 V +B       |
|  | 1.4  | 74   |  | 09.09  |   |  |  | 24.0322-0197.1 522197  |   | 258 22,0 20,2 V +B PD    |
|  | 1.4 Abarth   | 99   |  | 01.11  |   |  |  | 24.0122-0147.1 422147  | - Kit ESSEESSE  | 284 22,0 20,2 V +B       |
|  | 1.4 Abarth   | 118  |  | 05.11  |   |  |  | 24.0122-0283.1 422283  | + Kit ESSEESSE  | 284 22,0 20,2 V +B       |
|  | 1.4 Abarth   | 132  |  | 09.09  |   |  |  |  |   |                          |
|    | 0.9  | 63   |  | 09.09  |   |  |  | 24.0711-5221.3 360242  | 2  | Radsensor L=1080         |
|  | 0.9  | 77   |  | 12.13  |   |  |  |  |   |                          |
|  | 1.2  | 51   |  | 09.09  |   |  |  |  |   |                          |
|  | 1.3 D Multijet   | 55   |  | 09.09  |   |  |  |  |   |                          |
|  | 1.3 D Multijet   | 70   |  | 09.09  |   |  |  |  |   |                          |
|  | 1.4  | 74   |  | 09.09  |   |  |  |  |   |                          |
|  | 1.4 Abarth   | 99   |  | 01.11  |   |  |  |  |   |                          |
|  | 1.4 Abarth   | 118  |  | 05.11  |   |  |  |  |   |                          |
|  | 1.4 Abarth   | 132  |  | 09.09  |   |  |  |  |   |                          |
|    | 1.4  | 74   |  | 09.09  |   |  |  | 24.0111-0119.1 411119  |   | 241 11,0 9,2 +B          |
|  | 1.4 Abarth   | 99   |  | 01.11  |   |  |  | 24.0111-0119.1 411119  | - Kit ESSEESSE  | 241 11,0 9,2 +B          |
|  | 1.4 Abarth   | 118  |  | 05.11  |   |  |  |  |   |                          |
|  | 1.4 Abarth   | 132  |  | 09.09  |   |  |  |  |   |                          |
|    | 0.9  | 63   |  | 09.09  |   |  |  | 24.0711-5220.3 360274  | 2  | Radsensor L=706          |
|  | 0.9  | 77   |  | 12.13  |   |  |  |  |   |                          |
|  | 1.2  | 51   |  | 09.09  |   |  |  |  |   |                          |
|  | 1.3 D Multijet   | 55   |  | 09.09  |   |  |  |  |   |                          |
|  | 1.3 D Multijet   | 70   |  | 09.09  |   |  |  |  |   |                          |
|  | 1.4  | 74   |  | 09.09  |   |  |  |  |   |                          |
|  | 1.4 Abarth   | 99   |  | 01.11  |   |  |  |  |   |                          |
|  | 1.4 Abarth   | 118  |  | 05.11  |   |  |  |  |   |                          |
|  | 1.4 Abarth   | 132  |  | 09.09  |   |  |  |  |   |                          |
|   | 0.9  | 63   |  | 09.09  | 05.10   |  |  | 03.0137-0462.2 650462  |   | 180 x 32 HEB BDX         |
|  | 1.2  | 51   |  | 09.09  | 05.10   |  |  | 03.0137-9303.2 669303  |   | Bremsbacken-Zubehör BDX  |
|  | 1.3 D Multijet   | 55   |  | 09.09  | 05.10   |  |  |  |   |                          |
|  | 1.3 D Multijet   | 70   |  | 09.09  | 05.10   |  |  |  |   |                          |
|  | 0.9  | 63   |  | 06.10  |   |  |  | 03.0137-0506.2 650506  |   | 180 x 32 HEB AP          |
|  | 0.9  | 77   |  | 12.13  |   |  |  | 03.0137-9247.2 669247  |   | Bremsbacken-Zubehör AP   |
|  | 1.2  | 51   |  | 06.10  |   |  |  |  |   |                          |
|  | 1.3 D Multijet   | 55   |  | 06.10  |   |  |  |  |   |                          |
|  | 1.3 D Multijet   | 70   |  | 06.10  |   |  |  |  |   |                          |
|  | 0.9  | 63   |  | 09.09  |   |  |  | 24.0218-0011.1 480006  |   | 180/181,4 x 40           |
|  | 0.9  | 77   |  | 12.13  |   |  |  |  |   |                          |
|  | 1.2  | 51   |  | 09.09  |   |  |  |  |   |                          |
|  | 1.3 D Multijet   | 55   |  | 09.09  |   |  |  |  |   |                          |
|  | 1.3 D Multijet   | 70   |  | 09.09  |   |  |  |  |   |                          |
|  | 0.9  | 63   |  | 09.09  | 05.10   |  |  | 03.0520-8220.3 698220  |   | 20,64/180x32 TopKit BDX  |
|  | 1.2  | 51   |  | 09.09  | 05.10   |  |  |  |   |                          |
|  | 1.3 D Multijet   | 55   |  | 09.09  | 05.10   |  |  |  |   |                          |
|  | 1.3 D Multijet   | 70   |  | 09.09  | 05.10   |  |  |  |   |                          |
| <b>FIAT 500 L Kombi (12-)</b>  |  |  |  |  |   |  |  |  |   |                          |
|  | 0.9  | 77   |  | 08.12  |   |  |  | 13.0460-3840.2 603840  |   | 23981 19,6 +/WK/Zub/SBOS |
|  | 0.9 CNG  | 63   |  | 03.13  |   |  |  | 13.0470-3840.2 LD3840  |   | 23981 19,6 +/WK/Zub/SBOS |
|  | 1.3 D Multijet   | 62   |  | 08.12  |   |  |  |  |   |                          |
|  | 1.4  | 70   |  | 08.12  |   |  |  |  |   |                          |
|  | 1.6 D Multijet   | 77   |  | 08.12  |   |  |  |  |   |                          |
|  | 0.9  | 77   |  | 08.12  |   |  |  | 24.0122-0286.1 422286  | + Stahlfelgen <sup>3)</sup>   | 284 22,0 20,0 V +B       |
|  | 0.9 CNG  | 63   |  | 03.13  |   |  |  |  |   |                          |
|  | 1.3 D Multijet   | 62   |  | 08.12  |   |  |  |  |   |                          |
|  | 1.4  | 70   |  | 08.12  |   |  |  |  |   |                          |
|  | 1.6 D Multijet   | 77   |  | 08.12  |   |  |  |  |   |                          |
|  | 1.4  | 88   |  | 01.14  |   |  |  | 24.0128-0253.1 428253  |   | 305 28,0 26,0 V L +B     |
|  | 1.6 D Multijet   | 88   |  | 09.13  |   |  |  |  |   |                          |
|  | 0.9  | 77   |  | 08.12  |   |  |  | 13.0460-2789.2 602789  |   | 25652 17,1 +/WK/Zub/STRW |
|  | 0.9 CNG  | 63   |  | 03.13  |   |  |  | 13.0470-2789.2 LD2789  |   | 25652 17,1 +/WK/Zub/STRW |
|  | 1.3 D Multijet   | 62   |  | 08.12  |   |  |  |  |   |                          |
|  | 1.4  | 70   |  | 08.12  |   |  |  |  |   |                          |
|  | 1.6 D Multijet   | 77   |  | 08.12  |   |  |  |  |   |                          |
|  | 1.4  | 88   |  | 01.14  |   |  |  | 13.0460-2793.2 602793  |   | 25973 17,2 +/WK/Zub/STRW |
|  | 1.6 D Multijet   | 88   |  | 09.13  |   |  |  |  |   |                          |
|  | 0.9  | 77   |  | 08.12  |   |  |  | 24.0110-0378.1 410378  |   | 251 10,0 9,0 +B          |
|  | 0.9 CNG  | 63   |  | 03.13  |   |  |  |  |   |                          |
|  | 1.3 D Multijet   | 62   |  | 08.12  |   |  |  |  |   |                          |
|  | 1.4  | 70   |  | 08.12  |   |  |  |  |   |                          |
|  | 1.6 D Multijet   | 77   |  | 08.12  |   |  |  |  |   |                          |
|  | 1.4  | 88   |  | 01.14  |   |  |  | 24.0110-0393.1 410393  |   | 264 10,0 8,0 +B          |
|  | 1.6 D Multijet   | 88   |  | 09.13  |   |  |  |  |   |                          |

<sup>1)</sup> for vehicle with 1 WI / per autovettura con 1 RU / pour véhicule avec 1 TU / para vehículo con 1 CD

















<sup>2)</sup> for vehicles + 2 warn.contacts / per veicoli + 2 contatti d'allarme / pour véhic.+ 2 contacts d'alerte / para vehic.+ 2 contact.alarma

































<sup>3)</sup> + steel rims / + cerchioni in acciaio / + jantes en acier / + Llantas acero

|     |    |  |                 |    |  |  |    |  |
|--|--|--|---|--|---|--|--|--|
| <b>FIAT 500 L Kombi (12-)</b>  |  |  |   |  |   |  |  |  |
|    | 0.9<br>0.9 CNG<br>1.3 D Multijet<br>1.4<br>1.6 D Multijet  | 77<br>63<br>62<br>70<br>77   | 08.12<br>03.13<br>08.12<br>08.12<br>08.12   |  | 03.0137-9309.2  | 669309   |  | Bremsbacken-Zubehör AP   |
| <b>FIAT 500 X (14-)</b>  |  |  |   |  |   |  |  |  |
|    | 1.3 D Multijet<br>1.4<br>1.4<br>1.6 D Multijet<br>1.6 D MultiJet   | 70<br>100<br>103<br>84<br>88   | 06.15<br>09.14<br>09.14<br>09.14<br>09.14   |  | 24.0126-0168.1  | 426168   |  | 281 26,2 24,2 V +S +B  |
|    | 1.3 D Multijet<br>1.4<br>1.4<br>1.4 4x4<br>1.4 4x4<br>1.6<br>1.6<br>1.6 D Multijet<br>1.6 D MultiJet<br>2.0 D MultiJet 4x4<br>2.0 D MultiJet 4x4 | 70<br>100<br>103<br>120<br>125<br>81<br>82<br>84<br>88<br>100<br>103             | 06.15<br>09.14<br>09.14<br>09.14<br>09.14<br>11.14<br>09.14<br>09.14<br>09.14<br>09.14<br>09.14 |  | 24.0112-0170.1  | 412170   |  | 278 12,0 10,0 +S +B  |
| <b>FIAT ALBEA (02-12)</b>  |  |  |   |  |   |  |  |  |
|    | 1.2 i<br>1.2 i 16V<br>1.3 JTD<br>1.4 i<br>1.6 i 16V  | 44<br>59<br>51<br>57<br>76   | 03.02<br>03.02<br>03.02<br>03.02<br>03.02   | 12.12<br>12.12<br>12.12<br>12.12<br>12.12  | 13.0460-3849.2<br>13.0460-3982.2<br>13.0470-3982.2                                | 603849<br>603982<br>LD3982   |  | 24393 17,9 /Zub/S BOS<br>23705 18,1 +/WK/S BOS<br>23705 18,1 +/WK/S BOS            |
| <b>FIAT BARCHETTA (95-04)</b>  |  |  |   |  |   |  |  |  |
|    | 1.8 i 16V<br>1.8 i 16V   |  | 04.95<br>06.95  | 05.95<br>10.04   | 13.0460-2949.2<br>13.0460-7065.2  | 602949<br>607065   |  | 20833 17,0 +/WK/S TRW<br>21927 17,9 +/WK ATE                                       |
|    | 1.8 i 16V  |  | 04.95   | 10.04  | 24.0120-0142.1<br>24.0320-0142.1  | 420142<br>520142   |  | 258 20,0 18,2 V L +B<br>258 20,0 18,2 V L +B PD                                    |
|   | 1.8 i 16V  |  | 04.95   | 10.04  | 13.0460-2951.2<br>13.0460-0072.2<br>13.0460-2826.2                                | 602951<br>610072<br>602826   | + GG-Sättel <sup>1)</sup><br>+ GG-Sättel <sup>1)</sup><br>+ ALU-Sättel <sup>2)</sup>   | 21103 14,2 /S TRW<br>Belagsatz-Zubehör TRW<br>23177 14,2 /S TRW                    |
|  | 1.8 i 16V  |  | 04.95   | 10.04  | 24.0111-0119.1  | 411119   |  | 241 11,0 9,2 +B  |
| <b>FIAT BRAVA (95-01)</b>  |  |  |   |  |   |  |  |  |
|  | 1.2 i 16V<br>1.4 i 12V<br>1.6 16 V<br>1.6 i 16V<br>1.9 D<br>1.9 TD   | 76<br>76<br>76<br>55   | 12.98<br>09.95<br>01.99<br>09.95<br>09.95<br>06.96  | 10.01 + Schaltgetriebe <sup>3)</sup><br>10.01 + Schaltgetriebe <sup>3)</sup><br>12.02 + Schaltgetriebe <sup>3)</sup><br>10.01 + Schaltgetriebe <sup>3)</sup><br>10.01 + Schaltgetriebe <sup>3)</sup><br>10.01 + Schaltgetriebe <sup>3)</sup>   | 13.0460-7064.2  | 607064   |  | 21930 17,9 +/WK ATE  |
|  | 1.8 i 16V<br>1.9 JTD<br>1.9 TD<br>2.0  | 74<br>113  | 09.95<br>12.98<br>06.96<br>09.98  | 10.01<br>10.01<br>10.01<br>08.00   | 13.0460-7065.2  | 607065   |  | 21927 17,9 +/WK ATE  |
|  | 1.2 i 16V<br>1.4 i 12V<br>1.6 16 V<br>1.6 i 16V<br>1.9 D<br>1.9 TD   | 76<br>76<br>76<br>55   | 12.98<br>09.95<br>01.99<br>09.95<br>09.95<br>06.96  | 10.01 + Automatikgetriebe <sup>4)</sup><br>10.01 + Automatikgetriebe <sup>4)</sup><br>12.02 + Automatikgetriebe <sup>4)</sup><br>10.01 + Automatikgetriebe <sup>4)</sup><br>10.01 + Automatikgetriebe <sup>4)</sup><br>10.01 + Automatikgetriebe <sup>4)</sup>   | 13.0460-7065.2  | 607065   |  | 21927 17,9 +/WK ATE  |
|  | 1.2 i 16V<br>1.4 i 12V<br>1.6 16 V<br>1.6 i 16V<br>1.9 D<br>1.9 TD   | 76<br>76<br>76<br>55   | 12.98<br>09.95<br>01.99<br>09.95<br>09.95<br>06.96  | 10.01 + Schaltgetriebe <sup>3)</sup><br>10.01 + Schaltgetriebe <sup>3)</sup><br>12.02 + Schaltgetriebe <sup>3)</sup><br>10.01 + Schaltgetriebe <sup>3)</sup><br>10.01 + Schaltgetriebe <sup>3)</sup><br>10.01 + Schaltgetriebe <sup>3)</sup>   | 24.0112-0127.1  | 412127   |  | 258 12,0 10,2 +B   |
|  | 1.2 i 16V<br>1.4 i 12V<br>1.6 16 V<br>1.6 i 16V<br>1.8 i 16V<br>1.9 D<br>1.9 JTD<br>1.9 TD<br>2.0  | 76<br>76<br>76<br>55<br>74<br>113  | 12.98<br>09.95<br>01.99<br>09.95<br>09.95<br>06.96<br>12.98<br>06.96<br>06.96<br>09.98          | 10.01 + Automatikgetriebe <sup>4)</sup><br>10.01 + Automatikgetriebe <sup>4)</sup><br>12.02 + Automatikgetriebe <sup>4)</sup><br>10.01 + Automatikgetriebe <sup>4)</sup><br>10.01 + Automatikgetriebe <sup>4)</sup><br>10.01 + Automatikgetriebe <sup>4)</sup><br>10.01 + Automatikgetriebe <sup>4)</sup><br>10.01 + Automatikgetriebe <sup>4)</sup><br>10.01 + Automatikgetriebe <sup>4)</sup><br>08.00 | 24.0120-0142.1<br>24.0320-0142.1  | 420142<br>520142   |  | 258 20,0 18,2 V L +B<br>258 20,0 18,2 V L +B PD                                    |
|  | 1.4 i 12V<br>1.6 i 16V<br>1.8 i 16V<br>1.9 D<br>1.9 TD   |  | 09.95<br>09.95<br>09.95<br>09.95<br>06.96   | 11.98<br>11.98<br>11.98<br>11.98<br>11.98  | 24.0751-1149.3  | 360046   | 2   | Radsensor L=1160   |
|  | 1.2 i 16V<br>1.4 i 12V<br>1.6 16 V   | 76   | 12.98<br>12.98<br>01.99   | 10.01<br>10.01<br>12.02  | 24.0711-5015.3<br>24.0711-5016.3  | 360054<br>360055   | <br> | Radsensor L=1155<br>Radsensor L=1155   |

1) + cast iron caliper / + pinza in ghisa / + étriers en fonte grise / + fundición gris-pinza  
2) + aluminium calipers / + pinze in alluminio / + étriers en aluminium / + pinzas de aluminio  
3) + manual transmission / + scatola cambio velocità / + transmission mécanique / + cambio de velocidad  
4) + autom.transmission / + scatola cambio automatico / + transmission automatique / + cambio automático



|     |                   |  |  |  |                                |  |  |  |            |
|--|---|--|--|--|---|--|--|--|------------|
| <b>FIAT BRAVA (95-01)</b>  |   |  |  |  |   |  |  |  |            |
|    | 1.6 i 16V<br>1.8 i 16V<br>1.9 D<br>1.9 JTD<br>1.9 TD<br>2.0                                       | 113  | 12.98<br>12.98<br>12.98<br>12.98<br>12.98<br>09.98                               | 10.01<br>10.01<br>10.01<br>10.01<br>10.01<br>08.00                               |   | 24.0711-5015.3<br>24.0711-5016.3   | 360054<br>360055   | Radsensor L=1155<br>Radsensor L=1155   |            |
|    | 1.4 i 12V<br>1.6 i 16V<br>1.8 i 16V<br>1.9 D<br>1.9 TD  |  | 09.95<br>09.95<br>09.95<br>09.95<br>06.96  | 11.98<br>11.98<br>11.98<br>11.98<br>11.98  |   | 24.0721-1197.3<br>24.0721-1198.3   | 360037<br>360038   | Radsensor L=1095<br>Radsensor L=1095   |            |
|  | 1.2 i 16V<br>1.4 i 12V<br>1.6 16 V<br>1.6 i 16V<br>1.8 i 16V<br>1.9 D<br>1.9 JTD<br>1.9 TD<br>2.0 | 76<br>113  | 12.98<br>12.98<br>01.99<br>12.98<br>12.98<br>12.98<br>12.98<br>09.98             | 10.01<br>10.01<br>12.02<br>10.01<br>10.01<br>10.01<br>10.01<br>08.00             |   | 24.0711-5019.3<br>24.0711-5020.3   | 360056<br>360057   | Radsensor L=1105<br>Radsensor L=1105   |            |
|    | 1.2 i 16V<br>1.4 i 12V<br>1.9 D   |  | 12.98<br>09.95<br>09.95  | 10.01<br>10.01<br>10.01  | - ABS<br>- ABS<br>- ABS   | 03.0137-0274.2<br>03.0137-9179.2   | 650274<br>669179   | 180 x 32 HEB AUT<br>Bremsbacken-Zubehör  | AP<br>AP   |
|  | 1.4 i 12V<br>1.6 i 16V<br>1.8 i 16V<br>1.9 D<br>1.9 TD  |  | 09.95<br>09.95<br>09.95<br>09.95<br>06.96  |  | + ABS / VET: - 4255655<br>VET: - 4255655<br>VET: - 4255655<br>+ ABS / VET: - 4255655<br>VET: - 4255655          | 03.0137-0262.2<br>03.0137-9125.2   | 650262<br>669125   | 203 x 39<br>Bremsbacken-Zubehör  | BDX<br>BDX |
|  | 1.2 i 16V<br>1.4 i 12V<br>1.6 16 V<br>1.6 i 16V<br>1.8 i 16V<br>1.9 D<br>1.9 JTD<br>1.9 TD<br>2.0 | 76<br>113  | 12.98<br>01.99<br>12.98<br>09.98   | 10.01<br>10.01<br>10.01<br>10.01<br>10.01<br>10.01<br>10.01<br>08.00             | + ABS<br>+ ABS / VET: 4255656 -<br>VET: 4255656 -<br>VET: 4255656 -<br>+ ABS / VET: 4255656 -<br>VET: 4255656 - | 03.0137-0345.2<br>03.0137-9244.2   | 650345<br>669244   | 203 x 38 HEB<br>Bremsbacken-Zubehör  | AP<br>AP   |
|   | 1.2 i 16V<br>1.4 i 12V<br>1.9 D   |  | 12.98<br>09.95<br>09.95  | 10.01<br>10.01<br>10.01  | - ABS<br>- ABS<br>- ABS   | 24.0218-0011.1   | 480006   | 180/181,4 x 40   |            |
|  | 1.2 i 16V<br>1.4 i 12V<br>1.6 16 V<br>1.6 i 16V<br>1.8 i 16V<br>1.9 D<br>1.9 JTD<br>1.9 TD        | 76   | 12.98<br>09.95<br>01.99<br>09.95<br>09.95<br>12.98<br>06.96                      | 10.01<br>10.01<br>10.01<br>10.01<br>10.01<br>10.01<br>10.01                      | + ABS<br>+ ABS<br>+ ABS<br>+ ABS  | 24.0220-3007.1   | 480064   | 203/204,7 x 48,5   |            |
|  | 1.2 i 16V<br>1.4 i 12V<br>1.9 D   |  | 12.98<br>09.95<br>09.95  | 10.01<br>10.01<br>10.01  | - ABS<br>- ABS<br>- ABS   | 03.0520-5222.3   | 695222   | 22,20/180x32 TopKit  | AP         |
|  | 1.4 i 12V<br>1.6 i 16V<br>1.8 i 16V<br>1.9 D<br>1.9 TD  |  | 09.95<br>09.95<br>09.95<br>09.95<br>09.96  |  | + ABS / VET: - 4255655<br>VET: - 4255655<br>VET: - 4255655<br>+ ABS / VET: - 4255655<br>VET: - 4255655          | 03.0520-6722.3   | 696722   | 22,20/203x39 TopKit  | BDX        |
|  | 1.2 i 16V<br>1.4 i 12V<br>1.6 16 V<br>1.6 i 16V<br>1.8 i 16V<br>1.9 D<br>1.9 JTD<br>1.9 TD        | 76   | 12.98<br>01.99<br>12.98<br>09.98   | 10.01<br>10.01<br>10.01<br>10.01<br>10.01<br>10.01<br>10.01<br>08.00             | + ABS<br>+ ABS / VET: 4255656 -<br>VET: 4255656 -<br>VET: 4255656 -<br>+ ABS / VET: 4255656 -<br>VET: 4255656 - | 03.0520-6822.3   | 696822   | 22,20/203x38 TopKit  | AP         |
| <b>FIAT BRAVO (95-01)</b>  |   |  |  |  |   |  |  |  |            |
|  | 1.2 i 16V<br>1.4 i 12V<br>1.6 i 16V<br>1.9 D<br>1.9 TD  | 55   | 12.98<br>09.95<br>09.95<br>09.95<br>06.96  | 10.01<br>10.01<br>10.01<br>10.01<br>10.01  |   | 13.0460-7064.2   | 607064   | 21930 17,9 +/WK  | ATE        |
|  | 1.8 i 16V<br>1.9 JTD<br>1.9 TD  | 74   | 09.95<br>12.98<br>06.96  | 10.01<br>10.01<br>10.01  |   | 13.0460-7065.2   | 607065   | 21927 17,9 +/WK  | ATE        |
|  | 2.0 i 20V<br>2.0 i 20V  |  | 09.95<br>05.99   | 04.99<br>10.01   |   | 13.0460-7069.2   | 607069   | 21636 19,3 +/WK  | ATE        |
|  |   |  |  |  |   | 13.0460-7140.2<br>13.0470-7140.2   | 607140<br>LD7140   | 23289 19,3 +/WK<br>23289 19,3 +/WK   | ATE<br>ATE |
|  | 1.2 i 16V<br>1.4 i 12V<br>1.6 i 16V<br>1.9 D<br>1.9 TD  | 55   | 12.98<br>09.95<br>09.95<br>09.95<br>06.96  | 10.01<br>10.01<br>10.01<br>10.01<br>10.01  |   | 24.0112-0127.1   | 412127   | 258 12,0 10,2 +B   |            |
|  | 1.8 i 16V<br>1.9 JTD<br>1.9 TD  | 74   | 09.95<br>12.98<br>06.96  | 10.01<br>10.01<br>10.01  |   | 24.0120-0142.1<br>24.0320-0142.1   | 420142<br>520142   | 258 20,0 18,2 V L +B<br>258 20,0 18,2 V L +B PD                                    |            |

|     |    |  |  |  |  |  |  |     |                               |
|--|--|--|--|--|---|--|--|---|-------------------------------|
| <b>FIAT BRAVO (95-01)</b>  |  |  |  |  |   |  |  |   |                               |
|    | 2.0 i 20V  |  | 09.95  | 10.01  |   | 24.0122-0147.1   | 422147   | 284 22,0 20,2 V +B  |                               |
|    | 1.4 i 12V  |  | 09.95  | 11.98  |   | 24.0751-1149.3   | 360046   | 2  |                               |
|  | 1.6 i 16V  |  | 09.95  | 11.98  |   |  |  | Radsensor L=1160  |                               |
|  | 1.8 i 16V  |  | 09.95  | 11.98  |   |  |  |   |                               |
|  | 1.9 D  |  | 09.95  | 11.98  |   |  |  |   |                               |
|  | 1.9 TD   |  | 06.96  | 11.98  |   |  |  |   |                               |
|  | 2.0 i 20V  |  | 09.95  | 07.98  |   | 24.0751-1151.3   | 360047   | 2  |                               |
|    | 1.2 i 16V  |  | 12.98  | 10.01  |   | 24.0711-5015.3   | 360054   |    |                               |
|  | 1.4 i 12V  |  | 12.98  | 10.01  |   | 24.0711-5016.3   | 360055   |    |                               |
|  | 1.6 i 16V  |  | 12.98  | 10.01  |   |  |  | Radsensor L=1155  |                               |
|  | 1.8 i 16V  |  | 12.98  | 10.01  |   |  |  | Radsensor L=1155  |                               |
|  | 1.9 D  |  | 12.98  | 10.01  |   |  |  |   |                               |
|  | 1.9 JTD  |  | 12.98  | 10.01  |   |  |  |   |                               |
|  | 1.9 TD   |  | 12.98  | 10.01  |   |  |  |   |                               |
|  | 2.0 i 20V  |  | 08.98  | 10.01  |   |  |  |   |                               |
|    | 2.0 i 20V  |  | 09.95  | 10.01  |   | 13.0460-2951.2   | 602951   | + GG-Sättel <sup>1)</sup>   |                               |
|  |  |  |  |  |   | 13.0460-2826.2   | 602826   | + ALU-Sättel <sup>2)</sup>  |                               |
|  |  |  |  |  |   | 13.0460-0072.2   | 610072   | + GG-Sättel <sup>1)</sup>   |                               |
|  |  |  |  |  |   |  |  | 21103 14,2 /S <b>TRW</b>  |                               |
|  |  |  |  |  |   |  |  | 23177 14,2 /S <b>TRW</b>  |                               |
|  |  |  |  |  |   |  |  | Belagsatz-Zubehör <b>TRW</b>  |                               |
|    | 2.0 i 20V  |  | 09.95  | 10.01  |   | 24.0111-0119.1   | 411119   | 241 11,0 9,2 +B   |                               |
|    | 1.4 i 12V  |  | 09.95  | 11.98  |   | 24.0721-1197.3   | 360037   |    |                               |
|  | 1.6 i 16V  |  | 09.95  | 11.98  |   | 24.0721-1198.3   | 360038   |    |                               |
|  | 1.8 i 16V  |  | 09.95  | 11.98  |   |  |  | Radsensor L=1095  |                               |
|  | 1.9 D  |  | 09.95  | 11.98  |   |  |  | Radsensor L=1095  |                               |
|  | 1.9 TD   |  | 06.96  | 11.98  |   |  |  |   |                               |
|  | 2.0 i 20V  |  | 09.95  | 07.98  |   |  |  |   |                               |
|    | 1.2 i 16V  |  | 12.98  | 10.01  |   | 24.0711-5019.3   | 360056   |    |                               |
|  | 1.4 i 12V  |  | 12.98  | 10.01  |   | 24.0711-5020.3   | 360057   |    |                               |
|  | 1.6 i 16V  |  | 12.98  | 10.01  |   |  |  | Radsensor L=1105  |                               |
|  | 1.8 i 16V  |  | 12.98  | 10.01  |   |  |  | Radsensor L=1105  |                               |
|  | 1.9 D  |  | 12.98  | 10.01  |   |  |  |   |                               |
|  | 1.9 JTD  |  | 12.98  | 10.01  |   |  |  |   |                               |
|  | 1.9 TD   |  | 12.98  | 10.01  |   |  |  |   |                               |
|  | 2.0 i 20V  |  | 08.98  | 10.01  |   |  |  |   |                               |
|  |   | 1.2 i 16V  |  | 12.98  | 10.01   | - ABS  | 03.0137-0274.2   | 650274  | 180 x 32 HEB AUT <b>AP</b>    |
|  |  | 1.4 i 12V  |  | 09.95  | 10.01   | - ABS  | 03.0137-9179.2   | 669179  | Bremsbacken-Zubehör <b>AP</b> |
| 1.9 D  |  |  | 09.95  | 10.01  | - ABS   |  |  |   |                               |
| 1.4 i 12V  |  |  | 09.95  | 11.98  | + ABS   | 03.0137-0262.2   | 650262   | 203 x 39 <b>BDX</b>   |                               |
| 1.6 i 16V  |  |  | 09.95  | 11.98  | + ABS   | 03.0137-9125.2   | 669125   | Bremsbacken-Zubehör <b>BDX</b>  |                               |
|  | 1.8 i 16V  |  | 09.95  | 11.98  | + ABS   |  |  |   |                               |
|  | 1.9 D  |  | 09.95  | 11.98  | + ABS   |  |  |   |                               |
|  | 1.9 TD   |  | 06.96  | 11.98  | + ABS   |  |  |   |                               |
|  | 1.2 i 16V  |  | 12.98  | 10.01  | + ABS   | 03.0137-0345.2   | 650345   | 203 x 38 HEB <b>AP</b>  |                               |
|  | 1.4 i 12V  |  | 12.98  | 10.01  | + ABS   | 03.0137-9244.2   | 669244   | Bremsbacken-Zubehör <b>AP</b>   |                               |
|  | 1.6 i 16V  |  | 12.98  | 10.01  | + ABS   |  |  |   |                               |
|  | 1.8 i 16V  |  | 12.98  | 10.01  | + ABS   |  |  |   |                               |
|  | 1.2 i 16V  |  | 12.98  | 10.01  | - ABS   | 24.0218-0011.1   | 480006   | 180/181,4 x 40  |                               |
|  | 1.4 i 12V  |  | 09.95  | 10.01  | - ABS   |  |  |   |                               |
|  | 1.9 D  |  | 09.95  | 10.01  | - ABS   |  |  |   |                               |
|  | 1.2 i 16V  |  | 12.98  | 10.01  | + ABS   | 24.0220-3007.1   | 480064   | 203/204,7 x 48,5  |                               |
|  | 1.4 i 12V  |  | 09.95  | 10.01  | + ABS   |  |  |   |                               |
|  | 1.6 i 16V  |  | 09.95  | 10.01  | + ABS   |  |  |   |                               |
|  | 1.8 i 16V  |  | 09.95  | 10.01  | + ABS   |  |  |   |                               |
|  | 1.9 D  |  | 09.95  | 10.01  | + ABS   |  |  |   |                               |
|  | 1.9 JTD  |  | 12.98  | 10.01  | + ABS   |  |  |   |                               |
|  | 1.9 TD   |  | 06.96  | 10.01  | + ABS   |  |  |   |                               |
|  |  | 1.2 i 16V  |  | 12.98  | 10.01   | - ABS  | 03.0520-5222.3   | 695222  | 22,20/180x32 TopKit <b>AP</b> |
|  |  | 1.4 i 12V  |  | 09.95  | 10.01   | - ABS  |  |   |                               |
| 1.9 D  |  |  | 09.95  | 10.01  | - ABS   |  |  |   |                               |
| 1.4 i 12V  |  |  | 09.95  | 11.98  | + ABS   | 03.0520-6722.3   | 696722   | 22,20/203x39 TopKit <b>BDX</b>  |                               |
| 1.6 i 16V  |  |  | 09.95  | 11.98  | + ABS   |  |  |   |                               |
|  | 1.8 i 16V  |  | 09.95  | 11.98  | + ABS   |  |  |   |                               |
|  | 1.9 D  |  | 09.95  | 11.98  | + ABS   |  |  |   |                               |
|  | 1.9 TD   |  | 09.96  | 11.98  | + ABS   |  |  |   |                               |
|  | 1.2 i 16V  |  | 12.98  | 10.01  | + ABS   | 03.0520-6822.3   | 696822   | 22,20/203x38 TopKit <b>AP</b>   |                               |
|  | 1.4 i 12V  |  | 12.98  | 10.01  | + ABS   |  |  |   |                               |
|  | 1.6 i 16V  |  | 12.98  | 10.01  | + ABS   |  |  |   |                               |
|  | 1.8 i 16V  |  | 12.98  | 10.01  | + ABS   |  |  |   |                               |
|  | 1.9 D  |  | 12.98  | 10.01  | + ABS   |  |  |   |                               |
|  | 1.9 JTD  |  | 12.98  | 10.01  | + ABS   |  |  |   |                               |
|  | 1.9 TD   |  | 12.98  | 10.01  | + ABS   |  |  |   |                               |
|  | <b>FIAT BRAVO (07-)</b>  |  |  |  |   |  |  |   |                               |
|  |  | 1.4 i 16V  | 66   | 04.07  |   |  | 13.0460-3982.2   | 603982  | 23705 18,1 +/WK/S <b>BOS</b>  |
| 1.4 LPG  |  | 66   | 11.09  |  |   | 13.0470-3982.2   | LD3982   | 23705 18,1 +/WK/S <b>BOS</b>  |                               |
| 1.4 T-Jet  |  | 88   | 09.07  |  |   | 13.0460-3983.2   | 603983   | 23708 19,4 +/WK/S <b>BOS</b>  |                               |
| 1.6 D Multijet   |  |  | 03.08  |  |   | 13.0470-3983.2   | LD3983   | 23708 19,4 +/WK/S <b>BOS</b>  |                               |
| 1.9 D Multijet   |  |  | 04.07  |  |   |  |  |   |                               |
|  | 1.9 D Multijet   | 66   | 04.07  | 12.08  |   |  |  |   |                               |

<sup>1)</sup> + cast iron caliper / + pinza in ghisa / + étriers en fonte grise / + fundición gris-pinza  
<sup>2)</sup> + aluminium calipers / + pinze in alluminio / + étriers en aluminium / + pinzas de aluminio

| <b>FIAT BRAVO (07-)</b>         |                 |     |         |       |       |  |  |                |        |   |  |  |  |   |                 |            |  |  |  |  |
|---------------------------------|-----------------|-----|---------|-------|-------|--|--|----------------|--------|---|--|--|--|---|-----------------|------------|--|--|--|--|
|                                 | 1.4 16V         | 103 |         | 04.08 |       |  |  | 13.0460-3984.2 | 603984 |   |  |  |  | 23711 19,4 +/WK/S                               | <b>BOS</b>      |            |  |  |  |  |
|                                 | 1.4 T-Jet       | 110 |         | 09.07 |       |  |  | 13.0470-3984.2 | LD3984 |   |  |  |  | 23711 19,4 +/WK/S                               | <b>BOS</b>      |            |  |  |  |  |
|                                 | 1.9 D Multijet  | 110 |         | 04.07 |       |  |  |                |        |   |  |  |  |   |                 |            |  |  |  |  |
|                                 | 2.0 D Multijet  |     |         | 09.08 |       |  |  |                |        |   |  |  |  |   |                 |            |  |  |  |  |
|                                 | 1.4 i 16V       | 66  |         | 04.07 |       |  |  | 24.0122-0197.1 | 422197 |   |  |  |  | 258 22,0 20,2 V +B                              |                 |            |  |  |  |  |
|                                 | 1.4 LPG         | 66  |         | 11.09 |       |  |  | 24.0322-0197.1 | 522197 |   |  |  |  | <b>258 22,0 20,2 V +B PD</b>                    |                 |            |  |  |  |  |
|                                 | 1.4 T-Jet       | 88  |         | 09.07 |       |  |  | 24.0122-0147.1 | 422147 |   |  |  |  | 284 22,0 20,2 V +B                              |                 |            |  |  |  |  |
|                                 | 1.6 D Multijet  |     |         | 03.08 |       |  |  |                |        |   |  |  |  |   |                 |            |  |  |  |  |
|                                 | 1.9 D Multijet  |     |         | 04.07 |       |  |  |                |        |   |  |  |  |   |                 |            |  |  |  |  |
|                                 | 1.9 D Multijet  | 66  |         | 04.07 | 12.08 |  |  |                |        |   |  |  |  |   |                 |            |  |  |  |  |
|                                 | 1.4 16V         | 103 |         | 04.08 |       |  |  | 24.0126-0125.1 | 426125 |   |  |  |  | 281 26,0 24,2 V +B                              |                 |            |  |  |  |  |
|                                 | 1.4 T-Jet       | 110 |         | 09.07 |       |  |  |                |        |   |  |  |  |   |                 |            |  |  |  |  |
|                                 | 1.9 D Multijet  | 110 |         | 04.07 |       |  |  |                |        |   |  |  |  |   |                 |            |  |  |  |  |
|                                 | 2.0 D Multijet  |     |         | 09.08 |       |  |  |                |        |   |  |  |  |   |                 |            |  |  |  |  |
|                                 | 1.4 16V         | 103 |         | 04.08 |       |  |  | 13.0460-3991.2 | 603991 |   |  |  |  | 23714 16,6 /S                                   | <b>BOS</b>      |            |  |  |  |  |
|                                 | 1.4 i 16V       | 66  |         | 04.07 |       |  |  | 13.0470-3812.2 | LD3812 |   |  |  |  | 23714 17,6 /S                                   | <b>BOS</b>      |            |  |  |  |  |
|                                 | 1.4 LPG         | 66  |         | 11.09 |       |  |  | 13.0460-3861.2 | 603861 |   |  |  |  | 23714 17,6 +/WK/Zub/SBOS                        |                 |            |  |  |  |  |
|                                 | 1.4 T-Jet       | 88  |         | 09.07 |       |  |  |                |        |   |  |  |  |   |                 |            |  |  |  |  |
|                                 | 1.4 T-Jet       | 110 |         | 09.07 |       |  |  |                |        |   |  |  |  |   |                 |            |  |  |  |  |
|                                 | 1.6 D Multijet  |     |         | 03.08 |       |  |  |                |        |   |  |  |  |   |                 |            |  |  |  |  |
|                                 | 1.9 D Multijet  | 66  |         | 04.07 | 12.08 |  |  |                |        |   |  |  |  |   |                 |            |  |  |  |  |
|                                 | 1.9 D Multijet  | 110 |         | 04.07 |       |  |  |                |        |   |  |  |  |   |                 |            |  |  |  |  |
|                                 | 2.0 D Multijet  |     |         | 09.08 |       |  |  |                |        |   |  |  |  |   |                 |            |  |  |  |  |
|                                 | 2.0 D Multijet  |     |         | 09.08 |       |  |  |                |        |   |  |  |  |   |                 |            |  |  |  |  |
|                                 | 1.4 16V         | 103 |         | 04.08 |       |  |  | 24.0110-0190.1 | 410190 |   |  |  |  | 252 10,0 9,0 +B                                 |                 |            |  |  |  |  |
|                                 | 1.4 16V         | 103 |         | 04.08 |       |  |  |                |        |   |  |  |  |   |                 |            |  |  |  |  |
|                                 | 1.4 i 16V       | 66  |         | 04.07 |       |  |  |                |        |   |  |  |  |   |                 |            |  |  |  |  |
|                                 | 1.4 LPG         | 66  |         | 11.09 |       |  |  |                |        |   |  |  |  |   |                 |            |  |  |  |  |
|                                 | 1.4 T-Jet       | 88  |         | 09.07 |       |  |  |                |        |   |  |  |  |   |                 |            |  |  |  |  |
|                                 | 1.4 T-Jet       | 110 |         | 09.07 |       |  |  |                |        |   |  |  |  |   |                 |            |  |  |  |  |
|                                 | 1.6 D Multijet  |     |         | 03.08 |       |  |  |                |        |   |  |  |  |   |                 |            |  |  |  |  |
|                                 | 1.9 D Multijet  |     |         | 04.07 |       |  |  |                |        |   |  |  |  |   |                 |            |  |  |  |  |
|                                 | 1.9 D Multijet  | 66  |         | 04.07 | 12.08 |  |  |                |        |   |  |  |  |   |                 |            |  |  |  |  |
|                                 | 1.9 D Multijet  | 110 |         | 04.07 |       |  |  |                |        |   |  |  |  |   |                 |            |  |  |  |  |
|                                 | 2.0 D Multijet  |     |         | 09.08 |       |  |  |                |        |   |  |  |  |   |                 |            |  |  |  |  |
|                                 | 2.0 D Multijet  |     |         | 09.08 |       |  |  |                |        |   |  |  |  |   |                 |            |  |  |  |  |
| <b>FIAT CINQUECENTO (92-98)</b> |                 |     |         |       |       |  |  |                |        |   |  |  |  |   |                 |            |  |  |  |  |
|                                 | 1100 Sporting   |     |         | 11.94 | 05.98 |  |  | 13.0460-3949.2 | 603949 |   |  |  |  | 21365 17,0                                      | <b>BDX</b>      |            |  |  |  |  |
|                                 | 700             |     |         | 02.92 | 05.98 |  |  | 13.0460-0434.2 | 610434 |   |  |  |  | Belagsatz-Zubehör                               | <b>BDX</b>      |            |  |  |  |  |
|                                 | 900 i.e.        |     |         | 02.92 | 05.98 |  |  |                |        |   |  |  |  |   |                 |            |  |  |  |  |
|                                 | 1100 Sporting   |     |         | 11.94 | 05.98 |  |  | 24.0111-0119.1 | 411119 |   |  |  |  | 241 11,0 9,2 +B                                 |                 |            |  |  |  |  |
|                                 | 700             |     |         | 02.92 | 05.98 |  |  |                |        |   |  |  |  |   |                 |            |  |  |  |  |
|                                 | 900 i.e.        |     |         | 02.92 | 05.98 |  |  |                |        |   |  |  |  |   |                 |            |  |  |  |  |
|                                 | 1100 Sporting   |     |         | 11.94 | 05.98 |  |  | 03.0137-0015.2 | 650015 |   |  |  |  | 185 x 31 AUT                                    | <b>FI</b>       |            |  |  |  |  |
|                                 | 700             |     |         | 02.92 | 05.98 |  |  | 03.0137-9021.2 | 669021 |   |  |  |  | Bremsbacken-Zubehör                             | <b>FI</b>       |            |  |  |  |  |
|                                 | 900 i.e.        |     |         | 02.92 | 05.98 |  |  |                |        |   |  |  |  |   |                 |            |  |  |  |  |
|                                 | 700             |     |         | 02.92 | 05.98 |  |  | 24.0218-5001.1 | 480012 |   |  |  |  | 185/186,8 x 37                                  |                 |            |  |  |  |  |
|                                 | 900 i.e.        |     |         | 02.92 | 05.98 |  |  |                |        |   |  |  |  |   |                 |            |  |  |  |  |
|                                 | 1100 Sporting   |     |         | 11.94 | 05.98 |  |  | 24.0218-5002.1 | 480117 |   |  |  |  | 185/186,8 x 36,5                                |                 |            |  |  |  |  |
|                                 | 700             |     |         | 02.92 | 05.98 |  |  |                |        |   |  |  |  |   |                 |            |  |  |  |  |
|                                 | 1100 Sporting   |     |         | 11.94 | 05.98 |  |  | 03.0420-0319.3 | 680319 |   |  |  |  | 19,05/185x31 Kit                                | <b>FI</b>       |            |  |  |  |  |
|                                 | 700             |     |         | 02.92 | 05.98 |  |  |                |        |   |  |  |  |   |                 |            |  |  |  |  |
|                                 | 900 i.e.        |     |         | 02.92 | 05.98 |  |  |                |        |   |  |  |  |   |                 |            |  |  |  |  |
| <b>FIAT COUPE (94-00)</b>       |                 |     |         |       |       |  |  |                |        |   |  |  |  |   |                 |            |  |  |  |  |
|                                 | 1.8 i 16V       |     |         | 07.96 | 12.00 |  |  | 13.0460-7069.2 | 607069 |   |  |  |  | 21636 19,3 +/WK                                 | <b>ATE</b>      |            |  |  |  |  |
|                                 | 2.0 i 20V       |     |         | 01.97 | 12.00 |  |  |                |        |   |  |  |  |   |                 |            |  |  |  |  |
|                                 | 2.0 i 16V       |     |         | 12.93 | 06.96 |  |  | 13.0460-2979.2 | 602979 |   |  |  |  | 21147 19,0 +/WK/S                               | <b>TRW</b>      |            |  |  |  |  |
|                                 | 2.0 i 16V Turbo |     |         | 12.93 | 06.96 |  |  | 13.0460-7069.2 | 607069 |   |  |  |  | 21636 19,3 +/WK                                 | <b>ATE</b>      |            |  |  |  |  |
|                                 | 2.0 i 20V Turbo |     |         | 01.97 | 12.00 |  |  | 13.0460-4968.2 | 604968 |   |  |  |  | 21381 18,0 +/WK                                 | <b>BRE</b>      |            |  |  |  |  |
|                                 | 1.8 i 16V       |     |         | 07.96 | 12.00 |  |  | 24.0122-0107.1 | 422107 |   |  |  |  | 284 22,0 20,2 V +B                              |                 |            |  |  |  |  |
|                                 | 2.0 i 16V       |     |         | 12.93 | 06.96 |  |  |                |        |   |  |  |  |   |                 |            |  |  |  |  |
|                                 | 2.0 i 20V       |     |         | 01.97 | 12.00 |  |  |                |        |   |  |  |  |   |                 |            |  |  |  |  |
|                                 | 2.0 i 16V Turbo |     |         | 12.93 | 06.96 |  |  | 24.0122-0147.1 | 422147 |   |  |  |  | 284 22,0 20,2 V +B                              |                 |            |  |  |  |  |
|                                 | 2.0 i 20V Turbo |     |         | 01.97 | 12.00 |  |  | 24.0128-0120.1 | 428120 |   |  |  |  | 305 28,0 26,0 V                                 |                 |            |  |  |  |  |
|                                 | 1.8 i 16V       |     | 47167   | 07.96 | 12.00 |  |  | 13.0460-2951.2 | 602951 |   |  |  |  | 21103 14,2 /S                                   | <b>TRW</b>      |            |  |  |  |  |
|                                 | 2.0 i 16V       |     |         | 12.93 | 06.96 |  |  | 13.0460-0072.2 | 610072 |   |  |  |  | Belagsatz-Zubehör                               | <b>TRW</b>      |            |  |  |  |  |
|                                 | 2.0 i 16V Turbo |     |         | 12.93 | 06.96 |  |  |                |        |   |  |  |  |   |                 |            |  |  |  |  |
|                                 | 2.0 i 20V       |     | 47167   | 01.97 | 12.00 |  |  |                |        |   |  |  |  |   |                 |            |  |  |  |  |
|                                 | 2.0 i 20V Turbo |     | 47167   | 01.97 | 12.00 |  |  |                |        |   |  |  |  |   |                 |            |  |  |  |  |
|                                 | 1.8 i 16V       |     | 47168   | 12.00 | 12.00 |  |  | 13.0460-2826.2 | 602826 |   |  |  |  | + ALU-Sättel <sup>2)</sup>                      | 23177 14,2 /S   | <b>TRW</b> |  |  |  |  |
|                                 | 2.0 i 20V       |     | 47168   | 12.00 | 12.00 |  |  |                |        |   |  |  |  |   |                 |            |  |  |  |  |
|                                 | 2.0 i 20V Turbo |     | 47168   | 12.00 | 12.00 |  |  |                |        |   |  |  |  |   |                 |            |  |  |  |  |
|                                 | 1.8 i 16V       |     |         | 07.96 | 12.00 |  |  | 24.0111-0119.1 | 411119 |   |  |  |  | 241 11,0 9,2 +B                                 |                 |            |  |  |  |  |
|                                 | 2.0 i 16V       |     |         | 12.93 | 06.96 |  |  |                |        |   |  |  |  |   |                 |            |  |  |  |  |
|                                 | 2.0 i 16V Turbo |     |         | 12.93 | 06.96 |  |  |                |        |   |  |  |  |   |                 |            |  |  |  |  |
|                                 | 2.0 i 20V       |     |         | 01.97 | 12.00 |  |  |                |        |   |  |  |  |   |                 |            |  |  |  |  |
|                                 | 2.0 i 20V Turbo |     |         | 01.97 | 12.00 |  |  |                |        |   |  |  |  |   |                 |            |  |  |  |  |
|                                 | 2.0 i 20V Turbo |     |         | 01.97 | 12.00 |  |  |                |        |   |  |  |  |   |                 |            |  |  |  |  |
| <b>FIAT CROMA (05-10)</b>       |                 |     |         |       |       |  |  |                |        |   |  |  |  |   |                 |            |  |  |  |  |
|                                 | 1.8 i 16V       | 103 |         | 01.06 | 11.10 |  |  | 13.0460-7212.2 | 607212 |   |  |  |  | f. Bremssattel m.Stahlkolben <sup>3)</sup>      | 23738 20,1 +/WE | <b>ATE</b> |  |  |  |  |
|                                 | 1.9 D Multijet  | 85  |         | 06.05 | 11.10 |  |  | 13.0460-7172.2 | 607172 |   |  |  |  | f. Bremssattel m.Kunststoffkolben <sup>4)</sup> | 23402 20,1 +/WE | <b>ATE</b> |  |  |  |  |
|                                 | 1.9 JTD         | 88  |         | 06.05 | 11.10 |  |  | 13.0470-7172.2 | LD7172 |   |  |  |  | f. Bremssattel m.Kunststoffkolben <sup>4)</sup> | 23402 20,1 +/WE | <b>ATE</b> |  |  |  |  |
|                                 | 1.9 JTD 16V     |     | 2060169 |       | 11.10 |  |  | 24.8190-0719.2 | 620719 | 1 |  |  |  | Warnkontakt L=686mm                             |                 |            |  |  |  |  |
|                                 | 2.2 i 16V       | 108 |         | 06.05 | 11.10 |  |  |                |        |   |  |  |  |   |                 |            |  |  |  |  |

<sup>1)</sup> + cast iron caliper / + pinza in ghisa / + étriers en fonte grise / + fundición gris-pinza

<sup>2)</sup> + aluminium calipers / + pinze in alluminio / + étriers en aluminium / + pinzas de aluminio

<sup>3)</sup> for br.caliper +steel piston / per pinza fr. +pistone acciaio / pour étrier f. +piston en acier / para pinza fr. +pistón de acero

<sup>4)</sup> for br.caliper +plastic piston / per pinza fr. +pistone plastica / pour étrier fr. +piston plastique / para pinza fr. +pistón plástico



### FIAT CROMA (05-10)





















|  |   |                               |         |   |   |                                  |                  |  |   |     |
|--|---|-------------------------------|---------|---|---|----------------------------------|------------------|--|---|-----|
|  | 1.9 JTD 16V<br>2.4 JTD  | 147                           | 2060168 | 06.05<br>06.05                            | 11.10                                     | 13.0460-3824.2                   | 603824           |  | 24294 19,0 +WK/S                                      | TRW |
|  | 1.8 i 16V<br>1.9 D Multijet<br>1.9 JTD<br>1.9 JTD 16V<br>2.2 i 16V            | 103<br>85<br>88<br>108        | 2060169 | 01.06<br>06.05<br>06.05<br>06.05          | 11.10<br>11.10<br>11.10<br>11.10          | 24.0125-0141.1<br>24.0325-0141.1 | 425141<br>525141 |  | 285 24,9 22,0 V L +S +B<br>285 24,9 22,0 V L +S +B PD |     |
|  | 1.9 JTD 16V<br>2.4 JTD  | 147                           | 2060168 | 06.05<br>06.05                            | 11.10                                     | 24.0128-0185.1                   | 428185           |  | 305 28,0 26,0 V L +B                                  |     |
|  | 1.8 i 16V<br>1.9 D Multijet<br>1.9 JTD<br>1.9 JTD 16V<br>2.2 i 16V<br>2.4 JTD | 103<br>85<br>88<br>108<br>147 |         | 01.06<br>06.05<br>06.05<br>06.05<br>06.05 | 11.10<br>11.10<br>11.10<br>11.10<br>11.10 | 13.0460-3825.2                   | 603825           |  | 24348 17,1 /S   | TRW |
|  | 1.8 i 16V<br>1.9 D Multijet<br>1.9 JTD<br>2.2 i 16V                           | 103<br>85<br>88<br>108        |         | 01.06<br>06.05<br>06.05<br>06.05          | 11.10<br>11.10<br>11.10<br>11.10          | 24.0112-0157.1<br>24.0312-0157.1 | 412157<br>512157 |  | 278 11,9 10,0 +S +B<br>278 11,9 10,0 +S +B PD         |     |
|  | 1.9 JTD 16V<br>2.4 JTD  | 147                           |         | 06.05<br>06.05                            | 11.10<br>11.10                            | 24.0120-0173.1<br>24.0320-0173.1 | 420173<br>520173 |  | 292 19,9 18,0 V +S +B<br>292 19,9 18,0 V +S +B PD     |     |

### FIAT DOBLO (01-10)

|  |  |  |  |   |   |   |                  |        |   |                   |     |
|--|--|--|--|---|---|---|------------------|--------|---|-------------------|-----|
|  | 1.2 i.e.<br>1.3 JTD<br>1.6 i 16V<br>1.6 Natural Power<br>1.9 D<br>1.9 JTD<br>1.9 JTD   | 48<br>51<br>76<br>76<br>46<br>74<br>77                               |  | 01.01<br>05.04<br>10.01<br>09.02<br>01.01<br>10.01<br>07.03                                     | 09.05<br>09.05<br>09.05<br>09.05<br>09.05<br>09.05<br>09.05                                     | 13.0460-7141.2  | 607141           |        | 23842 18,1 +                                    | ATE               |     |
|  | 1.3 D Multijet<br>1.3 D Multijet<br>1.3 JTD<br>1.3 JTD<br>1.4 i<br>1.6 i 16V<br>1.6 Natural Power<br>1.9 D Multijet<br>1.9 JTD<br>1.9 JTD<br>1.9 JTD | 55<br>62<br>55<br>62<br>57<br>76<br>76<br>88<br>74<br>77<br>88       |  | 10.05<br>10.05<br>10.05<br>10.05<br>10.05<br>10.05<br>10.05<br>10.05<br>10.05<br>10.05<br>10.05 | 01.10<br>01.10<br>01.10<br>01.10<br>01.10<br>01.10<br>01.10<br>01.10<br>01.10<br>01.10<br>01.10 | + Bremsscheibendurchm. 284 mm <sup>1)</sup><br>+ Bremsscheibendurchm. 284 mm <sup>1)</sup><br>+ Bremsscheibendurchm. 284 mm <sup>1)</sup><br>+ Bremsscheibendurchm. 284 mm <sup>1)</sup><br>+ Bremsscheibendurchm. 284 mm <sup>1)</sup><br>+ Bremsscheibendurchm. 284 mm <sup>1)</sup><br>+ Bremsscheibendurchm. 284 mm <sup>1)</sup><br>+ Bremsscheibendurchm. 284 mm <sup>1)</sup><br>+ Bremsscheibendurchm. 284 mm <sup>1)</sup><br>+ Bremsscheibendurchm. 284 mm <sup>1)</sup><br>+ Bremsscheibendurchm. 284 mm <sup>1)</sup> | 13.0460-3811.2   | 603811 |   | 23708 19,2/S      | BOS |
|  | 1.3 D Multijet<br>1.3 D Multijet<br>1.3 JTD<br>1.3 JTD<br>1.4 i<br>1.6 i 16V<br>1.6 Natural Power<br>1.9 D Multijet<br>1.9 JTD<br>1.9 JTD<br>1.9 JTD | 55<br>62<br>55<br>62<br>57<br>76<br>76<br>88<br>74<br>77<br>88       |  | 10.05<br>10.05<br>10.05<br>10.05<br>10.05<br>10.05<br>10.05<br>10.05<br>10.05<br>10.05<br>10.05 | 01.10<br>01.10<br>01.10<br>01.10<br>01.10<br>01.10<br>01.10<br>01.10<br>01.10<br>01.10<br>01.10 | + Bremsscheibendurchm. 258 mm <sup>2)</sup><br>+ Bremsscheibendurchm. 258 mm <sup>2)</sup><br>+ Bremsscheibendurchm. 258 mm <sup>2)</sup><br>+ Bremsscheibendurchm. 258 mm <sup>2)</sup><br>+ Bremsscheibendurchm. 258 mm <sup>2)</sup><br>+ Bremsscheibendurchm. 258 mm <sup>2)</sup><br>+ Bremsscheibendurchm. 258 mm <sup>2)</sup><br>+ Bremsscheibendurchm. 258 mm <sup>2)</sup><br>+ Bremsscheibendurchm. 258 mm <sup>2)</sup><br>+ Bremsscheibendurchm. 258 mm <sup>2)</sup><br>+ Bremsscheibendurchm. 258 mm <sup>2)</sup> | 13.0460-3850.2   | 603850 |   | 23707 18,0 /Zub/S | BOS |
|  | 1.2 i.e.<br>1.3 JTD<br>1.6 i 16V<br>1.6 Natural Power<br>1.9 D<br>1.9 JTD<br>1.9 JTD   | 48<br>51<br>76<br>76<br>46<br>74<br>77                               |  | 01.01<br>05.04<br>10.01<br>09.02<br>01.01<br>10.01<br>07.03                                     | 09.05<br>09.05<br>09.05<br>09.05<br>09.05<br>09.05<br>09.05                                     | 24.0120-0142.1<br>24.0320-0142.1  | 420142<br>520142 |        | 258 20,0 18,2 V L +B<br>258 20,0 18,2 V L +B PD |                   |     |
|  | 1.3 D Multijet<br>1.3 D Multijet<br>1.3 JTD<br>1.3 JTD<br>1.4 i<br>1.6 i 16V<br>1.6 Natural Power<br>1.9 JTD<br>1.9 JTD<br>1.9 JTD<br>1.9 JTD        | 55<br>62<br>55<br>62<br>57<br>76<br>76<br>88<br>74<br>77<br>88<br>88 |  | 10.05<br>10.05<br>10.05<br>10.05<br>10.05<br>10.05<br>09.02<br>10.05<br>10.05<br>10.05<br>10.05 | 01.10<br>01.10<br>01.10<br>01.10<br>01.10<br>01.10<br>01.10<br>01.10<br>01.10<br>01.10<br>01.10 | 24.0122-0147.1  | 422147           |        | 284 22,0 20,2 V +B                              |                   |     |
|  | 1.3 D Multijet<br>1.3 D Multijet<br>1.3 JTD<br>1.3 JTD<br>1.4 i<br>1.6 i 16V<br>1.6 Natural Power<br>1.9 JTD<br>1.9 JTD<br>1.9 JTD<br>1.9 JTD        | 55<br>62<br>55<br>62<br>57<br>76<br>76<br>88<br>74<br>77<br>88<br>88 |  | 10.05<br>10.05<br>10.05<br>10.05<br>10.05<br>10.05<br>09.02<br>10.05<br>10.05<br>10.05<br>10.05 | 01.10<br>01.10<br>01.10<br>01.10<br>01.10<br>01.10<br>01.10<br>01.10<br>01.10<br>01.10<br>01.10 | 24.0122-0197.1<br>24.0322-0197.1  | 422197<br>522197 |        | 258 22,0 20,2 V +B<br>258 22,0 20,2 V +B PD     |                   |     |

<sup>1)</sup> + brake disc diameter 284mm / + diametro dischi freno 284mm / + diamètre disques frein 284mm / + diámetro disco freno 284mm

<sup>2)</sup> + brake disc diameter 258mm / + diametro dischi freno 258mm / + diamètre disques frein 258mm / + diámetro disco freno 258mm

|          |   |                |   |                |   |  |  |                |  |  |                                      |                |   |                |        |                |        |                |   |       |       |                   |    |         |   |       |       |                |    |         |   |       |       |                |    |                |   |       |       |                |        |               |   |                |       |                    |       |                    |   |         |       |                   |       |                   |   |         |       |                |       |                |   |       |       |         |       |                |       |           |       |         |       |         |       |                   |       |         |       |         |       |                |       |         |       |         |       |         |       |             |       |             |       |         |       |                  |       |                  |       |         |       |                  |       |                  |       |                |       |       |       |                |        |  |                                     |                |    |       |       |                |        |         |    |       |       |  |  |         |    |       |       |  |  |       |    |       |       |  |  |           |    |       |       |  |  |                   |    |       |       |  |  |                |    |       |       |  |  |         |    |       |       |  |  |         |    |       |       |  |  |         |    |       |       |
|--|---|----------------|---|----------------|---|--|--|----------------|--|--|--------------------------------------|----------------|---|----------------|--------|----------------|--------|----------------|---|-------|-------|-------------------|----|---------|---|-------|-------|----------------|----|---------|---|-------|-------|----------------|----|----------------|---|-------|-------|----------------|--------|---------------|---|----------------|-------|--------------------|-------|--------------------|---|---------|-------|-------------------|-------|-------------------|---|---------|-------|----------------|-------|----------------|---|-------|-------|---------|-------|----------------|-------|-----------|-------|---------|-------|---------|-------|-------------------|-------|---------|-------|---------|-------|----------------|-------|---------|-------|---------|-------|---------|-------|-------------|-------|-------------|-------|---------|-------|------------------|-------|------------------|-------|---------|-------|------------------|-------|------------------|-------|----------------|-------|-------|-------|----------------|--------|--|-------------------------------------|----------------|----|-------|-------|----------------|--------|---------|----|-------|-------|--|--|---------|----|-------|-------|--|--|-------|----|-------|-------|--|--|-----------|----|-------|-------|--|--|-------------------|----|-------|-------|--|--|----------------|----|-------|-------|--|--|---------|----|-------|-------|--|--|---------|----|-------|-------|--|--|---------|----|-------|-------|
| <b>FIAT DOBLO (01-10)</b>  |   |                |   |                |   |  |  |                |  |  |                                      |                |   |                |        |                |        |                |   |       |       |                   |    |         |   |       |       |                |    |         |   |       |       |                |    |                |   |       |       |                |        |               |   |                |       |                    |       |                    |   |         |       |                   |       |                   |   |         |       |                |       |                |   |       |       |         |       |                |       |           |       |         |       |         |       |                   |       |         |       |         |       |                |       |         |       |         |       |         |       |             |       |             |       |         |       |                  |       |                  |       |         |       |                  |       |                  |       |                |       |       |       |                |        |  |                                     |                |    |       |       |                |        |         |    |       |       |  |  |         |    |       |       |  |  |       |    |       |       |  |  |           |    |       |       |  |  |                   |    |       |       |  |  |                |    |       |       |  |  |         |    |       |       |  |  |         |    |       |       |  |  |         |    |       |       |
|    | <table border="1"> <tr><td>1.3 D Multijet</td><td>55</td><td>10.05</td><td>01.10</td><td>24.0711-5071.3</td><td>360180</td><td rowspan="18"></td><td rowspan="18">Radsensor L=1280<br/>Radsensor L=1265</td></tr> <tr><td>1.3 D Multijet</td><td>62</td><td>10.05</td><td>01.10</td><td>24.0711-5072.3</td><td>360080</td></tr> <tr><td>1.3 JTD</td><td>55</td><td>10.05</td><td>01.10</td><td></td><td></td></tr> <tr><td>1.3 JTD</td><td>62</td><td>10.05</td><td>01.10</td><td></td><td></td></tr> <tr><td>1.4 i</td><td>57</td><td>10.05</td><td>01.10</td><td></td><td></td></tr> <tr><td>1.6 i 16V</td><td>76</td><td>10.01</td><td>01.10</td><td></td><td></td></tr> <tr><td>1.6 i 16V Bus</td><td>76</td><td>10.01</td><td>01.10</td><td></td><td></td></tr> <tr><td>1.6 i 16V Kastenw.</td><td>76</td><td>10.01</td><td>01.10</td><td></td><td></td></tr> <tr><td>1.6 Natural Power</td><td>76</td><td>09.02</td><td>01.10</td><td></td><td></td></tr> <tr><td>1.9 D Multijet</td><td>88</td><td>10.05</td><td>01.10</td><td></td><td></td></tr> <tr><td>1.9 JTD</td><td>74</td><td>10.01</td><td>01.10</td><td></td><td></td></tr> <tr><td>1.9 JTD</td><td>77</td><td>07.03</td><td>01.10</td><td></td><td></td></tr> <tr><td>1.9 JTD</td><td>77</td><td>07.03</td><td>01.10</td><td></td><td></td></tr> <tr><td>1.9 JTD</td><td>88</td><td>10.05</td><td>01.10</td><td></td><td></td></tr> <tr><td>1.9 JTD Bus</td><td>74</td><td>10.01</td><td>01.10</td><td></td><td></td></tr> <tr><td>1.9 JTD Kastenw.</td><td>74</td><td>10.01</td><td>01.10</td><td></td><td></td></tr> <tr><td>1.9 JTD Kastenw.</td><td>77</td><td>07.03</td><td>01.10</td><td></td><td></td></tr> </table>   | 1.3 D Multijet | 55  | 10.05          | 01.10                                       | 24.0711-5071.3   | 360180   |                | Radsensor L=1280<br>Radsensor L=1265               | 1.3 D Multijet   | 62                                   | 10.05          | 01.10                                       | 24.0711-5072.3 | 360080 | 1.3 JTD        | 55     | 10.05          | 01.10                                       |       |       | 1.3 JTD           | 62 | 10.05   | 01.10                                       |       |       | 1.4 i          | 57 | 10.05   | 01.10                                       |       |       | 1.6 i 16V      | 76 | 10.01          | 01.10                                       |       |       | 1.6 i 16V Bus  | 76     | 10.01         | 01.10                                       |                |       | 1.6 i 16V Kastenw. | 76    | 10.01              | 01.10                                       |         |       | 1.6 Natural Power | 76    | 09.02             | 01.10                                       |         |       | 1.9 D Multijet | 88    | 10.05          | 01.10                                       |       |       | 1.9 JTD | 74    | 10.01          | 01.10 |           |       | 1.9 JTD | 77    | 07.03   | 01.10 |                   |       | 1.9 JTD | 77    | 07.03   | 01.10 |                |       | 1.9 JTD | 88    | 10.05   | 01.10 |         |       | 1.9 JTD Bus | 74    | 10.01       | 01.10 |         |       | 1.9 JTD Kastenw. | 74    | 10.01            | 01.10 |         |       | 1.9 JTD Kastenw. | 77    | 07.03            | 01.10 |                |       |       |       |                |        |  |                                     |                |    |       |       |                |        |         |    |       |       |  |  |         |    |       |       |  |  |       |    |       |       |  |  |           |    |       |       |  |  |                   |    |       |       |  |  |                |    |       |       |  |  |         |    |       |       |  |  |         |    |       |       |  |  |         |    |       |       |
| 1.3 D Multijet   | 55  | 10.05          | 01.10                                       | 24.0711-5071.3 | 360180                                      |  | Radsensor L=1280<br>Radsensor L=1265               |                |  |  |                                      |                |   |                |        |                |        |                |   |       |       |                   |    |         |   |       |       |                |    |         |   |       |       |                |    |                |   |       |       |                |        |               |   |                |       |                    |       |                    |   |         |       |                   |       |                   |   |         |       |                |       |                |   |       |       |         |       |                |       |           |       |         |       |         |       |                   |       |         |       |         |       |                |       |         |       |         |       |         |       |             |       |             |       |         |       |                  |       |                  |       |         |       |                  |       |                  |       |                |       |       |       |                |        |  |                                     |                |    |       |       |                |        |         |    |       |       |  |  |         |    |       |       |  |  |       |    |       |       |  |  |           |    |       |       |  |  |                   |    |       |       |  |  |                |    |       |       |  |  |         |    |       |       |  |  |         |    |       |       |  |  |         |    |       |       |
| 1.3 D Multijet   | 62  | 10.05          | 01.10                                       | 24.0711-5072.3 | 360080                                      |  |  |                |  |  |                                      |                |   |                |        |                |        |                |   |       |       |                   |    |         |   |       |       |                |    |         |   |       |       |                |    |                |   |       |       |                |        |               |   |                |       |                    |       |                    |   |         |       |                   |       |                   |   |         |       |                |       |                |   |       |       |         |       |                |       |           |       |         |       |         |       |                   |       |         |       |         |       |                |       |         |       |         |       |         |       |             |       |             |       |         |       |                  |       |                  |       |         |       |                  |       |                  |       |                |       |       |       |                |        |  |                                     |                |    |       |       |                |        |         |    |       |       |  |  |         |    |       |       |  |  |       |    |       |       |  |  |           |    |       |       |  |  |                   |    |       |       |  |  |                |    |       |       |  |  |         |    |       |       |  |  |         |    |       |       |  |  |         |    |       |       |
| 1.3 JTD  | 55  | 10.05          | 01.10                                       |                |   |  |  |                |  |  |                                      |                |   |                |        |                |        |                |   |       |       |                   |    |         |   |       |       |                |    |         |   |       |       |                |    |                |   |       |       |                |        |               |   |                |       |                    |       |                    |   |         |       |                   |       |                   |   |         |       |                |       |                |   |       |       |         |       |                |       |           |       |         |       |         |       |                   |       |         |       |         |       |                |       |         |       |         |       |         |       |             |       |             |       |         |       |                  |       |                  |       |         |       |                  |       |                  |       |                |       |       |       |                |        |  |                                     |                |    |       |       |                |        |         |    |       |       |  |  |         |    |       |       |  |  |       |    |       |       |  |  |           |    |       |       |  |  |                   |    |       |       |  |  |                |    |       |       |  |  |         |    |       |       |  |  |         |    |       |       |  |  |         |    |       |       |
| 1.3 JTD  | 62  | 10.05          | 01.10                                       |                |   |  |  |                |  |  |                                      |                |   |                |        |                |        |                |   |       |       |                   |    |         |   |       |       |                |    |         |   |       |       |                |    |                |   |       |       |                |        |               |   |                |       |                    |       |                    |   |         |       |                   |       |                   |   |         |       |                |       |                |   |       |       |         |       |                |       |           |       |         |       |         |       |                   |       |         |       |         |       |                |       |         |       |         |       |         |       |             |       |             |       |         |       |                  |       |                  |       |         |       |                  |       |                  |       |                |       |       |       |                |        |  |                                     |                |    |       |       |                |        |         |    |       |       |  |  |         |    |       |       |  |  |       |    |       |       |  |  |           |    |       |       |  |  |                   |    |       |       |  |  |                |    |       |       |  |  |         |    |       |       |  |  |         |    |       |       |  |  |         |    |       |       |
| 1.4 i  | 57  | 10.05          | 01.10                                       |                |   |  |  |                |  |  |                                      |                |   |                |        |                |        |                |   |       |       |                   |    |         |   |       |       |                |    |         |   |       |       |                |    |                |   |       |       |                |        |               |   |                |       |                    |       |                    |   |         |       |                   |       |                   |   |         |       |                |       |                |   |       |       |         |       |                |       |           |       |         |       |         |       |                   |       |         |       |         |       |                |       |         |       |         |       |         |       |             |       |             |       |         |       |                  |       |                  |       |         |       |                  |       |                  |       |                |       |       |       |                |        |  |                                     |                |    |       |       |                |        |         |    |       |       |  |  |         |    |       |       |  |  |       |    |       |       |  |  |           |    |       |       |  |  |                   |    |       |       |  |  |                |    |       |       |  |  |         |    |       |       |  |  |         |    |       |       |  |  |         |    |       |       |
| 1.6 i 16V  | 76  | 10.01          | 01.10                                       |                |   |  |  |                |  |  |                                      |                |   |                |        |                |        |                |   |       |       |                   |    |         |   |       |       |                |    |         |   |       |       |                |    |                |   |       |       |                |        |               |   |                |       |                    |       |                    |   |         |       |                   |       |                   |   |         |       |                |       |                |   |       |       |         |       |                |       |           |       |         |       |         |       |                   |       |         |       |         |       |                |       |         |       |         |       |         |       |             |       |             |       |         |       |                  |       |                  |       |         |       |                  |       |                  |       |                |       |       |       |                |        |  |                                     |                |    |       |       |                |        |         |    |       |       |  |  |         |    |       |       |  |  |       |    |       |       |  |  |           |    |       |       |  |  |                   |    |       |       |  |  |                |    |       |       |  |  |         |    |       |       |  |  |         |    |       |       |  |  |         |    |       |       |
| 1.6 i 16V Bus  | 76  | 10.01          | 01.10                                       |                |   |  |  |                |  |  |                                      |                |   |                |        |                |        |                |   |       |       |                   |    |         |   |       |       |                |    |         |   |       |       |                |    |                |   |       |       |                |        |               |   |                |       |                    |       |                    |   |         |       |                   |       |                   |   |         |       |                |       |                |   |       |       |         |       |                |       |           |       |         |       |         |       |                   |       |         |       |         |       |                |       |         |       |         |       |         |       |             |       |             |       |         |       |                  |       |                  |       |         |       |                  |       |                  |       |                |       |       |       |                |        |  |                                     |                |    |       |       |                |        |         |    |       |       |  |  |         |    |       |       |  |  |       |    |       |       |  |  |           |    |       |       |  |  |                   |    |       |       |  |  |                |    |       |       |  |  |         |    |       |       |  |  |         |    |       |       |  |  |         |    |       |       |
| 1.6 i 16V Kastenw.   | 76  | 10.01          | 01.10                                       |                |   |  |  |                |  |  |                                      |                |   |                |        |                |        |                |   |       |       |                   |    |         |   |       |       |                |    |         |   |       |       |                |    |                |   |       |       |                |        |               |   |                |       |                    |       |                    |   |         |       |                   |       |                   |   |         |       |                |       |                |   |       |       |         |       |                |       |           |       |         |       |         |       |                   |       |         |       |         |       |                |       |         |       |         |       |         |       |             |       |             |       |         |       |                  |       |                  |       |         |       |                  |       |                  |       |                |       |       |       |                |        |  |                                     |                |    |       |       |                |        |         |    |       |       |  |  |         |    |       |       |  |  |       |    |       |       |  |  |           |    |       |       |  |  |                   |    |       |       |  |  |                |    |       |       |  |  |         |    |       |       |  |  |         |    |       |       |  |  |         |    |       |       |
| 1.6 Natural Power  | 76  | 09.02          | 01.10                                       |                |   |  |  |                |  |  |                                      |                |   |                |        |                |        |                |   |       |       |                   |    |         |   |       |       |                |    |         |   |       |       |                |    |                |   |       |       |                |        |               |   |                |       |                    |       |                    |   |         |       |                   |       |                   |   |         |       |                |       |                |   |       |       |         |       |                |       |           |       |         |       |         |       |                   |       |         |       |         |       |                |       |         |       |         |       |         |       |             |       |             |       |         |       |                  |       |                  |       |         |       |                  |       |                  |       |                |       |       |       |                |        |  |                                     |                |    |       |       |                |        |         |    |       |       |  |  |         |    |       |       |  |  |       |    |       |       |  |  |           |    |       |       |  |  |                   |    |       |       |  |  |                |    |       |       |  |  |         |    |       |       |  |  |         |    |       |       |  |  |         |    |       |       |
| 1.9 D Multijet   | 88  | 10.05          | 01.10                                       |                |   |  |  |                |  |  |                                      |                |   |                |        |                |        |                |   |       |       |                   |    |         |   |       |       |                |    |         |   |       |       |                |    |                |   |       |       |                |        |               |   |                |       |                    |       |                    |   |         |       |                   |       |                   |   |         |       |                |       |                |   |       |       |         |       |                |       |           |       |         |       |         |       |                   |       |         |       |         |       |                |       |         |       |         |       |         |       |             |       |             |       |         |       |                  |       |                  |       |         |       |                  |       |                  |       |                |       |       |       |                |        |  |                                     |                |    |       |       |                |        |         |    |       |       |  |  |         |    |       |       |  |  |       |    |       |       |  |  |           |    |       |       |  |  |                   |    |       |       |  |  |                |    |       |       |  |  |         |    |       |       |  |  |         |    |       |       |  |  |         |    |       |       |
| 1.9 JTD  | 74  | 10.01          | 01.10                                       |                |   |  |  |                |  |  |                                      |                |   |                |        |                |        |                |   |       |       |                   |    |         |   |       |       |                |    |         |   |       |       |                |    |                |   |       |       |                |        |               |   |                |       |                    |       |                    |   |         |       |                   |       |                   |   |         |       |                |       |                |   |       |       |         |       |                |       |           |       |         |       |         |       |                   |       |         |       |         |       |                |       |         |       |         |       |         |       |             |       |             |       |         |       |                  |       |                  |       |         |       |                  |       |                  |       |                |       |       |       |                |        |  |                                     |                |    |       |       |                |        |         |    |       |       |  |  |         |    |       |       |  |  |       |    |       |       |  |  |           |    |       |       |  |  |                   |    |       |       |  |  |                |    |       |       |  |  |         |    |       |       |  |  |         |    |       |       |  |  |         |    |       |       |
| 1.9 JTD  | 77  | 07.03          | 01.10                                       |                |   |  |  |                |  |  |                                      |                |   |                |        |                |        |                |   |       |       |                   |    |         |   |       |       |                |    |         |   |       |       |                |    |                |   |       |       |                |        |               |   |                |       |                    |       |                    |   |         |       |                   |       |                   |   |         |       |                |       |                |   |       |       |         |       |                |       |           |       |         |       |         |       |                   |       |         |       |         |       |                |       |         |       |         |       |         |       |             |       |             |       |         |       |                  |       |                  |       |         |       |                  |       |                  |       |                |       |       |       |                |        |  |                                     |                |    |       |       |                |        |         |    |       |       |  |  |         |    |       |       |  |  |       |    |       |       |  |  |           |    |       |       |  |  |                   |    |       |       |  |  |                |    |       |       |  |  |         |    |       |       |  |  |         |    |       |       |  |  |         |    |       |       |
| 1.9 JTD  | 77  | 07.03          | 01.10                                       |                |   |  |  |                |  |  |                                      |                |   |                |        |                |        |                |   |       |       |                   |    |         |   |       |       |                |    |         |   |       |       |                |    |                |   |       |       |                |        |               |   |                |       |                    |       |                    |   |         |       |                   |       |                   |   |         |       |                |       |                |   |       |       |         |       |                |       |           |       |         |       |         |       |                   |       |         |       |         |       |                |       |         |       |         |       |         |       |             |       |             |       |         |       |                  |       |                  |       |         |       |                  |       |                  |       |                |       |       |       |                |        |  |                                     |                |    |       |       |                |        |         |    |       |       |  |  |         |    |       |       |  |  |       |    |       |       |  |  |           |    |       |       |  |  |                   |    |       |       |  |  |                |    |       |       |  |  |         |    |       |       |  |  |         |    |       |       |  |  |         |    |       |       |
| 1.9 JTD  | 88  | 10.05          | 01.10                                       |                |   |  |  |                |  |  |                                      |                |   |                |        |                |        |                |   |       |       |                   |    |         |   |       |       |                |    |         |   |       |       |                |    |                |   |       |       |                |        |               |   |                |       |                    |       |                    |   |         |       |                   |       |                   |   |         |       |                |       |                |   |       |       |         |       |                |       |           |       |         |       |         |       |                   |       |         |       |         |       |                |       |         |       |         |       |         |       |             |       |             |       |         |       |                  |       |                  |       |         |       |                  |       |                  |       |                |       |       |       |                |        |  |                                     |                |    |       |       |                |        |         |    |       |       |  |  |         |    |       |       |  |  |       |    |       |       |  |  |           |    |       |       |  |  |                   |    |       |       |  |  |                |    |       |       |  |  |         |    |       |       |  |  |         |    |       |       |  |  |         |    |       |       |
| 1.9 JTD Bus  | 74  | 10.01          | 01.10                                       |                |   |  |  |                |  |  |                                      |                |   |                |        |                |        |                |   |       |       |                   |    |         |   |       |       |                |    |         |   |       |       |                |    |                |   |       |       |                |        |               |   |                |       |                    |       |                    |   |         |       |                   |       |                   |   |         |       |                |       |                |   |       |       |         |       |                |       |           |       |         |       |         |       |                   |       |         |       |         |       |                |       |         |       |         |       |         |       |             |       |             |       |         |       |                  |       |                  |       |         |       |                  |       |                  |       |                |       |       |       |                |        |  |                                     |                |    |       |       |                |        |         |    |       |       |  |  |         |    |       |       |  |  |       |    |       |       |  |  |           |    |       |       |  |  |                   |    |       |       |  |  |                |    |       |       |  |  |         |    |       |       |  |  |         |    |       |       |  |  |         |    |       |       |
| 1.9 JTD Kastenw.   | 74  | 10.01          | 01.10                                       |                |   |  |  |                |  |  |                                      |                |   |                |        |                |        |                |   |       |       |                   |    |         |   |       |       |                |    |         |   |       |       |                |    |                |   |       |       |                |        |               |   |                |       |                    |       |                    |   |         |       |                   |       |                   |   |         |       |                |       |                |   |       |       |         |       |                |       |           |       |         |       |         |       |                   |       |         |       |         |       |                |       |         |       |         |       |         |       |             |       |             |       |         |       |                  |       |                  |       |         |       |                  |       |                  |       |                |       |       |       |                |        |  |                                     |                |    |       |       |                |        |         |    |       |       |  |  |         |    |       |       |  |  |       |    |       |       |  |  |           |    |       |       |  |  |                   |    |       |       |  |  |                |    |       |       |  |  |         |    |       |       |  |  |         |    |       |       |  |  |         |    |       |       |
| 1.9 JTD Kastenw.   | 77  | 07.03          | 01.10                                       |                |   |  |  |                |  |  |                                      |                |   |                |        |                |        |                |   |       |       |                   |    |         |   |       |       |                |    |         |   |       |       |                |    |                |   |       |       |                |        |               |   |                |       |                    |       |                    |   |         |       |                   |       |                   |   |         |       |                |       |                |   |       |       |         |       |                |       |           |       |         |       |         |       |                   |       |         |       |         |       |                |       |         |       |         |       |         |       |             |       |             |       |         |       |                  |       |                  |       |         |       |                  |       |                  |       |                |       |       |       |                |        |  |                                     |                |    |       |       |                |        |         |    |       |       |  |  |         |    |       |       |  |  |       |    |       |       |  |  |           |    |       |       |  |  |                   |    |       |       |  |  |                |    |       |       |  |  |         |    |       |       |  |  |         |    |       |       |  |  |         |    |       |       |
|    | <table border="1"> <tr><td>1.3 D Multijet</td><td>55</td><td>10.05</td><td>01.10</td><td>24.0711-5130.3</td><td>360106</td><td rowspan="18">2  + Kastenwagen <sup>1)</sup><br/>2  + Bus <sup>2)</sup></td><td rowspan="18">Radsensor L=1880<br/>Radsensor L=1880</td></tr> <tr><td>1.3 D Multijet</td><td>62</td><td>10.05</td><td>01.10</td><td>24.0711-5131.3</td><td>360107</td></tr> <tr><td>1.3 JTD</td><td>55</td><td>10.05</td><td>01.10</td><td></td><td></td></tr> <tr><td>1.3 JTD</td><td>62</td><td>10.05</td><td>01.10</td><td></td><td></td></tr> <tr><td>1.4 i</td><td>57</td><td>10.05</td><td>01.10</td><td></td><td></td></tr> <tr><td>1.6 i 16V</td><td>76</td><td>10.01</td><td>01.10</td><td></td><td></td></tr> <tr><td>1.6 i 16V Bus</td><td>76</td><td>10.01</td><td>01.10</td><td></td><td></td></tr> <tr><td>1.6 i 16V Kastenw.</td><td>76</td><td>10.01</td><td>01.10</td><td></td><td></td></tr> <tr><td>1.6 Natural Power</td><td>76</td><td>09.02</td><td>01.10</td><td></td><td></td></tr> <tr><td>1.9 D Multijet</td><td>88</td><td>10.05</td><td>01.10</td><td></td><td></td></tr> <tr><td>1.9 JTD</td><td>74</td><td>10.01</td><td>01.10</td><td></td><td></td></tr> <tr><td>1.9 JTD</td><td>77</td><td>07.03</td><td>01.10</td><td></td><td></td></tr> <tr><td>1.9 JTD</td><td>77</td><td>07.03</td><td>01.10</td><td></td><td></td></tr> <tr><td>1.9 JTD</td><td>88</td><td>10.05</td><td>01.10</td><td></td><td></td></tr> <tr><td>1.9 JTD Bus</td><td>74</td><td>10.01</td><td>01.10</td><td></td><td></td></tr> <tr><td>1.9 JTD Kastenw.</td><td>74</td><td>10.01</td><td>01.10</td><td></td><td></td></tr> <tr><td>1.9 JTD Kastenw.</td><td>77</td><td>07.03</td><td>01.10</td><td></td><td></td></tr> </table>  | 1.3 D Multijet | 55  | 10.05          | 01.10                                       |  |  | 24.0711-5130.3 | 360106   | 2  + Kastenwagen <sup>1)</sup><br>2  + Bus <sup>2)</sup> | Radsensor L=1880<br>Radsensor L=1880 | 1.3 D Multijet | 62  | 10.05          | 01.10  | 24.0711-5131.3 | 360107 | 1.3 JTD        | 55  | 10.05 | 01.10 |                   |    | 1.3 JTD | 62  | 10.05 | 01.10 |                |    | 1.4 i   | 57  | 10.05 | 01.10 |                |    | 1.6 i 16V      | 76  | 10.01 | 01.10 |                |        | 1.6 i 16V Bus | 76  | 10.01          | 01.10 |                    |       | 1.6 i 16V Kastenw. | 76  | 10.01   | 01.10 |                   |       | 1.6 Natural Power | 76  | 09.02   | 01.10 |                |       | 1.9 D Multijet | 88  | 10.05 | 01.10 |         |       | 1.9 JTD        | 74    | 10.01     | 01.10 |         |       | 1.9 JTD | 77    | 07.03             | 01.10 |         |       | 1.9 JTD | 77    | 07.03          | 01.10 |         |       | 1.9 JTD | 88    | 10.05   | 01.10 |             |       | 1.9 JTD Bus | 74    | 10.01   | 01.10 |                  |       | 1.9 JTD Kastenw. | 74    | 10.01   | 01.10 |                  |       | 1.9 JTD Kastenw. | 77    | 07.03          | 01.10 |       |       |                |        |  |                                     |                |    |       |       |                |        |         |    |       |       |  |  |         |    |       |       |  |  |       |    |       |       |  |  |           |    |       |       |  |  |                   |    |       |       |  |  |                |    |       |       |  |  |         |    |       |       |  |  |         |    |       |       |  |  |         |    |       |       |
| 1.3 D Multijet   | 55  | 10.05          | 01.10                                       | 24.0711-5130.3 | 360106                                      | 2  + Kastenwagen <sup>1)</sup><br>2  + Bus <sup>2)</sup> | Radsensor L=1880<br>Radsensor L=1880               |                |  |  |                                      |                |   |                |        |                |        |                |   |       |       |                   |    |         |   |       |       |                |    |         |   |       |       |                |    |                |   |       |       |                |        |               |   |                |       |                    |       |                    |   |         |       |                   |       |                   |   |         |       |                |       |                |   |       |       |         |       |                |       |           |       |         |       |         |       |                   |       |         |       |         |       |                |       |         |       |         |       |         |       |             |       |             |       |         |       |                  |       |                  |       |         |       |                  |       |                  |       |                |       |       |       |                |        |  |                                     |                |    |       |       |                |        |         |    |       |       |  |  |         |    |       |       |  |  |       |    |       |       |  |  |           |    |       |       |  |  |                   |    |       |       |  |  |                |    |       |       |  |  |         |    |       |       |  |  |         |    |       |       |  |  |         |    |       |       |
| 1.3 D Multijet   | 62  | 10.05          | 01.10                                       | 24.0711-5131.3 | 360107                                      |  |  |                |  |  |                                      |                |   |                |        |                |        |                |   |       |       |                   |    |         |   |       |       |                |    |         |   |       |       |                |    |                |   |       |       |                |        |               |   |                |       |                    |       |                    |   |         |       |                   |       |                   |   |         |       |                |       |                |   |       |       |         |       |                |       |           |       |         |       |         |       |                   |       |         |       |         |       |                |       |         |       |         |       |         |       |             |       |             |       |         |       |                  |       |                  |       |         |       |                  |       |                  |       |                |       |       |       |                |        |  |                                     |                |    |       |       |                |        |         |    |       |       |  |  |         |    |       |       |  |  |       |    |       |       |  |  |           |    |       |       |  |  |                   |    |       |       |  |  |                |    |       |       |  |  |         |    |       |       |  |  |         |    |       |       |  |  |         |    |       |       |
| 1.3 JTD  | 55  | 10.05          | 01.10                                       |                |   |  |  |                |  |  |                                      |                |   |                |        |                |        |                |   |       |       |                   |    |         |   |       |       |                |    |         |   |       |       |                |    |                |   |       |       |                |        |               |   |                |       |                    |       |                    |   |         |       |                   |       |                   |   |         |       |                |       |                |   |       |       |         |       |                |       |           |       |         |       |         |       |                   |       |         |       |         |       |                |       |         |       |         |       |         |       |             |       |             |       |         |       |                  |       |                  |       |         |       |                  |       |                  |       |                |       |       |       |                |        |  |                                     |                |    |       |       |                |        |         |    |       |       |  |  |         |    |       |       |  |  |       |    |       |       |  |  |           |    |       |       |  |  |                   |    |       |       |  |  |                |    |       |       |  |  |         |    |       |       |  |  |         |    |       |       |  |  |         |    |       |       |
| 1.3 JTD  | 62  | 10.05          | 01.10                                       |                |   |  |  |                |  |  |                                      |                |   |                |        |                |        |                |   |       |       |                   |    |         |   |       |       |                |    |         |   |       |       |                |    |                |   |       |       |                |        |               |   |                |       |                    |       |                    |   |         |       |                   |       |                   |   |         |       |                |       |                |   |       |       |         |       |                |       |           |       |         |       |         |       |                   |       |         |       |         |       |                |       |         |       |         |       |         |       |             |       |             |       |         |       |                  |       |                  |       |         |       |                  |       |                  |       |                |       |       |       |                |        |  |                                     |                |    |       |       |                |        |         |    |       |       |  |  |         |    |       |       |  |  |       |    |       |       |  |  |           |    |       |       |  |  |                   |    |       |       |  |  |                |    |       |       |  |  |         |    |       |       |  |  |         |    |       |       |  |  |         |    |       |       |
| 1.4 i  | 57  | 10.05          | 01.10                                       |                |   |  |  |                |  |  |                                      |                |   |                |        |                |        |                |   |       |       |                   |    |         |   |       |       |                |    |         |   |       |       |                |    |                |   |       |       |                |        |               |   |                |       |                    |       |                    |   |         |       |                   |       |                   |   |         |       |                |       |                |   |       |       |         |       |                |       |           |       |         |       |         |       |                   |       |         |       |         |       |                |       |         |       |         |       |         |       |             |       |             |       |         |       |                  |       |                  |       |         |       |                  |       |                  |       |                |       |       |       |                |        |  |                                     |                |    |       |       |                |        |         |    |       |       |  |  |         |    |       |       |  |  |       |    |       |       |  |  |           |    |       |       |  |  |                   |    |       |       |  |  |                |    |       |       |  |  |         |    |       |       |  |  |         |    |       |       |  |  |         |    |       |       |
| 1.6 i 16V  | 76  | 10.01          | 01.10                                       |                |   |  |  |                |  |  |                                      |                |   |                |        |                |        |                |   |       |       |                   |    |         |   |       |       |                |    |         |   |       |       |                |    |                |   |       |       |                |        |               |   |                |       |                    |       |                    |   |         |       |                   |       |                   |   |         |       |                |       |                |   |       |       |         |       |                |       |           |       |         |       |         |       |                   |       |         |       |         |       |                |       |         |       |         |       |         |       |             |       |             |       |         |       |                  |       |                  |       |         |       |                  |       |                  |       |                |       |       |       |                |        |  |                                     |                |    |       |       |                |        |         |    |       |       |  |  |         |    |       |       |  |  |       |    |       |       |  |  |           |    |       |       |  |  |                   |    |       |       |  |  |                |    |       |       |  |  |         |    |       |       |  |  |         |    |       |       |  |  |         |    |       |       |
| 1.6 i 16V Bus  | 76  | 10.01          | 01.10                                       |                |   |  |  |                |  |  |                                      |                |   |                |        |                |        |                |   |       |       |                   |    |         |   |       |       |                |    |         |   |       |       |                |    |                |   |       |       |                |        |               |   |                |       |                    |       |                    |   |         |       |                   |       |                   |   |         |       |                |       |                |   |       |       |         |       |                |       |           |       |         |       |         |       |                   |       |         |       |         |       |                |       |         |       |         |       |         |       |             |       |             |       |         |       |                  |       |                  |       |         |       |                  |       |                  |       |                |       |       |       |                |        |  |                                     |                |    |       |       |                |        |         |    |       |       |  |  |         |    |       |       |  |  |       |    |       |       |  |  |           |    |       |       |  |  |                   |    |       |       |  |  |                |    |       |       |  |  |         |    |       |       |  |  |         |    |       |       |  |  |         |    |       |       |
| 1.6 i 16V Kastenw.   | 76  | 10.01          | 01.10                                       |                |   |  |  |                |  |  |                                      |                |   |                |        |                |        |                |   |       |       |                   |    |         |   |       |       |                |    |         |   |       |       |                |    |                |   |       |       |                |        |               |   |                |       |                    |       |                    |   |         |       |                   |       |                   |   |         |       |                |       |                |   |       |       |         |       |                |       |           |       |         |       |         |       |                   |       |         |       |         |       |                |       |         |       |         |       |         |       |             |       |             |       |         |       |                  |       |                  |       |         |       |                  |       |                  |       |                |       |       |       |                |        |  |                                     |                |    |       |       |                |        |         |    |       |       |  |  |         |    |       |       |  |  |       |    |       |       |  |  |           |    |       |       |  |  |                   |    |       |       |  |  |                |    |       |       |  |  |         |    |       |       |  |  |         |    |       |       |  |  |         |    |       |       |
| 1.6 Natural Power  | 76  | 09.02          | 01.10                                       |                |   |  |  |                |  |  |                                      |                |   |                |        |                |        |                |   |       |       |                   |    |         |   |       |       |                |    |         |   |       |       |                |    |                |   |       |       |                |        |               |   |                |       |                    |       |                    |   |         |       |                   |       |                   |   |         |       |                |       |                |   |       |       |         |       |                |       |           |       |         |       |         |       |                   |       |         |       |         |       |                |       |         |       |         |       |         |       |             |       |             |       |         |       |                  |       |                  |       |         |       |                  |       |                  |       |                |       |       |       |                |        |  |                                     |                |    |       |       |                |        |         |    |       |       |  |  |         |    |       |       |  |  |       |    |       |       |  |  |           |    |       |       |  |  |                   |    |       |       |  |  |                |    |       |       |  |  |         |    |       |       |  |  |         |    |       |       |  |  |         |    |       |       |
| 1.9 D Multijet   | 88  | 10.05          | 01.10                                       |                |   |  |  |                |  |  |                                      |                |   |                |        |                |        |                |   |       |       |                   |    |         |   |       |       |                |    |         |   |       |       |                |    |                |   |       |       |                |        |               |   |                |       |                    |       |                    |   |         |       |                   |       |                   |   |         |       |                |       |                |   |       |       |         |       |                |       |           |       |         |       |         |       |                   |       |         |       |         |       |                |       |         |       |         |       |         |       |             |       |             |       |         |       |                  |       |                  |       |         |       |                  |       |                  |       |                |       |       |       |                |        |  |                                     |                |    |       |       |                |        |         |    |       |       |  |  |         |    |       |       |  |  |       |    |       |       |  |  |           |    |       |       |  |  |                   |    |       |       |  |  |                |    |       |       |  |  |         |    |       |       |  |  |         |    |       |       |  |  |         |    |       |       |
| 1.9 JTD  | 74  | 10.01          | 01.10                                       |                |   |  |  |                |  |  |                                      |                |   |                |        |                |        |                |   |       |       |                   |    |         |   |       |       |                |    |         |   |       |       |                |    |                |   |       |       |                |        |               |   |                |       |                    |       |                    |   |         |       |                   |       |                   |   |         |       |                |       |                |   |       |       |         |       |                |       |           |       |         |       |         |       |                   |       |         |       |         |       |                |       |         |       |         |       |         |       |             |       |             |       |         |       |                  |       |                  |       |         |       |                  |       |                  |       |                |       |       |       |                |        |  |                                     |                |    |       |       |                |        |         |    |       |       |  |  |         |    |       |       |  |  |       |    |       |       |  |  |           |    |       |       |  |  |                   |    |       |       |  |  |                |    |       |       |  |  |         |    |       |       |  |  |         |    |       |       |  |  |         |    |       |       |
| 1.9 JTD  | 77  | 07.03          | 01.10                                       |                |   |  |  |                |  |  |                                      |                |   |                |        |                |        |                |   |       |       |                   |    |         |   |       |       |                |    |         |   |       |       |                |    |                |   |       |       |                |        |               |   |                |       |                    |       |                    |   |         |       |                   |       |                   |   |         |       |                |       |                |   |       |       |         |       |                |       |           |       |         |       |         |       |                   |       |         |       |         |       |                |       |         |       |         |       |         |       |             |       |             |       |         |       |                  |       |                  |       |         |       |                  |       |                  |       |                |       |       |       |                |        |  |                                     |                |    |       |       |                |        |         |    |       |       |  |  |         |    |       |       |  |  |       |    |       |       |  |  |           |    |       |       |  |  |                   |    |       |       |  |  |                |    |       |       |  |  |         |    |       |       |  |  |         |    |       |       |  |  |         |    |       |       |
| 1.9 JTD  | 77  | 07.03          | 01.10                                       |                |   |  |  |                |  |  |                                      |                |   |                |        |                |        |                |   |       |       |                   |    |         |   |       |       |                |    |         |   |       |       |                |    |                |   |       |       |                |        |               |   |                |       |                    |       |                    |   |         |       |                   |       |                   |   |         |       |                |       |                |   |       |       |         |       |                |       |           |       |         |       |         |       |                   |       |         |       |         |       |                |       |         |       |         |       |         |       |             |       |             |       |         |       |                  |       |                  |       |         |       |                  |       |                  |       |                |       |       |       |                |        |  |                                     |                |    |       |       |                |        |         |    |       |       |  |  |         |    |       |       |  |  |       |    |       |       |  |  |           |    |       |       |  |  |                   |    |       |       |  |  |                |    |       |       |  |  |         |    |       |       |  |  |         |    |       |       |  |  |         |    |       |       |
| 1.9 JTD  | 88  | 10.05          | 01.10                                       |                |   |  |  |                |  |  |                                      |                |   |                |        |                |        |                |   |       |       |                   |    |         |   |       |       |                |    |         |   |       |       |                |    |                |   |       |       |                |        |               |   |                |       |                    |       |                    |   |         |       |                   |       |                   |   |         |       |                |       |                |   |       |       |         |       |                |       |           |       |         |       |         |       |                   |       |         |       |         |       |                |       |         |       |         |       |         |       |             |       |             |       |         |       |                  |       |                  |       |         |       |                  |       |                  |       |                |       |       |       |                |        |  |                                     |                |    |       |       |                |        |         |    |       |       |  |  |         |    |       |       |  |  |       |    |       |       |  |  |           |    |       |       |  |  |                   |    |       |       |  |  |                |    |       |       |  |  |         |    |       |       |  |  |         |    |       |       |  |  |         |    |       |       |
| 1.9 JTD Bus  | 74  | 10.01          | 01.10                                       |                |   |  |  |                |  |  |                                      |                |   |                |        |                |        |                |   |       |       |                   |    |         |   |       |       |                |    |         |   |       |       |                |    |                |   |       |       |                |        |               |   |                |       |                    |       |                    |   |         |       |                   |       |                   |   |         |       |                |       |                |   |       |       |         |       |                |       |           |       |         |       |         |       |                   |       |         |       |         |       |                |       |         |       |         |       |         |       |             |       |             |       |         |       |                  |       |                  |       |         |       |                  |       |                  |       |                |       |       |       |                |        |  |                                     |                |    |       |       |                |        |         |    |       |       |  |  |         |    |       |       |  |  |       |    |       |       |  |  |           |    |       |       |  |  |                   |    |       |       |  |  |                |    |       |       |  |  |         |    |       |       |  |  |         |    |       |       |  |  |         |    |       |       |
| 1.9 JTD Kastenw.   | 74  | 10.01          | 01.10                                       |                |   |  |  |                |  |  |                                      |                |   |                |        |                |        |                |   |       |       |                   |    |         |   |       |       |                |    |         |   |       |       |                |    |                |   |       |       |                |        |               |   |                |       |                    |       |                    |   |         |       |                   |       |                   |   |         |       |                |       |                |   |       |       |         |       |                |       |           |       |         |       |         |       |                   |       |         |       |         |       |                |       |         |       |         |       |         |       |             |       |             |       |         |       |                  |       |                  |       |         |       |                  |       |                  |       |                |       |       |       |                |        |  |                                     |                |    |       |       |                |        |         |    |       |       |  |  |         |    |       |       |  |  |       |    |       |       |  |  |           |    |       |       |  |  |                   |    |       |       |  |  |                |    |       |       |  |  |         |    |       |       |  |  |         |    |       |       |  |  |         |    |       |       |
| 1.9 JTD Kastenw.   | 77  | 07.03          | 01.10                                       |                |   |  |  |                |  |  |                                      |                |   |                |        |                |        |                |   |       |       |                   |    |         |   |       |       |                |    |         |   |       |       |                |    |                |   |       |       |                |        |               |   |                |       |                    |       |                    |   |         |       |                   |       |                   |   |         |       |                |       |                |   |       |       |         |       |                |       |           |       |         |       |         |       |                   |       |         |       |         |       |                |       |         |       |         |       |         |       |             |       |             |       |         |       |                  |       |                  |       |         |       |                  |       |                  |       |                |       |       |       |                |        |  |                                     |                |    |       |       |                |        |         |    |       |       |  |  |         |    |       |       |  |  |       |    |       |       |  |  |           |    |       |       |  |  |                   |    |       |       |  |  |                |    |       |       |  |  |         |    |       |       |  |  |         |    |       |       |  |  |         |    |       |       |
|    | <table border="1"> <tr><td>1.2 i.e.</td><td>48</td><td>01.01</td><td>01.04</td><td>03.0137-0415.2</td><td>650415</td><td rowspan="12"></td><td rowspan="12">228 x 42 HEB<br/>Bremsbacken-Zubehör</td></tr> <tr><td>1.6 i 16V</td><td>76</td><td>10.01</td><td>01.04</td><td>03.0137-9261.2</td><td>669261</td></tr> <tr><td>1.9 D</td><td>46</td><td>01.01</td><td>01.04</td><td></td><td></td></tr> <tr><td>1.9 JTD</td><td>74</td><td>10.01</td><td>01.04</td><td></td><td></td></tr> <tr><td>1.9 JTD</td><td>77</td><td>07.03</td><td>01.04</td><td></td><td></td></tr> <tr><td>1.3 D Multijet</td><td>55</td><td>02.04</td><td>09.05</td><td>03.0137-0457.2</td><td>650457</td><td rowspan="12"></td><td rowspan="12">228 x 42 HEB<br/>Bremsbacken-Zubehör</td></tr> <tr><td>1.3 D Multijet</td><td>62</td><td>02.04</td><td>09.05</td><td>03.0137-9309.2</td><td>669309</td></tr> <tr><td>1.3 JTD</td><td>55</td><td>02.04</td><td>09.05</td><td></td><td></td></tr> <tr><td>1.3 JTD</td><td>62</td><td>02.04</td><td>09.05</td><td></td><td></td></tr> <tr><td>1.4 i</td><td>57</td><td>02.04</td><td>09.05</td><td></td><td></td></tr> <tr><td>1.6 i 16V</td><td>76</td><td>02.04</td><td>09.05</td><td></td><td></td></tr> <tr><td>1.6 Natural Power</td><td>76</td><td>02.04</td><td>09.05</td><td></td><td></td></tr> <tr><td>1.9 D Multijet</td><td>88</td><td>02.04</td><td>09.05</td><td></td><td></td></tr> <tr><td>1.9 JTD</td><td>74</td><td>02.04</td><td>09.05</td><td></td><td></td></tr> <tr><td>1.9 JTD</td><td>77</td><td>02.04</td><td>09.05</td><td></td><td></td></tr> <tr><td>1.9 JTD</td><td>88</td><td>02.04</td><td>09.05</td><td></td><td></td></tr> <tr><td>1.3 D Multijet</td><td>55</td><td>10.05</td><td>01.10</td><td>03.0137-0457.2</td><td>650457</td><td rowspan="12"></td><td rowspan="12">228 x 42 HEB<br/>Bremsbacken-Zubehör</td></tr> <tr><td>1.3 D Multijet</td><td>62</td><td>10.05</td><td>01.10</td><td>03.0137-9296.2</td><td>669296</td></tr> <tr><td>1.3 JTD</td><td>55</td><td>10.05</td><td>01.10</td><td></td><td></td></tr> <tr><td>1.3 JTD</td><td>62</td><td>10.05</td><td>01.10</td><td></td><td></td></tr> <tr><td>1.4 i</td><td>57</td><td>10.05</td><td>01.10</td><td></td><td></td></tr> <tr><td>1.6 i 16V</td><td>76</td><td>10.05</td><td>01.10</td><td></td><td></td></tr> <tr><td>1.6 Natural Power</td><td>76</td><td>10.05</td><td>01.10</td><td></td><td></td></tr> <tr><td>1.9 D Multijet</td><td>88</td><td>10.05</td><td>01.10</td><td></td><td></td></tr> <tr><td>1.9 JTD</td><td>74</td><td>10.05</td><td>01.10</td><td></td><td></td></tr> <tr><td>1.9 JTD</td><td>77</td><td>10.05</td><td>01.10</td><td></td><td></td></tr> <tr><td>1.9 JTD</td><td>88</td><td>10.05</td><td>01.10</td><td></td><td></td></tr> </table> | 1.2 i.e.       | 48  | 01.01          | 01.04                                       |  |  | 03.0137-0415.2 | 650415   |  | 228 x 42 HEB<br>Bremsbacken-Zubehör  | 1.6 i 16V      | 76  | 10.01          | 01.04  | 03.0137-9261.2 | 669261 | 1.9 D          | 46  | 01.01 | 01.04 |                   |    | 1.9 JTD | 74  | 10.01 | 01.04 |                |    | 1.9 JTD | 77  | 07.03 | 01.04 |                |    | 1.3 D Multijet | 55  | 02.04 | 09.05 | 03.0137-0457.2 | 650457 |               | 228 x 42 HEB<br>Bremsbacken-Zubehör         | 1.3 D Multijet | 62    | 02.04              | 09.05 | 03.0137-9309.2     | 669309                                      | 1.3 JTD | 55    | 02.04             | 09.05 |                   |   | 1.3 JTD | 62    | 02.04          | 09.05 |                |   | 1.4 i | 57    | 02.04   | 09.05 |                |       | 1.6 i 16V | 76    | 02.04   | 09.05 |         |       | 1.6 Natural Power | 76    | 02.04   | 09.05 |         |       | 1.9 D Multijet | 88    | 02.04   | 09.05 |         |       | 1.9 JTD | 74    | 02.04       | 09.05 |             |       | 1.9 JTD | 77    | 02.04            | 09.05 |                  |       | 1.9 JTD | 88    | 02.04            | 09.05 |                  |       | 1.3 D Multijet | 55    | 10.05 | 01.10 | 03.0137-0457.2 | 650457 |  | 228 x 42 HEB<br>Bremsbacken-Zubehör | 1.3 D Multijet | 62 | 10.05 | 01.10 | 03.0137-9296.2 | 669296 | 1.3 JTD | 55 | 10.05 | 01.10 |  |  | 1.3 JTD | 62 | 10.05 | 01.10 |  |  | 1.4 i | 57 | 10.05 | 01.10 |  |  | 1.6 i 16V | 76 | 10.05 | 01.10 |  |  | 1.6 Natural Power | 76 | 10.05 | 01.10 |  |  | 1.9 D Multijet | 88 | 10.05 | 01.10 |  |  | 1.9 JTD | 74 | 10.05 | 01.10 |  |  | 1.9 JTD | 77 | 10.05 | 01.10 |  |  | 1.9 JTD | 88 | 10.05 | 01.10 |
| 1.2 i.e.   | 48  | 01.01          | 01.04                                       | 03.0137-0415.2 | 650415                                      |  | 228 x 42 HEB<br>Bremsbacken-Zubehör                |                |  |  |                                      |                |   |                |        |                |        |                |   |       |       |                   |    |         |   |       |       |                |    |         |   |       |       |                |    |                |   |       |       |                |        |               |   |                |       |                    |       |                    |   |         |       |                   |       |                   |   |         |       |                |       |                |   |       |       |         |       |                |       |           |       |         |       |         |       |                   |       |         |       |         |       |                |       |         |       |         |       |         |       |             |       |             |       |         |       |                  |       |                  |       |         |       |                  |       |                  |       |                |       |       |       |                |        |  |                                     |                |    |       |       |                |        |         |    |       |       |  |  |         |    |       |       |  |  |       |    |       |       |  |  |           |    |       |       |  |  |                   |    |       |       |  |  |                |    |       |       |  |  |         |    |       |       |  |  |         |    |       |       |  |  |         |    |       |       |
| 1.6 i 16V  | 76  | 10.01          | 01.04                                       | 03.0137-9261.2 | 669261                                      |  |  |                |  |  |                                      |                |   |                |        |                |        |                |   |       |       |                   |    |         |   |       |       |                |    |         |   |       |       |                |    |                |   |       |       |                |        |               |   |                |       |                    |       |                    |   |         |       |                   |       |                   |   |         |       |                |       |                |   |       |       |         |       |                |       |           |       |         |       |         |       |                   |       |         |       |         |       |                |       |         |       |         |       |         |       |             |       |             |       |         |       |                  |       |                  |       |         |       |                  |       |                  |       |                |       |       |       |                |        |  |                                     |                |    |       |       |                |        |         |    |       |       |  |  |         |    |       |       |  |  |       |    |       |       |  |  |           |    |       |       |  |  |                   |    |       |       |  |  |                |    |       |       |  |  |         |    |       |       |  |  |         |    |       |       |  |  |         |    |       |       |
| 1.9 D  | 46  | 01.01          | 01.04                                       |                |   |  |  |                |  |  |                                      |                |   |                |        |                |        |                |   |       |       |                   |    |         |   |       |       |                |    |         |   |       |       |                |    |                |   |       |       |                |        |               |   |                |       |                    |       |                    |   |         |       |                   |       |                   |   |         |       |                |       |                |   |       |       |         |       |                |       |           |       |         |       |         |       |                   |       |         |       |         |       |                |       |         |       |         |       |         |       |             |       |             |       |         |       |                  |       |                  |       |         |       |                  |       |                  |       |                |       |       |       |                |        |  |                                     |                |    |       |       |                |        |         |    |       |       |  |  |         |    |       |       |  |  |       |    |       |       |  |  |           |    |       |       |  |  |                   |    |       |       |  |  |                |    |       |       |  |  |         |    |       |       |  |  |         |    |       |       |  |  |         |    |       |       |
| 1.9 JTD  | 74  | 10.01          | 01.04                                       |                |   |  |  |                |  |  |                                      |                |   |                |        |                |        |                |   |       |       |                   |    |         |   |       |       |                |    |         |   |       |       |                |    |                |   |       |       |                |        |               |   |                |       |                    |       |                    |   |         |       |                   |       |                   |   |         |       |                |       |                |   |       |       |         |       |                |       |           |       |         |       |         |       |                   |       |         |       |         |       |                |       |         |       |         |       |         |       |             |       |             |       |         |       |                  |       |                  |       |         |       |                  |       |                  |       |                |       |       |       |                |        |  |                                     |                |    |       |       |                |        |         |    |       |       |  |  |         |    |       |       |  |  |       |    |       |       |  |  |           |    |       |       |  |  |                   |    |       |       |  |  |                |    |       |       |  |  |         |    |       |       |  |  |         |    |       |       |  |  |         |    |       |       |
| 1.9 JTD  | 77  | 07.03          | 01.04                                       |                |   |  |  |                |  |  |                                      |                |   |                |        |                |        |                |   |       |       |                   |    |         |   |       |       |                |    |         |   |       |       |                |    |                |   |       |       |                |        |               |   |                |       |                    |       |                    |   |         |       |                   |       |                   |   |         |       |                |       |                |   |       |       |         |       |                |       |           |       |         |       |         |       |                   |       |         |       |         |       |                |       |         |       |         |       |         |       |             |       |             |       |         |       |                  |       |                  |       |         |       |                  |       |                  |       |                |       |       |       |                |        |  |                                     |                |    |       |       |                |        |         |    |       |       |  |  |         |    |       |       |  |  |       |    |       |       |  |  |           |    |       |       |  |  |                   |    |       |       |  |  |                |    |       |       |  |  |         |    |       |       |  |  |         |    |       |       |  |  |         |    |       |       |
| 1.3 D Multijet   | 55  | 02.04          | 09.05                                       | 03.0137-0457.2 | 650457                                      |  |  |                | 228 x 42 HEB<br>Bremsbacken-Zubehör                |  |                                      |                |   |                |        |                |        |                |   |       |       |                   |    |         |   |       |       |                |    |         |   |       |       |                |    |                |   |       |       |                |        |               |   |                |       |                    |       |                    |   |         |       |                   |       |                   |   |         |       |                |       |                |   |       |       |         |       |                |       |           |       |         |       |         |       |                   |       |         |       |         |       |                |       |         |       |         |       |         |       |             |       |             |       |         |       |                  |       |                  |       |         |       |                  |       |                  |       |                |       |       |       |                |        |  |                                     |                |    |       |       |                |        |         |    |       |       |  |  |         |    |       |       |  |  |       |    |       |       |  |  |           |    |       |       |  |  |                   |    |       |       |  |  |                |    |       |       |  |  |         |    |       |       |  |  |         |    |       |       |  |  |         |    |       |       |
| 1.3 D Multijet   | 62  | 02.04          | 09.05                                       | 03.0137-9309.2 | 669309                                      |  |  |                |  |  |                                      |                |   |                |        |                |        |                |   |       |       |                   |    |         |   |       |       |                |    |         |   |       |       |                |    |                |   |       |       |                |        |               |   |                |       |                    |       |                    |   |         |       |                   |       |                   |   |         |       |                |       |                |   |       |       |         |       |                |       |           |       |         |       |         |       |                   |       |         |       |         |       |                |       |         |       |         |       |         |       |             |       |             |       |         |       |                  |       |                  |       |         |       |                  |       |                  |       |                |       |       |       |                |        |  |                                     |                |    |       |       |                |        |         |    |       |       |  |  |         |    |       |       |  |  |       |    |       |       |  |  |           |    |       |       |  |  |                   |    |       |       |  |  |                |    |       |       |  |  |         |    |       |       |  |  |         |    |       |       |  |  |         |    |       |       |
| 1.3 JTD  | 55  | 02.04          | 09.05                                       |                |   |  |  |                |  |  |                                      |                |   |                |        |                |        |                |   |       |       |                   |    |         |   |       |       |                |    |         |   |       |       |                |    |                |   |       |       |                |        |               |   |                |       |                    |       |                    |   |         |       |                   |       |                   |   |         |       |                |       |                |   |       |       |         |       |                |       |           |       |         |       |         |       |                   |       |         |       |         |       |                |       |         |       |         |       |         |       |             |       |             |       |         |       |                  |       |                  |       |         |       |                  |       |                  |       |                |       |       |       |                |        |  |                                     |                |    |       |       |                |        |         |    |       |       |  |  |         |    |       |       |  |  |       |    |       |       |  |  |           |    |       |       |  |  |                   |    |       |       |  |  |                |    |       |       |  |  |         |    |       |       |  |  |         |    |       |       |  |  |         |    |       |       |
| 1.3 JTD  | 62  | 02.04          | 09.05                                       |                |   |  |  |                |  |  |                                      |                |   |                |        |                |        |                |   |       |       |                   |    |         |   |       |       |                |    |         |   |       |       |                |    |                |   |       |       |                |        |               |   |                |       |                    |       |                    |   |         |       |                   |       |                   |   |         |       |                |       |                |   |       |       |         |       |                |       |           |       |         |       |         |       |                   |       |         |       |         |       |                |       |         |       |         |       |         |       |             |       |             |       |         |       |                  |       |                  |       |         |       |                  |       |                  |       |                |       |       |       |                |        |  |                                     |                |    |       |       |                |        |         |    |       |       |  |  |         |    |       |       |  |  |       |    |       |       |  |  |           |    |       |       |  |  |                   |    |       |       |  |  |                |    |       |       |  |  |         |    |       |       |  |  |         |    |       |       |  |  |         |    |       |       |
| 1.4 i  | 57  | 02.04          | 09.05                                       |                |   |  |  |                |  |  |                                      |                |   |                |        |                |        |                |   |       |       |                   |    |         |   |       |       |                |    |         |   |       |       |                |    |                |   |       |       |                |        |               |   |                |       |                    |       |                    |   |         |       |                   |       |                   |   |         |       |                |       |                |   |       |       |         |       |                |       |           |       |         |       |         |       |                   |       |         |       |         |       |                |       |         |       |         |       |         |       |             |       |             |       |         |       |                  |       |                  |       |         |       |                  |       |                  |       |                |       |       |       |                |        |  |                                     |                |    |       |       |                |        |         |    |       |       |  |  |         |    |       |       |  |  |       |    |       |       |  |  |           |    |       |       |  |  |                   |    |       |       |  |  |                |    |       |       |  |  |         |    |       |       |  |  |         |    |       |       |  |  |         |    |       |       |
| 1.6 i 16V  | 76  | 02.04          | 09.05                                       |                |   |  |  |                |  |  |                                      |                |   |                |        |                |        |                |   |       |       |                   |    |         |   |       |       |                |    |         |   |       |       |                |    |                |   |       |       |                |        |               |   |                |       |                    |       |                    |   |         |       |                   |       |                   |   |         |       |                |       |                |   |       |       |         |       |                |       |           |       |         |       |         |       |                   |       |         |       |         |       |                |       |         |       |         |       |         |       |             |       |             |       |         |       |                  |       |                  |       |         |       |                  |       |                  |       |                |       |       |       |                |        |  |                                     |                |    |       |       |                |        |         |    |       |       |  |  |         |    |       |       |  |  |       |    |       |       |  |  |           |    |       |       |  |  |                   |    |       |       |  |  |                |    |       |       |  |  |         |    |       |       |  |  |         |    |       |       |  |  |         |    |       |       |
| 1.6 Natural Power  | 76  | 02.04          | 09.05                                       |                |   |  |  |                |  |  |                                      |                |   |                |        |                |        |                |   |       |       |                   |    |         |   |       |       |                |    |         |   |       |       |                |    |                |   |       |       |                |        |               |   |                |       |                    |       |                    |   |         |       |                   |       |                   |   |         |       |                |       |                |   |       |       |         |       |                |       |           |       |         |       |         |       |                   |       |         |       |         |       |                |       |         |       |         |       |         |       |             |       |             |       |         |       |                  |       |                  |       |         |       |                  |       |                  |       |                |       |       |       |                |        |  |                                     |                |    |       |       |                |        |         |    |       |       |  |  |         |    |       |       |  |  |       |    |       |       |  |  |           |    |       |       |  |  |                   |    |       |       |  |  |                |    |       |       |  |  |         |    |       |       |  |  |         |    |       |       |  |  |         |    |       |       |
| 1.9 D Multijet   | 88  | 02.04          | 09.05                                       |                |   |  |  |                |  |  |                                      |                |   |                |        |                |        |                |   |       |       |                   |    |         |   |       |       |                |    |         |   |       |       |                |    |                |   |       |       |                |        |               |   |                |       |                    |       |                    |   |         |       |                   |       |                   |   |         |       |                |       |                |   |       |       |         |       |                |       |           |       |         |       |         |       |                   |       |         |       |         |       |                |       |         |       |         |       |         |       |             |       |             |       |         |       |                  |       |                  |       |         |       |                  |       |                  |       |                |       |       |       |                |        |  |                                     |                |    |       |       |                |        |         |    |       |       |  |  |         |    |       |       |  |  |       |    |       |       |  |  |           |    |       |       |  |  |                   |    |       |       |  |  |                |    |       |       |  |  |         |    |       |       |  |  |         |    |       |       |  |  |         |    |       |       |
| 1.9 JTD  | 74  | 02.04          | 09.05                                       |                |   |  |  |                |  |  |                                      |                |   |                |        |                |        |                |   |       |       |                   |    |         |   |       |       |                |    |         |   |       |       |                |    |                |   |       |       |                |        |               |   |                |       |                    |       |                    |   |         |       |                   |       |                   |   |         |       |                |       |                |   |       |       |         |       |                |       |           |       |         |       |         |       |                   |       |         |       |         |       |                |       |         |       |         |       |         |       |             |       |             |       |         |       |                  |       |                  |       |         |       |                  |       |                  |       |                |       |       |       |                |        |  |                                     |                |    |       |       |                |        |         |    |       |       |  |  |         |    |       |       |  |  |       |    |       |       |  |  |           |    |       |       |  |  |                   |    |       |       |  |  |                |    |       |       |  |  |         |    |       |       |  |  |         |    |       |       |  |  |         |    |       |       |
| 1.9 JTD  | 77  | 02.04          | 09.05                                       |                |   |  |  |                |  |  |                                      |                |   |                |        |                |        |                |   |       |       |                   |    |         |   |       |       |                |    |         |   |       |       |                |    |                |   |       |       |                |        |               |   |                |       |                    |       |                    |   |         |       |                   |       |                   |   |         |       |                |       |                |   |       |       |         |       |                |       |           |       |         |       |         |       |                   |       |         |       |         |       |                |       |         |       |         |       |         |       |             |       |             |       |         |       |                  |       |                  |       |         |       |                  |       |                  |       |                |       |       |       |                |        |  |                                     |                |    |       |       |                |        |         |    |       |       |  |  |         |    |       |       |  |  |       |    |       |       |  |  |           |    |       |       |  |  |                   |    |       |       |  |  |                |    |       |       |  |  |         |    |       |       |  |  |         |    |       |       |  |  |         |    |       |       |
| 1.9 JTD  | 88  | 02.04          | 09.05                                       |                |   |  |  |                |  |  |                                      |                |   |                |        |                |        |                |   |       |       |                   |    |         |   |       |       |                |    |         |   |       |       |                |    |                |   |       |       |                |        |               |   |                |       |                    |       |                    |   |         |       |                   |       |                   |   |         |       |                |       |                |   |       |       |         |       |                |       |           |       |         |       |         |       |                   |       |         |       |         |       |                |       |         |       |         |       |         |       |             |       |             |       |         |       |                  |       |                  |       |         |       |                  |       |                  |       |                |       |       |       |                |        |  |                                     |                |    |       |       |                |        |         |    |       |       |  |  |         |    |       |       |  |  |       |    |       |       |  |  |           |    |       |       |  |  |                   |    |       |       |  |  |                |    |       |       |  |  |         |    |       |       |  |  |         |    |       |       |  |  |         |    |       |       |
| 1.3 D Multijet   | 55  | 10.05          | 01.10                                       | 03.0137-0457.2 | 650457                                      |  | 228 x 42 HEB<br>Bremsbacken-Zubehör                |                |  |  |                                      |                |   |                |        |                |        |                |   |       |       |                   |    |         |   |       |       |                |    |         |   |       |       |                |    |                |   |       |       |                |        |               |   |                |       |                    |       |                    |   |         |       |                   |       |                   |   |         |       |                |       |                |   |       |       |         |       |                |       |           |       |         |       |         |       |                   |       |         |       |         |       |                |       |         |       |         |       |         |       |             |       |             |       |         |       |                  |       |                  |       |         |       |                  |       |                  |       |                |       |       |       |                |        |  |                                     |                |    |       |       |                |        |         |    |       |       |  |  |         |    |       |       |  |  |       |    |       |       |  |  |           |    |       |       |  |  |                   |    |       |       |  |  |                |    |       |       |  |  |         |    |       |       |  |  |         |    |       |       |  |  |         |    |       |       |
| 1.3 D Multijet   | 62  | 10.05          | 01.10                                       | 03.0137-9296.2 | 669296                                      |  |  |                |  |  |                                      |                |   |                |        |                |        |                |   |       |       |                   |    |         |   |       |       |                |    |         |   |       |       |                |    |                |   |       |       |                |        |               |   |                |       |                    |       |                    |   |         |       |                   |       |                   |   |         |       |                |       |                |   |       |       |         |       |                |       |           |       |         |       |         |       |                   |       |         |       |         |       |                |       |         |       |         |       |         |       |             |       |             |       |         |       |                  |       |                  |       |         |       |                  |       |                  |       |                |       |       |       |                |        |  |                                     |                |    |       |       |                |        |         |    |       |       |  |  |         |    |       |       |  |  |       |    |       |       |  |  |           |    |       |       |  |  |                   |    |       |       |  |  |                |    |       |       |  |  |         |    |       |       |  |  |         |    |       |       |  |  |         |    |       |       |
| 1.3 JTD  | 55  | 10.05          | 01.10                                       |                |   |  |  |                |  |  |                                      |                |   |                |        |                |        |                |   |       |       |                   |    |         |   |       |       |                |    |         |   |       |       |                |    |                |   |       |       |                |        |               |   |                |       |                    |       |                    |   |         |       |                   |       |                   |   |         |       |                |       |                |   |       |       |         |       |                |       |           |       |         |       |         |       |                   |       |         |       |         |       |                |       |         |       |         |       |         |       |             |       |             |       |         |       |                  |       |                  |       |         |       |                  |       |                  |       |                |       |       |       |                |        |  |                                     |                |    |       |       |                |        |         |    |       |       |  |  |         |    |       |       |  |  |       |    |       |       |  |  |           |    |       |       |  |  |                   |    |       |       |  |  |                |    |       |       |  |  |         |    |       |       |  |  |         |    |       |       |  |  |         |    |       |       |
| 1.3 JTD  | 62  | 10.05          | 01.10                                       |                |   |  |  |                |  |  |                                      |                |   |                |        |                |        |                |   |       |       |                   |    |         |   |       |       |                |    |         |   |       |       |                |    |                |   |       |       |                |        |               |   |                |       |                    |       |                    |   |         |       |                   |       |                   |   |         |       |                |       |                |   |       |       |         |       |                |       |           |       |         |       |         |       |                   |       |         |       |         |       |                |       |         |       |         |       |         |       |             |       |             |       |         |       |                  |       |                  |       |         |       |                  |       |                  |       |                |       |       |       |                |        |  |                                     |                |    |       |       |                |        |         |    |       |       |  |  |         |    |       |       |  |  |       |    |       |       |  |  |           |    |       |       |  |  |                   |    |       |       |  |  |                |    |       |       |  |  |         |    |       |       |  |  |         |    |       |       |  |  |         |    |       |       |
| 1.4 i  | 57  | 10.05          | 01.10                                       |                |   |  |  |                |  |  |                                      |                |   |                |        |                |        |                |   |       |       |                   |    |         |   |       |       |                |    |         |   |       |       |                |    |                |   |       |       |                |        |               |   |                |       |                    |       |                    |   |         |       |                   |       |                   |   |         |       |                |       |                |   |       |       |         |       |                |       |           |       |         |       |         |       |                   |       |         |       |         |       |                |       |         |       |         |       |         |       |             |       |             |       |         |       |                  |       |                  |       |         |       |                  |       |                  |       |                |       |       |       |                |        |  |                                     |                |    |       |       |                |        |         |    |       |       |  |  |         |    |       |       |  |  |       |    |       |       |  |  |           |    |       |       |  |  |                   |    |       |       |  |  |                |    |       |       |  |  |         |    |       |       |  |  |         |    |       |       |  |  |         |    |       |       |
| 1.6 i 16V  | 76  | 10.05          | 01.10                                       |                |   |  |  |                |  |  |                                      |                |   |                |        |                |        |                |   |       |       |                   |    |         |   |       |       |                |    |         |   |       |       |                |    |                |   |       |       |                |        |               |   |                |       |                    |       |                    |   |         |       |                   |       |                   |   |         |       |                |       |                |   |       |       |         |       |                |       |           |       |         |       |         |       |                   |       |         |       |         |       |                |       |         |       |         |       |         |       |             |       |             |       |         |       |                  |       |                  |       |         |       |                  |       |                  |       |                |       |       |       |                |        |  |                                     |                |    |       |       |                |        |         |    |       |       |  |  |         |    |       |       |  |  |       |    |       |       |  |  |           |    |       |       |  |  |                   |    |       |       |  |  |                |    |       |       |  |  |         |    |       |       |  |  |         |    |       |       |  |  |         |    |       |       |
| 1.6 Natural Power  | 76  | 10.05          | 01.10                                       |                |   |  |  |                |  |  |                                      |                |   |                |        |                |        |                |   |       |       |                   |    |         |   |       |       |                |    |         |   |       |       |                |    |                |   |       |       |                |        |               |   |                |       |                    |       |                    |   |         |       |                   |       |                   |   |         |       |                |       |                |   |       |       |         |       |                |       |           |       |         |       |         |       |                   |       |         |       |         |       |                |       |         |       |         |       |         |       |             |       |             |       |         |       |                  |       |                  |       |         |       |                  |       |                  |       |                |       |       |       |                |        |  |                                     |                |    |       |       |                |        |         |    |       |       |  |  |         |    |       |       |  |  |       |    |       |       |  |  |           |    |       |       |  |  |                   |    |       |       |  |  |                |    |       |       |  |  |         |    |       |       |  |  |         |    |       |       |  |  |         |    |       |       |
| 1.9 D Multijet   | 88  | 10.05          | 01.10                                       |                |   |  |  |                |  |  |                                      |                |   |                |        |                |        |                |   |       |       |                   |    |         |   |       |       |                |    |         |   |       |       |                |    |                |   |       |       |                |        |               |   |                |       |                    |       |                    |   |         |       |                   |       |                   |   |         |       |                |       |                |   |       |       |         |       |                |       |           |       |         |       |         |       |                   |       |         |       |         |       |                |       |         |       |         |       |         |       |             |       |             |       |         |       |                  |       |                  |       |         |       |                  |       |                  |       |                |       |       |       |                |        |  |                                     |                |    |       |       |                |        |         |    |       |       |  |  |         |    |       |       |  |  |       |    |       |       |  |  |           |    |       |       |  |  |                   |    |       |       |  |  |                |    |       |       |  |  |         |    |       |       |  |  |         |    |       |       |  |  |         |    |       |       |
| 1.9 JTD  | 74  | 10.05          | 01.10                                       |                |   |  |  |                |  |  |                                      |                |   |                |        |                |        |                |   |       |       |                   |    |         |   |       |       |                |    |         |   |       |       |                |    |                |   |       |       |                |        |               |   |                |       |                    |       |                    |   |         |       |                   |       |                   |   |         |       |                |       |                |   |       |       |         |       |                |       |           |       |         |       |         |       |                   |       |         |       |         |       |                |       |         |       |         |       |         |       |             |       |             |       |         |       |                  |       |                  |       |         |       |                  |       |                  |       |                |       |       |       |                |        |  |                                     |                |    |       |       |                |        |         |    |       |       |  |  |         |    |       |       |  |  |       |    |       |       |  |  |           |    |       |       |  |  |                   |    |       |       |  |  |                |    |       |       |  |  |         |    |       |       |  |  |         |    |       |       |  |  |         |    |       |       |
| 1.9 JTD  | 77  | 10.05          | 01.10                                       |                |   |  |  |                |  |  |                                      |                |   |                |        |                |        |                |   |       |       |                   |    |         |   |       |       |                |    |         |   |       |       |                |    |                |   |       |       |                |        |               |   |                |       |                    |       |                    |   |         |       |                   |       |                   |   |         |       |                |       |                |   |       |       |         |       |                |       |           |       |         |       |         |       |                   |       |         |       |         |       |                |       |         |       |         |       |         |       |             |       |             |       |         |       |                  |       |                  |       |         |       |                  |       |                  |       |                |       |       |       |                |        |  |                                     |                |    |       |       |                |        |         |    |       |       |  |  |         |    |       |       |  |  |       |    |       |       |  |  |           |    |       |       |  |  |                   |    |       |       |  |  |                |    |       |       |  |  |         |    |       |       |  |  |         |    |       |       |  |  |         |    |       |       |
| 1.9 JTD  | 88  | 10.05          | 01.10                                       |                |   |  |  |                |  |  |                                      |                |   |                |        |                |        |                |   |       |       |                   |    |         |   |       |       |                |    |         |   |       |       |                |    |                |   |       |       |                |        |               |   |                |       |                    |       |                    |   |         |       |                   |       |                   |   |         |       |                |       |                |   |       |       |         |       |                |       |           |       |         |       |         |       |                   |       |         |       |         |       |                |       |         |       |         |       |         |       |             |       |             |       |         |       |                  |       |                  |       |         |       |                  |       |                  |       |                |       |       |       |                |        |  |                                     |                |    |       |       |                |        |         |    |       |       |  |  |         |    |       |       |  |  |       |    |       |       |  |  |           |    |       |       |  |  |                   |    |       |       |  |  |                |    |       |       |  |  |         |    |       |       |  |  |         |    |       |       |  |  |         |    |       |       |
|    | <table border="1"> <tr><td>1.2 i.e.</td><td>48</td><td>01.01</td><td>09.05</td><td>24.0222-8018.1</td><td>480078</td><td rowspan="15"></td><td rowspan="15">228/230 x 48</td></tr> <tr><td>1.3 D Multijet</td><td>55</td><td>10.05</td><td>01.10</td><td></td><td></td></tr> <tr><td>1.3 D Multijet</td><td>62</td><td>10.05</td><td>01.10</td><td></td><td></td></tr> <tr><td>1.3 JTD</td><td>51</td><td>05.04</td><td>09.05</td><td></td><td></td></tr> <tr><td>1.3 JTD</td><td>55</td><td>10.05</td><td>01.10</td><td></td><td></td></tr> <tr><td>1.3 JTD</td><td>62</td><td>10.05</td><td>01.10</td><td></td><td></td></tr> <tr><td>1.4 i</td><td>57</td><td>10.05</td><td>01.10</td><td></td><td></td></tr> <tr><td>1.6 i 16V</td><td>76</td><td>10.01</td><td>01.10</td><td></td><td></td></tr> <tr><td>1.6 Natural Power</td><td>76</td><td>02.09</td><td>01.10</td><td></td><td></td></tr> <tr><td>1.9 D</td><td>46</td><td>01.01</td><td>09.05</td><td></td><td></td></tr> <tr><td>1.9 D Multijet</td><td>88</td><td>10.05</td><td>01.10</td><td></td><td></td></tr> <tr><td>1.9 JTD</td><td>74</td><td>10.01</td><td>01.10</td><td></td><td></td></tr> <tr><td>1.9 JTD</td><td>77</td><td>07.03</td><td>01.10</td><td></td><td></td></tr> <tr><td>1.9 JTD</td><td>88</td><td>10.05</td><td>01.10</td><td></td><td></td></tr> </table>   | 1.2 i.e.       | 48  | 01.01          | 09.05                                       |  |  | 24.0222-8018.1 | 480078   |  | 228/230 x 48                         | 1.3 D Multijet | 55  | 10.05          | 01.10  |                |        | 1.3 D Multijet | 62  | 10.05 | 01.10 |                   |    | 1.3 JTD | 51  | 05.04 | 09.05 |                |    | 1.3 JTD | 55  | 10.05 | 01.10 |                |    | 1.3 JTD        | 62  | 10.05 | 01.10 |                |        | 1.4 i         | 57  | 10.05          | 01.10 |                    |       | 1.6 i 16V          | 76  | 10.01   | 01.10 |                   |       | 1.6 Natural Power | 76  | 02.09   | 01.10 |                |       | 1.9 D          | 46  | 01.01 | 09.05 |         |       | 1.9 D Multijet | 88    | 10.05     | 01.10 |         |       | 1.9 JTD | 74    | 10.01             | 01.10 |         |       | 1.9 JTD | 77    | 07.03          | 01.10 |         |       | 1.9 JTD | 88    | 10.05   | 01.10 |             |       |             |       |         |       |                  |       |                  |       |         |       |                  |       |                  |       |                |       |       |       |                |        |  |                                     |                |    |       |       |                |        |         |    |       |       |  |  |         |    |       |       |  |  |       |    |       |       |  |  |           |    |       |       |  |  |                   |    |       |       |  |  |                |    |       |       |  |  |         |    |       |       |  |  |         |    |       |       |  |  |         |    |       |       |
| 1.2 i.e.   | 48  | 01.01          | 09.05                                       | 24.0222-8018.1 | 480078                                      |  | 228/230 x 48                                       |                |  |  |                                      |                |   |                |        |                |        |                |   |       |       |                   |    |         |   |       |       |                |    |         |   |       |       |                |    |                |   |       |       |                |        |               |   |                |       |                    |       |                    |   |         |       |                   |       |                   |   |         |       |                |       |                |   |       |       |         |       |                |       |           |       |         |       |         |       |                   |       |         |       |         |       |                |       |         |       |         |       |         |       |             |       |             |       |         |       |                  |       |                  |       |         |       |                  |       |                  |       |                |       |       |       |                |        |  |                                     |                |    |       |       |                |        |         |    |       |       |  |  |         |    |       |       |  |  |       |    |       |       |  |  |           |    |       |       |  |  |                   |    |       |       |  |  |                |    |       |       |  |  |         |    |       |       |  |  |         |    |       |       |  |  |         |    |       |       |
| 1.3 D Multijet   | 55  | 10.05          | 01.10                                       |                |   |  |  |                |  |  |                                      |                |   |                |        |                |        |                |   |       |       |                   |    |         |   |       |       |                |    |         |   |       |       |                |    |                |   |       |       |                |        |               |   |                |       |                    |       |                    |   |         |       |                   |       |                   |   |         |       |                |       |                |   |       |       |         |       |                |       |           |       |         |       |         |       |                   |       |         |       |         |       |                |       |         |       |         |       |         |       |             |       |             |       |         |       |                  |       |                  |       |         |       |                  |       |                  |       |                |       |       |       |                |        |  |                                     |                |    |       |       |                |        |         |    |       |       |  |  |         |    |       |       |  |  |       |    |       |       |  |  |           |    |       |       |  |  |                   |    |       |       |  |  |                |    |       |       |  |  |         |    |       |       |  |  |         |    |       |       |  |  |         |    |       |       |
| 1.3 D Multijet   | 62  | 10.05          | 01.10                                       |                |   |  |  |                |  |  |                                      |                |   |                |        |                |        |                |   |       |       |                   |    |         |   |       |       |                |    |         |   |       |       |                |    |                |   |       |       |                |        |               |   |                |       |                    |       |                    |   |         |       |                   |       |                   |   |         |       |                |       |                |   |       |       |         |       |                |       |           |       |         |       |         |       |                   |       |         |       |         |       |                |       |         |       |         |       |         |       |             |       |             |       |         |       |                  |       |                  |       |         |       |                  |       |                  |       |                |       |       |       |                |        |  |                                     |                |    |       |       |                |        |         |    |       |       |  |  |         |    |       |       |  |  |       |    |       |       |  |  |           |    |       |       |  |  |                   |    |       |       |  |  |                |    |       |       |  |  |         |    |       |       |  |  |         |    |       |       |  |  |         |    |       |       |
| 1.3 JTD  | 51  | 05.04          | 09.05                                       |                |   |  |  |                |  |  |                                      |                |   |                |        |                |        |                |   |       |       |                   |    |         |   |       |       |                |    |         |   |       |       |                |    |                |   |       |       |                |        |               |   |                |       |                    |       |                    |   |         |       |                   |       |                   |   |         |       |                |       |                |   |       |       |         |       |                |       |           |       |         |       |         |       |                   |       |         |       |         |       |                |       |         |       |         |       |         |       |             |       |             |       |         |       |                  |       |                  |       |         |       |                  |       |                  |       |                |       |       |       |                |        |  |                                     |                |    |       |       |                |        |         |    |       |       |  |  |         |    |       |       |  |  |       |    |       |       |  |  |           |    |       |       |  |  |                   |    |       |       |  |  |                |    |       |       |  |  |         |    |       |       |  |  |         |    |       |       |  |  |         |    |       |       |
| 1.3 JTD  | 55  | 10.05          | 01.10                                       |                |   |  |  |                |  |  |                                      |                |   |                |        |                |        |                |   |       |       |                   |    |         |   |       |       |                |    |         |   |       |       |                |    |                |   |       |       |                |        |               |   |                |       |                    |       |                    |   |         |       |                   |       |                   |   |         |       |                |       |                |   |       |       |         |       |                |       |           |       |         |       |         |       |                   |       |         |       |         |       |                |       |         |       |         |       |         |       |             |       |             |       |         |       |                  |       |                  |       |         |       |                  |       |                  |       |                |       |       |       |                |        |  |                                     |                |    |       |       |                |        |         |    |       |       |  |  |         |    |       |       |  |  |       |    |       |       |  |  |           |    |       |       |  |  |                   |    |       |       |  |  |                |    |       |       |  |  |         |    |       |       |  |  |         |    |       |       |  |  |         |    |       |       |
| 1.3 JTD  | 62  | 10.05          | 01.10                                       |                |   |  |  |                |  |  |                                      |                |   |                |        |                |        |                |   |       |       |                   |    |         |   |       |       |                |    |         |   |       |       |                |    |                |   |       |       |                |        |               |   |                |       |                    |       |                    |   |         |       |                   |       |                   |   |         |       |                |       |                |   |       |       |         |       |                |       |           |       |         |       |         |       |                   |       |         |       |         |       |                |       |         |       |         |       |         |       |             |       |             |       |         |       |                  |       |                  |       |         |       |                  |       |                  |       |                |       |       |       |                |        |  |                                     |                |    |       |       |                |        |         |    |       |       |  |  |         |    |       |       |  |  |       |    |       |       |  |  |           |    |       |       |  |  |                   |    |       |       |  |  |                |    |       |       |  |  |         |    |       |       |  |  |         |    |       |       |  |  |         |    |       |       |
| 1.4 i  | 57  | 10.05          | 01.10                                       |                |   |  |  |                |  |  |                                      |                |   |                |        |                |        |                |   |       |       |                   |    |         |   |       |       |                |    |         |   |       |       |                |    |                |   |       |       |                |        |               |   |                |       |                    |       |                    |   |         |       |                   |       |                   |   |         |       |                |       |                |   |       |       |         |       |                |       |           |       |         |       |         |       |                   |       |         |       |         |       |                |       |         |       |         |       |         |       |             |       |             |       |         |       |                  |       |                  |       |         |       |                  |       |                  |       |                |       |       |       |                |        |  |                                     |                |    |       |       |                |        |         |    |       |       |  |  |         |    |       |       |  |  |       |    |       |       |  |  |           |    |       |       |  |  |                   |    |       |       |  |  |                |    |       |       |  |  |         |    |       |       |  |  |         |    |       |       |  |  |         |    |       |       |
| 1.6 i 16V  | 76  | 10.01          | 01.10                                       |                |   |  |  |                |  |  |                                      |                |   |                |        |                |        |                |   |       |       |                   |    |         |   |       |       |                |    |         |   |       |       |                |    |                |   |       |       |                |        |               |   |                |       |                    |       |                    |   |         |       |                   |       |                   |   |         |       |                |       |                |   |       |       |         |       |                |       |           |       |         |       |         |       |                   |       |         |       |         |       |                |       |         |       |         |       |         |       |             |       |             |       |         |       |                  |       |                  |       |         |       |                  |       |                  |       |                |       |       |       |                |        |  |                                     |                |    |       |       |                |        |         |    |       |       |  |  |         |    |       |       |  |  |       |    |       |       |  |  |           |    |       |       |  |  |                   |    |       |       |  |  |                |    |       |       |  |  |         |    |       |       |  |  |         |    |       |       |  |  |         |    |       |       |
| 1.6 Natural Power  | 76  | 02.09          | 01.10                                       |                |   |  |  |                |  |  |                                      |                |   |                |        |                |        |                |   |       |       |                   |    |         |   |       |       |                |    |         |   |       |       |                |    |                |   |       |       |                |        |               |   |                |       |                    |       |                    |   |         |       |                   |       |                   |   |         |       |                |       |                |   |       |       |         |       |                |       |           |       |         |       |         |       |                   |       |         |       |         |       |                |       |         |       |         |       |         |       |             |       |             |       |         |       |                  |       |                  |       |         |       |                  |       |                  |       |                |       |       |       |                |        |  |                                     |                |    |       |       |                |        |         |    |       |       |  |  |         |    |       |       |  |  |       |    |       |       |  |  |           |    |       |       |  |  |                   |    |       |       |  |  |                |    |       |       |  |  |         |    |       |       |  |  |         |    |       |       |  |  |         |    |       |       |
| 1.9 D  | 46  | 01.01          | 09.05                                       |                |   |  |  |                |  |  |                                      |                |   |                |        |                |        |                |   |       |       |                   |    |         |   |       |       |                |    |         |   |       |       |                |    |                |   |       |       |                |        |               |   |                |       |                    |       |                    |   |         |       |                   |       |                   |   |         |       |                |       |                |   |       |       |         |       |                |       |           |       |         |       |         |       |                   |       |         |       |         |       |                |       |         |       |         |       |         |       |             |       |             |       |         |       |                  |       |                  |       |         |       |                  |       |                  |       |                |       |       |       |                |        |  |                                     |                |    |       |       |                |        |         |    |       |       |  |  |         |    |       |       |  |  |       |    |       |       |  |  |           |    |       |       |  |  |                   |    |       |       |  |  |                |    |       |       |  |  |         |    |       |       |  |  |         |    |       |       |  |  |         |    |       |       |
| 1.9 D Multijet   | 88  | 10.05          | 01.10                                       |                |   |  |  |                |  |  |                                      |                |   |                |        |                |        |                |   |       |       |                   |    |         |   |       |       |                |    |         |   |       |       |                |    |                |   |       |       |                |        |               |   |                |       |                    |       |                    |   |         |       |                   |       |                   |   |         |       |                |       |                |   |       |       |         |       |                |       |           |       |         |       |         |       |                   |       |         |       |         |       |                |       |         |       |         |       |         |       |             |       |             |       |         |       |                  |       |                  |       |         |       |                  |       |                  |       |                |       |       |       |                |        |  |                                     |                |    |       |       |                |        |         |    |       |       |  |  |         |    |       |       |  |  |       |    |       |       |  |  |           |    |       |       |  |  |                   |    |       |       |  |  |                |    |       |       |  |  |         |    |       |       |  |  |         |    |       |       |  |  |         |    |       |       |
| 1.9 JTD  | 74  | 10.01          | 01.10                                       |                |   |  |  |                |  |  |                                      |                |   |                |        |                |        |                |   |       |       |                   |    |         |   |       |       |                |    |         |   |       |       |                |    |                |   |       |       |                |        |               |   |                |       |                    |       |                    |   |         |       |                   |       |                   |   |         |       |                |       |                |   |       |       |         |       |                |       |           |       |         |       |         |       |                   |       |         |       |         |       |                |       |         |       |         |       |         |       |             |       |             |       |         |       |                  |       |                  |       |         |       |                  |       |                  |       |                |       |       |       |                |        |  |                                     |                |    |       |       |                |        |         |    |       |       |  |  |         |    |       |       |  |  |       |    |       |       |  |  |           |    |       |       |  |  |                   |    |       |       |  |  |                |    |       |       |  |  |         |    |       |       |  |  |         |    |       |       |  |  |         |    |       |       |
| 1.9 JTD  | 77  | 07.03          | 01.10                                       |                |   |  |  |                |  |  |                                      |                |   |                |        |                |        |                |   |       |       |                   |    |         |   |       |       |                |    |         |   |       |       |                |    |                |   |       |       |                |        |               |   |                |       |                    |       |                    |   |         |       |                   |       |                   |   |         |       |                |       |                |   |       |       |         |       |                |       |           |       |         |       |         |       |                   |       |         |       |         |       |                |       |         |       |         |       |         |       |             |       |             |       |         |       |                  |       |                  |       |         |       |                  |       |                  |       |                |       |       |       |                |        |  |                                     |                |    |       |       |                |        |         |    |       |       |  |  |         |    |       |       |  |  |       |    |       |       |  |  |           |    |       |       |  |  |                   |    |       |       |  |  |                |    |       |       |  |  |         |    |       |       |  |  |         |    |       |       |  |  |         |    |       |       |
| 1.9 JTD  | 88  | 10.05          | 01.10                                       |                |   |  |  |                |  |  |                                      |                |   |                |        |                |        |                |   |       |       |                   |    |         |   |       |       |                |    |         |   |       |       |                |    |                |   |       |       |                |        |               |   |                |       |                    |       |                    |   |         |       |                   |       |                   |   |         |       |                |       |                |   |       |       |         |       |                |       |           |       |         |       |         |       |                   |       |         |       |         |       |                |       |         |       |         |       |         |       |             |       |             |       |         |       |                  |       |                  |       |         |       |                  |       |                  |       |                |       |       |       |                |        |  |                                     |                |    |       |       |                |        |         |    |       |       |  |  |         |    |       |       |  |  |       |    |       |       |  |  |           |    |       |       |  |  |                   |    |       |       |  |  |                |    |       |       |  |  |         |    |       |       |  |  |         |    |       |       |  |  |         |    |       |       |
| <b>FIAT DOBLO (10-)</b>  |   |                |   |                |   |  |  |                |  |  |                                      |                |   |                |        |                |        |                |   |       |       |                   |    |         |   |       |       |                |    |         |   |       |       |                |    |                |   |       |       |                |        |               |   |                |       |                    |       |                    |   |         |       |                   |       |                   |   |         |       |                |       |                |   |       |       |         |       |                |       |           |       |         |       |         |       |                   |       |         |       |         |       |                |       |         |       |         |       |         |       |             |       |             |       |         |       |                  |       |                  |       |         |       |                  |       |                  |       |                |       |       |       |                |        |  |                                     |                |    |       |       |                |        |         |    |       |       |  |  |         |    |       |       |  |  |       |    |       |       |  |  |           |    |       |       |  |  |                   |    |       |       |  |  |                |    |       |       |  |  |         |    |       |       |  |  |         |    |       |       |  |  |         |    |       |       |
|    | <table border="1"> <tr><td>1.3 D Multijet</td><td>70</td><td>02.10</td><td>+ Bremsscheibendurchm. 284 mm <sup>3)</sup></td><td>13.0460-3827.2</td><td>603827</td><td rowspan="10"></td><td rowspan="10">23709 19,6 +WK/Zub/SBOS<br/>23709 19,6 +WK/Zub/SBOS</td></tr> <tr><td>1.4</td><td>88</td><td>02.10</td><td>+ Bremsscheibendurchm. 284 mm <sup>3)</sup></td><td>13.0470-3827.2</td><td>LD3827</td></tr> <tr><td>1.4</td><td>88</td><td>10.11</td><td>+ Bremsscheibendurchm. 284 mm <sup>3)</sup></td><td></td><td></td></tr> <tr><td>1.4 Natural Power</td><td>88</td><td>02.10</td><td>+ Bremsscheibendurchm. 284 mm <sup>3)</sup></td><td></td><td></td></tr> <tr><td>1.6 D Multijet</td><td>66</td><td>02.10</td><td>+ Bremsscheibendurchm. 284 mm <sup>3)</sup></td><td></td><td></td></tr> <tr><td>1.6 D Multijet</td><td>70</td><td>03.15</td><td>+ Bremsscheibendurchm. 284 mm <sup>3)</sup></td><td></td><td></td></tr> <tr><td>1.6 D Multijet</td><td>74</td><td>02.10</td><td>+ Bremsscheibendurchm. 284 mm <sup>3)</sup></td><td></td><td></td></tr> <tr><td>1.6 D Multijet</td><td>77</td><td>02.10</td><td>+ Bremsscheibendurchm. 284 mm <sup>3)</sup></td><td></td><td></td></tr> <tr><td>1.6 D Multijet</td><td>88</td><td>03.15</td><td>+ Bremsscheibendurchm. 284 mm <sup>3)</sup></td><td></td><td></td></tr> <tr><td>2.0 D Multijet</td><td>99</td><td>02.10</td><td>+ Bremsscheibendurchm. 284 mm <sup>3)</sup></td><td></td><td></td></tr> </table>   | 1.3 D Multijet | 70  | 02.10          | + Bremsscheibendurchm. 284 mm <sup>3)</sup> | 13.0460-3827.2   | 603827   |                | 23709 19,6 +WK/Zub/SBOS<br>23709 19,6 +WK/Zub/SBOS | 1.4  | 88                                   | 02.10          | + Bremsscheibendurchm. 284 mm <sup>3)</sup> | 13.0470-3827.2 | LD3827 | 1.4            | 88     | 10.11          | + Bremsscheibendurchm. 284 mm <sup>3)</sup> |       |       | 1.4 Natural Power | 88 | 02.10   | + Bremsscheibendurchm. 284 mm <sup>3)</sup> |       |       | 1.6 D Multijet | 66 | 02.10   | + Bremsscheibendurchm. 284 mm <sup>3)</sup> |       |       | 1.6 D Multijet | 70 | 03.15          | + Bremsscheibendurchm. 284 mm <sup>3)</sup> |       |       | 1.6 D Multijet | 74     | 02.10         | + Bremsscheibendurchm. 284 mm <sup>3)</sup> |                |       | 1.6 D Multijet     | 77    | 02.10              | + Bremsscheibendurchm. 284 mm <sup>3)</sup> |         |       | 1.6 D Multijet    | 88    | 03.15             | + Bremsscheibendurchm. 284 mm <sup>3)</sup> |         |       | 2.0 D Multijet | 99    | 02.10          | + Bremsscheibendurchm. 284 mm <sup>3)</sup> |       |       |         |       |                |       |           |       |         |       |         |       |                   |       |         |       |         |       |                |       |         |       |         |       |         |       |             |       |             |       |         |       |                  |       |                  |       |         |       |                  |       |                  |       |                |       |       |       |                |        |  |                                     |                |    |       |       |                |        |         |    |       |       |  |  |         |    |       |       |  |  |       |    |       |       |  |  |           |    |       |       |  |  |                   |    |       |       |  |  |                |    |       |       |  |  |         |    |       |       |  |  |         |    |       |       |  |  |         |    |       |       |
| 1.3 D Multijet   | 70  | 02.10          | + Bremsscheibendurchm. 284 mm <sup>3)</sup> | 13.0460-3827.2 | 603827                                      |  | 23709 19,6 +WK/Zub/SBOS<br>23709 19,6 +WK/Zub/SBOS |                |  |  |                                      |                |   |                |        |                |        |                |   |       |       |                   |    |         |   |       |       |                |    |         |   |       |       |                |    |                |   |       |       |                |        |               |   |                |       |                    |       |                    |   |         |       |                   |       |                   |   |         |       |                |       |                |   |       |       |         |       |                |       |           |       |         |       |         |       |                   |       |         |       |         |       |                |       |         |       |         |       |         |       |             |       |             |       |         |       |                  |       |                  |       |         |       |                  |       |                  |       |                |       |       |       |                |        |  |                                     |                |    |       |       |                |        |         |    |       |       |  |  |         |    |       |       |  |  |       |    |       |       |  |  |           |    |       |       |  |  |                   |    |       |       |  |  |                |    |       |       |  |  |         |    |       |       |  |  |         |    |       |       |  |  |         |    |       |       |
| 1.4  | 88  | 02.10          | + Bremsscheibendurchm. 284 mm <sup>3)</sup> | 13.0470-3827.2 | LD3827                                      |  |  |                |  |  |                                      |                |   |                |        |                |        |                |   |       |       |                   |    |         |   |       |       |                |    |         |   |       |       |                |    |                |   |       |       |                |        |               |   |                |       |                    |       |                    |   |         |       |                   |       |                   |   |         |       |                |       |                |   |       |       |         |       |                |       |           |       |         |       |         |       |                   |       |         |       |         |       |                |       |         |       |         |       |         |       |             |       |             |       |         |       |                  |       |                  |       |         |       |                  |       |                  |       |                |       |       |       |                |        |  |                                     |                |    |       |       |                |        |         |    |       |       |  |  |         |    |       |       |  |  |       |    |       |       |  |  |           |    |       |       |  |  |                   |    |       |       |  |  |                |    |       |       |  |  |         |    |       |       |  |  |         |    |       |       |  |  |         |    |       |       |
| 1.4  | 88  | 10.11          | + Bremsscheibendurchm. 284 mm <sup>3)</sup> |                |   |  |  |                |  |  |                                      |                |   |                |        |                |        |                |   |       |       |                   |    |         |   |       |       |                |    |         |   |       |       |                |    |                |   |       |       |                |        |               |   |                |       |                    |       |                    |   |         |       |                   |       |                   |   |         |       |                |       |                |   |       |       |         |       |                |       |           |       |         |       |         |       |                   |       |         |       |         |       |                |       |         |       |         |       |         |       |             |       |             |       |         |       |                  |       |                  |       |         |       |                  |       |                  |       |                |       |       |       |                |        |  |                                     |                |    |       |       |                |        |         |    |       |       |  |  |         |    |       |       |  |  |       |    |       |       |  |  |           |    |       |       |  |  |                   |    |       |       |  |  |                |    |       |       |  |  |         |    |       |       |  |  |         |    |       |       |  |  |         |    |       |       |
| 1.4 Natural Power  | 88  | 02.10          | + Bremsscheibendurchm. 284 mm <sup>3)</sup> |                |   |  |  |                |  |  |                                      |                |   |                |        |                |        |                |   |       |       |                   |    |         |   |       |       |                |    |         |   |       |       |                |    |                |   |       |       |                |        |               |   |                |       |                    |       |                    |   |         |       |                   |       |                   |   |         |       |                |       |                |   |       |       |         |       |                |       |           |       |         |       |         |       |                   |       |         |       |         |       |                |       |         |       |         |       |         |       |             |       |             |       |         |       |                  |       |                  |       |         |       |                  |       |                  |       |                |       |       |       |                |        |  |                                     |                |    |       |       |                |        |         |    |       |       |  |  |         |    |       |       |  |  |       |    |       |       |  |  |           |    |       |       |  |  |                   |    |       |       |  |  |                |    |       |       |  |  |         |    |       |       |  |  |         |    |       |       |  |  |         |    |       |       |
| 1.6 D Multijet   | 66  | 02.10          | + Bremsscheibendurchm. 284 mm <sup>3)</sup> |                |   |  |  |                |  |  |                                      |                |   |                |        |                |        |                |   |       |       |                   |    |         |   |       |       |                |    |         |   |       |       |                |    |                |   |       |       |                |        |               |   |                |       |                    |       |                    |   |         |       |                   |       |                   |   |         |       |                |       |                |   |       |       |         |       |                |       |           |       |         |       |         |       |                   |       |         |       |         |       |                |       |         |       |         |       |         |       |             |       |             |       |         |       |                  |       |                  |       |         |       |                  |       |                  |       |                |       |       |       |                |        |  |                                     |                |    |       |       |                |        |         |    |       |       |  |  |         |    |       |       |  |  |       |    |       |       |  |  |           |    |       |       |  |  |                   |    |       |       |  |  |                |    |       |       |  |  |         |    |       |       |  |  |         |    |       |       |  |  |         |    |       |       |
| 1.6 D Multijet   | 70  | 03.15          | + Bremsscheibendurchm. 284 mm <sup>3)</sup> |                |   |  |  |                |  |  |                                      |                |   |                |        |                |        |                |   |       |       |                   |    |         |   |       |       |                |    |         |   |       |       |                |    |                |   |       |       |                |        |               |   |                |       |                    |       |                    |   |         |       |                   |       |                   |   |         |       |                |       |                |   |       |       |         |       |                |       |           |       |         |       |         |       |                   |       |         |       |         |       |                |       |         |       |         |       |         |       |             |       |             |       |         |       |                  |       |                  |       |         |       |                  |       |                  |       |                |       |       |       |                |        |  |                                     |                |    |       |       |                |        |         |    |       |       |  |  |         |    |       |       |  |  |       |    |       |       |  |  |           |    |       |       |  |  |                   |    |       |       |  |  |                |    |       |       |  |  |         |    |       |       |  |  |         |    |       |       |  |  |         |    |       |       |
| 1.6 D Multijet   | 74  | 02.10          | + Bremsscheibendurchm. 284 mm <sup>3)</sup> |                |   |  |  |                |  |  |                                      |                |   |                |        |                |        |                |   |       |       |                   |    |         |   |       |       |                |    |         |   |       |       |                |    |                |   |       |       |                |        |               |   |                |       |                    |       |                    |   |         |       |                   |       |                   |   |         |       |                |       |                |   |       |       |         |       |                |       |           |       |         |       |         |       |                   |       |         |       |         |       |                |       |         |       |         |       |         |       |             |       |             |       |         |       |                  |       |                  |       |         |       |                  |       |                  |       |                |       |       |       |                |        |  |                                     |                |    |       |       |                |        |         |    |       |       |  |  |         |    |       |       |  |  |       |    |       |       |  |  |           |    |       |       |  |  |                   |    |       |       |  |  |                |    |       |       |  |  |         |    |       |       |  |  |         |    |       |       |  |  |         |    |       |       |
| 1.6 D Multijet   | 77  | 02.10          | + Bremsscheibendurchm. 284 mm <sup>3)</sup> |                |   |  |  |                |  |  |                                      |                |   |                |        |                |        |                |   |       |       |                   |    |         |   |       |       |                |    |         |   |       |       |                |    |                |   |       |       |                |        |               |   |                |       |                    |       |                    |   |         |       |                   |       |                   |   |         |       |                |       |                |   |       |       |         |       |                |       |           |       |         |       |         |       |                   |       |         |       |         |       |                |       |         |       |         |       |         |       |             |       |             |       |         |       |                  |       |                  |       |         |       |                  |       |                  |       |                |       |       |       |                |        |  |                                     |                |    |       |       |                |        |         |    |       |       |  |  |         |    |       |       |  |  |       |    |       |       |  |  |           |    |       |       |  |  |                   |    |       |       |  |  |                |    |       |       |  |  |         |    |       |       |  |  |         |    |       |       |  |  |         |    |       |       |
| 1.6 D Multijet   | 88  | 03.15          | + Bremsscheibendurchm. 284 mm <sup>3)</sup> |                |   |  |  |                |  |  |                                      |                |   |                |        |                |        |                |   |       |       |                   |    |         |   |       |       |                |    |         |   |       |       |                |    |                |   |       |       |                |        |               |   |                |       |                    |       |                    |   |         |       |                   |       |                   |   |         |       |                |       |                |   |       |       |         |       |                |       |           |       |         |       |         |       |                   |       |         |       |         |       |                |       |         |       |         |       |         |       |             |       |             |       |         |       |                  |       |                  |       |         |       |                  |       |                  |       |                |       |       |       |                |        |  |                                     |                |    |       |       |                |        |         |    |       |       |  |  |         |    |       |       |  |  |       |    |       |       |  |  |           |    |       |       |  |  |                   |    |       |       |  |  |                |    |       |       |  |  |         |    |       |       |  |  |         |    |       |       |  |  |         |    |       |       |
| 2.0 D Multijet   | 99  | 02.10          | + Bremsscheibendurchm. 284 mm <sup>3)</sup> |                |   |  |  |                |  |  |                                      |                |   |                |        |                |        |                |   |       |       |                   |    |         |   |       |       |                |    |         |   |       |       |                |    |                |   |       |       |                |        |               |   |                |       |                    |       |                    |   |         |       |                   |       |                   |   |         |       |                |       |                |   |       |       |         |       |                |       |           |       |         |       |         |       |                   |       |         |       |         |       |                |       |         |       |         |       |         |       |             |       |             |       |         |       |                  |       |                  |       |         |       |                  |       |                  |       |                |       |       |       |                |        |  |                                     |                |    |       |       |                |        |         |    |       |       |  |  |         |    |       |       |  |  |       |    |       |       |  |  |           |    |       |       |  |  |                   |    |       |       |  |  |                |    |       |       |  |  |         |    |       |       |  |  |         |    |       |       |  |  |         |    |       |       |

<sup>1)</sup> + Van / + Furgone / + Fourgonnette / + Furgón

<sup>2)</sup> + bus / + autobus / + autobus/car / + autobús

<sup>3)</sup> + brake disc diameter 284mm / + diametro dischi freno 284mm / + diamètre disques frein 284mm / + diámetro disco freno 284mm



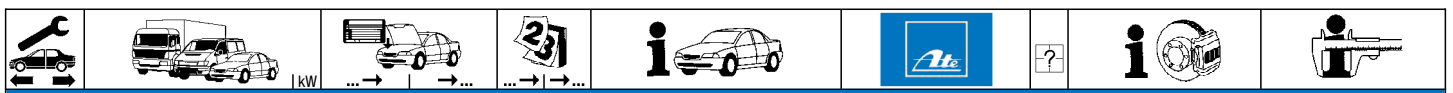

| FIAT DOBLO (10-)    |                   |    |       |   |   |                |        |   |  |                      |     |
|---------------------|-------------------|----|-------|---|---|----------------|--------|---|--|----------------------|-----|
|                     | 1.3 D Multijet    |    |       | 02.10                                       | + Bremsscheibendurchm. 305 mm <sup>1)</sup> | 13.0460-7265.2 | 607265 |   |  | 24727 20,7 +WK       | ATE |
|                     | 1.4               | 70 |       | 02.10                                       | + Bremsscheibendurchm. 305 mm <sup>1)</sup> |                |        |   |  |                      |     |
|                     | 1.4               | 88 |       | 10.11                                       | + Bremsscheibendurchm. 305 mm <sup>1)</sup> |                |        |   |  |                      |     |
|                     | 1.4 Natural Power | 88 |       | 02.10                                       | + Bremsscheibendurchm. 305 mm <sup>1)</sup> |                |        |   |  |                      |     |
|                     | 1.6 D Multijet    | 66 |       | 02.10                                       | + Bremsscheibendurchm. 305 mm <sup>1)</sup> |                |        |   |  |                      |     |
|                     | 1.6 D Multijet    | 70 |       | 03.15                                       | + Bremsscheibendurchm. 305 mm <sup>1)</sup> |                |        |   |  |                      |     |
|                     | 1.6 D Multijet    | 74 |       | 02.10                                       | + Bremsscheibendurchm. 305 mm <sup>1)</sup> |                |        |   |  |                      |     |
|                     | 1.6 D Multijet    | 77 |       | 02.10                                       | + Bremsscheibendurchm. 305 mm <sup>1)</sup> |                |        |   |  |                      |     |
|                     | 1.6 D Multijet    | 88 |       | 03.15                                       | + Bremsscheibendurchm. 305 mm <sup>1)</sup> |                |        |   |  |                      |     |
| 2.0 D Multijet      | 99                |    | 02.10 | + Bremsscheibendurchm. 305 mm <sup>1)</sup> |   |                |        |   |  |                      |     |
|                     | 1.3 D Multijet    |    |       | 02.10                                       |   | 24.0122-0145.1 | 422145 |   |  | 284 22,0 20,2 V +B   |     |
|                     | 1.4               | 70 |       | 02.10                                       |   |                |        |   |  |                      |     |
|                     | 1.4               | 88 |       | 10.11                                       |   |                |        |   |  |                      |     |
|                     | 1.4 Natural Power | 88 |       | 02.10                                       |   |                |        |   |  |                      |     |
|                     | 1.6 D Multijet    | 66 |       | 02.10                                       |   |                |        |   |  |                      |     |
|                     | 1.6 D Multijet    | 70 |       | 03.15                                       |   |                |        |   |  |                      |     |
|                     | 1.6 D Multijet    | 74 |       | 02.10                                       |   |                |        |   |  |                      |     |
|                     | 1.6 D Multijet    | 77 |       | 02.10                                       |   |                |        |   |  |                      |     |
|                     | 1.6 D Multijet    | 88 |       | 03.15                                       |   |                |        |   |  |                      |     |
| 2.0 D Multijet      | 99                |    | 02.10 |   |   |                |        |   |  |                      |     |
|                     | 1.3 D Multijet    |    |       | 02.10                                       |   | 24.0128-0253.1 | 428253 |   |  | 305 28,0 26,0 V L +B |     |
|                     | 1.4               | 70 |       | 02.10                                       |   |                |        |   |  |                      |     |
|                     | 1.4               | 88 |       | 10.11                                       |   |                |        |   |  |                      |     |
|                     | 1.4 Natural Power | 88 |       | 02.10                                       |   |                |        |   |  |                      |     |
|                     | 1.6 D Multijet    | 66 |       | 02.10                                       |   |                |        |   |  |                      |     |
|                     | 1.6 D Multijet    | 70 |       | 03.15                                       |   |                |        |   |  |                      |     |
|                     | 1.6 D Multijet    | 74 |       | 02.10                                       |   |                |        |   |  |                      |     |
|                     | 1.6 D Multijet    | 77 |       | 02.10                                       |   |                |        |   |  |                      |     |
|                     | 1.6 D Multijet    | 88 |       | 03.15                                       |   |                |        |   |  |                      |     |
| 2.0 D Multijet      | 99                |    | 02.10 |   |   |                |        |   |  |                      |     |
|                     | 1.3 D Multijet    |    |       | 02.10                                       |   | 24.0711-5288.3 | 360348 | 2 |  | Radsensor L=775      |     |
|                     | 1.4               | 70 |       | 02.10                                       |   |                |        |   |  |                      |     |
|                     | 1.4               | 88 |       | 10.11                                       |   |                |        |   |  |                      |     |
|                     | 1.4 Natural Power | 88 |       | 02.10                                       |   |                |        |   |  |                      |     |
|                     | 1.6 D Multijet    | 66 |       | 02.10                                       |   |                |        |   |  |                      |     |
|                     | 1.6 D Multijet    | 70 |       | 03.15                                       |   |                |        |   |  |                      |     |
|                     | 1.6 D Multijet    | 74 |       | 02.10                                       |   |                |        |   |  |                      |     |
|                     | 1.6 D Multijet    | 77 |       | 02.10                                       |   |                |        |   |  |                      |     |
|                     | 1.6 D Multijet    | 88 |       | 03.15                                       |   |                |        |   |  |                      |     |
| 2.0 D Multijet      | 99                |    | 02.10 |   |   |                |        |   |  |                      |     |
|                     | 1.3 D Multijet    |    |       | 02.10                                       |   | 24.0711-5289.3 | 360349 | 2 |  | Radsensor L=520      |     |
|                     | 1.4               | 70 |       | 02.10                                       |   |                |        |   |  |                      |     |
|                     | 1.4               | 88 |       | 10.11                                       |   |                |        |   |  |                      |     |
|                     | 1.4 Natural Power | 88 |       | 02.10                                       |   |                |        |   |  |                      |     |
|                     | 1.6 D Multijet    | 66 |       | 02.10                                       |   |                |        |   |  |                      |     |
|                     | 1.6 D Multijet    | 70 |       | 03.15                                       |   |                |        |   |  |                      |     |
|                     | 1.6 D Multijet    | 74 |       | 02.10                                       |   |                |        |   |  |                      |     |
|                     | 1.6 D Multijet    | 77 |       | 02.10                                       |   |                |        |   |  |                      |     |
|                     | 1.6 D Multijet    | 88 |       | 03.15                                       |   |                |        |   |  |                      |     |
| 2.0 D Multijet      | 99                |    | 02.10 |   |   |                |        |   |  |                      |     |
|                     | 1.3 D Multijet    |    |       | 02.10                                       | + 9" Bremse <sup>2)</sup>                   | 03.0137-0457.2 | 650457 |   |  | 228 x 42 HEB         | AP  |
|                     | 1.4               | 70 |       | 02.10                                       | + 9" Bremse <sup>2)</sup>                   | 03.0137-9296.2 | 669296 |   |  | Bremsbacken-Zubehör  |     |
|                     | 1.4               | 88 |       | 10.11                                       | + 9" Bremse <sup>2)</sup>                   |                |        |   |  |                      |     |
|                     | 1.4 Natural Power | 88 |       | 02.10                                       | + 9" Bremse <sup>2)</sup>                   |                |        |   |  |                      |     |
|                     | 1.6 D Multijet    | 66 |       | 02.10                                       | + 9" Bremse <sup>2)</sup>                   |                |        |   |  |                      |     |
|                     | 1.6 D Multijet    | 70 |       | 03.15                                       | + 9" Bremse <sup>2)</sup>                   |                |        |   |  |                      |     |
|                     | 1.6 D Multijet    | 74 |       | 02.10                                       | + 9" Bremse <sup>2)</sup>                   |                |        |   |  |                      |     |
|                     | 1.6 D Multijet    | 77 |       | 02.10                                       | + 9" Bremse <sup>2)</sup>                   |                |        |   |  |                      |     |
|                     | 1.6 D Multijet    | 88 |       | 03.15                                       | + 9" Bremse <sup>2)</sup>                   |                |        |   |  |                      |     |
| 2.0 D Multijet      | 99                |    | 02.10 | + 9" Bremse <sup>2)</sup>                   |   |                |        |   |  |                      |     |
|                     | 1.3 D Multijet    |    |       | 02.10                                       | + 10" Bremse <sup>3)</sup>                  | 03.0137-0505.2 | 650505 |   |  | 254 x 57 HEB         | AP  |
|                     | 1.4               | 70 |       | 02.10                                       | + 10" Bremse <sup>3)</sup>                  | 03.0137-9309.2 | 669309 |   |  | Bremsbacken-Zubehör  | AP  |
|                     | 1.4               | 88 |       | 10.11                                       | + 10" Bremse <sup>3)</sup>                  |                |        |   |  |                      |     |
|                     | 1.4 Natural Power | 88 |       | 02.10                                       | + 10" Bremse <sup>3)</sup>                  |                |        |   |  |                      |     |
|                     | 1.6 D Multijet    | 66 |       | 02.10                                       | + 10" Bremse <sup>3)</sup>                  |                |        |   |  |                      |     |
|                     | 1.6 D Multijet    | 70 |       | 03.15                                       | + 10" Bremse <sup>3)</sup>                  |                |        |   |  |                      |     |
|                     | 1.6 D Multijet    | 74 |       | 02.10                                       | + 10" Bremse <sup>3)</sup>                  |                |        |   |  |                      |     |
|                     | 1.6 D Multijet    | 77 |       | 02.10                                       | + 10" Bremse <sup>3)</sup>                  |                |        |   |  |                      |     |
|                     | 1.6 D Multijet    | 88 |       | 03.15                                       | + 10" Bremse <sup>3)</sup>                  |                |        |   |  |                      |     |
| 2.0 D Multijet      | 99                |    | 02.10 | + 10" Bremse <sup>3)</sup>                  |   |                |        |   |  |                      |     |
|                     | 1.3 D Multijet    |    |       | 02.10                                       | + 9" Bremse <sup>2)</sup>                   | 03.0521-0320.3 | 690320 |   |  | 20,64/228x42 TopKit  | AP  |
|                     | 1.4               | 70 |       | 02.10                                       | + 9" Bremse <sup>2)</sup>                   |                |        |   |  |                      |     |
|                     | 1.4               | 88 |       | 10.11                                       | + 9" Bremse <sup>2)</sup>                   |                |        |   |  |                      |     |
|                     | 1.4 Natural Power | 88 |       | 02.10                                       | + 9" Bremse <sup>2)</sup>                   |                |        |   |  |                      |     |
|                     | 1.6 D Multijet    | 66 |       | 02.10                                       | + 9" Bremse <sup>2)</sup>                   |                |        |   |  |                      |     |
|                     | 1.6 D Multijet    | 70 |       | 03.15                                       | + 9" Bremse <sup>2)</sup>                   |                |        |   |  |                      |     |
|                     | 1.6 D Multijet    | 74 |       | 02.10                                       | + 9" Bremse <sup>2)</sup>                   |                |        |   |  |                      |     |
|                     | 1.6 D Multijet    | 77 |       | 02.10                                       | + 9" Bremse <sup>2)</sup>                   |                |        |   |  |                      |     |
|                     | 1.6 D Multijet    | 88 |       | 03.15                                       | + 9" Bremse <sup>2)</sup>                   |                |        |   |  |                      |     |
| 2.0 D Multijet      | 99                |    | 02.10 | + 9" Bremse <sup>2)</sup>                   |   |                |        |   |  |                      |     |
| FIAT DUCATO (94-02) |                   |    |       |   |   |                |        |   |  |                      |     |
|                     | 1.9 D (10)        |    |       | 02.94                                       | 12.99                                       | 13.0460-2976.2 | 602976 |   |  | 21797 19,7 +WK/S     | TRW |
|                     | 1.9 TD (10)       |    |       | 02.94                                       | 12.99                                       |                |        |   |  |                      |     |
|                     | 1.9 TD CAT (10)   |    |       | 02.94                                       | 12.99                                       |                |        |   |  |                      |     |
|                     | 2.0 i (10/14)     |    |       | 02.94                                       | 12.99                                       |                |        |   |  |                      |     |
|                     | ↓                 | ↓  |       |   |   |                |        |   |  |                      |     |

<sup>1)</sup> + brake disc diameter 305mm / + diametro dischi freno 305mm / + diamètre disques frein 305mm / + diámetro disco freno 305mm

<sup>2)</sup> + 9" brake / + servofreno da 9" / + frein de 9" / + freno de 9"



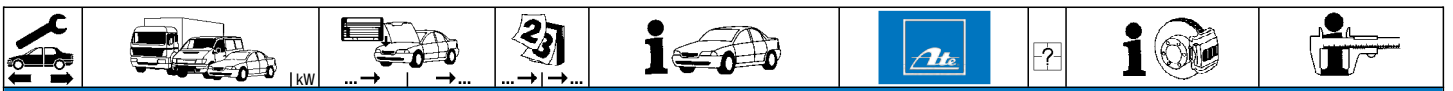











<sup>3)</sup> + 10" brake / + freno 10" / + frein de 10" / + freno de 10"



**FIAT DUCATO (94-02)**

|  |   |  |  |   |  |                       |  |                     |     |
|--|---|--|--|---|--|-----------------------|--|---------------------|-----|
|  | 2.5 D (14)<br>2.5 TDI (14)<br>2.5 TDI ECO (14)<br>2.8 D (14)<br>2.8 IDTD 4x4<br>2.8 TDI (14)  |  |  | 02.94 12.99<br>02.94 12.99<br>02.94 12.99<br>02.98 12.99<br>05.98 12.99<br>10.97 12.99  |  | 13.0460-2976.2 602976 |  | 21797 19,7 +/WK/S   | TRW |
|  | 1.9 D (10)<br>1.9 TD (10)<br>1.9 TD CAT (10)<br>2.0 i (10/14)<br>2.5 D (14)<br>2.5 TDI (14)<br>2.5 TDI ECO (14)<br>2.8 D (14)<br>2.8 IDTD 4x4<br>2.8 JTD (14)<br>2.8 TDI (14) |  |  | 01.00 10.01<br>01.00 10.01<br>01.00 10.01<br>01.00 10.01<br>01.00 10.01<br>01.00 10.01<br>01.00 10.01<br>01.00 10.01<br>01.00 09.01<br>11.00 10.01<br>01.00 10.01 |  | 13.0460-2850.2 602850 |  | 23602 19,7 +/WK/S   | TRW |
|  | 1.9 D (10)<br>1.9 TD (10)<br>1.9 TD CAT (10)<br>2.0 i (10/14)<br>2.0 JTD (14)<br>2.5 D (14)<br>2.5 TDI (14)<br>2.5 TDI ECO (14)<br>2.8 D (14)<br>2.8 JTD (14)<br>2.8 TDI (14) |  |  | 11.01 03.02<br>11.01 03.02<br>11.01 03.02<br>11.01 03.02<br>10.01 03.02<br>11.01 03.02<br>11.01 03.02<br>11.01 03.02<br>11.01 03.02<br>11.01 03.02<br>11.01 03.02 |  | 13.0460-4978.2 604978 |  | 23917 19,3 +/WK/Zub | BRE |
|  | 2.0 i (18)<br>2.5 D (18)<br>2.5 TDI (18)<br>2.5 TDI ECO (18)<br>2.8 D (18)<br>2.8 IDTD 4x4<br>2.8 TDI (18)  |  |  | 02.94 12.99<br>02.94 12.99<br>02.94 12.99<br>02.94 12.99<br>02.98 12.99<br>05.98 12.99<br>10.97 12.99   |  | 13.0460-2977.2 602977 |  | 21799 19,7 +/WK/S   | TRW |
|  | 2.0 i (18)<br>2.5 D (18)<br>2.5 TDI (18)<br>2.5 TDI ECO (18)<br>2.8 D (18)<br>2.8 IDTD 4x4<br>2.8 JTD (18)<br>2.8 TDI (18)  |  |  | 01.00 10.01<br>01.00 10.01<br>01.00 10.01<br>01.00 10.01<br>01.00 10.01<br>01.00 10.01<br>11.00 10.01<br>01.00 10.01  |  | 13.0460-2852.2 602852 |  | 23603 19,7 +/WK/S   | TRW |
|  | 2.0 i (18)<br>2.0 JTD (18)<br>2.5 D (18)<br>2.5 TDI (18)<br>2.5 TDI ECO (18)<br>2.8 D (18)<br>2.8 JTD (18)<br>2.8 TDI (18)  |  |  | 11.01 03.02<br>10.01 03.02<br>11.01 03.02<br>11.01 03.02<br>11.01 03.02<br>11.01 03.02<br>11.01 03.02<br>11.01 03.02  |  | 13.0460-4979.2 604979 |  | 23919 19,3 +/WK/Zub | BRE |
|  | 1.9 D (10)<br>1.9 TD (10)<br>1.9 TD CAT (10)<br>2.0 i (10/14)<br>2.5 D (14)<br>2.8 D (14)   |  |  | 02.94 10.01<br>02.94 10.01<br>02.94 10.01<br>02.94 10.01<br>02.94 10.01<br>02.98 10.01  |  | 24.0118-0108.1 418108 |  | 280 18,0 15,9 +B    |     |
|  | 2.5 TDI (14)<br>2.5 TDI ECO (14)<br>2.8 IDTD 4x4<br>2.8 JTD (14)<br>2.8 TDI (14)  |  |  | 02.94 10.01<br>02.94 10.01<br>05.98 09.01<br>11.00 10.01<br>10.97 10.01   |  | 24.0124-0127.1 424127 |  | 280 24,0 21,9 V +B  |     |
|  | 2.0 i (18)<br>2.5 D (18)<br>2.5 TDI (18)<br>2.5 TDI ECO (18)<br>2.8 D (18)<br>2.8 IDTD 4x4<br>2.8 JTD (18)<br>2.8 TDI (18)  |  |  | 02.94 10.01<br>02.94 10.01<br>02.94 10.01<br>02.94 10.01<br>02.98 10.01<br>05.98 09.01<br>11.00 10.01<br>10.97 10.01  |  | 24.0124-0138.1 424138 |  | 300 24,0 21,9 V +B  |     |
|  | 1.9 D (10)<br>1.9 TD (10)<br>1.9 TD CAT (10)<br>2.0 i (10/14)<br>2.0 JTD (14)<br>2.5 D (14)<br>2.5 TDI (14)<br>2.5 TDI ECO (14)<br>2.8 D (14)<br>2.8 JTD (14)<br>2.8 TDI (14) |  |  | 11.01 03.02<br>11.01 03.02<br>11.01 03.02<br>11.01 03.02<br>10.01 03.02<br>11.01 03.02<br>11.01 03.02<br>11.01 03.02<br>11.01 03.02<br>11.01 03.02<br>11.01 03.02 |  | 24.0124-0127.1 424127 |  | 280 24,0 21,9 V +B  |     |
|  | 2.0 i (18)<br>2.0 JTD (18)<br>2.5 D (18)<br>2.5 TDI (18)<br>2.5 TDI ECO (18)  |  |  | 11.01 03.02<br>10.01 03.02<br>11.01 03.02<br>11.01 03.02<br>11.01 03.02   |  | 24.0124-0138.1 424138 |  | 300 24,0 21,9 V +B  |     |



|     |   |  |  |    |  |  |  |  |
|--|---|--|--|--|---|--|--|--|
| <b>FIAT DUCATO (94-02)</b>   |   |  |  |  |   |  |  |  |
|    | 2.8 D (18)<br>2.8 JTD (18)<br>2.8 TDI (18)  |  |  | 11.01 03.02<br>11.01 03.02<br>11.01 03.02  |   | 24.0124-0138.1   | 424138   | 300 24,0 21,9 V +B   |
|    | 1.9 D (10)<br>1.9 TD (10)<br>1.9 TD CAT (10)<br>2.0 i (10/14/18)<br>2.0 JTD (14/18)<br>2.5 D (14/18)<br>2.5 TDI (14/18)<br>2.5 TDI ECO (14/18)<br>2.8 D (14/18)<br>2.8 JTD (14/18)<br>2.8 TDI (14/18) |  |  | 11.01 03.02<br>11.01 03.02<br>11.01 03.02<br>11.01 03.02<br>10.01 03.02<br>11.01 03.02<br>11.01 03.02<br>11.01 03.02<br>11.01 03.02<br>11.01 03.02<br>11.01 03.02                |   | 13.0460-4980.2   | 604980   | 23921 20,3 /Zub <b>BRE</b>   |
|    | 1.9 D (10)<br>1.9 TD (10)<br>1.9 TD CAT (10)<br>2.0 i (10/14)<br>2.0 JTD (14)<br>2.5 D (14)<br>2.5 TDI (14)<br>2.5 TDI ECO (14)<br>2.8 D (14)<br>2.8 JTD (14)<br>2.8 TDI (14)                         |  |  | 11.01 03.02<br>11.01 03.02<br>11.01 03.02<br>11.01 03.02<br>10.01 03.02<br>11.01 03.02<br>11.01 03.02<br>11.01 03.02<br>11.01 03.02<br>11.01 03.02<br>11.01 03.02                |   | 24.0116-0124.1   | 416124   | 280 16,0 14,2 +B   |
|  | 2.0 i (18)<br>2.0 JTD (18)<br>2.5 D (18)<br>2.5 TDI (18)<br>2.5 TDI ECO (18)<br>2.8 D (18)<br>2.8 JTD (18)<br>2.8 TDI (18)  |  |  | 11.01 03.02<br>10.01 03.02<br>11.01 03.02<br>11.01 03.02<br>11.01 03.02<br>11.01 03.02<br>11.01 03.02<br>11.01 03.02   |   | 24.0116-0125.1   | 416125   | 280 16,0 14,2 +B   |
|    | 1.9 D (10)<br>1.9 TD (10)<br>1.9 TD CAT (10)<br>2.0 i (10/14)<br>2.5 D (14)<br>2.5 TDI (14)<br>2.5 TDI ECO (14)<br>2.8 D (14)<br>2.8 IDTD 4x4<br>2.8 JTD (14)<br>2.8 TDI (14)                         |  |  | 02.94 10.01<br>02.94 10.01<br>02.94 10.01<br>02.94 10.01<br>02.94 10.01<br>02.94 10.01<br>02.94 10.01<br>02.98 10.01<br>05.98 09.01<br>11.00 10.01<br>10.97 10.01                |   | 03.0137-0333.2<br>03.0137-9219.2   | 650333<br>669219   | - Wohnmobil<br>254 x 57 HEB <b>TRW</b><br>Bremsbacken-Zubehör <b>TRW</b>           |
|  | 2.0 i (18)<br>2.5 D (18)<br>2.5 TDI (18)<br>2.5 TDI ECO (18)<br>2.8 D (18)<br>2.8 IDTD 4x4<br>2.8 JTD (18)<br>2.8 TDI (18)  |  |  | 02.94 10.01<br>02.94 10.01<br>02.94 10.01<br>02.94 10.01<br>02.98 10.01<br>05.98 09.01<br>11.00 10.01<br>10.97 10.01   |   | 03.0137-0334.2<br>03.0137-9219.2   | 650334<br>669219   | - Wohnmobil<br>254 x 57 HEB <b>TRW</b><br>Bremsbacken-Zubehör <b>TRW</b>           |
|  | 1.9 D (10)<br>1.9 TD (10)<br>1.9 TD CAT (10)<br>2.0 i (10/14)<br>2.0 JTD (14)<br>2.5 D (14)<br>2.5 TDI (14)<br>2.5 TDI ECO (14)<br>2.8 D (14)<br>2.8 JTD (14)<br>2.8 TDI (14)                         |  |  | 11.01 03.02<br>11.01 03.02<br>11.01 03.02<br>11.01 03.02<br>10.01 03.02<br>11.01 03.02<br>11.01 03.02<br>11.01 03.02<br>11.01 03.02<br>11.01 03.02<br>11.01 03.02                |   | 03.0137-0432.2<br>03.0137-9285.2   | 650432<br>669285   | - Quick Fit<br>254 x 57 HEB <b>AP</b><br>Bremsbacken-Zubehör <b>AP</b>             |
|  | 1.9 D (10)<br>1.9 TD (10)<br>1.9 TD CAT (10)<br>2.0 i (10/14)<br>2.0 JTD (14)<br>2.5 D (14)<br>2.5 TDI (14)<br>2.5 TDI ECO (14)<br>2.8 D (14)<br>2.8 IDTD 4x4<br>2.8 JTD (14)<br>2.8 TDI (14)         |  |  | 02.94 03.02<br>02.94 03.02<br>02.94 03.02<br>02.94 03.02<br>10.01 03.02<br>02.94 03.02<br>02.94 03.02<br>02.94 03.02<br>02.98 03.02<br>05.98 09.01<br>11.00 03.02<br>10.97 03.02 |   | 24.0225-4002.1   | 480048   | 254/255,6 x 63,5   |
|  | 2.0 i (18)<br>2.5 D (18)<br>2.5 TDI (18)<br>2.5 TDI ECO (18)<br>2.8 D (18)<br>2.8 IDTD 4x4<br>2.8 JTD (18)<br>2.8 TDI (18)  |  |  | 02.94 10.01<br>02.94 10.01<br>02.94 10.01<br>02.94 10.01<br>02.98 10.01<br>05.98 09.01<br>11.00 10.01<br>10.97 10.01   |   | 24.0225-4005.1   | 480070   | 254/255,6 x 64,5   |

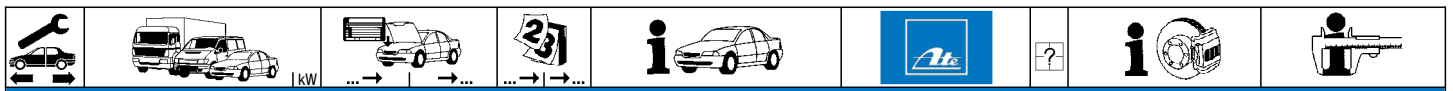

### FIAT DUCATO (94-02)

|                  |                  |  |       |       |       |                |        |                 |                     |     |
|------------------|------------------|--|-------|-------|-------|----------------|--------|-----------------|---------------------|-----|
|                  | 1.9 D (10)       |  |       | 02.94 | 10.01 | 03.0520-0925.3 | 690925 | - Wohnmobil     | 25,40/254x57 TopKit | TRW |
|                  | 1.9 TD (10)      |  |       | 02.94 | 10.01 |                |        |                 |                     |     |
|                  | 1.9 TD CAT (10)  |  |       | 02.94 | 10.01 |                |        |                 |                     |     |
|                  | 2.0 i (10/14)    |  |       | 02.94 | 10.01 |                |        |                 |                     |     |
|                  | 2.5 D (14)       |  |       | 02.94 | 10.01 |                |        |                 |                     |     |
|                  | 2.5 TDI (14)     |  |       | 02.94 | 10.01 | 03.0520-0226.3 | 690226 | - Wohnmobil     | 26,99/254x57 TopKit | TRW |
|                  | 2.5 TDI ECO (14) |  |       | 02.94 | 10.01 |                |        |                 |                     |     |
|                  | 2.8 D (14)       |  |       | 02.98 | 10.01 |                |        |                 |                     |     |
|                  | 2.8 iDTD 4x4     |  |       | 05.98 | 09.01 |                |        |                 |                     |     |
|                  | 2.8 JTD (14)     |  |       | 11.00 | 10.01 |                |        |                 |                     |     |
|                  | 2.8 TDI (14)     |  |       | 10.97 | 10.01 |                |        |                 |                     |     |
|                  | 2.0 i (18)       |  |       | 02.94 | 10.01 |                |        |                 |                     |     |
| 2.5 D (18)       |                  |  | 02.94 | 10.01 |       |                |        |                 |                     |     |
| 2.5 TDI (18)     |                  |  | 02.94 | 10.01 |       |                |        |                 |                     |     |
| 2.5 TDI ECO (18) |                  |  | 02.94 | 10.01 |       |                |        |                 |                     |     |
| 2.8 D (18)       |                  |  | 02.98 | 10.01 |       |                |        |                 |                     |     |
| 2.8 iDTD 4x4     |                  |  | 05.98 | 09.01 |       |                |        |                 |                     |     |
| 2.8 JTD (18)     |                  |  | 11.00 | 10.01 |       |                |        |                 |                     |     |
| 2.8 JTD (18)     |                  |  | 11.00 | 10.01 |       |                |        |                 |                     |     |
| 2.8 TDI (18)     |                  |  | 10.97 | 10.01 |       |                |        |                 |                     |     |
|                  | 1.9 D (10)       |  |       | 11.01 | 03.02 | 03.0520-0326.3 | 690326 | + Quick Fit     | 26,99/254x57 TopKit | AP  |
|                  | 1.9 TD (10)      |  |       | 11.01 | 03.02 |                |        |                 |                     |     |
|                  | 1.9 TD CAT (10)  |  |       | 11.01 | 03.02 |                |        |                 |                     |     |
|                  | 2.0 i (10/14)    |  |       | 11.01 | 03.02 |                |        |                 |                     |     |
|                  | 2.0 JTD (14)     |  |       | 10.01 | 03.02 |                |        |                 |                     |     |
|                  | 2.5 D (14)       |  |       | 11.01 | 03.02 |                |        |                 |                     |     |
|                  | 2.5 TDI (14)     |  |       | 11.01 | 03.02 |                |        |                 |                     |     |
|                  | 2.5 TDI ECO (14) |  |       | 11.01 | 03.02 |                |        |                 |                     |     |
|                  | 2.8 D (14)       |  |       | 11.01 | 03.02 |                |        |                 |                     |     |
|                  | 2.8 JTD (14)     |  |       | 11.01 | 03.02 |                |        |                 |                     |     |
|                  | 2.8 TDI (14)     |  |       | 11.01 | 03.02 |                |        |                 |                     |     |
|                  | 2.0 i (18)       |  |       | 11.01 | 03.02 | 03.0137-4002.2 | 654002 | - Stützlager 1) | 172 x 42 /Zub       |     |
|                  | 2.0 JTD (18)     |  |       | 10.01 | 03.02 |                |        |                 |                     |     |
|                  | 2.5 D (18)       |  |       | 11.01 | 03.02 |                |        |                 |                     |     |
|                  | 2.5 TDI (18)     |  |       | 11.01 | 03.02 |                |        |                 |                     |     |
|                  | 2.5 TDI ECO (18) |  |       | 11.01 | 03.02 |                |        |                 |                     |     |
|                  | 2.8 D (18)       |  |       | 11.01 | 03.02 |                |        |                 |                     |     |
|                  | 2.8 JTD (18)     |  |       | 11.01 | 03.02 |                |        |                 |                     |     |
|                  | 2.8 TDI (18)     |  |       | 11.01 | 03.02 |                |        |                 |                     |     |

### FIAT DUCATO (02-06)

|  |                       |    |  |       |       |                |        |             |                     |     |
|--|-----------------------|----|--|-------|-------|----------------|--------|-------------|---------------------|-----|
|  | 2.0 i (11/15)         | 81 |  | 04.02 | 07.06 | 13.0460-4978.2 | 604978 |             | 23917 19,3 +WK/Zub  | BRE |
|  | 2.0 JTD (11/15)       | 62 |  | 04.02 | 07.06 |                |        |             |                     |     |
|  | 2.3 JTD (11/15)       | 81 |  | 04.02 | 07.06 |                |        |             |                     |     |
|  | 2.8 JTD (11/15)       |    |  | 04.02 | 07.06 |                |        |             |                     |     |
|  | 2.8 JTD 4x4 (11/15)   | 94 |  | 07.02 | 07.06 |                |        |             |                     |     |
|  | 2.0 i (18)            | 81 |  | 04.02 | 07.06 | 13.0460-4979.2 | 604979 |             | 23919 19,3 +WK/Zub  | BRE |
|  | 2.0 JTD (18)          | 62 |  | 04.02 | 07.06 |                |        |             |                     |     |
|  | 2.3 JTD (18)          | 81 |  | 04.02 | 07.06 |                |        |             |                     |     |
|  | 2.8 JTD (18)          |    |  | 04.02 | 07.06 |                |        |             |                     |     |
|  | 2.8 JTD 4x4 (18)      | 94 |  | 07.02 | 07.06 |                |        |             |                     |     |
|  | 2.0 i (11/15)         | 81 |  | 04.02 | 07.06 | 24.0124-0127.1 | 424127 |             | 280 24,0 21,9 V +B  |     |
|  | 2.0 JTD (11/15)       | 62 |  | 04.02 | 07.06 |                |        |             |                     |     |
|  | 2.3 JTD (11/15)       | 81 |  | 04.02 | 07.06 |                |        |             |                     |     |
|  | 2.8 JTD (11/15)       |    |  | 04.02 | 07.06 |                |        |             |                     |     |
|  | 2.8 JTD 4x4 (11/15)   | 94 |  | 07.02 | 07.06 |                |        |             |                     |     |
|  | 2.0 i (18)            | 81 |  | 04.02 | 07.06 | 24.0124-0138.1 | 424138 |             | 300 24,0 21,9 V +B  |     |
|  | 2.0 JTD (18)          | 62 |  | 04.02 | 07.06 |                |        |             |                     |     |
|  | 2.3 JTD (18)          | 81 |  | 04.02 | 07.06 |                |        |             |                     |     |
|  | 2.8 JTD (18)          |    |  | 04.02 | 07.06 |                |        |             |                     |     |
|  | 2.8 JTD 4x4 (18)      | 94 |  | 07.02 | 07.06 |                |        |             |                     |     |
|  | 2.0 i (11/15/18)      | 81 |  | 04.02 | 07.06 | 13.0460-4980.2 | 604980 |             | 23921 20,3 /Zub     | BRE |
|  | 2.0 JTD (11/15/18)    | 62 |  | 04.02 | 07.06 |                |        |             |                     |     |
|  | 2.3 JTD (11/15/18)    | 81 |  | 04.02 | 07.06 |                |        |             |                     |     |
|  | 2.8 JTD (11/15/18)    |    |  | 04.02 | 07.06 |                |        |             |                     |     |
|  | 2.8 JTD 4x4(11/15/18) | 94 |  | 07.02 | 07.06 |                |        |             |                     |     |
|  | 2.0 i (11/15)         | 81 |  | 04.02 | 07.06 | 24.0116-0124.1 | 416124 |             | 280 16,0 14,2 +B    |     |
|  | 2.0 JTD (11/15)       | 62 |  | 04.02 | 07.06 |                |        |             |                     |     |
|  | 2.3 JTD (11/15)       | 81 |  | 04.02 | 07.06 |                |        |             |                     |     |
|  | 2.8 JTD (11/15)       |    |  | 04.02 | 07.06 |                |        |             |                     |     |
|  | 2.8 JTD 4x4 (11/15)   | 94 |  | 07.02 | 07.06 |                |        |             |                     |     |
|  | 2.0 i (18)            | 81 |  | 04.02 | 07.06 | 24.0116-0125.1 | 416125 |             | 280 16,0 14,2 +B    |     |
|  | 2.0 JTD (18)          | 62 |  | 04.02 | 07.06 |                |        |             |                     |     |
|  | 2.3 JTD (18)          | 81 |  | 04.02 | 07.06 |                |        |             |                     |     |
|  | 2.8 JTD (18)          |    |  | 04.02 | 07.06 |                |        |             |                     |     |
|  | 2.8 JTD 4x4 (18)      | 94 |  | 07.02 | 07.06 |                |        |             |                     |     |
|  | 2.0 i (11/15)         | 81 |  | 04.02 | 07.06 | 03.0137-0432.2 | 650432 | - Quick Fit | 254 x 57 HEB        | AP  |
|  | 2.0 JTD (11/15)       | 62 |  | 04.02 | 07.06 |                |        |             |                     |     |
|  | 2.3 JTD (11/15)       | 81 |  | 04.02 | 07.06 |                |        |             |                     |     |
|  | 2.8 JTD (11/15)       |    |  | 04.02 | 07.06 |                |        |             |                     |     |
|  | 2.8 JTD 4x4 (11/15)   | 94 |  | 07.02 | 07.06 |                |        |             |                     |     |
|  | 2.0 i (11/15)         | 81 |  | 04.02 | 07.06 | 03.0137-9285.2 | 669285 |             | Bremsbacken-Zubehör | AP  |
|  | 2.0 JTD (11/15)       | 62 |  | 04.02 | 07.06 |                |        |             |                     |     |
|  | 2.3 JTD (11/15)       | 81 |  | 04.02 | 07.06 |                |        |             |                     |     |
|  | 2.8 JTD (11/15)       |    |  | 04.02 | 07.06 |                |        |             |                     |     |
|  | 2.8 JTD 4x4 (11/15)   | 94 |  | 07.02 | 07.06 |                |        |             |                     |     |
|  | 2.0 i (11/15)         | 81 |  | 04.02 | 07.06 | 24.0225-4002.1 | 480048 |             | 254/255,6 x 63,5    |     |
|  | 2.0 JTD (11/15)       | 62 |  | 04.02 | 07.06 |                |        |             |                     |     |
|  | 2.3 JTD (11/15)       | 81 |  | 04.02 | 07.06 |                |        |             |                     |     |
|  | 2.8 JTD (11/15)       |    |  | 04.02 | 07.06 |                |        |             |                     |     |

1) - support bearing / - cuscinetto di spinta / - palier d'appui / - soporte de apoyo



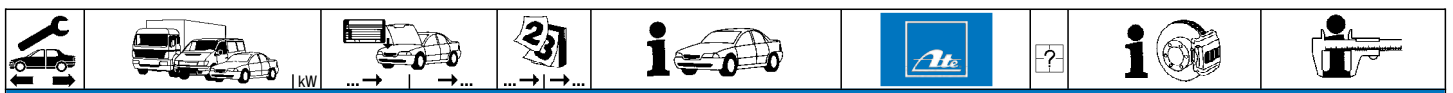

### FIAT DUCATO (02-06)

|  |                       |    |  |       |       |                |        |                 |                        |
|--|-----------------------|----|--|-------|-------|----------------|--------|-----------------|------------------------|
|  | 2.8 JTD 4x4 (11/15)   | 94 |  | 07.02 | 07.06 | 24.0225-4002.1 | 480048 |                 | 254/255,6 x 63,5       |
|  | 2.0 i (11/15)         | 81 |  | 04.02 | 07.06 | 03.0520-0326.3 | 690326 | + Quick Fit     | 26,99/254x57 TopKit AP |
|  | 2.0 JTD (11/15)       | 62 |  | 04.02 | 07.06 |                |        |                 |                        |
|  | 2.3 JTD (11/15)       | 81 |  | 04.02 | 07.06 |                |        |                 |                        |
|  | 2.8 JTD (11/15)       |    |  | 04.02 | 07.06 |                |        |                 |                        |
|  | 2.8 JTD 4x4 (11/15)   | 94 |  | 07.02 | 07.06 |                |        |                 |                        |
|  | 2.0 i (11/15/18)      | 81 |  | 04.02 | 07.06 | 03.0137-4002.2 | 654002 | - Stützlager 1) | 172 x 42 /Zub          |
|  | 2.0 JTD (11/15/18)    | 62 |  | 04.02 | 07.06 |                |        |                 |                        |
|  | 2.3 JTD (11/15/18)    | 81 |  | 04.02 | 07.06 |                |        |                 |                        |
|  | 2.8 JTD (11/15/18)    |    |  | 04.02 | 07.06 |                |        |                 |                        |
|  | 2.8 JTD 4x4(11/15/18) | 94 |  | 07.02 | 07.06 |                |        |                 |                        |

### FIAT DUCATO (06-)

|  |                    |     |  |       |                        |                |        |  |                          |
|--|--------------------|-----|--|-------|------------------------|----------------|--------|--|--------------------------|
|  | 140 Natural Power  | 100 |  | 04.09 | Nutzlast 110/150 2)    | 13.0460-4807.2 | 604807 |  | 24468 19,1 +/-WK/Zub BRE |
|  | 2.0 D 115 Multijet | 85  |  | 06.11 | Nutzlast 110/150 2)    |                |        |  |                          |
|  | 2.2 D 100 Multijet | 74  |  | 07.06 | Nutzlast 110/150 2)    |                |        |  |                          |
|  | 2.3 D 120 Multijet | 88  |  | 07.06 | Nutzlast 110/150 2)    |                |        |  |                          |
|  | 2.3 D 130 Multijet | 96  |  | 01.07 | Nutzlast 110/150 2)    |                |        |  |                          |
|  | 2.3 D 150 Multijet | 109 |  | 06.11 | Nutzlast 110/150 2)    |                |        |  |                          |
|  | 2.3 D 150 Multijet | 110 |  | 12.15 | Nutzlast 110/150 2)    |                |        |  |                          |
|  | 2.3 D 180 Multijet | 130 |  | 12.15 | Nutzlast 110/150 2)    |                |        |  |                          |
|  | 3.0 D 150 Multijet | 107 |  | 04.10 | Nutzlast 110/150 2)    |                |        |  |                          |
|  | 3.0 D 160 Multijet | 116 |  | 07.06 | Nutzlast 110/150 2)    |                |        |  |                          |
|  | 3.0 D Multijet     | 130 |  | 06.11 | Nutzlast 110/150 2)    |                |        |  |                          |
|  | 140 Natural Power  | 100 |  | 04.09 | Nutzlast leicht 170 3) | 13.0460-4809.2 | 604809 |  | 24468 19,1 +/-WK/Zub BRE |
|  | 2.0 D 115 Multijet | 85  |  | 06.11 | Nutzlast leicht 170 3) |                |        |  |                          |
|  | 2.2 D 100 Multijet | 74  |  | 07.06 | Nutzlast leicht 170 3) |                |        |  |                          |
|  | 2.3 D 120 Multijet | 88  |  | 07.06 | Nutzlast leicht 170 3) |                |        |  |                          |
|  | 2.3 D 130 Multijet | 96  |  | 01.07 | Nutzlast leicht 170 3) |                |        |  |                          |
|  | 2.3 D 150 Multijet | 109 |  | 06.11 | Nutzlast leicht 170 3) |                |        |  |                          |
|  | 2.3 D 150 Multijet | 110 |  | 12.15 | Nutzlast leicht 170 3) |                |        |  |                          |
|  | 2.3 D 180 Multijet | 130 |  | 12.15 | Nutzlast leicht 170 3) |                |        |  |                          |
|  | 3.0 D 150 Multijet | 107 |  | 04.10 | Nutzlast leicht 170 3) |                |        |  |                          |
|  | 3.0 D 160 Multijet | 116 |  | 07.06 | Nutzlast leicht 170 3) |                |        |  |                          |
|  | 3.0 D Multijet     | 130 |  | 06.11 | Nutzlast leicht 170 3) |                |        |  |                          |
|  | 140 Natural Power  | 100 |  | 04.09 | Nutzlast schwer 170 4) | 13.0460-4810.2 | 604810 |  | 24466 19,1 +/-WK/Zub BRE |
|  | 2.0 D 115 Multijet | 85  |  | 06.11 | Nutzlast schwer 170 4) |                |        |  |                          |
|  | 2.2 D 100 Multijet | 74  |  | 07.06 | Nutzlast schwer 170 4) |                |        |  |                          |
|  | 2.3 D 120 Multijet | 88  |  | 07.06 | Nutzlast schwer 170 4) |                |        |  |                          |
|  | 2.3 D 130 Multijet | 96  |  | 01.07 | Nutzlast schwer 170 4) |                |        |  |                          |
|  | 2.3 D 150 Multijet | 109 |  | 06.11 | Nutzlast schwer 170 4) |                |        |  |                          |
|  | 2.3 D 150 Multijet | 110 |  | 12.15 | Nutzlast schwer 170 4) |                |        |  |                          |
|  | 2.3 D 180 Multijet | 130 |  | 12.15 | Nutzlast schwer 170 4) |                |        |  |                          |
|  | 3.0 D 150 Multijet | 107 |  | 04.10 | Nutzlast schwer 170 4) |                |        |  |                          |
|  | 3.0 D 160 Multijet | 116 |  | 07.06 | Nutzlast schwer 170 4) |                |        |  |                          |
|  | 3.0 D Multijet     | 130 |  | 06.11 | Nutzlast schwer 170 4) |                |        |  |                          |
|  | 140 Natural Power  | 100 |  | 04.09 | Nutzlast 200 5)        | 13.0460-4811.2 | 604811 |  | 24466 19,1 +/-WK/Zub BRE |
|  | 2.0 D 115 Multijet | 85  |  | 06.11 | Nutzlast 200 5)        |                |        |  |                          |
|  | 2.2 D 100 Multijet | 74  |  | 07.06 | Nutzlast 200 5)        |                |        |  |                          |
|  | 2.3 D 120 Multijet | 88  |  | 07.06 | Nutzlast 200 5)        |                |        |  |                          |
|  | 2.3 D 130 Multijet | 96  |  | 01.07 | Nutzlast 200 5)        |                |        |  |                          |
|  | 2.3 D 150 Multijet | 109 |  | 06.11 | Nutzlast 200 5)        |                |        |  |                          |
|  | 2.3 D 150 Multijet | 110 |  | 12.15 | Nutzlast 200 5)        |                |        |  |                          |
|  | 2.3 D 180 Multijet | 130 |  | 12.15 | Nutzlast 200 5)        |                |        |  |                          |
|  | 3.0 D 150 Multijet | 107 |  | 04.10 | Nutzlast 200 5)        |                |        |  |                          |
|  | 3.0 D 160 Multijet | 116 |  | 07.06 | Nutzlast 200 5)        |                |        |  |                          |
|  | 3.0 D Multijet     | 130 |  | 06.11 | Nutzlast 200 5)        |                |        |  |                          |
|  | 140 Natural Power  | 100 |  | 04.09 | Nutzlast 110/150 2)    | 24.0124-0127.1 | 424127 |  | 280 24,0 21,9 V +B       |
|  | 2.0 D 115 Multijet | 85  |  | 06.11 | Nutzlast 110/150 2)    |                |        |  |                          |
|  | 2.2 D 100 Multijet | 74  |  | 07.06 | Nutzlast 110/150 2)    |                |        |  |                          |
|  | 2.3 D 120 Multijet | 88  |  | 07.06 | Nutzlast 110/150 2)    |                |        |  |                          |
|  | 2.3 D 130 Multijet | 96  |  | 01.07 | Nutzlast 110/150 2)    |                |        |  |                          |
|  | 2.3 D 150 Multijet | 109 |  | 06.11 | Nutzlast 110/150 2)    |                |        |  |                          |
|  | 2.3 D 150 Multijet | 110 |  | 12.15 | Nutzlast 110/150 2)    |                |        |  |                          |
|  | 2.3 D 180 Multijet | 130 |  | 12.15 | Nutzlast 110/150 2)    |                |        |  |                          |
|  | 3.0 D 150 Multijet | 107 |  | 04.10 | Nutzlast 110/150 2)    |                |        |  |                          |
|  | 3.0 D 160 Multijet | 116 |  | 07.06 | Nutzlast 110/150 2)    |                |        |  |                          |
|  | 3.0 D Multijet     | 130 |  | 06.11 | Nutzlast 110/150 2)    |                |        |  |                          |
|  | 140 Natural Power  | 100 |  | 04.09 | Nutzlast leicht 170 3) | 24.0128-0213.1 | 428213 |  | 280 28,0 25,9 V +B       |
|  | 2.0 D 115 Multijet | 85  |  | 06.11 | Nutzlast leicht 170 3) |                |        |  |                          |
|  | 2.2 D 100 Multijet | 74  |  | 07.06 | Nutzlast leicht 170 3) |                |        |  |                          |
|  | 2.3 D 120 Multijet | 88  |  | 07.06 | Nutzlast leicht 170 3) |                |        |  |                          |
|  | 2.3 D 130 Multijet | 96  |  | 01.07 | Nutzlast leicht 170 3) |                |        |  |                          |
|  | 2.3 D 150 Multijet | 109 |  | 06.11 | Nutzlast leicht 170 3) |                |        |  |                          |
|  | 2.3 D 150 Multijet | 110 |  | 12.15 | Nutzlast leicht 170 3) |                |        |  |                          |
|  | 2.3 D 180 Multijet | 130 |  | 12.15 | Nutzlast leicht 170 3) |                |        |  |                          |
|  | 3.0 D 150 Multijet | 107 |  | 04.10 | Nutzlast leicht 170 3) |                |        |  |                          |
|  | 3.0 D 160 Multijet | 116 |  | 07.06 | Nutzlast leicht 170 3) |                |        |  |                          |
|  | 3.0 D Multijet     | 130 |  | 06.11 | Nutzlast leicht 170 3) |                |        |  |                          |
|  | 140 Natural Power  | 100 |  | 04.09 | Nutzlast schwer 170 4) | 24.0124-0138.1 | 424138 |  | 300 24,0 21,9 V +B       |
|  | 2.0 D 115 Multijet | 85  |  | 06.11 | Nutzlast schwer 170 4) |                |        |  |                          |
|  | 2.2 D 100 Multijet | 74  |  | 07.06 | Nutzlast schwer 170 4) |                |        |  |                          |
|  | 2.3 D 120 Multijet | 88  |  | 07.06 | Nutzlast schwer 170 4) |                |        |  |                          |
|  | 2.3 D 130 Multijet | 96  |  | 01.07 | Nutzlast schwer 170 4) |                |        |  |                          |

1) - support bearing / - cuscinetto di spinta / - palier d'appui / - soporte de apoyo  
2) payload 110/150 / carico utile 110/150 / charge utile 110/150 / carga útil 110/150  
3) light payload 170 / carico utile leggero 170 / charge utile légère 170 / carga útil ligera 170  
4) heavy payload 170 / carico utile pesante 170 / charge utile lourde 170 / carga útil pesada 170  
5) payload 200 / carico utile 200 / charge utile 200 / carga útil 200





### FIAT DUCATO (06-)

|                    |                    |                    |       |                                   |  |  |                |        |                    |                |        |                    |                       |                  |
|--------------------|--------------------|--------------------|-------|-----------------------------------|--|--|----------------|--------|--------------------|----------------|--------|--------------------|-----------------------|------------------|
|                    | 2.3 D 150 Multijet | 109                |       | 06.11                             | Nutzlast schwer 17Q <sup>1)</sup>          | 24.0124-0138.1                             | 424138         |        | 300 24,0 21,9 V +B |                |        |                    |                       |                  |
|                    | 2.3 D 150 Multijet | 110                |       | 12.15                             | Nutzlast schwer 17Q <sup>1)</sup>          |  |                |        |                    |                |        |                    |                       |                  |
|                    | 2.3 D 180 Multijet | 130                |       | 12.15                             | Nutzlast schwer 17Q <sup>1)</sup>          |  |                |        |                    |                |        |                    |                       |                  |
|                    | 3.0 D 150 Multijet | 107                |       | 04.10                             | Nutzlast schwer 17Q <sup>1)</sup>          |  |                |        |                    |                |        |                    |                       |                  |
|                    | 3.0 D 160 Multijet | 116                |       | 07.06                             | Nutzlast schwer 17Q <sup>1)</sup>          |  |                |        |                    |                |        |                    |                       |                  |
|                    | 3.0 D Multijet     | 130                |       | 06.11                             | Nutzlast schwer 17Q <sup>1)</sup>          |  |                |        |                    |                |        |                    |                       |                  |
|                    | 140 Natural Power  | 100                |       | 04.09                             | Nutzlast 20Q <sup>2)</sup>                 | 24.0132-0131.1                             | 432131         |        | 300 32,0 29,9 V +B |                |        |                    |                       |                  |
|                    | 2.0 D 115 Multijet | 85                 |       | 06.11                             | Nutzlast 20Q <sup>2)</sup>                 |  |                |        |                    |                |        |                    |                       |                  |
|                    | 2.2 D 100 Multijet | 74                 |       | 07.06                             | Nutzlast 20Q <sup>2)</sup>                 |  |                |        |                    |                |        |                    |                       |                  |
|                    | 2.3 D 120 Multijet | 88                 |       | 07.06                             | Nutzlast 20Q <sup>2)</sup>                 |  |                |        |                    |                |        |                    |                       |                  |
|                    | 2.3 D 130 Multijet | 96                 |       | 01.07                             | Nutzlast 20Q <sup>2)</sup>                 |  |                |        |                    |                |        |                    |                       |                  |
|                    | 2.3 D 150 Multijet | 109                |       | 06.11                             | Nutzlast 20Q <sup>2)</sup>                 |  |                |        |                    |                |        |                    |                       |                  |
|                    | 2.3 D 150 Multijet | 110                |       | 12.15                             | Nutzlast 20Q <sup>2)</sup>                 |  |                |        |                    |                |        |                    |                       |                  |
|                    | 2.3 D 180 Multijet | 130                |       | 12.15                             | Nutzlast 20Q <sup>2)</sup>                 |  |                |        |                    |                |        |                    |                       |                  |
| 3.0 D 150 Multijet | 107                |                    | 04.10 | Nutzlast 20Q <sup>2)</sup>        |  |  |                |        |                    |                |        |                    |                       |                  |
| 3.0 D 160 Multijet | 116                |                    | 07.06 | Nutzlast 20Q <sup>2)</sup>        |  |  |                |        |                    |                |        |                    |                       |                  |
| 3.0 D Multijet     | 130                |                    | 06.11 | Nutzlast 20Q <sup>2)</sup>        |  |  |                |        |                    |                |        |                    |                       |                  |
|                    | 140 Natural Power  | 100                |       | 04.09                             | Nutzlast 110/150/17Q                       |  |                |        |                    | 13.0460-4812.2 | 604812 | Baumuster 30/33/35 | 24465 19,2 /Zub/S BRE |                  |
|                    | 2.0 D 115 Multijet | 85                 |       | 06.11                             | Nutzlast 110/150/17Q                       |  |                |        |                    |                |        |                    |                       |                  |
|                    | 2.2 D 100 Multijet | 74                 |       | 07.06                             | Nutzlast 110/150/17Q                       |  |                |        |                    |                |        |                    |                       |                  |
|                    | 2.3 D 120 Multijet | 88                 |       | 07.06                             | Nutzlast 110/150/17Q                       |  |                |        |                    |                |        |                    |                       |                  |
|                    | 2.3 D 130 Multijet | 96                 |       | 01.07                             | Nutzlast 110/150/17Q                       |  |                |        |                    |                |        |                    |                       |                  |
|                    | 2.3 D 150 Multijet | 109                |       | 06.11                             | Nutzlast 110/150/17Q                       |  |                |        |                    |                |        |                    |                       |                  |
|                    | 2.3 D 150 Multijet | 110                |       | 12.15                             | Nutzlast 110/150/17Q                       |  |                |        |                    |                |        |                    |                       |                  |
|                    | 2.3 D 180 Multijet | 130                |       | 12.15                             | Nutzlast 110/150/17Q                       |  |                |        |                    |                |        |                    |                       |                  |
|                    | 3.0 D 150 Multijet | 107                |       | 04.10                             | Nutzlast 110/150/17Q                       |  |                |        |                    |                |        |                    |                       |                  |
|                    | 3.0 D 160 Multijet | 116                |       | 07.06                             | Nutzlast 110/150/17Q                       |  |                |        |                    |                |        |                    |                       |                  |
|                    | 3.0 D Multijet     | 130                |       | 06.11                             | Nutzlast 110/150/17Q                       |  |                |        |                    |                |        |                    |                       |                  |
|                    |                    | 140 Natural Power  | 100   |                                   | 04.09                                      | Nutzlast 110/150+ leicht 17Q <sup>3)</sup> | 24.0116-0124.1 | 416124 |                    |                |        |                    |                       | 280 16,0 14,2 +B |
|                    |                    | 2.0 D 115 Multijet | 85    |                                   | 06.11                                      | Nutzlast 110/150+ leicht 17Q <sup>3)</sup> |                |        |                    |                |        |                    |                       |                  |
|                    |                    | 2.2 D 100 Multijet | 74    |                                   | 07.06                                      | Nutzlast 110/150+ leicht 17Q <sup>3)</sup> |                |        |                    |                |        |                    |                       |                  |
| 2.3 D 120 Multijet |                    | 88                 |       | 07.06                             | Nutzlast 110/150+ leicht 17Q <sup>3)</sup> |  |                |        |                    |                |        |                    |                       |                  |
| 2.3 D 130 Multijet |                    | 96                 |       | 01.07                             | Nutzlast 110/150+ leicht 17Q <sup>3)</sup> |  |                |        |                    |                |        |                    |                       |                  |
| 2.3 D 150 Multijet |                    | 109                |       | 06.11                             | Nutzlast 110/150+ leicht 17Q <sup>3)</sup> |  |                |        |                    |                |        |                    |                       |                  |
| 2.3 D 150 Multijet |                    | 110                |       | 12.15                             | Nutzlast 110/150+ leicht 17Q <sup>3)</sup> |  |                |        |                    |                |        |                    |                       |                  |
| 2.3 D 150 Multijet |                    | 110                |       | 12.15                             | Nutzlast 110/150+ leicht 17Q <sup>3)</sup> |  |                |        |                    |                |        |                    |                       |                  |
| 3.0 D 150 Multijet |                    | 107                |       | 04.10                             | Nutzlast 110/150+ leicht 17Q <sup>3)</sup> |  |                |        |                    |                |        |                    |                       |                  |
| 3.0 D 160 Multijet |                    | 116                |       | 07.06                             | Nutzlast 110/150+ leicht 17Q <sup>3)</sup> |  |                |        |                    |                |        |                    |                       |                  |
| 3.0 D Multijet     |                    | 130                |       | 06.11                             | Nutzlast 110/150+ leicht 17Q <sup>3)</sup> |  |                |        |                    |                |        |                    |                       |                  |
| 140 Natural Power  |                    | 100                |       | 04.09                             | Nutzlast schwer 17Q <sup>1)</sup>          | 24.0116-0125.1                             |                |        |                    | 416125         |        | 280 16,0 14,2 +B   |                       |                  |
| 2.0 D 115 Multijet |                    | 85                 |       | 06.11                             | Nutzlast schwer 17Q <sup>1)</sup>          |  |                |        |                    |                |        |                    |                       |                  |
| 2.2 D 100 Multijet |                    | 74                 |       | 07.06                             | Nutzlast schwer 17Q <sup>1)</sup>          |  |                |        |                    |                |        |                    |                       |                  |
| 2.3 D 120 Multijet | 88                 |                    | 07.06 | Nutzlast schwer 17Q <sup>1)</sup> |  |  |                |        |                    |                |        |                    |                       |                  |
| 2.3 D 130 Multijet | 96                 |                    | 01.07 | Nutzlast schwer 17Q <sup>1)</sup> |  |  |                |        |                    |                |        |                    |                       |                  |
| 2.3 D 150 Multijet | 109                |                    | 06.11 | Nutzlast schwer 17Q <sup>1)</sup> |  |  |                |        |                    |                |        |                    |                       |                  |
| 2.3 D 150 Multijet | 110                |                    | 12.15 | Nutzlast schwer 17Q <sup>1)</sup> |  |  |                |        |                    |                |        |                    |                       |                  |
| 2.3 D 180 Multijet | 130                |                    | 12.15 | Nutzlast schwer 17Q <sup>1)</sup> |  |  |                |        |                    |                |        |                    |                       |                  |
| 3.0 D 150 Multijet | 107                |                    | 04.10 | Nutzlast schwer 17Q <sup>1)</sup> |  |  |                |        |                    |                |        |                    |                       |                  |
| 3.0 D 160 Multijet | 116                |                    | 07.06 | Nutzlast schwer 17Q <sup>1)</sup> |  |  |                |        |                    |                |        |                    |                       |                  |
| 3.0 D Multijet     | 130                |                    | 06.11 | Nutzlast schwer 17Q <sup>1)</sup> |  |  |                |        |                    |                |        |                    |                       |                  |
|                    | 140 Natural Power  | 100                |       | 04.09                             | Nutzlast 20Q <sup>2)</sup>                 |  | 24.0116-0123.1 | 416123 |                    |                |        |                    | 300 16,0 14,2 +B      |                  |
|                    | 2.0 D 115 Multijet | 85                 |       | 06.11                             | Nutzlast 20Q <sup>2)</sup>                 |  |                |        |                    |                |        |                    |                       |                  |
|                    | 2.2 D 100 Multijet | 74                 |       | 07.06                             | Nutzlast 20Q <sup>2)</sup>                 |  |                |        |                    |                |        |                    |                       |                  |
|                    | 2.3 D 120 Multijet | 88                 |       | 07.06                             | Nutzlast 20Q <sup>2)</sup>                 |  |                |        |                    |                |        |                    |                       |                  |
|                    | 2.3 D 130 Multijet | 96                 |       | 01.07                             | Nutzlast 20Q <sup>2)</sup>                 |  |                |        |                    |                |        |                    |                       |                  |
|                    | 2.3 D 150 Multijet | 109                |       | 06.11                             | Nutzlast 20Q <sup>2)</sup>                 |  |                |        |                    |                |        |                    |                       |                  |
|                    | 2.3 D 150 Multijet | 110                |       | 12.15                             | Nutzlast 20Q <sup>2)</sup>                 |  |                |        |                    |                |        |                    |                       |                  |
|                    | 2.3 D 180 Multijet | 130                |       | 12.15                             | Nutzlast 20Q <sup>2)</sup>                 |  |                |        |                    |                |        |                    |                       |                  |
|                    | 3.0 D 150 Multijet | 107                |       | 04.10                             | Nutzlast 20Q <sup>2)</sup>                 |  |                |        |                    |                |        |                    |                       |                  |
|                    | 3.0 D 160 Multijet | 116                |       | 07.06                             | Nutzlast 20Q <sup>2)</sup>                 |  |                |        |                    |                |        |                    |                       |                  |
|                    | 3.0 D Multijet     | 130                |       | 06.11                             | Nutzlast 20Q <sup>2)</sup>                 |  |                |        |                    |                |        |                    |                       |                  |
|                    |                    | 140 Natural Power  | 100   |                                   | 07.06                                      |  |                |        |                    | 03.0137-4004.2 | 654004 |                    |                       | 172 x 42 /Zub    |
|                    |                    | 2.0 D 115 Multijet | 85    |                                   | 06.11                                      |  |                |        |                    |                |        |                    |                       |                  |
|                    |                    | 2.2 D 100 Multijet | 74    |                                   | 07.06                                      |  |                |        |                    |                |        |                    |                       |                  |
| 2.3 D 120 Multijet |                    | 88                 |       | 07.06                             |  |  |                |        |                    |                |        |                    |                       |                  |
| 2.3 D 130 Multijet |                    | 96                 |       | 07.06                             |  |  |                |        |                    |                |        |                    |                       |                  |
| 2.3 D 150 Multijet |                    | 109                |       | 06.10                             |  |  |                |        |                    |                |        |                    |                       |                  |
| 2.3 D 150 Multijet |                    | 110                |       | 12.15                             |  |  |                |        |                    |                |        |                    |                       |                  |
| 2.3 D 180 Multijet |                    | 130                |       | 12.15                             |  |  |                |        |                    |                |        |                    |                       |                  |
| 3.0 D 150 Multijet |                    | 107                |       | 07.06                             |  |  |                |        |                    |                |        |                    |                       |                  |
| 3.0 D 160 Multijet |                    | 116                |       | 07.06                             |  |  |                |        |                    |                |        |                    |                       |                  |
| 3.0 D Multijet     |                    | 130                |       | 06.10                             |  |  |                |        |                    |                |        |                    |                       |                  |

### FIAT FIORINO (93-01)

|  |        |  |  |       |       |                |        |  |                  |
|--|--------|--|--|-------|-------|----------------|--------|--|------------------|
|  | 1.3    |  |  | 09.93 | 03.01 | 13.0460-7063.2 | 607063 |  | 21962 18,0 + ATE |
|  | 1.4    |  |  | 09.93 | 03.01 |                |        |  |                  |
|  | 1.6    |  |  | 09.93 | 03.01 |                |        |  |                  |
|  | 1.7 D  |  |  | 09.93 | 03.01 |                |        |  |                  |
|  | 1.7 TD |  |  | 11.96 | 03.01 |                |        |  |                  |
|  | 1.3    |  |  | 09.93 | 03.01 | 24.0112-0122.1 | 412122 |  | 240 12,0 10,8    |
|  | 1.4    |  |  | 09.93 | 03.01 |                |        |  |                  |
|  | 1.6    |  |  | 09.93 | 03.01 |                |        |  |                  |
|  | 1.7 D  |  |  | 09.93 | 03.01 |                |        |  |                  |
|  | 1.7 TD |  |  | 11.96 | 03.01 |                |        |  |                  |

<sup>1)</sup> heavy payload 17Q / carico utile pesante 17Q / charge utile lourde 17Q / carga útil pesada 17Q

<sup>2)</sup> payload 20Q / carico utile 20Q / charge utile 20Q / carga útil 20Q

<sup>3)</sup> payload 110/150+ light 17Q / carico utile 110/150+ leggero 17Q / charge utile 110/150+ légère 17Q / carga útil 110/150+ ligera 17Q



### FIAT FIORINO (93-01)

|  |                                      |  |  |   |   |  |                                  |                  |  |                                     |
|--|--------------------------------------|--|--|---|---|--|----------------------------------|------------------|--|-------------------------------------|
|  | 1.3<br>1.4<br>1.6<br>1.7 D<br>1.7 TD |  |  | 09.93<br>09.93<br>09.93<br>09.93<br>11.96 | 03.01<br>03.01<br>03.01<br>03.01<br>03.01 |  | 03.0137-0208.2<br>03.0137-9081.2 | 650208<br>669081 |  | 228 x 42 HEB<br>Bremsbacken-Zubehör |
|  | 1.3<br>1.4<br>1.6<br>1.7 D<br>1.7 TD |  |  | 09.93<br>09.93<br>09.93<br>09.93<br>11.96 | 03.01<br>03.01<br>03.01<br>03.01<br>03.01 |  | 24.0222-8018.1                   | 480078           |  | 228/230 x 48                        |
|  | 1.3<br>1.4<br>1.6<br>1.7 D<br>1.7 TD |  |  | 09.93<br>09.93<br>09.93<br>09.93<br>11.96 | 03.01<br>03.01<br>03.01<br>03.01<br>03.01 |  | 03.0520-8820.3                   | 698820           |  | 20,64/228x42 TopKit                 |

### FIAT FIORINO / QUBO (08-)

|  |   |                                  |              |  |  |  |  |                            |      |   |
|--|---|----------------------------------|--------------|--|--|--|--|----------------------------|------|---|
|  | 1.3 D Multijet<br>1.3 D Multijet<br>1.4<br>1.4                              | 55<br>59<br>54<br>57             | 6446<br>6446 | 09.08<br>03.15<br>09.08<br>10.09                   |  | - Halbautomatik Selespeed <sup>1)</sup><br>- Halbautomatik Selespeed <sup>1)</sup> | 13.0460-3826.2<br>13.0470-3826.2                   | 603826<br>LD3826           |      | 23706 18,0 +/WK/Zub/SBOS<br>23706 18,0 +/WK/Zub/SBOS                              |
|  | 1.3 D Multijet<br>1.3 D Multijet<br>1.3 MPI<br>1.4<br>1.4                   | 55<br>59<br>52<br>54<br>57       | 6447<br>6447 | 09.08<br>03.15<br>01.07                            |  | + Halbautomatik Selespeed <sup>2)</sup><br>+ Halbautomatik Selespeed <sup>2)</sup> | 13.0460-3863.2                                     | 603863                     |      | 23706 18,0 +/WK/Zub/SBOS  |
|  | 1.3 D Multijet<br>1.3 D Multijet<br>1.3 MPI<br>1.4<br>1.4                   | 55<br>59<br>52<br>54<br>57       |              | 09.08<br>03.15<br>01.07<br>09.08<br>10.09          |  |  | 24.0122-0197.1<br>24.0322-0197.1                   | 422197<br>522197           |      | 258 22,0 20,2 V +B<br>258 22,0 20,2 V +B PD                                       |
|  | 1.3 D Multijet<br>1.3 D Multijet<br>1.3 MPI<br>1.4<br>1.4                   | 55<br>59<br>52<br>54<br>57       |              | 09.08<br>03.15<br>01.07<br>09.08<br>10.09          |  |  | 24.0122-0147.1                                     | 422147                     |      | 284 22,0 20,2 V +B  |
|  | 1.3 D Multijet<br>1.3 D Multijet<br>1.3 D Multijet<br>1.3 MPI<br>1.4<br>1.4 | 55<br>59<br>70<br>52<br>54<br>57 |              | 09.08<br>03.15<br>07.10<br>01.07<br>09.08<br>10.09 |  |  | 24.0711-5222.3                                     | 360309                     | 2    | Radsensor L=742   |
|  | 1.3 D Multijet<br>1.3 D Multijet<br>1.3 D Multijet<br>1.3 MPI<br>1.4<br>1.4 | 55<br>59<br>70<br>52<br>54<br>57 |              | 09.08<br>03.15<br>07.10<br>01.07<br>09.08<br>10.09 |  |  | 24.0711-5218.3<br>24.0711-5219.3                   | 360307<br>360308           | <br> | Radsensor L=764<br>Radsensor L=764  |
|  | 1.3 D Multijet<br>1.3 D Multijet<br>1.3 D Multijet<br>1.4<br>1.4            | 55<br>59<br>70<br>52<br>54       |              | 09.08<br>03.15<br>07.10<br>01.07<br>09.08          |  |  | 03.0137-0493.2                                     | 650493                     |      | 228 x 42 HEB <b>AP</b>  |
|  | 1.3 MPI<br>1.4<br>1.4   | 52<br>54<br>54                   |              | 01.07<br>09.08<br>09.08                            |  | - verstärkte Bremse <sup>3)</sup><br>+ verstärkte Bremse <sup>4)</sup>             | 03.0137-0479.2<br>03.0137-9310.2<br>03.0137-0457.2 | 650479<br>669310<br>650457 |      | 203 x 38 HEB <b>AP</b><br>Bremsbacken-Zubehör <b>AP</b><br>228 x 42 HEB <b>AP</b> |
|  | 1.3 D Multijet<br>1.3 D Multijet<br>1.3 D Multijet<br>1.4<br>1.4            | 55<br>59<br>70<br>54<br>57       |              | 09.08<br>03.15<br>07.10<br>09.08<br>10.09          |  | + verstärkte Bremse <sup>4)</sup>  | 24.0222-8018.1                                     | 480078                     |      | 228/230 x 48  |
|  | 1.3 MPI<br>1.4  | 52<br>54                         |              | 01.07<br>09.08                                     |  | - verstärkte Bremse <sup>3)</sup>  | 24.0220-3007.1                                     | 480064                     |      | 203/204,7 x 48,5  |
|  | 1.3 D Multijet<br>1.3 D Multijet<br>1.3 D Multijet                          | 55<br>59<br>70                   |              | 09.08<br>03.15<br>07.10                            |  |  | 03.0520-9220.3                                     | 699220                     |      | 20,64/203x38 TopKit <b>AP</b>   |

### FIAT FREEMONT (11-15)

|  |  |  |  |  |  |  |                |        |  |                                |
|--|--|--|--|--|--|--|----------------|--------|--|--------------------------------|
|  | 2.0 JTD<br>2.0 JTD<br>2.0 JTD AWD<br>2.4<br>3.6 V6<br>3.6 V6 AWD | 103<br>125<br>125<br>125<br>206<br>206 |  | 08.11<br>08.11<br>08.11<br>08.11<br>08.11<br>08.11 |  |  | 13.0460-2766.2 | 602766 |  | 24604 18,7 +/WK/Zub <b>BOS</b> |
|  | 2.0 JTD<br>2.0 JTD<br>2.0 JTD AWD<br>2.4<br>3.6 V6<br>3.6 V6 AWD | 103<br>125<br>125<br>125<br>206<br>206 |  | 08.11<br>08.11<br>08.11<br>08.11<br>08.11<br>08.11 |  |  | 24.0128-0263.1 | 428263 |  | 302 28,0 26,4 V L +B           |
|  | 2.0 JTD<br>2.0 JTD<br>2.0 JTD AWD<br>2.4<br>3.6 V6<br>3.6 V6 AWD | 103<br>125<br>125<br>125<br>206<br>206 |  | 08.11<br>08.11<br>08.11<br>08.11<br>08.11<br>08.11 |  | BRF-Bremsanlage <sup>5)</sup><br>BRF-Bremsanlage <sup>5)</sup><br>BRF-Bremsanlage <sup>5)</sup><br>BRF-Bremsanlage <sup>5)</sup><br>BRF-Bremsanlage <sup>5)</sup><br>BRF-Bremsanlage <sup>5)</sup> | 13.0460-2771.2 | 602771 |  | 24822 15,7 +/WK/Zub <b>TRW</b> |

<sup>1)</sup> - semi autom. Selespeed / - cambio semi autom. Selespeed / - boîte semi autom. Selespeed / - caja camb. semi autom. Selespeed  
<sup>2)</sup> + semi autom. Selespeed / + cambio semi autom. Selespeed / + boîte semi autom. Selespeed / + caja camb. semi autom. Selespeed  
<sup>3)</sup> - heavy duty brake / - freno reforzado / - frein renforcé / - freno reforzado  
<sup>4)</sup> + heavy duty brake / + freno reforzado / + frein renforcé / + freno reforzado  
<sup>5)</sup> BRF-brake system / impianto di frenante BRF / installation de frein BRF / construcción de freno BRF



### FIAT FREEMONT (11-15)

|  |             |     |  |       |  |                |        |  |                    |
|--|-------------|-----|--|-------|--|----------------|--------|--|--------------------|
|  | 2.0 JTD     | 103 |  | 08.11 |  | 24.0112-0199.1 | 412199 |  | 305 12,0 10,4 L +B |
|  | 2.0 JTD     | 125 |  | 08.11 |  |                |        |  |                    |
|  | 2.0 JTD AWD | 125 |  | 08.11 |  |                |        |  |                    |
|  | 2.4         | 125 |  | 08.11 |  |                |        |  |                    |
|  | 3.6 V6      | 206 |  | 08.11 |  |                |        |  |                    |
|  | 3.6 V6 AWD  | 206 |  | 08.11 |  |                |        |  |                    |





















### FIAT IDEA (04-12)

|  |                |    |  |       |       |                |        |  |                          |     |
|--|----------------|----|--|-------|-------|----------------|--------|--|--------------------------|-----|
|  | 1.2 i 16V      | 59 |  | 01.04 | 02.08 | 13.0460-3810.2 | 603810 |  | 23705 18,1 /S            | BOS |
|  | 1.3 JTD        | 51 |  | 01.04 | 07.12 | 13.0460-3818.2 | 603818 |  | 23706 18,1 +/WK/S        | BOS |
|  | 1.4            | 57 |  | 11.05 | 02.08 |                |        |  |                          |     |
|  | 1.4            | 70 |  | 01.04 | 02.08 |                |        |  |                          |     |
|  | 1.4 LPG        | 57 |  | 03.09 | 07.12 |                |        |  |                          |     |
|  | 1.8            | 81 |  | 01.08 | 07.10 |                |        |  |                          |     |
|  | 1.3 D Multijet | 66 |  | 11.05 | 02.08 | 13.0460-3811.2 | 603811 |  | 23708 19,2 /S            | BOS |
|  | 1.3 D Multijet | 70 |  | 05.08 | 07.12 | 13.0460-3827.2 | 603827 |  | 23709 19,6 +/WK/Zub/SBOS |     |
|  | 1.6 D Multijet | 88 |  | 05.08 | 07.12 | 13.0470-3827.2 | LD3827 |  | 23709 19,6 +/WK/Zub/SBOS |     |
|  | 1.9 JTD        | 74 |  | 01.04 | 02.08 |                |        |  |                          |     |
|  | 1.2 i 16V      | 59 |  | 01.04 | 02.08 | 24.0122-0197.1 | 422197 |  | 258 22,0 20,2 V +B       |     |
|  | 1.3 JTD        | 51 |  | 01.04 | 07.12 | 24.0322-0197.1 | 522197 |  | 258 22,0 20,2 V +B PD    |     |
|  | 1.4            | 57 |  | 11.05 | 02.08 |                |        |  |                          |     |
|  | 1.4            | 70 |  | 01.04 | 02.08 |                |        |  |                          |     |
|  | 1.4 LPG        | 57 |  | 03.09 | 07.12 |                |        |  |                          |     |
|  | 1.8            | 81 |  | 01.08 | 07.10 |                |        |  |                          |     |
|  | 1.3 D Multijet | 66 |  | 11.05 | 02.08 | 24.0122-0147.1 | 422147 |  | 284 22,0 20,2 V +B       |     |
|  | 1.3 D Multijet | 70 |  | 05.08 | 07.12 |                |        |  |                          |     |
|  | 1.6 D Multijet | 88 |  | 05.08 | 07.12 |                |        |  |                          |     |
|  | 1.9 JTD        | 74 |  | 01.04 | 02.08 |                |        |  |                          |     |
|  | 1.6 D Multijet | 88 |  | 05.08 | 07.12 | 13.0460-2879.2 | 602879 |  | 23601 13,7 /S            | TRW |
|  | 1.8            | 81 |  | 01.08 | 07.10 | 13.0470-2879.2 | LD2879 |  | 23601 13,7 /S            | TRW |
|  | 1.6 D Multijet | 88 |  | 05.08 | 07.12 | 24.0111-0119.1 | 411119 |  | 241 11,0 9,2 +B          |     |
|  | 1.8            | 81 |  | 01.08 | 07.10 |                |        |  |                          |     |
|  | 1.2 i 16V      | 59 |  | 01.04 | 02.08 | 03.0137-0479.2 | 650479 |  | 203 x 38 HEB             | AP  |
|  | 1.3 JTD        | 51 |  | 01.04 | 07.12 | 03.0137-9310.2 | 669310 |  | Bremsbacken-Zubehör      | AP  |
|  | 1.4            | 57 |  | 11.05 | 02.08 |                |        |  |                          |     |
|  | 1.4            | 70 |  | 01.04 | 02.08 |                |        |  |                          |     |
|  | 1.4 LPG        | 57 |  | 03.09 | 07.12 |                |        |  |                          |     |
|  | 1.3 D Multijet | 66 |  | 11.05 | 02.08 | 03.0137-0457.2 | 650457 |  | 228 x 42 HEB             | AP  |
|  | 1.3 D Multijet | 70 |  | 05.08 | 07.12 | 03.0137-9309.2 | 669309 |  | Bremsbacken-Zubehör      | AP  |
|  | 1.9 JTD        | 74 |  | 01.04 | 02.08 |                |        |  |                          |     |
|  | 1.2 i 16V      | 59 |  | 01.04 | 02.08 | 24.0220-3007.1 | 480064 |  | 203/204,7 x 48,5         |     |
|  | 1.3 JTD        | 51 |  | 01.04 | 07.12 |                |        |  |                          |     |
|  | 1.4            | 57 |  | 11.05 | 02.08 |                |        |  |                          |     |
|  | 1.4            | 70 |  | 01.04 | 02.08 |                |        |  |                          |     |
|  | 1.4 LPG        | 57 |  | 03.09 | 07.12 |                |        |  |                          |     |
|  | 1.3 D Multijet | 66 |  | 11.05 | 02.08 | 24.0222-8018.1 | 480078 |  | 228/230 x 48             |     |
|  | 1.3 D Multijet | 70 |  | 05.08 | 07.12 |                |        |  |                          |     |
|  | 1.9 JTD        | 74 |  | 01.04 | 02.08 |                |        |  |                          |     |
|  | 1.2 i 16V      | 59 |  | 01.04 | 06.05 | 03.0520-6922.3 | 696922 |  | 22,20/203x38 TopKit      | AP  |
|  | 1.3 JTD        | 51 |  | 01.04 | 07.12 |                |        |  |                          |     |
|  | 1.4            | 57 |  | 11.05 | 02.08 |                |        |  |                          |     |
|  | 1.4            | 70 |  | 01.04 | 06.05 |                |        |  |                          |     |
|  | 1.4 LPG        | 57 |  | 03.09 | 07.12 |                |        |  |                          |     |
|  | 1.3 D Multijet | 66 |  | 11.05 | 02.08 | 03.0520-9120.3 | 699120 |  | 20,64/228x42 TopKit      | AP  |
|  | 1.3 D Multijet | 70 |  | 05.08 | 07.12 |                |        |  |                          |     |
|  | 1.9 JTD        | 74 |  | 07.05 | 02.08 |                |        |  |                          |     |

### FIAT LINEA (07-11)

|  |                |    |  |       |       |                |        |   |                          |     |
|--|----------------|----|--|-------|-------|----------------|--------|---|--------------------------|-----|
|  | 1.3 D Multijet | 66 |  | 07.07 | 05.11 | 13.0460-3826.2 | 603826 |   | 23706 18,0 +/WK/Zub/SBOS |     |
|  | 1.4            |    |  | 07.07 | 05.11 | 13.0470-3826.2 | LD3826 |   | 23706 18,0 +/WK/Zub/SBOS |     |
|  | 1.4 T-Jet      |    |  | 07.07 | 05.11 | 13.0460-3818.2 | 603818 |   | 23706 18,1 +/WK/S        | BOS |
|  | 1.6            | 80 |  | 07.08 | 05.11 | 13.0460-3863.2 | 603863 |   | 23706 18,0 +/WK/Zub/SBOS |     |
|  | 1.6 D Multijet | 80 |  | 07.08 | 05.11 | 13.0460-3827.2 | 603827 |   | 23709 19,6 +/WK/Zub/SBOS |     |
|  | 1.9 16V        | 77 |  | 01.09 | 05.11 | 13.0470-3827.2 | LD3827 |   | 23709 19,6 +/WK/Zub/SBOS |     |
|  | 1.9 16V        | 77 |  | 07.08 | 05.11 |                |        |   |                          |     |
|  | 1.3 D Multijet | 66 |  | 07.07 | 05.11 | 24.0122-0197.1 | 422197 |   | 258 22,0 20,2 V +B       |     |
|  | 1.4            |    |  | 07.07 | 05.11 | 24.0322-0197.1 | 522197 |   | 258 22,0 20,2 V +B PD    |     |
|  | 1.4 T-Jet      |    |  | 07.07 | 05.11 | 24.0122-0147.1 | 422147 |   | 284 22,0 20,2 V +B       |     |
|  | 1.6            | 80 |  | 07.08 | 05.11 |                |        |   |                          |     |
|  | 1.6 D Multijet | 77 |  | 01.09 | 05.11 |                |        |   |                          |     |
|  | 1.9 16V        | 77 |  | 07.08 | 05.11 |                |        |   |                          |     |
|  | 1.3 D Multijet | 66 |  | 07.07 | 05.11 | 24.0711-5222.3 | 360309 | 2 | Radsensor L=742          |     |
|  | 1.4            |    |  | 07.07 | 05.11 |                |        |   |                          |     |
|  | 1.4 T-Jet      |    |  | 07.07 | 05.11 |                |        |   |                          |     |
|  | 1.6            | 80 |  | 07.08 | 05.11 |                |        |   |                          |     |
|  | 1.6 D Multijet | 77 |  | 01.09 | 05.11 |                |        |   |                          |     |
|  | 1.9 16V        | 77 |  | 07.08 | 05.11 |                |        |   |                          |     |
|  | 1.4 T-Jet      |    |  | 07.07 | 05.11 | 13.0460-2867.2 | 602867 |   | 23517 16,6 /S            | TRW |
|  | 1.6            | 80 |  | 07.08 | 05.11 | 13.0470-2867.2 | LD2867 |   | 23517 16,6 /S            | TRW |
|  | 1.6 D Multijet | 77 |  | 01.09 | 05.11 |                |        |   |                          |     |
|  | 1.9 16V        | 77 |  | 07.08 | 05.11 |                |        |   |                          |     |



|     |                  |  |  |                       |  |  |  |  |
|--|--|--|--|---|---|--|--|--|
| <b>FIAT LINEA (07-11)</b>  |  |  |  |   |   |  |  |  |
|    | 1.4 T-Jet<br>1.6<br>1.6 D Multijet<br>1.9 16V  | 80<br>77   |  | 07.07 05.11<br>07.08 05.11<br>01.09 05.11<br>07.08 05.11  |   | 24.0110-0190.1   | 410190   | 252 10,0 9,0 +B  |
|    | 1.3 D Multijet<br>1.4<br>1.4 T-Jet<br>1.6<br>1.6 D Multijet<br>1.9 16V                           | 66<br>80<br>77   |  | 07.07 05.11<br>07.07 05.11<br>07.07 05.11<br>07.08 05.11<br>01.09 05.11<br>07.08 05.11                |   | 24.0711-5218.3<br>24.0711-5219.3   | 360307<br>360308   | Radsensor L=764<br>Radsensor L=764   |
|    | 1.3 D Multijet<br>1.4  | 66   |  | 07.07 05.11<br>07.07 05.11  |   | 03.0137-0478.2<br>03.0137-9309.2   | 650478<br>669309   | 228 x 42 HEB<br>Bremsbacken-Zubehör  |
|    | 1.3 D Multijet<br>1.4  | 66   |  | 07.07 05.11<br>07.07 05.11  |   | 24.0222-8018.1   | 480078   | 228/230 x 48   |
|    | 1.3 D Multijet<br>1.4  | 66   |  | 07.07 05.11<br>07.07 05.11  |   | 03.0520-9020.3   | 699020   | 20,64/228x42 TopKit  |
| <b>FIAT MAREA (96-02)</b>  |  |  |  |   |   |  |  |  |
|    | 1.2 i 16V Lim.<br>1.4 i 12V<br>1.6<br>1.6 i 16V Lim.<br>1.9 TD                                   | 76<br>55   |  | 04.99 12.02<br>09.96 12.02<br>09.00 12.02<br>09.96 12.02<br>09.96 12.02                               |   | 13.0460-7064.2   | 607064   | 21930 17,9 +/WK  |
|  | 1.2 i 16V Kombi<br>1.6 i 16V Kombi<br>1.8 i 16V<br>1.9 JTD<br>1.9 TD                             | 74   |  | 04.99 12.02<br>09.96 12.02<br>09.96 12.02<br>04.99 12.02<br>09.96 12.02                               |   | 13.0460-7065.2   | 607065   | 21927 17,9 +/WK  |
|  | 2.0 i 20V<br>2.4 TD  |  |  | 09.96 04.99<br>09.96 04.99  |   | 13.0460-7069.2   | 607069   | 21636 19,3 +/WK  |
|  | 2.0 i 20V<br>2.4 JTD   |  |  | 05.99 12.02<br>04.99 12.02  |   | 13.0460-7140.2<br>13.0470-7140.2   | 607140<br>LD7140   | 23289 19,3 +/WK<br>23289 19,3 +/WK   |
|    | 1.2 i 16V Lim.<br>1.4 i 12V<br>1.6<br>1.6 i 16V Lim.<br>1.9 TD                                   | 76<br>55   |  | 04.99 12.02<br>09.96 12.02<br>09.00 12.02<br>09.96 12.02<br>09.96 12.02                               |   | 24.0112-0127.1   | 412127   | 258 12,0 10,2 +B   |
|  | 1.2 i 16V Kombi<br>1.6 i 16V Kombi<br>1.8 i 16V<br>1.9 JTD<br>1.9 TD                             | 74   |  | 04.99 12.02<br>09.96 12.02<br>09.96 12.02<br>04.99 12.02<br>09.96 12.02                               |   | 24.0120-0142.1<br>24.0320-0142.1   | 420142<br>520142   | 258 20,0 18,2 V L +B<br>258 20,0 18,2 V L +B PD                                    |
|  | 2.0 i 20V<br>2.4 JTD<br>2.4 TD   |  |  | 09.96 12.02<br>04.99 12.02<br>09.96 04.99   |   | 24.0122-0147.1   | 422147   | 284 22,0 20,2 V +B   |
|  | 2.0 i 20V<br>2.4 JTD<br>2.4 TD   |  |  | 09.96 12.02<br>04.99 12.02<br>09.96 04.99   |   | 13.0460-2951.2<br>13.0460-2826.2<br>13.0460-0072.2                                 | 602951<br>602826<br>610072   | + GG-Sättel <sup>1)</sup><br>+ ALU-Sättel <sup>2)</sup><br>Belagsatz-Zubehör       |
|  | 2.0 i 20V<br>2.4 JTD<br>2.4 TD   |  |  | 09.96 12.02<br>04.99 12.02<br>09.96 04.99   |   | 24.0111-0119.1   | 411119   | 241 11,0 9,2 +B  |
|  | 1.4 i 12V<br>1.6 i 16V Lim.<br>1.8 i 16V Lim.<br>1.9 TD Lim.                                     |  |  | 09.96 03.97<br>09.96 03.97<br>09.96 03.97<br>09.96 03.97  |   | 03.0137-0262.2<br>03.0137-9125.2   | 650262<br>669125   | 203 x 39<br>Bremsbacken-Zubehör  |
|  | 1.2 i 16V<br>1.4 i 12V<br>1.6<br>1.6 i 16V Lim.<br>1.8 i 16V Lim.<br>1.9 JTD Lim.<br>1.9 TD Lim. | 76   |  | 04.99 12.02<br>04.97 12.02<br>09.00 12.02<br>04.97 12.02<br>04.97 12.02<br>04.99 12.02<br>04.97 12.02 |   | 03.0137-0345.2<br>03.0137-9244.2   | 650345<br>669244   | 203 x 38 HEB<br>Bremsbacken-Zubehör  |
|  | 1.6 i 16V Kombi<br>1.8 i 16V Kombi<br>1.9 TD Kombi   |  |  | 09.96 03.97<br>09.96 03.97<br>09.96 03.97   |   | 03.0137-0208.2<br>03.0137-9081.2   | 650208<br>669081   | 228 x 42 HEB<br>Bremsbacken-Zubehör  |
|  | 1.6 i 16V Kombi<br>1.8 i 16V Kombi<br>1.9 JTD Kombi<br>1.9 TD Kombi                              |  |  | 04.97 12.02<br>04.97 12.02<br>04.99 12.02<br>04.97 12.02  |   | 03.0137-0352.2<br>03.0137-9234.2   | 650352<br>669234   | 228 x 43 HEB<br>Bremsbacken-Zubehör  |
|  | 1.2 i 16V<br>1.4 i 12V<br>1.6<br>1.6 i 16V Lim.<br>1.8 i 16V Lim.<br>1.9 JTD Lim.<br>1.9 TD Lim. | 76   |  | 04.99 12.02<br>09.96 12.02<br>09.00 12.02<br>09.96 12.02<br>09.96 12.02<br>04.99 12.02<br>09.96 12.02 |   | 24.0220-3007.1   | 480064   | 203/204,7 x 48,5   |
|  | 1.6 i 16V Kombi<br>1.8 i 16V Kombi<br>1.9 JTD Kombi<br>1.9 TD Kombi                              |  |  | 09.96 12.02<br>09.96 12.02<br>04.99 12.02<br>09.96 12.02  |   | 24.0222-8018.1   | 480078   | 228/230 x 48   |

<sup>1)</sup> + cast iron caliper / + pinza in ghisa / + étriers en fonte grise / + fundición gris-pinza  
<sup>2)</sup> + aluminium calipers / + pinze in alluminio / + étriers en aluminium / + pinzas de aluminio



### FIAT MAREA (96-02)

|                 |                 |       |       |       |                |        |  |                     |     |
|-----------------|-----------------|-------|-------|-------|----------------|--------|--|---------------------|-----|
|                 | 1.4 i 12V       |       | 09.96 | 03.97 | 03.0520-6722.3 | 696722 |  | 22,20/203x39 TopKit | BDX |
|                 | 1.6 i 16V Lim.  |       | 09.96 | 03.97 |                |        |  |                     |     |
|                 | 1.8 i 16V Lim.  |       | 09.96 | 03.97 |                |        |  |                     |     |
|                 | 1.9 TD Lim.     |       | 09.96 | 03.97 |                |        |  |                     |     |
| 76              | 1.2 i 16V       |       | 04.99 | 12.02 | 03.0520-6822.3 | 696822 |  | 22,20/203x38 TopKit | AP  |
|                 | 1.4 i 12V       |       | 04.97 | 12.02 |                |        |  |                     |     |
|                 | 1.6             |       | 09.00 | 12.02 |                |        |  |                     |     |
|                 | 1.6 i 16V Lim.  |       | 04.97 | 12.02 |                |        |  |                     |     |
|                 | 1.8 i 16V Lim.  |       | 04.97 | 12.02 |                |        |  |                     |     |
|                 | 1.9 JTD Lim.    |       | 04.99 | 12.02 |                |        |  |                     |     |
|                 | 1.9 TD Lim.     |       | 04.97 | 12.02 |                |        |  |                     |     |
|                 | 1.6 i 16V Kombi |       | 09.96 | 03.97 |                |        |  |                     |     |
| 1.8 i 16V Kombi |                 | 09.96 | 03.97 |       |                |        |  |                     |     |
| 1.9 TD Kombi    |                 | 09.96 | 03.97 |       |                |        |  |                     |     |
| 1.6 i 16V Kombi | 1.8 i 16V Kombi |       | 04.97 | 12.02 | 03.0520-7820.3 | 697820 |  | 20,64/228x43 TopKit | AP  |
|                 | 1.9 JTD Kombi   |       | 04.97 | 12.02 |                |        |  |                     |     |
|                 | 1.9 TD Kombi    |       | 04.99 | 12.02 |                |        |  |                     |     |
|                 | 1.9 TD Kombi    |       | 04.97 | 12.02 |                |        |  |                     |     |

### FIAT MULTIPLA (98-10)























|  |                   |  |       |       |                |        |  |                          |     |
|--|-------------------|--|-------|-------|----------------|--------|--|--------------------------|-----|
|  | 1.6               |  | 09.00 | 06.10 | 13.0460-7140.2 | 607140 |  | 23289 19,3 +/WK          | ATE |
|  | 1.6 16V           |  | 02.99 | 09.04 |                |        |  |                          |     |
|  | 1.6 16V Bipower   |  | 04.99 | 06.10 |                |        |  |                          |     |
|  | 1.9 JTD           |  | 02.99 | 09.04 |                |        |  |                          |     |
|  | 1.6 16V           |  | 10.04 | 06.10 | 13.0460-3827.2 | 603827 |  | 23709 19,6 +/WK/Zub/SBOS | BOS |
|  | 1.6 16V Bluepower |  | 04.99 | 06.10 |                |        |  |                          |     |
|  | 1.9 JTD           |  | 10.04 | 06.10 |                |        |  |                          |     |
|  | 1.9 JTD           |  | 10.04 | 06.10 |                |        |  |                          |     |
|  | 1.6               |  | 09.00 | 06.10 | 24.0122-0107.1 | 422107 |  | 284 22,0 20,2 V +B       |     |
|  | 1.6 16V           |  | 02.99 | 06.10 |                |        |  |                          |     |
|  | 1.6 16V Bipower   |  | 04.99 | 06.10 |                |        |  |                          |     |
|  | 1.9 JTD           |  | 02.99 | 06.10 |                |        |  |                          |     |
|  | 1.6               |  | 09.00 | 06.10 | 13.0460-3991.2 | 603991 |  | 23714 16,6 /S            | BOS |
|  | 1.6 16V           |  | 04.02 | 11.05 |                |        |  |                          |     |
|  | 1.9 JTD           |  | 04.02 | 11.05 |                |        |  |                          |     |
|  | 1.9 JTD           |  | 04.02 | 11.05 |                |        |  |                          |     |
|  | 1.6 16V           |  | 12.05 | 06.10 | 13.0460-3991.2 | 603991 |  | 23714 16,6 /S            | BOS |
|  | 1.6 16V Bipower   |  | 04.99 | 06.10 |                |        |  |                          |     |
|  | 1.6 16V Bluepower |  | 04.99 | 06.10 |                |        |  |                          |     |
|  | 1.9 JTD           |  | 12.05 | 06.10 |                |        |  |                          |     |
|  | 1.6               |  | 09.00 | 06.10 | 24.0110-0190.1 | 410190 |  | 252 10,0 9,0 +B          |     |
|  | 1.6 16V           |  | 04.02 | 06.10 |                |        |  |                          |     |
|  | 1.6 16V Bipower   |  | 04.99 | 06.10 |                |        |  |                          |     |
|  | 1.9 JTD           |  | 04.99 | 06.10 |                |        |  |                          |     |
|  | 1.6               |  | 09.00 | 06.10 | 03.0137-0352.2 | 650352 |  | 228 x 43 HEB             |     |
|  | 1.6 16V           |  | 02.99 | 06.10 |                |        |  |                          |     |
|  | 1.6 16V Bipower   |  | 04.99 | 06.10 |                |        |  |                          |     |
|  | 1.9 JTD           |  | 02.99 | 06.10 |                |        |  |                          |     |
|  | 1.6               |  | 09.00 | 06.10 | 24.0222-8018.1 | 480078 |  | 228/230 x 48             |     |
|  | 1.6 16V           |  | 02.99 | 06.10 |                |        |  |                          |     |
|  | 1.6 16V Bipower   |  | 04.99 | 06.10 |                |        |  |                          |     |
|  | 1.9 JTD           |  | 02.99 | 06.10 |                |        |  |                          |     |
|  | 1.6               |  | 09.00 | 06.10 | 03.0520-7820.3 | 697820 |  | 20,64/228x43 TopKit      | AP  |
|  | 1.6 16V           |  | 02.99 | 06.10 |                |        |  |                          |     |
|  | 1.6 16V Bipower   |  | 04.99 | 06.10 |                |        |  |                          |     |
|  | 1.9 JTD           |  | 02.99 | 06.10 |                |        |  |                          |     |

### FIAT PALIO / PALIO WEEKEND EUROPA (96-06)

|  |           |  |       |       |                |        |  |                         |     |                |        |  |                 |  |
|--|-----------|--|-------|-------|----------------|--------|--|-------------------------|-----|----------------|--------|--|-----------------|--|
|  | 1.0       |  | 04.96 | 02.98 | 13.0460-7113.2 | 607113 |  | 23218 18,0 +/WK         | ATE |                |        |  |                 |  |
|  | 1.2       |  | 10.97 | 02.98 |                |        |  |                         |     |                |        |  |                 |  |
|  | 1.7 TD    |  | 10.97 | 02.98 |                |        |  |                         |     |                |        |  |                 |  |
|  | 1.7 TD    |  | 10.97 | 02.98 |                |        |  |                         |     |                |        |  |                 |  |
|  | 1.0       |  | 03.98 | 11.98 | 13.0460-7128.2 | 607128 |  | 23220 18,0 +/WK         | ATE |                |        |  |                 |  |
|  | 1.2       |  | 03.98 | 11.98 |                |        |  |                         |     |                |        |  |                 |  |
|  | 1.7 TD    |  | 03.98 | 11.98 |                |        |  |                         |     |                |        |  |                 |  |
|  | 1.7 TD    |  | 03.98 | 11.98 |                |        |  |                         |     |                |        |  |                 |  |
|  | 1.6 i 16V |  | 10.97 | 09.00 | 13.0460-7108.2 | 607108 |  | 20907 18,1 +/WK         | ATE |                |        |  |                 |  |
|  | 1.0       |  | 12.98 | 12.06 |                |        |  |                         |     |                |        |  |                 |  |
|  | 1.2       |  | 12.98 | 12.06 |                |        |  |                         |     |                |        |  |                 |  |
|  | 1.3 JTD   |  | 09.03 | 12.06 |                |        |  |                         |     |                |        |  |                 |  |
|  | 1.5       |  | 02.02 | 12.06 | 13.0460-7126.2 | 607126 |  | 23552 18,1 +            | ATE |                |        |  |                 |  |
|  | 1.6 i 16V |  | 10.00 | 12.06 |                |        |  |                         |     |                |        |  |                 |  |
|  | 1.7 TD    |  | 12.98 | 12.06 |                |        |  |                         |     |                |        |  |                 |  |
|  | 1.9 D     |  | 03.01 | 12.06 |                |        |  |                         |     |                |        |  |                 |  |
|  | 1.9 JTD   |  | 09.01 | 12.06 |                |        |  |                         |     |                |        |  |                 |  |
|  | 1.0       |  | 04.96 | 11.98 |                |        |  |                         |     | 24.0120-0193.1 | 420193 |  | 240 20,0 18,2 V |  |
|  | 1.2       |  | 10.97 | 11.98 |                |        |  |                         |     |                |        |  |                 |  |
|  | 1.7 TD    |  | 10.97 | 11.98 |                |        |  |                         |     |                |        |  |                 |  |
|  | 1.0       |  | 12.98 | 12.06 | 24.0120-0142.1 | 420142 |  | 258 20,0 18,2 V L +B    |     |                |        |  |                 |  |
|  | 1.2       |  | 12.98 | 12.06 |                |        |  |                         |     |                |        |  |                 |  |
|  | 1.3 JTD   |  | 09.03 | 12.06 | 24.0320-0142.1 | 520142 |  | 258 20,0 18,2 V L +B PD |     |                |        |  |                 |  |
|  | 1.5       |  | 02.02 | 12.06 |                |        |  |                         |     |                |        |  |                 |  |
|  | 1.6 i 16V |  | 10.97 | 12.06 |                |        |  |                         |     |                |        |  |                 |  |
|  | 1.7 TD    |  | 12.98 | 12.06 |                |        |  |                         |     |                |        |  |                 |  |





|          |  |  |  |   |   |  |  |  |                            |  |  |
|--|--|--|--|---|---|--|--|--|----------------------------|--|--|
| <b>FIAT PALIO / PALIO WEEKEND EUROPA (96-06)</b>   |  |  |  |   |   |  |  |  |                            |  |  |
|    | 1.9 D<br>1.9 JTD   |  |  | 03.01<br>09.01  | 12.06<br>12.06  |  |  | 24.0120-0142.1<br>24.0320-0142.1                   | 420142<br>520142           |  | 258 20,0 18,2 VL +B<br>258 20,0 18,2 VL +B PD          |
|    | 1.0<br>1.2<br>1.5<br>1.6 i 16V<br>1.7 TD<br>1.9 D<br>1.9 JTD   |  |  | 04.96<br>10.97<br>02.02<br>10.97<br>10.97<br>03.01<br>09.01                   | 12.06<br>12.06<br>12.06<br>12.06<br>12.06<br>12.06<br>12.06                   |  |  | 03.0137-0352.2<br>03.0137-9234.2                   | 650352<br>669234           |  | 228 x 43 HEB<br>Bremsbacken-Zubehör                    |
|    | 1.0<br>1.2<br>1.5<br>1.6 i 16V<br>1.7 TD<br>1.9 D<br>1.9 JTD   |  |  | 04.96<br>10.97<br>02.02<br>10.97<br>10.97<br>03.01<br>09.01                   | 12.06<br>12.06<br>12.06<br>12.06<br>12.06<br>12.06<br>12.06                   |  |  | 24.0222-8018.1                                     | 480078                     |  | 228/230 x 48   |
|    | 1.0<br>1.2<br>1.5<br>1.6 i 16V<br>1.7 TD<br>1.9 D<br>1.9 JTD   |  |  | 04.96<br>10.97<br>02.02<br>10.97<br>10.97<br>03.01<br>09.01                   | 12.06<br>12.06<br>12.06<br>12.06<br>12.06<br>12.06<br>12.06                   |  |  | 03.0520-7820.3                                     | 697820                     |  | 20,64/228x43 TopKit AP                                 |
| <b>FIAT PALIO SW / SIENA (PL) (98-06)</b>  |  |  |  |   |   |  |  |  |                            |  |  |
|    | 1.4<br>1.6 i 16V   |  |  | 04.98<br>04.98  | 12.06<br>12.06  |  |  | 13.0460-7132.2<br>13.0460-7128.2                   | 607132<br>607128           |  | 23775 18,0 +<br>23220 18,0 +/WK ATE                    |
|    | 1.4<br>1.4<br>1.6 i 16V  |  |  | 02.98<br>04.98<br>02.98   | 12.06<br>12.06<br>12.06   |  |  | 24.0112-0122.1<br>24.0120-0193.1                   | 412122<br>420193           |  | 240 12,0 10,8<br>240 20,0 18,2 V                       |
|    | 1.4<br>1.6 i 16V   |  |  | 02.98<br>02.98  | 12.06<br>12.06  |  |  | 24.0218-5002.1                                     | 480117                     |  | 185/186,8 x 36,5                                       |
| <b>FIAT PANDA (86-02)</b>  |  |  |  |   |   |  |  |  |                            |  |  |
|   | 1000<br>1000 i.e.<br>1100<br>4x4<br>750<br>900   |  |  | 01.86<br>10.87<br>02.91<br>01.86<br>01.86<br>04.92                            | 12.92<br>12.02<br>12.02<br>12.02<br>12.97<br>12.96                            |  |  | 13.0460-3939.2<br>13.0460-0410.2                   | 603939<br>610410           |  | 20775 18,0 /WE<br>Belagsatz-Zubehör BDX                |
|  | 1100   |  |  | 02.91   | 12.02 + Schaltgetriebe <sup>1)</sup>  |  |  |  |                            |  |  |
|  | 1100   |  |  | 02.91   | 12.02 + Automatikgetriebe <sup>2)</sup>                                       |  |  | 13.0460-2941.2                                     | 602941                     |  | 20839 17,0 /WK/S TRW                                   |
|    | 1000<br>1000 i.e.<br>1100<br>4x4<br>750<br>900   |  |  | 01.86<br>10.87<br>02.91<br>01.86<br>01.86<br>04.92                            | 12.92<br>12.02<br>12.02<br>12.02<br>12.97<br>12.96                            |  |  | 24.0111-0130.1                                     | 411130                     |  | 227 10,8 9,0 +B  |
|  | 1100   |  |  | 02.91   | 12.02 + Automatikgetriebe <sup>2)</sup>                                       |  |  | 24.0112-0122.1                                     | 412122                     |  | 240 12,0 10,8  |
|    | 1000<br>1000 i.e.<br>1100<br>4x4<br>750<br>900   |  |  | 01.86<br>10.87<br>02.91<br>01.86<br>01.86<br>04.92                            | 12.92<br>12.02<br>12.02<br>12.02<br>12.97<br>12.96                            |  |  | 03.0137-0015.2<br>03.0137-0273.2<br>03.0137-9021.2 | 650015<br>650273<br>669021 |  | 185 x 31 AUT<br>185 x 31 AUT<br>Bremsbacken-Zubehör FI |
|    | 1000<br>1000 i.e.<br>1100<br>4x4<br>750<br>900   |  |  | 01.86<br>10.87<br>02.91<br>01.86<br>01.86<br>04.92                            | 12.92<br>12.02<br>12.02<br>12.02<br>12.97<br>12.96                            |  |  | 24.0218-5001.1                                     | 480012                     |  | 185/186,8 x 37   |
|    | 1000<br>1000 i.e.<br>1100<br>4x4<br>750<br>900   |  |  | 01.86<br>10.87<br>02.91<br>01.86<br>01.86<br>04.92                            | 12.92<br>12.02<br>12.02<br>12.02<br>12.97<br>12.96                            |  |  | 03.0420-0319.3<br>03.0520-4319.3                   | 680319<br>694319           |  | 19,05/185x31 Kit FI<br>19,05/185x31 TopKit AP          |
| <b>FIAT PANDA (03-13)</b>  |  |  |  |   |   |  |  |  |                            |  |  |
|    | 1.1<br>1.2<br>1.2  | 40<br>44<br>51                         |  | 09.03<br>09.03<br>03.10   | 06.13<br>06.13<br>06.13   |  |  | 13.0460-3807.2<br>13.0460-3950.2                   | 603807<br>603950           |  | 21436 17,0 /WE/Zub BDX<br>21436 17,0 BDX               |
|  | 1.2 4x4<br>1.2 4x4<br>1.2 LPG<br>1.2 LPG<br>1.2 Natural Power<br>1.3 D Multijet<br>1.3 JTD<br>1.3 JTD<br>1.4 Natural Power | 44<br>51<br>44<br>51<br>44<br>51<br>55 |  | 10.04<br>10.10<br>04.09<br>11.10<br>01.07<br>09.03<br>09.03<br>06.06<br>01.07 | 06.13<br>06.13<br>06.13<br>06.13<br>06.13<br>06.13<br>06.13<br>06.13<br>06.13 |  |  | 13.0460-3809.2                                     | 603809                     |  | 24072 17,9 /Zub/S BOS                                  |

<sup>1)</sup> + manual transmission / + scatola cambio velocità / + transmission mécanique / + cambio de velocidad  
<sup>2)</sup> + autom.transmission / + scatola cambio automatico / + transmission automatique / + cambio automático

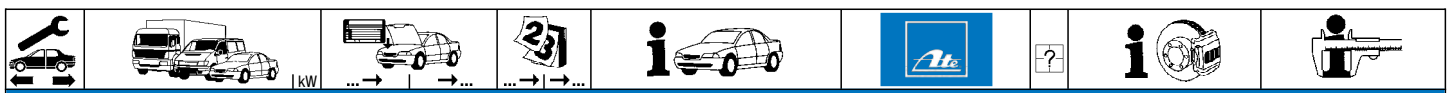



















**FIAT PANDA (03-13)**

|  |  |  |  |   |   |  |  |                            |                |   |
|--|--|--|--|---|---|--|--|----------------------------|----------------|---|
|  | 1.3 D Multijet 4x4<br>1.4  | 74                                     |  | 10.04<br>11.06  | 06.13<br>06.13  |  | 13.0460-3826.2<br>13.0470-3826.2<br>13.0460-3850.2 | 603826<br>LD3826<br>603850 |                | 23706 18,0 +/WK/Zub/SBOS<br>23706 18,0 +/WK/Zub/SBOS<br>23707 18,0 /Zub/S BOS |
|  | 1.1<br>1.2<br>1.2  | 40<br>44<br>51                         |  | 09.03<br>09.03<br>03.10   | 06.13<br>06.13<br>06.13   |  | 24.0111-0119.1                                     | 411119                     |                | 241 11,0 9,2 +B   |
|  | 1.2 4x4<br>1.2 4x4<br>1.2 LPG<br>1.2 LPG<br>1.2 Natural Power<br>1.3 D Multijet<br>1.3 JTD<br>1.3 JTD<br>1.4 Natural Power | 44<br>51<br>44<br>51<br>44<br>51<br>55 |  | 10.04<br>10.10<br>04.09<br>11.10<br>01.07<br>09.03<br>09.03<br>06.06<br>01.07 | 06.13<br>06.13<br>06.13<br>06.13<br>06.13<br>06.13<br>06.13<br>06.13<br>06.13 |  | 24.0120-0184.1                                     | 420184                     |                | 241 20,0 18,2 V +B  |
|  | 1.3 D Multijet 4x4<br>1.4  | 74                                     |  | 10.04<br>11.06  | 06.13<br>06.13  |  | 24.0122-0197.1<br>24.0322-0197.1                   | 422197<br>522197           |                | 258 22,0 20,2 V +B<br>258 22,0 20,2 V +B PD                                   |
|  | 1.2 4x4<br>1.2 4x4<br>1.3 D Multijet 4x4<br>1.4  | 44<br>51<br>74                         |  | 10.04<br>10.10<br>10.04<br>11.06  | 06.13<br>06.13<br>06.13<br>06.13  |  | 13.0460-2879.2<br>13.0470-2879.2                   | 602879<br>LD2879           |                | 23601 13,7 /S TRW<br>23601 13,7 /S TRW  |
|  | 1.2 4x4<br>1.2 4x4<br>1.3 D Multijet 4x4<br>1.4  | 44<br>51<br>74                         |  | 10.04<br>10.10<br>10.04<br>11.06  | 06.13<br>06.13<br>06.13<br>06.13  |  | 24.0111-0119.1                                     | 411119                     |                | 241 11,0 9,2 +B   |
|  | 1.1<br>1.2<br>1.2<br>1.3 D Multijet<br>1.3 JTD<br>1.3 JTD<br>1.4 Natural Power   | 40<br>44<br>51<br>51<br>55             |  | 09.03<br>09.03<br>03.10<br>09.03<br>09.03<br>06.06<br>01.07                   | 06.13<br>06.13<br>06.13<br>06.13<br>06.13<br>06.13<br>06.13                   |  | 03.0137-0434.2<br>03.0137-9179.2                   | 650434<br>669179           | - ABS<br>- ABS | 180 x 32 HEB AP<br>Bremsbacken-Zubehör AP                                     |
|  | 1.1<br>1.2<br>1.2<br>1.3 D Multijet<br>1.3 JTD<br>1.3 JTD<br>1.4 Natural Power   | 40<br>44<br>51<br>51<br>55             |  | 09.03<br>09.03<br>03.10<br>09.03<br>09.03<br>06.06<br>01.07                   | 05.10<br>05.10<br>05.10<br>05.10<br>05.10<br>05.10<br>05.10                   |  | 03.0137-0462.2<br>03.0137-9303.2                   | 650462<br>669303           | + ABS<br>+ ABS | 180 x 32 HEB BDX<br>Bremsbacken-Zubehör BDX                                   |
|  | 1.1<br>1.2<br>1.2<br>1.3 D Multijet<br>1.3 JTD<br>1.3 JTD  | 40<br>44<br>51<br>51<br>55             |  | 06.10<br>06.10<br>06.10<br>06.10<br>06.10<br>06.10                            | 06.13<br>06.13<br>06.13<br>06.13<br>06.13<br>06.13                            |  | 03.0137-0506.2<br>03.0137-9247.2                   | 650506<br>669247           | + ABS          | 180 x 32 HEB AP<br>Bremsbacken-Zubehör AP                                     |
|  | 1.2 LPG<br>1.2 LPG<br>1.2 Natural Power<br>1.4 Natural Power   | 44<br>51<br>44                         |  | 04.09<br>11.10<br>01.07<br>01.07  | 06.13<br>11.11<br>11.11<br>11.11  |  | 03.0137-0479.2<br>03.0137-9310.2                   | 650479<br>669310           |                | 203 x 38 HEB AP<br>Bremsbacken-Zubehör AP                                     |
|  | 1.1<br>1.2<br>1.2<br>1.3 D Multijet<br>1.3 JTD<br>1.3 JTD<br>1.4 Natural Power   | 40<br>44<br>51<br>51<br>55             |  | 09.03<br>09.03<br>03.10<br>09.03<br>09.03<br>06.06<br>01.07                   | 06.13<br>06.13<br>06.13<br>06.13<br>06.13<br>06.13<br>06.13                   |  | 24.0218-0011.1                                     | 480006                     |                | 180/181,4 x 40  |
|  | 1.2 LPG<br>1.2 LPG<br>1.2 Natural Power<br>1.4 Natural Power   | 44<br>51<br>44                         |  | 04.09<br>11.10<br>01.07<br>01.07  | 11.11<br>11.11<br>11.11<br>11.11  |  | 24.0220-3007.1                                     | 480064                     |                | 203/204,7 x 48,5  |
|  | 1.1<br>1.2<br>1.2<br>1.3 D Multijet<br>1.3 JTD<br>1.3 JTD<br>1.4 Natural Power   | 40<br>44<br>51<br>51<br>55             |  | 09.03<br>09.03<br>03.10<br>09.03<br>09.03<br>06.06<br>01.07                   | 06.13<br>06.13<br>06.13<br>06.13<br>06.13<br>06.13<br>06.13                   |  | 03.0520-7420.3                                     | 697420                     | - ABS          | 20,64/180x32 TopKit AP  |
|  | 1.1<br>1.2<br>1.2<br>1.3 D Multijet<br>1.3 JTD<br>1.3 JTD<br>1.4 Natural Power   | 40<br>44<br>51<br>51<br>55             |  | 09.03<br>09.03<br>03.10<br>09.03<br>09.03<br>06.06<br>01.07                   | 05.10<br>05.10<br>05.10<br>05.10<br>05.10<br>05.10<br>05.10                   |  | 03.0520-8220.3                                     | 698220                     | + ABS          | 20,64/180x32 TopKit BDX   |
|  | 1.2 LPG<br>1.2 LPG<br>1.2 Natural Power<br>1.4 Natural Power   | 44<br>51<br>44                         |  | 04.09<br>11.10<br>01.07<br>06.10  | 06.13<br>06.13<br>06.13<br>06.13  |  | 03.0520-9220.3                                     | 699220                     |                | 20,64/203x38 TopKit AP  |

**FIAT PANDA Cross (06-11)**

|  |                    |    |  |       |       |  |  |                            |  |   |
|--|--------------------|----|--|-------|-------|--|--|----------------------------|--|---|
|  | 1.3 D Multijet 4x4 | 51 |  | 04.06 | 08.11 |  | 13.0460-3826.2<br>13.0470-3826.2<br>13.0460-3850.2 | 603826<br>LD3826<br>603850 |  | 23706 18,0 +/WK/Zub/SBOS<br>23706 18,0 +/WK/Zub/SBOS<br>23707 18,0 /Zub/S BOS |
|--|--------------------|----|--|-------|-------|--|--|----------------------------|--|---|



|     |    |  |  |                          |  |  |  |    |
|--|--|--|--|--|---|--|--|--|
| <b>FIAT PANDA Cross (06-11)</b>  |  |  |  |  |   |  |  |  |
|    | 1.3 D Multijet 4x4   | 51   |  | 04.06  | 08.11   |  | 24.0122-0197.1 422197<br>24.0322-0197.1 522197                                     | 258 22,0 20,2 V +B<br>258 22,0 20,2 V +B PD  |
|    | 1.3 D Multijet 4x4   | 51   |  | 04.06  | 08.11   |  | 13.0460-2879.2 602879<br>13.0470-2879.2 LD2879                                     | 23601 13,7 /S TRW<br>23601 13,7 /S TRW   |
|    | 1.3 D Multijet 4x4   | 51   |  | 04.06  | 08.11   |  | 24.0111-0119.1 411119  | 241 11,0 9,2 +B  |
| <b>FIAT PANDA (12-)</b>  |  |  |  |  |   |  |  |  |
|    | 0.9<br>0.9<br>0.9<br>0.9 4x4<br>0.9 Natural Power<br>0.9 Natural Power<br>1.2<br>1.2 LPG<br>1.3 D Multijet<br>1.3 D Multijet<br>1.3 D Multijet 4x4<br>1.3 D Multijet 4x4 | 48<br>57<br>63<br>63<br>59<br>63<br>51<br>51<br>70<br>70<br>70<br>70             |  | 02.12<br>02.12<br>02.12<br>09.12<br>02.12<br>07.12<br>02.12<br>02.12<br>02.12<br>04.15<br>06.12<br>04.15 |   |  | 13.0460-7289.2 607289  | 25323 17,3 +/WK ATE  |
|    | 0.9<br>0.9<br>0.9 4x4<br>0.9 Natural Power<br>0.9 Natural Power<br>1.3 D Multijet<br>1.3 D Multijet<br>1.3 D Multijet 4x4<br>1.3 D Multijet 4x4                          | 57<br>63<br>63<br>59<br>63<br>70<br>70<br>70                                     |  | 02.12<br>02.12<br>09.12<br>02.12<br>07.12<br>02.12<br>04.15<br>06.12<br>04.15                            |   |  | 24.0122-0197.1 422197<br>24.0322-0197.1 522197<br>24.0112-0127.1 412127            | für Leichtmetallfelgen Serie 2 <sup>1)</sup> 258 22,0 20,2 V +B<br>für Leichtmetallfelgen Serie 2 <sup>1)</sup> 258 22,0 20,2 V +B PD<br>für Leichtmetallfelgen Serie 3 <sup>2)</sup> 258 12,0 10,2 +B |
|  | 0.9<br>1.2<br>1.2 LPG  | 48<br>51<br>51   |  | 02.12<br>02.12<br>02.12  |   |  | 24.0112-0127.1 412127  | 258 12,0 10,2 +B   |
|    | 0.9 4x4<br>1.3 D Multijet 4x4<br>1.3 D Multijet 4x4  | 63<br>70<br>70   |  | 09.12<br>06.12<br>04.15  |   |  | 13.0460-2783.2 602783  | 25410 14,4 +/WK/Zub/STRW   |
|   | 0.9 4x4<br>1.3 D Multijet 4x4<br>1.3 D Multijet 4x4  | 63<br>70<br>70   |  | 09.12<br>06.12<br>04.15  |   |  | 24.0111-0119.1 411119<br>24.0112-0127.1 412127                                     | - Leichtmetallfelgen <sup>3)</sup><br>+ Leichtmetallfelgen <sup>4)</sup> 241 11,0 9,2 +B<br>258 12,0 10,2 +B   |
|  | 0.9<br>0.9<br>0.9<br>0.9 Natural Power<br>0.9 Natural Power<br>1.2<br>1.2 LPG<br>1.3 D Multijet<br>1.3 D Multijet  | 48<br>57<br>63<br>59<br>63<br>51<br>51<br>70<br>70                               |  | 02.12<br>02.12<br>02.12<br>02.12<br>07.12<br>02.12<br>02.12<br>02.12<br>04.15                            |   |  | 03.0137-0479.2 650479<br>03.0137-9310.2 669310                                     | 203 x 38 HEB AP<br>Bremsbacken-Zubehör AP  |
| <b>FIAT PUNTO (93-00)</b>  |  |  |  |  |   |  |  |  |
|  | 1.1 i (55)<br>1.2 i (60) Cabrio<br>1.2 i (60/75) Lim.<br>1.7 D   |  |  | 11.93<br>03.94<br>11.93<br>01.95   | 09.99<br>06.00<br>09.99<br>05.97  |  | 13.0460-3950.2 603950<br>13.0460-3951.2 603951                                     | 21436 17,0 BDX<br>21436 16,2 /WK BDX   |
|  | 1.2 i (60) Cabrio<br>1.2 i (60/75) Lim.<br>1.4 GT<br>1.6 i (90) Cabrio<br>1.6 i (90) Lim.<br>1.7 TD  |  |  | 03.94<br>11.93<br>11.93<br>03.94<br>03.94<br>11.93   | 06.00<br>09.99<br>05.97<br>05.97<br>05.97<br>05.97                                |  | 13.0460-2949.2 602949  | 20833 17,0 +/WK/S TRW  |
|  | 1.2 i 16V (85) Cabrio<br>1.2 i 16V (85) Lim.<br>1.7 TD<br>1.4 GT   |  |  | 06.97<br>06.97<br>06.97<br>06.97   | 06.00<br>09.99<br>09.99<br>09.99  |  | 13.0460-7114.2 607114  | 23181 17,9 + ATE   |
|  | 1.2 i (55)<br>1.2 i (60) Cabrio<br>1.2 i (60) Cabrio<br>1.2 i (60/75) Lim.<br>1.2 i (60/75) Lim.<br>1.7 D  |  |  | 11.93<br>06.97<br>03.94<br>06.97<br>11.93<br>01.95   | 09.99<br>06.00<br>05.97<br>09.99<br>05.97<br>05.97                                |  | 24.0111-0119.1 411119  | 241 11,0 9,2 +B  |
|  | 1.2 i (60) Cabrio<br>1.2 i (60/75) Lim.<br>1.2 i 16V (85) Cabrio<br>1.2 i 16V (85) Lim.<br>1.6 i (90) Cabrio<br>1.6 i (90) Lim.<br>1.7 TD<br>1.4 GT                      |  |  | 03.94<br>11.93<br>06.97<br>06.97<br>03.94<br>03.94<br>11.93<br>11.93                                     | 05.97<br>05.97<br>06.00<br>09.99<br>05.97<br>05.97<br>09.99<br>09.99              |  | 24.0112-0127.1 412127  | 258 12,0 10,2 +B   |
|  | 1.4 GT   |  |  | 11.93  | 09.99   |  | 24.0120-0142.1 420142<br>24.0320-0142.1 520142                                     | 258 20,0 18,2 V L +B<br>258 20,0 18,2 V L +B PD  |
|  | 1.4 GT   |  |  | 11.93  | 05.97   |  | 13.0460-2951.2 602951<br>13.0460-0072.2 610072                                     | + GG-Sättel <sup>5)</sup> TRW<br>+ GG-Sättel <sup>5)</sup> TRW<br>Belagsatz-Zubehör TRW  |

<sup>1)</sup> for light alloy rims series 2 / per cerchione in lega serie 2 / pour jantes en alliage léger série 2 / para Llantas de aleación serie 2

<sup>2)</sup> for light alloy rims series 3 / per cerchione in lega serie 3 / pour jantes en alliage léger série 3 / para Llantas de aleación serie 3

<sup>3)</sup> - light alloy rims / - cerchioni in lega / - jantes en alliage léger / - Llantas de aleación ligera

<sup>4)</sup> + light alloy rims / + cerchioni in lega / + jantes en alliage léger / + Llantas de aleación ligera

<sup>5)</sup> + cast iron caliper / + pinza in ghisa / + étriers en fonte grise / + fundición gris-pinza



















| FIAT PUNTO (93-00) |  |  |  |   |   |  |  |                                      |                            |  |                        |
|--------------------|--|--|--|---|---|--|--|--------------------------------------|----------------------------|--|------------------------|
|                    | 1.4 GT   |  |  | 06.97   | 09.99   |  | 13.0460-2826.2   | 602826                               | + ALU-Sättel <sup>1)</sup> | 23177 14,2 /S TRW  |                        |
|                    | 1.4 GT   |  |  | 11.93   | 09.99   |  | 24.0111-0119.1   | 411119                               |                            | 241 11,0 9,2 +B  |                        |
|                    | 1.1 i (55)<br>1.2 i (60) Cabrio<br>1.2 i (60/75) Lim.<br>1.2 i 16V (85) Cabrio<br>1.2 i 16V (85) Lim.<br>1.6 i (90) Cabrio<br>1.6 i (90) Lim.<br>1.7 D<br>1.7 TD |  |  | 11.93<br>03.94<br>11.93<br>06.97<br>06.97<br>03.94<br>03.94<br>01.95<br>11.93 | 09.99<br>06.00<br>09.99<br>06.00<br>09.99<br>05.97<br>05.97<br>05.97<br>09.99 |  | 03.0137-0207.2<br>03.0137-0274.2<br>03.0137-9088.2<br>03.0137-9179.2 | 650207<br>650274<br>669088<br>669179 |                            | 180 x 32<br>180 x 32 HEB AUT<br>Bremsbacken-Zubehör<br>Bremsbacken-Zubehör | BDX<br>AP<br>BDX<br>AP |
|                    | 1.1 i (55)<br>1.2 i (60) Cabrio<br>1.2 i (60/75) Lim.<br>1.2 i 16V (85) Cabrio<br>1.2 i 16V (85) Lim.<br>1.6 i (90) Cabrio<br>1.6 i (90) Lim.<br>1.7 D<br>1.7 TD |  |  | 11.93<br>03.94<br>11.93<br>06.97<br>06.97<br>03.94<br>03.94<br>01.95<br>11.93 | 09.99<br>06.00<br>09.99<br>06.00<br>09.99<br>05.97<br>05.97<br>05.97<br>09.99 |  | 24.0218-0011.1   | 480006                               |                            | 180/181,4 x 40   |                        |
|                    | 1.1 i (55)<br>1.2 i (60) Cabrio<br>1.2 i (60/75) Lim.<br>1.2 i 16V (85) Cabrio<br>1.2 i 16V (85) Lim.<br>1.6 i (90) Cabrio<br>1.6 i (90) Lim.<br>1.7 D<br>1.7 TD |  |  | 11.93<br>03.94<br>11.93<br>06.97<br>06.97<br>03.94<br>03.94<br>01.95<br>11.93 | 09.99<br>06.00<br>09.99<br>06.00<br>09.99<br>05.97<br>05.97<br>05.97<br>09.99 |  | 03.0520-5120.3<br>03.0420-5220.3<br>03.0520-5220.3                   | 695120<br>685220<br>695220           |                            | 20,64/180x32 TopKit<br>20,64/180x32 Kit<br>20,64/180x32 TopKit             | BDX<br>AP<br>AP        |







| FIAT PUNTO (00-03) |   |  |  |   |   |   |                                  |                  |             |   |          |
|--------------------|---|--|--|---|---|---|----------------------------------|------------------|-------------|---|----------|
|                    | 1.2   |  |  | 10.99                                     | 06.03                                     |   | 13.0460-3950.2                   | 603950           |             | 21436 17,0 BDX                                  |          |
|                    | 1.2 16V                                       |  |  | 10.99                                     | 06.03                                     | + Schaltgetriebe <sup>2)</sup>  | 13.0460-3951.2                   | 603951           |             | 21436 16,2 /WK BDX                              |          |
|                    | 1.2 16V                                       |  |  | 10.99                                     | 06.03                                     | + Automatikgetriebe <sup>3)</sup>   | 13.0460-7114.2                   | 607114           |             | 23181 17,9 + ATE                                |          |
|                    | 1.9 D   |  |  | 10.99                                     | 06.03                                     |   | 13.0460-7125.2                   | 607125           |             | 21930 17,9 + ATE                                |          |
|                    | 1.8 i 16V                                     |  |  | 10.99                                     | 06.03                                     |   | 13.0460-7126.2                   | 607126           |             | 23552 18,1 + ATE                                |          |
|                    | 1.9 JTD                                       |  |  | 10.99                                     | 06.03                                     |   | 13.0460-7133.2                   | 607133           |             | 21927 17,9 + ATE                                |          |
|                    | 1.2   |  |  | 10.99                                     | 06.03                                     |   | 24.0111-0119.1                   | 411119           |             | 241 11,0 9,2 +B                                 |          |
|                    | 1.2 16V                                       |  |  | 10.99                                     | 06.03                                     |   | 24.0112-0127.1                   | 412127           |             | 258 12,0 10,2 +B                                |          |
|                    | 1.9 D   |  |  | 10.99                                     | 06.03                                     |   |                                  |                  |             |   |          |
|                    | 1.8 i 16V                                     |  |  | 10.99                                     | 06.03                                     |   | 24.0122-0197.1<br>24.0322-0197.1 | 422197<br>522197 |             | 258 22,0 20,2 V +B<br>258 22,0 20,2 V +B PD     |          |
|                    | 1.9 JTD                                       |  |  | 10.99                                     | 06.03                                     |   | 24.0120-0142.1<br>24.0320-0142.1 | 420142<br>520142 |             | 258 20,0 18,2 V L +B<br>258 20,0 18,2 V L +B PD |          |
|                    | 1.8 i 16V                                     |  |  | 10.99                                     | 06.03                                     |   | 13.0460-2879.2<br>13.0470-2879.2 | 602879<br>LD2879 |             | 23601 13,7 /S TRW<br>23601 13,7 /S TRW          |          |
|                    | 1.8 i 16V                                     |  |  | 10.99                                     | 06.03                                     |   | 24.0111-0119.1                   | 411119           |             | 241 11,0 9,2 +B                                 |          |
|                    | 1.2<br>1.2 16V                                |  |  | 10.99<br>10.99                            | 06.03<br>06.03                            | - ABS<br>- ABS/ + Schaltgetriebe <sup>4)</sup>                                      | 03.0137-0359.2<br>03.0137-9179.2 | 650359<br>669179 |             | 180 x 32 HEB<br>Bremsbacken-Zubehör             | AP<br>AP |
|                    | 1.2<br>1.2 16V<br>1.2 16V<br>1.9 D<br>1.9 JTD |  |  | 10.99<br>10.99<br>10.99<br>10.99<br>10.99 | 06.03<br>06.03<br>06.03<br>06.03<br>06.03 | + ABS<br>+ Automatikgetriebe <sup>3)</sup><br>+ ABS/ + Schaltgetriebe <sup>5)</sup> | 03.0137-0360.2<br>03.0137-9247.2 | 650360<br>669247 | - Quick Fit | 180 x 32 HEB<br>Bremsbacken-Zubehör             | AP<br>AP |
|                    | 1.2<br>1.2 16V<br>1.9 D<br>1.9 JTD            |  |  | 10.99<br>10.99<br>10.99<br>10.99          | 06.03<br>06.03<br>06.03<br>06.03          |   | 24.0218-0011.1                   | 480006           |             | 180/181,4 x 40                                  |          |
|                    | 1.2<br>1.2 16V                                |  |  | 10.99<br>10.99                            | 06.03<br>06.03                            | - ABS<br>- ABS/ + Schaltgetriebe <sup>4)</sup>                                      | 03.0520-7220.3                   | 697220           |             | 20,64/180x32 TopKit                             | AP       |
|                    | 1.2<br>1.2 16V                                |  |  | 10.99<br>10.99                            | 06.03<br>06.03                            | + ABS<br>+ ABS/ + Schaltgetriebe <sup>5)</sup>                                      | 03.0520-7920.3                   | 697920           | + Quick Fit | 20,64/180x32 TopKit                             | AP       |
|                    | 1.2 16V<br>1.9 D<br>1.9 JTD                   |  |  | 10.99<br>10.99<br>10.99                   | 06.03<br>06.03<br>06.03                   | + Automatikgetriebe <sup>3)</sup>   | 03.0520-6622.3                   | 696622           | + Quick Fit | 22,20/180x32 TopKit                             | AP       |

| FIAT PUNTO (03-06) |             |    |  |       |       |  |                |        |  |                     |
|--------------------|-------------|----|--|-------|-------|--|----------------|--------|--|---------------------|
|                    | 1.2         |    |  | 07.03 | 11.05 |  | 13.0460-3950.2 | 603950 |  | 21436 17,0 BDX      |
|                    | 1.2 16V     |    |  | 07.03 | 11.05 |  | 13.0460-7114.2 | 607114 |  | 23181 17,9 + ATE    |
|                    | 1.3 JTD 16V |    |  | 07.03 | 11.05 |  | 13.0460-7133.2 | 607133 |  | 21927 17,9 + ATE    |
|                    | 1.4 i 16V   |    |  | 07.03 | 11.05 |  |                |        |  |                     |
|                    | 1.9 JTD     | 63 |  | 07.03 | 11.05 |  |                |        |  |                     |
|                    | 1.8 i 16V   |    |  | 07.03 | 11.05 |  | 13.0460-7140.2 | 607140 |  | 23289 19,3 +/WK ATE |
|                    | 1.9 JTD     | 74 |  | 07.03 | 11.05 |  | 13.0470-7140.2 | LD7140 |  | 23289 19,3 +/WK ATE |

<sup>1)</sup> + aluminium calipers / + pinze in alluminio / + étriers en aluminium / + pinzas de aluminio  
<sup>2)</sup> + manual transmission / + scatola cambio velocità / + transmission mécanique / + cambio de velocidad  
<sup>3)</sup> + autom.transmission / + scatola cambio automatico / + transmission automatique / + cambio automático  
<sup>4)</sup> - ABS/ + manual transmission / - ABS/+ scatola camb.velocità / - ABS/ + transmission mécanique / - ABS/ + cambio de velocidad  
<sup>5)</sup> + ABS/ + manual transm. / + ABS/+ scatola camb.velocità / + ABS/ + transmission mécanique / + ABS/ + cambio de velocidad

|     |    |  |  |                                   |  |  |  |  |   |   |            |
|--|--|--|--|---|---|--|--|--|---|---|------------|
| <b>FIAT PUNTO (03-06)</b>  |  |  |  |   |   |  |  |  |   |   |            |
|    | 1.2<br>1.2 16V   |  |  | 07.03<br>07.03  | 11.05<br>11.05  |  | 24.0112-0127.1   | 412127   | 258 12,0 10,2 +B                                |   |            |
|  | 1.3 JTD 16V<br>1.4 i 16V<br>1.9 JTD  | 63   |  | 07.03<br>07.03<br>07.03   | 11.05<br>11.05<br>11.05   |  | 24.0120-0142.1<br>24.0320-0142.1   | 420142<br>520142   | 258 20,0 18,2 V L +B<br>258 20,0 18,2 V L +B PD |   |            |
|  | 1.8 i 16V<br>1.9 JTD   | 74   |  | 07.03<br>07.03  | 11.05<br>11.05  |  | 24.0122-0107.1   | 422107   | 284 22,0 20,2 V +B                              |   |            |
|    | 1.8 i 16V<br>1.9 JTD   | 74   |  | 07.03<br>07.03  | 11.05<br>11.05  |  | 13.0460-2879.2<br>13.0470-2879.2   | 602879<br>LD2879   | 23601 13,7 /S<br>23601 13,7 /S                  | TRW<br>TRW  |            |
|    | 1.8 i 16V<br>1.9 JTD   | 74   |  | 07.03<br>07.03  | 11.05<br>11.05  |  | 24.0111-0119.1   | 411119   | 241 11,0 9,2 +B                                 |   |            |
|    | 1.2<br>1.2 16V<br>1.3 JTD 16V<br>1.9 JTD   | 63   |  | 07.03<br>07.03<br>07.03<br>07.03  | 11.05<br>11.05<br>11.05<br>11.05  |  | 03.0137-0360.2<br>03.0137-9247.2   | 650360<br>669247   | - Quick Fit                                     | 180 x 32 HEB<br>Bremsbacken-Zubehör               | AP<br>AP   |
|  | 1.4 i 16V  |  |  | 07.03   | 06.05   |  | 03.0137-0479.2<br>03.0137-9310.2   | 650479<br>669310   |   | 203 x 38 HEB<br>Bremsbacken-Zubehör               | AP<br>AP   |
|  | 1.4 i 16V  |  |  | 07.05   | 11.05   |  | 03.0137-0479.2<br>03.0137-9310.2   | 650479<br>669310   |   | 203 x 38 HEB<br>Bremsbacken-Zubehör               | AP<br>AP   |
|    | 1.2<br>1.2 16V<br>1.3 JTD 16V<br>1.9 JTD   | 63   |  | 07.03<br>07.03<br>07.03<br>07.03  | 11.05<br>11.05<br>11.05<br>11.05  |  | 24.0218-0011.1   | 480006   |   | 180/181,4 x 40                                    |            |
|  | 1.4 i 16V  |  |  | 07.03   | 11.05   |  | 24.0220-3007.1   | 480064   |   | 203/204,7 x 48,5                                  |            |
|    | 1.2<br>1.2 16V<br>1.3 JTD 16V<br>1.9 JTD   | 63   |  | 07.03<br>07.03<br>07.03<br>07.03  | 11.05<br>11.05<br>11.05<br>11.05  |  | 03.0520-7220.3   | 697220   |   | 20,64/180x32 TopKit                               | AP         |
|  | 1.4 i 16V  |  |  | 07.03   | 11.05   |  | 03.0520-6622.3   | 696622   | + Quick Fit                                     | 22,20/180x32 TopKit                               | AP         |
|  | 1.4 i 16V  |  |  | 07.03   | 11.05   |  | 03.0520-8620.3   | 698620   |   | 20,64/203x38 TopKit                               | AP         |
| <b>FIAT PUNTO / PUNTO EVO (09-)</b>  |  |  |  |   |   |  |  |  |   |   |            |
|    | 1.3 D Multijet<br>1.3 D Multijet<br>1.3 D Multijet<br>1.4 16V<br>1.6 D Multijet  | 51<br>66<br>70<br>99<br>88   |  | 10.09<br>10.09<br>10.09<br>10.09<br>10.09   |   |  | 13.0460-3864.2   | 603864   |   | 23709 19,6 +/WK/Zub/SBOS                          |            |
|  | 1.2<br>1.2<br>1.3 D Multijet<br>1.3 D Multijet<br>1.4<br>1.4 16V<br>1.4 LPG<br>1.4 Natural Power   | 48<br>51<br>55<br>62<br>77<br>57<br>57   |  | 10.09<br>10.09<br>10.09<br>10.09<br>10.09<br>06.09<br>10.09   | 04.10<br>04.10<br>04.10<br>04.10<br>04.10<br>04.10<br>04.10                       |  | 13.0460-3863.2   | 603863   |   | 23706 18,0 +/WK/Zub/SBOS                          |            |
|  | 0.9<br>0.9 Bifuel<br>0.9 Twinair Turbo<br>1.2<br>1.2<br>1.3 D Multijet<br>1.3 D Multijet<br>1.4<br>1.4 16V<br>1.4 LPG<br>1.4 MultiAir<br>1.4 MultiAir<br>1.4 Natural Power<br>1.4 Abarth | 77<br>63<br>63<br>48<br>51<br>55<br>62<br>77<br>57<br>77<br>99<br>57             |  | 11.13<br>03.12<br>03.12<br>05.10<br>05.10<br>05.10<br>05.10<br>05.10<br>05.10<br>03.12<br>03.12<br>05.10          |   |  | 13.0460-7288.2<br>13.0470-7288.2   | 607288<br>LD7288   |   | 25429 17,5 +/WK<br>25429 17,5 +/WK                | ATE<br>ATE |
|  | 0.9<br>0.9 Bifuel<br>0.9 Twinair Turbo<br>1.2<br>1.2<br>1.3 D Multijet<br>1.3 D Multijet<br>1.3 D Multijet<br>1.4<br>1.4 16V<br>1.4 LPG<br>1.4 MultiAir<br>1.4 Natural Power             | 77<br>63<br>63<br>48<br>51<br>51<br>55<br>62<br>77<br>57<br>77<br>57             |  | 11.13<br>03.12<br>03.12<br>10.09<br>10.09<br>07.08<br>10.09<br>10.09<br>10.09<br>10.09<br>06.09<br>03.12<br>10.09 |   |  | 24.0122-0231.1<br>24.0322-0231.1   | 422231<br>522231   |   | 257 22,0 20,0 V +S +B<br>257 22,0 20,0 V +S +B PD |            |
|  | 1.3 D Multijet<br>1.3 D Multijet<br>1.4 16V<br>1.4 MultiAir<br>1.6 D Multijet<br>1.4 Abarth  | 66<br>70<br>99<br>99<br>88   |  | 10.09<br>10.09<br>10.09<br>03.12<br>10.09   |   |  | 24.0122-0241.1   | 422241   |   | 284 22,0 20,0 V +S +B                             |            |
|  | 0.9<br>0.9 Bifuel<br>0.9 Twinair Turbo<br>1.2  | 77<br>63<br>63<br>48   |  | 11.13<br>03.12<br>03.12<br>10.09  |   |  | 13.0460-3862.2   | 603862   |   | 25451 17,6 +/WK/Zub/SBOS                          |            |



| KW   |  | ...            |       | ...   |                | ...            |                | ...    |  | ... |       | ...                 |                      |                   |
|--|--|----------------|-------|-------|----------------|----------------|----------------|--------|--|-----|-------|---------------------|----------------------|-------------------|
| <b>FIAT PUNTO / PUNTO EVO (09-)</b>  |  |                |       |       |                |                |                |        |  |     |       |                     |                      |                   |
|    | 1.2  | 51             |       | 10.09 |                | 13.0460-3862.2 | 603862         |        |  |     |       | 25451               | 17,6 +WK/Zub/SBOS    |                   |
|  | 1.3 D Multijet   | 51             |       | 07.08 |                |                |                |        |  |     |       |                     |                      |                   |
|  | 1.3 D Multijet   | 55             |       | 09.09 |                |                |                |        |  |     |       |                     |                      |                   |
|  | 1.3 D Multijet   | 62             |       | 10.09 |                |                |                |        |  |     |       |                     |                      |                   |
|  | 1.3 D Multijet   | 66             |       | 10.09 |                |                |                |        |  |     |       |                     |                      |                   |
|  | 1.3 D Multijet   | 70             |       | 10.09 |                |                |                |        |  |     |       |                     |                      |                   |
|  | 1.4  |                |       | 10.09 |                |                |                |        |  |     |       |                     |                      |                   |
|  | 1.4 16V  | 77             |       | 10.09 |                |                |                |        |  |     |       |                     |                      |                   |
|  | 1.4 16V  | 99             |       | 10.09 |                |                |                |        |  |     |       |                     |                      |                   |
|  | 1.4 Abarth   |                |       | 10.09 |                |                |                |        |  |     |       |                     |                      |                   |
|  | 1.4 LPG  | 57             |       | 06.09 |                |                |                |        |  |     |       |                     |                      |                   |
|  | 1.4 MultiAir   | 77             |       | 03.12 |                |                |                |        |  |     |       |                     |                      |                   |
|  | 1.4 MultiAir   | 99             |       | 03.12 |                |                |                |        |  |     |       |                     |                      |                   |
|  | 1.4 Natural Power  | 57             |       | 10.09 |                |                |                |        |  |     |       |                     |                      |                   |
| 1.6 D Multijet   | 88   |                | 10.09 |       |                |                |                |        |  |     |       |                     |                      |                   |
|    | 0.9  | 77             |       | 11.13 |                | 24.0110-0323.1 | 410323         |        |  |     |       | 264                 | 10,0 8,0 +B          |                   |
|  | 0.9 Bifuel   | 63             |       | 03.12 |                |                |                |        |  |     |       |                     |                      |                   |
|  | 0.9 Twinair Turbo  | 63             |       | 03.12 |                |                |                |        |  |     |       |                     |                      |                   |
|  | 1.2  | 48             |       | 10.09 |                |                |                |        |  |     |       |                     |                      |                   |
|  | 1.2  | 51             |       | 10.09 |                |                |                |        |  |     |       |                     |                      |                   |
|  | 1.3 D Multijet   | 51             |       | 07.08 |                |                |                |        |  |     |       |                     |                      |                   |
|  | 1.3 D Multijet   | 55             |       | 09.09 |                |                |                |        |  |     |       |                     |                      |                   |
|  | 1.3 D Multijet   | 62             |       | 10.09 |                |                |                |        |  |     |       |                     |                      |                   |
|  | 1.3 D Multijet   | 66             |       | 10.09 |                |                |                |        |  |     |       |                     |                      |                   |
|  | 1.3 D Multijet   | 70             |       | 10.09 |                |                |                |        |  |     |       |                     |                      |                   |
|  | 1.4  |                |       | 10.09 |                |                |                |        |  |     |       |                     |                      |                   |
|  | 1.4 16V  | 77             |       | 10.09 |                |                |                |        |  |     |       |                     |                      |                   |
|  | 1.4 16V  | 99             |       | 10.09 |                |                |                |        |  |     |       |                     |                      |                   |
|  | 1.4 Abarth   |                |       | 10.09 |                |                |                |        |  |     |       |                     |                      |                   |
| 1.4 LPG  | 57   |                | 06.09 |       |                |                |                |        |  |     |       |                     |                      |                   |
| 1.4 MultiAir   | 77   |                | 03.12 |       |                |                |                |        |  |     |       |                     |                      |                   |
| 1.4 MultiAir   | 99   |                | 03.12 |       |                |                |                |        |  |     |       |                     |                      |                   |
| 1.4 Natural Power  | 57   |                | 10.09 |       |                |                |                |        |  |     |       |                     |                      |                   |
| 1.6 D Multijet   | 88   |                | 10.09 |       |                |                |                |        |  |     |       |                     |                      |                   |
|    | 0.9  | 77             |       | 11.13 |                | 03.0137-0479.2 | 650479         |        |  |     |       | 203 x 38 HEB        | AP                   |                   |
|  | 0.9 Bifuel   | 63             |       | 03.12 |                | 03.0137-9310.2 | 669310         |        |  |     |       | Bremsbacken-Zubehör | AP                   |                   |
|  | 0.9 Twinair Turbo  | 63             |       | 03.12 |                |                |                |        |  |     |       |                     |                      |                   |
|  | 1.2  | 48             |       | 10.09 |                |                |                |        |  |     |       |                     |                      |                   |
|  | 1.3 D Multijet   | 51             |       | 07.08 |                | 03.0137-0478.2 | 650478         |        |  |     |       | 228 x 42 HEB        | AP                   |                   |
|  | 1.3 D Multijet   | 55             |       | 10.09 |                |                |                |        |  |     |       |                     |                      |                   |
|  | 1.3 D Multijet   | 62             |       | 10.09 |                |                |                |        |  |     |       |                     |                      |                   |
|  | 1.3 D Multijet   | 66             |       | 10.09 |                |                |                |        |  |     |       |                     |                      |                   |
|  | 1.3 D Multijet   | 70             |       | 10.09 |                |                |                |        |  |     |       |                     |                      |                   |
|  | 1.4  |                |       | 10.09 |                |                |                |        |  |     |       |                     |                      |                   |
|  | 1.4 16V  | 77             |       | 10.09 |                |                |                |        |  |     |       |                     |                      |                   |
|  | 1.4 16V  | 99             |       | 10.09 |                |                |                |        |  |     |       |                     |                      |                   |
|  | 1.4 MultiAir   | 77             |       | 03.12 |                |                |                |        |  |     |       |                     |                      |                   |
|  | 1.4 MultiAir   | 99             |       | 03.12 |                |                |                |        |  |     |       |                     |                      |                   |
|  | 1.3 D Multijet   | 51             |       | 07.08 |                | 24.0222-8037.1 | 480302         |        |  |     |       | 228/230 x 48        |                      |                   |
|  | 1.3 D Multijet   | 55             |       | 10.09 |                |                |                |        |  |     |       |                     |                      |                   |
|  | 1.3 D Multijet   | 62             |       | 10.09 |                |                |                |        |  |     |       |                     |                      |                   |
|  | 1.3 D Multijet   | 66             |       | 10.09 |                |                |                |        |  |     |       |                     |                      |                   |
|  | 1.3 D Multijet   | 70             |       | 10.09 |                |                |                |        |  |     |       |                     |                      |                   |
|  | 1.4  |                |       | 10.09 |                |                |                |        |  |     |       |                     |                      |                   |
|  | 1.4 16V  | 77             |       | 10.09 |                |                |                |        |  |     |       |                     |                      |                   |
|  | 1.4 16V  | 99             |       | 10.09 |                |                |                |        |  |     |       |                     |                      |                   |
|  | 1.4 MultiAir   | 77             |       | 03.12 |                |                |                |        |  |     |       |                     |                      |                   |
|  | 1.4 MultiAir   | 99             |       | 03.12 |                |                |                |        |  |     |       |                     |                      |                   |
|  | <b>FIAT GRANDE PUNTO (06-11)</b>   |                |       |       |                |                |                |        |  |     |       |                     |                      |                   |
|  |  | 1.2            |       |       | 10.05          | 08.10          | 13.0460-3826.2 | 603826 |  |     |       |                     | 23706                | 18,0 +WK/Zub/SBOS |
|  |  | 1.3 D Multijet | 51    |       | 10.05          | 08.10          | 13.0470-3826.2 | LD3826 |  |     |       |                     | 23706                | 18,0 +WK/Zub/SBOS |
|  |  | 1.4            |       |       | 10.05          | 08.10          |                |        |  |     |       |                     |                      |                   |
| 1.4 16V  |  |                |       | 10.05 | 01.11          |                |                |        |  |     |       |                     |                      |                   |
| 1.4 LPG  |  | 57             |       | 12.08 | 01.11          |                |                |        |  |     |       |                     |                      |                   |
| 1.4 Natural Power  |  | 57             |       | 07.08 | 01.11          |                |                |        |  |     |       |                     |                      |                   |
| 1.3 D Multijet   |  | 66             |       | 10.05 | 01.11          | 13.0460-3827.2 | 603827         |        |  |     |       | 23709               | 19,6 +WK/Zub/SBOS    |                   |
| 1.4 T-Jet  |  | 88             |       | 07.07 | 01.11          | 13.0470-3827.2 | LD3827         |        |  |     |       | 23709               | 19,6 +WK/Zub/SBOS    |                   |
| 1.6 D Multijet   |  | 88             |       | 07.08 | 01.11          |                |                |        |  |     |       |                     |                      |                   |
| 1.9 JTD  |  | 88             |       | 10.05 | 01.11          |                |                |        |  |     |       |                     |                      |                   |
| 1.9 JTD  |  | 96             |       | 02.06 | 01.11          |                |                |        |  |     |       |                     |                      |                   |
| 1.4 Abarth   |  | 114            |       | 10.07 | 01.11          | 13.0460-4853.2 | 604853         |        |  |     |       | 24162               | 15,2 +WK BRE         |                   |
| 1.4 Abarth   |  | 132            |       | 12.07 | 01.11          | 13.0470-4853.2 | LD4853         |        |  |     |       | 24162               | 15,2 +WK BRE         |                   |
| 1.2  |  |                |       | 09.10 | 01.11          | 13.0460-3863.2 | 603863         |        |  |     |       | 23706               | 18,0 +WK/Zub/SBOS    |                   |
| 1.2  | 51   |                | 09.10 | 01.11 |                |                |                |        |  |     |       |                     |                      |                   |
| 1.3 D Multijet   | 51   |                | 09.10 | 01.11 |                |                |                |        |  |     |       |                     |                      |                   |
| 1.3 D Multijet   | 55   |                | 09.10 | 01.11 |                |                |                |        |  |     |       |                     |                      |                   |
| 1.4  |  |                | 09.10 | 01.11 |                |                |                |        |  |     |       |                     |                      |                   |
| 1.3 D Multijet   | 62   |                | 04.10 | 01.11 | 13.0460-3864.2 | 603864         |                |        |  |     | 23709 | 19,6 +WK/Zub/SBOS   |                      |                   |
|  | 1.2  |                |       | 10.05 | 01.11          | 24.0112-0184.1 | 412184         |        |  |     |       | 257                 | 12,0 10,0 +S +B      |                   |
|  |  |                |       |       |                | 24.0122-0231.1 | 422231         |        |  |     |       | 257                 | 22,0 20,0 V +S +B    |                   |
|  |  |                |       |       |                | 24.0322-0231.1 | 522231         |        |  |     |       | 257                 | 22,0 20,0 V +S +B PD |                   |
|  |  |                |       |       |                |                |                |        |  |     |       |                     |                      |                   |
|  | 1.2  | 51             |       | 09.10 | 01.11          | 24.0122-0231.1 | 422231         |        |  |     |       | 257                 | 22,0 20,0 V +S +B    |                   |
|  | 1.3 D Multijet   | 51             |       | 10.05 | 01.11          | 24.0322-0231.1 | 522231         |        |  |     |       | 257                 | 22,0 20,0 V +S +B PD |                   |
| 1.3 D Multijet   | 55   |                | 04.08 | 01.11 |                |                |                |        |  |     |       |                     |                      |                   |
| 1.4  |  |                | 10.05 | 01.11 |                |                |                |        |  |     |       |                     |                      |                   |

1) - ventilated discs / - dischi ventilati / - disques ventilés / - disco ventilado  
2) + ventilated discs / + dischi ventilati / + disques ventilés / + disco ventilado





### FIAT GRANDE PUNTO (06-11)

|            |                   |     |       |       |                |                |        |                    |                          |     |
|------------|-------------------|-----|-------|-------|----------------|----------------|--------|--------------------|--------------------------|-----|
|            | 1.4 16V           | 57  |       | 10.05 | 01.11          | 24.0122-0231.1 | 422231 |                    | 257 22,0 20,0 V +S +B    |     |
|            | 1.4 LPG           |     |       | 12.08 | 01.11          | 24.0322-0231.1 | 522231 |                    | 257 22,0 20,0 V +S +B PD |     |
|            | 1.4 Natural Power | 57  |       | 07.08 | 01.11          |                |        |                    |                          |     |
|            | 1.3 D Multijet    | 62  |       | 04.10 | 01.11          | 24.0122-0241.1 | 422241 |                    | 284 22,0 20,0 V +S +B    |     |
|            | 1.3 D Multijet    | 66  |       | 10.05 | 01.11          |                |        |                    |                          |     |
|            | 1.4 T-Jet         | 88  |       | 07.07 | 01.11          |                |        |                    |                          |     |
|            | 1.6 D Multijet    | 88  |       | 07.08 | 01.11          |                |        |                    |                          |     |
|            | 1.9 JTD           | 88  |       | 10.05 | 01.11          |                |        |                    |                          |     |
| 1.9 JTD    | 96                |     | 02.06 | 01.11 |                |                |        |                    |                          |     |
| 1.4 Abarth | 114               |     | 10.07 | 01.11 | 24.0128-0219.1 | 428219         |        | 305 28,0 26,0 V +B |                          |     |
| 1.4 Abarth | 132               |     | 12.07 | 01.11 |                |                |        |                    |                          |     |
|            | 1.4 Abarth        | 114 |       | 10.07 | 01.11          | 13.0460-3828.2 | 603828 |                    | 24349 17,5/S             | BOS |
|            | 1.4 Abarth        | 132 |       | 12.07 | 01.11          | 13.0470-3828.2 | LD3828 |                    | 24349 17,5/S             | BOS |
|            | 1.4 T-Jet         | 88  |       | 07.07 | 01.11          |                |        |                    |                          |     |
|            | 1.6 D Multijet    | 88  |       | 07.08 | 01.11          |                |        |                    |                          |     |
|            | 1.9 JTD           | 88  |       | 10.05 | 01.11          |                |        |                    |                          |     |
|            | 1.9 JTD           | 96  |       | 02.06 | 01.11          |                |        |                    |                          |     |
|            | 1.4 Abarth        | 114 |       | 10.07 | 01.11          | 24.0110-0323.1 | 410323 |                    | 264 10,0 8,0 +B          |     |
|            | 1.4 Abarth        | 132 |       | 12.07 | 01.11          |                |        |                    |                          |     |
|            | 1.4 T-Jet         | 88  |       | 07.07 | 01.11          |                |        |                    |                          |     |
|            | 1.6 D Multijet    | 88  |       | 07.08 | 01.11          |                |        |                    |                          |     |
|            | 1.9 JTD           | 88  |       | 10.05 | 01.11          |                |        |                    |                          |     |
|            | 1.9 JTD           | 96  |       | 02.06 | 01.11          |                |        |                    |                          |     |
|            | 1.2               |     |       | 10.05 | 01.11          | 03.0137-0479.2 | 650479 |                    | 203 x 38 HEB             | AP  |
|            |                   |     |       |       |                | 03.0137-9310.2 | 669310 |                    | Bremsbacken-Zubehör      | AP  |
|            | 1.2               | 51  |       | 09.10 | 01.11          | 03.0137-0478.2 | 650478 |                    | 228 x 42 HEB             | AP  |
|            | 1.3 D Multijet    | 51  |       | 10.05 | 01.11          | 03.0137-9309.2 | 669309 |                    | Bremsbacken-Zubehör      | AP  |
|            | 1.3 D Multijet    | 55  |       | 04.08 | 01.11          |                |        |                    |                          |     |
|            | 1.3 D Multijet    | 62  |       | 04.10 | 01.11          |                |        |                    |                          |     |
|            | 1.3 D Multijet    | 66  |       | 10.05 | 01.11          |                |        |                    |                          |     |
|            | 1.4               |     |       | 10.05 | 01.11          |                |        |                    |                          |     |
|            | 1.4 16V           |     |       | 10.05 | 01.11          |                |        |                    |                          |     |
|            | 1.4 LPG           | 57  |       | 12.08 | 01.11          |                |        |                    |                          |     |
|            | 1.4 Natural Power | 57  |       | 07.08 | 01.11          |                |        |                    |                          |     |
|            | 1.3 D Multijet    | 62  |       | 09.10 | 01.11          | 24.0222-8037.1 | 480302 |                    | 228/230 x 48             |     |
| 1.4        |                   |     | 09.10 | 01.11 |                |                |        |                    |                          |     |
|            | 1.2               |     |       | 10.05 | 01.11          | 24.0220-3035.1 | 480300 |                    | 203/204,7 x 47           |     |
|            | 1.3 D Multijet    | 51  |       | 10.05 | 01.11          | 24.0222-8037.1 | 480302 |                    | 228/230 x 48             |     |
|            | 1.3 D Multijet    | 55  |       | 04.08 | 01.11          |                |        |                    |                          |     |
|            | 1.3 D Multijet    | 66  |       | 10.05 | 01.11          |                |        |                    |                          |     |
|            | 1.4               |     |       | 10.05 | 01.11          |                |        |                    |                          |     |
|            | 1.4 16V           |     |       | 10.05 | 01.11          |                |        |                    |                          |     |
|            | 1.4 LPG           | 57  |       | 12.08 | 01.11          |                |        |                    |                          |     |
|            | 1.4 Natural Power | 57  |       | 07.08 | 01.11          |                |        |                    |                          |     |
|            | 1.3 D Multijet    | 62  |       | 09.10 | 01.11          | 24.0222-8037.1 | 480302 |                    | 228/230 x 48             |     |
|            | 1.4               |     |       | 09.10 | 01.11          |                |        |                    |                          |     |
|            | 1.2               |     |       | 10.05 | 01.11          | 03.0520-9220.3 | 699220 |                    | 20,64/203x38 TopKit      | AP  |
|            | 1.2               | 51  |       | 09.10 | 01.11          | 03.0520-9020.3 | 699020 |                    | 20,64/228x42 TopKit      | AP  |
|            | 1.3 D Multijet    | 51  |       | 10.05 | 01.11          |                |        |                    |                          |     |
|            | 1.3 D Multijet    | 66  |       | 10.05 | 01.11          |                |        |                    |                          |     |
|            | 1.4               |     |       | 10.05 | 01.11          |                |        |                    |                          |     |
|            | 1.4 16V           |     |       | 10.05 | 01.11          |                |        |                    |                          |     |
|            | 1.4 LPG           | 57  |       | 12.08 | 01.11          |                |        |                    |                          |     |
|            | 1.4 Natural Power | 57  |       | 07.08 | 01.11          |                |        |                    |                          |     |

### FIAT SCUDO (95-06)

|  |           |  |  |       |       |                |        |  |                       |     |
|--|-----------|--|--|-------|-------|----------------|--------|--|-----------------------|-----|
|  | 1.6 i.e.  |  |  | 11.95 | 12.06 | 13.0460-3957.2 | 603957 |  | 23042 19,0 /WK/Zub    | BDX |
|  | 1.9 D     |  |  | 11.95 | 12.06 |                |        |  |                       |     |
|  | 1.9 TD    |  |  | 11.95 | 12.06 |                |        |  |                       |     |
|  | 2.0 i 16V |  |  | 06.00 | 12.06 |                |        |  |                       |     |
|  | 2.0 JTD   |  |  | 12.99 | 12.06 |                |        |  |                       |     |
|  | 1.6 i.e.  |  |  | 11.95 | 09.03 | 13.0460-2978.2 | 602978 |  | 21801 19,0 +/WK/S     | TRW |
|  | 1.9 D     |  |  | 11.95 | 09.03 |                |        |  |                       |     |
|  | 1.9 TD    |  |  | 11.95 | 09.03 |                |        |  |                       |     |
|  | 2.0 i 16V |  |  | 06.00 | 09.03 |                |        |  |                       |     |
|  | 2.0 JTD   |  |  | 12.99 | 09.03 |                |        |  |                       |     |
|  | 1.6 i.e.  |  |  | 10.03 | 12.06 | 13.0460-2863.2 | 602863 |  | 20261 19,0 +/WK/S     | TRW |
|  | 1.9 D     |  |  | 10.03 | 12.06 |                |        |  |                       |     |
|  | 1.9 TD    |  |  | 10.03 | 12.06 |                |        |  |                       |     |
|  | 2.0 i 16V |  |  | 10.03 | 12.06 |                |        |  |                       |     |
|  | 2.0 JTD   |  |  | 10.03 | 12.06 |                |        |  |                       |     |
|  | 1.6 i.e.  |  |  | 11.95 | 12.06 | 24.0120-0155.1 | 420155 |  | 258 20,0 18,2 V L +B  |     |
|  | 1.9 D     |  |  | 11.95 | 12.06 |                |        |  |                       |     |
|  | 1.9 TD    |  |  | 11.95 | 12.06 |                |        |  |                       |     |
|  | 2.0 i 16V |  |  | 06.00 | 12.06 |                |        |  |                       |     |
|  | 2.0 JTD   |  |  | 12.99 | 12.06 |                |        |  |                       |     |
|  | 1.6 i.e.  |  |  | 11.95 | 09.03 | 24.0126-0104.1 | 426104 |  | 281 26,0 24,2 V +B    |     |
|  | 1.9 D     |  |  | 11.95 | 09.03 |                |        |  |                       |     |
|  | 1.9 TD    |  |  | 11.95 | 09.03 |                |        |  |                       |     |
|  | 2.0 i 16V |  |  | 06.00 | 09.03 |                |        |  |                       |     |
|  | 2.0 JTD   |  |  | 12.99 | 09.03 |                |        |  |                       |     |
|  | 1.6 i.e.  |  |  | 10.03 | 12.06 | 24.0128-0136.1 | 428136 |  | 285 28,0 26,0 V +B    |     |
|  | 1.9 D     |  |  | 10.03 | 12.06 | 24.0328-0136.1 | 528136 |  | 285 28,0 26,0 V +B PD |     |
|  | 1.9 TD    |  |  | 10.03 | 12.06 |                |        |  |                       |     |
|  | 2.0 i 16V |  |  | 10.03 | 12.06 |                |        |  |                       |     |
|  | 2.0 JTD   |  |  | 10.03 | 12.06 |                |        |  |                       |     |



| FIAT SCUDO (95-06) |   |  |  |   |   |  |                                  |                  |  |                                 |
|--------------------|---|--|--|---|---|--|----------------------------------|------------------|--|---------------------------------|
|                    | 1.6 i.e.<br>1.9 D<br>1.9 TD<br>2.0 i 16V<br>2.0 JTD |  |  | 11.95<br>11.95<br>11.95<br>06.00<br>12.99 | 12.06<br>12.06<br>12.06<br>12.06<br>12.06 |  | 03.0137-0314.2<br>03.0137-9208.2 | 650314<br>669208 |  | 255 x 61<br>Bremsbacken-Zubehör |
|                    | 1.6 i.e.<br>1.9 D<br>1.9 TD<br>2.0 i 16V<br>2.0 JTD |  |  | 11.95<br>11.95<br>11.95<br>06.00<br>12.99 | 12.06<br>12.06<br>12.06<br>12.06<br>12.06 |  | 24.0225-5003.1                   | 480066           |  | 255/256 x 67                    |
|                    | 1.6 i.e.<br>1.9 D<br>1.9 TD<br>2.0 i 16V<br>2.0 JTD |  |  | 11.95<br>11.95<br>11.95<br>06.00<br>12.99 | 12.06<br>12.06<br>12.06<br>12.06<br>12.06 |  | 03.0520-2619.3                   | 692619           |  | 19,05/255x61 TopKit BDX         |

| FIAT SCUDO (07-) |  |  |  |   |  |   |                                  |                            |             |   |
|------------------|--|--|--|---|--|---|----------------------------------|----------------------------|-------------|---|
|                  | 1.6 D Multijet<br>2.0 D Multijet<br>2.0 D Multijet<br>2.0 D Multijet<br>2.0 D Multijet<br>2.0 D Multijet 4x4                   | 66<br>88<br>94<br>100<br>120<br>94       |  | 01.07<br>01.07<br>04.11<br>01.07<br>07.10<br>04.11          |  |   | 13.0460-2738.2                   | 602738                     |             | 24595 18,5 +/WK/Zub/STRW  |
|                  | 1.6 D Multijet<br>1.6 D Multijet<br>2.0 D Multijet<br>2.0 D Multijet<br>2.0 D Multijet<br>2.0 D Multijet<br>2.0 D Multijet 4x4 | 66<br>66<br>88<br>94<br>100<br>120<br>94 |  | 01.07<br>01.07<br>01.07<br>04.11<br>01.07<br>07.10<br>04.11 |  | + HA-Trommelbremse <sup>1)</sup><br>+ HA-Scheibenbremse <sup>2)</sup> | 24.0128-0214.1<br>24.0128-0216.1 | 428214<br>428216<br>428216 |             | 280 28,0 26,0 V +S +B<br>304 28,0 26,0 V +S +B<br>304 28,0 26,0 V +S +B |
|                  | 1.6 D Multijet<br>2.0 D Multijet<br>2.0 D Multijet<br>2.0 D Multijet<br>2.0 D Multijet<br>2.0 D Multijet 4x4                   | 66<br>88<br>94<br>100<br>120<br>94       |  | 01.07<br>01.07<br>04.11<br>01.07<br>07.10<br>04.11          |  |   | 13.0460-2739.2                   | 602739                     |             | 24578 16,5 /Zub/S TRW   |
|                  | 1.6 D Multijet<br>2.0 D Multijet<br>2.0 D Multijet<br>2.0 D Multijet<br>2.0 D Multijet<br>2.0 D Multijet 4x4                   | 66<br>88<br>94<br>100<br>120<br>94       |  | 01.07<br>01.07<br>04.11<br>01.07<br>07.10<br>04.11          |  |   | 24.0114-0116.1                   | 414116                     |             | 290 14,0 12,0 +S +B   |
|                  | 1.6 D Multijet   | 66                                       |  | 01.07   |  |   | 03.0137-0334.2<br>03.0137-9219.2 | 650334<br>669219           | - Wohnmobil | 254 x 57 HEB<br>Bremsbacken-Zubehör TRW<br>TRW                          |
|                  | 1.6 D Multijet   | 66                                       |  | 01.07   |  |   | 24.0225-4021.1                   | 480311                     |             | 254/256,2 x 68  |
|                  | 1.6 D Multijet   | 66                                       |  | 01.07   |  |   | 03.0520-7122.3                   | 697122                     | - Wohnmobil | 22,20/254x57 TopKit TRW   |

| FIAT SEDICI (06-) |  |  |  |  |  |  |                |        |  |                          |
|-------------------|--|--|--|--|--|--|----------------|--------|--|--------------------------|
|                   | 1.6 16V<br>1.6 16V<br>1.6 16V 4x4<br>1.6 16V 4x4<br>1.9 D Multijet<br>1.9 D Multijet 4x4<br>2.0 D Multijet<br>2.0 D Multijet 4x4 | 79<br>88<br>79<br>88<br>88<br>88<br>99<br>99 |  | 06.06<br>06.06<br>06.06<br>06.06<br>06.06<br>06.06<br>06.06<br>06.06 |  |  | 13.0460-2715.2 | 602715 |  | 24391 16,6 +/WK/Zub/STRW |
|                   | 1.6 16V<br>1.6 16V<br>1.6 16V 4x4<br>1.6 16V 4x4<br>1.9 D Multijet<br>1.9 D Multijet 4x4<br>2.0 D Multijet<br>2.0 D Multijet 4x4 | 79<br>88<br>79<br>88<br>88<br>88<br>99<br>99 |  | 06.06<br>06.06<br>06.06<br>06.06<br>06.06<br>06.06<br>06.06<br>06.06 |  |  | 24.0122-0252.1 | 422252 |  | 280 22,0 20,0 V +B       |
|                   | 1.6 16V<br>1.6 16V<br>1.6 16V 4x4<br>1.6 16V 4x4<br>1.9 D Multijet<br>1.9 D Multijet 4x4<br>2.0 D Multijet<br>2.0 D Multijet 4x4 | 79<br>88<br>79<br>88<br>88<br>88<br>99<br>99 |  | 06.06<br>06.06<br>06.06<br>06.06<br>06.06<br>06.06<br>06.06<br>06.06 |  |  | 13.0460-5929.2 | 605929 |  | 21719 15,0 +/WK AKE      |
|                   | 1.6 16V<br>1.6 16V<br>1.6 16V 4x4<br>1.6 16V 4x4<br>1.9 D Multijet<br>1.9 D Multijet 4x4<br>2.0 D Multijet<br>2.0 D Multijet 4x4 | 79<br>88<br>79<br>88<br>88<br>88<br>99<br>99 |  | 06.06<br>06.06<br>06.06<br>06.06<br>06.06<br>06.06<br>06.06<br>06.06 |  |  | 24.0109-0167.1 | 409167 |  | 278 9,0 8,0 +B           |

<sup>1)</sup> + RA drum brake / + P freno a tamburo / + frein à tambour essieu AR / + ET-tambores de freno

<sup>2)</sup> + RA disc brake / + P disco freno / + frein à disque essieu AR / + ET-disco de freno





























| FIAT SEDICI (06-) |                    |    |  |       |  |                |        |  |  |                                     |     |  |
|-------------------|--------------------|----|--|-------|--|----------------|--------|--|--|-------------------------------------|-----|--|
|                   | 1.6 16V            | 79 |  | 06.06 |  | 03.0137-0490.2 | 650490 |  |  | 220 x 35 HEB<br>Bremsbacken-Zubehör | BOS |  |
|                   | 1.6 16V            | 88 |  | 06.06 |  | 03.0137-9319.2 | 669319 |  |  |                                     | BOS |  |
|                   | 1.6 16V 4x4        | 79 |  | 06.06 |  |                |        |  |  |                                     |     |  |
|                   | 1.6 16V 4x4        | 88 |  | 06.06 |  |                |        |  |  |                                     |     |  |
|                   | 1.9 D Multijet     | 88 |  | 06.06 |  |                |        |  |  |                                     |     |  |
|                   | 1.9 D Multijet 4x4 | 88 |  | 06.06 |  |                |        |  |  |                                     |     |  |
|                   | 2.0 D Multijet     | 99 |  | 06.06 |  |                |        |  |  |                                     |     |  |
|                   | 2.0 D Multijet 4x4 | 99 |  | 06.06 |  |                |        |  |  |                                     |     |  |
|                   | 1.6 16V            | 79 |  | 06.06 |  | 03.0520-7719.3 | 697719 |  |  | 19,05/220x35 TopKit                 | BOS |  |
|                   | 1.6 16V            | 88 |  | 06.06 |  |                |        |  |  |                                     |     |  |
|                   | 1.6 16V 4x4        | 79 |  | 06.06 |  |                |        |  |  |                                     |     |  |
|                   | 1.6 16V 4x4        | 88 |  | 06.06 |  |                |        |  |  |                                     |     |  |
|                   | 1.9 D Multijet     | 88 |  | 06.06 |  |                |        |  |  |                                     |     |  |
|                   | 1.9 D Multijet 4x4 | 88 |  | 06.06 |  |                |        |  |  |                                     |     |  |
|                   | 2.0 D Multijet     | 99 |  | 06.06 |  |                |        |  |  |                                     |     |  |
|                   | 2.0 D Multijet 4x4 | 99 |  | 06.06 |  |                |        |  |  |                                     |     |  |

| FIAT SEICENTO (98-08) |           |  |  |       |       |                |        |  |  |                                     |     |
|-----------------------|-----------|--|--|-------|-------|----------------|--------|--|--|-------------------------------------|-----|
|                       | 1100 i.e. |  |  | 04.98 | 03.08 | 13.0460-3950.2 | 603950 |  |  | 21436 17,0                          | BDX |
|                       | 900 i.e.  |  |  | 04.98 | 03.08 |                |        |  |  |                                     |     |
|                       | 1100 i.e. |  |  | 04.98 | 03.08 | 24.0111-0119.1 | 411119 |  |  | 241 11,0 9,2 +B                     |     |
|                       | 900 i.e.  |  |  | 04.98 | 03.08 |                |        |  |  |                                     |     |
|                       | 1100 i.e. |  |  | 04.98 | 03.08 | 03.0137-0015.2 | 650015 |  |  | 185 x 31 AUT<br>Bremsbacken-Zubehör | FI  |
|                       | 900 i.e.  |  |  | 04.98 | 03.08 | 03.0137-9021.2 | 669021 |  |  |                                     |     |
|                       | 1100 i.e. |  |  | 04.98 | 03.08 | 24.0218-5002.1 | 480117 |  |  | 185/186,8 x 36,5                    |     |
|                       | 900 i.e.  |  |  | 04.98 | 03.08 |                |        |  |  |                                     |     |
|                       | 1100 i.e. |  |  | 04.98 | 03.08 | 03.0420-0319.3 | 680319 |  |  | 19,05/185x31 Kit                    | FI  |
|                       | 900 i.e.  |  |  | 04.98 | 03.08 |                |        |  |  |                                     |     |
|                       | Eletrica  |  |  | 03.00 | 03.08 |                |        |  |  |                                     |     |

| FIAT STILO / STILO Multi Wagon (01-08) |                |     |       |       |                |                |        |  |                          |                    |                       |                   |     |                   |     |
|--|----------------|-----|-------|-------|----------------|----------------|--------|--|--------------------------|--------------------|-----------------------|-------------------|-----|-------------------|-----|
|  | 1.2 i 16V      | 59  |       | 02.02 | 03.08          | 13.0460-3982.2 | 603982 |  |                          | 23705 18,1 +/WK/S  | BOS                   |                   |     |                   |     |
|  | 1.4 i 16V      |     |       | 01.04 | 03.08          | 13.0470-3982.2 | LD3982 |  |                          |                    |                       | 23705 18,1 +/WK/S | BOS |                   |     |
|  | 1.6 16V        |     |       | 10.01 | 03.08          | 13.0460-3983.2 | 603983 |  |                          | 23708 19,4 +/WK/S  | BOS                   |                   |     |                   |     |
|  | 1.8 16V        |     |       | 10.01 | 03.08          | 13.0470-3983.2 | LD3983 |  |                          |                    |                       | 23708 19,4 +/WK/S | BOS |                   |     |
|  | 1.9 D Multijet |     |       | 09.05 | 03.08          | 13.0460-0454.2 | 610454 |  |                          |                    |                       | Belagsatz-Zubehör | BOS |                   |     |
|  | 1.9 JTD        |     |       | 02.02 | 03.08          |                |        |  |                          |                    |                       |                   |     |                   |     |
|  | 1.9 JTD        |     |       | 10.01 | 03.08          |                |        |  |                          |                    |                       |                   |     |                   |     |
|  | 1.6 16V        | 100 |       | 04.05 | 03.08          | 13.0460-3984.2 | 603984 |  |                          |                    |                       | 23711 19,4 +/WK/S | BOS |                   |     |
|  | 1.9 D Multijet | 110 |       | 09.05 | 03.08          | 13.0470-3984.2 | LD3984 |  |                          |                    |                       |                   |     | 23711 19,4 +/WK/S | BOS |
|  | 1.9 JTD        |     |       | 01.04 | 03.08          | 13.0460-0454.2 | 610454 |  |                          |                    |                       |                   |     | Belagsatz-Zubehör | BOS |
| 2.4 20V                                |                |     | 10.01 | 03.08 |                |                |        |  |                          |                    |                       |                   |     |                   |     |
|  | 1.2 i 16V      | 59  |       | 02.02 | 03.08          | 24.0122-0197.1 | 422197 |  |                          | 258 22,0 20,2 V +B | 258 22,0 20,2 V +B PD |                   |     |                   |     |
|  | 1.4 i 16V      |     |       | 01.04 | 03.08          | 24.0322-0197.1 | 522197 |  |                          |                    |                       |                   |     |                   |     |
|  | 1.6 16V        |     |       | 10.01 | 03.08          | 24.0122-0147.1 | 422147 |  |                          | 281 26,0 24,2 V +B |                       |                   |     |                   |     |
|  | 1.8 16V        |     |       | 10.01 | 03.08          |                |        |  |                          |                    |                       |                   |     |                   |     |
|  | 1.9 D Multijet |     |       | 09.05 | 03.08          |                |        |  |                          |                    |                       |                   |     |                   |     |
|  | 1.9 JTD        |     |       | 02.02 | 03.08          |                |        |  |                          |                    |                       |                   |     |                   |     |
|  | 1.9 JTD        |     |       | 10.01 | 03.08          |                |        |  |                          |                    |                       |                   |     |                   |     |
|  | 1.6 16V        | 100 |       | 04.05 | 03.08          | 24.0126-0125.1 | 426125 |  |                          |                    |                       |                   |     |                   |     |
| 1.9 D Multijet                         | 110            |     | 09.05 | 03.08 |                |                |        |  |                          |                    |                       |                   |     |                   |     |
|  | 1.2 i 16V      | 59  |       | 02.02 | 05.05          | 13.0460-3991.2 | 603991 |  |                          | 23714 16,6 /S      | BOS                   |                   |     |                   |     |
|  | 1.4 i 16V      |     |       | 01.04 | 05.05          | 13.0460-0256.2 | 610256 |  |                          |                    |                       | 23714 16,6 /S     | BOS |                   |     |
|  | 1.6 16V        |     |       | 10.01 | 05.05          |                |        |  |                          | 23714 17,6 /S      | BOS                   |                   |     |                   |     |
|  | 1.6 16V        | 100 |       | 04.05 | 05.05          |                |        |  |                          |                    |                       |                   |     |                   |     |
|  | 1.8 16V        |     |       | 10.01 | 05.05          |                |        |  |                          |                    |                       |                   |     |                   |     |
|  | 1.9 JTD        |     |       | 02.02 | 05.05          |                |        |  |                          |                    |                       |                   |     |                   |     |
|  | 1.9 JTD        |     |       | 10.01 | 05.05          |                |        |  |                          |                    |                       |                   |     |                   |     |
|  | 1.9 JTD        |     |       | 01.04 | 05.05          |                |        |  |                          |                    |                       |                   |     |                   |     |
|  | 2.4 20V        |     |       | 10.01 | 05.05          |                |        |  |                          |                    |                       |                   |     |                   |     |
|  | 1.2 i 16V      | 59  |       | 06.05 | 03.08          | 13.0460-3991.2 | 603991 |  |                          |                    |                       | 23714 16,6 /S     | BOS |                   |     |
| 1.4 i 16V                              |                |     | 06.05 | 03.08 | 13.0470-3812.2 | LD3812         |        |  | 23714 17,6 /S            | BOS                |                       |                   |     |                   |     |
| 1.6 16V                                |                |     | 06.05 | 03.08 | 13.0460-3861.2 | 603861         |        |  | 23714 17,6 +/WK/Zub/SBOS | BOS                |                       |                   |     |                   |     |
| 1.6 16V                                | 100            |     | 06.05 | 03.08 |                |                |        |  |                          |                    |                       |                   |     |                   |     |
| 1.8 16V                                |                |     | 06.05 | 03.08 |                |                |        |  |                          |                    |                       |                   |     |                   |     |
| 1.9 D Multijet                         |                |     | 09.05 | 03.08 |                |                |        |  |                          |                    |                       |                   |     |                   |     |
| 1.9 D Multijet                         | 110            |     | 09.05 | 03.08 |                |                |        |  |                          |                    |                       |                   |     |                   |     |
| 1.9 JTD                                |                |     | 06.05 | 03.08 |                |                |        |  |                          |                    |                       |                   |     |                   |     |
| 1.9 JTD                                |                |     | 06.05 | 03.08 |                |                |        |  |                          |                    |                       |                   |     |                   |     |
| 2.4 20V                                |                |     | 06.05 | 03.08 |                |                |        |  |                          |                    |                       |                   |     |                   |     |
|  | 1.2 i 16V      | 59  |       | 02.02 | 03.08          | 24.0110-0190.1 | 410190 |  |                          | 252 10,0 9,0 +B    |                       |                   |     |                   |     |
|  | 1.4 i 16V      |     |       | 01.04 | 03.08          |                |        |  |                          |                    |                       |                   |     |                   |     |
|  | 1.6 16V        |     |       | 10.01 | 03.08          |                |        |  |                          |                    |                       |                   |     |                   |     |
|  | 1.6 16V        | 100 |       | 04.05 | 03.08          |                |        |  |                          |                    |                       |                   |     |                   |     |
|  | 1.8 16V        |     |       | 10.01 | 03.08          |                |        |  |                          |                    |                       |                   |     |                   |     |
|  | 1.9 D Multijet |     |       | 09.05 | 03.08          |                |        |  |                          |                    |                       |                   |     |                   |     |
| 1.9 D Multijet                         | 110            |     | 09.05 | 03.08 |                |                |        |  |                          |                    |                       |                   |     |                   |     |

|     |  |  |  |  |  |  |  |  |
|--|--|--|--|--|---|--|--|--|
| <b>FIAT STILO / STILO Multi Wagon (01-08)</b>                                      |  |  |  |  |   |  |  |  |
|    | 1.9 JTD<br>1.9 JTD<br>1.9 JTD<br>2.4 20V   |  | 02.02<br>10.01<br>01.04<br>10.01   | 03.08<br>03.08<br>03.08<br>03.08   | 24.0110-0190.1  | 410190   |  | 252 10,0 9,0 +B  |
| <b>FIAT STRADA / PICK-UP (99-11)</b>   |  |  |  |  |   |  |  |  |
|    | 1.2<br>1.3 JTD<br>1.7 TD<br>1.9 D<br>1.9 JTD                                     | 62<br>51<br>46<br>59   | 05.99<br>05.06<br>05.99<br>12.00<br>04.03  | 12.11<br>12.11<br>12.11<br>12.11<br>12.11  | 13.0460-7126.2  | 607126   |  | 23552 18,1 + ATE   |
|    | 1.2<br>1.3 JTD<br>1.7 TD<br>1.9 D<br>1.9 JTD                                     | 62<br>51<br>46<br>59   | 05.99<br>05.06<br>05.99<br>12.00<br>04.03  | 12.11<br>12.11<br>12.11<br>12.11<br>12.11  | 24.0120-0142.1<br>24.0320-0142.1  | 420142<br>520142   |  | 258 20,0 18,2 V L +B<br>258 20,0 18,2 V L +B PD                                    |
|    | 1.2<br>1.3 JTD<br>1.7 TD<br>1.9 D<br>1.9 JTD                                     | 62<br>51<br>46<br>59   | 05.99<br>05.06<br>05.99<br>12.00<br>04.03  | 12.11<br>12.11<br>12.11<br>12.11<br>12.11  | 03.0137-0471.2  | 650471   |  | 228 x 42 HEB   |
|    | 1.2<br>1.3 JTD<br>1.7 TD<br>1.9 D<br>1.9 JTD                                     | 62<br>51<br>46<br>59   | 05.99<br>05.06<br>05.99<br>12.00<br>04.03  | 12.11<br>12.11<br>12.11<br>12.11<br>12.11  | 24.0222-8018.1  | 480078   |  | 228/230 x 48   |
| <b>FIAT STRADA (11-)</b>   |  |  |  |  |   |  |  |  |
|    | 1.3 D Multijet   | 70   | 01.11  |  | 24.0120-0142.1  | 420142   |  | 258 20,0 18,2 V L +B   |
|    | 1.3 D Multijet   | 70   | 01.11  |  | 24.0222-8018.1  | 480078   |  | 228/230 x 48   |
| <b>FIAT ULYSSE (94-02)</b>   |  |  |  |  |   |  |  |  |
|    | 1.8 i.e.<br>1.9 TD<br>2.0<br>2.0 16V<br>2.0 JTD<br>2.0 Turbo<br>2.1 TD           | 89<br>108  | 06.96<br>01.95<br>06.94<br>06.94<br>10.99<br>06.94<br>06.96                      | 07.02<br>07.02<br>07.02<br>07.02<br>07.02<br>07.02<br>10.99                      | 13.0460-3957.2<br>13.0460-2978.2  | 603957<br>602978   |  | 23042 19,0 /WK/Zub BDX<br>21801 19,0 +/WK/S TRW                                    |
|  | 1.8 i.e.<br>1.9 TD<br>2.0<br>2.0 16V<br>2.0 JTD<br>2.0 Turbo<br>2.1 TD           | 89<br>108  | 06.96<br>01.95<br>06.94<br>06.94<br>10.99<br>06.94<br>06.96                      | 07.02<br>07.02<br>07.02<br>07.02<br>07.02<br>07.02<br>10.99                      | 24.0120-0155.1<br>24.0126-0104.1  | 420155<br>426104   |  | 258 20,0 18,2 V L +B<br>281 26,0 24,2 V +B   |
|  | 1.8 i.e.<br>1.9 TD<br>2.0<br>2.0 16V<br>2.0 JTD<br>2.0 Turbo<br>2.1 TD           | 89<br>108  | 06.96<br>01.95<br>06.94<br>06.94<br>10.99<br>06.94<br>06.96                      | 07.02<br>07.02<br>07.02<br>07.02<br>07.02<br>07.02<br>10.99                      | 13.0460-7061.2  | 607061   |  | 21275 17,0 +/WK ATE  |
|  | 1.8 i.e.<br>1.9 TD<br>2.0<br>2.0 16V<br>2.0 JTD<br>2.0 Turbo<br>2.1 TD           | 89<br>108  | 06.96<br>01.95<br>06.94<br>06.94<br>10.99<br>06.94<br>06.96                      | 07.02<br>07.02<br>07.02<br>07.02<br>07.02<br>07.02<br>10.99                      | 24.0110-0218.1  | 410218   |  | 295 10,0 8,0 +B  |
|  | 1.8 i.e.<br>1.9 TD<br>2.0<br>2.0 JTD<br>2.1 TD                                   | 89   | 06.96<br>01.95<br>06.94<br>10.99<br>06.99  | 07.02<br>07.02<br>07.02<br>07.02<br>10.99  | 03.0137-0314.2<br>03.0137-9208.2  | 650314<br>669208   |  | 255 x 61<br>Bremsbacken-Zubehör  |
|  | 1.8 i.e.<br>1.9 TD<br>2.0<br>2.0 JTD<br>2.1 TD                                   | 89   | 06.96<br>01.95<br>06.94<br>10.99<br>06.96  | 07.02<br>07.02<br>07.02<br>07.02<br>10.99  | 24.0225-5003.1  | 480066   |  | 255/256 x 67   |
|  | 1.8 i.e.<br>1.9 TD<br>2.0<br>2.0 JTD<br>2.1 TD                                   | 89   | 06.96<br>01.95<br>06.94<br>10.99<br>06.99  | 07.02<br>07.02<br>07.02<br>07.02<br>10.99  | 03.0520-2619.3  | 692619   |  | 19,05/255x61 TopKit BDX  |
|  | 1.8 i.e.<br>1.9 TD<br>2.0<br>2.0 16V<br>2.0 JTD<br>2.0 Turbo                     | 89<br>108  | 06.96<br>01.95<br>06.94<br>06.94<br>10.99<br>06.94                               | 07.02<br>07.02<br>07.02<br>07.02<br>07.02<br>07.02                               | 03.0137-4018.2<br>03.0137-9249.2<br>03.0137-9700.2<br>03.0137-9702.2              | 654018<br>669249<br>669700<br>669702   |  | 180 x 30 /Zub<br>Bremsbacken-Zubehör<br>Bremsbacken-Zubehör<br>Spreizschloß Satz   |
| ↓  | ↓  |  |  |  |   |  |  |  |



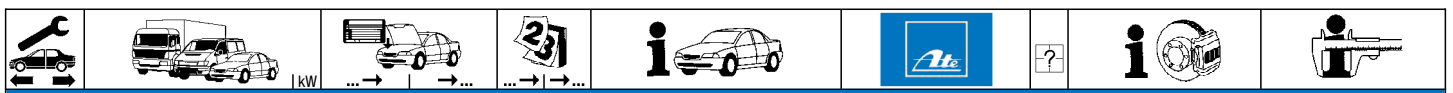

### FIAT ULYSSE (94-02)

|  |        |  |       |       |                |        |  |                     |
|--|--------|--|-------|-------|----------------|--------|--|---------------------|
|  | 2.1 TD |  | 06.96 | 10.99 | 03.0137-4018.2 | 654018 |  | 180 x 30 /Zub       |
|  |        |  |       |       | 03.0137-9249.2 | 669249 |  | Bremsbacken-Zubehör |
|  |        |  |       |       | 03.0137-9700.2 | 669700 |  | Bremsbacken-Zubehör |
|  |        |  |       |       | 03.0137-9702.2 | 669702 |  | Spreizschloß Satz   |

### FIAT ULYSSE (02-11)

|  |                |     |       |       |                |        |   |                       |     |
|--|----------------|-----|-------|-------|----------------|--------|---|-----------------------|-----|
|  | 2.0 D Multijet | 88  | 05.06 | 01.11 | 13.0460-2863.2 | 602863 |   | 20261 19,0 +/WK/S     | TRW |
|  | 2.0 D Multijet | 100 | 05.06 | 01.11 |                |        |   |                       |     |
|  | 2.0 i 16V      | 100 | 08.02 | 01.11 |                |        |   |                       |     |
|  | 2.0 JTD        | 79  | 05.03 | 01.11 |                |        |   |                       |     |
|  | 2.0 JTD        | 80  | 08.02 | 01.11 |                |        |   |                       |     |
|  | 2.2 JTD        | 94  | 08.02 | 01.11 |                |        |   |                       |     |
|  | 2.2 JTD        | 120 | 03.08 | 01.11 |                |        |   |                       |     |
|  | 2.2 D Multijet | 125 | 03.08 | 01.11 | 13.0460-2752.2 | 602752 |   | 24839 19,4 +/WK/S     | TRW |
|  | 3.0 i V6       | 150 | 08.02 | 01.11 | 13.0460-4995.2 | 604995 |   | 23575 15,6 +/WK       | BRE |
|  | 2.0 D Multijet | 88  | 05.06 | 01.11 | 24.0128-0136.1 | 428136 |   | 285 28,0 26,0 V +B    |     |
|  | 2.0 D Multijet | 100 | 05.06 | 01.11 | 24.0328-0136.1 | 528136 |   | 285 28,0 26,0 V +B PD |     |
|  | 2.0 i 16V      | 100 | 08.02 | 01.11 |                |        |   |                       |     |
|  | 2.0 JTD        | 79  | 05.03 | 01.11 |                |        |   |                       |     |
|  | 2.0 JTD        | 80  | 08.02 | 01.11 |                |        |   |                       |     |
|  | 2.2 JTD        | 94  | 08.02 | 01.11 |                |        |   |                       |     |
|  | 2.2 JTD        | 120 | 03.08 | 01.11 |                |        |   |                       |     |
|  | 2.2 D Multijet | 125 | 03.08 | 01.11 | 24.0132-0126.1 | 432126 |   | 310 32,0 30,0 V       |     |
|  | 3.0 i V6       | 150 | 08.02 | 01.11 | 24.0132-0126.1 | 432126 |   | 310 32,0 30,0 V       |     |
|  | 2.0 D Multijet | 88  | 05.06 | 01.11 | 13.0460-2819.2 | 602819 |   | 20961 17,6 /S         | TRW |
|  | 2.0 D Multijet | 100 | 05.06 | 01.11 | 13.0460-0072.2 | 610072 |   | Belagsatz-Zubehör     | TRW |
|  | 2.0 i 16V      | 100 | 08.02 | 01.11 |                |        |   |                       |     |
|  | 2.0 JTD        | 79  | 05.03 | 01.11 |                |        |   |                       |     |
|  | 2.0 JTD        | 80  | 08.02 | 01.11 |                |        |   |                       |     |
|  | 2.2 D Multijet | 125 | 03.08 | 01.11 |                |        |   |                       |     |
|  | 2.2 JTD        | 94  | 08.02 | 01.11 |                |        |   |                       |     |
|  | 2.2 JTD        | 120 | 03.08 | 01.11 |                |        |   |                       |     |
|  | 3.0 i V6       | 150 | 08.02 | 01.11 |                |        |   |                       |     |
|  | 2.0 D Multijet | 88  | 05.06 | 01.11 | 24.0112-0156.1 | 412156 |   | 272 12,0 10,0 +B      |     |
|  | 2.0 D Multijet | 100 | 05.06 | 01.11 |                |        |   |                       |     |
|  | 2.0 i 16V      | 100 | 08.02 | 01.11 |                |        |   |                       |     |
|  | 2.0 JTD        | 79  | 05.03 | 01.11 |                |        |   |                       |     |
|  | 2.0 JTD        | 80  | 08.02 | 01.11 |                |        |   |                       |     |
|  | 2.2 D Multijet | 125 | 03.08 | 01.11 |                |        |   |                       |     |
|  | 2.2 JTD        | 94  | 08.02 | 01.11 |                |        |   |                       |     |
|  | 2.2 JTD        | 120 | 03.08 | 01.11 |                |        |   |                       |     |
|  | 3.0 i V6       | 150 | 08.02 | 01.11 |                |        |   |                       |     |
|  | 2.0 D Multijet | 88  | 05.06 | 01.11 | 24.0711-6066.3 | 360130 | 2 | Radsensor L=955       |     |
|  | 2.0 D Multijet | 100 | 05.06 | 01.11 |                |        |   |                       |     |
|  | 2.0 i 16V      | 100 | 08.02 | 01.11 |                |        |   |                       |     |
|  | 2.0 JTD        | 79  | 05.03 | 01.11 |                |        |   |                       |     |
|  | 2.0 JTD        | 80  | 08.02 | 01.11 |                |        |   |                       |     |
|  | 2.2 D Multijet | 125 | 03.08 | 01.11 |                |        |   |                       |     |
|  | 2.2 JTD        | 94  | 08.02 | 01.11 |                |        |   |                       |     |
|  | 2.2 JTD        | 120 | 03.08 | 01.11 |                |        |   |                       |     |
|  | 3.0 i V6       | 150 | 08.02 | 01.11 |                |        |   |                       |     |

### FORD B-MAX (12-)

|  |              |     |       |  |                |        |  |                     |     |
|--|--------------|-----|-------|--|----------------|--------|--|---------------------|-----|
|  | 1.0 EcoBoost | 74  | 10.12 |  | 13.0460-2784.2 | 602784 |  | 25134 17,2 +/Zub/S  | TRW |
|  | 1.0 EcoBoost | 88  | 10.12 |  | 13.0470-2784.2 | LD2784 |  | 25134 17,2 +/Zub/S  | TRW |
|  | 1.0 EcoBoost | 92  | 10.12 |  |                |        |  |                     |     |
|  | 1.0 EcoBoost | 103 | 02.16 |  |                |        |  |                     |     |
|  | 1.4 Duratec  | 66  | 10.12 |  |                |        |  |                     |     |
|  | 1.4 LPG      | 63  | 08.13 |  |                |        |  |                     |     |
|  | 1.5 TDCi     | 55  | 10.12 |  |                |        |  |                     |     |
|  | 1.5 TDCi     | 70  | 04.15 |  |                |        |  |                     |     |
|  | 1.6 TDCi     | 70  | 10.12 |  |                |        |  |                     |     |
|  | 1.6 Ti-VCT   | 77  | 10.12 |  |                |        |  |                     |     |
|  | 1.0 EcoBoost | 74  | 10.12 |  | 24.0123-0122.1 | 423122 |  | 278 23,0 21,0 V +B  |     |
|  | 1.0 EcoBoost | 88  | 10.12 |  |                |        |  |                     |     |
|  | 1.0 EcoBoost | 92  | 10.12 |  |                |        |  |                     |     |
|  | 1.0 EcoBoost | 103 | 02.16 |  |                |        |  |                     |     |
|  | 1.4 Duratec  | 66  | 10.12 |  |                |        |  |                     |     |
|  | 1.4 LPG      | 63  | 08.13 |  |                |        |  |                     |     |
|  | 1.5 TDCi     | 55  | 10.12 |  |                |        |  |                     |     |
|  | 1.5 TDCi     | 70  | 04.15 |  |                |        |  |                     |     |
|  | 1.6 TDCi     | 70  | 10.12 |  |                |        |  |                     |     |
|  | 1.6 Ti-VCT   | 77  | 10.12 |  |                |        |  |                     |     |
|  | 1.0 EcoBoost | 74  | 10.12 |  | 03.0137-0512.2 | 650512 |  | 228 x 42 HEB        |     |
|  | 1.0 EcoBoost | 88  | 10.12 |  | 03.0137-9313.2 | 669313 |  | Bremsbacken-Zubehör |     |
|  | 1.0 EcoBoost | 92  | 10.12 |  |                |        |  |                     |     |
|  | 1.0 EcoBoost | 103 | 02.16 |  |                |        |  |                     |     |
|  | 1.4 Duratec  | 66  | 10.12 |  |                |        |  |                     |     |
|  | 1.4 LPG      | 63  | 08.13 |  |                |        |  |                     |     |
|  | 1.5 TDCi     | 55  | 10.12 |  |                |        |  |                     |     |
|  | 1.5 TDCi     | 70  | 04.15 |  |                |        |  |                     |     |
|  | 1.6 TDCi     | 70  | 10.12 |  |                |        |  |                     |     |
|  | 1.6 Ti-VCT   | 77  | 10.12 |  |                |        |  |                     |     |

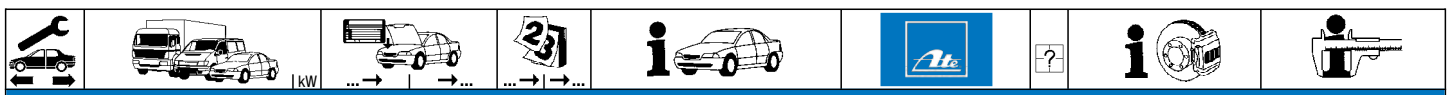

















**FORD C-MAX I (07-10)**



















|           |           |     |       |       |                |                |        |   |       |   |                |                |                |        |
|-----------|-----------|-----|-------|-------|----------------|----------------|--------|---|-------|---|----------------|----------------|----------------|--------|
|           | 1.6 i 16V | 74  |       | 03.07 | 10.10          | 13.0460-7193.2 | 607193 |   |       | 23723 18,1 +<br>23723 18,1 +                    | ATE<br>ATE     |                |                |        |
|           | 1.6 TDCi  |     |       | 03.07 | 10.10          |                |        |   |       |   |                | 13.0470-7193.2 | LD7193         |        |
|           | 1.6 TDCi  | 66  |       | 03.07 | 10.10          |                |        |   |       |   |                |                |                |        |
|           | 1.8 i 16V |     |       | 03.07 | 10.10          |                |        |   |       |   |                |                |                |        |
|           | 1.8 TDCi  | 85  |       | 03.07 | 10.10          |                |        |   |       |   |                |                |                |        |
|           | 2.0 i 16V | 107 |       | 03.07 | 10.10          |                |        |   |       |   |                |                |                |        |
|           | 2.0 TDCi  |     |       | 03.07 | 10.10          |                |        |   |       |   |                |                |                |        |
| 2.0 TDCi  | 81        |     | 02.08 | 10.10 |                |                |        |   |       |   |                |                |                |        |
|           | 1.8 TDCi  | 85  |       | 03.07 | 10.10          | 24.0125-0162.1 | 425162 |   |       | 300 25,0 23,0 V L +B<br>300 25,0 23,0 V L +B PD |                |                |                |        |
|           | 2.0 i 16V | 107 |       | 03.07 | 10.10          |                |        |   |       |   | 24.0325-0162.1 | 525162         |                |        |
|           | 2.0 TDCi  |     |       | 03.07 | 10.10          |                |        |   |       |   |                |                |                |        |
|           | 2.0 TDCi  | 81  |       | 02.08 | 10.10          |                |        |   |       |   |                |                |                |        |
|           | 1.6 i 16V | 74  |       | 03.07 | 10.10          |                |        |   |       |   |                |                | 24.0125-0117.1 | 425117 |
| 1.6 TDCi  |           |     | 03.07 | 10.10 | 24.0325-0117.1 | 525117         |        |   |       |   |                |                |                |        |
| 1.6 TDCi  | 66        |     | 03.07 | 10.10 |                |                |        |   |       |   |                |                |                |        |
| 1.8 i 16V |           |     | 03.07 | 10.10 |                |                |        |   |       |   |                |                |                |        |
|           | 1.6 i 16V | 74  |       | 03.07 | 10.10          | 24.0711-5123.3 | 360065 | 2 | - ESP | Radsensor                                       |                |                |                |        |
|           | 1.6 TDCi  |     |       | 03.07 | 10.10          |                |        |   |       |   | 24.0711-5133.3 | 360095         | 2              | + ESP  |
|           | 1.6 TDCi  | 66  |       | 03.07 | 10.10          |                |        |   |       |   |                |                |                |        |
|           | 1.8 i 16V |     |       | 03.07 | 10.10          |                |        |   |       |   |                |                |                |        |
|           | 1.8 TDCi  | 85  |       | 03.07 | 10.10          |                |        |   |       |   |                |                |                |        |
|           | 2.0 i 16V | 107 |       | 03.07 | 10.10          |                |        |   |       |   |                |                |                |        |
|           | 2.0 TDCi  |     |       | 03.07 | 10.10          |                |        |   |       |   |                |                |                |        |
| 2.0 TDCi  | 81        |     | 02.08 | 10.10 |                |                |        |   |       |   |                |                |                |        |
|           | 1.6 i 16V | 74  |       | 03.07 | 10.10          | 13.0460-7195.2 | 607195 |   |       | 23482 16,6 +<br>23482 16,6 +                    | ATE<br>ATE     |                |                |        |
|           | 1.6 TDCi  |     |       | 03.07 | 10.10          |                |        |   |       |   |                | 13.0470-7195.2 | LD7195         |        |
|           | 1.6 TDCi  | 66  |       | 03.07 | 10.10          |                |        |   |       |   |                |                |                |        |
|           | 1.8 i 16V |     |       | 03.07 | 10.10          |                |        |   |       |   |                |                |                |        |
|           | 1.8 TDCi  | 85  |       | 03.07 | 10.10          |                |        |   |       |   |                |                |                |        |
|           | 2.0 i 16V | 107 |       | 03.07 | 10.10          |                |        |   |       |   |                |                |                |        |
|           | 2.0 TDCi  |     |       | 03.07 | 10.10          |                |        |   |       |   |                |                |                |        |
| 2.0 TDCi  | 81        |     | 02.08 | 10.10 |                |                |        |   |       |   |                |                |                |        |
|           | 1.6 i 16V | 74  |       | 03.07 | 10.10          | 24.0111-0155.1 | 411155 |   |       | 265 11,0 9,0 +B<br>265 11,0 9,0 +B PD           |                |                |                |        |
|           | 1.6 TDCi  |     |       | 03.07 | 10.10          |                |        |   |       |   | 24.0311-0155.1 | 511155         |                |        |
|           | 1.6 TDCi  | 66  |       | 03.07 | 10.10          |                |        |   |       |   |                |                |                |        |
|           | 1.8 i 16V |     |       | 03.07 | 10.10          |                |        |   |       |   |                |                |                |        |
|           | 1.8 TDCi  | 85  |       | 03.07 | 10.10          |                |        |   |       |   |                |                | 24.0111-0158.1 | 411158 |
| 2.0 i 16V | 107       |     | 03.07 | 10.10 | 24.0311-0158.1 | 511158         |        |   |       |   |                |                |                |        |
| 2.0 TDCi  |           |     | 03.07 | 10.10 |                |                |        |   |       |   |                |                |                |        |
| 2.0 TDCi  | 81        |     | 02.08 | 10.10 |                |                |        |   |       |   |                |                |                |        |
|           | 1.6 i 16V | 74  |       | 03.07 | 10.10          | 24.0711-6220.3 | 360256 | 2 |       | Radsensor                                       |                |                |                |        |
|           | 1.6 TDCi  |     |       | 03.07 | 10.10          |                |        |   |       |   |                |                |                |        |
|           | 1.6 TDCi  | 66  |       | 03.07 | 10.10          |                |        |   |       |   |                |                |                |        |
|           | 1.8 i 16V |     |       | 03.07 | 10.10          |                |        |   |       |   |                |                |                |        |
|           | 1.8 TDCi  | 85  |       | 03.07 | 10.10          |                |        |   |       |   |                |                |                |        |
|           | 2.0 i 16V | 107 |       | 03.07 | 10.10          |                |        |   |       |   |                |                |                |        |
|           | 2.0 TDCi  |     |       | 03.07 | 10.10          |                |        |   |       |   |                |                |                |        |
| 2.0 TDCi  | 81        |     | 02.08 | 10.10 |                |                |        |   |       |   |                |                |                |        |

**FORD C-MAX II (10-)**

|          |                   |     |       |       |  |                |        |  |  |   |                |                |        |
|----------|-------------------|-----|-------|-------|--|----------------|--------|--|--|---|----------------|----------------|--------|
|          | 1.0 EcoBoost      | 74  |       | 09.12 |  | 13.0460-7193.2 | 607193 |  |  | 23723 18,1 +<br>23723 18,1 +                    | ATE<br>ATE     |                |        |
|          | 1.0 EcoBoost      | 92  |       | 09.12 |  |                |        |  |  |   |                | 13.0470-7193.2 | LD7193 |
|          | 1.5 EcoBoost      | 110 |       | 03.15 |  |                |        |  |  |   |                |                |        |
|          | 1.5 EcoBoost      | 134 |       | 03.15 |  |                |        |  |  |   |                |                |        |
|          | 1.5 TDCi          | 70  |       | 03.15 |  |                |        |  |  |   |                |                |        |
|          | 1.5 TDCi          | 88  |       | 03.15 |  |                |        |  |  |   |                |                |        |
|          | 1.5 TDCi ECOnetic | 77  |       | 03.15 |  |                |        |  |  |   |                |                |        |
|          | 1.6 CNG           | 86  |       | 01.13 |  |                |        |  |  |   |                |                |        |
|          | 1.6 EcoBoost      | 110 |       | 12.10 |  |                |        |  |  |   |                |                |        |
|          | 1.6 EcoBoost      | 134 |       | 12.10 |  |                |        |  |  |   |                |                |        |
|          | 1.6 Flexifuel     | 88  |       | 02.11 |  |                |        |  |  |   |                |                |        |
|          | 1.6 LPG           | 88  |       | 02.12 |  |                |        |  |  |   |                |                |        |
|          | 1.6 TDCi          | 70  |       | 12.10 |  |                |        |  |  |   |                |                |        |
|          | 1.6 TDCi          | 85  |       | 12.10 |  |                |        |  |  |   |                |                |        |
|          | 1.6 Ti-VCT        | 63  |       | 12.10 |  |                |        |  |  |   |                |                |        |
|          | 1.6 Ti-VCT        | 77  |       | 12.10 |  |                |        |  |  |   |                |                |        |
|          | 1.6 Ti-VCT        | 88  |       | 02.12 |  |                |        |  |  |   |                |                |        |
|          | 1.6 Ti-VCT        | 92  |       | 12.10 |  |                |        |  |  |   |                |                |        |
|          | 2.0 TDCi          | 85  |       | 12.10 |  |                |        |  |  |   |                |                |        |
|          | 2.0 TDCi          | 100 |       | 02.11 |  |                |        |  |  |   |                |                |        |
| 2.0 TDCi | 103               |     | 12.10 |       |  |                |        |  |  |   |                |                |        |
| 2.0 TDCi | 110               |     | 03.15 |       |  |                |        |  |  |   |                |                |        |
| 2.0 TDCi | 120               |     | 12.10 |       |  |                |        |  |  |   |                |                |        |
| 2.0 TDCi | 125               |     | 03.15 |       |  |                |        |  |  |   |                |                |        |
|          | 1.0 EcoBoost      | 74  |       | 09.12 |  | 24.0125-0199.1 | 425199 |  |  | 278 25,0 23,0 V L +B<br>278 25,0 23,0 V L +B PD |                |                |        |
|          | 1.0 EcoBoost      | 92  |       | 09.12 |  |                |        |  |  |   | 24.0325-0199.1 | 525199         |        |
|          | 1.5 EcoBoost      | 110 |       | 03.15 |  |                |        |  |  |   |                |                |        |
|          | 1.5 EcoBoost      | 134 |       | 03.15 |  |                |        |  |  |   |                |                |        |
|          | 1.6 CNG           | 86  |       | 01.13 |  |                |        |  |  |   |                |                |        |
|          | 1.6 Flexifuel     | 88  |       | 02.11 |  |                |        |  |  |   |                |                |        |
|          | 1.6 LPG           | 88  |       | 02.12 |  |                |        |  |  |   |                |                |        |
|          | 1.6 TDCi          | 70  |       | 12.10 |  |                |        |  |  |   |                |                |        |
|          | 1.6 TDCi          | 85  |       | 12.10 |  |                |        |  |  |   |                |                |        |
|          | 1.6 Ti-VCT        | 63  |       | 12.10 |  |                |        |  |  |   |                |                |        |
|          | 1.6 Ti-VCT        | 77  |       | 12.10 |  |                |        |  |  |   |                |                |        |
|          | 1.6 Ti-VCT        | 88  |       | 02.12 |  |                |        |  |  |   |                |                |        |
|          | 1.6 Ti-VCT        | 92  |       | 12.10 |  |                |        |  |  |   |                |                |        |
|          | 1.6 Ti-VCT        | 88  |       | 02.12 |  |                |        |  |  |   |                |                |        |



















|     |  |  |  |  |  |  |       |  |
|--|--|--|--|--|---|--|---|--|
| <b>FORD C-MAX II (10-)</b>   |  |  |  |  |   |  |   |  |
|    | 1.6 Ti-VCT   | 92   |  | 12.10  |   | 24.0125-0199.1 425199<br>24.0325-0199.1 525199                                     |   | 278 25,0 23,0 VL +B<br>278 25,0 23,0 VL +B PD                                      |
|  | 1.5 TDCi   | 70   |  | 03.15  |   | 24.0125-0162.1 425162  |   | 300 25,0 23,0 VL +B  |
|  | 1.5 TDCi   | 88   |  | 03.15  |   | 24.0325-0162.1 525162  |   | 300 25,0 23,0 VL +B PD   |
|  | 1.5 TDCi ECOnetic  | 77   |  | 03.15  |   | 24.0125-0199.1 425199  |   | 278 25,0 23,0 VL +B  |
|  | 1.6 EcoBoost   | 110  |  | 12.10  |   | 24.0325-0199.1 525199  |   | 278 25,0 23,0 VL +B PD   |
|  | 1.6 EcoBoost   | 134  |  | 12.10  |   |  |   |  |
|  | 2.0 TDCi   | 85   |  | 12.10  |   |  |   |  |
|  | 2.0 TDCi   | 100  |  | 02.11  |   |  |   |  |
|  | 2.0 TDCi   | 103  |  | 12.10  |   |  |   |  |
|  | 2.0 TDCi   | 110  |  | 03.15  |   |  |   |  |
|  | 2.0 TDCi   | 120  |  | 12.10  |   |  |   |  |
|  | 2.0 TDCi   | 125  |  | 03.15  |   |  |   |  |
|  | 2.0 Energi Hybrid  | 136  |  | 01.15  |   | 24.0125-0162.1 425162<br>24.0325-0162.1 525162                                     |   | 300 25,0 23,0 VL +B<br>300 25,0 23,0 VL +B PD                                      |
|    | 1.6 EcoBoost   | 110  |  | 12.10  | 12.10   | 24.0711-5123.3 360065  | 2    | Radsensor  |
|  | 1.6 EcoBoost   | 134  |  | 12.10  | 12.10   |  |   |  |
|  | 1.6 TDCi   | 70   |  | 12.10  | 12.10   |  |   |  |
|  | 1.6 TDCi   | 85   |  | 12.10  | 12.10   |  |   |  |
|  | 1.6 Ti-VCT   | 63   |  | 12.10  | 12.10   |  |   |  |
|  | 1.6 Ti-VCT   | 77   |  | 12.10  | 12.10   |  |   |  |
|  | 1.6 Ti-VCT   | 92   |  | 12.10  | 12.10   |  |   |  |
|  | 2.0 TDCi   | 85   |  | 12.10  | 12.10   |  |   |  |
|  | 2.0 TDCi   | 103  |  | 12.10  | 12.10   |  |   |  |
|  | 2.0 TDCi   | 120  |  | 12.10  | 12.10   |  |   |  |
|  | 1.0 EcoBoost   | 74   |  | 09.12  |   | 24.0711-5357.3 360354  | 2    | Radsensor  |
|  | 1.0 EcoBoost   | 92   |  | 09.12  |   |  |   |  |
|  | 1.5 EcoBoost   | 110  |  | 03.15  |   |  |   |  |
|  | 1.5 EcoBoost   | 134  |  | 03.15  |   |  |   |  |
|  | 1.5 TDCi   | 70   |  | 03.15  |   |  |   |  |
|  | 1.5 TDCi   | 88   |  | 03.15  |   |  |   |  |
|  | 1.5 TDCi ECOnetic  | 77   |  | 03.15  |   |  |   |  |
|  | 1.6 CNG  | 86   |  | 01.13  |   |  |   |  |
|  | 1.6 EcoBoost   | 110  |  | 01.11  |   |  |   |  |
|  | 1.6 EcoBoost   | 134  |  | 01.11  |   |  |   |  |
|  | 1.6 Flexifuel  | 88   |  | 02.11  |   |  |   |  |
|  | 1.6 LPG  | 88   |  | 02.12  |   |  |   |  |
|  | 1.6 TDCi   | 70   |  | 01.11  |   |  |   |  |
|  | 1.6 TDCi   | 85   |  | 01.11  |   |  |   |  |
|  | 1.6 Ti-VCT   | 63   |  | 01.11  |   |  |   |  |
|  | 1.6 Ti-VCT   | 77   |  | 01.11  |   |  |   |  |
|  | 1.6 Ti-VCT   | 88   |  | 02.12  |   |  |   |  |
|  | 1.6 Ti-VCT   | 92   |  | 01.11  |   |  |   |  |
|  | 2.0 TDCi   | 85   |  | 01.11  |   |  |   |  |
|  | 2.0 TDCi   | 100  |  | 02.11  |   |  |   |  |
|  | 2.0 TDCi   | 103  |  | 01.11  |   |  |   |  |
|  | 2.0 TDCi   | 110  |  | 03.15  |   |  |   |  |
|  | 2.0 TDCi   | 120  |  | 01.11  |   |  |   |  |
|  | 2.0 TDCi   | 125  |  | 03.15  |   |  |   |  |
|  | 2.0 Energi Hybrid  | 136  |  | 01.15  |   | 24.0711-5123.3 360065  | 2  | Radsensor  |
|  | 1.0 EcoBoost   | 74   |  | 09.12  |   | 13.0460-7195.2 607195  |   | 23482 16,6 + ATE   |
|  | 1.0 EcoBoost   | 92   |  | 09.12  |   | 13.0470-7195.2 LD7195  |   | 23482 16,6 + ATE   |
|  | 1.5 EcoBoost   | 110  |  | 03.15  |   |  |   |  |
|  | 1.5 EcoBoost   | 134  |  | 03.15  |   |  |   |  |
|  | 1.5 TDCi   | 70   |  | 03.15  |   |  |   |  |
|  | 1.5 TDCi   | 88   |  | 03.15  |   |  |   |  |
|  | 1.5 TDCi ECOnetic  | 77   |  | 03.15  |   |  |   |  |
|  | 1.6 CNG  | 86   |  | 01.13  |   |  |   |  |
|  | 1.6 EcoBoost   | 110  |  | 12.10  |   |  |   |  |
|  | 1.6 EcoBoost   | 134  |  | 12.10  |   |  |   |  |
|  | 1.6 Flexifuel  | 88   |  | 02.11  |   |  |   |  |
|  | 1.6 LPG  | 88   |  | 02.12  |   |  |   |  |
|  | 1.6 TDCi   | 70   |  | 12.10  |   |  |   |  |
|  | 1.6 TDCi   | 85   |  | 12.10  |   |  |   |  |
|  | 1.6 Ti-VCT   | 63   |  | 12.10  |   |  |   |  |
|  | 1.6 Ti-VCT   | 77   |  | 12.10  |   |  |   |  |
|  | 1.6 Ti-VCT   | 88   |  | 02.12  |   |  |   |  |
|  | 1.6 Ti-VCT   | 92   |  | 12.10  |   |  |   |  |
|  | 2.0 TDCi   | 85   |  | 12.10  |   |  |   |  |
|  | 2.0 TDCi   | 100  |  | 02.11  |   |  |   |  |
|  | 2.0 TDCi   | 103  |  | 12.10  |   |  |   |  |
|  | 2.0 TDCi   | 110  |  | 03.15  |   |  |   |  |
|  | 2.0 TDCi   | 120  |  | 12.10  |   |  |   |  |
|  | 2.0 TDCi   | 125  |  | 03.15  |   |  |   |  |
|  | 1.0 EcoBoost   | 74   |  | 09.12  |   | 24.0111-0172.1 411172  |   | 280 11,0 9,0 +B  |
|  | 1.0 EcoBoost   | 92   |  | 09.12  |   |  |   |  |
|  | 1.5 EcoBoost   | 110  |  | 03.15  |   |  |   |  |
|  | 1.5 EcoBoost   | 134  |  | 03.15  |   |  |   |  |
|  | 1.5 TDCi   | 70   |  | 03.15  |   |  |   |  |
|  | 1.5 TDCi   | 88   |  | 03.15  |   |  |   |  |
|  | 1.5 TDCi ECOnetic  | 77   |  | 03.15  |   |  |   |  |
|  | 1.6 CNG  | 86   |  | 01.13  |   |  |   |  |
|  | 1.6 EcoBoost   | 110  |  | 12.10  |   |  |   |  |
|  | 1.6 EcoBoost   | 134  |  | 12.10  |   |  |   |  |
|  | 1.6 Flexifuel  | 88   |  | 02.11  |   |  |   |  |
|  | 1.6 LPG  | 88   |  | 02.12  |   |  |   |  |







| FORD C-MAX II (10-)  |  |  |  |  |   |  |  |   |                 |
|--|--|--|--|--|---|--|--|---|-----------------|
|     |  |  |  |  |  |  |  |                                     |                 |
|    | 1.6 TDCi   | 70   |  | 12.10  |   | 24.0111-0172.1   | 411172   |   | 280 11,0 9,0 +B |
|  | 1.6 TDCi   | 85   |  | 12.10  |   |  |  |   |                 |
|  | 1.6 Ti-VCT   | 63   |  | 12.10  |   |  |  |   |                 |
|  | 1.6 Ti-VCT   | 77   |  | 12.10  |   |  |  |   |                 |
|  | 1.6 Ti-VCT   | 88   |  | 02.12  |   |  |  |   |                 |
|  | 1.6 Ti-VCT   | 92   |  | 12.10  |   |  |  |   |                 |
|  | 2.0 Energi Hybrid  | 136  |  | 01.15  |   |  |  |   |                 |
|  | 2.0 TDCi   | 85   |  | 12.10  |   |  |  |   |                 |
|  | 2.0 TDCi   | 100  |  | 02.11  |   |  |  |   |                 |
|  | 2.0 TDCi   | 103  |  | 12.10  |   |  |  |   |                 |
|  | 2.0 TDCi   | 110  |  | 03.15  |   |  |  |   |                 |
|  | 2.0 TDCi   | 120  |  | 12.10  |   |  |  |   |                 |
|  | 2.0 TDCi   | 125  |  | 03.15  |   |  |  |   |                 |
|    | 1.6 EcoBoost   | 110  |  | 12.10  | 12.10   | 24.0711-6220.3   | 360256   | 2  - Parkassistent <sup>1)</sup>   | Radsensor       |
|  | 1.6 EcoBoost   | 134  |  | 12.10  | 12.10   |  |  |   |                 |
|  | 1.6 TDCi   | 70   |  | 12.10  | 12.10   |  |  |   |                 |
|  | 1.6 TDCi   | 85   |  | 12.10  | 12.10   |  |  |   |                 |
|  | 1.6 Ti-VCT   | 63   |  | 12.10  | 12.10   |  |  |   |                 |
|  | 1.6 Ti-VCT   | 77   |  | 12.10  | 12.10   |  |  |   |                 |
|  | 1.6 Ti-VCT   | 92   |  | 12.10  | 12.10   |  |  |   |                 |
|  | 2.0 TDCi   | 85   |  | 12.10  | 12.10   |  |  |   |                 |
|  | 2.0 TDCi   | 103  |  | 12.10  | 12.10   |  |  |   |                 |
|  | 2.0 TDCi   | 120  |  | 12.10  | 12.10   |  |  |   |                 |
|  | 1.0 EcoBoost   | 74   |  | 09.12  |   | 24.0711-6296.3   | 360357   | 2  - Parkassistent <sup>1)</sup>   | Radsensor       |
|  | 1.0 EcoBoost   | 92   |  | 09.12  |   |  |  |   |                 |
|  | 1.5 EcoBoost   | 110  |  | 03.15  |   |  |  |   |                 |
|  | 1.5 EcoBoost   | 134  |  | 03.15  |   |  |  |   |                 |
|  | 1.5 TDCi   | 70   |  | 03.15  |   |  |  |   |                 |
|  | 1.5 TDCi   | 88   |  | 03.15  |   |  |  |   |                 |
|  | 1.5 TDCi ECOnetic  | 77   |  | 03.15  |   |  |  |   |                 |
|  | 1.6 CNG  | 86   |  | 01.13  |   |  |  |   |                 |
|  | 1.6 EcoBoost   | 110  |  | 01.11  |   |  |  |   |                 |
|  | 1.6 EcoBoost   | 134  |  | 01.11  |   |  |  |   |                 |
|  | 1.6 Flexifuel  | 88   |  | 02.11  |   |  |  |   |                 |
|  | 1.6 LPG  | 88   |  | 02.12  |   |  |  |   |                 |
|  | 1.6 TDCi   | 70   |  | 01.11  |   |  |  |   |                 |
|  | 1.6 TDCi   | 85   |  | 01.11  |   |  |  |   |                 |
|  | 1.6 Ti-VCT   | 63   |  | 01.11  |   |  |  |   |                 |
|  | 1.6 Ti-VCT   | 77   |  | 01.11  |   |  |  |   |                 |
|  | 1.6 Ti-VCT   | 88   |  | 02.12  |   |  |  |   |                 |
|  | 1.6 Ti-VCT   | 92   |  | 01.11  |   |  |  |   |                 |
|  | 2.0 TDCi   | 85   |  | 12.10  |   |  |  |   |                 |
|  | 2.0 TDCi   | 100  |  | 02.11  |   |  |  |   |                 |
|  | 2.0 TDCi   | 103  |  | 01.11  |   |  |  |   |                 |
|  | 2.0 TDCi   | 110  |  | 03.15  |   |  |  |   |                 |
|  | 2.0 TDCi   | 120  |  | 01.11  |   |  |  |   |                 |
|  | 2.0 TDCi   | 125  |  | 03.15  |   |  |  |   |                 |
|  | 1.0 EcoBoost   | 74   |  | 09.12  |   | 24.0711-6351.3   | 360358   | 2  + Parkassistent <sup>2)</sup> | Radsensor       |
|  | 1.0 EcoBoost   | 92   |  | 09.12  |   |  |  |   |                 |
|  | 1.5 EcoBoost   | 110  |  | 03.15  |   |  |  |   |                 |
|  | 1.5 EcoBoost   | 134  |  | 03.15  |   |  |  |   |                 |
|  | 1.5 TDCi   | 70   |  | 03.15  |   |  |  |   |                 |
|  | 1.5 TDCi   | 88   |  | 03.15  |   |  |  |   |                 |
|  | 1.5 TDCi ECOnetic  | 77   |  | 03.15  |   |  |  |   |                 |
|  | 1.6 CNG  | 86   |  | 01.13  |   |  |  |   |                 |
|  | 1.6 EcoBoost   | 110  |  | 12.10  |   |  |  |   |                 |
|  | 1.6 EcoBoost   | 134  |  | 12.10  |   |  |  |   |                 |
|  | 1.6 Flexifuel  | 88   |  | 02.11  |   |  |  |   |                 |
|  | 1.6 LPG  | 88   |  | 02.12  |   |  |  |   |                 |
|  | 1.6 TDCi   | 70   |  | 12.10  |   |  |  |   |                 |
|  | 1.6 TDCi   | 85   |  | 12.10  |   |  |  |   |                 |
|  | 1.6 Ti-VCT   | 63   |  | 12.10  |   |  |  |   |                 |
|  | 1.6 Ti-VCT   | 77   |  | 12.10  |   |  |  |   |                 |
|  | 1.6 Ti-VCT   | 88   |  | 02.12  |   |  |  |   |                 |
|  | 1.6 Ti-VCT   | 92   |  | 12.10  |   |  |  |   |                 |
|  | 2.0 TDCi   | 85   |  | 12.10  |   |  |  |   |                 |
|  | 2.0 TDCi   | 100  |  | 02.11  |   |  |  |   |                 |
|  | 2.0 TDCi   | 103  |  | 12.10  |   |  |  |   |                 |
|  | 2.0 TDCi   | 110  |  | 03.15  |   |  |  |   |                 |
|  | 2.0 TDCi   | 120  |  | 12.10  |   |  |  |   |                 |
|  | 2.0 TDCi   | 125  |  | 03.15  |   |  |  |   |                 |
|  | 2.0 Energi Hybrid  | 136  |  | 01.15  |   | 24.0711-6220.3   | 360256   | 2  - Parkassistent <sup>1)</sup> | Radsensor       |
|  |  |  |  |  |   | 24.0711-6351.3   | 360358   | 2  + Parkassistent <sup>2)</sup> | Radsensor       |
| FORD GRAND C-MAX (10-)   |  |  |  |  |   |  |  |   |                 |
|  | 1.0 EcoBoost   | 74   |  | 09.12  |   | 13.0460-7193.2   | 607193   |   | 23723 18,1 +    |
|  | 1.0 EcoBoost   | 92   |  | 09.12  |   | 13.0470-7193.2   | LD7193   |   | 23723 18,1 +    |
|  | 1.5 EcoBoost   | 110  |  | 03.15  |   |  |  |   |                 |
|  | 1.5 EcoBoost   | 134  |  | 03.15  |   |  |  |   |                 |
|  | 1.5 TDCi   | 70   |  | 03.15  |   |  |  |   |                 |
|  | 1.5 TDCi   | 88   |  | 03.15  |   |  |  |   |                 |
|  | 1.6 EcoBoost   | 110  |  | 12.10  |   |  |  |   |                 |
|  | 1.6 EcoBoost   | 134  |  | 12.10  |   |  |  |   |                 |
|  | 1.6 Flexifuel  | 88   |  | 02.11  |   |  |  |   |                 |
|  | 1.6 LPG  | 86   |  | 02.12  |   |  |  |   |                 |
|  | 1.6 TDCi   | 70   |  | 12.10  |   |  |  |   |                 |
|  | 1.6 TDCi   | 85   |  | 12.10  |   |  |  |   |                 |
|  |  |  |  |  |   |  |  |   |                 |

<sup>1)</sup> - parking assistant / - assistente di parcheggio / - assistance au stationnement / - assistente de aparcamiento  
<sup>2)</sup> + parking assistant / + assistente di parcheggio / + assistance au stationnement / + assistente de aparcamiento



|     |    |   |   |  |  |  |     |  |
|--|--|---|---|--|---|--|---|--|
| <b>FORD GRAND C-MAX (10-)</b>  |  |   |   |  |   |  |   |  |
|    | 1.6 Ti-VCT<br>1.6 Ti-VCT<br>2.0 TDCi<br>2.0 TDCi<br>2.0 TDCi<br>2.0 TDCi<br>2.0 TDCi<br>2.0 TDCi   | 77<br>92<br>85<br>100<br>103<br>110<br>120<br>125   | 12.10<br>12.10<br>12.10<br>12.10<br>12.10<br>03.15<br>12.10<br>03.15  |  | 13.0460-7193.2<br>13.0470-7193.2  | 607193<br>LD7193   |   | 23723 18,1 +<br>23723 18,1 +<br>ATE<br>ATE   |
|    | 1.0 EcoBoost<br>1.0 EcoBoost<br>1.5 EcoBoost<br>1.5 EcoBoost<br>1.5 TDCi<br>1.5 TDCi<br>1.6 EcoBoost<br>1.6 EcoBoost<br>1.6 Flexifuel<br>1.6 LPG<br>1.6 TDCi<br>1.6 TDCi<br>1.6 Ti-VCT<br>1.6 Ti-VCT<br>2.0 TDCi<br>2.0 TDCi<br>2.0 TDCi<br>2.0 TDCi<br>2.0 TDCi<br>2.0 TDCi | 74<br>92<br>110<br>134<br>70<br>88<br>110<br>134<br>88<br>86<br>70<br>85<br>77<br>92<br>85<br>100<br>103<br>110<br>120<br>125 | 09.12<br>09.12<br>03.15<br>03.15<br>03.15<br>03.15<br>12.10<br>12.10<br>02.11<br>02.12<br>12.10<br>12.10<br>12.10<br>12.10<br>12.10<br>12.10<br>03.15<br>12.10<br>03.15 |  | 24.0125-0162.1<br>24.0325-0162.1  | 425162<br>525162   |   | 300 25,0 23,0 V L +B<br>300 25,0 23,0 V L +B PD                                    |
|    | 1.6 EcoBoost<br>1.6 EcoBoost<br>1.6 TDCi<br>1.6 TDCi<br>1.6 Ti-VCT<br>1.6 Ti-VCT<br>2.0 TDCi<br>2.0 TDCi<br>2.0 TDCi<br>2.0 TDCi   | 110<br>134<br>70<br>85<br>77<br>92<br>85<br>100<br>103<br>120   | 12.10<br>12.10<br>12.10<br>12.10<br>12.10<br>12.10<br>12.10<br>12.10<br>12.10<br>12.10  | 12.10<br>12.10   | 24.0711-5123.3  | 360065   | 2  | Radsensor  |
|  | 1.0 EcoBoost<br>1.0 EcoBoost<br>1.5 EcoBoost<br>1.5 EcoBoost<br>1.5 TDCi<br>1.5 TDCi<br>1.6 EcoBoost<br>1.6 EcoBoost<br>1.6 Flexifuel<br>1.6 LPG<br>1.6 TDCi<br>1.6 TDCi<br>1.6 Ti-VCT<br>1.6 Ti-VCT<br>2.0 TDCi<br>2.0 TDCi<br>2.0 TDCi<br>2.0 TDCi<br>2.0 TDCi<br>2.0 TDCi | 74<br>92<br>110<br>134<br>70<br>88<br>110<br>134<br>88<br>86<br>70<br>85<br>77<br>92<br>85<br>100<br>103<br>110<br>120<br>125 | 09.12<br>09.12<br>03.15<br>03.15<br>03.15<br>03.15<br>01.11<br>01.11<br>02.11<br>02.12<br>01.11<br>01.11<br>01.11<br>01.11<br>01.11<br>01.11<br>03.15<br>01.11<br>03.15 |  | 24.0711-5357.3  | 360354   | 2  | Radsensor  |
|  | 1.0 EcoBoost<br>1.0 EcoBoost<br>1.5 EcoBoost<br>1.5 EcoBoost<br>1.5 TDCi<br>1.5 TDCi<br>1.6 EcoBoost<br>1.6 EcoBoost<br>1.6 Flexifuel<br>1.6 LPG<br>1.6 TDCi<br>1.6 TDCi<br>1.6 Ti-VCT<br>1.6 Ti-VCT<br>2.0 TDCi<br>2.0 TDCi<br>2.0 TDCi<br>2.0 TDCi<br>2.0 TDCi<br>2.0 TDCi | 74<br>92<br>110<br>134<br>70<br>88<br>110<br>134<br>88<br>86<br>70<br>85<br>77<br>92<br>85<br>100<br>103<br>110<br>120<br>125 | 09.12<br>09.12<br>03.15<br>03.15<br>03.15<br>03.15<br>12.10<br>12.10<br>02.11<br>02.12<br>12.10<br>12.10<br>12.10<br>12.10<br>12.10<br>12.10<br>03.15<br>12.10<br>03.15 |  | 13.0460-7195.2<br>13.0470-7195.2  | 607195<br>LD7195   |   | 23482 16,6 +<br>23482 16,6 +<br>ATE<br>ATE   |
|  | 1.0 EcoBoost<br>1.0 EcoBoost<br>1.5 EcoBoost<br>1.5 EcoBoost<br>1.5 TDCi<br>1.5 TDCi<br>1.6 EcoBoost<br>1.6 EcoBoost<br>1.6 Flexifuel  | 74<br>92<br>110<br>134<br>70<br>88<br>110<br>134<br>88  | 09.12<br>09.12<br>03.15<br>03.15<br>03.15<br>03.15<br>12.10<br>12.10<br>02.11   |  | 24.0111-0172.1  | 411172   |   | 280 11,0 9,0 +B  |



| FORD GRAND C-MAX (10-)   |               |     |  |       |       |                |        |   |                               |                       |
|--|---------------|-----|--|-------|-------|----------------|--------|---|-------------------------------|-----------------------|
|    | 1.6 LPG       | 86  |  | 02.12 |       | 24.0111-0172.1 | 411172 |   |                               | 280 11,0 9,0 +B       |
|  | 1.6 TDCi      | 70  |  | 12.10 |       |                |        |   |                               |                       |
|  | 1.6 TDCi      | 85  |  | 12.10 |       |                |        |   |                               |                       |
|  | 1.6 Ti-VCT    | 77  |  | 12.10 |       |                |        |   |                               |                       |
|  | 1.6 Ti-VCT    | 92  |  | 12.10 |       |                |        |   |                               |                       |
|  | 2.0 TDCi      | 85  |  | 12.10 |       |                |        |   |                               |                       |
|  | 2.0 TDCi      | 100 |  | 12.10 |       |                |        |   |                               |                       |
|  | 2.0 TDCi      | 103 |  | 12.10 |       |                |        |   |                               |                       |
|  | 2.0 TDCi      | 110 |  | 03.15 |       |                |        |   |                               |                       |
|  | 2.0 TDCi      | 120 |  | 12.10 |       |                |        |   |                               |                       |
|  | 2.0 TDCi      | 125 |  | 03.15 |       |                |        |   |                               |                       |
|    | 1.6 EcoBoost  | 110 |  | 12.10 | 12.10 | 24.0711-6220.3 | 360256 | 2 | - Parkassistent <sup>1)</sup> | Radsensor             |
|  | 1.6 EcoBoost  | 134 |  | 12.10 | 12.10 |                |        |   |                               |                       |
|  | 1.6 TDCi      | 70  |  | 12.10 | 12.10 |                |        |   |                               |                       |
|  | 1.6 TDCi      | 85  |  | 12.10 | 12.10 |                |        |   |                               |                       |
|  | 1.6 Ti-VCT    | 77  |  | 12.10 | 12.10 |                |        |   |                               |                       |
|  | 1.6 Ti-VCT    | 92  |  | 12.10 | 12.10 |                |        |   |                               |                       |
|  | 2.0 TDCi      | 85  |  | 12.10 | 12.10 |                |        |   |                               |                       |
|  | 2.0 TDCi      | 100 |  | 12.10 | 12.10 |                |        |   |                               |                       |
|  | 2.0 TDCi      | 103 |  | 12.10 | 12.10 |                |        |   |                               |                       |
|  | 2.0 TDCi      | 120 |  | 12.10 | 12.10 |                |        |   |                               |                       |
|  | 2.0 TDCi      | 120 |  | 12.10 | 12.10 |                |        |   |                               |                       |
|  | 2.0 TDCi      | 125 |  | 12.10 | 12.10 |                |        |   |                               |                       |
|  | 1.0 EcoBoost  | 74  |  | 09.12 |       | 24.0711-6296.3 | 360357 | 2 | - Parkassistent <sup>1)</sup> | Radsensor             |
|  | 1.0 EcoBoost  | 92  |  | 09.12 |       |                |        |   |                               |                       |
|  | 1.5 EcoBoost  | 110 |  | 03.15 |       |                |        |   |                               |                       |
|  | 1.5 EcoBoost  | 134 |  | 03.15 |       |                |        |   |                               |                       |
|  | 1.5 TDCi      | 70  |  | 03.15 |       |                |        |   |                               |                       |
|  | 1.5 TDCi      | 88  |  | 03.15 |       |                |        |   |                               |                       |
|  | 1.6 EcoBoost  | 110 |  | 01.11 |       |                |        |   |                               |                       |
|  | 1.6 EcoBoost  | 134 |  | 01.11 |       |                |        |   |                               |                       |
|  | 1.6 Flexifuel | 88  |  | 02.11 |       |                |        |   |                               |                       |
|  | 1.6 LPG       | 86  |  | 02.12 |       |                |        |   |                               |                       |
|  | 1.6 TDCi      | 70  |  | 01.11 |       |                |        |   |                               |                       |
|  | 1.6 TDCi      | 85  |  | 01.11 |       |                |        |   |                               |                       |
|  | 1.6 Ti-VCT    | 77  |  | 01.11 |       |                |        |   |                               |                       |
|  | 1.6 Ti-VCT    | 92  |  | 01.11 |       |                |        |   |                               |                       |
|  | 2.0 TDCi      | 85  |  | 01.11 |       |                |        |   |                               |                       |
|  | 2.0 TDCi      | 100 |  | 01.11 |       |                |        |   |                               |                       |
|  | 2.0 TDCi      | 103 |  | 01.11 |       |                |        |   |                               |                       |
|  | 2.0 TDCi      | 110 |  | 03.15 |       |                |        |   |                               |                       |
|  | 2.0 TDCi      | 120 |  | 01.11 |       |                |        |   |                               |                       |
|  | 2.0 TDCi      | 125 |  | 03.15 |       |                |        |   |                               |                       |
|  | 1.0 EcoBoost  | 74  |  | 09.12 |       | 24.0711-6351.3 | 360358 | 2 | + Parkassistent <sup>2)</sup> | Radsensor             |
|  | 1.0 EcoBoost  | 92  |  | 09.12 |       |                |        |   |                               |                       |
|  | 1.5 EcoBoost  | 110 |  | 03.15 |       |                |        |   |                               |                       |
|  | 1.5 EcoBoost  | 134 |  | 03.15 |       |                |        |   |                               |                       |
|  | 1.5 TDCi      | 70  |  | 03.15 |       |                |        |   |                               |                       |
|  | 1.5 TDCi      | 88  |  | 03.15 |       |                |        |   |                               |                       |
|  | 1.6 EcoBoost  | 110 |  | 12.10 |       |                |        |   |                               |                       |
|  | 1.6 EcoBoost  | 134 |  | 12.10 |       |                |        |   |                               |                       |
|  | 1.6 Flexifuel | 88  |  | 02.11 |       |                |        |   |                               |                       |
|  | 1.6 LPG       | 86  |  | 02.12 |       |                |        |   |                               |                       |
|  | 1.6 TDCi      | 70  |  | 12.10 |       |                |        |   |                               |                       |
|  | 1.6 TDCi      | 85  |  | 12.10 |       |                |        |   |                               |                       |
|  | 1.6 Ti-VCT    | 77  |  | 12.10 |       |                |        |   |                               |                       |
|  | 1.6 Ti-VCT    | 92  |  | 12.10 |       |                |        |   |                               |                       |
|  | 2.0 TDCi      | 85  |  | 12.10 |       |                |        |   |                               |                       |
|  | 2.0 TDCi      | 100 |  | 12.10 |       |                |        |   |                               |                       |
|  | 2.0 TDCi      | 103 |  | 12.10 |       |                |        |   |                               |                       |
|  | 2.0 TDCi      | 110 |  | 03.15 |       |                |        |   |                               |                       |
|  | 2.0 TDCi      | 120 |  | 12.10 |       |                |        |   |                               |                       |
|  | 2.0 TDCi      | 125 |  | 03.15 |       |                |        |   |                               |                       |
| FORD CARGO (87-98)   |               |     |  |       |       |                |        |   |                               |                       |
|  | 6.5 t         |     |  | 09.87 | 12.98 | 24.0130-0105.1 | 430105 |   |                               | 322 30,0 27,4 V       |
|  | 7.5 t         |     |  | 09.87 | 12.98 |                |        |   |                               |                       |
| FORD COUGAR (98-01)  |               |     |  |       |       |                |        |   |                               |                       |
|  | 2.0 i 16V     |     |  | 09.98 | 12.01 | 13.0460-7057.2 | 607057 |   |                               | 21394 17,5 + ATE      |
|  | 2.5 i V6      |     |  | 09.98 | 12.01 | 13.0460-7056.2 | 607056 |   |                               | 21396 17,5 +/WK ATE   |
|  | 2.5 ST 200    |     |  | 01.00 | 12.01 |                |        |   |                               |                       |
|  | 2.0 i 16V     |     |  | 09.98 | 12.01 | 24.0124-0120.1 | 424120 |   |                               | 260 24,0 22,2 V +B    |
|  | 2.5 i V6      |     |  | 09.98 | 12.01 | 24.0324-0120.1 | 524120 |   |                               | 260 24,0 22,2 V +B PD |
|  | 2.5 ST 200    |     |  | 01.00 | 12.01 | 24.0124-0149.1 | 424149 |   |                               | 278 24,1 22,2 V +B    |
|  | 2.0 i 16V     |     |  | 09.98 | 12.01 | 13.0460-3963.2 | 603963 |   |                               | 21586 15,0 BDX        |
|  | 2.5 i V6      |     |  | 08.99 | 12.01 |                |        |   |                               |                       |
|  | 2.5 i V6      |     |  | 09.98 | 07.99 | 13.0460-3964.2 | 603964 |   |                               | 23410 15,0 +/WK BDX   |
|  | 2.0 i 16V     |     |  | 09.98 | 12.01 | 24.0120-0146.1 | 420146 |   |                               | 253 20,0 18,0 V +B    |
|  | 2.5 i V6      |     |  | 09.98 | 12.01 | 24.0320-0146.1 | 520146 |   |                               | 253 20,0 18,0 V +B PD |

<sup>1)</sup> - parking assistant / - assistente di parcheggio / - assistance au stationnement / - asistente de aparcamiento







<sup>2)</sup> + parking assistant / + assistente di parcheggio / + assistance au stationnement / + asistente de aparcamiento



| FORD ECOSPORT II (14-) |              |     |  |       |  |                |        |  |  |                    |     |
|------------------------|--------------|-----|--|-------|--|----------------|--------|--|--|--------------------|-----|
|                        | 1.0 EcoBoost | 92  |  | 02.14 |  | 13.0460-7193.2 | 607193 |  |  | 23723 18,1 +       | ATE |
|                        | 1.0 EcoBoost | 103 |  | 03.16 |  | 13.0470-7193.2 | LD7193 |  |  | 23723 18,1 +       | ATE |
|                        | 1.5 TDCi     | 66  |  | 02.14 |  |                |        |  |  |                    |     |
|                        | 1.5 TDCi     | 70  |  | 05.15 |  |                |        |  |  |                    |     |
|                        | 1.5 Ti       | 82  |  | 02.14 |  |                |        |  |  |                    |     |
|                        | 1.0 EcoBoost | 92  |  | 02.14 |  | 24.0125-0210.1 | 425210 |  |  | 278 25,0 23,0 V +B |     |
|                        | 1.0 EcoBoost | 103 |  | 03.16 |  |                |        |  |  |                    |     |
|                        | 1.5 TDCi     | 66  |  | 02.14 |  |                |        |  |  |                    |     |
|                        | 1.5 TDCi     | 70  |  | 05.15 |  |                |        |  |  |                    |     |
|                        | 1.5 Ti       | 82  |  | 02.14 |  |                |        |  |  |                    |     |

| FORD ESCORT VII (95-00) |                    |    |  |       |       |                |        |   |                           |                       |     |
|-------------------------|--------------------|----|--|-------|-------|----------------|--------|---|---------------------------|-----------------------|-----|
|                         | 1.3 i              |    |  | 02.95 | 02.99 | 13.0460-3965.2 | 603965 |   | + Feder <sup>1)</sup>     | 23300 18,0 +          | BDX |
|                         | 1.4 i              |    |  | 02.95 | 02.99 | 13.0460-0412.2 | 610412 |   | - ABS                     | Belagsatz-Zubehör     | BDX |
|                         | 1.6 i 16V          |    |  | 02.95 | 07.00 | 13.0460-0413.2 | 610413 |   | + ABS                     | Belagsatz-Zubehör     | BDX |
|                         | 1.8 D              |    |  | 02.95 | 02.99 |                |        |   |                           |                       |     |
|                         | 1.8 i 16V          | 77 |  | 02.95 | 02.99 |                |        |   |                           |                       |     |
|                         | 1.8 i 16V          | 85 |  | 02.95 | 02.99 |                |        |   |                           |                       |     |
|                         | 1.8 TD             |    |  | 02.95 | 07.00 |                |        |   |                           |                       |     |
|                         | 1.8 i 16V          | 96 |  | 02.95 | 02.99 | 13.0460-7040.2 | 607040 |   |                           | 20907 18,0 +          | ATE |
|                         | RS 2000            |    |  | 02.95 | 02.99 |                |        |   |                           |                       |     |
|                         | 1.3 i              |    |  | 02.95 | 02.99 | 24.0120-0147.1 | 420147 |   |                           | 240 20,0 18,0 V +B    |     |
|                         | 1.4 i              |    |  | 02.95 | 02.99 | 24.0320-0147.1 | 520147 |   |                           | 240 20,0 18,0 V +B PD |     |
|                         | 1.6 i 16V          |    |  | 02.95 | 07.00 |                |        |   |                           |                       |     |
|                         | 1.8 D              |    |  | 02.95 | 02.99 |                |        |   |                           |                       |     |
|                         | 1.8 i 16V          | 77 |  | 02.95 | 02.99 |                |        |   |                           |                       |     |
|                         | 1.8 i 16V          | 85 |  | 02.95 | 02.99 |                |        |   |                           |                       |     |
|                         | 1.8 TD             |    |  | 02.95 | 07.00 |                |        |   |                           |                       |     |
|                         | 1.8 i 16V          | 96 |  | 02.95 | 02.99 | 24.0124-0125.1 | 424125 |   |                           | 260 24,2 22,2 V       |     |
|                         | RS 2000            |    |  | 02.95 | 02.99 |                |        |   |                           |                       |     |
|                         | 2.0 i 16V Cosworth |    |  | 02.95 | 12.95 | 24.0124-0148.1 | 424148 |   |                           | 278 24,0 22,2 V       |     |
|                         | 1.3 i              |    |  | 02.95 | 02.99 | 24.0711-1368.1 | 360025 | 2 |                           | Radsensor L=722       |     |
|                         | 1.4 i              |    |  | 02.95 | 02.99 |                |        |   |                           |                       |     |
|                         | 1.6 i 16V          |    |  | 02.95 | 07.00 |                |        |   |                           |                       |     |
|                         | 1.8 D              |    |  | 02.95 | 02.99 |                |        |   |                           |                       |     |
|                         | 1.8 i 16V          |    |  | 02.95 | 02.99 |                |        |   |                           |                       |     |
|                         | 1.8 TD             |    |  | 02.95 | 07.00 |                |        |   |                           |                       |     |
|                         | 2.0 i 16V Cosworth |    |  | 02.95 | 12.95 |                |        |   |                           |                       |     |
|                         | 1.6 i 16V          |    |  | 02.95 | 07.00 | 13.0460-4058.2 | 604058 |   | + ABS                     | 21832 14,9            | ATE |
|                         | 1.8 D              |    |  | 02.95 | 02.99 | 13.0460-0436.2 | 610436 |   | + ABS                     | Belagsatz-Zubehör     | ATE |
|                         | 1.8 i 16V          |    |  | 02.95 | 02.99 |                |        |   |                           |                       |     |
|                         | 1.8 TD             |    |  | 02.95 | 07.00 |                |        |   |                           |                       |     |
|                         | 1.6 i 16V          |    |  | 02.95 | 07.00 | 24.0110-0213.1 | 410213 |   |                           | 270 10,0 8,6          |     |
|                         | 1.8 D              |    |  | 02.95 | 02.99 |                |        |   |                           |                       |     |
|                         | 1.8 i 16V          |    |  | 02.95 | 02.99 |                |        |   |                           |                       |     |
|                         | 1.8 TD             |    |  | 02.95 | 07.00 |                |        |   |                           |                       |     |
|                         | 1.3 i              |    |  | 02.95 | 02.99 | 24.0751-1134.3 | 360045 | 1 |                           | Radsensor L=835/835   |     |
|                         | 1.4 i              |    |  | 02.95 | 02.99 |                |        |   |                           |                       |     |
|                         | 1.6 i 16V          |    |  | 02.95 | 07.00 |                |        |   |                           |                       |     |
|                         | 1.8 D              |    |  | 02.95 | 02.99 |                |        |   |                           |                       |     |
|                         | 1.8 i 16V          |    |  | 02.95 | 02.99 |                |        |   |                           |                       |     |
|                         | 1.8 TD             |    |  | 02.95 | 07.00 |                |        |   |                           |                       |     |
|                         | 2.0 i 16V Cosworth |    |  | 02.95 | 12.95 |                |        |   |                           |                       |     |
|                         | 1.3 i Kombi        |    |  | 02.95 | 07.95 | 03.0137-0237.2 | 650237 |   | + 7" Bremse <sup>2)</sup> | 180 x 32 HEB          | TRW |
|                         | 1.3 i Lim.         |    |  | 02.95 | 03.96 | 03.0137-9217.2 | 669217 |   | + 7" Bremse <sup>2)</sup> | Bremsbacken-Zubehör   | TRW |
|                         | 1.4 i Kombi        |    |  | 02.95 | 07.95 |                |        |   |                           |                       |     |
|                         | 1.3 i Kombi        |    |  | 08.95 | 02.99 | 03.0137-0337.2 | 650337 |   | + 7" Bremse <sup>2)</sup> | 180 x 32 HEB          | TRW |
|                         | 1.3 i Lim.         |    |  | 04.96 | 02.99 | 03.0137-9217.2 | 669217 |   | + 7" Bremse <sup>2)</sup> | Bremsbacken-Zubehör   | TRW |
|                         | 1.4 i Cabrio       |    |  | 02.95 | 02.99 |                |        |   |                           |                       |     |
|                         | 1.4 i Kombi        |    |  | 08.95 | 02.99 |                |        |   |                           |                       |     |
|                         | 1.4 i Lim.         |    |  | 02.95 | 02.99 |                |        |   |                           |                       |     |
|                         | 1.6 i 16V Cabrio   |    |  | 02.95 | 07.00 |                |        |   |                           |                       |     |
|                         | 1.6 i 16V Kombi    |    |  | 02.95 | 07.00 |                |        |   |                           |                       |     |
|                         | 1.6 i 16V Lim.     |    |  | 02.95 | 07.00 |                |        |   |                           |                       |     |
|                         | 1.8 D              |    |  | 02.95 | 07.00 |                |        |   |                           |                       |     |
|                         | 1.8 TD             |    |  | 02.95 | 07.00 |                |        |   |                           |                       |     |
|                         | 1.3 i Kombi        |    |  | 02.95 | 02.99 | 03.0137-0338.2 | 650338 |   | + 8" Bremse <sup>3)</sup> | 203 x 38 HEB          |     |
|                         | 1.3 i Lim.         |    |  | 02.95 | 02.99 | 03.0137-0346.2 | 650346 |   | + 8" Bremse <sup>3)</sup> | 203 x 38 HEB          |     |
|                         | 1.4 i Kombi        |    |  | 02.95 | 02.99 | 03.0137-9251.2 | 669251 |   | + 8" Bremse <sup>3)</sup> | Bremsbacken-Zubehör   |     |
|                         | 1.4 i Lim.         |    |  | 02.95 | 02.99 | 03.0137-9177.2 | 669177 |   | + 8" Bremse <sup>3)</sup> | Bremsbacken-Zubehör   |     |
|                         | 1.6 i 16V Cabrio   |    |  | 02.95 | 07.00 |                |        |   |                           |                       |     |
|                         | 1.6 i 16V Kombi    |    |  | 02.95 | 07.00 |                |        |   |                           |                       |     |
|                         | 1.6 i 16V Lim.     |    |  | 02.95 | 07.00 |                |        |   |                           |                       |     |
|                         | 1.8 D              |    |  | 02.95 | 07.00 | 03.0137-0338.2 | 650338 |   | + 8" Bremse <sup>3)</sup> | 203 x 38 HEB          |     |
|                         | 1.8 i 16V          |    |  | 02.95 | 07.00 | 03.0137-9251.2 | 669251 |   | + 8" Bremse <sup>3)</sup> | Bremsbacken-Zubehör   |     |
|                         | 1.8 i 16V Cabrio   |    |  | 02.95 | 07.00 | 03.0137-9177.2 | 669177 |   | + 8" Bremse <sup>3)</sup> | Bremsbacken-Zubehör   |     |
|                         | 1.8 TD             |    |  | 02.95 | 07.00 |                |        |   |                           |                       |     |
|                         | 1.4 i Cabrio       |    |  | 02.95 | 02.99 | 03.0137-0346.2 | 650346 |   | + 8" Bremse <sup>3)</sup> | 203 x 38 HEB          |     |
|                         | 1.8 D              |    |  | 02.95 | 07.00 | 03.0137-9251.2 | 669251 |   | + 8" Bremse <sup>3)</sup> | Bremsbacken-Zubehör   |     |
|                         | 1.8 i 16V          |    |  | 02.95 | 07.00 | 03.0137-9177.2 | 669177 |   | + 8" Bremse <sup>3)</sup> | Bremsbacken-Zubehör   |     |
|                         | 1.8 i 16V Cabrio   |    |  | 02.95 | 07.00 |                |        |   |                           |                       |     |
|                         | 1.8 TD             |    |  | 02.95 | 07.00 |                |        |   |                           |                       |     |
|                         | 2.0 i 16V Cosworth |    |  | 02.95 | 02.99 |                |        |   |                           |                       |     |
|                         | RS 2000            |    |  | 02.95 | 02.99 |                |        |   |                           |                       |     |

1) + spring / + molla / + ressort / + muelle  
2) + 7" brake / + freno de 7" / + frein de 7" / + freno de 7  
3) + 8" brake / + servofreno da 8" / + frein de 8" / + freno de 8"

| FORD ESCORT VII (95-00)  |  |                                  |  |  |  |  |                                  |                  |  |  |
|--|--|----------------------------------|--|--|--|--|----------------------------------|------------------|--|--|
|    | 1.4 i Kastenw.<br>1.8 D Kastenw.   |                                  |  | 02.95<br>02.95   | 02.99<br>02.99   | - ABS  | 03.0137-0282.2<br>03.0137-9184.2 | 650282<br>669184 | + Kastenwagen <sup>1)</sup><br>+ Kastenwagen <sup>1)</sup> | 229 x 45 HEB<br>Bremsbacken-Zubehör          |
|    | 1.3 i Kombi<br>1.3 i Lim.<br>1.4 i Cabrio<br>1.4 i Kombi<br>1.4 i Lim.<br>1.6 i 16V Cabrio<br>1.6 i 16V Kombi<br>1.6 i 16V Lim.<br>1.8 D<br>1.8 TD   |                                  |  | 02.95<br>02.95<br>02.95<br>02.95<br>02.95<br>02.95<br>02.95<br>02.95<br>02.95<br>02.95                                     | 02.99<br>02.99<br>02.99<br>02.99<br>02.99<br>07.00<br>07.00<br>07.00<br>07.00<br>07.00                                     | - ABS<br>- ABS<br>- ABS<br>- ABS<br>- ABS<br>- ABS<br>- ABS<br>- ABS<br>- ABS<br>- ABS                                     | 24.0218-0024.2<br>24.0218-0724.2 | 480079<br>480206 | + 7" Bremse <sup>2)</sup><br>+ 7" Bremse <sup>2)</sup>     | 180/181 x 44 - Lager<br>180/181 x 44 + Lager |
|  | 1.3 i Kombi<br>1.3 i Lim.<br>1.4 i Cabrio<br>1.4 i Kombi<br>1.4 i Lim.<br>1.6 i 16V Cabrio<br>1.6 i 16V Kombi<br>1.6 i 16V Lim.<br>1.8 D<br>1.8 i 16V<br>1.8 i 16V Cabrio<br>1.8 TD<br>2.0 i 16V Cosworth<br>RS 2000 |                                  |  | 02.95<br>02.95<br>02.95<br>02.95<br>02.95<br>02.95<br>02.95<br>02.95<br>02.95<br>02.95<br>02.95<br>02.95<br>02.95<br>02.95 | 07.95<br>07.95<br>07.95<br>07.95<br>07.95<br>07.95<br>07.95<br>07.95<br>07.95<br>07.95<br>07.95<br>07.95<br>07.95<br>07.95 | + ABS<br>+ ABS<br>+ ABS<br>+ ABS<br>+ ABS<br>+ ABS<br>+ ABS<br>+ ABS<br>+ ABS<br>+ ABS<br>+ ABS<br>+ ABS<br>+ ABS<br>+ ABS | 24.0220-3004.2                   | 480023           | + 8" Bremse/ ohne Sensorring <sup>3)</sup>                 | 203/204 x 49                                 |
|  | 1.3 i Kombi<br>1.3 i Lim.<br>1.4 i Cabrio<br>1.4 i Kombi<br>1.4 i Lim.<br>1.6 i 16V Cabrio<br>1.6 i 16V Kombi<br>1.6 i 16V Lim.<br>1.8 D<br>1.8 i 16V<br>1.8 i 16V Cabrio<br>1.8 TD<br>2.0 i 16V Cosworth<br>RS 2000 |                                  |  | 08.95<br>08.95<br>08.95<br>08.95<br>08.95<br>08.95<br>08.95<br>08.95<br>08.95<br>08.95<br>08.95<br>08.95<br>08.95<br>08.95 | 02.99<br>02.99<br>02.99<br>02.99<br>02.99<br>07.00<br>07.00<br>07.00<br>07.00<br>07.00<br>07.00<br>07.00<br>07.00<br>07.00 | + ABS<br>+ ABS<br>+ ABS<br>+ ABS<br>+ ABS<br>+ ABS<br>+ ABS<br>+ ABS<br>+ ABS<br>+ ABS<br>+ ABS<br>+ ABS<br>+ ABS<br>+ ABS | 24.0220-3009.2                   | 480080           | + 8" Bremse/ ohne Sensorring <sup>3)</sup>                 | 203/204 x 49                                 |
|  | 1.4 i Cabrio<br>1.6 i 16V Cabrio<br>1.8 D<br>1.8 TD  |                                  |  | 02.95<br>02.95<br>02.95<br>02.95   | 02.99<br>07.95<br>07.95<br>07.95   | - ABS<br>- ABS<br>- ABS<br>- ABS   | 03.0520-5519.3                   | 695519           | Abmessungen beachten                                       | 19,05/180x32 TopKit TRW                      |
|  | 1.3 i Kombi<br>1.3 i Lim.<br>1.4 i Cabrio<br>1.4 i Kombi<br>1.4 i Lim.<br>1.6 i 16V Cabrio<br>1.6 i 16V Kombi<br>1.6 i 16V Lim.<br>1.8 D<br>1.8 i 16V<br>1.8 i 16V Cabrio<br>1.8 TD                                  |                                  |  | 02.95<br>02.95<br>02.95<br>02.95<br>02.95<br>08.95<br>02.95<br>02.95<br>02.95<br>02.95<br>02.95<br>02.95<br>02.95          | 02.99<br>02.99<br>02.99<br>02.99<br>02.99<br>07.00<br>07.95<br>07.00<br>07.00<br>07.95<br>07.00<br>07.00<br>07.00          | + ABS<br>+ ABS<br>+ ABS<br>+ ABS<br>+ ABS<br>+ ABS<br>+ ABS<br>+ ABS<br>+ ABS<br>+ ABS<br>+ ABS<br>+ ABS<br>+ ABS          | 03.0520-6422.3                   | 696422           | Abmessungen beachten                                       | 22,20/203x38 TopKit TRW                      |
|  | 1.6 i 16V<br>1.8 D<br>1.8 i 16V<br>1.8 TD  |                                  |  | 02.95<br>02.95<br>02.95<br>02.95   | 07.00<br>02.99<br>02.99<br>07.00   | + ABS<br>+ ABS<br>+ ABS<br>+ ABS   | 03.0137-9701.2                   | 669701           |  | Bremsbacken-Zubehör                          |
| FORD FIESTA IV (96-02)   |  |                                  |  |  |  |  |                                  |                  |  |  |
|  | 1.0 i<br>1.25 i 16V<br>1.3 i Lim.<br>1.8 D Lim.  | 55                               |  | 02.97<br>01.96<br>01.96<br>01.96   | 01.00<br>01.00<br>01.00<br>01.00   | + Schaltgetriebe <sup>4)</sup>   | 13.0460-7073.2                   | 607073           |  | 21202 16,9 + ATE                             |
|  | 1.0 i<br>1.25 i 16V<br>1.3 i Kastenw.<br>1.4 i 16V<br>1.6 i 16V<br>1.8 D Kastenw.  | 55<br>44<br>66<br>76             |  | 02.97<br>01.96<br>01.96<br>02.96<br>10.99<br>01.96   | 01.00<br>01.00<br>01.00<br>01.00<br>01.00<br>01.00   | + Automatikgetriebe <sup>5)</sup>  | 13.0460-7071.2                   | 607071           |  | 20640 17,5 + ATE                             |
|  | 1.0 i<br>1.25 i 16V<br>1.3 i<br>1.4 i 16V<br>1.6<br>1.6 i 16V<br>1.8 D<br>1.8 DI   | 55<br>66<br>65<br>76<br>44<br>55 |  | 02.97<br>02.00<br>02.00<br>02.00<br>02.00<br>02.00<br>02.00<br>03.00   | 03.02<br>03.02<br>03.02<br>03.02<br>03.02<br>03.02<br>03.02<br>03.02   | - ABS<br>+ ABS   | 13.0460-7148.2<br>13.0460-7142.2 | 607148<br>607142 |  | 23200 18,0 + ATE<br>23604 18,3 + ATE         |
|  | 1.0 i<br>1.25 i 16V<br>1.3 i Lim.<br>1.8 D Lim.  | 55                               |  | 02.97<br>01.96<br>01.96<br>01.96   | 01.00<br>01.00<br>01.00<br>01.00   | + Schaltgetriebe <sup>4)</sup>   | 24.0112-0141.1<br>24.0312-0141.1 | 412141<br>512141 |  | 239 12,0 10,0 +B<br>239 12,0 10,0 +B PD      |

<sup>1)</sup> + Van / + Furgone / + Fourgonnette / + Furgón

<sup>2)</sup> + 7" brake / + freno de 7" / + frein de 7" / + freno de 7

<sup>3)</sup> + 8"brake/ without sensorring / + servofr.da 8"/senza sensori / + fr.de 8"/ sans secours ABS / + fr.8"/sin anillo sensor ABS

<sup>4)</sup> + manual transmission / + scatola cambio velocità / + transmission mécanique / + cambio de velocidad

<sup>5)</sup> + autom.transmission / + scatola cambio automatico / + transmission automatique / + cambio automático





















| FORD FIESTA IV (96-02) |                |    |       |       |       |                                   |                |                                      |  |   |  |
|------------------------|----------------|----|-------|-------|-------|-----------------------------------|----------------|--------------------------------------|--|---|--|
|                        | 1.0 i          |    |       | 02.97 | 01.00 | + Automatikgetriebe <sup>1)</sup> | 24.0120-0147.1 | 420147                               |  | 240 20,0 18,0 V +B<br>240 20,0 18,0 V +B PD |  |
|                        | 1.25 i 16V     | 55 |       | 01.96 | 01.00 |                                   | 24.0320-0147.1 | 520147                               |  |   |  |
|                        | 1.3 i Kastenw. | 44 |       | 01.96 | 01.00 |                                   |                |                                      |  |   |  |
|                        | 1.4 i 16V      | 66 |       | 02.96 | 01.00 |                                   |                |                                      |  |   |  |
|                        | 1.6 i 16V      | 76 |       | 10.99 | 01.00 |                                   |                |                                      |  |   |  |
|                        | 1.8 D Kastenw. |    |       | 01.96 | 01.00 |                                   |                |                                      |  |   |  |
|                        | 1.0 i          |    |       | 02.00 | 03.02 |                                   |                | 24.0120-0147.1                       | 420147   |   | - ABS  |
| 1.25 i 16V             | 55             |    | 02.00 | 03.02 |       | 24.0320-0147.1                    | 520147         | - ABS                                |  |   |  |
| 1.3 i                  |                |    | 02.00 | 03.02 |       | 24.0122-0172.1                    | 422172         | + ABS                                |  |   |  |
| 1.4 i 16V              | 66             |    | 02.00 | 03.02 |       | 24.0322-0172.1                    | 522172         | + ABS                                |  |   |  |
| 1.6                    | 65             |    | 02.00 | 03.02 |       |                                   |                |                                      |  |   |  |
| 1.6 i 16V              | 76             |    | 02.00 | 03.02 |       |                                   |                |                                      |  |   |  |
| 1.8 D                  | 44             |    | 02.00 | 03.02 |       |                                   |                |                                      |  |   |  |
| 1.8 DI                 | 55             |    | 03.00 | 03.02 |       |                                   |                |                                      |  |   |  |
|                        | 1.0 i          |    |       | 02.97 | 03.02 |                                   | 24.0711-1367.1 | 360024                               | 2  | Radsensor L=875                             |  |
|                        | 1.25 i 16V     | 55 |       | 01.96 | 03.02 |                                   |                |                                      |  |   |  |
|                        | 1.3 i Lim.     |    |       | 01.96 | 03.02 |                                   |                |                                      |  |   |  |
|                        | 1.4 i 16V      | 66 |       | 02.96 | 03.02 |                                   |                |                                      |  |   |  |
|                        | 1.6            | 65 |       | 02.00 | 03.02 |                                   |                |                                      |  |   |  |
|                        | 1.6 i 16V      | 76 |       | 10.99 | 03.02 |                                   |                |                                      |  |   |  |
|                        | 1.8 D Lim.     |    |       | 01.96 | 03.02 |                                   |                |                                      |  |   |  |
| 1.8 DI                 | 55             |    | 03.00 | 03.02 |       |                                   |                |                                      |  |   |  |
|                        | 1.3 i Kastenw. | 44 |       | 01.96 | 03.02 |                                   | 24.0711-1367.1 | 360024                               | 2  | Radsensor L=875                             |  |
|                        | 1.8 D Kastenw. |    |       | 01.96 | 03.02 |                                   |                |                                      |  |   |  |
|                        | 1.0 i          |    |       | 02.97 | 11.98 |                                   | 24.0751-1173.3 | 360048                               | 1  |   | Radsensor L=785/800                          |
|                        | 1.25 i 16V     | 55 |       | 01.96 | 11.98 |                                   |                |                                      |  |   |  |
|                        | 1.3 i Lim.     |    |       | 01.96 | 11.98 |                                   |                |                                      |  |   |  |
|                        | 1.4 i 16V      | 66 |       | 02.96 | 11.98 |                                   |                |                                      |  |   |  |
|                        | 1.8 D Lim.     |    |       | 01.96 | 11.98 |                                   |                |                                      |  |   |  |
| 1.0 i                  |                |    | 12.98 | 03.02 |       | 24.0713-1121.3                    | 360036         | 1                                    | Radsensor L=785/800  |   |  |
| 1.25 i 16V             | 55             |    | 12.98 | 03.02 |       |                                   |                |                                      |  |   |  |
| 1.3 i Lim.             |                |    | 12.98 | 03.02 |       |                                   |                |                                      |  |   |  |
| 1.4 i 16V              | 66             |    | 12.98 | 03.02 |       |                                   |                |                                      |  |   |  |
| 1.6                    | 65             |    | 02.00 | 03.02 |       |                                   |                |                                      |  |   |  |
| 1.6 i 16V              | 76             |    | 10.99 | 03.02 |       |                                   |                |                                      |  |   |  |
| 1.8 D Lim.             |                |    | 12.98 | 03.02 |       |                                   |                |                                      |  |   |  |
| 1.8 DI                 | 55             |    | 03.00 | 03.02 |       |                                   |                |                                      |  |   |  |
|                        | 1.3 i Kastenw. | 44 |       | 01.96 | 03.02 |                                   | 24.0741-1118.3 | 360044                               | 1  | Radsensor L=1300/2300                       |  |
|                        | 1.8 D Kastenw. |    |       | 01.96 | 03.02 |                                   |                |                                      |  |   |  |
|                        | 1.0 i          |    |       | 02.97 | 01.00 |                                   | 03.0137-0337.2 | 650337                               |  |   | 180 x 32 HEB<br>Bremsbacken-Zubehör TRW      |
|                        | 1.25 i 16V     | 55 |       | 01.96 | 01.00 |                                   | 03.0137-9217.2 | 669217                               |  |   |  |
|                        | 1.3 i Lim.     |    |       | 01.96 | 01.00 |                                   |                |                                      |  |   |  |
|                        | 1.4 i 16V      | 66 |       | 02.96 | 01.00 |                                   |                |                                      |  |   |  |
|                        | 1.6 i 16V      | 76 |       | 10.99 | 01.00 |                                   |                |                                      |  |   |  |
| 1.8 D Lim.             |                |    | 01.96 | 01.00 |       |                                   |                |                                      |  |   |  |
| 1.0 i                  |                |    | 02.00 | 03.02 |       | 03.0137-0412.2                    | 650412         | - ABS                                | 180 x 32 HEB<br>203 x 38 HEB<br>Bremsbacken-Zubehör AP       |   |  |
| 1.25 i 16V             | 55             |    | 02.00 | 03.02 |       | 03.0137-0394.2                    | 650394         | + ABS                                |  |   |  |
| 1.3 i Lim.             |                |    | 02.00 | 03.02 |       | 03.0137-9179.2                    | 669179         | - ABS                                |  |   |  |
| 1.4 i 16V              | 66             |    | 02.00 | 03.02 |       | 03.0137-9259.2                    | 669259         | + ABS                                |  |   |  |
| 1.6                    | 65             |    | 02.00 | 03.02 |       |                                   |                |                                      |  |   |  |
| 1.6 i 16V              | 76             |    | 02.00 | 03.02 |       |                                   |                |                                      |  |   |  |
| 1.8 D Lim.             |                |    | 02.00 | 03.02 |       |                                   |                |                                      |  |   |  |
| 1.8 DI Lim.            | 55             |    | 03.00 | 03.02 |       |                                   |                |                                      |  |   |  |
|                        | 1.3 i Kastenw. | 44 |       | 01.96 | 03.02 |                                   | 03.0137-0338.2 | 650338                               |  | 203 x 38 HEB<br>Bremsbacken-Zubehör         |  |
|                        | 1.8 D Kastenw. |    |       | 01.96 | 03.02 |                                   | 03.0137-9177.2 | 669177                               |  |   |  |
|                        | 1.0 i          |    |       | 02.97 | 01.00 |                                   | 24.0218-0024.2 | 480079                               | ohne Sensorring <sup>2)</sup>                                |   | 180/181 x 44 - Lager<br>180/181 x 44 + Lager |
|                        | 1.25 i 16V     | 55 |       | 01.96 | 01.00 |                                   | 24.0218-0724.2 | 480206                               | + ABS/ ohne Sensorring <sup>3)</sup>                         |   |  |
|                        | 1.3 i Lim.     |    |       | 01.96 | 01.00 |                                   |                |                                      |  |   |  |
|                        | 1.4 i 16V      | 66 |       | 02.96 | 01.00 |                                   |                |                                      |  |   |  |
|                        | 1.6 i 16V      | 76 |       | 10.99 | 01.00 |                                   |                |                                      |  |   |  |
| 1.8 D Lim.             |                |    | 01.96 | 01.00 |       |                                   |                |                                      |  |   |  |
| 1.0 i                  |                |    | 02.00 | 03.02 |       | 24.0218-0024.2                    | 480079         | - ABS                                | 180/181 x 44 - Lager<br>180/181 x 44 + Lager<br>203/204 x 49 |   |  |
| 1.25 i 16V             | 55             |    | 02.00 | 03.02 |       | 24.0218-0724.2                    | 480206         | - ABS                                |  |   |  |
| 1.3 i Lim.             |                |    | 02.00 | 03.02 |       | 24.0220-3009.2                    | 480080         | + ABS/ ohne Sensorring <sup>3)</sup> |  |   |  |
| 1.4 i 16V              | 66             |    | 02.00 | 03.02 |       |                                   |                |                                      |  |   |  |
| 1.6                    | 65             |    | 02.00 | 03.02 |       |                                   |                |                                      |  |   |  |
| 1.6 i 16V              | 76             |    | 02.00 | 03.02 |       |                                   |                |                                      |  |   |  |
| 1.8 D Lim.             |                |    | 02.00 | 03.02 |       |                                   |                |                                      |  |   |  |
| 1.8 DI                 | 55             |    | 03.00 | 03.02 |       |                                   |                |                                      |  |   |  |
|                        | 1.3 i Kastenw. | 44 |       | 01.96 | 03.02 |                                   | 24.0220-3008.2 | 480075                               |  | 203/204 x 45                                |  |
|                        | 1.8 D Kastenw. |    |       | 01.96 | 03.02 |                                   |                |                                      |  |   |  |
|                        | 1.0 i          |    |       | 02.97 | 01.00 |                                   | 03.0520-3617.3 | 693617                               |  |   | 17,78/180x32 TopKit TRW                      |
|                        | 1.25 i 16V     | 55 |       | 01.96 | 01.00 |                                   |                |                                      |  |   |  |
|                        | 1.3 i Lim.     |    |       | 01.96 | 01.00 |                                   |                |                                      |  |   |  |
|                        | 1.8 D Lim.     |    |       | 01.96 | 01.00 |                                   |                |                                      |  |   |  |
|                        | 1.0 i          |    |       | 02.00 | 03.02 |                                   | 03.0520-6219.3 | 696219                               | - ABS  |   |  |
| 1.25 i 16V             | 55             |    | 02.00 | 03.02 |       | 03.0520-6319.3                    | 696319         | + ABS                                |  |   |  |
| 1.3 i Lim.             |                |    | 02.00 | 03.02 |       |                                   |                |                                      |  |   |  |
| 1.8 D Lim.             |                |    | 02.00 | 03.02 |       |                                   |                |                                      |  |   |  |
| 1.8 DI Lim.            |                |    | 03.00 | 03.02 |       |                                   |                |                                      |  |   |  |
| 1.0 i                  |                |    | 02.97 | 03.02 |       | 03.0520-5519.3                    | 695519         |                                      | 19,05/180x32 TopKit TRW                                      |   |  |
| 1.25 i 16V             | 55             |    | 01.96 | 03.02 |       |                                   |                |                                      |  |   |  |
| 1.4 i 16V              | 66             |    | 02.96 | 03.02 |       |                                   |                |                                      |  |   |  |
| 1.6                    | 65             |    | 02.00 | 03.02 |       |                                   |                |                                      |  |   |  |

<sup>1)</sup> + autom.transmission / + scatola cambio automatico / + transmission automatique / + cambio automático

<sup>2)</sup> without sensor ring / senza sensori / sans secours ABS / sin anillo sensor ABS















<sup>3)</sup> + ABS/ without sensor ring / + ABS/ senza sensore / + ABS/ sans secours ABS / + ABS/ sin anillo sensor ABS

<sup>4)</sup> + manual transmission / + scatola cambio velocità / + transmission mécanique / + cambio de velocidad























|     |  |  |  |  |  |  |  |  |
|--|--|--|--|--|---|--|--|--|
| <b>FORD FIESTA IV (96-02)</b>  |  |  |  |  |   |  |  |  |
|    | 1.6 i 16V  | 76   | 10.99  | 03.02  | 03.0520-5519.3  | 695519   |  | 19,05/180x32 TopKit TRW  |
|  | 1.3 i Kastenw.   | 44   | 01.96  | 03.02  | 03.0520-6422.3  | 696422   |  | 22,20/203x38 TopKit TRW  |
|  | 1.8 D Kastenw.   |  | 01.96  | 03.02  |   |  |  |  |
|  | 1.8 DI Kastenw.  | 55   | 03.00  | 03.02  |   |  |  |  |
| <b>FORD FIESTA V (02-08)</b>   |  |  |  |  |   |  |  |  |
|    | 1.25 i 16V   | 51   | 03.03  | 08.08  | 13.0460-7142.2  | 607142   |  | 23604 18,3 + ATE   |
|  | 1.25 i 16V   | 55   | 05.02  | 08.08  |   |  |  |  |
|  | 1.3 i  | 44   | 04.02  | 08.08  |   |  |  |  |
|  | 1.3 i  | 51   | 04.02  | 08.08  |   |  |  |  |
|  | 1.4 i 16V  | 59   | 04.02  | 08.08  |   |  |  |  |
|  | 1.4 TDCi   | 50   | 04.02  | 08.08  |   |  |  |  |
|  | 1.6 i 16V  | 74   | 04.02  | 08.08  |   |  |  |  |
|  | 1.6 TDCi   | 66   | 10.04  | 08.08  |   |  |  |  |
|  | ST 150   | 110  | 11.04  | 08.08  | 13.0460-7186.2  | 607186   |  | 23440 17,6 + ATE   |
|    | 1.25 i 16V   | 51   | 03.03  | 08.08  | 24.0122-0172.1  | 422172   |  | 258 22,0 20,0 V +B   |
|  | 1.25 i 16V   | 55   | 05.02  | 08.08  | 24.0322-0172.1  | 522172   |  | 258 22,0 20,0 V +B PD  |
|  | 1.3 i  | 44   | 04.02  | 08.08  |   |  |  |  |
|  | 1.3 i  | 51   | 04.02  | 08.08  |   |  |  |  |
|  | 1.4 i 16V  | 59   | 04.02  | 08.08  |   |  |  |  |
|  | 1.4 TDCi   | 50   | 04.02  | 08.08  |   |  |  |  |
|  | 1.6 i 16V  | 74   | 04.02  | 08.08  |   |  |  |  |
|  | 1.6 TDCi   | 66   | 10.04  | 08.08  |   |  |  |  |
|    | 1.25 i 16V   | 51   | 03.03  | 08.08  | 24.0711-5138.1  | 360110   | 2  | Radsensor L=775  |
|  | 1.25 i 16V   | 55   | 05.02  | 08.08  |   |  |  |  |
|  | 1.3 i  | 44   | 04.02  | 08.08  |   |  |  |  |
|  | 1.3 i  | 51   | 04.02  | 08.08  |   |  |  |  |
|  | 1.4 i 16V  | 59   | 04.02  | 08.08  |   |  |  |  |
|  | 1.4 TDCi   | 50   | 04.02  | 08.08  |   |  |  |  |
|  | 1.6 i 16V  | 74   | 04.02  | 08.08  |   |  |  |  |
|  | 1.6 TDCi   | 66   | 10.04  | 08.08  |   |  |  |  |
|  | ST 150   | 110  | 11.04  | 08.08  |   |  |  |  |
|    | ST 150   | 110  | 11.04  | 08.08  | 13.0460-2835.2  | 602835   |  | 23353 14,8 /WE/S TRW   |
|    | ST 150   | 110  | 11.04  | 08.08  | 24.0110-0115.1  | 410115   |  | 253 10,2 8,9 +B  |
|   | 1.25 i 16V   | 51   | 03.03  | 08.08  | 24.0711-6118.3  | 360188   | 1  | Radsensor L=937/958  |
|  | 1.25 i 16V   | 55   | 05.02  | 08.08  |   |  |  |  |
|  | 1.3 i  | 44   | 04.02  | 08.08  |   |  |  |  |
|  | 1.3 i  | 51   | 04.02  | 08.08  |   |  |  |  |
|  | 1.4 i 16V  | 59   | 04.02  | 08.08  |   |  |  |  |
|  | 1.4 TDCi   | 50   | 04.02  | 08.08  |   |  |  |  |
|  | 1.6 i 16V  | 74   | 04.02  | 08.08  |   |  |  |  |
|  | 1.6 TDCi   | 66   | 10.04  | 08.08  |   |  |  |  |
|  | ST 150   | 110  | 11.04  | 08.08  |   |  |  |  |
|  | 1.25 i 16V   | 51   | 03.03  | 08.08  | 03.0137-0394.2  | 650394   |  | 203 x 38 HEB   |
|  | 1.25 i 16V   | 55   | 05.02  | 08.08  | 03.0137-9259.2  | 669259   |  | Bremsbacken-Zubehör  |
|  | 1.3 i  | 44   | 04.02  | 08.08  |   |  |  |  |
|  | 1.3 i  | 51   | 04.02  | 08.08  |   |  |  |  |
|  | 1.4 i 16V  | 59   | 04.02  | 08.08  |   |  |  |  |
|  | 1.4 TDCi   | 50   | 04.02  | 08.08  |   |  |  |  |
|  | 1.6 i 16V  | 74   | 04.02  | 08.08  |   |  |  |  |
|  | 1.6 TDCi   | 66   | 10.04  | 08.08  |   |  |  |  |
|  | 1.25 i 16V   | 51   | 03.03  | 08.08  | 24.0220-3026.2  | 480175   | ohne Sensorring <sup>1)</sup>  | 203/204,3 x 44,5 - Lager   |
|  | 1.25 i 16V   | 55   | 05.02  | 08.08  | 24.0220-3726.2  | 480216   | mit Sensorring <sup>2)</sup>   | 203/204,3 x 44,5 + Lager   |
|  | 1.3 i  | 44   | 04.02  | 08.08  |   |  |  |  |
|  | 1.3 i  | 51   | 04.02  | 08.08  |   |  |  |  |
|  | 1.4 i 16V  | 59   | 04.02  | 08.08  |   |  |  |  |
|  | 1.4 TDCi   | 50   | 04.02  | 08.08  |   |  |  |  |
|  | 1.6 i 16V  | 74   | 04.02  | 08.08  |   |  |  |  |
|  | 1.6 TDCi   | 66   | 10.04  | 08.08  |   |  |  |  |
|  | 1.25 i 16V   | 51   | 03.03  | 08.08  | 03.0520-6319.3  | 696319   |  | 19,05/203x38 TopKit AP   |
|  | 1.25 i 16V   | 55   | 05.02  | 08.08  |   |  |  |  |
|  | 1.3 i  | 44   | 04.02  | 08.08  |   |  |  |  |
|  | 1.3 i  | 51   | 04.02  | 08.08  |   |  |  |  |
|  | 1.4 i 16V  | 59   | 04.02  | 08.08  |   |  |  |  |
|  | 1.4 TDCi   | 50   | 04.02  | 08.08  |   |  |  |  |
|  | 1.6 i 16V  | 74   | 04.02  | 08.08  |   |  |  |  |
|  | 1.6 TDCi   | 66   | 10.04  | 08.08  |   |  |  |  |
| <b>FORD FIESTA VI (08-)</b>  |  |  |  |  |   |  |  |  |
|  | 1.0  | 48   | 10.12  |  | 13.0460-5794.2  | 605794   |  | 24283 15,5 +/WK/Zub/STRW   |
|  | 1.0  | 59   | 10.12  |  |   |  |  |  |
|  | 1.0 EcoBoost   | 74   | 10.12  |  |   |  |  |  |
|  | 1.0 EcoBoost   | 92   | 10.12  |  |   |  |  |  |
|  | 1.0 Sport EcoBoost   | 103  | 05.14  |  |   |  |  |  |
|  | 1.25 i 16V   | 44   | 09.08  |  |   |  |  |  |
|  | 1.25 i 16V   | 60   | 09.08  |  |   |  |  |  |
|  | 1.4 Duratec LPG  |  | 06.09  |  |   |  |  |  |
|  | 1.4 i 16V  | 71   | 09.08  |  |   |  |  |  |
|  | 1.4 TDCi   | 50   | 01.09  |  |   |  |  |  |
|  | 1.4 TDCi   | 51   | 07.10  |  |   |  |  |  |
|  | 1.5 TDCi   | 55   | 10.12  |  |   |  |  |  |
|  | 1.5 TDCi   | 70   | 05.15  |  |   |  |  |  |

<sup>1)</sup> without sensor ring / senza sensori / sans secours ABS / sin anillo sensor ABS

<sup>2)</sup> with sensor ring / con sensori / avec secours ABS / con anillo sensor ABS













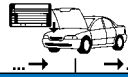







|     |    |  |    |  |                 |  |  |             |
|--|--|--|--|--|--|--|--|---|
| <b>FORD FIESTA VI (08-)</b>  |  |  |  |  |  |  |  |   |
|    | 1.6 TDCi 55<br>1.6 TDCi 66<br>1.6 TDCi 70<br>1.6 Ti-VCT 77<br>1.6 Ti-VCT 88<br>1.6 Ti-VCT 99<br>1.6 EcoBoost ST 134  |  | 09.08<br>09.08<br>02.10<br>10.12<br>09.08<br>12.10<br>01.13  |  | 13.0460-5794.2 605794<br>13.0460-2784.2 602784<br>13.0470-2784.2 LD2784                          |  |  | 24283 15,5 +/WK/Zub/STRW<br>25134 17,2 +/Zub/S TRW<br>25134 17,2 +/Zub/S TRW                  |
|    | 1.0 48<br>1.0 59<br>1.0 EcoBoost 74<br>1.0 EcoBoost 92<br>1.0 Sport EcoBoost 103<br>1.25 i 16V 44<br>1.25 i 16V 60<br>1.4 Duratec LPG<br>1.4 i 16V 71<br>1.4 TDCi 50<br>1.4 TDCi 51<br>1.5 TDCi 55<br>1.5 TDCi 70<br>1.6 TDCi 55<br>1.6 TDCi 66<br>1.6 TDCi 70<br>1.6 Ti-VCT 77<br>1.6 Ti-VCT 88<br>1.6 Ti-VCT 99<br>1.6 EcoBoost ST 134 |  | 10.12<br>10.12<br>10.12<br>10.12<br>05.14<br>09.08<br>09.08<br>06.09<br>09.08<br>01.09<br>07.10<br>10.12<br>05.15<br>09.08<br>09.08<br>02.10<br>10.12<br>09.08<br>12.10<br>01.13 |  | 24.0123-0113.1 423113<br>24.0323-0113.1 523113<br>24.0123-0122.1 423122<br>13.0460-2835.2 602835 |  |  | 258 23,0 21,0 V L +B<br>258 23,0 21,0 V L +B PD<br>278 23,0 21,0 V +B<br>23353 14,8 /WE/S TRW |
|    | 1.6 EcoBoost ST 134  |  | 01.13  |  | 24.0110-0115.1 410115  |  |  | 253 10,2 8,9 +B   |
|    | 1.0 48<br>1.0 59<br>1.0 EcoBoost 74<br>1.0 EcoBoost 92<br>1.0 Sport EcoBoost 103<br>1.25 i 16V 44<br>1.25 i 16V 60<br>1.4 Duratec LPG<br>1.4 i 16V 71<br>1.4 TDCi 50<br>1.4 TDCi 51<br>1.5 TDCi 55<br>1.5 TDCi 70<br>1.6 TDCi 55<br>1.6 TDCi 66<br>1.6 TDCi 70<br>1.6 Ti-VCT 77<br>1.6 Ti-VCT 88<br>1.6 Ti-VCT 99                        |  | 10.12<br>10.12<br>10.12<br>10.12<br>05.14<br>09.08<br>09.08<br>06.09<br>09.08<br>01.09<br>07.10<br>10.12<br>05.15<br>09.08<br>09.08<br>02.10<br>10.12<br>09.08<br>12.10          |  | 03.0137-0497.2 650497<br>03.0137-9304.2 669304   |  |  | 200 x 32 HEB<br>Bremsbacken-Zubehör   |
|  | 1.25 i 16V 44<br>1.25 i 16V 60<br>1.4 Duratec LPG<br>1.4 i 16V 71<br>1.4 TDCi 50<br>1.4 TDCi 51<br>1.6 TDCi 55<br>1.6 TDCi 66<br>1.6 TDCi 70<br>1.6 Ti-VCT 88<br>1.6 Ti-VCT 99   |  | 09.08<br>09.08<br>06.09<br>09.08<br>01.09<br>07.10<br>09.08<br>09.08<br>02.10<br>09.08<br>12.10  |  | 24.0220-0009.1 480317  |  |  | 200/201,5 x 40,3  |
|  | 1.0 48<br>1.0 59<br>1.0 EcoBoost 74<br>1.0 EcoBoost 92<br>1.0 Sport EcoBoost 103<br>1.25 i 16V 44<br>1.25 i 16V 60<br>1.4 Duratec LPG<br>1.4 i 16V 71<br>1.4 TDCi 50<br>1.4 TDCi 51<br>1.5 TDCi 55<br>1.5 TDCi 70<br>1.6 TDCi 55<br>1.6 TDCi 66<br>1.6 TDCi 70<br>1.6 Ti-VCT 77<br>1.6 Ti-VCT 88<br>1.6 Ti-VCT 99                        |  | 10.12<br>10.12<br>10.12<br>10.12<br>05.14<br>09.08<br>09.08<br>06.09<br>09.08<br>01.09<br>07.10<br>10.12<br>05.15<br>09.08<br>09.08<br>02.10<br>10.12<br>09.08<br>12.10          |  | 03.0520-7619.3 697619  |  |  | 19,05/200x32 TopKit   |



















|     |  |  |  |  |  |  |  |             |                          |                 |
|--|--|--|--|--|---|--|--|---|--------------------------|-----------------|
| <b>FORD FOCUS I (98-04)</b>  |  |  |  |  |   |  |  |   |                          |                 |
|    | 1.4 i 16V  |  |  | 10.98  | 09.04   | 13.0460-7121.2   | 607121   |   | 23154 19,0 +             | ATE             |
|  | 1.6 i 16V  |  |  | 10.98  | 09.04   |  |  |   |                          |                 |
|  | 1.8 BiFuel   |  |  | 02.03  | 01.05   |  |  |   |                          |                 |
|  | 1.8 i 16V  |  |  | 10.98  | 09.04   |  |  |   |                          |                 |
|  | 1.8 TDCi   |  |  | 03.01  | 09.04   |  |  |   |                          |                 |
|  | 1.8 Turbo DI   |  |  | 10.98  | 09.04   |  |  |   |                          |                 |
|  | 2.0 i 16V  |  |  | 10.98  | 09.04   |  |  |   |                          |                 |
|  | ST 170   |  |  | 03.02  | 09.04   | 13.0460-7186.2   | 607186   |   | 23440 17,6 +             | ATE             |
|  | RS 2.0   |  |  | 10.02  | 09.04   | 13.0460-4832.2   | 604832   |   | 21381 18,0 +             | BRE             |
|    | 1.4 i 16V  |  |  | 10.98  | 09.04   | 24.0122-0172.1   | 422172   |   | 258 22,0 20,0 V +B       |                 |
|  | 1.6 i 16V  |  |  | 10.98  | 09.04   | 24.0322-0172.1   | 522172   |   | 258 22,0 20,0 V +B PD    |                 |
|  | 1.8 BiFuel   |  |  | 02.03  | 01.05   |  |  |   |                          |                 |
|  | 1.8 i 16V  |  |  | 10.98  | 09.04   |  |  |   |                          |                 |
|  | 1.8 TDCi   |  |  | 03.01  | 09.04   |  |  |   |                          |                 |
|  | 1.8 Turbo DI   |  |  | 10.98  | 09.04   |  |  |   |                          |                 |
|  | 2.0 i 16V  |  |  | 10.98  | 09.04   |  |  |   |                          |                 |
|  | ST 170   |  |  | 03.02  | 09.04   | 24.0124-0198.1   | 424198   |   | 300 24,0 22,0 V          |                 |
|    | 1.4 i 16V  |  |  | 10.98  | 09.04   | 24.0711-5049.3   | 360028   | 2          |                          | Radsensor L=841 |
|  | 1.6 i 16V  |  |  | 10.98  | 09.04   |  |  |   |                          |                 |
|  | 1.8 BiFuel   |  |  | 02.03  | 01.05   |  |  |   |                          |                 |
|  | 1.8 i 16V  |  |  | 10.98  | 09.04   |  |  |   |                          |                 |
|  | 1.8 TDCi   |  |  | 03.01  | 09.04   |  |  |   |                          |                 |
|  | 1.8 Turbo DI   |  |  | 10.98  | 09.04   |  |  |   |                          |                 |
|  | 2.0 i 16V  |  |  | 10.98  | 09.04   |  |  |   |                          |                 |
|  | RS 2.0   |  |  | 10.02  | 09.04   |  |  |   |                          |                 |
|  | ST 170   |  |  | 03.02  | 09.04   |  |  |   |                          |                 |
|    | 1.4 i 16V  |  |  | 10.98  | 09.04   | 13.0460-2835.2   | 602835   |   | 23353 14,8 /WE/S         | TRW             |
|  | 1.6 i 16V  |  |  | 10.98  | 09.04   |  |  |   |                          |                 |
|  | 1.8 BiFuel   |  |  | 02.03  | 01.05   |  |  |   |                          |                 |
|  | 1.8 i 16V  |  |  | 10.98  | 09.04   |  |  |   |                          |                 |
|  | 1.8 TDCi   |  |  | 03.01  | 09.04   |  |  |   |                          |                 |
|  | 1.8 Turbo DI   |  |  | 10.98  | 09.04   |  |  |   |                          |                 |
|  | 2.0 i 16V  |  |  | 10.98  | 09.04   |  |  |   |                          |                 |
|  | RS 2.0   |  |  | 10.02  | 09.04   |  |  |   |                          |                 |
|  | ST 170   |  |  | 03.02  | 09.04   |  |  |   |                          |                 |
|    | 1.4 i 16V  |  |  | 10.98  | 09.04   | 24.0110-0115.1   | 410115   |   | 253 10,2 8,9 +B          |                 |
|  | 1.6 i 16V  |  |  | 10.98  | 09.04   | 24.0310-0115.1   | 510115   |   | 253 10,2 8,9 +B PD       |                 |
|  | 1.8 BiFuel   |  |  | 02.03  | 01.05   |  |  |   |                          |                 |
|  | 1.8 i 16V  |  |  | 10.98  | 09.04   |  |  |   |                          |                 |
|  | 1.8 TDCi   |  |  | 03.01  | 09.04   |  |  |   |                          |                 |
|  | 1.8 Turbo DI   |  |  | 10.98  | 09.04   |  |  |   |                          |                 |
|  | 2.0 i 16V  |  |  | 10.98  | 09.04   |  |  |   |                          |                 |
|  | ST 170   |  |  | 03.02  | 09.04   | 24.0110-0313.1   | 410313   |   | 280 10,2 8,9             |                 |
|  | 1.4 i 16V  |  |  | 10.98  | 09.04   | 24.0711-6039.3   | 360029   |  - ESP   |                          | Radsensor L=597 |
|  | 1.6 i 16V  |  |  | 10.98  | 09.04   | 24.0711-6040.3   | 360030   |  - ESP   |                          | Radsensor L=637 |
|  | 1.8 BiFuel   |  |  | 02.03  | 01.05   |  |  |   |                          |                 |
|  | 1.8 i 16V  |  |  | 10.98  | 09.04   |  |  |   |                          |                 |
|  | 1.8 TDCi   |  |  | 03.01  | 09.04   |  |  |   |                          |                 |
|  | 1.8 Turbo DI   |  |  | 10.98  | 09.04   |  |  |   |                          |                 |
|  | 2.0 i 16V  |  |  | 10.98  | 09.04   |  |  |   |                          |                 |
|  | RS 2.0   |  |  | 10.02  | 09.04   |  |  |   |                          |                 |
|  | ST 170   |  |  | 03.02  | 09.04   |  |  |   |                          |                 |
|  | 1.4 i 16V  |  |  | 10.98  | 09.04   | 24.0711-6039.3   | 360029   | 2  + ESP |                          | Radsensor L=597 |
|  | 1.6 i 16V  |  |  | 10.98  | 09.04   |  |  |   |                          |                 |
|  | 1.8 BiFuel   |  |  | 02.03  | 01.05   |  |  |   |                          |                 |
|  | 1.8 i 16V  |  |  | 10.98  | 09.04   |  |  |   |                          |                 |
|  | 1.8 TDCi   |  |  | 03.01  | 09.04   |  |  |   |                          |                 |
|  | 1.8 Turbo DI   |  |  | 10.98  | 09.04   |  |  |   |                          |                 |
|  | 2.0 i 16V  |  |  | 10.98  | 09.04   |  |  |   |                          |                 |
|  | RS 2.0   |  |  | 10.02  | 09.04   |  |  |   |                          |                 |
|  | ST 170   |  |  | 03.02  | 09.04   |  |  |   |                          |                 |
|  | 1.4 i 16V  |  |  | 10.98  | 09.04   | 03.0137-0356.2   | 650356   |   | 203 x 38 HEB             |                 |
|  | 1.6 i 16V  |  |  | 10.98  | 09.04   | 03.0137-9235.2   | 669235   |   | Bremsbacken-Zubehör      |                 |
|  | 1.8 BiFuel   |  |  | 02.03  | 01.05   |  |  |   |                          |                 |
|  | 1.8 i 16V  |  |  | 10.98  | 09.04   |  |  |   |                          |                 |
|  | 1.8 Turbo DI   |  |  | 10.98  | 09.04   |  |  |   |                          |                 |
|  | 1.4 i 16V  |  |  | 10.98  | 09.04   | 24.0220-3020.2   | 480131   | ohne Sensorring <sup>1)</sup>   | 203/204,3 x 44,5 - Lager |                 |
|  | 1.6 i 16V  |  |  | 10.98  | 09.04   | 24.0220-3720.2   | 480210   | ohne Sensorring <sup>1)</sup>   | 203/204,3 x 44,5 + Lager |                 |
|  | 1.8 BiFuel   |  |  | 02.03  | 01.05   |  |  |   |                          |                 |
|  | 1.8 i 16V  |  |  | 10.98  | 09.04   |  |  |   |                          |                 |
|  | 1.8 Turbo DI   |  |  | 10.98  | 09.04   |  |  |   |                          |                 |
|  | 1.4 i 16V Lim.   |  |  | 10.98  | 09.04   | 03.0520-6620.3   | 696620   |   | 20,64/203x38 TopKit      | TRW             |
|  | 1.6 i 16V Lim.   |  |  | 10.98  | 09.04   |  |  |   |                          |                 |
|  | 1.8 i 16V Lim.   |  |  | 10.98  | 09.04   |  |  |   |                          |                 |
|  | 1.8 Turbo DI Kombi   |  |  | 10.98  | 09.04   |  |  |   |                          |                 |
|  | 1.4 i 16V Kombi  |  |  | 10.98  | 09.04   | 03.0520-6222.3   | 696222   |   | 22,20/203x38 TopKit      |                 |
|  | 1.6 i 16V Kombi  |  |  | 10.98  | 09.04   |  |  |   |                          |                 |
|  | 1.8 BiFuel   |  |  | 02.03  | 01.05   |  |  |   |                          |                 |
|  | 1.8 i 16V Kombi  |  |  | 10.98  | 09.04   |  |  |   |                          |                 |
|  | 1.8 Turbo DI Lim.  |  |  | 10.98  | 09.04   | 03.0520-5919.3   | 695919   |   | 19,05/203x38 TopKit      |                 |

<sup>1)</sup> without sensor ring / senza sensori / sans secours ABS / sin anillo sensor ABS



|     |  |  |  |  |  |  |            |           |                         |     |
|--|--|--|--|--|---|--|--|---|-------------------------|-----|
| <b>FORD FOCUS II (05-11)</b>   |  |  |  |  |   |  |  |   |                         |     |
|    | 1.4 i 16V  | 59   |  | 10.04  | 02.11   | 13.0460-7193.2   | 607193   |   | 23723 18,1 +            | ATE |
|  | 1.6 i 16V  | 74   |  | 10.04  | 02.11   | 13.0470-7193.2   | LD7193   |   | 23723 18,1 +            | ATE |
|  | 1.6 TDCi   |  |  | 10.04  | 02.11   |  |  |   |                         |     |
|  | 1.6 TDCi   | 66   |  | 01.05  | 02.11   |  |  |   |                         |     |
|  | 1.6 Ti VCT   | 85   |  | 10.04  | 02.11   |  |  |   |                         |     |
|  | 1.8 i 16V  | 92   |  | 01.06  | 02.11   |  |  |   |                         |     |
|  | 1.8 TDCi   | 85   |  | 01.05  | 02.11   |  |  |   |                         |     |
|  | 2.0 i 16V  | 107  |  | 10.04  | 02.11   |  |  |   |                         |     |
|  | 2.0 TDCi   |  |  | 10.04  | 02.11   |  |  |   |                         |     |
|  | 2.0 TDCi   | 81   |  | 02.08  | 02.11   |  |  |   |                         |     |
| 2.5 ST   | 166  |  | 10.05  | 02.11  | 13.0460-7204.2  | 607204   |  | 23912 18,8 +  | ATE                     |     |
|  |  |  |  |  | 13.0470-7204.2  | LD7204   |  | 23912 18,8 +  | ATE                     |     |
|    | 1.4 i 16V  | 59   |  | 10.04  | 02.11   | 24.0125-0117.1   | 425117   |   | 278 25,0 23,0 V L +B    |     |
|  | 1.6 i 16V  | 74   |  | 10.04  | 02.11   | 24.0325-0117.1   | 525117   |   | 278 25,0 23,0 V L +B PD |     |
|  | 1.6 TDCi   |  |  | 10.04  | 02.11   |  |  |   |                         |     |
|  | 1.6 TDCi   | 66   |  | 01.05  | 02.11   |  |  |   |                         |     |
|  | 1.6 Ti VCT   | 85   |  | 10.04  | 02.11   |  |  |   |                         |     |
|  | 1.8 i 16V  | 92   |  | 01.06  | 02.11   |  |  |   |                         |     |
|  | 1.8 TDCi   | 85   |  | 01.05  | 02.11   | 24.0125-0162.1   | 425162   |   | 300 25,0 23,0 V L +B    |     |
|  | 2.0 i 16V  | 107  |  | 10.04  | 02.11   | 24.0325-0162.1   | 525162   |   | 300 25,0 23,0 V L +B PD |     |
|  | 2.0 TDCi   |  |  | 10.04  | 02.11   |  |  |   |                         |     |
|  | 2.0 TDCi   | 81   |  | 02.08  | 02.11   |  |  |   |                         |     |
| 2.5 ST   | 166  |  | 10.05  | 12.10  | 24.0125-0197.1  | 425197   |  | 320 25,0 23,0 V L +B  |                         |     |
|  |  |  |  |  | 24.0325-0197.1  | 525197   |  | 320 25,0 23,0 V L +B PD   |                         |     |
| 2.5 ST   | 166  |  | 01.11  | 02.11  | 24.0125-0209.1  | 425209   |  | 320 25,0 23,0 V L +B  |                         |     |
|    | 1.4 i 16V  | 59   |  | 10.04  | 11.10   | 24.0711-5123.3   | 360065   | 2  - ESP | Radsensor               |     |
|  | 1.6 i 16V  | 74   |  | 10.04  | 11.10   | 24.0711-5133.3   | 360095   | 2  + ESP | Radsensor               |     |
|  | 1.6 TDCi   |  |  | 10.04  | 11.10   |  |  |   |                         |     |
|  | 1.6 TDCi   | 66   |  | 01.05  | 11.10   |  |  |   |                         |     |
|  | 1.6 Ti VCT   | 85   |  | 10.04  | 11.10   |  |  |   |                         |     |
|  | 1.8 i 16V  | 92   |  | 01.06  | 11.10   |  |  |   |                         |     |
|  | 1.8 TDCi   | 85   |  | 01.05  | 11.10   |  |  |   |                         |     |
|  | 2.0 i 16V  | 107  |  | 10.04  | 11.10   |  |  |   |                         |     |
|  | 2.0 TDCi   |  |  | 10.04  | 11.10   |  |  |   |                         |     |
|  | 2.0 TDCi   | 81   |  | 02.08  | 11.10   |  |  |   |                         |     |
|  | 2.5 RS   | 224  |  | 01.09  | 11.10   |  |  |   |                         |     |
|  | 2.5 RS 500   | 257  |  | 05.10  | 11.10   |  |  |   |                         |     |
|  | 2.5 ST   | 166  |  | 10.05  | 11.10   |  |  |   |                         |     |
|  | 1.4 i 16V  | 59   |  | 12.10  | 02.11   | 24.0711-5357.3   | 360354   | 2  - ESP | Radsensor               |     |
| 1.6 i 16V  | 74   |  | 12.10  | 02.11  | 24.0711-5133.3  | 360095   | 2  + ESP | Radsensor   |                         |     |
| 1.6 TDCi   |  |  | 12.10  | 02.11  |   |  |  |   |                         |     |
| 1.6 TDCi   | 66   |  | 12.10  | 02.11  |   |  |  |   |                         |     |
| 1.6 Ti VCT   | 85   |  | 12.10  | 02.11  |   |  |  |   |                         |     |
| 1.8 i 16V  | 92   |  | 12.10  | 02.11  |   |  |  |   |                         |     |
| 1.8 TDCi   | 85   |  | 12.10  | 02.11  |   |  |  |   |                         |     |
| 2.0 i 16V  | 107  |  | 12.10  | 02.11  |   |  |  |   |                         |     |
| 2.0 TDCi   |  |  | 12.10  | 02.11  |   |  |  |   |                         |     |
| 2.0 TDCi   | 81   |  | 12.10  | 02.11  |   |  |  |   |                         |     |
| 2.5 RS   | 224  |  | 12.10  | 02.11  |   |  |  |   |                         |     |
| 2.5 RS 500   | 257  |  | 12.10  | 02.11  |   |  |  |   |                         |     |
| 2.5 ST   | 166  |  | 12.10  | 02.11  |   |  |  |   |                         |     |
|  | 1.4 i 16V  | 59   |  | 10.04  | 02.11   | 13.0460-7195.2   | 607195   |   | 23482 16,6 +            | ATE |
|  | 1.6 i 16V  | 74   |  | 10.04  | 02.11   | 13.0470-7195.2   | LD7195   |   | 23482 16,6 +            | ATE |
|  | 1.6 TDCi   |  |  | 10.04  | 02.11   |  |  |   |                         |     |
|  | 1.6 TDCi   | 66   |  | 01.05  | 02.11   |  |  |   |                         |     |
|  | 1.6 Ti VCT   | 85   |  | 10.04  | 02.11   |  |  |   |                         |     |
|  | 1.8 i 16V  | 92   |  | 01.06  | 02.11   |  |  |   |                         |     |
|  | 1.8 TDCi   | 85   |  | 01.05  | 02.11   |  |  |   |                         |     |
|  | 2.0 i 16V  | 107  |  | 10.04  | 02.11   |  |  |   |                         |     |
|  | 2.0 TDCi   |  |  | 10.04  | 02.11   |  |  |   |                         |     |
|  | 2.0 TDCi   | 81   |  | 02.08  | 02.11   |  |  |   |                         |     |
| 2.5 ST   | 166  |  | 10.05  | 02.11  |   |  |  |   |                         |     |
| 2.5 RS   | 224  |  | 01.09  | 02.11  | 13.0460-2723.2  | 602723   |  | 24537 16,1 /Zub/S   | TRW                     |     |
| 2.5 RS 500   | 257  |  | 05.10  | 02.11  | 13.0470-2723.2  | LD2723   |  | 24537 16,1 /Zub/S   | TRW                     |     |
|  | 1.4 i 16V  | 59   |  | 10.04  | 02.11   | 24.0111-0155.1   | 411155   |   | 265 11,0 9,0 +B         |     |
|  | 1.6 i 16V  | 74   |  | 10.04  | 02.11   | 24.0311-0155.1   | 511155   |   | 265 11,0 9,0 +B PD      |     |
|  | 1.6 TDCi   |  |  | 10.04  | 02.11   |  |  |   |                         |     |
|  | 1.6 TDCi   | 66   |  | 01.05  | 02.11   |  |  |   |                         |     |
|  | 1.6 Ti VCT   | 85   |  | 10.04  | 02.11   |  |  |   |                         |     |
|  | 1.8 i 16V  | 92   |  | 01.06  | 02.11   |  |  |   |                         |     |
|  | 1.6 TDCi   |  |  | 10.04  | 02.11   |  |  |   |                         |     |
|  | 1.6 TDCi   | 66   |  | 01.05  | 02.11   | 24.0111-0158.1   | 411158   |   | 280 11,0 9,0 +S +B      |     |
|  | 1.8 TDCi   | 85   |  | 01.05  | 02.11   | 24.0311-0158.1   | 511158   |   | 280 11,0 9,0 +B PD      |     |
|  | 2.0 i 16V  | 107  |  | 10.04  | 02.11   |  |  |   |                         |     |
| 2.0 TDCi   |  |  | 10.04  | 02.11  |   |  |  |   |                         |     |
| 2.0 TDCi   | 81   |  | 02.08  | 02.11  |   |  |  |   |                         |     |
| 2.5 ST   | 166  |  | 10.05  | 02.11  |   |  |  |   |                         |     |
| 2.5 RS   | 224  |  | 01.09  | 02.11  | 24.0111-0145.1  | 411145   |  | 302 10,9 9,0 +S +B  |                         |     |
| 2.5 RS 500   | 257  |  | 05.10  | 02.11  | 24.0311-0145.1  | 511145   |  | 302 10,9 9,0 +B PD  |                         |     |
|  | 1.4 i 16V  | 59   |  | 10.04  | 02.11   | 24.0711-6220.3   | 360256   | 2      | Radsensor               |     |
|  | 1.6 i 16V  | 74   |  | 10.04  | 02.11   |  |  |   |                         |     |
|  | 1.6 TDCi   |  |  | 10.04  | 02.11   |  |  |   |                         |     |
|  | 1.6 TDCi   | 66   |  | 01.05  | 02.11   |  |  |   |                         |     |
|  | 1.6 Ti VCT   | 85   |  | 10.04  | 02.11   |  |  |   |                         |     |
|  | 1.8 i 16V  | 92   |  | 01.06  | 02.11   |  |  |   |                         |     |

|     |   |   |  |   |  |  |  |       |   |  |
|--|---|---|--|---|---|--|--|---|---|--|
| <b>FORD FOCUS II (05-11)</b>   |   |   |  |   |   |  |  |   |   |  |
|    | 1.8 TDCi<br>2.0 i 16V<br>2.0 TDCi<br>2.0 TDCi<br>2.5 RS<br>2.5 RS 500<br>2.5 ST   | 85<br>107<br>81<br>224<br>257<br>166  |  | 01.05<br>10.04<br>10.04<br>02.08<br>01.09<br>05.10<br>10.05   | 02.11<br>02.11<br>02.11<br>02.11<br>02.11<br>02.11<br>02.11                       | 24.0711-6220.3   | 360256   | 2    | Radsensor                                       |  |
|    | 1.4 i 16V   | 59  |  | 10.04   | 02.11   | 03.0137-0467.2<br>03.0137-9279.2   | 650467<br>669279   |   | 228 x 42 HEB<br>Bremsbacken-Zubehör             |  |
|    | 1.4 i 16V   | 59  |  | 10.04   | 02.11   | 24.0222-8035.1   | 480188   |   | 229/230,3 x 50,4                                |  |
|    | 1.4 i 16V   | 59  |  | 10.04   | 02.11   | 03.0520-8120.3   | 698120   |   | 20,64/228x42 TopKit AP                          |  |
| <b>FORD FOCUS III (11-)</b>  |   |   |  |   |   |  |  |   |   |  |
|    | 1.0 EcoBoost<br>1.0 EcoBoost<br>1.5 EcoBoost<br>1.5 EcoBoost<br>1.5 TDCi<br>1.5 TDCi<br>1.5 TDCi ECOnetic<br>1.6 EcoBoost<br>1.6 EcoBoost<br>1.6 Flexifuel<br>1.6 LPG<br>1.6 TDCi<br>1.6 TDCi<br>1.6 TDCi<br>1.6 TDCi ECOnetic<br>1.6 Ti-VCT<br>1.6 Ti-VCT<br>1.6 Ti-VCT<br>1.6 Ti-VCT<br>1.6 Ti-VCT Flexifuel<br>2.0<br>2.0 TDCi<br>2.0 TDCi<br>2.0 TDCi<br>2.0 TDCi<br>2.0 TDCi<br>2.0 TDCi | 74<br>92<br>110<br>134<br>70<br>88<br>77<br>110<br>134<br>110<br>88<br>70<br>85<br>77<br>63<br>77<br>88<br>92<br>88<br>110<br>85<br>100<br>103<br>110<br>120<br>136 |  | 02.12<br>02.12<br>09.14<br>09.14<br>09.14<br>09.14<br>09.14<br>03.11<br>03.11<br>07.13<br>02.12<br>03.11<br>03.11<br>03.11<br>04.12<br>08.11<br>03.11<br>02.12<br>03.11<br>03.11<br>11.14<br>03.11<br>11.14 |   |  | 13.0460-7193.2<br>13.0470-7193.2   | 607193<br>LD7193  |   | 23723 18,1 +<br>23723 18,1 +<br>ATE<br>ATE |
|  | 1.5 EcoBoost<br>1.5 EcoBoost<br>1.5 TDCi<br>1.5 TDCi<br>1.5 TDCi ECOnetic<br>1.6 EcoBoost<br>1.6 EcoBoost<br>1.6 Flexifuel<br>1.6 TDCi<br>1.6 Ti-VCT<br>1.6 Ti-VCT<br>2.0<br>2.0 TDCi<br>2.0 TDCi<br>2.0 TDCi<br>2.0 TDCi<br>2.0 TDCi<br>2.0 TDCi   | 110<br>134<br>70<br>88<br>77<br>110<br>134<br>110<br>85<br>77<br>92<br>110<br>85<br>100<br>103<br>110<br>120<br>136   |  | 09.14<br>09.14<br>09.14<br>09.14<br>09.14<br>03.11<br>03.11<br>07.13<br>03.11<br>03.11<br>03.11<br>10.13<br>03.11<br>03.11<br>03.11<br>11.14<br>03.11<br>11.14  |   | 24.0125-0162.1<br>24.0325-0162.1   | 425162<br>525162   |   | 300 25,0 23,0 V L +B<br>300 25,0 23,0 V L +B PD |  |
|  | 1.0 EcoBoost<br>1.0 EcoBoost<br>1.6 LPG<br>1.6 TDCi<br>1.6 TDCi<br>1.6 TDCi ECOnetic<br>1.6 Ti-VCT<br>1.6 Ti-VCT<br>1.6 Ti-VCT<br>1.6 Ti-VCT<br>1.6 Ti-VCT Flexifuel<br>Electric<br>2.0 EcoBoost ST   | 74<br>92<br>88<br>70<br>85<br>77<br>63<br>77<br>88<br>92<br>88<br>107<br>184  |  | 02.12<br>02.12<br>02.12<br>03.11<br>03.11<br>04.12<br>08.11<br>03.11<br>02.12<br>03.11<br>07.13   |   | 24.0125-0199.1<br>24.0325-0199.1   | 425199<br>525199   |   | 278 25,0 23,0 V L +B<br>278 25,0 23,0 V L +B PD |  |
|  | 1.0 EcoBoost<br>1.0 EcoBoost<br>1.5 EcoBoost<br>1.5 EcoBoost<br>1.5 TDCi<br>1.5 TDCi<br>1.5 TDCi ECOnetic<br>1.6 EcoBoost<br>1.6 EcoBoost<br>1.6 Flexifuel<br>1.6 LPG   | 74<br>92<br>110<br>134<br>70<br>88<br>77<br>110<br>134<br>110<br>88   |  | 02.12<br>02.12<br>09.14<br>09.14<br>09.14<br>09.14<br>09.14<br>03.11<br>03.11<br>07.13<br>02.12   |   | 24.0711-5357.3   | 360354   | 2  | Radsensor                                       |  |

**FORD FOCUS III (11-)**

|          |                      |       |       |                |        |                       |                                       |            |
|----------|----------------------|-------|-------|----------------|--------|-----------------------|---------------------------------------|------------|
|          | 1.6 TDCi             | 70    | 03.11 | 24.0711-5357.3 | 360354 | 2                     | Radsensor                             |            |
|          | 1.6 TDCi             | 85    | 03.11 |                |        |                       |                                       |            |
|          | 1.6 TDCi ECOnetic    | 77    | 04.12 |                |        |                       |                                       |            |
|          | 1.6 Ti-VCT           | 63    | 08.11 |                |        |                       |                                       |            |
|          | 1.6 Ti-VCT           | 77    | 03.11 |                |        |                       |                                       |            |
|          | 1.6 Ti-VCT           | 88    | 02.12 |                |        |                       |                                       |            |
|          | 1.6 Ti-VCT           | 92    | 03.11 |                |        |                       |                                       |            |
|          | 1.6 Ti-VCT Flexifuel | 88    | 03.11 |                |        |                       |                                       |            |
|          | 2.0                  | 110   | 10.13 |                |        |                       |                                       |            |
|          | 2.0 EcoBoost ST      | 184   | 06.12 |                |        |                       |                                       |            |
|          | 2.0 TDCi             | 85    | 03.11 |                |        |                       |                                       |            |
|          | 2.0 TDCi             | 100   | 03.11 |                |        |                       |                                       |            |
|          | 2.0 TDCi             | 103   | 03.11 |                |        |                       |                                       |            |
|          | 2.0 TDCi             | 110   | 11.14 |                |        |                       |                                       |            |
|          | 2.0 TDCi             | 120   | 03.11 |                |        |                       |                                       |            |
| 2.0 TDCi | 136                  | 11.14 |       |                |        |                       |                                       |            |
| 2.3 RS   | 257                  | 07.15 |       |                |        |                       |                                       |            |
| Electric | 107                  | 07.13 |       |                |        |                       |                                       |            |
|          | 1.0 EcoBoost         | 74    | 02.12 | 13.0460-7195.2 | 607195 |                       | 23482 16,6 +<br>23482 16,6 +          | ATE<br>ATE |
|          | 1.0 EcoBoost         | 92    | 02.12 |                |        |                       |                                       |            |
|          | 1.5 EcoBoost         | 110   | 09.14 |                |        |                       |                                       |            |
|          | 1.5 EcoBoost         | 134   | 09.14 |                |        |                       |                                       |            |
|          | 1.5 TDCi             | 70    | 09.14 |                |        |                       |                                       |            |
|          | 1.5 TDCi             | 88    | 09.14 |                |        |                       |                                       |            |
|          | 1.5 TDCi ECOnetic    | 77    | 09.14 |                |        |                       |                                       |            |
|          | 1.6 EcoBoost         | 110   | 03.11 |                |        |                       |                                       |            |
|          | 1.6 EcoBoost         | 134   | 03.11 |                |        |                       |                                       |            |
|          | 1.6 Flexifuel        | 110   | 07.13 |                |        |                       |                                       |            |
|          | 1.6 LPG              | 88    | 02.12 |                |        |                       |                                       |            |
|          | 1.6 TDCi             | 70    | 03.11 |                |        |                       |                                       |            |
|          | 1.6 TDCi             | 85    | 03.11 |                |        |                       |                                       |            |
|          | 1.6 TDCi ECOnetic    | 77    | 04.12 |                |        |                       |                                       |            |
|          | 1.6 Ti-VCT           | 63    | 08.11 |                |        |                       |                                       |            |
|          | 1.6 Ti-VCT           | 77    | 03.11 |                |        |                       |                                       |            |
|          | 1.6 Ti-VCT           | 88    | 02.12 |                |        |                       |                                       |            |
|          | 1.6 Ti-VCT           | 92    | 03.11 |                |        |                       |                                       |            |
|          | 1.6 Ti-VCT Flexifuel | 88    | 03.11 |                |        |                       |                                       |            |
|          | 2.0                  | 110   | 10.13 |                |        |                       |                                       |            |
|          | 2.0 EcoBoost ST      | 184   | 06.12 |                |        |                       |                                       |            |
|          | 2.0 TDCi             | 85    | 03.11 |                |        |                       |                                       |            |
|          | 2.0 TDCi             | 100   | 03.11 |                |        |                       |                                       |            |
|          | 2.0 TDCi             | 103   | 03.11 |                |        |                       |                                       |            |
|          | 2.0 TDCi             | 110   | 11.14 |                |        |                       |                                       |            |
| 2.0 TDCi | 120                  | 03.11 |       |                |        |                       |                                       |            |
| 2.0 TDCi | 136                  | 11.14 |       |                |        |                       |                                       |            |
| 2.3 RS   | 257                  | 07.15 |       |                |        |                       |                                       |            |
|          | 1.0 EcoBoost         | 74    | 02.12 | 24.0111-0171.1 | 411171 |                       | 271 11,0 9,0 +B<br>271 11,0 9,0 +B PD |            |
|          | 1.0 EcoBoost         | 92    | 02.12 |                |        |                       |                                       |            |
|          | 1.5 EcoBoost         | 110   | 09.14 |                |        |                       |                                       |            |
|          | 1.5 EcoBoost         | 134   | 09.14 |                |        |                       |                                       |            |
|          | 1.5 TDCi             | 70    | 09.14 |                |        |                       |                                       |            |
|          | 1.5 TDCi             | 88    | 09.14 |                |        |                       |                                       |            |
|          | 1.5 TDCi ECOnetic    | 77    | 09.14 |                |        |                       |                                       |            |
|          | 1.6 EcoBoost         | 110   | 03.11 |                |        |                       |                                       |            |
|          | 1.6 EcoBoost         | 134   | 03.11 |                |        |                       |                                       |            |
|          | 1.6 Flexifuel        | 110   | 07.13 |                |        |                       |                                       |            |
|          | 1.6 LPG              | 88    | 02.12 |                |        |                       |                                       |            |
|          | 1.6 TDCi             | 70    | 03.11 |                |        |                       |                                       |            |
|          | 1.6 TDCi             | 85    | 03.11 |                |        |                       |                                       |            |
|          | 1.6 TDCi ECOnetic    | 77    | 04.12 |                |        |                       |                                       |            |
|          | 1.6 Ti-VCT           | 63    | 08.11 |                |        |                       |                                       |            |
|          | 1.6 Ti-VCT           | 77    | 03.11 |                |        |                       |                                       |            |
|          | 1.6 Ti-VCT           | 88    | 02.12 |                |        |                       |                                       |            |
|          | 1.6 Ti-VCT           | 92    | 03.11 |                |        |                       |                                       |            |
|          | 1.6 Ti-VCT Flexifuel | 88    | 03.11 |                |        |                       |                                       |            |
|          | 2.0                  | 110   | 10.13 |                |        |                       |                                       |            |
|          | 2.0 EcoBoost ST      | 184   | 06.12 |                |        |                       |                                       |            |
|          | 2.0 TDCi             | 85    | 03.11 |                |        |                       |                                       |            |
|          | 2.0 TDCi             | 100   | 03.11 |                |        |                       |                                       |            |
|          | 2.0 TDCi             | 103   | 03.11 |                |        |                       |                                       |            |
|          | 2.0 TDCi             | 110   | 11.14 |                |        |                       |                                       |            |
| 2.0 TDCi | 120                  | 03.11 |       |                |        |                       |                                       |            |
| 2.0 TDCi | 136                  | 11.14 |       |                |        |                       |                                       |            |
| Electric | 107                  | 07.13 |       |                |        |                       |                                       |            |
|          | 1.0 EcoBoost         | 74    | 02.12 | 24.0711-6351.3 | 360358 | 2  + Active City Stop | Radsensor                             |            |
|          | 1.0 EcoBoost         | 92    | 02.12 |                |        |                       |                                       |            |
|          | 1.5 EcoBoost         | 110   | 09.14 |                |        |                       |                                       |            |
|          | 1.5 EcoBoost         | 134   | 09.14 |                |        |                       |                                       |            |
|          | 1.5 TDCi             | 70    | 09.14 |                |        |                       |                                       |            |
|          | 1.5 TDCi             | 88    | 09.14 |                |        |                       |                                       |            |
|          | 1.5 TDCi ECOnetic    | 77    | 09.14 |                |        |                       |                                       |            |
|          | 1.6 EcoBoost         | 110   | 03.11 |                |        |                       |                                       |            |
|          | 1.6 EcoBoost         | 134   | 03.11 |                |        |                       |                                       |            |
|          | 1.6 Flexifuel        | 110   | 07.13 |                |        |                       |                                       |            |
|          | 1.6 LPG              | 88    | 02.12 |                |        |                       |                                       |            |
|          | 1.6 TDCi             | 70    | 03.11 |                |        |                       |                                       |            |
|          | 1.6 TDCi             | 85    | 03.11 |                |        |                       |                                       |            |
|          | ↓                    |       |       |                |        |                       |                                       |            |
|          | ↓                    |       |       |                |        |                       |                                       |            |
|          |                      |       |       |                |        |                       |                                       |            |



### FORD FOCUS III (11-)

|  |                      |     |  |       |  |                |        |   |                    |                     |
|--|----------------------|-----|--|-------|--|----------------|--------|---|--------------------|---------------------|
|  | 1.6 TDCi ECOnetic    | 77  |  | 04.12 |  | 24.0711-6351.3 | 360358 | 2 | + Active City Stop | Radsensor           |
|  | 1.6 Ti-VCT           | 63  |  | 08.11 |  | 24.0711-6296.3 | 360357 | 2 | - Active City Stop | Radsensor           |
|  | 1.6 Ti-VCT           | 77  |  | 03.11 |  |                |        |   |                    |                     |
|  | 1.6 Ti-VCT           | 88  |  | 02.12 |  |                |        |   |                    |                     |
|  | 1.6 Ti-VCT           | 92  |  | 03.11 |  |                |        |   |                    |                     |
|  | 1.6 Ti-VCT Flexifuel | 88  |  | 03.11 |  |                |        |   |                    |                     |
|  | 2.0                  | 110 |  | 10.13 |  |                |        |   |                    |                     |
|  | 2.0 EcoBoost ST      | 184 |  | 06.12 |  |                |        |   |                    |                     |
|  | 2.0 TDCi             | 85  |  | 03.11 |  |                |        |   |                    |                     |
|  | 2.0 TDCi             | 100 |  | 03.11 |  |                |        |   |                    |                     |
|  | 2.0 TDCi             | 103 |  | 03.11 |  |                |        |   |                    |                     |
|  | 2.0 TDCi             | 110 |  | 11.14 |  |                |        |   |                    |                     |
|  | 2.0 TDCi             | 120 |  | 03.11 |  |                |        |   |                    |                     |
|  | 2.0 TDCi             | 136 |  | 11.14 |  |                |        |   |                    |                     |
|  | 2.3 RS               | 257 |  | 07.15 |  |                |        |   |                    |                     |
|  | Electric             | 107 |  | 07.13 |  |                |        |   |                    |                     |
|  | 1.0 EcoBoost         | 74  |  | 02.12 |  | 03.0137-0512.2 | 650512 |   |                    | 228 x 42 HEB        |
|  | 1.0 EcoBoost         | 92  |  | 02.12 |  | 03.0137-9313.2 | 669313 |   |                    | Bremsbacken-Zubehör |
|  | 1.5 EcoBoost         | 110 |  | 09.14 |  |                |        |   |                    |                     |
|  | 1.5 EcoBoost         | 134 |  | 09.14 |  |                |        |   |                    |                     |
|  | 1.5 TDCi             | 70  |  | 09.14 |  |                |        |   |                    |                     |
|  | 1.5 TDCi             | 88  |  | 09.14 |  |                |        |   |                    |                     |
|  | 1.5 TDCi ECOnetic    | 77  |  | 09.14 |  |                |        |   |                    |                     |
|  | 1.6 EcoBoost         | 110 |  | 03.11 |  |                |        |   |                    |                     |
|  | 1.6 EcoBoost         | 134 |  | 03.11 |  |                |        |   |                    |                     |
|  | 1.6 Flexifuel        | 110 |  | 07.13 |  |                |        |   |                    |                     |
|  | 1.6 LPG              | 88  |  | 02.12 |  |                |        |   |                    |                     |
|  | 1.6 TDCi             | 70  |  | 03.11 |  |                |        |   |                    |                     |
|  | 1.6 TDCi             | 85  |  | 03.11 |  |                |        |   |                    |                     |
|  | 1.6 TDCi ECOnetic    | 77  |  | 04.12 |  |                |        |   |                    |                     |
|  | 1.6 Ti-VCT           | 63  |  | 08.11 |  |                |        |   |                    |                     |
|  | 1.6 Ti-VCT           | 77  |  | 03.11 |  |                |        |   |                    |                     |
|  | 1.6 Ti-VCT           | 88  |  | 02.12 |  |                |        |   |                    |                     |
|  | 1.6 Ti-VCT           | 92  |  | 03.11 |  |                |        |   |                    |                     |
|  | 1.6 Ti-VCT Flexifuel | 88  |  | 03.11 |  |                |        |   |                    |                     |
|  | 2.0                  | 110 |  | 10.13 |  |                |        |   |                    |                     |
|  | 2.0 TDCi             | 85  |  | 03.11 |  |                |        |   |                    |                     |
|  | 2.0 TDCi             | 100 |  | 03.11 |  |                |        |   |                    |                     |
|  | 2.0 TDCi             | 103 |  | 03.11 |  |                |        |   |                    |                     |
|  | 2.0 TDCi             | 110 |  | 11.14 |  |                |        |   |                    |                     |
|  | 2.0 TDCi             | 120 |  | 03.11 |  |                |        |   |                    |                     |
|  | 2.0 TDCi             | 136 |  | 11.14 |  |                |        |   |                    |                     |
|  | Electric             | 107 |  | 07.13 |  |                |        |   |                    |                     |

























### FORD FOCUS C-MAX (03-07)

|  |            |     |  |       |       |                |        |   |                             |                         |     |
|--|------------|-----|--|-------|-------|----------------|--------|---|-----------------------------|-------------------------|-----|
|  | 1.6 i 16V  | 74  |  | 08.03 | 03.07 | 13.0460-7193.2 | 607193 |   |                             | 23723 18,1 +            | ATE |
|  | 1.6 TDCi   | 66  |  | 01.05 | 03.07 | 13.0470-7193.2 | LD7193 |   |                             | 23723 18,1 +            | ATE |
|  | 1.6 TDCi   | 80  |  | 08.03 | 03.07 |                |        |   |                             |                         |     |
|  | 1.6 Ti VCT | 85  |  | 08.04 | 03.07 |                |        |   |                             |                         |     |
|  | 1.8 i 16V  | 88  |  | 08.03 | 03.07 |                |        |   |                             |                         |     |
|  | 1.8 i 16V  | 92  |  | 04.04 | 03.07 |                |        |   |                             |                         |     |
|  | 1.8 TDCi   | 85  |  | 01.05 | 03.07 |                |        |   |                             |                         |     |
|  | 2.0 i 16V  | 107 |  | 04.04 | 03.07 |                |        |   |                             |                         |     |
|  | 2.0 TDCi   | 100 |  | 08.03 | 03.07 |                |        |   |                             |                         |     |
|  | 1.6 i 16V  | 74  |  | 08.03 | 03.07 | 24.0125-0117.1 | 425117 |   | + 15"/16" Rad <sup>1)</sup> | 278 25,0 23,0 V L +B    |     |
|  | 1.6 TDCi   | 66  |  | 01.05 | 03.07 | 24.0325-0117.1 | 525117 |   | + 15"/16" Rad <sup>1)</sup> | 278 25,0 23,0 V L +B PD |     |
|  | 1.6 TDCi   | 80  |  | 08.03 | 03.07 | 24.0125-0162.1 | 425162 |   | + 17" Rad <sup>2)</sup>     | 300 25,0 23,0 V L +B    |     |
|  | 1.6 Ti VCT | 85  |  | 08.04 | 03.07 | 24.0325-0162.1 | 525162 |   | + 17" Rad <sup>2)</sup>     | 300 25,0 23,0 V L +B PD |     |
|  | 1.8 i 16V  | 88  |  | 08.03 | 03.07 |                |        |   |                             |                         |     |
|  | 1.8 i 16V  | 92  |  | 04.04 | 03.07 |                |        |   |                             |                         |     |
|  | 1.8 TDCi   | 85  |  | 01.05 | 03.07 |                |        |   |                             |                         |     |
|  | 2.0 i 16V  | 107 |  | 04.04 | 03.07 |                |        |   |                             |                         |     |
|  | 2.0 TDCi   | 100 |  | 08.03 | 03.07 |                |        |   |                             |                         |     |
|  | 1.6 i 16V  | 74  |  | 08.03 | 03.07 | 24.0711-5123.3 | 360065 | 2 | - ESP                       | Radsensor               |     |
|  | 1.6 TDCi   | 66  |  | 01.05 | 03.07 | 24.0711-5133.3 | 360095 | 2 | + ESP                       | Radsensor               |     |
|  | 1.6 TDCi   | 80  |  | 08.03 | 03.07 |                |        |   |                             |                         |     |
|  | 1.6 Ti VCT | 85  |  | 08.04 | 03.07 |                |        |   |                             |                         |     |
|  | 1.8 i 16V  | 88  |  | 08.03 | 03.07 |                |        |   |                             |                         |     |
|  | 1.8 i 16V  | 92  |  | 04.04 | 03.07 |                |        |   |                             |                         |     |
|  | 1.8 TDCi   | 85  |  | 01.05 | 03.07 |                |        |   |                             |                         |     |
|  | 2.0 i 16V  | 107 |  | 04.04 | 03.07 |                |        |   |                             |                         |     |
|  | 2.0 TDCi   | 100 |  | 08.03 | 03.07 |                |        |   |                             |                         |     |
|  | 1.6 i 16V  | 74  |  | 08.03 | 03.07 | 13.0460-7195.2 | 607195 |   |                             | 23482 16,6 +            | ATE |
|  | 1.6 TDCi   | 66  |  | 01.05 | 03.07 | 13.0470-7195.2 | LD7195 |   |                             | 23482 16,6 +            | ATE |
|  | 1.6 TDCi   | 80  |  | 08.03 | 03.07 |                |        |   |                             |                         |     |
|  | 1.6 Ti VCT | 85  |  | 08.04 | 03.07 |                |        |   |                             |                         |     |
|  | 1.8 i 16V  | 88  |  | 08.03 | 03.07 |                |        |   |                             |                         |     |
|  | 1.8 i 16V  | 92  |  | 04.04 | 03.07 |                |        |   |                             |                         |     |
|  | 1.8 TDCi   | 85  |  | 01.05 | 03.07 |                |        |   |                             |                         |     |
|  | 2.0 i 16V  | 107 |  | 04.04 | 03.07 |                |        |   |                             |                         |     |
|  | 2.0 TDCi   | 100 |  | 08.03 | 03.07 |                |        |   |                             |                         |     |
|  | 1.6 i 16V  | 74  |  | 08.03 | 03.07 | 24.0111-0155.1 | 411155 |   |                             | 265 11,0 9,0 +B         |     |
|  | 1.6 TDCi   | 66  |  | 01.05 | 03.07 | 24.0311-0155.1 | 511155 |   |                             | 265 11,0 9,0 +B PD      |     |
|  | 1.6 TDCi   | 80  |  | 08.03 | 03.07 |                |        |   |                             |                         |     |
|  | 1.6 Ti VCT | 85  |  | 08.04 | 03.07 |                |        |   |                             |                         |     |
|  | 1.8 i 16V  | 88  |  | 08.03 | 03.07 |                |        |   |                             |                         |     |
|  | 1.8 i 16V  | 92  |  | 04.04 | 03.07 |                |        |   |                             |                         |     |

<sup>1)</sup> + 15"/16" wheel / + ruota 15"/16" / + roue 15"/16" / + rueda 15"/16"

<sup>2)</sup> + 17" wheel / + ruota 17" / + roue 17" / + rueda 17"

















|     |  |  |  |  |  |  |  |       |   |
|--|--|--|--|--|---|--|--|---|---|
| <b>FORD FOCUS C-MAX (03-07)</b>  |  |  |  |  |   |  |  |   |   |
|    | 1.6 TDCi   | 66   | 01.05  | 03.07  | + Bremsscheibendurchm. 280 mm   | 24.0111-0158.1   | 411158   | 280 11,0 9,0 +S +B<br>280 11,0 9,0 +B PD  |   |
|  | 1.6 TDCi   | 80   | 08.03  | 03.07  | + Bremsscheibendurchm. 280 mm   | 24.0311-0158.1   | 511158   |   |   |
|  | 1.8 TDCi   | 85   | 01.05  | 03.07  |   |  |  |   |   |
|  | 2.0 i 16V  | 107  | 04.04  | 03.07  |   |  |  |   |   |
|  | 2.0 TDCi   | 100  | 08.03  | 03.07  |   |  |  |   |   |
|    | 1.6 i 16V  | 74   | 08.03  | 03.07  |   | 24.0711-6220.3   | 360256   | 2    | Radsensor   |
|  | 1.6 TDCi   | 66   | 01.05  | 03.07  |   |  |  |   |   |
|  | 1.6 TDCi   | 80   | 08.03  | 03.07  |   |  |  |   |   |
|  | 1.6 Ti VCT   | 85   | 08.04  | 03.07  |   |  |  |   |   |
|  | 1.8 i 16V  | 88   | 08.03  | 03.07  |   |  |  |   |   |
|  | 1.8 i 16V  | 92   | 04.04  | 03.07  |   |  |  |   |   |
|  | 1.8 TDCi   | 85   | 01.05  | 03.07  |   |  |  |   |   |
|  | 2.0 i 16V  | 107  | 04.04  | 03.07  |   |  |  |   |   |
|  | 2.0 TDCi   | 100  | 08.03  | 03.07  |   |  |  |   |   |
| <b>FORD FUSION (02-12)</b>   |  |  |  |  |   |  |  |   |   |
|    | 1.25 i 16V   | 55   | 08.04  | 09.12  |   | 13.0460-7142.2   | 607142   |   | 23604 18,3 + ATE                                      |
|  | 1.4 i 16V  | 59   | 07.02  | 09.12  |   |  |  |   |   |
|  | 1.4 TDCi   | 50   | 07.02  | 09.12  |   |  |  |   |   |
|  | 1.6 i 16V  | 74   | 07.02  | 09.12  |   |  |  |   |   |
|  | 1.6 TDCi   | 66   | 10.04  | 09.12  |   |  |  |   |   |
|    | 1.25 i 16V   | 55   | 08.04  | 09.12  |   | 24.0122-0172.1   | 422172   |   | 258 22,0 20,0 V +B<br>258 22,0 20,0 V +B PD           |
|  | 1.4 i 16V  | 59   | 07.02  | 09.12  |   | 24.0322-0172.1   | 522172   |   |   |
|  | 1.4 TDCi   | 50   | 07.02  | 09.12  |   |  |  |   |   |
|  | 1.6 i 16V  | 74   | 07.02  | 09.12  |   |  |  |   |   |
|  | 1.6 TDCi   | 66   | 10.04  | 09.12  |   |  |  |   |   |
|    | 1.25 i 16V   | 55   | 08.04  | 09.12  |   | 24.0711-5139.1   | 360235   | 2    | Radsensor L=790                                       |
|  | 1.4 i 16V  | 59   | 07.02  | 09.12  |   |  |  |   |   |
|  | 1.4 TDCi   | 50   | 07.02  | 09.12  |   |  |  |   |   |
|  | 1.6 i 16V  | 74   | 07.02  | 09.12  |   |  |  |   |   |
|  | 1.6 TDCi   | 66   | 10.04  | 09.12  |   |  |  |   |   |
|    | 1.25 i 16V   | 55   | 08.04  | 09.12  |   | 24.0711-6118.3   | 360188   | 1    | Radsensor L=937/958                                   |
|  | 1.4 i 16V  | 59   | 07.02  | 09.12  |   |  |  |   |   |
|  | 1.4 TDCi   | 50   | 07.02  | 09.12  |   |  |  |   |   |
|  | 1.6 i 16V  | 74   | 07.02  | 09.12  |   |  |  |   |   |
|  | 1.6 TDCi   | 66   | 10.04  | 09.12  |   |  |  |   |   |
|   | 1.25 i 16V   | 55   | 08.04  | 09.12  |   | 03.0137-0394.2   | 650394   |   | 203 x 38 HEB<br>Bremsbacken-Zubehör                   |
|  | 1.4 i 16V  | 59   | 07.02  | 09.12  |   | 03.0137-9259.2   | 669259   |   |   |
|  | 1.4 TDCi   | 50   | 07.02  | 09.12  |   |  |  |   |   |
|  | 1.6 i 16V  | 74   | 07.02  | 09.12  |   |  |  |   |   |
|  | 1.6 TDCi   | 66   | 10.04  | 09.12  |   |  |  |   |   |
|  | 1.25 i 16V   | 55   | 08.04  | 09.12  |   | 24.0220-3026.2   | 480175   | ohne Sensorring <sup>1)</sup>   | 203/204,3 x 44,5 - Lager                              |
|  | 1.4 i 16V  | 59   | 07.02  | 09.12  |   | 24.0220-3726.2   | 480216   | mit Sensorring <sup>2)</sup>  | 203/204,3 x 44,5 + Lager                              |
|  | 1.4 TDCi   | 50   | 07.02  | 09.12  |   |  |  |   |   |
|  | 1.6 i 16V  | 74   | 07.02  | 09.12  |   |  |  |   |   |
|  | 1.6 TDCi   | 66   | 10.04  | 09.12  |   |  |  |   |   |
|  | 1.25 i 16V   | 55   | 08.04  | 09.12  |   | 03.0520-6319.3   | 696319   |   | 19,05/203x38 TopKit AP                                |
|  | 1.4 i 16V  | 59   | 07.02  | 09.12  |   |  |  |   |   |
|  | 1.4 TDCi   | 50   | 07.02  | 09.12  |   |  |  |   |   |
|  | 1.6 i 16V  | 74   | 07.02  | 09.12  |   |  |  |   |   |
|  | 1.6 TDCi   | 66   | 10.04  | 09.12  |   |  |  |   |   |
| <b>FORD GALAXY I (95-06)</b>   |  |  |  |  |   |  |  |   |   |
|  | 1.9 TDI  | 66   | 01.96  | 03.00  |   | 13.0460-7076.2   | 607076   |   | 21848 19,8 + ATE                                      |
|  | 1.9 TDI  | 81   | 10.97  | 03.00  |   |  |  |   |   |
|  | 2.0 i  |  | 09.95  | 04.01  |   |  |  |   |   |
|  | 2.3 i 16V  |  | 01.97  | 04.01  |   |  |  |   |   |
|  | 2.8 i V6   | 128  | 09.95  | 03.00  |   |  |  |   |   |
|  | 1.9 TDI  | 66   | 04.00  | 04.01  |   | 13.0460-7143.2   | 607143   |   | 21849 19,8 +/WK ATE                                   |
|  | 1.9 TDI  | 85   | 04.00  | 04.01  |   |  |  |   |   |
|  | 1.9 TDI  | 66   | 05.01  | 04.06  |   | 13.0460-7154.2   | 607154   |   | 23418 19,4 +/WK ATE                                   |
|  | 1.9 TDI  | 85   | 05.01  | 04.06  |   |  |  |   |   |
|  | 1.9 TDI  | 96   | 02.03  | 04.06  |   |  |  |   |   |
|  | 1.9 TDI  | 110  | 05.05  |  |   |  |  |   |   |
|  | 2.0 i  |  | 05.01  | 04.06  |   | 13.0460-7156.2   | 607156   |   | 23034 19,4 + ATE                                      |
|  | 2.3 i 16V  |  | 05.01  | 04.06  |   |  |  |   |   |
|  | 2.8 i V6   | 150  | 04.00  | 04.06  |   | 13.0460-7153.2   | 607153   |   | 23269 19,8 +/WK ATE                                   |
|  | 1.9 TDI  | 66   | 01.96  | 04.01  |   | 24.0125-0114.1   | 425114   |   | 288 25,1 21,0 V L +S +B<br>288 25,1 21,0 V L +S +B PD |
|  | 1.9 TDI  | 81   | 10.97  | 03.00  |   | 24.0325-0114.1   | 525114   |   |   |
|  | 1.9 TDI  | 85   | 04.00  | 04.01  |   |  |  |   |   |
|  | 2.0 i  |  | 09.95  | 04.01  |   |  |  |   |   |
|  | 2.3 i 16V  |  | 01.97  | 04.01  |   |  |  |   |   |
|  | 2.8 i V6   | 128  | 09.95  | 03.00  |   |  |  |   |   |
|  | 1.9 TDI  | 66   | 05.01  | 04.06  |   | 24.0126-0115.1   | 426115   |   | 300 26,0 22,0 V L +B<br>300 26,0 22,0 V L +B PD       |
|  | 1.9 TDI  | 85   | 05.01  | 04.06  |   | 24.0326-0115.1   | 526115   |   |   |
|  | 1.9 TDI  | 96   | 02.03  | 04.06  |   |  |  |   |   |
|  | 1.9 TDI  | 110  | 05.05  | 04.06  |   |  |  |   |   |
|  | 2.0 i  |  | 05.01  | 04.06  |   |  |  |   |   |
|  | 2.3 i 16V  |  | 05.01  | 04.06  |   |  |  |   |   |
|  | 2.8 i V6   | 150  | 04.00  | 04.06  |   | 24.0126-0119.1   | 426119   |   | 313 25,9 22,0 V L +B<br>313 25,9 22,0 V L +B PD       |
|  |  |  |  |  |   | 24.0326-0119.1   | 526119   |   |   |
|  | 1.9 TDI  | 66   | 01.96  | 08.97  |   | 24.0731-1183.3   | 360194   | 2  | Radsensor L=460                                       |
|  | 2.0 i  |  | 09.95  | 08.97  |   |  |  |   |   |
|  | 2.3 i 16V  |  | 01.97  | 08.97  |   |  |  |   |   |
|  | 2.8 i V6   | 128  | 09.95  | 08.97  |   |  |  |   |   |

<sup>1)</sup> without sensor ring / senza sensori / sans secours ABS / sin anillo sensor ABS



























<sup>2)</sup> with sensor ring / con sensori / avec secours ABS / con anillo sensor ABS



|     |  |  |  |  |  |  |  |  |                             |                             |
|--|--|--|--|--|---|--|--|--|-----------------------------|-----------------------------|
| <b>FORD GALAXY I (95-06)</b>   |  |  |  |  |   |  |  |  |                             |                             |
|    | 1.9 TDI  | 66   |  | 09.97  | 03.00   | 24.0713-1101.3   | 360143   | 2  | Radsensor L=464             |                             |
|  | 1.9 TDI  | 81   |  | 10.97  | 03.00   |  |  |  |                             |                             |
|  | 2.0 i  |  |  | 09.97  | 03.00   |  |  |  |                             |                             |
|  | 2.3 i 16V  |  |  | 09.97  | 03.00   |  |  |  |                             |                             |
|  | 2.8 i V6   | 128  |  | 09.97  | 03.00   |  |  |  |                             |                             |
|  | 1.9 TDI  | 66   |  | 04.00  | 10.02   | 24.0713-1128.3   | 360200   | + Leitung f. Warnkontakt 1)  |                             | Radsensor L=474             |
|  | 1.9 TDI  | 85   |  | 04.00  | 10.02   | 24.0713-1127.3   | 360204   |  |                             |                             |
|  | 2.0 i  |  |  | 04.00  | 10.02   |  |  |  |                             | Radsensor L=474             |
|  | 2.3 i 16V  |  |  | 04.00  | 10.02   |  |  |  |                             |                             |
|  | 2.8 i V6   | 150  |  | 04.00  | 10.02   | 24.0713-1128.3   | 360200   | 2  |                             | + Leitung f. Warnkontakt 1) |
| 1.9 TDI  | 66   |  | 11.02  | 04.06  | 24.0711-6114.3  | 360281   | - Leitung f. Warnkontakt 2)  | Radsensor L=479  |                             |                             |
| 1.9 TDI  | 85   |  | 11.02  | 04.06  | 24.0711-6115.3  | 360282   |  |  |                             |                             |
| 1.9 TDI  | 96   |  | 02.03  | 04.06  |   |  |  | Radsensor L=479  |                             |                             |
| 1.9 TDI  | 110  |  | 05.05  | 04.06  |   |  |  |  |                             |                             |
| 2.0 i  |  |  | 11.02  | 04.06  |   |  |  |  |                             |                             |
| 2.3 i 16V  |  |  | 11.02  | 04.06  |   |  |  |  |                             |                             |
| 2.8 i V6   | 150  |  | 11.02  | 04.06  |   |  |  |  |                             |                             |
|    | 1.9 TDI  | 66   |  | 01.96  | 03.00   | 13.0460-2819.2   | 602819   |  | 20961 17,6 /S               | TRW                         |
|  | 1.9 TDI  | 81   |  | 10.97  | 03.00   | 13.0460-0072.2   | 610072   |  | Belagsatz-Zubehör           | TRW                         |
|  | 2.0 i  |  |  | 09.95  | 04.06   |  |  |  |                             |                             |
|  | 2.3 i 16V  |  |  | 01.97  | 04.06   |  |  |  |                             |                             |
|  | 2.8 i V6   | 128  |  | 09.95  | 03.00   |  |  |  |                             |                             |
|  | 1.9 TDI  | 66   |  | 04.00  | 04.06   | 13.0460-2859.2   | 602859   |  | 20961 17,2 +/WK/Zub/STRW    |                             |
|  | 1.9 TDI  | 85   |  | 04.00  | 04.06   |  |  |  |                             |                             |
|  | 1.9 TDI  | 96   |  | 02.03  | 04.06   |  |  |  |                             |                             |
|  | 1.9 TDI  | 110  |  | 05.05  | 04.06   | 13.0460-2872.2   | 602872   |  | 23446 16,5 +/WK/Zub/STRW    |                             |
|  | 2.8 i V6   | 150  |  | 04.00  | 04.06   | 13.0460-0225.2   | 610225   |  | Belagsatz-Zubehör           |                             |
|    | 1.9 TDI  | 66   |  | 01.96  | 04.06   | 24.0110-0223.1   | 410223   |  | 268 10,0 8,0 +S +B          |                             |
|  | 1.9 TDI  | 81   |  | 10.97  | 03.00   | 24.0310-0223.1   | 510223   |  | 268 10,0 8,0 +S +B PD       |                             |
|  | 1.9 TDI  | 85   |  | 04.00  | 04.06   |  |  |  |                             |                             |
|  | 1.9 TDI  | 96   |  | 02.03  | 04.06   |  |  |  |                             |                             |
|  | 1.9 TDI  | 110  |  | 05.05  | 04.06   |  |  |  |                             |                             |
|  | 2.0 i  |  |  | 09.95  | 04.06   |  |  |  |                             |                             |
|  | 2.3 i 16V  |  |  | 01.97  | 04.06   |  |  |  |                             |                             |
|  | 2.8 i V6   | 128  |  | 09.95  | 03.00   |  |  |  |                             |                             |
|  | 2.8 i V6   | 150  |  | 04.00  | 04.06   | 24.0113-0194.1   | 413194   |  | 294 13,5 11,5 +B            |                             |
|  | 2.8 i V6   | 150  |  | 04.00  | 04.06   | 24.0713-1102.3   | 360144   | 2  | Radsensor L=1026            |                             |
|   | 1.9 TDI  | 66   |  | 01.96  | 03.00   |  |  |  |                             |                             |
|  | 1.9 TDI  | 81   |  | 10.97  | 03.00   |  |  |  |                             |                             |
|  | 2.0 i  |  |  | 09.95  | 03.00   |  |  |  |                             |                             |
|  | 2.3 i 16V  |  |  | 01.97  | 03.00   |  |  |  |                             |                             |
|  | 2.8 i V6   | 128  |  | 09.95  | 03.00   |  |  |  |                             |                             |
|  | 1.9 TDI  | 66   |  | 04.00  | 10.02   | 24.0713-1124.3   | 360201   | + Leitung f. Warnkontakt 1)  | Radsensor L=1026            |                             |
|  | 1.9 TDI  | 85   |  | 04.00  | 10.02   | 24.0713-1125.3   | 360202   |  |                             |                             |
|  | 2.0 i  |  |  | 04.00  | 10.02   |  |  |  | Radsensor L=1026            |                             |
|  | 2.3 i 16V  |  |  | 04.00  | 10.02   |  |  |  |                             |                             |
|  | 1.9 TDI  | 66   |  | 11.02  | 04.06   | 24.0711-6111.3   | 360243   | 2  | - Leitung f. Warnkontakt 2) | Radsensor L=1031            |
| 1.9 TDI  | 85   |  | 11.02  | 04.06  |   |  |  |  |                             |                             |
| 1.9 TDI  | 96   |  | 02.03  | 04.06  |   |  |  |  |                             |                             |
| 2.0 i  |  |  | 11.02  | 04.06  |   |  |  |  |                             |                             |
| 2.3 i 16V  |  |  | 11.02  | 04.06  |   |  |  |  |                             |                             |
| 1.9 TDI  | 110  |  | 05.05  | 04.06  | 24.0711-6111.3  | 360243   | + Leitung f. Warnkontakt 1)  | Radsensor L=1031   |                             |                             |
|  |  |  |  |  | 24.0711-6113.3  | 360228   |  |  | Radsensor L=1031            |                             |
| 2.8 i V6   | 150  |  | 04.00  | 10.02  | 24.0713-1126.3  | 360203   | 2  | + Leitung f. Warnkontakt 1)  | Radsensor L=1026            |                             |
| 2.8 i V6   | 150  |  | 11.02  | 04.06  | 24.0711-6113.3  | 360228   | 2  | + Leitung f. Warnkontakt 1)  | Radsensor L=1031            |                             |
| <b>FORD GALAXY II (06-)</b>  |  |  |  |  |   |  |  |  |                             |                             |
|  | 1.6 EcoBoost   | 118  |  | 02.11  |   | 13.0460-7228.2   | 607228   |  | 24123 20,3 +                | ATE                         |
|  | 1.6 TDCi   | 85   |  | 02.11  |   | 13.0470-7228.2   | LD7228   |  | 24123 20,3 +                | ATE                         |
|  | 1.8 TDCi   | 74   |  | 04.06  |   |  |  |  |                             |                             |
|  | 1.8 TDCi   | 92   |  | 04.06  |   |  |  |  |                             |                             |
|  | 2.0 Flexifuel  | 107  |  | 05.06  |   |  |  |  |                             |                             |
|  | 2.0 i 16V  | 107  |  | 04.06  |   |  |  |  |                             |                             |
|  | 2.0 TDCi   | 85   |  | 10.07  |   |  |  |  |                             |                             |
|  | 2.0 TDCi   | 96   |  | 04.06  |   |  |  |  |                             |                             |
|  | 2.0 TDCi   | 100  |  | 05.06  |   |  |  |  |                             |                             |
|  | 2.0 TDCi   | 103  |  | 04.06  |   |  |  |  |                             |                             |
|  | 2.0 TDCi   | 120  |  | 03.10  |   |  |  |  |                             |                             |
|  | 2.2 TDCi   | 129  |  | 11.08  |   |  |  |  |                             |                             |
|  | 2.2 TDCi   | 147  |  | 07.10  |   |  |  |  |                             |                             |
|  | 2.3 i 16V  | 118  |  | 07.07  |   |  |  |  |                             |                             |
|  | 2.0 SCTi EcoBoost  | 149  |  | 03.10  |   | 13.0460-7243.2   | 607243   |  | 24142 20,6 +                | ATE                         |
| 2.2 TDCi   | 129  |  | 04.08  | 10.08  | 13.0470-7243.2  | LD7243   |  | 24142 20,6 +   | ATE                         |                             |
|  | 1.6 EcoBoost   | 118  |  | 02.11  |   | 24.0128-0154.1   | 428154   |  | 300 28,0 26,0 V L +S +B     |                             |
|  | 1.6 TDCi   | 85   |  | 02.11  |   | 24.0328-0154.1   | 528154   |  | 300 28,0 26,0 V L +S +B PD  |                             |
|  | 1.8 TDCi   | 74   |  | 04.06  |   |  |  |  |                             |                             |
|  | 1.8 TDCi   | 92   |  | 04.06  |   |  |  |  |                             |                             |
|  | 2.0 Flexifuel  | 107  |  | 05.06  |   |  |  |  |                             |                             |
|  | 2.0 i 16V  | 107  |  | 04.06  |   |  |  |  |                             |                             |
|  | 2.0 TDCi   | 85   |  | 10.07  |   |  |  |  |                             |                             |
|  | 2.0 TDCi   | 96   |  | 04.06  |   |  |  |  |                             |                             |
|  | 2.0 TDCi   | 100  |  | 05.06  |   |  |  |  |                             |                             |
|  | 2.0 TDCi   | 103  |  | 04.06  |   |  |  |  |                             |                             |
| 2.0 TDCi   | 120  |  | 03.10  |  |   |  |  |  |                             |                             |
| 2.2 TDCi   | 129  |  | 11.08  |  |   |  |  |  |                             |                             |

1) + cable f.br.ppad wear indicat. / + cavo p.indic.usura guarn.fr. / + câbl.l'ind.d'usur.garnit.fr. / + cabl.p.indica.desg.guarn.fr.

2) - cable f.br.ppad wear indicat. / - cavo p.indic.usura guarn.fr. / - câbl.l'ind.d'usur.garnit.fr. / - cabl.p.indica.desg.guarn.fr.

|     |     |  |  |  |  |  |  |       |                       |
|--|---|--|--|--|---|--|--|---|-----------------------|
| <b>FORD GALAXY II (06-)</b>  |   |  |  |  |   |  |  |   |                       |
|    | 2.2 TDCi  | 147  |  | 07.10  |   | 24.0128-0154.1   | 428154   | 300 28,0 26,0 V L +S +B   |                       |
|  | 2.3 i 16V   | 118  |  | 07.07  |   | 24.0328-0154.1   | 528154   | 300 28,0 26,0 V L +S +B PD  |                       |
|  | 2.0 SCTi EcoBoost   | 149  |  | 03.10  |   | 24.0128-0162.1   | 428162   | 316 28,0 26,0 V L +S +B   |                       |
|  | 2.2 TDCi  | 129  |  | 04.08  | 10.08   | 24.0328-0162.1   | 528162   | 316 28,0 26,0 V L +S +B PD  |                       |
|    | 1.6 EcoBoost  | 118  |  | 02.11  |   | 24.0711-5123.3   | 360065   | 2    | Radsensor             |
|  | 1.6 TDCi  | 85   |  | 02.11  |   |  |  |   |                       |
|  | 1.8 TDCi  | 74   |  | 04.06  |   |  |  |   |                       |
|  | 1.8 TDCi  | 92   |  | 04.06  |   |  |  |   |                       |
|  | 2.0 Flexifuel   | 107  |  | 05.06  |   |  |  |   |                       |
|  | 2.0 i 16V   | 107  |  | 04.06  |   |  |  |   |                       |
|  | 2.0 SCTi EcoBoost   | 149  |  | 03.10  |   |  |  |   |                       |
|  | 2.0 TDCi  | 85   |  | 10.07  |   |  |  |   |                       |
|  | 2.0 TDCi  | 96   |  | 04.06  |   |  |  |   |                       |
|  | 2.0 TDCi  | 100  |  | 05.06  |   |  |  |   |                       |
|  | 2.0 TDCi  | 103  |  | 04.06  |   |  |  |   |                       |
|  | 2.0 TDCi  | 120  |  | 03.10  |   |  |  |   |                       |
|  | 2.2 TDCi  | 129  |  | 04.08  |   |  |  |   |                       |
|  | 2.2 TDCi  | 147  |  | 07.10  |   |  |  |   |                       |
| 2.3 i 16V  | 118   |  | 07.07  |  |   |  |  |   |                       |
|    | 1.6 EcoBoost  | 118  |  | 02.11  |   | 13.0460-2723.2   | 602723   | + mechanische Feststellbremse 1)  | 24537 16,1 /Zub/S     |
|  | 1.6 TDCi  | 85   |  | 02.11  |   | 13.0470-2723.2   | LD2723   | + mechanische Feststellbremse 1)  | 24537 16,1 /Zub/S     |
|  | 1.8 TDCi  | 74   |  | 04.06  |   | 13.0460-2722.2   | 602722   | + elektrische Feststellbremse 2)  | 24496 17,3 /Zub/S     |
|  | 1.8 TDCi  | 92   |  | 04.06  |   | 13.0470-2722.2   | LD2722   | + elektrische Feststellbremse 2)  | 24496 17,3 /Zub/S     |
|  | 2.0 Flexifuel   | 107  |  | 05.06  |   |  |  |   |                       |
|  | 2.0 i 16V   | 107  |  | 04.06  |   |  |  |   |                       |
|  | 2.0 SCTi EcoBoost   | 149  |  | 03.10  |   |  |  |   |                       |
|  | 2.0 TDCi  | 85   |  | 10.07  |   |  |  |   |                       |
|  | 2.0 TDCi  | 96   |  | 04.06  |   |  |  |   |                       |
|  | 2.0 TDCi  | 100  |  | 05.06  |   |  |  |   |                       |
|  | 2.0 TDCi  | 103  |  | 04.06  |   |  |  |   |                       |
|  | 2.0 TDCi  | 120  |  | 03.10  |   |  |  |   |                       |
|  | 2.2 TDCi  | 129  |  | 04.08  |   |  |  |   |                       |
|  | 2.2 TDCi  | 147  |  | 07.10  |   |  |  |   |                       |
| 2.3 i 16V  | 118   |  | 07.07  |  |   |  |  |   |                       |
|    | 1.6 EcoBoost  | 118  |  | 02.11  |   | 24.0111-0145.1   | 411145   |   | 302 10,9 9,0 +S +B    |
|  | 1.6 TDCi  | 85   |  | 02.11  |   | 24.0311-0145.1   | 511145   |   | 302 10,9 9,0 +B PD    |
|  | 1.8 TDCi  | 74   |  | 04.06  |   |  |  |   |                       |
|  | 1.8 TDCi  | 92   |  | 04.06  |   |  |  |   |                       |
|  | 2.0 Flexifuel   | 107  |  | 05.06  |   |  |  |   |                       |
|  | 2.0 i 16V   | 107  |  | 04.06  |   |  |  |   |                       |
|  | 2.0 SCTi EcoBoost   | 149  |  | 03.10  |   |  |  |   |                       |
|  | 2.0 TDCi  | 85   |  | 10.07  |   |  |  |   |                       |
|  | 2.0 TDCi  | 96   |  | 04.06  |   |  |  |   |                       |
|  | 2.0 TDCi  | 100  |  | 05.06  |   |  |  |   |                       |
|  | 2.0 TDCi  | 103  |  | 04.06  |   |  |  |   |                       |
|  | 2.0 TDCi  | 120  |  | 03.10  |   |  |  |   |                       |
|  | 2.2 TDCi  | 129  |  | 04.08  |   |  |  |   |                       |
|  | 2.2 TDCi  | 147  |  | 07.10  |   |  |  |   |                       |
| 2.3 i 16V  | 118   |  | 07.07  |  |   |  |  |   |                       |
|  | 1.6 EcoBoost  | 118  |  | 02.11  |   | 24.0711-6220.3   | 360256   | 2  | Radsensor             |
|  | 1.6 TDCi  | 85   |  | 02.11  |   |  |  |   |                       |
|  | 1.8 TDCi  | 74   |  | 04.06  |   |  |  |   |                       |
|  | 1.8 TDCi  | 92   |  | 04.06  |   |  |  |   |                       |
|  | 2.0 Flexifuel   | 107  |  | 05.06  |   |  |  |   |                       |
|  | 2.0 i 16V   | 107  |  | 04.06  |   |  |  |   |                       |
|  | 2.0 SCTi EcoBoost   | 149  |  | 03.10  |   |  |  |   |                       |
|  | 2.0 TDCi  | 85   |  | 10.07  |   |  |  |   |                       |
|  | 2.0 TDCi  | 96   |  | 04.06  |   |  |  |   |                       |
|  | 2.0 TDCi  | 100  |  | 05.06  |   |  |  |   |                       |
|  | 2.0 TDCi  | 103  |  | 04.06  |   |  |  |   |                       |
|  | 2.0 TDCi  | 120  |  | 03.10  |   |  |  |   |                       |
|  | 2.2 TDCi  | 129  |  | 04.08  |   |  |  |   |                       |
|  | 2.2 TDCi  | 147  |  | 07.10  |   |  |  |   |                       |
| 2.3 i 16V  | 118   |  | 07.07  |  |   |  |  |   |                       |
| <b>FORD KA I (96-08)</b>   |   |  |  |  |   |  |  |   |                       |
|  | 1.0 i   |  |  | 11.96  | 01.00   | 13.0460-7073.2   | 607073   |   | 21202 16,9 +          |
|  | 1.3 i   |  |  | 11.96  | 01.00   |  |  |   | ATE                   |
|  | 1.0 i   |  |  | 02.00  | 12.08   | 13.0460-7148.2   | 607148   |   | 23200 18,0 +          |
|  | 1.3 i   |  |  | 02.00  | 12.08   |  |  |   | ATE                   |
|  | 1.6   | 70   |  | 09.00  | 12.08   | 13.0460-7142.2   | 607142   |   | 23604 18,3 +          |
|  | 1.6 i   |  |  | 08.03  | 12.08   |  |  |   | ATE                   |
|  | 1.0 i   |  |  | 11.96  | 01.00   | 24.0112-0141.1   | 412141   |   | 239 12,0 10,0 +B      |
|  | 1.3 i   |  |  | 11.96  | 01.00   | 24.0312-0141.1   | 512141   |   | 239 12,0 10,0 +B PD   |
|  | 1.0 i   |  |  | 02.00  | 12.08   | 24.0120-0147.1   | 420147   |   | 240 20,0 18,0 V +B    |
|  | 1.3 i   |  |  | 02.00  | 12.08   | 24.0320-0147.1   | 520147   |   | 240 20,0 18,0 V +B PD |
|  | 1.6   | 70   |  | 09.00  | 12.08   | 24.0122-0172.1   | 422172   |   | 258 22,0 20,0 V +B    |
|  | 1.6 i   |  |  | 08.03  | 12.08   | 24.0322-0172.1   | 522172   |   | 258 22,0 20,0 V +B PD |
|  | 1.0 i   |  |  | 11.96  | 08.04   | 24.0711-1369.1   | 360026   | 2  | Radsensor L=795       |
|  | 1.3 i   |  |  | 11.96  | 08.04   |  |  |   |                       |
|  | 1.6   | 70   |  | 09.00  | 08.04   |  |  |   |                       |
|  | 1.6 i   |  |  | 08.03  | 08.04   |  |  |   |                       |
|  | 1.0 i   |  |  | 09.04  | 12.08   | 24.0711-6166.3   | 360139   | 2  | Radsensor L=793       |
|  | 1.3 i   |  |  | 09.04  | 12.08   |  |  |   |                       |
|  | 1.6   | 70   |  | 09.04  | 12.08   |  |  |   |                       |
|  |  |  |  |  |   |  |  |   |                       |

1) + mechanical parking brake / + fr. stazionamento meccanico / + frein à main mécanique / + freno de mano mecánica

2) + electric parking brake / + freno a mano elettrico / + frein à main électrique / + freno de mano eléctrico



| FORD KA I (96-08) |       |    |  |       |       |  |                |        |                    |                         |
|-------------------|-------|----|--|-------|-------|--|----------------|--------|--------------------|-------------------------|
|                   | 1.6 i |    |  | 09.04 | 12.08 |  | 24.0711-6166.3 | 360139 | 2                  | Radsensor L=793         |
|                   | 1.0 i |    |  | 11.96 | 08.04 |  | 24.0751-1199.3 | 360053 | 1                  | Radsensor L=650/1540    |
|                   | 1.3 i |    |  | 11.96 | 08.04 |  |                |        |                    |                         |
|                   | 1.6   | 70 |  | 09.00 | 08.04 |  | 24.0751-1158.3 | 360098 | 1                  | Radsensor L=660/1575    |
|                   | 1.6 i |    |  | 08.03 | 08.04 |  |                |        |                    |                         |
|                   | 1.0 i |    |  | 09.04 | 12.08 |  | 24.0711-6179.3 | 360140 | 1                  | Radsensor L=660/1586    |
|                   | 1.3 i |    |  | 09.04 | 12.08 |  |                |        |                    |                         |
|                   | 1.6   | 70 |  | 09.04 | 12.08 |  |                |        |                    |                         |
|                   | 1.6 i |    |  | 09.04 | 12.08 |  |                |        |                    |                         |
|                   | 1.0 i |    |  | 11.96 | 01.00 |  | 03.0137-0337.2 | 650337 |                    | 180 x 32 HEB TRW        |
|                   | 1.3 i |    |  | 11.96 | 01.00 |  | 03.0137-9217.2 | 669217 |                    | Bremsbacken-Zubehör TRW |
|                   | 1.0 i |    |  | 02.00 | 12.08 |  | 03.0137-0412.2 | 650412 |                    | 180 x 32 HEB AP         |
|                   | 1.3 i |    |  | 02.00 | 12.08 |  | 03.0137-9179.2 | 669179 |                    | Bremsbacken-Zubehör AP  |
|                   | 1.6   | 70 |  | 09.00 | 12.08 |  | 03.0137-0394.2 | 650394 |                    | 203 x 38 HEB            |
|                   | 1.6 i |    |  | 08.03 | 12.08 |  | 03.0137-9259.2 | 669259 |                    | Bremsbacken-Zubehör     |
|                   | 1.0 i |    |  | 11.96 | 12.08 |  | 24.0218-0024.2 | 480079 |                    | 180/181 x 44 - Lager    |
|                   | 1.3 i |    |  | 11.96 | 12.08 |  | 24.0218-0724.2 | 480206 |                    | 180/181 x 44 + Lager    |
|                   | 1.6   | 70 |  | 09.00 | 12.08 |  | 24.0220-3009.2 | 480080 | ohne Sensorring 1) | 203/204 x 49            |
|                   | 1.6 i |    |  | 08.03 | 12.08 |  |                |        |                    |                         |
|                   | 1.0 i |    |  | 11.96 | 01.00 |  | 03.0520-5519.3 | 695519 |                    | 19,05/180x32 TopKit TRW |
|                   | 1.3 i |    |  | 11.96 | 01.00 |  |                |        |                    |                         |
|                   | 1.0 i |    |  | 02.00 | 12.08 |  | 03.0520-6219.3 | 696219 |                    | 19,05/180x32 TopKit AP  |
|                   | 1.3 i |    |  | 02.00 | 12.08 |  |                |        |                    |                         |
|                   | 1.6   | 70 |  | 09.00 | 12.08 |  | 03.0520-6319.3 | 696319 |                    | 19,05/203x38 TopKit AP  |
|                   | 1.6 i |    |  | 08.03 | 12.08 |  |                |        |                    |                         |

| FORD KA II (08-) |           |    |  |       |       |  |                |        |   |                          |
|------------------|-----------|----|--|-------|-------|--|----------------|--------|---|--------------------------|
|                  | 1.2 i 16V | 51 |  | 10.08 |       |  | 13.0460-3838.2 | 603838 |   | 21436 17,0 /WK/Zub BOS   |
|                  | 1.3 TDCi  | 55 |  | 10.08 |       |  | 13.0470-3838.2 | LD3838 |   | 21436 17,0 /WK/Zub BOS   |
|                  | 1.2 i 16V | 51 |  | 10.08 |       |  | 13.0460-3846.2 | 603846 |   | 24072 17,9 +/WK/Zub/SBOS |
|                  | 1.3 TDCi  | 55 |  | 10.08 |       |  | 13.0470-3846.2 | LD3846 |   | 24072 17,9 +/WK/Zub/SBOS |
|                  | 1.2 i 16V | 51 |  | 10.08 |       |  | 24.0111-0119.1 | 411119 |   | 241 11,0 9,2 +B          |
|                  | 1.3 TDCi  | 55 |  | 10.08 |       |  | 24.0120-0184.1 | 420184 |   | 241 20,0 18,2 V +B       |
|                  | 1.2 i 16V | 51 |  | 10.08 |       |  | 24.0711-5221.3 | 360242 | 2 | Radsensor L=1080         |
|                  | 1.3 TDCi  | 55 |  | 10.08 |       |  |                |        |   |                          |
|                  | 1.2 i 16V | 51 |  | 10.08 |       |  | 24.0711-5220.3 | 360274 | 2 | Radsensor L=706          |
|                  | 1.3 TDCi  | 55 |  | 10.08 |       |  |                |        |   |                          |
|                  | 1.2 i 16V | 51 |  | 10.08 | 05.10 |  | 03.0137-0462.2 | 650462 |   | 180 x 32 HEB BDX         |
|                  | 1.3 TDCi  | 55 |  | 10.08 | 05.10 |  | 03.0137-9303.2 | 669303 |   | Bremsbacken-Zubehör BDX  |
|                  | 1.2 i 16V | 51 |  | 06.10 |       |  | 03.0137-0506.2 | 650506 |   | 180 x 32 HEB AP          |
|                  | 1.3 TDCi  | 55 |  | 06.10 |       |  | 03.0137-9247.2 | 669247 |   | Bremsbacken-Zubehör AP   |
|                  | 1.2 i 16V | 51 |  | 10.08 |       |  | 24.0218-0011.1 | 480006 |   | 180/181,4 x 40           |
|                  | 1.3 TDCi  | 55 |  | 10.08 |       |  |                |        |   |                          |
|                  | 1.2 i 16V | 51 |  | 10.08 | 05.10 |  | 03.0520-8220.3 | 698220 |   | 20,64/180x32 TopKit BDX  |
|                  | 1.3 TDCi  | 55 |  | 10.08 | 05.10 |  |                |        |   |                          |

| FORD KUGA I (08-12) |              |     |  |       |       |  |                |        |   |                         |
|---------------------|--------------|-----|--|-------|-------|--|----------------|--------|---|-------------------------|
|                     | 2.0 TDCi     | 100 |  | 04.08 | 12.12 |  | 13.0460-7193.2 | 607193 |   | 23723 18,1 + ATE        |
|                     | 2.0 TDCi     | 103 |  | 03.10 | 12.12 |  | 13.0470-7193.2 | LD7193 |   | 23723 18,1 + ATE        |
|                     | 2.0 TDCi 4x4 | 100 |  | 04.08 | 12.12 |  |                |        |   |                         |
|                     | 2.0 TDCi 4x4 | 103 |  | 03.10 | 12.12 |  |                |        |   |                         |
|                     | 2.0 TDCi 4x4 | 120 |  | 03.10 | 12.12 |  |                |        |   |                         |
|                     | 2.5 i        | 147 |  | 03.09 | 12.12 |  |                |        |   |                         |
|                     | 2.5 i 4x4    | 147 |  | 11.08 | 12.12 |  |                |        |   |                         |
|                     | 2.0 TDCi     | 100 |  | 04.08 | 12.12 |  | 24.0125-0162.1 | 425162 |   | 300 25,0 23,0 V L +B    |
|                     | 2.0 TDCi     | 103 |  | 03.10 | 12.12 |  | 24.0325-0162.1 | 525162 |   | 300 25,0 23,0 V L +B PD |
|                     | 2.0 TDCi 4x4 | 100 |  | 04.08 | 12.12 |  |                |        |   |                         |
|                     | 2.0 TDCi 4x4 | 103 |  | 03.10 | 12.12 |  |                |        |   |                         |
|                     | 2.0 TDCi 4x4 | 120 |  | 03.10 | 12.12 |  |                |        |   |                         |
|                     | 2.5 i        | 147 |  | 03.09 | 12.12 |  |                |        |   |                         |
|                     | 2.5 i 4x4    | 147 |  | 11.08 | 12.12 |  |                |        |   |                         |
|                     | 2.0 TDCi     | 100 |  | 04.08 | 11.10 |  | 24.0711-5123.3 | 360065 | 2 | Radsensor               |
|                     | 2.0 TDCi     | 103 |  | 03.10 | 11.10 |  |                |        |   |                         |
|                     | 2.0 TDCi 4x4 | 100 |  | 04.08 | 11.10 |  |                |        |   |                         |
|                     | 2.0 TDCi 4x4 | 103 |  | 03.10 | 11.10 |  |                |        |   |                         |
|                     | 2.0 TDCi 4x4 | 120 |  | 03.10 | 11.10 |  |                |        |   |                         |
|                     | 2.5 i        | 147 |  | 03.09 | 11.10 |  |                |        |   |                         |
|                     | 2.5 i 4x4    | 147 |  | 11.08 | 11.10 |  |                |        |   |                         |
|                     | 2.0 TDCi     | 100 |  | 12.10 | 12.12 |  | 24.0711-5357.3 | 360354 | 2 | Radsensor               |
|                     | 2.0 TDCi     | 103 |  | 12.10 | 12.12 |  |                |        |   |                         |
|                     | 2.0 TDCi 4x4 | 100 |  | 12.10 | 12.12 |  |                |        |   |                         |
|                     | 2.0 TDCi 4x4 | 103 |  | 12.10 | 12.12 |  |                |        |   |                         |
|                     | 2.0 TDCi 4x4 | 120 |  | 12.10 | 12.12 |  |                |        |   |                         |
|                     | 2.5 i        | 147 |  | 12.10 | 12.12 |  |                |        |   |                         |
|                     | 2.5 i 4x4    | 147 |  | 12.10 | 12.12 |  |                |        |   |                         |

1) without sensor ring / senza sensori / sans secours ABS / sin anillo sensor ABS



### FORD KUGA I (08-12)

|              |              |     |       |       |                |                |        |                   |                    |                    |
|--------------|--------------|-----|-------|-------|----------------|----------------|--------|-------------------|--------------------|--------------------|
|              | 2.0 TDCi     | 100 |       | 04.08 | 12.12          | 13.0460-2723.2 | 602723 |                   | 24537 16,1 /Zub/S  | TRW                |
|              | 2.0 TDCi     | 103 |       | 03.10 | 12.12          |                |        |                   |                    |                    |
|              | 2.0 TDCi 4x4 | 100 |       | 04.08 | 12.12          |                |        |                   |                    |                    |
|              | 2.0 TDCi 4x4 | 103 |       | 03.10 | 12.12          |                |        |                   |                    |                    |
|              | 2.0 TDCi 4x4 | 120 |       | 03.10 | 12.12          |                |        |                   |                    |                    |
|              | 2.5 i        | 147 |       | 03.09 | 12.12          |                |        |                   |                    |                    |
| 2.5 i 4x4    | 147          |     | 11.08 | 12.12 |                |                |        | 24537 16,1 /Zub/S | TRW                |                    |
|              | 2.0 TDCi     | 100 |       | 04.08 | 12.12          | 24.0111-0145.1 | 411145 |                   | 302 10,9 9,0 +S +B | 302 10,9 9,0 +B PD |
|              | 2.0 TDCi     | 103 |       | 03.10 | 12.12          |                |        |                   |                    |                    |
|              | 2.0 TDCi 4x4 | 100 |       | 04.08 | 12.12          |                |        |                   |                    |                    |
|              | 2.0 TDCi 4x4 | 103 |       | 03.10 | 12.12          |                |        |                   |                    |                    |
|              | 2.0 TDCi 4x4 | 120 |       | 03.10 | 12.12          |                |        |                   |                    |                    |
|              | 2.5 i        | 147 |       | 03.09 | 12.12          |                |        |                   |                    |                    |
| 2.5 i 4x4    | 147          |     | 11.08 | 12.12 |                |                |        |                   |                    |                    |
|              | 2.0 TDCi     | 100 |       | 04.08 | 12.12          | 24.0711-6220.3 | 360256 | 2                 |                    | Radsensor          |
|              | 2.0 TDCi     | 103 |       | 03.10 | 12.12          |                |        |                   |                    |                    |
|              | 2.5 i        | 147 |       | 03.09 | 12.12          |                |        |                   |                    |                    |
|              | 2.0 TDCi 4x4 | 100 |       | 04.08 | 12.12          |                |        |                   |                    |                    |
| 2.0 TDCi 4x4 | 103          |     | 03.10 | 12.12 | 24.0711-6144.3 | 360137         | 2      |                   | Radsensor          |                    |
| 2.0 TDCi 4x4 | 103          |     | 03.10 | 12.12 |                |                |        |                   |                    |                    |
| 2.0 TDCi 4x4 | 120          |     | 03.10 | 12.12 |                |                |        |                   |                    |                    |
| 2.5 i 4x4    | 147          |     | 11.08 | 12.12 |                |                |        |                   |                    |                    |

### FORD KUGA II (13-)

























|                  |                  |     |       |       |       |                |        |   |                      |                         |                |        |   |                      |           |
|------------------|------------------|-----|-------|-------|-------|----------------|--------|---|----------------------|-------------------------|----------------|--------|---|----------------------|-----------|
|                  | 1.5 EcoBoost     | 88  |       | 01.16 |       | 13.0460-7193.2 | 607193 |   | 23723 18,1 +         | ATE                     |                |        |   |                      |           |
|                  | 1.5 EcoBoost     | 110 |       | 09.14 |       |                |        |   |                      |                         |                |        |   |                      |           |
|                  | 1.6 EcoBoost     | 110 |       | 01.13 |       |                |        |   |                      |                         |                |        |   |                      |           |
|                  | 2.5              | 110 |       | 01.14 |       |                |        |   |                      |                         |                |        |   |                      |           |
|                  | 1.5 EcoBoost     | 88  |       | 01.16 |       | 24.0125-0162.1 | 425162 |   | 300 25,0 23,0 V L +B | 300 25,0 23,0 V L +B PD |                |        |   |                      |           |
|                  | 1.5 EcoBoost     | 110 |       | 09.14 |       |                |        |   |                      |                         |                |        |   |                      |           |
|                  | 1.6 EcoBoost     | 110 |       | 01.13 |       |                |        |   |                      |                         |                |        |   |                      |           |
|                  | 1.6 EcoBoost 4x4 | 110 |       | 01.13 |       |                |        |   |                      |                         |                |        |   |                      |           |
|                  | 2.5              | 110 |       | 01.14 |       |                |        |   |                      |                         |                |        |   |                      |           |
|                  | 1.6 EcoBoost 4x4 | 134 |       | 01.13 | 09.14 |                |        |   |                      |                         | 24.0125-0209.1 | 425209 |   | 320 25,0 23,0 V L +B |           |
| 2.0 TDCi         | 85               |     | 03.13 | 09.14 |       |                |        |   |                      |                         |                |        |   |                      |           |
| 2.0 TDCi         | 103              |     | 01.13 | 09.14 |       |                |        |   |                      |                         |                |        |   |                      |           |
| 2.0 TDCi 4x4     | 103              |     | 03.13 | 09.14 |       |                |        |   |                      |                         |                |        |   |                      |           |
| 2.0 TDCi 4x4     | 120              |     | 01.13 | 09.14 |       |                |        |   |                      |                         |                |        |   |                      |           |
| 2.0 TDCi 4x4     | 120              |     | 01.13 | 09.14 |       |                |        |   |                      |                         |                |        |   |                      |           |
|                  | 1.5 EcoBoost 4x4 | 134 |       | 09.14 |       | 24.0125-0209.1 | 425209 | 2 |                      | 320 25,0 23,0 V L +B    |                |        |   |                      |           |
|                  | 1.6 EcoBoost 4x4 | 134 |       | 10.14 |       |                |        |   |                      |                         |                |        |   |                      |           |
|                  | 2.0 TDCi         | 85  |       | 10.14 |       |                |        |   |                      |                         |                |        |   |                      |           |
|                  | 2.0 TDCi         | 88  |       | 09.14 |       |                |        |   |                      |                         |                |        |   |                      |           |
|                  | 2.0 TDCi         | 103 |       | 10.14 |       |                |        |   |                      |                         |                |        |   |                      |           |
|                  | 2.0 TDCi         | 110 |       | 09.14 |       |                |        |   |                      |                         |                |        |   |                      |           |
|                  | 2.0 TDCi 4x4     | 103 |       | 10.14 |       |                |        |   |                      |                         |                |        |   |                      |           |
|                  | 2.0 TDCi 4x4     | 110 |       | 09.14 |       |                |        |   |                      |                         |                |        |   |                      |           |
|                  | 2.0 TDCi 4x4     | 120 |       | 10.14 |       |                |        |   |                      |                         |                |        |   |                      |           |
|                  | 2.0 TDCi 4x4     | 132 |       | 09.14 |       |                |        |   |                      |                         |                |        |   |                      |           |
|                  | 1.5 EcoBoost     | 88  |       | 01.16 |       |                |        |   |                      |                         | 24.0711-5357.3 | 360354 | 2 |                      | Radsensor |
|                  | 1.5 EcoBoost     | 110 |       | 09.14 |       |                |        |   |                      |                         |                |        |   |                      |           |
|                  | 1.5 EcoBoost 4x4 | 134 |       | 09.14 |       |                |        |   |                      |                         |                |        |   |                      |           |
|                  | 1.6 EcoBoost     | 110 |       | 01.13 |       |                |        |   |                      |                         |                |        |   |                      |           |
| 1.6 EcoBoost 4x4 | 110              |     | 01.13 |       |       |                |        |   |                      |                         |                |        |   |                      |           |
| 1.6 EcoBoost 4x4 | 134              |     | 01.13 |       |       |                |        |   |                      |                         |                |        |   |                      |           |
| 2.0 TDCi         | 85               |     | 03.13 |       |       |                |        |   |                      |                         |                |        |   |                      |           |
| 2.0 TDCi         | 88               |     | 09.14 |       |       |                |        |   |                      |                         |                |        |   |                      |           |
| 2.0 TDCi         | 103              |     | 01.13 |       |       |                |        |   |                      |                         |                |        |   |                      |           |
| 2.0 TDCi         | 110              |     | 09.14 |       |       |                |        |   |                      |                         |                |        |   |                      |           |
| 2.0 TDCi 4x4     | 103              |     | 03.13 |       |       |                |        |   |                      |                         |                |        |   |                      |           |
| 2.0 TDCi 4x4     | 110              |     | 09.14 |       |       |                |        |   |                      |                         |                |        |   |                      |           |
| 2.0 TDCi 4x4     | 120              |     | 01.13 |       |       |                |        |   |                      |                         |                |        |   |                      |           |
| 2.0 TDCi 4x4     | 132              |     | 09.14 |       |       |                |        |   |                      |                         |                |        |   |                      |           |
| 2.5              | 110              |     | 01.14 |       |       |                |        |   |                      |                         |                |        |   |                      |           |
|                  | 1.5 EcoBoost     | 88  |       | 01.16 |       | 13.0460-7195.2 | 607195 |   | 23482 16,6 +         | ATE                     |                |        |   |                      |           |
|                  | 1.5 EcoBoost     | 110 |       | 09.14 |       |                |        |   |                      |                         |                |        |   |                      |           |
|                  | 1.5 EcoBoost 4x4 | 134 |       | 09.14 |       |                |        |   |                      |                         |                |        |   |                      |           |
|                  | 1.6 EcoBoost     | 110 |       | 01.13 |       |                |        |   |                      |                         |                |        |   |                      |           |
|                  | 1.6 EcoBoost 4x4 | 110 |       | 01.13 |       |                |        |   |                      |                         |                |        |   |                      |           |
|                  | 1.6 EcoBoost 4x4 | 134 |       | 01.13 |       |                |        |   |                      |                         |                |        |   |                      |           |
|                  | 2.0 TDCi         | 85  |       | 03.13 |       |                |        |   |                      |                         |                |        |   |                      |           |
|                  | 2.0 TDCi         | 88  |       | 09.14 |       |                |        |   |                      |                         |                |        |   |                      |           |
|                  | 2.0 TDCi         | 103 |       | 01.13 |       |                |        |   |                      |                         |                |        |   |                      |           |
|                  | 2.0 TDCi         | 110 |       | 09.14 |       |                |        |   |                      |                         |                |        |   |                      |           |
|                  | 2.0 TDCi 4x4     | 103 |       | 03.13 |       |                |        |   |                      |                         |                |        |   |                      |           |
|                  | 2.0 TDCi 4x4     | 110 |       | 09.14 |       |                |        |   |                      |                         |                |        |   |                      |           |
|                  | 2.0 TDCi 4x4     | 120 |       | 01.13 |       |                |        |   |                      |                         |                |        |   |                      |           |
|                  | 2.0 TDCi 4x4     | 132 |       | 09.14 |       |                |        |   |                      |                         |                |        |   |                      |           |
| 2.5              | 110              |     | 01.14 |       |       |                |        |   |                      |                         |                |        |   |                      |           |
|                  | 1.5 EcoBoost     | 88  |       | 01.16 |       | 24.0111-0172.1 | 411172 |   | 280 11,0 9,0 +B      |                         |                |        |   |                      |           |
|                  | 1.5 EcoBoost     | 110 |       | 09.14 |       |                |        |   |                      |                         |                |        |   |                      |           |
|                  | 1.5 EcoBoost 4x4 | 134 |       | 09.14 |       |                |        |   |                      |                         |                |        |   |                      |           |
|                  | 1.6 EcoBoost     | 110 |       | 01.13 |       |                |        |   |                      |                         |                |        |   |                      |           |
|                  | 1.6 EcoBoost 4x4 | 110 |       | 01.13 |       |                |        |   |                      |                         |                |        |   |                      |           |
|                  | 1.6 EcoBoost 4x4 | 134 |       | 01.13 |       |                |        |   |                      |                         |                |        |   |                      |           |
|                  | 2.0 TDCi         | 85  |       | 03.13 |       |                |        |   |                      |                         |                |        |   |                      |           |
|                  | 2.0 TDCi         | 88  |       | 09.14 |       |                |        |   |                      |                         |                |        |   |                      |           |
|                  | 2.0 TDCi         | 103 |       | 01.13 |       |                |        |   |                      |                         |                |        |   |                      |           |
|                  | 2.0 TDCi         | 103 |       | 01.13 |       |                |        |   |                      |                         |                |        |   |                      |           |



| FORD KUGA II (13-)     |                  |     |  |       |   |                |        |   |                               |                       |
|------------------------|------------------|-----|--|-------|---|----------------|--------|---|-------------------------------|-----------------------|
|                        | 2.0 TDCi         | 110 |  | 09.14 |   | 24.0111-0172.1 | 411172 |   |                               | 280 11,0 9,0 +B       |
|                        | 2.0 TDCi 4x4     | 103 |  | 03.13 |   |                |        |   |                               |                       |
|                        | 2.0 TDCi 4x4     | 110 |  | 09.14 |   |                |        |   |                               |                       |
|                        | 2.0 TDCi 4x4     | 120 |  | 01.13 |   |                |        |   |                               |                       |
|                        | 2.0 TDCi 4x4     | 132 |  | 09.14 |   |                |        |   |                               |                       |
|                        | 2.5              | 110 |  | 01.14 |   |                |        |   |                               |                       |
|                        | 1.5 EcoBoost     | 88  |  | 01.16 |   | 24.0711-6296.3 | 360357 | 2 | - Parkassistent <sup>1)</sup> | Radsensor             |
|                        | 1.5 EcoBoost     | 110 |  | 09.14 |   | 24.0711-6351.3 | 360358 | 2 | + Parkassistent <sup>2)</sup> | Radsensor             |
|                        | 1.5 EcoBoost 4x4 | 134 |  | 09.14 |   |                |        |   |                               |                       |
|                        | 1.6 EcoBoost     | 110 |  | 01.13 |   |                |        |   |                               |                       |
|                        | 1.6 EcoBoost 4x4 | 110 |  | 01.13 |   |                |        |   |                               |                       |
|                        | 1.6 EcoBoost 4x4 | 134 |  | 01.13 |   |                |        |   |                               |                       |
|                        | 2.0 TDCi         | 85  |  | 03.13 |   |                |        |   |                               |                       |
|                        | 2.0 TDCi         | 88  |  | 09.14 |   |                |        |   |                               |                       |
|                        | 2.0 TDCi         | 103 |  | 01.13 |   |                |        |   |                               |                       |
|                        | 2.0 TDCi         | 110 |  | 09.14 |   |                |        |   |                               |                       |
|                        | 2.0 TDCi 4x4     | 103 |  | 03.13 |   |                |        |   |                               |                       |
|                        | 2.0 TDCi 4x4     | 110 |  | 09.14 |   |                |        |   |                               |                       |
|                        | 2.0 TDCi 4x4     | 120 |  | 01.13 |   |                |        |   |                               |                       |
|                        | 2.0 TDCi 4x4     | 132 |  | 09.14 |   |                |        |   |                               |                       |
| FORD MAVERICK (97-98)  |                  |     |  |       |   |                |        |   |                               |                       |
|                        | 2.4 i            |     |  | 10.96 | 03.98                                   | 13.0460-5959.2 | 605959 |   |                               | 21481 15,5 TRW        |
|                        | 2.7 TD           |     |  | 10.96 | 03.98                                   |                |        |   |                               |                       |
|                        | 2.4 i            |     |  | 10.96 | 03.98                                   | 24.0126-0109.1 | 426109 |   |                               | 277 26,0 24,0 V +B    |
|                        | 2.7 TD           |     |  | 10.96 | 03.98                                   |                |        |   |                               |                       |
|                        | 2.4 i            |     |  | 10.96 | 03.98                                   | 03.0137-0376.2 | 650376 |   |                               | 254 x 58 HEB          |
|                        | 2.7 TD           |     |  | 10.96 | 03.98                                   | 03.0137-9169.2 | 669169 |   |                               | Bremsbacken-Zubehör   |
|                        | 2.4 i            |     |  | 10.96 | 03.98                                   | 24.0225-4014.1 | 480155 |   |                               | 254/255,5 x 65        |
|                        | 2.7 TD           |     |  | 10.96 | 03.98                                   |                |        |   |                               |                       |
| FORD MAVERICK (01-07)  |                  |     |  |       |   |                |        |   |                               |                       |
|                        | 2.0 i 16V        | 91  |  | 02.01 | 06.07 + HA-Trommelbremse <sup>3)</sup>  | 13.0460-7205.2 | 607205 |   |                               | 23787 19,0 + ATE      |
|                        | 2.3 i 16V        | 110 |  | 03.04 | 06.07 + HA-Trommelbremse <sup>3)</sup>  |                |        |   |                               |                       |
|                        | 3.0 i 24V        | 149 |  | 03.04 | 06.07 + HA-Trommelbremse <sup>3)</sup>  |                |        |   |                               |                       |
|                        | 3.0 i V6         | 145 |  | 02.01 | 06.07 + HA-Trommelbremse <sup>3)</sup>  |                |        |   |                               |                       |
|                        | 2.0 i 16V        | 91  |  | 02.01 | 06.07 + HA-Scheibenbremse <sup>4)</sup> | 13.0460-7234.2 | 607234 |   |                               | 24438 16,1 + ATE      |
|                        | 2.3 i 16V        | 110 |  | 03.04 | 06.07 + HA-Scheibenbremse <sup>4)</sup> |                |        |   |                               |                       |
|                        | 3.0 i 24V        | 149 |  | 03.04 | 06.07 + HA-Scheibenbremse <sup>4)</sup> |                |        |   |                               |                       |
|                        | 3.0 i V6         | 145 |  | 02.01 | 06.07 + HA-Scheibenbremse <sup>4)</sup> |                |        |   |                               |                       |
|                        | 2.0 i 16V        | 91  |  | 02.01 | 06.07 + HA-Trommelbremse <sup>3)</sup>  | 24.0124-0735.1 | 424735 |   |                               | 278 24,0 22,0 V +B    |
|                        | 2.3 i 16V        | 110 |  | 03.04 | 06.07 + HA-Trommelbremse <sup>3)</sup>  |                |        |   |                               |                       |
|                        | 3.0 i 24V        | 149 |  | 03.04 | 06.07 + HA-Trommelbremse <sup>3)</sup>  |                |        |   |                               |                       |
|                        | 3.0 i V6         | 145 |  | 02.01 | 06.07 + HA-Trommelbremse <sup>3)</sup>  |                |        |   |                               |                       |
|                        | 2.0 i 16V        | 91  |  | 02.01 | 06.07 + HA-Scheibenbremse <sup>4)</sup> | 24.0126-0151.1 | 426151 |   |                               | 303 26,0 24,0 V +B    |
|                        | 2.3 i 16V        | 110 |  | 03.04 | 06.07 + HA-Scheibenbremse <sup>4)</sup> |                |        |   |                               |                       |
|                        | 3.0 i 24V        | 149 |  | 03.04 | 06.07 + HA-Scheibenbremse <sup>4)</sup> |                |        |   |                               |                       |
|                        | 3.0 i V6         | 145 |  | 02.01 | 06.07 + HA-Scheibenbremse <sup>4)</sup> |                |        |   |                               |                       |
|                        | 2.0 i 16V        | 91  |  | 02.01 | 06.07                                   | 13.0460-7235.2 | 607235 |   |                               | 24670 18,0 + ATE      |
|                        | 2.3 i 16V        | 110 |  | 03.04 | 06.07                                   |                |        |   |                               |                       |
|                        | 3.0 i 24V        | 149 |  | 03.04 | 06.07                                   |                |        |   |                               |                       |
|                        | 3.0 i V6         | 145 |  | 02.01 | 06.07                                   |                |        |   |                               |                       |
|                        | 2.0 i 16V        | 91  |  | 02.01 | 06.07                                   | 24.0112-0181.1 | 412181 |   |                               | 302 12,0 11,0 +B      |
|                        | 2.3 i 16V        | 110 |  | 03.04 | 06.07                                   |                |        |   |                               |                       |
|                        | 3.0 i 24V        | 149 |  | 03.04 | 06.07                                   |                |        |   |                               |                       |
|                        | 3.0 i V6         | 145 |  | 02.01 | 06.07                                   |                |        |   |                               |                       |
|                        | 2.0 i 16V        | 91  |  | 02.01 | 06.07                                   | 03.0137-0416.2 | 650416 |   |                               | 229 x 43              |
|                        | 2.3 i 16V        | 110 |  | 03.04 | 06.07                                   | 03.0137-9262.2 | 669262 |   |                               | Bremsbacken-Zubehör   |
|                        | 3.0 i 24V        | 149 |  | 03.04 | 06.07                                   |                |        |   |                               |                       |
|                        | 3.0 i V6         | 145 |  | 02.01 | 06.07                                   |                |        |   |                               |                       |
| FORD MONDEO II (96-00) |                  |     |  |       |   |                |        |   |                               |                       |
|                        | 1.6 i 16V        |     |  | 10.96 | 09.00                                   | 13.0460-7057.2 | 607057 |   |                               | 21394 17,5 + ATE      |
|                        | 1.8 i 16V        |     |  | 10.96 | 09.00                                   | 13.0460-7056.2 | 607056 |   |                               | 21396 17,5 +WK ATE    |
|                        | 1.8 TD           |     |  | 10.96 | 09.00                                   |                |        |   |                               |                       |
|                        | 2.0 i 16V        |     |  | 10.96 | 09.00                                   |                |        |   |                               |                       |
|                        | 2.5 i 24V        |     |  | 12.97 | 09.00                                   |                |        |   |                               |                       |
|                        | 2.5 ST 200       |     |  | 05.99 | 09.00                                   |                |        |   |                               |                       |
|                        | 2.5 i 24V        |     |  | 10.96 | 11.97                                   | 13.0460-7165.2 | 607165 |   |                               | 21358 19,8 + ATE      |
|                        |                  |     |  |       |   | 13.0460-7163.2 | 607163 |   |                               | 21910 19,8 +WK ATE    |
|                        | 1.6 i 16V        |     |  | 10.96 | 09.00                                   | 24.0124-0120.1 | 424120 |   |                               | 260 24,0 22,2 V +B    |
|                        | 1.8 i 16V        |     |  | 10.96 | 09.00                                   | 24.0324-0120.1 | 524120 |   |                               | 260 24,0 22,2 V +B PD |
|                        | 1.8 TD           |     |  | 10.96 | 09.00                                   |                |        |   |                               |                       |
|                        | 2.0 i 16V        |     |  | 10.96 | 09.00                                   |                |        |   |                               |                       |
|                        | 1.8 i 16V        |     |  | 10.96 | 09.00                                   | 24.0124-0149.1 | 424149 |   |                               | 278 24,1 22,2 V +B    |
|                        | 2.5 i 24V        |     |  | 10.96 | 09.00                                   |                |        |   |                               |                       |
|                        | 2.5 ST 200       |     |  | 05.99 | 09.00                                   |                |        |   |                               |                       |

<sup>1)</sup> - parking assistant / - assistente di parcheggio / - assistance au stationnement / - asistente de aparcamiento  
<sup>2)</sup> + parking assistant / + assistente di parcheggio / + assistance au stationnement / + asistente de aparcamiento  
<sup>3)</sup> + RA drum brake / + P freno a tamburo / + frein à tambour essieu AR / + ET-tambores de freno  
<sup>4)</sup> + RA disc brake / + P disco freno / + frein à disque essieu AR / + ET-disco de freno  
<sup>5)</sup> + 15" wheel / + ruota 15" / + roue 15" / + rueda 15"



|     |    |  |  |   |  |  |  |    |
|--|--|--|--|---|---|--|--|--|
| <b>FORD MONDEO II (96-00)</b>  |  |  |  |   |   |  |  |  |
|    | 1.6 i 16V<br>1.8 i 16V<br>1.8 TD<br>2.0 i 16V<br>2.5 i 24V<br>2.5 ST 200   |  |  | 10.96 09.00<br>10.96 09.00<br>10.96 09.00<br>10.96 09.00<br>10.96 09.00<br>05.99 09.00  |   | 13.0460-3963.2 603963<br>13.0460-3964.2 603964<br>13.0460-0428.2 610428            |  | - Ghia Modelle <sup>1)</sup><br>+ Ghia Modelle <sup>2)</sup><br><br>21586 15,0 BDX<br>23410 15,0 +/WK BDX<br>Belagsatz-Zubehör BDX |
|    | 1.6 i 16V<br>1.8 i 16V<br>1.8 TD<br>2.0 i 16V<br>2.5 i 24V<br>2.5 ST 200   |  |  | 10.96 09.00<br>10.96 09.00<br>10.96 09.00<br>10.96 09.00<br>10.96 09.00<br>05.99 09.00  |   | 24.0120-0146.1 420146<br>24.0320-0146.1 520146                                     |  | 253 20,0 18,0 V +B<br>253 20,0 18,0 V +B PD  |
|    | 1.6 i 16V Lim.<br>1.8 i 16V Lim.<br>1.8 TD Lim.  |  |  | 10.96 09.00<br>10.96 09.00<br>10.96 09.00   |   | 03.0137-0272.2 650272<br>03.0137-9177.2 669177                                     |  | 203 x 39 HEB<br>Bremsbacken-Zubehör  |
|    | 1.6 i 16V Lim.<br>1.8 i 16V Lim.<br>1.8 TD Lim.  |  |  | 10.96 09.00<br>10.96 09.00<br>10.96 09.00   |   | 03.0137-0253.2 650253<br>03.0137-9153.2 669153                                     |  | 228 x 45 HEB<br>Bremsbacken-Zubehör  |
|    | 1.6 i 16V Lim.<br>1.8 i 16V Lim.<br>1.8 TD Lim.  |  |  | 10.96 09.00<br>10.96 09.00<br>10.96 09.00   |   | 24.0220-3006.1 480062  |  | 203/204,5 x 48,5   |
|    | 1.6 i 16V Lim.<br>1.8 i 16V Lim.<br>1.8 TD Lim.  |  |  | 10.96 09.00<br>10.96 09.00<br>10.96 09.00   |   | 24.0222-8014.1 480031  |  | 229/230,1 x 54   |
|   | 1.6 i 16V Lim.<br>1.8 i 16V Lim.<br>1.8 TD Lim.  |  |  | 10.96 09.00<br>10.96 09.00<br>10.96 09.00   |   | 03.0420-2122.3 682122  |  | 22,20/203x39 Kit TRW   |
|  | 2.0 i 16V Lim.   |  |  | 10.96 09.00   |   | 03.0520-2320.3 692320  |  | 20,64/228x45 TopKit TRW  |
|  | 1.6 i 16V Kombi<br>1.8 i 16V Kombi<br>2.0 i 16V Lim.   |  |  | 10.96 09.00<br>10.96 09.00<br>10.96 09.00   |   | 03.0520-2222.3 692222  |  | 22,20/228x45 TopKit TRW  |
| <b>FORD MONDEO III (00-07)</b>   |  |  |  |   |   |  |  |  |
|    | 1.8 i 16V<br>1.8 SCi<br>2.0 DI<br>2.0 i 16V<br>2.0 TDCi<br>2.2 TDCi<br>2.5 i V6<br>3.0 i V6<br>ST 220                                |  |  | 10.00 03.07<br>06.03 03.07<br>10.00 03.07<br>10.00 03.07<br>10.01 03.07<br>09.04 03.07<br>10.00 03.07<br>09.04 03.07<br>04.02 03.07 |   | 13.0460-3987.2 603987<br>13.0470-3987.2 LD3987                                     |  | 23279 18,4 /S BOS<br>23279 18,4 /S BOS   |
|  | 1.8 i 16V<br>1.8 SCi<br>2.0 DI<br>2.0 i 16V<br>2.0 TDCi<br>2.2 TDCi<br>2.5 i V6<br>3.0 i V6<br>ST 220                                |  |  | 10.00 03.07<br>06.03 03.07<br>10.00 03.07<br>10.00 03.07<br>10.01 03.07<br>09.04 03.07<br>10.00 03.07<br>09.04 03.07<br>04.02 03.07 |   | 24.0124-0161.1 424161<br>24.0324-0161.1 524161                                     |  | 300 23,9 22,0 V +B<br>300 23,9 22,0 V +B PD  |
|  | 1.8 i 16V<br>1.8 SCi<br>2.0 DI<br>2.0 i 16V<br>2.0 TDCi<br>2.5 i V6<br>ST 220  |  |  | 10.00 08.04<br>06.03 08.04<br>10.00 08.04<br>10.00 08.04<br>10.01 08.04<br>10.00 08.04<br>04.02 08.04                               |   | 13.0460-3988.2 603988<br>13.0470-3988.2 LD3988                                     |  | 23557 17,2 /S BOS<br>23557 17,2 /S BOS   |
|  | 1.8 i 16V<br>1.8 SCi<br>2.0 DI<br>2.0 i 16V<br>2.0 TDCi<br>2.2 TDCi<br>2.5 i V6<br>3.0 i V6<br>ST 220                                |  |  | 09.04 03.07<br>09.04 03.07<br>09.04 03.07<br>09.04 03.07<br>09.04 03.07<br>09.04 03.07<br>09.04 03.07<br>09.04 03.07<br>09.04 03.07 |   | 13.0460-3831.2 603831<br>13.0470-3831.2 LD3831                                     |  | 24260 17,3 /Zub/S BOS<br>24260 17,3 /Zub/S BOS   |
|  | 1.8 i 16V<br>1.8 SCi<br>2.0 DI<br>2.0 i 16V<br>2.0 TDCi<br>2.2 TDCi<br>2.5 i V6<br>3.0 i V6<br>ST 220                                |  |  | 10.00 03.07<br>06.03 03.07<br>10.00 03.07<br>10.00 03.07<br>10.01 03.07<br>09.04 03.07<br>10.00 03.07<br>09.04 03.07<br>04.02 03.07 |   | 24.0112-0154.1 412154<br>24.0312-0154.1 512154                                     |  | 280 12,0 10,0 +B<br>280 12,0 10,0 +B PD  |
| <b>FORD MONDEO IV (07-14)</b>  |  |  |  |   |   |  |  |  |
|  | 1.6 EcoBoost 118<br>1.6 TDCi 85<br>1.6 Ti VCT 81<br>1.6 Ti VCT 88<br>1.6 Ti VCT 92<br>1.8 TDCi 74<br>1.8 TDCi 92<br>2.0 EcoBoost 176 |  |  | 02.11 09.14<br>02.11 09.14<br>04.07 09.14<br>07.10 09.14<br>04.07 09.14<br>04.07 09.14<br>06.07 09.14<br>07.10 09.14                |   | 13.0460-7228.2 607228<br>13.0470-7228.2 LD7228                                     |  | 24123 20,3 + ATE<br>24123 20,3 + ATE   |

<sup>1)</sup> - Ghia model / - modello Ghia / - modèles Ghia / - modelo Ghia

<sup>2)</sup> + Ghia model / + modello Ghia / + modèles Ghia / + modelo Ghia



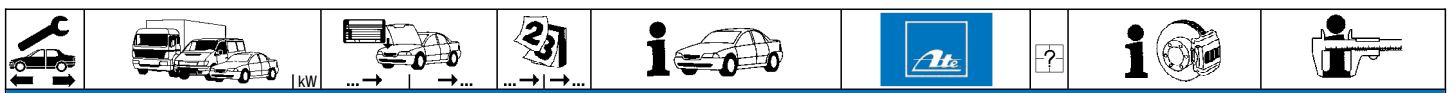























































**FORD MONDEO IV (07-14)**

|  |   |   |  |   |   |                                  |                  |                    |   |            |
|--|---|---|--|---|---|----------------------------------|------------------|--------------------|---|------------|
|  | 2.0 Flexifuel<br>2.0 i 16V<br>2.0 LPG<br>2.0 SCTi<br>2.0 TDCi<br>2.0 TDCi<br>2.0 TDCi<br>2.0 TDCi<br>2.0 TDCi<br>2.2 TDCi<br>2.2 TDCi<br>2.3 i 16V<br>2.5 i 20V   | 107<br>107<br>107<br>149<br>85<br>96<br>100<br>103<br>120<br>129<br>147<br>118<br>162   |  | 03.07<br>04.07<br>07.09<br>03.10<br>10.07<br>04.07<br>03.07<br>04.07<br>03.10<br>04.08<br>11.10<br>07.07<br>04.07   | 09.14<br>09.14<br>09.14<br>09.14<br>09.14<br>09.14<br>09.14<br>09.14<br>09.14<br>09.14<br>09.14<br>09.14<br>09.14   | 13.0460-7228.2<br>13.0470-7228.2 | 607228<br>LD7228 |                    | 24123 20,3 +<br>24123 20,3 +                    | ATE<br>ATE |
|  | 1.6 EcoBoost<br>1.6 TDCi<br>1.6 Ti VCT<br>1.6 Ti VCT<br>1.6 Ti VCT<br>1.8 TDCi<br>1.8 TDCi<br>2.0 EcoBoost<br>2.0 Flexifuel<br>2.0 i 16V<br>2.0 LPG<br>2.0 SCTi<br>2.0 TDCi<br>2.0 TDCi<br>2.0 TDCi<br>2.0 TDCi<br>2.0 TDCi<br>2.2 TDCi<br>2.2 TDCi<br>2.3 i 16V<br>2.5 i 20V | 118<br>85<br>81<br>88<br>92<br>74<br>92<br>176<br>107<br>107<br>107<br>149<br>85<br>96<br>100<br>103<br>120<br>129<br>147<br>118<br>162 |  | 02.11<br>02.11<br>04.07<br>07.10<br>04.07<br>04.07<br>06.07<br>07.10<br>03.07<br>04.07<br>07.09<br>03.10<br>10.07<br>04.07<br>03.07<br>04.07<br>03.10<br>04.08<br>11.10<br>07.07<br>04.07 | 09.14<br>09.14<br>09.14<br>09.14<br>09.14<br>09.14<br>09.14<br>09.14<br>09.14<br>09.14<br>09.14<br>09.14<br>09.14<br>09.14<br>09.14<br>09.14<br>09.14<br>09.14<br>09.14<br>09.14<br>09.14 | 24.0128-0250.1<br>24.0328-0250.1 | 428250<br>528250 |                    | 300 28,0 26,0 V L +B<br>300 28,0 26,0 V L +B PD |            |
|  | 1.6 EcoBoost<br>1.6 TDCi<br>1.6 Ti VCT<br>1.6 Ti VCT<br>1.6 Ti VCT<br>1.8 TDCi<br>1.8 TDCi<br>2.0 EcoBoost<br>2.0 Flexifuel<br>2.0 i 16V<br>2.0 LPG<br>2.0 SCTi<br>2.0 TDCi<br>2.0 TDCi<br>2.0 TDCi<br>2.0 TDCi<br>2.0 TDCi<br>2.2 TDCi<br>2.2 TDCi<br>2.3 i 16V<br>2.5 i 20V | 118<br>85<br>81<br>88<br>92<br>74<br>92<br>176<br>107<br>107<br>107<br>149<br>85<br>96<br>100<br>103<br>120<br>129<br>147<br>118<br>162 |  | 02.11<br>02.11<br>04.07<br>07.10<br>04.07<br>04.07<br>06.07<br>07.10<br>03.07<br>04.07<br>07.09<br>03.10<br>10.07<br>04.07<br>03.07<br>04.07<br>03.10<br>04.08<br>11.10<br>07.07<br>04.07 | 09.14<br>09.14<br>09.14<br>09.14<br>09.14<br>09.14<br>09.14<br>09.14<br>09.14<br>09.14<br>09.14<br>09.14<br>09.14<br>09.14<br>09.14<br>09.14<br>09.14<br>09.14<br>09.14<br>09.14<br>09.14 | 24.0711-5123.3<br>24.0711-5133.3 | 360065<br>360095 | 2 - ESP<br>2 + ESP | Radsensor<br>Radsensor                          |            |
|  | 1.6 EcoBoost<br>1.6 TDCi<br>1.6 Ti VCT<br>1.6 Ti VCT<br>1.6 Ti VCT<br>1.8 TDCi<br>1.8 TDCi<br>2.0 EcoBoost<br>2.0 Flexifuel<br>2.0 i 16V<br>2.0 LPG<br>2.0 SCTi<br>2.0 TDCi<br>2.0 TDCi<br>2.0 TDCi<br>2.0 TDCi<br>2.0 TDCi<br>2.2 TDCi<br>2.2 TDCi<br>2.3 i 16V<br>2.5 i 20V | 118<br>85<br>81<br>88<br>92<br>74<br>92<br>176<br>107<br>107<br>107<br>149<br>85<br>96<br>100<br>103<br>120<br>129<br>147<br>118<br>162 |  | 02.11<br>02.11<br>04.07<br>07.10<br>04.07<br>04.07<br>06.07<br>07.10<br>03.07<br>04.07<br>07.09<br>03.10<br>10.07<br>04.07<br>03.07<br>04.07<br>03.10<br>04.08<br>11.10<br>07.07<br>04.07 | 09.14<br>09.14<br>09.14<br>09.14<br>09.14<br>09.14<br>09.14<br>09.14<br>09.14<br>09.14<br>09.14<br>09.14<br>09.14<br>09.14<br>09.14<br>09.14<br>09.14<br>09.14<br>09.14<br>09.14<br>09.14 | 13.0460-2723.2<br>13.0470-2723.2 | 602723<br>LD2723 |                    | 24537 16,1 /Zub/S<br>24537 16,1 /Zub/S          | TRW<br>TRW |
|  | 1.6 EcoBoost<br>1.6 TDCi<br>1.6 Ti VCT<br>1.6 Ti VCT<br>1.6 Ti VCT<br>1.8 TDCi<br>1.8 TDCi<br>2.0 EcoBoost<br>2.0 Flexifuel<br>2.0 i 16V<br>2.0 LPG<br>2.0 SCTi<br>2.0 TDCi<br>2.0 TDCi<br>2.0 TDCi<br>2.0 TDCi<br>2.0 TDCi<br>2.2 TDCi<br>2.2 TDCi<br>2.3 i 16V<br>2.5 i 20V | 118<br>85<br>81<br>88<br>92<br>74<br>92<br>176<br>107<br>107<br>107<br>149<br>85<br>96<br>100<br>103<br>120<br>129<br>147<br>118<br>162 |  | 02.11<br>02.11<br>04.07<br>07.10<br>04.07<br>04.07<br>06.07<br>07.10<br>03.07<br>04.07<br>07.09<br>03.10<br>10.07<br>04.07<br>03.07<br>04.07<br>03.10<br>04.08<br>11.10<br>07.07<br>04.07 | 09.14<br>09.14<br>09.14<br>09.14<br>09.14<br>09.14<br>09.14<br>09.14<br>09.14<br>09.14<br>09.14<br>09.14<br>09.14<br>09.14<br>09.14<br>09.14<br>09.14<br>09.14<br>09.14<br>09.14<br>09.14 | 24.0111-0145.1<br>24.0311-0145.1 | 411145<br>511145 |                    | 302 10,9 9,0 +S +B<br>302 10,9 9,0 +B PD        |            |



















|          |  |              |       |       |                |        |   |                      |   |                      |              |           |  |       |       |                |                |        |                    |                   |     |           |       |       |       |       |  |  |            |     |  |        |       |  |       |       |  |              |     |  |       |       |  |  |  |  |              |     |  |       |       |  |  |  |  |              |     |  |       |       |  |  |  |  |              |     |  |       |       |  |  |  |  |               |     |  |       |       |  |  |  |  |           |     |  |       |       |  |  |  |  |          |     |  |       |       |  |  |  |  |              |     |  |       |       |  |  |  |  |              |     |  |       |       |  |  |  |  |                   |     |  |       |       |  |  |  |  |          |     |  |       |       |  |  |  |  |          |     |  |       |       |  |  |  |  |          |     |  |       |       |  |  |  |  |          |     |  |       |       |  |  |  |  |          |     |  |       |       |  |  |  |  |           |     |  |       |       |  |  |  |  |           |     |  |       |       |  |  |  |  |
|--|--|--------------|-------|-------|----------------|--------|---|----------------------|---|----------------------|--------------|-----------|--|-------|-------|----------------|----------------|--------|--------------------|-------------------|-----|-----------|-------|-------|-------|-------|--|--|------------|-----|--|--------|-------|--|-------|-------|--|--------------|-----|--|-------|-------|--|--|--|--|--------------|-----|--|-------|-------|--|--|--|--|--------------|-----|--|-------|-------|--|--|--|--|--------------|-----|--|-------|-------|--|--|--|--|---------------|-----|--|-------|-------|--|--|--|--|-----------|-----|--|-------|-------|--|--|--|--|----------|-----|--|-------|-------|--|--|--|--|--------------|-----|--|-------|-------|--|--|--|--|--------------|-----|--|-------|-------|--|--|--|--|-------------------|-----|--|-------|-------|--|--|--|--|----------|-----|--|-------|-------|--|--|--|--|----------|-----|--|-------|-------|--|--|--|--|----------|-----|--|-------|-------|--|--|--|--|----------|-----|--|-------|-------|--|--|--|--|----------|-----|--|-------|-------|--|--|--|--|-----------|-----|--|-------|-------|--|--|--|--|-----------|-----|--|-------|-------|--|--|--|--|
| <b>FORD MONDEO IV (07-14)</b>  |  |              |       |       |                |        |   |                      |   |                      |              |           |  |       |       |                |                |        |                    |                   |     |           |       |       |       |       |  |  |            |     |  |        |       |  |       |       |  |              |     |  |       |       |  |  |  |  |              |     |  |       |       |  |  |  |  |              |     |  |       |       |  |  |  |  |              |     |  |       |       |  |  |  |  |               |     |  |       |       |  |  |  |  |           |     |  |       |       |  |  |  |  |          |     |  |       |       |  |  |  |  |              |     |  |       |       |  |  |  |  |              |     |  |       |       |  |  |  |  |                   |     |  |       |       |  |  |  |  |          |     |  |       |       |  |  |  |  |          |     |  |       |       |  |  |  |  |          |     |  |       |       |  |  |  |  |          |     |  |       |       |  |  |  |  |          |     |  |       |       |  |  |  |  |           |     |  |       |       |  |  |  |  |           |     |  |       |       |  |  |  |  |
|    | <table border="1"> <tr><td>2.0 SCTi</td><td>149</td><td></td><td>03.10</td><td>09.14</td><td>24.0111-0145.1</td><td>411145</td><td></td><td>302 10,9 9,0 +S +B</td></tr> <tr><td>2.0 TDCi</td><td>85</td><td></td><td>10.07</td><td>09.14</td><td>24.0311-0145.1</td><td>511145</td><td></td><td>302 10,9 9,0 +B PD</td></tr> <tr><td>2.0 TDCi</td><td>96</td><td></td><td>04.07</td><td>09.14</td><td></td><td></td><td></td><td></td></tr> <tr><td>2.0 TDCi</td><td>100</td><td></td><td>03.07</td><td>09.14</td><td></td><td></td><td></td><td></td></tr> <tr><td>2.0 TDCi</td><td>103</td><td></td><td>04.07</td><td>09.14</td><td></td><td></td><td></td><td></td></tr> <tr><td>2.0 TDCi</td><td>120</td><td></td><td>03.10</td><td>09.14</td><td></td><td></td><td></td><td></td></tr> <tr><td>2.2 TDCi</td><td>129</td><td></td><td>04.08</td><td>09.14</td><td></td><td></td><td></td><td></td></tr> <tr><td>2.2 TDCi</td><td>147</td><td></td><td>11.10</td><td>09.14</td><td></td><td></td><td></td><td></td></tr> <tr><td>2.3 i 16V</td><td>118</td><td></td><td>07.07</td><td>09.14</td><td></td><td></td><td></td><td></td></tr> <tr><td>2.5 i 20V</td><td>162</td><td></td><td>04.07</td><td>09.14</td><td></td><td></td><td></td><td></td></tr> </table>  | 2.0 SCTi     | 149   |       | 03.10          | 09.14  | 24.0111-0145.1  | 411145               |   | 302 10,9 9,0 +S +B   | 2.0 TDCi     | 85        |  | 10.07 | 09.14 | 24.0311-0145.1 | 511145         |        | 302 10,9 9,0 +B PD | 2.0 TDCi          | 96  |           | 04.07 | 09.14 |       |       |  |  | 2.0 TDCi   | 100 |  | 03.07  | 09.14 |  |       |       |  | 2.0 TDCi     | 103 |  | 04.07 | 09.14 |  |  |  |  | 2.0 TDCi     | 120 |  | 03.10 | 09.14 |  |  |  |  | 2.2 TDCi     | 129 |  | 04.08 | 09.14 |  |  |  |  | 2.2 TDCi     | 147 |  | 11.10 | 09.14 |  |  |  |  | 2.3 i 16V     | 118 |  | 07.07 | 09.14 |  |  |  |  | 2.5 i 20V | 162 |  | 04.07 | 09.14 |  |  |  |  |          |     |  |       |       |  |  |  |  |              |     |  |       |       |  |  |  |  |              |     |  |       |       |  |  |  |  |                   |     |  |       |       |  |  |  |  |          |     |  |       |       |  |  |  |  |          |     |  |       |       |  |  |  |  |          |     |  |       |       |  |  |  |  |          |     |  |       |       |  |  |  |  |          |     |  |       |       |  |  |  |  |           |     |  |       |       |  |  |  |  |           |     |  |       |       |  |  |  |  |
| 2.0 SCTi   | 149  |              | 03.10 | 09.14 | 24.0111-0145.1 | 411145 |   | 302 10,9 9,0 +S +B   |   |                      |              |           |  |       |       |                |                |        |                    |                   |     |           |       |       |       |       |  |  |            |     |  |        |       |  |       |       |  |              |     |  |       |       |  |  |  |  |              |     |  |       |       |  |  |  |  |              |     |  |       |       |  |  |  |  |              |     |  |       |       |  |  |  |  |               |     |  |       |       |  |  |  |  |           |     |  |       |       |  |  |  |  |          |     |  |       |       |  |  |  |  |              |     |  |       |       |  |  |  |  |              |     |  |       |       |  |  |  |  |                   |     |  |       |       |  |  |  |  |          |     |  |       |       |  |  |  |  |          |     |  |       |       |  |  |  |  |          |     |  |       |       |  |  |  |  |          |     |  |       |       |  |  |  |  |          |     |  |       |       |  |  |  |  |           |     |  |       |       |  |  |  |  |           |     |  |       |       |  |  |  |  |
| 2.0 TDCi   | 85   |              | 10.07 | 09.14 | 24.0311-0145.1 | 511145 |   | 302 10,9 9,0 +B PD   |   |                      |              |           |  |       |       |                |                |        |                    |                   |     |           |       |       |       |       |  |  |            |     |  |        |       |  |       |       |  |              |     |  |       |       |  |  |  |  |              |     |  |       |       |  |  |  |  |              |     |  |       |       |  |  |  |  |              |     |  |       |       |  |  |  |  |               |     |  |       |       |  |  |  |  |           |     |  |       |       |  |  |  |  |          |     |  |       |       |  |  |  |  |              |     |  |       |       |  |  |  |  |              |     |  |       |       |  |  |  |  |                   |     |  |       |       |  |  |  |  |          |     |  |       |       |  |  |  |  |          |     |  |       |       |  |  |  |  |          |     |  |       |       |  |  |  |  |          |     |  |       |       |  |  |  |  |          |     |  |       |       |  |  |  |  |           |     |  |       |       |  |  |  |  |           |     |  |       |       |  |  |  |  |
| 2.0 TDCi   | 96   |              | 04.07 | 09.14 |                |        |   |                      |   |                      |              |           |  |       |       |                |                |        |                    |                   |     |           |       |       |       |       |  |  |            |     |  |        |       |  |       |       |  |              |     |  |       |       |  |  |  |  |              |     |  |       |       |  |  |  |  |              |     |  |       |       |  |  |  |  |              |     |  |       |       |  |  |  |  |               |     |  |       |       |  |  |  |  |           |     |  |       |       |  |  |  |  |          |     |  |       |       |  |  |  |  |              |     |  |       |       |  |  |  |  |              |     |  |       |       |  |  |  |  |                   |     |  |       |       |  |  |  |  |          |     |  |       |       |  |  |  |  |          |     |  |       |       |  |  |  |  |          |     |  |       |       |  |  |  |  |          |     |  |       |       |  |  |  |  |          |     |  |       |       |  |  |  |  |           |     |  |       |       |  |  |  |  |           |     |  |       |       |  |  |  |  |
| 2.0 TDCi   | 100  |              | 03.07 | 09.14 |                |        |   |                      |   |                      |              |           |  |       |       |                |                |        |                    |                   |     |           |       |       |       |       |  |  |            |     |  |        |       |  |       |       |  |              |     |  |       |       |  |  |  |  |              |     |  |       |       |  |  |  |  |              |     |  |       |       |  |  |  |  |              |     |  |       |       |  |  |  |  |               |     |  |       |       |  |  |  |  |           |     |  |       |       |  |  |  |  |          |     |  |       |       |  |  |  |  |              |     |  |       |       |  |  |  |  |              |     |  |       |       |  |  |  |  |                   |     |  |       |       |  |  |  |  |          |     |  |       |       |  |  |  |  |          |     |  |       |       |  |  |  |  |          |     |  |       |       |  |  |  |  |          |     |  |       |       |  |  |  |  |          |     |  |       |       |  |  |  |  |           |     |  |       |       |  |  |  |  |           |     |  |       |       |  |  |  |  |
| 2.0 TDCi   | 103  |              | 04.07 | 09.14 |                |        |   |                      |   |                      |              |           |  |       |       |                |                |        |                    |                   |     |           |       |       |       |       |  |  |            |     |  |        |       |  |       |       |  |              |     |  |       |       |  |  |  |  |              |     |  |       |       |  |  |  |  |              |     |  |       |       |  |  |  |  |              |     |  |       |       |  |  |  |  |               |     |  |       |       |  |  |  |  |           |     |  |       |       |  |  |  |  |          |     |  |       |       |  |  |  |  |              |     |  |       |       |  |  |  |  |              |     |  |       |       |  |  |  |  |                   |     |  |       |       |  |  |  |  |          |     |  |       |       |  |  |  |  |          |     |  |       |       |  |  |  |  |          |     |  |       |       |  |  |  |  |          |     |  |       |       |  |  |  |  |          |     |  |       |       |  |  |  |  |           |     |  |       |       |  |  |  |  |           |     |  |       |       |  |  |  |  |
| 2.0 TDCi   | 120  |              | 03.10 | 09.14 |                |        |   |                      |   |                      |              |           |  |       |       |                |                |        |                    |                   |     |           |       |       |       |       |  |  |            |     |  |        |       |  |       |       |  |              |     |  |       |       |  |  |  |  |              |     |  |       |       |  |  |  |  |              |     |  |       |       |  |  |  |  |              |     |  |       |       |  |  |  |  |               |     |  |       |       |  |  |  |  |           |     |  |       |       |  |  |  |  |          |     |  |       |       |  |  |  |  |              |     |  |       |       |  |  |  |  |              |     |  |       |       |  |  |  |  |                   |     |  |       |       |  |  |  |  |          |     |  |       |       |  |  |  |  |          |     |  |       |       |  |  |  |  |          |     |  |       |       |  |  |  |  |          |     |  |       |       |  |  |  |  |          |     |  |       |       |  |  |  |  |           |     |  |       |       |  |  |  |  |           |     |  |       |       |  |  |  |  |
| 2.2 TDCi   | 129  |              | 04.08 | 09.14 |                |        |   |                      |   |                      |              |           |  |       |       |                |                |        |                    |                   |     |           |       |       |       |       |  |  |            |     |  |        |       |  |       |       |  |              |     |  |       |       |  |  |  |  |              |     |  |       |       |  |  |  |  |              |     |  |       |       |  |  |  |  |              |     |  |       |       |  |  |  |  |               |     |  |       |       |  |  |  |  |           |     |  |       |       |  |  |  |  |          |     |  |       |       |  |  |  |  |              |     |  |       |       |  |  |  |  |              |     |  |       |       |  |  |  |  |                   |     |  |       |       |  |  |  |  |          |     |  |       |       |  |  |  |  |          |     |  |       |       |  |  |  |  |          |     |  |       |       |  |  |  |  |          |     |  |       |       |  |  |  |  |          |     |  |       |       |  |  |  |  |           |     |  |       |       |  |  |  |  |           |     |  |       |       |  |  |  |  |
| 2.2 TDCi   | 147  |              | 11.10 | 09.14 |                |        |   |                      |   |                      |              |           |  |       |       |                |                |        |                    |                   |     |           |       |       |       |       |  |  |            |     |  |        |       |  |       |       |  |              |     |  |       |       |  |  |  |  |              |     |  |       |       |  |  |  |  |              |     |  |       |       |  |  |  |  |              |     |  |       |       |  |  |  |  |               |     |  |       |       |  |  |  |  |           |     |  |       |       |  |  |  |  |          |     |  |       |       |  |  |  |  |              |     |  |       |       |  |  |  |  |              |     |  |       |       |  |  |  |  |                   |     |  |       |       |  |  |  |  |          |     |  |       |       |  |  |  |  |          |     |  |       |       |  |  |  |  |          |     |  |       |       |  |  |  |  |          |     |  |       |       |  |  |  |  |          |     |  |       |       |  |  |  |  |           |     |  |       |       |  |  |  |  |           |     |  |       |       |  |  |  |  |
| 2.3 i 16V  | 118  |              | 07.07 | 09.14 |                |        |   |                      |   |                      |              |           |  |       |       |                |                |        |                    |                   |     |           |       |       |       |       |  |  |            |     |  |        |       |  |       |       |  |              |     |  |       |       |  |  |  |  |              |     |  |       |       |  |  |  |  |              |     |  |       |       |  |  |  |  |              |     |  |       |       |  |  |  |  |               |     |  |       |       |  |  |  |  |           |     |  |       |       |  |  |  |  |          |     |  |       |       |  |  |  |  |              |     |  |       |       |  |  |  |  |              |     |  |       |       |  |  |  |  |                   |     |  |       |       |  |  |  |  |          |     |  |       |       |  |  |  |  |          |     |  |       |       |  |  |  |  |          |     |  |       |       |  |  |  |  |          |     |  |       |       |  |  |  |  |          |     |  |       |       |  |  |  |  |           |     |  |       |       |  |  |  |  |           |     |  |       |       |  |  |  |  |
| 2.5 i 20V  | 162  |              | 04.07 | 09.14 |                |        |   |                      |   |                      |              |           |  |       |       |                |                |        |                    |                   |     |           |       |       |       |       |  |  |            |     |  |        |       |  |       |       |  |              |     |  |       |       |  |  |  |  |              |     |  |       |       |  |  |  |  |              |     |  |       |       |  |  |  |  |              |     |  |       |       |  |  |  |  |               |     |  |       |       |  |  |  |  |           |     |  |       |       |  |  |  |  |          |     |  |       |       |  |  |  |  |              |     |  |       |       |  |  |  |  |              |     |  |       |       |  |  |  |  |                   |     |  |       |       |  |  |  |  |          |     |  |       |       |  |  |  |  |          |     |  |       |       |  |  |  |  |          |     |  |       |       |  |  |  |  |          |     |  |       |       |  |  |  |  |          |     |  |       |       |  |  |  |  |           |     |  |       |       |  |  |  |  |           |     |  |       |       |  |  |  |  |
|    | <table border="1"> <tr><td>1.6 EcoBoost</td><td>118</td><td></td><td>02.11</td><td>09.14</td><td>24.0711-6220.3</td><td>360256</td><td>2 </td><td>Radsensor</td></tr> <tr><td>1.6 TDCi</td><td>85</td><td></td><td>02.11</td><td>09.14</td><td></td><td></td><td></td><td></td></tr> <tr><td>1.6 Ti VCT</td><td>81</td><td></td><td>04.07</td><td>09.14</td><td></td><td></td><td></td><td></td></tr> <tr><td>1.6 Ti VCT</td><td>88</td><td></td><td>07.10</td><td>09.14</td><td></td><td></td><td></td><td></td></tr> <tr><td>1.6 Ti VCT</td><td>92</td><td></td><td>04.07</td><td>09.14</td><td></td><td></td><td></td><td></td></tr> <tr><td>1.8 TDCi</td><td>74</td><td></td><td>04.07</td><td>09.14</td><td></td><td></td><td></td><td></td></tr> <tr><td>1.8 TDCi</td><td>92</td><td></td><td>06.07</td><td>09.14</td><td></td><td></td><td></td><td></td></tr> <tr><td>2.0 EcoBoost</td><td>176</td><td></td><td>07.10</td><td>09.14</td><td></td><td></td><td></td><td></td></tr> <tr><td>2.0 Flexifuel</td><td>107</td><td></td><td>03.07</td><td>09.14</td><td></td><td></td><td></td><td></td></tr> <tr><td>2.0 i 16V</td><td>107</td><td></td><td>04.07</td><td>09.14</td><td></td><td></td><td></td><td></td></tr> <tr><td>2.0 LPG</td><td>107</td><td></td><td>07.09</td><td>09.14</td><td></td><td></td><td></td><td></td></tr> <tr><td>2.0 SCTi</td><td>149</td><td></td><td>03.10</td><td>09.14</td><td></td><td></td><td></td><td></td></tr> <tr><td>2.0 TDCi</td><td>85</td><td></td><td>10.07</td><td>09.14</td><td></td><td></td><td></td><td></td></tr> <tr><td>2.0 TDCi</td><td>96</td><td></td><td>04.07</td><td>09.14</td><td></td><td></td><td></td><td></td></tr> <tr><td>2.0 TDCi</td><td>100</td><td></td><td>03.07</td><td>09.14</td><td></td><td></td><td></td><td></td></tr> <tr><td>2.0 TDCi</td><td>103</td><td></td><td>04.07</td><td>09.14</td><td></td><td></td><td></td><td></td></tr> <tr><td>2.0 TDCi</td><td>120</td><td></td><td>03.10</td><td>09.14</td><td></td><td></td><td></td><td></td></tr> <tr><td>2.2 TDCi</td><td>129</td><td></td><td>04.08</td><td>09.14</td><td></td><td></td><td></td><td></td></tr> <tr><td>2.2 TDCi</td><td>147</td><td></td><td>11.10</td><td>09.14</td><td></td><td></td><td></td><td></td></tr> <tr><td>2.3 i 16V</td><td>118</td><td></td><td>07.07</td><td>09.14</td><td></td><td></td><td></td><td></td></tr> <tr><td>2.5 i 20V</td><td>162</td><td></td><td>04.07</td><td>09.14</td><td></td><td></td><td></td><td></td></tr> </table> | 1.6 EcoBoost | 118   |       | 02.11          | 09.14  | 24.0711-6220.3  | 360256               | 2  | Radsensor            | 1.6 TDCi     | 85        |  | 02.11 | 09.14 |                |                |        |                    | 1.6 Ti VCT        | 81  |           | 04.07 | 09.14 |       |       |  |  | 1.6 Ti VCT | 88  |  | 07.10  | 09.14 |  |       |       |  | 1.6 Ti VCT   | 92  |  | 04.07 | 09.14 |  |  |  |  | 1.8 TDCi     | 74  |  | 04.07 | 09.14 |  |  |  |  | 1.8 TDCi     | 92  |  | 06.07 | 09.14 |  |  |  |  | 2.0 EcoBoost | 176 |  | 07.10 | 09.14 |  |  |  |  | 2.0 Flexifuel | 107 |  | 03.07 | 09.14 |  |  |  |  | 2.0 i 16V | 107 |  | 04.07 | 09.14 |  |  |  |  | 2.0 LPG  | 107 |  | 07.09 | 09.14 |  |  |  |  | 2.0 SCTi     | 149 |  | 03.10 | 09.14 |  |  |  |  | 2.0 TDCi     | 85  |  | 10.07 | 09.14 |  |  |  |  | 2.0 TDCi          | 96  |  | 04.07 | 09.14 |  |  |  |  | 2.0 TDCi | 100 |  | 03.07 | 09.14 |  |  |  |  | 2.0 TDCi | 103 |  | 04.07 | 09.14 |  |  |  |  | 2.0 TDCi | 120 |  | 03.10 | 09.14 |  |  |  |  | 2.2 TDCi | 129 |  | 04.08 | 09.14 |  |  |  |  | 2.2 TDCi | 147 |  | 11.10 | 09.14 |  |  |  |  | 2.3 i 16V | 118 |  | 07.07 | 09.14 |  |  |  |  | 2.5 i 20V | 162 |  | 04.07 | 09.14 |  |  |  |  |
| 1.6 EcoBoost   | 118  |              | 02.11 | 09.14 | 24.0711-6220.3 | 360256 | 2  | Radsensor            |   |                      |              |           |  |       |       |                |                |        |                    |                   |     |           |       |       |       |       |  |  |            |     |  |        |       |  |       |       |  |              |     |  |       |       |  |  |  |  |              |     |  |       |       |  |  |  |  |              |     |  |       |       |  |  |  |  |              |     |  |       |       |  |  |  |  |               |     |  |       |       |  |  |  |  |           |     |  |       |       |  |  |  |  |          |     |  |       |       |  |  |  |  |              |     |  |       |       |  |  |  |  |              |     |  |       |       |  |  |  |  |                   |     |  |       |       |  |  |  |  |          |     |  |       |       |  |  |  |  |          |     |  |       |       |  |  |  |  |          |     |  |       |       |  |  |  |  |          |     |  |       |       |  |  |  |  |          |     |  |       |       |  |  |  |  |           |     |  |       |       |  |  |  |  |           |     |  |       |       |  |  |  |  |
| 1.6 TDCi   | 85   |              | 02.11 | 09.14 |                |        |   |                      |   |                      |              |           |  |       |       |                |                |        |                    |                   |     |           |       |       |       |       |  |  |            |     |  |        |       |  |       |       |  |              |     |  |       |       |  |  |  |  |              |     |  |       |       |  |  |  |  |              |     |  |       |       |  |  |  |  |              |     |  |       |       |  |  |  |  |               |     |  |       |       |  |  |  |  |           |     |  |       |       |  |  |  |  |          |     |  |       |       |  |  |  |  |              |     |  |       |       |  |  |  |  |              |     |  |       |       |  |  |  |  |                   |     |  |       |       |  |  |  |  |          |     |  |       |       |  |  |  |  |          |     |  |       |       |  |  |  |  |          |     |  |       |       |  |  |  |  |          |     |  |       |       |  |  |  |  |          |     |  |       |       |  |  |  |  |           |     |  |       |       |  |  |  |  |           |     |  |       |       |  |  |  |  |
| 1.6 Ti VCT   | 81   |              | 04.07 | 09.14 |                |        |   |                      |   |                      |              |           |  |       |       |                |                |        |                    |                   |     |           |       |       |       |       |  |  |            |     |  |        |       |  |       |       |  |              |     |  |       |       |  |  |  |  |              |     |  |       |       |  |  |  |  |              |     |  |       |       |  |  |  |  |              |     |  |       |       |  |  |  |  |               |     |  |       |       |  |  |  |  |           |     |  |       |       |  |  |  |  |          |     |  |       |       |  |  |  |  |              |     |  |       |       |  |  |  |  |              |     |  |       |       |  |  |  |  |                   |     |  |       |       |  |  |  |  |          |     |  |       |       |  |  |  |  |          |     |  |       |       |  |  |  |  |          |     |  |       |       |  |  |  |  |          |     |  |       |       |  |  |  |  |          |     |  |       |       |  |  |  |  |           |     |  |       |       |  |  |  |  |           |     |  |       |       |  |  |  |  |
| 1.6 Ti VCT   | 88   |              | 07.10 | 09.14 |                |        |   |                      |   |                      |              |           |  |       |       |                |                |        |                    |                   |     |           |       |       |       |       |  |  |            |     |  |        |       |  |       |       |  |              |     |  |       |       |  |  |  |  |              |     |  |       |       |  |  |  |  |              |     |  |       |       |  |  |  |  |              |     |  |       |       |  |  |  |  |               |     |  |       |       |  |  |  |  |           |     |  |       |       |  |  |  |  |          |     |  |       |       |  |  |  |  |              |     |  |       |       |  |  |  |  |              |     |  |       |       |  |  |  |  |                   |     |  |       |       |  |  |  |  |          |     |  |       |       |  |  |  |  |          |     |  |       |       |  |  |  |  |          |     |  |       |       |  |  |  |  |          |     |  |       |       |  |  |  |  |          |     |  |       |       |  |  |  |  |           |     |  |       |       |  |  |  |  |           |     |  |       |       |  |  |  |  |
| 1.6 Ti VCT   | 92   |              | 04.07 | 09.14 |                |        |   |                      |   |                      |              |           |  |       |       |                |                |        |                    |                   |     |           |       |       |       |       |  |  |            |     |  |        |       |  |       |       |  |              |     |  |       |       |  |  |  |  |              |     |  |       |       |  |  |  |  |              |     |  |       |       |  |  |  |  |              |     |  |       |       |  |  |  |  |               |     |  |       |       |  |  |  |  |           |     |  |       |       |  |  |  |  |          |     |  |       |       |  |  |  |  |              |     |  |       |       |  |  |  |  |              |     |  |       |       |  |  |  |  |                   |     |  |       |       |  |  |  |  |          |     |  |       |       |  |  |  |  |          |     |  |       |       |  |  |  |  |          |     |  |       |       |  |  |  |  |          |     |  |       |       |  |  |  |  |          |     |  |       |       |  |  |  |  |           |     |  |       |       |  |  |  |  |           |     |  |       |       |  |  |  |  |
| 1.8 TDCi   | 74   |              | 04.07 | 09.14 |                |        |   |                      |   |                      |              |           |  |       |       |                |                |        |                    |                   |     |           |       |       |       |       |  |  |            |     |  |        |       |  |       |       |  |              |     |  |       |       |  |  |  |  |              |     |  |       |       |  |  |  |  |              |     |  |       |       |  |  |  |  |              |     |  |       |       |  |  |  |  |               |     |  |       |       |  |  |  |  |           |     |  |       |       |  |  |  |  |          |     |  |       |       |  |  |  |  |              |     |  |       |       |  |  |  |  |              |     |  |       |       |  |  |  |  |                   |     |  |       |       |  |  |  |  |          |     |  |       |       |  |  |  |  |          |     |  |       |       |  |  |  |  |          |     |  |       |       |  |  |  |  |          |     |  |       |       |  |  |  |  |          |     |  |       |       |  |  |  |  |           |     |  |       |       |  |  |  |  |           |     |  |       |       |  |  |  |  |
| 1.8 TDCi   | 92   |              | 06.07 | 09.14 |                |        |   |                      |   |                      |              |           |  |       |       |                |                |        |                    |                   |     |           |       |       |       |       |  |  |            |     |  |        |       |  |       |       |  |              |     |  |       |       |  |  |  |  |              |     |  |       |       |  |  |  |  |              |     |  |       |       |  |  |  |  |              |     |  |       |       |  |  |  |  |               |     |  |       |       |  |  |  |  |           |     |  |       |       |  |  |  |  |          |     |  |       |       |  |  |  |  |              |     |  |       |       |  |  |  |  |              |     |  |       |       |  |  |  |  |                   |     |  |       |       |  |  |  |  |          |     |  |       |       |  |  |  |  |          |     |  |       |       |  |  |  |  |          |     |  |       |       |  |  |  |  |          |     |  |       |       |  |  |  |  |          |     |  |       |       |  |  |  |  |           |     |  |       |       |  |  |  |  |           |     |  |       |       |  |  |  |  |
| 2.0 EcoBoost   | 176  |              | 07.10 | 09.14 |                |        |   |                      |   |                      |              |           |  |       |       |                |                |        |                    |                   |     |           |       |       |       |       |  |  |            |     |  |        |       |  |       |       |  |              |     |  |       |       |  |  |  |  |              |     |  |       |       |  |  |  |  |              |     |  |       |       |  |  |  |  |              |     |  |       |       |  |  |  |  |               |     |  |       |       |  |  |  |  |           |     |  |       |       |  |  |  |  |          |     |  |       |       |  |  |  |  |              |     |  |       |       |  |  |  |  |              |     |  |       |       |  |  |  |  |                   |     |  |       |       |  |  |  |  |          |     |  |       |       |  |  |  |  |          |     |  |       |       |  |  |  |  |          |     |  |       |       |  |  |  |  |          |     |  |       |       |  |  |  |  |          |     |  |       |       |  |  |  |  |           |     |  |       |       |  |  |  |  |           |     |  |       |       |  |  |  |  |
| 2.0 Flexifuel  | 107  |              | 03.07 | 09.14 |                |        |   |                      |   |                      |              |           |  |       |       |                |                |        |                    |                   |     |           |       |       |       |       |  |  |            |     |  |        |       |  |       |       |  |              |     |  |       |       |  |  |  |  |              |     |  |       |       |  |  |  |  |              |     |  |       |       |  |  |  |  |              |     |  |       |       |  |  |  |  |               |     |  |       |       |  |  |  |  |           |     |  |       |       |  |  |  |  |          |     |  |       |       |  |  |  |  |              |     |  |       |       |  |  |  |  |              |     |  |       |       |  |  |  |  |                   |     |  |       |       |  |  |  |  |          |     |  |       |       |  |  |  |  |          |     |  |       |       |  |  |  |  |          |     |  |       |       |  |  |  |  |          |     |  |       |       |  |  |  |  |          |     |  |       |       |  |  |  |  |           |     |  |       |       |  |  |  |  |           |     |  |       |       |  |  |  |  |
| 2.0 i 16V  | 107  |              | 04.07 | 09.14 |                |        |   |                      |   |                      |              |           |  |       |       |                |                |        |                    |                   |     |           |       |       |       |       |  |  |            |     |  |        |       |  |       |       |  |              |     |  |       |       |  |  |  |  |              |     |  |       |       |  |  |  |  |              |     |  |       |       |  |  |  |  |              |     |  |       |       |  |  |  |  |               |     |  |       |       |  |  |  |  |           |     |  |       |       |  |  |  |  |          |     |  |       |       |  |  |  |  |              |     |  |       |       |  |  |  |  |              |     |  |       |       |  |  |  |  |                   |     |  |       |       |  |  |  |  |          |     |  |       |       |  |  |  |  |          |     |  |       |       |  |  |  |  |          |     |  |       |       |  |  |  |  |          |     |  |       |       |  |  |  |  |          |     |  |       |       |  |  |  |  |           |     |  |       |       |  |  |  |  |           |     |  |       |       |  |  |  |  |
| 2.0 LPG  | 107  |              | 07.09 | 09.14 |                |        |   |                      |   |                      |              |           |  |       |       |                |                |        |                    |                   |     |           |       |       |       |       |  |  |            |     |  |        |       |  |       |       |  |              |     |  |       |       |  |  |  |  |              |     |  |       |       |  |  |  |  |              |     |  |       |       |  |  |  |  |              |     |  |       |       |  |  |  |  |               |     |  |       |       |  |  |  |  |           |     |  |       |       |  |  |  |  |          |     |  |       |       |  |  |  |  |              |     |  |       |       |  |  |  |  |              |     |  |       |       |  |  |  |  |                   |     |  |       |       |  |  |  |  |          |     |  |       |       |  |  |  |  |          |     |  |       |       |  |  |  |  |          |     |  |       |       |  |  |  |  |          |     |  |       |       |  |  |  |  |          |     |  |       |       |  |  |  |  |           |     |  |       |       |  |  |  |  |           |     |  |       |       |  |  |  |  |
| 2.0 SCTi   | 149  |              | 03.10 | 09.14 |                |        |   |                      |   |                      |              |           |  |       |       |                |                |        |                    |                   |     |           |       |       |       |       |  |  |            |     |  |        |       |  |       |       |  |              |     |  |       |       |  |  |  |  |              |     |  |       |       |  |  |  |  |              |     |  |       |       |  |  |  |  |              |     |  |       |       |  |  |  |  |               |     |  |       |       |  |  |  |  |           |     |  |       |       |  |  |  |  |          |     |  |       |       |  |  |  |  |              |     |  |       |       |  |  |  |  |              |     |  |       |       |  |  |  |  |                   |     |  |       |       |  |  |  |  |          |     |  |       |       |  |  |  |  |          |     |  |       |       |  |  |  |  |          |     |  |       |       |  |  |  |  |          |     |  |       |       |  |  |  |  |          |     |  |       |       |  |  |  |  |           |     |  |       |       |  |  |  |  |           |     |  |       |       |  |  |  |  |
| 2.0 TDCi   | 85   |              | 10.07 | 09.14 |                |        |   |                      |   |                      |              |           |  |       |       |                |                |        |                    |                   |     |           |       |       |       |       |  |  |            |     |  |        |       |  |       |       |  |              |     |  |       |       |  |  |  |  |              |     |  |       |       |  |  |  |  |              |     |  |       |       |  |  |  |  |              |     |  |       |       |  |  |  |  |               |     |  |       |       |  |  |  |  |           |     |  |       |       |  |  |  |  |          |     |  |       |       |  |  |  |  |              |     |  |       |       |  |  |  |  |              |     |  |       |       |  |  |  |  |                   |     |  |       |       |  |  |  |  |          |     |  |       |       |  |  |  |  |          |     |  |       |       |  |  |  |  |          |     |  |       |       |  |  |  |  |          |     |  |       |       |  |  |  |  |          |     |  |       |       |  |  |  |  |           |     |  |       |       |  |  |  |  |           |     |  |       |       |  |  |  |  |
| 2.0 TDCi   | 96   |              | 04.07 | 09.14 |                |        |   |                      |   |                      |              |           |  |       |       |                |                |        |                    |                   |     |           |       |       |       |       |  |  |            |     |  |        |       |  |       |       |  |              |     |  |       |       |  |  |  |  |              |     |  |       |       |  |  |  |  |              |     |  |       |       |  |  |  |  |              |     |  |       |       |  |  |  |  |               |     |  |       |       |  |  |  |  |           |     |  |       |       |  |  |  |  |          |     |  |       |       |  |  |  |  |              |     |  |       |       |  |  |  |  |              |     |  |       |       |  |  |  |  |                   |     |  |       |       |  |  |  |  |          |     |  |       |       |  |  |  |  |          |     |  |       |       |  |  |  |  |          |     |  |       |       |  |  |  |  |          |     |  |       |       |  |  |  |  |          |     |  |       |       |  |  |  |  |           |     |  |       |       |  |  |  |  |           |     |  |       |       |  |  |  |  |
| 2.0 TDCi   | 100  |              | 03.07 | 09.14 |                |        |   |                      |   |                      |              |           |  |       |       |                |                |        |                    |                   |     |           |       |       |       |       |  |  |            |     |  |        |       |  |       |       |  |              |     |  |       |       |  |  |  |  |              |     |  |       |       |  |  |  |  |              |     |  |       |       |  |  |  |  |              |     |  |       |       |  |  |  |  |               |     |  |       |       |  |  |  |  |           |     |  |       |       |  |  |  |  |          |     |  |       |       |  |  |  |  |              |     |  |       |       |  |  |  |  |              |     |  |       |       |  |  |  |  |                   |     |  |       |       |  |  |  |  |          |     |  |       |       |  |  |  |  |          |     |  |       |       |  |  |  |  |          |     |  |       |       |  |  |  |  |          |     |  |       |       |  |  |  |  |          |     |  |       |       |  |  |  |  |           |     |  |       |       |  |  |  |  |           |     |  |       |       |  |  |  |  |
| 2.0 TDCi   | 103  |              | 04.07 | 09.14 |                |        |   |                      |   |                      |              |           |  |       |       |                |                |        |                    |                   |     |           |       |       |       |       |  |  |            |     |  |        |       |  |       |       |  |              |     |  |       |       |  |  |  |  |              |     |  |       |       |  |  |  |  |              |     |  |       |       |  |  |  |  |              |     |  |       |       |  |  |  |  |               |     |  |       |       |  |  |  |  |           |     |  |       |       |  |  |  |  |          |     |  |       |       |  |  |  |  |              |     |  |       |       |  |  |  |  |              |     |  |       |       |  |  |  |  |                   |     |  |       |       |  |  |  |  |          |     |  |       |       |  |  |  |  |          |     |  |       |       |  |  |  |  |          |     |  |       |       |  |  |  |  |          |     |  |       |       |  |  |  |  |          |     |  |       |       |  |  |  |  |           |     |  |       |       |  |  |  |  |           |     |  |       |       |  |  |  |  |
| 2.0 TDCi   | 120  |              | 03.10 | 09.14 |                |        |   |                      |   |                      |              |           |  |       |       |                |                |        |                    |                   |     |           |       |       |       |       |  |  |            |     |  |        |       |  |       |       |  |              |     |  |       |       |  |  |  |  |              |     |  |       |       |  |  |  |  |              |     |  |       |       |  |  |  |  |              |     |  |       |       |  |  |  |  |               |     |  |       |       |  |  |  |  |           |     |  |       |       |  |  |  |  |          |     |  |       |       |  |  |  |  |              |     |  |       |       |  |  |  |  |              |     |  |       |       |  |  |  |  |                   |     |  |       |       |  |  |  |  |          |     |  |       |       |  |  |  |  |          |     |  |       |       |  |  |  |  |          |     |  |       |       |  |  |  |  |          |     |  |       |       |  |  |  |  |          |     |  |       |       |  |  |  |  |           |     |  |       |       |  |  |  |  |           |     |  |       |       |  |  |  |  |
| 2.2 TDCi   | 129  |              | 04.08 | 09.14 |                |        |   |                      |   |                      |              |           |  |       |       |                |                |        |                    |                   |     |           |       |       |       |       |  |  |            |     |  |        |       |  |       |       |  |              |     |  |       |       |  |  |  |  |              |     |  |       |       |  |  |  |  |              |     |  |       |       |  |  |  |  |              |     |  |       |       |  |  |  |  |               |     |  |       |       |  |  |  |  |           |     |  |       |       |  |  |  |  |          |     |  |       |       |  |  |  |  |              |     |  |       |       |  |  |  |  |              |     |  |       |       |  |  |  |  |                   |     |  |       |       |  |  |  |  |          |     |  |       |       |  |  |  |  |          |     |  |       |       |  |  |  |  |          |     |  |       |       |  |  |  |  |          |     |  |       |       |  |  |  |  |          |     |  |       |       |  |  |  |  |           |     |  |       |       |  |  |  |  |           |     |  |       |       |  |  |  |  |
| 2.2 TDCi   | 147  |              | 11.10 | 09.14 |                |        |   |                      |   |                      |              |           |  |       |       |                |                |        |                    |                   |     |           |       |       |       |       |  |  |            |     |  |        |       |  |       |       |  |              |     |  |       |       |  |  |  |  |              |     |  |       |       |  |  |  |  |              |     |  |       |       |  |  |  |  |              |     |  |       |       |  |  |  |  |               |     |  |       |       |  |  |  |  |           |     |  |       |       |  |  |  |  |          |     |  |       |       |  |  |  |  |              |     |  |       |       |  |  |  |  |              |     |  |       |       |  |  |  |  |                   |     |  |       |       |  |  |  |  |          |     |  |       |       |  |  |  |  |          |     |  |       |       |  |  |  |  |          |     |  |       |       |  |  |  |  |          |     |  |       |       |  |  |  |  |          |     |  |       |       |  |  |  |  |           |     |  |       |       |  |  |  |  |           |     |  |       |       |  |  |  |  |
| 2.3 i 16V  | 118  |              | 07.07 | 09.14 |                |        |   |                      |   |                      |              |           |  |       |       |                |                |        |                    |                   |     |           |       |       |       |       |  |  |            |     |  |        |       |  |       |       |  |              |     |  |       |       |  |  |  |  |              |     |  |       |       |  |  |  |  |              |     |  |       |       |  |  |  |  |              |     |  |       |       |  |  |  |  |               |     |  |       |       |  |  |  |  |           |     |  |       |       |  |  |  |  |          |     |  |       |       |  |  |  |  |              |     |  |       |       |  |  |  |  |              |     |  |       |       |  |  |  |  |                   |     |  |       |       |  |  |  |  |          |     |  |       |       |  |  |  |  |          |     |  |       |       |  |  |  |  |          |     |  |       |       |  |  |  |  |          |     |  |       |       |  |  |  |  |          |     |  |       |       |  |  |  |  |           |     |  |       |       |  |  |  |  |           |     |  |       |       |  |  |  |  |
| 2.5 i 20V  | 162  |              | 04.07 | 09.14 |                |        |   |                      |   |                      |              |           |  |       |       |                |                |        |                    |                   |     |           |       |       |       |       |  |  |            |     |  |        |       |  |       |       |  |              |     |  |       |       |  |  |  |  |              |     |  |       |       |  |  |  |  |              |     |  |       |       |  |  |  |  |              |     |  |       |       |  |  |  |  |               |     |  |       |       |  |  |  |  |           |     |  |       |       |  |  |  |  |          |     |  |       |       |  |  |  |  |              |     |  |       |       |  |  |  |  |              |     |  |       |       |  |  |  |  |                   |     |  |       |       |  |  |  |  |          |     |  |       |       |  |  |  |  |          |     |  |       |       |  |  |  |  |          |     |  |       |       |  |  |  |  |          |     |  |       |       |  |  |  |  |          |     |  |       |       |  |  |  |  |           |     |  |       |       |  |  |  |  |           |     |  |       |       |  |  |  |  |
| <b>FORD MONDEO V (14-)</b>   |  |              |       |       |                |        |   |                      |   |                      |              |           |  |       |       |                |                |        |                    |                   |     |           |       |       |       |       |  |  |            |     |  |        |       |  |       |       |  |              |     |  |       |       |  |  |  |  |              |     |  |       |       |  |  |  |  |              |     |  |       |       |  |  |  |  |              |     |  |       |       |  |  |  |  |               |     |  |       |       |  |  |  |  |           |     |  |       |       |  |  |  |  |          |     |  |       |       |  |  |  |  |              |     |  |       |       |  |  |  |  |              |     |  |       |       |  |  |  |  |                   |     |  |       |       |  |  |  |  |          |     |  |       |       |  |  |  |  |          |     |  |       |       |  |  |  |  |          |     |  |       |       |  |  |  |  |          |     |  |       |       |  |  |  |  |          |     |  |       |       |  |  |  |  |           |     |  |       |       |  |  |  |  |           |     |  |       |       |  |  |  |  |
|    | <table border="1"> <tr><td>1.0 EcoBoost</td><td>92</td><td></td><td>02.15</td><td></td><td>24.0128-0286.1</td><td>428286</td><td></td><td>300 28,0 26,5 V L +B</td></tr> <tr><td>1.5 EcoBoost</td><td>118</td><td></td><td>10.14</td><td></td><td></td><td></td><td></td><td></td></tr> <tr><td>1.5 TDCi</td><td>88</td><td></td><td>03.15</td><td></td><td></td><td></td><td></td><td></td></tr> <tr><td>1.6 TDCi</td><td>85</td><td></td><td>10.14</td><td></td><td></td><td></td><td></td><td></td></tr> <tr><td>2.0 EcoBoost</td><td>146</td><td></td><td>05.15</td><td></td><td></td><td></td><td></td><td></td></tr> <tr><td>2.0 EcoBoost</td><td>149</td><td></td><td>10.14</td><td></td><td></td><td></td><td></td><td></td></tr> <tr><td>2.0 EcoBoost</td><td>176</td><td></td><td>10.14</td><td></td><td></td><td></td><td></td><td></td></tr> <tr><td>2.0 Hybrid</td><td></td><td></td><td>10.14</td><td></td><td></td><td></td><td></td><td></td></tr> <tr><td>2.0 TDCi</td><td>110</td><td></td><td>10.14</td><td></td><td></td><td></td><td></td><td></td></tr> <tr><td>2.0 TDCi</td><td>132</td><td></td><td>10.14</td><td></td><td></td><td></td><td></td><td></td></tr> <tr><td>2.0 TDCi</td><td>154</td><td></td><td>05.15</td><td></td><td></td><td></td><td></td><td></td></tr> <tr><td>2.0 TDCi 4x4</td><td>110</td><td></td><td>02.15</td><td></td><td></td><td></td><td></td><td></td></tr> <tr><td>2.0 TDCi 4x4</td><td>132</td><td></td><td>02.15</td><td></td><td></td><td></td><td></td><td></td></tr> <tr><td>2.0 TDCi Bi-Turbo</td><td>155</td><td></td><td>03.15</td><td></td><td></td><td></td><td></td><td></td></tr> <tr><td>2.5</td><td>110</td><td></td><td>05.15</td><td></td><td></td><td></td><td></td><td></td></tr> </table>   | 1.0 EcoBoost | 92    |       | 02.15          |        | 24.0128-0286.1  | 428286               |   | 300 28,0 26,5 V L +B | 1.5 EcoBoost | 118       |  | 10.14 |       |                |                |        |                    | 1.5 TDCi          | 88  |           | 03.15 |       |       |       |  |  | 1.6 TDCi   | 85  |  | 10.14  |       |  |       |       |  | 2.0 EcoBoost | 146 |  | 05.15 |       |  |  |  |  | 2.0 EcoBoost | 149 |  | 10.14 |       |  |  |  |  | 2.0 EcoBoost | 176 |  | 10.14 |       |  |  |  |  | 2.0 Hybrid   |     |  | 10.14 |       |  |  |  |  | 2.0 TDCi      | 110 |  | 10.14 |       |  |  |  |  | 2.0 TDCi  | 132 |  | 10.14 |       |  |  |  |  | 2.0 TDCi | 154 |  | 05.15 |       |  |  |  |  | 2.0 TDCi 4x4 | 110 |  | 02.15 |       |  |  |  |  | 2.0 TDCi 4x4 | 132 |  | 02.15 |       |  |  |  |  | 2.0 TDCi Bi-Turbo | 155 |  | 03.15 |       |  |  |  |  | 2.5      | 110 |  | 05.15 |       |  |  |  |  |          |     |  |       |       |  |  |  |  |          |     |  |       |       |  |  |  |  |          |     |  |       |       |  |  |  |  |          |     |  |       |       |  |  |  |  |           |     |  |       |       |  |  |  |  |           |     |  |       |       |  |  |  |  |
| 1.0 EcoBoost   | 92   |              | 02.15 |       | 24.0128-0286.1 | 428286 |   | 300 28,0 26,5 V L +B |   |                      |              |           |  |       |       |                |                |        |                    |                   |     |           |       |       |       |       |  |  |            |     |  |        |       |  |       |       |  |              |     |  |       |       |  |  |  |  |              |     |  |       |       |  |  |  |  |              |     |  |       |       |  |  |  |  |              |     |  |       |       |  |  |  |  |               |     |  |       |       |  |  |  |  |           |     |  |       |       |  |  |  |  |          |     |  |       |       |  |  |  |  |              |     |  |       |       |  |  |  |  |              |     |  |       |       |  |  |  |  |                   |     |  |       |       |  |  |  |  |          |     |  |       |       |  |  |  |  |          |     |  |       |       |  |  |  |  |          |     |  |       |       |  |  |  |  |          |     |  |       |       |  |  |  |  |          |     |  |       |       |  |  |  |  |           |     |  |       |       |  |  |  |  |           |     |  |       |       |  |  |  |  |
| 1.5 EcoBoost   | 118  |              | 10.14 |       |                |        |   |                      |   |                      |              |           |  |       |       |                |                |        |                    |                   |     |           |       |       |       |       |  |  |            |     |  |        |       |  |       |       |  |              |     |  |       |       |  |  |  |  |              |     |  |       |       |  |  |  |  |              |     |  |       |       |  |  |  |  |              |     |  |       |       |  |  |  |  |               |     |  |       |       |  |  |  |  |           |     |  |       |       |  |  |  |  |          |     |  |       |       |  |  |  |  |              |     |  |       |       |  |  |  |  |              |     |  |       |       |  |  |  |  |                   |     |  |       |       |  |  |  |  |          |     |  |       |       |  |  |  |  |          |     |  |       |       |  |  |  |  |          |     |  |       |       |  |  |  |  |          |     |  |       |       |  |  |  |  |          |     |  |       |       |  |  |  |  |           |     |  |       |       |  |  |  |  |           |     |  |       |       |  |  |  |  |
| 1.5 TDCi   | 88   |              | 03.15 |       |                |        |   |                      |   |                      |              |           |  |       |       |                |                |        |                    |                   |     |           |       |       |       |       |  |  |            |     |  |        |       |  |       |       |  |              |     |  |       |       |  |  |  |  |              |     |  |       |       |  |  |  |  |              |     |  |       |       |  |  |  |  |              |     |  |       |       |  |  |  |  |               |     |  |       |       |  |  |  |  |           |     |  |       |       |  |  |  |  |          |     |  |       |       |  |  |  |  |              |     |  |       |       |  |  |  |  |              |     |  |       |       |  |  |  |  |                   |     |  |       |       |  |  |  |  |          |     |  |       |       |  |  |  |  |          |     |  |       |       |  |  |  |  |          |     |  |       |       |  |  |  |  |          |     |  |       |       |  |  |  |  |          |     |  |       |       |  |  |  |  |           |     |  |       |       |  |  |  |  |           |     |  |       |       |  |  |  |  |
| 1.6 TDCi   | 85   |              | 10.14 |       |                |        |   |                      |   |                      |              |           |  |       |       |                |                |        |                    |                   |     |           |       |       |       |       |  |  |            |     |  |        |       |  |       |       |  |              |     |  |       |       |  |  |  |  |              |     |  |       |       |  |  |  |  |              |     |  |       |       |  |  |  |  |              |     |  |       |       |  |  |  |  |               |     |  |       |       |  |  |  |  |           |     |  |       |       |  |  |  |  |          |     |  |       |       |  |  |  |  |              |     |  |       |       |  |  |  |  |              |     |  |       |       |  |  |  |  |                   |     |  |       |       |  |  |  |  |          |     |  |       |       |  |  |  |  |          |     |  |       |       |  |  |  |  |          |     |  |       |       |  |  |  |  |          |     |  |       |       |  |  |  |  |          |     |  |       |       |  |  |  |  |           |     |  |       |       |  |  |  |  |           |     |  |       |       |  |  |  |  |
| 2.0 EcoBoost   | 146  |              | 05.15 |       |                |        |   |                      |   |                      |              |           |  |       |       |                |                |        |                    |                   |     |           |       |       |       |       |  |  |            |     |  |        |       |  |       |       |  |              |     |  |       |       |  |  |  |  |              |     |  |       |       |  |  |  |  |              |     |  |       |       |  |  |  |  |              |     |  |       |       |  |  |  |  |               |     |  |       |       |  |  |  |  |           |     |  |       |       |  |  |  |  |          |     |  |       |       |  |  |  |  |              |     |  |       |       |  |  |  |  |              |     |  |       |       |  |  |  |  |                   |     |  |       |       |  |  |  |  |          |     |  |       |       |  |  |  |  |          |     |  |       |       |  |  |  |  |          |     |  |       |       |  |  |  |  |          |     |  |       |       |  |  |  |  |          |     |  |       |       |  |  |  |  |           |     |  |       |       |  |  |  |  |           |     |  |       |       |  |  |  |  |
| 2.0 EcoBoost   | 149  |              | 10.14 |       |                |        |   |                      |   |                      |              |           |  |       |       |                |                |        |                    |                   |     |           |       |       |       |       |  |  |            |     |  |        |       |  |       |       |  |              |     |  |       |       |  |  |  |  |              |     |  |       |       |  |  |  |  |              |     |  |       |       |  |  |  |  |              |     |  |       |       |  |  |  |  |               |     |  |       |       |  |  |  |  |           |     |  |       |       |  |  |  |  |          |     |  |       |       |  |  |  |  |              |     |  |       |       |  |  |  |  |              |     |  |       |       |  |  |  |  |                   |     |  |       |       |  |  |  |  |          |     |  |       |       |  |  |  |  |          |     |  |       |       |  |  |  |  |          |     |  |       |       |  |  |  |  |          |     |  |       |       |  |  |  |  |          |     |  |       |       |  |  |  |  |           |     |  |       |       |  |  |  |  |           |     |  |       |       |  |  |  |  |
| 2.0 EcoBoost   | 176  |              | 10.14 |       |                |        |   |                      |   |                      |              |           |  |       |       |                |                |        |                    |                   |     |           |       |       |       |       |  |  |            |     |  |        |       |  |       |       |  |              |     |  |       |       |  |  |  |  |              |     |  |       |       |  |  |  |  |              |     |  |       |       |  |  |  |  |              |     |  |       |       |  |  |  |  |               |     |  |       |       |  |  |  |  |           |     |  |       |       |  |  |  |  |          |     |  |       |       |  |  |  |  |              |     |  |       |       |  |  |  |  |              |     |  |       |       |  |  |  |  |                   |     |  |       |       |  |  |  |  |          |     |  |       |       |  |  |  |  |          |     |  |       |       |  |  |  |  |          |     |  |       |       |  |  |  |  |          |     |  |       |       |  |  |  |  |          |     |  |       |       |  |  |  |  |           |     |  |       |       |  |  |  |  |           |     |  |       |       |  |  |  |  |
| 2.0 Hybrid   |  |              | 10.14 |       |                |        |   |                      |   |                      |              |           |  |       |       |                |                |        |                    |                   |     |           |       |       |       |       |  |  |            |     |  |        |       |  |       |       |  |              |     |  |       |       |  |  |  |  |              |     |  |       |       |  |  |  |  |              |     |  |       |       |  |  |  |  |              |     |  |       |       |  |  |  |  |               |     |  |       |       |  |  |  |  |           |     |  |       |       |  |  |  |  |          |     |  |       |       |  |  |  |  |              |     |  |       |       |  |  |  |  |              |     |  |       |       |  |  |  |  |                   |     |  |       |       |  |  |  |  |          |     |  |       |       |  |  |  |  |          |     |  |       |       |  |  |  |  |          |     |  |       |       |  |  |  |  |          |     |  |       |       |  |  |  |  |          |     |  |       |       |  |  |  |  |           |     |  |       |       |  |  |  |  |           |     |  |       |       |  |  |  |  |
| 2.0 TDCi   | 110  |              | 10.14 |       |                |        |   |                      |   |                      |              |           |  |       |       |                |                |        |                    |                   |     |           |       |       |       |       |  |  |            |     |  |        |       |  |       |       |  |              |     |  |       |       |  |  |  |  |              |     |  |       |       |  |  |  |  |              |     |  |       |       |  |  |  |  |              |     |  |       |       |  |  |  |  |               |     |  |       |       |  |  |  |  |           |     |  |       |       |  |  |  |  |          |     |  |       |       |  |  |  |  |              |     |  |       |       |  |  |  |  |              |     |  |       |       |  |  |  |  |                   |     |  |       |       |  |  |  |  |          |     |  |       |       |  |  |  |  |          |     |  |       |       |  |  |  |  |          |     |  |       |       |  |  |  |  |          |     |  |       |       |  |  |  |  |          |     |  |       |       |  |  |  |  |           |     |  |       |       |  |  |  |  |           |     |  |       |       |  |  |  |  |
| 2.0 TDCi   | 132  |              | 10.14 |       |                |        |   |                      |   |                      |              |           |  |       |       |                |                |        |                    |                   |     |           |       |       |       |       |  |  |            |     |  |        |       |  |       |       |  |              |     |  |       |       |  |  |  |  |              |     |  |       |       |  |  |  |  |              |     |  |       |       |  |  |  |  |              |     |  |       |       |  |  |  |  |               |     |  |       |       |  |  |  |  |           |     |  |       |       |  |  |  |  |          |     |  |       |       |  |  |  |  |              |     |  |       |       |  |  |  |  |              |     |  |       |       |  |  |  |  |                   |     |  |       |       |  |  |  |  |          |     |  |       |       |  |  |  |  |          |     |  |       |       |  |  |  |  |          |     |  |       |       |  |  |  |  |          |     |  |       |       |  |  |  |  |          |     |  |       |       |  |  |  |  |           |     |  |       |       |  |  |  |  |           |     |  |       |       |  |  |  |  |
| 2.0 TDCi   | 154  |              | 05.15 |       |                |        |   |                      |   |                      |              |           |  |       |       |                |                |        |                    |                   |     |           |       |       |       |       |  |  |            |     |  |        |       |  |       |       |  |              |     |  |       |       |  |  |  |  |              |     |  |       |       |  |  |  |  |              |     |  |       |       |  |  |  |  |              |     |  |       |       |  |  |  |  |               |     |  |       |       |  |  |  |  |           |     |  |       |       |  |  |  |  |          |     |  |       |       |  |  |  |  |              |     |  |       |       |  |  |  |  |              |     |  |       |       |  |  |  |  |                   |     |  |       |       |  |  |  |  |          |     |  |       |       |  |  |  |  |          |     |  |       |       |  |  |  |  |          |     |  |       |       |  |  |  |  |          |     |  |       |       |  |  |  |  |          |     |  |       |       |  |  |  |  |           |     |  |       |       |  |  |  |  |           |     |  |       |       |  |  |  |  |
| 2.0 TDCi 4x4   | 110  |              | 02.15 |       |                |        |   |                      |   |                      |              |           |  |       |       |                |                |        |                    |                   |     |           |       |       |       |       |  |  |            |     |  |        |       |  |       |       |  |              |     |  |       |       |  |  |  |  |              |     |  |       |       |  |  |  |  |              |     |  |       |       |  |  |  |  |              |     |  |       |       |  |  |  |  |               |     |  |       |       |  |  |  |  |           |     |  |       |       |  |  |  |  |          |     |  |       |       |  |  |  |  |              |     |  |       |       |  |  |  |  |              |     |  |       |       |  |  |  |  |                   |     |  |       |       |  |  |  |  |          |     |  |       |       |  |  |  |  |          |     |  |       |       |  |  |  |  |          |     |  |       |       |  |  |  |  |          |     |  |       |       |  |  |  |  |          |     |  |       |       |  |  |  |  |           |     |  |       |       |  |  |  |  |           |     |  |       |       |  |  |  |  |
| 2.0 TDCi 4x4   | 132  |              | 02.15 |       |                |        |   |                      |   |                      |              |           |  |       |       |                |                |        |                    |                   |     |           |       |       |       |       |  |  |            |     |  |        |       |  |       |       |  |              |     |  |       |       |  |  |  |  |              |     |  |       |       |  |  |  |  |              |     |  |       |       |  |  |  |  |              |     |  |       |       |  |  |  |  |               |     |  |       |       |  |  |  |  |           |     |  |       |       |  |  |  |  |          |     |  |       |       |  |  |  |  |              |     |  |       |       |  |  |  |  |              |     |  |       |       |  |  |  |  |                   |     |  |       |       |  |  |  |  |          |     |  |       |       |  |  |  |  |          |     |  |       |       |  |  |  |  |          |     |  |       |       |  |  |  |  |          |     |  |       |       |  |  |  |  |          |     |  |       |       |  |  |  |  |           |     |  |       |       |  |  |  |  |           |     |  |       |       |  |  |  |  |
| 2.0 TDCi Bi-Turbo  | 155  |              | 03.15 |       |                |        |   |                      |   |                      |              |           |  |       |       |                |                |        |                    |                   |     |           |       |       |       |       |  |  |            |     |  |        |       |  |       |       |  |              |     |  |       |       |  |  |  |  |              |     |  |       |       |  |  |  |  |              |     |  |       |       |  |  |  |  |              |     |  |       |       |  |  |  |  |               |     |  |       |       |  |  |  |  |           |     |  |       |       |  |  |  |  |          |     |  |       |       |  |  |  |  |              |     |  |       |       |  |  |  |  |              |     |  |       |       |  |  |  |  |                   |     |  |       |       |  |  |  |  |          |     |  |       |       |  |  |  |  |          |     |  |       |       |  |  |  |  |          |     |  |       |       |  |  |  |  |          |     |  |       |       |  |  |  |  |          |     |  |       |       |  |  |  |  |           |     |  |       |       |  |  |  |  |           |     |  |       |       |  |  |  |  |
| 2.5  | 110  |              | 05.15 |       |                |        |   |                      |   |                      |              |           |  |       |       |                |                |        |                    |                   |     |           |       |       |       |       |  |  |            |     |  |        |       |  |       |       |  |              |     |  |       |       |  |  |  |  |              |     |  |       |       |  |  |  |  |              |     |  |       |       |  |  |  |  |              |     |  |       |       |  |  |  |  |               |     |  |       |       |  |  |  |  |           |     |  |       |       |  |  |  |  |          |     |  |       |       |  |  |  |  |              |     |  |       |       |  |  |  |  |              |     |  |       |       |  |  |  |  |                   |     |  |       |       |  |  |  |  |          |     |  |       |       |  |  |  |  |          |     |  |       |       |  |  |  |  |          |     |  |       |       |  |  |  |  |          |     |  |       |       |  |  |  |  |          |     |  |       |       |  |  |  |  |           |     |  |       |       |  |  |  |  |           |     |  |       |       |  |  |  |  |
|    | <table border="1"> <tr><td>1.0 EcoBoost</td><td>92</td><td></td><td>02.15</td><td></td><td>24.0111-0185.1</td><td>411185</td><td>elektrische Feststellbremse <sup>1)</sup></td><td>204 11,0 9,5 +B</td></tr> <tr><td>1.5 EcoBoost</td><td>118</td><td></td><td>10.14</td><td></td><td></td><td></td><td></td><td></td></tr> <tr><td>1.5 TDCi</td><td>88</td><td></td><td>03.15</td><td></td><td></td><td></td><td></td><td></td></tr> <tr><td>1.6 TDCi</td><td>85</td><td></td><td>10.14</td><td></td><td></td><td></td><td></td><td></td></tr> <tr><td>2.0 EcoBoost</td><td>146</td><td></td><td>05.15</td><td></td><td></td><td></td><td></td><td></td></tr> <tr><td>2.0 EcoBoost</td><td>149</td><td></td><td>10.14</td><td></td><td></td><td></td><td></td><td></td></tr> <tr><td>2.0 EcoBoost</td><td>176</td><td></td><td>10.14</td><td></td><td></td><td></td><td></td><td></td></tr> <tr><td>2.0 Hybrid</td><td></td><td></td><td>10.14</td><td></td><td></td><td></td><td></td><td></td></tr> <tr><td>2.0 TDCi</td><td>110</td><td></td><td>10.14</td><td></td><td></td><td></td><td></td><td></td></tr> <tr><td>2.0 TDCi</td><td>132</td><td></td><td>10.14</td><td></td><td></td><td></td><td></td><td></td></tr> <tr><td>2.0 TDCi</td><td>154</td><td></td><td>05.15</td><td></td><td></td><td></td><td></td><td></td></tr> <tr><td>2.0 TDCi 4x4</td><td>110</td><td></td><td>02.15</td><td></td><td></td><td></td><td></td><td></td></tr> <tr><td>2.0 TDCi 4x4</td><td>132</td><td></td><td>02.15</td><td></td><td></td><td></td><td></td><td></td></tr> <tr><td>2.0 TDCi Bi-Turbo</td><td>155</td><td></td><td>03.15</td><td></td><td></td><td></td><td></td><td></td></tr> <tr><td>2.5</td><td>110</td><td></td><td>05.15</td><td></td><td></td><td></td><td></td><td></td></tr> </table>   | 1.0 EcoBoost | 92    |       | 02.15          |        | 24.0111-0185.1  | 411185               | elektrische Feststellbremse <sup>1)</sup>   | 204 11,0 9,5 +B      | 1.5 EcoBoost | 118       |  | 10.14 |       |                |                |        |                    | 1.5 TDCi          | 88  |           | 03.15 |       |       |       |  |  | 1.6 TDCi   | 85  |  | 10.14  |       |  |       |       |  | 2.0 EcoBoost | 146 |  | 05.15 |       |  |  |  |  | 2.0 EcoBoost | 149 |  | 10.14 |       |  |  |  |  | 2.0 EcoBoost | 176 |  | 10.14 |       |  |  |  |  | 2.0 Hybrid   |     |  | 10.14 |       |  |  |  |  | 2.0 TDCi      | 110 |  | 10.14 |       |  |  |  |  | 2.0 TDCi  | 132 |  | 10.14 |       |  |  |  |  | 2.0 TDCi | 154 |  | 05.15 |       |  |  |  |  | 2.0 TDCi 4x4 | 110 |  | 02.15 |       |  |  |  |  | 2.0 TDCi 4x4 | 132 |  | 02.15 |       |  |  |  |  | 2.0 TDCi Bi-Turbo | 155 |  | 03.15 |       |  |  |  |  | 2.5      | 110 |  | 05.15 |       |  |  |  |  |          |     |  |       |       |  |  |  |  |          |     |  |       |       |  |  |  |  |          |     |  |       |       |  |  |  |  |          |     |  |       |       |  |  |  |  |           |     |  |       |       |  |  |  |  |           |     |  |       |       |  |  |  |  |
| 1.0 EcoBoost   | 92   |              | 02.15 |       | 24.0111-0185.1 | 411185 | elektrische Feststellbremse <sup>1)</sup>   | 204 11,0 9,5 +B      |   |                      |              |           |  |       |       |                |                |        |                    |                   |     |           |       |       |       |       |  |  |            |     |  |        |       |  |       |       |  |              |     |  |       |       |  |  |  |  |              |     |  |       |       |  |  |  |  |              |     |  |       |       |  |  |  |  |              |     |  |       |       |  |  |  |  |               |     |  |       |       |  |  |  |  |           |     |  |       |       |  |  |  |  |          |     |  |       |       |  |  |  |  |              |     |  |       |       |  |  |  |  |              |     |  |       |       |  |  |  |  |                   |     |  |       |       |  |  |  |  |          |     |  |       |       |  |  |  |  |          |     |  |       |       |  |  |  |  |          |     |  |       |       |  |  |  |  |          |     |  |       |       |  |  |  |  |          |     |  |       |       |  |  |  |  |           |     |  |       |       |  |  |  |  |           |     |  |       |       |  |  |  |  |
| 1.5 EcoBoost   | 118  |              | 10.14 |       |                |        |   |                      |   |                      |              |           |  |       |       |                |                |        |                    |                   |     |           |       |       |       |       |  |  |            |     |  |        |       |  |       |       |  |              |     |  |       |       |  |  |  |  |              |     |  |       |       |  |  |  |  |              |     |  |       |       |  |  |  |  |              |     |  |       |       |  |  |  |  |               |     |  |       |       |  |  |  |  |           |     |  |       |       |  |  |  |  |          |     |  |       |       |  |  |  |  |              |     |  |       |       |  |  |  |  |              |     |  |       |       |  |  |  |  |                   |     |  |       |       |  |  |  |  |          |     |  |       |       |  |  |  |  |          |     |  |       |       |  |  |  |  |          |     |  |       |       |  |  |  |  |          |     |  |       |       |  |  |  |  |          |     |  |       |       |  |  |  |  |           |     |  |       |       |  |  |  |  |           |     |  |       |       |  |  |  |  |
| 1.5 TDCi   | 88   |              | 03.15 |       |                |        |   |                      |   |                      |              |           |  |       |       |                |                |        |                    |                   |     |           |       |       |       |       |  |  |            |     |  |        |       |  |       |       |  |              |     |  |       |       |  |  |  |  |              |     |  |       |       |  |  |  |  |              |     |  |       |       |  |  |  |  |              |     |  |       |       |  |  |  |  |               |     |  |       |       |  |  |  |  |           |     |  |       |       |  |  |  |  |          |     |  |       |       |  |  |  |  |              |     |  |       |       |  |  |  |  |              |     |  |       |       |  |  |  |  |                   |     |  |       |       |  |  |  |  |          |     |  |       |       |  |  |  |  |          |     |  |       |       |  |  |  |  |          |     |  |       |       |  |  |  |  |          |     |  |       |       |  |  |  |  |          |     |  |       |       |  |  |  |  |           |     |  |       |       |  |  |  |  |           |     |  |       |       |  |  |  |  |
| 1.6 TDCi   | 85   |              | 10.14 |       |                |        |   |                      |   |                      |              |           |  |       |       |                |                |        |                    |                   |     |           |       |       |       |       |  |  |            |     |  |        |       |  |       |       |  |              |     |  |       |       |  |  |  |  |              |     |  |       |       |  |  |  |  |              |     |  |       |       |  |  |  |  |              |     |  |       |       |  |  |  |  |               |     |  |       |       |  |  |  |  |           |     |  |       |       |  |  |  |  |          |     |  |       |       |  |  |  |  |              |     |  |       |       |  |  |  |  |              |     |  |       |       |  |  |  |  |                   |     |  |       |       |  |  |  |  |          |     |  |       |       |  |  |  |  |          |     |  |       |       |  |  |  |  |          |     |  |       |       |  |  |  |  |          |     |  |       |       |  |  |  |  |          |     |  |       |       |  |  |  |  |           |     |  |       |       |  |  |  |  |           |     |  |       |       |  |  |  |  |
| 2.0 EcoBoost   | 146  |              | 05.15 |       |                |        |   |                      |   |                      |              |           |  |       |       |                |                |        |                    |                   |     |           |       |       |       |       |  |  |            |     |  |        |       |  |       |       |  |              |     |  |       |       |  |  |  |  |              |     |  |       |       |  |  |  |  |              |     |  |       |       |  |  |  |  |              |     |  |       |       |  |  |  |  |               |     |  |       |       |  |  |  |  |           |     |  |       |       |  |  |  |  |          |     |  |       |       |  |  |  |  |              |     |  |       |       |  |  |  |  |              |     |  |       |       |  |  |  |  |                   |     |  |       |       |  |  |  |  |          |     |  |       |       |  |  |  |  |          |     |  |       |       |  |  |  |  |          |     |  |       |       |  |  |  |  |          |     |  |       |       |  |  |  |  |          |     |  |       |       |  |  |  |  |           |     |  |       |       |  |  |  |  |           |     |  |       |       |  |  |  |  |
| 2.0 EcoBoost   | 149  |              | 10.14 |       |                |        |   |                      |   |                      |              |           |  |       |       |                |                |        |                    |                   |     |           |       |       |       |       |  |  |            |     |  |        |       |  |       |       |  |              |     |  |       |       |  |  |  |  |              |     |  |       |       |  |  |  |  |              |     |  |       |       |  |  |  |  |              |     |  |       |       |  |  |  |  |               |     |  |       |       |  |  |  |  |           |     |  |       |       |  |  |  |  |          |     |  |       |       |  |  |  |  |              |     |  |       |       |  |  |  |  |              |     |  |       |       |  |  |  |  |                   |     |  |       |       |  |  |  |  |          |     |  |       |       |  |  |  |  |          |     |  |       |       |  |  |  |  |          |     |  |       |       |  |  |  |  |          |     |  |       |       |  |  |  |  |          |     |  |       |       |  |  |  |  |           |     |  |       |       |  |  |  |  |           |     |  |       |       |  |  |  |  |
| 2.0 EcoBoost   | 176  |              | 10.14 |       |                |        |   |                      |   |                      |              |           |  |       |       |                |                |        |                    |                   |     |           |       |       |       |       |  |  |            |     |  |        |       |  |       |       |  |              |     |  |       |       |  |  |  |  |              |     |  |       |       |  |  |  |  |              |     |  |       |       |  |  |  |  |              |     |  |       |       |  |  |  |  |               |     |  |       |       |  |  |  |  |           |     |  |       |       |  |  |  |  |          |     |  |       |       |  |  |  |  |              |     |  |       |       |  |  |  |  |              |     |  |       |       |  |  |  |  |                   |     |  |       |       |  |  |  |  |          |     |  |       |       |  |  |  |  |          |     |  |       |       |  |  |  |  |          |     |  |       |       |  |  |  |  |          |     |  |       |       |  |  |  |  |          |     |  |       |       |  |  |  |  |           |     |  |       |       |  |  |  |  |           |     |  |       |       |  |  |  |  |
| 2.0 Hybrid   |  |              | 10.14 |       |                |        |   |                      |   |                      |              |           |  |       |       |                |                |        |                    |                   |     |           |       |       |       |       |  |  |            |     |  |        |       |  |       |       |  |              |     |  |       |       |  |  |  |  |              |     |  |       |       |  |  |  |  |              |     |  |       |       |  |  |  |  |              |     |  |       |       |  |  |  |  |               |     |  |       |       |  |  |  |  |           |     |  |       |       |  |  |  |  |          |     |  |       |       |  |  |  |  |              |     |  |       |       |  |  |  |  |              |     |  |       |       |  |  |  |  |                   |     |  |       |       |  |  |  |  |          |     |  |       |       |  |  |  |  |          |     |  |       |       |  |  |  |  |          |     |  |       |       |  |  |  |  |          |     |  |       |       |  |  |  |  |          |     |  |       |       |  |  |  |  |           |     |  |       |       |  |  |  |  |           |     |  |       |       |  |  |  |  |
| 2.0 TDCi   | 110  |              | 10.14 |       |                |        |   |                      |   |                      |              |           |  |       |       |                |                |        |                    |                   |     |           |       |       |       |       |  |  |            |     |  |        |       |  |       |       |  |              |     |  |       |       |  |  |  |  |              |     |  |       |       |  |  |  |  |              |     |  |       |       |  |  |  |  |              |     |  |       |       |  |  |  |  |               |     |  |       |       |  |  |  |  |           |     |  |       |       |  |  |  |  |          |     |  |       |       |  |  |  |  |              |     |  |       |       |  |  |  |  |              |     |  |       |       |  |  |  |  |                   |     |  |       |       |  |  |  |  |          |     |  |       |       |  |  |  |  |          |     |  |       |       |  |  |  |  |          |     |  |       |       |  |  |  |  |          |     |  |       |       |  |  |  |  |          |     |  |       |       |  |  |  |  |           |     |  |       |       |  |  |  |  |           |     |  |       |       |  |  |  |  |
| 2.0 TDCi   | 132  |              | 10.14 |       |                |        |   |                      |   |                      |              |           |  |       |       |                |                |        |                    |                   |     |           |       |       |       |       |  |  |            |     |  |        |       |  |       |       |  |              |     |  |       |       |  |  |  |  |              |     |  |       |       |  |  |  |  |              |     |  |       |       |  |  |  |  |              |     |  |       |       |  |  |  |  |               |     |  |       |       |  |  |  |  |           |     |  |       |       |  |  |  |  |          |     |  |       |       |  |  |  |  |              |     |  |       |       |  |  |  |  |              |     |  |       |       |  |  |  |  |                   |     |  |       |       |  |  |  |  |          |     |  |       |       |  |  |  |  |          |     |  |       |       |  |  |  |  |          |     |  |       |       |  |  |  |  |          |     |  |       |       |  |  |  |  |          |     |  |       |       |  |  |  |  |           |     |  |       |       |  |  |  |  |           |     |  |       |       |  |  |  |  |
| 2.0 TDCi   | 154  |              | 05.15 |       |                |        |   |                      |   |                      |              |           |  |       |       |                |                |        |                    |                   |     |           |       |       |       |       |  |  |            |     |  |        |       |  |       |       |  |              |     |  |       |       |  |  |  |  |              |     |  |       |       |  |  |  |  |              |     |  |       |       |  |  |  |  |              |     |  |       |       |  |  |  |  |               |     |  |       |       |  |  |  |  |           |     |  |       |       |  |  |  |  |          |     |  |       |       |  |  |  |  |              |     |  |       |       |  |  |  |  |              |     |  |       |       |  |  |  |  |                   |     |  |       |       |  |  |  |  |          |     |  |       |       |  |  |  |  |          |     |  |       |       |  |  |  |  |          |     |  |       |       |  |  |  |  |          |     |  |       |       |  |  |  |  |          |     |  |       |       |  |  |  |  |           |     |  |       |       |  |  |  |  |           |     |  |       |       |  |  |  |  |
| 2.0 TDCi 4x4   | 110  |              | 02.15 |       |                |        |   |                      |   |                      |              |           |  |       |       |                |                |        |                    |                   |     |           |       |       |       |       |  |  |            |     |  |        |       |  |       |       |  |              |     |  |       |       |  |  |  |  |              |     |  |       |       |  |  |  |  |              |     |  |       |       |  |  |  |  |              |     |  |       |       |  |  |  |  |               |     |  |       |       |  |  |  |  |           |     |  |       |       |  |  |  |  |          |     |  |       |       |  |  |  |  |              |     |  |       |       |  |  |  |  |              |     |  |       |       |  |  |  |  |                   |     |  |       |       |  |  |  |  |          |     |  |       |       |  |  |  |  |          |     |  |       |       |  |  |  |  |          |     |  |       |       |  |  |  |  |          |     |  |       |       |  |  |  |  |          |     |  |       |       |  |  |  |  |           |     |  |       |       |  |  |  |  |           |     |  |       |       |  |  |  |  |
| 2.0 TDCi 4x4   | 132  |              | 02.15 |       |                |        |   |                      |   |                      |              |           |  |       |       |                |                |        |                    |                   |     |           |       |       |       |       |  |  |            |     |  |        |       |  |       |       |  |              |     |  |       |       |  |  |  |  |              |     |  |       |       |  |  |  |  |              |     |  |       |       |  |  |  |  |              |     |  |       |       |  |  |  |  |               |     |  |       |       |  |  |  |  |           |     |  |       |       |  |  |  |  |          |     |  |       |       |  |  |  |  |              |     |  |       |       |  |  |  |  |              |     |  |       |       |  |  |  |  |                   |     |  |       |       |  |  |  |  |          |     |  |       |       |  |  |  |  |          |     |  |       |       |  |  |  |  |          |     |  |       |       |  |  |  |  |          |     |  |       |       |  |  |  |  |          |     |  |       |       |  |  |  |  |           |     |  |       |       |  |  |  |  |           |     |  |       |       |  |  |  |  |
| 2.0 TDCi Bi-Turbo  | 155  |              | 03.15 |       |                |        |   |                      |   |                      |              |           |  |       |       |                |                |        |                    |                   |     |           |       |       |       |       |  |  |            |     |  |        |       |  |       |       |  |              |     |  |       |       |  |  |  |  |              |     |  |       |       |  |  |  |  |              |     |  |       |       |  |  |  |  |              |     |  |       |       |  |  |  |  |               |     |  |       |       |  |  |  |  |           |     |  |       |       |  |  |  |  |          |     |  |       |       |  |  |  |  |              |     |  |       |       |  |  |  |  |              |     |  |       |       |  |  |  |  |                   |     |  |       |       |  |  |  |  |          |     |  |       |       |  |  |  |  |          |     |  |       |       |  |  |  |  |          |     |  |       |       |  |  |  |  |          |     |  |       |       |  |  |  |  |          |     |  |       |       |  |  |  |  |           |     |  |       |       |  |  |  |  |           |     |  |       |       |  |  |  |  |
| 2.5  | 110  |              | 05.15 |       |                |        |   |                      |   |                      |              |           |  |       |       |                |                |        |                    |                   |     |           |       |       |       |       |  |  |            |     |  |        |       |  |       |       |  |              |     |  |       |       |  |  |  |  |              |     |  |       |       |  |  |  |  |              |     |  |       |       |  |  |  |  |              |     |  |       |       |  |  |  |  |               |     |  |       |       |  |  |  |  |           |     |  |       |       |  |  |  |  |          |     |  |       |       |  |  |  |  |              |     |  |       |       |  |  |  |  |              |     |  |       |       |  |  |  |  |                   |     |  |       |       |  |  |  |  |          |     |  |       |       |  |  |  |  |          |     |  |       |       |  |  |  |  |          |     |  |       |       |  |  |  |  |          |     |  |       |       |  |  |  |  |          |     |  |       |       |  |  |  |  |           |     |  |       |       |  |  |  |  |           |     |  |       |       |  |  |  |  |
| <b>FORD PROBE (93-97)</b>  |  |              |       |       |                |        |   |                      |   |                      |              |           |  |       |       |                |                |        |                    |                   |     |           |       |       |       |       |  |  |            |     |  |        |       |  |       |       |  |              |     |  |       |       |  |  |  |  |              |     |  |       |       |  |  |  |  |              |     |  |       |       |  |  |  |  |              |     |  |       |       |  |  |  |  |               |     |  |       |       |  |  |  |  |           |     |  |       |       |  |  |  |  |          |     |  |       |       |  |  |  |  |              |     |  |       |       |  |  |  |  |              |     |  |       |       |  |  |  |  |                   |     |  |       |       |  |  |  |  |          |     |  |       |       |  |  |  |  |          |     |  |       |       |  |  |  |  |          |     |  |       |       |  |  |  |  |          |     |  |       |       |  |  |  |  |          |     |  |       |       |  |  |  |  |           |     |  |       |       |  |  |  |  |           |     |  |       |       |  |  |  |  |
|    | <table border="1"> <tr><td>2.0 i 16V</td><td></td><td></td><td>01.94</td><td>09.97</td><td>13.0460-5954.2</td><td>605954</td><td></td><td>23845 15,8 +WK/Zub</td><td>SUM</td></tr> <tr><td>2.5 i 24V</td><td></td><td></td><td>01.93</td><td>09.97</td><td>13.0460-0443.2</td><td>610443</td><td></td><td>Belagsatz-Zubehör</td><td>SUM</td></tr> </table>   | 2.0 i 16V    |       |       | 01.94          | 09.97  | 13.0460-5954.2  | 605954               |   | 23845 15,8 +WK/Zub   | SUM          | 2.5 i 24V |  |       | 01.93 | 09.97          | 13.0460-0443.2 | 610443 |                    | Belagsatz-Zubehör | SUM |           |       |       |       |       |  |  |            |     |  |        |       |  |       |       |  |              |     |  |       |       |  |  |  |  |              |     |  |       |       |  |  |  |  |              |     |  |       |       |  |  |  |  |              |     |  |       |       |  |  |  |  |               |     |  |       |       |  |  |  |  |           |     |  |       |       |  |  |  |  |          |     |  |       |       |  |  |  |  |              |     |  |       |       |  |  |  |  |              |     |  |       |       |  |  |  |  |                   |     |  |       |       |  |  |  |  |          |     |  |       |       |  |  |  |  |          |     |  |       |       |  |  |  |  |          |     |  |       |       |  |  |  |  |          |     |  |       |       |  |  |  |  |          |     |  |       |       |  |  |  |  |           |     |  |       |       |  |  |  |  |           |     |  |       |       |  |  |  |  |
| 2.0 i 16V  |  |              | 01.94 | 09.97 | 13.0460-5954.2 | 605954 |   | 23845 15,8 +WK/Zub   | SUM   |                      |              |           |  |       |       |                |                |        |                    |                   |     |           |       |       |       |       |  |  |            |     |  |        |       |  |       |       |  |              |     |  |       |       |  |  |  |  |              |     |  |       |       |  |  |  |  |              |     |  |       |       |  |  |  |  |              |     |  |       |       |  |  |  |  |               |     |  |       |       |  |  |  |  |           |     |  |       |       |  |  |  |  |          |     |  |       |       |  |  |  |  |              |     |  |       |       |  |  |  |  |              |     |  |       |       |  |  |  |  |                   |     |  |       |       |  |  |  |  |          |     |  |       |       |  |  |  |  |          |     |  |       |       |  |  |  |  |          |     |  |       |       |  |  |  |  |          |     |  |       |       |  |  |  |  |          |     |  |       |       |  |  |  |  |           |     |  |       |       |  |  |  |  |           |     |  |       |       |  |  |  |  |
| 2.5 i 24V  |  |              | 01.93 | 09.97 | 13.0460-0443.2 | 610443 |   | Belagsatz-Zubehör    | SUM   |                      |              |           |  |       |       |                |                |        |                    |                   |     |           |       |       |       |       |  |  |            |     |  |        |       |  |       |       |  |              |     |  |       |       |  |  |  |  |              |     |  |       |       |  |  |  |  |              |     |  |       |       |  |  |  |  |              |     |  |       |       |  |  |  |  |               |     |  |       |       |  |  |  |  |           |     |  |       |       |  |  |  |  |          |     |  |       |       |  |  |  |  |              |     |  |       |       |  |  |  |  |              |     |  |       |       |  |  |  |  |                   |     |  |       |       |  |  |  |  |          |     |  |       |       |  |  |  |  |          |     |  |       |       |  |  |  |  |          |     |  |       |       |  |  |  |  |          |     |  |       |       |  |  |  |  |          |     |  |       |       |  |  |  |  |           |     |  |       |       |  |  |  |  |           |     |  |       |       |  |  |  |  |
|    | <table border="1"> <tr><td>2.0 i 16V</td><td></td><td></td><td>01.94</td><td>09.97</td><td>24.0124-0129.1</td><td>424129</td><td></td><td>258 24,0 22,0 V +B</td><td></td></tr> <tr><td>2.5 i 24V</td><td></td><td></td><td>01.93</td><td>09.97</td><td></td><td></td><td></td><td></td><td></td></tr> </table>  | 2.0 i 16V    |       |       | 01.94          | 09.97  | 24.0124-0129.1  | 424129               |   | 258 24,0 22,0 V +B   |              | 2.5 i 24V |  |       | 01.93 | 09.97          |                |        |                    |                   |     |           |       |       |       |       |  |  |            |     |  |        |       |  |       |       |  |              |     |  |       |       |  |  |  |  |              |     |  |       |       |  |  |  |  |              |     |  |       |       |  |  |  |  |              |     |  |       |       |  |  |  |  |               |     |  |       |       |  |  |  |  |           |     |  |       |       |  |  |  |  |          |     |  |       |       |  |  |  |  |              |     |  |       |       |  |  |  |  |              |     |  |       |       |  |  |  |  |                   |     |  |       |       |  |  |  |  |          |     |  |       |       |  |  |  |  |          |     |  |       |       |  |  |  |  |          |     |  |       |       |  |  |  |  |          |     |  |       |       |  |  |  |  |          |     |  |       |       |  |  |  |  |           |     |  |       |       |  |  |  |  |           |     |  |       |       |  |  |  |  |
| 2.0 i 16V  |  |              | 01.94 | 09.97 | 24.0124-0129.1 | 424129 |   | 258 24,0 22,0 V +B   |   |                      |              |           |  |       |       |                |                |        |                    |                   |     |           |       |       |       |       |  |  |            |     |  |        |       |  |       |       |  |              |     |  |       |       |  |  |  |  |              |     |  |       |       |  |  |  |  |              |     |  |       |       |  |  |  |  |              |     |  |       |       |  |  |  |  |               |     |  |       |       |  |  |  |  |           |     |  |       |       |  |  |  |  |          |     |  |       |       |  |  |  |  |              |     |  |       |       |  |  |  |  |              |     |  |       |       |  |  |  |  |                   |     |  |       |       |  |  |  |  |          |     |  |       |       |  |  |  |  |          |     |  |       |       |  |  |  |  |          |     |  |       |       |  |  |  |  |          |     |  |       |       |  |  |  |  |          |     |  |       |       |  |  |  |  |           |     |  |       |       |  |  |  |  |           |     |  |       |       |  |  |  |  |
| 2.5 i 24V  |  |              | 01.93 | 09.97 |                |        |   |                      |   |                      |              |           |  |       |       |                |                |        |                    |                   |     |           |       |       |       |       |  |  |            |     |  |        |       |  |       |       |  |              |     |  |       |       |  |  |  |  |              |     |  |       |       |  |  |  |  |              |     |  |       |       |  |  |  |  |              |     |  |       |       |  |  |  |  |               |     |  |       |       |  |  |  |  |           |     |  |       |       |  |  |  |  |          |     |  |       |       |  |  |  |  |              |     |  |       |       |  |  |  |  |              |     |  |       |       |  |  |  |  |                   |     |  |       |       |  |  |  |  |          |     |  |       |       |  |  |  |  |          |     |  |       |       |  |  |  |  |          |     |  |       |       |  |  |  |  |          |     |  |       |       |  |  |  |  |          |     |  |       |       |  |  |  |  |           |     |  |       |       |  |  |  |  |           |     |  |       |       |  |  |  |  |
|    | <table border="1"> <tr><td>2.0 i 16V</td><td></td><td></td><td>01.94</td><td>09.97</td><td>13.0460-5973.2</td><td>605973</td><td></td><td>21766 13,5</td><td></td></tr> <tr><td>2.5 i 24V</td><td></td><td></td><td>01.93</td><td>09.97</td><td>13.0460-0245.2</td><td>610245</td><td></td><td>Belagsatz-Zubehör</td><td></td></tr> </table>   | 2.0 i 16V    |       |       | 01.94          | 09.97  | 13.0460-5973.2  | 605973               |   | 21766 13,5           |              | 2.5 i 24V |  |       | 01.93 | 09.97          | 13.0460-0245.2 | 610245 |                    | Belagsatz-Zubehör |     |           |       |       |       |       |  |  |            |     |  |        |       |  |       |       |  |              |     |  |       |       |  |  |  |  |              |     |  |       |       |  |  |  |  |              |     |  |       |       |  |  |  |  |              |     |  |       |       |  |  |  |  |               |     |  |       |       |  |  |  |  |           |     |  |       |       |  |  |  |  |          |     |  |       |       |  |  |  |  |              |     |  |       |       |  |  |  |  |              |     |  |       |       |  |  |  |  |                   |     |  |       |       |  |  |  |  |          |     |  |       |       |  |  |  |  |          |     |  |       |       |  |  |  |  |          |     |  |       |       |  |  |  |  |          |     |  |       |       |  |  |  |  |          |     |  |       |       |  |  |  |  |           |     |  |       |       |  |  |  |  |           |     |  |       |       |  |  |  |  |
| 2.0 i 16V  |  |              | 01.94 | 09.97 | 13.0460-5973.2 | 605973 |   | 21766 13,5           |   |                      |              |           |  |       |       |                |                |        |                    |                   |     |           |       |       |       |       |  |  |            |     |  |        |       |  |       |       |  |              |     |  |       |       |  |  |  |  |              |     |  |       |       |  |  |  |  |              |     |  |       |       |  |  |  |  |              |     |  |       |       |  |  |  |  |               |     |  |       |       |  |  |  |  |           |     |  |       |       |  |  |  |  |          |     |  |       |       |  |  |  |  |              |     |  |       |       |  |  |  |  |              |     |  |       |       |  |  |  |  |                   |     |  |       |       |  |  |  |  |          |     |  |       |       |  |  |  |  |          |     |  |       |       |  |  |  |  |          |     |  |       |       |  |  |  |  |          |     |  |       |       |  |  |  |  |          |     |  |       |       |  |  |  |  |           |     |  |       |       |  |  |  |  |           |     |  |       |       |  |  |  |  |
| 2.5 i 24V  |  |              | 01.93 | 09.97 | 13.0460-0245.2 | 610245 |   | Belagsatz-Zubehör    |   |                      |              |           |  |       |       |                |                |        |                    |                   |     |           |       |       |       |       |  |  |            |     |  |        |       |  |       |       |  |              |     |  |       |       |  |  |  |  |              |     |  |       |       |  |  |  |  |              |     |  |       |       |  |  |  |  |              |     |  |       |       |  |  |  |  |               |     |  |       |       |  |  |  |  |           |     |  |       |       |  |  |  |  |          |     |  |       |       |  |  |  |  |              |     |  |       |       |  |  |  |  |              |     |  |       |       |  |  |  |  |                   |     |  |       |       |  |  |  |  |          |     |  |       |       |  |  |  |  |          |     |  |       |       |  |  |  |  |          |     |  |       |       |  |  |  |  |          |     |  |       |       |  |  |  |  |          |     |  |       |       |  |  |  |  |           |     |  |       |       |  |  |  |  |           |     |  |       |       |  |  |  |  |
|    | <table border="1"> <tr><td>2.0 i 16V</td><td></td><td></td><td>01.94</td><td>09.97</td><td>24.0110-0234.1</td><td>410234</td><td></td><td>261 10,0 8,0 +B</td><td></td></tr> <tr><td>2.5 i 24V</td><td></td><td></td><td>01.93</td><td>09.97</td><td></td><td></td><td></td><td></td><td></td></tr> </table>   | 2.0 i 16V    |       |       | 01.94          | 09.97  | 24.0110-0234.1  | 410234               |   | 261 10,0 8,0 +B      |              | 2.5 i 24V |  |       | 01.93 | 09.97          |                |        |                    |                   |     |           |       |       |       |       |  |  |            |     |  |        |       |  |       |       |  |              |     |  |       |       |  |  |  |  |              |     |  |       |       |  |  |  |  |              |     |  |       |       |  |  |  |  |              |     |  |       |       |  |  |  |  |               |     |  |       |       |  |  |  |  |           |     |  |       |       |  |  |  |  |          |     |  |       |       |  |  |  |  |              |     |  |       |       |  |  |  |  |              |     |  |       |       |  |  |  |  |                   |     |  |       |       |  |  |  |  |          |     |  |       |       |  |  |  |  |          |     |  |       |       |  |  |  |  |          |     |  |       |       |  |  |  |  |          |     |  |       |       |  |  |  |  |          |     |  |       |       |  |  |  |  |           |     |  |       |       |  |  |  |  |           |     |  |       |       |  |  |  |  |
| 2.0 i 16V  |  |              | 01.94 | 09.97 | 24.0110-0234.1 | 410234 |   | 261 10,0 8,0 +B      |   |                      |              |           |  |       |       |                |                |        |                    |                   |     |           |       |       |       |       |  |  |            |     |  |        |       |  |       |       |  |              |     |  |       |       |  |  |  |  |              |     |  |       |       |  |  |  |  |              |     |  |       |       |  |  |  |  |              |     |  |       |       |  |  |  |  |               |     |  |       |       |  |  |  |  |           |     |  |       |       |  |  |  |  |          |     |  |       |       |  |  |  |  |              |     |  |       |       |  |  |  |  |              |     |  |       |       |  |  |  |  |                   |     |  |       |       |  |  |  |  |          |     |  |       |       |  |  |  |  |          |     |  |       |       |  |  |  |  |          |     |  |       |       |  |  |  |  |          |     |  |       |       |  |  |  |  |          |     |  |       |       |  |  |  |  |           |     |  |       |       |  |  |  |  |           |     |  |       |       |  |  |  |  |
| 2.5 i 24V  |  |              | 01.93 | 09.97 |                |        |   |                      |   |                      |              |           |  |       |       |                |                |        |                    |                   |     |           |       |       |       |       |  |  |            |     |  |        |       |  |       |       |  |              |     |  |       |       |  |  |  |  |              |     |  |       |       |  |  |  |  |              |     |  |       |       |  |  |  |  |              |     |  |       |       |  |  |  |  |               |     |  |       |       |  |  |  |  |           |     |  |       |       |  |  |  |  |          |     |  |       |       |  |  |  |  |              |     |  |       |       |  |  |  |  |              |     |  |       |       |  |  |  |  |                   |     |  |       |       |  |  |  |  |          |     |  |       |       |  |  |  |  |          |     |  |       |       |  |  |  |  |          |     |  |       |       |  |  |  |  |          |     |  |       |       |  |  |  |  |          |     |  |       |       |  |  |  |  |           |     |  |       |       |  |  |  |  |           |     |  |       |       |  |  |  |  |
| <b>FORD PUMA (97-01)</b>   |  |              |       |       |                |        |   |                      |   |                      |              |           |  |       |       |                |                |        |                    |                   |     |           |       |       |       |       |  |  |            |     |  |        |       |  |       |       |  |              |     |  |       |       |  |  |  |  |              |     |  |       |       |  |  |  |  |              |     |  |       |       |  |  |  |  |              |     |  |       |       |  |  |  |  |               |     |  |       |       |  |  |  |  |           |     |  |       |       |  |  |  |  |          |     |  |       |       |  |  |  |  |              |     |  |       |       |  |  |  |  |              |     |  |       |       |  |  |  |  |                   |     |  |       |       |  |  |  |  |          |     |  |       |       |  |  |  |  |          |     |  |       |       |  |  |  |  |          |     |  |       |       |  |  |  |  |          |     |  |       |       |  |  |  |  |          |     |  |       |       |  |  |  |  |           |     |  |       |       |  |  |  |  |           |     |  |       |       |  |  |  |  |
|    | <table border="1"> <tr><td>1.4 i 16V</td><td></td><td></td><td>02.98</td><td>01.00</td><td>13.0460-7071.2</td><td>607071</td><td></td><td>20640 17,5 +</td><td>ATE</td></tr> <tr><td>1.7 i 16V</td><td></td><td></td><td>06.97</td><td>01.00</td><td></td><td></td><td></td><td></td><td></td></tr> <tr><td>ST 160</td><td></td><td></td><td>06.99</td><td>01.00</td><td></td><td></td><td></td><td></td><td></td></tr> </table>   | 1.4 i 16V    |       |       | 02.98          | 01.00  | 13.0460-7071.2  | 607071               |   | 20640 17,5 +         | ATE          | 1.7 i 16V |  |       | 06.97 | 01.00          |                |        |                    |                   |     | ST 160    |       |       | 06.99 | 01.00 |  |  |            |     |  |        |       |  |       |       |  |              |     |  |       |       |  |  |  |  |              |     |  |       |       |  |  |  |  |              |     |  |       |       |  |  |  |  |              |     |  |       |       |  |  |  |  |               |     |  |       |       |  |  |  |  |           |     |  |       |       |  |  |  |  |          |     |  |       |       |  |  |  |  |              |     |  |       |       |  |  |  |  |              |     |  |       |       |  |  |  |  |                   |     |  |       |       |  |  |  |  |          |     |  |       |       |  |  |  |  |          |     |  |       |       |  |  |  |  |          |     |  |       |       |  |  |  |  |          |     |  |       |       |  |  |  |  |          |     |  |       |       |  |  |  |  |           |     |  |       |       |  |  |  |  |           |     |  |       |       |  |  |  |  |
| 1.4 i 16V  |  |              | 02.98 | 01.00 | 13.0460-7071.2 | 607071 |   | 20640 17,5 +         | ATE   |                      |              |           |  |       |       |                |                |        |                    |                   |     |           |       |       |       |       |  |  |            |     |  |        |       |  |       |       |  |              |     |  |       |       |  |  |  |  |              |     |  |       |       |  |  |  |  |              |     |  |       |       |  |  |  |  |              |     |  |       |       |  |  |  |  |               |     |  |       |       |  |  |  |  |           |     |  |       |       |  |  |  |  |          |     |  |       |       |  |  |  |  |              |     |  |       |       |  |  |  |  |              |     |  |       |       |  |  |  |  |                   |     |  |       |       |  |  |  |  |          |     |  |       |       |  |  |  |  |          |     |  |       |       |  |  |  |  |          |     |  |       |       |  |  |  |  |          |     |  |       |       |  |  |  |  |          |     |  |       |       |  |  |  |  |           |     |  |       |       |  |  |  |  |           |     |  |       |       |  |  |  |  |
| 1.7 i 16V  |  |              | 06.97 | 01.00 |                |        |   |                      |   |                      |              |           |  |       |       |                |                |        |                    |                   |     |           |       |       |       |       |  |  |            |     |  |        |       |  |       |       |  |              |     |  |       |       |  |  |  |  |              |     |  |       |       |  |  |  |  |              |     |  |       |       |  |  |  |  |              |     |  |       |       |  |  |  |  |               |     |  |       |       |  |  |  |  |           |     |  |       |       |  |  |  |  |          |     |  |       |       |  |  |  |  |              |     |  |       |       |  |  |  |  |              |     |  |       |       |  |  |  |  |                   |     |  |       |       |  |  |  |  |          |     |  |       |       |  |  |  |  |          |     |  |       |       |  |  |  |  |          |     |  |       |       |  |  |  |  |          |     |  |       |       |  |  |  |  |          |     |  |       |       |  |  |  |  |           |     |  |       |       |  |  |  |  |           |     |  |       |       |  |  |  |  |
| ST 160   |  |              | 06.99 | 01.00 |                |        |   |                      |   |                      |              |           |  |       |       |                |                |        |                    |                   |     |           |       |       |       |       |  |  |            |     |  |        |       |  |       |       |  |              |     |  |       |       |  |  |  |  |              |     |  |       |       |  |  |  |  |              |     |  |       |       |  |  |  |  |              |     |  |       |       |  |  |  |  |               |     |  |       |       |  |  |  |  |           |     |  |       |       |  |  |  |  |          |     |  |       |       |  |  |  |  |              |     |  |       |       |  |  |  |  |              |     |  |       |       |  |  |  |  |                   |     |  |       |       |  |  |  |  |          |     |  |       |       |  |  |  |  |          |     |  |       |       |  |  |  |  |          |     |  |       |       |  |  |  |  |          |     |  |       |       |  |  |  |  |          |     |  |       |       |  |  |  |  |           |     |  |       |       |  |  |  |  |           |     |  |       |       |  |  |  |  |
|  | <table border="1"> <tr><td>1.4 i 16V</td><td></td><td></td><td>02.00</td><td>10.00</td><td>13.0460-7142.2</td><td>607142</td><td></td><td>23604 18,3 +</td><td>ATE</td></tr> <tr><td>1.6 i 16V</td><td></td><td></td><td>08.00</td><td>12.01</td><td></td><td></td><td></td><td></td><td></td></tr> <tr><td>1.7 i 16V</td><td></td><td></td><td>02.00</td><td>12.01</td><td></td><td></td><td></td><td></td><td></td></tr> <tr><td>ST 160</td><td></td><td></td><td>02.00</td><td>12.01</td><td></td><td></td><td></td><td></td><td></td></tr> </table>  | 1.4 i 16V    |       |       | 02.00          | 10.00  | 13.0460-7142.2  | 607142               |   | 23604 18,3 +         | ATE          | 1.6 i 16V |  |       | 08.00 | 12.01          |                |        |                    |                   |     | 1.7 i 16V |       |       | 02.00 | 12.01 |  |  |            |     |  | ST 160 |       |  | 02.00 | 12.01 |  |              |     |  |       |       |  |  |  |  |              |     |  |       |       |  |  |  |  |              |     |  |       |       |  |  |  |  |              |     |  |       |       |  |  |  |  |               |     |  |       |       |  |  |  |  |           |     |  |       |       |  |  |  |  |          |     |  |       |       |  |  |  |  |              |     |  |       |       |  |  |  |  |              |     |  |       |       |  |  |  |  |                   |     |  |       |       |  |  |  |  |          |     |  |       |       |  |  |  |  |          |     |  |       |       |  |  |  |  |          |     |  |       |       |  |  |  |  |          |     |  |       |       |  |  |  |  |          |     |  |       |       |  |  |  |  |           |     |  |       |       |  |  |  |  |           |     |  |       |       |  |  |  |  |
| 1.4 i 16V  |  |              | 02.00 | 10.00 | 13.0460-7142.2 | 607142 |   | 23604 18,3 +         | ATE   |                      |              |           |  |       |       |                |                |        |                    |                   |     |           |       |       |       |       |  |  |            |     |  |        |       |  |       |       |  |              |     |  |       |       |  |  |  |  |              |     |  |       |       |  |  |  |  |              |     |  |       |       |  |  |  |  |              |     |  |       |       |  |  |  |  |               |     |  |       |       |  |  |  |  |           |     |  |       |       |  |  |  |  |          |     |  |       |       |  |  |  |  |              |     |  |       |       |  |  |  |  |              |     |  |       |       |  |  |  |  |                   |     |  |       |       |  |  |  |  |          |     |  |       |       |  |  |  |  |          |     |  |       |       |  |  |  |  |          |     |  |       |       |  |  |  |  |          |     |  |       |       |  |  |  |  |          |     |  |       |       |  |  |  |  |           |     |  |       |       |  |  |  |  |           |     |  |       |       |  |  |  |  |
| 1.6 i 16V  |  |              | 08.00 | 12.01 |                |        |   |                      |   |                      |              |           |  |       |       |                |                |        |                    |                   |     |           |       |       |       |       |  |  |            |     |  |        |       |  |       |       |  |              |     |  |       |       |  |  |  |  |              |     |  |       |       |  |  |  |  |              |     |  |       |       |  |  |  |  |              |     |  |       |       |  |  |  |  |               |     |  |       |       |  |  |  |  |           |     |  |       |       |  |  |  |  |          |     |  |       |       |  |  |  |  |              |     |  |       |       |  |  |  |  |              |     |  |       |       |  |  |  |  |                   |     |  |       |       |  |  |  |  |          |     |  |       |       |  |  |  |  |          |     |  |       |       |  |  |  |  |          |     |  |       |       |  |  |  |  |          |     |  |       |       |  |  |  |  |          |     |  |       |       |  |  |  |  |           |     |  |       |       |  |  |  |  |           |     |  |       |       |  |  |  |  |
| 1.7 i 16V  |  |              | 02.00 | 12.01 |                |        |   |                      |   |                      |              |           |  |       |       |                |                |        |                    |                   |     |           |       |       |       |       |  |  |            |     |  |        |       |  |       |       |  |              |     |  |       |       |  |  |  |  |              |     |  |       |       |  |  |  |  |              |     |  |       |       |  |  |  |  |              |     |  |       |       |  |  |  |  |               |     |  |       |       |  |  |  |  |           |     |  |       |       |  |  |  |  |          |     |  |       |       |  |  |  |  |              |     |  |       |       |  |  |  |  |              |     |  |       |       |  |  |  |  |                   |     |  |       |       |  |  |  |  |          |     |  |       |       |  |  |  |  |          |     |  |       |       |  |  |  |  |          |     |  |       |       |  |  |  |  |          |     |  |       |       |  |  |  |  |          |     |  |       |       |  |  |  |  |           |     |  |       |       |  |  |  |  |           |     |  |       |       |  |  |  |  |
| ST 160   |  |              | 02.00 | 12.01 |                |        |   |                      |   |                      |              |           |  |       |       |                |                |        |                    |                   |     |           |       |       |       |       |  |  |            |     |  |        |       |  |       |       |  |              |     |  |       |       |  |  |  |  |              |     |  |       |       |  |  |  |  |              |     |  |       |       |  |  |  |  |              |     |  |       |       |  |  |  |  |               |     |  |       |       |  |  |  |  |           |     |  |       |       |  |  |  |  |          |     |  |       |       |  |  |  |  |              |     |  |       |       |  |  |  |  |              |     |  |       |       |  |  |  |  |                   |     |  |       |       |  |  |  |  |          |     |  |       |       |  |  |  |  |          |     |  |       |       |  |  |  |  |          |     |  |       |       |  |  |  |  |          |     |  |       |       |  |  |  |  |          |     |  |       |       |  |  |  |  |           |     |  |       |       |  |  |  |  |           |     |  |       |       |  |  |  |  |

<sup>1)</sup> electric parking brake / fr.di stazionamento elettrico / frein à main électrique / freno de mano eléctrico

|     |  |  |  |  |  |  |     |  |
|--|--|--|--|--|---|--|---|--|
| <b>FORD PUMA (97-01)</b>   |  |  |  |  |   |  |   |  |
|    | 1.4 i 16V  |  | 02.98  | 01.00  | 24.0120-0147.1  | 420147   |   | 240 20,0 18,0 V +B   |
|  | 1.7 i 16V<br>ST 160  |  | 06.97  | 01.00  | 24.0320-0147.1  | 520147   |   | 240 20,0 18,0 V +B PD  |
|    | 1.4 i 16V  |  | 02.00  | 10.00  | 24.0122-0172.1  | 422172   |   | 258 22,0 20,0 V +B   |
|  | 1.6 i 16V<br>1.7 i 16V<br>ST 160   |  | 08.00<br>02.00<br>02.00  | 12.01<br>12.01<br>12.01  | 24.0322-0172.1  | 522172   |   | 258 22,0 20,0 V +B PD  |
|    | 1.4 i 16V  |  | 02.98  | 10.00  | 24.0711-1367.1  | 360024   | 2  | Radsensor L=875  |
|  | 1.6 i 16V<br>1.7 i 16V   |  | 08.00<br>06.97   | 12.01<br>12.01   |   |  |   |  |
|    | 1.4 i 16V  |  | 02.98  | 12.98  | 24.0751-1173.3  | 360048   | 1  | Radsensor L=785/800  |
|  | 1.7 i 16V  |  | 06.97  | 12.98  |   |  |   |  |
|    | 1.4 i 16V  |  | 01.99  | 10.00  | 24.0713-1121.3  | 360036   | 1  | Radsensor L=785/800  |
|  | 1.6 i 16V<br>1.7 i 16V   |  | 08.00<br>01.99   | 12.01<br>12.01   |   |  |   |  |
|   | 1.4 i 16V  |  | 02.98  | 01.00  | 03.0137-0337.2  | 650337   |   | 180 x 32 HEB <b>TRW</b>  |
|  | 1.7 i 16V<br>ST 160  |  | 06.97<br>06.99   | 01.00<br>01.00   | 03.0137-9217.2  | 669217   |   | Bremsbacken-Zubehör <b>TRW</b>   |
|  | 1.4 i 16V  |  | 02.00  | 10.00  | 03.0137-0394.2  | 650394   |   | 203 x 38 HEB   |
|  | 1.6 i 16V<br>1.7 i 16V<br>ST 160   |  | 08.00<br>02.00<br>02.00  | 12.01<br>12.01<br>12.01  | 03.0137-9259.2  | 669259   |   | Bremsbacken-Zubehör  |
|  | 1.4 i 16V  |  | 02.98  | 01.00  | 24.0218-0024.2  | 480079   |   | 180/181 x 44 - Lager   |
|  | 1.7 i 16V<br>ST 160  |  | 06.97<br>06.99   | 01.00<br>01.00   | 24.0218-0724.2  | 480206   |   | 180/181 x 44 + Lager   |
|  | 1.4 i 16V  |  | 02.98  | 01.00  | 24.0218-0024.2  | 480079   | ohne Sensorring <sup>1)</sup>   | 180/181 x 44 - Lager   |
|  | 1.7 i 16V<br>ST 160  |  | 06.97<br>06.99   | 01.00<br>01.00   | 24.0218-0724.2  | 480206   | ohne Sensorring <sup>1)</sup>   | 180/181 x 44 + Lager   |
|  | 1.4 i 16V  |  | 02.00  | 10.00  | 24.0220-3009.2  | 480080   | ohne Sensorring <sup>1)</sup>   | 203/204 x 49   |
|  | 1.6 i 16V<br>1.7 i 16V<br>ST 160   |  | 08.00<br>02.00<br>02.00  | 12.01<br>12.01<br>12.01  |   |  |   |  |
|  | 1.4 i 16V  |  | 02.98  | 01.00  | 03.0520-3617.3  | 693617   |   | 17,78/180x32 TopKit <b>TRW</b>   |
|  | 1.7 i 16V<br>ST 160  |  | 06.97<br>06.99   | 01.00<br>01.00   |   |  |   |  |
|  | 1.4 i 16V  |  | 02.00  | 10.00  | 03.0520-6319.3  | 696319   |   | 19,05/203x38 TopKit <b>AP</b>  |
|  | 1.6 i 16V<br>1.7 i 16V<br>ST 160   |  | 08.00<br>02.00<br>02.00  | 12.01<br>12.01<br>12.01  |   |  |   |  |
| <b>FORD RANGER II (10-11)</b>  |  |  |  |  |   |  |   |  |
|  | 2.5 TDCi   | 105  | 04.10  | 10.11  | 24.0124-0245.1  | 424245   |   | 256 24,0 22,0 V L +B   |
|  | 3.0 TDCi   | 115  | 04.10  | 10.11  |   |  |   |  |
|  | 2.5 TDCi   | 105  | 04.10  | 10.11  | 24.0128-0226.1  | 428226   |   | 289 28,0 26,0 V L +B   |
|  | 2.5 TDCi 4x4<br>3.0 TDCi<br>3.0 TDCi 4x4   | 105<br>115<br>115  | 04.10<br>04.10<br>04.10  | 10.11<br>10.11<br>10.11  |   |  |   |  |
| <b>FORD RANGER (11-)</b>   |  |  |  |  |   |  |   |  |
|  | 2.2 TDCi   |  | 11.11  |  | 13.0460-8014.2  | 608014   |   | 25632 15,5 +WK/Zub/S   |
|  | 2.2 TDCi   | 96   | 05.15  |  |   |  |   |  |
|  | 2.2 TDCi   | 118  | 05.15  |  |   |  |   |  |
|  | 2.2 TDCi 4x4<br>2.2 TDCi 4x4<br>2.2 TDCi 4x4<br>2.2 TDCi 4x4<br>3.2 TDCi 4x4     | 92<br>96<br>110<br>118<br>147  | 11.11<br>05.15<br>11.11<br>05.15<br>11.11  |  |   |  |   |  |
|  | 2.2 TDCi   |  | 11.11  |  | 03.0137-0519.2  | 650519   | + verbesserter Lage/Fahrzeughöhe <sup>2)</sup>  | 294 x 56   |
|  | 2.2 TDCi   | 96   | 05.15  |  |   |  |   |  |
|  | 2.2 TDCi   | 118  | 05.15  |  |   |  |   |  |
|  | 2.2 TDCi 4x4<br>2.2 TDCi 4x4<br>2.2 TDCi 4x4<br>2.2 TDCi 4x4<br>3.2 TDCi 4x4     | 92<br>96<br>110<br>118<br>147  | 11.11<br>05.15<br>11.11<br>05.15<br>11.11  |  |   |  |   |  |
| <b>FORD SCORPIO / GRANADA (GB) (95-98)</b>   |  |  |  |  |   |  |   |  |
|  | 2.0 i  |  | 10.94  | 08.98  | 13.0460-7057.2  | 607057   |   | 21394 17,5 + <b>ATE</b>  |
|  | 2.3 i 16V<br>2.5 TD<br>2.9 i   |  | 05.96<br>10.94<br>01.95  | 08.98<br>08.98<br>08.98  |   |  |   |  |
|  | 2.0 i  |  | 10.94  | 08.98  | 24.0124-0120.1  | 424120   |   | 260 24,0 22,2 V +B   |
|  | 2.3 i 16V<br>2.5 TD<br>2.9 i   |  | 05.96<br>10.94<br>01.95  | 08.98<br>08.98<br>08.98  | 24.0324-0120.1  | 524120   |   | 260 24,0 22,2 V +B PD  |
|  | 2.9 i 24V  |  | 10.94  | 08.98  | 24.0124-0149.1  | 424149   |   | 278 24,1 22,2 V +B   |
|  | 2.0 i<br>2.3 i 16V<br>2.5 TD<br>2.9 i<br>2.9 i 24V                               |  | 10.94<br>05.96<br>10.94<br>01.95<br>10.94  | 08.98<br>08.98<br>08.98<br>08.98<br>08.98  | 13.0460-2928.2  | 602928   |   | 20981 13,8 /S <b>TRW</b>   |

<sup>1)</sup> without sensor ring / senza sensori / sans secours ABS / sin anillo sensor ABS

<sup>2)</sup> + improved position/vehicle height / + pos.migliorata/altezza veicolo / + pos.améliorée/hauteur véhicule / + pos.mejorada/altura vehiculo

|     |   |                         |  |    |  |                |       |    |
|--|---|---|--|--|---|--|---|--|
| <b>FORD SCORPIO / GRANADA (GB) (95-98)</b>   |   |   |  |  |   |  |   |  |
|    | 2.0 i Lim.<br>2.3 i 16V Lim.<br>2.5 TD Lim.<br>2.9 i Lim.   |   |  | 10.94 08.98<br>05.96 08.98<br>10.94 08.98<br>01.95 08.98   |   | 24.0110-0115.1 410115<br>24.0310-0115.1 510115   |   | 253 10,2 8,9 +B<br>253 10,2 8,9 +B PD  |
|  | 2.0 i Kombi<br>2.3 i 16V Kombi<br>2.5 TD Kombi<br>2.9 i Kombi   |   |  | 10.94 08.98<br>05.96 08.98<br>10.94 08.98<br>01.95 08.98   |   | 24.0120-0146.1 420146<br>24.0320-0146.1 520146   |   | 253 20,0 18,0 V +B<br>253 20,0 18,0 V +B PD  |
| <b>FORD S-MAX (06-)</b>  |   |   |  |  |   |  |   |  |
|    | 1.6 EcoBoost<br>1.6 TDCi<br>1.8 TDCi<br>1.8 TDCi<br>2.0 i 16V<br>2.0 TDCi<br>2.0 TDCi<br>2.0 TDCi<br>2.0 TDCi<br>2.0 TDCi<br>2.2 TDCi<br>2.2 TDCi<br>2.3 i 16V  | 118<br>85<br>74<br>92<br>107<br>85<br>96<br>100<br>103<br>120<br>129<br>147<br>118                      |  | 02.11<br>02.11<br>01.07<br>04.06<br>04.06<br>10.07<br>04.06<br>05.06<br>04.06<br>03.10<br>11.08<br>07.10<br>07.07                            |   | 13.0460-7228.2 607228<br>13.0470-7228.2 LD7228   |   | 24123 20,3 +<br>ATE<br>24123 20,3 +<br>ATE   |
|  | 2.0 EcoBoost<br>2.0 SCTi EcoBoost<br>2.2 TDCi<br>2.5 ST   | 176<br>149<br>129<br>162  |  | 07.10<br>03.10<br>04.08<br>04.06   | 10.08   | 13.0460-7243.2 607243<br>13.0470-7243.2 LD7243   |   | 24142 20,6 +<br>ATE<br>24142 20,6 +<br>ATE   |
|    | 1.6 EcoBoost<br>1.6 TDCi<br>1.8 TDCi<br>1.8 TDCi<br>2.0 EcoBoost<br>2.0 i 16V<br>2.0 TDCi<br>2.0 TDCi<br>2.0 TDCi<br>2.0 TDCi<br>2.2 TDCi<br>2.2 TDCi<br>2.3 i 16V  | 118<br>85<br>74<br>92<br>176<br>107<br>85<br>96<br>100<br>103<br>120<br>129<br>147<br>118               |  | 02.11<br>02.11<br>01.07<br>04.06<br>05.11<br>04.06<br>10.07<br>04.06<br>05.06<br>04.06<br>03.10<br>11.08<br>07.10<br>07.07                   |   | 24.0128-0154.1 428154<br>24.0328-0154.1 528154   |   | 300 28,0 26,0 V L +S +B<br>300 28,0 26,0 V L +S +B PD  |
|  | 2.0 EcoBoost<br>2.0 SCTi EcoBoost<br>2.2 TDCi<br>2.5 ST   | 176<br>149<br>129<br>162  |  | 07.10<br>03.10<br>04.08<br>04.06   | 04.11<br>10.08  | 24.0128-0162.1 428162<br>24.0328-0162.1 528162   |   | 316 28,0 26,0 V L +S +B<br>316 28,0 26,0 V L +S +B PD  |
|  | 1.6 EcoBoost<br>1.6 TDCi<br>1.8 TDCi<br>1.8 TDCi<br>2.0 EcoBoost<br>2.0 i 16V<br>2.0 SCTi EcoBoost<br>2.0 TDCi<br>2.0 TDCi<br>2.0 TDCi<br>2.0 TDCi<br>2.0 TDCi<br>2.2 TDCi<br>2.2 TDCi<br>2.3 i 16V<br>2.5 ST | 118<br>85<br>74<br>92<br>176<br>107<br>149<br>85<br>96<br>100<br>103<br>120<br>129<br>147<br>118<br>162 |  | 02.11<br>02.11<br>01.07<br>04.06<br>07.10<br>04.06<br>03.10<br>10.07<br>04.06<br>05.06<br>04.06<br>03.10<br>04.08<br>07.10<br>07.07<br>04.06 |   | 24.0711-5123.3 360065  | 2  | Radsensor  |
|  | 1.6 EcoBoost<br>1.6 TDCi<br>1.8 TDCi<br>1.8 TDCi<br>2.0 EcoBoost<br>2.0 i 16V<br>2.0 SCTi EcoBoost<br>2.0 TDCi<br>2.0 TDCi<br>2.0 TDCi<br>2.0 TDCi<br>2.0 TDCi<br>2.2 TDCi<br>2.2 TDCi<br>2.3 i 16V<br>2.5 ST | 118<br>85<br>74<br>92<br>176<br>107<br>149<br>85<br>96<br>100<br>103<br>120<br>129<br>147<br>118<br>162 |  | 02.11<br>02.11<br>01.07<br>04.06<br>07.10<br>04.06<br>03.10<br>10.07<br>04.06<br>05.06<br>04.06<br>03.10<br>04.08<br>07.10<br>07.07<br>04.06 |   | 13.0460-2723.2 602723<br>13.0470-2723.2 LD2723<br>13.0460-2722.2 602722<br>13.0470-2722.2 LD2722 |   | + mechanische Feststellbremse 1)<br>24537 16,1 /Zub/S TRW<br>+ mechanische Feststellbremse 1)<br>24537 16,1 /Zub/S TRW<br>+ elektrische Feststellbremse 2)<br>24496 17,3 /Zub/S TRW<br>+ elektrische Feststellbremse 2)<br>24496 17,3 /Zub/S TRW |
|  | 1.6 EcoBoost<br>1.6 TDCi<br>1.8 TDCi<br>1.8 TDCi<br>2.0 EcoBoost<br>2.0 i 16V<br>2.0 SCTi EcoBoost<br>2.0 TDCi<br>2.0 TDCi  | 118<br>85<br>74<br>92<br>176<br>107<br>149<br>85<br>96  |  | 02.11<br>02.11<br>01.07<br>04.06<br>07.10<br>04.06<br>03.10<br>10.07<br>04.06  |   | 24.0111-0145.1 411145<br>24.0311-0145.1 511145   |   | 302 10,9 9,0 +S +B<br>302 10,9 9,0 +B PD   |

1) + mechanical parking brake / + fr. stazionamento meccanico / + frein à main mécanique / + freno de mano mecánica

2) + electric parking brake / + freno a mano elettrico / + frein à main électrique / + freno de mano eléctrico



### FORD S-MAX (06-)

|           |                   |     |       |       |  |                |        |   |  |
|-----------|-------------------|-----|-------|-------|--|----------------|--------|---|--|
|           | 2.0 TDCi          | 100 |       | 05.06 |  | 24.0111-0145.1 | 411145 |   | 302 10,9 9,0 +S +B<br>302 10,9 9,0 +B PD |
|           | 2.0 TDCi          | 103 |       | 04.06 |  | 24.0311-0145.1 | 511145 |   |  |
|           | 2.0 TDCi          | 120 |       | 03.10 |  |                |        |   |  |
|           | 2.2 TDCi          | 129 |       | 04.08 |  |                |        |   |  |
|           | 2.2 TDCi          | 147 |       | 07.10 |  |                |        |   |  |
|           | 2.3 i 16V         | 118 |       | 07.07 |  |                |        |   |  |
|           | 2.5 ST            | 162 |       | 04.06 |  |                |        |   |  |
|           | 1.6 EcoBoost      | 118 |       | 02.11 |  | 24.0711-6220.3 | 360256 | 2 | Radsensor                                |
|           | 1.6 TDCi          | 85  |       | 02.11 |  |                |        |   |  |
|           | 1.8 TDCi          | 74  |       | 01.07 |  |                |        |   |  |
|           | 1.8 TDCi          | 92  |       | 04.06 |  |                |        |   |  |
|           | 2.0 EcoBoost      | 176 |       | 07.10 |  |                |        |   |  |
|           | 2.0 i 16V         | 107 |       | 04.06 |  |                |        |   |  |
|           | 2.0 SCTi EcoBoost | 149 |       | 03.10 |  |                |        |   |  |
|           | 2.0 TDCi          | 85  |       | 10.07 |  |                |        |   |  |
|           | 2.0 TDCi          | 96  |       | 04.06 |  |                |        |   |  |
|           | 2.0 TDCi          | 100 |       | 05.06 |  |                |        |   |  |
|           | 2.0 TDCi          | 103 |       | 04.06 |  |                |        |   |  |
|           | 2.0 TDCi          | 120 |       | 03.10 |  |                |        |   |  |
|           | 2.2 TDCi          | 129 |       | 04.08 |  |                |        |   |  |
|           | 2.2 TDCi          | 147 |       | 07.10 |  |                |        |   |  |
| 2.3 i 16V | 118               |     | 07.07 |       |  |                |        |   |  |
| 2.5 ST    | 162               |     | 04.06 |       |  |                |        |   |  |

### FORD STREET KA (03-06)

|  |       |    |  |       |       |                |        |   |                                     |                       |
|--|-------|----|--|-------|-------|----------------|--------|---|-------------------------------------|-----------------------|
|  | 1.6 i | 70 |  | 02.03 | 02.06 | 13.0460-7142.2 | 607142 |   | 23604 18,3 +                        | ATE                   |
|  | 1.6 i | 70 |  | 02.03 | 02.06 | 24.0122-0172.1 | 422172 |   | 258 22,0 20,0 V +B                  | 258 22,0 20,0 V +B PD |
|  |       |    |  |       |       | 24.0322-0172.1 | 522172 |   |                                     |                       |
|  | 1.6 i | 70 |  | 02.03 | 08.04 | 24.0711-1369.1 | 360026 | 2 | Radsensor L=795                     |                       |
|  | 1.6 i | 70 |  | 09.04 | 02.06 | 24.0711-6166.3 | 360139 | 2 | Radsensor L=793                     |                       |
|  | 1.6 i | 70 |  | 02.03 | 08.04 | 24.0751-1158.3 | 360098 | 2 | Radsensor L=660/1575                |                       |
|  | 1.6 i | 70 |  | 09.04 | 02.06 | 24.0711-6179.3 | 360140 | 2 | Radsensor L=660/1586                |                       |
|  | 1.6 i | 70 |  | 02.03 | 02.06 | 03.0137-0394.2 | 650394 |   | 203 x 38 HEB<br>Bremsbacken-Zubehör |                       |
|  |       |    |  |       |       | 03.0137-9259.2 | 669259 |   |                                     |                       |
|  | 1.6 i | 70 |  | 02.03 | 02.06 | 24.0220-3009.2 | 480080 |   | ohne Sensorring <sup>1)</sup>       | 203/204 x 49          |
|  | 1.6 i | 70 |  | 02.03 | 02.06 | 03.0520-6319.3 | 696319 |   | 19,05/203x38 TopKit                 | AP                    |

### FORD TOURNEO (94-00)

|  |        |    |  |       |                               |                |        |                                  |                     |     |
|--|--------|----|--|-------|-------------------------------|----------------|--------|----------------------------------|---------------------|-----|
|  | 2.0    |    |  | 07.94 | 03.00 + 14" Rad <sup>2)</sup> | 13.0460-3960.2 | 603960 |                                  | 21470 18,0 /WE      | BDX |
|  | 2.4 D  | 55 |  | 07.94 | 03.00 + 14" Rad <sup>2)</sup> | 13.0460-0427.2 | 610427 |                                  | Belagsatz-Zubehör   |     |
|  | 2.5 D  |    |  | 07.94 | 03.00 + 14" Rad <sup>2)</sup> |                |        |                                  |                     |     |
|  | 2.5 TD |    |  | 07.94 | 03.00 + 14" Rad <sup>2)</sup> |                |        |                                  |                     |     |
|  | 2.0    |    |  | 07.94 | 03.00 + 15" Rad <sup>3)</sup> | 13.0460-3959.2 | 603959 |                                  | 21469 18,0 /WE      | BDX |
|  | 2.4 D  | 55 |  | 07.94 | 03.00 + 15" Rad <sup>3)</sup> | 13.0460-0427.2 | 610427 |                                  | Belagsatz-Zubehör   |     |
|  | 2.5 D  |    |  | 07.94 | 03.00 + 15" Rad <sup>3)</sup> |                |        |                                  |                     |     |
|  | 2.5 TD |    |  | 07.94 | 03.00 + 15" Rad <sup>3)</sup> |                |        |                                  |                     |     |
|  | 2.0    |    |  | 07.94 | 03.00 + 14" Rad <sup>2)</sup> | 24.0124-0131.1 | 424131 |                                  | 254 24,2 22,2 V +B  |     |
|  | 2.4 D  | 55 |  | 07.94 | 03.00 + 14" Rad <sup>2)</sup> |                |        |                                  |                     |     |
|  | 2.5 D  |    |  | 07.94 | 03.00 + 14" Rad <sup>2)</sup> |                |        |                                  |                     |     |
|  | 2.5 TD |    |  | 07.94 | 03.00 + 14" Rad <sup>2)</sup> |                |        |                                  |                     |     |
|  | 2.0    |    |  | 07.94 | 03.00 + 15" Rad <sup>3)</sup> | 24.0124-0132.1 | 424132 |                                  | 270 24,2 22,2 V +B  |     |
|  | 2.4 D  | 55 |  | 07.94 | 03.00 + 15" Rad <sup>3)</sup> |                |        |                                  |                     |     |
|  | 2.5 D  |    |  | 07.94 | 03.00 + 15" Rad <sup>3)</sup> |                |        |                                  |                     |     |
|  | 2.5 TD |    |  | 07.94 | 03.00 + 15" Rad <sup>3)</sup> |                |        |                                  |                     |     |
|  | 2.0    |    |  | 07.94 | 03.00 + 80-120                | 03.0137-0331.2 | 650331 | + Einfachbereifung <sup>4)</sup> | 254 x 52            |     |
|  | 2.4 D  | 55 |  | 07.94 | 03.00 + 80-120                | 03.0137-9193.2 | 669193 | + Einfachbereifung <sup>4)</sup> | Bremsbacken-Zubehör |     |
|  | 2.5 D  |    |  | 07.94 | 03.00 + 80-120                |                |        |                                  |                     |     |
|  | 2.5 TD |    |  | 07.94 | 03.00 + 80-120                |                |        |                                  |                     |     |
|  | 2.0    |    |  | 07.94 | 03.00 + 130-190               | 03.0137-0332.2 | 650332 | + Doppelbereifung <sup>5)</sup>  | 280 x 65            |     |
|  | 2.4 D  | 55 |  | 07.94 | 03.00 + 130-190               | 03.0137-9194.2 | 669194 | + Doppelbereifung <sup>5)</sup>  | Bremsbacken-Zubehör |     |
|  | 2.5 D  |    |  | 07.94 | 03.00 + 130-190               |                |        |                                  |                     |     |
|  | 2.5 TD |    |  | 07.94 | 03.00 + 130-190               |                |        |                                  |                     |     |
|  | 2.0    |    |  | 07.94 | 03.00 + 80-120                | 24.0225-4004.1 | 480069 | + Einfachbereifung <sup>4)</sup> | 254/256 x 57,5      |     |
|  | 2.4 D  | 55 |  | 07.94 | 03.00 + 80-120                |                |        |                                  |                     |     |
|  | 2.5 D  |    |  | 07.94 | 03.00 + 80-120                |                |        |                                  |                     |     |
|  | 2.5 TD |    |  | 07.94 | 03.00 + 80-120                |                |        |                                  |                     |     |
|  | 2.0    |    |  | 07.94 | 03.00 + 130-190               | 24.0228-0001.1 | 480068 | + Doppelbereifung <sup>5)</sup>  | 280/282 x 75,5      |     |
|  | 2.4 D  | 55 |  | 07.94 | 03.00 + 130-190               |                |        |                                  |                     |     |
|  | 2.5 D  |    |  | 07.94 | 03.00 + 130-190               |                |        |                                  |                     |     |
|  | 2.5 TD |    |  | 07.94 | 03.00 + 130-190               |                |        |                                  |                     |     |

<sup>1)</sup> without sensor ring / senza sensori / sans secours ABS / sin anillo sensor ABS

<sup>2)</sup> + 14" wheel / + ruota 14" / + roue 14" / + rueda 14"

<sup>3)</sup> + 15" wheel / + ruota 15" / + roue 15" / + rueda 15"

<sup>4)</sup> + single tyre / + ruota singola / + roue simple / + cubierta simple

<sup>5)</sup> + twin tyres / + ruote gemellate / + roue jumelée / + cubierta doble





**FORD TRANSIT (95-00)**

|                      |                      |       |       |       |                |        |                         |                    |     |                |        |                         |                    |     |
|----------------------|----------------------|-------|-------|-------|----------------|--------|-------------------------|--------------------|-----|----------------|--------|-------------------------|--------------------|-----|
|                      | 2.0 Bus              | 84    | 09.95 | 03.00 | 13.0460-3960.2 | 603960 | + 14" Rad <sup>1)</sup> | 21470 18,0 /WE     | BDX |                |        |                         |                    |     |
|                      | 2.0 CNG Bus          | 84    | 06.94 | 03.00 |                |        |                         |                    |     |                |        |                         |                    |     |
|                      | 2.0 Kasten           | 84    | 06.94 | 03.00 |                |        |                         |                    |     | 13.0460-0427.2 | 610427 | + 14" Rad <sup>1)</sup> | Belagsatz-Zubehör  | BDX |
|                      | 2.0 Pritsche/Fahrg.  | 84    | 08.94 | 03.00 |                |        |                         |                    |     |                |        |                         |                    |     |
|                      | 2.5 DI Bus           | 51    | 08.94 | 03.00 |                |        |                         |                    |     |                |        |                         |                    |     |
|                      | 2.5 DI Bus           | 56    | 07.94 | 03.00 |                |        |                         |                    |     |                |        |                         |                    |     |
|                      | 2.5 DI Bus           | 85    | 08.97 | 03.00 |                |        |                         |                    |     |                |        |                         |                    |     |
|                      | 2.5 DI Kasten        | 51    | 06.94 | 03.00 |                |        |                         |                    |     |                |        |                         |                    |     |
|                      | 2.5 DI Kasten        | 56    | 06.94 | 03.00 |                |        |                         |                    |     |                |        |                         |                    |     |
|                      | 2.5 DI Kasten        | 85    | 05.99 | 03.00 |                |        |                         |                    |     |                |        |                         |                    |     |
|                      | 2.5 DI Prits./Fahrg. | 51    | 08.94 | 03.00 |                |        |                         |                    |     |                |        |                         |                    |     |
|                      | 2.5 DI Prits./Fahrg. | 56    | 08.94 | 03.00 |                |        |                         |                    |     |                |        |                         |                    |     |
|                      | 2.5 DI Prits./Fahrg. | 85    | 05.99 | 03.00 |                |        |                         |                    |     |                |        |                         |                    |     |
|                      | 2.5 TD Bus           | 55    | 08.94 | 03.00 |                |        |                         |                    |     |                |        |                         |                    |     |
|                      | 2.5 TD Bus           | 63    | 01.95 | 03.00 |                |        |                         |                    |     |                |        |                         |                    |     |
|                      | 2.5 TD Bus           | 74    | 07.94 | 03.00 |                |        |                         |                    |     |                |        |                         |                    |     |
|                      | 2.5 TD Kasten        | 55    | 10.98 | 03.00 |                |        |                         |                    |     |                |        |                         |                    |     |
|                      | 2.5 TD Kasten        | 63    | 06.94 | 03.00 |                |        |                         |                    |     |                |        |                         |                    |     |
|                      | 2.5 TD Kasten        | 74    | 06.94 | 03.00 |                |        |                         |                    |     |                |        |                         |                    |     |
|                      | 2.5 TD Prits./Fahrg. | 55    | 10.98 | 03.00 |                |        |                         |                    |     |                |        |                         |                    |     |
| 2.5 TD Prits./Fahrg. | 63                   | 08.94 | 03.00 |       |                |        |                         |                    |     |                |        |                         |                    |     |
| 2.5 TD Prits./Fahrg. | 74                   | 08.94 | 03.00 |       |                |        |                         |                    |     |                |        |                         |                    |     |
|                      | 2.0 Bus              | 84    | 09.95 | 03.00 | 13.0460-3959.2 | 603959 | + 15" Rad <sup>2)</sup> | 21469 18,0 /WE     | BDX |                |        |                         |                    |     |
|                      | 2.0 CNG Bus          | 84    | 06.94 | 03.00 |                |        |                         |                    |     |                |        |                         |                    |     |
|                      | 2.0 Kasten           | 84    | 06.94 | 03.00 |                |        |                         |                    |     | 13.0460-0427.2 | 610427 | + 15" Rad <sup>2)</sup> | Belagsatz-Zubehör  | BDX |
|                      | 2.0 Pritsche/Fahrg.  | 84    | 08.94 | 03.00 |                |        |                         |                    |     |                |        |                         |                    |     |
|                      | 2.5 DI Bus           | 51    | 08.94 | 03.00 |                |        |                         |                    |     |                |        |                         |                    |     |
|                      | 2.5 DI Bus           | 56    | 07.94 | 03.00 |                |        |                         |                    |     |                |        |                         |                    |     |
|                      | 2.5 DI Bus           | 85    | 08.97 | 03.00 |                |        |                         |                    |     |                |        |                         |                    |     |
|                      | 2.5 DI Kasten        | 51    | 06.94 | 03.00 |                |        |                         |                    |     |                |        |                         |                    |     |
|                      | 2.5 DI Kasten        | 56    | 06.94 | 03.00 |                |        |                         |                    |     |                |        |                         |                    |     |
|                      | 2.5 DI Kasten        | 85    | 05.99 | 03.00 |                |        |                         |                    |     |                |        |                         |                    |     |
|                      | 2.5 DI Prits./Fahrg. | 51    | 08.94 | 03.00 |                |        |                         |                    |     |                |        |                         |                    |     |
|                      | 2.5 DI Prits./Fahrg. | 56    | 08.94 | 03.00 |                |        |                         |                    |     |                |        |                         |                    |     |
|                      | 2.5 DI Prits./Fahrg. | 85    | 05.99 | 03.00 |                |        |                         |                    |     |                |        |                         |                    |     |
|                      | 2.5 TD Bus           | 55    | 08.94 | 03.00 |                |        |                         |                    |     |                |        |                         |                    |     |
|                      | 2.5 TD Bus           | 63    | 01.95 | 03.00 |                |        |                         |                    |     |                |        |                         |                    |     |
|                      | 2.5 TD Bus           | 74    | 07.94 | 03.00 |                |        |                         |                    |     |                |        |                         |                    |     |
|                      | 2.5 TD Kasten        | 55    | 10.98 | 03.00 |                |        |                         |                    |     |                |        |                         |                    |     |
|                      | 2.5 TD Kasten        | 63    | 06.94 | 03.00 |                |        |                         |                    |     |                |        |                         |                    |     |
|                      | 2.5 TD Kasten        | 74    | 06.94 | 03.00 |                |        |                         |                    |     |                |        |                         |                    |     |
|                      | 2.5 TD Prits./Fahrg. | 55    | 10.98 | 03.00 |                |        |                         |                    |     |                |        |                         |                    |     |
| 2.5 TD Prits./Fahrg. | 63                   | 08.94 | 03.00 |       |                |        |                         |                    |     |                |        |                         |                    |     |
| 2.5 TD Prits./Fahrg. | 74                   | 08.94 | 03.00 |       |                |        |                         |                    |     |                |        |                         |                    |     |
|                      | 2.0 Bus              | 84    | 09.95 | 03.00 | 24.0124-0131.1 | 424131 | + 14" Rad <sup>1)</sup> | 254 24,2 22,2 V +B |     |                |        |                         |                    |     |
|                      | 2.0 CNG Bus          | 84    | 06.94 | 03.00 |                |        |                         |                    |     |                |        |                         |                    |     |
|                      | 2.0 Kasten           | 84    | 06.94 | 03.00 |                |        |                         |                    |     | 24.0124-0132.1 | 424132 | + 15" Rad <sup>2)</sup> | 270 24,2 22,2 V +B |     |
|                      | 2.0 Pritsche/Fahrg.  | 84    | 08.94 | 03.00 |                |        |                         |                    |     |                |        |                         |                    |     |
|                      | 2.5 DI Bus           | 51    | 08.94 | 03.00 |                |        |                         |                    |     |                |        |                         |                    |     |
|                      | 2.5 DI Bus           | 56    | 07.94 | 03.00 |                |        |                         |                    |     |                |        |                         |                    |     |
|                      | 2.5 DI Bus           | 85    | 08.97 | 03.00 |                |        |                         |                    |     |                |        |                         |                    |     |
|                      | 2.5 DI Kasten        | 51    | 06.94 | 03.00 |                |        |                         |                    |     |                |        |                         |                    |     |
|                      | 2.5 DI Kasten        | 56    | 06.94 | 03.00 |                |        |                         |                    |     |                |        |                         |                    |     |
|                      | 2.5 DI Kasten        | 85    | 05.99 | 03.00 |                |        |                         |                    |     |                |        |                         |                    |     |
|                      | 2.5 DI Prits./Fahrg. | 51    | 08.94 | 03.00 |                |        |                         |                    |     |                |        |                         |                    |     |
|                      | 2.5 DI Prits./Fahrg. | 56    | 08.94 | 03.00 |                |        |                         |                    |     |                |        |                         |                    |     |
|                      | 2.5 DI Prits./Fahrg. | 85    | 05.99 | 03.00 |                |        |                         |                    |     |                |        |                         |                    |     |
|                      | 2.5 TD Bus           | 55    | 08.94 | 03.00 |                |        |                         |                    |     |                |        |                         |                    |     |
|                      | 2.5 TD Bus           | 63    | 01.95 | 03.00 |                |        |                         |                    |     |                |        |                         |                    |     |
|                      | 2.5 TD Bus           | 74    | 07.94 | 03.00 |                |        |                         |                    |     |                |        |                         |                    |     |
|                      | 2.5 TD Kasten        | 55    | 10.98 | 03.00 |                |        |                         |                    |     |                |        |                         |                    |     |
|                      | 2.5 TD Kasten        | 63    | 06.94 | 03.00 |                |        |                         |                    |     |                |        |                         |                    |     |
|                      | 2.5 TD Kasten        | 74    | 06.94 | 03.00 |                |        |                         |                    |     |                |        |                         |                    |     |
|                      | 2.5 TD Prits./Fahrg. | 55    | 10.98 | 03.00 |                |        |                         |                    |     |                |        |                         |                    |     |
| 2.5 TD Prits./Fahrg. | 63                   | 08.94 | 03.00 |       |                |        |                         |                    |     |                |        |                         |                    |     |
| 2.5 TD Prits./Fahrg. | 74                   | 08.94 | 03.00 |       |                |        |                         |                    |     |                |        |                         |                    |     |

<sup>1)</sup> + 14" wheel / + ruota 14" / + roue 14" / + rueda 14"

<sup>2)</sup> + 15" wheel / + ruota 15" / + roue 15" / + rueda 15"







### FORD TRANSIT (95-00)

|  |                      |    |       |       |                                |                |        |                                 |                |
|--|----------------------|----|-------|-------|--------------------------------|----------------|--------|---------------------------------|----------------|
|  | 2.5 TD Kasten        | 74 | 06.94 | 03.00 | FT130/150S/150L/190/190A/190EF | 24.0228-0001.1 | 480068 | + Doppelbereifung <sup>1)</sup> | 280/282 x 75,5 |
|  | 2.5 TD Prits./Fahrg. | 55 | 10.98 | 03.00 | FT130/150S/150L/190/190A/190EF |                |        |                                 |                |
|  | 2.5 TD Prits./Fahrg. | 63 | 08.94 | 03.00 | FT130/150S/150L/190/190A/190EF |                |        |                                 |                |
|  | 2.5 TD Prits./Fahrg. | 74 | 08.94 | 03.00 | FT130/150S/150L/190/190A/190EF |                |        |                                 |                |



























### FORD TRANSIT (00-06)

|  |               |     |       |       |                                 |                |        |                                  |                       |
|--|---------------|-----|-------|-------|---------------------------------|----------------|--------|----------------------------------|-----------------------|
|  | 2.0 DI        |     | 08.00 | 04.06 | Serie 260/280/300 <sup>2)</sup> | 13.0460-3992.2 | 603992 |                                  | 23434 18,7 +/WK/S BOS |
|  | 2.0 TDCi      |     | 08.02 | 04.06 | Serie 260/280/300 <sup>2)</sup> |                |        |                                  |                       |
|  | 2.3 i 16V     |     | 04.01 | 04.06 | Serie 260/280/300 <sup>2)</sup> |                |        |                                  |                       |
|  | 2.4 DI        |     | 01.00 | 04.06 | Serie 260/280/300 <sup>2)</sup> |                |        |                                  |                       |
|  | 2.4 TDCi      |     | 03.04 | 04.06 | Serie 260/280/300 <sup>2)</sup> |                |        |                                  |                       |
|  | 2.4 TDE       |     | 11.01 | 04.06 | Serie 260/280/300 <sup>2)</sup> |                |        |                                  |                       |
|  | 2.0 DI        |     | 08.00 | 04.06 | Serie 330/350 <sup>3)</sup>     | 13.0460-3993.2 | 603993 |                                  | 23577 18,7 +/WK/S BOS |
|  | 2.0 TDCi      |     | 08.02 | 04.06 | Serie 330/350 <sup>3)</sup>     |                |        |                                  |                       |
|  | 2.3 16V RWD   |     | 08.00 | 04.06 |                                 |                |        |                                  |                       |
|  | 2.3 i 16V     |     | 04.01 | 04.06 | Serie 330/350 <sup>3)</sup>     |                |        |                                  |                       |
|  | 2.4 DI        |     | 01.00 | 04.06 | Serie 330/350 <sup>3)</sup>     |                |        |                                  |                       |
|  | 2.4 DI RWD    |     | 01.00 | 04.06 |                                 |                |        |                                  |                       |
|  | 2.4 TD Allrad | 55  | 08.00 | 04.06 |                                 |                |        |                                  |                       |
|  | 2.4 TDCi      |     | 03.04 | 04.06 | Serie 330/350 <sup>3)</sup>     |                |        |                                  |                       |
|  | 2.4 TDCi RWD  | 101 | 03.04 | 04.06 |                                 |                |        |                                  |                       |
|  | 2.4 TDE       |     | 11.01 | 04.06 | Serie 330/350 <sup>3)</sup>     |                |        |                                  |                       |
|  | 2.4 TDE RWD   |     | 11.01 | 04.06 |                                 |                |        |                                  |                       |
|  | 2.0 DI        |     | 08.00 | 04.06 | Serie 260/280/300 <sup>2)</sup> | 24.0124-0167.1 | 424167 |                                  | 276 24,5 22,1 V +B    |
|  | 2.0 TDCi      |     | 08.02 | 04.06 | Serie 260/280/300 <sup>2)</sup> |                |        |                                  |                       |
|  | 2.3 i 16V     |     | 04.01 | 04.06 | Serie 260/280/300 <sup>2)</sup> |                |        |                                  |                       |
|  | 2.4 DI        |     | 01.00 | 04.06 | Serie 260/280/300 <sup>2)</sup> |                |        |                                  |                       |
|  | 2.4 TDCi      |     | 03.04 | 04.06 | Serie 260/280/300 <sup>2)</sup> |                |        |                                  |                       |
|  | 2.4 TDE       |     | 11.01 | 04.06 | Serie 260/280/300 <sup>2)</sup> |                |        |                                  |                       |
|  | 2.0 DI        |     | 08.00 | 04.06 | Serie 330/350 <sup>3)</sup>     | 24.0124-0168.1 | 424168 |                                  | 294 24,5 22,1 V +B    |
|  | 2.0 TDCi      |     | 08.02 | 04.06 | Serie 330/350 <sup>3)</sup>     |                |        |                                  |                       |
|  | 2.3 16V RWD   |     | 08.00 | 04.06 |                                 |                |        |                                  |                       |
|  | 2.3 i 16V     |     | 04.01 | 04.06 | Serie 330/350 <sup>3)</sup>     |                |        |                                  |                       |
|  | 2.4 DI        |     | 01.00 | 04.06 | Serie 330/350 <sup>3)</sup>     |                |        |                                  |                       |
|  | 2.4 DI RWD    |     | 01.00 | 04.06 |                                 |                |        |                                  |                       |
|  | 2.4 TD Allrad | 55  | 08.00 | 04.06 |                                 |                |        |                                  |                       |
|  | 2.4 TDCi      |     | 03.04 | 04.06 | Serie 330/350 <sup>3)</sup>     |                |        |                                  |                       |
|  | 2.4 TDCi RWD  | 101 | 03.04 | 04.06 |                                 |                |        |                                  |                       |
|  | 2.4 TDE       |     | 11.01 | 04.06 | Serie 330/350 <sup>3)</sup>     |                |        |                                  |                       |
|  | 2.4 TDE RWD   |     | 11.01 | 04.06 |                                 |                |        |                                  |                       |
|  | 2.0 DI        |     | 08.00 | 04.06 |                                 | 03.0137-0427.2 | 650427 |                                  | 254 x 52 HEB          |
|  | 2.0 TDCi      |     | 08.02 | 04.06 |                                 | 03.0137-9268.2 | 669268 |                                  | Bremsbacken-Zubehör   |
|  | 2.3 i 16V     |     | 04.01 | 04.06 |                                 |                |        |                                  |                       |
|  | 2.4 DI        |     | 01.00 | 04.06 |                                 |                |        |                                  |                       |
|  | 2.4 TDCi      |     | 03.04 | 04.06 |                                 |                |        |                                  |                       |
|  | 2.4 TDE       |     | 11.01 | 04.06 |                                 |                |        |                                  |                       |
|  | 2.3 16V RWD   |     | 08.00 | 04.06 |                                 | 03.0137-0411.2 | 650411 |                                  | 280 x 65 HEB          |
|  | 2.4 DI RWD    |     | 01.00 | 04.06 |                                 | 03.0137-9268.2 | 669268 |                                  | Bremsbacken-Zubehör   |
|  | 2.4 TD Allrad | 55  | 08.00 | 04.06 |                                 |                |        |                                  |                       |
|  | 2.4 TDCi RWD  | 101 | 03.04 | 04.06 |                                 |                |        |                                  |                       |
|  | 2.4 TDE RWD   |     | 11.01 | 04.06 |                                 |                |        |                                  |                       |
|  | 2.0 DI        |     | 08.00 | 04.06 |                                 | 24.0225-4016.1 | 480171 | Serie 260/280/300 <sup>2)</sup>  | 254/256 x 60,1        |
|  | 2.0 TDCi      |     | 08.02 | 04.06 |                                 |                |        |                                  |                       |
|  | 2.3 i 16V     |     | 04.01 | 04.06 |                                 |                |        |                                  |                       |
|  | 2.4 DI        |     | 01.00 | 04.06 |                                 |                |        |                                  |                       |
|  | 2.4 TDCi      |     | 03.04 | 04.06 |                                 |                |        |                                  |                       |
|  | 2.4 TDE       |     | 11.01 | 04.06 |                                 |                |        |                                  |                       |
|  | 2.3 16V RWD   |     | 08.00 | 04.06 |                                 | 24.0228-0004.1 | 480173 | + Einfachbereifung <sup>4)</sup> | 280/282 x 80,3        |
|  | 2.4 DI RWD    |     | 01.00 | 04.06 |                                 | 24.0228-0003.1 | 480172 | + Doppelbereifung <sup>1)</sup>  | 280/282 x 75,5        |
|  | 2.4 TD Allrad | 55  | 08.00 | 04.06 |                                 |                |        |                                  |                       |
|  | 2.4 TDCi RWD  | 101 | 03.04 | 04.06 |                                 |                |        |                                  |                       |
|  | 2.4 TDE RWD   |     | 11.01 | 04.06 |                                 |                |        |                                  |                       |
|  | 2.0 DI        |     | 08.00 | 04.06 |                                 | 03.0520-1125.3 | 691125 |                                  | 25,40/254x52 TopKit   |
|  | 2.0 TDCi      |     | 08.02 | 04.06 |                                 |                |        |                                  |                       |
|  | 2.3 16V RWD   |     | 08.00 | 04.06 |                                 | 03.0520-1225.3 | 691225 |                                  | 25,40/280x65 TopKit   |
|  | 2.3 i 16V     |     | 04.01 | 04.06 |                                 |                |        |                                  |                       |
|  | 2.4 DI        |     | 01.00 | 04.06 |                                 |                |        |                                  |                       |
|  | 2.4 DI RWD    |     | 01.00 | 04.06 |                                 |                |        |                                  |                       |
|  | 2.4 TD Allrad | 55  | 08.00 | 04.06 |                                 |                |        |                                  |                       |
|  | 2.4 TDCi      |     | 03.04 | 04.06 |                                 |                |        |                                  |                       |
|  | 2.4 TDCi RWD  | 101 | 03.04 | 04.06 |                                 |                |        |                                  |                       |
|  | 2.4 TDE       |     | 11.01 | 04.06 |                                 |                |        |                                  |                       |
|  | 2.4 TDE RWD   |     | 11.01 | 04.06 |                                 |                |        |                                  |                       |

### FORD TRANSIT (06-14)

|  |              |  |       |       |                                 |                |        |  |                          |
|--|--------------|--|-------|-------|---------------------------------|----------------|--------|--|--------------------------|
|  | 2.2 TDCi FWD |  | 05.06 | 04.14 | Serie 260/280/300 <sup>2)</sup> | 13.0460-3833.2 | 603833 |  | 24485 19,0 /WK/Zub/S BOS |
|  | 2.2 TDCi 4x4 |  | 10.11 | 04.14 |                                 | 13.0460-3834.2 | 603834 |  | 24484 19,0 /WK/Zub/S BOS |
|  | 2.2 TDCi FWD |  | 05.06 | 04.14 | Serie 330/350 <sup>3)</sup>     |                |        |  |                          |
|  | 2.2 TDCi RWD |  | 10.11 | 04.14 |                                 |                |        |  |                          |
|  | 2.3 16V RWD  |  | 05.06 | 04.14 |                                 |                |        |  |                          |
|  | 2.4 TDCi 4x4 |  | 05.06 | 04.14 |                                 |                |        |  |                          |
|  | 2.4 TDCi RWD |  | 05.06 | 04.14 |                                 |                |        |  |                          |
|  | 3.2 TDCi RWD |  | 09.07 | 04.14 |                                 |                |        |  |                          |

1) + twin tyres / + ruote gemellate / + roue jumelée / + cubierta doble  
 2) 260/280/300 series / Série 260/280/300 / Série 260/280/300 / Serie 260/280/300  
 3) 330/350 series / Série 330/350 / Série 330/350 / Serie 330/350  
 4) + single tyre / + ruota singola / + roue simple / + cubierta simple

|     |  |  |  |  |  |  |  |                         |
|--|--|--|--|--|---|--|--|---|
| <b>FORD TRANSIT (06-14)</b>  |  |  |  |  |   |  |  |   |
|    | 2.2 TDCi FWD   |  | 05.06  | 04.14  | Serie 260/280/300 <sup>1)</sup>   | 24.0128-0156.1   | 428156   | 280 28,0 25,0 V +S +B   |
|  | 2.2 TDCi 4x4   |  | 10.11  | 04.14  | + Einfachbereifung <sup>2)</sup>  | 24.0128-0157.1   | 428157   | 300 28,0 25,0 V +S +B   |
|  | 2.2 TDCi FWD   |  | 05.06  | 04.14  | Serie 330/350 <sup>3)</sup>   |  |  |   |
|  | 2.4 TDCi 4x4   |  | 10.11  | 04.14  | + Einfachbereifung <sup>2)</sup>  |  |  |   |
|  | 2.4 TDCi RWD   |  | 05.06  | 04.14  | + Einfachbereifung <sup>2)</sup>  |  |  |   |
|  | 2.4 TDCi 4x4   |  | 05.06  | 04.14  | + Einfachbereifung <sup>2)</sup>  |  |  |   |
|  | 2.4 TDCi RWD   |  | 05.06  | 04.14  | + Einfachbereifung <sup>2)</sup>  |  |  |   |
|  | 3.2 TDCi RWD   |  | 09.07  | 04.14  | + Einfachbereifung <sup>2)</sup>  |  |  |   |
|    | 2.2 TDCi 4x4   |  | 10.11  | 04.14  |   | 13.0460-3835.2   | 603835   | 24486 17,9 /WK/Zub/S BOS  |
|  | 2.2 TDCi FWD   |  | 05.06  | 04.14  |   |  |  |   |
|  | 2.2 TDCi RWD   |  | 10.11  | 04.14  |   |  |  |   |
|  | 2.4 TDCi 4x4   |  | 05.06  | 04.14  |   |  |  |   |
|  | 2.4 TDCi RWD   |  | 05.06  | 04.14  |   |  |  |   |
|  | 3.2 TDCi RWD   |  | 09.07  | 04.14  |   |  |  |   |
|  | 2.3 16V RWD  |  | 05.06  | 04.14  |   | 13.0460-3835.2   | 603835   | 24486 17,9 /WK/Zub/S BOS  |
|  |  |  |  |  |   | 13.0460-4862.2   | 604862   | 29123 20,3 /WK/Zub/S BRE  |
|  |  |  |  |  |   |  |  | + Einfachbereifung <sup>2)</sup>  |
|  |  |  |  |  |   |  |  | + Doppelbereifung <sup>4)</sup>   |
|    | 2.2 TDCi FWD   |  | 05.06  | 04.14  |   | 24.0116-0116.2   | 416116   | 280 16,0 13,0 +B  |
|  | 2.2 TDCi 4x4   |  | 10.11  | 04.14  |   | 24.0116-0126.1   | 416126   | 280 16,0 13,0 +B  |
|  | 2.2 TDCi RWD   |  | 10.11  | 04.14  |   |  |  |   |
|  | 2.3 16V RWD  |  | 05.06  | 04.14  | + Einfachbereifung <sup>2)</sup>  |  |  |   |
|  | 2.4 TDCi 4x4   |  | 05.06  | 04.14  |   |  |  |   |
|  | 2.4 TDCi RWD   |  | 05.06  | 04.14  |   |  |  |   |
|  | 3.2 TDCi RWD   |  | 09.07  | 04.14  |   |  |  |   |
|  | 2.3 16V RWD  |  | 11.07  | 04.14  | + Doppelbereifung <sup>4)</sup>   | 24.0116-0134.1   | 416134   | 284 16,0 13,0 +B  |
|    | 2.2 TDCi FWD   |  | 05.06  | 04.14  |   | 03.0137-0427.2   | 650427   | 254 x 52 HEB  |
|  |  |  |  |  |   | 03.0137-9268.2   | 669268   | Bremsbacken-Zubehör   |
|    | 2.2 TDCi FWD   |  | 05.06  | 04.14  |   | 24.0225-4016.1   | 480171   | 254/256 x 60,1  |
|    | 2.2 TDCi FWD   |  | 05.06  | 04.14  |   | 03.0520-1125.3   | 691125   | 25,40/254x52 TopKit   |
| <b>FORD TRANSIT (14-)</b>  |  |  |  |  |   |  |  |   |
|    | 2.0 TDCi   | 77   | 03.16  |  |   | 24.8190-0026.2   | 620026   | 2  Warnkontakt L=312mm |
|  | 2.0 TDCi   | 96   | 03.16  |  |   |  |  |   |
|  | 2.0 TDCi   | 125  | 03.16  |  |   |  |  |   |
|  | 2.2 TDCi   | 74   | 05.14  |  |   |  |  |   |
|  | 2.2 TDCi   | 92   | 05.14  |  |   |  |  |   |
|  | 2.2 TDCi   | 114  | 05.14  |  |   |  |  |   |
|  | 2.2 TDCi AWD   | 92   | 05.14  |  |   |  |  |   |
|  | 2.2 TDCi AWD   | 114  | 05.14  |  |   |  |  |   |
|  | 2.0 TDCi   | 77   | 03.16  |  | Serie 10/60/70/80/90/250/300 <sup>6)</sup>  | 24.0133-0101.1   | 433101   | + Einfachbereifung <sup>2)</sup>  |
|  | 2.0 TDCi   | 96   | 03.16  |  | Serie 10/60/70/80/90/250/300 <sup>6)</sup>  |  |  | 288 33,0 30,0 V L +S +B   |
|  | 2.0 TDCi   | 125  | 03.16  |  | Serie 10/60/70/80/90/250/300 <sup>6)</sup>  |  |  |   |
|  | 2.2 TDCi   | 74   | 05.14  |  | Serie 10/60/70/80/90/250/300 <sup>6)</sup>  |  |  |   |
|  | 2.2 TDCi   | 92   | 05.14  |  | Serie 10/60/70/80/90/250/300 <sup>6)</sup>  |  |  |   |
|  | 2.2 TDCi   | 114  | 05.14  |  | Serie 10/60/70/80/90/250/300 <sup>6)</sup>  |  |  |   |
|  | 2.2 TDCi AWD   | 92   | 05.14  |  | Serie 10/60/70/80/90/250/300 <sup>6)</sup>  |  |  |   |
|  | 2.2 TDCi AWD   | 114  | 05.14  |  | Serie 10/60/70/80/90/250/300 <sup>6)</sup>  |  |  |   |
| <b>FORD TRANSIT COURIER / TOURNEO COURIER (14-)</b>                                |  |  |  |  |   |  |  |   |
|  | 1.0 EcoBoost   | 74   | 02.14  |  |   | 13.0460-2784.2   | 602784   | 25134 17,2 +/Zub/S TRW  |
|  | 1.5 TDCi   | 55   | 02.14  |  |   | 13.0470-2784.2   | LD2784   | 25134 17,2 +/Zub/S TRW  |
|  | 1.5 TDCi   | 70   | 05.15  |  |   |  |  |   |
|  | 1.6 TDCi   | 70   | 02.14  |  |   |  |  |   |
|  | 1.0 EcoBoost   | 74   | 02.14  |  |   | 24.0123-0122.1   | 423122   | + Leichtmetallfelgen <sup>7)</sup>  |
|  | 1.5 TDCi   | 55   | 02.14  |  |   |  |  | 278 23,0 21,0 V +B  |
|  | 1.5 TDCi   | 70   | 05.15  |  |   |  |  |   |
|  | 1.6 TDCi   | 70   | 02.14  |  |   |  |  |   |
|  | 1.0 EcoBoost   | 74   | 02.14  |  |   | 03.0137-0512.2   | 650512   | 228 x 42 HEB  |
|  | 1.5 TDCi   | 55   | 02.14  |  |   | 03.0137-9313.2   | 669313   | Bremsbacken-Zubehör   |
|  | 1.5 TDCi   | 70   | 05.15  |  |   |  |  |   |
|  | 1.6 TDCi   | 70   | 02.14  |  |   |  |  |   |
| <b>FORD TRANSIT CONNECT / TOURNEO CONNECT (03-13)</b>                              |  |  |  |  |   |  |  |   |
|  | 1.8 16V  | 85   | 06.02  | 08.13  |   | 13.0460-7186.2   | 607186   | 23440 17,6 + ATE  |
|  | 1.8 Di   | 55   | 06.02  | 08.13  |   |  |  |   |
|  | 1.8 TDCi   | 66   | 06.02  | 08.13  |   |  |  |   |
|  | 1.8 TDCi   | 81   | 08.06  | 08.13  |   |  |  |   |
|  | 1.8 16V  | 85   | 06.02  | 08.13  |   | 24.0124-0179.1   | 424179   | 278 24,0 22,0 V +B  |
|  | 1.8 Di   | 55   | 06.02  | 08.13  |   |  |  |   |
|  | 1.8 TDCi   | 66   | 06.02  | 08.13  |   |  |  |   |
|  | 1.8 TDCi   | 81   | 08.06  | 08.13  |   |  |  |   |
|  | 1.8 16V  | 85   | 06.02  | 08.13  |   | 24.0711-5148.3   | 360111   | 2  Radsensor L=602   |
|  | 1.8 Di   | 55   | 06.02  | 08.13  |   |  |  |   |
|  | 1.8 TDCi   | 66   | 06.02  | 08.13  |   |  |  |   |
|  | 1.8 TDCi   | 81   | 08.06  | 08.13  |   |  |  |   |
|  | 1.8 16V  | 85   | 06.02  | 08.13  |   | 13.0460-7160.2   | 607160   | 23482 16,7 + ATE  |
|  | 1.8 Di   | 55   | 06.02  | 08.13  |   | 13.0460-7194.2   | 607194   | 23482 16,6 + ATE  |
|  | 1.8 TDCi   | 66   | 06.02  | 08.13  |   | 13.0470-7194.2   | LD7194   | 23482 16,6 + ATE  |
|  | 1.8 TDCi   | 81   | 08.06  | 08.13  |   |  |  |   |

<sup>1)</sup> 260/280/300 series / Serie 260/280/300 / Série 260/280/300 / Serie 260/280/300

<sup>2)</sup> + single tyre / + ruota singola / + roue simple / + cubierta simple



























<sup>3)</sup> 330/350 series / Serie 330/350 / Série 330/350 / Serie 330/350

<sup>4)</sup> + twin tyres / + ruote gemellate / + roue jumelée / + cubierta doble

<sup>5)</sup> + ABS/ with sensor ring / + ABS/ con sensore / + ABS/ avec secours ABS / + ABS/ con anillo sensor ABS

<sup>6)</sup> 10/60/70/80/90/250/300 series / Serie 10/60/70/80/90/250/300 / Série 10/60/70/80/90/250/300 / Serie 10/60/70/80/90/250/300

<sup>7)</sup> + light alloy rims / + cerchi in lega / + jantes en alliage léger / + Llantas de aleación ligera

|     |                      |  |  |   |  |  |    |  |
|--|--|--|--|---|---|--|--|--|
| <b>FORD TRANSIT CONNECT / TOURNEO CONNECT (03-13)</b>                              |  |  |  |   |   |  |  |  |
|    | 1.8 16V<br>1.8 Di<br>1.8 TDCi<br>1.8 TDCi  | 85<br>55<br>66<br>81   | 06.02<br>06.02<br>06.02<br>08.06   | 08.13<br>08.13<br>08.13<br>08.13  | 24.0111-0154.1  | 411154   |  | 278 11,0 9,0 +B  |
|    | 1.8 16V<br>1.8 Di<br>1.8 TDCi<br>1.8 TDCi  | 85<br>55<br>66<br>81   | 06.02<br>06.02<br>06.02<br>08.06   | 09.12<br>09.12<br>09.12<br>09.12  | 24.0711-6139.3  | 360134   | 2   | Radsensor L=638  |
|    | 1.8 16V<br>1.8 Di<br>1.8 TDCi<br>1.8 TDCi  | 85<br>55<br>66<br>81   | 10.12<br>10.12<br>10.12<br>10.12   | 08.13<br>08.13<br>08.13<br>08.13  | 24.0711-6220.3  | 360256   | 2   | Radsensor  |
|    | 1.8 16V<br>1.8 Di<br>1.8 TDCi<br>1.8 TDCi  | 85<br>55<br>66<br>81   | 06.02<br>06.02<br>06.02<br>08.06   | 08.13<br>08.13<br>08.13<br>08.13  | 03.0137-0438.2<br>03.0137-9279.2  | 650438<br>669279   |  | 228 x 57 HEB<br>Bremsbacken-Zubehör  |
|    | 1.8 16V<br>1.8 Di<br>1.8 TDCi<br>1.8 TDCi  | 85<br>55<br>66<br>81   | 06.02<br>06.02<br>06.02<br>08.06   | 08.13<br>08.13<br>08.13<br>08.13  | 24.0222-8033.1  | 480181   |  | 228/229,6 x 68   |
|    | 1.8 16V<br>1.8 Di<br>1.8 TDCi<br>1.8 TDCi  | 85<br>55<br>66<br>81   | 06.02<br>06.02<br>06.02<br>08.06   | 08.13<br>08.13<br>08.13<br>08.13  | 03.0520-8020.3  | 698020   |  | 20,64/228x57 TopKit AP   |
| <b>FORD TRANSIT CONNECT / TOURNEO CONNECT (13-)</b>                                |  |  |  |   |   |  |  |  |
|    | 1.0 EcoBoost<br>1.5 TDCi<br>1.5 TDCi<br>1.5 TDCi<br>1.6 EcoBoost<br>1.6 TDCi<br>1.6 TDCi<br>1.6 TDCi | 74<br>55<br>74<br>88<br>110<br>55<br>70<br>85                                    | 09.13<br>05.15<br>05.15<br>05.15<br>09.13<br>09.13<br>09.13<br>09.13             | + kurzer Radstand <sup>1)</sup><br>+ kurzer Radstand <sup>1)</sup><br>+ kurzer Radstand <sup>1)</sup><br>+ kurzer Radstand <sup>1)</sup><br>+ kurzer Radstand <sup>1)</sup><br>+ kurzer Radstand <sup>1)</sup><br>+ kurzer Radstand <sup>1)</sup> | 13.0460-7193.2<br>13.0470-7193.2  | 607193<br>LD7193   |  | 23723 18,1 +<br>23723 18,1 +<br><b>ATE</b>   |
|    | 1.0 EcoBoost<br>1.5 TDCi<br>1.5 TDCi<br>1.5 TDCi<br>1.6 EcoBoost<br>1.6 TDCi<br>1.6 TDCi<br>1.6 TDCi | 74<br>55<br>74<br>88<br>110<br>55<br>70<br>85                                    | 09.13<br>05.15<br>05.15<br>05.15<br>09.13<br>09.13<br>09.13<br>09.13             | + langer Radstand <sup>2)</sup><br>+ langer Radstand <sup>2)</sup><br>+ langer Radstand <sup>2)</sup><br>+ langer Radstand <sup>2)</sup><br>+ langer Radstand <sup>2)</sup><br>+ langer Radstand <sup>2)</sup><br>+ langer Radstand <sup>2)</sup> | 13.0460-7193.2<br>13.0470-7193.2  | 607193<br>LD7193   | - erhöhte Zuladung <sup>3)</sup><br>- erhöhte Zuladung <sup>3)</sup>   | 23723 18,1 +<br>23723 18,1 +<br><b>ATE</b><br><b>ATE</b>                           |
|    | 1.0 EcoBoost<br>1.5 TDCi<br>1.5 TDCi<br>1.5 TDCi<br>1.6 EcoBoost<br>1.6 TDCi<br>1.6 TDCi<br>1.6 TDCi | 74<br>55<br>74<br>88<br>110<br>55<br>70<br>85                                    | 09.13<br>05.15<br>05.15<br>05.15<br>09.13<br>09.13<br>09.13<br>09.13             | - Taxi<br>- Taxi<br>- Taxi<br>- Taxi<br>- Taxi<br>- Taxi<br>- Taxi  | 24.0125-0162.1<br>24.0325-0162.1<br>24.0125-0209.1                                | 425162<br>525162<br>425209   | + Leichtmetallfelgen <sup>4)</sup><br>+ Leichtmetallfelgen <sup>4)</sup><br>+ erhöhte Zuladung <sup>5)</sup>   | 300 25,0 23,0 V L +B<br><b>300 25,0 23,0 V L +B PD</b><br>320 25,0 23,0 V L +B     |
|   | 1.0 EcoBoost<br>1.5 TDCi<br>1.5 TDCi<br>1.5 TDCi<br>1.6 EcoBoost<br>1.6 TDCi<br>1.6 TDCi<br>1.6 TDCi | 74<br>55<br>74<br>88<br>110<br>55<br>70<br>85                                    | 09.13<br>05.15<br>05.15<br>05.15<br>09.13<br>09.13<br>09.13<br>09.13             |   | 24.0711-5357.3  | 360354   | 2    | Radsensor  |
|  | 1.0 EcoBoost<br>1.5 TDCi<br>1.5 TDCi<br>1.5 TDCi<br>1.6 EcoBoost<br>1.6 TDCi<br>1.6 TDCi<br>1.6 TDCi | 74<br>55<br>74<br>88<br>110<br>55<br>70<br>85                                    | 09.13<br>05.15<br>05.15<br>05.15<br>09.13<br>09.13<br>09.13<br>09.13             |   | 13.0460-7195.2<br>13.0470-7195.2  | 607195<br>LD7195   |  | 23482 16,6 +<br>23482 16,6 +<br><b>ATE</b><br><b>ATE</b>                           |
|  | 1.0 EcoBoost<br>1.5 TDCi<br>1.5 TDCi<br>1.5 TDCi<br>1.6 EcoBoost<br>1.6 TDCi<br>1.6 TDCi<br>1.6 TDCi | 74<br>55<br>74<br>88<br>110<br>55<br>70<br>85                                    | 09.13<br>05.15<br>05.15<br>05.15<br>09.13<br>09.13<br>09.13<br>09.13             |   | 24.0111-0172.1  | 411172   |  | 280 11,0 9,0 +B  |
|  | 1.0 EcoBoost<br>1.5 TDCi<br>1.5 TDCi<br>1.5 TDCi<br>1.6 EcoBoost<br>1.6 TDCi<br>1.6 TDCi<br>1.6 TDCi | 74<br>55<br>74<br>88<br>110<br>55<br>70<br>85                                    | 09.13<br>05.15<br>05.15<br>05.15<br>09.13<br>09.13<br>09.13<br>09.13             |   | 24.0711-6296.3<br>24.0711-6351.3  | 360357<br>360358   | 2  - Active City Stop<br>2  + Active City Stop | Radsensor<br>Radsensor   |

1) + short wheel base / + passo lungo / + empattement court / + distancia corta entre ejes  
2) + long wheel base / + passo lungo / + empattement long / + distancia larga entre ejes  
3) - increased payload / - carico utile maggiorato / - charge utile augmentée / - incremento de carga  
4) + light alloy rims / + cerchi in lega / + jantes en alliage léger / + Llantas de aleación ligera  
5) + increased payload / + carico utile maggiorato / + charge utile augmentée / + incremento de carga



### FORD TRANSIT CUSTOM / TOURNEO CUSTOM (12-)

|  |          |     |       |  |                |        |   |  |                         |
|--|----------|-----|-------|--|----------------|--------|---|--|-------------------------|
|  | 2.0 TDCi | 77  | 12.15 | - Serie 330 <sup>1)</sup>                      | 24.8190-0021.2 | 620021 | 1 |  | Warnkontakt L=478mm     |
|  | 2.0 TDCi | 96  | 12.15 | - Serie 330 <sup>1)</sup>                      |                |        |   |  |                         |
|  | 2.0 TDCi | 125 | 12.15 | - Serie 330 <sup>1)</sup>                      |                |        |   |  |                         |
|  | 2.2 TDCi | 74  | 05.12 | - Serie 330 <sup>1)</sup>                      |                |        |   |  |                         |
|  | 2.2 TDCi | 92  | 05.12 | - Serie 330 <sup>1)</sup>                      |                |        |   |  |                         |
|  | 2.2 TDCi | 114 | 05.12 | - Serie 330 <sup>1)</sup>                      |                |        |   |  |                         |
|  | 2.0 TDCi | 77  | 12.15 | + Serie 330 <sup>2)</sup>                      | 24.8190-0026.2 | 620026 | 1 |  | Warnkontakt L=312mm     |
|  | 2.0 TDCi | 96  | 12.15 | + Serie 330 <sup>2)</sup>                      |                |        |   |  |                         |
|  | 2.0 TDCi | 125 | 12.15 | + Serie 330 <sup>2)</sup>                      |                |        |   |  |                         |
|  | 2.2 TDCi | 74  | 05.12 | + Serie 330 <sup>2)</sup>                      |                |        |   |  |                         |
|  | 2.2 TDCi | 92  | 05.12 | + Serie 330 <sup>2)</sup>                      |                |        |   |  |                         |
|  | 2.2 TDCi | 114 | 05.12 | + Serie 330 <sup>2)</sup>                      |                |        |   |  |                         |
|  | 2.0 TDCi | 77  | 12.15 | - Serie 290S Sport / - Serie 330 <sup>3)</sup> | 24.0133-0101.1 | 433101 |   |  | 288 33,0 30,0 V L +S +B |
|  | 2.0 TDCi | 96  | 12.15 | - Serie 290S Sport / - Serie 330 <sup>3)</sup> |                |        |   |  |                         |
|  | 2.0 TDCi | 125 | 12.15 | - Serie 290S Sport / - Serie 330 <sup>3)</sup> |                |        |   |  |                         |
|  | 2.2 TDCi | 74  | 05.12 | - Serie 290S Sport / - Serie 330 <sup>3)</sup> |                |        |   |  |                         |
|  | 2.2 TDCi | 92  | 05.12 | - Serie 290S Sport / - Serie 330 <sup>3)</sup> |                |        |   |  |                         |
|  | 2.2 TDCi | 114 | 05.12 | - Serie 290S Sport / - Serie 330 <sup>3)</sup> |                |        |   |  |                         |
|  | 2.0 TDCi | 77  | 12.15 |  | 24.8190-0021.2 | 620021 | 1 |  | Warnkontakt L=478mm     |
|  | 2.0 TDCi | 96  | 12.15 |  |                |        |   |  |                         |
|  | 2.0 TDCi | 125 | 12.15 |  |                |        |   |  |                         |
|  | 2.2 TDCi | 74  | 05.12 |  |                |        |   |  |                         |
|  | 2.2 TDCi | 92  | 05.12 |  |                |        |   |  |                         |
|  | 2.2 TDCi | 114 | 05.12 |  |                |        |   |  |                         |

### HONDA ACCORD (93-98)

|  |                       |  |       |       |                                   |                |        |  |       |                                |            |
|--|-----------------------|--|-------|-------|-----------------------------------|----------------|--------|--|-------|--------------------------------|------------|
|  | 1.8 i (CE7)           |  | 01.96 | 09.98 | + Schaltgetriebe <sup>4)</sup>    | 13.0460-5955.2 | 605955 |  | 21879 | 18,6 +/WK<br>Belagsatz-Zubehör | AKE<br>AKE |
|  | 2.0 i (CC7)           |  | 01.93 | 12.95 | + Schaltgetriebe <sup>4)</sup>    |                |        |  |       |                                |            |
|  | 2.0 i (CE8)           |  | 01.96 | 09.98 | + Schaltgetriebe <sup>4)</sup>    |                |        |  |       |                                |            |
|  | 2.0 TDi (CF1)         |  | 01.96 | 09.98 |                                   |                |        |  |       |                                |            |
|  | 1.8 i (CE7)           |  | 01.96 | 09.98 | + Automatikgetriebe <sup>5)</sup> |                |        |  |       |                                |            |
|  | 2.0 i (CC7)           |  | 01.93 | 12.95 | + Automatikgetriebe <sup>5)</sup> |                |        |  |       |                                |            |
|  | 2.0 i (CE8)           |  | 01.96 | 09.98 | + Automatikgetriebe <sup>5)</sup> |                |        |  |       |                                |            |
|  | 2.0 i Aero Deck (CE2) |  | 01.94 | 01.98 |                                   |                |        |  |       |                                |            |
|  | 2.0 i Coupe (CD9)     |  | 01.94 | 01.98 |                                   |                |        |  |       |                                |            |
|  | 2.0 i LS Coupe (CD9)  |  | 01.94 | 01.98 |                                   |                |        |  |       |                                |            |
|  | 2.2 i Aero Deck (CE1) |  | 01.94 | 01.98 |                                   | 13.0460-5929.2 | 605929 |  | 21719 | 15,0 +/WK<br>Belagsatz-Zubehör | AKE        |
|  | 2.2 i Coupe (CD7)     |  | 01.94 | 01.98 |                                   |                |        |  |       |                                |            |
|  | 2.2 i ES Coupe (CD7)  |  | 01.94 | 01.98 |                                   |                |        |  |       |                                |            |
|  | 2.2 i VTEC (CE9)      |  | 01.96 | 09.98 |                                   |                |        |  |       |                                |            |
|  | 2.3 i (CC7)           |  | 01.93 | 12.95 |                                   |                |        |  |       |                                |            |
|  | 2.0 i Aero Deck (CE2) |  | 01.94 | 01.98 |                                   |                |        |  |       |                                |            |
|  | 2.0 i Coupe (CD9)     |  | 01.94 | 01.98 |                                   |                |        |  |       |                                |            |
|  | 2.0 i LS Coupe (CD9)  |  | 01.94 | 01.98 |                                   |                |        |  |       |                                |            |
|  | 2.0 TDi (CF1)         |  | 01.96 | 09.98 |                                   |                |        |  |       |                                |            |
|  | 2.2 i Aero Deck (CE1) |  | 01.94 | 01.98 |                                   |                |        |  |       |                                |            |
|  | 2.2 i Coupe (CD7)     |  | 01.94 | 01.98 |                                   | 24.0110-0233.1 | 410233 |  |       | 260 10,0 8,0 +S +B             |            |
|  | 2.2 i ES Coupe (CD7)  |  | 01.94 | 01.98 |                                   |                |        |  |       |                                |            |
|  | 2.2 i VTEC (CE9)      |  | 01.96 | 09.98 |                                   |                |        |  |       |                                |            |
|  | 2.3 i (CC7)           |  | 01.93 | 12.95 |                                   |                |        |  |       |                                |            |
|  | 1.8 i (CE7)           |  | 01.96 | 09.98 |                                   |                |        |  |       |                                |            |
|  | 2.0 i (CC7)           |  | 01.93 | 12.95 |                                   |                |        |  |       |                                |            |
|  | 2.0 i (CE8)           |  | 01.96 | 09.98 |                                   |                |        |  |       |                                |            |
|  | 2.0 i Aero Deck (CE2) |  | 01.94 | 01.98 |                                   |                |        |  |       |                                |            |
|  | 2.0 i Coupe (CD9)     |  | 01.94 | 01.98 |                                   |                |        |  |       |                                |            |
|  | 2.0 i LS Coupe (CD9)  |  | 01.94 | 01.98 |                                   |                |        |  |       |                                |            |

<sup>1)</sup> - series 330 / - serie 330 / - Série 330 / - serie 330

<sup>2)</sup> + series 330 / + serie 330 / + Série 330 / + serie 330





















<sup>3)</sup> - series 290S Sport / - series 330 / - serie 290S Sport / - serie 330 / - Série 290S Sport / - Série 330 / - serie 290S Sport / - serie 330

<sup>4)</sup> + manual transmission / + scatola cambio velocità / + transmission mécanique / + cambio de velocidad

<sup>5)</sup> + autom.transmission / + scatola cambio automatico / + transmission automatique / + cambio automático





|     |    |  |  |  |  |  |  |  |
|--|--|--|--|--|---|--|--|--|
| <b>HONDA ACCORD (98-02)</b>  |  |  |  |  |   |  |  |  |
|    | 1.6 i 16V (CG7)<br>1.6 i 16V (CH5)   | 85<br>85   |  | 10.98<br>10.98   | 12.02<br>12.02  | 13.0460-5861.2   | 605861   | 23097 17,1 +/WK/Zub/S  |
|  | 1.8 VTEC (CG8)<br>1.8 VTEC (CH6)<br>2.0 TDiC (CH2)<br>2.0 TDiC (CH8)<br>2.0 VTEC (CG9)<br>2.0 VTEC (CH7)<br>2.3 VTEC (CL3)<br>2.3 VTEC (CL4)                     | 100<br>100<br>77<br>77<br>108<br>108<br>113<br>113                               |  | 10.98<br>10.98<br>02.99<br>02.99<br>10.98<br>10.98<br>01.01<br>01.01             | 12.02<br>12.02<br>10.00<br>10.00<br>01.01<br>01.01<br>12.02<br>12.02              | 13.0460-5825.2   | 605825   | 23094 16,5 +/WK/Zub/STRW   |
|    | 1.6 i 16V (CG7)<br>1.6 i 16V (CH5)   | 85<br>85   |  | 10.98<br>10.98   | 12.02<br>12.02  | 24.0123-0105.1   | 423105   | + 14" Rad <sup>1)</sup><br>260 23,0 21,0 V   |
|  | 1.8 VTEC (CG8)<br>1.8 VTEC (CH6)<br>2.0 TDiC (CH2)<br>2.0 TDiC (CH8)<br>2.0 VTEC (CG9)<br>2.0 VTEC (CH7)<br>2.3 VTEC (CL3)<br>2.3 VTEC (CL4)                     | 100<br>100<br>77<br>77<br>108<br>108<br>113<br>113                               |  | 10.98<br>10.98<br>02.99<br>02.99<br>10.98<br>10.98<br>01.01<br>01.01             | 12.02<br>12.02<br>10.00<br>10.00<br>01.01<br>01.01<br>12.02<br>12.02              | 24.0125-0146.1   | 425146   | + 15" Rad <sup>3)</sup><br>282 25,0 23,0 V +B                                      |
|  | 2.3 VTEC (CL3)<br>2.3 VTEC (CL4)   | 113<br>113   |  | 01.01<br>01.01   | 12.02<br>12.02  | 24.0125-0183.1   | 425183   | + 15" Rad <sup>3)</sup><br>282 25,0 23,0 V   |
|    | 1.8 VTEC (CG8)<br>1.8 VTEC (CH6)<br>2.0 TDiC (CH2)<br>2.0 TDiC (CH8)<br>2.0 VTEC (CG9)<br>2.0 VTEC (CH7)<br>2.2 Type R (CH1)<br>2.3 VTEC (CL3)<br>2.3 VTEC (CL4) | 100<br>100<br>77<br>77<br>108<br>108<br>156<br>113<br>113                        |  | 10.98<br>10.98<br>02.99<br>02.99<br>10.98<br>10.98<br>02.99<br>01.01<br>01.01    | 12.02<br>12.02<br>10.00<br>10.00<br>01.01<br>01.01<br>12.02<br>12.02<br>12.02     | 13.0460-5827.2   | 605827   | 23527 14,5 +/WK/S TRW  |
|    | 1.8 VTEC (CG8)<br>1.8 VTEC (CH6)<br>2.0 TDiC (CH2)<br>2.0 TDiC (CH8)<br>2.0 VTEC (CG9)<br>2.0 VTEC (CH7)   | 100<br>100<br>77<br>77<br>108<br>108   |  | 10.98<br>10.98<br>02.99<br>02.99<br>10.98<br>10.98                               | 12.02<br>12.02<br>10.00<br>10.00<br>01.01<br>01.01                                | 24.0110-0295.1   | 410295   | für 4-Loch-Felge <sup>2)</sup><br>260 10,0 8,0 +B                                  |
| <b>HONDA ACCORD Coupe (98-03)</b>  |  |  |  |  |   |  |  |  |
|   | 2.0 i 16V (CG4)<br>2.0 i 16V (CG4)<br>3.0 i V6 (CG2)<br>3.0 VTEC (CG2)   | 107<br>108<br>147<br>152   |  | 11.99<br>02.98<br>02.98<br>10.01   | 10.02<br>06.03<br>06.03<br>06.03  | 13.0460-5982.2   | 605982   | 21651 17,5 +/WK  |
|  | 2.0 i 16V (CG4)<br>2.0 i 16V (CG4)<br>3.0 i V6 (CG2)<br>3.0 VTEC (CG2)   | 107<br>108<br>147<br>152   |  | 11.99<br>02.98<br>02.98<br>10.01   | 10.02<br>06.03<br>06.03<br>06.03  | 13.0460-5929.2   | 605929   | 21719 15,0 +/WK AKE  |
|  | 2.0 i 16V (CG4)<br>2.0 i 16V (CG4)<br>3.0 i V6 (CG2)<br>3.0 VTEC (CG2)   | 107<br>108<br>147<br>152   |  | 11.99<br>02.98<br>02.98<br>10.01   | 10.02<br>06.03<br>06.03<br>06.03  | 24.0109-0145.1   | 409145   | 260 9,0 8,0  |
|  | 3.0 i V6 (CG2)<br>3.0 VTEC (CG2)   | 147<br>152   |  | 02.98<br>10.01   | 06.03<br>06.03  | 24.0109-0709.1   | 409709   | 260 9,0 8,0  |
| <b>HONDA ACCORD Limousine (03-08)</b>  |  |  |  |  |   |  |  |  |
|  | 2.0 16V (CL7)<br>2.0 16V (CL8) Allrad<br>2.2 i-CTDi (CN1)<br>2.4 16V (CL9)<br>2.4 16V (CM5)<br>2.4 VTEC (CM5)<br>2.4 VTEC E (CM5)                                | 114<br>114<br>103<br>140<br>113<br>122<br>118                                    |  | 02.03<br>02.03<br>01.04<br>02.03<br>09.06<br>04.06<br>02.03                      | 05.08<br>05.08<br>05.08<br>05.08<br>05.08<br>07.08<br>09.05                       | 13.0460-5714.2   | 605714   | 23720 17,5 +/WK ATE  |
|  | 2.0 16V (CL7)<br>2.0 16V (CL8) Allrad<br>2.2 i-CTDi (CN1)<br>2.4 16V (CL9)<br>2.4 16V (CM5)<br>2.4 VTEC (CM5)<br>2.4 VTEC E (CM5)                                | 114<br>114<br>103<br>140<br>113<br>122<br>118                                    |  | 02.03<br>02.03<br>01.04<br>02.03<br>09.06<br>04.06<br>02.03                      | 05.08<br>05.08<br>05.08<br>05.08<br>05.08<br>07.08<br>09.05                       | 24.0125-0187.1   | 425187   | + 15" Rad <sup>3)</sup><br>280 25,0 23,0 V +B                                      |
|  | 2.0 16V (CL7)<br>2.0 16V (CL8) Allrad<br>2.2 i-CTDi (CN1)<br>2.4 16V (CL9)<br>2.4 16V (CM5)<br>2.4 VTEC (CM5)<br>2.4 VTEC E (CM5)                                | 114<br>114<br>103<br>140<br>113<br>122<br>118                                    |  | 02.03<br>02.03<br>01.04<br>02.03<br>09.06<br>04.06<br>02.03                      | 05.08<br>05.08<br>05.08<br>05.08<br>05.08<br>07.08<br>09.05                       | 24.0125-0174.1   | 425174   | + 16" Rad <sup>5)</sup><br>300 25,0 23,0 V +B                                      |
|  | 2.0 16V (CL7)<br>2.0 16V (CL8) Allrad<br>2.2 i-CTDi (CN1)<br>2.4 16V (CL9)<br>2.4 16V (CM5)<br>2.4 VTEC (CM5)<br>2.4 VTEC E (CM5)                                | 114<br>114<br>103<br>140<br>113<br>122<br>118                                    |  | 02.03<br>02.03<br>01.04<br>02.03<br>09.06<br>04.06<br>02.03                      | 05.08<br>05.08<br>05.08<br>05.08<br>05.08<br>07.08<br>09.05                       | 13.0460-5827.2   | 605827   | 23527 14,5 +/WK/S TRW  |
|  | 2.4 16V (CL9)  | 140  |  | 02.03  | 05.08   | 13.0460-5711.2   | 605711   | 23652 15,7 +/WK  |
|  | 2.0 16V (CL7)<br>2.0 16V (CL8) Allrad<br>2.2 i-CTDi (CN1)<br>2.4 16V (CL9)<br>2.4 16V (CM5)  | 114<br>114<br>103<br>140<br>113  |  | 02.03<br>02.03<br>01.04<br>02.03<br>09.06  | 05.08<br>05.08<br>05.08<br>05.08<br>05.08   | 24.0110-0321.1   | 410321   | 260 10,0 8,0 +B  |

1) + 14" wheel / + ruota 14" / + roue 14" / + rueda 14"



























2) for 4 bore wheel rim / per cerchione a 4 fori / pour jante à 4 trous / para Llantas de 4 taladros

3) + 15" wheel / + ruota 15" / + roue 15" / + rueda 15"

4) for 5 bore wheel rim / per cerchione a 5 fori / pour jante à 5 trous / para Llantas de 5 taladros

5) + 16" wheel / + ruota 16" / + roue 16" / + rueda 16"





























|     |                              |  |  |    |  |  |  |  |
|--|--|--|--|--|---|--|--|--|
| <b>HONDA ACCORD Limousine (03-08)</b>  |  |  |  |  |   |  |  |  |
|    | 2.4 VTEC (CM5)<br>2.4 VTEC E (CM5)   | 122<br>118   | 04.06<br>02.03   | 07.08<br>09.05   | 24.0110-0321.1  | 410321   |  | 260 10,0 8,0 +B  |
| <b>HONDA ACCORD Kombi (03-08)</b>  |  |  |  |  |   |  |  |  |
|    | 2.0 i 16V (CM1)<br>2.2 CTDi (CM2)<br>2.4 i 16V (CM2)<br>2.4 VTEC E<br>2.4 VTEC T                             | 114<br>103<br>140<br>118<br>147  | 04.03<br>01.04<br>04.03<br>09.03<br>09.03  | 05.08<br>05.08<br>05.08<br>09.05<br>05.08  | 13.0460-5714.2  | 605714   |  | 23720 17,5 +/WK ATE  |
|    | 2.0 i 16V (CM1)<br>2.2 CTDi (CM2)<br>2.4 i 16V (CM2)<br>2.4 VTEC E<br>2.4 VTEC T                             | 114<br>103<br>140<br>118<br>147  | 04.03<br>01.04<br>04.03<br>09.03<br>09.03  | 05.08<br>05.08<br>05.08<br>09.05<br>05.08  | 24.0125-0187.1  | 425187   | + 15" Rad <sup>1)</sup>  | 280 25,0 23,0 V +B   |
|    | 2.0 i 16V (CM1)<br>2.2 CTDi (CM2)<br>2.4 i 16V (CM2)<br>2.4 VTEC E<br>2.4 VTEC T                             | 114<br>103<br>140<br>118<br>147  | 04.03<br>01.04<br>04.03<br>09.03<br>09.03  | 05.08<br>05.08<br>05.08<br>09.05<br>05.08  | 24.0125-0174.1  | 425174   | + 16" Rad <sup>2)</sup>  | 300 25,0 23,0 V +B   |
|    | 2.4 i 16V (CM2)<br>2.4 VTEC E<br>2.4 VTEC T  | 140<br>118<br>147  | 04.03<br>09.03<br>09.03  | 05.08<br>09.05<br>05.08  | 13.0460-5827.2  | 605827   |  | 23527 14,5 +/WK/S TRW  |
|    | 2.0 i 16V (CM1)<br>2.2 CTDi (CM2)<br>2.4 i 16V (CM2)<br>2.4 VTEC E<br>2.4 VTEC T                             | 114<br>103<br>140<br>118<br>147  | 04.03<br>01.04<br>04.03<br>09.03<br>09.03  | 05.08<br>05.08<br>05.08<br>09.05<br>05.08  | 13.0460-5711.2  | 605711   |  | 23652 15,7 +/WK  |
|    | 2.0 i 16V (CM1)<br>2.2 CTDi (CM2)<br>2.4 i 16V (CM2)<br>2.4 VTEC E<br>2.4 VTEC T                             | 114<br>103<br>140<br>118<br>147  | 04.03<br>01.04<br>04.03<br>09.03<br>09.03  | 05.08<br>05.08<br>05.08<br>09.05<br>05.08  | 24.0109-0161.1  | 409161   |  | 282 9,0 7,5 +B   |
| <b>HONDA ACCORD VIII Limousine (08-)</b>   |  |  |  |  |   |  |  |  |
|   | 2.0 VTEC (CU1)<br>2.0 VTEC (CU1)<br>2.4 VTEC (CU2)<br>2.4 VTEC (CU2)   | 110<br>115<br>133<br>148   | 07.08<br>07.08<br>07.08<br>07.08   | + Bremsscheibendurchm. 320mm <sup>3)</sup><br>+ Bremsscheibendurchm. 320mm <sup>3)</sup><br>+ Bremsscheibendurchm. 320mm <sup>3)</sup><br>+ Bremsscheibendurchm. 320mm <sup>3)</sup> | 24.0132-0172.1  | 432172   |  | 320 32,0 30,0 V L +S +B  |
|  | 2.0 VTEC (CU1)<br>2.0 VTEC (CU1)<br>2.2 i-DTEC (CU3)<br>2.2 i-DTEC (CU3)<br>2.4 VTEC (CU2)<br>2.4 VTEC (CU2) | 110<br>115<br>110<br>132<br>133<br>148   | 07.08<br>07.08<br>07.08<br>07.08<br>07.08<br>07.08                               | + Schaltgetriebe <sup>4)</sup><br>+ Schaltgetriebe <sup>4)</sup><br><br>+ Schaltgetriebe <sup>4)</sup><br>+ Schaltgetriebe <sup>4)</sup>   | 13.0460-5648.2  | 605648   |  | 24435 14,8 +/WK/Zub NIS  |
|  | 2.0 VTEC (CU1)<br>2.0 VTEC (CU1)<br>2.2 i-DTEC (CU3)<br>2.2 i-DTEC (CU3)<br>2.4 VTEC (CU2)<br>2.4 VTEC (CU2) | 110<br>115<br>110<br>132<br>133<br>148   | 07.08<br>07.08<br>07.08<br>07.08<br>07.08<br>07.08                               | + Schaltgetriebe <sup>4)</sup><br>+ Schaltgetriebe <sup>4)</sup><br><br>+ Schaltgetriebe <sup>4)</sup><br>+ Schaltgetriebe <sup>4)</sup>   | 24.0109-0169.1  | 409169   |  | 282 9,0 8,0 +S +B  |
|  | 2.0 VTEC (CU1)<br>2.0 VTEC (CU1)<br>2.2 i-DTEC (CU3)<br>2.2 i-DTEC (CU3)<br>2.4 VTEC (CU2)<br>2.4 VTEC (CU2) | 110<br>115<br>110<br>132<br>133<br>148   | 07.08<br>07.08<br>07.08<br>07.08<br>07.08<br>07.08                               |  | 03.0137-4019.2  | 654019   |  | 190 x 26 /Zub  |
| <b>HONDA ACCORD VIII Kombi (08-)</b>   |  |  |  |  |   |  |  |  |
|  | 2.0 VTEC (CW1)<br>2.2 i-DTEC (CW3)   | 115<br>132   | 07.08<br>07.08   | + Bremsscheibendurchm. 320mm <sup>3)</sup><br>+ Bremsscheibendurchm. 320mm <sup>3)</sup>   | 24.0132-0172.1  | 432172   |  | 320 32,0 30,0 V L +S +B  |
|  | 2.0 VTEC (CW1)<br>2.0 VTEC (CW1)<br>2.2 i-DTEC (CW3)<br>2.2 i-DTEC (CW3)<br>2.4 VTEC (CW2)                   | 110<br>115<br>110<br>132<br>148  | 07.08<br>07.08<br>07.08<br>07.08<br>07.08  | + Schaltgetriebe <sup>4)</sup><br>+ Schaltgetriebe <sup>4)</sup>   | 13.0460-5648.2  | 605648   |  | 24435 14,8 +/WK/Zub NIS  |
|  | 2.0 VTEC (CW1)<br>2.0 VTEC (CW1)<br>2.2 i-DTEC (CW3)<br>2.2 i-DTEC (CW3)<br>2.4 VTEC (CW2)                   | 110<br>115<br>110<br>132<br>148  | 07.08<br>07.08<br>07.08<br>07.08<br>07.08  | + Schaltgetriebe <sup>4)</sup><br>+ Schaltgetriebe <sup>4)</sup>   | 24.0109-0169.1  | 409169   |  | 282 9,0 8,0 +S +B  |
|  | 2.0 VTEC (CW1)<br>2.0 VTEC (CW1)<br>2.2 i-DTEC (CW3)<br>2.2 i-DTEC (CW3)<br>2.4 VTEC (CW2)                   | 110<br>115<br>110<br>132<br>148  | 07.08<br>07.08<br>07.08<br>07.08<br>07.08  |  | 03.0137-4019.2  | 654019   |  | 190 x 26 /Zub  |
| <b>HONDA CITY (08-)</b>  |  |  |  |  |   |  |  |  |
|  | 1.4 VTEC   | 73   | 09.08  |  | 13.0460-5943.2  | 605943   |  | 21697 15,0 +/WK SUM  |
|  | 1.4 VTEC   | 73   | 09.08  |  | 24.0121-0115.1  | 421115   |  | 258 21,0 19,0 V +S +B  |
|  | 1.4 VTEC   | 73   | 09.08  |  | 13.0460-5731.2  | 605731   |  | 21738 13,5 +/WK  |

<sup>1)</sup> + 15" wheel / + ruota 15" / + roue 15" / + rueda 15"























<sup>2)</sup> + 16" wheel / + ruota 16" / + roue 16" / + rueda 16"

<sup>3)</sup> + brake disc diameter 320mm / + diametro dischi freno 320mm / + diamètre disques frein 320mm / + diametro disco freno 320mm























<sup>4)</sup> + manual transmission / + scatola cambio velocità / + transmission mécanique / + cambio de velocidad

|     |  |  |  |  |  |  |  |  |
|--|--|--|--|--|---|--|--|--|
| <b>HONDA CITY (08-)</b>  |  |  |  |  |   |  |  |  |
|    | 1.4 VTEC   | 73   |  | 09.08  |   | 24.0109-0168.1   | 409168   | 239 9,0 8,0 +S +B  |
| <b>HONDA CIVIC (3/4-tuerig) (95-01)</b>  |  |  |  |  |   |  |  |  |
|    | 1.4 i (EJ9)  | 55   | 11.95  | 12.97  |   | 13.0460-5943.2   | 605943   | 21697 15,0 +/WK <b>SUM</b>   |
|  | 1.4 i (EJ9)  | 66   | 11.95  | 12.97  |   | 13.0460-0073.2   | 610073   | Belagsatz-Zubehör  |
|  | 1.4 i (EJ9)  | 55   | 01.98  | 01.01  |   | 13.0460-5820.2   | 605820   | 21694 16,3 +/WK <b>SUM</b>   |
|  | 1.4 i (EJ9)  | 66   | 01.98  | 01.01  |   | 13.0460-0073.2   | 610073   | Belagsatz-Zubehör  |
|  | 1.5 VTEC (EK3)   | 84   | 11.95  | 01.01  |   |  |  |  |
|  | 1.6 VTEC (EK1)   | 84   | 11.95  | 01.01  |   |  |  |  |
|  | 1.6 VTEC (EK4)   | 118  | 11.95  | 01.01  |   |  |  |  |
|    | 1.4 i (EJ9)  | 55   | 11.95  | 01.01  | - ABS   | 24.0121-0104.1   | 421104   | 240 21,0 19,0 V +S +B <b>SUM</b>   |
|  | 1.4 i (EJ9)  | 66   | 11.95  | 01.01  | - ABS   |  |  |  |
|  | 1.5 VTEC (EK3)   | 84   | 11.95  | 01.01  | - ABS   |  |  |  |
|  | 1.4 i (EJ9)  | 55   | 11.95  | 01.01  | + ABS   | 24.0121-0105.1   | 421105   | 262 21,0 19,0 V +S +B  |
|  | 1.4 i (EJ9)  | 66   | 11.95  | 01.01  | + ABS   |  |  |  |
|  | 1.5 VTEC (EK3)   | 84   | 11.95  | 01.01  | + ABS   |  |  |  |
|  | 1.6 VTEC (EK1)   | 84   | 11.95  | 01.01  |   |  |  |  |
|  | 1.6 VTEC (EK4)   | 118  | 11.95  | 01.01  |   |  |  |  |
|    | 1.5 VTEC (EK3)   | 84   | 11.95  | 01.01  |   | 13.0460-5731.2   | 605731   | 21738 13,5 +/WK  |
|  | 1.6 VTEC (EK4)   | 118  | 11.95  | 01.01  |   | 13.0460-0329.2   | 610329   | Belagsatz-Zubehör  |
|    | 1.5 VTEC (EK3)   | 84   | 11.95  | 01.01  |   | 24.0109-0111.1   | 409111   | 239 9,0 8,0 +S +B  |
|  | 1.6 VTEC (EK4)   | 118  | 11.95  | 01.01  |   |  |  |  |
|    | 1.4 i (EJ9)  | 55   | 11.95  | 01.01  | - ABS   | 03.0137-0284.2   | 650284   | 180 x 31   |
|  | 1.4 i (EJ9)  | 66   | 11.95  | 01.01  | + ABS   | 03.0137-9096.2   | 669096   | Bremsbacken-Zubehör  |
|  | 1.4 i (EJ9)  | 66   | 11.95  | 01.01  | + ABS   | 03.0137-0294.2   | 650294   | 200 x 36   |
|  | 1.5 VTEC (EK3)   | 84   | 11.95  | 01.01  |   | 03.0137-9097.2   | 669097   | Bremsbacken-Zubehör  |
|  | 1.6 VTEC (EK1)   | 84   | 11.95  | 01.01  |   |  |  |  |
|    | 1.4 i (EJ9)  | 55   | 11.95  | 01.01  | - ABS   | 24.0218-0018.1   | 480063   | 180/181 x 38   |
| <b>HONDA CIVIC (3-tuerig) (01-05)</b>  |  |  |  |  |   |  |  |  |
|   | 1.4 i 16V  | 66   | 02.01  | 12.05  |   | 13.0460-2803.2   | 602803   | 21515 17,5 +/WK/S <b>TRW</b>   |
|  | 1.6 i 16V  | 81   | 02.01  | 12.05  |   | 13.0460-0142.2   | 610142   | Belagsatz-Zubehör  |
|  | 1.6 i 16V  | 81   |  |  |   | 13.0460-5755.2   | 605755   | 23178 16,6 +/WK <b>SUM</b>   |
|  | 1.7 CTDi   | 74   | 01.02  | 12.05  |   | 13.0460-5861.2   | 605861   | 23097 17,1 +/WK/Zub/S  |
|  | 1.7 CTDi   | 74   | 01.02  | 12.05  |   | 13.0460-5755.2   | 605755   | + Sportfahrwerk <sup>1)</sup>  |
|  | 2.0 Type R   | 147  | 09.01  | 12.05  |   | 13.0460-5755.2   | 605755   | 23178 16,6 +/WK <b>SUM</b>   |
|  | 1.4 i 16V  | 66   | 02.01  | 12.05  |   | 24.0121-0105.1   | 421105   | 262 21,0 19,0 V +S +B  |
|  | 1.6 i 16V  | 81   | 02.01  | 12.05  |   | 24.0125-0173.1   | 425173   | + Sportfahrwerk <sup>1)</sup>  |
|  | 1.6 i 16V  | 81   |  |  |   | 24.0125-0173.1   | 425173   | 300 25,0 23,0 V +S +B  |
|  | 1.7 CTDi   | 74   | 01.02  | 12.05  |   | 24.0123-0111.1   | 423111   | 260 23,0 21,0 V +S +B  |
|  | 1.7 CTDi   | 74   | 01.02  | 12.05  |   | 24.0125-0173.1   | 425173   | + Sportfahrwerk <sup>1)</sup>  |
|  | 2.0 Type R   | 147  | 09.01  | 12.05  |   | 24.0125-0173.1   | 425173   | 300 25,0 23,0 V +S +B  |
|  | 1.4 i 16V  | 66   | 02.01  | 12.05  |   | 13.0460-5929.2   | 605929   | 21719 15,0 +/WK <b>AKE</b>   |
|  | 1.6 i 16V  | 81   | 02.01  | 12.05  |   |  |  |  |
|  | 1.7 CTDi   | 74   | 01.02  | 12.05  |   |  |  |  |
|  | 2.0 Type R   | 147  | 09.01  | 12.05  |   |  |  |  |
|  | 1.4 i 16V  | 66   | 02.01  | 12.05  |   | 24.0109-0143.1   | 409143   | 260 9,0 8,0 +S   |
|  | 1.6 i 16V  | 81   | 02.01  | 12.05  |   | 24.0110-0279.1   | 410279   | + Sportfahrwerk <sup>1)</sup>  |
|  | 1.6 i 16V  | 81   | 02.01  | 12.05  |   |  |  | 260 10,0 8,0 +S +B   |
|  | 1.7 CTDi   | 74   | 01.02  | 12.05  |   |  |  |  |
|  | 2.0 Type R   | 147  | 09.01  | 12.05  |   | 24.0110-0279.1   | 410279   | 260 10,0 8,0 +S +B   |
| <b>HONDA CIVIC (4-tuerig) (01-05)</b>  |  |  |  |  |   |  |  |  |
|  | 1.3 IMA  | 61   | 01.04  | 12.05  |   | 13.0460-2803.2   | 602803   | 21515 17,5 +/WK/S <b>TRW</b>   |
|  | 1.4 i 16V  | 66   | 02.01  | 12.05  |   | 13.0460-5820.2   | 605820   | 21694 16,3 +/WK <b>SUM</b>   |
|  | 1.6 i 16V  | 81   | 02.01  | 12.05  |   |  |  |  |
|  | 1.3 IMA  | 61   | 01.04  | 12.05  |   | 24.0121-0105.1   | 421105   | 262 21,0 19,0 V +S +B  |
|  | 1.4 i 16V  | 66   | 02.01  | 12.05  |   | 24.0121-0702.1   | 421702   | + Sportfahrwerk <sup>1)</sup>  |
|  | 1.6 i 16V  | 81   | 02.01  | 12.05  |   |  |  | 262 21,0 19,0 V +S +B  |
|  | 1.3 IMA  | 61   | 01.04  | 12.05  |   | 13.0460-5929.2   | 605929   | 21719 15,0 +/WK <b>AKE</b>   |
|  | 1.4 i 16V  | 66   | 02.01  | 12.05  |   |  |  |  |
|  | 1.6 i 16V  | 81   | 02.01  | 12.05  |   |  |  |  |
|  | 1.3 IMA  | 61   | 01.04  | 12.05  |   | 24.0109-0143.1   | 409143   | 260 9,0 8,0 +S   |
|  | 1.4 i 16V  | 66   | 02.01  | 12.05  |   | 24.0110-0279.1   | 410279   | + Sportfahrwerk <sup>1)</sup>  |
|  | 1.6 i 16V  | 81   | 02.01  | 12.05  |   |  |  | 260 10,0 8,0 +S +B   |
|  | 1.3 IMA  | 61   | 01.04  | 12.05  |   | 03.0137-0294.2   | 650294   | 200 x 36   |
|  | 1.4 i 16V  | 66   | 02.01  | 12.05  |   |  |  |  |
|  | 1.6 i 16V  | 81   | 02.01  | 12.05  |   |  |  |  |
| <b>HONDA CIVIC (5-tuerig) (97-01)</b>  |  |  |  |  |   |  |  |  |
|  | 1.4 i 16V (MB2)  |  | 01.97  | 02.01  |   | 13.0460-5920.2   | 605920   | 21322 15,0 +/WK <b>AKE</b>   |
|  | 1.5 i 16V (MB3)  |  | 01.97  | 02.01  |   | 13.0460-0308.2   | 610308   | Belagsatz-Zubehör <b>AKE</b>   |
|  | 1.6 i 16V (MB4)  |  | 01.97  | 02.01  |   | 13.0460-2803.2   | 602803   | 21515 17,5 +/WK/S <b>TRW</b>   |
|  | 1.6 VTi  |  | 01.97  | 02.01  |   | 13.0460-0142.2   | 610142   | Belagsatz-Zubehör  |
|  | 2.0 i TD (MB7)   |  | 01.97  | 02.01  |   |  |  |  |

<sup>1)</sup> + sports suspension / + sospensione sportiva / + châssis de sport / + suspensión deportiva

|     |                       |  |  |  |  |  |  |                         |
|--|---|--|--|--|---|--|--|---|
| <b>HONDA CIVIC (5-tuerig) (97-01)</b>  |   |  |  |  |   |  |  |   |
|    | 1.4 i 16V (MB2)<br>1.5 i 16V (MB3)<br>1.6 i 16V (MB4)<br>1.6 VTi<br>2.0 i TD (MB7)                    |  | 01.97<br>01.97<br>01.97<br>01.97<br>01.97  | 02.01<br>02.01<br>02.01<br>02.01<br>02.01  | 24.0121-0105.1  | 421105   |  | 262 21,0 19,0 V +S +B   |
|  | 1.8 i 16V (MB6)   |  | 01.97  | 02.01  | 24.0123-0106.1  | 423106   |  | 282 23,0 21,0 V   |
|    | 1.4 i 16V (MB2)<br>1.5 i 16V (MB3)<br>1.6 i 16V (MB4)<br>1.6 VTi<br>2.0 i TD (MB7)                    |  | 01.97<br>01.97<br>01.97<br>01.97<br>01.97  | 12.98 + ABS<br>12.98 + ABS<br>12.98<br>12.98<br>12.98                            | 13.0460-5998.2<br>13.0460-0430.2  | 605998<br>610430   |  | 21312 12,8 +WK<br>Belagsatz-Zubehör<br><b>AKE</b>   |
|  | 1.4 i 16V (MB2)<br>1.5 i 16V (MB3)<br>1.6 i 16V (MB4)<br>1.6 VTi<br>1.8 i 16V (MB6)<br>2.0 i TD (MB7) |  | 01.99<br>01.99<br>01.99<br>01.99<br>01.97<br>01.99                               | 02.01 + ABS<br>02.01 + ABS<br>02.01<br>02.01<br>02.01<br>02.01                   | 13.0460-5929.2  | 605929   |  | 21719 15,0 +WK<br><b>AKE</b>  |
|    | 1.4 i 16V (MB2)<br>1.5 i 16V (MB3)<br>1.6 i 16V (MB4)<br>1.6 VTi<br>2.0 i TD (MB7)                    |  | 01.97<br>01.97<br>01.97<br>01.97<br>01.97  | 12.98 + ABS<br>02.01 + ABS<br>02.01<br>02.01<br>02.01                            | 24.0110-0212.1  | 410212   |  | 239 10,0 8,0 +S +B  |
|  | 1.4 i 16V (MB2)<br>1.5 i 16V (MB3)  |  | 01.99<br>01.97   | 02.01 + ABS<br>02.01   | 24.0109-0143.1  | 409143   |  | 260 9,0 8,0 +S  |
|  | 1.8 i 16V (MB6)   |  | 01.97  | 02.01  | 24.0110-0233.1  | 410233   |  | 260 10,0 8,0 +S +B  |
|    | 1.4 i 16V (MB2)<br>1.5 i 16V (MB3)  |  | 11.98<br>11.98   | 02.01 - ABS<br>02.01 - ABS   | 03.0137-0339.2  | 650339   |  | 203 x 38  |
|    | 1.5 i 16V (MB3)   |  | 02.97  | 02.01  | 24.0220-3016.1  | 480107   |  | 203/204 x 45,5  |
| <b>HONDA CIVIC (5-tuerig) (01-05)</b>  |   |  |  |  |   |  |  |   |
|    | 1.4 i 16V (EU7)<br>1.6 VTEC (EU8)   | 66<br>81   | 02.01<br>02.01   | 12.05<br>12.05   | 13.0460-2803.2<br>13.0460-0142.2<br>13.0460-5820.2<br>13.0460-5878.2              | 602803<br>610142<br>605820<br>605878   | + Sportfahrwerk <sup>1)</sup>  | 21515 17,5 +WK/S<br>Belagsatz-Zubehör<br>21694 16,3 +WK<br>23729 16,9 +WK/Zub<br><b>TRW</b><br><b>SUM</b> |
|  | 1.7 CTDi (EU9)  | 74   | 01.02  | 12.05  | 13.0460-5861.2<br>13.0460-5878.2  | 605861<br>605878   | + Sportfahrwerk <sup>1)</sup>  | 23097 17,1 +WK/Zub/S<br>23729 16,9 +WK/Zub  |
|  | 2.0 i Sport (EV1)   | 118  | 01.04  | 12.05  | 13.0460-5878.2  | 605878   |  | 23729 16,9 +WK/Zub  |
|  | 1.4 i 16V (EU7)<br>1.6 VTEC (EU8)<br>1.7 CTDi (EU9)   | 66<br>81<br>74   | 02.01<br>02.01<br>01.02  | 12.05<br>12.05<br>12.05  | 24.0121-0105.1<br>24.0123-0109.1<br>24.0123-0111.1<br>24.0123-0109.1              | 421105<br>423109<br>423111<br>423109   | + Sportfahrwerk <sup>1)</sup>  | 262 21,0 19,0 V +S +B<br>282 23,0 21,0 V +S +B<br>260 23,0 21,0 V +S +B<br>282 23,0 21,0 V +S +B          |
|  | 2.0 i Sport (EV1)   | 118  | 01.04  | 12.05  | 24.0123-0109.1  | 423109   |  | 282 23,0 21,0 V +S +B   |
|  | 1.4 i 16V (EU7)<br>1.6 VTEC (EU8)<br>1.7 CTDi (EU9)<br>2.0 i Sport (EV1)                              | 66<br>81<br>74<br>118  | 02.01<br>02.01<br>01.02<br>01.04   | 12.05<br>12.05<br>12.05<br>12.05   | 13.0460-5929.2  | 605929   |  | 21719 15,0 +WK<br><b>AKE</b>  |
|  | 1.4 i 16V (EU7)<br>1.6 VTEC (EU8)<br>1.7 CTDi (EU9)<br>2.0 i Sport (EV1)                              | 66<br>81<br>74<br>118  | 02.01<br>02.01<br>01.02<br>01.04   | 12.05<br>12.05<br>12.05<br>12.05   | 24.0109-0143.1<br>24.0110-0279.1  | 409143<br>410279   | + Sportfahrwerk <sup>1)</sup>  | 260 9,0 8,0 +S<br>260 10,0 8,0 +S +B  |
|  | 1.6 VTEC (EU8)  | ▶ 81   | 02.01  | 12.05  | 24.0109-0143.1<br>24.0110-0279.1  | 409143<br>410279   | + Sportfahrwerk <sup>1)</sup>  | 260 9,0 8,0 +S<br>260 10,0 8,0 +S +B  |
|  | 1.4 i 16V (EU7)   | ▶ 66   | 02.01  | 12.05  | 03.0137-0287.2<br>03.0137-9190.2  | 650287<br>669190   |  | 220 x 36<br>Bremsbacken-Zubehör   |
| <b>HONDA CIVIC IX (5-tuerig) (12-)</b>   |   |  |  |  |   |  |  |   |
|  | 1.4 i-VTEC<br>1.6 i-DTEC<br>1.6 i-VTEC<br>1.8 i-VTEC<br>2.0 i-VTEC<br>2.2 i-DTEC                      | 73<br>88<br>92<br>104<br>114<br>110  | 02.12<br>02.13<br>02.12<br>02.12<br>06.12<br>02.12                               |  | 13.0460-7284.2  | 607284   |  | 25804 17,3 +WK<br><b>ATE</b>  |
|  | 1.4 i-VTEC<br>1.6 i-DTEC<br>1.6 i-VTEC<br>1.8 i-VTEC<br>2.0 i-VTEC<br>2.2 i-DTEC                      | 73<br>88<br>92<br>104<br>114<br>110  | 02.12<br>02.13<br>02.12<br>02.12<br>06.12<br>02.12                               |  | 13.0460-7290.2  | 607290   |  | 25054 15,0 +WK<br><b>ATE</b>  |
|  | 1.4 i-VTEC<br>1.6 i-DTEC<br>1.6 i-VTEC<br>1.8 i-VTEC<br>2.0 i-VTEC<br>2.2 i-DTEC                      | 73<br>88<br>92<br>104<br>114<br>110  | 02.12<br>02.13<br>02.12<br>02.12<br>06.12<br>02.12                               |  | 24.0110-0380.1  | 410380   |  | 276 10,0 8,0 +B   |

<sup>1)</sup> + sports suspension / + sospensione sportiva / + châssis de sport / + suspensión deportiva

|     |     |  |  |  |  |  |  |  |                       |
|--|---|--|--|--|---|--|--|--|-----------------------|
| <b>HONDA CIVIC Hatchback (FK/FN) (05-12)</b>                                       |   |  |  |  |   |  |  |  |                       |
|    | 1.6 i 16V (FK4)   | 84   |  | 09.05  | 12.12   |  | 13.0460-5878.2   | 605878   | 23729 16,9 +/WK/Zub   |
|  | 1.4 i-VTEC (FK1)  | 61   |  | 01.06  | 01.12   |  | 13.0460-5756.2   | 605756   | 24087 17,4 +/WK/Zub/S |
|  | 1.4 i-VTEC (FK1/FN4)  | 73   |  | 10.08  | 12.12   |  |  |  |                       |
|  | 1.8 i-VTEC (FK2/FN1)  | 103  |  | 01.06  | 12.12   |  |  |  |                       |
|  | 2.2 CTDi (FK3/FN3)  | 103  |  | 01.06  | 12.12   |  |  |  |                       |
|  | 2.0 i-VTEC (FN2)  | 110  |  | 12.06  | 12.10   |  | 13.0460-5755.2   | 605755   | 23178 16,6 +/WK SUM   |
|  | 2.0 Type R (FN2)  | 148  |  | 09.06  | 12.12   |  |  |  |                       |
|    | 1.4 i-VTEC (FK1)  | 61   |  | 01.06  | 01.12   |  | 24.0123-0110.1   | 423110   | 282 23,0 21,0 V +S +B |
|  | 1.4 i-VTEC (FK1/FN4)  | 73   |  | 10.08  | 12.12   |  |  |  |                       |
|  | 1.6 i 16V (FK4)   | 84   |  | 09.05  | 12.12   |  |  |  |                       |
|  | 1.8 i-VTEC (FK2/FN1)  | 103  |  | 01.06  | 12.12   |  |  |  |                       |
|  | 2.2 CTDi (FK3/FN3)  | 103  |  | 01.06  | 12.12   |  |  |  |                       |
|    | 1.6 i 16V (FK4)   | 84   |  | 09.05  | 12.12   |  | 13.0460-5929.2   | 605929   | 21719 15,0 +/WK AKE   |
|  | 1.4 i-VTEC (FK1)  | 61   |  | 01.06  | 01.12   |  | 13.0460-5757.2   | 605757   | 24086 15,8 +/WK/Zub/S |
|  | 1.4 i-VTEC (FK1/FN4)  | 73   |  | 10.08  | 12.12   |  |  |  |                       |
|  | 1.8 i-VTEC (FK2/FN1)  | 103  |  | 01.06  | 12.12   |  |  |  |                       |
|  | 2.0 i-VTEC (FN2)  | 110  |  | 12.06  | 12.10   |  |  |  |                       |
|  | 2.0 Type R (FN2)  | 148  |  | 09.06  | 12.12   |  |  |  |                       |
|  | 2.2 CTDi (FK3/FN3)  | 103  |  | 01.06  | 12.12   |  |  |  |                       |
|    | 1.4 i-VTEC (FK1)  | 61   |  | 01.06  | 01.12   |  | 24.0109-0158.1   | 409158   | 260 9,0 8,0 +S +B     |
|  | 1.4 i-VTEC (FK1/FN4)  | 73   |  | 10.08  | 12.12   |  |  |  |                       |
|  | 1.6 i 16V (FK4)   | 84   |  | 09.05  | 12.12   |  |  |  |                       |
|  | 1.8 i-VTEC (FK2/FN1)  | 103  |  | 01.06  | 12.12   |  |  |  |                       |
|  | 2.0 i-VTEC (FN2)  | 110  |  | 12.06  | 12.10   |  |  |  |                       |
|  | 2.0 Type R (FN2)  | 148  |  | 09.06  | 12.12   |  |  |  |                       |
|  | 2.2 CTDi (FK3/FN3)  | 103  |  | 01.06  | 12.12   |  |  |  |                       |
| <b>HONDA CIVIC Stufenheck (FD) (05-12)</b>   |   |  |  |  |   |  |  |  |                       |
|    | 1.3 (FD3)   | 85   |  | 02.06  | 02.12   |  | 13.0460-5820.2   | 605820   | 21694 16,3 +/WK SUM   |
|  | 1.3 Hybrid (FD3)  | 70   |  | 01.06  | 02.12   |  |  |  |                       |
|  | 1.6 16V (FD4)   | 92   |  | 09.05  | 12.12   |  | 13.0460-5878.2   | 605878   | 23729 16,9 +/WK/Zub   |
|  | 1.6 16V (FD4/FD6)   | 84   |  | 09.05  | 12.12   |  |  |  |                       |
|  | 1.8 16V (FD1)   | 97   |  | 01.06  | 12.12   |  |  |  |                       |
|  | 1.8 16V (FD1)   | 103  |  | 02.06  | 02.12   |  |  |  |                       |
|  | 1.8 FlexFuel (FD1)  | 103  |  | 11.06  | 12.12   |  |  |  |                       |
|  | 1.8 i-VTEC (FD1/FD7)  | 103  |  | 09.05  | 02.12   |  |  |  |                       |
|  | 2.0 16V (FD2)   | 114  |  | 02.06  | 02.12   |  | 13.0460-5755.2   | 605755   | 23178 16,6 +/WK SUM   |
|   | 1.3 (FD3)   | 85   |  | 02.06  | 02.12   |  | 24.0121-0702.1   | 421702   | 262 21,0 19,0 V +S +B |
|  | 1.3 Hybrid (FD3)  | 70   |  | 01.06  | 02.12   |  |  |  |                       |
|  | 1.3 Hybrid (FD3)  | 85   |  | 01.10  | 02.12   |  |  |  |                       |
|  | 1.6 16V (FD4)   | 92   |  | 09.05  | 12.12   |  | 24.0123-0110.1   | 423110   | 282 23,0 21,0 V +S +B |
|  | 1.6 16V (FD4/FD6)   | 84   |  | 09.05  | 12.12   |  |  |  |                       |
|  | 1.8 16V (FD1)   | 97   |  | 01.06  | 12.12   |  |  |  |                       |
|  | 1.8 16V (FD1)   | 103  |  | 02.06  | 02.12   |  |  |  |                       |
|  | 1.8 FlexFuel (FD1)  | 103  |  | 11.06  | 12.12   |  |  |  |                       |
|  | 1.8 i-VTEC (FD1/FD7)  | 103  |  | 09.05  | 02.12   |  |  |  |                       |
|  | 1.3 (FD3)   | 85   |  | 02.06  | 02.12   |  | 13.0460-5929.2   | 605929   | 21719 15,0 +/WK AKE   |
|  | 1.3 Hybrid (FD3)  | 70   |  | 01.06  | 02.12   |  |  |  |                       |
|  | 1.3 Hybrid (FD3)  | 85   |  | 01.10  | 02.12   |  |  |  |                       |
|  | 1.6 16V (FD4)   | 92   |  | 09.05  | 12.12   |  |  |  |                       |
|  | 1.6 16V (FD4/FD6)   | 84   |  | 09.05  | 12.12   |  |  |  |                       |
|  | 1.8 16V (FD1)   | 97   |  | 01.06  | 12.12   |  |  |  |                       |
|  | 1.8 16V (FD1)   | 103  |  | 02.06  | 02.12   |  |  |  |                       |
|  | 1.8 FlexFuel (FD1)  | 103  |  | 11.06  | 12.12   |  |  |  |                       |
|  | 1.8 i-VTEC (FD1/FD7)  | 103  |  | 09.05  | 02.12   |  |  |  |                       |
|  | 2.0 16V (FD2)   | 114  |  | 02.06  | 02.12   |  | 13.0460-5757.2   | 605757   | 24086 15,8 +/WK/Zub/S |
|  | 1.3 (FD3)   | 85   |  | 02.06  | 02.12   |  | 24.0109-0158.1   | 409158   | 260 9,0 8,0 +S +B     |
|  | 1.3 Hybrid (FD3)  | 70   |  | 01.06  | 02.12   |  |  |  |                       |
|  | 1.3 Hybrid (FD3)  | 85   |  | 01.10  | 02.12   |  |  |  |                       |
|  | 1.6 16V (FD4)   | 92   |  | 09.05  | 12.12   |  |  |  |                       |
|  | 1.6 16V (FD4/FD6)   | 84   |  | 09.05  | 12.12   |  |  |  |                       |
|  | 1.8 16V (FD1)   | 97   |  | 01.06  | 12.12   |  |  |  |                       |
|  | 1.8 16V (FD1)   | 103  |  | 02.06  | 02.12   |  |  |  |                       |
|  | 1.8 FlexFuel (FD1)  | 103  |  | 11.06  | 12.12   |  |  |  |                       |
|  | 1.8 i-VTEC (FD1/FD7)  | 103  |  | 09.05  | 02.12   |  |  |  |                       |
|  | 2.0 16V (FD2)   | 114  |  | 02.06  | 02.12   |  |  |  |                       |
| <b>HONDA CIVIC AERODECK (98-01)</b>  |   |  |  |  |   |  |  |  |                       |
|  | 1.4 i 16V (MB8)   | 55   |  | 02.98  | 02.01   |  | 13.0460-2803.2   | 602803   | 21515 17,5 +/WK/S TRW |
|  | 1.4 i 16V (MB8)   | 66   |  | 02.98  | 02.01   |  | 13.0460-0142.2   | 610142   | Belagsatz-Zubehör     |
|  | 1.5 VTEC (MB9)  | 84   |  | 02.98  | 02.01   |  |  |  |                       |
|  | 1.6 i 16V (MC1)   | 85   |  | 02.98  | 02.01   |  |  |  |                       |
|  | 2.0 TDiC (MC3)  | 77   |  | 02.98  | 02.01   |  |  |  |                       |
|  | 1.8 VTEC (MC2)  | 124  |  | 02.98  | 02.01   |  | 13.0460-5982.2   | 605982   | 21651 17,5 +/WK       |
|  | 1.4 i 16V (MB8)   | 55   |  | 02.98  | 02.01   |  | 24.0121-0105.1   | 421105   | 262 21,0 19,0 V +S +B |
|  | 1.4 i 16V (MB8)   | 66   |  | 02.98  | 02.01   |  |  |  |                       |
|  | 1.5 VTEC (MB9)  | 84   |  | 02.98  | 02.01   |  |  |  |                       |
|  | 1.6 i 16V (MC1)   | 85   |  | 02.98  | 02.01   |  |  |  |                       |
|  | 2.0 TDiC (MC3)  | 77   |  | 02.98  | 02.01   |  |  |  |                       |
|  | 1.8 VTEC (MC2)  | 124  |  | 02.98  | 02.01   |  | 24.0123-0106.1   | 423106   | 282 23,0 21,0 V       |
|  | 1.4 i 16V (MB8)   | 55   |  | 02.98  | 12.98   | + ABS  | 13.0460-5998.2   | 605998   | 21312 12,8 +/WK AKE   |
|  | 1.4 i 16V (MB8)   | 66   |  | 02.98  | 12.98   | + ABS  |  |  |                       |
|  | 2.0 TDiC (MC3)  | 77   |  | 02.98  | 02.01   |  |  |  |                       |
|  | 1.4 i 16V (MB8)   | 55   |  | 01.99  | 02.01   | + ABS  | 13.0460-5929.2   | 605929   | 21719 15,0 +/WK AKE   |
|  |  |  |  |  |   |  |  |  |                       |



### HONDA CIVIC AERODECK (98-01)

|  |                 |     |  |       |       |       |                |        |  |       |              |                |
|--|-----------------|-----|--|-------|-------|-------|----------------|--------|--|-------|--------------|----------------|
|  | 1.4 i 16V (MB8) | 66  |  | 01.99 | 02.01 | + ABS | 13.0460-5929.2 | 605929 |  | 21719 | 15,0 +/WK    | AKE            |
|  | 1.5 VTEC (MB9)  | 84  |  | 02.98 | 02.01 | + ABS |                |        |  |       |              |                |
|  | 1.6 i 16V (MC1) | 85  |  | 02.98 | 02.01 |       |                |        |  |       |              |                |
|  | 1.8 VTEC (MC2)  | 124 |  | 02.98 | 02.01 |       |                |        |  |       |              |                |
|  | 1.4 i 16V (MB8) | 55  |  | 02.98 | 12.98 | + ABS | 24.0110-0212.1 | 410212 |  |       | 239          | 10,0 8,0 +S +B |
|  | 1.4 i 16V (MB8) | 66  |  | 02.98 | 12.98 | + ABS |                |        |  |       |              |                |
|  | 1.5 VTEC (MB9)  | 84  |  | 02.98 | 12.98 | + ABS |                |        |  |       |              |                |
|  | 2.0 TDiC (MC3)  | 77  |  | 02.98 | 02.01 |       |                |        |  |       |              |                |
|  | 1.4 i 16V (MB8) | 55  |  | 01.99 | 02.01 | + ABS | 24.0109-0143.1 | 409143 |  |       | 260          | 9,0 8,0 +S     |
|  | 1.4 i 16V (MB8) | 66  |  | 01.99 | 02.01 | + ABS |                |        |  |       |              |                |
|  | 1.5 VTEC (MB9)  | 84  |  | 01.99 | 02.01 | + ABS |                |        |  |       |              |                |
|  | 1.6 i 16V (MC1) | 85  |  | 02.98 | 02.01 |       |                |        |  |       |              |                |
|  | 1.8 VTEC (MC2)  | 124 |  | 02.98 | 02.01 |       | 24.0110-0233.1 | 410233 |  |       | 260          | 10,0 8,0 +S +B |
|  | 1.4 i 16V (MB8) | 55  |  | 02.98 | 02.01 | - ABS | 03.0137-0339.2 | 650339 |  |       | 203          | x 38           |
|  | 1.4 i 16V (MB8) | 66  |  | 02.98 | 02.01 | - ABS |                |        |  |       |              |                |
|  | 1.5 VTEC (MB9)  | 84  |  | 02.98 | 02.01 | - ABS |                |        |  |       |              |                |
|  | 1.4 i 16V (MB8) | 55  |  | 02.98 | 02.01 | - ABS | 24.0220-3016.1 | 480107 |  |       | 203/204      | x 45,5         |
|  | 1.4 i 16V (MB8) | 66  |  | 02.98 | 02.01 | - ABS |                |        |  |       |              |                |
|  | 1.5 VTEC (MB9)  | 84  |  | 02.98 | 02.01 | - ABS |                |        |  |       |              |                |
|  | 1.4 i 16V (MB8) | 55  |  | 02.98 | 02.01 | - ABS | 03.0420-4519.3 | 684519 |  |       | 19,05/203x38 | Kit            |
|  | 1.4 i 16V (MB8) | 66  |  | 02.98 | 02.01 | - ABS |                |        |  |       |              |                |
|  | 1.5 VTEC (MB9)  | 84  |  | 02.98 | 02.01 | - ABS |                |        |  |       |              |                |

### HONDA CIVIC COUPE (96-01)

|  |                |     |  |       |       |  |                |        |  |  |       |                   |                     |
|--|----------------|-----|--|-------|-------|--|----------------|--------|--|--|-------|-------------------|---------------------|
|  | 1.6 i (EJ6)    | 77  |  | 01.96 | 01.01 |  | 13.0460-5943.2 | 605943 |  |  | 21697 | 15,0 +/WK         | SUM                 |
|  | 1.6 VTEC (EJ8) | 92  |  | 01.96 | 01.01 |  | 13.0460-0073.2 | 610073 |  |  |       |                   |                     |
|  | 1.6 VTEC (EM1) | 118 |  | 04.99 | 01.01 |  | 13.0460-5820.2 | 605820 |  |  | 21694 | 16,3 +/WK         | SUM                 |
|  | 1.6 VTEC (EM1) | 118 |  | 04.99 | 01.01 |  | 13.0460-0073.2 | 610073 |  |  |       |                   |                     |
|  | 1.6 i (EJ6)    | 77  |  | 01.96 | 01.01 |  | 24.0121-0104.1 | 421104 |  |  | 240   | 21,0 19,0 V +S +B | SUM                 |
|  | 1.6 VTEC (EJ8) | 92  |  | 01.96 | 01.01 |  | 24.0121-0105.1 | 421105 |  |  | 262   | 21,0 19,0 V +S +B |                     |
|  | 1.6 VTEC (EM1) | 118 |  | 04.99 | 01.01 |  |                |        |  |  |       |                   |                     |
|  | 1.6 VTEC (EM1) | 118 |  | 04.99 | 01.01 |  | 13.0460-5731.2 | 605731 |  |  | 21738 | 13,5 +/WK         |                     |
|  | 1.6 VTEC (EM1) | 118 |  | 04.99 | 01.01 |  | 24.0109-0111.1 | 409111 |  |  | 239   | 9,0 8,0 +S +B     |                     |
|  | 1.6 i (EJ6)    | 77  |  | 01.96 | 01.01 |  | 03.0137-0294.2 | 650294 |  |  | 200   | x 36              |                     |
|  | 1.6 VTEC (EJ8) | 92  |  | 01.96 | 01.01 |  | 03.0137-9097.2 | 669097 |  |  |       |                   | Bremsbacken-Zubehör |

### HONDA CIVIC COUPE (01-04)

|  |                 |    |  |       |       |  |                |        |  |  |       |                   |                    |
|--|-----------------|----|--|-------|-------|--|----------------|--------|--|--|-------|-------------------|--------------------|
|  | 1.6 i 16V (EM6) | 81 |  | 02.01 | 10.04 |  | 13.0460-5820.2 | 605820 |  |  | 21694 | 16,3 +/WK         | SUM                |
|  | 1.7 i 16V (EM2) | 88 |  | 02.01 | 10.04 |  |                |        |  |  |       |                   |                    |
|  | 1.7 VTEC (EM2)  | 92 |  | 02.01 | 10.04 |  |                |        |  |  |       |                   |                    |
|  | 1.6 i 16V (EM6) | 81 |  | 02.01 | 10.04 |  | 24.0121-0105.1 | 421105 |  |  | 262   | 21,0 19,0 V +S +B |                    |
|  | 1.7 i 16V (EM2) | 88 |  | 02.01 | 10.04 |  | 24.0123-0109.1 | 423109 |  |  | 282   | 23,0 21,0 V +S +B |                    |
|  | 1.7 VTEC (EM2)  | 92 |  | 02.01 | 10.04 |  |                |        |  |  |       |                   | + Sportfahrwerk 1) |
|  | 1.6 i 16V (EM6) | 81 |  | 02.01 | 10.04 |  | 13.0460-5929.2 | 605929 |  |  | 21719 | 15,0 +/WK         | AKE                |
|  | 1.7 i 16V (EM2) | 88 |  | 02.01 | 10.04 |  |                |        |  |  |       |                   |                    |
|  | 1.7 VTEC (EM2)  | 92 |  | 02.01 | 10.04 |  |                |        |  |  |       |                   |                    |
|  | 1.6 i 16V (EM6) | 81 |  | 02.01 | 10.04 |  | 24.0109-0143.1 | 409143 |  |  | 260   | 9,0 8,0 +S        |                    |
|  | 1.7 i 16V (EM2) | 88 |  | 02.01 | 10.04 |  | 24.0110-0279.1 | 410279 |  |  | 260   | 10,0 8,0 +S +B    |                    |
|  | 1.7 VTEC (EM2)  | 92 |  | 02.01 | 10.04 |  |                |        |  |  |       |                   | + Sportfahrwerk 1) |

### HONDA CR-V I (97-02)

|  |                 |     |  |       |       |  |                |        |  |  |         |                   |                     |
|--|-----------------|-----|--|-------|-------|--|----------------|--------|--|--|---------|-------------------|---------------------|
|  | 2.0 i 16V (RD1) | 94  |  | 01.97 | 04.99 |  | 13.0460-5982.2 | 605982 |  |  | 21651   | 17,5 +/WK         |                     |
|  | 2.0 i 16V (RD1) | 98  |  | 04.99 | 02.02 |  | 13.0460-0075.2 | 610075 |  |  |         |                   | Belagsatz-Zubehör   |
|  | 2.0 i 16V (RD1) | 108 |  | 04.99 | 02.02 |  |                |        |  |  |         |                   |                     |
|  | 2.0 i 16V (RD1) | 94  |  | 01.97 | 04.99 |  | 24.0123-0104.1 | 423104 |  |  | 282     | 23,0 21,0 V +S +B |                     |
|  | 2.0 i 16V (RD1) | 98  |  | 04.99 | 02.02 |  |                |        |  |  |         |                   |                     |
|  | 2.0 i 16V (RD1) | 108 |  | 04.99 | 02.02 |  |                |        |  |  |         |                   |                     |
|  | 2.0 i 16V (RD1) | 94  |  | 01.97 | 04.99 |  | 03.0137-0287.2 | 650287 |  |  | 220     | x 36              |                     |
|  | 2.0 i 16V (RD1) | 98  |  | 04.99 | 02.02 |  | 03.0137-9190.2 | 669190 |  |  |         |                   | Bremsbacken-Zubehör |
|  | 2.0 i 16V (RD1) | 108 |  | 04.99 | 02.02 |  |                |        |  |  |         |                   |                     |
|  | 2.0 i 16V (RD1) | 94  |  | 01.97 | 04.99 |  | 24.0222-0002.1 | 480141 |  |  | 220/221 | x 44,5            |                     |
|  | 2.0 i 16V (RD1) | 98  |  | 04.99 | 02.02 |  |                |        |  |  |         |                   |                     |
|  | 2.0 i 16V (RD1) | 108 |  | 04.99 | 02.02 |  |                |        |  |  |         |                   |                     |

### HONDA CR-V II (02-06)

|  |                 |     |  |       |       |              |                |        |  |  |       |                   |  |
|--|-----------------|-----|--|-------|-------|--------------|----------------|--------|--|--|-------|-------------------|--|
|  | 2.0 16V         | 110 |  | 07.02 | 09.06 | + 15" Rad 2) | 13.0460-5860.2 | 605860 |  |  | 23868 | 17,1 +/WK/Zub     |  |
|  | 2.0 16V         | 112 |  | 03.02 | 09.06 | + 15" Rad 2) |                |        |  |  |       |                   |  |
|  | 2.2 CTDi        | 103 |  | 02.05 | 09.06 | + 15" Rad 2) |                |        |  |  |       |                   |  |
|  | 2.4 VTEC Allrad | 118 |  | 03.02 | 09.06 | + 15" Rad 2) |                |        |  |  |       |                   |  |
|  | 2.0 16V         | 110 |  | 07.02 | 09.06 | + 16" Rad 3) | 13.0460-5753.2 | 605753 |  |  | 24638 | 20,0 +/WK/Zub/S   |  |
|  | 2.0 16V         | 112 |  | 03.02 | 09.06 | + 16" Rad 3) |                |        |  |  |       |                   |  |
|  | 2.2 CTDi        | 103 |  | 02.05 | 09.06 | + 16" Rad 3) |                |        |  |  |       |                   |  |
|  | 2.4 VTEC Allrad | 118 |  | 03.02 | 09.06 | + 16" Rad 3) |                |        |  |  |       |                   |  |
|  | 2.0 16V         | 110 |  | 07.02 | 09.06 | + 15" Rad 2) | 24.0123-0109.1 | 423109 |  |  | 282   | 23,0 21,0 V +S +B |  |
|  | 2.0 16V         | 112 |  | 03.02 | 09.06 | + 15" Rad 2) |                |        |  |  |       |                   |  |
|  | 2.2 CTDi        | 103 |  | 02.05 | 09.06 | + 15" Rad 2) |                |        |  |  |       |                   |  |
|  | 2.4 VTEC Allrad | 118 |  | 03.02 | 09.06 | + 15" Rad 2) |                |        |  |  |       |                   |  |
|  | 2.0 16V         | 110 |  | 07.02 | 09.06 | + 16" Rad 3) | 24.0125-0182.1 | 425182 |  |  | 300   | 25,0 23,0 V +S    |  |



















1) + sports suspension / + sospensione sportiva / + châssis de sport / + suspensión deportiva

2) + 15" wheel / + ruota 15" / + roue 15" / + rueda 15"

3) + 16" wheel / + ruota 16" / + roue 16" / + rueda 16"



































|     |    |  |                          |                          |  |  |  |  |
|--|--|--|--|--|---|--|--|--|
| <b>HONDA CR-V II (02-06)</b>   |  |  |  |  |   |  |  |  |
|    | 2.0 16V<br>2.2 CTDi<br>2.4 VTEC Allrad   | 112<br>103<br>118  | 03.02<br>02.05<br>03.02  | 09.06 + 16" Rad <sup>1)</sup><br>09.06 + 16" Rad <sup>1)</sup><br>09.06 + 16" Rad <sup>1)</sup>          | 24.0125-0182.1  | 425182   |  | 300 25,0 23,0 V +S   |
|    | 2.0 16V<br>2.0 16V<br>2.2 CTDi<br>2.4 VTEC Allrad  | 110<br>112<br>103<br>118   | 07.02<br>03.02<br>02.05<br>03.02   | 12.04<br>09.06<br>09.06<br>12.04   | 13.0460-5711.2  | 605711   |  | 23652 15,7 +/WK  |
|  | 2.0 16V<br>2.4 VTEC Allrad   | 110<br>118   | 01.05<br>01.05   | 09.06<br>09.06   | 13.0460-5754.2  | 605754   |  | 24635 16,9 +/WK/Zub/S  |
|    | 2.0 16V<br>2.0 16V<br>2.4 VTEC Allrad  | 110<br>112<br>118  | 07.02<br>03.02<br>03.02  | 12.04<br>12.04<br>12.04  | 24.0109-0144.1  | 409144   |  | 282 9,0 8,0 +S +B  |
|  | 2.0 16V<br>2.0 16V<br>2.2 CTDi<br>2.4 VTEC Allrad  | 110<br>112<br>103<br>118   | 01.05<br>01.05<br>02.05<br>01.05   | 09.06<br>09.06<br>09.06<br>09.06   | 24.0109-0151.1  | 409151   |  | 305 9,0 7,5 +S +B  |
|    | 2.0 16V<br>2.0 16V<br>2.4 VTEC Allrad  | 110<br>112<br>118  | 07.02<br>03.02<br>03.02  | 12.04<br>12.04<br>12.04  | 03.0137-0442.2  | 650442   |  | 167 x 35   |
|  | 2.0 16V<br>2.0 16V<br>2.2 CTDi<br>2.4 VTEC Allrad  | 110<br>112<br>103<br>118   | 01.05<br>01.05<br>02.05<br>01.05   | 09.06<br>09.06<br>09.06<br>09.06   | 03.0137-3021.2  | 653021   |  | 198 x 35   |
| <b>HONDA CR-V III (07-12)</b>  |  |  |  |  |   |  |  |  |
|    | 2.0 i-VTEC<br>2.0 i-VTEC<br>2.0 i-VTEC 4WD<br>2.2 CTDi 4WD<br>2.2 i-DTEC 4WD<br>2.4 i-VTEC<br>2.4 i-VTEC<br>2.4 i-VTEC 4WD<br>2.4 i-VTEC 4WD<br>2.4 i-VTEC 4WD<br>2.4 i-VTEC 4WD | 105<br>110<br>110<br>103<br>110<br>118<br>125<br>134<br>118<br>122<br>124<br>125 | 11.09<br>01.07<br>01.07<br>01.07<br>01.07<br>01.07<br>04.07<br>01.07<br>01.07<br>09.09<br>09.07<br>04.07 | 09.12<br>09.12<br>09.12<br>09.12<br>09.12<br>09.12<br>09.12<br>09.12<br>09.12<br>09.12<br>09.12<br>09.12 | 13.0460-5753.2  | 605753   |  | 24638 20,0 +/WK/Zub/S  |
|   | 2.0 i-VTEC<br>2.0 i-VTEC<br>2.0 i-VTEC 4WD<br>2.2 CTDi 4WD<br>2.2 i-DTEC 4WD<br>2.4 i-VTEC<br>2.4 i-VTEC<br>2.4 i-VTEC 4WD<br>2.4 i-VTEC 4WD<br>2.4 i-VTEC 4WD<br>2.4 i-VTEC 4WD | 105<br>110<br>110<br>103<br>110<br>118<br>125<br>134<br>118<br>122<br>124<br>125 | 11.09<br>01.07<br>01.07<br>01.07<br>01.07<br>01.07<br>04.07<br>01.07<br>01.07<br>09.09<br>09.07<br>04.07 | 09.12<br>09.12<br>09.12<br>09.12<br>09.12<br>09.12<br>09.12<br>09.12<br>09.12<br>09.12<br>09.12<br>09.12 | 24.0128-0217.1  | 428217   |  | 293 28,0 26,0 V +S +B  |
|  | 2.0 i-VTEC<br>2.0 i-VTEC<br>2.0 i-VTEC 4WD<br>2.2 CTDi 4WD<br>2.2 i-DTEC 4WD<br>2.4 i-VTEC<br>2.4 i-VTEC<br>2.4 i-VTEC 4WD<br>2.4 i-VTEC 4WD<br>2.4 i-VTEC 4WD<br>2.4 i-VTEC 4WD | 105<br>110<br>110<br>103<br>110<br>118<br>125<br>134<br>118<br>122<br>124<br>125 | 11.09<br>01.07<br>01.07<br>01.07<br>01.07<br>01.07<br>04.07<br>01.07<br>01.07<br>09.09<br>09.07<br>04.07 | 09.12<br>09.12<br>09.12<br>09.12<br>09.12<br>09.12<br>09.12<br>09.12<br>09.12<br>09.12<br>09.12<br>09.12 | 13.0460-5754.2  | 605754   |  | 24635 16,9 +/WK/Zub/S  |
|  | 2.0 i-VTEC<br>2.0 i-VTEC<br>2.0 i-VTEC 4WD<br>2.2 CTDi 4WD<br>2.2 i-DTEC 4WD<br>2.4 i-VTEC<br>2.4 i-VTEC<br>2.4 i-VTEC 4WD<br>2.4 i-VTEC 4WD<br>2.4 i-VTEC 4WD<br>2.4 i-VTEC 4WD | 105<br>110<br>110<br>103<br>110<br>118<br>125<br>134<br>118<br>122<br>124<br>125 | 11.09<br>01.07<br>01.07<br>01.07<br>01.07<br>01.07<br>04.07<br>01.07<br>01.07<br>09.09<br>09.07<br>04.07 | 09.12<br>09.12<br>09.12<br>09.12<br>09.12<br>09.12<br>09.12<br>09.12<br>09.12<br>09.12<br>09.12<br>09.12 | 24.0110-0329.1  | 410329   |  | 302 10,0 8,0 +S +B   |
|  | 2.0 i-VTEC<br>2.0 i-VTEC<br>2.0 i-VTEC 4WD<br>2.2 CTDi 4WD<br>2.2 i-DTEC 4WD<br>2.4 i-VTEC<br>2.4 i-VTEC<br>2.4 i-VTEC 4WD<br>2.4 i-VTEC 4WD<br>2.4 i-VTEC 4WD<br>2.4 i-VTEC 4WD | 105<br>110<br>110<br>103<br>110<br>118<br>125<br>134<br>118<br>122<br>124<br>125 | 11.09<br>01.07<br>01.07<br>01.07<br>01.07<br>01.07<br>04.07<br>01.07<br>01.07<br>09.09<br>09.07<br>04.07 | 09.12<br>09.12<br>09.12<br>09.12<br>09.12<br>09.12<br>09.12<br>09.12<br>09.12<br>09.12<br>09.12<br>09.12 | 03.0137-3021.2  | 653021   |  | 198 x 35   |



























<sup>1)</sup> + 16" wheel / + ruota 16" / + roue 16" / + rueda 16"



|     |  |  |  |                                   |  |  |  |  |
|--|--|--|--|---|---|--|--|--|
| <b>HONDA CR-V IV (12-)</b>   |  |  |  |   |   |  |  |  |
|    | 1.6 i-DTEC<br>2.0 16V<br>2.0 16V<br>2.0 16V AWD<br>2.2 i-DTEC 4WD                | 88<br>110<br>114<br>114<br>110   |  | 10.13<br>01.12<br>10.12<br>10.12<br>10.12   |   | 13.0460-5753.2<br>605753   |  | 24638 20,0 +/WK/Zub/S  |
|    | 1.6 i-DTEC<br>2.0 16V<br>2.0 16V<br>2.0 16V AWD                                  | 88<br>110<br>114<br>114  |  | 10.13<br>01.12<br>10.12<br>10.12  |   | 24.0128-0217.1<br>428217   |  | 293 28,0 26,0 V +S +B  |
|    | 1.6 i-DTEC<br>2.0 16V<br>2.0 16V<br>2.0 16V AWD<br>2.2 i-DTEC 4WD                | 88<br>110<br>114<br>114<br>110   |  | 10.13<br>01.12<br>10.12<br>10.12<br>10.12   |   | 13.0460-5754.2<br>605754   |  | 24635 16,9 +/WK/Zub/S  |
|    | 1.6 i-DTEC<br>2.0 16V<br>2.0 16V<br>2.0 16V AWD<br>2.2 i-DTEC 4WD                | 88<br>110<br>114<br>114<br>110   |  | 10.13<br>01.12<br>10.12<br>10.12<br>10.12   |   | 24.0110-0329.1<br>410329   |  | 302 10,0 8,0 +S +B   |
| <b>HONDA CRX (92-98)</b>   |  |  |  |   |   |  |  |  |
|    | 1.6 i 16V VTEC (EG2)<br>1.6 i 16V VTEC (EH6)                                     | 118<br>92  |  | 01.92 12.98<br>01.92 12.98  |   | 13.0460-5820.2<br>605820   |  | 21694 16,3 +/WK <b>SUM</b>   |
|    | 1.6 i 16V VTEC (EG2)<br>1.6 i 16V VTEC (EH6)                                     | 118<br>92  |  | 01.92 12.98<br>01.92 12.98  |   | 24.0121-0105.1<br>421105   |  | 262 21,0 19,0 V +S +B  |
|    | 1.6 i 16V VTEC (EG2)<br>1.6 i 16V VTEC (EH6)                                     | 118<br>92  |  | 01.92 12.98<br>01.92 12.98 + ABS  |   | 13.0460-5998.2<br>13.0460-0430.2<br>605998<br>610430                               |  | 21312 12,8 +/WK <b>AKE</b><br>Belagsatz-Zubehör <b>AKE</b>                         |
|    | 1.6 i 16V VTEC (EG2)<br>1.6 i 16V VTEC (EH6)                                     | 118<br>92  |  | 01.92 12.98<br>01.92 12.98 + ABS  |   | 24.0109-0111.1<br>409111   |  | 239 9,0 8,0 +S +B  |
|    | 1.6 i 16V VTEC (EH6)   | 92   |  | 01.92 12.98 - ABS   |   | 03.0137-0284.2<br>03.0137-9096.2<br>650284<br>669096                               |  | 180 x 31<br>Bremsbacken-Zubehör  |
|    | 1.6 i 16V VTEC (EH6)   | 92   |  | 01.92 12.98 - ABS   |   | 24.0218-0018.1<br>480063   |  | 180/181 x 38   |
| <b>HONDA FR-V (05-09)</b>  |  |  |  |   |   |  |  |  |
|  | 1.7 VTEC (BE1)<br>1.8 VTEC (BE1)<br>2.0 VTEC (BE3)<br>2.2 CTDi (BE5)             | 92<br>103<br>110<br>103  |  | 02.05 06.09<br>01.07 06.09<br>02.05 06.09<br>07.05 06.09  |   | 13.0460-5878.2<br>605878   |  | 23729 16,9 +/WK/Zub  |
|  | 1.7 VTEC (BE1)<br>1.8 VTEC (BE1)<br>2.0 VTEC (BE3)<br>2.2 CTDi (BE5)             | 92<br>103<br>110<br>103  |  | 02.05 06.09<br>01.07 06.09<br>02.05 06.09<br>07.05 06.09  |   | 24.0123-0110.1<br>423110   |  | 282 23,0 21,0 V +S +B  |
|  | 1.7 VTEC (BE1)<br>1.8 VTEC (BE1)<br>2.0 VTEC (BE3)<br>2.2 CTDi (BE5)             | 92<br>103<br>110<br>103  |  | 02.05 06.09<br>01.07 06.09<br>02.05 06.09<br>07.05 06.09  |   | 24.0125-0189.1<br>425189   |  | 282 25,0 23,0 V +S +B  |
|  | 1.7 VTEC (BE1)<br>1.8 VTEC (BE1)<br>2.0 VTEC (BE3)<br>2.2 CTDi (BE5)             | 92<br>103<br>110<br>103  |  | 02.05 06.09<br>01.07 06.09<br>02.05 06.09<br>07.05 06.09  |   | 13.0460-5711.2<br>605711   |  | 23652 15,7 +/WK  |
|  | 1.7 VTEC (BE1)<br>1.8 VTEC (BE1)<br>2.0 VTEC (BE3)<br>2.2 CTDi (BE5)             | 92<br>103<br>110<br>103  |  | 02.05 06.09<br>01.07 06.09<br>02.05 06.09<br>07.05 06.09  |   | 24.0112-0172.1<br>412172   |  | 282 12,0 10,0 +S   |
|  | 1.7 VTEC (BE1)<br>1.8 VTEC (BE1)<br>2.0 VTEC (BE3)<br>2.2 CTDi (BE5)             | 92<br>103<br>110<br>103  |  | 02.05 06.09<br>01.07 06.09<br>02.05 06.09<br>07.05 06.09  |   | 03.0137-0442.2<br>650442   |  | 167 x 35   |
| <b>HONDA HR-V (99-05)</b>  |  |  |  |   |   |  |  |  |
|  | 1.6 i 16V<br>1.6 i 16V 4WD<br>1.6 i 16V 4WD                                      | 77<br>77<br>91   |  | 02.99 09.05<br>02.99 09.05<br>10.99 09.05   |   | 13.0460-5982.2<br>605982   |  | 21651 17,5 +/WK  |
|  | 1.6 i 16V<br>1.6 i 16V 4WD<br>1.6 i 16V 4WD                                      | 77<br>77<br>91   |  | 02.99 09.05<br>02.99 09.05<br>10.99 09.05   |   | 24.0123-0104.1<br>423104   |  | 282 23,0 21,0 V +S +B  |
|  | 1.6 i 16V<br>1.6 i 16V 4WD<br>1.6 i 16V 4WD                                      | 77<br>77<br>91   |  | 02.99 09.05 + 3 türig <sup>1)</sup><br>02.99 09.05 + 3 türig <sup>1)</sup><br>10.99 09.05 + 3 türig <sup>1)</sup> |   | 03.0137-0294.2<br>03.0137-9252.2<br>650294<br>669252                               |  | 200 x 36<br>Bremsbacken-Zubehör  |
|  | 1.6 i 16V<br>1.6 i 16V 4WD<br>1.6 i 16V 4WD                                      | 77<br>77<br>91   |  | 02.99 09.05 + 5 türig <sup>2)</sup><br>02.99 09.05 + 5 türig <sup>2)</sup><br>10.99 09.05 + 5 türig <sup>2)</sup> |   | 03.0137-0287.2<br>03.0137-9190.2<br>650287<br>669190                               |  | 220 x 36<br>Bremsbacken-Zubehör  |
|  | 1.6 i 16V<br>1.6 i 16V 4WD<br>1.6 i 16V 4WD                                      | 77<br>77<br>91   |  | 02.99 09.05 + 3 türig <sup>1)</sup><br>02.99 09.05 + 3 türig <sup>1)</sup><br>10.99 09.05 + 3 türig <sup>1)</sup> |   | 24.0220-0043.1<br>480185   |  | 200/201 x 44,5   |
|  | 1.6 i 16V<br>1.6 i 16V 4WD<br>1.6 i 16V 4WD                                      | 77<br>77<br>91   |  | 02.99 09.05 + 5 türig <sup>2)</sup><br>02.99 09.05 + 5 türig <sup>2)</sup><br>10.99 09.05 + 5 türig <sup>2)</sup> |   | 24.0222-0002.1<br>480141   |  | 220/221 x 44,5   |























<sup>1)</sup> + 3 door / + 3 porte / + 3 portes / + 3 puertas

<sup>2)</sup> + 5 door / + 5 porte / + 5 portes / + 5 puertas

























|     |                               |  |  |  |  |  |  |  |  |                          |
|--|---|--|--|--|---|--|--|--|--|--------------------------|
| <b>HONDA INSIGHT (00-06)</b>   |   |  |  |  |   |  |  |  |  |                          |
|    | 1.0 VTEC (ZE1)<br>1.0 VTEC Hybrid (ZE1)   | 50<br>56   |  | 08.00<br>08.00   | 10.04<br>12.06  |  | 24.0117-0101.1   | 417101   | 231 17,0 15,0 V                                | <b>AKE</b>               |
| <b>HONDA INSIGHT (09-13)</b>   |   |  |  |  |   |  |  |  |  |                          |
|    | 1.3 Hybrid<br>1.3 Hybrid  | 65<br>73   |  | 04.09<br>04.09   | 09.13<br>09.13  |  | 13.0460-5620.2   | 605620   | 24979 15,9 +/WK/Zub                            | <b>AKE</b>               |
|    | 1.3 Hybrid<br>1.3 Hybrid  | 65<br>73   |  | 04.09<br>04.09   | 09.13<br>09.13  |  | 24.0121-0105.1   | 421105   | 262 21,0 19,0 V +S +B                          |                          |
|    | 1.3 Hybrid<br>1.3 Hybrid  | 65<br>73   |  | 04.09<br>04.09   | 09.13<br>09.13  |  | 13.0460-5929.2   | 605929   | 21719 15,0 +/WK                                | <b>AKE</b>               |
|    | 1.3 Hybrid<br>1.3 Hybrid  | 65<br>73   |  | 04.09<br>04.09   | 09.13<br>09.13  |  | 24.0109-0162.1   | 409162   | 260 9,0 8,0 +S +B                              |                          |
| <b>HONDA INTEGRA R (97-01)</b>   |   |  |  |  |   |  |  |  |  |                          |
|    | 1.8 Type R (DC2)  | 140  |  | 11.97  | 10.01   |  | 24.0123-0104.1   | 423104   | 282 23,0 21,0 V +S +B                          |                          |
|    | 1.8 Type R (DC2)  | 140  |  | 11.97  | 10.01   |  | 13.0460-5929.2   | 605929   | 21719 15,0 +/WK                                | <b>AKE</b>               |
| <b>HONDA JAZZ (02-08)</b>  |   |  |  |  |   |  |  |  |  |                          |
|    | 1.2 (GD5)<br>1.2 (GE2)<br>1.4 (GD1)<br>1.4 (GE3)<br>1.4 (GE3)<br>1.7 (GD3)                                    | 57<br>59<br>61<br>65<br>67<br>92   |  | 03.02<br>10.05<br>03.02<br>04.05<br>09.05<br>01.04                               | 10.08<br>10.08<br>10.08<br>10.08<br>10.08<br>10.08                                |  | 13.0460-5943.2   | 605943   | 21697 15,0 +/WK                                | <b>SUM</b>               |
|    | 1.2 (GD5)<br>1.4 (GD1)  | 57<br>61   |  | 03.02<br>03.02   | 12.03<br>12.03  |  | 24.0121-0113.1   | 421113   | 240 21,0 19,0 V +S +B                          |                          |
|   | 1.2 (GD5)<br>1.2 (GE2)<br>1.4 (GD1)<br>1.4 (GE3)<br>1.4 (GE3)<br>1.7 (GD3)                                    | 57<br>59<br>61<br>65<br>67<br>92   |  | 01.04<br>10.05<br>01.04<br>04.05<br>09.05<br>01.04                               | 10.08<br>10.08<br>10.08<br>10.08<br>10.08<br>10.08                                |  | 24.0121-0115.1   | 421115   | 258 21,0 19,0 V +S +B                          |                          |
|  | 1.2 (GD5)<br>1.2 (GE2)<br>1.4 (GD1)<br>1.4 (GE3)<br>1.4 (GE3)<br>1.7 (GD3)                                    | 57<br>59<br>61<br>65<br>67<br>92   |  | 01.04<br>10.05<br>01.04<br>04.05<br>09.05<br>01.04                               | 10.08 + ABS<br>10.08<br>10.08 + ABS<br>10.08<br>10.08<br>10.08                    |  | 13.0460-5731.2   | 605731   | 21738 13,5 +/WK                                |                          |
|  | 1.2 (GD5)<br>1.2 (GE2)<br>1.4 (GD1)<br>1.4 (GE3)<br>1.4 (GE3)<br>1.7 (GD3)                                    | 57<br>59<br>61<br>65<br>67<br>92   |  | 01.04<br>10.05<br>01.04<br>04.05<br>09.05<br>01.04                               | 10.08 + ABS<br>10.08<br>10.08 + ABS<br>10.08<br>10.08<br>10.08                    |  | 24.0109-0111.1   | 409111   | 239 9,0 8,0 +S +B                              |                          |
|  | 1.2 (GD5)<br>1.4 (GD1)  | 57<br>61   |  | 03.02<br>03.02   | 12.03 - ABS<br>12.03 - ABS  |  | 03.0137-0422.2<br>03.0137-9284.2   | 650422<br>669284   | 180 x 31<br>Bremsbacken-Zubehör                |                          |
|  | 1.2 (GD5)<br>1.4 (GD1)  | 57<br>61   |  | 03.02<br>03.02   | 12.03 - ABS<br>12.03 - ABS  |  | 24.0218-0048.1   | 480314   | 180/181 x 39                                   |                          |
| <b>HONDA JAZZ (08-15)</b>  |   |  |  |  |   |  |  |  |  |                          |
|  | 1.2 i-VTEC<br>1.2 i-VTEC<br>1.3 Hybrid<br>1.4 Flexfuel<br>1.4 i 16V<br>1.4 i 16V<br>1.5 Flexfuel<br>1.5 i 16V | 66<br>66<br>65<br>74<br>73<br>74<br>88<br>88                                     |  | 07.08<br>01.09<br>04.11<br>11.08<br>07.08<br>11.08<br>07.08<br>07.08             | 12.08   |  | 13.0460-5943.2<br>13.0460-5620.2   | 605943<br>605620   | 21697 15,0 +/WK<br>24979 15,9 +/WK/Zub         | <b>SUM</b><br><b>AKE</b> |
|  | 1.2 i-VTEC<br>1.2 i-VTEC<br>1.3 Hybrid<br>1.4 Flexfuel<br>1.4 i 16V<br>1.4 i 16V<br>1.5 Flexfuel<br>1.5 i 16V | 66<br>66<br>65<br>74<br>73<br>74<br>88<br>88                                     |  | 07.08<br>01.09<br>04.11<br>11.08<br>07.08<br>11.08<br>07.08<br>07.08             | 12.08   |  | 24.0121-0115.1<br>24.0121-0105.1   | 421115<br>421105   | 258 21,0 19,0 V +S +B<br>262 21,0 19,0 V +S +B |                          |
|  | 1.3 Hybrid<br>1.2 i-VTEC<br>1.4 Flexfuel<br>1.4 i 16V<br>1.4 i 16V<br>1.5 Flexfuel<br>1.5 i 16V               | 65<br>66<br>74<br>73<br>74<br>88<br>88   |  | 04.11<br>07.08<br>11.08<br>07.08<br>11.08<br>07.08<br>07.08                      |   |  | 13.0460-5929.2<br>13.0460-5731.2   | 605929<br>605731   | 21719 15,0 +/WK<br>21738 13,5 +/WK             | <b>AKE</b>               |

























|     |  |  |  |  |  |  |  |  |
|--|--|--|--|--|---|--|--|--|
| <b>HONDA JAZZ (08-15)</b>  |  |  |  |  |   |  |  |  |
|    | 1.3 Hybrid   | 65   |  | 04.11  |   | 24.0109-0162.1   | 409162   | 260 9,0 8,0 +S +B  |
|  | 1.2 i-VTEC   | 66   |  | 07.08  | 12.08   | 24.0109-0111.1   | 409111   | 239 9,0 8,0 +S +B  |
|  | 1.5 Flexfuel   | 88   |  | 07.08  | 12.08   |  |  |  |
|  | 1.5 i 16V  | 88   |  | 07.08  | 12.08   |  |  |  |
| <b>HONDA JAZZ (15-)</b>  |  |  |  |  |   |  |  |  |
|    | 1.3 i-VTEC   | 75   |  | 09.15  |   | 24.0121-0105.1   | 421105   | 262 21,0 19,0 V +S +B  |
| <b>HONDA LEGEND (96-04)</b>  |  |  |  |  |   |  |  |  |
|    | 3.5 i 24V (KA9)  | 151  |  | 02.96  | 10.97   | 13.0460-5982.2   | 605982   | 21651 17,5 +WK   |
|  | 3.5 i 24V (KA9)  | 153  |  | 11.97  | 12.98   |  |  |  |
|    | 3.5 i 24V (KA9)  | 151  |  | 02.96  | 10.97   | 24.0123-0104.1   | 423104   | 282 23,0 21,0 V +S +B  |
|  | 3.5 i 24V (KA9)  | 153  |  | 11.97  | 12.98   |  |  |  |
|    | 3.5 i 24V (KA9)  | 151  |  | 02.96  | 10.97   | 13.0460-5711.2   | 605711   | 23652 15,7 +WK   |
|  |  |  |  |  |   | 13.0460-0287.2   | 610287   | Belagsatz-Zubehör  |
|  | 3.5 i 24V (KA9)  | 153  |  | 11.97  | 12.98   | 13.0460-0287.2   | 610287   | Belagsatz-Zubehör  |
|  | 3.5 i 24V (KA9)  | 153  |  | 01.99  | 09.04   | 13.0460-5711.2   | 605711   | 23652 15,7 +WK   |
|  |  |  |  |  |   | 13.0460-0287.2   | 610287   | Belagsatz-Zubehör  |
|    | 3.5 i 24V (KA9)  | 151  |  | 02.96  | 10.97   | 24.0109-0132.1   | 409132   | 282 9,0 7,5  |
|  | 3.5 i 24V (KA9)  | 153  |  | 11.97  | 12.98   |  |  |  |
| <b>HONDA LOGO (99-02)</b>  |  |  |  |  |   |  |  |  |
|    | 1.3 i  | 48   |  | 02.99  | 03.02   | 13.0460-5943.2   | 605943   | 21697 15,0 +WK <b>SUM</b>  |
|    | 1.3 i  | 48   |  | 02.99  | 03.02   | 24.0121-0113.1   | 421113   | 240 21,0 19,0 V +S +B  |
|    | 1.3 i  | 48   |  | 02.99  | 03.02   | 03.0137-0294.2   | 650294   | 200 x 36   |
|  |  |  |  |  |   | 03.0137-9252.2   | 669252   | Bremsbacken-Zubehör  |
| <b>HONDA NSX (01-05)</b>   |  |  |  |  |   |  |  |  |
|  | 3.0 i V6 (NA1)   | 188  |  | 10.01  | 09.05 + Automatikgetriebe <sup>1)</sup>   | 13.0460-5982.2   | 605982   | 21651 17,5 +WK   |
|  | 3.2 i V6 (NA2)   | 206  |  | 10.01  | 09.05   |  |  |  |
| <b>HONDA PRELUDE (96-00)</b>   |  |  |  |  |   |  |  |  |
|  | 2.0 i 16V (BB9)  | 98   |  | 10.96  | 10.00   | 13.0460-5955.2   | 605955   | 21879 18,6 +WK <b>AKE</b>  |
|  |  |  |  |  |   | 13.0460-0075.2   | 610075   | Belagsatz-Zubehör  |
|  | 2.2 i 16V  | 147  |  | 10.96  | 10.00   | 13.0460-5982.2   | 605982   | 21651 17,5 +WK   |
|  | 2.2 i 16V (BB6/BB8)  | 136  |  | 10.96  | 10.00   | 13.0460-0075.2   | 610075   | Belagsatz-Zubehör  |
|  | 2.0 i 16V (BB9)  | 98   |  | 10.96  | 10.00   | 24.0123-0105.1   | 423105   | 260 23,0 21,0 V  |
|  | 2.2 i 16V  | 147  |  | 10.96  | 10.00   | 24.0123-0104.1   | 423104   | 282 23,0 21,0 V +S +B  |
|  | 2.2 i 16V (BB6/BB8)  | 136  |  | 10.96  | 10.00   |  |  |  |
|  | 2.0 i 16V (BB9)  | 98   |  | 10.96  | 10.00   | 13.0460-5929.2   | 605929   | 21719 15,0 +WK <b>AKE</b>  |
|  | 2.2 i 16V  | 147  |  | 10.96  | 10.00   | 13.0460-0287.2   | 610287   | Belagsatz-Zubehör  |
|  | 2.2 i 16V (BB6/BB8)  | 136  |  | 10.96  | 10.00   |  |  |  |
|  | 2.0 i 16V (BB9)  | 98   |  | 10.96  | 10.00   | 24.0109-0141.1   | 409141   | 260 9,0 8,0 +S   |
| <b>HONDA S2000 (99-04)</b>   |  |  |  |  |   |  |  |  |
|  | 2.0 VTEC (AP1)   | 177  |  | 06.99  | 09.04   | 13.0460-5755.2   | 605755   | 23178 16,6 +WK <b>SUM</b>  |
|  | 2.0 VTEC (AP1)   | 177  |  | 06.99  | 09.04   | 24.0125-0706.1   | 425706   | 300 25,0 23,0 V  |
|  | 2.0 VTEC (AP1)   | 177  |  | 06.99  | 09.04   | 13.0460-5929.2   | 605929   | 21719 15,0 +WK <b>AKE</b>  |
|  | 2.0 VTEC (AP1)   | 177  |  | 06.99  | 09.04   | 24.0112-0707.1   | 412707   | 282 12,0 10,0  |
| <b>HONDA SHUTTLE / ODYSSEY (95-01)</b>   |  |  |  |  |   |  |  |  |
|  | 2.2 i 16V (RA)   | 110  |  | 01.95  | 12.97   | 13.0460-5982.2   | 605982   | 21651 17,5 +WK   |
|  | 2.3 i 16V (RA)   | 110  |  | 01.98  | 05.01   | 13.0460-0075.2   | 610075   | Belagsatz-Zubehör  |
|  | 2.2 i 16V (RA)   | 110  |  | 01.95  | 12.97   | 24.0123-0104.1   | 423104   | 282 23,0 21,0 V +S +B  |
|  | 2.3 i 16V (RA)   | 110  |  | 01.98  | 05.01   |  |  |  |
|  | 2.2 i 16V (RA)   | 110  |  | 01.95  | 12.97   | 13.0460-5711.2   | 605711   | 23652 15,7 +WK   |
|  | 2.3 i 16V (RA)   | 110  |  | 01.98  | 05.01   | 13.0460-0287.2   | 610287   | Belagsatz-Zubehör  |

<sup>1)</sup> + autom.transmission / + scatola cambio automatico / + transmission automatique / + cambio automático

|     |                     |  |  |  |  |  |  |  |                                     |
|--|---|--|--|--|---|--|--|--|-------------------------------------|
| <b>HONDA SHUTTLE / ODYSSEY (95-01)</b>   |   |  |  |  |   |  |  |  |                                     |
|    | 2.2 i 16V (RA)<br>2.3 i 16V (RA)  | 110<br>110   |  | 01.95<br>01.98   | 12.97<br>05.01  |  | 24.0109-0132.1   | 409132   | 282 9,0 7,5                         |
| <b>HONDA STREAM (01-05)</b>  |   |  |  |  |   |  |  |  |                                     |
|    | 1.7 i 16V (RN1)<br>2.0 i 16V (RN1)  | 92<br>115  |  | 05.01<br>05.01   | 09.05 + 15" Rad 1)<br>09.05 + 15" Rad 1)  |  | 13.0460-5878.2   | 605878   | 23729 16,9 +/WK/Zub                 |
|    | 1.7 i 16V (RN1)<br>2.0 i 16V (RN1)  | 92<br>115  |  | 05.01<br>05.01   | 09.05 + 15" Rad 1)<br>09.05 + 15" Rad 1)  |  | 24.0123-0109.1   | 423109   | 282 23,0 21,0 V +S +B               |
|    | 1.7 i 16V (RN1)<br>2.0 i 16V (RN1)  | 92<br>115  |  | 05.01<br>05.01   | 09.05<br>09.05  |  | 13.0460-5711.2   | 605711   | 23652 15,7 +/WK                     |
|    | 1.7 i 16V (RN1)<br>2.0 i 16V (RN1)  | 92<br>115  |  | 05.01<br>05.01   | 09.05<br>09.05  |  | 24.0112-0172.1   | 412172   | 282 12,0 10,0 +S                    |
|    | 1.7 i 16V (RN1)<br>2.0 i 16V (RN1)  | 92<br>115  |  | 05.01<br>05.01   | 09.05<br>09.05  |  | 03.0137-0442.2   | 650442   | 167 x 35                            |
| <b>HYUNDAI ACCENT I (94-99)</b>  |   |  |  |  |   |  |  |  |                                     |
|    | 1.3 i 12V<br>1.3 i 12V<br>1.3 i 12V<br>1.3 i 12V<br>1.5 16V<br>1.5 i 12V<br>1.5 i 16V               | 40<br>44<br>55<br>62<br>76<br>65<br>73   |  | 09.95<br>10.94<br>10.94<br>10.94<br>10.94<br>10.94<br>10.95                      | 05.98<br>12.99<br>12.99<br>12.99<br>12.99<br>12.99<br>12.99                       |  | 13.0460-5936.2   | 605936   | 21012 15,0 AKE                      |
|    | 1.3 i 12V<br>1.3 i 12V<br>1.3 i 12V<br>1.3 i 12V<br>1.5 16V<br>1.5 i 12V<br>1.5 i 16V               | 40<br>44<br>55<br>62<br>76<br>65<br>73   |  | 09.95<br>10.94<br>10.94<br>10.94<br>10.94<br>10.94<br>10.95                      | 05.98<br>12.99<br>12.99<br>12.99<br>12.99<br>12.99<br>12.99                       |  | 24.0119-0109.1   | 419109   | 242 19,1 17,0 V +B                  |
|    | 1.3 i 12V<br>1.3 i 12V<br>1.3 i 12V<br>1.3 i 12V<br>1.5 16V<br>1.5 i 12V<br>1.5 i 16V               | 40<br>44<br>55<br>62<br>76<br>65<br>73   |  | 09.95<br>10.94<br>10.94<br>10.94<br>10.94<br>10.94<br>10.95                      | 05.98<br>12.99<br>12.99<br>12.99<br>12.99<br>12.99<br>12.99                       |  | 03.0137-0366.2<br>03.0137-9277.2   | 650366<br>669277   | 180 x 32 HEB<br>Bremsbacken-Zubehör |
|    | 1.3 i 12V<br>1.3 i 12V<br>1.3 i 12V<br>1.3 i 12V<br>1.5 16V<br>1.5 i 12V<br>1.5 i 16V               | 40<br>44<br>55<br>62<br>76<br>65<br>73   |  | 09.95<br>10.94<br>10.94<br>10.94<br>10.94<br>10.94<br>10.95                      | 05.96<br>05.96<br>05.96<br>05.96<br>05.96<br>05.96<br>05.96                       |  | 24.0218-0027.1   | 480099   | 180/182 x 44                        |
|    | 1.3 i 12V<br>1.3 i 12V<br>1.3 i 12V<br>1.3 i 12V<br>1.5 16V<br>1.5 i 12V<br>1.5 i 16V               | 40<br>44<br>55<br>62<br>76<br>65<br>73   |  | 06.96<br>06.96<br>06.96<br>06.96<br>06.96<br>06.96<br>06.96                      | 05.98<br>12.99<br>12.99<br>12.99<br>12.99<br>12.99<br>12.99                       |  | 24.0218-0034.1   | 480129   | 180/182 x 44,6                      |
|   | 1.3 i 12V<br>1.3 i 12V<br>1.3 i 12V<br>1.3 i 12V<br>1.5 16V<br>1.5 i 12V<br>1.5 i 16V               | 40<br>44<br>55<br>62<br>76<br>65<br>73   |  | 09.95<br>10.94<br>10.94<br>10.94<br>10.94<br>10.94<br>10.95                      | 05.98<br>12.99<br>12.99<br>12.99<br>12.99<br>12.99<br>12.99                       |  | 03.0520-7519.3   | 697519   | 19,05/180x32 TopKit                 |
| <b>HYUNDAI ACCENT II (00-05)</b>   |   |  |  |  |   |  |  |  |                                     |
|  | 1.3 i 12V<br>1.3 i 12V<br>1.3 i 12V<br>1.3 i 12V<br>1.5 CRDi<br>1.5 i 12V<br>1.5 i 16V<br>1.6 i 16V | 55<br>61<br>62<br>63<br>60<br>66<br>75<br>77                                     |  | 01.00<br>01.00<br>08.02<br>01.00<br>04.02<br>01.00<br>09.00<br>10.02             | 09.05<br>09.05<br>09.05<br>09.05<br>09.05<br>09.05<br>09.05<br>09.05              |  | 13.0460-5872.2   | 605872   | 21012 15,0 +/WK/Zub AKE             |
|  | 1.3 i 12V<br>1.3 i 12V<br>1.3 i 12V<br>1.3 i 12V<br>1.5 CRDi<br>1.5 i 12V<br>1.5 i 16V<br>1.6 i 16V | 55<br>61<br>62<br>63<br>60<br>66<br>75<br>77                                     |  | 01.00<br>01.00<br>08.02<br>01.00<br>04.02<br>01.00<br>09.00<br>10.02             | 09.05<br>09.05<br>09.05<br>09.05<br>09.05<br>09.05<br>09.05<br>09.05              |  | 24.0119-0114.1   | 419114   | 241 19,0 17,0 V +B                  |

















1) + 15" wheel / + ruota 15" / + roue 15" / + rueda 15"











|     |    kW |  |  |  |  |  |  |  |  |                     |
|--|---|--|--|--|---|--|--|--|--|---------------------|
| <b>HYUNDAI ACCENT II (00-05)</b>   |   |  |  |  |   |  |  |  |  |                     |
|    | 1.3 i 12V   | 55   |  | 01.00  | 07.02   |  | 03.0137-0429.2   | 650429   | 180 x 37 HEB<br>Bremsbacken-Zubehör                |                     |
|  | 1.3 i 12V   | 61   |  | 01.00  | 07.02   |  | 03.0137-9276.2   | 669276   |  |                     |
|  | 1.3 i 12V   | 63   |  | 01.00  | 09.05   |  |  |  |  |                     |
|  | 1.5 CRDi  | 60   |  | 04.02  | 07.02   |  |  |  |  |                     |
|  | 1.5 i 12V   | 66   |  | 01.00  | 07.02   |  |  |  |  |                     |
|  | 1.5 i 16V   | 75   |  | 09.00  | 07.02   |  |  |  |  |                     |
|    | 1.3 i 12V   | 55   |  | 08.02  | 09.05   |  | 03.0137-0437.2   | 650437   | 203 x 38 HEB<br>Bremsbacken-Zubehör                |                     |
|  | 1.3 i 12V   | 61   |  | 08.02  | 09.05   |  | 03.0137-9270.2   | 669270   |  |                     |
|  | 1.3 i 12V   | 62   |  | 08.02  | 09.05   |  |  |  |  |                     |
|  | 1.5 CRDi  | 60   |  | 08.02  | 09.05   |  |  |  |  |                     |
|  | 1.5 i 12V   | 66   |  | 08.02  | 09.05   |  |  |  |  |                     |
|  | 1.5 i 16V   | 75   |  | 08.02  | 09.05   |  |  |  |  |                     |
|    | 1.3 i 12V   | 55   |  | 01.00  | 07.02   |  | 24.0218-0008.1   | 480313   | 180/182 x 45,1                                     |                     |
|  | 1.3 i 12V   | 61   |  | 01.00  | 07.02   |  |  |  |  |                     |
|  | 1.3 i 12V   | 63   |  | 01.00  | 09.05   |  |  |  |  |                     |
|  | 1.5 CRDi  | 60   |  | 04.02  | 07.02   |  |  |  |  |                     |
|  | 1.5 i 12V   | 66   |  | 01.00  | 07.02   |  |  |  |  |                     |
|  | 1.5 i 16V   | 75   |  | 09.00  | 07.02   |  |  |  |  |                     |
|    | 1.3 i 12V   | 55   |  | 01.00  | 07.02   |  | 03.0520-7419.3   | 697419   | 19,05/180x37 TopKit                                |                     |
|  | 1.3 i 12V   | 61   |  | 01.00  | 07.02   |  |  |  |  |                     |
|  | 1.3 i 12V   | 63   |  | 01.00  | 09.05   |  |  |  |  |                     |
|  | 1.5 CRDi  | 60   |  | 04.02  | 07.02   |  |  |  |  |                     |
|  | 1.5 i 12V   | 66   |  | 01.00  | 07.02   |  |  |  |  |                     |
|  | 1.5 i 16V   | 75   |  | 09.00  | 07.02   |  |  |  |  |                     |
|    | 1.3 i 12V   | 55   |  | 08.02  | 09.05   |  | 03.0520-4517.3   | 694517   | 17,78/203x38 TopKit                                |                     |
|  | 1.3 i 12V   | 61   |  | 08.02  | 09.05   |  |  |  |  |                     |
|  | 1.3 i 12V   | 62   |  | 08.02  | 09.05   |  |  |  |  |                     |
|  | 1.5 CRDi  | 60   |  | 08.02  | 09.05   |  |  |  |  |                     |
|  | 1.5 i 12V   | 66   |  | 08.02  | 09.05   |  |  |  |  |                     |
|  | 1.5 i 16V   | 75   |  | 08.02  | 09.05   |  |  |  |  |                     |
|    | 1.6 i 16V   | 77   |  | 10.02  | 09.05   |  |  |  |  |                     |
|  | <b>HYUNDAI ACCENT III (05-10)</b>   |  |  |  |   |  |  |  |  |                     |
|  |       | 1.4 16V  | 71   |  | 10.05   | 11.10  |  | 13.0460-5779.2   | 605779   | 24317 17,6 +/WK/Zub |
|  |   | 1.5 16V  | 70   |  | 01.08   | 11.10  |  |  |  |                     |
|  |   | 1.5 CRDi   | 81   |  | 10.05   | 11.10  |  |  |  |                     |
|  |   | 1.5 LPG  | 70   |  | 01.08   | 11.10  |  |  |  |                     |
| 1.6 16V  |   | 82   |  | 10.05  | 11.10   |  |  |  |  |                     |
|   | 1.4 16V   | 71   |  | 10.05  | 11.10   |  | 24.0122-0260.1   | 422260   | 256 22,0 20,0 V +B                                 |                     |
|  | 1.5 16V   | 70   |  | 01.08  | 11.10   |  |  |  |  |                     |
|  | 1.5 CRDi  | 81   |  | 10.05  | 11.10   |  |  |  |  |                     |
|  | 1.5 LPG   | 70   |  | 01.08  | 11.10   |  |  |  |  |                     |
|  | 1.6 16V   | 82   |  | 10.05  | 11.10   |  |  |  |  |                     |
|  | 1.4 16V   | 71   |  | 10.05  | 11.10   | + ABS  | 13.0460-5780.2   | 605780   | 24320 15,3 +/WK/Zub                                |                     |
|  | 1.5 16V   | 70   |  | 01.08  | 11.10   | + ABS  |  |  |  |                     |
|  | 1.5 CRDi  | 81   |  | 10.05  | 11.10   | + ABS  |  |  |  |                     |
|  | 1.5 LPG   | 70   |  | 01.08  | 11.10   | + ABS  |  |  |  |                     |
|  | 1.6 16V   | 82   |  | 10.05  | 11.10   | + ABS  |  |  |  |                     |
|  | 1.4 16V   | 71   |  | 10.05  | 11.10   | + ABS  | 24.0110-0312.1   | 410312   | 262 10,0 8,4 +B                                    |                     |
|  | 1.5 CRDi  | 81   |  | 10.05  | 11.10   | + ABS  |  |  |  |                     |
|  | 1.6 16V   | 82   |  | 10.05  | 11.10   | + ABS  |  |  |  |                     |
|  | 1.4 16V   | 71   |  | 10.05  | 11.10   | - ABS  | 03.0137-0495.2   | 650495   | 203 x 32 HEB                                       |                     |
|  | 1.5 16V   | 70   |  | 01.08  | 11.10   | - ABS  |  |  |  |                     |
|  | 1.5 CRDi  | 81   |  | 10.05  | 11.10   | - ABS  |  |  |  |                     |
|  | 1.5 LPG   | 70   |  | 01.08  | 11.10   | - ABS  |  |  |  |                     |
|  | 1.6 16V   | 82   |  | 10.05  | 11.10   | - ABS  |  |  |  |                     |
|  | 1.4 16V   | 71   |  | 10.05  | 11.10   | + ABS  | 03.0137-3022.2   | 653022   | 170 x 32 HEB                                       |                     |
|  | 1.5 16V   | 70   |  | 01.08  | 11.10   | + ABS  |  |  |  |                     |
|  | 1.5 CRDi  | 81   |  | 10.05  | 11.10   | + ABS  |  |  |  |                     |
|  | 1.5 LPG   | 70   |  | 01.08  | 11.10   | + ABS  |  |  |  |                     |
|  | 1.6 16V   | 82   |  | 10.05  | 11.10   | + ABS  |  |  |  |                     |
| <b>HYUNDAI ACCENT IV (10-)</b>   |   |  |  |  |   |  |  |  |  |                     |
|  | 1.4 16V   | 79   |  | 11.10  |   |  | 13.0460-5646.2   | 605646   | 25348 17,8 +/WK/Zub MAN                            |                     |
|  | 1.4 CRDi  | 66   |  | 11.10  |   |  |  |  |  |                     |
|  | 1.6 16V   | 90   |  | 11.10  |   |  |  |  |  |                     |
|  | 1.6 16V   | 91   |  | 11.10  |   |  |  |  |  |                     |
|  | 1.6 CCVT-I  | 92   |  | 11.10  |   |  |  |  |  |                     |
|  | 1.6 CRDi  | 94   |  | 10.11  |   |  |  |  |  |                     |
|  | 1.6 CRDi  | 100  |  | 04.11  |   |  |  |  |  |                     |
|  | 1.4 16V   | 79   |  | 11.10  |   | + ABS  | 13.0460-5786.2   | 605786   | 24934 15,5 +/WK/Zub AKE<br>24934 15,5 +/WK/Zub AKE |                     |
|  | 1.4 CRDi  | 66   |  | 11.10  |   | + ABS  | 13.0470-5786.2   | LD5786   |  |                     |
|  | 1.6 16V   | 90   |  | 11.10  |   | + ABS  |  |  |  |                     |
|  | 1.6 16V   | 91   |  | 11.10  |   | + ABS  |  |  |  |                     |
|  | 1.6 CCVT-I  | 92   |  | 11.10  |   | + ABS  |  |  |  |                     |
|  | 1.6 CRDi  | 94   |  | 10.11  |   | + ABS  |  |  |  |                     |
|  | 1.6 CRDi  | 100  |  | 04.11  |   | + ABS  |  |  |  |                     |
|  | 1.4 16V   | 79   |  | 11.10  |   | + ABS  | 24.0110-0398.1   | 410398   | 262 10,0 8,4 L +B                                  |                     |
|  | 1.4 CRDi  | 66   |  | 11.10  |   | + ABS  |  |  |  |                     |
|  | 1.6 16V   | 90   |  | 11.10  |   | + ABS  |  |  |  |                     |
|  | 1.6 16V   | 91   |  | 11.10  |   | + ABS  |  |  |  |                     |
|  | 1.6 CCVT-I  | 92   |  | 11.10  |   | + ABS  |  |  |  |                     |
|  | 1.6 CRDi  | 94   |  | 10.11  |   | + ABS  |  |  |  |                     |
|  | 1.6 CRDi  | 100  |  | 04.11  |   | + ABS  |  |  |  |                     |

















|     |  |  |  |  |  |  |  |  |                               |                     |
|--|--|--|--|--|---|--|--|--|-------------------------------|---------------------|
| <b>HYUNDAI ATOS (98-08)</b>  |  |  |  |  |   |  |  |  |                               |                     |
|    | 0.8  | 38   |  | 04.99  | 07.03   |  | 13.0460-5803.2   | 605803   | 23238 16,0 +/WK               |                     |
|  | 1.0 i 12V  | 40   |  | 02.98  | 01.01   |  |  |  |                               |                     |
|  | 1.0 i 12V  | 40   |  | 02.01  | 03.02   |  | 13.0460-5829.2   | 605829   | 24277 16,0 +/WK/Zub           |                     |
|  | 1.0 i 12V  | 43   |  | 02.01  | 07.03   |  |  |  |                               |                     |
|  | 1.1 i 12V  | 43   |  | 08.03  | 05.05   |  |  |  |                               |                     |
|    | 1.1 i 12V  | 46   |  | 03.04  | 02.08   |  |  |  |                               |                     |
|  | 0.8  | 38   |  | 04.99  | 07.03   |  | 24.0111-0125.1   | 411125   | 230 11,0 8,4 +B               |                     |
|  | 1.0 i 12V  | 40   |  | 02.98  | 01.01   |  |  |  |                               |                     |
|  | 1.0 i 12V  | 40   |  | 02.01  | 03.02   |  | 24.0118-0138.1   | 418138   | 234 18,0 16,0 V +B            |                     |
|  | 1.0 i 12V  | 43   |  | 02.01  | 07.03   |  |  |  |                               |                     |
|    | 1.1 i 12V  | 43   |  | 08.03  | 05.05   |  |  |  |                               |                     |
|  | 1.1 i 12V  | 46   |  | 03.04  | 02.08   |  |  |  |                               |                     |
|  | 0.8  | 38   |  | 04.99  | 07.03   |  | 03.0137-0386.2   | 650386   | 180 x 30 HEB                  |                     |
|  | 1.0 i 12V  | 40   |  | 02.98  | 03.02   |  | 03.0137-9277.2   | 669277   | Bremsbacken-Zubehör           |                     |
|  | 1.0 i 12V  | 43   |  | 03.01  | 07.03   |  |  |  |                               |                     |
|    | 1.1 i 12V  | 43   |  | 08.03  | 05.05   |  |  |  |                               |                     |
|  | 1.1 i 12V  | 46   |  | 03.04  | 02.08   |  |  |  |                               |                     |
|  | 0.8  | 38   |  | 04.99  | 07.03   |  | 24.0218-0044.2   | 480174   | ohne Sensorring <sup>1)</sup> |                     |
|  | 1.0 i 12V  | 40   |  | 02.98  | 03.02   |  |  |  | 180/182 x 36                  |                     |
|  | 1.0 i 12V  | 43   |  | 03.01  | 07.03   |  |  |  |                               |                     |
|    | 1.1 i 12V  | 43   |  | 08.03  | 05.05   |  |  |  |                               |                     |
|  | 1.1 i 12V  | 46   |  | 03.04  | 02.08   |  |  |  |                               |                     |
|  | 0.8  | 38   |  | 04.99  | 07.03   |  | 03.0520-4617.3   | 694617   | 17,78/180x30 TopKit           |                     |
|  | 1.0 i 12V  | 40   |  | 02.98  | 03.02   |  |  |  |                               |                     |
|  | 1.0 i 12V  | 43   |  | 03.01  | 07.03   |  |  |  |                               |                     |
|    | 1.1 i 12V  | 43   |  | 08.03  | 05.05   |  |  |  |                               |                     |
|  | 1.1 i 12V  | 46   |  | 03.04  | 02.08   |  |  |  |                               |                     |
|  | <b>HYUNDAI ATOS PRIME (99-08)</b>  |  |  |  |   |  |  |  |                               |                     |
|  |  | 1.0 i 12V  | 40   |  | 08.99   | 01.01  |  | 13.0460-5803.2   | 605803                        | 23238 16,0 +/WK     |
|  |  | 1.0 i 12V  | 40   |  | 02.01   | 07.02  |  | 13.0460-5829.2   | 605829                        | 24277 16,0 +/WK/Zub |
| 1.0 i 12V  |  | 43   |  | 08.01  | 12.05   |  |  |  |                               |                     |
| 1.1 i 12V  |  | 43   |  | 06.03  | 01.07   |  |  |  |                               |                     |
| 1.1 i 12V  |  | 46   |  | 09.05  | 08.08   |  |  |  |                               |                     |
|    | 1.0 i 12V  | 40   |  | 08.99  | 01.01   |  | 24.0111-0125.1   | 411125   | 230 11,0 8,4 +B               |                     |
|  | 1.0 i 12V  | 40   |  | 02.01  | 07.02   |  | 24.0118-0138.1   | 418138   | 234 18,0 16,0 V +B            |                     |
|  | 1.0 i 12V  | 43   |  | 08.01  | 12.05   |  |  |  |                               |                     |
|  | 1.1 i 12V  | 43   |  | 06.03  | 01.07   |  |  |  |                               |                     |
|  | 1.1 i 12V  | 46   |  | 09.05  | 08.08   |  |  |  |                               |                     |
|   | 1.0 i 12V  | 40   |  | 08.99  | 02.01   |  | 03.0137-0386.2   | 650386   | 180 x 30 HEB                  |                     |
|  | 1.0 i 12V  | 43   |  | 03.01  | 12.05   |  | 03.0137-9277.2   | 669277   | Bremsbacken-Zubehör           |                     |
|  | 1.1 i 12V  | 43   |  | 06.03  | 01.07   |  |  |  |                               |                     |
|  | 1.1 i 12V  | 46   |  | 09.05  | 08.08   |  |  |  |                               |                     |
|  | 1.0 i 12V  | 40   |  | 08.99  | 02.01   |  | 24.0218-0044.2   | 480174   | ohne Sensorring <sup>1)</sup> |                     |
|  | 1.0 i 12V  | 43   |  | 03.01  | 07.01   |  |  |  | 180/182 x 36                  |                     |
|  | 1.0 i 12V  | 40   |  | 08.99  | 02.01   |  | 03.0520-4617.3   | 694617   | 17,78/180x30 TopKit           |                     |
|  | 1.0 i 12V  | 43   |  | 03.01  | 12.05   |  |  |  |                               |                     |
|  | 1.1 i 12V  | 43   |  | 06.03  | 01.07   |  |  |  |                               |                     |
|  | 1.1 i 12V  | 46   |  | 09.05  | 08.08   |  |  |  |                               |                     |
| <b>HYUNDAI CENTENNIAL (99-09)</b>  |  |  |  |  |   |  |  |  |                               |                     |
|  | 3.5 V6   | 155  |  | 10.99  | 03.09   | - ⊕  | 13.0460-5622.2   | 605622   | 23726 16,5 +/WK/Zub MAN       |                     |
|  | 4.5 V8   | 195  |  | 10.99  | 09.03   | - ⊕  |  |  |                               |                     |
| <b>HYUNDAI COUPE (RD) (96-02)</b>  |  |  |  |  |   |  |  |  |                               |                     |
|  | 1.6 i 16V  | 79   |  | 08.00  | 04.02   |  | 13.0460-5933.2   | 605933   | 21725 16,8 +/WK AKE           |                     |
|  | 1.6 i 16V  | 84   |  | 12.96  | 04.02   |  |  |  |                               |                     |
|  | 1.6 i 16V  | 85   |  | 03.98  | 04.02   |  |  |  |                               |                     |
|  | 2.0 i 16V  | 99   |  | 03.01  | 04.02   |  |  |  |                               |                     |
|  | 2.0 i 16V  | 101  |  | 08.99  | 04.02   |  |  |  |                               |                     |
|  | 2.0 i 16V  | 102  |  | 08.96  | 04.02   |  |  |  |                               |                     |
|  | 1.6 i 16V  | 84   |  | 12.96  | 08.98   |  | 24.0122-0170.1   | 422170   | 257 22,0 20,0 V               |                     |
|  | 1.6 i 16V  | 85   |  | 03.98  | 08.98   |  | 24.0322-0170.1   | 522170   | 257 22,0 20,0 V PD            |                     |
|  | 2.0 i 16V  | 102  |  | 08.96  | 08.98   |  |  |  |                               |                     |
|  | 1.6 i 16V  | 79   |  | 08.00  | 04.02   |  | 24.0124-0706.1   | 424706   | 257 24,0 22,4 V               |                     |
|  | 1.6 i 16V  | 84   |  | 09.98  | 04.02   |  |  |  |                               |                     |
|  | 1.6 i 16V  | 85   |  | 09.98  | 04.02   |  |  |  |                               |                     |
|  | 2.0 i 16V  | 99   |  | 03.01  | 04.02   |  |  |  |                               |                     |
|  | 2.0 i 16V  | 101  |  | 08.99  | 04.02   |  |  |  |                               |                     |
|  | 2.0 i 16V  | 102  |  | 09.98  | 04.02   |  |  |  |                               |                     |
|  | 1.6 i 16V  | 79   |  | 08.00  | 04.02   | + ABS  | 13.0460-5874.2   | 605874   | 21553 14,0 +/WK/Zub SUM       |                     |
|  | 1.6 i 16V  | 84   |  | 12.96  | 04.02   | + ABS  |  |  |                               |                     |
|  | 1.6 i 16V  | 85   |  | 03.98  | 04.02   | + ABS  |  |  |                               |                     |
|  | 2.0 i 16V  | 99   |  | 03.01  | 04.02   |  |  |  |                               |                     |
|  | 2.0 i 16V  | 101  |  | 08.99  | 04.02   |  |  |  |                               |                     |
|  | 2.0 i 16V  | 102  |  | 08.96  | 04.02   |  |  |  |                               |                     |
|  | 1.6 i 16V  | 79   |  | 08.00  | 04.02   | + ABS  | 24.0110-0264.1   | 410264   | 258 10,0 8,0 +B               |                     |
|  | 1.6 i 16V  | 84   |  | 12.96  | 04.02   | + ABS  |  |  |                               |                     |
|  | 1.6 i 16V  | 85   |  | 03.98  | 04.02   | + ABS  |  |  |                               |                     |

<sup>1)</sup> without sensor ring / senza sensori / sans secours ABS / sin anillo sensor ABS

























|     |   |  |                          |                          |  |  |  |  |
|--|---|--|--|--|---|--|--|--|
| <b>HYUNDAI COUPE (RD) (96-02)</b>  |   |  |  |  |   |  |  |  |
|    | 1.6 i 16V<br>1.6 i 16V<br>1.6 i 16V   | 79<br>84<br>85   | 08.00<br>12.96<br>03.98  | 04.02<br>04.02<br>04.02  | - ABS<br>- ABS<br>- ABS   | 03.0137-0369.2<br>03.0137-9270.2   | 650369<br>669270   | 203 x 39 HEB<br>Bremsbacken-Zubehör  |
|    | 1.6 i 16V<br>1.6 i 16V<br>1.6 i 16V   | 79<br>84<br>85   | 08.00<br>12.96<br>03.98  | 04.02<br>04.02<br>04.02  | - ABS<br>- ABS<br>- ABS   | 24.0220-3045.1   | 480191   | 203/204,5 x 45,5   |
| <b>HYUNDAI COUPE (GK) (02-09)</b>  |   |  |  |  |   |  |  |  |
|    | 1.6 i 16V<br>1.6 i 16V<br>2.0 CCVT<br>2.0 i 16V<br>2.0 i 16V<br>2.7 i V6<br>2.7 i V6  | 77<br>79<br>105<br>100<br>102<br>121<br>123                                      | 03.02<br>03.02<br>02.03<br>08.01<br>03.02<br>01.07<br>03.02  | 08.09<br>08.09<br>08.09<br>08.09<br>08.09<br>08.09<br>08.09  |   | 13.0460-5873.2<br>13.0460-0139.2   | 605873<br>610139   | 23891 16,9 +/WK<br>Belagsatz-Zubehör <b>MAN</b>                                    |
|    | 1.6 i 16V<br>1.6 i 16V<br>2.0 CCVT<br>2.0 i 16V<br>2.0 i 16V<br>2.7 i V6<br>2.7 i V6  | 77<br>79<br>105<br>100<br>102<br>121<br>123                                      | 03.02<br>03.02<br>02.03<br>08.01<br>03.02<br>01.07<br>03.02  | 08.09<br>08.09<br>08.09<br>08.09<br>08.09<br>08.09<br>08.09  |   | 24.0126-0128.1   | 426128   | 280 26,0 24,4 V L +B   |
|    | 1.6 i 16V<br>1.6 i 16V<br>2.0 CCVT<br>2.0 i 16V<br>2.0 i 16V<br>2.7 i V6<br>2.7 i V6  | 77<br>79<br>105<br>100<br>102<br>121<br>123                                      | 03.02<br>03.02<br>02.03<br>08.01<br>03.02<br>01.07<br>03.02  | 08.09<br>08.09<br>08.09<br>08.09<br>08.09<br>08.09<br>08.09  |   | 13.0460-5874.2   | 605874   | 21553 14,0 +/WK/Zub <b>SUM</b>   |
|    | 1.6 i 16V<br>1.6 i 16V<br>2.0 CCVT<br>2.0 i 16V<br>2.0 i 16V<br>2.7 i V6<br>2.7 i V6  | 77<br>79<br>105<br>100<br>102<br>121<br>123                                      | 03.02<br>03.02<br>02.03<br>08.01<br>03.02<br>01.07<br>03.02  | 08.09<br>08.09<br>08.09<br>08.09<br>08.09<br>08.09<br>08.09  |   | 24.0110-0298.1   | 410298   | 258 10,0 8,0   |
| <b>HYUNDAI ELANTRA (00-06)</b>   |   |  |  |  |   |  |  |  |
|   | 1.5 16V<br>1.5 D<br>1.6 i 16V<br>1.6 i 16V<br>1.8 i 16V<br>1.8 i 16V<br>2.0 i 16V<br>2.0 i 16V  | 75<br>82<br>66<br>79<br>79<br>97<br>102<br>104                                   | 09.00<br>06.00<br>06.00<br>06.00<br>06.00<br>06.00<br>06.00<br>06.00                                     | 05.01<br>05.01<br>05.01<br>05.01<br>05.01<br>05.01<br>05.01<br>05.01                                     |   | 13.0460-5933.2   | 605933   | 21725 16,8 +/WK <b>AKE</b>   |
|  | 1.5 16V<br>1.5 D<br>1.6 i 16V<br>1.6 i 16V<br>1.8 i 16V<br>1.8 i 16V<br>2.0 CRDi<br>2.0 i 16V<br>2.0 i 16V  | 75<br>82<br>66<br>79<br>79<br>97<br>83<br>102<br>104                             | 06.01<br>06.01<br>06.01<br>06.01<br>06.01<br>04.01<br>06.01<br>06.01                                     | 07.03<br>07.03<br>07.03<br>07.03<br>07.03<br>07.03<br>07.03<br>07.03                                     |   | 13.0460-5875.2   | 605875   | 24031 17,7 +/WK <b>MAN</b>   |
|  | 1.5 16V<br>1.5 D<br>1.6 i 16V<br>1.6 i 16V<br>1.6 i 16V<br>1.8 i 16V<br>1.8 i 16V<br>2.0 CRDi<br>2.0 i 16V<br>2.0 i 16V<br>2.0 i 16V              | 75<br>82<br>77<br>79<br>82<br>93<br>97<br>83<br>102<br>104<br>105                | 08.03<br>08.03<br>08.03<br>08.03<br>08.03<br>06.04<br>08.03<br>08.03<br>08.03<br>08.03<br>10.03          | 07.06<br>07.06<br>05.06<br>05.06<br>05.06<br>05.06<br>05.06<br>05.06<br>05.06<br>05.06<br>05.06          |   | 13.0460-5876.2   | 605876   | 24369 17,2 +/WK <b>MAN</b>   |
|  | 1.5 16V<br>1.5 D<br>1.6 i 16V<br>1.6 i 16V<br>1.6 i 16V<br>1.6 i 16V<br>1.8 i 16V<br>1.8 i 16V<br>2.0 CRDi<br>2.0 i 16V<br>2.0 i 16V<br>2.0 i 16V | 75<br>82<br>66<br>77<br>79<br>82<br>79<br>93<br>97<br>83<br>102<br>104<br>105    | 09.00<br>06.00<br>06.00<br>08.03<br>06.00<br>08.03<br>06.04<br>06.00<br>04.01<br>06.00<br>06.00<br>10.03 | 07.06<br>07.06<br>07.03<br>05.06<br>07.03<br>05.06<br>05.06<br>05.06<br>06.03<br>05.06<br>05.06<br>05.06 | - ABS<br>- ABS  | 24.0124-0184.1   | 424184   | 257 24,0 22,1 V +B   |
|  | 1.6 i 16V<br>1.6 i 16V<br>2.0 CRDi  | 77<br>82<br>83   | 08.03<br>08.03<br>07.03  | 05.06<br>05.06<br>05.06  | + ABS<br>+ ABS  | 24.0126-0129.1   | 426129   | 280 26,0 24,4 V +B   |

| HYUNDAI ELANTRA (00-06)  |   |          |             |                |             |                |        |       |                     |          |                     |                     |             |             |           |       |             |             |           |       |             |              |              |       |       |           |           |       |       |           |           |       |       |           |           |       |       |           |           |       |       |          |          |       |       |           |           |       |       |           |           |       |       |           |           |       |       |       |
|--|---|----------|-------------|----------------|-------------|----------------|--------|-------|---------------------|----------|---------------------|---------------------|-------------|-------------|-----------|-------|-------------|-------------|-----------|-------|-------------|--------------|--------------|-------|-------|-----------|-----------|-------|-------|-----------|-----------|-------|-------|-----------|-----------|-------|-------|-----------|-----------|-------|-------|----------|----------|-------|-------|-----------|-----------|-------|-------|-----------|-----------|-------|-------|-----------|-----------|-------|-------|-------|
|    | <table border="1"> <tr><td>1.5 16V</td><td>75</td><td>09.00</td><td>07.06</td><td rowspan="13">13.0460-5874.2</td><td rowspan="13">605874</td><td rowspan="13">+ ABS</td><td rowspan="13">21553 14,0 +/WK/Zub</td><td rowspan="13">SUM</td></tr> <tr><td>1.5 D</td><td>82</td><td>06.00</td><td>07.06</td></tr> <tr><td>1.6 i 16V</td><td>66</td><td>06.00</td><td>05.06</td></tr> <tr><td>1.6 i 16V</td><td>77</td><td>08.03</td><td>05.06</td></tr> <tr><td>1.6 i 16V</td><td>79</td><td>06.00</td><td>05.06</td></tr> <tr><td>1.6 i 16V</td><td>82</td><td>08.03</td><td>05.06</td></tr> <tr><td>1.8 i 16V</td><td>79</td><td>06.00</td><td>07.03</td></tr> <tr><td>1.8 i 16V</td><td>93</td><td>06.04</td><td>05.06</td></tr> <tr><td>1.8 i 16V</td><td>97</td><td>06.00</td><td>05.06</td></tr> <tr><td>2.0 CRDi</td><td>83</td><td>04.01</td><td>05.06</td></tr> <tr><td>2.0 i 16V</td><td>102</td><td>06.00</td><td>05.06</td></tr> <tr><td>2.0 i 16V</td><td>104</td><td>06.00</td><td>05.06</td></tr> <tr><td>2.0 i 16V</td><td>105</td><td>10.03</td><td>05.06</td></tr> </table> | 1.5 16V  | 75          | 09.00          | 07.06       | 13.0460-5874.2 | 605874 | + ABS | 21553 14,0 +/WK/Zub | SUM      | 1.5 D               | 82                  | 06.00       | 07.06       | 1.6 i 16V | 66    | 06.00       | 05.06       | 1.6 i 16V | 77    | 08.03       | 05.06        | 1.6 i 16V    | 79    | 06.00 | 05.06     | 1.6 i 16V | 82    | 08.03 | 05.06     | 1.8 i 16V | 79    | 06.00 | 07.03     | 1.8 i 16V | 93    | 06.04 | 05.06     | 1.8 i 16V | 97    | 06.00 | 05.06    | 2.0 CRDi | 83    | 04.01 | 05.06     | 2.0 i 16V | 102   | 06.00 | 05.06     | 2.0 i 16V | 104   | 06.00 | 05.06     | 2.0 i 16V | 105   | 10.03 | 05.06 |
| 1.5 16V  | 75  | 09.00    | 07.06       | 13.0460-5874.2 | 605874      |                |        |       |                     |          | + ABS               | 21553 14,0 +/WK/Zub | SUM         |             |           |       |             |             |           |       |             |              |              |       |       |           |           |       |       |           |           |       |       |           |           |       |       |           |           |       |       |          |          |       |       |           |           |       |       |           |           |       |       |           |           |       |       |       |
| 1.5 D  | 82  | 06.00    | 07.06       |                |             |                |        |       |                     |          |                     |                     |             |             |           |       |             |             |           |       |             |              |              |       |       |           |           |       |       |           |           |       |       |           |           |       |       |           |           |       |       |          |          |       |       |           |           |       |       |           |           |       |       |           |           |       |       |       |
| 1.6 i 16V  | 66  | 06.00    | 05.06       |                |             |                |        |       |                     |          |                     |                     |             |             |           |       |             |             |           |       |             |              |              |       |       |           |           |       |       |           |           |       |       |           |           |       |       |           |           |       |       |          |          |       |       |           |           |       |       |           |           |       |       |           |           |       |       |       |
| 1.6 i 16V  | 77  | 08.03    | 05.06       |                |             |                |        |       |                     |          |                     |                     |             |             |           |       |             |             |           |       |             |              |              |       |       |           |           |       |       |           |           |       |       |           |           |       |       |           |           |       |       |          |          |       |       |           |           |       |       |           |           |       |       |           |           |       |       |       |
| 1.6 i 16V  | 79  | 06.00    | 05.06       |                |             |                |        |       |                     |          |                     |                     |             |             |           |       |             |             |           |       |             |              |              |       |       |           |           |       |       |           |           |       |       |           |           |       |       |           |           |       |       |          |          |       |       |           |           |       |       |           |           |       |       |           |           |       |       |       |
| 1.6 i 16V  | 82  | 08.03    | 05.06       |                |             |                |        |       |                     |          |                     |                     |             |             |           |       |             |             |           |       |             |              |              |       |       |           |           |       |       |           |           |       |       |           |           |       |       |           |           |       |       |          |          |       |       |           |           |       |       |           |           |       |       |           |           |       |       |       |
| 1.8 i 16V  | 79  | 06.00    | 07.03       |                |             |                |        |       |                     |          |                     |                     |             |             |           |       |             |             |           |       |             |              |              |       |       |           |           |       |       |           |           |       |       |           |           |       |       |           |           |       |       |          |          |       |       |           |           |       |       |           |           |       |       |           |           |       |       |       |
| 1.8 i 16V  | 93  | 06.04    | 05.06       |                |             |                |        |       |                     |          |                     |                     |             |             |           |       |             |             |           |       |             |              |              |       |       |           |           |       |       |           |           |       |       |           |           |       |       |           |           |       |       |          |          |       |       |           |           |       |       |           |           |       |       |           |           |       |       |       |
| 1.8 i 16V  | 97  | 06.00    | 05.06       |                |             |                |        |       |                     |          |                     |                     |             |             |           |       |             |             |           |       |             |              |              |       |       |           |           |       |       |           |           |       |       |           |           |       |       |           |           |       |       |          |          |       |       |           |           |       |       |           |           |       |       |           |           |       |       |       |
| 2.0 CRDi   | 83  | 04.01    | 05.06       |                |             |                |        |       |                     |          |                     |                     |             |             |           |       |             |             |           |       |             |              |              |       |       |           |           |       |       |           |           |       |       |           |           |       |       |           |           |       |       |          |          |       |       |           |           |       |       |           |           |       |       |           |           |       |       |       |
| 2.0 i 16V  | 102   | 06.00    | 05.06       |                |             |                |        |       |                     |          |                     |                     |             |             |           |       |             |             |           |       |             |              |              |       |       |           |           |       |       |           |           |       |       |           |           |       |       |           |           |       |       |          |          |       |       |           |           |       |       |           |           |       |       |           |           |       |       |       |
| 2.0 i 16V  | 104   | 06.00    | 05.06       |                |             |                |        |       |                     |          |                     |                     |             |             |           |       |             |             |           |       |             |              |              |       |       |           |           |       |       |           |           |       |       |           |           |       |       |           |           |       |       |          |          |       |       |           |           |       |       |           |           |       |       |           |           |       |       |       |
| 2.0 i 16V  | 105   | 10.03    | 05.06       |                |             |                |        |       |                     |          |                     |                     |             |             |           |       |             |             |           |       |             |              |              |       |       |           |           |       |       |           |           |       |       |           |           |       |       |           |           |       |       |          |          |       |       |           |           |       |       |           |           |       |       |           |           |       |       |       |
|    | <table border="1"> <tr><td>1.5 16V</td><td>75</td><td>09.00</td><td>07.06</td><td rowspan="13">24.0110-0264.1</td><td rowspan="13">410264</td><td rowspan="13">+ ABS</td><td rowspan="13">258 10,0 8,0 +B</td></tr> <tr><td>1.5 D</td><td>82</td><td>06.00</td><td>07.06</td></tr> <tr><td>1.6 i 16V</td><td>66</td><td>06.00</td><td>05.06</td></tr> <tr><td>1.6 i 16V</td><td>77</td><td>08.03</td><td>05.06</td></tr> <tr><td>1.6 i 16V</td><td>79</td><td>06.00</td><td>05.06</td></tr> <tr><td>1.6 i 16V</td><td>82</td><td>08.03</td><td>05.06</td></tr> <tr><td>1.8 i 16V</td><td>79</td><td>06.00</td><td>07.03</td></tr> <tr><td>1.8 i 16V</td><td>93</td><td>06.04</td><td>05.06</td></tr> <tr><td>1.8 i 16V</td><td>97</td><td>06.00</td><td>05.06</td></tr> <tr><td>2.0 CRDi</td><td>83</td><td>04.01</td><td>05.06</td></tr> <tr><td>2.0 i 16V</td><td>102</td><td>06.00</td><td>05.06</td></tr> <tr><td>2.0 i 16V</td><td>104</td><td>06.00</td><td>05.06</td></tr> <tr><td>2.0 i 16V</td><td>105</td><td>10.03</td><td>05.06</td></tr> </table>                              | 1.5 16V  | 75          | 09.00          | 07.06       | 24.0110-0264.1 | 410264 | + ABS | 258 10,0 8,0 +B     | 1.5 D    | 82                  | 06.00               | 07.06       | 1.6 i 16V   | 66        | 06.00 | 05.06       | 1.6 i 16V   | 77        | 08.03 | 05.06       | 1.6 i 16V    | 79           | 06.00 | 05.06 | 1.6 i 16V | 82        | 08.03 | 05.06 | 1.8 i 16V | 79        | 06.00 | 07.03 | 1.8 i 16V | 93        | 06.04 | 05.06 | 1.8 i 16V | 97        | 06.00 | 05.06 | 2.0 CRDi | 83       | 04.01 | 05.06 | 2.0 i 16V | 102       | 06.00 | 05.06 | 2.0 i 16V | 104       | 06.00 | 05.06 | 2.0 i 16V | 105       | 10.03 | 05.06 |       |
| 1.5 16V  | 75  | 09.00    | 07.06       | 24.0110-0264.1 | 410264      |                |        |       |                     | + ABS    | 258 10,0 8,0 +B     |                     |             |             |           |       |             |             |           |       |             |              |              |       |       |           |           |       |       |           |           |       |       |           |           |       |       |           |           |       |       |          |          |       |       |           |           |       |       |           |           |       |       |           |           |       |       |       |
| 1.5 D  | 82  | 06.00    | 07.06       |                |             |                |        |       |                     |          |                     |                     |             |             |           |       |             |             |           |       |             |              |              |       |       |           |           |       |       |           |           |       |       |           |           |       |       |           |           |       |       |          |          |       |       |           |           |       |       |           |           |       |       |           |           |       |       |       |
| 1.6 i 16V  | 66  | 06.00    | 05.06       |                |             |                |        |       |                     |          |                     |                     |             |             |           |       |             |             |           |       |             |              |              |       |       |           |           |       |       |           |           |       |       |           |           |       |       |           |           |       |       |          |          |       |       |           |           |       |       |           |           |       |       |           |           |       |       |       |
| 1.6 i 16V  | 77  | 08.03    | 05.06       |                |             |                |        |       |                     |          |                     |                     |             |             |           |       |             |             |           |       |             |              |              |       |       |           |           |       |       |           |           |       |       |           |           |       |       |           |           |       |       |          |          |       |       |           |           |       |       |           |           |       |       |           |           |       |       |       |
| 1.6 i 16V  | 79  | 06.00    | 05.06       |                |             |                |        |       |                     |          |                     |                     |             |             |           |       |             |             |           |       |             |              |              |       |       |           |           |       |       |           |           |       |       |           |           |       |       |           |           |       |       |          |          |       |       |           |           |       |       |           |           |       |       |           |           |       |       |       |
| 1.6 i 16V  | 82  | 08.03    | 05.06       |                |             |                |        |       |                     |          |                     |                     |             |             |           |       |             |             |           |       |             |              |              |       |       |           |           |       |       |           |           |       |       |           |           |       |       |           |           |       |       |          |          |       |       |           |           |       |       |           |           |       |       |           |           |       |       |       |
| 1.8 i 16V  | 79  | 06.00    | 07.03       |                |             |                |        |       |                     |          |                     |                     |             |             |           |       |             |             |           |       |             |              |              |       |       |           |           |       |       |           |           |       |       |           |           |       |       |           |           |       |       |          |          |       |       |           |           |       |       |           |           |       |       |           |           |       |       |       |
| 1.8 i 16V  | 93  | 06.04    | 05.06       |                |             |                |        |       |                     |          |                     |                     |             |             |           |       |             |             |           |       |             |              |              |       |       |           |           |       |       |           |           |       |       |           |           |       |       |           |           |       |       |          |          |       |       |           |           |       |       |           |           |       |       |           |           |       |       |       |
| 1.8 i 16V  | 97  | 06.00    | 05.06       |                |             |                |        |       |                     |          |                     |                     |             |             |           |       |             |             |           |       |             |              |              |       |       |           |           |       |       |           |           |       |       |           |           |       |       |           |           |       |       |          |          |       |       |           |           |       |       |           |           |       |       |           |           |       |       |       |
| 2.0 CRDi   | 83  | 04.01    | 05.06       |                |             |                |        |       |                     |          |                     |                     |             |             |           |       |             |             |           |       |             |              |              |       |       |           |           |       |       |           |           |       |       |           |           |       |       |           |           |       |       |          |          |       |       |           |           |       |       |           |           |       |       |           |           |       |       |       |
| 2.0 i 16V  | 102   | 06.00    | 05.06       |                |             |                |        |       |                     |          |                     |                     |             |             |           |       |             |             |           |       |             |              |              |       |       |           |           |       |       |           |           |       |       |           |           |       |       |           |           |       |       |          |          |       |       |           |           |       |       |           |           |       |       |           |           |       |       |       |
| 2.0 i 16V  | 104   | 06.00    | 05.06       |                |             |                |        |       |                     |          |                     |                     |             |             |           |       |             |             |           |       |             |              |              |       |       |           |           |       |       |           |           |       |       |           |           |       |       |           |           |       |       |          |          |       |       |           |           |       |       |           |           |       |       |           |           |       |       |       |
| 2.0 i 16V  | 105   | 10.03    | 05.06       |                |             |                |        |       |                     |          |                     |                     |             |             |           |       |             |             |           |       |             |              |              |       |       |           |           |       |       |           |           |       |       |           |           |       |       |           |           |       |       |          |          |       |       |           |           |       |       |           |           |       |       |           |           |       |       |       |
|    | <table border="1"> <tr><td>1.5 16V</td><td>75</td><td>09.00</td><td>10.01</td><td rowspan="9">03.0137-9270.2</td><td rowspan="9">669270</td><td rowspan="9"></td><td rowspan="9">Bremsbacken-Zubehör</td></tr> <tr><td>1.5 D</td><td>82</td><td>06.00</td><td>10.01</td></tr> <tr><td>1.6 i 16V</td><td>66</td><td>06.00</td><td>10.01</td></tr> <tr><td>1.6 i 16V</td><td>79</td><td>06.00</td><td>10.01</td></tr> <tr><td>1.8 i 16V</td><td>79</td><td>06.00</td><td>10.01</td></tr> <tr><td>1.8 i 16V</td><td>97</td><td>06.00</td><td>10.01</td></tr> <tr><td>2.0 CRDi</td><td>83</td><td>04.01</td><td>10.01</td></tr> <tr><td>2.0 i 16V</td><td>102</td><td>06.00</td><td>10.01</td></tr> <tr><td>2.0 i 16V</td><td>104</td><td>06.00</td><td>10.01</td></tr> </table>  | 1.5 16V  | 75          | 09.00          | 10.01       | 03.0137-9270.2 | 669270 |       | Bremsbacken-Zubehör | 1.5 D    | 82                  | 06.00               | 10.01       | 1.6 i 16V   | 66        | 06.00 | 10.01       | 1.6 i 16V   | 79        | 06.00 | 10.01       | 1.8 i 16V    | 79           | 06.00 | 10.01 | 1.8 i 16V | 97        | 06.00 | 10.01 | 2.0 CRDi  | 83        | 04.01 | 10.01 | 2.0 i 16V | 102       | 06.00 | 10.01 | 2.0 i 16V | 104       | 06.00 | 10.01 |          |          |       |       |           |           |       |       |           |           |       |       |           |           |       |       |       |
| 1.5 16V  | 75  | 09.00    | 10.01       | 03.0137-9270.2 | 669270      |                |        |       |                     |          | Bremsbacken-Zubehör |                     |             |             |           |       |             |             |           |       |             |              |              |       |       |           |           |       |       |           |           |       |       |           |           |       |       |           |           |       |       |          |          |       |       |           |           |       |       |           |           |       |       |           |           |       |       |       |
| 1.5 D  | 82  | 06.00    | 10.01       |                |             |                |        |       |                     |          |                     |                     |             |             |           |       |             |             |           |       |             |              |              |       |       |           |           |       |       |           |           |       |       |           |           |       |       |           |           |       |       |          |          |       |       |           |           |       |       |           |           |       |       |           |           |       |       |       |
| 1.6 i 16V  | 66  | 06.00    | 10.01       |                |             |                |        |       |                     |          |                     |                     |             |             |           |       |             |             |           |       |             |              |              |       |       |           |           |       |       |           |           |       |       |           |           |       |       |           |           |       |       |          |          |       |       |           |           |       |       |           |           |       |       |           |           |       |       |       |
| 1.6 i 16V  | 79  | 06.00    | 10.01       |                |             |                |        |       |                     |          |                     |                     |             |             |           |       |             |             |           |       |             |              |              |       |       |           |           |       |       |           |           |       |       |           |           |       |       |           |           |       |       |          |          |       |       |           |           |       |       |           |           |       |       |           |           |       |       |       |
| 1.8 i 16V  | 79  | 06.00    | 10.01       |                |             |                |        |       |                     |          |                     |                     |             |             |           |       |             |             |           |       |             |              |              |       |       |           |           |       |       |           |           |       |       |           |           |       |       |           |           |       |       |          |          |       |       |           |           |       |       |           |           |       |       |           |           |       |       |       |
| 1.8 i 16V  | 97  | 06.00    | 10.01       |                |             |                |        |       |                     |          |                     |                     |             |             |           |       |             |             |           |       |             |              |              |       |       |           |           |       |       |           |           |       |       |           |           |       |       |           |           |       |       |          |          |       |       |           |           |       |       |           |           |       |       |           |           |       |       |       |
| 2.0 CRDi   | 83  | 04.01    | 10.01       |                |             |                |        |       |                     |          |                     |                     |             |             |           |       |             |             |           |       |             |              |              |       |       |           |           |       |       |           |           |       |       |           |           |       |       |           |           |       |       |          |          |       |       |           |           |       |       |           |           |       |       |           |           |       |       |       |
| 2.0 i 16V  | 102   | 06.00    | 10.01       |                |             |                |        |       |                     |          |                     |                     |             |             |           |       |             |             |           |       |             |              |              |       |       |           |           |       |       |           |           |       |       |           |           |       |       |           |           |       |       |          |          |       |       |           |           |       |       |           |           |       |       |           |           |       |       |       |
| 2.0 i 16V  | 104   | 06.00    | 10.01       |                |             |                |        |       |                     |          |                     |                     |             |             |           |       |             |             |           |       |             |              |              |       |       |           |           |       |       |           |           |       |       |           |           |       |       |           |           |       |       |          |          |       |       |           |           |       |       |           |           |       |       |           |           |       |       |       |
|    | <table border="1"> <tr><td>1.5 16V</td><td>75</td><td>09.00</td><td>10.01</td><td rowspan="9">24.0220-3045.1</td><td rowspan="9">480191</td><td rowspan="9">- ABS</td><td rowspan="9">203/204,5 x 45,5</td></tr> <tr><td>1.5 D</td><td>82</td><td>06.00</td><td>10.01</td></tr> <tr><td>1.6 i 16V</td><td>66</td><td>06.00</td><td>10.01</td></tr> <tr><td>1.6 i 16V</td><td>79</td><td>06.00</td><td>10.01</td></tr> <tr><td>1.8 i 16V</td><td>79</td><td>06.00</td><td>10.01</td></tr> <tr><td>1.8 i 16V</td><td>97</td><td>06.00</td><td>10.01</td></tr> <tr><td>2.0 CRDi</td><td>83</td><td>04.01</td><td>10.01</td></tr> <tr><td>2.0 i 16V</td><td>102</td><td>06.00</td><td>10.01</td></tr> <tr><td>2.0 i 16V</td><td>104</td><td>06.00</td><td>10.01</td></tr> </table>  | 1.5 16V  | 75          | 09.00          | 10.01       | 24.0220-3045.1 | 480191 | - ABS | 203/204,5 x 45,5    | 1.5 D    | 82                  | 06.00               | 10.01       | 1.6 i 16V   | 66        | 06.00 | 10.01       | 1.6 i 16V   | 79        | 06.00 | 10.01       | 1.8 i 16V    | 79           | 06.00 | 10.01 | 1.8 i 16V | 97        | 06.00 | 10.01 | 2.0 CRDi  | 83        | 04.01 | 10.01 | 2.0 i 16V | 102       | 06.00 | 10.01 | 2.0 i 16V | 104       | 06.00 | 10.01 |          |          |       |       |           |           |       |       |           |           |       |       |           |           |       |       |       |
| 1.5 16V  | 75  | 09.00    | 10.01       | 24.0220-3045.1 | 480191      |                |        |       |                     | - ABS    | 203/204,5 x 45,5    |                     |             |             |           |       |             |             |           |       |             |              |              |       |       |           |           |       |       |           |           |       |       |           |           |       |       |           |           |       |       |          |          |       |       |           |           |       |       |           |           |       |       |           |           |       |       |       |
| 1.5 D  | 82  | 06.00    | 10.01       |                |             |                |        |       |                     |          |                     |                     |             |             |           |       |             |             |           |       |             |              |              |       |       |           |           |       |       |           |           |       |       |           |           |       |       |           |           |       |       |          |          |       |       |           |           |       |       |           |           |       |       |           |           |       |       |       |
| 1.6 i 16V  | 66  | 06.00    | 10.01       |                |             |                |        |       |                     |          |                     |                     |             |             |           |       |             |             |           |       |             |              |              |       |       |           |           |       |       |           |           |       |       |           |           |       |       |           |           |       |       |          |          |       |       |           |           |       |       |           |           |       |       |           |           |       |       |       |
| 1.6 i 16V  | 79  | 06.00    | 10.01       |                |             |                |        |       |                     |          |                     |                     |             |             |           |       |             |             |           |       |             |              |              |       |       |           |           |       |       |           |           |       |       |           |           |       |       |           |           |       |       |          |          |       |       |           |           |       |       |           |           |       |       |           |           |       |       |       |
| 1.8 i 16V  | 79  | 06.00    | 10.01       |                |             |                |        |       |                     |          |                     |                     |             |             |           |       |             |             |           |       |             |              |              |       |       |           |           |       |       |           |           |       |       |           |           |       |       |           |           |       |       |          |          |       |       |           |           |       |       |           |           |       |       |           |           |       |       |       |
| 1.8 i 16V  | 97  | 06.00    | 10.01       |                |             |                |        |       |                     |          |                     |                     |             |             |           |       |             |             |           |       |             |              |              |       |       |           |           |       |       |           |           |       |       |           |           |       |       |           |           |       |       |          |          |       |       |           |           |       |       |           |           |       |       |           |           |       |       |       |
| 2.0 CRDi   | 83  | 04.01    | 10.01       |                |             |                |        |       |                     |          |                     |                     |             |             |           |       |             |             |           |       |             |              |              |       |       |           |           |       |       |           |           |       |       |           |           |       |       |           |           |       |       |          |          |       |       |           |           |       |       |           |           |       |       |           |           |       |       |       |
| 2.0 i 16V  | 102   | 06.00    | 10.01       |                |             |                |        |       |                     |          |                     |                     |             |             |           |       |             |             |           |       |             |              |              |       |       |           |           |       |       |           |           |       |       |           |           |       |       |           |           |       |       |          |          |       |       |           |           |       |       |           |           |       |       |           |           |       |       |       |
| 2.0 i 16V  | 104   | 06.00    | 10.01       |                |             |                |        |       |                     |          |                     |                     |             |             |           |       |             |             |           |       |             |              |              |       |       |           |           |       |       |           |           |       |       |           |           |       |       |           |           |       |       |          |          |       |       |           |           |       |       |           |           |       |       |           |           |       |       |       |
| HYUNDAI ELANTRA (06-11)  |   |          |             |                |             |                |        |       |                     |          |                     |                     |             |             |           |       |             |             |           |       |             |              |              |       |       |           |           |       |       |           |           |       |       |           |           |       |       |           |           |       |       |          |          |       |       |           |           |       |       |           |           |       |       |           |           |       |       |       |
|  | <table border="1"> <tr><td>1.6 CRDi</td><td>85</td><td>11.05</td><td>12.11</td><td rowspan="4">13.0460-5873.2</td><td rowspan="4">605873</td><td rowspan="4"></td><td rowspan="4">23891 16,9 +/WK</td><td rowspan="4">MAN</td></tr> <tr><td>1.6 CVVT</td><td>90</td><td>06.06</td><td>12.11</td></tr> <tr><td>1.6 D</td><td>85</td><td>05.06</td><td>12.11</td></tr> <tr><td>2.0 CVVT</td><td>105</td><td>06.06</td><td>12.11</td></tr> </table>  | 1.6 CRDi | 85          | 11.05          | 12.11       | 13.0460-5873.2 | 605873 |       | 23891 16,9 +/WK     | MAN      | 1.6 CVVT            | 90                  | 06.06       | 12.11       | 1.6 D     | 85    | 05.06       | 12.11       | 2.0 CVVT  | 105   | 06.06       | 12.11        |              |       |       |           |           |       |       |           |           |       |       |           |           |       |       |           |           |       |       |          |          |       |       |           |           |       |       |           |           |       |       |           |           |       |       |       |
| 1.6 CRDi   | 85  | 11.05    | 12.11       | 13.0460-5873.2 | 605873      |                |        |       |                     |          |                     | 23891 16,9 +/WK     | MAN         |             |           |       |             |             |           |       |             |              |              |       |       |           |           |       |       |           |           |       |       |           |           |       |       |           |           |       |       |          |          |       |       |           |           |       |       |           |           |       |       |           |           |       |       |       |
| 1.6 CVVT   | 90  | 06.06    | 12.11       |                |             |                |        |       |                     |          |                     |                     |             |             |           |       |             |             |           |       |             |              |              |       |       |           |           |       |       |           |           |       |       |           |           |       |       |           |           |       |       |          |          |       |       |           |           |       |       |           |           |       |       |           |           |       |       |       |
| 1.6 D  | 85  | 05.06    | 12.11       |                |             |                |        |       |                     |          |                     |                     |             |             |           |       |             |             |           |       |             |              |              |       |       |           |           |       |       |           |           |       |       |           |           |       |       |           |           |       |       |          |          |       |       |           |           |       |       |           |           |       |       |           |           |       |       |       |
| 2.0 CVVT   | 105   | 06.06    | 12.11       |                |             |                |        |       |                     |          |                     |                     |             |             |           |       |             |             |           |       |             |              |              |       |       |           |           |       |       |           |           |       |       |           |           |       |       |           |           |       |       |          |          |       |       |           |           |       |       |           |           |       |       |           |           |       |       |       |
|  | <table border="1"> <tr><td>1.6 CRDi</td><td>85</td><td>11.05</td><td>12.11</td><td rowspan="4">24.0126-0157.1</td><td rowspan="4">426157</td><td rowspan="4"></td><td rowspan="4">275 26,0 24,0 V +B</td></tr> <tr><td>1.6 CVVT</td><td>90</td><td>06.06</td><td>12.11</td></tr> <tr><td>1.6 D</td><td>85</td><td>05.06</td><td>12.11</td></tr> <tr><td>2.0 CVVT</td><td>105</td><td>06.06</td><td>12.11</td></tr> </table>   | 1.6 CRDi | 85          | 11.05          | 12.11       | 24.0126-0157.1 | 426157 |       | 275 26,0 24,0 V +B  | 1.6 CVVT | 90                  | 06.06               | 12.11       | 1.6 D       | 85        | 05.06 | 12.11       | 2.0 CVVT    | 105       | 06.06 | 12.11       |              |              |       |       |           |           |       |       |           |           |       |       |           |           |       |       |           |           |       |       |          |          |       |       |           |           |       |       |           |           |       |       |           |           |       |       |       |
| 1.6 CRDi   | 85  | 11.05    | 12.11       | 24.0126-0157.1 | 426157      |                |        |       |                     |          | 275 26,0 24,0 V +B  |                     |             |             |           |       |             |             |           |       |             |              |              |       |       |           |           |       |       |           |           |       |       |           |           |       |       |           |           |       |       |          |          |       |       |           |           |       |       |           |           |       |       |           |           |       |       |       |
| 1.6 CVVT   | 90  | 06.06    | 12.11       |                |             |                |        |       |                     |          |                     |                     |             |             |           |       |             |             |           |       |             |              |              |       |       |           |           |       |       |           |           |       |       |           |           |       |       |           |           |       |       |          |          |       |       |           |           |       |       |           |           |       |       |           |           |       |       |       |
| 1.6 D  | 85  | 05.06    | 12.11       |                |             |                |        |       |                     |          |                     |                     |             |             |           |       |             |             |           |       |             |              |              |       |       |           |           |       |       |           |           |       |       |           |           |       |       |           |           |       |       |          |          |       |       |           |           |       |       |           |           |       |       |           |           |       |       |       |
| 2.0 CVVT   | 105   | 06.06    | 12.11       |                |             |                |        |       |                     |          |                     |                     |             |             |           |       |             |             |           |       |             |              |              |       |       |           |           |       |       |           |           |       |       |           |           |       |       |           |           |       |       |          |          |       |       |           |           |       |       |           |           |       |       |           |           |       |       |       |
|  | <table border="1"> <tr><td>1.6 CRDi</td><td>85</td><td>11.05</td><td>12.11 + ABS</td><td rowspan="4">13.0460-5833.2</td><td rowspan="4">605833</td><td rowspan="4"></td><td rowspan="4">23543 14,4 +/WK/Zub</td><td rowspan="4">AKE</td></tr> <tr><td>1.6 CVVT</td><td>90</td><td>06.06</td><td>12.11 + ABS</td></tr> <tr><td>1.6 D</td><td>85</td><td>05.06</td><td>12.11 + ABS</td></tr> <tr><td>2.0 CVVT</td><td>105</td><td>06.06</td><td>12.11 + ABS</td></tr> </table>  | 1.6 CRDi | 85          | 11.05          | 12.11 + ABS | 13.0460-5833.2 | 605833 |       | 23543 14,4 +/WK/Zub | AKE      | 1.6 CVVT            | 90                  | 06.06       | 12.11 + ABS | 1.6 D     | 85    | 05.06       | 12.11 + ABS | 2.0 CVVT  | 105   | 06.06       | 12.11 + ABS  |              |       |       |           |           |       |       |           |           |       |       |           |           |       |       |           |           |       |       |          |          |       |       |           |           |       |       |           |           |       |       |           |           |       |       |       |
| 1.6 CRDi   | 85  | 11.05    | 12.11 + ABS | 13.0460-5833.2 | 605833      |                |        |       |                     |          |                     | 23543 14,4 +/WK/Zub | AKE         |             |           |       |             |             |           |       |             |              |              |       |       |           |           |       |       |           |           |       |       |           |           |       |       |           |           |       |       |          |          |       |       |           |           |       |       |           |           |       |       |           |           |       |       |       |
| 1.6 CVVT   | 90  | 06.06    | 12.11 + ABS |                |             |                |        |       |                     |          |                     |                     |             |             |           |       |             |             |           |       |             |              |              |       |       |           |           |       |       |           |           |       |       |           |           |       |       |           |           |       |       |          |          |       |       |           |           |       |       |           |           |       |       |           |           |       |       |       |
| 1.6 D  | 85  | 05.06    | 12.11 + ABS |                |             |                |        |       |                     |          |                     |                     |             |             |           |       |             |             |           |       |             |              |              |       |       |           |           |       |       |           |           |       |       |           |           |       |       |           |           |       |       |          |          |       |       |           |           |       |       |           |           |       |       |           |           |       |       |       |
| 2.0 CVVT   | 105   | 06.06    | 12.11 + ABS |                |             |                |        |       |                     |          |                     |                     |             |             |           |       |             |             |           |       |             |              |              |       |       |           |           |       |       |           |           |       |       |           |           |       |       |           |           |       |       |          |          |       |       |           |           |       |       |           |           |       |       |           |           |       |       |       |
|  | <table border="1"> <tr><td>1.6 CRDi</td><td>85</td><td>11.05</td><td>12.11 + ABS</td><td rowspan="4">24.0110-0338.1</td><td rowspan="4">410338</td><td rowspan="4"></td><td rowspan="4">262 10,0 8,4 +B</td></tr> <tr><td>1.6 CVVT</td><td>90</td><td>06.06</td><td>12.11 + ABS</td></tr> <tr><td>1.6 D</td><td>85</td><td>05.06</td><td>12.11 + ABS</td></tr> <tr><td>2.0 CVVT</td><td>105</td><td>06.06</td><td>12.11 + ABS</td></tr> </table>  | 1.6 CRDi | 85          | 11.05          | 12.11 + ABS | 24.0110-0338.1 | 410338 |       | 262 10,0 8,4 +B     | 1.6 CVVT | 90                  | 06.06               | 12.11 + ABS | 1.6 D       | 85        | 05.06 | 12.11 + ABS | 2.0 CVVT    | 105       | 06.06 | 12.11 + ABS |              |              |       |       |           |           |       |       |           |           |       |       |           |           |       |       |           |           |       |       |          |          |       |       |           |           |       |       |           |           |       |       |           |           |       |       |       |
| 1.6 CRDi   | 85  | 11.05    | 12.11 + ABS | 24.0110-0338.1 | 410338      |                |        |       |                     |          | 262 10,0 8,4 +B     |                     |             |             |           |       |             |             |           |       |             |              |              |       |       |           |           |       |       |           |           |       |       |           |           |       |       |           |           |       |       |          |          |       |       |           |           |       |       |           |           |       |       |           |           |       |       |       |
| 1.6 CVVT   | 90  | 06.06    | 12.11 + ABS |                |             |                |        |       |                     |          |                     |                     |             |             |           |       |             |             |           |       |             |              |              |       |       |           |           |       |       |           |           |       |       |           |           |       |       |           |           |       |       |          |          |       |       |           |           |       |       |           |           |       |       |           |           |       |       |       |
| 1.6 D  | 85  | 05.06    | 12.11 + ABS |                |             |                |        |       |                     |          |                     |                     |             |             |           |       |             |             |           |       |             |              |              |       |       |           |           |       |       |           |           |       |       |           |           |       |       |           |           |       |       |          |          |       |       |           |           |       |       |           |           |       |       |           |           |       |       |       |
| 2.0 CVVT   | 105   | 06.06    | 12.11 + ABS |                |             |                |        |       |                     |          |                     |                     |             |             |           |       |             |             |           |       |             |              |              |       |       |           |           |       |       |           |           |       |       |           |           |       |       |           |           |       |       |          |          |       |       |           |           |       |       |           |           |       |       |           |           |       |       |       |
| HYUNDAI ELANTRA (11-)  |   |          |             |                |             |                |        |       |                     |          |                     |                     |             |             |           |       |             |             |           |       |             |              |              |       |       |           |           |       |       |           |           |       |       |           |           |       |       |           |           |       |       |          |          |       |       |           |           |       |       |           |           |       |       |           |           |       |       |       |
|  | <table border="1"> <tr><td>1.6 16V</td><td>94</td><td>06.11</td><td></td><td rowspan="6">13.0460-5645.2</td><td rowspan="6">605645</td><td rowspan="6"></td><td rowspan="6">25692 17,2 +/WK/Zub</td></tr> <tr><td>1.6 16V</td><td>97</td><td>06.11</td><td></td></tr> <tr><td>1.6 CRDi</td><td>100</td><td>01.16</td><td></td></tr> <tr><td>1.8 16V</td><td>110</td><td>06.11</td><td></td></tr> <tr><td>1.8 16V Flex</td><td>118</td><td>02.11</td><td></td></tr> <tr><td>2.0 GDI</td><td>112</td><td>01.16</td><td></td></tr> </table>  | 1.6 16V  | 94          | 06.11          |             | 13.0460-5645.2 | 605645 |       | 25692 17,2 +/WK/Zub | 1.6 16V  | 97                  | 06.11               |             | 1.6 CRDi    | 100       | 01.16 |             | 1.8 16V     | 110       | 06.11 |             | 1.8 16V Flex | 118          | 02.11 |       | 2.0 GDI   | 112       | 01.16 |       |           |           |       |       |           |           |       |       |           |           |       |       |          |          |       |       |           |           |       |       |           |           |       |       |           |           |       |       |       |
| 1.6 16V  | 94  | 06.11    |             | 13.0460-5645.2 | 605645      |                |        |       |                     |          | 25692 17,2 +/WK/Zub |                     |             |             |           |       |             |             |           |       |             |              |              |       |       |           |           |       |       |           |           |       |       |           |           |       |       |           |           |       |       |          |          |       |       |           |           |       |       |           |           |       |       |           |           |       |       |       |
| 1.6 16V  | 97  | 06.11    |             |                |             |                |        |       |                     |          |                     |                     |             |             |           |       |             |             |           |       |             |              |              |       |       |           |           |       |       |           |           |       |       |           |           |       |       |           |           |       |       |          |          |       |       |           |           |       |       |           |           |       |       |           |           |       |       |       |
| 1.6 CRDi   | 100   | 01.16    |             |                |             |                |        |       |                     |          |                     |                     |             |             |           |       |             |             |           |       |             |              |              |       |       |           |           |       |       |           |           |       |       |           |           |       |       |           |           |       |       |          |          |       |       |           |           |       |       |           |           |       |       |           |           |       |       |       |
| 1.8 16V  | 110   | 06.11    |             |                |             |                |        |       |                     |          |                     |                     |             |             |           |       |             |             |           |       |             |              |              |       |       |           |           |       |       |           |           |       |       |           |           |       |       |           |           |       |       |          |          |       |       |           |           |       |       |           |           |       |       |           |           |       |       |       |
| 1.8 16V Flex   | 118   | 02.11    |             |                |             |                |        |       |                     |          |                     |                     |             |             |           |       |             |             |           |       |             |              |              |       |       |           |           |       |       |           |           |       |       |           |           |       |       |           |           |       |       |          |          |       |       |           |           |       |       |           |           |       |       |           |           |       |       |       |
| 2.0 GDI  | 112   | 01.16    |             |                |             |                |        |       |                     |          |                     |                     |             |             |           |       |             |             |           |       |             |              |              |       |       |           |           |       |       |           |           |       |       |           |           |       |       |           |           |       |       |          |          |       |       |           |           |       |       |           |           |       |       |           |           |       |       |       |
|  | <table border="1"> <tr><td>1.6 16V</td><td>94</td><td>06.11</td><td></td><td rowspan="6">13.0460-5786.2</td><td rowspan="6">605786</td><td rowspan="6"></td><td rowspan="6">24934 15,5 +/WK/Zub</td><td rowspan="6">AKE</td></tr> <tr><td>1.6 16V</td><td>97</td><td>06.11</td><td></td></tr> <tr><td>1.6 CRDi</td><td>100</td><td>01.16</td><td></td></tr> <tr><td>1.8 16V</td><td>110</td><td>06.11</td><td></td></tr> <tr><td>1.8 16V Flex</td><td>118</td><td>02.11</td><td></td></tr> <tr><td>2.0 GDI</td><td>112</td><td>01.16</td><td></td></tr> </table>  | 1.6 16V  | 94          | 06.11          |             | 13.0460-5786.2 | 605786 |       | 24934 15,5 +/WK/Zub | AKE      | 1.6 16V             | 97                  | 06.11       |             | 1.6 CRDi  | 100   | 01.16       |             | 1.8 16V   | 110   | 06.11       |              | 1.8 16V Flex | 118   | 02.11 |           | 2.0 GDI   | 112   | 01.16 |           |           |       |       |           |           |       |       |           |           |       |       |          |          |       |       |           |           |       |       |           |           |       |       |           |           |       |       |       |
| 1.6 16V  | 94  | 06.11    |             | 13.0460-5786.2 | 605786      |                |        |       |                     |          |                     | 24934 15,5 +/WK/Zub | AKE         |             |           |       |             |             |           |       |             |              |              |       |       |           |           |       |       |           |           |       |       |           |           |       |       |           |           |       |       |          |          |       |       |           |           |       |       |           |           |       |       |           |           |       |       |       |
| 1.6 16V  | 97  | 06.11    |             |                |             |                |        |       |                     |          |                     |                     |             |             |           |       |             |             |           |       |             |              |              |       |       |           |           |       |       |           |           |       |       |           |           |       |       |           |           |       |       |          |          |       |       |           |           |       |       |           |           |       |       |           |           |       |       |       |
| 1.6 CRDi   | 100   | 01.16    |             |                |             |                |        |       |                     |          |                     |                     |             |             |           |       |             |             |           |       |             |              |              |       |       |           |           |       |       |           |           |       |       |           |           |       |       |           |           |       |       |          |          |       |       |           |           |       |       |           |           |       |       |           |           |       |       |       |
| 1.8 16V  | 110   | 06.11    |             |                |             |                |        |       |                     |          |                     |                     |             |             |           |       |             |             |           |       |             |              |              |       |       |           |           |       |       |           |           |       |       |           |           |       |       |           |           |       |       |          |          |       |       |           |           |       |       |           |           |       |       |           |           |       |       |       |
| 1.8 16V Flex   | 118   | 02.11    |             |                |             |                |        |       |                     |          |                     |                     |             |             |           |       |             |             |           |       |             |              |              |       |       |           |           |       |       |           |           |       |       |           |           |       |       |           |           |       |       |          |          |       |       |           |           |       |       |           |           |       |       |           |           |       |       |       |
| 2.0 GDI  | 112   | 01.16    |             |                |             |                |        |       |                     |          |                     |                     |             |             |           |       |             |             |           |       |             |              |              |       |       |           |           |       |       |           |           |       |       |           |           |       |       |           |           |       |       |          |          |       |       |           |           |       |       |           |           |       |       |           |           |       |       |       |
|  | <table border="1"> <tr><td>1.6 16V</td><td>94</td><td>06.11</td><td></td><td rowspan="6">24.0110-0368.1</td><td rowspan="6">410368</td><td rowspan="6"></td><td rowspan="6">262 10,0 8,4 +B</td></tr> <tr><td>1.6 16V</td><td>97</td><td>06.11</td><td></td></tr> <tr><td>1.6 CRDi</td><td>100</td><td>01.16</td><td></td></tr> <tr><td>1.8 16V</td><td>110</td><td>06.11</td><td></td></tr> <tr><td>1.8 16V Flex</td><td>118</td><td>02.11</td><td></td></tr> <tr><td>2.0 GDI</td><td>112</td><td>01.16</td><td></td></tr> </table>  | 1.6 16V  | 94          | 06.11          |             | 24.0110-0368.1 | 410368 |       | 262 10,0 8,4 +B     | 1.6 16V  | 97                  | 06.11               |             | 1.6 CRDi    | 100       | 01.16 |             | 1.8 16V     | 110       | 06.11 |             | 1.8 16V Flex | 118          | 02.11 |       | 2.0 GDI   | 112       | 01.16 |       |           |           |       |       |           |           |       |       |           |           |       |       |          |          |       |       |           |           |       |       |           |           |       |       |           |           |       |       |       |
| 1.6 16V  | 94  | 06.11    |             | 24.0110-0368.1 | 410368      |                |        |       |                     |          | 262 10,0 8,4 +B     |                     |             |             |           |       |             |             |           |       |             |              |              |       |       |           |           |       |       |           |           |       |       |           |           |       |       |           |           |       |       |          |          |       |       |           |           |       |       |           |           |       |       |           |           |       |       |       |
| 1.6 16V  | 97  | 06.11    |             |                |             |                |        |       |                     |          |                     |                     |             |             |           |       |             |             |           |       |             |              |              |       |       |           |           |       |       |           |           |       |       |           |           |       |       |           |           |       |       |          |          |       |       |           |           |       |       |           |           |       |       |           |           |       |       |       |
| 1.6 CRDi   | 100   | 01.16    |             |                |             |                |        |       |                     |          |                     |                     |             |             |           |       |             |             |           |       |             |              |              |       |       |           |           |       |       |           |           |       |       |           |           |       |       |           |           |       |       |          |          |       |       |           |           |       |       |           |           |       |       |           |           |       |       |       |
| 1.8 16V  | 110   | 06.11    |             |                |             |                |        |       |                     |          |                     |                     |             |             |           |       |             |             |           |       |             |              |              |       |       |           |           |       |       |           |           |       |       |           |           |       |       |           |           |       |       |          |          |       |       |           |           |       |       |           |           |       |       |           |           |       |       |       |
| 1.8 16V Flex   | 118   | 02.11    |             |                |             |                |        |       |                     |          |                     |                     |             |             |           |       |             |             |           |       |             |              |              |       |       |           |           |       |       |           |           |       |       |           |           |       |       |           |           |       |       |          |          |       |       |           |           |       |       |           |           |       |       |           |           |       |       |       |
| 2.0 GDI  | 112   | 01.16    |             |                |             |                |        |       |                     |          |                     |                     |             |             |           |       |             |             |           |       |             |              |              |       |       |           |           |       |       |           |           |       |       |           |           |       |       |           |           |       |       |          |          |       |       |           |           |       |       |           |           |       |       |           |           |       |       |       |

|     |    kW   |  |    |  |  |  |  |  |
|--|---|--|--|--|---|--|--|--|
| <b>HYUNDAI GALLOPER (98-03)</b>  |   |  |  |  |   |  |  |  |
|    | 2.5 Tci D 77<br>2.5 TD 65<br>2.5 TD Intercooler 73<br>2.6 TD Allrad 63<br>3.0 i V6 104  |  | 08.98 12.03<br>08.98 12.03<br>08.98 12.03<br>08.98 06.03<br>08.98 12.03  |  | 13.0460-5885.2 605885   |  |  | 23518 17,0 +WK/Zub <b>SUM</b>  |
|    | 2.5 Tci D 77<br>2.5 TD 65<br>2.5 TD Intercooler 73<br>2.6 TD Allrad 63<br>3.0 i V6 104  |  | 08.98 12.03 - ABS<br>08.98 12.03 - ABS<br>08.98 12.03 - ABS<br>08.98 06.03 - ABS<br>08.98 12.03 - ABS  |  | 24.0122-0175.1 422175   |  |  | 277 22,0 20,4 V  |
|  | 2.5 Tci D 77<br>2.5 TD 65<br>2.5 TD Intercooler 73<br>2.6 TD Allrad 63<br>3.0 i V6 104  |  | 08.98 12.03 + ABS<br>08.98 12.03 + ABS<br>08.98 12.03 + ABS<br>08.98 06.03 + ABS<br>08.98 12.03 + ABS  |  | 24.0122-0237.1 422237   |  |  | 277 22,0 20,4 V +B   |
| <b>HYUNDAI GETZ (02-09)</b>  |   |  |  |  |   |  |  |  |
|    | 1.1 i 12V 46<br>1.1 i 12V 49<br>1.3 i 12V 60<br>1.3 i 12V 63<br>1.4 i 16V 71<br>1.5 CRDi 60<br>1.5 CRDi 65<br>1.5 CRDi GLS 75<br>1.5 CRDi GLS 81<br>1.5 i GL 73<br>1.6 i 16V 77<br>1.6 i 16V 78 |  | 09.02 07.05<br>08.05 02.09<br>09.02 04.05<br>09.03 04.05<br>08.05 02.09<br>03.03 04.05<br>08.05 02.09<br>07.04 07.05<br>08.05 02.09<br>08.02 07.05 - ⊕<br>09.02 07.05<br>08.05 02.09   |  | 13.0460-5872.2 605872   |  |  | 21012 15,0 +WK/Zub <b>AKE</b>  |
|    | 1.1 i 12V 46<br>1.1 i 12V 49<br>1.3 i 12V 60<br>1.3 i 12V 63<br>1.4 i 16V 71<br>1.5 CRDi 60<br>1.5 CRDi GLS 75<br>1.5 CRDi GLS 81<br>1.5 i GL 73<br>1.6 i 16V 77<br>1.6 i 16V 78                |  | 09.02 07.05<br>08.05 02.09<br>09.02 04.05<br>09.03 04.05<br>08.05 02.09<br>03.03 04.05<br>07.04 07.05<br>08.05 02.09<br>08.02 07.05 - ⊕<br>09.02 07.05<br>08.05 02.09  |  | 24.0119-0115.1 419115   |  | + 13" Rad 1)   | 241 19,0 17,0 V +B   |
|  | 1.1 i 12V 46<br>1.1 i 12V 49<br>1.3 i 12V 60<br>1.3 i 12V 63<br>1.4 i 16V 71<br>1.5 CRDi 60<br>1.5 CRDi 65<br>1.5 CRDi GLS 75<br>1.5 CRDi GLS 81<br>1.6 i 16V 77<br>1.6 i 16V 78                |  | 09.02 07.05<br>08.05 02.09<br>09.02 04.05<br>09.03 04.05<br>08.05 02.09<br>03.03 04.05<br>08.05 02.09<br>07.04 07.05<br>08.05 02.09<br>09.02 07.05<br>08.05 02.09  |  | 24.0119-0116.1 419116   |  | + 14" Rad 2)   | 256 19,0 17,0 V +B   |
|  | 1.4 i 16V 71<br>1.5 CRDi 60<br>1.5 CRDi 65<br>1.5 CRDi GLS 75<br>1.5 CRDi GLS 81<br>1.6 i 16V 77<br>1.6 i 16V 78  |  | 08.05 02.09 + ABS<br>03.03 04.05 + ABS<br>08.05 02.09 + ABS<br>07.04 07.05 + ABS<br>08.05 02.09 + ABS<br>09.02 07.05 + ABS<br>08.05 02.09 + ABS  |  | 13.0460-5833.2 605833   |  |  | 23543 14,4 +WK/Zub <b>AKE</b>  |
|  | 1.4 i 16V 71<br>1.5 CRDi 60<br>1.5 CRDi 65<br>1.5 CRDi GLS 75<br>1.5 CRDi GLS 81<br>1.6 i 16V 77<br>1.6 i 16V 78  |  | 08.05 02.09 + ABS<br>03.03 04.05 + ABS<br>08.05 02.09 + ABS<br>07.04 07.05 + ABS<br>08.05 02.09 + ABS<br>09.02 07.05 + ABS<br>08.05 02.09 + ABS  |  | 24.0110-0312.1 410312   |  |  | 262 10,0 8,4 +B  |
|  | 1.1 i 12V 46<br>1.1 i 12V 49<br>1.3 i 12V 60<br>1.3 i 12V 63<br>1.4 i 16V 71<br>1.5 CRDi 60<br>1.5 CRDi 65<br>1.5 CRDi GLS 75<br>1.5 CRDi GLS 81<br>1.5 i GL 73<br>1.6 i 16V 77<br>1.6 i 16V 78 |  | 09.02 07.05 - ABS<br>08.05 02.09 - ABS<br>09.02 04.05 - ABS<br>09.03 04.05 - ABS<br>08.05 02.09 - ABS<br>03.03 04.05 - ABS<br>08.05 02.09 - ABS<br>07.04 07.05 - ABS<br>08.05 02.09 - ABS<br>08.02 07.05 - ⊕ / - ABS<br>09.02 07.05 - ABS<br>08.05 02.09 - ABS |  | 03.0137-9292.2 669292   |  |  | Bremsbacken-Zubehör  |
|  | 1.1 i 12V 46<br>1.1 i 12V 49<br>1.3 i 12V 60<br>1.3 i 12V 63<br>1.4 i 16V 71<br>1.5 CRDi 60<br>1.5 CRDi 65<br>1.5 i GL 73<br>1.6 i 16V 77   |  | 09.02 07.05 + ABS<br>08.05 02.09 + ABS<br>09.02 04.05 + ABS<br>09.03 04.05 + ABS<br>08.05 02.09 + ABS<br>03.03 04.05 + ABS<br>08.05 02.09 + ABS<br>08.02 07.05 - ⊕ / + ABS<br>09.02 07.05 + ABS  |  | 03.0137-0456.2 650456   |  |  | 203 x 32 HEB   |

1) + 13" wheel / + ruota 13" / + roue 13" / + rueda 13"

2) + 14" wheel / + ruota 14" / + roue 14" / + rueda 14"

|     |  |  |  |  |  |  |  |  |
|--|--|--|--|--|---|--|--|--|
| <b>HYUNDAI GETZ (02-09)</b>  |  |  |  |  |   |  |  |  |
|    | 1.6 i 16V  | 78   |  | 08.05  | 02.09 + ABS   | 03.0137-0456.2   | 650456   | 203 x 32 HEB   |
|    | 1.1 i 12V  | 46   |  | 09.02  | 07.05 + ABS   | 24.0220-3038.1   | 480315   | 203/205,2 x 38,3   |
|  | 1.1 i 12V  | 49   |  | 08.05  | 02.09 + ABS   |  |  |  |
|  | 1.3 i 12V  | 60   |  | 09.02  | 04.05 + ABS   |  |  |  |
|  | 1.3 i 12V  | 63   |  | 09.03  | 04.05 + ABS   |  |  |  |
|  | 1.4 i 16V  | 71   |  | 08.05  | 02.09 + ABS   |  |  |  |
|  | 1.5 CRDi   | 60   |  | 03.03  | 04.05 + ABS   |  |  |  |
|  | 1.5 CRDi   | 65   |  | 08.05  | 02.09 + ABS   |  |  |  |
|  | 1.5 i GL   | 73   |  | 08.02  | 07.05 - ⊕ / + ABS   |  |  |  |
|  | 1.6 i 16V  | 77   |  | 09.02  | 07.05 + ABS   |  |  |  |
|  | 1.6 i 16V  | 78   |  | 08.05  | 02.09 + ABS   |  |  |  |
|    | 1.1 i 12V  | 46   |  | 09.02  | 07.05   | 03.0520-4417.3   | 694417   | 17,78/203x32 TopKit  |
|  | 1.1 i 12V  | 49   |  | 08.05  | 02.09   |  |  |  |
|  | 1.3 i 12V  | 60   |  | 09.02  | 04.05   |  |  |  |
|  | 1.3 i 12V  | 63   |  | 09.03  | 04.05   |  |  |  |
|  | 1.4 i 16V  | 71   |  | 08.05  | 02.09   |  |  |  |
|  | 1.5 CRDi   | 60   |  | 03.03  | 04.05   |  |  |  |
|  | 1.5 CRDi   | 65   |  | 08.05  | 02.09   |  |  |  |
|  | 1.5 CRDi GLS   | 75   |  | 07.04  | 07.05   |  |  |  |
|  | 1.5 CRDi GLS   | 81   |  | 08.05  | 02.09   |  |  |  |
|  | 1.5 i GL   | 73   |  | 08.02  | 07.05 - ⊕   |  |  |  |
|  | 1.6 i 16V  | 77   |  | 09.02  | 07.05   |  |  |  |
|  | 1.6 i 16V  | 78   |  | 08.05  | 02.09   |  |  |  |
|    | 1.5 CRDi   | 60   |  | 03.03  | 04.05   | 03.0137-3024.2   | 653024   | 170 x 32 HEB   |
|  | 1.5 CRDi   | 65   |  | 08.05  | 02.09   |  |  |  |
|  | 1.5 CRDi GLS   | 75   |  | 07.04  | 07.05   |  |  |  |
|  | 1.5 CRDi GLS   | 81   |  | 08.05  | 02.09   |  |  |  |
|  | 1.6 i 16V  | 77   |  | 09.02  | 07.05   |  |  |  |
|  | 1.6 i 16V  | 78   |  | 08.05  | 02.09   |  |  |  |
| <b>HYUNDAI GRANDEUR (99-05)</b>  |  |  |  |  |   |  |  |  |
|    | 2.5 i V6   | 120  |  | 06.99  | 05.05   | 13.0460-5833.2   | 605833   | 23543 14,4 +/WK/Zub AKE  |
|  | 3.0 i V6   | 138  |  | 09.99  | 10.02   |  |  |  |
|  | 3.0 i V6   | 153  |  | 10.01  | 05.05   |  |  |  |
|  | 3.5 i V6   | 145  |  | 10.02  | 05.05   |  |  |  |
|   | 2.5 i V6   | 120  |  | 06.99  | 05.05   | 24.0110-0318.1   | 410318   | 262 10,0 8,4 +B  |
|  | 3.0 i V6   | 138  |  | 09.99  | 10.02   |  |  |  |
|  | 3.0 i V6   | 153  |  | 10.01  | 05.05   |  |  |  |
|  | 3.5 i V6   | 145  |  | 10.02  | 05.05   |  |  |  |
| <b>HYUNDAI GRANDEUR (05-10)</b>  |  |  |  |  |   |  |  |  |
|  | 2.2 CRDi   | 110  |  | 06.06  | 12.10   | 13.0460-5639.2   | 605639   | 24618 17,5 +/WK  |
|  | 2.2 CRDi   | 114  |  | 06.06  | 12.10   |  |  |  |
|  | 2.7 i V6   | 141  |  | 06.06  | 12.10   |  |  |  |
|  | 3.3 i V6   | 173  |  | 04.05  | 12.10   |  |  |  |
|  | 2.2 CRDi   | 110  |  | 06.06  | 12.10   | 13.0460-5833.2   | 605833   | 23543 14,4 +/WK/Zub AKE  |
|  | 2.2 CRDi   | 114  |  | 06.06  | 12.10   |  |  |  |
|  | 2.7 i V6   | 141  |  | 06.06  | 12.10   |  |  |  |
|  | 3.3 i V6   | 173  |  | 04.05  | 12.10   |  |  |  |
|  | 2.2 CRDi   | 110  |  | 06.06  | 05.07   | 24.0110-0336.1   | 410336   | 284 10,0 8,4 +B  |
|  | 2.2 CRDi   | 114  |  | 06.06  | 05.07   |  |  |  |
|  | 2.7 i V6   | 141  |  | 06.06  | 05.07   |  |  |  |
|  | 3.3 i V6   | 173  |  | 04.05  | 05.07   |  |  |  |
|  | 2.2 CRDi   | 110  |  | 06.07  | 06.10   | 24.0110-0336.1   | 410336   | 284 10,0 8,4 +B  |
|  | 2.2 CRDi   | 114  |  | 06.07  | 12.10   |  |  |  |
|  | 2.7 i V6   | 141  |  | 06.07  | 12.10   |  |  |  |
|  | 3.3 i V6   | 173  |  | 06.07  | 12.10   |  |  |  |
|  | 2.2 CRDi   | 110  |  | 07.10  | 12.10   | 24.0110-0367.1   | 410367   | 284 10,0 8,4 +B  |
| <b>HYUNDAI GRANDEUR (HG) (11-)</b>   |  |  |  |  |   |  |  |  |
|  | 2.4 16V  |  |  | 01.11  |   | 24.0110-0388.1   | 410388   | - elektrische Feststellbremse <sup>1)</sup> 284 10,0 8,4 L +B                      |
| <b>HYUNDAI GRAND SANTA FE (13-)</b>  |  |  |  |  |   |  |  |  |
|  | 2.2 CRDi Allrad  | 145  |  | 06.13  |   | 13.0460-5777.2   | 605777   | 24351 16,3 +/WK/Zub  |
|  | 3.4 Allrad   | 199  |  | 02.14  |   |  |  |  |
|  | 2.2 CRDi Allrad  | 145  |  | 06.13  |   | 24.0128-0248.1   | 428248   | 321 28,0 26,4 V L +B   |
|  | 3.4 Allrad   | 199  |  | 02.14  |   |  |  |  |
|  | 2.2 CRDi Allrad  | 145  |  | 06.13  |   | 13.0460-5633.2   | 605633   | 25520 15,8 +/WK/Zub AKE  |
|  | 3.4 Allrad   | 199  |  | 02.14  |   |  |  |  |
|  | 2.2 CRDi Allrad  | 145  |  | 06.13  |   | 24.0111-0170.1   | 411170   | 302 11,0 9,4 L +B  |

<sup>1)</sup> - electric parking brake / - freno a mano elettrico / - frein à main électrique / - freno de mano eléctrico



### HYUNDAI H-1 KASTEN (00-07)

|          |          |     |       |       |       |                |        |  |       |               |                |     |
|----------|----------|-----|-------|-------|-------|----------------|--------|--|-------|---------------|----------------|-----|
|          | 2.4      | 82  |       | 03.00 | 04.04 | 13.0460-5792.2 | 605792 |  | 23536 | 17,6 +/WK/Zub |                |     |
|          | 2.4      | 107 |       | 11.01 | 10.02 |                |        |  |       |               |                |     |
|          | 2.5 TDiC | 59  |       | 03.00 | 09.00 |                |        |  |       |               |                |     |
|          | 2.5 TDiC | 73  |       | 03.00 | 12.01 |                |        |  |       |               |                |     |
|          | 2.4      | 107 |       | 11.02 | 04.04 |                |        |  |       |               |                |     |
|          | 2.5 CRDi | 81  |       | 07.01 | 04.04 |                |        |  |       |               |                |     |
|          | 2.5 CRDi | 103 |       | 08.03 | 04.04 |                |        |  |       |               |                |     |
| 2.5 TDiC | 73       |     | 01.02 | 04.04 |       |                |        |  |       |               |                |     |
| 2.6 CRDi | 79       |     | 08.05 | 12.07 |       |                |        |  |       |               |                |     |
|          | 2.4      | 82  |       | 03.00 | 04.04 | 24.0124-0220.1 | 424220 |  | 254   | 24,0 22,4 V   |                |     |
|          | 2.5 TDiC | 59  |       | 03.00 | 09.00 |                |        |  |       |               |                |     |
|          | 2.5 TDiC | 73  |       | 03.00 | 10.02 |                |        |  |       |               |                |     |
|          | 2.4      | 107 |       | 11.01 | 10.02 |                |        |  |       |               |                |     |
|          | 2.5 TDiC | 73  |       | 11.02 | 04.04 |                |        |  |       |               |                |     |
|          | 2.4      | 107 |       | 11.02 | 04.04 |                |        |  |       |               |                |     |
|          | 2.5 CRDi | 81  |       | 07.01 | 04.04 |                |        |  |       |               |                |     |
| 2.5 CRDi | 103      |     | 08.03 | 04.04 |       |                |        |  |       |               |                |     |
| 2.6 CRDi | 79       |     | 08.05 | 12.07 |       |                |        |  |       |               |                |     |
|          | 2.4      | 107 |       | 11.01 | 04.04 | 13.0460-5637.2 | 605637 |  | + ABS | 24448         | 14,9 +/WK/Zub  | MAN |
|          | 2.5 CRDi | 81  |       | 07.01 | 04.04 |                |        |  |       |               |                |     |
|          | 2.5 CRDi | 103 |       | 08.03 | 04.04 |                |        |  |       |               |                |     |
|          | 2.6 CRDi | 79  |       | 08.05 | 12.07 |                |        |  |       |               |                |     |
|          | 2.4      | 107 |       | 11.01 | 04.04 |                |        |  |       |               |                |     |
|          | 2.5 CRDi | 81  |       | 07.01 | 04.04 |                |        |  |       |               |                |     |
|          | 2.5 CRDi | 103 |       | 08.03 | 04.04 |                |        |  |       |               |                |     |
| 2.6 CRDi | 79       |     | 08.05 | 12.07 |       |                |        |  |       |               |                |     |
|          | 2.4      | 107 |       | 11.01 | 04.04 | 24.0120-0232.1 | 420232 |  | + ABS | 303           | 20,0 18,4 V +B |     |
|          | 2.5 CRDi | 81  |       | 07.01 | 04.04 |                |        |  |       |               |                |     |
|          | 2.5 CRDi | 103 |       | 08.03 | 04.04 |                |        |  |       |               |                |     |
|          | 2.6 CRDi | 79  |       | 08.05 | 12.07 |                |        |  |       |               |                |     |
|          | 2.4      | 107 |       | 11.01 | 04.04 |                |        |  |       |               |                |     |
|          | 2.5 CRDi | 81  |       | 07.01 | 04.04 |                |        |  |       |               |                |     |
|          | 2.5 CRDi | 103 |       | 08.03 | 04.04 |                |        |  |       |               |                |     |
| 2.6 CRDi | 79       |     | 08.05 | 12.07 |       |                |        |  |       |               |                |     |
|          | 2.4      | 82  |       | 03.00 | 04.04 | 03.0137-0488.2 | 650488 |  |       | 270 x 53      | HEB            |     |
|          | 2.4      | 107 |       | 11.01 | 04.04 |                |        |  |       |               |                |     |
|          | 2.5 CRDi | 81  |       | 07.01 | 04.04 |                |        |  |       |               |                |     |
|          | 2.5 CRDi | 103 |       | 08.03 | 04.04 |                |        |  |       |               |                |     |
|          | 2.5 TDiC | 59  |       | 03.00 | 09.00 |                |        |  |       |               |                |     |
|          | 2.5 TDiC | 73  |       | 03.00 | 04.04 |                |        |  |       |               |                |     |
|          | 2.6 CRDi | 79  |       | 08.05 | 12.07 |                |        |  |       |               |                |     |
|          |          |     |       |       |       |                |        |  |       |               |                |     |

























### HYUNDAI H-1 KASTEN (08-)

|  |          |     |  |       |  |                |        |  |       |          |               |     |
|--|----------|-----|--|-------|--|----------------|--------|--|-------|----------|---------------|-----|
|  | 2.5 CRDi | 81  |  | 02.08 |  | 13.0460-5799.2 | 605799 |  |       | 24597    | 17,7 +/WK/Zub |     |
|  | 2.5 CRDi | 85  |  | 12.08 |  |                |        |  |       |          |               |     |
|  | 2.5 CRDi | 85  |  | 08.11 |  |                |        |  |       |          |               |     |
|  | 2.5 CRDi | 100 |  | 08.09 |  |                |        |  |       |          |               |     |
|  | 2.5 CRDi | 120 |  | 02.08 |  |                |        |  |       |          |               |     |
|  | 2.5 CRDi | 125 |  | 02.08 |  |                |        |  |       |          |               |     |
|  |          |     |  |       |  |                |        |  |       |          |               |     |
|  | 2.5 CRDi | 81  |  | 02.08 |  | 13.0460-5636.2 | 605636 |  | + ABS | 24599    | 14,9 +/WK/Zub | MAN |
|  | 2.5 CRDi | 85  |  | 12.08 |  |                |        |  |       |          |               |     |
|  | 2.5 CRDi | 85  |  | 08.11 |  |                |        |  |       |          |               |     |
|  | 2.5 CRDi | 100 |  | 08.09 |  |                |        |  |       |          |               |     |
|  | 2.5 CRDi | 120 |  | 02.08 |  |                |        |  |       |          |               |     |
|  | 2.5 CRDi | 125 |  | 02.08 |  |                |        |  |       |          |               |     |
|  |          |     |  |       |  |                |        |  |       |          |               |     |
|  | 2.5 CRDi | 81  |  | 02.08 |  | 03.0137-3031.2 | 653031 |  | + ABS | 209 x 40 |               |     |
|  | 2.5 CRDi | 85  |  | 12.08 |  |                |        |  |       |          |               |     |
|  | 2.5 CRDi | 85  |  | 08.11 |  |                |        |  |       |          |               |     |
|  | 2.5 CRDi | 100 |  | 08.09 |  |                |        |  |       |          |               |     |
|  | 2.5 CRDi | 120 |  | 02.08 |  |                |        |  |       |          |               |     |
|  | 2.5 CRDi | 125 |  | 02.08 |  |                |        |  |       |          |               |     |
|  |          |     |  |       |  |                |        |  |       |          |               |     |

















### HYUNDAI H-1 STAREX (97-07)

|              |              |         |     |       |       |                |        |  |  |       |                |       |                |        |  |  |          |             |
|--------------|--------------|---------|-----|-------|-------|----------------|--------|--|--|-------|----------------|-------|----------------|--------|--|--|----------|-------------|
|              | 2.4          | 82      |     | 06.97 | 04.04 | 13.0460-5792.2 | 605792 |  |  | 23536 | 17,6 +/WK/Zub  |       |                |        |  |  |          |             |
|              | 2.4          | 101     |     | 02.03 | 04.04 |                |        |  |  |       |                |       |                |        |  |  |          |             |
|              | 2.4 4WD      | 82      |     | 02.98 | 04.04 |                |        |  |  |       |                |       |                |        |  |  |          |             |
|              | 2.4 4WD      | 99      |     | 06.01 | 04.04 |                |        |  |  |       |                |       |                |        |  |  |          |             |
|              | 2.5 CRDi     | 103     |     | 12.02 | 04.04 |                |        |  |  |       |                |       |                |        |  |  |          |             |
|              | 2.5 CRDi 4WD | 103     |     | 12.02 | 04.04 |                |        |  |  |       |                |       |                |        |  |  |          |             |
|              | 2.5 TCi      | 73      |     | 06.00 | 04.04 |                |        |  |  |       |                |       |                |        |  |  |          |             |
|              | 2.5 TDiC     | 59      |     | 06.97 | 04.04 |                |        |  |  |       |                |       |                |        |  |  |          |             |
|              | 2.5 TDiC     | 74      |     | 05.04 | 12.07 |                |        |  |  |       |                |       |                |        |  |  |          |             |
|              | 2.5 TDiC 4WD | 59      |     | 02.98 | 04.04 |                |        |  |  |       |                |       |                |        |  |  |          |             |
|              | 2.6 TDiC     | 63      |     | 10.97 | 04.04 |                |        |  |  |       |                |       |                |        |  |  |          |             |
|              |              |         |     |       |       |                |        |  |  |       |                |       |                |        |  |  |          |             |
|              |              | 2.4     | 82  |       | 06.97 |                |        |  |  |       |                | 04.04 | 24.0124-0220.1 | 424220 |  |  | 254      | 24,0 22,4 V |
|              |              | 2.4     | 101 |       | 02.03 |                |        |  |  |       |                | 04.04 |                |        |  |  |          |             |
| 2.5 CRDi     |              | 103     |     | 12.02 | 04.04 |                |        |  |  |       |                |       |                |        |  |  |          |             |
| 2.5 TCi      |              | 73      |     | 06.00 | 04.04 |                |        |  |  |       |                |       |                |        |  |  |          |             |
| 2.5 TDiC     |              | 59      |     | 06.97 | 04.04 |                |        |  |  |       |                |       |                |        |  |  |          |             |
| 2.6 TDiC     |              | 63      |     | 10.97 | 04.04 |                |        |  |  |       |                |       |                |        |  |  |          |             |
|              |              |         |     |       |       |                |        |  |  |       |                |       |                |        |  |  |          |             |
|              | 2.4 4WD      | 99      |     | 07.03 | 04.04 | 24.0126-0169.1 | 426169 |  |  | 274   | 26,0 24,4 V +B |       |                |        |  |  |          |             |
|              | 2.5 CRDi     | 103     |     | 07.03 | 04.04 |                |        |  |  |       |                |       |                |        |  |  |          |             |
|              | 2.5 TDiC     | 74      |     | 05.04 | 12.07 |                |        |  |  |       |                |       |                |        |  |  |          |             |
|              |              |         |     |       |       |                |        |  |  |       |                |       |                |        |  |  |          |             |
|              |              | 2.4     | 82  |       | 06.97 |                |        |  |  |       |                | 04.04 | 03.0137-0488.2 | 650488 |  |  | 270 x 53 | HEB         |
|              |              | 2.4     | 101 |       | 02.03 |                |        |  |  |       |                | 04.04 |                |        |  |  |          |             |
|              |              | 2.4 4WD | 82  |       | 02.98 |                |        |  |  |       |                | 04.04 |                |        |  |  |          |             |
| 2.4 4WD      |              | 99      |     | 06.01 | 04.04 |                |        |  |  |       |                |       |                |        |  |  |          |             |
| 2.5 CRDi     |              | 103     |     | 12.02 | 04.04 |                |        |  |  |       |                |       |                |        |  |  |          |             |
| 2.5 CRDi 4WD |              | 103     |     | 12.02 | 04.04 |                |        |  |  |       |                |       |                |        |  |  |          |             |
| 2.5 TCi      |              | 73      |     | 06.00 | 04.04 |                |        |  |  |       |                |       |                |        |  |  |          |             |
| 2.5 TDiC     |              | 59      |     | 06.97 | 04.04 |                |        |  |  |       |                |       |                |        |  |  |          |             |
| 2.5 TDiC     |              | 74      |     | 05.04 | 12.07 |                |        |  |  |       |                |       |                |        |  |  |          |             |
| 2.5 TDiC 4WD |              | 59      |     | 02.98 | 04.04 |                |        |  |  |       |                |       |                |        |  |  |          |             |
| 2.6 TDiC     |              | 63      |     | 10.97 | 04.04 |                |        |  |  |       |                |       |                |        |  |  |          |             |
|              |              |         |     |       |       |                |        |  |  |       |                |       |                |        |  |  |          |             |











|     |  kW              |  |  |  |  |  |  |  |
|--|--|--|--|--|---|--|--|--|
| <b>HYUNDAI H-1 STAREX (07-)</b>  |  |  |  |  |   |  |  |  |
|    | 2.5 CRDi<br>2.5 CRDi   | 81<br>125  |  | 07.10<br>09.07   |   |  | 13.0460-5799.2<br>605799   | 24597 17,7 +WK/Zub   |
|    | 2.5 CRDi<br>2.5 CRDi   | 81<br>125  |  | 07.10<br>09.07   |   |  | 13.0460-5636.2<br>605636   | 24599 14,9 +WK/Zub MAN   |
|    | 2.5 CRDi<br>2.5 CRDi   | 81<br>125  |  | 07.10<br>09.07   |   |  | 03.0137-3031.2<br>653031   | 209 x 40   |
| <b>HYUNDAI H 100 (93-00)</b>   |  |  |  |  |   |  |  |  |
|    | 2.4<br>2.4<br>2.5 D<br>2.5 D<br>2.5 TD   | 84<br>90<br>55<br>57<br>59   |  | 01.97<br>07.93<br>07.93<br>12.94<br>07.93  | 03.00<br>03.00<br>11.94<br>03.00<br>03.00   |  | 13.0460-5718.2<br>605718   | 23081 18,0 +WK TRW   |
|    | 2.4<br>2.4<br>2.5 D<br>2.5 D<br>2.5 TD   | 84<br>90<br>55<br>57<br>59   |  | 01.97<br>07.93<br>07.93<br>12.94<br>07.93  | 03.00<br>03.00<br>11.94<br>03.00<br>03.00   |  | 24.0120-0166.1<br>420166   | 253 20,0 18,4 V  |
|    | 2.4<br>2.4<br>2.5 D<br>2.5 D<br>2.5 TD   | 84<br>90<br>55<br>57<br>59   |  | 01.97<br>07.93<br>07.93<br>12.94<br>07.93  | 03.00<br>03.00<br>11.94<br>03.00<br>03.00   |  | 03.0137-0036.2<br>650036   | 254 x 57 TRW   |
| <b>HYUNDAI HIGHWAY VAN (00-04)</b>   |  |  |  |  |   |  |  |  |
|    | 2.0 CRDi<br>2.0 CVVT<br>2.0 i 16V<br>2.7 i V6  | 83<br>104<br>100<br>125  |  | 03.01<br>11.03<br>03.00<br>03.00   | 03.04<br>03.04<br>03.04<br>03.04  |  | 13.0460-5832.2<br>605832   | 23569 16,5 +WK/Zub   |
|    | 2.0 CRDi<br>2.0 CVVT<br>2.0 i 16V<br>2.7 i V6  | 83<br>104<br>100<br>125  |  | 03.01<br>11.03<br>03.00<br>03.00   | 03.04<br>03.04<br>03.04<br>03.04  |  | 24.0126-0126.1<br>426126   | 276 26,0 24,0 V +B   |
|    | 2.0 CRDi<br>2.0 CVVT<br>2.0 i 16V<br>2.7 i V6  | 83<br>104<br>100<br>125  |  | 03.01<br>11.03<br>03.00<br>03.00   | 03.04<br>03.04<br>03.04<br>03.04  |  | 13.0460-5833.2<br>605833   | 23543 14,4 +WK/Zub AKE   |
|   | 2.0 CRDi<br>2.0 CVVT<br>2.0 i 16V<br>2.7 i V6  | 83<br>104<br>100<br>125  |  | 03.01<br>11.03<br>03.00<br>03.00   | 03.04<br>03.04<br>03.04<br>03.04  |  | 24.0110-0286.1<br>410286   | 284 10,0 8,4 +B  |
| <b>HYUNDAI i10 (08-13)</b>   |  |  |  |  |   |  |  |  |
|  | 1.0 12V<br>1.1 12V<br>1.1 12V<br>1.1 12V<br>1.1 CRDi<br>1.1 LPG<br>1.2 12V<br>1.2 16V<br>1.2 16V | 51<br>48<br>49<br>51<br>55<br>51<br>57<br>59<br>63                               |  | 01.11<br>01.08<br>01.08<br>04.11<br>01.08<br>04.11<br>11.08<br>01.08<br>04.11    | 11.13<br>11.13<br>11.13<br>11.13<br>11.13<br>11.13<br>11.13<br>11.13<br>11.13     |  | 13.0460-5776.2<br>605776   | 24275 16,5 +WK/Zub AKE   |
|  | 1.0 12V<br>1.1 12V<br>1.1 12V<br>1.1 12V<br>1.1 LPG<br>1.2 12V<br>1.2 16V<br>1.2 16V             | 51<br>48<br>49<br>51<br>51<br>57<br>59<br>63                                     |  | 01.11<br>01.08<br>01.08<br>04.11<br>04.11<br>11.08<br>01.08<br>04.11             | 11.13<br>11.13<br>11.13<br>11.13<br>11.13<br>11.13<br>11.13<br>11.13              |  | 24.0118-0145.1<br>418145   | 241 18,0 16,0 V +B   |
|  | 1.1 CRDi   | 55   |  | 01.08  | 11.13   |  | 24.0118-0144.1<br>418144   | 252 18,0 16,0 V +B   |
|  | 1.0 12V<br>1.1 12V<br>1.1 12V<br>1.1 12V<br>1.1 CRDi<br>1.1 LPG<br>1.2 12V<br>1.2 16V<br>1.2 16V | 51<br>48<br>49<br>51<br>55<br>51<br>57<br>59<br>63                               |  | 01.11<br>01.08<br>01.08<br>04.11<br>01.08<br>04.11<br>11.08<br>01.08<br>04.11    | 11.13<br>11.13<br>11.13<br>11.13<br>11.13<br>11.13<br>11.13<br>11.13<br>11.13     |  | 13.0460-5775.2<br>605775   | 24276 14,8 +WK/Zub   |
|  | 1.0 12V<br>1.1 12V<br>1.1 12V<br>1.1 12V<br>1.1 CRDi<br>1.1 LPG<br>1.2 12V<br>1.2 16V<br>1.2 16V | 51<br>48<br>49<br>51<br>55<br>51<br>57<br>59<br>63                               |  | 01.11<br>01.08<br>01.08<br>04.11<br>01.08<br>04.11<br>11.08<br>01.08<br>04.11    | 11.13<br>11.13<br>11.13<br>11.13<br>11.13<br>11.13<br>11.13<br>11.13<br>11.13     |  | 24.0110-0324.1<br>410324   | 234 10,0 8,0 +B  |



|     |   |  |   |  |  |  |  |  |
|--|---|--|---|--|---|--|--|--|
| <b>HYUNDAI i10 (13-)</b>   |   |  |   |  |   |  |  |  |
|    | 1.0 12V<br>1.0 12V LPG<br>1.2 16V   | 49<br>49<br>64   | 12.13<br>02.14<br>12.13   |  | 24.0118-0144.1  | 418144   |  | 252 18,0 16,0 V +B   |
|  | 1.0 12V<br>1.0 12V LPG<br>1.2 16V   | 49<br>49<br>64   | 12.13<br>02.14<br>12.13   | - Leichtmetallfelgen <sup>1)</sup><br>- Leichtmetallfelgen <sup>1)</sup>         | 24.0118-0145.1  | 418145   | Produktionsland (EU)   | 241 18,0 16,0 V +B   |
|    | 1.0 12V<br>1.0 12V LPG<br>1.2 16V   | 49<br>49<br>64   | 12.13<br>02.14<br>12.13   |  | 24.0110-0394.1  | 410394   |  | 234 10,0 8,4 +B  |
| <b>HYUNDAI i20 (08-14)</b>   |   |  |   |  |   |  |  |  |
|    | 1.2 16V<br>1.2 16V<br>1.2 16V   | 57<br>59<br>63   | 09.08 12.14<br>09.08 12.14<br>03.12 12.14   | - ESP<br>- ESP<br>- ESP  | 13.0460-5776.2  | 605776   |  | 24275 16,5 +/WK/Zub AKE  |
|  | 1.1 CRDi<br>1.2 16V<br>1.2 16V<br>1.2 16V<br>1.2 16V<br>1.4 16V<br>1.4 CRDi<br>1.4 CRDi<br>1.6 16V<br>1.6 16V<br>1.6 CRDi<br>1.6 CRDi | 55<br>57<br>59<br>63<br>74<br>55<br>66<br>91<br>93<br>85<br>94                   | 03.12 12.14<br>09.08 12.14 + ESP<br>09.08 12.14 + ESP<br>03.12 12.14 + ESP<br>09.08 12.14<br>08.09 12.14<br>09.08 12.14<br>12.08 12.14<br>09.08 12.14<br>09.08 12.14<br>01.09 12.14   |  | 13.0460-5779.2  | 605779   |  | 24317 17,6 +/WK/Zub  |
|    | 1.2 16V<br>1.2 16V<br>1.2 16V   | 57<br>59<br>63   | 09.08 12.14<br>09.08 12.14<br>03.12 12.14   | - ESP<br>- ESP<br>- ESP  | 24.0118-0151.1  | 418151   |  | 256 18,0 16,0 V +B   |
|  | 1.1 CRDi<br>1.2 16V<br>1.2 16V<br>1.2 16V<br>1.4 16V<br>1.4 CRDi<br>1.4 CRDi<br>1.6 16V<br>1.6 16V<br>1.6 CRDi<br>1.6 CRDi            | 55<br>57<br>59<br>63<br>74<br>55<br>66<br>91<br>93<br>85<br>94                   | 03.12 12.14<br>09.08 12.14 + ESP<br>09.08 12.14 + ESP<br>03.12 12.14 + ESP<br>09.08 12.14<br>08.09 12.14<br>09.08 12.14<br>12.08 12.14<br>09.08 12.14<br>09.08 12.14<br>01.09 12.14   |  | 24.0122-0260.1  | 422260   |  | 256 22,0 20,0 V +B   |
|  | 1.1 CRDi<br>1.2 16V<br>1.2 16V<br>1.2 16V<br>1.4 16V<br>1.4 CRDi<br>1.4 CRDi<br>1.6 16V<br>1.6 16V<br>1.6 CRDi<br>1.6 CRDi            | 55<br>57<br>59<br>63<br>74<br>55<br>66<br>91<br>93<br>85<br>94                   | 03.12 12.14<br>09.08 12.14 + ESP<br>09.08 12.14 + ESP<br>03.12 12.14 + ESP<br>09.08 12.14<br>08.09 12.14<br>09.08 12.14<br>12.08 12.14<br>09.08 12.14<br>09.08 12.14<br>01.09 12.14   |  | 13.0460-5780.2  | 605780   |  | 24320 15,3 +/WK/Zub  |
|  | 1.1 CRDi<br>1.2 16V<br>1.2 16V<br>1.2 16V<br>1.4 16V<br>1.4 CRDi<br>1.4 CRDi<br>1.6 16V<br>1.6 16V<br>1.6 CRDi<br>1.6 CRDi            | 55<br>57<br>59<br>63<br>74<br>55<br>66<br>91<br>93<br>85<br>94                   | 03.12 12.14<br>09.08 12.14 + ESP<br>09.08 12.14 + ESP<br>03.12 12.14 + ESP<br>09.08 12.14<br>08.09 12.14<br>09.08 12.14<br>12.08 12.14<br>09.08 12.14<br>09.08 12.14<br>01.09 12.14   |  | 24.0110-0312.1  | 410312   |  | 262 10,0 8,4 +B  |
|  | 1.1 CRDi<br>1.2 16V<br>1.2 16V<br>1.2 16V<br>1.4 16V<br>1.4 CRDi<br>1.4 CRDi<br>1.6 16V<br>1.6 16V<br>1.6 CRDi<br>1.6 CRDi            | 55<br>57<br>59<br>63<br>74<br>55<br>66<br>91<br>93<br>85<br>94                   | 03.12 12.14 + ESP<br>09.08 12.14 + ESP<br>09.08 12.14 + ESP<br>03.12 12.14 + ESP<br>09.08 12.14 + ESP<br>08.09 12.14 + ESP<br>09.08 12.14 + ESP<br>12.08 12.14 + ESP<br>09.08 12.14 + ESP<br>09.08 12.14 + ESP<br>01.09 12.14 + ESP |  | 03.0137-3026.2  | 653026   |  | 167 x 32 HEB   |
| <b>HYUNDAI i20 / i20 COUPE (GB) (14-)</b>  |   |  |   |  |   |  |  |  |
|  | 1.0 T-GDI<br>1.0 T-GDI<br>1.1 blue CRDi<br>1.1 CRDi<br>1.2<br>1.2<br>1.2 LPGi<br>1.4<br>1.4 CRDi                                      | 74<br>88<br>55<br>55<br>55<br>62<br>61<br>74<br>66                               | 01.16<br>01.16<br>12.14<br>12.14<br>12.14<br>12.14<br>11.14<br>12.14<br>12.14   |  | 13.0460-5646.2  | 605646   |  | 25348 17,8 +/WK/Zub MAN  |

<sup>1)</sup> - light alloy rims / - cerchi in lega / - jantes en alliage léger / - Llantas de aleación ligera



| HYUNDAI i20 / i20 COUPE (GB) (14-)   |  | HYUNDAI i30 (07-11) |  | HYUNDAI i30 (GD) (11-) |  |  |
|--|--|---------------------|--|------------------------|--|--|
|    | 1.0 T-GDI 74<br>1.0 T-GDI 88<br>1.1 blue CRDi 55<br>1.1 CRDi 55<br>1.2 55<br>1.2 62<br>1.2 LPGI 61<br>1.4 74<br>1.4 CRDi 66                                    |                     | 01.16<br>01.16<br>12.14<br>12.14<br>12.14<br>12.14<br>11.14<br>12.14<br>12.14  |                        | 24.0110-0398.1 410398                          | 262 10,0 8,4 L +B  |
|    | 1.4 16V 77<br>1.4 16V 80<br>1.6 16V 85<br>1.6 16V 90<br>1.6 16V 93<br>1.6 CRDi 66<br>1.6 CRDi 85<br>1.6 CRDi 94<br>2.0 16V 105<br>2.0 CRDi 100<br>2.0 CRDi 103 |                     | 10.07 10.11<br>10.07 10.11<br>10.07 10.11<br>10.07 10.11<br>02.08 10.11<br>10.07 10.11<br>10.07 10.11<br>02.08 10.11<br>10.07 10.11<br>02.08 10.11<br>10.07 10.11  |                        | 13.0460-5742.2 605742                          | 23966 17,7 +/-WK   |
|    | 1.4 16V 77<br>1.4 16V 80<br>1.6 16V 85<br>1.6 16V 90<br>1.6 16V 93<br>1.6 CRDi 66<br>1.6 CRDi 85<br>1.6 CRDi 94<br>2.0 16V 105<br>2.0 CRDi 100<br>2.0 CRDi 103 |                     | 10.07 10.11<br>10.07 10.11<br>10.07 10.11<br>10.07 10.11<br>02.08 10.11<br>10.07 10.11<br>10.07 10.11<br>02.08 10.11<br>10.07 10.11<br>02.08 10.11<br>10.07 10.11  |                        | 24.0126-0150.1 426150<br>24.0128-0234.1 428234 | + 15" Bremssystem<br>+ 16" Bremssystem<br>280 26,0 24,4 V L +B<br>300 28,0 26,4 V +B |
|    | 1.4 16V 77<br>1.4 16V 80<br>1.6 16V 85<br>1.6 16V 90<br>1.6 16V 93<br>1.6 CRDi 66<br>1.6 CRDi 85<br>1.6 CRDi 94<br>2.0 16V 105<br>2.0 CRDi 100<br>2.0 CRDi 103 |                     | 10.07 10.11<br>10.07 10.11<br>10.07 10.11<br>10.07 10.11<br>02.08 10.11<br>10.07 10.11<br>10.07 10.11<br>02.08 10.11<br>10.07 10.11<br>02.08 10.11<br>10.07 10.11  |                        | 13.0460-5780.2 605780                          | 24320 15,3 +/-WK/Zub   |
|  | 1.4 16V 77<br>1.4 16V 80<br>1.6 16V 85<br>1.6 16V 90<br>1.6 16V 93<br>1.6 CRDi 66<br>1.6 CRDi 85<br>1.6 CRDi 94<br>2.0 16V 105<br>2.0 CRDi 100<br>2.0 CRDi 103 |                     | 10.07 10.11<br>10.07 10.11<br>10.07 10.11<br>10.07 10.11<br>02.08 10.11<br>10.07 10.11<br>10.07 10.11<br>02.08 10.11<br>10.07 10.11<br>02.08 10.11<br>10.07 10.11  |                        | 24.0110-0332.1 410332                          | 262 10,0 8,0 +B  |
|  | 1.4 16V 77<br>1.4 16V 80<br>1.6 16V 85<br>1.6 16V 90<br>1.6 16V 93<br>1.6 CRDi 66<br>1.6 CRDi 85<br>1.6 CRDi 94<br>2.0 16V 105<br>2.0 CRDi 100<br>2.0 CRDi 103 |                     | 10.07 10.11<br>10.07 10.11<br>10.07 10.11<br>10.07 10.11<br>02.08 10.11<br>10.07 10.11<br>10.07 10.11<br>02.08 10.11<br>10.07 10.11<br>02.08 10.11<br>10.07 10.11  |                        | 03.0137-3029.2 653029                          | 167 x 26   |
|  | 1.4 16V 73<br>1.4 CRDi 66<br>1.6 16V 88<br>1.6 CRDi 81<br>1.6 CRDi 94<br>1.6 CRDi 100<br>1.6 GDI 95<br>1.6 GDI 99  |                     | 11.11 03.13 + 15" Rad <sup>1)</sup><br>11.11 05.13 + 15" Rad <sup>1)</sup><br>01.12 05.13 + 15" Rad <sup>1)</sup><br>06.12 05.13 + 15" Rad <sup>1)</sup><br>11.11 05.13 + 15" Rad <sup>1)</sup><br>11.11 05.13 + 15" Rad <sup>1)</sup><br>11.11 05.13 + 15" Rad <sup>1)</sup><br>11.11 05.13 + 15" Rad <sup>1)</sup> |                        | 13.0460-5645.2 605645                          | 25692 17,2 +/-WK/Zub   |
|  | 1.4 16V 73<br>1.4 CRDi 66<br>1.6 16V 88<br>1.6 CRDi 81<br>1.6 CRDi 94<br>1.6 CRDi 100<br>1.6 GDI 99  |                     | 06.13 + 15" Rad <sup>1)</sup><br>06.13 + 15" Rad <sup>1)</sup><br>06.13 + 15" Rad <sup>1)</sup><br>06.13 + 15" Rad <sup>1)</sup><br>06.13 + 15" Rad <sup>1)</sup><br>04.13 + 15" Rad <sup>1)</sup><br>06.13 + 15" Rad <sup>1)</sup>  |                        | 13.0460-5645.2 605645                          | 25692 17,2 +/-WK/Zub   |
|  | 1.4 16V 74<br>1.6 137<br>1.6 T-GDI 137   |                     | 12.14 + 15" Rad <sup>1)</sup><br>12.14 + 15" Rad <sup>1)</sup><br>01.15 + 15" Rad <sup>1)</sup>  |                        | 13.0460-5645.2 605645                          | 25692 17,2 +/-WK/Zub   |

<sup>1)</sup> + 15" wheel / + ruota 15" / + roue 15" / + rueda 15"



### HYUNDAI i30 (GD) (11-)

|           |           |     |       |                         |                         |                |        |  |  |   |                |        |  |  |   |                   |                   |
|-----------|-----------|-----|-------|-------------------------|-------------------------|----------------|--------|--|--|---|----------------|--------|--|--|---|-------------------|-------------------|
|           | 1.4 16V   | 73  |       | 11.11                   | + 15" Rad <sup>1)</sup> | 24.0123-0123.1 | 423123 |  |  | 280 23,1 21,0 V L +B                        |                |        |  |  |   |                   |                   |
|           | 1.4 16V   | 74  |       | 12.14                   | + 15" Rad <sup>1)</sup> |                |        |  |  |   |                |        |  |  |   |                   |                   |
|           | 1.4 CRDi  | 66  |       | 11.11                   | + 15" Rad <sup>1)</sup> |                |        |  |  |   |                |        |  |  |   |                   |                   |
|           | 1.6       | 137 |       | 12.14                   | + 15" Rad <sup>1)</sup> |                |        |  |  |   |                |        |  |  |   |                   |                   |
|           | 1.6 16V   | 88  |       | 01.12                   | + 15" Rad <sup>1)</sup> |                |        |  |  |   |                |        |  |  |   |                   |                   |
|           | 1.6 CRDi  | 81  |       | 06.12                   | + 15" Rad <sup>1)</sup> |                |        |  |  |   |                |        |  |  |   |                   |                   |
|           | 1.6 CRDi  | 94  |       | 11.11                   | + 15" Rad <sup>1)</sup> |                |        |  |  |   |                |        |  |  |   |                   |                   |
|           | 1.6 CRDi  | 100 |       | 11.11                   | + 15" Rad <sup>1)</sup> |                |        |  |  |   |                |        |  |  |   |                   |                   |
|           | 1.6 GDI   | 95  |       | 11.11                   | + 15" Rad <sup>1)</sup> |                |        |  |  |   |                |        |  |  |   |                   |                   |
|           | 1.6 GDI   | 99  |       | 11.11                   | + 15" Rad <sup>1)</sup> |                |        |  |  |   |                |        |  |  |   |                   |                   |
|           | 1.6 T-GDI | 137 |       | 01.15                   | + 15" Rad <sup>1)</sup> |                |        |  |  |   |                |        |  |  |   |                   |                   |
|           | 1.4 16V   | 73  |       | 11.11                   | + 16" Rad <sup>2)</sup> |                |        |  |  |   | 24.0128-0234.1 | 428234 |  |  | 300 28,0 26,4 V +B                          |                   |                   |
|           | 1.4 16V   | 74  |       | 12.14                   | + 16" Rad <sup>2)</sup> |                |        |  |  |   |                |        |  |  |   |                   |                   |
|           | 1.4 CRDi  | 66  |       | 11.11                   | + 16" Rad <sup>2)</sup> |                |        |  |  |   |                |        |  |  |   |                   |                   |
|           | 1.6       | 137 |       | 12.14                   | + 16" Rad <sup>2)</sup> |                |        |  |  |   |                |        |  |  |   |                   |                   |
|           | 1.6 16V   | 88  |       | 01.12                   | + 16" Rad <sup>2)</sup> |                |        |  |  |   |                |        |  |  |   |                   |                   |
|           | 1.6 CRDi  | 81  |       | 06.12                   | + 16" Rad <sup>2)</sup> |                |        |  |  |   |                |        |  |  |   |                   |                   |
|           | 1.6 CRDi  | 94  |       | 11.11                   | + 16" Rad <sup>2)</sup> |                |        |  |  |   |                |        |  |  |   |                   |                   |
|           | 1.6 CRDi  | 100 |       | 11.11                   | + 16" Rad <sup>2)</sup> |                |        |  |  |   |                |        |  |  |   |                   |                   |
| 1.6 GDI   | 95        |     | 11.11 | + 16" Rad <sup>2)</sup> |                         |                |        |  |  |   |                |        |  |  |   |                   |                   |
| 1.6 GDI   | 99        |     | 11.11 | + 16" Rad <sup>2)</sup> |                         |                |        |  |  |   |                |        |  |  |   |                   |                   |
| 1.6 T-GDI | 137       |     | 01.15 | + 16" Rad <sup>2)</sup> |                         |                |        |  |  |   |                |        |  |  |   |                   |                   |
|           | 1.4 16V   | 73  |       | 11.11                   |                         | 24.0110-0379.1 | 410379 |  |  | - elektrische Feststellbremse <sup>3)</sup> |                |        |  |  |   | 262 10,0 8,4 L +B |                   |
|           | 1.4 16V   | 74  |       | 12.14                   |                         |                |        |  |  |   |                |        |  |  |   |                   |                   |
|           | 1.4 CRDi  | 66  |       | 11.11                   |                         |                |        |  |  |   |                |        |  |  |   |                   |                   |
|           | 1.6       | 137 |       | 12.14                   |                         |                |        |  |  |   |                |        |  |  |   |                   |                   |
|           | 1.6 16V   | 88  |       | 01.12                   |                         |                |        |  |  |   |                |        |  |  |   |                   |                   |
|           | 1.6 CRDi  | 81  |       | 06.12                   |                         |                |        |  |  |   |                |        |  |  |   |                   |                   |
|           | 1.6 CRDi  | 94  |       | 11.11                   |                         |                |        |  |  |   |                |        |  |  |   |                   |                   |
|           | 1.6 CRDi  | 100 |       | 11.11                   |                         |                |        |  |  |   |                |        |  |  |   |                   |                   |
|           | 1.6 GDI   | 95  |       | 11.11                   |                         |                |        |  |  |   |                |        |  |  |   |                   |                   |
|           | 1.6 GDI   | 99  |       | 11.11                   |                         |                |        |  |  |   |                |        |  |  |   |                   |                   |
|           | 1.6 T-GDI | 137 |       | 01.15                   |                         |                |        |  |  |   |                |        |  |  |   |                   |                   |
|           | 1.4 16V   | 73  |       | 11.11                   |                         |                |        |  |  |   | 24.0110-0383.1 | 410383 |  |  | + elektrische Feststellbremse <sup>4)</sup> |                   | 284 10,0 8,4 L +B |
|           | 1.4 16V   | 74  |       | 12.14                   |                         |                |        |  |  |   |                |        |  |  |   |                   |                   |
|           | 1.4 CRDi  | 66  |       | 11.11                   |                         |                |        |  |  |   |                |        |  |  |   |                   |                   |
|           | 1.6       | 137 |       | 12.14                   |                         |                |        |  |  |   |                |        |  |  |   |                   |                   |
|           | 1.6 16V   | 88  |       | 01.12                   |                         |                |        |  |  |   |                |        |  |  |   |                   |                   |
|           | 1.6 CRDi  | 81  |       | 06.12                   |                         |                |        |  |  |   |                |        |  |  |   |                   |                   |
|           | 1.6 CRDi  | 94  |       | 11.11                   |                         |                |        |  |  |   |                |        |  |  |   |                   |                   |
|           | 1.6 CRDi  | 100 |       | 11.11                   |                         |                |        |  |  |   |                |        |  |  |   |                   |                   |
| 1.6 GDI   | 95        |     | 11.11 |                         |                         |                |        |  |  |   |                |        |  |  |   |                   |                   |
| 1.6 GDI   | 99        |     | 11.11 |                         |                         |                |        |  |  |   |                |        |  |  |   |                   |                   |
| 1.6 T-GDI | 137       |     | 01.15 |                         |                         |                |        |  |  |   |                |        |  |  |   |                   |                   |

### HYUNDAI i30 CW Kombi (08-12)

















|          |          |         |    |       |       |                |                |        |  |  |                 |                     |                |        |  |  |                   |                      |
|----------|----------|---------|----|-------|-------|----------------|----------------|--------|--|--|-----------------|---------------------|----------------|--------|--|--|-------------------|----------------------|
|          | 1.4 16V  | 77      |    | 02.08 | 06.12 | 13.0460-5742.2 | 605742         |        |  |  | 23966 17,7 +/WK |                     |                |        |  |  |                   |                      |
|          | 1.4 16V  | 80      |    | 11.09 | 06.12 |                |                |        |  |  |                 |                     |                |        |  |  |                   |                      |
|          | 1.6 16V  | 85      |    | 02.08 | 06.12 |                |                |        |  |  |                 |                     |                |        |  |  |                   |                      |
|          | 1.6 16V  | 88      |    | 01.10 | 06.12 |                |                |        |  |  |                 |                     |                |        |  |  |                   |                      |
|          | 1.6 16V  | 90      |    | 02.08 | 06.12 |                |                |        |  |  |                 |                     |                |        |  |  |                   |                      |
|          | 1.6 16V  | 93      |    | 02.08 | 06.12 |                |                |        |  |  |                 |                     |                |        |  |  |                   |                      |
|          | 1.6 CRDi | 66      |    | 02.08 | 06.12 |                |                |        |  |  |                 |                     |                |        |  |  |                   |                      |
|          | 1.6 CRDi | 85      |    | 02.08 | 06.12 |                |                |        |  |  |                 |                     |                |        |  |  |                   |                      |
|          | 1.6 CRDi | 94      |    | 02.08 | 06.12 |                |                |        |  |  |                 |                     |                |        |  |  |                   |                      |
|          | 2.0 16V  | 105     |    | 02.08 | 06.12 |                |                |        |  |  |                 |                     |                |        |  |  |                   |                      |
|          | 2.0 CRDi | 100     |    | 01.10 | 06.12 |                |                |        |  |  |                 |                     |                |        |  |  |                   |                      |
|          | 2.0 CRDi | 103     |    | 02.08 | 06.12 |                |                |        |  |  |                 |                     |                |        |  |  |                   |                      |
|          |          | 1.4 16V | 77 |       | 02.08 |                |                |        |  |  |                 | 06.12               | 24.0126-0150.1 | 426150 |  |  | + 15" Bremssystem | 280 26,0 24,4 V L +B |
|          |          | 1.4 16V | 80 |       | 11.09 |                |                |        |  |  |                 | 06.12               |                |        |  |  |                   |                      |
| 1.6 16V  |          | 85      |    | 02.08 | 06.12 |                |                |        |  |  |                 |                     |                |        |  |  |                   |                      |
| 1.6 16V  |          | 88      |    | 01.10 | 06.12 |                |                |        |  |  |                 |                     |                |        |  |  |                   |                      |
| 1.6 16V  |          | 90      |    | 02.08 | 06.12 |                |                |        |  |  |                 |                     |                |        |  |  |                   |                      |
| 1.6 16V  |          | 93      |    | 02.08 | 06.12 |                |                |        |  |  |                 |                     |                |        |  |  |                   |                      |
| 1.6 CRDi |          | 66      |    | 02.08 | 06.12 |                |                |        |  |  |                 |                     |                |        |  |  |                   |                      |
| 1.6 CRDi |          | 85      |    | 02.08 | 06.12 |                |                |        |  |  |                 |                     |                |        |  |  |                   |                      |
| 1.6 CRDi |          | 94      |    | 02.08 | 06.12 |                |                |        |  |  |                 |                     |                |        |  |  |                   |                      |
| 2.0 16V  |          | 105     |    | 02.08 | 06.12 |                |                |        |  |  |                 |                     |                |        |  |  |                   |                      |
| 2.0 CRDi |          | 100     |    | 01.10 | 06.12 |                |                |        |  |  |                 |                     |                |        |  |  |                   |                      |
| 2.0 CRDi |          | 103     |    | 02.08 | 06.12 |                |                |        |  |  |                 |                     |                |        |  |  |                   |                      |
|          |          | 1.4 16V | 77 |       | 02.08 | 06.12          | 13.0460-5780.2 | 605780 |  |  |                 | 24320 15,3 +/WK/Zub |                |        |  |  |                   |                      |
|          |          | 1.4 16V | 80 |       | 11.09 | 06.12          |                |        |  |  |                 |                     |                |        |  |  |                   |                      |
|          | 1.6 16V  | 85      |    | 02.08 | 06.12 |                |                |        |  |  |                 |                     |                |        |  |  |                   |                      |
|          | 1.6 16V  | 88      |    | 01.10 | 06.12 |                |                |        |  |  |                 |                     |                |        |  |  |                   |                      |
|          | 1.6 16V  | 90      |    | 02.08 | 06.12 |                |                |        |  |  |                 |                     |                |        |  |  |                   |                      |
|          | 1.6 16V  | 93      |    | 02.08 | 06.12 |                |                |        |  |  |                 |                     |                |        |  |  |                   |                      |
|          | 1.6 CRDi | 66      |    | 02.08 | 06.12 |                |                |        |  |  |                 |                     |                |        |  |  |                   |                      |
|          | 1.6 CRDi | 85      |    | 02.08 | 06.12 |                |                |        |  |  |                 |                     |                |        |  |  |                   |                      |
|          | 1.6 CRDi | 94      |    | 02.08 | 06.12 |                |                |        |  |  |                 |                     |                |        |  |  |                   |                      |
|          | 2.0 16V  | 105     |    | 02.08 | 06.12 |                |                |        |  |  |                 |                     |                |        |  |  |                   |                      |
|          | 2.0 CRDi | 100     |    | 01.10 | 06.12 |                |                |        |  |  |                 |                     |                |        |  |  |                   |                      |
|          | 2.0 CRDi | 103     |    | 02.08 | 06.12 |                |                |        |  |  |                 |                     |                |        |  |  |                   |                      |
|          |          | 1.4 16V | 77 |       | 02.08 | 06.12          |                |        |  |  |                 |                     | 24.0110-0332.1 | 410332 |  |  |                   | 262 10,0 8,0 +B      |
|          |          | 1.4 16V | 80 |       | 11.09 | 06.12          |                |        |  |  |                 |                     |                |        |  |  |                   |                      |
| 1.6 16V  |          | 85      |    | 02.08 | 06.12 |                |                |        |  |  |                 |                     |                |        |  |  |                   |                      |
| 1.6 16V  |          | 88      |    | 01.10 | 06.12 |                |                |        |  |  |                 |                     |                |        |  |  |                   |                      |
| 1.6 16V  |          | 90      |    | 02.08 | 06.12 |                |                |        |  |  |                 |                     |                |        |  |  |                   |                      |

<sup>1)</sup> + 15" wheel / + ruota 15" / + roue 15" / + rueda 15"

<sup>2)</sup> + 16" wheel / + ruota 16" / + roue 16" / + rueda 16"

<sup>3)</sup> - electric parking brake / - freno a mano elettrico / - frein à main électrique / - freno de mano eléctrico

<sup>4)</sup> + electric parking brake / + freno a mano elettrico / + frein à main électrique / + freno de mano eléctrico

|     |   |  |                          |   |  |  |  |  |
|--|---|--|--|---|---|--|--|--|
| <b>HYUNDAI i30 CW Kombi (08-12)</b>  |   |  |  |   |   |  |  |  |
|    | 1.6 16V<br>1.6 CRDi<br>1.6 CRDi<br>1.6 CRDi<br>2.0 16V<br>2.0 CRDi<br>2.0 CRDi  | 93<br>66<br>85<br>94<br>105<br>100<br>103  | 02.08<br>02.08<br>02.08<br>02.08<br>02.08<br>01.10<br>02.08  | 06.12<br>06.12<br>06.12<br>06.12<br>06.12<br>06.12<br>06.12   | 24.0110-0332.1  | 410332   |  | 262 10,0 8,0 +B  |
|    | 1.4 16V<br>1.4 16V<br>1.6 16V<br>1.6 16V<br>1.6 16V<br>1.6 16V<br>1.6 CRDi<br>1.6 CRDi<br>1.6 CRDi<br>1.6 CRDi<br>2.0 16V<br>2.0 CRDi<br>2.0 CRDi | 77<br>80<br>85<br>88<br>90<br>93<br>66<br>85<br>94<br>105<br>100<br>103          | 02.08<br>11.09<br>02.08<br>01.10<br>02.08<br>02.08<br>02.08<br>02.08<br>02.08<br>02.08<br>01.10<br>02.08 | 06.12<br>06.12<br>06.12<br>06.12<br>06.12<br>06.12<br>06.12<br>06.12<br>06.12<br>06.12<br>06.12<br>06.12  | 03.0137-3029.2  | 653029   |  | 167 x 26   |
| <b>HYUNDAI i30 CW Kombi (12-)</b>  |   |  |  |   |   |  |  |  |
|    | 1.4<br>1.4 16V<br>1.4 CRDi<br>1.6 CRDi<br>1.6 CRDi<br>1.6 CRDi<br>1.6 GDI<br>1.6 GDI<br>1.6 GDI   | 74<br>73<br>66<br>81<br>94<br>100<br>88<br>95<br>99                              | 06.12<br>06.12<br>06.12<br>06.12<br>06.12<br>06.12<br>06.12<br>06.12<br>06.12                            | + 15" Bremssystem<br>+ 15" Bremssystem<br>+ 15" Bremssystem<br>+ 15" Bremssystem<br>+ 15" Bremssystem<br>+ 15" Bremssystem<br>+ 15" Bremssystem | 13.0460-5645.2  | 605645   |  | 25692 17,2 +/WK/Zub  |
|    | 1.4<br>1.4 16V<br>1.4 CRDi<br>1.6 CRDi<br>1.6 CRDi<br>1.6 CRDi<br>1.6 GDI<br>1.6 GDI<br>1.6 GDI   | 74<br>73<br>66<br>81<br>94<br>100<br>88<br>95<br>99                              | 06.12<br>06.12<br>06.12<br>06.12<br>06.12<br>06.12<br>06.12<br>06.12<br>06.12                            | + 15" Bremssystem<br>+ 15" Bremssystem<br>+ 15" Bremssystem<br>+ 15" Bremssystem<br>+ 15" Bremssystem<br>+ 15" Bremssystem<br>+ 15" Bremssystem | 24.0123-0123.1  | 423123   |  | 280 23,1 21,0 V L +B   |
|  | 1.4<br>1.4 16V<br>1.4 CRDi<br>1.6 CRDi<br>1.6 CRDi<br>1.6 CRDi<br>1.6 GDI<br>1.6 GDI<br>1.6 GDI   | 74<br>73<br>66<br>81<br>94<br>100<br>88<br>95<br>99                              | 06.12<br>06.12<br>06.12<br>06.12<br>06.12<br>06.12<br>06.12<br>06.12<br>06.12                            | + 16" Bremssystem<br>+ 16" Bremssystem<br>+ 16" Bremssystem<br>+ 16" Bremssystem<br>+ 16" Bremssystem<br>+ 16" Bremssystem<br>+ 16" Bremssystem | 24.0128-0234.1  | 428234   |  | 300 28,0 26,4 V +B   |
|  | 1.4<br>1.4 16V<br>1.4 CRDi<br>1.6 CRDi<br>1.6 CRDi<br>1.6 CRDi<br>1.6 GDI<br>1.6 GDI<br>1.6 GDI   | 74<br>73<br>66<br>81<br>94<br>100<br>88<br>95<br>99                              | 06.12<br>06.12<br>06.12<br>06.12<br>06.12<br>06.12<br>06.12<br>06.12<br>06.12                            |   | 24.0110-0379.1  | 410379   | - elektrische Feststellbremse 1)   | 262 10,0 8,4 L +B  |
|  | 1.4<br>1.4 16V<br>1.4 CRDi<br>1.6 CRDi<br>1.6 CRDi<br>1.6 CRDi<br>1.6 GDI<br>1.6 GDI<br>1.6 GDI   | 74<br>73<br>66<br>81<br>94<br>100<br>88<br>95<br>99                              | 06.12<br>06.12<br>06.12<br>06.12<br>06.12<br>06.12<br>06.12<br>06.12<br>06.12                            |   | 24.0110-0383.1  | 410383   | + elektrische Feststellbremse 2)   | 284 10,0 8,4 L +B  |
| <b>HYUNDAI i40 (12-)</b>   |   |  |  |   |   |  |  |  |
|  | 1.6 16V<br>1.7 CRDi<br>1.7 CRDi<br>1.7 CRDi<br>2.0 16V<br>2.0 16V<br>2.0 CVVT   | 99<br>85<br>100<br>104<br>121<br>130<br>110                                      | 03.12<br>03.12<br>03.12<br>01.15<br>03.12<br>03.12<br>10.12  | + 16" Rad 3)<br>+ 16" Rad 3)<br>+ 16" Rad 3)<br>+ 16" Rad 3)<br>+ 16" Rad 3)<br>+ 16" Rad 3)  | 24.0128-0256.1  | 428256   |  | 300 28,0 26,4 V L +B   |
|  | 1.6 16V<br>1.7 CRDi<br>1.7 CRDi<br>1.7 CRDi<br>2.0 16V<br>2.0 16V<br>2.0 CVVT   | 99<br>85<br>100<br>104<br>121<br>130<br>110                                      | 03.12<br>03.12<br>03.12<br>01.15<br>03.12<br>03.12<br>10.12  | + 17"/18" Rad 4)<br>+ 17"/18" Rad 4)<br>+ 17"/18" Rad 4)<br>+ 17"/18" Rad 4)<br>+ 17"/18" Rad 4)<br>+ 17"/18" Rad 4)                            | 24.0128-0258.1  | 428258   |  | 320 28,1 26,4 V L +B   |
|  | 1.6 16V<br>1.7 CRDi<br>1.7 CRDi<br>1.7 CRDi   | 99<br>85<br>100<br>104   | 03.12<br>03.12<br>03.12<br>01.15   |   | 13.0460-5786.2<br>13.0470-5786.2  | 605786<br>LD5786   |  | 24934 15,5 +/WK/Zub<br>24934 15,5 +/WK/Zub<br><b>AKE</b><br><b>AKE</b>             |

1) - electric parking brake / - freno a mano elettrico / - frein à main électrique / - freno de mano eléctrico  
2) + electric parking brake / + freno a mano elettrico / + frein à main électrique / + freno de mano eléctrico  
3) + 16" wheel / + ruota 16" / + roue 16" / + rueda 16"  
4) + 17"/18" wheel / + ruota 17"/18" / + roue 17"/18" / + rueda 17"/18"

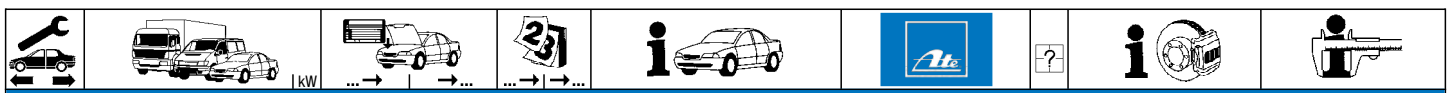

| HYUNDAI i40 (12-)          |              |     |  |       |                             |  |                |        |  |                      |     |
|----------------------------|--------------|-----|--|-------|-----------------------------|--|----------------|--------|--|----------------------|-----|
|                            | 2.0 16V      | 121 |  | 03.12 |                             |  | 13.0460-5786.2 | 605786 |  | 24934 15,5 +/-WK/Zub | AKE |
|                            | 2.0 16V      | 130 |  | 03.12 |                             |  | 13.0470-5786.2 | LD5786 |  | 24934 15,5 +/-WK/Zub | AKE |
|                            | 2.0 CVVT     | 110 |  | 10.12 |                             |  |                |        |  |                      |     |
|                            | 1.6 16V      | 99  |  | 03.12 | + 16" Rad <sup>1)</sup>     |  | 24.0110-0370.1 | 410370 |  | 284 10,0 8,4 +B      |     |
|                            | 1.7 CRDi     | 85  |  | 03.12 | + 16" Rad <sup>1)</sup>     |  |                |        |  |                      |     |
|                            | 1.7 CRDi     | 100 |  | 03.12 | + 16" Rad <sup>1)</sup>     |  |                |        |  |                      |     |
|                            | 1.7 CRDi     | 104 |  | 01.15 | + 16" Rad <sup>1)</sup>     |  |                |        |  |                      |     |
|                            | 2.0 16V      | 121 |  | 03.12 | + 16" Rad <sup>1)</sup>     |  |                |        |  |                      |     |
|                            | 2.0 16V      | 130 |  | 03.12 | + 16" Rad <sup>1)</sup>     |  |                |        |  |                      |     |
|                            | 2.0 CVVT     | 110 |  | 10.12 | + 16" Rad <sup>1)</sup>     |  |                |        |  |                      |     |
|                            | 1.6 16V      | 99  |  | 03.12 | + 17"/18" Rad <sup>2)</sup> |  | 24.0110-0369.1 | 410369 |  | 300 10,0 8,4 +B      |     |
|                            | 1.7 CRDi     | 85  |  | 03.12 | + 17"/18" Rad <sup>2)</sup> |  |                |        |  |                      |     |
|                            | 1.7 CRDi     | 100 |  | 03.12 | + 17"/18" Rad <sup>2)</sup> |  |                |        |  |                      |     |
|                            | 1.7 CRDi     | 104 |  | 01.15 | + 17"/18" Rad <sup>2)</sup> |  |                |        |  |                      |     |
|                            | 2.0 16V      | 121 |  | 03.12 | + 17"/18" Rad <sup>2)</sup> |  |                |        |  |                      |     |
|                            | 2.0 16V      | 130 |  | 03.12 | + 17"/18" Rad <sup>2)</sup> |  |                |        |  |                      |     |
|                            | 2.0 CVVT     | 110 |  | 10.12 | + 17"/18" Rad <sup>2)</sup> |  |                |        |  |                      |     |
| HYUNDAI i40 CW Kombi (11-) |              |     |  |       |                             |  |                |        |  |                      |     |
|                            | 1.6 16V      | 99  |  | 06.11 | + 16" Rad <sup>1)</sup>     |  | 24.0128-0256.1 | 428256 |  | 300 28,0 26,4 V L +B |     |
|                            | 1.7 CRDi     | 85  |  | 06.11 | + 16" Rad <sup>1)</sup>     |  |                |        |  |                      |     |
|                            | 1.7 CRDi     | 100 |  | 06.11 | + 16" Rad <sup>1)</sup>     |  |                |        |  |                      |     |
|                            | 2.0 16V      | 130 |  | 06.11 | + 16" Rad <sup>1)</sup>     |  |                |        |  |                      |     |
|                            | 2.0 CVVT     | 110 |  | 10.12 | + 16" Rad <sup>1)</sup>     |  |                |        |  |                      |     |
|                            | 2.0 GDI      | 121 |  | 03.12 | + 16" Rad <sup>1)</sup>     |  |                |        |  |                      |     |
|                            | 1.6 16V      | 99  |  | 06.11 | + 17"/18" Rad <sup>2)</sup> |  | 24.0128-0258.1 | 428258 |  | 320 28,1 26,4 V L +B |     |
|                            | 1.7 CRDi     | 85  |  | 06.11 | + 17"/18" Rad <sup>2)</sup> |  |                |        |  |                      |     |
|                            | 1.7 CRDi     | 100 |  | 06.11 | + 17"/18" Rad <sup>2)</sup> |  |                |        |  |                      |     |
|                            | 2.0 16V      | 130 |  | 06.11 | + 17"/18" Rad <sup>2)</sup> |  |                |        |  |                      |     |
|                            | 2.0 CVVT     | 110 |  | 10.12 | + 17"/18" Rad <sup>2)</sup> |  |                |        |  |                      |     |
|                            | 2.0 GDI      | 121 |  | 03.12 | + 17"/18" Rad <sup>2)</sup> |  |                |        |  |                      |     |
|                            | 1.6 16V      | 99  |  | 06.11 |                             |  | 13.0460-5786.2 | 605786 |  | 24934 15,5 +/-WK/Zub | AKE |
|                            | 1.7 CRDi     | 85  |  | 06.11 |                             |  | 13.0470-5786.2 | LD5786 |  | 24934 15,5 +/-WK/Zub | AKE |
|                            | 1.7 CRDi     | 100 |  | 06.11 |                             |  |                |        |  |                      |     |
|                            | 2.0 16V      | 130 |  | 06.11 |                             |  |                |        |  |                      |     |
|                            | 2.0 CVVT     | 110 |  | 10.12 |                             |  |                |        |  |                      |     |
|                            | 2.0 GDI      | 121 |  | 03.12 |                             |  |                |        |  |                      |     |
|                            | 1.6 16V      | 99  |  | 06.11 | + 16" Rad <sup>1)</sup>     |  | 24.0110-0370.1 | 410370 |  | 284 10,0 8,4 +B      |     |
|                            | 1.7 CRDi     | 85  |  | 06.11 | + 16" Rad <sup>1)</sup>     |  |                |        |  |                      |     |
|                            | 1.7 CRDi     | 100 |  | 06.11 | + 16" Rad <sup>1)</sup>     |  |                |        |  |                      |     |
|                            | 2.0 16V      | 130 |  | 06.11 | + 16" Rad <sup>1)</sup>     |  |                |        |  |                      |     |
|                            | 2.0 CVVT     | 110 |  | 10.12 | + 16" Rad <sup>1)</sup>     |  |                |        |  |                      |     |
|                            | 2.0 GDI      | 121 |  | 03.12 | + 16" Rad <sup>1)</sup>     |  |                |        |  |                      |     |
|                            | 1.6 16V      | 99  |  | 06.11 | + 17"/18" Rad <sup>2)</sup> |  | 24.0110-0369.1 | 410369 |  | 300 10,0 8,4 +B      |     |
|                            | 1.7 CRDi     | 85  |  | 06.11 | + 17"/18" Rad <sup>2)</sup> |  |                |        |  |                      |     |
|                            | 1.7 CRDi     | 100 |  | 06.11 | + 17"/18" Rad <sup>2)</sup> |  |                |        |  |                      |     |
|                            | 2.0 16V      | 130 |  | 06.11 | + 17"/18" Rad <sup>2)</sup> |  |                |        |  |                      |     |
|                            | 2.0 CVVT     | 110 |  | 10.12 | + 17"/18" Rad <sup>2)</sup> |  |                |        |  |                      |     |
|                            | 2.0 GDI      | 121 |  | 03.12 | + 17"/18" Rad <sup>2)</sup> |  |                |        |  |                      |     |
| HYUNDAI ix20 (10-)         |              |     |  |       |                             |  |                |        |  |                      |     |
|                            | 1.4 16V      | 66  |  | 11.10 |                             |  | 13.0460-5641.2 | 605641 |  | 25187 17,8 +/-WK/Zub |     |
|                            | 1.4 16V      | 74  |  | 11.10 |                             |  |                |        |  |                      |     |
|                            | 1.4 CRDi     | 57  |  | 06.11 |                             |  |                |        |  |                      |     |
|                            | 1.4 CRDi     | 66  |  | 11.10 |                             |  |                |        |  |                      |     |
|                            | 1.6 16V      | 92  |  | 11.10 |                             |  |                |        |  |                      |     |
|                            | 1.6 CRDi     | 85  |  | 06.11 |                             |  |                |        |  |                      |     |
|                            | 1.6 CRDi     | 94  |  | 06.11 |                             |  |                |        |  |                      |     |
|                            | 1.4 16V      | 66  |  | 11.10 |                             |  | 24.0126-0150.1 | 426150 |  | 280 26,0 24,4 V L +B |     |
|                            | 1.4 16V      | 74  |  | 11.10 |                             |  |                |        |  |                      |     |
|                            | 1.4 CRDi     | 57  |  | 06.11 |                             |  |                |        |  |                      |     |
|                            | 1.4 CRDi     | 66  |  | 11.10 |                             |  |                |        |  |                      |     |
|                            | 1.6 16V      | 92  |  | 11.10 |                             |  |                |        |  |                      |     |
|                            | 1.6 CRDi     | 85  |  | 06.11 |                             |  |                |        |  |                      |     |
|                            | 1.6 CRDi     | 94  |  | 06.11 |                             |  |                |        |  |                      |     |
|                            | 1.4 16V      | 66  |  | 11.10 |                             |  | 24.0110-0357.1 | 410357 |  | 258 10,0 8,0 +B      |     |
|                            | 1.4 16V      | 74  |  | 11.10 |                             |  |                |        |  |                      |     |
|                            | 1.4 CRDi     | 57  |  | 06.11 |                             |  |                |        |  |                      |     |
|                            | 1.4 CRDi     | 66  |  | 11.10 |                             |  |                |        |  |                      |     |
|                            | 1.6 16V      | 92  |  | 11.10 |                             |  |                |        |  |                      |     |
|                            | 1.6 CRDi     | 85  |  | 06.11 |                             |  |                |        |  |                      |     |
|                            | 1.6 CRDi     | 94  |  | 06.11 |                             |  |                |        |  |                      |     |
| HYUNDAI ix35 (09-)         |              |     |  |       |                             |  |                |        |  |                      |     |
|                            | 1.6 16V      | 99  |  | 11.10 | 04.13 Produktionsland       |  | 13.0460-5600.2 | 605600 |  | 24501 16,7 +/-WK     | SUM |
|                            | 1.7 CRDi     | 85  |  | 11.10 | 04.13 Produktionsland       |  |                |        |  |                      |     |
|                            | 2.0 16V      | 120 |  | 04.10 | 04.13 Produktionsland       |  |                |        |  |                      |     |
|                            | 2.0 16V 4WD  | 120 |  | 04.10 | 04.13 Produktionsland       |  |                |        |  |                      |     |
|                            | 2.0 CRDi     | 100 |  | 04.10 | 04.13 Produktionsland       |  |                |        |  |                      |     |
|                            | 2.0 CRDi     | 130 |  | 01.12 | 04.13 Produktionsland       |  |                |        |  |                      |     |
|                            | 2.0 CRDi     | 135 |  | 04.10 | 04.13 Produktionsland       |  |                |        |  |                      |     |
|                            | 2.0 CRDi 4WD | 100 |  | 04.10 | Produktionsland             |  |                |        |  |                      |     |
|                            | 2.0 CRDi 4WD | 130 |  | 01.12 | Produktionsland             |  |                |        |  |                      |     |
|                            | 2.0 CRDi 4WD | 135 |  | 04.10 | Produktionsland             |  |                |        |  |                      |     |
|                            | 2.0 CVVT     | 110 |  | 08.09 |                             |  |                |        |  |                      |     |
|                            | 1.6 16V      | 99  |  | 11.10 | Produktionsland             |  | 13.0460-5600.2 | 605600 |  | 24501 16,7 +/-WK     | SUM |

1) + 16" wheel / + ruota 16" / + roue 16" / + rueda 16"  
 2) + 17"/18" wheel / + ruota 17"/18" / + roue 17"/18" / + rueda 17"/18"

































**HYUNDAI ix35 (09-)**

|              |              |       |       |                 |                 |                |        |                      |                      |                      |
|--------------|--------------|-------|-------|-----------------|-----------------|----------------|--------|----------------------|----------------------|----------------------|
|              | 1.7 CRDi     | 85    | 11.10 |                 | Produktionsland | 13.0460-5600.2 | 605600 |                      | 24501 16,7 +/WK      | SUM                  |
|              | 2.0 16V      | 120   | 04.10 | 07.13           | Produktionsland |                |        |                      |                      |                      |
|              | 2.0 16V 4WD  | 120   | 04.10 | 07.13           | Produktionsland |                |        |                      |                      |                      |
|              | 2.0 CRDi     | 100   | 04.10 |                 | Produktionsland |                |        |                      |                      |                      |
|              | 2.0 CRDi     | 130   | 01.12 |                 | Produktionsland |                |        |                      |                      |                      |
|              | 2.0 CRDi     | 135   | 04.10 |                 | Produktionsland |                |        |                      |                      |                      |
|              | 2.0 CRDi 4WD | 100   | 04.10 |                 | Produktionsland |                |        |                      |                      |                      |
|              | 2.0 CRDi 4WD | 130   | 01.12 |                 | Produktionsland |                |        |                      |                      |                      |
|              | 2.0 CRDi 4WD | 135   | 04.10 |                 | Produktionsland |                |        |                      |                      |                      |
| 2.0 16V      | 122          | 08.13 |       | Produktionsland | 13.0460-5600.2  | 605600         |        | 24501 16,7 +/WK      | SUM                  |                      |
| 2.0 16V 4WD  | 122          | 08.13 |       | Produktionsland |                 |                |        |                      |                      |                      |
|              | 1.7 CRDi     | 85    | 11.10 |                 |                 | 24.0128-0256.1 | 428256 |                      | 300 28,0 26,4 V L +B |                      |
|              | 2.0 CRDi     | 100   | 04.10 |                 |                 |                |        |                      |                      |                      |
|              | 2.0 CRDi     | 130   | 01.12 |                 |                 |                |        |                      |                      |                      |
|              | 2.0 CRDi     | 135   | 04.10 |                 |                 |                |        |                      |                      |                      |
|              | 2.0 CRDi 4WD | 100   | 04.10 |                 |                 |                |        |                      |                      |                      |
|              | 2.0 CRDi 4WD | 130   | 01.12 |                 |                 |                |        |                      |                      |                      |
|              | 2.0 CRDi 4WD | 135   | 04.10 |                 |                 |                |        |                      |                      |                      |
|              | 1.6 16V      | 99    | 11.10 |                 |                 | 24.0128-0256.1 | 428256 |                      |                      | 300 28,0 26,4 V L +B |
|              | 2.0 16V      | 120   | 04.10 | 07.13           |                 |                |        |                      |                      |                      |
|              | 2.0 16V 4WD  | 122   | 08.13 |                 |                 |                |        |                      |                      |                      |
| 2.0 16V 4WD  | 120          | 04.10 | 07.13 |                 |                 |                |        |                      |                      |                      |
| 2.0 16V 4WD  | 122          | 08.13 |       |                 |                 |                |        |                      |                      |                      |
| 2.0 CVVT     | 110          | 08.09 |       |                 |                 |                |        |                      |                      |                      |
| FCEV         | 53           | 10.12 |       |                 | 24.0128-0258.1  | 428258         |        | 320 28,1 26,4 V L +B |                      |                      |
| Fuel Cell    | 100          | 09.14 |       |                 |                 |                |        |                      |                      |                      |
|              | 1.6 16V      | 99    | 11.10 | 03.13           | Produktionsland | 13.0460-5780.2 | 605780 |                      | 24320 15,3 +/WK/Zub  |                      |
|              | 1.7 CRDi     | 85    | 11.10 | 03.13           | Produktionsland |                |        |                      |                      |                      |
|              | 2.0 16V      | 120   | 04.10 | 03.13           | Produktionsland |                |        |                      |                      |                      |
|              | 2.0 16V 4WD  | 120   | 04.10 |                 | Produktionsland |                |        |                      |                      |                      |
|              | 2.0 CRDi     | 100   | 04.10 | 03.13           | Produktionsland |                |        |                      |                      |                      |
|              | 2.0 CRDi     | 130   | 01.12 |                 | Produktionsland |                |        |                      |                      |                      |
|              | 2.0 CRDi     | 130   | 01.12 | 03.13           | Produktionsland |                |        |                      |                      |                      |
|              | 2.0 CRDi     | 135   | 04.10 | 03.13           | Produktionsland |                |        |                      |                      |                      |
|              | 2.0 CRDi 4WD | 100   | 04.10 |                 | Produktionsland |                |        |                      |                      |                      |
|              | 2.0 CRDi 4WD | 135   | 04.10 |                 | Produktionsland |                |        |                      |                      |                      |
|              | 2.0 CVVT     | 110   | 08.09 |                 | Produktionsland |                |        |                      |                      |                      |
|              | 1.6 16V      | 99    | 11.10 | 11.11           | Produktionsland | 13.0460-5780.2 | 605780 |                      |                      | 24320 15,3 +/WK/Zub  |
|              | 1.7 CRDi     | 85    | 11.10 | 11.11           | Produktionsland |                |        |                      |                      |                      |
| 2.0 16V      | 120          | 04.10 | 11.11 | Produktionsland |                 |                |        |                      |                      |                      |
| 2.0 16V 4WD  | 120          | 04.10 |       | Produktionsland |                 |                |        |                      |                      |                      |
| 2.0 CRDi     | 100          | 04.10 | 11.11 | Produktionsland |                 |                |        |                      |                      |                      |
| 2.0 CRDi     | 130          | 01.12 |       | Produktionsland |                 |                |        |                      |                      |                      |
| 2.0 CRDi     | 135          | 04.10 | 11.11 | Produktionsland |                 |                |        |                      |                      |                      |
| 2.0 CRDi 4WD | 100          | 04.10 |       | Produktionsland |                 |                |        |                      |                      |                      |
| 2.0 CRDi 4WD | 135          | 04.10 |       | Produktionsland |                 |                |        |                      |                      |                      |
| 1.6 16V      | 99           | 12.11 |       | Produktionsland | 13.0460-5780.2  | 605780         |        | 24320 15,3 +/WK/Zub  |                      |                      |
| 1.7 CRDi     | 85           | 12.11 |       | Produktionsland |                 |                |        |                      |                      |                      |
| 2.0 16V      | 120          | 12.11 | 07.13 | Produktionsland |                 |                |        |                      |                      |                      |
| 2.0 16V      | 120          | 12.11 | 07.13 | Produktionsland |                 |                |        |                      |                      |                      |
| 2.0 16V      | 122          | 08.13 |       | Produktionsland |                 |                |        |                      |                      |                      |
| 2.0 CRDi     | 100          | 12.11 |       | Produktionsland |                 |                |        |                      |                      |                      |
| 2.0 CRDi     | 130          | 12.11 |       | Produktionsland |                 |                |        |                      |                      |                      |
| 2.0 CRDi     | 135          | 12.11 |       | Produktionsland |                 |                |        |                      |                      |                      |
| 2.0 16V 4WD  | 122          | 08.13 |       | Produktionsland | 13.0460-5780.2  | 605780         |        | 24320 15,3 +/WK/Zub  |                      |                      |
|              | 1.6 16V      | 99    | 11.10 |                 |                 | 24.0110-0332.1 | 410332 |                      | 262 10,0 8,0 +B      |                      |
|              | 1.7 CRDi     | 85    | 11.10 |                 |                 |                |        |                      |                      |                      |
|              | 2.0 16V      | 120   | 04.10 | 07.13           |                 |                |        |                      |                      |                      |
|              | 2.0 16V      | 122   | 08.13 |                 |                 |                |        |                      |                      |                      |
|              | 2.0 CRDi     | 100   | 04.10 |                 |                 |                |        |                      |                      |                      |
|              | 2.0 CRDi     | 130   | 01.12 |                 |                 |                |        |                      |                      |                      |
|              | 2.0 CRDi     | 135   | 04.10 |                 |                 |                |        |                      |                      |                      |
|              | 2.0 CVVT     | 110   | 08.09 |                 |                 |                |        |                      |                      |                      |
|              | 2.0 16V 4WD  | 120   | 04.10 | 07.13           |                 | 24.0110-0286.1 | 410286 |                      |                      | 284 10,0 8,4 +B      |
|              | 2.0 CRDi 4WD | 100   | 04.10 |                 |                 |                |        |                      |                      |                      |
| 2.0 CRDi 4WD | 130          | 01.12 |       |                 |                 |                |        |                      |                      |                      |
| 2.0 CRDi 4WD | 135          | 04.10 |       |                 |                 |                |        |                      |                      |                      |
| 2.0 16V 4WD  | 122          | 08.13 |       |                 | 24.0110-0286.1  | 410286         |        | 284 10,0 8,4 +B      |                      |                      |
| FCEV         | 53           | 10.12 |       |                 | 24.0110-0388.1  | 410388         |        | 284 10,0 8,4 L +B    |                      |                      |
| Fuel Cell    | 100          | 09.14 |       |                 |                 |                |        |                      |                      |                      |
|              | 1.6 16V      | 99    | 11.10 |                 |                 | 03.0137-3029.2 | 653029 |                      | 167 x 26             |                      |
|              | 1.7 CRDi     | 85    | 11.10 |                 |                 |                |        |                      |                      |                      |
|              | 2.0 16V      | 120   | 04.10 | 07.13           |                 |                |        |                      |                      |                      |
|              | 2.0 16V      | 122   | 08.13 |                 |                 |                |        |                      |                      |                      |
|              | 2.0 CRDi     | 100   | 04.10 |                 |                 |                |        |                      |                      |                      |
|              | 2.0 CRDi     | 130   | 01.12 |                 |                 |                |        |                      |                      |                      |
|              | 2.0 CRDi     | 135   | 04.10 |                 |                 |                |        |                      |                      |                      |
|              | 2.0 CVVT     | 110   | 08.09 |                 |                 |                |        |                      |                      |                      |
|              | 2.0 16V 4WD  | 120   | 04.10 | 07.13           |                 | 03.0137-3030.2 | 653030 |                      |                      | 189 x 40 HEB         |
|              | 2.0 16V 4WD  | 122   | 08.13 |                 |                 |                |        |                      |                      |                      |
| 2.0 CRDi 4WD | 100          | 04.10 |       |                 |                 |                |        |                      |                      |                      |
| 2.0 CRDi 4WD | 130          | 01.12 |       |                 |                 |                |        |                      |                      |                      |
| 2.0 CRDi 4WD | 135          | 04.10 |       |                 |                 |                |        |                      |                      |                      |



| HYUNDAI ix55 (08-12)   |  |             |             |                |             |                  |                     |                      |             |                      |        |                 |                     |           |     |       |       |                |        |       |       |            |     |       |       |            |     |       |       |           |     |       |       |         |     |       |       |
|--|--|-------------|-------------|----------------|-------------|------------------|---------------------|----------------------|-------------|----------------------|--------|-----------------|---------------------|-----------|-----|-------|-------|----------------|--------|-------|-------|------------|-----|-------|-------|------------|-----|-------|-------|-----------|-----|-------|-------|---------|-----|-------|-------|
|    | <table border="1"> <tr><td>3.0 V6 CRDi</td><td>176</td><td>09.08</td><td>12.12</td><td rowspan="6">13.0460-5638.2</td><td rowspan="6">605638</td><td rowspan="6">25889 16,9 +/WK/Zub</td><td rowspan="6">AKE</td></tr> <tr><td>3.0 V6 CRDi</td><td>184</td><td>09.11</td><td>12.12</td></tr> <tr><td>3.8 V6</td><td>194</td><td>01.11</td><td>12.12</td></tr> <tr><td>3.8 V6 AWD</td><td>191</td><td>01.08</td><td>12.12</td></tr> <tr><td>3.8 V6 AWD</td><td>194</td><td>01.11</td><td>12.12</td></tr> <tr><td>3.8 V6 AWD</td><td>199</td><td>01.08</td><td>12.12</td></tr> </table>  | 3.0 V6 CRDi | 176         | 09.08          | 12.12       | 13.0460-5638.2   | 605638              | 25889 16,9 +/WK/Zub  | AKE         | 3.0 V6 CRDi          | 184    | 09.11           | 12.12               | 3.8 V6    | 194 | 01.11 | 12.12 | 3.8 V6 AWD     | 191    | 01.08 | 12.12 | 3.8 V6 AWD | 194 | 01.11 | 12.12 | 3.8 V6 AWD | 199 | 01.08 | 12.12 |           |     |       |       |         |     |       |       |
| 3.0 V6 CRDi  | 176  | 09.08       | 12.12       | 13.0460-5638.2 | 605638      |                  |                     |                      |             | 25889 16,9 +/WK/Zub  | AKE    |                 |                     |           |     |       |       |                |        |       |       |            |     |       |       |            |     |       |       |           |     |       |       |         |     |       |       |
| 3.0 V6 CRDi  | 184  | 09.11       | 12.12       |                |             |                  |                     |                      |             |                      |        |                 |                     |           |     |       |       |                |        |       |       |            |     |       |       |            |     |       |       |           |     |       |       |         |     |       |       |
| 3.8 V6   | 194  | 01.11       | 12.12       |                |             |                  |                     |                      |             |                      |        |                 |                     |           |     |       |       |                |        |       |       |            |     |       |       |            |     |       |       |           |     |       |       |         |     |       |       |
| 3.8 V6 AWD   | 191  | 01.08       | 12.12       |                |             |                  |                     |                      |             |                      |        |                 |                     |           |     |       |       |                |        |       |       |            |     |       |       |            |     |       |       |           |     |       |       |         |     |       |       |
| 3.8 V6 AWD   | 194  | 01.11       | 12.12       |                |             |                  |                     |                      |             |                      |        |                 |                     |           |     |       |       |                |        |       |       |            |     |       |       |            |     |       |       |           |     |       |       |         |     |       |       |
| 3.8 V6 AWD   | 199  | 01.08       | 12.12       |                |             |                  |                     |                      |             |                      |        |                 |                     |           |     |       |       |                |        |       |       |            |     |       |       |            |     |       |       |           |     |       |       |         |     |       |       |
|    | <table border="1"> <tr><td>3.0 V6 CRDi</td><td>176</td><td>09.08</td><td>12.12</td><td rowspan="6">24.0132-0169.1</td><td rowspan="6">432169</td><td rowspan="6">321 32,0 30,0 V L +B</td><td rowspan="6"></td></tr> <tr><td>3.0 V6 CRDi</td><td>184</td><td>09.11</td><td>12.12</td></tr> <tr><td>3.8 V6</td><td>194</td><td>01.11</td><td>12.12</td></tr> <tr><td>3.8 V6 AWD</td><td>191</td><td>01.08</td><td>12.12</td></tr> <tr><td>3.8 V6 AWD</td><td>194</td><td>01.11</td><td>12.12</td></tr> <tr><td>3.8 V6 AWD</td><td>199</td><td>01.08</td><td>12.12</td></tr> </table>  | 3.0 V6 CRDi | 176         | 09.08          | 12.12       | 24.0132-0169.1   | 432169              | 321 32,0 30,0 V L +B |             | 3.0 V6 CRDi          | 184    | 09.11           | 12.12               | 3.8 V6    | 194 | 01.11 | 12.12 | 3.8 V6 AWD     | 191    | 01.08 | 12.12 | 3.8 V6 AWD | 194 | 01.11 | 12.12 | 3.8 V6 AWD | 199 | 01.08 | 12.12 |           |     |       |       |         |     |       |       |
| 3.0 V6 CRDi  | 176  | 09.08       | 12.12       | 24.0132-0169.1 | 432169      |                  |                     |                      |             | 321 32,0 30,0 V L +B |        |                 |                     |           |     |       |       |                |        |       |       |            |     |       |       |            |     |       |       |           |     |       |       |         |     |       |       |
| 3.0 V6 CRDi  | 184  | 09.11       | 12.12       |                |             |                  |                     |                      |             |                      |        |                 |                     |           |     |       |       |                |        |       |       |            |     |       |       |            |     |       |       |           |     |       |       |         |     |       |       |
| 3.8 V6   | 194  | 01.11       | 12.12       |                |             |                  |                     |                      |             |                      |        |                 |                     |           |     |       |       |                |        |       |       |            |     |       |       |            |     |       |       |           |     |       |       |         |     |       |       |
| 3.8 V6 AWD   | 191  | 01.08       | 12.12       |                |             |                  |                     |                      |             |                      |        |                 |                     |           |     |       |       |                |        |       |       |            |     |       |       |            |     |       |       |           |     |       |       |         |     |       |       |
| 3.8 V6 AWD   | 194  | 01.11       | 12.12       |                |             |                  |                     |                      |             |                      |        |                 |                     |           |     |       |       |                |        |       |       |            |     |       |       |            |     |       |       |           |     |       |       |         |     |       |       |
| 3.8 V6 AWD   | 199  | 01.08       | 12.12       |                |             |                  |                     |                      |             |                      |        |                 |                     |           |     |       |       |                |        |       |       |            |     |       |       |            |     |       |       |           |     |       |       |         |     |       |       |
|    | <table border="1"> <tr><td>3.0 V6 CRDi</td><td>176</td><td>09.08</td><td>12.12</td><td rowspan="6">13.0460-5636.2</td><td rowspan="6">605636</td><td rowspan="6">24599 14,9 +/WK/Zub</td><td rowspan="6">MAN</td></tr> <tr><td>3.0 V6 CRDi</td><td>184</td><td>09.11</td><td>12.12</td></tr> <tr><td>3.8 V6</td><td>194</td><td>01.11</td><td>12.12</td></tr> <tr><td>3.8 V6 AWD</td><td>191</td><td>01.08</td><td>12.12</td></tr> <tr><td>3.8 V6 AWD</td><td>194</td><td>01.11</td><td>12.12</td></tr> <tr><td>3.8 V6 AWD</td><td>199</td><td>01.08</td><td>12.12</td></tr> </table>  | 3.0 V6 CRDi | 176         | 09.08          | 12.12       | 13.0460-5636.2   | 605636              | 24599 14,9 +/WK/Zub  | MAN         | 3.0 V6 CRDi          | 184    | 09.11           | 12.12               | 3.8 V6    | 194 | 01.11 | 12.12 | 3.8 V6 AWD     | 191    | 01.08 | 12.12 | 3.8 V6 AWD | 194 | 01.11 | 12.12 | 3.8 V6 AWD | 199 | 01.08 | 12.12 |           |     |       |       |         |     |       |       |
| 3.0 V6 CRDi  | 176  | 09.08       | 12.12       | 13.0460-5636.2 | 605636      |                  |                     |                      |             | 24599 14,9 +/WK/Zub  | MAN    |                 |                     |           |     |       |       |                |        |       |       |            |     |       |       |            |     |       |       |           |     |       |       |         |     |       |       |
| 3.0 V6 CRDi  | 184  | 09.11       | 12.12       |                |             |                  |                     |                      |             |                      |        |                 |                     |           |     |       |       |                |        |       |       |            |     |       |       |            |     |       |       |           |     |       |       |         |     |       |       |
| 3.8 V6   | 194  | 01.11       | 12.12       |                |             |                  |                     |                      |             |                      |        |                 |                     |           |     |       |       |                |        |       |       |            |     |       |       |            |     |       |       |           |     |       |       |         |     |       |       |
| 3.8 V6 AWD   | 191  | 01.08       | 12.12       |                |             |                  |                     |                      |             |                      |        |                 |                     |           |     |       |       |                |        |       |       |            |     |       |       |            |     |       |       |           |     |       |       |         |     |       |       |
| 3.8 V6 AWD   | 194  | 01.11       | 12.12       |                |             |                  |                     |                      |             |                      |        |                 |                     |           |     |       |       |                |        |       |       |            |     |       |       |            |     |       |       |           |     |       |       |         |     |       |       |
| 3.8 V6 AWD   | 199  | 01.08       | 12.12       |                |             |                  |                     |                      |             |                      |        |                 |                     |           |     |       |       |                |        |       |       |            |     |       |       |            |     |       |       |           |     |       |       |         |     |       |       |
|    | <table border="1"> <tr><td>3.0 V6 CRDi</td><td>176</td><td>09.08</td><td>12.12</td><td rowspan="6">24.0118-0154.1</td><td rowspan="6">418154</td><td rowspan="6">324 18,0 16,0 V +B</td><td rowspan="6"></td></tr> <tr><td>3.0 V6 CRDi</td><td>184</td><td>09.11</td><td>12.12</td></tr> <tr><td>3.8 V6</td><td>194</td><td>01.11</td><td>12.12</td></tr> <tr><td>3.8 V6 AWD</td><td>191</td><td>01.08</td><td>12.12</td></tr> <tr><td>3.8 V6 AWD</td><td>194</td><td>01.11</td><td>12.12</td></tr> <tr><td>3.8 V6 AWD</td><td>199</td><td>01.08</td><td>12.12</td></tr> </table>  | 3.0 V6 CRDi | 176         | 09.08          | 12.12       | 24.0118-0154.1   | 418154              | 324 18,0 16,0 V +B   |             | 3.0 V6 CRDi          | 184    | 09.11           | 12.12               | 3.8 V6    | 194 | 01.11 | 12.12 | 3.8 V6 AWD     | 191    | 01.08 | 12.12 | 3.8 V6 AWD | 194 | 01.11 | 12.12 | 3.8 V6 AWD | 199 | 01.08 | 12.12 |           |     |       |       |         |     |       |       |
| 3.0 V6 CRDi  | 176  | 09.08       | 12.12       | 24.0118-0154.1 | 418154      |                  |                     |                      |             | 324 18,0 16,0 V +B   |        |                 |                     |           |     |       |       |                |        |       |       |            |     |       |       |            |     |       |       |           |     |       |       |         |     |       |       |
| 3.0 V6 CRDi  | 184  | 09.11       | 12.12       |                |             |                  |                     |                      |             |                      |        |                 |                     |           |     |       |       |                |        |       |       |            |     |       |       |            |     |       |       |           |     |       |       |         |     |       |       |
| 3.8 V6   | 194  | 01.11       | 12.12       |                |             |                  |                     |                      |             |                      |        |                 |                     |           |     |       |       |                |        |       |       |            |     |       |       |            |     |       |       |           |     |       |       |         |     |       |       |
| 3.8 V6 AWD   | 191  | 01.08       | 12.12       |                |             |                  |                     |                      |             |                      |        |                 |                     |           |     |       |       |                |        |       |       |            |     |       |       |            |     |       |       |           |     |       |       |         |     |       |       |
| 3.8 V6 AWD   | 194  | 01.11       | 12.12       |                |             |                  |                     |                      |             |                      |        |                 |                     |           |     |       |       |                |        |       |       |            |     |       |       |            |     |       |       |           |     |       |       |         |     |       |       |
| 3.8 V6 AWD   | 199  | 01.08       | 12.12       |                |             |                  |                     |                      |             |                      |        |                 |                     |           |     |       |       |                |        |       |       |            |     |       |       |            |     |       |       |           |     |       |       |         |     |       |       |
|    | <table border="1"> <tr><td>3.0 V6 CRDi</td><td>176</td><td>09.08</td><td>12.12</td><td rowspan="6">03.0137-3031.2</td><td rowspan="6">653031</td><td rowspan="6">209 x 40</td><td rowspan="6"></td></tr> <tr><td>3.0 V6 CRDi</td><td>184</td><td>09.11</td><td>12.12</td></tr> <tr><td>3.8 V6</td><td>194</td><td>01.11</td><td>12.12</td></tr> <tr><td>3.8 V6 AWD</td><td>191</td><td>01.08</td><td>12.12</td></tr> <tr><td>3.8 V6 AWD</td><td>194</td><td>01.11</td><td>12.12</td></tr> <tr><td>3.8 V6 AWD</td><td>199</td><td>01.08</td><td>12.12</td></tr> </table>  | 3.0 V6 CRDi | 176         | 09.08          | 12.12       | 03.0137-3031.2   | 653031              | 209 x 40             |             | 3.0 V6 CRDi          | 184    | 09.11           | 12.12               | 3.8 V6    | 194 | 01.11 | 12.12 | 3.8 V6 AWD     | 191    | 01.08 | 12.12 | 3.8 V6 AWD | 194 | 01.11 | 12.12 | 3.8 V6 AWD | 199 | 01.08 | 12.12 |           |     |       |       |         |     |       |       |
| 3.0 V6 CRDi  | 176  | 09.08       | 12.12       | 03.0137-3031.2 | 653031      |                  |                     |                      |             | 209 x 40             |        |                 |                     |           |     |       |       |                |        |       |       |            |     |       |       |            |     |       |       |           |     |       |       |         |     |       |       |
| 3.0 V6 CRDi  | 184  | 09.11       | 12.12       |                |             |                  |                     |                      |             |                      |        |                 |                     |           |     |       |       |                |        |       |       |            |     |       |       |            |     |       |       |           |     |       |       |         |     |       |       |
| 3.8 V6   | 194  | 01.11       | 12.12       |                |             |                  |                     |                      |             |                      |        |                 |                     |           |     |       |       |                |        |       |       |            |     |       |       |            |     |       |       |           |     |       |       |         |     |       |       |
| 3.8 V6 AWD   | 191  | 01.08       | 12.12       |                |             |                  |                     |                      |             |                      |        |                 |                     |           |     |       |       |                |        |       |       |            |     |       |       |            |     |       |       |           |     |       |       |         |     |       |       |
| 3.8 V6 AWD   | 194  | 01.11       | 12.12       |                |             |                  |                     |                      |             |                      |        |                 |                     |           |     |       |       |                |        |       |       |            |     |       |       |            |     |       |       |           |     |       |       |         |     |       |       |
| 3.8 V6 AWD   | 199  | 01.08       | 12.12       |                |             |                  |                     |                      |             |                      |        |                 |                     |           |     |       |       |                |        |       |       |            |     |       |       |            |     |       |       |           |     |       |       |         |     |       |       |
| HYUNDAI LANTRA/ELANTRA (95-00)   |  |             |             |                |             |                  |                     |                      |             |                      |        |                 |                     |           |     |       |       |                |        |       |       |            |     |       |       |            |     |       |       |           |     |       |       |         |     |       |       |
|    | <table border="1"> <tr><td>1.5 12V</td><td>65</td><td>05.95</td><td>05.00 - ABS</td><td rowspan="8">13.0460-5872.2</td><td rowspan="8">605872</td><td rowspan="8">21012 15,0 +/WK/Zub</td><td rowspan="8">AKE</td></tr> <tr><td>1.5 12V</td><td>65</td><td>05.95</td><td>05.00 + ABS</td></tr> <tr><td>1.5 16V</td><td>76</td><td>11.95</td><td>10.00</td></tr> <tr><td>1.6 16V</td><td></td><td>05.95</td><td>05.00</td></tr> <tr><td>1.6 16V</td><td>76</td><td>11.95</td><td>10.00</td></tr> <tr><td>1.8 16V</td><td>94</td><td>05.95</td><td>05.00</td></tr> <tr><td>1.9 D</td><td>50</td><td>03.98</td><td>09.00</td></tr> <tr><td>2.0 16V</td><td>102</td><td>05.95</td><td>05.00</td></tr> </table> | 1.5 12V     | 65          | 05.95          | 05.00 - ABS | 13.0460-5872.2   | 605872              | 21012 15,0 +/WK/Zub  | AKE         | 1.5 12V              | 65     | 05.95           | 05.00 + ABS         | 1.5 16V   | 76  | 11.95 | 10.00 | 1.6 16V        |        | 05.95 | 05.00 | 1.6 16V    | 76  | 11.95 | 10.00 | 1.8 16V    | 94  | 05.95 | 05.00 | 1.9 D     | 50  | 03.98 | 09.00 | 2.0 16V | 102 | 05.95 | 05.00 |
| 1.5 12V  | 65   | 05.95       | 05.00 - ABS | 13.0460-5872.2 | 605872      |                  |                     |                      |             | 21012 15,0 +/WK/Zub  | AKE    |                 |                     |           |     |       |       |                |        |       |       |            |     |       |       |            |     |       |       |           |     |       |       |         |     |       |       |
| 1.5 12V  | 65   | 05.95       | 05.00 + ABS |                |             |                  |                     |                      |             |                      |        |                 |                     |           |     |       |       |                |        |       |       |            |     |       |       |            |     |       |       |           |     |       |       |         |     |       |       |
| 1.5 16V  | 76   | 11.95       | 10.00       |                |             |                  |                     |                      |             |                      |        |                 |                     |           |     |       |       |                |        |       |       |            |     |       |       |            |     |       |       |           |     |       |       |         |     |       |       |
| 1.6 16V  |  | 05.95       | 05.00       |                |             |                  |                     |                      |             |                      |        |                 |                     |           |     |       |       |                |        |       |       |            |     |       |       |            |     |       |       |           |     |       |       |         |     |       |       |
| 1.6 16V  | 76   | 11.95       | 10.00       |                |             |                  |                     |                      |             |                      |        |                 |                     |           |     |       |       |                |        |       |       |            |     |       |       |            |     |       |       |           |     |       |       |         |     |       |       |
| 1.8 16V  | 94   | 05.95       | 05.00       |                |             |                  |                     |                      |             |                      |        |                 |                     |           |     |       |       |                |        |       |       |            |     |       |       |            |     |       |       |           |     |       |       |         |     |       |       |
| 1.9 D  | 50   | 03.98       | 09.00       |                |             |                  |                     |                      |             |                      |        |                 |                     |           |     |       |       |                |        |       |       |            |     |       |       |            |     |       |       |           |     |       |       |         |     |       |       |
| 2.0 16V  | 102  | 05.95       | 05.00       |                |             |                  |                     |                      |             |                      |        |                 |                     |           |     |       |       |                |        |       |       |            |     |       |       |            |     |       |       |           |     |       |       |         |     |       |       |
|  | <table border="1"> <tr><td>1.5 12V</td><td>65</td><td>05.95</td><td>05.00 - ABS</td><td rowspan="8">24.0119-0111.1</td><td rowspan="8">419111</td><td rowspan="8">242 19,2 17,0 V</td><td rowspan="8"></td></tr> <tr><td>1.5 12V</td><td>65</td><td>05.95</td><td>05.00 + ABS</td></tr> <tr><td>1.5 16V</td><td>76</td><td>11.95</td><td>10.00</td></tr> <tr><td>1.6 16V</td><td></td><td>05.95</td><td>05.00</td></tr> <tr><td>1.6 16V</td><td>76</td><td>11.95</td><td>10.00</td></tr> <tr><td>1.8 16V</td><td>94</td><td>05.95</td><td>05.00</td></tr> <tr><td>1.9 D</td><td>50</td><td>03.98</td><td>09.00</td></tr> <tr><td>2.0 16V</td><td>102</td><td>05.95</td><td>05.00</td></tr> </table>        | 1.5 12V     | 65          | 05.95          | 05.00 - ABS | 24.0119-0111.1   | 419111              | 242 19,2 17,0 V      |             | 1.5 12V              | 65     | 05.95           | 05.00 + ABS         | 1.5 16V   | 76  | 11.95 | 10.00 | 1.6 16V        |        | 05.95 | 05.00 | 1.6 16V    | 76  | 11.95 | 10.00 | 1.8 16V    | 94  | 05.95 | 05.00 | 1.9 D     | 50  | 03.98 | 09.00 | 2.0 16V | 102 | 05.95 | 05.00 |
| 1.5 12V  | 65   | 05.95       | 05.00 - ABS | 24.0119-0111.1 | 419111      |                  |                     |                      |             | 242 19,2 17,0 V      |        |                 |                     |           |     |       |       |                |        |       |       |            |     |       |       |            |     |       |       |           |     |       |       |         |     |       |       |
| 1.5 12V  | 65   | 05.95       | 05.00 + ABS |                |             |                  |                     |                      |             |                      |        |                 |                     |           |     |       |       |                |        |       |       |            |     |       |       |            |     |       |       |           |     |       |       |         |     |       |       |
| 1.5 16V  | 76   | 11.95       | 10.00       |                |             |                  |                     |                      |             |                      |        |                 |                     |           |     |       |       |                |        |       |       |            |     |       |       |            |     |       |       |           |     |       |       |         |     |       |       |
| 1.6 16V  |  | 05.95       | 05.00       |                |             |                  |                     |                      |             |                      |        |                 |                     |           |     |       |       |                |        |       |       |            |     |       |       |            |     |       |       |           |     |       |       |         |     |       |       |
| 1.6 16V  | 76   | 11.95       | 10.00       |                |             |                  |                     |                      |             |                      |        |                 |                     |           |     |       |       |                |        |       |       |            |     |       |       |            |     |       |       |           |     |       |       |         |     |       |       |
| 1.8 16V  | 94   | 05.95       | 05.00       |                |             |                  |                     |                      |             |                      |        |                 |                     |           |     |       |       |                |        |       |       |            |     |       |       |            |     |       |       |           |     |       |       |         |     |       |       |
| 1.9 D  | 50   | 03.98       | 09.00       |                |             |                  |                     |                      |             |                      |        |                 |                     |           |     |       |       |                |        |       |       |            |     |       |       |            |     |       |       |           |     |       |       |         |     |       |       |
| 2.0 16V  | 102  | 05.95       | 05.00       |                |             |                  |                     |                      |             |                      |        |                 |                     |           |     |       |       |                |        |       |       |            |     |       |       |            |     |       |       |           |     |       |       |         |     |       |       |
|  | <table border="1"> <tr><td>1.5 12V</td><td>65</td><td>05.95</td><td>05.00 + ABS</td><td rowspan="8">13.0460-5874.2</td><td rowspan="8">605874</td><td rowspan="8">21553 14,0 +/WK/Zub</td><td rowspan="8">SUM</td></tr> <tr><td>1.5 16V</td><td>76</td><td>11.95</td><td>10.00</td></tr> <tr><td>1.6 16V</td><td></td><td>05.95</td><td>05.00</td></tr> <tr><td>1.6 16V</td><td>76</td><td>11.95</td><td>10.00</td></tr> <tr><td>1.8 16V</td><td>94</td><td>05.95</td><td>05.00</td></tr> <tr><td>1.9 D</td><td>50</td><td>03.98</td><td>09.00</td></tr> <tr><td>2.0 16V</td><td>102</td><td>05.95</td><td>05.00</td></tr> </table>  | 1.5 12V     | 65          | 05.95          | 05.00 + ABS | 13.0460-5874.2   | 605874              | 21553 14,0 +/WK/Zub  | SUM         | 1.5 16V              | 76     | 11.95           | 10.00               | 1.6 16V   |     | 05.95 | 05.00 | 1.6 16V        | 76     | 11.95 | 10.00 | 1.8 16V    | 94  | 05.95 | 05.00 | 1.9 D      | 50  | 03.98 | 09.00 | 2.0 16V   | 102 | 05.95 | 05.00 |         |     |       |       |
| 1.5 12V  | 65   | 05.95       | 05.00 + ABS | 13.0460-5874.2 | 605874      |                  |                     |                      |             | 21553 14,0 +/WK/Zub  | SUM    |                 |                     |           |     |       |       |                |        |       |       |            |     |       |       |            |     |       |       |           |     |       |       |         |     |       |       |
| 1.5 16V  | 76   | 11.95       | 10.00       |                |             |                  |                     |                      |             |                      |        |                 |                     |           |     |       |       |                |        |       |       |            |     |       |       |            |     |       |       |           |     |       |       |         |     |       |       |
| 1.6 16V  |  | 05.95       | 05.00       |                |             |                  |                     |                      |             |                      |        |                 |                     |           |     |       |       |                |        |       |       |            |     |       |       |            |     |       |       |           |     |       |       |         |     |       |       |
| 1.6 16V  | 76   | 11.95       | 10.00       |                |             |                  |                     |                      |             |                      |        |                 |                     |           |     |       |       |                |        |       |       |            |     |       |       |            |     |       |       |           |     |       |       |         |     |       |       |
| 1.8 16V  | 94   | 05.95       | 05.00       |                |             |                  |                     |                      |             |                      |        |                 |                     |           |     |       |       |                |        |       |       |            |     |       |       |            |     |       |       |           |     |       |       |         |     |       |       |
| 1.9 D  | 50   | 03.98       | 09.00       |                |             |                  |                     |                      |             |                      |        |                 |                     |           |     |       |       |                |        |       |       |            |     |       |       |            |     |       |       |           |     |       |       |         |     |       |       |
| 2.0 16V  | 102  | 05.95       | 05.00       |                |             |                  |                     |                      |             |                      |        |                 |                     |           |     |       |       |                |        |       |       |            |     |       |       |            |     |       |       |           |     |       |       |         |     |       |       |
|  | <table border="1"> <tr><td>1.5 12V</td><td>65</td><td>05.95</td><td>05.00 + ABS</td><td rowspan="8">24.0110-0264.1</td><td rowspan="8">410264</td><td rowspan="8">258 10,0 8,0 +B</td><td rowspan="8"></td></tr> <tr><td>1.5 16V</td><td>76</td><td>11.95</td><td>10.00</td></tr> <tr><td>1.6 16V</td><td></td><td>05.95</td><td>05.00</td></tr> <tr><td>1.6 16V</td><td>76</td><td>11.95</td><td>10.00</td></tr> <tr><td>1.8 16V</td><td>94</td><td>05.95</td><td>05.00</td></tr> <tr><td>1.9 D</td><td>50</td><td>03.98</td><td>09.00</td></tr> <tr><td>2.0 16V</td><td>102</td><td>05.95</td><td>05.00</td></tr> </table>   | 1.5 12V     | 65          |                |             | 05.95            | 05.00 + ABS         | 24.0110-0264.1       | 410264      |                      |        | 258 10,0 8,0 +B |                     | 1.5 16V   | 76  | 11.95 | 10.00 | 1.6 16V        |        | 05.95 | 05.00 | 1.6 16V    | 76  | 11.95 | 10.00 | 1.8 16V    | 94  | 05.95 | 05.00 | 1.9 D     | 50  | 03.98 | 09.00 | 2.0 16V | 102 | 05.95 | 05.00 |
| 1.5 12V  | 65   | 05.95       | 05.00 + ABS | 24.0110-0264.1 | 410264      | 258 10,0 8,0 +B  |                     |                      |             |                      |        |                 |                     |           |     |       |       |                |        |       |       |            |     |       |       |            |     |       |       |           |     |       |       |         |     |       |       |
| 1.5 16V  | 76   | 11.95       | 10.00       |                |             |                  |                     |                      |             |                      |        |                 |                     |           |     |       |       |                |        |       |       |            |     |       |       |            |     |       |       |           |     |       |       |         |     |       |       |
| 1.6 16V  |  | 05.95       | 05.00       |                |             |                  |                     |                      |             |                      |        |                 |                     |           |     |       |       |                |        |       |       |            |     |       |       |            |     |       |       |           |     |       |       |         |     |       |       |
| 1.6 16V  | 76   | 11.95       | 10.00       |                |             |                  |                     |                      |             |                      |        |                 |                     |           |     |       |       |                |        |       |       |            |     |       |       |            |     |       |       |           |     |       |       |         |     |       |       |
| 1.8 16V  | 94   | 05.95       | 05.00       |                |             |                  |                     |                      |             |                      |        |                 |                     |           |     |       |       |                |        |       |       |            |     |       |       |            |     |       |       |           |     |       |       |         |     |       |       |
| 1.9 D  | 50   | 03.98       | 09.00       |                |             |                  |                     |                      |             |                      |        |                 |                     |           |     |       |       |                |        |       |       |            |     |       |       |            |     |       |       |           |     |       |       |         |     |       |       |
| 2.0 16V  | 102  | 05.95       | 05.00       |                |             |                  |                     |                      |             |                      |        |                 |                     |           |     |       |       |                |        |       |       |            |     |       |       |            |     |       |       |           |     |       |       |         |     |       |       |
|  | <table border="1"> <tr><td>1.5 12V</td><td>65</td><td>05.95</td><td>05.00 - ABS</td><td rowspan="2">03.0137-0369.2</td><td rowspan="2">650369</td><td rowspan="2">203 x 39 HEB</td><td rowspan="2">Bremsbacken-Zubehör</td></tr> <tr><td></td><td></td><td></td><td></td><td>03.0137-9270.2</td><td>669270</td></tr> </table>  | 1.5 12V     | 65          |                |             |                  |                     | 05.95                | 05.00 - ABS | 03.0137-0369.2       | 650369 | 203 x 39 HEB    | Bremsbacken-Zubehör |           |     |       |       | 03.0137-9270.2 | 669270 |       |       |            |     |       |       |            |     |       |       |           |     |       |       |         |     |       |       |
| 1.5 12V  | 65   | 05.95       | 05.00 - ABS | 03.0137-0369.2 | 650369      | 203 x 39 HEB     | Bremsbacken-Zubehör |                      |             |                      |        |                 |                     |           |     |       |       |                |        |       |       |            |     |       |       |            |     |       |       |           |     |       |       |         |     |       |       |
|  |  |             |             |                |             |                  |                     | 03.0137-9270.2       | 669270      |                      |        |                 |                     |           |     |       |       |                |        |       |       |            |     |       |       |            |     |       |       |           |     |       |       |         |     |       |       |
|  | <table border="1"> <tr><td>1.5 12V</td><td>65</td><td>05.95</td><td>05.00 - ABS</td><td>24.0220-3045.1</td><td>480191</td><td>203/204,5 x 45,5</td><td></td></tr> </table>   | 1.5 12V     | 65          | 05.95          | 05.00 - ABS | 24.0220-3045.1   | 480191              | 203/204,5 x 45,5     |             |                      |        |                 |                     |           |     |       |       |                |        |       |       |            |     |       |       |            |     |       |       |           |     |       |       |         |     |       |       |
| 1.5 12V  | 65   | 05.95       | 05.00 - ABS | 24.0220-3045.1 | 480191      | 203/204,5 x 45,5 |                     |                      |             |                      |        |                 |                     |           |     |       |       |                |        |       |       |            |     |       |       |            |     |       |       |           |     |       |       |         |     |       |       |
| HYUNDAI MATRIX (01-10)   |  |             |             |                |             |                  |                     |                      |             |                      |        |                 |                     |           |     |       |       |                |        |       |       |            |     |       |       |            |     |       |       |           |     |       |       |         |     |       |       |
|  | <table border="1"> <tr><td>1.5 16V</td><td>75</td><td>06.01</td><td>02.02</td><td rowspan="4">13.0460-5933.2</td><td rowspan="4">605933</td><td rowspan="4">21725 16,8 +/WK</td><td rowspan="4">AKE</td></tr> <tr><td>1.5 CRDi</td><td>60</td><td>10.01</td><td>02.02</td></tr> <tr><td>1.6 i 16V</td><td>76</td><td>06.01</td><td>02.02</td></tr> <tr><td>1.8 i 16V</td><td>90</td><td>06.01</td><td>02.02</td></tr> </table>   | 1.5 16V     | 75          | 06.01          | 02.02       | 13.0460-5933.2   | 605933              | 21725 16,8 +/WK      | AKE         | 1.5 CRDi             | 60     | 10.01           | 02.02               | 1.6 i 16V | 76  | 06.01 | 02.02 | 1.8 i 16V      | 90     | 06.01 | 02.02 |            |     |       |       |            |     |       |       |           |     |       |       |         |     |       |       |
| 1.5 16V  | 75   | 06.01       | 02.02       | 13.0460-5933.2 | 605933      |                  |                     |                      |             | 21725 16,8 +/WK      | AKE    |                 |                     |           |     |       |       |                |        |       |       |            |     |       |       |            |     |       |       |           |     |       |       |         |     |       |       |
| 1.5 CRDi   | 60   | 10.01       | 02.02       |                |             |                  |                     |                      |             |                      |        |                 |                     |           |     |       |       |                |        |       |       |            |     |       |       |            |     |       |       |           |     |       |       |         |     |       |       |
| 1.6 i 16V  | 76   | 06.01       | 02.02       |                |             |                  |                     |                      |             |                      |        |                 |                     |           |     |       |       |                |        |       |       |            |     |       |       |            |     |       |       |           |     |       |       |         |     |       |       |
| 1.8 i 16V  | 90   | 06.01       | 02.02       |                |             |                  |                     |                      |             |                      |        |                 |                     |           |     |       |       |                |        |       |       |            |     |       |       |            |     |       |       |           |     |       |       |         |     |       |       |
|  | <table border="1"> <tr><td>1.5 16V</td><td>75</td><td>03.02</td><td>08.10</td><td rowspan="8">13.0460-5875.2</td><td rowspan="8">605875</td><td rowspan="8">24031 17,7 +/WK</td><td rowspan="8">MAN</td></tr> <tr><td>1.5 CRDi</td><td>60</td><td>03.02</td><td>08.10</td></tr> <tr><td>1.5 CRDi</td><td>75</td><td>12.04</td><td>08.10</td></tr> <tr><td>1.5 CRDi VGT</td><td>81</td><td>08.05</td><td>08.10</td></tr> <tr><td>1.6 i 16V</td><td>66</td><td>01.02</td><td>12.05</td></tr> <tr><td>1.6 i 16V</td><td>76</td><td>03.02</td><td>08.10</td></tr> <tr><td>1.8 i 16V</td><td>90</td><td>03.02</td><td>08.10</td></tr> </table>  | 1.5 16V     | 75          | 03.02          | 08.10       | 13.0460-5875.2   | 605875              | 24031 17,7 +/WK      | MAN         | 1.5 CRDi             | 60     | 03.02           | 08.10               | 1.5 CRDi  | 75  | 12.04 | 08.10 | 1.5 CRDi VGT   | 81     | 08.05 | 08.10 | 1.6 i 16V  | 66  | 01.02 | 12.05 | 1.6 i 16V  | 76  | 03.02 | 08.10 | 1.8 i 16V | 90  | 03.02 | 08.10 |         |     |       |       |
| 1.5 16V  | 75   | 03.02       | 08.10       | 13.0460-5875.2 | 605875      |                  |                     |                      |             | 24031 17,7 +/WK      | MAN    |                 |                     |           |     |       |       |                |        |       |       |            |     |       |       |            |     |       |       |           |     |       |       |         |     |       |       |
| 1.5 CRDi   | 60   | 03.02       | 08.10       |                |             |                  |                     |                      |             |                      |        |                 |                     |           |     |       |       |                |        |       |       |            |     |       |       |            |     |       |       |           |     |       |       |         |     |       |       |
| 1.5 CRDi   | 75   | 12.04       | 08.10       |                |             |                  |                     |                      |             |                      |        |                 |                     |           |     |       |       |                |        |       |       |            |     |       |       |            |     |       |       |           |     |       |       |         |     |       |       |
| 1.5 CRDi VGT   | 81   | 08.05       | 08.10       |                |             |                  |                     |                      |             |                      |        |                 |                     |           |     |       |       |                |        |       |       |            |     |       |       |            |     |       |       |           |     |       |       |         |     |       |       |
| 1.6 i 16V  | 66   | 01.02       | 12.05       |                |             |                  |                     |                      |             |                      |        |                 |                     |           |     |       |       |                |        |       |       |            |     |       |       |            |     |       |       |           |     |       |       |         |     |       |       |
| 1.6 i 16V  | 76   | 03.02       | 08.10       |                |             |                  |                     |                      |             |                      |        |                 |                     |           |     |       |       |                |        |       |       |            |     |       |       |            |     |       |       |           |     |       |       |         |     |       |       |
| 1.8 i 16V  | 90   | 03.02       | 08.10       |                |             |                  |                     |                      |             |                      |        |                 |                     |           |     |       |       |                |        |       |       |            |     |       |       |            |     |       |       |           |     |       |       |         |     |       |       |

|     |  kW   |                                 |  |    |  |  |  |  |
|--|---|---|--|--|---|--|--|--|
| <b>HYUNDAI MATRIX (01-10)</b>  |   |   |  |  |   |  |  |  |
|    | 1.5 16V<br>1.5 CRDi<br>1.5 CRDi<br>1.5 CRDi VGT<br>1.6 i 16V<br>1.6 i 16V<br>1.8 i 16V  | 75<br>60<br>75<br>81<br>66<br>76<br>90  |  | 06.01 08.10<br>10.01 08.10<br>12.04 08.10<br>08.05 08.10<br>01.02 12.05<br>06.01 08.10<br>06.01 08.10  |   | 24.0124-0184.1<br>424184   |  | 257 24,0 22,1 V +B   |
|    | 1.5 16V<br>1.5 CRDi<br>1.5 CRDi<br>1.5 CRDi VGT<br>1.6 i 16V<br>1.6 i 16V<br>1.8 i 16V  | 75<br>60<br>75<br>81<br>66<br>76<br>90  |  | 06.01 08.10 + ABS<br>10.01 08.10 + ABS<br>12.04 08.10 + ABS<br>08.05 08.10 + ABS<br>01.02 12.05 + ABS<br>06.01 08.10 + ABS<br>06.01 08.10  |   | 13.0460-5833.2<br>605833   |  | 23543 14,4 +/WK/Zub AKE  |
|    | 1.5 16V<br>1.5 CRDi<br>1.5 CRDi<br>1.5 CRDi VGT<br>1.6 i 16V<br>1.6 i 16V<br>1.8 i 16V  | 75<br>60<br>75<br>81<br>66<br>76<br>90  |  | 06.01 08.10 + ABS<br>10.01 08.10 + ABS<br>12.04 08.10 + ABS<br>08.05 08.10 + ABS<br>01.02 12.05 + ABS<br>06.01 08.10 + ABS<br>06.01 08.10  |   | 24.0110-0317.1<br>410317   |  | 262 10,0 8,4   |
|    | 1.5 16V<br>1.5 CRDi<br>1.5 CRDi<br>1.5 CRDi VGT<br>1.6 i 16V<br>1.6 i 16V   | 75<br>60<br>75<br>81<br>66<br>76  |  | 06.01 08.10 - ABS<br>10.01 08.10 - ABS<br>12.04 08.10 - ABS<br>08.05 08.10 - ABS<br>01.02 12.05 - ABS<br>06.01 08.10 - ABS   |   | 03.0137-0437.2<br>650437   |  | 203 x 38 HEB   |
|    | 1.5 16V<br>1.5 CRDi<br>1.5 CRDi<br>1.5 CRDi VGT<br>1.6 i 16V<br>1.6 i 16V<br>1.8 i 16V  | 75<br>60<br>75<br>81<br>66<br>76<br>90  |  | 06.01 08.10 + ABS<br>10.01 08.10 + ABS<br>12.04 08.10 + ABS<br>08.05 08.10 + ABS<br>01.02 12.05 + ABS<br>06.01 08.10 + ABS<br>06.01 08.10  |   | 03.0137-3025.2<br>653025   |  | 170 x 27   |
| <b>HYUNDAI SANTA FE I (SM) (01-06)</b>   |   |   |  |  |   |  |  |  |
|    | 2.0 CRDi<br>2.0 CRDi 4x4<br>2.0 CRDi 4x4<br>2.0 CRDi 4x4<br>2.0 i 16V<br>2.2 CRDi<br>2.2 CRDi 4x4<br>2.4 i 16V<br>2.4 i 16V<br>2.4 i 16V 4x4<br>2.4 i 16V 4x4<br>2.7 i V6<br>2.7 i V6 4x4<br>2.7 i V6 4x4<br>2.7 i V6 4x4<br>2.7 i V6 4x4 | 83<br>83<br>92<br>107<br>99<br>110<br>110<br>100<br>107<br>100<br>107<br>107<br>139<br>127<br>129<br>132<br>139 |  | 08.01 02.06<br>04.01 02.06<br>08.03 02.06<br>11.03 02.06<br>08.01 02.06<br>10.05 02.06<br>10.05 02.06<br>02.01 02.06<br>02.01 02.06<br>02.01 02.06<br>02.01 02.06<br>10.05 02.06<br>02.01 02.06<br>09.02 02.06<br>02.01 02.06<br>10.05 02.06   |   | 13.0460-5832.2<br>605832   |  | 23569 16,5 +/WK/Zub  |
|  | 2.0 CRDi<br>2.0 CRDi 4x4<br>2.0 CRDi 4x4<br>2.0 CRDi 4x4<br>2.0 i 16V<br>2.2 CRDi<br>2.2 CRDi 4x4<br>2.4 i 16V<br>2.4 i 16V<br>2.4 i 16V 4x4<br>2.4 i 16V 4x4<br>2.7 i V6<br>2.7 i V6 4x4<br>2.7 i V6 4x4<br>2.7 i V6 4x4<br>2.7 i V6 4x4 | 83<br>83<br>92<br>107<br>99<br>110<br>110<br>100<br>107<br>100<br>107<br>107<br>139<br>127<br>129<br>132<br>139 |  | 08.01 02.06<br>04.01 02.06<br>08.03 02.06<br>11.03 02.06<br>08.01 02.06<br>10.05 02.06<br>10.05 02.06<br>02.01 02.06<br>02.01 02.06<br>02.01 02.06<br>02.01 02.06<br>10.05 02.06<br>02.01 02.06<br>09.02 02.06<br>02.01 02.06<br>10.05 02.06   |   | 24.0126-0126.1<br>24.0126-0127.1<br>426126<br>426127                               | + 15" Rad <sup>1)</sup><br>+ 16" Rad <sup>2)</sup>                                 | 276 26,0 24,0 V +B<br>294 26,0 24,4 V +B   |
|  | 2.0 CRDi<br>2.0 CRDi 4x4<br>2.0 CRDi 4x4<br>2.0 CRDi 4x4<br>2.0 i 16V<br>2.2 CRDi<br>2.2 CRDi 4x4<br>2.4 i 16V<br>2.4 i 16V<br>2.4 i 16V 4x4<br>2.4 i 16V 4x4<br>2.7 i V6<br>2.7 i V6 4x4<br>2.7 i V6 4x4<br>2.7 i V6 4x4<br>2.7 i V6 4x4 | 83<br>83<br>92<br>107<br>99<br>110<br>110<br>100<br>107<br>100<br>107<br>107<br>139<br>127<br>129<br>132<br>139 |  | 08.01 02.06 + ABS<br>04.01 02.06 + ABS<br>08.03 02.06 + ABS<br>11.03 02.06 + ABS<br>08.01 02.06 + ABS<br>10.05 02.06 + ABS<br>10.05 02.06 + ABS<br>02.01 02.06 + ABS<br>02.01 02.06 + ABS<br>02.01 02.06 + ABS<br>02.01 02.06 + ABS<br>10.05 02.06 + ABS<br>02.01 02.06 + ABS<br>09.02 02.06 + ABS<br>02.01 02.06 + ABS<br>10.05 02.06 + ABS |   | 13.0460-5833.2<br>605833   |  | 23543 14,4 +/WK/Zub AKE  |

<sup>1)</sup> + 15" wheel / + ruota 15" / + roue 15" / + rueda 15"

<sup>2)</sup> + 16" wheel / + ruota 16" / + roue 16" / + rueda 16"

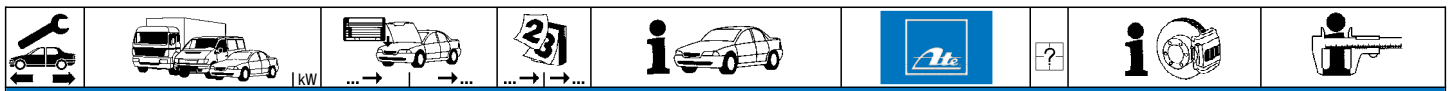























**HYUNDAI SANTA FE I (SM) (01-06)**

|  |   |  |  |  |                |        |  |                 |
|--|---|--|--|--|----------------|--------|--|-----------------|
|  | 2.0 CRDi 83<br>2.0 CRDi 4x4 83<br>2.0 CRDi 4x4 92<br>2.0 CRDi 4x4 107<br>2.0 i 16V 99<br>2.2 CRDi 110<br>2.2 CRDi 4x4 110<br>2.4 i 16V 100<br>2.4 i 16V 107<br>2.4 i 16V 4x4 100<br>2.4 i 16V 4x4 107<br>2.7 i V6 139<br>2.7 i V6 4x4 127<br>2.7 i V6 4x4 129<br>2.7 i V6 4x4 132<br>2.7 i V6 4x4 139 |  | 08.01<br>04.01<br>08.03<br>11.03<br>08.01<br>10.05<br>10.05<br>02.01<br>02.01<br>02.01<br>10.05<br>02.01<br>02.01<br>09.02<br>02.01<br>10.05 | + ABS<br>+ ABS<br>+ ABS<br>+ ABS<br>+ ABS<br>+ ABS<br>+ ABS<br>+ ABS<br>+ ABS<br>+ ABS<br>+ ABS<br>+ ABS<br>+ ABS<br>+ ABS<br>+ ABS<br>+ ABS | 24.0110-0286.1 | 410286 |  | 284 10,0 8,4 +B |
|  | 2.0 CRDi 83<br>2.0 CRDi 4x4 83<br>2.0 CRDi 4x4 92<br>2.0 CRDi 4x4 107<br>2.0 i 16V 99<br>2.2 CRDi 110<br>2.2 CRDi 4x4 110<br>2.4 i 16V 100<br>2.4 i 16V 107<br>2.4 i 16V 4x4 100<br>2.4 i 16V 4x4 107<br>2.7 i V6 139<br>2.7 i V6 4x4 127<br>2.7 i V6 4x4 129<br>2.7 i V6 4x4 132<br>2.7 i V6 4x4 139 |  | 08.01<br>04.01<br>08.03<br>11.03<br>08.01<br>10.05<br>10.05<br>02.01<br>02.01<br>02.01<br>10.05<br>02.01<br>02.01<br>09.02<br>02.01<br>10.05 | + ABS<br>+ ABS<br>+ ABS<br>+ ABS<br>+ ABS<br>+ ABS<br>+ ABS<br>+ ABS<br>+ ABS<br>+ ABS<br>+ ABS<br>+ ABS<br>+ ABS<br>+ ABS<br>+ ABS          | 03.0137-3004.2 | 653004 |  | 190 x 40 HEB    |

**HYUNDAI SANTA FE II (CM) (06-12)**

|  |  |  |   |  |                |        |  |                        |
|--|--|--|---|--|----------------|--------|--|------------------------|
|  | 2.0 CRDi 110<br>2.0 CRDi 4x4 110<br>2.2 CRDi 102<br>2.2 CRDi 110<br>2.2 CRDi 114<br>2.2 CRDi 145<br>2.2 CRDi 4x4 102<br>2.2 CRDi 4x4 110<br>2.2 CRDi 4x4 114<br>2.2 CRDi 4x4 145<br>2.4 128<br>2.4 4x4 128<br>2.7 V6 125<br>2.7 V6 139<br>2.7 V6 4x4 125<br>2.7 V6 4x4 139 |  | 12.10<br>12.10<br>03.06<br>03.06<br>03.06<br>01.09<br>03.06<br>03.06<br>03.06<br>01.09<br>07.10<br>07.10<br>03.06<br>03.06<br>03.06 |  | 13.0460-5777.2 | 605777 |  | 24351 16,3 +WK/Zub     |
|  | 2.2 CRDi 102<br>2.2 CRDi 110<br>2.2 CRDi 114<br>2.2 CRDi 4x4 102<br>2.2 CRDi 4x4 110<br>2.2 CRDi 4x4 114<br>2.7 V6 125<br>2.7 V6 139<br>2.7 V6 4x4 125<br>2.7 V6 4x4 139   |  | 03.06<br>03.06<br>03.06<br>03.06<br>03.06<br>03.06<br>03.06<br>03.06<br>03.06<br>03.06  |  | 24.0128-0158.1 | 428158 |  | 321 28,0 26,4 V +B     |
|  | 2.0 CRDi 110<br>2.0 CRDi 4x4 110<br>2.2 CRDi 145<br>2.2 CRDi 4x4 145<br>2.4 128<br>2.4 4x4 128   |  | 12.10<br>12.10<br>01.09<br>01.09<br>07.10<br>07.10  |  | 24.0128-0248.1 | 428248 |  | 321 28,0 26,4 V L +B   |
|  | 2.2 CRDi 102<br>2.2 CRDi 110<br>2.2 CRDi 114<br>2.2 CRDi 4x4 102<br>2.2 CRDi 4x4 110<br>2.2 CRDi 4x4 114<br>2.7 V6 125<br>2.7 V6 139<br>2.7 V6 4x4 125<br>2.7 V6 4x4 139   |  | 03.06<br>03.06<br>03.06<br>03.06<br>03.06<br>03.06<br>03.06<br>03.06<br>03.06<br>03.06  |  | 13.0460-5782.2 | 605782 |  | 24488 14,9 +WK/Zub     |
|  | 2.0 CRDi 110<br>2.0 CRDi 4x4 110<br>2.2 CRDi 145<br>2.2 CRDi 4x4 145<br>2.4 128<br>2.4 4x4 128   |  | 12.10<br>12.10<br>01.09<br>01.09<br>07.10<br>07.10  |  | 13.0460-5633.2 | 605633 |  | 25520 15,8 +WK/Zub AKE |
|  | 2.2 CRDi 102<br>2.2 CRDi 110<br>2.2 CRDi 114<br>2.2 CRDi 4x4 102<br>2.2 CRDi 4x4 110   |  | 03.06<br>03.06<br>03.06<br>03.06<br>03.06   |  | 24.0111-0146.1 | 411146 |  | 302 11,0 9,4 +B        |



|     |  |  |  |  |  |  |  |  |                         |
|--|--|--|--|--|---|--|--|--|-------------------------|
| <b>HYUNDAI SANTA FE II (CM) (06-12)</b>  |  |  |  |  |   |  |  |  |                         |
|    | 2.2 CRDi 4x4   | 114  |  | 03.06  |   |  | 24.0111-0146.1   | 411146   | 302 11,0 9,4 +B         |
|  | 2.7 V6   | 125  |  | 03.06  |   |  |  |  |                         |
|  | 2.7 V6   | 139  |  | 03.06  |   |  |  |  |                         |
|  | 2.7 V6 4x4   | 125  |  | 03.06  |   |  |  |  |                         |
|  | 2.7 V6 4x4   | 139  |  | 03.06  |   |  |  |  |                         |
|    | 2.0 CRDi   | 110  |  | 12.10  |   |  | 24.0111-0170.1   | 411170   | 302 11,0 9,4 L +B       |
|  | 2.0 CRDi 4x4   | 110  |  | 12.10  |   |  |  |  |                         |
|  | 2.2 CRDi   | 145  |  | 01.09  |   |  |  |  |                         |
|  | 2.2 CRDi 4x4   | 145  |  | 01.09  |   |  |  |  |                         |
|  | 2.4  | 128  |  | 07.10  |   |  |  |  |                         |
| 2.4 4x4  | 128  |  | 07.10  |  |   |  |  |  |                         |
|    | 2.2 CRDi   | 102  |  | 03.06  |   |  | 03.0137-3032.2   | 653032   | 189 x 31                |
|  | 2.2 CRDi   | 110  |  | 03.06  |   |  |  |  |                         |
|  | 2.2 CRDi   | 114  |  | 03.06  |   |  |  |  |                         |
|  | 2.2 CRDi   | 145  |  | 01.09  | 09.09   |  |  |  |                         |
|  | 2.2 CRDi 4x4   | 102  |  | 03.06  |   |  |  |  |                         |
|  | 2.2 CRDi 4x4   | 110  |  | 03.06  |   |  |  |  |                         |
|  | 2.2 CRDi 4x4   | 114  |  | 03.06  |   |  |  |  |                         |
|  | 2.2 CRDi 4x4   | 145  |  | 01.09  | 09.09   |  |  |  |                         |
|  | 2.7 V6   | 125  |  | 03.06  |   |  |  |  |                         |
|  | 2.7 V6   | 139  |  | 03.06  |   |  |  |  |                         |
|    | 2.2 CRDi   | 145  |  | 10.09  | 11.10   |  | 03.0137-3027.2   | 653027   | 189 x 26                |
|  | 2.2 CRDi 4x4   | 145  |  | 10.09  | 11.10   |  |  |  |                         |
|  | 2.4  | 128  |  | 07.10  | 11.10   |  |  |  |                         |
|  | 2.4 4x4  | 128  |  | 07.10  | 11.10   |  |  |  |                         |
| <b>HYUNDAI SANTA FE III (DM) (12-)</b>   |  |  |  |  |   |  |  |  |                         |
|    | 2.0 CRDi   | 110  |  | 09.12  |   |  | 13.0460-5777.2   | 605777   | 24351 16,3 +/WK/Zub     |
|  | 2.0 CRDi 4WD   | 110  |  | 09.12  |   |  |  |  |                         |
|  | 2.2 CRDi   | 145  |  | 09.12  |   |  |  |  |                         |
|  | 2.2 CRDi 4WD   | 145  |  | 09.12  |   |  |  |  |                         |
|  | 2.4 16V  | 141  |  | 09.12  |   |  |  |  |                         |
|  | 2.4 16V 4WD  | 141  |  | 09.12  |   |  |  |  |                         |
|  | 2.4 CCVT   | 129  |  | 09.12  |   |  |  |  |                         |
| 2.4 CCVT 4WD   | 129  |  | 09.12  |  |   |  |  |  |                         |
|   | 2.0 CRDi   | 110  |  | 09.12  |   |  | 24.0128-0248.1   | 428248   | 321 28,0 26,4 V L +B    |
|  | 2.0 CRDi 4WD   | 110  |  | 09.12  |   |  |  |  |                         |
|  | 2.2 CRDi   | 145  |  | 09.12  |   |  |  |  |                         |
|  | 2.2 CRDi 4WD   | 145  |  | 09.12  |   |  |  |  |                         |
|  | 2.4 16V  | 141  |  | 09.12  |   |  |  |  |                         |
|  | 2.4 16V 4WD  | 141  |  | 09.12  |   |  |  |  |                         |
|  | 2.4 CCVT   | 129  |  | 09.12  |   |  |  |  |                         |
| 2.4 CCVT 4WD   | 129  |  | 09.12  |  |   |  |  |  |                         |
|  | 2.0 CRDi   | 110  |  | 09.12  |   |  | 13.0460-5633.2   | 605633   | 25520 15,8 +/WK/Zub AKE |
|  | 2.0 CRDi 4WD   | 110  |  | 09.12  |   |  |  |  |                         |
|  | 2.2 CRDi   | 145  |  | 09.12  |   |  |  |  |                         |
|  | 2.2 CRDi 4WD   | 145  |  | 09.12  |   |  |  |  |                         |
|  | 2.4 16V  | 141  |  | 09.12  |   |  |  |  |                         |
|  | 2.4 16V 4WD  | 141  |  | 09.12  |   |  |  |  |                         |
|  | 2.4 CCVT   | 129  |  | 09.12  |   |  |  |  |                         |
| 2.4 CCVT 4WD   | 129  |  | 09.12  |  |   |  |  |  |                         |
|  | 2.0 CRDi   | 110  |  | 09.12  |   |  | 24.0111-0170.1   | 411170   | 302 11,0 9,4 L +B       |
|  | 2.0 CRDi 4WD   | 110  |  | 09.12  |   |  |  |  |                         |
|  | 2.2 CRDi   | 145  |  | 09.12  |   |  |  |  |                         |
|  | 2.2 CRDi 4WD   | 145  |  | 09.12  |   |  |  |  |                         |
|  | 2.4 16V  | 141  |  | 09.12  |   |  |  |  |                         |
|  | 2.4 16V 4WD  | 141  |  | 09.12  |   |  |  |  |                         |
|  | 2.4 CCVT   | 129  |  | 09.12  |   |  |  |  |                         |
| 2.4 CCVT 4WD   | 129  |  | 09.12  |  |   |  |  |  |                         |
| <b>HYUNDAI SANTAMO (98-02)</b>   |  |  |  |  |   |  |  |  |                         |
|  | 2.0 i  | 77   |  | 10.98  | 10.02   | - ABS  | 24.0124-0136.1   | 424136   | 256 24,0 21,5 V +B      |
|  | 2.0 i 16V  | 102  |  | 02.99  | 10.02   | - ABS  |  |  |                         |
|  | 2.0 i 16V 4x4  | 102  |  | 02.99  | 10.02   | - ABS  |  |  |                         |
|  | 2.0 i  | 77   |  | 10.98  | 10.02   | + ABS  | 24.0124-0146.1   | 424146   | 256 24,0 22,4 V +B      |
|  | 2.0 i 16V  | 102  |  | 02.99  | 10.02   | + ABS  |  |  |                         |
|  | 2.0 i 16V 4x4  | 102  |  | 02.99  | 10.02   | + ABS  |  |  |                         |
|  | 2.0 i  | 77   |  | 10.98  | 10.02   | + ABS  | 24.0118-0141.1   | 418141   | 266 18,0 16,4 V         |
|  | 2.0 i 16V  | 102  |  | 02.99  | 10.02   | + ABS  |  |  |                         |
|  | 2.0 i 16V 4x4  | 102  |  | 02.99  | 10.02   | + ABS  |  |  |                         |
| <b>HYUNDAI SONATA (Y-3) (93-98)</b>  |  |  |  |  |   |  |  |  |                         |
|  | 1.8 i  | 72   |  | 07.93  | 05.98   |  | 13.0460-5933.2   | 605933   | 21725 16,8 +/WK AKE     |
|  | 2.0 i 16V  |  |  | 07.93  | 05.98   |  |  |  |                         |
|  | 3.0 i V6   | 107  |  | 07.93  | 05.98   |  |  |  |                         |
|  | 1.8 i  | 72   |  | 07.93  | 05.98   |  | 24.0122-0169.1   | 422169   | 257 22,0 20,0 V         |
|  | 2.0 i 16V  |  |  | 07.93  | 05.98   |  |  |  |                         |
|  | 3.0 i V6   | 107  |  | 07.93  | 05.98   |  |  |  |                         |



















**HYUNDAI SONATA (EF) (98-04)**

|          |           |       |             |                |                |        |  |          |               |     |                |        |       |           |                |  |
|----------|-----------|-------|-------------|----------------|----------------|--------|--|----------|---------------|-----|----------------|--------|-------|-----------|----------------|--|
|          | 2.0 i 16V | 100   | 06.98       | 09.01          | 13.0460-5933.2 | 605933 |  | 21725    | 16,8 +/WK     | AKE |                |        |       |           |                |  |
|          | 2.4 i 16V | 105   | 03.98       | 09.01          |                |        |  |          |               |     |                |        |       |           |                |  |
|          | 2.5 i V6  | 118   | 06.98       | 09.01          |                |        |  |          |               |     |                |        |       |           |                |  |
|          | 2.5 i V6  | 127   | 06.98       | 09.01          |                |        |  |          |               |     |                |        |       |           |                |  |
|          | 2.0 i 16V | 96    | 10.01       | 12.04          |                |        |  |          |               |     | 13.0460-5873.2 | 605873 | 23891 | 16,9 +/WK | MAN            |  |
|          | 2.0 i 16V | 106   | 10.01       | 12.04          |                |        |  |          |               |     |                |        |       |           |                |  |
|          | 2.4 i 16V | 104   | 10.01       | 12.04          |                |        |  |          |               |     |                |        |       |           |                |  |
|          | 2.7 i V6  | 123   | 10.01       | 12.04          |                |        |  |          |               |     |                |        |       |           |                |  |
| 2.7 i V6 | 127       | 10.01 | 12.04       |                |                |        |  |          |               |     |                |        |       |           |                |  |
| 2.7 i V6 | 129       | 11.02 | 12.04       | 13.0460-0139.2 | 610139         |        |  | MAN      |               |     |                |        |       |           |                |  |
| 2.7 i V6 | 132       | 10.01 | 12.04       |                |                |        |  |          |               |     |                |        |       |           |                |  |
|          | 2.0 i 16V | 100   | 06.98       | 09.01          | 24.0124-0706.1 | 424706 |  | 257      | 24,0 22,4 V   |     |                |        |       |           |                |  |
|          | 2.4 i 16V | 105   | 03.98       | 09.01          |                |        |  |          |               |     |                |        |       |           |                |  |
|          | 2.5 i V6  | 118   | 06.98       | 09.01          |                |        |  |          |               |     |                |        |       |           |                |  |
|          | 2.5 i V6  | 127   | 06.98       | 09.01          |                |        |  |          |               |     |                |        |       |           |                |  |
|          | 2.0 i 16V | 96    | 10.01       | 12.04          |                |        |  |          |               |     | 24.0126-0129.1 | 426129 |       | 280       | 26,0 24,4 V +B |  |
|          | 2.0 i 16V | 106   | 10.01       | 12.04          |                |        |  |          |               |     |                |        |       |           |                |  |
|          | 2.4 i 16V | 104   | 10.01       | 12.04          |                |        |  |          |               |     |                |        |       |           |                |  |
|          | 2.7 i V6  | 123   | 10.01       | 12.04          |                |        |  |          |               |     |                |        |       |           |                |  |
| 2.7 i V6 | 127       | 10.01 | 12.04       |                |                |        |  |          |               |     |                |        |       |           |                |  |
| 2.7 i V6 | 129       | 11.02 | 12.04       | 13.0460-5833.2 | 605833         |        |  | 23543    | 14,4 +/WK/Zub | AKE |                |        |       |           |                |  |
| 2.7 i V6 | 132       | 10.01 | 12.04       |                |                |        |  |          |               |     |                |        |       |           |                |  |
|          | 2.0 i 16V | 96    | 10.01       | 12.04 + ABS    | 24.0110-0317.1 | 410317 |  | 262      | 10,0 8,4      |     |                |        |       |           |                |  |
|          | 2.0 i 16V | 100   | 06.98       | 09.01 + ABS    |                |        |  |          |               |     |                |        |       |           |                |  |
|          | 2.0 i 16V | 106   | 10.01       | 12.04 + ABS    |                |        |  |          |               |     |                |        |       |           |                |  |
|          | 2.4 i 16V | 104   | 10.01       | 12.04          |                |        |  |          |               |     |                |        |       |           |                |  |
|          | 2.4 i 16V | 105   | 03.98       | 09.01 + ABS    |                |        |  |          |               |     |                |        |       |           |                |  |
|          | 2.5 i V6  | 118   | 06.98       | 09.01 + ABS    |                |        |  |          |               |     |                |        |       |           |                |  |
|          | 2.5 i V6  | 127   | 06.98       | 09.01          |                |        |  |          |               |     |                |        |       |           |                |  |
|          | 2.7 i V6  | 123   | 10.01       | 12.04          |                |        |  |          |               |     |                |        |       |           |                |  |
| 2.7 i V6 | 127       | 10.01 | 12.04       |                |                |        |  |          |               |     |                |        |       |           |                |  |
| 2.7 i V6 | 129       | 11.02 | 12.04       | 03.0137-3024.2 | 653024         |        |  | 170 x 32 | HEB           |     |                |        |       |           |                |  |
| 2.7 i V6 | 132       | 10.01 | 12.04 + ABS |                |                |        |  |          |               |     |                |        |       |           |                |  |

**HYUNDAI SONATA (NF) (05-10)**























|          |          |       |       |       |                |        |  |       |                  |  |
|----------|----------|-------|-------|-------|----------------|--------|--|-------|------------------|--|
|          | 2.0 CRDi | 100   | 02.06 | 12.10 | 13.0460-5639.2 | 605639 |  | 24618 | 17,5 +/WK        |  |
|          | 2.0 CRDi | 103   | 02.06 | 12.10 |                |        |  |       |                  |  |
|          | 2.0 CRDi | 105   | 02.06 | 12.10 |                |        |  |       |                  |  |
|          | 2.0 CRDi | 110   | 03.09 | 12.10 |                |        |  |       |                  |  |
|          | 2.0 GLSi | 119   | 07.08 | 12.10 |                |        |  |       |                  |  |
|          | 2.0 VVTi | 106   | 05.05 | 12.10 |                |        |  |       |                  |  |
|          | 2.0 VVTi | 121   | 01.08 | 12.10 |                |        |  |       |                  |  |
|          | 2.4      | 125   | 06.08 | 12.10 |                |        |  |       |                  |  |
|          | 2.4 VVTi | 119   | 01.05 | 12.10 |                |        |  |       |                  |  |
|          | 2.4 VVTi | 127   | 06.08 | 12.10 |                |        |  |       |                  |  |
|          | 3.3 VVTi | 171   | 01.05 | 12.10 |                |        |  |       |                  |  |
| 3.3 VVTi | 173      | 06.05 | 12.10 |       |                |        |  |       |                  |  |
| 3.3 VVTi | 184      | 01.08 | 12.10 |       |                |        |  |       |                  |  |
|          | 2.0 VVTi | 106   | 05.05 | 01.06 | 24.0126-0128.1 | 426128 |  | 280   | 26,0 24,4 V L +B |  |
|          | 2.4 VVTi | 119   | 01.05 | 01.06 |                |        |  |       |                  |  |
|          | 3.3 VVTi | 171   | 01.05 | 01.06 |                |        |  |       |                  |  |
|          | 3.3 VVTi | 173   | 06.05 | 01.06 |                |        |  |       |                  |  |
|          | 2.0 CRDi | 100   | 02.06 | 10.07 | 24.0128-0256.1 | 428256 |  | 300   | 28,0 26,4 V L +B |  |
|          | 2.0 CRDi | 103   | 02.06 | 10.07 |                |        |  |       |                  |  |
|          | 2.0 CRDi | 105   | 02.06 | 10.07 |                |        |  |       |                  |  |
|          | 2.0 VVTi | 106   | 02.06 | 10.07 |                |        |  |       |                  |  |
|          | 2.4 VVTi | 119   | 02.06 | 10.07 |                |        |  |       |                  |  |
|          | 3.3 VVTi | 171   | 02.06 | 10.07 |                |        |  |       |                  |  |
|          | 3.3 VVTi | 173   | 02.06 | 10.07 |                |        |  |       |                  |  |
|          | 2.0 CRDi | 100   | 11.07 | 12.10 | 24.0128-0256.1 | 428256 |  | 300   | 28,0 26,4 V L +B |  |
|          | 2.0 CRDi | 103   | 11.07 | 12.10 |                |        |  |       |                  |  |
|          | 2.0 CRDi | 105   | 11.07 | 12.10 |                |        |  |       |                  |  |
|          | 2.0 CRDi | 110   | 03.09 | 12.10 |                |        |  |       |                  |  |
|          | 2.0 GLSi | 119   | 07.08 | 12.10 |                |        |  |       |                  |  |
|          | 2.0 VVTi | 106   | 11.07 | 12.10 |                |        |  |       |                  |  |
|          | 2.0 VVTi | 121   | 01.08 | 12.10 |                |        |  |       |                  |  |
|          | 2.4      | 125   | 06.08 | 12.10 |                |        |  |       |                  |  |
| 2.4 VVTi | 119      | 11.07 | 12.10 |       |                |        |  |       |                  |  |









|     |  |  |  |  |  |  |  |  |
|--|--|--|--|--|---|--|--|--|
| <b>HYUNDAI SONATA (NF) (05-10)</b>   |  |  |  |  |   |  |  |  |
|    | 2.4 VVTi   | 127  |  | 06.08  | 12.10   | 24.0128-0256.1   | 428256   | 300 28,0 26,4 V L +B   |
|  | 3.3 VVTi   | 171  |  | 11.07  | 12.10   |  |  |  |
|  | 3.3 VVTi   | 173  |  | 11.07  | 12.10   |  |  |  |
|  | 3.3 VVTi   | 184  |  | 01.08  | 12.10   |  |  |  |
|    | 2.0 CRDi   | 103  |  | 02.06  | 12.10   | 13.0460-5833.2   | 605833   | 23543 14,4 +/WK/Zub AKE  |
|  | 2.0 CRDi   | 105  |  | 02.06  | 12.10   |  |  |  |
|  | 2.0 GLSi   | 119  |  | 07.08  | 12.10   |  |  |  |
|  | 2.0 VVTi   | 106  |  | 02.06  | 12.10   |  |  |  |
|  | 2.0 VVTi   | 121  |  | 06.08  | 12.10   |  |  |  |
|  | 2.4  | 125  |  | 06.08  | 12.10   |  |  |  |
|  | 2.4 VVTi   | 119  |  | 02.06  | 12.10   |  |  |  |
|  | 3.3 VVTi   | 171  |  | 02.06  | 12.10   |  |  |  |
|  | 3.3 VVTi   | 173  |  | 02.06  | 12.10   |  |  |  |
|  | 2.0 VVTi   | 121  |  | 01.08  | 12.10   | 13.0460-5780.2   | 605780   | 24320 15,3 +/WK/Zub  |
|  | 2.4 VVTi   | 127  |  | 06.08  | 12.10   |  |  |  |
|  | 3.3 VVTi   | 184  |  | 01.08  | 12.10   |  |  |  |
|  | 2.0 CRDi   | 100  |  | 02.06  | 12.10   | 13.0460-5786.2   | 605786   | 24934 15,5 +/WK/Zub AKE  |
|  | 2.0 CRDi   | 110  |  | 03.09  | 12.10   |  |  |  |
|    | 2.0 VVTi   | 106  |  | 05.05  | 01.06   | 24.0110-0318.1   | 410318   | 262 10,0 8,4 +B  |
|  | 2.4 VVTi   | 119  |  | 01.05  | 01.06   |  |  |  |
|  | 3.3 VVTi   | 171  |  | 01.05  | 01.06   |  |  |  |
|  | 3.3 VVTi   | 173  |  | 06.05  | 01.06   |  |  |  |
|  | 2.4 VVTi   | 119  |  | 06.07  | 12.10   | 24.0110-0367.1   | 410367   | 284 10,0 8,4 +B  |
|  | 2.4 VVTi   | 127  |  | 06.08  | 12.10   |  |  |  |
|  | 3.3 VVTi   | 171  |  | 06.07  | 12.10   |  |  |  |
|  | 3.3 VVTi   | 173  |  | 06.07  | 12.10   |  |  |  |
|  | 3.3 VVTi   | 184  |  | 01.08  | 12.10   |  |  |  |
|    | 2.0 CRDi   | 100  |  | 02.06  | 12.10   | 03.0137-3025.2   | 653025   | 170 x 27   |
|  | 2.0 CRDi   | 103  |  | 02.06  | 12.10   |  |  |  |
|  | 2.0 CRDi   | 105  |  | 02.06  | 12.10   |  |  |  |
|  | 2.0 CRDi   | 110  |  | 03.09  | 12.10   |  |  |  |
|  | 2.0 GLSi   | 119  |  | 07.08  | 12.10   |  |  |  |
|  | 2.0 VVTi   | 106  |  | 05.05  | 12.10   |  |  |  |
|  | 2.0 VVTi   | 121  |  | 01.08  | 12.10   |  |  |  |
|  | 2.4  | 125  |  | 06.08  | 12.10   |  |  |  |
|  | 2.4 VVTi   | 119  |  | 01.05  | 12.10   |  |  |  |
|  | 2.4 VVTi   | 127  |  | 06.08  | 12.10   |  |  |  |
|  | 3.3 VVTi   | 171  |  | 01.05  | 12.10   |  |  |  |
|  | 3.3 VVTi   | 173  |  | 06.05  | 12.10   |  |  |  |
|  | 3.3 VVTi   | 184  |  | 01.08  | 12.10   |  |  |  |
| <b>HYUNDAI SONATA (YF) (09-)</b>   |  |  |  |  |   |  |  |  |
|  | 2.0 16V  | 110  |  | 01.09  | 11.10   | 13.0460-5641.2   | 605641   | 25187 17,8 +/WK/Zub  |
|  | 2.4 16V  | 128  |  | 01.09  | 11.10   |  |  |  |
|  | 2.4 16V  | 131  |  | 01.09  | 11.10   |  |  |  |
|  | 2.4 GDI  | 148  |  | 01.09  | 11.10   |  |  |  |
|  | 2.0 16V  | 110  |  | 12.10  |   | 13.0460-5641.2   | 605641   | 25187 17,8 +/WK/Zub  |
|  | 2.0 16V  | 121  |  | 01.11  |   |  |  |  |
|  | 2.0 Hybrid   | 110  |  | 01.11  |   |  |  |  |
|  | 2.4 16V  | 128  |  | 12.10  |   |  |  |  |
|  | 2.4 16V  | 131  |  | 12.10  |   |  |  |  |
|  | 2.4 16V  | 133  |  | 10.12  |   |  |  |  |
|  | 2.4 GDI  | 148  |  | 12.10  |   |  |  |  |
|  | 2.0 16V  | 110  |  | 01.09  |   | 13.0460-5780.2   | 605780   | 24320 15,3 +/WK/Zub  |
|  | 2.0 16V  | 121  |  | 01.11  |   |  |  |  |
|  | 2.0 Hybrid   | 110  |  | 01.11  |   |  |  |  |
|  | 2.4 16V  | 128  |  | 01.09  |   |  |  |  |
|  | 2.4 16V  | 131  |  | 01.09  |   |  |  |  |
|  | 2.4 16V  | 133  |  | 10.12  |   |  |  |  |
|  | 2.4 GDI  | 148  |  | 01.09  |   |  |  |  |
| <b>HYUNDAI TERRACAN (01-07)</b>  |  |  |  |  |   |  |  |  |
|  | 2.5 TDiC   | 74   |  | 06.01  | 10.03   | 13.0460-5886.2   | 605886   | 24059 16,7 +/WK/Zub  |
|  | 2.5 TDiC 4WD   | 74   |  | 06.01  | 10.03   |  |  |  |
|  | 2.9 CRDi   | 110  |  | 11.01  | 07.03   |  |  |  |
|  | 2.9 CRDi 4WD   | 110  |  | 11.01  | 07.03   |  |  |  |
|  | 2.9 CRDi 4WD   | 120  |  | 08.03  | 10.03   |  |  |  |
|  | 3.5 i V6 4WD   | 143  |  | 12.01  | 10.03   |  |  |  |
|  | 3.5 i V6 4WD   | 147  |  | 12.01  | 10.03   |  |  |  |
|  | 2.5 TDiC   | 74   |  | 11.03  | 12.07   | 13.0460-5622.2   | 605622   | 23726 16,5 +/WK/Zub MAN  |
|  | 2.5 TDiC 4WD   | 74   |  | 11.03  | 12.07   |  |  |  |
|  | 2.9 CRDi 4WD   | 120  |  | 11.03  | 12.07   |  |  |  |
|  | 3.5 i V6 4WD   | 143  |  | 11.03  | 12.07   |  |  |  |
|  | 3.5 i V6 4WD   | 147  |  | 11.03  | 12.07   |  |  |  |
|  | 2.5 TDiC   | 74   |  | 06.01  | 10.03   | 24.0127-0100.1   | 427100   | 281 27,0 25,4 V +B   |
|  | 2.5 TDiC 4WD   | 74   |  | 06.01  | 10.03   |  |  |  |
|  | 2.9 CRDi   | 110  |  | 11.01  | 07.03   |  |  |  |
|  | 2.9 CRDi 4WD   | 110  |  | 11.01  | 07.03   |  |  |  |
|  | 2.9 CRDi 4WD   | 120  |  | 08.03  | 10.03   |  |  |  |
|  | 3.5 i V6 4WD   | 143  |  | 12.01  | 10.03   |  |  |  |
|  | 3.5 i V6 4WD   | 147  |  | 12.01  | 10.03   |  |  |  |
|  | 2.5 TDiC   | 74   |  | 11.03  | 12.07   | 24.0128-0224.1   | 428224   | 304 28,0 26,4 V +B   |
|  | 2.5 TDiC 4WD   | 74   |  | 11.03  | 12.07   |  |  |  |
|  | 2.9 CRDi 4WD   | 120  |  | 11.03  | 12.07   |  |  |  |
|  | 3.5 i V6 4WD   | 143  |  | 11.03  | 12.07   |  |  |  |
|  | 3.5 i V6 4WD   | 147  |  | 11.03  | 12.07   |  |  |  |

1) - Europe / - Europa / - Europe / - Europa



























|     |    kW  |  |    |  |  |  |  |  |
|--|--|--|--|--|---|--|--|--|
| <b>HYUNDAI TERRACAN (01-07)</b>  |  |  |  |  |   |  |  |  |
|    | 2.5 TDiC 74<br>2.5 TDiC 4WD 74<br>2.9 CRDi 110<br>2.9 CRDi 4WD 110<br>2.9 CRDi 4WD 120<br>3.5 i V6 4WD 143<br>3.5 i V6 4WD 147   |  | 06.01 12.07<br>06.01 12.07<br>11.01 07.03<br>11.01 07.03<br>08.03 12.07<br>12.01 12.07<br>12.01 12.07  |  | 13.0460-0135.2 610135   |  |  | Belagsatz-Zubehör  |
|    | 2.5 TDiC 74<br>2.5 TDiC 4WD 74<br>2.9 CRDi 110<br>2.9 CRDi 4WD 110<br>2.9 CRDi 4WD 120<br>3.5 i V6 4WD 143<br>3.5 i V6 4WD 147   |  | 06.01 12.07<br>06.01 12.07<br>11.01 07.03<br>11.01 07.03<br>08.03 12.07<br>12.01 12.07<br>12.01 12.07  |  | 03.0137-3014.2 653014   |  |  | 190 x 40   |
| <b>HYUNDAI TIBURON Coupe (06-08)</b>   |  |  |  |  |   |  |  |  |
|    | 1.6 CVVT 78<br>2.0 CVVT 105<br>2.7 V6 123  |  | 10.06 12.08<br>10.06 12.08<br>01.06 12.08  |  | 13.0460-5873.2 605873   |  |  | 23891 16,9 +/WK MAN  |
|    | 1.6 CVVT 78<br>2.0 CVVT 105<br>2.7 V6 123  |  | 10.06 12.08<br>10.06 12.08<br>01.06 12.08  |  | 24.0126-0128.1 426128   |  |  | 280 26,0 24,4 V L +B   |
|    | 1.6 CVVT 78<br>2.0 CVVT 105<br>2.7 V6 123  |  | 10.06 12.08<br>10.06 12.08<br>01.06 12.08  |  | 13.0460-5874.2 605874   |  |  | 21553 14,0 +/WK/Zub SUM  |
|    | 1.6 CVVT 78<br>2.0 CVVT 105<br>2.7 V6 123  |  | 10.06 12.08<br>10.06 12.08<br>01.06 12.08  |  | 24.0110-0298.1 410298   |  |  | 258 10,0 8,0   |
| <b>HYUNDAI TRAJET (00-08)</b>  |  |  |  |  |   |  |  |  |
|    | 2.0 CRDi 83<br>2.0 CRDi 92<br>2.0 CVVT 104<br>2.0 i 16V 100<br>2.0 i 16V 103<br>2.7 i V6 127   |  | 04.01 07.08<br>08.05 07.08<br>11.03 07.08<br>03.00 10.03<br>01.04 07.08<br>09.00 07.08   |  | 13.0460-5832.2 605832   |  |  | 23569 16,5 +/WK/Zub  |
|    | 2.0 CRDi 83<br>2.0 CRDi 92<br>2.0 CVVT 104<br>2.0 i 16V 100<br>2.0 i 16V 103<br>2.7 i V6 127   |  | 04.01 07.08<br>08.05 07.08<br>11.03 07.08<br>03.00 10.03<br>01.04 07.08<br>09.00 07.08   |  | 24.0126-0126.1 426126   |  |  | 276 26,0 24,0 V +B   |
|  | 2.0 CRDi 83<br>2.0 CRDi 92<br>2.0 CVVT 104<br>2.0 i 16V 100<br>2.0 i 16V 103<br>2.7 i V6 127   |  | 04.01 07.08<br>08.05 07.08<br>11.03 07.08<br>03.00 10.03<br>01.04 07.08<br>09.00 07.08   |  | 13.0460-5833.2 605833   |  |  | 23543 14,4 +/WK/Zub AKE  |
|  | 2.0 CRDi 83<br>2.0 CRDi 92<br>2.0 CVVT 104<br>2.0 i 16V 100<br>2.0 i 16V 103<br>2.7 i V6 127   |  | 04.01 07.08<br>08.05 07.08<br>11.03 07.08<br>03.00 10.03<br>01.04 07.08<br>09.00 07.08   |  | 24.0110-0286.1 410286   |  |  | 284 10,0 8,4 +B  |
| <b>HYUNDAI TUCSON (04-10)</b>  |  |  |  |  |   |  |  |  |
|  | 2.0 CRDi 83<br>2.0 CRDi 88<br>2.0 CRDi 100<br>2.0 CRDi 103<br>2.0 CRDi Allrad 83<br>2.0 CRDi Allrad 88<br>2.0 CRDi Allrad 100<br>2.0 CRDi Allrad 103<br>2.0 i 16V 104<br>2.0 i 16V Allrad 104<br>2.7 i 24V Allrad 129  |  | 08.04 12.07<br>01.07 12.07<br>01.06 12.07<br>01.06 12.07<br>08.04 12.07<br>01.07 12.07<br>01.06 12.07<br>01.06 12.07<br>08.04 12.07<br>08.04 12.07<br>08.04 12.07  |  | 13.0460-5873.2 605873<br>13.0460-0139.2 610139                                    |  |  | 23891 16,9 +/WK MAN<br>Belagsatz-Zubehör MAN                                       |
|  | 2.0 CRDi 83<br>2.0 CRDi 88<br>2.0 CRDi 100<br>2.0 CRDi 103<br>2.0 CRDi 110<br>2.0 CRDi Allrad 83<br>2.0 CRDi Allrad 88<br>2.0 CRDi Allrad 100<br>2.0 CRDi Allrad 103<br>2.0 CRDi Allrad 110<br>2.0 i 16V 104<br>2.0 i 16V Allrad 104<br>2.7 i 24V Allrad 129 |  | 01.08 03.10<br>01.08 03.10<br>01.08 03.10<br>01.08 03.10<br>01.09 03.10<br>01.08 03.10<br>01.08 03.10<br>01.08 03.10<br>01.08 03.10<br>01.08 03.10<br>01.09 03.10<br>01.08 03.10<br>01.08 03.10<br>01.08 03.10 |  | 13.0460-5873.2 605873   |  |  | 23891 16,9 +/WK MAN  |
|  | 2.0 CRDi 83<br>2.0 CRDi 88<br>2.0 CRDi 100<br>2.0 CRDi 103<br>2.0 CRDi Allrad 83<br>2.0 CRDi Allrad 88   |  | 08.04 12.07<br>01.07 12.07<br>01.06 12.07<br>01.06 12.07<br>08.04 12.07<br>01.07 12.07   |  | 24.0126-0128.1 426128   |  | + Bremsscheibe 280mm <sup>1)</sup>   | 280 26,0 24,4 V L +B   |
|  |  |  | 01.07 12.07  |  |   |  |  |  |

<sup>1)</sup> + brake disc 280mm / + dischi freno 280mm / + disques de frein 280mm / + disco de freno 280mm

| HYUNDAI TUCSON (04-10)   |  |          |       |       |       |                |        |  |                                    |                         |                |                |        |  |                 |                         |
|--|--|----------|-------|-------|-------|----------------|--------|--|------------------------------------|-------------------------|----------------|----------------|--------|--|-----------------|-------------------------|
|    | 2.0 CRDi Allrad  | 100      |       | 01.06 | 12.07 | 24.0126-0128.1 | 426128 |  | + Bremsscheibe 280mm <sup>1)</sup> | 280 26,0 24,4 V L +B    |                |                |        |  |                 |                         |
|  | 2.0 CRDi Allrad  | 103      |       | 01.06 | 12.07 |                |        |  |                                    |                         |                |                |        |  |                 |                         |
|  | 2.0 i 16V  | 104      |       | 08.04 | 12.07 |                |        |  |                                    |                         |                |                |        |  |                 |                         |
|  | 2.0 i 16V Allrad   | 104      |       | 08.04 | 12.07 |                |        |  |                                    |                         |                |                |        |  |                 |                         |
|  | 2.7 i 24V Allrad   | 129      |       | 08.04 | 12.07 |                |        |  |                                    |                         |                |                |        |  |                 |                         |
|  | 2.0 CRDi   | 83       |       | 01.08 | 03.10 | 24.0128-0256.1 | 428256 |  | + Bremsscheibe 300mm <sup>2)</sup> | 300 28,0 26,4 V L +B    |                |                |        |  |                 |                         |
|  | 2.0 CRDi   | 88       |       | 01.08 | 03.10 |                |        |  |                                    |                         |                |                |        |  |                 |                         |
|  | 2.0 CRDi   | 100      |       | 01.08 | 03.10 |                |        |  |                                    |                         |                |                |        |  |                 |                         |
|  | 2.0 CRDi   | 103      |       | 01.08 | 03.10 |                |        |  |                                    |                         |                |                |        |  |                 |                         |
|  | 2.0 CRDi   | 110      |       | 01.09 | 03.10 |                |        |  |                                    |                         |                |                |        |  |                 |                         |
|  | 2.0 CRDi Allrad  | 83       |       | 01.08 | 03.10 |                |        |  |                                    |                         |                |                |        |  |                 |                         |
|  | 2.0 CRDi Allrad  | 88       |       | 01.08 | 03.10 |                |        |  |                                    |                         |                |                |        |  |                 |                         |
|  | 2.0 CRDi Allrad  | 100      |       | 01.08 | 03.10 |                |        |  |                                    |                         |                |                |        |  |                 |                         |
|  | 2.0 CRDi Allrad  | 103      |       | 01.08 | 03.10 |                |        |  |                                    |                         |                |                |        |  |                 |                         |
|  | 2.0 CRDi Allrad  | 110      |       | 01.09 | 03.10 |                |        |  |                                    |                         |                |                |        |  |                 |                         |
|  | 2.0 i 16V  | 104      |       | 01.08 | 03.10 |                |        |  |                                    |                         |                |                |        |  |                 |                         |
|  | 2.0 i 16V Allrad   | 104      |       | 01.08 | 03.10 |                |        |  |                                    |                         |                |                |        |  |                 |                         |
|  | 2.7 i 24V Allrad   | 129      |       | 01.08 | 03.10 |                |        |  |                                    |                         |                |                |        |  |                 |                         |
|  |    | 2.0 CRDi | 83    |       | 08.04 |                |        |  |                                    |                         | 12.07          | 13.0460-5833.2 | 605833 |  |                 | 23543 14,4 +/WK/Zub AKE |
|  |  | 2.0 CRDi | 88    |       | 01.07 |                |        |  |                                    |                         | 12.07          |                |        |  |                 |                         |
| 2.0 CRDi   |  | 100      |       | 01.06 | 12.07 |                |        |  |                                    |                         |                |                |        |  |                 |                         |
| 2.0 CRDi   |  | 103      |       | 01.06 | 12.07 |                |        |  |                                    |                         |                |                |        |  |                 |                         |
| 2.0 CRDi Allrad  |  | 83       |       | 08.04 | 12.07 |                |        |  |                                    |                         |                |                |        |  |                 |                         |
| 2.0 CRDi Allrad  |  | 88       |       | 01.07 | 12.07 |                |        |  |                                    |                         |                |                |        |  |                 |                         |
| 2.0 CRDi Allrad  |  | 100      |       | 01.06 | 12.07 |                |        |  |                                    |                         |                |                |        |  |                 |                         |
| 2.0 CRDi Allrad  |  | 103      |       | 01.06 | 12.07 |                |        |  |                                    |                         |                |                |        |  |                 |                         |
| 2.0 i 16V  |  | 104      |       | 08.04 | 12.07 |                |        |  |                                    |                         |                |                |        |  |                 |                         |
| 2.0 i 16V Allrad   |  | 104      |       | 08.04 | 12.07 |                |        |  |                                    |                         |                |                |        |  |                 |                         |
| 2.7 i 24V Allrad   |  | 129      |       | 08.04 | 12.07 |                |        |  |                                    |                         |                |                |        |  |                 |                         |
| 2.0 CRDi   |  | 83       |       | 01.08 | 03.10 | 13.0460-5786.2 | 605786 |  |                                    | 24934 15,5 +/WK/Zub AKE |                |                |        |  |                 |                         |
| 2.0 CRDi   |  | 88       |       | 01.08 | 03.10 |                |        |  |                                    |                         |                |                |        |  |                 |                         |
| 2.0 CRDi   |  | 100      |       | 01.08 | 03.10 |                |        |  |                                    |                         |                |                |        |  |                 |                         |
| 2.0 CRDi   |  | 103      |       | 01.08 | 03.10 |                |        |  |                                    |                         |                |                |        |  |                 |                         |
| 2.0 CRDi   |  | 110      |       | 01.09 | 03.10 |                |        |  |                                    |                         |                |                |        |  |                 |                         |
| 2.0 CRDi Allrad  |  | 83       |       | 01.08 | 03.10 |                |        |  |                                    |                         |                |                |        |  |                 |                         |
| 2.0 CRDi Allrad  |  | 88       |       | 01.08 | 03.10 |                |        |  |                                    |                         |                |                |        |  |                 |                         |
| 2.0 CRDi Allrad  |  | 100      |       | 01.08 | 03.10 |                |        |  |                                    |                         |                |                |        |  |                 |                         |
| 2.0 CRDi Allrad  |  | 103      |       | 01.08 | 03.10 |                |        |  |                                    |                         |                |                |        |  |                 |                         |
| 2.0 CRDi Allrad  | 110  |          | 01.09 | 03.10 |       |                |        |  |                                    |                         |                |                |        |  |                 |                         |
| 2.0 i 16V  | 104  |          | 01.08 | 03.10 |       |                |        |  |                                    |                         |                |                |        |  |                 |                         |
| 2.0 i 16V Allrad   | 104  |          | 01.08 | 03.10 |       |                |        |  |                                    |                         |                |                |        |  |                 |                         |
| 2.7 i 24V Allrad   | 129  |          | 01.08 | 03.10 |       |                |        |  |                                    |                         |                |                |        |  |                 |                         |
|  | 2.0 CRDi   | 83       |       | 08.04 | 03.10 |                |        |  |                                    |                         | 24.0110-0318.1 | 410318         |        |  | 262 10,0 8,4 +B |                         |
|  | 2.0 CRDi   | 88       |       | 01.07 | 03.10 |                |        |  |                                    |                         |                |                |        |  |                 |                         |
|  | 2.0 CRDi   | 100      |       | 01.06 | 03.10 |                |        |  |                                    |                         |                |                |        |  |                 |                         |
|  | 2.0 CRDi   | 103      |       | 01.06 | 03.10 |                |        |  |                                    |                         |                |                |        |  |                 |                         |
|  | 2.0 CRDi   | 110      |       | 01.09 | 03.10 |                |        |  |                                    |                         |                |                |        |  |                 |                         |
|  | 2.0 i 16V  | 104      |       | 08.04 | 03.10 | 24.0110-0286.1 | 410286 |  |                                    | 284 10,0 8,4 +B         |                |                |        |  |                 |                         |
|  | 2.0 CRDi Allrad  | 83       |       | 08.04 | 03.10 |                |        |  |                                    |                         |                |                |        |  |                 |                         |
|  | 2.0 CRDi Allrad  | 88       |       | 01.07 | 03.10 |                |        |  |                                    |                         |                |                |        |  |                 |                         |
|  | 2.0 CRDi Allrad  | 100      |       | 01.06 | 03.10 |                |        |  |                                    |                         |                |                |        |  |                 |                         |
|  | 2.0 CRDi Allrad  | 103      |       | 01.06 | 03.10 |                |        |  |                                    |                         |                |                |        |  |                 |                         |
|  | 2.0 CRDi Allrad  | 110      |       | 01.09 | 03.10 |                |        |  |                                    |                         |                |                |        |  |                 |                         |
|  | 2.0 i 16V Allrad   | 104      |       | 08.04 | 03.10 |                |        |  |                                    |                         |                |                |        |  |                 |                         |
|  | 2.7 i 24V Allrad   | 129      |       | 08.04 | 03.10 |                |        |  |                                    |                         |                |                |        |  |                 |                         |
|  |  | 2.0 CRDi | 83    |       | 08.04 |                |        |  |                                    |                         | 03.10          | 03.0137-3016.2 | 653016 |  |                 | 167 x 27                |
|  |  | 2.0 CRDi | 88    |       | 01.07 |                |        |  |                                    |                         | 03.10          |                |        |  |                 |                         |
| 2.0 CRDi   |  | 100      |       | 01.06 | 03.10 |                |        |  |                                    |                         |                |                |        |  |                 |                         |
| 2.0 CRDi   |  | 103      |       | 01.06 | 03.10 |                |        |  |                                    |                         |                |                |        |  |                 |                         |
| 2.0 CRDi   |  | 110      |       | 01.09 | 03.10 |                |        |  |                                    |                         |                |                |        |  |                 |                         |
| 2.0 i 16V  |  | 104      |       | 08.04 | 03.10 | 03.0137-3004.2 | 653004 |  |                                    | 190 x 40 HEB            |                |                |        |  |                 |                         |
| 2.0 CRDi Allrad  |  | 83       |       | 08.04 | 03.10 |                |        |  |                                    |                         |                |                |        |  |                 |                         |
| 2.0 CRDi Allrad  |  | 88       |       | 01.07 | 03.10 |                |        |  |                                    |                         |                |                |        |  |                 |                         |
| 2.0 CRDi Allrad  |  | 100      |       | 01.06 | 03.10 |                |        |  |                                    |                         |                |                |        |  |                 |                         |
| 2.0 CRDi Allrad  |  | 103      |       | 01.06 | 03.10 |                |        |  |                                    |                         |                |                |        |  |                 |                         |
| 2.0 CRDi Allrad  | 110  |          | 01.09 | 03.10 |       |                |        |  |                                    |                         |                |                |        |  |                 |                         |
| 2.0 i 16V Allrad   | 104  |          | 08.04 | 03.10 |       |                |        |  |                                    |                         |                |                |        |  |                 |                         |
| 2.7 i 24V Allrad   | 129  |          | 08.04 | 03.10 |       |                |        |  |                                    |                         |                |                |        |  |                 |                         |
| HYUNDAI TUCSON (15-)   |  |          |       |       |       |                |        |  |                                    |                         |                |                |        |  |                 |                         |
|  | 1.6  | 130      |       | 06.15 |       | 13.0460-5600.2 | 605600 |  |                                    | 24501 16,7 +/WK SUM     |                |                |        |  |                 |                         |
|  | 1.6 GDI  | 97       |       | 06.15 |       |                |        |  |                                    |                         |                |                |        |  |                 |                         |
|  | 1.7 CRDi   | 85       |       | 06.15 |       |                |        |  |                                    |                         |                |                |        |  |                 |                         |
|  | 1.7 CRDi   | 104      |       | 06.15 |       |                |        |  |                                    |                         |                |                |        |  |                 |                         |
|  | 2.0 CRDi   | 100      |       | 06.15 |       |                |        |  |                                    |                         |                |                |        |  |                 |                         |
|  | 1.6 Allrad   | 129      |       | 06.15 |       | 13.0460-5600.2 | 605600 |  |                                    | 24501 16,7 +/WK SUM     |                |                |        |  |                 |                         |
|  | 1.6 Allrad   | 130      |       | 06.15 |       |                |        |  |                                    |                         |                |                |        |  |                 |                         |
|  | 2.0 CRDi Allrad  | 100      |       | 06.15 |       |                |        |  |                                    |                         |                |                |        |  |                 |                         |
|  | 2.0 CRDi Allrad  | 136      |       | 06.15 |       |                |        |  |                                    |                         |                |                |        |  |                 |                         |
|  |  |          |       |       |       |                |        |  |                                    |                         |                |                |        |  |                 |                         |
| HYUNDAI VELOSTER (11-)   |  |          |       |       |       |                |        |  |                                    |                         |                |                |        |  |                 |                         |
|  | 1.6 16V  | 95       |       | 10.11 | 04.12 | 13.0460-5645.2 | 605645 |  |                                    | 25692 17,2 +/WK/Zub     |                |                |        |  |                 |                         |
|  | 1.6 GDI  | 103      |       | 03.11 | 04.12 |                |        |  |                                    |                         |                |                |        |  |                 |                         |
|  | 1.6 16V  | 95       |       | 05.12 |       | 13.0460-5645.2 | 605645 |  |                                    | 25692 17,2 +/WK/Zub     |                |                |        |  |                 |                         |
|  | 1.6 GDI  | 103      |       | 05.12 |       |                |        |  |                                    |                         |                |                |        |  |                 |                         |

<sup>1)</sup> + brake disc 280mm / + dischi freno 280mm / + disques de frein 280mm / + disco de freno 280mm

























<sup>2)</sup> + brake disc 300mm / + dischi freno 300mm / + disques de frein 300mm / + disco de freno 300mm

|     |  |  |  |  |  |  |  |  |
|--|--|--|--|--|---|--|--|--|
| <b>HYUNDAI VELOSTER (11-)</b>  |  |  |  |  |   |  |  |  |
|    | 1.6 T-GDI  | 137  |  | 10.12  |   | 24.0128-0234.1   | 428234   | 300 28,0 26,4 V +B   |
|    | 1.6 16V  | 95   |  | 10.11  |   | 13.0460-5786.2   | 605786   | 24934 15,5 +/WK/Zub AKE  |
|  | 1.6 GDI  | 103  |  | 03.11  |   | 13.0470-5786.2   | LD5786   | 24934 15,5 +/WK/Zub AKE  |
|  | 1.6 T-GDI  | 137  |  | 10.12  |   |  |  |  |
|    | 1.6 16V  | 95   |  | 10.11  |   | 24.0110-0368.1   | 410368   | 262 10,0 8,4 +B  |
|  | 1.6 GDI  | 103  |  | 03.11  |   |  |  |  |
|  | 1.6 T-GDI  | 137  |  | 10.12  |   |  |  |  |
| <b>HYUNDAI XG (98-05)</b>  |  |  |  |  |   |  |  |  |
|    | 2.5 i V6 (XG25)  | 120  |  | 12.98  | 09.05   | 13.0460-5833.2   | 605833   | 23543 14,4 +/WK/Zub AKE  |
|  | 3.0 i V6 (XG30)  | 138  |  | 12.98  | 09.05   |  |  |  |
|  | 3.0 i V6 (XG30)  | 145  |  | 09.99  | 09.03   |  |  |  |
|  | 3.5 i V6 (XG35)  | 145  |  | 04.03  | 09.05   |  |  |  |
|    | 2.5 i V6 (XG25)  | 120  |  | 12.98  | 09.05   | 24.0110-0318.1   | 410318   | 262 10,0 8,4 +B  |
|  | 3.0 i V6 (XG30)  | 138  |  | 12.98  | 09.05   |  |  |  |
|  | 3.0 i V6 (XG30)  | 145  |  | 09.99  | 09.03   |  |  |  |
|  | 3.5 i V6 (XG35)  | 145  |  | 04.03  | 09.05   |  |  |  |
| <b>INFINITI EX/QX50 (J50) (08-)</b>  |  |  |  |  |   |  |  |  |
|    | 2.5 V6 4WD   | 175  |  | 04.10  |   | 13.0460-5778.2   | 605778   | 23698 16,8 +/WK SUM  |
|  | 3.0d 4WD   | 175  |  | 04.10  |   |  |  |  |
|  | 3.7 V6 4WD   | 228  |  | 02.11  | + RBS   |  |  |  |
|  | 3.7 V6 4WD   | 228  |  | 10.08  |   |  |  |  |
|  | 3.7 V6 4WD   | 235  |  | 02.11  | + RBS   |  |  |  |
|  | 3.7 V6 4WD   | 235  |  | 09.10  |   |  |  |  |
| <b>INFINITI FX (S50) (03-08)</b>   |  |  |  |  |   |  |  |  |
|    | 3.5 V6   | 206  |  | 02.03  | 12.08   | 24.0116-0122.1   | 416122   | 308 16,0 14,0 V +B   |
|  | 3.5 V6 4WD   | 206  |  | 01.03  | 12.08   |  |  |  |
|  | 4.5 V8   | 232  |  | 02.03  | 12.08   |  |  |  |
|  | 4.5 V8 4WD   | 232  |  | 01.03  | 12.08   |  |  |  |
| <b>INFINITI FX/QX70 (S51) (08-)</b>  |  |  |  |  |   |  |  |  |
|    | 3.0 d 4WD  | 175  |  | 04.10  |   | 03.0137-3041.2   | 653041   | 190 x 33/20  |
|  | 3.7 V6 4WD   | 235  |  | 10.08  |   |  |  |  |
|  | 5.0 V8 4WD   | 287  |  | 10.08  |   |  |  |  |
|  | 5.0 V8 4WD   | 287  |  | 08.13  |   |  |  |  |
|  | 5.0 V8 4WD   | 309  |  | 06.13  |   |  |  |  |
| <b>INFINITI G25/G37 (V36) (07-13)</b>  |  |  |  |  |   |  |  |  |
|  | 2.5 V6   | 163  |  | 01.11  |   | 13.0460-5778.2   | 605778   | - 4-Rad Lenkung <sup>1)</sup> 23698 16,8 +/WK SUM                                  |
|  | 3.7 V6   | 235  |  | 11.09  | + RBS   |  |  |  |
|  | 3.7 V6   | 235  |  | 10.08  |   |  |  |  |
|  | 3.7 V6   | 240  |  | 01.12  |   |  |  |  |
|  | 3.7 V6   | 243  |  | 11.09  | + RBS   |  |  |  |
|  | 3.7 V6   | 243  |  | 10.08  |   |  |  |  |
|  | 3.7 V6 4WD   | 235  |  | 11.09  | + RBS   |  |  |  |
|  | 3.7 V6 4WD   | 235  |  | 10.08  |   |  |  |  |
|  | 3.7 V6   | 235  |  | 10.08  | 01.10 + RBS   | 24.0128-0153.1   | 428153   | 320 28,0 26,0 V L +B   |
|  | 3.7 V6   | 243  |  | 10.08  | 01.10 + RBS   |  |  |  |
|  | 3.7 V6 4WD   | 235  |  | 10.08  | 01.10 + RBS   |  |  |  |
| <b>INFINITI G37/Q60 Coupe (CV36) (07-15)</b>                                       |  |  |  |  |   |  |  |  |
|  | 3.7 V6   | 235  |  | 09.10  |   | 13.0460-5778.2   | 605778   | - Sportpaket <sup>2)</sup> 23698 16,8 +/WK SUM                                     |
|  | 3.7 V6   | 243  |  | 09.07  |   |  |  |  |
| <b>INFINITI G37/Q60 Cabriolet (HV36) (10-15)</b>                                   |  |  |  |  |   |  |  |  |
|  | 3.7 V6   | 235  |  | 01.10  | + RBS   | 13.0460-5778.2   | 605778   | - 19" Rad <sup>3)</sup> 23698 16,8 +/WK SUM  |
|  | 3.7 V6   | 235  |  | 09.10  |   |  |  |  |
| <b>INFINITI M35/M45 (Y50) (05-)</b>  |  |  |  |  |   |  |  |  |
|  | 3.5 V6   | 206  |  | 07.06  | 12.13   | 24.0128-0153.1   | 428153   | 320 28,0 26,0 V L +B   |
|  | 3.5 V6 4WD   | 206  |  | 07.06  | 12.13   |  |  |  |
|  | 4.5 V8   | 250  |  | 07.06  | 12.13   |  |  |  |
| <b>INFINITI M/Q70 (Y51) (10-)</b>  |  |  |  |  |   |  |  |  |
|  | 2.2d RWD   | 125  |  | 10.14  |   | 13.0460-5778.2   | 605778   | 23698 16,8 +/WK SUM  |
|  | 2.5 V6 RWD   | 163  |  | 07.10  |   | 13.0460-5778.2   | 605778   | - 4-Rad Lenkung <sup>1)</sup> 23698 16,8 +/WK SUM                                  |
|  | 3.0d RWD   | 175  |  | 03.10  |   |  |  |  |
|  | 3.7 V6 4WD   | 243  |  | 01.12  |   |  |  |  |
|  | 3.7 V6 RWD   | 235  |  | 03.10  |   |  |  |  |
|  | 3.7 V6 RWD   | 243  |  | 01.12  |   |  |  |  |
|  | 5.6 V8 4WD   | 300  |  | 03.10  |   |  |  |  |
|  | 5.6 V8 RWD   | 309  |  | 01.12  |   |  |  |  |
|  | 3.5 Hybrid RWD   | 225  |  | 04.11  |   | 13.0460-5778.2   | 605778   | 23698 16,8 +/WK SUM  |
|  | 2.2d RWD   | 125  |  | 10.14  |   | 24.0116-0122.1   | 416122   | 308 16,0 14,0 V +B   |
|  | 2.5 V6 RWD   | 163  |  | 07.10  |   | 24.0116-0122.1   | 416122   | - 4-Rad Lenkung <sup>1)</sup> 308 16,0 14,0 V +B                                   |
|  | 3.0d RWD   | 175  |  | 03.10  |   |  |  |  |
|  | 3.7 V6 4WD   | 243  |  | 01.12  |   |  |  |  |
|  | 3.7 V6 RWD   | 235  |  | 03.10  |   |  |  |  |
|  | 3.7 V6 RWD   | 243  |  | 01.12  |   |  |  |  |



























<sup>1)</sup> - 4 wheel steering / - 4 route sterzanti / - 4 roues directionnelles / + dirección sobre cuatro ruedas

<sup>2)</sup> - sport package / - pacchetto sportivo / - version sport / - kit deportivo

<sup>3)</sup> - 19" wheel / - ruota 19" / - roue 19" / - rueda 19"

|     |    |  |  |  |  |  |  |  |   |
|--|--|--|--|--|---|--|--|--|---|
| <b>INFINITI M/Q70 (Y51) (10-)</b>  |  |  |  |  |   |  |  |  |   |
|    | 5.6 V8 4WD<br>5.6 V8 RWD<br>3.5 Hybrid RWD   | 300<br>309<br>225  |  | 03.10<br>01.12<br>04.11  |   | 24.0116-0122.1<br>416122   |  | - 4-Rad Lenkung <sup>1)</sup>  | 308 16,0 14,0 V +B                          |
|    | 2.2d RWD<br>2.5 V6 RWD<br>3.0d RWD<br>3.5 Hybrid RWD<br>3.7 V6 4WD<br>3.7 V6 RWD<br>3.7 V6 RWD<br>5.6 V8 4WD<br>5.6 V8 RWD | 125<br>163<br>175<br>225<br>243<br>235<br>243<br>300<br>309                      |  | 10.14<br>07.10<br>03.10<br>04.11<br>01.12<br>03.10<br>01.12<br>03.10<br>01.12    |   | 03.0137-3041.2<br>653041   |  |  | 190 x 33/20                                 |
| <b>INFINITI Q50 (V37) (13-)</b>  |  |  |  |  |   |  |  |  |   |
|    | 2.0 Turbo<br>2.2 D<br>3.5 V6 Hybrid<br>3.5 V6 Hybrid 4WD   | 155<br>125<br>268<br>268   |  | 04.14<br>04.13<br>04.13<br>04.13   |   | 24.0116-0122.1<br>416122   |  |  | 308 16,0 14,0 V +B                          |
| <b>ISUZU D-MAX (8DH) (02-12)</b>   |  |  |  |  |   |  |  |  |   |
|    | 2.5 D<br>2.5 D 4x4<br>3.0 DiTD<br>3.0 DiTD 4x4   | 74<br>74<br>96<br>96   |  | 10.02<br>05.03<br>05.02<br>05.03<br>10.02<br>05.03<br>05.02<br>05.03             |   | 03.0137-0445.2<br>650445   |  |  | 294 x 47                                    |
| <b>ISUZU TROOPER (91-98)</b>   |  |  |  |  |   |  |  |  |   |
|    | 3.1 TDi<br>3.2 V6  | 84<br>130  |  | 08.91<br>07.98<br>08.91<br>07.98   |   | 13.0460-5926.2<br>605926   |  |  | 21845 16,5 +/WK AKE                         |
|    | 3.1 TDi<br>3.2 V6  | 84<br>130  |  | 08.91<br>07.98<br>08.91<br>07.98   |   | 24.0126-0111.1<br>426111   |  |  | 280 26,0 24,6 V +B                          |
|    | 3.1 TDi<br>3.2 V6  | 84<br>130  |  | 08.91<br>07.98<br>08.91<br>07.98   |   | 13.0460-5927.2<br>605927   |  |  | 21875 16,0 +/WK AKE                         |
|   | 3.1 TDi<br>3.2 V6  | 84<br>130  |  | 08.91<br>07.98<br>08.91<br>07.98   |   | 24.0118-0122.1<br>418122   |  |  | 313 18,0 16,6 V +B                          |
| <b>ISUZU TROOPER (98-04)</b>   |  |  |  |  |   |  |  |  |   |
|  | 3.0 DiTD<br>3.5 V6   | 118<br>158   |  | 08.98<br>08.04<br>08.98<br>08.04   |   | 13.0460-5926.2<br>605926   |  |  | 21845 16,5 +/WK AKE                         |
|  | 3.0 DiTD<br>3.5 V6   | 118<br>158   |  | 08.98<br>08.04<br>08.98<br>08.04   |   | 24.0126-0111.1<br>426111   |  |  | 280 26,0 24,6 V +B                          |
|  | 3.0 DiTD<br>3.5 V6   | 118<br>158   |  | 08.98<br>08.04<br>08.98<br>08.04   |   | 13.0460-5927.2<br>605927   |  |  | 21875 16,0 +/WK AKE                         |
|  | 3.0 DiTD<br>3.5 V6   | 118<br>158   |  | 08.98<br>08.04<br>08.98<br>08.04   |   | 24.0118-0122.1<br>418122   |  |  | 313 18,0 16,6 V +B                          |
| <b>IVECO CAMPAGNOLA (08-10)</b>  |  |  |  |  |   |  |  |  |   |
|  | 3.0 HPI 4x4<br>3.0 HPT 4x4   | 107<br>130   |  | 09.08<br>12.10<br>09.08<br>12.10   |   | 13.0460-2750.2<br>602750   |  |  | 20741 15,0 TRW                              |
|  | 3.0 HPI 4x4<br>3.0 HPT 4x4   | 107<br>130   |  | 09.08<br>12.10<br>09.08<br>12.10   |   | 13.0460-2751.2<br>602751   |  |  | 21418 15,5 TRW                              |
| <b>IVECO DAILY I / GRINTA (78-99)</b>  |  |  |  |  |   |  |  |  |   |
|  | 28 F 8<br>30 F 8<br>32 F 8<br>35 F 8<br>40 F 8   |  |  | 01.78<br>05.81<br>01.78<br>05.81<br>01.78<br>05.81<br>01.78<br>05.81             |   | 13.0460-0415.2<br>610415   |  |  | Belagsatz-Zubehör AP                        |
|  | 30.8<br>35.8<br>40.8   |  |  | 06.81<br>05.86<br>06.81<br>05.86<br>06.81<br>05.86                               |   | 13.0460-0415.2<br>610415   |  |  | Belagsatz-Zubehör AP                        |
|  | 30.8<br>35.8<br>40.8   |  |  | 06.86<br>12.88<br>06.86<br>12.88<br>06.86<br>12.88                               |   | 13.0460-0415.2<br>610415   |  |  | Belagsatz-Zubehör AP                        |
|  | 30.8<br>35.8<br>40.8   |  |  | 01.89<br>08.97<br>01.89<br>08.97<br>01.89<br>08.97                               |   | 13.0460-4955.2<br>604955<br>13.0460-0415.2<br>610415                               |  |  | 21048 18,3 +/WK BRE<br>Belagsatz-Zubehör AP |
|  | 30.8<br>35.8<br>40.8   |  |  | 09.97<br>04.99<br>09.97<br>04.99<br>09.97<br>04.99                               |   | 13.0460-4918.2<br>604918   |  |  | 29140 18,3 +/WK BRE                         |
|  | 30.9<br>30.9   |  |  | 01.89<br>08.97<br>09.97<br>04.99   |   | 13.0460-4913.2<br>604913<br>13.0460-4919.2<br>604919                               |  |  | 29037 18,3 +/WK BRE<br>29139 18,3 +/WK BRE  |
|  | 45.10<br>49.10   |  |  | 01.89<br>08.97<br>01.89<br>08.97   |   | 13.0460-7903.2<br>607903   |  |  | 29012 18,0 +/WK PER                         |

<sup>1)</sup> - 4 wheel steering / - 4 route sterzanti / - 4 roues directionnelles / + dirección sobre cuatro ruedas





























|     |  |  |  |  |  |  |  |  |                    |
|--|--|--|--|--|---|--|--|--|--------------------|
| <b>IVECO DAILY I / GRINTA (78-99)</b>  |  |  |  |  |   |  |  |  |                    |
|    | 35.10  |  |  | 01.96  | 04.99   | 13.0460-4966.2   | 604966   | 29121 20,3 /WE/S   | <b>BRE</b>         |
|  | 35.12  |  |  | 01.96  | 04.99   | 13.0460-4989.2   | 604989   | 29212 17,3 /WE/S   | <b>BRE</b>         |
|  | 49.12  |  |  | 01.96  | 04.99   | 24.8190-1304.2   | 621304   | Warnkontakt L=289mm  |                    |
|  | 59.12  |  |  | 01.90  | 08.97   | 13.0460-7906.2   | 607906   | 29001 20,0 +/WK  | <b>PER</b>         |
|    | 28 F 8   |  |  | 01.78  | 05.81   | 24.0114-0110.2   | 414110   | 267 14,2 12,8  |                    |
|  | 30 F 8   |  |  | 01.78  | 05.81   |  |  |  |                    |
|  | 30.8   |  |  | 06.81  | 05.96   |  |  |  |                    |
|  | 32 F 8   |  |  | 01.78  | 05.81   |  |  |  |                    |
|  | 35 F 8   |  |  | 01.78  | 05.81   |  |  |  |                    |
|  | 35.8   |  |  | 06.81  | 05.96   |  |  |  |                    |
|  | 40 F 8   |  |  | 01.78  | 05.81   |  |  |  |                    |
|    | 35.10  |  |  | 01.96  | 04.99   | 13.0460-4966.2   | 604966   | 29121 20,3 /WE/S   | <b>BRE</b>         |
|  | 35.12  |  |  | 01.96  | 04.99   | 24.8190-1304.2   | 621304   | Warnkontakt L=289mm  |                    |
|  | 49.12  |  |  | 01.96  | 04.99   |  |  |  |                    |
|  | 60.12  |  |  | 01.96  | 04.99   | 13.0460-4966.2   | 604966   | 29121 20,3 /WE/S   | <b>BRE</b>         |
|    | 28 F 8   |  |  | 01.78  | 05.81   | 03.0137-0309.2   | 650309   | + Einfachbereifung <sup>1)</sup>   | 254 x 70           |
|  | 30 F 8   |  |  | 01.78  | 05.81   |  |  |  |                    |
|  | 30.8   |  |  | 06.81  | 04.99   |  |  |  |                    |
|  | 32 F 8   |  |  | 01.78  | 05.81   |  |  |  |                    |
|  | 35 F 8   |  |  | 01.78  | 05.81   | 03.0137-0300.2   | 650300   | + Doppelbereifung <sup>2)</sup>  | 254 x 89           |
|  | 35.8   |  |  | 06.81  | 04.99   |  |  |  |                    |
|  | 40 F 8   |  |  | 01.78  | 05.81   |  |  |  |                    |
|    | 35.10  |  |  | 01.96  | 04.99   | 03.0137-3005.2   | 653005   | 172 x 42   |                    |
|  | 35.12  |  |  | 01.96  | 04.99   |  |  |  |                    |
|  | 49.12  |  |  | 01.96  | 04.99   |  |  |  |                    |
| <b>IVECO DAILY II (99-06)</b>  |  |  |  |  |   |  |  |  |                    |
|    | 29   |  |  | 05.99  | 04.06   | 13.0460-4966.2   | 604966   | 29121 20,3 /WE/S   | <b>BRE</b>         |
|  | 35 C   |  |  | 05.99  | 04.06   | 13.0460-4989.2   | 604989   | 29212 17,3 /WE/S   | <b>BRE</b>         |
|  | 35 S   |  |  | 05.99  | 04.06   | 24.8190-1304.2   | 621304   | Warnkontakt L=289mm  |                    |
|  | 49   |  |  | 05.99  | 04.06   |  |  |  |                    |
|    | 50 C   |  |  | 01.01  | 04.06   | 13.0460-4847.2   | 604847   | 29160 20,3 /WE/Zub/S   | <b>BRE</b>         |
|  | 65 C   |  |  | 11.01  | 04.06   |  |  |  |                    |
|   | 29   |  |  | 05.99  | 04.06   | 24.0122-0262.1   | 422262   | 276 22,0 19,0  |                    |
|  | 35 S   |  |  | 05.99  | 04.06   |  |  |  |                    |
|  | 29   |  |  | 05.99  | 04.06   | 13.0460-4996.2   | 604996   | 29123 20,3 /WE   | <b>BRE</b>         |
|  | 35 C   |  |  | 05.99  | 04.06   |  |  |  |                    |
|  | 50 C   |  |  | 05.99  | 04.06   |  |  |  |                    |
|  | 35 C   |  |  | 05.99  | 04.06   | 13.0460-4966.2   | 604966   | 29121 20,3 /WE/S   | <b>BRE</b>         |
|  | 35 S   |  |  | 05.99  | 04.06   | 24.8190-1304.2   | 621304   | Warnkontakt L=289mm  |                    |
|  | 49   |  |  | 05.99  | 04.06   |  |  |  |                    |
|  | 60 C   |  |  | 05.99  | 04.06   | 13.0460-4966.2   | 604966   | 29121 20,3 /WE/S   | <b>BRE</b>         |
|  | 65 C   |  |  | 05.99  | 04.06   | 24.8190-1304.2   | 621304   | Warnkontakt L=289mm  |                    |
|  | 29   |  |  | 05.99  | 04.06   | 24.0116-0129.1   | 416129   | - ABS  | 276 16,0 13,0      |
|  | 35 S   |  |  | 05.99  | 04.06   | 24.0116-0128.1   | 416128   | + ABS/ mit Sensorring <sup>3)</sup>  | 276 16,0 13,0      |
|  | 29   |  |  | 05.99  | 04.06   | 03.0137-3005.2   | 653005   | 172 x 42   |                    |
|  | 35 C   |  |  | 05.99  | 04.06   |  |  |  |                    |
|  | 50 C   |  |  | 05.99  | 04.06   |  |  |  |                    |
|  | 29   |  |  | 05.99  | 04.06   |  |  |  |                    |
| <b>IVECO DAILY III (06-13)</b>   |  |  |  |  |   |  |  |  |                    |
|  | 29 L   |  |  | 05.06  | 12.13   | 13.0460-4830.2   | 604830   | 29229 20,7 /WE/Zub   | <b>BRE</b>         |
|  | 35 C   |  |  | 05.06  | 12.13   |  |  |  |                    |
|  | 35 S   |  |  | 05.06  | 12.13   |  |  |  |                    |
|  | 65   |  |  | 05.06  | 12.13   | 13.0460-4828.2   | 604828   | 29122 22,1 /WE   | <b>BRE</b>         |
|  | 29 L   |  |  | 05.06  | 12.13   | 24.0128-0239.1   | 428239   | 290 28,0 25,0 V +B   |                    |
|  | 35 C   |  |  | 05.06  | 12.13   | 24.0128-0238.1   | 428238   | + 6-Loch-Felge <sup>4)</sup>   | 300 28,0 25,0 V +B |
|  | 35 S   |  |  | 05.06  | 12.13   |  |  |  |                    |
|  | 65   |  |  | 05.06  | 12.13   | 24.0128-0238.1   | 428238   | 300 28,0 25,0 V +B   |                    |
|  | 29 L   |  |  | 05.06  | 12.13   | 13.0460-4823.2   | 604823   | 29232 21,0 /WE/Zub   | <b>BRE</b>         |
|  | 35 C   |  |  | 05.06  | 12.13   | 13.0460-4996.2   | 604996   | 29123 20,3 /WE   | <b>BRE</b>         |
|  | 35 S   |  |  | 05.06  | 12.13   |  |  |  |                    |
|  | 65   |  |  | 05.06  | 12.13   | 13.0460-4829.2   | 604829   | 29231 22,7 +/WE/Zub  | <b>BRE</b>         |
|  | 29 L   |  |  | 05.06  | 12.13   | 24.0124-0228.1   | 424228   | 294 24,0 21,0 V +B   |                    |
|  | 35 C   |  |  | 05.06  | 12.13   |  |  |  |                    |
|  | 35 S   |  |  | 05.06  | 12.13   |  |  |  |                    |
| <b>IVECO DAILY V (11-)</b>   |  |  |  |  |   |  |  |  |                    |
|  | 26 L   |  |  | 09.11  |   | 13.0460-4830.2   | 604830   | 29229 20,7 /WE/Zub   | <b>BRE</b>         |
|  | 29 L   |  |  | 09.11  |   |  |  |  |                    |
|  | 35 C   |  |  | 09.11  |   |  |  |  |                    |
|  | 35 S   |  |  | 09.11  |   |  |  |  |                    |
|  | 26 L   |  |  | 09.11  |   | 24.0128-0238.1   | 428238   | 300 28,0 25,0 V +B   |                    |
|  | 29 L   |  |  | 09.11  |   |  |  |  |                    |
|  | 35 C   |  |  | 09.11  |   |  |  |  |                    |
|  | 35 S   |  |  | 09.11  |   |  |  |  |                    |

<sup>1)</sup> + single tyre / + ruota singola / + roue simple / + cubierta simple

<sup>2)</sup> + twin tyres / + ruote gemellate / + roue jumelée / + cubierta doble

<sup>3)</sup> + ABS/ with sensor ring / + ABS/ con sensore / + ABS/ avec secours ABS / + ABS/ con anillo sensor ABS

<sup>4)</sup> + 6 bore wheel rim / + cerchione a 6 fori / + jante à 6 trous / + Llantas de 6 taladros

|     |  |  |  |  |  |  |  |    |
|--|--|--|--|--|---|--|--|--|
| <b>IVECO DAILY V (11-)</b>   |  |  |  |  |   |  |  |  |
|    | 26 L<br>29 L<br>35 S<br>35 C   |  |  | 09.11<br>09.11<br>09.11<br>09.11   |   |  | 13.0460-4996.2 604996  | 29123 20,3 /WE <b>BRE</b>  |
|    | 26 L<br>29 L<br>35 C<br>35 S   |  |  | 09.11<br>09.11<br>09.11<br>09.11   |   |  | 13.0460-4823.2 604823<br>24.0124-0228.1 424228                                     | 29232 21,0 /WE/Zub <b>BRE</b><br>294 24,0 21,0 V +B  |
| <b>IVECO EURO CARGO (06-)</b>  |  |  |  |  |   |  |  |  |
|    | 75 E 14<br>75 E 16<br>80 E 18  | 103<br>118<br>130  |  | 09.06<br>09.06<br>09.06  |   |  | 13.0460-4844.2 604844  | 29256 27,0 /WE <b>BRE</b>  |
|    | 75 E 14<br>75 E 16<br>80 E 18  | 103<br>118<br>130  |  | 09.06<br>09.06<br>09.06  |   |  | 13.0460-4844.2 604844  | 29256 27,0 /WE <b>BRE</b>  |
| <b>IVECO MASSIF (08-10)</b>  |  |  |  |  |   |  |  |  |
|    | 3.0 HPI 4x4<br>3.0 HPT 4x4   | 107<br>130   |  | 09.08<br>09.08   | 12.10<br>12.10  |  | 13.0460-2750.2 602750  | 20741 15,0 <b>TRW</b>  |
|    | 3.0 HPI 4x4<br>3.0 HPT 4x4   | 107<br>130   |  | 09.08<br>09.08   | 12.10<br>12.10  |  | 13.0460-2751.2 602751  | 21418 15,5 <b>TRW</b>  |
| <b>JAGUAR F-Type (X152) (12-)</b>  |  |  |  |  |   |  |  |  |
|    | 3.0 V6<br>3.0 V6<br>3.0 V6 AWD<br>5.0 SVR<br>5.0 V8<br>5.0 V8<br>5.0 V8 AWD      | 250<br>280<br>280<br>423<br>364<br>405<br>405                                    |  | 10.12<br>10.12<br>12.14<br>12.15<br>10.12<br>10.13<br>12.14                      |   |  | 24.0711-5238.3 360441  | 2  - Keramikbremse <sup>1)</sup><br>Radsensor L=450 |
| <b>JAGUAR S-Type (CCX) (99-08)</b>   |  |  |  |  |   |  |  |  |
|    | 3.0 V6<br>4.0 V8<br>4.2 V8 Supercharged  | 175<br>203<br>298  | M45254   | 01.99<br>01.99<br>11.01  | 10.07<br>04.02  |  | 13.0460-2729.2 602729  | 23423 17,8 /Zub/S <b>TRW</b>   |
|   | 2.5 V6<br>2.7 D<br>4.2 V8  | 147<br>152<br>219  |  | 04.02<br>06.04<br>04.02  | 10.07<br>10.07<br>10.07   |  | 13.0460-2898.2 602898  | 23908 18,0 /WE/Zub/S <b>TRW</b>  |
|  | 4.2 V8 Supercharged<br>R 4.2 V8  | 298<br>291   | M45255<br>N52047   | 04.02  | 10.07   |  | 13.0460-4841.2 604841  | 23489 16,3 <b>BRE</b>  |
|  | 3.0 V6<br>4.0 V8   | 175<br>203   |  | 01.99<br>01.99   | 01.00<br>04.02  |  | 24.0130-0120.1 430120  | 300 30,0 28,0 V +B   |
|  | 2.5 V6<br>2.7 D<br>3.0 V6<br>4.2 V8  | 147<br>152<br>175<br>219   |  | 04.02<br>06.04<br>02.00<br>04.02   | 10.07<br>10.07<br>10.07<br>10.07  |  | 24.0130-0182.1 430182  | 320 30,0 28,4 V +B   |
|  | 2.5 V6<br>2.7 D<br>3.0 V6<br>4.0 V8  | 147<br>152<br>175<br>203   |  | 04.02<br>06.04<br>01.99<br>01.99   | 10.07<br>10.07<br>10.07<br>04.02  |  | 13.0460-2730.2 602730  | 23424 17,6 /S <b>TRW</b>   |
|  | 4.2 V8<br>R 4.2 V8<br>4.2 V8 Supercharged  | 219<br>291<br>298  |  | 04.02<br>04.02<br>11.01  | 10.07<br>10.07<br>12.08   |  | 13.0460-7209.2 607209<br>13.0460-4964.2 604964<br>13.0460-4964.2 604964            | 23482 16,6 +<br>21381 15,0 <b>ATE</b><br><b>BRE</b><br>21381 15,0 <b>BRE</b>   |
|  | 2.5 V6<br>2.7 D<br>3.0 V6<br>4.0 V8<br>4.2 V8                                    | 147<br>152<br>175<br>203<br>219  | N52047<br>N52047<br>N52047<br>N52047<br>N52047                                   | 04.02<br>06.04<br>01.99<br>01.99<br>04.02  |   |  | 24.0120-0708.1 420708  | 288 20,0 18,5 V +B   |
|  | 2.5 V6<br>2.7 D<br>3.0 V6<br>4.0 V8<br>4.2 V8                                    | 147<br>152<br>175<br>203<br>219  | N52048<br>N52048<br>N52048<br>N52048<br>N52048                                   |  | 10.07<br>10.07<br>10.07<br>04.02<br>10.07   |  | 24.0120-0238.1 420238  | 326 20,0 18,0 V L +B   |
| <b>JAGUAR X-Type (CF1) Limousine (01-09)</b>                                       |  |  |  |  |   |  |  |  |
|  | 2.0 D<br>2.0 V6<br>2.2 D<br>2.2 D<br>2.2 D<br>2.5 V6<br>3.0 V6                   | 96<br>115<br>107<br>110<br>114<br>144<br>169                                     | J04730<br>J04730<br>J04730<br>J04730<br>J04730<br>J04730<br>J04730               | 07.03<br>03.02<br>01.07<br>10.05<br>10.05<br>06.01<br>06.01                      |   |  | 13.0460-3987.2 603987<br>13.0470-3987.2 LD3987                                     | 23279 18,4 /S <b>BOS</b><br>23279 18,4 /S <b>BOS</b>   |
|  | 2.0 D<br>2.0 V6<br>2.2 D<br>2.2 D<br>2.2 D<br>2.5 V6<br>3.0 V6                   | 96<br>115<br>107<br>110<br>114<br>144<br>169                                     | J52300<br>J52300<br>J52300<br>J52300<br>J52300<br>J52300<br>J52300               | 07.03<br>03.02<br>01.07<br>10.05<br>10.05<br>06.01<br>06.01                      |   |  | 24.0124-0161.1 424161<br>24.0324-0161.1 524161                                     | 300 23,9 22,0 V +B<br>300 23,9 22,0 V +B <b>PD</b>   |
|  | 2.0 D<br>2.0 V6<br>2.2 D   | 96<br>115<br>107   | J52301<br>J52301<br>J52301   |  | 11.09<br>10.05<br>11.09   |  | 24.0124-0161.1 424161<br>24.0324-0161.1 524161                                     | 300 23,9 22,0 V +B<br>300 23,9 22,0 V +B <b>PD</b>   |

<sup>1)</sup> - ceramic brake / - freno in ceramica / - frein de céramique / - freno de cerámica





### JAGUAR X-Type (CF1) Limousine (01-09)

|        |        |        |        |       |       |                |        |  |                       |
|--------|--------|--------|--------|-------|-------|----------------|--------|--|-----------------------|
|        | 2.2 D  | 110    | J52301 |       | 11.09 | 24.0124-0161.1 | 424161 |  | 300 23,9 22,0 V +B    |
|        | 2.2 D  | 114    | J52301 |       | 11.09 | 24.0324-0161.1 | 524161 |  | 300 23,9 22,0 V +B PD |
|        | 2.5 V6 | 144    | J52301 |       | 11.09 |                |        |  |                       |
|        | 3.0 V6 | 169    | J52301 |       | 11.07 |                |        |  |                       |
|        |        |        |        |       |       |                |        |  |                       |
|        | 2.0 D  | 96     | E73993 | 07.03 |       | 13.0460-3988.2 | 603988 |  | 23557 17,2 /S BOS     |
|        | 2.0 V6 | 115    | E73993 | 03.02 |       | 13.0470-3988.2 | LD3988 |  | 23557 17,2 /S BOS     |
|        | 2.2 D  | 107    | E73993 | 01.07 |       |                |        |  |                       |
|        | 2.2 D  | 110    | E73993 | 10.05 |       |                |        |  |                       |
|        | 2.2 D  | 114    | E73993 | 10.05 |       |                |        |  |                       |
|        | 2.5 V6 | 144    | E73993 | 06.01 |       |                |        |  |                       |
|        | 3.0 V6 | 169    | E73993 | 06.01 |       |                |        |  |                       |
|        | 2.0 D  | 96     | E73994 |       | 11.09 | 13.0460-3831.2 | 603831 |  | 24260 17,3 /Zub/S BOS |
|        | 2.0 V6 | 115    | E73994 |       | 10.05 | 13.0470-3831.2 | LD3831 |  | 24260 17,3 /Zub/S BOS |
|        | 2.2 D  | 107    | E73994 |       | 11.09 |                |        |  |                       |
| 2.2 D  | 110    | E73994 |        | 11.09 |       |                |        |  |                       |
| 2.2 D  | 114    | E73994 |        | 11.09 |       |                |        |  |                       |
| 2.5 V6 | 144    | E73994 |        | 11.09 |       |                |        |  |                       |
| 3.0 V6 | 169    | E73994 |        | 11.07 |       |                |        |  |                       |
|        | 2.0 D  | 96     | J52300 | 07.03 |       | 24.0112-0154.1 | 412154 |  | 280 12,0 10,0 +B      |
|        | 2.0 V6 | 115    | J52300 | 03.02 |       | 24.0312-0154.1 | 512154 |  | 280 12,0 10,0 +B PD   |
|        | 2.2 D  | 107    | J52300 | 01.07 |       |                |        |  |                       |
|        | 2.2 D  | 110    | J52300 | 10.05 |       |                |        |  |                       |
|        | 2.2 D  | 114    | J52300 | 10.05 |       |                |        |  |                       |
|        | 2.5 V6 | 144    | J52300 | 06.01 |       |                |        |  |                       |
|        | 3.0 V6 | 169    | J52300 | 06.01 |       |                |        |  |                       |
|        | 2.0 D  | 96     | J52301 |       | 11.09 | 24.0112-0154.1 | 412154 |  | 280 12,0 10,0 +B      |
|        | 2.0 V6 | 115    | J52301 |       | 10.05 | 24.0312-0154.1 | 512154 |  | 280 12,0 10,0 +B PD   |
|        | 2.2 D  | 107    | J52301 |       | 11.09 |                |        |  |                       |
| 2.2 D  | 110    | J52301 |        | 11.09 |       |                |        |  |                       |
| 2.2 D  | 114    | J52301 |        | 11.09 |       |                |        |  |                       |
| 2.5 V6 | 144    | J52301 |        | 11.09 |       |                |        |  |                       |
| 3.0 V6 | 169    | J52301 |        | 11.07 |       |                |        |  |                       |

### JAGUAR X-Type (CF1) Kombi (03-09)

|        |        |        |        |       |       |                |        |  |                       |
|--------|--------|--------|--------|-------|-------|----------------|--------|--|-----------------------|
|        | 2.0 D  | 96     | J04730 | 02.04 |       | 13.0460-3987.2 | 603987 |  | 23279 18,4 /S BOS     |
|        | 2.0 V6 | 115    | J04730 | 11.03 |       | 13.0470-3987.2 | LD3987 |  | 23279 18,4 /S BOS     |
|        | 2.2 D  | 107    | J04730 | 01.07 |       |                |        |  |                       |
|        | 2.2 D  | 110    | J04730 | 10.05 |       |                |        |  |                       |
|        | 2.2 D  | 114    | J04730 | 10.05 |       |                |        |  |                       |
|        | 2.5 V6 | 144    | J04730 | 02.04 |       |                |        |  |                       |
|        | 3.0 V6 | 169    | J04730 | 02.04 |       |                |        |  |                       |
|        | 2.0 D  | 96     | J52300 | 02.04 |       | 24.0124-0161.1 | 424161 |  | 300 23,9 22,0 V +B    |
|        | 2.0 V6 | 115    | J52300 | 11.03 |       | 24.0324-0161.1 | 524161 |  | 300 23,9 22,0 V +B PD |
|        | 2.2 D  | 107    | J52300 | 01.07 |       |                |        |  |                       |
|        | 2.2 D  | 110    | J52300 | 10.05 |       |                |        |  |                       |
|        | 2.2 D  | 114    | J52300 | 10.05 |       |                |        |  |                       |
|        | 2.5 V6 | 144    | J52300 | 02.04 |       |                |        |  |                       |
|        | 3.0 V6 | 169    | J52300 | 02.04 |       |                |        |  |                       |
|        | 2.0 D  | 96     | J52301 |       | 12.09 | 24.0124-0161.1 | 424161 |  | 300 23,9 22,0 V +B    |
|        | 2.0 V6 | 115    | J52301 |       | 03.09 | 24.0324-0161.1 | 524161 |  | 300 23,9 22,0 V +B PD |
|        | 2.2 D  | 107    | J52301 |       | 12.09 |                |        |  |                       |
| 2.2 D  | 110    | J52301 |        | 12.09 |       |                |        |  |                       |
| 2.2 D  | 114    | J52301 |        | 12.09 |       |                |        |  |                       |
| 2.5 V6 | 144    | J52301 |        | 12.09 |       |                |        |  |                       |
| 3.0 V6 | 169    | J52301 |        | 12.09 |       |                |        |  |                       |
|        | 2.0 D  | 96     | E73993 | 02.04 |       | 13.0460-3988.2 | 603988 |  | 23557 17,2 /S BOS     |
|        | 2.0 V6 | 115    | E73993 | 11.03 |       | 13.0470-3988.2 | LD3988 |  | 23557 17,2 /S BOS     |
|        | 2.2 D  | 107    | E73993 | 01.07 |       |                |        |  |                       |
|        | 2.2 D  | 110    | E73993 | 10.05 |       |                |        |  |                       |
|        | 2.2 D  | 114    | E73993 | 10.05 |       |                |        |  |                       |
|        | 2.5 V6 | 144    | E73993 | 02.04 |       |                |        |  |                       |
|        | 3.0 V6 | 169    | E73993 | 02.04 |       |                |        |  |                       |
|        | 2.0 D  | 96     | E73994 |       | 12.09 | 13.0460-3831.2 | 603831 |  | 24260 17,3 /Zub/S BOS |
|        | 2.0 V6 | 115    | E73994 |       | 03.09 | 13.0470-3831.2 | LD3831 |  | 24260 17,3 /Zub/S BOS |
|        | 2.2 D  | 107    | E73994 |       | 12.09 |                |        |  |                       |
| 2.2 D  | 110    | E73994 |        | 12.09 |       |                |        |  |                       |
| 2.2 D  | 114    | E73994 |        | 12.09 |       |                |        |  |                       |
| 2.5 V6 | 144    | E73994 |        | 12.09 |       |                |        |  |                       |
| 3.0 V6 | 169    | E73994 |        | 12.09 |       |                |        |  |                       |
|        | 2.0 D  | 96     | J52300 | 02.04 |       | 24.0112-0154.1 | 412154 |  | 280 12,0 10,0 +B      |
|        | 2.0 V6 | 115    | J52300 | 11.03 |       | 24.0312-0154.1 | 512154 |  | 280 12,0 10,0 +B PD   |
|        | 2.2 D  | 107    | J52300 | 01.07 |       |                |        |  |                       |
|        | 2.2 D  | 110    | J52300 | 10.05 |       |                |        |  |                       |
|        | 2.2 D  | 114    | J52300 | 10.05 |       |                |        |  |                       |
|        | 2.5 V6 | 144    | J52300 | 02.04 |       |                |        |  |                       |
|        | 3.0 V6 | 169    | J52300 | 02.04 |       |                |        |  |                       |
|        | 2.0 D  | 96     | J52301 |       | 12.09 | 24.0112-0154.1 | 412154 |  | 280 12,0 10,0 +B      |
|        | 2.0 V6 | 115    | J52301 |       | 03.09 | 24.0312-0154.1 | 512154 |  | 280 12,0 10,0 +B PD   |
|        | 2.2 D  | 107    | J52301 |       | 12.09 |                |        |  |                       |
| 2.2 D  | 110    | J52301 |        | 12.09 |       |                |        |  |                       |
| 2.2 D  | 114    | J52301 |        | 12.09 |       |                |        |  |                       |
| 2.5 V6 | 144    | J52301 |        | 12.09 |       |                |        |  |                       |
| 3.0 V6 | 169    | J52301 |        | 12.09 |       |                |        |  |                       |

































### JAGUAR XF (CC9) (08-)

|                   |                   |            |        |   |                |        |   |  |                     |
|-------------------|-------------------|------------|--------|---|----------------|--------|---|--|---------------------|
|                   | 2.0 16V           | 177        |        | 06.12                                       | 24.0130-0226.1 | 430226 |   |  | 326 30,0 28,0 VL +B |
|                   | 2.2 D             | 120        |        | 04.11                                       |                |        |   |  |                     |
|                   | 2.2 D             | 140        |        | 05.11                                       |                |        |   |  |                     |
|                   | 2.2 D             | 147        |        | 03.12                                       |                |        |   |  |                     |
|                   | 2.7 D             | 152        |        | 03.08                                       |                |        |   |  |                     |
|                   | 3.0 D             | 155        |        | 03.09                                       |                |        |   |  |                     |
|                   | 3.0 D             | 177        |        | 03.09                                       |                |        |   |  |                     |
|                   | 3.0 D             | 202        |        | 03.09                                       |                |        |   |  |                     |
|                   | 3.0 V6            | 175        |        | 03.08                                       |                |        |   |  |                     |
|                   | 4.2 V8            | 219        |        | 03.08                                       |                |        |   |  |                     |
|                   |                   |            |        | + Bremsscheibendurchm. 326 mm <sup>1)</sup> |                |        |   |  |                     |
|                   |                   |            |        | + Bremsscheibendurchm. 326 mm <sup>1)</sup> |                |        |   |  |                     |
|                   |                   |            |        | + Bremsscheibendurchm. 326 mm <sup>1)</sup> |                |        |   |  |                     |
| 5.0 V8 Kompressor |                   | 346        |        | 01.09                                       | 24.0136-0122.1 | 436122 |   |  | 380 36,0 34,0 VL +B |
| 5.0 V8 Kompressor |                   | 375        |        | 03.09                                       |                |        |   |  |                     |
| 5.0 XFR-S         |                   | 405        |        | 10.12                                       |                |        |   |  |                     |
|                   | 2.0 16V           | 177        |        | 06.12                                       | 13.0460-7209.2 | 607209 |   |  | 23482 16,6 + ATE    |
|                   | 2.2 D             | 120        |        | 04.11                                       |                |        |   |  |                     |
|                   | 2.2 D             | 140        |        | 05.11                                       |                |        |   |  |                     |
|                   | 2.2 D             | 147        |        | 03.12                                       |                |        |   |  |                     |
|                   | 2.7 D             | 152        |        | 03.08                                       |                |        |   |  |                     |
|                   | 3.0 D             | 155        | S20572 | 03.09                                       |                |        |   |  |                     |
|                   | 3.0 D             | 177        | S20572 | 03.09                                       |                |        |   |  |                     |
|                   | 3.0 D             | 202        | S20572 | 03.09                                       |                |        |   |  |                     |
|                   | 3.0 V6            | 175        | S20572 | 03.08                                       |                |        |   |  |                     |
|                   | 3.0 V6            | 179        | S20572 | 03.08                                       |                |        |   |  |                     |
|                   | 3.0 V6            | 250        |        | 03.12                                       |                |        |   |  |                     |
|                   | 3.0 V6 AWD        | 250        |        | 10.12                                       |                |        |   |  |                     |
|                   | 4.2 V8            | 219        | S20572 | 03.08                                       |                |        |   |  |                     |
|                   | 4.2 V8            | 313        | S20572 | 07.09                                       |                |        |   |  |                     |
|                   | 4.2 V8 Kompressor | 306        | S20572 | 03.08                                       |                |        |   |  |                     |
|                   | 5.0 V8            | 283        | S20572 | 03.09                                       |                |        |   |  |                     |
|                   | 5.0 V8 Kompressor | 346        | B32752 | 01.09                                       |                |        |   |  |                     |
| 5.0 V8 Kompressor | 375               | B32752     | 03.09  |   |                |        |   |  |                     |
| 5.0 V8 Kompressor |                   | 346 B32753 |        |   | 13.0460-7255.2 | 607255 |   |  | 25114 15,8 + ATE    |
| 5.0 V8 Kompressor |                   | 375 B32753 |        |   |                |        |   |  |                     |
| 5.0 XFR-S         |                   | 405        |        | 10.12                                       |                |        |   |  |                     |
|                   | 2.0 16V           | 177        | S49010 | 06.12                                       | 24.0120-0238.1 | 420238 |   |  | 326 20,0 18,0 VL +B |
|                   | 2.2 D             | 120        | S49010 | 04.11                                       |                |        |   |  |                     |
|                   | 2.2 D             | 140        | S49010 | 05.11                                       |                |        |   |  |                     |
|                   | 2.2 D             | 147        | S49010 | 03.12                                       |                |        |   |  |                     |
|                   | 2.7 D             | 152        |        | 03.08                                       |                |        |   |  |                     |
|                   | 3.0 D             | 155        | S49010 | 03.09                                       |                |        |   |  |                     |
|                   | 3.0 D             | 177        |        | 03.09                                       |                |        |   |  |                     |
|                   | 3.0 D             | 202        |        | 03.09                                       |                |        |   |  |                     |
|                   | 3.0 V6            | 175        |        | 03.08                                       |                |        |   |  |                     |
|                   | 3.0 V6            | 179        |        | 03.08                                       |                |        |   |  |                     |
|                   | 3.0 V6            | 250        | S49010 | 03.12                                       |                |        |   |  |                     |
|                   | 3.0 V6 AWD        | 250        | S49010 | 10.12                                       |                |        |   |  |                     |
|                   | 4.2 V8            | 219        |        | 03.08                                       |                |        |   |  |                     |
|                   | 4.2 V8            | 313        |        | 07.09                                       |                |        |   |  |                     |
|                   | 4.2 V8 Kompressor | 306        |        | 03.08                                       |                |        |   |  |                     |
| 5.0 V8            | 283               |            | 03.09  |   |                |        |   |  |                     |
| 2.0 16V           |                   | 177 S49011 |        |   | 24.0120-0238.1 | 420238 |   |  | 326 20,0 18,0 VL +B |
| 2.2 D             |                   | 120 S49011 |        |   |                |        |   |  |                     |
| 2.2 D             |                   | 140 S49011 |        |   |                |        |   |  |                     |
| 2.2 D             |                   | 147 S49011 |        |   |                |        |   |  |                     |
| 3.0 D             |                   | 155 S49011 |        |   |                |        |   |  |                     |
| 3.0 V6            |                   | 250 S49011 |        |   |                |        |   |  |                     |
| 3.0 V6 AWD        |                   | 250 S49011 |        |   |                |        |   |  |                     |
| 5.0 V8 Kompressor |                   | 346        |        | 01.09                                       | 24.0126-0174.1 | 426174 |   |  | 376 26,0 24,0 VL +B |
| 5.0 V8 Kompressor |                   | 375        |        | 03.09                                       |                |        |   |  |                     |
| 5.0 XFR-S         |                   | 405        |        | 10.12                                       |                |        |   |  |                     |
|                   | 2.0 16V           | 177        | R47154 |   | 24.0711-5238.3 | 360441 | 2 |  | Radsensor L=450     |
|                   | 2.2 D             | 120        | R47154 |   |                |        |   |  |                     |
|                   | 2.2 D             | 140        | R47154 |   |                |        |   |  |                     |
|                   | 2.2 D             | 147        | R47154 |   |                |        |   |  |                     |
|                   | 2.7 D             | 152        | R47154 |   |                |        |   |  |                     |
|                   | 3.0 D             | 155        | R47154 |   |                |        |   |  |                     |
|                   | 3.0 D             | 177        | R47154 |   |                |        |   |  |                     |
|                   | 3.0 D             | 202        | R47154 |   |                |        |   |  |                     |
|                   | 3.0 V6            | 175        | R47154 |   |                |        |   |  |                     |
|                   | 3.0 V6            | 179        | R47154 |   |                |        |   |  |                     |
|                   | 3.0 V6            | 250        | R47154 |   |                |        |   |  |                     |
|                   | 3.0 V6 AWD        | 250        | R47154 |   |                |        |   |  |                     |
|                   | 4.2 V8            | 219        | R47154 |   |                |        |   |  |                     |
|                   | 4.2 V8            | 313        | R47154 |   |                |        |   |  |                     |
| 4.2 V8 Kompressor | 306               | R47154     |        |   |                |        |   |  |                     |
| 5.0 V8            | 283               | R47154     |        |   |                |        |   |  |                     |
| 5.0 V8 Kompressor | 346               | R47154     |        |   |                |        |   |  |                     |
| 5.0 V8 Kompressor | 375               | R47154     |        |   |                |        |   |  |                     |

### JAGUAR XF Sportbrake (CC9) (12-)

|           |       |     |  |   |                |        |  |  |                     |
|-----------|-------|-----|--|---|----------------|--------|--|--|---------------------|
|           | 2.2 D | 120 |  | 09.12                                       | 24.0130-0226.1 | 430226 |  |  | 326 30,0 28,0 VL +B |
|           | 2.2 D | 147 |  | 09.12                                       |                |        |  |  |                     |
|           | 3.0 D | 177 |  | 09.12                                       |                |        |  |  |                     |
|           | 3.0 D | 202 |  | 09.12                                       |                |        |  |  |                     |
|           |       |     |  | + Bremsscheibendurchm. 326 mm <sup>1)</sup> |                |        |  |  |                     |
|           |       |     |  | + Bremsscheibendurchm. 326 mm <sup>1)</sup> |                |        |  |  |                     |
| 5.0 XFR-S |       | 405 |  | 02.14                                       | 24.0136-0122.1 | 436122 |  |  | 380 36,0 34,0 VL +B |

<sup>1)</sup> + brake disc diameter 326mm / + diametro dischi freno 326mm / + diamètre disques frein 326mm / + diámetro disco freno 326mm

|     |  |  |  |  |  |  |  |     |   |                      |            |
|--|--|--|--|--|---|--|--|---|---|----------------------|------------|
| <b>JAGUAR XF Sportbrake (CC9) (12-)</b>  |  |  |  |  |   |  |  |   |   |                      |            |
|    | 2.2 D  | 120  |  | 09.12  |   | 13.0460-7209.2   | 607209   |   | 23482 16,6 +  | ATE                  |            |
|  | 2.2 D  | 147  |  | 09.12  |   |  |  |   |   |                      |            |
|  | 3.0 D  | 177  |  | 09.12  |   |  |  |   |   |                      |            |
|  | 3.0 D  | 202  |  | 09.12  |   |  |  |   |   |                      |            |
|  | 5.0 XFR-S  | 405  |  | 02.14  |   | 13.0460-7255.2   | 607255   |   | 25114 15,8 +  | ATE                  |            |
|    | 2.2 D  | 120  | S49010   | 09.12  |   | 24.0120-0238.1   | 420238   |   | 326 20,0 18,0 V L +B  |                      |            |
|  | 2.2 D  | 147  | S49010   | 09.12  |   |  |  |   |   |                      |            |
|  | 3.0 D  | 177  | S49010   | 09.12  |   |  |  |   |   |                      |            |
|  | 3.0 D  | 202  | S49010   | 09.12  |   |  |  |   |   |                      |            |
|  | 2.2 D  | 120  | S49011   |  |   | 24.0120-0238.1   | 420238   |   | 326 20,0 18,0 V L +B  |                      |            |
|  | 2.2 D  | 147  | S49011   |  |   |  |  |   |   |                      |            |
|  | 3.0 D  | 177  | S49011   |  |   |  |  |   |   |                      |            |
|  | 3.0 D  | 202  | S49011   |  |   |  |  |   |   |                      |            |
| 5.0 XFR-S  | 405  |  | 02.14  |  | 24.0126-0174.1  | 426174   |  | 376 26,0 24,0 V L +B  |   |                      |            |
|    | 2.2 D  | 120  | R47154   |  |   | 24.0711-5238.3   | 360441   | 2  | Radsensor L=450   |                      |            |
|  | 2.2 D  | 147  | R47154   |  |   |  |  |   |   |                      |            |
|  | 3.0 D  | 177  | R47154   |  |   |  |  |   |   |                      |            |
|  | 3.0 D  | 202  | R47154   |  |   |  |  |   |   |                      |            |
|  | 5.0 XFR-S  | 405  | R47154   |  |   |  |  |   |   |                      |            |
| <b>JAGUAR XJ (X300) (94-97)</b>  |  |  |  |  |   |  |  |   |   |                      |            |
|    | 12 6.0   | 229  |  | 11.94  | 07.97   | 13.0460-7138.2   | 607138   | 2   | 23126 17,5 +/WE   | ATE                  |            |
|  | 6 3.2  | 155  |  | 11.94  | 07.97   | 24.8190-1302.2   | 621302   |   | Warnkontakt L=276mm   |                      |            |
|  | 6 Sovereign 4.0  | 177  |  | 11.94  | 07.97   |  |  |   |   |                      |            |
|  | R Super Charged 4.0  | 235  |  | 11.94  | 07.97   |  |  |   |   |                      |            |
|    | 12 6.0   | 229  |  | 11.94  | 07.97   | 24.0128-0138.1   | 428138   |   | 291 28,1 26,0 V +B  |                      |            |
|  | 6 3.2  | 155  |  | 11.94  | 07.97   |  |  |   |   |                      |            |
|  | 6 Sovereign 4.0  | 177  |  | 11.94  | 07.97   |  |  |   |   |                      |            |
|  | R Super Charged 4.0  | 235  |  | 11.94  | 07.97   |  |  |   |   |                      |            |
|    | 12 6.0   | 229  |  | 11.94  | 07.97   | 24.0120-0188.1   | 420188   |   | 305 20,0 18,5 V +B  |                      |            |
|  | 6 3.2  | 155  |  | 11.94  | 07.97   |  |  |   |   |                      |            |
|  | 6 Sovereign 4.0  | 177  |  | 11.94  | 07.97   |  |  |   |   |                      |            |
|  | R Super Charged 4.0  | 235  |  | 11.94  | 07.97   |  |  |   |   |                      |            |
|    | 12 6.0   | 229  |  | 11.94  | 07.97   | 03.0137-9700.2   | 669700   |   | Bremsbacken-Zubehör   |                      |            |
|  | 6 3.2  | 155  |  | 11.94  | 07.97   |  |  |   |   |                      |            |
|  | 6 Sovereign 4.0  | 177  |  | 11.94  | 07.97   |  |  |   |   |                      |            |
|  | R Super Charged 4.0  | 235  |  | 11.94  | 07.97   |  |  |   |   |                      |            |
| <b>JAGUAR XJ (NAW,NBW) (97-03)</b>   |  |  |  |  |   |  |  |   |   |                      |            |
|  | XJ8 3.2  | 174  |  | 07.97  | 05.03   | - Sportpaket <sup>1)</sup>   | 13.0460-7138.2   | 607138  |   | 23126 17,5 +/WE      | ATE        |
|  | XJ8 4.0  | 209  |  | 07.97  | 05.03   |  |  |   |   |                      |            |
|  | XJ8 4.0  | 216  |  | 10.97  | 05.03   |  |  |   |   |                      |            |
|  | XJ8 3.2  | 174  |  | 07.97  | 05.03   | - Sportpaket <sup>1)</sup>   | 24.0129-0100.1   | 429100  |   | 305 28,5 26,0 V +B   |            |
|  | XJ8 4.0  | 209  |  | 07.97  | 05.03   |  |  |   |   |                      |            |
|  | XJ8 4.0  | 216  |  | 10.97  | 05.03   |  |  |   |   |                      |            |
|  | XJR 4.0 Kompressor   | 267  |  | 07.97  | 05.03   |  |  |   |   |                      |            |
|  | XJ8 3.2  | 174  |  | 07.97  | 05.03   | + Sportpaket <sup>2)</sup>   | 24.0128-0229.1   | 428229  |   | 325 28,3 26,0 V +B   |            |
|  | XJ8 4.0  | 209  |  | 07.97  | 05.03   |  | 24.0751-1145.3   | 360171  | 2  | Radsensor            |            |
|  | XJ8 4.0  | 216  |  | 07.97  | 05.03   |  |  |   |   |                      |            |
|  | XJR 4.0 Kompressor   | 267  |  | 07.97  | 05.03   |  |  |   |   |                      |            |
|  | XJ8 3.2  | 174  |  | 07.97  | 05.03   | - Sportpaket <sup>1)</sup>   | 13.0460-7246.2   | 607246  |   | 21275 17,0 +/WE      | ATE        |
|  | XJ8 4.0  | 209  |  | 07.97  | 07.99   |  |  |   |   |                      |            |
|  | XJ8 4.0  | 216  |  | 10.97  | 05.03   |  |  |   |   |                      |            |
|  | XJ8 4.0  | 209  |  | 08.99  | 05.03   |  | 13.0460-7241.2   | 607241  |   | 24487 16,5 +/WE      | ATE        |
|  | XJ8 3.2  | 174  |  | 07.97  | 05.03   | - Sportpaket <sup>1)</sup>   | 24.0120-0188.1   | 420188  |   | 305 20,0 18,5 V +B   |            |
|  | XJ8 4.0  | 209  |  | 07.97  | 05.03   |  |  |   |   |                      |            |
|  | XJ8 4.0  | 216  |  | 10.97  | 05.03   |  |  |   |   |                      |            |
|  | XJ8 3.2  | 174  |  | 07.97  | 05.03   |  | 24.0751-1145.3   | 360171  | 2  | Radsensor            |            |
|  | XJ8 4.0  | 209  |  | 07.97  | 05.03   |  |  |   |   |                      |            |
|  | XJ8 4.0  | 216  |  | 10.97  | 05.03   |  |  |   |   |                      |            |
|  | XJR 4.0 Kompressor   | 267  |  | 07.97  | 05.03   |  |  |   |   |                      |            |
|  | XJ8 3.2  | 174  |  | 07.97  | 05.03   |  | 03.0137-9700.2   | 669700  |   | Bremsbacken-Zubehör  |            |
|  | XJ8 4.0  | 209  |  | 07.97  | 05.03   |  |  |   |   |                      |            |
|  | XJ8 4.0  | 216  |  | 10.97  | 05.03   |  |  |   |   |                      |            |
|  | XJR 4.0 Kompressor   | 267  |  | 07.97  | 05.03   |  |  |   |   |                      |            |
| <b>JAGUAR XJ (X350,X358) (03-09)</b>   |  |  |  |  |   |  |  |   |   |                      |            |
|  | XJ6 2.7 D  | 152  | H32733   |  | 03.09   |  | 13.0460-2898.2   | 602898  |   | 23908 18,0 /WE/Zub/S | TRW        |
|  | XJ6 3.0  | 175  |  |  | 05.03   | 03.09  |  |   |   |                      |            |
|  | XJ6 3.0  | 179  |  |  | 04.04   | 01.07  |  |   |   |                      |            |
|  | XJ8 3.5  | 190  |  |  | 05.03   | 03.09  |  |   |   |                      |            |
|  | XJ8 4.2  | 219  |  |  | 05.03   | 03.09  |  |   |   |                      |            |
|  | XJR 4.2 Kompressor   | 291  |  |  | 05.03   | 03.09  |  | 13.0460-4841.2  | 604841  |                      | 23489 16,3 |
|  | XJ6 2.7 D  | 152  | H32732   |  | 10.05   |  | 24.0130-0226.1   | 430226  |   | 326 30,0 28,0 V L +B |            |
|  | XJ6 2.7 D  | 152  | H32733   |  | 03.09   |  | 24.0130-0182.1   | 430182  |   | 320 30,0 28,4 V +B   |            |
|  | XJ6 3.0  | 175  |  |  | 05.03   | 03.09  |  |   |   |                      |            |
|  | XJ6 3.0  | 179  |  |  | 04.04   | 01.07  |  |   |   |                      |            |
|  | XJ8 3.5  | 190  |  |  | 05.03   | 03.09  |  |   |   |                      |            |
|  | XJ8 4.2  | 219  |  |  | 05.03   | 03.09  |  |   |   |                      |            |

<sup>1)</sup> - sport package / - pacchetto sportivo / - version sport / - kit deportivo  
<sup>2)</sup> + sports package / + pacchetto sportivo / + version sport / + kit deportivo





### JAGUAR XJ (X350,X358) (03-09)

|                    |           |        |        |        |       |                |        |  |                    |     |       |
|--------------------|-----------|--------|--------|--------|-------|----------------|--------|--|--------------------|-----|-------|
|                    | XJ6 2.7 D | 152    | G27960 | 10.05  |       | 13.0460-2730.2 | 602730 |  | 23424 17,6 /S      | TRW |       |
|                    | XJ6 3.0   | 175    |        | 05.03  |       |                |        |  |                    |     | 03.09 |
|                    | XJ6 3.0   | 179    |        | 04.04  |       |                |        |  |                    |     | 01.07 |
|                    | XJ8 3.5   | 190    |        | 05.03  |       |                |        |  |                    |     | 03.09 |
|                    | XJ8 4.2   | 219    |        | 05.03  |       |                |        |  |                    |     | 03.09 |
| XJ6 2.7 D          | 152       | G27961 | G30744 |        |       | 13.0460-2730.2 | 602730 |  | 23424 17,6 /S      | TRW |       |
| XJ6 2.7 D          | 152       | G49701 |        | 03.09  |       | 13.0460-7209.2 | 607209 |  | 23482 16,6 +       | ATE |       |
| XJR 4.2 Kompressor | 291       |        |        | 05.03  | 03.09 | 13.0460-4964.2 | 604964 |  | 21381 15,0         | BRE |       |
|                    | XJ6 2.7 D | 152    | G22035 | 10.05  |       | 24.0120-0708.1 | 420708 |  | 288 20,0 18,0 V +B |     |       |
|                    | XJ6 3.0   | 175    |        | 05.03  |       |                |        |  |                    |     | 03.09 |
|                    | XJ6 3.0   | 179    |        | 04.04  |       |                |        |  |                    |     | 01.07 |
|                    | XJ8 3.5   | 190    |        | 05.03  |       |                |        |  |                    |     | 03.09 |
|                    | XJ8 4.2   | 219    |        | 05.03  |       |                |        |  |                    |     | 03.09 |
|                    | XJ6 2.7 D | 152    |        | G49701 |       |                |        |  |                    |     |       |





























### JAGUAR XJ (X351) (09-)

|            |            |        |        |       |  |                |        |   |                      |     |
|------------|------------|--------|--------|-------|--|----------------|--------|---|----------------------|-----|
|            | 5.0 V8     | 346    |        | 10.09 |  | 24.0136-0122.1 | 436122 |   | 380 36,0 34,0 V L +B |     |
|            | 5.0 V8     | 375    |        | 10.09 |  |                |        |   |                      |     |
|            | 5.0 V8     | 405    |        | 06.13 |  |                |        |   |                      |     |
|            | 2.0 16V    | 177    |        | 05.12 |  | 13.0460-7209.2 | 607209 |   | 23482 16,6 +         | ATE |
|            | 3.0 V6     | 175    |        | 01.11 |  |                |        |   |                      |     |
|            | 3.0 V6     | 250    |        | 03.12 |  |                |        |   |                      |     |
|            | 3.0 V6 AWD | 250    |        | 10.12 |  |                |        |   |                      |     |
|            | 3.0 V6 D   | 202    |        | 10.09 |  |                |        |   |                      |     |
|            | 5.0 V8     | 283    |        | 10.09 |  |                |        |   |                      |     |
|            | 5.0 V8     | 346    |        | 10.09 |  | 13.0460-7255.2 | 607255 |   | 25114 15,8 +         | ATE |
| 5.0 V8     | 375        |        | 10.09  |       |  |                |        |   |                      |     |
| 5.0 V8     | 405        |        | 06.13  |       |  |                |        |   |                      |     |
|            | 2.0 16V    | 177    | V39426 | 05.12 |  | 24.0120-0238.1 | 420238 |   | 326 20,0 18,0 V L +B |     |
|            | 3.0 V6     | 175    | V39426 | 01.11 |  |                |        |   |                      |     |
|            | 3.0 V6     | 250    | V39426 | 03.12 |  |                |        |   |                      |     |
|            | 3.0 V6 AWD | 250    | V39426 | 10.12 |  |                |        |   |                      |     |
|            | 3.0 V6 D   | 202    | V39426 | 10.09 |  |                |        |   |                      |     |
|            | 5.0 V8     | 283    | V39426 | 10.09 |  |                |        |   |                      |     |
|            | 2.0 16V    | 177    | V39427 |       |  | 24.0120-0238.1 | 420238 |   | 326 20,0 18,0 V L +B |     |
| 3.0 V6     | 175        | V39427 |        |       |  |                |        |   |                      |     |
| 3.0 V6     | 250        | V39427 |        |       |  |                |        |   |                      |     |
| 3.0 V6 AWD | 250        | V39427 |        |       |  |                |        |   |                      |     |
| 3.0 V6 D   | 202        | V39427 |        |       |  |                |        |   |                      |     |
| 5.0 V8     | 283        | V39427 |        |       |  |                |        |   |                      |     |
| 5.0 V8     | 346        |        |        | 10.09 |  | 24.0126-0174.1 | 426174 |   | 376 26,0 24,0 V L +B |     |
| 5.0 V8     | 375        |        |        | 10.09 |  |                |        |   |                      |     |
| 5.0 V8     | 405        |        |        | 06.13 |  |                |        |   |                      |     |
|            | 3.0 V6 AWD | 250    |        | 10.12 |  | 24.0711-5238.3 | 360441 | 2 | Radsensor L=450      |     |

### JAGUAR XK8 Coupe (QEV) (96-05)















|  |            |     |  |       |       |                |        |   |  |     |
|--|------------|-----|--|-------|-------|----------------|--------|---|--|-----|
|  | 4.0 V8     | 209 |  | 03.96 | 07.05 | 13.0460-7138.2 | 607138 | 2 | 23126 17,5 +/WE<br>Warnkontakt L=276mm   | ATE |
|  | 4.0 V8     | 216 |  | 05.96 | 07.99 | 24.8190-1302.2 | 621302 |   |  |     |
|  | 4.0 V8     | 267 |  | 02.98 | 07.05 |                |        |   |  |     |
|  | 4.0 XKR V8 | 276 |  | 05.98 | 07.05 |                |        |   |  |     |
|  | 4.2 V8     | 219 |  | 08.02 | 07.05 |                |        |   |  |     |
|  | R 4.2 V8   | 291 |  | 08.02 | 07.05 |                |        |   |  |     |
|  | 4.0 V8     | 209 |  | 03.96 | 07.05 | 24.0129-0100.1 | 429100 |   | 305 28,5 26,0 V +B<br>325 28,3 26,0 V +B |     |
|  | 4.0 V8     | 216 |  | 05.96 | 07.99 | 24.0128-0229.1 | 428229 |   |  |     |
|  | 4.0 V8     | 267 |  | 02.98 | 07.05 |                |        |   |  |     |
|  | 4.0 XKR V8 | 276 |  | 05.98 | 07.05 |                |        |   |  |     |
|  | 4.2 V8     | 219 |  | 08.02 | 07.05 |                |        |   |  |     |
|  | R 4.2 V8   | 291 |  | 08.02 | 07.05 |                |        |   |  |     |
|  | 4.0 V8     | 209 |  | 03.96 | 07.05 | 24.0751-1145.3 | 360171 | 2 | Radsensor                                |     |
|  | 4.0 V8     | 216 |  | 05.96 | 07.99 |                |        |   |  |     |
|  | 4.0 V8     | 267 |  | 02.98 | 07.05 |                |        |   |  |     |
|  | 4.0 XKR V8 | 276 |  | 05.98 | 07.05 |                |        |   |  |     |
|  | 4.0 V8     | 209 |  | 03.96 | 07.05 | 13.0460-7241.2 | 607241 |   | 24487 16,5 +/WE                          | ATE |
|  | 4.0 V8     | 216 |  | 05.96 | 07.99 |                |        |   |  |     |
|  | 4.0 V8     | 267 |  | 02.98 | 07.05 |                |        |   |  |     |
|  | 4.0 XKR V8 | 276 |  | 05.98 | 07.05 |                |        |   |  |     |
|  | 4.2 V8     | 219 |  | 08.02 | 07.05 |                |        |   |  |     |
|  | R 4.2 V8   | 291 |  | 08.02 | 07.05 |                |        |   |  |     |
|  | 4.0 V8     | 209 |  | 03.96 | 07.05 | 24.0120-0188.1 | 420188 |   | 305 20,0 18,5 V +B                       |     |
|  | 4.0 V8     | 216 |  | 05.96 | 07.99 |                |        |   |  |     |
|  | 4.0 V8     | 267 |  | 02.98 | 07.05 |                |        |   |  |     |
|  | 4.0 XKR V8 | 276 |  | 05.98 | 07.05 |                |        |   |  |     |
|  | 4.2 V8     | 219 |  | 08.02 | 07.05 |                |        |   |  |     |
|  | R 4.2 V8   | 291 |  | 08.02 | 07.05 |                |        |   |  |     |
|  | 4.0 V8     | 209 |  | 03.96 | 07.05 | 24.0751-1145.3 | 360171 | 2 | Radsensor                                |     |
|  | 4.0 V8     | 216 |  | 05.96 | 07.99 |                |        |   |  |     |
|  | 4.0 V8     | 267 |  | 02.98 | 07.05 |                |        |   |  |     |
|  | 4.0 XKR V8 | 276 |  | 05.98 | 07.05 |                |        |   |  |     |

1) - sport package / - pacchetto sportivo / - version sport / - kit deportivo

|     |                 |    |  |  |  |  |  |                        |
|--|---|--|--|--|---|--|--|--|
| <b>JAGUAR XK8 Coupe (QEV) (96-05)</b>  |   |  |  |  |   |  |  |  |
|    | 4.0 V8<br>4.0 V8<br>4.0 V8<br>4.0 XKR V8<br>4.2 V8<br>R 4.2 V8                                  | 209<br>216<br>267<br>276<br>219<br>291   |  | 03.96<br>05.96<br>02.98<br>05.98<br>08.02<br>08.02                               | 07.05<br>07.99<br>07.05<br>07.05<br>07.05<br>07.05                                | 03.0137-9700.2   | 669700   | Bremsbacken-Zubehör  |
| <b>JAGUAR XK8 Convertible (QDV) (96-05)</b>  |   |  |  |  |   |  |  |  |
|    | 4.0 V8<br>4.0 V8<br>4.0 V8<br>4.0 XKR V8<br>4.2 V8<br>R 4.2 V8                                  | 209<br>216<br>267<br>276<br>219<br>291   |  | 03.96<br>05.96<br>02.98<br>05.98<br>08.02<br>08.02                               | 07.05<br>07.99<br>07.05<br>07.05<br>07.05<br>07.05                                | 13.0460-7138.2<br>24.8190-1302.2   | 607138<br>621302   | 2<br>- Sportpaket 1)<br>ATE<br>Warnkontakt L=276mm   |
|    | 4.0 V8<br>4.0 V8<br>4.0 V8<br>4.0 XKR V8<br>4.2 V8<br>R 4.2 V8                                  | 209<br>216<br>267<br>276<br>219<br>291   |  | 03.96<br>05.96<br>02.98<br>05.98<br>08.02<br>08.02                               | 07.05<br>07.99<br>07.05<br>07.05<br>07.05<br>07.05                                | 24.0129-0100.1<br>24.0128-0229.1   | 429100<br>428229   | 305 28,5 26,0 V +B<br>325 28,3 26,0 V +B   |
|    | 4.0 V8<br>4.0 V8<br>4.0 V8<br>4.0 XKR V8  | 209<br>216<br>267<br>276   |  | 03.96<br>05.96<br>02.98<br>05.98   | 07.05<br>07.99<br>07.05<br>07.05  | 24.0751-1145.3   | 360171   | 2 <br>Radsensor         |
|    | 4.0 V8<br>4.0 V8<br>4.0 V8<br>4.0 XKR V8<br>4.2 V8<br>R 4.2 V8                                  | 209<br>216<br>267<br>276<br>219<br>291   |  | 03.96<br>05.96<br>02.98<br>05.98<br>08.02<br>08.02                               | 07.05<br>07.99<br>07.05<br>07.05<br>07.05<br>07.05                                | 13.0460-7241.2   | 607241   | 24487 16,5 +/WE<br>ATE   |
|    | 4.0 V8<br>4.0 V8<br>4.0 V8<br>4.0 XKR V8<br>4.2 V8<br>R 4.2 V8                                  | 209<br>216<br>267<br>276<br>219<br>291   |  | 03.96<br>05.96<br>02.98<br>05.98<br>08.02<br>08.02                               | 07.05<br>07.99<br>07.05<br>07.05<br>07.05<br>07.05                                | 24.0120-0188.1   | 420188   | 305 20,0 18,5 V +B<br>- Sportpaket 1)  |
|   | 4.0 V8<br>4.0 V8<br>4.0 V8<br>4.0 XKR V8  | 209<br>216<br>267<br>276   |  | 03.96<br>05.96<br>02.98<br>05.98   | 07.05<br>07.99<br>07.05<br>07.05  | 24.0751-1145.3   | 360171   | 2 <br>Radsensor         |
| <b>JAGUAR XK Coupe (06-)</b>   |   |  |  |  |   |  |  |  |
|  | 5.0 XKR<br>5.0 XKR<br>5.0 XKR-S   | 375<br>390<br>405  |  | 01.09<br>09.10<br>01.11  |   | 24.0136-0122.1   | 436122   | - Alcon-Bremse 2)<br>380 36,0 34,0 V L +B  |
|  | 3.5 XK<br>4.2 XK8<br>4.2 XKR<br>4.2 XKR<br>4.2 XKR<br>5.0 V8<br>5.0 XKR<br>5.0 XKR<br>5.0 XKR-S | 190 B32753<br>219 B32753<br>291 B32753<br>306 B32753<br>313 B32753<br>283 B32753<br>375 B32753<br>390 B32753<br>405 B32753 |  |  |   | 24.0711-5238.3   | 360441   | 2 <br>Radsensor L=450 |
|  | 5.0 XKR<br>5.0 XKR  | 375<br>390   | B32752<br>B32752   | 01.09<br>09.10   |   | 13.0460-7209.2   | 607209   | 23482 16,6 +<br>ATE  |
|  | 5.0 XKR<br>5.0 XKR<br>5.0 XKR-S   | 375 B32753<br>390 B32753<br>405  |  | 01.11  |   | 13.0460-7255.2   | 607255   | - Alcon-Bremse 2)<br>25114 15,8 +<br>ATE   |
|  | 5.0 XKR<br>5.0 XKR<br>5.0 XKR-S   | 375<br>390<br>405  |  | 01.09<br>09.10<br>01.11  |   | 24.0126-0174.1   | 426174   | - Alcon-Bremse 2)<br>376 26,0 24,0 V L +B  |
|  | 3.5 XK<br>4.2 XK8<br>4.2 XKR<br>4.2 XKR<br>4.2 XKR<br>5.0 V8<br>5.0 XKR<br>5.0 XKR<br>5.0 XKR-S | 190 B32753<br>219 B32753<br>291 B32753<br>306 B32753<br>313 B32753<br>283 B32753<br>375 B32753<br>390 B32753<br>405 B32753 |  |  |   | 24.0711-5238.3   | 360441   | 2 <br>Radsensor L=450 |
| <b>JAGUAR XK Convertible (06-)</b>   |   |  |  |  |   |  |  |  |
|  | 5.0 XKR<br>5.0 XKR-S  | 375<br>405   |  | 01.09<br>01.11   |   | 24.0136-0122.1   | 436122   | - Alcon-Bremse 2)<br>380 36,0 34,0 V L +B  |
|  | 3.6 V8<br>4.2 XK8<br>4.2 XKR<br>4.2 XKR<br>5.0 V8<br>5.0 XKR<br>5.0 XKR-S                       | 190 B32753<br>219 B32753<br>306 B32753<br>313 B32753<br>283 B32753<br>375 B32753<br>405 B32753                             |  |  |   | 24.0711-5238.3   | 360441   | 2 <br>Radsensor L=450 |

1) - sport package / - pacchetto sportivo / - version sport / - kit deportivo

2) - Alcon brake / - freno Alcon / - frein de Alcon / - freno Alcon

| JAGUAR XK Convertible (06-)  |  |  |   |   |  |   |   |  |                         |     |
|--|--|--|---|---|--|---|---|--|-------------------------|-----|
|    | 5.0 XKR 375<br>5.0 XKR 375 B32753<br>5.0 XKR-S 405   | B32752   | 01.09   |   | 13.0460-7209.2 607209<br>13.0460-7255.2 607255 |   |   | 23482 16,6 +<br>25114 15,8 +   | ATE                     |     |
|  |  |  | 01.11   |   |  |   |   | - Alcon-Bremse <sup>1)</sup>   |                         |     |
|    | 5.0 XKR 375<br>5.0 XKR-S 405   |  | 01.09<br>01.11  |   | 24.0126-0174.1 426174                          |   |   | - Alcon-Bremse <sup>1)</sup>   | 376 26,0 24,0 V L +B    |     |
|    | 3.6 V8 190<br>4.2 XK8 219<br>4.2 XKR 306<br>4.2 XKR 313<br>5.0 V8 283<br>5.0 XKR 375<br>5.0 XKR-S 405  | B32753<br>B32753<br>B32753<br>B32753<br>B32753<br>B32753<br>B32753 |   |   | 24.0711-5238.3 360441                          | 2 |  |  | Radsensor L=450         |     |
| JEEP CHEROKEE (XJ) (95-01)   |  |  |   |   |  |   |   |  |                         |     |
|    | 2.5 i 4x4 90<br>2.5 TDi 4x4 85<br>4.0 i 4x4 131  |  | 10.96<br>10.96<br>01.95   | 09.01<br>09.01<br>09.01   | 24.0124-0702.1 424702                          |   |   |  | 280 24,0 22,7 V +B      |     |
| JEEP CHEROKEE (KJ) (01-08)   |  |  |   |   |  |   |   |  |                         |     |
|    | 2.4 16V 108<br>2.4 16V Laredo 108<br>2.5 CRD 105<br>2.8 CRD 110<br>2.8 CRD 120<br>3.7 4WD 157<br>3.7 V6 150<br>3.7 V6 155<br>3.7 V6 Laredo 150 |  | 09.01<br>10.01<br>09.01<br>11.02<br>11.04<br>10.04<br>08.03<br>09.01<br>10.01 | 01.08<br>09.04<br>01.08<br>01.08<br>01.08<br>10.07<br>01.08<br>01.08<br>09.04 | 13.0460-2899.2 602899                          |   |   |  | 23638 18,3 +/WK TRW     |     |
|    | 2.4 16V 108<br>2.4 16V Laredo 108<br>2.5 CRD 105<br>2.8 CRD 110<br>2.8 CRD 120<br>3.7 4WD 157<br>3.7 V6 150<br>3.7 V6 155<br>3.7 V6 Laredo 150 |  | 09.01<br>10.01<br>09.01<br>11.02<br>11.04<br>10.04<br>08.03<br>09.01<br>10.01 | 01.08<br>09.04<br>01.08<br>01.08<br>01.08<br>10.07<br>01.08<br>01.08<br>09.04 | 24.0128-0708.1 428708                          |   |   |  | 288 28,0 26,0 V L       |     |
| JEEP CHEROKEE (KK) (08-12)   |  |  |   |   |  |   |   |  |                         |     |
|  | 2.8 CRDi 4WD 130<br>2.8 CRDi 4WD 147<br>3.7 V6 157<br>3.7 V6 4WD 151<br>3.7 V6 4WD 157   |  | 05.08<br>01.10<br>01.08<br>01.08<br>01.08                                     | 12.12<br>12.12<br>12.12<br>12.12<br>12.12                                     | 13.0460-8013.2 608013                          |   |   | - verstärktes Fahrwerk <sup>2)</sup>   | 24604 16,5 +/WK/Zub BOS |     |
|  | 2.8 CRDi 4WD 130<br>2.8 CRDi 4WD 147<br>3.7 V6 157<br>3.7 V6 4WD 151<br>3.7 V6 4WD 157   |  | 05.08<br>01.10<br>01.08<br>01.08<br>01.08                                     | 12.12<br>12.12<br>12.12<br>12.12<br>12.12                                     | 13.0460-5629.2 605629                          |   |   |  | 24602 16,0 +/WK/Zub     |     |
| JEEP CHEROKEE (KL) (13-)   |  |  |   |   |  |   |   |  |                         |     |
|  | 2.0 CRD 103<br>2.0 CRD 4x4 103<br>2.0 CRD 4x4 125<br>2.2 CRD 4x4 136<br>2.2 CRD 4x4 147<br>3.2 V6 4x4 200                                      |  | 04.14<br>04.14<br>04.14<br>08.15<br>08.15<br>11.13                            |   | 24.0128-0191.1 428191                          |   |   |  | 330 28,0 26,0 V +S +B   |     |
|  | 2.0 CRD 103<br>2.0 CRD 4x4 103<br>2.0 CRD 4x4 125<br>2.2 CRD 4x4 136<br>2.2 CRD 4x4 147<br>3.2 V6 4x4 200                                      |  | 04.14<br>04.14<br>04.14<br>08.15<br>08.15<br>11.13                            |   | 24.0112-0214.1 412214                          |   |   | BRF-Bremsanlage <sup>3)</sup><br>BRF-Bremsanlage <sup>3)</sup><br>BRF-Bremsanlage <sup>3)</sup><br>BRF-Bremsanlage <sup>3)</sup><br>BRF-Bremsanlage <sup>3)</sup><br>BRF-Bremsanlage <sup>3)</sup> | 278 12,0 10,4 +S +B     |     |
| JEEP COMMANDER (XK) (05-10)  |  |  |   |   |  |   |   |  |                         |     |
|  | 3.0 CRD 160<br>3.7 V6 157<br>4.7 V8 170<br>5.7 V8 240  |  | 04.06<br>09.05<br>09.05<br>09.05  | 12.10<br>12.10<br>12.10<br>12.10  | 24.0130-0223.1 430223                          |   |   |  | 328 30,0 28,5 V +B      |     |
|  | 3.0 CRD 160<br>3.7 V6 157<br>4.7 V8 170<br>5.7 V8 240  |  | 04.06<br>09.05<br>09.05<br>09.05  | 12.10<br>12.10<br>12.10<br>12.10  | 24.0114-0118.1 414118                          |   |   |  | 320 14,0 12,5 +B        |     |
| JEEP COMPASS (MK49) (06-)  |  |  |   |   |  |   |   |  |                         |     |
|  | 2.0 16V 115<br>2.0 CRD 103<br>2.0 CRD 4x4 103<br>2.2 CRD 100<br>2.2 CRD 4x4 100<br>2.2 CRD 4x4 120<br>2.4 16V 125<br>2.4 16V 4x4 125           |  | 05.11<br>08.06<br>09.06<br>05.11<br>05.11<br>12.10<br>09.06<br>09.06          |   | 13.0460-5760.2 605760                          |   |   | + 17" Rad <sup>4)</sup><br>+ 17" Rad <sup>4)</sup><br><br><br><br><br>+ 17" Rad <sup>4)</sup><br>+ 17" Rad <sup>4)</sup>   | 23584 16,4 /WK          | AKE |

<sup>1)</sup> - Alcon brake / - freno Alcon / - frein de Alcon / - freno Alcon

<sup>2)</sup> - reinforced suspension / - sospensione rinforzata / - châssis renforcé / - suspensión reforzada

<sup>3)</sup> BRF-brake system / impianto di frenante BRF / installation de frein BRF / construcción de freno BRF

<sup>4)</sup> + 17" wheel / + ruota 17" / + roue 17" / + rueda 17"

























| JEEP COMPASS (MK49) (06-)              |                |     |  |       |                         |                |        |  |                     |
|--|----------------|-----|--|-------|-------------------------|----------------|--------|--|---------------------|
|  | 2.0 16V        | 115 |  | 05.11 |                         | 24.0126-0170.1 | 426170 |  | 294 26,0 24,4 V +B  |
|  | 2.0 CRD        | 103 |  | 08.06 |                         |                |        |  |                     |
|  | 2.0 CRD 4x4    | 103 |  | 09.06 |                         |                |        |  |                     |
|  | 2.2 CRD        | 100 |  | 05.11 |                         |                |        |  |                     |
|  | 2.2 CRD 4x4    | 100 |  | 05.11 |                         |                |        |  |                     |
|  | 2.2 CRD 4x4    | 120 |  | 12.10 |                         |                |        |  |                     |
|  | 2.4 16V        | 125 |  | 09.06 |                         |                |        |  |                     |
|  | 2.4 16V 4x4    | 125 |  | 09.06 |                         |                |        |  |                     |
|  | 2.0 16V        | 115 |  | 05.11 | + 17" Rad <sup>1)</sup> | 13.0460-5735.2 | 605735 |  | 24014 16,0 +/WK AKE |
|  | 2.0 CRD        | 103 |  | 08.06 |                         |                |        |  |                     |
|  | 2.0 CRD 4x4    | 103 |  | 09.06 |                         |                |        |  |                     |
|  | 2.2 CRD        | 100 |  | 05.11 | + 17" Rad <sup>1)</sup> |                |        |  |                     |
|  | 2.2 CRD 4x4    | 100 |  | 05.11 | + 17" Rad <sup>1)</sup> |                |        |  |                     |
|  | 2.2 CRD 4x4    | 120 |  | 12.10 | + 17" Rad <sup>1)</sup> |                |        |  |                     |
|  | 2.4 16V        | 125 |  | 09.06 |                         |                |        |  |                     |
|  | 2.4 16V 4x4    | 125 |  | 09.06 |                         |                |        |  |                     |
|  | 2.0 16V        | 115 |  | 05.11 | + 18" Rad <sup>2)</sup> | 13.0460-5855.2 | 605855 |  | 23582 16,0 +        |
|  | 2.2 CRD        | 100 |  | 05.11 | + 18" Rad <sup>2)</sup> |                |        |  |                     |
|  | 2.2 CRD 4x4    | 100 |  | 05.11 | + 18" Rad <sup>2)</sup> |                |        |  |                     |
|  | 2.2 CRD 4x4    | 120 |  | 12.10 | + 18" Rad <sup>2)</sup> |                |        |  |                     |
|  | 2.0 16V        | 115 |  | 05.11 | + 17" Rad <sup>1)</sup> | 24.0110-0363.1 | 410363 |  | 262 10,0 8,4 +B     |
|  | 2.0 CRD        | 103 |  | 08.06 |                         |                |        |  |                     |
|  | 2.0 CRD 4x4    | 103 |  | 09.06 |                         |                |        |  |                     |
|  | 2.2 CRD        | 100 |  | 05.11 | + 17" Rad <sup>1)</sup> |                |        |  |                     |
|  | 2.2 CRD 4x4    | 100 |  | 05.11 | + 17" Rad <sup>1)</sup> |                |        |  |                     |
|  | 2.2 CRD 4x4    | 120 |  | 12.10 | + 17" Rad <sup>1)</sup> |                |        |  |                     |
|  | 2.4 16V        | 125 |  | 09.06 |                         |                |        |  |                     |
|  | 2.4 16V 4x4    | 125 |  | 09.06 |                         |                |        |  |                     |
|  | 2.0 16V        | 115 |  | 05.11 | + 18" Rad <sup>2)</sup> | 24.0110-0361.1 | 410361 |  | 302 10,0 8,4 +B     |
|  | 2.2 CRD        | 100 |  | 05.11 | + 18" Rad <sup>2)</sup> |                |        |  |                     |
|  | 2.2 CRD 4x4    | 100 |  | 05.11 | + 18" Rad <sup>2)</sup> |                |        |  |                     |
|  | 2.2 CRD 4x4    | 120 |  | 12.10 | + 18" Rad <sup>2)</sup> |                |        |  |                     |
|  | 2.0 16V        | 115 |  | 05.11 |                         | 03.0137-3023.2 | 653023 |  | 170 x 32            |
|  | 2.0 CRD        | 103 |  | 08.06 |                         |                |        |  |                     |
|  | 2.0 CRD 4x4    | 103 |  | 09.06 |                         |                |        |  |                     |
|  | 2.2 CRD        | 100 |  | 05.11 |                         |                |        |  |                     |
|  | 2.2 CRD 4x4    | 100 |  | 05.11 |                         |                |        |  |                     |
|  | 2.2 CRD 4x4    | 120 |  | 12.10 |                         |                |        |  |                     |
|  | 2.4 16V        | 125 |  | 09.06 |                         |                |        |  |                     |
|  | 2.4 16V 4x4    | 125 |  | 09.06 |                         |                |        |  |                     |
| JEEP GRAND CHEROKEE I (ZJ) (93-99)     |                |     |  |       |                         |                |        |  |                     |
|  | 4.0            |     |  | 01.93 | 12.93                   | 24.0124-0702.1 | 424702 |  | 280 24,0 22,7 V +B  |
|  | 5.2            |     |  | 01.93 | 12.93                   |                |        |  |                     |
|  | 2.5 TD         |     |  | 01.94 | 04.99                   | 24.0124-0702.1 | 424702 |  | 280 24,0 22,7 V +B  |
|  | 4.0            |     |  | 01.94 | 04.99                   |                |        |  |                     |
|  | 5.2            |     |  | 01.94 | 04.99                   |                |        |  |                     |
|  | 5.9            |     |  | 08.97 | 04.99                   |                |        |  |                     |
| JEEP GRAND CHEROKEE II (WJ,WG) (99-05) |                |     |  |       |                         |                |        |  |                     |
|  | 2.7 CRD 4x4    | 120 |  | 10.01 | 09.02                   | 13.0460-7206.2 | 607206 |  | 23631 18,6 +/WK ATE |
|  | 3.1 TD         | 103 |  | 04.99 | 09.02                   |                |        |  |                     |
|  | 4.0            | 140 |  | 10.98 | 09.02                   |                |        |  |                     |
|  | 4.0 4x4        | 140 |  | 04.99 | 09.02                   |                |        |  |                     |
|  | 4.7 V8         | 162 |  | 04.99 | 08.00                   |                |        |  |                     |
|  | 4.7 V8         | 164 |  | 08.00 | 09.02                   |                |        |  |                     |
|  | 4.7 V8         | 190 |  | 10.01 | 09.02                   |                |        |  |                     |
|  | 4.7 V8         | 167 |  | 10.04 | 09.05                   | 24.0130-0223.1 | 430223 |  | 328 30,0 28,5 V +B  |
|  | 2.7 CRD 4x4    | 120 |  | 10.04 | 09.05                   | 24.0126-0130.1 | 426130 |  | 305 26,0 24,5 V +B  |
|  | 2.7 CRD 4x4    | 120 |  | 10.01 | 09.05                   |                |        |  |                     |
|  | 2.7 CRD Laredo | 120 |  | 10.04 | 09.05                   |                |        |  |                     |
|  | 3.1 TD         | 103 |  | 04.99 | 09.05                   |                |        |  |                     |
|  | 4.0            | 140 |  | 04.99 | 09.04                   |                |        |  |                     |
|  | 4.0 4x4        | 140 |  | 04.99 | 09.05                   |                |        |  |                     |
|  | 4.7 V8         | 162 |  | 04.99 | 08.00                   |                |        |  |                     |
|  | 4.7 V8         | 164 |  | 08.00 | 09.05                   |                |        |  |                     |
|  | 4.7 V8         | 190 |  | 10.01 | 09.05                   |                |        |  |                     |
|  | 4.7 V8 4x4     | 167 |  | 06.03 | 09.05                   |                |        |  |                     |
|  | 4.7 V8         | 167 |  | 10.04 | 09.05                   | 24.0114-0118.1 | 414118 |  | 320 14,0 12,5 +B    |
|  | 2.7 CRD 4x4    | 120 |  | 10.04 | 09.05                   | 24.0110-0299.1 | 410299 |  | 305 10,0 8,5        |
|  | 2.7 CRD 4x4    | 120 |  | 10.01 | 09.05                   |                |        |  |                     |
|  | 2.7 CRD Laredo | 120 |  | 10.04 | 09.05                   |                |        |  |                     |
|  | 3.1 TD         | 103 |  | 04.99 | 09.05                   |                |        |  |                     |
|  | 4.0            | 140 |  | 04.99 | 09.04                   |                |        |  |                     |
|  | 4.0 4x4        | 140 |  | 04.99 | 09.05                   |                |        |  |                     |
|  | 4.7 V8         | 162 |  | 04.99 | 08.00                   |                |        |  |                     |
|  | 4.7 V8         | 164 |  | 08.00 | 09.05                   |                |        |  |                     |
|  | 4.7 V8         | 190 |  | 10.01 | 09.05                   |                |        |  |                     |
|  | 4.7 V8 4x4     | 167 |  | 06.03 | 09.05                   |                |        |  |                     |
| JEEP GRAND CHEROKEE III (WH) (05-10)   |                |     |  |       |                         |                |        |  |                     |
|  | 3.0 CRD        | 160 |  | 06.05 | 12.10                   | 24.0130-0223.1 | 430223 |  | 328 30,0 28,5 V +B  |
|  | 3.0 CRD 4x4    | 155 |  | 05.06 | 12.10                   |                |        |  |                     |
|  | 3.0 CRD 4x4    | 160 |  | 06.05 | 12.10                   |                |        |  |                     |
|  | 3.7 V6         | 157 |  | 06.05 | 12.10                   |                |        |  |                     |
|  | 3.7 V6 4x4     | 157 |  | 06.05 | 12.10                   |                |        |  |                     |

<sup>1)</sup> + 17" wheel / + ruota 17" / + roue 17" / + rueda 17"

<sup>2)</sup> + 18" wheel / + ruota 18" / + roue 18" / + rueda 18"





























|     |   |  |  |                 |   |  |  |  |
|--|---|--|--|---|--|--|--|--|
| <b>JEEP GRAND CHEROKEE III (WH) (05-10)</b>  |   |  |  |   |  |  |  |  |
|    | 4.7 V8<br>4.7 V8<br>4.7 V8 4x4<br>5.7 V8 4x4<br>5.7 V8 4x4  | 164<br>223<br>170<br>240<br>259  |  | 06.05<br>09.07<br>06.05<br>06.05<br>01.09   | 12.10<br>12.08<br>12.10<br>12.10<br>12.10  | 24.0130-0223.1   | 430223   | 328 30,0 28,5 V +B   |
|    | 3.0 CRD 4x4<br>3.0 CRD 4x4<br>3.0 CRD 4x4<br>3.7 V6<br>3.7 V6 4x4<br>4.7 V8<br>4.7 V8<br>4.7 V8 4x4<br>5.7 V8 4x4<br>5.7 V8 4x4<br>6.1 SRT8 4x4 | 155<br>160<br>160<br>157<br>157<br>164<br>223<br>170<br>240<br>259<br>313        |  | 05.06<br>06.05<br>06.05<br>06.05<br>06.05<br>06.05<br>09.07<br>06.05<br>06.05<br>01.09<br>03.06 | 12.10<br>12.10<br>12.10<br>12.10<br>12.10<br>12.10<br>12.08<br>12.10<br>12.10<br>12.10<br>12.10                                      | 24.0114-0118.1   | 414118   | 320 14,0 12,5 +B   |
| <b>JEEP GRAND CHEROKEE IV (WK) (10-)</b>   |   |  |  |   |  |  |  |  |
|    | 3.0 CRD V6 4x4<br>3.0 CRD V6 4x4<br>3.6 V6 4x4<br>5.7 V8 4x4<br>6.4 SRT8 4x4  | 140<br>177<br>210<br>259<br>346  |  | 02.11<br>02.11<br>11.10<br>11.10<br>03.11   |  | 13.0460-7282.2<br>13.0470-7282.2<br>13.0460-7282.2                                 | 607282<br>LD7282<br>607282   | 25192 21,3 +/WK<br>25192 21,3 +/WK<br>25192 21,3 +/WK<br>ATE<br>ATE                |
| <b>JEEP PATRIOT (MK74) (07-)</b>   |   |  |  |   |  |  |  |  |
|    | 2.2 CRD 4x4   | 100  |  | 01.11   |  | 13.0460-5760.2   | 605760   | 23584 16,4 /WK<br>AKE  |
|    | 2.0 16V<br>2.0 CRD<br>2.0 CRD 4x4<br>2.2 CRD 4x4<br>2.2 CRD 4x4<br>2.4 16V<br>2.4 16V 4x4<br>2.4 Eco + 4x4                                      | 115<br>103<br>103<br>100<br>120<br>125<br>125<br>125                             |  | 01.11<br>02.07<br>02.07<br>01.11<br>01.11<br>06.09<br>01.08<br>07.08                            |  | 24.0126-0170.1   | 426170   | 294 26,0 24,4 V +B   |
|   | 2.2 CRD 4x4<br>2.2 CRD 4x4<br>2.0 16V<br>2.0 CRD<br>2.0 CRD 4x4<br>2.2 CRD 4x4<br>2.2 CRD 4x4<br>2.4 16V<br>2.4 16V 4x4<br>2.4 Eco + 4x4        | 100<br>120<br>115<br>103<br>103<br>100<br>120<br>125<br>125<br>125               |  | 01.11<br>01.11<br>01.11<br>02.07<br>02.07<br>01.11<br>01.11<br>06.09<br>01.08<br>07.08          | + 17" Rad <sup>1)</sup><br>+ 17" Rad <sup>1)</sup><br><br><br><br><br><br><br><br>+ 18" Rad <sup>2)</sup><br>+ 18" Rad <sup>2)</sup> | 13.0460-5735.2<br>13.0460-5855.2   | 605735<br>605855   | + ABS<br>+ ABS<br>24014 16,0 +/WK<br>AKE<br>23582 16,0 +                           |
|  | 2.2 CRD 4x4<br>2.2 CRD 4x4<br>2.0 16V<br>2.0 CRD<br>2.0 CRD 4x4<br>2.2 CRD 4x4<br>2.2 CRD 4x4<br>2.4 16V<br>2.4 16V 4x4<br>2.4 Eco + 4x4        | 100<br>120<br>115<br>103<br>103<br>100<br>120<br>125<br>125<br>125               |  | 01.11<br>01.11<br>01.11<br>02.07<br>02.07<br>01.11<br>01.11<br>06.09<br>01.08<br>07.08          | + 17" Rad <sup>1)</sup><br>+ 17" Rad <sup>1)</sup><br><br><br><br><br><br><br><br>+ 18" Rad <sup>2)</sup><br>+ 18" Rad <sup>2)</sup> | 24.0110-0363.1<br>24.0110-0361.1   | 410363<br>410361   | + ABS<br>+ ABS<br>262 10,0 8,4 +B<br>302 10,0 8,4 +B                               |
|  | 2.0 16V<br>2.0 CRD<br>2.0 CRD 4x4<br>2.2 CRD 4x4<br>2.2 CRD 4x4<br>2.4 16V<br>2.4 16V 4x4<br>2.4 Eco + 4x4                                      | 115<br>103<br>103<br>100<br>120<br>125<br>125<br>125                             |  | 01.11<br>02.07<br>02.07<br>01.11<br>01.11<br>06.09<br>01.08<br>07.08                            |  | 03.0137-3023.2   | 653023   | + ABS<br>170 x 32  |
| <b>JEEP RENEGADE (BU) (14-)</b>  |   |  |  |   |  |  |  |  |
|  | 1.6 CRD<br>2.0 CRD  | 88<br>88   |  | 07.14<br>07.14  |  | 24.0126-0168.1   | 426168   | 281 26,2 24,2 V +S +B  |
|  | 1.4<br>1.4 4x4<br>1.6<br>1.6 CRD<br>2.0 CRD<br>2.0 CRD 4x4<br>2.0 CRD 4x4   | 103<br>125<br>81<br>88<br>88<br>103<br>125                                       |  | 07.14<br>07.14<br>07.14<br>07.14<br>07.14<br>07.14<br>07.14                                     |  | 24.0112-0170.1   | 412170   | 278 12,0 10,0 +S +B  |
| <b>JEEP WRANGLER II (TJ) (96-07)</b>   |   |  |  |   |  |  |  |  |
|  | 2.8 CRDi<br>3.8   | 130<br>153   |  | 11.06<br>02.06  | 04.07<br>04.07   | 13.0460-8013.2   | 608013   | 24604 16,5 +/WK/Zub<br>BOS   |
|  | 2.5   | 87   |  | 08.96   | 12.98  | 24.0124-0702.1   | 424702   | 280 24,0 22,7 V +B   |























<sup>1)</sup> + 17" wheel / + ruota 17" / + roue 17" / + rueda 17"

<sup>2)</sup> + 18" wheel / + ruota 18" / + roue 18" / + rueda 18"

<sup>3)</sup> - reinforced suspension / - sospensione rinforzata / - châssis renforcé / - suspensión reforzada

|     |                                  |  |  |  |  |  |  |  |                               |
|--|--|--|--|--|---|--|--|--|-------------------------------|
| <b>JEEP WRANGLER II (TJ) (96-07)</b>   |  |  |  |  |   |  |  |  |                               |
|    | 2.8 CRDi<br>3.8  | 130<br>153   |  | 11.06<br>02.06   | 04.07<br>04.07  |  | 13.0460-5629.2   | 605629   | 24602 16,0 +WK/Zub            |
|    | 2.8 CRDi<br>3.8  | 130<br>153   |  | 11.06<br>02.06   | 04.07<br>04.07  |  | 24.0112-0193.1   | 412193   | 316 12,0 10,4 +B              |
| <b>JEEP WRANGLER III (JK) (07-)</b>  |  |  |  |  |   |  |  |  |                               |
|    | 2.8 CRD<br>2.8 CRD<br>3.6 V6<br>3.8<br>3.8   | 130<br>147<br>209<br>146<br>151  |  | 04.07<br>11.10<br>10.11<br>04.07<br>01.10  |   |  | 13.0460-8013.2   | 608013   | 24604 16,5 +WK/Zub <b>BOS</b> |
|    | 2.8 CRD<br>2.8 CRD<br>3.6 V6<br>3.8<br>3.8   | 130<br>147<br>209<br>146<br>151  |  | 04.07<br>11.10<br>10.11<br>04.07<br>01.10  |   |  | 13.0460-5629.2   | 605629   | 24602 16,0 +WK/Zub            |
|    | 2.8 CRD<br>2.8 CRD<br>3.6 V6<br>3.8<br>3.8   | 130<br>147<br>209<br>146<br>151  |  | 04.07<br>11.10<br>10.11<br>04.07<br>01.10  |   |  | 24.0112-0193.1   | 412193   | 316 12,0 10,4 +B              |
| <b>KIA BESTA (96-03)</b>   |  |  |  |  |   |  |  |  |                               |
|    | 2.2 D<br>2.4 D<br>2.4 D  | 48<br>51<br>53   |  | 02.96<br>11.97<br>11.97  | 12.03<br>12.03<br>12.03   |  | 13.0460-5806.2   | 605806   | 20002 15,0 +WK                |
| <b>KIA BONGO (03-10)</b>   |  |  |  |  |   |  |  |  |                               |
|    | 2.4 TDCi<br>2.9 TDCi<br>2.9 TDCi 4WD   | 69<br>90<br>90   |  | 10.03<br>10.03<br>10.03  | 12.10<br>12.10<br>12.10   |  | 13.0460-5806.2   | 605806   | 20002 15,0 +WK                |
| <b>KIA CARENS I (00-02)</b>  |  |  |  |  |   |  |  |  |                               |
|    | 1.8 i 16V  | 81   |  | 11.00  | 06.02   |  | 13.0460-5868.2   | 605868   | 23873 15,8 +WK <b>SUM</b>     |
|   | 1.8 i 16V  | 81   |  | 11.00  | 06.02   |  | 24.0124-0173.1   | 424173   | 258 24,0 22,0 V               |
|  | 1.8 i 16V  | 81   |  | 11.00  | 06.02 + ABS   |  | 13.0460-5871.2   | 605871   | 23455 13,7 +WK <b>SUM</b>     |
|  | 1.8 i 16V  | 81   |  | 11.00  | 06.02 + ABS   |  | 24.0110-0308.1   | 410308   | 261 10,0 8,0 +S +B            |
| <b>KIA CARENS II (02-06)</b>   |  |  |  |  |   |  |  |  |                               |
|  | 1.6 i 16V<br>1.8 i 16V<br>2.0 CRDi<br>2.0 CRDi<br>2.0 CVVT   | 77<br>93<br>83<br>103<br>102   |  | 07.02<br>07.02<br>07.02<br>11.05<br>08.04  | 04.06<br>04.06<br>04.06<br>04.06<br>04.06   |  | 13.0460-5742.2   | 605742   | 23966 17,7 +WK                |
|  | 1.6 i 16V<br>1.8 i 16V<br>2.0 CRDi<br>2.0 CRDi<br>2.0 CVVT   | 77<br>93<br>83<br>103<br>102   |  | 07.02<br>07.02<br>07.02<br>11.05<br>08.04  | 04.06<br>04.06<br>04.06<br>04.06<br>04.06   |  | 24.0126-0143.1   | 426143   | 280 26,0 24,0 V L +S +B       |
|  | 1.6 i 16V<br>1.8 i 16V<br>2.0 CRDi<br>2.0 CRDi<br>2.0 CVVT   | 77<br>93<br>83<br>103<br>102   |  | 07.02<br>07.02<br>07.02<br>11.05<br>08.04  | 04.06 + ABS<br>04.06 + ABS<br>04.06 + ABS<br>04.06 + ABS<br>04.06 + ABS           |  | 13.0460-5871.2   | 605871   | 23455 13,7 +WK <b>SUM</b>     |
|  | 1.6 i 16V<br>1.8 i 16V<br>2.0 CRDi<br>2.0 CRDi<br>2.0 CVVT   | 77<br>93<br>83<br>103<br>102   |  | 07.02<br>07.02<br>07.02<br>11.05<br>08.04  | 04.06 + ABS<br>04.06 + ABS<br>04.06 + ABS<br>04.06 + ABS<br>04.06 + ABS           |  | 24.0110-0308.1   | 410308   | 261 10,0 8,0 +S +B            |
| <b>KIA CARENS III (06-13)</b>  |  |  |  |  |   |  |  |  |                               |
|  | 1.6 CRDi 110<br>1.6 CRDi 128<br>1.6 CVVT<br>1.6 CVVT<br>2.0 CRDi 115<br>2.0 CRDi 135<br>2.0 CRDi 140<br>2.0 CVVT | 85<br>94<br>93<br>97<br>85<br>100<br>103<br>106                                  |  | 10.10<br>10.10<br>10.10<br>08.09<br>05.07<br>08.09<br>09.06<br>09.06             | 02.13<br>02.13<br>02.13<br>02.13<br>02.13<br>02.13<br>02.13<br>02.13              |  | 13.0460-5600.2   | 605600   | 24501 16,7 +WK <b>SUM</b>     |
|  | 1.6 CRDi 110<br>1.6 CRDi 128<br>1.6 CVVT<br>1.6 CVVT<br>2.0 CRDi 115<br>2.0 CRDi 135                             | 85<br>94<br>93<br>97<br>85<br>100  |  | 10.10<br>10.10<br>10.10<br>08.09<br>05.07<br>08.09                               | 02.13<br>02.13<br>02.13<br>02.13<br>02.13<br>02.13                                |  | 24.0126-0171.1   | 426171   | 280 26,0 24,0 V L +B          |

1) - reinforced suspension / - sospensione rinforzata / - châssis renforcé / - suspensión reforzada

|     |                                  |  |  |  |  |  |  |  |
|--|--|--|--|--|---|--|--|--|
| <b>KIA CARENS III (06-13)</b>  |  |  |  |  |   |  |  |  |
|    | 2.0 CRDi 140<br>2.0 CVVT   | 103<br>106   |  | 09.06<br>09.06   | 02.13<br>02.13  | 24.0126-0171.1   | 426171   | 280 26,0 24,0 V L +B   |
|    | 1.6 CRDi 110<br>1.6 CRDi 128<br>1.6 CVVT<br>1.6 CVVT<br>2.0 CRDi 115<br>2.0 CRDi 135<br>2.0 CRDi 140<br>2.0 CVVT | 85<br>94<br>93<br>97<br>85<br>100<br>103<br>106                                  |  | 10.10<br>10.10<br>10.10<br>08.09<br>05.07<br>08.09<br>09.06<br>09.06             | 02.13<br>02.13<br>02.13<br>02.13<br>02.13<br>02.13<br>02.13<br>02.13              | 13.0460-5601.2   | 605601   | 24491 16,0 +/WK  |
|    | 1.6 CRDi 110<br>1.6 CRDi 128<br>1.6 CVVT<br>1.6 CVVT<br>2.0 CRDi 115<br>2.0 CRDi 135<br>2.0 CRDi 140<br>2.0 CVVT | 85<br>94<br>93<br>97<br>85<br>100<br>103<br>106                                  |  | 10.10<br>10.10<br>10.10<br>08.09<br>05.07<br>08.09<br>09.06<br>09.06             | 02.13<br>02.13<br>02.13<br>02.13<br>02.13<br>02.13<br>02.13<br>02.13              | 24.0110-0341.1   | 410341   | 275 10,0 8,4 +B  |
|    | 1.6 CRDi 110<br>1.6 CRDi 128<br>1.6 CVVT<br>1.6 CVVT<br>2.0 CRDi 115<br>2.0 CRDi 135<br>2.0 CRDi 140<br>2.0 CVVT | 85<br>94<br>93<br>97<br>85<br>100<br>103<br>106                                  |  | 10.10<br>10.10<br>10.10<br>08.09<br>05.07<br>08.09<br>09.06<br>09.06             | 02.13<br>02.13<br>02.13<br>02.13<br>02.13<br>02.13<br>02.13<br>02.13              | 03.0137-3038.2   | 653038   | 167 x 32   |
| <b>KIA CARENS IV (13-)</b>   |  |  |  |  |   |  |  |  |
|    | 1.6 GDi<br>1.7 CRDi<br>1.7 CRDi<br>1.7 CRDi<br>2.0 GDi<br>2.0 GDi  | 99<br>85<br>100<br>104<br>122<br>130   |  | 03.13<br>03.13<br>03.13<br>07.15<br>03.13<br>03.13                               |   | 24.0128-0256.1   | 428256   | 300 28,0 26,4 V L +B   |
|    | 1.6 GDi<br>1.7 CRDi<br>1.7 CRDi<br>1.7 CRDi<br>2.0 GDi<br>2.0 GDi  | 99<br>85<br>100<br>104<br>122<br>130   |  | 03.13<br>03.13<br>03.13<br>07.15<br>03.13<br>03.13                               |   | 24.0110-0392.1   | 410392   | 284 10,0 8,4 +B  |
| <b>KIA CARNIVAL I (99-01)</b>  |  |  |  |  |   |  |  |  |
|  | 2.5 i<br>2.5 V6<br>2.9 TDi   | 132<br>121<br>93   |  | 10.00<br>08.99<br>08.99  | 10.01<br>10.01<br>10.01   | 13.0460-5897.2<br>13.0460-0107.2   | 605897<br>610107   | 21822 17,5 +/WK<br>Belagsatz-Zubehör   |
|  | 2.5 i<br>2.5 V6<br>2.9 TDi   | 132<br>121<br>93   |  | 10.00<br>08.99<br>08.99  | 10.01<br>10.01<br>10.01   | 24.0124-0195.1   | 424195   | 274 24,1 22,0 V  |
| <b>KIA CARNIVAL II (01-06)</b>   |  |  |  |  |   |  |  |  |
|  | 2.5 V6<br>2.5 V6<br>2.9 CRDi<br>2.9 TD<br>3.5  | 110<br>132<br>106<br>93<br>143   |  | 10.01<br>10.01<br>10.01<br>10.01<br>07.02  | 08.06<br>08.06<br>08.06<br>08.06<br>08.06   | 13.0460-5725.2   | 605725   | 23649 17,2 +/WK  |
|  | 2.5 V6<br>2.5 V6<br>2.9 CRDi<br>2.9 TD<br>3.5  | 110<br>132<br>106<br>93<br>143   |  | 10.01<br>10.01<br>10.01<br>10.01<br>07.02  | 11.03<br>11.03<br>11.03<br>11.03<br>11.03   | 24.0126-0135.1   | 426135   | 274 26,2 24,0 V +B   |
|  | 2.5 V6<br>2.5 V6<br>2.9 CRDi<br>2.9 TD<br>3.5  | 110<br>132<br>106<br>93<br>143   |  | 12.03<br>12.03<br>12.03<br>12.03<br>12.03  | 08.06<br>08.06<br>08.06<br>08.06<br>08.06   | 24.0128-0211.1   | 428211   | 274 28,3 26,0 V +B   |
|  | 2.5 V6<br>2.5 V6<br>2.9 CRDi<br>2.9 TD   | 110<br>132<br>106<br>93  |  | 12.03<br>12.03<br>12.03<br>12.03   | 08.06<br>08.06<br>08.06<br>08.06  | 03.0137-0484.2   | 650484   | 295 x 53 HEB   |
| <b>KIA CARNIVAL / GRAND CARNIVAL III (06-)</b>                                     |  |  |  |  |   |  |  |  |
|  | 2.2 CRDi<br>2.2 CRDi<br>2.7 V6<br>2.9 CRDi<br>2.9 CRDi LX  | 110<br>143<br>139<br>136<br>141  |  | 01.10<br>01.10<br>06.06<br>06.06<br>09.06  |   | 13.0460-5799.2   | 605799   | 24597 17,7 +/WK/Zub  |
|  | 2.2 CRDi<br>2.2 CRDi<br>2.7 V6<br>2.9 CRDi<br>2.9 CRDi LX  | 110<br>143<br>139<br>136<br>141  |  | 01.10<br>01.10<br>06.06<br>06.06<br>09.06  |   | 24.0128-0220.1   | 428220   | 300 28,0 26,0 V +B   |



**KIA CARNIVAL / GRAND CARNIVAL III (06-)**

|  |   |  |   |  |                       |  |                        |
|--|---|--|---|--|-----------------------|--|------------------------|
|  | 2.2 CRDi 110<br>2.2 CRDi 143<br>2.7 V6 139<br>2.9 CRDi 136<br>2.9 CRDi LX 141 |  | 01.10<br>01.10<br>06.06<br>06.06<br>09.06 |  | 13.0460-5771.2 605771 |  | 24599 14,9 +WK/Zub MAN |
|  | 2.2 CRDi 110<br>2.2 CRDi 143<br>2.7 V6 139<br>2.9 CRDi 136<br>2.9 CRDi LX 141 |  | 01.10<br>01.10<br>06.06<br>06.06<br>09.06 |  | 24.0112-0185.1 412185 |  | 324 11,9 10,4          |

**KIA CEE'D Limousine (06-12)**

|  |   |  |  |  |                       |  |                      |
|--|---|--|--|--|-----------------------|--|----------------------|
|  | 1.4 16V 66<br>1.4 16V 77<br>1.4 16V 80<br>1.6 16V 85<br>1.6 16V 90<br>1.6 16V 92<br>1.6 16V 93<br>1.6 CRDi 115 85<br>1.6 CRDi 128 94<br>1.6 CRDi 90 66<br>2.0 16V 105<br>2.0 CRDi 103 |  | 06.10 09.12<br>12.06 09.12<br>12.06 09.12<br>09.07 09.12<br>12.06 09.12<br>10.10 09.12<br>02.08 09.12<br>12.06 09.12<br>10.10 09.12<br>12.06 09.12<br>12.06 09.12<br>09.07 09.12 |  | 13.0460-5742.2 605742 |  | 23966 17,7 +WK       |
|  | 1.4 16V 66<br>1.4 16V 77<br>1.4 16V 80<br>1.6 16V 85<br>1.6 16V 90<br>1.6 16V 92<br>1.6 16V 93<br>1.6 CRDi 115 85<br>1.6 CRDi 128 94<br>1.6 CRDi 90 66<br>2.0 16V 105<br>2.0 CRDi 103 |  | 06.10 09.12<br>12.06 09.12<br>12.06 09.12<br>09.07 09.12<br>12.06 09.12<br>10.10 09.12<br>02.08 09.12<br>12.06 09.12<br>10.10 09.12<br>12.06 09.12<br>12.06 09.12<br>09.07 09.12 |  | 24.0126-0150.1 426150 |  | 280 26,0 24,4 V L +B |
|  | 1.4 16V 66<br>1.4 16V 77<br>1.4 16V 80<br>1.6 16V 85<br>1.6 16V 90<br>1.6 16V 92<br>1.6 16V 93<br>1.6 CRDi 115 85<br>1.6 CRDi 128 94<br>1.6 CRDi 90 66<br>2.0 16V 105<br>2.0 CRDi 103 |  | 06.10 09.12<br>12.06 09.12<br>12.06 09.12<br>09.07 09.12<br>12.06 09.12<br>10.10 09.12<br>02.08 09.12<br>12.06 09.12<br>10.10 09.12<br>12.06 09.12<br>12.06 09.12<br>09.07 09.12 |  | 13.0460-5780.2 605780 |  | 24320 15,3 +WK/Zub   |
|  | 1.4 16V 66<br>1.4 16V 77<br>1.4 16V 80<br>1.6 16V 85<br>1.6 16V 90<br>1.6 16V 92<br>1.6 16V 93<br>1.6 CRDi 115 85<br>1.6 CRDi 128 94<br>1.6 CRDi 90 66<br>2.0 16V 105<br>2.0 CRDi 103 |  | 06.10 09.12<br>12.06 09.12<br>12.06 09.12<br>09.07 09.12<br>12.06 09.12<br>10.10 09.12<br>02.08 09.12<br>12.06 09.12<br>10.10 09.12<br>12.06 09.12<br>12.06 09.12<br>09.07 09.12 |  | 24.0110-0332.1 410332 |  | 262 10,0 8,0 +B      |
|  | 1.4 16V 66<br>1.4 16V 77<br>1.4 16V 80<br>1.6 16V 85<br>1.6 16V 90<br>1.6 16V 92<br>1.6 16V 93<br>1.6 CRDi 115 85<br>1.6 CRDi 128 94<br>1.6 CRDi 90 66<br>2.0 16V 105<br>2.0 CRDi 103 |  | 06.10 09.12<br>12.06 09.12<br>12.06 09.12<br>09.07 09.12<br>12.06 09.12<br>10.10 09.12<br>02.08 09.12<br>12.06 09.12<br>10.10 09.12<br>12.06 09.12<br>12.06 09.12<br>09.07 09.12 |  | 03.0137-3029.2 653029 |  | 167 x 26             |

**KIA CEE'D Kombi (07-13)**

|  |   |  |  |  |                       |  |                |
|--|---|--|--|--|-----------------------|--|----------------|
|  | 1.4 16V 66<br>1.4 16V 77<br>1.4 16V 80<br>1.6 16V 85<br>1.6 16V 90<br>1.6 16V 92<br>1.6 16V 93<br>1.6 CRDi 115 85<br>1.6 CRDi 128 94<br>1.6 CRDi 90 66<br>2.0 16V 105<br>2.0 CRDi 103 |  | 10.10 03.13<br>10.10 03.13<br>09.07 03.13<br>09.07 03.13<br>09.07 03.13<br>06.09 03.13<br>09.07 03.13<br>09.07 03.13<br>10.10 03.13<br>09.07 03.13<br>09.07 03.13<br>09.07 03.13 |  | 13.0460-5742.2 605742 |  | 23966 17,7 +WK |
|--|---|--|--|--|-----------------------|--|----------------|



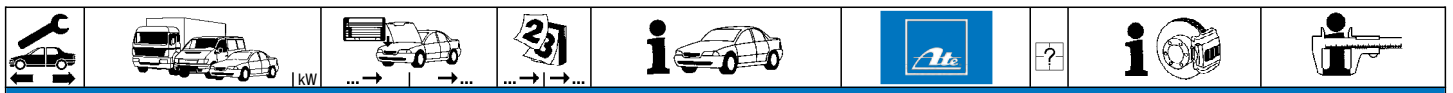























**KIA CEE'D Kombi (07-13)**

|  |   |  |  |  |                       |  |                      |
|--|---|--|--|--|-----------------------|--|----------------------|
|  | 1.4 16V 66<br>1.4 16V 77<br>1.4 16V 80<br>1.6 16V 85<br>1.6 16V 90<br>1.6 16V 92<br>1.6 16V 93<br>1.6 CRDi 115 85<br>1.6 CRDi 128 94<br>1.6 CRDi 90 66<br>2.0 16V 105<br>2.0 CRDi 103 |  |  | 10.10 03.13<br>10.10 03.13<br>09.07 03.13<br>09.07 03.13<br>09.07 03.13<br>06.09 03.13<br>09.07 03.13<br>09.07 03.13<br>10.10 03.13<br>09.07 03.13<br>09.07 03.13                | 24.0126-0150.1 426150 |  | 280 26,0 24,4 V L +B |
|  | 1.4 16V 66<br>1.4 16V 77<br>1.4 16V 80<br>1.6 16V 85<br>1.6 16V 90<br>1.6 16V 92<br>1.6 16V 93<br>1.6 CRDi 115 85<br>1.6 CRDi 128 94<br>1.6 CRDi 90 66<br>2.0 16V 105<br>2.0 CRDi 103 |  |  | 10.10 03.13<br>10.10 03.13<br>09.07 03.13<br>09.07 03.13<br>09.07 03.13<br>06.09 03.13<br>09.07 03.13<br>09.07 03.13<br>10.10 03.13<br>09.07 03.13<br>09.07 03.13<br>09.07 03.13 | 13.0460-5780.2 605780 |  | 24320 15,3 +/WK/Zub  |
|  | 1.4 16V 66<br>1.4 16V 77<br>1.4 16V 80<br>1.6 16V 85<br>1.6 16V 90<br>1.6 16V 92<br>1.6 16V 93<br>1.6 CRDi 115 85<br>1.6 CRDi 128 94<br>1.6 CRDi 90 66<br>2.0 16V 105<br>2.0 CRDi 103 |  |  | 10.10 03.13<br>10.10 03.13<br>09.07 03.13<br>09.07 03.13<br>09.07 03.13<br>06.09 03.13<br>09.07 03.13<br>09.07 03.13<br>10.10 03.13<br>09.07 03.13<br>09.07 03.13<br>09.07 03.13 | 24.0110-0332.1 410332 |  | 262 10,0 8,0 +B      |
|  | 1.6 CRDi 128 94   |  |  | 10.10 03.13  | 24.0110-0332.1 410332 |  | 262 10,0 8,0 +B      |
|  | 1.4 16V 66<br>1.4 16V 77<br>1.4 16V 80<br>1.6 16V 85<br>1.6 16V 90<br>1.6 16V 92<br>1.6 16V 93<br>1.6 CRDi 115 85<br>1.6 CRDi 128 94<br>1.6 CRDi 90 66<br>2.0 16V 105<br>2.0 CRDi 103 |  |  | 10.10 03.13<br>10.10 03.13<br>09.07 03.13<br>09.07 03.13<br>09.07 03.13<br>06.09 03.13<br>09.07 03.13<br>09.07 03.13<br>10.10 03.13<br>09.07 03.13<br>09.07 03.13<br>09.07 03.13 | 03.0137-3029.2 653029 |  | 167 x 26             |

**KIA CEE'D (12-)**

























|  |  |  |  |   |                       |                   |                      |
|--|--|--|--|---|-----------------------|-------------------|----------------------|
|  | 1.4 CRDi 90 66<br>1.4 CVVT 66<br>1.4 CVVT 73<br>1.6 CRDi 110 81<br>1.6 CRDi 115 85<br>1.6 CRDi 128 94<br>1.6 CRDi 90 66<br>1.6 CVVT 92<br>1.6 GDI 99   |  |  | 05.12 04.13<br>05.12 04.13<br>05.12 04.13<br>05.12 04.13<br>05.12 04.13<br>05.12 04.13<br>05.12 04.13<br>05.12 04.13<br>05.12 04.13 | 13.0460-5645.2 605645 | + 15" Bremssystem | 25692 17,2 +/WK/Zub  |
|  | 1.0 T-GDI 74<br>1.0 T-GDI 88<br>1.4 CRDi 90 66<br>1.4 CVVT 66<br>1.4 CVVT 73<br>1.6 CRDi 110 81<br>1.6 CRDi 115 85<br>1.6 CRDi 128 94<br>1.6 CRDi 136 100<br>1.6 CRDi 90 66<br>1.6 CVVT 92<br>1.6 GDI 99<br>1.6 GT 150 |  |  | 07.15<br>07.15<br>05.13<br>05.13<br>05.13<br>05.13<br>05.13<br>07.15<br>05.12<br>05.13<br>05.13<br>07.13                            | 13.0460-5645.2 605645 | + 15" Bremssystem | 25692 17,2 +/WK/Zub  |
|  | 1.0 T-GDI 74<br>1.0 T-GDI 88<br>1.6 CRDi 136 100   |  |  | 07.15<br>07.15<br>07.15   | 24.0123-0123.1 423123 | + 15" Bremssystem | 280 23,1 21,0 V L +B |
|  | 1.4 CRDi 90 66<br>1.4 CVVT 66<br>1.4 CVVT 73<br>1.6 CRDi 110 81<br>1.6 CRDi 115 85<br>1.6 CRDi 128 94<br>1.6 CRDi 90 66<br>1.6 CVVT 92<br>1.6 GDI 99<br>1.6 GT 150   |  |  | 05.12<br>05.12<br>05.12<br>05.12<br>05.12<br>05.12<br>05.12<br>05.12<br>05.12<br>07.13  | 24.0128-0234.1 428234 | + 16" Bremssystem | 300 28,0 26,4 V +B   |

























|     |   |  |  |                                   |  |  |  |  |                        |
|--|---|--|--|---|---|--|--|--|------------------------|
| <b>KIA CEE'D (12-)</b>   |   |  |  |   |   |  |  |  |                        |
|    | 1.0 T-GDI<br>1.0 T-GDI<br>1.4 CRDi 90<br>1.4 CVVT<br>1.4 CVVT<br>1.6 CRDi 110<br>1.6 CRDi 115<br>1.6 CRDi 128<br>1.6 CRDi 136<br>1.6 CRDi 90<br>1.6 CVVT<br>1.6 GDI<br>1.6 GT | 74<br>88<br>66<br>66<br>73<br>81<br>85<br>94<br>100<br>66<br>92<br>99<br>150     |  | 07.15<br>07.15<br>05.12<br>05.12<br>05.12<br>05.12<br>05.12<br>05.12<br>07.15<br>05.12<br>05.12<br>05.12<br>07.13 |   | 24.0110-0379.1   | 410379   | - elektrische Feststellbremse <sup>1)</sup>  | 262 10,0 8,4 L +B      |
|  | 1.0 T-GDI<br>1.0 T-GDI<br>1.4 CRDi 90<br>1.4 CVVT<br>1.4 CVVT<br>1.6 CRDi 110<br>1.6 CRDi 115<br>1.6 CRDi 128<br>1.6 CRDi 136<br>1.6 CRDi 90<br>1.6 CVVT<br>1.6 GDI<br>1.6 GT | 74<br>88<br>66<br>66<br>73<br>81<br>85<br>94<br>100<br>66<br>92<br>99<br>150     |  | 07.15<br>07.15<br>05.12<br>05.12<br>05.12<br>05.12<br>05.12<br>05.12<br>07.15<br>05.12<br>05.12<br>05.12<br>07.13 |   | 24.0110-0383.1   | 410383   | + elektrische Feststellbremse <sup>2)</sup>  | 284 10,0 8,4 L +B      |
| <b>KIA CERATO (04-09)</b>  |   |  |  |   |   |  |  |  |                        |
|    | 1.5 CRDi<br>1.6 CRDi<br>1.6 i 16V<br>1.6 i 16V<br>2.0 CRDi<br>2.0 i 16V   | 75<br>85<br>77<br>90<br>83<br>105  |  | 07.05 06.09<br>06.05 06.09<br>04.04 06.09<br>05.06 06.09<br>04.04 06.09<br>04.04 06.09                            |   | 13.0460-5791.2   | 605791   |  | 24218 17,5 +WK/Zub     |
|    | 1.5 CRDi<br>1.6 CRDi<br>1.6 i 16V<br>1.6 i 16V<br>2.0 CRDi<br>2.0 i 16V   | 75<br>85<br>77<br>90<br>83<br>105  |  | 07.05 06.09<br>06.05 06.09<br>04.04 06.09<br>05.06 06.09<br>04.04 06.09<br>04.04 06.09                            |   | 24.0126-0155.1   | 426155   |  | 275 26,0 24,0 V +S +B  |
|  | 1.5 CRDi<br>1.6 CRDi<br>1.6 i 16V<br>1.6 i 16V<br>2.0 CRDi<br>2.0 i 16V   | 75<br>85<br>77<br>90<br>83<br>105  |  | 07.05 06.09<br>06.05 06.09<br>04.04 06.09<br>05.06 06.09<br>04.04 06.09<br>04.04 06.09                            |   | 13.0460-5874.2   | 605874   |  | 21553 14,0 +WK/Zub SUM |
|  | 1.5 CRDi<br>1.6 CRDi<br>1.6 i 16V<br>1.6 i 16V<br>2.0 CRDi<br>2.0 i 16V   | 75<br>85<br>77<br>90<br>83<br>105  |  | 07.05 06.09<br>06.05 06.09<br>04.04 06.09<br>05.06 06.09<br>04.04 06.09<br>04.04 06.09                            |   | 24.0110-0334.1   | 410334   |  | 258 10,0 8,0 +B        |
| <b>KIA CERATO (09-)</b>  |   |  |  |   |   |  |  |  |                        |
|  | 1.6 16V<br>1.6 16V<br>2.0 16V<br>2.0 16V  | 90<br>93<br>110<br>115   |  | 01.10 08.10<br>01.10 08.10<br>07.09 08.10<br>03.10 08.10  |   | 13.0460-5742.2   | 605742   |  | 23966 17,7 +WK         |
|  | 1.6 16V<br>1.6 16V<br>2.0 16V<br>2.0 16V  | 90<br>93<br>110<br>115   |  | 01.10<br>01.10<br>07.09<br>03.10  |   | 24.0110-0362.1   | 410362   | + ESP  | 262 10,0 8,4 +B        |
| <b>KIA CERATO KOUP (09-)</b>   |   |  |  |   |   |  |  |  |                        |
|  | 1.6 16V<br>2.0 16V  | 93<br>115  |  | 01.10<br>01.09  | - ⊖<br>- ⊖  | 13.0460-5742.2   | 605742   | - ABS  | 23966 17,7 +WK         |
|  | 1.6 16V<br>2.0 16V<br>1.6 CVVT  | 93<br>115<br>150   |  | 01.10<br>01.09<br>09.13   | - ⊖<br>- ⊖  | 24.0110-0362.1   | 410362   | + ABS  | 262 10,0 8,4 +B        |
|  |   |  |  |   |   | 24.0110-0368.1   | 410368   |  | 262 10,0 8,4 +B        |
| <b>KIA CLARUS (96-01)</b>  |   |  |  |   |   |  |  |  |                        |
|  | 1.8 i 16V<br>2.0 i 16V  | 85<br>98   |  | 05.96 08.01<br>05.96 08.01  |   | 13.0460-5868.2   | 605868   |  | 23873 15,8 +WK SUM     |
|  |   |  |  |   |   | 13.0460-5712.2   | 605712   |  | 23450 17,5 +WK ATE     |
|  | 1.8 i 16V<br>2.0 i 16V  | 85<br>98   |  | 05.96 08.01<br>05.96 08.01  |   | 24.0124-0173.1   | 424173   |  | 258 24,0 22,0 V        |
|  | 2.0 i 16V   | 98   |  | 05.96 08.01   | + ABS   | 13.0460-5871.2   | 605871   |  | 23455 13,7 +WK SUM     |
|  |   |  |  |   |   | 13.0460-0296.2   | 610296   |  | Belagsatz-Zubehör SUM  |
|  | 2.0 i 16V   | 98   |  | 05.96 08.01   | + ABS   | 24.0110-0308.1   | 410308   |  | 261 10,0 8,0 +S +B     |

<sup>1)</sup> - electric parking brake / - freno a mano elettrico / - frein à main électrique / - freno de mano eléctrico

<sup>2)</sup> + electric parking brake / + freno a mano elettrico / + frein à main électrique / + freno de mano eléctrico

|     |    |  |  |  |  |  |  |  |
|--|--|--|--|--|---|--|--|--|
| <b>KIA JOICE (00-03)</b>   |  |  |  |  |   |  |  |  |
|    | 2.0 i 16V<br>2.0 i 16V   | 88<br>102  |  | 09.01<br>01.00   | 08.03<br>08.03  |  | 13.0460-5933.2<br>605933   | 21725 16,8 +/WK<br><b>AKE</b>  |
|    | 2.0 i 16V<br>2.0 i 16V   | 88<br>102  |  | 09.01<br>01.00   | 08.03<br>08.03  | - ABS<br>- ABS   | 24.0124-0136.1<br>424136   | 256 24,0 21,5 V +B   |
|  | 2.0 i 16V<br>2.0 i 16V   | 88<br>102  |  | 09.01<br>01.00   | 08.03<br>08.03  | + ABS<br>+ ABS   | 24.0124-0146.1<br>424146   | 256 24,0 22,4 V +B   |
|    | 2.0 i 16V<br>2.0 i 16V   | 88<br>102  |  | 09.01<br>01.00   | 08.03<br>08.03  | + ABS<br>+ ABS   | 24.0118-0141.1<br>418141   | 266 18,0 16,4 V  |
| <b>KIA MAGENTIS (01-05)</b>  |  |  |  |  |   |  |  |  |
|    | 2.0 i 16V<br>2.5 i V6  | 100<br>124   |  | 05.01<br>05.01   | 10.05<br>10.05  |  | 13.0460-5873.2<br>13.0460-0139.2   | 605873<br>610139   |
|  | 2.0 i 16V<br>2.5 i V6  | 100<br>124   |  | 05.01<br>05.01   | 08.02<br>08.02  |  | 24.0125-0177.1<br>425177   | 257 24,5 22,4 V +B   |
|  | 2.0 i 16V<br>2.5 i V6  | 100<br>124   |  | 09.02<br>09.02   | 10.05<br>10.05  |  | 24.0126-0129.1<br>426129   | 280 26,0 24,4 V +B   |
|    | 2.0 i 16V<br>2.5 i V6  | 100<br>124   |  | 05.01<br>05.01   | 10.05<br>10.05  | + ABS<br>+ ABS   | 13.0460-5833.2<br>605833   | 23543 14,4 +/WK/Zub<br><b>AKE</b>  |
|    | 2.0 i 16V<br>2.5 i V6  | 100<br>124   |  | 05.01<br>05.01   | 10.05<br>10.05  | + ABS<br>+ ABS   | 24.0110-0317.1<br>410317   | 262 10,0 8,4   |
|    | 2.0 i 16V<br>2.5 i V6  | 100<br>124   |  | 05.01<br>05.01   | 10.05<br>10.05  | + ABS<br>+ ABS   | 03.0137-3024.2<br>653024   | 170 x 32 HEB   |
| <b>KIA MAGENTIS (05-10)</b>  |  |  |  |  |   |  |  |  |
|    | 2.0 CRDi<br>2.0 CRDi<br>2.0 CRDi<br>2.0 i 16V<br>2.0 i 16V<br>2.7 i V6<br>2.7 i V6 | 100<br>103<br>110<br>106<br>121<br>138<br>142                                    |  | 11.05<br>04.06<br>04.06<br>11.05<br>07.09<br>11.05<br>07.09                      | 12.08<br>12.10<br>12.10<br>12.10<br>12.10<br>12.10<br>12.10                       |  | 13.0460-5873.2<br>13.0460-0139.2   | 605873<br>610139   |
|   | 2.0 CRDi<br>2.0 CRDi<br>2.0 CRDi<br>2.0 i 16V<br>2.0 i 16V<br>2.7 i V6<br>2.7 i V6 | 100<br>103<br>110<br>106<br>121<br>138<br>142                                    |  | 11.05<br>04.06<br>04.06<br>11.05<br>07.09<br>11.05<br>07.09                      | 12.08<br>12.10<br>12.10<br>12.10<br>12.10<br>12.10<br>12.10                       |  | 24.0126-0128.1<br>426128   | 280 26,0 24,4 V L +B   |
|  | 2.0 CRDi<br>2.0 CRDi<br>2.0 CRDi<br>2.0 i 16V<br>2.0 i 16V<br>2.7 i V6<br>2.7 i V6 | 100<br>103<br>110<br>106<br>121<br>138<br>142                                    |  | 11.05<br>04.06<br>04.06<br>11.05<br>07.09<br>11.05<br>07.09                      | 12.08<br>12.10<br>12.10<br>12.10<br>12.10<br>12.10<br>12.10                       |  | 13.0460-5833.2<br>605833   | 23543 14,4 +/WK/Zub<br><b>AKE</b>  |
|  | 2.0 CRDi<br>2.0 CRDi<br>2.0 CRDi<br>2.0 i 16V<br>2.0 i 16V<br>2.7 i V6<br>2.7 i V6 | 100<br>103<br>110<br>106<br>121<br>138<br>142                                    |  | 11.05<br>04.06<br>04.06<br>11.05<br>07.09<br>11.05<br>07.09                      | 12.08<br>12.10<br>12.10<br>12.10<br>12.10<br>12.10<br>12.10                       |  | 24.0110-0318.1<br>410318   | 262 10,0 8,4 +B  |
|  | 2.0 CRDi<br>2.0 CRDi<br>2.0 CRDi<br>2.0 i 16V<br>2.0 i 16V<br>2.7 i V6<br>2.7 i V6 | 100<br>103<br>110<br>106<br>121<br>138<br>142                                    |  | 11.05<br>04.06<br>04.06<br>11.05<br>07.09<br>11.05<br>07.09                      | 12.08<br>12.10<br>12.10<br>12.10<br>12.10<br>12.10<br>12.10                       |  | 03.0137-3025.2<br>653025   | 170 x 27   |
| <b>KIA MENTOR I (GB) (96-01)</b>   |  |  |  |  |   |  |  |  |
|  | 1.5 16V  | 65   |  | 01.96  | 04.01   |  | 13.0460-5923.2<br>605923   | 23384 18,3 +/WK<br><b>ATE</b>  |
|  | 1.5 16V<br>1.5 16V   | 65<br>65   |  | 01.96<br>01.98   | 12.97<br>04.01  |  | 24.0120-0162.1<br>24.0120-0177.1   | 420162<br>420177   |
|  | 1.5 16V  | 65   |  | 01.96  | 04.01   | + ABS  | 13.0460-5871.2<br>605871   | 23455 13,7 +/WK<br><b>SUM</b>  |
|  | 1.5 16V  | 65   |  | 01.96  | 04.01   | + ABS  | 24.0110-0301.1<br>410301   | 261 10,0 8,0 +B  |
|  | 1.5 16V  | 65   |  | 01.96  | 04.01   | - ABS  | 03.0137-0377.2<br>03.0137-9241.2   | 650377<br>669241   |

|     |     |  |  |  |   |  |  |  |
|--|---|--|--|--|--|--|--|--|
| <b>KIA MENTOR I (GB) (96-01)</b>   |   |  |  |  |  |  |  |  |
|    | 1.5 16V   | 65   | 01.96  | 04.01  | - ABS  | 24.0220-0031.1   | 480125   | 200/201 x 41,5   |
| <b>KIA MENTOR II (GB) (01-04)</b>  |   |  |  |  |  |  |  |  |
|    | 1.6 i 16V   | 75   | 05.01  | 08.04  |  | 13.0460-5868.2   | 605868   | 23873 15,8 +/WK <b>SUM</b>   |
|    | 1.6 i 16V   | 75   | 05.01  | 08.04  |  | 24.0124-0185.1   | 424185   | 258 24,0 22,0 V +B   |
|    | 1.6 i 16V   | 75   | 05.01  | 08.04  | + ABS  | 13.0460-5871.2   | 605871   | 23455 13,7 +/WK <b>SUM</b>   |
|    | 1.6 i 16V   | 75   | 05.01  | 08.04  | + ABS  | 24.0110-0301.1   | 410301   | 261 10,0 8,0 +B  |
|    | 1.6 i 16V   | 75   | 05.01  | 08.04  | - ABS  | 03.0137-0377.2   | 650377   | 200 x 36   |
|    | 1.6 i 16V   | 75   | 05.01  | 08.04  | - ABS  | 24.0220-0031.1   | 480125   | 200/201 x 41,5   |
| <b>KIA OPIRUS (03-10)</b>  |   |  |  |  |  |  |  |  |
|    | 2.7 i V6<br>3.3 i V6<br>3.8 i V6  | 139<br>173<br>196  | 10.06<br>10.06<br>10.06  | 08.07<br>08.07<br>08.07  |  | 24.0110-0336.1   | 410336   | 284 10,0 8,4 +B  |
|  | 2.7 i V6<br>3.3 i V6<br>3.8 i V6  | 139<br>173<br>196  | 09.07<br>09.07<br>09.07  | 05.10<br>05.10<br>05.10  |  | 24.0110-0336.1   | 410336   | 284 10,0 8,4 +B  |
| <b>KIA OPTIMA (TF) (12-15)</b>   |   |  |  |  |  |  |  |  |
|    | 1.7 CRDi<br>2.0 16V<br>2.0 16V<br>2.0 CVVL<br>2.4 16V<br>2.4 16V                    | 100<br>125<br>204<br>121<br>132<br>149   | 03.12<br>03.12<br>03.12<br>03.12<br>03.12  |  |  | 24.0128-0258.1   | 428258   | + ALU-Felgen <sup>1)</sup><br>320 28,1 26,4 V L +B                                 |
|  | 1.7 CRDi<br>2.0 16V<br>2.0 16V<br>2.0 CVVL<br>2.0 CVVT Hybrid<br>2.4 16V<br>2.4 16V | 100<br>125<br>204<br>121<br>110<br>132<br>149                                    | 03.12<br>03.12<br>03.12<br>03.12<br>03.12<br>03.12                               |  |  | 24.0128-0256.1   | 428256   | + Stahlfelgen <sup>2)</sup><br>300 28,0 26,4 V L +B                                |
|  | 1.7 CRDi<br>2.0 16V<br>2.0 16V<br>2.0 CVVL<br>2.0 CVVT Hybrid<br>2.4 16V<br>2.4 16V | 100<br>125<br>204<br>121<br>110<br>132<br>149                                    | 03.12<br>03.12<br>03.12<br>03.12<br>03.12<br>03.12                               |  | - elektrische Feststellbremse <sup>3)</sup><br>- elektrische Feststellbremse <sup>3)</sup><br>- elektrische Feststellbremse <sup>3)</sup><br>- elektrische Feststellbremse <sup>3)</sup>   | 13.0460-5786.2   | 605786   | 24934 15,5 +/WK/Zub <b>AKE</b>   |
|  | 1.7 CRDi<br>2.0 16V<br>2.0 16V<br>2.0 CVVL<br>2.4 16V<br>2.4 16V                    | 100<br>125<br>204<br>121<br>132<br>149   | 03.12<br>03.12<br>03.12<br>03.12<br>03.12  |  | + elektrische Feststellbremse <sup>4)</sup><br>+ elektrische Feststellbremse <sup>4)</sup><br>+ elektrische Feststellbremse <sup>4)</sup><br>+ elektrische Feststellbremse <sup>4)</sup><br>+ elektrische Feststellbremse <sup>4)</sup>  | 13.0460-5786.2<br>13.0470-5786.2   | 605786<br>LD5786   | 24934 15,5 +/WK/Zub <b>AKE</b><br>24934 15,5 +/WK/Zub <b>AKE</b>                   |
|  | 1.7 CRDi<br>2.0 16V<br>2.0 16V<br>2.0 CVVL<br>2.0 CVVT Hybrid<br>2.4 16V<br>2.4 16V | 100<br>125<br>204<br>121<br>110<br>132<br>149                                    | 03.12<br>03.12<br>03.12<br>03.12<br>03.12<br>03.12                               |  | - elektrische Feststellbremse <sup>3)</sup><br>- elektrische Feststellbremse <sup>3)</sup><br>- elektrische Feststellbremse <sup>3)</sup><br>- elektrische Feststellbremse <sup>3)</sup><br>- elektrische Feststellbremse <sup>3)</sup><br>- elektrische Feststellbremse <sup>3)</sup> | 24.0110-0388.1   | 410388   | 284 10,0 8,4 L +B  |
| <b>KIA OPTIMA (JF) (15-)</b>   |   |  |  |  |  |  |  |  |
|  | 1.7 CRDi<br>2.0 CVVL  | 104<br>120   | 11.15<br>09.15   |  |  | 24.0128-0256.1   | 428256   | + 16"/17" Rad <sup>5)</sup><br>300 28,0 26,4 V L +B                                |
|  | 1.7 CRDi<br>2.0 CVVL  | 104<br>120   | 11.15<br>09.15   |  |  | 24.0128-0258.1   | 428258   | + 18" Rad <sup>6)</sup><br>320 28,1 26,4 V L +B                                    |
| <b>KIA PICANTO (BA) (04-11)</b>  |   |  |  |  |  |  |  |  |
|  | 1.0<br>1.0<br>1.1<br>1.1 CRDi   | 45<br>46<br>48<br>55   | 09.05<br>11.09<br>04.04<br>11.05   | 04.11<br>04.11<br>04.11<br>04.11   |  | 13.0460-5776.2   | 605776   | 24275 16,5 +/WK/Zub <b>AKE</b>   |
|  | 1.0<br>1.0<br>1.1   | 45<br>46<br>48   | 09.05<br>11.09<br>04.04  | 04.11<br>04.11<br>04.11  |  | 24.0118-0145.1   | 418145   | 241 18,0 16,0 V +B   |
|  | 1.1 CRDi  | 55   | 11.05  | 04.11  |  | 24.0118-0144.1   | 418144   | 252 18,0 16,0 V +B   |

<sup>1)</sup> + aluminium rims / + cerchi in alluminio / + jantes en aluminium / + Llantas de aluminio

<sup>2)</sup> + steel rims / + cerchi in acciaio / + jantes en acier / + Llantas acero

<sup>3)</sup> - electric parking brake / - freno a mano elettrico / - frein à main électrique / - freno de mano eléctrico





















<sup>4)</sup> + electric parking brake / + freno a mano elettrico / + frein à main électrique / + freno de mano eléctrico

<sup>5)</sup> + 16"/17" wheel / + ruota 16"/17" / + roue 16"/17" / + ruedas 16"/17"



























<sup>6)</sup> + 18" wheel / + ruota 18" / + roue 18" / + rueda 18"

| <b>KIA PICANTO (BA) (04-11)</b>    |             |    |  |       |       |       |  |                |        |  |                               |  |  |       |           |                     |           |
|------------------------------------|-------------|----|--|-------|-------|-------|--|----------------|--------|--|-------------------------------|--|--|-------|-----------|---------------------|-----------|
|                                    | 1.0         | 45 |  | 09.05 | 04.11 | + ABS |  | 13.0460-5775.2 | 605775 |  |                               |  |  | 24276 | 14,8      | +WK/Zub             |           |
|                                    | 1.0         | 46 |  | 11.09 | 04.11 | + ABS |  |                |        |  |                               |  |  |       |           |                     |           |
|                                    | 1.1         | 48 |  | 04.04 | 04.11 | + ABS |  |                |        |  |                               |  |  |       |           |                     |           |
|                                    | 1.1 CRDi    | 55 |  | 11.05 | 04.11 | + ABS |  |                |        |  |                               |  |  |       |           |                     |           |
|                                    | 1.0         | 45 |  | 09.05 | 04.11 | + ABS |  | 24.0110-0324.1 | 410324 |  |                               |  |  |       | 234       | 10,0                | 8,0 +B    |
|                                    | 1.0         | 46 |  | 11.09 | 04.11 | + ABS |  |                |        |  |                               |  |  |       |           |                     |           |
|                                    | 1.1         | 48 |  | 04.04 | 04.11 | + ABS |  |                |        |  |                               |  |  |       |           |                     |           |
|                                    | 1.1 CRDi    | 55 |  | 11.05 | 04.11 | + ABS |  |                |        |  |                               |  |  |       |           |                     |           |
|                                    | 1.0         | 45 |  | 09.05 | 04.11 |       |  | 03.0137-0511.2 | 650511 |  | - ABS                         |  |  |       | 180       | x 32                |           |
|                                    | 1.0         | 46 |  | 11.09 | 04.11 |       |  |                |        |  |                               |  |  |       |           |                     |           |
|                                    | 1.1         | 48 |  | 04.04 | 04.11 |       |  |                |        |  |                               |  |  |       |           |                     |           |
|                                    | 1.1 CRDi    | 55 |  | 11.05 | 04.11 |       |  |                |        |  |                               |  |  |       |           |                     |           |
| <b>KIA PICANTO (TA) (11-)</b>      |             |    |  |       |       |       |  |                |        |  |                               |  |  |       |           |                     |           |
|                                    | 1.0 12V     | 51 |  | 05.11 |       |       |  | 13.0460-5649.2 | 605649 |  |                               |  |  | 25365 | 16,0      | +WK/Zub             | MAN       |
|                                    | 1.0 Bi-Fuel | 59 |  | 05.11 |       |       |  |                |        |  |                               |  |  |       |           |                     |           |
|                                    | 1.0 Bi-Fuel | 60 |  | 05.11 |       |       |  |                |        |  |                               |  |  |       |           |                     |           |
|                                    | 1.2 16V     | 63 |  | 09.11 |       |       |  |                |        |  |                               |  |  |       |           |                     |           |
|                                    | 1.0 12V     | 51 |  | 05.11 |       |       |  | 24.0118-0145.1 | 418145 |  |                               |  |  |       | 241       | 18,0                | 16,0 V +B |
|                                    | 1.0 Bi-Fuel | 59 |  | 05.11 |       |       |  |                |        |  |                               |  |  |       |           |                     |           |
|                                    | 1.0 Bi-Fuel | 60 |  | 05.11 |       |       |  |                |        |  |                               |  |  |       |           |                     |           |
|                                    | 1.2 16V     | 63 |  | 09.11 |       |       |  |                |        |  |                               |  |  |       |           |                     |           |
|                                    | 1.0 12V     | 51 |  | 05.11 |       |       |  | 13.0460-5775.2 | 605775 |  |                               |  |  | 24276 | 14,8      | +WK/Zub             |           |
|                                    | 1.0 Bi-Fuel | 59 |  | 05.11 |       |       |  |                |        |  |                               |  |  |       |           |                     |           |
|                                    | 1.0 Bi-Fuel | 60 |  | 05.11 |       |       |  |                |        |  |                               |  |  |       |           |                     |           |
|                                    | 1.2 16V     | 63 |  | 09.11 |       |       |  |                |        |  |                               |  |  |       |           |                     |           |
|                                    | 1.0 12V     | 51 |  | 05.11 |       |       |  | 24.0110-0324.1 | 410324 |  |                               |  |  |       | 234       | 10,0                | 8,0 +B    |
|                                    | 1.0 Bi-Fuel | 59 |  | 05.11 |       |       |  |                |        |  |                               |  |  |       |           |                     |           |
|                                    | 1.0 Bi-Fuel | 60 |  | 05.11 |       |       |  |                |        |  |                               |  |  |       |           |                     |           |
|                                    | 1.2 16V     | 63 |  | 09.11 |       |       |  |                |        |  |                               |  |  |       |           |                     |           |
|                                    | 1.0 12V     | 51 |  | 05.11 |       |       |  | 03.0137-0516.2 | 650516 |  |                               |  |  |       | 180       | x 27                |           |
|                                    | 1.0 Bi-Fuel | 59 |  | 05.11 |       |       |  |                |        |  |                               |  |  |       |           |                     |           |
|                                    | 1.0 Bi-Fuel | 60 |  | 05.11 |       |       |  |                |        |  |                               |  |  |       |           |                     |           |
|                                    | 1.2 16V     | 63 |  | 09.11 |       |       |  |                |        |  |                               |  |  |       |           |                     |           |
| <b>KIA PREGIO (97-04)</b>          |             |    |  |       |       |       |  |                |        |  |                               |  |  |       |           |                     |           |
|                                    | 2.5 TCiD    | 69 |  | 09.02 | 09.04 |       |  | 13.0460-5725.2 | 605725 |  |                               |  |  | 23649 | 17,2      | +WK                 |           |
|                                    | 2.7 D       | 60 |  | 01.99 | 12.01 |       |  |                |        |  |                               |  |  |       |           |                     |           |
|                                    | 2.5 TCiD    | 69 |  | 09.02 | 03.04 |       |  | 03.0137-0486.2 | 650486 |  |                               |  |  |       | 260       | x 51                |           |
|                                    | 2.7 D       | 60 |  | 10.97 | 12.01 |       |  |                |        |  |                               |  |  |       |           |                     |           |
| <b>KIA PRIDE Limousine (96-00)</b> |             |    |  |       |       |       |  |                |        |  |                               |  |  |       |           |                     |           |
|                                    | 1.3 i 16V   | 47 |  | 10.96 | 10.00 |       |  | 13.0460-5970.2 | 605970 |  |                               |  |  | 21355 | 13,5      | +WK                 | SUM       |
|                                    |             |    |  |       |       |       |  | 13.0460-0451.2 | 610451 |  |                               |  |  |       |           | Belagsatz-Zubehör   | SUM       |
|                                    | 1.3 i 16V   | 47 |  | 10.96 | 10.00 |       |  | 24.0113-0165.1 | 413165 |  |                               |  |  |       | 219       | 13,0                | 11,0      |
|                                    |             |    |  |       |       |       |  |                |        |  |                               |  |  |       |           |                     |           |
|                                    | 1.3 i 16V   | 47 |  | 10.96 | 10.00 |       |  | 03.0137-0204.2 | 650204 |  |                               |  |  |       | 170       | x 25                |           |
|                                    |             |    |  |       |       |       |  | 03.0137-9113.2 | 669113 |  |                               |  |  |       |           | Bremsbacken-Zubehör |           |
|                                    | 1.3 i 16V   | 47 |  | 10.96 | 10.00 |       |  | 24.0217-0001.1 | 480198 |  | ohne Sensorring <sup>1)</sup> |  |  |       | 170/171,5 | x 34,5              |           |
|                                    |             |    |  |       |       |       |  |                |        |  |                               |  |  |       |           |                     |           |
| <b>KIA PRIDE Kombi (99-01)</b>     |             |    |  |       |       |       |  |                |        |  |                               |  |  |       |           |                     |           |
|                                    | 1.3         | 47 |  | 08.99 | 05.01 |       |  | 13.0460-5970.2 | 605970 |  |                               |  |  | 21355 | 13,5      | +WK                 | SUM       |
|                                    |             |    |  |       |       |       |  | 13.0460-0451.2 | 610451 |  |                               |  |  |       |           | Belagsatz-Zubehör   | SUM       |
|                                    | 1.3         | 47 |  | 08.99 | 05.01 |       |  | 24.0113-0165.1 | 413165 |  |                               |  |  |       | 219       | 13,0                | 11,0      |
|                                    |             |    |  |       |       |       |  |                |        |  |                               |  |  |       |           |                     |           |
|                                    | 1.3         | 47 |  | 08.99 | 05.01 |       |  | 03.0137-0204.2 | 650204 |  |                               |  |  |       | 170       | x 25                |           |
|                                    |             |    |  |       |       |       |  | 03.0137-9113.2 | 669113 |  |                               |  |  |       |           | Bremsbacken-Zubehör |           |
|                                    | 1.3         | 47 |  | 08.99 | 05.01 |       |  | 24.0217-0001.1 | 480198 |  | ohne Sensorring <sup>1)</sup> |  |  |       | 170/171,5 | x 34,5              |           |
|                                    |             |    |  |       |       |       |  |                |        |  |                               |  |  |       |           |                     |           |
| <b>KIA PRIDE (05-11)</b>           |             |    |  |       |       |       |  |                |        |  |                               |  |  |       |           |                     |           |
|                                    | 1.4 i 16V   | 71 |  | 03.05 | 08.11 |       |  | 13.0460-5779.2 | 605779 |  |                               |  |  | 24317 | 17,6      | +WK/Zub             |           |
|                                    | 1.5 CRDi    | 81 |  | 03.05 | 08.11 |       |  |                |        |  |                               |  |  |       |           |                     |           |
|                                    | 1.6 i 16V   | 82 |  | 03.05 | 08.11 |       |  |                |        |  |                               |  |  |       |           |                     |           |
|                                    | 1.4 i 16V   | 71 |  | 03.05 | 08.11 |       |  | 24.0122-0260.1 | 422260 |  |                               |  |  |       | 256       | 22,0                | 20,0 V +B |
|                                    | 1.5 CRDi    | 81 |  | 03.05 | 08.11 |       |  |                |        |  |                               |  |  |       |           |                     |           |
|                                    | 1.6 i 16V   | 82 |  | 03.05 | 08.11 |       |  |                |        |  |                               |  |  |       |           |                     |           |
|                                    | 1.4 i 16V   | 71 |  | 03.05 | 08.11 | + ABS |  | 13.0460-5780.2 | 605780 |  |                               |  |  | 24320 | 15,3      | +WK/Zub             |           |
|                                    | 1.5 CRDi    | 81 |  | 03.05 | 08.11 | + ABS |  |                |        |  |                               |  |  |       |           |                     |           |
|                                    | 1.6 i 16V   | 82 |  | 03.05 | 08.11 | + ABS |  |                |        |  |                               |  |  |       |           |                     |           |

<sup>1)</sup> without sensor ring / senza sensori / sans secours ABS / sin anillo sensor ABS

|     |    |  |  |                 |                |  |  |  |  |
|--|--|--|--|---|---|--|--|--|--|
| <b>KIA PRIDE (05-11)</b>   |  |  |  |   |   |  |  |  |  |
|    | 1.4 i 16V<br>1.5 CRDi<br>1.6 i 16V   | 71<br>81<br>82   |  | 03.05<br>03.05<br>03.05   | 08.11<br>08.11<br>08.11   | + ABS<br>+ ABS<br>+ ABS  | 24.0110-0312.1   | 410312   | 262 10,0 8,4 +B  |
|    | 1.4 i 16V<br>1.5 CRDi<br>1.6 i 16V   | 71<br>81<br>82   |  | 03.05<br>03.05<br>03.05   | 08.11<br>08.11<br>08.11   | - ABS<br>- ABS<br>- ABS  | 03.0137-0495.2   | 650495   | 203 x 32 HEB   |
|    | 1.4 i 16V<br>1.5 CRDi<br>1.6 i 16V   | 71<br>81<br>82   |  | 03.05<br>03.05<br>03.05   | 08.11<br>08.11<br>08.11   | + ABS<br>+ ABS<br>+ ABS  | 03.0137-3022.2   | 653022   | 170 x 32 HEB   |
| <b>KIA PRO CEE'D (08-13)</b>   |  |  |  |   |   |  |  |  |  |
|    | 1.4 16V<br>1.4 16V<br>1.4 16V<br>1.6 16V<br>1.6 16V<br>1.6 16V<br>1.6 CRDi 115<br>1.6 CRDi 128<br>1.6 CRDi 90<br>2.0 16V<br>2.0 CRDi 140 | 66<br>77<br>80<br>90<br>92<br>93<br>85<br>94<br>66<br>105<br>103                 |  | 06.10<br>02.08<br>02.08<br>02.08<br>10.10<br>02.08<br>02.08<br>10.10<br>02.08<br>02.08<br>02.08 | 03.13<br>03.13<br>03.13<br>03.13<br>03.13<br>03.13<br>03.13<br>03.13<br>03.13<br>03.13<br>03.13 |  | 13.0460-5742.2   | 605742   | 23966 17,7 +/WK  |
|    | 1.4 16V<br>1.4 16V<br>1.4 16V<br>1.6 16V<br>1.6 16V<br>1.6 16V<br>1.6 CRDi 115<br>1.6 CRDi 128<br>1.6 CRDi 90<br>2.0 16V<br>2.0 CRDi 140 | 66<br>77<br>80<br>90<br>92<br>93<br>85<br>94<br>66<br>105<br>103                 |  | 06.10<br>02.08<br>02.08<br>02.08<br>10.10<br>02.08<br>02.08<br>10.10<br>02.08<br>02.08<br>02.08 | 03.13<br>03.13<br>03.13<br>03.13<br>03.13<br>03.13<br>03.13<br>03.13<br>03.13<br>03.13<br>03.13 |  | 24.0126-0150.1   | 426150   | 280 26,0 24,4 V L +B   |
|    | 1.4 16V<br>1.4 16V<br>1.4 16V<br>1.6 16V<br>1.6 16V<br>1.6 16V<br>1.6 CRDi 115<br>1.6 CRDi 128<br>1.6 CRDi 90<br>2.0 16V<br>2.0 CRDi 140 | 66<br>77<br>80<br>90<br>92<br>93<br>85<br>94<br>66<br>105<br>103                 |  | 06.10<br>02.08<br>02.08<br>02.08<br>10.10<br>02.08<br>02.08<br>10.10<br>02.08<br>02.08<br>02.08 | 03.13<br>03.13<br>03.13<br>03.13<br>03.13<br>03.13<br>03.13<br>03.13<br>03.13<br>03.13<br>03.13 |  | 13.0460-5780.2   | 605780   | 24320 15,3 +/WK/Zub  |
|  | 1.4 16V<br>1.4 16V<br>1.4 16V<br>1.6 16V<br>1.6 16V<br>1.6 16V<br>1.6 CRDi 115<br>1.6 CRDi 128<br>1.6 CRDi 90<br>2.0 16V<br>2.0 CRDi 140 | 66<br>77<br>80<br>90<br>92<br>93<br>85<br>94<br>66<br>105<br>103                 |  | 06.10<br>02.08<br>02.08<br>02.08<br>10.10<br>02.08<br>02.08<br>10.10<br>02.08<br>02.08<br>02.08 | 03.13<br>03.13<br>03.13<br>03.13<br>03.13<br>03.13<br>03.13<br>03.13<br>03.13<br>03.13<br>03.13 |  | 24.0110-0332.1   | 410332   | 262 10,0 8,0 +B  |
|  | 1.4 16V<br>1.4 16V<br>1.4 16V<br>1.6 16V<br>1.6 16V<br>1.6 16V<br>1.6 CRDi 115<br>1.6 CRDi 128<br>1.6 CRDi 90<br>2.0 16V<br>2.0 CRDi 140 | 66<br>77<br>80<br>90<br>92<br>93<br>85<br>94<br>66<br>105<br>103                 |  | 06.10<br>02.08<br>02.08<br>02.08<br>10.10<br>02.08<br>02.08<br>10.10<br>02.08<br>02.08<br>02.08 | 03.13<br>03.13<br>03.13<br>03.13<br>03.13<br>03.13<br>03.13<br>03.13<br>03.13<br>03.13<br>03.13 |  | 03.0137-3029.2   | 653029   | 167 x 26   |
| <b>KIA PRO CEE'D (13-)</b>   |  |  |  |   |   |  |  |  |  |
|  | 1.4 CRDi<br>1.4 CVVT<br>1.6 CRDi<br>1.6 CRDi<br>1.6 GDI  | 66<br>73<br>81<br>94<br>99   |  | 03.13<br>03.13<br>03.13<br>03.13<br>03.13   |   |  | 13.0460-5645.2   | 605645   | + 15" Bremssystem<br>25692 17,2 +/WK/Zub                         |
|  | 1.4 CRDi<br>1.4 CVVT<br>1.6 CRDi<br>1.6 CRDi<br>1.6 GDI  | 66<br>73<br>81<br>94<br>99   |  | 03.13<br>03.13<br>03.13<br>03.13<br>03.13   |   |  | 24.0128-0234.1   | 428234   | + 16" Bremssystem<br>300 28,0 26,4 V +B                          |
|  | 1.4 CRDi<br>1.4 CVVT<br>1.6 CRDi<br>1.6 CRDi<br>1.6 GDI  | 66<br>73<br>81<br>94<br>99   |  | 03.13<br>03.13<br>03.13<br>03.13<br>03.13   |   |  | 24.0110-0379.1   | 410379   | - elektrische Feststellbremse <sup>1)</sup><br>262 10,0 8,4 L +B |
|  | 1.4 CRDi<br>1.4 CVVT<br>1.6 CRDi   | 66<br>73<br>81   |  | 03.13<br>03.13<br>03.13   |   |  | 24.0110-0383.1   | 410383   | + elektrische Feststellbremse <sup>2)</sup><br>284 10,0 8,4 L +B |

1) - electric parking brake / - freno a mano elettrico / - frein à main électrique / - freno de mano eléctrico  
2) + electric parking brake / + freno a mano elettrico / + frein à main électrique / + freno de mano eléctrico





























|     |                |  |  |  |    |  |  |                           |
|--|--|--|--|--|---|--|--|---|
| <b>KIA PRO CEE'D (13-)</b>   |  |  |  |  |   |  |  |   |
|    | 1.6 CRDi<br>1.6 GDI  | 94<br>99   |  | 03.13<br>03.13   |   | 24.0110-0383.1   | 410383   | + elektrische Feststellbremse <sup>1)</sup> 284 10,0 8,4 L +B   |
| <b>KIA RETONA (99-03)</b>  |  |  |  |  |   |  |  |   |
|    | 2.0 i 16V<br>2.0 TDi   | 94<br>61   |  | 05.00<br>06.99   | 08.03<br>08.03  | 13.0460-5896.2   | 605896   | 23442 15,3 +/WK   |
|    | 2.0 i 16V<br>2.0 TDi   | 94<br>61   |  | 05.00<br>06.99   | 08.03<br>08.03  | 24.0124-0172.1   | 424172   | 285 24,0 22,4 V   |
| <b>KIA RIO I (DC) (00-05)</b>  |  |  |  |  |   |  |  |   |
|    | 1.3 i<br>1.3 i<br>1.5 i 16V  | 55<br>60<br>72   |  | 08.00<br>08.00<br>08.00  | 06.02<br>06.02<br>06.02   | 13.0460-5944.2<br>13.0460-0149.2   | 605944<br>610149   | 21654 15,0 +/WK<br>Belagsatz-Zubehör <b>SUM</b>   |
|    | 1.3 i<br>1.3 i<br>1.5 i 16V<br>1.5 i 16V<br>1.5 i 16V  | 55<br>60<br>70<br>71<br>72   |  | 07.02<br>07.02<br>09.02<br>09.02<br>07.02  | 02.05<br>02.05<br>02.05<br>02.05<br>02.05   | 13.0460-5868.2   | 605868   | 23873 15,8 +/WK <b>SUM</b>  |
|    | 1.3 i<br>1.3 i<br>1.5 i 16V  | 55<br>60<br>72   |  | 08.00<br>08.00<br>08.00  | 06.02<br>06.02<br>06.02   | 24.0122-0227.1   | 422227   | 235 22,0 20,0 V   |
|    | 1.3 i<br>1.3 i<br>1.5 i 16V<br>1.5 i 16V<br>1.5 i 16V  | 55<br>60<br>70<br>71<br>72   |  | 07.02<br>07.02<br>09.02<br>09.02<br>07.02  | 02.05<br>02.05<br>02.05<br>02.05<br>02.05   | 24.0124-0187.1   | 424187   | 254 24,0 22,0 V +B  |
|    | 1.3 i<br>1.3 i<br>1.5 i 16V  | 55<br>60<br>72   |  | 08.00<br>08.00<br>08.00  | 06.02<br>06.02<br>06.02   | 03.0137-0436.2   | 650436   | 200 x 26  |
|    | 1.3 i<br>1.3 i<br>1.5 i 16V<br>1.5 i 16V<br>1.5 i 16V  | 55<br>60<br>70<br>71<br>72   |  | 07.02<br>07.02<br>09.02<br>09.02<br>07.02  | 02.05<br>02.05<br>02.05<br>02.05<br>02.05   | 03.0137-0455.2   | 650455   | 200 x 31  |
|    | 1.3 i<br>1.3 i<br>1.5 i 16V  | 55<br>60<br>72   |  | 08.00<br>08.00<br>08.00  | 06.02<br>06.02<br>06.02   | 24.0220-0006.1<br>24.0220-0706.2   | 480309<br>480215   | ohne Sensorring <sup>2)</sup><br>ohne Sensorring <sup>2)</sup> 200/201 x 31 - Lager<br>200/201 x 31 + Lager |
| <b>KIA RIO II (JB) (05-11)</b>   |  |  |  |  |   |  |  |   |
|   | 1.4 i 16V<br>1.5 CRDi<br>1.5 CRDi<br>1.6 i 16V   | 71<br>65<br>81<br>82   |  | 03.05<br>06.08<br>03.05<br>03.05   | 08.11<br>08.11<br>08.11<br>08.11  | 13.0460-5779.2   | 605779   | 24317 17,6 +/WK/Zub   |
|  | 1.4 i 16V<br>1.5 CRDi<br>1.5 CRDi<br>1.6 i 16V   | 71<br>65<br>81<br>82   |  | 03.05<br>06.08<br>03.05<br>03.05   | 08.11<br>08.11<br>08.11<br>08.11  | 24.0122-0260.1   | 422260   | 256 22,0 20,0 V +B  |
|  | 1.4 i 16V<br>1.5 CRDi<br>1.5 CRDi<br>1.6 i 16V   | 71<br>65<br>81<br>82   |  | 03.05<br>06.08<br>03.05<br>03.05   | 08.11<br>08.11<br>08.11<br>08.11  | 13.0460-5780.2   | 605780   | 24320 15,3 +/WK/Zub   |
|  | 1.4 i 16V<br>1.5 CRDi<br>1.5 CRDi<br>1.6 i 16V   | 71<br>65<br>81<br>82   |  | 03.05<br>06.08<br>03.05<br>03.05   | 08.11<br>08.11<br>08.11<br>08.11  | 24.0110-0312.1   | 410312   | 262 10,0 8,4 +B   |
|  | 1.4 i 16V<br>1.5 CRDi<br>1.5 CRDi<br>1.6 i 16V   | 71<br>65<br>81<br>82   |  | 03.05<br>06.08<br>03.05<br>03.05   | 08.11<br>08.11<br>08.11<br>08.11  | 03.0137-0495.2   | 650495   | 203 x 32 HEB  |
|  | 1.4 i 16V<br>1.5 CRDi<br>1.5 CRDi<br>1.6 i 16V   | 71<br>65<br>81<br>82   |  | 03.05<br>06.08<br>03.05<br>03.05   | 08.11<br>08.11<br>08.11<br>08.11  | 03.0137-3022.2   | 653022   | 170 x 32 HEB  |
| <b>KIA RIO III (UB) (11-)</b>  |  |  |  |  |   |  |  |   |
|  | 1.1 CRDi<br>1.2 CVVT<br>1.25 CVVT<br>1.25 CVVT<br>1.4 CRDi<br>1.4 CVVT<br>1.4 CVVT<br>1.6 CVVT | 55<br>62<br>63<br>65<br>66<br>79<br>80<br>90                                     |  | 09.11<br>11.14<br>09.11<br>09.11<br>09.11<br>09.11<br>09.11<br>06.12             |   | 13.0460-5646.2   | 605646   | 25348 17,8 +/WK/Zub <b>MAN</b>  |
|  | 1.1 CRDi<br>1.2 CVVT<br>1.4 CRDi<br>1.4 CVVT<br>1.4 CVVT                                       | 55<br>62<br>66<br>79<br>80   |  | 02.12<br>11.14<br>02.12<br>02.12<br>02.12  | + 15" Rad <sup>3)</sup><br>+ 15" Rad <sup>3)</sup><br>+ 15" Rad <sup>3)</sup><br>+ 15" Rad <sup>3)</sup><br>+ 15" Rad <sup>3)</sup> | 24.0122-0260.1   | 422260   | 256 22,0 20,0 V +B  |



































<sup>1)</sup> + electric parking brake / + freno a mano elettrico / + frein à main électrique / + freno de mano eléctrico

























<sup>2)</sup> without sensor ring / senza sensori / sans secours ABS / sin anillo sensor ABS

<sup>3)</sup> + 15" wheel / + ruota 15" / + roue 15" / + rueda 15"



|     |                |  |  |  |  |  |  |  |            |
|--|--|--|--|--|---|--|--|--|------------|
| <b>KIA RIO III (UB) (11-)</b>  |  |  |  |  |   |  |  |  |            |
|    | 1.1 CRDi<br>1.2 CVVT<br>1.25 CVVT<br>1.25 CVVT<br>1.4 CRDi<br>1.4 CVVT<br>1.4 CVVT<br>1.6 CVVT | 55<br>62<br>63<br>65<br>66<br>79<br>80<br>90                                     |  | 09.11<br>11.14<br>09.11<br>09.11<br>09.11<br>09.11<br>09.11<br>06.12             |   | 13.0460-5786.2<br>13.0470-5786.2   | 605786<br>LD5786   | 24934 15,5 +WK/Zub<br>24934 15,5 +WK/Zub   | AKE<br>AKE |
|    | 1.1 CRDi<br>1.2 CVVT<br>1.25 CVVT<br>1.25 CVVT<br>1.4 CRDi<br>1.4 CVVT<br>1.4 CVVT<br>1.6 CVVT | 55<br>62<br>63<br>65<br>66<br>79<br>80<br>90                                     |  | 09.11<br>11.14<br>09.11<br>09.11<br>09.11<br>09.11<br>09.11<br>06.12             |   | 24.0110-0398.1   | 410398   | 262 10,0 8,4 L +B  |            |
| <b>KIA SEDONA I (GB) (99-01)</b>   |  |  |  |  |   |  |  |  |            |
|    | 2.5 i V6<br>2.9 TDi  | 121<br>93  |  | 04.99<br>04.99   | 09.01<br>09.01  | 13.0460-5897.2<br>13.0460-0107.2   | 605897<br>610107   | 21822 17,5 +WK<br>Belagsatz-Zubehör  |            |
|    | 2.5 i V6<br>2.9 TDi  | 121<br>93  |  | 04.99<br>04.99   | 09.01<br>09.01  | 24.0124-0195.1   | 424195   | 274 24,1 22,0 V  |            |
| <b>KIA SEDONA II (GB) (01-06)</b>  |  |  |  |  |   |  |  |  |            |
|    | 2.5 i V6<br>2.9 CRDi   | 110<br>106   |  | 10.01<br>10.01   | 10.06<br>10.06  | 13.0460-5725.2   | 605725   | 23649 17,2 +WK   |            |
|    | 2.5 i V6<br>2.9 CRDi   | 110<br>106   |  | 10.01<br>10.01   | 11.03<br>11.03  | 24.0126-0135.1   | 426135   | 274 26,2 24,0 V +B   |            |
|    | 2.5 i V6<br>2.9 CRDi   | 110<br>106   |  | 12.03<br>12.03   | 10.06<br>10.06  | 24.0128-0211.1   | 428211   | 274 28,3 26,0 V +B   |            |
|    | 2.5 i V6<br>2.9 CRDi   | 110<br>106   |  | 12.03<br>12.03   | 10.06<br>10.06  | 03.0137-0484.2   | 650484   | 295 x 53 HEB   |            |
| <b>KIA SEDONA III (GB) (06-)</b>   |  |  |  |  |   |  |  |  |            |
|   | 2.2 CRDi<br>2.2 CRDi<br>2.7 V6<br>2.9 CRDi<br>2.9 CRDi LX                                      | 110<br>143<br>139<br>136<br>141  |  | 01.10<br>01.10<br>06.06<br>06.06<br>09.06  |   | 13.0460-5799.2   | 605799   | 24597 17,7 +WK/Zub   |            |
|  | 2.2 CRDi<br>2.2 CRDi<br>2.7 V6<br>2.9 CRDi<br>2.9 CRDi LX                                      | 110<br>143<br>139<br>136<br>141  |  | 01.10<br>01.10<br>06.06<br>06.06<br>09.06  |   | 24.0128-0220.1   | 428220   | 300 28,0 26,0 V +B   |            |
|  | 2.2 CRDi<br>2.2 CRDi<br>2.7 V6<br>2.9 CRDi<br>2.9 CRDi LX                                      | 110<br>143<br>139<br>136<br>141  |  | 01.10<br>01.10<br>06.06<br>06.06<br>09.06  |   | 13.0460-5771.2   | 605771   | 24599 14,9 +WK/Zub   | MAN        |
|  | 2.2 CRDi<br>2.2 CRDi<br>2.7 V6<br>2.9 CRDi<br>2.9 CRDi LX                                      | 110<br>143<br>139<br>136<br>141  |  | 01.10<br>01.10<br>06.06<br>06.06<br>09.06  |   | 24.0112-0185.1   | 412185   | 324 11,9 10,4  |            |
| <b>KIA SEPHIA I (93-98)</b>  |  |  |  |  |   |  |  |  |            |
|  | 1.5 16V<br>1.6 i<br>1.8 16V  |  |  | 02.96<br>10.93<br>01.95  | 12.98<br>06.96<br>12.98   | 13.0460-5923.2   | 605923   | 23384 18,3 +WK   | ATE        |
|  | 1.5 16V<br>1.6 i<br>1.8 16V  |  |  | 02.96<br>10.93<br>01.95  | 12.98<br>06.96<br>12.98   | 24.0120-0162.1   | 420162   | 243 20,0 18,0 V  |            |
|  | 1.5 16V<br>1.6 i<br>1.8 16V  |  |  | 02.96<br>10.93<br>01.95  | 12.98 + ABS<br>06.96 + ABS<br>12.98 + ABS   | 13.0460-5924.2<br>13.0460-0436.2   | 605924<br>610436   | 21832 14,9<br>Belagsatz-Zubehör  | ATE<br>ATE |
|  | 1.5 16V<br>1.6 i<br>1.8 16V  |  |  | 02.96<br>10.93<br>01.95  | 12.98 + ABS<br>06.96 + ABS<br>12.98 + ABS   | 24.0110-0300.1   | 410300   | 270 10,0 8,0   |            |
|  | 1.5 16V<br>1.6 i<br>1.8 16V  |  |  | 02.96<br>10.93<br>01.95  | 12.98 - ABS<br>06.96 - ABS<br>12.98 - ABS   | 03.0137-0377.2<br>03.0137-9241.2   | 650377<br>669241   | 200 x 36<br>Bremsbacken-Zubehör  |            |
|  | 1.5 16V<br>1.6 i<br>1.8 16V  |  |  | 02.96<br>10.93<br>01.95  | 12.98 - ABS<br>06.96 - ABS<br>12.98 - ABS   | 24.0220-0031.1   | 480125   | 200/201 x 41,5   |            |
| <b>KIA SEPHIA I (98-01)</b>  |  |  |  |  |   |  |  |  |            |
|  | 1.5 i 16V<br>1.8 i 16V   | 65<br>81   |  | 02.98<br>02.98   | 03.01<br>03.01  | 13.0460-5923.2   | 605923   | 23384 18,3 +WK   | ATE        |

|     |   |  |  |  |  |  |  |  |                                 |
|--|---|--|--|--|---|--|--|--|---------------------------------|
| <b>KIA SEPHIA I (98-01)</b>  |   |  |  |  |   |  |  |  |                                 |
|    | 1.5 i 16V<br>1.8 i 16V  | 65<br>81   |  | 02.98<br>02.98   | 03.01<br>03.01  |  | 24.0120-0177.1<br>420177   | 242 20,0 18,0 V  |                                 |
|    | 1.5 i 16V<br>1.8 i 16V  | 65<br>81   |  | 02.98<br>02.98   | 03.01<br>03.01  |  | 03.0137-0377.2<br>03.0137-9241.2   | 650377<br>669241   | 200 x 36<br>Bremsbacken-Zubehör |
|    | 1.5 i 16V<br>1.8 i 16V  | 65<br>81   |  | 02.98<br>02.98   | 03.01<br>03.01  |  | 24.0220-0031.1<br>480125   |  | 200/201 x 41,5                  |
| <b>KIA SEPHIA II (01-04)</b>   |   |  |  |  |   |  |  |  |                                 |
|    | 1.6 i 16V   | 75   |  | 05.01  | 08.04   |  | 13.0460-5868.2<br>605868   |  | 23873 15,8 +/WK <b>SUM</b>      |
|    | 1.6 i 16V   | 75   |  | 05.01  | 08.04   |  | 24.0124-0185.1<br>424185   |  | 258 24,0 22,0 V +B              |
|    | 1.6 i 16V   | 75   |  | 05.01  | 08.04 + ABS   |  | 13.0460-5871.2<br>605871   |  | 23455 13,7 +/WK <b>SUM</b>      |
|    | 1.6 i 16V   | 75   |  | 05.01  | 08.04 + ABS   |  | 24.0110-0301.1<br>410301   |  | 261 10,0 8,0 +B                 |
|    | 1.6 i 16V   | 75   |  | 05.01  | 08.04 - ABS   |  | 03.0137-0377.2<br>03.0137-9241.2   | 650377<br>669241   | 200 x 36<br>Bremsbacken-Zubehör |
|    | 1.6 i 16V   | 75   |  | 05.01  | 08.04 - ABS   |  | 24.0220-0031.1<br>480125   |  | 200/201 x 41,5                  |
| <b>KIA SHUMA I (97-01)</b>   |   |  |  |  |   |  |  |  |                                 |
|    | 1.5 i 16V<br>1.8 i 16V  | 65<br>81   |  | 10.97<br>10.97   | 04.01<br>04.01  |  | 13.0460-5923.2<br>605923   |  | 23384 18,3 +/WK <b>ATE</b>      |
|    | 1.5 i 16V<br>1.8 i 16V  | 65<br>81   |  | 10.97<br>10.97   | 04.01<br>04.01  |  | 24.0120-0177.1<br>420177   |  | 242 20,0 18,0 V                 |
|   | 1.5 i 16V<br>1.8 i 16V  | 65<br>81   |  | 10.97<br>10.97   | 04.01 + ABS<br>04.01 + ABS  |  | 13.0460-5871.2<br>605871   |  | 23455 13,7 +/WK <b>SUM</b>      |
|  | 1.5 i 16V<br>1.8 i 16V  | 65<br>81   |  | 10.97<br>10.97   | 04.01 + ABS<br>04.01 + ABS  |  | 24.0110-0301.1<br>410301   |  | 261 10,0 8,0 +B                 |
|  | 1.5 i 16V<br>1.8 i 16V  | 65<br>81   |  | 10.97<br>10.97   | 04.01 - ABS<br>04.01 - ABS  |  | 03.0137-0377.2<br>03.0137-9241.2   | 650377<br>669241   | 200 x 36<br>Bremsbacken-Zubehör |
|  | 1.5 i 16V<br>1.8 i 16V  | 65<br>81   |  | 10.97<br>10.97   | 04.01 - ABS<br>04.01 - ABS  |  | 24.0220-0031.1<br>480125   |  | 200/201 x 41,5                  |
| <b>KIA SHUMA II (01-04)</b>  |   |  |  |  |   |  |  |  |                                 |
|  | 1.6 i 16V<br>1.8 i 16V  | 75<br>84   |  | 05.01<br>04.03   | 08.04<br>08.04  |  | 13.0460-5868.2<br>605868   |  | 23873 15,8 +/WK <b>SUM</b>      |
|  | 1.6 i 16V<br>1.8 i 16V  | 75<br>84   |  | 05.01<br>04.03   | 08.04<br>08.04  |  | 24.0124-0185.1<br>424185   |  | 258 24,0 22,0 V +B              |
|  | 1.6 i 16V<br>1.8 i 16V  | 75<br>84   |  | 05.01<br>04.03   | 08.04 + ABS<br>08.04 + ABS  |  | 13.0460-5871.2<br>605871   |  | 23455 13,7 +/WK <b>SUM</b>      |
|  | 1.6 i 16V<br>1.8 i 16V  | 75<br>84   |  | 05.01<br>04.03   | 08.04 + ABS<br>08.04 + ABS  |  | 24.0110-0301.1<br>410301   |  | 261 10,0 8,0 +B                 |
|  | 1.6 i 16V<br>1.8 i 16V  | 75<br>84   |  | 05.01<br>04.03   | 08.04 - ABS<br>08.04 - ABS  |  | 03.0137-0377.2<br>03.0137-9241.2   | 650377<br>669241   | 200 x 36<br>Bremsbacken-Zubehör |
|  | 1.6 i 16V<br>1.8 i 16V  | 75<br>84   |  | 05.01<br>04.03   | 08.04 - ABS<br>08.04 - ABS  |  | 24.0220-0031.1<br>480125   |  | 200/201 x 41,5                  |
| <b>KIA SORENTO (JC) (02-09)</b>  |   |  |  |  |   |  |  |  |                                 |
|  | 2.4 i 16V<br>2.5 CRDi<br>2.5 CRDi<br>2.5 CRDi<br>3.3 i V6<br>3.3 i V6<br>3.5 i V6 | 102<br>103<br>120<br>125<br>177<br>182<br>143                                    |  | 08.02<br>08.02<br>05.06<br>12.06<br>12.06<br>11.07<br>08.02                      | 11.06<br>11.06<br>10.09<br>10.09<br>10.09<br>10.09<br>10.09                       |  | 13.0460-5772.2<br>605772   |  | 24092 17,1 +/WK/Zub <b>SUM</b>  |
|  | 2.4 i 16V<br>2.5 CRDi<br>3.5 i V6   | 102<br>103<br>143  |  | 08.02<br>08.02<br>08.02  | 11.06<br>11.06<br>10.09   |  | 24.0128-0200.1<br>428200   |  | 302 28,0 26,0 V +B              |
|  | 2.5 CRDi<br>2.5 CRDi  | 120<br>125   |  | 05.06<br>12.06   | 10.09<br>10.09  |  | 24.0128-0227.1<br>428227   |  | 302 28,0 26,4 V +B              |
|  | ↓   |  |  |  |   |  |  |  |                                 |

|     |         |  |  |  |       |  |  |  |
|--|---|--|--|--|--|--|--|--|
| <b>KIA SORENTO (JC) (02-09)</b>  |   |  |  |  |  |  |  |  |
|    | 3.3 i V6<br>3.3 i V6  | 177<br>182   |  | 12.06<br>11.07   | 10.09<br>10.09   | 24.0128-0227.1   | 428227   | 302 28,0 26,4 V +B   |
|    | 2.4 i 16V<br>2.5 CRDi<br>2.5 CRDi<br>2.5 CRDi<br>3.3 i V6<br>3.3 i V6<br>3.5 i V6       | 102<br>103<br>120<br>125<br>177<br>182<br>143                                    |  | 08.02<br>08.02<br>05.06<br>12.06<br>12.06<br>11.07<br>08.02                      | 11.06<br>11.06<br>10.09<br>10.09<br>10.09<br>10.09<br>10.09                            | 13.0460-5773.2   | 605773   | 24058 15,5 +/WK/Zub  |
|    | 2.4 i 16V<br>2.5 CRDi<br>3.5 i V6   | 102<br>103<br>143  |  | 08.02<br>08.02<br>08.02  | 11.06<br>08.06<br>10.09  | 24.0120-0202.1   | 420202   | 315 20,0 18,4 V  |
|  | 2.5 CRDi<br>2.5 CRDi<br>2.5 CRDi<br>3.3 i V6<br>3.3 i V6                                | 103<br>120<br>125<br>177<br>182  |  | 09.06<br>05.06<br>12.06<br>12.06<br>11.07  | 11.06<br>10.09<br>10.09<br>10.09<br>10.09  | 24.0120-0207.1   | 420207   | 315 20,0 18,4 V +B   |
|    | 2.4 i 16V<br>2.5 CRDi<br>3.5 i V6   | 102<br>103<br>143  |  | 08.02<br>08.02<br>08.02  | 11.06<br>11.06<br>10.09  | 03.0137-3009.2   | 653009   | 190 x 40   |
|  | 2.5 CRDi<br>2.5 CRDi<br>3.3 i V6<br>3.3 i V6  | 120<br>125<br>177<br>182   |  | 05.06<br>12.06<br>12.06<br>11.07   | 10.09<br>10.09<br>10.09<br>10.09   | 03.0137-3028.2   | 653028   | 190 x 40   |
| <b>KIA SORENTO (XM) (09-14)</b>  |   |  |  |  |  |  |  |  |
|    | 2.0 CRDi<br>2.0 CRDi 4WD<br>2.2 CRDi<br>2.2 CRDi 4WD<br>2.4 16V<br>2.4 16V 4WD          | 110<br>110<br>145<br>145<br>128<br>128   |  | 11.10<br>11.10<br>11.09<br>11.09<br>11.09<br>11.09                               | 12.14<br>12.14<br>12.14<br>12.14<br>12.14<br>12.14                                     | 13.0460-5777.2   | 605777   | 24351 16,3 +/WK/Zub  |
|    | 2.0 CRDi<br>2.0 CRDi 4WD<br>2.2 CRDi<br>2.2 CRDi 4WD<br>2.4 16V<br>2.4 16V 4WD          | 110<br>110<br>145<br>145<br>128<br>128   |  | 11.10<br>11.10<br>11.09<br>11.09<br>11.09<br>11.09                               | 12.14<br>12.14<br>12.14<br>12.14<br>12.14<br>12.14                                     | 24.0128-0248.1   | 428248   | 321 28,0 26,4 V L +B   |
|  | 2.0 CRDi<br>2.0 CRDi 4WD<br>2.2 CRDi<br>2.2 CRDi 4WD<br>2.4 16V<br>2.4 16V 4WD          | 110<br>110<br>145<br>145<br>128<br>128   |  | 11.10<br>11.10<br>11.09<br>11.09<br>11.09<br>11.09                               | 12.14<br>12.14<br>12.14<br>12.14<br>12.14<br>12.14                                     | 13.0460-5633.2   | 605633   | 25520 15,8 +/WK/Zub AKE  |
|  | 2.0 CRDi<br>2.0 CRDi 4WD<br>2.2 CRDi<br>2.2 CRDi 4WD<br>2.4 16V<br>2.4 16V 4WD          | 110<br>110<br>145<br>145<br>128<br>128   |  | 11.10<br>11.10<br>11.09<br>11.09<br>11.09<br>11.09                               | 12.14<br>12.14<br>12.14<br>12.14<br>12.14<br>12.14                                     | 24.0111-0170.1   | 411170   | 302 11,0 9,4 L +B  |
|  | 2.2 CRDi<br>2.2 CRDi 4WD<br>2.4 16V<br>2.4 16V 4WD                                      | 145<br>145<br>128<br>128   |  | 11.09<br>11.09<br>11.09<br>11.09   | 10.10<br>10.10<br>10.10<br>10.10   | 03.0137-3027.2   | 653027   | 189 x 26   |
| <b>KIA SORENTO (UM) (15-)</b>  |   |  |  |  |  |  |  |  |
|  | 2.2 CRDi<br>2.2 CRDi 4WD  | 147<br>147   |  | 01.15<br>01.15   |  | 24.0128-0248.1   | 428248   | 321 28,0 26,4 V L +B   |
|  | 2.4 GDI 2WD   | 138  |  | 01.15  |  | 13.0460-5636.2   | 605636   | - Sportpaket <sup>1)</sup> 24599 14,9 +/WK/Zub MAN                                 |
| <b>KIA SOUL (09-14)</b>  |   |  |  |  |  |  |  |  |
|  | 1.6 CRDi 115<br>1.6 CRDi 128<br>1.6 CVVT<br>1.6 CVVT<br>1.6 CVVT<br>1.6 Flex<br>1.6 GDI | 85<br>94<br>77<br>93<br>95<br>94<br>103  |  | 02.09<br>02.09<br>02.09<br>02.09<br>03.12<br>01.11<br>06.11                      | 02.14<br>02.14<br>02.14<br>02.14<br>02.14<br>02.14<br>02.14                            | 13.0460-5873.2<br>13.0460-0139.2   | 605873<br>610139   | 23891 16,9 +/WK Belagsatz-Zubehör MAN  |
|  | 1.6 CRDi 115<br>1.6 CRDi 128<br>1.6 CVVT<br>1.6 CVVT<br>1.6 CVVT<br>1.6 Flex<br>1.6 GDI | 85<br>94<br>77<br>93<br>95<br>94<br>103  |  | 02.09<br>02.09<br>02.09<br>02.09<br>03.12<br>01.11<br>06.11                      | 02.14<br>02.14<br>02.14<br>02.14<br>02.14<br>02.14<br>02.14                            | 24.0126-0150.1   | 426150   | 280 26,0 24,4 V L +B   |
|  | 1.6 CRDi 115<br>1.6 CRDi 128<br>1.6 CVVT<br>1.6 CVVT<br>1.6 CVVT<br>1.6 Flex            | 85<br>94<br>77<br>93<br>95<br>94   |  | 02.09<br>02.09<br>02.09<br>02.09<br>03.12<br>01.11                               | 02.14 + ABS<br>02.14 + ABS<br>02.14 + ABS<br>02.14 + ABS<br>02.14 + ABS<br>02.14 + ABS | 13.0460-5786.2<br>13.0470-5786.2   | 605786<br>LD5786   | 24934 15,5 +/WK/Zub AKE<br>24934 15,5 +/WK/Zub AKE                                 |
|  |   |  |  |  |  |  |  |  |

<sup>1)</sup> - sport package / - pacchetto sportivo / - version sport / - kit deportivo

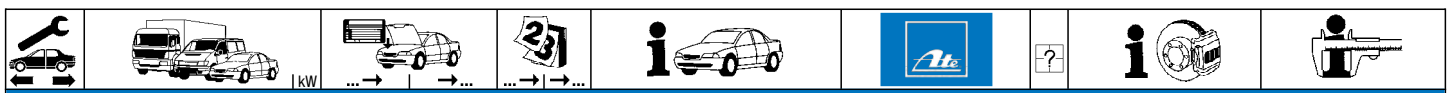

| KIA SOUL (09-14) |              |     |  |       |       |       |                |        |  |  |            |
|------------------|--------------|-----|--|-------|-------|-------|----------------|--------|--|--|------------|
|                  | 1.6 GDI      | 103 |  | 06.11 | 02.14 | + ABS | 13.0460-5786.2 | 605786 |  | 24934 15,5 +/WK/Zub<br>24934 15,5 +/WK/Zub | AKE<br>AKE |
|                  | 1.6 CRDi 115 | 85  |  | 02.09 | 02.14 | + ABS | 24.0110-0362.1 | 410362 |  | 262 10,0 8,4 +B                            |            |
|                  | 1.6 CRDi 128 | 94  |  | 02.09 | 02.14 | + ABS |                |        |  |  |            |
|                  | 1.6 CVVT     | 77  |  | 02.09 | 02.14 | + ABS |                |        |  |  |            |
|                  | 1.6 CVVT     | 93  |  | 02.09 | 02.14 | + ABS |                |        |  |  |            |
|                  | 1.6 CVVT     | 95  |  | 03.12 | 02.14 | + ABS |                |        |  |  |            |
|                  | 1.6 Flex     | 94  |  | 01.11 | 02.14 | + ABS |                |        |  |  |            |
|                  | 1.6 GDI      | 103 |  | 06.11 | 02.14 | + ABS |                |        |  |  |            |
|                  | 1.6 CRDi 115 | 85  |  | 02.09 | 02.14 | + ABS | 03.0137-3026.2 | 653026 |  | 167 x 32 HEB                               |            |
|                  | 1.6 CRDi 128 | 94  |  | 02.09 | 02.14 | + ABS |                |        |  |  |            |
|                  | 1.6 CVVT     | 77  |  | 02.09 | 02.14 | + ABS |                |        |  |  |            |
|                  | 1.6 CVVT     | 93  |  | 02.09 | 02.14 | + ABS |                |        |  |  |            |
|                  | 1.6 CVVT     | 95  |  | 03.12 | 02.14 | + ABS |                |        |  |  |            |
|                  | 1.6 Flex     | 94  |  | 01.11 | 02.14 | + ABS |                |        |  |  |            |
|                  | 1.6 GDI      | 103 |  | 06.11 | 02.14 | + ABS |                |        |  |  |            |

| KIA SOUL (14-) |          |    |  |       |  |  |                |        |                   |                      |  |
|----------------|----------|----|--|-------|--|--|----------------|--------|-------------------|----------------------|--|
|                | 1.6 CRDi | 94 |  | 02.14 |  |  | 13.0460-5641.2 | 605641 | + 15" Bremssystem | 25187 17,8 +/WK/Zub  |  |
|                | 1.6 GDI  | 97 |  | 02.14 |  |  |                |        |                   |                      |  |
|                | 1.6 MPi  | 91 |  | 02.14 |  |  |                |        |                   |                      |  |
|                | 1.6 CRDi | 94 |  | 02.14 |  |  | 24.0126-0150.1 | 426150 | + 15" Bremssystem | 280 26,0 24,4 V L +B |  |
|                | 1.6 GDI  | 97 |  | 02.14 |  |  | 24.0128-0234.1 | 426234 | + 16" Bremssystem | 300 28,0 26,4 V +B   |  |
|                | 1.6 MPi  | 91 |  | 02.14 |  |  |                |        |                   |                      |  |
|                | Electric |    |  | 06.14 |  |  |                |        |                   |                      |  |
|                | 1.6 CRDi | 94 |  | 02.14 |  |  | 24.0110-0368.1 | 410368 |                   | 262 10,0 8,4 +B      |  |
|                | 1.6 GDI  | 97 |  | 02.14 |  |  |                |        |                   |                      |  |
|                | 1.6 MPi  | 91 |  | 02.14 |  |  |                |        |                   |                      |  |

| KIA SPORTAGE (94-03) |               |    |  |       |       |  |                |        |  |                 |  |
|----------------------|---------------|----|--|-------|-------|--|----------------|--------|--|-----------------|--|
|                      | 2.0 i 16V     | 87 |  | 10.00 | 08.03 |  | 13.0460-5896.2 | 605896 |  | 23442 15,3 +/WK |  |
|                      | 2.0 i 16V     | 94 |  | 10.99 | 08.03 |  |                |        |  |                 |  |
|                      | 2.0 i 16V 4WD | 87 |  | 10.00 | 08.03 |  |                |        |  |                 |  |
|                      | 2.0 i 16V 4WD | 94 |  | 10.99 | 08.03 |  |                |        |  |                 |  |
|                      | 2.0 TDi 4WD   | 61 |  | 06.99 | 08.03 |  |                |        |  |                 |  |
|                      | 2.0 i 16V     | 87 |  | 10.00 | 08.03 |  | 24.0124-0172.1 | 424172 |  | 285 24,0 22,4 V |  |
|                      | 2.0 i 16V     | 94 |  | 10.99 | 08.03 |  |                |        |  |                 |  |
|                      | 2.0 i 16V 4WD | 87 |  | 10.00 | 08.03 |  |                |        |  |                 |  |
|                      | 2.0 i 16V 4WD | 94 |  | 04.94 | 08.03 |  |                |        |  |                 |  |
|                      | 2.0 i 4WD     | 70 |  | 04.94 | 08.99 |  |                |        |  |                 |  |
|                      | 2.0 TDi 4WD   | 61 |  | 10.97 | 08.03 |  |                |        |  |                 |  |

| KIA SPORTAGE (04-10) |               |     |  |       |       |  |                |        |                                    |                      |     |
|----------------------|---------------|-----|--|-------|-------|--|----------------|--------|------------------------------------|----------------------|-----|
|                      | 2.0 CRDi      | 83  |  | 02.05 | 12.07 |  | 13.0460-5873.2 | 605873 |                                    | 23891 16,9 +/WK      | MAN |
|                      | 2.0 CRDi      | 100 |  | 01.06 | 12.07 |  | 13.0460-0139.2 | 610139 |                                    | Belagsatz-Zubehör    | MAN |
|                      | 2.0 CRDi      | 103 |  | 01.06 | 12.07 |  |                |        |                                    |                      |     |
|                      | 2.0 CRDi 4WD  | 83  |  | 09.04 | 12.07 |  |                |        |                                    |                      |     |
|                      | 2.0 CRDi 4WD  | 100 |  | 01.06 | 12.07 |  |                |        |                                    |                      |     |
|                      | 2.0 CRDi 4WD  | 103 |  | 01.06 | 12.07 |  |                |        |                                    |                      |     |
|                      | 2.0 i 16V     | 104 |  | 09.04 | 12.07 |  |                |        |                                    |                      |     |
|                      | 2.0 i 16V 4WD | 104 |  | 09.04 | 12.07 |  |                |        |                                    |                      |     |
|                      | 2.7 i V6 4WD  | 129 |  | 09.04 | 12.07 |  |                |        |                                    |                      |     |
|                      | 2.0 CRDi      | 83  |  | 01.08 | 05.10 |  | 13.0460-5600.2 | 605600 |                                    | 24501 16,7 +/WK      | SUM |
|                      | 2.0 CRDi      | 100 |  | 01.08 | 05.10 |  |                |        |                                    |                      |     |
|                      | 2.0 CRDi      | 103 |  | 01.08 | 05.10 |  |                |        |                                    |                      |     |
|                      | 2.0 CRDi      | 110 |  | 09.08 | 05.10 |  |                |        |                                    |                      |     |
|                      | 2.0 CRDi 4WD  | 83  |  | 01.08 | 05.10 |  |                |        |                                    |                      |     |
|                      | 2.0 CRDi 4WD  | 100 |  | 01.08 | 05.10 |  |                |        |                                    |                      |     |
|                      | 2.0 CRDi 4WD  | 103 |  | 01.08 | 05.10 |  |                |        |                                    |                      |     |
|                      | 2.0 CRDi 4WD  | 110 |  | 09.08 | 05.10 |  |                |        |                                    |                      |     |
|                      | 2.0 i 16V     | 104 |  | 01.08 | 05.10 |  |                |        |                                    |                      |     |
|                      | 2.0 i 16V 4WD | 104 |  | 01.08 | 05.10 |  |                |        |                                    |                      |     |
|                      | 2.7 i V6 4WD  | 129 |  | 01.08 | 05.10 |  |                |        |                                    |                      |     |
|                      | 2.0 CRDi      | 83  |  | 02.05 | 12.07 |  | 24.0126-0128.1 | 426128 | + Bremsscheibe 280mm <sup>1)</sup> | 280 26,0 24,4 V L +B |     |
|                      | 2.0 CRDi      | 100 |  | 01.06 | 12.07 |  |                |        |                                    |                      |     |
|                      | 2.0 CRDi      | 103 |  | 01.06 | 12.07 |  |                |        |                                    |                      |     |
|                      | 2.0 CRDi 4WD  | 83  |  | 09.04 | 12.07 |  |                |        |                                    |                      |     |
|                      | 2.0 CRDi 4WD  | 100 |  | 01.06 | 12.07 |  |                |        |                                    |                      |     |
|                      | 2.0 CRDi 4WD  | 103 |  | 01.06 | 12.07 |  |                |        |                                    |                      |     |
|                      | 2.0 i 16V     | 104 |  | 09.04 | 12.07 |  |                |        |                                    |                      |     |
|                      | 2.0 i 16V 4WD | 104 |  | 09.04 | 12.07 |  |                |        |                                    |                      |     |
|                      | 2.7 i V6 4WD  | 129 |  | 09.04 | 12.07 |  |                |        |                                    |                      |     |
|                      | 2.0 CRDi      | 83  |  | 01.08 | 05.10 |  | 24.0128-0280.1 | 428280 |                                    | 300 28,0 26,4 V L +B |     |
|                      | 2.0 CRDi      | 100 |  | 01.08 | 05.10 |  |                |        |                                    |                      |     |
|                      | 2.0 CRDi      | 103 |  | 01.08 | 05.10 |  |                |        |                                    |                      |     |
|                      | 2.0 CRDi      | 110 |  | 09.08 | 05.10 |  |                |        |                                    |                      |     |
|                      | 2.0 CRDi 4WD  | 83  |  | 01.08 | 05.10 |  |                |        |                                    |                      |     |
|                      | 2.0 CRDi 4WD  | 100 |  | 01.08 | 05.10 |  |                |        |                                    |                      |     |
|                      | 2.0 CRDi 4WD  | 103 |  | 01.08 | 05.10 |  |                |        |                                    |                      |     |
|                      | 2.0 CRDi 4WD  | 110 |  | 09.08 | 05.10 |  |                |        |                                    |                      |     |
|                      | 2.0 i 16V     | 104 |  | 01.08 | 05.10 |  |                |        |                                    |                      |     |
|                      | 2.0 i 16V 4WD | 104 |  | 01.08 | 05.10 |  |                |        |                                    |                      |     |
|                      | 2.7 i V6 4WD  | 129 |  | 01.08 | 05.10 |  |                |        |                                    |                      |     |

<sup>1)</sup> + brake disc 280mm / + dischi freno 280mm / + disques de frein 280mm / + disco de freno 280mm

























**KIA SPORTAGE (04-10)**

|               |               |       |       |       |                |        |  |                     |     |                |        |  |                     |  |
|---------------|---------------|-------|-------|-------|----------------|--------|--|---------------------|-----|----------------|--------|--|---------------------|--|
|               | 2.0 CRDi      | 83    | 02.05 | 12.06 | 13.0460-5833.2 | 605833 |  | 23543 14,4 +/WK/Zub | AKE |                |        |  |                     |  |
|               | 2.0 CRDi      | 100   | 01.06 | 12.06 |                |        |  |                     |     |                |        |  |                     |  |
|               | 2.0 CRDi      | 103   | 01.06 | 12.06 |                |        |  |                     |     |                |        |  |                     |  |
|               | 2.0 CRDi 4WD  | 83    | 09.04 | 12.06 |                |        |  |                     |     |                |        |  |                     |  |
|               | 2.0 CRDi 4WD  | 100   | 01.06 | 12.06 |                |        |  |                     |     |                |        |  |                     |  |
|               | 2.0 CRDi 4WD  | 103   | 01.06 | 12.06 |                |        |  |                     |     |                |        |  |                     |  |
|               | 2.0 i 16V     | 104   | 09.04 | 12.06 |                |        |  |                     |     |                |        |  |                     |  |
|               | 2.0 i 16V 4WD | 104   | 09.04 | 12.06 |                |        |  |                     |     |                |        |  |                     |  |
|               | 2.7 i V6 4WD  | 129   | 09.04 | 05.10 |                |        |  |                     |     |                |        |  |                     |  |
|               | 2.0 CRDi      | 83    | 01.07 | 05.10 |                |        |  |                     |     | 13.0460-5780.2 | 605780 |  | 24320 15,3 +/WK/Zub |  |
| 2.0 CRDi      | 100           | 01.07 | 05.10 |       |                |        |  |                     |     |                |        |  |                     |  |
| 2.0 CRDi      | 103           | 01.07 | 05.10 |       |                |        |  |                     |     |                |        |  |                     |  |
| 2.0 CRDi      | 110           | 09.08 | 05.10 |       |                |        |  |                     |     |                |        |  |                     |  |
| 2.0 CRDi 4WD  | 83            | 01.07 | 05.10 |       |                |        |  |                     |     |                |        |  |                     |  |
| 2.0 CRDi 4WD  | 100           | 01.07 | 05.10 |       |                |        |  |                     |     |                |        |  |                     |  |
| 2.0 CRDi 4WD  | 103           | 01.07 | 05.10 |       |                |        |  |                     |     |                |        |  |                     |  |
| 2.0 CRDi 4WD  | 110           | 09.08 | 05.10 |       |                |        |  |                     |     |                |        |  |                     |  |
| 2.0 i 16V     | 104           | 01.07 | 05.10 |       |                |        |  |                     |     |                |        |  |                     |  |
| 2.0 i 16V 4WD | 104           | 01.07 | 05.10 |       |                |        |  |                     |     |                |        |  |                     |  |
|               | 2.0 CRDi      | 83    | 02.05 | 05.10 | 24.0110-0318.1 | 410318 |  | 262 10,0 8,4 +B     |     |                |        |  |                     |  |
|               | 2.0 CRDi      | 100   | 01.06 | 05.10 |                |        |  |                     |     |                |        |  |                     |  |
|               | 2.0 CRDi      | 103   | 01.06 | 05.10 |                |        |  |                     |     |                |        |  |                     |  |
|               | 2.0 CRDi      | 110   | 09.08 | 05.10 |                |        |  |                     |     |                |        |  |                     |  |
|               | 2.0 i 16V     | 104   | 09.04 | 05.10 |                |        |  |                     |     |                |        |  |                     |  |
|               | 2.0 CRDi 4WD  | 83    | 09.04 | 05.10 |                |        |  |                     |     | 24.0110-0286.1 | 410286 |  | 284 10,0 8,4 +B     |  |
|               | 2.0 CRDi 4WD  | 100   | 01.06 | 05.10 |                |        |  |                     |     |                |        |  |                     |  |
|               | 2.0 CRDi 4WD  | 103   | 01.06 | 05.10 |                |        |  |                     |     |                |        |  |                     |  |
|               | 2.0 CRDi 4WD  | 110   | 09.08 | 05.10 |                |        |  |                     |     |                |        |  |                     |  |
|               | 2.0 i 16V 4WD | 104   | 09.04 | 05.10 |                |        |  |                     |     |                |        |  |                     |  |
| 2.7 i V6 4WD  | 129           | 09.04 | 05.10 |       |                |        |  |                     |     |                |        |  |                     |  |
|               | 2.0 CRDi      | 83    | 02.05 | 05.10 | 03.0137-3016.2 | 653016 |  | 167 x 27            |     |                |        |  |                     |  |
|               | 2.0 CRDi      | 100   | 01.06 | 05.10 |                |        |  |                     |     |                |        |  |                     |  |
|               | 2.0 CRDi      | 103   | 01.06 | 05.10 |                |        |  |                     |     |                |        |  |                     |  |
|               | 2.0 CRDi      | 110   | 09.08 | 05.10 |                |        |  |                     |     |                |        |  |                     |  |
|               | 2.0 i 16V     | 104   | 09.04 | 05.10 |                |        |  |                     |     |                |        |  |                     |  |
|               | 2.0 CRDi 4WD  | 83    | 09.04 | 05.10 |                |        |  |                     |     | 03.0137-3004.2 | 653004 |  | 190 x 40 HEB        |  |
|               | 2.0 CRDi 4WD  | 100   | 01.06 | 05.10 |                |        |  |                     |     |                |        |  |                     |  |
|               | 2.0 CRDi 4WD  | 103   | 01.06 | 05.10 |                |        |  |                     |     |                |        |  |                     |  |
|               | 2.0 CRDi 4WD  | 110   | 09.08 | 05.10 |                |        |  |                     |     |                |        |  |                     |  |
|               | 2.0 i 16V 4WD | 104   | 09.04 | 05.10 |                |        |  |                     |     |                |        |  |                     |  |
| 2.7 i V6 4WD  | 129           | 09.04 | 05.10 |       |                |        |  |                     |     |                |        |  |                     |  |

**KIA SPORTAGE (10-15)**

|          |              |       |       |                |                |        |                 |                      |     |                |        |  |                 |  |
|----------|--------------|-------|-------|----------------|----------------|--------|-----------------|----------------------|-----|----------------|--------|--|-----------------|--|
|          | 1.6 GDI      | 99    | 02.11 |                | 13.0460-5600.2 | 605600 |                 | 24501 16,7 +/WK      | SUM |                |        |  |                 |  |
|          | 1.7 CRDi     | 85    | 02.11 |                |                |        |                 |                      |     |                |        |  |                 |  |
|          | 2.0 CRDi     | 100   | 07.10 |                |                |        |                 |                      |     |                |        |  |                 |  |
|          | 2.0 CRDi     | 135   | 08.10 | 07.11          |                |        |                 |                      |     |                |        |  |                 |  |
|          | 2.0 CRDi AWD | 100   | 07.10 |                |                |        |                 |                      |     |                |        |  |                 |  |
|          | 2.0 CRDi AWD | 135   | 08.10 |                |                |        |                 |                      |     |                |        |  |                 |  |
|          | 2.0 CVVT     | 120   | 07.10 | 07.11          |                |        |                 |                      |     |                |        |  |                 |  |
|          | 2.0 CVVT     | 122   | 07.10 |                |                |        |                 |                      |     |                |        |  |                 |  |
|          | 2.0 CVVT AWD | 120   | 07.10 |                |                |        |                 |                      |     |                |        |  |                 |  |
|          | 2.0 CVVT AWD | 122   | 07.10 |                |                |        |                 |                      |     |                |        |  |                 |  |
| 2.0 CRDi | 135          | 08.11 |       | 13.0460-5600.2 | 605600         |        | 24501 16,7 +/WK | SUM                  |     |                |        |  |                 |  |
| 2.0 CVVT | 120          | 08.11 |       |                |                |        |                 |                      |     |                |        |  |                 |  |
|          | 1.6 GDI      | 99    | 02.11 |                | 24.0128-0256.1 | 428256 |                 | 300 28,0 26,4 V L +B |     |                |        |  |                 |  |
|          | 1.7 CRDi     | 85    | 02.11 |                |                |        |                 |                      |     |                |        |  |                 |  |
|          | 2.0 CRDi     | 100   | 07.10 |                |                |        |                 |                      |     |                |        |  |                 |  |
|          | 2.0 CRDi     | 135   | 08.10 |                |                |        |                 |                      |     |                |        |  |                 |  |
|          | 2.0 CRDi AWD | 100   | 07.10 |                |                |        |                 |                      |     |                |        |  |                 |  |
|          | 2.0 CRDi AWD | 135   | 08.10 |                |                |        |                 |                      |     |                |        |  |                 |  |
|          | 2.0 CVVT     | 120   | 07.10 |                |                |        |                 |                      |     |                |        |  |                 |  |
|          | 2.0 CVVT     | 122   | 07.10 |                |                |        |                 |                      |     |                |        |  |                 |  |
|          | 2.0 CVVT AWD | 120   | 07.10 |                |                |        |                 |                      |     |                |        |  |                 |  |
|          | 2.0 CVVT AWD | 122   | 07.10 |                |                |        |                 |                      |     |                |        |  |                 |  |
|          | 1.6 GDI      | 99    | 02.11 |                | 13.0460-5780.2 | 605780 |                 | 24320 15,3 +/WK/Zub  |     |                |        |  |                 |  |
|          | 1.7 CRDi     | 85    | 02.11 |                |                |        |                 |                      |     |                |        |  |                 |  |
|          | 2.0 CRDi     | 100   | 07.10 |                |                |        |                 |                      |     |                |        |  |                 |  |
|          | 2.0 CRDi     | 135   | 08.10 |                |                |        |                 |                      |     |                |        |  |                 |  |
|          | 2.0 CRDi AWD | 100   | 07.10 |                |                |        |                 |                      |     |                |        |  |                 |  |
|          | 2.0 CRDi AWD | 135   | 08.10 |                |                |        |                 |                      |     |                |        |  |                 |  |
|          | 2.0 CVVT     | 120   | 07.10 |                |                |        |                 |                      |     |                |        |  |                 |  |
|          | 2.0 CVVT     | 122   | 07.10 |                |                |        |                 |                      |     |                |        |  |                 |  |
|          | 2.0 CVVT AWD | 120   | 07.10 |                |                |        |                 |                      |     |                |        |  |                 |  |
|          | 2.0 CVVT AWD | 122   | 07.10 |                |                |        |                 |                      |     |                |        |  |                 |  |
|          | 1.6 GDI      | 99    | 02.11 |                | 24.0110-0332.1 | 410332 |                 | 262 10,0 8,0 +B      |     |                |        |  |                 |  |
|          | 1.7 CRDi     | 85    | 02.11 |                |                |        |                 |                      |     |                |        |  |                 |  |
|          | 2.0 CRDi     | 100   | 07.10 |                |                |        |                 |                      |     |                |        |  |                 |  |
|          | 2.0 CRDi     | 135   | 08.10 |                |                |        |                 |                      |     |                |        |  |                 |  |
|          | 2.0 CVVT     | 120   | 07.10 |                |                |        |                 |                      |     |                |        |  |                 |  |
|          | 2.0 CVVT     | 122   | 07.10 |                |                |        |                 |                      |     |                |        |  |                 |  |
|          | 2.0 CRDi AWD | 100   | 07.10 |                |                |        |                 |                      |     | 24.0110-0286.1 | 410286 |  | 284 10,0 8,4 +B |  |
|          | 2.0 CRDi AWD | 135   | 08.10 |                |                |        |                 |                      |     |                |        |  |                 |  |
|          | 2.0 CVVT AWD | 120   | 07.10 |                |                |        |                 |                      |     |                |        |  |                 |  |
|          | 2.0 CVVT AWD | 122   | 07.10 |                |                |        |                 |                      |     |                |        |  |                 |  |





























| KIA SPORTAGE (10-15)   |   | KIA SPORTAGE (15-)   |   | KIA VENGA (10-)  |   | LADA 110 Stufenheck (2110) (95-07)   |  | LADA 111 Kombi (2111) (95-08)  |  |
|--|---|--|---|--|---|--|--|--|--|
|     |                   |  |                       |    |  |  |  |  |  |
|    | 2.0 CRDi AWD<br>2.0 CRDi AWD<br>2.0 CVT AWD<br>2.0 CVT AWD  | 100<br>135<br>120<br>122   | 07.10<br>08.10<br>07.10<br>07.10  |  | 03.0137-3030.2  | 653030   |  |  | 189 x 40 HEB   |
|    | 1.6 GDI<br>1.6 GDI<br>1.6 GDI AWD<br>1.7 CRDi<br>2.0 CRDi<br>2.0 CRDi AWD<br>2.0 CRDi AWD         | 97<br>130<br>130<br>85<br>100<br>100<br>136                                      | 09.15<br>09.15<br>09.15<br>09.15<br>09.15<br>09.15<br>09.15   | Produktionsland <br>Produktionsland  | 13.0460-5600.2  | 605600   |  |  | 24501 16,7 +/-WK <b>SUM</b>                            |
|    | 1.4 CRDi 75<br>1.4 CRDi 75<br>1.4 CRDi 90<br>1.4 CVVT<br>1.6 CRDi 115<br>1.6 CRDi 128<br>1.6 CVVT | 55<br>57<br>66<br>66<br>85<br>94<br>92   | 02.10<br>02.10<br>02.10<br>02.10<br>02.10<br>02.10<br>02.10   |  | 13.0460-2772.2  | 602772   |  |  | 25184 19,4 +/-WK/Zub/STRW                              |
|    | 1.4 CRDi 75<br>1.4 CRDi 75<br>1.4 CRDi 90<br>1.4 CVVT<br>1.6 CRDi 115<br>1.6 CRDi 128<br>1.6 CVVT | 55<br>57<br>66<br>66<br>85<br>94<br>92   | 02.10<br>02.10<br>02.10<br>02.10<br>02.10<br>02.10<br>02.10   |  | 24.0126-0150.1  | 426150   |  |  | 280 26,0 24,4 V L +B                                   |
|    | 1.4 CRDi 75<br>1.4 CRDi 75<br>1.4 CRDi 90<br>1.4 CVVT<br>1.6 CRDi 115<br>1.6 CRDi 128<br>1.6 CVVT | 55<br>57<br>66<br>66<br>85<br>94<br>92   | 02.10<br>02.10<br>02.10<br>02.10<br>02.10<br>02.10<br>02.10   |  | 13.0460-2868.2<br>13.0470-2868.2  | 602868<br>LD2868   |  |  | 23417 15,3 +/-WK/Zub/STRW<br>23417 15,3 +/-WK/Zub/STRW |
|    | 1.4 CRDi 75<br>1.4 CRDi 75<br>1.4 CRDi 90<br>1.4 CVVT<br>1.6 CRDi 115<br>1.6 CRDi 128<br>1.6 CVVT | 55<br>57<br>66<br>66<br>85<br>94<br>92   | 02.10<br>02.10<br>02.10<br>02.10<br>02.10<br>02.10<br>02.10   |  | 24.0110-0357.1  | 410357   |  |  | 258 10,0 8,0 +B  |
|  | 1.5<br>1.5<br>1.5 i 16V<br>1.6<br>1.6   | 54<br>57<br>70<br>60<br>66   | 01.95 08.07<br>01.95 08.07<br>01.95 08.07<br>01.00 08.07<br>01.00 08.07                               |  | 13.0460-2965.2  | 602965   |  |  | 21170 17,3 <b>TRW</b>                                  |
|  | 1.5<br>1.5<br>1.5 i 16V<br>1.6<br>1.6   | 54<br>57<br>70<br>60<br>66   | 01.95 09.00<br>01.95 09.00<br>01.95 09.00<br>01.00 08.07<br>01.00 08.07                               |  | 24.0112-0125.1<br>24.0312-0125.1  | 412125<br>512125   |  |  | 239 12,0 10,8 +B<br><b>239 12,0 10,8 +B PD</b>         |
|  | 1.5<br>1.5 i 16V<br>2.0 i<br>Winkel   | 56<br>67<br>110<br>88  | 10.00 08.07<br>10.00 08.07<br>08.96 08.07<br>06.97 08.07  |  | 24.0120-0186.1<br>24.0120-0187.1  | 420186<br>420187   | + 13" Rad <sup>1)</sup><br>+ 14" Rad <sup>2)</sup>                                 |  | 239 19,5 18,0 V<br>260 20,0 18,5 V +B                  |
|  | 1.5<br>1.5<br>1.5 i 16V<br>1.6<br>1.6<br>2.0 i<br>Winkel  | 54<br>57<br>70<br>60<br>66<br>110<br>88  | 01.95 08.07<br>01.95 08.07<br>01.95 08.07<br>01.00 08.07<br>01.00 08.07<br>08.96 08.07<br>06.97 08.07 |  | 03.0137-0231.2<br>03.0137-9118.2  | 650231<br>669118   |  |  | 200 x 41<br>Bremsbacken-Zubehör                        |
|  | 1.5<br>1.5<br>1.5 i 16V<br>1.6<br>1.6<br>2.0 i<br>Winkel  | 54<br>57<br>70<br>60<br>66<br>110<br>88  | 01.95 08.07<br>01.95 08.07<br>01.95 08.07<br>01.00 08.07<br>01.00 08.07<br>08.96 08.07<br>06.97 08.07 |  | 24.0220-0020.1  | 480059   |  |  | 200/201,5 x 50   |
|  | 1.5<br>1.5 i 16V<br>1.6<br>1.6  | 57<br>70<br>60<br>66   | 01.95 12.08<br>01.95 12.08<br>01.05 12.08<br>03.06 12.08  |  | 13.0460-2965.2  | 602965   |  |  | 21170 17,3 <b>TRW</b>                                  |
|  | 1.5<br>1.5 i 16V  | 57<br>70   | 01.95 09.00<br>01.95 09.00  |  | 24.0112-0125.1<br>24.0312-0125.1  | 412125<br>512125   |  |  | 239 12,0 10,8 +B<br><b>239 12,0 10,8 +B PD</b>         |
|  | 1.5<br>1.5 i 16V<br>1.6<br>1.6  | 56<br>67<br>60<br>66   | 10.00 12.08<br>10.00 12.08<br>01.05 12.08<br>03.06 12.08  |  | 24.0120-0186.1<br>24.0120-0187.1  | 420186<br>420187   | + 13" Rad <sup>1)</sup><br>+ 14" Rad <sup>2)</sup>                                 |  | 239 19,5 18,0 V<br>260 20,0 18,5 V +B                  |

<sup>1)</sup> + 13" wheel / + ruota 13" / + roue 13" / + rueda 13"

<sup>2)</sup> + 14" wheel / + ruota 14" / + roue 14" / + rueda 14"



|          |             |       |       |                |                |        |  |  |  |  |  |  |   |
|--|-------------|-------|-------|----------------|----------------|--------|--|--|--|--|--|--|---|
| <b>LADA 111 Kombi (2111) (95-08)</b>   |             |       |       |                |                |        |  |  |  |  |  |  |   |
|    | 1.5         | 57    | 01.95 | 12.08          | 03.0137-0231.2 | 650231 |  |  |  |  |  |  | 200 x 41<br>Bremsbacken-Zubehör         |
|  | 1.5 i 16V   | 70    | 01.95 | 12.08          |                |        |  |  |  |  |  |  |   |
|  | 1.6         | 60    | 01.05 | 12.08          |                |        |  |  |  |  |  |  |   |
|  | 1.6         | 66    | 03.06 | 12.08          |                |        |  |  |  |  |  |  |   |
|    | 1.5         | 57    | 01.95 | 12.08          | 24.0220-0020.1 | 480059 |  |  |  |  |  |  | 200/201,5 x 50                          |
|  | 1.5 i 16V   | 70    | 01.95 | 12.08          |                |        |  |  |  |  |  |  |   |
|  | 1.6         | 60    | 01.05 | 12.08          |                |        |  |  |  |  |  |  |   |
|  | 1.6         | 66    | 03.06 | 12.08          |                |        |  |  |  |  |  |  |   |
| <b>LADA 112 Fließheck (2112) (95-08)</b>   |             |       |       |                |                |        |  |  |  |  |  |  |   |
|    | 1.5         | 54    | 01.95 | 12.08          | 13.0460-2965.2 | 602965 |  |  |  |  |  |  | 21170 17,3 TRW                          |
|  | 1.5         | 57    | 01.95 | 12.08          |                |        |  |  |  |  |  |  |   |
|  | 1.5 i 16V   | 70    | 01.95 | 12.08          |                |        |  |  |  |  |  |  |   |
|  | 1.6         | 60    | 01.05 | 12.08          |                |        |  |  |  |  |  |  |   |
|  | 1.6         | 66    | 03.06 | 12.08          |                |        |  |  |  |  |  |  |   |
|    | 1.5         | 54    | 01.95 | 09.00          | 24.0112-0125.1 | 412125 |  |  |  |  |  |  | 239 12,0 10,8 +B<br>239 12,0 10,8 +B PD |
|  | 1.5         | 57    | 01.95 | 09.00          |                |        |  |  |  |  |  |  |   |
|  | 1.5 i 16V   | 70    | 01.95 | 09.00          | 24.0120-0186.1 | 420186 |  |  |  |  |  |  | 239 19,5 18,0 V<br>260 20,0 18,5 V +B   |
|  | 1.5         | 56    | 10.00 | 12.08          |                |        |  |  |  |  |  |  |   |
|  | 1.5 i 16V   | 67    | 10.00 | 12.08          |                |        |  |  |  |  |  |  |   |
| 1.6  | 60          | 01.05 | 12.08 | 24.0120-0187.1 | 420187         |        |  |  |  |  |  |  |   |
| 1.6  | 66          | 03.06 | 12.08 |                |                |        |  |  |  |  |  |  |   |
|    | 1.5         | 54    | 01.95 | 12.08          | 03.0137-0231.2 | 650231 |  |  |  |  |  |  | 200 x 41<br>Bremsbacken-Zubehör         |
|  | 1.5         | 57    | 01.95 | 12.08          |                |        |  |  |  |  |  |  |   |
|  | 1.5 i 16V   | 70    | 01.95 | 12.08          |                |        |  |  |  |  |  |  |   |
|  | 1.6         | 60    | 01.05 | 12.08          |                |        |  |  |  |  |  |  |   |
|  | 1.6         | 66    | 03.06 | 12.08          |                |        |  |  |  |  |  |  |   |
|    | 1.5         | 54    | 01.95 | 12.08          | 24.0220-0020.1 | 480059 |  |  |  |  |  |  | 200/201,5 x 50                          |
|  | 1.5         | 57    | 01.95 | 12.08          |                |        |  |  |  |  |  |  |   |
|  | 1.5 i 16V   | 70    | 01.95 | 12.08          |                |        |  |  |  |  |  |  |   |
|  | 1.6         | 60    | 01.05 | 12.08          |                |        |  |  |  |  |  |  |   |
|  | 1.6         | 66    | 03.06 | 12.08          |                |        |  |  |  |  |  |  |   |
| <b>LADA KALINA (1117/1118/1119) (04-)</b>  |             |       |       |                |                |        |  |  |  |  |  |  |   |
|    | 1.4 16V     | 66    | 11.08 |                | 13.0460-2965.2 | 602965 |  |  |  |  |  |  | 21170 17,3 TRW                          |
|  | 1.4 16V LPG | 65    | 11.08 |                |                |        |  |  |  |  |  |  |   |
|  | 1.6 16V     | 60    | 10.04 |                |                |        |  |  |  |  |  |  |   |
|  | 1.6 16V     | 62    | 01.10 |                |                |        |  |  |  |  |  |  |   |
|  | 1.6 16V     | 66    | 10.04 |                |                |        |  |  |  |  |  |  |   |
|   | 1.4 16V     | 66    | 11.08 |                | 24.0120-0187.1 | 420187 |  |  |  |  |  |  | 260 20,0 18,5 V +B                      |
|  | 1.4 16V LPG | 65    | 11.08 |                |                |        |  |  |  |  |  |  |   |
|  | 1.6 16V     | 60    | 10.04 |                |                |        |  |  |  |  |  |  |   |
|  | 1.6 16V     | 62    | 01.10 |                |                |        |  |  |  |  |  |  |   |
|  | 1.6 16V     | 66    | 10.04 |                |                |        |  |  |  |  |  |  |   |
|    | 1.4 16V     | 66    | 11.08 |                | 03.0137-0231.2 | 650231 |  |  |  |  |  |  | 200 x 41<br>Bremsbacken-Zubehör         |
|  | 1.4 16V LPG | 65    | 11.08 |                |                |        |  |  |  |  |  |  |   |
|  | 1.6 16V     | 60    | 10.04 |                |                |        |  |  |  |  |  |  |   |
|  | 1.6 16V     | 62    | 01.10 |                |                |        |  |  |  |  |  |  |   |
|  | 1.6 16V     | 66    | 10.04 |                |                |        |  |  |  |  |  |  |   |
|    | 1.4 16V     | 66    | 11.08 |                | 24.0220-0020.1 | 480059 |  |  |  |  |  |  | 200/201,5 x 50                          |
|  | 1.4 16V LPG | 65    | 11.08 |                |                |        |  |  |  |  |  |  |   |
|  | 1.6 16V     | 60    | 10.04 |                |                |        |  |  |  |  |  |  |   |
|  | 1.6 16V     | 62    | 01.10 |                |                |        |  |  |  |  |  |  |   |
|  | 1.6 16V     | 66    | 10.04 |                |                |        |  |  |  |  |  |  |   |
| <b>LADA PRIORA (2170/2172) (08-)</b>   |             |       |       |                |                |        |  |  |  |  |  |  |   |
|    | 1.6 i 16V   | 60    | 12.08 |                | 13.0460-2965.2 | 602965 |  |  |  |  |  |  | 21170 17,3 TRW                          |
|  | 1.6 i 16V   | 72    | 12.08 |                |                |        |  |  |  |  |  |  |   |
|  | 1.6 LPG     | 71    | 12.08 |                |                |        |  |  |  |  |  |  |   |
|    | 1.6 i 16V   | 60    | 12.08 |                | 03.0137-0231.2 | 650231 |  |  |  |  |  |  | 200 x 41<br>Bremsbacken-Zubehör         |
|  | 1.6 i 16V   | 72    | 12.08 |                |                |        |  |  |  |  |  |  |   |
|  | 1.6 LPG     | 71    | 12.08 |                |                |        |  |  |  |  |  |  |   |
|    | 1.6 i 16V   | 60    | 12.08 |                | 24.0220-0020.1 | 480059 |  |  |  |  |  |  | 200/201,5 x 50                          |
|  | 1.6 i 16V   | 72    | 12.08 |                |                |        |  |  |  |  |  |  |   |
|  | 1.6 LPG     | 71    | 12.08 |                |                |        |  |  |  |  |  |  |   |
| <b>LADA SAMARA (2108/2109) (86-99)</b>   |             |       |       |                |                |        |  |  |  |  |  |  |   |
|    | 1100        |       | 09.88 | 12.99          | 13.0460-2965.2 | 602965 |  |  |  |  |  |  | 21170 17,3 TRW                          |
|  | 1300        |       | 07.86 | 12.99          |                |        |  |  |  |  |  |  |   |
|  | 1500        |       | 07.87 | 12.99          |                |        |  |  |  |  |  |  |   |
|    | 1100        |       | 09.88 | 12.99          | 24.0112-0125.1 | 412125 |  |  |  |  |  |  | 239 12,0 10,8 +B<br>239 12,0 10,8 +B PD |
|  | 1300        |       | 07.86 | 12.99          |                |        |  |  |  |  |  |  |   |
|  | 1500        |       | 07.87 | 12.99          |                |        |  |  |  |  |  |  |   |
|    | 1100        |       | 09.88 | 12.99          | 03.0137-0231.2 | 650231 |  |  |  |  |  |  | 200 x 41<br>Bremsbacken-Zubehör         |
|  | 1300        |       | 07.86 | 12.99          |                |        |  |  |  |  |  |  |   |
|  | 1500        |       | 07.87 | 12.99          |                |        |  |  |  |  |  |  |   |
|    | 1100        |       | 09.88 | 12.99          | 24.0220-0020.1 | 480059 |  |  |  |  |  |  | 200/201,5 x 50                          |
|  | 1300        |       | 07.86 | 12.99          |                |        |  |  |  |  |  |  |   |
|  | 1500        |       | 07.87 | 12.99          |                |        |  |  |  |  |  |  |   |

1) + 13" wheel / + ruota 13" / + roue 13" / + rueda 13"

2) + 14" wheel / + ruota 14" / + roue 14" / + rueda 14"



### LADA NIVA II (2123) (02-)

|  |                                   |                |                         |  |                |        |  |           |          |
|--|-----------------------------------|----------------|-------------------------|--|----------------|--------|--|-----------|----------|
|  | 1.7 i 4x4<br>1.7 i 4x4<br>1.7 LPG | 59<br>61<br>57 | 09.02<br>08.04<br>09.02 |  | 13.0460-8006.2 | 608006 |  | 20660     | 15,6     |
|  | 1.7 i 4x4<br>1.7 i 4x4<br>1.7 LPG | 59<br>61<br>57 | 09.02<br>08.04<br>09.02 |  | 24.0112-0130.1 | 412130 |  | 272       | 11,0 9,9 |
|  | 1.7 i 4x4<br>1.7 i 4x4<br>1.7 LPG | 59<br>61<br>57 | 09.02<br>08.04<br>09.02 |  | 03.0137-0232.2 | 650232 |  | 250       | x 51     |
|  | 1.7 i 4x4<br>1.7 i 4x4<br>1.7 LPG | 59<br>61<br>57 | 09.02<br>08.04<br>09.02 |  | 24.0225-0004.1 | 480058 |  | 250/251,5 | x 57,5   |























### LANCIA DEDRA (94-99)

|  |   |    |   |   |  |                            |  |                |   |                   |
|--|---|----|---|---|--|----------------------------|--|----------------|---|-------------------|
|  | 1.6<br>1.8 i.e.<br>2.0 i.e.   |    | 11.93<br>08.99<br>11.93                   | 08.99<br>08.99<br>08.99                   | 13.0460-2949.2<br>13.0460-7131.2                   | 602949<br>607131           |  | 20833<br>21193 | 17,0 +/WK/S<br>18,0 +/WK                    | TRW<br>ATE        |
|  | 1.9 TD  |    | 11.93                                     | 08.99                                     | 13.0460-7065.2                                     | 607065                     |  | 21927          | 17,9 +/WK                                   | ATE               |
|  | 1.8 GT 16V<br>2.0 i.e. 16V  |    | 03.96<br>11.93                            | 08.99<br>08.99                            | 13.0460-7129.2                                     | 607129                     |  | 23229          | 18,1 +/WK                                   | ATE               |
|  | 1.6<br>1.9 TD   | 68 | 11.93<br>11.93                            | 08.99<br>08.99                            | 24.0112-0127.1                                     | 412127                     |  | 258            | 12,0 10,2 +B                                |                   |
|  | 1.9 TD  | 66 | 11.93                                     | 08.99                                     | 24.0122-0147.1                                     | 422147                     |  | 284            | 22,0 20,2 V +B                              |                   |
|  | 1.6<br>1.8 i.e.<br>2.0 i.e.   |    | 01.96<br>11.93<br>11.93                   | 07.99<br>08.99<br>08.99                   | 24.0120-0142.1<br>24.0320-0142.1                   | 420142<br>520142           |  | 258            | 20,0 18,2 V L +B<br>258 20,0 18,2 V L +B PD |                   |
|  | 1.8 GT 16V<br>2.0 i.e. 16V  |    | 03.96<br>11.93                            | 08.99<br>08.99                            | 24.0122-0197.1<br>24.0322-0197.1                   | 422197<br>522197           |  | 258            | 22,0 20,2 V +B<br>258 22,0 20,2 V +B PD     |                   |
|  | 2.0 i.e. Integrale  |    | 11.93                                     | 08.99                                     | 24.0122-0107.1                                     | 422107                     |  | 284            | 22,0 20,2 V +B                              |                   |
|  | 1.8 GT 16V<br>1.8 i.e.<br>1.9 TD<br>2.0 i.e.<br>2.0 i.e. 16V        |    | 03.96<br>11.93<br>11.93<br>11.93<br>11.93 | 08.99<br>08.99<br>08.99<br>08.99<br>08.99 | 13.0460-2951.2<br>13.0460-0072.2<br>13.0460-2826.2 | 602951<br>610072<br>602826 | + GG-Sättel <sup>3)</sup><br>+ GG-Sättel <sup>3)</sup><br>+ ALU-Sättel <sup>4)</sup> | 21103<br>23177 | 14,2 /S<br>14,2 /S                          | TRW<br>TRW<br>TRW |
|  | 1.6<br>1.8 GT 16V<br>1.8 i.e.<br>1.9 TD<br>2.0 i.e.<br>2.0 i.e. 16V |    | 01.96<br>03.96<br>11.93<br>11.93<br>11.93 | 07.99<br>08.99<br>08.99<br>08.99<br>08.99 | 24.0111-0119.1                                     | 411119                     |  | 241            | 11,0 9,2 +B                                 |                   |
|  | 1.6   |    | 11.93                                     | 08.99                                     | 03.0137-0207.2<br>03.0137-9088.2                   | 650207<br>669088           |  | 180            | x 32<br>Bremsbacken-Zubehör                 | BDX<br>BDX        |
|  | 1.6   |    | 11.93                                     | 08.99                                     | 24.0218-0011.1                                     | 480006                     |  | 180/181,4      | x 40  |                   |
|  | 1.6   |    | 11.93                                     | 08.99                                     | 03.0420-4322.3                                     | 684322                     |  | 22,20/180x32   | Kit   | BDX               |

### LANCIA DELTA (94-99)







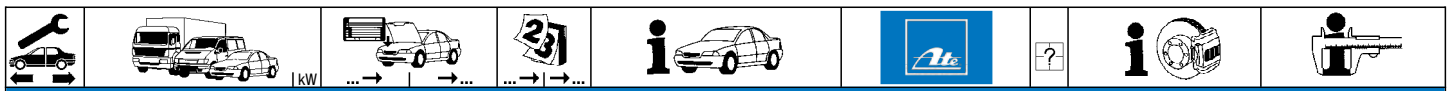















|  |   |    |  |  |  |                            |  |                   |   |                   |
|--|---|----|--|--|--|----------------------------|--|-------------------|---|-------------------|
|  | 1.4 i.e.<br>1.6 i.e.  |    | 11.93<br>11.93                                     | 08.99<br>08.99                                     | 13.0460-7064.2                                     | 607064                     |  | 21930             | 17,9 +/WK                                       | ATE               |
|  | 1.6 i.e.<br>1.8<br>1.8 i.e.<br>2.0 TD                             | 66 | 11.93<br>02.96<br>11.93<br>07.94                   | 08.99<br>09.99<br>08.99<br>08.99                   | 13.0460-7065.2<br>13.0460-2949.2                   | 607065<br>602949           |  | 21927<br>20833    | 17,9 +/WK<br>17,0 +/WK/S                        | ATE<br>TRW        |
|  | 2.0 HF Turbo<br>2.0 i.e. 16V                                      |    | 11.93<br>11.93                                     | 08.99<br>08.99                                     | 13.0460-2979.2                                     | 602979                     |  | 21147             | 19,0 +/WK/S                                     | TRW               |
|  | 2.0 HF Integrale<br>2.0 i.e.16V Integrale                         |    | 11.93<br>11.93                                     | 08.99<br>08.99                                     | 13.0460-4958.2                                     | 604958                     |  | 21381             | 17,3 +/WK                                       | BRE               |
|  | 1.4 i.e.<br>1.6 i.e.<br>1.8<br>1.8 i.e.<br>2.0 TD<br>2.0 i.e. 16V | 66 | 11.93<br>11.93<br>02.96<br>11.93<br>07.94<br>11.93 | 08.99<br>08.99<br>09.99<br>08.99<br>08.99<br>08.99 | 24.0111-0119.1<br>24.0112-0127.1                   | 411119<br>412127           |  | 241<br>258        | 11,0 9,2 +B<br>12,0 10,2 +B                     |                   |
|  | 2.0 HF Turbo<br>2.0 HF Integrale<br>2.0 i.e.16V Integrale         |    | 11.93<br>11.93<br>11.93                            | 08.99<br>08.99<br>08.99                            | 24.0122-0107.1<br>24.0122-0147.1<br>24.0126-0114.1 | 422107<br>422147<br>426114 |  | 284<br>284<br>281 | 22,0 20,2 V +B<br>22,0 20,2 V +B<br>26,0 24,2 V |                   |
|  | 1.8<br>1.8 i.e.<br>2.0 HF Turbo<br>2.0 i.e. 16V<br>2.0 TD         | 66 | 02.96<br>11.93<br>11.93<br>11.93<br>07.94          | 09.99<br>08.99<br>08.99<br>08.99<br>08.99          | 13.0460-2951.2<br>13.0460-2826.2<br>13.0460-0072.2 | 602951<br>602826<br>610072 | + GG-Sättel <sup>3)</sup><br>+ ALU-Sättel <sup>4)</sup><br>+ GG-Sättel <sup>3)</sup> | 21103<br>23177    | 14,2 /S<br>14,2 /S                              | TRW<br>TRW<br>TRW |
|  | 1.8<br>1.8 i.e.<br>2.0 HF Turbo<br>2.0 i.e. 16V<br>2.0 TD         | 66 | 02.96<br>11.93<br>11.93<br>11.93<br>07.94          | 09.99<br>08.99<br>08.99<br>08.99<br>08.99          | 24.0111-0119.1                                     | 411119                     |  | 241               | 11,0 9,2 +B                                     |                   |
|  | 2.0 HF Integrale<br>2.0 i.e.16V Integrale                         |    | 11.93<br>11.93                                     | 08.99<br>08.99                                     | 24.0110-0209.1                                     | 410209                     |  | 251               | 10,0 9,0 +B                                     |                   |

1) - catalytic converter / - catalizzatore / - catalyseur / - catalizador  
 2) + catalytic converter / + catalizzatore / + catalyseur / + catalizador  
 3) + cast iron caliper / + pinza in ghisa / + étriers en fonte grise / + fundición gris-pinza  
 4) + aluminium calipers / + pinze in alluminio / + étriers en aluminium / + pinzas de aluminio

|     |   |  |  |  |  |  |  |  |  |                          |
|--|---|--|--|--|---|--|--|--|--|--------------------------|
| <b>LANCIA DELTA (94-99)</b>  |   |  |  |  |   |  |  |  |  |                          |
|    | 1.4 i.e.<br>1.6 i.e.  |  | 11.93<br>11.93   | 08.99<br>08.99   | 03.0137-0207.2<br>03.0137-9088.2  | 650207<br>669088   |  | 180 x 32<br>Bremsbacken-Zubehör  | <b>BDX</b><br><b>BDX</b>               |                          |
|    | 1.4 i.e.<br>1.6 i.e.  |  | 11.93<br>11.93   | 08.99<br>08.99   | 24.0218-0011.1  | 480006   |  | 180/181,4 x 40   |  |                          |
|    | 1.4 i.e.<br>1.6 i.e.  |  | 11.93<br>11.93   | 08.99<br>08.99   | 03.0420-4322.3  | 684322   |  | 22,20/180x32 Kit   | <b>BDX</b>                             |                          |
| <b>LANCIA DELTA / Chrysler Delta (08-)</b>   |   |  |  |  |   |  |  |  |  |                          |
|    | 1.4 16V<br>1.4 Bifuel<br>1.6 D Multijet<br>1.6 D Multijet   | 88<br>88<br>77<br>88   | 08.08<br>07.11<br>04.11<br>08.08   |  | 13.0460-3983.2<br>13.0470-3983.2  | 603983<br>LD3983   |  | 23708 19,4 +/WK/S<br>23708 19,4 +/WK/S   | <b>BOS</b><br><b>BOS</b>               |                          |
|  | 1.4 16V<br>1.4 16V Turbo  | 103<br>110   | 07.10<br>08.08   |  | 13.0460-3984.2<br>13.0470-3984.2  | 603984<br>LD3984   |  | 23711 19,4 +/WK/S<br>23711 19,4 +/WK/S   | <b>BOS</b><br><b>BOS</b>               |                          |
|  | 1.8 Di 16V<br>1.9 D Multijet<br>2.0 D Multijet  | 147<br>140<br>121  | 01.09<br>08.08<br>08.08  |  | 13.0460-7265.2  | 607265   |  | 24727 20,7 +/WK  | <b>ATE</b>                             |                          |
|    | 1.4 16V<br>1.4 Bifuel<br>1.6 D Multijet<br>1.6 D Multijet   | 88<br>88<br>77<br>88   | 08.08<br>07.11<br>04.11<br>08.08   |  | 24.0122-0147.1  | 422147   |  | 284 22,0 20,2 V +B   |  |                          |
|  | 1.4 16V<br>1.4 16V Turbo  | 103<br>110   | 07.10<br>08.08   |  | 24.0126-0125.1  | 426125   |  | 281 26,0 24,2 V +B   |  |                          |
|  | 1.9 D Multijet<br>2.0 D Multijet  | 140<br>121   | 08.08<br>08.08   |  | 24.0128-0243.1  | 428243   |  | 305 28,0 26,0 V L +B   |  |                          |
|    | 1.4 16V<br>1.4 16V<br>1.4 16V Turbo<br>1.4 Bifuel<br>1.6 D Multijet<br>1.6 D Multijet<br>1.8 Di 16V<br>1.9 D Multijet<br>2.0 D Multijet             | 88<br>103<br>110<br>88<br>77<br>88<br>147<br>140<br>121                          | 08.08<br>07.10<br>08.08<br>07.11<br>04.11<br>08.08<br>01.09<br>08.08<br>08.08    |  | 13.0460-3991.2<br>13.0470-3812.2<br>13.0460-3861.2                                | 603991<br>LD3812<br>603861   |  | 23714 16,6 /S<br>23714 17,6 /S<br>23714 17,6 +/WK/Zub/SBOS                         | <b>BOS</b><br><b>BOS</b><br><b>BOS</b> |                          |
|   | 1.4 16V<br>1.4 16V<br>1.4 16V Turbo<br>1.4 Bifuel<br>1.6 D Multijet<br>1.6 D Multijet<br>1.8 Di 16V<br>1.9 D Multijet<br>2.0 D Multijet             | 88<br>103<br>110<br>88<br>77<br>88<br>147<br>140<br>121                          | 08.08<br>07.10<br>08.08<br>07.11<br>04.11<br>08.08<br>01.09<br>08.08<br>08.08    |  | 24.0110-0190.1  | 410190   |  | 252 10,0 9,0 +B  |  |                          |
| <b>LANCIA FLAVIA (12-)</b>   |   |  |  |  |   |  |  |  |  |                          |
|  | 2.4 16V   | 125  | 03.12  |  | 13.0460-5760.2  | 605760   |  | 23584 16,4 /WK   | <b>AKE</b>                             |                          |
|  | 2.4 16V   | 125  | 03.12  |  | 13.0460-5855.2  | 605855   |  | 23582 16,0 +   |  |                          |
|  | 2.4 16V   | 125  | 03.12  |  | 24.0110-0361.1  | 410361   |  | 302 10,0 8,4 +B  |  |                          |
|  | 2.4 16V   | 125  | 03.12  |  | 03.0137-3023.2  | 653023   |  | 170 x 32   |  |                          |
| <b>LANCIA KAPPA (95-01)</b>  |   |  |  |  |   |  |  |  |  |                          |
|  | 2.0 i.e.<br>2.0 i.e. 16V Turbo<br>2.0 i.e. 20V Turbo<br>2.4 i.e.<br>2.4 JTD<br>2.4 TD<br>3.0 i.e. V6 Kombi<br>3.0 i.e. V6 Lim.<br>3.0 i.e. V6 Coupe |  | 01.95<br>07.95<br>06.98<br>01.95<br>06.98<br>01.95<br>01.95<br>01.95<br>01.95    | 10.01<br>10.01<br>10.01<br>10.01<br>10.01<br>10.01<br>10.01<br>10.01             |   | 13.0460-2987.2   | 602987   |  | 23168 19,0 +/WK/S                      | <b>TRW</b>               |
|  | 2.0 i.e.<br>2.0 i.e. 16V Turbo<br>2.0 i.e. 20V Turbo<br>2.4 i.e.<br>2.4 JTD<br>2.4 TD<br>3.0 i.e. V6  |  | 01.95<br>07.95<br>06.98<br>01.95<br>06.98<br>01.95<br>01.95                      | 10.01<br>10.01<br>10.01<br>10.01<br>10.01<br>10.01<br>10.01                      |   | 13.0460-4971.2<br>13.0470-4971.2   | 604971<br>LD4971   |  | 23092 16,0 +/WK<br>23092 16,0 +/WK     | <b>BRE</b><br><b>BRE</b> |
|  | 2.0 i.e.<br>2.0 i.e. 16V Turbo<br>2.0 i.e. 20V Turbo<br>2.4 i.e.<br>2.4 JTD<br>3.0 i.e. V6  |  | 01.95<br>07.95<br>06.98<br>01.95<br>06.98<br>01.95                               | 10.01<br>10.01<br>10.01<br>10.01<br>10.01<br>10.01                               |   | 24.0122-0191.1<br>24.0126-0133.1   | 422191<br>426133   |  | 281 22,0 20,2 V<br>281 26,0 24,2 V     |                          |
|  | 2.0 i.e.<br>2.0 i.e. 16V Turbo<br>2.0 i.e. 20V Turbo<br>2.4 i.e.<br>2.4 JTD   |  | 01.95<br>07.95<br>06.98<br>01.95<br>06.98  | 10.01<br>10.01<br>10.01<br>10.01<br>10.01  |   | 13.0460-2827.2   | 602827   |  | 21606 16,7 /S                          | <b>TRW</b>               |
| ↓  | ↓   |  |  |  |   |  |  |  |  |                          |





















| LANCIA KAPPA (95-01) |  |  |  |  |  |  |  |  |  |   |                                  |
|----------------------|--|--|--|--|--|--|--|--|--|---|----------------------------------|
|                      | 2.4 TD<br>3.0 i.e. V6  |  |  | 01.95<br>01.95   | 10.01<br>10.01   |  |  | 13.0460-2827.2<br>602827   |  | 21606 16,7 /S   | TRW                              |
|                      | 2.0 i.e.<br>2.0 i.e. 16V Turbo<br>2.0 i.e. 20V Turbo<br>2.4 i.e.<br>2.4 JTD<br>2.4 TD<br>3.0 i.e. V6   |  |  | 01.95<br>07.95<br>06.98<br>01.95<br>06.98<br>01.95<br>01.95  | 10.01<br>10.01<br>10.01<br>10.01<br>10.01<br>10.01<br>10.01  |  |  | 24.0110-0290.1<br>410290   |  | 276 10,0 9,0 +B   |                                  |
| LANCIA LYBRA (99-05) |  |  |  |  |  |  |  |  |  |   |                                  |
|                      | 1.6 i 16V<br>1.6<br>1.6 i 16V<br>1.8 i 16V<br>1.9 JTD<br>2.0 i 20V<br>2.4 JTD  |  |  | 10.99<br>10.00<br>03.00<br>10.99<br>10.99<br>10.99<br>10.99  | 02.00<br>10.05<br>12.05<br>03.00<br>03.00<br>03.00<br>03.00  |  |  | 13.0460-7105.2<br>607105<br>13.0460-7139.2<br>607139<br>13.0470-7139.2<br>LD7139<br>13.0460-7069.2<br>607069   |  | 23140 19,4 +/WK<br>23140 19,4 +/WK<br>23140 19,4 +/WK<br>21636 19,3 +/WK  | ATE<br>ATE<br>ATE<br>ATE         |
|                      | 1.8 i 16V<br>1.9 JTD<br>2.0 i 20V<br>2.4 20V<br>2.4 JTD  |  |  | 04.00<br>04.00<br>04.00<br>10.01<br>04.00  | 12.05<br>12.05<br>12.05<br>12.05<br>12.05  |  |  | 13.0460-7140.2<br>607140<br>13.0470-7140.2<br>LD7140   |  | 23289 19,3 +/WK<br>23289 19,3 +/WK  | ATE<br>ATE                       |
|                      | 1.6 i 16V<br>1.6<br>1.8 i 16V<br>1.9 JTD<br>2.0 i 20V<br>2.4 20V<br>2.4 JTD  |  |  | 10.99<br>10.00<br>10.99<br>10.99<br>10.99<br>10.01<br>10.99  | 12.05<br>10.05<br>12.05<br>12.05<br>12.05<br>12.05<br>12.05  |  |  | 24.0115-0112.1<br>415112<br>24.0122-0147.1<br>422147   |  | 281 15,0 13,2<br>284 22,0 20,2 V +B   |                                  |
|                      | 1.6<br>1.6 i 16V<br>1.8 i 16V<br>1.9 JTD<br>2.0 i 20V<br>2.4 20V<br>2.4 JTD  |  |  | 10.00<br>10.99<br>10.99<br>10.99<br>10.99<br>10.01<br>10.99  | 10.05<br>12.05<br>12.05<br>12.05<br>12.05<br>12.05<br>12.05  |  |  | 13.0460-2867.2<br>602867<br>13.0470-2867.2<br>LD2867   |  | 23517 16,6 /S<br>23517 16,6 /S  | TRW<br>TRW                       |
|                      | 1.6<br>1.6 i 16V<br>1.8 i 16V<br>1.9 JTD<br>2.0 i 20V<br>2.4 20V<br>2.4 JTD  |  |  | 10.00<br>10.99<br>10.99<br>10.99<br>10.99<br>10.01<br>10.99  | 10.05<br>12.05<br>12.05<br>12.05<br>12.05<br>12.05<br>12.05  |  |  | 24.0110-0190.1<br>410190   |  | 252 10,0 9,0 +B   |                                  |
| LANCIA MUSA (04-13)  |  |  |  |  |  |  |  |  |  |   |                                  |
|                      | 1.4<br>1.4<br>1.4<br>1.4 LPG<br>1.3 D Multijet<br>1.3 D Multijet<br>1.3 D Multijet<br>1.6 D Multijet<br>1.6 D Multijet<br>1.9 D Multijet                   | 57<br>66<br>70<br>57<br>51<br>66<br>70<br>85<br>88<br>74             |  | 07.05<br>10.07<br>10.04<br>11.10<br>10.04<br>09.06<br>08.09<br>07.08<br>06.08<br>10.04                   | 12.13<br>12.13<br>12.13<br>12.13<br>12.13<br>12.13<br>12.13<br>12.13<br>12.13<br>12.13                   |  |  | 13.0460-3810.2<br>603810<br>13.0460-3818.2<br>603818<br>13.0460-3811.2<br>603811<br>13.0460-3827.2<br>603827<br>13.0470-3827.2<br>LD3827                             |  | 23705 18,1 /S<br>23706 18,1 +/WK/S<br>23708 19,2 /S<br>23709 19,6 +/WK/Zub/SBOS<br>23709 19,6 +/WK/Zub/SBOS       | BOS<br>BOS<br>BOS<br>BOS         |
|                      | 1.4<br>1.4<br>1.4<br>1.4 LPG<br>1.3 D Multijet<br>1.3 D Multijet<br>1.3 D Multijet<br>1.6 D Multijet<br>1.6 D Multijet<br>1.9 D Multijet                   | 57<br>66<br>70<br>57<br>51<br>66<br>70<br>85<br>88<br>74             |  | 07.05<br>10.07<br>10.04<br>11.10<br>10.04<br>09.06<br>08.09<br>07.08<br>06.08<br>10.04                   | 12.13<br>12.13<br>12.13<br>12.13<br>12.13<br>12.13<br>12.13<br>12.13<br>12.13<br>12.13                   |  |  | 24.0122-0197.1<br>422197<br>24.0322-0197.1<br>522197<br>24.0122-0147.1<br>422147   |  | 258 22,0 20,2 V +B<br>258 22,0 20,2 V +B PD<br>284 22,0 20,2 V +B   |                                  |
|                      | 1.6 D Multijet<br>1.6 D Multijet   | 85<br>88   |  | 07.08<br>06.08   | 12.13<br>12.13   |  |  | 13.0460-2879.2<br>602879<br>13.0470-2879.2<br>LD2879   |  | 23601 13,7 /S<br>23601 13,7 /S  | TRW<br>TRW                       |
|                      | 1.6 D Multijet<br>1.6 D Multijet   | 85<br>88   |  | 07.08<br>06.08   | 12.13<br>12.13   |  |  | 24.0111-0119.1<br>411119   |  | 241 11,0 9,2 +B   |                                  |
|                      | 1.3 D Multijet<br>1.4<br>1.4<br>1.4<br>1.4 LPG<br>1.3 D Multijet<br>1.3 D Multijet<br>1.3 D Multijet<br>1.6 D Multijet<br>1.6 D Multijet<br>1.9 D Multijet | 51<br>70<br>57<br>66<br>70<br>57<br>51<br>66<br>70<br>85<br>88<br>74 |  | 10.04<br>10.04<br>07.05<br>10.07<br>07.05<br>11.10<br>10.04<br>09.06<br>08.09<br>07.08<br>06.08<br>10.04 | 06.05<br>06.05<br>12.13<br>12.13<br>12.13<br>12.13<br>12.13<br>12.13<br>12.13<br>12.13<br>12.13<br>12.13 |  |  | 03.0137-0479.2<br>650479<br>03.0137-9310.2<br>669310<br>03.0137-0479.2<br>650479<br>03.0137-9310.2<br>669310<br>03.0137-0457.2<br>650457<br>03.0137-9309.2<br>669309 |  | 203 x 38 HEB<br>Bremsbacken-Zubehör<br>203 x 38 HEB<br>Bremsbacken-Zubehör<br>228 x 42 HEB<br>Bremsbacken-Zubehör | AP<br>AP<br>AP<br>AP<br>AP<br>AP |































|     |  |  |  |  |  |  |  |  |
|--|--|--|--|--|---|--|--|--|
| <b>LANCIA MUSA (04-13)</b>   |  |  |  |  |   |  |  |  |
|    | 1.4  | 57   |  | 07.05  | 12.13   | 24.0220-3007.1   | 480064   | 203/204,7 x 48,5   |
|  | 1.4  | 66   |  | 10.07  | 12.13   |  |  |  |
|  | 1.4  | 70   |  | 10.04  | 12.13   |  |  |  |
|  | 1.4 LPG  | 57   |  | 11.10  | 12.13   |  |  |  |
|  | 1.3 D Multijet   | 51   |  | 10.04  | 12.13   | 24.0222-8018.1   | 480078   | 228/230 x 48   |
| 1.3 D Multijet   | 66   |  | 09.06  | 12.13  |   |  |  |  |
| 1.3 D Multijet   | 70   |  | 08.09  | 12.13  |   |  |  |  |
| 1.9 D Multijet   | 74   |  | 10.04  | 12.13  |   |  |  |  |
|    | 1.3 D Multijet   | 51   |  | 10.04  | 06.05   | 03.0520-6922.3   | 696922   | 22,20/203x38 TopKit AP   |
|  | 1.4  | 70   |  | 10.04  | 06.05   |  |  |  |
|    | 1.3 D Multijet   | 51   |  | 07.05  | 12.13   | 03.0520-9120.3   | 699120   | 20,64/228x42 TopKit AP   |
|  | 1.3 D Multijet   | 66   |  | 07.05  | 12.13   |  |  |  |
|  | 1.3 D Multijet   | 70   |  | 08.09  | 12.13   |  |  |  |
|  | 1.9 D Multijet   | 74   |  | 07.05  | 12.13   |  |  |  |
| <b>LANCIA PHEDRA (02-10)</b>   |  |  |  |  |   |  |  |  |
|    | 2.0 D Multijet   | 100  |  | 07.06  | 09.10   | 13.0460-2863.2   | 602863   | 20261 19,0 +/-WK/S TRW   |
|  | 2.0 i 16V  | 100  |  | 08.02  | 09.10   |  |  |  |
|  | 2.0 JTD  | 80   |  | 08.02  | 09.10   |  |  |  |
|  | 2.2 JTD  | 94   |  | 08.02  | 09.10   |  |  |  |
|  | 2.2 D Multijet   | 125  |  | 03.08  | 09.10   | 13.0460-2752.2   | 602752   | 24839 19,4 +/-WK/S TRW   |
| 2.2 JTD  | 120  |  | 04.06  | 09.10  |   |  |  |  |
| 3.0 i V6   | 150  |  | 08.02  | 09.10  | 13.0460-4995.2  | 604995   | 23575 15,6 +/-WK BRE   |  |
|    | 2.0 D Multijet   | 100  |  | 07.06  | 09.10   | 24.0128-0136.1   | 428136   | 285 28,0 26,0 V +B   |
|  | 2.0 i 16V  | 100  |  | 08.02  | 09.10   | 24.0328-0136.1   | 528136   | 285 28,0 26,0 V +B PD  |
|  | 2.0 JTD  | 80   |  | 08.02  | 09.10   |  |  |  |
|  | 2.2 JTD  | 94   |  | 08.02  | 09.10   |  |  |  |
|  | 2.2 D Multijet   | 125  |  | 03.08  | 09.10   | 24.0132-0126.1   | 432126   | 310 32,0 30,0 V  |
| 2.2 JTD  | 120  |  | 04.06  | 09.10  |   |  |  |  |
| 3.0 i V6   | 150  |  | 08.02  | 09.10  |   |  |  |  |
|    | 2.0 D Multijet   | 100  |  | 07.06  | 09.10   | 13.0460-2819.2   | 602819   | 20961 17,6 /S TRW  |
|  | 2.0 i 16V  | 100  |  | 08.02  | 09.10   | 13.0460-0072.2   | 610072   | Belagsatz-Zubehör TRW  |
|  | 2.0 JTD  | 80   |  | 08.02  | 09.10   |  |  |  |
|  | 2.2 D Multijet   | 125  |  | 03.08  | 09.10   |  |  |  |
|  | 2.2 JTD  | 94   |  | 08.02  | 09.10   |  |  |  |
| 2.2 JTD  | 120  |  | 04.06  | 09.10  |   |  |  |  |
| 3.0 i V6   | 150  |  | 08.02  | 09.10  |   |  |  |  |
|   | 2.0 D Multijet   | 100  |  | 07.06  | 09.10   | 24.0112-0156.1   | 412156   | 272 12,0 10,0 +B   |
|  | 2.0 i 16V  | 100  |  | 08.02  | 09.10   |  |  |  |
|  | 2.0 JTD  | 80   |  | 08.02  | 09.10   |  |  |  |
|  | 2.2 D Multijet   | 125  |  | 03.08  | 09.10   |  |  |  |
|  | 2.2 JTD  | 94   |  | 08.02  | 09.10   |  |  |  |
| 2.2 JTD  | 120  |  | 04.06  | 09.10  |   |  |  |  |
| 3.0 i V6   | 150  |  | 08.02  | 09.10  |   |  |  |  |
|  | 2.0 D Multijet   | 100  |  | 07.06  | 09.10   | 24.0711-6066.3   | 360130   | 2 Radsensor L=955  |
|  | 2.0 i 16V  | 100  |  | 08.02  | 09.10   |  |  |  |
|  | 2.0 JTD  | 80   |  | 08.02  | 09.10   |  |  |  |
|  | 2.2 D Multijet   | 125  |  | 03.08  | 09.10   |  |  |  |
|  | 2.2 JTD  | 94   |  | 08.02  | 09.10   |  |  |  |
| 2.2 JTD  | 120  |  | 04.06  | 09.10  |   |  |  |  |
| 3.0 i V6   | 150  |  | 08.02  | 09.10  |   |  |  |  |
| <b>LANCIA THEMA (11-)</b>  |  |  |  |  |   |  |  |  |
|  | 3.0 V6 CRD   | 140  |  | 09.11  |   | 03.0137-4014.2   | 654014   | 183 x 31 /Zub  |
|  | 3.0 V6 CRD   | 176  |  | 09.11  |   |  |  |  |
|  | 3.6 4WD  | 210  |  | 09.11  |   |  |  |  |
|  | 3.6 V6 WT  | 210  |  | 09.11  |   |  |  |  |
| <b>LANCIA THESIS (02-07)</b>   |  |  |  |  |   |  |  |  |
|  | 2.0 i 20V Turbo  |  |  | 07.02  | 12.07   | 13.0460-2704.2   | 602704   | 23761 18,8 /WK/S TRW   |
|  | 2.4 i 20V  |  |  | 07.02  | 12.07   |  |  |  |
|  | 2.4 JTD  |  |  | 07.02  | 12.07   |  |  |  |
|  | 3.0 i V6   |  |  | 07.02  | 12.07   |  |  | - gepanzerte Fahrzeuge <sup>1)</sup>   |
|  | 3.2 i V6   |  |  | 05.03  | 12.07   |  |  |  |
|  | 2.0 i 20V Turbo  |  |  | 07.02  | 12.07   | 24.0128-0179.1   | 428179   | 306 28,0 26,0 V +B   |
|  | 2.4 i 20V  |  |  | 07.02  | 12.07   |  |  |  |
|  | 2.4 JTD  |  |  | 07.02  | 12.07   |  |  |  |
|  | 3.0 i V6   |  |  | 07.02  | 12.07   |  |  | - gepanzerte Fahrzeuge <sup>1)</sup>   |
|  | 3.2 i V6   |  |  | 05.03  | 12.07   |  |  |  |
|  | 2.0 i 20V Turbo  |  |  | 07.02  | 12.07   | 13.0460-2707.2   | 602707   | elektrische Feststellbremse <sup>2)</sup> 23760 17,7 /S TRW                        |
|  | 2.4 i 20V  |  |  | 07.02  | 12.07   | 13.0470-2707.2   | LD2707   | elektrische Feststellbremse <sup>2)</sup> 23760 17,7 /S TRW                        |
|  | 2.4 JTD  |  |  | 07.02  | 12.07   |  |  |  |
|  | 3.0 i V6   |  |  | 07.02  | 12.07   |  |  |  |
|  | 3.2 i V6   |  |  | 05.03  | 12.07   |  |  |  |
|  | 2.0 i 20V Turbo  |  |  | 07.02  | 12.07   | 24.0122-0234.1   | 422234   | elektrische Feststellbremse <sup>2)</sup> 281 22,0 20,2 V                          |
|  | 2.4 i 20V  |  |  | 07.02  | 12.07   |  |  |  |
|  | 2.4 JTD  |  |  | 07.02  | 12.07   |  |  |  |
|  | 3.0 i V6   |  |  | 07.02  | 12.07   |  |  | - gepanzerte Fahrzeuge <sup>1)</sup>   |
|  | 3.2 i V6   |  |  | 05.03  | 12.07   |  |  |  |
| <b>LANCIA Y (96-03)</b>  |  |  |  |  |   |  |  |  |
|  | 1.1 i  |  |  | 05.97  | 12.98   | 13.0460-3950.2   | 603950   | 21436 17,0 BDX   |
|  | 1.2 i  | 44   |  | 10.00  | 07.03   | 13.0460-3951.2   | 603951   | 21436 16,2 /WK BDX   |
|  | 1.2 i  | 44   |  | 01.96  | 09.00   |  |  |  |
|  | 1.2 i  | 44   |  | 10.00  | 07.03   | 13.0460-7114.2   | 607114   | 23181 17,9 + ATE   |
| ↓  |  |  |  |  |   |  |  |  |

<sup>1)</sup> - armoured vehicles / - veicoli blindati / - véhicules blindé / - vehículo blindado

<sup>2)</sup> electric parking brake / fr.di stazionamento elettrico / frein à main électrique / freno de mano eléctrico

|     |   |        |  |   |  |                |  |        |
|--|---|--|--|---|---|--|--|--|
| <b>LANCIA Y (96-03)</b>  |   |  |  |   |   |  |  |  |
|    | 1.2 i 16V<br>1.2 i 16V<br>1.4 i<br>1.4 i  | 59<br>63   |  | 10.00 07.03<br>05.97 09.00<br>01.99 07.03<br>01.96 12.98  |   | 13.0460-7114.2 607114  |  | 23181 17,9 + ATE   |
|    | 1.1 i<br>1.2 i<br>1.2 i<br>1.2 i 16V<br>1.2 i 16V<br>1.4 i  | 44<br>44<br>44<br>59<br>63   |  | 05.97 12.98<br>10.00 07.03<br>01.96 09.00<br>10.00 07.03<br>05.97 09.00<br>01.96 12.98  | - ABS<br>+ ABS  | 24.0111-0119.1 411119<br>24.0112-0127.1 412127   |  | 20833 17,0 +WK/S TRW<br>241 11,0 9,2 +B<br>258 12,0 10,2 +B                              |
|    | 1.1 i<br>1.2 i<br>1.2 i 16V<br>1.2 i 16V<br>1.4 i   | 44<br>59<br>63   |  | 05.97 12.98<br>01.96 07.03<br>10.00 07.03<br>05.97 09.00<br>01.96 12.98   |   | 03.0137-0207.2 650207<br>03.0137-0274.2 650274<br>03.0137-9088.2 669088<br>03.0137-9179.2 669179 |  | 180 x 32 BDX<br>180 x 32 HEB AUT AP<br>Bremsbacken-Zubehör BDX<br>Bremsbacken-Zubehör AP |
|    | 1.1 i<br>1.2 i<br>1.2 i 16V<br>1.4 i  | 44<br>59<br>63   |  | 05.97 12.98<br>01.96 07.03<br>10.00 07.03<br>05.97 09.00<br>01.96 12.98   |   | 24.0218-0011.1 480006  |  | 180/181,4 x 40   |
|    | 1.1 i<br>1.2 i<br>1.2 i 16V<br>1.2 i 16V<br>1.4 i   | 44<br>59<br>63   |  | 05.97 12.98<br>01.96 07.03<br>10.00 07.03<br>05.97 09.00<br>01.96 12.98   |   | 03.0520-5120.3 695120<br>03.0420-5220.3 685220<br>03.0520-5220.3 695220                          |  | 20,64/180x32 TopKit BDX<br>20,64/180x32 Kit AP<br>20,64/180x32 TopKit AP                 |
| <b>LANCIA YPSILON (03-11)</b>  |   |  |  |   |   |  |  |  |
|    | 1.2 i<br>1.2 i 16V<br>1.3 JTD<br>1.4 i<br>1.4 i 16V<br>1.2<br>1.2 i<br>1.2 i 16V<br>1.3 JTD<br>1.3 JTD<br>1.3 JTD<br>1.3 JTD<br>1.4 i<br>1.4 i 16V<br>1.4 LPG | 44<br>59<br>51<br>57<br>70<br>51<br>44<br>59<br>51<br>55<br>66<br>77<br>57<br>70<br>57 |  | 06.03 07.06<br>06.03 07.06<br>06.03 07.06<br>02.06 07.06<br>06.03 07.06<br>08.10 06.11<br>08.06 06.11<br>08.06 06.11<br>08.06 06.11<br>10.06 06.11<br>10.06 06.11<br>07.07 06.11<br>08.06 06.11<br>08.06 06.11<br>11.10 06.11 |   | 13.0460-2878.2 602878<br>13.0460-2724.2 602724   |  | 24073 16,7 /S TRW<br>24073 16,7 +WK/S TRW  |
|  | 1.2 i<br>1.2<br>1.2 i 16V<br>1.3 JTD<br>1.3 JTD<br>1.3 JTD<br>1.3 JTD<br>1.4 i<br>1.4 i 16V<br>1.4 LPG  | 44<br>51<br>59<br>51<br>55<br>66<br>77<br>57<br>70<br>57                               |  | 06.03 06.11<br>08.10 06.11<br>06.03 06.11<br>06.03 06.11<br>10.06 06.11<br>10.06 06.11<br>07.07 06.11<br>02.06 06.11<br>06.03 06.11<br>11.10 06.11  |   | 24.0112-0127.1 412127<br>24.0122-0197.1 422197<br>24.0322-0197.1 522197                          |  | 258 12,0 10,2 +B<br>258 22,0 20,2 V +B<br>258 22,0 20,2 V +B PD                          |
|  | 1.2<br>1.2 i<br>1.2 i 16V<br>1.3 JTD<br>1.3 JTD<br>1.3 JTD<br>1.3 JTD<br>1.4 i<br>1.4 i 16V<br>1.4 LPG  | 51<br>44<br>59<br>51<br>55<br>66<br>77<br>57<br>70<br>57                               |  | 08.10 06.11<br>06.03 06.11<br>06.03 06.11<br>06.03 06.11<br>10.06 06.11<br>10.06 06.11<br>07.07 06.11<br>02.06 06.11<br>06.03 06.11<br>11.10 06.11  |   | 03.0137-0439.2 650439<br>03.0137-9274.2 669274   |  | 203 x 39 HEB<br>Bremsbacken-Zubehör BOS  |
|  | 1.2<br>1.2 i<br>1.2 i 16V<br>1.3 JTD<br>1.3 JTD<br>1.3 JTD<br>1.3 JTD<br>1.4 i<br>1.4 i 16V<br>1.4 LPG  | 51<br>44<br>59<br>51<br>55<br>66<br>77<br>57<br>70<br>57                               |  | 08.10 06.11<br>06.03 06.11<br>06.03 06.11<br>06.03 06.11<br>10.06 06.11<br>10.06 06.11<br>07.07 06.11<br>02.06 06.11<br>06.03 06.11<br>11.10 06.11  |   | 24.0220-3007.1 480064  |  | 203/204,7 x 48,5   |
|  | 1.2 i<br>1.4 i<br>1.4 LPG<br>1.2<br>1.2 i 16V<br>1.3 JTD<br>1.3 JTD<br>1.3 JTD<br>1.3 JTD<br>1.4 i 16V  | 44<br>57<br>57<br>51<br>59<br>51<br>55<br>66<br>77<br>70                               |  | 06.03 06.11<br>02.06 06.11<br>11.10 06.11<br>08.10 06.11<br>06.03 06.11<br>06.03 06.11<br>10.06 06.11<br>10.06 06.11<br>07.07 06.11<br>06.03 06.11  |   | 03.0520-7019.3 697019<br>03.0520-9320.3 699320   |  | 19,05/203x39 TopKit<br>20,64/203x39 TopKit   |

















|     |  |  |  |  |  |  |  |  |
|--|--|--|--|--|---|--|--|--|
| <b>LANCIA YPSILON / Chrysler Ypsilon (11-)</b>                                     |  |  |  |  |   |  |  |  |
|    | 0.9<br>0.9 Twinair<br>1.2<br>1.2 Bifuel<br>1.2 Bifuel<br>1.3 D Multijet          | 59<br>63<br>51<br>49<br>51<br>70   | 12.13<br>05.11<br>05.11<br>05.11<br>04.15<br>05.11                               |  | 13.0460-7289.2  | 607289   |  | 25323 17,3 +WK ATE   |
|    | 0.9<br>0.9 Twinair<br>1.3 D Multijet   | 59<br>63<br>70   | 12.13<br>05.11<br>05.11  |  | 24.0122-0197.1<br>24.0322-0197.1  | 422197<br>522197   |  | 258 22,0 20,2 V +B<br>258 22,0 20,2 V +B PD  |
|    | 0.9<br>0.9 Twinair<br>1.2<br>1.2 Bifuel<br>1.2 Bifuel<br>1.3 D Multijet          | 59<br>63<br>51<br>49<br>51<br>70   | 12.13<br>05.11<br>05.11<br>05.11<br>04.15<br>05.11                               |  | 03.0137-0479.2<br>03.0137-9310.2  | 650479<br>669310   |  | 203 x 38 HEB AP<br>Bremsbacken-Zubehör AP  |
| <b>LANCIA ZETA (94-02)</b>   |  |  |  |  |   |  |  |  |
|    | 2.0 i.e. 16V<br>2.0 i.e. Turbo<br>2.0 JTD<br>2.1 TD                              |  | 05.98 09.02<br>06.94 09.02<br>09.99 09.02<br>06.96 09.99                         |  | 13.0460-2978.2  | 602978   |  | 21801 19,0 +WK/S TRW   |
|    | 2.0 i.e. 16V<br>2.0 i.e. Turbo<br>2.0 JTD<br>2.1 TD                              |  | 05.98 09.02<br>06.94 09.02<br>09.99 09.02<br>06.96 09.99                         |  | 24.0126-0104.1  | 426104   |  | 281 26,0 24,2 V +B   |
|    | 2.0 i.e. 16V<br>2.0 i.e. Turbo<br>2.0 JTD<br>2.1 TD                              |  | 05.98 09.02 + ABS<br>06.94 09.02<br>09.99 09.02 + ABS<br>06.96 09.99             |  | 13.0460-7061.2  | 607061   |  | 21275 17,0 +WK ATE   |
|    | 2.0 i.e. 16V<br>2.0 i.e. Turbo<br>2.0 JTD<br>2.1 TD                              |  | 05.98 09.02 + ABS<br>06.94 09.02<br>09.99 09.02 + ABS<br>06.96 09.99             |  | 24.0110-0218.1  | 410218   |  | 295 10,0 8,0 +B  |
|    | 2.0 i.e. 16V<br>2.0 JTD  |  | 05.98 09.02 - ABS<br>09.99 09.02 - ABS   |  | 03.0137-0314.2<br>03.0137-9208.2  | 650314<br>669208   |  | 255 x 61<br>Bremsbacken-Zubehör  |
|  | 2.0 i.e. 16V<br>2.0 JTD  |  | 05.98 09.02 - ABS<br>09.99 09.02 - ABS   |  | 24.0225-5003.1  | 480066   |  | 255/256 x 67   |
|  | 2.0 i.e. 16V<br>2.0 JTD  |  | 05.98 09.02 - ABS<br>09.99 09.02 - ABS   |  | 03.0520-2619.3  | 692619   |  | 19,05/255x61 TopKit BDX  |
|  | 2.0 i.e. 16V<br>2.0 i.e. Turbo<br>2.0 JTD<br>2.1 TD                              |  | 05.98 09.02<br>06.94 09.02<br>09.99 09.02<br>06.96 09.99                         |  | 03.0137-4018.2<br>03.0137-9249.2<br>03.0137-9700.2                                | 654018<br>669249<br>669700   |  | 180 x 30 /Zub<br>Bremsbacken-Zubehör<br>Bremsbacken-Zubehör                        |
| <b>LAND ROVER DEFENDER Cabrio (07-)</b>  |  |  |  |  |   |  |  |  |
|  | 2.2 Td4 4x4<br>2.4 Td4 4x4   | 90<br>90   | 08.11<br>05.07   |  | 13.0460-6925.2  | 606925   |  | 21519 17,8 /Zub AP   |
|  | 2.2 Td4 4x4<br>2.4 Td4 4x4   | 90<br>90   | 08.11<br>05.07   | - belüftete Scheiben <sup>1)</sup><br>- belüftete Scheiben <sup>1)</sup>         | 24.0114-0108.1  | 414108   |  | 299 14,0 13,0 +B   |
|  | 2.2 Td4 4x4<br>2.4 Td4 4x4   | 90<br>90   | 08.11<br>05.07   | + belüftete Scheiben <sup>2)</sup><br>+ belüftete Scheiben <sup>2)</sup>         | 24.0124-0143.1  | 424143   |  | 299 24,0 22,0 V +B   |
|  | 2.2 Td4 4x4<br>2.4 Td4 4x4   | 90<br>90   | 08.11<br>05.07   |  | 13.0460-6924.2  | 606924   |  | 23471 17,5 +/Zub AP  |
|  | 2.2 Td4 4x4<br>2.4 Td4 4x4   | 90<br>90   | 08.11<br>05.07   |  | 24.0114-0115.1  | 414115   |  | 298 14,0 13,0  |
| <b>LAND ROVER DEFENDER Pick-up (07-)</b>   |  |  |  |  |   |  |  |  |
|  | 2.2 Td4 4x4<br>2.4 Td4 4x4   | 90<br>90   | 08.11<br>05.07   |  | 13.0460-6925.2  | 606925   |  | 21519 17,8 /Zub AP   |
|  | 2.2 Td4 4x4<br>2.4 Td4 4x4   | 90<br>90   | 08.11<br>05.07   | - belüftete Scheiben <sup>1)</sup><br>- belüftete Scheiben <sup>1)</sup>         | 24.0114-0108.1  | 414108   |  | 299 14,0 13,0 +B   |
|  | 2.2 Td4 4x4<br>2.4 Td4 4x4   | 90<br>90   | 08.11<br>05.07   | + belüftete Scheiben <sup>2)</sup><br>+ belüftete Scheiben <sup>2)</sup>         | 24.0124-0143.1  | 424143   |  | 299 24,0 22,0 V +B   |
|  | 2.2 Td4 4x4<br>2.4 Td4 4x4   | 90<br>90   | 08.11<br>05.07   |  | 13.0460-6924.2  | 606924   |  | 23471 17,5 +/Zub AP  |
|  | 2.2 Td4 4x4<br>2.4 Td4 4x4   | 90<br>90   | 08.11<br>05.07   |  | 24.0114-0115.1  | 414115   |  | 298 14,0 13,0  |





<sup>1)</sup> - ventilated discs / - dischi ventilati / - disques ventilés / - disco ventilado  
<sup>2)</sup> + ventilated discs / + dischi ventilati / + disques ventilés / + disco ventilado



| LAND ROVER DEFENDER Pritsche/Fahrgestell (11-) |             |     |          |       |       |                                    |                |        |  |                                    |                    |
|--|-------------|-----|----------|-------|-------|------------------------------------|----------------|--------|--|------------------------------------|--------------------|
|  | 2.2 Td4 4x4 | 90  |          | 08.11 |       |                                    | 13.0460-6925.2 | 606925 |  | 21519 17,8 /Zub                    | AP                 |
|  | 2.2 Td4 4x4 | 90  |          | 08.11 |       | - belüftete Scheiben <sup>1)</sup> | 24.0114-0108.1 | 414108 |  | 299 14,0 13,0 +B                   |                    |
|  | 2.2 Td4 4x4 | 90  |          | 08.11 |       | + belüftete Scheiben <sup>2)</sup> | 24.0124-0143.1 | 424143 |  | 299 24,0 22,0 V +B                 |                    |
|  | 2.2 Td4 4x4 | 90  |          | 08.11 |       |                                    | 13.0460-6924.2 | 606924 |  | 23471 17,5 +/Zub                   | AP                 |
|  | 2.2 Td4 4x4 | 90  |          | 08.11 |       |                                    | 24.0114-0115.1 | 414115 |  | 298 14,0 13,0                      |                    |
| LAND ROVER DEFENDER Station Wagon (07-)        |             |     |          |       |       |                                    |                |        |  |                                    |                    |
|  | 2.2 Td4 4x4 | 90  |          | 08.11 |       |                                    | 13.0460-6925.2 | 606925 |  | 21519 17,8 /Zub                    | AP                 |
|  | 2.2 Td4 4x4 | 110 |          | 02.15 |       |                                    |                |        |  |                                    |                    |
|  | 2.4 Td4 4x4 | 90  |          | 05.07 |       |                                    |                |        |  |                                    |                    |
|  | 2.2 Td4 4x4 | 90  |          | 08.11 |       | - belüftete Scheiben <sup>1)</sup> | 24.0114-0108.1 | 414108 |  | 299 14,0 13,0 +B                   |                    |
|  | 2.2 Td4 4x4 | 110 |          | 02.15 |       | - belüftete Scheiben <sup>1)</sup> |                |        |  |                                    |                    |
|  | 2.4 Td4 4x4 | 90  |          | 05.07 |       | - belüftete Scheiben <sup>1)</sup> |                |        |  |                                    |                    |
|  | 2.2 Td4 4x4 | 90  |          | 08.11 |       | + belüftete Scheiben <sup>2)</sup> | 24.0124-0143.1 | 424143 |  | 299 24,0 22,0 V +B                 |                    |
|  | 2.2 Td4 4x4 | 110 |          | 02.15 |       | + belüftete Scheiben <sup>2)</sup> |                |        |  |                                    |                    |
|  | 2.4 Td4 4x4 | 90  |          | 05.07 |       | + belüftete Scheiben <sup>2)</sup> |                |        |  |                                    |                    |
|  | 2.2 Td4 4x4 | 90  |          | 08.11 |       |                                    | 13.0460-6924.2 | 606924 |  | 23471 17,5 +/Zub                   | AP                 |
|  | 2.4 Td4 4x4 | 90  |          | 05.07 |       |                                    | 13.0460-6917.2 | 606917 |  | 21237 15,5 +/WK/Zub                | AP                 |
|  | 2.2 Td4 4x4 | 110 |          | 02.15 |       |                                    | 13.0460-6924.2 | 606924 |  | 23471 17,5 +/Zub                   | AP                 |
|  | 2.2 Td4 4x4 | 90  |          | 08.11 |       |                                    | 24.0114-0115.1 | 414115 |  | 298 14,0 13,0                      |                    |
|  | 2.4 Td4 4x4 | 90  |          | 05.07 |       |                                    | 24.0113-0189.1 | 413189 |  | 290 12,5 11,7 +B                   |                    |
|  | 2.2 Td4 4x4 | 110 |          | 02.15 |       |                                    | 24.0114-0115.1 | 414115 |  | 298 14,0 13,0                      |                    |
| LAND ROVER DISCOVERY I (89-98)                 |             |     |          |       |       |                                    |                |        |  |                                    |                    |
|  | 2.0 16V 4x4 | 99  | KA034313 | 09.93 |       |                                    | 13.0460-6926.2 | 606926 |  | 21160 19,2 +/WK/Zub                | AP                 |
|  | 2.5 D 4x4   | 90  | KA034313 | 07.94 |       |                                    |                |        |  |                                    |                    |
|  | 2.5 TDI 4x4 | 83  | KA034313 | 09.89 |       |                                    |                |        |  |                                    |                    |
|  | 3.5 V8 4x4  | 113 | KA034313 | 09.89 |       |                                    |                |        |  |                                    |                    |
|  | 3.9 V8 4x4  | 134 | KA034313 | 09.93 |       |                                    |                |        |  |                                    |                    |
|  | 3.9 V8 4x4  | 136 | KA034313 | 07.94 |       |                                    |                |        |  |                                    |                    |
|  | 2.0 16V 4x4 | 99  | MA081992 | 10.98 |       |                                    | 13.0460-6916.2 | 606916 |  | 21459 18,5 +/WK                    | AP                 |
|  | 2.5 D 4x4   | 90  | MA081992 | 10.98 |       |                                    | 13.0460-6922.2 | 606922 |  | 21459 17,5 /Zub                    | AP                 |
|  | 2.5 TDI 4x4 | 83  | MA081992 | 10.98 |       |                                    | 13.0460-0154.2 | 610154 |  | Belagsatz-Zubehör                  | AP                 |
|  | 3.5 V8 4x4  | 113 | MA081992 | 06.94 |       |                                    |                |        |  |                                    |                    |
|  | 3.9 V8 4x4  | 134 | MA081992 | 10.98 |       |                                    |                |        |  |                                    |                    |
|  | 3.9 V8 4x4  | 136 | MA081992 | 10.98 |       |                                    |                |        |  |                                    |                    |
|  | 2.0 16V 4x4 | 99  |          | 09.93 | 10.98 |                                    | 24.0114-0108.1 | 414108 |  | - belüftete Scheiben <sup>1)</sup> | 299 14,0 13,0 +B   |
|  | 2.5 D 4x4   | 90  |          | 07.94 | 10.98 |                                    | 24.0124-0143.1 | 424143 |  | + belüftete Scheiben <sup>2)</sup> | 299 24,0 22,0 V +B |
|  | 2.5 TDI 4x4 | 83  |          | 09.89 | 10.98 |                                    |                |        |  |                                    |                    |
|  | 3.5 V8 4x4  | 113 |          | 09.89 | 06.94 |                                    |                |        |  |                                    |                    |
|  | 3.9 V8 4x4  | 134 |          | 09.93 | 10.98 |                                    |                |        |  |                                    |                    |
|  | 3.9 V8 4x4  | 136 |          | 07.94 | 10.98 |                                    |                |        |  |                                    |                    |
|  | 2.0 16V 4x4 | 99  |          | 09.93 | 10.98 |                                    | 13.0460-6917.2 | 606917 |  | 21237 15,5 +/WK/Zub                | AP                 |
|  | 2.5 D 4x4   | 90  |          | 07.94 | 10.98 |                                    | 13.0460-0414.2 | 610414 |  | Belagsatz-Zubehör                  | AP                 |
|  | 2.5 TDI 4x4 | 83  |          | 09.89 | 10.98 |                                    |                |        |  |                                    |                    |
|  | 3.5 V8 4x4  | 113 |          | 09.89 | 06.94 |                                    |                |        |  |                                    |                    |
|  | 3.9 V8 4x4  | 134 |          | 09.93 | 10.98 |                                    |                |        |  |                                    |                    |
|  | 3.9 V8 4x4  | 136 |          | 07.94 | 10.98 |                                    |                |        |  |                                    |                    |
|  | 2.0 16V 4x4 | 99  |          | 09.93 | 10.98 |                                    | 24.0113-0189.1 | 413189 |  | 290 12,5 11,7 +B                   |                    |
|  | 2.5 D 4x4   | 90  |          | 07.94 | 10.98 |                                    |                |        |  |                                    |                    |
|  | 2.5 TDI 4x4 | 83  |          | 09.89 | 10.98 |                                    |                |        |  |                                    |                    |
|  | 3.5 V8 4x4  | 113 |          | 09.89 | 06.94 |                                    |                |        |  |                                    |                    |
|  | 3.9 V8 4x4  | 134 |          | 09.93 | 10.98 |                                    |                |        |  |                                    |                    |
|  | 3.9 V8 4x4  | 136 |          | 07.94 | 10.98 |                                    |                |        |  |                                    |                    |
| LAND ROVER DISCOVERY II (94-04)                |             |     |          |       |       |                                    |                |        |  |                                    |                    |
|  | 2.0 16V 4x4 | 99  |          | 01.94 | 11.98 |                                    | 13.0460-6916.2 | 606916 |  | 21459 18,5 +/WK                    | AP                 |
|  | 2.5 Td5 4x4 | 102 |          | 01.99 | 06.04 |                                    | 13.0460-6922.2 | 606922 |  | 21459 17,5 /Zub                    | AP                 |
|  | 4.0 V8 4x4  | 136 |          | 11.98 | 06.04 |                                    | 13.0460-0154.2 | 610154 |  | Belagsatz-Zubehör                  | AP                 |
|  | 2.0 16V 4x4 | 99  |          | 01.94 | 04.95 |                                    | 24.0124-0143.1 | 424143 |  | 299 24,0 22,0 V +B                 |                    |
|  | 2.0 16V 4x4 | 99  |          | 05.95 | 11.98 |                                    | 24.0114-0108.1 | 414108 |  | 299 14,0 13,0 +B                   |                    |
|  | 2.5 Td5 4x4 | 102 |          | 01.99 | 06.04 |                                    | 24.0125-0176.1 | 425176 |  | 298 25,0 22,0 V +B                 |                    |
|  | 4.0 V8 4x4  | 136 |          | 11.98 | 06.04 |                                    |                |        |  |                                    |                    |
|  | 2.0 16V 4x4 | 99  |          | 01.94 | 11.98 |                                    | 13.0460-6917.2 | 606917 |  | 21237 15,5 +/WK/Zub                | AP                 |
|  | 2.5 Td5 4x4 | 102 |          | 01.99 | 06.04 |                                    | 13.0460-0414.2 | 610414 |  | Belagsatz-Zubehör                  | AP                 |
|  | 4.0 V8 4x4  | 136 |          | 11.98 | 06.04 |                                    | 13.0460-2721.2 | 602721 |  | 23458 15,6 /Zub/S                  | TRW                |
|  | 2.0 16V 4x4 | 99  |          | 01.94 | 11.98 |                                    |                |        |  |                                    |                    |
|  | 2.0 16V 4x4 | 99  |          | 01.94 | 11.98 |                                    | 24.0113-0189.1 | 413189 |  | 290 12,5 11,7 +B                   |                    |
|  | 2.5 Td5 4x4 | 102 |          | 01.99 | 06.04 |                                    | 24.0113-0197.1 | 413197 |  | 305 12,6 11,7 +B                   |                    |
|  | 4.0 V8 4x4  | 136 |          | 11.98 | 06.04 |                                    |                |        |  |                                    |                    |

<sup>1)</sup> - ventilated discs / - dischi ventilati / - disques ventilés / - disco ventilado  
<sup>2)</sup> + ventilated discs / + dischi ventilati / + disques ventilés / + disco ventilado

|     |  |  |  |  |  |  |  |  |   |  |
|--|--|--|--|--|---|--|--|--|---|--|
| <b>LAND ROVER DISCOVERY III (04-09)</b>  |  |  |  |  |   |  |  |  |   |  |
|    | 2.7 TD 4x4   | 140  |  | 07.04  | 07.06   | - gepanzerte Fahrzeuge <sup>1)</sup>   | 13.0460-2728.2   | 602728   | 1 | 24191 18,1 +/WE/Zub/STRW<br>Warnkontakt L=1147mm |
|  | 4.0 4x4  | 160  |  | 02.05  | 07.06   | - gepanzerte Fahrzeuge <sup>1)</sup>   | 24.8190-1305.2   | 621305   |   |  |
|  | 4.0 4x4  | 161  |  | 02.05  | 07.06   | - gepanzerte Fahrzeuge <sup>1)</sup>   |  |  |   |  |
|  | 4.0 V6 4x4   | 156  |  | 10.04  | 07.06   | - gepanzerte Fahrzeuge <sup>1)</sup>   |  |  |   |  |
|  | 4.0 V6 4x4   | 160  |  | 10.04  | 07.06   | - gepanzerte Fahrzeuge <sup>1)</sup>   |  |  |   |  |
|  | 4.4 4x4  | 220  |  | 07.04  | 07.06   | - gepanzerte Fahrzeuge <sup>1)</sup>   |  |  |   |  |
|    | 2.7 TD 4x4   | 140  |  | 08.06  | 08.09   | - gepanzerte Fahrzeuge <sup>1)</sup>   | 13.0460-2728.2   | 602728   | 1 | 24191 18,1 +/WE/Zub/STRW<br>Warnkontakt L=1175mm |
|  | 4.0 4x4  | 160  |  | 08.06  | 08.09   | - gepanzerte Fahrzeuge <sup>1)</sup>   | 24.8190-0946.2   | 620946   |   |  |
|  | 4.0 4x4  | 161  |  | 08.06  | 08.09   | - gepanzerte Fahrzeuge <sup>1)</sup>   |  |  |   |  |
|  | 4.0 V6 4x4   | 156  |  | 08.06  | 08.09   | - gepanzerte Fahrzeuge <sup>1)</sup>   |  |  |   |  |
|  | 4.0 V6 4x4   | 160  |  | 08.06  | 08.09   | - gepanzerte Fahrzeuge <sup>1)</sup>   |  |  |   |  |
|  | 4.4 4x4  | 220  |  | 08.06  | 08.09   | - gepanzerte Fahrzeuge <sup>1)</sup>   |  |  |   |  |
|    | 2.7 TD 4x4   | 140  |  | 07.04  | 08.09   | - gepanzerte Fahrzeuge <sup>1)</sup>   | 24.0130-0178.1   | 430178   |   | 317 30,0 27,0 V +B                               |
|  | 4.0 4x4  | 160  |  | 02.05  | 08.09   | - gepanzerte Fahrzeuge <sup>1)</sup>   |  |  |   |  |
|  | 4.0 4x4  | 161  |  | 02.05  | 08.09   | - gepanzerte Fahrzeuge <sup>1)</sup>   |  |  |   |  |
|  | 4.0 V6 4x4   | 156  |  | 10.04  | 08.09   | - gepanzerte Fahrzeuge <sup>1)</sup>   |  |  |   |  |
|  | 4.0 V6 4x4   | 160  |  | 10.04  | 08.09   | - gepanzerte Fahrzeuge <sup>1)</sup>   |  |  |   |  |
|  | 4.4 4x4  | 220  |  | 07.04  | 08.09   | - gepanzerte Fahrzeuge <sup>1)</sup>   | 24.0130-0188.1   | 430188   |   |  |
|    | 2.7 TD 4x4   | 140  |  | 07.04  | 08.09   | - gepanzerte Fahrzeuge <sup>1)</sup>   | 13.0460-2719.2   | 602719   | 1 | 24192 17,4 +/WE/Zub/STRW<br>Warnkontakt L=1156mm |
|  | 4.0 4x4  | 160  |  | 02.05  | 08.09   | - gepanzerte Fahrzeuge <sup>1)</sup>   | 24.8190-1306.2   | 621306   |   |  |
|  | 4.0 4x4  | 161  |  | 02.05  | 08.09   | - gepanzerte Fahrzeuge <sup>1)</sup>   |  |  |   |  |
|  | 4.0 V6 4x4   | 156  |  | 10.04  | 08.09   | - gepanzerte Fahrzeuge <sup>1)</sup>   |  |  |   |  |
|  | 4.0 V6 4x4   | 160  |  | 10.04  | 08.09   | - gepanzerte Fahrzeuge <sup>1)</sup>   |  |  |   |  |
|  | 4.4 4x4  | 220  |  | 07.04  | 08.09   | - gepanzerte Fahrzeuge <sup>1)</sup>   |  |  |   |  |
|  | 2.7 TD 4x4   | 140  |  | 07.04  | 08.09   | - gepanzerte Fahrzeuge <sup>1)</sup>   | 24.0120-0210.1   | 420210   |   | 325 20,0 17,0 V +B                               |
|  | 4.0 4x4  | 160  |  | 02.05  | 08.09   | - gepanzerte Fahrzeuge <sup>1)</sup>   |  |  |   |  |
|  | 4.0 4x4  | 161  |  | 02.05  | 08.09   | - gepanzerte Fahrzeuge <sup>1)</sup>   |  |  |   |  |
|  | 4.0 V6 4x4   | 156  |  | 10.04  | 08.09   | - gepanzerte Fahrzeuge <sup>1)</sup>   |  |  |   |  |
|  | 4.0 V6 4x4   | 160  |  | 10.04  | 08.09   | - gepanzerte Fahrzeuge <sup>1)</sup>   |  |  |   |  |
|  | 4.4 4x4  | 220  |  | 07.04  | 08.09   | - gepanzerte Fahrzeuge <sup>1)</sup>   |  |  |   |  |
|  | 2.7 TD 4x4   | 140  |  | 07.04  | 08.09   | - gepanzerte Fahrzeuge <sup>1)</sup>   | 03.0137-3040.2   | 653040   |   | 210 x 30 HEB                                     |
|  | 4.0 4x4  | 160  |  | 02.05  | 08.09   | - gepanzerte Fahrzeuge <sup>1)</sup>   |  |  |   |  |
|  | 4.0 4x4  | 161  |  | 02.05  | 08.09   | - gepanzerte Fahrzeuge <sup>1)</sup>   |  |  |   |  |
|  | 4.0 V6 4x4   | 156  |  | 10.04  | 08.09   | - gepanzerte Fahrzeuge <sup>1)</sup>   |  |  |   |  |
|  | 4.0 V6 4x4   | 160  |  | 10.04  | 08.09   | - gepanzerte Fahrzeuge <sup>1)</sup>   |  |  |   |  |
|  | 4.4 4x4  | 220  |  | 07.04  | 08.09   | - gepanzerte Fahrzeuge <sup>1)</sup>   |  |  |   |  |





















|  |              |     |          |       |  |                                      |                |        |   |                          |
|--|--------------|-----|----------|-------|--|--------------------------------------|----------------|--------|---|--------------------------|
| <b>LAND ROVER DISCOVERY IV (09-)</b>   |              |     |          |       |  |                                      |                |        |   |                          |
|   | 2.7 TD 4x4   | 140 |          | 09.09 |  |                                      | 13.0460-2728.2 | 602728 | 1 | 24191 18,1 +/WE/Zub/STRW |
|  | 3.0 4x4      | 250 |          | 08.13 |  |                                      | 13.0460-2762.2 | 602762 |   |                          |
|  | 3.0 SDV6 4x4 | 188 |          | 11.09 |  |                                      |                |        |   |                          |
|  | 3.0 TD 4x4   | 155 |          | 05.10 |  |                                      |                |        |   |                          |
|  | 3.0 TD 4x4   | 180 |          | 09.09 |  |                                      |                |        |   |                          |
|  | 3.0 TD 4x4   | 183 |          | 07.12 |  |                                      |                |        |   |                          |
|  | 3.0 TD 4x4   | 200 |          | 09.09 |  |                                      |                |        |   |                          |
|  | 4.0 4x4      | 160 |          | 09.09 |  |                                      |                |        |   |                          |
|  | 5.0 V8 4x4   | 276 |          | 09.09 |  |                                      |                |        |   |                          |
|  | 2.7 TD 4x4   | 140 |          | 09.09 |  |                                      | 24.0130-0178.1 | 430178 |   | 317 30,0 27,0 V +B       |
|  | 3.0 4x4      | 250 | AA222221 | 08.13 |  |                                      | 24.0130-0195.1 | 430195 |   |                          |
|  | 3.0 SDV6 4x4 | 188 | AA222221 | 11.09 |  |                                      |                |        |   |                          |
|  | 3.0 TD 4x4   | 155 | AA222221 | 05.10 |  |                                      |                |        |   |                          |
|  | 3.0 TD 4x4   | 180 | AA222221 | 09.09 |  |                                      |                |        |   |                          |
|  | 3.0 TD 4x4   | 183 | AA222221 | 07.12 |  |                                      |                |        |   |                          |
|  | 3.0 TD 4x4   | 200 | AA222221 | 09.09 |  |                                      |                |        |   |                          |
|  | 4.0 4x4      | 160 | AA222221 | 09.09 |  |                                      |                |        |   |                          |
|  | 5.0 V8 4x4   | 276 | AA222221 | 09.09 |  |                                      |                |        |   |                          |
|  | 2.7 TD 4x4   | 140 |          | 09.09 |  |                                      | 24.8190-1306.2 | 621306 | 1 | Warnkontakt L=1156mm     |
|  | 3.0 4x4      | 250 | AA546302 | 08.13 |  | - gepanzerte Fahrzeuge <sup>1)</sup> | 13.0460-2731.2 | 602731 |   |                          |
|  | 3.0 SDV6 4x4 | 188 | AA546302 | 11.09 |  | - gepanzerte Fahrzeuge <sup>1)</sup> |                |        |   |                          |
|  | 3.0 TD 4x4   | 155 | AA546302 | 05.10 |  | - gepanzerte Fahrzeuge <sup>1)</sup> |                |        |   |                          |
|  | 3.0 TD 4x4   | 180 | AA546302 | 09.09 |  | - gepanzerte Fahrzeuge <sup>1)</sup> |                |        |   |                          |
|  | 3.0 TD 4x4   | 183 | AA546302 | 07.12 |  | - gepanzerte Fahrzeuge <sup>1)</sup> |                |        |   |                          |
|  | 3.0 TD 4x4   | 200 | AA546302 | 09.09 |  | - gepanzerte Fahrzeuge <sup>1)</sup> |                |        |   |                          |
|  | 4.0 4x4      | 160 | AA546302 | 09.09 |  | - gepanzerte Fahrzeuge <sup>1)</sup> |                |        |   |                          |
|  | 5.0 V8 4x4   | 276 | AA546302 | 09.09 |  | - gepanzerte Fahrzeuge <sup>1)</sup> |                |        |   |                          |
|  | 2.7 TD 4x4   | 140 |          | 09.09 |  |                                      | 24.0120-0210.1 | 420210 |   | 325 20,0 17,0 V +B       |
|  | 3.0 4x4      | 250 |          | 08.13 |  | - gepanzerte Fahrzeuge <sup>1)</sup> | 24.0120-0201.1 | 420201 |   |                          |
|  | 3.0 SDV6 4x4 | 188 |          | 11.09 |  | - gepanzerte Fahrzeuge <sup>1)</sup> |                |        |   |                          |
|  | 3.0 TD 4x4   | 155 |          | 05.10 |  | - gepanzerte Fahrzeuge <sup>1)</sup> |                |        |   |                          |
|  | 3.0 TD 4x4   | 180 |          | 09.09 |  | - gepanzerte Fahrzeuge <sup>1)</sup> |                |        |   |                          |
|  | 3.0 TD 4x4   | 183 |          | 07.12 |  | - gepanzerte Fahrzeuge <sup>1)</sup> |                |        |   |                          |
|  | 3.0 TD 4x4   | 200 |          | 09.09 |  | - gepanzerte Fahrzeuge <sup>1)</sup> |                |        |   |                          |
|  | 4.0 4x4      | 160 |          | 09.09 |  | - gepanzerte Fahrzeuge <sup>1)</sup> |                |        |   |                          |
|  | 5.0 V8 4x4   | 276 |          | 09.09 |  | - gepanzerte Fahrzeuge <sup>1)</sup> |                |        |   |                          |
|  | 2.7 TD 4x4   | 140 |          | 09.09 |  |                                      | 03.0137-3040.2 | 653040 |   | 210 x 30 HEB             |
|  | 3.0 4x4      | 250 |          | 08.13 |  |                                      |                |        |   |                          |
|  | 3.0 SDV6 4x4 | 188 |          | 11.09 |  |                                      |                |        |   |                          |
|  | 3.0 TD 4x4   | 155 |          | 05.10 |  |                                      |                |        |   |                          |
|  | 3.0 TD 4x4   | 180 |          | 09.09 |  |                                      |                |        |   |                          |
|  | 3.0 TD 4x4   | 183 |          | 07.12 |  |                                      |                |        |   |                          |
|  | 3.0 TD 4x4   | 200 |          | 09.09 |  |                                      |                |        |   |                          |
|  | 4.0 4x4      | 160 |          | 09.09 |  |                                      |                |        |   |                          |
|  | 5.0 V8 4x4   | 276 |          | 09.09 |  |                                      |                |        |   |                          |

<sup>1)</sup> - armoured vehicles / - veicoli blindati / - véhicule blindé / - vehículo blindado





























| LAND ROVER DISCOVERY SPORT (14-)   |  |  |  |  |       |                                  |                  |   |   |                 |
|------------------------------------|--|--|--|--|-------|----------------------------------|------------------|---|---|-----------------|
|                                    | 2.0 D 2WD<br>2.0 D 4WD   | 110<br>132   |  | 09.14<br>06.15   |       | 13.0460-7228.2<br>13.0470-7228.2 | 607228<br>LD7228 |   | 24123 20,3 +<br>24123 20,3 +                          | ATE<br>ATE      |
|                                    | 2.0 D 2WD  | 110  |  | 09.14  |       | 24.0128-0154.1<br>24.0328-0154.1 | 428154<br>528154 |   | 300 28,0 26,0 V L +S +B<br>300 28,0 26,0 V L +S +B PD |                 |
|                                    | 2.0 4WD<br>2.0 D 2WD<br>2.0 D 4WD<br>2.2 D 4WD<br>2.2 D 4WD  | 177<br>110<br>132<br>110<br>140                      | FH999999<br>FH999999                                     | 09.14<br>09.14<br>06.15<br>09.14<br>09.14                            |       | 24.0711-5363.3                   | 360377           | 2 |   | Radsensor L=815 |
| LAND ROVER FREELANDER (LN) (98-06) |  |  |  |  |       |                                  |                  |   |   |                 |
|                                    | 1.8 16V 4x4<br>1.8 16V 4x4<br>2.0 DI 4x4<br>2.0 Td4 4x4<br>2.0 Td4 4x4<br>2.5 V6 4x4                     | 86<br>88<br>72<br>80<br>82<br>130                    | YA999999<br>YA999999<br>YA999999<br>YA999999<br>YA999999 | 11.00<br>02.98<br>02.98<br>11.01<br>11.00<br>11.00                   | 11.00 | 13.0460-5830.2                   | 605830           |   | 23158 17,5 /Zub/S                                     | TRW             |
|                                    | 1.8 16V 4x4<br>2.0 Td4 4x4<br>2.0 Td4 4x4<br>2.5 V6 4x4  | 86<br>80<br>82<br>130                                | 1A000001<br>1A000001<br>1A000001<br>1A000001             | 10.06<br>10.06<br>10.06<br>10.06                                     |       | 13.0460-2718.2                   | 602718           |   | 23615 18,3 /S   | TRW             |
|                                    | 1.8 16V 4x4<br>1.8 16V 4x4<br>2.0 DI 4x4<br>2.0 Td4 4x4<br>2.0 Td4 4x4<br>2.5 V6 4x4                     | 86<br>88<br>72<br>80<br>82<br>130                    | YA999999<br>YA999999<br>YA999999<br>YA999999<br>YA999999 | 11.00<br>02.98<br>02.98<br>11.01<br>11.00<br>11.00                   | 11.00 | 24.0114-0113.1                   | 414113           |   | 262 14,0 11,0 +B                                      |                 |
|                                    | 1.8 16V 4x4<br>2.0 Td4 4x4<br>2.0 Td4 4x4<br>2.5 V6 4x4  | 86<br>80<br>82<br>130                                | 1A000001<br>1A000001<br>1A000001<br>1A000001             | 10.06<br>10.06<br>10.06<br>10.06                                     |       | 24.0121-0114.1                   | 421114           |   | 277 21,0 18,0 V +B                                    |                 |
|                                    | 1.8 16V 4x4<br>1.8 16V 4x4<br>2.0 DI 4x4<br>2.0 Td4 4x4<br>2.0 Td4 4x4<br>2.5 V6 4x4                     | 86<br>88<br>72<br>80<br>82<br>130                    | YA999999<br>YA999999<br>YA999999<br>YA999999<br>YA999999 | 11.00<br>02.98<br>02.98<br>11.01<br>11.00<br>11.00                   | 11.00 | 03.0137-0440.2<br>03.0137-9282.2 | 650440<br>669282 |   | 254 x 39 HEB<br>Bremsbacken-Zubehör                   |                 |
|                                    | 1.8 16V 4x4<br>2.0 Td4 4x4<br>2.0 Td4 4x4<br>2.5 V6 4x4  | 86<br>80<br>82<br>130                                | 1A000001<br>1A000001<br>1A000001<br>1A000001             | 10.06<br>10.06<br>10.06<br>10.06                                     |       | 03.0137-0480.2<br>03.0137-9282.2 | 650480<br>669282 |   | 254 x 45 HEB<br>Bremsbacken-Zubehör                   |                 |
|                                    | 1.8 16V 4x4<br>1.8 16V 4x4<br>2.0 DI 4x4<br>2.0 Td4 4x4<br>2.0 Td4 4x4<br>2.5 V6 4x4                     | 86<br>88<br>72<br>80<br>82<br>130                    | YA999999<br>YA999999<br>YA999999<br>YA999999<br>YA999999 | 11.00<br>02.98<br>02.98<br>11.01<br>11.00<br>11.00                   | 11.00 | 24.0225-4017.1                   | 480182           |   | 254/255,5 x 47  |                 |
|                                    | 1.8 16V 4x4<br>2.0 Td4 4x4<br>2.0 Td4 4x4<br>2.5 V6 4x4  | 86<br>80<br>82<br>130                                | 1A000001<br>1A000001<br>1A000001<br>1A000001             | 10.06<br>10.06<br>10.06<br>10.06                                     |       | 24.0225-4020.1                   | 480310           |   | 254/255,5 x 57,3                                      |                 |
| LAND ROVER FREELANDER 2 (FA) (06-) |  |  |  |  |       |                                  |                  |   |   |                 |
|                                    | 2.0 4x4<br>2.2 SD4 4x4<br>2.2 TD4<br>2.2 TD4 4x4<br>2.2 TD4 4x4<br>2.2 TD4 4x4<br>2.2 TD4 4x4<br>3.2 4x4 | 177<br>140<br>110<br>110<br>112<br>115<br>118<br>171 |  | 10.11<br>08.10<br>08.10<br>10.06<br>01.07<br>10.06<br>10.06<br>10.06 |       | 13.0460-7228.2<br>13.0470-7228.2 | 607228<br>LD7228 |   | 24123 20,3 +<br>24123 20,3 +                          | ATE<br>ATE      |
|                                    | 2.2 SD4 4x4<br>2.2 TD4<br>2.2 TD4 4x4<br>2.2 TD4 4x4<br>2.2 TD4 4x4<br>2.2 TD4 4x4<br>3.2 4x4            | 140<br>110<br>110<br>112<br>115<br>118<br>171        |  | 08.10<br>08.10<br>10.06<br>01.07<br>10.06<br>10.06                   |       | 24.0128-0154.1<br>24.0328-0154.1 | 428154<br>528154 |   | 300 28,0 26,0 V L +S +B<br>300 28,0 26,0 V L +S +B PD |                 |
|                                    | 2.0 4x4<br>2.2 SD4 4x4<br>2.2 TD4<br>2.2 TD4 4x4<br>2.2 TD4 4x4<br>2.2 TD4 4x4<br>2.2 TD4 4x4<br>3.2 4x4 | 177<br>140<br>110<br>110<br>112<br>115<br>118<br>171 |  | 10.11<br>08.10<br>08.10<br>10.06<br>01.07<br>10.06<br>10.06          |       | 24.0711-5205.3                   | 360359           | 2 |   | Radsensor L=880 |
|                                    | 2.2 SD4 4x4<br>2.2 TD4<br>2.2 TD4 4x4<br>2.2 TD4 4x4<br>2.2 TD4 4x4<br>2.2 TD4 4x4                       | 140<br>110<br>110<br>112<br>115<br>118               |  | 08.10<br>08.10<br>10.06<br>01.07<br>10.06<br>10.06                   |       | 13.0460-2737.2                   | 602737           |   | 24537 15,8 /Zub/S                                     | TRW             |

|     |                          |  |  |        |   |  |  |                     |
|--|--|--|--|--|--|--|--|---|
| <b>LAND ROVER FREELANDER 2 (FA) (06-)</b>  |  |  |  |  |  |  |  |   |
|    | 2.2 SD4 4x4<br>2.2 TD4<br>2.2 TD4 4x4<br>2.2 TD4 4x4<br>2.2 TD4 4x4<br>2.2 TD4 4x4                       | 140<br>110<br>110<br>112<br>115<br>118   |  | 08.10<br>08.10<br>10.06<br>01.07<br>10.06<br>10.06                                     |  | 24.0112-0186.1   | 412186   | 302 12,0 10,0 +B  |
|  | 2.0 4x4<br>3.2 4x4   | 177<br>171   | CH999999   | 10.11<br>10.06   |  | 24.0120-0218.1   | 420218   | 302 20,0 18,0 V +B  |
|    | 2.0 4x4<br>2.2 SD4 4x4<br>2.2 TD4<br>2.2 TD4 4x4<br>2.2 TD4 4x4<br>2.2 TD4 4x4<br>2.2 TD4 4x4<br>3.2 4x4 | 177<br>140<br>110<br>110<br>112<br>115<br>118<br>171                             | CH999999   | 10.11<br>08.10<br>08.10<br>10.06<br>01.07<br>10.06<br>10.06<br>10.06                   |  | 24.0711-5228.3   | 360360   | 2  Radsensor L=775 |
|  | 2.0 4x4  | 177  | DH000001   |  |  | 24.0711-5438.3   | 360384   | 2  Radsensor L=795 |
|    | 2.0 4x4<br>2.2 SD4 4x4<br>2.2 TD4<br>2.2 TD4 4x4<br>2.2 TD4 4x4<br>2.2 TD4 4x4<br>2.2 TD4 4x4<br>3.2 4x4 | 177<br>140<br>110<br>110<br>112<br>115<br>118<br>171                             |  | 10.11<br>08.10<br>08.10<br>10.06<br>01.07<br>10.06<br>10.06<br>10.06                   |  | 03.0137-3017.2   | 653017   | 185 x 30  |
| <b>LAND ROVER RANGE ROVER II (LP) (94-02)</b>                                      |  |  |  |  |  |  |  |   |
|    | 2.5 D 4x4<br>2.5 TD 4x4<br>3.9 4x4<br>4.0 4x4<br>4.6 4x4<br>4.6 4x4                                      | 83<br>100<br>140<br>136<br>160<br>165  |  | 07.94 03.02<br>07.94 03.02<br>07.94 03.02<br>06.98 03.02<br>06.98 03.02<br>07.94 03.02 |  | 13.0460-2720.2   | 602720   | 23452 19,0 /S TRW   |
|    | 2.5 D 4x4<br>2.5 TD 4x4<br>3.9 4x4<br>4.0 4x4<br>4.6 4x4<br>4.6 4x4                                      | 83<br>100<br>140<br>136<br>160<br>165  |  | 07.94 03.02<br>07.94 03.02<br>07.94 03.02<br>06.98 03.02<br>06.98 03.02<br>07.94 03.02 |  | 24.0125-0164.1   | 425164   | 297 25,0 22,0 V +B  |
|   | 2.5 D 4x4<br>2.5 TD 4x4<br>3.9 4x4<br>4.0 4x4<br>4.6 4x4<br>4.6 4x4                                      | 83<br>100<br>140<br>136<br>160<br>165  |  | 07.94 03.02<br>07.94 03.02<br>07.94 03.02<br>06.98 03.02<br>06.98 03.02<br>07.94 03.02 |  | 13.0460-2721.2   | 602721   | 23458 15,6 /Zub/S TRW   |
|  | 2.5 D 4x4<br>2.5 TD 4x4<br>3.9 4x4<br>4.0 4x4<br>4.6 4x4<br>4.6 4x4                                      | 83<br>100<br>140<br>136<br>160<br>165  |  | 07.94 03.02<br>07.94 03.02<br>07.94 03.02<br>06.98 03.02<br>06.98 03.02<br>07.94 03.02 |  | 24.0113-0197.1   | 413197   | 305 12,6 11,7 +B  |
| <b>LAND ROVER RANGE ROVER III (LM) (02-12)</b>                                     |  |  |  |  |  |  |  |   |
|  | 3.0 TD 6 4x4<br>3.6 TD 8 4x4<br>4.2 4x4<br>4.4 4x4<br>4.4 4x4<br>4.4 4x4                                 | 130<br>200<br>291<br>210<br>220<br>225   | 5A999999<br>5A999999<br>5A999999<br>5A999999<br>5A999999<br>5A999999             | 03.02<br>04.06<br>05.05<br>03.02<br>08.04<br>05.05                                     | - gepanzerte Fahrzeuge <sup>1)</sup><br>- gepanzerte Fahrzeuge <sup>1)</sup><br>- gepanzerte Fahrzeuge <sup>1)</sup><br>- gepanzerte Fahrzeuge <sup>1)</sup><br>- gepanzerte Fahrzeuge <sup>1)</sup><br>- gepanzerte Fahrzeuge <sup>1)</sup> | 13.0460-7224.2<br>24.8190-0304.2   | 607224<br>620304   | 1 23397 19,4 +/WE ATE<br>Warnkontakt L=724mm  |
|  | 3.0 TD 6 4x4<br>4.4 4x4<br>4.4 4x4<br>4.4 4x4  | 130 6A000001<br>210 6A000001<br>220 6A000001<br>225 6A000001                     |  | 08.12<br>08.12<br>08.12<br>08.12   | - gepanzerte Fahrzeuge <sup>1)</sup><br>- gepanzerte Fahrzeuge <sup>1)</sup><br>- gepanzerte Fahrzeuge <sup>1)</sup><br>- gepanzerte Fahrzeuge <sup>1)</sup>   | 13.0460-2728.2<br>24.8190-0304.2   | 602728<br>620304   | 1 24191 18,1 +/WE/Zub/STRW<br>Warnkontakt L=724mm   |
|  | 3.6 TD 8 4x4<br>4.2 4x4  | 200 6A000001<br>291 6A000001   | 9A999999   | 08.12<br>08.12   | - gepanzerte Fahrzeuge <sup>1)</sup><br>- gepanzerte Fahrzeuge <sup>1)</sup>   | 13.0460-4837.2<br>24.8190-0944.2   | 604837<br>620944   | 1 20217 17,1 /WE BRE<br>Warnkontakt L=841,5mm   |
|  | 3.6 TD 8 4x4<br>5.0 V8 4x4   | 200 BA347977<br>276 BA347977   |  | 08.12<br>08.12   | - gepanzerte Fahrzeuge <sup>1)</sup><br>- gepanzerte Fahrzeuge <sup>1)</sup>   | 13.0460-2762.2   | 602762   | 25021 18,5 +/WE/Zub/STRW  |
|  | 3.0 TD 6 4x4<br>3.6 TD 8 4x4<br>4.2 4x4<br>4.4 4x4<br>4.4 4x4<br>4.4 4x4                                 | 130<br>200<br>291<br>210<br>220<br>225   | 5A999999<br>5A999999<br>5A999999<br>5A999999<br>5A999999<br>5A999999             | 03.02<br>04.06<br>05.05<br>03.02<br>08.04<br>05.05                                     | - gepanzerte Fahrzeuge <sup>1)</sup><br>- gepanzerte Fahrzeuge <sup>1)</sup><br>- gepanzerte Fahrzeuge <sup>1)</sup><br>- gepanzerte Fahrzeuge <sup>1)</sup><br>- gepanzerte Fahrzeuge <sup>1)</sup><br>- gepanzerte Fahrzeuge <sup>1)</sup> | 24.0130-0184.1   | 430184   | 344 29,9 28,4 V L +B  |
|  | 3.0 TD 6 4x4<br>4.4 4x4<br>4.4 4x4   | 130 6A000001<br>220 6A000001<br>225 6A000001                                     |  | 08.12<br>08.12<br>08.12  | - gepanzerte Fahrzeuge <sup>1)</sup><br>- gepanzerte Fahrzeuge <sup>1)</sup><br>- gepanzerte Fahrzeuge <sup>1)</sup>   | 24.0130-0196.1   | 430196   | 344 30,0 27,0 V +B  |
|  | 3.6 TD 8 4x4<br>4.2 4x4<br>5.0 V8 4x4  | 200 6A000001<br>291 6A000001<br>276  | 9A999999   | 08.12<br>08.12<br>08.12  | - gepanzerte Fahrzeuge <sup>1)</sup><br>- gepanzerte Fahrzeuge <sup>1)</sup><br>- gepanzerte Fahrzeuge <sup>1)</sup>   | 24.0130-0197.1   | 430197   | 360 30,0 27,0 V +B  |
|  | 3.0 TD 6 4x4<br>3.6 TD 8 4x4<br>4.2 4x4<br>4.4 4x4<br>4.4 4x4<br>4.4 4x4                                 | 130<br>200<br>291<br>210<br>220<br>225   | 5A999999<br>5A999999<br>5A999999<br>5A999999<br>5A999999<br>5A999999             | 03.02<br>04.06<br>05.05<br>03.02<br>08.04<br>05.05                                     | - gepanzerte Fahrzeuge <sup>1)</sup><br>- gepanzerte Fahrzeuge <sup>1)</sup><br>- gepanzerte Fahrzeuge <sup>1)</sup><br>- gepanzerte Fahrzeuge <sup>1)</sup><br>- gepanzerte Fahrzeuge <sup>1)</sup><br>- gepanzerte Fahrzeuge <sup>1)</sup> | 13.0460-7079.2<br>13.0470-7079.2<br>24.8190-1308.2                                 | 607079<br>LD7079<br>621308   | 1 21487 17,3 +/WE ATE<br>21487 17,3 +/WE ATE<br>Warnkontakt L=1118mm                                  |

1) - armoured vehicles / - veicoli blindati / - véhicule blindé / - vehículo blindado





|     |  |  |  |  |  |  |  |  |   |  |
|--|--|--|--|--|---|--|--|--|---|--|
| <b>LAND ROVER RANGE ROVER III (LM) (02-12)</b>                                     |  |  |  |  |   |  |  |  |   |  |
|    | 3.0 TD 6 4x4   | 130  | 6A000001   |  | 08.12   | - gepanzerte Fahrzeuge <sup>1)</sup>   | 13.0460-2719.2   | 602719   |   | 24192 17,4 +/WE/Zub/STRW<br>Warnkontakt L=1158mm |
|  | 4.2 4x4  | 291  | 6A000001   |  | 08.12   | - gepanzerte Fahrzeuge <sup>1)</sup>   | 24.8190-0305.2   | 620305   |   |  |
|  | 4.4 4x4  | 210  | 6A000001   |  | 08.12   | - gepanzerte Fahrzeuge <sup>1)</sup>   |  |  |   |  |
|  | 4.4 4x4  | 220  | 6A000001   |  | 08.12   | - gepanzerte Fahrzeuge <sup>1)</sup>   |  |  |   |  |
|  | 4.4 4x4  | 225  | 6A000001   |  | 08.12   | - gepanzerte Fahrzeuge <sup>1)</sup>   |  |  |   |  |
|    | 3.6 TD 8 4x4   | 200  | 6A000001   |  | 08.12   | - gepanzerte Fahrzeuge <sup>1)</sup>   | 13.0460-2731.2   | 602731   |   | 24192 17,1 +/WE/Zub/STRW                         |
|  | 5.0 V8 4x4   | 276  |  | 09.09  | 08.12   | - gepanzerte Fahrzeuge <sup>1)</sup>   |  |  |   |  |
|    | 3.0 TD 6 4x4   | 130  | 3A129289   | 03.02  |   | - gepanzerte Fahrzeuge <sup>1)</sup>   | 24.0113-0197.1   | 413197   |   | 305 12,6 11,7 +B                                 |
|  | 3.6 TD 8 4x4   | 200  | 3A129289   | 04.06  |   | - gepanzerte Fahrzeuge <sup>1)</sup>   |  |  |   |  |
|  | 4.2 4x4  | 291  | 3A129289   | 05.05  |   | - gepanzerte Fahrzeuge <sup>1)</sup>   |  |  |   |  |
|  | 4.4 4x4  | 210  | 3A129289   | 03.02  |   | - gepanzerte Fahrzeuge <sup>1)</sup>   |  |  |   |  |
|  | 3.0 TD 6 4x4   | 130  | 3A129290   | 5A999999   |   |  | - gepanzerte Fahrzeuge <sup>1)</sup>   | 24.0112-0168.1   | 412168  |  |
|    | 3.6 TD 8 4x4   | 200  | 3A129290   | 9A999999   |   | - gepanzerte Fahrzeuge <sup>1)</sup>   |  |  |   |  |
|  | 4.2 4x4  | 291  | 3A129290   | 5A999999   |   | - gepanzerte Fahrzeuge <sup>1)</sup>   |  |  |   |  |
|  | 4.4 4x4  | 210  | 3A129290   | 5A999999   |   | - gepanzerte Fahrzeuge <sup>1)</sup>   |  |  |   |  |
|  | 4.4 4x4  | 220  | 5A999999   | 08.04  |   | - gepanzerte Fahrzeuge <sup>1)</sup>   |  |  |   |  |
|  | 4.4 4x4  | 225  | 5A999999   | 05.05  |   | - gepanzerte Fahrzeuge <sup>1)</sup>   |  |  |   |  |
|    | 3.6 TD 8 4x4   | 200  | AA000001   |  | 08.12   | - gepanzerte Fahrzeuge <sup>1)</sup>   | 24.0120-0200.1   | 420200   |   | 354 20,0 17,0 V L +B                             |
|  | 5.0 V8 4x4   | 276  |  | 09.09  | 08.12   | - gepanzerte Fahrzeuge <sup>1)</sup>   |  |  |   |  |
|    | 3.0 TD 6 4x4   | 130  | 6A000001   |  | 08.12   | - gepanzerte Fahrzeuge <sup>1)</sup>   | 24.0120-0200.1   | 420200   |   | 354 20,0 17,0 V L +B                             |
|  | 4.2 4x4  | 291  | 6A000001   |  | 08.12   | - gepanzerte Fahrzeuge <sup>1)</sup>   |  |  |   |  |
|  | 4.4 4x4  | 210  | 6A000001   |  | 08.12   | - gepanzerte Fahrzeuge <sup>1)</sup>   |  |  |   |  |
|  | 4.4 4x4  | 220  | 6A000001   |  | 08.12   | - gepanzerte Fahrzeuge <sup>1)</sup>   |  |  |   |  |
|  | 4.4 4x4  | 225  | 6A000001   |  | 08.12   | - gepanzerte Fahrzeuge <sup>1)</sup>   |  |  |   |  |
|    | 3.0 TD 6 4x4   | 130  |  | 03.02  | 08.12   |  | 03.0137-0451.2   | 650451   |   | 210 x 30   |
|  | 3.6 TD 8 4x4   | 200  |  | 04.06  | 08.12   |  |  |  |   |  |
|  | 4.2 4x4  | 291  |  | 05.05  | 08.12   |  |  |  |   |  |
|  | 4.4 4x4  | 210  |  | 03.02  | 08.12   |  |  |  |   |  |
|  | 4.4 4x4  | 220  |  | 08.04  | 08.12   |  |  |  |   |  |
|  | 4.4 4x4  | 225  |  | 05.05  | 08.12   |  |  |  |   |  |
|  | 4.4 TD V8 4x4  | 230  |  | 07.10  | 08.12   |  |  |  |   |  |
|  | 5.0 V8 4x4   | 276  |  | 09.09  | 08.12   |  |  |  |   |  |
|  | 5.0 V8 4x4   | 375  |  | 09.09  | 08.12   |  |  |  |   |  |
|  |  |  |  |  |   |  |  |  |   |  |
| <b>LAND ROVER RANGE ROVER IV (LG) (12-)</b>  |  |  |  |  |   |  |  |  |   |  |
|    | 3.0 4x4  | 250  |  | 10.13  |   | + 19" Rad <sup>2)</sup>  | 13.0460-2762.2   | 602762   |   | 25021 18,5 +/WE/Zub/STRW                         |
|  | 3.0 4x4  | 280  |  | 06.15  |   | + 19" Rad <sup>2)</sup>  |  |  |   |  |
|  | 3.0 TD 4x4   | 183  | EA000001   |  |   |  |  |  |   |  |
| <b>LAND ROVER RANGE ROVER EVOQUE (SAL) (11-)</b>                                   |  |  |  |  |   |  |  |  |   |  |
|  | 2.0 16V 4x4  | 177  |  | 06.11  |   |  | 13.0460-7228.2   | 607228   |   | 24123 20,3 + ATE                                 |
|  | 2.0 eD4  | 110  |  | 06.15  |   | + 16" Rad <sup>3)</sup>  | 13.0470-7228.2   | LD7228   |   | 24123 20,3 + ATE                                 |
|  | 2.0 TD4 4x4  | 110  |  | 06.15  |   | + 16" Rad <sup>3)</sup>  |  |  |   |  |
|  | 2.0 TD4 4x4  | 132  |  | 05.15  |   | + 16" Rad <sup>3)</sup>  |  |  |   |  |
|  | 2.2 eD4  | 110  |  | 06.11  |   |  |  |  |   |  |
|  | 2.2 SD4 4x4  | 140  |  | 06.11  |   |  |  |  |   |  |
|  | 2.0 16V 4x4  | 177  |  | 06.11  |   |  | 24.0128-0154.1   | 428154   |   | 300 28,0 26,0 V L +S +B                          |
|  | 2.0 eD4  | 110  |  | 06.15  |   | + 16" Rad <sup>3)</sup>  | 24.0328-0154.1   | 528154   |   | 300 28,0 26,0 V L +S +B PD                       |
|  | 2.0 TD4 4x4  | 110  |  | 06.15  |   | + 16" Rad <sup>3)</sup>  |  |  |   |  |
|  | 2.0 TD4 4x4  | 132  |  | 05.15  |   | + 16" Rad <sup>3)</sup>  |  |  |   |  |
|  | 2.2 eD4  | 110  |  | 06.11  |   |  |  |  |   |  |
|  | 2.2 SD4 4x4  | 140  |  | 06.11  |   |  |  |  |   |  |
|  | 2.0 16V 4x4  | 177  |  | 06.11  |   |  | 24.0711-5363.3   | 360377   | 2  | Radsensor L=815                                  |
|  | 2.0 eD4  | 110  | EH999999   | 06.15  |   |  |  |  |   |  |
|  | 2.0 TD4 4x4  | 110  | EH999999   | 06.15  |   |  |  |  |   |  |
|  | 2.0 TD4 4x4  | 132  | EH999999   | 05.15  |   |  |  |  |   |  |
|  | 2.2 eD4  | 110  |  | 06.11  |   |  |  |  |   |  |
|  | 2.2 SD4 4x4  | 140  |  | 06.11  |   |  |  |  |   |  |
|  | 2.0 16V 4x4  | 177  |  | 06.11  |   |  | 13.0460-2722.2   | 602722   |   | 24496 17,3 /Zub/S TRW                            |
|  | 2.0 eD4  | 110  | FH999999   | 06.15  |   |  | 13.0470-2722.2   | LD2722   |   | 24496 17,3 /Zub/S TRW                            |
|  | 2.0 TD4 4x4  | 110  | FH999999   | 06.15  |   |  |  |  |   |  |
|  | 2.0 TD4 4x4  | 132  | FH999999   | 05.15  |   |  |  |  |   |  |
|  | 2.2 eD4  | 110  |  | 06.11  |   |  |  |  |   |  |
|  | 2.2 SD4 4x4  | 140  |  | 06.11  |   |  |  |  |   |  |
|  | 2.0 16V 4x4  | 177  |  | 06.11  |   |  | 24.0111-0145.1   | 411145   |   | 302 10,9 9,0 +S +B                               |
|  | 2.0 eD4  | 110  | FH999999   | 06.15  |   |  | 24.0311-0145.1   | 511145   |   | 302 10,9 9,0 +B PD                               |
|  | 2.0 TD4 4x4  | 110  | FH999999   | 06.15  |   |  |  |  |   |  |
|  | 2.0 TD4 4x4  | 132  | FH999999   | 05.15  |   |  |  |  |   |  |
|  | 2.2 eD4  | 110  |  | 06.11  |   |  |  |  |   |  |
|  | 2.2 SD4 4x4  | 140  |  | 06.11  |   |  |  |  |   |  |
|  | 2.0 16V 4x4  | 177  |  | 06.11  |   |  | 24.0711-5362.3   | 360376   | 2  | Radsensor L=709                                  |
|  | 2.0 eD4  | 110  | DH999999   | 06.15  |   |  |  |  |   |  |
|  | 2.0 TD4 4x4  | 110  | DH999999   | 06.15  |   |  |  |  |   |  |
|  | 2.0 TD4 4x4  | 132  | DH999999   | 05.15  |   |  |  |  |   |  |
|  | 2.2 eD4  | 110  |  | 06.11  |   |  |  |  |   |  |
|  | 2.2 SD4 4x4  | 140  |  | 06.11  |   |  |  |  |   |  |

























<sup>1)</sup> - armoured vehicles / - veicoli blindati / - vehicule blindé / - vehículo blindado

<sup>2)</sup> + 19" wheel / + ruota 19" / + roue 19" / + rueda 19"

<sup>3)</sup> + 16" wheel / + ruota 16" / + roue 16" / + rueda 16"

<sup>4)</sup> - parking assistant / - assistente di parcheggio / - assistance au stationnement / - asistente de aparcamiento























|     |    |  |                                      |                 |    |  |  |                                 |  |      |
|--|--|--|--|---|---|--|--|---|--|------|
| <b>LAND ROVER RANGE ROVER EVOQUE Cabriolet (16-)</b>                               |  |  |  |   |   |  |  |   |  |      |
|    | 2.0 16V 4x4<br>2.0 TD4 4x4<br>2.0 TD4 4x4  | 177<br>110<br>132  |  | 02.16<br>02.16<br>02.16   | + Bremsscheibendurchm. 300 mm <sup>1)</sup><br>+ Bremsscheibendurchm. 300 mm <sup>1)</sup><br>+ Bremsscheibendurchm. 300 mm <sup>1)</sup> | 13.0460-7228.2<br>13.0470-7228.2   | 607228<br>LD7228   | 24123 20,3 +<br>24123 20,3 +  | ATE<br>ATE                                       |      |
|    | 2.0 16V 4x4<br>2.0 TD4 4x4<br>2.0 TD4 4x4  | 177<br>110<br>132  | FH999999<br>FH999999<br>FH999999   | 02.16<br>02.16<br>02.16   |   | 24.0128-0154.1<br>24.0328-0154.1   | 428154<br>528154   | 300 28,0 26,0 V L +S +B<br>300 28,0 26,0 V L +S +B PD   |  |      |
|    | 2.0 16V 4x4<br>2.0 TD4 4x4<br>2.0 TD4 4x4  | 177<br>110<br>132  | FH999999<br>FH999999<br>FH999999   | 02.16<br>02.16<br>02.16   |   | 13.0460-2722.2<br>13.0470-2722.2   | 602722<br>LD2722   | 24496 17,3 /Zub/S<br>24496 17,3 /Zub/S  | TRW<br>TRW                                       |      |
|    | 2.0 16V 4x4<br>2.0 TD4 4x4<br>2.0 TD4 4x4  | 177<br>110<br>132  | FH999999<br>FH999999<br>FH999999   | 02.16<br>02.16<br>02.16   |   | 24.0111-0145.1<br>24.0311-0145.1   | 411145<br>511145   | 302 10,9 9,0 +S +B<br>302 10,9 9,0 +B PD  |  |      |
|    | 2.0 16V 4x4<br>2.0 TD4 4x4<br>2.0 TD4 4x4  | 177<br>110<br>132  |  | 02.16<br>02.16<br>02.16   |   | 24.0711-5362.3   | 360376   | 2  - Parkassistent <sup>2)</sup> | Radsensor L=709                                  |      |
| <b>LAND ROVER RANGE ROVER SPORT (LS) (05-13)</b>                                   |  |  |  |   |   |  |  |   |  |      |
|    | 2.7 TD V6 4x4<br>3.6 TD V8 4x4<br>4.2 V8 4x4<br>4.4 V8 4x4<br>4.2 V8 4x4   | 140<br>200<br>287<br>220<br>287  |  | 02.05<br>04.06<br>02.05<br>02.05<br>02.05   |   | 13.0460-4837.2<br>24.8190-1307.2   | 604837<br>621307   | 1   | 20217 17,1 /WE<br>Warnkontakt L=1185mm           | BRE  |
|    | 2.7 TD V6 4x4<br>4.4 V8 4x4  | 140<br>220   | 6A999999<br>6A999999   | 02.05<br>02.05  |   | 13.0460-2728.2<br>24.8190-0945.2   | 602728<br>620945   | 1   | 24191 18,1 +/WE/Zub/STRW<br>Warnkontakt L=1227mm | STRW |
|    | 2.7 TD V6 4x4<br>4.4 V8 4x4  | 140<br>220   | 7A000001<br>7A000001   | 10.09<br>10.09  |   | 13.0460-2728.2<br>24.8190-0949.2   | 602728<br>620949   | 1   | 24191 18,1 +/WE/Zub/STRW<br>Warnkontakt L=1228mm | STRW |
|    | 3.0 TD V6 4x4<br>3.0 TD V6 4x4<br>3.0 TD V6 4x4<br>3.0 TD V6 4x4<br>3.6 TD V8 4x4<br>5.0 V8 4x4<br>5.0 V8 4x4<br>5.0 V8 4x4  | 155<br>180<br>183<br>188<br>200<br>276<br>372<br>375                             |  | 05.10<br>09.09<br>08.12<br>06.11<br>01.10<br>07.09<br>04.09<br>09.09                            | 06.13<br>06.13<br>06.13<br>06.13<br>06.13<br>06.13<br>06.13<br>06.13  | 13.0460-2762.2   | 602762   |   | 25021 18,5 +/WE/Zub/STRW                         | STRW |
|   | 2.7 TD V6 4x4<br>4.4 V8 4x4  | 140<br>220   |  | 02.05<br>02.05  | 10.09 + 17" Rad <sup>3)</sup><br>10.09 + 17" Rad <sup>3)</sup>  | 24.0130-0178.1<br>24.0130-0188.1   | 430178<br>430188   |   | 317 30,0 27,0 V +B<br>338 30,0 27,0 V +B         |      |
|  | 2.7 TD V6 4x4<br>3.0 TD V6 4x4<br>3.0 TD V6 4x4<br>3.0 TD V6 4x4<br>3.0 TD V6 4x4<br>3.6 TD V8 4x4<br>4.2 V8 4x4<br>4.4 V8 4x4<br>5.0 V8 4x4<br>5.0 V8 4x4<br>5.0 V8 4x4 | 140<br>155<br>180<br>183<br>188<br>200<br>287<br>220<br>276<br>372<br>375        | AA215622<br>AA215622<br>AA215622<br>AA215622<br>AA215622<br>AA215622<br>AA215622<br>AA215622<br>AA215622<br>AA215622 | 02.05<br>05.10<br>09.09<br>08.12<br>06.11<br>04.06<br>02.05<br>02.05<br>07.09<br>04.09<br>09.09 | 10.09 + 18"/19" Rad<br>10.09 + 18"/19" Rad  | 24.0130-0195.1   | 430195   |   | 360 30,0 27,0 V +B                               |      |
|  | 2.7 TD V6 4x4<br>3.6 TD V8 4x4<br>4.2 V8 4x4<br>4.4 V8 4x4   | 140<br>200<br>287<br>220   |  | 02.05<br>04.06<br>02.05<br>02.05  | 10.09<br>06.13<br>10.09<br>10.09  | 13.0460-2719.2<br>24.8190-1306.2   | 602719<br>621306   | 1   | 24192 17,4 +/WE/Zub/STRW<br>Warnkontakt L=1156mm | STRW |
|  | 3.0 TD V6 4x4<br>3.0 TD V6 4x4<br>3.0 TD V6 4x4<br>3.0 TD V6 4x4<br>5.0 V8 4x4<br>5.0 V8 4x4   | 155<br>180<br>183<br>188<br>276<br>372   |  | 05.10<br>09.09<br>08.12<br>06.11<br>07.09<br>04.09  | 06.13<br>06.13<br>06.13<br>06.13<br>06.13<br>06.13  | 13.0460-2731.2   | 602731   |   | 24192 17,1 +/WE/Zub/STRW                         | STRW |
|  | 2.7 TD V6 4x4<br>2.7 TD V6 4x4<br>3.0 TD V6 4x4<br>3.0 TD V6 4x4<br>3.0 TD V6 4x4<br>3.6 TD V8 4x4<br>4.2 V8 4x4<br>4.4 V8 4x4<br>5.0 V8 4x4<br>5.0 V8 4x4               | 140<br>140<br>155<br>180<br>183<br>188<br>200<br>287<br>220<br>276<br>372        |  | 02.05<br>02.05<br>05.10<br>09.09<br>08.12<br>06.11<br>04.06<br>02.05<br>02.05<br>07.09<br>04.09 | 10.09 + 17" Rad <sup>3)</sup><br>10.09 + 18"/19" Rad  | 24.0120-0210.1<br>24.0120-0201.1   | 420210<br>420201   |   | 325 20,0 17,0 V +B<br>350 20,0 17,0 V +B         |      |
|  | 2.7 TD V6 4x4<br>3.0 TD V6 4x4<br>3.0 TD V6 4x4<br>3.0 TD V6 4x4<br>3.0 TD V6 4x4<br>3.6 TD V8 4x4<br>4.2 V8 4x4<br>4.4 V8 4x4<br>5.0 V8 4x4<br>5.0 V8 4x4               | 140<br>155<br>180<br>183<br>188<br>200<br>287<br>220<br>276<br>372               |  | 02.05<br>05.10<br>09.09<br>08.12<br>06.11<br>04.06<br>02.05<br>02.05<br>07.09<br>04.09          | 10.09<br>06.13<br>06.13<br>06.13<br>06.13<br>06.13<br>06.13<br>06.13<br>06.13<br>06.13  | 03.0137-3040.2   | 653040   |   | 210 x 30 HEB                                     |      |

<sup>1)</sup> + brake disc diameter 300mm / + diametro dischi freno 300mm / + diamètre disques frein 300mm / + diámetro disco freno 300mm

<sup>2)</sup> - parking assistant / - assistente di parcheggio / - assistance au stationnement / - asistente de aparcamiento

<sup>3)</sup> + 17" wheel / + ruota 17" / + roue 17" / + rueda 17"





































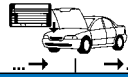

















| LAND ROVER RANGE ROVER SPORT (LW) (13-)  |                   |     |  |       |       |                         |                |        |  |                         |
|--|-------------------|-----|--|-------|-------|-------------------------|----------------|--------|--|-------------------------|
|    | 3.0 TD 4x4        | 155 |  | 04.13 |       | + 19" Rad <sup>1)</sup> | 13.0460-2762.2 | 602762 |  | 25021 18,5 +WE/Zub/STRW |
|  | 3.0 TD 4x4        | 183 |  | 04.13 |       | + 19" Rad <sup>1)</sup> |                |        |  |                         |
|  | 3.0 TD 4x4        | 190 |  | 04.13 |       |                         |                |        |  |                         |
|  | 3.0 TD 4x4        | 215 |  | 04.13 |       |                         |                |        |  |                         |
|  | 3.0 TD 4x4        | 225 |  | 09.14 |       |                         |                |        |  |                         |
|  | 3.0 V6 4x4        | 250 |  | 04.13 |       |                         |                |        |  |                         |
| LEXUS CT 200 (11-)   |                   |     |  |       |       |                         |                |        |  |                         |
|    | 200h (ZWA10)      | 73  |  | 03.11 |       |                         | 13.0460-5617.2 | 605617 |  | 24451 15,6 /Zub         |
|    | 200h (ZWA10)      | 73  |  | 03.11 |       |                         | 24.0125-0196.1 | 425196 |  | 255 25,0 22,0 V +B      |
|    | 200h (ZWA10)      | 73  |  | 03.11 |       |                         | 13.0460-5769.2 | 605769 |  | 24610 15,0 +WK          |
|    | 200h (ZWA10)      | 73  |  | 03.11 |       | Typ B <sup>2)</sup>     | 24.0110-0364.1 | 410364 |  | 279 10,0 8,5 +B         |
|  | 200h (ZWA10)      | 73  |  | 03.11 |       | Typ E <sup>3)</sup>     | 24.0109-0163.1 | 409163 |  | 259 9,0 7,5 +B          |
| LEXUS ES 300/330 (96-06)   |                   |     |  |       |       |                         |                |        |  |                         |
|    | 3.0 V6            | 140 |  | 10.96 | 07.01 |                         | 24.0128-0115.1 | 428115 |  | 275 28,0 26,0 V +B      |
|    | 3.0 V6            | 140 |  | 10.96 | 07.01 |                         | 13.0460-5840.2 | 605840 |  | 21833 15,0 +WK AKE      |
|  | 3.0 V6            | 157 |  | 08.01 | 10.06 |                         | 13.0460-5738.2 | 605738 |  | 23702 15,1 /Zub         |
|  | 3.0 V6            | 158 |  | 10.01 | 10.06 |                         |                |        |  |                         |
|  | 3.3 V6            | 168 |  | 06.03 | 10.06 |                         |                |        |  |                         |
| LEXUS ES 350 (06-12)   |                   |     |  |       |       |                         |                |        |  |                         |
|    | 3.5 V6            | 204 |  | 03.06 | 06.12 |                         | 13.0460-5764.2 | 605764 |  | 24350 17,3 /Zub AKE     |
|    | 3.5 V6            | 204 |  | 03.06 | 06.12 |                         | 24.0128-0159.1 | 428159 |  | 296 28,0 25,0 V +B      |
|   | 3.5 V6            | 204 |  | 03.06 | 06.12 |                         | 13.0460-5765.2 | 605765 |  | 24338 15,5 AKE          |
|  | 3.5 V6            | 204 |  | 03.06 | 06.12 |                         | 03.0137-0402.2 | 650402 |  | 170 x 40                |
| LEXUS ES 250/300/350 (GSV,ASV,AVV) (12-)   |                   |     |  |       |       |                         |                |        |  |                         |
|  | 250               | 135 |  | 06.12 |       |                         | 13.0460-5764.2 | 605764 |  | 24350 17,3 /Zub AKE     |
|  | 300h              | 118 |  | 06.12 |       |                         |                |        |  |                         |
|  | 350               | 183 |  | 01.14 |       |                         |                |        |  |                         |
|  | 350               | 204 |  | 06.12 |       |                         |                |        |  |                         |
|  | 250               | 135 |  | 06.12 |       |                         | 24.0128-0159.1 | 428159 |  | 296 28,0 25,0 V +B      |
|  | 300h              | 118 |  | 06.12 |       |                         |                |        |  |                         |
|  | 350               | 183 |  | 01.14 |       |                         |                |        |  |                         |
|  | 350               | 204 |  | 06.12 |       |                         |                |        |  |                         |
|  | 250               | 135 |  | 06.12 |       |                         | 13.0460-5765.2 | 605765 |  | 24338 15,5 AKE          |
|  | 300h              | 118 |  | 06.12 |       |                         |                |        |  |                         |
|  | 350               | 183 |  | 01.14 |       |                         |                |        |  |                         |
|  | 350               | 204 |  | 06.12 |       |                         |                |        |  |                         |
| LEXUS GS 300 (93-97)   |                   |     |  |       |       |                         |                |        |  |                         |
|  | 300 (JZS147)      | 156 |  | 03.93 | 08.97 |                         | 03.0137-0400.2 | 650400 |  | 190 x 45                |
|  |                   |     |  |       |       |                         | 03.0137-9272.2 | 669272 |  | Bremsbacken-Zubehör     |
| LEXUS GS 300 (97-05)   |                   |     |  |       |       |                         |                |        |  |                         |
|  | 3.0 i V6 (JZS160) | 161 |  | 10.00 | 03.05 |                         | 24.0132-0701.1 | 432701 |  | 296 32,0 30,0 V +B      |
|  | 3.0 i V6 (JZS160) | 163 |  | 08.97 | 10.00 |                         |                |        |  |                         |
|  | 4.0 i V8 (JZS160) | 216 |  | 12.97 | 11.00 |                         |                |        |  |                         |
|  | 3.0 i V6 (JZS160) | 161 |  | 10.00 | 03.05 |                         | 13.0460-5748.2 | 605748 |  | 23429 15,5 /WK          |
|  | 3.0 i V6 (JZS160) | 163 |  | 08.97 | 10.00 |                         |                |        |  |                         |
|  | 4.0 i V8 (JZS160) | 216 |  | 12.97 | 11.00 |                         |                |        |  |                         |
|  | 3.0 i V6 (JZS160) | 161 |  | 10.00 | 03.05 |                         | 24.0112-0703.1 | 412703 |  | 307 12,0 10,5 +B        |
|  | 3.0 i V6 (JZS160) | 163 |  | 08.97 | 10.00 |                         |                |        |  |                         |
|  | 4.0 i V8 (JZS160) | 216 |  | 12.97 | 11.00 |                         |                |        |  |                         |
|  | 3.0 i V6 (JZS160) | 161 |  | 10.00 | 03.05 |                         | 03.0137-0400.2 | 650400 |  | 190 x 45                |
|  | 3.0 i V6 (JZS160) | 163 |  | 08.97 | 10.00 |                         | 03.0137-9272.2 | 669272 |  | Bremsbacken-Zubehör     |
|  | 4.0 i V8 (JZS160) | 216 |  | 12.97 | 11.00 |                         |                |        |  |                         |
| LEXUS GS 430 (00-05)   |                   |     |  |       |       |                         |                |        |  |                         |
|  | 4.3 i V8 (UZS161) | 208 |  | 11.00 | 10.01 |                         | 24.0132-0701.1 | 432701 |  | 296 32,0 30,0 V +B      |
|  | 4.3 i V8 (UZS161) | 208 |  | 11.00 | 03.05 |                         | 13.0460-5748.2 | 605748 |  | 23429 15,5 /WK          |

<sup>1)</sup> + 19" wheel / + ruota 19" / + roue 19" / + rueda 19"





























<sup>2)</sup> type B / tipo B / type B / tipo B

<sup>3)</sup> type E / tipo E / type E / tipo E

























|     |  |  |  |  |  |  |  |  |                                 |
|--|--|--|--|--|---|--|--|--|---------------------------------|
| <b>LEXUS GS 430 (00-05)</b>  |  |  |  |  |   |  |  |  |                                 |
|    | 4.3 i V8 (UZS161)  | 208  |  | 11.00  | 03.05   |  | 24.0112-0703.1   | 412703   | 307 12,0 10,5 +B                |
|    | 4.3 i V8 (UZS161)  | 208  |  | 11.00  | 03.05   |  | 03.0137-0400.2<br>03.0137-9272.2   | 650400<br>669272   | 190 x 45<br>Bremsbacken-Zubehör |
| <b>LEXUS GS (GRS_, GWS_) (05-11)</b>   |  |  |  |  |   |  |  |  |                                 |
|    | 3.0 VVTi   | 170  |  | 04.05  | 11.11   |  | 13.0460-5789.2   | 605789   | 20325 17,2 +/-WK                |
|  | 3.0 VVTi   | 183  |  | 04.05  | 11.11   |  |  |  |                                 |
|  | 350  | 226  |  | 04.08  | 11.11   |  |  |  |                                 |
|  | 350  | 232  |  | 05.08  | 11.11   |  |  |  |                                 |
|  | 350 AWD  | 226  |  | 04.08  | 11.11   |  |  |  |                                 |
|  | 350 AWD  | 232  |  | 05.08  | 11.11   |  |  |  |                                 |
|  | 4.3 VVTi   | 208  |  | 04.05  | 11.11   |  |  |  |                                 |
|  | 4.3 VVTi   | 221  |  | 04.05  | 11.11   |  |  |  |                                 |
|  | 450 h  | 218  |  | 02.06  | 11.11   |  |  |  |                                 |
|  | 450 h  | 254  |  | 02.06  | 11.11   |  |  |  |                                 |
|  | 460  | 255  |  | 05.08  | 11.11   |  |  |  |                                 |
|    | 3.0 VVTi   | 170  |  | 04.05  | 11.11   |  | 24.0130-0201.1   | 430201   | 334 30,0 27,0 V +B              |
|  | 3.0 VVTi   | 183  |  | 04.05  | 11.11   |  | 24.0130-0202.1   | 430202   | 334 30,0 27,0 V +B              |
|  | 4.3 VVTi   | 208  |  | 04.05  | 11.11   |  |  |  |                                 |
|  | 4.3 VVTi   | 221  |  | 04.05  | 11.11   |  |  |  |                                 |
|  | 450 h  | 218  |  | 02.06  | 11.11   |  |  |  |                                 |
|  | 450 h  | 254  |  | 02.06  | 11.11   |  |  |  |                                 |
|  | 460  | 255  |  | 05.08  | 11.11   |  |  |  |                                 |
|  | 350  | 226  |  | 04.08  | 09.08   |  | 24.0130-0201.1   | 430201   | 334 30,0 27,0 V +B              |
|  | 350  | 232  |  | 05.08  | 09.08   |  |  |  |                                 |
|  | 350 AWD  | 226  |  | 04.08  | 09.08   |  |  |  |                                 |
|  | 350 AWD  | 232  |  | 05.08  | 09.08   |  |  |  |                                 |
|    | 3.0 VVTi   | 170  |  | 04.05  | 11.11   |  | 13.0460-5790.2   | 605790   | 24323 15,5 +/-WK                |
|  | 3.0 VVTi   | 183  |  | 04.05  | 11.11   |  |  |  |                                 |
|  | 350  | 226  |  | 04.08  | 11.11   |  |  |  |                                 |
|  | 350  | 232  |  | 05.08  | 11.11   |  |  |  |                                 |
|  | 350 AWD  | 226  |  | 04.08  | 11.11   |  |  |  |                                 |
|  | 350 AWD  | 232  |  | 05.08  | 11.11   |  |  |  |                                 |
|  | 4.3 VVTi   | 208  |  | 04.05  | 11.11   |  |  |  |                                 |
|  | 4.3 VVTi   | 221  |  | 04.05  | 11.11   |  |  |  |                                 |
|  | 450 h  | 218  |  | 02.06  | 11.11   |  |  |  |                                 |
|  | 450 h  | 254  |  | 02.06  | 11.11   |  |  |  |                                 |
|  | 3.0 VVTi   | 170  |  | 04.05  | 11.11   |  | 24.0118-0147.1   | 418147   | 310 18,0 16,5 V +B              |
|  | 3.0 VVTi   | 183  |  | 04.05  | 11.11   |  |  |  |                                 |
|  | 350  | 226  |  | 04.08  | 11.11   |  |  |  |                                 |
|  | 350  | 232  |  | 05.08  | 11.11   |  |  |  |                                 |
|  | 350 AWD  | 226  |  | 04.08  | 11.11   |  |  |  |                                 |
|  | 350 AWD  | 232  |  | 05.08  | 11.11   |  |  |  |                                 |
|  | 4.3 VVTi   | 208  |  | 04.05  | 11.11   |  |  |  |                                 |
|  | 4.3 VVTi   | 221  |  | 04.05  | 11.11   |  |  |  |                                 |
|  | 450 h  | 218  |  | 02.06  | 11.11   |  |  |  |                                 |
|  | 450 h  | 254  |  | 02.06  | 11.11   |  |  |  |                                 |
|  | 460  | 255  |  | 05.08  | 11.11   |  |  |  |                                 |
| <b>LEXUS GS (GRL1_, GWL1_) (12-)</b>   |  |  |  |  |   |  |  |  |                                 |
|  | GS 200 t   | 180  |  | 09.15  |   |  | 13.0460-5789.2   | 605789   | 20325 17,2 +/-WK                |
|  | GS 250   | 154  |  | 01.12  |   |  |  |  |                                 |
|  | GS 250   | 158  |  | 01.12  |   |  |  |  |                                 |
|  | GS 300 h   | 133  |  | 10.13  |   |  | 13.0460-5789.2   | 605789   | 20325 17,2 +/-WK                |
|  | GS 350   | 234  |  | 01.12  |   |  |  |  |                                 |
|  | GS 350 AWD   | 234  |  | 01.12  |   |  |  |  |                                 |
|  | GS 450 h   | 215  |  | 01.12  |   |  | 13.0460-5789.2   | 605789   | 20325 17,2 +/-WK                |
|  | GS 450 h   | 217  |  | 01.12  |   |  |  |  |                                 |
|  | GS 200 t   | 180  |  | 09.15  |   |  | 24.0130-0201.1   | 430201   | 334 30,0 27,0 V +B              |
|  | GS 250   | 154  |  | 01.12  |   |  | 24.0130-0202.1   | 430202   | 334 30,0 27,0 V +B              |
|  | GS 250   | 158  |  | 01.12  |   |  |  |  |                                 |
| <b>LEXUS GX 470 (J12) (01-09)</b>  |  |  |  |  |   |  |  |  |                                 |
|  | 4.7 V8   | 175  |  | 11.01  | 11.09   |  | 13.0460-5747.2   | 605747   | 24024 17,0 +/-WK                |
|  | 4.7 V8   | 199  |  | 11.01  | 11.09   |  |  |  |                                 |
|  | 4.7 V8   | 175  |  | 11.01  | 11.09   |  | 24.0128-0194.1   | 428194   | 338 28,0 26,0 V +B              |
|  | 4.7 V8   | 199  |  | 11.01  | 11.09   |  |  |  |                                 |
|  | 4.7 V8   | 175  |  | 11.01  | 11.09   |  | 13.0460-5744.2   | 605744   | 21947 15,4                      |
|  | 4.7 V8   | 199  |  | 11.01  | 11.09   |  |  |  |                                 |
|  | 4.7 V8   | 175  |  | 11.01  | 11.09   |  | 24.0118-0709.1   | 418709   | 312 18,0 16,0 V +B              |
|  | 4.7 V8   | 199  |  | 11.01  | 11.09   |  |  |  |                                 |
|  | 4.7 V8   | 175  |  | 11.01  | 11.09   |  | 03.0137-3007.2   | 653007   | 209 x 45                        |
|  | 4.7 V8   | 199  |  | 11.01  | 11.09   |  |  |  |                                 |

|     |    kW |  |  |  |  |  |  |  |
|--|---|--|--|--|---|--|--|--|
| <b>LEXUS GX 470 (URJ15) (09-)</b>  |   |  |  |  |   |  |  |  |
|    | 4.7 V8<br>4.7 V8  | 218<br>225   |  | 11.09<br>01.10   |   | 13.0460-5747.2   | 605747   | 24024 17,0 +/WK  |
|    | 4.7 V8<br>4.7 V8  | 218<br>225   |  | 11.09<br>01.10   |   | 13.0460-5744.2   | 605744   | 21947 15,4   |
|    | 4.7 V8<br>4.7 V8  | 218<br>225   |  | 11.09<br>01.10   |   | 03.0137-3007.2   | 653007   | 209 x 45   |
| <b>LEXUS HS 250 (ANF) (09-)</b>  |   |  |  |  |   |  |  |  |
|    | 250h Hybrid   | 110  |  | 09.09  |   | 13.0460-5767.2   | 605767   | 24336 17,5 AKE   |
|    | 250h Hybrid   | 110  |  | 09.09  |   | 24.0125-0178.1   | 425178   | 275 25,0 22,0 V +B   |
|    | 250h Hybrid   | 110  |  | 09.09  |   | 13.0460-5765.2   | 605765   | 24338 15,5 AKE   |
|    | 250h Hybrid   | 110  |  | 09.09  |   | 24.0112-0714.1   | 412714   | 281 12,0 10,5 +B   |
|    | 250h Hybrid   | 110  |  | 09.09  |   | 03.0137-3012.2   | 653012   | 172 x 32   |
| <b>LEXUS IS 200 (99-05)</b>  |   |  |  |  |   |  |  |  |
|    | 2.0 i V6 (GXE10)<br>3.0 i V6 (JCE10)  | 114<br>157   |  | 04.99<br>09.01   | 09.05<br>09.05  | 24.0132-0701.1   | 432701   | 296 32,0 30,0 V +B   |
|    | 2.0 i V6 (GXE10)<br>3.0 i V6 (JCE10)  | 114<br>157   |  | 04.99<br>09.01   | 09.05<br>09.05  | 13.0460-5748.2   | 605748   | 23429 15,5 /WK   |
|    | 2.0 i V6 (GXE10)<br>3.0 i V6 (JCE10)  | 114<br>157   |  | 04.99<br>09.01   | 09.05<br>09.05  | 24.0112-0703.1   | 412703   | 307 12,0 10,5 +B   |
|   | 2.0 i V6 (GXE10)<br>3.0 i V6 (JCE10)  | 114<br>157   |  | 04.99<br>09.01   | 09.05<br>09.05  | 03.0137-0400.2<br>03.0137-9272.2   | 650400<br>669272   | 190 x 45<br>Bremsbacken-Zubehör  |
| <b>LEXUS IS 200/220/250/350 (05-)</b>  |   |  |  |  |   |  |  |  |
|  | 200 d (ALE20)<br>220 d (ALE20)<br>250 (GSE20)<br>250 (GSE20)                          | 110<br>130<br>153<br>158   |  | 07.10<br>10.05<br>10.05<br>11.10   |   | 13.0460-5770.2   | 605770   | 23983 17,0   |
|  | 200 d (ALE20)<br>220 d (ALE20)<br>250 (GSE20)<br>250 (GSE20)                          | 110<br>130<br>153<br>158   |  | 07.10<br>10.05<br>10.05<br>11.10   |   | 24.0128-0740.1   | 428740   | 296 28,0 26,0 V +B   |
|  | 200 d (ALE20)<br>220 d (ALE20)<br>250 (GSE20)<br>250 (GSE20)                          | 110<br>130<br>153<br>158   |  | 07.10<br>10.05<br>10.05<br>11.10   |   | 13.0460-5790.2   | 605790   | 24323 15,5 +/WK  |
|  | 220 d (ALE20)<br>250 (GSE20)  | 130<br>153   |  | 10.05<br>10.05   | 06.06<br>06.06  | 24.0110-0335.1   | 410335   | 291 10,0 8,5 +B  |
|  | 200 d (ALE20)<br>220 d (ALE20)<br>250 (GSE20)<br>250 (GSE20)                          | 110<br>130<br>153<br>158   |  | 07.10<br>07.06<br>07.06<br>11.10   |   | 24.0118-0147.1   | 418147   | 310 18,0 16,5 V +B   |
| <b>LEXUS IS 200/250/300 (13-)</b>  |   |  |  |  |   |  |  |  |
|  | 250<br>300h   | 153<br>133   |  | 04.13<br>04.13   | F-Sport <sup>1)</sup>   | 13.0460-5770.2   | 605770   | 23983 17,0   |
|  | 250<br>300h   | 153<br>133   |  | 04.13<br>04.13   |   | 24.0128-0740.1   | 428740   | 296 28,0 26,0 V +B   |
| <b>LEXUS LS 400 (94-00)</b>  |   |  |  |  |   |  |  |  |
|  | 4.0 i V8<br>4.0 i V8<br>4.0 i V8<br>4.0 i V8  | 194<br>203<br>209<br>216   |  | 12.94<br>09.98<br>09.97<br>10.97   | 08.97<br>07.00<br>09.98<br>07.00  | 03.0137-0400.2   | 650400   | 190 x 45   |
| <b>LEXUS LS 460 (06-)</b>  |   |  |  |  |   |  |  |  |
|  | 4.6 VVTi<br>4.6 VVTi<br>4.6 VVTi<br>4.6 VVTi AWD                                      | 255<br>280<br>283<br>270   |  | 05.08<br>04.06<br>12.08<br>12.08   | 08.09<br>08.09<br>08.09<br>08.09  | 13.0460-5607.2   | 605607   | 24245 18,5 /WE/Zub   |

<sup>1)</sup> F Sport / F Sport / F Sport / F Sport



























|     |  |  |  |  |  |  |  |  |                     |
|--|--|--|--|--|---|--|--|--|---------------------|
| <b>LEXUS LS 460 (06-)</b>  |  |  |  |  |   |  |  |  |                     |
|    | 4.6 VVTi   | 255  |  | 05.08  |   |  | 13.0460-5608.2   | 605608   | 24244 18,5 /WE/Zub  |
|  | 4.6 VVTi   | 270  |  | 10.09  |   |  |  |  |                     |
|  | 4.6 VVTi   | 280  |  | 04.06  |   |  |  |  |                     |
|  | 4.6 VVTi   | 283  |  | 12.08  |   |  |  |  |                     |
|  | 4.6 VVTi AWD   | 270  |  | 12.08  |   |  |  |  |                     |
|  | 4.6 VVTi AWD   | 272  |  | 09.12  |   |  |  |  |                     |
|  | 4.6 VVTi AWD   | 283  |  | 10.09  |   |  |  |  |                     |
| <b>LEXUS LS 600 (07-)</b>  |  |  |  |  |   |  |  |  |                     |
|    | 600h Hybrid  | 290  |  | 08.07  |   |  | 13.0460-5607.2   | 605607   | 24245 18,5 /WE/Zub  |
|    | 600h Hybrid  | 290  |  | 08.07  |   |  | 13.0460-5608.2   | 605608   | 24244 18,5 /WE/Zub  |
| <b>LEXUS LX 470 (98-08)</b>  |  |  |  |  |   |  |  |  |                     |
|    | 4.7 V8 4x4 (UZJ100)  | 170  |  | 05.98  | 03.08   |  | 13.0460-5746.2   | 605746   | 23524 17,4 +/WK SUM |
|  | 4.7 V8 4x4 (UZJ100)  | 173  |  | 09.01  | 03.08   |  |  |  |                     |
|  | 4.7 V8 4x4 (UZJ100)  | 197  |  | 05.98  | 10.02   |  |  |  |                     |
|  | 4.7 V8 4x4 (UZJ100)  | 202  |  | 08.02  | 03.08   |  |  |  |                     |
|    | 4.7 V8 4x4 (UZJ100)  | 170  |  | 05.98  | 03.08   |  | 24.0132-0148.1   | 432148   | 313 32,0 30,0 V +B  |
|  | 4.7 V8 4x4 (UZJ100)  | 173  |  | 09.01  | 03.08   |  |  |  |                     |
|  | 4.7 V8 4x4 (UZJ100)  | 197  |  | 05.98  | 10.02   |  |  |  |                     |
|  | 4.7 V8 4x4 (UZJ100)  | 202  |  | 08.02  | 03.08   |  |  |  |                     |
|    | 4.7 V8 4x4 (UZJ100)  | 170  |  | 05.98  | 03.08   |  | 13.0460-5749.2   | 605749   | 23539 17,3          |
|  | 4.7 V8 4x4 (UZJ100)  | 173  |  | 09.01  | 03.08   |  |  |  |                     |
|  | 4.7 V8 4x4 (UZJ100)  | 197  |  | 05.98  | 10.02   |  |  |  |                     |
|  | 4.7 V8 4x4 (UZJ100)  | 202  |  | 08.02  | 03.08   |  |  |  |                     |
|    | 4.7 V8 4x4 (UZJ100)  | 170  |  | 05.98  | 03.08   |  | 24.0118-0143.1   | 418143   | 329 18,0 16,0 V +B  |
|  | 4.7 V8 4x4 (UZJ100)  | 173  |  | 09.01  | 03.08   |  |  |  |                     |
|  | 4.7 V8 4x4 (UZJ100)  | 197  |  | 05.98  | 10.02   |  |  |  |                     |
|  | 4.7 V8 4x4 (UZJ100)  | 202  |  | 08.02  | 03.08   |  |  |  |                     |
|    | 4.7 V8 4x4 (UZJ100)  | 170  |  | 05.98  | 03.08   |  | 03.0137-3008.2   | 653008   | 230 x 45            |
|  | 4.7 V8 4x4 (UZJ100)  | 173  |  | 09.01  | 03.08   |  |  |  |                     |
|  | 4.7 V8 4x4 (UZJ100)  | 197  |  | 05.98  | 10.02   |  |  |  |                     |
|  | 4.7 V8 4x4 (UZJ100)  | 202  |  | 08.02  | 03.08   |  |  |  |                     |
| <b>LEXUS LX 570 (URJ) (07-)</b>  |  |  |  |  |   |  |  |  |                     |
|   | 5.7 V8 4x4   | 270  |  | 11.07  |   |  | 13.0460-5619.2   | 605619   | 24653 17,3 /Zub     |
|  | 5.7 V8 4x4   | 282  |  | 11.07  |   |  |  |  |                     |
| <b>LEXUS NX (14-)</b>  |  |  |  |  |   |  |  |  |                     |
|  | 200t AWD   | 175  |  | 07.14  |   |  | 13.0460-5634.2   | 605634   | 24452 17,5 /Zub ADV |
|  |  |  |  |  |   |  | 13.0470-5634.2   | LD5634   | 24452 17,5 /Zub ADV |
|  | 300h   | 114  |  | 07.14  |   |  | 13.0460-5634.2   | 605634   | 24452 17,5 /Zub ADV |
|  | 300h AWD   | 114  |  | 07.14  |   |  |  |  |                     |
| <b>LEXUS RC (14-)</b>  |  |  |  |  |   |  |  |  |                     |
|  | RC 200 t   | 180  |  | 08.15  |   |  | 13.0460-5789.2   | 605789   | + Sportpaket 1)     |
|  | RC 350   | 234  |  | 09.14  |   |  |  |  | 20325 17,2 +/WK     |
| <b>LEXUS RX 300 (MCU_) (00-03)</b>   |  |  |  |  |   |  |  |  |                     |
|  | 300 V6   | 148  |  | 07.00  | 03.03   |  | 13.0460-5882.2   | 605882   | 23703 17,9 /WK      |
|  | 300 V6 4x4   | 148  |  | 10.00  | 05.03   |  |  |  |                     |
|  | 300 V6   | 148  |  | 07.00  | 03.03   |  | 24.0128-0186.1   | 428186   | 296 28,0 26,0 V +B  |
|  | 300 V6 4x4   | 148  |  | 10.00  | 05.03   |  |  |  |                     |
|  | 300 V6 4x4   | 164  |  | 10.00  | 05.03   |  |  |  |                     |
|  | 300 V6   | 148  |  | 07.00  | 03.03   |  | 13.0460-5840.2   | 605840   | 21833 15,0 +/WK AKE |
|  | 300 V6 4x4   | 148  |  | 10.00  | 05.03   |  |  |  |                     |
|  | 300 V6 4x4   | 164  |  | 10.00  | 05.03   |  |  |  |                     |
|  | 300 V6   | 148  |  | 07.00  | 03.03   |  | 24.0110-0712.1   | 410712   | 288 10,0 8,5 +B     |
|  | 300 V6 4x4   | 148  |  | 10.00  | 05.03   |  |  |  |                     |
|  | 300 V6 4x4   | 164  |  | 10.00  | 05.03   |  |  |  |                     |
|  | 300 V6   | 148  |  | 07.00  | 03.03   |  | 03.0137-0402.2   | 650402   | 170 x 40            |
|  | 300 V6 4x4   | 148  |  | 10.00  | 05.03   |  |  |  |                     |
|  | 300 V6 4x4   | 164  |  | 10.00  | 05.03   |  |  |  |                     |
| <b>LEXUS RX 300/350/400 (MCU_) (03-08)</b>   |  |  |  |  |   |  |  |  |                     |
|  | 3.3  | 171  |  | 05.03  | 01.06   |  | 13.0460-5750.2   | 605750   | 23734 16,8          |
|  | 3.3 AWD  | 171  |  | 05.03  | 12.08   |  |  |  |                     |
|  | 300 AWD  | 150  |  | 05.03  | 12.08   |  |  |  |                     |
|  | 350  | 203  |  | 02.06  | 12.08   |  |  |  |                     |
|  | 350 AWD  | 203  |  | 02.06  | 12.08   |  |  |  |                     |
|  | 400h   | 155  |  | 09.05  | 12.08   |  |  |  |                     |
|  | 400h AWD   | 155  |  | 09.04  | 12.08   |  |  |  |                     |
|  | 3.3  | 171  |  | 05.03  | 01.06   |  | 24.0128-0753.1   | 428753   | 319 28,0 26,0 V +B  |
|  | 3.3 AWD  | 171  |  | 05.03  | 12.08   |  |  |  |                     |
|  | 300 AWD  | 150  |  | 05.03  | 12.08   |  |  |  |                     |
|  | 350  | 203  |  | 02.06  | 12.08   |  |  |  |                     |
|  | 350 AWD  | 203  |  | 02.06  | 12.08   |  |  |  |                     |
|  | 400h   | 155  |  | 09.05  | 12.08   |  |  |  |                     |
|  |  |  |  |  |   |  |  |  |                     |

1) + sports package / + pacchetto sportivo / + version sport / + kit deportivo

|     |  |  |  |  |  |  |  |  |
|--|--|--|--|--|---|--|--|--|
| <b>LEXUS RX 300/350/400 (MCU ) (03-08)</b>   |  |  |  |  |   |  |  |  |
|    | 400h AWD   | 155  |  | 09.04  | 12.08   | 24.0128-0753.1   | 428753   | 319 28,0 26,0 V +B   |
|    | 3.3  | 171  |  | 05.03  | 01.06   | 13.0460-5734.2   | 605734   | 23967 15,1 SUM   |
|  | 3.3 AWD  | 171  |  | 05.03  | 12.08   |  |  |  |
|  | 300 AWD  | 150  |  | 05.03  | 12.08   |  |  |  |
|  | 350  | 203  |  | 02.06  | 12.08   |  |  |  |
|  | 350 AWD  | 203  |  | 02.06  | 12.08   |  |  |  |
|  | 400h   | 155  |  | 09.05  | 12.08   |  |  |  |
|  | 400h AWD   | 155  |  | 09.04  | 12.08   |  |  |  |
|    | 3.3  | 171  |  | 05.03  | 01.06   | 24.0110-0316.1   | 410316   | 288 10,0 8,5 +B  |
|  | 3.3 AWD  | 171  |  | 05.03  | 12.08   |  |  |  |
|  | 300 AWD  | 150  |  | 05.03  | 12.08   |  |  |  |
|  | 350  | 203  |  | 02.06  | 12.08   |  |  |  |
|  | 350 AWD  | 203  |  | 02.06  | 12.08   |  |  |  |
|  | 400h   | 155  |  | 09.05  | 12.08   |  |  |  |
|  | 400h AWD   | 155  |  | 09.04  | 12.08   |  |  |  |
| <b>LEXUS RX 270/350/450 (GYL ) (09-15)</b>   |  |  |  |  |   |  |  |  |
|    | 270  | 138  |  | 01.09  |   | 13.0460-5634.2   | 605634   | 24452 17,5 /Zub ADV  |
|  | 350  | 206  |  | 01.09  |   | 13.0470-5634.2   | LD5634   | 24452 17,5 /Zub ADV  |
|  | 350 AWD  | 204  |  | 01.09  |   |  |  |  |
|  | 350 AWD  | 206  |  | 01.09  |   |  |  |  |
|  | 450h   | 183  |  | 01.09  |   |  |  |  |
|  | 450h AWD   | 183  |  | 01.09  |   |  |  |  |
|    | 270  | 138  |  | 01.09  |   | 13.0460-5635.2   | 605635   | 24918 15,0 AKE   |
|  | 350  | 206  |  | 01.09  |   | 13.0470-5635.2   | LD5635   | 24918 15,0 AKE   |
|  | 350 AWD  | 204  |  | 01.09  |   |  |  |  |
|  | 350 AWD  | 206  |  | 01.09  |   |  |  |  |
|  | 450h   | 183  |  | 01.09  |   |  |  |  |
|  | 450h AWD   | 183  |  | 01.09  |   |  |  |  |
| <b>LEXUS SC 430 (UZZ40) (01-10)</b>  |  |  |  |  |   |  |  |  |
|    | 4.3 V8   | 210  |  | 05.01  | 10.01   | 24.0132-0701.1   | 432701   | 296 32,0 30,0 V +B   |
|  | 4.3 V8   | 215  |  | 05.01  | 10.01   |  |  |  |
|  | 4.3 V8   | 244  |  | 05.01  | 10.01   |  |  |  |
|    | 4.3 V8   | 210  |  | 05.01  | 07.10   | 13.0460-5748.2   | 605748   | 23429 15,5 /WK   |
|  | 4.3 V8   | 215  |  | 05.01  | 07.10   |  |  |  |
|  | 4.3 V8   | 244  |  | 05.01  | 07.10   |  |  |  |
|   | 4.3 V8   | 210  |  | 05.01  | 07.10   | 24.0112-0703.1   | 412703   | 307 12,0 10,5 +B   |
|  | 4.3 V8   | 215  |  | 05.01  | 07.10   |  |  |  |
|  | 4.3 V8   | 244  |  | 05.01  | 07.10   |  |  |  |
|  | 4.3 V8   | 210  |  | 05.01  | 07.10   | 03.0137-0400.2   | 650400   | 190 x 45   |
|  | 4.3 V8   | 215  |  | 05.01  | 07.10   |  |  |  |
|  | 4.3 V8   | 244  |  | 05.01  | 07.10   |  |  |  |
| <b>MAYBACH (W240) (02-12)</b>  |  |  |  |  |   |  |  |  |
|  | 5.5 V12 (57)   |  |  | 06.02  | 12.12   | 24.8190-0410.2   | 620410   | 2 Warnkontakt L=97,5mm   |
|  | 5.5 V12 L (62)   |  |  | 06.02  | 12.12   |  |  |  |
|  | 6.0 V12 (57S)  |  |  | 09.05  | 12.12   |  |  |  |
|  | 5.5 V12 (57)   |  |  | 06.02  | 12.12   | 24.8190-0410.2   | 620410   | 1 Warnkontakt L=97,5mm   |
|  | 5.5 V12 L (62)   |  |  | 06.02  | 12.12   |  |  |  |
|  | 6.0 V12 (57S)  |  |  | 09.05  | 12.12   |  |  |  |
| <b>MAZDA 121 (96-03)</b>   |  |  |  |  |   |  |  |  |
|  | 1.25 i 16V   | 55   |  | 03.96  | 01.00   | 13.0460-7073.2   | 607073   | 21202 16,9 + ATE   |
|  | 1.3 i  | 37   |  | 03.96  | 01.00   |  |  |  |
|  | 1.3 i  | 44   |  | 03.96  | 01.00   |  |  |  |
|  | 1.8 D  | 44   |  | 03.96  | 01.00   |  |  |  |
|  | 1.25 i 16V   | 55   |  | 03.96  | 01.00   | 13.0460-7071.2   | 607071   | 20640 17,5 + ATE   |
|  | 1.25 i 16V   | 55   |  | 02.00  | 03.03   | 13.0460-7148.2   | 607148   | - ABS ATE  |
|  | 1.3 i  | 37   |  | 02.00  | 03.03   | 13.0460-7142.2   | 607142   | + ABS ATE  |
|  | 1.3 i  | 44   |  | 02.00  | 03.03   |  |  |  |
|  | 1.8 D  | 44   |  | 02.00  | 03.03   |  |  |  |
|  | 1.25 i 16V   | 55   |  | 03.96  | 01.00   | 24.0112-0141.1   | 412141   | 239 12,0 10,0 +B   |
|  | 1.3 i  | 37   |  | 03.96  | 01.00   | 24.0312-0141.1   | 512141   | 239 12,0 10,0 +B PD  |
|  | 1.3 i  | 44   |  | 03.96  | 01.00   |  |  |  |
|  | 1.8 D  | 44   |  | 03.96  | 01.00   |  |  |  |
|  | 1.25 i 16V   | 55   |  | 03.96  | 01.00   | 24.0120-0147.1   | 420147   | 240 20,0 18,0 V +B   |
|  | 1.25 i 16V   | 55   |  | 02.00  | 03.03   | 24.0320-0147.1   | 520147   | 240 20,0 18,0 V +B PD  |
|  | 1.3 i  | 37   |  | 02.00  | 03.03   | 24.0120-0147.1   | 420147   | - ABS  |
|  | 1.3 i  | 44   |  | 02.00  | 03.03   | 24.0320-0147.1   | 520147   | - ABS  |
|  | 1.3 i  | 44   |  | 02.00  | 03.03   | 24.0122-0172.1   | 422172   | + ABS  |
|  | 1.8 D  | 44   |  | 02.00  | 03.03   | 24.0322-0172.1   | 522172   | + ABS  |
|  | 1.25 i 16V   | 55   |  | 03.96  | 03.03   | 24.0711-1367.1   | 360024   | 2 Radsensor L=875  |
|  | 1.3 i  | 37   |  | 03.96  | 03.03   |  |  |  |
|  | 1.3 i  | 44   |  | 03.96  | 03.03   |  |  |  |
|  | 1.8 D  | 44   |  | 03.96  | 03.03   |  |  |  |
|  | 1.25 i 16V   | 55   |  | 03.96  | 11.98   | 24.0751-1173.3   | 360048   | 1 Radsensor L=785/800  |
|  | 1.3 i  | 37   |  | 03.96  | 11.98   |  |  |  |
|  | 1.3 i  | 44   |  | 03.96  | 11.98   |  |  |  |
|  | 1.8 D  | 44   |  | 03.96  | 11.98   |  |  |  |
|  | 1.25 i 16V   | 55   |  | 12.98  | 03.03   | 24.0713-1121.3   | 360036   | 1 Radsensor L=785/800  |
|  | 1.3 i  | 37   |  | 12.98  | 03.03   |  |  |  |

1) + manual transmission / + scatola cambio velocità / + transmission mécanique / + cambio de velocidad  
2) + autom.transmission / + scatola cambio automatico / + transmission automatique / + cambio automático























|     |    |  |  |  |  |  |  |       |                            |                         |
|--|--|--|--|--|---|--|--|---|----------------------------|-------------------------|
| <b>MAZDA 121 (96-03)</b>   |  |  |  |  |   |  |  |   |                            |                         |
|    | 1.3 i<br>1.8 D   | 44<br>44   |  | 12.98<br>12.98   | 03.03<br>03.03  | 24.0713-1121.3   | 360036   | 1    | Radsensor L=785/800        |                         |
|    | 1.25 i 16V   | 55   |  | 03.96  | 01.00   | 03.0137-0337.2   | 650337   |   | 180 x 32 HEB               |                         |
|  | 1.3 i  | 37   |  | 03.96  | 01.00   | 03.0137-9217.2   | 669217   |   | TRW<br>Bremsbacken-Zubehör |                         |
|  | 1.3 i  | 44   |  | 03.96  | 01.00   |  |  |   |                            |                         |
|  | 1.8 D  | 44   |  | 03.96  | 01.00   |  |  |   |                            |                         |
|    | 1.25 i 16V   | 55   |  | 02.00  | 03.03   | 03.0137-0412.2   | 650412   | - ABS   | 180 x 32 HEB               |                         |
|  | 1.3 i  | 37   |  | 02.00  | 03.03   | 03.0137-9179.2   | 669179   | - ABS   | TRW<br>Bremsbacken-Zubehör |                         |
|  | 1.3 i  | 44   |  | 02.00  | 03.03   | 03.0137-0394.2   | 650394   | + ABS   | 203 x 38 HEB               |                         |
|  | 1.8 D  | 44   |  | 02.00  | 03.03   | 03.0137-9259.2   | 669259   | + ABS   | AP<br>Bremsbacken-Zubehör  |                         |
|    | 1.25 i 16V   | 55   |  | 03.96  | 01.00   | 24.0218-0024.2   | 480079   | ohne Sensorring <sup>1)</sup>   | 180/181 x 44 - Lager       |                         |
|  | 1.3 i  | 37   |  | 03.96  | 01.00   | 24.0218-0724.2   | 480206   | ohne Sensorring <sup>1)</sup>   | 180/181 x 44 + Lager       |                         |
|  | 1.3 i  | 44   |  | 03.96  | 01.00   |  |  |   |                            |                         |
|  | 1.8 D  | 44   |  | 03.96  | 01.00   |  |  |   |                            |                         |
|    | 1.25 i 16V   | 55   |  | 02.00  | 03.03   | 24.0218-0024.2   | 480079   | - ABS   | 180/181 x 44 - Lager       |                         |
|  | 1.3 i  | 37   |  | 02.00  | 03.03   | 24.0218-0724.2   | 480206   | - ABS   | 180/181 x 44 + Lager       |                         |
|  | 1.3 i  | 44   |  | 02.00  | 03.03   | 24.0220-3009.2   | 480080   | + ABS/ ohne Sensorring <sup>2)</sup>  | 203/204 x 49               |                         |
|  | 1.8 D  | 44   |  | 02.00  | 03.03   |  |  |   |                            |                         |
|    | 1.25 i 16V   | 55   |  | 03.96  | 01.00   | 03.0520-3617.3   | 693617   |   | 17,78/180x32 TopKit        |                         |
|  | 1.3 i  | 37   |  | 03.96  | 01.00   |  |  |   | TRW                        |                         |
|  | 1.3 i  | 44   |  | 03.96  | 01.00   |  |  |   |                            |                         |
|  | 1.8 D  | 44   |  | 03.96  | 01.00   |  |  |   |                            |                         |
|    | 1.25 i 16V   | 55   |  | 02.00  | 03.03   | 03.0520-6219.3   | 696219   | - ABS   | 19,05/180x32 TopKit        |                         |
|  | 1.3 i  | 37   |  | 02.00  | 03.03   | 03.0520-6319.3   | 696319   | + ABS   | AP<br>19,05/203x38 TopKit  |                         |
|  | 1.3 i  | 44   |  | 02.00  | 03.03   |  |  |   |                            |                         |
|  | 1.8 D  | 44   |  | 02.00  | 03.03   |  |  |   |                            |                         |
|    | 1.25 i 16V   | 55   |  | 03.96  | 03.03   | 03.0520-5519.3   | 695519   |   | 19,05/180x32 TopKit        |                         |
| <b>MAZDA 2 (DY) (03-07)</b>  |  |  |  |  |   |  |  |   |                            |                         |
|    | 1.2 16V  | 55   |  | 02.03  | 09.07   | 13.0460-7142.2   | 607142   |   | 23604 18,3 +               |                         |
|  | 1.25 16V   | 55   |  | 04.03  | 09.07   |  |  |   | ATE                        |                         |
|  | 1.3 16V  | 67   |  | 04.03  | 09.07   |  |  |   |                            |                         |
|  | 1.4 16V  | 59   |  | 02.03  | 09.07   |  |  |   |                            |                         |
|  | 1.4 CD   | 50   |  | 04.03  | 09.07   |  |  |   |                            |                         |
|  | 1.5 16V  | 82   |  | 04.03  | 09.07   |  |  |   |                            |                         |
|    | 1.2 16V  | 55   |  | 02.03  | 09.07   | 24.0122-0172.1   | 422172   |   | 258 22,0 20,0 V +B         |                         |
|  | 1.25 16V   | 55   |  | 04.03  | 09.07   | 24.0322-0172.1   | 522172   |   | 258 22,0 20,0 V +B PD      |                         |
|  | 1.3 16V  | 67   |  | 04.03  | 09.07   |  |  |   |                            |                         |
|  | 1.4 16V  | 59   |  | 02.03  | 09.07   |  |  |   |                            |                         |
|  | 1.4 CD   | 50   |  | 04.03  | 09.07   |  |  |   |                            |                         |
|  | 1.5 16V  | 82   |  | 04.03  | 09.07   |  |  |   |                            |                         |
|  | 1.2 16V  | 55   |  | 02.03  | 09.07   | 24.0711-6118.3   | 360188   | 2  | Radsensor L=937/958        |                         |
|  | 1.25 16V   | 55   |  | 04.03  | 09.07   |  |  |   |                            |                         |
|  | 1.3 16V  | 67   |  | 04.03  | 09.07   |  |  |   |                            |                         |
|  | 1.4 16V  | 59   |  | 02.03  | 09.07   |  |  |   |                            |                         |
|  | 1.4 CD   | 50   |  | 04.03  | 09.07   |  |  |   |                            |                         |
|  | 1.5 16V  | 82   |  | 04.03  | 09.07   |  |  |   |                            |                         |
|  | 1.2 16V  | 55   |  | 02.03  | 09.07   | 03.0137-0394.2   | 650394   |   | 203 x 38 HEB               |                         |
|  | 1.25 16V   | 55   |  | 04.03  | 09.07   | 03.0137-9259.2   | 669259   |   | TRW<br>Bremsbacken-Zubehör |                         |
|  | 1.3 16V  | 67   |  | 04.03  | 09.07   |  |  |   |                            |                         |
|  | 1.4 16V  | 59   |  | 02.03  | 09.07   |  |  |   |                            |                         |
|  | 1.4 CD   | 50   |  | 04.03  | 09.07   |  |  |   |                            |                         |
|  | 1.5 16V  | 82   |  | 04.03  | 09.07   |  |  |   |                            |                         |
|  | 1.2 16V  | 55   |  | 02.03  | 09.07   | 03.0520-6319.3   | 696319   |   | 19,05/203x38 TopKit        |                         |
|  | 1.25 16V   | 55   |  | 04.03  | 09.07   |  |  |   | AP                         |                         |
|  | 1.3 16V  | 67   |  | 04.03  | 09.07   |  |  |   |                            |                         |
|  | 1.4 16V  | 59   |  | 02.03  | 09.07   |  |  |   |                            |                         |
|  | 1.4 CD   | 50   |  | 04.03  | 09.07   |  |  |   |                            |                         |
|  | 1.5 16V  | 82   |  | 04.03  | 09.07   |  |  |   |                            |                         |
|  | 1.2 16V  | 55   |  | 02.03  | 09.07   |  |  |   |                            |                         |
|  | 1.25 16V   | 55   |  | 04.03  | 09.07   |  |  |   |                            |                         |
|  | 1.3 16V  | 67   |  | 04.03  | 09.07   |  |  |   |                            |                         |
|  | 1.4 16V  | 59   |  | 02.03  | 09.07   |  |  |   |                            |                         |
|  | 1.4 CD   | 50   |  | 04.03  | 09.07   |  |  |   |                            |                         |
|  | 1.5 16V  | 82   |  | 04.03  | 09.07   |  |  |   |                            |                         |
|  | 1.6 16V  | 74   |  | 02.03  | 09.07   |  |  |   |                            |                         |
|  | <b>MAZDA 2 (DE) (07-14)</b>  |  |  |  |   |  |  |   |                            |                         |
|  |  | 1.3 16V  | 55   |  | 10.07   | 12.14  | 13.0460-5794.2   | 605794  |                            | 24283 15,5 +WK/Zub/STRW |
|  |  | 1.3 16V  | 63   |  | 10.07   | 12.14  |  |   |                            |                         |
| 1.3 BiFuel   |  | 55   |  | 05.11  | 12.14   |  |  |   |                            |                         |
| 1.3 BiFuel   |  | 62   |  | 05.11  | 12.14   |  |  |   |                            |                         |
| 1.3 MZR  |  | 62   |  | 01.10  | 12.14   |  |  |   |                            |                         |
| 1.4 MZR-CD   |  | 50   |  | 01.08  | 12.14   |  |  |   |                            |                         |
| 1.5 16V  |  | 76   |  | 10.07  | 12.14   |  |  |   |                            |                         |
| 1.5 MZR  |  | 75   |  | 06.11  | 12.14   |  |  |   |                            |                         |
| 1.6 MZ-CD  |  | 66   |  | 10.08  | 12.14   |  |  |   |                            |                         |
| 1.6 MZ-CD  |  | 70   |  | 06.11  | 12.14   |  |  |   |                            |                         |
|  | 1.3 16V  | 55   |  | 10.07  | 12.14   | 24.0123-0112.1   | 423112   |   | 258 23,0 21,0 V L +B       |                         |
|  | 1.3 16V  | 63   |  | 10.07  | 12.14   |  |  |   |                            |                         |
|  | 1.3 BiFuel   | 55   |  | 05.11  | 12.14   |  |  |   |                            |                         |
|  | 1.3 BiFuel   | 62   |  | 05.11  | 12.14   |  |  |   |                            |                         |
|  | 1.3 MZR  | 62   |  | 01.10  | 12.14   |  |  |   |                            |                         |
|  | 1.4 MZR-CD   | 50   |  | 01.08  | 12.14   |  |  |   |                            |                         |
| 1.5 16V  | 76   |  | 10.07  | 12.14  |   |  |  |   |                            |                         |
| 1.5 MZR  | 75   |  | 06.11  | 12.14  |   |  |  |   |                            |                         |













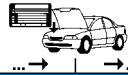









<sup>1)</sup> without sensor ring / senza sensori / sans secours ABS / sin anillo sensor ABS

<sup>2)</sup> + ABS/ without sensor ring / + ABS/ senza sensore / + ABS/ sans secours ABS / + ABS/ sin anillo sensor ABS

<sup>3)</sup> + manual transmission / + scatola cambio velocità / + transmission mécanique / + cambio de velocidad

<sup>4)</sup> + autom.transmission / + scatola cambio automatico / + transmission automatique / + cambio automático

|     |    |     |  |                                   |                                  |  |  |                    |
|--|--|---|--|---|---|--|--|--|
| <b>MAZDA 2 (DE) (07-14)</b>  |  |   |  |   |   |  |  |  |
|    | 1.6 MZ-CD<br>1.6 MZ-CD   | 66<br>70  |  | 10.08<br>06.11  | 12.14<br>12.14  | 24.0123-0112.1   | 423112   | 258 23,0 21,0 V L +B   |
|    | 1.3 16V<br>1.3 BiFuel<br>1.3 BiFuel<br>1.3 MZR<br>1.4 MZR-CD<br>1.5 16V<br>1.5 MZR<br>1.6 MZ-CD<br>1.6 MZ-CD   | 55<br>63<br>55<br>62<br>62<br>50<br>76<br>75<br>66<br>70                            |  | 10.07<br>10.07<br>05.11<br>01.10<br>01.08<br>10.07<br>06.11<br>10.08<br>06.11                                     | 12.14<br>12.14<br>12.14<br>12.14<br>12.14<br>12.14<br>12.14<br>12.14<br>12.14                                     | 03.0137-0501.2   | 650501   | 200 x 32 HEB <b>TRW</b>  |
|    | 1.3 16V<br>1.3 16V<br>1.3 MZR<br>1.4 MZR-CD<br>1.5 16V<br>1.5 MZR<br>1.6 MZ-CD<br>1.6 MZ-CD  | 55<br>63<br>62<br>50<br>76<br>75<br>66<br>70  |  | 10.07<br>10.07<br>01.10<br>01.08<br>10.07<br>06.11<br>10.08<br>06.11  | 12.14<br>12.14<br>12.14<br>12.14<br>12.14<br>12.14<br>12.14<br>12.14  | 03.0520-7819.3   | 697819   | 19,05/200x32 TopKit  |
| <b>MAZDA 3 (BK) (03-09)</b>  |  |   |  |   |   |  |  |  |
|    | 1.4 i 16V<br>1.4 i 16V<br>1.6 CiTD<br>1.6 i 16V<br>2.0 i 16V<br>2.0 i 16V<br>2.0 MZR-CD<br>2.3 i 16V<br>2.3 i 16V Sport<br>2.3 MZR<br>2.3 DiSi Turbo MPS<br>2.3 MPS<br>2.3 MPS | 59<br>62<br>80<br>77<br>104<br>110<br>105<br>118<br>126<br>115<br>184<br>191<br>196 |  | 10.03<br>10.03<br>06.04<br>10.03<br>04.04<br>10.03<br>12.06<br>10.03<br>10.03<br>03.04<br>06.06<br>12.06<br>01.07 | 05.09<br>03.06<br>05.09<br>05.09<br>06.06<br>05.09<br>05.09<br>09.04<br>05.09<br>05.09<br>06.09<br>06.09<br>05.09 | 13.0460-7193.2<br>13.0470-7193.2   | 607193<br>LD7193   | 23723 18,1 +<br>23723 18,1 + <b>ATE</b><br><b>ATE</b>  |
|    | 1.4 i 16V<br>1.4 i 16V<br>1.6 CiTD<br>1.6 i 16V<br>2.0 i 16V<br>2.0 i 16V<br>2.0 MZR-CD<br>2.3 i 16V<br>2.3 i 16V Sport<br>2.3 MZR<br>2.3 DiSi Turbo MPS<br>2.3 MPS<br>2.3 MPS | 59<br>62<br>80<br>77<br>104<br>110<br>105<br>118<br>126<br>115<br>184<br>191<br>196 |  | 10.03<br>10.03<br>06.04<br>10.03<br>04.04<br>10.03<br>12.06<br>10.03<br>10.03<br>03.04<br>06.06<br>12.06<br>01.07 | 05.09<br>03.06<br>05.09<br>05.09<br>06.06<br>05.09<br>05.09<br>09.04<br>05.09<br>05.09<br>06.09<br>06.09<br>05.09 | 24.0125-0165.1<br>24.0125-0170.1<br>24.0125-0195.1                                 | 425165<br>425170<br>425195   | 278 25,0 23,0 V L +B<br>300 25,0 23,0 V L +B<br>320 25,0 23,0 V L +B                                 |
|  | 1.4 i 16V<br>1.4 i 16V<br>1.6 CiTD<br>1.6 i 16V<br>2.0 i 16V<br>2.0 i 16V<br>2.0 MZR-CD<br>2.3 DiSi Turbo MPS<br>2.3 i 16V<br>2.3 i 16V Sport<br>2.3 MPS<br>2.3 MPS<br>2.3 MZR | 59<br>62<br>80<br>77<br>104<br>110<br>105<br>184<br>118<br>126<br>191<br>196<br>115 |  | 10.03<br>10.03<br>06.04<br>10.03<br>04.04<br>10.03<br>12.06<br>06.06<br>10.03<br>10.03<br>12.06<br>01.07<br>03.04 | 05.09<br>03.06<br>05.09<br>05.09<br>06.06<br>05.09<br>05.09<br>06.09<br>09.04<br>05.09<br>05.09<br>05.09<br>05.09 | 24.0711-5123.3   | 360065   | 2 <br>Radsensor |
|  | 1.4 i 16V<br>1.4 i 16V<br>1.6 CiTD<br>1.6 i 16V<br>2.0 i 16V<br>2.0 i 16V<br>2.0 MZR-CD<br>2.3 DiSi Turbo MPS<br>2.3 i 16V<br>2.3 i 16V Sport<br>2.3 MPS<br>2.3 MPS<br>2.3 MZR | 59<br>62<br>80<br>77<br>104<br>110<br>105<br>184<br>118<br>126<br>191<br>196<br>115 |  | 10.03<br>10.03<br>06.04<br>10.03<br>04.04<br>10.03<br>12.06<br>06.06<br>10.03<br>10.03<br>12.06<br>01.07<br>03.04 | 05.09<br>03.06<br>05.09<br>05.09<br>06.06<br>05.09<br>05.09<br>06.09<br>09.04<br>05.09<br>05.09<br>05.09<br>05.09 | 13.0460-7195.2<br>13.0470-7195.2   | 607195<br>LD7195   | 23482 16,6 +<br>23482 16,6 + <b>ATE</b><br><b>ATE</b>  |
|  | 1.4 i 16V<br>1.4 i 16V<br>1.6 CiTD<br>1.6 i 16V<br>2.0 i 16V<br>2.0 i 16V<br>2.0 MZR-CD<br>2.3 DiSi Turbo MPS<br>2.3 i 16V<br>2.3 i 16V Sport<br>2.3 MPS                       | 59<br>62<br>80<br>77<br>104<br>110<br>105<br>184<br>118<br>126<br>191               |  | 10.03<br>10.03<br>06.04<br>10.03<br>04.04<br>10.03<br>12.06<br>06.06<br>10.03<br>10.03<br>12.06                   | 05.09<br>03.06<br>05.09<br>05.09<br>06.06<br>05.09<br>05.09<br>06.09<br>09.04<br>05.09<br>05.09                   | 24.0111-0164.1<br>24.0111-0160.1   | 411164<br>411160   | 265 11,0 9,0 +B<br>280 11,0 9,0 +B   |
|  |   |   |  |   |   |  |  |  |

|     |    |     |  |                                   |                                  |  |  |  |  |
|--|--|---|--|---|---|--|--|--|--|
| <b>MAZDA 3 (BK) (03-09)</b>  |  |   |  |   |   |  |  |  |  |
|    | 2.3 MPS<br>2.3 MZR   | 196<br>115  |  | 01.07<br>03.04  | 05.09<br>05.09  |  | 24.0111-0160.1   | 411160   | 280 11,0 9,0 +B  |
|    | 1.4 i 16V<br>1.4 i 16V<br>1.6 CiTD<br>1.6 i 16V<br>2.0 i 16V<br>2.0 i 16V<br>2.0 MZR-CD<br>2.3 DiSi Turbo MPS<br>2.3 i 16V<br>2.3 i 16V Sport<br>2.3 MPS<br>2.3 MPS<br>2.3 MZR | 59<br>62<br>80<br>77<br>104<br>110<br>105<br>184<br>118<br>126<br>191<br>196<br>115 |  | 10.03<br>10.03<br>06.04<br>10.03<br>04.04<br>10.03<br>12.06<br>06.06<br>10.03<br>10.03<br>12.06<br>01.07<br>03.04 | 05.09<br>03.06<br>05.09<br>05.09<br>06.06<br>05.09<br>05.09<br>06.09<br>09.04<br>05.09<br>05.09<br>05.09<br>05.09 |  | 24.0711-6220.3   | 360256   | 2 <br>Radsensor   |
| <b>MAZDA 3 (BL) (09-13)</b>  |  |   |  |   |   |  |  |  |  |
|    | 1.6 MZR<br>1.6 MZR<br>1.6 MZR-CD<br>1.6 MZR-CD<br>2.0 MZR<br>2.0 MZR<br>2.0 MZR DISI<br>2.2 MZR-CD<br>2.2 MZR-CD<br>2.3 MPS Turbo  | 77<br>79<br>80<br>85<br>108<br>110<br>111<br>110<br>136<br>191                      |  | 06.09<br>01.10<br>06.09<br>11.10<br>06.10<br>06.09<br>06.09<br>06.09<br>06.09<br>06.09                            | 11.13<br>11.13<br>11.13<br>11.13<br>11.13<br>11.13<br>11.13<br>11.13<br>11.13<br>11.13                            |  | 13.0460-7193.2<br>13.0470-7193.2   | 607193<br>LD7193   | 23723 18,1 +<br>23723 18,1 +<br>ATE<br>ATE   |
|    | 1.6 MZR<br>1.6 MZR<br>1.6 MZR-CD<br>1.6 MZR-CD<br>2.0 MZR<br>2.0 MZR<br>2.0 MZR DISI<br>2.2 MZR-CD<br>2.2 MZR-CD<br>2.3 MPS Turbo  | 77<br>79<br>80<br>85<br>108<br>110<br>111<br>110<br>136<br>191                      |  | 06.09<br>01.10<br>06.09<br>11.10<br>06.10<br>06.09<br>06.09<br>06.09<br>06.09<br>06.09                            | 11.13<br>11.13<br>11.13<br>11.13<br>11.13<br>11.13<br>11.13<br>11.13<br>11.13<br>11.13                            |  | 13.0460-7204.2<br>13.0470-7204.2   | 607204<br>LD7204   | 23912 18,8 +<br>23912 18,8 +<br>ATE<br>ATE   |
|  | 1.6 MZR<br>1.6 MZR<br>1.6 MZR-CD<br>1.6 MZR-CD<br>2.0 MZR<br>2.0 MZR<br>2.0 MZR DISI<br>2.2 MZR-CD<br>2.2 MZR-CD<br>2.3 MPS Turbo  | 77<br>79<br>80<br>85<br>108<br>110<br>111<br>110<br>136<br>191                      |  | 06.09<br>01.10<br>06.09<br>11.10<br>06.10<br>06.09<br>06.09<br>06.09<br>06.09<br>06.09                            | 11.13<br>11.13<br>11.13<br>11.13<br>11.13<br>11.13<br>11.13<br>11.13<br>11.13<br>11.13                            |  | 24.0125-0165.1<br>24.0125-0170.1<br>24.0125-0195.1                                 | 425165<br>425170<br>425195   | 278 25,0 23,0 V L +B<br>300 25,0 23,0 V L +B<br>320 25,0 23,0 V L +B                                 |
|  | 1.6 MZR<br>1.6 MZR<br>1.6 MZR-CD<br>1.6 MZR-CD<br>2.0 MZR<br>2.0 MZR<br>2.0 MZR DISI<br>2.2 MZR-CD<br>2.2 MZR-CD<br>2.3 MPS Turbo  | 77<br>79<br>80<br>85<br>108<br>110<br>111<br>110<br>136<br>191                      |  | 06.09<br>01.10<br>06.09<br>11.10<br>06.10<br>06.09<br>06.09<br>06.09<br>06.09<br>06.09                            | 11.13<br>11.13<br>11.13<br>11.13<br>11.13<br>11.13<br>11.13<br>11.13<br>11.13<br>11.13                            |  | 24.0711-5123.3   | 360065   | 2 <br>Radsensor |
|  | 1.6 MZR<br>1.6 MZR<br>1.6 MZR-CD<br>1.6 MZR-CD<br>2.0 MZR<br>2.0 MZR<br>2.0 MZR DISI<br>2.2 MZR-CD<br>2.2 MZR-CD<br>2.3 MPS Turbo  | 77<br>79<br>80<br>85<br>108<br>110<br>111<br>110<br>136<br>191                      |  | 06.09<br>01.10<br>06.09<br>11.10<br>06.10<br>06.09<br>06.09<br>06.09<br>06.09<br>06.09                            | 11.13<br>11.13<br>11.13<br>11.13<br>11.13<br>11.13<br>11.13<br>11.13<br>11.13<br>11.13                            |  | 13.0460-7195.2<br>13.0470-7195.2   | 607195<br>LD7195   | 23482 16,6 +<br>23482 16,6 +<br>ATE<br>ATE   |
|  | 1.6 MZR<br>1.6 MZR<br>1.6 MZR-CD<br>1.6 MZR-CD<br>2.0 MZR<br>2.0 MZR<br>2.0 MZR DISI<br>2.2 MZR-CD<br>2.2 MZR-CD<br>2.3 MPS Turbo  | 77<br>79<br>80<br>85<br>108<br>110<br>111<br>110<br>136<br>191                      |  | 06.09<br>01.10<br>06.09<br>11.10<br>06.10<br>06.09<br>06.09<br>06.09<br>06.09<br>06.09                            | 11.13<br>11.13<br>11.13<br>11.13<br>11.13<br>11.13<br>11.13<br>11.13<br>11.13<br>11.13                            |  | 24.0111-0164.1   | 411164   | 265 11,0 9,0 +B  |
|  | 1.6 MZR<br>1.6 MZR<br>1.6 MZR-CD<br>1.6 MZR-CD<br>2.0 MZR<br>2.0 MZR<br>2.0 MZR DISI<br>2.2 MZR-CD<br>2.2 MZR-CD<br>2.3 MPS Turbo  | 77<br>79<br>80<br>85<br>108<br>110<br>111<br>110<br>136<br>191                      |  | 06.09<br>01.10<br>06.09<br>11.10<br>06.10<br>06.09<br>06.09<br>06.09<br>06.09<br>06.09                            | 11.13<br>11.13<br>11.13<br>11.13<br>11.13<br>11.13<br>11.13<br>11.13<br>11.13<br>11.13                            |  | 24.0111-0160.1   | 411160   | 280 11,0 9,0 +B  |
|  | 1.6 MZR<br>1.6 MZR<br>1.6 MZR-CD<br>1.6 MZR-CD<br>2.0 MZR<br>2.0 MZR<br>2.0 MZR DISI<br>2.2 MZR-CD<br>2.2 MZR-CD<br>2.3 MPS Turbo  | 77<br>79<br>80<br>85<br>108<br>110<br>111<br>110<br>136<br>191                      |  | 06.09<br>01.10<br>06.09<br>11.10<br>06.10<br>06.09<br>06.09<br>06.09<br>06.09<br>06.09                            | 11.13<br>11.13<br>11.13<br>11.13<br>11.13<br>11.13<br>11.13<br>11.13<br>11.13<br>11.13                            |  | 24.0711-6220.3   | 360256   | 2 <br>Radsensor |
| <b>MAZDA 3 (BM) (13-)</b>  |  |   |  |   |   |  |  |  |  |
|  | 1.5 Skyaktiv-D 105<br>2.0 Skyaktiv-G 120<br>2.0 Skyaktiv-G 150<br>2.0 Skyaktiv-G 165<br>2.2 Skyaktiv-D 150   | 77<br>88<br>110<br>121<br>110   |  | 02.16<br>09.13<br>11.13<br>09.13<br>09.13   |   |  | 24.0125-0208.1   | 425208   | 295 25,0 23,0 V +B   |



| MAZDA 3 (BM) (13-)                            |                    |     |  |       |       |                               |  |                |        |  |                     |     |
|---|--------------------|-----|--|-------|-------|-------------------------------|--|----------------|--------|--|---------------------|-----|
|   | 1.5 Skyaktiv-D 105 | 77  |  | 02.16 |       |                               |  | 24.0109-0181.1 | 409181 |  | 265 9,0 7,0 +B      |     |
|   | 1.5 Skyaktiv-G 100 | 74  |  | 09.13 |       |                               |  |                |        |  |                     |     |
|   | 1.6 Skyaktiv-G 105 | 77  |  | 09.13 |       |                               |  |                |        |  |                     |     |
|   | 2.0 Skyaktiv-G 120 | 88  |  | 09.13 |       |                               |  |                |        |  |                     |     |
|   | 2.0 Skyaktiv-G 150 | 110 |  | 11.13 |       |                               |  |                |        |  |                     |     |
|   | 2.0 Skyaktiv-G 165 | 121 |  | 09.13 |       |                               |  |                |        |  |                     |     |
|   | 2.2 Skyaktiv-D 150 | 110 |  | 09.13 |       |                               |  |                |        |  |                     |     |
| MAZDA 323 Limousine/323 C/323 F/323 S (94-98) |                    |     |  |       |       |                               |  |                |        |  |                     |     |
|   | 1.3 i 16V (BA1)    |     |  | 05.94 | 08.98 |                               |  | 13.0460-5944.2 | 605944 |  | 21654 15,0 +/WK     | SUM |
|   | 1.5 i 16V (BA1)    |     |  | 05.94 | 08.98 |                               |  | 13.0460-0339.2 | 610339 |  | Belagsatz-Zubehör   | SUM |
|   | 1.8 i (BA1)        |     |  | 05.94 | 08.98 | + 5 türig <sup>1)</sup>       |  |                |        |  |                     |     |
|   | 1.6 TD (BA1)       |     |  | 05.94 | 08.98 |                               |  | 13.0460-5974.2 | 605974 |  | 21539 15,0 +/WK     | SUM |
|   | 1.8 i (BA1)        |     |  | 05.94 | 08.98 | + 4 türig <sup>2)</sup>       |  |                |        |  |                     |     |
|   | 1.8 i (BA1)        |     |  | 05.94 | 08.98 | + 3 türig <sup>3)</sup>       |  |                |        |  |                     |     |
|   | 2.0 D              |     |  | 10.96 | 08.98 |                               |  |                |        |  |                     |     |
|   | 1.3 i 16V (BA1)    |     |  | 05.94 | 08.98 |                               |  | 24.0118-0113.1 | 418113 |  | 235 18,0 16,0 V +B  |     |
|   | 1.5 i 16V (BA1)    |     |  | 05.94 | 08.98 |                               |  | 24.0122-0166.1 | 422166 |  | 235 22,0 20,0 V +B  |     |
|   | 1.6 TD (BA1)       |     |  | 05.94 | 08.98 |                               |  | 24.0122-0165.1 | 422165 |  | 257 22,0 20,0 V     |     |
|   | 1.8 i (BA1)        |     |  | 05.94 | 08.98 |                               |  |                |        |  |                     |     |
|   | 2.0 D              |     |  | 10.96 | 08.98 |                               |  |                |        |  |                     |     |
|   | 1.3 i 16V (BA1)    |     |  | 05.94 | 08.98 |                               |  | 03.0137-0278.2 | 650278 |  | 200 x 36            |     |
|   | 1.5 i 16V (BA1)    |     |  | 05.94 | 08.98 |                               |  | 03.0137-9239.2 | 669239 |  | Bremsbacken-Zubehör |     |
|   | 1.8 i (BA1)        |     |  | 05.94 | 08.98 |                               |  |                |        |  |                     |     |
|   | 2.0 D              |     |  | 10.96 | 08.98 |                               |  |                |        |  |                     |     |
|   | 1.3 i 16V (BA1)    |     |  | 05.94 | 08.98 |                               |  | 24.0220-0026.1 | 480104 |  | 200/201 x 42        |     |
|   | 1.5 i 16V (BA1)    |     |  | 05.94 | 08.98 |                               |  |                |        |  |                     |     |
|   | 1.8 i (BA1)        |     |  | 05.94 | 08.98 |                               |  |                |        |  |                     |     |
|   | 2.0 D              |     |  | 10.96 | 08.98 |                               |  |                |        |  |                     |     |
| MAZDA 323 Limousine/323 F/323 P/323 S (98-03) |                    |     |  |       |       |                               |  |                |        |  |                     |     |
|   | 1.3 i 16V (BJ)     | 53  |  | 01.01 | 10.03 |                               |  | 13.0460-5802.2 | 605802 |  | 23490 15,4 /WK/Zub  |     |
|   | 1.3 i 16V (BJ)     | 54  |  | 08.98 | 12.00 |                               |  |                |        |  |                     |     |
|   | 1.5 i 16V (BJ)     | 65  |  | 08.98 | 12.00 |                               |  |                |        |  |                     |     |
|   | 1.6 i 16V (BJ)     | 70  |  | 01.01 | 10.03 |                               |  | 13.0460-5954.2 | 605954 |  | 23845 15,8 +/WK/Zub | SUM |
|   | 1.6 i 16V (BJ)     | 72  |  | 01.01 | 10.03 |                               |  |                |        |  |                     |     |
|   | 1.8 i 16V (BJ)     | 84  |  | 08.98 | 12.00 |                               |  |                |        |  |                     |     |
|   | 2.0 D (BJ)         | 52  |  | 08.98 | 12.00 |                               |  |                |        |  |                     |     |
|   | 2.0 DiTD (BJ)      | 74  |  | 01.01 | 10.03 |                               |  |                |        |  |                     |     |
|   | 2.0 i 16V (BJ)     | 96  |  | 01.01 | 10.03 | - Sportfahrwerk <sup>4)</sup> |  |                |        |  |                     |     |
|   | 2.0 TD (BJ)        | 66  |  | 08.98 | 12.00 |                               |  |                |        |  |                     |     |
|   | 2.0 i 16V (BJ)     | 96  |  | 01.01 | 10.03 | + Sportfahrwerk <sup>5)</sup> |  | 13.0460-5831.2 | 605831 |  | 23777 16,0 +/WK/Zub | SUM |
|   | 1.3 i 16V (BJ)     | 53  |  | 01.01 | 10.03 |                               |  | 24.0122-0207.1 | 422207 |  | 235 22,0 20,0 V +B  |     |
|   | 1.3 i 16V (BJ)     | 54  |  | 08.98 | 12.00 |                               |  |                |        |  |                     |     |
|   | 1.5 i 16V (BJ)     | 65  |  | 08.98 | 12.00 |                               |  |                |        |  |                     |     |
|   | 1.6 i 16V (BJ)     | 70  |  | 01.01 | 10.03 |                               |  | 24.0124-0164.1 | 424164 |  | 258 24,0 22,0 V +B  |     |
|   | 1.6 i 16V (BJ)     | 72  |  | 01.01 | 10.03 |                               |  |                |        |  |                     |     |
|   | 1.8 i 16V (BJ)     | 84  |  | 08.98 | 12.00 |                               |  |                |        |  |                     |     |
|   | 2.0 D (BJ)         | 52  |  | 08.98 | 12.00 |                               |  |                |        |  |                     |     |
|   | 2.0 DiTD (BJ)      | 74  |  | 01.01 | 10.03 |                               |  |                |        |  |                     |     |
|   | 2.0 i 16V (BJ)     | 96  |  | 01.01 | 10.03 | - Sportfahrwerk <sup>4)</sup> |  |                |        |  |                     |     |
|   | 2.0 TD (BJ)        | 66  |  | 08.98 | 12.00 |                               |  |                |        |  |                     |     |
|   | 2.0 i 16V (BJ)     | 96  |  | 01.01 | 10.03 | + Sportfahrwerk <sup>5)</sup> |  | 24.0124-0175.1 | 424175 |  | 274 24,5 22,0 V +B  |     |
|   | 1.6 i 16V (BJ)     | 70  |  | 01.01 | 10.03 |                               |  | 13.0460-5804.2 | 605804 |  | 24045 13,7          | AKE |
|   | 1.6 i 16V (BJ)     | 72  |  | 01.01 | 10.03 |                               |  | 13.0460-0234.2 | 610234 |  | Belagsatz-Zubehör   |     |
|   | 1.8 i 16V (BJ)     | 84  |  | 08.98 | 12.00 |                               |  |                |        |  |                     |     |
|   | 2.0 D (BJ)         | 52  |  | 08.98 | 12.00 |                               |  |                |        |  |                     |     |
|   | 2.0 DiTD (BJ)      | 74  |  | 01.01 | 10.03 |                               |  |                |        |  |                     |     |
|   | 2.0 i 16V (BJ)     | 96  |  | 01.01 | 10.03 |                               |  |                |        |  |                     |     |
|   | 2.0 TD (BJ)        | 66  |  | 08.98 | 12.00 |                               |  |                |        |  |                     |     |
|   | 1.6 i 16V (BJ)     | 70  |  | 01.01 | 10.03 |                               |  | 24.0110-0269.1 | 410269 |  | 261 10,0 8,0 +B     |     |
|   | 1.6 i 16V (BJ)     | 72  |  | 01.01 | 10.03 |                               |  |                |        |  |                     |     |
|   | 1.8 i 16V (BJ)     | 84  |  | 08.98 | 12.00 |                               |  |                |        |  |                     |     |
|   | 2.0 D (BJ)         | 52  |  | 08.98 | 12.00 |                               |  |                |        |  |                     |     |
|   | 2.0 DiTD (BJ)      | 74  |  | 01.01 | 10.03 |                               |  |                |        |  |                     |     |
|   | 2.0 i 16V (BJ)     | 96  |  | 01.01 | 10.03 | - Sportfahrwerk <sup>4)</sup> |  |                |        |  |                     |     |
|   | 2.0 TD (BJ)        | 66  |  | 08.98 | 12.00 |                               |  |                |        |  |                     |     |
|   | 2.0 i 16V (BJ)     | 96  |  | 01.01 | 10.03 | + Sportfahrwerk <sup>5)</sup> |  | 24.0110-0302.1 | 410302 |  | 280 10,0 8,0 +B     |     |
|   | 1.3 i 16V (BJ)     | 53  |  | 01.01 | 10.03 |                               |  | 03.0137-0407.2 | 650407 |  | 200 x 36            |     |
|   | 1.3 i 16V (BJ)     | 54  |  | 08.98 | 12.00 |                               |  | 03.0137-9263.2 | 669263 |  | Bremsbacken-Zubehör |     |
|   | 1.5 i 16V (BJ)     | 65  |  | 08.98 | 12.00 |                               |  |                |        |  |                     |     |
|   | 2.0 TD (BJ)        | 66  |  | 08.98 | 12.00 |                               |  |                |        |  |                     |     |
|   | 1.3 i 16V (BJ)     | 53  |  | 01.01 | 10.03 |                               |  | 24.0220-0026.1 | 480104 |  | 200/201 x 42        |     |
|   | 1.3 i 16V (BJ)     | 54  |  | 08.98 | 12.00 |                               |  |                |        |  |                     |     |
|   | 1.5 i 16V (BJ)     | 65  |  | 08.98 | 12.00 |                               |  |                |        |  |                     |     |
|   | 2.0 TD (BJ)        | 66  |  | 08.98 | 12.00 |                               |  |                |        |  |                     |     |
| MAZDA 5 (CR) (05-10)                          |                    |     |  |       |       |                               |  |                |        |  |                     |     |
|   | 1.8 16V            | 85  |  | 03.05 | 05.10 |                               |  | 13.0460-7193.2 | 607193 |  | 23723 18,1 +        | ATE |
|   | 2.0 16V            | 107 |  | 03.05 | 05.10 |                               |  | 13.0470-7193.2 | LD7193 |  | 23723 18,1 +        | ATE |
|   | 2.0 CiTD           | 81  |  | 03.05 | 05.10 |                               |  |                |        |  |                     |     |
|   | 2.0 CiTD           | 105 |  | 06.05 | 05.10 |                               |  |                |        |  |                     |     |



























<sup>1)</sup> + 5 door / + 5 porte / + 5 portes / + 5 puertas

<sup>2)</sup> + 4 door / + 4 porte / + 4 portes / + 4 puertas

<sup>3)</sup> + 3 door / + 3 porte / + 3 portes / + 3 puertas



















<sup>4)</sup> - sports suspension / - sospensione sportiva / - châssis de sport / - suspensión deportiva

<sup>5)</sup> + sports suspension / + sospensione sportiva / + châssis de sport / + suspensión deportiva





















|     |  |  |  |  |  |  |  |       |                      |
|--|--|--|--|--|---|--|--|---|----------------------|
| <b>MAZDA 5 (CR) (05-10)</b>  |  |  |  |  |   |  |  |   |                      |
|    | 1.8 16V  | 85   |  | 03.05  | 05.10   | 24.0125-0165.1   | 425165   | + 15" Rad <sup>1)</sup>   | 278 25,0 23,0 V L +B |
|  | 2.0 16V  | 107  |  | 03.05  | 05.10   | 24.0125-0170.1   | 425170   | + 16" Rad <sup>2)</sup>   | 300 25,0 23,0 V L +B |
|  | 2.0 CiTD   | 81   |  | 03.05  | 05.10   |  |  |   |                      |
|  | 2.0 CiTD   | 105  |  | 06.05  | 05.10   |  |  |   |                      |
|    | 1.8 16V  | 85   |  | 03.05  | 05.10   | 24.0711-5123.3   | 360065   | 2    | Radsensor            |
|  | 2.0 16V  | 107  |  | 03.05  | 05.10   |  |  |   |                      |
|  | 2.0 CiTD   | 81   |  | 03.05  | 05.10   |  |  |   |                      |
|  | 2.0 CiTD   | 105  |  | 06.05  | 05.10   |  |  |   |                      |
|    | 1.8 16V  | 85   |  | 03.05  | 05.10   | 13.0460-7195.2   | 607195   |   | 23482 16,6 +         |
|  | 2.0 16V  | 107  |  | 03.05  | 05.10   | 13.0470-7195.2   | LD7195   |   | 23482 16,6 +         |
|  | 2.0 CiTD   | 81   |  | 03.05  | 05.10   |  |  |   | ATE                  |
|  | 2.0 CiTD   | 105  |  | 06.05  | 05.10   |  |  |   | ATE                  |
|    | 1.8 16V  | 85   |  | 03.05  | 05.10   | 24.0111-0160.1   | 411160   | + 15" Rad <sup>1)</sup>   | 280 11,0 9,0 +B      |
|  | 2.0 16V  | 107  |  | 03.05  | 05.10   |  |  |   |                      |
|  | 2.0 CiTD   | 81   |  | 03.05  | 05.10   |  |  |   |                      |
|  | 2.0 CiTD   | 105  |  | 06.05  | 05.10   |  |  |   |                      |
|    | 1.8 16V  | 85   |  | 03.05  | 05.10   | 24.0111-0165.1   | 411165   | + 16" Rad <sup>2)</sup>   | 302 11,0 9,0 +B      |
|  | 2.0 16V  | 107  |  | 03.05  | 05.10   |  |  |   |                      |
|  | 2.0 CiTD   | 81   |  | 03.05  | 05.10   |  |  |   |                      |
|  | 2.0 CiTD   | 105  |  | 03.05  | 05.10   |  |  |   |                      |
|    | 1.8 16V  | 85   |  | 03.05  | 05.10   | 24.0711-6220.3   | 360256   | 2    | Radsensor            |
|  | 2.0 16V  | 107  |  | 03.05  | 05.10   |  |  |   |                      |
|  | 2.0 CiTD   | 81   |  | 03.05  | 05.10   |  |  |   |                      |
|  | 2.0 CiTD   | 105  |  | 06.05  | 05.10   |  |  |   |                      |
| <b>MAZDA 5 (CW) (10-)</b>  |  |  |  |  |   |  |  |   |                      |
|    | 1.6 CD   | 85   |  | 09.10  |   | 13.0460-7193.2   | 607193   |   | 23723 18,1 +         |
|  | 1.8 16V  | 85   |  | 09.10  |   | 13.0470-7193.2   | LD7193   |   | 23723 18,1 +         |
|  | 2.0 16V  | 106  |  | 01.11  |   |  |  |   | ATE                  |
|  | 2.0 16V  | 108  |  | 01.11  |   |  |  |   |                      |
|  | 2.0 16V  | 110  |  | 09.10  |   |  |  |   |                      |
|    | 1.6 CD   | 85   |  | 09.10  |   | 24.0125-0165.1   | 425165   | + 15" Rad <sup>1)</sup>   | 278 25,0 23,0 V L +B |
|  | 1.8 16V  | 85   |  | 09.10  |   | 24.0125-0170.1   | 425170   | + 16" Rad <sup>2)</sup>   | 300 25,0 23,0 V L +B |
|  | 2.0 16V  | 106  |  | 01.11  |   |  |  |   |                      |
|  | 2.0 16V  | 108  |  | 01.11  |   |  |  |   |                      |
|  | 2.0 16V  | 110  |  | 09.10  |   |  |  |   |                      |
|   | 1.6 CD   | 85   |  | 09.10  |   | 24.0711-5123.3   | 360065   | 2   | Radsensor            |
|  | 1.8 16V  | 85   |  | 09.10  |   |  |  |   |                      |
|  | 2.0 16V  | 106  |  | 01.11  |   |  |  |   |                      |
|  | 2.0 16V  | 108  |  | 01.11  |   |  |  |   |                      |
|  | 2.0 16V  | 110  |  | 09.10  |   |  |  |   |                      |
|  | 1.6 CD   | 85   |  | 09.10  |   | 13.0460-7195.2   | 607195   |   | 23482 16,6 +         |
|  | 1.8 16V  | 85   |  | 09.10  |   | 13.0470-7195.2   | LD7195   |   | 23482 16,6 +         |
|  | 2.0 16V  | 106  |  | 01.11  |   |  |  |   | ATE                  |
|  | 2.0 16V  | 108  |  | 01.11  |   |  |  |   |                      |
|  | 2.0 16V  | 110  |  | 09.10  |   |  |  |   |                      |
|  | 1.6 CD   | 85   |  | 09.10  |   | 24.0111-0160.1   | 411160   | + 15" Rad <sup>1)</sup>   | 280 11,0 9,0 +B      |
|  | 1.8 16V  | 85   |  | 09.10  |   | 24.0111-0165.1   | 411165   | + 16" Rad <sup>2)</sup>   | 302 11,0 9,0 +B      |
|  | 2.0 16V  | 106  |  | 01.11  |   |  |  |   |                      |
|  | 2.0 16V  | 108  |  | 01.11  |   |  |  |   |                      |
|  | 2.0 16V  | 110  |  | 09.10  |   |  |  |   |                      |
|  | 1.6 CD   | 85   |  | 09.10  |   | 24.0711-6220.3   | 360256   | 2  | Radsensor            |
|  | 1.8 16V  | 85   |  | 09.10  |   |  |  |   |                      |
|  | 2.0 16V  | 106  |  | 01.11  |   |  |  |   |                      |
|  | 2.0 16V  | 108  |  | 01.11  |   |  |  |   |                      |
|  | 2.0 16V  | 110  |  | 09.10  |   |  |  |   |                      |
| <b>MAZDA 6 Limousine (GG) (02-07)</b>  |  |  |  |  |   |  |  |   |                      |
|  | 1.8 16V  | 88   |  | 08.02  | 07.07   | 13.0460-5822.2   | 605822   |   | 24246 16,8 +/WK      |
|  | 2.0 16V  | 104  |  | 06.02  | 07.07   | 13.0460-0260.2   | 610260   |   | Belagsatz-Zubehör    |
|  | 2.0 16V  | 108  |  | 03.05  | 07.07   | 13.0460-0261.2   | 610261   |   | 24046 18,6 +/WK      |
|  | 2.0 DI   | 89   |  | 08.02  | 07.07   |  |  |   | Belagsatz-Zubehör    |
|  | 2.0 DI   | 100  |  | 06.02  | 07.07   |  |  |   |                      |
|  | 2.0 DI   | 105  |  | 06.05  | 07.07   |  |  |   |                      |
|  | 2.3 16V  | 119  |  | 07.03  | 02.05   |  |  |   |                      |
|  | 2.3 16V  | 120  |  | 03.05  | 07.07   |  |  |   |                      |
|  | 1.8 16V  | 88   |  | 08.02  | 07.07   | 24.0124-0175.1   | 424175   |   | 274 24,5 22,0 V +B   |
|  | 2.0 16V  | 104  |  | 06.02  | 07.07   | 24.0125-0147.1   | 425147   |   | 283 25,0 23,0 V +B   |
|  | 2.0 16V  | 108  |  | 03.05  | 07.07   |  |  |   |                      |
|  | 2.0 DI   | 89   |  | 08.02  | 07.07   |  |  |   |                      |
|  | 2.0 DI   | 100  |  | 06.02  | 07.07   |  |  |   |                      |
|  | 2.0 DI   | 105  |  | 06.05  | 07.07   |  |  |   |                      |
|  | 2.3 16V  | 119  |  | 07.03  | 02.05   |  |  |   |                      |
|  | 2.3 16V  | 120  |  | 03.05  | 07.07   |  |  |   |                      |
| 2.3 16V  | 122  |  | 06.02  | 07.07  |   |  |  |   |                      |























<sup>1)</sup> + 15" wheel / + ruota 15" / + roue 15" / + rueda 15"











<sup>2)</sup> + 16" wheel / + ruota 16" / + roue 16" / + rueda 16"

|     |  |  |  |  |  |  |  |  |                     |
|--|--|--|--|--|---|--|--|--|---------------------|
| <b>MAZDA 6 Limousine (GG) (02-07)</b>  |  |  |  |  |   |  |  |  |                     |
|    | 1.8 16V  | 88   |  | 08.02  | 07.07   |  |  |  |                     |
|  | 2.0 16V  | 104  |  | 06.02  | 07.07   |  | 13.0460-5804.2   | 605804   | 24045 13,7          |
|  | 2.0 16V  | 108  |  | 03.05  | 07.07   |  | 13.0460-0234.2   | 610234   | Belagsatz-Zubehör   |
|  | 2.0 DI   | 89   |  | 08.02  | 07.07   |  |  |  |                     |
|  | 2.0 DI   | 100  |  | 06.02  | 07.07   |  |  |  |                     |
|  | 2.0 DI   | 105  |  | 06.05  | 07.07   |  |  |  |                     |
|  | 2.3 16V  | 119  |  | 07.03  | 02.05   |  |  |  |                     |
|  | 2.3 16V  | 120  |  | 03.05  | 07.07   |  |  |  |                     |
|  | 2.3 16V  | 122  |  | 06.02  | 07.07   |  |  |  |                     |
|    | 1.8 16V  | 88   |  | 08.02  | 07.07   |  | 24.0110-0302.1   | 410302   |                     |
|  | 2.0 16V  | 104  |  | 06.02  | 07.07   |  |  |  |                     |
|  | 2.0 16V  | 108  |  | 03.05  | 07.07   |  |  |  |                     |
|  | 2.0 DI   | 89   |  | 08.02  | 07.07   |  |  |  |                     |
|  | 2.0 DI   | 100  |  | 06.02  | 07.07   |  |  |  |                     |
|  | 2.0 DI   | 105  |  | 06.05  | 07.07   |  |  |  |                     |
|  | 2.3 16V  | 119  |  | 07.03  | 02.05   |  |  |  |                     |
|  | 2.3 16V  | 120  |  | 03.05  | 07.07   |  |  |  |                     |
|  | 2.3 16V  | 122  |  | 06.02  | 07.07   |  |  |  |                     |
| <b>MAZDA 6 Kombi (GY) (02-07)</b>  |  |  |  |  |   |  |  |  |                     |
|    | 1.8 16V  | 88   |  | 08.02  | 07.07   |  | 13.0460-5821.2   | 605821   | 24046 18,6 +/WK     |
|  | 2.0 16V  | 104  |  | 08.02  | 07.07   |  | 13.0460-0261.2   | 610261   | Belagsatz-Zubehör   |
|  | 2.0 16V  | 108  |  | 03.05  | 07.07   |  |  |  |                     |
|  | 2.0 CITD 4x4   | 89   |  | 10.02  | 02.05   |  |  |  |                     |
|  | 2.0 CITD 4x4   | 100  |  | 10.02  | 02.05   |  |  |  |                     |
|  | 2.0 DI   | 89   |  | 08.02  | 07.07   |  |  |  |                     |
|  | 2.0 DI   | 100  |  | 08.02  | 07.07   |  |  |  |                     |
|  | 2.0 DI   | 105  |  | 06.05  | 07.07   |  |  |  |                     |
|  | 2.3 16V  | 122  |  | 08.02  | 07.07   |  |  |  |                     |
|  | 2.3 16V AWD  | 119  |  | 11.02  | 07.07   |  |  |  |                     |
|    | 1.8 16V  | 88   |  | 08.02  | 07.07   |  | 24.0125-0147.1   | 425147   |                     |
|  | 2.0 16V  | 104  |  | 08.02  | 07.07   |  |  |  |                     |
|  | 2.0 16V  | 108  |  | 03.05  | 07.07   |  |  |  |                     |
|  | 2.0 CITD 4x4   | 89   |  | 10.02  | 02.05   |  |  |  |                     |
|  | 2.0 CITD 4x4   | 100  |  | 10.02  | 02.05   |  |  |  |                     |
|  | 2.0 DI   | 89   |  | 08.02  | 07.07   |  |  |  |                     |
|  | 2.0 DI   | 100  |  | 08.02  | 07.07   |  |  |  |                     |
|  | 2.0 DI   | 105  |  | 06.05  | 07.07   |  |  |  |                     |
|  | 2.3 16V  | 122  |  | 08.02  | 07.07   |  |  |  |                     |
|  | 2.3 16V AWD  | 119  |  | 11.02  | 07.07   |  |  |  |                     |
|  | 1.8 16V  | 88   |  | 08.02  | 07.07   |  | 13.0460-5804.2   | 605804   | 24045 13,7          |
|  | 2.0 16V  | 104  |  | 08.02  | 07.07   |  | 13.0460-0234.2   | 610234   | Belagsatz-Zubehör   |
|  | 2.0 16V  | 108  |  | 03.05  | 07.07   |  |  |  |                     |
|  | 2.0 CITD 4x4   | 89   |  | 10.02  | 02.05   |  |  |  |                     |
|  | 2.0 CITD 4x4   | 100  |  | 10.02  | 02.05   |  |  |  |                     |
|  | 2.0 DI   | 89   |  | 08.02  | 07.07   |  |  |  |                     |
|  | 2.0 DI   | 100  |  | 08.02  | 07.07   |  |  |  |                     |
|  | 2.0 DI   | 105  |  | 06.05  | 07.07   |  |  |  |                     |
|  | 2.3 16V  | 122  |  | 08.02  | 07.07   |  |  |  |                     |
|  | 2.3 16V AWD  | 119  |  | 11.02  | 07.07   |  |  |  |                     |
|  | 1.8 16V  | 88   |  | 08.02  | 07.07   |  | 24.0110-0302.1   | 410302   |                     |
|  | 2.0 16V  | 104  |  | 08.02  | 07.07   |  |  |  |                     |
|  | 2.0 16V  | 108  |  | 03.05  | 07.07   |  |  |  |                     |
|  | 2.0 CITD 4x4   | 89   |  | 10.02  | 02.05   |  |  |  |                     |
|  | 2.0 CITD 4x4   | 100  |  | 10.02  | 02.05   |  |  |  |                     |
|  | 2.0 DI   | 89   |  | 08.02  | 07.07   |  |  |  |                     |
|  | 2.0 DI   | 100  |  | 08.02  | 07.07   |  |  |  |                     |
|  | 2.0 DI   | 105  |  | 06.05  | 07.07   |  |  |  |                     |
|  | 2.3 16V  | 122  |  | 08.02  | 07.07   |  |  |  |                     |
|  | 2.3 16V AWD  | 119  |  | 11.02  | 07.07   |  |  |  |                     |
| <b>MAZDA 6 (GH) (07-12)</b>  |  |  |  |  |   |  |  |  |                     |
|  | 1.8 MZR  | 88   |  | 08.07  | 12.12   |  | 13.0460-5610.2   | 605610   | 24582 17,4 +/WK/Zub |
|  | 2.0 MZR  | 108  |  | 08.07  | 12.12   |  |  |  |                     |
|  | 2.0 MZR  | 114  |  | 01.10  | 12.12   |  |  |  |                     |
|  | 2.0 MZR-CD   | 103  |  | 08.07  | 12.12   |  |  |  |                     |
|  | 2.2 MZR-CD   | 92   |  | 01.09  | 12.12   |  |  |  |                     |
|  | 2.2 MZR-CD   | 95   |  | 01.10  | 12.12   |  |  |  |                     |
|  | 2.2 MZR-CD   | 120  |  | 01.09  | 12.12   |  |  |  |                     |
|  | 2.2 MZR-CD   | 132  |  | 01.10  | 12.12   |  |  |  |                     |
|  | 2.2 MZR-CD   | 136  |  | 01.09  | 12.12   |  |  |  |                     |
|  | 2.5 MZR  | 125  |  | 08.07  | 12.12   |  |  |  |                     |
|  | 1.8 MZR  | 88   |  | 08.07  | 12.12   |  | 24.0125-0188.1   | 425188   |                     |
|  | 2.0 MZR  | 108  |  | 08.07  | 12.12   |  |  |  |                     |
|  | 2.0 MZR  | 114  |  | 01.10  | 12.12   |  |  |  |                     |
|  | 2.0 MZR-CD   | 103  |  | 08.07  | 12.12   |  |  |  |                     |
|  | 2.2 MZR-CD   | 92   |  | 01.09  | 12.12   |  |  |  |                     |
|  | 2.2 MZR-CD   | 95   |  | 01.10  | 12.12   |  |  |  |                     |
|  | 2.2 MZR-CD   | 120  |  | 01.09  | 12.12   |  |  |  |                     |
|  | 2.2 MZR-CD   | 132  |  | 01.10  | 12.12   |  |  |  |                     |
|  | 2.2 MZR-CD   | 136  |  | 01.09  | 12.12   |  |  |  |                     |
|  | 2.5 MZR  | 125  |  | 08.07  | 12.12   |  |  |  |                     |
|  | 1.8 MZR  | 88   |  | 08.07  | 12.12   |  | 13.0460-5804.2   | 605804   | 24045 13,7          |
|  | 2.0 MZR  | 108  |  | 08.07  | 12.12   |  | 13.0460-0234.2   | 610234   | Belagsatz-Zubehör   |
|  | 2.0 MZR  | 114  |  | 01.10  | 12.12   |  |  |  |                     |
|  | 2.0 MZR-CD   | 103  |  | 08.07  | 12.12   |  |  |  |                     |
|  | 2.2 MZR-CD   | 92   |  | 01.09  | 12.12   |  |  |  |                     |



|     |                                |  |  |        |       |  |  |  |            |
|--|--|--|--|--|--|--|--|--|------------|
| <b>MAZDA 6 (GH) (07-12)</b>  |  |  |  |  |  |  |  |  |            |
|    | 2.2 MZR-CD<br>2.2 MZR-CD<br>2.2 MZR-CD<br>2.2 MZR-CD<br>2.5 MZR  | 95<br>120<br>132<br>136<br>125   |  | 01.10<br>01.09<br>01.10<br>01.09<br>08.07  | 12.12<br>12.12<br>12.12<br>12.12<br>12.12  | 13.0460-5804.2<br>13.0460-0234.2   | 605804<br>610234   | 24045 13,7<br>Belagsatz-Zubehör  | AKE        |
|    | 1.8 MZR<br>2.0 MZR<br>2.0 MZR<br>2.0 MZR-CD<br>2.2 MZR-CD<br>2.2 MZR-CD<br>2.2 MZR-CD<br>2.2 MZR-CD<br>2.5 MZR | 88<br>108<br>114<br>103<br>92<br>95<br>120<br>132<br>136<br>125                  |  | 08.07<br>08.07<br>01.10<br>08.07<br>01.09<br>01.10<br>01.09<br>01.10<br>01.09<br>08.07 | 12.12<br>12.12<br>12.12<br>12.12<br>12.12<br>12.12<br>12.12<br>12.12<br>12.12<br>12.12 | 24.0110-0302.1   | 410302   | 280 10,0 8,0 +B  |            |
| <b>MAZDA 626 (GE) (91-97)</b>  |  |  |  |  |  |  |  |  |            |
|    | 1.8 i<br>1.8 i<br>1.8 i<br>2.0 D<br>2.0 D GLX<br>2.0 i<br>2.0 i 4WD<br>2.5 i V6                                | 66<br>77<br>78<br>56<br>55<br>85<br>85<br>121                                    |  | 08.94<br>08.91<br>05.94<br>05.94<br>10.92<br>08.91<br>04.92<br>09.91                   | 04.97<br>04.97<br>06.97<br>06.97<br>04.97<br>04.97<br>04.97<br>04.97                   | 13.0460-5954.2<br>13.0460-0443.2   | 605954<br>610443   | 23845 15,8 +/WK/Zub<br>Belagsatz-Zubehör   | SUM<br>SUM |
|    | 1.8 i<br>1.8 i<br>1.8 i<br>2.0 D<br>2.0 D GLX<br>2.0 i<br>2.0 i 4WD<br>2.5 i V6                                | 66<br>77<br>78<br>56<br>55<br>85<br>85<br>121                                    |  | 08.94<br>08.91<br>05.94<br>05.94<br>10.92<br>08.91<br>04.92<br>01.92                   | 04.97<br>04.97<br>06.97<br>06.97<br>04.97<br>04.97<br>04.97<br>04.97                   | 24.0124-0129.1   | 424129   | 258 24,0 22,0 V +B   |            |
|    | 1.8 i<br>1.8 i<br>1.8 i<br>2.0 D<br>2.0 D GLX<br>2.0 i<br>2.0 i 4WD<br>2.5 i V6                                | 66<br>77<br>78<br>56<br>55<br>85<br>85<br>121                                    |  | 08.94<br>08.91<br>05.94<br>05.94<br>10.92<br>08.91<br>04.92<br>01.92                   | 04.97<br>04.97<br>06.97<br>06.97<br>04.97<br>04.97<br>04.97<br>04.97                   | 13.0460-5973.2<br>13.0460-0245.2   | 605973<br>610245   | 21766 13,5<br>Belagsatz-Zubehör  |            |
|  | 1.8 i<br>1.8 i<br>1.8 i<br>2.0 D<br>2.0 D GLX<br>2.0 i<br>2.0 i 4WD<br>2.5 i V6                                | 66<br>77<br>78<br>56<br>55<br>85<br>85<br>121                                    |  | 08.94<br>08.91<br>05.94<br>05.94<br>10.92<br>08.91<br>04.92<br>01.92                   | 04.97<br>04.97<br>06.97<br>06.97<br>04.97<br>04.97<br>04.97<br>04.97                   | 24.0110-0234.1   | 410234   | 261 10,0 8,0 +B  |            |
| <b>MAZDA 626 (GF) (97-02)</b>  |  |  |  |  |  |  |  |  |            |
|  | 1.8 i 16V<br>2.0 DiTD<br>2.0 i 16V<br>2.0 i 16V<br>2.0 i 16V<br>2.0 Turbo DI                                   | 66<br>66<br>85<br>93<br>100<br>74  |  | 05.97<br>04.98<br>05.97<br>01.98<br>02.98<br>04.98                                     | 11.99<br>11.99<br>11.99<br>11.99<br>11.99<br>11.99                                     | 13.0460-5954.2   | 605954   | 23845 15,8 +/WK/Zub  | SUM        |
|  | 1.8 i 16V<br>2.0 DiTD<br>2.0 i 16V<br>2.0 i 16V<br>2.0 i 16V<br>2.0 TD<br>2.0 Turbo DI                         | 74<br>66<br>85<br>93<br>100<br>81<br>74  |  | 12.99<br>12.99<br>12.99<br>12.99<br>12.99<br>10.00<br>12.99                            | 10.02<br>10.02<br>10.02<br>10.02<br>10.02<br>10.02<br>10.02                            | 13.0460-5831.2   | 605831   | 23777 16,0 +/WK/Zub  | SUM        |
|  | 1.8 i 16V<br>1.8 i 16V<br>2.0 DiTD<br>2.0 i 16V<br>2.0 i 16V<br>2.0 i 16V<br>2.0 TD<br>2.0 Turbo DI            | 66<br>74<br>66<br>85<br>93<br>100<br>81<br>74                                    |  | 05.97<br>12.99<br>04.98<br>05.97<br>01.98<br>02.98<br>10.00<br>04.98                   | 11.99<br>10.02<br>10.02<br>10.02<br>10.02<br>10.02<br>10.02<br>10.02                   | 24.0124-0129.1   | 424129   | 258 24,0 22,0 V +B   |            |
|  | 2.0 DiTD<br>2.0 i 16V<br>2.0 i 16V<br>2.0 i 16V<br>2.0 TD<br>2.0 Turbo DI                                      | 66<br>85<br>93<br>100<br>81<br>74  |  | 04.98<br>05.97<br>01.98<br>02.98<br>10.00<br>04.98                                     | 10.02<br>10.02<br>10.02<br>10.02<br>10.02<br>10.02                                     | 13.0460-5804.2<br>13.0460-0234.2   | 605804<br>610234   | 24045 13,7<br>Belagsatz-Zubehör  | AKE        |
|  | 2.0 DiTD<br>2.0 i 16V<br>2.0 i 16V<br>2.0 i 16V<br>2.0 TD<br>2.0 Turbo DI                                      | 66<br>85<br>93<br>100<br>81<br>74  |  | 04.98<br>05.97<br>01.98<br>02.98<br>10.00<br>04.98                                     | 10.02<br>10.02<br>10.02<br>10.02<br>10.02<br>10.02                                     | 24.0110-0234.1   | 410234   | 261 10,0 8,0 +B  |            |

|     |  |  |  |  |  |  |  |  |
|--|--|--|--|--|---|--|--|--|
| <b>MAZDA 626 (GF) (97-02)</b>  |  |  |  |  |   |  |  |  |
|    | 1.8 i 16V  | 66   | 05.97  | 11.99  | 03.0137-0431.2  | 650431   |  | 229 x 43<br>Bremsbacken-Zubehör  |
|  | 1.8 i 16V  | 74   | 12.99  | 10.02  | 03.0137-0416.2  | 650416   |  | 229 x 43<br>Bremsbacken-Zubehör  |
|  |  |  |  |  | 03.0137-9262.2  | 669262   |  |  |
| <b>MAZDA 626 Kombi (GV) (92-98)</b>  |  |  |  |  |   |  |  |  |
|    | 2.0 D  | 55   | 04.92  | 01.98  | 13.0460-5932.2  | 605932   |  | 21378 15,0 +/WK <b>AKE</b>   |
|  | 2.0 D  | 60   | 11.94  | 04.96  |   |  |  |  |
|  | 2.0 GLX  | 86   | 04.92  | 02.95  |   |  |  |  |
|  | 2.0 i  | 66   | 04.92  | 01.98  |   |  |  |  |
|  | 2.0 i 12V 4WD  | 85   | 04.92  | 01.98  |   |  |  |  |
|  | 2.2 i 12V  | 85   | 04.92  | 01.98  |   |  |  |  |
|    | 2.0 D  | 55   | 04.92  | 01.98  | 24.0124-0105.1  | 424105   |  | 264 24,0 22,0 V  |
|  | 2.0 D  | 60   | 11.94  | 04.96  |   |  |  |  |
|  | 2.0 GLX  | 86   | 04.92  | 02.95  |   |  |  |  |
|  | 2.0 i  | 66   | 04.92  | 01.98  |   |  |  |  |
|  | 2.0 i 12V 4WD  | 85   | 04.92  | 01.98  |   |  |  |  |
|  | 2.2 i 12V  | 85   | 04.92  | 01.98  |   |  |  |  |
|    | 2.0 D  | 55   | 04.92  | 01.98  | 13.0460-5995.2  | 605995   |  | 21558 13,0   |
|  | 2.0 D  | 60   | 11.94  | 04.96  |   |  |  |  |
|  | 2.0 GLX  | 86   | 04.92  | 02.95  |   |  |  |  |
|  | 2.0 i  | 66   | 04.92  | 01.98  |   |  |  |  |
|  | 2.2 i 12V  | 85   | 04.92  | 01.98  |   |  |  |  |
|    | 2.0 D  | 55   | 04.92  | 01.98  | 24.0110-0256.1  | 410256   |  | 259 10,0 8,0   |
|  | 2.0 D  | 60   | 11.94  | 04.96  |   |  |  |  |
|  | 2.0 GLX  | 86   | 04.92  | 02.95  |   |  |  |  |
|  | 2.0 i  | 66   | 04.92  | 01.98  |   |  |  |  |
|  | 2.2 i 12V  | 85   | 04.92  | 01.98  |   |  |  |  |
| <b>MAZDA 626 Kombi (GW) (98-02)</b>  |  |  |  |  |   |  |  |  |
|    | 1.8 i 16V  | 66   | 02.98  | 12.99  | 13.0460-5954.2  | 605954   |  | 23845 15,8 +/WK/Zub <b>SUM</b>   |
|  | 2.0 i 16V  | 85   | 02.98  | 09.99  |   |  |  |  |
|  | 2.0 i 16V  | 93   | 01.98  | 09.99  |   |  |  |  |
|  | 2.0 i 16V  | 100  | 02.98  | 09.99  |   |  |  |  |
|  | 2.0 Turbo DI   | 74   | 04.98  | 09.99  |   |  |  |  |
|  | 1.8 i 16V  | 74   | 01.00  | 10.02  | 13.0460-5831.2  | 605831   |  | 23777 16,0 +/WK/Zub <b>SUM</b>   |
|  | 2.0 DiTD   | 66   | 09.99  | 10.02  |   |  |  |  |
|  | 2.0 i 16V  | 85   | 10.99  | 10.02  |   |  |  |  |
|  | 2.0 i 16V  | 93   | 10.99  | 10.02  |   |  |  |  |
|  | 2.0 i 16V  | 100  | 10.99  | 10.02  |   |  |  |  |
|  | 2.0 TD   | 81   | 10.00  | 10.02  |   |  |  |  |
|  | 2.0 Turbo DI   | 74   | 10.99  | 10.02  |   |  |  |  |
|  | 1.8 i 16V  | 66   | 02.98  | 12.99  | 24.0124-0129.1  | 424129   |  | 258 24,0 22,0 V +B   |
|  | 1.8 i 16V  | 74   | 01.00  | 10.02  |   |  |  |  |
|  | 2.0 i 16V  | 85   | 02.98  | 10.02  |   |  |  |  |
|  | 2.0 i 16V  | 93   | 01.98  | 10.02  |   |  |  |  |
|  | 2.0 i 16V  | 100  | 02.98  | 10.02  |   |  |  |  |
|  | 2.0 DiTD   | 66   | 09.99  | 10.02  | 24.0124-0175.1  | 424175   |  | 274 24,5 22,0 V +B   |
|  | 2.0 TD   | 81   | 10.00  | 10.02  |   |  |  |  |
|  | 2.0 Turbo DI   | 74   | 04.98  | 10.02  |   |  |  |  |
|  | 1.8 i 16V  | 66   | 02.98  | 12.99  | 13.0460-5804.2  | 605804   |  | 24045 13,7 <b>AKE</b>  |
|  | 1.8 i 16V  | 74   | 01.00  | 10.02  | 13.0460-0234.2  | 610234   |  | Belagsatz-Zubehör  |
|  | 2.0 DiTD   | 66   | 09.99  | 10.02  |   |  |  |  |
|  | 2.0 i 16V  | 85   | 02.98  | 10.02  |   |  |  |  |
|  | 2.0 i 16V  | 93   | 01.98  | 10.02  |   |  |  |  |
|  | 2.0 i 16V  | 100  | 02.98  | 10.02  |   |  |  |  |
|  | 2.0 TD   | 81   | 10.00  | 10.02  |   |  |  |  |
|  | 2.0 Turbo DI   | 74   | 04.98  | 10.02  |   |  |  |  |
|  | 1.8 i 16V  | 66   | 02.98  | 12.99  | 24.0110-0234.1  | 410234   |  | 261 10,0 8,0 +B  |
|  | 1.8 i 16V  | 74   | 01.00  | 10.02  |   |  |  |  |
|  | 2.0 i 16V  | 85   | 02.98  | 10.02  |   |  |  |  |
|  | 2.0 i 16V  | 93   | 01.98  | 10.02  |   |  |  |  |
|  | 2.0 i 16V  | 100  | 02.98  | 10.02  |   |  |  |  |
|  | 2.0 DiTD   | 66   | 09.99  | 10.02  | 24.0110-0302.1  | 410302   |  | 280 10,0 8,0 +B  |
|  | 2.0 TD   | 81   | 10.00  | 10.02  |   |  |  |  |
|  | 2.0 Turbo DI   | 74   | 04.98  | 10.02  |   |  |  |  |
| <b>MAZDA B2500 (02-06)</b>   |  |  |  |  |   |  |  |  |
|  | 2.5 D 4WD  | 62   | 08.02  | 07.06  | 13.0460-5795.2  | 605795   |  | 24353 16,0 +/WK/Zub  |
|  | 2.5 TDiC 4WD   | 80   | 08.02  | 07.06  |   |  |  |  |
|  | 2.5 D 4WD  | 62   | 08.02  | 07.06  | 24.0128-0226.1  | 428226   |  | 289 28,0 26,0 V L +B   |
|  | 2.5 TDiC 4WD   | 80   | 08.02  | 07.06  |   |  |  |  |
| <b>MAZDA BT-50 (06-12)</b>   |  |  |  |  |   |  |  |  |
|  | 2.5 CD 4x4   | 105  | 12.06  | 07.12  | 13.0460-5795.2  | 605795   |  | 24353 16,0 +/WK/Zub  |
|  | 3.0 CDVi 4x4   | 115  | 12.06  | 07.12  |   |  |  |  |
|  | 2.5 CD 4x4   | 105  | 12.06  | 07.12  | 24.0128-0226.1  | 428226   |  | 289 28,0 26,0 V L +B   |
|  | 3.0 CDVi 4x4   | 115  | 12.06  | 07.12  |   |  |  |  |

| MAZDA CX-3 (15-)   |  | MAZDA CX-5 (11-)  |   | MAZDA CX-7 (06-13)  |  | MAZDA CX-9 (07-) |        |                                    |                    |
|--|--|---|---|---|--|------------------|--------|------------------------------------|--------------------|
|    | 1.5 D AWD<br>2.0<br>2.0 AWD  | 77<br>88<br>110   | 01.15<br>05.15<br>05.15   |   |  | 24.0125-0208.1   | 425208 | + belüftete Scheiben <sup>1)</sup> | 295 25,0 23,0 V +B |
|    | 2.0 16V<br>2.0 16V<br>2.0 16V AWD<br>2.0 16V AWD<br>2.0 16V AWD<br>2.2 D<br>2.2 D AWD<br>2.2 D AWD<br>2.5 AWD  | 114<br>121<br>113<br>114<br>118<br>110<br>110<br>129<br>141               | 07.12<br>11.11<br>07.12<br>07.12<br>11.11<br>04.12<br>04.12<br>04.12<br>02.15                   |   |  | 24.0110-0381.1   | 410381 |                                    | 303 10,0 8,0 +B    |
|    | 2.2 MZR-CD<br>2.2 MZR-CD AWD<br>2.2 MZR-CD AWD<br>2.3 DISI<br>2.3 DISI AWD<br>2.3 MZR DISI Turbo<br>2.3 MZR DISI Turbo<br>2.3 MZR DISI Turbo<br>2.3 MZR DISI Turbo<br>2.3 MZR DISI Turbo<br>2.3 MZR DISI TurboAWD<br>2.5 MZR | 127<br>120<br>136<br>182<br>182<br>175<br>179<br>190<br>191<br>179<br>120 | 09.09<br>01.12<br>09.09<br>01.12<br>01.12<br>11.06<br>01.07<br>10.07<br>09.09<br>01.07<br>09.09 | 09.13<br>09.13<br>09.13<br>09.13<br>09.13<br>09.13<br>09.13<br>09.13<br>09.13<br>09.13<br>09.13   |  | 13.0460-5606.2   | 605606 |                                    | 24544 18,1 /WK/Zub |
|    | 2.2 MZR-CD<br>2.2 MZR-CD AWD<br>2.2 MZR-CD AWD<br>2.3 DISI<br>2.3 DISI AWD<br>2.3 MZR DISI Turbo<br>2.3 MZR DISI Turbo<br>2.3 MZR DISI Turbo<br>2.3 MZR DISI Turbo<br>2.3 MZR DISI Turbo<br>2.3 MZR DISI TurboAWD            | 127<br>120<br>136<br>182<br>182<br>175<br>179<br>190<br>191<br>179        | 09.09<br>01.12<br>09.09<br>01.12<br>01.12<br>11.06<br>01.07<br>10.07<br>09.09<br>01.07          | 09.13<br>09.13<br>+ Schaltgetriebe <sup>2)</sup><br>+ Schaltgetriebe <sup>2)</sup><br>+ Schaltgetriebe <sup>2)</sup><br>+ Schaltgetriebe <sup>2)</sup><br>+ Schaltgetriebe <sup>2)</sup><br>+ Schaltgetriebe <sup>2)</sup><br>+ Schaltgetriebe <sup>2)</sup><br>+ Schaltgetriebe <sup>2)</sup><br>+ Schaltgetriebe <sup>2)</sup>                            |  | 24.0128-0233.1   | 428233 |                                    | 320 28,0 26,0 V +B |
|  | 2.2 MZR-CD<br>2.2 MZR-CD AWD<br>2.3 DISI<br>2.3 DISI AWD<br>2.3 MZR DISI Turbo<br>2.3 MZR DISI Turbo<br>2.3 MZR DISI Turbo<br>2.3 MZR DISI Turbo<br>2.3 MZR DISI Turbo<br>2.3 MZR DISI TurboAWD<br>2.5 MZR                   | 127<br>136<br>182<br>182<br>175<br>179<br>190<br>191<br>179<br>120        | 09.09<br>09.09<br>01.12<br>01.12<br>11.06<br>01.07<br>10.07<br>09.09<br>01.07<br>09.09          | 09.13<br>09.13<br>+ Automatikgetriebe <sup>3)</sup><br>+ Automatikgetriebe <sup>3)</sup><br>+ Automatikgetriebe <sup>3)</sup><br>+ Automatikgetriebe <sup>3)</sup><br>+ Automatikgetriebe <sup>3)</sup><br>+ Automatikgetriebe <sup>3)</sup><br>+ Automatikgetriebe <sup>3)</sup><br>+ Automatikgetriebe <sup>3)</sup><br>+ Automatikgetriebe <sup>3)</sup> |  | 24.0128-0228.1   | 428228 |                                    | 296 28,0 26,0 V +B |
|  | 2.2 MZR-CD<br>2.2 MZR-CD AWD<br>2.3 DISI<br>2.3 DISI AWD<br>2.3 MZR DISI Turbo<br>2.3 MZR DISI Turbo<br>2.3 MZR DISI Turbo<br>2.3 MZR DISI Turbo<br>2.3 MZR DISI TurboAWD  | 127<br>136<br>182<br>182<br>175<br>179<br>190<br>191<br>179               | 09.09<br>09.09<br>01.12<br>01.12<br>11.06<br>01.07<br>10.07<br>09.09<br>01.07                   | 09.13<br>09.13<br>09.13<br>09.13<br>09.13<br>09.13<br>09.13<br>09.13<br>09.13   |  | 13.0460-5605.2   | 605605 |                                    | 24545 16,9 /Zub    |
|  | 2.2 MZR-CD<br>2.2 MZR-CD AWD   | 127<br>120  | 09.09<br>01.12  | 09.13<br>09.13  |  | 24.0118-0158.1   | 418158 |                                    | 325 18,0 16,0 V +B |
|  | 2.2 MZR-CD AWD<br>2.3 DISI<br>2.3 DISI AWD<br>2.3 MZR DISI Turbo<br>2.3 MZR DISI Turbo<br>2.3 MZR DISI Turbo<br>2.3 MZR DISI Turbo<br>2.3 MZR DISI Turbo<br>2.3 MZR DISI TurboAWD<br>2.5 MZR                                 | 136<br>182<br>182<br>175<br>179<br>190<br>191<br>179<br>120               | 09.09<br>01.12<br>01.12<br>11.06<br>01.07<br>10.07<br>09.09<br>01.07<br>09.09                   | 09.13<br>09.13<br>09.13<br>09.13<br>09.13<br>09.13<br>09.13<br>09.13<br>09.13   |  | 24.0118-0150.1   | 418150 |                                    | 302 18,0 16,0 V +B |
|  | 3.5<br>3.5 AWD<br>3.7<br>3.7 AWD   | 193<br>193<br>204<br>204  | 01.07<br>01.07<br>01.07<br>01.07  |   |  | 13.0460-5606.2   | 605606 |                                    | 24544 18,1 /WK/Zub |
|  | 3.5<br>3.5 AWD<br>3.7<br>3.7 AWD   | 193<br>193<br>204<br>204  | 01.07<br>01.07<br>01.07<br>01.07  |   |  | 24.0128-0233.1   | 428233 |                                    | 320 28,0 26,0 V +B |
|  | 3.5<br>3.5 AWD<br>3.7<br>3.7 AWD   | 193<br>193<br>204<br>204  | 01.07<br>01.07<br>01.07<br>01.07  |   |  | 13.0460-5605.2   | 605605 |                                    | 24545 16,9 /Zub    |
|  | 3.5<br>3.5 AWD<br>3.7<br>3.7 AWD   | 193<br>193<br>204<br>204  | 01.07<br>01.07<br>01.07<br>01.07  |   |  | 24.0118-0158.1   | 418158 |                                    | 325 18,0 16,0 V +B |

<sup>1)</sup> + ventilated discs / + dischi ventilati / + disques ventilés / + disco ventilado

<sup>2)</sup> + manual transmission / + scatola cambio velocità / + transmission mécanique / + cambio de velocidad

<sup>3)</sup> + autom.transmission / + scatola cambio automatico / + transmission automatique / + cambio automático



















| <b>MAZDA DEMIO (98-02)</b>                |   |                                      |                  |  |  |  |  |                                  |                  |  |  |  |  |  |  |  |  |                                       |            |
|---|---|--------------------------------------|------------------|--|--|--|--|----------------------------------|------------------|--|--|--|--|--|--|--|--|---------------------------------------|------------|
|   | 1.3 i 16V<br>1.3 i 16V<br>1.5 i 16V   | 46<br>53<br>55                       |                  | 08.98<br>08.98<br>04.00                            | 10.02<br>03.00<br>10.02                            |  |  | 13.0460-5944.2<br>13.0460-0149.2 | 605944<br>610149 |  |  |  |  |  |  |  |  | 21654 15,0 +/-WK<br>Belagsatz-Zubehör | SUM<br>SUM |
|   | 1.3 i 16V<br>1.3 i 16V<br>1.5 i 16V   | 46<br>53<br>55                       |                  | 08.98<br>08.98<br>04.00                            | 10.02<br>03.00<br>10.02                            |  |  | 24.0122-0166.1                   | 422166           |  |  |  |  |  |  |  |  | 235 22,0 20,0 V +B                    |            |
|   | 1.3 i 16V<br>1.3 i 16V<br>1.5 i 16V   | 46<br>53<br>55                       |                  | 08.98<br>08.98<br>04.00                            | 10.02<br>03.00<br>10.02                            |  |  | 03.0137-0401.2<br>03.0137-9266.2 | 650401<br>669266 |  |  |  |  |  |  |  |  | 200 x 31<br>Bremsbacken-Zubehör       |            |
|   | 1.3 i 16V<br>1.3 i 16V  | 46<br>53                             | 144782<br>144782 | 08.98<br>08.98                                     |  |  |  | 24.0220-0026.1                   | 480104           |  |  |  |  |  |  |  |  | 200/201 x 42                          |            |
| <b>MAZDA E2000/E2200 Bus (87-97)</b>      |   |                                      |                  |  |  |  |  |                                  |                  |  |  |  |  |  |  |  |  |                                       |            |
|   | 2.0<br>2.0 4WD<br>2.2 D<br>2.2 D 4WD  |                                      |                  | 12.87<br>12.87<br>12.87<br>12.87                   | 03.97<br>03.97<br>03.97<br>03.97                   |  |  | 13.0460-5806.2                   | 605806           |  |  |  |  |  |  |  |  | 20002 15,0 +/-WK                      |            |
|   | 2.0<br>2.0 4WD<br>2.2 D<br>2.2 D 4WD  |                                      |                  | 12.87<br>12.87<br>12.87<br>12.87                   | 03.97<br>03.97<br>03.97<br>03.97                   |  |  | 03.0137-0486.2                   | 650486           |  |  |  |  |  |  |  |  | 260 x 51                              |            |
| <b>MAZDA E2000/E2200 Kasten (87-97)</b>   |   |                                      |                  |  |  |  |  |                                  |                  |  |  |  |  |  |  |  |  |                                       |            |
|   | 2.0<br>2.2 D  |                                      |                  | 12.87<br>12.87                                     | 03.97<br>03.97                                     |  |  | 13.0460-5806.2                   | 605806           |  |  |  |  |  |  |  |  | 20002 15,0 +/-WK                      |            |
|   | 2.0<br>2.2 D  |                                      |                  | 12.87<br>12.87                                     | 03.97<br>03.97                                     |  |  | 03.0137-0486.2                   | 650486           |  |  |  |  |  |  |  |  | 260 x 51                              |            |
| <b>MAZDA E2000/E2200 Pritsche (87-97)</b> |   |                                      |                  |  |  |  |  |                                  |                  |  |  |  |  |  |  |  |  |                                       |            |
|   | 2.0<br>2.2 D  |                                      |                  | 12.87<br>12.87                                     | 03.97<br>03.97                                     |  |  | 13.0460-5806.2                   | 605806           |  |  |  |  |  |  |  |  | 20002 15,0 +/-WK                      |            |
|   | 2.0<br>2.2 D  |                                      |                  | 12.87<br>12.87                                     | 03.97<br>03.97 + Einfachbereifung <sup>1)</sup>    |  |  | 03.0137-0486.2                   | 650486           |  |  |  |  |  |  |  |  | 260 x 51                              |            |
| <b>MAZDA MPV I (94-99)</b>                |   |                                      |                  |  |  |  |  |                                  |                  |  |  |  |  |  |  |  |  |                                       |            |
|   | 2.5 TD (LV52)<br>3.0 V6 (LV52)<br>3.0 V6 (LV52)   | 85<br>109<br>113                     |                  | 05.96<br>05.96<br>05.96                            | 08.99<br>08.99<br>08.99                            |  |  | 13.0460-5627.2                   | 605627           |  |  |  |  |  |  |  |  | 21569 14,9 +/-WK                      | AKE        |
| <b>MAZDA MPV II (99-05)</b>               |   |                                      |                  |  |  |  |  |                                  |                  |  |  |  |  |  |  |  |  |                                       |            |
|   | 2.0 16V (LW19)<br>2.0 16V (LW19)<br>2.0 CiTD (LW19)<br>2.3 16V (LW19)<br>2.5 V6 (LW19)<br>3.0 V6 (LW19) | 88<br>90<br>100<br>104<br>125<br>147 |                  | 08.00<br>09.99<br>07.02<br>07.02<br>09.99<br>03.02 | 06.02<br>07.00<br>10.05<br>10.05<br>03.02<br>10.05 |  |  | 13.0460-5884.2                   | 605884           |  |  |  |  |  |  |  |  | 23515 15,8 /WK/Zub                    | SUM        |
|   | 2.0 16V (LW19)<br>2.0 16V (LW19)<br>2.3 16V (LW19)<br>2.5 V6 (LW19)                                     | 88<br>90<br>104<br>125               |                  | 08.00<br>09.99<br>07.02<br>09.99                   | 06.02<br>07.00<br>10.05<br>03.02                   |  |  | 24.0128-0175.1                   | 428175           |  |  |  |  |  |  |  |  | 274 28,0 26,0 V                       |            |
|   | 2.0 CiTD (LW19)<br>2.3 16V (LW19)<br>3.0 V6 (LW19)  | 100<br>104<br>147                    |                  | 07.02<br>09.03<br>09.03                            | 10.05<br>10.05<br>10.05                            |  |  | 24.0128-0180.1                   | 428180           |  |  |  |  |  |  |  |  | 296 28,0 26,0 V                       |            |
|   | 2.0 CiTD (LW19)<br>2.3 16V (LW19)<br>3.0 V6 (LW19)  | 100<br>104<br>147                    |                  | 09.03<br>09.03<br>09.03                            | 10.05<br>10.05<br>10.05                            |  |  | 13.0460-5736.2                   | 605736           |  |  |  |  |  |  |  |  | 24215 15,7 +/-WK/Zub                  |            |
|   | 2.0 CiTD (LW19)<br>2.3 16V (LW19)<br>3.0 V6 (LW19)  | 100<br>104<br>147                    |                  | 09.03<br>09.03<br>09.03                            | 10.05<br>10.05<br>10.05                            |  |  | 24.0118-0148.1                   | 418148           |  |  |  |  |  |  |  |  | 286 18,0 16,0 V +B                    |            |
|   | 2.0 16V (LW19)<br>2.0 16V (LW19)<br>2.0 CiTD (LW19)<br>2.3 16V (LW19)<br>2.5 V6 (LW19)<br>3.0 V6 (LW19) | 88<br>90<br>100<br>104<br>125<br>147 |                  | 08.00<br>09.99<br>07.02<br>07.02<br>09.99<br>03.02 | 06.02<br>07.00<br>08.03<br>08.03<br>03.02<br>08.03 |  |  | 03.0137-0473.2                   | 650473           |  |  |  |  |  |  |  |  | 254 x 52                              |            |
| <b>MAZDA MX-3 (91-98)</b>                 |   |                                      |                  |  |  |  |  |                                  |                  |  |  |  |  |  |  |  |  |                                       |            |
|   | 1.6 i (EC)<br>1.8 i V6 (EC)   |                                      |                  | 07.91<br>07.91                                     | 12.98<br>12.98                                     |  |  | 13.0460-5974.2                   | 605974           |  |  |  |  |  |  |  |  | 21539 15,0 +/-WK                      | SUM        |
|   | 1.6 i (EC)<br>1.8 i V6 (EC)   |                                      |                  | 07.91<br>07.91                                     | 12.98<br>12.98                                     |  |  | 24.0122-0165.1                   | 422165           |  |  |  |  |  |  |  |  | 257 22,0 20,0 V                       |            |
|   | 1.6 i (EC)<br>1.8 i V6 (EC)   |                                      |                  | 07.91<br>07.91                                     | 12.98 + ABS<br>12.98                               |  |  | 13.0460-5824.2                   | 605824           |  |  |  |  |  |  |  |  | 20008 13,0                            | AKE        |
|   | 1.6 i (EC)<br>1.8 i V6 (EC)   |                                      |                  | 07.91<br>07.91                                     | 12.98 + ABS<br>12.98                               |  |  | 24.0109-0131.1                   | 409131           |  |  |  |  |  |  |  |  | 251 9,0 8,0 +B                        |            |

<sup>1)</sup> + single tyre / + ruota singola / + roue simple / + cubierta simple

| <b>MAZDA MX-3 (91-98)</b>      |                    |     |  |       |       |       |  |  |                |        |  |  |  |  |  |  |              |                     |
|--------------------------------|--------------------|-----|--|-------|-------|-------|--|--|----------------|--------|--|--|--|--|--|--|--------------|---------------------|
|                                | 1.6 i (EC)         |     |  | 07.91 | 12.98 | - ABS |  |  | 03.0137-0278.2 | 650278 |  |  |  |  |  |  | 200 x 36     | Bremsbacken-Zubehör |
|                                | 1.6 i (EC)         |     |  | 07.91 | 12.98 | - ABS |  |  | 24.0220-0026.1 | 480104 |  |  |  |  |  |  | 200/201 x 42 |                     |
| <b>MAZDA MX-5 (NA) (89-98)</b> |                    |     |  |       |       |       |  |  |                |        |  |  |  |  |  |  |              |                     |
|                                | 1.6 i (NA1)        | 66  |  | 01.95 | 04.98 | - ABS |  |  | 13.0460-5979.2 | 605979 |  |  |  |  |  |  | 21552        | 14,5                |
|                                | 1.6 i (NA1)        | 85  |  | 08.89 | 08.93 | - ABS |  |  |                |        |  |  |  |  |  |  |              |                     |
|                                | 1.6 i (NA1)        | 66  |  | 01.95 | 04.98 | + ABS |  |  | 13.0460-5834.2 | 605834 |  |  |  |  |  |  | 23354        | 13,0 /WK/Zub        |
|                                | 1.6 i (NA1)        | 85  |  | 08.89 | 08.93 | + ABS |  |  | 13.0460-0278.2 | 610278 |  |  |  |  |  |  |              | Belagsatz-Zubehör   |
|                                | 1.8 i (NA1)        | 96  |  | 09.93 | 04.98 |       |  |  |                |        |  |  |  |  |  |  |              |                     |
|                                | 1.6 i (NA1)        | 66  |  | 01.95 | 04.98 | - ABS |  |  | 24.0118-0113.1 | 418113 |  |  |  |  |  |  | 235          | 18,0 16,0 V +B      |
|                                | 1.6 i (NA1)        | 85  |  | 08.89 | 08.93 | - ABS |  |  |                |        |  |  |  |  |  |  |              |                     |
|                                | 1.6 i (NA1)        | 66  |  | 01.95 | 04.98 | + ABS |  |  | 24.0120-0169.1 | 420169 |  |  |  |  |  |  | 255          | 20,0 18,0 V +B      |
|                                | 1.6 i (NA1)        | 85  |  | 08.89 | 08.93 | + ABS |  |  |                |        |  |  |  |  |  |  |              |                     |
|                                | 1.8 i (NA1)        | 96  |  | 09.93 | 04.98 |       |  |  |                |        |  |  |  |  |  |  |              |                     |
|                                | 1.6 i (NA1)        | 66  |  | 01.95 | 04.98 | - ABS |  |  | 13.0460-5972.2 | 605972 |  |  |  |  |  |  | 21559        | 11,5                |
|                                | 1.6 i (NA1)        | 85  |  | 08.89 | 08.93 | - ABS |  |  |                |        |  |  |  |  |  |  |              |                     |
|                                | 1.6 i (NA1)        | 66  |  | 01.95 | 04.98 | + ABS |  |  | 13.0460-5865.2 | 605865 |  |  |  |  |  |  | 23387        | 12,6 +/WK/Zub       |
|                                | 1.6 i (NA1)        | 85  |  | 08.89 | 08.93 | + ABS |  |  |                |        |  |  |  |  |  |  |              | AKE                 |
|                                | 1.8 i (NA1)        | 96  |  | 09.93 | 04.98 |       |  |  |                |        |  |  |  |  |  |  |              |                     |
|                                | 1.6 i (NA1)        | 66  |  | 01.95 | 04.98 | - ABS |  |  | 24.0109-0127.1 | 409127 |  |  |  |  |  |  | 231          | 9,0 8,0             |
|                                | 1.6 i (NA1)        | 85  |  | 08.89 | 08.93 | - ABS |  |  |                |        |  |  |  |  |  |  |              |                     |
|                                | 1.6 i (NA1)        | 66  |  | 01.95 | 04.98 | + ABS |  |  | 24.0109-0131.1 | 409131 |  |  |  |  |  |  | 251          | 9,0 8,0 +B          |
|                                | 1.6 i (NA1)        | 85  |  | 08.89 | 08.93 | + ABS |  |  |                |        |  |  |  |  |  |  |              |                     |
|                                | 1.8 i (NA1)        | 96  |  | 09.93 | 04.98 |       |  |  |                |        |  |  |  |  |  |  |              |                     |
| <b>MAZDA MX-5 (NB) (98-05)</b> |                    |     |  |       |       |       |  |  |                |        |  |  |  |  |  |  |              |                     |
|                                | 1.6 16V (NB18)     | 81  |  | 05.98 | 07.00 |       |  |  | 13.0460-5834.2 | 605834 |  |  |  |  |  |  | 23354        | 13,0 /WK/Zub        |
|                                | 1.8 16V (NB1)      | 103 |  | 05.98 | 07.00 |       |  |  | 13.0460-0278.2 | 610278 |  |  |  |  |  |  |              | Belagsatz-Zubehör   |
|                                | 1.6 Sport (NB18)   | 81  |  | 08.00 | 10.05 |       |  |  | 13.0460-5867.2 | 605867 |  |  |  |  |  |  | 23863        | 14,3 /WK/Zub        |
|                                | 1.8 16V (NB18)     | 102 |  | 08.00 | 10.05 |       |  |  |                |        |  |  |  |  |  |  |              |                     |
|                                | 1.8 16V (NB18)     | 107 |  | 08.00 | 10.05 |       |  |  |                |        |  |  |  |  |  |  |              |                     |
|                                | 1.6 16V (NB18)     | 81  |  | 05.98 | 07.00 |       |  |  | 24.0120-0169.1 | 420169 |  |  |  |  |  |  | 255          | 20,0 18,0 V +B      |
|                                | 1.8 16V (NB1)      | 103 |  | 05.98 | 07.00 |       |  |  |                |        |  |  |  |  |  |  |              |                     |
|                                | 1.6 Sport (NB18)   | 81  |  | 08.00 | 10.05 |       |  |  | 24.0122-0235.1 | 422235 |  |  |  |  |  |  | 270          | 22,0 20,0 V         |
|                                | 1.8 16V (NB18)     | 102 |  | 08.00 | 10.05 |       |  |  |                |        |  |  |  |  |  |  |              |                     |
|                                | 1.8 16V (NB18)     | 107 |  | 08.00 | 10.05 |       |  |  |                |        |  |  |  |  |  |  |              |                     |
|                                | 1.6 16V (NB18)     | 81  |  | 05.98 | 07.03 |       |  |  | 13.0460-5865.2 | 605865 |  |  |  |  |  |  | 23387        | 12,6 +/WK/Zub       |
|                                | 1.8 16V (NB1)      | 103 |  | 05.98 | 07.03 |       |  |  |                |        |  |  |  |  |  |  |              | AKE                 |
|                                | 1.8 16V (NB18)     | 102 |  | 08.00 | 10.00 |       |  |  | 13.0460-5866.2 | 605866 |  |  |  |  |  |  | 23876        | 12,4 +/WK           |
|                                | 1.8 16V (NB18)     | 107 |  | 08.00 | 10.00 |       |  |  |                |        |  |  |  |  |  |  |              | AKE                 |
|                                | 1.6 Sport (NB18)   | 81  |  | 08.03 | 10.05 |       |  |  | 13.0460-5732.2 | 605732 |  |  |  |  |  |  | 24029        | 12,5 +/WK/Zub       |
|                                | 1.8 16V (NB1)      | 103 |  | 08.03 | 10.05 |       |  |  |                |        |  |  |  |  |  |  |              | AKE                 |
|                                | 1.8 16V (NB18)     | 102 |  | 11.00 | 10.05 |       |  |  |                |        |  |  |  |  |  |  |              |                     |
|                                | 1.8 16V (NB18)     | 107 |  | 11.00 | 10.05 |       |  |  |                |        |  |  |  |  |  |  |              |                     |
|                                | 1.6 16V (NB18)     | 81  |  | 05.98 | 07.00 |       |  |  | 24.0109-0131.1 | 409131 |  |  |  |  |  |  | 251          | 9,0 8,0 +B          |
|                                | 1.8 16V (NB1)      | 103 |  | 05.98 | 07.00 |       |  |  |                |        |  |  |  |  |  |  |              |                     |
|                                | 1.6 Sport (NB18)   | 81  |  | 08.00 | 10.05 |       |  |  | 24.0110-0307.1 | 410307 |  |  |  |  |  |  | 276          | 10,0 8,0            |
|                                | 1.8 16V (NB18)     | 102 |  | 08.00 | 10.05 |       |  |  |                |        |  |  |  |  |  |  |              |                     |
|                                | 1.8 16V (NB18)     | 107 |  | 08.00 | 10.05 |       |  |  |                |        |  |  |  |  |  |  |              |                     |
| <b>MAZDA MX-5 (NC) (05-)</b>   |                    |     |  |       |       |       |  |  |                |        |  |  |  |  |  |  |              |                     |
|                                | 1.8 16V (NC18)     | 93  |  | 03.05 |       |       |  |  | 13.0460-5761.2 | 605761 |  |  |  |  |  |  | 24297        | 14,4 /WK/Zub        |
|                                | 2.0 16V (NC18)     | 118 |  | 03.05 |       |       |  |  |                |        |  |  |  |  |  |  |              |                     |
|                                | 1.8 16V (NC18)     | 93  |  | 03.05 |       |       |  |  | 24.0122-0249.1 | 422249 |  |  |  |  |  |  | 290          | 22,0 20,0 V +B      |
|                                | 2.0 16V (NC18)     | 118 |  | 03.05 |       |       |  |  |                |        |  |  |  |  |  |  |              |                     |
|                                | 1.8 16V (NC18)     | 93  |  | 03.05 |       |       |  |  | 13.0460-5762.2 | 605762 |  |  |  |  |  |  | 24298        | 14,0 +/WK/Zub       |
|                                | 2.0 16V (NC18)     | 118 |  | 03.05 |       |       |  |  |                |        |  |  |  |  |  |  |              |                     |
|                                | 1.8 16V (NC18)     | 93  |  | 03.05 |       |       |  |  | 24.0110-0302.1 | 410302 |  |  |  |  |  |  | 280          | 10,0 8,0 +B         |
|                                | 2.0 16V (NC18)     | 118 |  | 03.05 |       |       |  |  |                |        |  |  |  |  |  |  |              |                     |
| <b>MAZDA MX-5 (ND) (15-)</b>   |                    |     |  |       |       |       |  |  |                |        |  |  |  |  |  |  |              |                     |
|                                | 1.5 SKYACTIV-G 131 | 96  |  | 04.15 |       |       |  |  | 13.0460-5762.2 | 605762 |  |  |  |  |  |  | 24298        | 14,0 +/WK/Zub       |
|                                | 2.0 SKYACTIV-G 160 | 118 |  | 04.15 |       |       |  |  |                |        |  |  |  |  |  |  |              |                     |
| <b>MAZDA MX-6 (91-97)</b>      |                    |     |  |       |       |       |  |  |                |        |  |  |  |  |  |  |              |                     |
|                                | 2.0 (GE1)          | 85  |  | 07.91 | 08.97 |       |  |  | 13.0460-5954.2 | 605954 |  |  |  |  |  |  | 23845        | 15,8 +/WK/Zub       |
|                                | 2.5 V6 (GE1/GE7)   | 120 |  | 08.94 | 08.97 |       |  |  | 13.0460-0443.2 | 610443 |  |  |  |  |  |  |              | SUM                 |
|                                | 2.5 V6 (GE1/GE7)   | 121 |  | 07.91 | 08.97 |       |  |  |                |        |  |  |  |  |  |  |              | Belagsatz-Zubehör   |
|                                | 2.5 V6 (GE1/GE7)   | 123 |  | 02.93 | 08.97 |       |  |  |                |        |  |  |  |  |  |  |              |                     |
|                                | 2.0 (GE1)          | 85  |  | 07.91 | 08.97 |       |  |  | 24.0124-0129.1 | 424129 |  |  |  |  |  |  | 258          | 24,0 22,0 V +B      |
|                                | 2.5 V6 (GE1/GE7)   | 120 |  | 08.94 | 08.97 |       |  |  |                |        |  |  |  |  |  |  |              |                     |
|                                | 2.5 V6 (GE1/GE7)   | 121 |  | 07.91 | 08.97 |       |  |  |                |        |  |  |  |  |  |  |              |                     |
|                                | 2.5 V6 (GE1/GE7)   | 123 |  | 02.93 | 08.97 |       |  |  |                |        |  |  |  |  |  |  |              |                     |

1) - sport package / - pacchetto sportivo / - version sport / - kit deportivo  
2) + sports package / + pacchetto sportivo / + version sport / + kit deportivo



| MAZDA MX-6 (91-97)   |   |                            |  |   |   |                                  |                  |  |  |  |  |  |            |
|--|---|----------------------------|--|---|---|----------------------------------|------------------|--|--|--|--|--|------------|
|    | 2.0 (GE1)<br>2.5 V6 (GE1/GE7)<br>2.5 V6 (GE1/GE7)<br>2.5 V6 (GE1/GE7) | 85<br>120<br>121<br>123    |  | 07.91<br>08.94<br>07.91<br>02.93          | 08.97<br>08.97<br>08.97<br>08.97          | 13.0460-5973.2<br>13.0460-0245.2 | 605973<br>610245 |  |  |  |  | 21766 13,5<br>Belagsatz-Zubehör              |            |
|    | 2.0 (GE1)<br>2.5 V6 (GE1/GE7)<br>2.5 V6 (GE1/GE7)<br>2.5 V6 (GE1/GE7) | 85<br>120<br>121<br>123    |  | 07.91<br>08.94<br>07.91<br>02.93          | 08.97<br>08.97<br>08.97<br>08.97          | 24.0110-0234.1                   | 410234           |  |  |  |  | 261 10,0 8,0 +B                              |            |
| MAZDA PREMACY (CP) (99-05)   |   |                            |  |   |   |                                  |                  |  |  |  |  |  |            |
|    | 1.8 i 16V<br>1.9 i 16V<br>2.0 DiTD<br>2.0 DiTD                        | 74<br>84<br>66<br>74       |  | 07.99<br>07.99<br>10.99<br>07.00          | 03.05<br>03.05<br>06.00<br>03.05          | 13.0460-5954.2                   | 605954           |  | 5 Sitzplätze <sup>1)</sup>   |  |  | 23845 15,8 +/WK/Zub                          | SUM        |
|    | 1.8 i 16V<br>1.9 i 16V<br>2.0 DiTD<br>2.0 DiTD<br>2.0 i 16V           | 74<br>84<br>66<br>74<br>96 |  | 07.99<br>07.99<br>10.99<br>07.00<br>11.01 | 03.05<br>03.05<br>06.00<br>03.05<br>03.05 | 13.0460-5831.2                   | 605831           |  | 7 Sitzplätze <sup>2)</sup>   |  |  | 23777 16,0 +/WK/Zub                          | SUM        |
|    | 1.8 i 16V<br>1.9 i 16V<br>2.0 DiTD<br>2.0 DiTD                        | 74<br>84<br>66<br>74       |  | 07.99<br>07.99<br>10.99<br>07.00          | 03.05<br>03.05<br>06.00<br>03.05          | 24.0124-0129.1                   | 424129           |  | 5 Sitzplätze <sup>1)</sup>   |  |  | 258 24,0 22,0 V +B                           |            |
|    | 1.8 i 16V<br>1.9 i 16V<br>2.0 DiTD<br>2.0 DiTD<br>2.0 i 16V           | 74<br>84<br>66<br>74<br>96 |  | 07.99<br>07.99<br>10.99<br>07.00<br>11.01 | 03.05<br>03.05<br>06.00<br>03.05<br>03.05 | 24.0124-0175.1                   | 424175           |  | 7 Sitzplätze <sup>2)</sup>   |  |  | 274 24,5 22,0 V +B                           |            |
|    | 1.8 i 16V<br>1.9 i 16V<br>2.0 DiTD<br>2.0 DiTD<br>2.0 i 16V           | 74<br>84<br>66<br>74<br>96 |  | 07.99<br>07.99<br>10.99<br>07.00<br>11.01 | 03.05<br>03.05<br>06.00<br>03.05<br>03.05 | 13.0460-5804.2<br>13.0460-0234.2 | 605804<br>610234 |  |  |  |  | 24045 13,7<br>Belagsatz-Zubehör              | AKE        |
|    | 1.8 i 16V<br>1.9 i 16V<br>2.0 DiTD<br>2.0 DiTD<br>2.0 i 16V           | 74<br>84<br>66<br>74<br>96 |  | 07.99<br>07.99<br>10.99<br>07.00<br>11.01 | 03.05<br>03.05<br>06.00<br>03.05<br>03.05 | 24.0110-0234.1                   | 410234           |  | 5 Sitzplätze <sup>1)</sup>   |  |  | 261 10,0 8,0 +B                              |            |
|    | 1.8 i 16V<br>1.9 i 16V<br>2.0 DiTD<br>2.0 DiTD<br>2.0 i 16V           | 74<br>84<br>66<br>74<br>96 |  | 07.99<br>07.99<br>10.99<br>07.00<br>11.01 | 03.05<br>03.05<br>06.00<br>03.05<br>03.05 | 24.0110-0302.1                   | 410302           |  | 7 Sitzplätze <sup>2)</sup>   |  |  | 280 10,0 8,0 +B                              |            |
|   | 1.8 i 16V<br>1.9 i 16V<br>2.0 DiTD                                    | 74<br>84<br>66             |  | 07.99<br>07.99<br>10.99                   | 12.99<br>12.99<br>12.99                   | 03.0137-0431.2<br>03.0137-9262.2 | 650431<br>669262 |  | - ABS<br>- ABS   |  |  | 229 x 43<br>Bremsbacken-Zubehör              |            |
|  | 1.8 i 16V<br>1.9 i 16V<br>2.0 DiTD<br>2.0 DiTD                        | 74<br>84<br>66<br>74       |  | 01.00<br>01.00<br>01.00<br>07.00          | 07.01<br>07.01<br>06.00<br>07.01          | 03.0137-0416.2<br>03.0137-9262.2 | 650416<br>669262 |  | - ABS<br>- ABS   |  |  | 229 x 43<br>Bremsbacken-Zubehör              |            |
| MAZDA PREMACY (CR) (05-10)   |   |                            |  |   |   |                                  |                  |  |  |  |  |  |            |
|  | 2.0 i 16V   | 107                        |  | 03.05                                     | 05.10 + ⊕                                 | 13.0460-7193.2<br>13.0470-7193.2 | 607193<br>LD7193 |  |  |  |  | 23723 18,1 +<br>23723 18,1 +                 | ATE<br>ATE |
|  | 2.0 i 16V   | 107                        |  | 03.05                                     | 05.10 + ⊕                                 | 24.0125-0165.1<br>24.0125-0170.1 | 425165<br>425170 |  | + 15" Rad <sup>3)</sup><br>+ 16" Rad <sup>4)</sup>   |  |  | 278 25,0 23,0 V L +B<br>300 25,0 23,0 V L +B |            |
|  | 2.0 i 16V   | 107                        |  | 03.05                                     | 05.10 + ⊕                                 | 13.0460-7195.2<br>13.0470-7195.2 | 607195<br>LD7195 |  |  |  |  | 23482 16,6 +<br>23482 16,6 +                 | ATE<br>ATE |
|  | 2.0 i 16V<br>2.0 i 16V  | 107<br>107                 |  | 03.05<br>03.05                            | 05.10 + ⊕<br>05.10 + ⊕                    | 24.0111-0160.1<br>24.0111-0165.1 | 411160<br>411165 |  | + 15" Rad <sup>3)</sup><br>+ 16" Rad <sup>4)</sup>   |  |  | 280 11,0 9,0 +B<br>302 11,0 9,0 +B           |            |
| MAZDA RX-8 (03-12)   |   |                            |  |   |   |                                  |                  |  |  |  |  |  |            |
|  | 2.6 Wankel<br>2.6 Wankel<br>2.6 Wankel<br>2.6 Wankel                  | 141<br>158<br>170<br>177   |  | 10.03<br>11.03<br>10.03<br>11.03          | 06.12<br>06.12<br>06.12<br>06.12          | 13.0460-5877.2                   | 605877           |  |  |  |  | 24042 16,3                                   | SUM        |
|  | 2.6 Wankel<br>2.6 Wankel<br>2.6 Wankel<br>2.6 Wankel                  | 141<br>158<br>170<br>177   |  | 10.03<br>11.03<br>10.03<br>11.03          | 06.12<br>06.12<br>06.12<br>06.12          | 24.0124-0217.1                   | 424217           |  | - Sportfahrwerk <sup>5)</sup><br>- Sportfahrwerk <sup>5)</sup><br>- Sportfahrwerk <sup>5)</sup><br>- Sportfahrwerk <sup>5)</sup> |  |  | 303 24,0 22,0 V +B                           |            |
|  | 2.6 Wankel<br>2.6 Wankel<br>2.6 Wankel<br>2.6 Wankel                  | 141<br>158<br>170<br>177   |  | 10.03<br>11.03<br>10.03<br>11.03          | 06.12<br>06.12<br>06.12<br>06.12          | 24.0124-0218.1                   | 424218           |  | + Sportfahrwerk <sup>6)</sup><br>+ Sportfahrwerk <sup>6)</sup><br>+ Sportfahrwerk <sup>6)</sup><br>+ Sportfahrwerk <sup>6)</sup> |  |  | 323 24,0 22,0 V +B                           |            |
|  | 2.6 Wankel<br>2.6 Wankel<br>2.6 Wankel<br>2.6 Wankel                  | 141<br>158<br>170<br>177   |  | 10.03<br>11.03<br>10.03<br>11.03          | 06.12<br>06.12<br>06.12<br>06.12          | 13.0460-5856.2                   | 605856           |  |  |  |  | 24039 14,4 +/WK                              |            |

<sup>1)</sup> 5 seats / posto a sedere 5 / place siège 5 / plaza sentada 5

<sup>2)</sup> 7 seats / posto a sedere 7 / place siège 7 / plaza sentada 7

































<sup>3)</sup> + 15" wheel / + ruota 15" / + roue 15" / + rueda 15"

<sup>4)</sup> + 16" wheel / + ruota 16" / + roue 16" / + rueda 16"

<sup>5)</sup> - sports suspension / - sospensione sportiva / - châssis de sport / - suspensión deportiva

<sup>6)</sup> + sports suspension / + sospensione sportiva / + châssis de sport / + suspensión deportiva



|     |             |  |  |  |                        |  |  |                         |
|--|---|--|--|--|---|--|--|---|
| <b>MAZDA RX-8 (03-12)</b>  |   |  |  |  |   |  |  |   |
|    | 2.6 Wankel<br>2.6 Wankel<br>2.6 Wankel<br>2.6 Wankel  | 141<br>158<br>170<br>177   |  | 10.03<br>11.03<br>10.03<br>11.03   | 09.05<br>09.05<br>09.05<br>09.05  | 24.0118-0149.1   | 418149   | 302 18,0 16,0 V +B  |
| <b>MAZDA TRIBUTE (00-04)</b>   |   |  |  |  |   |  |  |   |
|    | 2.0 i 16V<br>2.0 i 16V 4WD<br>3.0 i V6 4WD  | 91<br>91<br>145  |  | 03.00<br>03.00<br>03.00  | 03.04<br>03.04<br>03.04   | 13.0460-7205.2   | 607205   | 23787 19,0 + ATE  |
|    | 2.0 i 16V<br>2.0 i 16V 4WD<br>3.0 i V6 4WD  | 91<br>91<br>145  |  | 03.00<br>03.00<br>03.00  | 03.04<br>03.04<br>03.04   | 24.0124-0735.1   | 424735   | 278 24,0 22,0 V +B  |
|    | 2.0 i 16V<br>2.0 i 16V 4WD<br>3.0 i V6 4WD  | 91<br>91<br>145  |  | 03.00<br>03.00<br>03.00  | 03.04<br>03.04<br>03.04   | 03.0137-0416.2<br>03.0137-9262.2   | 650416<br>669262   | 229 x 43<br>Bremsbacken-Zubehör   |
| <b>MAZDA TRIBUTE (04-08)</b>   |   |  |  |  |   |  |  |   |
|    | 2.3 i 16V AWD<br>3.0 i V6 AWD   | 110<br>149   |  | 04.04<br>04.04   | 02.05 + HA-Trommelbremse <sup>1)</sup><br>02.05 + HA-Trommelbremse <sup>1)</sup>                        | 13.0460-7205.2   | 607205   | 23787 19,0 + ATE  |
|    | 2.3 i 16V AWD<br>3.0 i V6 AWD   | 110<br>149   |  | 04.04<br>04.04   | 05.08 + HA-Scheibenbremse <sup>2)</sup><br>05.08 + HA-Scheibenbremse <sup>2)</sup>                      | 13.0460-7234.2   | 607234   | 24438 16,1 + ATE  |
|    | 2.3 i 16V AWD<br>3.0 i V6 AWD   | 110<br>149   |  | 04.04<br>04.04   | 05.08 + ABS<br>05.08 + ABS  | 13.0460-7235.2   | 607235   | 24670 18,0 + ATE  |
|    | 2.3 i 16V AWD<br>3.0 i V6 AWD   | 110<br>149   |  | 04.04<br>04.04   | 05.08 + ABS<br>05.08 + ABS  | 24.0112-0181.1   | 412181   | 302 12,0 11,0 +B  |
|    | 2.3 i 16V AWD<br>3.0 i V6 AWD   | 110<br>149   |  | 04.04<br>04.04   | 02.05 - ABS<br>02.05 - ABS  | 03.0137-0416.2<br>03.0137-9262.2   | 650416<br>669262   | 229 x 43<br>Bremsbacken-Zubehör   |
| <b>MAZDA XEDOS 6 (92-00)</b>   |   |  |  |  |   |  |  |   |
|    | 1.6 i 16V (CA1)<br>2.0 i V6 (CA1)   |  |  | 06.92<br>06.92   | 09.99<br>10.00  | 13.0460-5954.2<br>13.0460-0443.2   | 605954<br>610443   | 23845 15,8 +WK/Zub<br>Belagsatz-Zubehör SUM   |
|   | 1.6 i 16V (CA1)<br>2.0 i V6 (CA1)   |  |  | 06.92<br>06.92   | 09.99<br>10.00  | 24.0124-0129.1   | 424129   | 258 24,0 22,0 V +B  |
|  | 1.6 i 16V (CA1)<br>2.0 i V6 (CA1)   |  |  | 06.92<br>06.92   | 09.99<br>10.00  | 13.0460-5973.2<br>13.0460-0245.2   | 605973<br>610245   | 21766 13,5<br>Belagsatz-Zubehör   |
|  | 1.6 i 16V (CA1)<br>2.0 i V6 (CA1)   |  |  | 06.92<br>06.92   | 09.99<br>10.00  | 24.0110-0234.1   | 410234   | 261 10,0 8,0 +B   |
| <b>MAZDA XEDOS 9 (93-02)</b>   |   |  |  |  |   |  |  |   |
|  | 2.0 i V6 (TA1)<br>2.3 i V6 (TA2)<br>2.5 i V6 (TA1)<br>2.5 i V6 4WS (TA7)                    | 105<br>155<br>123<br>123   |  | 07.93<br>02.95<br>07.93<br>07.93   | 01.00<br>01.00<br>06.00<br>06.00  | 24.0128-0175.1   | 428175   | 274 28,0 26,0 V   |
|  | 2.0 i V6 (TA1)<br>2.3 i V6 (TA2)<br>2.5 i V6 (TA1)<br>2.5 i V6 (TA12)<br>2.5 i V6 4WS (TA7) | 105<br>155<br>123<br>120<br>123  |  | 10.98<br>02.95<br>10.98<br>07.00<br>10.98  | 01.00<br>01.00<br>06.00<br>09.02<br>06.00   | 13.0460-5625.2   | 605625   | 21319 14,9 +WK  |
| <b>MERCEDES BENZ A-Klasse (W168) (97-04)</b>                                       |   |  |  |  |   |  |  |   |
|  | A 140<br>A 160 CDI<br>A 160 CDI   | 60<br>44<br>55   |  | 09.97<br>08.98<br>02.01  | 08.04 + kurzer Radstand <sup>3)</sup><br>01.01<br>08.04   | 13.0460-2833.2<br>13.0470-2833.2<br>13.0460-0163.2<br>24.8190-0401.2               | 602833<br>LD2833<br>610163<br>620401   | 23070 17,0 /WE/Zub/S<br>23070 17,0 /WE/Zub/S<br>Belagsatz-Zubehör<br>Warnkontakt L=95mm TRW<br>TRW<br>TRW |
|  | A 140<br>A 160<br>A 170 CDI<br>A 170 CDI<br>A 190   | 60<br>75<br>66<br>70<br>92   |  | 09.97<br>09.97<br>03.98<br>02.01<br>05.99  | 08.04 + langer Radstand <sup>4)</sup><br>08.04 - (BR)<br>01.01<br>08.04<br>08.04 - (BR)                 | 13.0460-2776.2<br>13.0470-2776.2<br>13.0460-0024.2<br>24.8190-0401.2               | 602776<br>LD2776<br>610024<br>620401   | 23070 17,0 /WE/Zub/S<br>23070 17,0 /WE/Zub/S<br>Belagsatz-Zubehör<br>Warnkontakt L=95mm TRW<br>TRW<br>TRW |
|  | A 160<br>A 190  | 75<br>92   |  | 05.99<br>05.99   | 08.04 + (BR)<br>08.04 + (BR)  | 24.8190-0401.2   | 620401   | Warnkontakt L=95mm  |
|  | A 210 Evolution   | 103  |  | 03.02  | 08.04   | 24.8190-0401.2   | 620401   | Warnkontakt L=95mm  |
|  | A 140<br>A 160 CDI<br>A 160 CDI   | 60<br>44<br>55   |  | 09.97<br>08.98<br>02.01  | 08.04 + kurzer Radstand <sup>3)</sup><br>01.01<br>08.04   | 24.0112-0144.1<br>24.0312-0144.1   | 412144<br>512144   | 260 12,0 10,0 L +S +B<br>260 12,0 10,0 L +S +B PD   |
|  | A 140<br>A 160<br>A 170 CDI<br>A 170 CDI<br>A 190   | 60<br>75<br>66<br>70<br>92   |  | 09.97<br>09.97<br>03.98<br>02.01<br>05.99  | 08.04 + langer Radstand <sup>4)</sup><br>08.04<br>01.01<br>08.04<br>08.04 + (BR)                        | 24.0122-0168.1<br>24.0322-0168.1   | 422168<br>522168   | 260 22,0 19,4 V L +S +B<br>260 22,0 19,4 V L +S +B PD   |
|  | A 190   | 92   |  | 05.99  | 08.04 - (BR)  | 24.0122-0208.1   | 422208   | 276 22,0 19,4 V L +B  |
|  | A 160<br>A 170 CDI<br>A 190<br>A 210 Evolution  | 75<br>70<br>92<br>103  |  | 09.97<br>02.01<br>05.99<br>03.02   | 08.04 + langer Radstand <sup>4)</sup><br>08.04 + langer Radstand <sup>4)</sup><br>08.04 - (BR)<br>08.04 | 13.0460-2855.2<br>13.0470-2855.2<br>13.0460-0144.2                                 | 602855<br>LD2855<br>610144   | 23138 14,6 /S<br>23138 14,6 /S<br>Belagsatz-Zubehör TRW<br>TRW<br>TRW                                     |

<sup>1)</sup> + RA drum brake / + P freno a tamburo / + frein à tambour essieu AR / + ET-tambores de freno

<sup>2)</sup> + RA disc brake / + P disco freno / + frein à disque essieu AR / + ET-disco de freno

<sup>3)</sup> + short wheel base / + passo lungo / + empattement court / + distancia corta entre ejes

<sup>4)</sup> + long wheel base / + passo lungo / + empattement long / + distancia larga entre ejes















**MERCEDES BENZ A-Klasse (W168) (97-04)**

|  |   |  |                               |   |   |   |                                  |                  |  |   |
|--|---|--|-------------------------------|---|---|---|----------------------------------|------------------|--|---|
|  | A 160<br>A 170 CDI<br>A 190<br>A 210 Evolution                              | 75<br>70<br>92<br>103                  |                               | 09.97<br>02.01<br>05.99<br>03.02                            | 08.04<br>08.04<br>08.04<br>08.04                            | + langer Radstand <sup>1)</sup><br>+ langer Radstand <sup>1)</sup><br>- BR<br>+ langer Radstand <sup>1)</sup> | 24.0108-0111.1<br>24.0308-0111.1 | 408111<br>508111 |  | 258 8,0 7,0 +B<br>258 8,0 7,0 +B PD         |
|  | A 140<br>A 160<br>A 160 CDI<br>A 160 CDI<br>A 170 CDI<br>A 170 CDI          | 60<br>75<br>44<br>55<br>66<br>70       |                               | 09.97<br>09.97<br>08.98<br>02.01<br>03.98<br>02.01          | 08.04<br>08.04<br>01.01<br>08.04<br>01.01<br>08.04          | + kurzer Radstand / - BR <sup>2)</sup><br>+ kurzer Radstand <sup>3)</sup>                                     | 03.0137-0349.2<br>03.0137-9232.2 | 650349<br>669232 |  | 180 x 42 HEB TRW<br>Bremsbacken-Zubehör TRW |
|  | A 140<br>A 160<br>A 160 CDI<br>A 160 CDI<br>A 170 CDI<br>A 170 CDI<br>A 190 | 60<br>75<br>44<br>55<br>66<br>70<br>92 |                               | 09.97<br>09.97<br>08.98<br>02.01<br>03.98<br>02.01<br>05.99 | 08.04<br>08.04<br>01.01<br>08.04<br>01.01<br>08.04<br>08.04 | + kurzer Radstand <sup>3)</sup><br>+ kurzer Radstand <sup>3)</sup><br>+ BR                                    | 24.0218-0023.1                   | 480077           |  | 180/181,2 x 48                              |
|  | A 140<br>A 160<br>A 170 CDI   | 60<br>75<br>66                         | J078973<br>J078973<br>J078973 | 09.97<br>09.97<br>03.98                                     |   | + kurzer Radstand / - BR <sup>2)</sup>  | 03.0520-4619.3                   | 694619           |  | 19,05/180x42 TopKit TRW                     |
|  | A 140<br>A 160<br>A 160 CDI<br>A 160 CDI<br>A 170 CDI<br>A 170 CDI          | 60<br>75<br>44<br>55<br>66<br>70       | J078974<br>J078974            | 08.04<br>08.98<br>02.01<br>01.01<br>02.01                   | 08.04<br>08.04<br>01.01<br>08.04<br>01.01<br>08.04          | + kurzer Radstand / - BR <sup>2)</sup><br>+ kurzer Radstand <sup>3)</sup>                                     | 03.0520-3417.3                   | 693417           |  | 17,78/180x42 TopKit TRW                     |
|  | A 160<br>A 170 CDI<br>A 190<br>A 210 Evolution                              | 75<br>70<br>92<br>103                  |                               | 09.97<br>02.01<br>05.99<br>03.02                            | 08.04<br>08.04<br>08.04<br>08.04                            | + langer Radstand <sup>1)</sup><br>+ langer Radstand <sup>1)</sup><br>- BR                                    | 03.0137-0170.2                   | 650170           |  | 164 x 20 /Zub                               |

**MERCEDES BENZ A-Klasse (W169) (04-12)**

|  |   |  |          |   |   |  |  |                                      |   |  |
|--|---|--|----------|---|---|--|--|--------------------------------------|---|--|
|  | A 150 / A 160<br>A 160 CDI  | 70<br>60                                       | J 215300 | 08.04<br>08.04  | 05.12<br>08.04  | - erhöhte Zuladung <sup>4)</sup>                                     | 13.0460-2885.2<br>13.0470-2885.2<br>24.8190-0410.2                   | 602885<br>LD2885<br>620410           | 1 | 24077 19,1 /WE/Zub/S TRW<br>24077 19,1 /WE/Zub/S TRW<br>Warnkontakt L=97,5mm   |
|  | A 160 CDI<br>A 160 CDI<br>A 170<br>A 180<br>A 180 CDI<br>A 200  | 60<br>60<br>85<br>85<br>80<br>100              | J 215301 | 08.04<br>08.04<br>08.04<br>04.09<br>08.04<br>08.04                            | 05.12<br>05.12<br>05.12<br>05.12<br>05.12<br>05.12                            | + erhöhte Zuladung <sup>5)</sup><br>- erhöhte Zuladung <sup>4)</sup> | 13.0460-2711.2<br>13.0470-2711.2<br>24.8190-0410.2                   | 602711<br>LD2711<br>620410           | 1 | 24077 19,1 /WE/Zub/S TRW<br>24077 19,1 /WE/Zub/S TRW<br>Warnkontakt L=97,5mm   |
|  | A 200 CDI<br>A 200 Turbo<br>E-Cell  | 142<br>50                                      |          | 08.04<br>03.05<br>12.10   | 05.12<br>05.12<br>05.12   |  | 13.0460-2708.2<br>13.0470-2708.2<br>24.8190-0410.2                   | 602708<br>LD2708<br>620410           | 1 | 23881 20,0 /WE/Zub/S TRW<br>23881 20,0 /WE/Zub/S TRW<br>Warnkontakt L=97,5mm   |
|  | A 150 / A 160<br>A 160 CDI  | 70<br>60                                       |          | 08.04<br>08.04  | 05.12<br>05.12  |  | 24.0112-0167.1<br>24.0312-0167.1<br>24.0122-0232.1<br>24.0322-0232.1 | 412167<br>512167<br>422232<br>522232 |   | - erhöhte Zuladung <sup>4)</sup><br>- erhöhte Zuladung <sup>4)</sup><br>+ erhöhte Zuladung <sup>5)</sup><br>+ erhöhte Zuladung <sup>5)</sup><br>276 12,0 10,0 L +S +B<br>276 12,0 10,0 L +S +B PD<br>276 22,0 19,4 V L +S +B<br>276 22,0 19,4 V L +S +B PD |
|  | A 170<br>A 180<br>A 180 CDI<br>A 200  | 85<br>85<br>80<br>100                          |          | 08.04<br>04.09<br>08.04<br>08.04  | 05.12<br>05.12<br>05.12<br>05.12  |  | 24.0122-0232.1<br>24.0322-0232.1                                     | 422232<br>522232                     |   | 276 22,0 19,4 V L +S +B<br>276 22,0 19,4 V L +S +B PD  |
|  | A 200 CDI<br>A 200 Turbo<br>E-Cell  | 142<br>50                                      |          | 08.04<br>03.05<br>12.10   | 05.12<br>05.12<br>05.12   |  | 24.0125-0167.1<br>24.0325-0167.1                                     | 425167<br>525167                     |   | 288 25,0 22,4 V L +S +B<br>288 25,0 22,4 V L +S +B PD  |
|  | E-Cell  | 50   |          | 12.10   | 05.12   |  | 13.0460-2855.2<br>13.0470-2855.2<br>13.0460-0144.2                   | 602855<br>LD2855<br>610144           |   | 23138 14,6 /S TRW<br>23138 14,6 /S TRW<br>Belagsatz-Zubehör TRW  |
|  | A 150 / A 160<br>A 160 CDI<br>A 170<br>A 180<br>A 180 CDI<br>A 200<br>A 200 CDI<br>A 200 CDI<br>A 200 Turbo<br>E-Cell | 70<br>60<br>85<br>85<br>80<br>100<br>142<br>50 |          | 08.04<br>08.04<br>08.04<br>04.09<br>08.04<br>08.04<br>08.04<br>03.05<br>12.10 | 05.12<br>05.12<br>05.12<br>05.12<br>05.12<br>05.12<br>05.12<br>05.12<br>05.12 |  | 13.0460-2712.2<br>13.0470-2712.2                                     | 602712<br>LD2712                     |   | 23138 14,6 /Zub/S TRW<br>23138 14,6 /Zub/S TRW   |
|  | A 150 / A 160<br>A 160 CDI<br>A 170<br>A 180<br>A 180 CDI<br>A 200<br>A 200 CDI<br>A 200 Turbo<br>E-Cell              | 70<br>60<br>85<br>85<br>80<br>100<br>142<br>50 |          | 08.04<br>08.04<br>08.04<br>04.09<br>08.04<br>08.04<br>08.04<br>03.05<br>12.10 | 05.12<br>05.12<br>05.12<br>05.12<br>05.12<br>05.12<br>05.12<br>05.12<br>05.12 |  | 24.0108-0113.1<br>24.0308-0113.1                                     | 408113<br>508113                     |   | 258 8,0 7,0 +S +B<br>258 8,0 7,0 +S +B PD  |
|  | A 150 / A 160<br>A 160 CDI<br>A 170<br>A 180<br>A 180 CDI<br>A 200<br>A 200 CDI<br>A 200 Turbo<br>E-Cell              | 70<br>60<br>85<br>85<br>80<br>100<br>142<br>50 |          | 08.04<br>08.04<br>08.04<br>04.09<br>08.04<br>08.04<br>08.04<br>03.05<br>12.10 | 05.12<br>05.12<br>05.12<br>05.12<br>05.12<br>05.12<br>05.12<br>05.12<br>05.12 |  | 03.0137-0170.2   | 650170                               |   | 164 x 20 /Zub  |

1) + long wheel base / + passo lungo / + empattement long / + distancia larga entre ejes  
2) + short wheel base / - BR / + passo corto / - BR / + empattement court / - BR / + distanc.corta entre ejes / - BR  
3) + short wheel base / + passo lungo / + empattement court / + distancia corta entre ejes  
4) - increased payload / - carico utile maggiorato / - charge utile augmentée / - incremento de carga  
5) + increased payload / + carico utile maggiorato / + charge utile augmentée / + incremento de carga

|     |  |  |  |  |  |   |  |    |  |                          |
|--|--|--|--|--|---|---|--|--|--|--------------------------|
| <b>MERCEDES BENZ A-Klasse (W176) (12-)</b>   |  |  |  |  |   |   |  |  |  |                          |
|    | A 180  | 90   |  | 06.12  |   | 13.0460-2778.2 602778<br>13.0470-2778.2 LD2778<br>13.0460-2779.2 602779<br>13.0470-2779.2 LD2779<br>24.8190-0067.2 620067 | 1  | + Stahlfelgen <sup>1)</sup><br>+ Stahlfelgen <sup>1)</sup><br>+ Leichtmetallfelgen <sup>2)</sup><br>+ Leichtmetallfelgen <sup>2)</sup> | 25326 19,3 +/WE/S<br>25326 19,3 +/WE/S<br>24869 19,3 +/WE/S<br>24869 19,3 +/WE/S<br>Warnkontakt L=92,5mm | TRW<br>TRW<br>TRW<br>TRW |
|  | A 160 CDI  | 66   |  | 06.13  |   | 13.0460-2778.2 602778<br>13.0470-2778.2 LD2778  |  | - Sportpaket / - Sportpaket AMG <sup>3)</sup>  | 25326 19,3 +/WE/S  | TRW                      |
|  | A 180 CDI  | 80   |  | 06.12  |   | 13.0460-2779.2 602779<br>13.0470-2779.2 LD2779<br>13.0470-2779.2 LD2779<br>24.8190-0067.2 620067                          | 1  | + Sportpaket / + Sportpaket AMG <sup>4)</sup><br>+ Sportpaket / + Sportpaket AMG <sup>4)</sup>   | 25326 19,3 +/WE/S<br>24869 19,3 +/WE/S<br>24869 19,3 +/WE/S<br>Warnkontakt L=92,5mm                      | TRW<br>TRW<br>TRW        |
|  | A 160  | 75   |  | 07.15  |   | 13.0460-2779.2 602779   |  |  | 24869 19,3 +/WE/S  | TRW                      |
|  | A 200  | 115  |  | 06.12  |   | 13.0470-2779.2 LD2779   |  |  | 24869 19,3 +/WE/S  | TRW                      |
|  | A 200 CDI  | 100  |  | 06.12  | 02.14   | 24.8190-0067.2 620067   | 1  |  |  |                          |
|  | A 200 CDI  | 100  |  | 02.14  |   |   |  |  |  |                          |
|  | A 200 CDI 4-Matic  | 100  |  | 02.14  |   |   |  |  |  |                          |
|  | A 220 4-matic  | 135  |  | 05.14  |   |   |  |  |  |                          |
|  | A 220 CDI  | 125  |  | 06.12  |   |   |  |  |  |                          |
|  | A 220 CDI 4-Matic  | 125  |  | 09.12  |   |   |  |  |  |                          |
|  | A 220 d  | 130  |  | 07.15  |   |   |  |  |  |                          |
|  | A 220 d 4-matic  | 130  |  | 07.15  |   |   |  |  |  |                          |
|  | A 250  | 155  |  | 06.12  |   |   |  |  |  |                          |
|  | A 250  | 160  |  | 07.15  |   |   |  |  |  |                          |
| A 250 4-Matic  | 155  |  | 06.13  |  |   |   |  |  |  |                          |
| A 250 4-matic  | 160  |  | 07.15  |  |   |   |  |  |  |                          |
| A 45 AMG   |  |  | 06.13  |  | 24.8190-0067.2 620067   | 1   |  | Warnkontakt L=92,5mm   |  |                          |
|    | A 180  | 90   |  | 06.12  |   | - Sportpaket / - Sportpaket AMG <sup>3)</sup><br>24.0125-0200.1 425200<br>24.0128-0276.1 428276                           |  | - Leichtmetallfelgen <sup>5)</sup><br>+ Leichtmetallfelgen <sup>2)</sup>   | 280 25,0 22,4 V L +S +B<br>295 28,0 25,4 V L +S +B   |                          |
|  | A 160 CDI  | 66   |  | 06.13  |   | - Sportpaket / - Sportpaket AMG <sup>3)</sup>   |  |  | 280 25,0 22,4 V L +S +B  |                          |
|  | A 180 CDI  | 80   |  | 06.12  |   | - Sportpaket / - Sportpaket AMG <sup>3)</sup>   |  |  | 280 25,0 22,4 V L +S +B  |                          |
|  | A 160  | 75   |  | 07.15  |   | - Sportpaket / - Sportpaket AMG <sup>3)</sup>   |  | 24.0128-0276.1 428276  | 295 28,0 25,4 V L +S +B  |                          |
|  | A 200  | 115  |  | 06.12  |   | - Sportpaket / - Sportpaket AMG <sup>3)</sup>   |  |  |  |                          |
|  | A 200 CDI  | 100  |  | 06.12  | 02.14   | - Sportpaket / - Sportpaket AMG <sup>3)</sup>   |  |  |  |                          |
|  | A 200 CDI  | 100  |  | 02.14  |   | - Sportpaket / - Sportpaket AMG <sup>3)</sup>   |  |  |  |                          |
|  | A 200 CDI 4-Matic  | 100  |  | 02.14  |   | - Sportpaket / - Sportpaket AMG <sup>3)</sup>   |  |  |  |                          |
|  | A 160  | 75   |  | 07.15  |   | + Sportpaket / + Sportpaket AMG <sup>4)</sup>   |  | 24.0128-0262.1 428262  | 295 28,0 26,0 V L +S +B  |                          |
|  | A 160 CDI  | 66   |  | 06.13  |   | + Sportpaket / + Sportpaket AMG <sup>4)</sup>   |  |  |  |                          |
|  | A 180  | 90   |  | 06.12  |   | + Sportpaket / + Sportpaket AMG <sup>4)</sup>   |  |  |  |                          |
|  | A 180 CDI  | 80   |  | 06.12  |   | + Sportpaket / + Sportpaket AMG <sup>4)</sup>   |  |  |  |                          |
|  | A 200  | 115  |  | 06.12  |   | + Sportpaket / + Sportpaket AMG <sup>4)</sup>   |  |  |  |                          |
|  | A 200 CDI  | 100  |  | 06.12  | 02.14   | + Sportpaket / + Sportpaket AMG <sup>4)</sup>   |  |  |  |                          |
|  | A 200 CDI  | 100  |  | 02.14  |   | + Sportpaket / + Sportpaket AMG <sup>4)</sup>   |  |  |  |                          |
|  | A 200 CDI 4-Matic  | 100  |  | 02.14  |   | + Sportpaket / + Sportpaket AMG <sup>4)</sup>   |  |  |  |                          |
|  | A 250  | 155  |  | 06.12  |   | - Sportpaket / - Sportpaket AMG <sup>3)</sup>   |  | 24.0130-0237.1 430237  | 320 30,0 28,0 V L +S +B  |                          |
|  | A 250  | 160  |  | 07.15  |   | - Sportpaket / - Sportpaket AMG <sup>3)</sup>   |  |  |  |                          |
|  | A 250 4-Matic  | 155  |  | 06.13  |   | - Sportpaket / - Sportpaket AMG <sup>3)</sup>   |  |  |  |                          |
|  | A 250 4-matic  | 160  |  | 07.15  |   | - Sportpaket / - Sportpaket AMG <sup>3)</sup>   |  |  |  |                          |
|  | A 220 4-matic  | 135  |  | 05.14  |   | - Sportpaket / - Sportpaket AMG <sup>3)</sup>   |  | 24.0128-0275.1 428275  | 295 28,0 25,4 V L +S +B  |                          |
|  | A 220 CDI  | 125  |  | 06.12  |   | - Sportpaket / - Sportpaket AMG <sup>3)</sup>   |  |  |  |                          |
|  | A 220 CDI 4-Matic  | 125  |  | 09.12  |   | - Sportpaket / - Sportpaket AMG <sup>3)</sup>   |  |  |  |                          |
|  | A 220 d  | 130  |  | 07.15  |   | - Sportpaket / - Sportpaket AMG <sup>3)</sup>   |  |  |  |                          |
|  | A 220 d 4-matic  | 130  |  | 07.15  |   | - Sportpaket / - Sportpaket AMG <sup>3)</sup>   |  |  |  |                          |
| A 220 4-matic  | 135  |  | 05.14  |  | + Sportpaket / + Sportpaket AMG <sup>4)</sup>                                     |   | 24.0130-0238.1 430238  | + gelochte Bremsscheibe <sup>6)</sup>  | 320 30,0 28,0 V L +S +B  |                          |
| A 220 CDI  | 125  |  | 06.12  |  | + Sportpaket / + Sportpaket AMG <sup>4)</sup>                                     |   |  |  |  |                          |
| A 220 CDI 4-Matic  | 125  |  | 09.12  |  | + Sportpaket / + Sportpaket AMG <sup>4)</sup>                                     |   |  |  |  |                          |
| A 220 d  | 130  |  | 07.15  |  | + Sportpaket / + Sportpaket AMG <sup>4)</sup>                                     |   |  |  |  |                          |
| A 220 d 4-matic  | 130  |  | 07.15  |  | + Sportpaket / + Sportpaket AMG <sup>4)</sup>                                     |   |  |  |  |                          |
| A 250  | 155  |  | 06.12  |  | + Sportpaket / + Sportpaket AMG <sup>4)</sup>                                     |   |  |  |  |                          |
| A 250  | 160  |  | 07.15  |  | + Sportpaket / + Sportpaket AMG <sup>4)</sup>                                     |   |  |  |  |                          |
| A 250 4-Matic  | 155  |  | 06.13  |  | + Sportpaket / + Sportpaket AMG <sup>4)</sup>                                     |   |  |  |  |                          |
| A 250 4-matic  | 160  |  | 07.15  |  | + Sportpaket / + Sportpaket AMG <sup>4)</sup>                                     |   |  |  |  |                          |
|  | A 160  | 75   |  | 07.15  |   | 24.0711-5388.3 360380   | 2  |  | Radsensor L=910  |                          |
|  | A 160 CDI  | 66   |  | 06.13  |   |   |  |  |  |                          |
|  | A 180  | 90   |  | 06.12  |   |   |  |  |  |                          |
|  | A 180 CDI  | 80   |  | 06.12  |   |   |  |  |  |                          |
|  | A 200  | 115  |  | 06.12  |   |   |  |  |  |                          |
|  | A 200 CDI  | 100  |  | 06.12  | 02.14   |   |  |  |  |                          |
|  | A 200 CDI  | 100  |  | 02.14  |   |   |  |  |  |                          |
|  | A 200 CDI 4-Matic  | 100  |  | 02.14  |   |   |  |  |  |                          |
|  | A 220 4-matic  | 135  |  | 05.14  |   |   |  |  |  |                          |
|  | A 220 CDI  | 125  |  | 06.12  |   |   |  |  |  |                          |
|  | A 220 CDI 4-Matic  | 125  |  | 09.12  |   |   |  |  |  |                          |
|  | A 220 d  | 130  |  | 07.15  |   |   |  |  |  |                          |
|  | A 220 d 4-matic  | 130  |  | 07.15  |   |   |  |  |  |                          |
|  | A 250  | 155  |  | 06.12  |   |   |  |  |  |                          |
|  | A 250  | 160  |  | 07.15  |   |   |  |  |  |                          |
| A 250 4-Matic  | 155  |  | 06.13  |  |   |   |  |  |  |                          |
| A 250 4-matic  | 160  |  | 07.15  |  |   |   |  |  |  |                          |
| A 45 AMG   |  |  | 06.13  |  |   |   |  |  |  |                          |
|  | A 160  | 75   |  | 07.15  |   | 13.0460-2786.2 602786   |  | elektrische Feststellbremse <sup>7)</sup>  | 24848 18,3 /WE/Zub/S   | TRW                      |
|  | A 160 CDI  | 66   |  | 06.13  |   | 13.0470-2786.2 LD2786   |  | elektrische Feststellbremse <sup>7)</sup>  | 24848 18,3 /WE/Zub/S   | TRW                      |
|  | A 180  | 90   |  | 06.12  |   |   |  |  |  |                          |
|  | A 180 CDI  | 80   |  | 06.12  |   |   |  |  |  |                          |
|  | A 200  | 115  |  | 06.12  |   |   |  |  |  |                          |
|  | A 200 CDI  | 100  |  | 06.12  | 02.14   |   |  |  |  |                          |
|  | A 200 CDI  | 100  |  | 02.14  |   |   |  |  |  |                          |
| A 200 CDI 4-Matic  | 100  |  | 02.14  |  |   |   |  |  |  |                          |

<sup>1)</sup> + steel rims / + cerchioni in acciaio / + jantes en acier / + Llantas acero

<sup>2)</sup> + light alloy rims / + cerchioni in lega / + jantes en alliage léger / + Llantas de aleación ligera

<sup>3)</sup> - sport package/- sport package AMG / - pacchetto sportivo/- pacchetto sport.AMG / - version sport/- version sport AMG / - kit sportivo/- kit sportivo AMG

<sup>4)</sup> + sports package/+ sports package AMG / + pacchetto sportivo/+ pacchetto sport.AMG / + version sport/+ version sport AMG / + kit sportivo/+ kit sportivo AMG

<sup>5)</sup> - light alloy rims / - cerchioni in lega / - jantes en alliage léger / - Llantas de aleación ligera

<sup>6)</sup> + perforated brake disc / + disco freno perforato / + disque de frein perforé / + disco de freno perforado

<sup>7)</sup> electric parking brake / fr/di stazionamento elettrico / frein à main électrique / freno de mano eléctrico















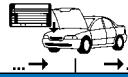



### MERCEDES BENZ A-Klasse (W176) (12-)

|                   |                   |     |       |       |       |                |        |   |   |                      |                  |
|-------------------|-------------------|-----|-------|-------|-------|----------------|--------|---|---|----------------------|------------------|
|                   | A 220 4-matic     | 135 |       | 05.14 |       | 13.0460-2786.2 | 602786 |   | elektrische Feststellbremse <sup>1)</sup> | 24848 18,3 /WE/Zub/S | TRW              |
|                   | A 220 CDI         | 125 |       | 06.12 |       | 13.0470-2786.2 | LD2786 |   | elektrische Feststellbremse <sup>1)</sup> | 24848 18,3 /WE/Zub/S | TRW              |
|                   | A 220 CDI 4-Matic | 125 |       | 09.12 |       |                |        |   |   |                      |                  |
|                   | A 220 d           | 130 |       | 07.15 |       |                |        |   |   |                      |                  |
|                   | A 220 d 4-matic   | 130 |       | 07.15 |       |                |        |   |   |                      |                  |
|                   | A 250             | 155 |       | 06.12 |       |                |        |   |   |                      |                  |
|                   | A 250             | 160 |       | 07.15 |       |                |        |   |   |                      |                  |
|                   | A 250 4-Matic     | 155 |       | 06.13 |       |                |        |   |   |                      |                  |
|                   | A 250 4-matic     | 160 |       | 07.15 |       |                |        |   |   |                      |                  |
|                   | A 160             | 75  |       | 07.15 |       | 24.0109-0173.1 | 409173 |   | elektrische Feststellbremse <sup>1)</sup> | 276 9,0 7,3 L +S +B  |                  |
|                   | A 160 CDI         | 66  |       | 06.13 |       |                |        |   |   |                      |                  |
|                   | A 180             | 90  |       | 06.12 |       |                |        |   |   |                      |                  |
|                   | A 180 CDI         | 80  |       | 06.12 |       |                |        |   |   |                      |                  |
|                   | A 200             | 115 |       | 06.12 |       |                |        |   |   |                      |                  |
|                   | A 200 CDI         | 100 |       | 06.12 | 02.14 |                |        |   |   |                      |                  |
|                   | A 200 CDI         | 100 |       | 02.14 |       |                |        |   |   |                      |                  |
|                   | A 200 CDI 4-Matic | 100 |       | 02.14 |       | 24.0110-0382.1 | 410382 |   | elektrische Feststellbremse <sup>1)</sup> | 295 10,0 8,3 +S +B   |                  |
|                   | A 220 4-matic     | 135 |       | 05.14 |       |                |        |   |   |                      |                  |
|                   | A 220 CDI         | 125 |       | 06.12 |       |                |        |   |   |                      |                  |
| A 220 CDI 4-Matic | 125               |     | 09.12 |       |       |                |        |   |   |                      |                  |
| A 220 d           | 130               |     | 07.15 |       |       |                |        |   |   |                      |                  |
| A 220 d 4-matic   | 130               |     | 07.15 |       |       |                |        |   |   |                      |                  |
| A 250             | 155               |     | 06.12 |       |       |                |        |   |   |                      |                  |
| A 250             | 160               |     | 07.15 |       |       |                |        |   |   |                      |                  |
| A 250 4-Matic     | 155               |     | 06.13 |       |       |                |        |   |   |                      |                  |
| A 250 4-matic     | 160               |     | 07.15 |       |       |                |        |   |   |                      |                  |
| A 250 4-matic     | 160               |     | 07.15 |       |       |                |        |   |   |                      |                  |
| A 250 4-matic     | 160               |     | 06.13 |       |       |                |        |   |   |                      |                  |
| A 250 4-matic     | 160               |     | 07.15 |       |       |                |        |   |   |                      |                  |
| A 250 4-matic     | 160               |     | 06.13 |       |       |                |        |   |   |                      |                  |
| A 45 AMG          |                   |     | 06.13 |       |       |                |        |   |   |                      |                  |
|                   | A 160             | 75  |       | 07.15 |       | 24.0711-5527.3 | 360405 | 2 |   |                      | Radsensor L=1045 |
|                   | A 160 CDI         | 66  |       | 06.13 |       |                |        |   |   |                      |                  |
|                   | A 180             | 90  |       | 06.12 |       |                |        |   |   |                      |                  |
|                   | A 180 CDI         | 80  |       | 06.12 |       |                |        |   |   |                      |                  |
|                   | A 200             | 115 |       | 06.12 |       |                |        |   |   |                      |                  |
|                   | A 200 CDI         | 100 |       | 06.12 | 02.14 |                |        |   |   |                      |                  |
|                   | A 200 CDI         | 100 |       | 02.14 |       |                |        |   |   |                      |                  |
|                   | A 200 CDI 4-Matic | 100 |       | 02.14 |       |                |        |   |   |                      |                  |
|                   | A 220 4-matic     | 135 |       | 05.14 |       |                |        |   |   |                      |                  |
|                   | A 220 CDI         | 125 |       | 06.12 |       |                |        |   |   |                      |                  |
|                   | A 220 CDI 4-Matic | 125 |       | 09.12 |       |                |        |   |   |                      |                  |
|                   | A 220 d           | 130 |       | 07.15 |       |                |        |   |   |                      |                  |
|                   | A 220 d 4-matic   | 130 |       | 07.15 |       |                |        |   |   |                      |                  |
|                   | A 250             | 155 |       | 06.12 |       |                |        |   |   |                      |                  |
|                   | A 250             | 160 |       | 07.15 |       |                |        |   |   |                      |                  |
|                   | A 250 4-Matic     | 155 |       | 06.13 |       |                |        |   |   |                      |                  |
|                   | A 250 4-matic     | 160 |       | 07.15 |       |                |        |   |   |                      |                  |
|                   | A 45 AMG          |     |       | 06.13 |       |                |        |   |   |                      |                  |

### MERCEDES BENZ B-Klasse (W245) (05-11)

|                      |                      |     |       |       |       |                |        |   |  |                            |     |
|----------------------|----------------------|-----|-------|-------|-------|----------------|--------|---|--|----------------------------|-----|
|                      | B 150 / B 160        | 70  |       | 03.05 | 04.11 | 13.0460-2711.2 | 602711 |   |  | 24077 19,1 /WE/Zub/S       | TRW |
|                      | B 160 BlueEfficiency |     |       | 04.09 | 04.11 | 13.0470-2711.2 | LD2711 |   |  | 24077 19,1 /WE/Zub/S       | TRW |
|                      | B 170 / B 180        | 85  |       | 03.05 | 04.11 | 24.8190-0410.2 | 620410 | 1 |  | Warnkontakt L=97,5mm       |     |
|                      | B 180 BlueEfficiency |     |       | 04.09 | 04.11 |                |        |   |  |                            |     |
|                      | B 170 NGT            | 85  |       | 04.08 | 04.09 | 13.0460-2708.2 | 602708 |   |  | 23881 20,0 /WE/Zub/S       | TRW |
|                      | B 180 CDI            | 80  |       | 03.05 | 04.11 | 13.0470-2708.2 | LD2708 |   |  | 23881 20,0 /WE/Zub/S       | TRW |
|                      | B 180 NGT            | 85  |       | 04.09 | 04.11 | 24.8190-0410.2 | 620410 | 1 |  | Warnkontakt L=97,5mm       |     |
|                      | B 200                | 100 |       | 03.05 | 04.11 |                |        |   |  |                            |     |
|                      | B 200 CDI            | 103 |       | 03.05 | 04.11 |                |        |   |  |                            |     |
|                      | B 200 Turbo          | 142 |       | 03.05 | 04.11 |                |        |   |  |                            |     |
|                      | B 150 / B 160        | 70  |       | 03.05 | 04.11 | 24.0122-0232.1 | 422232 |   |  | 276 22,0 19,4 V L +S +B    |     |
|                      | B 160 BlueEfficiency |     |       | 04.09 | 04.11 | 24.0322-0232.1 | 522232 |   |  | 276 22,0 19,4 V L +S +B PD |     |
| B 170 / B 180        | 85                   |     | 03.05 | 04.11 |       |                |        |   |  |                            |     |
| B 180 BlueEfficiency |                      |     | 04.09 | 04.11 |       |                |        |   |  |                            |     |
|                      | B 170 NGT            | 85  |       | 04.08 | 04.09 | 24.0125-0167.1 | 425167 |   |  | 288 25,0 22,4 V L +S +B    |     |
|                      | B 180 CDI            | 80  |       | 04.05 | 10.11 | 24.0325-0167.1 | 525167 |   |  | 288 25,0 22,4 V L +S +B PD |     |
|                      | B 180 NGT            | 85  |       | 04.09 | 10.11 |                |        |   |  |                            |     |
|                      | B 200                | 100 |       | 04.05 | 10.11 |                |        |   |  |                            |     |
|                      | B 200 CDI            | 103 |       | 04.05 | 10.11 |                |        |   |  |                            |     |
|                      | B 200 Turbo          | 142 |       | 04.05 | 10.11 |                |        |   |  |                            |     |
|                      | B 150 / B 160        | 70  |       | 03.05 | 04.11 | 13.0460-2712.2 | 602712 |   |  | 23138 14,6 /Zub/S          | TRW |
|                      | B 160 BlueEfficiency |     |       | 04.09 | 04.11 | 13.0470-2712.2 | LD2712 |   |  | 23138 14,6 /Zub/S          | TRW |
|                      | B 170 / B 180        | 85  |       | 03.05 | 04.11 |                |        |   |  |                            |     |
|                      | B 170 NGT            | 85  |       | 04.08 | 04.09 |                |        |   |  |                            |     |
| B 180 BlueEfficiency |                      |     | 04.09 | 04.11 |       |                |        |   |  |                            |     |
| B 180 CDI            | 80                   |     | 03.05 | 04.11 |       |                |        |   |  |                            |     |
| B 180 NGT            | 85                   |     | 04.09 | 04.11 |       |                |        |   |  |                            |     |
| B 200                | 100                  |     | 03.05 | 04.11 |       |                |        |   |  |                            |     |
| B 200 CDI            | 103                  |     | 03.05 | 04.11 |       |                |        |   |  |                            |     |
| B 200 Turbo          | 142                  |     | 03.05 | 04.11 |       |                |        |   |  |                            |     |
|                      | B 150 / B 160        | 70  |       | 03.05 | 04.11 | 24.0108-0113.1 | 408113 |   |  | 258 8,0 7,0 +S +B          |     |
|                      | B 160 BlueEfficiency |     |       | 04.09 | 04.11 | 24.0308-0113.1 | 508113 |   |  | 258 8,0 7,0 +S +B PD       |     |
|                      | B 170 / B 180        | 85  |       | 03.05 | 04.11 |                |        |   |  |                            |     |
|                      | B 170 NGT            | 85  |       | 04.08 | 04.09 |                |        |   |  |                            |     |
|                      | B 180 BlueEfficiency |     |       | 04.09 | 04.11 |                |        |   |  |                            |     |
|                      | B 180 CDI            | 80  |       | 03.05 | 04.11 |                |        |   |  |                            |     |
|                      | B 180 NGT            | 85  |       | 04.09 | 04.11 |                |        |   |  |                            |     |
|                      | B 200                | 100 |       | 03.05 | 04.11 |                |        |   |  |                            |     |
|                      | B 200 CDI            | 103 |       | 03.05 | 04.11 |                |        |   |  |                            |     |
|                      | B 200 Turbo          | 142 |       | 03.05 | 04.11 |                |        |   |  |                            |     |

<sup>1)</sup> electric parking brake / fr.di stazionamento elettrico / frein à main électrique / freno de mano eléctrico

















































|     |   |                          |  |    |  |                        |  |                                    |  |                          |
|--|---|--|--|--|---|--|--|--|--|--------------------------|
| <b>MERCEDES BENZ B-Klasse (W245) (05-11)</b>                                       |   |  |  |  |   |  |  |  |  |                          |
|    | B 150 / B 160<br>B 160 BlueEfficiency<br>B 170 / B 180<br>B 170 NGT<br>B 180 BlueEfficiency<br>B 180 CDI<br>B 180 NGT<br>B 200<br>B 200 CDI<br>B 200 Turbo  | 70<br>85<br>85<br>80<br>85<br>100<br>103<br>142  |  | 03.05<br>04.09<br>03.05<br>04.08<br>04.09<br>03.05<br>04.09<br>03.05<br>03.05<br>03.05   | 04.11<br>04.11<br>04.11<br>04.09<br>04.11<br>04.11<br>04.11<br>04.11<br>04.11     | 03.0137-0170.2   | 650170   | 164 x 20 /Zub  |  |                          |
| <b>MERCEDES BENZ B-Klasse (W246/W242) (11-)</b>                                    |   |  |  |  |   |  |  |  |  |                          |
|    | B 160<br>B 160 CDI<br>B 180<br>B 180 CDI<br>B 200 CDI   | 75<br>66<br>90<br>80<br>100  |  | 07.15<br>05.13<br>11.11<br>11.11<br>11.11  |   | 13.0460-2778.2<br>13.0470-2778.2<br>13.0460-2779.2<br>13.0470-2779.2<br>24.8190-0067.2                   | 602778<br>LD2778<br>602779<br>LD2779<br>620067                                     | - Sportpaket <sup>1)</sup><br>- Sportpaket <sup>1)</sup><br>+ Sportpaket <sup>2)</sup><br>+ Sportpaket <sup>2)</sup> | 25326 19,3 +/WE/S<br>25326 19,3 +/WE/S<br>24869 19,3 +/WE/S<br>24869 19,3 +/WE/S<br>Warnkontakt L=92,5mm   | TRW<br>TRW<br>TRW<br>TRW |
|  | B 200 CDI<br>B 200 CDI 4-matic<br>B 200 CGI<br>B 200 Natural Gas<br>B 220 4-matic<br>B 220 4-Matic<br>B 220 CDI<br>B 220 CDI<br>B 250<br>B 250 4-matic<br>Electric Drive  | 100<br>100<br>115<br>115<br>130<br>135<br>125<br>130<br>155<br>155<br>132                                |  | 08.14<br>08.14<br>11.11<br>11.12<br>09.14<br>05.13<br>12.12<br>09.14<br>09.12<br>08.14<br>11.14  |   | 13.0460-2779.2<br>13.0470-2779.2<br>24.8190-0067.2   | 602779<br>LD2779<br>620067   |  | 24869 19,3 +/WE/S<br>24869 19,3 +/WE/S<br>Warnkontakt L=92,5mm   | TRW<br>TRW               |
|    | B 160<br>B 160 CDI<br>B 180<br>B 180 CDI<br>B 200 CDI<br>B 200 CGI<br>B 200 Natural Gas   | 75<br>66<br>90<br>80<br>100<br>115<br>115  |  | 07.15<br>05.13<br>11.11<br>11.11<br>11.11<br>11.11<br>11.12  |   | 24.0125-0200.1<br>24.0128-0262.1   | 425200<br>428262   | - Sportpaket <sup>1)</sup><br>+ Sportpaket <sup>2)</sup>   | 280 25,0 22,4 V L +S +B<br>295 28,0 26,0 V L +S +B   |                          |
|  | B 200 CDI<br>B 200 CDI 4-matic<br>B 220 4-matic<br>B 220 4-Matic<br>B 220 CDI<br>B 220 CDI<br>B 250<br>B 250 4-matic<br>Electric Drive  | 100<br>100<br>130<br>135<br>125<br>130<br>155<br>155<br>132  |  | 08.14<br>08.14<br>09.14<br>05.13<br>12.12<br>09.14<br>09.12<br>08.14<br>11.14  |   | 24.0128-0275.1<br>24.0130-0238.1<br>24.0130-0237.1<br>24.0130-0238.1<br>24.0128-0275.1<br>24.0128-0262.1 | 428275<br>430238<br>430237<br>430238<br>428275<br>428262                           | - Sportpaket <sup>1)</sup><br>+ Sportpaket <sup>2)</sup><br>- Sportpaket <sup>1)</sup><br>+ Sportpaket <sup>2)</sup> | 295 28,0 25,4 V L +S +B<br>320 30,0 28,0 V L +S +B<br>320 30,0 28,0 V L +S +B<br>320 30,0 28,0 V L +S +B<br>295 28,0 25,4 V L +S +B<br>295 28,0 26,0 V L +S +B |                          |
|  | B 160<br>B 160 CDI<br>B 180<br>B 180 CDI<br>B 200 CDI<br>B 200 CDI<br>B 200 CDI 4-matic<br>B 200 CGI<br>B 200 Natural Gas<br>B 220 4-matic<br>B 220 4-Matic<br>B 220 CDI<br>B 220 CDI<br>B 250<br>B 250 4-matic<br>Electric Drive | 75<br>66<br>90<br>80<br>100<br>100<br>100<br>115<br>115<br>130<br>135<br>125<br>130<br>155<br>155<br>132 |  | 07.15<br>05.13<br>11.11<br>11.11<br>11.11<br>08.14<br>08.14<br>11.11<br>11.12<br>09.14<br>05.13<br>12.12<br>09.14<br>09.12<br>08.14<br>11.14 |   | 24.0711-5388.3   | 360380   | 2                               | Radsensor L=910  |                          |
|  | B 160<br>B 160 CDI<br>B 180<br>B 180 CDI<br>B 200 CDI<br>B 200 CDI<br>B 200 CDI 4-matic<br>B 200 CGI<br>B 200 Natural Gas<br>B 220 4-matic<br>B 220 4-Matic<br>B 220 CDI<br>B 220 CDI<br>B 250<br>B 250 4-matic<br>Electric Drive | 75<br>66<br>90<br>80<br>100<br>100<br>100<br>115<br>115<br>130<br>135<br>125<br>130<br>155<br>155<br>132 |  | 07.15<br>05.13<br>11.11<br>11.11<br>11.11<br>08.14<br>08.14<br>11.11<br>11.12<br>09.14<br>05.13<br>12.12<br>09.14<br>09.12<br>08.14<br>11.14 |   | 13.0460-2786.2<br>13.0470-2786.2   | 602786<br>LD2786   | elektrische Feststellbremse <sup>3)</sup><br>elektrische Feststellbremse <sup>3)</sup>                               | 24848 18,3 /WE/Zub/S<br>24848 18,3 /WE/Zub/S   | TRW<br>TRW               |
|  | B 160<br>B 160 CDI<br>B 180<br>B 180 CDI<br>B 200 CDI<br>B 200 CGI<br>B 200 Natural Gas   | 75<br>66<br>90<br>80<br>100<br>115<br>115  |  | 07.15<br>05.13<br>11.11<br>11.11<br>11.11<br>11.11<br>11.12  |   | 24.0109-0173.1   | 409173   | elektrische Feststellbremse <sup>3)</sup>  | 276 9,0 7,3 L +S +B  |                          |
|  | B 200 CDI<br>B 200 CDI 4-matic  | 100<br>100   |  | 08.14<br>08.14   |   | 24.0110-0382.1   | 410382   | elektrische Feststellbremse <sup>3)</sup>  | 295 10,0 8,3 +S +B   |                          |

<sup>1)</sup> - sport package / - pacchetto sportivo / - version sport / - kit deportivo

<sup>2)</sup> + sports package / + pacchetto sportivo / + version sport / + kit deportivo

<sup>3)</sup> electric parking brake / fr.di stazionamento elettrico / frein à main électrique / freno de mano eléctrico



|     |   |                          |    |    |  |  |     |  |            |
|--|---|--|--|--|---|--|---|--|------------|
| <b>MERCEDES BENZ B-Klasse (W246/W242) (11-)</b>                                    |   |  |  |  |   |  |   |  |            |
|    | B 220 4-matic<br>B 220 4-Matic<br>B 220 CDI<br>B 220 CDI<br>B 250<br>B 250 4-matic<br>Electric Drive  | 130<br>135<br>125<br>130<br>155<br>155<br>132  | 09.14<br>05.13<br>12.12<br>09.14<br>09.12<br>08.14<br>11.14  |  | 24.0110-0382.1  | 410382   | elektrische Feststellbremse <sup>1)</sup>   | 295 10,0 8,3 +S +B   |            |
|    | B 160<br>B 160 CDI<br>B 180<br>B 180 CDI<br>B 200 CDI<br>B 200 CDI<br>B 200 CDI 4-matic<br>B 200 CGI<br>B 200 Natural Gas<br>B 220 4-matic<br>B 220 4-Matic<br>B 220 CDI<br>B 220 CDI<br>B 250<br>B 250 4-matic<br>Electric Drive | 75<br>66<br>90<br>80<br>100<br>100<br>100<br>115<br>115<br>130<br>135<br>125<br>130<br>155<br>155<br>132 | 07.15<br>05.13<br>11.11<br>11.11<br>11.11<br>08.14<br>08.14<br>11.11<br>11.12<br>09.14<br>05.13<br>12.12<br>09.14<br>09.12<br>08.14<br>11.14 |  | 24.0711-5527.3  | 360405   | 2  | Radsensor L=1045   |            |
| <b>MERCEDES BENZ CITAN (W415) (12-)</b>  |   |  |  |  |   |  |   |  |            |
|    | 108 CDI<br>108 CDI BE<br>109 CDI<br>109 CDI BE<br>111 CDI<br>111 CDI BE<br>112 BE   | 55<br>55<br>66<br>66<br>81<br>81<br>84   | 09.12<br>09.12<br>09.12<br>09.12<br>06.13<br>06.13<br>06.13  |  | 13.0460-2709.2<br>13.0470-2709.2  | 602709<br>LD2709   | + 14" Rad <sup>2)</sup><br>+ 14" Rad <sup>2)</sup>                                    | 23973 17,4 /Zub/S<br>23973 17,4 /Zub/S   | TRW<br>TRW |
|  | 108 CDI<br>108 CDI BE<br>109 CDI<br>109 CDI BE<br>111 CDI<br>111 CDI BE<br>112 BE   | 55<br>55<br>66<br>66<br>81<br>81<br>84   | 09.12<br>09.12<br>09.12<br>09.12<br>06.13<br>06.13<br>06.13  |  | 13.0460-2742.2  | 602742   | + 15"/16" Rad <sup>3)</sup>   | 24693 17,5 /Zub/S  | TRW        |
|   | 108 CDI<br>108 CDI BE<br>109 CDI<br>109 CDI BE<br>111 CDI<br>111 CDI BE<br>112 BE   | 55<br>55<br>66<br>66<br>81<br>81<br>84   | 09.12<br>09.12<br>09.12<br>09.12<br>06.13<br>06.13<br>06.13  |  | 24.0122-0270.1<br>24.0124-0222.1  | 422270<br>424222   | + 14" Rad <sup>2)</sup><br>+ 15"/16" Rad <sup>3)</sup>                                | 258 22,0 19,8 V L +S +B<br>280 24,0 21,8 V L +S +B                                 |            |
|  | 108 CDI<br>108 CDI BE<br>109 CDI<br>109 CDI BE  | 55<br>55<br>66<br>66   | 09.12<br>09.12<br>09.12<br>09.12   | 01.13 +    / + Skandinavien<br>01.13 +    / + Skandinavien<br>01.13 +    / + Skandinavien<br>01.13 +    / + Skandinavien   | 24.0126-0180.1  | 426180   | + 15"/16" Rad <sup>3)</sup>   | 280 26,0 23,8 V L +S +B  |            |
|  | 108 CDI<br>108 CDI BE<br>109 CDI<br>109 CDI BE<br>111 CDI<br>111 CDI BE<br>112 BE   | 55<br>55<br>66<br>66<br>81<br>81<br>84   | 02.13<br>02.13<br>02.13<br>02.13<br>06.13<br>06.13<br>06.13  | +    / + Skandinavien<br>+    / + Skandinavien<br>+    / + Skandinavien<br>+    / + Skandinavien<br>+    / + Skandinavien<br>+    / + Skandinavien | 24.0124-0222.1  | 424222   | + 15"/16" Rad <sup>3)</sup>   | 280 24,0 21,8 V L +S +B  |            |
|  | 108 CDI<br>108 CDI BE<br>109 CDI<br>109 CDI BE<br>111 CDI<br>111 CDI BE<br>112 BE   | 55<br>55<br>66<br>66<br>81<br>81<br>84   | 09.12<br>09.12<br>09.12<br>09.12<br>06.13<br>06.13<br>06.13  |  | 13.0460-2744.2  | 602744   | + 15"/16" Rad <sup>3)</sup>   | 24692 15,9 /Zub/S  | TRW        |
|  | 108 CDI<br>108 CDI BE<br>109 CDI<br>109 CDI BE<br>111 CDI<br>111 CDI BE<br>112 BE   | 55<br>55<br>66<br>66<br>81<br>81<br>84   | 09.12<br>09.12<br>09.12<br>09.12<br>06.13<br>06.13<br>06.13  |  | 24.0111-0182.2  | 411182   | + 15"/16" Rad <sup>3)</sup>   | 274 11,0 9,5 +B  |            |
|  | 108 CDI<br>108 CDI BE<br>109 CDI<br>109 CDI BE<br>111 CDI<br>111 CDI BE<br>112 BE   | 55<br>55<br>66<br>66<br>81<br>81<br>84   | 09.12<br>09.12<br>09.12<br>09.12<br>06.13<br>06.13<br>06.13  |  | 03.0137-0496.2<br>03.0137-9228.2  | 650496<br>669228   | + 14" Rad <sup>2)</sup>   | 228 x 42 HEB<br>Bremsbacken-Zubehör  | BDX<br>BDX |
|  | 108 CDI<br>108 CDI BE<br>109 CDI<br>109 CDI BE<br>111 CDI<br>111 CDI BE<br>112 BE   | 55<br>55<br>66<br>66<br>81<br>81<br>84   | 09.12<br>09.12<br>09.12<br>09.12<br>06.13<br>06.13<br>06.13  |  | 03.0520-7222.3  | 697222   | + 14" Rad <sup>2)</sup>   | 22,20/228x42 TopKit  |            |

<sup>1)</sup> electric parking brake / fr.di stazionamento elettrico / frein à main électrique / freno de mano eléctrico

<sup>2)</sup> + 14" wheel / + ruota 14" / + roue 14" / + rueda 14"

<sup>3)</sup> + 15"/16" wheel / + ruota 15"/16" / + roue 15"/16" / + rueda 15"/16"



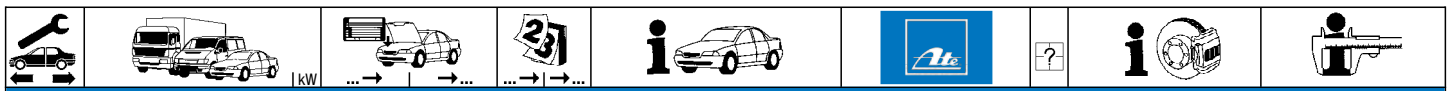





















**MERCEDES BENZ C-Klasse (W202) Limousine (93-00)**

|           |                  |                   |                   |       |       |                |                |        |  |                            |                     |
|-----------|------------------|-------------------|-------------------|-------|-------|----------------|----------------|--------|--|----------------------------|---------------------|
|           | C 180            |                   |                   | 03.93 | 05.00 | 13.0460-2975.2 | 602975         |        |  | 21439 20,3 /WE/S           | TRW                 |
|           | C 200            |                   |                   | 01.94 | 05.00 | 13.0470-2975.2 | LD2975         |        |  | 21439 20,3 /WE/S           | TRW                 |
|           | C 200 CDI        |                   |                   | 03.98 | 05.00 | 24.8190-0401.2 | 620401         | 2      |  | Warnkontakt L=95mm         |                     |
|           | C 200 D          |                   |                   | 03.93 | 05.00 |                |                |        |  |                            |                     |
|           | C 220            |                   |                   | 03.93 | 08.96 |                |                |        |  |                            |                     |
|           | C 220 CDI        |                   |                   | 09.97 | 05.00 |                |                |        |  |                            |                     |
|           | C 220 D          |                   |                   | 06.93 | 05.00 |                |                |        |  |                            |                     |
|           | C 230            |                   |                   | 07.96 | 06.97 |                |                |        |  |                            |                     |
|           | C 250 D          |                   |                   | 06.93 | 08.95 |                |                |        |  |                            |                     |
|           | C 280            |                   | A344660 / F331440 | 06.93 |       |                |                |        |  |                            |                     |
|           | C 200 Kompressor |                   |                   | 10.95 | 05.00 | 13.0460-7086.2 | 607086         |        |  | 21664 19,8 +/-WE           | ATE                 |
|           | C 230 Kompressor |                   |                   | 09.95 | 05.00 | 13.0470-7086.2 | LD7086         |        |  | 21664 19,8 +/-WE           | ATE                 |
|           | C 240            |                   |                   | 06.97 | 05.00 | 24.8190-0401.2 | 620401         | 2      |  | Warnkontakt L=95mm         |                     |
|           | C 250 TD         |                   |                   | 09.95 | 05.00 |                |                |        |  |                            |                     |
|           | C 280            |                   | A344661 / F331441 | 05.00 |       |                |                |        |  |                            |                     |
|           | C 36 AMG         |                   |                   | 05.94 | 08.97 | 13.0460-4201.2 | 604201         |        |  | 21153 17,5 /WE             | ATE                 |
|           |                  |                   |                   |       |       | 24.8190-0401.2 | 620401         | 2      |  | Warnkontakt L=95mm         |                     |
|           | C 43 AMG         |                   |                   | 09.97 | 05.00 | 13.0460-7183.2 | 607183         |        |  | 21484 20,5 +/-WE           | ATE                 |
|           |                  |                   |                   |       |       | 24.8190-0419.2 | 620419         | 2      |  | Warnkontakt L=74mm         |                     |
|           |                  | C 180             |                   |       | 03.93 | 05.00          | 24.0112-0128.1 | 412128 |  |                            | 284 12,0 10,0 +S +B |
| C 200 D   |                  |                   |                   | 03.93 | 05.00 | 13.8190-0330.1 | 990134         |        |  | Halterschraube             |                     |
| C 220 D   |                  |                   | A545906 / F647651 | 06.93 | 05.00 |                |                |        |  |                            |                     |
| C 230     |                  |                   |                   |       | 06.97 |                |                |        |  |                            |                     |
| C 250 D   |                  |                   |                   | 06.93 | 08.95 |                |                |        |  |                            |                     |
| C 200     |                  |                   |                   | 01.94 | 05.00 | 24.0122-0132.1 | 422132         |        |  | 284 22,0 19,4 V L +S +B    |                     |
| C 200 CDI |                  |                   |                   | 03.98 | 05.00 | 24.0322-0132.1 | 522132         |        |  | 284 22,0 19,4 V L +S +B PD |                     |
| C 220     |                  |                   |                   | 03.93 | 08.96 | 13.8190-0330.1 | 990134         |        |  | Halterschraube             |                     |
| C 220 CDI |                  |                   |                   | 09.97 | 05.00 |                |                |        |  |                            |                     |
| C 230     |                  |                   | A545905 / F647650 | 07.96 |       |                |                |        |  |                            |                     |
|           | C 280            |                   | A344660 / F331440 | 06.93 |       |                |                |        |  |                            |                     |
|           | C 200 Kompressor |                   |                   | 10.95 | 05.00 | 24.0125-0110.1 | 425110         |        |  | 288 25,0 22,4 V L +S +B    |                     |
|           | C 230 Kompressor |                   |                   | 09.95 | 05.00 | 24.0325-0110.1 | 525110         |        |  | 288 25,0 22,4 V L +S +B PD |                     |
|           | C 240            |                   |                   | 06.97 | 05.00 | 13.8190-0330.1 | 990134         |        |  | Halterschraube             |                     |
|           | C 250 TD         |                   |                   | 09.95 | 05.00 |                |                |        |  |                            |                     |
|           | C 280            |                   | A344661 / F331441 | 05.00 |       |                |                |        |  |                            |                     |
|           | C 36 AMG         |                   | A344660 / F331440 | 05.94 |       | 13.8190-0330.1 | 990134         |        |  | Halterschraube             |                     |
|           | C 36 AMG         |                   | A344661 / F331441 |       | 08.97 | 24.0128-0126.1 | 428126         |        |  | 316 28,0 25,4 V L +B       |                     |
|           |                  |                   |                   |       |       | 13.8190-0330.1 | 990134         |        |  | Halterschraube             |                     |
|           | C 43 AMG         |                   |                   | 09.97 | 05.00 | 13.8190-0330.1 | 990134         |        |  | Halterschraube             |                     |
|           | C 180            |                   |                   | 03.93 | 05.00 | 24.0751-1141.3 | 360196         |        |  | Radsensor L=503            |                     |
|           | C 200            |                   |                   | 01.94 | 05.00 | 24.0751-1142.3 | 360197         |        |  | Radsensor L=503            |                     |
|           | C 200 CDI        |                   |                   | 03.98 | 05.00 | 24.0711-6021.3 | 360076         |        |  | Radsensor L=549            |                     |
|           | C 200 D          |                   |                   | 03.93 | 05.00 | 24.0711-6022.3 | 360077         |        |  | Radsensor L=549            |                     |
|           | C 200 Kompressor |                   |                   | 10.95 | 05.00 |                |                |        |  |                            |                     |
|           | C 220            |                   |                   | 03.93 | 08.96 |                |                |        |  |                            |                     |
|           | C 220 CDI        |                   |                   | 09.97 | 05.00 |                |                |        |  |                            |                     |
|           | C 220 D          |                   |                   | 06.93 | 05.00 |                |                |        |  |                            |                     |
|           | C 230            |                   |                   | 07.96 | 06.97 |                |                |        |  |                            |                     |
|           | C 230 Kompressor |                   |                   | 09.95 | 05.00 |                |                |        |  |                            |                     |
|           | C 240            |                   |                   | 06.97 | 05.00 |                |                |        |  |                            |                     |
|           | C 250 D          |                   |                   | 06.93 | 08.95 |                |                |        |  |                            |                     |
|           | C 250 TD         |                   |                   | 09.95 | 05.00 |                |                |        |  |                            |                     |
|           | C 280            |                   |                   | 06.93 | 05.00 |                |                |        |  |                            |                     |
|           | C 36 AMG         |                   |                   | 05.94 | 08.97 |                |                |        |  |                            |                     |
|           | C 43 AMG         |                   |                   | 09.97 | 05.00 |                |                |        |  |                            |                     |
|           |                  |                   |                   |       |       |                |                |        |  |                            |                     |
|           |                  |                   |                   |       |       |                |                |        |  |                            |                     |
|           |                  |                   |                   |       |       |                |                |        |  |                            |                     |
|           |                  |                   |                   |       |       |                |                |        |  |                            |                     |
|           | C 180            |                   | A419828 / F443892 | 03.93 |       | 13.0460-4034.2 | 604034         |        |  | 20687 15,5                 | ATE                 |
|           | C 200            |                   | A419828 / F443892 | 01.94 |       | 13.0460-0186.2 | 610186         |        |  | Belagsatz-Zubehör          | ATE                 |
|           | C 200 D          |                   | A419828 / F443892 | 03.93 |       |                |                |        |  |                            |                     |
|           | C 220            |                   | A419828 / F443892 | 03.93 |       |                |                |        |  |                            |                     |
|           | C 220 D          |                   | A419828 / F443892 | 06.93 |       |                |                |        |  |                            |                     |
|           | C 250 D          |                   | A419828 / F443892 | 06.93 |       |                |                |        |  |                            |                     |
|           | C 280            |                   | A344660 / F331440 | 06.93 |       |                |                |        |  |                            |                     |
|           |                  | 142               |                   |       |       | - ASR/ - ETS   |                |        |  |                            |                     |
|           | C 180            |                   | A419829 / F443893 |       | 05.00 | 13.0460-4060.2 | 604060         |        |  | 21900 15,0                 | ATE                 |
|           | C 200            |                   | A419829 / F443893 |       | 05.00 | 13.0460-0229.2 | 610229         |        |  | Belagsatz-Zubehör          | ATE                 |
| C 200 CDI |                  |                   | 03.98             | 05.00 |       |                |                |        |  |                            |                     |
| C 200 D   |                  | A419829 / F443893 |                   | 05.00 |       |                |                |        |  |                            |                     |
| C 220     |                  | A419829 / F443893 |                   | 08.96 |       |                |                |        |  |                            |                     |
| C 220 CDI |                  |                   | 09.97             | 05.00 |       |                |                |        |  |                            |                     |
| C 220 D   |                  | A419829 / F443893 |                   | 05.00 |       |                |                |        |  |                            |                     |
| C 230     |                  |                   | 07.96             | 06.97 |       |                |                |        |  |                            |                     |
| C 250 D   |                  | A419829 / F443893 |                   | 08.95 |       |                |                |        |  |                            |                     |
|           | C 200 Kompressor |                   | A487047 / F576240 | 10.95 |       | 13.0460-3805.2 | 603805         |        |  | 21197 15,0 /WE             | ATE                 |
|           | C 230 Kompressor |                   | A487047 / F576240 | 09.95 |       | 13.0470-3805.2 | LD3805         |        |  | 21197 15,0 /WE             | ATE                 |
|           | C 240            |                   | A487047 / F576240 | 06.97 |       | 24.8190-0401.2 | 620401         |        |  | Warnkontakt L=95mm         |                     |
|           | C 250 TD         |                   | A487047 / F576240 | 09.95 |       |                |                |        |  |                            |                     |
|           | C 280            |                   |                   | 05.97 |       |                |                |        |  |                            |                     |
|           | C 280            |                   | A487047 / F576240 | 06.97 |       |                |                |        |  |                            |                     |
|           | C 36 AMG         |                   | A344660 / F331440 | 05.94 |       |                |                |        |  |                            |                     |
|           | C 200 Kompressor |                   | A487048 / F576241 |       | 05.00 | 13.0460-4064.2 | 604064         |        |  | 21919 15,3 /Zub            | ATE                 |
|           | C 230 Kompressor |                   | A487048 / F576241 |       | 05.00 | 13.0470-4064.2 | LD4064         |        |  | 21919 15,3 /Zub            | ATE                 |
|           | C 240            |                   | A487048 / F576241 |       | 05.00 | 13.0460-0229.2 | 610229         |        |  | Belagsatz-Zubehör          | ATE                 |
| C 250 TD  |                  | A487048 / F576241 |                   | 05.00 |       |                |                |        |  |                            |                     |
| C 280     |                  | A487048 / F576241 |                   | 05.00 |       |                |                |        |  |                            |                     |
| C 280     |                  | 145               |                   | 05.00 |       |                |                |        |  |                            |                     |
| C 280     |                  | 142               |                   | 06.93 | 05.97 | 13.0460-3504.2 | 603504         |        |  | 21301 15,5 /WE             | ATE                 |
|           |                  |                   |                   |       |       | 24.8190-0401.2 | 620401         | 1      |  | Warnkontakt L=95mm         |                     |



| MERCEDÉS BENZ C-Klasse (W202) Limousine (93-00)                                    |   |                   |  |  |  |  |  |  |   |   |   |  |
|--|---|-------------------|--|--|--|--|--|--|---|---|---|--|
|    | C 36 AMG<br>C 43 AMG  | A344661 / F331441 |  | 09.97  | 08.97<br>05.00   |  | 13.0460-4047.2<br>13.0470-4047.2<br>13.0460-0236.2<br>24.8190-0401.2                   | 604047<br>LD4047<br>610236<br>620401           | 1 | 21305 15,7 /WE<br>21305 15,7 /WE<br>Belagsatz-Zubehör<br>Warnkontakt L=95mm                 | ATE<br>ATE<br>ATE   |  |
|    | C 180<br>C 200<br>C 200 CDI<br>C 200 D<br>C 220<br>C 220 CDI<br>C 220 D<br>C 230<br>C 250 D<br>C 280  | 142               | A344660 / F331440  | 03.93<br>01.94<br>03.98<br>03.93<br>03.93<br>09.97<br>06.93<br>07.96<br>06.93  | 05.00<br>05.00<br>05.00<br>05.00<br>08.96<br>05.00<br>05.00<br>06.97<br>08.95  |  | 24.0109-0120.1<br>24.0309-0120.1   | 409120<br>509120                               |   | 258 9,0 7,3 +S +B<br>258 9,0 7,3 +S +B PD   |   |  |
|  | C 200 Kompressor<br>C 230 Kompressor<br>C 240<br>C 250 TD<br>C 280<br>C 280   | 142<br>145        | A344661 / F331441  | 10.95<br>09.95<br>06.97<br>09.95<br>05.97<br>06.97   | 05.00<br>05.00<br>05.00<br>05.00<br>05.97<br>05.00   |  | 24.0109-0114.1<br>24.0309-0114.1   | 409114<br>509114                               |   | 278 9,0 7,3 +S +B<br>278 9,0 7,3 +S +B PD   |   |  |
|  | C 36 AMG<br>C 36 AMG<br>C 43 AMG  |                   | A344660 / F331440<br>A344661 / F331441   | 05.94<br>08.97<br>09.97  |  |  | 24.0124-0188.1<br>24.0110-0217.1<br>24.0310-0217.1<br>24.0122-0228.1                   | 424188<br>410217<br>510217<br>422228           |   | 278 24,0 21,4 V L +B<br>290 10,0 8,3 +S +B<br>290 10,0 8,3 +S +B PD<br>300 22,0 19,4 V L +B |   |  |
|    | C 180<br>C 200<br>C 200 CDI<br>C 200 D<br>C 200 Kompressor<br>C 220<br>C 220 CDI<br>C 220 D<br>C 230<br>C 230 Kompressor<br>C 240<br>C 250 D<br>C 250 TD<br>C 280<br>C 36 AMG<br>C 43 AMG |                   | F 980773<br>F 980773<br>F 980773<br>F 980773<br>F 980773<br>F 980773<br>F 980773<br>F 980773<br>F 980773<br>F 980773<br>F 980773<br>F 980773<br>F 980773<br>F 980773<br>F 980773<br>F 980773 | 03.93<br>01.94<br>03.98<br>03.93<br>10.95<br>03.93<br>09.97<br>06.93<br>07.96<br>09.95<br>06.97<br>06.93<br>09.95<br>06.93<br>05.94<br>09.97 |  |  | 24.0751-1162.3<br>24.0751-1143.3<br>24.0751-1144.3<br>24.0711-6035.3<br>24.0711-6036.3 | 360099<br>360096<br>360097<br>360277<br>360278 | 2 | + ABS<br>+ ASR<br>+ ASR<br>+ ESP<br>+ ESP   | Radsensor L=390<br>Radsensor L=621<br>Radsensor L=958<br>Radsensor L=632<br>Radsensor L=979       |  |
|  | C 180<br>C 200<br>C 200 CDI<br>C 200 D<br>C 200 Kompressor<br>C 220<br>C 220 CDI<br>C 220 D<br>C 230<br>C 230 Kompressor<br>C 240<br>C 250 D<br>C 250 TD<br>C 280<br>C 36 AMG<br>C 43 AMG |                   | F 980774<br>F 980774<br>F 980774<br>F 980774<br>F 980774<br>F 980774<br>F 980774<br>F 980774<br>F 980774<br>F 980774<br>F 980774<br>F 980774<br>F 980774<br>F 980774<br>F 980774<br>F 980774 | 05.00<br>05.00<br>05.00<br>05.00<br>08.96<br>05.00<br>05.00<br>06.97<br>05.00<br>05.00<br>05.00<br>08.95<br>05.00<br>05.00<br>08.97<br>05.00 |  |  | 24.0751-1162.3<br>24.0751-1143.3<br>24.0751-1144.3<br>24.0711-6012.3<br>24.0711-6064.3 | 360099<br>360096<br>360097<br>360276<br>360279 | 2 | + ABS<br>+ ASR<br>+ ASR<br>+ ESP<br>+ ESP   | Radsensor L=390<br>Radsensor L=621<br>Radsensor L=958<br>Radsensor L=1720/1345<br>Radsensor L=899 |  |
|  | C 180<br>C 200<br>C 200 CDI<br>C 200 D<br>C 200 Kompressor<br>C 220<br>C 220 CDI<br>C 220 D<br>C 230<br>C 230 Kompressor<br>C 240<br>C 250 D<br>C 250 TD<br>C 280<br>C 36 AMG<br>C 43 AMG |                   |  | 03.93<br>01.94<br>03.98<br>03.93<br>10.95<br>03.93<br>09.97<br>06.93<br>07.96<br>09.95<br>06.97<br>06.93<br>09.95<br>06.93<br>05.94<br>09.97 | 05.00<br>05.00<br>05.00<br>05.00<br>05.00<br>08.96<br>05.00<br>05.00<br>06.97<br>05.00<br>05.00<br>08.95<br>05.00<br>05.00<br>08.97<br>05.00 |  | 03.0137-0170.2   | 650170   |   | 164 x 20 /Zub   |   |  |
| MERCEDÉS BENZ C-Klasse (S202) Kombi (96-01)  |   |                   |  |  |  |  |  |  |   |   |   |  |
|  | C 180<br>C 200<br>C 200 CDI<br>C 200 D<br>C 220 CDI<br>C 220 D<br>C 230   |                   |  | 06.96<br>06.96<br>03.98<br>07.96<br>09.97<br>06.96<br>06.96  | 04.01<br>04.01<br>04.01<br>04.01<br>04.01<br>04.01<br>06.97  |  | 13.0460-2975.2<br>13.0470-2975.2<br>24.8190-0401.2                                     | 602975<br>LD2975<br>620401                     | 2 | 21439 20,3 /WE/S<br>21439 20,3 /WE/S<br>Warnkontakt L=95mm                                  | TRW<br>TRW  |  |
|  | C 200 Kompressor<br>C 230 Kompressor<br>C 240<br>C 250 TD<br>C 280  |                   |  | 11.96<br>06.97<br>06.97<br>06.96<br>06.97  | 04.01<br>04.01<br>04.01<br>04.01<br>04.01  |  | 13.0460-7086.2<br>13.0470-7086.2<br>24.8190-0401.2                                     | 607086<br>LD7086<br>620401                     | 2 | 21664 19,8 +/-WE<br>21664 19,8 +/-WE<br>Warnkontakt L=95mm                                  | ATE<br>ATE  |  |
| ↓  |   |                   |  |  |  |  |  |  |   |   |   |  |

|     |   |    |                                   |                                   |       |  |    |           |  |  |
|--|---|--|---|---|--|--|--|---|--|--|
| <b>MERCEDES BENZ C-Klasse (S202) Kombi (96-01)</b>                                 |   |  |   |   |  |  |  |   |  |  |
|    | C 43 AMG  |  | 09.97   | 04.01   | 13.0460-7183.2<br>24.8190-0419.2   | 607183<br>620419   | 2  | 21484 20,5 +WE<br>Warnkontakt L=74mm  | ATE  |  |
|    | C 180<br>C 200<br>C 200 CDI<br>C 200 D<br>C 220 CDI<br>C 220 D<br>C 230   |  | 06.96<br>06.96<br>03.98<br>07.96<br>09.97<br>06.96<br>06.96   | 04.01<br>04.01<br>04.01<br>04.01<br>04.01<br>04.01<br>06.97   | 24.0122-0132.1<br>24.0322-0132.1<br>13.8190-0330.1                                     | 422132<br>522132<br>990134   | 4  | 284 22,0 19,4 V L +S +B<br>284 22,0 19,4 V L +S +B PD<br>Halterschraube                     |  |  |
|  | C 200 Kompressor<br>C 230 Kompressor<br>C 240<br>C 250 TD<br>C 280  |  | 11.96<br>06.97<br>06.97<br>06.96<br>06.97   | 04.01<br>04.01<br>04.01<br>04.01<br>04.01   | 24.0125-0110.1<br>24.0325-0110.1<br>13.8190-0330.1                                     | 425110<br>525110<br>990134   | 4  | 288 25,0 22,4 V L +S +B<br>288 25,0 22,4 V L +S +B PD<br>Halterschraube                     |  |  |
|  | C 43 AMG  |  | 09.97   | 04.01   | 13.8190-0330.1   | 990134   | 4  | Halterschraube  |  |  |
|    | C 180<br>C 200<br>C 200 CDI<br>C 200 D<br>C 200 Kompressor<br>C 220 CDI<br>C 220 D<br>C 230<br>C 230 Kompressor<br>C 240<br>C 250 TD<br>C 280<br>C 43 AMG |  | 06.96<br>06.96<br>03.98<br>07.96<br>11.96<br>09.97<br>06.96<br>06.96<br>06.97<br>06.97<br>06.96<br>06.97<br>09.97 | 04.01<br>04.01<br>04.01<br>04.01<br>04.01<br>04.01<br>04.01<br>06.97<br>04.01<br>04.01<br>04.01<br>04.01<br>04.01 | 24.0751-1141.3<br>24.0751-1142.3<br>24.0711-6021.3<br>24.0711-6022.3                   | 360196<br>360197<br>360076<br>360077   | <input type="checkbox"/> - ESP<br><input type="checkbox"/> - ESP<br><input type="checkbox"/> + ESP<br><input type="checkbox"/> + ESP                                     |   | Radsensor L=503<br>Radsensor L=503<br>Radsensor L=549<br>Radsensor L=549 |  |
|    | C 180<br>C 200<br>C 200 CDI<br>C 200 D<br>C 200 Kompressor<br>C 220 CDI<br>C 220 D<br>C 230<br>C 250 TD   | F576240<br>F576240<br>F576240<br>F576240<br>F576240<br>F576240<br>F576240<br>F576240<br>F576240  | 06.96<br>06.96<br>03.98<br>07.96<br>11.96<br>09.97<br>06.96<br>06.96  |   | 13.0460-3805.2<br>13.0470-3805.2<br>24.8190-0401.2                                     | 603805<br>LD3805<br>620401   | 1  | 21197 15,0 /WE<br>21197 15,0 /WE<br>Warnkontakt L=95mm                                      | ATE<br>ATE   |  |
|  | C 180<br>C 200<br>C 200 CDI<br>C 200 D<br>C 200 Kompressor<br>C 220 CDI<br>C 220 D<br>C 230<br>C 230 Kompressor<br>C 240<br>C 250 TD<br>C 280             | F576241<br>F576241<br>F576241<br>F576241<br>F576241<br>F576241<br>F576241<br>F576241<br>F576241<br>F576241<br>F576241                                    | 06.96<br>06.96<br>04.01<br>04.01<br>04.01<br>04.01<br>04.01<br>06.97<br>06.97<br>06.97<br>04.01<br>04.01          | 04.01<br>04.01<br>04.01<br>04.01<br>04.01<br>04.01<br>04.01<br>04.01<br>04.01<br>04.01<br>04.01<br>04.01          | 13.0460-4064.2<br>13.0470-4064.2<br>13.0460-0229.2                                     | 604064<br>LD4064<br>610229   |  | 21919 15,3 /Zub<br>21919 15,3 /Zub<br>Belagsatz-Zubehör                                     | ATE<br>ATE<br>ATE  |  |
|  | C 43 AMG  |  | 09.97   | 04.01   | 13.0460-4047.2<br>13.0470-4047.2<br>13.0460-0236.2<br>24.8190-0401.2                   | 604047<br>LD4047<br>610236<br>620401   | 1  | 21305 15,7 /WE<br>21305 15,7 /WE<br>Belagsatz-Zubehör<br>Warnkontakt L=95mm                 | ATE<br>ATE<br>ATE  |  |
|  | C 180<br>C 200<br>C 200 CDI<br>C 200 D<br>C 200 Kompressor<br>C 220 CDI<br>C 220 D<br>C 230<br>C 230 Kompressor<br>C 240<br>C 250 TD<br>C 280             |  | 06.96<br>06.96<br>03.98<br>07.96<br>11.96<br>09.97<br>06.96<br>06.96<br>06.97<br>06.97<br>06.96<br>06.97          | 04.01<br>04.01<br>04.01<br>04.01<br>04.01<br>04.01<br>04.01<br>06.97<br>04.01<br>04.01<br>04.01<br>04.01          | 24.0109-0114.1<br>24.0309-0114.1   | 409114<br>509114   |  | 278 9,0 7,3 +S +B<br>278 9,0 7,3 +S +B PD   |  |  |
|  | C 43 AMG  |  | 09.97   | 04.01   | 24.0122-0228.1   | 422228   |  | 300 22,0 19,4 V L +B  |  |  |
|  | C 180<br>C 200<br>C 200 CDI<br>C 200 D<br>C 200 Kompressor<br>C 220 CDI<br>C 220 D<br>C 230<br>C 230 Kompressor<br>C 240<br>C 250 TD<br>C 280<br>C 43 AMG | F 980773<br>F 980773<br>F 980773<br>F 980773<br>F 980773<br>F 980773<br>F 980773<br>F 980773<br>F 980773<br>F 980773<br>F 980773<br>F 980773<br>F 980773 | 06.96<br>06.96<br>03.98<br>07.96<br>11.96<br>09.97<br>06.96<br>06.96<br>06.97<br>06.97<br>06.96<br>06.97<br>09.97 |   | 24.0751-1162.3<br>24.0751-1143.3<br>24.0751-1144.3<br>24.0711-6035.3<br>24.0711-6036.3 | 360099<br>360096<br>360097<br>360277<br>360278                                     | 2 <input type="checkbox"/> + ABS<br><input type="checkbox"/> + ASR<br><input type="checkbox"/> + ASR<br><input type="checkbox"/> + ESP<br><input type="checkbox"/> + ESP | Radsensor L=390<br>Radsensor L=621<br>Radsensor L=958<br>Radsensor L=632<br>Radsensor L=979 |  |  |
|  | C 180<br>C 200<br>C 200 CDI<br>C 200 D<br>C 200 Kompressor<br>C 220 CDI   | F 980774<br>F 980774<br>F 980774<br>F 980774<br>F 980774<br>F 980774   | 04.01<br>04.01<br>04.01<br>04.01<br>04.01<br>04.01  |   | 24.0751-1162.3<br>24.0751-1143.3<br>24.0751-1144.3<br>24.0711-6035.3<br>24.0711-6064.3 | 360099<br>360096<br>360097<br>360277<br>360279                                     | 2 <input type="checkbox"/> + ABS<br><input type="checkbox"/> + ASR<br><input type="checkbox"/> + ASR<br><input type="checkbox"/> + ESP<br><input type="checkbox"/> + ESP | Radsensor L=390<br>Radsensor L=621<br>Radsensor L=958<br>Radsensor L=632<br>Radsensor L=899 |  |  |



### MERCEDES BENZ C-Klasse (S202) Kombi (96-01)

|  |                  |          |  |       |       |                |        |  |   |
|--|------------------|----------|--|-------|-------|----------------|--------|--|---|
|  | C 220 D          | F 980774 |  | 04.01 |       | 24.0751-1162.3 | 360099 | 2<br>+ ABS<br>+ ASR<br>+ ASR<br>+ ESP<br>+ ESP | Radsensor L=390<br>Radsensor L=621<br>Radsensor L=958<br>Radsensor L=632<br>Radsensor L=899 |
|  | C 230            | F 980774 |  | 06.97 |       | 24.0751-1143.3 | 360096 |  |   |
|  | C 230 Kompressor | F 980774 |  | 04.01 |       | 24.0751-1144.3 | 360097 |  |   |
|  | C 240            | F 980774 |  | 04.01 |       | 24.0711-6035.3 | 360277 |  |   |
|  | C 250 TD         | F 980774 |  | 04.01 |       | 24.0711-6064.3 | 360279 |  |   |
|  | C 280            | F 980774 |  | 04.01 |       |                |        |  |   |
|  | C 43 AMG         | F 980774 |  | 04.01 |       |                |        |  |   |
|  | C 180            |          |  | 06.96 | 04.01 | 03.0137-0170.2 | 650170 |  | 164 x 20 /Zub   |
|  | C 200            |          |  | 06.96 | 04.01 |                |        |  |   |
|  | C 200 CDI        |          |  | 03.98 | 04.01 |                |        |  |   |
|  | C 200 D          |          |  | 07.96 | 04.01 |                |        |  |   |
|  | C 200 Kompressor |          |  | 11.96 | 04.01 |                |        |  |   |
|  | C 220 CDI        |          |  | 09.97 | 04.01 |                |        |  |   |
|  | C 220 D          |          |  | 06.96 | 04.01 |                |        |  |   |
|  | C 230            |          |  | 06.96 | 06.97 |                |        |  |   |
|  | C 230 Kompressor |          |  | 06.97 | 04.01 |                |        |  |   |
|  | C 240            |          |  | 06.97 | 04.01 |                |        |  |   |
|  | C 250 TD         |          |  | 06.96 | 04.01 |                |        |  |   |
|  | C 280            |          |  | 06.97 | 04.01 |                |        |  |   |
|  | C 43 AMG         |          |  | 09.97 | 04.01 |                |        |  |   |

### MERCEDES BENZ C-Klasse (W203) Limousine (00-07)

|                      |                      |                     |                     |       |   |   |                |   |  |        |
|----------------------|----------------------|---------------------|---------------------|-------|---|---|----------------|---|--|--------|
|                      | C 180                |                     |                     | 04.00 | 04.07   | 13.0460-2726.2                                | 602726         | 2 | 23144 19,8 +/WE/Zub/STRW<br>23144 19,8 +/WE/Zub/STRW<br>Warnkontakt L=97,5mm |        |
|                      | C 180 Kompressor     |                     |                     | 05.02 | 04.07   | - Sportpaket / - Sportpaket AMG <sup>1)</sup> | 13.0470-2726.2 |   |  | LD2726 |
|                      | C 200 CDI            | 90                  |                     | 04.00 | 04.07   | - Sportpaket / - Sportpaket AMG <sup>1)</sup> | 24.8190-0410.2 |   |  | 620410 |
|                      | C 200 CDI            |                     |                     | 04.03 | 04.07   | - Sportpaket / - Sportpaket AMG <sup>1)</sup> |                |   |  |        |
|                      | C 200 CGI Kompressor |                     |                     | 07.03 | 04.07   | - Sportpaket / - Sportpaket AMG <sup>1)</sup> |                |   |  |        |
|                      | C 200 Kompressor     |                     |                     | 04.00 | 04.07   | - Sportpaket / - Sportpaket AMG <sup>1)</sup> |                |   |  |        |
|                      | C 200 Kompressor     | 120                 |                     | 05.00 | 05.02   |   |                |   |  |        |
|                      | C 220 CDI            |                     |                     | 04.00 | 04.07   | - Sportpaket / - Sportpaket AMG <sup>1)</sup> |                |   |  |        |
|                      | C 220 CDI            | 110                 |                     | 02.04 | 04.07   | - Sportpaket / - Sportpaket AMG <sup>1)</sup> |                |   |  |        |
|                      | C 180 Kompressor     |                     | A 660226 / F 565688 | 05.02 | 04.07   | + Sportpaket / + Sportpaket AMG <sup>2)</sup> | 13.0460-4990.2 |   |  | 604990 |
| C 200 CDI            | 90                   | A 660226 / F 565688 | 04.00               | 04.07 | + Sportpaket / + Sportpaket AMG <sup>2)</sup> | 13.0470-4990.2                                | LD4990         |   |  |        |
| C 200 CDI            |                      | A 660226 / F 565688 | 04.03               | 04.07 | + Sportpaket / + Sportpaket AMG <sup>2)</sup> | 24.8190-0410.2                                | 620410         |   |  |        |
| C 200 CGI Kompressor |                      | A 660226 / F 565688 | 07.03               | 04.07 | + Sportpaket / + Sportpaket AMG <sup>2)</sup> | 13.0460-0275.2                                | 610275         |   |  |        |
| C 200 Kompressor     |                      | A 660226 / F 565688 | 04.00               | 04.07 | + Sportpaket / + Sportpaket AMG <sup>2)</sup> |   |                |   |  |        |
| C 220 CDI            | 110                  | A 660226 / F 565688 | 04.00               | 04.07 | + Sportpaket / + Sportpaket AMG <sup>2)</sup> |   |                |   |  |        |
| C 220 CDI            |                      | A 660226 / F 565688 | 02.04               | 04.07 | + Sportpaket / + Sportpaket AMG <sup>2)</sup> |   |                |   |  |        |
| C 230 Kompressor     |                      | A 660226 / F 565688 | 02.04               | 04.07 | + Sportpaket / + Sportpaket AMG <sup>2)</sup> |   |                |   |  |        |
| C 240                |                      | A 660226 / F 565688 | 04.00               | 04.07 | + Sportpaket / + Sportpaket AMG <sup>2)</sup> |   |                |   |  |        |
| C 270 CDI            |                      | A 660226 / F 565688 | 08.00               | 04.07 | + Sportpaket / + Sportpaket AMG <sup>2)</sup> |   |                |   |  |        |
| C 320                |                      | A 660226 / F 565688 | 04.00               | 04.07 | + Sportpaket / + Sportpaket AMG <sup>2)</sup> |   |                |   |  |        |
| C 180 Kompressor     | 90                   | A 660227 / F 565689 | 04.07               | 04.07 | + Sportpaket / + Sportpaket AMG <sup>2)</sup> | 13.0460-4994.2                                | 604994         |   |  |        |
| C 200 CDI            |                      | A 660227 / F 565689 | 04.07               | 04.07 | + Sportpaket / + Sportpaket AMG <sup>2)</sup> | 13.0470-4994.2                                | LD4994         |   |  |        |
| C 200 CGI Kompressor |                      | A 660227 / F 565689 | 04.07               | 04.07 | + Sportpaket / + Sportpaket AMG <sup>2)</sup> | 24.8190-0410.2                                | 620410         |   |  |        |
| C 200 Kompressor     | 110                  | A 660227 / F 565689 | 04.07               | 04.07 | + Sportpaket / + Sportpaket AMG <sup>2)</sup> |   |                |   |  |        |
| C 220 CDI            |                      | A 660227 / F 565689 | 04.07               | 04.07 | + Sportpaket / + Sportpaket AMG <sup>2)</sup> |   |                |   |  |        |
| C 230                |                      | A 660227 / F 565689 | 06.05               | 04.07 | + Sportpaket / + Sportpaket AMG <sup>2)</sup> |   |                |   |  |        |
| C 230 Kompressor     |                      | A 660227 / F 565689 | 04.07               | 04.07 | + Sportpaket / + Sportpaket AMG <sup>2)</sup> |   |                |   |  |        |
| C 240                |                      | A 660227 / F 565689 | 04.07               | 04.07 | + Sportpaket / + Sportpaket AMG <sup>2)</sup> |   |                |   |  |        |
| C 270 CDI            |                      | A 660227 / F 565689 | 04.07               | 04.07 | + Sportpaket / + Sportpaket AMG <sup>2)</sup> |   |                |   |  |        |
| C 280                |                      | A 660227 / F 565689 | 06.05               | 04.07 | + Sportpaket / + Sportpaket AMG <sup>2)</sup> |   |                |   |  |        |
| C 280 4-matic        |                      | A 660227 / F 565689 | 06.05               | 04.07 | + Sportpaket / + Sportpaket AMG <sup>2)</sup> |   |                |   |  |        |
| C 320                |                      | A 660227 / F 565689 | 04.07               | 04.07 | + Sportpaket / + Sportpaket AMG <sup>2)</sup> |   |                |   |  |        |
| C 320 CDI            |                      | A 660227 / F 565689 | 02.05               | 04.07 | - Sportpaket / - Sportpaket AMG <sup>1)</sup> |   |                |   |  |        |
| C 350                |                      | A 660227 / F 565689 | 06.05               | 04.07 | - Sportpaket / - Sportpaket AMG <sup>1)</sup> |   |                |   |  |        |
| C 230                |                      |                     | 06.05               | 04.07 | - Sportpaket / - Sportpaket AMG <sup>1)</sup> | 13.0460-2727.2                                | 602727         |   |  |        |
| C 230 Kompressor     |                      |                     | 02.04               | 04.07 | - Sportpaket / - Sportpaket AMG <sup>1)</sup> | 13.0470-2727.2                                | LD2727         |   |  |        |
| C 240                |                      |                     | 04.00               | 04.07 | - Sportpaket / - Sportpaket AMG <sup>1)</sup> | 24.8190-0410.2                                | 620410         |   |  |        |
| C 240 4-matic        |                      |                     | 07.02               | 04.07 |   |   |                |   |  |        |
| C 270 CDI            |                      |                     | 08.00               | 04.07 | - Sportpaket / - Sportpaket AMG <sup>1)</sup> |   |                |   |  |        |
| C 280                |                      |                     | 06.05               | 04.07 | - Sportpaket / - Sportpaket AMG <sup>1)</sup> |   |                |   |  |        |
| C 280 4-matic        |                      |                     | 06.05               | 04.07 | - Sportpaket / - Sportpaket AMG <sup>1)</sup> |   |                |   |  |        |
| C 320                |                      |                     | 04.00               | 04.07 | - Sportpaket / - Sportpaket AMG <sup>1)</sup> |   |                |   |  |        |
| C 320 4-matic        |                      |                     | 07.02               | 04.07 |   |   |                |   |  |        |
| C 30 CDI AMG         |                      |                     | 01.03               | 04.07 |   | 13.0460-4990.2                                | 604990         |   |  |        |
| C 320 CDI            |                      |                     | 02.05               | 04.07 | + Sportpaket / + Sportpaket AMG <sup>2)</sup> | 13.0470-4990.2                                | LD4990         |   |  |        |
| C 350                |                      |                     | 06.05               | 04.07 | + Sportpaket / + Sportpaket AMG <sup>2)</sup> | 24.8190-0410.2                                | 620410         |   |  |        |
| C 350 4-matic        |                      |                     | 06.05               | 04.07 |   | 13.0460-0269.2                                | 610269         |   |  |        |
|                      |                      |                     |                     |       |   | 13.0460-0237.2                                | 610237         |   |  |        |
| C 32 AMG Kompressor  |                      |                     | 03.01               | 04.07 |   | 13.0460-4990.2                                | 604990         |   |  |        |
| C 55 AMG             |                      |                     | 02.04               | 04.07 |   | 24.8190-0410.2                                | 620410         |   |  |        |
|                      |                      |                     |                     |       |   | 13.0460-0269.2                                | 610269         |   |  |        |
|                      |                      |                     |                     |       |   | 13.0460-0237.2                                | 610237         |   |  |        |
|                      | C 180                |                     |                     | 04.00 | 04.07   | 24.0125-0110.1                                | 425110         | 2 | 288 25,0 22,4 V L +S +B<br>288 25,0 22,4 V L +S +B PD                        |        |
|                      | C 180 Kompressor     |                     |                     | 05.02 | 04.07   | - Sportpaket / - Sportpaket AMG <sup>1)</sup> | 24.0325-0110.1 |   |  | 525110 |
|                      | C 200 CDI            | 90                  |                     | 04.00 | 04.07   | - Sportpaket / - Sportpaket AMG <sup>1)</sup> |                |   |  |        |
|                      | C 200 CDI            |                     |                     | 04.03 | 04.07   | - Sportpaket / - Sportpaket AMG <sup>1)</sup> |                |   |  |        |
|                      | C 200 CGI Kompressor |                     |                     | 07.03 | 04.07   | - Sportpaket / - Sportpaket AMG <sup>1)</sup> |                |   |  |        |
|                      | C 200 Kompressor     |                     |                     | 04.00 | 04.07   | - Sportpaket / - Sportpaket AMG <sup>1)</sup> |                |   |  |        |
|                      | C 200 Kompressor     | 120                 |                     | 05.00 | 05.02   |   |                |   |  |        |
|                      | C 220 CDI            |                     |                     | 04.00 | 04.07   | - Sportpaket / - Sportpaket AMG <sup>1)</sup> |                |   |  |        |
|                      | C 220 CDI            | 110                 |                     | 02.04 | 04.07   | - Sportpaket / - Sportpaket AMG <sup>1)</sup> |                |   |  |        |
|                      | C 180 Kompressor     |                     |                     | 05.02 | 04.07   | + Sportpaket / + Sportpaket AMG <sup>2)</sup> | 24.0128-0177.1 |   |  | 428177 |
| C 200 CDI            | 90                   |                     | 04.00               | 04.07 | + Sportpaket / + Sportpaket AMG <sup>2)</sup> |   |                |   |  |        |
| C 200 CDI            |                      |                     | 04.03               | 04.07 | + Sportpaket / + Sportpaket AMG <sup>2)</sup> |   |                |   |  |        |
| C 200 CGI Kompressor |                      |                     | 07.03               | 04.07 | + Sportpaket / + Sportpaket AMG <sup>2)</sup> |   |                |   |  |        |

<sup>1)</sup> - sport package/- sport package AMG / - pacchetto sportivo/- pacchetto sport.AMG / - version sport/- version sport AMG / - kit deportivo/- kit deportivo AMG  
<sup>2)</sup> + sports package/+ sports package AMG / + pacchetto sportivo/+ pacchetto sport.AMG / + version sport/+ version sport AMG / + kit deportivo/+ kit deportivo AMG



**MERCEDES BENZ C-Klasse (W203) Limousine (00-07)**

|                     |                      |       |       |   |   |                |                         |   |   |                |        |                         |   |
|---------------------|----------------------|-------|-------|---|---|----------------|-------------------------|---|---|----------------|--------|-------------------------|---|
|                     | C 200 Kompressor     |       | 04.00 | 04.07   | + Sportpaket / + Sportpaket AMG <sup>1)</sup> | 24.0128-0177.1 | 428177                  |   | 330 28,0 26,0 V L +B  |                |        |                         |   |
|                     | C 220 CDI            | 110   | 04.00 | 04.07   | + Sportpaket / + Sportpaket AMG <sup>1)</sup> |                |                         |   |   |                |        |                         |   |
|                     | C 220 CDI            |       | 02.04 | 04.07   | + Sportpaket / + Sportpaket AMG <sup>1)</sup> |                |                         |   |   |                |        |                         |   |
|                     | C 230                |       | 06.05 | 04.07   | + Sportpaket / + Sportpaket AMG <sup>1)</sup> |                |                         |   |   |                |        |                         |   |
|                     | C 230 Kompressor     |       | 02.04 | 04.07   | + Sportpaket / + Sportpaket AMG <sup>1)</sup> |                |                         |   |   |                |        |                         |   |
|                     | C 240                |       | 04.00 | 04.07   | + Sportpaket / + Sportpaket AMG <sup>1)</sup> |                |                         |   |   |                |        |                         |   |
|                     | C 270 CDI            |       | 08.00 | 04.07   | + Sportpaket / + Sportpaket AMG <sup>1)</sup> |                |                         |   |   |                |        |                         |   |
|                     | C 280                |       | 06.05 | 04.07   | + Sportpaket / + Sportpaket AMG <sup>1)</sup> |                |                         |   |   |                |        |                         |   |
|                     | C 280 4-matic        |       | 06.05 | 04.07   | + Sportpaket / + Sportpaket AMG <sup>1)</sup> |                |                         |   |   |                |        |                         |   |
|                     | C 320                |       | 04.00 | 04.07   | + Sportpaket / + Sportpaket AMG <sup>1)</sup> |                |                         |   |   |                |        |                         |   |
|                     | C 230                |       | 06.05 | 04.07   | - Sportpaket / - Sportpaket AMG <sup>2)</sup> |                |                         |   |   | 24.0128-0106.1 | 428106 | 300 28,0 25,4 V L +S +B |   |
|                     | C 230 Kompressor     |       | 02.04 | 04.07   | - Sportpaket / - Sportpaket AMG <sup>2)</sup> |                |                         |   |   |                |        |                         |   |
|                     | C 240                |       | 04.00 | 04.07   | - Sportpaket / - Sportpaket AMG <sup>2)</sup> |                |                         |   |   |                |        |                         |   |
| C 240 4-matic       |                      | 07.02 | 04.07 |   |   |                |                         |   |   |                |        |                         |   |
| C 270 CDI           |                      | 08.00 | 04.07 | - Sportpaket / - Sportpaket AMG <sup>2)</sup> |   |                |                         |   |   |                |        |                         |   |
| C 280               |                      | 06.05 | 04.07 | - Sportpaket / - Sportpaket AMG <sup>2)</sup> |   |                |                         |   |   |                |        |                         |   |
| C 280 4-matic       |                      | 06.05 | 04.07 | - Sportpaket / - Sportpaket AMG <sup>2)</sup> |   |                |                         |   |   |                |        |                         |   |
| C 320               |                      | 04.00 | 04.07 | - Sportpaket / - Sportpaket AMG <sup>2)</sup> |   |                |                         |   |   |                |        |                         |   |
| C 320 4-matic       |                      | 07.02 | 04.07 |   |   |                |                         |   |   |                |        |                         |   |
| C 30 CDI AMG        |                      | 01.03 | 04.07 |   | 24.0130-0180.1                                | 430180         | 345 30,0 28,0 V L +B    |   |   |                |        |                         |   |
| C 32 AMG Kompressor |                      | 03.01 | 04.07 |   |   |                |                         |   |   |                |        |                         |   |
| C 320 CDI           |                      | 02.05 | 04.07 | + Sportpaket / + Sportpaket AMG <sup>1)</sup> |   |                |                         |   |   |                |        |                         |   |
| C 350               |                      | 06.05 | 04.07 | + Sportpaket / + Sportpaket AMG <sup>1)</sup> |   |                |                         |   |   |                |        |                         |   |
| C 350 4-matic       |                      | 06.05 | 04.07 | + Sportpaket / + Sportpaket AMG <sup>1)</sup> |   |                |                         |   |   |                |        |                         |   |
| C 320 CDI           |                      | 02.05 | 04.07 | - Sportpaket / - Sportpaket AMG <sup>2)</sup> | 24.0128-0188.1                                | 428188         | 330 28,0 26,0 V L +S +B |   |   |                |        |                         |   |
| C 350               |                      | 06.05 | 04.07 | - Sportpaket / - Sportpaket AMG <sup>2)</sup> |   |                |                         |   |   |                |        |                         |   |
| C 350 4-matic       |                      | 06.05 | 04.07 | - Sportpaket / - Sportpaket AMG <sup>2)</sup> | 24.0130-0171.1                                | 430171         | 345 30,0 27,4 V L +B    |   |   |                |        |                         |   |
|                     | C 180                |       | 04.00 | 04.07   |   | 24.0711-6001.3 | 360119                  | 2   | Radsensor L=565   |                |        |                         |   |
|                     | C 180 Kompressor     |       | 05.02 | 04.07   |   |                |                         |   |   |                |        |                         |   |
|                     | C 200 CDI            | 90    | 04.00 | 04.07   |   |                |                         |   |   |                |        |                         |   |
|                     | C 200 CDI            |       | 04.03 | 04.07   |   |                |                         |   |   |                |        |                         |   |
|                     | C 200 CGI Kompressor |       | 07.03 | 04.07   |   |                |                         |   |   |                |        |                         |   |
|                     | C 200 Kompressor     |       | 04.00 | 04.07   |   |                |                         |   |   |                |        |                         |   |
|                     | C 200 Kompressor     | 120   | 05.00 | 05.02   |   |                |                         |   |   |                |        |                         |   |
|                     | C 220 CDI            |       | 04.00 | 04.07   |   |                |                         |   |   |                |        |                         |   |
|                     | C 220 CDI            | 110   | 02.04 | 04.07   |   |                |                         |   |   |                |        |                         |   |
|                     | C 230                |       | 06.05 | 04.07   |   |                |                         |   |   |                |        |                         |   |
|                     | C 230 Kompressor     |       | 02.04 | 04.07   |   |                |                         |   |   |                |        |                         |   |
|                     | C 240                |       | 04.00 | 04.07   |   |                |                         |   |   |                |        |                         |   |
|                     | C 270 CDI            |       | 08.00 | 04.07   |   |                |                         |   |   |                |        |                         |   |
|                     | C 280                |       | 06.05 | 04.07   |   |                |                         |   |   |                |        |                         |   |
|                     | C 30 CDI AMG         |       | 01.03 | 04.07   |   |                |                         |   |   |                |        |                         |   |
|                     | C 32 AMG Kompressor  |       | 03.01 | 04.07   |   |                |                         |   |   |                |        |                         |   |
|                     | C 320                |       | 04.00 | 04.07   |   |                |                         |   |   |                |        |                         |   |
|                     | C 320 CDI            |       | 02.05 | 04.07   |   |                |                         |   |   |                |        |                         |   |
|                     | C 350                |       | 06.05 | 04.07   |   |                |                         |   |   |                |        |                         |   |
|                     | C 55 AMG             |       | 02.04 | 04.07   |   |                |                         |   |   |                |        |                         |   |
|                     | C 240 4-matic        |       | 07.02 | 04.07   |   |                |                         |   |   | 24.0711-6073.3 | 360083 | 2                       | Radsensor L=666   |
|                     | C 280 4-matic        |       | 06.05 | 04.07   |   |                |                         |   |   |                |        |                         |   |
|                     | C 320 4-matic        |       | 07.02 | 04.07   |   |                |                         |   |   |                |        |                         |   |
| C 350 4-matic       |                      | 06.05 | 04.07 |   |   |                |                         |   |   |                |        |                         |   |
|                     | C 180                |       | 04.00 | 04.07   |   | 13.0460-4064.2 | 604064                  | 1   | 21919 15,3 /Zub<br>21919 15,3 /Zub<br>Belagsatz-Zubehör<br>Warnkontakt L=97,5mm |                |        |                         |   |
|                     | C 180 Kompressor     |       | 05.02 | 04.07   | - Sportpaket / - Sportpaket AMG <sup>2)</sup> |                |                         |   |   |                |        |                         |   |
|                     | C 200 CDI            | 90    | 04.00 | 04.07   | - Sportpaket / - Sportpaket AMG <sup>2)</sup> |                |                         |   |   |                |        |                         |   |
|                     | C 200 CDI            |       | 04.03 | 04.07   | - Sportpaket / - Sportpaket AMG <sup>2)</sup> |                |                         |   |   |                |        |                         |   |
|                     | C 200 CGI Kompressor |       | 07.03 | 04.07   | - Sportpaket / - Sportpaket AMG <sup>2)</sup> |                |                         |   |   |                |        |                         |   |
|                     | C 200 Kompressor     |       | 04.00 | 04.07   | - Sportpaket / - Sportpaket AMG <sup>2)</sup> |                |                         |   |   |                |        |                         |   |
|                     | C 200 Kompressor     | 120   | 05.00 | 05.02   |   |                |                         |   |   |                |        |                         |   |
|                     | C 220 CDI            |       | 04.00 | 04.07   | - Sportpaket / - Sportpaket AMG <sup>2)</sup> |                |                         |   |   |                |        |                         |   |
|                     | C 220 CDI            | 110   | 02.04 | 04.07   | - Sportpaket / - Sportpaket AMG <sup>2)</sup> |                |                         |   |   |                |        |                         |   |
|                     | C 180 Kompressor     |       | 05.02 | 04.07   | + Sportpaket / + Sportpaket AMG <sup>1)</sup> |                |                         |   |   | 13.0460-4065.2 | 604065 | 1                       | 21899 15,3 /WE/Zub<br>21899 15,3 /WE/Zub<br>Belagsatz-Zubehör<br>Warnkontakt L=97,5mm |
|                     | C 200 CDI            | 90    | 04.00 | 04.07   | + Sportpaket / + Sportpaket AMG <sup>1)</sup> |                |                         |   |   |                |        |                         |   |
|                     | C 200 CDI            |       | 04.03 | 04.07   | + Sportpaket / + Sportpaket AMG <sup>1)</sup> |                |                         |   |   |                |        |                         |   |
|                     | C 200 CGI Kompressor |       | 07.03 | 04.07   | + Sportpaket / + Sportpaket AMG <sup>1)</sup> |                |                         |   |   |                |        |                         |   |
|                     | C 200 Kompressor     |       | 04.00 | 04.07   | + Sportpaket / + Sportpaket AMG <sup>1)</sup> |                |                         |   |   |                |        |                         |   |
|                     | C 220 CDI            |       | 04.00 | 04.07   | + Sportpaket / + Sportpaket AMG <sup>1)</sup> |                |                         |   |   |                |        |                         |   |
|                     | C 220 CDI            | 110   | 02.04 | 04.07   | + Sportpaket / + Sportpaket AMG <sup>1)</sup> |                |                         |   |   |                |        |                         |   |
|                     | C 230                |       | 06.05 | 04.07   |   |                |                         |   |   |                |        |                         |   |
|                     | C 230 Kompressor     |       | 02.04 | 04.07   |   |                |                         |   |   |                |        |                         |   |
|                     | C 240                |       | 04.00 | 04.07   |   |                |                         |   |   |                |        |                         |   |
|                     | C 240 4-matic        |       | 07.02 | 04.07   |   |                |                         |   |   |                |        |                         |   |
|                     | C 270 CDI            |       | 08.00 | 04.07   |   |                |                         |   |   |                |        |                         |   |
|                     | C 280                |       | 06.05 | 04.07   |   |                |                         |   |   |                |        |                         |   |
|                     | C 280 4-matic        |       | 06.05 | 04.07   |   |                |                         |   |   |                |        |                         |   |
| C 320               |                      | 04.00 | 04.07 |   |   |                |                         |   |   |                |        |                         |   |
| C 320 4-matic       |                      | 07.02 | 04.07 |   |   |                |                         |   |   |                |        |                         |   |
| C 320 CDI           |                      | 02.05 | 04.07 |   |   |                |                         |   |   |                |        |                         |   |
| C 350               |                      | 06.05 | 04.07 |   |   |                |                         |   |   |                |        |                         |   |
| C 350 4-matic       |                      | 06.05 | 04.07 |   |   |                |                         |   |   |                |        |                         |   |
| C 30 CDI AMG        |                      | 01.03 | 04.07 |   | 13.0460-4047.2                                | 604047         | 2                       | 21305 15,7 /WE<br>21305 15,7 /WE<br>Belagsatz-Zubehör<br>Warnkontakt L=97,5mm |   |                |        |                         |   |
| C 32 AMG Kompressor |                      | 03.01 | 04.07 |   |   |                |                         |   |   |                |        |                         |   |
| C 55 AMG            |                      | 02.04 | 04.07 |   |   |                |                         |   |   |                |        |                         |   |
|                     |                      |       |       |   | 13.0470-4064.2                                | LD4064         |                         |   |   |                |        |                         |   |
|                     |                      |       |       |   | 13.0460-0229.2                                | 610229         |                         |   |   |                |        |                         |   |
|                     |                      |       |       |   | 24.8190-0410.2                                | 620410         |                         |   |   |                |        |                         |   |
|                     |                      |       |       |   | 13.0470-4065.2                                | LD4065         |                         |   |   |                |        |                         |   |
|                     |                      |       |       |   | 13.0460-0231.2                                | 610231         |                         |   |   |                |        |                         |   |
|                     |                      |       |       |   | 24.8190-0410.2                                | 620410         |                         |   |   |                |        |                         |   |
|                     |                      |       |       |   | 13.0460-4047.2                                | 604047         |                         |   |   |                |        |                         |   |
|                     |                      |       |       |   | 13.0470-4047.2                                | LD4047         |                         |   |   |                |        |                         |   |
|                     |                      |       |       |   | 13.0460-0236.2                                | 610236         |                         |   |   |                |        |                         |   |
|                     |                      |       |       |   | 24.8190-0410.2                                | 620410         |                         |   |   |                |        |                         |   |

<sup>1)</sup> + sports package/+ sports package AMG / + pacchetto sportivo/+ pacchetto sport.AMG / + version sport/+ version sport AMG / + kit deportivo/+ kit deportivo AMG

<sup>2)</sup> - sport package/- sport package AMG / - pacchetto sportivo/- pacchetto sport.AMG / - version sport/- version sport AMG / - kit deportivo/- kit deportivo AMG







**MERCEDES BENZ C-Klasse (W203) Limousine (00-07)**

|                      |                      |       |       |   |   |                |        |                          |                      |                       |
|----------------------|----------------------|-------|-------|---|---|----------------|--------|--------------------------|----------------------|-----------------------|
|                      | C 180                |       | 04.00 | 04.07   |   | 24.0109-0114.1 | 409114 |                          |                      | 278 9,0 7,3 +S +B     |
|                      | C 180 Kompressor     |       | 05.02 | 04.07   | - Sportpaket / - Sportpaket AMG <sup>1)</sup> | 24.0309-0114.1 | 509114 |                          |                      | 278 9,0 7,3 +S +B PD  |
|                      | C 200 CDI            |       | 04.00 | 04.07   | - Sportpaket / - Sportpaket AMG <sup>1)</sup> |                |        |                          |                      |                       |
|                      | C 200 CDI            | 90    | 04.03 | 04.07   | - Sportpaket / - Sportpaket AMG <sup>1)</sup> |                |        |                          |                      |                       |
|                      | C 200 CGI Kompressor |       | 07.03 | 04.07   | - Sportpaket / - Sportpaket AMG <sup>1)</sup> |                |        |                          |                      |                       |
|                      | C 200 Kompressor     |       | 04.00 | 04.07   | - Sportpaket / - Sportpaket AMG <sup>1)</sup> |                |        |                          |                      |                       |
|                      | C 200 Kompressor     | 120   | 05.00 | 05.02   |   |                |        |                          |                      |                       |
|                      | C 220 CDI            |       | 04.00 | 04.07   | - Sportpaket / - Sportpaket AMG <sup>1)</sup> |                |        |                          |                      |                       |
|                      | C 220 CDI            | 110   | 02.04 | 04.07   | - Sportpaket / - Sportpaket AMG <sup>1)</sup> |                |        |                          |                      |                       |
|                      | C 230                |       | 06.05 | 04.07   | - Sportpaket / - Sportpaket AMG <sup>1)</sup> |                |        |                          |                      |                       |
|                      | C 180 Kompressor     |       | 05.02 | 04.07   | + Sportpaket / + Sportpaket AMG <sup>2)</sup> | 24.0110-0217.1 | 410217 |                          |                      | 290 10,0 8,3 +S +B    |
|                      | C 200 CDI            |       | 04.00 | 04.07   | + Sportpaket / + Sportpaket AMG <sup>2)</sup> | 24.0310-0217.1 | 510217 |                          |                      | 290 10,0 8,3 +S +B PD |
|                      | C 200 CDI            | 90    | 04.03 | 04.07   | + Sportpaket / + Sportpaket AMG <sup>2)</sup> |                |        |                          |                      |                       |
| C 200 CGI Kompressor |                      | 07.03 | 04.07 | + Sportpaket / + Sportpaket AMG <sup>2)</sup> |   |                |        |                          |                      |                       |
| C 200 Kompressor     |                      | 04.00 | 04.07 | + Sportpaket / + Sportpaket AMG <sup>2)</sup> |   |                |        |                          |                      |                       |
| C 220 CDI            |                      | 04.00 | 04.07 | + Sportpaket / + Sportpaket AMG <sup>2)</sup> |   |                |        |                          |                      |                       |
| C 220 CDI            | 110                  | 02.04 | 04.07 | + Sportpaket / + Sportpaket AMG <sup>2)</sup> |   |                |        |                          |                      |                       |
| C 230                |                      | 06.05 | 04.07 | + Sportpaket / + Sportpaket AMG <sup>2)</sup> |   |                |        |                          |                      |                       |
| C 230 Kompressor     |                      | 02.04 | 04.07 |   |   |                |        |                          |                      |                       |
| C 240                |                      | 04.00 | 04.07 |   |   |                |        |                          |                      |                       |
| C 240 4-matic        |                      | 07.02 | 04.07 |   |   |                |        |                          |                      |                       |
| C 270 CDI            |                      | 08.00 | 04.07 |   |   |                |        |                          |                      |                       |
| C 280                |                      | 06.05 | 04.07 |   |   |                |        |                          |                      |                       |
| C 280 4-matic        |                      | 06.05 | 04.07 |   |   |                |        |                          |                      |                       |
| C 320                |                      | 04.00 | 04.07 |   |   |                |        |                          |                      |                       |
| C 320 4-matic        |                      | 07.02 | 04.07 |   |   |                |        |                          |                      |                       |
| C 320 CDI            |                      | 02.05 | 04.07 |   |   |                |        |                          |                      |                       |
| C 350                |                      | 06.05 | 04.07 |   |   |                |        |                          |                      |                       |
| C 350 4-matic        |                      | 06.05 | 04.07 |   |   |                |        |                          |                      |                       |
| C 30 CDI AMG         |                      | 01.03 | 04.07 |   | 24.0122-0228.1                                | 422228         |        |                          | 300 22,0 19,4 V L +B |                       |
| C 32 AMG Kompressor  |                      | 03.01 | 04.07 |   |   |                |        |                          |                      |                       |
| C 55 AMG             |                      | 02.04 | 04.07 |   |   |                |        |                          |                      |                       |
|                      | C 180                |       | 04.00 | 04.07   |   | 24.0711-6054.3 | 360184 | <input type="checkbox"/> |                      | Radsensor L=1102      |
|                      | C 180 Kompressor     |       | 05.02 | 04.07   |   | 24.0711-6053.3 | 360183 | <input type="checkbox"/> |                      | Radsensor L=948       |
|                      | C 200 CDI            |       | 04.00 | 04.07   |   |                |        |                          |                      |                       |
|                      | C 200 CDI            | 90    | 04.03 | 04.07   |   |                |        |                          |                      |                       |
|                      | C 200 CGI Kompressor |       | 07.03 | 04.07   |   |                |        |                          |                      |                       |
|                      | C 200 Kompressor     |       | 04.00 | 04.07   |   |                |        |                          |                      |                       |
|                      | C 200 Kompressor     | 120   | 05.00 | 05.02   |   |                |        |                          |                      |                       |
|                      | C 220 CDI            |       | 04.00 | 04.07   |   |                |        |                          |                      |                       |
|                      | C 220 CDI            | 110   | 02.04 | 04.07   |   |                |        |                          |                      |                       |
|                      | C 230                |       | 06.05 | 04.07   |   |                |        |                          |                      |                       |
|                      | C 230 Kompressor     |       | 02.04 | 04.07   |   |                |        |                          |                      |                       |
|                      | C 240                |       | 04.00 | 04.07   |   |                |        |                          |                      |                       |
|                      | C 270 CDI            |       | 08.00 | 04.07   |   |                |        |                          |                      |                       |
|                      | C 280                |       | 06.05 | 04.07   |   |                |        |                          |                      |                       |
|                      | C 30 CDI AMG         |       | 01.03 | 04.07   |   |                |        |                          |                      |                       |
|                      | C 32 AMG Kompressor  |       | 03.01 | 04.07   |   |                |        |                          |                      |                       |
|                      | C 320                |       | 04.00 | 04.07   |   |                |        |                          |                      |                       |
|                      | C 320 CDI            |       | 02.05 | 04.07   |   |                |        |                          |                      |                       |
|                      | C 350                |       | 06.05 | 04.07   |   |                |        |                          |                      |                       |
|                      | C 55 AMG             |       | 02.04 | 04.07   |   |                |        |                          |                      |                       |
|                      | C 240 4-matic        |       | 07.02 | 04.07   |   | 24.0711-6054.3 | 360184 | <input type="checkbox"/> |                      | Radsensor L=1102      |
|                      | C 280 4-matic        |       | 06.05 | 04.07   |   | 24.0711-6053.3 | 360183 | <input type="checkbox"/> |                      | Radsensor L=948       |
|                      | C 320 4-matic        |       | 07.02 | 04.07   |   |                |        |                          |                      |                       |
| C 350 4-matic        |                      | 06.05 | 04.07 |   |   |                |        |                          |                      |                       |
|                      | C 180                |       | 04.00 | 04.07   |   | 03.0137-4013.2 | 654013 |                          |                      | 164 x 20 /Zub         |
|                      | C 180 Kompressor     |       | 05.02 | 04.07   |   | 03.0137-9248.2 | 669248 |                          |                      | Bremsbacken-Zubehör   |
|                      | C 200 CDI            |       | 04.00 | 04.07   |   |                |        |                          |                      |                       |
|                      | C 200 CDI            | 90    | 04.03 | 04.07   |   |                |        |                          |                      |                       |
|                      | C 200 CGI Kompressor |       | 07.03 | 04.07   |   |                |        |                          |                      |                       |
|                      | C 200 Kompressor     |       | 04.00 | 04.07   |   |                |        |                          |                      |                       |
|                      | C 200 Kompressor     | 120   | 05.00 | 05.02   |   |                |        |                          |                      |                       |
|                      | C 220 CDI            |       | 04.00 | 04.07   |   |                |        |                          |                      |                       |
|                      | C 220 CDI            | 110   | 02.04 | 04.07   |   |                |        |                          |                      |                       |
|                      | C 230                |       | 06.05 | 04.07   |   |                |        |                          |                      |                       |
|                      | C 230 Kompressor     |       | 02.04 | 04.07   |   |                |        |                          |                      |                       |
|                      | C 240                |       | 04.00 | 04.07   |   |                |        |                          |                      |                       |
|                      | C 240 4-matic        |       | 07.02 | 04.07   |   |                |        |                          |                      |                       |
|                      | C 270 CDI            |       | 08.00 | 04.07   |   |                |        |                          |                      |                       |
|                      | C 280                |       | 06.05 | 04.07   |   |                |        |                          |                      |                       |
|                      | C 280 4-matic        |       | 06.05 | 04.07   |   |                |        |                          |                      |                       |
|                      | C 30 CDI AMG         |       | 01.03 | 04.07   |   |                |        |                          |                      |                       |
|                      | C 32 AMG Kompressor  |       | 03.01 | 04.07   |   |                |        |                          |                      |                       |
|                      | C 320                |       | 04.00 | 04.07   |   |                |        |                          |                      |                       |
|                      | C 320 4-matic        |       | 07.02 | 04.07   |   |                |        |                          |                      |                       |
|                      | C 320 CDI            |       | 02.05 | 04.07   |   |                |        |                          |                      |                       |
|                      | C 350                |       | 06.05 | 04.07   |   |                |        |                          |                      |                       |
|                      | C 350 4-matic        |       | 06.05 | 04.07   |   |                |        |                          |                      |                       |
| C 55 AMG             |                      | 02.04 | 04.07 |   |   |                |        |                          |                      |                       |

**MERCEDES BENZ C-Klasse (S203) Kombi (01-07)**

|  |                      |    |       |       |   |                |        |   |  |                          |
|--|----------------------|----|-------|-------|---|----------------|--------|---|--|--------------------------|
|  | C 180                |    | 03.01 | 09.07 |   | 13.0460-2726.2 | 602726 |   |  | 23144 19,8 +/WE/Zub/STRW |
|  | C 180 Kompressor     |    | 05.02 | 09.07 | - Sportpaket / - Sportpaket AMG <sup>1)</sup> | 13.0470-2726.2 | LD2726 |   |  | 23144 19,8 +/WE/Zub/STRW |
|  | C 200 CDI            |    | 03.01 | 09.07 | - Sportpaket / - Sportpaket AMG <sup>1)</sup> | 24.8190-0410.2 | 620410 | 2 |  | Warnkontakt L=97,5mm     |
|  | C 200 CDI            | 90 | 04.03 | 09.07 | - Sportpaket / - Sportpaket AMG <sup>1)</sup> |                |        |   |  |                          |
|  | C 200 CGI Kompressor |    | 07.03 | 09.07 | - Sportpaket / - Sportpaket AMG <sup>1)</sup> |                |        |   |  |                          |

<sup>1)</sup> - sport package/- sport package AMG / - pacchetto sportivo/- pacchetto sport.AMG / - version sport/- version sport AMG / - kit deportivo/- kit deportivo AMG  
<sup>2)</sup> + sports package/+ sports package AMG / + pacchetto sportivo/+ pacchetto sport.AMG / + version sport/+ version sport AMG / + kit deportivo/+ kit deportivo AMG



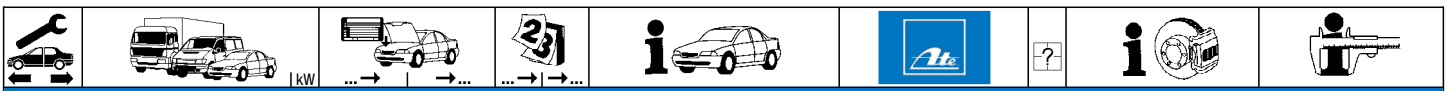

**MERCEDES BENZ C-Klasse (S203) Kombi (01-07)**

|  |                      |     |                     |       |       |   |                |        |   |  |  |
|--|----------------------|-----|---------------------|-------|-------|---|----------------|--------|---|--|--|
|  | C 200 Kompressor     | 120 |                     | 05.02 | 09.07 | - Sportpaket / - Sportpaket AMG <sup>1)</sup> | 13.0460-2726.2 | 602726 | 2 |  | 23144 19,8 +/WE/Zub/STRW<br>Warnkontakt L=97,5mm   |
|  | C 200 Kompressor     |     |                     | 03.01 | 04.02 |   | 13.0470-2726.2 | LD2726 |   |  |  |
|  | C 220 CDI            |     |                     | 03.01 | 09.07 | - Sportpaket / - Sportpaket AMG <sup>1)</sup> | 24.8190-0410.2 | 620410 |   |  |  |
|  | C 220 CDI            | 110 |                     | 02.04 | 09.07 | - Sportpaket / - Sportpaket AMG <sup>1)</sup> |                |        |   |  |  |
|  | C 180 Kompressor     |     | A 660226 / F 565688 | 05.02 | 09.07 | + Sportpaket / + Sportpaket AMG <sup>2)</sup> | 13.0460-4990.2 | 604990 | 2 |  | 23745 17,4 +/WE(1,8/7) BRE<br>23745 17,4 +/WE(1,8/7) BRE<br>Warnkontakt L=97,5mm<br>Belagsatz-Zubehör                          |
|  | C 200 CDI            | 90  | A 660226 / F 565688 | 03.01 | 09.07 | + Sportpaket / + Sportpaket AMG <sup>2)</sup> | 13.0470-4990.2 | LD4990 |   |  |  |
|  | C 200 CDI            |     | A 660226 / F 565688 | 04.03 | 09.07 | + Sportpaket / + Sportpaket AMG <sup>2)</sup> | 24.8190-0410.2 | 620410 |   |  |  |
|  | C 200 CGI Kompressor |     | A 660227 / F 565689 | 07.03 | 09.07 | + Sportpaket / + Sportpaket AMG <sup>2)</sup> | 13.0460-0275.2 | 610275 |   |  |  |
|  | C 200 Kompressor     |     | A 660226 / F 565688 | 05.02 | 09.07 | + Sportpaket / + Sportpaket AMG <sup>2)</sup> |                |        |   |  |  |
|  | C 220 CDI            |     | A 660226 / F 565688 | 03.01 | 09.07 | + Sportpaket / + Sportpaket AMG <sup>2)</sup> |                |        |   |  |  |
|  | C 220 CDI            | 110 | A 660226 / F 565688 | 02.04 | 09.07 | + Sportpaket / + Sportpaket AMG <sup>2)</sup> |                |        |   |  |  |
|  | C 240                |     | A 660226 / F 565688 | 03.01 | 09.07 | + Sportpaket / + Sportpaket AMG <sup>2)</sup> |                |        |   |  |  |
|  | C 270 CDI            |     | A 660226 / F 565688 | 03.01 | 09.07 | + Sportpaket / + Sportpaket AMG <sup>2)</sup> |                |        |   |  |  |
|  | C 320                |     | A 660226 / F 565688 | 03.01 | 09.07 | + Sportpaket / + Sportpaket AMG <sup>2)</sup> |                |        |   |  |  |
|  | C 30 CDI AMG         |     |                     | 01.03 | 09.07 |   | 13.0460-4990.2 | 604990 | 2 |  | 23745 17,4 +/WE(1,8/7) BRE<br>23745 17,4 +/WE(1,8/7) BRE<br>Warnkontakt L=97,5mm<br>Belagsatz-Zubehör<br>Belagsatz-Zubehör BRE |
|  | C 320 CDI            |     |                     | 02.05 | 09.07 | + Sportpaket / + Sportpaket AMG <sup>2)</sup> | 13.0470-4990.2 | LD4990 |   |  |  |
|  | C 350                |     |                     | 06.05 | 09.07 | + Sportpaket / + Sportpaket AMG <sup>2)</sup> | 24.8190-0410.2 | 620410 |   |  |  |
|  | C 350 4-matic        |     |                     | 06.05 | 09.07 |   | 13.0460-0269.2 | 610269 |   |  |  |
|  |                      |     |                     | 06.05 | 09.07 |   | 13.0460-0237.2 | 610237 |   |  |  |
|  | C 180 Kompressor     | 90  | A 660227 / F 565689 | 09.07 | 09.07 | + Sportpaket / + Sportpaket AMG <sup>2)</sup> | 13.0460-4994.2 | 604994 | 2 |  | 23945 16,5 /WE BRE<br>23945 16,5 /WE BRE<br>Warnkontakt L=97,5mm   |
|  | C 200 CDI            |     | A 660227 / F 565689 | 09.07 | 09.07 | + Sportpaket / + Sportpaket AMG <sup>2)</sup> | 13.0470-4994.2 | LD4994 |   |  |  |
|  | C 200 CGI Kompressor |     | A 660227 / F 565689 | 09.07 | 09.07 | + Sportpaket / + Sportpaket AMG <sup>2)</sup> | 24.8190-0410.2 | 620410 |   |  |  |
|  | C 200 Kompressor     |     | A 660227 / F 565689 | 09.07 | 09.07 | + Sportpaket / + Sportpaket AMG <sup>2)</sup> |                |        |   |  |  |
|  | C 220 CDI            | 110 | A 660227 / F 565689 | 09.07 | 09.07 | + Sportpaket / + Sportpaket AMG <sup>2)</sup> |                |        |   |  |  |
|  | C 230                |     |                     | 06.05 | 09.07 | + Sportpaket / + Sportpaket AMG <sup>2)</sup> |                |        |   |  |  |
|  | C 230 Kompressor     |     |                     | 02.04 | 09.07 | + Sportpaket / + Sportpaket AMG <sup>2)</sup> |                |        |   |  |  |
|  | C 240                |     | A 660227 / F 565689 | 09.07 | 09.07 | + Sportpaket / + Sportpaket AMG <sup>2)</sup> |                |        |   |  |  |
|  | C 270 CDI            |     | A 660227 / F 565689 | 09.07 | 09.07 | + Sportpaket / + Sportpaket AMG <sup>2)</sup> |                |        |   |  |  |
|  | C 280                |     |                     | 06.05 | 09.07 | + Sportpaket / + Sportpaket AMG <sup>2)</sup> |                |        |   |  |  |
|  | C 280 4-matic        |     |                     | 06.05 | 09.07 | + Sportpaket / + Sportpaket AMG <sup>2)</sup> |                |        |   |  |  |
|  | C 320                |     | A 660227 / F 565689 | 02.05 | 09.07 | - Sportpaket / - Sportpaket AMG <sup>1)</sup> |                |        |   |  |  |
|  | C 350                |     |                     | 06.05 | 09.07 | - Sportpaket / - Sportpaket AMG <sup>1)</sup> |                |        |   |  |  |
|  | C 230                |     |                     | 06.05 | 09.07 | - Sportpaket / - Sportpaket AMG <sup>1)</sup> | 13.0460-2727.2 | 602727 | 2 |  | 23144 19,8 +/WE/Zub/STRW<br>Warnkontakt L=97,5mm   |
|  | C 230 Kompressor     |     |                     | 02.04 | 09.07 | - Sportpaket / - Sportpaket AMG <sup>1)</sup> | 13.0470-2727.2 | LD2727 |   |  |  |
|  | C 240                |     |                     | 03.01 | 09.07 | - Sportpaket / - Sportpaket AMG <sup>1)</sup> | 24.8190-0410.2 | 620410 |   |  |  |
|  | C 240 4-matic        |     |                     | 07.02 | 09.07 | - Sportpaket / - Sportpaket AMG <sup>1)</sup> |                |        |   |  |  |
|  | C 270 CDI            |     |                     | 03.01 | 09.07 | - Sportpaket / - Sportpaket AMG <sup>1)</sup> |                |        |   |  |  |
|  | C 280                |     |                     | 06.05 | 09.07 | - Sportpaket / - Sportpaket AMG <sup>1)</sup> |                |        |   |  |  |
|  | C 280 4-matic        |     |                     | 06.05 | 09.07 | - Sportpaket / - Sportpaket AMG <sup>1)</sup> |                |        |   |  |  |
|  | C 320                |     |                     | 03.01 | 09.07 | - Sportpaket / - Sportpaket AMG <sup>1)</sup> |                |        |   |  |  |
|  | C 320 4-matic        |     |                     | 07.02 | 09.07 |   |                |        |   |  |  |
|  | C 32 Kompressor AMG  |     |                     | 03.01 | 09.07 |   | 13.0460-4990.2 | 604990 | 2 |  | 23745 17,4 +/WE(1,8/7) BRE<br>Warnkontakt L=97,5mm<br>Belagsatz-Zubehör<br>Belagsatz-Zubehör BRE                               |
|  | C 55 AMG             |     |                     | 02.04 | 09.07 |   | 24.8190-0410.2 | 620410 |   |  |  |
|  |                      |     |                     |       |       |   | 13.0460-0269.2 | 610269 |   |  |  |
|  |                      |     |                     |       |       |   | 13.0460-0237.2 | 610237 |   |  |  |
|  | C 180                |     |                     | 03.01 | 09.07 |   | 24.0125-0110.1 | 425110 |   |  | 288 25,0 22,4 V L +S +B<br>288 25,0 22,4 V L +S +B PD  |
|  | C 180 Kompressor     |     |                     | 05.02 | 09.07 | - Sportpaket / - Sportpaket AMG <sup>1)</sup> | 24.0325-0110.1 | 525110 |   |  |  |
|  | C 200 CDI            | 90  |                     | 03.01 | 09.07 | - Sportpaket / - Sportpaket AMG <sup>1)</sup> |                |        |   |  |  |
|  | C 200 CDI            |     |                     | 04.03 | 09.07 | - Sportpaket / - Sportpaket AMG <sup>1)</sup> |                |        |   |  |  |
|  | C 200 CGI Kompressor |     |                     | 07.03 | 09.07 | - Sportpaket / - Sportpaket AMG <sup>1)</sup> |                |        |   |  |  |
|  | C 200 Kompressor     | 120 |                     | 05.02 | 09.07 | - Sportpaket / - Sportpaket AMG <sup>1)</sup> |                |        |   |  |  |
|  | C 200 Kompressor     |     |                     | 03.01 | 04.02 |   |                |        |   |  |  |
|  | C 220 CDI            | 110 |                     | 03.01 | 09.07 | - Sportpaket / - Sportpaket AMG <sup>1)</sup> |                |        |   |  |  |
|  | C 220 CDI            |     |                     | 02.04 | 09.07 | - Sportpaket / - Sportpaket AMG <sup>1)</sup> |                |        |   |  |  |
|  | C 180 Kompressor     |     |                     | 05.02 | 09.07 | + Sportpaket / + Sportpaket AMG <sup>2)</sup> | 24.0128-0177.1 | 428177 |   |  | 330 28,0 26,0 V L +B   |
|  | C 200 CDI            | 90  |                     | 03.01 | 09.07 | + Sportpaket / + Sportpaket AMG <sup>2)</sup> |                |        |   |  |  |
|  | C 200 CDI            |     |                     | 04.03 | 09.07 | + Sportpaket / + Sportpaket AMG <sup>2)</sup> |                |        |   |  |  |
|  | C 200 CGI Kompressor |     |                     | 07.03 | 09.07 | + Sportpaket / + Sportpaket AMG <sup>2)</sup> |                |        |   |  |  |
|  | C 200 Kompressor     |     |                     | 05.02 | 09.07 | + Sportpaket / + Sportpaket AMG <sup>2)</sup> |                |        |   |  |  |
|  | C 220 CDI            | 110 |                     | 03.01 | 09.07 | + Sportpaket / + Sportpaket AMG <sup>2)</sup> |                |        |   |  |  |
|  | C 220 CDI            |     |                     | 02.04 | 09.07 | + Sportpaket / + Sportpaket AMG <sup>2)</sup> |                |        |   |  |  |
|  | C 230                |     |                     | 06.05 | 09.07 | + Sportpaket / + Sportpaket AMG <sup>2)</sup> |                |        |   |  |  |
|  | C 230 Kompressor     |     |                     | 02.04 | 09.07 | + Sportpaket / + Sportpaket AMG <sup>2)</sup> |                |        |   |  |  |
|  | C 240                |     |                     | 03.01 | 09.07 | + Sportpaket / + Sportpaket AMG <sup>2)</sup> |                |        |   |  |  |
|  | C 270 CDI            |     |                     | 03.01 | 09.07 | + Sportpaket / + Sportpaket AMG <sup>2)</sup> |                |        |   |  |  |
|  | C 280                |     |                     | 06.05 | 09.07 | + Sportpaket / + Sportpaket AMG <sup>2)</sup> |                |        |   |  |  |
|  | C 280 4-matic        |     |                     | 06.05 | 09.07 | + Sportpaket / + Sportpaket AMG <sup>2)</sup> |                |        |   |  |  |
|  | C 320                |     |                     | 03.01 | 09.07 | + Sportpaket / + Sportpaket AMG <sup>2)</sup> |                |        |   |  |  |
|  | C 320                |     |                     | 03.01 | 09.07 | + Sportpaket / + Sportpaket AMG <sup>2)</sup> |                |        |   |  |  |
|  | C 230                |     |                     | 06.05 | 09.07 | - Sportpaket / - Sportpaket AMG <sup>1)</sup> | 24.0128-0106.1 | 428106 |   |  | 300 28,0 25,4 V L +S +B<br>300 28,0 25,4 V L +S +B PD  |
|  | C 230 Kompressor     |     |                     | 02.04 | 09.07 | - Sportpaket / - Sportpaket AMG <sup>1)</sup> | 24.0328-0106.1 | 528106 |   |  |  |
|  | C 240                |     |                     | 03.01 | 09.07 | - Sportpaket / - Sportpaket AMG <sup>1)</sup> |                |        |   |  |  |
|  | C 240 4-matic        |     |                     | 07.02 | 09.07 |   |                |        |   |  |  |
|  | C 270 CDI            |     |                     | 03.01 | 09.07 | - Sportpaket / - Sportpaket AMG <sup>1)</sup> |                |        |   |  |  |
|  | C 280                |     |                     | 06.05 | 09.07 | - Sportpaket / - Sportpaket AMG <sup>1)</sup> |                |        |   |  |  |
|  | C 280 4-matic        |     |                     | 06.05 | 09.07 | - Sportpaket / - Sportpaket AMG <sup>1)</sup> |                |        |   |  |  |
|  | C 320                |     |                     | 03.01 | 09.07 | - Sportpaket / - Sportpaket AMG <sup>1)</sup> |                |        |   |  |  |
|  | C 320 4-matic        |     |                     | 07.02 | 09.07 |   |                |        |   |  |  |
|  | C 30 CDI AMG         |     |                     | 01.03 | 09.07 |   | 24.0130-0180.1 | 430180 |   |  | 345 30,0 28,0 V L +B   |
|  | C 32 Kompressor AMG  |     |                     | 03.01 | 09.07 |   |                |        |   |  |  |
|  | C 320 CDI            |     |                     | 02.05 | 09.07 | + Sportpaket / + Sportpaket AMG <sup>2)</sup> |                |        |   |  |  |
|  | C 350                |     |                     | 06.05 | 09.07 | + Sportpaket / + Sportpaket AMG <sup>2)</sup> |                |        |   |  |  |
|  | C 350 4-matic        |     |                     | 06.05 | 09.07 | + Sportpaket / + Sportpaket AMG <sup>2)</sup> |                |        |   |  |  |
|  | C 55 AMG             |     |                     | 02.04 | 09.07 |   |                |        |   |  |  |
|  | C 320 CDI            |     |                     | 02.05 | 09.07 | - Sportpaket / - Sportpaket AMG <sup>1)</sup> | 24.0128-0188.1 | 428188 |   |  | 330 28,0 26,0 V L +S +B  |
|  | C 350                |     |                     | 06.05 | 09.07 | - Sportpaket / - Sportpaket AMG <sup>1)</sup> |                |        |   |  |  |

<sup>1)</sup> - sport package/- sport package AMG / - pacchetto sportivo/- pacchetto sport.AMG / - version sport/- version sport AMG / - kit deportivo/- kit deportivo AMG  
<sup>2)</sup> + sports package/+ sports package AMG / + pacchetto sportivo/+ pacchetto sport.AMG / + version sport/+ version sport AMG / + kit deportivo/+ kit deportivo AMG





**MERCEDES BENZ C-Klasse (S203) Kombi (01-07)**

|  |                      |     |       |       |   |                |        |   |                               |
|--|----------------------|-----|-------|-------|---|----------------|--------|---|-------------------------------|
|  | C 350 4-matic        |     | 06.05 | 09.07 | - Sportpaket / - Sportpaket AMG <sup>1)</sup> | 24.0130-0171.1 | 430171 |   | 345 30,0 27,4 V L +B          |
|  | C 180                |     | 03.01 | 09.07 |   | 24.0711-6001.3 | 360119 | 2 | Radsensor L=565               |
|  | C 180 Kompressor     |     | 05.02 | 09.07 |   |                |        |   |                               |
|  | C 200 CDI            | 90  | 03.01 | 09.07 |   |                |        |   |                               |
|  | C 200 CDI            |     | 04.03 | 09.07 |   |                |        |   |                               |
|  | C 200 CGI Kompressor |     | 07.03 | 09.07 |   |                |        |   |                               |
|  | C 200 Kompressor     |     | 05.02 | 09.07 |   |                |        |   |                               |
|  | C 200 Kompressor     | 120 | 03.01 | 04.02 |   |                |        |   |                               |
|  | C 220 CDI            |     | 03.01 | 09.07 |   |                |        |   |                               |
|  | C 220 CDI            | 110 | 02.04 | 09.07 |   |                |        |   |                               |
|  | C 230                |     | 06.05 | 09.07 |   |                |        |   |                               |
|  | C 230 Kompressor     |     | 02.04 | 09.07 |   |                |        |   |                               |
|  | C 240                |     | 03.01 | 09.07 |   |                |        |   |                               |
|  | C 270 CDI            |     | 03.01 | 09.07 |   |                |        |   |                               |
|  | C 280                |     | 06.05 | 09.07 |   |                |        |   |                               |
|  | C 30 CDI AMG         |     | 01.03 | 09.07 |   |                |        |   |                               |
|  | C 32 Kompressor AMG  |     | 03.01 | 09.07 |   |                |        |   |                               |
|  | C 320                |     | 03.01 | 09.07 |   |                |        |   |                               |
|  | C 320 CDI            |     | 02.05 | 09.07 |   |                |        |   |                               |
|  | C 350                |     | 06.05 | 09.07 |   |                |        |   |                               |
|  | C 55 AMG             |     | 02.04 | 09.07 |   |                |        |   |                               |
|  | C 240 4-matic        |     | 07.02 | 09.07 |   | 24.0711-6073.3 | 360083 | 2 | Radsensor L=666               |
|  | C 280 4-matic        |     | 06.05 | 09.07 |   |                |        |   |                               |
|  | C 320 4-matic        |     | 07.02 | 09.07 |   |                |        |   |                               |
|  | C 350 4-matic        |     | 06.05 | 09.07 |   |                |        |   |                               |
|  | C 180                |     | 03.01 | 09.07 |   | 13.0460-4065.2 | 604065 |   | 21899 15,3 /WE/Zub <b>ATE</b> |
|  | C 180 Kompressor     |     | 05.02 | 09.07 |   | 13.0470-4065.2 | LD4065 |   | 21899 15,3 /WE/Zub <b>ATE</b> |
|  | C 200 CDI            | 90  | 03.01 | 09.07 |   | 13.0460-0231.2 | 610231 |   | Belagsatz-Zubehör <b>ATE</b>  |
|  | C 200 CDI            |     | 04.03 | 09.07 |   | 24.8190-0410.2 | 620410 | 1 | Warnkontakt L=97,5mm          |
|  | C 200 CGI Kompressor |     | 07.03 | 09.07 |   |                |        |   |                               |
|  | C 200 Kompressor     |     | 05.02 | 09.07 |   |                |        |   |                               |
|  | C 200 Kompressor     | 120 | 03.01 | 04.02 |   |                |        |   |                               |
|  | C 220 CDI            |     | 03.01 | 09.07 |   |                |        |   |                               |
|  | C 220 CDI            | 110 | 02.04 | 09.07 |   |                |        |   |                               |
|  | C 230                |     | 06.05 | 09.07 |   |                |        |   |                               |
|  | C 230 Kompressor     |     | 02.04 | 09.07 |   |                |        |   |                               |
|  | C 240                |     | 03.01 | 09.07 |   |                |        |   |                               |
|  | C 240 4-matic        |     | 07.02 | 09.07 |   |                |        |   |                               |
|  | C 270 CDI            |     | 03.01 | 09.07 |   |                |        |   |                               |
|  | C 280                |     | 06.05 | 09.07 |   |                |        |   |                               |
|  | C 280 4-matic        |     | 06.05 | 09.07 |   |                |        |   |                               |
|  | C 320                |     | 03.01 | 09.07 |   |                |        |   |                               |
|  | C 320 4-matic        |     | 07.02 | 09.07 |   |                |        |   |                               |
|  | C 320 CDI            |     | 02.05 | 09.07 |   |                |        |   |                               |
|  | C 350                |     | 06.05 | 09.07 |   |                |        |   |                               |
|  | C 350 4-matic        |     | 06.05 | 09.07 | + Sportpaket / + Sportpaket AMG <sup>2)</sup> |                |        |   |                               |
|  | C 30 CDI AMG         |     | 01.03 | 09.07 |   | 13.0460-4047.2 | 604047 |   | 21305 15,7 /WE <b>ATE</b>     |
|  | C 32 Kompressor AMG  |     | 03.01 | 09.07 |   | 13.0470-4047.2 | LD4047 |   | 21305 15,7 /WE <b>ATE</b>     |
|  | C 350 4-matic        |     | 06.05 | 09.07 | - Sportpaket / - Sportpaket AMG <sup>1)</sup> | 13.0460-0236.2 | 610236 |   | Belagsatz-Zubehör <b>ATE</b>  |
|  | C 55 AMG             |     | 02.04 | 09.07 |   | 24.8190-0410.2 | 620410 | 1 | Warnkontakt L=97,5mm          |
|  | C 180                |     | 03.01 | 09.07 |   | 24.0110-0217.1 | 410217 |   | 290 10,0 8,3 +S +B            |
|  | C 180 Kompressor     |     | 05.02 | 09.07 |   | 24.0310-0217.1 | 510217 |   | 290 10,0 8,3 +S +B PD         |
|  | C 200 CDI            | 90  | 03.01 | 09.07 |   |                |        |   |                               |
|  | C 200 CDI            |     | 04.03 | 09.07 |   |                |        |   |                               |
|  | C 200 CGI Kompressor |     | 07.03 | 09.07 |   |                |        |   |                               |
|  | C 200 Kompressor     |     | 05.02 | 09.07 |   |                |        |   |                               |
|  | C 200 Kompressor     | 120 | 03.01 | 04.02 |   |                |        |   |                               |
|  | C 220 CDI            |     | 03.01 | 09.07 |   |                |        |   |                               |
|  | C 220 CDI            | 110 | 02.04 | 09.07 |   |                |        |   |                               |
|  | C 230                |     | 06.05 | 09.07 |   |                |        |   |                               |
|  | C 230 Kompressor     |     | 02.04 | 09.07 |   |                |        |   |                               |
|  | C 240                |     | 03.01 | 09.07 |   |                |        |   |                               |
|  | C 240 4-matic        |     | 07.02 | 09.07 |   |                |        |   |                               |
|  | C 270 CDI            |     | 03.01 | 09.07 |   |                |        |   |                               |
|  | C 280                |     | 06.05 | 09.07 |   |                |        |   |                               |
|  | C 280 4-matic        |     | 06.05 | 09.07 |   |                |        |   |                               |
|  | C 320                |     | 03.01 | 09.07 |   |                |        |   |                               |
|  | C 320 4-matic        |     | 07.02 | 09.07 |   |                |        |   |                               |
|  | C 320 CDI            |     | 02.05 | 09.07 |   |                |        |   |                               |
|  | C 350                |     | 06.05 | 09.07 |   |                |        |   |                               |
|  | C 30 CDI AMG         |     | 01.03 | 09.07 |   | 24.0122-0228.1 | 422228 |   | 300 22,0 19,4 V L +B          |
|  | C 32 Kompressor AMG  |     | 03.01 | 09.07 |   |                |        |   |                               |
|  | C 350 4-matic        |     | 06.05 | 09.07 |   |                |        |   |                               |
|  | C 55 AMG             |     | 02.04 | 09.07 |   |                |        |   |                               |
|  | C 180                |     | 03.01 | 09.07 |   | 24.0711-6054.3 | 360184 |   | Radsensor L=1102              |
|  | C 180 Kompressor     |     | 05.02 | 09.07 |   | 24.0711-6053.3 | 360183 |   | Radsensor L=948               |
|  | C 200 CDI            | 90  | 03.01 | 09.07 |   |                |        |   |                               |
|  | C 200 CDI            |     | 04.03 | 09.07 |   |                |        |   |                               |
|  | C 200 CGI Kompressor |     | 07.03 | 09.07 |   |                |        |   |                               |
|  | C 200 Kompressor     |     | 05.02 | 09.07 |   |                |        |   |                               |
|  | C 200 Kompressor     | 120 | 03.01 | 04.02 |   |                |        |   |                               |
|  | C 220 CDI            |     | 03.01 | 09.07 |   |                |        |   |                               |
|  | C 220 CDI            | 110 | 02.04 | 09.07 |   |                |        |   |                               |
|  | C 230                |     | 06.05 | 09.07 |   |                |        |   |                               |

<sup>1)</sup> - sport package/- sport package AMG / - pacchetto sportivo/- pacchetto sport.AMG / - version sport/- version sport AMG / - kit deportivo/- kit deportivo AMG

<sup>2)</sup> + sports package/+ sports package AMG / + pacchetto sportivo/+ pacchetto sport.AMG / + version sport/+ version sport AMG / + kit deportivo/+ kit deportivo AMG

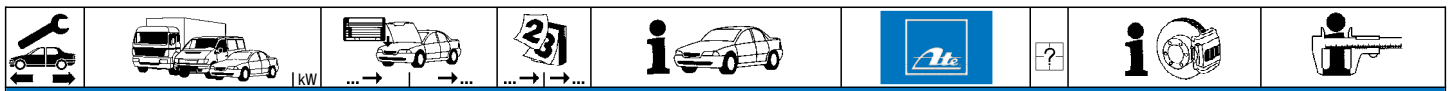

**MERCEDES BENZ C-Klasse (S203) Kombi (01-07)**

|  |                      |     |       |       |                |        |  |  |                                      |
|--|----------------------|-----|-------|-------|----------------|--------|--|--|--------------------------------------|
|  | C 230 Kompressor     |     | 02.04 | 09.07 | 24.0711-6054.3 | 360184 |  |  | Radsensor L=1102<br>Radsensor L=948  |
|  | C 240                |     | 03.01 | 09.07 | 24.0711-6053.3 | 360183 |  |  |                                      |
|  | C 240 4-matic        |     | 07.02 | 09.07 |                |        |  |  |                                      |
|  | C 270 CDI            |     | 03.01 | 09.07 |                |        |  |  |                                      |
|  | C 280                |     | 06.05 | 09.07 |                |        |  |  |                                      |
|  | C 280 4-matic        |     | 06.05 | 09.07 |                |        |  |  |                                      |
|  | C 30 CDI AMG         |     | 01.03 | 09.07 |                |        |  |  |                                      |
|  | C 32 Kompressor AMG  |     | 03.01 | 09.07 |                |        |  |  |                                      |
|  | C 320                |     | 03.01 | 09.07 |                |        |  |  |                                      |
|  | C 320 4-matic        |     | 07.02 | 09.07 |                |        |  |  |                                      |
|  | C 320 CDI            |     | 02.05 | 09.07 |                |        |  |  |                                      |
|  | C 350                |     | 06.05 | 09.07 |                |        |  |  |                                      |
|  | C 350 4-matic        |     | 06.05 | 09.07 |                |        |  |  |                                      |
|  | C 55 AMG             |     | 02.04 | 09.07 |                |        |  |  |                                      |
|  | C 180                |     | 03.01 | 09.07 | 03.0137-4013.2 | 654013 |  |  | 164 x 20 /Zub<br>Bremsbacken-Zubehör |
|  | C 180 Kompressor     |     | 05.02 | 09.07 | 03.0137-9248.2 | 669248 |  |  |                                      |
|  | C 200 CDI            |     | 03.01 | 09.07 |                |        |  |  |                                      |
|  | C 200 CDI            | 90  | 04.03 | 09.07 |                |        |  |  |                                      |
|  | C 200 CGI Kompressor |     | 07.03 | 09.07 |                |        |  |  |                                      |
|  | C 200 Kompressor     |     | 05.02 | 09.07 |                |        |  |  |                                      |
|  | C 200 Kompressor     | 120 | 03.01 | 04.02 |                |        |  |  |                                      |
|  | C 220 CDI            |     | 03.01 | 09.07 |                |        |  |  |                                      |
|  | C 220 CDI            | 110 | 02.04 | 09.07 |                |        |  |  |                                      |
|  | C 230                |     | 06.05 | 09.07 |                |        |  |  |                                      |
|  | C 230 Kompressor     |     | 02.04 | 09.07 |                |        |  |  |                                      |
|  | C 240                |     | 03.01 | 09.07 |                |        |  |  |                                      |
|  | C 240 4-matic        |     | 07.02 | 09.07 |                |        |  |  |                                      |
|  | C 270 CDI            |     | 03.01 | 09.07 |                |        |  |  |                                      |
|  | C 280                |     | 06.05 | 09.07 |                |        |  |  |                                      |
|  | C 280 4-matic        |     | 06.05 | 09.07 |                |        |  |  |                                      |
|  | C 30 CDI AMG         |     | 01.03 | 09.07 |                |        |  |  |                                      |
|  | C 32 Kompressor AMG  |     | 03.01 | 09.07 |                |        |  |  |                                      |
|  | C 320                |     | 03.01 | 09.07 |                |        |  |  |                                      |
|  | C 320 4-matic        |     | 07.02 | 09.07 |                |        |  |  |                                      |
|  | C 320 CDI            |     | 02.05 | 09.07 |                |        |  |  |                                      |
|  | C 350                |     | 06.05 | 09.07 |                |        |  |  |                                      |
|  | C 350 4-matic        |     | 06.05 | 09.07 |                |        |  |  |                                      |
|  | C 55 AMG             |     | 02.04 | 09.07 |                |        |  |  |                                      |

**MERCEDES BENZ C-Klasse (CL203) Sportcoupe (01-08)**

|                  |                      |       |       |                |                |        |                            |  |  |   |                            |  |
|------------------|----------------------|-------|-------|----------------|----------------|--------|----------------------------|--|--|---|----------------------------|--|
|                  | C 160 Kompressor     |       | 04.05 | 05.08          | 13.0460-2726.2 | 602726 | 1                          |  | 23144 19,8 +/WE/Zub/STRW<br>23144 19,8 +/WE/Zub/STRW<br>Warnkontakt L=97,5mm |   |                            |  |
|                  | C 180                |       | 03.01 | 05.08          | 13.0470-2726.2 | LD2726 |                            |  |  |   |                            |  |
|                  | C 180 Kompressor     |       | 05.02 | 05.08          | 24.8190-0410.2 | 620410 |                            |  |  |   |                            |  |
|                  | C 200 CDI            |       | 07.03 | 05.08          |                |        |                            |  |  |   |                            |  |
|                  | C 200 CGI Kompressor |       | 07.03 | 05.08          |                |        |                            |  |  |   |                            |  |
|                  | C 200 Kompressor     |       | 03.01 | 05.08          |                |        |                            |  |  |   |                            |  |
|                  | C 220                |       | 05.02 | 05.08          |                |        |                            |  |  |   |                            |  |
|                  | C 220 CDI            |       | 03.01 | 05.08          |                |        |                            |  |  |   |                            |  |
|                  | C 230 Kompressor     |       | 03.01 | 05.08          | 13.0460-2727.2 | 602727 |                            |  |  | 2 | + AUS J USA<br>+ AUS J USA | 23144 19,8 +/WE/Zub/STRW<br>23144 19,8 +/WE/Zub/STRW<br>23144 19,8 +/WE/Zub/STRW<br>23144 19,8 +/WE/Zub/STRW<br>Warnkontakt L=97,5mm |
|                  | C 230                |       | 06.05 | 05.08          | 13.0470-2727.2 | LD2727 |                            |  |  |   |                            |  |
| C 320            |                      | 09.02 | 05.08 | 13.0470-2727.2 | LD2727         | 2      |                            | 23144 19,8 +/WE/Zub/STRW<br>23144 19,8 +/WE/Zub/STRW<br>Warnkontakt L=97,5mm                                   |  |   |                            |  |
| C 350            |                      | 06.05 | 05.08 | 13.0460-4994.2 | 604994         | 1      |                            | 23945 16,5 /WE BRE<br>23945 16,5 /WE BRE<br>Warnkontakt L=97,5mm   |  |   |                            |  |
| C 30 CDI AMG     |                      | 09.02 | 05.08 | 13.0470-4994.2 | LD4994         |        |                            |  |  |   |                            |  |
|                  |                      |       |       | 24.8190-0410.2 | 620410         |        |                            |  |  |   |                            |  |
|                  |                      |       |       | 13.0460-4990.2 | 604990         | 1      |                            | 23745 17,4 +/WE(1,8/7) BRE<br>23745 17,4 +/WE(1,8/7) BRE<br>Belagsatz-Zubehör<br>Warnkontakt L=97,5mm          |  |   |                            |  |
|                  |                      |       |       | 13.0470-4990.2 | LD4990         |        |                            |  |  |   |                            |  |
|                  |                      |       |       | 13.0460-0275.2 | 610275         |        |                            |  |  |   |                            |  |
|                  |                      |       |       | 24.8190-0410.2 | 620410         |        |                            |  |  |   |                            |  |
|                  | C 160 Kompressor     |       | 04.05 | 05.08          | 24.0125-0110.1 | 425110 |                            |  | 288 25,0 22,4 V L +S +B<br>288 25,0 22,4 V L +S +B PD                        |   |                            |  |
|                  | C 180                |       | 03.01 | 05.08          | 24.0325-0110.1 | 525110 |                            |  |  |   |                            |  |
|                  | C 180 Kompressor     |       | 05.02 | 05.08          |                |        |                            |  |  |   |                            |  |
|                  | C 200 CDI            |       | 07.03 | 05.08          |                |        |                            |  |  |   |                            |  |
|                  | C 200 CGI Kompressor |       | 07.03 | 05.08          |                |        |                            |  |  |   |                            |  |
|                  | C 200 Kompressor     |       | 03.01 | 05.08          |                |        |                            |  |  |   |                            |  |
|                  | C 220                |       | 05.02 | 05.08          |                |        |                            |  |  |   |                            |  |
|                  | C 220 CDI            |       | 03.01 | 05.08          |                |        |                            |  |  |   |                            |  |
|                  | C 230                |       | 06.05 | 05.08          | 24.0128-0106.1 | 428106 |                            |  |  |   |                            | 300 28,0 25,4 V L +S +B<br>300 28,0 25,4 V L +S +B PD  |
|                  | C 320                |       | 09.02 | 05.08          | 24.0328-0106.1 | 528106 |                            |  |  |   |                            |  |
| C 350            |                      | 06.05 | 05.08 | 24.0128-0188.1 | 428188         |        |                            | 330 28,0 26,0 V L +S +B  |  |   |                            |  |
| C 30 CDI AMG     |                      | 09.02 | 05.08 | 24.0130-0180.1 | 430180         |        |                            | 345 30,0 28,0 V L +B   |  |   |                            |  |
| C 230 Kompressor |                      | 03.01 | 05.08 | 24.0128-0106.1 | 428106         |        | + AUS J USA<br>+ AUS J USA | 300 28,0 25,4 V L +S +B<br>300 28,0 25,4 V L +S +B PD<br>288 25,0 22,4 V L +S +B<br>288 25,0 22,4 V L +S +B PD |  |   |                            |  |
|                  |                      |       |       | 24.0328-0106.1 | 528106         |        |                            |  |  |   |                            |  |
|                  |                      |       |       | 24.0125-0110.1 | 425110         |        |                            |  |  |   |                            |  |
|                  |                      |       |       | 24.0325-0110.1 | 525110         |        |                            |  |  |   |                            |  |
|                  | C 160 Kompressor     |       | 04.05 | 05.08          | 24.0711-6001.3 | 360119 | 2                          |  | Radsensor L=565  |   |                            |  |
|                  | C 180                |       | 03.01 | 05.08          |                |        |                            |  |  |   |                            |  |
|                  | C 180 Kompressor     |       | 05.02 | 05.08          |                |        |                            |  |  |   |                            |  |
|                  | C 200 CDI            |       | 07.03 | 05.08          |                |        |                            |  |  |   |                            |  |
|                  | C 200 CGI Kompressor |       | 07.03 | 05.08          |                |        |                            |  |  |   |                            |  |
|                  | C 200 Kompressor     |       | 03.01 | 05.08          |                |        |                            |  |  |   |                            |  |
|                  | C 220                |       | 05.02 | 05.08          |                |        |                            |  |  |   |                            |  |





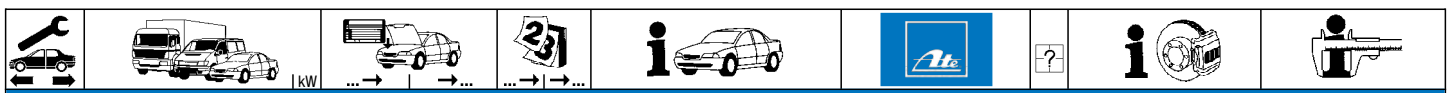

**MERCEDES BENZ C-Klasse (CLC203) Coupe (08-10)**

|  |   |  |  |   |   |  |  |  |   |  |   |  |
|--|---|--|--|---|---|--|--|--|---|--|---|--|
|  | CLC 350   |  |  | 05.08   | 10.10   |  |  | 13.0460-4994.2 604994<br>13.0470-4994.2 LD4994<br>24.8190-0410.2 620410                          | 1 |  | 23945 16,5 /WE<br>23945 16,5 /WE<br>Warnkontakt L=97,5mm                              | <b>BRE</b><br><b>BRE</b>               |
|  | CLC 160<br>CLC 180 Kompressor<br>CLC 200 CDI<br>CLC 220 CDI   |  |  | 01.09<br>05.08<br>05.08<br>05.08                            | 10.10<br>10.10<br>10.10<br>10.10                            |  |  | 24.0125-0110.1 425110<br>24.0325-0110.1 525110   |   |  | 288 25,0 22,4 V L +S +B<br>288 25,0 22,4 V L +S +B PD                                 |  |
|  | CLC 200 Kompressor<br>CLC 230<br>CLC 350  |  |  | 05.08<br>05.08<br>05.08                                     | 10.10<br>10.10<br>10.10                                     |  |  | 24.0128-0106.1 428106<br>24.0328-0106.1 528106<br>24.0128-0188.1 428188                          |   |  | 300 28,0 25,4 V L +S +B<br>300 28,0 25,4 V L +S +B PD<br>330 28,0 26,0 V L +S +B      |  |
|  | CLC 160<br>CLC 180 Kompressor<br>CLC 200 CDI<br>CLC 200 Kompressor<br>CLC 220 CDI<br>CLC 230<br>CLC 350 |  |  | 01.09<br>05.08<br>05.08<br>05.08<br>05.08<br>05.08<br>05.08 | 10.10<br>10.10<br>10.10<br>10.10<br>10.10<br>10.10<br>10.10 |  |  | 24.0711-6001.3 360119  | 2 |  | Radsensor L=565   |  |
|  | CLC 160<br>CLC 180 Kompressor<br>CLC 200 CDI<br>CLC 220 CDI   |  |  | 01.09<br>05.08<br>05.08<br>05.08                            | 10.10<br>10.10<br>10.10<br>10.10                            |  |  | 13.0460-4064.2 604064<br>13.0470-4064.2 LD4064<br>13.0460-0229.2 610229<br>24.8190-0410.2 620410 | 1 |  | 21919 15,3 /Zub<br>21919 15,3 /Zub<br>Belagsatz-Zubehör<br>Warnkontakt L=97,5mm       | <b>ATE</b><br><b>ATE</b><br><b>ATE</b> |
|  | CLC 200 Kompressor<br>CLC 230<br>CLC 350  |  |  | 05.08<br>05.08<br>05.08                                     | 10.10<br>10.10<br>10.10                                     |  |  | 13.0460-4065.2 604065<br>13.0470-4065.2 LD4065<br>13.0460-0231.2 610231<br>24.8190-0410.2 620410 | 1 |  | 21899 15,3 /WE/Zub<br>21899 15,3 /WE/Zub<br>Belagsatz-Zubehör<br>Warnkontakt L=97,5mm | <b>ATE</b><br><b>ATE</b><br><b>ATE</b> |
|  | CLC 160<br>CLC 180 Kompressor<br>CLC 200 CDI<br>CLC 220 CDI   |  |  | 01.09<br>05.08<br>05.08<br>05.08                            | 10.10<br>10.10<br>10.10<br>10.10                            |  |  | 24.0109-0114.1 409114<br>24.0109-0114.1 409114<br>24.0309-0114.1 509114                          |   |  | 278 9,0 7,3 +S +B<br>278 9,0 7,3 +S +B<br>278 9,0 7,3 +S +B PD                        |  |
|  | CLC 200 Kompressor<br>CLC 230<br>CLC 350  |  |  | 05.08<br>05.08<br>05.08                                     | 10.10<br>10.10<br>10.10                                     |  |  | 24.0110-0217.1 410217<br>24.0310-0217.1 510217   |   |  | 290 10,0 8,3 +S +B<br>290 10,0 8,3 +S +B PD   |  |
|  | CLC 160<br>CLC 180 Kompressor<br>CLC 200 CDI<br>CLC 200 Kompressor<br>CLC 220 CDI<br>CLC 230<br>CLC 350 |  |  | 01.09<br>05.08<br>05.08<br>05.08<br>05.08<br>05.08<br>05.08 | 10.10<br>10.10<br>10.10<br>10.10<br>10.10<br>10.10<br>10.10 |  |  | 24.0711-6054.3 360184<br>24.0711-6053.3 360183   |   |  | Radsensor L=1102<br>Radsensor L=948   |  |
|  | CLC 160<br>CLC 180 Kompressor<br>CLC 200 CDI<br>CLC 200 Kompressor<br>CLC 220 CDI<br>CLC 230<br>CLC 350 |  |  | 01.09<br>05.08<br>05.08<br>05.08<br>05.08<br>05.08<br>05.08 | 10.10<br>10.10<br>10.10<br>10.10<br>10.10<br>10.10<br>10.10 |  |  | 03.0137-4013.2 654013<br>03.0137-9248.2 669248   |   |  | 164 x 20 /Zub<br>Bremsbacken-Zubehör  |  |

**MERCEDES BENZ C-Klasse (W204) Limousine (07-14)**

|  |                   |     |  |       |       |   |                |        |   |  |                      |            |
|--|-------------------|-----|--|-------|-------|---|----------------|--------|---|--|----------------------|------------|
|  | C 180 CDI         | 88  |  | 01.11 | 01.14 | - Sportpaket / - Sportpaket AMG <sup>1)</sup> | 13.0460-2733.2 | 602733 |   |  | 24306 20,3 /WE/Zub/S | <b>TRW</b> |
|  | C 180 CGI         | 115 |  | 04.09 | 01.14 | - Sportpaket / - Sportpaket AMG <sup>1)</sup> | 13.0470-2733.2 | LD2733 |   |  | 24306 20,3 /WE/Zub/S | <b>TRW</b> |
|  | C 180 Kompressor  | 115 |  | 01.08 | 01.14 | - Sportpaket / - Sportpaket AMG <sup>1)</sup> | 24.8190-0410.2 | 620410 | 1 |  | Warnkontakt L=97,5mm |            |
|  | C 180 Kompressor  | 115 |  | 03.07 | 01.14 | - Sportpaket / - Sportpaket AMG <sup>1)</sup> |                |        |   |  |                      |            |
|  | C 200 CDI         | 100 |  | 01.11 | 01.14 | - Sportpaket / - Sportpaket AMG <sup>1)</sup> |                |        |   |  |                      |            |
|  | C 200 CDI         | 100 |  | 03.07 | 01.14 | - Sportpaket / - Sportpaket AMG <sup>1)</sup> |                |        |   |  |                      |            |
|  | C 180 CDI         | 88  |  | 01.11 | 01.14 | + Sportpaket / + Sportpaket AMG <sup>2)</sup> | 13.0460-2732.2 | 602732 |   |  | 24306 20,3 /WE/Zub/S | <b>TRW</b> |
|  | C 180 CGI         | 115 |  | 04.09 | 01.14 | + Sportpaket / + Sportpaket AMG <sup>2)</sup> | 13.0470-2732.2 | LD2732 |   |  | 24306 20,3 /WE/Zub/S | <b>TRW</b> |
|  | C 180 Kompressor  | 115 |  | 01.08 | 01.14 | + Sportpaket / + Sportpaket AMG <sup>2)</sup> | 13.0470-9000.2 | LD9000 |   |  | 24306 20,3 /WE/Zub/S | <b>TRW</b> |
|  | C 180 Kompressor  | 115 |  | 03.07 | 01.14 | + Sportpaket / + Sportpaket AMG <sup>2)</sup> | 24.8190-0410.2 | 620410 | 1 |  | Warnkontakt L=97,5mm |            |
|  | C 200             | 137 |  | 05.11 | 01.14 |   |                |        |   |  |                      |            |
|  | C 200 CDI         | 100 |  | 01.11 | 01.14 | + Sportpaket / + Sportpaket AMG <sup>2)</sup> |                |        |   |  |                      |            |
|  | C 200 CDI         | 100 |  | 03.07 | 01.14 | + Sportpaket / + Sportpaket AMG <sup>2)</sup> |                |        |   |  |                      |            |
|  | C 200 CGI         | 135 |  | 04.09 | 01.14 |   |                |        |   |  |                      |            |
|  | C 200 Kompressor  | 135 |  | 03.07 | 01.14 |   |                |        |   |  |                      |            |
|  | C 220 CDI         | 120 |  | 03.07 | 01.14 |   |                |        |   |  |                      |            |
|  | C 220 CDI         | 125 |  | 03.07 | 01.14 |   |                |        |   |  |                      |            |
|  | C 220 CDI         | 125 |  | 12.08 | 01.14 |   |                |        |   |  |                      |            |
|  | C 220 CDI 4-matic | 125 |  | 02.13 | 01.14 |   |                |        |   |  |                      |            |
|  | C 230             | 150 |  | 03.07 | 01.14 |   |                |        |   |  |                      |            |
|  | C 230 4-matic     | 150 |  | 07.07 | 01.14 |   |                |        |   |  |                      |            |
|  | C 250 CDI         | 150 |  | 08.08 | 01.14 |   |                |        |   |  |                      |            |
|  | C 250 CDI 4-matic | 150 |  | 01.11 | 01.14 | - Sportpaket / - Sportpaket AMG <sup>1)</sup> |                |        |   |  |                      |            |
|  | C 250 CGI         | 150 |  | 04.09 | 01.14 |   |                |        |   |  |                      |            |
|  | C 280             | 170 |  | 03.07 | 01.14 | - Sportpaket / - Sportpaket AMG <sup>1)</sup> |                |        |   |  |                      |            |
|  | C 280 4-matic     | 170 |  | 07.07 | 01.14 | - Sportpaket / - Sportpaket AMG <sup>1)</sup> |                |        |   |  |                      |            |
|  | C 300             | 170 |  | 07.09 | 01.14 | - Sportpaket / - Sportpaket AMG <sup>1)</sup> |                |        |   |  |                      |            |
|  | C 300 4-matic     | 170 |  | 04.09 | 01.14 | - Sportpaket / - Sportpaket AMG <sup>1)</sup> |                |        |   |  |                      |            |
|  | C 250 CDI 4-matic | 150 |  | 01.11 | 01.14 | + Sportpaket / + Sportpaket AMG <sup>2)</sup> | 13.0460-2734.2 | 602734 |   |  | 24310 19,0 +/WE/S    | <b>TRW</b> |
|  | C 280             | 170 |  | 03.07 | 01.14 | + Sportpaket / + Sportpaket AMG <sup>2)</sup> | 13.0470-2734.2 | LD2734 |   |  | 24310 19,0 + /WE/S   | <b>TRW</b> |
|  | C 280 4-matic     | 170 |  | 07.07 | 01.14 | + Sportpaket / + Sportpaket AMG <sup>2)</sup> | 24.8190-0410.2 | 620410 | 1 |  | Warnkontakt L=97,5mm |            |
|  | C 300             | 170 |  | 07.09 | 01.14 | + Sportpaket / + Sportpaket AMG <sup>2)</sup> |                |        |   |  |                      |            |
|  | C 300 4-matic     | 170 |  | 04.09 | 01.14 | + Sportpaket / + Sportpaket AMG <sup>2)</sup> |                |        |   |  |                      |            |
|  | C 300 CDI 4-matic | 170 |  | 01.11 | 01.14 |   |                |        |   |  |                      |            |
|  | C 300 CGI         | 185 |  | 02.11 | 01.14 |   |                |        |   |  |                      |            |
|  | C 300 CGI 4-matic | 185 |  | 02.11 | 01.14 |   |                |        |   |  |                      |            |
|  | C 320 CDI         | 165 |  | 03.07 | 01.14 |   |                |        |   |  |                      |            |



















<sup>1)</sup> - sport package/- sport package AMG / - pacchetto sportivo/- pacchetto sport.AMG / - version sport/- version sport AMG / - kit deportivo/- kit deportivo AMG  
<sup>2)</sup> + sports package/+ sports package AMG / + pacchetto sportivo/+ pacchetto sport.AMG / + version sport/+ version sport AMG / + kit deportivo/+ kit deportivo AMG









|          |                          |       |       |   |                |   |  |                            |
|--|--------------------------|-------|-------|---|----------------|---|--|----------------------------|
| MERCEDES BENZ C-Klasse (W204) Limousine (07-14)  |                          |       |       |   |                |   |  |                            |
|    | C 350 CDI 4-matic 165    | 07.09 | 01.14 | - Sportpaket / - Sportpaket AMG <sup>1)</sup> | 24.0132-0101.1 | 432101  |  | 322 32,0 29,4 V L +S +B    |
|  | C 350 CDI 4-matic 170    | 10.09 | 01.14 | - Sportpaket / - Sportpaket AMG <sup>1)</sup> | 24.0332-0101.1 | 532101  |  | 322 32,0 29,4 V L +S +B PD |
|  | C 350 CGI 215            | 09.08 | 01.14 | - Sportpaket / - Sportpaket AMG <sup>1)</sup> |                |   |  |                            |
|  | C 63 AMG                 | 09.07 | 01.14 |   | 24.0136-0108.1 | 436108  | - AMG-Performance Package  | 360 36,0 34,0 V L +S +B    |
|    | C 180 CDI 88             | 01.11 | 01.14 |   | 24.0711-6189.3 | 360246  | 2  SA Code: 808/809/800/801 | Radsensor L=618            |
|  | C 180 CGI 115            | 04.09 | 01.14 |   | 24.0711-6390.3 | 360406  | 2  SA Code: 802/803/804/805 | Radsensor L=618            |
|  | C 180 Kompressor 115     | 01.08 | 01.14 |   |                |   |  |                            |
|  | C 180 Kompressor 115     | 03.07 | 01.14 |   |                |   |  |                            |
|  | C 180 Kompressor Eco 115 | 01.09 | 01.14 |   |                |   |  |                            |
|  | C 200 137                | 05.11 | 01.14 |   |                |   |  |                            |
|  | C 200 CDI 100            | 01.11 | 01.14 |   |                |   |  |                            |
|  | C 200 CDI 100            | 03.07 | 01.14 |   |                |   |  |                            |
|  | C 200 CGI 135            | 04.09 | 01.14 |   |                |   |  |                            |
|  | C 200 Kompressor 135     | 03.07 | 01.14 |   |                |   |  |                            |
|  | C 220 CDI 120            | 03.07 | 01.14 |   |                |   |  |                            |
|  | C 220 CDI 125            | 03.07 | 01.14 |   |                |   |  |                            |
|  | C 220 CDI 125            | 12.08 | 01.14 |   |                |   |  |                            |
|  | C 230 150                | 03.07 | 01.14 |   |                |   |  |                            |
|  | C 250 CDI 150            | 10.08 | 01.14 |   |                |   |  |                            |
|  | C 250 CGI 150            | 04.09 | 01.14 |   |                |   |  |                            |
|  | C 280 170                | 03.07 | 01.14 |   |                |   |  |                            |
|  | C 300 170                | 07.09 | 01.14 |   |                |   |  |                            |
|  | C 300 CGI 185            | 02.11 | 01.14 |   |                |   |  |                            |
|  | C 320 CDI 165            | 03.07 | 01.14 |   |                |   |  |                            |
|  | C 350 200                | 03.07 | 01.14 |   |                |   |  |                            |
|  | C 350 225                | 01.11 | 01.14 |   |                |   |  |                            |
|  | C 350 CDI 165            | 04.09 | 01.14 |   |                |   |  |                            |
|  | C 350 CDI 170            | 10.09 | 01.14 |   |                |   |  |                            |
|  | C 350 CDI 195            | 06.11 | 01.14 |   |                |   |  |                            |
|  | C 350 CGI 215            | 09.08 | 01.14 |   |                |   |  |                            |
|  | C 220 CDI 4-matic 125    | 02.13 | 01.14 |   | 24.0711-5330.3 | 360417  | 2                           | Radsensor L=733            |
|  | C 230 4-matic 150        | 07.07 | 01.14 |   |                |   |  |                            |
|  | C 250 CDI 4-matic 150    | 01.11 | 01.14 |   |                |   |  |                            |
|  | C 280 4-matic 170        | 07.07 | 01.14 |   |                |   |  |                            |
|  | C 300 4-matic 170        | 04.09 | 01.14 |   |                |   |  |                            |
|  | C 300 CDI 4-matic 170    | 01.11 | 01.14 |   |                |   |  |                            |
|  | C 300 CGI 4-matic 185    | 02.11 | 01.14 |   |                |   |  |                            |
|  | C 320 CDI 4-matic 165    | 07.07 | 01.14 |   |                |   |  |                            |
|  | C 350 4-matic 200        | 07.07 | 01.14 |   |                |   |  |                            |
| C 350 4-matic 225  | 01.11                    | 01.14 |       |   |                |   |  |                            |
| C 350 CDI 4-matic 165  | 07.09                    | 01.14 |       |   |                |   |  |                            |
| C 350 CDI 4-matic 170  | 10.09                    | 01.14 |       |   |                |   |  |                            |
|    | C 180 CDI 88             | 01.11 | 01.14 |   | 13.0460-7244.2 | 607244  |  | 24253 17,8 +/WE ATE        |
|  | C 180 CGI 115            | 04.09 | 01.14 |   | 13.0470-7244.2 | LD7244  |  | 24253 17,8 +/WE ATE        |
|  | C 180 Kompressor 115     | 01.08 | 01.14 |   | 24.8190-0410.2 | 620410  | 1                         | Warmkontakt L=97,5mm       |
|  | C 180 Kompressor 115     | 03.07 | 01.14 |   |                |   |  |                            |
|  | C 200 137                | 05.11 | 01.14 |   |                |   |  |                            |
|  | C 200 CDI 100            | 01.11 | 01.14 |   |                |   |  |                            |
|  | C 200 CDI 100            | 03.07 | 01.14 |   |                |   |  |                            |
|  | C 200 CGI 135            | 04.09 | 01.14 |   |                |   |  |                            |
|  | C 200 Kompressor 135     | 03.07 | 01.14 |   |                |   |  |                            |
|  | C 220 CDI 120            | 03.07 | 01.14 |   |                |   |  |                            |
|  | C 220 CDI 125            | 03.07 | 01.14 |   |                |   |  |                            |
|  | C 220 CDI 125            | 12.08 | 01.14 |   |                |   |  |                            |
|  | C 220 CDI 4-matic 125    | 02.13 | 01.14 |   |                |   |  |                            |
|  | C 230 150                | 03.07 | 01.14 |   |                |   |  |                            |
|  | C 230 4-matic 150        | 07.07 | 01.14 |   |                |   |  |                            |
|  | C 250 CDI 4-matic 150    | 01.11 | 01.14 |   |                |   |  |                            |
|  | C 250 CGI 150            | 04.09 | 01.14 |   |                |   |  |                            |
|  | C 280 170                | 03.07 | 01.14 |   |                |   |  |                            |
|  | C 280 4-matic 170        | 07.07 | 01.14 |   |                |   |  |                            |
|  | C 300 170                | 07.09 | 01.14 |   |                |   |  |                            |
|  | C 300 4-matic 170        | 04.09 | 01.14 |   |                |   |  |                            |
|  | C 300 CGI 185            | 02.11 | 01.14 |   |                |   |  |                            |
|  | C 300 CGI 4-matic 185    | 02.11 | 01.14 |   |                |   |  |                            |
|  | C 350 225                | 01.11 | 01.14 |   |                |   |  |                            |
|  | C 350 4-matic 200        | 07.07 | 01.14 |   |                |   |  |                            |
|  | C 350 4-matic 225        | 01.11 | 01.14 |   |                |   |  |                            |
|  | C 250 CDI 150            | 08.08 | 01.14 |   | 13.0460-7257.2 | 607257  |  | 24253 18,0 +/WE ATE        |
|  | C 300 CDI 4-matic 170    | 01.11 | 01.14 |   | 13.0470-7257.2 | LD7257  |  | 24253 18,0 +/WE ATE        |
|  | C 320 CDI 165            | 03.07 | 01.14 |   | 13.0460-7244.2 | 607244  |  | 24253 17,8 +/WE ATE        |
|  | C 320 CDI 4-matic 165    | 07.07 | 01.14 |   | 13.0470-7244.2 | LD7244  |  | 24253 17,8 +/WE ATE        |
| C 350 200  | 03.07                    | 01.14 |       | 24.8190-0410.2                                | 620410         | 1  | Warmkontakt L=97,5mm   |                            |
| C 350 4-matic 200  | 07.07                    | 01.14 |       |   |                |   |  |                            |
| C 350 CDI 165  | 04.09                    | 01.14 |       |   |                |   |  |                            |
| C 350 CDI 170  | 10.09                    | 01.14 |       |   |                |   |  |                            |
| C 350 CDI 195  | 06.11                    | 01.14 |       |   |                |   |  |                            |
| C 350 CDI 4-matic 165  | 07.09                    | 01.14 |       |   |                |   |  |                            |
| C 350 CDI 4-matic 170  | 10.09                    | 01.14 |       |   |                |   |  |                            |
| C 350 CGI 215  | 09.08                    | 01.14 |       |   |                |   |  |                            |
| C 63 AMG   | 09.07                    | 01.14 |       | 24.8190-0420.2                                | 620420         | 1   | Warmkontakt L=119mm  |                            |
|    | C 180 CDI 88             | 01.11 | 01.14 | - Sportpaket / - Sportpaket AMG <sup>1)</sup> | 24.0109-0154.1 | 409154  |  | 278 9,0 7,3 +S +B          |
|  | C 180 CGI 115            | 04.09 | 01.14 | - Sportpaket / - Sportpaket AMG <sup>1)</sup> | 24.0309-0154.1 | 509154  |  | 278 9,0 7,3 +S +B PD       |
|  | C 180 Kompressor 115     | 01.08 | 01.14 | - Sportpaket / - Sportpaket AMG <sup>1)</sup> |                |   |  |                            |
|  | C 180 Kompressor 115     | 03.07 | 01.14 | - Sportpaket / - Sportpaket AMG <sup>1)</sup> |                |   |  |                            |
|  | C 200 CDI 100            | 01.14 | 01.14 | - Sportpaket / - Sportpaket AMG <sup>1)</sup> |                |   |  |                            |

<sup>1)</sup> - sport package/- sport package AMG / - pacchetto sportivo/- pacchetto sport.AMG / - version sport/- version sport AMG / - kit deportivo/- kit deportivo AMG

<sup>2)</sup> + cast iron caliper / + pinza in ghisa / + étriers en fonte grise / + fundición gris-pinza

<sup>3)</sup> + aluminium calipers / + pinze in alluminio / + étriers en aluminium / + pinzas de aluminio

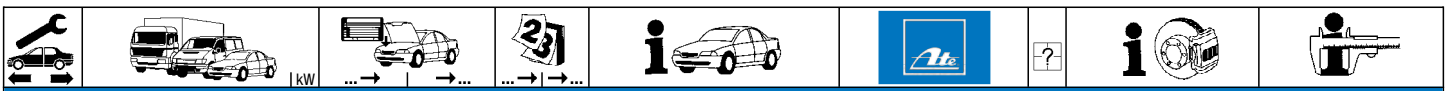

**MERCEDES BENZ C-Klasse (W204) Limousine (07-14)**

|  |                      |     |                     |       |       |   |                |        |   |                         |
|--|----------------------|-----|---------------------|-------|-------|---|----------------|--------|---|-------------------------|
|  | C 200 CDI            | 100 |                     | 03.07 | 01.14 | - Sportpaket / - Sportpaket AMG <sup>1)</sup> | 24.0109-0154.1 | 409154 |   | 278 9,0 7,3 +S +B       |
|  |                      |     |                     |       |       |   | 24.0309-0154.1 | 509154 |   | 278 9,0 7,3 +S +B PD    |
|  | C 180 CDI            | 88  |                     | 01.11 | 01.14 | + Sportpaket / + Sportpaket AMG <sup>2)</sup> | 24.0110-0328.1 | 410328 |   | 300 10,0 8,3 +S +B      |
|  | C 180 CGI            | 115 |                     | 04.09 | 01.14 | + Sportpaket / + Sportpaket AMG <sup>2)</sup> | 24.0310-0328.1 | 510328 |   | 300 10,0 8,3 +S +B PD   |
|  | C 180 Kompressor     | 115 |                     | 01.08 | 01.14 | + Sportpaket / + Sportpaket AMG <sup>2)</sup> |                |        |   |                         |
|  | C 180 Kompressor     | 115 |                     | 03.07 | 01.14 | + Sportpaket / + Sportpaket AMG <sup>2)</sup> |                |        |   |                         |
|  | C 200                | 137 |                     | 05.11 | 01.14 |   |                |        |   |                         |
|  | C 200 CDI            | 100 | A 394602 / F 483835 | 01.11 | 01.14 | - Sportpaket / - Sportpaket AMG <sup>1)</sup> |                |        |   |                         |
|  | C 200 CDI            | 100 |                     | 01.11 | 01.14 | + Sportpaket / + Sportpaket AMG <sup>2)</sup> |                |        |   |                         |
|  | C 200 CDI            | 100 |                     | 03.07 | 01.14 | + Sportpaket / + Sportpaket AMG <sup>2)</sup> |                |        |   |                         |
|  | C 200 CGI            | 135 |                     | 04.09 | 01.14 |   |                |        |   |                         |
|  | C 200 Kompressor     | 135 |                     | 03.07 | 01.14 |   |                |        |   |                         |
|  | C 220 CDI            | 120 |                     | 03.07 | 01.14 |   |                |        |   |                         |
|  | C 220 CDI            | 125 |                     | 03.07 | 01.14 |   |                |        |   |                         |
|  | C 220 CDI            | 125 |                     | 12.08 | 01.14 |   |                |        |   |                         |
|  | C 220 CDI 4-matic    | 125 |                     | 02.13 | 01.14 |   |                |        |   |                         |
|  | C 230                | 150 |                     | 03.07 | 01.14 |   |                |        |   |                         |
|  | C 230 4-matic        | 150 |                     | 07.07 | 01.14 |   |                |        |   |                         |
|  | C 250 CDI 4-matic    | 150 |                     | 01.11 | 01.14 | + Sportpaket / + Sportpaket AMG <sup>2)</sup> |                |        |   |                         |
|  | C 250 CGI            | 150 |                     | 04.09 | 01.14 |   |                |        |   |                         |
|  | C 280                | 170 |                     | 03.07 | 01.14 |   |                |        |   |                         |
|  | C 280 4-matic        | 170 |                     | 07.07 | 01.14 |   |                |        |   |                         |
|  | C 300                | 170 |                     | 07.09 | 01.14 |   |                |        |   |                         |
|  | C 300 4-matic        | 170 |                     | 04.09 | 01.14 |   |                |        |   |                         |
|  | C 250 CDI            | 150 |                     | 10.08 | 01.14 |   | 24.0120-0208.1 | 420208 |   | 300 22,0 19,4 V L +S +B |
|  | C 250 CDI 4-matic    | 150 |                     | 01.11 | 01.14 | - Sportpaket / - Sportpaket AMG <sup>1)</sup> |                |        |   |                         |
|  | C 300 CDI 4-matic    | 170 |                     | 01.11 | 01.14 |   |                |        |   |                         |
|  | C 300 CGI            | 185 |                     | 02.11 | 01.14 |   |                |        |   |                         |
|  | C 300 CGI 4-matic    | 185 |                     | 02.11 | 01.14 |   |                |        |   |                         |
|  | C 320 CDI            | 165 |                     | 03.07 | 01.14 |   |                |        |   |                         |
|  | C 320 CDI 4-matic    | 165 |                     | 07.07 | 01.14 |   |                |        |   |                         |
|  | C 350                | 200 |                     | 03.07 | 01.14 |   |                |        |   |                         |
|  | C 350                | 225 |                     | 01.11 | 01.14 |   |                |        |   |                         |
|  | C 350 4-matic        | 200 |                     | 07.07 | 01.14 |   |                |        |   |                         |
|  | C 350 4-matic        | 225 |                     | 01.11 | 01.14 |   |                |        |   |                         |
|  | C 350 CDI            | 165 |                     | 04.09 | 01.14 |   |                |        |   |                         |
|  | C 350 CDI            | 170 |                     | 10.09 | 01.14 |   |                |        |   |                         |
|  | C 350 CDI            | 195 |                     | 06.11 | 01.14 |   |                |        |   |                         |
|  | C 350 CDI 4-matic    | 165 |                     | 07.09 | 01.14 |   |                |        |   |                         |
|  | C 350 CDI 4-matic    | 170 |                     | 10.09 | 01.14 |   |                |        |   |                         |
|  | C 350 CGI            | 215 |                     | 09.08 | 01.14 |   |                |        |   |                         |
|  | C 180 CDI            | 88  |                     | 01.11 | 01.14 |   | 24.0711-6191.3 | 360247 | 2 | Radsensor L=945         |
|  | C 180 CGI            | 115 |                     | 04.09 | 01.14 |   |                |        |   |                         |
|  | C 180 Kompressor     | 115 |                     | 01.08 | 01.14 |   |                |        |   |                         |
|  | C 180 Kompressor     | 115 |                     | 03.07 | 01.14 |   |                |        |   |                         |
|  | C 180 Kompressor Eco | 115 |                     | 01.09 | 01.14 |   |                |        |   |                         |
|  | C 200                | 137 |                     | 05.11 | 01.14 |   |                |        |   |                         |
|  | C 200 CDI            | 100 |                     | 01.11 | 01.14 |   |                |        |   |                         |
|  | C 200 CDI            | 100 |                     | 03.07 | 01.14 |   |                |        |   |                         |
|  | C 200 CGI            | 135 |                     | 04.09 | 01.14 |   |                |        |   |                         |
|  | C 200 Kompressor     | 135 |                     | 03.07 | 01.14 |   |                |        |   |                         |
|  | C 220 CDI            | 120 |                     | 03.07 | 01.14 |   |                |        |   |                         |
|  | C 220 CDI            | 125 |                     | 03.07 | 01.14 |   |                |        |   |                         |
|  | C 220 CDI            | 125 |                     | 12.08 | 01.14 |   |                |        |   |                         |
|  | C 220 CDI 4-matic    | 125 |                     | 02.13 | 01.14 |   |                |        |   |                         |
|  | C 230                | 150 |                     | 03.07 | 01.14 |   |                |        |   |                         |
|  | C 230 4-matic        | 150 |                     | 07.07 | 01.14 |   |                |        |   |                         |
|  | C 250 CDI            | 150 |                     | 10.08 | 01.14 |   |                |        |   |                         |
|  | C 250 CDI 4-matic    | 150 |                     | 01.11 | 01.14 |   |                |        |   |                         |
|  | C 250 CGI            | 150 |                     | 04.09 | 01.14 |   |                |        |   |                         |
|  | C 280                | 170 |                     | 03.07 | 01.14 |   |                |        |   |                         |
|  | C 280 4-matic        | 170 |                     | 07.07 | 01.14 |   |                |        |   |                         |
|  | C 300                | 170 |                     | 07.09 | 01.14 |   |                |        |   |                         |
|  | C 300 4-matic        | 170 |                     | 04.09 | 01.14 |   |                |        |   |                         |
|  | C 300 CDI 4-matic    | 170 |                     | 01.11 | 01.14 |   |                |        |   |                         |
|  | C 300 CGI            | 185 |                     | 02.11 | 01.14 |   |                |        |   |                         |
|  | C 300 CGI 4-matic    | 185 |                     | 02.11 | 01.14 |   |                |        |   |                         |
|  | C 320 CDI            | 165 |                     | 03.07 | 01.14 |   |                |        |   |                         |
|  | C 320 CDI 4-matic    | 165 |                     | 07.07 | 01.14 |   |                |        |   |                         |
|  | C 350                | 200 |                     | 03.07 | 01.14 |   |                |        |   |                         |
|  | C 350                | 225 |                     | 01.11 | 01.14 |   |                |        |   |                         |
|  | C 350 4-matic        | 200 |                     | 07.07 | 01.14 |   |                |        |   |                         |
|  | C 350 4-matic        | 225 |                     | 01.11 | 01.14 |   |                |        |   |                         |
|  | C 350 CDI            | 165 |                     | 04.09 | 01.14 |   |                |        |   |                         |
|  | C 350 CDI            | 170 |                     | 10.09 | 01.14 |   |                |        |   |                         |
|  | C 350 CDI            | 195 |                     | 06.11 | 01.14 |   |                |        |   |                         |
|  | C 350 CDI 4-matic    | 165 |                     | 07.09 | 01.14 |   |                |        |   |                         |
|  | C 350 CDI 4-matic    | 170 |                     | 10.09 | 01.14 |   |                |        |   |                         |
|  | C 350 CGI            | 215 |                     | 09.08 | 01.14 |   |                |        |   |                         |
|  | C 63 AMG             |     |                     | 09.07 | 01.14 |   |                |        |   |                         |
|  | C 180 CDI            | 88  |                     | 01.11 | 01.14 |   | 03.0137-4005.2 | 654005 |   | 164 x 25 /Zub           |
|  | C 180 CGI            | 115 |                     | 04.09 | 01.14 |   |                |        |   |                         |
|  | C 180 Kompressor     | 115 |                     | 01.08 | 01.14 |   |                |        |   |                         |
|  | C 180 Kompressor     | 115 |                     | 03.07 | 01.14 |   |                |        |   |                         |
|  | C 180 Kompressor Eco | 115 |                     | 01.09 | 01.14 |   |                |        |   |                         |
|  | C 200                | 137 |                     | 05.11 | 01.14 |   |                |        |   |                         |
|  | C 200 CDI            | 100 |                     | 01.11 | 01.14 |   |                |        |   |                         |

<sup>1)</sup> - sport package/- sport package AMG / - pacchetto sportivo/- pacchetto sport.AMG / - version sport/- version sport AMG / - kit sportivo/- kit sportivo AMG

<sup>2)</sup> + sports package/+ sports package AMG / + pacchetto sportivo/+ pacchetto sport.AMG / + version sport/+ version sport AMG / + kit sportivo/+ kit sportivo AMG



**MERCEDES BENZ C-Klasse (W204) Limousine (07-14)**

|  |                   |     |  |       |       |  |                |        |  |  |               |
|--|-------------------|-----|--|-------|-------|--|----------------|--------|--|--|---------------|
|  | C 200 CDI         | 100 |  | 03.07 | 01.14 |  | 03.0137-4005.2 | 654005 |  |  | 164 x 25 /Zub |
|  | C 200 CGI         | 135 |  | 04.09 | 01.14 |  |                |        |  |  |               |
|  | C 200 Kompressor  | 135 |  | 03.07 | 01.14 |  |                |        |  |  |               |
|  | C 220 CDI         | 120 |  | 03.07 | 01.14 |  |                |        |  |  |               |
|  | C 220 CDI         | 125 |  | 03.07 | 01.14 |  |                |        |  |  |               |
|  | C 220 CDI         | 125 |  | 12.08 | 01.14 |  |                |        |  |  |               |
|  | C 220 CDI 4-matic | 125 |  | 02.13 | 01.14 |  |                |        |  |  |               |
|  | C 230             | 150 |  | 03.07 | 01.14 |  |                |        |  |  |               |
|  | C 230 4-matic     | 150 |  | 07.07 | 01.14 |  |                |        |  |  |               |
|  | C 250 CDI         | 150 |  | 10.08 | 01.14 |  |                |        |  |  |               |
|  | C 250 CDI 4-matic | 150 |  | 01.11 | 01.14 |  |                |        |  |  |               |
|  | C 250 CGI         | 150 |  | 04.09 | 01.14 |  |                |        |  |  |               |
|  | C 280             | 170 |  | 03.07 | 01.14 |  |                |        |  |  |               |
|  | C 280 4-matic     | 170 |  | 07.07 | 01.14 |  |                |        |  |  |               |
|  | C 300             | 170 |  | 07.09 | 01.14 |  |                |        |  |  |               |
|  | C 300 4-matic     | 170 |  | 04.09 | 01.14 |  |                |        |  |  |               |
|  | C 300 CDI 4-matic | 170 |  | 01.11 | 01.14 |  |                |        |  |  |               |
|  | C 300 CGI         | 185 |  | 02.11 | 01.14 |  |                |        |  |  |               |
|  | C 300 CGI 4-matic | 185 |  | 02.11 | 01.14 |  |                |        |  |  |               |
|  | C 320 CDI         | 165 |  | 03.07 | 01.14 |  |                |        |  |  |               |
|  | C 320 CDI 4-matic | 165 |  | 07.07 | 01.14 |  |                |        |  |  |               |
|  | C 350             | 200 |  | 03.07 | 01.14 |  |                |        |  |  |               |
|  | C 350             | 225 |  | 01.11 | 01.14 |  |                |        |  |  |               |
|  | C 350 4-matic     | 200 |  | 07.07 | 01.14 |  |                |        |  |  |               |
|  | C 350 4-matic     | 225 |  | 01.11 | 01.14 |  |                |        |  |  |               |
|  | C 350 CDI         | 165 |  | 04.09 | 01.14 |  |                |        |  |  |               |
|  | C 350 CDI         | 170 |  | 10.09 | 01.14 |  |                |        |  |  |               |
|  | C 350 CDI         | 195 |  | 06.11 | 01.14 |  |                |        |  |  |               |
|  | C 350 CDI 4-matic | 165 |  | 07.09 | 01.14 |  |                |        |  |  |               |
|  | C 350 CDI 4-matic | 170 |  | 10.09 | 01.14 |  |                |        |  |  |               |
|  | C 350 CGI         | 215 |  | 09.08 | 01.14 |  |                |        |  |  |               |
|  | C 63 AMG          |     |  | 09.07 | 01.14 |  |                |        |  |  |               |

**MERCEDES BENZ C-Klasse (S204) Kombi (07-14)**

|  |                    |     |  |       |       |   |                |        |   |                              |                            |
|--|--------------------|-----|--|-------|-------|---|----------------|--------|---|------------------------------|----------------------------|
|  | C 180 CDI BE       | 88  |  | 01.11 | 08.14 | - Sportpaket / - Sportpaket AMG <sup>1)</sup> | 13.0460-2733.2 | 602733 |   |                              | 24306 20,3 /WE/Zub/S TRW   |
|  | C 180 CGI          | 115 |  | 04.09 | 08.14 | - Sportpaket / - Sportpaket AMG <sup>1)</sup> | 13.0470-2733.2 | LD2733 |   |                              | 24306 20,3 /WE/Zub/S TRW   |
|  | C 180 Kompressor   | 115 |  | 09.07 | 08.14 | - Sportpaket / - Sportpaket AMG <sup>1)</sup> | 24.8190-0410.2 | 620410 | 1 |                              | Warnkontakt L=97,5mm       |
|  | C 180 Kompressor   | 115 |  | 01.08 | 08.14 | - Sportpaket / - Sportpaket AMG <sup>1)</sup> |                |        |   |                              |                            |
|  | C 200 CDI          | 100 |  | 09.07 | 08.14 | - Sportpaket / - Sportpaket AMG <sup>1)</sup> |                |        |   |                              |                            |
|  | C 200 CDI          | 100 |  | 08.10 | 08.14 | - Sportpaket / - Sportpaket AMG <sup>1)</sup> |                |        |   |                              |                            |
|  | C 180 CDI BE       | 88  |  | 01.11 | 08.14 | + Sportpaket / + Sportpaket AMG <sup>2)</sup> | 13.0460-2732.2 | 602732 |   |                              | 24306 20,3 /WE/Zub/S TRW   |
|  | C 180 CGI          | 115 |  | 04.09 | 08.14 | + Sportpaket / + Sportpaket AMG <sup>2)</sup> | 13.0470-2732.2 | LD2732 |   |                              | 24306 20,3 /WE/Zub/S TRW   |
|  | C 180 Kompressor   | 115 |  | 09.07 | 08.14 | + Sportpaket / + Sportpaket AMG <sup>2)</sup> | 13.0470-9000.2 | LD9000 |   | + Taxi                       | 24306 20,3 /WE/Zub/S TRW   |
|  | C 180 Kompressor   | 115 |  | 01.08 | 08.14 | + Sportpaket / + Sportpaket AMG <sup>2)</sup> | 24.8190-0410.2 | 620410 | 1 |                              | Warnkontakt L=97,5mm       |
|  | C 200 CDI          | 100 |  | 09.07 | 08.14 | + Sportpaket / + Sportpaket AMG <sup>2)</sup> |                |        |   |                              |                            |
|  | C 200 CDI          | 100 |  | 08.10 | 08.14 | + Sportpaket / + Sportpaket AMG <sup>2)</sup> |                |        |   |                              |                            |
|  | C 200 CGI          | 135 |  | 04.09 | 08.14 |   |                |        |   |                              |                            |
|  | C 200 Kompressor   | 135 |  | 09.07 | 08.14 |   |                |        |   |                              |                            |
|  | C 220 CDI          | 120 |  | 01.07 | 08.14 |   |                |        |   |                              |                            |
|  | C 220 CDI          | 125 |  | 09.07 | 08.14 |   |                |        |   |                              |                            |
|  | C 220 CDI          | 125 |  | 12.08 | 08.14 |   |                |        |   |                              |                            |
|  | C 220 CDI 4-matic  | 125 |  | 02.13 | 08.14 |   |                |        |   |                              |                            |
|  | C 230              | 150 |  | 09.07 | 08.14 |   |                |        |   |                              |                            |
|  | C 250 CDI          | 150 |  | 04.09 | 08.14 |   |                |        |   |                              |                            |
|  | C 250 CDI 4matic   | 150 |  | 04.09 | 08.14 | - Sportpaket / - Sportpaket AMG <sup>1)</sup> |                |        |   |                              |                            |
|  | C 250 CGI          | 150 |  | 04.09 | 08.14 |   |                |        |   |                              |                            |
|  | C 280              | 170 |  | 09.07 | 08.14 | - Sportpaket / - Sportpaket AMG <sup>1)</sup> |                |        |   |                              |                            |
|  | C 300              | 170 |  | 08.07 | 08.14 | - Sportpaket / - Sportpaket AMG <sup>1)</sup> |                |        |   |                              |                            |
|  | C 250 CDI 4matic   | 150 |  | 04.09 | 08.14 | + Sportpaket / + Sportpaket AMG <sup>2)</sup> | 13.0460-2734.2 | 602734 |   |                              | 24310 19,0 +/-WE/S TRW     |
|  | C 280              | 170 |  | 09.07 | 08.14 | + Sportpaket / + Sportpaket AMG <sup>2)</sup> | 13.0470-2734.2 | LD2734 |   |                              | 24310 19,0 +/-WE/S TRW     |
|  | C 300              | 170 |  | 08.07 | 08.14 | + Sportpaket / + Sportpaket AMG <sup>2)</sup> | 24.8190-0410.2 | 620410 | 1 |                              | Warnkontakt L=97,5mm       |
|  | C 320 CDI          | 165 |  | 09.07 | 08.14 |   |                |        |   |                              |                            |
|  | C 320 CDI 4-matic  | 165 |  | 09.07 | 08.14 |   |                |        |   |                              |                            |
|  | C 350              | 200 |  | 09.07 | 08.14 |   |                |        |   |                              |                            |
|  | C 350 CDI          | 165 |  | 08.07 | 08.14 |   |                |        |   |                              |                            |
|  | C 350 CDI          | 195 |  | 06.11 | 08.14 |   |                |        |   |                              |                            |
|  | C 350 CDI 4-matic  | 170 |  | 10.09 | 08.14 |   |                |        |   |                              |                            |
|  | C 350 CDI BlueEff. | 170 |  | 04.09 | 08.14 |   |                |        |   |                              |                            |
|  | C 350 CGI          | 225 |  | 06.11 | 08.14 |   |                |        |   |                              |                            |
|  | C 63 AMG           |     |  | 09.07 | 08.14 |   | 13.0460-4839.2 | 604839 |   | - roter Sattel <sup>3)</sup> | 24455 16,8 /WE BRE         |
|  |                    |     |  |       |       |   | 24.8190-0420.2 | 620420 | 1 |                              | Warnkontakt L=119mm        |
|  | C 180 CDI BE       | 88  |  | 01.11 | 08.14 | - Sportpaket / - Sportpaket AMG <sup>1)</sup> | 24.0125-0179.1 | 425179 |   |                              | 288 25,0 22,4 V L +S +B    |
|  | C 180 CGI          | 115 |  | 04.09 | 08.14 | - Sportpaket / - Sportpaket AMG <sup>1)</sup> | 24.0325-0179.1 | 525179 |   |                              | 288 25,0 22,4 V L +S +B PD |
|  | C 180 Kompressor   | 115 |  | 09.07 | 08.14 | - Sportpaket / - Sportpaket AMG <sup>1)</sup> |                |        |   |                              |                            |
|  | C 180 Kompressor   | 115 |  | 01.08 | 08.14 | - Sportpaket / - Sportpaket AMG <sup>1)</sup> |                |        |   |                              |                            |
|  | C 200 CDI          | 100 |  | 09.07 | 08.14 | - Sportpaket / - Sportpaket AMG <sup>1)</sup> |                |        |   |                              |                            |
|  | C 200 CDI          | 100 |  | 08.10 | 08.14 | - Sportpaket / - Sportpaket AMG <sup>1)</sup> |                |        |   |                              |                            |
|  | C 180 CDI BE       | 88  |  | 01.11 | 08.14 | + Sportpaket / + Sportpaket AMG <sup>2)</sup> | 24.0128-0100.1 | 428100 |   |                              | 295 28,0 26,0 V L +S +B    |
|  | C 180 CGI          | 115 |  | 04.09 | 08.14 | + Sportpaket / + Sportpaket AMG <sup>2)</sup> |                |        |   |                              |                            |
|  | C 180 Kompressor   | 115 |  | 09.07 | 08.14 | + Sportpaket / + Sportpaket AMG <sup>2)</sup> |                |        |   |                              |                            |
|  | C 180 Kompressor   | 115 |  | 01.08 | 08.14 | + Sportpaket / + Sportpaket AMG <sup>2)</sup> |                |        |   |                              |                            |
|  | C 200 CDI          | 100 |  | 09.07 | 08.14 | + Sportpaket / + Sportpaket AMG <sup>2)</sup> |                |        |   |                              |                            |
|  | C 200 CDI          | 100 |  | 08.10 | 08.14 | + Sportpaket / + Sportpaket AMG <sup>2)</sup> |                |        |   |                              |                            |
|  | C 200 CGI          | 135 |  | 04.09 | 08.14 | + Sportpaket / + Sportpaket AMG <sup>2)</sup> |                |        |   |                              |                            |
|  | C 200 Kompressor   | 135 |  | 09.07 | 08.14 | + Sportpaket / + Sportpaket AMG <sup>2)</sup> |                |        |   |                              |                            |
|  | C 220 CDI          | 120 |  | 01.07 | 08.14 | + Sportpaket / + Sportpaket AMG <sup>2)</sup> |                |        |   |                              |                            |
|  | C 220 CDI          | 125 |  | 09.07 | 08.14 | + Sportpaket / + Sportpaket AMG <sup>2)</sup> |                |        |   |                              |                            |

<sup>1)</sup> - sport package/- sport package AMG / - pacchetto sportivo/- pacchetto sport.AMG / - version sport/- version sport AMG / - kit deportivo/- kit deportivo AMG  
<sup>2)</sup> + sports package/+ sports package AMG / + pacchetto sportivo/+ pacchetto sport.AMG / + version sport/+ version sport AMG / + kit deportivo/+ kit deportivo AMG  
<sup>3)</sup> - red caliper / - pinza rossa / - étrier rouge / - pinza roja



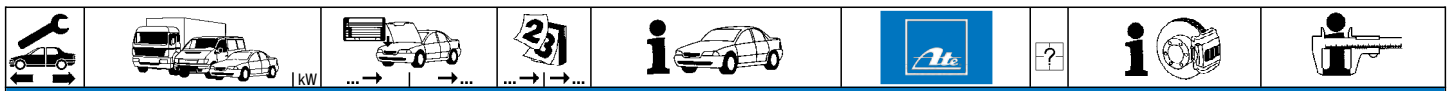

**MERCEDES BENZ C-Klasse (S204) Kombi (07-14)**

|                    |                    |       |       |   |   |                |        |                         |                            |                      |                |                         |   |     |                 |
|--------------------|--------------------|-------|-------|---|---|----------------|--------|-------------------------|----------------------------|----------------------|----------------|-------------------------|---|-----|-----------------|
|                    | C 220 CDI          | 125   | 12.08 | 08.14   | + Sportpaket / + Sportpaket AMG <sup>1)</sup> | 24.0128-0100.1 | 428100 |                         | 295 28,0 26,0 V L +S +B    |                      |                |                         |   |     |                 |
|                    | C 220 CDI 4-matic  | 125   | 02.13 | 08.14   | + Sportpaket / + Sportpaket AMG <sup>1)</sup> |                |        |                         |                            |                      |                |                         |   |     |                 |
|                    | C 230              | 150   | 09.07 | 08.14   | + Sportpaket / + Sportpaket AMG <sup>1)</sup> |                |        |                         |                            |                      |                |                         |   |     |                 |
|                    | C 250 CDI          | 150   | 04.09 | 08.14   | + Sportpaket / + Sportpaket AMG <sup>1)</sup> |                |        |                         |                            |                      |                |                         |   |     |                 |
|                    | C 250 CGI          | 150   | 04.09 | 08.14   | + Sportpaket / + Sportpaket AMG <sup>1)</sup> |                |        |                         |                            |                      |                |                         |   |     |                 |
|                    | C 200 CDI          | 100   | 09.07 | 08.14   | - Sportpaket / - Sportpaket AMG <sup>2)</sup> | 24.0128-0155.1 | 428155 |                         | 295 28,0 25,4 V L +S +B    |                      |                |                         |   |     |                 |
|                    | C 200 CGI          | 135   | 04.09 | 08.14   | - Sportpaket / - Sportpaket AMG <sup>2)</sup> |                |        |                         |                            |                      |                |                         |   |     |                 |
|                    | C 200 Kompressor   | 135   | 09.07 | 08.14   | - Sportpaket / - Sportpaket AMG <sup>2)</sup> |                |        |                         |                            |                      |                |                         |   |     |                 |
|                    | C 220 CDI          | 120   | 01.07 | 08.14   | - Sportpaket / - Sportpaket AMG <sup>2)</sup> |                |        |                         |                            |                      |                |                         |   |     |                 |
|                    | C 220 CDI          | 125   | 09.07 | 08.14   | - Sportpaket / - Sportpaket AMG <sup>2)</sup> |                |        |                         |                            |                      |                |                         |   |     |                 |
|                    | C 220 CDI          | 125   | 12.08 | 08.14   | - Sportpaket / - Sportpaket AMG <sup>2)</sup> |                |        |                         |                            |                      |                |                         |   |     |                 |
|                    | C 220 CDI 4-matic  | 125   | 02.13 | 08.14   | - Sportpaket / - Sportpaket AMG <sup>2)</sup> |                |        |                         |                            |                      |                |                         |   |     |                 |
|                    | C 230              | 150   | 09.07 | 08.14   | - Sportpaket / - Sportpaket AMG <sup>2)</sup> |                |        |                         |                            |                      |                |                         |   |     |                 |
|                    | C 250 CDI          | 150   | 04.09 | 08.14   | - Sportpaket / - Sportpaket AMG <sup>2)</sup> |                |        |                         |                            |                      |                |                         |   |     |                 |
|                    | C 250 CDI 4matic   | 150   | 04.09 | 08.14   | - Sportpaket / - Sportpaket AMG <sup>2)</sup> |                |        |                         |                            |                      |                |                         |   |     |                 |
| C 250 CGI          | 150                | 04.09 | 08.14 | - Sportpaket / - Sportpaket AMG <sup>2)</sup> |   |                |        |                         |                            |                      |                |                         |   |     |                 |
| C 280              | 170                | 09.07 | 08.14 | - Sportpaket / - Sportpaket AMG <sup>2)</sup> |   |                |        |                         |                            |                      |                |                         |   |     |                 |
| C 300              | 170                | 08.07 | 08.14 | - Sportpaket / - Sportpaket AMG <sup>2)</sup> |   |                |        |                         |                            |                      |                |                         |   |     |                 |
| C 250 CDI 4matic   | 150                | 04.09 | 08.14 | + Sportpaket / + Sportpaket AMG <sup>1)</sup> | 24.0132-0100.1                                |                |        |                         |                            | 432100               |                | 322 32,0 30,0 V L +S +B |   |     |                 |
| C 280              | 170                | 09.07 | 08.14 | + Sportpaket / + Sportpaket AMG <sup>1)</sup> |   |                |        |                         |                            |                      |                |                         |   |     |                 |
| C 300              | 170                | 08.07 | 08.14 | + Sportpaket / + Sportpaket AMG <sup>1)</sup> |   |                |        |                         |                            |                      |                |                         |   |     |                 |
| C 320 CDI          | 165                | 09.07 | 08.14 | + Sportpaket / + Sportpaket AMG <sup>1)</sup> |   |                |        |                         |                            |                      |                |                         |   |     |                 |
| C 320 CDI          | 165                | 09.07 | 08.14 | - Sportpaket / - Sportpaket AMG <sup>2)</sup> |   |                |        |                         |                            |                      |                |                         |   |     |                 |
| C 320 CDI 4-matic  | 165                | 09.07 | 08.14 | + Sportpaket / + Sportpaket AMG <sup>1)</sup> |   |                |        |                         |                            |                      |                |                         |   |     |                 |
| C 350              | 200                | 09.07 | 08.14 | + Sportpaket / + Sportpaket AMG <sup>1)</sup> |   |                |        |                         |                            |                      |                |                         |   |     |                 |
| C 350 CDI          | 165                | 08.07 | 08.14 | + Sportpaket / + Sportpaket AMG <sup>1)</sup> |   |                |        |                         |                            |                      |                |                         |   |     |                 |
| C 350 CDI          | 195                | 06.11 | 08.14 | + Sportpaket / + Sportpaket AMG <sup>1)</sup> |   |                |        |                         |                            |                      |                |                         |   |     |                 |
| C 350 CDI 4-matic  | 170                | 10.09 | 08.14 | + Sportpaket / + Sportpaket AMG <sup>1)</sup> |   |                |        |                         |                            |                      |                |                         |   |     |                 |
| C 350 CDI BlueEff. | 170                | 04.09 | 08.14 | + Sportpaket / + Sportpaket AMG <sup>1)</sup> |   |                |        |                         |                            |                      |                |                         |   |     |                 |
| C 350 CGI          | 225                | 06.11 | 08.14 | + Sportpaket / + Sportpaket AMG <sup>1)</sup> |   |                |        |                         |                            |                      |                |                         |   |     |                 |
| C 320 CDI          | 165                | 09.07 | 08.14 | - Sportpaket / - Sportpaket AMG <sup>2)</sup> |   | 24.0132-0101.1 | 432101 |                         | 322 32,0 29,4 V L +S +B    |                      |                |                         |   |     |                 |
| C 320 CDI 4-matic  | 165                | 09.07 | 08.14 | - Sportpaket / - Sportpaket AMG <sup>2)</sup> |   |                |        |                         |                            |                      |                |                         |   |     |                 |
| C 350              | 200                | 09.07 | 08.14 | - Sportpaket / - Sportpaket AMG <sup>2)</sup> |   | 24.0332-0101.1 | 532101 |                         | 322 32,0 29,4 V L +S +B PD |                      |                |                         |   |     |                 |
| C 350 CDI          | 165                | 08.07 | 08.14 | - Sportpaket / - Sportpaket AMG <sup>2)</sup> |   |                |        |                         |                            |                      |                |                         |   |     |                 |
| C 350 CDI          | 195                | 06.11 | 08.14 | - Sportpaket / - Sportpaket AMG <sup>2)</sup> | 24.0136-0108.1                                | 436108         |        | 360 36,0 34,0 V L +S +B |                            |                      |                |                         |   |     |                 |
| C 350 CDI 4-matic  | 170                | 10.09 | 08.14 | - Sportpaket / - Sportpaket AMG <sup>2)</sup> |   |                |        |                         |                            |                      |                |                         |   |     |                 |
| C 350 CDI BlueEff. | 170                | 04.09 | 08.14 | - Sportpaket / - Sportpaket AMG <sup>2)</sup> |   |                |        |                         |                            |                      |                |                         |   |     |                 |
| C 350 CGI          | 225                | 06.11 | 08.14 | - Sportpaket / - Sportpaket AMG <sup>2)</sup> |   |                |        |                         |                            |                      |                |                         |   |     |                 |
| C 63 AMG           |                    | 09.07 | 08.14 |   |   |                |        |                         |                            |                      |                |                         |   |     |                 |
|                    | C 180 CDI BE       | 88    | 01.11 | 08.14   |   | 24.0711-6189.3 | 360246 | 2                       | SA Code: 808/809/800/801   | Radsensor L=618      |                |                         |   |     |                 |
|                    | C 180 CGI          | 115   | 04.09 | 08.14   |   |                |        |                         |                            |                      |                |                         |   |     |                 |
|                    | C 180 Kompressor   | 115   | 09.07 | 08.14   |   | 24.0711-6390.3 | 360406 | 2                       | SA Code: 802/803/804/805   | Radsensor L=618      |                |                         |   |     |                 |
|                    | C 180 Kompressor   | 115   | 01.08 | 08.14   |   |                |        |                         |                            |                      |                |                         |   |     |                 |
|                    | C 200 CDI          | 100   | 09.07 | 08.14   |   | 24.0711-5330.3 | 360417 | 2                       |                            | Radsensor L=733      |                |                         |   |     |                 |
|                    | C 200 CDI          | 100   | 08.10 | 08.14   |   |                |        |                         |                            |                      |                |                         |   |     |                 |
|                    | C 200 CGI          | 135   | 04.09 | 08.14   |   |                |        |                         |                            |                      |                |                         |   |     |                 |
|                    | C 200 Kompressor   | 135   | 09.07 | 08.14   |   |                |        |                         |                            |                      |                |                         |   |     |                 |
|                    | C 220 CDI          | 120   | 01.07 | 08.14   |   |                |        |                         |                            |                      |                |                         |   |     |                 |
|                    | C 220 CDI          | 125   | 09.07 | 08.14   |   |                |        |                         |                            |                      |                |                         |   |     |                 |
|                    | C 220 CDI          | 125   | 12.08 | 08.14   |   |                |        |                         |                            |                      |                |                         |   |     |                 |
|                    | C 230              | 150   | 09.07 | 08.14   |   |                |        |                         |                            |                      |                |                         |   |     |                 |
|                    | C 250 CDI          | 150   | 04.09 | 08.14   |   |                |        |                         |                            |                      |                |                         |   |     |                 |
|                    | C 250 CGI          | 150   | 04.09 | 08.14   |   |                |        |                         |                            |                      |                |                         |   |     |                 |
|                    | C 280              | 170   | 09.07 | 08.14   |   |                |        |                         |                            |                      |                |                         |   |     |                 |
|                    | C 300              | 170   | 08.07 | 08.14   |   |                |        |                         |                            |                      |                |                         |   |     |                 |
|                    | C 320 CDI          | 165   | 09.07 | 08.14   |   |                |        |                         |                            |                      |                |                         |   |     |                 |
|                    | C 350              | 200   | 09.07 | 08.14   |   |                |        |                         |                            |                      |                |                         |   |     |                 |
|                    | C 350 CDI          | 165   | 08.07 | 08.14   |   |                |        |                         |                            |                      |                |                         |   |     |                 |
|                    | C 350 CDI          | 195   | 06.11 | 08.14   |   |                |        |                         |                            |                      |                |                         |   |     |                 |
|                    | C 350 CDI BlueEff. | 170   | 04.09 | 08.14   |   |                |        |                         |                            |                      |                |                         |   |     |                 |
|                    | C 350 CGI          | 225   | 06.11 | 08.14   |   |                |        |                         |                            |                      |                |                         |   |     |                 |
|                    | C 250 CDI 4matic   | 150   | 04.09 | 08.14   |   |                |        |                         |                            |                      | 24.0711-5330.3 | 360417                  | 2 |     | Radsensor L=733 |
|                    | C 320 CDI 4-matic  | 165   | 09.07 | 08.14   |   |                |        |                         |                            |                      |                |                         |   |     |                 |
|                    | C 350 CDI 4-matic  | 170   | 10.09 | 08.14   |   |                |        |                         |                            |                      | 24.0711-5330.3 | 360417                  | 2 |     | Radsensor L=733 |
| C 220 CDI 4-matic  | 125                | 02.13 | 08.14 |   |   |                |        |                         |                            |                      |                |                         |   |     |                 |
|                    | C 180 CDI BE       | 88    | 01.11 | 08.14   |   |                |        |                         |                            |                      | 13.0460-7244.2 | 607244                  |   | ATE |                 |
|                    | C 180 CGI          | 115   | 04.09 | 08.14   |   |                |        |                         |                            |                      |                |                         |   |     |                 |
|                    | C 180 Kompressor   | 115   | 09.07 | 08.14   |   |                |        |                         |                            |                      | 13.0470-7244.2 | LD7244                  |   | ATE |                 |
|                    | C 180 Kompressor   | 115   | 01.08 | 08.14   |   |                |        |                         |                            |                      |                |                         |   |     |                 |
|                    | C 200 CDI          | 100   | 09.07 | 08.14   |   | 24.8190-0410.2 | 620410 | 1                       |                            | Warnkontakt L=97,5mm |                |                         |   |     |                 |
|                    | C 200 CDI          | 100   | 08.10 | 08.14   |   |                |        |                         |                            |                      |                |                         |   |     |                 |
|                    | C 200 CGI          | 135   | 04.09 | 08.14   |   | 24.8190-0410.2 | 620410 | 1                       |                            | Warnkontakt L=97,5mm |                |                         |   |     |                 |
|                    | C 200 Kompressor   | 135   | 09.07 | 08.14   |   |                |        |                         |                            |                      |                |                         |   |     |                 |
|                    | C 220 CDI          | 120   | 01.07 | 08.14   |   |                |        |                         |                            |                      |                |                         |   |     |                 |
|                    | C 220 CDI          | 125   | 09.07 | 08.14   |   |                |        |                         |                            |                      |                |                         |   |     |                 |
|                    | C 220 CDI          | 125   | 12.08 | 08.14   |   |                |        |                         |                            |                      |                |                         |   |     |                 |
|                    | C 220 CDI 4-matic  | 125   | 02.13 | 08.14   |   |                |        |                         |                            |                      |                |                         |   |     |                 |
|                    | C 230              | 150   | 09.07 | 08.14   |   |                |        |                         |                            |                      |                |                         |   |     |                 |
|                    | C 250 CDI 4matic   | 150   | 04.09 | 08.14   | + Sportpaket / + Sportpaket AMG <sup>1)</sup> |                |        |                         |                            |                      |                |                         |   |     |                 |
|                    | C 250 CGI          | 150   | 04.09 | 08.14   |   |                |        |                         |                            |                      |                |                         |   |     |                 |
| C 280              | 170                | 09.07 | 08.14 |   |   |                |        |                         |                            |                      |                |                         |   |     |                 |
| C 300              | 170                | 08.07 | 08.14 |   |   |                |        |                         |                            |                      |                |                         |   |     |                 |
| C 350 CGI          | 225                | 06.11 | 08.14 |   |   |                |        |                         |                            |                      |                |                         |   |     |                 |

<sup>1)</sup> + sports package/+ sports package AMG / + pacchetto sportivo/+ pacchetto sport.AMG / + version sport/+ version sport AMG / + kit sportivo/+ kit sportivo AMG

<sup>2)</sup> - sport package/- sport package AMG / - pacchetto sportivo/- pacchetto sport.AMG / - version sport/- version sport AMG / - kit sportivo/- kit sportivo AMG



**MERCEDES BENZ C-Klasse (S204) Kombi (07-14)**

|                    |                    |       |       |   |   |                |   |  |  |                          |
|--------------------|--------------------|-------|-------|---|---|----------------|---|--|--|--------------------------|
|                    | C 250 CDI          | 150   | 04.09 | 08.14   | - Sportpaket / - Sportpaket AMG <sup>3)</sup> | 13.0460-7257.2 | 607257                                      | + GG-Sättel <sup>1)</sup><br>+ GG-Sättel <sup>1)</sup><br>+ ALU-Sättel <sup>2)</sup><br>+ ALU-Sättel <sup>2)</sup> | 24253 18,0 +WE<br>24253 18,0 +WE<br>24253 17,8 +WE<br>24253 17,8 +WE<br>Warnkontakt L=97,5mm | ATE<br>ATE<br>ATE<br>ATE |
|                    | C 250 CDI 4matic   | 150   | 04.09 | 08.14   |   | LD7257         |   |  |  |                          |
|                    | C 320 CDI          | 165   | 09.07 | 08.14   |   | 13.0460-7244.2 | 607244                                      |  |  |                          |
|                    | C 320 CDI 4-matic  | 165   | 09.07 | 08.14   |   | 13.0470-7244.2 | LD7244                                      |  |  |                          |
|                    | C 350              | 200   | 09.07 | 08.14   |   | 24.8190-0410.2 | 620410                                      |  |  |                          |
|                    | C 350 CDI          | 165   | 08.07 | 08.14   |   |                |   |  |  |                          |
|                    | C 350 CDI          | 195   | 06.11 | 08.14   |   |                |   |  |  |                          |
|                    | C 350 CDI 4-matic  | 170   | 10.09 | 08.14   |   |                |   |  |  |                          |
|                    | C 350 CDI BlueEff. | 170   | 04.09 | 08.14   |   |                |   |  |  |                          |
|                    | C 63 AMG           |       | 09.07 | 08.14   |   | 24.8190-0420.2 | 620420                                      |  |  |                          |
|                    | C 180 CDI BE       | 88    | 01.11 | 08.14   | - Sportpaket / - Sportpaket AMG <sup>3)</sup> | 24.0109-0154.1 | 409154                                      |  | 278 9,0 7,3 +S +B<br>278 9,0 7,3 +S +B PD  |                          |
|                    | C 180 CGI          | 115   | 04.09 | 08.14   | - Sportpaket / - Sportpaket AMG <sup>3)</sup> | 24.0309-0154.1 | 509154                                      |  |  |                          |
|                    | C 180 Kompressor   | 115   | 09.07 | 08.14   | - Sportpaket / - Sportpaket AMG <sup>3)</sup> |                |   |  |  |                          |
|                    | C 180 Kompressor   | 115   | 01.08 | 08.14   | - Sportpaket / - Sportpaket AMG <sup>3)</sup> |                |   |  |  |                          |
|                    | C 200 CDI          | 100   | 09.07 | 08.14   | - Sportpaket / - Sportpaket AMG <sup>3)</sup> |                |   |  |  |                          |
|                    | C 200 CDI          | 100   | 08.10 | 08.14   | - Sportpaket / - Sportpaket AMG <sup>3)</sup> |                |   |  |  |                          |
|                    | C 180 CDI BE       | 88    | 01.11 | 08.14   | + Sportpaket / + Sportpaket AMG <sup>4)</sup> | 24.0110-0328.1 | 410328                                      |  |  |                          |
|                    | C 180 CGI          | 115   | 04.09 | 08.14   | + Sportpaket / + Sportpaket AMG <sup>4)</sup> | 24.0310-0328.1 | 510328                                      |  |  |                          |
|                    | C 180 Kompressor   | 115   | 09.07 | 08.14   | + Sportpaket / + Sportpaket AMG <sup>4)</sup> |                |   |  |  |                          |
|                    | C 180 Kompressor   | 115   | 01.08 | 08.14   | + Sportpaket / + Sportpaket AMG <sup>4)</sup> |                |   |  |  |                          |
| C 200 CDI          | 100                | 09.07 | 08.14 | + Sportpaket / + Sportpaket AMG <sup>4)</sup> |   |                |   |  |  |                          |
| C 200 CDI          | 100                | 08.10 | 08.14 | + Sportpaket / + Sportpaket AMG <sup>4)</sup> |   |                |   |  |  |                          |
| C 200 CGI          | 135                | 04.09 | 08.14 |   |   |                | 300 10,0 8,3 +S +B<br>300 10,0 8,3 +S +B PD |  |  |                          |
| C 200 Kompressor   | 135                | 09.07 | 08.14 |   |   |                |   |  |  |                          |
| C 220 CDI          | 120                | 01.07 | 08.14 |   |   |                |   |  |  |                          |
| C 220 CDI          | 125                | 09.07 | 08.14 |   |   |                |   |  |  |                          |
| C 220 CDI          | 125                | 12.08 | 08.14 |   |   |                |   |  |  |                          |
| C 220 CDI 4-matic  | 125                | 02.13 | 08.14 |   |   |                |   |  |  |                          |
| C 230              | 150                | 09.07 | 08.14 |   |   |                |   |  |  |                          |
| C 250 CDI 4matic   | 150                | 04.09 | 08.14 | + Sportpaket / + Sportpaket AMG <sup>4)</sup> |   |                |   |  |  |                          |
| C 250 CGI          | 150                | 04.09 | 08.14 |   |   |                |   |  |  |                          |
| C 280              | 170                | 09.07 | 08.14 |   |   |                |   |  |  |                          |
| C 300              | 170                | 08.07 | 08.14 |   |   |                |   |  |  |                          |
| C 250 CDI          | 150                | 04.09 | 08.14 |   | 24.0120-0208.1                                | 420208         | 300 22,0 19,4 V L +S +B                     |  |  |                          |
| C 250 CDI 4matic   | 150                | 04.09 | 08.14 | - Sportpaket / - Sportpaket AMG <sup>3)</sup> |   |                |   |  |  |                          |
| C 320 CDI          | 165                | 09.07 | 08.14 |   |   |                |   |  |  |                          |
| C 320 CDI 4-matic  | 165                | 09.07 | 08.14 |   |   |                |   |  |  |                          |
| C 350              | 200                | 09.07 | 08.14 |   |   |                |   |  |  |                          |
| C 350 CDI          | 165                | 08.07 | 08.14 |   |   |                |   |  |  |                          |
| C 350 CDI          | 195                | 06.11 | 08.14 |   |   |                |   |  |  |                          |
| C 350 CDI 4-matic  | 170                | 10.09 | 08.14 |   |   |                |   |  |  |                          |
| C 350 CDI BlueEff. | 170                | 04.09 | 08.14 |   |   |                |   |  |  |                          |
| C 350 CGI          | 225                | 06.11 | 08.14 |   |   |                |   |  |  |                          |
|                    | C 180 CDI BE       | 88    | 01.11 | 08.14   |   | 24.0711-6191.3 | 360247                                      | 2  | Radsensor L=945  |                          |
|                    | C 180 CGI          | 115   | 04.09 | 08.14   |   |                |   |  |  |                          |
|                    | C 180 Kompressor   | 115   | 09.07 | 08.14   |   |                |   |  |  |                          |
|                    | C 180 Kompressor   | 115   | 01.08 | 08.14   |   |                |   |  |  |                          |
|                    | C 200 CDI          | 100   | 09.07 | 08.14   |   |                |   |  |  |                          |
|                    | C 200 CDI          | 100   | 08.10 | 08.14   |   |                |   |  |  |                          |
|                    | C 200 CGI          | 135   | 04.09 | 08.14   |   |                |   |  |  |                          |
|                    | C 200 Kompressor   | 135   | 09.07 | 08.14   |   |                |   |  |  |                          |
|                    | C 220 CDI          | 120   | 01.07 | 08.14   |   |                |   |  |  |                          |
|                    | C 220 CDI          | 125   | 09.07 | 08.14   |   |                |   |  |  |                          |
|                    | C 220 CDI          | 125   | 12.08 | 08.14   |   |                |   |  |  |                          |
|                    | C 220 CDI 4-matic  | 125   | 02.13 | 08.14   |   |                |   |  |  |                          |
|                    | C 230              | 150   | 09.07 | 08.14   |   |                |   |  |  |                          |
|                    | C 250 CDI          | 150   | 04.09 | 08.14   |   |                |   |  |  |                          |
|                    | C 250 CDI 4matic   | 150   | 04.09 | 08.14   |   |                |   |  |  |                          |
|                    | C 250 CGI          | 150   | 04.09 | 08.14   |   |                |   |  |  |                          |
|                    | C 280              | 170   | 09.07 | 08.14   |   |                |   |  |  |                          |
|                    | C 300              | 170   | 08.07 | 08.14   |   |                |   |  |  |                          |
|                    | C 320 CDI          | 165   | 09.07 | 08.14   |   |                |   |  |  |                          |
|                    | C 320 CDI 4-matic  | 165   | 09.07 | 08.14   |   |                |   |  |  |                          |
|                    | C 350              | 200   | 09.07 | 08.14   |   |                |   |  |  |                          |
|                    | C 350 CDI          | 165   | 08.07 | 08.14   |   |                |   |  |  |                          |
|                    | C 350 CDI          | 195   | 06.11 | 08.14   |   |                |   |  |  |                          |
|                    | C 350 CDI 4-matic  | 170   | 10.09 | 08.14   |   |                |   |  |  |                          |
|                    | C 350 CDI BlueEff. | 170   | 04.09 | 08.14   |   |                |   |  |  |                          |
| C 350 CGI          | 225                | 06.11 | 08.14 |   |   |                |   |  |  |                          |
| C 63 AMG           |                    | 09.07 | 08.14 |   |   |                |   |  |  |                          |
|                    | C 180 CDI BE       | 88    | 01.11 | 08.14   |   | 03.0137-4005.2 | 654005                                      |  | 164 x 25 /Zub  |                          |
|                    | C 180 CGI          | 115   | 04.09 | 08.14   |   |                |   |  |  |                          |
|                    | C 180 Kompressor   | 115   | 09.07 | 08.14   |   |                |   |  |  |                          |
|                    | C 180 Kompressor   | 115   | 01.08 | 08.14   |   |                |   |  |  |                          |
|                    | C 200 CDI          | 100   | 09.07 | 08.14   |   |                |   |  |  |                          |
|                    | C 200 CDI          | 100   | 08.10 | 08.14   |   |                |   |  |  |                          |
|                    | C 200 CGI          | 135   | 04.09 | 08.14   |   |                |   |  |  |                          |
|                    | C 200 Kompressor   | 135   | 09.07 | 08.14   |   |                |   |  |  |                          |
|                    | C 220 CDI          | 120   | 01.07 | 08.14   |   |                |   |  |  |                          |
|                    | C 220 CDI          | 125   | 09.07 | 08.14   |   |                |   |  |  |                          |
|                    | C 220 CDI          | 125   | 12.08 | 08.14   |   |                |   |  |  |                          |
|                    | C 220 CDI 4-matic  | 125   | 02.13 | 08.14   |   |                |   |  |  |                          |
|                    | C 230              | 150   | 09.07 | 08.14   |   |                |   |  |  |                          |
|                    | C 250 CDI          | 150   | 04.09 | 08.14   |   |                |   |  |  |                          |
|                    | C 250 CDI 4matic   | 150   | 04.09 | 08.14   |   |                |   |  |  |                          |
| C 250 CGI          | 150                | 04.09 | 08.14 |   |   |                |   |  |  |                          |
| C 280              | 170                | 09.07 | 08.14 |   |   |                |   |  |  |                          |

<sup>1)</sup> + cast iron caliper / + pinza in ghisa / + étriers en fonte grise / + fundición gris-pinza

















<sup>2)</sup> + aluminium calipers / + pinze in alluminio / + étriers en aluminium / + pinzas de aluminio

<sup>3)</sup> - sport package/- sport package AMG / - pacchetto sportivo/- pacchetto sport.AMG / - version sport/- version sport AMG / - kit sportivo/- kit sportivo AMG

<sup>4)</sup> + sports package/+ sports package AMG / + pacchetto sportivo/+ pacchetto sport.AMG / + version sport/+ version sport AMG / + kit sportivo/+ kit sportivo AMG





|     |  |  |  |  |  |  |  |  |
|--|--|--|--|--|---|--|--|--|
| <b>MERCEDES BENZ C-Klasse (S204) Kombi (07-14)</b>                                 |  |  |  |  |   |  |  |  |
|    | C 300  | 170  | 08.07  | 08.14  | 03.0137-4005.2  | 654005   |  | 164 x 25 /Zub  |
|  | C 320 CDI  | 165  | 09.07  | 08.14  |   |  |  |  |
|  | C 320 CDI 4-matic  | 165  | 09.07  | 08.14  |   |  |  |  |
|  | C 350  | 200  | 09.07  | 08.14  |   |  |  |  |
|  | C 350 CDI  | 165  | 08.07  | 08.14  |   |  |  |  |
|  | C 350 CDI  | 195  | 06.11  | 08.14  |   |  |  |  |
|  | C 350 CDI 4-matic  | 170  | 10.09  | 08.14  |   |  |  |  |
|  | C 350 CDI BlueEff.   | 170  | 04.09  | 08.14  |   |  |  |  |
|  | C 350 CGI  | 225  | 06.11  | 08.14  |   |  |  |  |
|  | C 63 AMG   |  | 09.07  | 08.14  |   |  |  |  |
| <b>MERCEDES BENZ C-Klasse (C204) Coupe (11-)</b>                                   |  |  |  |  |   |  |  |  |
|    | C 180  | 115  | 01.13  |  | - Sportpaket / - Sportpaket AMG <sup>1)</sup>                                     | 13.0460-2733.2   | 602733   | 24306 20,3 /WE/Zub/S TRW   |
|  | C 180 CGI  | 115  | 06.11  |  | - Sportpaket / - Sportpaket AMG <sup>1)</sup>                                     | 13.0470-2733.2   | LD2733   | 24306 20,3 /WE/Zub/S TRW   |
|  |  |  |  |  |   | 24.8190-0410.2   | 620410   | Warnkontakt L=97,5mm   |
|  | C 180  | 115  | 01.13  |  | + Sportpaket / + Sportpaket AMG <sup>2)</sup>                                     | 13.0460-2732.2   | 602732   | 24306 20,3 /WE/Zub/S TRW   |
|  | C 180 CGI  | 115  | 06.11  |  | + Sportpaket / + Sportpaket AMG <sup>2)</sup>                                     | 13.0470-2732.2   | LD2732   | 24306 20,3 /WE/Zub/S TRW   |
|  | C 200 CGI  | 135  | 06.11  |  | - Sport Edition [P84]   | 24.8190-0410.2   | 620410   | Warnkontakt L=97,5mm   |
|  | C 220 CDI  | 125  | 06.11  |  |   |  |  |  |
|  | C 250 CDI  | 150  | 06.11  |  | - Sport Edition [P84]   |  |  |  |
|  | C 250 CGI  | 150  | 06.11  |  | - Sport Edition [P84]   |  |  |  |
|  | C 200 CGI  | 135  | 06.11  |  | + Sport Edition [P84]   | 13.0460-2734.2   | 602734   | 24310 19,0 +/WE/S TRW  |
|  | C 250 CDI  | 150  | 06.11  |  | + Sport Edition [P84]   | 13.0470-2734.2   | LD2734   | 24310 19,0 +/WE/S TRW  |
|  | C 250 CGI  | 150  | 06.11  |  | + Sport Edition [P84]   | 24.8190-0410.2   | 620410   | Warnkontakt L=97,5mm   |
|  | C 350  | 225  | 06.11  |  |   |  |  |  |
|  | C 350 4-matic  | 225  | 09.13  |  |   |  |  |  |
|  | C 63 AMG   | 336  | 06.11  |  |   | 13.0460-4839.2   | 604839   | 24455 16,8 /WE BRE   |
|  | C 63 AMG   | 373  | 11.12  |  |   | 24.8190-0420.2   | 620420   | Warnkontakt L=119mm  |
|    | C 180  | 115  | 01.13  |  | - Sportpaket / - Sportpaket AMG <sup>1)</sup>                                     | 24.0125-0179.1   | 425179   | 288 25,0 22,4 V L +S +B  |
|  | C 180 CGI  | 115  | 06.11  |  | - Sportpaket / - Sportpaket AMG <sup>1)</sup>                                     | 24.0325-0179.1   | 525179   | 288 25,0 22,4 V L +S +B PD   |
|  | C 180  | 115  | 01.13  |  | + Sportpaket / + Sportpaket AMG <sup>2)</sup>                                     | 24.0128-0100.1   | 428100   | 295 28,0 26,0 V L +S +B  |
|  | C 180 CGI  | 115  | 06.11  |  | + Sportpaket / + Sportpaket AMG <sup>2)</sup>                                     |  |  |  |
|  | C 200 CGI  | 135  | 06.11  |  | + Sportpaket / + Sportpaket AMG <sup>2)</sup>                                     |  |  |  |
|  | C 220 CDI  | 125  | 06.11  |  | + Sportpaket / + Sportpaket AMG <sup>2)</sup>                                     |  |  |  |
|  | C 250 CDI  | 150  | 06.11  |  | + Sportpaket / + Sportpaket AMG <sup>2)</sup>                                     |  |  |  |
|  | C 250 CGI  | 150  | 06.11  |  | + Sportpaket / + Sportpaket AMG <sup>2)</sup>                                     |  |  |  |
|  | C 200 CGI  | 135  | 06.11  |  | + Sport Edition [P84]   | 24.0132-0168.1   | 432168   | 344 32,0 30,0 V L +S +B  |
|  | C 250 CDI  | 150  | 06.11  |  | + Sport Edition [P84]   |  |  |  |
|  | C 250 CGI  | 150  | 06.11  |  | + Sport Edition [P84]   |  |  |  |
|  | C 200 CGI  | 135  | 06.11  |  | - Sportpaket / - Sportpaket AMG <sup>1)</sup>                                     | 24.0128-0155.1   | 428155   | 295 28,0 25,4 V L +S +B  |
|  | C 220 CDI  | 125  | 06.11  |  | - Sportpaket / - Sportpaket AMG <sup>1)</sup>                                     |  |  |  |
|  | C 250 CDI  | 150  | 06.11  |  | - Sportpaket / - Sportpaket AMG <sup>1)</sup>                                     |  |  |  |
|  | C 250 CGI  | 150  | 06.11  |  | - Sportpaket / - Sportpaket AMG <sup>1)</sup>                                     |  |  |  |
|  | C 350  | 225  | 06.11  |  | - Sportpaket / - Sportpaket AMG <sup>1)</sup>                                     | 24.0132-0101.1   | 432101   | 322 32,0 29,4 V L +S +B  |
|  | C 350 4-matic  | 225  | 09.13  |  | - Sportpaket / - Sportpaket AMG <sup>1)</sup>                                     | 24.0332-0101.1   | 532101   | 322 32,0 29,4 V L +S +B PD   |
|  | C 350  | 225  | 06.11  |  | + Sportpaket / + Sportpaket AMG <sup>2)</sup>                                     | 24.0132-0100.1   | 432100   | 322 32,0 30,0 V L +S +B  |
|  | C 350 4-matic  | 225  | 09.13  |  | + Sportpaket / + Sportpaket AMG <sup>2)</sup>                                     |  |  |  |
|  | C 63 AMG   | 336  | 06.11  |  |   | 24.0136-0108.1   | 436108   | 360 36,0 34,0 V L +S +B  |
|  | C 63 AMG   | 373  | 11.12  |  |   |  |  |  |
|  | C 180  | 115  | 01.13  |  |   | 24.0711-6390.3   | 360406   | 2 Radsensor L=618  |
|  | C 180 CGI  | 115  | 06.11  |  |   |  |  |  |
|  | C 200 CGI  | 135  | 06.11  |  |   |  |  |  |
|  | C 220 CDI  | 125  | 06.11  |  |   |  |  |  |
|  | C 250 CDI  | 150  | 06.11  |  |   |  |  |  |
|  | C 250 CGI  | 150  | 06.11  |  |   |  |  |  |
|  | C 350  | 225  | 06.11  |  |   |  |  |  |
|  | C 350 4-matic  | 225  | 09.13  |  |   | 24.0711-5330.3   | 360417   | 2 Radsensor L=733  |
|  | C 180  | 115  | 01.13  |  |   | 13.0460-7244.2   | 607244   | 24253 17,8 +/WE ATE  |
|  | C 180 CGI  | 115  | 06.11  |  |   | 13.0470-7244.2   | LD7244   | 24253 17,8 +/WE ATE  |
|  | C 200 CGI  | 135  | 06.11  |  |   | 24.8190-0410.2   | 620410   | Warnkontakt L=97,5mm   |
|  | C 220 CDI  | 125  | 06.11  |  |   |  |  |  |
|  | C 250 CDI  | 150  | 06.11  |  |   |  |  |  |
|  | C 250 CGI  | 150  | 06.11  |  |   |  |  |  |
|  | C 350  | 225  | 06.11  |  |   |  |  |  |
|  | C 350 4-matic  | 225  | 09.13  |  |   |  |  |  |
|  | C 63 AMG   | 336  | 06.11  |  |   | 24.8190-0410.2   | 620410   | Warnkontakt L=97,5mm   |
|  | C 63 AMG   | 373  | 11.12  |  |   |  |  |  |
|  | C 63 AMG Black Series  | 380  | 01.12  |  |   | 24.8190-0420.2   | 620420   | Warnkontakt L=119mm  |
|  | C 180  | 115  | 01.13  |  | - Sportpaket / - Sportpaket AMG <sup>1)</sup>                                     | 24.0109-0154.1   | 409154   | 278 9,0 7,3 +S +B  |
|  | C 180 CGI  | 115  | 06.11  |  | - Sportpaket / - Sportpaket AMG <sup>1)</sup>                                     | 24.0309-0154.1   | 509154   | 278 9,0 7,3 +S +B PD   |
|  | C 180  | 115  | 01.13  |  | + Sportpaket / + Sportpaket AMG <sup>2)</sup>                                     | 24.0110-0328.1   | 410328   | 300 10,0 8,3 +S +B   |
|  | C 180 CGI  | 115  | 06.11  |  | + Sportpaket / + Sportpaket AMG <sup>2)</sup>                                     | 24.0310-0328.1   | 510328   | 300 10,0 8,3 +S +B PD  |
|  | C 200 CGI  | 135  | 06.11  |  |   |  |  |  |
|  | C 220 CDI  | 125  | 06.11  |  |   |  |  |  |
|  | C 250 CGI  | 150  | 06.11  |  |   |  |  |  |
|  | C 250 CDI  | 150  | 06.11  |  |   | 24.0120-0208.1   | 420208   | 300 22,0 19,4 V L +S +B  |
|  | C 350  | 225  | 06.11  |  |   |  |  |  |
|  | C 350 4-matic  | 225  | 09.13  |  |   |  |  |  |
|  | C 180  | 115  | 01.13  |  |   | 24.0711-6191.3   | 360247   | 2 Radsensor L=945  |
|  | C 180 CGI  | 115  | 06.11  |  |   |  |  |  |
|  | C 200 CGI  | 135  | 06.11  |  |   |  |  |  |
|  | C 220 CDI  | 125  | 06.11  |  |   |  |  |  |
|  | C 250 CDI  | 150  | 06.11  |  |   |  |  |  |
|  | C 250 CGI  | 150  | 06.11  |  |   |  |  |  |

<sup>1)</sup> - sport package/- sport package AMG / - pacchetto sportivo/- pacchetto sport.AMG / - version sport/- version sport AMG / - kit deportivo/- kit deportivo AMG  
<sup>2)</sup> + sports package/+ sports package AMG / + pacchetto sportivo/+ pacchetto sport.AMG / + version sport/+ version sport AMG / + kit deportivo/+ kit deportivo AMG





### MERCEDES BENZ C-Klasse (C204) Coupe (11-)

|  |                       |     |       |  |                |        |   |  |                 |
|--|-----------------------|-----|-------|--|----------------|--------|---|--|-----------------|
|  | C 350                 | 225 | 06.11 |  | 24.0711-6191.3 | 360247 | 2 |  | Radsensor L=945 |
|  | C 350 4-matic         | 225 | 09.13 |  |                |        |   |  |                 |
|  | C 63 AMG              | 336 | 06.11 |  |                |        |   |  |                 |
|  | C 63 AMG              | 373 | 11.12 |  |                |        |   |  |                 |
|  | C 180                 | 115 | 01.13 |  | 03.0137-4005.2 | 654005 |   |  | 164 x 25 /Zub   |
|  | C 180 CGI             | 115 | 06.11 |  |                |        |   |  |                 |
|  | C 200 CGI             | 135 | 06.11 |  |                |        |   |  |                 |
|  | C 220 CDI             | 125 | 06.11 |  |                |        |   |  |                 |
|  | C 250 CDI             | 150 | 06.11 |  |                |        |   |  |                 |
|  | C 250 CGI             | 150 | 06.11 |  |                |        |   |  |                 |
|  | C 350                 | 225 | 06.11 |  |                |        |   |  |                 |
|  | C 350 4-matic         | 225 | 09.13 |  |                |        |   |  |                 |
|  | C 63 AMG              | 336 | 06.11 |  |                |        |   |  |                 |
|  | C 63 AMG              | 373 | 11.12 |  |                |        |   |  |                 |
|  | C 63 AMG Black Series | 380 | 01.10 |  | 03.0137-4007.2 | 654007 |   |  | 180 x 25 /Zub   |

### MERCEDES BENZ C-Klasse (W205) Limousine (14-)

|  |                       |     |       |                                |                |        |   |                              |                         |
|--|-----------------------|-----|-------|--------------------------------|----------------|--------|---|------------------------------|-------------------------|
|  | C 160                 | 95  | 04.15 | - Sportpaket AMG <sup>1)</sup> | 13.0460-2792.2 | 602792 |   |                              | XXXXX 19,6 +/WE/S TRW   |
|  | C 180                 | 115 | 02.14 | - Sportpaket AMG <sup>1)</sup> | 13.0470-2792.2 | LD2792 |   |                              | XXXXX 19,6 +/WE/S TRW   |
|  | C 180 BlueTec         | 85  | 05.14 | - Sportpaket AMG <sup>1)</sup> | 24.8190-0067.2 | 620067 | 1 |                              | Warnkontakt L=92,5mm    |
|  | C 200                 | 135 | 02.14 | - Sportpaket AMG <sup>1)</sup> |                |        |   |                              |                         |
|  | C 200 4-matic         | 135 | 04.15 | - Sportpaket AMG <sup>1)</sup> |                |        |   |                              |                         |
|  | C 200 BlueTec         | 100 | 05.14 | - Sportpaket AMG <sup>1)</sup> |                |        |   |                              |                         |
|  | C 200 d               | 100 | 10.15 | - Sportpaket AMG <sup>1)</sup> |                |        |   |                              |                         |
|  | C 220 BlueTec         | 125 | 02.14 | - Sportpaket AMG <sup>1)</sup> |                |        |   |                              |                         |
|  | C 220 BlueTec 4-matic | 125 | 04.15 | - Sportpaket AMG <sup>1)</sup> |                |        |   |                              |                         |
|  | C 160                 | 95  | 04.15 | + Sportpaket AMG <sup>2)</sup> | 24.8190-0067.2 | 620067 | 1 |                              | Warnkontakt L=92,5mm    |
|  | C 180                 | 115 | 02.14 | + Sportpaket AMG <sup>2)</sup> |                |        |   |                              |                         |
|  | C 180 BlueTec         | 85  | 05.14 | + Sportpaket AMG <sup>2)</sup> |                |        |   |                              |                         |
|  | C 200                 | 135 | 02.14 | + Sportpaket AMG <sup>2)</sup> |                |        |   |                              |                         |
|  | C 200 4-matic         | 135 | 04.15 | + Sportpaket AMG <sup>2)</sup> |                |        |   |                              |                         |
|  | C 200 BlueTec         | 100 | 05.14 | + Sportpaket AMG <sup>2)</sup> |                |        |   |                              |                         |
|  | C 200 d               | 100 | 10.15 | + Sportpaket AMG <sup>2)</sup> |                |        |   |                              |                         |
|  | C 220 BlueTec         | 125 | 02.14 | + Sportpaket AMG <sup>2)</sup> |                |        |   |                              |                         |
|  | C 220 BlueTec 4-matic | 125 | 04.15 | + Sportpaket AMG <sup>2)</sup> |                |        |   |                              |                         |
|  | C 250 BlueTec         | 150 | 02.14 | - Sportpaket AMG <sup>1)</sup> |                |        |   |                              |                         |
|  | C 250 CGI             | 155 | 03.14 | - Sportpaket AMG <sup>1)</sup> |                |        |   |                              |                         |
|  | C 300 BlueTec Hybrid  | 150 | 05.14 | - Sportpaket AMG <sup>1)</sup> |                |        |   |                              |                         |
|  | C 250 BlueTec 4-matic | 150 | 05.14 | - Sportpaket AMG <sup>1)</sup> | 24.8190-0067.2 | 620067 | 1 |                              | Warnkontakt L=92,5mm    |
|  | C 300                 | 180 | 09.15 | - Sportpaket AMG <sup>1)</sup> |                |        |   |                              |                         |
|  | C 250 BlueTec         | 150 | 02.14 | + Sportpaket AMG <sup>2)</sup> | 24.8190-0067.2 | 620067 | 1 |                              | Warnkontakt L=92,5mm    |
|  | C 250 BlueTec 4-matic | 150 | 02.14 | + Sportpaket AMG <sup>2)</sup> |                |        |   |                              |                         |
|  | C 250 CGI             | 155 | 03.14 | + Sportpaket AMG <sup>2)</sup> |                |        |   |                              |                         |
|  | C 300                 | 180 | 09.15 | + Sportpaket AMG <sup>2)</sup> |                |        |   |                              |                         |
|  | C 300 BlueTec Hybrid  | 150 | 05.14 | + Sportpaket AMG <sup>2)</sup> |                |        |   |                              |                         |
|  | C 350 e Hybrid        |     | 02.15 |                                |                |        |   |                              |                         |
|  | C 400 4-matic         | 245 | 10.14 |                                |                |        |   |                              |                         |
|  | C 450 AMG 4-matic     | 270 | 04.15 | + Sportpaket AMG <sup>2)</sup> |                |        |   |                              |                         |
|  | C 450 AMG 4-matic     | 270 | 04.15 | - Sportpaket AMG <sup>1)</sup> | 24.8190-0067.2 | 620067 | 1 |                              | Warnkontakt L=92,5mm    |
|  | C 63 AMG              | 350 | 10.14 |                                | 24.0136-0108.1 | 436108 |   | - roter Sattel <sup>3)</sup> | 360 36,0 34,0 V L +S +B |
|  | C 63 S AMG            | 375 | 10.14 |                                |                |        |   |                              |                         |
|  | C 160                 | 95  | 04.15 |                                | 24.8190-0067.2 | 620067 | 1 |                              | Warnkontakt L=92,5mm    |
|  | C 180                 | 115 | 02.14 |                                |                |        |   |                              |                         |
|  | C 180 BlueTec         | 85  | 05.14 |                                |                |        |   |                              |                         |
|  | C 200                 | 135 | 02.14 |                                |                |        |   |                              |                         |
|  | C 200 4-matic         | 135 | 04.15 |                                |                |        |   |                              |                         |
|  | C 200 BlueTec         | 100 | 05.14 |                                |                |        |   |                              |                         |
|  | C 200 d               | 100 | 10.15 |                                |                |        |   |                              |                         |
|  | C 220 BlueTec         | 125 | 02.14 |                                |                |        |   |                              |                         |
|  | C 220 BlueTec 4-matic | 125 | 04.15 |                                |                |        |   |                              |                         |
|  | C 250 BlueTec         | 150 | 02.14 |                                |                |        |   |                              |                         |
|  | C 250 BlueTec 4-matic | 150 | 02.14 |                                |                |        |   |                              |                         |
|  | C 250 CGI             | 155 | 03.14 |                                |                |        |   |                              |                         |
|  | C 300                 | 180 | 09.15 |                                |                |        |   |                              |                         |
|  | C 300 BlueTec Hybrid  | 150 | 05.14 |                                |                |        |   |                              |                         |
|  | C 350 e Hybrid        |     | 02.15 |                                |                |        |   |                              |                         |
|  | C 400 4-matic         | 245 | 10.14 |                                |                |        |   |                              |                         |
|  | C 450 AMG 4-matic     | 270 | 04.15 | + Sportpaket AMG <sup>2)</sup> |                |        |   |                              |                         |
|  | C 450 AMG 4-matic     | 270 | 04.15 | - Sportpaket AMG <sup>1)</sup> | 24.8190-0067.2 | 620067 | 1 |                              | Warnkontakt L=92,5mm    |
|  | C 63 AMG              | 350 | 10.14 |                                | 24.8190-0410.2 | 620410 | 1 |                              | Warnkontakt L=97,5mm    |
|  | C 63 S AMG            | 375 | 10.14 |                                |                |        |   |                              |                         |

### MERCEDES BENZ C-Klasse (S205) Kombi (14-)

|  |                 |     |       |                                |                |        |   |  |                       |
|--|-----------------|-----|-------|--------------------------------|----------------|--------|---|--|-----------------------|
|  | C 160           | 95  | 04.15 | - Sportpaket AMG <sup>1)</sup> | 13.0460-2792.2 | 602792 |   |  | XXXXX 19,6 +/WE/S TRW |
|  | C 180           | 115 | 09.14 | - Sportpaket AMG <sup>1)</sup> | 13.0470-2792.2 | LD2792 |   |  | XXXXX 19,6 +/WE/S TRW |
|  | C 180 BlueTec   | 85  | 09.14 | - Sportpaket AMG <sup>1)</sup> | 24.8190-0067.2 | 620067 | 1 |  | Warnkontakt L=92,5mm  |
|  | C 200           | 135 | 09.14 | - Sportpaket AMG <sup>1)</sup> |                |        |   |  |                       |
|  | C 200 4-matic   | 135 | 04.15 | - Sportpaket AMG <sup>1)</sup> |                |        |   |  |                       |
|  | C 200 BlueTec   | 100 | 09.14 | - Sportpaket AMG <sup>1)</sup> |                |        |   |  |                       |
|  | C 200 d         | 100 | 10.15 | - Sportpaket AMG <sup>1)</sup> |                |        |   |  |                       |
|  | C 220 BlueTec   | 125 | 09.14 | - Sportpaket AMG <sup>1)</sup> |                |        |   |  |                       |
|  | C 220 d 4-matic | 125 | 04.15 | - Sportpaket AMG <sup>1)</sup> |                |        |   |  |                       |
|  | C 160           | 95  | 04.15 | + Sportpaket AMG <sup>2)</sup> | 24.8190-0067.2 | 620067 | 1 |  | Warnkontakt L=92,5mm  |
|  | C 180           | 115 | 09.14 | + Sportpaket AMG <sup>2)</sup> |                |        |   |  |                       |

1) - sport package AMG / - pacchetto sportivo AMG / - version sport AMG / - kit deportivo AMG  
 2) + sports package AMG / + pacchetto sportivo AMG / + version sport AMG / + kit deportivo AMG  
 3) - red caliper / - pinza rossa / - étrier rouge / - pinza roja





### MERCEDES BENZ C-Klasse (S205) Kombi (14-)

|                   |                       |       |                                |                                |                |        |   |                              |                         |
|-------------------|-----------------------|-------|--------------------------------|--------------------------------|----------------|--------|---|------------------------------|-------------------------|
|                   | C 180 BlueTec         | 85    | 09.14                          | + Sportpaket AMG <sup>1)</sup> | 24.8190-0067.2 | 620067 | 1 |                              | Warnkontakt L=92,5mm    |
|                   | C 200                 | 135   | 09.14                          | + Sportpaket AMG <sup>1)</sup> |                |        |   |                              |                         |
|                   | C 200 4-matic         | 135   | 04.15                          | + Sportpaket AMG <sup>1)</sup> |                |        |   |                              |                         |
|                   | C 200 BlueTec         | 100   | 09.14                          | + Sportpaket AMG <sup>1)</sup> |                |        |   |                              |                         |
|                   | C 200 d               | 100   | 10.15                          | + Sportpaket AMG <sup>1)</sup> |                |        |   |                              |                         |
|                   | C 220 BlueTec         | 125   | 09.14                          | + Sportpaket AMG <sup>1)</sup> |                |        |   |                              |                         |
|                   | C 220 d 4-matic       | 125   | 04.15                          | + Sportpaket AMG <sup>1)</sup> |                |        |   |                              |                         |
|                   | C 250 BlueTec         | 150   | 09.14                          | - Sportpaket AMG <sup>2)</sup> |                |        |   |                              |                         |
|                   | C 250 CGI             | 155   | 09.14                          | - Sportpaket AMG <sup>2)</sup> |                |        |   |                              |                         |
|                   | C 300 BlueTec Hybrid  | 150   | 10.14                          | - Sportpaket AMG <sup>2)</sup> |                |        |   |                              |                         |
| C 400 4-matic     | 245                   | 10.14 | - Sportpaket AMG <sup>2)</sup> |                                |                |        |   |                              |                         |
|                   | C 250 BlueTec         | 150   | 09.14                          | + Sportpaket AMG <sup>1)</sup> | 24.8190-0067.2 | 620067 | 1 |                              | Warnkontakt L=92,5mm    |
|                   | C 250 BlueTec 4-matic | 150   | 10.14                          | + Sportpaket AMG <sup>1)</sup> |                |        |   |                              |                         |
|                   | C 250 CGI             | 155   | 09.14                          | + Sportpaket AMG <sup>1)</sup> |                |        |   |                              |                         |
|                   | C 300                 | 180   | 09.15                          | + Sportpaket AMG <sup>1)</sup> |                |        |   |                              |                         |
|                   | C 300 BlueTec Hybrid  | 150   | 10.14                          | + Sportpaket AMG <sup>1)</sup> |                |        |   |                              |                         |
|                   | C 350 e Hybrid        | 150   | 02.15                          | + Sportpaket AMG <sup>1)</sup> |                |        |   |                              |                         |
|                   | C 400 4-matic         | 245   | 10.14                          | + Sportpaket AMG <sup>1)</sup> |                |        |   |                              |                         |
|                   | C 250 BlueTec 4-matic | 150   | 10.14                          | - Sportpaket AMG <sup>2)</sup> | 24.8190-0067.2 | 620067 | 1 |                              | Warnkontakt L=92,5mm    |
|                   | C 300                 | 180   | 09.15                          | - Sportpaket AMG <sup>2)</sup> |                |        |   |                              |                         |
|                   | C 450 AMG 4-matic     | 270   | 04.15                          | - Sportpaket AMG <sup>2)</sup> | 24.8190-0067.2 | 620067 | 1 |                              | Warnkontakt L=92,5mm    |
|                   | C 63 AMG              | 350   | 10.14                          |                                |                |        |   |                              |                         |
| C 63 S AMG        | 375                   | 10.14 |                                |                                | 24.0136-0108.1 | 436108 |   | - roter Sattel <sup>3)</sup> | 360 36,0 34,0 V L +S +B |
|                   | C 160                 | 95    | 04.15                          |                                | 24.8190-0067.2 | 620067 | 1 |                              | Warnkontakt L=92,5mm    |
|                   | C 180                 | 115   | 09.14                          |                                |                |        |   |                              |                         |
|                   | C 180 BlueTec         | 85    | 09.14                          |                                |                |        |   |                              |                         |
|                   | C 200                 | 135   | 09.14                          |                                |                |        |   |                              |                         |
|                   | C 200 4-matic         | 135   | 04.15                          |                                |                |        |   |                              |                         |
|                   | C 200 BlueTec         | 100   | 09.14                          |                                |                |        |   |                              |                         |
|                   | C 200 d               | 100   | 10.15                          |                                |                |        |   |                              |                         |
|                   | C 220 BlueTec         | 125   | 09.14                          |                                |                |        |   |                              |                         |
|                   | C 220 d 4-matic       | 125   | 04.15                          |                                |                |        |   |                              |                         |
|                   | C 250 BlueTec         | 150   | 09.14                          |                                |                |        |   |                              |                         |
|                   | C 250 BlueTec 4-matic | 150   | 10.14                          |                                |                |        |   |                              |                         |
|                   | C 250 CGI             | 155   | 09.14                          |                                |                |        |   |                              |                         |
|                   | C 300                 | 180   | 09.15                          |                                |                |        |   |                              |                         |
|                   | C 300 BlueTec Hybrid  | 150   | 10.14                          |                                |                |        |   |                              |                         |
| C 350 e Hybrid    | 150                   | 02.15 |                                |                                |                |        |   |                              |                         |
| C 400 4-matic     | 245                   | 10.14 |                                |                                |                |        |   |                              |                         |
| C 450 AMG 4-matic | 270                   | 04.15 | + Sportpaket AMG <sup>1)</sup> |                                |                |        |   |                              |                         |
| C 450 AMG 4-matic | 270                   | 04.15 | - Sportpaket AMG <sup>2)</sup> | 24.8190-0067.2                 | 620067         | 1      |   | Warnkontakt L=92,5mm         |                         |

### MERCEDES BENZ C-Klasse (C205) Coupe (15-)

|                  |                  |       |                                |                                |                |        |                              |                         |                                |                  |     |                |        |
|------------------|------------------|-------|--------------------------------|--------------------------------|----------------|--------|------------------------------|-------------------------|--------------------------------|------------------|-----|----------------|--------|
|                  | C 180            | 115   | 10.15                          |                                | 13.0460-2792.2 | 602792 | 1                            |                         | - AMG Sportpaket <sup>4)</sup> | XXXXX 19,6 +WE/S | TRW |                |        |
|                  | C 200            | 135   | 10.15                          |                                |                |        |                              |                         |                                |                  |     |                |        |
|                  | C 200 4-matic    | 135   | 04.16                          |                                |                |        |                              |                         |                                |                  |     |                |        |
|                  | C 220 d          | 125   | 10.15                          |                                |                |        |                              |                         |                                |                  |     |                |        |
|                  | C 220 d 4-matic  | 125   | 04.16                          |                                |                |        |                              |                         |                                |                  |     |                |        |
|                  | C 250            | 155   | 10.15                          |                                |                |        |                              |                         |                                |                  |     |                |        |
|                  | C 250 d          | 150   | 10.15                          | - Sportpaket AMG <sup>2)</sup> |                |        |                              |                         |                                |                  |     |                |        |
|                  | C 250 d 4-matic  | 150   | 04.16                          | - Sportpaket AMG <sup>2)</sup> |                |        |                              |                         |                                |                  |     |                |        |
|                  | C 300            | 180   | 10.15                          | - Sportpaket AMG <sup>2)</sup> |                |        |                              |                         |                                |                  |     |                |        |
|                  | C 250 d          | 150   | 10.15                          | + Sportpaket AMG <sup>1)</sup> |                |        |                              |                         |                                |                  |     | 24.8190-0067.2 | 620067 |
| C 250 d 4-matic  | 150              | 04.16 | + Sportpaket AMG <sup>1)</sup> |                                |                |        |                              |                         |                                |                  |     |                |        |
| C 300            | 180              | 10.15 | + Sportpaket AMG <sup>1)</sup> |                                |                |        |                              |                         |                                |                  |     |                |        |
| C 400 4-matic    | 245              | 04.16 | + Sportpaket AMG <sup>1)</sup> |                                |                |        |                              |                         |                                |                  |     |                |        |
| C 43 AMG 4-matic | 270              | 04.16 |                                |                                |                |        |                              |                         |                                |                  |     |                |        |
| C 63 AMG         | 350              | 02.16 |                                |                                |                |        |                              |                         |                                |                  |     |                |        |
| C 63 AMG S       | 375              | 02.16 |                                |                                |                |        |                              |                         |                                |                  |     |                |        |
| C 63 AMG S       | 375              | 02.16 |                                |                                |                |        |                              |                         |                                |                  |     |                |        |
| C 63 AMG S       | 375              | 02.16 |                                | 24.0136-0108.1                 | 436108         |        | - roter Sattel <sup>3)</sup> | 360 36,0 34,0 V L +S +B |                                |                  |     |                |        |
|                  | C 180            | 115   | 10.15                          |                                | 24.8190-0067.2 | 620067 | 1                            |                         | Warnkontakt L=92,5mm           |                  |     |                |        |
|                  | C 200            | 135   | 10.15                          |                                |                |        |                              |                         |                                |                  |     |                |        |
|                  | C 200 4-matic    | 135   | 04.16                          |                                |                |        |                              |                         |                                |                  |     |                |        |
|                  | C 220 d          | 125   | 10.15                          |                                |                |        |                              |                         |                                |                  |     |                |        |
|                  | C 220 d 4-matic  | 125   | 04.16                          |                                |                |        |                              |                         |                                |                  |     |                |        |
|                  | C 250            | 155   | 10.15                          |                                |                |        |                              |                         |                                |                  |     |                |        |
|                  | C 250 d          | 150   | 10.15                          |                                |                |        |                              |                         |                                |                  |     |                |        |
|                  | C 250 d 4-matic  | 150   | 04.16                          |                                |                |        |                              |                         |                                |                  |     |                |        |
|                  | C 300            | 180   | 10.15                          |                                |                |        |                              |                         |                                |                  |     |                |        |
|                  | C 400 4-matic    | 245   | 04.16                          |                                |                |        |                              |                         |                                |                  |     |                |        |
|                  | C 43 AMG 4-matic | 270   | 04.16                          |                                |                |        |                              |                         |                                |                  |     |                |        |
| C 63 AMG         | 350              | 02.16 |                                | 24.8190-0067.2                 | 620067         | 1      |                              | Warnkontakt L=92,5mm    |                                |                  |     |                |        |
| C 63 AMG S       | 375              | 02.16 |                                | 24.8190-0410.2                 | 620410         | 1      |                              | Warnkontakt L=97,5mm    |                                |                  |     |                |        |

### MERCEDES BENZ C-Klasse (A205) Cabrio (16-)

|       |                 |       |                                |                                |                |        |   |                      |                  |     |
|-------|-----------------|-------|--------------------------------|--------------------------------|----------------|--------|---|----------------------|------------------|-----|
|       | C 180           | 115   | 06.16                          | - Sportpaket AMG <sup>2)</sup> | 13.0460-2792.2 | 602792 | 1 |                      | XXXXX 19,6 +WE/S | TRW |
|       | C 200           | 135   | 06.16                          | - Sportpaket AMG <sup>2)</sup> |                |        |   |                      |                  |     |
|       | C 200 4-matic   | 135   | 06.16                          | - Sportpaket AMG <sup>2)</sup> |                |        |   |                      |                  |     |
|       | C 220 d         | 125   | 06.16                          | - Sportpaket AMG <sup>2)</sup> |                |        |   |                      |                  |     |
|       | C 220 d 4-matic | 125   | 06.16                          | - Sportpaket AMG <sup>2)</sup> |                |        |   |                      |                  |     |
| C 180 | 115             | 06.16 | + Sportpaket AMG <sup>1)</sup> | 24.8190-0067.2                 | 620067         | 1      |   | Warnkontakt L=92,5mm |                  |     |

<sup>1)</sup> + sports package AMG / + pacchetto sportivo AMG / + version sport AMG / + kit deportivo AMG

<sup>2)</sup> - sport package AMG / - pacchetto sportivo AMG / - version sport AMG / - kit deportivo AMG

<sup>3)</sup> - red caliper / - pinza rossa / - étrier rouge / - pinza roja

<sup>4)</sup> - AMG sports package / - kit sportivo AMG / - version sport AMG / - paquete deportivo AMG



### MERCEDES BENZ C-Klasse (A205) Cabrio (16-)

|  |                  |     |       |                                |                |        |   |  |                      |
|--|------------------|-----|-------|--------------------------------|----------------|--------|---|--|----------------------|
|  | C 200            | 135 | 06.16 | + Sportpaket AMG <sup>1)</sup> | 24.8190-0067.2 | 620067 | 1 |  | Warnkontakt L=92,5mm |
|  | C 200 4-matic    | 135 | 06.16 | + Sportpaket AMG <sup>1)</sup> |                |        |   |  |                      |
|  | C 220 d          | 125 | 06.16 | + Sportpaket AMG <sup>1)</sup> |                |        |   |  |                      |
|  | C 220 d 4-matic  | 125 | 06.16 | + Sportpaket AMG <sup>1)</sup> |                |        |   |  |                      |
|  | C 250            | 155 | 06.16 | - Sportpaket AMG <sup>2)</sup> | 24.8190-0067.2 | 620067 | 1 |  | Warnkontakt L=92,5mm |
|  | C 250 d          | 150 | 06.16 | - Sportpaket AMG <sup>2)</sup> |                |        |   |  |                      |
|  | C 300            | 180 | 06.16 | - Sportpaket AMG <sup>2)</sup> |                |        |   |  |                      |
|  | C 250            | 155 | 06.16 | + Sportpaket AMG <sup>1)</sup> | 24.8190-0067.2 | 620067 | 1 |  | Warnkontakt L=92,5mm |
|  | C 250 d          | 150 | 06.16 | + Sportpaket AMG <sup>1)</sup> |                |        |   |  |                      |
|  | C 300            | 180 | 06.16 | + Sportpaket AMG <sup>1)</sup> |                |        |   |  |                      |
|  | C 400 4-matic    | 245 | 06.16 | + Sportpaket AMG <sup>1)</sup> |                |        |   |  |                      |
|  | C 180            | 115 | 06.16 |                                | 24.8190-0067.2 | 620067 | 1 |  | Warnkontakt L=92,5mm |
|  | C 200            | 135 | 06.16 |                                |                |        |   |  |                      |
|  | C 200 4-matic    | 135 | 06.16 |                                |                |        |   |  |                      |
|  | C 220 d          | 125 | 06.16 |                                |                |        |   |  |                      |
|  | C 220 d 4-matic  | 125 | 06.16 |                                |                |        |   |  |                      |
|  | C 250            | 155 | 06.16 |                                |                |        |   |  |                      |
|  | C 250 d          | 150 | 06.16 |                                |                |        |   |  |                      |
|  | C 300            | 180 | 06.16 |                                |                |        |   |  |                      |
|  | C 400 4-matic    | 245 | 06.16 |                                |                |        |   |  |                      |
|  | C 43 AMG 4-matic | 270 | 10.16 |                                | 24.8190-0067.2 | 620067 | 1 |  |                      |

### MERCEDES BENZ CL-Klasse (C140) Coupe (96-99)

|  |        |  |       |       |                |        |   |       |   |                   |
|--|--------|--|-------|-------|----------------|--------|---|-------|---|-------------------|
|  | CL 420 |  | 06.96 | 02.99 | 13.0460-9033.2 | 609033 | 4 |       | 21303 18,9 /WE<br>Belagsatz-Zubehör<br>Warnkontakt L=95mm                   | ATE               |
|  | CL 500 |  | 06.96 | 02.99 | 13.0460-0263.2 | 610263 |   |       |   |                   |
|  | CL 600 |  | 06.96 | 02.99 | 24.8190-0401.2 | 620401 |   |       |   |                   |
|  | CL 420 |  | 06.96 | 02.99 | 24.0130-0100.1 | 430100 |   |       | 320 30,0 27,4 V L +B  |                   |
|  | CL 500 |  | 06.96 | 02.99 |                |        |   |       |   |                   |
|  | CL 600 |  | 06.96 | 02.99 |                |        |   |       |   |                   |
|  | CL 420 |  | 06.96 | 02.99 | 13.0460-4047.2 | 604047 | 4 | + ASR | 21305 15,7 /WE<br>21305 15,7 /WE<br>Belagsatz-Zubehör<br>Warnkontakt L=95mm | ATE<br>ATE<br>ATE |
|  | CL 500 |  | 06.96 | 02.99 | 13.0470-4047.2 | LD4047 |   |       |   |                   |
|  | CL 600 |  | 06.96 | 02.99 | 13.0460-0236.2 | 610236 |   |       |   |                   |
|  | CL 420 |  | 06.96 | 02.99 | 24.0122-0133.1 | 422133 |   |       | 300 22,0 19,4 V L +B  |                   |
|  | CL 500 |  | 06.96 | 02.99 |                |        |   |       |   |                   |
|  | CL 600 |  | 06.96 | 02.99 |                |        |   |       |   |                   |
|  | CL 420 |  | 06.96 | 02.99 | 03.0137-0244.2 | 650244 |   |       | 164 x 25 /Zub   |                   |
|  | CL 500 |  | 06.96 | 02.99 |                |        |   |       |   |                   |
|  | CL 600 |  | 06.96 | 02.99 |                |        |   |       |   |                   |

### MERCEDES BENZ CL-Klasse (C215) Coupe (99-06)

|  |                      |  |       |       |                |        |   |  |   |     |
|--|----------------------|--|-------|-------|----------------|--------|---|--|---|-----|
|  | CL 500               |  | 03.99 | 08.06 | 13.0460-4984.2 | 604984 | 2 |  | 23271 17,4 +/WE(1,8)<br>Belagsatz-Zubehör<br>Warnkontakt L=97,5mm | BRE |
|  | CL 55 AMG            |  | 03.99 | 08.06 | 13.0460-0269.2 | 610269 |   |  |   |     |
|  | CL 600               |  | 03.99 | 08.06 | 24.8190-0410.2 | 620410 |   |  |   |     |
|  | CL 55 Kompressor AMG |  | 06.02 | 08.06 | 13.0460-4997.2 | 604997 | 2 |  | 23944 17,5 +/WE<br>Warnkontakt L=97,5mm                           | BRE |
|  | CL 65 AMG            |  | 09.03 | 08.06 | 24.8190-0410.2 | 620410 |   |  |   |     |
|  | CL 500               |  | 03.99 | 08.06 | 24.0132-0115.1 | 432115 |   |  |   |     |
|  | CL 55 AMG            |  | 10.99 | 08.06 | 24.0132-0125.1 | 432125 | 4 |  | 330 32,0 30,0 V L +B<br>Halterschraube                            |     |
|  | CL 600               |  | 03.99 | 08.06 | 13.8190-0330.1 | 990134 |   |  |   |     |
|  | CL 55 Kompressor AMG |  | 06.02 | 08.06 | 24.0136-0105.1 | 436105 |   |  |   |     |
|  | CL 500               |  | 03.99 | 08.06 | 13.0460-4069.2 | 604069 | 1 |  | 23078 15,9 /WE<br>Warnkontakt L=97,5mm                            | ATE |
|  | CL 55 AMG            |  | 10.99 | 08.06 | 24.8190-0410.2 | 620410 |   |  |   |     |
|  | CL 600               |  | 03.99 | 08.06 |                |        |   |  |   |     |
|  | CL 55 Kompressor AMG |  | 06.02 | 08.06 | 13.0460-4998.2 | 604998 | 1 |  | 23478 16,5 /WE<br>Warnkontakt L=97,5mm                            | BRE |
|  | CL 65 AMG            |  | 09.03 | 08.06 | 24.8190-0410.2 | 620410 |   |  |   |     |
|  | CL 500               |  | 03.99 | 08.06 | 13.0460-4819.2 | 604819 |   |  |   |     |
|  | CL 55 AMG            |  | 10.99 | 08.06 | 24.8190-0410.2 | 620410 | 1 |  | 23478 14,6 /WE<br>Warnkontakt L=97,5mm                            | BRE |
|  | CL 55 Kompressor AMG |  | 06.02 | 08.06 | 24.0122-0192.1 | 422192 |   |  |   |     |
|  | CL 600               |  | 03.99 | 08.06 | 24.0122-0213.1 | 422213 |   |  |   |     |
|  | CL 500               |  | 03.99 | 08.06 | 24.0126-0137.1 | 426137 |   |  | 300 26,0 24,0 V L +B  |     |
|  | CL 55 AMG            |  | 03.99 | 08.06 | 03.0137-4016.2 | 654016 |   |  |   |     |
|  | CL 55 Kompressor AMG |  | 06.02 | 08.06 | 03.0137-9297.2 | 669297 |   |  |   |     |
|  | CL 600               |  | 03.99 | 08.06 |                |        |   |  | 180 x 25 /Zub<br>Bremsbacken-Zubehör                              |     |
|  | CL 55 AMG            |  | 10.99 | 08.06 |                |        |   |  |   |     |
|  | CL 55 Kompressor AMG |  | 06.02 | 08.06 |                |        |   |  |   |     |













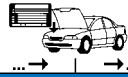



### MERCEDES BENZ CL-Klasse (C216) Coupe (06-14)

|  |                       |     |       |       |                |        |   |  |                                       |     |
|--|-----------------------|-----|-------|-------|----------------|--------|---|--|---------------------------------------|-----|
|  | CL 500                | 285 | 07.06 | 03.14 | 13.0460-4817.2 | 604817 | 1 |  | 23960 18,3 /WE<br>Warnkontakt L=119mm | BRE |
|  | CL 500 4-matic        | 285 | 03.08 | 03.14 | 24.8190-0420.2 | 620420 |   |  |                                       |     |
|  | CL 500                | 320 | 02.11 | 03.14 | 24.8190-0410.2 | 620410 |   |  |                                       |     |
|  | CL 500 4-matic        | 320 | 02.11 | 03.14 |                |        |   |  |                                       |     |
|  | CL 500 BlueEfficiency | 320 | 10.10 | 03.14 |                |        |   |  |                                       |     |
|  | CL 600                | 380 | 07.06 | 03.14 | 13.0460-4839.2 | 604839 | 1 |  | 24455 16,8 /WE<br>Warnkontakt L=119mm | BRE |
|  | CL 63 AMG             | 386 | 01.07 | 03.14 | 24.8190-0420.2 | 620420 |   |  |                                       |     |
|  | CL 63 AMG             | 400 | 02.11 | 03.14 |                |        |   |  |                                       |     |
|  | CL 63 AMG             | 420 | 01.10 | 03.14 |                |        |   |  |                                       |     |
|  | CL 65 AMG             | 450 | 01.07 | 03.14 |                |        |   |  |                                       |     |
|  | CL 65 AMG             | 463 | 02.11 | 03.14 |                |        |   |  |                                       |     |
|  | CL 500                | 285 | 07.06 | 03.14 | 24.0132-0138.1 | 432138 |   |  | 350 32,0 30,0 V L +S +B               |     |
|  | CL 500 4-matic        | 285 | 03.08 | 03.14 |                |        |   |  |                                       |     |
|  | CL 500                | 320 | 02.11 | 03.14 | 24.0136-0102.1 | 436102 |   |  |                                       |     |
|  | CL 500 4-matic        | 320 | 02.11 | 03.14 |                |        |   |  | 360 36,0 34,0 V L +B                  |     |
|  | CL 500 4-matic        | 320 | 02.11 | 03.14 |                |        |   |  |                                       |     |

<sup>1)</sup> + sports package AMG / + pacchetto sportivo AMG / + version sport AMG / + kit deportivo AMG





















<sup>2)</sup> - sport package AMG / - pacchetto sportivo AMG / - version sport AMG / - kit deportivo AMG



|     |  |  |  |  |  |  |  |  |
|--|--|--|--|--|---|--|--|--|
| <b>MERCEDES BENZ CL-Klasse (C216) Coupe (06-14)</b>                                |  |  |  |  |   |  |  |  |
|    | CL 500 BlueEfficiency  |  | 10.10  | 03.14  | 24.0136-0102.1  | 436102   |  | 360 36,0 34,0 V L +B   |
|  | CL 600   | 380  | 07.06  | 03.14  | 24.0136-0108.1  | 436108   |  | 360 36,0 34,0 V L +S +B  |
|    | CL 500   | 285  | 07.06  | 03.14  | 24.0711-6348.3  | 360334   | 2  | Radsensor L=1002   |
|  | CL 500   | 320  | 02.11  | 03.14  |   |  |  |  |
|  | CL 600   | 380  | 07.06  | 03.14  |   |  |  |  |
|  | CL 63 AMG  | 386  | 01.07  | 03.14  |   |  |  |  |
|  | CL 63 AMG  | 400  | 02.11  | 03.14  |   |  |  |  |
|  | CL 63 AMG  | 420  | 01.10  | 03.14  |   |  |  |  |
|  | CL 65 AMG  | 450  | 01.07  | 03.14  |   |  |  |  |
|  | CL 65 AMG  | 463  | 02.11  | 03.14  |   |  |  |  |
|  | CL 500 4-matic   | 285 A 024307   |  | 03.14  | 24.0711-5463.3  | 360385   | 2  | Radsensor L=798  |
|  | CL 500 4-matic   | 320 A 024307   |  | 03.14  |   |  |  |  |
|  | CL 500 BlueEfficiency  | A 024307   |  | 03.14  |   |  |  |  |
|    | CL 500   | 285  | 07.06  | 03.14  | 13.0460-7171.2  | 607171   |  | 23334 16,7 +/WE ATE  |
|  | CL 500 4-matic   | 285  | 03.08  | 03.14  | 13.0470-7171.2  | LD7171   |  | 23334 16,7 +/WE ATE  |
|  |  |  |  |  | 24.8190-0410.2  | 620410   | 1  | Warnkontakt L=97,5mm   |
|  | CL 500   | 320  | 02.11  | 03.14  | 24.8190-0410.2  | 620410   | 1  | Warnkontakt L=97,5mm   |
|  | CL 500 4-matic   | 320  | 02.11  | 03.14  |   |  |  |  |
|  | CL 500 BlueEfficiency  |  | 10.10  | 03.14  |   |  |  |  |
|  | CL 600   | 380  | 07.06  | 03.14  | 13.0460-4998.2  | 604998   |  | 23478 16,5 /WE BRE   |
|  |  |  |  |  | 24.8190-0410.2  | 620410   | 1  | Warnkontakt L=97,5mm   |
|  | CL 63 AMG  | 386  | 01.07  | 03.14  | 24.8190-0420.2  | 620420   | 1  | Warnkontakt L=119mm  |
|  | CL 63 AMG  | 400  | 02.11  | 03.14  |   |  |  |  |
|  | CL 63 AMG  | 420  | 01.10  | 03.14  |   |  |  |  |
|  | CL 65 AMG  | 450  | 01.07  | 03.14  |   |  |  |  |
|  | CL 65 AMG  | 463  | 02.11  | 03.14  |   |  |  |  |
|    | CL 500   | 285  | 07.06  | 03.14  | 24.0124-0212.1  | 424212   |  | 320 24,0 21,4 V L +S +B  |
|  | CL 500   | 320  | 02.11  | 03.14  |   |  |  |  |
|  | CL 500 4-matic   | 285  | 03.08  | 03.14  |   |  |  |  |
|  | CL 500 4-matic   | 320  | 02.11  | 03.14  |   |  |  |  |
|  | CL 500 BlueEfficiency  |  | 10.10  | 03.14  |   |  |  |  |
|  | CL 600   | 380  | 07.06  | 03.14  | 24.0126-0149.1  | 426149   |  | 330 26,0 23,4 V L +S +B  |
|    | CL 500   | 285  | A 024306   | 07.06  | 24.0711-6349.3  | 360333   | 2  | Radsensor L=675  |
|  | CL 500   | 320  | A 024306   | 02.11  |   |  |  |  |
|  | CL 500 4-matic   | 285  | A 024306   | 03.08  |   |  |  |  |
|  | CL 500 4-matic   | 320  | A 024306   | 02.11  |   |  |  |  |
|  | CL 500 BlueEfficiency  |  | A 024306   | 10.10  |   |  |  |  |
|  | CL 600   | 380  | A 024306   | 07.06  |   |  |  |  |
|  | CL 63 AMG  | 386  | A 024306   | 01.07  |   |  |  |  |
|  | CL 63 AMG  | 400  | A 024306   | 02.11  |   |  |  |  |
|  | CL 63 AMG  | 420  | A 024306   | 01.10  |   |  |  |  |
|  | CL 65 AMG  | 450  | A 024306   | 01.07  |   |  |  |  |
|  | CL 65 AMG  | 463  | A 024306   | 02.11  |   |  |  |  |
|  | CL 500   | 285 A 024307   |  | 03.14  | 24.0711-6331.3  | 360364   | 2  | Radsensor L=675  |
|  | CL 500   | 320 A 024307   |  | 03.14  |   |  |  |  |
|  | CL 500 4-matic   | 285 A 024307   |  | 03.14  |   |  |  |  |
|  | CL 500 4-matic   | 320 A 024307   |  | 03.14  |   |  |  |  |
|  | CL 500 BlueEfficiency  | A 024307   |  | 03.14  |   |  |  |  |
|  | CL 600   | 380 A 024307   |  | 03.14  |   |  |  |  |
|  | CL 63 AMG  | 386 A 024307   |  | 03.14  |   |  |  |  |
|  | CL 63 AMG  | 400 A 024307   |  | 03.14  |   |  |  |  |
|  | CL 63 AMG  | 420 A 024307   |  | 03.14  |   |  |  |  |
|  | CL 65 AMG  | 450 A 024307   |  | 03.14  |   |  |  |  |
|  | CL 65 AMG  | 463 A 024307   |  | 03.14  |   |  |  |  |
|  | CL 500   | 285  | 07.06  | 03.14  | 03.0137-4006.2  | 654006   |  | 180 x 25 /Zub  |
|  | CL 500   | 320  | 02.11  | 03.14  |   |  |  |  |
|  | CL 500 4-matic   | 285  | 03.08  | 03.14  |   |  |  |  |
|  | CL 500 4-matic   | 320  | 02.11  | 03.14  |   |  |  |  |
|  | CL 500 BlueEfficiency  |  | 10.10  | 03.14  |   |  |  |  |
|  | CL 600   | 380  | 07.06  | 03.14  |   |  |  |  |
|  | CL 63 AMG  | 386  | 01.07  | 03.14  |   |  |  |  |
|  | CL 63 AMG  | 400  | 02.11  | 03.14  |   |  |  |  |
|  | CL 63 AMG  | 420  | 01.10  | 03.14  |   |  |  |  |
|  | CL 65 AMG  | 450  | 01.07  | 03.14  |   |  |  |  |
|  | CL 65 AMG  | 463  | 02.11  | 03.14  |   |  |  |  |
| <b>MERCEDES BENZ CLA-Klasse (C117) Coupe (13-)</b>                                 |  |  |  |  |   |  |  |  |
|  | CLA 180  | 90   | 01.13  |  | 13.0460-2779.2  | 602779   |  | 24869 19,3 +/WE/S TRW  |
|  | CLA 180 BE   | 90   | 01.13  |  | 13.0470-2779.2  | LD2779   |  | 24869 19,3 +/WE/S TRW  |
|  | CLA 180 CDI  | 80   | 10.13  |  | 24.8190-0067.2  | 620067   | 1  | Warnkontakt L=92,5mm   |
|  | CLA 200  | 115  | 01.13  |  |   |  |  |  |
|  | CLA 200 CDI  | 100  | 07.14  |  |   |  |  |  |
|  | CLA 200 CDI  | 100  | 06.13  |  |   |  |  |  |
|  | CLA 200 CDI 4-matic  | 100  | 07.14  |  |   |  |  |  |
|  | CLA 220 4-matic  | 135  | 04.16  |  |   |  |  |  |
|  | CLA 220 CDI  | 125  | 01.13  |  |   |  |  |  |
|  | CLA 220 CDI  | 130  | 09.14  |  |   |  |  |  |
|  | CLA 220 CDI 4-matic  | 125  | 07.14  |  |   |  |  |  |
|  | CLA 220 CDI 4-matic  | 130  | 09.14  |  |   |  |  |  |
|  | CLA 250  | 155  | 01.13  |  |   |  |  |  |
|  | CLA 250  | 160  | 07.15  |  |   |  |  |  |
|  | CLA 250 4-Matic  | 155  | 07.13  |  |   |  |  |  |
|  | CLA 250 4-matic  | 160  | 07.15  |  |   |  |  |  |
|  | CLA 45 AMG 4-Matic   |  | 07.13  |  | 24.8190-0067.2  | 620067   | 1  | Warnkontakt L=92,5mm   |























|     |    |  |  |  |  |  |      |      |   |                                |   |
|--|--|--|--|--|---|--|--|--|---|--------------------------------|---|
| <b>MERCEDES BENZ CLA-Klasse (X117) Shooting Brake (15-)</b>                        |  |  |  |  |   |  |  |  |   |                                |   |
|    | CLA 220 d  | 120  |  | 01.15  |   | 13.0460-2779.2   | 602779   | 1   | 24869 19,3 +/WE/S TRW<br>24869 19,3 +/WE/S TRW<br>Warnkontakt L=92,5mm                |                                |   |
|  | CLA 220 d 4-matic  | 120  |  | 09.15  |   | 13.0470-2779.2   | LD2779   |  |   |                                |   |
|  | CLA 250  | 155  |  | 01.15  |   | 24.8190-0067.2   | 620067   |  |   |                                |   |
|  | CLA 250 4-matic  | 155  |  | 01.15  |   |  |  |  |   |                                |   |
|  | CLA 250 4-matic  | 160  |  | 07.15  |   |  |  |  |   |                                |   |
| CLA 45 AMG 4-matic   |  |  |  | 01.15  |   | 24.8190-0067.2   | 620067   | 1   | Warnkontakt L=92,5mm  |                                |   |
|    | CLA 180  | 90   |  | 01.15  |   | 24.0128-0276.1   | 428276   | - Sportpaket AMG <sup>1)</sup><br>+ Sportpaket AMG <sup>2)</sup>                       | 295 28,0 25,4 V L +S +B<br>295 28,0 26,0 V L +S +B                                    |                                |   |
|  | CLA 180 d  | 80   |  | 07.15  |   | 24.0128-0262.1   | 428262   |  |   |                                |   |
|  | CLA 200  | 115  |  | 01.15  |   |  |  |  |   |                                |   |
|  | CLA 200 CDI  | 100  |  | 01.15  |   |  |  |  |   |                                |   |
|  | CLA 200 CDI 4-matic  | 100  |  | 01.15  |   |  |  |  |   |                                |   |
|  | CLA 250  | 155  |  | 01.15  |   | 24.0130-0237.1   | 430237   |  |   |                                |   |
|  | CLA 250 4-matic  | 155  |  | 01.15  |   | 24.0130-0238.1   | 430238   |  |   |                                |   |
|  | CLA 250 4-matic  | 160  |  | 07.15  |   |  |  |  |   |                                |   |
|  | CLA 220 CDI  | 130  |  | 01.15  |   | 24.0128-0275.1   | 428275   |  |   |                                |   |
|  | CLA 220 CDI 4-matic  | 130  |  | 01.15  |   | 24.0130-0238.1   | 430238   |  |   |                                |   |
| CLA 220 d  | 120  |  | 01.15  |  |   |  | - Sportpaket AMG <sup>1)</sup><br>+ Sportpaket AMG <sup>2)</sup>                       | 295 28,0 25,4 V L +S +B<br>320 30,0 28,0 V L +S +B                                     |   |                                |   |
| CLA 220 d 4-matic  | 120  |  | 09.15  |  |   |  |  |  |   |                                |   |
| CLA 180  | 90   |  | 01.15  |  | 24.0711-5388.3  | 360380   |  |  | 2  | Radsensor L=910                |   |
| CLA 180 d  | 80   |  | 07.15  |  |   |  |  |  |   |                                |   |
| CLA 200  | 115  |  | 01.15  |  |   |  |  |  |   |                                |   |
| CLA 200 CDI  | 100  |  | 01.15  |  |   |  |  |  |   |                                |   |
| CLA 200 CDI 4-matic  | 100  |  | 01.15  |  |   |  |  |  |   |                                |   |
| CLA 220 4-matic  | 135  |  | 04.16  |  |   |  |  |  |   |                                |   |
| CLA 220 CDI  | 130  |  | 01.15  |  |   |  |  |  |   |                                |   |
| CLA 220 CDI 4-matic  | 130  |  | 01.15  |  |   |  |  |  |   |                                |   |
| CLA 220 d  | 120  |  | 01.15  |  |   |  |  |  |   |                                |   |
| CLA 220 d 4-matic  | 120  |  | 09.15  |  |   |  |  |  |   |                                |   |
| CLA 250  | 155  |  | 01.15  |  |   |  | elektrische Feststellbremse <sup>3)</sup><br>elektrische Feststellbremse <sup>3)</sup> | 24848 18,3 /WE/Zub/S TRW<br>24848 18,3 /WE/Zub/S TRW                                   |   |                                |   |
| CLA 250 4-matic  | 155  |  | 01.15  |  |   |  |  |  |   |                                |   |
| CLA 250 4-matic  | 160  |  | 07.15  |  |   |  |  |  |   |                                |   |
| CLA 45 AMG 4-matic   | 160  |  | 01.15  |  |   |  |  |  |   |                                |   |
|    | CLA 180  | 90   |  | 01.15  |   | 13.0460-2786.2   | 602786   | elektrische Feststellbremse <sup>3)</sup><br>elektrische Feststellbremse <sup>3)</sup> | 24848 18,3 /WE/Zub/S TRW<br>24848 18,3 /WE/Zub/S TRW                                  |                                |   |
|  | CLA 180 d  | 80   |  | 07.15  |   | 13.0470-2786.2   | LD2786   |  |   |                                |   |
|  | CLA 200  | 115  |  | 01.15  |   |  |  |  |   |                                |   |
|  | CLA 200 CDI  | 100  |  | 01.15  |   |  |  |  |   |                                |   |
|  | CLA 200 CDI 4-matic  | 100  |  | 01.15  |   |  |  |  |   |                                |   |
|  | CLA 220 CDI  | 130  |  | 01.15  |   |  |  |  |   |                                |   |
|  | CLA 220 CDI 4-matic  | 130  |  | 01.15  |   |  |  |  |   |                                |   |
|  | CLA 220 d  | 120  |  | 01.15  |   |  |  |  |   |                                |   |
|  | CLA 220 d 4-matic  | 120  |  | 09.15  |   |  |  |  |   |                                |   |
|  | CLA 250  | 155  |  | 01.15  |   |  |  |  |   |                                |   |
|  | CLA 180  | 90   |  | 01.15  |   | 24.0110-0382.1   | 410382   | elektrische Feststellbremse <sup>3)</sup>  | 295 10,0 8,3 +S +B  |                                |   |
|  | CLA 180 d  | 80   |  | 07.15  |   |  |  |  |   |                                |   |
|  | CLA 200  | 115  |  | 01.15  |   |  |  |  |   |                                |   |
|  | CLA 200 CDI  | 100  |  | 01.15  |   |  |  |  |   |                                |   |
|  | CLA 220 CDI  | 130  |  | 01.15  |   |  |  |  |   |                                |   |
|  | CLA 220 d  | 120  |  | 01.15  |   |  |  |  |   |                                |   |
|  | CLA 250  | 155  |  | 01.15  |   |  |  |  |   |                                |   |
|  | CLA 250 4-matic  | 160  |  | 07.15  |   |  |  |  |   |                                |   |
|  |  |  |  |  |   |  |  |  |   | - Sportpaket AMG <sup>1)</sup> |   |
|  |  | CLA 180  | 90   |  | 01.15   |  | 24.0711-5527.3   |  |   | 360405                         | 2  |
| CLA 180 d  |  | 80   |  | 07.15  |   |  |  |  |   |                                |   |
| CLA 200  |  | 115  |  | 01.15  |   |  |  |  |   |                                |   |
| CLA 200 CDI  |  | 100  |  | 01.15  |   |  |  |  |   |                                |   |
| CLA 200 CDI 4-matic  |  | 100  |  | 01.15  |   |  |  |  |   |                                |   |
| CLA 220 4-matic  |  | 135  |  | 04.16  |   |  |  |  |   |                                |   |
| CLA 220 CDI  |  | 130  |  | 01.15  |   |  |  |  |   |                                |   |
| CLA 220 CDI 4-matic  |  | 130  |  | 01.15  |   |  |  |  |   |                                |   |
| CLA 220 d  |  | 120  |  | 01.15  |   |  |  |  |   |                                |   |
| CLA 220 d 4-matic  |  | 120  |  | 09.15  |   |  |  |  |   |                                |   |
| CLA 250  |  | 155  |  | 01.15  |   |  |  |  |   |                                |   |
| CLA 250 4-matic  |  | 155  |  | 01.15  |   |  |  |  |   |                                |   |
| CLA 250 4-matic  |  | 160  |  | 07.15  |   |  |  |  |   |                                |   |
| CLA 45 AMG 4-matic   |  | 160  |  | 01.15  |   |  |  |  |   |                                |   |
| <b>MERCEDES BENZ CLK-Klasse (C208) Coupe (97-02)</b>                               |  |  |  |  |   |  |  |  |   |                                |   |
|  | CLK 200  | 100  |  | 06.97  | 06.02   | 13.0460-7086.2   | 607086   | 2  | 21664 19,8 +/WE ATE<br>21664 19,8 +/WE ATE<br>Warnkontakt L=95mm                      |                                |   |
|  | CLK 200 Kompressor   | 120  |  | 06.00  | 06.02   | 13.0470-7086.2   | LD7086   |  |   |                                |   |
|  | CLK 200 Kompressor   | 141  |  | 06.97  | 06.02   | 24.8190-0401.2   | 620401   |  |   |                                |   |
|  | CLK 230 Kompressor   | 142  |  | 06.97  | 06.02   |  |  |  |   |                                |   |
|  | CLK 230 Kompressor   | 145  |  | 06.00  | 06.02   |  |  |  |   |                                |   |
|  | CLK 320  | 160  |  | 06.97  | 06.02   | 13.0460-7087.2   | 607087   | 2  | 21670 19,4 +/WE ATE<br>21670 19,4 +/WE ATE<br>Warnkontakt L=95mm                      |                                |   |
|  | CLK 430  | 205  |  | 03.98  | 06.02   | 13.0470-7087.2   | LD7087   |  |   |                                |   |
|  |  |  |  |  |   | 24.8190-0401.2   | 620401   |  |   |                                |   |
|  | CLK 430  | 205  | F129678  | 03.98  |   | 13.0460-4201.2   | 604201   |  |   |                                |   |
|  |  |  |  |  |   | 24.8190-0401.2   | 620401   |  |   |                                |   |
|  | CLK 430  | 205  | F129679  | 08.99  | 06.02   | 13.0460-7183.2   | 607183   |  |   |                                |   |
|  | CLK 55 AMG   | 255  |  | 08.99  | 06.02   | 24.8190-0419.2   | 620419   |  |   |                                |   |
|  | CLK 200  | 100  |  | 06.97  | 06.02   | 24.0125-0110.1   | 425110   |  |   | 4                              | 288 25,0 22,4 V L +S +B<br>288 25,0 22,4 V L +S +B PD<br>Halterschraube                 |
|  | CLK 200 Kompressor   | 120  |  | 06.00  | 06.02   | 24.0325-0110.1   | 525110   |  |   |                                |   |
|  | CLK 200 Kompressor   | 141  |  | 06.97  | 06.02   | 13.8190-0330.1   | 990134   |  |   |                                |   |
| CLK 230 Kompressor   | 142  |  | 06.97  | 06.02  |   |  |  |  |   |                                |   |
| CLK 230 Kompressor   | 145  |  | 06.00  | 06.02  |   |  |  |  |   |                                |   |

1) - sport package AMG / - pacchetto sportivo AMG / - version sport AMG / - kit deportivo AMG  
2) + sports package AMG / + pacchetto sportivo AMG / + version sport AMG / + kit deportivo AMG  
3) electric parking brake / fr.di stazionamento elettrico / frein à main électrique / freno de mano eléctrico



|     |  |  |  |  |  |  |  |  |
|--|--|--|--|--|---|--|--|--|
| <b>MERCEDES BENZ CLK-Klasse (C208) Coupe (97-02)</b>                               |  |  |  |  |   |  |  |  |
|    | CLK 320  | 160  |  | 06.97  | 06.02   | 24.0128-0106.1   | 428106   | 300 28,0 25,4 V L +S +B  |
|  | CLK 430  | 205  |  | 03.98  | 06.02   | 24.0328-0106.1   | 528106   | 300 28,0 25,4 V L +S +B PD   |
|  | CLK 430  | 205  | F129678  | 03.98  | - AUS   | 13.8190-0330.1   | 990134   | 4 Halterschraube   |
|  | CLK 430  | 205  | F129679  |  | 06.02   | 24.0128-0126.1   | 428126   | 316 28,0 25,4 V L +B   |
| CLK 430  | 205  | F129679  |  | 06.02  | 13.8190-0330.1  | 990134   | 4 Halterschraube   |  |
| CLK 430  | 205  | F129679  |  | 06.02  | 24.0132-0159.1  | 432159   | 330 32,0 29,4 V L +B   |  |
| CLK 55 AMG   | 255  |  |  | 08.99  | 06.02   | 13.8190-0330.1   | 990134   | 4 Halterschraube   |
|    | CLK 200  | 100  | F 129678   | 06.97  |   | 24.0751-1141.3   | 360196   | Radsonder L=503  |
|  | CLK 200 Kompressor   | 141  | F 129678   | 06.97  |   | 24.0751-1142.3   | 360197   | Radsonder L=503  |
|  | CLK 230 Kompressor   | 142  | F 129678   | 06.97  |   |  |  |  |
|  | CLK 320  | 160  | F 129678   | 06.97  | - ESP   |  |  |  |
|  | CLK 200  | 100  | F 129679   |  | 06.02   | 24.0711-6021.3   | 360076   | Radsonder L=549  |
|  | CLK 200 Kompressor   | 120  |  |  | 06.00   | 24.0711-6022.3   | 360077   | Radsonder L=549  |
| CLK 200 Kompressor   | 141  | F 129679   |  | 06.02  |   |  |  |  |
| CLK 230 Kompressor   | 142  | F 129679   |  | 06.02  |   |  |  |  |
| CLK 230 Kompressor   | 145  |  |  | 06.00  | 06.02   |  |  |  |
|    | CLK 200  | 100  | F 000850   | 06.97  |   | 13.0460-3805.2   | 603805   | 21197 15,0 /WE   |
|  | CLK 200 Kompressor   | 120  | F 000850   | 06.00  |   | 13.0470-3805.2   | LD3805   | 21197 15,0 /WE   |
|  | CLK 200 Kompressor   | 141  | F 000850   | 06.97  |   | 13.0460-0215.2   | 610215   | Belagsatz-Zubehör  |
|  | CLK 230 Kompressor   | 142  | F 000850   | 06.97  |   |  |  |  |
|  | CLK 230 Kompressor   | 145  | F 000850   | 06.00  |   |  |  |  |
|  | CLK 230 Kompressor   | 145  | F 000851 / T 000001  |  | 06.02   | 13.0460-4064.2   | 604064   | 21919 15,3 /Zub  |
| CLK 200 Kompressor   | 120  | F 000851 / T 000001  |  | 06.02  | 13.0470-4064.2  | LD4064   | 21919 15,3 /Zub  |  |
| CLK 200 Kompressor   | 141  | F 000851 / T 000001  |  | 06.02  | 13.0460-0229.2  | 610229   | Belagsatz-Zubehör  |  |
| CLK 230 Kompressor   | 142  | F 000851 / T 000001  |  | 06.02  |   |  |  |  |
| CLK 230 Kompressor   | 145  | F 000851 / T 000001  |  | 06.02  |   |  |  |  |
|    | CLK 320  | 160  | F 196683 / T 098095  | 06.97  |   | 13.0460-4047.2   | 604047   | 21305 15,7 /WE   |
|  | CLK 430  | 205  |  | 03.98  | 06.02   | 13.0470-4047.2   | LD4047   | 21305 15,7 /WE   |
|  | CLK 55 AMG   | 255  |  | 08.99  | 06.02   | 13.0460-0236.2   | 610236   | Belagsatz-Zubehör  |
|  | CLK 320  | 160  | F 196684 / T 098096  |  | 06.02   | 24.8190-0401.2   | 620401   | Warnkontakt L=95mm   |
|  | CLK 320  | 160  | F 196684 / T 098096  |  | 06.02   | 13.0460-4065.2   | 604065   | 21899 15,3 /WE/Zub   |
| CLK 430  | 205  |  |  | 06.02  | 13.0470-4065.2  | LD4065   | 21899 15,3 /WE/Zub   |  |
| CLK 55 AMG   | 255  |  |  | 06.02  | 13.0460-0231.2  | 610231   | Belagsatz-Zubehör  |  |
|    | CLK 200  | 100  |  | 06.97  | 06.02   | 24.0109-0114.1   | 409114   | 278 9,0 7,3 +S +B  |
|  | CLK 200 Kompressor   | 120  |  | 06.00  | 06.02   | 24.0309-0114.1   | 509114   | 278 9,0 7,3 +S +B PD   |
|  | CLK 200 Kompressor   | 141  |  | 06.97  | 06.02   |  |  |  |
|  | CLK 230 Kompressor   | 142  |  | 06.97  | 06.02   |  |  |  |
|  | CLK 230 Kompressor   | 145  |  | 06.00  | 06.02   |  |  |  |
|  | CLK 320  | 160  |  | 06.97  | 06.02   | 24.0110-0217.1   | 410217   | 290 10,0 8,3 +S +B   |
| CLK 430  | 205  | F 129678   | 03.98  |  | 24.0310-0217.1  | 510217   | 290 10,0 8,3 +S +B PD  |  |
| CLK 430  | 205  | F 126679   |  | 06.02  | 24.0122-0228.1  | 422228   | 300 22,0 19,4 V L +B   |  |
| CLK 55 AMG   | 255  |  | 08.99  | 06.02  |   |  |  |  |
|  | CLK 200  | 100  | F 129678   | 06.97  |   | 24.0751-1143.3   | 360096   | Radsonder L=621  |
|  | CLK 200 Kompressor   | 141  | F 129678   | 06.97  |   | 24.0751-1144.3   | 360097   | Radsonder L=958  |
|  | CLK 230 Kompressor   | 142  | F 129678   | 06.97  |   |  |  |  |
|  | CLK 320  | 160  | F 129678   | 06.97  | - ESP   |  |  |  |
|  | CLK 200  | 100  | F 129679   |  | 06.02   | 24.0711-6035.3   | 360277   | Radsonder L=632  |
|  | CLK 200 Kompressor   | 141  | F 129679   |  | 06.02   | 24.0711-6036.3   | 360278   | Radsonder L=979  |
| CLK 230 Kompressor   | 142  | F 129679   |  | 06.02  |   |  |  |  |
| CLK 200 Kompressor   | 120  |  |  | 06.00  | 06.02   | 24.0711-6035.3   | 360277   | Radsonder L=632  |
| CLK 230 Kompressor   | 145  |  |  | 06.00  | 06.02   | 24.0711-6064.3   | 360279   | Radsonder L=899  |
|  | CLK 200  | 100  |  | 06.97  | 06.02   | 03.0137-0170.2   | 650170   | 164 x 20 /Zub  |
|  | CLK 200 Kompressor   | 120  |  | 06.00  | 06.02   |  |  |  |
|  | CLK 200 Kompressor   | 141  |  | 06.97  | 06.02   |  |  |  |
|  | CLK 230 Kompressor   | 142  |  | 06.97  | 06.02   |  |  |  |
|  | CLK 230 Kompressor   | 145  |  | 06.00  | 06.02   |  |  |  |
|  | CLK 320  | 160  |  | 06.97  | 06.02   |  |  |  |
|  | CLK 430  | 205  |  | 03.98  | 06.02   |  |  |  |
| CLK 55 AMG   | 255  |  | 08.99  | 06.02  |   |  |  |  |
| <b>MERCEDES BENZ CLK-Klasse (A208) Cabrio (98-03)</b>                              |  |  |  |  |   |  |  |  |
|  | CLK 200  | 100  |  | 06.98  | 06.03   | 13.0460-7086.2   | 607086   | 21664 19,8 +/WE  |
|  | CLK 200 Kompressor   | 120  |  | 06.00  | 06.03   | 13.0470-7086.2   | LD7086   | 21664 19,8 +/WE  |
|  | CLK 200 Kompressor   | 141  |  | 06.98  | 06.03   | 24.8190-0401.2   | 620401   | Warnkontakt L=95mm   |
|  | CLK 230 Kompressor   | 142  |  | 06.98  | 06.03   | 13.0460-7087.2   | 607087   | 21670 19,4 +/WE  |
|  | CLK 230 Kompressor   | 145  |  | 06.00  | 06.03   | 13.0470-7087.2   | LD7087   | 21670 19,4 +/WE  |
|  | CLK 320  | 160  |  | 06.98  | 06.03   | 24.8190-0401.2   | 620401   | Warnkontakt L=95mm   |
| CLK 430  | 205  |  | 06.99  | 06.03  | 13.0460-7183.2  | 607183   | 21484 20,5 +/WE  |  |
| CLK 55 AMG   | 255  |  | 01.00  | 06.03  | 24.8190-0419.2  | 620419   | Warnkontakt L=74mm   |  |
|  | CLK 200  | 100  |  | 06.98  | 06.03   | 24.0125-0110.1   | 425110   | 288 25,0 22,4 V L +S +B  |
|  | CLK 200 Kompressor   | 120  |  | 06.00  | 06.03   | 24.0325-0110.1   | 525110   | 288 25,0 22,4 V L +S +B PD   |
|  | CLK 200 Kompressor   | 141  |  | 06.98  | 06.03   | 13.8190-0330.1   | 990134   | 4 Halterschraube   |
|  | CLK 230 Kompressor   | 142  |  | 06.98  | 06.03   | 24.0128-0106.1   | 428106   | 300 28,0 25,4 V L +S +B  |
|  | CLK 230 Kompressor   | 145  |  | 06.00  | 06.03   | 24.0328-0106.1   | 528106   | 300 28,0 25,4 V L +S +B PD   |
|  | CLK 320  | 160  |  | 06.98  | 06.03   | 13.8190-0330.1   | 990134   | 4 Halterschraube   |
| CLK 430  | 205  |  | 06.99  | 06.03  | 24.0132-0159.1  | 432159   | 330 32,0 29,4 V L +B   |  |
| CLK 55 AMG   | 255  |  | 01.00  | 06.03  | 13.8190-0330.1  | 990134   | 4 Halterschraube   |  |

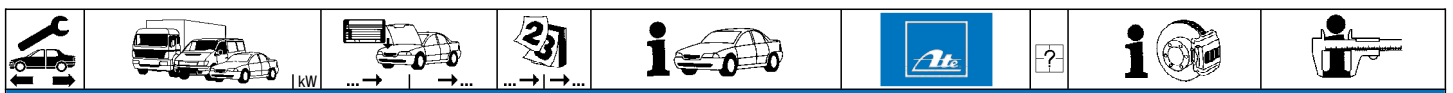

**MERCEDES BENZ CLK-Klasse (A208) Cabrio (98-03)**

















|                    |                    |                     |                     |       |                |                |        |       |                                    |   |                   |
|--------------------|--------------------|---------------------|---------------------|-------|----------------|----------------|--------|-------|------------------------------------|---|-------------------|
|                    | CLK 200            | 100                 | T 028295            | 06.98 |                | 24.0751-1141.3 | 360196 | - ESP |                                    | Radsensor L=503<br>Radsensor L=503                      |                   |
|                    | CLK 200 Kompressor | 141                 | T 028295            | 06.98 |                | 24.0751-1142.3 | 360197 |       |                                    |   |                   |
|                    | CLK 230 Kompressor | 142                 | T 028295            | 06.98 |                |                |        |       |                                    |   |                   |
|                    | CLK 320            | 160                 | T 028295            | 06.98 |                |                |        |       |                                    |   |                   |
|                    | CLK 200            | 100                 | T 028296            | 06.03 |                | 24.0711-6021.3 | 360076 |       |                                    |   |                   |
| CLK 200 Kompressor | 120                |                     | 06.00               | 06.03 | 24.0711-6022.3 | 360077         |        |       | Radsensor L=549<br>Radsensor L=549 |   |                   |
| CLK 200 Kompressor | 141                | T 028296            | 06.03               |       |                |                |        |       |                                    |   |                   |
| CLK 230 Kompressor | 142                | T 028296            | 06.03               |       |                |                |        |       |                                    |   |                   |
| CLK 230 Kompressor | 145                |                     | 06.00               | 06.03 |                |                |        |       |                                    |   |                   |
|                    | CLK 200            | 100                 |                     | 06.98 | 06.03          | 13.0460-4064.2 | 604064 |       |                                    | 21919 15,3 /Zub<br>21919 15,3 /Zub<br>Belagsatz-Zubehör | ATE<br>ATE<br>ATE |
|                    | CLK 200 Kompressor | 120                 | F 196683 / T 098095 | 06.00 |                | 13.0460-4047.2 | 604047 |       |                                    | 21305 15,7 /WE<br>21305 15,7 /WE<br>Belagsatz-Zubehör   | ATE<br>ATE<br>ATE |
|                    | CLK 200 Kompressor | 141                 | F 196683 / T 098095 | 06.98 |                | 13.0470-4047.2 | LD4047 |       |                                    | Warnkontakt L=95mm                                      |                   |
|                    | CLK 230 Kompressor | 142                 | F 196683 / T 098095 | 06.98 |                | 13.0460-0236.2 | 610236 |       |                                    |   |                   |
|                    | CLK 230 Kompressor | 145                 | F 196683 / T 098095 | 06.00 |                | 24.8190-0401.2 | 620401 | 1     |                                    |   |                   |
|                    | CLK 320            | 160                 | F 196683 / T 098095 | 06.98 |                |                |        |       |                                    |   |                   |
|                    | CLK 430            | 205                 | F 196683 / T 098095 | 06.99 |                |                |        |       |                                    |   |                   |
|                    | CLK 55 AMG         | 255                 | F 196683 / T 098095 | 01.00 |                |                |        |       |                                    |   |                   |
|                    | CLK 200 Kompressor | 120                 | F 196684 / T 098096 | 06.03 |                | 13.0460-4065.2 | 604065 |       |                                    | 21899 15,3 /WE/Zub                                      | ATE               |
|                    | CLK 200 Kompressor | 141                 | F 196684 / T 098096 | 06.03 |                | 13.0470-4065.2 | LD4065 |       |                                    | 21899 15,3 /WE/Zub                                      | ATE               |
| CLK 230 Kompressor | 142                | F 196684 / T 098096 | 06.03               |       | 24.8190-0401.2 | 620401         | 1      |       | Warnkontakt L=95mm                 |   |                   |
| CLK 230 Kompressor | 145                | F 196684 / T 098096 | 06.03               |       |                |                |        |       |                                    |   |                   |
| CLK 320            | 160                | F 196684 / T 098096 | 06.03               |       |                |                |        |       |                                    |   |                   |
| CLK 430            | 205                | F 196684 / T 098096 | 06.03               |       |                |                |        |       |                                    |   |                   |
| CLK 55 AMG         | 255                | F 196684 / T 098096 | 06.03               |       |                |                |        |       |                                    |   |                   |
|                    | CLK 200            | 100                 |                     | 06.98 | 06.03          | 24.0109-0114.1 | 409114 |       |                                    | 278 9,0 7,3 +S +B<br>278 9,0 7,3 +S +B PD               |                   |
|                    | CLK 200 Kompressor | 120                 |                     | 06.00 | 06.03          | 24.0110-0217.1 | 410217 |       |                                    | 290 10,0 8,3 +S +B<br>290 10,0 8,3 +S +B PD             |                   |
|                    | CLK 200 Kompressor | 141                 |                     | 06.98 | 06.03          | 24.0310-0217.1 | 510217 |       |                                    |   |                   |
|                    | CLK 230 Kompressor | 142                 |                     | 06.98 | 06.03          |                |        |       |                                    |   |                   |
|                    | CLK 230 Kompressor | 145                 |                     | 06.00 | 06.03          |                |        |       |                                    |   |                   |
| CLK 320            | 160                |                     | 06.98               | 06.03 |                |                |        |       |                                    |   |                   |
| CLK 430            | 205                |                     | 06.99               | 06.03 | 24.0122-0228.1 | 422228         |        |       | 300 22,0 19,4 V L +B               |   |                   |
| CLK 55 AMG         | 255                |                     | 01.00               | 06.03 |                |                |        |       |                                    |   |                   |
|                    | CLK 200            | 100                 | T 028295            | 06.98 |                | 24.0751-1143.3 | 360096 |       |                                    | Radsensor L=621<br>Radsensor L=958                      |                   |
|                    | CLK 200 Kompressor | 141                 | T 028295            | 06.98 |                | 24.0751-1144.3 | 360097 |       |                                    |   |                   |
|                    | CLK 230 Kompressor | 142                 | T 028295            | 06.98 |                |                |        |       |                                    |   |                   |
|                    | CLK 320            | 160                 | T 028295            | 06.98 |                |                |        |       |                                    |   |                   |
|                    | CLK 200            | 100                 | T 028296            | 06.03 |                | 24.0711-6035.3 | 360277 |       |                                    | Radsensor L=632<br>Radsensor L=979                      |                   |
| CLK 200 Kompressor | 120                |                     | 06.00               | 06.03 | 24.0711-6036.3 | 360278         |        |       |                                    |   |                   |
| CLK 200 Kompressor | 141                | T 028296            | 06.03               |       |                |                |        |       |                                    |   |                   |
| CLK 230 Kompressor | 142                | T 028296            | 06.03               |       |                |                |        |       |                                    |   |                   |
| CLK 230 Kompressor | 145                |                     | 06.00               | 06.03 |                |                |        |       |                                    |   |                   |
|                    | CLK 200            | 100                 |                     | 06.98 | 06.03          | 03.0137-0170.2 | 650170 |       |                                    | 164 x 20 /Zub   |                   |
|                    | CLK 200 Kompressor | 120                 |                     | 06.00 | 06.03          |                |        |       |                                    |   |                   |
|                    | CLK 200 Kompressor | 141                 |                     | 06.98 | 06.03          |                |        |       |                                    |   |                   |
|                    | CLK 230 Kompressor | 142                 |                     | 06.98 | 06.03          |                |        |       |                                    |   |                   |
|                    | CLK 230 Kompressor | 145                 |                     | 06.00 | 06.03          |                |        |       |                                    |   |                   |
|                    | CLK 320            | 160                 |                     | 06.98 | 06.03          |                |        |       |                                    |   |                   |
|                    | CLK 430            | 205                 |                     | 06.99 | 06.03          |                |        |       |                                    |   |                   |
| CLK 55 AMG         | 255                |                     | 01.00               | 06.03 |                |                |        |       |                                    |   |                   |

**MERCEDES BENZ CLK-Klasse (C209) Coupe (02-09)**

|                    |                    |             |          |       |                |                |                |        |                                    |                                    |                         |
|--------------------|--------------------|-------------|----------|-------|----------------|----------------|----------------|--------|------------------------------------|------------------------------------|-------------------------|
|                    | CLK 200 CGI        | 125         |          | 09.02 | 04.09          | 13.0460-4994.2 | 604994         |        | + Sportpaket / + Sportpaket AMG 1) | 23945 16,5 /WE                     | BRE                     |
|                    | CLK 200 Kompressor | 120         |          | 09.02 | 04.09          | 13.0470-4994.2 | LD4994         |        | + Sportpaket / + Sportpaket AMG 1) | 23945 16,5 /WE                     | BRE                     |
|                    | CLK 220 CDI        |             |          | 05.05 | 04.09          | 13.0460-2726.2 | 602726         |        | - Sportpaket / - Sportpaket AMG 2) | 23144 19,8 +/WE/Zub/STRW           |                         |
|                    | CLK 240            | 160         |          | 05.02 | 04.09          | 13.0460-2727.2 | 602727         |        | - Sportpaket / - Sportpaket AMG 2) | 23144 19,8 +/WE/Zub/STRW           |                         |
|                    | CLK 320            |             |          | 05.02 | 04.09          | 13.0470-2727.2 | LD2727         |        | - Sportpaket / - Sportpaket AMG 2) | 23144 19,8 +/WE/Zub/STRW           |                         |
|                    | CLK 200 Kompressor | 135         |          | 10.06 | 04.09          | 13.0460-4994.2 | 604994         |        | + Sportpaket / + Sportpaket AMG 1) | 23945 16,5 /WE                     | BRE                     |
|                    | CLK 270 CDI        |             |          | 10.02 | 04.09          | 13.0470-4994.2 | LD4994         |        | + Sportpaket / + Sportpaket AMG 1) | 23945 16,5 /WE                     | BRE                     |
|                    | CLK 280            | 170         |          | 05.05 | 04.09          | 13.0460-2727.2 | 602727         |        | - Sportpaket / - Sportpaket AMG 2) | 23144 19,8 +/WE/Zub/STRW           |                         |
|                    |                    |             |          |       |                | 13.0470-2727.2 | LD2727         |        | - Sportpaket / - Sportpaket AMG 2) | 23144 19,8 +/WE/Zub/STRW           |                         |
|                    |                    |             |          |       |                | 24.8190-0410.2 | 620410         | 1      | + Sportpaket / + Sportpaket AMG 1) | Warnkontakt L=97,5mm               |                         |
|                    |                    |             |          |       |                | 13.0460-0275.2 | 610275         |        | + Sportpaket / + Sportpaket AMG 1) | Belagsatz-Zubehör                  |                         |
|                    | CLK 320 CDI        | 165         |          | 05.05 | 04.09          | 13.0460-4994.2 | 604994         |        | - Sportpaket / - Sportpaket AMG 2) | 23945 16,5 /WE                     | BRE                     |
|                    | CLK 350            | 200         |          | 05.05 | 04.09          | 13.0470-4994.2 | LD4994         |        | - Sportpaket / - Sportpaket AMG 2) | 23945 16,5 /WE                     | BRE                     |
|                    |                    |             |          |       |                | 13.0460-4990.2 | 604990         |        | + Sportpaket / + Sportpaket AMG 1) | 23745 17,4 +/WE(1,8/7)             | BRE                     |
|                    |                    |             |          |       |                | 13.0470-4990.2 | LD4990         |        | + Sportpaket / + Sportpaket AMG 1) | 23745 17,4 +/WE(1,8/7)             | BRE                     |
|                    |                    |             |          |       |                | 13.0460-0275.2 | 610275         |        | + Sportpaket / + Sportpaket AMG 1) | Belagsatz-Zubehör                  |                         |
|                    |                    |             |          |       |                | 24.8190-0410.2 | 620410         | 1      | + Sportpaket / + Sportpaket AMG 1) | Warnkontakt L=97,5mm               |                         |
|                    | CLK 500            | 225         |          | 05.02 | 04.09          | 13.0460-4990.2 | 604990         |        | - Sportpaket / - Sportpaket AMG 2) | 23745 17,4 +/WE(1,8/7)             | BRE                     |
|                    | CLK 500            | 285         |          | 06.06 | 04.09          | 13.0460-0275.2 | 610275         |        | - Sportpaket / - Sportpaket AMG 2) | 23745 17,4 +/WE(1,8/7)             | BRE                     |
|                    | CLK 55 AMG         | 270         | F 123374 | 09.02 |                | 24.8190-0410.2 | 620410         | 1      | + Sportpaket / + Sportpaket AMG 1) | Warnkontakt L=97,5mm               |                         |
|                    | CLK 55 AMG         | 270         | F 123375 |       | 04.09          | 13.0460-4806.2 | 604806         |        | - Sportpaket / - Sportpaket AMG 2) | 23955 16,2 /WE                     | BRE                     |
|                    | CLK 63 AMG         |             |          | 04.06 | 04.09          | 24.8190-0420.2 | 620420         | 1      | + Sportpaket / + Sportpaket AMG 1) | Warnkontakt L=119mm                |                         |
|                    |                    | CLK 200 CGI | 125      |       | 09.02          | 04.09          | 24.0125-0110.1 | 425110 |                                    | - Sportpaket / - Sportpaket AMG 2) | 288 25,0 22,4 V L +S +B |
| CLK 200 Kompressor |                    | 120         |          | 09.02 | 04.09          | 24.0325-0110.1 | 525110         |        | - Sportpaket / - Sportpaket AMG 2) | 288 25,0 22,4 V L +S +B PD         |                         |
| CLK 220 CDI        |                    |             |          | 05.05 | 04.09          | 24.0128-0177.1 | 428177         |        | + Sportpaket / + Sportpaket AMG 1) | 330 28,0 26,0 V L +B               |                         |
| CLK 240            |                    |             |          | 05.02 | 04.09          | 24.0128-0106.1 | 428106         |        |                                    | 300 28,0 25,4 V L +S +B            |                         |
| CLK 320            | 160                |             | 05.02    | 04.09 | 24.0328-0106.1 | 528106         |                |        | 300 28,0 25,4 V L +S +B PD         |                                    |                         |











1) + sports package/+ sports package AMG / + pacchetto sportivo/+ pacchetto sport.AMG / + version sport/+ version sport AMG / + kit sportivo/+ kit sportivo AMG  
 2) - sport package/- sport package AMG / - pacchetto sportivo/- pacchetto sport.AMG / - version sport/- version sport AMG / - kit sportivo/- kit sportivo AMG

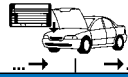

|     |  |  |  |  |  |  |  |  |                                   |
|--|--|--|--|--|---|--|--|--|-----------------------------------|
| <b>MERCEDES BENZ CLK-Klasse (C209) Coupe (02-09)</b>                               |  |  |  |  |   |  |  |  |                                   |
|    | CLK 200 Kompressor   | 135  |  | 10.06  | 04.09   | 24.0128-0106.1   | 428106   | - Sportpaket / - Sportpaket AMG 1)   | 300 28,0 25,4 V L +S +B           |
|  | CLK 270 CDI  |  |  | 10.02  | 04.09   | 24.0328-0106.1   | 528106   | - Sportpaket / - Sportpaket AMG 1)   | <b>300 28,0 25,4 V L +S +B PD</b> |
|  | CLK 280  | 170  |  | 05.05  | 04.09   | 24.0128-0177.1   | 428177   | + Sportpaket / + Sportpaket AMG 2)   | 330 28,0 26,0 V L +B              |
|  | CLK 320 CDI  | 165  |  | 05.05  | 04.09   | 24.0128-0188.1   | 428188   | - Sportpaket / - Sportpaket AMG 1)   | 330 28,0 26,0 V L +S +B           |
|  | CLK 350  | 200  |  | 05.05  | 04.09   | 24.0130-0180.1   | 430180   | + Sportpaket / + Sportpaket AMG 2)   | 345 30,0 28,0 V L +B              |
|  | CLK 500  | 225  |  | 05.02  | 04.09   | 24.0130-0171.1   | 430171   | - Sportpaket / - Sportpaket AMG 1)   | 345 30,0 27,4 V L +B              |
|  | CLK 500  | 285  |  | 06.06  | 04.09   | 24.0130-0180.1   | 430180   | + Sportpaket / + Sportpaket AMG 2)   | 345 30,0 28,0 V L +B              |
| CLK 55 AMG   | 270  | F 123374   | 09.02  |  | 24.0130-0180.1  | 430180   |  | 345 30,0 28,0 V L +B   |                                   |
|    | CLK 200 CGI  | 125  |  | 09.02  | 04.09   | 24.0711-6001.3   | 360119   | 2  | Radsensor L=565                   |
|  | CLK 200 Kompressor   | 120  |  | 09.02  | 04.09   |  |  |  |                                   |
|  | CLK 200 Kompressor   | 135  |  | 10.06  | 04.09   |  |  |  |                                   |
|  | CLK 220 CDI  |  |  | 05.05  | 04.09   |  |  |  |                                   |
|  | CLK 240  |  |  | 05.02  | 04.09   |  |  |  |                                   |
|  | CLK 270 CDI  |  |  | 10.02  | 04.09   |  |  |  |                                   |
|  | CLK 280  | 170  |  | 05.05  | 04.09   |  |  |  |                                   |
|  | CLK 320  | 160  |  | 05.02  | 04.09   |  |  |  |                                   |
|  | CLK 320 CDI  | 165  |  | 05.05  | 04.09   |  |  |  |                                   |
|  | CLK 350  | 200  |  | 05.05  | 04.09   |  |  |  |                                   |
|  | CLK 500  | 225  |  | 05.02  | 04.09   |  |  |  |                                   |
|  | CLK 500  | 285  |  | 06.06  | 04.09   |  |  |  |                                   |
|  | CLK 55 AMG   | 270  |  | 09.02  | 04.09   |  |  |  |                                   |
|  | CLK 63 AMG   |  |  | 04.06  | 04.09   |  |  |  | - AMG Black Series                |
|    | CLK 200 CGI  | 125  |  | 09.02  | 04.09   | 13.0460-4064.2   | 604064   | - Sportpaket / - Sportpaket AMG 1)   | 21919 15,3 /Zub                   |
|  | CLK 200 Kompressor   | 120  |  | 09.02  | 04.09   | 13.0470-4064.2   | LD4064   | - Sportpaket / - Sportpaket AMG 1)   | 21919 15,3 /Zub                   |
|  | CLK 220 CDI  |  |  | 05.05  | 04.09   | 13.0460-4065.2   | 604065   | + Sportpaket / + Sportpaket AMG 2)   | 21899 15,3 /WE/Zub                |
|  |  |  |  |  |   | 13.0470-4065.2   | LD4065   | + Sportpaket / + Sportpaket AMG 2)   | 21899 15,3 /WE/Zub                |
|  |  |  |  |  |   | 24.8190-0410.2   | 620410   |  | Warnkontakt L=97,5mm              |
|  |  |  |  |  |   | 13.0460-0229.2   | 610229   |  | Belagsatz-Zubehör                 |
|  |  |  |  |  |   |  |  |  | ATE                               |
|  |  |  |  |  |   |  |  |  | ATE                               |
|  |  |  |  |  |   |  |  |  | ATE                               |
|  |  |  |  |  |   |  |  |  | ATE                               |
|    | CLK 200 Kompressor   | 135  |  | 10.06  | 04.09   | 13.0460-4065.2   | 604065   |  | 21899 15,3 /WE/Zub                |
|  | CLK 240  |  |  | 05.02  | 04.09   | 13.0470-4065.2   | LD4065   |  | 21899 15,3 /WE/Zub                |
|  | CLK 270 CDI  |  |  | 10.02  | 04.09   | 13.0460-0258.2   | 610258   |  | Belagsatz-Zubehör                 |
|  | CLK 280  | 170  |  | 05.05  | 04.09   | 24.8190-0410.2   | 620410   | 1  | Warnkontakt L=97,5mm              |
|  | CLK 320  | 160  |  | 05.02  | 04.09   |  |  |  |                                   |
|  | CLK 320 CDI  | 165  |  | 05.05  | 04.09   |  |  |  |                                   |
|  | CLK 350  | 200  |  | 05.05  | 04.09   |  |  |  |                                   |
|  | CLK 500  | 225  |  | 05.02  | 04.09   | 13.0460-4047.2   | 604047   |  | 21305 15,7 /WE                    |
|  | CLK 500  | 285  |  | 06.06  | 04.09   | 13.0470-4047.2   | LD4047   |  | 21305 15,7 /WE                    |
|  | CLK 55 AMG   | 270  | F 123374   | 09.02  |   | 13.0460-0236.2   | 610236   |  | Belagsatz-Zubehör                 |
| CLK 55 AMG   | 270  | F 123375   |  | 04.09  | 24.8190-0410.2  | 620410   | 1  | Warnkontakt L=97,5mm   |                                   |
| CLK 63 AMG   |  |  | 04.06  | 04.09  | 13.0460-4819.2  | 604819   |  | 23478 14,6 /WE   |                                   |
| CLK 63 AMG   |  |  |  |  | 24.8190-0410.2  | 620410   | 1  | Warnkontakt L=97,5mm   |                                   |
|  | CLK 200 CGI  | 125  |  | 09.02  | 04.09   | 24.0109-0114.1   | 409114   | - Sportpaket / - Sportpaket AMG 1)   | 278 9,0 7,3 +S +B                 |
|  | CLK 200 Kompressor   | 120  |  | 09.02  | 04.09   | 24.0309-0114.1   | 509114   | - Sportpaket / - Sportpaket AMG 1)   | <b>278 9,0 7,3 +S +B PD</b>       |
|  | CLK 220 CDI  |  |  | 05.05  | 04.09   | 24.0110-0217.1   | 410217   | + Sportpaket / + Sportpaket AMG 2)   | 290 10,0 8,3 +S +B                |
|  |  |  |  |  |   | 24.0310-0217.1   | 510217   | + Sportpaket / + Sportpaket AMG 2)   | <b>290 10,0 8,3 +S +B PD</b>      |
|  | CLK 200 Kompressor   | 135  |  | 10.06  | 04.09   | 24.0110-0217.1   | 410217   |  | 290 10,0 8,3 +S +B                |
|  | CLK 240  |  |  | 05.02  | 04.09   | 24.0310-0217.1   | 510217   |  | <b>290 10,0 8,3 +S +B PD</b>      |
|  | CLK 270 CDI  |  |  | 10.02  | 04.09   |  |  |  |                                   |
|  | CLK 280  | 170  |  | 05.05  | 04.09   |  |  |  |                                   |
|  | CLK 320  | 160  |  | 05.02  | 04.09   |  |  |  |                                   |
|  | CLK 320 CDI  | 165  |  | 05.05  | 04.09   |  |  |  |                                   |
| CLK 350  | 200  |  | 05.05  | 04.09  |   |  |  |  |                                   |
| CLK 500  | 225  |  | 05.02  | 04.09  | 24.0122-0228.1  | 422228   |  | 300 22,0 19,4 V L +B   |                                   |
| CLK 500  | 285  |  | 06.06  | 04.09  |   |  |  |  |                                   |
| CLK 55 AMG   | 270  | F 123374   | 09.02  |  |   |  |  |  |                                   |
|  | CLK 200 CGI  | 125  |  | 09.02  | 04.09   | 24.0711-6054.3   | 360184   |  | Radsensor L=1102                  |
|  | CLK 200 Kompressor   | 120  |  | 09.02  | 04.09   | 24.0711-6053.3   | 360183   |  | Radsensor L=948                   |
|  | CLK 200 Kompressor   | 135  |  | 10.06  | 04.09   |  |  |  |                                   |
|  | CLK 220 CDI  |  |  | 05.05  | 04.09   |  |  |  |                                   |
|  | CLK 240  |  |  | 05.02  | 04.09   |  |  |  |                                   |
|  | CLK 270 CDI  |  |  | 10.02  | 04.09   |  |  |  |                                   |
|  | CLK 280  | 170  |  | 05.05  | 04.09   |  |  |  |                                   |
|  | CLK 320  | 160  |  | 05.02  | 04.09   |  |  |  |                                   |
|  | CLK 320 CDI  | 165  |  | 05.05  | 04.09   |  |  |  |                                   |
|  | CLK 350  | 200  |  | 05.05  | 04.09   |  |  |  |                                   |
|  | CLK 500  | 225  |  | 05.02  | 04.09   |  |  |  |                                   |
|  | CLK 500  | 285  |  | 06.06  | 04.09   |  |  |  |                                   |
|  | CLK 55 AMG   | 270  |  | 09.02  | 04.09   |  |  |  |                                   |
|  | CLK 63 AMG   |  |  | 04.06  | 04.09   |  |  |  |                                   |
|  | CLK 200 CGI  | 125  |  | 09.02  | 04.09   | 03.0137-4013.2   | 654013   |  | 164 x 20 /Zub                     |
|  | CLK 200 Kompressor   | 120  |  | 09.02  | 04.09   | 03.0137-9248.2   | 669248   |  | Bremsbacken-Zubehör               |
|  | CLK 200 Kompressor   | 135  |  | 10.06  | 04.09   |  |  |  |                                   |
|  | CLK 220 CDI  |  |  | 05.05  | 04.09   |  |  |  |                                   |
|  | CLK 240  |  |  | 05.02  | 04.09   |  |  |  |                                   |
|  | CLK 270 CDI  |  |  | 10.02  | 04.09   |  |  |  |                                   |
|  | CLK 280  | 170  |  | 05.05  | 04.09   |  |  |  |                                   |
|  | CLK 320  | 160  |  | 05.02  | 04.09   |  |  |  |                                   |
|  | CLK 320 CDI  | 165  |  | 05.05  | 04.09   |  |  |  |                                   |
|  | CLK 350  | 200  |  | 05.05  | 04.09   |  |  |  |                                   |
| CLK 500  | 225  |  | 05.02  | 04.09  |   |  |  |  |                                   |
| CLK 500  | 285  |  | 06.06  | 04.09  |   |  |  |  |                                   |
| CLK 55 AMG   | 270  |  | 09.02  | 04.09  |   |  |  |  |                                   |
| CLK 63 AMG   |  |  | 04.06  | 04.09  |   |  |  |  |                                   |



















1) - sport package/- sport package AMG / - pacchetto sportivo/- pacchetto sport.AMG / - version sport/- version sport AMG / - kit deportivo/- kit deportivo AMG  
2) + sports package/+ sports package AMG / + pacchetto sportivo/+ pacchetto sport.AMG / + version sport/+ version sport AMG / + kit deportivo/+ kit deportivo AMG



|   |    |  |  |                 |                         |   |    |    |  |
|--|--|--|--|---|--|---|--|--|--|
| <b>MERCEDES BENZ CLK-Klasse (A209) Cabrio (03-09)</b>                            |  |  |  |   |  |   |  |  |  |
|  | CLK 200 CGI  | 125  |  | 05.03   | 12.09  | 13.0460-2726.2 602726<br>13.0470-2726.2 LD2726<br>24.8190-0410.2 620410   | 1  | 23144 19,8 +/WE/Zub/STRW<br>23144 19,8 +/WE/Zub/STRW<br>Warnkontakt L=97,5mm   |  |
|  | CLK 240<br>CLK 320   | 125<br>160   |  | 05.03<br>05.03  | 12.09<br>12.09   | 13.0460-2727.2 602727<br>13.0470-2727.2 LD2727<br>24.8190-0410.2 620410   | 2  | 23144 19,8 +/WE/Zub/STRW<br>23144 19,8 +/WE/Zub/STRW<br>Warnkontakt L=97,5mm   |  |
|  | CLK 200 Kompressor<br>CLK 200 Kompressor<br>CLK 280  | 120<br>135<br>170  |  | 05.03<br>10.06<br>05.05   | 12.09<br>12.09<br>12.09  | 13.0460-2727.2 602727<br>13.0470-2727.2 LD2727<br>13.0460-4994.2 604994<br>13.0470-4994.2 LD4994<br>24.8190-0410.2 620410   | 1  | - Sportpaket / - Sportpaket AMG 1)<br>- Sportpaket / - Sportpaket AMG 1)<br>+ Sportpaket / + Sportpaket AMG 2)<br>+ Sportpaket / + Sportpaket AMG 2)<br>23144 19,8 +/WE/Zub/STRW<br>23144 19,8 +/WE/Zub/STRW<br>23945 16,5 /WE BRE<br>23945 16,5 /WE BRE<br>Warnkontakt L=97,5mm   |  |
|  | CLK 320 CDI<br>CLK 350   | 165<br>200   |  | 05.05<br>05.05  | 12.09<br>12.09   | 13.0460-4994.2 604994<br>13.0470-4994.2 LD4994<br>13.0460-4990.2 604990<br>13.0470-4990.2 LD4990<br>13.0460-0275.2 610275<br>24.8190-0416.2 620416<br>24.8190-0410.2 620410 | 1  | - Sportpaket / - Sportpaket AMG 1)<br>- Sportpaket / - Sportpaket AMG 1)<br>+ Sportpaket / + Sportpaket AMG 2)<br>+ Sportpaket / + Sportpaket AMG 2)<br>23945 16,5 /WE BRE<br>23945 16,5 /WE BRE<br>23745 17,4 +/WE(1,8/7) BRE<br>23745 17,4 +/WE(1,8/7) BRE<br>Belagsatz-Zubehör<br>Warnkontakt L=100mm<br>Warnkontakt L=97,5mm |  |
|  | CLK 500<br>CLK 500<br>CLK 55 AMG   | 225<br>285<br>270  |  | 05.03<br>06.06<br>05.03   | 12.09<br>12.09<br>12.09  | 13.0460-4990.2 604990<br>13.0460-0275.2 610275<br>24.8190-0410.2 620410   | 1  | 23745 17,4 +/WE(1,8/7) BRE<br>Belagsatz-Zubehör<br>Warnkontakt L=97,5mm  |  |
|  | CLK 55 AMG<br>CLK 63 AMG   | 270<br>354   | T 023346 / F 103001  |   | 12.09<br>04.06   | 12.09<br>12.09  | 13.0460-4806.2 604806<br>24.8190-0420.2 620420   | 1  | 23955 16,2 /WE BRE<br>Warnkontakt L=119mm  |
|  | CLK 200 CGI  | 125  |  | 05.03   | 12.09  | 24.0125-0110.1 425110<br>24.0325-0110.1 525110  |  | 288 25,0 22,4 V L +S +B<br>288 25,0 22,4 V L +S +B PD  |  |
|  | CLK 240<br>CLK 320   | 125<br>160   |  | 05.03<br>05.03  | 12.09<br>12.09   | 24.0128-0106.1 428106<br>24.0328-0106.1 528106  |  | 300 28,0 25,4 V L +S +B<br>300 28,0 25,4 V L +S +B PD  |  |
|  | CLK 200 Kompressor<br>CLK 200 Kompressor<br>CLK 280  | 120<br>135<br>170  |  | 05.03<br>10.06<br>05.05   | 12.09<br>12.09<br>12.09  | 24.0128-0106.1 428106<br>24.0328-0106.1 528106<br>24.0128-0177.1 428177   |  | - Sportpaket / - Sportpaket AMG 1)<br>- Sportpaket / - Sportpaket AMG 1)<br>+ Sportpaket / + Sportpaket AMG 2)<br>300 28,0 25,4 V L +S +B<br>300 28,0 25,4 V L +S +B PD<br>330 28,0 26,0 V L +B  |  |
|  | CLK 320 CDI<br>CLK 350   | 165<br>200   |  | 05.05<br>05.05  | 12.09<br>12.09   | 24.0128-0188.1 428188<br>24.0130-0180.1 430180  |  | - Sportpaket / - Sportpaket AMG 1)<br>+ Sportpaket / + Sportpaket AMG 2)<br>330 28,0 26,0 V L +S +B<br>345 30,0 28,0 V L +B  |  |
| CLK 500<br>CLK 500<br>CLK 55 AMG   | 225<br>285<br>270  |  | 05.03<br>06.06<br>05.03  | 12.09<br>12.09<br>12.09   | 24.0130-0171.1 430171<br>24.0130-0180.1 430180<br>24.0130-0180.1 430180                                  |   | - Sportpaket / - Sportpaket AMG 1)<br>+ Sportpaket / + Sportpaket AMG 2)<br>345 30,0 27,4 V L +B<br>345 30,0 28,0 V L +B<br>345 30,0 28,0 V L +B |  |  |
| CLK 63 AMG   | 354  | T 033979 / F 123374  | 05.03  | 12.09   | 24.0130-0180.1 430180  |   | 345 30,0 28,0 V L +B   |  |  |
|  | CLK 200 CGI  | 125  |  | 05.03   | 12.09  | 24.0711-6001.3 360119   | 2  | Radsensor L=565  |  |
|  | CLK 200 Kompressor<br>CLK 200 Kompressor<br>CLK 240<br>CLK 280<br>CLK 320<br>CLK 320 CDI<br>CLK 350<br>CLK 500<br>CLK 500<br>CLK 55 AMG<br>CLK 63 AMG  | 125<br>120<br>135<br>125<br>170<br>160<br>165<br>200<br>225<br>285<br>270<br>354 |  | 05.03<br>05.03<br>10.06<br>05.03<br>05.05<br>05.03<br>05.05<br>05.03<br>06.06<br>05.03<br>04.06 | 12.09<br>12.09<br>12.09<br>12.09<br>12.09<br>12.09<br>12.09<br>12.09<br>12.09<br>12.09<br>12.09<br>12.09 |   |  |  |  |
|  | CLK 200 CGI  | 125  |  | 05.03   | 12.09  | 13.0460-4064.2 604064<br>13.0470-4064.2 LD4064<br>13.0460-0229.2 610229   |  | 21919 15,3 /Zub ATE<br>21919 15,3 /Zub ATE<br>Belagsatz-Zubehör ATE  |  |
|  | CLK 200 Kompressor<br>CLK 200 Kompressor<br>CLK 240<br>CLK 280<br>CLK 320<br>CLK 320 CDI<br>CLK 350  | 120<br>135<br>125<br>170<br>160<br>165<br>200                                    |  | 05.03<br>10.06<br>05.03<br>05.05<br>05.03<br>05.05  | 12.09<br>12.09<br>12.09<br>12.09<br>12.09<br>12.09   | 13.0460-4065.2 604065<br>13.0470-4065.2 LD4065<br>13.0460-0258.2 610258<br>24.8190-0410.2 620410  |  | 21899 15,3 /WE/Zub ATE<br>21899 15,3 /WE/Zub ATE<br>Belagsatz-Zubehör ATE<br>Warnkontakt L=97,5mm  |  |
|  | CLK 500<br>CLK 500<br>CLK 55 AMG   | 225<br>285<br>270  |  | 05.03<br>06.06<br>05.03   | 12.09<br>12.09<br>12.09  | 13.0460-4047.2 604047<br>13.0470-4047.2 LD4047<br>13.0460-0236.2 610236<br>24.8190-0410.2 620410  | 1  | 21305 15,7 /WE ATE<br>21305 15,7 /WE ATE<br>Belagsatz-Zubehör ATE<br>Warnkontakt L=97,5mm  |  |
|  | CLK 55 AMG<br>CLK 63 AMG   | 270<br>354   | T 023346 / F 103001  |   | 12.09<br>04.06   | 12.09<br>12.09  | 13.0460-4819.2 604819<br>24.8190-0410.2 620410   | 1  | 23478 14,6 /WE BRE<br>Warnkontakt L=97,5mm |
|  | CLK 200 CGI  | 125  |  | 05.03   | 12.09  | 24.0109-0114.1 409114<br>24.0309-0114.1 509114  |  | 278 9,0 7,3 +S +B<br>278 9,0 7,3 +S +B PD  |  |
|  | CLK 200 Kompressor<br>CLK 200 Kompressor<br>CLK 240<br>CLK 280<br>CLK 320<br>CLK 320 CDI<br>CLK 350  | 120<br>135<br>125<br>170<br>160<br>165<br>200                                    |  | 05.03<br>10.06<br>05.03<br>05.05<br>05.03<br>05.05  | 12.09<br>12.09<br>12.09<br>12.09<br>12.09<br>12.09   | 24.0110-0217.1 410217<br>24.0310-0217.1 510217  |  | 290 10,0 8,3 +S +B<br>290 10,0 8,3 +S +B PD  |  |
|  | CLK 500<br>CLK 500<br>CLK 55 AMG   | 225<br>285<br>270  |  | 05.03<br>06.06<br>05.03   | 12.09<br>12.09<br>12.09  | 24.0122-0228.1 422228   |  | 300 22,0 19,4 V L +B   |  |
|  | CLK 200 CGI<br>CLK 200 Kompressor<br>CLK 200 Kompressor<br>CLK 240<br>CLK 280<br>CLK 320<br>CLK 320 CDI<br>CLK 350<br>CLK 500<br>CLK 500<br>CLK 55 AMG | 125<br>120<br>135<br>125<br>170<br>160<br>165<br>200<br>225<br>285<br>270        |  | 05.03<br>05.03<br>10.06<br>05.03<br>05.05<br>05.03<br>05.05<br>05.03<br>06.06<br>05.03          | 12.09<br>12.09<br>12.09<br>12.09<br>12.09<br>12.09<br>12.09<br>12.09<br>12.09<br>12.09                   | 24.0711-6054.3 360184<br>24.0711-6053.3 360183  |  | Radsensor L=1102<br>Radsensor L=948  |  |

1) - sport package/- sport package AMG / - pacchetto sportivo/- pacchetto sport.AMG / - version sport/- version sport AMG / - kit deportivo/- kit deportivo AMG  
2) + sports package/+ sports package AMG / + pacchetto sportivo/+ pacchetto sport.AMG / + version sport/+ version sport AMG / + kit deportivo/+ kit deportivo AMG



|     |   |  |  |                          |                         |  |  |    |   |
|--|---|--|--|--|--|--|--|--|---|
| <b>MERCEDES BENZ CLK-Klasse (A209) Cabrio (03-09)</b>                              |   |  |  |  |  |  |  |  |   |
|    | CLK 55 AMG<br>CLK 63 AMG  | 270<br>354   |  | 05.03<br>04.06   | 12.09<br>12.09   | 24.0711-6054.3<br>24.0711-6053.3   | 360184<br>360183   | <br> | Radsensor L=1102<br>Radsensor L=948   |
|    | CLK 200 CGI<br>CLK 200 Kompressor<br>CLK 200 Kompressor<br>CLK 240<br>CLK 280<br>CLK 320<br>CLK 320 CDI<br>CLK 350<br>CLK 500<br>CLK 500<br>CLK 55 AMG<br>CLK 63 AMG  | 125<br>120<br>135<br>125<br>170<br>160<br>165<br>200<br>225<br>285<br>270<br>354 |  | 05.03<br>05.03<br>10.06<br>05.03<br>05.05<br>05.03<br>05.05<br>05.05<br>05.03<br>06.06<br>05.03<br>04.06 | 12.09<br>12.09<br>12.09<br>12.09<br>12.09<br>12.09<br>12.09<br>12.09<br>12.09<br>12.09<br>12.09<br>12.09 | 03.0137-4013.2<br>03.0137-9248.2   | 654013<br>669248   |  | 164 x 20 /Zub<br>Bremsbacken-Zubehör  |
| <b>MERCEDES BENZ CLS-Klasse (C219) Coupe (04-10)</b>                               |   |  |  |  |  |  |  |  |   |
|    | CLS 320 CDI<br>CLS 320 CDI  | 155<br>165   | A 038331<br>A 038331   | 05.05<br>05.05   |  | 13.0460-4990.2<br>13.0470-4990.2   | 604990<br>LD4990   |  | 23745 17,4 +/WE(1,8/7) BRE<br>23745 17,4 +/WE(1,8/7) BRE  |
|  | CLS 280 / CLS 300<br>CLS 320 CDI<br>CLS 320 CDI<br>CLS 350<br>CLS 350 CDI<br>CLS 350 CDI<br>CLS 350 CDI<br>CLS 350 CGI<br>CLS 350 CGI                                 | 170<br>155<br>165<br>200<br>165<br>200<br>215<br>215                             | A 038332<br>A 038332   | 10.07<br>08.04<br>04.09<br>04.09<br>04.09<br>04.06   | 10.10<br>10.10<br>10.10<br>10.10<br>10.10<br>10.10<br>10.10  | 13.0460-4990.2<br>13.0470-4990.2<br>13.0460-0155.2<br>24.8190-0410.2               | 604990<br>LD4990<br>610155<br>620410   | 2<br>2   | 23745 17,4 +/WE(1,8/7) BRE<br>23745 17,4 +/WE(1,8/7) BRE<br>Belagsatz-Zubehör BRE<br>Warnkontakt L=97,5mm |
|  | CLS 500   | 225  |  | 08.04  | 10.10  | 13.0460-4990.2<br>13.0460-0275.2<br>24.8190-0416.2<br>24.8190-0410.2               | 604990<br>610275<br>620416<br>620410   | 1<br>1   | 23745 17,4 +/WE(1,8/7) BRE<br>Belagsatz-Zubehör<br>Warnkontakt L=100mm<br>Warnkontakt L=97,5mm            |
|  | CLS 500 / CLS 550   | 285  | A 069799   | 04.06  |  | 13.0460-4817.2<br>24.8190-0410.2   | 604817<br>620410   | 1  | 23960 18,3 /WE BRE<br>Warnkontakt L=97,5mm  |
|  | CLS 500 / CLS 550   | 285  | A 069800   |  | 10.10  | 13.0460-4817.2<br>24.8190-0420.2   | 604817<br>620420   | 1  | 23960 18,3 /WE BRE<br>Warnkontakt L=119mm   |
|  | CLS 55 AMG  | 350  |  | 01.05  | 10.10  | 13.0460-4997.2<br>24.8190-0416.2<br>24.8190-0410.2                                 | 604997<br>620416<br>620410   | 1<br>1   | 23944 17,5 +/WE BRE<br>Warnkontakt L=100mm<br>Warnkontakt L=97,5mm  |
|  | CLS 63 AMG  | 378  |  | 04.06  | 10.10  | 13.0460-4839.2<br>24.8190-0420.2   | 604839<br>620420   | 1  | - AMG-Performance Package<br>24455 16,8 /WE BRE<br>Warnkontakt L=119mm                                    |
|  | CLS 320 CDI<br>CLS 320 CDI<br>CLS 350 CDI<br>CLS 350 CDI  | 155<br>165<br>165<br>200   |  | 05.05<br>05.05<br>04.09<br>04.09   | 10.10<br>10.10<br>10.10<br>10.10   | 24.0128-0142.1<br>24.0328-0142.1<br>13.8190-0330.1                                 | 428142<br>528142<br>990134   | 4  | 312 28,0 25,4 V L +B<br>312 28,0 25,4 V L +B PD<br>Halterschraube   |
|  | CLS 280 / CLS 300<br>CLS 350<br>CLS 350 CGI<br>CLS 350 CGI<br>CLS 500   | 170<br>200<br>215<br>215<br>225  |  | 10.07<br>08.04<br>04.09<br>04.06<br>08.04  | 10.10<br>10.10<br>10.10<br>10.10<br>10.10  | 24.0132-0144.1<br>24.0332-0144.1<br>13.8190-0330.1                                 | 432144<br>532144<br>990134   | 4  | 330 32,0 29,4 V L +S +B<br>330 32,0 29,4 V L +S +B PD<br>Halterschraube                                   |
|  | CLS 500 / CLS 550   | 285  |  | 04.06  | 10.10  | 24.0132-0139.1   | 432139   |  | 350 32,0 29,4 V L +S +B   |
|  | CLS 55 AMG  | 350  |  | 01.05  | 10.10  | 24.0136-0102.1<br>13.8190-0330.1   | 436102<br>990134   | 4  | - AMG-Performance Package<br>360 36,0 34,0 V L +B<br>Halterschraube                                       |
|  | CLS 280 / CLS 300<br>CLS 320 CDI<br>CLS 320 CDI<br>CLS 350<br>CLS 350 CDI<br>CLS 350 CDI<br>CLS 350 CDI<br>CLS 350 CGI<br>CLS 350 CGI<br>CLS 500<br>CLS 500 / CLS 550 | 170<br>155<br>165<br>200<br>165<br>200<br>215<br>215<br>225<br>285               |  | 10.07<br>05.05<br>05.05<br>08.04<br>04.09<br>04.09<br>04.09<br>04.06<br>08.04<br>04.06                   | 10.10<br>10.10<br>10.10<br>10.10<br>10.10<br>10.10<br>10.10<br>10.10<br>10.10<br>10.10                   | 13.0460-7171.2<br>13.0470-7171.2<br>24.8190-0410.2                                 | 607171<br>LD7171<br>620410   | 1  | 23334 16,7 +/WE ATE<br>23334 16,7 +/WE ATE<br>Warnkontakt L=97,5mm  |
|  | CLS 55 AMG  | 350  |  | 01.05  | 10.10  | 13.0460-4998.2<br>24.8190-0410.2   | 604998<br>620410   | 1  | 23478 16,5 /WE BRE<br>Warnkontakt L=97,5mm  |
|  | CLS 63 AMG  | 378  |  | 04.06  | 10.10  | 24.8190-0420.2   | 620420   | 1  | Warnkontakt L=119mm   |
|  | CLS 280 / CLS 300<br>CLS 320 CDI<br>CLS 320 CDI<br>CLS 350<br>CLS 350 CDI<br>CLS 350 CDI<br>CLS 350 CDI<br>CLS 350 CGI<br>CLS 350 CGI<br>CLS 500                      | 170<br>155<br>165<br>200<br>165<br>200<br>215<br>215<br>225                      |  | 10.07<br>05.05<br>05.05<br>08.04<br>04.09<br>04.09<br>04.09<br>04.06<br>08.04                            | 10.10<br>10.10<br>10.10<br>10.10<br>10.10<br>10.10<br>10.10<br>10.10<br>10.10                            | 24.0122-0201.1<br>13.8190-0330.1   | 422201<br>990134   | 4  | 300 22,0 19,4 V +S +B<br>Halterschraube   |
|  | CLS 500 / CLS 550   | 285  |  | 04.06  | 10.10  | 24.0124-0236.1   | 424236   |  | 320 24,0 21,4 V L +S +B   |
|  | CLS 55 AMG<br>CLS 63 AMG  | 350<br>378   |  | 01.05<br>04.06   | 10.10<br>10.10   | 24.0126-0136.1   | 426136   |  | 330 26,0 24,0 V L +B  |
|  | CLS 280 / CLS 300<br>CLS 320 CDI<br>CLS 320 CDI<br>CLS 350<br>CLS 350 CDI<br>CLS 350 CDI  | 170<br>155<br>165<br>200<br>165<br>200   |  | 10.07<br>05.05<br>05.05<br>08.04<br>04.09<br>04.09   | 10.10<br>10.10<br>10.10<br>10.10<br>10.10<br>10.10   | 03.0137-4017.2<br>03.0137-9297.2   | 654017<br>669297   |  | 180 x 25 /Zub<br>Bremsbacken-Zubehör  |



**MERCEDES BENZ CLS-Klasse (C219) Coupe (04-10)**















|  |                   |     |       |       |                |        |  |                                      |
|--|-------------------|-----|-------|-------|----------------|--------|--|--------------------------------------|
|  | CLS 350 CGI       | 215 | 04.09 | 10.10 | 03.0137-4017.2 | 654017 |  | 180 x 25 /Zub<br>Bremsbacken-Zubehör |
|  | CLS 350 CGI       | 215 | 04.06 | 10.10 | 03.0137-9297.2 | 669297 |  |                                      |
|  | CLS 500           | 225 | 08.04 | 10.10 |                |        |  |                                      |
|  | CLS 500 / CLS 550 | 285 | 04.06 | 10.10 |                |        |  |                                      |
|  | CLS 55 AMG        | 350 | 01.05 | 10.10 |                |        |  |                                      |
|  | CLS 63 AMG        | 378 | 04.06 | 10.10 |                |        |  |                                      |

**MERCEDES BENZ CLS-Klasse (C218) Coupe (10-)**

|                      |                     |       |       |                |                |        |  |   |   |   |
|----------------------|---------------------|-------|-------|----------------|----------------|--------|--|---|---|---|
|                      | CLS 220 BlueTec     | 150   | 05.14 |                | 13.0460-2734.2 | 602734 | 1  | 24310 19,0 +/WE/S TRW<br>24310 19,0 + /WE/S TRW<br>Warnkontakt L=97,5mm |   |   |
|                      | CLS 250 BT 4-matic  | 150   | 05.14 |                | 13.0470-2734.2 | LD2734 |  |   |   |   |
|                      | CLS 250 CDI         | 150   | 11.10 |                | 24.8190-0410.2 | 620410 |  |   |   |   |
|                      | CLS 350 BlueTec     | 185   | 01.13 |                |                |        |  |   |   |   |
|                      | CLS 350 BT 4-matic  | 185   | 01.13 |                |                |        |  |   |   |   |
|                      | CLS 350 CDI         | 195   | 11.10 |                |                |        |  |   |   |   |
|                      | CLS 350 CDI 4-matic | 195   | 09.11 |                |                |        |  |   |   |   |
|                      | CLS 350 CGI         | 225   | 11.10 |                |                |        |  |   |   |   |
|                      | CLS 350 d 4-matic   | 190   | 04.15 |                |                |        |  |   |   |   |
|                      | CLS 400             | 245   | 05.14 |                |                |        |  |   |   |   |
|                      | CLS 400 4-matic     | 245   | 05.14 |                |                |        |  |   |   |   |
|                      | CLS 500             | 300   | 11.10 |                | 24.8190-0410.2 | 620410 |  |   | 1 | Warnkontakt L=97,5mm                          |
| CLS 500 4-matic      | 300                 | 11.10 |       |                |                |        |  |   |   |   |
| CLS 63 AMG           | 386                 | 03.11 |       | 24.8190-0420.2 | 620420         | 1      | Warnkontakt L=119mm  |   |   |   |
| CLS 63 AMG           | 412                 | 01.11 |       |                |                |        |  |   |   |   |
| CLS 63 AMG 4-matic   | 410                 | 01.13 |       | 24.8190-0420.2 | 620420         | 1      | - Keramikbremse <sup>2)</sup>                                      | Warnkontakt L=119mm   |   |   |
| CLS 63 AMG S         | 430                 | 01.13 |       |                |                |        |  |   |   |   |
| CLS 63 AMG S 4-matic | 430                 | 01.13 |       |                |                |        |  |   |   |   |
| CLS 350 BlueTec      | 185                 | 01.13 |       | 13.0460-4863.2 | 604863         | 1      | 24976 17,5 /WE BRE<br>Warnkontakt L=97,5mm                         |   |   |   |
| CLS 350 BT 4-matic   | 185                 | 01.13 |       | 24.8190-0410.2 | 620410         |        |  |   |   |   |
| CLS 350 CDI          | 195                 | 11.10 |       |                |                |        |  |   |   |   |
| CLS 350 CDI 4-matic  | 195                 | 09.11 |       |                |                |        |  |   |   |   |
| CLS 350 CGI          | 225                 | 11.10 |       |                |                |        |  |   |   |   |
| CLS 350 d 4-matic    | 190                 | 04.15 |       |                |                |        |  |   |   |   |
| CLS 400              | 245                 | 05.14 |       |                |                |        |  |   |   |   |
| CLS 400 4-matic      | 245                 | 05.14 |       |                |                |        |  |   |   |   |
| CLS 250 CDI          | 150                 | 11.10 |       | 24.8190-0410.2 | 620410         |        |  | 1   |   | Warnkontakt L=97,5mm                          |
| CLS 350 BlueTec      | 185                 | 01.13 |       | 24.0132-0170.1 | 432170         |        |  |   |   | 322 32,0 30,0 V L +S +B                       |
| CLS 350 BT 4-matic   | 185                 | 01.13 |       | 24.0132-0170.1 | 432170         |        |  |   |   | - Sportpaket / - Sportpaket AMG <sup>1)</sup> |
| CLS 350 CDI          | 195                 | 11.10 |       |                |                |        |  |   |   |   |
| CLS 350 CDI 4-matic  | 195                 | 09.11 |       |                |                |        |  |   |   |   |
| CLS 350 CGI          | 225                 | 11.10 |       |                |                |        |  |   |   |   |
| CLS 350 d 4-matic    | 190                 | 04.15 |       |                |                |        |  |   |   |   |
| CLS 220 BlueTec      | 150                 | 05.14 |       | 24.0132-0170.1 | 432170         |        |  | 322 32,0 30,0 V L +S +B   |   |   |
| CLS 250 BT 4-matic   | 150                 | 05.14 |       |                |                |        |  |   |   |   |
| CLS 220 BlueTec      | 150                 | 05.14 |       | 13.0460-7259.2 | 607259         | 1      | 24862 16,7 +/WE ATE<br>24862 16,7 +/WE ATE<br>Warnkontakt L=97,5mm |   |   |   |
| CLS 250 BT 4-matic   | 150                 | 05.14 |       | 13.0470-7259.2 | LD7259         |        |  |   |   |   |
| CLS 250 CDI          | 150                 | 11.10 |       | 24.8190-0410.2 | 620410         |        |  |   |   |   |
| CLS 350 BlueTec      | 185                 | 01.13 |       |                |                |        |  |   |   |   |
| CLS 350 BT 4-matic   | 185                 | 01.13 |       |                |                |        |  |   |   |   |
| CLS 350 CDI          | 195                 | 11.10 |       |                |                |        |  |   |   |   |
| CLS 350 CDI 4-matic  | 195                 | 09.11 |       |                |                |        |  |   |   |   |
| CLS 350 CGI          | 225                 | 11.10 |       |                |                |        |  |   |   |   |
| CLS 350 d 4-matic    | 190                 | 04.15 |       |                |                |        |  |   |   |   |
| CLS 400              | 245                 | 05.14 |       |                |                |        |  |   |   |   |
| CLS 400 4-matic      | 245                 | 05.14 |       |                |                |        |  |   |   |   |
| CLS 500              | 300                 | 11.10 |       |                |                |        |  |   |   |   |
| CLS 500 4-matic      | 300                 | 11.10 |       |                |                |        |  |   |   |   |
| CLS 63 AMG           | 386                 | 03.11 |       | 24.8190-0420.2 | 620420         | 1      |  | Warnkontakt L=119mm   |   |   |
| CLS 63 AMG           | 412                 | 01.11 |       |                |                |        |  |   |   |   |
| CLS 63 AMG 4-matic   | 410                 | 01.13 |       |                |                |        |  |   |   |   |
| CLS 63 AMG S         | 430                 | 01.13 |       |                |                |        |  |   |   |   |
| CLS 63 AMG S 4-matic | 430                 | 01.13 |       |                |                |        |  |   |   |   |
| CLS 220 BlueTec      | 150                 | 05.14 |       | 24.0110-0278.1 | 410278         |        | 300 10,0 8,3 +S +B<br>300 10,0 8,3 +S +B PD                        |   |   |   |
| CLS 250 BT 4-matic   | 150                 | 05.14 |       | 24.0310-0278.1 | 510278         |        |  |   |   |   |
| CLS 250 CDI          | 150                 | 11.10 |       |                |                |        |  |   |   |   |
| CLS 350 BlueTec      | 185                 | 01.13 |       | 24.0122-0201.1 | 422201         |        |  | 300 22,0 19,4 V +S +B   |   |   |
| CLS 350 BT 4-matic   | 185                 | 01.13 |       |                |                |        |  |   |   |   |
| CLS 350 CDI          | 195                 | 11.10 |       |                |                |        |  |   |   |   |
| CLS 350 CDI 4-matic  | 195                 | 09.11 |       |                |                |        |  |   |   |   |
| CLS 350 CGI          | 225                 | 11.10 |       |                |                |        |  |   |   |   |
| CLS 350 d 4-matic    | 190                 | 04.15 |       |                |                |        |  |   |   |   |
| CLS 400              | 245                 | 05.14 |       |                |                |        |  |   |   |   |
| CLS 400 4-matic      | 245                 | 05.14 |       |                |                |        |  |   |   |   |
| CLS 500              | 300                 | 11.10 |       | 24.0124-0236.1 | 424236         |        |  | 320 24,0 21,4 V L +S +B   |   |   |
| CLS 500 4-matic      | 300                 | 11.10 |       |                |                |        |  |   |   |   |
| CLS 220 BlueTec      | 150                 | 05.14 |       | 03.0137-4007.2 | 654007         |        | 180 x 25 /Zub  |   |   |   |
| CLS 250 BT 4-matic   | 150                 | 05.14 |       |                |                |        |  |   |   |   |
| CLS 250 CDI          | 150                 | 11.10 |       |                |                |        |  |   |   |   |
| CLS 350 BlueTec      | 185                 | 01.13 |       |                |                |        |  |   |   |   |
| CLS 350 BT 4-matic   | 185                 | 01.13 |       |                |                |        |  |   |   |   |
| CLS 350 CDI          | 195                 | 11.10 |       |                |                |        |  |   |   |   |
| CLS 350 CDI 4-matic  | 195                 | 09.11 |       |                |                |        |  |   |   |   |
| CLS 350 CGI          | 225                 | 11.10 |       |                |                |        |  |   |   |   |
| CLS 350 d 4-matic    | 190                 | 04.15 |       |                |                |        |  |   |   |   |
| CLS 400              | 245                 | 05.14 |       |                |                |        |  |   |   |   |
| CLS 400 4-matic      | 245                 | 05.14 |       |                |                |        |  |   |   |   |
| CLS 500              | 300                 | 11.10 |       |                |                |        |  |   |   |   |
| CLS 500 4-matic      | 300                 | 11.10 |       |                |                |        |  |   |   |   |

<sup>1)</sup> - sport package/- sport package AMG / - pacchetto sportivo/- pacchetto sport.AMG / - version sport/- version sport AMG / - kit deportivo/- kit deportivo AMG  
<sup>2)</sup> - ceramic brake / - freno in ceramica / - frein de céramique / - freno de cerámica  
<sup>3)</sup> + sports package/+ sports package AMG / + pacchetto sportivo/+ pacchetto sport.AMG / + version sport/+ version sport AMG / + kit deportivo/+ kit deportivo AMG



|     |  |  |  |  |  |  |  |  |
|--|--|--|--|--|---|--|--|--|
| <b>MERCEDES BENZ CLS-Klasse (C218) Coupe (10-)</b>                                 |  |  |  |  |   |  |  |  |
|    | CLS 63 AMG   | 386  | 03.11  |  | 03.0137-4007.2  | 654007   |  | 180 x 25 /Zub  |
|  | CLS 63 AMG   | 412  | 01.11  |  |   |  |  |  |
|  | CLS 63 AMG 4-matic   | 410  | 01.13  |  |   |  |  |  |
|  | CLS 63 AMG S   | 430  | 01.13  |  |   |  |  |  |
|  | CLS 63 AMG S 4-matic   | 430  | 01.13  |  |   |  |  |  |
| <b>MERCEDES BENZ CLS-Klasse (X218) Shooting Brake (12-)</b>                        |  |  |  |  |   |  |  |  |
|    | CLS 220 BlueTec  |  | 05.14  |  | 13.0460-2734.2  | 602734   |  | 24310 19,0 +/WE/S TRW  |
|  | CLS 250 BT 4-matic   | 150  | 05.14  |  | 13.0470-2734.2  | LD2734   |  | 24310 19,0 + /WE/S TRW   |
|  | CLS 250 CDI  | 150  | 09.12  |  | 24.8190-0410.2  | 620410   | 1  | Warnkontakt L=97,5mm   |
|  | CLS 350  | 225  | 09.12  |  | 13.0460-2734.2  | 602734   |  | 24310 19,0 +/WE/S TRW  |
|  | CLS 350 BlueTec  | 190  | 05.14  |  | 13.0470-2734.2  | LD2734   |  | 24310 19,0 + /WE/S TRW   |
|  | CLS 350 BT 4-matic   | 185  | 05.14  |  | 13.0460-4863.2  | 604863   |  | 24976 17,5 /WE BRE   |
|  | CLS 350 CDI  | 195  | 09.12  |  | 24.8190-0410.2  | 620410   | 1  | Warnkontakt L=97,5mm   |
|  | CLS 350 CDI 4-matic  | 195  | 09.12  |  |   |  |  |  |
|  | CLS 350 d 4-matic  | 190  | 04.15  |  |   |  |  |  |
|  | CLS 400  | 245  | 05.14  |  | 13.0460-4863.2  | 604863   |  | 24976 17,5 /WE BRE   |
|  | CLS 400 4-matic  | 245  | 05.14  |  | 24.8190-0410.2  | 620410   | 1  | Warnkontakt L=97,5mm   |
|  | CLS 500  | 300  | 09.12  |  | 24.8190-0410.2  | 620410   | 1  | Warnkontakt L=97,5mm   |
|  | CLS 500 4-matic  | 300  | 09.12  |  |   |  |  |  |
|  | CLS 63 AMG   | 386  | 09.12  |  | 24.8190-0420.2  | 620420   | 1  | Warnkontakt L=119mm  |
|  | CLS 63 AMG   | 410  | 01.13  |  |   |  |  |  |
|  | CLS 63 AMG 4-matic   | 410  | 01.13  |  |   |  |  |  |
|  | CLS 63 AMG S   | 430  | 01.13  |  |   |  |  |  |
|  | CLS 63 AMG S 4-matic   | 430  | 01.13  |  |   |  |  |  |
|    | CLS 220 BlueTec  |  | 05.14  |  | 24.0132-0170.1  | 432170   |  | 322 32,0 30,0 V L +S +B  |
|  | CLS 250 BT 4-matic   | 150  | 05.14  |  |   |  |  |  |
|  | CLS 250 CDI  | 150  | 09.12  |  |   |  |  |  |
|  | CLS 350  | 225  | 09.12  |  | 24.0132-0170.1  | 432170   |  | 322 32,0 30,0 V L +S +B  |
|  | CLS 350 BlueTec  | 190  | 05.14  |  |   |  |  |  |
|  | CLS 350 BT 4-matic   | 185  | 05.14  |  |   |  |  |  |
|  | CLS 350 CDI  | 195  | 09.12  |  |   |  |  |  |
|  | CLS 350 CDI 4-matic  | 195  | 09.12  |  |   |  |  |  |
|  | CLS 350 d 4-matic  | 190  | 04.15  |  |   |  |  |  |
|    | CLS 220 BlueTec  |  | 05.14  |  | 13.0460-7259.2  | 607259   |  | 24862 16,7 +/WE ATE  |
|  | CLS 250 BT 4-matic   | 150  | 05.14  |  | 13.0470-7259.2  | LD7259   |  | 24862 16,7 +/WE ATE  |
|  | CLS 250 CDI  | 150  | 09.12  |  | 24.8190-0410.2  | 620410   | 1  | Warnkontakt L=97,5mm   |
|  | CLS 350  | 225  | 09.12  |  |   |  |  |  |
|  | CLS 350 BlueTec  | 190  | 05.14  |  |   |  |  |  |
|  | CLS 350 BT 4-matic   | 185  | 05.14  |  |   |  |  |  |
|  | CLS 350 CDI  | 195  | 09.12  |  |   |  |  |  |
|  | CLS 350 CDI 4-matic  | 195  | 09.12  |  |   |  |  |  |
|  | CLS 350 d 4-matic  | 190  | 04.15  |  |   |  |  |  |
|  | CLS 400  | 245  | 05.14  |  |   |  |  |  |
|  | CLS 400 4-matic  | 245  | 05.14  |  |   |  |  |  |
|  | CLS 500  | 300  | 09.12  |  |   |  |  |  |
|  | CLS 500 4-matic  | 300  | 09.12  |  |   |  |  |  |
|  | CLS 63 AMG   | 386  | 09.12  |  | 24.8190-0420.2  | 620420   | 1  | Warnkontakt L=119mm  |
|  | CLS 63 AMG   | 410  | 01.13  |  |   |  |  |  |
|  | CLS 63 AMG 4-matic   | 410  | 01.13  |  |   |  |  |  |
|  | CLS 63 AMG S   | 430  | 01.13  |  |   |  |  |  |
|  | CLS 63 AMG S 4-matic   | 430  | 01.13  |  |   |  |  |  |
|  | CLS 220 BlueTec  |  | 05.14  |  | 24.0110-0278.1  | 410278   |  | 300 10,0 8,3 +S +B   |
|  | CLS 250 BT 4-matic   | 150  | 05.14  |  | 24.0310-0278.1  | 510278   |  | 300 10,0 8,3 +S +B PD  |
|  | CLS 250 CDI  | 150  | 09.12  |  |   |  |  |  |
|  | CLS 250 BT 4-matic   | 150  | 05.14  |  | 24.0122-0201.1  | 422201   |  | 300 22,0 19,4 V L +S +B  |
|  | CLS 350  | 225  | 09.12  |  |   |  |  |  |
|  | CLS 350 BlueTec  | 190  | 05.14  |  |   |  |  |  |
|  | CLS 350 BT 4-matic   | 185  | 05.14  |  |   |  |  |  |
|  | CLS 350 CDI  | 195  | 09.12  |  |   |  |  |  |
|  | CLS 350 CDI 4-matic  | 195  | 09.12  |  |   |  |  |  |
|  | CLS 350 d 4-matic  | 190  | 04.15  |  |   |  |  |  |
|  | CLS 400  | 245  | 05.14  |  |   |  |  |  |
|  | CLS 400 4-matic  | 245  | 05.14  |  |   |  |  |  |
|  | CLS 500  | 300  | 09.12  |  | 24.0124-0236.1  | 424236   |  | 320 24,0 21,4 V L +S +B  |
|  | CLS 500 4-matic  | 300  | 09.12  |  |   |  |  |  |
|  | CLS 220 BlueTec  |  | 05.14  |  | 03.0137-4007.2  | 654007   |  | 180 x 25 /Zub  |
|  | CLS 250 BT 4-matic   | 150  | 05.14  |  |   |  |  |  |
|  | CLS 250 CDI  | 150  | 09.12  |  |   |  |  |  |
|  | CLS 350  | 225  | 09.12  |  |   |  |  |  |
|  | CLS 350 BlueTec  | 190  | 05.14  |  |   |  |  |  |
|  | CLS 350 BT 4-matic   | 185  | 05.14  |  |   |  |  |  |
|  | CLS 350 CDI  | 195  | 09.12  |  |   |  |  |  |
|  | CLS 350 CDI 4-matic  | 195  | 09.12  |  |   |  |  |  |
|  | CLS 350 d 4-matic  | 190  | 04.15  |  |   |  |  |  |
|  | CLS 400  | 245  | 05.14  |  |   |  |  |  |
|  | CLS 400 4-matic  | 245  | 05.14  |  |   |  |  |  |
|  | CLS 500  | 300  | 09.12  |  |   |  |  |  |
|  | CLS 500 4-matic  | 300  | 09.12  |  |   |  |  |  |
|  | CLS 63 AMG   | 386  | 09.12  |  |   |  |  |  |
|  | CLS 63 AMG   | 410  | 01.13  |  |   |  |  |  |
|  | CLS 63 AMG 4-matic   | 410  | 01.13  |  |   |  |  |  |
|  | CLS 63 AMG S   | 430  | 01.13  |  |   |  |  |  |
|  | CLS 63 AMG S 4-matic   | 430  | 01.13  |  |   |  |  |  |

1) - sport package / - pacchetto sportivo / - version sport / - kit deportivo  
2) + sports package / + pacchetto sportivo / + version sport / + kit deportivo  
3) - ceramic brake / - freno in ceramica / - frein de céramique / - freno de cerámica





**MERCEDES BENZ E-Klasse (C124) Coupe (93-97)**

|  |          |          |          |       |       |                |                |   |  |                         |                      |
|--|----------|----------|----------|-------|-------|----------------|----------------|---|--|-------------------------|----------------------|
|  | E 200    | 100      |          | 06.93 | 06.97 | 13.0460-2927.2 | 602927         | 2 |  | 20941 19,3 /WE/S        | TRW                  |
|  | E 220    | 110      |          | 06.93 | 06.97 | 13.0470-2927.2 | LD2927         |   |  | 20941 19,3 /WE/S        | TRW                  |
|  |          |          |          |       |       | 24.8190-0402.2 | 620402         |   |  | Warnkontakt L=68(150)mm |                      |
|  | E 320    | 162      | B 862121 | 06.93 |       | 13.0460-4201.2 | 604201         |   |  | 21153 17,5 /WE          | ATE                  |
|  | E 36 AMG | 195      |          | 06.93 | 04.95 | 24.8190-0401.2 | 620401         | 2 |  | Warnkontakt L=95mm      |                      |
|  | E 36 AMG | 200      |          | 05.94 | 06.97 |                |                |   |  |                         |                      |
|  | E 320    | 162      | B 862122 |       | 06.97 | 13.0460-4202.2 | 604202         | 2 |  | 21153 16,0 /WE          | ATE                  |
|  | E 200    | 100      |          | 06.93 | 06.97 | 24.8190-0401.2 | 620401         |   |  | 284 22,0 19,4 V L +S +B |                      |
|  | E 220    | 110      |          | 06.93 | 06.97 |                |                |   |  |                         |                      |
|  | E 320    | 162      | B 862121 | 06.93 |       | 24.0122-0136.1 | 422136         |   |  | 295 22,0 19,4 V L +B    |                      |
|  | E 320    | 162      | B 862122 |       | 06.97 | 24.0125-0107.1 | 425107         |   |  | 294 25,0 22,4 V L +B    |                      |
|  | E 36 AMG | 195      |          | 06.93 | 04.95 | 24.0130-0121.1 | 430121         | 4 |  | 320 30,0 28,0 V L +B    |                      |
|  | E 36 AMG | 200      |          | 05.94 | 06.97 | 24.0130-0122.1 | 430122         |   |  | 320 30,0 28,0 V L +B    |                      |
|  |          |          |          |       |       | 13.8190-0242.1 | 990124         |   |  | Halterschraube          |                      |
|  | E 200    | 100      |          | 06.93 | 06.97 | 13.0460-4034.2 | 604034         |   |  | 20687 15,5              | ATE                  |
|  | E 220    | 110      |          | 06.93 | 06.97 | 13.0460-0186.2 | 610186         |   |  | Belagsatz-Zubehör       | ATE                  |
|  | E 320    | 162      |          | 06.93 | 06.97 | 13.0460-3805.2 | 603805         |   |  | 21197 15,0 /WE          | ATE                  |
|  |          | E 36 AMG | 195      |       | 06.93 | 04.95          | 13.0470-3805.2 |   |  | LD3805                  | 21197 15,0 /WE       |
|  | E 36 AMG | 200      |          | 05.94 | 06.97 | 24.8190-0401.2 | 620401         | 2 |  | Warnkontakt L=95mm      |                      |
|  |          |          |          |       |       | 13.0460-0186.2 | 610186         |   |  | Belagsatz-Zubehör       | ATE                  |
|  | E 200    | 100      |          | 06.93 | 06.97 | 24.0109-0120.1 | 409120         |   |  | 258 9,0 7,3 +S +B       |                      |
|  | E 220    | 110      |          | 06.93 | 06.97 | 24.0309-0120.1 | 509120         |   |  | 258 9,0 7,3 +S +B PD    |                      |
|  | E 320    | 162      |          | 06.93 | 06.97 | 24.0109-0114.1 | 409114         |   |  | 278 9,0 7,3 +S +B       |                      |
|  |          | E 36 AMG | 195      |       | 06.93 | 04.95          | 24.0309-0114.1 |   |  | 509114                  | 278 9,0 7,3 +S +B PD |
|  | E 36 AMG | 200      |          | 05.94 | 06.97 |                |                |   |  |                         |                      |
|  | E 200    | 100      |          | 06.93 | 06.97 | 03.0137-0170.2 | 650170         |   |  |                         | 164 x 20 /Zub        |
|  | E 220    | 110      |          | 06.93 | 06.97 |                |                |   |  |                         |                      |
|  | E 320    | 162      |          | 06.93 | 06.97 |                |                |   |  |                         |                      |
|  | E 36 AMG | 195      |          | 06.93 | 04.95 |                |                |   |  |                         |                      |
|  | E 36 AMG | 200      |          | 05.94 | 06.97 |                |                |   |  |                         |                      |

**MERCEDES BENZ E-Klasse (A124) Cabrio (93-98)**

|  |          |     |          |       |       |                |        |   |  |                         |               |
|--|----------|-----|----------|-------|-------|----------------|--------|---|--|-------------------------|---------------|
|  | E 200    | 100 |          | 06.93 | 03.98 | 13.0460-2927.2 | 602927 | 2 |  | 20941 19,3 /WE/S        | TRW           |
|  | E 220    | 110 |          | 06.93 | 03.98 | 13.0470-2927.2 | LD2927 |   |  | 20941 19,3 /WE/S        | TRW           |
|  |          |     |          |       |       | 24.8190-0402.2 | 620402 |   |  | Warnkontakt L=68(150)mm |               |
|  | E 320    | 162 | B 862121 | 06.93 |       | 13.0460-4201.2 | 604201 |   |  | 21153 17,5 /WE          | ATE           |
|  | E 36 AMG | 200 |          | 05.94 | 03.98 | 24.8190-0401.2 | 620401 | 2 |  | Warnkontakt L=95mm      |               |
|  | E 320    | 162 | B 862122 |       | 03.98 | 13.0460-4202.2 | 604202 | 2 |  | 21153 16,0 /WE          | ATE           |
|  |          |     |          |       |       | 24.8190-0401.2 | 620401 |   |  | Warnkontakt L=95mm      |               |
|  |          |     |          |       |       | 13.0460-0268.2 | 610268 |   |  | Belagsatz-Zubehör       |               |
|  | E 200    | 100 |          | 06.93 | 03.98 | 24.0122-0123.1 | 422123 | 4 |  | 284 22,0 19,4 V L +S +B |               |
|  | E 220    | 110 |          | 06.93 | 03.98 | 13.8190-0242.1 | 990124 |   |  | Halterschraube          |               |
|  | E 320    | 162 | B 862121 | 06.93 |       | 24.0122-0136.1 | 422136 |   |  | 295 22,0 19,4 V L +B    |               |
|  |          |     |          |       |       | 13.8190-0242.1 | 990124 |   |  | Halterschraube          |               |
|  | E 320    | 162 | B 862122 |       | 03.98 | 24.0125-0107.1 | 425107 | 4 |  | 294 25,0 22,4 V L +B    |               |
|  |          |     |          |       |       | 13.8190-0242.1 | 990124 |   |  | Halterschraube          |               |
|  | E 36 AMG | 200 |          | 05.94 | 03.98 | 24.0130-0121.1 | 430121 | 4 |  | 320 30,0 28,0 V L +B    |               |
|  |          |     |          |       |       | 24.0130-0122.1 | 430122 |   |  | 320 30,0 28,0 V L +B    |               |
|  |          |     |          |       |       | 13.8190-0242.1 | 990124 |   |  | Halterschraube          |               |
|  | E 200    | 100 |          | 06.93 | 03.98 | 13.0460-3805.2 | 603805 | 2 |  | 21197 15,0 /WE          | ATE           |
|  | E 220    | 110 |          | 06.93 | 03.98 | 13.0470-3805.2 | LD3805 |   |  | 21197 15,0 /WE          | ATE           |
|  | E 320    | 162 |          | 06.93 | 03.98 | 24.8190-0401.2 | 620401 |   |  | Warnkontakt L=95mm      |               |
|  | E 36 AMG | 200 |          | 05.94 | 03.98 | 13.0460-0186.2 | 610186 |   |  | Belagsatz-Zubehör       | ATE           |
|  | E 200    | 100 |          | 06.93 | 03.98 | 24.0109-0114.1 | 409114 |   |  | 278 9,0 7,3 +S +B       |               |
|  | E 220    | 110 |          | 06.93 | 03.98 | 24.0309-0114.1 | 509114 |   |  | 278 9,0 7,3 +S +B PD    |               |
|  | E 320    | 162 |          | 06.93 | 03.98 |                |        |   |  |                         |               |
|  | E 36 AMG | 200 |          | 05.94 | 03.98 |                |        |   |  |                         |               |
|  | E 200    | 100 |          | 06.93 | 03.98 | 03.0137-0170.2 | 650170 |   |  |                         | 164 x 20 /Zub |
|  | E 220    | 110 |          | 06.93 | 03.98 |                |        |   |  |                         |               |
|  | E 320    | 162 |          | 06.93 | 03.98 |                |        |   |  |                         |               |
|  | E 36 AMG | 195 |          | 06.93 | 03.98 |                |        |   |  |                         |               |
|  | E 36 AMG | 200 |          | 05.94 | 03.98 |                |        |   |  |                         |               |

**MERCEDES BENZ E-Klasse (W210) Limousine (95-02)**

|               |                  |     |       |       |       |                |        |   |                    |                 |     |   |                    |                 |     |   |                    |                    |   |   |                    |                    |   |   |                    |                    |  |   |  |                    |  |   |  |                    |  |   |  |                    |  |   |  |                    |  |   |  |                    |  |   |  |                    |  |   |  |                    |  |   |  |                    |  |   |  |                 |     |   |  |                 |     |
|---------------|------------------|-----|-------|-------|-------|----------------|--------|---|--------------------|-----------------|-----|---|--------------------|-----------------|-----|---|--------------------|--------------------|---|---|--------------------|--------------------|---|---|--------------------|--------------------|--|---|--|--------------------|--|---|--|--------------------|--|---|--|--------------------|--|---|--|--------------------|--|---|--|--------------------|--|---|--|--------------------|--|---|--|--------------------|--|---|--|--------------------|--|---|--|-----------------|-----|---|--|-----------------|-----|
|               | E 200            |     |       | 06.95 | 04.02 | 13.0460-7086.2 | 607086 | 2 |                    | 21664 19,8 +/WE | ATE |   |                    |                 |     |   |                    |                    |   |   |                    |                    |   |   |                    |                    |  |   |  |                    |  |   |  |                    |  |   |  |                    |  |   |  |                    |  |   |  |                    |  |   |  |                    |  |   |  |                    |  |   |  |                    |  |   |  |                 |     |   |  |                 |     |
|               | E 200 CDI        |     |       | 07.98 | 04.02 | 13.0470-7086.2 | LD7086 |   |                    |                 |     | 2 |                    | 21664 19,8 +/WE | ATE |   |                    |                    |   |   |                    |                    |   |   |                    |                    |  |   |  |                    |  |   |  |                    |  |   |  |                    |  |   |  |                    |  |   |  |                    |  |   |  |                    |  |   |  |                    |  |   |  |                    |  |   |  |                 |     |   |  |                 |     |
|               | E 200 D          |     |       | 10.96 | 04.02 | 24.8190-0401.2 | 620401 |   |                    |                 |     |   |                    |                 |     | 2 |                    | Warnkontakt L=95mm |   |   |                    |                    |   |   |                    |                    |  |   |  |                    |  |   |  |                    |  |   |  |                    |  |   |  |                    |  |   |  |                    |  |   |  |                    |  |   |  |                    |  |   |  |                    |  |   |  |                 |     |   |  |                 |     |
|               | E 200 Kompressor | 120 |       | 08.00 | 04.02 |                |        |   |                    |                 |     |   |                    |                 |     |   |                    |                    |   | 2 |                    | Warnkontakt L=95mm |   |   |                    |                    |  |   |  |                    |  |   |  |                    |  |   |  |                    |  |   |  |                    |  |   |  |                    |  |   |  |                    |  |   |  |                    |  |   |  |                    |  |   |  |                 |     |   |  |                 |     |
|               | E 220 CDI        |     |       | 07.98 | 04.02 |                |        |   |                    |                 |     |   |                    |                 |     |   |                    |                    |   |   |                    |                    |   | 2 |                    | Warnkontakt L=95mm |  |   |  |                    |  |   |  |                    |  |   |  |                    |  |   |  |                    |  |   |  |                    |  |   |  |                    |  |   |  |                    |  |   |  |                    |  |   |  |                 |     |   |  |                 |     |
|               | E 220 D          |     |       | 06.95 | 06.98 |                |        |   |                    |                 |     |   |                    |                 |     |   |                    |                    |   |   |                    |                    |   |   |                    |                    |  | 2 |  | Warnkontakt L=95mm |  |   |  |                    |  |   |  |                    |  |   |  |                    |  |   |  |                    |  |   |  |                    |  |   |  |                    |  |   |  |                    |  |   |  |                 |     |   |  |                 |     |
|               | E 230            |     |       | 06.95 | 08.97 |                |        |   |                    |                 |     |   |                    |                 |     |   |                    |                    |   |   |                    |                    |   |   |                    |                    |  |   |  |                    |  | 2 |  | Warnkontakt L=95mm |  |   |  |                    |  |   |  |                    |  |   |  |                    |  |   |  |                    |  |   |  |                    |  |   |  |                    |  |   |  |                 |     |   |  |                 |     |
|               | E 240            |     |       | 09.97 | 04.02 |                |        |   |                    |                 |     |   |                    |                 |     |   |                    |                    |   |   |                    |                    |   |   |                    |                    |  |   |  |                    |  |   |  |                    |  | 2 |  | Warnkontakt L=95mm |  |   |  |                    |  |   |  |                    |  |   |  |                    |  |   |  |                    |  |   |  |                    |  |   |  |                 |     |   |  |                 |     |
|               | E 250 D          |     |       | 06.95 | 04.02 |                |        |   |                    |                 |     |   |                    |                 |     |   |                    |                    |   |   |                    |                    |   |   |                    |                    |  |   |  |                    |  |   |  |                    |  |   |  |                    |  | 2 |  | Warnkontakt L=95mm |  |   |  |                    |  |   |  |                    |  |   |  |                    |  |   |  |                    |  |   |  |                 |     |   |  |                 |     |
|               | E 250 D          |     |       | 06.95 | 04.02 |                |        |   |                    |                 |     |   |                    |                 |     |   |                    |                    |   |   |                    |                    |   |   |                    |                    |  |   |  |                    |  |   |  |                    |  |   |  |                    |  |   |  |                    |  | 2 |  | Warnkontakt L=95mm |  |   |  |                    |  |   |  |                    |  |   |  |                    |  |   |  |                 |     |   |  |                 |     |
|               | E 250 TD         |     |       | 09.97 | 04.02 |                |        |   |                    |                 |     |   |                    |                 |     |   |                    |                    |   |   |                    |                    |   |   |                    |                    |  |   |  |                    |  |   |  |                    |  |   |  |                    |  |   |  |                    |  |   |  |                    |  | 2 |  | Warnkontakt L=95mm |  |   |  |                    |  |   |  |                    |  |   |  |                 |     |   |  |                 |     |
|               | E 290 TD         |     |       | 01.96 | 04.02 |                |        |   |                    |                 |     |   |                    |                 |     |   |                    |                    |   |   |                    |                    |   |   |                    |                    |  |   |  |                    |  |   |  |                    |  |   |  |                    |  |   |  |                    |  |   |  |                    |  |   |  |                    |  | 2 |  | Warnkontakt L=95mm |  |   |  |                    |  |   |  |                 |     |   |  |                 |     |
|               | E 300 D          |     |       | 06.95 | 04.02 |                |        |   |                    |                 |     |   |                    |                 |     |   |                    |                    |   |   |                    |                    |   |   |                    |                    |  |   |  |                    |  |   |  |                    |  |   |  |                    |  |   |  |                    |  |   |  |                    |  |   |  |                    |  |   |  |                    |  | 2 |  | Warnkontakt L=95mm |  |   |  |                 |     |   |  |                 |     |
|               | E 200 Kompressor | 137 |       | 09.97 | 04.02 | 13.0460-7087.2 | 607087 |   |                    |                 |     |   |                    |                 |     |   |                    |                    |   |   |                    |                    |   |   |                    |                    |  |   |  |                    |  |   |  |                    |  |   |  |                    |  |   |  |                    |  |   |  |                    |  |   |  |                    |  |   |  |                    |  |   |  |                    |  | 2 |  | 21670 19,4 +/WE | ATE |   |  |                 |     |
|               | E 240            |     |       | 09.97 | 04.02 | 13.0470-7087.2 | LD7087 |   |                    |                 |     |   |                    |                 |     |   |                    |                    |   |   |                    |                    |   |   |                    |                    |  |   |  |                    |  |   |  |                    |  |   |  |                    |  |   |  |                    |  |   |  |                    |  |   |  |                    |  |   |  |                    |  |   |  |                    |  |   |  |                 |     | 2 |  | 21670 19,4 +/WE | ATE |
|               | E 270 CDI        |     |       | 07.99 | 04.02 | 24.8190-0401.2 | 620401 |   |                    |                 |     |   |                    |                 |     |   |                    |                    |   |   |                    |                    |   |   |                    |                    |  |   |  |                    |  |   |  |                    |  |   |  |                    |  |   |  |                    |  |   |  |                    |  |   |  |                    |  |   |  |                    |  |   |  |                    |  |   |  |                 |     |   |  |                 |     |
| E 280         |                  |     | 01.96 | 04.02 |       |                | 2      |   | Warnkontakt L=95mm |                 |     |   |                    |                 |     |   |                    |                    |   |   |                    |                    |   |   |                    |                    |  |   |  |                    |  |   |  |                    |  |   |  |                    |  |   |  |                    |  |   |  |                    |  |   |  |                    |  |   |  |                    |  |   |  |                    |  |   |  |                 |     |   |  |                 |     |
| E 280 4-matic |                  |     | 10.96 | 04.02 |       |                |        |   |                    |                 | 2   |   | Warnkontakt L=95mm |                 |     |   |                    |                    |   |   |                    |                    |   |   |                    |                    |  |   |  |                    |  |   |  |                    |  |   |  |                    |  |   |  |                    |  |   |  |                    |  |   |  |                    |  |   |  |                    |  |   |  |                    |  |   |  |                 |     |   |  |                 |     |
| E 300 TD      |                  |     | 10.96 | 04.02 |       |                |        |   |                    |                 |     |   |                    |                 | 2   |   | Warnkontakt L=95mm |                    |   |   |                    |                    |   |   |                    |                    |  |   |  |                    |  |   |  |                    |  |   |  |                    |  |   |  |                    |  |   |  |                    |  |   |  |                    |  |   |  |                    |  |   |  |                    |  |   |  |                 |     |   |  |                 |     |
| E 320         |                  |     | 06.95 | 04.02 |       |                |        |   |                    |                 |     |   |                    |                 |     |   |                    |                    | 2 |   | Warnkontakt L=95mm |                    |   |   |                    |                    |  |   |  |                    |  |   |  |                    |  |   |  |                    |  |   |  |                    |  |   |  |                    |  |   |  |                    |  |   |  |                    |  |   |  |                    |  |   |  |                 |     |   |  |                 |     |
| E 320 4-matic |                  |     | 06.97 | 04.02 |       |                |        |   |                    |                 |     |   |                    |                 |     |   |                    |                    |   |   |                    |                    | 2 |   | Warnkontakt L=95mm |                    |  |   |  |                    |  |   |  |                    |  |   |  |                    |  |   |  |                    |  |   |  |                    |  |   |  |                    |  |   |  |                    |  |   |  |                    |  |   |  |                 |     |   |  |                 |     |

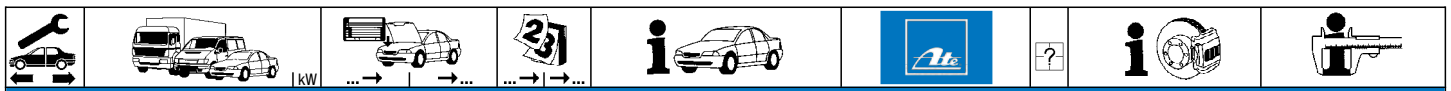

**MERCEDES BENZ E-Klasse (W210) Limousine (95-02)**

|  |                  |     |                     |       |             |     |                |        |   |  |                            |     |
|--|------------------|-----|---------------------|-------|-------------|-----|----------------|--------|---|--|----------------------------|-----|
|  | E 320 CDI        |     |                     | 07.99 | 04.02       |     | 13.0460-7087.2 | 607087 |   |  | 21670 19,4 +/WE            | ATE |
|  | E 420            |     | A 962231 / X 027613 | 01.96 |             |     | 13.0470-7087.2 | LD7087 |   |  | 21670 19,4 +/WE            | ATE |
|  | E 430            |     | A 962231 / X 027613 | 09.97 |             |     | 24.8190-0401.2 | 620401 | 2 |  | Warnkontakt L=95mm         |     |
|  | E 420            |     | A 962232 / X 027614 |       | 04.02       |     | 13.0460-7183.2 | 607183 |   |  | 21484 20,5 +/WE            | ATE |
|  | E 430            |     | A 962232 / X 027614 |       | 04.02       |     | 24.8190-0419.2 | 620419 | 2 |  | Warnkontakt L=74mm         |     |
|  | E 430 4-matic    |     |                     | 05.99 | 04.02       |     |                |        |   |  |                            |     |
|  | E 50 AMG         |     |                     | 01.96 | 08.97       |     |                |        |   |  |                            |     |
|  | E 55 AMG         |     |                     | 09.97 | 04.02       |     |                |        |   |  |                            |     |
|  | E 200            |     |                     | 06.95 | 04.02       |     | 24.0125-0110.1 | 425110 |   |  | 288 25,0 22,4 V L +S +B    |     |
|  | E 200 CDI        |     |                     | 07.98 | 04.02       |     | 24.0325-0110.1 | 525110 |   |  | 288 25,0 22,4 V L +S +B PD |     |
|  | E 200 D          |     |                     | 10.96 | 04.02 + P   |     | 13.8190-0330.1 | 990134 | 4 |  | Halterschraube             |     |
|  | E 200 Kompressor | 120 |                     | 08.00 | 04.02       |     |                |        |   |  |                            |     |
|  | E 220 CDI        |     |                     | 07.98 | 04.02       |     |                |        |   |  |                            |     |
|  | E 220 D          |     |                     | 06.95 | 06.98       |     |                |        |   |  |                            |     |
|  | E 230            |     |                     | 06.95 | 08.97       |     |                |        |   |  |                            |     |
|  | E 240            |     |                     | 09.97 | 04.02 - ESP |     |                |        |   |  |                            |     |
|  | E 250 D          |     |                     | 06.95 | 04.02       |     |                |        |   |  |                            |     |
|  | E 250 D          |     |                     | 06.95 | 04.02 + I   |     |                |        |   |  |                            |     |
|  | E 250 TD         |     |                     | 09.97 | 04.02       |     |                |        |   |  |                            |     |
|  | E 290 TD         |     |                     | 01.96 | 04.02       |     |                |        |   |  |                            |     |
|  | E 300 D          |     |                     | 06.95 | 04.02       |     |                |        |   |  |                            |     |
|  | E 200 Kompressor | 137 |                     | 09.97 | 04.02       |     | 24.0128-0106.1 | 428106 |   |  | 300 28,0 25,4 V L +S +B    |     |
|  | E 240            |     |                     | 09.97 | 04.02 + ESP |     | 24.0328-0106.1 | 528106 |   |  | 300 28,0 25,4 V L +S +B PD |     |
|  | E 270 CDI        |     |                     | 07.99 | 04.02       |     | 13.8190-0330.1 | 990134 | 4 |  | Halterschraube             |     |
|  | E 280            |     |                     | 01.96 | 04.02       |     |                |        |   |  |                            |     |
|  | E 280 4-matic    |     |                     | 10.96 | 04.02       |     |                |        |   |  |                            |     |
|  | E 300 TD         |     |                     | 10.96 | 04.02       |     |                |        |   |  |                            |     |
|  | E 320            |     |                     | 06.95 | 04.02       |     |                |        |   |  |                            |     |
|  | E 320 4-matic    |     |                     | 06.97 | 04.02       |     |                |        |   |  |                            |     |
|  | E 320 CDI        |     |                     | 07.99 | 04.02       |     |                |        |   |  |                            |     |
|  | E 420            |     | A 962231 / X 027613 | 01.96 |             |     | 24.0128-0126.1 | 428126 |   |  | 316 28,0 25,4 V L +B       |     |
|  | E 430            |     | A 962231 / X 027613 | 09.97 |             |     | 13.8190-0330.1 | 990134 | 4 |  | Halterschraube             |     |
|  | E 420            |     | A 962232 / X 027614 |       | 04.02       |     | 24.0132-0159.1 | 432159 |   |  | 330 32,0 29,4 V L +B       |     |
|  | E 430            |     | A 962232 / X 027614 |       | 04.02       |     | 13.8190-0330.1 | 990134 | 4 |  | Halterschraube             |     |
|  | E 430 4-matic    |     |                     | 05.99 | 04.02       |     |                |        |   |  |                            |     |
|  | E 50 AMG         |     |                     | 01.96 | 08.97       |     | 13.8190-0330.1 | 990134 | 4 |  | Halterschraube             |     |
|  | E 55 AMG         |     |                     | 09.97 | 04.02       |     | 13.8190-0330.1 | 990134 | 4 |  | Halterschraube             |     |
|  | E 200            |     | A379346             | 06.95 |             |     | 13.0460-3805.2 | 603805 |   |  | 21197 15,0 /WE             | ATE |
|  | E 200 D          |     | A379346             | 10.96 |             | + P | 13.0470-3805.2 | LD3805 |   |  | 21197 15,0 /WE             | ATE |
|  | E 220 D          |     | A379346             | 06.95 |             |     | 13.0460-0215.2 | 610215 |   |  | Belagsatz-Zubehör          | ATE |
|  | E 230            |     | A379346             | 06.95 |             |     | 24.8190-0401.2 | 620401 | 2 |  | Warnkontakt L=95mm         |     |
|  | E 240            |     | A379346             | 09.97 |             |     |                |        |   |  |                            |     |
|  | E 250 D          |     | A379346             | 06.95 |             |     |                |        |   |  |                            |     |
|  | E 250 D          |     | A379346             | 06.95 |             | + I |                |        |   |  |                            |     |
|  | E 290 TD         |     | A379346             | 01.96 |             |     |                |        |   |  |                            |     |
|  | E 300 D          |     | A379346             | 06.95 |             |     |                |        |   |  |                            |     |
|  | E 200            |     | A379347             |       | 04.02       |     | 13.0460-4064.2 | 604064 |   |  | 21919 15,3 /Zub            | ATE |
|  | E 200 CDI        |     |                     | 07.98 | 04.02       |     | 13.0470-4064.2 | LD4064 |   |  | 21919 15,3 /Zub            | ATE |
|  | E 200 D          |     | A379347             |       | 04.02 + P   |     | 13.0460-0229.2 | 610229 |   |  | Belagsatz-Zubehör          | ATE |
|  | E 200 Kompressor | 120 |                     | 08.00 | 04.02       |     |                |        |   |  |                            |     |
|  | E 200 Kompressor | 137 |                     | 09.97 | 04.02       |     |                |        |   |  |                            |     |
|  | E 220 CDI        |     |                     | 07.98 | 04.02       |     |                |        |   |  |                            |     |
|  | E 220 D          |     | A379347             |       | 06.98       |     |                |        |   |  |                            |     |
|  | E 230            |     | A379347             |       | 08.97       |     |                |        |   |  |                            |     |
|  | E 240            |     | A379347             |       | 04.02       |     |                |        |   |  |                            |     |
|  | E 250 D          |     | A379347             |       | 04.02       |     |                |        |   |  |                            |     |
|  | E 250 D          |     | A379347             |       | 04.02 + I   |     |                |        |   |  |                            |     |
|  | E 250 TD         |     |                     | 09.97 | 04.02       |     |                |        |   |  |                            |     |
|  | E 290 TD         |     | A379347             |       | 04.02       |     |                |        |   |  |                            |     |
|  | E 300 D          |     | A379347             |       | 04.02       |     |                |        |   |  |                            |     |
|  | E 280            |     | A379346             | 01.96 |             |     | 13.0460-4047.2 | 604047 |   |  | 21305 15,7 /WE             | ATE |
|  | E 280 4-matic    |     | A379346             | 10.96 |             |     | 13.0470-4047.2 | LD4047 |   |  | 21305 15,7 /WE             | ATE |
|  | E 300 TD         |     | A379346             | 10.96 |             |     | 24.8190-0401.2 | 620401 | 2 |  | Warnkontakt L=95mm         |     |
|  | E 320            |     | A379346             | 06.95 |             |     |                |        |   |  |                            |     |
|  | E 320 4-matic    |     | A379346             | 06.97 |             |     |                |        |   |  |                            |     |
|  | E 420            |     | A379346             | 01.96 |             |     |                |        |   |  |                            |     |
|  | E 430            |     | A379346             | 09.97 |             |     |                |        |   |  |                            |     |
|  | E 55 AMG         |     |                     | 09.97 | 04.02       |     |                |        |   |  |                            |     |
|  | E 270 CDI        |     |                     | 07.99 | 04.02       |     | 13.0460-4065.2 | 604065 |   |  | 21899 15,3 /WE/Zub         | ATE |
|  | E 280            |     | A379347             |       | 04.02       |     | 13.0470-4065.2 | LD4065 |   |  | 21899 15,3 /WE/Zub         | ATE |
|  | E 280 4-matic    |     | A379347             |       | 04.02       |     | 13.0460-0258.2 | 610258 |   |  | Belagsatz-Zubehör          |     |
|  | E 300 TD         |     | A379347             |       | 04.02       |     | 24.8190-0401.2 | 620401 | 2 |  | Warnkontakt L=95mm         |     |
|  | E 320            |     | A379347             |       | 04.02       |     |                |        |   |  |                            |     |
|  | E 320 4-matic    |     | A379347             |       | 04.02       |     |                |        |   |  |                            |     |
|  | E 320 CDI        |     |                     | 07.99 | 04.02       |     |                |        |   |  |                            |     |
|  | E 420            |     | A379347             |       | 08.97       |     |                |        |   |  |                            |     |
|  | E 430            |     | A379347             |       | 04.02       |     |                |        |   |  |                            |     |
|  | E 430 4-matic    |     |                     | 05.99 | 04.02       |     | 13.0460-4047.2 | 604047 |   |  | 21305 15,7 /WE             | ATE |
|  |                  |     |                     |       |             |     | 13.0470-4047.2 | LD4047 |   |  | 21305 15,7 /WE             | ATE |
|  |                  |     |                     |       |             |     | 13.0460-0236.2 | 610236 |   |  | Belagsatz-Zubehör          | ATE |
|  |                  |     |                     |       |             |     | 24.8190-0401.2 | 620401 | 2 |  | Warnkontakt L=95mm         |     |
|  | E 50 AMG         |     |                     | 01.96 | 08.97       |     | 24.8190-0401.2 | 620401 | 2 |  | Warnkontakt L=95mm         |     |



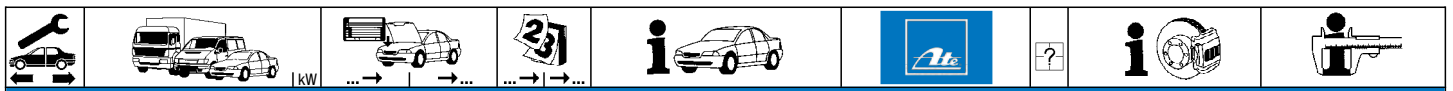

**MERCEDES BENZ E-Klasse (W210) Limousine (95-02)**

|                  |                  |       |       |                |                |        |                       |                      |
|------------------|------------------|-------|-------|----------------|----------------|--------|-----------------------|----------------------|
|                  | E 200            |       | 06.95 | 04.02          | 24.0109-0114.1 | 409114 |                       | 278 9,0 7,3 +S +B    |
|                  | E 200 CDI        |       | 07.98 | 04.02          | 24.0309-0114.1 | 509114 |                       | 278 9,0 7,3 +S +B PD |
|                  | E 200 D          |       | 10.96 | 04.02 + P      |                |        |                       |                      |
|                  | E 200 Kompressor | 120   | 08.00 | 04.02          |                |        |                       |                      |
|                  | E 220 CDI        |       | 07.98 | 04.02          |                |        |                       |                      |
|                  | E 220 D          |       | 06.95 | 06.98          |                |        |                       |                      |
|                  | E 230            |       | 06.95 | 08.97          |                |        |                       |                      |
|                  | E 240            |       | 09.97 | 04.02          |                |        |                       |                      |
|                  | E 250 D          |       | 06.95 | 04.02          |                |        |                       |                      |
|                  | E 250 D          |       | 06.95 | 04.02 + I      |                |        |                       |                      |
| E 250 TD         |                  | 09.97 | 04.02 |                |                |        |                       |                      |
| E 290 TD         |                  | 01.96 | 04.02 |                |                |        |                       |                      |
| E 300 D          |                  | 06.95 | 04.02 |                |                |        |                       |                      |
| E 200 Kompressor | 137              | 09.97 | 04.02 | 24.0110-0217.1 | 410217         |        | 290 10,0 8,3 +S +B    |                      |
| E 270 CDI        |                  | 07.99 | 04.02 | 24.0310-0217.1 | 510217         |        | 290 10,0 8,3 +S +B PD |                      |
| E 280            |                  | 01.96 | 04.02 |                |                |        |                       |                      |
| E 280 4-matic    |                  | 10.96 | 04.02 |                |                |        |                       |                      |
| E 300 TD         |                  | 10.96 | 04.02 |                |                |        |                       |                      |
| E 320            |                  | 06.95 | 04.02 |                |                |        |                       |                      |
| E 320 4-matic    |                  | 06.97 | 04.02 |                |                |        |                       |                      |
| E 320 CDI        |                  | 07.99 | 04.02 |                |                |        |                       |                      |
| E 420            |                  | 01.96 | 08.97 |                |                |        |                       |                      |
| E 430            |                  | 09.97 | 04.02 |                |                |        |                       |                      |
| E 50 AMG         |                  | 01.96 | 08.97 | 24.0122-0218.1 | 422218         |        | 300 22,0 19,4 V L +B  |                      |
| E 430 4-matic    |                  | 05.99 | 04.02 | 24.0122-0228.1 | 422228         |        | 300 22,0 19,4 V L +B  |                      |
| E 55 AMG         |                  | 09.97 | 04.02 |                |                |        |                       |                      |
|                  | E 200            |       | 06.95 | 04.02          | 03.0137-0170.2 | 650170 |                       | 164 x 20 /Zub        |
|                  | E 200 CDI        |       | 07.98 | 04.02          |                |        |                       |                      |
|                  | E 200 D          |       | 10.96 | 04.02 + P      |                |        |                       |                      |
|                  | E 200 Kompressor | 120   | 08.00 | 04.02          |                |        |                       |                      |
|                  | E 200 Kompressor | 137   | 09.97 | 04.02          |                |        |                       |                      |
|                  | E 220 CDI        |       | 07.98 | 04.02          |                |        |                       |                      |
|                  | E 220 D          |       | 06.95 | 06.98          |                |        |                       |                      |
|                  | E 230            |       | 06.95 | 08.97          |                |        |                       |                      |
|                  | E 240            |       | 09.97 | 04.02          |                |        |                       |                      |
|                  | E 250 D          |       | 06.95 | 04.02          |                |        |                       |                      |
|                  | E 250 D          |       | 06.95 | 04.02 + I      |                |        |                       |                      |
|                  | E 250 TD         |       | 09.97 | 04.02          |                |        |                       |                      |
|                  | E 270 CDI        |       | 07.99 | 04.02          |                |        |                       |                      |
|                  | E 280            |       | 01.96 | 04.02          |                |        |                       |                      |
|                  | E 280 4-matic    |       | 10.96 | 04.02          |                |        |                       |                      |
|                  | E 290 TD         |       | 01.96 | 04.02          |                |        |                       |                      |
|                  | E 300 D          |       | 06.95 | 04.02          |                |        |                       |                      |
|                  | E 300 TD         |       | 10.96 | 04.02          |                |        |                       |                      |
|                  | E 320            |       | 06.95 | 04.02          |                |        |                       |                      |
|                  | E 320 4-matic    |       | 06.97 | 04.02          |                |        |                       |                      |
|                  | E 320 CDI        |       | 07.99 | 04.02          |                |        |                       |                      |
|                  | E 420            |       | 01.96 | 08.97          |                |        |                       |                      |
|                  | E 430            |       | 09.97 | 04.02          |                |        |                       |                      |
|                  | E 430 4-matic    |       | 05.99 | 04.02          |                |        |                       |                      |
|                  | E 50 AMG         |       | 01.96 | 08.97          |                |        |                       |                      |
|                  | E 55 AMG         |       | 09.97 | 04.02          |                |        |                       |                      |

**MERCEDES BENZ E-Klasse (S210) Kombi (96-03)**

|               |                  |                     |                                       |   |                |        |                    |                            |     |
|---------------|------------------|---------------------|---------------------------------------|---|----------------|--------|--------------------|----------------------------|-----|
|               | E 200            |                     | 05.96                                 | 04.03                                       | 13.0460-7086.2 | 607086 |                    | 21664 19,8 +/WE            | ATE |
|               | E 200 Kompressor | 120                 | 08.00                                 | 04.03                                       | 13.0470-7086.2 | LD7086 |                    | 21664 19,8 +/WE            | ATE |
|               | E 220 CDI        |                     | 07.98                                 | 04.03 + Radstand 2833mm <sup>1)</sup>       | 24.8190-0401.2 | 620401 | 2                  | Warnkontakt L=95mm         |     |
|               | E 230            |                     | 05.96                                 | 08.97                                       |                |        |                    |                            |     |
|               | E 240            |                     | 09.97                                 | 04.03 - ESP                                 |                |        |                    |                            |     |
|               | E 250 D          |                     | 05.96                                 | 04.03 + Radstand 2833mm <sup>1)</sup>       |                |        |                    |                            |     |
|               | E 250 D          |                     | 05.96                                 | 04.03 + I / + Radstand 2833mm <sup>2)</sup> |                |        |                    |                            |     |
|               | E 250 TD         |                     | 09.97                                 | 04.03                                       |                |        |                    |                            |     |
|               | E 290 TD         |                     | 05.96                                 | 04.03 + Radstand 2833mm <sup>1)</sup>       |                |        |                    |                            |     |
|               | E 200 Kompressor | 137                 | 09.97                                 | 04.03                                       | 13.0460-7087.2 | 607087 |                    | 21670 19,4 +/WE            | ATE |
| E 220 CDI     |                  | 07.98               | 04.03 + Radstand 3570mm <sup>3)</sup> | 13.0470-7087.2                              | LD7087         | 2      | 21670 19,4 +/WE    | ATE                        |     |
| E 240         |                  | 09.97               | 04.03 + ESP                           | 24.8190-0401.2                              | 620401         | 2      | Warnkontakt L=95mm |                            |     |
| E 250 D       |                  | 05.96               | 04.03 + Radstand 3570mm <sup>3)</sup> |   |                |        |                    |                            |     |
| E 270 CDI     |                  | 07.99               | 04.03                                 |   |                |        |                    |                            |     |
| E 280         |                  | 10.96               | 04.03 + Radstand 3570mm <sup>3)</sup> |   |                |        |                    |                            |     |
| E 280 4-matic |                  | 10.96               | 04.03                                 |   |                |        |                    |                            |     |
| E 290 TD      |                  | 05.96               | 04.03 + Radstand 3570mm <sup>3)</sup> |   |                |        |                    |                            |     |
| E 300 TD      |                  | 10.96               | 04.03                                 |   |                |        |                    |                            |     |
| E 320         |                  | 10.96               | 04.03                                 |   |                |        |                    |                            |     |
| E 320 4-matic |                  | 06.97               | 04.03                                 |   |                |        |                    |                            |     |
| E 320 CDI     |                  | 07.99               | 04.03                                 |   |                |        |                    |                            |     |
| E 420         |                  | A 962231 / X 027613 | 05.96                                 |   | 13.0460-4201.2 | 604201 |                    | 21153 17,5 /WE             | ATE |
| E 430         |                  | A 962231 / X 027613 | 09.97                                 |   | 24.8190-0401.2 | 620401 | 2                  | Warnkontakt L=95mm         |     |
| E 420         |                  | A 962232 / X 027614 |                                       | 04.03                                       | 13.0460-7183.2 | 607183 |                    | 21484 20,5 +/WE            | ATE |
| E 430         |                  | A 962232 / X 027614 |                                       | 04.03                                       | 24.8190-0419.2 | 620419 | 2                  | Warnkontakt L=74mm         |     |
| E 430 4-matic |                  |                     | 05.99                                 | 04.03                                       |                |        |                    |                            |     |
| E 55 AMG      |                  |                     | 09.97                                 | 04.03                                       |                |        |                    |                            |     |
|               | E 200            |                     | 05.96                                 | 04.03                                       | 24.0125-0110.1 | 425110 |                    | 288 25,0 22,4 V L +S +B    |     |
|               | E 200 Kompressor | 120                 | 08.00                                 | 04.03                                       | 24.0325-0110.1 | 525110 |                    | 288 25,0 22,4 V L +S +B PD |     |
|               | E 220 CDI        |                     | 07.98                                 | 04.03 + Radstand 2833mm <sup>1)</sup>       | 13.8190-0330.1 | 990134 | 4                  | Halterschraube             |     |
|               | E 230            |                     | 05.96                                 | 08.97                                       |                |        |                    |                            |     |
| E 240         |                  | 09.97               | 04.03 - ESP                           |   |                |        |                    |                            |     |

<sup>1)</sup> + wheel base 2833 mm / + passo 2833 mm / + empattement 2833 mm / + distancia entre ejes 2833 mm

<sup>2)</sup> + I / + wheel base 2833mm / + I / + passo 2833mm / + I / + empattement 2833mm / + I / + dist.entre ejes 2833mm

<sup>3)</sup> + wheel base 3570 mm / + passo 3570 mm / + empattement 3570 mm / + distancia entre ejes 3570 mm

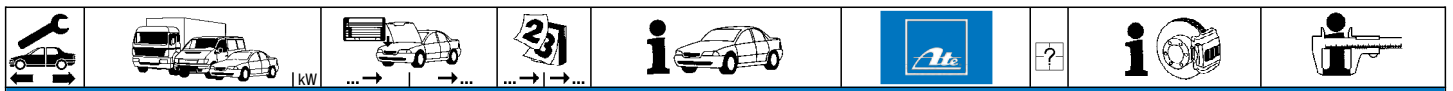

**MERCEDES BENZ E-Klasse (S210) Kombi (96-03)**

|               |                     |                     |       |                                 |                                       |                |                |               |   |   |
|---------------|---------------------|---------------------|-------|---------------------------------|---------------------------------------|----------------|----------------|---------------|---|---|
|               | E 250 D             |                     | 05.96 | 04.03                           | + Radstand 2833mm <sup>1)</sup>       | 24.0125-0110.1 | 425110         | 4             | 288 25,0 22,4 V L +S +B<br>288 25,0 22,4 V L +S +B PD<br>Halterschraube                 |   |
|               | E 250 D             |                     | 05.96 | 04.03                           | + ☉ / + Radstand 2833mm <sup>2)</sup> | 24.0325-0110.1 | 525110         |               |   |   |
|               | E 250 TD            |                     | 09.97 | 04.03                           |                                       | 13.8190-0330.1 | 990134         |               |   |   |
|               | E 290 TD            |                     | 05.96 | 04.03                           | + Radstand 2833mm <sup>1)</sup>       |                |                |               |   |   |
|               | E 200 Kompressor    | 137                 |       | 09.97                           | 04.03                                 |                | 24.0128-0106.1 | 428106        | 4   | 300 28,0 25,4 V L +S +B<br>300 28,0 25,4 V L +S +B PD<br>Halterschraube |
|               | E 220 CDI           |                     | 07.98 | 04.03                           | + Radstand 3570mm <sup>3)</sup>       | 24.0328-0106.1 | 528106         |               |   |   |
|               | E 240               |                     | 09.97 | 04.03                           | + ESP                                 | 13.8190-0330.1 | 990134         |               |   |   |
|               | E 250 D             |                     | 05.96 | 04.03                           | + Radstand 3570mm <sup>3)</sup>       |                |                |               |   |   |
|               | E 270 CDI           |                     | 07.99 | 04.03                           |                                       |                |                |               |   |   |
|               | E 280               |                     | 10.96 | 04.03                           | + Radstand 3570mm <sup>3)</sup>       |                |                |               |   |   |
| E 280 4-matic |                     | 10.96               | 04.03 |                                 |                                       |                |                |               |   |   |
| E 290 TD      |                     | 05.96               | 04.03 | + Radstand 3570mm <sup>3)</sup> |                                       |                |                |               |   |   |
| E 300 TD      |                     | 10.96               | 04.03 |                                 |                                       |                |                |               |   |   |
| E 320         |                     | 10.96               | 04.03 |                                 |                                       |                |                |               |   |   |
| E 320 4-matic |                     | 06.97               | 04.03 |                                 |                                       |                |                |               |   |   |
| E 320 CDI     |                     | 07.99               | 04.03 |                                 |                                       |                |                |               |   |   |
| E 420         |                     | A 962231 / X 027613 | 05.96 |                                 |                                       | 24.0128-0126.1 | 428126         | 4             | 316 28,0 25,4 V L +B<br>Halterschraube  |   |
| E 430         |                     | A 962231 / X 027613 | 09.97 |                                 |                                       | 13.8190-0330.1 | 990134         |               |   |   |
| E 420         | A 962232 / X 027614 |                     |       | 04.03                           |                                       | 24.0132-0159.1 | 432159         | 4             | 330 32,0 29,4 V L +B<br>Halterschraube  |   |
| E 430         | A 962232 / X 027614 |                     |       | 04.03                           |                                       | 13.8190-0330.1 | 990134         |               |   |   |
| E 430 4-matic |                     |                     | 05.99 | 04.03                           |                                       |                |                |               |   |   |
| E 55 AMG      |                     |                     | 09.97 | 04.03                           |                                       | 13.8190-0330.1 | 990134         | 4             | Halterschraube  |   |
|               | E 200               |                     | 05.96 | 04.03                           |                                       | 13.0460-4047.2 | 604047         | 2             | 21305 15,7 /WE ATE<br>21305 15,7 /WE ATE<br>Belagsatz-Zubehör ATE<br>Warnkontakt L=95mm |   |
|               | E 200 Kompressor    |                     | 09.97 | 04.03                           |                                       | 13.0470-4047.2 | LD4047         |               |   |   |
|               | E 220 CDI           |                     | 07.98 | 04.03                           |                                       | 13.0460-0239.2 | 610239         |               |   |   |
|               | E 230               |                     | 05.96 | 08.97                           |                                       | 24.8190-0401.2 | 620401         |               |   |   |
|               | E 240               |                     | 09.97 | 04.03                           |                                       |                |                |               |   |   |
|               | E 250 D             |                     | 05.96 | 04.03                           | + Radstand 3570mm <sup>3)</sup>       |                |                |               |   |   |
|               | E 250 D             |                     | 05.96 | 04.03                           | + Radstand 2833mm <sup>1)</sup>       |                |                |               |   |   |
|               | E 250 D             |                     | 05.96 | 04.03                           | + ☉ / + Radstand 2833mm <sup>2)</sup> |                |                |               |   |   |
|               | E 250 TD            |                     | 09.97 | 04.03                           |                                       |                |                |               |   |   |
|               | E 270 CDI           |                     | 07.99 | 04.03                           |                                       |                |                |               |   |   |
|               | E 280               |                     | 10.96 | 04.03                           | + Radstand 3570mm <sup>3)</sup>       |                |                |               |   |   |
|               | E 280 4-matic       |                     | 10.96 | 04.03                           |                                       |                |                |               |   |   |
|               | E 290 TD            |                     | 05.96 | 04.03                           |                                       |                |                |               |   |   |
|               | E 300 TD            |                     | 10.96 | 04.03                           |                                       |                |                |               |   |   |
|               | E 320               |                     | 10.96 | 04.03                           |                                       |                |                |               |   |   |
|               | E 320 4-matic       |                     | 06.97 | 04.03                           |                                       |                |                |               |   |   |
|               | E 320 CDI           |                     | 07.99 | 04.03                           |                                       |                |                |               |   |   |
|               | E 420               |                     | 05.96 | 08.97                           |                                       |                |                |               |   |   |
|               | E 430               |                     | 09.97 | 04.03                           |                                       |                |                |               |   |   |
|               | E 430 4-matic       |                     | 05.99 | 04.03                           |                                       | 13.0460-4047.2 | 604047         |               |   | 2   |
| E 55 AMG      |                     | 09.97               | 04.03 |                                 | 13.0470-4047.2                        | LD4047         |                |               |   |   |
|               |                     |                     |       |                                 | 13.0460-0236.2                        | 610236         |                |               |   |   |
|               |                     |                     |       |                                 | 24.8190-0401.2                        | 620401         |                |               |   |   |
|               | E 200               |                     | 05.96 | 04.03                           |                                       | 24.0112-0149.1 | 412149         |               | 290 12,0 10,3 +B  |   |
|               | E 220 CDI           |                     | 07.98 | 04.03                           |                                       |                |                |               |   |   |
|               | E 230               |                     | 05.96 | 08.97                           |                                       |                |                |               |   |   |
|               | E 250 D             |                     | 05.96 | 04.03                           | + Radstand 3570mm <sup>3)</sup>       |                |                |               |   |   |
|               | E 250 D             |                     | 05.96 | 04.03                           | + Radstand 2833mm <sup>1)</sup>       |                |                |               |   |   |
|               | E 250 D             |                     | 05.96 | 04.03                           | + ☉ / + Radstand 2833mm <sup>2)</sup> |                |                |               |   |   |
|               | E 290 TD            |                     | 05.96 | 04.03                           |                                       |                |                |               |   |   |
|               | E 420               |                     | 05.96 | 08.97                           |                                       |                |                |               |   |   |
|               | E 200 Kompressor    |                     | 09.97 | 04.03                           |                                       | 24.0112-0149.1 | 412149         |               |   |   |
|               | E 240               |                     | 09.97 | 04.03                           |                                       |                |                |               |   |   |
| E 250 TD      |                     | 09.97               | 04.03 |                                 |                                       |                |                |               |   |   |
| E 270 CDI     |                     | 07.99               | 04.03 |                                 |                                       |                |                |               |   |   |
| E 280         |                     | 10.96               | 04.03 | + Radstand 3570mm <sup>3)</sup> |                                       |                |                |               |   |   |
| E 280 4-matic |                     | 10.96               | 04.03 |                                 |                                       |                |                |               |   |   |
| E 300 TD      |                     | 10.96               | 04.03 |                                 |                                       |                |                |               |   |   |
| E 320         |                     | 10.96               | 04.03 |                                 |                                       |                |                |               |   |   |
| E 320 4-matic |                     | 06.97               | 04.03 |                                 |                                       |                |                |               |   |   |
| E 320 CDI     |                     | 07.99               | 04.03 |                                 |                                       |                |                |               |   |   |
| E 430         |                     | 09.97               | 04.03 |                                 |                                       |                |                |               |   |   |
|               | E 200               |                     | 05.96 | 04.03                           |                                       | 03.0137-4012.2 | 654012         |               | 164 x 25 /Zub<br>Bremsbacken-Zubehör  |   |
|               | E 200 Kompressor    |                     | 09.97 | 04.03                           |                                       | 03.0137-9248.2 | 669248         |               |   |   |
|               | E 220 CDI           |                     | 07.98 | 04.03                           | + Radstand 2833mm <sup>1)</sup>       |                |                |               |   |   |
|               | E 230               |                     | 05.96 | 08.97                           |                                       |                |                |               |   |   |
|               | E 240               |                     | 09.97 | 04.03                           |                                       |                |                |               |   |   |
|               | E 250 D             |                     | 05.96 | 04.03                           | + Radstand 2833mm <sup>1)</sup>       |                |                |               |   |   |
|               | E 250 D             |                     | 05.96 | 04.03                           | + ☉ / + Radstand 2833mm <sup>2)</sup> |                |                |               |   |   |
|               | E 250 TD            |                     | 09.97 | 04.03                           |                                       |                |                |               |   |   |
|               | E 270 CDI           |                     | 07.99 | 04.03                           | + Radstand 2833mm <sup>1)</sup>       |                |                |               |   |   |
|               | E 280               |                     | 10.96 | 04.03                           | + Radstand 3570mm <sup>3)</sup>       |                |                |               |   |   |
|               | E 280 4-matic       |                     | 10.96 | 04.03                           |                                       |                |                |               |   |   |
|               | E 290 TD            |                     | 05.96 | 04.03                           | + Radstand 2833mm <sup>1)</sup>       |                |                |               |   |   |
|               | E 300 TD            |                     | 10.96 | 04.03                           |                                       |                |                |               |   |   |
|               | E 320               |                     | 10.96 | 04.03                           |                                       |                |                |               |   |   |
|               | E 320 4-matic       |                     | 06.97 | 04.03                           |                                       |                |                |               |   |   |
|               | E 320 CDI           |                     | 07.99 | 04.03                           |                                       |                |                |               |   |   |
|               | E 420               |                     | 05.96 | 08.97                           |                                       |                |                |               |   |   |
| E 430         |                     | 09.97               | 04.03 |                                 |                                       |                |                |               |   |   |
| E 430 4-matic |                     | 05.99               | 04.03 |                                 |                                       |                |                |               |   |   |
| E 55 AMG      |                     | 09.97               | 04.03 |                                 |                                       |                |                |               |   |   |
| E 220 CDI     |                     | 07.98               | 04.03 | + Radstand 3570mm <sup>3)</sup> | 03.0137-0244.2                        | 650244         |                | 164 x 25 /Zub |   |   |
| E 250 D       |                     | 05.96               | 04.03 | + Radstand 3570mm <sup>3)</sup> |                                       |                |                |               |   |   |

1) + wheel base 2833 mm / + passo 2833 mm / + empattement 2833 mm / + distancia entre ejes 2833 mm  
 2) + ☉ / + wheel base 2833mm / + ☉ / + passo 2833mm / + ☉ / + empattement 2833mm / + ☉ / + dist.entre ejes 2833mm  
 3) + wheel base 3570 mm / + passo 3570 mm / + empattement 3570 mm / + distancia entre ejes 3570 mm











**MERCEDES BENZ E-Klasse (W211) Limousine (02-09)**

|                     |                  |          |       |       |   |   |                |        |                            |                         |
|---------------------|------------------|----------|-------|-------|---|---|----------------|--------|----------------------------|-------------------------|
|                     | E 220 CDI        | 120      |       | 03.03 | 02.09   | - Sportpaket / - Sportpaket AMG <sup>1)</sup> | 24.0128-0176.1 | 428176 |                            | 295 28,0 25,4 V L +S +B |
|                     | E 220 CDI        | 125      |       | 04.06 | 02.09   | - Sportpaket / - Sportpaket AMG <sup>1)</sup> | 24.0328-0176.1 | 528176 |                            | 295 28,0 25,4 V L +B PD |
|                     | E 230            | 150      |       | 04.06 | 02.09   | - Sportpaket / - Sportpaket AMG <sup>1)</sup> |                |        |                            |                         |
|                     | E 240            | 130      |       | 03.02 | 02.09   |   |                |        |                            |                         |
|                     | E 200 CDI        | 75       |       | 05.02 | 02.09   | + Sportpaket / + Sportpaket AMG <sup>2)</sup> | 24.0132-0153.1 | 432153 |                            | 330 32,0 30,0 V L +S +B |
|                     | E 200 CDI        | 90       |       | 05.02 | 02.09   | + Sportpaket / + Sportpaket AMG <sup>2)</sup> |                |        |                            |                         |
|                     | E 200 CDI        | 100      |       | 04.06 | 02.09   | + Sportpaket / + Sportpaket AMG <sup>2)</sup> |                |        |                            |                         |
|                     | E 200 Kompressor | 120      |       | 05.02 | 02.09   | + Sportpaket / + Sportpaket AMG <sup>2)</sup> |                |        |                            |                         |
|                     | E 200 Kompressor | 135      |       | 04.06 | 02.09   | + Sportpaket / + Sportpaket AMG <sup>2)</sup> |                |        |                            |                         |
|                     | E 200 NGT        | 120      |       | 03.04 | 02.09   | + Sportpaket / + Sportpaket AMG <sup>2)</sup> |                |        |                            |                         |
|                     | E 220 CDI        | 100      |       | 03.02 | 02.09   | + Sportpaket / + Sportpaket AMG <sup>2)</sup> |                |        |                            |                         |
|                     | E 220 CDI        | 110      |       | 03.02 | 02.09   | + Sportpaket / + Sportpaket AMG <sup>2)</sup> |                |        |                            |                         |
|                     | E 220 CDI        | 120      |       | 03.03 | 02.09   | + Sportpaket / + Sportpaket AMG <sup>2)</sup> |                |        |                            |                         |
|                     | E 220 CDI        | 125      |       | 04.06 | 02.09   | + Sportpaket / + Sportpaket AMG <sup>2)</sup> |                |        |                            |                         |
|                     | E 230            | 150      |       | 04.06 | 02.09   | + Sportpaket / + Sportpaket AMG <sup>2)</sup> |                |        |                            |                         |
|                     | E 280            | 170      |       | 05.05 | 02.09   | + Sportpaket / + Sportpaket AMG <sup>2)</sup> |                |        |                            |                         |
|                     | E 280 CDI        | 140      |       | 03.05 | 02.09   | + Sportpaket / + Sportpaket AMG <sup>2)</sup> |                |        |                            |                         |
|                     | E 300 Bluetec    | 155      |       | 09.07 | 02.09   | + Sportpaket / + Sportpaket AMG <sup>2)</sup> |                |        |                            |                         |
|                     | E 320 CDI        | 165      |       | 03.05 | 02.09   | + Sportpaket / + Sportpaket AMG <sup>2)</sup> |                |        |                            |                         |
|                     | E 350            | 200      |       | 12.04 | 02.09   | + Sportpaket / + Sportpaket AMG <sup>2)</sup> |                |        |                            |                         |
| E 350 CGI           | 215              |          | 09.07 | 02.09 | + Sportpaket / + Sportpaket AMG <sup>2)</sup> |   |                |        |                            |                         |
| E 500               | 225              |          | 03.02 | 02.09 | + Sportpaket / + Sportpaket AMG <sup>2)</sup> |   |                |        |                            |                         |
| E 240 4-matic       | 130              |          | 03.03 | 02.09 |   | 24.0130-0179.1                                | 430179         |        | 304 30,0 27,4 V L +B       |                         |
| E 280 4-matic       | 170              |          | 05.05 | 02.09 | - Sportpaket / - Sportpaket AMG <sup>1)</sup> |   |                |        |                            |                         |
| E 280 CDI 4-matic   | 140              |          | 03.05 | 02.09 | - Sportpaket / - Sportpaket AMG <sup>1)</sup> |   |                |        |                            |                         |
| E 320 4-matic       | 165              |          | 03.03 | 02.09 |   |   |                |        |                            |                         |
| E 320 CDI 4-matic   | 165              |          | 03.05 | 02.09 | - Sportpaket / - Sportpaket AMG <sup>1)</sup> |   |                |        |                            |                         |
| E 350 4-matic       | 200              |          | 12.04 | 02.09 | - Sportpaket / - Sportpaket AMG <sup>1)</sup> |   |                |        |                            |                         |
| E 250 CDI           | 150              |          | 08.08 | 02.09 |   | 24.0128-0176.1                                | 428176         |        | 295 28,0 25,4 V L +S +B    |                         |
| E 270 CDI           | 120              |          | 03.02 | 02.09 |   | 24.0328-0176.1                                | 528176         |        | 295 28,0 25,4 V L +B PD    |                         |
| E 270 CDI           | 130              |          | 03.02 | 02.09 |   |   |                |        |                            |                         |
| E 280               | 170              |          | 05.05 | 02.09 | - Sportpaket / - Sportpaket AMG <sup>1)</sup> |   |                |        |                            |                         |
| E 280 CDI           | 130              |          | 05.04 | 02.09 |   |   |                |        |                            |                         |
| E 280 CDI           | 140              |          | 03.05 | 02.09 | - Sportpaket / - Sportpaket AMG <sup>1)</sup> |   |                |        |                            |                         |
| E 300 Bluetec       | 155              |          | 09.07 | 02.09 | - Sportpaket / - Sportpaket AMG <sup>1)</sup> |   |                |        |                            |                         |
| E 320               | 165 A 400548     |          |       | 02.09 |   |   |                |        |                            |                         |
| E 320 CDI           | 150 A 400548     |          |       | 02.09 |   |   |                |        |                            |                         |
| E 320 CDI           | 165              |          | 03.05 | 02.09 | - Sportpaket / - Sportpaket AMG <sup>1)</sup> |   |                |        |                            |                         |
| E 280 4-matic       | 170              |          | 05.05 | 02.09 | + Sportpaket / + Sportpaket AMG <sup>2)</sup> | 24.0132-0136.1                                | 432136         |        | 330 32,0 30,0 V L +B       |                         |
| E 280 CDI 4-matic   | 140              |          | 03.05 | 02.09 | + Sportpaket / + Sportpaket AMG <sup>2)</sup> |   |                |        |                            |                         |
| E 320 CDI 4-matic   | 165              |          | 03.05 | 02.09 | + Sportpaket / + Sportpaket AMG <sup>2)</sup> |   |                |        |                            |                         |
| E 350 4-matic       | 200              |          | 12.04 | 02.09 | + Sportpaket / + Sportpaket AMG <sup>2)</sup> |   |                |        |                            |                         |
| E 500 4-matic       | 225              |          | 10.03 | 02.09 | + Sportpaket / + Sportpaket AMG <sup>2)</sup> |   |                |        |                            |                         |
| E 500 4-matic       | 285              |          | 04.06 | 02.09 | + Sportpaket / + Sportpaket AMG <sup>2)</sup> |   |                |        |                            |                         |
| E 320               | 165              | A 400547 | 03.02 |       |   | 24.0128-0142.1                                | 428142         |        | 312 28,0 25,4 V L +B       |                         |
| E 320 CDI           | 150              | A 400547 | 11.02 |       |   | 24.0328-0142.1                                | 528142         |        | 312 28,0 25,4 V L +B PD    |                         |
| E 350               | 200              |          | 12.04 | 02.09 | - Sportpaket / - Sportpaket AMG <sup>1)</sup> | 24.0132-0144.1                                | 432144         |        | 330 32,0 29,4 V L +S +B    |                         |
| E 350 CGI           | 215              |          | 09.07 | 02.09 | - Sportpaket / - Sportpaket AMG <sup>1)</sup> | 24.0332-0144.1                                | 532144         |        | 330 32,0 29,4 V L +S +B PD |                         |
| E 400 CDI           | 191              |          | 03.03 | 02.09 |   |   |                |        |                            |                         |
| E 500               | 225              |          | 03.02 | 02.09 | - Sportpaket / - Sportpaket AMG <sup>1)</sup> |   |                |        |                            |                         |
| E 420 CDI           | 231              |          | 01.06 | 02.09 | - Sportpaket / - Sportpaket AMG <sup>1)</sup> | 24.0132-0139.1                                | 432139         |        | 350 32,0 29,4 V L +S +B    |                         |
| E 500               | 285              |          | 04.06 | 02.09 | - Sportpaket / - Sportpaket AMG <sup>1)</sup> |   |                |        |                            |                         |
| E 420 CDI           | 231              |          | 01.06 | 02.09 | + Sportpaket / + Sportpaket AMG <sup>2)</sup> | 24.0132-0138.1                                | 432138         |        | 350 32,0 30,0 V L +S +B    |                         |
| E 500               | 285              |          | 04.06 | 02.09 | + Sportpaket / + Sportpaket AMG <sup>2)</sup> |   |                |        |                            |                         |
| E 500 4-matic       | 225              |          | 10.03 | 02.09 | - Sportpaket / - Sportpaket AMG <sup>1)</sup> | 24.0132-0154.1                                | 432154         |        | 330 32,0 29,4 V L +B       |                         |
| E 500 4-matic       | 285              |          | 04.06 | 02.09 | - Sportpaket / - Sportpaket AMG <sup>1)</sup> |   |                |        |                            |                         |
| E 55 Kompressor AMG | 350              |          | 10.02 | 02.09 |   | 24.0136-0102.1                                | 436102         |        | 360 36,0 34,0 V L +B       |                         |
|                     | E 200 CDI        | 75       |       | 05.02 | 02.09   |   | 13.0460-7171.2 | 607171 |                            | 23334 16,7 +/-WE ATE    |
|                     | E 200 CDI        | 90       |       | 05.02 | 02.09   |   | 13.0470-7171.2 | LD7171 |                            | 23334 16,7 +/-WE ATE    |
|                     | E 200 CDI        | 100      |       | 04.06 | 02.09   |   | 24.8190-0410.2 | 620410 | 1                          | Warnkontakt L=97,5mm    |
|                     | E 200 Kompressor | 120      |       | 05.02 | 02.09   |   |                |        |                            |                         |
|                     | E 200 Kompressor | 135      |       | 04.06 | 02.09   |   |                |        |                            |                         |
|                     | E 200 NGT        | 120      |       | 03.04 | 02.09   |   |                |        |                            |                         |
|                     | E 220 CDI        | 100      |       | 03.02 | 02.09   |   |                |        |                            |                         |
|                     | E 220 CDI        | 110      |       | 03.02 | 02.09   |   |                |        |                            |                         |
|                     | E 220 CDI        | 120      |       | 03.03 | 02.09   |   |                |        |                            |                         |
|                     | E 220 CDI        | 125      |       | 04.06 | 02.09   |   |                |        |                            |                         |
|                     | E 230            | 150      |       | 04.06 | 02.09   |   |                |        |                            |                         |
|                     | E 240            | 130      |       | 03.02 | 02.09   |   |                |        |                            |                         |
|                     | E 240 4-matic    | 130      |       | 03.03 | 02.09   |   |                |        |                            |                         |
|                     | E 250 CDI        | 150      |       | 08.08 | 02.09   |   |                |        |                            |                         |
|                     | E 270 CDI        | 120      |       | 03.02 | 02.09   |   |                |        |                            |                         |
|                     | E 270 CDI        | 130      |       | 03.02 | 02.09   |   |                |        |                            |                         |
|                     | E 280            | 170      |       | 05.05 | 02.09   |   |                |        |                            |                         |
|                     | E 280 4-matic    | 170      |       | 05.05 | 02.09   |   |                |        |                            |                         |
|                     | E 280 CDI        | 130      |       | 05.04 | 02.09   |   |                |        |                            |                         |
|                     | E 280 CDI        | 140      |       | 03.05 | 02.09   |   |                |        |                            |                         |
| E 280 CDI 4-matic   | 140              |          | 03.05 | 02.09 |   |   |                |        |                            |                         |
| E 300 Bluetec       | 155              |          | 09.07 | 02.09 |   |   |                |        |                            |                         |
| E 320               | 165              |          | 03.02 | 02.09 |   |   |                |        |                            |                         |
| E 320 4-matic       | 165              |          | 03.03 | 02.09 |   |   |                |        |                            |                         |
| E 320 CDI           | 150              |          | 11.02 | 02.09 |   |   |                |        |                            |                         |
| E 320 CDI           | 165              |          | 03.05 | 02.09 |   |   |                |        |                            |                         |
| E 320 CDI 4-matic   | 165              |          | 03.05 | 02.09 |   |   |                |        |                            |                         |
| E 350               | 200              |          | 12.04 | 02.09 |   |   |                |        |                            |                         |
| E 350 4-matic       | 200              |          | 12.04 | 02.09 |   |   |                |        |                            |                         |

<sup>1)</sup> - sport package/- sport package AMG / - pacchetto sportivo/- pacchetto sport.AMG / - version sport/- version sport AMG / - kit deportivo/- kit deportivo AMG

<sup>2)</sup> + sports package/+ sports package AMG / + pacchetto sportivo/+ pacchetto sport.AMG / + version sport/+ version sport AMG / + kit deportivo/+ kit deportivo AMG





**MERCEDES BENZ E-Klasse (W211) Limousine (02-09)**

|                     |                     |              |          |       |  |  |                |                                       |                                      |  |            |
|---------------------|---------------------|--------------|----------|-------|--|--|----------------|---------------------------------------|--------------------------------------|--|------------|
|                     | E 350 CGI           | 215          |          | 09.07 | 02.09  | 13.0460-7171.2   | 607171         | 1                                     |                                      | 23334 16,7 +WE<br>23334 16,7 +WE<br>Warnkontakt L=97,5mm | ATE<br>ATE |
|                     | E 400 CDI           | 191          |          | 03.03 | 02.09  | 13.0470-7171.2   | LD7171         |                                       |                                      |  |            |
|                     | E 420 CDI           | 231          |          | 01.06 | 02.09  | 24.8190-0410.2   | 620410         |                                       |                                      |  |            |
|                     | E 500               | 225          |          | 03.02 | 02.09  |  |                |                                       |                                      |  |            |
|                     | E 500               | 285          |          | 04.06 | 02.09  |  |                |                                       |                                      |  |            |
|                     | E 500 4-matic       | 225          |          | 10.03 | 02.09  |  |                |                                       |                                      |  |            |
|                     | E 500 4-matic       | 285          |          | 04.06 | 02.09  |  |                |                                       |                                      |  |            |
|                     | E 55 Kompressor AMG | 350          |          | 10.02 | 02.09  | 13.0460-4998.2   | 604998         |                                       |                                      |  |            |
|                     |                     |              |          |       |  | 24.8190-0410.2   | 620410         |                                       |                                      |  |            |
|                     |                     |              |          |       |  | 24.8190-0420.2   | 620420         |                                       |                                      |  |            |
|                     |                     |              |          |       |  |  |                | 23478 16,5 /WE<br>Warnkontakt L=119mm | BRE                                  |  |            |
|                     | E 200 CDI           | 75           |          | 05.02 | 02.09  | - Taxi / - Sportpaket / - Sportpaket AMG <sup>1)</sup> | 24.0110-0278.1 | 410278                                |                                      | 300 10,0 8,3 +S +B<br>300 10,0 8,3 +S +B PD              |            |
|                     | E 200 CDI           | 90           |          | 05.02 | 02.09  | - Taxi / - Sportpaket / - Sportpaket AMG <sup>1)</sup> | 24.0310-0278.1 | 510278                                |                                      |  |            |
|                     | E 200 CDI           | 100          |          | 04.06 | 02.09  | - Taxi / - Sportpaket / - Sportpaket AMG <sup>1)</sup> |                |                                       |                                      |  |            |
|                     | E 200 Kompressor    | 120          |          | 05.02 | 02.09  | - Taxi / - Sportpaket / - Sportpaket AMG <sup>1)</sup> |                |                                       |                                      |  |            |
|                     | E 200 Kompressor    | 135          |          | 04.06 | 02.09  | - Taxi / - Sportpaket / - Sportpaket AMG <sup>1)</sup> |                |                                       |                                      |  |            |
|                     | E 200 NGT           | 120          |          | 03.04 | 02.09  | - Taxi / - Sportpaket / - Sportpaket AMG <sup>1)</sup> |                |                                       |                                      |  |            |
|                     | E 220 CDI           | 100          |          | 03.02 | 02.09  | - Taxi / - Sportpaket / - Sportpaket AMG <sup>1)</sup> |                |                                       |                                      |  |            |
|                     | E 220 CDI           | 110          |          | 03.02 | 02.09  | - Taxi / - Sportpaket / - Sportpaket AMG <sup>1)</sup> |                |                                       |                                      |  |            |
|                     | E 220 CDI           | 120          |          | 03.03 | 02.09  | - Taxi / - Sportpaket / - Sportpaket AMG <sup>1)</sup> |                |                                       |                                      |  |            |
|                     | E 220 CDI           | 125          |          | 04.06 | 02.09  | - Taxi / - Sportpaket / - Sportpaket AMG <sup>1)</sup> |                |                                       |                                      |  |            |
|                     | E 230               | 150          |          | 04.06 | 02.09  | - Sportpaket / - Sportpaket AMG <sup>2)</sup>          |                |                                       |                                      |  |            |
|                     | E 240               | 130          |          | 03.02 | 02.09  | - Taxi   |                |                                       |                                      |  |            |
|                     | E 240 4-matic       | 130          |          | 03.03 | 02.09  |  |                |                                       |                                      |  |            |
|                     | E 250 CDI           | 150          |          | 08.08 | 02.09  | - Taxi   |                |                                       |                                      |  |            |
|                     | E 270 CDI           | 120          |          | 03.02 | 02.09  | - Taxi   |                |                                       |                                      |  |            |
|                     | E 270 CDI           | 130          |          | 03.02 | 02.09  | - Taxi   |                |                                       |                                      |  |            |
|                     | E 280 4-matic       | 170          |          | 05.05 | 02.09  | - Sportpaket / - Sportpaket AMG <sup>2)</sup>          |                |                                       |                                      |  |            |
|                     | E 280 CDI           | 140          |          | 03.05 | 02.09  | - Sportpaket / - Sportpaket AMG <sup>2)</sup>          |                |                                       |                                      |  |            |
|                     | E 280 CDI 4-matic   | 140          |          | 03.05 | 02.09  | - Sportpaket / - Sportpaket AMG <sup>2)</sup>          |                |                                       |                                      |  |            |
|                     | E 320               | 165          | A 400547 | 03.02 |  | - Taxi   |                |                                       |                                      |  |            |
|                     | E 320 4-matic       | 165 X 122526 |          |       | 02.09  |  |                |                                       |                                      |  |            |
|                     | E 320 CDI           | 150          | A 400547 | 11.02 |  | - Taxi   |                |                                       |                                      |  |            |
|                     | E 200 CDI           | 75           |          | 05.02 | 02.09  | + Taxi   | 24.0122-0201.1 | 422201                                |                                      |  |            |
|                     | E 200 CDI           | 75           |          | 05.02 | 02.09  | - Taxi / + Sportpaket / + Sportpaket AMG <sup>3)</sup> |                |                                       |                                      |  |            |
|                     | E 200 CDI           | 90           |          | 05.02 | 02.09  | + Taxi   |                |                                       |                                      |  |            |
|                     | E 200 CDI           | 90           |          | 05.02 | 02.09  | - Taxi / + Sportpaket / + Sportpaket AMG <sup>3)</sup> |                |                                       |                                      |  |            |
|                     | E 200 CDI           | 100          |          | 04.06 | 02.09  | + Taxi   |                |                                       |                                      |  |            |
|                     | E 200 CDI           | 100          |          | 04.06 | 02.09  | - Taxi / + Sportpaket / + Sportpaket AMG <sup>3)</sup> |                |                                       |                                      |  |            |
|                     | E 200 Kompressor    | 120          |          | 05.02 | 02.09  | + Taxi   |                |                                       |                                      |  |            |
|                     | E 200 Kompressor    | 120          |          | 05.02 | 02.09  | - Taxi / + Sportpaket / + Sportpaket AMG <sup>3)</sup> |                |                                       |                                      |  |            |
|                     | E 200 Kompressor    | 135          |          | 04.06 | 02.09  | + Taxi   |                |                                       |                                      |  |            |
|                     | E 200 Kompressor    | 135          |          | 04.06 | 02.09  | - Taxi / + Sportpaket / + Sportpaket AMG <sup>3)</sup> |                |                                       |                                      |  |            |
|                     | E 200 NGT           | 120          |          | 03.04 | 02.09  | + Taxi   |                |                                       |                                      |  |            |
|                     | E 200 NGT           | 120          |          | 03.04 | 02.09  | - Taxi / + Sportpaket / + Sportpaket AMG <sup>3)</sup> |                |                                       |                                      |  |            |
|                     | E 220 CDI           | 100          |          | 03.02 | 02.09  | + Taxi   |                |                                       |                                      |  |            |
| E 220 CDI           | 100                 |              | 03.02    | 02.09 | - Taxi / + Sportpaket / + Sportpaket AMG <sup>3)</sup> |  |                |                                       |                                      |  |            |
| E 220 CDI           | 110                 |              | 03.02    | 02.09 | + Taxi   |  |                |                                       |                                      |  |            |
| E 220 CDI           | 110                 |              | 03.02    | 02.09 | - Taxi / + Sportpaket / + Sportpaket AMG <sup>3)</sup> |  |                |                                       |                                      |  |            |
| E 220 CDI           | 120                 |              | 03.03    | 02.09 | + Taxi   |  |                |                                       |                                      |  |            |
| E 220 CDI           | 120                 |              | 03.03    | 02.09 | - Taxi / + Sportpaket / + Sportpaket AMG <sup>3)</sup> |  |                |                                       |                                      |  |            |
| E 220 CDI           | 125                 |              | 04.06    | 02.09 | + Taxi   |  |                |                                       |                                      |  |            |
| E 220 CDI           | 125                 |              | 04.06    | 02.09 | - Taxi / + Sportpaket / + Sportpaket AMG <sup>3)</sup> |  |                |                                       |                                      |  |            |
| E 230               | 150                 |              | 04.06    | 02.09 | + Sportpaket / + Sportpaket AMG <sup>4)</sup>          |  |                |                                       |                                      |  |            |
| E 240               | 130                 |              | 03.02    | 02.09 | + Taxi   |  |                |                                       |                                      |  |            |
| E 250 CDI           | 150                 |              | 08.08    | 02.09 | + Taxi   |  |                |                                       |                                      |  |            |
| E 270 CDI           | 120                 |              | 03.02    | 02.09 | + Taxi   |  |                |                                       |                                      |  |            |
| E 270 CDI           | 130                 |              | 03.02    | 02.09 | + Taxi   |  |                |                                       |                                      |  |            |
| E 280               | 170                 |              | 05.05    | 02.09 |  |  |                |                                       |                                      |  |            |
| E 280 4-matic       | 170                 |              | 05.05    | 02.09 | + Sportpaket / + Sportpaket AMG <sup>4)</sup>          |  |                |                                       |                                      |  |            |
| E 280 CDI           | 130                 |              | 05.04    | 02.09 |  |  |                |                                       |                                      |  |            |
| E 280 CDI           | 140                 |              | 03.05    | 02.09 | + Sportpaket / + Sportpaket AMG <sup>4)</sup>          |  |                |                                       |                                      |  |            |
| E 280 CDI 4-matic   | 140                 |              | 03.05    | 02.09 | + Sportpaket / + Sportpaket AMG <sup>4)</sup>          |  |                |                                       |                                      |  |            |
| E 300 Bluetec       | 155                 |              | 09.07    | 02.09 |  |  |                |                                       |                                      |  |            |
| E 320               | 165                 |              | 03.02    | 02.09 | + Taxi   |  |                |                                       |                                      |  |            |
| E 320               | 165 A 400548        |              | 02.09    |       | - Taxi   |  |                |                                       |                                      |  |            |
| E 320 4-matic       | 165                 | X 122525     | 03.03    |       |  |  |                |                                       |                                      |  |            |
| E 320 CDI           | 150                 |              | 11.02    | 02.09 | + Taxi   |  |                |                                       |                                      |  |            |
| E 320 CDI           | 150 A 400548        |              | 02.09    |       | - Taxi   |  |                |                                       |                                      |  |            |
| E 320 CDI           | 165                 |              | 03.05    | 02.09 |  |  |                |                                       |                                      |  |            |
| E 320 CDI 4-matic   | 165                 |              | 03.05    | 02.09 |  |  |                |                                       |                                      |  |            |
| E 350               | 200                 |              | 12.04    | 02.09 |  |  |                |                                       |                                      |  |            |
| E 350 4-matic       | 200                 |              | 12.04    | 02.09 |  |  |                |                                       |                                      |  |            |
| E 350 CGI           | 215                 |              | 09.07    | 02.09 |  |  |                |                                       |                                      |  |            |
| E 400 CDI           | 191                 |              | 03.03    | 02.09 |  |  |                |                                       |                                      |  |            |
| E 500               | 225                 |              | 03.02    | 02.09 |  |  |                |                                       |                                      |  |            |
| E 500 4-matic       | 225                 |              | 10.03    | 02.09 |  |  |                |                                       |                                      |  |            |
| E 500 4-matic       | 285                 |              | 04.06    | 02.09 |  |  |                |                                       |                                      |  |            |
| E 420 CDI           | 231                 |              | 01.06    | 02.09 | 24.0124-0236.1   | 424236   |                | 320 20,0 21,4 V L +S +B               |                                      |  |            |
| E 500               | 285                 |              | 04.06    | 02.09 |  |  |                |                                       |                                      |  |            |
| E 55 Kompressor AMG | 350                 |              | 10.02    | 02.09 | 24.0126-0136.1   | 426136   |                | 330 26,0 24,0 V L +B                  |                                      |  |            |
| E 63 AMG            | 378                 |              | 03.06    | 02.09 |  |  |                |                                       |                                      |  |            |
|                     | E 200 CDI           | 75           |          | 05.02 | 02.09  | 03.0137-4017.2   | 654017         |                                       | 180 x 25 /Zub<br>Bremsbacken-Zubehör |  |            |
|                     | E 200 CDI           | 90           |          | 05.02 | 02.09  | 03.0137-9297.2   | 669297         |                                       |                                      |  |            |
|                     | E 200 CDI           | 100          |          | 04.06 | 02.09  |  |                |                                       |                                      |  |            |
|                     | E 200 Kompressor    | 120          |          | 05.02 | 02.09  |  |                |                                       |                                      |  |            |
|                     | E 200 Kompressor    | 135          |          | 04.06 | 02.09  |  |                |                                       |                                      |  |            |

<sup>1)</sup> -Taxi/-sports pack./-sports pack.AMG / -Taxi/-pacch.sport./-pacch.sport AMG / -Taxi/-vers.sport/-vers.sport AMG / -Taxi/-kit deport./-kit deport. AMG  
<sup>2)</sup> - sport package/- sport package AMG / - pacchetto sportivo/- pacchetto sport.AMG / - version sport/- version sport AMG / - kit deportivo/- kit deportivo AMG  
<sup>3)</sup> -Taxi/+sports pack./+sports pack.AMG / -Taxi/+pacch.sport./+pacch.sport AMG / -Taxi/+vers.sport./+vers.sport AMG / -Taxi/+kit deport./+kit deport. AMG  
<sup>4)</sup> + sports package/+ sports package AMG / + pacchetto sportivo/+ pacchetto sport.AMG / + version sport/+ version sport AMG / + kit deportivo/+ kit deportivo AMG



| MERCEDES BENZ E-Klasse (S211) Kombi (03-09) |                     |     |  |       |       |  |                |        |   |   |     |
|---|---------------------|-----|--|-------|-------|--|----------------|--------|---|---|-----|
|   | E 63 AMG            | 378 |  | 03.06 | 10.09 |  | 13.0460-4839.2 | 604839 | 1 | 24455 16,8 /WE<br>Warnkontakt L=119mm   | BRE |
|   | E 200 CDI           | 100 |  | 04.06 | 10.09 | - Sportpaket / - Sportpaket AMG <sup>1)</sup>          | 24.0128-0176.1 | 428176 |   | 295 28,0 25,4 V L +S +B                 |     |
|   | E 200 Kompressor    | 120 |  | 03.03 | 10.09 | - Sportpaket / - Sportpaket AMG <sup>1)</sup>          | 24.0328-0176.1 | 528176 |   | 295 28,0 25,4 V L +B PD                 |     |
|   | E 200 Kompressor    | 135 |  | 04.06 | 10.09 | - Sportpaket / - Sportpaket AMG <sup>1)</sup>          |                |        |   |   |     |
|   | E 220 CDI           |     |  | 03.03 | 10.09 | - Sportpaket / - Sportpaket AMG <sup>1)</sup>          |                |        |   |   |     |
|   | E 220 CDI           | 125 |  | 04.06 | 10.09 | - Sportpaket / - Sportpaket AMG <sup>1)</sup>          |                |        |   |   |     |
|   | E 240               | 130 |  | 03.03 | 10.09 |  |                |        |   |   |     |
|   | E 270 CDI           | 120 |  | 03.03 | 10.09 |  |                |        |   |   |     |
|   | E 270 CDI           | 130 |  | 03.03 | 10.09 |  |                |        |   |   |     |
|   | E 280 CDI           | 140 |  | 03.05 | 10.09 | - Sportpaket / - Sportpaket AMG <sup>1)</sup>          |                |        |   |   |     |
|   | E 230               | 150 |  | 05.07 | 10.09 | - Sportpaket / - Sportpaket AMG <sup>1)</sup>          | 24.0128-0142.1 | 428142 |   | 312 28,0 25,4 V L +B                    |     |
|   | E 280               | 170 |  | 05.05 | 10.09 | - Sportpaket / - Sportpaket AMG <sup>1)</sup>          | 24.0328-0142.1 | 528142 |   | 312 28,0 25,4 V L +B PD                 |     |
|   | E 280 CDI           | 130 |  | 05.04 | 10.09 |  |                |        |   |   |     |
|   | E 320               | 165 |  | 03.03 | 10.09 |  |                |        |   |   |     |
|   | E 320 CDI           | 150 |  | 03.03 | 10.09 |  |                |        |   |   |     |
|   | E 320 CDI           | 165 |  | 03.05 | 10.09 |  |                |        |   |   |     |
|   | E 200 CDI           | 100 |  | 04.06 | 10.09 | + Sportpaket / + Sportpaket AMG <sup>2)</sup>          | 24.0132-0153.1 | 432153 |   | 330 32,0 30,0 V L +S +B                 |     |
|   | E 200 Kompressor    | 120 |  | 03.03 | 10.09 | + Sportpaket / + Sportpaket AMG <sup>2)</sup>          |                |        |   |   |     |
|   | E 200 Kompressor    | 135 |  | 04.06 | 10.09 | + Sportpaket / + Sportpaket AMG <sup>2)</sup>          |                |        |   |   |     |
|   | E 220 CDI           |     |  | 03.03 | 10.09 | + Sportpaket / + Sportpaket AMG <sup>2)</sup>          |                |        |   |   |     |
|   | E 220 CDI           | 125 |  | 04.06 | 10.09 | + Sportpaket / + Sportpaket AMG <sup>2)</sup>          |                |        |   |   |     |
|   | E 230               | 150 |  | 05.07 | 10.09 | + Sportpaket / + Sportpaket AMG <sup>2)</sup>          |                |        |   |   |     |
|   | E 280               | 170 |  | 05.05 | 10.09 | + Sportpaket / + Sportpaket AMG <sup>2)</sup>          |                |        |   |   |     |
|   | E 280 CDI           | 140 |  | 03.05 | 10.09 | + Sportpaket / + Sportpaket AMG <sup>2)</sup>          |                |        |   |   |     |
|   | E 350               | 200 |  | 12.04 | 10.09 | + Sportpaket / + Sportpaket AMG <sup>2)</sup>          |                |        |   |   |     |
|   | E 350 CGI           | 215 |  | 05.06 | 10.09 | + Sportpaket / + Sportpaket AMG <sup>2)</sup>          |                |        |   |   |     |
|   | E 500               | 225 |  | 10.03 | 10.09 | + Sportpaket / + Sportpaket AMG <sup>2)</sup>          |                |        |   |   |     |
|   | E 350               | 200 |  | 12.04 | 10.09 | - Sportpaket / - Sportpaket AMG <sup>1)</sup>          | 24.0132-0144.1 | 432144 |   | 330 32,0 29,4 V L +S +B                 |     |
|   | E 350 CGI           | 215 |  | 05.06 | 10.09 | - Sportpaket / - Sportpaket AMG <sup>1)</sup>          | 24.0332-0144.1 | 532144 |   | 330 32,0 29,4 V L +S +B PD              |     |
|   | E 500               | 225 |  | 10.03 | 10.09 | - Sportpaket / - Sportpaket AMG <sup>1)</sup>          |                |        |   |   |     |
|   | E 240 4-matic       | 130 |  | 07.03 | 10.09 |  | 24.0130-0179.1 | 430179 |   | 304 30,0 27,4 V L +B                    |     |
|   | E 280 4-matic       | 170 |  | 05.05 | 10.09 | - Sportpaket / - Sportpaket AMG <sup>1)</sup>          |                |        |   |   |     |
|   | E 280 CDI 4-matic   | 140 |  | 05.05 | 10.09 | - Sportpaket / - Sportpaket AMG <sup>1)</sup>          |                |        |   |   |     |
|   | E 320 4-matic       | 165 |  | 07.03 | 10.09 |  |                |        |   |   |     |
|   | E 320 CDI 4-matic   | 165 |  | 05.05 | 10.09 | - Sportpaket / - Sportpaket AMG <sup>1)</sup>          |                |        |   |   |     |
|   | E 350 4-matic       | 200 |  | 12.04 | 10.09 | - Sportpaket / - Sportpaket AMG <sup>1)</sup>          |                |        |   |   |     |
|   | E 280 4-matic       | 170 |  | 05.05 | 10.09 | + Sportpaket / + Sportpaket AMG <sup>2)</sup>          | 24.0132-0136.1 | 432136 |   | 330 32,0 30,0 V L +B                    |     |
|   | E 280 CDI 4-matic   | 140 |  | 05.05 | 10.09 | + Sportpaket / + Sportpaket AMG <sup>2)</sup>          |                |        |   |   |     |
|   | E 320 CDI 4-matic   | 165 |  | 05.05 | 10.09 | + Sportpaket / + Sportpaket AMG <sup>2)</sup>          |                |        |   |   |     |
|   | E 350 4-matic       | 200 |  | 12.04 | 10.09 | + Sportpaket / + Sportpaket AMG <sup>2)</sup>          |                |        |   |   |     |
|   | E 500 4-matic       | 225 |  | 10.03 | 10.09 | + Sportpaket / + Sportpaket AMG <sup>2)</sup>          |                |        |   |   |     |
|   | E 500 4-matic       | 285 |  | 04.06 | 10.09 | + Sportpaket / + Sportpaket AMG <sup>2)</sup>          |                |        |   |   |     |
|   | E 500 4-matic       | 225 |  | 10.03 | 10.09 | - Sportpaket / - Sportpaket AMG <sup>1)</sup>          | 24.0132-0154.1 | 432154 |   | 330 32,0 29,4 V L +B                    |     |
|   | E 500 4-matic       | 285 |  | 04.06 | 10.09 | - Sportpaket / - Sportpaket AMG <sup>1)</sup>          |                |        |   |   |     |
|   | E 500               | 285 |  | 04.06 | 10.09 |  | 24.0132-0139.1 | 432139 |   | 350 32,0 29,4 V L +S +B                 |     |
|   |                     |     |  |       |       |  | 24.0132-0138.1 | 432138 |   | 350 32,0 30,0 V L +S +B                 |     |
|   | E 55 Kompressor AMG | 350 |  | 07.03 | 10.09 |  | 24.0136-0102.1 | 436102 |   | 360 36,0 34,0 V L +B                    |     |
|   | E 200 CDI           | 100 |  | 04.06 | 10.09 |  | 13.0460-7171.2 | 607171 | 1 | 23334 16,7 +/WE<br>Warnkontakt L=97,5mm | ATE |
|   | E 200 Kompressor    | 120 |  | 03.03 | 10.09 |  | 13.0470-7171.2 | LD7171 |   |   | ATE |
|   | E 200 Kompressor    | 135 |  | 04.06 | 10.09 |  | 24.8190-0410.2 | 620410 |   |   |     |
|   | E 220 CDI           |     |  | 03.03 | 10.09 |  |                |        |   |   |     |
|   | E 220 CDI           | 125 |  | 04.06 | 10.09 |  |                |        |   |   |     |
|   | E 230               | 150 |  | 05.07 | 10.09 |  |                |        |   |   |     |
|   | E 240               | 130 |  | 03.03 | 10.09 |  |                |        |   |   |     |
|   | E 240 4-matic       | 130 |  | 07.03 | 10.09 |  |                |        |   |   |     |
|   | E 270 CDI           | 120 |  | 03.03 | 10.09 |  |                |        |   |   |     |
|   | E 270 CDI           | 130 |  | 03.03 | 10.09 |  |                |        |   |   |     |
|   | E 280               | 170 |  | 05.05 | 10.09 |  |                |        |   |   |     |
|   | E 280 4-matic       | 170 |  | 05.05 | 10.09 |  |                |        |   |   |     |
|   | E 280 CDI           | 130 |  | 05.04 | 10.09 |  |                |        |   |   |     |
|   | E 280 CDI           | 140 |  | 03.05 | 10.09 |  |                |        |   |   |     |
|   | E 280 CDI 4-matic   | 140 |  | 05.05 | 10.09 |  |                |        |   |   |     |
|   | E 320               | 165 |  | 03.03 | 10.09 |  |                |        |   |   |     |
|   | E 320 4-matic       | 165 |  | 07.03 | 10.09 |  |                |        |   |   |     |
|   | E 320 CDI           | 150 |  | 03.03 | 10.09 |  |                |        |   |   |     |
|   | E 320 CDI           | 165 |  | 03.05 | 10.09 |  |                |        |   |   |     |
|   | E 320 CDI 4-matic   | 165 |  | 05.05 | 10.09 |  |                |        |   |   |     |
|   | E 350               | 200 |  | 12.04 | 10.09 |  |                |        |   |   |     |
|   | E 350 4-matic       | 200 |  | 12.04 | 10.09 |  |                |        |   |   |     |
|   | E 350 CGI           | 215 |  | 05.06 | 10.09 |  |                |        |   |   |     |
|   | E 500               | 225 |  | 10.03 | 10.09 |  |                |        |   |   |     |
|   | E 500               | 285 |  | 04.06 | 10.09 |  |                |        |   |   |     |
|   | E 500 4-matic       | 225 |  | 10.03 | 10.09 |  |                |        |   |   |     |
|   | E 500 4-matic       | 285 |  | 04.06 | 10.09 |  |                |        |   |   |     |
|   | E 55 Kompressor AMG | 350 |  | 07.03 | 10.09 |  | 13.0460-4998.2 | 604998 | 1 | 23478 16,5 /WE<br>Warnkontakt L=97,5mm  | BRE |
|   | E 63 AMG            | 378 |  | 03.06 | 10.09 |  | 24.8190-0420.2 | 620420 | 1 | Warnkontakt L=119mm                     |     |
|   | E 200 CDI           | 100 |  | 04.06 | 10.09 | - Taxi / - Sportpaket / - Sportpaket AMG <sup>3)</sup> | 24.0110-0278.1 | 410278 |   | 300 10,0 8,3 +S +B                      |     |
|   | E 200 Kompressor    | 120 |  | 03.03 | 10.09 | - Taxi / - Sportpaket / - Sportpaket AMG <sup>3)</sup> | 24.0310-0278.1 | 510278 |   | 300 10,0 8,3 +S +B PD                   |     |
|   | E 200 Kompressor    | 135 |  | 04.06 | 10.09 | - Taxi / - Sportpaket / - Sportpaket AMG <sup>3)</sup> |                |        |   |   |     |
|   | E 220 CDI           |     |  | 03.03 | 10.09 | - Taxi / - Sportpaket / - Sportpaket AMG <sup>3)</sup> |                |        |   |   |     |
|   | E 220 CDI           | 125 |  | 04.06 | 10.09 | - Taxi / - Sportpaket / - Sportpaket AMG <sup>3)</sup> |                |        |   |   |     |
|   | E 240               | 130 |  | 03.03 | 10.09 | - Taxi   |                |        |   |   |     |

<sup>1)</sup> - sport package/- sport package AMG / - pacchetto sportivo/- pacchetto sport.AMG / - version sport/- version sport AMG / - kit deportivo/- kit deportivo AMG  
<sup>2)</sup> + sports package/+ sports package AMG / + pacchetto sportivo/+ pacchetto sport.AMG / + version sport/+ version sport AMG / + kit deportivo/+ kit deportivo AMG  
<sup>3)</sup> - Taxi/-sports pack./-sports pack.AMG / - Taxi/-pacch.sport./-pacch.sport AMG / - Taxi/-vers.sport/-vers.sport AMG / - Taxi/-kit deport./-kit deport. AMG





**MERCEDES BENZ E-Klasse (S211) Kombi (03-09)**

|  |                     |     |  |       |       |  |                |        |  |  |                         |
|--|---------------------|-----|--|-------|-------|--|----------------|--------|--|--|-------------------------|
|  | E 240 4-matic       | 130 |  | 07.03 | 10.09 |  | 24.0110-0278.1 | 410278 |  |  | 300 10,0 8,3 +S +B      |
|  | E 200 CDI           | 100 |  | 04.06 | 10.09 | + Taxi   | 24.0122-0201.1 | 422201 |  |  | 300 22,0 19,4 V +S +B   |
|  | E 200 CDI           | 100 |  | 04.06 | 10.09 | - Taxi / + Sportpaket / + Sportpaket AMG <sup>1)</sup> |                |        |  |  |                         |
|  | E 200 Kompressor    | 120 |  | 03.03 | 10.09 | + Taxi   |                |        |  |  |                         |
|  | E 200 Kompressor    | 120 |  | 03.03 | 10.09 | - Taxi / + Sportpaket / + Sportpaket AMG <sup>1)</sup> |                |        |  |  |                         |
|  | E 200 Kompressor    | 135 |  | 04.06 | 10.09 | + Taxi   |                |        |  |  |                         |
|  | E 200 Kompressor    | 135 |  | 04.06 | 10.09 | - Taxi / + Sportpaket / + Sportpaket AMG <sup>1)</sup> |                |        |  |  |                         |
|  | E 220 CDI           |     |  | 03.03 | 10.09 | + Taxi   |                |        |  |  |                         |
|  | E 220 CDI           |     |  | 03.03 | 10.09 | - Taxi / + Sportpaket / + Sportpaket AMG <sup>1)</sup> |                |        |  |  |                         |
|  | E 220 CDI           | 125 |  | 04.06 | 10.09 | + Taxi   |                |        |  |  |                         |
|  | E 220 CDI           | 125 |  | 04.06 | 10.09 | - Taxi / + Sportpaket / + Sportpaket AMG <sup>1)</sup> |                |        |  |  |                         |
|  | E 230               | 150 |  | 05.07 | 10.09 |  |                |        |  |  |                         |
|  | E 240               | 130 |  | 03.03 | 10.09 | + Taxi   |                |        |  |  |                         |
|  | E 270 CDI           | 120 |  | 03.03 | 10.09 |  |                |        |  |  |                         |
|  | E 270 CDI           | 130 |  | 03.03 | 10.09 |  |                |        |  |  |                         |
|  | E 280               | 170 |  | 05.05 | 10.09 |  |                |        |  |  |                         |
|  | E 280 4-matic       | 170 |  | 05.05 | 10.09 |  |                |        |  |  |                         |
|  | E 280 CDI           | 130 |  | 05.04 | 10.09 |  |                |        |  |  |                         |
|  | E 280 CDI           | 140 |  | 03.05 | 10.09 |  |                |        |  |  |                         |
|  | E 280 CDI 4-matic   | 140 |  | 05.05 | 10.09 |  |                |        |  |  |                         |
|  | E 320               | 165 |  | 03.03 | 10.09 |  |                |        |  |  |                         |
|  | E 320 4-matic       | 165 |  | 07.03 | 10.09 |  |                |        |  |  |                         |
|  | E 320 CDI           | 150 |  | 03.03 | 10.09 |  |                |        |  |  |                         |
|  | E 320 CDI           | 165 |  | 03.05 | 10.09 |  |                |        |  |  |                         |
|  | E 320 CDI 4-matic   | 165 |  | 05.05 | 10.09 |  |                |        |  |  |                         |
|  | E 350               | 200 |  | 12.04 | 10.09 |  |                |        |  |  |                         |
|  | E 350 4-matic       | 200 |  | 12.04 | 10.09 |  |                |        |  |  |                         |
|  | E 350 CGI           | 215 |  | 05.06 | 10.09 |  |                |        |  |  |                         |
|  | E 500               | 225 |  | 10.03 | 10.09 |  |                |        |  |  |                         |
|  | E 500 4-matic       | 225 |  | 10.03 | 10.09 |  |                |        |  |  |                         |
|  | E 500 4-matic       | 285 |  | 04.06 | 10.09 |  |                |        |  |  |                         |
|  | E 500               | 285 |  | 04.06 | 10.09 |  | 24.0124-0236.1 | 424236 |  |  | 320 24,0 21,4 V L +S +B |
|  | E 55 Kompressor AMG | 350 |  | 07.03 | 10.09 |  | 24.0126-0136.1 | 426136 |  |  | 330 26,0 24,0 V L +B    |
|  | E 63 AMG            | 378 |  | 03.06 | 10.09 |  |                |        |  |  |                         |
|  | E 200 CDI           | 100 |  | 04.06 | 10.09 |  | 03.0137-4017.2 | 654017 |  |  | 180 x 25 /Zub           |
|  | E 200 Kompressor    | 120 |  | 03.03 | 10.09 |  | 03.0137-9297.2 | 669297 |  |  | Bremsbacken-Zubehör     |
|  | E 200 Kompressor    | 135 |  | 04.06 | 10.09 |  |                |        |  |  |                         |
|  | E 220 CDI           |     |  | 03.03 | 10.09 |  |                |        |  |  |                         |
|  | E 220 CDI           | 125 |  | 04.06 | 10.09 |  |                |        |  |  |                         |
|  | E 230               | 150 |  | 05.07 | 10.09 |  |                |        |  |  |                         |
|  | E 240               | 130 |  | 03.03 | 10.09 |  |                |        |  |  |                         |
|  | E 240 4-matic       | 130 |  | 07.03 | 10.09 |  |                |        |  |  |                         |
|  | E 270 CDI           | 120 |  | 03.03 | 10.09 |  |                |        |  |  |                         |
|  | E 270 CDI           | 130 |  | 03.03 | 10.09 |  |                |        |  |  |                         |
|  | E 280               | 170 |  | 05.05 | 10.09 |  |                |        |  |  |                         |
|  | E 280 4-matic       | 170 |  | 05.05 | 10.09 |  |                |        |  |  |                         |
|  | E 280 CDI           | 130 |  | 05.04 | 10.09 |  |                |        |  |  |                         |
|  | E 280 CDI           | 140 |  | 03.05 | 10.09 |  |                |        |  |  |                         |
|  | E 280 CDI 4-matic   | 140 |  | 05.05 | 10.09 |  |                |        |  |  |                         |
|  | E 320               | 165 |  | 03.03 | 10.09 |  |                |        |  |  |                         |
|  | E 320 4-matic       | 165 |  | 07.03 | 10.09 |  |                |        |  |  |                         |
|  | E 320 CDI           | 150 |  | 03.03 | 10.09 |  |                |        |  |  |                         |
|  | E 320 CDI           | 165 |  | 03.05 | 10.09 |  |                |        |  |  |                         |
|  | E 320 CDI 4-matic   | 165 |  | 05.05 | 10.09 |  |                |        |  |  |                         |
|  | E 350               | 200 |  | 12.04 | 10.09 |  |                |        |  |  |                         |
|  | E 350 4-matic       | 200 |  | 12.04 | 10.09 |  |                |        |  |  |                         |
|  | E 350 CGI           | 215 |  | 05.06 | 10.09 |  |                |        |  |  |                         |
|  | E 500               | 225 |  | 10.03 | 10.09 |  |                |        |  |  |                         |
|  | E 500               | 285 |  | 04.06 | 10.09 |  |                |        |  |  |                         |
|  | E 500 4-matic       | 225 |  | 10.03 | 10.09 |  |                |        |  |  |                         |
|  | E 500 4-matic       | 285 |  | 04.06 | 10.09 |  |                |        |  |  |                         |
|  | E 55 Kompressor AMG | 350 |  | 07.03 | 10.09 |  |                |        |  |  |                         |
|  | E 63 AMG            | 378 |  | 03.06 | 10.09 |  |                |        |  |  |                         |

**MERCEDES BENZ E-Klasse (W212) Limousine (09-)**

|  |                       |     |          |       |  |   |                |        |   |        |                          |
|--|-----------------------|-----|----------|-------|--|---|----------------|--------|---|--------|--------------------------|
|  | E 200                 | 135 |          | 01.13 |  | - Sportpaket / - Sportpaket AMG <sup>2)</sup> | 13.0460-2732.2 | 602732 |   |        | 24306 20,3 /WE/Zub/S TRW |
|  | E 200 CDI             | 100 |          | 03.09 |  | - Sportpaket / - Sportpaket AMG <sup>2)</sup> | 13.0470-2732.2 | LD2732 |   |        | 24306 20,3 /WE/Zub/S TRW |
|  | E 200 CGI             | 135 |          | 08.09 |  | - Sportpaket / - Sportpaket AMG <sup>2)</sup> | 13.0470-9000.2 | LD9000 |   | + Taxi | 24306 20,3 /WE/Zub/S TRW |
|  | E 200 NGT             | 115 |          | 07.13 |  | - Sportpaket / - Sportpaket AMG <sup>2)</sup> | 24.8190-0410.2 | 620410 | 1 |        | Warnkontakt L=97,5mm     |
|  | E 200 NGT             | 120 |          | 03.09 |  | - Sportpaket / - Sportpaket AMG <sup>2)</sup> |                |        |   |        |                          |
|  | E 220 BlueTec         | 130 |          | 05.14 |  | - Sportpaket / - Sportpaket AMG <sup>2)</sup> |                |        |   |        |                          |
|  | E 220 CDI             |     |          | 03.09 |  | - Sportpaket / - Sportpaket AMG <sup>2)</sup> |                |        |   |        |                          |
|  | E 250                 |     |          | 03.09 |  | - Sportpaket / - Sportpaket AMG <sup>2)</sup> |                |        |   |        |                          |
|  | E 250 CDI             | 150 | A 001284 | 03.09 |  | - Sportpaket / - Sportpaket AMG <sup>2)</sup> |                |        |   |        |                          |
|  | E 200                 | 135 |          | 01.13 |  | + Sportpaket / + Sportpaket AMG <sup>3)</sup> | 13.0460-2734.2 | 602734 |   |        | 24310 19,0 +/WE/S TRW    |
|  | E 200 CDI             | 100 |          | 03.09 |  | + Sportpaket / + Sportpaket AMG <sup>3)</sup> | 13.0470-2734.2 | LD2734 |   |        | 24310 19,0 +/WE/S TRW    |
|  | E 200 CGI             | 135 |          | 08.09 |  | + Sportpaket / + Sportpaket AMG <sup>3)</sup> | 24.8190-0410.2 | 620410 | 1 |        | Warnkontakt L=97,5mm     |
|  | E 200 NGT             | 115 |          | 07.13 |  | + Sportpaket / + Sportpaket AMG <sup>3)</sup> |                |        |   |        |                          |
|  | E 200 NGT             | 120 |          | 03.09 |  | + Sportpaket / + Sportpaket AMG <sup>3)</sup> |                |        |   |        |                          |
|  | E 220 BlueTec         | 130 |          | 05.14 |  | + Sportpaket / + Sportpaket AMG <sup>3)</sup> |                |        |   |        |                          |
|  | E 220 BlueTec 4-matic | 125 |          | 01.15 |  | + Sportpaket / + Sportpaket AMG <sup>3)</sup> |                |        |   |        |                          |
|  | E 220 CDI             |     |          | 03.09 |  | + Sportpaket / + Sportpaket AMG <sup>3)</sup> |                |        |   |        |                          |
|  | E 250                 |     |          | 03.09 |  | + Sportpaket / + Sportpaket AMG <sup>3)</sup> |                |        |   |        |                          |
|  | E 250                 | 155 |          | 01.13 |  | + Sportpaket / + Sportpaket AMG <sup>3)</sup> |                |        |   |        |                          |
|  | E 250 CDI             | 150 |          | 03.09 |  | + Sportpaket / + Sportpaket AMG <sup>3)</sup> |                |        |   |        |                          |
|  | E 250 CDI             | 150 | A 001285 |       |  | - Sportpaket / - Sportpaket AMG <sup>2)</sup> |                |        |   |        |                          |

<sup>1)</sup> -Taxi/+sports pack./+sports pack.AMG / -Taxi/+pacch.sport/+pacch.sport AMG / -Taxi/+vers.sport/+vers.sport AMG / -Taxi/+kit deport./+kit deport. AMG  
<sup>2)</sup> - sport package/- sport package AMG / - pacchetto sportivo/- pacchetto sport.AMG / - version sport/- version sport AMG / - kit deportivo/- kit deportivo AMG  
<sup>3)</sup> + sports package/+ sports package AMG / + pacchetto sportivo/+ pacchetto sport.AMG / + version sport/+ version sport AMG / + kit deportivo/+ kit deportivo AMG





**MERCEDES BENZ E-Klasse (W212) Limousine (09-)**

|                       |                       |          |          |       |   |   |                |        |  |                               |                         |
|-----------------------|-----------------------|----------|----------|-------|---|---|----------------|--------|--|-------------------------------|-------------------------|
|                       | E 250 CDI 4-matic     | 150      |          | 03.09 |   | 13.0460-2734.2                                | 602734         |        |  | 24310 19,0 +/WE/S             | TRW                     |
|                       | E 250 CGI             | 150      |          | 01.09 |   | 13.0470-2734.2                                | LD2734         |        |  | 24310 19,0 +/WE/S             | TRW                     |
|                       | E 300                 | 170      |          | 03.09 |   | 24.8190-0410.2                                | 620410         | 1      |  | Warnkontakt L=97,5mm          |                         |
|                       | E 300 BE 4-matic      | 185      |          | 07.11 |   |   |                |        |  |                               |                         |
|                       | E 300 BlueEfficiency  | 185      |          | 07.11 |   |   |                |        |  |                               |                         |
|                       | E 300 BlueTec Hybrid  | 150      |          | 06.12 |   |   |                |        |  |                               |                         |
|                       | E 300 CDI             |          |          | 04.11 |   |   |                |        |  |                               |                         |
|                       | E 350                 | 200      |          | 03.09 |   |   |                |        |  |                               |                         |
|                       | E 350                 | 225      |          | 09.11 |   |   |                |        |  |                               |                         |
|                       | E 350 4-matic         | 200      |          | 03.09 |   |   |                |        |  |                               |                         |
|                       | E 350 4-matic         | 225      |          | 09.11 |   |   |                |        |  |                               |                         |
|                       | E 350 BlueTec         | 155      |          | 03.09 |   |   |                |        |  |                               |                         |
|                       | E 350 BlueTec         | 185      |          | 01.13 |   |   |                |        |  |                               |                         |
|                       | E 350 BlueTec         | 190      |          | 05.14 |   |   |                |        |  |                               |                         |
|                       | E 350 BlueTec 4-matic | 185      |          | 01.13 |   |   |                |        |  |                               |                         |
|                       | E 350 BT 4-matic      | 190      |          | 05.14 |   |   |                |        |  |                               |                         |
|                       | E 350 CDI             | 170      |          | 03.09 |   |   |                |        |  |                               |                         |
| E 350 CDI             | 195                   |          | 09.14    |       |   |   |                |        |  |                               |                         |
| E 350 CDI             | 195                   |          | 03.11    |       |   |   |                |        |  |                               |                         |
| E 350 CDI 4-matic     | 170                   |          | 03.09    |       |   |   |                |        |  |                               |                         |
| E 350 CDI 4-matic     | 195                   |          | 03.11    |       |   |   |                |        |  |                               |                         |
| E 350 CGI             | 215                   |          | 03.09    |       |   |   |                |        |  |                               |                         |
| E 400 Hybrid          |                       |          | 06.12    |       | - Sportpaket / - Sportpaket AMG <sup>1)</sup> | 13.0460-2734.2                                | 602734         |        |  | 24310 19,0 +/WE/S             | TRW                     |
|                       |                       |          |          |       |   | 24.8190-0410.2                                | 620410         | 1      |  | Warnkontakt L=97,5mm          |                         |
| E 350 BlueTec         | 185                   |          | 01.13    |       | + Sportpaket / + Sportpaket AMG <sup>2)</sup> | 13.0460-4863.2                                | 604863         |        |  | 24976 17,5 /WE                | BRE                     |
| E 350 BlueTec         | 190                   |          | 05.14    |       | + Sportpaket / + Sportpaket AMG <sup>2)</sup> | 24.8190-0410.2                                | 620410         | 1      |  | Warnkontakt L=97,5mm          |                         |
| E 350 BlueTec 4-matic | 185                   |          | 01.13    |       | + Sportpaket / + Sportpaket AMG <sup>2)</sup> |   |                |        |  |                               |                         |
| E 350 BT 4-matic      | 190                   |          | 05.14    |       | + Sportpaket / + Sportpaket AMG <sup>2)</sup> |   |                |        |  |                               |                         |
| E 400                 | 245                   |          | 01.13    |       |   |   |                |        |  |                               |                         |
| E 400 4-matic         | 245                   |          | 07.14    |       |   |   |                |        |  |                               |                         |
| E 400 4-matic         | 245                   |          | 01.13    |       |   |   |                |        |  |                               |                         |
| E 400 Hybrid          |                       |          | 06.12    |       | + Sportpaket / + Sportpaket AMG <sup>2)</sup> |   |                |        |  |                               |                         |
| E 500                 | 285                   |          | 03.09    |       |   |   |                |        |  |                               |                         |
| E 500 4-matic         | 285                   |          | 03.09    |       |   |   |                |        |  |                               |                         |
| E 400                 | 245                   |          | 07.14    |       |   | 24.8190-0410.2                                | 620410         | 1      |  | Warnkontakt L=97,5mm          |                         |
| E 500                 | 300                   |          | 09.11    |       |   | 24.8190-0410.2                                | 620410         | 1      |  | Warnkontakt L=97,5mm          |                         |
| E 500 4-matic         | 300                   |          | 09.11    |       |   |   |                |        |  |                               |                         |
| E 63 AMG              | 386                   |          | 03.09    |       |   | 13.0460-4839.2                                | 604839         |        |  | - Keramikbremse <sup>3)</sup> | 24455 16,8 /WE          |
|                       |                       |          |          |       |   | 24.8190-0420.2                                | 620420         | 1      |  | Warnkontakt L=119mm           | BRE                     |
| E 63 AMG              | 386                   |          | 02.11    |       |   | 24.8190-0420.2                                | 620420         | 1      |  | - Keramikbremse <sup>3)</sup> | Warnkontakt L=119mm     |
| E 63 AMG              | 410                   |          | 02.11    |       |   |   |                |        |  |                               |                         |
| E 63 AMG 4-matic      | 410                   |          | 02.11    |       |   |   |                |        |  |                               |                         |
| E 63 AMG S            | 430                   |          | 04.13    |       |   |   |                |        |  |                               |                         |
| E 63 AMG S 4-matic    | 430                   |          | 04.13    |       |   |   |                |        |  |                               |                         |
|                       | E 200                 | 135      |          | 01.13 |   | - Sportpaket / - Sportpaket AMG <sup>1)</sup> | 24.0128-0155.1 | 428155 |  |                               | 295 28,0 25,4 V L +S +B |
|                       | E 200 CDI             | 100      |          | 03.09 |   | - Sportpaket / - Sportpaket AMG <sup>1)</sup> |                |        |  |                               |                         |
|                       | E 200 CGI             | 135      |          | 08.09 |   | - Sportpaket / - Sportpaket AMG <sup>1)</sup> |                |        |  |                               |                         |
|                       | E 200 NGT             | 115      |          | 07.13 |   | - Sportpaket / - Sportpaket AMG <sup>1)</sup> |                |        |  |                               |                         |
|                       | E 200 NGT             | 120      |          | 03.09 |   | - Sportpaket / - Sportpaket AMG <sup>1)</sup> |                |        |  |                               |                         |
|                       | E 220 BlueTec         | 130      |          | 05.14 |   | - Sportpaket / - Sportpaket AMG <sup>1)</sup> |                |        |  |                               |                         |
|                       | E 220 CDI             |          |          | 03.09 |   | - Sportpaket / - Sportpaket AMG <sup>1)</sup> |                |        |  |                               |                         |
|                       | E 250                 |          |          | 03.09 |   | - Sportpaket / - Sportpaket AMG <sup>1)</sup> |                |        |  |                               |                         |
|                       | E 250 CDI             | 150      | A 001284 | 03.09 |   | - Sportpaket / - Sportpaket AMG <sup>1)</sup> |                |        |  |                               |                         |
|                       | E 200                 | 135      |          | 01.13 |   | + Sportpaket / + Sportpaket AMG <sup>2)</sup> | 24.0132-0100.1 | 432100 |  |                               | 322 32,0 30,0 V L +S +B |
|                       | E 200 CDI             | 100      |          | 03.09 |   | + Sportpaket / + Sportpaket AMG <sup>2)</sup> |                |        |  |                               |                         |
|                       | E 200 CGI             | 135      |          | 08.09 |   | + Sportpaket / + Sportpaket AMG <sup>2)</sup> |                |        |  |                               |                         |
|                       | E 200 NGT             | 115      |          | 07.13 |   | + Sportpaket / + Sportpaket AMG <sup>2)</sup> |                |        |  |                               |                         |
|                       | E 200 NGT             | 120      |          | 03.09 |   | + Sportpaket / + Sportpaket AMG <sup>2)</sup> |                |        |  |                               |                         |
|                       | E 220 BlueTec         | 130      |          | 05.14 |   | + Sportpaket / + Sportpaket AMG <sup>2)</sup> |                |        |  |                               |                         |
|                       | E 220 BlueTec 4-matic | 125      |          | 01.15 |   | + Sportpaket / + Sportpaket AMG <sup>2)</sup> |                |        |  |                               |                         |
|                       | E 220 CDI             |          |          | 03.09 |   | + Sportpaket / + Sportpaket AMG <sup>2)</sup> |                |        |  |                               |                         |
| E 250                 |                       |          | 03.09    |       | + Sportpaket / + Sportpaket AMG <sup>2)</sup> |   |                |        |  |                               |                         |
| E 250                 | 155                   |          | 01.13    |       | + Sportpaket / + Sportpaket AMG <sup>2)</sup> |   |                |        |  |                               |                         |
| E 250 CDI             | 150                   |          | 03.09    |       | + Sportpaket / + Sportpaket AMG <sup>2)</sup> |   |                |        |  |                               |                         |
| E 250 CDI 4-matic     | 150                   |          | 03.09    |       | + Sportpaket / + Sportpaket AMG <sup>2)</sup> |   |                |        |  |                               |                         |
| E 250 CGI             | 150                   |          | 01.09    |       | + Sportpaket / + Sportpaket AMG <sup>2)</sup> |   |                |        |  |                               |                         |
| E 300                 | 170                   |          | 03.09    |       | + Sportpaket / + Sportpaket AMG <sup>2)</sup> |   |                |        |  |                               |                         |
| E 300 BE 4-matic      | 185                   |          | 07.11    |       | + Sportpaket / + Sportpaket AMG <sup>2)</sup> |   |                |        |  |                               |                         |
| E 300 BlueEfficiency  | 185                   |          | 07.11    |       | + Sportpaket / + Sportpaket AMG <sup>2)</sup> |   |                |        |  |                               |                         |
| E 300 BlueTec Hybrid  | 150                   |          | 06.12    |       | + Sportpaket / + Sportpaket AMG <sup>2)</sup> |   |                |        |  |                               |                         |
| E 300 CDI             |                       |          | 04.11    |       | + Sportpaket / + Sportpaket AMG <sup>2)</sup> |   |                |        |  |                               |                         |
| E 350                 | 200                   |          | 03.09    |       | + Sportpaket / + Sportpaket AMG <sup>2)</sup> |   |                |        |  |                               |                         |
| E 350                 | 225                   |          | 09.11    |       | + Sportpaket / + Sportpaket AMG <sup>2)</sup> |   |                |        |  |                               |                         |
| E 350 4-matic         | 200                   |          | 03.09    |       | + Sportpaket / + Sportpaket AMG <sup>2)</sup> |   |                |        |  |                               |                         |
| E 350 4-matic         | 225                   |          | 09.11    |       | + Sportpaket / + Sportpaket AMG <sup>2)</sup> |   |                |        |  |                               |                         |
| E 350 BlueTec         | 155                   |          | 03.09    |       | + Sportpaket / + Sportpaket AMG <sup>2)</sup> |   |                |        |  |                               |                         |
| E 350 CDI             | 170                   |          | 03.09    |       | + Sportpaket / + Sportpaket AMG <sup>2)</sup> |   |                |        |  |                               |                         |
| E 350 CDI             | 195                   |          | 09.14    |       | + Sportpaket / + Sportpaket AMG <sup>2)</sup> |   |                |        |  |                               |                         |
| E 350 CDI             | 195                   |          | 03.11    |       | + Sportpaket / + Sportpaket AMG <sup>2)</sup> |   |                |        |  |                               |                         |
| E 350 CDI 4-matic     | 170                   |          | 03.09    |       | + Sportpaket / + Sportpaket AMG <sup>2)</sup> |   |                |        |  |                               |                         |
| E 350 CDI 4-matic     | 195                   |          | 03.11    |       | + Sportpaket / + Sportpaket AMG <sup>2)</sup> |   |                |        |  |                               |                         |
| E 350 CGI             | 215                   |          | 03.09    |       | + Sportpaket / + Sportpaket AMG <sup>2)</sup> |   |                |        |  |                               |                         |
| E 220 BlueTec 4-matic | 125                   |          | 01.15    |       | - Sportpaket / - Sportpaket AMG <sup>1)</sup> | 24.0132-0101.1                                | 432101         |        |  | 322 32,0 29,4 V L +S +B       |                         |
| E 250                 | 155                   |          | 01.13    |       | - Sportpaket / - Sportpaket AMG <sup>1)</sup> | 24.0332-0101.1                                | 532101         |        |  | 322 32,0 29,4 V L +S +B PD    |                         |
| E 250 CDI             | 150                   | A 001285 |          |       | - Sportpaket / - Sportpaket AMG <sup>1)</sup> |   |                |        |  |                               |                         |
| E 250 CDI 4-matic     | 150                   |          | 03.09    |       | - Sportpaket / - Sportpaket AMG <sup>1)</sup> |   |                |        |  |                               |                         |

1) - sport package/- sport package AMG / - pacchetto sportivo/- pacchetto sport.AMG / - version sport/- version sport AMG / - kit deportivo/- kit deportivo AMG  
 2) + sports package/+ sports package AMG / + pacchetto sportivo/+ pacchetto sport.AMG / + version sport/+ version sport AMG / + kit deportivo/+ kit deportivo AMG  
 3) - ceramic brake / - freno in ceramica / - frein de céramique / - freno de cerámica





**MERCEDES BENZ E-Klasse (W212) Limousine (09-)**

|  |                       |     |       |   |                |        |        |                            |
|--|-----------------------|-----|-------|---|----------------|--------|--------|----------------------------|
|  | E 250 CGI             | 150 | 01.09 | - Sportpaket / - Sportpaket AMG <sup>1)</sup> | 24.0132-0101.1 | 432101 |        | 322 32,0 29,4 V L +S +B    |
|  | E 300                 | 170 | 03.09 | - Sportpaket / - Sportpaket AMG <sup>1)</sup> | 24.0332-0101.1 | 532101 |        | 322 32,0 29,4 V L +S +B PD |
|  | E 300 BE 4-matic      | 185 | 07.11 | - Sportpaket / - Sportpaket AMG <sup>1)</sup> |                |        |        |                            |
|  | E 300 BlueEfficiency  | 185 | 07.11 | - Sportpaket / - Sportpaket AMG <sup>1)</sup> |                |        |        |                            |
|  | E 300 BlueTec Hybrid  | 150 | 06.12 | - Sportpaket / - Sportpaket AMG <sup>1)</sup> |                |        |        |                            |
|  | E 300 CDI             | 200 | 04.11 | - Sportpaket / - Sportpaket AMG <sup>1)</sup> |                |        |        |                            |
|  | E 350                 | 225 | 03.09 | - Sportpaket / - Sportpaket AMG <sup>1)</sup> |                |        |        |                            |
|  | E 350 4-matic         | 200 | 09.11 | - Sportpaket / - Sportpaket AMG <sup>1)</sup> |                |        |        |                            |
|  | E 350 4-matic         | 225 | 03.09 | - Sportpaket / - Sportpaket AMG <sup>1)</sup> |                |        |        |                            |
|  | E 350 Bluetec         | 155 | 09.11 | - Sportpaket / - Sportpaket AMG <sup>1)</sup> |                |        |        |                            |
|  | E 350 BlueTec         | 185 | 03.09 | - Sportpaket / - Sportpaket AMG <sup>1)</sup> |                |        |        |                            |
|  | E 350 BlueTec         | 185 | 01.13 | - Sportpaket / - Sportpaket AMG <sup>1)</sup> |                |        |        |                            |
|  | E 350 BlueTec         | 190 | 05.14 | - Sportpaket / - Sportpaket AMG <sup>1)</sup> |                |        |        |                            |
|  | E 350 BlueTec 4-matic | 185 | 01.13 | - Sportpaket / - Sportpaket AMG <sup>1)</sup> |                |        |        |                            |
|  | E 350 BT 4-matic      | 190 | 05.14 | - Sportpaket / - Sportpaket AMG <sup>1)</sup> |                |        |        |                            |
|  | E 350 CDI             | 170 | 03.09 | - Sportpaket / - Sportpaket AMG <sup>1)</sup> |                |        |        |                            |
|  | E 350 CDI             | 195 | 09.14 | - Sportpaket / - Sportpaket AMG <sup>1)</sup> |                |        |        |                            |
|  | E 350 CDI             | 195 | 03.11 | - Sportpaket / - Sportpaket AMG <sup>1)</sup> |                |        |        |                            |
|  | E 350 CDI 4-matic     | 170 | 03.09 | - Sportpaket / - Sportpaket AMG <sup>1)</sup> |                |        |        |                            |
|  | E 350 CDI 4-matic     | 195 | 03.11 | - Sportpaket / - Sportpaket AMG <sup>1)</sup> |                |        |        |                            |
|  | E 350 CGI             | 215 | 03.09 | - Sportpaket / - Sportpaket AMG <sup>1)</sup> |                |        |        |                            |
|  | E 400 Hybrid          |     | 06.12 | - Sportpaket / - Sportpaket AMG <sup>1)</sup> |                |        |        |                            |
|  | E 350 BlueTec         | 185 | 01.13 | + Sportpaket / + Sportpaket AMG <sup>2)</sup> | 24.0132-0168.1 | 432168 |        | 344 32,0 30,0 V L +S +B    |
|  | E 350 BlueTec         | 190 | 05.14 | + Sportpaket / + Sportpaket AMG <sup>2)</sup> |                |        |        |                            |
|  | E 350 BlueTec 4-matic | 185 | 01.13 | + Sportpaket / + Sportpaket AMG <sup>2)</sup> |                |        |        |                            |
|  | E 350 BT 4-matic      | 190 | 05.14 | + Sportpaket / + Sportpaket AMG <sup>2)</sup> |                |        |        |                            |
|  | E 400                 | 245 | 07.14 |   |                |        |        |                            |
|  | E 400                 | 245 | 01.13 |   |                |        |        |                            |
|  | E 400 4-matic         | 245 | 07.14 |   |                |        |        |                            |
|  | E 400 4-matic         | 245 | 01.13 |   |                |        |        |                            |
|  | E 400 Hybrid          |     | 06.12 | + Sportpaket / + Sportpaket AMG <sup>2)</sup> |                |        |        |                            |
|  | E 500                 | 285 | 03.09 |   |                |        |        |                            |
|  | E 500 4-matic         | 285 | 03.09 |   |                |        |        |                            |
|  | E 500                 | 300 | 09.11 |   | 24.0136-0108.1 | 436108 |        | 360 36,0 34,0 V L +S +B    |
|  | E 500 4-matic         | 300 | 09.11 |   |                |        |        |                            |
|  | E 200                 | 135 | 01.13 |   | 13.0460-7259.2 | 607259 |        | 24862 16,7 +/-WE ATE       |
|  | E 200 CDI             | 100 | 03.09 |   | 13.0470-7259.2 | LD7259 |        | 24862 16,7 +/-WE ATE       |
|  | E 200 CGI             | 135 | 08.09 |   | 13.0470-9001.2 | LD9001 | + Taxi | 24862 16,7 +/-WE ATE       |
|  | E 200 NGT             | 115 | 07.13 |   | 24.8190-0410.2 | 620410 | 1      | Warnkontakt L=97,5mm       |
|  | E 200 NGT             | 120 | 03.09 |   |                |        |        |                            |
|  | E 220 BlueTec         | 130 | 05.14 |   |                |        |        |                            |
|  | E 220 BlueTec 4-matic | 125 | 01.15 |   |                |        |        |                            |
|  | E 220 CDI             |     | 03.09 |   |                |        |        |                            |
|  | E 250                 |     | 03.09 |   |                |        |        |                            |
|  | E 250                 | 155 | 01.13 |   |                |        |        |                            |
|  | E 250 CDI             | 150 | 03.09 |   |                |        |        |                            |
|  | E 250 CDI 4-matic     | 150 | 03.09 |   |                |        |        |                            |
|  | E 250 CGI             | 150 | 01.09 |   |                |        |        |                            |
|  | E 300                 | 170 | 03.09 |   |                |        |        |                            |
|  | E 300 BE 4-matic      | 185 | 07.11 |   |                |        |        |                            |
|  | E 300 BlueEfficiency  | 185 | 07.11 |   |                |        |        |                            |
|  | E 300 BlueTec Hybrid  | 150 | 06.12 |   |                |        |        |                            |
|  | E 300 CDI             |     | 04.11 |   |                |        |        |                            |
|  | E 350                 | 200 | 03.09 |   |                |        |        |                            |
|  | E 350                 | 225 | 09.11 |   |                |        |        |                            |
|  | E 350 4-matic         | 200 | 03.09 |   |                |        |        |                            |
|  | E 350 4-matic         | 225 | 09.11 |   |                |        |        |                            |
|  | E 350 Bluetec         | 155 | 03.09 |   |                |        |        |                            |
|  | E 350 BlueTec         | 185 | 01.13 |   |                |        |        |                            |
|  | E 350 BlueTec         | 190 | 05.14 |   |                |        |        |                            |
|  | E 350 BlueTec 4-matic | 185 | 01.13 |   |                |        |        |                            |
|  | E 350 BT 4-matic      | 190 | 05.14 |   |                |        |        |                            |
|  | E 350 CDI             | 170 | 03.09 |   |                |        |        |                            |
|  | E 350 CDI             | 195 | 09.14 |   |                |        |        |                            |
|  | E 350 CDI             | 195 | 03.11 |   |                |        |        |                            |
|  | E 350 CDI 4-matic     | 170 | 03.09 |   |                |        |        |                            |
|  | E 350 CDI 4-matic     | 195 | 03.11 |   |                |        |        |                            |
|  | E 350 CGI             | 215 | 03.09 |   |                |        |        |                            |
|  | E 400                 | 245 | 07.14 |   |                |        |        |                            |
|  | E 400                 | 245 | 01.13 |   |                |        |        |                            |
|  | E 400 4-matic         | 245 | 07.14 |   |                |        |        |                            |
|  | E 400 4-matic         | 245 | 01.13 |   |                |        |        |                            |
|  | E 400 Hybrid          |     | 06.12 |   |                |        |        |                            |
|  | E 500                 | 285 | 03.09 |   |                |        |        |                            |
|  | E 500                 | 300 | 09.11 |   |                |        |        |                            |
|  | E 500 4-matic         | 285 | 03.09 |   |                |        |        |                            |
|  | E 500 4-matic         | 300 | 09.11 |   |                |        |        |                            |
|  | E 63 AMG              | 386 | 03.09 |   | 24.8190-0420.2 | 620420 | 1      | Warnkontakt L=119mm        |
|  | E 63 AMG              | 386 | 02.11 |   |                |        |        |                            |
|  | E 63 AMG              | 410 | 02.11 |   |                |        |        |                            |
|  | E 63 AMG 4-matic      | 410 | 02.11 |   |                |        |        |                            |
|  | E 63 AMG S            | 430 | 04.13 |   |                |        |        |                            |
|  | E 63 AMG S 4-matic    | 430 | 04.13 |   |                |        |        |                            |

<sup>1)</sup> - sport package/- sport package AMG / - pacchetto sportivo/- pacchetto sport.AMG / - version sport/- version sport AMG / - kit deportivo/- kit deportivo AMG  
<sup>2)</sup> + sports package/+ sports package AMG / + pacchetto sportivo/+ pacchetto sport.AMG / + version sport/+ version sport AMG / + kit deportivo/+ kit deportivo AMG





**MERCEDES BENZ E-Klasse (W212) Limousine (09-)**

|                       |                       |           |          |          |       |                |                |        |                         |                       |
|-----------------------|-----------------------|-----------|----------|----------|-------|----------------|----------------|--------|-------------------------|-----------------------|
|                       | E 200                 | 135       |          | 01.13    |       | 24.0110-0278.1 | 410278         |        | 300 10,0 8,3 +S +B      |                       |
|                       | E 200 CDI             | 100       |          | 03.09    |       | 24.0310-0278.1 | 510278         |        | 300 10,0 8,3 +S +B PD   |                       |
|                       | E 200 CGI             | 135       |          | 08.09    |       |                |                |        |                         |                       |
|                       | E 200 NGT             | 115       |          | 07.13    |       |                |                |        |                         |                       |
|                       | E 200 NGT             | 120       |          | 03.09    |       |                |                |        |                         |                       |
|                       | E 220 BlueTec         | 130       |          | 05.14    |       |                |                |        |                         |                       |
|                       | E 220 BlueTec 4-matic | 125       |          | 01.15    |       |                |                |        |                         |                       |
|                       | E 220 CDI             |           |          | 03.09    |       |                |                |        |                         |                       |
|                       | E 250                 |           |          | 03.09    |       |                |                |        |                         |                       |
|                       | E 250                 | 155       |          | 01.13    |       |                |                |        |                         |                       |
|                       | E 250 CDI             | 150       | A 007599 |          |       |                |                |        |                         |                       |
|                       | E 250 CDI 4-matic     | 150       |          | 03.09    |       |                |                |        |                         |                       |
|                       | E 250 CGI             | 150       |          | 01.09    |       |                |                |        |                         |                       |
|                       |                       | E 250 CDI | 150      | A 007598 | 03.09 |                | 24.0122-0201.1 | 422201 |                         | 300 22,0 19,4 V +S +B |
|                       |                       | E 300     | 170      |          | 03.09 |                |                |        |                         |                       |
| E 300 BE 4-matic      |                       | 185       |          | 07.11    |       |                |                |        |                         |                       |
| E 300 BlueEfficiency  |                       | 185       |          | 07.11    |       |                |                |        |                         |                       |
| E 300 BlueTec Hybrid  |                       | 150       |          | 06.12    |       |                |                |        |                         |                       |
| E 300 CDI             |                       |           |          | 04.11    |       |                |                |        |                         |                       |
| E 350                 |                       | 200       |          | 03.09    |       |                |                |        |                         |                       |
| E 350                 |                       | 225       |          | 09.11    |       |                |                |        |                         |                       |
| E 350 4-matic         |                       | 200       |          | 03.09    |       |                |                |        |                         |                       |
| E 350 4-matic         |                       | 225       |          | 09.11    |       |                |                |        |                         |                       |
| E 350 Bluetec         |                       | 155       |          | 03.09    |       |                |                |        |                         |                       |
| E 350 BlueTec         |                       | 185       |          | 01.13    |       |                |                |        |                         |                       |
| E 350 BlueTec         |                       | 190       |          | 05.14    |       |                |                |        |                         |                       |
| E 350 BlueTec 4-matic |                       | 185       |          | 01.13    |       |                |                |        |                         |                       |
| E 350 BT 4-matic      |                       | 190       |          | 05.14    |       |                |                |        |                         |                       |
| E 350 CDI             |                       | 170       |          | 03.09    |       |                |                |        |                         |                       |
| E 350 CDI             |                       | 195       |          | 09.14    |       |                |                |        |                         |                       |
| E 350 CDI             |                       | 195       |          | 03.11    |       |                |                |        |                         |                       |
| E 350 CDI 4-matic     |                       | 170       |          | 03.09    |       |                |                |        |                         |                       |
| E 350 CDI 4-matic     |                       | 195       |          | 03.11    |       |                |                |        |                         |                       |
| E 350 CGI             |                       | 215       |          | 03.09    |       |                |                |        |                         |                       |
| E 400                 |                       | 245       |          | 07.14    |       |                |                |        |                         |                       |
| E 400                 |                       | 245       |          | 01.13    |       |                |                |        |                         |                       |
| E 400 4-matic         |                       | 245       |          | 07.14    |       |                |                |        |                         |                       |
| E 400 4-matic         |                       | 245       |          | 01.13    |       |                |                |        |                         |                       |
| E 400 Hybrid          |                       |           | 06.12    |          |       |                |                |        |                         |                       |
|                       | E 500                 | 285       |          | 03.09    |       | 24.0124-0236.1 | 424236         |        | 320 24,0 21,4 V L +S +B |                       |
|                       | E 500                 | 300       |          | 09.11    |       |                |                |        |                         |                       |
|                       | E 500 4-matic         | 285       |          | 03.09    |       |                |                |        |                         |                       |
|                       | E 500 4-matic         | 300       |          | 09.11    |       |                |                |        |                         |                       |
|                       | E 200                 | 135       |          | 01.13    |       | 03.0137-4007.2 | 654007         |        | 180 x 25 /Zub           |                       |
|                       | E 200 CDI             | 100       |          | 03.09    |       |                |                |        |                         |                       |
|                       | E 200 CGI             | 135       |          | 08.09    |       |                |                |        |                         |                       |
|                       | E 200 NGT             | 115       |          | 07.13    |       |                |                |        |                         |                       |
|                       | E 200 NGT             | 120       |          | 03.09    |       |                |                |        |                         |                       |
|                       | E 220 BlueTec         | 130       |          | 05.14    |       |                |                |        |                         |                       |
|                       | E 220 BlueTec 4-matic | 125       |          | 01.15    |       |                |                |        |                         |                       |
|                       | E 220 CDI             |           |          | 03.09    |       |                |                |        |                         |                       |
|                       | E 250                 |           |          | 03.09    |       |                |                |        |                         |                       |
|                       | E 250                 | 155       |          | 01.13    |       |                |                |        |                         |                       |
|                       | E 250 CDI             | 150       |          | 03.09    |       |                |                |        |                         |                       |
|                       | E 250 CDI 4-matic     | 150       |          | 03.09    |       |                |                |        |                         |                       |
|                       | E 250 CGI             | 150       |          | 01.09    |       |                |                |        |                         |                       |
|                       | E 300                 | 170       |          | 03.09    |       |                |                |        |                         |                       |
|                       | E 300 BE 4-matic      | 185       |          | 07.11    |       |                |                |        |                         |                       |
|                       | E 300 BlueEfficiency  | 185       |          | 07.11    |       |                |                |        |                         |                       |
|                       | E 300 BlueTec Hybrid  | 150       |          | 06.12    |       |                |                |        |                         |                       |
|                       | E 300 CDI             |           |          | 04.11    |       |                |                |        |                         |                       |
|                       | E 350                 | 200       |          | 03.09    |       |                |                |        |                         |                       |
|                       | E 350                 | 225       |          | 09.11    |       |                |                |        |                         |                       |
|                       | E 350 4-matic         | 200       |          | 03.09    |       |                |                |        |                         |                       |
|                       | E 350 4-matic         | 225       |          | 09.11    |       |                |                |        |                         |                       |
|                       | E 350 Bluetec         | 155       |          | 03.09    |       |                |                |        |                         |                       |
|                       | E 350 BlueTec         | 185       |          | 01.13    |       |                |                |        |                         |                       |
|                       | E 350 BlueTec         | 190       |          | 05.14    |       |                |                |        |                         |                       |
|                       | E 350 BlueTec 4-matic | 185       |          | 01.13    |       |                |                |        |                         |                       |
|                       | E 350 BT 4-matic      | 190       |          | 05.14    |       |                |                |        |                         |                       |
|                       | E 350 CDI             | 170       |          | 03.09    |       |                |                |        |                         |                       |
|                       | E 350 CDI             | 195       |          | 09.14    |       |                |                |        |                         |                       |
|                       | E 350 CDI             | 195       |          | 03.11    |       |                |                |        |                         |                       |
|                       | E 350 CDI 4-matic     | 170       |          | 03.09    |       |                |                |        |                         |                       |
|                       | E 350 CDI 4-matic     | 195       |          | 03.11    |       |                |                |        |                         |                       |
|                       | E 350 CGI             | 215       |          | 03.09    |       |                |                |        |                         |                       |
|                       | E 400                 | 245       |          | 07.14    |       |                |                |        |                         |                       |
|                       | E 400                 | 245       |          | 01.13    |       |                |                |        |                         |                       |
| E 400 4-matic         | 245                   |           | 07.14    |          |       |                |                |        |                         |                       |
| E 400 4-matic         | 245                   |           | 01.13    |          |       |                |                |        |                         |                       |
| E 400 Hybrid          |                       |           | 06.12    |          |       |                |                |        |                         |                       |
| E 500                 | 285                   |           | 03.09    |          |       |                |                |        |                         |                       |
| E 500                 | 300                   |           | 09.11    |          |       |                |                |        |                         |                       |
| E 500 4-matic         | 285                   |           | 03.09    |          |       |                |                |        |                         |                       |
| E 500 4-matic         | 300                   |           | 09.11    |          |       |                |                |        |                         |                       |
| E 63 AMG              | 386                   |           | 03.09    |          |       |                |                |        |                         |                       |
| E 63 AMG              | 386                   |           | 02.11    |          |       |                |                |        |                         |                       |

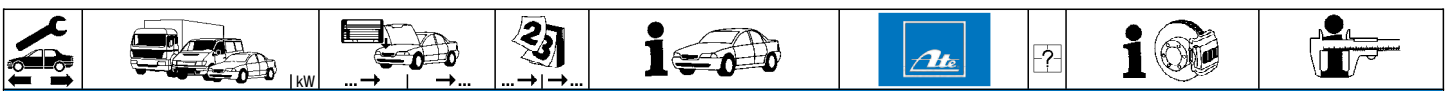

**MERCEDES BENZ E-Klasse (W212) Limousine (09-)**

|  |                    |     |       |  |                |        |  |  |               |
|--|--------------------|-----|-------|--|----------------|--------|--|--|---------------|
|  | E 63 AMG           | 410 | 02.11 |  | 03.0137-4007.2 | 654007 |  |  | 180 x 25 /Zub |
|  | E 63 AMG 4-matic   | 410 | 02.11 |  |                |        |  |  |               |
|  | E 63 AMG S         | 430 | 04.13 |  |                |        |  |  |               |
|  | E 63 AMG S 4-matic | 430 | 04.13 |  |                |        |  |  |               |

**MERCEDES BENZ E-Klasse (S212) Kombi (09-)**

|  |                       |     |       |   |                |        |   |                               |                          |
|--|-----------------------|-----|-------|---|----------------|--------|---|-------------------------------|--------------------------|
|  | E 200                 | 135 | 03.13 | - Sportpaket / - Sportpaket AMG <sup>1)</sup> | 13.0460-2732.2 | 602732 |   |                               | 24306 20,3 /WE/Zub/S TRW |
|  | E 200 CDI             | 100 | 11.09 | - Sportpaket / - Sportpaket AMG <sup>1)</sup> | 13.0470-2732.2 | LD2732 |   |                               | 24306 20,3 /WE/Zub/S TRW |
|  | E 200 CGI             | 135 | 11.09 | - Sportpaket / - Sportpaket AMG <sup>1)</sup> | 13.0470-9000.2 | LD9000 |   |                               | 24306 20,3 /WE/Zub/S TRW |
|  | E 220 BlueTec         | 130 | 05.15 | + Sportpaket / - Sportpaket AMG <sup>1)</sup> | 24.8190-0410.2 | 620410 | 1 | + Taxi                        | Warnkontakt L=97,5mm     |
|  | E 220 CDI             | 125 | 11.09 | - Sportpaket / - Sportpaket AMG <sup>1)</sup> |                |        |   |                               |                          |
|  | E 200                 | 135 | 03.13 | + Sportpaket / + Sportpaket AMG <sup>2)</sup> | 13.0460-2734.2 | 602734 |   |                               | 24310 19,0 +/WE/S TRW    |
|  | E 200 CDI             | 100 | 11.09 | + Sportpaket / + Sportpaket AMG <sup>2)</sup> | 13.0470-2734.2 | LD2734 |   |                               | 24310 19,0 + /WE/S TRW   |
|  | E 200 CGI             | 135 | 11.09 | + Sportpaket / + Sportpaket AMG <sup>2)</sup> | 24.8190-0410.2 | 620410 | 1 |                               | Warnkontakt L=97,5mm     |
|  | E 220 BlueTec         | 130 | 05.15 | + Sportpaket / + Sportpaket AMG <sup>2)</sup> |                |        |   |                               |                          |
|  | E 220 BlueTec 4-matic | 125 | 12.14 |   |                |        |   |                               |                          |
|  | E 220 CDI             | 125 | 11.09 | + Sportpaket / + Sportpaket AMG <sup>2)</sup> |                |        |   |                               |                          |
|  | E 250                 | 155 | 03.13 |   |                |        |   |                               |                          |
|  | E 250 CDI             | 150 | 11.09 |   |                |        |   |                               |                          |
|  | E 250 CDI 4-matic     | 150 | 07.10 |   |                |        |   |                               |                          |
|  | E 250 CGI             | 150 | 11.09 |   |                |        |   |                               |                          |
|  | E 300                 | 170 | 11.09 |   |                |        |   |                               |                          |
|  | E 300                 | 185 | 07.11 |   |                |        |   |                               |                          |
|  | E 300 4-matic         | 185 | 07.11 |   |                |        |   |                               |                          |
|  | E 300 BlueTec Hybrid  | 150 | 06.12 |   |                |        |   |                               |                          |
|  | E 300 CDI             | 150 | 03.11 |   |                |        |   |                               |                          |
|  | E 300 CDI             | 170 | 11.09 |   |                |        |   |                               |                          |
|  | E 350                 | 200 | 11.09 |   |                |        |   |                               |                          |
|  | E 350                 | 225 | 09.11 |   |                |        |   |                               |                          |
|  | E 350 4-matic         | 200 | 11.09 |   |                |        |   |                               |                          |
|  | E 350 4-matic         | 225 | 09.11 |   |                |        |   |                               |                          |
|  | E 350 BlueTec         | 155 | 11.09 |   |                |        |   |                               |                          |
|  | E 350 BlueTec         | 185 | 01.13 | - Sportpaket / - Sportpaket AMG <sup>1)</sup> |                |        |   |                               |                          |
|  | E 350 BlueTec         | 190 | 07.14 | - Sportpaket / - Sportpaket AMG <sup>1)</sup> |                |        |   |                               |                          |
|  | E 350 BlueTec 4-matic | 185 | 01.13 | - Sportpaket / - Sportpaket AMG <sup>1)</sup> |                |        |   |                               |                          |
|  | E 350 BlueTec 4-matic | 190 | 07.14 | - Sportpaket / - Sportpaket AMG <sup>1)</sup> |                |        |   |                               |                          |
|  | E 350 CDI             | 170 | 11.09 |   |                |        |   |                               |                          |
|  | E 350 CDI             | 195 | 07.11 |   |                |        |   |                               |                          |
|  | E 350 CDI 4-matic     | 170 | 11.09 |   |                |        |   |                               |                          |
|  | E 350 CDI 4-matic     | 195 | 07.11 |   |                |        |   |                               |                          |
|  | E 350 CGI             | 215 | 11.09 |   |                |        |   |                               |                          |
|  | E 350 BlueTec         | 185 | 01.13 | + Sportpaket / + Sportpaket AMG <sup>2)</sup> | 13.0460-4863.2 | 604863 |   |                               | 24976 17,5 /WE BRE       |
|  | E 350 BlueTec         | 190 | 07.14 | + Sportpaket / + Sportpaket AMG <sup>2)</sup> | 24.8190-0410.2 | 620410 | 2 |                               | Warnkontakt L=97,5mm     |
|  | E 350 BlueTec 4-matic | 185 | 01.13 | + Sportpaket / + Sportpaket AMG <sup>2)</sup> |                |        |   |                               |                          |
|  | E 350 BlueTec 4-matic | 190 | 07.14 | + Sportpaket / + Sportpaket AMG <sup>2)</sup> |                |        |   |                               |                          |
|  | E 400                 | 245 | 01.13 |   |                |        |   |                               |                          |
|  | E 400 4-matic         | 245 | 01.13 |   |                |        |   |                               |                          |
|  | E 400 4-matic         | 245 | 07.14 |   |                |        |   |                               |                          |
|  | E 500                 | 285 | 11.09 |   |                |        |   |                               |                          |
|  | E 400                 | 245 | 07.14 |   | 24.8190-0410.2 | 620410 | 2 |                               | Warnkontakt L=97,5mm     |
|  | E 500                 | 300 | 09.11 |   | 24.8190-0410.2 | 620410 | 1 |                               | Warnkontakt L=97,5mm     |
|  | E 500 4-matic         | 300 | 09.11 |   |                |        |   |                               |                          |
|  | E 63 AMG              | 386 | 11.09 |   | 24.8190-0420.2 | 620420 | 1 |                               | Warnkontakt L=119mm      |
|  | E 63 AMG              | 386 | 02.11 |   | 24.8190-0420.2 | 620420 | 2 | - Keramikbremse <sup>3)</sup> | Warnkontakt L=119mm      |
|  | E 63 AMG 4-matic      | 410 | 02.11 |   |                |        |   |                               |                          |
|  | E 63 AMG S            | 430 | 04.13 |   |                |        |   |                               |                          |
|  | E 63 AMG S 4-matic    | 430 | 04.13 |   |                |        |   |                               |                          |
|  | E 200                 | 135 | 03.13 | - Sportpaket / - Sportpaket AMG <sup>1)</sup> | 24.0128-0155.1 | 428155 |   |                               | 295 28,0 25,4 V L +S +B  |
|  | E 200 CDI             | 100 | 11.09 | - Sportpaket / - Sportpaket AMG <sup>1)</sup> |                |        |   |                               |                          |
|  | E 200 CGI             | 135 | 11.09 | - Sportpaket / - Sportpaket AMG <sup>1)</sup> |                |        |   |                               |                          |
|  | E 220 BlueTec         | 130 | 05.15 | - Sportpaket / - Sportpaket AMG <sup>1)</sup> |                |        |   |                               |                          |
|  | E 220 CDI             | 125 | 11.09 | - Sportpaket / - Sportpaket AMG <sup>1)</sup> |                |        |   |                               |                          |
|  | E 200                 | 135 | 03.13 | + Sportpaket / + Sportpaket AMG <sup>2)</sup> | 24.0132-0100.1 | 432100 |   |                               | 322 32,0 30,0 V L +S +B  |
|  | E 200 CDI             | 100 | 11.09 | + Sportpaket / + Sportpaket AMG <sup>2)</sup> |                |        |   |                               |                          |
|  | E 200 CGI             | 135 | 11.09 | + Sportpaket / + Sportpaket AMG <sup>2)</sup> |                |        |   |                               |                          |
|  | E 220 BlueTec         | 130 | 05.15 | + Sportpaket / + Sportpaket AMG <sup>2)</sup> |                |        |   |                               |                          |
|  | E 220 BlueTec 4-matic | 125 | 12.14 | + Sportpaket / + Sportpaket AMG <sup>2)</sup> |                |        |   |                               |                          |
|  | E 220 CDI             | 125 | 11.09 | + Sportpaket / + Sportpaket AMG <sup>2)</sup> |                |        |   |                               |                          |
|  | E 250                 | 155 | 03.13 | + Sportpaket / + Sportpaket AMG <sup>2)</sup> |                |        |   |                               |                          |
|  | E 250 CDI             | 150 | 11.09 | + Sportpaket / + Sportpaket AMG <sup>2)</sup> |                |        |   |                               |                          |
|  | E 250 CDI 4-matic     | 150 | 07.10 | + Sportpaket / + Sportpaket AMG <sup>2)</sup> |                |        |   |                               |                          |
|  | E 250 CGI             | 150 | 11.09 | + Sportpaket / + Sportpaket AMG <sup>2)</sup> |                |        |   |                               |                          |
|  | E 300                 | 170 | 11.09 | + Sportpaket / + Sportpaket AMG <sup>2)</sup> |                |        |   |                               |                          |
|  | E 300                 | 185 | 07.11 | + Sportpaket / + Sportpaket AMG <sup>2)</sup> |                |        |   |                               |                          |
|  | E 300 4-matic         | 185 | 07.11 | + Sportpaket / + Sportpaket AMG <sup>2)</sup> |                |        |   |                               |                          |
|  | E 300 BlueTec Hybrid  | 150 | 06.12 | + Sportpaket / + Sportpaket AMG <sup>2)</sup> |                |        |   |                               |                          |
|  | E 300 CDI             | 150 | 03.11 | + Sportpaket / + Sportpaket AMG <sup>2)</sup> |                |        |   |                               |                          |
|  | E 300 CDI             | 170 | 11.09 | + Sportpaket / + Sportpaket AMG <sup>2)</sup> |                |        |   |                               |                          |
|  | E 350                 | 200 | 11.09 | + Sportpaket / + Sportpaket AMG <sup>2)</sup> |                |        |   |                               |                          |
|  | E 350                 | 225 | 09.11 | + Sportpaket / + Sportpaket AMG <sup>2)</sup> |                |        |   |                               |                          |
|  | E 350 4-matic         | 200 | 11.09 | + Sportpaket / + Sportpaket AMG <sup>2)</sup> |                |        |   |                               |                          |
|  | E 350 4-matic         | 225 | 09.11 | + Sportpaket / + Sportpaket AMG <sup>2)</sup> |                |        |   |                               |                          |
|  | E 350 BlueTec         | 155 | 11.09 | + Sportpaket / + Sportpaket AMG <sup>2)</sup> |                |        |   |                               |                          |
|  | E 350 CDI             | 170 | 11.09 | + Sportpaket / + Sportpaket AMG <sup>2)</sup> |                |        |   |                               |                          |
|  | E 350 CDI             | 195 | 07.11 | + Sportpaket / + Sportpaket AMG <sup>2)</sup> |                |        |   |                               |                          |

1) - sport package/- sport package AMG / - pacchetto sportivo/- pacchetto sport.AMG / - version sport/- version sport AMG / - kit deportivo/- kit deportivo AMG  
 2) + sports package/+ sports package AMG / + pacchetto sportivo/+ pacchetto sport.AMG / + version sport/+ version sport AMG / + kit deportivo/+ kit deportivo AMG  
 3) - ceramic brake / - freno in ceramica / - frein de céramique / - freno de cerámica



**MERCEDES BENZ E-Klasse (S212) Kombi (09-)**

|                   |                       |       |   |   |                |        |        |                            |
|-------------------|-----------------------|-------|---|---|----------------|--------|--------|----------------------------|
|                   | E 350 CDI 4-matic     | 170   | 11.09   | + Sportpaket / + Sportpaket AMG <sup>1)</sup> | 24.0132-0100.1 | 432100 |        | 322 32,0 30,0 V L +S +B    |
|                   | E 350 CDI 4-matic     | 195   | 07.11   | + Sportpaket / + Sportpaket AMG <sup>1)</sup> |                |        |        |                            |
|                   | E 350 CGI             | 215   | 11.09   | + Sportpaket / + Sportpaket AMG <sup>1)</sup> |                |        |        |                            |
|                   | E 220 BlueTec 4-matic | 125   | 12.14   | - Sportpaket / - Sportpaket AMG <sup>2)</sup> | 24.0132-0101.1 | 432101 |        | 322 32,0 29,4 V L +S +B    |
|                   | E 250                 | 155   | 03.13   | - Sportpaket / - Sportpaket AMG <sup>2)</sup> | 24.0332-0101.1 | 532101 |        | 322 32,0 29,4 V L +S +B PD |
|                   | E 250 CDI             | 150   | 11.09   | - Sportpaket / - Sportpaket AMG <sup>2)</sup> |                |        |        |                            |
|                   | E 250 CDI 4-matic     | 150   | 07.10   | - Sportpaket / - Sportpaket AMG <sup>2)</sup> |                |        |        |                            |
|                   | E 250 CGI             | 150   | 11.09   | - Sportpaket / - Sportpaket AMG <sup>2)</sup> |                |        |        |                            |
|                   | E 300                 | 170   | 11.09   | - Sportpaket / - Sportpaket AMG <sup>2)</sup> |                |        |        |                            |
|                   | E 300                 | 185   | 07.11   | - Sportpaket / - Sportpaket AMG <sup>2)</sup> |                |        |        |                            |
|                   | E 300 4-matic         | 185   | 07.11   | - Sportpaket / - Sportpaket AMG <sup>2)</sup> |                |        |        |                            |
|                   | E 300 BlueTec Hybrid  | 150   | 06.12   | - Sportpaket / - Sportpaket AMG <sup>2)</sup> |                |        |        |                            |
|                   | E 300 CDI             | 150   | 03.11   | - Sportpaket / - Sportpaket AMG <sup>2)</sup> |                |        |        |                            |
|                   | E 300 CDI             | 170   | 11.09   | - Sportpaket / - Sportpaket AMG <sup>2)</sup> |                |        |        |                            |
|                   | E 350                 | 200   | 11.09   | - Sportpaket / - Sportpaket AMG <sup>2)</sup> |                |        |        |                            |
|                   | E 350                 | 225   | 09.11   | - Sportpaket / - Sportpaket AMG <sup>2)</sup> |                |        |        |                            |
|                   | E 350 4-matic         | 200   | 11.09   | - Sportpaket / - Sportpaket AMG <sup>2)</sup> |                |        |        |                            |
|                   | E 350 4-matic         | 225   | 09.11   | - Sportpaket / - Sportpaket AMG <sup>2)</sup> |                |        |        |                            |
|                   | E 350 BlueTec         | 155   | 11.09   | - Sportpaket / - Sportpaket AMG <sup>2)</sup> |                |        |        |                            |
|                   | E 350 BlueTec         | 185   | 01.13   | - Sportpaket / - Sportpaket AMG <sup>2)</sup> |                |        |        |                            |
|                   | E 350 BlueTec         | 190   | 07.14   | - Sportpaket / - Sportpaket AMG <sup>2)</sup> |                |        |        |                            |
|                   | E 350 BlueTec 4-matic | 185   | 01.13   | - Sportpaket / - Sportpaket AMG <sup>2)</sup> |                |        |        |                            |
|                   | E 350 BlueTec 4-matic | 190   | 07.14   | - Sportpaket / - Sportpaket AMG <sup>2)</sup> |                |        |        |                            |
| E 350 CDI         | 170                   | 11.09 | - Sportpaket / - Sportpaket AMG <sup>2)</sup> |   |                |        |        |                            |
| E 350 CDI         | 195                   | 07.11 | - Sportpaket / - Sportpaket AMG <sup>2)</sup> |   |                |        |        |                            |
| E 350 CDI 4-matic | 170                   | 11.09 | - Sportpaket / - Sportpaket AMG <sup>2)</sup> |   |                |        |        |                            |
| E 350 CDI 4-matic | 195                   | 07.11 | - Sportpaket / - Sportpaket AMG <sup>2)</sup> |   |                |        |        |                            |
| E 350 CGI         | 215                   | 11.09 | - Sportpaket / - Sportpaket AMG <sup>2)</sup> |   |                |        |        |                            |
|                   | E 350 BlueTec         | 185   | 01.13   | + Sportpaket / + Sportpaket AMG <sup>1)</sup> | 24.0132-0168.1 | 432168 |        | 344 32,0 30,0 V L +S +B    |
|                   | E 350 BlueTec         | 190   | 07.14   | + Sportpaket / + Sportpaket AMG <sup>1)</sup> |                |        |        |                            |
|                   | E 350 BlueTec 4-matic | 185   | 01.13   | + Sportpaket / + Sportpaket AMG <sup>1)</sup> |                |        |        |                            |
|                   | E 350 BlueTec 4-matic | 190   | 07.14   | + Sportpaket / + Sportpaket AMG <sup>1)</sup> |                |        |        |                            |
|                   | E 400                 | 245   | 01.13   |   |                |        |        |                            |
|                   | E 400                 | 245   | 07.14   |   |                |        |        |                            |
|                   | E 400 4-matic         | 245   | 01.13   |   |                |        |        |                            |
|                   | E 400 4-matic         | 245   | 07.14   |   |                |        |        |                            |
|                   | E 500                 | 285   | 11.09   |   |                |        |        |                            |
|                   | E 500                 | 300   | 09.11   |   | 24.0136-0108.1 | 436108 |        | 360 36,0 34,0 V L +S +B    |
| E 500 4-matic     | 300                   | 09.11 |   |   |                |        |        |                            |
|                   | E 200                 | 135   | 03.13   |   | 13.0460-7259.2 | 607259 |        | 24862 16,7 +/WE ATE        |
|                   | E 200 CDI             | 100   | 11.09   |   | 13.0470-7259.2 | LD7259 |        | 24862 16,7 +/WE ATE        |
|                   | E 200 CGI             | 135   | 11.09   |   | 13.0470-9001.2 | LD9001 | + Taxi | 24862 16,7 +/WE ATE        |
|                   | E 220 BlueTec         | 130   | 05.15   |   | 24.8190-0410.2 | 620410 | 1      | Warnkontakt L=97,5mm       |
|                   | E 220 BlueTec 4-matic | 125   | 12.14   |   |                |        |        |                            |
|                   | E 220 CDI             | 125   | 11.09   |   |                |        |        |                            |
|                   | E 250                 | 155   | 03.13   |   |                |        |        |                            |
|                   | E 250 CDI             | 150   | 11.09   |   |                |        |        |                            |
|                   | E 250 CDI 4-matic     | 150   | 07.10   |   |                |        |        |                            |
|                   | E 250 CGI             | 150   | 11.09   |   |                |        |        |                            |
|                   | E 300                 | 170   | 11.09   |   |                |        |        |                            |
|                   | E 300                 | 185   | 07.11   |   |                |        |        |                            |
|                   | E 300 4-matic         | 185   | 07.11   |   |                |        |        |                            |
|                   | E 300 BlueTec Hybrid  | 150   | 06.12   |   |                |        |        |                            |
|                   | E 300 CDI             | 150   | 03.11   |   |                |        |        |                            |
|                   | E 300 CDI             | 170   | 11.09   |   |                |        |        |                            |
|                   | E 350                 | 200   | 11.09   |   |                |        |        |                            |
|                   | E 350                 | 225   | 09.11   |   |                |        |        |                            |
|                   | E 350 4-matic         | 200   | 11.09   |   |                |        |        |                            |
|                   | E 350 4-matic         | 225   | 09.11   |   |                |        |        |                            |
|                   | E 350 BlueTec         | 155   | 11.09   |   |                |        |        |                            |
|                   | E 350 BlueTec         | 185   | 01.13   |   |                |        |        |                            |
|                   | E 350 BlueTec         | 190   | 07.14   |   |                |        |        |                            |
|                   | E 350 BlueTec 4-matic | 185   | 01.13   |   |                |        |        |                            |
|                   | E 350 BlueTec 4-matic | 190   | 07.14   |   |                |        |        |                            |
|                   | E 350 CDI             | 170   | 11.09   |   |                |        |        |                            |
|                   | E 350 CDI             | 195   | 07.11   |   |                |        |        |                            |
|                   | E 350 CDI 4-matic     | 170   | 11.09   |   |                |        |        |                            |
|                   | E 350 CDI 4-matic     | 195   | 07.11   |   |                |        |        |                            |
|                   | E 350 CGI             | 215   | 11.09   |   |                |        |        |                            |
| E 400             | 245                   | 01.13 |   |   |                |        |        |                            |
| E 400             | 245                   | 07.14 |   |   |                |        |        |                            |
| E 400 4-matic     | 245                   | 01.13 |   |   |                |        |        |                            |
| E 400 4-matic     | 245                   | 07.14 |   |   |                |        |        |                            |
| E 500             | 285                   | 11.09 |   |   |                |        |        |                            |
| E 500             | 300                   | 09.11 |   |   |                |        |        |                            |
| E 500 4-matic     | 300                   | 09.11 |   |   |                |        |        |                            |
|                   | E 63 AMG              | 386   | 11.09   |   | 24.8190-0420.2 | 620420 | 1      | Warnkontakt L=119mm        |
|                   | E 63 AMG              | 386   | 02.11   |   | 24.8190-0420.2 | 620420 | 1      | Warnkontakt L=119mm        |
|                   | E 63 AMG              | 410   | 02.11   |   |                |        |        |                            |
|                   | E 63 AMG 4-matic      | 410   | 02.11   |   |                |        |        |                            |
|                   | E 63 AMG S            | 430   | 04.13   |   |                |        |        |                            |
|                   | E 63 AMG S 4-matic    | 430   | 04.13   |   |                |        |        |                            |
|                   | E 200                 | 135   | 03.13   |   | 24.0110-0278.1 | 410278 |        | 300 10,0 8,3 +S +B         |
|                   | E 200 CDI             | 100   | 11.09   |   | 24.0310-0278.1 | 510278 |        | 300 10,0 8,3 +S +B PD      |
|                   | E 200 CGI             | 135   | 11.09   |   |                |        |        |                            |
|                   | E 220 BlueTec         | 130   | 05.15   |   |                |        |        |                            |

<sup>1)</sup> + sports package/+ sports package AMG / + pacchetto sportivo/+ pacchetto sport.AMG / + version sport/+ version sport AMG / + kit deportivo/+ kit deportivo AMG

<sup>2)</sup> - sport package/- sport package AMG / - pacchetto sportivo/- pacchetto sport.AMG / - version sport/- version sport AMG / - kit deportivo/- kit deportivo AMG



**MERCEDES BENZ E-Klasse (S212) Kombi (09-)**

|                       |                       |       |       |                |                |  |  |   |
|-----------------------|-----------------------|-------|-------|----------------|----------------|--|--|---|
|                       | E 220 BlueTec 4-matic | 125   | 12.14 | 24.0110-0278.1 | 410278         |  |  | 300 10,0 8,3 +S +B<br>300 10,0 8,3 +S +B PD |
|                       | E 220 CDI             | 125   | 11.09 | 24.0310-0278.1 | 510278         |  |  |   |
|                       | E 250                 | 155   | 03.13 |                |                |  |  |   |
|                       | E 250 CDI             | 150   | 11.09 |                |                |  |  |   |
|                       | E 250 CDI 4-matic     | 150   | 07.10 |                |                |  |  |   |
|                       | E 250 CGI             | 150   | 11.09 |                |                |  |  |   |
|                       | E 300                 | 170   | 11.09 | 24.0122-0201.1 | 422201         |  |  |   |
|                       | E 300                 | 185   | 07.11 |                |                |  |  |   |
|                       | E 300 4-matic         | 185   | 07.11 |                |                |  |  |   |
|                       | E 300 BlueTec Hybrid  | 150   | 06.12 |                |                |  |  |   |
|                       | E 300 CDI             | 150   | 03.11 |                |                |  |  |   |
|                       | E 300 CDI             | 170   | 11.09 |                |                |  |  |   |
|                       | E 350                 | 200   | 11.09 |                |                |  |  |   |
|                       | E 350                 | 225   | 09.11 |                |                |  |  |   |
|                       | E 350 4-matic         | 200   | 11.09 |                |                |  |  |   |
|                       | E 350 4-matic         | 225   | 09.11 |                |                |  |  |   |
|                       | E 350 BlueTec         | 155   | 11.09 |                |                |  |  |   |
|                       | E 350 BlueTec         | 185   | 01.13 |                |                |  |  |   |
|                       | E 350 BlueTec         | 190   | 07.14 |                |                |  |  |   |
|                       | E 350 BlueTec 4-matic | 185   | 01.13 |                |                |  |  |   |
|                       | E 350 BlueTec 4-matic | 190   | 07.14 |                |                |  |  |   |
|                       | E 350 CDI             | 170   | 11.09 |                |                |  |  |   |
|                       | E 350 CDI             | 195   | 07.11 |                |                |  |  |   |
|                       | E 350 CDI 4-matic     | 170   | 11.09 |                |                |  |  |   |
|                       | E 350 CDI 4-matic     | 195   | 07.11 |                |                |  |  |   |
|                       | E 350 CGI             | 215   | 11.09 |                |                |  |  |   |
|                       | E 400                 | 245   | 01.13 |                |                |  |  |   |
|                       | E 400                 | 245   | 07.14 |                |                |  |  |   |
|                       | E 400 4-matic         | 245   | 01.13 |                |                |  |  |   |
|                       | E 400 4-matic         | 245   | 07.14 |                |                |  |  |   |
|                       | E 500                 | 285   | 11.09 | 24.0124-0236.1 | 424236         |  |  |   |
|                       | E 500                 | 300   | 09.11 |                |                |  |  |   |
|                       | E 500 4-matic         | 300   | 09.11 |                |                |  |  |   |
|                       |                       | E 200 | 135   | 03.13          | 03.0137-4007.2 |  |  |   |
| E 200 CDI             |                       | 100   | 11.09 |                |                |  |  |   |
| E 200 CGI             |                       | 135   | 11.09 |                |                |  |  |   |
| E 220 BlueTec         |                       | 130   | 05.15 |                |                |  |  |   |
| E 220 BlueTec 4-matic |                       | 125   | 12.14 |                |                |  |  |   |
| E 220 CDI             |                       | 125   | 11.09 |                |                |  |  |   |
| E 250                 |                       | 155   | 03.13 |                |                |  |  |   |
| E 250 CDI             |                       | 150   | 11.09 |                |                |  |  |   |
| E 250 CDI 4-matic     |                       | 150   | 07.10 |                |                |  |  |   |
| E 250 CGI             |                       | 150   | 11.09 |                |                |  |  |   |
| E 300                 |                       | 170   | 11.09 |                |                |  |  |   |
| E 300                 |                       | 185   | 07.11 |                |                |  |  |   |
| E 300 4-matic         |                       | 185   | 07.11 |                |                |  |  |   |
| E 300 BlueTec Hybrid  |                       | 150   | 06.12 |                |                |  |  |   |
| E 300 CDI             |                       | 150   | 03.11 |                |                |  |  |   |
| E 300 CDI             |                       | 170   | 11.09 |                |                |  |  |   |
| E 350                 |                       | 200   | 11.09 |                |                |  |  |   |
| E 350                 |                       | 225   | 09.11 |                |                |  |  |   |
| E 350 4-matic         |                       | 200   | 11.09 |                |                |  |  |   |
| E 350 4-matic         |                       | 225   | 09.11 |                |                |  |  |   |
| E 350 BlueTec         |                       | 155   | 11.09 |                |                |  |  |   |
| E 350 BlueTec         |                       | 185   | 01.13 |                |                |  |  |   |
| E 350 BlueTec         |                       | 190   | 07.14 |                |                |  |  |   |
| E 350 BlueTec 4-matic |                       | 185   | 01.13 |                |                |  |  |   |
| E 350 BlueTec 4-matic |                       | 190   | 07.14 |                |                |  |  |   |
| E 350 CDI             |                       | 170   | 11.09 |                |                |  |  |   |
| E 350 CDI             |                       | 195   | 07.11 |                |                |  |  |   |
| E 350 CDI 4-matic     |                       | 170   | 11.09 |                |                |  |  |   |
| E 350 CDI 4-matic     |                       | 195   | 07.11 |                |                |  |  |   |
| E 350 CGI             |                       | 215   | 11.09 |                |                |  |  |   |
| E 400                 |                       | 245   | 01.13 |                |                |  |  |   |
| E 400                 |                       | 245   | 07.14 |                |                |  |  |   |
| E 400 4-matic         |                       | 245   | 01.13 |                |                |  |  |   |
| E 400 4-matic         |                       | 245   | 07.14 |                |                |  |  |   |
| E 500                 | 285                   | 11.09 |       |                |                |  |  |   |
| E 500                 | 300                   | 09.11 |       |                |                |  |  |   |
| E 500 4-matic         | 300                   | 09.11 |       |                |                |  |  |   |
| E 63 AMG              | 386                   | 02.11 |       |                |                |  |  |   |
| E 63 AMG              | 386                   | 11.09 |       |                |                |  |  |   |
| E 63 AMG              | 410                   | 02.11 |       |                |                |  |  |   |
| E 63 AMG 4-matic      | 410                   | 02.11 |       |                |                |  |  |   |
| E 63 AMG S            | 430                   | 04.13 |       |                |                |  |  |   |
| E 63 AMG S 4-matic    | 430                   | 04.13 |       |                |                |  |  |   |

**MERCEDES BENZ E-Klasse (C207) Coupe (09-)**

|  |               |     |       |   |                |        |   |  |
|--|---------------|-----|-------|---|----------------|--------|---|--|
|  | E 200         | 135 | 03.13 | - Sportpaket / - Sportpaket AMG <sup>1)</sup> | 13.0460-2732.2 | 602732 | 1 | 24306 20,3 /WE/Zub/S TRW<br>24306 20,3 /WE/Zub/S TRW<br>Warnkontakt L=97,5mm |
|  | E 200 CGI     | 135 | 09.09 | - Sportpaket / - Sportpaket AMG <sup>1)</sup> | 13.0470-2732.2 | LD2732 |   |  |
|  | E 220 BlueTec | 130 | 05.14 | - Sportpaket / - Sportpaket AMG <sup>1)</sup> | 24.8190-0410.2 | 620410 |   |  |
|  | E 220 CDI     | 120 | 07.14 | - Sportpaket / - Sportpaket AMG <sup>1)</sup> |                |        |   |  |
|  | E 220 CDI     | 125 | 05.09 | - Sportpaket / - Sportpaket AMG <sup>1)</sup> |                |        |   |  |
|  | E 250 CGI     | 150 | 05.09 | - Sportpaket / - Sportpaket AMG <sup>1)</sup> |                |        |   |  |
|  | E 200         | 135 | 03.13 | + Sportpaket / + Sportpaket AMG <sup>2)</sup> | 13.0460-2734.2 | 602734 | 1 | 24310 19,0 +/-WE/S TRW<br>24310 19,0 +/-WE/S TRW<br>Warnkontakt L=97,5mm     |
|  | E 200 CGI     | 135 | 09.09 | + Sportpaket / + Sportpaket AMG <sup>2)</sup> | 13.0470-2734.2 | LD2734 |   |  |
|  | E 220 BlueTec | 130 | 05.14 | + Sportpaket / + Sportpaket AMG <sup>2)</sup> | 24.8190-0410.2 | 620410 |   |  |

<sup>1)</sup> - sport package/- sport package AMG / - pacchetto sportivo/- pacchetto sport.AMG / - version sport/- version sport AMG / - kit deportivo/- kit deportivo AMG  
<sup>2)</sup> + sports package/+ sports package AMG / + pacchetto sportivo/+ pacchetto sport.AMG / + version sport/+ version sport AMG / + kit deportivo/+ kit deportivo AMG



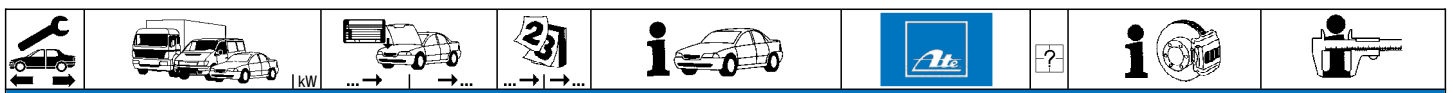

**MERCEDES BENZ E-Klasse (C207) Coupe (09-)**

|                  |                  |       |   |   |                |        |   |  |  |            |  |  |  |                          |
|------------------|------------------|-------|---|---|----------------|--------|---|--|--|------------|--|--|--|--------------------------|
|                  | E 220 CDI        | 120   | 07.14   | + Sportpaket / + Sportpaket AMG <sup>1)</sup> | 13.0460-2734.2 | 602734 | 1 |  | 24310 19,0 +/-WE/S<br>24310 19,0 +/-WE/S<br>Warnkontakt L=97,5mm | TRW<br>TRW |  |  |  |                          |
|                  | E 220 CDI        | 125   | 05.09   | + Sportpaket / + Sportpaket AMG <sup>1)</sup> | 13.0470-2734.2 | LD2734 |   |  |  |            |  |  |  |                          |
|                  | E 250            | 155   | 03.13   |   | 24.8190-0410.2 | 620410 |   |  |  |            |  |  |  |                          |
|                  | E 250 CDI        | 150   | 05.09   |   |                |        |   |  |  |            |  |  |  |                          |
|                  | E 250 CGI        | 150   | 05.09   | + Sportpaket / + Sportpaket AMG <sup>1)</sup> |                |        |   |  |  |            |  |  |  |                          |
|                  | E 300 CGI        | 185   | 04.11   |   |                |        |   |  |  |            |  |  |  |                          |
|                  | E 320            | 200   | 07.14   |   |                |        |   |  |  |            |  |  |  |                          |
|                  | E 350            | 200   | 05.11   |   |                |        |   |  |  |            |  |  |  |                          |
|                  | E 350            | 225   | 09.09   |   |                |        |   |  |  |            |  |  |  |                          |
|                  | E 350 4-matic BE | 225   | 02.13   |   |                |        |   |  |  |            |  |  |  |                          |
| E 350 BlueTec    | 185              | 01.13 |   |   |                |        |   |  |  |            |  |  |  |                          |
| E 350 BlueTec    | 190              | 05.14 |   |   |                |        |   |  |  |            |  |  |  |                          |
| E 350 CDI        | 170              | 05.09 |   |   |                |        |   |  |  |            |  |  |  |                          |
| E 350 CDI        | 195              | 04.11 |   |   |                |        |   |  |  |            |  |  |  |                          |
| E 350 CGI        | 215              | 05.09 |   |   |                |        |   |  |  |            |  |  |  |                          |
| E 400            | 245              | 07.14 |   | 13.0460-2734.2                                | 602734         | 1      |   | 24310 19,0 +/-WE/S<br>Warnkontakt L=97,5mm | TRW  |            |  |  |  |                          |
| E 400            | 245              | 03.13 |   | 24.8190-0410.2                                | 620410         |        |   |  |  |            |  |  |  |                          |
| E 500            | 285              | 05.09 |   |   |                |        |   |  |  |            |  |  |  |                          |
| E 500            | 300              | 06.13 |   |   |                |        |   |  |  |            |  |  |  |                          |
| E 550 CGI        | 300              | 09.11 |   | 24.8190-0410.2                                | 620410         | 1      |   | Warnkontakt L=97,5mm                       |  |            |  |  |  |                          |
|                  | E 200            | 135   | 03.13   | - Sportpaket / - Sportpaket AMG <sup>2)</sup> | 24.0132-0101.1 | 432101 |   |  | 322 32,0 29,4 V L +S +B<br>322 32,0 29,4 V L +S +B PD            |            |  |  |  |                          |
|                  | E 250            | 155   | 03.13   | - Sportpaket / - Sportpaket AMG <sup>2)</sup> | 24.0332-0101.1 | 532101 |   |  |  |            |  |  |  |                          |
|                  | E 250 CDI        | 150   | 05.09   | - Sportpaket / - Sportpaket AMG <sup>2)</sup> |                |        |   |  |  |            |  |  |  |                          |
|                  | E 300 CGI        | 185   | 04.11   | - Sportpaket / - Sportpaket AMG <sup>2)</sup> |                |        |   |  |  |            |  |  |  |                          |
|                  | E 350            | 200   | 05.11   | - Sportpaket / - Sportpaket AMG <sup>2)</sup> |                |        |   |  |  |            |  |  |  |                          |
|                  | E 350            | 225   | 09.09   | - Sportpaket / - Sportpaket AMG <sup>2)</sup> |                |        |   |  |  |            |  |  |  |                          |
|                  | E 350 4-matic BE | 225   | 02.13   | - Sportpaket / - Sportpaket AMG <sup>2)</sup> |                |        |   |  |  |            |  |  |  |                          |
|                  | E 350 BlueTec    | 185   | 01.13   | - Sportpaket / - Sportpaket AMG <sup>2)</sup> |                |        |   |  |  |            |  |  |  |                          |
|                  | E 350 BlueTec    | 190   | 05.14   | - Sportpaket / - Sportpaket AMG <sup>2)</sup> |                |        |   |  |  |            |  |  |  |                          |
|                  | E 350 CDI        | 170   | 05.09   | - Sportpaket / - Sportpaket AMG <sup>2)</sup> |                |        |   |  |  |            |  |  |  |                          |
|                  | E 350 CDI        | 195   | 04.11   | - Sportpaket / - Sportpaket AMG <sup>2)</sup> |                |        |   |  |  |            |  |  |  |                          |
|                  | E 350 CGI        | 215   | 05.09   | - Sportpaket / - Sportpaket AMG <sup>2)</sup> |                |        |   |  |  |            |  |  |  |                          |
|                  | E 200            | 135   | 03.13   | + Sportpaket / + Sportpaket AMG <sup>1)</sup> | 24.0132-0100.1 | 432100 |   |  |  |            |  |  | 322 32,0 30,0 V L +S +B  |                          |
|                  | E 220 BlueTec    | 130   | 05.14   | + Sportpaket / + Sportpaket AMG <sup>1)</sup> |                |        |   |  |  |            |  |  |  |                          |
|                  | E 220 CDI        | 120   | 07.14   | + Sportpaket / + Sportpaket AMG <sup>1)</sup> |                |        |   |  |  |            |  |  |  |                          |
|                  | E 220 CDI        | 125   | 05.09   | + Sportpaket / + Sportpaket AMG <sup>1)</sup> |                |        |   |  |  |            |  |  |  |                          |
| E 250            | 155              | 03.13 | + Sportpaket / + Sportpaket AMG <sup>1)</sup> |   |                |        |   |  |  |            |  |  |  |                          |
| E 250 CDI        | 150              | 05.09 | + Sportpaket / + Sportpaket AMG <sup>1)</sup> |   |                |        |   |  |  |            |  |  |  |                          |
| E 300 CGI        | 185              | 04.11 | + Sportpaket / + Sportpaket AMG <sup>1)</sup> |   |                |        |   |  |  |            |  |  |  |                          |
| E 350            | 200              | 05.11 | + Sportpaket / + Sportpaket AMG <sup>1)</sup> |   |                |        |   |  |  |            |  |  |  |                          |
| E 350            | 225              | 09.09 | + Sportpaket / + Sportpaket AMG <sup>1)</sup> |   |                |        |   |  |  |            |  |  |  |                          |
| E 350 4-matic BE | 225              | 02.13 | + Sportpaket / + Sportpaket AMG <sup>1)</sup> |   |                |        |   |  |  |            |  |  |  |                          |
| E 350 BlueTec    | 185              | 01.13 | + Sportpaket / + Sportpaket AMG <sup>1)</sup> |   |                |        |   |  |  |            |  |  |  |                          |
| E 350 BlueTec    | 190              | 05.14 | + Sportpaket / + Sportpaket AMG <sup>1)</sup> |   |                |        |   |  |  |            |  |  |  |                          |
| E 350 CDI        | 170              | 05.09 | + Sportpaket / + Sportpaket AMG <sup>1)</sup> |   |                |        |   |  |  |            |  |  |  |                          |
| E 350 CDI        | 195              | 04.11 | + Sportpaket / + Sportpaket AMG <sup>1)</sup> |   |                |        |   |  |  |            |  |  |  |                          |
| E 350 CGI        | 215              | 05.09 | + Sportpaket / + Sportpaket AMG <sup>1)</sup> |   |                |        |   |  |  |            |  |  |  |                          |
| E 200 CGI        | 135              | 09.09 |   | 24.0128-0155.1                                | 428155         |        |   | 295 28,0 25,4 V L +S +B                    |  |            |  |  |  |                          |
| E 220 BlueTec    | 130              | 05.14 | - Sportpaket / - Sportpaket AMG <sup>2)</sup> |   |                |        |   |  |  |            |  |  |  |                          |
| E 220 CDI        | 120              | 07.14 | - Sportpaket / - Sportpaket AMG <sup>2)</sup> |   |                |        |   |  |  |            |  |  |  |                          |
| E 220 CDI        | 125              | 05.09 | - Sportpaket / - Sportpaket AMG <sup>2)</sup> |   |                |        |   |  |  |            |  |  |  |                          |
| E 250 CGI        | 150              | 05.09 | - Sportpaket / - Sportpaket AMG <sup>2)</sup> |   |                |        |   |  |  |            |  |  |  |                          |
| E 320            | 200              | 07.14 |   | 24.0132-0168.1                                | 432168         |        |   | 344 32,0 30,0 V L +S +B                    |  |            |  |  |  |                          |
| E 400            | 245              | 07.14 |   |   |                |        |   |  |  |            |  |  |  |                          |
| E 400            | 245              | 03.13 |   |   |                |        |   |  |  |            |  |  |  |                          |
| E 500            | 285              | 05.09 |   |   |                |        |   |  |  |            |  |  |  |                          |
| E 500            | 300              | 06.13 |   |   |                |        |   |  |  |            |  |  |  |                          |
| E 550 CGI        | 300              | 09.11 |   | 24.0136-0108.1                                | 436108         |        |   | 360 36,0 34,0 V L +S +B                    |  |            |  |  |  |                          |
|                  | E 200            | 135   | 03.13   |   | 13.0460-7244.2 | 607244 | 1 |  | 24253 17,8 +/-WE<br>24253 17,8 +/-WE<br>Warnkontakt L=97,5mm     | ATE<br>ATE |  |  |  |                          |
|                  | E 200 CGI        | 135   | 09.09   |   | 13.0470-7244.2 | LD7244 |   |  |  |            |  |  |  |                          |
|                  | E 220 BlueTec    | 130   | 05.14   |   | 24.8190-0410.2 | 620410 |   |  |  |            |  |  |  |                          |
|                  | E 220 CDI        | 120   | 07.14   |   |                |        |   |  |  |            |  |  |  |                          |
|                  | E 220 CDI        | 125   | 05.09   |   |                |        |   |  |  |            |  |  |  |                          |
|                  | E 250            | 155   | 03.13   |   |                |        |   |  |  |            |  |  |  |                          |
|                  | E 250 CDI        | 150   | 05.09   |   |                |        |   |  |  |            |  |  |  |                          |
|                  | E 250 CGI        | 150   | 05.09   |   |                |        |   |  |  |            |  |  |  |                          |
|                  | E 320            | 200   | 07.14   |   |                |        |   |  |  |            |  |  |  |                          |
|                  | E 350 4-matic BE | 225   | 02.13   |   |                |        |   |  |  |            |  |  |  |                          |
|                  | E 350 BlueTec    | 185   | 01.13   |   |                |        |   |  |  |            |  |  |  |                          |
|                  | E 350 BlueTec    | 190   | 05.14   |   |                |        |   |  |  |            |  |  |  |                          |
|                  | E 400            | 245   | 07.14   |   |                |        |   |  |  |            |  |  |  |                          |
|                  | E 400            | 245   | 03.13   |   |                |        |   |  |  |            |  |  |  |                          |
|                  | E 300 CGI        | 185   | 04.11   |   | 13.0460-7257.2 | 607257 |   |  |  |            |  |  | 24253 18,0 +/-WE<br>24253 18,0 +/-WE<br>24253 17,8 +/-WE<br>24253 17,8 +/-WE<br>Warnkontakt L=97,5mm | ATE<br>ATE<br>ATE<br>ATE |
|                  | E 350            | 225   | 09.09   |   | 13.0470-7257.2 | LD7257 |   |  |  |            |  |  |  |                          |
|                  | E 350 CDI        | 170   | 05.09   |   | 13.0460-7244.2 | 607244 |   |  |  |            |  |  |  |                          |
| E 350 CDI        | 195              | 04.11 |   | 13.0470-7244.2                                | LD7244         |        |   |  |  |            |  |  |  |                          |
| E 350 CGI        | 215              | 05.09 |   | 24.8190-0410.2                                | 620410         |        |   |  |  |            |  |  |  |                          |
| E 500            | 285              | 05.09 |   |   |                |        |   |  |  |            |  |  |  |                          |
| E 500            | 300              | 06.13 |   |   |                |        |   |  |  |            |  |  |  |                          |
| E 550 CGI        | 300              | 09.11 |   |   |                |        |   |  |  |            |  |  |  |                          |
|                  | E 200            | 135   | 03.13   |   | 24.0110-0328.1 | 410328 |   |  | 300 10,0 8,3 +S +B<br>300 10,0 8,3 +S +B PD                      |            |  |  |  |                          |
|                  | E 200 CGI        | 135   | 09.09   |   | 24.0310-0328.1 | 510328 |   |  |  |            |  |  |  |                          |
|                  | E 220 BlueTec    | 130   | 05.14   |   |                |        |   |  |  |            |  |  |  |                          |
|                  | E 220 CDI        | 120   | 07.14   |   |                |        |   |  |  |            |  |  |  |                          |
|                  | E 220 CDI        | 125   | 05.09   |   |                |        |   |  |  |            |  |  |  |                          |
| E 250            | 155              | 03.13 |   |   |                |        |   |  |  |            |  |  |  |                          |











<sup>1)</sup> + sports package/+ sports package AMG / + pacchetto sportivo/+ pacchetto sport.AMG / + version sport/+ version sport AMG / + kit deportivo/+ kit deportivo AMG



<sup>2)</sup> - sport package/- sport package AMG / - pacchetto sportivo/- pacchetto sport.AMG / - version sport/- version sport AMG / - kit deportivo/- kit deportivo AMG

<sup>3)</sup> + cast iron caliper / + pinza in ghisa / + étriers en fonte grise / + fundición gris-pinza

<sup>4)</sup> + aluminium calipers / + pinze in alluminio / + étriers en aluminium / + pinzas de aluminio



|   |  |  |  |  |  |  |  |  |
|--|--|--|--|--|---|--|--|--|
| <b>MERCEDES BENZ E-Klasse (C207) Coupe (09-)</b>                                 |  |  |  |  |   |  |  |  |
|  | E 250 CDI  | 150  | 05.09  |  | 24.0110-0328.1  | 410328   |  | 300 10,0 8,3 +S +B   |
|  | E 250 CGI  | 150  | 05.09  |  | 24.0310-0328.1  | 510328   |  | 300 10,0 8,3 +S +B PD  |
|  | E 300 CGI  | 185  | 04.11  |  | 24.0120-0208.1  | 420208   |  | 300 22,0 19,4 V L +S +B  |
|  | E 320  | 200  | 07.14  |  |   |  |  |  |
|  | E 350  | 225  | 09.09  |  |   |  |  |  |
|  | E 350 4-matic BE   | 225  | 02.13  |  |   |  |  |  |
|  | E 350 BlueTec  | 185  | 01.13  |  |   |  |  |  |
|  | E 350 BlueTec  | 190  | 05.14  |  |   |  |  |  |
|  | E 350 CDI  | 170  | 05.09  |  |   |  |  |  |
|  | E 350 CDI  | 195  | 04.11  |  |   |  |  |  |
|  | E 350 CGI  | 215  | 05.09  |  |   |  |  |  |
|  | E 400  | 245  | 07.14  |  |   |  |  |  |
|  | E 400  | 245  | 03.13  |  |   |  |  |  |
|  | E 500  | 285  | 05.09  |  |   |  |  |  |
|  | E 500  | 300  | 06.13  |  |   |  |  |  |
| E 550 CGI  | 300  | 09.11  |  |  |   |  |  |  |
|  | E 200  | 135  | 03.13  |  | 03.0137-4005.2  | 654005   |  | 164 x 25 /Zub  |
|  | E 200 CGI  | 135  | 09.09  |  |   |  |  |  |
|  | E 220 BlueTec  | 130  | 05.14  |  |   |  |  |  |
|  | E 220 CDI  | 120  | 07.14  |  |   |  |  |  |
|  | E 220 CDI  | 125  | 05.09  |  |   |  |  |  |
|  | E 250  | 155  | 03.13  |  |   |  |  |  |
|  | E 250 CDI  | 150  | 05.09  |  |   |  |  |  |
|  | E 250 CGI  | 150  | 05.09  |  |   |  |  |  |
|  | E 300 CGI  | 185  | 04.11  |  |   |  |  |  |
|  | E 320  | 200  | 07.14  |  |   |  |  |  |
|  | E 350  | 225  | 09.09  |  |   |  |  |  |
|  | E 350 4-matic BE   | 225  | 02.13  |  |   |  |  |  |
|  | E 350 BlueTec  | 185  | 01.13  |  |   |  |  |  |
|  | E 350 BlueTec  | 190  | 05.14  |  |   |  |  |  |
|  | E 350 CDI  | 170  | 05.09  |  |   |  |  |  |
|  | E 350 CDI  | 195  | 04.11  |  |   |  |  |  |
|  | E 350 CGI  | 215  | 05.09  |  |   |  |  |  |
|  | E 400  | 245  | 07.14  |  |   |  |  |  |
|  | E 400  | 245  | 03.13  |  |   |  |  |  |
|  | E 500  | 285  | 05.09  |  |   |  |  |  |
|  | E 500  | 300  | 06.13  |  |   |  |  |  |
| E 550 CGI  | 300  | 09.11  |  |  |   |  |  |  |

| <b>MERCEDES BENZ E-Klasse (A207) Cabrio (10-)</b>                                  |               |       |   |   |                |        |                       |                            |
|--|---------------|-------|---|---|----------------|--------|-----------------------|----------------------------|
|  | E 200         | 135   | 03.13   | - Sportpaket / - Sportpaket AMG <sup>1)</sup> | 13.0460-2732.2 | 602732 |                       | 24306 20,3 /WE/Zub/S TRW   |
|  | E 200 CGI     | 135   | 03.10   | - Sportpaket / - Sportpaket AMG <sup>1)</sup> | 13.0470-2732.2 | LD2732 |                       | 24306 20,3 /WE/Zub/S TRW   |
|  | E 220 BlueTec | 130   | 05.14   | - Sportpaket / - Sportpaket AMG <sup>1)</sup> | 24.8190-0410.2 | 620410 | 2                     | Warnkontakt L=97,5mm       |
|  | E 220 CDI     | 125   | 03.10   | - Sportpaket / - Sportpaket AMG <sup>1)</sup> |                |        |                       |                            |
|  | E 250 CGI     | 150   | 03.10   | - Sportpaket / - Sportpaket AMG <sup>1)</sup> |                |        |                       |                            |
|  | E 200         | 135   | 03.13   | + Sportpaket / + Sportpaket AMG <sup>2)</sup> | 13.0460-2734.2 | 602734 |                       | 24310 19,0 +/WE/S TRW      |
|  | E 200 CGI     | 135   | 03.10   | + Sportpaket / + Sportpaket AMG <sup>2)</sup> | 13.0470-2734.2 | LD2734 |                       | 24310 19,0 +/WE/S TRW      |
|  | E 220 BlueTec | 130   | 05.14   | + Sportpaket / + Sportpaket AMG <sup>2)</sup> | 24.8190-0410.2 | 620410 | 2                     | Warnkontakt L=97,5mm       |
|  | E 220 CDI     | 125   | 03.10   | + Sportpaket / + Sportpaket AMG <sup>2)</sup> |                |        |                       |                            |
|  | E 250         | 155   | 03.13   |   |                |        |                       |                            |
|  | E 250 CDI     | 150   | 03.10   |   |                |        |                       |                            |
|  | E 250 CGI     | 150   | 03.10   | + Sportpaket / + Sportpaket AMG <sup>2)</sup> |                |        |                       |                            |
|  | E 300 CGI     | 185   | 03.10   |   |                |        |                       |                            |
|  | E 320         | 200   | 07.14   |   |                |        |                       |                            |
|  | E 350         | 225   | 04.11   |   |                |        |                       |                            |
| E 350 BlueTec  | 185           | 01.13 |   |   |                |        |                       |                            |
| E 350 BlueTec  | 190           | 05.14 |   |   |                |        |                       |                            |
| E 350 CDI  | 170           | 03.10 |   |   |                |        |                       |                            |
| E 350 CDI  | 195           | 04.11 |   |   |                |        |                       |                            |
| E 350 CGI  | 215           | 03.10 |   |   |                |        |                       |                            |
| E 400  | 245           | 07.14 |   | 13.0460-2734.2                                | 602734         |        | 24310 19,0 +/WE/S TRW |                            |
| E 400  | 245           | 03.13 |   | 24.8190-0410.2                                | 620410         | 2      | Warnkontakt L=97,5mm  |                            |
| E 500  | 285           | 03.10 |   |   |                |        |                       |                            |
| E 500  | 300           | 06.13 |   | 24.8190-0410.2                                | 620410         | 1      | Warnkontakt L=97,5mm  |                            |
| E 550 CGI  | 300           | 09.11 |   |   |                |        |                       |                            |
|  | E 200         | 135   | 03.13   | - Sportpaket / - Sportpaket AMG <sup>1)</sup> | 24.0132-0101.1 | 432101 |                       | 322 32,0 29,4 V L +S +B    |
|  | E 250         | 155   | 03.13   | - Sportpaket / - Sportpaket AMG <sup>1)</sup> | 24.0332-0101.1 | 532101 |                       | 322 32,0 29,4 V L +S +B PD |
|  | E 250 CDI     | 150   | 03.10   | - Sportpaket / - Sportpaket AMG <sup>1)</sup> |                |        |                       |                            |
|  | E 300 CGI     | 185   | 03.10   | - Sportpaket / - Sportpaket AMG <sup>1)</sup> |                |        |                       |                            |
|  | E 350         | 225   | 04.11   | - Sportpaket / - Sportpaket AMG <sup>1)</sup> |                |        |                       |                            |
|  | E 350 BlueTec | 185   | 03.10   | - Sportpaket / - Sportpaket AMG <sup>1)</sup> |                |        |                       |                            |
|  | E 350 BlueTec | 190   | 05.14   | - Sportpaket / - Sportpaket AMG <sup>1)</sup> |                |        |                       |                            |
|  | E 350 CDI     | 170   | 03.10   | - Sportpaket / - Sportpaket AMG <sup>1)</sup> |                |        |                       |                            |
|  | E 350 CDI     | 195   | 04.11   | - Sportpaket / - Sportpaket AMG <sup>1)</sup> |                |        |                       |                            |
|  | E 350 CGI     | 215   | 03.10   | - Sportpaket / - Sportpaket AMG <sup>1)</sup> |                |        |                       |                            |
|  | E 200         | 135   | 03.13   | + Sportpaket / + Sportpaket AMG <sup>2)</sup> | 24.0132-0100.1 | 432100 |                       | 322 32,0 30,0 V L +S +B    |
|  | E 220 BlueTec | 130   | 05.14   | + Sportpaket / + Sportpaket AMG <sup>2)</sup> |                |        |                       |                            |
|  | E 220 CDI     | 125   | 03.10   | + Sportpaket / + Sportpaket AMG <sup>2)</sup> |                |        |                       |                            |
|  | E 250         | 155   | 03.13   | + Sportpaket / + Sportpaket AMG <sup>2)</sup> |                |        |                       |                            |
|  | E 250 CDI     | 150   | 03.10   | + Sportpaket / + Sportpaket AMG <sup>2)</sup> |                |        |                       |                            |
| E 300 CGI  | 185           | 03.10 | + Sportpaket / + Sportpaket AMG <sup>2)</sup> |   |                |        |                       |                            |
| E 320  | 200           | 07.14 | + Sportpaket / + Sportpaket AMG <sup>2)</sup> |   |                |        |                       |                            |
| E 350  | 225           | 04.11 | + Sportpaket / + Sportpaket AMG <sup>2)</sup> |   |                |        |                       |                            |
| E 350 BlueTec  | 185           | 01.13 | + Sportpaket / + Sportpaket AMG <sup>2)</sup> |   |                |        |                       |                            |
| E 350 BlueTec  | 190           | 05.14 | + Sportpaket / + Sportpaket AMG <sup>2)</sup> |   |                |        |                       |                            |
| E 350 CDI  | 170           | 03.10 | + Sportpaket / + Sportpaket AMG <sup>2)</sup> |   |                |        |                       |                            |

<sup>1)</sup> - sport package/- sport package AMG / - pacchetto sportivo/- pacchetto sport.AMG / - version sport/- version sport AMG / - kit deportivo/- kit deportivo AMG  
<sup>2)</sup> + sports package/+ sports package AMG / + pacchetto sportivo/+ pacchetto sport.AMG / + version sport/+ version sport AMG / + kit deportivo/+ kit deportivo AMG





**MERCEDES BENZ E-Klasse (A207) Cabrio (10-)**

|               |               |     |       |       |   |                |        |                         |  |
|---------------|---------------|-----|-------|-------|---|----------------|--------|-------------------------|--|
|               | E 350 CDI     | 195 |       | 04.11 | + Sportpaket / + Sportpaket AMG <sup>1)</sup> | 24.0132-0100.1 | 432100 |                         | 322 32,0 30,0 V L +S +B                                    |
|               | E 350 CGI     | 215 |       | 03.10 | + Sportpaket / + Sportpaket AMG <sup>1)</sup> |                |        |                         |  |
|               | E 200 CGI     | 135 |       | 03.10 |   | 24.0128-0155.1 | 428155 |                         | 295 28,0 25,4 V L +S +B                                    |
|               | E 220 BlueTec | 130 |       | 05.14 | - Sportpaket / - Sportpaket AMG <sup>2)</sup> |                |        |                         |  |
|               | E 220 CDI     | 125 |       | 03.10 | - Sportpaket / - Sportpaket AMG <sup>2)</sup> |                |        |                         |  |
|               | E 250 CGI     | 150 |       | 03.10 |   |                |        |                         |  |
|               | E 320         | 200 |       | 07.14 | - Sportpaket / - Sportpaket AMG <sup>2)</sup> | 24.0132-0168.1 | 432168 |                         | 344 32,0 30,0 V L +S +B                                    |
|               | E 400         | 245 |       | 07.14 |   |                |        |                         |  |
| E 400         | 245           |     | 03.13 |       |   |                |        |                         |  |
| E 500         | 285           |     | 03.10 |       |   |                |        |                         |  |
| E 500         | 300           |     | 06.13 |       | 24.0136-0108.1                                | 436108         |        | 360 36,0 34,0 V L +S +B |  |
| E 550 CGI     | 300           |     | 09.11 |       |   |                |        |                         |  |
|               | E 200         | 135 |       | 03.13 |   | 13.0460-7244.2 | 607244 | 1                       | 24253 17,8 +/WE<br>24253 17,8 +/WE<br>Warnkontakt L=97,5mm |
|               | E 200 CGI     | 135 |       | 03.10 |   | 13.0470-7244.2 | LD7244 |                         |  |
|               | E 220 BlueTec | 130 |       | 05.14 |   | 24.8190-0410.2 | 620410 |                         |  |
|               | E 220 CDI     | 125 |       | 03.10 |   |                |        |                         |  |
|               | E 250         | 155 |       | 03.13 |   |                |        |                         |  |
|               | E 250 CDI     | 150 |       | 03.10 |   |                |        |                         |  |
|               | E 250 CGI     | 150 |       | 03.10 |   |                |        |                         |  |
|               | E 300 CGI     | 185 |       | 03.10 |   |                |        |                         |  |
|               | E 320         | 200 |       | 07.14 |   |                |        |                         |  |
|               | E 350 BlueTec | 185 |       | 01.13 |   |                |        |                         |  |
|               | E 350 BlueTec | 190 |       | 05.14 |   |                |        |                         |  |
|               | E 400         | 245 |       | 07.14 |   |                |        |                         |  |
|               | E 400         | 245 |       | 03.13 |   |                |        |                         |  |
|               | E 350         | 225 |       | 04.11 |   | 13.0460-7257.2 | 607257 |                         |  |
|               | E 350 CDI     | 170 |       | 03.10 |   | 13.0470-7257.2 | LD7257 |                         |  |
|               | E 350 CDI     | 195 |       | 04.11 |   | 13.0460-7244.2 | 607244 |                         |  |
| E 350 CGI     | 215           |     | 03.10 |       | 13.0470-7244.2                                | LD7244         |        |                         |  |
| E 500         | 285           |     | 03.10 |       | 24.8190-0410.2                                | 620410         |        |                         |  |
| E 500         | 300           |     | 06.13 |       |   |                |        |                         |  |
| E 550 CGI     | 300           |     | 09.11 |       |   |                |        |                         |  |
|               | E 200         | 135 |       | 03.13 |   | 24.0110-0328.1 | 410328 |                         | 300 10,0 8,3 +S +B   |
|               | E 200 CGI     | 135 |       | 03.10 |   | 24.0310-0328.1 | 510328 |                         | 300 10,0 8,3 +S +B PD                                      |
|               | E 220 BlueTec | 130 |       | 05.14 |   |                |        |                         |  |
|               | E 220 CDI     | 125 |       | 03.10 |   |                |        |                         |  |
|               | E 250         | 155 |       | 03.13 |   |                |        |                         |  |
|               | E 250 CDI     | 150 |       | 03.10 |   |                |        |                         |  |
|               | E 250 CGI     | 150 |       | 03.10 |   |                |        |                         |  |
|               | E 300 CGI     | 185 |       | 03.10 |   | 24.0120-0208.1 | 420208 |                         | 300 22,0 19,4 V L +S +B                                    |
|               | E 320         | 200 |       | 07.14 |   |                |        |                         |  |
|               | E 350         | 225 |       | 04.11 |   |                |        |                         |  |
| E 350 BlueTec | 185           |     | 01.13 |       |   |                |        |                         |  |
| E 350 BlueTec | 190           |     | 05.14 |       |   |                |        |                         |  |
| E 350 CDI     | 170           |     | 03.10 |       |   |                |        |                         |  |
| E 350 CDI     | 195           |     | 04.11 |       |   |                |        |                         |  |
| E 350 CGI     | 215           |     | 03.10 |       |   |                |        |                         |  |
| E 400         | 245           |     | 07.14 |       |   |                |        |                         |  |
| E 400         | 245           |     | 03.13 |       |   |                |        |                         |  |
| E 500         | 285           |     | 03.10 |       |   |                |        |                         |  |
| E 500         | 300           |     | 06.13 |       |   |                |        |                         |  |
| E 550 CGI     | 300           |     | 09.11 |       |   |                |        |                         |  |
|               | E 200         | 135 |       | 03.13 |   | 03.0137-4005.2 | 654005 |                         | 164 x 25 /Zub  |
|               | E 200 CGI     | 135 |       | 03.10 |   |                |        |                         |  |
|               | E 220 BlueTec | 130 |       | 05.14 |   |                |        |                         |  |
|               | E 220 CDI     | 125 |       | 03.10 |   |                |        |                         |  |
|               | E 250         | 155 |       | 03.13 |   |                |        |                         |  |
|               | E 250 CDI     | 150 |       | 03.10 |   |                |        |                         |  |
|               | E 250 CGI     | 150 |       | 03.10 |   |                |        |                         |  |
|               | E 300 CGI     | 185 |       | 03.10 |   |                |        |                         |  |
|               | E 320         | 200 |       | 07.14 |   |                |        |                         |  |
|               | E 350         | 225 |       | 04.11 |   |                |        |                         |  |
|               | E 350 BlueTec | 185 |       | 01.13 |   |                |        |                         |  |
|               | E 350 BlueTec | 190 |       | 05.14 |   |                |        |                         |  |
|               | E 350 CDI     | 170 |       | 03.10 |   |                |        |                         |  |
|               | E 350 CDI     | 195 |       | 04.11 |   |                |        |                         |  |
|               | E 350 CGI     | 215 |       | 03.10 |   |                |        |                         |  |
|               | E 400         | 245 |       | 07.14 |   |                |        |                         |  |
| E 400         | 245           |     | 03.13 |       |   |                |        |                         |  |
| E 500         | 285           |     | 03.10 |       |   |                |        |                         |  |
| E 500         | 300           |     | 06.13 |       |   |                |        |                         |  |
| E 550 CGI     | 300           |     | 09.11 |       |   |                |        |                         |  |

**MERCEDES BENZ E-Klasse (W213) Limousine (16-)**

|  |         |     |  |       |  |                |        |   |  |                      |     |
|--|---------|-----|--|-------|--|----------------|--------|---|--|----------------------|-----|
|  | E 200   | 135 |  | 01.16 |  | 13.0460-2792.2 | 602792 | 1 | - AMG Sportpaket <sup>5)</sup><br>- AMG Sportpaket <sup>5)</sup> | XXXXX 19,6 +/WE/S    | TRW |
|  | E 220 d | 120 |  | 01.16 |  | 13.0470-2792.2 | LD2792 |   |  | XXXXX 19,6 +/WE/S    | TRW |
|  | E 220 d | 143 |  | 01.16 |  | 24.8190-0067.2 | 620067 |   |  | Warnkontakt L=92,5mm |     |
|  | E 350 d | 190 |  | 01.16 |  | 24.8190-0067.2 | 620067 | 1 |  | Warnkontakt L=92,5mm |     |
|  | E 200   | 135 |  | 01.16 |  | 24.8190-0067.2 | 620067 | 1 |  | Warnkontakt L=92,5mm |     |
|  | E 220 d | 120 |  | 01.16 |  |                |        |   |  |                      |     |
|  | E 220 d | 143 |  | 01.16 |  |                |        |   |  |                      |     |
|  | E 350 d | 190 |  | 01.16 |  | 24.8190-0067.2 | 620067 | 1 |  | Warnkontakt L=92,5mm |     |





















<sup>1)</sup> + sports package/+ sports package AMG / + pacchetto sportivo/+ pacchetto sport.AMG / + version sport/+ version sport AMG / + kit deportivo/+ kit deportivo AMG

<sup>2)</sup> - sport package/- sport package AMG / - pacchetto sportivo/- pacchetto sport.AMG / - version sport/- version sport AMG / - kit deportivo/- kit deportivo AMG

<sup>3)</sup> + cast iron caliper / + pinza in ghisa / + étriers en fonte grise / + fundición gris-pinza

<sup>4)</sup> + aluminium calipers / + pinze in alluminio / + étriers en aluminium / + pinzas de aluminio

















<sup>5)</sup> - AMG sports package / - kit sportivo AMG / - version sport AMG / - paquete deportivo AMG









|     |  |  |  |  |  |  |  |  |  |            |
|--|--|--|--|--|---|--|--|--|--|------------|
| <b>MERCEDES BENZ E-Klasse (S213) Kombi (16-)</b>                                   |  |  |  |  |   |  |  |  |  |            |
|    | E 200  | 135  | 07.16  |  | 13.0460-2792.2  | 602792   | - AMG Sportpaket <sup>1)</sup><br>- AMG Sportpaket <sup>1)</sup>                   | XXXXX 19,6 +WE/S<br>XXXXX 19,6 +WE/S<br>Warnkontakt L=92,5mm                       | TRW<br>TRW   |            |
|  | E 220 d  | 143  | 07.16  |  | 13.0470-2792.2  | LD2792   |  |  |  |            |
|  | E 250  | 155  | 07.16  |  | 24.8190-0067.2  | 620067   | 1  | Warnkontakt L=92,5mm   |  |            |
|    | E 200  | 135  | 07.16  |  | 24.8190-0067.2  | 620067   | 1  | Warnkontakt L=92,5mm   |  |            |
|  | E 220 d  | 143  | 07.16  |  | 24.8190-0067.2  | 620067   | 1  | Warnkontakt L=92,5mm   |  |            |
|  | E 250  | 155  | 07.16  |  |   |  |  |  |  |            |
| <b>MERCEDES BENZ G-Klasse (W463) (90-)</b>   |  |  |  |  |   |  |  |  |  |            |
|    | 200 GE   | 85   | 01.90  |  | 13.0460-4401.2  | 604401   | - belüftete Scheiben <sup>2)</sup><br>+ belüftete Scheiben <sup>3)</sup>           | 20784 18,0 /WE<br>Belagsatz-Zubehör<br>Warnkontakt L=261mm<br>Warnkontakt L=72mm   | ATE<br>ATE   |            |
|  | 230 GE   |  | 06.90  |  | 13.0460-0158.2  | 610158   |  |  |  |            |
|  | 250 GD   |  | 06.90  |  | 24.8190-0406.2  | 620406   |  |  |  |            |
|  | 300 GD   |  | 09.89  |  | 24.8190-0411.2  | 620411   |  |  |  |            |
|  | 300 GE   |  | 06.90  |  |   |  |  |  |  |            |
|  | 350 G Turbo  |  | 09.91  |  |   |  |  |  |  |            |
|  | G 270 CDI  |  | 10.01  |  |   |  |  |  |  |            |
|  | G 300 TD   |  | 08.96  |  |   |  |  |  |  |            |
|  | G 320  |  | 09.94  |  |   |  |  |  |  |            |
|  | G 36 AMG   |  | 01.95  |  |   |  |  |  |  |            |
|  | G 400 CDI  |  | 12.00  |  |   |  |  |  |  |            |
|  | G 500  |  | 04.98  |  |   |  |  |  |  |            |
|  | G 500 E  |  | 09.93  |  |   |  |  |  |  |            |
|  | G 55 AMG   |  | 04.99  |  |   |  |  |  |  |            |
|    | G 320 CDI  | 180  | 09.06  |  | 13.0460-4401.2  | 604401   | 2  | 20784 18,0 /WE<br>Warnkontakt L=261mm  | ATE  |            |
|  | G 350 CDI BlueTec  |  | 06.10  |  | 24.8190-0406.2  | 620406   |  |  |  |            |
|  | G 350 d  |  | 06.15  |  |   |  |  |  |  |            |
|  | G 500  |  | 05.08  |  |   |  |  |  |  |            |
|    | 200 GE   | 85   | 01.90  |  | 24.0116-0133.1  | 416133   | - belüftete Scheiben <sup>2)</sup><br>+ belüftete Scheiben <sup>3)</sup>           | 303 16,0 13,0 +S +B<br>315 30,0 27,4 V L +S +B                                     |  |            |
|  | 230 GE   |  | 06.90  |  | 24.0130-0217.1  | 430217   |  |  |  |            |
|  | 250 GD   |  | 06.90  |  |   |  |  |  |  |            |
|  | 300 GD   |  | 09.89  |  |   |  |  |  |  |            |
|  | 300 GE   |  | 06.90  |  |   |  |  |  |  |            |
|  | 350 G Turbo  |  | 09.91  |  |   |  |  |  |  |            |
|  | G 270 CDI  |  | 10.01  |  |   |  |  |  |  |            |
|  | G 300 TD   |  | 08.96  |  |   |  |  |  |  |            |
|  | G 320  |  | 09.94  |  |   |  |  |  |  |            |
|  | G 36 AMG   |  | 01.95  |  |   |  |  |  |  |            |
|  | G 400 CDI  |  | 12.00  |  |   |  |  |  |  |            |
|  | G 500  |  | 04.98  |  |   |  |  |  |  |            |
|  | G 500 E  |  | 09.93  |  |   |  |  |  |  |            |
|  | G 55 AMG   |  | 04.99  |  |   |  |  |  |  |            |
|  | G 320 CDI  | 180  | 09.06  |  | 24.0116-0133.1  | 416133   | 2  | 303 16,0 13,0 +S +B<br>315 30,0 27,4 V L +S +B                                     |  |            |
|  | G 350 CDI BlueTec  |  | 06.10  |  | 24.0130-0217.1  | 430217   |  |  |  |            |
|  | G 350 d  |  | 06.15  |  |   |  |  |  |  |            |
|  | G 500  |  | 05.08  |  |   |  |  |  |  |            |
|  | G 320 CDI  | 285  | 09.06  |  | 13.0460-3990.2  | 603990   | 2  | 23021 18,9 /WE<br>Warnkontakt L=84(185)mm  | BOS  |            |
|  | G 350 CDI BlueTec  |  | 06.10  |  | 24.8190-0407.2  | 620407   |  |  |  |            |
|  | G 350 d  |  | 06.15  |  |   |  |  |  |  |            |
|  | G 500  |  | 05.08  |  |   |  |  |  |  |            |
|  | G 65 AMG   | 450  | 06.12  |  | 13.0460-7219.2  | 607219   | 2  | 23923 17,6 +WE<br>Warnkontakt L=98mm   | ATE  |            |
|  |  |  |  |  | 24.8190-0425.2  | 620425   |  |  |  |            |
|  |  |  |  |  | 24.0116-0110.1  | 416110   |  |  |  |            |
|  |  |  |  |  | 24.0130-0217.1  | 430217   |  |  |  |            |
|  | 200 GE   | 85   | 01.90  |  | 24.0226-0001.1  | 480050   |  | 260/261,5 x 63,5   |  |            |
|  | 230 GE   |  | 06.90  |  |   |  |  |  |  |            |
|  | 250 GD   |  | 06.90  |  |   |  |  |  |  |            |
|  | 300 GD   |  | 09.89  |  |   |  |  |  |  |            |
|  | 300 GE   |  | 06.90  |  |   |  |  |  |  |            |
|  | 350 G Turbo  |  | 09.91  |  |   |  |  |  |  |            |
|  | G 270 CDI  |  | 10.01  |  |   |  |  |  |  |            |
|  | G 300 TD   |  | 08.96  |  |   |  |  |  |  |            |
|  | G 320  |  | 09.94  |  |   |  |  |  |  |            |
|  | G 36 AMG   |  | 01.95  |  |   |  |  |  |  |            |
|  | G 400 CDI  |  | 12.00  |  |   |  |  |  |  |            |
|  | G 500  |  | 04.98  |  |   |  |  |  |  |            |
|  | G 500 E  |  | 09.93  |  |   |  |  |  |  |            |
|  | G 55 AMG   |  | 04.99  |  |   |  |  |  |  |            |
|  | G 320 CDI  | 180  | 09.06  |  | 03.0137-4001.2  | 654001   |  | 160 x 40 /Zub  |  |            |
|  | G 350 d  |  | 06.15  |  |   |  |  |  |  |            |
|  | G 400 CDI  |  | 12.00  |  |   |  |  |  |  |            |
|  | G 500  |  | 04.98  |  |   |  |  |  |  |            |
|  | G 500  |  | 05.08  | 285  |   |  |  |  |  |            |
|  | G 55 AMG   |  | 04.99  |  |   |  |  |  |  |            |
|  | G 65 AMG   | 450  | 06.12  |  |   |  |  |  |  |            |
|  |  |  |  |  |   |  |  |  |  |            |
|  |  |  |  |  |   |  |  |  |  |            |
|  |  |  |  |  |   |  |  |  |  |            |
|  |  |  |  |  |   |  |  |  |  |            |
|  |  |  |  |  |   |  |  |  |  |            |
| <b>MERCEDES BENZ G-Klasse (W463) Cabrio (90-)</b>                                  |  |  |  |  |   |  |  |  |  |            |
|  | 200 GE   |  | 01.90  |  | 13.0460-4401.2  | 604401   | 2  | - belüftete Scheiben <sup>2)</sup><br>- belüftete Scheiben <sup>2)</sup>           | 20784 18,0 /WE<br>Belagsatz-Zubehör<br>Warnkontakt L=261mm | ATE<br>ATE |
|  | 230 GE   |  | 06.90  |  | 13.0460-0158.2  | 610158   |  |  |  |            |
|  | 300 GD   |  | 12.90  |  | 24.8190-0406.2  | 620406   |  |  |  |            |
|  | 300 GE   |  | 09.89  |  |   |  |  |  |  |            |
|  | 320 GE   |  | 09.94  |  |   |  |  |  |  |            |
|  | 350 G Turbo  |  | 09.91  |  |   |  |  |  |  |            |
|  | G 300 TD   |  | 09.96  |  |   |  |  |  |  |            |

<sup>1)</sup> - AMG sports package / - kit sportivo AMG / - version sport AMG / - paquete deportivo AMG























<sup>2)</sup> - ventilated discs / - dischi ventilati / - disques ventilés / - disco ventilado

<sup>3)</sup> + ventilated discs / + dischi ventilati / + disques ventilés / + disco ventilado

|   |  |  |  |  |  |  |  |  |  |            |
|--|--|--|--|--|---|--|--|--|--|------------|
| <b>MERCEDES BENZ G-Klasse (W463) Cabrio (90-)</b>                                |  |  |  |  |   |  |  |  |  |            |
|  | G 320  |  | 11.97  |  | 13.0460-4401.2  | 604401   |  | - belüftete Scheiben <sup>1)</sup><br>- belüftete Scheiben <sup>1)</sup>           | 20784 18,0 /WE<br>Belagsatz-Zubehör<br>Warnkontakt L=261mm | ATE<br>ATE |
|  | G 400 CDI  |  | 12.00  |  | 13.0460-0158.2  | 610158   |  |  |  |            |
|  | G 500  |  | 04.98  |  | 24.8190-0406.2  | 620406   | 2  |  |  |            |
|  | G 320 CDI  |  | 06.10  |  | 13.0460-4401.2  | 604401   |  |  | 20784 18,0 /WE<br>Warnkontakt L=261mm                      | ATE        |
|  | G 350 CDI BlueTec  |  | 06.10  |  | 24.8190-0406.2  | 620406   | 2  |  |  |            |
|  | 200 GE   |  | 01.90  |  | 24.0116-0133.1  | 416133   |  | - belüftete Scheiben <sup>1)</sup><br>+ belüftete Scheiben <sup>2)</sup>           | 303 16,0 13,0 +S +B<br>315 30,0 27,4 V L +S +B             |            |
|  | 230 GE   |  | 06.90  |  | 24.0130-0217.1  | 430217   |  |  |  |            |
|  | 300 GD   |  | 12.90  |  |   |  |  |  |  |            |
|  | 300 GE   |  | 09.89  |  |   |  |  |  |  |            |
|  | 320 GE   |  | 09.94  |  |   |  |  |  |  |            |
|  | 350 G Turbo  |  | 09.91  |  |   |  |  |  |  |            |
|  | G 300 TD   |  | 09.96  |  |   |  |  |  |  |            |
|  | G 320  |  | 11.97  |  |   |  |  |  |  |            |
|  | G 400 CDI  |  | 12.00  |  |   |  |  |  |  |            |
|  | G 500  |  | 04.98  |  |   |  |  |  |  |            |
|  | G 320 CDI  |  | 09.06  |  | 24.0116-0133.1  | 416133   |  |  |  |            |
| G 350 CDI BlueTec  |  | 06.10  |  | 24.0130-0217.1   | 430217  |  |  | 315 30,0 27,4 V L +S +B  |  |            |
|  | G 320 CDI  |  | 09.06  |  | 13.0460-3990.2  | 603990   |  |  | 23021 18,9 /WE<br>Warnkontakt L=84(185)mm                  | BOS        |
|  | G 350 CDI BlueTec  |  | 06.10  |  | 24.8190-0407.2  | 620407   | 2  |  |  |            |
|  | G 320 CDI  |  | 09.06  |  | 24.0116-0110.1  | 416110   |  |  | 272 16,0 14,0 L +S +B                                      |            |
|  | G 350 CDI BlueTec  |  | 06.10  |  |   |  |  |  |  |            |
|  | 200 GE   |  | 01.90  |  | 24.0226-0001.1  | 480050   |  |  | 260/261,5 x 63,5   |            |
|  | 230 GE   |  | 06.90  |  |   |  |  |  |  |            |
|  | 300 GD   |  | 12.90  |  |   |  |  |  |  |            |
|  | 300 GE   |  | 09.89  |  |   |  |  |  |  |            |
|  | 320 GE   |  | 09.94  |  |   |  |  |  |  |            |
|  | 350 G Turbo  |  | 09.91  |  |   |  |  |  |  |            |
|  | G 300 TD   |  | 09.96  |  |   |  |  |  |  |            |
|  | G 320  |  | 11.97  |  |   |  |  |  |  |            |
|  | G 400 CDI  |  | 12.00  |  |   |  |  |  |  |            |
|  | G 500  |  | 04.98  |  |   |  |  |  |  |            |
|  | G 400 CDI  |  | 12.00  |  | 03.0137-4001.2  | 654001   |  |  | 160 x 40 /Zub  |            |
|  | G 500  |  | 04.98  |  |   |  |  |  |  |            |

| <b>MERCEDES BENZ GL-Klasse (X164) (06-12)</b>                                      |                    |  |       |       |                |        |   |  |  |            |
|--|--------------------|--|-------|-------|----------------|--------|---|--|--|------------|
|   | GL 320 CDI 4-matic |  | 03.06 | 06.12 | 13.0460-7220.2 | 607220 |   | - verstärkte Bremsanlage <sup>3)</sup><br>+ verstärkte Bremsanlage <sup>4)</sup> | 23922 21,0 +/WE<br>24151 21,0 +/WE<br>Warnkontakt L=98mm | ATE<br>ATE |
|  | GL 350 BT 4-matic  |  | 05.09 | 06.12 | 13.0460-7271.2 | 607271 |   |  |  |            |
|  | GL 350 CDI 4-matic |  | 05.09 | 06.12 | 24.8190-0425.2 | 620425 | 1 |  |  |            |
|  | GL 420 CDI 4-matic |  | 03.06 | 06.12 | 13.0460-7271.2 | 607271 |   |  | 24151 21,0 +/WE<br>Warnkontakt L=98mm                    | ATE        |
|  | GL 450 4-matic     |  | 03.06 | 06.12 | 24.8190-0425.2 | 620425 | 1 |  |  |            |
|  | GL 450 CDI 4-matic |  | 05.09 | 06.12 |                |        |   |  |  |            |
|  | GL 500 4-matic     |  | 03.06 | 06.12 |                |        |   |  |  |            |
|  |                    |  | 03.06 | 06.12 |                |        |   |  |  |            |
|  | GL 320 CDI 4-matic |  | 03.06 | 06.12 | 24.0132-0157.1 | 432157 |   | - verstärkte Bremsanlage <sup>3)</sup><br>+ verstärkte Bremsanlage <sup>4)</sup> | 350 32,0 29,4 V L +S +B<br>375 32,0 29,4 V L +S +B       |            |
|  | GL 350 BT 4-matic  |  | 05.09 | 06.12 | 24.0132-0167.1 | 432167 |   |  |  |            |
|  | GL 350 CDI 4-matic |  | 05.09 | 06.12 |                |        |   |  |  |            |
|  | GL 420 CDI 4-matic |  | 03.06 | 06.12 | 24.0132-0167.1 | 432167 |   |  | 375 32,0 29,4 V L +S +B                                  |            |
|  | GL 450 4-matic     |  | 03.06 | 06.12 |                |        |   |  |  |            |
|  | GL 450 CDI 4-matic |  | 05.09 | 06.12 |                |        |   |  |  |            |
|  | GL 500 4-matic     |  | 03.06 | 06.12 |                |        |   |  |  |            |
|  |                    |  | 03.06 | 06.12 |                |        |   |  |  |            |
|  | GL 320 CDI 4-matic |  | 03.06 | 06.12 | 13.0460-7219.2 | 607219 |   |  | 23923 17,6 +/WE<br>23923 17,6 +/WE<br>Warnkontakt L=98mm | ATE<br>ATE |
|  | GL 350 BT 4-matic  |  | 05.09 | 06.12 | 13.0470-7219.2 | LD7219 |   |  |  |            |
|  | GL 350 CDI 4-matic |  | 05.09 | 06.12 | 24.8190-0425.2 | 620425 | 1 |  |  |            |
|  | GL 420 CDI 4-matic |  | 03.06 | 06.12 |                |        |   |  |  |            |
|  | GL 450 4-matic     |  | 03.06 | 06.12 |                |        |   |  |  |            |
|  | GL 450 CDI 4-matic |  | 05.09 | 06.12 |                |        |   |  |  |            |
|  | GL 320 CDI 4-matic |  | 03.06 | 06.12 | 24.0122-0226.1 | 422226 |   |  | 330 22,0 19,4 V L +S +B                                  |            |
|  | GL 350 BT 4-matic  |  | 05.09 | 06.12 |                |        |   |  |  |            |
|  | GL 350 CDI 4-matic |  | 05.09 | 06.12 |                |        |   |  |  |            |
|  | GL 420 CDI 4-matic |  | 03.06 | 06.12 |                |        |   |  |  |            |
|  | GL 450 4-matic     |  | 03.06 | 06.12 |                |        |   |  |  |            |
|  | GL 450 CDI 4-matic |  | 05.09 | 06.12 |                |        |   |  |  |            |
|  | GL 320 CDI 4-matic |  | 03.06 | 06.12 | 24.0711-5412.3 | 360415 | 2 |  | Radsensor L=200  |            |
|  | GL 350 BT 4-matic  |  | 05.09 | 06.12 |                |        |   |  |  |            |
|  | GL 350 CDI 4-matic |  | 05.09 | 06.12 |                |        |   |  |  |            |
|  | GL 420 CDI 4-matic |  | 03.06 | 06.12 |                |        |   |  |  |            |
|  | GL 450 4-matic     |  | 03.06 | 06.12 |                |        |   |  |  |            |
|  | GL 450 CDI 4-matic |  | 05.09 | 06.12 |                |        |   |  |  |            |
|  | GL 320 CDI 4-matic |  | 03.06 | 06.12 | 03.0137-0451.2 | 650451 |   |  | 210 x 30   |            |
|  | GL 350 BT 4-matic  |  | 05.09 | 06.12 |                |        |   |  |  |            |
|  | GL 350 CDI 4-matic |  | 05.09 | 06.12 |                |        |   |  |  |            |
|  | GL 420 CDI 4-matic |  | 03.06 | 06.12 |                |        |   |  |  |            |
|  | GL 450 4-matic     |  | 03.06 | 06.12 |                |        |   |  |  |            |
|  | GL 450 CDI 4-matic |  | 05.09 | 06.12 |                |        |   |  |  |            |



































1) - ventilated discs / - dischi ventilati / - disques ventilés / - disco ventilado  
2) + ventilated discs / + dischi ventilati / + disques ventilés / + disco ventilado  
3) - heavy duty br.system / - sistema di fr.rinforzato / - système de fr.renforcé / - sistema de fr.reforzado  
4) + heavy duty br.system / + sistema fr.rinforzato / + système de fr.renforcé / + sistema de fr.reforzado

|     |  |  |  |  |  |     |       |  |     |
|--|--|--|--|--|---|---|---|--|-----|
| <b>MERCEDES BENZ GL-Klasse / GLS-Klasse (X166) (12-)</b>                           |  |  |  |  |   |   |   |  |     |
|    | GL 500 4-matic   | 320  | 07.12  |  | 13.0460-7283.2  | 607283  |   | 25531 19,3 +/WE  | ATE |
|  | GLS 500 4-matic  | 335  | 11.15  |  | 24.8190-0425.2  | 620425  | 1    | Warnkontakt L=98mm   |     |
|  | GL 63 AMG  |  | 07.12  |  | 13.0460-4839.2  | 604839  |   | 24455 16,8 /WE   | BRE |
|  | GLS 63 AMG 4-matic   | 430  |  | 11.15  | 24.8190-0420.2  | 620420  | 1    | Warnkontakt L=119mm  |     |
|  | GL 350 BT 4-matic  | 190  | 07.12  |  | 13.0460-7282.2  | 607282  |   | 25192 21,3 +/WK  | ATE |
|  | GLS 350 d 4-matic  | 190  | 11.15  |  | 13.0470-7282.2  | LD7282  |   | 25192 21,3 +/WK  | ATE |
|  |  |  |  |  | 13.0460-7283.2  | 607283  |   | 25531 19,3 +/WE  | ATE |
|  |  |  |  |  | 24.8190-0425.2  | 620425  | 1    | Warnkontakt L=98mm   |     |
|  | GL 400 4-matic   | 245  | 08.13  |  | 13.0460-7282.2  | 607282  |   | 25192 21,3 +/WK  | ATE |
|  | GLS 400 4-matic  | 245  | 11.15  |  | 13.0460-7283.2  | 607283  |   | 25531 19,3 +/WE  | ATE |
|  |  |  |  |  | 24.8190-0425.2  | 620425  | 1    | Warnkontakt L=98mm   |     |
|    | GL 350 BT 4-matic  | 190  | 07.12  |  | 13.0460-2782.2  | 602782  |   | 25215 18,6 +/WE/Zub/STRW   |     |
|  | GL 400 4-matic   | 245  | 08.13  |  | 13.0470-2782.2  | LD2782  |   | 25215 18,6 +/WE/Zub/STRW   |     |
|  | GL 500 4-matic   | 320  | 07.12  |  | 24.8190-0410.2  | 620410  | 1   | Warnkontakt L=97,5mm   |     |
|  | GLS 350 d 4-matic  | 190  | 11.15  |  |   |   |   |  |     |
|  | GLS 400 4-matic  | 245  | 11.15  |  |   |   |   |  |     |
|  | GLS 500 4-matic  | 335  | 11.15  |  |   |   |   |  |     |
|  | GL 63 AMG  |  | 07.12  |  | 24.8190-0410.2  | 620410  | 1   | Warnkontakt L=97,5mm   |     |
|  | GLS 63 AMG 4-matic   | 430  | 11.15  |  | 24.8190-0410.2  | 620410  | 1   | Warnkontakt L=97,5mm   |     |
| <b>MERCEDES BENZ GLA-Klasse (X156) (13-)</b>                                       |  |  |  |  |   |   |   |  |     |
|    | GLA 180  | 90   | 02.15  |  | 13.0460-2779.2  | 602779  |   | 24869 19,3 +/WE/S  | TRW |
|  | GLA 180 CDI  | 80   | 07.14  |  | 13.0470-2779.2  | LD2779  |   | 24869 19,3 +/WE/S  | TRW |
|  | GLA 200  | 115  | 12.13  |  | 24.8190-0067.2  | 620067  | 1    | Warnkontakt L=92,5mm   |     |
|  | GLA 200 CDI  | 100  | 12.13  |  |   |   |   |  |     |
|  | GLA 200 CDI 4-matic  | 100  | 12.13  |  |   |   |   |  |     |
|  | GLA 220 CDI  | 120  | 12.13  |  |   |   |   |  |     |
|  | GLA 220 CDI  | 125  | 12.13  |  |   |   |   |  |     |
|  | GLA 220 CDI 4-matic  | 120  | 12.13  |  |   |   |   |  |     |
|  | GLA 220 CDI 4-matic  | 125  | 12.13  |  |   |   |   |  |     |
|  | GLA 220 d  | 130  | 07.15  |  |   |   |   |  |     |
|  | GLA 220 d 4-matic  | 130  | 07.15  |  |   |   |   |  |     |
| GLA 250  | 155  | 12.13  |  |  |   |   |   |  |     |
| GLA 250 4-matic  | 155  | 12.13  |  |  |   |   |   |  |     |
| GLA 45 AMG   |  | 05.14  |  | 24.8190-0067.2   | 620067  | 1  | Warnkontakt L=92,5mm  |  |     |
|   | GLA 180  | 90   | 02.15  | - Sportpaket AMG <sup>3)</sup>   | 24.0128-0276.1  | 428276  |   | 295 28,0 25,4 V L +S +B  |     |
|  | GLA 180 CDI  | 80   | 07.14  | - Sportpaket AMG <sup>3)</sup>   |   |   |   |  |     |
|  | GLA 200  | 115  | 12.13  | - Sportpaket AMG <sup>3)</sup>   |   |   |   |  |     |
|  | GLA 180  | 90   | 02.15  | + Sportpaket AMG <sup>4)</sup>   | 24.0128-0262.1  | 428262  |   | 295 28,0 26,0 V L +S +B  |     |
|  | GLA 180 CDI  | 80   | 07.14  | + Sportpaket AMG <sup>4)</sup>   |   |   |   |  |     |
|  | GLA 200  | 115  | 12.13  | + Sportpaket AMG <sup>4)</sup>   |   |   |   |  |     |
|  | GLA 200 CDI  | 100  | 12.13  | + Sportpaket AMG <sup>4)</sup>   |   |   |   |  |     |
|  | GLA 200 CDI 4-matic  | 100  | 12.13  | + Sportpaket AMG <sup>4)</sup>   |   |   |   |  |     |
|  | GLA 200 CDI  | 100  | 12.13  | - Sportpaket AMG <sup>3)</sup>   | 24.0128-0275.1  | 428275  |   | 295 28,0 25,4 V L +S +B  |     |
|  | GLA 200 CDI 4-matic  | 100  | 12.13  | - Sportpaket AMG <sup>3)</sup>   |   |   |   |  |     |
|  | GLA 220 CDI  | 120  | 12.13  | - Sportpaket AMG <sup>3)</sup>   |   |   |   |  |     |
|  | GLA 220 CDI  | 125  | 12.13  | - Sportpaket AMG <sup>3)</sup>   |   |   |   |  |     |
|  | GLA 220 CDI 4-matic  | 120  | 12.13  | - Sportpaket AMG <sup>3)</sup>   |   |   |   |  |     |
|  | GLA 220 CDI 4-matic  | 125  | 12.13  | - Sportpaket AMG <sup>3)</sup>   |   |   |   |  |     |
|  | GLA 220 d  | 130  | 07.15  | - Sportpaket AMG <sup>3)</sup>   |   |   |   |  |     |
|  | GLA 220 d 4-matic  | 130  | 07.15  | - Sportpaket AMG <sup>3)</sup>   |   |   |   |  |     |
|  | GLA 250  | 155  | 12.13  | - Sportpaket AMG <sup>3)</sup>   | 24.0130-0237.1  | 430237  |   | 320 30,0 28,0 V L +S +B  |     |
| GLA 220 CDI  | 120  | 12.13  | + Sportpaket AMG <sup>4)</sup>   | 24.0130-0238.1   | 430238  |   | 320 30,0 28,0 V L +S +B   |  |     |
| GLA 220 CDI  | 125  | 12.13  | + Sportpaket AMG <sup>4)</sup>   |  |   |   |   |  |     |
| GLA 220 CDI 4-matic  | 120  | 12.13  | + Sportpaket AMG <sup>4)</sup>   |  |   |   |   |  |     |
| GLA 220 CDI 4-matic  | 125  | 12.13  | + Sportpaket AMG <sup>4)</sup>   |  |   |   |   |  |     |
| GLA 220 d  | 130  | 07.15  | + Sportpaket AMG <sup>4)</sup>   |  |   |   |   |  |     |
| GLA 220 d 4-matic  | 130  | 07.15  | + Sportpaket AMG <sup>4)</sup>   |  |   |   |   |  |     |
| GLA 250  | 155  | 12.13  | + Sportpaket AMG <sup>4)</sup>   |  |   |   |   |  |     |
| GLA 250 4-matic  | 155  | 12.13  | + Sportpaket AMG <sup>4)</sup>   |  |   |   |   |  |     |
|  | GLA 180  | 90   | 02.15  |  | 24.0711-5388.3  | 360380  | 2  | Radsensor L=910  |     |
|  | GLA 180 CDI  | 80   | 07.14  |  |   |   |   |  |     |
|  | GLA 200  | 115  | 12.13  |  |   |   |   |  |     |
|  | GLA 200 CDI  | 100  | 12.13  |  |   |   |   |  |     |
|  | GLA 200 CDI 4-matic  | 100  | 12.13  |  |   |   |   |  |     |
|  | GLA 220 CDI  | 120  | 12.13  |  |   |   |   |  |     |
|  | GLA 220 CDI  | 125  | 12.13  |  |   |   |   |  |     |
|  | GLA 220 CDI 4-matic  | 120  | 12.13  |  |   |   |   |  |     |
|  | GLA 220 CDI 4-matic  | 125  | 12.13  |  |   |   |   |  |     |
|  | GLA 220 d  | 130  | 07.15  |  |   |   |   |  |     |
|  | GLA 220 d 4-matic  | 130  | 07.15  |  |   |   |   |  |     |
| GLA 250  | 155  | 12.13  |  |  |   |   |   |  |     |
| GLA 250 4-matic  | 155  | 12.13  |  |  |   |   |   |  |     |
| GLA 45 AMG   |  | 05.14  |  |  |   |   |   |  |     |
|  | GLA 180  | 90   | 02.15  |  | 13.0460-2786.2  | 602786  |   | 24848 18,3 /WE/Zub/S   | TRW |
|  | GLA 180 CDI  | 80   | 07.14  |  | 13.0470-2786.2  | LD2786  |   | 24848 18,3 /WE/Zub/S   | TRW |
|  | GLA 200  | 115  | 12.13  |  |   |   |   |  |     |
|  | GLA 200 CDI  | 100  | 12.13  |  |   |   |   |  |     |
|  | GLA 200 CDI 4-matic  | 100  | 12.13  |  |   |   |   |  |     |
|  | GLA 220 CDI  | 120  | 12.13  |  |   |   |   |  |     |
|  | GLA 220 CDI  | 125  | 12.13  |  |   |   |   |  |     |
|  | GLA 220 CDI 4-matic  | 120  | 12.13  |  |   |   |   |  |     |
|  | GLA 220 CDI 4-matic  | 125  | 12.13  |  |   |   |   |  |     |
|  | GLA 220 d  | 130  | 07.15  |  |   |   |   |  |     |

<sup>1)</sup> - AMG sports package / - kit sportivo AMG / - version sport AMG / - paquete deportivo AMG  
<sup>2)</sup> + AMG sports package / + pacchetto sportivo AMG / + version Sport AMG / + kit deportivo AMG  
<sup>3)</sup> - sport package AMG / - pacchetto sportivo AMG / - version sport AMG / - kit deportivo AMG  
<sup>4)</sup> + sports package AMG / + pacchetto sportivo AMG / + version sport AMG / + kit deportivo AMG  
<sup>5)</sup> electric parking brake / fr/di stazionamento elettrico / frein à main électrique / freno de mano eléctrico





|     |   |       |    |  |  |  |       |  |
|--|---|---|--|--|---|--|---|--|
| <b>MERCEDES BENZ GLA-Klasse (X156) (13-)</b>                                       |   |   |  |  |   |  |   |  |
|    | GLA 220 d 4-matic<br>GLA 250  | 130<br>155  | 07.15<br>12.13   |  | 13.0460-2786.2<br>13.0470-2786.2  | 602786<br>LD2786   | elektrische Feststellbremse 1)<br>elektrische Feststellbremse 1)                        | 24848 18,3 /WE/Zub/S TRW<br>24848 18,3 /WE/Zub/S TRW                               |
|    | GLA 180<br>GLA 180 CDI<br>GLA 200<br>GLA 200 CDI<br>GLA 200 CDI 4-matic<br>GLA 220 CDI<br>GLA 220 CDI<br>GLA 220 CDI 4-matic<br>GLA 220 CDI 4-matic<br>GLA 220 d<br>GLA 220 d 4-matic<br>GLA 250                                  | 90<br>80<br>115<br>100<br>100<br>120<br>125<br>120<br>125<br>130<br>130<br>155        | 02.15<br>07.14<br>12.13<br>12.13<br>12.13<br>12.13<br>12.13<br>12.13<br>12.13<br>07.15<br>07.15<br>12.13                   |  | 24.0110-0382.1  | 410382   |   | 295 10,0 8,3 +S +B   |
|    | GLA 180<br>GLA 180 CDI<br>GLA 200<br>GLA 200 CDI<br>GLA 200 CDI 4-matic<br>GLA 220 CDI<br>GLA 220 CDI<br>GLA 220 CDI 4-matic<br>GLA 220 CDI 4-matic<br>GLA 220 d<br>GLA 220 d 4-matic<br>GLA 250<br>GLA 250 4-matic<br>GLA 45 AMG | 90<br>80<br>115<br>100<br>100<br>120<br>125<br>120<br>125<br>130<br>130<br>155<br>155 | 02.15<br>07.14<br>12.13<br>12.13<br>12.13<br>12.13<br>12.13<br>12.13<br>12.13<br>07.15<br>07.15<br>12.13<br>12.13<br>05.14 |  | 24.0711-5527.3  | 360405   | 2    | Radsensor L=1045   |
| <b>MERCEDES BENZ GLC-Klasse (X253) (15-)</b>                                       |   |   |  |  |   |  |   |  |
|    | GLC 220 d 4-matic<br>GLC 250 4-matic<br>GLC 250 d 4-matic<br>GLC 300 4-matic  | 125<br>155<br>150<br>180  | 06.15<br>06.15<br>06.15<br>07.15   |  | 24.8190-0067.2  | 620067   | 1    | Warnkontakt L=92,5mm   |
|  | GLC 350 e 4-matic<br>GLC AMG 43 4-matic   | 155<br>270  | 01.16<br>04.16   |  | 24.8190-0067.2  | 620067   | 1    | Warnkontakt L=92,5mm   |
|    | GLC 220 d 4-matic<br>GLC 250 4-matic<br>GLC 250 d 4-matic<br>GLC 300 4-matic<br>GLC 350 e 4-matic<br>GLC AMG 43 4-matic   | 125<br>155<br>150<br>180<br>155<br>270  | 06.15<br>06.15<br>06.15<br>07.15<br>01.16<br>04.16   |  | 24.8190-0067.2  | 620067   | 1    | Warnkontakt L=92,5mm   |
| <b>MERCEDES BENZ GLC-Klasse (C253) Coupe (16-)</b>                                 |   |   |  |  |   |  |   |  |
|  | GLC 220 d 4-matic<br>GLC 250 4-matic<br>GLC 250 d 4-matic   | 125<br>155<br>150   | 06.16<br>06.16<br>06.16  | - Sportpaket AMG 2)<br>- Sportpaket AMG 2)<br>- Sportpaket AMG 2)                | 24.8190-0067.2  | 620067   | 1  | Warnkontakt L=92,5mm   |
|  | GLC 220 d 4-matic<br>GLC 250 4-matic<br>GLC 250 d 4-matic   | 125<br>155<br>150   | 06.16<br>06.16<br>06.16  | + Sportpaket AMG 3)<br>+ Sportpaket AMG 3)<br>+ Sportpaket AMG 3)                | 24.8190-0067.2  | 620067   | 1  | Warnkontakt L=92,5mm   |
|  | GLC 220 d 4-matic<br>GLC 250 4-matic<br>GLC 250 d 4-matic   | 125<br>155<br>150   | 06.16<br>06.16<br>06.16  |  | 24.8190-0067.2  | 620067   | 1  | Warnkontakt L=92,5mm   |
| <b>MERCEDES BENZ GLE-Klasse (C292) Coupe (15-)</b>                                 |   |   |  |  |   |  |   |  |
|  | GLE 350 d 4-matic<br>GLE 400 4-matic  | 190<br>245  | 03.15<br>03.15   |  | 24.8190-0425.2  | 620425   |    | Warnkontakt L=98mm<br>Warnkontakt L=98mm   |
|  | GLE 450 AMG 4-matic<br>GLE 500 4-matic  | 270<br>335  | 03.15<br>10.15   |  | 24.8190-0425.2  | 620425   |    | Warnkontakt L=98mm   |
|  | GLE 63 AMG 4-matic<br>GLE 63 AMG S 4-matic  | 410<br>430  | 03.15<br>03.15   |  | 24.8190-0420.2  | 620420   |    | Warnkontakt L=119mm  |
|  | GLE 350 d 4-matic   | 190   | 03.15  |  | 24.0132-0178.1<br>24.0132-0179.1  | 432178<br>432179   | - AMG Sportpaket 4)<br>+ AMG Sportpaket 5)  | 330 32,0 29,4 V L +S +B<br>350 32,0 29,4 V L +S +B                                 |
|  | GLE 350 d 4-matic   | 190   | 03.15  | - Sportpaket AMG 2)  | 13.0460-2781.2<br>13.0470-2781.2<br>24.8190-0410.2                                | 602781<br>LD2781<br>620410   | 1  | 25215 18,6 +/WE/Zub/STRW<br>25215 18,6 +/WE/Zub/STRW<br>Warnkontakt L=97,5mm       |
|  | GLE 350 d 4-matic<br>GLE 400 4-matic<br>GLE 450 AMG 4-matic<br>GLE 500 4-matic  | 190<br>245<br>270<br>335  | 03.15<br>03.15<br>03.15<br>10.15   | + Sportpaket AMG 3)  | 13.0460-2782.2<br>13.0470-2782.2<br>24.8190-0410.2                                | 602782<br>LD2782<br>620410   | 1  | 25215 18,6 +/WE/Zub/STRW<br>25215 18,6 +/WE/Zub/STRW<br>Warnkontakt L=97,5mm       |
|  | GLE 500 4-matic<br>GLE 63 AMG 4-matic<br>GLE 63 AMG S 4-matic   | 335<br>410<br>430   | 10.15<br>03.15<br>03.15  | - Sportpaket 6)<br>+ Sportpaket 7)   | 24.8190-0410.2  | 620410   | 1  | Warnkontakt L=97,5mm   |
|  | GLE 350 d 4-matic<br>GLE 400 4-matic  | 190<br>245  | 03.15<br>03.15   |  | 24.0114-0119.1<br>24.0122-0288.1<br>24.0122-0288.1                                | 414119<br>422288<br>422288   | - AMG Sportpaket 4)<br>+ AMG Sportpaket 5)<br>- AMG Sportpaket 4)                       | 325 14,0 11,4 L +S +B<br>330 22,0 19,4 V L +B<br>330 22,0 19,4 V L +B              |
| <b>MERCEDES BENZ GLK-Klasse (X204) (08-15)</b>                                     |   |   |  |  |   |  |   |  |
|  | GLK 200<br>GLK 200 CDI<br>GLK 220 BT 4-matic<br>GLK 220 CDI   | 135<br>105  | 08.13<br>07.10<br>03.12<br>04.09   |  | 13.0460-3852.2<br>13.0470-3852.2<br>24.8190-0410.2                                | 603852<br>LD3852<br>620410   | 1   | 24867 20,7 +/WE/Zub/SBOS<br>24867 20,7 +/WE/Zub/SBOS<br>Warnkontakt L=97,5mm       |

1) electric parking brake / fr.di stazionamento elettrico / frein à main électrique / freno de mano eléctrico

2) - sport package AMG / - pacchetto sportivo AMG / - version sport AMG / - kit deportivo AMG

3) + sports package AMG / + pacchetto sportivo AMG / + version sport AMG / + kit deportivo AMG

4) - AMG sports package / - kit sportivo AMG / - version sport AMG / - paquete deportivo AMG

5) + AMG sports package / + pacchetto sportivo AMG / + version sport AMG / + kit deportivo AMG

6) - sport package / - pacchetto sportivo / - version sport / - kit deportivo

7) + sports package / + pacchetto sportivo / + version sport / + kit deportivo



**MERCEDES BENZ GLK-Klasse (X204) (08-15)**

|  |   |   |  |  |                            |   |  |
|--|---|---|--|--|----------------------------|---|--|
|  | GLK 220 CDI 4-matic<br>GLK 250<br>GLK 250 4-matic<br>GLK 250 BT 4-matic<br>GLK 250 CDI 4-matic<br>GLK 280 4-matic<br>GLK 300 4-matic<br>GLK 300 4-matic<br>GLK 320 CDI 4-matic<br>GLK 350<br>GLK 350 4-matic<br>GLK 350 4-matic<br>GLK 350 CDI 4-matic<br>GLK 350 CDI 4-matic<br>GLK 350 CDI 4-matic  | 155<br>155<br>155<br>150<br>170<br>170<br>185<br>165<br>200<br>200<br>225<br>165<br>170<br>195        | 04.09<br>08.13<br>08.13<br>03.12<br>09.08<br>09.08<br>04.09<br>09.09<br>09.08<br>09.08<br>09.08<br>09.08<br>04.09<br>02.10<br>07.12                            | 13.0460-3852.2<br>13.0470-3852.2<br>24.8190-0410.2 | 603852<br>LD3852<br>620410 | 1 | 24867 20,7 +/WE/Zub/SBOS<br>24867 20,7 +/WE/Zub/SBOS<br>Warnkontakt L=97,5mm |
|  | GLK 200<br>GLK 200 CDI<br>GLK 220 BT 4-matic<br>GLK 220 CDI<br>GLK 220 CDI 4-matic<br>GLK 250<br>GLK 250 4-matic<br>GLK 250 BT 4-matic<br>GLK 250 CDI 4-matic<br>GLK 280 4-matic<br>GLK 300 4-matic<br>GLK 300 4-matic<br>GLK 320 CDI 4-matic<br>GLK 350<br>GLK 350 4-matic<br>GLK 350 4-matic<br>GLK 350 CDI 4-matic<br>GLK 350 CDI 4-matic<br>GLK 350 CDI 4-matic | 135<br>105<br>155<br>155<br>150<br>170<br>170<br>185<br>165<br>200<br>200<br>225<br>165<br>170<br>195 | 08.13<br>07.10<br>03.12<br>04.09<br>04.09<br>08.13<br>08.13<br>03.12<br>09.08<br>09.08<br>04.09<br>09.09<br>09.08<br>09.08<br>09.08<br>04.09<br>02.10<br>07.12 | 24.0132-0144.1<br>24.0332-0144.1                   | 432144<br>532144           | 1 | 330 32,0 29,4 V L +S +B<br>330 32,0 29,4 V L +S +B PD                        |
|  | GLK 200<br>GLK 200 CDI<br>GLK 220 BT 4-matic<br>GLK 220 CDI<br>GLK 220 CDI 4-matic<br>GLK 250<br>GLK 250 4-matic<br>GLK 250 BT 4-matic<br>GLK 250 CDI 4-matic<br>GLK 280 4-matic<br>GLK 300 4-matic<br>GLK 300 4-matic<br>GLK 320 CDI 4-matic<br>GLK 350<br>GLK 350 4-matic<br>GLK 350 4-matic<br>GLK 350 CDI 4-matic<br>GLK 350 CDI 4-matic<br>GLK 350 CDI 4-matic | 135<br>105<br>155<br>155<br>150<br>170<br>170<br>185<br>165<br>200<br>200<br>225<br>165<br>170<br>195 | 08.13<br>07.10<br>03.12<br>04.09<br>04.09<br>08.13<br>08.13<br>03.12<br>09.08<br>09.08<br>04.09<br>09.09<br>09.08<br>09.08<br>09.08<br>04.09<br>02.10<br>07.12 | 24.0711-5330.3                                     | 360417                     | 2 | Radsensor L=733  |
|  | GLK 200<br>GLK 200 CDI<br>GLK 220 BT 4-matic<br>GLK 220 CDI<br>GLK 220 CDI 4-matic<br>GLK 250<br>GLK 250 4-matic<br>GLK 250 BT 4-matic<br>GLK 250 CDI 4-matic<br>GLK 280 4-matic<br>GLK 300 4-matic<br>GLK 300 4-matic<br>GLK 320 CDI 4-matic<br>GLK 350<br>GLK 350 4-matic<br>GLK 350 4-matic<br>GLK 350 CDI 4-matic<br>GLK 350 CDI 4-matic<br>GLK 350 CDI 4-matic | 135<br>105<br>155<br>155<br>150<br>170<br>170<br>185<br>165<br>200<br>200<br>225<br>165<br>170<br>195 | 08.13<br>07.10<br>03.12<br>04.09<br>04.09<br>08.13<br>08.13<br>03.12<br>09.08<br>09.08<br>04.09<br>09.09<br>09.08<br>09.08<br>09.08<br>04.09<br>02.10<br>07.12 | 13.0460-7257.2<br>13.0470-7257.2<br>24.8190-0410.2 | 607257<br>LD7257<br>620410 | 1 | 24253 18,0 +/WE ATE<br>24253 18,0 +/WE ATE<br>Warnkontakt L=97,5mm           |
|  | GLK 200<br>GLK 200 CDI<br>GLK 220 BT 4-matic<br>GLK 220 CDI<br>GLK 220 CDI 4-matic<br>GLK 250<br>GLK 250 4-matic<br>GLK 250 BT 4-matic<br>GLK 250 CDI 4-matic<br>GLK 280 4-matic<br>GLK 300 4-matic<br>GLK 300 4-matic<br>GLK 320 CDI 4-matic<br>GLK 350<br>GLK 350 4-matic<br>GLK 350 4-matic  | 135<br>105<br>155<br>155<br>150<br>170<br>170<br>185<br>165<br>200<br>200                             | 08.13<br>07.10<br>03.12<br>04.09<br>04.09<br>08.13<br>08.13<br>03.12<br>09.08<br>09.08<br>04.09<br>09.09<br>09.08<br>09.08                                     | 24.0122-0201.1                                     | 422201                     | 1 | 300 22,0 19,4 V +S +B  |















**MERCEDES BENZ GLK-Klasse (X204) (08-15)**

|  |   |   |  |  |  |                |        |   |                       |
|--|---|---|--|--|--|----------------|--------|---|-----------------------|
|  | GLK 350 4-matic<br>GLK 350 CDI 4-matic<br>GLK 350 CDI 4-matic<br>GLK 350 CDI 4-matic  | 225<br>165<br>170<br>195  |  | 09.08<br>04.09<br>02.10<br>07.12   |  | 24.0122-0201.1 | 422201 |   | 300 22,0 19,4 V +S +B |
|  | GLK 200<br>GLK 200 CDI<br>GLK 220 BT 4-matic<br>GLK 220 CDI<br>GLK 220 CDI 4-matic<br>GLK 250<br>GLK 250 4-matic<br>GLK 250 BT 4-matic<br>GLK 250 CDI 4-matic<br>GLK 280 4-matic<br>GLK 300 4-matic<br>GLK 300 4-matic<br>GLK 320 CDI 4-matic<br>GLK 350<br>GLK 350 4-matic<br>GLK 350 4-matic<br>GLK 350 CDI 4-matic<br>GLK 350 CDI 4-matic<br>GLK 350 CDI 4-matic | 135<br>105<br><br><br><br>155<br>155<br><br>150<br>170<br>170<br>185<br>165<br>200<br>200<br>225<br>165<br>170<br>195 |  | 08.13<br>07.10<br>03.12<br>04.09<br>04.09<br>08.13<br>08.13<br>03.12<br>09.08<br>09.08<br>04.09<br>09.09<br>09.08<br>09.08<br>09.08<br>04.09<br>02.10<br>07.12 |  | 24.0711-6200.3 | 360328 | 2 | Radsensor L=995       |
|  | GLK 200<br>GLK 200 CDI<br>GLK 220 BT 4-matic<br>GLK 220 CDI<br>GLK 220 CDI 4-matic<br>GLK 250<br>GLK 250 4-matic<br>GLK 250 BT 4-matic<br>GLK 250 CDI 4-matic<br>GLK 280 4-matic<br>GLK 300 4-matic<br>GLK 300 4-matic<br>GLK 320 CDI 4-matic<br>GLK 350<br>GLK 350 4-matic<br>GLK 350 4-matic<br>GLK 350 CDI 4-matic<br>GLK 350 CDI 4-matic<br>GLK 350 CDI 4-matic | 135<br>105<br><br><br><br>155<br>155<br><br>150<br>170<br>170<br>185<br>165<br>200<br>200<br>225<br>165<br>170<br>195 |  | 08.13<br>07.10<br>03.12<br>04.09<br>04.09<br>08.13<br>08.13<br>03.12<br>09.08<br>09.08<br>04.09<br>09.09<br>09.08<br>09.08<br>09.08<br>04.09<br>02.10<br>07.12 |  | 03.0137-4007.2 | 654007 |   | 180 x 25 /Zub         |

**MERCEDES BENZ M-Klasse (W163) (98-05)**

|  |   |  |  |   |                |  |                                      |      |  |
|--|---|--|--|---|----------------|--|--------------------------------------|------|--|
|  | ML 230<br>ML 270 CDI<br>ML 270 CDI<br>ML 320<br>ML 320<br>ML 430<br>ML 430                                      |  | X754619<br>A289559<br>X754619<br>A289559<br>X707755<br>A145272 | 03.98<br>09.99<br>09.99<br>03.98<br>03.98<br>09.98<br>09.98                                     | 06.05          | 13.0460-8004.2   | 608004                               |      | 23193 16,4 +/WK/Zub  |
|  | ML 270 CDI<br>ML 270 CDI<br>ML 320<br>ML 320<br>ML 350  | X754620<br>A289560<br>X754620<br>A289560                                 |  | 06.05<br>06.05<br>08.02<br>08.02<br>09.02   | 06.05          | 13.0460-4984.2<br>13.0470-4984.2<br>13.0460-0269.2<br>24.8190-0412.2 | 604984<br>LD4984<br>610269<br>620412 | 2    | 23271 17,4 +/WE(1,8) BRE<br>23271 17,4 +/WE(1,8) BRE<br>Belagsatz-Zubehör<br>Warnkontakt L=114mm |
|  | ML 400 CDI<br>ML 430<br>ML 430  |  | X707756<br>A145273   | 07.01<br>06.05<br>06.05   | 06.05          | 13.0460-4984.2<br>13.0460-0269.2<br>24.8190-0412.2                   | 604984<br>610269<br>620412           | 2    | 23271 17,4 +/WE(1,8) BRE<br>Belagsatz-Zubehör<br>Warnkontakt L=114mm                             |
|  | ML 500<br>ML 55 AMG   |  |  | 07.01<br>09.99  | 06.05<br>06.05 | 13.0460-4984.2<br>13.0460-0269.2<br>24.8190-0412.2                   | 604984<br>610269<br>620412           | 2    | 23271 17,4 +/WE(1,8) BRE<br>Belagsatz-Zubehör<br>Warnkontakt L=114mm                             |
|  | ML 230<br>ML 270 CDI<br>ML 270 CDI<br>ML 320<br>ML 320<br>ML 430<br>ML 430                                      |  | X754619<br>A289559<br>X754619<br>A289559<br>X707755<br>A145272 | 03.98<br>09.99<br>09.99<br>03.98<br>03.98<br>09.98<br>09.98                                     | 06.05          | 24.0126-0116.1   | 426116                               |      | 303 26,0 23,0 V L +B   |
|  | ML 270 CDI<br>ML 270 CDI<br>ML 320<br>ML 320<br>ML 350<br>ML 400 CDI<br>ML 430<br>ML 430<br>ML 500<br>ML 55 AMG | X754620<br>A289560<br>X754620<br>A289560<br><br>X707756<br>A145273       |  | 06.05<br>06.05<br>08.02<br>08.02<br>09.02<br>07.01<br>06.05<br>06.05<br>06.05<br>07.01<br>09.99 | 06.05          | 24.0132-0114.1   | 432114                               |      | 345 31,9 30,0 V L +B   |
|  | ML 270 CDI<br>ML 270 CDI<br>ML 320<br>ML 320<br>ML 350<br>ML 400 CDI<br>ML 400 CDI                              | X 778321<br>A 371935<br>X 778321<br>A 371935<br><br>X 778321<br>A 371935 |  | 06.05<br>06.05<br>06.05<br>06.05<br>06.05<br>09.02<br>06.05                                     | 06.05          | 24.0711-6058.3<br>24.0711-6057.3                                     | 360129<br>360128                     | <br> | Radsensor L=832<br>Radsensor L=812   |

| MERCEDES BENZ M-Klasse (W163) (98-05)  |  |  |  |   |   |  |                            |  |  |
|--|--|--|--|---|---|--|----------------------------|--|--|
|    | ML 500<br>ML 500   | X 778321<br>A 371935   |  | 06.05<br>06.05  |   | 24.0711-6058.3<br>24.0711-6057.3                   | 360129<br>360128           | <br>     | Radsensor L=832<br>Radsensor L=812                             |
|    | ML 230<br>ML 320<br>ML 430   |  |  | 03.98<br>03.98<br>09.98   | 11.98<br>11.98<br>11.98   | 13.0460-8005.2                                     | 608005                     |  | 23189 16,7 +/WK/Zub  |
|  | ML 230<br>ML 270 CDI<br>ML 270 CDI<br>ML 320<br>ML 320<br>ML 430<br>ML 430   |  | X754619<br>A289559<br>X754619<br>A289559<br>X707755<br>A145272 | 12.98<br>09.99<br>09.99<br>12.98<br>12.98<br>12.98  | 06.05   | 13.0460-8007.2                                     | 608007                     |  | 23190 16,7 +/WK/Zub  |
|  | ML 270 CDI<br>ML 270 CDI<br>ML 320<br>ML 320<br>ML 350<br>ML 400 CDI<br>ML 430<br>ML 430<br>ML 500<br>ML 55 AMG  | X754620<br>A289560<br>X754620<br>A289560<br><br>X707756<br>A145273   |  | 06.05<br>06.05<br>08.02<br>08.02<br>09.02<br>07.01<br>06.05<br>06.05<br>07.01<br>09.99          | 06.05<br>06.05<br>08.02<br>08.02<br>06.05<br>06.05<br>06.05<br>06.05<br>06.05<br>06.05          | 13.0460-4977.2<br>13.0470-4977.2<br>24.8190-0411.2 | 604977<br>LD4977<br>620411 | 2  | 23157 15,8 /WE/Zub<br>23157 15,8 /WE/Zub<br>Warnkontakt L=72mm |
|    | ML 230<br>ML 270 CDI<br>ML 270 CDI<br>ML 320<br>ML 320<br>ML 430<br>ML 430   |  | X754619<br>A289559<br>X754619<br>A289559<br>X707755<br>A145272 | 03.98<br>09.99<br>09.99<br>03.98<br>03.98<br>09.98  | 06.05   | 24.0115-0111.1                                     | 415111                     |  | 285 15,0 13,0 +B   |
|  | ML 270 CDI<br>ML 270 CDI<br>ML 320<br>ML 320<br>ML 350<br>ML 400 CDI<br>ML 430<br>ML 430<br>ML 500<br>ML 55 AMG  | X754620<br>A289560<br>X754620<br>A289560<br><br>X707756<br>A145273   |  | 06.05<br>06.05<br>08.02<br>08.02<br>09.02<br>07.01<br>06.05<br>06.05<br>07.01<br>09.99          | 06.05<br>06.05<br>08.02<br>08.02<br>06.05<br>06.05<br>06.05<br>06.05<br>06.05<br>06.05          | 24.0114-0111.1                                     | 414111                     |  | 331 13,9 12,3 +B   |
|  | ML 270 CDI<br>ML 270 CDI<br>ML 320<br>ML 320<br>ML 350<br>ML 400 CDI<br>ML 400 CDI<br>ML 500<br>ML 500<br>ML 55 AMG<br>ML 55 AMG   | X 778321<br>A 371935<br>X 778321<br>A 371935<br><br>X 778321<br>A 371935<br>X 778321<br>A 371935<br>X 778321<br>A 371935 |  | 06.05<br>06.05<br>06.05<br>08.02<br>09.02<br>06.05<br>06.05<br>06.05<br>06.05<br>06.05<br>06.05 |   | 24.0711-6056.3<br>24.0711-6055.3                   | 360082<br>360081           | <br> | Radsensor L=502<br>Radsensor L=502                             |
|  | ML 230<br>ML 270 CDI<br>ML 320<br>ML 350<br>ML 400 CDI<br>ML 430<br>ML 500<br>ML 55 AMG  |  |  | 03.98<br>09.99<br>03.98<br>09.02<br>07.01<br>09.98<br>07.01<br>09.99                            | 06.05<br>06.05<br>08.02<br>06.05<br>06.05<br>06.05<br>06.05<br>06.05                            | 03.0137-4014.2<br>03.0137-9269.2                   | 654014<br>669269           |  | 183 x 31 /Zub<br>Bremsbacken-Zubehör                           |
| MERCEDES BENZ M-Klasse (W164) (05-11)  |  |  |  |   |   |  |                            |  |  |
|  | ML 280 CDI<br>ML 300<br>ML 300 CDI 4-matic<br>ML 320 CDI<br>ML 350<br>ML 350 BT 4-matic<br>ML 350 CDI 4-matic  |  |  | 07.05<br>05.09<br>07.09<br>07.05<br>07.05<br>05.09<br>07.09                                     | 05.11<br>05.11<br>05.11<br>05.11<br>05.11<br>05.11<br>05.11                                     | 13.0460-7220.2<br>13.0470-7220.2<br>24.8190-0425.2 | 607220<br>LD7220<br>620425 | 1  | 23922 21,0 +/WE<br>23922 21,0 +/WE<br>Warnkontakt L=98mm       |
|  | ML 420 CDI 4-matic<br>ML 450 CDI 4-matic<br>ML 450 Hybrid 4-matic<br>ML 500<br>ML 63 AMG   |  |  | 04.06<br>09.09<br>08.09<br>07.05<br>09.05   | 05.11<br>05.11<br>05.11<br>05.11<br>05.11   | 13.0460-7220.2<br>24.8190-0425.2                   | 607220<br>620425           | 1  | 23922 21,0 +/WE<br>Warnkontakt L=98mm                          |
|  | ML 280 CDI<br>ML 300<br>ML 300 CDI 4-matic<br>ML 320 CDI<br>ML 350<br>ML 350 BT 4-matic<br>ML 350 CDI 4-matic<br>ML 420 CDI 4-matic<br>ML 450 CDI 4-matic<br>ML 450 Hybrid 4-matic<br>ML 500 |  |  | 07.05<br>05.09<br>07.09<br>07.05<br>07.05<br>05.09<br>07.09<br>04.06<br>09.09<br>08.09<br>07.05 | 05.11<br>05.11<br>05.11<br>05.11<br>05.11<br>05.11<br>05.11<br>05.11<br>05.11<br>05.11<br>05.11 | 24.0132-0158.1<br>24.0332-0158.1                   | 432158<br>532158           |  | 330 32,0 29,4 V L +S +B<br>330 32,0 29,4 V L +S +B PD          |
|  | ML 280 CDI<br>ML 300   |  |  | 07.05<br>05.09  | 05.11<br>05.11  | 24.0132-0157.1                                     | 432157                     |  | 350 32,0 29,4 V L +S +B  |

1) - 18" wheel / - ruota 18" / - roue 18" / - rueda 18"  
2) + 18" wheel / + ruota 18" / + roue 18" / + rueda 18"





### MERCEDES BENZ M-Klasse (W164) (05-11)

|  |   |  |  |  |   |  |                            |   |  |
|--|---|--|--|--|---|--|----------------------------|---|--|
|  | ML 300 CDI 4-matic<br>ML 320 CDI<br>ML 350<br>ML 350 BT 4-matic<br>ML 350 CDI 4-matic<br>ML 420 CDI 4-matic<br>ML 450 CDI 4-matic<br>ML 450 Hybrid 4-matic<br>ML 500                                      |  | 07.09<br>07.05<br>07.05<br>05.09<br>07.09<br>04.06<br>09.09<br>08.09<br>07.05                            | 05.11<br>05.11<br>05.11<br>05.11<br>05.11<br>05.11<br>05.11<br>05.11<br>05.11                            | + 18" Rad <sup>1)</sup><br>+ 18" Rad <sup>1)</sup><br>+ 18" Rad <sup>1)</sup><br>+ 18" Rad <sup>1)</sup><br>+ 18" Rad <sup>1)</sup><br>+ 18" Rad <sup>1)</sup><br>+ 18" Rad <sup>1)</sup><br>+ 18" Rad <sup>1)</sup><br>+ 18" Rad <sup>1)</sup>   | 24.0132-0157.1                                     | 432157                     |   | 350 32,0 29,4 V L +S +B                                  |
|  | ML 280 CDI<br>ML 300<br>ML 300 CDI 4-matic<br>ML 320 CDI<br>ML 350<br>ML 350 BT 4-matic<br>ML 350 CDI 4-matic<br>ML 420 CDI 4-matic<br>ML 450 CDI 4-matic<br>ML 450 Hybrid 4-matic<br>ML 500<br>ML 63 AMG |  | 07.05<br>05.09<br>07.09<br>07.05<br>07.05<br>05.09<br>07.09<br>04.06<br>09.09<br>08.09<br>07.05<br>09.05 | 05.11<br>05.11<br>05.11<br>05.11<br>05.11<br>05.11<br>05.11<br>05.11<br>05.11<br>05.11<br>05.11<br>05.11 |   | 13.0460-7219.2<br>13.0470-7219.2<br>24.8190-0425.2 | 607219<br>LD7219<br>620425 | 1 | 23923 17,6 +/WE<br>23923 17,6 +/WE<br>Warnkontakt L=98mm |
|  | ML 280 CDI<br>ML 300<br>ML 300 CDI 4-matic<br>ML 320 CDI<br>ML 350<br>ML 350 BT 4-matic<br>ML 350 CDI 4-matic<br>ML 420 CDI 4-matic<br>ML 450 CDI 4-matic<br>ML 450 Hybrid 4-matic<br>ML 500              |  | 07.05<br>05.09<br>07.09<br>07.05<br>07.05<br>05.09<br>07.09<br>04.06<br>09.09<br>08.09<br>07.05          | 05.11<br>05.11<br>05.11<br>05.11<br>05.11<br>05.11<br>05.11<br>05.11<br>05.11<br>05.11<br>05.11          | - 18" Rad <sup>2)</sup><br>- 18" Rad <sup>2)</sup><br>- 18" Rad <sup>2)</sup><br>- 18" Rad <sup>2)</sup><br>- 18" Rad <sup>2)</sup><br>- 18" Rad <sup>2)</sup><br>- 18" Rad <sup>2)</sup><br>- 18" Rad <sup>2)</sup><br>- 18" Rad <sup>2)</sup><br>- 18" Rad <sup>2)</sup><br>- 18" Rad <sup>2)</sup> | 24.0114-0114.1                                     | 414114                     |   | 330 14,0 11,4 L +S +B                                    |
|  | ML 280 CDI<br>ML 300<br>ML 300 CDI 4-matic<br>ML 320 CDI<br>ML 350<br>ML 350 BT 4-matic<br>ML 350 CDI 4-matic<br>ML 420 CDI 4-matic<br>ML 450 CDI 4-matic<br>ML 450 Hybrid 4-matic<br>ML 500              |  | 07.05<br>05.09<br>07.09<br>07.05<br>07.05<br>05.09<br>07.09<br>04.06<br>09.09<br>08.09<br>07.05          | 05.11<br>05.11<br>05.11<br>05.11<br>05.11<br>05.11<br>05.11<br>05.11<br>05.11<br>05.11<br>05.11          | + 18" Rad <sup>1)</sup><br>+ 18" Rad <sup>1)</sup><br>+ 18" Rad <sup>1)</sup><br>+ 18" Rad <sup>1)</sup><br>+ 18" Rad <sup>1)</sup><br>+ 18" Rad <sup>1)</sup><br>+ 18" Rad <sup>1)</sup><br>+ 18" Rad <sup>1)</sup><br>+ 18" Rad <sup>1)</sup><br>+ 18" Rad <sup>1)</sup><br>+ 18" Rad <sup>1)</sup> | 24.0122-0226.1                                     | 422226                     |   | 330 22,0 19,4 V L +S +B                                  |
|  | ML 280 CDI<br>ML 300<br>ML 300 CDI 4-matic<br>ML 320 CDI<br>ML 350<br>ML 350 BT 4-matic<br>ML 350 CDI 4-matic<br>ML 420 CDI 4-matic<br>ML 450 CDI 4-matic<br>ML 450 Hybrid 4-matic<br>ML 500<br>ML 63 AMG |  | 07.05<br>05.09<br>07.09<br>07.05<br>07.05<br>05.09<br>07.09<br>04.06<br>09.09<br>08.09<br>07.05<br>09.05 | 05.11<br>05.11<br>05.11<br>05.11<br>05.11<br>05.11<br>05.11<br>05.11<br>05.11<br>05.11<br>05.11<br>05.11 |   | 03.0137-0451.2                                     | 650451                     |   | 210 x 30   |

### MERCEDES BENZ M-Klasse/GLE-Klasse (W166) (11-)

|  |  |  |  |  |  |  |                                      |             |  |                   |
|--|--|--|--|--|--|--|--------------------------------------|-------------|--|-------------------|
|  | GLE 250 d 150<br>GLE 250 d 4-matic 150<br>GLE 350 d 4-matic 190<br>ML 250 CDI BT 4-matic 150<br>ML 300 4-matic 185<br>ML 350 BT 4-matic 190<br>ML 350 CDI 4-matic 170<br>ML 400 Hybrid 4-matic |  | 04.15<br>04.15<br>04.15<br>06.11<br>04.14<br>06.11<br>06.11<br>02.12 |  |  | 13.0460-7282.2<br>13.0470-7282.2<br>24.8190-0425.2                   | 607282<br>LD7282<br>620425           | 1           | 25192 21,3 +/WK<br>25192 21,3 +/WK<br>Warnkontakt L=98mm   | ATE<br>ATE        |
|  | GLE 320 4-matic 200<br>ML 350 BE 4-matic 225   |  | 10.15<br>06.11   |  |  | 13.0460-7282.2<br>13.0470-7282.2<br>13.0460-7283.2<br>24.8190-0425.2 | 607282<br>LD7282<br>607283<br>620425 | 1           | - AMG Sportpaket <sup>3)</sup><br>- AMG Sportpaket <sup>3)</sup><br>+ AMG Sportpaket <sup>4)</sup><br>Warnkontakt L=98mm | ATE<br>ATE<br>ATE |
|  | GLE 400 4-matic 245<br>ML 400 4-matic 245  |  | 04.15<br>08.13   |  |  | 13.0460-7282.2<br>13.0460-7283.2<br>24.8190-0425.2                   | 607282<br>607283<br>620425           | 1           | - AMG Sportpaket <sup>3)</sup><br>+ AMG Sportpaket <sup>4)</sup><br>Warnkontakt L=98mm                                   | ATE<br>ATE        |
|  | GLE 500 4-matic 320<br>GLE 500 e 4-matic 245<br>GLE 500 e Hybrid 325<br>ML 500 BE 4-matic 300  |  | 04.15<br>04.15<br>04.15<br>02.12                                     |  |  | 13.0460-7283.2<br>24.8190-0425.2                                     | 607283<br>620425                     | 1           | Warnkontakt L=98mm   | ATE               |
|  | GLE 450 AMG 4-matic 270  |  | 10.15  |  |  | 13.0460-7283.2<br>24.8190-0425.2<br>24.8190-0420.2                   | 607283<br>620425<br>620420           | 1<br>1<br>1 | - Sportpaket <sup>5)</sup><br>- Sportpaket <sup>5)</sup><br>+ Sportpaket <sup>6)</sup><br>Warnkontakt L=119mm            | ATE               |
|  | GLE AMG 63 4-matic<br>ML 63 AMG 4-matic  |  | 04.15<br>04.12   |  |  | 13.0460-4839.2<br>24.8190-0420.2                                     | 604839<br>620420                     | 1           | Warnkontakt L=119mm  | BRE               |
|  | GLE AMG 63 S 4-matic 430   |  | 04.15  |  |  | 24.8190-0420.2   | 620420                               | 1           | Warnkontakt L=119mm  |                   |

<sup>1)</sup> + 18" wheel / + ruota 18" / + roue 18" / + rueda 18"

<sup>2)</sup> - 18" wheel / - ruota 18" / - roue 18" / - rueda 18"

<sup>3)</sup> - AMG sports package / - kit sportivo AMG / - version sport AMG / - paquete deportivo AMG

<sup>4)</sup> + AMG sports package / + pacchetto sportivo AMG / + version Sport AMG / + kit deportivo AMG

<sup>5)</sup> - sport package / - pacchetto sportivo / - version sport / - kit deportivo

<sup>6)</sup> + sports package / + pacchetto sportivo / + version sport / + kit deportivo



**MERCEDES BENZ M-Klasse/GLE-Klasse (W166) (11-)**

|                       |                       |          |          |       |                |                |        |                                |                                |                          |
|-----------------------|-----------------------|----------|----------|-------|----------------|----------------|--------|--------------------------------|--------------------------------|--------------------------|
|                       | GLE 250 d             | 150      |          | 04.15 |                | 24.0132-0178.1 | 432178 |                                | - AMG Sportpaket <sup>1)</sup> | 330 32,0 29,4 V L +S +B  |
|                       | GLE 250 d 4-matic     | 150      |          | 04.15 |                | 24.0132-0179.1 | 432179 |                                | + AMG Sportpaket <sup>2)</sup> | 350 32,0 29,4 V L +S +B  |
|                       | GLE 350 d 4-matic     | 190      |          | 04.15 |                |                |        |                                |                                |                          |
|                       | ML 250 CDI BT 4-matic | 150      |          | 06.11 |                |                |        |                                |                                |                          |
|                       | ML 300 4-matic        | 185      |          | 04.14 |                |                |        |                                |                                |                          |
|                       | ML 350 BT 4-matic     | 190      |          | 06.11 |                |                |        |                                |                                |                          |
|                       | ML 350 CDI 4-matic    | 170      |          | 06.11 |                |                |        |                                |                                |                          |
| ML 400 Hybrid 4-matic |                       |          | 02.12    |       |                |                |        |                                |                                |                          |
|                       | GLE 250 d             | 150      |          | 04.15 |                | 13.0460-2781.2 | 602781 |                                | - AMG Sportpaket <sup>1)</sup> | 25215 18,6 +/WE/Zub/STRW |
|                       | GLE 250 d 4-matic     | 150      |          | 04.15 |                | 13.0470-2781.2 | LD2781 |                                | - AMG Sportpaket <sup>1)</sup> | 25215 18,6 +/WE/Zub/STRW |
|                       | GLE 350 d 4-matic     | 190      |          | 04.15 |                | 13.0460-2782.2 | 602782 |                                | + AMG Sportpaket <sup>2)</sup> | 25215 18,6 +/WE/Zub/STRW |
|                       | ML 250 CDI BT 4-matic | 150      |          | 06.11 |                | 13.0470-2782.2 | LD2782 |                                | + AMG Sportpaket <sup>2)</sup> | 25215 18,6 +/WE/Zub/STRW |
|                       | ML 300 4-matic        | 185      |          | 04.14 |                | 24.8190-0410.2 | 620410 | 1                              |                                | Warnkontakt L=97,5mm     |
|                       | ML 350 BT 4-matic     | 190      |          | 06.11 |                |                |        |                                |                                |                          |
|                       | ML 350 CDI 4-matic    | 170      |          | 06.11 |                |                |        |                                |                                |                          |
|                       | ML 400 Hybrid 4-matic |          |          | 02.12 |                |                |        |                                |                                |                          |
|                       | GLE 320 4-matic       | 200      |          | 10.15 |                | 13.0460-2782.2 | 602782 |                                |                                | 25215 18,6 +/WE/Zub/STRW |
|                       | GLE 400 4-matic       | 245      |          | 04.15 |                | 13.0470-2782.2 | LD2782 |                                |                                | 25215 18,6 +/WE/Zub/STRW |
|                       | GLE 450 AMG 4-matic   | 270      |          | 10.15 |                | 24.8190-0410.2 | 620410 | 1                              |                                | Warnkontakt L=97,5mm     |
|                       | GLE 500 4-matic       | 320      |          | 04.15 |                |                |        |                                |                                |                          |
|                       | GLE 500 e 4-matic     | 245      |          | 04.15 |                |                |        |                                |                                |                          |
|                       | GLE 500 e Hybrid      | 325      |          | 04.15 |                |                |        |                                |                                |                          |
| ML 350 BE 4-matic     | 225                   |          | 06.11    |       |                |                |        |                                |                                |                          |
| ML 400 4-matic        | 245                   |          | 08.13    |       |                |                |        |                                |                                |                          |
| ML 500 BE 4-matic     | 300                   |          | 02.12    |       |                |                |        |                                |                                |                          |
| GLE AMG 63 4-matic    |                       |          | 04.15    |       | 24.8190-0410.2 | 620410         | 1      |                                | Warnkontakt L=97,5mm           |                          |
| ML 63 AMG 4-matic     |                       |          | 04.12    |       |                |                |        |                                |                                |                          |
| GLE 450 AMG 4-matic   | 270                   |          | 10.15    |       | 24.8190-0410.2 | 620410         | 1      |                                | Warnkontakt L=97,5mm           |                          |
| GLE AMG 63 S 4-matic  | 430                   |          | 04.15    |       |                |                |        |                                |                                |                          |
|                       | ML 250 CDI BT 4-matic | 150      | L 174198 | 06.11 |                | 24.0114-0119.1 | 414119 |                                | - AMG Sportpaket <sup>1)</sup> | 325 14,0 11,4 L +S +B    |
|                       | ML 350 BT 4-matic     | 190      | L 174198 | 06.11 |                | 24.0122-0287.1 | 422287 |                                | + AMG Sportpaket <sup>2)</sup> | 330 22,0 19,4 V L +S +B  |
|                       | ML 350 CDI 4-matic    | 170      | L 174198 | 06.11 |                |                |        |                                |                                |                          |
|                       | ML 400 Hybrid 4-matic |          | L 174198 | 02.12 |                |                |        |                                |                                |                          |
|                       | GLE 250 d             | 150      |          | 04.15 |                | 24.0114-0119.1 | 414119 |                                | - AMG Sportpaket <sup>1)</sup> | 325 14,0 11,4 L +S +B    |
|                       | GLE 250 d 4-matic     | 150      |          | 04.15 |                | 24.0122-0288.1 | 422288 |                                | + AMG Sportpaket <sup>2)</sup> | 330 22,0 19,4 V L +B     |
|                       | GLE 350 d 4-matic     | 190      |          | 04.15 |                |                |        |                                |                                |                          |
|                       | ML 250 CDI BT 4-matic | 150      | L 174199 |       |                |                |        |                                |                                |                          |
|                       | ML 300 4-matic        | 185      |          | 04.14 |                |                |        |                                |                                |                          |
|                       | ML 350 BT 4-matic     | 190      | L 174199 |       |                |                |        |                                |                                |                          |
| ML 350 CDI 4-matic    | 170                   | L 174199 |          |       |                |                |        |                                |                                |                          |
| ML 400 Hybrid 4-matic |                       | L 174199 |          |       |                |                |        |                                |                                |                          |
| ML 350 BE 4-matic     | 225                   | A 174198 | 06.11    |       | 24.0122-0288.1 | 422288         |        | - AMG Sportpaket <sup>1)</sup> | 330 22,0 19,4 V L +B           |                          |
| GLE 320 4-matic       | 200                   |          | 10.15    |       | 24.0122-0288.1 | 422288         |        | - AMG Sportpaket <sup>1)</sup> | 330 22,0 19,4 V L +B           |                          |
| GLE 400 4-matic       | 245                   |          | 04.15    |       |                |                |        |                                |                                |                          |
| ML 350 BE 4-matic     | 225                   | A 174199 |          |       |                |                |        |                                |                                |                          |
| ML 400 4-matic        | 245                   |          | 08.13    |       |                |                |        |                                |                                |                          |

**MERCEDES BENZ R-Klasse (W251,V251) (06-12)**

|                  |                   |  |       |       |                |                |        |   |                         |                            |     |
|------------------|-------------------|--|-------|-------|----------------|----------------|--------|---|-------------------------|----------------------------|-----|
|                  | R 280             |  |       | 01.07 | 10.12          | 13.0460-7220.2 | 607220 |   |                         | 23922 21,0 +/WE            | ATE |
|                  | R 280 4-matic     |  |       | 05.07 | 10.12          | 13.0470-7220.2 | LD7220 |   |                         | 23922 21,0 +/WE            | ATE |
|                  | R 280 CDI         |  |       | 05.06 | 10.12          | 24.8190-0425.2 | 620425 | 1 |                         | Warnkontakt L=98mm         |     |
|                  | R 280 CDI 4-matic |  |       | 11.05 | 10.12          |                |        |   |                         |                            |     |
|                  | R 300             |  |       | 07.09 | 10.12          |                |        |   |                         |                            |     |
|                  | R 300 CDI         |  |       | 07.09 | 10.12          |                |        |   |                         |                            |     |
|                  | R 300 CDI 4-matic |  |       | 07.09 | 10.12          |                |        |   |                         |                            |     |
|                  | R 320 CDI 4-matic |  |       | 11.05 | 10.12          |                |        |   |                         |                            |     |
|                  | R 350             |  |       | 11.05 | 10.12          |                |        |   |                         |                            |     |
|                  | R 350 BT 4-matic  |  |       | 05.09 | 10.12          |                |        |   |                         |                            |     |
|                  | R 350 CDI 4-matic |  |       | 05.09 | 10.12          |                |        |   |                         |                            |     |
|                  | R 350 4-matic     |  |       | 01.06 | 10.12          | 13.0460-7220.2 | 607220 |   |                         | 23922 21,0 +/WE            | ATE |
|                  | R 500 4-matic     |  |       | 11.05 | 10.12          | 24.8190-0425.2 | 620425 | 1 |                         | Warnkontakt L=98mm         |     |
| R 63 AMG         |                   |  | 11.05 | 10.12 | 24.8190-0425.2 | 620425         | 1      |   | Warnkontakt L=98mm      |                            |     |
|                  | R 280             |  |       | 01.07 | 10.12          | 24.0132-0158.1 | 432158 |   |                         | 330 32,0 29,4 V L +S +B    |     |
|                  | R 280 4-matic     |  |       | 05.07 | 10.12          | 24.0332-0158.1 | 532158 |   |                         | 330 32,0 29,4 V L +S +B PD |     |
|                  | R 280 CDI         |  |       | 05.06 | 10.12          |                |        |   |                         |                            |     |
|                  | R 280 CDI 4-matic |  |       | 11.05 | 10.12          |                |        |   |                         |                            |     |
|                  | R 300             |  |       | 01.07 | 10.12          |                |        |   |                         |                            |     |
|                  | R 300 CDI         |  |       | 07.09 | 10.12          |                |        |   |                         |                            |     |
|                  | R 300 CDI 4-matic |  |       | 07.09 | 10.12          |                |        |   |                         |                            |     |
|                  | R 320 CDI 4-matic |  |       | 11.05 | 10.12          |                |        |   |                         |                            |     |
|                  | R 350             |  |       | 11.05 | 10.12          |                |        |   |                         |                            |     |
|                  | R 350 4-matic     |  |       | 01.06 | 10.12          |                |        |   |                         |                            |     |
|                  | R 350 BT 4-matic  |  |       | 05.09 | 10.12          |                |        |   |                         |                            |     |
|                  | R 350 CDI 4-matic |  |       | 05.09 | 10.12          |                |        |   |                         |                            |     |
|                  | R 280 CDI         |  |       | 05.06 | 10.12          | 24.0132-0157.1 | 432157 |   |                         | 350 32,0 29,4 V L +S +B    |     |
| R 350 BT 4-matic |                   |  | 05.09 | 10.12 |                |                |        |   |                         |                            |     |
| R 500 4-matic    |                   |  | 11.05 | 10.12 |                |                |        |   |                         |                            |     |
| R 63 AMG         |                   |  | 11.05 | 10.12 |                |                |        |   |                         |                            |     |
|                  | R 280             |  |       | 01.07 | 10.12          | 13.0460-7219.2 | 607219 |   | + 18" Rad <sup>6)</sup> | 23923 17,6 +/WE            | ATE |
|                  | R 280 CDI 4-matic |  |       | 11.05 | 10.12          | 13.0470-7219.2 | LD7219 |   | + 18" Rad <sup>6)</sup> | 23923 17,6 +/WE            | ATE |
|                  | R 300             |  |       | 07.09 | 10.12          | 24.8190-0425.2 | 620425 | 1 |                         | Warnkontakt L=98mm         |     |
|                  | R 300 CDI         |  |       | 07.09 | 10.12          |                |        |   |                         |                            |     |
|                  | R 300 CDI 4-matic |  |       | 07.09 | 10.12          |                |        |   |                         |                            |     |
|                  | R 320 CDI 4-matic |  |       | 11.05 | 10.12          |                |        |   |                         |                            |     |
| R 350            |                   |  | 11.05 | 10.12 |                |                |        |   |                         |                            |     |

1) - AMG sports package / - kit sportivo AMG / - version sport AMG / - paquete deportivo AMG  
 2) + AMG sports package / + pacchetto sportivo AMG / + version Sport AMG / + kit deportivo AMG  
 3) - sport package / - pacchetto sportivo / - version sport / - kit deportivo  
 4) + sports package / + pacchetto sportivo / + version sport / + kit deportivo  
 5) - 18" wheel / - ruota 18" / - roue 18" / - rueda 18"  
 6) + 18" wheel / + ruota 18" / + roue 18" / + rueda 18"





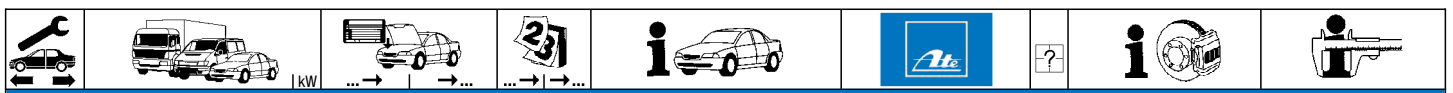

**MERCEDES BENZ R-Klasse (W251,V251) (06-12)**

|                   |                   |       |       |                |                |   |  |  |            |
|-------------------|-------------------|-------|-------|----------------|----------------|---|--|--|------------|
|                   | R 350 BT 4-matic  | 05.09 | 10.12 | 13.0460-7219.2 | 607219         | 1 | + 18" Rad <sup>1)</sup><br>+ 18" Rad <sup>1)</sup>                       | 23923 17,6 +/WE<br>23923 17,6 +/WE<br>Warnkontakt L=98mm | ATE<br>ATE |
|                   | R 350 CDI 4-matic | 05.09 | 10.12 | 13.0470-7219.2 | LD7219         |   |  |  |            |
|                   | R 500 4-matic     | 11.05 | 10.12 | 24.8190-0425.2 | 620425         |   |  |  |            |
|                   | R 280 4-matic     | 05.07 | 10.12 | 13.0460-7219.2 | 607219         |   |  |  |            |
|                   | R 280 CDI         | 05.06 | 10.12 | 13.0470-7219.2 | LD7219         | 1 |  | 23923 17,6 +/WE<br>23923 17,6 +/WE<br>Warnkontakt L=98mm | ATE<br>ATE |
|                   | R 350 4-matic     | 01.06 | 10.12 | 24.8190-0425.2 | 620425         |   |  |  |            |
|                   | R 63 AMG          | 11.05 | 10.12 | 24.8190-0425.2 | 620425         |   |  |  |            |
|                   | R 280             | 01.07 | 10.12 | 24.0114-0114.1 | 414114         |   |  |  |            |
|                   | R 280 4-matic     | 05.07 | 10.12 | 24.0122-0226.1 | 422226         | 2 | - belüftete Scheiben <sup>2)</sup><br>+ belüftete Scheiben <sup>3)</sup> | 330 14,0 11,4 L +S +B<br>330 22,0 19,4 V L +S +B         |            |
|                   | R 280 CDI         | 05.06 | 10.12 |                |                |   |  |  |            |
|                   | R 280 CDI 4-matic | 11.05 | 10.12 |                |                |   |  |  |            |
|                   | R 300             | 01.07 | 10.12 |                |                |   |  |  |            |
|                   | R 300 CDI         | 07.09 | 10.12 |                |                |   |  |  |            |
|                   | R 300 CDI 4-matic | 07.09 | 10.12 |                |                |   |  |  |            |
|                   | R 320 CDI 4-matic | 11.05 | 10.12 |                |                |   |  |  |            |
|                   | R 350             | 11.05 | 10.12 |                |                |   |  |  |            |
|                   | R 350 4-matic     | 01.06 | 10.12 |                |                |   |  |  |            |
|                   | R 350 BT 4-matic  | 05.09 | 10.12 |                |                |   |  |  |            |
|                   | R 350 CDI 4-matic | 05.09 | 10.12 |                |                |   |  |  |            |
|                   | R 500 4-matic     | 11.05 | 10.12 |                |                |   |  |  |            |
|                   | R 63 AMG          | 11.05 | 10.12 |                |                |   |  |  |            |
|                   |                   | R 280 | 01.07 | 10.12          | 24.0711-5412.3 |   |  |  |            |
| R 280 4-matic     |                   | 05.07 | 10.12 |                |                |   |  |  |            |
| R 280 CDI         |                   | 05.06 | 10.12 |                |                |   |  |  |            |
| R 280 CDI 4-matic |                   | 11.05 | 10.12 |                |                |   |  |  |            |
| R 300             |                   | 01.07 | 10.12 |                |                |   |  |  |            |
| R 300 CDI         |                   | 07.09 | 10.12 |                |                |   |  |  |            |
| R 300 CDI 4-matic |                   | 07.09 | 10.12 |                |                |   |  |  |            |
| R 320 CDI 4-matic |                   | 11.05 | 10.12 |                |                |   |  |  |            |
| R 350             |                   | 11.05 | 10.12 |                |                |   |  |  |            |
| R 350 4-matic     |                   | 01.06 | 10.12 |                |                |   |  |  |            |
| R 350 BT 4-matic  |                   | 05.09 | 10.12 |                |                |   |  |  |            |
| R 350 CDI 4-matic |                   | 05.09 | 10.12 |                |                |   |  |  |            |
| R 500 4-matic     |                   | 11.05 | 10.12 |                |                |   |  |  |            |
| R 63 AMG          |                   | 11.05 | 10.12 |                |                |   |  |  |            |
|                   | R 280             | 01.07 | 10.12 | 03.0137-0451.2 | 650451         |   |  | 210 x 30   |            |
|                   | R 280 CDI         | 05.06 | 10.12 |                |                |   |  |  |            |
|                   | R 280 CDI 4-matic | 11.05 | 10.12 |                |                |   |  |  |            |
|                   | R 300             | 01.07 | 10.12 |                |                |   |  |  |            |
|                   | R 300 CDI         | 07.09 | 10.12 |                |                |   |  |  |            |
|                   | R 300 CDI 4-matic | 07.09 | 10.12 |                |                |   |  |  |            |
|                   | R 320 CDI 4-matic | 11.05 | 10.12 |                |                |   |  |  |            |
|                   | R 350             | 11.05 | 10.12 |                |                |   |  |  |            |
|                   | R 350 4-matic     | 01.06 | 10.12 |                |                |   |  |  |            |
|                   | R 350 BT 4-matic  | 05.09 | 10.12 |                |                |   |  |  |            |
|                   | R 350 CDI 4-matic | 05.09 | 10.12 |                |                |   |  |  |            |
|                   | R 500 4-matic     | 11.05 | 10.12 |                |                |   |  |  |            |
|                   | R 63 AMG          | 11.05 | 10.12 |                |                |   |  |  |            |

**MERCEDES BENZ S-Klasse (W140) (93-98)**

|  |                    |       |       |                |        |   |       |   |                   |
|--|--------------------|-------|-------|----------------|--------|---|-------|---|-------------------|
|  | S 280 / 300 SE 2.8 | 07.93 | 10.98 | 13.0460-9033.2 | 609033 | 4 |       | 21303 18,9 /WE<br>Belagsatz-Zubehör<br>Warnkontakt L=95mm                   | ATE               |
|  | S 300 TD           | 04.96 | 10.98 | 13.0460-0263.2 | 610263 |   |       |   |                   |
|  | S 320              | 07.93 | 10.98 | 24.8190-0401.2 | 620401 |   |       |   |                   |
|  | S 350 TD           | 07.93 | 06.96 |                |        |   |       |   |                   |
|  | S 420              | 07.93 | 10.98 |                |        |   |       |   |                   |
|  | S 420 C            | 04.94 | 05.96 |                |        |   |       |   |                   |
|  | S 500              | 07.93 | 10.98 |                |        |   |       |   |                   |
|  | S 500 C            | 07.93 | 05.96 |                |        |   |       |   |                   |
|  | S 600              | 07.93 | 10.98 |                |        |   |       |   |                   |
|  | S 600 C            | 07.93 | 05.96 |                |        |   |       |   |                   |
|  | S 280 / 300 SE 2.8 | 07.93 | 10.98 | 24.0130-0100.1 | 430100 |   |       | 320 30,0 27,4 V L +B  |                   |
|  | S 300 TD           | 04.96 | 10.98 |                |        |   |       |   |                   |
|  | S 320              | 07.93 | 10.98 |                |        |   |       |   |                   |
|  | S 350 TD           | 07.93 | 06.96 |                |        |   |       |   |                   |
|  | S 420              | 07.93 | 10.98 |                |        |   |       |   |                   |
|  | S 420 C            | 04.94 | 05.96 |                |        |   |       |   |                   |
|  | S 500              | 07.93 | 10.98 |                |        |   |       |   |                   |
|  | S 500 C            | 07.93 | 05.96 |                |        |   |       |   |                   |
|  | S 600              | 07.93 | 10.98 |                |        |   |       |   |                   |
|  | S 600 C            | 07.93 | 05.96 |                |        |   |       |   |                   |
|  | S 280 / 300 SE 2.8 | 07.93 | 10.98 | 13.0460-4047.2 | 604047 | 4 | + ASR | 21305 15,7 /WE<br>21305 15,7 /WE<br>Belagsatz-Zubehör<br>Warnkontakt L=95mm | ATE<br>ATE<br>ATE |
|  | S 300 TD           | 04.96 | 10.98 | 13.0470-4047.2 | LD4047 |   |       |   |                   |
|  | S 320              | 07.93 | 10.98 | 13.0460-0239.2 | 610239 |   |       |   |                   |
|  | S 350 TD           | 07.93 | 06.96 | 24.8190-0401.2 | 620401 |   |       |   |                   |
|  | S 420              | 07.93 | 10.98 | 13.0460-4047.2 | 604047 |   |       |   |                   |
|  | S 420 C            | 04.94 | 05.96 | 13.0470-4047.2 | LD4047 | 4 | + ASR | 21305 15,7 /WE<br>21305 15,7 /WE<br>Belagsatz-Zubehör<br>Warnkontakt L=95mm | ATE<br>ATE<br>ATE |
|  | S 500              | 07.93 | 10.98 | 13.0460-0239.2 | 610239 |   |       |   |                   |
|  | S 500 C            | 07.93 | 05.96 | 24.8190-0401.2 | 620401 |   |       |   |                   |
|  | S 600              | 07.93 | 10.98 |                |        |   |       |   |                   |
|  | S 600 C            | 07.93 | 05.96 |                |        |   |       |   |                   |
|  | S 280 / 300 SE 2.8 | 07.93 | 10.98 | 24.0112-0129.1 | 412129 |   |       | 290 12,0 9,8 L +B   |                   |
|  | S 300 TD           | 04.96 | 10.98 |                |        |   |       |   |                   |
|  | S 320              | 07.93 | 10.98 |                |        |   |       |   |                   |
|  | S 350 TD           | 07.93 | 06.96 |                |        |   |       |   |                   |
|  | S 420              | 07.93 | 10.98 | 24.0122-0133.1 | 422133 |   |       | 300 22,0 19,4 V L +B  |                   |
|  | S 420 C            | 04.94 | 05.96 |                |        |   |       |   |                   |
|  | S 500              | 07.93 | 10.98 |                |        |   |       |   |                   |

<sup>1)</sup> + 18" wheel / + ruota 18" / + roue 18" / + rueda 18"

<sup>2)</sup> - ventilated discs / - dischi ventilati / - disques ventilés / - disco ventilado

<sup>3)</sup> + ventilated discs / + dischi ventilati / + disques ventilés / + disco ventilado





**MERCEDES BENZ S-Klasse (W140) (93-98)**

|  |   |  |  |  |  |                |        |  |  |                      |
|--|---|--|--|--|--|----------------|--------|--|--|----------------------|
|  | S 500 C<br>S 600<br>S 600 C   |  |  | 07.93 05.96<br>07.93 10.98<br>07.93 05.96  |  | 24.0122-0133.1 | 422133 |  |  | 300 22,0 19,4 V L +B |
|  | S 280 / 300 SE 2.8<br>S 300 TD<br>S 320<br>S 350 TD<br>S 420<br>S 420 C<br>S 500<br>S 500 C<br>S 600<br>S 600 C |  |  | 07.93 10.98<br>04.96 10.98<br>07.93 10.98<br>07.93 06.96<br>07.93 10.98<br>04.94 05.96<br>07.93 10.98<br>07.93 05.96<br>07.93 10.98<br>07.93 05.96 |  | 03.0137-0244.2 | 650244 |  |  | 164 x 25 /Zub        |

**MERCEDES BENZ S-Klasse (W220) (98-06)**

|  |   |            |  |  |  |  |  |        |  |  |
|--|---|------------|--|--|--|--|--|--------|--|--|
|  | S 280<br>S 320<br>S 320 CDI   | 145        |  | 11.98 08.02<br>11.98 08.02<br>08.99 08.02  |  | 13.0460-4984.2<br>13.0470-4984.2<br>13.0460-0275.2<br>24.8190-0410.2   | 604984<br>LD4984<br>610275<br>620410                               |        |  | 23271 17,4 +/WE(1,8) BRE<br>23271 17,4 +/WE(1,8) BRE<br>Belagsatz-Zubehör<br>Warnkontakt L=97,5mm  |
|  | S 400 CDI<br>S 430  |            |  | 08.00 08.02<br>11.98 08.02   |  | 13.0460-4984.2<br>13.0460-0269.2<br>24.8190-0410.2   | 604984<br>610269<br>620410   | 2      |  | 23271 17,4 +/WE(1,8) BRE<br>Belagsatz-Zubehör<br>Warnkontakt L=97,5mm  |
|  | S 500<br>S 55 AMG   |            |  | 11.98 08.02<br>04.99 08.02   | - gepanzerte Fahrzeuge 1)                              | 13.0460-4984.2<br>13.0460-0269.2<br>24.8190-0410.2   | 604984<br>610269<br>620410   | 2      |  | 23271 17,4 +/WE(1,8) BRE<br>Belagsatz-Zubehör<br>Warnkontakt L=97,5mm  |
|  | S 280<br>S 320<br>S 320 CDI<br>S 320 CDI<br>S 350<br>S 370                          | 145<br>150 |  | 09.02 03.06<br>09.02 03.06<br>09.02 03.06<br>09.02 03.06<br>09.02 03.06<br>08.04 03.06                               |  | 13.0460-4990.2<br>13.0470-4990.2<br>13.0460-4984.2<br>13.0470-4984.2<br>13.0460-0275.2<br>24.8190-0416.2<br>24.8190-0410.2 | 604990<br>LD4990<br>604984<br>LD4984<br>610275<br>620416<br>620410 | 1<br>1 |  | 23745 17,4 +/WE(1,8/7) BRE<br>23745 17,4 +/WE(1,8/7) BRE<br>23271 17,4 +/WE(1,8) BRE<br>23271 17,4 +/WE(1,8) BRE<br>Belagsatz-Zubehör<br>Warnkontakt L=100mm<br>Warnkontakt L=97,5mm |
|  | S 400 CDI<br>S 430  |            |  | 09.02 03.06<br>09.02 03.06   |  | 13.0460-4990.2<br>13.0470-4990.2<br>13.0460-4984.2<br>13.0470-4984.2<br>13.0460-0275.2<br>24.8190-0416.2<br>24.8190-0410.2 | 604990<br>LD4990<br>604984<br>LD4984<br>610275<br>620416<br>620410 | 1<br>1 |  | 23745 17,4 +/WE(1,8/7) BRE<br>23745 17,4 +/WE(1,8/7) BRE<br>23271 17,4 +/WE(1,8) BRE<br>23271 17,4 +/WE(1,8) BRE<br>Belagsatz-Zubehör<br>Warnkontakt L=100mm<br>Warnkontakt L=97,5mm |
|  | S 500<br>S 55 AMG<br>S 600  |            |  | 09.02 03.06<br>09.02 03.06<br>08.99 03.06  | - gepanzerte Fahrzeuge 1)<br>- gepanzerte Fahrzeuge 1) | 13.0460-4990.2<br>13.0460-4984.2<br>13.0460-0275.2<br>24.8190-0416.2<br>24.8190-0410.2                                     | 604990<br>604984<br>610275<br>620416<br>620410                     | 1<br>1 |  | 23745 17,4 +/WE(1,8/7) BRE<br>23271 17,4 +/WE(1,8) BRE<br>Belagsatz-Zubehör<br>Warnkontakt L=100mm<br>Warnkontakt L=97,5mm   |
|  | S 350 4-matic   |            |  | 06.03 03.06  |  | 13.0460-7203.2<br>24.8190-0416.2<br>24.8190-0410.2   | 607203<br>620416<br>620410   | 1<br>1 |  | 21670 19,3 +/WE ATE<br>Warnkontakt L=100mm<br>Warnkontakt L=97,5mm   |
|  | S 430 4-matic<br>S 500 4-matic  |            |  | 09.02 03.06<br>09.02 03.06   |  | 13.0460-7183.2<br>24.8190-0425.2   | 607183<br>620425   | 1      |  | 21484 20,5 +/WE ATE<br>Warnkontakt L=98mm  |
|  | S 55 Kompressor AMG<br>S 63 AMG<br>S 65 AMG   |            |  | 06.02 03.06<br>09.01 03.06<br>03.04 03.06  |  | 13.0460-4997.2<br>24.8190-0410.2   | 604997<br>620410   | 2      |  | 23944 17,5 +/WE BRE<br>Warnkontakt L=97,5mm  |
|  | S 500<br>S 600  |            |  | 11.98 03.06<br>08.99 03.06   | + gepanzerte Fahrzeuge 2)<br>+ gepanzerte Fahrzeuge 2) | 24.8190-0410.2   | 620410   | 2      |  | Warnkontakt L=97,5mm   |
|  | S 280<br>S 320<br>S 350<br>S 370  |            |  | 11.98 03.06<br>11.98 03.06<br>09.02 03.06<br>08.04 03.06   |  | 24.0128-0125.1<br>13.8190-0330.1   | 428125<br>990134   | 4      |  | 312 28,0 26,0 V L +B<br>Halterschraube   |
|  | S 320 CDI<br>S 320 CDI<br>S 400 CDI<br>S 430<br>S 500                               | 145<br>150 |  | 08.99 03.06<br>09.02 03.06<br>08.00 03.06<br>11.98 03.06<br>11.98 03.06  | - gepanzerte Fahrzeuge 1)                              | 24.0132-0115.1<br>13.8190-0330.1   | 432115<br>990134   | 4      |  | 330 32,0 30,0 V L +B<br>Halterschraube   |
|  | S 350 4-matic   |            |  | 06.03 03.06  |  | 24.0130-0172.1<br>13.8190-0330.1   | 430172<br>990134   | 4      |  | 304 30,0 27,4 V L +B<br>Halterschraube   |
|  | S 430 4-matic<br>S 500 4-matic  |            |  | 09.02 03.06<br>09.02 03.06   |  | 24.0132-0136.1<br>13.8190-0330.1   | 432136<br>990134   | 4      |  | 330 32,0 30,0 V L +B<br>Halterschraube   |
|  | S 55 AMG<br>S 600   |            |  | 04.99 03.06<br>08.99 03.06   | - gepanzerte Fahrzeuge 1)                              | 24.0132-0125.1<br>13.8190-0330.1   | 432125<br>990134   | 4      |  | 345 32,0 30,0 V L +B<br>Halterschraube   |
|  | S 55 Kompressor AMG   |            |  | 06.02 03.06  |  | 24.0136-0105.1   | 436105   |        |  | 360 36,0 34,0 V L +B   |
|  | S 280<br>S 320<br>S 320 CDI<br>S 370<br>S 400 CDI<br>S 430<br>S 500<br>S 55 AMG     | 145        |  | 11.98 03.06<br>11.98 03.06<br>08.99 03.06<br>08.04 03.06<br>08.00 09.02<br>11.98 09.02<br>11.98 09.02<br>04.99 09.02 | - gepanzerte Fahrzeuge 1)                              | 13.0460-4069.2<br>24.8190-0410.2   | 604069<br>620410   | 1      |  | 23078 15,9 /WE ATE<br>Warnkontakt L=97,5mm   |
|  | S 320 CDI<br>S 350<br>S 350 4-matic<br>S 400 CDI<br>S 430<br>S 430 4-matic<br>S 500 | 150        |  | 09.02 03.06<br>09.02 03.06<br>06.03 03.06<br>10.02 03.06<br>10.02 03.06<br>09.02 03.06<br>10.02 03.06                | - gepanzerte Fahrzeuge 1)                              | 13.0460-7171.2<br>13.0470-7171.2<br>24.8190-0410.2   | 607171<br>LD7171<br>620410   | 1      |  | 23334 16,7 +/WE ATE<br>23334 16,7 +/WE ATE<br>Warnkontakt L=97,5mm   |

1) - armoured vehicles / - veicoli blindati / - véhicule blindé / - vehículo blindado  
2) + armoured vehicles / + veicoli blindati / + véhicule blindé / + vehículo blindado





### MERCEDES BENZ S-Klasse (W220) (98-06)

|  |  |            |  |   |  |  |  |                                      |   |  |   |                   |
|--|--|------------|--|---|--|--|--|--------------------------------------|---|--|---|-------------------|
|  | S 500 4-matic<br>S 600   |            |  | 09.02<br>08.99  | 03.06<br>03.06   | - gepanzerte Fahrzeuge <sup>1)</sup>   | 13.0460-7171.2<br>13.0470-7171.2<br>24.8190-0410.2                   | 607171<br>LD7171<br>620410           | 1 |  | 23334 16,7 +/WE<br>23334 16,7 +/WE<br>Warnkontakt L=97,5mm                    | ATE<br>ATE        |
|  | S 55 Kompressor AMG  |            |  | 06.02   | 03.06  |  | 13.0460-4998.2<br>24.8190-0410.2                                     | 604998<br>620410                     | 1 |  | 23478 16,5 /WE<br>Warnkontakt L=97,5mm  | BRE               |
|  | S 500<br>S 600   |            |  | 11.98<br>08.99  | 03.06<br>03.06   | + gepanzerte Fahrzeuge <sup>2)</sup><br>+ gepanzerte Fahrzeuge <sup>2)</sup> | 13.0460-4047.2<br>13.0470-4047.2<br>13.0460-0236.2<br>24.8190-0410.2 | 604047<br>LD4047<br>610236<br>620410 | 1 |  | 21305 15,7 /WE<br>21305 15,7 /WE<br>Belagsatz-Zubehör<br>Warnkontakt L=97,5mm | ATE<br>ATE<br>ATE |
|  | S 63 AMG<br>S 65 AMG   |            |  | 09.01<br>03.04  | 03.06<br>03.06   |  | 13.0460-4819.2<br>24.8190-0410.2                                     | 604819<br>620410                     | 1 |  | 23478 14,6 /WE<br>Warnkontakt L=97,5mm  | BRE               |
|  | S 280<br>S 320<br>S 320 CDI<br>S 320 CDI<br>S 350<br>S 370<br>S 430  | 145<br>150 |  | 11.98<br>11.98<br>08.99<br>09.02<br>09.02<br>08.04<br>10.02   | 03.06<br>03.06<br>03.06<br>03.06<br>03.06<br>03.06<br>03.06  |  | 24.0111-0153.1   | 411153                               |   |  | 300 11,0 9,3 +B   |                   |
|  | S 350 4-matic<br>S 400 CDI<br>S 430<br>S 430 4-matic<br>S 500<br>S 500 4-matic   |            |  | 06.03<br>08.00<br>11.98<br>09.02<br>11.98<br>09.02  | 03.06<br>03.06<br>09.02<br>03.06<br>03.06<br>03.06   | - gepanzerte Fahrzeuge <sup>1)</sup>   | 24.0122-0192.1   | 422192                               |   |  | 300 22,0 19,4 V L +B  |                   |
|  | S 55 AMG   |            |  | 04.99   | 03.06  |  | 24.0122-0213.1   | 422213                               |   |  | 315 22,0 19,4 V L +B  |                   |
|  | S 55 Kompressor AMG  |            |  | 06.02   | 03.06  |  | 24.0126-0137.1   | 426137                               |   |  | 330 26,0 24,0 V L +B  |                   |
|  | S 280<br>S 320<br>S 320 CDI<br>S 320 CDI<br>S 350<br>S 350 4-matic<br>S 370<br>S 400 CDI<br>S 430<br>S 430 4-matic<br>S 500<br>S 500 4-matic<br>S 55 AMG<br>S 55 Kompressor AMG<br>S 600 | 145<br>150 |  | 11.98<br>11.98<br>08.99<br>09.02<br>09.02<br>06.03<br>08.04<br>08.00<br>11.98<br>09.02<br>11.98<br>09.02<br>04.99<br>06.02<br>08.99 | 03.06<br>03.06<br>03.06<br>03.06<br>03.06<br>03.06<br>03.06<br>03.06<br>03.06<br>03.06<br>03.06<br>03.06<br>03.06<br>03.06<br>03.06<br>03.06 | - gepanzerte Fahrzeuge <sup>1)</sup>   | 03.0137-4016.2<br>03.0137-9297.2                                     | 654016<br>669297                     |   |  | 180 x 25 /Zub<br>Bremsbacken-Zubehör  |                   |

### MERCEDES BENZ S-Klasse (W221) (06-13)

|  |  |   |          |  |   |  |  |                                      |             |  |   |                   |
|--|--|---|----------|--|---|--|--|--------------------------------------|-------------|--|---|-------------------|
|  | S 250 CDI<br>S 280 / S 300<br>S 320 CDI<br>S 320 CDI / S 350 CDI<br>S 320 CDI 4-matic<br>S 320 CDI 4-matic<br>S 350<br>S 350 4-matic<br>S 350 BlueTec<br>S 350 BlueTec 4-matic<br>S 350 CGI<br>S 350 CGI 4-matic<br>S 400 Hybrid<br>S 450<br>S 450 4-matic<br>S 500<br>S 500 4-matic | 150<br>170<br>155<br>173<br>155<br>173<br>200<br>200<br>190<br>190<br>225<br>225<br>205<br>250<br>250<br>285<br>285 |          | 01.11<br>04.06<br>12.05<br>12.05<br>12.05<br>05.06<br>12.05<br>02.07<br>04.11<br>04.11<br>04.11<br>06.09<br>04.06<br>04.06<br>12.05<br>04.06 | 05.13<br>05.13<br>05.13<br>05.13<br>05.13<br>05.13<br>05.13<br>05.13<br>05.13<br>05.13<br>05.13<br>05.13<br>05.13<br>05.13<br>05.13<br>05.13<br>05.13 |  | 13.0460-4817.2<br>24.8190-0420.2                                     | 604817<br>620420                     | 1           |  | 23960 18,3 /WE<br>Warnkontakt L=119mm   | BRE               |
|  | S 420 CDI / S 450 CDI  | 235   |          | 04.06  | 05.13   |  | 13.0460-4817.2<br>13.0460-4984.2<br>24.8190-0420.2<br>24.8190-0410.2 | 604817<br>604984<br>620420<br>620410 | 2<br>1<br>1 | + gepanzerte Fahrzeuge <sup>2)</sup><br>+ gepanzerte Fahrzeuge <sup>2)</sup>                             | 23960 18,3 /WE<br>23271 17,4 +/WE(1,8)<br>Warnkontakt L=119mm<br>Warnkontakt L=97,5mm | BRE<br>BRE        |
|  | S 600  | 380   | A 000100 | 12.05  |   |  | 13.0460-4997.2<br>13.0460-4839.2<br>13.0460-4984.2<br>24.8190-0410.2 | 604997<br>604839<br>604984<br>620410 | 2<br>2<br>1 | - AMG Sportpaket <sup>3)</sup><br>+ AMG Sportpaket <sup>4)</sup><br>+ gepanzerte Fahrzeuge <sup>2)</sup> | 23944 17,5 +/WE<br>24455 16,8 /WE<br>23271 17,4 +/WE(1,8)<br>Warnkontakt L=97,5mm     | BRE<br>BRE<br>BRE |
|  | S 600  | 380   | A 000101 |  | 05.13   |  | 13.0460-4839.2<br>13.0460-4984.2<br>24.8190-0420.2<br>24.8190-0410.2 | 604839<br>604984<br>620420<br>620410 | 2<br>1<br>1 | + gepanzerte Fahrzeuge <sup>2)</sup><br>+ gepanzerte Fahrzeuge <sup>2)</sup>                             | 24455 16,8 /WE<br>23271 17,4 +/WE(1,8)<br>Warnkontakt L=119mm<br>Warnkontakt L=97,5mm | BRE<br>BRE        |
|  | S 63 AMG<br>S 65 AMG   |   |          | 01.07<br>04.06   | 05.13<br>05.13  |  | 24.8190-0420.2   | 620420                               | 1           |  | Warnkontakt L=119mm   |                   |
|  | S 250 CDI<br>S 280 / S 300<br>S 320 CDI<br>S 320 CDI / S 350 CDI<br>S 350<br>S 350 4-matic<br>S 350 BlueTec<br>S 350 CGI<br>S 350 CGI 4-matic<br>S 400 Hybrid<br>S 500   | 150<br>170<br>155<br>173<br>200<br>200<br>190<br>225<br>225<br>205<br>285   |          | 01.11<br>04.06<br>12.05<br>12.05<br>12.05<br>02.07<br>04.11<br>04.11<br>04.11<br>06.09<br>12.05  | 05.13<br>05.13<br>05.13<br>05.13<br>05.13<br>05.13<br>05.13<br>05.13<br>05.13<br>05.13<br>05.13   | - Sportpaket AMG <sup>5)</sup><br>- Sportpaket AMG <sup>5)</sup><br>- Sportpaket AMG <sup>5)</sup><br>- Sportpaket AMG <sup>5)</sup><br>- Sportpaket AMG <sup>5)</sup><br>- Sportpaket AMG <sup>5)</sup><br>- Sportpaket AMG <sup>5)</sup><br>- Sportpaket AMG <sup>5)</sup><br>- Sportpaket AMG <sup>5)</sup><br>- Sportpaket AMG <sup>5)</sup><br>- Sportpaket AMG <sup>5)</sup> | 24.0132-0137.1   | 432137                               |             |  | 335 32,0 30,0 V L +S +B   |                   |

1) - armoured vehicles / - veicoli blindati / - véhicule blindé / - vehículo blindado  
2) + armoured vehicles / + veicoli blindati / + véhicule blindé / + vehículo blindado  
3) - AMG sports package / - kit sportivo AMG / - version sport AMG / - paquete deportivo AMG  
4) + AMG sports package / + pacchetto sportivo AMG / + version Sport AMG / + kit deportivo AMG  
5) - sport package AMG / - pacchetto sportivo AMG / - version sport AMG / - kit deportivo AMG

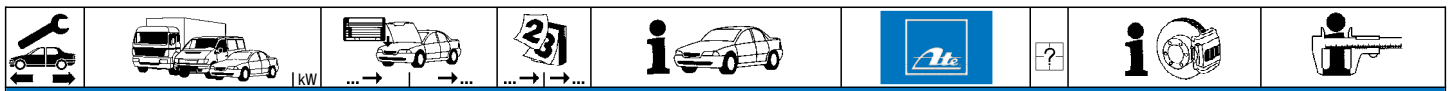











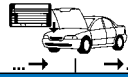

**MERCEDES BENZ S-Klasse (W221) (06-13)**

|                       |                       |              |          |       |                                |                                |                |        |   |  |
|-----------------------|-----------------------|--------------|----------|-------|--------------------------------|--------------------------------|----------------|--------|---|--|
|                       | S 250 CDI             | 150          |          | 01.11 | 05.13                          | + Sportpaket AMG <sup>1)</sup> | 24.0132-0138.1 | 432138 |   | 350 32,0 30,0 V L +S +B  |
|                       | S 280 / S 300         | 170          |          | 04.06 | 05.13                          | + Sportpaket AMG <sup>1)</sup> |                |        |   |  |
|                       | S 320 CDI             | 155          |          | 12.05 | 05.13                          | + Sportpaket AMG <sup>1)</sup> |                |        |   |  |
|                       | S 320 CDI / S 350 CDI | 173          |          | 12.05 | 05.13                          | + Sportpaket AMG <sup>1)</sup> |                |        |   |  |
|                       | S 320 CDI 4-matic     | 155          |          | 12.05 | 05.13                          |                                |                |        |   |  |
|                       | S 320 CDI 4-matic     | 173          |          | 05.06 | 05.13                          |                                |                |        |   |  |
|                       | S 350                 | 200          |          | 12.05 | 05.13                          | + Sportpaket AMG <sup>1)</sup> |                |        |   |  |
|                       | S 350 4-matic         | 200          |          | 02.07 | 05.13                          | + Sportpaket AMG <sup>1)</sup> |                |        |   |  |
|                       | S 350 BlueTec         | 190          |          | 04.11 | 05.13                          | + Sportpaket AMG <sup>1)</sup> |                |        |   |  |
|                       | S 350 BlueTec 4-matic | 190          |          | 04.11 | 05.13                          |                                |                |        |   |  |
| S 350 CGI             | 225                   |              | 04.11    | 05.13 | + Sportpaket AMG <sup>1)</sup> |                                |                |        |   |  |
| S 350 CGI 4-matic     | 225                   |              | 04.11    | 05.13 | + Sportpaket AMG <sup>1)</sup> |                                |                |        |   |  |
| S 400 Hybrid          | 205                   |              | 06.09    | 05.13 | + Sportpaket AMG <sup>1)</sup> |                                |                |        |   |  |
| S 420 CDI / S 450 CDI | 235                   |              | 04.06    | 05.13 |                                |                                |                |        |   |  |
| S 450                 | 250                   |              | 04.06    | 05.13 |                                |                                |                |        |   |  |
| S 450 4-matic         | 250                   |              | 04.06    | 05.13 |                                |                                |                |        |   |  |
| S 500                 | 285                   |              | 12.05    | 05.13 | + Sportpaket AMG <sup>1)</sup> |                                |                |        |   |  |
| S 500 4-matic         | 285                   |              | 04.06    | 05.13 |                                |                                |                |        |   |  |
| S 500 CGI             | 320                   |              | 04.11    | 05.13 |                                |                                |                |        |   |  |
| S 500 CGI 4-matic     | 320                   |              | 03.11    | 05.13 |                                |                                |                |        |   |  |
| S 600                 | 380                   |              | 12.05    | 05.13 |                                |                                |                |        |   |  |
|                       | S 280 / S 300         | 170          |          | 04.06 | 05.13                          |                                | 24.0711-6348.3 | 360334 | 2 | Radsensor L=1002   |
|                       | S 320 CDI             | 155          |          | 12.05 | 05.13                          |                                |                |        |   |  |
|                       | S 320 CDI / S 350 CDI | 173          |          | 12.05 | 05.13                          |                                |                |        |   |  |
|                       | S 350                 | 200          |          | 12.05 | 05.13                          |                                |                |        |   |  |
|                       | S 350 BlueTec         | 190          |          | 04.11 | 05.13                          |                                |                |        |   |  |
|                       | S 350 CGI             | 225          |          | 04.11 | 05.13                          |                                |                |        |   |  |
|                       | S 400 Hybrid          | 205          |          | 06.09 | 05.13                          |                                |                |        |   |  |
|                       | S 420 CDI / S 450 CDI | 235          |          | 04.06 | 05.13                          |                                |                |        |   |  |
|                       | S 450                 | 250          |          | 04.06 | 05.13                          |                                |                |        |   |  |
|                       | S 500                 | 285          |          | 12.05 | 05.13                          |                                |                |        |   |  |
| S 500 CGI             | 320                   |              | 04.11    | 05.13 |                                |                                |                |        |   |  |
| S 600                 | 380                   |              | 12.05    | 05.13 |                                |                                |                |        |   |  |
| S 63 AMG              |                       |              | 01.07    | 05.13 |                                |                                |                |        |   |  |
| S 65 AMG              |                       |              | 04.06    | 05.13 |                                |                                |                |        |   |  |
|                       | S 250 CDI             | 150          | A 362911 | 01.11 |                                |                                | 24.0711-5463.3 | 360385 | 2 | Radsensor L=798  |
|                       | S 320 CDI 4-matic     | 155 A 293048 | A 362911 |       |                                |                                |                |        |   |  |
|                       | S 320 CDI 4-matic     | 173 A 293048 | A 362911 |       |                                |                                |                |        |   |  |
|                       | S 350 4-matic         | 200 A 293048 | A 362911 |       |                                |                                |                |        |   |  |
|                       | S 350 BlueTec 4-matic | 190          | A 362911 | 04.11 |                                |                                |                |        |   |  |
|                       | S 350 CGI 4-matic     | 225          | A 362911 | 04.11 |                                |                                |                |        |   |  |
|                       | S 450 4-matic         | 250 A 293048 | A 362911 |       |                                |                                |                |        |   |  |
|                       | S 500 4-matic         | 285 A 293048 | A 362911 |       |                                |                                |                |        |   |  |
|                       | S 500 CGI 4-matic     | 320          | A 362911 | 03.11 |                                |                                |                |        |   |  |
|                       | S 250 CDI             | 150 A 362912 |          |       | 05.13                          |                                |                |        |   |  |
| S 320 CDI 4-matic     | 155 A 362912          |              |          | 05.13 |                                |                                |                |        |   |  |
| S 320 CDI 4-matic     | 173 A 362912          |              |          | 05.13 |                                |                                |                |        |   |  |
| S 350 4-matic         | 200 A 362912          |              |          | 05.13 |                                |                                |                |        |   |  |
| S 350 BlueTec 4-matic | 190 A 362912          |              |          | 05.13 |                                |                                |                |        |   |  |
| S 350 CGI 4-matic     | 225 A 362912          |              |          | 05.13 |                                |                                |                |        |   |  |
| S 450 4-matic         | 250 A 362912          |              |          | 05.13 |                                |                                |                |        |   |  |
| S 500 4-matic         | 285 A 362912          |              |          | 05.13 |                                |                                |                |        |   |  |
| S 500 CGI 4-matic     | 320 A 362912          |              |          | 05.13 |                                |                                |                |        |   |  |
|                       | S 250 CDI             | 150          |          | 01.11 | 05.13                          |                                | 24.8190-0410.2 | 620410 | 1 | Warnkontakt L=97,5mm   |
|                       | S 320 CDI             | 155 A 289059 |          |       | 05.13                          |                                |                |        |   |  |
|                       | S 320 CDI / S 350 CDI | 173 A 289059 |          |       | 05.13                          |                                |                |        |   |  |
|                       | S 320 CDI 4-matic     | 155 A 289059 |          |       | 05.13                          |                                |                |        |   |  |
|                       | S 320 CDI 4-matic     | 173 A 289059 |          |       | 05.13                          |                                |                |        |   |  |
|                       | S 350                 | 200 A 289059 |          |       | 05.13                          |                                |                |        |   |  |
|                       | S 350 4-matic         | 200 A 289059 |          |       | 05.13                          |                                |                |        |   |  |
|                       | S 350 BlueTec         | 190          |          | 04.11 | 05.13                          | + Sportpaket AMG <sup>1)</sup> |                |        |   |  |
|                       | S 350 BlueTec 4-matic | 190          |          | 04.11 | 05.13                          | + Sportpaket AMG <sup>1)</sup> |                |        |   |  |
|                       | S 350 CGI             | 225          |          | 04.11 | 05.13                          | + Sportpaket AMG <sup>1)</sup> |                |        |   |  |
| S 350 CGI 4-matic     | 225                   |              | 04.11    | 05.13 | + Sportpaket AMG <sup>1)</sup> |                                |                |        |   |  |
| S 400 Hybrid          | 205 A 289059          |              |          | 05.13 |                                |                                |                |        |   |  |
| S 450                 | 250 A 289059          |              |          | 05.13 |                                |                                |                |        |   |  |
| S 450 4-matic         | 250 A 289059          |              |          | 05.13 |                                |                                |                |        |   |  |
| S 500                 | 285 A 289059          |              |          | 05.13 |                                |                                |                |        |   |  |
| S 500 4-matic         | 285 A 289059          |              |          | 05.13 |                                |                                |                |        |   |  |
| S 500 CGI             | 320                   |              | 04.11    | 05.13 |                                |                                |                |        |   |  |
| S 500 CGI 4-matic     | 320                   |              | 03.11    | 05.13 |                                |                                |                |        |   |  |
|                       | S 280 / S 300         | 170          |          | 04.06 | 05.13                          |                                | 13.0460-7171.2 | 607171 | 1 | 23334 16,7 +/WE ATE<br>23334 16,7 +/WE ATE<br>Warnkontakt L=97,5mm |
|                       | S 320 CDI             | 155          | A 289058 | 12.05 |                                |                                |                |        |   |  |
|                       | S 320 CDI / S 350 CDI | 173          | A 289058 | 12.05 |                                |                                |                |        |   |  |
|                       | S 320 CDI 4-matic     | 155          | A 289058 | 12.05 |                                |                                |                |        |   |  |
|                       | S 320 CDI 4-matic     | 173          | A 289058 | 05.06 |                                |                                |                |        |   |  |
|                       | S 350                 | 200          | A 289058 | 12.05 |                                |                                |                |        |   |  |
|                       | S 350 4-matic         | 200          | A 289058 | 02.07 |                                |                                |                |        |   |  |
|                       | S 350 BlueTec         | 190          |          | 04.11 | 05.13                          | - Sportpaket AMG <sup>2)</sup> |                |        |   |  |
|                       | S 350 BlueTec 4-matic | 190          |          | 04.11 | 05.13                          | - Sportpaket AMG <sup>2)</sup> |                |        |   |  |
|                       | S 350 CGI             | 225          |          | 04.11 | 05.13                          | - Sportpaket AMG <sup>2)</sup> |                |        |   |  |
| S 350 CGI 4-matic     | 225                   |              | 04.11    | 05.13 | - Sportpaket AMG <sup>2)</sup> |                                |                |        |   |  |
| S 400 Hybrid          | 205                   | A 289058     | 06.09    |       |                                |                                |                |        |   |  |
| S 420 CDI / S 450 CDI | 235                   |              | 04.06    | 05.13 |                                |                                |                |        |   |  |
| S 450                 | 250                   | A 289058     | 04.06    |       |                                |                                |                |        |   |  |
| S 450 4-matic         | 250                   | A 289058     | 04.06    |       |                                |                                |                |        |   |  |

<sup>1)</sup> + sports package AMG / + pacchetto sportivo AMG / + version sport AMG / + kit deportivo AMG  
<sup>2)</sup> - sport package AMG / - pacchetto sportivo AMG / - version sport AMG / - kit deportivo AMG



|    |  |  |  |  |  |  |  |  |                         |                     |
|---|--|--|--|--|---|--|--|--|-------------------------|---------------------|
| <b>MERCEDES BENZ S-Klasse (W221) (06-13)</b>                                      |  |  |  |  |   |  |  |  |                         |                     |
|   | S 500  | 285  | A 289058   | 12.05  |   | 13.0460-7171.2   | 607171   |  |                         |                     |
|   | S 500 4-matic  | 285  | A 289058   | 04.06  |   | 13.0470-7171.2   | LD7171   |  |                         |                     |
|   |  |  |  |  |   | 24.8190-0410.2   | 620410   | 1  |                         |                     |
|   | S 600  | 380  |  | 12.05  | 05.13   | 13.0460-4998.2   | 604998   | 1  |                         |                     |
|   |  |  |  |  | 24.8190-0410.2  | 620410   |  | 23334 16,7 +/WE<br>23334 16,7 +/WE<br>Warnkontakt L=97,5mm                         |                         |                     |
|   | S 63 AMG   |  |  | 01.07  | 05.13   |  |  | 1  |                         |                     |
|   | S 65 AMG   |  |  | 04.06  | 05.13   | 24.8190-0420.2   | 620420   | 1  |                         |                     |
|   |  |  |  |  |   |  |  |  | Warnkontakt L=119mm     |                     |
|   | S 250 CDI  | 150  |  | 01.11  | 05.13   | - Sportpaket AMG <sup>1)</sup>   | 24.0112-0183.1   | 412183   |                         |                     |
|   | S 280 / S 300  | 170  | A 265575   | 04.06  |   |  |  |  |                         |                     |
|   | S 320 CDI  | 155  | A 265575   | 12.05  |   |  |  |  |                         |                     |
|   | S 320 CDI / S 350 CDI  | 173  | A 265575   | 12.05  |   |  |  |  |                         |                     |
|   | S 320 CDI 4-matic  | 155  | A 265575   | 12.05  |   |  |  |  |                         |                     |
|   | S 320 CDI 4-matic  | 173  | A 265575   | 05.06  |   |  |  |  |                         |                     |
|   | S 350  | 200  | A 265575   | 12.05  |   |  |  |  |                         |                     |
|   | S 350 4-matic  | 200  | A 265575   | 02.07  |   |  |  |  |                         |                     |
|   | S 400 Hybrid   | 205  |  | 06.09  | 05.13   | - Sportpaket AMG <sup>1)</sup>   |  |  |                         |                     |
|   |  |  |  |  |   |  |  |  |                         | 300 12,0 10,0 +S +B |
|   |  | S 280 / S 300  | 170  | A 265576   | 05.13   |  | 24.0122-0229.1   | 422229   |                         |                     |
|   |  | S 320 CDI  | 155  | A 265576   | 05.13   |  | 24.0124-0212.1   | 424212   |                         |                     |
|   | S 320 CDI / S 350 CDI  | 173  | A 265576   | 05.13  |   |  |  |  |                         |                     |
|   | S 320 CDI 4-matic  | 155  | A 265576   | 05.13  |   |  |  |  |                         |                     |
|   | S 320 CDI 4-matic  | 173  | A 265576   | 05.13  |   |  |  |  |                         |                     |
|   | S 350  | 200  | A 265576   | 05.13  |   |  |  |  |                         |                     |
|   | S 350 4-matic  | 200  | A 265576   | 05.13  |   |  |  |  |                         |                     |
|   | S 350 BlueTec  | 190  |  | 04.11  | 05.13   |  |  |  |                         |                     |
|   | S 350 BlueTec 4-matic  | 190  |  | 04.11  | 05.13   |  |  |  |                         |                     |
|   | S 350 CGI  | 225  |  | 04.11  | 05.13   |  |  |  |                         |                     |
|   | S 350 CGI 4-matic  | 225  |  | 04.11  | 05.13   |  |  |  |                         |                     |
|   | S 250 CDI  | 150  |  | 01.11  | 05.13   | + Sportpaket AMG <sup>4)</sup>   | 24.0124-0212.1   | 424212   |                         |                     |
|   | S 400 Hybrid   | 205  |  | 06.09  | 05.13   | + Sportpaket AMG <sup>4)</sup>   |  |  |                         |                     |
|   | S 420 CDI / S 450 CDI  | 235  |  | 04.06  | 05.13   |  |  |  |                         |                     |
|   | S 450  | 250  |  | 04.06  | 05.13   |  |  |  |                         |                     |
|   | S 450 4-matic  | 250  |  | 04.06  | 05.13   |  |  |  |                         |                     |
|   | S 500  | 285  |  | 12.05  | 05.13   |  |  |  |                         |                     |
|   | S 500 4-matic  | 285  |  | 04.06  | 05.13   |  |  |  |                         |                     |
|   | S 500 CGI  | 320  |  | 04.11  | 05.13   |  |  |  |                         |                     |
|   | S 500 CGI 4-matic  | 320  |  | 03.11  | 05.13   |  |  |  |                         |                     |
|   | S 600  | 380  |  | 12.05  | 05.13   |  |  |  |                         |                     |
|   |  |  |  |  |   | 24.0126-0149.1   | 426149   |  |                         |                     |
|   |  |  |  |  |   |  |  |  | 330 26,0 23,4 V L +S +B |                     |
|  | S 280 / S 300  | 170  | A 293047   | 04.06  |   | 24.0711-6349.3   | 360333   | 2  |                         |                     |
|   | S 320 CDI  | 155  | A 293047   | 12.05  |   |  |  |  |                         |                     |
|   | S 320 CDI / S 350 CDI  | 173  | A 293047   | 12.05  |   |  |  |  |                         |                     |
|   | S 320 CDI 4-matic  | 155  | A 293047   | 12.05  |   |  |  |  |                         |                     |
|   | S 320 CDI 4-matic  | 173  | A 293047   | 05.06  |   |  |  |  |                         |                     |
|   | S 350  | 200  | A 293047   | 12.05  |   |  |  |  |                         |                     |
|   | S 350 4-matic  | 200  | A 293047   | 02.07  |   |  |  |  |                         |                     |
|   | S 420 CDI / S 450 CDI  | 235  | A 293047   | 04.06  |   |  |  |  |                         |                     |
|   | S 450  | 250  | A 293047   | 04.06  |   |  |  |  |                         |                     |
|   | S 450 4-matic  | 250  | A 293047   | 04.06  |   |  |  |  |                         |                     |
|   | S 500  | 285  | A 293047   | 12.05  |   |  |  |  |                         |                     |
|   | S 500 4-matic  | 285  | A 293047   | 04.06  |   |  |  |  |                         |                     |
| S 600   | 380  | A 293047   | 12.05  |  |   |  |  |  |                         |                     |
| S 63 AMG  |  | A 293047   | 01.07  |  |   |  |  |  |                         |                     |
| S 65 AMG  |  | A 293047   | 04.06  |  |   |  |  |  |                         |                     |
|   | S 250 CDI  | 150  |  | 01.11  | 05.13   | 24.0711-6331.3   | 360364   | 2  |                         |                     |
|   | S 280 / S 300  | 170  | A 293048   | 05.13  |   |  |  |  |                         |                     |
|   | S 320 CDI  | 155  | A 293048   | 05.13  |   |  |  |  |                         |                     |
|   | S 320 CDI / S 350 CDI  | 173  | A 293048   | 05.13  |   |  |  |  |                         |                     |
|   | S 320 CDI 4-matic  | 155  | A 293048   | 05.13  |   |  |  |  |                         |                     |
|   | S 320 CDI 4-matic  | 173  | A 293048   | 05.13  |   |  |  |  |                         |                     |
|   | S 350  | 200  | A 293048   | 05.13  |   |  |  |  |                         |                     |
|   | S 350 4-matic  | 200  | A 293048   | 05.13  |   |  |  |  |                         |                     |
|   | S 350 BlueTec  | 190  |  | 04.11  | 05.13   |  |  |  |                         |                     |
|   | S 350 BlueTec 4-matic  | 190  |  | 04.11  | 05.13   |  |  |  |                         |                     |
|   | S 350 CGI  | 225  |  | 04.11  | 05.13   |  |  |  |                         |                     |
|   | S 350 CGI 4-matic  | 225  |  | 04.11  | 05.13   |  |  |  |                         |                     |
|   | S 400 Hybrid   | 205  |  | 06.09  | 05.13   |  |  |  |                         |                     |
|   | S 420 CDI / S 450 CDI  | 235  | A 293048   | 05.13  |   |  |  |  |                         |                     |
|   | S 450  | 250  | A 293048   | 05.13  |   |  |  |  |                         |                     |
|   | S 450 4-matic  | 250  | A 293048   | 05.13  |   |  |  |  |                         |                     |
|   | S 500  | 285  | A 293048   | 05.13  |   |  |  |  |                         |                     |
|   | S 500 4-matic  | 285  | A 293048   | 05.13  |   |  |  |  |                         |                     |
|   | S 500 CGI  | 320  |  | 04.11  | 05.13   |  |  |  |                         |                     |
|   | S 500 CGI 4-matic  | 320  |  | 03.11  | 05.13   |  |  |  |                         |                     |
|   | S 600  | 380  | A 293048   | 05.13  |   |  |  |  |                         |                     |
|   | S 63 AMG   |  | A 293048   | 05.13  |   |  |  |  |                         |                     |
|   | S 65 AMG   |  | A 293048   | 05.13  |   |  |  |  |                         |                     |
|   |  |  |  |  |   | 03.0137-4006.2   | 654006   |  |                         |                     |
|   |  |  |  |  |   |  |  |  | 180 x 25 /Zub           |                     |

1) - sport package AMG / - pacchetto sportivo AMG / - version sport AMG / - kit deportivo AMG  
2) - AMG sports package / - kit sportivo AMG / - version sport AMG / - paquete deportivo AMG  
3) + AMG sports package / + pacchetto sportivo AMG / + version Sport AMG / + kit deportivo AMG  
4) + sports package AMG / + pacchetto sportivo AMG / + version sport AMG / + kit deportivo AMG

| <b>MERCEDES BENZ S-Klasse (W221) (06-13)</b>      |                       |     |  |       |       |                                      |                |        |  |                          |     |
|---|-----------------------|-----|--|-------|-------|--------------------------------------|----------------|--------|--|--------------------------|-----|
|   | S 350 CGI 4-matic     | 225 |  | 04.11 | 05.13 |                                      | 03.0137-4006.2 | 654006 |  | 180 x 25 /Zub            |     |
|   | S 400 Hybrid          | 205 |  | 06.09 | 05.13 |                                      |                |        |  |                          |     |
|   | S 420 CDI / S 450 CDI | 235 |  | 04.06 | 05.13 |                                      |                |        |  |                          |     |
|   | S 450                 | 250 |  | 04.06 | 05.13 |                                      |                |        |  |                          |     |
|   | S 450 4-matic         | 250 |  | 04.06 | 05.13 |                                      |                |        |  |                          |     |
|   | S 500                 | 285 |  | 12.05 | 05.13 |                                      |                |        |  |                          |     |
|   | S 500 4-matic         | 285 |  | 04.06 | 05.13 |                                      |                |        |  |                          |     |
|   | S 500 CGI             | 320 |  | 04.11 | 05.13 |                                      |                |        |  |                          |     |
|   | S 500 CGI 4-matic     | 320 |  | 03.11 | 05.13 |                                      |                |        |  |                          |     |
|   | S 600                 | 380 |  | 12.05 | 05.13 | - gepanzerte Fahrzeuge <sup>1)</sup> |                |        |  |                          |     |
|   | S 63 AMG              |     |  | 01.07 | 05.13 | - gepanzerte Fahrzeuge <sup>1)</sup> |                |        |  |                          |     |
|   | S 65 AMG              |     |  | 04.06 | 05.13 | - gepanzerte Fahrzeuge <sup>1)</sup> |                |        |  |                          |     |
| <b>MERCEDES BENZ S-Klasse (W222) (13-)</b>        |                       |     |  |       |       |                                      |                |        |  |                          |     |
|   | S 320                 | 200 |  | 05.14 |       |                                      | 13.0460-4869.2 | 604869 | - Sportpaket AMG <sup>2)</sup>         | 25183 17,9 +/WE          | BRE |
|   | S 350 BT              | 190 |  | 03.13 |       |                                      | 13.0460-4870.2 | 604870 | + Sportpaket AMG <sup>3)</sup>         | 25179 17,8 /WE           | BRE |
|   | S 350 BT 4-matic      | 185 |  | 02.14 |       |                                      | 24.8190-0959.2 | 620959 |  | Warnkontakt L=102mm      |     |
|   | S 350 BT 4-matic      | 190 |  | 02.14 |       |                                      |                |        |  |                          |     |
|   | S 400 Hybrid          | 225 |  | 03.13 |       |                                      |                |        |  |                          |     |
|   | S 300 BT Hybrid       | 150 |  | 02.14 |       |                                      | 13.0460-4870.2 | 604870 | + Sportpaket AMG <sup>3)</sup>         | 25179 17,8 /WE           | BRE |
|   | S 300 BT Hybrid       | 170 |  | 02.14 |       |                                      | 24.8190-0959.2 | 620959 |  | Warnkontakt L=102mm      |     |
|   | S 400                 | 245 |  | 03.14 |       |                                      | 13.0460-4870.2 | 604870 |  | 25179 17,8 /WE           | BRE |
|   | S 400 4-matic         | 245 |  | 11.14 |       |                                      | 24.8190-0959.2 | 620959 |  | Warnkontakt L=102mm      |     |
|   | S 500                 | 335 |  | 03.13 |       |                                      |                |        |  |                          |     |
|   | S 500 4-matic         | 335 |  | 09.13 |       |                                      |                |        |  |                          |     |
|   | S 500 Hybrid          | 245 |  | 07.14 |       |                                      |                |        |  |                          |     |
|   | S 500 Maybach         | 335 |  | 12.14 |       | - gepanzerte Fahrzeuge <sup>1)</sup> |                |        |  |                          |     |
|   | S 63 AMG              | 430 |  | 09.13 |       |                                      | 13.0460-4839.2 | 604839 | - Keramikbremse <sup>4)</sup>          | 24455 16,8 /WE           | BRE |
|   | S 63 AMG 4-matic      | 430 |  | 09.13 |       |                                      | 24.8190-0420.2 | 620420 | - Keramikbremse <sup>4)</sup>          | Warnkontakt L=119mm      |     |
|   | S 65 AMG              | 463 |  | 03.14 |       |                                      |                |        |  |                          |     |
|   | S 600                 | 390 |  | 04.14 |       |                                      | 24.8190-0420.2 | 620420 |  | Warnkontakt L=119mm      |     |
|   | S 600 Maybach         | 390 |  | 12.14 |       | - gepanzerte Fahrzeuge <sup>1)</sup> |                |        |  |                          |     |
|   | S 300 BT Hybrid       | 150 |  | 02.14 |       |                                      | 13.0460-2780.2 | 602780 |  | 25071 18,8 +/WE/Zub/STRW |     |
|   | S 300 BT Hybrid       | 170 |  | 02.14 |       |                                      | 24.8190-0410.2 | 620410 |  | Warnkontakt L=97,5mm     |     |
|   | S 320                 | 200 |  | 05.14 |       |                                      |                |        |  |                          |     |
|   | S 350 BT              | 190 |  | 03.13 |       |                                      |                |        |  |                          |     |
|   | S 350 BT 4-matic      | 185 |  | 02.14 |       |                                      |                |        |  |                          |     |
|   | S 350 BT 4-matic      | 190 |  | 02.14 |       |                                      |                |        |  |                          |     |
|   | S 400                 | 245 |  | 03.14 |       |                                      |                |        |  |                          |     |
|   | S 400 4-matic         | 245 |  | 11.14 |       |                                      |                |        |  |                          |     |
|   | S 400 Hybrid          | 225 |  | 03.13 |       |                                      |                |        |  |                          |     |
|   | S 500                 | 335 |  | 03.13 |       |                                      |                |        |  |                          |     |
|   | S 500 4-matic         | 335 |  | 09.13 |       |                                      |                |        |  |                          |     |
|   | S 500 Hybrid          | 245 |  | 07.14 |       |                                      |                |        |  |                          |     |
|   | S 500 Maybach         | 335 |  | 12.14 |       | - gepanzerte Fahrzeuge <sup>1)</sup> |                |        |  |                          |     |
|   | S 63 AMG              | 430 |  | 09.13 |       |                                      | 24.8190-0410.2 | 620410 |  | Warnkontakt L=97,5mm     |     |
|   | S 63 AMG 4-matic      | 430 |  | 09.13 |       |                                      |                |        |  |                          |     |
|   | S 65 AMG              | 463 |  | 03.14 |       |                                      |                |        |  |                          |     |
|   | S 600                 | 390 |  | 04.14 |       |                                      | 24.8190-0410.2 | 620410 |  | Warnkontakt L=97,5mm     |     |
|   | S 600 Maybach         | 390 |  | 12.14 |       | - gepanzerte Fahrzeuge <sup>1)</sup> |                |        |  |                          |     |
| <b>MERCEDES BENZ S-Klasse (C217) Coupe (14-)</b>  |                       |     |  |       |       |                                      |                |        |  |                          |     |
|   | S 500                 | 335 |  | 11.14 |       |                                      | 13.0460-4870.2 | 604870 |  | 25179 17,8 /WE           | BRE |
|   | S 500 4-Matic         | 335 |  | 04.14 |       |                                      | 24.8190-0959.2 | 620959 |  | Warnkontakt L=102mm      |     |
|   | S 63 AMG              | 430 |  | 07.14 |       |                                      | 24.8190-0420.2 | 620420 | - Keramikbremse <sup>4)</sup>          | Warnkontakt L=119mm      |     |
|   | S 63 AMG 4-Matic      | 430 |  | 04.14 |       |                                      |                |        |  |                          |     |
|   | S 65 AMG              | 463 |  | 07.14 |       |                                      |                |        |  |                          |     |
|   | S 500                 | 335 |  | 11.14 |       |                                      | 13.0460-2780.2 | 602780 | - verstärkte Bremsanlage <sup>5)</sup> | 25071 18,8 +/WE/Zub/STRW |     |
|   | S 500 4-Matic         | 335 |  | 04.14 |       |                                      | 24.8190-0410.2 | 620410 |  | Warnkontakt L=97,5mm     |     |
|   | S 63 AMG 4-Matic      | 430 |  | 04.14 |       |                                      | 13.0460-2780.2 | 602780 | - Keramikbremse <sup>4)</sup>          | 25071 18,8 +/WE/Zub/STRW |     |
|   |                       |     |  |       |       |                                      | 24.8190-0410.2 | 620410 |  | Warnkontakt L=97,5mm     |     |
|   | S 63 AMG              | 430 |  | 07.14 |       |                                      | 24.8190-0410.2 | 620410 |  | Warnkontakt L=97,5mm     |     |
|   | S 65 AMG              | 463 |  | 07.14 |       |                                      |                |        |  |                          |     |
| <b>MERCEDES BENZ S-Klasse (A217) Cabrio (15-)</b> |                       |     |  |       |       |                                      |                |        |  |                          |     |
|   | S 500                 | 335 |  | 12.15 |       |                                      | 13.0460-4870.2 | 604870 |  | 25179 17,8 /WE           | BRE |
|   |                       |     |  |       |       |                                      | 24.8190-0959.2 | 620959 |  | Warnkontakt L=102mm      |     |
|   | S 63 AMG 4-matic      | 430 |  | 12.15 |       |                                      | 24.8190-0420.2 | 620420 | - Keramikbremse <sup>4)</sup>          | Warnkontakt L=119mm      |     |
|   | S 65 AMG              | 463 |  | 04.16 |       |                                      |                |        |  |                          |     |
|   | S 500                 | 335 |  | 12.15 |       |                                      | 13.0460-2780.2 | 602780 |  | 25071 18,8 +/WE/Zub/STRW |     |
|   |                       |     |  |       |       |                                      | 24.8190-0410.2 | 620410 |  | Warnkontakt L=97,5mm     |     |
|   | S 63 AMG 4-matic      | 430 |  | 12.15 |       |                                      | 24.8190-0410.2 | 620410 |  | Warnkontakt L=97,5mm     |     |
|   | S 65 AMG              | 463 |  | 04.16 |       |                                      |                |        |  |                          |     |
| <b>MERCEDES BENZ SL-Klasse (R129) (93-01)</b>     |                       |     |  |       |       |                                      |                |        |  |                          |     |
|   | SL 280                | 142 |  | 08.93 | 09.01 |                                      | 13.0460-4201.2 | 604201 |  | 21153 17,5 /WE           | ATE |
|   | SL 320                | 170 |  | 08.93 | 09.01 |                                      | 24.8190-0401.2 | 620401 |  | Warnkontakt L=95mm       |     |
|   | SL 500                | 235 |  | 08.93 | 09.01 |                                      | 13.0460-0219.2 | 610219 |  | Belagsatz-Zubehör        | ATE |
|   | SL 60 AMG             | 280 |  | 05.94 | 09.01 |                                      |                |        |  |                          |     |

<sup>1)</sup> - armoured vehicles / - veicoli blindati / - véhicules blindés / - vehículo blindado

<sup>2)</sup> - sport package AMG / - pacchetto sportivo AMG / - version sport AMG / - kit deportivo AMG

<sup>3)</sup> + sports package AMG / + pacchetto sportivo AMG / + version sport AMG / + kit deportivo AMG

<sup>4)</sup> - ceramic brake / - freno in ceramica / - frein de céramique / - freno de cerámica

<sup>5)</sup> - heavy duty br.system / - sistema di fr.rinforzato / - système de fr.renforcé / - sistema de fr.reforzado



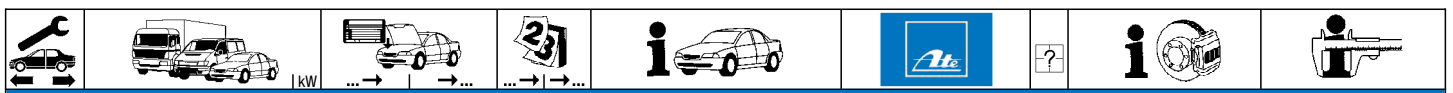

**MERCEDES BENZ SL-Klasse (R129) (93-01)**

|           |           |          |          |       |                |                |                       |                       |   |                                  |  |                          |
|-----------|-----------|----------|----------|-------|----------------|----------------|-----------------------|-----------------------|---|----------------------------------|--|--------------------------|
|           | SL 280    | 150      | F 187941 | 08.93 |                | 13.0460-4201.2 | 604201                | - ESP                 | 2 | - ESP<br>+ ESP<br>+ ESP<br>+ ESP | 21153 17,5 /WE<br>23271 17,4 +/WE(1,8)<br>23271 17,4 +/WE(1,8)<br>Belagsatz-Zubehör<br>Belagsatz-Zubehör<br>Warnkontakt L=95mm | ATE<br>BRE<br>BRE<br>ATE |
|           | SL 320    | 165      | F 187941 | 05.98 |                | 13.0460-4984.2 | 604984                |                       |   |                                  |  |                          |
|           |           |          |          |       |                | 13.0470-4984.2 | LD4984                |                       |   |                                  |  |                          |
|           |           |          |          |       |                | 13.0460-0269.2 | 610269                |                       |   |                                  |  |                          |
|           |           |          |          |       | 13.0460-0219.2 | 610219         |                       |                       |   |                                  |  |                          |
|           |           |          |          |       | 24.8190-0401.2 | 620401         |                       |                       |   |                                  |  |                          |
|           | SL 280    | 150      | F 187942 |       | 09.01          | 13.0460-4984.2 | 604984                |                       | 2 |                                  | 23271 17,4 +/WE(1,8)<br>23271 17,4 +/WE(1,8)<br>Belagsatz-Zubehör<br>Warnkontakt L=95mm  | BRE<br>BRE               |
|           | SL 320    | 165      | F 187942 |       | 09.01          | 13.0470-4984.2 | LD4984                |                       |   |                                  |  |                          |
|           |           |          |          |       |                | 13.0460-0269.2 | 610269                |                       |   |                                  |  |                          |
|           |           |          |          |       |                | 24.8190-0401.2 | 620401                |                       |   |                                  |  |                          |
|           | SL 500    | 225      |          | 05.98 | 09.01          | 13.0460-4984.2 | 604984                |                       | 2 |                                  | 23271 17,4 +/WE(1,8)<br>Belagsatz-Zubehör<br>Warnkontakt L=95mm  | BRE                      |
|           | SL 55 AMG | 260      |          | 03.00 | 09.01          | 13.0460-0269.2 | 610269                |                       |   |                                  |  |                          |
|           |           |          |          |       |                | 24.8190-0401.2 | 620401                |                       |   |                                  |  |                          |
|           |           |          |          |       |                |                |                       |                       |   |                                  |  |                          |
|           | SL 600    |          |          | 08.93 | 09.01          | 13.0460-4201.2 | 604201                | - ESP                 |   | + ESP<br>+ ESP                   | 21153 17,5 /WE<br>23271 17,4 +/WE(1,8)<br>Belagsatz-Zubehör<br>Belagsatz-Zubehör<br>Warnkontakt L=95mm                         | ATE<br>BRE<br>ATE        |
|           | SL 280    | 142      |          | 08.93 | 09.01          | 24.0128-0103.1 | 428103                | - ESP                 | 4 | + SL Edition<br>+ ESP<br>+ ESP   | 300 28,0 25,4 V L +B<br>320 30,0 28,0 V L +B<br>320 30,0 28,0 V L +B   | ATE<br>ATE<br>ATE        |
|           | SL 320    | 170      |          | 08.93 | 09.01          | 24.0130-0121.1 | 430121                |                       |   |                                  |  |                          |
|           |           |          |          |       |                | 24.0130-0122.1 | 430122                |                       |   |                                  |  |                          |
|           | SL 280    | 150      | F 187941 | 08.93 |                | 24.0128-0103.1 | 428103                | - ESP                 |   |                                  |  |                          |
|           | SL 320    | 165      | F 187941 | 05.98 |                |                |                       |                       |   |                                  |  |                          |
|           | SL 280    | 150      | F 187942 |       | 09.01          | 24.0132-0147.1 | 432147                |                       |   |                                  |  |                          |
|           | SL 320    | 165      | F 187942 |       | 09.01          |                |                       |                       |   |                                  |  |                          |
|           | SL 500    | 225      |          | 05.98 | 09.01          |                |                       |                       |   |                                  |  |                          |
|           | SL 55 AMG | 260      |          | 03.00 | 09.01          |                |                       |                       |   |                                  |  |                          |
|           | SL 500    | 235      | F103936  | 08.93 |                | 24.0128-0103.1 | 428103                | - AMG Technikpaket 1) |   |                                  |  |                          |
| SL 60 AMG | 280       | F103936  | 05.94    |       | 13.8190-0242.1 | 990124         |                       |                       |   |                                  |  |                          |
| SL 500    | 235       |          | 08.93    | 09.01 | 24.0130-0121.1 | 430121         | + AMG Technikpaket 2) |                       |   |                                  |  |                          |
| SL 500    | 235       | F103937  |          | 09.01 | 24.0130-0122.1 | 430122         | - AMG Technikpaket 1) |                       |   |                                  |  |                          |
| SL 60 AMG | 280       | F103937  |          | 09.01 | 13.8190-0242.1 | 990124         |                       |                       |   |                                  |  |                          |
| SL 600    |           |          | 08.93    | 09.01 |                |                |                       |                       |   |                                  |  |                          |
|           | SL 280    | 142      | F 125157 | 08.93 |                | 13.0460-3805.2 | 603805                |                       | 4 | + ASR                            | 21197 15,0 /WE<br>21197 15,0 /WE<br>Belagsatz-Zubehör<br>Warnkontakt L=95mm  | ATE<br>ATE<br>ATE        |
|           | SL 320    | 170      | F 125157 | 08.93 |                | 13.0470-3805.2 | LD3805                |                       |   |                                  |  |                          |
|           |           |          |          |       |                | 13.0460-0215.2 | 610215                |                       |   |                                  |  |                          |
|           |           |          |          |       |                | 24.8190-0401.2 | 620401                |                       |   |                                  |  |                          |
|           | SL 280    | 142      | F 125158 |       | 09.01          | 13.0460-4047.2 | 604047                |                       |   |                                  |  |                          |
|           | SL 280    | 150      |          | 08.93 | 09.01          | 13.0470-4047.2 | LD4047                |                       |   |                                  |  |                          |
|           | SL 320    | 165      |          | 05.98 | 09.01          | 13.0460-0236.2 | 610236                |                       |   |                                  |  |                          |
|           | SL 320    | 170      | F 125158 |       | 09.01          | 24.8190-0401.2 | 620401                |                       |   |                                  |  |                          |
|           | SL 500    | 235      | F 125157 | 08.93 |                | 13.0460-3805.2 | 603805                |                       |   |                                  |  |                          |
|           | SL 60 AMG | 280      | F 125157 | 05.94 |                | 13.0460-0215.2 | 610215                |                       |   |                                  |  |                          |
|           |           |          |          |       | 24.8190-0401.2 | 620401         |                       |                       |   |                                  |  |                          |
| SL 500    | 225       |          | 05.98    | 09.01 | 13.0460-4047.2 | 604047         |                       |                       |   |                                  |  |                          |
| SL 500    | 235       | F 125158 |          | 09.01 | 13.0460-0236.2 | 610236         |                       |                       |   |                                  |  |                          |
| SL 55 AMG | 260       |          | 03.00    | 09.01 | 24.8190-0401.2 | 620401         |                       |                       |   |                                  |  |                          |
| SL 60 AMG | 280       | F 125158 |          | 09.01 |                |                |                       |                       |   |                                  |  |                          |
| SL 600    | 280       | F 125158 |          | 08.93 | 09.01          |                |                       |                       |   |                                  |  |                          |
|           | SL 280    | 150      | F 187942 |       | 09.01          | 24.0122-0218.1 | 422218                | - SL Edition          | 1 |                                  | 300 22,0 19,4 V L +B   | ATE<br>ATE<br>ATE        |
|           | SL 320    | 165      | F 187942 |       | 09.01          |                |                       |                       |   |                                  |  |                          |
|           | SL 500    | 225      |          | 05.98 | 09.01          |                |                       |                       |   |                                  |  |                          |
|           | SL 55 AMG | 260      |          | 03.00 | 09.01          |                |                       |                       |   |                                  |  |                          |
|           | SL 280    | 142      | F 125157 | 08.93 |                | 24.0109-0103.1 | 409103                |                       |   |                                  |  |                          |
|           | SL 320    | 170      | F 125157 | 08.93 |                |                |                       |                       |   |                                  |  |                          |
|           | SL 500    | 235      | F 103936 | 08.93 |                |                |                       |                       |   |                                  |  |                          |
|           | SL 60 AMG | 280      | F 103936 | 05.94 |                |                |                       |                       |   |                                  |  |                          |
|           | SL 280    | 142      | F 125158 |       | 09.01          | 24.0110-0293.1 | 410293                | - ESP                 |   |                                  |  |                          |
|           | SL 280    | 150      | F 187941 | 08.93 |                | 24.0122-0218.1 | 422218                | + ESP                 |   |                                  |  |                          |
| SL 320    | 165       | F 187941 | 05.98    |       |                |                |                       |                       |   |                                  |  |                          |
| SL 320    | 170       | F 125158 |          | 09.01 |                |                |                       |                       |   |                                  |  |                          |
| SL 500    | 235       | F 125158 |          | 09.01 |                |                |                       |                       |   |                                  |  |                          |
| SL 60 AMG | 280       | F 125158 |          | 09.01 |                |                |                       |                       |   |                                  |  |                          |
| SL 600    |           |          | 08.93    | 09.01 | 24.0122-0218.1 | 422218         |                       |                       |   |                                  |  |                          |
|           | SL 280    | 142      |          | 08.93 | 09.01          | 03.0137-0170.2 | 650170                |                       | 2 |                                  | 164 x 20 /Zub  | BRE                      |
|           | SL 280    | 150      |          | 08.93 | 09.01          |                |                       |                       |   |                                  |  |                          |
|           | SL 320    | 165      |          | 05.98 | 09.01          |                |                       |                       |   |                                  |  |                          |
|           | SL 320    | 170      |          | 08.93 | 09.01          |                |                       |                       |   |                                  |  |                          |
|           | SL 500    | 225      |          | 05.98 | 09.01          |                |                       |                       |   |                                  |  |                          |
|           | SL 500    | 235      |          | 08.93 | 09.01          |                |                       |                       |   |                                  |  |                          |
|           | SL 55 AMG | 260      |          | 03.00 | 09.01          |                |                       |                       |   |                                  |  |                          |
|           | SL 60 AMG | 280      |          | 05.94 | 09.01          |                |                       |                       |   |                                  |  |                          |
|           | SL 600    |          |          | 08.93 | 09.01          |                |                       |                       |   |                                  |  |                          |
|           |           |          |          | 08.93 | 09.01          |                |                       |                       |   |                                  |  |                          |

**MERCEDES BENZ SL-Klasse (R230) (01-11)**

|        |        |     |       |       |                 |                 |                |        |   |   |                                       |     |
|--------|--------|-----|-------|-------|-----------------|-----------------|----------------|--------|---|---|---------------------------------------|-----|
|        | SL 280 | 170 |       | 11.07 | 11.11           | + Sportpaket 3) | 13.0460-4817.2 | 604817 | 2 |   | 23960 18,3 /WE<br>Warnkontakt L=119mm | BRE |
|        | SL 300 | 170 |       | 04.09 | 11.11           | + Sportpaket 3) | 24.8190-0420.2 | 620420 |   |   |                                       |     |
|        | SL 350 | 200 |       | 03.06 | 11.11           | + Sportpaket 3) |                |        |   |   |                                       |     |
|        | SL 350 | 232 |       | 04.08 | 11.11           | + Sportpaket 3) |                |        |   |   |                                       |     |
|        | SL 500 | 285 |       | 03.06 | 11.11           |                 |                |        |   |   |                                       |     |
| SL 280 | 170    |     | 11.07 | 11.11 | - Sportpaket 4) | 13.0460-4990.2  | 604990         | 2      |   | 23745 17,4 +/WE(1,8/7)<br>23745 17,4 +/WE(1,8/7)<br>Belagsatz-Zubehör<br>Warnkontakt L=97,5mm | BRE<br>BRE                            |     |
| SL 300 | 170    |     | 04.09 | 11.11 | - Sportpaket 4) | 13.0470-4990.2  | LD4990         |        |   |   |                                       |     |
| SL 350 | 180    |     | 02.03 | 11.11 |                 | 13.0460-0275.2  | 610275         |        |   |   |                                       |     |
| SL 350 | 200    |     | 03.06 | 11.11 | - Sportpaket 4) | 24.8190-0410.2  | 620410         |        |   |   |                                       |     |

1) - AMG Performance package / - Performance package AMG / - Performance package AMG / - Performance package AMG  
 2) + AMG Performance package / + Performance package AMG / + Performance package AMG / + Performance package AMG  
 3) + sports package / + pacchetto sportivo / + version sport / + kit sportivo  
 4) - sport package / - pacchetto sportivo / - version sport / - kit sportivo



































| MERCEDES BENZ SL-Klasse (R230) (01-11) |           |          |          |       |                            |                            |                |        |   |   |  |   |
|--|-----------|----------|----------|-------|----------------------------|----------------------------|----------------|--------|---|---|--|---|
|  | SL 350    | 232      |          | 04.08 | 11.11                      | - Sportpaket <sup>1)</sup> | 13.0460-4990.2 | 604990 |   | 23745 17,4 +/WE(1,8/7) BRE<br>Belagsatz-Zubehör<br>Warnkontakt L=97,5mm |  |   |
|  | SL 500    | 225      |          | 09.01 | 11.11                      | - Sportpaket <sup>1)</sup> | 13.0460-0275.2 | 610275 |   |   |  |   |
|  |           |          |          |       |                            |                            | 24.8190-0410.2 | 620410 | 2   |   |  |   |
|  | SL 500    | 225      |          | 09.01 | 11.11                      | + Sportpaket <sup>2)</sup> | 13.0460-4990.2 | 604990 |   |   | 23745 17,4 +/WE(1,8/7) BRE<br>Belagsatz-Zubehör<br>Warnkontakt L=119mm |   |
|  |           |          |          |       |                            |                            | 13.0460-0275.2 | 610275 |   |   |  |   |
|  |           |          |          |       |                            |                            | 24.8190-0420.2 | 620420 | 2   |   |  |   |
|  | SL 55 AMG | 350      |          | 09.01 | 11.11                      |                            | 13.0460-4997.2 | 604997 |   |   |  | 23944 17,5 +/WE BRE<br>Warnkontakt L=97,5mm |
|  | SL 55 AMG | 368      |          | 06.02 | 11.11                      |                            | 24.8190-0410.2 | 620410 | 2   |   |  |   |
|  | SL 600    | 368      | F 134504 | 04.03 |                            |                            |                |        |   |   |  |   |
|  | SL 600    | 380      | F 134504 | 03.06 |                            |                            |                |        |   |   |  |   |
| SL 65 AMG                              | 450       | F 122820 | 03.04    |       |                            |                            |                |        |   |   |  |   |
| SL 65 AMG                              | 450       | F 122821 |          | 11.11 |                            | 24.8190-0420.2             | 620420         | 2      |   |   |  |   |
| SL 600                                 | 368       | F 134505 |          | 11.11 |                            | 24.8190-0420.2             | 620420         | 2      |   |   |  |   |
| SL 600                                 | 380       | F 134505 |          | 11.11 |                            |                            |                |        |   |   |  |   |
| SL 63 AMG                              | 386       |          | 11.07    | 11.11 |                            | 13.0460-4839.2             | 604839         |        | 24455 16,8 /WE BRE<br>Warnkontakt L=119mm         |   |  |   |
| SL 65 AMG BlackSeries                  | 493       |          | 07.08    | 11.11 |                            | 24.8190-0420.2             | 620420         | 2      |   |   |  |   |
| SL 55 AMG                              | 380       |          | 03.06    | 11.11 |                            | 13.0460-4839.2             | 604839         |        |   | 24455 16,8 /WE BRE<br>Warnkontakt L=119mm                               |  |   |
|  |           |          |          |       |                            | 24.8190-0420.2             | 620420         | 2      |   |   |  |   |
|  |           |          |          |       |                            |                            |                |        |   |   |  |   |
|  |           |          |          |       |                            |                            |                |        |   |   |  |   |
|  |           |          |          |       |                            |                            |                |        |   |   |  |   |
|  |           |          |          |       |                            |                            |                |        |   |   |  |   |
|  |           |          |          |       |                            |                            |                |        |   |   |  |   |
|  |           |          |          |       |                            |                            |                |        |   |   |  |   |
|  |           |          |          |       |                            |                            |                |        |   |   |  |   |
|  |           |          |          |       |                            |                            |                |        |   |   |  |   |
|  | SL 280    | 170      |          | 11.07 | 11.11                      | + Sportpaket <sup>2)</sup> | 24.0132-0138.1 | 432138 |   | 350 32,0 30,0 V L +S +B   |  |   |
|  | SL 300    | 170      |          | 04.09 | 11.11                      | + Sportpaket <sup>2)</sup> |                |        |   |   |  |   |
|  | SL 350    | 200      |          | 03.06 | 11.11                      | + Sportpaket <sup>2)</sup> |                |        |   |   |  |   |
|  | SL 350    | 232      |          | 04.08 | 11.11                      | + Sportpaket <sup>2)</sup> |                |        |   |   |  |   |
|  | SL 500    | 285      |          | 03.06 | 11.11                      |                            |                |        |   |   |  |   |
|  | SL 350    | 180      |          | 02.03 | 11.11                      |                            | 24.0128-0163.1 | 428163 |   |   | 312 28,0 26,0 V L +B<br>Halterschraube                                 |   |
|  |           |          |          |       |                            |                            | 13.8190-0330.1 | 990134 | 4   |   |  |   |
|  | SL 280    | 170      |          | 11.07 | 11.11                      | - Sportpaket <sup>1)</sup> | 24.0132-0153.1 | 432153 |   |   |  |   |
|  | SL 300    | 170      |          | 04.09 | 11.11                      | - Sportpaket <sup>1)</sup> | 13.8190-0330.1 | 990134 | 4   |   |  |   |
|  | SL 350    | 200      |          | 03.06 | 11.11                      | - Sportpaket <sup>1)</sup> |                |        |   |   |  |   |
| SL 350                                 | 232       |          | 04.08    | 11.11 | - Sportpaket <sup>1)</sup> |                            |                |        |   |   |  |   |
| SL 500                                 | 225       |          | 09.01    | 11.11 |                            |                            |                |        |   |   |  |   |
| SL 600                                 | 368       |          | 04.03    | 11.11 |                            | 24.0136-0102.1             | 436102         |        |   |   |  |   |
| SL 600                                 | 380       |          | 03.06    | 11.11 |                            |                            |                |        |   |   |  |   |
| SL 55 AMG                              | 350       |          | 09.01    | 11.11 |                            | 24.0136-0102.1             | 436102         |        | 360 36,0 34,0 V L +B<br>- AMG-Performance Package |   |  |   |
| SL 55 AMG                              | 368       |          | 06.02    | 11.11 |                            |                            |                |        |   |   |  |   |
|  | SL 280    | 170      |          | 11.07 | 11.11                      |                            | 13.0460-7171.2 | 607171 |   |   | 23334 16,7 +/WE ATE<br>23334 16,7 +/WE ATE<br>Warnkontakt L=97,5mm     |   |
|  | SL 300    | 170      |          | 04.09 | 11.11                      |                            | 13.0470-7171.2 | LD7171 |   |   |  |   |
|  | SL 350    | 180      |          | 02.03 | 11.11                      |                            | 24.8190-0410.2 | 620410 |   | 1   |  |   |
|  | SL 350    | 200      |          | 03.06 | 11.11                      |                            |                |        |   |   |  |   |
|  | SL 350    | 232      |          | 04.08 | 11.11                      |                            |                |        |   |   |  |   |
|  | SL 500    | 225      |          | 09.01 | 11.11                      |                            |                |        |   |   |  |   |
|  | SL 500    | 285      |          | 03.06 | 11.11                      |                            |                |        |   |   |  |   |
|  | SL 55 AMG | 350      |          | 09.01 | 11.11                      |                            | 13.0460-4998.2 | 604998 |   |   |  |   |
|  | SL 55 AMG | 368      |          | 06.02 | 11.11                      |                            | 24.8190-0410.2 | 620410 | 1   |   |  |   |
|  | SL 600    | 368      |          | 04.03 | 11.11                      |                            |                |        |   |   |  |   |
| SL 600                                 | 380       |          | 03.06    | 11.11 |                            |                            |                |        |   |   |  |   |
| SL 65 AMG                              | 450       | F 122820 | 03.04    |       |                            | 13.0460-4819.2             | 604819         |        | 23478 16,5 /WE BRE<br>Warnkontakt L=97,5mm        |   |  |   |
|  |           |          |          |       |                            | 24.8190-0410.2             | 620410         | 1      |   |   |  |   |
| SL 55 AMG                              | 380       |          | 03.06    | 11.11 |                            | 24.8190-0420.2             | 620420         | 1      |   |   |  |   |
| SL 63 AMG                              | 386       |          | 11.07    | 11.11 |                            |                            |                |        |   |   |  |   |
| SL 65 AMG                              | 450       | F 122821 |          | 11.11 |                            |                            |                |        |   |   |  |   |
| SL 65 AMG BlackSeries                  | 493       |          | 07.08    | 11.11 |                            |                            |                |        |   |   |  |   |
|  |           |          |          |       |                            |                            |                |        |   |   |  |   |
|  |           |          |          |       |                            |                            |                |        |   |   |  |   |
|  |           |          |          |       |                            |                            |                |        |   |   |  |   |
|  |           |          |          |       |                            |                            |                |        |   |   |  |   |
|  | SL 280    | 170      |          | 11.07 | 11.11                      |                            | 24.0112-0183.1 | 412183 |   | 300 12,0 10,0 +S +B<br>320 24,0 22,0 V L +S +B                          |  |   |
|  | SL 300    | 170      |          | 04.09 | 11.11                      |                            | 24.0124-0226.1 | 424226 |   |   |  |   |
|  | SL 350    | 200      |          | 03.06 | 11.11                      |                            |                |        |   |   |  |   |
|  | SL 350    | 232      |          | 04.08 | 11.11                      |                            |                |        |   |   |  |   |
|  | SL 350    | 180      |          | 02.03 | 11.11                      |                            | 24.0110-0351.1 | 410351 |   |   |  |   |
|  | SL 500    | 225      |          | 09.01 | 11.11                      |                            | 24.0122-0229.1 | 422229 |   |   |  |   |
|  | SL 500    | 285      |          | 03.06 | 11.11                      |                            | 24.0124-0212.1 | 424212 |   |   |  |   |
|  |           |          |          |       |                            |                            | 24.0124-0226.1 | 424226 |   |   |  |   |
|  | SL 600    | 368      |          | 04.03 | 11.11                      |                            | 24.0126-0149.1 | 426149 |   |   |  |   |
|  | SL 600    | 380      |          | 03.06 | 11.11                      |                            |                |        |   |   |  |   |
|  | SL 280    | 170      |          | 11.07 | 11.11                      |                            | 03.0137-4017.2 | 654017 |   | 180 x 25 /Zub<br>Bremsbacken-Zubehör                                    |  |   |
|  | SL 300    | 170      |          | 04.09 | 11.11                      |                            | 03.0137-9297.2 | 669297 |   |   |  |   |
|  | SL 350    | 180      |          | 02.03 | 11.11                      |                            |                |        |   |   |  |   |
|  | SL 350    | 200      |          | 03.06 | 11.11                      |                            |                |        |   |   |  |   |
|  | SL 350    | 232      |          | 04.08 | 11.11                      |                            |                |        |   |   |  |   |
|  | SL 500    | 225      |          | 09.01 | 11.11                      |                            |                |        |   |   |  |   |
|  | SL 500    | 285      |          | 03.06 | 11.11                      |                            |                |        |   |   |  |   |
|  | SL 55 AMG | 350      |          | 09.01 | 11.11                      |                            |                |        |   |   |  |   |
|  | SL 55 AMG | 368      |          | 06.02 | 11.11                      |                            |                |        |   |   |  |   |
|  | SL 55 AMG | 380      |          | 03.06 | 11.11                      |                            |                |        |   |   |  |   |
| SL 600                                 | 368       |          | 04.03    | 11.11 |                            |                            |                |        |   |   |  |   |
| SL 600                                 | 380       |          | 03.06    | 11.11 |                            |                            |                |        |   |   |  |   |
| SL 63 AMG                              | 386       |          | 11.07    | 11.11 |                            |                            |                |        |   |   |  |   |
| SL 65 AMG                              | 450       |          | 03.04    | 11.11 |                            |                            |                |        |   |   |  |   |
| SL 65 AMG BlackSeries                  | 493       |          | 07.08    | 11.11 |                            |                            |                |        |   |   |  |   |

**MERCEDES BENZ SL-Klasse (R231) (12-)**

















|  |        |     |  |       |       |  |                |        |   |  |
|--|--------|-----|--|-------|-------|--|----------------|--------|---|--|
|  | SL 350 | 225 |  | 03.12 | 11.12 |  | 13.0460-4869.2 | 604869 |   | - AMG Sportpaket <sup>3)</sup><br>+ AMG Sportpaket / + verst. Bremse <sup>4)</sup><br>25183 17,9 +/WE BRE<br>25179 17,8 /WE BRE<br>Warnkontakt L=102mm |
|  | SL 500 | 320 |  | 03.12 | 11.12 |  | 13.0460-4870.2 | 604870 |   |  |
|  | SL 350 | 225 |  | 12.12 |       |  | 13.0460-4870.2 | 604870 |   | + AMG Sportpaket / + verst. Bremse <sup>4)</sup><br>25179 17,8 /WE BRE<br>Warnkontakt L=102mm  |
|  | SL 400 | 245 |  | 04.14 |       |  | 24.8190-0959.2 | 620959 | 1 |  |

<sup>1)</sup> - sport package / - pacchetto sportivo / - version sport / - kit deportivo  
<sup>2)</sup> + sports package / + pacchetto sportivo / + version sport / + kit deportivo  
<sup>3)</sup> - AMG sports package / - kit sportivo AMG / - version sport AMG / - paquete deportivo AMG  
<sup>4)</sup> + AMG sports package/+ heavy-duty br. / + pacchetto sportivo AMG/+ fr.rinforzato / + vers. sport AMG/+ fr.renforcé / + kit deportivo AMG/+ fr.reforzado



|     |  |  |  |  |  |  |  |  |  |                                  |
|--|--|--|--|--|---|--|--|--|--|----------------------------------|
| <b>MERCEDES BENZ SL-Klasse (R231) (12-)</b>  |  |  |  |  |   |  |  |  |  |                                  |
|    | SL 400   | 270  |  | 04.14  |   | 13.0460-4870.2   | 604870   | + AMG Sportpaket / + verst.Bremse 1)   | 25179 17,8 /WE<br>Warnkontakt L=102mm                                    | <b>BRE</b>                       |
|  | SL 500   | 320  |  | 12.12  |   | 24.8190-0959.2   | 620959   |  |  |                                  |
|    | SL 63 AMG  |  |  | 03.12  |   | 24.8190-0420.2   | 620420   |  | Warnkontakt L=119mm  |                                  |
|  | SL 65 AMG  | 463  |  | 03.12  |   |  |  |  |  |                                  |
|    | SL 350   | 225  |  | 03.12  |   | 13.0460-2780.2   | 602780   | 1  | Warnkontakt L=97,5mm   | <b>25071</b> 18,8 +/-WE/Zub/STRW |
|  | SL 400   | 245  |  | 04.14  |   | 24.8190-0410.2   | 620410   |  |  |                                  |
|  | SL 400   | 270  |  | 04.14  |   |  |  |  |  |                                  |
|  | SL 500   | 320  |  | 03.12  |   |  |  |  |  |                                  |
|  | SL 500   | 335  |  | 04.15  |   |  |  |  |  |                                  |
|    | SL 63 AMG  |  |  | 03.12  |   | 24.8190-0410.2   | 620410   | 1  | Warnkontakt L=97,5mm   |                                  |
|  | SL 65 AMG  | 463  |  | 03.12  |   |  |  |  |  |                                  |
|    | SL 350   | 225  |  | 03.12  |   | 24.0711-6266.3   | 360435   | 2  | Radsensor L=1093   |                                  |
|  | SL 400   | 245  |  | 04.14  |   |  |  |  |  |                                  |
|  | SL 400   | 270  |  | 04.14  |   |  |  |  |  |                                  |
|  | SL 500   | 320  |  | 03.12  |   |  |  |  |  |                                  |
|  | SL 500   | 335  |  | 04.15  |   |  |  |  |  |                                  |
|  | SL 63 AMG  |  |  | 03.12  |   |  |  |  |  |                                  |
|  | SL 65 AMG  | 463  |  | 03.12  |   |  |  |  |  |                                  |
| <b>MERCEDES BENZ SLK-Klasse (R170) (96-04)</b>                                     |  |  |  |  |   |  |  |  |  |                                  |
|    | SLK 200  | 100  |  | 09.96  | 03.04   | 13.0460-7086.2   | 607086   | 2  | 21664 19,8 +/-WE<br>Warnkontakt L=95mm                                   | <b>ATE</b>                       |
|  | SLK 200 Kompressor   | 120  |  | 03.00  | 03.04   | 13.0470-7086.2   | LD7086   |  |  |                                  |
|  | SLK 200 Kompressor   | 141  |  | 09.96  | 03.04   | 24.8190-0401.2   | 620401   |  |  |                                  |
|  | SLK 230 Kompressor   | 142  |  | 09.96  | 03.04   |  |  |  |  |                                  |
|  | SLK 230 Kompressor   | 145  |  | 03.00  | 03.04   |  |  |  |  |                                  |
|  | SLK 320  | 160  |  | 04.00  | 03.04   |  |  |  |  |                                  |
|    | SLK 32 AMG   | 260  |  | 03.01  | 03.04   | 13.0460-7087.2   | 607087   | 2  | 21670 19,4 +/-WE<br>Warnkontakt L=95mm                                   | <b>ATE</b>                       |
|  |  |  |  |  |   | 13.0470-7087.2   | LD7087   |  |  |                                  |
|    | SLK 200  | 100  |  | 09.96  | 03.04   | 24.8190-0419.2   | 620419   | 2  | 21484 20,5 +/-WE<br>Warnkontakt L=74mm                                   | <b>ATE</b>                       |
|  | SLK 200 Kompressor   | 120  |  | 03.00  | 03.04   | 13.0460-7183.2   | 607183   |  |  |                                  |
|  | SLK 200 Kompressor   | 141  |  | 09.96  | 03.04   | 24.0125-0110.1   | 425110   |  |  |                                  |
|  | SLK 230 Kompressor   | 142  |  | 09.96  | 03.04   | 24.0325-0110.1   | 525110   |  |  |                                  |
|  | SLK 230 Kompressor   | 145  |  | 09.96  | 03.04   | 13.8190-0330.1   | 990134   |  |  |                                  |
|  | SLK 320  | 160  |  | 04.00  | 03.04   |  |  |  |  |                                  |
|    | SLK 200  | 100  |  | 09.96  | 03.04   | 24.0128-0106.1   | 428106   | 4  | 288 25,0 22,4 V L +S +B<br>288 25,0 22,4 V L +S +B PD<br>Halterschraube  | <b>ATE</b>                       |
|  | SLK 200 Kompressor   | 120  |  | 03.00  | 03.04   | 24.0328-0106.1   | 528106   |  |  |                                  |
|  | SLK 200 Kompressor   | 141  |  | 09.96  | 03.04   | 13.8190-0330.1   | 990134   |  |  |                                  |
|  | SLK 230 Kompressor   | 142  |  | 09.96  | 03.04   |  |  |  |  |                                  |
|  | SLK 230 Kompressor   | 145  |  | 03.00  | 03.04   |  |  |  |  |                                  |
|  | SLK 320  | 160  |  | 04.00  | 03.04   |  |  |  |  |                                  |
|    | SLK 32 AMG   | 260  |  | 03.01  | 03.04   | 24.0132-0159.1   | 432159   | 4  | 300 28,0 25,4 V L +S +B<br>300 28,0 25,4 V L +S +B PD<br>Halterschraube  | <b>ATE</b>                       |
|  |  |  |  |  |   |  |  |  |  |                                  |
|  |  |  |  |  |   |  |  |  |  |                                  |
|  |  |  |  |  |   |  |  |  |  |                                  |
|  |  |  |  |  |   |  |  |  |  |                                  |
|  |  |  |  |  |   |  |  |  |  |                                  |
|  | SLK 200  | 100  |  | 09.96  | 03.04   | 24.0751-1141.3   | 360196   | - ESP<br>- ESP<br>+ ESP<br>+ ESP   | Radsensor L=503<br>Radsensor L=503<br>Radsensor L=549<br>Radsensor L=549 | <b>ATE</b>                       |
|  | SLK 200 Kompressor   | 120  |  | 03.00  | 03.04   | 24.0751-1142.3   | 360197   |  |  |                                  |
|  | SLK 200 Kompressor   | 141  |  | 09.96  | 03.04   | 24.0711-6021.3   | 360076   |  |  |                                  |
|  | SLK 230 Kompressor   | 142  |  | 09.96  | 03.04   | 24.0711-6022.3   | 360077   |  |  |                                  |
|  | SLK 230 Kompressor   | 145  |  | 03.00  | 03.04   |  |  |  |  |                                  |
|  | SLK 32 AMG   | 260  |  | 03.01  | 03.04   |  |  |  |  |                                  |
|  | SLK 200  | 100  | F017687  | 09.96  |   | 13.0460-3805.2   | 603805   | 2  | 21197 15,0 /WE<br>21197 15,0 /WE<br>Warnkontakt L=95mm                   | <b>ATE</b>                       |
|  | SLK 200 Kompressor   | 141  | F017687  | 09.96  |   | 13.0470-3805.2   | LD3805   |  |  |                                  |
|  | SLK 230 Kompressor   | 142  | F017687  | 09.96  |   | 24.8190-0401.2   | 620401   |  |  |                                  |
|  | SLK 200  | 100  | F017688  |  | 03.04   | 13.0460-4064.2   | 604064   |  |  |                                  |
|  | SLK 200 Kompressor   | 120  |  | 03.00  | 03.04   | 13.0470-4064.2   | LD4064   |  |  |                                  |
|  | SLK 200 Kompressor   | 141  | F017688  |  | 03.04   | 13.0460-0229.2   | 610229   |  |  |                                  |
|  | SLK 230 Kompressor   | 142  | F017688  |  | 03.04   |  |  | 2  | 21919 15,3 /Zub<br>21919 15,3 /Zub<br>Belagsatz-Zubehör                  | <b>ATE</b>                       |
|  | SLK 230 Kompressor   | 145  |  | 03.00  | 03.04   |  |  |  |  |                                  |
|  | SLK 320  | 160  |  | 04.00  | 03.04   |  |  |  |  |                                  |
|  | SLK 32 AMG   | 260  |  | 03.01  | 03.04   | 13.0460-4047.2   | 604047   |  |  |                                  |
|  |  |  |  |  |   | 13.0460-0236.2   | 610236   |  |  |                                  |
|  |  |  |  |  |   | 24.0109-0114.1   | 409114   |  |  |                                  |
|  | SLK 200  | 100  |  | 09.96  | 03.04   | 24.0309-0114.1   | 509114   | 2  | 278 9,0 7,3 +S +B<br>278 9,0 7,3 +S +B PD                                | <b>ATE</b>                       |
|  | SLK 200 Kompressor   | 120  |  | 03.00  | 03.04   |  |  |  |  |                                  |
|  | SLK 200 Kompressor   | 141  |  | 09.96  | 03.04   |  |  |  |  |                                  |
|  | SLK 230 Kompressor   | 142  |  | 09.96  | 03.04   |  |  |  |  |                                  |
|  | SLK 230 Kompressor   | 145  |  | 03.00  | 03.04   |  |  |  |  |                                  |
|  | SLK 320  | 160  |  | 04.00  | 03.04   |  |  |  |  |                                  |
|  | SLK 32 AMG   | 260  |  | 03.01  | 03.04   | 24.0122-0228.1   | 422228   | 2  | 300 22,0 19,4 V L +B   | <b>ATE</b>                       |
|  |  |  |  |  |   |  |  |  |  |                                  |
|  |  |  |  |  |   |  |  |  |  |                                  |
|  |  |  |  |  |   |  |  |  |  |                                  |
|  |  |  |  |  |   |  |  |  |  |                                  |
|  |  |  |  |  |   |  |  |  |  |                                  |
|  | SLK 200  | 100  |  | 09.96  | 03.04   | 24.0751-1153.3   | 360296   | + ASR<br>+ ASR<br>+ ESP / - ASR<br>+ ESP / - ASR                                   | Radsensor L=456<br>Radsensor L=456<br>Radsensor L=427<br>Radsensor L=427 | <b>ATE</b>                       |
|  | SLK 200 Kompressor   | 120  |  | 03.00  | 03.04   | 24.0751-1154.3   | 360297   |  |  |                                  |
|  | SLK 200 Kompressor   | 141  |  | 09.96  | 03.04   | 24.0711-6023.3   | 360078   |  |  |                                  |
|  | SLK 230 Kompressor   | 142  |  | 09.96  | 03.04   | 24.0711-6024.3   | 360079   |  |  |                                  |
|  | SLK 230 Kompressor   | 145  |  | 03.00  | 03.04   |  |  |  |  |                                  |
|  | SLK 32 AMG   | 260  |  | 03.01  | 03.04   |  |  |  |  |                                  |
|  | SLK 320  | 160  |  | 04.00  | 03.04   |  |  | 2  | 164 x 20 /Zub  | <b>ATE</b>                       |
|  | SLK 200  | 100  |  | 09.96  | 03.04   | 03.0137-0170.2   | 650170   |  |  |                                  |
|  | SLK 200 Kompressor   | 120  |  | 03.00  | 03.04   |  |  |  |  |                                  |
|  | SLK 200 Kompressor   | 141  |  | 09.96  | 03.04   |  |  |  |  |                                  |
|  | SLK 230 Kompressor   | 142  |  | 09.96  | 03.04   |  |  |  |  |                                  |
|  | SLK 230 Kompressor   | 145  |  | 03.00  | 03.04   |  |  |  |  |                                  |
| SLK 32 AMG   | 260  |  | 03.01  | 03.04  |   |  |  |  |  |                                  |
|  | SLK 320  | 160  |  | 04.00  | 03.04   |  |  | 2  | 164 x 20 /Zub  | <b>ATE</b>                       |
|  | SLK 200  | 100  |  | 09.96  | 03.04   |  |  |  |  |                                  |
|  | SLK 200 Kompressor   | 120  |  | 03.00  | 03.04   |  |  |  |  |                                  |
|  | SLK 200 Kompressor   | 141  |  | 09.96  | 03.04   |  |  |  |  |                                  |
|  | SLK 230 Kompressor   | 142  |  | 09.96  | 03.04   |  |  |  |  |                                  |
|  | SLK 230 Kompressor   | 145  |  | 03.00  | 03.04   |  |  |  |  |                                  |
| SLK 32 AMG   | 260  |  | 03.01  | 03.04  |   |  |  |  |  |                                  |
|  | SLK 320  | 160  |  | 04.00  | 03.04   |  |  | 2  | 164 x 20 /Zub  | <b>ATE</b>                       |
|  | SLK 200  | 100  |  | 09.96  | 03.04   |  |  |  |  |                                  |
|  | SLK 200 Kompressor   | 120  |  | 03.00  | 03.04   |  |  |  |  |                                  |
|  | SLK 200 Kompressor   | 141  |  | 09.96  | 03.04   |  |  |  |  |                                  |
|  | SLK 230 Kompressor   | 142  |  | 09.96  | 03.04   |  |  |  |  |                                  |
|  | SLK 230 Kompressor   | 145  |  | 03.00  | 03.04   |  |  |  |  |                                  |
| SLK 32 AMG   | 260  |  | 03.01  | 03.04  |   |  |  |  |  |                                  |
|  | SLK 320  | 160  |  | 04.00  | 03.04   |  |  | 2  | 164 x 20 /Zub  | <b>ATE</b>                       |
|  | SLK 200  | 100  |  | 09.96  | 03.04   |  |  |  |  |                                  |
|  | SLK 200 Kompressor   | 120  |  | 03.00  | 03.04   |  |  |  |  |                                  |
|  | SLK 200 Kompressor   | 141  |  | 09.96  | 03.04   |  |  |  |  |                                  |
|  | SLK 230 Kompressor   | 142  |  | 09.96  | 03.04   |  |  |  |  |                                  |
|  | SLK 230 Kompressor   | 145  |  | 03.00  | 03.04   |  |  |  |  |                                  |
| SLK 32 AMG   | 260  |  | 03.01  | 03.04  |   |  |  |  |  |                                  |
|  | SLK 320  | 160  |  | 04.00  | 03.04   |  |  | 2  | 164 x 20 /Zub  | <b>ATE</b>                       |
|  | SLK 200  | 100  |  | 09.96  | 03.04   |  |  |  |  |                                  |
|  | SLK 200 Kompressor   | 120  |  | 03.00  | 03.04   |  |  |  |  |                                  |
|  | SLK 200 Kompressor   | 141  |  | 09.96  | 03.04   |  |  |  |  |                                  |
|  | SLK 230 Kompressor   | 142  |  | 09.96  | 03.04   |  |  |  |  |                                  |
|  | SLK 230 Kompressor   | 145  |  | 03.00  | 03.04   |  |  |  |  |                                  |
| SLK 32 AMG   | 260  |  | 03.01  | 03.04  |   |  |  |  |  |                                  |
|  | SLK 320  | 160  |  | 04.00  | 03.04   |  |  | 2  | 164 x 20 /Zub  | <b>ATE</b>                       |
|  | SLK 200  | 100  |  | 09.96  | 03.04   |  |  |  |  |                                  |
|  | SLK 200 Kompressor   | 120  |  | 03.00  | 03.04   |  |  |  |  |                                  |
|  | SLK 200 Kompressor   | 141  |  | 09.96  | 03.04   |  |  |  |  |                                  |
|  | SLK 230 Kompressor   | 142  |  | 09.96  | 03.04   |  |  |  |  |                                  |
|  | SLK 230 Kompressor   | 145  |  | 03.00  | 03.04   |  |  |  |  |                                  |
| SLK 32 AMG   | 260  |  | 03.01  | 03.04  |   |  |  |  |  |                                  |
|  | SLK 320  | 160  |  | 04.00  | 03.04   |  |  | 2  | 164 x 20 /Zub  | <b>ATE</b>                       |
|  | SLK 200  | 100  |  | 09.96  | 03.04   |  |  |  |  |                                  |
|  | SLK 200 Kompressor   | 120  |  | 03.00  | 03.04   |  |  |  |  |                                  |
|  | SLK 200 Kompressor   | 141  |  | 09.96  | 03.04   |  |  |  |  |                                  |
|  | SLK 230 Kompressor   | 142  |  | 09.96  | 03.04   |  |  |  |  |                                  |
|  | SLK 230 Kompressor   | 145  |  | 03.00  | 03.04   |  |  |  |  |                                  |
| SLK 32 AMG   | 260  |  | 03.01  | 03.04  |   |  |  |  |  |                                  |
|  | SLK 320  | 160  |  | 04.00  | 03.04   |  |  | 2  | 164 x 20 /Zub  | <b>ATE</b>                       |
|  | SLK 200  | 100  |  | 09.96  | 03.04   |  |  |  |  |                                  |
|  | SLK 200 Kompressor   | 120  |  | 03.00  | 03.04   |  |  |  |  |                                  |
|  | SLK 200 Kompressor   | 141  |  | 09.96  | 03.04   |  |  |  |  |                                  |
|  | SLK 230 Kompressor   | 142  |  | 09.96  | 03.04   |  |  |  |  |                                  |
|  | SLK 230 Kompressor   | 145  |  | 03.00  | 03.04   |  |  |  |  |                                  |
| SLK 32 AMG   | 260  |  | 03.01  | 03.04  |   |  |  |  |  |                                  |

1) + AMG sports package/+ heavy-duty br. / + pacchetto sportivo AMG/+ fr.rinforzato / + vers. sport AMG/+ fr.renforcé / + kit deportivo AMG/+ fr.reforzado

|     |  |  |  |  |  |  |                |  |   |
|--|--|--|--|--|---|--|--|--|---|
| <b>MERCEDES BENZ SLK-Klasse (R171) (04-11)</b>                                     |  |  |  |  |   |  |  |  |   |
|    | SLK 200 Kompressor   | 120  |  | 03.04  | 01.11   | - Sportpaket <sup>1)</sup>   | 13.0460-2726.2 602726<br>13.0470-2726.2 LD2726<br>24.8190-0410.2 620410                          | 1  | 23144 19,8 +/WE/Zub/STRW<br>23144 19,8 +/WE/Zub/STRW<br>Warnkontakt L=97,5mm                          |
|  | SLK 200 Kompressor   | 135  |  | 01.08  | 01.11   | - Sportpaket <sup>1)</sup>   | 13.0460-2727.2 602727  |  | 23144 19,8 +/WE/Zub/STRW  |
|  | SLK 280  | 170  |  | 04.05  | 01.11   | - Sportpaket <sup>1)</sup>   | 13.0470-2727.2 LD2727  |  | 23144 19,8 +/WE/Zub/STRW  |
|  | SLK 300  | 170  |  | 03.09  | 01.11   | - Sportpaket <sup>1)</sup>   | 24.8190-0410.2 620410  | 2  | Warnkontakt L=97,5mm  |
|  | SLK 350  | 200  | F 117328   | 03.04  |   |  | 13.0460-4990.2 604990<br>13.0470-4990.2 LD4990<br>13.0460-0275.2 610275<br>24.8190-0410.2 620410 | 1  | 23745 17,4 +/WE(1,8/7, BRE<br>23745 17,4 +/WE(1,8/7, BRE<br>Belagsatz-Zubehör<br>Warnkontakt L=97,5mm |
|  | SLK 200 Kompressor   | 120  |  | 03.04  | 01.11   | + Sportpaket <sup>2)</sup>   | 13.0460-4994.2 604994  |  | 23945 16,5 /WE BRE  |
|  | SLK 200 Kompressor   | 135  |  | 01.08  | 01.11   | + Sportpaket <sup>2)</sup>   | 13.0470-4994.2 LD4994  |  | 23945 16,5 /WE BRE  |
|  | SLK 280  | 170  |  | 04.05  | 01.11   | + Sportpaket <sup>2)</sup>   | 13.0460-0155.2 610155  |  | Belagsatz-Zubehör BRE   |
|  | SLK 300  | 170  |  | 03.09  | 01.11   | + Sportpaket <sup>2)</sup>   | 24.8190-0410.2 620410  | 1  | Warnkontakt L=97,5mm  |
|  | SLK 350  | 200  | F 117329   |  | 01.11   |  |  |  |   |
| SLK 350  | 224  |  | 01.08  | 01.11  |   |  |  |  |   |
| SLK 55 AMG   |  | F 197201   | 03.04  |  |   | 13.0460-4806.2 604806<br>24.8190-0420.2 620420                                     | 1  | 23955 16,2 /WE BRE<br>Warnkontakt L=119mm  |   |
| SLK 55 AMG   |  | F 197202   |  | 01.11  |   | 13.0460-4990.2 604990<br>24.8190-0420.2 620420                                     | 1  | 23745 17,4 +/WE(1,8/7, BRE<br>Warnkontakt L=119mm                                  |   |
|    | SLK 200 Kompressor   | 120  |  | 03.04  | 01.11   | - Sportpaket <sup>1)</sup>   | 24.0125-0110.1 425110<br>24.0325-0110.1 525110   |  | 288 25,0 22,4 V L +S +B<br>288 25,0 22,4 V L +S +B PD   |
|  | SLK 200 Kompressor   | 135  |  | 01.08  | 01.11   | - Sportpaket <sup>1)</sup>   | 24.0128-0106.1 428106  |  | 300 28,0 25,4 V L +S +B   |
|  | SLK 280  | 170  |  | 04.05  | 01.11   | - Sportpaket <sup>1)</sup>   | 24.0328-0106.1 528106  |  | 300 28,0 25,4 V L +S +B PD  |
|  | SLK 300  | 170  |  | 03.09  | 01.11   | - Sportpaket <sup>1)</sup>   |  |  |   |
|  | SLK 200 Kompressor   | 120  |  | 03.04  | 01.11   | + Sportpaket <sup>2)</sup>   | 24.0128-0177.1 428177  |  | 330 28,0 26,0 V L +B  |
|  | SLK 200 Kompressor   | 135  |  | 01.08  | 01.11   | + Sportpaket <sup>2)</sup>   |  |  |   |
|  | SLK 280  | 170  |  | 04.05  | 01.11   | + Sportpaket <sup>2)</sup>   |  |  |   |
|  | SLK 300  | 170  |  | 03.09  | 01.11   | + Sportpaket <sup>2)</sup>   |  |  |   |
|  | SLK 350  | 200  |  | 03.04  | 01.11   |  |  |  |   |
|  | SLK 350  | 224  |  | 01.08  | 01.11   |  |  |  |   |
| SLK 55 AMG   |  | F 194373   | 03.04  |  | - AMG Black Series  | 13.8190-0330.1 990134  |  | Halterschraube   |   |
| SLK 55 AMG   |  | F 194374   |  | 01.11  | - AMG Black Series  | 24.0130-0180.1 430180  |  | 345 30,0 28,0 V L +B   |   |
|    | SLK 200 Kompressor   | 120  |  | 03.04  | 01.11   |  | 24.0711-6001.3 360119  | 2  | Radsensor L=565   |
|  | SLK 200 Kompressor   | 135  |  | 01.08  | 01.11   |  |  |  |   |
|  | SLK 280  | 170  |  | 04.05  | 01.11   |  |  |  |   |
|  | SLK 300  | 170  |  | 03.09  | 01.11   |  |  |  |   |
|  | SLK 350  | 200  |  | 03.04  | 01.11   |  |  |  |   |
|  | SLK 350  | 224  |  | 01.08  | 01.11   |  |  |  |   |
|  | SLK 55 AMG   |  |  | 03.04  | 01.11   |  |  |  |   |
|  | SLK 55 AMG   |  |  |  |   |  |  |  |   |
|  | SLK 200 Kompressor   | 120  |  | 03.04  | 01.11   | - Sportpaket <sup>1)</sup>   | 13.0460-4064.2 604064  |  | 21919 15,3 /Zub ATE<br>21919 15,3 /Zub ATE<br>Belagsatz-Zubehör ATE                                   |
|  | SLK 200 Kompressor   | 135  |  | 01.08  | 01.11   | - Sportpaket <sup>1)</sup>   | 13.0470-4064.2 LD4064  |  |   |
|  | SLK 280  | 170  |  | 04.05  | 01.11   | - Sportpaket <sup>1)</sup>   | 13.0460-0229.2 610229  |  |   |
|  | SLK 300  | 170  |  | 03.09  | 01.11   | - Sportpaket <sup>1)</sup>   |  |  |   |
|  | SLK 200 Kompressor   | 120  |  | 03.04  | 01.11   | + Sportpaket <sup>2)</sup>   | 13.0460-4065.2 604065  |  | 21899 15,3 /WE/Zub ATE<br>21899 15,3 /WE/Zub ATE<br>Belagsatz-Zubehör<br>Warnkontakt L=97,5mm         |
|  | SLK 200 Kompressor   | 135  |  | 01.08  | 01.11   | + Sportpaket <sup>2)</sup>   | 13.0470-4065.2 LD4065  |  |   |
|  | SLK 280  | 170  |  | 04.05  | 01.11   | + Sportpaket <sup>2)</sup>   | 13.0460-0258.2 610258  |  |   |
|  | SLK 300  | 170  |  | 03.09  | 01.11   | + Sportpaket <sup>2)</sup>   | 24.8190-0410.2 620410  | 1  |   |
|  | SLK 350  | 200  |  | 03.04  | 01.11   |  |  |  |   |
|  | SLK 350  | 224  |  | 01.08  | 01.11   |  |  |  |   |
| SLK 55 AMG   |  |  | 03.04  | 01.11  |   | 13.0460-4819.2 604819<br>24.8190-0410.2 620410                                     | 1  | 23478 14,6 /WE BRE<br>Warnkontakt L=97,5mm   |   |
|  | SLK 200 Kompressor   | 120  |  | 03.04  | 01.11   | - Sportpaket <sup>1)</sup>   | 24.0109-0114.1 409114  |  | 278 9,0 7,3 +S +B<br>278 9,0 7,3 +S +B PD   |
|  | SLK 200 Kompressor   | 135  |  | 01.08  | 01.11   | - Sportpaket <sup>1)</sup>   | 24.0309-0114.1 509114  |  |   |
|  | SLK 280  | 170  |  | 04.05  | 01.11   | - Sportpaket <sup>1)</sup>   |  |  |   |
|  | SLK 300  | 170  |  | 03.09  | 01.11   | - Sportpaket <sup>1)</sup>   |  |  |   |
|  | SLK 200 Kompressor   | 120  |  | 03.04  | 01.11   | + Sportpaket <sup>2)</sup>   | 24.0110-0217.1 410217  |  | 290 10,0 8,3 +S +B<br>290 10,0 8,3 +S +B PD   |
|  | SLK 200 Kompressor   | 135  |  | 01.08  | 01.11   | + Sportpaket <sup>2)</sup>   | 24.0310-0217.1 510217  |  |   |
|  | SLK 280  | 170  |  | 04.05  | 01.11   | + Sportpaket <sup>2)</sup>   |  |  |   |
|  | SLK 300  | 170  |  | 03.09  | 01.11   | + Sportpaket <sup>2)</sup>   |  |  |   |
|  | SLK 350  | 200  |  | 03.04  | 01.11   |  |  |  |   |
|  | SLK 350  | 224  |  | 01.08  | 01.11   |  |  |  |   |
| SLK 55 AMG   |  | F 197202   |  | 01.11  |   | 24.0122-0228.1 422228  |  | 300 22,0 19,4 V L +B   |   |
|  | SLK 200 Kompressor   | 120  |  | 03.04  | 01.11   |  | 24.0711-6110.3 360133  |  | Radsensor L=706   |
|  | SLK 200 Kompressor   | 135  |  | 01.08  | 01.11   |  | 24.0711-6109.3 360132  |  | Radsensor L=1075  |
|  | SLK 280  | 170  |  | 04.05  | 01.11   |  |  |  |   |
|  | SLK 300  | 170  |  | 03.09  | 01.11   |  |  |  |   |
|  | SLK 350  | 200  |  | 03.04  | 01.11   |  |  |  |   |
|  | SLK 350  | 224  |  | 01.08  | 01.11   |  |  |  |   |
|  | SLK 55 AMG   |  |  | 03.04  | 01.11   |  |  |  |   |
|  | SLK 55 AMG   |  |  |  |   |  |  |  |   |
|  | SLK 200 Kompressor   | 120  |  | 03.04  | 01.11   |  | 03.0137-4013.2 654013  |  | 164 x 20 /Zub<br>Bremsbacken-Zubehör  |
|  | SLK 200 Kompressor   | 135  |  | 01.08  | 01.11   |  | 03.0137-9248.2 669248  |  |   |
|  | SLK 280  | 170  |  | 04.05  | 01.11   |  |  |  |   |
|  | SLK 300  | 170  |  | 03.09  | 01.11   |  |  |  |   |
|  | SLK 350  | 200  |  | 03.04  | 01.11   |  |  |  |   |
|  | SLK 350  | 224  |  | 01.08  | 01.11   |  |  |  |   |
|  | SLK 55 AMG   |  |  | 03.04  | 01.11   |  |  |  |   |
|  | SLK 55 AMG   |  |  |  |   |  |  |  |   |
| <b>MERCEDES BENZ SLK-Klasse / SLC-Klasse (R172) (11-)</b>                          |  |  |  |  |   |  |  |  |   |
|  | SLC 180  | 115  |  | 01.16  |   |  | 13.0460-2732.2 602732  |  | - Sportpaket / - Sportpaket AMG <sup>3)</sup> 24306 20,3 /WE/Zub/S TRW                                |
|  | SLK 200  | 135  |  | 02.11  |   |  | 13.0470-2732.2 LD2732  |  | - Sportpaket / - Sportpaket AMG <sup>3)</sup> 24306 20,3 /WE/Zub/S TRW                                |
|  | SLK 250  | 150  |  | 02.11  |   |  | 13.0460-2734.2 602734  |  | + Sportpaket / + Sportpaket AMG <sup>4)</sup> 24310 19,0 +/WE/S TRW                                   |
|  |  |  |  |  |   |  | 13.0470-2734.2 LD2734  |  | + Sportpaket / + Sportpaket AMG <sup>4)</sup> 24310 19,0 +/WE/S TRW                                   |
|  |  |  |  |  |   | 24.8190-0410.2 620410  | 1  | Warnkontakt L=97,5mm   |   |





















<sup>1)</sup> - sport package / - pacchetto sportivo / - version sport / - kit sportivo

<sup>2)</sup> + sports package / + pacchetto sportivo / + version sport / + kit sportivo

























<sup>3)</sup> - sport package/- sport package AMG / - pacchetto sportivo/- pacchetto sport.AMG / - version sport/- version sport AMG / - kit sportivo/- kit sportivo AMG

<sup>4)</sup> + sports package/+ sports package AMG / + pacchetto sportivo/+ pacchetto sport.AMG / + version sport/+ version sport AMG / + kit sportivo/+ kit sportivo AMG



|     |   |  |                          |  |  |  |     |   |
|--|---|--|--|--|---|--|---|---|
| <b>MERCEDES BENZ SLK-Klasse / SLC-Klasse (R172) (11-)</b>                          |   |  |  |  |   |  |   |   |
|    | SLC 200<br>SLC 250 d<br>SLC 300<br>SLK 200<br>SLK 250 CDI<br>SLK 300<br>SLK 350<br>SLK 55 AMG   | 135<br>150<br>180<br>135<br>150<br>180<br>225<br>310                             | 01.16<br>01.16<br>01.16<br>04.15<br>01.12<br>07.15<br>02.11<br>01.12                                     |  | 13.0460-2734.2<br>13.0470-2734.2<br>24.8190-0410.2                                | 602734<br>LD2734<br>620410   | 1   | 24310 19,0 +/WE/S TRW<br>24310 19,0 +/WE/S TRW<br>Warnkontakt L=97,5mm  |
|    | SLC 200<br>SLC 250 d<br>SLC 300<br>SLK 200<br>SLK 200<br>SLK 200<br>SLK 250<br>SLK 250 CDI<br>SLK 300<br>SLC 180<br>SLK 350<br>SLK 55 AMG               | 135<br>150<br>180<br>135<br>135<br>135<br>150<br>150<br>180<br>115<br>225<br>310 | 01.16<br>01.16<br>01.16<br>04.15<br>02.11<br>02.11<br>01.12<br>07.15<br>01.16<br>02.11<br>01.12          |  | 24.0132-0101.1<br>24.0332-0101.1<br>24.0132-0175.1                                | 432101<br>532101<br>432175   |   | - Sportpaket / - Sportpaket AMG <sup>1)</sup><br>- Sportpaket / - Sportpaket AMG <sup>1)</sup><br>+ Sportpaket / + Sportpaket AMG <sup>2)</sup><br>295 28,0 25,4 V L +S +B<br>322 32,0 29,4 V L +S +B PD<br>344 32,0 30,0 V L +S +B |
|    | SLC 180<br>SLC 200<br>SLC 250 d<br>SLC 300<br>SLC 43 AMG<br>SLK 200<br>SLK 200<br>SLK 200<br>SLK 250<br>SLK 250 CDI<br>SLK 300<br>SLK 350<br>SLK 55 AMG | 115<br>135<br>150<br>180<br>270<br>135<br>135<br>150<br>150<br>180<br>225<br>310 | 01.16<br>01.16<br>01.16<br>01.16<br>01.16<br>04.15<br>02.11<br>02.11<br>01.12<br>07.15<br>02.11<br>01.12 |  | 24.0128-0155.1<br>24.0132-0175.1  | 428155<br>432175   |   | - Sportpaket / - Sportpaket AMG <sup>1)</sup><br>+ Sportpaket / + Sportpaket AMG <sup>2)</sup><br>- AMG-Performance Package<br>295 28,0 25,4 V L +S +B<br>344 32,0 30,0 V L +S +B<br>360 36,0 34,0 V L +B                           |
|    | SLC 180<br>SLC 200<br>SLC 250 d<br>SLC 300<br>SLK 200<br>SLK 200<br>SLK 200<br>SLK 250<br>SLK 250 CDI<br>SLK 300<br>SLK 350<br>SLK 55 AMG               | 115<br>135<br>150<br>180<br>270<br>135<br>135<br>150<br>150<br>180<br>225<br>310 | 01.16<br>01.16<br>01.16<br>01.16<br>01.16<br>04.15<br>02.11<br>02.11<br>01.12<br>07.15<br>02.11<br>01.12 |  | 13.0460-2786.2<br>13.0470-2786.2<br>24.8190-0410.2                                | 602786<br>LD2786<br>620410   | 1   | 24848 18,3 /WE/Zub/S TRW<br>24848 18,3 /WE/Zub/S TRW<br>Warnkontakt L=97,5mm  |
|  | SLC 180<br>SLC 200<br>SLC 250 d<br>SLC 300<br>SLK 200<br>SLK 200<br>SLK 200<br>SLK 250<br>SLK 250 CDI<br>SLK 300<br>SLK 350                             | 115<br>135<br>150<br>180<br>135<br>135<br>150<br>150<br>180<br>225               | 01.16<br>01.16<br>01.16<br>01.16<br>04.15<br>02.11<br>02.11<br>01.12<br>07.15<br>02.11                   |  | 24.0110-0391.1  | 410391   |   | 300 10,0 8,3 +L +S +B   |
|  | SLC 180<br>SLC 200<br>SLC 250 d<br>SLC 300<br>SLC 43 AMG<br>SLK 200<br>SLK 200<br>SLK 200<br>SLK 250<br>SLK 250 CDI<br>SLK 300<br>SLK 350<br>SLK 55 AMG | 115<br>135<br>150<br>180<br>270<br>135<br>135<br>150<br>150<br>180<br>225<br>310 | 01.16<br>01.16<br>01.16<br>01.16<br>01.16<br>04.15<br>02.11<br>02.11<br>01.12<br>07.15<br>02.11<br>01.12 |  | 24.0711-6258.3  | 360434   |  | Radsensor L=1055  |
| <b>MERCEDES BENZ SLR-Klasse (C199) Coupe (04-09)</b>                               |   |  |  |  |   |  |   |   |
|  | SLR 5.4 McLaren   | 460  | 12.03<br>12.09   |  | 24.8190-0410.2  | 620410   | 2   | Warnkontakt L=97,5mm  |
| <b>MERCEDES BENZ SLS AMG 63 / ROADSTER (C197) (10-14)</b>                          |   |  |  |  |   |  |   |   |
|  | 6.2<br>6.2 GT   | 420<br>435   | 03.10<br>10.12   | 04.14<br>04.14   | 24.8190-0420.2  | 620420   | 1   | - Keramikbremse <sup>3)</sup><br>Warnkontakt L=119mm  |
|  | 6.2<br>6.2 GT   | 420<br>435   | 03.10<br>10.12   | 04.14<br>04.14   | 24.8190-0420.2  | 620420   | 1   | Warnkontakt L=119mm   |
| <b>MERCEDES BENZ Vaneo (BM414) (02-05)</b>   |   |  |  |  |   |  |   |   |
|  | 1.4<br>1.6<br>1.6<br>1.7 CDI<br>1.7 CDI   | 60<br>60<br>75<br>55<br>67   | 06.02<br>02.02<br>02.02<br>02.02<br>02.02  | 12.05<br>12.05<br>12.05<br>12.05<br>12.05  | 13.0460-2828.2<br>13.0460-0257.2<br>24.8190-0410.2                                | 602828<br>610257<br>620410   | 1   | 23070 19,5 /WE/S TRW<br>Belagsatz-Zubehör<br>Warnkontakt L=97,5mm   |
|  |   |  |  |  |   |  |   |   |

1) - sport package/- sport package AMG / - pacchetto sportivo/- pacchetto sport.AMG / - version sport/- version sport AMG / - kit deportivo/- kit deportivo AMG  
2) + sports package/+ sports package AMG / + pacchetto sportivo/+ pacchetto sport.AMG / + version sport/+ version sport AMG / + kit deportivo/+ kit deportivo AMG  
3) - ceramic brake / - freno in ceramica / - frein de céramique / - freno de cerámica

|     |                            |  |  |  |  |  |  |     |   |
|--|--|--|--|--|---|--|--|---|---|
| <b>MERCEDES BENZ Vaneo (BM414) (02-05)</b>   |  |  |  |  |   |  |  |   |   |
|    | 1.9  | 92   |  | 02.02  | 12.05   |  | 13.0460-2828.2 602828<br>13.0460-0257.2 610257<br>24.8190-0410.2 620410            | 1   | 23070 19,5 /WE/S TRW<br>Belagsatz-Zubehör<br>Warnkontakt L=97,5mm         |
|    | 1.4<br>1.6<br>1.6<br>1.7 CDI<br>1.7 CDI<br>1.9   | 60<br>60<br>75<br>55<br>67<br>92   |  | 06.02<br>02.02<br>02.02<br>02.02<br>02.02<br>02.02                               | 12.05<br>12.05<br>12.05<br>12.05<br>12.05<br>12.05                                |  | 24.0122-0199.1 422199<br>24.0322-0199.1 522199                                     |   | 270 22,0 19,4 V L +B<br>270 22,0 19,4 V L +B PD                           |
|    | 1.4<br>1.6<br>1.6<br>1.7 CDI<br>1.7 CDI<br>1.9   | 60<br>60<br>75<br>55<br>67<br>92   |  | 06.02<br>02.02<br>02.02<br>02.02<br>02.02<br>02.02                               | 12.05<br>12.05<br>12.05<br>12.05<br>12.05<br>12.05                                |  | 13.0460-2855.2 602855<br>13.0470-2855.2 LD2855<br>13.0460-0144.2 610144            |   | 23138 14,6 /S TRW<br>23138 14,6 /S TRW<br>Belagsatz-Zubehör TRW           |
|    | 1.4<br>1.6<br>1.6<br>1.7 CDI<br>1.7 CDI<br>1.9   | 60<br>60<br>75<br>55<br>67<br>92   |  | 06.02<br>02.02<br>02.02<br>02.02<br>02.02<br>02.02                               | 12.05<br>12.05<br>12.05<br>12.05<br>12.05<br>12.05                                |  | 24.0108-0111.1 408111<br>24.0308-0111.1 508111                                     |   | 258 8,0 7,0 +B<br>258 8,0 7,0 +B PD                                       |
|    | 1.4<br>1.6<br>1.6<br>1.7 CDI<br>1.7 CDI<br>1.9   | 60<br>60<br>75<br>55<br>67<br>92   |  | 06.02<br>02.02<br>02.02<br>02.02<br>02.02<br>02.02                               | 12.05<br>12.05<br>12.05<br>12.05<br>12.05<br>12.05                                |  | 03.0137-4013.2 654013  |   | 164 x 20 /Zub   |
| <b>MERCEDES BENZ V-Klasse (BM638) (96-03)</b>                                      |  |  |  |  |   |  |  |   |   |
|    | V 200<br>V 200 CDI<br>V 220 CDI<br>V 230<br>V 230 TD<br>V 280  |  |  | 09.96<br>03.99<br>03.99<br>09.96<br>09.96<br>09.97                               | 08.03<br>08.03<br>08.03<br>08.03<br>08.03<br>08.03                                |  | 13.0460-7196.2 607196<br>24.8190-0417.2 620417                                     | 2   | 21576 20,7 +/WE ATE<br>Warnkontakt L=99(167)mm                            |
|    | V 200<br>V 200 CDI<br>V 220 CDI<br>V 230<br>V 230 TD<br>V 280  |  |  | 09.96<br>03.99<br>03.99<br>09.96<br>09.96<br>09.97                               | 08.03<br>08.03<br>08.03<br>08.03<br>08.03<br>08.03                                |  | 13.0460-3980.2 603980<br>13.0460-0250.2 610250<br>24.8190-0407.2 620407            | 2   | 23022 20,9 /WE BOS<br>Belagsatz-Zubehör BOS<br>Warnkontakt L=84(185)mm    |
|  | V 200<br>V 200 CDI<br>V 220 CDI<br>V 230<br>V 230 TD<br>V 280  |  |  | 09.96<br>03.99<br>03.99<br>09.96<br>09.96<br>09.97                               | 08.03<br>08.03<br>08.03<br>08.03<br>08.03<br>08.03                                |  | 24.0122-0162.1 422162<br>24.0322-0162.1 522162                                     |   | 276 22,0 19,0 V +S +B<br>276 22,0 19,0 V L +S +B PD                       |
|  | V 200<br>V 200 CDI<br>V 220 CDI<br>V 230<br>V 230 TD<br>V 280  |  |  | 09.96<br>03.99<br>03.99<br>09.96<br>09.96<br>09.97                               | 08.03<br>08.03<br>08.03<br>08.03<br>08.03<br>08.03                                |  | 13.0460-7085.2 607085<br>13.0460-3985.2 603985<br>13.0460-0288.2 610288            |   | 21904 16,9 +/WK ATE<br>23020 17,9 BOS<br>Belagsatz-Zubehör, + WBOS        |
|  | V 200<br>V 200 CDI<br>V 220 CDI<br>V 230<br>V 230 TD<br>V 280  |  |  | 09.96<br>03.99<br>03.99<br>09.96<br>09.96<br>09.97                               | 08.03<br>08.03<br>08.03<br>08.03<br>08.03<br>08.03                                |  | 24.0110-0228.1 410228  |   | 280 10,0 8,0 L +S +B  |
|  | V 200<br>V 200 CDI<br>V 220 CDI<br>V 230<br>V 230 TD<br>V 280  |  |  | 09.96<br>03.99<br>03.99<br>09.96<br>09.96<br>09.97                               | 08.03<br>08.03<br>08.03<br>08.03<br>08.03<br>08.03                                |  | 03.0137-4011.2 654011<br>03.0137-9248.2 669248                                     |   | 178 x 20 /Zub<br>Bremsbacken-Zubehör                                      |
| <b>MERCEDES BENZ V-Klasse (BM447) (14-)</b>  |  |  |  |  |   |  |  |   |   |
|  | V 200 CDI  | 100  |  | 03.14  |   |  | 13.0460-4826.2 604826<br>13.0460-4877.2 604877<br>24.8190-0424.2 620424            | 1  | 29192 20,7 /WE/Zub BRE<br>29192 20,3 /WE/Zub BRE<br>Warnkontakt L=103,2mm |
|  | V 200 CDI<br>V 200 CDI 4-matic<br>V 220 CDI<br>V 220 CDI 4-matic<br>V 250 BlueTec<br>V 250 BlueTec 4-matic | 100<br>100<br>120<br>120<br>140<br>140   |  | 03.14<br>04.15<br>03.14<br>04.15<br>03.14<br>12.14                               |   |  | 24.8190-0424.2 620424  | 1  | Warnkontakt L=103,2mm   |
|  | V 200 CDI<br>V 200 CDI 4-matic<br>V 220 CDI<br>V 220 CDI 4-matic<br>V 250 BlueTec<br>V 250 BlueTec 4-matic | 100<br>100<br>120<br>120<br>140<br>140   |  | 03.14<br>04.15<br>03.14<br>04.15<br>03.14<br>12.14                               |   |  | 24.0128-0145.1 428145  | + Stahlfelgen <sup>1)</sup>   | 300 28,0 25,0 V L +S +B   |

<sup>1)</sup> + steel rims / + cerchioni in acciaio / + jantes en acier / + Llantas acero



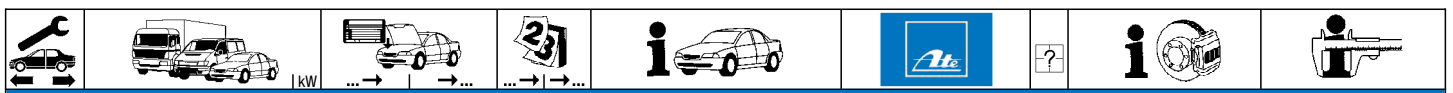

**MERCEDES BENZ V-Klasse (BM447) (14-)**

|  |  |  |  |  |  |                |        |   |                                    |                           |
|--|--|--|--|--|--|----------------|--------|---|------------------------------------|---------------------------|
|  | V 200 CDI<br>V 200 CDI 4-matic<br>V 220 CDI<br>V 220 CDI 4-matic<br>V 250 BlueTec<br>V 250 BlueTec 4-matic | 100<br>100<br>120<br>120<br>140<br>140 |  | 03.14<br>04.15<br>03.14<br>04.15<br>03.14<br>12.14 |  | 24.0711-5529.3 | 360432 | 2 |                                    | Radsensor L=1135          |
|  | V 200 CDI<br>V 200 CDI 4-matic<br>V 220 CDI<br>V 220 CDI 4-matic<br>V 250 BlueTec<br>V 250 BlueTec 4-matic | 100<br>100<br>120<br>120<br>140<br>140 |  | 03.14<br>04.15<br>03.14<br>04.15<br>03.14<br>12.14 |  | 13.0460-4882.2 | 604882 |   |                                    | 22102 18,2 /WE <b>BRE</b> |
|  | V 200 CDI<br>V 200 CDI 4-matic<br>V 220 CDI<br>V 220 CDI 4-matic<br>V 250 BlueTec<br>V 250 BlueTec 4-matic | 100<br>100<br>120<br>120<br>140<br>140 |  | 03.14<br>04.15<br>03.14<br>04.15<br>03.14<br>12.14 |  | 24.0112-0213.1 | 412213 |   | + Leichtmetallfelgen <sup>1)</sup> | 300 12,0 9,0 L +S +B      |
|  | V 200 CDI<br>V 200 CDI 4-matic<br>V 220 CDI<br>V 220 CDI 4-matic<br>V 250 BlueTec<br>V 250 BlueTec 4-matic | 100<br>100<br>120<br>120<br>140<br>140 |  | 03.14<br>04.15<br>03.14<br>04.15<br>03.14<br>12.14 |  | 24.0711-5530.3 | 360433 | 2 |                                    | Radsensor L=940           |
|  | V 200 CDI<br>V 200 CDI 4-matic<br>V 220 CDI<br>V 220 CDI 4-matic<br>V 250 BlueTec<br>V 250 BlueTec 4-matic | 100<br>100<br>120<br>120<br>140<br>140 |  | 03.14<br>04.15<br>03.14<br>04.15<br>03.14<br>12.14 |  | 03.0137-4009.2 | 654009 |   |                                    | 186 x 20 /Zub             |

**MERCEDES BENZ VIANO (BM639) (03-14)**

|  |   |  |  |   |   |  |                            |   |  |   |
|--|---|--|--|---|---|--|----------------------------|---|--|---|
|  | 2.0 CDI<br>2.0 CDI 4-matic<br>2.2 CDI<br>2.2 CDI 4-matic<br>3.0<br>3.0 CDI<br>3.2<br>3.5<br>3.7 |  | 342257<br>342257<br>342257<br>342257<br>342257<br>342257<br>342257<br>342257<br>342257 | 08.03<br>07.10<br>08.03<br>07.10<br>08.03<br>03.06<br>08.03<br>09.07<br>06.04 |   | 13.0460-3819.2<br>24.8190-0418.2                   | 603819<br>620418           | 2 |  | 24007 20,8 /WK/S <b>BOS</b><br>Warnkontakt L=95mm                                       |
|  | 2.0 CDI<br>2.0 CDI 4-matic<br>2.2 CDI<br>2.2 CDI 4-matic<br>3.0<br>3.0 CDI<br>3.2<br>3.5<br>3.7 | 342258<br>342258<br>342258<br>342258<br>140 342258<br>342258<br>160 342258<br>190 342258<br>170 342258 |  | 02.14<br>02.14<br>02.14<br>02.14<br>02.14<br>02.14<br>02.14<br>02.14<br>02.14 |   | 13.0460-4826.2<br>13.0460-4877.2<br>24.8190-0424.2 | 604826<br>604877<br>620424 | 2 |  | 29192 20,7 /WE/Zub <b>BRE</b><br>29192 20,3 /WE/Zub <b>BRE</b><br>Warnkontakt L=103,2mm |
|  | 2.0 CDI<br>2.0 CDI 4-matic<br>2.2 CDI<br>2.2 CDI 4-matic<br>3.0<br>3.0 CDI<br>3.2<br>3.5<br>3.7 |  |  | 08.03<br>07.10<br>08.03<br>07.10<br>08.03<br>03.06<br>08.03<br>09.07<br>06.04 | 02.14<br>02.14<br>02.14<br>02.14<br>02.14<br>02.14<br>02.14<br>02.14<br>02.14 | 24.0128-0145.1                                     | 428145                     |   |  | 300 28,0 25,0 V L +S +B   |
|  | 2.0 CDI<br>2.0 CDI 4-matic<br>2.2 CDI<br>2.2 CDI 4-matic<br>3.0<br>3.0 CDI<br>3.2<br>3.5<br>3.7 |  |  | 08.03<br>07.10<br>08.03<br>07.10<br>08.03<br>03.06<br>08.03<br>09.07<br>06.04 | 02.14<br>02.14<br>02.14<br>02.14<br>02.14<br>02.14<br>02.14<br>02.14<br>02.14 | 13.0460-3821.2<br>24.8190-0418.2                   | 603821<br>620418           | 2 |  | 24008 18,3 /WK/S <b>BOS</b><br>Warnkontakt L=95mm                                       |
|  | 2.0 CDI<br>2.0 CDI 4-matic<br>2.2 CDI<br>2.2 CDI 4-matic<br>3.0<br>3.0 CDI<br>3.2<br>3.5<br>3.7 |  |  | 08.03<br>07.10<br>08.03<br>07.10<br>08.03<br>03.06<br>08.03<br>09.07<br>06.04 | 02.14<br>02.14<br>02.14<br>02.14<br>02.14<br>02.14<br>02.14<br>02.14<br>02.14 | 24.0110-0280.1                                     | 410280                     |   |  | 296 10,0 8,0 +S +B  |
|  | 2.0 CDI<br>2.0 CDI 4-matic<br>2.2 CDI<br>2.2 CDI 4-matic<br>3.0<br>3.0 CDI<br>3.2<br>3.5<br>3.7 |  |  | 08.03<br>07.10<br>08.03<br>07.10<br>08.03<br>03.06<br>08.03<br>09.07<br>06.04 | 02.14<br>02.14<br>02.14<br>02.14<br>02.14<br>02.14<br>02.14<br>02.14<br>02.14 | 03.0137-4009.2                                     | 654009                     |   |  | 186 x 20 /Zub   |

<sup>1)</sup> + light alloy rims / + cerchioni in lega / + jantes en alliage léger / + Llantas de aleación ligera





**MERCEDES BENZ VITO (BM638) (96-03)**

|     |         |  |       |       |       |  |                |        |   |  |  |                   |
|-----|---------|--|-------|-------|-------|--|----------------|--------|---|--|--|-------------------|
|     | 108 CDI |  |       | 03.99 | 08.03 |  | 13.0460-7196.2 | 607196 | 2 |  | 21576 20,7 +/WE<br>Warnkontakt L=99(167)mm                     | ATE               |
|     | 108 D   |  |       | 03.96 | 08.03 |  | 24.8190-0417.2 | 620417 |   |  |  |                   |
|     | 110 CDI |  |       | 03.99 | 08.03 |  |                |        |   |  |  |                   |
|     | 110 D   |  |       | 03.96 | 08.03 |  |                |        |   |  |  |                   |
|     | 112 CDI |  |       | 03.99 | 08.03 |  |                |        |   |  |  |                   |
|     | 113     |  |       | 03.96 | 08.03 |  |                |        |   |  |  |                   |
| 114 |         |  | 12.96 | 08.03 |       |  |                |        |   |  |  |                   |
|     | 108 CDI |  |       | 03.99 | 08.03 |  | 13.0460-3980.2 | 603980 | 2 |  | 23022 20,9 /WE<br>Belagsatz-Zubehör<br>Warnkontakt L=84(185)mm | BOS<br>BOS        |
|     | 108 D   |  |       | 03.96 | 08.03 |  | 13.0460-0250.2 | 610250 |   |  |  |                   |
|     | 110 CDI |  |       | 03.99 | 08.03 |  | 24.8190-0407.2 | 620407 |   |  |  |                   |
|     | 110 D   |  |       | 03.96 | 08.03 |  |                |        |   |  |  |                   |
|     | 112 CDI |  |       | 03.99 | 08.03 |  |                |        |   |  |  |                   |
|     | 113     |  |       | 03.96 | 08.03 |  |                |        |   |  |  |                   |
| 114 |         |  | 12.96 | 08.03 |       |  |                |        |   |  |  |                   |
|     | 108 CDI |  |       | 03.99 | 08.03 |  | 24.0122-0162.1 | 422162 |   |  | 276 22,0 19,0 V +S +B<br>276 22,0 19,0 V L +S +B PD            |                   |
|     | 108 D   |  |       | 03.96 | 08.03 |  | 24.0322-0162.1 | 522162 |   |  |  |                   |
|     | 110 CDI |  |       | 03.99 | 08.03 |  |                |        |   |  |  |                   |
|     | 110 D   |  |       | 03.96 | 08.03 |  |                |        |   |  |  |                   |
|     | 112 CDI |  |       | 03.99 | 08.03 |  |                |        |   |  |  |                   |
|     | 113     |  |       | 03.96 | 08.03 |  |                |        |   |  |  |                   |
| 114 |         |  | 12.96 | 08.03 |       |  |                |        |   |  |  |                   |
|     | 108 CDI |  |       | 03.99 | 08.03 |  | 13.0460-7085.2 | 607085 |   |  | 21904 16,9 +/WK<br>23020 17,9<br>Belagsatz-Zubehör, + WBOS     | ATE<br>BOS<br>BOS |
|     | 108 D   |  |       | 03.96 | 08.03 |  | 13.0460-3985.2 | 603985 |   |  |  |                   |
|     | 110 CDI |  |       | 03.99 | 08.03 |  | 13.0460-0288.2 | 610288 |   |  |  |                   |
|     | 110 D   |  |       | 03.96 | 08.03 |  |                |        |   |  |  |                   |
|     | 112 CDI |  |       | 03.99 | 08.03 |  |                |        |   |  |  |                   |
|     | 113     |  |       | 03.96 | 08.03 |  |                |        |   |  |  |                   |
| 114 |         |  | 12.96 | 08.03 |       |  |                |        |   |  |  |                   |
|     | 108 CDI |  |       | 03.99 | 08.03 |  | 24.0110-0228.1 | 410228 |   |  | 280 10,0 8,0 L +S +B   |                   |
|     | 108 D   |  |       | 03.96 | 08.03 |  |                |        |   |  |  |                   |
|     | 110 CDI |  |       | 03.99 | 08.03 |  |                |        |   |  |  |                   |
|     | 110 D   |  |       | 03.96 | 08.03 |  |                |        |   |  |  |                   |
|     | 112 CDI |  |       | 03.99 | 08.03 |  |                |        |   |  |  |                   |
|     | 113     |  |       | 03.96 | 08.03 |  |                |        |   |  |  |                   |
| 114 |         |  | 12.96 | 08.03 |       |  |                |        |   |  |  |                   |
|     | 108 CDI |  |       | 03.99 | 08.03 |  | 03.0137-4011.2 | 654011 |   |  | 178 x 20 /Zub<br>Bremsbacken-Zubehör                           |                   |
|     | 108 D   |  |       | 03.96 | 08.03 |  | 03.0137-9248.2 | 669248 |   |  |  |                   |
|     | 110 CDI |  |       | 03.99 | 08.03 |  |                |        |   |  |  |                   |
|     | 110 D   |  |       | 03.96 | 08.03 |  |                |        |   |  |  |                   |
|     | 112 CDI |  |       | 03.99 | 08.03 |  |                |        |   |  |  |                   |
|     | 113     |  |       | 03.96 | 08.03 |  |                |        |   |  |  |                   |
| 114 |         |  | 12.96 | 08.03 |       |  |                |        |   |  |  |                   |

**MERCEDES BENZ VITO (BM639) (03-14)**

|                 |                 |        |        |       |       |  |                |                |   |  |  |     |        |   |  |   |            |
|-----------------|-----------------|--------|--------|-------|-------|--|----------------|----------------|---|--|--|-----|--------|---|--|---|------------|
|                 | 109 CDI         |        | 342257 | 08.03 |       |  | 13.0460-3819.2 | 603819         | 2 |  | 24007 20,8 /WK/S<br>Warnkontakt L=95mm | BOS |        |   |  |   |            |
|                 | 109 CDI 4-matic | 70     | 407625 | 09.07 |       |  | 24.8190-0418.2 | 620418         |   |  |  |     |        |   |  |   |            |
|                 | 110 CDI         | 70     | 342257 | 09.10 |       |  |                |                |   |  |  |     |        |   |  |   |            |
|                 | 111 CDI         |        | 342257 | 08.03 |       |  |                |                |   |  |  |     |        |   |  |   |            |
|                 | 111 CDI 4-matic | 80     | 407625 | 09.07 |       |  |                |                |   |  |  |     |        |   |  |   |            |
|                 | 113 CDI         | 100    | 342257 | 09.10 |       |  |                |                |   |  |  |     |        |   |  |   |            |
|                 | 113 CDI 4-matic | 100    | 407625 | 09.10 |       |  |                |                |   |  |  |     |        |   |  |   |            |
|                 | 115 CDI         | 110    | 342257 | 08.03 |       |  |                |                |   |  |  |     |        |   |  |   |            |
|                 | 115 CDI 4-matic | 110    | 407625 | 09.07 |       |  |                |                |   |  |  |     |        |   |  |   |            |
|                 | 116 CDI         | 120    | 342257 | 09.10 |       |  |                |                |   |  |  |     |        |   |  |   |            |
|                 | 116 CDI 4-matic | 120    | 407625 | 09.10 |       |  |                |                |   |  |  |     |        |   |  |   |            |
|                 | 119             | 140    | 342257 | 08.03 |       |  |                |                |   |  |  |     |        |   |  |   |            |
|                 | 120 CDI         | 150    | 342257 | 09.07 |       |  |                |                |   |  |  |     |        |   |  |   |            |
|                 | 122             | 160    | 342257 | 08.03 |       |  |                |                |   |  |  |     |        |   |  |   |            |
|                 | 122 CDI         | 165    | 342257 | 09.10 |       |  |                |                |   |  |  |     |        |   |  |   |            |
|                 | 123             | 170    | 342257 | 06.04 |       |  |                |                |   |  |  |     |        |   |  |   |            |
|                 | 123             | 190    | 342257 | 09.07 |       |  |                |                |   |  |  |     |        |   |  |   |            |
|                 | 126             | 190    | 342257 | 09.07 |       |  |                |                |   |  |  |     |        |   |  |   |            |
|                 | E-Cell          | 60     |        | 03.12 | 02.14 |  |                |                |   |  |  |     |        |   |  |   |            |
|                 | 109 CDI         |        | 342258 |       | 02.14 |  |                | 13.0460-4826.2 |   |  |  |     | 604826 | 2 |  | 29192 20,7 /WE/Zub<br>29192 20,3 /WE/Zub<br>Warnkontakt L=103,2mm | BRE<br>BRE |
|                 | 109 CDI 4-matic | 70     | 407626 |       | 02.14 |  |                | 13.0460-4877.2 |   |  |  |     | 604877 |   |  |   |            |
| 110 CDI         | 70              | 342258 |        | 02.14 |       |  | 24.8190-0424.2 | 620424         |   |  |  |     |        |   |  |   |            |
| 111 CDI         |                 | 342258 |        | 02.14 |       |  |                |                |   |  |  |     |        |   |  |   |            |
| 111 CDI 4-matic | 80              | 407626 |        | 02.14 |       |  |                |                |   |  |  |     |        |   |  |   |            |
| 113 CDI         | 100             | 342258 |        | 02.14 |       |  |                |                |   |  |  |     |        |   |  |   |            |
| 113 CDI 4-matic | 100             | 407626 |        | 02.14 |       |  |                |                |   |  |  |     |        |   |  |   |            |
| 115 CDI         | 110             | 342258 |        | 02.14 |       |  |                |                |   |  |  |     |        |   |  |   |            |
| 115 CDI 4-matic | 110             | 407626 |        | 02.14 |       |  |                |                |   |  |  |     |        |   |  |   |            |
| 116 CDI         | 120             | 342258 |        | 02.14 |       |  |                |                |   |  |  |     |        |   |  |   |            |
| 116 CDI 4-matic | 120             | 407626 |        | 02.14 |       |  |                |                |   |  |  |     |        |   |  |   |            |
| 119             | 140             | 342258 |        | 02.14 |       |  |                |                |   |  |  |     |        |   |  |   |            |
| 120 CDI         | 150             | 342258 |        | 02.14 |       |  |                |                |   |  |  |     |        |   |  |   |            |
| 122             | 160             | 342258 |        | 02.14 |       |  |                |                |   |  |  |     |        |   |  |   |            |
| 122 CDI         | 165             | 342258 |        | 02.14 |       |  |                |                |   |  |  |     |        |   |  |   |            |
| 123             | 170             | 342258 |        | 02.14 |       |  |                |                |   |  |  |     |        |   |  |   |            |
| 123             | 190             | 342258 |        | 02.14 |       |  |                |                |   |  |  |     |        |   |  |   |            |
| 126             | 190             | 342258 |        | 02.14 |       |  |                |                |   |  |  |     |        |   |  |   |            |
| E-Cell          | 60              |        | 03.12  | 02.14 |       |  |                |                |   |  |  |     |        |   |  |   |            |
|                 | 109 CDI         |        |        | 08.03 | 02.14 |  | 24.0128-0145.1 | 428145         |   |  | 300 28,0 25,0 V L +S +B                |     |        |   |  |   |            |
|                 | 109 CDI 4-matic | 70     |        | 09.07 | 02.14 |  |                |                |   |  |  |     |        |   |  |   |            |
|                 | 110 CDI         | 70     |        | 09.10 | 02.14 |  |                |                |   |  |  |     |        |   |  |   |            |
|                 | 111 CDI         |        |        | 08.03 | 02.14 |  |                |                |   |  |  |     |        |   |  |   |            |



























**MERCEDES BENZ VITO (BM639) (03-14)**

|         |                 |        |        |       |                |                |        |                        |  |
|---------|-----------------|--------|--------|-------|----------------|----------------|--------|------------------------|--|
|         | 111 CDI 4-matic | 80     |        | 09.07 | 02.14          | 24.0128-0145.1 | 428145 |                        | 300 28,0 25,0 VL +S +B                     |
|         | 113 CDI         | 100    |        | 09.10 | 02.14          |                |        |                        |  |
|         | 113 CDI 4-matic | 100    |        | 09.10 | 02.14          |                |        |                        |  |
|         | 115 CDI         | 110    |        | 08.03 | 02.14          |                |        |                        |  |
|         | 115 CDI 4-matic | 110    |        | 09.07 | 02.14          |                |        |                        |  |
|         | 116 CDI         | 120    |        | 09.10 | 02.14          |                |        |                        |  |
|         | 116 CDI 4-matic | 120    |        | 09.10 | 02.14          |                |        |                        |  |
|         | 119             | 140    |        | 08.03 | 02.14          |                |        |                        |  |
|         | 120 CDI         | 150    |        | 09.07 | 02.14          |                |        |                        |  |
|         | 122             | 160    |        | 08.03 | 02.14          |                |        |                        |  |
|         | 122 CDI         | 165    | 444279 | 09.10 | 02.14          |                |        |                        |  |
|         | 123             | 170    |        | 06.04 | 02.14          |                |        |                        |  |
|         | 123             | 190    |        | 09.07 | 02.14          |                |        |                        |  |
|         | 126             | 190    | 444279 | 09.07 | 02.14          |                |        |                        |  |
|         | E-Cell          | 60     |        | 03.12 | 02.14          |                |        |                        |  |
| 122 CDI | 165             | 444280 |        | 02.14 | 24.0128-0145.1 | 428145         |        | 300 28,0 25,0 VL +S +B |  |
| 126     | 190             | 444280 |        | 02.14 |                |                |        |                        |  |
|         | 109 CDI         |        |        | 08.03 | 02.14          | 13.0460-3821.2 | 603821 | 2                      | 24008 18,3 /WK/S BOS<br>Warnkontakt L=95mm |
|         | 109 CDI 4-matic | 70     |        | 09.07 | 02.14          |                |        |                        |  |
|         | 110 CDI         | 70     |        | 09.10 | 02.14          |                |        |                        |  |
|         | 111 CDI         |        |        | 08.03 | 02.14          |                |        |                        |  |
|         | 111 CDI 4-matic | 80     |        | 09.07 | 02.14          |                |        |                        |  |
|         | 113 CDI         | 100    |        | 09.10 | 02.14          |                |        |                        |  |
|         | 113 CDI 4-matic | 100    |        | 09.10 | 02.14          |                |        |                        |  |
|         | 115 CDI         | 110    |        | 08.03 | 02.14          |                |        |                        |  |
|         | 115 CDI 4-matic | 110    |        | 09.07 | 02.14          |                |        |                        |  |
|         | 116 CDI         | 120    |        | 09.10 | 02.14          |                |        |                        |  |
|         | 116 CDI 4-matic | 120    |        | 09.10 | 02.14          |                |        |                        |  |
|         | 119             | 140    |        | 08.03 | 02.14          |                |        |                        |  |
|         | 120 CDI         | 150    |        | 09.07 | 02.14          |                |        |                        |  |
|         | 122             | 160    |        | 08.03 | 02.14          |                |        |                        |  |
|         | 122 CDI         | 165    |        | 09.10 | 02.14          |                |        |                        |  |
| 123     | 170             |        | 06.04  | 02.14 |                |                |        |                        |  |
| 123     | 190             |        | 09.07  | 02.14 |                |                |        |                        |  |
| 126     | 190             |        | 09.07  | 02.14 |                |                |        |                        |  |
| E-Cell  | 60              |        | 03.12  | 02.14 |                |                |        |                        |  |
|         | 109 CDI         |        |        | 08.03 | 02.14          | 24.0110-0280.1 | 410280 |                        | 296 10,0 8,0 +S +B                         |
|         | 109 CDI 4-matic | 70     |        | 09.07 | 02.14          |                |        |                        |  |
|         | 110 CDI         | 70     |        | 09.10 | 02.14          |                |        |                        |  |
|         | 111 CDI         |        |        | 08.03 | 02.14          |                |        |                        |  |
|         | 111 CDI 4-matic | 80     |        | 09.07 | 02.14          |                |        |                        |  |
|         | 113 CDI         | 100    |        | 09.10 | 02.14          |                |        |                        |  |
|         | 113 CDI 4-matic | 100    |        | 09.10 | 02.14          |                |        |                        |  |
|         | 115 CDI         | 110    |        | 08.03 | 02.14          |                |        |                        |  |
|         | 115 CDI 4-matic | 110    |        | 09.07 | 02.14          |                |        |                        |  |
|         | 116 CDI         | 120    |        | 09.10 | 02.14          |                |        |                        |  |
|         | 116 CDI 4-matic | 120    |        | 09.10 | 02.14          |                |        |                        |  |
|         | 119             | 140    |        | 08.03 | 02.14          |                |        |                        |  |
|         | 120 CDI         | 150    |        | 09.07 | 02.14          |                |        |                        |  |
|         | 122             | 160    |        | 08.03 | 02.14          |                |        |                        |  |
|         | 122 CDI         | 165    |        | 09.10 | 02.14          |                |        |                        |  |
| 123     | 170             |        | 06.04  | 02.14 |                |                |        |                        |  |
| 123     | 190             |        | 09.07  | 02.14 |                |                |        |                        |  |
| 126     | 190             |        | 09.07  | 02.14 |                |                |        |                        |  |
| E-Cell  | 60              |        | 03.12  | 02.14 |                |                |        |                        |  |
|         | 109 CDI         |        |        | 08.03 | 02.14          | 03.0137-4009.2 | 654009 |                        | 186 x 20 /Zub                              |
|         | 109 CDI 4-matic | 70     |        | 09.07 | 02.14          |                |        |                        |  |
|         | 110 CDI         | 70     |        | 09.10 | 02.14          |                |        |                        |  |
|         | 111 CDI         |        |        | 08.03 | 02.14          |                |        |                        |  |
|         | 111 CDI 4-matic | 80     |        | 09.07 | 02.14          |                |        |                        |  |
|         | 113 CDI         | 100    |        | 09.10 | 02.14          |                |        |                        |  |
|         | 113 CDI 4-matic | 100    |        | 09.10 | 02.14          |                |        |                        |  |
|         | 115 CDI         | 110    |        | 08.03 | 02.14          |                |        |                        |  |
|         | 115 CDI 4-matic | 110    |        | 09.07 | 02.14          |                |        |                        |  |
|         | 116 CDI         | 120    |        | 09.10 | 02.14          |                |        |                        |  |
|         | 116 CDI 4-matic | 120    |        | 09.10 | 02.14          |                |        |                        |  |
|         | 119             | 140    |        | 08.03 | 02.14          |                |        |                        |  |
|         | 120 CDI         | 150    |        | 09.07 | 02.14          |                |        |                        |  |
|         | 122             | 160    |        | 08.03 | 02.14          |                |        |                        |  |
|         | 122 CDI         | 165    |        | 09.10 | 02.14          |                |        |                        |  |
| 123     | 170             |        | 06.04  | 02.14 |                |                |        |                        |  |
| 123     | 190             |        | 09.07  | 02.14 |                |                |        |                        |  |
| 126     | 190             |        | 09.07  | 02.14 |                |                |        |                        |  |
| E-Cell  | 60              |        | 03.12  | 02.14 |                |                |        |                        |  |

**MERCEDES BENZ VITO (W447) (14-)**

|  |                     |     |  |       |  |                |        |   |   |
|--|---------------------|-----|--|-------|--|----------------|--------|---|---|
|  | 109 CDI             | 65  |  | 10.14 |  | 13.0460-4826.2 | 604826 | 1 | 29192 20,7 /WE/Zub BRE<br>29192 20,3 /WE/Zub BRE<br>Warnkontakt L=103,2mm |
|  | 111 CDI             | 84  |  | 10.14 |  |                |        |   |   |
|  | 114 CDI             | 100 |  | 10.14 |  | 13.0460-4884.2 | 604884 | 1 | 22062 20,7 /WE BRE<br>Warnkontakt L=103,2mm                               |
|  | 114 CDI 4-matic     | 100 |  | 07.15 |  |                |        |   |   |
|  | 116 CDI             | 120 |  | 10.14 |  |                |        |   |   |
|  | 116 CDI 4-matic     | 120 |  | 07.15 |  |                |        |   |   |
|  | 119 BlueTec         | 140 |  | 10.14 |  |                |        |   |   |
|  | 119 BlueTec 4-matic | 140 |  | 12.14 |  |                |        |   |   |
|  |                     |     |  |       |  | 24.8190-0424.2 | 620424 |   |   |

|     |    |  |  |   |       |  |     |    |
|--|--|--|--|---|--|--|---|--|
| <b>MERCEDES BENZ VITO (W447) (14-)</b>   |  |  |  |   |  |  |   |  |
|    | 109 CDI<br>111 CDI   | 65<br>84   |  | 10.14<br>10.14  | 24.0128-0145.1   | 428145   | + Stahlfelgen <sup>1)</sup>   | 300 28,0 25,0 V L +S +B  |
|    | 114 CDI<br>114 CDI 4-matic<br>116 CDI<br>116 CDI 4-matic<br>119 BlueTec<br>119 BlueTec 4-matic                                 | 100<br>100<br>120<br>120<br>140<br>140   |  | 10.14<br>07.15<br>10.14<br>07.15<br>10.14<br>12.14  | 24.0711-5529.3   | 360432   | 2  | Radsensor L=1135   |
|    | 109 CDI<br>111 CDI<br>114 CDI<br>114 CDI 4-matic<br>116 CDI<br>116 CDI 4-matic<br>119 BlueTec<br>119 BlueTec 4-matic           | 65<br>84<br>100<br>100<br>120<br>120<br>140<br>140                               |  | 10.14<br>10.14<br>10.14<br>07.15<br>10.14<br>07.15<br>10.14<br>12.14  | 13.0460-4882.2<br>24.8190-0424.2   | 604882<br>620424   | 1   | 22102 18,2 /WE <b>BRE</b><br>Warnkontakt L=103,2mm   |
|    | 109 CDI<br>111 CDI<br>114 CDI<br>114 CDI 4-matic<br>116 CDI<br>116 CDI 4-matic<br>119 BlueTec<br>119 BlueTec 4-matic           | 65<br>84<br>100<br>100<br>120<br>120<br>140<br>140                               |  | 10.14<br>10.14<br>10.14<br>07.15<br>10.14<br>07.15<br>10.14<br>12.14  | 24.0112-0213.1   | 412213   | + ALU-Felgen <sup>2)</sup>  | 300 12,0 9,0 L +S +B   |
|    | 109 CDI<br>111 CDI<br>114 CDI<br>114 CDI 4-matic<br>116 CDI<br>116 CDI 4-matic<br>119 BlueTec<br>119 BlueTec 4-matic           | 65<br>84<br>100<br>100<br>120<br>120<br>140<br>140                               |  | 10.14<br>10.14<br>10.14<br>07.15<br>10.14<br>07.15<br>10.14<br>12.14  | 24.0711-5530.3   | 360433   | 2  | Radsensor L=940  |
|    | 109 CDI<br>111 CDI<br>114 CDI<br>114 CDI 4-matic<br>116 CDI<br>116 CDI 4-matic<br>119 BlueTec<br>119 BlueTec 4-matic           | 65<br>84<br>100<br>100<br>120<br>120<br>140<br>140                               |  | 10.14<br>10.14<br>10.14<br>07.15<br>10.14<br>07.15<br>10.14<br>12.14  | 03.0137-4009.2   | 654009   |   | 186 x 20 /Zub  |
| <b>MERCEDES BENZ Transporter (BM 901/902) SPRINTER (95-06)</b>                     |  |  |  |   |  |  |   |  |
|  | 208 CDI<br>208 D<br>210 D<br>211 CDI<br>212 D<br>213 CDI<br>214<br>214<br>216 CDI  |  |  | 04.00 05.06<br>02.95 05.06<br>01.97 05.06<br>04.00 05.06<br>02.95 05.06<br>04.00 05.06<br>04.00 05.06<br>02.95 05.06<br>04.00 05.06 | 13.0460-7196.2<br>24.8190-0417.2   | 607196<br>620417   | 2   | 21576 20,7 +/WE <b>ATE</b><br>Warnkontakt L=99(167)mm  |
|  | 208 CDI<br>208 D<br>210 D<br>211 CDI<br>212 D<br>213 CDI<br>214<br>214<br>216 CDI  | 92<br>105  |  | 04.00 05.06<br>02.95 05.06<br>01.97 05.06<br>04.00 05.06<br>02.95 05.06<br>04.00 05.06<br>04.00 05.06<br>02.95 05.06<br>04.00 05.06 | 13.0460-7909.2<br>13.0460-0281.2<br>24.8190-0417.2                                     | 607909<br>610281<br>620417   | 2   | für Vorg. 13.0460-7904.2 <sup>3)</sup><br>29153 20,0 /WE/Zub/S <b>PER</b><br>Belagsatz-Zubehör <b>PER</b><br>Warnkontakt L=99(167)mm             |
|  | 208 CDI<br>208 D<br>210 D<br>211 CDI<br>212 D<br>213 CDI<br>214<br>214<br>216 CDI  | 92<br>105  |  | 04.00 05.06<br>02.95 05.06<br>01.97 05.06<br>04.00 05.06<br>02.95 05.06<br>04.00 05.06<br>04.00 05.06<br>02.95 05.06<br>04.00 05.06 | 24.0122-0161.1<br>24.0322-0161.1   | 422161<br>522161   |   | 276 22,0 19,0 V L +S +B<br>276 22,0 19,0 V L +S +B <b>PD</b>   |
|  | 208 CDI<br>208 D<br>210 D<br>211 CDI<br>212 D<br>213 CDI<br>214<br>214<br>216 CDI  | 92<br>105  |  | 04.00 05.06<br>02.95 05.06<br>01.97 05.06<br>04.00 05.06<br>02.95 05.06<br>04.00 05.06<br>04.00 05.06<br>02.95 05.06<br>04.00 05.06 | 13.0460-7083.2<br>13.0460-7084.2<br>13.0460-3990.2<br>13.0460-0250.2<br>24.8190-0407.2 | 607083<br>607084<br>603990<br>610250<br>620407                                     | 2   | 21621 17,3 +/WE <b>ATE</b><br>21592 18,8 +/WE <b>ATE</b><br>23021 18,9 /WE <b>BOS</b><br>Belagsatz-Zubehör <b>BOS</b><br>Warnkontakt L=84(185)mm |
|  | 208 CDI (BM 901)<br>208 D (BM 901)<br>210 D (BM 901)<br>211 CDI (BM 901)<br>212 D (BM 901)<br>213 CDI (BM 901)<br>214 (BM 901) | 92   |  | 04.00 05.06<br>02.95 05.06<br>01.97 05.06<br>04.00 05.06<br>02.95 05.06<br>04.00 05.06<br>04.00 05.06                               | 24.0112-0142.1   | 412142   |   | 258 12,0 10,0 L +S +B  |
|  |  |  |  |   |  |  |   |  |

<sup>1)</sup> + steel rims / + cerchi in acciaio / + jantes en acier / + Llantas acero

<sup>2)</sup> + aluminium rims / + cerchi in alluminio / + jantes en aluminium / + Llantas de aluminio

<sup>3)</sup> f.precede.13.0460-7904.2 / p.prece.13.0460-7904.2 / p.préd.13.0460-7904.2 / p.prede.13.0460-7904.2

























**MERCEDES BENZ Transporter (BM 901/902) SPRINTER (95-06)**

|                  |                  |       |       |       |                |        |  |                       |                       |
|------------------|------------------|-------|-------|-------|----------------|--------|--|-----------------------|-----------------------|
|                  | 214 (BM 901)     | 105   | 02.95 | 05.06 | 24.0112-0142.1 | 412142 |  | 258 12,0 10,0 L +S +B |                       |
|                  | 216 CDI (BM 901) |       | 04.00 | 05.06 |                |        |  |                       |                       |
|                  | 208 CDI (BM 902) |       | 04.00 | 05.06 | 24.0116-0110.1 | 416110 |  |                       | 272 16,0 14,0 L +S +B |
|                  | 208 D (BM 902)   |       | 02.95 | 05.06 |                |        |  |                       |                       |
|                  | 210 D (BM 902)   |       | 01.97 | 05.06 |                |        |  |                       |                       |
|                  | 211 CDI (BM 902) |       | 04.00 | 05.06 |                |        |  |                       |                       |
|                  | 212 D (BM 902)   |       | 02.95 | 05.06 |                |        |  |                       |                       |
|                  | 213 CDI (BM 902) |       | 04.00 | 05.06 |                |        |  |                       |                       |
|                  | 214 (BM 902)     | 92    | 04.00 | 05.06 |                |        |  |                       |                       |
| 214 (BM 902)     | 105              | 02.95 | 05.06 |       |                |        |  |                       |                       |
| 216 CDI (BM 902) |                  | 04.00 | 05.06 |       |                |        |  |                       |                       |
|                  | 208 CDI          |       | 04.00 | 05.06 | 03.0137-0397.2 | 650397 | 160 x 40<br>160 x 40 /Zub<br>Bremsbacken-Zubehör |                       |                       |
|                  | 208 D            |       | 02.95 | 05.06 |                |        |  |                       |                       |
|                  | 210 D            |       | 01.97 | 05.06 |                |        |  |                       |                       |
|                  | 211 CDI          |       | 04.00 | 05.06 | 03.0137-4001.2 | 654001 |  |                       |                       |
|                  | 212 D            |       | 02.95 | 05.06 |                |        |  |                       |                       |
|                  | 213 CDI          |       | 04.00 | 05.06 | 03.0137-9255.2 | 669255 |  |                       |                       |
|                  | 214              | 92    | 04.00 | 05.06 |                |        |  |                       |                       |
|                  | 214              | 105   | 02.95 | 05.06 |                |        |  |                       |                       |
| 216 CDI          |                  | 04.00 | 05.06 |       |                |        |  |                       |                       |

**MERCEDES BENZ Transporter (BM 903/904) SPRINTER (95-06)**

|         |         |       |       |       |                |        |  |   |                |        |  |                      |
|---------|---------|-------|-------|-------|----------------|--------|--|---|----------------|--------|--|----------------------|
|         | 308 CDI |       | 04.00 | 05.06 | 13.0460-7196.2 | 607196 |  | 21576 20,7 +/-WE<br>Warnkontakt L=99(167)mm           |                |        |  |                      |
|         | 308 D   |       | 02.95 | 05.06 |                |        |  |   |                |        |  |                      |
|         | 310 D   |       | 02.95 | 05.06 | 13.0460-7909.2 | 607909 |  |   |                |        |  |                      |
|         | 311 CDI |       | 04.00 | 05.06 |                |        |  |   |                |        |  |                      |
|         | 312 D   |       | 02.95 | 05.06 |                |        |  |   |                |        |  |                      |
|         | 313 CDI |       | 04.00 | 05.06 |                |        |  |   |                |        |  |                      |
|         | 314     | 92    | 04.00 | 05.06 |                |        |  |   |                |        |  |                      |
|         | 314     | 105   | 02.95 | 05.06 |                |        |  |   |                |        |  |                      |
|         | 316 CDI |       | 04.00 | 05.06 |                |        |  |   |                |        |  |                      |
|         | 408 CDI |       | 04.00 | 05.06 |                |        |  |   |                |        |  |                      |
|         | 408 D   |       | 06.95 | 05.06 |                |        |  |   |                |        |  |                      |
|         | 410 D   |       | 09.96 | 05.06 |                |        |  |   |                |        |  |                      |
|         | 411 CDI |       | 04.00 | 05.06 |                |        |  |   |                |        |  |                      |
|         | 412 D   |       | 06.95 | 05.06 |                |        |  |   |                |        |  |                      |
|         | 413 CDI |       | 04.00 | 05.06 |                |        |  |   |                |        |  |                      |
|         | 414     | 92    | 04.00 | 05.06 |                |        |  |   |                |        |  |                      |
|         | 414     | 105   | 06.95 | 05.06 |                |        |  |   |                |        |  |                      |
|         | 416 CDI |       | 04.00 | 05.06 |                |        |  |   |                |        |  |                      |
|         | 308 CDI |       | 04.00 | 05.06 |                |        |  |   | 13.0460-0281.2 | 610281 |  |                      |
|         | 308 D   |       | 02.95 | 05.06 |                |        |  |   |                |        |  |                      |
| 310 D   |         | 02.95 | 05.06 |       |                |        |  |   |                |        |  |                      |
| 311 CDI |         | 04.00 | 05.06 |       |                |        |  |   |                |        |  |                      |
| 312 D   |         | 02.95 | 05.06 |       |                |        |  |   |                |        |  |                      |
| 313 CDI |         | 04.00 | 05.06 |       |                |        |  |   |                |        |  |                      |
| 314     | 92      | 04.00 | 05.06 |       |                |        |  |   |                |        |  |                      |
| 314     | 105     | 02.95 | 05.06 |       |                |        |  |   |                |        |  |                      |
| 316 CDI |         | 04.00 | 05.06 |       |                |        |  |   |                |        |  |                      |
| 408 CDI |         | 04.00 | 05.06 |       |                |        |  |   |                |        |  |                      |
| 408 D   |         | 06.95 | 05.06 |       |                |        |  |   |                |        |  |                      |
| 410 D   |         | 09.96 | 05.06 |       |                |        |  |   |                |        |  |                      |
| 411 CDI |         | 04.00 | 05.06 |       |                |        |  |   |                |        |  |                      |
| 412 D   |         | 06.95 | 05.06 |       |                |        |  |   |                |        |  |                      |
| 413 CDI |         | 04.00 | 05.06 |       |                |        |  |   |                |        |  |                      |
| 414     | 92      | 04.00 | 05.06 |       |                |        |  |   |                |        |  |                      |
| 414     | 105     | 06.95 | 05.06 |       |                |        |  |   |                |        |  |                      |
| 416 CDI |         | 04.00 | 05.06 |       |                |        |  |   |                |        |  |                      |
|         | 308 CDI |       | 04.00 | 05.06 | 24.0122-0161.1 | 422161 |  | 276 22,0 19,0 V L +S +B<br>276 22,0 19,0 V L +S +B PD |                |        |  |                      |
|         | 308 D   |       | 02.95 | 05.06 |                |        |  |   |                |        |  |                      |
|         | 310 D   |       | 02.95 | 05.06 | 24.0322-0161.1 | 522161 |  |   |                |        |  |                      |
|         | 311 CDI |       | 04.00 | 05.06 |                |        |  |   |                |        |  |                      |
|         | 312 D   |       | 02.95 | 05.06 |                |        |  |   |                |        |  |                      |
|         | 313 CDI |       | 04.00 | 05.06 |                |        |  |   |                |        |  |                      |
|         | 314     | 92    | 04.00 | 05.06 |                |        |  |   |                |        |  |                      |
|         | 314     | 105   | 02.95 | 05.06 |                |        |  |   |                |        |  |                      |
|         | 316 CDI |       | 04.00 | 05.06 |                |        |  |   |                |        |  |                      |
|         | 408 CDI |       | 04.00 | 05.06 |                |        |  |   |                |        |  |                      |
|         | 408 D   |       | 06.95 | 05.06 |                |        |  |   |                |        |  |                      |
|         | 410 D   |       | 09.96 | 05.06 |                |        |  |   |                |        |  |                      |
|         | 411 CDI |       | 04.00 | 05.06 |                |        |  |   |                |        |  |                      |
|         | 412 D   |       | 06.95 | 05.06 |                |        |  |   |                |        |  |                      |
|         | 413 CDI |       | 04.00 | 05.06 |                |        |  |   |                |        |  |                      |
|         | 414     | 92    | 04.00 | 05.06 |                |        |  |   |                |        |  |                      |
|         | 414     | 105   | 06.95 | 05.06 |                |        |  |   |                |        |  |                      |
|         | 416 CDI |       | 04.00 | 05.06 |                |        |  |   |                |        |  |                      |
|         | 308 CDI |       | 04.00 | 05.06 |                |        |  |   | 24.0122-0245.1 | 422245 |  | 285 22,0 19,0 V L +B |
|         | 308 D   |       | 02.95 | 05.06 |                |        |  |   |                |        |  |                      |
| 310 D   |         | 02.95 | 05.06 |       |                |        |  |   |                |        |  |                      |
| 311 CDI |         | 04.00 | 05.06 |       |                |        |  |   |                |        |  |                      |
| 312 D   |         | 02.95 | 05.06 |       |                |        |  |   |                |        |  |                      |
| 313 CDI |         | 04.00 | 05.06 |       |                |        |  |   |                |        |  |                      |
| 314     | 92      | 04.00 | 05.06 |       |                |        |  |   |                |        |  |                      |
| 314     | 105     | 02.95 | 05.06 |       |                |        |  |   |                |        |  |                      |
| 316 CDI |         | 04.00 | 05.06 |       |                |        |  |   |                |        |  |                      |
| 408 CDI |         | 04.00 | 05.06 |       |                |        |  |   |                |        |  |                      |
| 408 D   |         | 06.95 | 05.06 |       |                |        |  |   |                |        |  |                      |

1) f.predec.13.0460-7904.2 / p.prece.13.0460-7904.2 / p.préd.13.0460-7904.2 / p.prede.13.0460-7904.2



|     |                        |  |  |   |  |                |  |                           |
|--|--|--|--|---|---|--|--|---|
| <b>MERCEDES BENZ Transporter (BM 903/904) SPRINTER (95-06)</b>                     |  |  |  |   |   |  |  |   |
|    | 410 D<br>411 CDI<br>412 D<br>413 CDI<br>414<br>414<br>416 CDI  | 92<br>105  |  | 09.96 05.06<br>04.00 05.06<br>06.95 05.06<br>04.00 05.06<br>04.00 05.06<br>06.95 05.06<br>04.00 05.06                               |   | 24.0122-0245.1 422245  |  | 285 22,0 19,0 V L +B  |
|    | 308 CDI<br>308 D<br>310 D<br>311 CDI<br>312 D<br>313 CDI<br>314<br>314<br>316 CDI                      | 92<br>105  |  | 04.00 05.06<br>02.95 05.06<br>02.95 05.06<br>04.00 05.06<br>02.95 05.06<br>04.00 05.06<br>04.00 05.06<br>02.95 05.06<br>04.00 05.06 |   | 13.0460-7084.2 607084<br>13.0460-3990.2 603990<br>13.0460-0250.2 610250<br>24.8190-0407.2 620407 | 2  | 21592 18,8 +/WE ATE<br>23021 18,9 /WE BOS<br>Belagsatz-Zubehör BOS<br>Warnkontakt L=84(185)mm               |
|    | 408 CDI<br>408 D<br>410 D<br>411 CDI<br>412 D<br>413 CDI<br>414<br>414<br>416 CDI                      | 92<br>105  |  | 04.00 05.06<br>06.95 05.06<br>09.96 05.06<br>04.00 05.06<br>06.95 05.06<br>04.00 05.06<br>04.00 05.06<br>06.95 05.06<br>04.00 05.06 |   | 13.0460-7909.2 607909<br>24.8190-0417.2 620417<br>13.0460-0281.2 610281                          | 2  | 29153 20,0 /WE/Zub/S PER<br>Warnkontakt L=99(167)mm<br>Belagsatz-Zubehör PER                                |
|  | 308 CDI<br>308 D<br>310 D<br>311 CDI<br>312 D<br>313 CDI<br>314<br>314<br>316 CDI                      | 92<br>105  |  | 04.00 05.06<br>02.95 05.06<br>02.95 05.06<br>04.00 05.06<br>02.95 05.06<br>04.00 05.06<br>04.00 05.06<br>02.95 05.06<br>04.00 05.06 |   | 24.0116-0110.1 416110  |  | 272 16,0 14,0 L +S +B   |
|  | 408 CDI<br>408 D<br>410 D<br>411 CDI<br>412 D<br>413 CDI<br>414<br>414<br>416 CDI                      | 92<br>105  |  | 04.00 05.06<br>06.95 05.06<br>09.96 05.06<br>04.00 05.06<br>06.95 05.06<br>04.00 05.06<br>04.00 05.06<br>06.95 05.06<br>04.00 05.06 |   | 24.0122-0196.1 422196  |  | 285 21,9 19,0 V L +B  |
|  | 308 CDI<br>308 D<br>310 D<br>311 CDI<br>312 D<br>313 CDI<br>314<br>314<br>316 CDI                      | 92<br>105  |  | 04.00 05.06<br>02.95 05.06<br>02.95 05.06<br>04.00 05.06<br>02.95 05.06<br>04.00 05.06<br>04.00 05.06<br>02.95 05.06<br>04.00 05.06 |   | 03.0137-0397.2 650397<br>03.0137-4001.2 654001<br>03.0137-9255.2 669255                          |  | 160 x 40<br>160 x 40 /Zub<br>Bremsbacken-Zubehör  |
|  | 408 CDI<br>408 D<br>410 D<br>411 CDI<br>412 D<br>413 CDI<br>414<br>414<br>416 CDI                      | 92<br>105  |  | 04.00 05.06<br>06.95 05.06<br>09.96 05.06<br>04.00 05.06<br>06.95 05.06<br>04.00 05.06<br>04.00 05.06<br>06.95 05.06<br>04.00 05.06 |   | 03.0137-4015.2 654015<br>03.0137-9256.2 669256   |  | 170 x 40 /Zub<br>Bremsbacken-Zubehör  |
| <b>MERCEDES BENZ Transporter (BM 905) SPRINTER (01-06)</b>                         |  |  |  |   |   |  |  |   |
|  | 616 CDI<br>616 CDI   |  |  | 04.01 05.06<br>04.01 05.06  |   | 13.0460-7909.2 607909<br>13.0460-0281.2 610281<br>24.8190-0417.2 620417                          | 2  | für Vorg. 13.0460-7904.2 2)<br>29153 20,0 /WE/Zub/S PER<br>Belagsatz-Zubehör PER<br>Warnkontakt L=99(167)mm |
|  | 616 CDI<br>616 CDI   |  |  | 04.01 05.06<br>04.01 05.06  |   | 13.0460-4975.2 604975<br>24.8190-0415.2 620415   | 2  | 29160 20,8 /WE BRE<br>WK Satz L=238/148mm   |
|  | 616 CDI<br>616 CDI   |  |  | 04.01 05.06<br>04.01 05.06  |   | 24.0122-0161.1 422161<br>24.0322-0161.1 522161   |  | 276 22,0 19,0 V L +S +B<br>276 22,0 19,0 V L +S +B PD   |
|  | 616 CDI  |  |  | 04.01 05.06   |   | 24.0126-0144.1 426144  |  | 290 26,0 23,0 V L   |
|  | 616 CDI  |  |  | 04.01 05.06   |   | 13.0460-6015.2 606015<br>24.8190-0423.2 620423   | 2  | 29835 21,7 /WE ATE<br>Warnkontakt L=199/144mm   |
| <b>MERCEDES BENZ Transporter (BM 906) SPRINTER (06-)</b>                           |  |  |  |   |   |  |  |   |
|  | 209 CDI<br>210 CDI<br>211 CDI<br>213 CDI<br>214 CDI<br>215 CDI<br>216<br>216 CDI<br>218 CDI<br>219 CDI |  |  | 04.06<br>03.09<br>04.06<br>04.06<br>04.16<br>04.06<br>09.08<br>03.09<br>04.06<br>03.09  |   | 13.0460-4826.2 604826<br>13.0460-4877.2 604877<br>24.8190-0424.2 620424                          | 2  | 29192 20,7 /WE/Zub BRE<br>29192 20,3 /WE/Zub BRE<br>Warnkontakt L=103,2mm                                   |

1) only for predecess.no.13.0460-7904.2 / solo per nu.precedenti 13.0460-7904.2 / uniquement.pour no.précéd.13.0460-7904.2 / sólo para nu.precedentes 13.0460-7904.2

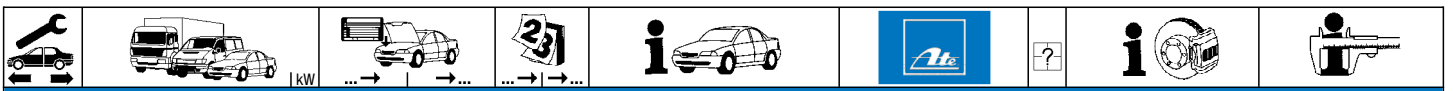



2) f.predec.13.0460-7904.2 / p.prece.13.0460-7904.2 / p.préd.13.0460-7904.2 / p.prede.13.0460-7904.2



**MERCEDES BENZ Transporter (BM 906) SPRINTER (06-)**

|  |             |     |       |  |                |        |   |                        |            |
|--|-------------|-----|-------|--|----------------|--------|---|------------------------|------------|
|    | 224         |     | 04.06 |  | 13.0460-4826.2 | 604826 |   | 29192 20,7 /WE/Zub     | <b>BRE</b> |
|  | 309 CDI     |     | 04.06 |  | 13.0460-4877.2 | 604877 |   | 29192 20,3 /WE/Zub     | <b>BRE</b> |
|  | 310 CDI     |     | 03.09 |  | 24.8190-0424.2 | 620424 | 2 | Warnkontakt L=103,2mm  |            |
|  | 311 CDI     |     | 04.06 |  |                |        |   |                        |            |
|  | 311 CDI 4x4 |     | 02.08 |  |                |        |   |                        |            |
|  | 313 CDI     |     | 04.06 |  |                |        |   |                        |            |
|  | 313 CDI 4x4 |     | 06.06 |  |                |        |   |                        |            |
|  | 314 CDI     |     | 05.16 |  |                |        |   |                        |            |
|  | 314 CDI 4x4 |     | 05.16 |  |                |        |   |                        |            |
|  | 315 CDI     |     | 04.06 |  |                |        |   |                        |            |
|  | 315 CDI 4x4 |     | 02.08 |  |                |        |   |                        |            |
|  | 316         |     | 09.08 |  |                |        |   |                        |            |
|  | 316 CDI     |     | 03.09 |  |                |        |   |                        |            |
|  | 316 CDI 4x4 |     | 03.09 |  |                |        |   |                        |            |
|  | 316 LGT     | 115 | 09.08 |  |                |        |   |                        |            |
|  | 316 NGT     |     | 09.08 |  |                |        |   |                        |            |
|  | 318 CDI     |     | 04.06 |  |                |        |   |                        |            |
|  | 318 CDI 4x4 |     | 02.08 |  |                |        |   |                        |            |
|  | 319 CDI     |     | 03.09 |  |                |        |   |                        |            |
|  | 319 CDI 4x4 |     | 03.09 |  |                |        |   |                        |            |
|  | 324         |     | 04.06 |  |                |        |   |                        |            |
|  | 411 CDI     | 80  | 06.09 |  | 13.0460-4827.2 | 604827 |   | 29200 21,0 /WE/Zub     | <b>BRE</b> |
|  | 413 CDI     |     | 04.06 |  | 24.8190-0424.2 | 620424 | 2 | Warnkontakt L=103,2mm  |            |
|  | 415 CDI     |     | 04.06 |  |                |        |   |                        |            |
|  | 416 CDI     | 120 | 03.09 |  |                |        |   |                        |            |
|  | 418 CDI     |     | 04.06 |  |                |        |   |                        |            |
|  | 419 CDI     | 140 | 03.09 |  |                |        |   |                        |            |
|  | 424         |     | 04.06 |  |                |        |   |                        |            |
|  | 509 CDI     |     | 04.06 |  |                |        |   |                        |            |
|  | 510 CDI     | 70  | 03.09 |  |                |        |   |                        |            |
|  | 511 CDI     |     | 04.06 |  |                |        |   |                        |            |
|  | 511 CDI 4x4 | 80  | 06.06 |  |                |        |   |                        |            |
|  | 513 CDI     |     | 03.09 |  |                |        |   |                        |            |
|  | 513 CDI 4x4 | 95  | 06.06 |  |                |        |   |                        |            |
|  | 514 CDI     |     | 05.16 |  |                |        |   |                        |            |
|  | 514 CDI 4x4 |     | 05.16 |  |                |        |   |                        |            |
|  | 515 CDI     |     | 04.06 |  |                |        |   |                        |            |
|  | 515 CDI 4x4 | 110 | 06.06 |  |                |        |   |                        |            |
|  | 516         | 115 | 09.08 |  |                |        |   |                        |            |
|  | 516 CDI     |     | 03.09 |  |                |        |   |                        |            |
|  | 516 CDI 4x4 | 120 | 06.06 |  |                |        |   |                        |            |
|  | 516 NGT     | 115 | 09.08 |  |                |        |   |                        |            |
|  | 518 CDI     |     | 04.06 |  |                |        |   |                        |            |
|  | 518 CDI 4x4 | 135 | 06.06 |  |                |        |   |                        |            |
|  | 519 CDI     |     | 03.09 |  |                |        |   |                        |            |
|  | 519 CDI 4x4 | 140 | 03.09 |  |                |        |   |                        |            |
|  | 524         |     | 04.06 |  |                |        |   |                        |            |
|  | 209 CDI     |     | 04.06 |  | 24.0128-0203.1 | 428203 |   | 300 28,0 25,0 VL +S +B |            |
|  | 210 CDI     |     | 03.09 |  |                |        |   |                        |            |
|  | 211 CDI     |     | 04.06 |  |                |        |   |                        |            |
|  | 213 CDI     |     | 04.06 |  |                |        |   |                        |            |
|  | 214 CDI     |     | 04.16 |  |                |        |   |                        |            |
|  | 215 CDI     |     | 04.06 |  |                |        |   |                        |            |
|  | 216         |     | 09.08 |  |                |        |   |                        |            |
|  | 216 CDI     |     | 03.09 |  |                |        |   |                        |            |
|  | 218 CDI     |     | 04.06 |  |                |        |   |                        |            |
|  | 219 CDI     |     | 03.09 |  |                |        |   |                        |            |
|  | 224         |     | 04.06 |  |                |        |   |                        |            |
|  | 309 CDI     |     | 04.06 |  |                |        |   |                        |            |
|  | 310 CDI     |     | 03.09 |  |                |        |   |                        |            |
|  | 311 CDI     |     | 04.06 |  |                |        |   |                        |            |
|  | 311 CDI 4x4 |     | 02.08 |  |                |        |   |                        |            |
|  | 313 CDI     |     | 04.06 |  |                |        |   |                        |            |
|  | 313 CDI 4x4 |     | 06.06 |  |                |        |   |                        |            |
|  | 314 CDI     |     | 05.16 |  |                |        |   |                        |            |
|  | 314 CDI 4x4 |     | 05.16 |  |                |        |   |                        |            |
|  | 315 CDI     |     | 04.06 |  |                |        |   |                        |            |
|  | 315 CDI 4x4 |     | 02.08 |  |                |        |   |                        |            |
|  | 316         |     | 09.08 |  |                |        |   |                        |            |
|  | 316 CDI     |     | 03.09 |  |                |        |   |                        |            |
|  | 316 CDI 4x4 |     | 03.09 |  |                |        |   |                        |            |
|  | 316 LGT     | 115 | 09.08 |  |                |        |   |                        |            |
|  | 316 NGT     |     | 09.08 |  |                |        |   |                        |            |
|  | 318 CDI     |     | 04.06 |  |                |        |   |                        |            |
|  | 318 CDI 4x4 |     | 02.08 |  |                |        |   |                        |            |
|  | 319 CDI     |     | 03.09 |  |                |        |   |                        |            |
|  | 319 CDI 4x4 |     | 03.09 |  |                |        |   |                        |            |
|  | 324         |     | 04.06 |  |                |        |   |                        |            |
|  | 411 CDI     | 80  | 06.09 |  |                |        |   |                        |            |
|  | 413 CDI     |     | 04.06 |  |                |        |   |                        |            |
|  | 415 CDI     |     | 04.06 |  |                |        |   |                        |            |
|  | 416 CDI     | 120 | 03.09 |  |                |        |   |                        |            |
|  | 418 CDI     |     | 04.06 |  |                |        |   |                        |            |
|  | 419 CDI     | 140 | 03.09 |  |                |        |   |                        |            |
|  | 424         |     | 04.06 |  |                |        |   |                        |            |
|  | 509 CDI     |     | 04.06 |  |                |        |   |                        |            |
|  | 510 CDI     | 70  | 03.09 |  |                |        |   |                        |            |
| ↓  |             |     |       |  |                |        |   |                        |            |



| MERCEDES BENZ Transporter (BM 906) SPRINTER (06-)                                  |   |  |  |  |                                  |                  |  |   |
|--|---|--|--|--|----------------------------------|------------------|--|---|
|    | 511 CDI<br>511 CDI 4x4<br>513 CDI<br>513 CDI 4x4<br>514 CDI<br>514 CDI 4x4<br>515 CDI<br>515 CDI 4x4<br>516<br>516 CDI<br>516 CDI 4x4<br>516 NGT<br>518 CDI<br>518 CDI 4x4<br>519 CDI<br>519 CDI 4x4<br>524   | 80<br>95<br>110<br>115<br>120<br>115<br>135<br>140 | 04.06<br>06.06<br>03.09<br>06.06<br>05.16<br>05.16<br>04.06<br>06.06<br>09.08<br>03.09<br>06.06<br>09.08<br>04.06<br>06.06<br>03.09<br>03.09<br>04.06  |  | 24.0128-0203.1                   | 428203           |  | 300 28,0 25,0 VL +S +B                          |
|    | 209 CDI<br>210 CDI<br>211 CDI<br>213 CDI<br>214 CDI<br>215 CDI<br>216<br>216 CDI<br>218 CDI<br>219 CDI<br>224<br>309 CDI<br>310 CDI<br>311 CDI<br>313 CDI<br>314 CDI<br>315 CDI<br>316<br>316 CDI<br>316 LGT<br>316 NGT<br>318 CDI<br>319 CDI<br>324<br>411 CDI<br>413 CDI<br>415 CDI<br>416 CDI<br>418 CDI<br>419 CDI<br>424<br>509 CDI<br>510 CDI<br>511 CDI<br>513 CDI<br>514 CDI<br>515 CDI<br>516<br>516 CDI<br>516 NGT<br>518 CDI<br>519 CDI<br>524 | 115<br>80<br>120<br>140<br>70<br>115<br>115        | 04.06<br>03.09<br>04.06<br>04.06<br>04.16<br>04.06<br>09.08<br>03.09<br>04.06<br>03.09<br>04.06<br>04.06<br>05.16<br>04.06<br>09.08<br>03.09<br>09.08<br>09.08<br>04.06<br>03.09<br>04.06<br>06.09<br>04.06<br>04.06<br>03.09<br>04.06<br>04.06<br>03.09<br>05.16<br>04.06<br>09.08<br>03.09<br>09.08<br>04.06<br>03.09<br>04.06 |  | 24.0711-5531.3                   | 360426           | 2  Hersteller ATE <sup>1)</sup>   | Radsensor L=855                                 |
|  | 311 CDI 4x4<br>313 CDI 4x4<br>314 CDI 4x4<br>315 CDI 4x4<br>316 CDI 4x4<br>318 CDI 4x4<br>319 CDI 4x4<br>511 CDI 4x4<br>513 CDI 4x4<br>514 CDI 4x4<br>515 CDI 4x4<br>516 CDI 4x4<br>518 CDI 4x4<br>519 CDI 4x4  | 80<br>95<br>110<br>120<br>135<br>140               | 02.08<br>06.06<br>05.16<br>02.08<br>03.09<br>02.08<br>03.09<br>06.06<br>06.06<br>05.16<br>06.06<br>06.06<br>06.06<br>03.09   |  | 24.0711-5532.3                   | 360442           | 2  Hersteller ATE <sup>1)</sup> | Radsensor L=675                                 |
|  | 209 CDI<br>210 CDI<br>211 CDI<br>213 CDI<br>214 CDI<br>215 CDI<br>216<br>216 CDI<br>218 CDI<br>219 CDI<br>224<br>309 CDI<br>310 CDI   |  | 04.06<br>03.09<br>04.06<br>04.06<br>04.16<br>04.06<br>09.08<br>03.09<br>04.06<br>03.09<br>04.06<br>04.06<br>03.09  |  | 13.0460-3837.2<br>24.8190-0418.2 | 603837<br>620418 | 2  | 29190 20,2 +/-WK/Zub/SBOS<br>Warnkontakt L=95mm |

<sup>1)</sup> manufacturer restriction ATE / limitazione costruttore ATE / montage d'origine ATE / restricción de fabricante ATE



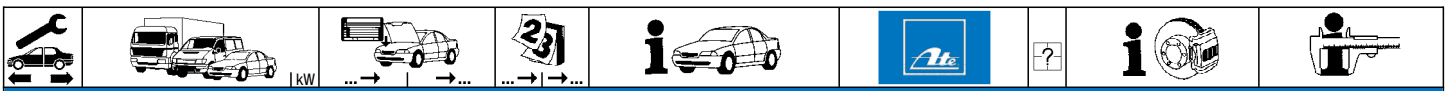

**MERCEDES BENZ Transporter (BM 906) SPRINTER (06-)**

|             |             |         |       |                |        |   |   |       |                |        |   |                                     |
|-------------|-------------|---------|-------|----------------|--------|---|---|-------|----------------|--------|---|-------------------------------------|
|             | 311 CDI     |         | 04.06 | 13.0460-3837.2 | 603837 | 2 | 29190 20,2 +WK/Zub/SBOS<br>Warnkontakt L=95mm |       |                |        |   |                                     |
|             | 311 CDI 4x4 |         | 02.08 |                |        |   |   |       |                |        |   |                                     |
|             | 313 CDI     |         | 04.06 |                |        |   |   |       |                |        |   |                                     |
|             | 313 CDI 4x4 |         | 06.06 |                |        |   |   |       |                |        |   |                                     |
|             | 314 CDI     |         | 05.16 |                |        |   |   |       |                |        |   |                                     |
|             | 314 CDI 4x4 |         | 05.16 |                |        |   |   |       |                |        |   |                                     |
|             | 315 CDI     |         | 04.06 |                |        |   |   |       |                |        |   |                                     |
|             | 315 CDI 4x4 |         | 02.08 |                |        |   |   |       |                |        |   |                                     |
|             | 316         |         | 09.08 |                |        |   |   |       |                |        |   |                                     |
|             | 316 CDI     |         | 03.09 |                |        |   |   |       |                |        |   |                                     |
|             | 316 CDI 4x4 |         | 03.09 |                |        |   |   |       |                |        |   |                                     |
|             | 316 LGT     | 115     | 09.08 |                |        |   |   |       |                |        |   |                                     |
|             | 316 NGT     |         | 09.08 |                |        |   |   |       |                |        |   |                                     |
|             | 318 CDI     |         | 04.06 |                |        |   |   |       |                |        |   |                                     |
|             | 318 CDI 4x4 |         | 02.08 |                |        |   |   |       |                |        |   |                                     |
|             | 319 CDI     |         | 03.09 |                |        |   |   |       |                |        |   |                                     |
|             | 319 CDI 4x4 |         | 03.09 |                |        |   |   |       |                |        |   |                                     |
|             | 324         |         | 04.06 |                |        |   |   |       |                |        |   |                                     |
|             |             | 411 CDI | 80    |                |        |   |   | 06.09 | 13.0460-3842.2 | 603842 | 2 | 29217 20,5 /S<br>Warnkontakt L=84mm |
|             |             | 413 CDI |       |                |        |   |   | 04.06 |                |        |   |                                     |
| 415 CDI     |             |         | 04.06 |                |        |   |   |       |                |        |   |                                     |
| 416 CDI     |             | 120     | 03.09 |                |        |   |   |       |                |        |   |                                     |
| 418 CDI     |             |         | 04.06 |                |        |   |   |       |                |        |   |                                     |
| 419 CDI     |             | 140     | 03.09 |                |        |   |   |       |                |        |   |                                     |
| 424         |             |         | 04.06 |                |        |   |   |       |                |        |   |                                     |
| 509 CDI     |             |         | 04.06 |                |        |   |   |       |                |        |   |                                     |
| 510 CDI     |             | 70      | 03.09 |                |        |   |   |       |                |        |   |                                     |
| 511 CDI     |             |         | 04.06 |                |        |   |   |       |                |        |   |                                     |
| 511 CDI 4x4 |             | 80      | 06.06 |                |        |   |   |       |                |        |   |                                     |
| 513 CDI     |             |         | 03.09 |                |        |   |   |       |                |        |   |                                     |
| 513 CDI 4x4 |             | 95      | 06.06 |                |        |   |   |       |                |        |   |                                     |
| 514 CDI     |             |         | 05.16 |                |        |   |   |       |                |        |   |                                     |
| 514 CDI 4x4 |             |         | 05.16 |                |        |   |   |       |                |        |   |                                     |
| 515 CDI     |             |         | 04.06 |                |        |   |   |       |                |        |   |                                     |
| 515 CDI 4x4 |             | 110     | 06.06 |                |        |   |   |       |                |        |   |                                     |
| 516         |             | 115     | 09.08 |                |        |   |   |       |                |        |   |                                     |
| 516 CDI     |             |         | 03.09 |                |        |   |   |       |                |        |   |                                     |
| 516 CDI 4x4 |             | 120     | 06.06 |                |        |   |   |       |                |        |   |                                     |
| 516 NGT     | 115         | 09.08   |       |                |        |   |   |       |                |        |   |                                     |
| 518 CDI     |             | 04.06   |       |                |        |   |   |       |                |        |   |                                     |
| 518 CDI 4x4 | 135         | 06.06   |       |                |        |   |   |       |                |        |   |                                     |
| 519 CDI     |             | 03.09   |       |                |        |   |   |       |                |        |   |                                     |
| 519 CDI 4x4 | 140         | 03.09   |       |                |        |   |   |       |                |        |   |                                     |
| 524         |             | 04.06   |       |                |        |   |   |       |                |        |   |                                     |
|             | 209 CDI     |         | 04.06 | 24.0116-0121.1 | 416121 |   | 298 16,0 14,0 +S +B                           |       |                |        |   |                                     |
|             | 210 CDI     |         | 03.09 |                |        |   |   |       |                |        |   |                                     |
|             | 211 CDI     |         | 04.06 |                |        |   |   |       |                |        |   |                                     |
|             | 213 CDI     |         | 04.06 |                |        |   |   |       |                |        |   |                                     |
|             | 214 CDI     |         | 04.16 |                |        |   |   |       |                |        |   |                                     |
|             | 215 CDI     |         | 04.06 |                |        |   |   |       |                |        |   |                                     |
|             | 216         |         | 09.08 |                |        |   |   |       |                |        |   |                                     |
|             | 216 CDI     |         | 03.09 |                |        |   |   |       |                |        |   |                                     |
|             | 218 CDI     |         | 04.06 |                |        |   |   |       |                |        |   |                                     |
|             | 219 CDI     |         | 03.09 |                |        |   |   |       |                |        |   |                                     |
|             | 224         |         | 04.06 |                |        |   |   |       |                |        |   |                                     |
|             | 309 CDI     |         | 04.06 |                |        |   |   |       |                |        |   |                                     |
|             | 310 CDI     |         | 03.09 |                |        |   |   |       |                |        |   |                                     |
|             | 311 CDI     |         | 04.06 |                |        |   |   |       |                |        |   |                                     |
|             | 311 CDI 4x4 |         | 02.08 |                |        |   |   |       |                |        |   |                                     |
|             | 313 CDI     |         | 04.06 |                |        |   |   |       |                |        |   |                                     |
|             | 313 CDI 4x4 |         | 06.06 |                |        |   |   |       |                |        |   |                                     |
|             | 314 CDI     |         | 05.16 |                |        |   |   |       |                |        |   |                                     |
|             | 314 CDI 4x4 |         | 05.16 |                |        |   |   |       |                |        |   |                                     |
|             | 315 CDI     |         | 04.06 |                |        |   |   |       |                |        |   |                                     |
| 315 CDI 4x4 |             | 02.08   |       |                |        |   |   |       |                |        |   |                                     |
| 316         |             | 09.08   |       |                |        |   |   |       |                |        |   |                                     |
| 316 CDI     |             | 03.09   |       |                |        |   |   |       |                |        |   |                                     |
| 316 CDI 4x4 |             | 03.09   |       |                |        |   |   |       |                |        |   |                                     |
| 316 LGT     | 115         | 09.08   |       |                |        |   |   |       |                |        |   |                                     |
| 316 NGT     |             | 09.08   |       |                |        |   |   |       |                |        |   |                                     |
| 318 CDI     |             | 04.06   |       |                |        |   |   |       |                |        |   |                                     |
| 318 CDI 4x4 |             | 02.08   |       |                |        |   |   |       |                |        |   |                                     |
| 319 CDI     |             | 03.09   |       |                |        |   |   |       |                |        |   |                                     |
| 319 CDI 4x4 |             | 03.09   |       |                |        |   |   |       |                |        |   |                                     |
| 324         |             | 04.06   |       |                |        |   |   |       |                |        |   |                                     |
|             | 411 CDI     | 80      | 06.09 | 24.0128-0202.1 | 428202 |   | 303 28,0 25,0 V L +B                          |       |                |        |   |                                     |
|             | 413 CDI     |         | 04.06 |                |        |   |   |       |                |        |   |                                     |
|             | 415 CDI     |         | 04.06 |                |        |   |   |       |                |        |   |                                     |
|             | 416 CDI     | 120     | 03.09 |                |        |   |   |       |                |        |   |                                     |
|             | 418 CDI     |         | 04.06 |                |        |   |   |       |                |        |   |                                     |
|             | 419 CDI     | 140     | 03.09 |                |        |   |   |       |                |        |   |                                     |
|             | 424         |         | 04.06 |                |        |   |   |       |                |        |   |                                     |
|             | 509 CDI     |         | 04.06 |                |        |   |   |       |                |        |   |                                     |
|             | 510 CDI     | 70      | 03.09 |                |        |   |   |       |                |        |   |                                     |
|             | 511 CDI     |         | 04.06 |                |        |   |   |       |                |        |   |                                     |
| 511 CDI 4x4 | 80          | 06.06   |       |                |        |   |   |       |                |        |   |                                     |
| 513 CDI     |             | 03.09   |       |                |        |   |   |       |                |        |   |                                     |







| MERCEDES BENZ Transporter VARIO (96-13)         |                       |     |       |       |       |  |                |        |   |  |
|---|-----------------------|-----|-------|-------|-------|--|----------------|--------|---|--|
|   | VARIO 512 D           |     |       | 09.96 | 12.13 |  | 24.0130-0198.1 | 430198 |   | 304 30,0 26,0 V L<br>324 30,0 26,0 V L     |
|   | VARIO 612 D           |     |       | 09.96 | 12.13 |  | 24.0130-0103.1 | 430103 |   |  |
|   | VARIO 613 D / 614 D   |     |       | 09.96 | 12.13 |  |                |        |   |  |
|   | VARIO 615 D / 616 D   |     |       | 09.98 | 12.13 |  |                |        |   |  |
|   | VARIO 618 D           |     |       | 09.96 | 12.13 |  |                |        |   |  |
|   | VARIO 810 D           |     |       | 09.96 | 12.13 |  |                |        |   |  |
|   | VARIO 812 D           |     |       | 09.96 | 12.13 |  |                |        |   |  |
|   | VARIO 813 D / 814 D   |     |       | 09.96 | 12.13 |  |                |        |   |  |
|   | VARIO 813 DA / 814 DA |     |       | 09.96 | 12.13 |  |                |        |   |  |
|   | VARIO 815 D / 816 D   |     |       | 09.96 | 12.13 |  |                |        |   |  |
|   | VARIO 815 DA / 816 DA |     |       | 09.96 | 12.13 |  |                |        |   |  |
|   | VARIO 818 D           |     |       | 09.96 | 12.13 |  |                |        |   |  |
| VARIO 818 DA                                    |                       |     | 09.06 | 12.13 |       |  |                |        |   |  |
|   | VARIO 512 D           |     |       | 09.96 | 12.13 |  | 24.0130-0190.1 | 430190 |   | 304 29,9 26,0 V L<br>324 29,9 26,0 V L     |
|   | VARIO 612 D           |     |       | 09.96 | 12.13 |  |                |        |   |  |
|   | VARIO 810 D           |     |       | 09.96 | 12.13 |  |                |        |   |  |
|   | VARIO 812 D           |     |       | 09.96 | 12.13 |  |                |        |   |  |
|   | VARIO 613 D / 614 D   |     |       | 09.96 | 12.13 |  | 24.0130-0191.1 | 430191 |   |  |
|   | VARIO 615 D / 616 D   |     |       | 09.98 | 12.13 |  |                |        |   |  |
|   | VARIO 618 D           |     |       | 09.96 | 12.13 |  |                |        |   |  |
|   | VARIO 813 D / 814 D   |     |       | 09.96 | 12.13 |  |                |        |   |  |
|   | VARIO 813 DA / 814 DA |     |       | 09.96 | 12.13 |  |                |        |   |  |
|   | VARIO 815 D / 816 D   |     |       | 09.96 | 12.13 |  |                |        |   |  |
|   | VARIO 815 DA / 816 DA |     |       | 09.96 | 12.13 |  |                |        |   |  |
|   | VARIO 818 D           |     |       | 09.96 | 12.13 |  |                |        |   |  |
| VARIO 818 DA                                    |                       |     | 09.06 | 12.13 |       |  |                |        |   |  |
| MERCEDES NFZ. UNIMOG 20 (BM 405.050) (07-)      |                       |     |       |       |       |  |                |        |   |  |
|   | U 20 (BM 405.050)     |     |       | 12.07 |       |  | 24.8190-0403.2 | 620403 | 4 | Warnkontakt L=315mm                        |
|   | U 20 (BM 405.050)     |     |       | 12.07 |       |  | 24.8190-0403.2 | 620403 | 4 | Warnkontakt L=315mm                        |
| MERCEDES NFZ. UNIMOG 300-400 (BM 405.1) (00-)   |                       |     |       |       |       |  |                |        |   |  |
|   | U 300 (BM 405.100)    |     |       | 03.00 |       |  | 24.8190-0403.2 | 620403 | 4 | Warnkontakt L=315mm                        |
|   | U 300 (BM 405.101)    |     |       | 03.00 |       |  |                |        |   |  |
|   | U 300 (BM 405.120)    |     |       | 03.00 |       |  |                |        |   |  |
|   | U 300 (BM 405.121)    |     |       | 03.00 |       |  |                |        |   |  |
|   | U 300 (BM 405.100)    |     |       | 03.00 |       |  | 24.8190-0403.2 | 620403 | 4 | Warnkontakt L=315mm                        |
|   | U 300 (BM 405.101)    |     |       | 03.00 |       |  |                |        |   |  |
|   | U 300 (BM 405.120)    |     |       | 03.00 |       |  |                |        |   |  |
|   | U 300 (BM 405.121)    |     |       | 03.00 |       |  |                |        |   |  |
| MERCEDES NFZ. UNIMOG 3000-5000 (BM 437.4) (02-) |                       |     |       |       |       |  |                |        |   |  |
|   | U 3000 (BM 437.420)   |     |       | 09.02 |       |  | 24.8190-0403.2 | 620403 | 2 | Warnkontakt L=315mm                        |
|   | U 3000 (BM 437.421)   |     |       | 09.02 |       |  |                |        |   |  |
|   | U 3000 (BM 437.425)   |     |       | 09.02 |       |  |                |        |   |  |
|   | U 3000 (BM 437.426)   |     |       | 09.02 |       |  |                |        |   |  |
|   | U 4000 (BM 437.420)   |     |       | 09.02 |       |  |                |        |   |  |
|   | U 4000 (BM 437.421)   |     |       | 09.02 |       |  |                |        |   |  |
|   | U 4000 (BM 437.425)   |     |       | 09.02 |       |  |                |        |   |  |
|   | U 4000 (BM 437.426)   |     |       | 09.02 |       |  |                |        |   |  |
|   | U 3000 (BM 437.420)   |     |       | 09.02 |       |  | 24.8190-0403.2 | 620403 | 4 | Warnkontakt L=315mm                        |
|   | U 3000 (BM 437.421)   |     |       | 09.02 |       |  |                |        |   |  |
|   | U 3000 (BM 437.425)   |     |       | 09.02 |       |  |                |        |   |  |
|   | U 3000 (BM 437.426)   |     |       | 09.02 |       |  |                |        |   |  |
|   | U 4000 (BM 437.420)   |     |       | 09.02 |       |  |                |        |   |  |
|   | U 4000 (BM 437.421)   |     |       | 09.02 |       |  |                |        |   |  |
|   | U 4000 (BM 437.425)   |     |       | 09.02 |       |  |                |        |   |  |
|   | U 4000 (BM 437.426)   |     |       | 09.02 |       |  |                |        |   |  |
| MG ZR (01-05)                                   |                       |     |       |       |       |  |                |        |   |  |
|   | 105                   | 76  |       | 06.01 | 12.05 |  | 13.0460-2803.2 | 602803 |   | 21515 17,5 +/WK/S TRW<br>Belagsatz-Zubehör |
|   | 120                   | 86  |       | 06.01 | 12.05 |  | 13.0460-0142.2 | 610142 |   |  |
|   | 2.0 TD                | 74  |       | 06.01 | 12.05 |  |                |        |   |  |
|   | 160                   | 118 |       | 06.01 | 12.05 |  | 13.0460-5825.2 | 605825 |   | 23094 16,5 +/WK/Zub/STRW                   |
|   | 105                   | 76  |       | 06.01 | 12.05 |  | 24.0113-0198.1 | 413198 |   | 262 13,0 11,0 +B                           |
|   | 120                   | 86  |       | 06.01 | 12.05 |  |                |        |   |  |
|   | 2.0 TD                | 74  |       | 06.01 | 12.05 |  |                |        |   |  |
|   | 105                   | 76  |       | 06.01 | 12.05 |  | 24.0121-0105.1 | 421105 |   | 262 21,0 19,0 V +S +B                      |
|   | 120                   | 86  |       | 06.01 | 12.05 |  |                |        |   |  |
|   | 2.0 TD                | 74  |       | 06.01 | 12.05 |  |                |        |   |  |
|   | 160                   | 118 |       | 06.01 | 12.05 |  | 24.0125-0161.1 | 425161 |   | 282 25,0 23,0 V                            |
|   | 105                   | 76  |       | 06.01 | 12.05 |  | 13.0460-5998.2 | 605998 |   | 21312 12,8 +/WK AKE                        |
|   | 120                   | 86  |       | 06.01 | 12.05 |  |                |        |   |  |
|   | 2.0 TD                | 74  |       | 06.01 | 12.05 |  |                |        |   |  |
|   | 160                   | 118 |       | 06.01 | 12.05 |  | 13.0460-5929.2 | 605929 |   | 21719 15,0 +/WK AKE                        |
|   | 105                   | 76  |       | 06.01 | 12.05 |  | 24.0110-0212.1 | 410212 |   | 239 10,0 8,0 +S +B                         |
|   | 120                   | 86  |       | 06.01 | 12.05 |  |                |        |   |  |
|   | 2.0 TD                | 74  |       | 06.01 | 12.05 |  |                |        |   |  |
|   | 160                   | 118 |       | 06.01 | 12.05 |  | 24.0110-0326.1 | 410326 |   | 260 10,0 8,0                               |



| MG ZS (01-05) |        |     |  |       |       |  |                |        |  |                         |
|---------------|--------|-----|--|-------|-------|--|----------------|--------|--|-------------------------|
|               | 120    | 86  |  | 07.01 | 12.05 |  | 13.0460-5825.2 | 605825 |  | 23094 16,5 +WK/Zub/STRW |
|               | 180    | 130 |  | 07.01 | 12.05 |  |                |        |  |                         |
|               | 2.0 TD | 74  |  | 01.04 | 12.05 |  |                |        |  |                         |
|               | 2.0 TD | 83  |  | 01.04 | 12.05 |  |                |        |  |                         |
|               | 120    | 86  |  | 07.01 | 12.05 |  | 24.0125-0161.1 | 425161 |  | 282 25,0 23,0 V         |
|               | 180    | 130 |  | 07.01 | 12.05 |  |                |        |  |                         |
|               | 2.0 TD | 74  |  | 01.04 | 12.05 |  |                |        |  |                         |
|               | 2.0 TD | 83  |  | 01.04 | 12.05 |  |                |        |  |                         |
|               | 120    | 86  |  | 07.01 | 12.05 |  | 24.0110-0326.1 | 410326 |  | 260 10,0 8,0            |
|               | 180    | 130 |  | 07.01 | 12.05 |  |                |        |  |                         |
|               | 2.0 TD | 74  |  | 01.04 | 12.05 |  |                |        |  |                         |
|               | 2.0 TD | 83  |  | 01.04 | 12.05 |  |                |        |  |                         |



























| MG ZT Limousine (01-05) |                 |     |  |       |       |                                       |                |        |   |                                   |                   |
|-------------------------|-----------------|-----|--|-------|-------|---------------------------------------|----------------|--------|---|-----------------------------------|-------------------|
|                         | 1.8 16V (160)   | 118 |  | 06.01 | 12.05 | + Bremsscheibe 284 X 22 <sup>1)</sup> | 13.0460-7144.2 | 607144 | 1 | 23112 19,1 + Warnkontakt L=1103mm | ATE               |
|                         | 1.8 T 16V (160) | 118 |  | 01.03 | 12.05 | + Bremsscheibe 284 X 22 <sup>1)</sup> | 24.8190-2801.2 | 622801 |   |                                   |                   |
|                         | 2.0 CDTi        | 85  |  | 06.02 | 09.03 | + Bremsscheibe 284 X 22 <sup>1)</sup> |                |        |   |                                   |                   |
|                         | 2.0 CDTi        | 96  |  | 11.02 | 12.05 | + Bremsscheibe 284 X 22 <sup>1)</sup> |                |        |   |                                   |                   |
|                         | 2.5 V6 (180)    | 130 |  | 01.03 | 12.05 | + Bremsscheibe 284 X 22 <sup>1)</sup> |                |        |   |                                   |                   |
|                         | 2.5 V6 (190)    | 140 |  | 06.01 | 12.05 | + Bremsscheibe 325 X 25 <sup>2)</sup> | 13.0460-7155.2 | 607155 | 1 | 23183 20,3 +WE                    | ATE               |
|                         | 4.6 V8 (260X)   | 191 |  | 10.03 | 12.05 | + Bremsscheibe 325 X 25 <sup>2)</sup> | 13.0470-7155.2 | LD7155 |   |                                   |                   |
|                         |                 |     |  |       |       |                                       | 24.8190-2801.2 | 622801 |   |                                   |                   |
|                         |                 |     |  |       |       |                                       |                |        |   |                                   |                   |
|                         |                 |     |  |       |       |                                       |                |        |   |                                   |                   |
|                         | 1.8 16V (160)   | 118 |  | 06.01 | 12.05 |                                       | 24.0122-0206.1 | 422206 |   | 284 22,0 19,0 V +B                |                   |
|                         | 1.8 T 16V (160) | 118 |  | 01.03 | 12.05 |                                       |                |        |   |                                   |                   |
|                         | 2.0 CDTi        | 85  |  | 06.02 | 09.03 |                                       |                |        |   |                                   |                   |
|                         | 2.0 CDTi        | 96  |  | 11.02 | 12.05 |                                       |                |        |   |                                   |                   |
|                         | 2.5 V6 (180)    | 130 |  | 01.03 | 12.05 |                                       |                |        |   |                                   |                   |
|                         | 1.8 16V (160)   | 118 |  | 06.01 | 12.05 |                                       | 13.0460-3605.2 | 603605 | 1 | 20180 17,3 +WE                    | ATE               |
|                         | 1.8 T 16V (160) | 118 |  | 01.03 | 12.05 |                                       | 13.0470-3605.2 | LD3605 |   |                                   |                   |
|                         | 2.0 CDTi        | 85  |  | 06.02 | 09.03 |                                       | 24.8190-2802.2 | 622802 |   |                                   |                   |
|                         | 2.0 CDTi        | 96  |  | 11.02 | 12.05 |                                       |                |        |   |                                   |                   |
|                         | 2.5 V6 (180)    | 130 |  | 01.03 | 12.05 |                                       |                |        |   |                                   |                   |
|                         | 2.5 V6 (190)    | 140 |  | 06.01 | 12.05 |                                       | 24.8190-2802.2 | 622802 | 1 | Warnkontakt L=846mm               |                   |
|                         | 4.6 V8 (260X)   | 191 |  | 10.03 | 12.05 |                                       |                |        |   |                                   |                   |
|                         |                 |     |  |       |       |                                       |                |        |   |                                   |                   |
|                         |                 |     |  |       |       |                                       |                |        |   |                                   |                   |
|                         |                 |     |  |       |       |                                       |                |        |   |                                   |                   |
|                         | 1.8 16V (160)   | 118 |  | 06.01 | 12.05 |                                       | 24.0110-0270.1 | 410270 |   | 280 10,0 8,0 +B                   |                   |
|                         | 1.8 T 16V (160) | 118 |  | 01.03 | 12.05 |                                       |                |        |   |                                   |                   |
|                         | 2.0 CDTi        | 85  |  | 06.02 | 09.03 |                                       |                |        |   |                                   |                   |
|                         | 2.0 CDTi        | 96  |  | 11.02 | 12.05 |                                       |                |        |   |                                   |                   |
|                         | 2.5 V6 (180)    | 130 |  | 01.03 | 12.05 |                                       |                |        |   |                                   |                   |
|                         | 2.5 V6 (190)    | 140 |  | 06.01 | 12.05 |                                       |                |        |   | 160 x 20                          | Bremssack-Zubehör |
|                         | 1.8 16V (160)   | 118 |  | 06.01 | 12.05 |                                       | 03.0137-0408.2 | 650408 |   |                                   |                   |
|                         | 1.8 T 16V (160) | 118 |  | 01.03 | 12.05 |                                       | 03.0137-9701.2 | 669701 |   |                                   |                   |
|                         | 2.0 CDTi        | 85  |  | 06.02 | 09.03 |                                       | 03.0137-9702.2 | 669702 |   |                                   |                   |
|                         | 2.0 CDTi        | 96  |  | 11.02 | 12.05 |                                       |                |        |   |                                   |                   |
|                         | 2.5 V6 (180)    | 130 |  | 01.03 | 12.05 |                                       |                |        |   | Spreizschloß Satz                 |                   |
|                         | 2.5 V6 (190)    | 140 |  | 06.01 | 12.05 |                                       |                |        |   |                                   |                   |
|                         |                 |     |  |       |       |                                       |                |        |   |                                   |                   |
|                         |                 |     |  |       |       |                                       |                |        |   |                                   |                   |
|                         |                 |     |  |       |       |                                       |                |        |   |                                   |                   |

| MG ZT-T Kombi (01-05) |                 |     |  |       |       |                                       |                |        |   |                                   |                   |
|-----------------------|-----------------|-----|--|-------|-------|---------------------------------------|----------------|--------|---|-----------------------------------|-------------------|
|                       | 1.8 16V (160)   | 118 |  | 10.01 | 12.05 | + Bremsscheibe 284 X 22 <sup>1)</sup> | 13.0460-7144.2 | 607144 | 1 | 23112 19,1 + Warnkontakt L=1103mm | ATE               |
|                       | 1.8 T 16V (160) | 118 |  | 01.03 | 12.05 | + Bremsscheibe 284 X 22 <sup>1)</sup> | 24.8190-2801.2 | 622801 |   |                                   |                   |
|                       | 2.0 CDTi        | 85  |  | 06.02 | 09.03 | + Bremsscheibe 284 X 22 <sup>1)</sup> |                |        |   |                                   |                   |
|                       | 2.0 CDTi        | 96  |  | 11.02 | 12.05 | + Bremsscheibe 284 X 22 <sup>1)</sup> |                |        |   |                                   |                   |
|                       | 2.5 V6 (180)    | 130 |  | 01.03 | 12.05 | + Bremsscheibe 284 X 22 <sup>1)</sup> |                |        |   |                                   |                   |
|                       | 2.5 V6 (190)    | 140 |  | 10.01 | 12.05 | + Bremsscheibe 325 X 25 <sup>2)</sup> | 13.0460-7155.2 | 607155 | 1 | 23183 20,3 +WE                    | ATE               |
|                       | 4.6 V8 (260X)   | 191 |  | 10.03 | 12.05 | + Bremsscheibe 325 X 25 <sup>2)</sup> | 13.0470-7155.2 | LD7155 |   |                                   |                   |
|                       |                 |     |  |       |       |                                       | 24.8190-2801.2 | 622801 |   |                                   |                   |
|                       |                 |     |  |       |       |                                       |                |        |   |                                   |                   |
|                       |                 |     |  |       |       |                                       |                |        |   |                                   |                   |
|                       | 1.8 16V (160)   | 118 |  | 10.01 | 12.05 | + Bremsscheibe 284 X 22 <sup>1)</sup> | 24.0122-0206.1 | 422206 |   | 284 22,0 19,0 V +B                |                   |
|                       | 1.8 T 16V (160) | 118 |  | 01.03 | 12.05 | + Bremsscheibe 284 X 22 <sup>1)</sup> |                |        |   |                                   |                   |
|                       | 2.0 CDTi        | 85  |  | 06.02 | 09.03 | + Bremsscheibe 284 X 22 <sup>1)</sup> |                |        |   |                                   |                   |
|                       | 2.0 CDTi        | 96  |  | 11.02 | 12.05 | + Bremsscheibe 284 X 22 <sup>1)</sup> |                |        |   |                                   |                   |
|                       | 2.5 V6 (180)    | 130 |  | 01.03 | 12.05 | + Bremsscheibe 284 X 22 <sup>1)</sup> |                |        |   |                                   |                   |
|                       | 2.5 V6 (190)    | 140 |  | 10.01 | 12.05 |                                       | 13.0460-3605.2 | 603605 | 1 | 20180 17,3 +WE                    | ATE               |
|                       | 1.8 16V (160)   | 118 |  | 01.03 | 12.05 |                                       | 13.0470-3605.2 | LD3605 |   |                                   |                   |
|                       | 2.0 CDTi        | 85  |  | 06.02 | 09.03 |                                       | 24.8190-2802.2 | 622802 |   |                                   |                   |
|                       | 2.0 CDTi        | 96  |  | 11.02 | 12.05 |                                       |                |        |   |                                   |                   |
|                       | 2.5 V6 (180)    | 130 |  | 01.03 | 12.05 |                                       |                |        |   |                                   |                   |
|                       | 2.5 V6 (190)    | 140 |  | 10.01 | 12.05 |                                       | 24.8190-2802.2 | 622802 | 1 | Warnkontakt L=846mm               |                   |
|                       | 4.6 V8 (260X)   | 191 |  | 10.03 | 12.05 |                                       |                |        |   |                                   |                   |
|                       |                 |     |  |       |       |                                       |                |        |   |                                   |                   |
|                       |                 |     |  |       |       |                                       |                |        |   |                                   |                   |
|                       |                 |     |  |       |       |                                       |                |        |   |                                   |                   |
|                       | 1.8 16V (160)   | 118 |  | 10.01 | 12.05 |                                       | 24.0110-0270.1 | 410270 |   | 280 10,0 8,0 +B                   |                   |
|                       | 1.8 T 16V (160) | 118 |  | 01.03 | 12.05 |                                       |                |        |   |                                   |                   |
|                       | 2.0 CDTi        | 85  |  | 06.02 | 09.03 |                                       |                |        |   |                                   |                   |
|                       | 2.0 CDTi        | 96  |  | 11.02 | 12.05 |                                       |                |        |   |                                   |                   |
|                       | 2.5 V6 (180)    | 130 |  | 01.03 | 12.05 |                                       |                |        |   |                                   |                   |
|                       | 2.5 V6 (190)    | 140 |  | 10.01 | 12.05 |                                       |                |        |   | 160 x 20                          | Bremssack-Zubehör |
|                       | 1.8 16V (160)   | 118 |  | 10.01 | 12.05 |                                       | 03.0137-0408.2 | 650408 |   |                                   |                   |
|                       | 1.8 T 16V (160) | 118 |  | 01.03 | 12.05 |                                       | 03.0137-9701.2 | 669701 |   |                                   |                   |
|                       | 2.0 CDTi        | 85  |  | 06.02 | 09.03 |                                       | 03.0137-9702.2 | 669702 |   |                                   |                   |
|                       | 2.0 CDTi        | 96  |  | 11.02 | 12.05 |                                       |                |        |   |                                   |                   |
|                       | 2.5 V6 (180)    | 130 |  | 01.03 | 12.05 |                                       |                |        |   | Spreizschloß Satz                 |                   |
|                       | 2.5 V6 (190)    | 140 |  | 10.01 | 12.05 |                                       |                |        |   |                                   |                   |
|                       |                 |     |  |       |       |                                       |                |        |   |                                   |                   |
|                       |                 |     |  |       |       |                                       |                |        |   |                                   |                   |
|                       |                 |     |  |       |       |                                       |                |        |   |                                   |                   |























<sup>1)</sup> + brake disc 284 X 22 / + dischi freno 284 X 22 / + disque de frein 284 X 22 / + disco de freno 284 X 22

<sup>2)</sup> + brake disc 325 X 25 / + dischi freno 325 X 25 / + disque de frein 325 X 25 / + disco de freno 325 X 25



|     |         |  |  |  |  |  |  |                           |
|--|---|--|--|--|---|--|--|---|
| <b>MG MGF (RD) (95-02)</b>   |   |  |  |  |   |  |  |   |
|    | 1.6<br>1.8 i 16V<br>1.8 i VVC   | 82<br>88<br>107  |  | 02.00<br>03.95<br>03.95  | 04.02<br>04.02<br>04.02   | 13.0460-2804.2   | 602804   | 21518 17,0 TRW  |
|    | 1.6<br>1.8 i 16V<br>1.8 i VVC   | 82<br>88<br>107  |  | 02.00<br>03.95<br>03.95  | 04.02<br>04.02<br>04.02   | 24.0122-0177.1   | 422177   | 241 22,0 20,0 V +B  |
| <b>MG MG TF (02-05)</b>  |   |  |  |  |   |  |  |   |
|    | 115<br>120<br>135   | 85<br>88<br>100  |  | 03.02<br>03.02<br>03.02  | 12.05<br>12.05<br>12.05   | 13.0460-2804.2   | 602804   | 21518 17,0 TRW  |
|    | 115<br>120<br>135   | 85<br>88<br>100  |  | 03.02<br>03.02<br>03.02  | 12.05<br>12.05<br>12.05   | 24.0122-0177.1   | 422177   | 241 22,0 20,0 V +B  |
| <b>MINI F55 (14-)</b>  |   |  |  |  |   |  |  |   |
|    | Cooper<br>Cooper D<br>One<br>One D<br>One First   | 100<br>85<br>75<br>70<br>55  |  | 10.14<br>10.14<br>10.14<br>10.14<br>03.15  |   | 24.8190-0941.2   | 620941   | 1  Warnkontakt L=648mm   |
|  | Cooper S<br>Cooper SD   | 141<br>125   |  | 10.14<br>10.14   |   | 24.8190-0941.2   | 620941   | 1  Warnkontakt L=648mm   |
|    | Cooper<br>Cooper D<br>One<br>One D<br>One First   | 100<br>85<br>75<br>70<br>55  |  | 10.14<br>10.14<br>10.14<br>10.14<br>03.15  |   | 24.0122-0292.1   | 422292   | 280 22,0 20,4 V L +S +B   |
|    | Cooper<br>Cooper D<br>Cooper S<br>Cooper SD<br>One<br>One D<br>One First                | 100<br>85<br>141<br>125<br>75<br>70<br>55  |  | 10.14<br>10.14<br>10.14<br>10.14<br>10.14<br>10.14<br>03.15                      |   | 24.8190-0942.2   | 620942   | 1 Warnkontakt L=641mm   |
|    | Cooper<br>Cooper D<br>Cooper S<br>Cooper SD<br>One<br>One D<br>One First                | 100<br>85<br>141<br>125<br>75<br>70<br>55  |  | 10.14<br>10.14<br>10.14<br>10.14<br>10.14<br>10.14<br>03.15                      |   | 24.0110-0396.1   | 410396   | 259 10,0 8,4 L +S +B  |
| <b>MINI F56 (13-)</b>  |   |  |  |  |   |  |  |   |
|  | Cooper<br>Cooper D<br>One<br>One<br>One D   | 100<br>85<br>55<br>75<br>70  |  | 11.13<br>11.13<br>06.14<br>11.13<br>11.13  |   | 24.8190-0941.2   | 620941   | 1  Warnkontakt L=648mm |
|  | Cooper S<br>Cooper SD<br>John Cooper Works  | 141<br>125<br>170  |  | 11.13<br>06.14<br>03.15  |   | 24.8190-0941.2   | 620941   | 1  Warnkontakt L=648mm |
|  | Cooper<br>Cooper D<br>One<br>One<br>One D   | 100<br>85<br>55<br>75<br>70  |  | 11.13<br>11.13<br>06.14<br>11.13<br>11.13  |   | 24.0122-0292.1   | 422292   | 280 22,0 20,4 V L +S +B   |
|  | Cooper<br>Cooper D<br>Cooper S<br>Cooper SD<br>John Cooper Works<br>One<br>One<br>One D | 100<br>85<br>141<br>125<br>170<br>55<br>75<br>70                                 |  | 11.13<br>11.13<br>11.13<br>06.14<br>03.15<br>06.14<br>11.13<br>11.13             |   | 24.8190-0942.2   | 620942   | 1 Warnkontakt L=641mm   |
|  | Cooper<br>Cooper D<br>Cooper S<br>Cooper SD<br>John Cooper Works<br>One<br>One<br>One D | 100<br>85<br>141<br>125<br>170<br>55<br>75<br>70                                 |  | 11.13<br>11.13<br>11.13<br>06.14<br>03.15<br>06.14<br>11.13<br>11.13             |   | 24.0110-0396.1   | 410396   | 259 10,0 8,4 L +S +B  |
| <b>MINI F57 Cabrio (15-)</b>   |   |  |  |  |   |  |  |   |
|  | Cooper<br>Cooper D<br>One   | 100<br>85<br>75  |  | 11.15<br>11.15<br>03.16  |   | 24.0122-0292.1   | 422292   | 280 22,0 20,4 V L +S +B   |
|  | Cooper<br>Cooper D<br>Cooper S<br>Cooper SD<br>One                                      | 100<br>85<br>141<br>125<br>75  |  | 11.15<br>11.15<br>11.15<br>03.16<br>03.16  |   | 24.8190-0942.2   | 620942   | 1 Warnkontakt L=641mm   |



|     |  |  |  |                       |  |  |  |  |
|--|--|--|--|---|---|--|--|--|
| <b>MINI F57 Cabrio (15-)</b>   |  |  |  |   |   |  |  |  |
|    | Cooper<br>Cooper D<br>Cooper S<br>Cooper SD<br>One                               | 100<br>85<br>141<br>125<br>75  |  | 11.15<br>11.15<br>11.15<br>03.16<br>03.16   |   | 24.0110-0396.1   | 410396   | 259 10,0 8,4 L +S +B   |
| <b>MINI R50 / R53 (00-06)</b>  |  |  |  |   |   |  |  |  |
|    | Cooper<br>Cooper S<br>One<br>One 1.4<br>One D                                    | 85<br>66   |  | 06.00 11.06<br>07.02 11.06<br>06.00 11.06<br>06.00 11.06<br>03.03 11.06                               |   | 13.0460-7161.2<br>13.0470-7161.2<br>24.8190-0235.2                                 | 607161<br>LD7161<br>620235   | 23281 18,3 +/WE ATE<br>23281 18,3 +/WE ATE<br>Warnkontakt L=883mm                  |
|  | Cooper JCW<br>Cooper JCW S   | 155<br>147   |  | 11.03 02.06<br>11.03 02.06  |   | 13.0460-2725.2<br>13.0470-2725.2<br>24.8190-0235.2                                 | 602725<br>LD2725<br>620235   | 23984 17,8 +/WE/Zub/STRW<br>23984 17,8 +/WE/Zub/STRW<br>Warnkontakt L=883mm        |
|  | Cooper JCW<br>Cooper JCW S   | 155<br>147   |  | 03.06 11.06<br>03.06 11.06  |   | 13.0460-2725.2<br>13.0470-2725.2<br>24.8190-0235.2                                 | 602725<br>LD2725<br>620235   | 23984 17,8 +/WE/Zub/STRW<br>23984 17,8 +/WE/Zub/STRW<br>Warnkontakt L=883mm        |
|    | Cooper<br>Cooper S<br>One<br>One 1.4<br>One D                                    | 85<br>66   |  | 06.00 11.06<br>07.02 11.06<br>06.00 11.06<br>06.00 11.06<br>03.03 11.06                               |   | 24.0122-0204.1<br>24.0322-0204.1   | 422204<br>522204   | 276 22,0 20,4 V L +B<br>276 22,0 19,6 V L +B PD                                    |
|  | Cooper JCW<br>Cooper JCW S   | 155<br>147   |  | 11.03 11.06<br>11.03 11.06  |   | 24.0122-0244.1   | 422244   | 294 22,0 20,4 V L +B   |
|    | Cooper<br>Cooper JCW<br>Cooper JCW S<br>Cooper S<br>One<br>One 1.4<br>One D      | 85<br>155<br>147<br>66   |  | 06.00 11.06<br>11.03 11.06<br>11.03 11.06<br>07.02 11.06<br>06.00 11.06<br>06.00 11.06<br>03.03 11.06 |   | 24.0710-2013.1   | 360220   | Radsensor L=570/178  |
|    | Cooper<br>Cooper JCW<br>Cooper JCW S<br>Cooper S<br>One<br>One 1.4<br>One D      | 85<br>155<br>147<br>66   |  | 06.00 11.06<br>11.03 11.06<br>11.03 11.06<br>07.02 11.06<br>06.00 11.06<br>06.00 11.06<br>03.03 11.06 |   | 13.0460-7162.2<br>13.0470-7162.2<br>24.8190-0236.2                                 | 607162<br>LD7162<br>620236   | 23716 15,8 +/WE ATE<br>23716 15,8 +/WE ATE<br>Warnkontakt L=1130mm                 |
|   | Cooper<br>Cooper JCW<br>Cooper JCW S<br>Cooper S<br>One<br>One 1.4<br>One D      | 85<br>155<br>147<br>66   |  | 06.00 11.06<br>11.03 11.06<br>11.03 11.06<br>07.02 11.06<br>06.00 11.06<br>06.00 11.06<br>03.03 11.06 |   | 24.0110-0271.1<br>24.0310-0271.1   | 410271<br>510271   | 259 10,0 8,4 +B<br>259 10,0 7,6 +B PD  |
|  | Cooper<br>Cooper JCW<br>Cooper JCW S<br>Cooper S<br>One<br>One 1.4<br>One D      | 85<br>155<br>147<br>66   |  | 06.00 11.06<br>11.03 11.06<br>11.03 11.06<br>07.02 11.06<br>06.00 11.06<br>06.00 11.06<br>03.03 11.06 |   | 24.0710-2021.1   | 360312   | Radsensor L=905  |
| <b>MINI R52 Cabrio (04-08)</b>   |  |  |  |   |   |  |  |  |
|  | Cooper<br>Cooper S<br>One  | 85<br>125<br>66  |  | 04.04 08.08<br>04.04 08.08<br>04.04 08.08   |   | 13.0460-7161.2<br>13.0470-7161.2<br>24.8190-0235.2                                 | 607161<br>LD7161<br>620235   | 23281 18,3 +/WE ATE<br>23281 18,3 +/WE ATE<br>Warnkontakt L=883mm                  |
|  | Cooper S JCW   | 155  |  | 11.03 05.06   |   | 13.0460-2725.2<br>13.0470-2725.2<br>24.8190-0235.2                                 | 602725<br>LD2725<br>620235   | 23984 17,8 +/WE/Zub/STRW<br>23984 17,8 +/WE/Zub/STRW<br>Warnkontakt L=883mm        |
|  | Cooper S JCW   | 155  |  | 06.06 08.08   |   | 13.0460-2725.2<br>13.0470-2725.2<br>24.8190-0235.2                                 | 602725<br>LD2725<br>620235   | 23984 17,8 +/WE/Zub/STRW<br>23984 17,8 +/WE/Zub/STRW<br>Warnkontakt L=883mm        |
|  | Cooper<br>Cooper S<br>One  | 85<br>125<br>66  |  | 04.04 08.08<br>04.04 08.08<br>04.04 08.08   |   | 24.0122-0204.1<br>24.0322-0204.1   | 422204<br>522204   | 276 22,0 20,4 V L +B<br>276 22,0 19,6 V L +B PD                                    |
|  | Cooper S JCW   | 155  |  | 11.03 08.08   |   | 24.0122-0244.1   | 422244   | 294 22,0 20,4 V L +B   |
|  | Cooper<br>Cooper S<br>Cooper S JCW<br>One  | 85<br>125<br>155<br>66   |  | 04.04 08.08<br>04.04 08.08<br>11.03 08.08<br>04.04 08.08  |   | 24.0710-2013.1   | 360220   | Radsensor L=570/178  |
|  | Cooper<br>Cooper S<br>Cooper S JCW<br>One  | 85<br>125<br>155<br>66   |  | 04.04 08.08<br>04.04 08.08<br>11.03 08.08<br>04.04 08.08  |   | 13.0460-7162.2<br>13.0470-7162.2<br>24.8190-0236.2                                 | 607162<br>LD7162<br>620236   | 23716 15,8 +/WE ATE<br>23716 15,8 +/WE ATE<br>Warnkontakt L=1130mm                 |
|  | Cooper<br>Cooper S<br>Cooper S JCW<br>One  | 85<br>125<br>155<br>66   |  | 04.04 08.08<br>04.04 08.08<br>11.03 08.08<br>04.04 08.08  |   | 24.0110-0271.1<br>24.0310-0271.1   | 410271<br>510271   | 259 10,0 8,4 +B<br>259 10,0 7,6 +B PD  |
|  | Cooper<br>Cooper S<br>Cooper S JCW<br>One  | 85<br>125<br>155<br>66   |  | 04.04 08.08<br>04.04 08.08<br>11.03 08.08<br>04.04 08.08  |   | 24.0710-2021.1   | 360312   | Radsensor L=905  |

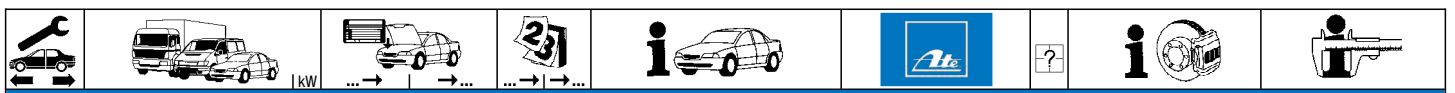

### MINI R55 Clubman (07-14)

|  |                   |     |       |       |                |        |   |  |  |
|--|-------------------|-----|-------|-------|----------------|--------|---|--|--|
|  | Cooper            |     | 09.07 | 06.14 | 13.0460-2710.2 | 602710 | 1 |  | 23915 17,6 +/WE/Zub/STRW<br>Warnkontakt L=802mm  |
|  | Cooper D          |     | 09.07 | 06.14 | 13.0470-2710.2 | LD2710 |   |  |  |
|  | Cooper SD         | 105 | 02.11 | 06.14 | 24.8190-0277.2 | 620277 |   |  |  |
|  | One               |     | 03.10 | 06.14 |                |        |   |  |  |
|  | One D             | 66  | 03.10 | 06.14 |                |        |   |  |  |
|  | Cooper S          |     | 09.07 | 06.14 | 13.0460-2725.2 | 602725 | 1 |  | 23984 17,8 +/WE/Zub/STRW<br>Warnkontakt L=802mm  |
|  |                   |     |       |       | 13.0470-2725.2 | LD2725 |   |  |  |
|  |                   |     |       |       | 24.8190-0277.2 | 620277 |   |  |  |
|  | John Cooper Works | 155 | 03.08 | 06.14 | 24.8190-0277.2 | 620277 | 1 |  | Warnkontakt L=802mm                              |
|  |                   |     |       |       |                |        |   |  |  |
|  |                   |     |       |       |                |        |   |  |  |
|  | Cooper            |     | 09.07 | 06.14 | 24.0122-0248.1 | 422248 |   |  | 280 22,0 20,4 V L +B<br>280 22,0 20,4 V L +B PD  |
|  | Cooper D          |     | 09.07 | 06.14 | 24.0322-0248.1 | 522248 |   |  |  |
|  | Cooper SD         | 105 | 02.11 | 06.14 |                |        |   |  |  |
|  | One               |     | 03.10 | 06.14 |                |        |   |  |  |
|  | One D             | 66  | 03.10 | 06.14 |                |        |   |  |  |
|  | Cooper S          |     | 09.07 | 06.14 | 24.0122-0247.1 | 422247 |   |  | 294 22,0 20,4 V L +B<br>294 22,0 20,4 V L +B PD  |
|  |                   |     |       |       | 24.0322-0247.1 | 522247 |   |  |  |
|  |                   |     |       |       |                |        |   |  |  |
|  | Cooper            |     | 09.07 | 08.10 | 13.0460-2714.2 | 602714 | 1 |  | 24289 16,9 +/WE/Zub/STRW<br>Warnkontakt L=1130mm |
|  | Cooper D          |     | 09.07 | 08.10 | 13.0470-2714.2 | LD2714 |   |  |  |
|  | Cooper S          |     | 09.07 | 08.10 | 24.8190-0278.2 | 620278 |   |  |  |
|  | John Cooper Works | 155 | 03.08 | 08.10 |                |        |   |  |  |
|  | One               |     | 03.10 | 08.10 |                |        |   |  |  |
|  | One D             | 66  | 03.10 | 08.10 |                |        |   |  |  |
|  | Cooper            |     | 09.10 | 06.14 | 13.0460-2714.2 | 602714 | 1 |  | 24289 16,9 +/WE/Zub/STRW<br>Warnkontakt L=1141mm |
|  | Cooper D          |     | 09.10 | 06.14 | 13.0470-2714.2 | LD2714 |   |  |  |
|  | Cooper S          |     | 09.10 | 06.14 | 24.8190-0010.2 | 620010 |   |  |  |
|  | Cooper SD         | 105 | 02.11 | 06.14 |                |        |   |  |  |
|  | John Cooper Works | 155 | 09.10 | 06.14 |                |        |   |  |  |
|  | One               |     | 09.10 | 06.14 |                |        |   |  |  |
|  | One D             | 66  | 09.10 | 06.14 |                |        |   |  |  |
|  |                   |     |       |       |                |        |   |  |  |
|  |                   |     |       |       |                |        |   |  |  |
|  | Cooper            |     | 09.07 | 06.14 | 24.0110-0271.1 | 410271 |   |  | 259 10,0 8,4 +B<br>259 10,0 7,6 +B PD            |
|  | Cooper D          |     | 09.07 | 06.14 | 24.0310-0271.1 | 510271 |   |  |  |
|  | Cooper S          |     | 09.07 | 06.14 |                |        |   |  |  |
|  | Cooper SD         | 105 | 02.11 | 06.14 |                |        |   |  |  |
|  | One               |     | 03.10 | 06.14 |                |        |   |  |  |
|  | One D             | 66  | 03.10 | 06.14 |                |        |   |  |  |

### MINI F54 Clubman (15-)

|  |                 |     |       |  |                |        |   |  |                         |
|--|-----------------|-----|-------|--|----------------|--------|---|--|-------------------------|
|  | One             | 75  | 07.15 |  | 24.0122-0292.1 | 422292 |   |  | 280 22,0 20,4 V L +S +B |
|  | One D           | 85  | 11.15 |  |                |        |   |  |                         |
|  | Cooper S        | 141 | 07.15 |  | 24.0124-0260.1 | 424260 |   |  |                         |
|  | Cooper SD       | 140 | 11.15 |  |                |        |   |  | 307 24,0 22,4 V L +B    |
|  | Cooper SDX All4 | 140 | 01.16 |  |                |        |   |  |                         |
|  | Cooper SX All4  | 141 | 01.16 |  |                |        |   |  |                         |
|  | Cooper          | 100 | 07.15 |  | 24.8190-0942.2 | 620942 | 1 |  | Warnkontakt L=641mm     |
|  | Cooper D        | 110 | 07.15 |  |                |        |   |  |                         |
|  | Cooper S        | 141 | 07.15 |  |                |        |   |  |                         |
|  | Cooper SD       | 140 | 11.15 |  |                |        |   |  |                         |
|  | Cooper SDX All4 | 140 | 01.16 |  |                |        |   |  |                         |
|  | Cooper SX All4  | 141 | 01.16 |  |                |        |   |  |                         |
|  | One             | 75  | 11.15 |  |                |        |   |  |                         |
|  | One D           | 85  | 11.15 |  |                |        |   |  |                         |
|  |                 |     |       |  |                |        |   |  |                         |

### MINI R55 Clubvan (12-)





|  |          |    |       |  |                |        |   |  |  |
|--|----------|----|-------|--|----------------|--------|---|--|--|
|  | Cooper   | 90 | 12.12 |  | 13.0460-2710.2 | 602710 | 1 |  | 23915 17,6 +/WE/Zub/STRW<br>Warnkontakt L=808mm  |
|  | Cooper D | 82 | 12.12 |  | 13.0470-2710.2 | LD2710 |   |  |  |
|  | One      | 72 | 12.12 |  | 24.8190-0009.2 | 620009 |   |  |  |
|  | Cooper   | 90 | 12.12 |  | 24.0122-0248.1 | 422248 |   |  | 280 22,0 20,4 V L +B<br>280 22,0 20,4 V L +B PD  |
|  | Cooper D | 82 | 12.12 |  | 24.0322-0248.1 | 522248 |   |  |  |
|  | One      | 72 | 12.12 |  |                |        |   |  |  |
|  | Cooper   | 90 | 12.12 |  | 13.0460-2714.2 | 602714 | 1 |  | 24289 16,9 +/WE/Zub/STRW<br>Warnkontakt L=1141mm |
|  | Cooper D | 82 | 12.12 |  | 13.0470-2714.2 | LD2714 |   |  |  |
|  | One      | 72 | 12.12 |  | 24.8190-0010.2 | 620010 |   |  |  |
|  | Cooper   | 90 | 12.12 |  | 24.0110-0271.1 | 410271 |   |  | 259 10,0 8,4 +B                                  |
|  | Cooper D | 82 | 12.12 |  |                |        |   |  |  |
|  | One      | 72 | 12.12 |  |                |        |   |  |  |

### MINI R56 (06-14)







|  |                      |     |       |       |                |        |   |  |   |
|--|----------------------|-----|-------|-------|----------------|--------|---|--|---|
|  | Cooper               | 85  | 03.10 | 06.14 | 13.0460-2710.2 | 602710 | 1 |  | 23915 17,6 +/WE/Zub/STRW<br>Warnkontakt L=802mm |
|  | Cooper               | 88  | 11.06 | 06.14 | 13.0470-2710.2 | LD2710 |   |  |   |
|  | Cooper               | 90  | 03.10 | 06.14 | 24.8190-0277.2 | 620277 |   |  |   |
|  | Cooper D             |     | 04.07 | 06.14 |                |        |   |  |   |
|  | Cooper SD            |     | 02.11 | 06.14 |                |        |   |  |   |
|  | One                  | 55  | 03.09 | 06.14 |                |        |   |  |   |
|  | One                  | 70  | 04.07 | 06.14 |                |        |   |  |   |
|  | One                  | 72  | 03.10 | 06.14 |                |        |   |  |   |
|  | One D                | 66  | 03.10 | 06.14 |                |        |   |  |   |
|  | Cooper S             |     | 03.10 | 06.14 | 13.0460-2725.2 | 602725 | 1 |  | 23984 17,8 +/WE/Zub/STRW<br>Warnkontakt L=802mm |
|  | Cooper S             | 128 | 11.06 | 06.14 | 13.0470-2725.2 | LD2725 |   |  |   |
|  | Cooper S             | 147 | 01.12 | 06.14 | 24.8190-0277.2 | 620277 |   |  |   |
|  | John Cooper Works    | 155 | 03.08 | 06.14 | 24.8190-0277.2 | 620277 | 1 |  | Warnkontakt L=802mm                             |
|  | John Cooper Works    | 160 | 07.07 | 06.14 |                |        |   |  |   |
|  | John Cooper Works GP | 160 | 09.12 | 06.14 |                |        |   |  |   |























### MINI R56 (06-14)



















|  |  |          |    |       |       |                |                |        |  |  |
|--|--|----------|----|-------|-------|----------------|----------------|--------|--|--|
|    | Cooper   | 85       |    | 03.10 | 06.14 | 24.0122-0248.1 | 422248         |        |  | 280 22,0 20,4 V L +B<br>280 22,0 20,4 V L +B PD                              |
|  | Cooper S   | 88       |    | 11.06 | 06.14 | 24.0322-0248.1 | 522248         |        |  |  |
|  | Cooper   | 90       |    | 03.10 | 06.14 |                |                |        |  |  |
|  | Cooper D   |          |    | 04.07 | 06.14 |                |                |        |  |  |
|  | Cooper SD  |          |    | 02.11 | 06.14 |                |                |        |  |  |
|  | One  | 55       |    | 03.09 | 06.14 |                |                |        |  |  |
|  | One  | 70       |    | 04.07 | 06.14 |                |                |        |  |  |
|  | One  | 72       |    | 03.10 | 06.14 |                |                |        |  |  |
|  | One D  | 66       |    | 03.10 | 06.14 |                |                |        |  |  |
|  |  | Cooper S |    |       | 03.10 | 06.14          | 24.0122-0247.1 | 422247 |  |  |
|  | Cooper S   | 128      |    | 11.06 | 06.14 | 24.0322-0247.1 | 522247         |        |  |  |
|  | Cooper S   | 147      |    | 01.12 | 06.14 |                |                |        |  |  |
|    | Cooper   | 85       |    | 03.10 | 08.10 | 13.0460-2714.2 | 602714         |        |  | 24289 16,9 +/WE/Zub/STRW<br>24289 16,9 +/WE/Zub/STRW<br>Warnkontakt L=1130mm |
|  | Cooper   | 88       |    | 11.06 | 08.10 | 13.0470-2714.2 | LD2714         |        |  |  |
|  | Cooper   | 90       |    | 03.10 | 08.10 | 24.8190-0278.2 | 620278         | 1      |  |  |
|  | Cooper D   |          |    | 04.07 | 08.10 |                |                |        |  |  |
|  | Cooper S   |          |    | 03.10 | 08.10 |                |                |        |  |  |
|  | Cooper S   | 128      |    | 11.06 | 08.10 |                |                |        |  |  |
|  | John Cooper Works  | 155      |    | 03.08 | 08.10 |                |                |        |  |  |
|  | John Cooper Works  | 160      |    | 07.07 | 08.10 |                |                |        |  |  |
|  | One  | 55       |    | 03.09 | 08.10 |                |                |        |  |  |
|  | One  | 70       |    | 04.07 | 08.10 |                |                |        |  |  |
|  | One  | 72       |    | 03.10 | 08.10 |                |                |        |  |  |
|  | One D  | 66       |    | 03.10 | 08.10 |                |                |        |  |  |
|  |  | Cooper   | 85 |       | 09.10 | 06.14          | 13.0460-2714.2 | 602714 |  |  |
| Cooper   |  | 88       |    | 09.10 | 06.14 | 13.0470-2714.2 | LD2714         |        |  |  |
| Cooper   |  | 90       |    | 09.10 | 06.14 | 24.8190-0010.2 | 620010         | 1      |  |  |
| Cooper D   |  |          |    | 09.10 | 06.14 |                |                |        |  |  |
| Cooper S   |  |          |    | 09.10 | 06.14 |                |                |        |  |  |
| Cooper S   |  | 128      |    | 09.10 | 06.14 |                |                |        |  |  |
| Cooper S   |  | 147      |    | 01.12 | 06.14 |                |                |        |  |  |
| Cooper SD  |  |          |    | 02.11 | 06.14 |                |                |        |  |  |
| John Cooper Works  |  | 155      |    | 09.10 | 06.14 |                |                |        |  |  |
| John Cooper Works  |  | 160      |    | 09.10 | 06.14 |                |                |        |  |  |
| John Cooper Works GP   |  | 160      |    | 09.12 | 06.14 |                |                |        |  |  |
| One  |  | 55       |    | 09.10 | 06.14 |                |                |        |  |  |
| One  |  | 70       |    | 09.10 | 06.14 |                |                |        |  |  |
| One  |  | 72       |    | 09.10 | 06.14 |                |                |        |  |  |
| One D  |  | 66       |    | 09.10 | 06.14 |                |                |        |  |  |
|  | Cooper   | 85       |    | 03.10 | 06.14 | 24.0110-0271.1 | 410271         |        |  | 259 10,0 8,4 +B  |
|  | Cooper   | 88       |    | 11.06 | 06.14 |                |                |        |  |  |
|  | Cooper   | 90       |    | 03.10 | 06.14 |                |                |        |  |  |
|  | Cooper D   |          |    | 04.07 | 06.14 |                |                |        |  |  |
|  | Cooper S   |          |    | 03.10 | 06.14 |                |                |        |  |  |
|  | Cooper S   | 128      |    | 11.06 | 06.14 |                |                |        |  |  |
|  | Cooper S   | 147      |    | 01.12 | 06.14 |                |                |        |  |  |
|  | Cooper SD  |          |    | 02.11 | 06.14 |                |                |        |  |  |
|  | One  | 55       |    | 03.09 | 06.14 |                |                |        |  |  |
|  | One  | 70       |    | 04.07 | 06.14 |                |                |        |  |  |
|  | One  | 72       |    | 03.10 | 06.14 |                |                |        |  |  |
|  | One D  | 66       |    | 03.10 | 06.14 |                |                |        |  |  |

### MINI R57 Cabrio (09-14)

|  |                   |     |  |       |       |                |        |   |  |  |
|--|-------------------|-----|--|-------|-------|----------------|--------|---|--|--|
|  | Cooper            |     |  | 01.09 | 06.14 | 13.0460-2710.2 | 602710 |   |  | 23915 17,6 +/WE/Zub/STRW<br>23915 17,6 +/WE/Zub/STRW<br>Warnkontakt L=802mm  |
|  | Cooper            | 90  |  | 03.10 | 06.14 | 13.0470-2710.2 | LD2710 |   |  |  |
|  | Cooper D          | 82  |  | 06.10 | 06.14 | 24.8190-0277.2 | 620277 | 1 |  |  |
|  | Cooper SD         | 105 |  | 02.11 | 06.14 |                |        |   |  |  |
|  | One               | 72  |  | 03.10 | 06.14 |                |        |   |  |  |
|  | Cooper S          |     |  | 03.10 | 06.14 | 13.0460-2725.2 | 602725 |   |  | 23984 17,8 +/WE/Zub/STRW<br>23984 17,8 +/WE/Zub/STRW<br>Warnkontakt L=802mm  |
|  | Cooper S          | 128 |  | 01.09 | 06.14 | 13.0470-2725.2 | LD2725 |   |  |  |
|  |                   |     |  |       |       | 24.8190-0277.2 | 620277 | 1 |  |  |
|  | John Cooper Works | 155 |  | 03.09 | 06.14 | 24.8190-0277.2 | 620277 | 1 |  | Warnkontakt L=802mm  |
|  | Cooper            |     |  | 01.09 | 06.14 | 24.0122-0248.1 | 422248 |   |  | 280 22,0 20,4 V L +B<br>280 22,0 20,4 V L +B PD                              |
|  | Cooper            | 90  |  | 03.10 | 06.14 | 24.0322-0248.1 | 522248 |   |  |  |
|  | Cooper D          | 82  |  | 06.10 | 06.14 |                |        |   |  |  |
|  | Cooper SD         | 105 |  | 02.11 | 06.14 |                |        |   |  |  |
|  | One               | 72  |  | 03.10 | 06.14 |                |        |   |  |  |
|  | Cooper S          |     |  | 03.10 | 06.14 | 24.0122-0247.1 | 422247 |   |  | 294 22,0 20,4 V L +B<br>294 22,0 20,4 V L +B PD                              |
|  | Cooper S          | 128 |  | 01.09 | 06.14 | 24.0322-0247.1 | 522247 |   |  |  |
|  | Cooper            |     |  | 01.09 | 08.10 | 13.0460-2714.2 | 602714 |   |  | 24289 16,9 +/WE/Zub/STRW<br>24289 16,9 +/WE/Zub/STRW<br>Warnkontakt L=1130mm |
|  | Cooper            | 90  |  | 03.10 | 08.10 | 13.0470-2714.2 | LD2714 |   |  |  |
|  | Cooper D          | 82  |  | 06.10 | 08.10 | 24.8190-0278.2 | 620278 | 1 |  |  |
|  | Cooper S          |     |  | 03.10 | 08.10 |                |        |   |  |  |
|  | Cooper S          | 128 |  | 01.09 | 08.10 |                |        |   |  |  |
|  | John Cooper Works | 155 |  | 03.09 | 08.10 |                |        |   |  |  |
|  | One               | 72  |  | 03.10 | 08.10 |                |        |   |  |  |
|  | Cooper            |     |  | 09.10 | 06.14 | 13.0460-2714.2 | 602714 |   |  | 24289 16,9 +/WE/Zub/STRW<br>24289 16,9 +/WE/Zub/STRW<br>Warnkontakt L=1141mm |
|  | Cooper            | 90  |  | 09.10 | 06.14 | 13.0470-2714.2 | LD2714 |   |  |  |
|  | Cooper D          | 82  |  | 09.10 | 06.14 | 24.8190-0010.2 | 620010 | 1 |  |  |
|  | Cooper S          |     |  | 09.10 | 06.14 |                |        |   |  |  |
|  | Cooper S          | 128 |  | 09.10 | 06.14 |                |        |   |  |  |
|  | Cooper SD         | 105 |  | 02.11 | 06.14 |                |        |   |  |  |
|  | John Cooper Works | 155 |  | 09.10 | 06.14 |                |        |   |  |  |
|  | One               | 72  |  | 09.10 | 06.14 |                |        |   |  |  |



|     |    |  |                          |  |  |  |  |  |
|--|--|--|--|--|---|--|--|--|
| <b>MINI R57 Cabrio (09-14)</b>   |  |  |  |  |   |  |  |  |
|    | Cooper<br>Cooper<br>Cooper D<br>Cooper S<br>Cooper S<br>Cooper SD<br>One   | 90<br>82<br>128<br>105<br>72   | 01.09<br>03.10<br>06.10<br>03.10<br>01.09<br>02.11<br>03.10  | 06.14<br>06.14<br>06.14<br>06.14<br>06.14<br>06.14<br>06.14                      | 24.0110-0271.1  | 410271   |  | 259 10,0 8,4 +B  |
| <b>MINI R58 Coupe (11-)</b>  |  |  |  |  |   |  |  |  |
|    | Cooper<br>Cooper SD  |  | 10.11<br>10.11   |  | 13.0460-2710.2<br>13.0470-2710.2<br>24.8190-0009.2                                | 602710<br>LD2710<br>620009   | 1  | 23915 17,6 +/WE/Zub/STRW<br>23915 17,6 +/WE/Zub/STRW<br>Warnkontakt L=808mm        |
|  | Cooper S   |  | 10.11  |  | 13.0460-2725.2<br>13.0470-2725.2<br>24.8190-0009.2                                | 602725<br>LD2725<br>620009   | 1  | 23984 17,8 +/WE/Zub/STRW<br>23984 17,8 +/WE/Zub/STRW<br>Warnkontakt L=808mm        |
|  | Cooper S JCW   | 155  | 10.11  |  | 24.8190-0009.2  | 620009   | 1  | Warnkontakt L=808mm  |
|    | Cooper<br>Cooper SD  |  | 10.11<br>10.11   |  | 24.0122-0248.1<br>24.0322-0248.1  | 422248<br>522248   |  | 280 22,0 20,4 V L +B<br>280 22,0 20,4 V L +B PD                                    |
|  | Cooper S   |  | 10.11  |  | 24.0122-0247.1<br>24.0322-0247.1  | 422247<br>522247   |  | 294 22,0 20,4 V L +B<br>294 22,0 20,4 V L +B PD                                    |
|    | Cooper<br>Cooper S<br>Cooper S JCW<br>Cooper SD  | 155  | 10.11<br>10.11<br>10.11<br>10.11   |  | 13.0460-2714.2<br>13.0470-2714.2<br>24.8190-0010.2                                | 602714<br>LD2714<br>620010   | 1  | 24289 16,9 +/WE/Zub/STRW<br>24289 16,9 +/WE/Zub/STRW<br>Warnkontakt L=1141mm       |
|    | Cooper<br>Cooper S<br>Cooper SD  |  | 10.11<br>10.11<br>10.11  |  | 24.0110-0271.1<br>24.0310-0271.1  | 410271<br>510271   |  | 259 10,0 8,4 +B<br>259 10,0 7,6 +B PD  |
| <b>MINI R59 Roadster (12-)</b>   |  |  |  |  |   |  |  |  |
|    | Cooper<br>Cooper SD  |  | 02.12<br>02.12   |  | 13.0460-2710.2<br>13.0470-2710.2<br>24.8190-0009.2                                | 602710<br>LD2710<br>620009   | 1  | 23915 17,6 +/WE/Zub/STRW<br>23915 17,6 +/WE/Zub/STRW<br>Warnkontakt L=808mm        |
|  | Cooper S   |  | 02.12  |  | 13.0460-2725.2<br>13.0470-2725.2<br>24.8190-0009.2                                | 602725<br>LD2725<br>620009   | 1  | 23984 17,8 +/WE/Zub/STRW<br>23984 17,8 +/WE/Zub/STRW<br>Warnkontakt L=808mm        |
|  | Cooper S JCW   | 155  | 02.12  |  | 24.8190-0009.2  | 620009   | 1  | Warnkontakt L=808mm  |
|   | Cooper<br>Cooper SD  |  | 02.12<br>02.12   |  | 24.0122-0248.1<br>24.0322-0248.1  | 422248<br>522248   |  | 280 22,0 20,4 V L +B<br>280 22,0 20,4 V L +B PD                                    |
|  | Cooper S   |  | 02.12  |  | 24.0122-0247.1<br>24.0322-0247.1  | 422247<br>522247   |  | 294 22,0 20,4 V L +B<br>294 22,0 20,4 V L +B PD                                    |
|  | Cooper<br>Cooper S<br>Cooper S JCW<br>Cooper SD  | 155  | 02.12<br>02.12<br>02.12<br>02.12   |  | 13.0460-2714.2<br>13.0470-2714.2<br>24.8190-0010.2                                | 602714<br>LD2714<br>620010   | 1  | 24289 16,9 +/WE/Zub/STRW<br>24289 16,9 +/WE/Zub/STRW<br>Warnkontakt L=1141mm       |
|  | Cooper<br>Cooper S<br>Cooper SD  |  | 02.12<br>02.12<br>02.12  |  | 24.0110-0271.1<br>24.0310-0271.1  | 410271<br>510271   |  | 259 10,0 8,4 +B<br>259 10,0 7,6 +B PD  |
| <b>MINI R60 Countryman (10-)</b>   |  |  |  |  |   |  |  |  |
|  | Cooper<br>Cooper All4<br>Cooper D<br>Cooper S<br>Cooper S<br>Cooper S All4<br>Cooper S JCW<br>Cooper SD<br>Cooper SD All4<br>Cooper D All4<br>One<br>One D | 90<br>90<br>82<br>147<br>147<br>160<br>105<br>82<br>72<br>66                     | 09.10<br>11.14<br>09.10<br>09.10<br>02.12<br>09.10<br>09.12<br>02.11<br>02.11<br>09.10<br>09.10<br>09.10 |  | 13.0460-2725.2<br>13.0470-2725.2<br>24.8190-0306.2                                | 602725<br>LD2725<br>620306   | 1  | 23984 17,8 +/WE/Zub/STRW<br>23984 17,8 +/WE/Zub/STRW<br>Warnkontakt L=908mm        |
|  | Cooper<br>Cooper All4<br>Cooper D<br>Cooper SD<br>Cooper SD All4<br>Cooper D All4<br>One<br>One D  | 90<br>90<br>82<br>105<br>82<br>72<br>66  | 09.10<br>11.14<br>09.10<br>02.11<br>02.11<br>09.10<br>09.10<br>09.10                                     |  | 24.0122-0271.1  | 422271   |  | 294 22,0 20,4 V L +S +B  |
|  | Cooper S<br>Cooper S<br>Cooper S All4<br>Cooper S JCW  | 147<br>147<br>160  | 09.10<br>02.12<br>09.10<br>09.12   |  | 24.0124-0240.1  | 424240   |  | 307 24,0 22,4 V L +S +B  |
|  | Cooper<br>Cooper All4<br>Cooper D<br>Cooper S<br>Cooper S<br>Cooper S All4<br>Cooper S JCW<br>Cooper SD<br>Cooper SD All4<br>Cooper D All4<br>One<br>One D | 90<br>90<br>82<br>147<br>147<br>160<br>105<br>82<br>72<br>66                     | 09.10<br>11.14<br>09.10<br>09.10<br>02.12<br>09.10<br>09.12<br>02.11<br>02.11<br>09.10<br>09.10<br>09.10 |  | 13.0460-2713.2<br>13.0470-2713.2<br>24.8190-0307.2                                | 602713<br>LD2713<br>620307   | 1  | 23623 17,4 +/WE/Zub/STRW<br>23623 17,4 +/WE/Zub/STRW<br>Warnkontakt L=957mm        |
| ↓  | ↓  |  |  |  |   |  |  |  |

|     |  |  |  |  |  |  |     |  |
|--|--|--|--|--|---|--|---|--|
| <b>MINI R60 Countryman (10-)</b>   |  |  |  |  |   |  |   |  |
|    | Cooper   | 90   | 09.10  |  | 24.0110-0358.1  | 410358   |   | 280 10,0 8,4 +S +B   |
|  | Cooper All4  | 90   | 11.14  |  |   |  |   |  |
|  | Cooper D   | 82   | 09.10  |  |   |  |   |  |
|  | Cooper S   |  | 09.10  |  |   |  |   |  |
|  | Cooper S   | 147  | 02.12  |  |   |  |   |  |
|  | Cooper S All4  |  | 09.10  |  |   |  |   |  |
|  | Cooper SD  | 105  | 02.11  |  |   |  |   |  |
|  | Cooper SD All4   |  | 02.11  |  |   |  |   |  |
|  | Cooper D All4  | 82   | 09.10  |  |   |  |   |  |
|  | One  | 72   | 09.10  |  |   |  |   |  |
|  | One D  | 66   | 09.10  |  |   |  |   |  |
| <b>MINI R61 Paceman (12-)</b>  |  |  |  |  |   |  |   |  |
|    | Cooper   | 90   | 11.12  |  | 13.0460-2725.2  | 602725   |   | 23984 17,8 +/WE/Zub/STRW   |
|  | Cooper All4  | 90   | 07.14  |  | 13.0470-2725.2  | LD2725   |   | 23984 17,8 +/WE/Zub/STRW   |
|  | Cooper D   | 82   | 11.12  |  | 24.8190-0306.2  | 620306   | 1   | Warnkontakt L=908mm  |
|  | Cooper D All4  | 82   | 11.12  |  |   |  |   |  |
|  | Cooper S   | 135  | 11.12  |  |   |  |   |  |
|  | Cooper S All4  | 135  | 11.12  |  |   |  |   |  |
|  | Cooper S JCW   | 160  | 11.12  |  |   |  |   |  |
|  | Cooper SD  | 105  | 11.12  |  |   |  |   |  |
|  | Cooper SD All4   | 105  | 11.12  |  |   |  |   |  |
|    | Cooper   | 90   | 11.12  |  | 24.0122-0271.1  | 422271   |   | 294 22,0 20,4 V L +S +B  |
|  | Cooper All4  | 90   | 07.14  |  |   |  |   |  |
|  | Cooper D   | 82   | 11.12  |  |   |  |   |  |
|  | Cooper D All4  | 82   | 11.12  |  |   |  |   |  |
|  | Cooper SD  | 105  | 11.12  |  |   |  |   |  |
|  | Cooper SD All4   | 105  | 11.12  |  |   |  |   |  |
|  | Cooper S   | 135  | 11.12  |  | 24.0124-0240.1  | 424240   |   | 307 24,0 22,4 V L +S +B  |
|  | Cooper S All4  | 135  | 11.12  |  |   |  |   |  |
|  | Cooper S JCW   | 160  | 11.12  |  |   |  |   |  |
|    | Cooper   | 90   | 11.12  |  | 13.0460-2713.2  | 602713   |   | 23623 17,4 +/WE/Zub/STRW   |
|  | Cooper All4  | 90   | 07.14  |  | 13.0470-2713.2  | LD2713   |   | 23623 17,4 +/WE/Zub/STRW   |
|  | Cooper D   | 82   | 11.12  |  | 24.8190-0307.2  | 620307   | 2   | Warnkontakt L=957mm  |
|  | Cooper D All4  | 82   | 11.12  |  |   |  |   |  |
|  | Cooper S   | 135  | 11.12  |  |   |  |   |  |
|  | Cooper S All4  | 135  | 11.12  |  |   |  |   |  |
|  | Cooper S JCW   | 160  | 11.12  |  |   |  |   |  |
|  | Cooper SD  | 105  | 11.12  |  |   |  |   |  |
|  | Cooper SD All4   | 105  | 11.12  |  |   |  |   |  |
|  | Cooper   | 90   | 11.12  |  | 24.0110-0358.1  | 410358   |   | 280 10,0 8,4 +S +B   |
|  | Cooper All4  | 90   | 07.14  |  |   |  |   |  |
|  | Cooper D   | 82   | 11.12  |  |   |  |   |  |
|  | Cooper D All4  | 82   | 11.12  |  |   |  |   |  |
|  | Cooper S   | 135  | 11.12  |  |   |  |   |  |
|  | Cooper S All4  | 135  | 11.12  |  |   |  |   |  |
|  | Cooper SD  | 105  | 11.12  |  |   |  |   |  |
|  | Cooper SD All4   | 105  | 11.12  |  |   |  |   |  |
| <b>MITSUBISHI ASX (10-)</b>  |  |  |  |  |   |  |   |  |
|  | 1.6 DI-D   | 84   | 07.15  |  | 13.0460-5760.2  | 605760   |   | 23584 16,4 /WK AKE   |
|  | 1.6 DI-D 4WD   | 84   | 07.15  |  |   |  |   |  |
|  | 1.6 i 16V  | 85   | 06.10  |  |   |  |   |  |
|  | 1.6 i 16V  | 86   | 06.10  |  |   |  |   |  |
|  | 1.8 DI-D   | 85   | 06.10  |  |   |  |   |  |
|  | 1.8 DI-D   | 110  | 06.10  |  |   |  |   |  |
|  | 1.8 DI-D 4WD   | 85   | 06.10  |  |   |  |   |  |
|  | 1.8 DI-D 4WD   | 110  | 06.10  |  |   |  |   |  |
|  | 1.8 i 16V  | 102  | 02.10  |  |   |  |   |  |
|  | 1.8 i 16V 4WD  | 102  | 02.10  |  |   |  |   |  |
|  | 2.0 i 16V  | 110  | 06.10  |  |   |  |   |  |
|  | 2.0 i 16V  | 118  | 06.10  |  |   |  |   |  |
|  | 2.0 i 16V 4WD  | 110  | 06.10  |  |   |  |   |  |
|  | 2.0 i 16V 4WD  | 118  | 06.10  |  |   |  |   |  |
|  | 2.2 Di-D 4WD   | 110  | 04.13  |  |   |  |   |  |
|  | 1.6 i 16V  | 85   | 06.10  |  | 24.0126-0170.1  | 426170   |   | 294 26,0 24,4 V +B   |
|  | 1.6 i 16V  | 86   | 06.10  |  |   |  |   |  |
|  | 1.8 DI-D   | 85   | 06.10  |  |   |  |   |  |
|  | 1.8 DI-D   | 110  | 06.10  |  |   |  |   |  |
|  | 1.8 DI-D 4WD   | 85   | 06.10  |  |   |  |   |  |
|  | 1.8 DI-D 4WD   | 110  | 06.10  |  |   |  |   |  |
|  | 1.8 i 16V  | 102  | 02.10  |  |   |  |   |  |
|  | 1.8 i 16V 4WD  | 102  | 02.10  |  |   |  |   |  |
|  | 2.0 i 16V  | 110  | 06.10  |  |   |  |   |  |
|  | 2.0 i 16V  | 118  | 06.10  |  |   |  |   |  |
|  | 2.0 i 16V 4WD  | 110  | 06.10  |  |   |  |   |  |
|  | 2.0 i 16V 4WD  | 118  | 06.10  |  |   |  |   |  |
|  | 1.6 DI-D   | 84   | 07.15  |  | 24.0710-5005.4  | 360337   |  | Radsensor L=920  |
|  | 1.6 DI-D 4WD   | 84   | 07.15  |  | 24.0710-5006.4  | 360338   |  | Radsensor L=936  |
|  | 1.6 i 16V  | 85   | 06.10  |  |   |  |   |  |
|  | 1.6 i 16V  | 86   | 06.10  |  |   |  |   |  |
|  | 1.8 DI-D   | 85   | 06.10  |  |   |  |   |  |
|  | 1.8 DI-D   | 110  | 06.10  |  |   |  |   |  |
|  | 1.8 DI-D 4WD   | 85   | 06.10  |  |   |  |   |  |
|  | 1.8 DI-D 4WD   | 110  | 06.10  |  |   |  |   |  |
|  | 1.8 i 16V  | 102  | 02.10  |  |   |  |   |  |
|  | 1.8 i 16V 4WD  | 102  | 02.10  |  |   |  |   |  |



### MITSUBISHI ASX (10-)

|               |               |       |       |       |                |        |  |  |                 |
|---------------|---------------|-------|-------|-------|----------------|--------|--|--|-----------------|
|               | 2.0 i 16V     | 110   | 06.10 |       | 24.0710-5005.4 | 360337 |  |  | Radsensor L=920 |
|               | 2.0 i 16V     | 118   | 06.10 |       | 24.0710-5006.4 | 360338 |  |  | Radsensor L=936 |
|               | 2.0 i 16V 4WD | 110   | 06.10 |       |                |        |  |  |                 |
|               | 2.0 i 16V 4WD | 118   | 06.10 |       |                |        |  |  |                 |
|               | 2.2 Di-D 4WD  | 110   | 04.13 |       |                |        |  |  |                 |
|               | 1.6 i 16V     | 85    | 06.10 | 06.12 | 13.0460-5855.2 | 605855 |  |  | 23582 16,0 +    |
|               | 1.6 i 16V     | 86    | 06.10 | 06.12 |                |        |  |  |                 |
|               | 1.8 DI-D      | 85    | 06.10 | 06.12 |                |        |  |  |                 |
|               | 1.8 DI-D      | 110   | 06.10 | 06.12 |                |        |  |  |                 |
|               | 1.8 DI-D 4WD  | 85    | 06.10 | 06.12 |                |        |  |  |                 |
|               | 1.8 DI-D 4WD  | 110   | 06.10 | 06.12 |                |        |  |  |                 |
|               | 1.8 i 16V     | 102   | 02.10 | 06.12 |                |        |  |  |                 |
|               | 1.8 i 16V 4WD | 102   | 02.10 | 06.12 |                |        |  |  |                 |
|               | 2.0 i 16V     | 110   | 06.10 | 06.12 |                |        |  |  |                 |
|               | 2.0 i 16V     | 118   | 06.10 | 06.12 |                |        |  |  |                 |
|               | 2.0 i 16V 4WD | 110   | 06.10 | 06.12 |                |        |  |  |                 |
| 2.0 i 16V 4WD | 118           | 06.10 | 06.12 |       |                |        |  |  |                 |
|               | 1.6 i 16V     | 85    | 06.10 | 06.12 | 24.0110-0360.1 | 410360 |  |  | 302 10,0 8,4 +B |
|               | 1.6 i 16V     | 86    | 06.10 | 06.12 |                |        |  |  |                 |
|               | 1.8 DI-D      | 85    | 06.10 | 06.12 |                |        |  |  |                 |
|               | 1.8 DI-D      | 110   | 06.10 | 06.12 |                |        |  |  |                 |
|               | 1.8 DI-D 4WD  | 85    | 06.10 | 06.12 |                |        |  |  |                 |
|               | 1.8 DI-D 4WD  | 110   | 06.10 | 06.12 |                |        |  |  |                 |
|               | 1.8 i 16V     | 102   | 02.10 | 06.12 |                |        |  |  |                 |
|               | 1.8 i 16V 4WD | 102   | 02.10 | 06.12 |                |        |  |  |                 |
|               | 2.0 i 16V     | 110   | 06.10 | 06.12 |                |        |  |  |                 |
|               | 2.0 i 16V     | 118   | 06.10 | 06.12 |                |        |  |  |                 |
|               | 2.0 i 16V 4WD | 110   | 06.10 | 06.12 |                |        |  |  |                 |
| 2.0 i 16V 4WD | 118           | 06.10 | 06.12 |       |                |        |  |  |                 |
|               | 1.6 i 16V     | 85    | 06.10 |       | 03.0137-3023.2 | 653023 |  |  | 170 x 32        |
|               | 1.6 i 16V     | 86    | 06.10 |       |                |        |  |  |                 |
|               | 1.8 DI-D      | 85    | 06.10 |       |                |        |  |  |                 |
|               | 1.8 DI-D      | 110   | 06.10 |       |                |        |  |  |                 |
|               | 1.8 DI-D 4WD  | 85    | 06.10 |       |                |        |  |  |                 |
|               | 1.8 DI-D 4WD  | 110   | 06.10 |       |                |        |  |  |                 |
|               | 1.8 i 16V     | 102   | 02.10 |       |                |        |  |  |                 |
|               | 1.8 i 16V 4WD | 102   | 02.10 |       |                |        |  |  |                 |
|               | 2.0 i 16V     | 110   | 06.10 |       |                |        |  |  |                 |
|               | 2.0 i 16V     | 118   | 06.10 |       |                |        |  |  |                 |
|               | 2.0 i 16V 4WD | 110   | 06.10 |       |                |        |  |  |                 |
| 2.0 i 16V 4WD | 118           | 06.10 |       |       |                |        |  |  |                 |
| 2.2 Di-D 4WD  | 110           | 04.13 |       |       |                |        |  |  |                 |

### MITSUBISHI CARISMA (95-06)

|                      |                      |       |       |       |                |        |  |  |                      |     |
|----------------------|----------------------|-------|-------|-------|----------------|--------|--|--|----------------------|-----|
|                      | 1.6 i (DA1A)         | 66    | 07.95 | 02.99 | 13.0460-5987.2 | 605987 |  |  | 23080 15,0           | TRW |
|                      | 1.6 i 16V (DA1A)     | 70    | 12.98 | 06.06 |                |        |  |  |                      |     |
|                      | 1.6 i 16V (DA1A)     | 73    | 05.97 | 06.06 |                |        |  |  |                      |     |
|                      | 1.9 TD (DA4A)        | 66    | 10.96 | 02.99 |                |        |  |  |                      |     |
|                      | 1.6 i (DA1A)         | 66    | 03.99 | 06.00 |                |        |  |  |                      |     |
|                      | 1.6 i 16V (DA1A)     | 76    | 06.99 | 08.00 | 13.0460-2830.2 | 602830 |  |  | 21920 14,6 /WK/Zub/S | TRW |
|                      | 1.8 i (DA2A)         | 85    | 07.95 | 06.98 |                |        |  |  |                      |     |
|                      | 1.8 i 16V (DA2A)     | 103   | 07.95 | 06.98 |                |        |  |  |                      |     |
|                      | 1.8 i 16V GDI (DA2A) | 92    | 09.97 | 08.00 |                |        |  |  |                      |     |
|                      | 1.9 TD (DA4A)        | 66    | 03.99 | 09.00 |                |        |  |  |                      |     |
|                      | 1.3 i (DA6A)         | 55    | 09.00 | 10.04 |                |        |  |  |                      |     |
|                      | 1.6 i (DA1A)         | 66    | 07.00 | 06.06 |                |        |  |  |                      |     |
|                      | 1.6 i 16V (DA1A)     | 76    | 09.00 | 06.06 |                |        |  |  |                      |     |
|                      | 1.8 i (DA2A)         | 85    | 07.98 | 06.06 |                |        |  |  |                      |     |
|                      | 1.8 i 16V (DA2A)     | 103   | 07.98 | 06.06 |                |        |  |  |                      |     |
|                      | 1.8 i 16V GDI (DA2A) | 90    | 10.00 | 06.06 | 24.0118-0120.1 | 418120 |  |  | 236 18,0 16,4 V +B   |     |
|                      | 1.8 i 16V GDI (DA2A) | 92    | 09.00 | 06.06 |                |        |  |  |                      |     |
|                      | 1.9 DI-D (DA5A)      | 75    | 09.00 | 06.06 |                |        |  |  |                      |     |
|                      | 1.9 DI-D (DA5A)      | 85    | 09.00 | 06.06 |                |        |  |  |                      |     |
|                      | 1.6 i (DA1A)         | 66    | 07.95 | 02.99 |                |        |  |  |                      |     |
|                      | 1.6 i 16V (DA1A)     | 70    | 12.98 | 06.06 |                |        |  |  |                      |     |
|                      | 1.6 i 16V (DA1A)     | 73    | 05.97 | 06.06 |                |        |  |  |                      |     |
|                      | 1.9 TD (DA4A)        | 66    | 10.96 | 02.99 |                |        |  |  |                      |     |
|                      | 1.6 i (DA1A)         | 66    | 03.99 | 06.00 |                |        |  |  |                      |     |
|                      | 1.6 i 16V (DA1A)     | 76    | 06.99 | 08.00 |                |        |  |  |                      |     |
|                      | 1.8 i (DA2A)         | 85    | 07.95 | 02.99 |                |        |  |  |                      |     |
|                      | 1.8 i 16V (DA2A)     | 103   | 07.95 | 02.99 |                |        |  |  |                      |     |
|                      | 1.8 i 16V GDI (DA2A) | 92    | 09.97 | 08.00 |                |        |  |  |                      |     |
|                      | 1.9 TD (DA4A)        | 66    | 03.99 | 09.00 |                |        |  |  |                      |     |
|                      | 1.3 i (DA6A)         | 55    | 09.00 | 10.04 |                |        |  |  |                      |     |
| 1.6 i (DA1A)         | 66                   | 07.00 | 06.06 |       |                |        |  |  |                      |     |
| 1.6 i 16V (DA1A)     | 76                   | 09.00 | 06.06 |       |                |        |  |  |                      |     |
| 1.8 i (DA2A)         | 85                   | 03.99 | 06.06 |       |                |        |  |  |                      |     |
| 1.8 i 16V (DA2A)     | 103                  | 03.99 | 06.06 |       |                |        |  |  |                      |     |
| 1.8 i 16V GDI (DA2A) | 90                   | 10.00 | 06.06 |       |                |        |  |  |                      |     |
| 1.8 i 16V GDI (DA2A) | 92                   | 09.00 | 06.06 |       |                |        |  |  |                      |     |
| 1.9 DI-D (DA5A)      | 75                   | 09.00 | 06.06 |       |                |        |  |  |                      |     |
| 1.9 DI-D (DA5A)      | 85                   | 09.00 | 06.06 |       |                |        |  |  |                      |     |



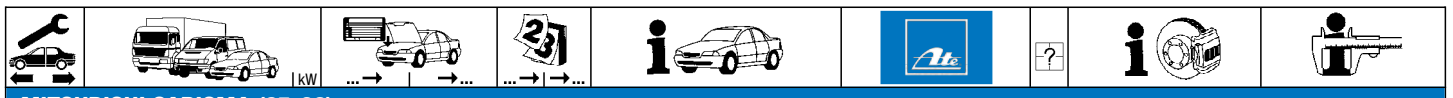

### MITSUBISHI CARISMA (95-06)

|                      |                      |     |       |       |       |       |                |        |  |                                     |     |                 |  |
|----------------------|----------------------|-----|-------|-------|-------|-------|----------------|--------|--|-------------------------------------|-----|-----------------|--|
|                      | 1.6 i (DA1A)         | 66  |       | 07.95 | 05.99 | + ABS | 13.0460-5826.2 | 605826 |  | 21872 14,5 +WK<br>Belagsatz-Zubehör | AKE |                 |  |
|                      | 1.6 i 16V (DA1A)     | 70  |       | 12.98 | 06.06 | + ABS | 13.0460-0116.2 | 610116 |  |                                     |     |                 |  |
|                      | 1.6 i 16V (DA1A)     | 73  |       | 05.97 | 06.06 | + ABS |                |        |  |                                     |     |                 |  |
|                      | 1.6 i 16V (DA1A)     | 76  |       | 06.99 | 08.00 | + ABS |                |        |  |                                     |     |                 |  |
|                      | 1.8 i (DA2A)         | 85  |       | 07.95 | 10.97 | + ABS |                |        |  |                                     |     |                 |  |
|                      | 1.8 i 16V (DA2A)     | 103 |       | 07.95 | 10.97 | + ABS |                |        |  |                                     |     |                 |  |
|                      | 1.8 i 16V GDI (DA2A) | 92  |       | 08.97 | 05.99 | + ABS |                |        |  |                                     |     |                 |  |
|                      | 1.9 TD (DA4A)        | 66  |       | 10.96 | 09.00 | + ABS |                |        |  |                                     |     |                 |  |
|                      |                      |     |       |       |       |       |                |        |  |                                     |     |                 |  |
|                      | 1.3 i (DA6A)         | 55  |       | 09.00 | 10.04 |       | 13.0460-2831.2 | 602831 |  | 21861 15,2 /WK/S                    | TRW |                 |  |
|                      | 1.6 i (DA1A)         | 66  |       | 06.99 | 06.06 | + ABS |                |        |  |                                     |     |                 |  |
|                      | 1.6 i 16V (DA1A)     | 76  |       | 09.00 | 06.06 | + ABS |                |        |  |                                     |     |                 |  |
|                      | 1.8 i (DA2A)         | 85  |       | 11.97 | 06.06 | + ABS |                |        |  |                                     |     |                 |  |
|                      | 1.8 i 16V (DA2A)     | 103 |       | 11.97 | 06.06 | + ABS |                |        |  |                                     |     |                 |  |
|                      | 1.8 i 16V GDI (DA2A) | 90  |       | 10.00 | 06.06 | + ABS |                |        |  |                                     |     |                 |  |
|                      | 1.8 i 16V GDI (DA2A) | 92  |       | 06.99 | 06.06 | + ABS |                |        |  |                                     |     |                 |  |
|                      | 1.9 DI-D (DA5A)      | 75  |       | 09.00 | 06.06 |       |                |        |  |                                     |     |                 |  |
|                      | 1.9 DI-D (DA5A)      | 85  |       | 09.00 | 06.06 |       |                |        |  |                                     |     |                 |  |
|                      |                      |     |       |       |       |       |                |        |  |                                     |     |                 |  |
|                      | 1.6 i (DA1A)         | 66  |       | 07.95 | 05.99 | + ABS | 24.0110-0266.1 | 410266 |  | 236 10,0 8,4                        |     |                 |  |
|                      | 1.6 i 16V (DA1A)     | 70  |       | 12.98 | 06.06 | + ABS |                |        |  |                                     |     |                 |  |
|                      | 1.6 i 16V (DA1A)     | 73  |       | 05.97 | 06.06 | + ABS |                |        |  |                                     |     |                 |  |
|                      | 1.6 i 16V (DA1A)     | 76  |       | 06.99 | 08.00 | + ABS |                |        |  |                                     |     |                 |  |
|                      | 1.9 TD (DA4A)        | 66  |       | 10.96 | 09.00 | + ABS |                |        |  |                                     |     |                 |  |
|                      |                      |     |       |       |       |       |                |        |  |                                     |     |                 |  |
|                      | 1.3 i (DA6A)         | 55  |       | 09.00 | 10.04 |       | 24.0110-0229.1 | 410229 |  |                                     |     | 260 10,0 8,4 +B |  |
|                      | 1.6 i (DA1A)         | 66  |       | 06.99 | 06.06 | + ABS |                |        |  |                                     |     |                 |  |
|                      | 1.6 i 16V (DA1A)     | 76  |       | 09.00 | 06.06 | + ABS |                |        |  |                                     |     |                 |  |
| 1.8 i (DA2A)         | 85                   |     | 07.95 | 06.06 | + ABS |       |                |        |  |                                     |     |                 |  |
| 1.8 i 16V (DA2A)     | 103                  |     | 07.95 | 06.06 | + ABS |       |                |        |  |                                     |     |                 |  |
| 1.8 i 16V GDI (DA2A) | 90                   |     | 10.00 | 06.06 | + ABS |       |                |        |  |                                     |     |                 |  |
| 1.8 i 16V GDI (DA2A) | 92                   |     | 08.97 | 06.06 | + ABS |       |                |        |  |                                     |     |                 |  |
| 1.9 DI-D (DA5A)      | 75                   |     | 09.00 | 06.06 |       |       |                |        |  |                                     |     |                 |  |
| 1.9 DI-D (DA5A)      | 85                   |     | 09.00 | 06.06 |       |       |                |        |  |                                     |     |                 |  |
|                      |                      |     |       |       |       |       |                |        |  |                                     |     |                 |  |
|                      | 1.6 i (DA1A)         | 66  |       | 07.95 | 06.06 | - ABS | 03.0137-0289.2 | 650289 |  | 203 x 37<br>Bremsbacken-Zubehör     |     |                 |  |
|                      | 1.6 i 16V (DA1A)     | 70  |       | 12.98 | 06.06 | - ABS | 03.0137-9192.2 | 669192 |  |                                     |     |                 |  |
|                      | 1.6 i 16V (DA1A)     | 73  |       | 05.97 | 06.06 | - ABS |                |        |  |                                     |     |                 |  |
|                      | 1.8 i (DA2A)         | 85  |       | 07.95 | 06.06 | - ABS |                |        |  |                                     |     |                 |  |
|                      | 1.8 i 16V (DA2A)     | 103 |       | 07.95 | 06.06 | - ABS |                |        |  |                                     |     |                 |  |
|                      | 1.8 i 16V GDI (DA2A) | 90  |       | 10.00 | 06.06 | - ABS |                |        |  |                                     |     |                 |  |
|                      | 1.8 i 16V GDI (DA2A) | 92  |       | 09.97 | 06.06 | - ABS |                |        |  |                                     |     |                 |  |
|                      | 1.9 TD (DA4A)        | 66  |       | 10.96 | 09.00 | - ABS |                |        |  |                                     |     |                 |  |
|                      |                      |     |       |       |       |       |                |        |  |                                     |     |                 |  |
|                      | 1.6 i 16V (DA1A)     | 76  |       | 06.99 | 06.06 | - ABS | 03.0137-0428.2 | 650428 |  | 203 x 39 HEB                        |     |                 |  |
|                      | 1.6 i (DA1A)         | 66  |       | 07.95 | 06.06 | - ABS | 24.0220-3017.1 | 480108 |  | 203/205 x 42,0                      |     |                 |  |
|                      | 1.6 i 16V (DA1A)     | 70  |       | 12.98 | 06.06 | - ABS |                |        |  |                                     |     |                 |  |
|                      | 1.6 i 16V (DA1A)     | 73  |       | 05.97 | 06.06 | - ABS |                |        |  |                                     |     |                 |  |
|                      | 1.9 TD (DA4A)        | 66  |       | 10.96 | 02.99 | - ABS |                |        |  |                                     |     |                 |  |
|                      |                      |     |       |       |       |       |                |        |  |                                     |     |                 |  |
|                      | 1.6 i 16V (DA1A)     | 76  |       | 06.99 | 06.06 | - ABS | 24.0220-3028.1 | 480169 |  |                                     |     | 203/205 x 41,   |  |
|                      | 1.8 i (DA2A)         | 85  |       | 07.95 | 06.06 | - ABS |                |        |  |                                     |     |                 |  |
|                      | 1.8 i 16V (DA2A)     | 103 |       | 07.95 | 06.06 | - ABS |                |        |  |                                     |     |                 |  |
|                      | 1.8 i 16V GDI (DA2A) | 90  |       | 10.00 | 06.06 | - ABS |                |        |  |                                     |     |                 |  |
| 1.8 i 16V GDI (DA2A) | 92                   |     | 09.97 | 06.06 | - ABS |       |                |        |  |                                     |     |                 |  |
| 1.9 TD (DA4A)        | 66                   |     | 03.99 | 09.00 | - ABS |       |                |        |  |                                     |     |                 |  |

### MITSUBISHI COLT/LANCER Limousine (96-03)

|  |                  |    |  |       |       |  |                |        |       |                                     |            |
|--|------------------|----|--|-------|-------|--|----------------|--------|-------|-------------------------------------|------------|
|  | 1.3 i 12V (CJ1A) | 55 |  | 05.96 | 08.00 |  | 13.0460-5889.2 | 605889 |       | 21650 15,0 /WK<br>Belagsatz-Zubehör | SUM<br>SUM |
|  | 1.3 i 12V (CK1A) | 55 |  | 05.96 | 07.01 |  | 13.0460-0233.2 | 610233 |       |                                     |            |
|  | 1.3 i 16V (CJ1A) | 60 |  | 09.00 | 06.03 |  |                |        |       |                                     |            |
|  | 1.6 i 16V (CJ4A) | 66 |  | 05.96 | 08.00 |  |                |        |       |                                     |            |
|  | 1.6 i 16V (CJ4A) | 76 |  | 09.00 | 06.03 |  |                |        |       |                                     |            |
|  | 1.6 i 16V (CK4A) | 66 |  | 05.96 | 07.01 |  |                |        |       |                                     |            |
|  | 1.3 i 12V (CJ1A) | 55 |  | 05.96 | 08.00 |  | 24.0118-0120.1 | 418120 |       | 236 18,0 16,4 V +B                  |            |
|  | 1.3 i 12V (CK1A) | 55 |  | 05.96 | 07.01 |  |                |        |       |                                     |            |
|  | 1.3 i 16V (CJ1A) | 60 |  | 09.00 | 06.03 |  |                |        |       |                                     |            |
|  | 1.6 i 16V (CJ4A) | 66 |  | 05.96 | 08.00 |  |                |        |       |                                     |            |
|  | 1.6 i 16V (CJ4A) | 76 |  | 09.00 | 06.03 |  |                |        |       |                                     |            |
|  | 1.6 i 16V (CK4A) | 66 |  | 05.96 | 07.01 |  |                |        |       |                                     |            |
|  | 1.3 i 12V (CJ1A) | 55 |  | 05.96 | 08.00 |  | 03.0137-0255.2 | 650255 | - ABS | 180 x 37<br>Bremsbacken-Zubehör     |            |
|  | 1.3 i 12V (CK1A) | 55 |  | 05.96 | 07.01 |  | 03.0137-9155.2 | 669155 | - ABS |                                     |            |
|  | 1.3 i 16V (CJ1A) | 60 |  | 09.00 | 06.03 |  |                |        |       |                                     |            |
|  | 1.6 i 16V (CJ4A) | 66 |  | 05.96 | 08.00 |  |                |        |       |                                     |            |
|  | 1.6 i 16V (CJ4A) | 76 |  | 09.00 | 06.03 |  |                |        |       |                                     |            |
|  | 1.6 i 16V (CK4A) | 66 |  | 05.96 | 07.01 |  |                |        |       |                                     |            |
|  | 1.3 i 12V (CJ1A) | 55 |  | 05.96 | 08.00 |  | 03.0137-0289.2 | 650289 | + ABS | 203 x 37<br>Bremsbacken-Zubehör     |            |
|  | 1.3 i 12V (CK1A) | 55 |  | 05.96 | 07.01 |  | 03.0137-9192.2 | 669192 | + ABS |                                     |            |
|  | 1.3 i 16V (CJ1A) | 60 |  | 09.00 | 06.03 |  |                |        |       |                                     |            |
|  | 1.6 i 16V (CJ4A) | 66 |  | 05.96 | 08.00 |  |                |        |       |                                     |            |
|  | 1.6 i 16V (CJ4A) | 76 |  | 09.00 | 06.03 |  |                |        |       |                                     |            |
|  | 1.6 i 16V (CK4A) | 66 |  | 05.96 | 07.01 |  |                |        |       |                                     |            |
|  | 1.3 i 12V (CJ1A) | 55 |  | 05.96 | 08.00 |  | 24.0220-3017.1 | 480108 | + ABS | 203/205 x 42,0                      |            |
|  | 1.3 i 12V (CK1A) | 55 |  | 05.96 | 07.01 |  |                |        |       |                                     |            |
|  | 1.3 i 16V (CJ1A) | 60 |  | 09.00 | 06.03 |  |                |        |       |                                     |            |
|  | 1.6 i 16V (CJ4A) | 66 |  | 05.96 | 08.00 |  |                |        |       |                                     |            |
|  | 1.6 i 16V (CJ4A) | 76 |  | 09.00 | 06.03 |  |                |        |       |                                     |            |
|  | 1.6 i 16V (CK4A) | 66 |  | 05.96 | 07.01 |  |                |        |       |                                     |            |





### MITSUBISHI COLT (04-12)

|  |   |  |  |   |   |                          |  |                      |     |
|--|---|--|--|---|---|--------------------------|--|----------------------|-----|
|  | 1.1 Bifuel<br>1.1 i 12V (Z32A)<br>1.3 Bifuel<br>1.3 i 16V<br>1.3 i 16V (Z34A)<br>1.5 DI-D (Z38A)<br>1.5 DI-D (Z39A)<br>1.5 i 16V (Z27A)<br>1.5 i 16V (Z36A)                                       | 55<br>55<br>70<br>68<br>70<br>50<br>70<br>72<br>80               |  | 10.04<br>10.04<br>06.04<br>10.04<br>06.04<br>08.04<br>08.04<br>09.04<br>06.04                   | 06.12<br>06.12<br>06.12<br>06.12<br>06.12<br>06.12<br>06.12<br>02.06<br>06.12                   | 13.0460-2896.2<br>602896 |  | 21920 16,6 /WK/Zub/S | TRW |
|  | 1.1 Bifuel<br>1.1 i 12V (Z32A)<br>1.3 Bifuel<br>1.3 i 16V<br>1.3 i 16V (Z34A)<br>1.5 DI-D (Z38A)<br>1.5 DI-D (Z39A)<br>1.5 i 16V (Z27A)<br>1.5 i 16V (Z36A)                                       | 55<br>55<br>70<br>68<br>70<br>50<br>70<br>72<br>80               |  | 10.04<br>10.04<br>06.04<br>10.04<br>06.04<br>08.04<br>08.04<br>09.04<br>06.04                   | 06.12<br>06.12<br>06.12<br>06.12<br>06.12<br>06.12<br>06.12<br>02.06<br>06.12                   | 24.0124-0192.1<br>424192 |  | 256 24,0 21,5 V +B   |     |
|  | 1.1 Bifuel<br>1.1 i 12V (Z32A)  | 55<br>55   |  | 10.04<br>10.04  | 06.12<br>06.12  | 13.0460-2831.2<br>602831 |  | 21861 15,2 /WK/S     | TRW |
|  | 1.3 Bifuel<br>1.3 i 16V<br>1.3 i 16V (Z34A)<br>1.5 CZT (Z37A)<br>1.5 DI-D (Z38A)<br>1.5 DI-D (Z39A)<br>1.5 i 16V (Z27A)<br>1.5 i 16V (Z36A)<br>1.5 i 16V (Z37A)                                   | 70<br>68<br>70<br>110<br>50<br>70<br>72<br>80<br>132             |  | 06.04<br>10.04<br>06.04<br>03.05<br>08.04<br>08.04<br>09.04<br>06.04<br>05.07                   | 06.12<br>06.12<br>06.12<br>06.12<br>06.12<br>06.12<br>02.06<br>06.12<br>06.12                   | 13.0460-2897.2<br>602897 |  | 21861 15,2 /WK/S     | TRW |
|  | 1.1 Bifuel<br>1.1 i 12V (Z32A)<br>1.3 Bifuel<br>1.3 i 16V<br>1.3 i 16V (Z34A)<br>1.5 CZT (Z37A)<br>1.5 DI-D (Z38A)<br>1.5 DI-D (Z39A)<br>1.5 i 16V (Z27A)<br>1.5 i 16V (Z36A)<br>1.5 i 16V (Z37A) | 55<br>55<br>70<br>68<br>70<br>110<br>50<br>70<br>72<br>80<br>132 |  | 10.04<br>10.04<br>06.04<br>10.04<br>06.04<br>03.05<br>08.04<br>08.04<br>09.04<br>06.04<br>05.07 | 06.12<br>06.12<br>06.12<br>06.12<br>06.12<br>06.12<br>06.12<br>06.12<br>02.06<br>06.12<br>06.12 | 24.0110-0304.1<br>410304 |  | 250 10,0 8,0 +B      |     |
|  | 1.1 Bifuel<br>1.1 i 12V (Z32A)<br>1.3 Bifuel<br>1.3 i 16V<br>1.3 i 16V (Z34A)<br>1.5 DI-D (Z38A)<br>1.5 DI-D (Z39A)   | 55<br>55<br>70<br>68<br>70<br>50<br>70                           |  | 10.04<br>10.04<br>06.04<br>10.04<br>06.04<br>08.04<br>08.04                                     | 06.12<br>06.12<br>06.12<br>06.12<br>06.12<br>06.12<br>06.12                                     | 03.0137-0477.2<br>650477 |  | 203 x 38 HEB         |     |
|  | 1.1 Bifuel<br>1.1 i 12V (Z32A)<br>1.3 Bifuel<br>1.3 i 16V<br>1.3 i 16V (Z34A)<br>1.5 DI-D (Z38A)<br>1.5 DI-D (Z39A)   | 55<br>55<br>70<br>68<br>70<br>50<br>70                           |  | 10.04<br>10.04<br>06.04<br>10.04<br>06.04<br>08.04<br>08.04                                     | 06.12<br>06.12<br>06.12<br>06.12<br>06.12<br>06.12<br>06.12                                     | 03.0520-7319.3<br>697319 |  | 19,05/203x38 TopKit  |     |

### MITSUBISHI COLT CZC Cabriolet (06-09)

|  |                                    |           |  |                |                |                          |  |                      |     |
|--|------------------------------------|-----------|--|----------------|----------------|--------------------------|--|----------------------|-----|
|  | 1.5 16V (Z36A)                     | 80        |  | 05.06          | 07.09          | 13.0460-2896.2<br>602896 |  | 21920 16,6 /WK/Zub/S | TRW |
|  | 1.5 16V (Z36A)                     | 80        |  | 05.06          | 07.09          | 24.0124-0192.1<br>424192 |  | 256 24,0 21,5 V +B   |     |
|  | 1.5 16V (Z36A)<br>1.5 Turbo (Z37A) | 80<br>110 |  | 05.06<br>05.06 | 07.09<br>07.09 | 13.0460-2831.2<br>602831 |  | 21861 15,2 /WK/S     | TRW |
|  | 1.5 16V (Z36A)<br>1.5 Turbo (Z37A) | 80<br>110 |  | 05.06<br>05.06 | 07.09<br>07.09 | 24.0110-0304.1<br>410304 |  | 250 10,0 8,0 +B      |     |

### MITSUBISHI ECLIPSE II (95-99)

|  |                          |            |  |                |                |  |  |                                      |            |
|--|--------------------------|------------|--|----------------|----------------|--|--|--------------------------------------|------------|
|  | 2.0 GS 16V<br>2.0 GT 16V | 107<br>157 |  | 12.95<br>12.95 | 04.99<br>04.99 | 13.0460-5952.2<br>605952                             |  | 21647 16,0 +/WK                      | SUM        |
|  | 2.0 GS 16V<br>2.0 GT 16V | 107<br>157 |  | 12.95<br>12.95 | 04.99<br>04.99 | 24.0124-0142.1<br>424142                             |  | 256 24,0 22,4 V                      |            |
|  | 2.0 GS 16V<br>2.0 GT 16V | 107<br>157 |  | 12.95<br>12.95 | 04.99<br>04.99 | 13.0460-5980.2<br>605980<br>13.0460-0150.2<br>610150 |  | 21706 15,5 +/WK<br>Belagsatz-Zubehör | AKE<br>AKE |
|  | 2.0 GS 16V<br>2.0 GT 16V | 107<br>157 |  | 12.95<br>12.95 | 04.99<br>04.99 | 24.0110-0704.1<br>410704                             |  | 262 10,0 8,4 +B                      |            |

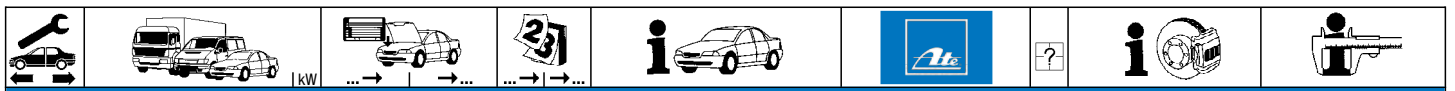

**MITSUBISHI GALANT (96-03)**

|  |                  |     |  |       |       |                |        |  |  |                     |     |
|--|------------------|-----|--|-------|-------|----------------|--------|--|--|---------------------|-----|
|  | 2.0 i 16V (EA2)  | 100 |  | 10.96 | 11.97 | 13.0460-5952.2 | 605952 |  |  | 21647 16,0 +/WK     | SUM |
|  | 2.0 i 16V (EA2W) | 100 |  | 10.96 | 11.97 |                |        |  |  |                     |     |
|  | 2.0 TDI (EA6)    | 66  |  | 10.96 | 07.01 |                |        |  |  |                     |     |
|  | 2.5 i V6 (EA5)   | 120 |  | 10.96 | 11.97 |                |        |  |  |                     |     |
|  | 2.0 i 16V (EA2)  | 100 |  | 12.97 | 03.00 | 13.0460-5958.2 | 605958 |  |  | 21363 15,8 +/WK     | AKE |
|  | 2.0 i 16V (EA2W) | 100 |  | 12.97 | 03.00 | 13.0460-0235.2 | 610235 |  |  | Belagsatz-Zubehör   |     |
|  | 2.4 GDi (EA3)    | 110 |  | 03.99 | 03.00 |                |        |  |  |                     |     |
|  | 2.5 i V6 (EA5)   | 120 |  | 12.97 | 03.00 |                |        |  |  |                     |     |
|  | 2.0 i 16V (EA2)  | 98  |  | 04.00 | 10.03 | 13.0460-5760.2 | 605760 |  |  | 23584 16,4 /WK      | AKE |
|  | 2.0 i 16V (EA2)  | 100 |  | 04.00 | 10.03 |                |        |  |  |                     |     |
|  | 2.0 i 16V (EA2W) | 98  |  | 04.00 | 10.03 |                |        |  |  |                     |     |
|  | 2.0 i 16V (EA2W) | 100 |  | 04.00 | 10.03 |                |        |  |  |                     |     |
|  | 2.4 GDi (EA3)    | 106 |  | 04.00 | 10.03 |                |        |  |  |                     |     |
|  | 2.4 GDi (EA3)    | 110 |  | 04.00 | 10.03 |                |        |  |  |                     |     |
|  | 2.5 i V6 (EA5)   | 118 |  | 04.00 | 10.03 |                |        |  |  |                     |     |
|  | 2.5 i V6 (EA5)   | 120 |  | 04.00 | 10.03 |                |        |  |  |                     |     |
|  | 2.0 i 16V (EA2)  | 100 |  | 10.96 | 11.97 | 24.0124-0136.1 | 424136 |  |  | 256 24,0 21,5 V +B  |     |
|  | 2.0 i 16V (EA2W) | 100 |  | 10.96 | 11.97 |                |        |  |  |                     |     |
|  | 2.0 TDI (EA6)    | 66  |  | 10.96 | 07.01 |                |        |  |  |                     |     |
|  | 2.5 i V6 (EA5)   | 120 |  | 10.96 | 11.97 |                |        |  |  |                     |     |
|  | 2.0 i 16V (EA2)  | 100 |  | 12.97 | 03.00 | 24.0124-0170.1 | 424170 |  |  | 276 24,0 22,4 V +B  |     |
|  | 2.0 i 16V (EA2W) | 100 |  | 12.97 | 03.00 |                |        |  |  |                     |     |
|  | 2.4 GDi (EA3)    | 110 |  | 03.99 | 03.00 |                |        |  |  |                     |     |
|  | 2.5 i V6 (EA5)   | 120 |  | 12.97 | 03.00 |                |        |  |  |                     |     |
|  | 2.0 i 16V (EA2)  | 98  |  | 04.00 | 10.03 | 24.0126-0131.1 | 426131 |  |  | 276 26,0 24,4 V +B  |     |
|  | 2.0 i 16V (EA2)  | 100 |  | 04.00 | 10.03 |                |        |  |  |                     |     |
|  | 2.0 i 16V (EA2W) | 98  |  | 04.00 | 10.03 |                |        |  |  |                     |     |
|  | 2.0 i 16V (EA2W) | 100 |  | 04.00 | 10.03 |                |        |  |  |                     |     |
|  | 2.4 GDi (EA3)    | 106 |  | 04.00 | 10.03 |                |        |  |  |                     |     |
|  | 2.4 GDi (EA3)    | 110 |  | 04.00 | 10.03 |                |        |  |  |                     |     |
|  | 2.5 i V6 (EA5)   | 118 |  | 04.00 | 10.03 |                |        |  |  |                     |     |
|  | 2.5 i V6 (EA5)   | 120 |  | 04.00 | 10.03 |                |        |  |  |                     |     |
|  | 2.0 i 16V (EA2)  | 98  |  | 04.00 | 10.03 | 13.0460-5980.2 | 605980 |  |  | 21706 15,5 +/WK     | AKE |
|  | 2.0 i 16V (EA2)  | 100 |  | 10.96 | 10.03 |                |        |  |  |                     |     |
|  | 2.0 i 16V (EA2W) | 98  |  | 04.00 | 10.03 |                |        |  |  |                     |     |
|  | 2.0 i 16V (EA2W) | 100 |  | 10.96 | 10.03 |                |        |  |  |                     |     |
|  | 2.4 GDi (EA3)    | 106 |  | 04.00 | 10.03 |                |        |  |  |                     |     |
|  | 2.4 GDi (EA3)    | 110 |  | 03.99 | 10.03 |                |        |  |  |                     |     |
|  | 2.5 i V6 (EA5)   | 118 |  | 04.00 | 10.03 |                |        |  |  |                     |     |
|  | 2.5 i V6 (EA5)   | 120 |  | 10.96 | 10.03 |                |        |  |  |                     |     |
|  | 2.0 i 16V (EA2)  | 98  |  | 04.00 | 10.03 | 24.0110-0240.1 | 410240 |  |  | 262 10,0 8,4 +B     |     |
|  | 2.0 i 16V (EA2)  | 100 |  | 10.96 | 10.03 |                |        |  |  |                     |     |
|  | 2.0 i 16V (EA2W) | 98  |  | 04.00 | 10.03 |                |        |  |  |                     |     |
|  | 2.0 i 16V (EA2W) | 100 |  | 10.96 | 10.03 |                |        |  |  |                     |     |
|  | 2.4 GDi (EA3)    | 106 |  | 04.00 | 10.03 |                |        |  |  |                     |     |
|  | 2.4 GDi (EA3)    | 110 |  | 03.99 | 10.03 |                |        |  |  |                     |     |
|  | 2.5 i V6 (EA5)   | 118 |  | 04.00 | 10.03 |                |        |  |  |                     |     |
|  | 2.5 i V6 (EA5)   | 120 |  | 10.96 | 10.03 |                |        |  |  |                     |     |
|  | 2.0 TDI (EA6)    | 66  |  | 10.96 | 07.01 | 03.0137-0289.2 | 650289 |  |  | 203 x 37            |     |
|  |                  |     |  |       |       | 03.0137-9192.2 | 669192 |  |  | Bremsbacken-Zubehör |     |
|  | 2.0 i 16V (EA2)  | 98  |  | 04.00 | 10.03 | 03.0137-0452.2 | 650452 |  |  | 167 x 32            |     |
|  | 2.0 i 16V (EA2)  | 100 |  | 10.96 | 10.03 |                |        |  |  |                     |     |
|  | 2.0 i 16V (EA2W) | 98  |  | 04.00 | 10.03 |                |        |  |  |                     |     |
|  | 2.0 i 16V (EA2W) | 100 |  | 10.96 | 10.03 |                |        |  |  |                     |     |
|  | 2.4 GDi (EA3)    | 106 |  | 04.00 | 10.03 |                |        |  |  |                     |     |
|  | 2.4 GDi (EA3)    | 110 |  | 03.99 | 10.03 |                |        |  |  |                     |     |
|  | 2.5 i V6 (EA5)   | 118 |  | 04.00 | 10.03 |                |        |  |  |                     |     |
|  | 2.5 i V6 (EA5)   | 120 |  | 10.96 | 10.03 |                |        |  |  |                     |     |

**MITSUBISHI GALANT Stufenheck (03-)**

|  |         |     |  |       |  |                |        |  |  |                |     |
|--|---------|-----|--|-------|--|----------------|--------|--|--|----------------|-----|
|  | 2.4 GDi | 116 |  | 10.03 |  | 13.0460-5760.2 | 605760 |  |  | 23584 16,4 /WK | AKE |
|  | 2.4 GDi | 116 |  | 10.03 |  | 03.0137-3023.2 | 653023 |  |  | 170 x 32       |     |





























**MITSUBISHI GALLOPER (99-03)**

|  |                    |     |  |       |       |                |        |  |  |                     |     |
|--|--------------------|-----|--|-------|-------|----------------|--------|--|--|---------------------|-----|
|  | 2.5 TD             | 65  |  | 01.99 | 12.03 | 13.0460-5885.2 | 605885 |  |  | 23518 17,0 +/WK/Zub | SUM |
|  | 2.5 TD Intercooler | 73  |  | 01.99 | 12.03 |                |        |  |  |                     |     |
|  | 3.0 V6             | 104 |  | 01.99 | 12.03 |                |        |  |  |                     |     |
|  | 2.5 TD             | 65  |  | 01.99 | 12.03 | 24.0122-0175.1 | 422175 |  |  | 277 22,0 20,4 V     |     |
|  | 2.5 TD Intercooler | 73  |  | 01.99 | 12.03 |                |        |  |  |                     |     |
|  | 3.0 V6             | 104 |  | 01.99 | 12.03 |                |        |  |  |                     |     |
|  | 2.5 TD             | 65  |  | 01.99 | 12.03 | 24.0122-0237.1 | 422237 |  |  | 277 22,0 20,4 V +B  |     |
|  | 2.5 TD Intercooler | 73  |  | 01.99 | 12.03 |                |        |  |  |                     |     |
|  | 3.0 V6             | 104 |  | 01.99 | 12.03 |                |        |  |  |                     |     |

**MITSUBISHI GRANDIS (04-10)**

|  |                 |     |  |       |       |                |        |  |  |                   |     |
|--|-----------------|-----|--|-------|-------|----------------|--------|--|--|-------------------|-----|
|  | 2.0 DI-D (NA8W) | 100 |  | 09.05 | 08.10 | 13.0460-5853.2 | 605853 |  |  | 23488 15,4 /WK    | SUM |
|  | 2.0 DI-D (NA8W) | 103 |  | 02.07 | 08.10 | 13.0460-0222.2 | 610222 |  |  | Belagsatz-Zubehör | SUM |
|  | 2.4 16V (NA4W)  | 121 |  | 04.04 | 08.10 |                |        |  |  |                   |     |
|  | 2.4 16V (NA4W)  | 130 |  | 04.04 | 08.10 |                |        |  |  |                   |     |



































|     |                                      |  |  |  |  |  |  |  |
|--|--|--|--|--|---|--|--|--|
| <b>MITSUBISHI GRANDIS (04-10)</b>  |  |  |  |  |   |  |  |  |
|    | 2.0 DI-D (NA8W)<br>2.0 DI-D (NA8W)<br>2.4 16V (NA4W)<br>2.4 16V (NA4W)   | 100<br>103<br>121<br>130   |  | 09.05<br>02.07<br>04.04<br>04.04   | 08.10<br>08.10<br>08.10<br>08.10  | 24.0126-0162.1   | 426162   | 290 26,0 24,4 V +B   |
|    | 2.0 DI-D (NA8W)<br>2.0 DI-D (NA8W)<br>2.4 16V (NA4W)<br>2.4 16V (NA4W)   | 100<br>103<br>121<br>130   |  | 09.05<br>02.07<br>04.04<br>04.04   | 08.10<br>08.10<br>08.10<br>08.10  | 13.0460-5855.2<br>13.0460-0137.2   | 605855<br>610137   | 23582 16,0 +<br>Belagsatz-Zubehör  |
|    | 2.0 DI-D (NA8W)<br>2.0 DI-D (NA8W)<br>2.4 16V (NA4W)<br>2.4 16V (NA4W)   | 100<br>103<br>121<br>130   |  | 09.05<br>02.07<br>04.04<br>04.04   | 08.10<br>08.10<br>08.10<br>08.10  | 24.0110-0344.1   | 410344   | 302 10,0 8,4 +B  |
|    | 2.0 DI-D (NA8W)<br>2.0 DI-D (NA8W)<br>2.4 16V (NA4W)<br>2.4 16V (NA4W)   | 100<br>103<br>121<br>130   |  | 09.05<br>02.07<br>04.04<br>04.04   | 08.10<br>08.10<br>08.10<br>08.10  | 03.0137-3015.2<br>03.0137-9307.2   | 653015<br>669307   | 190 x 32<br>Bremsbacken-Zubehör  |
| <b>MITSUBISHI i (10-)</b>  |  |  |  |  |   |  |  |  |
|    | 0.7 Turbo<br>0.7 Turbo 4x4   | 38<br>47   |  | 01.10<br>08.10   |   | 13.0460-5621.2   | 605621   | 24423 14,6 /Zub  |
| <b>MITSUBISHI i-MiEV (09-14)</b>   |  |  |  |  |   |  |  |  |
|    | i-MiEV<br>i-MiEV   | 35<br>49   |  | 07.09<br>02.11   | 04.14   | 13.0460-5621.2   | 605621   | 24423 14,6 /Zub  |
|    | i-MiEV<br>i-MiEV   | 35<br>49   |  | 07.09<br>02.11   | 04.14   | 24.0117-0110.1   | 417110   | 257 17,0 15,0 +B   |
| <b>MITSUBISHI L 200 (96-06)</b>  |  |  |  |  |   |  |  |  |
|    | 2.0 i (K62T)<br>2.4 i 4WD (K75T)<br>2.5 D (K64T)<br>2.5 TD 4WD (K64T)<br>2.5 TD 4WD (K74T)                           | 90<br>97<br>55<br>66<br>73   |  | 06.96<br>06.96<br>06.96<br>06.96<br>06.96  | 05.00<br>05.00 - ABS<br>05.00 - ABS<br>07.01 - ABS<br>05.00 - ABS                 | 13.0460-5890.2   | 605890   | 23290 15,5 /WK <b>AKE</b>  |
|    | 2.4 i 4WD (K75T)<br>2.5 D (K64T)<br>2.5 TD 4WD (K74T)  | 97<br>55<br>73   |  | 01.99<br>06.00<br>06.96  | 07.01 + ABS<br>07.01 + ABS<br>07.01 + ABS   | 13.0460-5958.2<br>13.0460-0235.2   | 605958<br>610235   | 21363 15,8 +/WK <b>AKE</b><br>Belagsatz-Zubehör                                    |
|  | 2.0 i (K62T)<br>2.5 D (K64T)<br>2.5 TD 4WD (K64T)  | 90<br>55<br>66   |  | 06.96<br>06.96<br>06.96  | 07.01<br>07.01<br>07.01   | 24.0124-0207.1   | 424207   | 254 24,0 22,4 V  |
|  | 2.4 i 4WD (K75T)<br>2.5 TD 4WD (K74T)<br>2.5 TD 4WD (K74T)<br>2.5 TDi 4WD (K74T)                                     | 97<br>73<br>85<br>98   |  | 06.96<br>06.96<br>08.01<br>08.01   | 07.01<br>07.01<br>04.06 + 15" Rad 1)<br>04.06 + 15" Rad 1)                        | 24.0124-0140.1   | 424140   | 276 24,0 22,4 V +B   |
|  | 2.5 TD 4WD (K74T)<br>2.5 TDi 4WD (K74T)  | 85<br>98   |  | 08.01<br>08.01   | 04.06 + 16" Rad 2)<br>04.06 + 16" Rad 2)  | 24.0124-0724.1   | 424724   | 314 24,0 22,4 V +B   |
|  | 2.0 i (K62T)<br>2.5 D (K64T)<br>2.5 TD 4WD (K64T)  | 90<br>55<br>66   |  | 06.96<br>06.96<br>06.96  | 07.01<br>07.01<br>07.01   | 03.0137-0482.2   | 650482   | 254 x 52   |
|  | 2.4 i 4WD (K75T)<br>2.5 TD 4WD (K74T)<br>2.5 TD 4WD (K74T)<br>2.5 TDi 4WD (K74T)                                     | 97<br>73<br>85<br>98   |  | 06.96<br>06.96<br>08.01<br>08.01   | 07.01<br>07.01<br>04.06<br>04.06  | 03.0137-0474.2<br>03.0137-9291.2   | 650474<br>669291   | 270 x 52<br>Bremsbacken-Zubehör  |
| <b>MITSUBISHI L 200 (06-15)</b>  |  |  |  |  |   |  |  |  |
|  | 2.5 DI-D<br>2.5 DI-D<br>2.5 DI-D 4x4<br>2.5 DI-D 4x4<br>2.5 DI-D 4x4<br>2.5 DI-D RWD<br>2.5 DI-D RWD<br>2.5 DI-D RWD | 103<br>123<br>100<br>103<br>131<br>94<br>100<br>123                              |  | 04.10<br>10.07<br>01.06<br>04.10<br>04.10<br>01.06<br>08.07                      |   | 13.0460-5631.2   | 605631   | 24529 16,0 +/WK  |
| <b>MITSUBISHI L 200 (15-)</b>  |  |  |  |  |   |  |  |  |
|  | 2.4 DI-D (KJ0T)  | 113  |  | 09.15  |   | 13.0460-5631.2   | 605631   | 24529 16,0 +/WK  |
| <b>MITSUBISHI L 300 (94-00) (Kabine und Chassis)</b>                               |  |  |  |  |   |  |  |  |
|  | 2.0 (P13T)<br>2.5 TD (P15T)  | 85<br>64   |  | 06.94<br>06.94   | 04.00<br>05.99  | 13.0460-5940.2   | 605940   | 21373 16,0 +/WK <b>SUM</b>   |
|  | 2.0 (P13T)<br>2.5 TD (P15T)  | 85<br>64   |  | 06.94<br>06.94   | 04.00<br>05.99  | 24.0122-0155.1   | 422155   | Abmessungen beachten<br>258 22,0 20,4 V  |
| <b>MITSUBISHI L 400 (96-05)</b>  |  |  |  |  |   |  |  |  |
|  | 2.0<br>2.5 TD<br>2.5 TD 4x4  | 83<br>64<br>64   |  | 06.96<br>06.96<br>09.96  | 06.05 - Europa 3)<br>05.99 - ABS<br>05.99 - ABS                                   | 13.0460-5890.2   | 605890   | 23290 15,5 /WK <b>AKE</b>  |

1) + 15" wheel / + ruota 15" / + roue 15" / + rueda 15"

2) + 16" wheel / + ruota 16" / + roue 16" / + rueda 16"

3) - Europe / - Europa / - Europe / - Europa

|     |                                 |  |  |  |  |  |  |                        |            |
|--|---|--|--|--|---|--|--|--|------------|
| <b>MITSUBISHI L 400 (96-05)</b>  |   |  |  |  |   |  |  |  |            |
|    | 2.4<br>2.4 4x4<br>2.5 TD<br>2.5 TD 4x4  | 97<br>94<br>64<br>64   |  | 06.96<br>09.96<br>06.99<br>06.99   | 06.05<br>06.05<br>+ ABS<br>+ ABS  | 13.0460-5958.2<br>13.0460-0235.2   | 605958<br>610235   | 21363 15,8 +WK<br>Belagsatz-Zubehör  | <b>AKE</b> |
|    | 2.4<br>2.4 4x4  | 97<br>94   |  | 06.96<br>09.96   | 06.05<br>06.05  | 24.0124-0202.1   | 424202   | 276 24,0 22,4 V  |            |
|    | 2.4 4x4   | 94   |  | 06.96  | 06.05   | 24.0118-0140.1   | 418140   | 315 18,0 16,4 +B   |            |
|    | 2.0<br>2.0<br>2.5 TD<br>2.5 TD 4x4  | 83<br>85<br>64<br>64   |  | 06.96<br>06.96<br>06.96<br>09.96   | 06.05<br>06.05<br>06.05<br>06.05  | 03.0137-0482.2   | 650482   | 254 x 52   |            |
| <b>MITSUBISHI LANCER Evolution (99-03)</b>   |   |  |  |  |   |  |  |  |            |
|    | 2.0 16V (CP9A)  | 206  |  | 01.99  | 08.03   | 13.0460-4973.2   | 604973   | 23325 16,0 +WK   | <b>BRE</b> |
|    | 2.0 16V (CP9A)  | 206  |  | 01.99  | 08.03   | 13.0460-4974.2   | 604974   | 21580 14,6 +WK   | <b>BRE</b> |
| <b>MITSUBISHI LANCER Evolution (04-07)</b>   |   |  |  |  |   |  |  |  |            |
|    | 2.0 i 16V 4WD (CT9A)<br>2.0 i 16V (CT9A)  | 195<br>206   |  | 03.04<br>01.06   | 12.05<br>08.07  | 13.0460-5958.2<br>13.0460-0235.2   | 605958<br>610235   | 21363 15,8 +WK<br>Belagsatz-Zubehör  | <b>AKE</b> |
|    | 2.0 i 16V (CT9A)  | 206  |  | 01.06  | 08.07   | 13.0460-5760.2   | 605760   | 23584 16,4 /WK   | <b>AKE</b> |
|    | 2.0 i 16V (CT9A)  | 206  |  | 01.06  | 08.07   | 13.0460-5735.2   | 605735   | 24014 16,0 +WK   | <b>AKE</b> |
|    | 2.0 i 16V (CT9A)  | 206  |  | 01.06  | 08.07   | 24.0110-0704.1   | 410704   | 262 10,0 8,4 +B  |            |
|   | 2.0 i 16V (CT9A)<br>2.0 i 16V 4WD (CT9A)  | 206<br>195   |  | 01.06<br>03.04   | 08.07<br>12.05  | 03.0137-0453.2   | 650453   | 167 x 32   |            |
| <b>MITSUBISHI LANCER Evolution (CZ4A) (07-)</b>                                    |   |  |  |  |   |  |  |  |            |
|  | 2.0 i 16V<br>2.0 i 16V<br>2.0 i 16V<br>2.0 i 16V  | 206<br>217<br>242<br>264   |  | 10.07<br>10.07<br>08.07<br>08.07   |   | 03.0137-3015.2<br>03.0137-9307.2   | 653015<br>669307   | 190 x 32<br>Bremsbacken-Zubehör  |            |
| <b>MITSUBISHI LANCER Limousine (03-07)</b>   |   |  |  |  |   |  |  |  |            |
|  | 1.3 i 16V (CS1A)<br>1.6 i 16V (CS3A)<br>2.0 i 16V (CS9A)  | 60<br>72<br>99   |  | 09.03<br>09.03<br>12.03  | 03.07<br>03.07<br>03.07   | 13.0460-5760.2   | 605760   | 23584 16,4 /WK   | <b>AKE</b> |
|  | 1.3 i 16V (CS1A)<br>1.6 i 16V (CS3A)<br>2.0 i 16V (CS9A)  | 60<br>72<br>99   |  | 09.03<br>09.03<br>12.03  | 03.07<br>03.07<br>03.07   | 24.0126-0131.1<br>24.0126-0134.1   | 426131<br>426134   | 276 26,0 24,4 V +B<br>276 26,0 24,4 V +B<br>+ 4-Loch-Felge <sup>1)</sup><br>+ 5-Loch-Felge <sup>2)</sup> |            |
|  | 1.3 i 16V (CS1A)<br>1.6 i 16V (CS3A)<br>2.0 i 16V (CS9A)  | 60<br>72<br>99   |  | 09.03<br>09.03<br>12.03  | 03.07<br>03.07<br>03.07   | 13.0460-5735.2   | 605735   | 24014 16,0 +WK   | <b>AKE</b> |
|  | 1.3 i 16V (CS1A)<br>1.6 i 16V (CS3A)<br>2.0 i 16V (CS9A)  | 60<br>72<br>99   |  | 09.03<br>09.03<br>12.03  | 03.07<br>03.07<br>03.07   | 24.0110-0240.1<br>24.0110-0704.1   | 410240<br>410704   | 262 10,0 8,4 +B<br>262 10,0 8,4 +B<br>+ 4-Loch-Felge <sup>1)</sup><br>+ 5-Loch-Felge <sup>2)</sup>       |            |
|  | 1.3 i 16V (CS1A)<br>1.6 i 16V (CS3A)<br>2.0 i 16V (CS9A)  | 60<br>72<br>99   |  | 09.03<br>09.03<br>12.03  | 03.07<br>03.07<br>03.07   | 03.0137-0453.2   | 650453   | 167 x 32   |            |
| <b>MITSUBISHI LANCER Kombi (03-07)</b>   |   |  |  |  |   |  |  |  |            |
|  | 1.6 i 16V (CS3W)<br>2.0 i 16V (CS9W)<br>2.4 i 16V (CS9W)  | 72<br>99<br>98   |  | 09.03<br>09.03<br>09.03  | 03.07<br>03.07<br>03.07   | 13.0460-5760.2   | 605760   | 23584 16,4 /WK   | <b>AKE</b> |
|  | 1.6 i 16V (CS3W)<br>2.0 i 16V (CS9W)<br>2.4 i 16V (CS9W)  | 72<br>99<br>98   |  | 09.03<br>09.03<br>09.03  | 03.07<br>03.07<br>03.07   | 24.0126-0131.1<br>24.0126-0134.1   | 426131<br>426134   | 276 26,0 24,4 V +B<br>276 26,0 24,4 V +B<br>+ 4-Loch-Felge <sup>1)</sup><br>+ 5-Loch-Felge <sup>2)</sup> |            |
|  | 1.6 i 16V (CS3W)<br>2.0 i 16V (CS9W)<br>2.4 i 16V (CS9W)  | 72<br>99<br>98   |  | 09.03<br>09.03<br>09.03  | 03.07<br>03.07<br>03.07   | 13.0460-5735.2   | 605735   | 24014 16,0 +WK   | <b>AKE</b> |
|  | 1.6 i 16V (CS3W)<br>2.0 i 16V (CS9W)<br>2.4 i 16V (CS9W)  | 72<br>99<br>98   |  | 09.03<br>09.03<br>09.03  | 03.07<br>03.07<br>03.07   | 24.0110-0240.1<br>24.0110-0704.1   | 410240<br>410704   | 262 10,0 8,4 +B<br>262 10,0 8,4 +B<br>+ 4-Loch-Felge <sup>1)</sup><br>+ 5-Loch-Felge <sup>2)</sup>       |            |
|  | 1.6 i 16V (CS3W)<br>2.0 i 16V (CS9W)<br>2.4 i 16V (CS9W)  | 72<br>99<br>98   |  | 09.03<br>09.03<br>09.03  | 03.07<br>03.07<br>03.07   | 03.0137-0453.2   | 650453   | 167 x 32   |            |
| <b>MITSUBISHI LANCER Stufenheck/Sportlimousine (CY_A) (07-)</b>                    |   |  |  |  |   |  |  |  |            |
|  | 1.5 16V (CY2A)<br>1.6 16V ((CY1A)<br>1.8 16V (CY3A)<br>1.8 16V (CY3A)<br>1.8 16V Flex (CY3A)<br>1.8 DI-D (CY9A) | 80<br>86<br>103<br>105<br>103<br>85  |  | 06.08<br>05.10<br>05.10<br>02.08<br>03.09<br>05.10                               |   | 13.0460-5760.2   | 605760   | 23584 16,4 /WK   | <b>AKE</b> |

<sup>1)</sup> + 4 bore wheel rim / + cerchione a 4 fori / + jante à 4 trous / + Llantas de 4 taladros

<sup>2)</sup> + 5 bore wheel rim / + cerchione a 5 fori / + jante à 5 trous / + Llantas de 5 taladros





























**MITSUBISHI LANCER Stufenheck/Sportlimousine (CY\_A) (07-)**

















|  |  |   |       |   |  |                                    |     |
|--|--|---|-------|---|--|------------------------------------|-----|
|  | 1.8 DI-D (CY9A) 110<br>2.0 16V (CY4A) 108<br>2.0 16V (CY4A) 113<br>2.0 16V Turbo (CY4A) 177<br>2.0 DI-D (CY8A) 103   | 06.10<br>01.09<br>10.07<br>10.11<br>01.08   |       | 13.0460-5760.2 605760   |  | 23584 16,4 /WK                     | AKE |
|  | 1.5 16V (CY2A) 80<br>1.6 16V ((CY1A) 86<br>1.8 16V (CY3A) 103<br>1.8 16V (CY3A) 105<br>1.8 16V Flex (CY3A) 103<br>1.8 DI-D (CY9A) 85<br>1.8 DI-D (CY9A) 110<br>2.0 16V (CY4A) 108<br>2.0 16V (CY4A) 113<br>2.0 16V Turbo (CY4A) 177<br>2.0 DI-D (CY8A) 103 | 06.08<br>05.10<br>02.08<br>04.09<br>03.09<br>05.10<br>06.10<br>01.09<br>10.07<br>10.11<br>01.08 |       | 24.0126-0164.1 426164   |  | 276 26,0 24,4 V +B                 |     |
|  | 1.5 16V (CY2A) 80<br>1.6 16V ((CY1A) 86<br>1.8 16V (CY3A) 103<br>1.8 16V (CY3A) 105<br>1.8 16V Flex (CY3A) 103<br>1.8 DI-D (CY9A) 85<br>1.8 DI-D (CY9A) 110<br>2.0 16V (CY4A) 108<br>2.0 16V (CY4A) 113<br>2.0 16V Turbo (CY4A) 177<br>2.0 DI-D (CY8A) 103 | 06.08<br>05.10<br>05.10<br>02.08<br>03.09<br>05.10<br>06.10<br>01.09<br>10.07<br>10.08<br>01.08 | 03.09 | 24.0124-0215.1 424215<br>24.0710-5005.4 360337<br>24.0710-5006.4 360338 |  | Radsensor L=920<br>Radsensor L=936 |     |
|  | 1.5 16V (CY2A) 80<br>1.6 16V ((CY1A) 86<br>1.8 16V (CY3A) 103<br>1.8 16V (CY3A) 105<br>1.8 16V Flex (CY3A) 103<br>1.8 DI-D (CY9A) 85<br>1.8 DI-D (CY9A) 110<br>2.0 16V (CY4A) 108<br>2.0 16V (CY4A) 113<br>2.0 16V Turbo (CY4A) 177<br>2.0 DI-D (CY8A) 103 | 06.08<br>05.10<br>05.10<br>02.08<br>03.09<br>05.10<br>06.10<br>01.09<br>10.07<br>10.08<br>01.08 |       | 13.0460-5735.2 605735   |  | 24014 16,0 +/WK                    | AKE |
|  | 1.5 16V (CY2A) 80<br>1.6 16V ((CY1A) 86<br>1.8 16V (CY3A) 103<br>1.8 16V (CY3A) 105<br>1.8 16V Flex (CY3A) 103<br>1.8 DI-D (CY9A) 85<br>1.8 DI-D (CY9A) 110<br>2.0 16V (CY4A) 108<br>2.0 16V (CY4A) 113<br>2.0 16V Turbo (CY4A) 177<br>2.0 DI-D (CY8A) 103 | 06.08<br>05.10<br>05.10<br>02.08<br>03.09<br>05.10<br>06.10<br>01.09<br>10.07<br>10.08<br>01.08 |       | 24.0110-0345.1 410345   |  | 262 10,0 8,4 +B                    |     |
|  | 1.5 16V (CY2A) 80<br>1.6 16V ((CY1A) 86<br>1.8 16V (CY3A) 103<br>1.8 16V (CY3A) 105<br>1.8 16V Flex (CY3A) 103<br>1.8 DI-D (CY9A) 85<br>1.8 DI-D (CY9A) 110<br>2.0 16V (CY4A) 108<br>2.0 16V (CY4A) 113<br>2.0 16V Turbo (CY4A) 177<br>2.0 DI-D (CY8A) 103 | 06.08<br>05.10<br>05.10<br>02.08<br>03.09<br>05.10<br>06.10<br>01.09<br>10.07<br>10.08<br>01.08 |       | 24.0710-5003.4 360335<br>24.0710-5004.4 360336                          |  | Radsensor L=984<br>Radsensor L=952 |     |
|  | 1.5 16V (CY2A) 80<br>1.6 16V ((CY1A) 86<br>1.8 16V (CY3A) 103<br>1.8 16V (CY3A) 105<br>1.8 16V Flex (CY3A) 103<br>1.8 DI-D (CY9A) 85<br>1.8 DI-D (CY9A) 110<br>2.0 16V (CY4A) 108<br>2.0 16V (CY4A) 113<br>2.0 16V Turbo (CY4A) 177<br>2.0 DI-D (CY8A) 103 | 06.08<br>05.10<br>05.10<br>02.08<br>03.09<br>05.10<br>06.10<br>01.09<br>10.07<br>10.08<br>01.08 |       | 03.0137-3023.2 653023   |  | 170 x 32                           |     |



















**MITSUBISHI LANCER Sportback (CX\_A) (08-)**

|  |  |  |  |                       |  |                |     |
|--|--|--|--|-----------------------|--|----------------|-----|
|  | 1.5 16V (CX2A) 80<br>1.5 Bifuel (CX2A) 80<br>1.6 16V (CX1A) 86<br>1.8 16V (CX3A) 103<br>1.8 16V (CX3A) 105<br>1.8 16V Flex (CX3A) 103<br>1.8 Bifuel (CX3A) 105<br>1.8 DI-D (CX9A) 85<br>1.8 DI-D (CX9A) 110<br>2.0 DI-D (CX8A) 103 | 06.08<br>03.10<br>05.10<br>03.09<br>06.08<br>03.09<br>02.10<br>05.10<br>06.10<br>06.08 |  | 13.0460-5760.2 605760 |  | 23584 16,4 /WK | AKE |
|--|--|--|--|-----------------------|--|----------------|-----|



|     |     |  |  |  |  |  |     |  |
|--|---|--|--|--|---|--|---|--|
| <b>MITSUBISHI LANCER Sportback (CX_A) (08-)</b>                                    |   |  |  |  |   |  |   |  |
|    | 1.5 16V (CX2A)  | 80   | 06.08  | 03.09  | 24.0126-0164.1  | 426164   |   | 276 26,0 24,4 V +B   |
|  | 1.8 16V (CX3A)  | 105  | 06.08  | 03.09  |   |  |   |  |
|  | 2.0 DI-D (CX8A)   | 103  | 06.08  | 03.09  |   |  |   |  |
|  | 1.5 16V (CX2A)  | 80   | 06.08  |  | 24.0126-0164.1  | 426164   |   | 276 26,0 24,4 V +B   |
|  | 1.5 Bifuel (CX2A)   | 80   | 03.10  |  |   |  |   |  |
|  | 1.6 16V (CX1A)  | 86   | 05.10  |  |   |  |   |  |
|  | 1.8 16V (CX3A)  | 103  | 03.09  |  |   |  |   |  |
|  | 1.8 16V (CX3A)  | 105  | 06.08  |  |   |  |   |  |
|  | 1.8 16V Flex (CX3A)   | 103  | 03.09  |  |   |  |   |  |
|  | 1.8 Bifuel (CX3A)   | 105  | 02.10  |  |   |  |   |  |
| 1.8 DI-D (CX9A)  | 85  | 05.10  |  |  |   |  |   |  |
| 1.8 DI-D (CX9A)  | 110   | 06.10  |  |  |   |  |   |  |
| 2.0 DI-D (CX8A)  | 103   | 06.08  |  |  |   |  |   |  |
| 2.0 Ralliart (CX4A)  | 177   |  | 10.08  |  | 24.0124-0215.1  | 424215   |   | 294 24,0 22,4 V +B   |
| 2.0 Ralliart (CX4A)  | 184   |  | 08.11  |  |   |  |   |  |
|    | 1.5 16V (CX2A)  | 80   | 06.08  |  | 24.0710-5005.4  | 360337   |    | Radsensor L=920  |
|  | 1.5 Bifuel (CX2A)   | 80   | 03.10  |  | 24.0710-5006.4  | 360338   |    | Radsensor L=936  |
|  | 1.6 16V (CX1A)  | 86   | 05.10  |  |   |  |   |  |
|  | 1.8 16V (CX3A)  | 103  | 03.09  |  |   |  |   |  |
|  | 1.8 16V (CX3A)  | 105  | 06.08  |  |   |  |   |  |
|  | 1.8 16V Flex (CX3A)   | 103  | 03.09  |  |   |  |   |  |
|  | 1.8 Bifuel (CX3A)   | 105  | 02.10  |  |   |  |   |  |
|  | 1.8 DI-D (CX9A)   | 85   | 05.10  |  |   |  |   |  |
|  | 1.8 DI-D (CX9A)   | 110  | 06.10  |  |   |  |   |  |
|  | 2.0 DI-D (CX8A)   | 103  | 06.08  |  |   |  |   |  |
| 2.0 Ralliart (CX4A)  | 177   |  | 10.08  |  |   |  |   |  |
| 2.0 Ralliart (CX4A)  | 184   |  | 08.11  |  |   |  |   |  |
|    | 1.5 16V (CX2A)  | 80   | 06.08  |  | 13.0460-5735.2  | 605735   |   | 24014 16,0 +/-WK AKE   |
|  | 1.5 Bifuel (CX2A)   | 80   | 03.10  |  |   |  |   |  |
|  | 1.6 16V (CX1A)  | 86   | 05.10  |  |   |  |   |  |
|  | 1.8 16V (CX3A)  | 103  | 03.09  |  |   |  |   |  |
|  | 1.8 16V (CX3A)  | 105  | 06.08  |  |   |  |   |  |
|  | 1.8 16V Flex (CX3A)   | 103  | 03.09  |  |   |  |   |  |
|  | 1.8 Bifuel (CX3A)   | 105  | 02.10  |  |   |  |   |  |
|  | 1.8 DI-D (CX9A)   | 85   | 05.10  |  |   |  |   |  |
|  | 1.8 DI-D (CX9A)   | 110  | 06.10  |  |   |  |   |  |
|  | 2.0 DI-D (CX8A)   | 103  | 06.08  |  |   |  |   |  |
| 2.0 Ralliart (CX4A)  | 177   |  | 10.08  |  | 13.0460-5855.2  | 605855   |   | 23582 16,0 + Belagsatz-Zubehör   |
| 2.0 Ralliart (CX4A)  | 184   |  | 08.11  |  | 13.0460-0137.2  | 610137   |   |  |
|   | 1.5 16V (CX2A)  | 80   | 06.08  |  | 24.0110-0345.1  | 410345   |   | 262 10,0 8,4 +B  |
|  | 1.5 Bifuel (CX2A)   | 80   | 03.10  |  |   |  |   |  |
|  | 1.6 16V (CX1A)  | 86   | 05.10  |  |   |  |   |  |
|  | 1.8 16V (CX3A)  | 103  | 03.09  |  |   |  |   |  |
|  | 1.8 16V (CX3A)  | 105  | 06.08  |  |   |  |   |  |
|  | 1.8 16V Flex (CX3A)   | 103  | 03.09  |  |   |  |   |  |
|  | 1.8 Bifuel (CX3A)   | 105  | 02.10  |  |   |  |   |  |
|  | 1.8 DI-D (CX9A)   | 85   | 05.10  |  |   |  |   |  |
|  | 1.8 DI-D (CX9A)   | 110  | 06.10  |  |   |  |   |  |
|  | 2.0 DI-D (CX8A)   | 103  | 06.08  |  |   |  |   |  |
| 2.0 Ralliart (CX4A)  | 177   |  | 10.08  |  | 24.0110-0330.1  | 410330   |   | 302 10,0 8,4 +B  |
| 2.0 Ralliart (CX4A)  | 184   |  | 08.11  |  |   |  |   |  |
|  | 2.0 Ralliart (CX4A)   | 177  | 10.08  |  | 24.0710-5003.4  | 360335   |  | Radsensor L=984  |
|  | 2.0 Ralliart (CX4A)   | 184  | 08.11  |  | 24.0710-5004.4  | 360336   |  | Radsensor L=952  |
|  | 1.5 16V (CX2A)  | 80   | 06.08  |  | 03.0137-3023.2  | 653023   |   | 170 x 32   |
|  | 1.5 Bifuel (CX2A)   | 80   | 03.10  |  |   |  |   |  |
|  | 1.6 16V (CX1A)  | 86   | 05.10  |  |   |  |   |  |
|  | 1.8 16V (CX3A)  | 103  | 03.09  |  |   |  |   |  |
|  | 1.8 16V (CX3A)  | 105  | 06.08  |  |   |  |   |  |
|  | 1.8 16V Flex (CX3A)   | 103  | 03.09  |  |   |  |   |  |
|  | 1.8 Bifuel (CX3A)   | 105  | 02.10  |  |   |  |   |  |
|  | 1.8 DI-D (CX9A)   | 85   | 05.10  |  |   |  |   |  |
|  | 1.8 DI-D (CX9A)   | 110  | 06.10  |  |   |  |   |  |
|  | 2.0 DI-D (CX8A)   | 103  | 06.08  |  |   |  |   |  |
| 2.0 Ralliart (CX4A)  | 177   |  | 10.08  |  | 03.0137-3015.2  | 653015   |   | 190 x 32   |
| 2.0 Ralliart (CX4A)  | 184   |  | 08.11  |  |   |  |   |  |
| <b>MITSUBISHI OUTLANDER I (03-06)</b>  |   |  |  |  |   |  |   |  |
|  | 2.0 i 16V   | 100  | 05.03  | 10.06  | 13.0460-5958.2  | 605958   |   | 21363 15,8 +/-WK AKE   |
|  | 2.0 i 16V 4WD   | 93   | 05.03  | 10.06  | 13.0460-0235.2  | 610235   |   | Belagsatz-Zubehör  |
|  | 2.0 i 16V 4WD   | 100  | 05.03  | 10.06  |   |  |   |  |
|  | 2.0 i 16V 4WD   | 177  | 05.03  | 10.06  |   |  |   |  |
|  | 2.0 i 16V Turbo 4WD   | 148  | 04.04  | 10.06  |   |  |   |  |
|  | 2.4 GDI 4WD   | 121  | 01.05  | 10.06  |   |  |   |  |
|  | 2.4 i 16V 4WD   | 102  | 05.03  | 10.06  |   |  |   |  |
|  | 2.4 i 16V 4WD   | 118  | 11.03  | 10.06  |   |  |   |  |
|  | 2.4 i 16V 4WD   | 119  | 05.03  | 10.06  |   |  |   |  |
|  | 2.4 i 16V 4WD   | 121  | 10.05  | 10.06  |   |  |   |  |
| 2.4 Mivec  | 118   | 07.03  | 10.06  |  |   |  |   |  |
|  | 2.0 i 16V   | 100  | 05.03  | 10.06  | 24.0124-0215.1  | 424215   |   | 294 24,0 22,4 V +B   |
|  | 2.0 i 16V 4WD   | 93   | 05.03  | 10.06  |   |  |   |  |
|  | 2.0 i 16V 4WD   | 100  | 05.03  | 10.06  |   |  |   |  |
|  | 2.0 i 16V 4WD   | 177  | 05.03  | 10.06  |   |  |   |  |
|  | 2.0 i 16V Turbo 4WD   | 148  | 04.04  | 10.06  |   |  |   |  |
|  | 2.4 GDI 4WD   | 121  | 01.05  | 10.06  |   |  |   |  |
|  | 2.4 i 16V 4WD   | 102  | 05.03  | 10.06  |   |  |   |  |
|  |  |  |  |  |   |  |   |  |

|     |    |         |  |                                   |                                  |  |  |  |
|--|--|---|--|---|---|--|--|--|
| <b>MITSUBISHI OUTLANDER I (03-06)</b>  |  |   |  |   |   |  |  |  |
|    | 2.4 i 16V 4WD<br>2.4 i 16V 4WD<br>2.4 i 16V 4WD<br>2.4 Mivec   | 118<br>119<br>121<br>118  |  | 11.03<br>05.03<br>10.05<br>07.03  | 10.06<br>10.06<br>10.06<br>10.06  | 24.0124-0215.1   | 424215   | 294 24,0 22,4 V +B   |
|    | 2.0 i 16V<br>2.0 i 16V 4WD<br>2.0 i 16V 4WD<br>2.0 i 16V 4WD<br>2.0 i 16V Turbo 4WD<br>2.4 GDI 4WD<br>2.4 i 16V 4WD<br>2.4 i 16V 4WD<br>2.4 i 16V 4WD<br>2.4 i 16V 4WD<br>2.4 Mivec        | 100<br>93<br>100<br>177<br>148<br>121<br>102<br>118<br>119<br>121<br>118                |  | 05.03<br>05.03<br>05.03<br>05.03<br>04.04<br>01.05<br>05.03<br>11.03<br>05.03<br>10.05<br>07.03                   | 10.06<br>10.06<br>10.06<br>10.06<br>10.06<br>10.06<br>10.06<br>10.06<br>10.06<br>10.06<br>10.06                   | 13.0460-5735.2   | 605735   | 24014 16,0 +/WK AKE  |
|    | 2.0 i 16V<br>2.0 i 16V 4WD<br>2.0 i 16V 4WD<br>2.0 i 16V 4WD<br>2.0 i 16V Turbo 4WD<br>2.4 GDI 4WD<br>2.4 i 16V 4WD<br>2.4 i 16V 4WD<br>2.4 i 16V 4WD<br>2.4 i 16V 4WD<br>2.4 Mivec        | 100<br>93<br>100<br>177<br>148<br>121<br>102<br>118<br>119<br>121<br>118                |  | 05.03<br>05.03<br>05.03<br>05.03<br>04.04<br>01.05<br>05.03<br>11.03<br>05.03<br>10.05<br>07.03                   | 10.06<br>10.06<br>10.06<br>10.06<br>10.06<br>10.06<br>10.06<br>10.06<br>10.06<br>10.06<br>10.06                   | 24.0110-0704.1   | 410704   | 262 10,0 8,4 +B  |
|    | 2.0 i 16V<br>2.0 i 16V 4WD<br>2.0 i 16V 4WD<br>2.0 i 16V 4WD<br>2.0 i 16V Turbo 4WD<br>2.4 GDI 4WD<br>2.4 i 16V 4WD<br>2.4 i 16V 4WD<br>2.4 i 16V 4WD<br>2.4 i 16V 4WD<br>2.4 Mivec        | 100<br>93<br>100<br>177<br>148<br>121<br>102<br>118<br>119<br>121<br>118                |  | 05.03<br>05.03<br>05.03<br>05.03<br>04.04<br>01.05<br>05.03<br>11.03<br>05.03<br>10.05<br>07.03                   | 10.06<br>10.06<br>10.06<br>10.06<br>10.06<br>10.06<br>10.06<br>10.06<br>10.06<br>10.06<br>10.06                   | 03.0137-0453.2   | 650453   | 167 x 32   |
| <b>MITSUBISHI OUTLANDER II (06-12)</b>   |  |   |  |   |   |  |  |  |
|   | 2.0 DI-D<br>2.0 i 16V<br>2.0 i 16V 4x4<br>2.2 DI-D<br>2.2 DI-D 4x4<br>2.2 DI-D 4x4<br>2.2 DI-D 4x4   | 103<br>108<br>108<br>130<br>115<br>130<br>130   |  | 01.07<br>11.06<br>11.06<br>11.06<br>08.07<br>11.06<br>11.12   | 11.12<br>11.12<br>11.12<br>11.12<br>11.12<br>11.12<br>11.12   | 13.0460-5958.2   | 605958   | 21363 15,8 +/WK AKE  |
|  | 2.4 Flex 4x4<br>2.4 i 16V<br>2.4 Mivec 4x4<br>3.0 V6 4x4   | 125<br>125<br>125<br>162  |  | 09.07<br>11.06<br>09.07<br>11.06  | 11.12<br>11.12<br>11.12<br>11.12  | 13.0460-5958.2<br>13.0460-5760.2   | 605958<br>605760   | 21363 15,8 +/WK AKE<br>23584 16,4 /WK AKE  |
|  | 2.0 DI-D<br>2.0 i 16V<br>2.0 i 16V 4x4<br>2.2 DI-D<br>2.2 DI-D 4x4<br>2.2 DI-D 4x4<br>2.2 DI-D 4x4<br>2.4 Flex 4x4<br>2.4 i 16V<br>2.4 Mivec 4x4<br>3.0 V6 4x4<br>3.0 V6 4x4<br>3.0 V6 FWD | 103<br>108<br>108<br>130<br>103<br>115<br>130<br>125<br>125<br>125<br>162<br>177<br>162 |  | 01.07<br>11.06<br>11.06<br>11.06<br>09.10<br>08.07<br>11.06<br>09.07<br>11.06<br>09.07<br>11.06<br>10.09<br>11.06 | 11.12<br>11.12<br>11.12<br>11.12<br>11.12<br>11.12<br>11.12<br>11.12<br>11.12<br>11.12<br>11.12<br>11.12<br>11.12 | 24.0124-0215.1   | 424215   | 294 24,0 22,4 V +B   |
|  | 2.0 DI-D<br>2.0 i 16V<br>2.0 i 16V 4x4<br>2.2 DI-D<br>2.2 DI-D 4x4<br>2.2 DI-D 4x4<br>2.2 DI-D 4x4<br>2.4 Flex 4x4<br>2.4 i 16V<br>2.4 Mivec 4x4<br>3.0 V6 4x4<br>3.0 V6 4x4<br>3.0 V6 FWD | 103<br>108<br>108<br>130<br>103<br>115<br>130<br>125<br>125<br>125<br>162<br>177<br>162 |  | 01.07<br>11.06<br>11.06<br>11.06<br>09.10<br>08.07<br>11.06<br>09.07<br>11.06<br>09.07<br>11.06<br>10.09<br>11.06 | 11.12<br>11.12<br>11.12<br>11.12<br>11.12<br>11.12<br>11.12<br>11.12<br>11.12<br>11.12<br>11.12<br>11.12<br>11.12 | 24.0710-5005.4<br>24.0710-5006.4   | 360337<br>360338   | Radsensor L=920<br>Radsensor L=936   |
|  | 2.0 i 16V<br>2.0 DI-D<br>2.0 i 16V 4x4<br>2.2 DI-D<br>2.2 DI-D 4x4<br>2.2 DI-D 4x4<br>2.2 DI-D 4x4<br>2.4 Flex 4x4<br>2.4 i 16V<br>2.4 Mivec 4x4   | 108<br>103<br>108<br>130<br>103<br>115<br>130<br>125<br>125<br>125                      |  | 11.06<br>01.07<br>11.06<br>11.06<br>09.10<br>08.07<br>11.06<br>09.07<br>11.06<br>09.07                            | 11.12<br>11.12<br>11.12<br>11.12<br>11.12<br>11.12<br>11.12<br>11.12<br>11.12<br>11.12                            | 13.0460-5735.2<br>13.0460-5855.2<br>13.0460-0137.2                                 | 605735<br>605855<br>610137   | 24014 16,0 +/WK AKE<br>23582 16,0 +<br>Belagsatz-Zubehör                           |
| ↓  | ↓  |   |  |   |   |  |  |  |



















|     |    |  |  |  |  |  |  |  |                                    |        |                                      |
|--|--|--|--|--|---|--|--|--|------------------------------------|--------|--------------------------------------|
| <b>MITSUBISHI OUTLANDER II (06-12)</b>   |  |  |  |  |   |  |  |  |                                    |        |                                      |
|    | 3.0 V6 4x4   | 162  |  | 11.06  | 11.12   |  | 13.0460-5855.2   | 605855   | 23582 16,0 +<br>Belagsatz-Zubehör  |        |                                      |
|  | 3.0 V6 4x4   | 177  |  | 10.09  | 11.12   |  | 13.0460-0137.2   | 610137   |                                    |        |                                      |
|  | 3.0 V6 FWD   | 162  |  | 11.06  | 11.12   |  |  |  |                                    |        |                                      |
|    | 2.0 i 16V  | 108  |  | 11.06  | 11.12   |  | 24.0110-0704.1   | 410704   | 262 10,0 8,4 +B                    |        |                                      |
|  | 2.4 i 16V  | 125  |  | 11.06  | 11.12   |  |  |  |                                    |        |                                      |
|  | 2.4 Mivec 4x4  | 125  |  | 09.07  | 11.12   |  |  |  |                                    |        |                                      |
|  | 2.0 DI-D   | 103  |  | 01.07  | 11.12   |  | 24.0110-0330.1   | 410330   |                                    |        |                                      |
|  | 2.2 DI-D 4x4   | 115  |  | 08.07  | 11.12   |  |  |  |                                    |        |                                      |
|  | 2.4 Flex 4x4   | 125  |  | 09.07  | 11.12   | + CVT Automatikgetriebe (stufenlos) <sup>1)</sup>                                  |  |  |                                    |        |                                      |
|  | 2.4 Mivec 4x4  | 125  |  | 09.07  | 11.12   |  |  |  |                                    |        |                                      |
|  | 3.0 V6 4x4   | 162  |  | 11.06  | 11.12   |  |  |  |                                    |        |                                      |
|  | 3.0 V6 4x4   | 177  |  | 10.09  | 11.12   |  |  |  |                                    |        |                                      |
|  | 3.0 V6 FWD   | 162  |  | 11.06  | 11.12   |  |  |  |                                    |        |                                      |
|    | 2.0 i 16V 4x4  | 108  |  | 11.06  | 11.12   |  | 24.0110-0360.1   | 410360   | 302 10,0 8,4 +B                    |        |                                      |
|  | 2.2 DI-D   | 130  |  | 11.06  | 11.12   |  |  |  |                                    |        |                                      |
|  | 2.2 DI-D 4x4   | 103  |  | 09.10  | 11.12   |  |  |  |                                    |        |                                      |
|  | 2.2 DI-D 4x4   | 130  |  | 11.06  | 11.12   |  |  |  |                                    |        |                                      |
|  | 2.4 Flex 4x4   | 125  |  | 09.07  | 11.12   | + Schaltgetriebe <sup>2)</sup>   |  |  |                                    |        |                                      |
|  | 2.4 Mivec 4x4  | 125  |  | 09.07  | 11.12   |  |  |  |                                    |        |                                      |
|  | 2.0 DI-D   | 103  |  | 01.07  | 11.12   |  | 24.0710-5003.4   | 360335   |                                    |        |                                      |
|  | 2.2 DI-D   | 130  |  | 11.06  | 11.12   |  | 24.0710-5004.4   | 360336   |                                    |        |                                      |
|  | 2.2 DI-D 4x4   | 103  |  | 09.10  | 11.12   |  |  |  |                                    |        |                                      |
|  | 2.2 DI-D 4x4   | 115  |  | 08.07  | 11.12   |  |  |  |                                    |        |                                      |
|    | 2.2 DI-D 4x4   | 130  |  | 11.06  | 11.12   |  |  |  | Radsensor L=984<br>Radsensor L=952 |        |                                      |
|  | 2.4 Flex 4x4   | 125  |  | 09.07  | 11.12   |  |  |  |                                    |        |                                      |
|  | 2.4 i 16V  | 125  |  | 11.06  | 11.12   |  |  |  |                                    |        |                                      |
|  | 2.4 Mivec 4x4  | 125  |  | 09.07  | 11.12   |  |  |  |                                    |        |                                      |
|  | 3.0 V6 4x4   | 162  |  | 11.06  | 11.12   |  |  |  |                                    |        |                                      |
|  | 3.0 V6 4x4   | 177  |  | 10.09  | 11.12   |  |  |  |                                    |        |                                      |
|  | 3.0 V6 FWD   | 162  |  | 11.06  | 11.12   |  |  |  |                                    |        |                                      |
|  | 2.0 i 16V  | 108  |  | 11.06  | 11.12   |  | 03.0137-3023.2   | 653023   |                                    |        |                                      |
|  | 2.0 i 16V 4x4  | 108  |  | 11.06  | 11.12   |  |  |  |                                    |        |                                      |
|  | 2.2 DI-D   | 130  |  | 11.06  | 11.12   | - 3. Sitzreihe <sup>3)</sup>   |  |  |                                    |        |                                      |
| 2.2 DI-D 4x4   | 103  |  | 09.10  | 11.12  | - 3. Sitzreihe <sup>3)</sup>  |  |  |  |                                    |        |                                      |
| 2.2 DI-D 4x4   | 130  |  | 11.06  | 11.12  | - 3. Sitzreihe <sup>3)</sup>  |  |  |  |                                    |        |                                      |
| 2.4 Flex 4x4   | 125  |  | 09.07  | 11.12  |   |  |  |  |                                    |        |                                      |
| 2.4 i 16V  | 125  |  | 11.06  | 11.12  |   |  |  |  |                                    |        |                                      |
| 2.4 Mivec 4x4  | 125  |  | 09.07  | 11.12  |   |  |  |  |                                    |        |                                      |
|    | 2.0 DI-D   | 103  |  | 01.07  | 11.12   |  | 03.0137-3015.2   | 653015   | 170 x 32                           |        |                                      |
|  | 2.2 DI-D   | 130  |  | 11.06  | 11.12   | + 3. Sitzreihe <sup>4)</sup>   | 03.0137-9307.2   | 669307   |                                    |        |                                      |
|  | 2.2 DI-D 4x4   | 103  |  | 09.10  | 11.12   | + 3. Sitzreihe <sup>4)</sup>   |  |  |                                    |        |                                      |
|  | 2.2 DI-D 4x4   | 115  |  | 08.07  | 11.12   |  |  |  |                                    |        |                                      |
|  | 2.2 DI-D 4x4   | 130  |  | 11.06  | 11.12   | + 3. Sitzreihe <sup>4)</sup>   |  |  |                                    |        |                                      |
|  | 3.0 V6 4x4   | 162  |  | 11.06  | 11.12   |  |  |  |                                    |        |                                      |
|  | 3.0 V6 4x4   | 177  |  | 10.09  | 11.12   |  |  |  |                                    |        |                                      |
|  | 3.0 V6 FWD   | 162  |  | 11.06  | 11.12   |  |  |  |                                    |        |                                      |
|  | <b>MITSUBISHI OUTLANDER III (12-)</b>  |  |  |  |   |  |  |  |                                    |        |                                      |
|  |  | 2.0 16V  | 107  |  | 10.12   |  |  | 13.0460-5958.2   |                                    | 605958 | 21363 15,8 +/WK<br>Belagsatz-Zubehör |
| 2.0 16V  |  | 110  |  | 08.12  |   |  | 13.0460-0235.2   | 610235   |                                    |        |                                      |
| 2.0 16V 4WD  |  | 107  |  | 10.12  |   |  |  |  |                                    |        |                                      |
| 2.0 16V 4WD  |  | 110  |  | 08.12  |   |  |  |  |                                    |        |                                      |
| 2.0 16V Hybrid 4WD   |  | 89   |  | 12.12  |   |  |  |  |                                    |        |                                      |
| 2.2 DI-D   |  | 110  |  | 08.12  |   |  |  |  |                                    |        |                                      |
| 2.2 DI-D 4WD   |  | 110  |  | 08.12  |   |  |  |  |                                    |        |                                      |
|  | 2.4 16V 4WD  | 124  |  | 10.12  |   |  | 13.0460-5760.2   | 605760   | 23584 16,4 /WK<br>AKE              |        |                                      |
|  | 2.0 16V  | 107  |  | 10.12  |   |  | 24.0124-0215.1   | 424215   |                                    |        |                                      |
|  | 2.0 16V  | 110  |  | 08.12  |   |  |  |  |                                    |        |                                      |
|  | 2.0 16V 4WD  | 107  |  | 10.12  |   |  |  |  |                                    |        |                                      |
|  | 2.0 16V 4WD  | 110  |  | 08.12  |   |  |  |  |                                    |        |                                      |
|  | 2.2 DI-D   | 110  |  | 08.12  |   |  |  |  |                                    |        |                                      |
|  | 2.2 DI-D 4WD   | 110  |  | 08.12  |   |  |  |  |                                    |        |                                      |
|  | 2.4 16V 4WD  | 124  |  | 10.12  |   |  | 24.0126-0170.1   | 426170   | 294 24,0 22,4 V +B                 |        |                                      |
|  | 2.0 16V  | 107  |  | 10.12  |   |  | 24.0710-5005.4   | 360337   |                                    |        |                                      |
|  | 2.0 16V  | 110  |  | 08.12  |   |  | 24.0710-5006.4   | 360338   |                                    |        |                                      |
|  | 2.0 16V 4WD  | 107  |  | 10.12  |   |  |  |  |                                    |        |                                      |
|  | 2.0 16V 4WD  | 110  |  | 08.12  |   |  |  |  |                                    |        |                                      |
|  | 2.0 16V Hybrid 4WD   | 89   |  | 12.12  |   |  |  |  |                                    |        |                                      |
|  | 2.2 DI-D   | 110  |  | 08.12  |   |  |  |  |                                    |        |                                      |
|  | 2.2 DI-D 4WD   | 110  |  | 08.12  |   |  |  |  | Radsensor L=920<br>Radsensor L=936 |        |                                      |
|  | 2.4 16V 4WD  | 124  |  | 10.12  |   |  |  |  |                                    |        |                                      |
|  | <b>MITSUBISHI PAJERO (90-00)</b>   |  |  |  |   |  |  |  |                                    |        |                                      |
|  |  | 2.4 (V21C/V21W)  | 82   |  | 12.90   | 03.00  |  | 13.0460-5958.2   |                                    | 605958 | 21363 15,8 +/WK<br>Belagsatz-Zubehör |
|  |  | 2.4 (V41W)   | 82   |  | 12.90   | 03.00  |  | 13.0460-0235.2   |                                    | 610235 |                                      |
|  |  | 2.5 TD (V24C/V24W)   | 73   |  | 12.90   | 03.00  |  |  |                                    |        |                                      |
|  |  | 2.5 TD (V44W)  | 73   |  | 12.90   | 03.00  |  |  |                                    |        |                                      |
| 2.8 D 4x4 (V26W)   |  | 71   |  | 11.93  | 03.00   |  |  |  |                                    |        |                                      |
| 2.8 TD (V46W)  |  | 92   |  | 11.93  | 03.00   |  |  |  |                                    |        |                                      |
| 3.0 V6 (V23C/V23W)   |  |  |  | 12.90  | 03.00   |  |  |  |                                    |        |                                      |
| 3.0 V6 (V43W)  |  | 130  |  | 12.90  | 03.00   |  |  |  |                                    |        |                                      |
| 3.5 V6 (V25W)  |  | 153  |  | 11.93  | 03.00   |  |  |  |                                    |        |                                      |
| 3.5 V6 (V45W)  |  | 143  |  | 11.93  | 03.00   |  |  |  |                                    |        |                                      |

<sup>1)</sup> + CVT autom.transmission (stepless) / + cambio autom. (continuo) / + transm.autom. (en continu) / + caja de camb.autom.(de progres.continua)

<sup>2)</sup> + manual transmission / + scatola cambio velocità / + transmission mécanique / + cambio de velocidad























<sup>3)</sup> - 3rd seat row / - 3a fila di sedili / - 3ème rangée de sièges / - 3a fila de asientos

<sup>4)</sup> + 3rd seat row / + 3a fila di sedili / + 3ème rangée de sièges / + 3a fila de asientos

|     |  |  |  |  |  |  |  |  |                     |
|--|--|--|--|--|---|--|--|--|---------------------|
| <b>MITSUBISHI PAJERO (90-00)</b>   |  |  |  |  |   |  |  |  |                     |
|    | 2.4 (V21C/V21W)  | 82   |  | 12.90  | 03.00   |  | 24.0124-0140.1   | 424140   | 276 24,0 22,4 V +B  |
|  | 2.4 (V41W)   | 82   |  | 12.90  | 03.00   |  |  |  |                     |
|  | 2.5 TD (V24C/V24W)   | 73   |  | 12.90  | 03.00   |  |  |  |                     |
|  | 2.5 TD (V44W)  | 73   |  | 12.90  | 03.00   |  |  |  |                     |
|  | 2.8 D 4x4 (V26W)   | 71   |  | 11.93  | 03.00   |  |  |  |                     |
|  | 2.8 TD (V46W)  | 92   |  | 11.93  | 03.00   |  |  |  |                     |
|  | 3.0 V6 (V23C/V23W)   |  |  | 12.90  | 03.00   |  |  |  |                     |
|  | 3.0 V6 (V43W)  | 130  |  | 12.90  | 03.00   |  |  |  |                     |
|  | 3.5 V6 (V25W)  | 153  |  | 11.93  | 03.00   | - ABS  | 24.0127-0101.1   | 427101   | 276 27,0 25,4 V     |
|  | 3.5 V6 (V45W)  | 143  |  | 11.93  | 03.00   | - ABS  |  |  |                     |
|    | 2.4 (V21C/V21W)  | 82   |  | 12.90  | 03.00   |  | 13.0460-5981.2   | 605981   | 21840 14,4 +/-WK    |
|  | 2.4 (V41W)   | 82   |  | 12.90  | 03.00   |  |  |  |                     |
|  | 2.5 TD (V24C/V24W)   | 73   |  | 12.90  | 03.00   |  |  |  |                     |
|  | 2.5 TD (V44W)  | 73   |  | 12.90  | 03.00   |  |  |  |                     |
|  | 2.8 D 4x4 (V26W)   | 71   |  | 11.93  | 03.00   |  |  |  |                     |
|  | 2.8 TD (V46W)  | 92   |  | 11.93  | 03.00   |  |  |  |                     |
|  | 3.0 V6 (V23C/V23W)   |  |  | 12.90  | 03.00   |  |  |  |                     |
|  | 3.0 V6 (V43W)  | 130  |  | 12.90  | 03.00   |  |  |  |                     |
|  | 3.5 V6 (V25W)  | 153  |  | 11.93  | 03.00   |  |  |  |                     |
|  | 3.5 V6 (V45W)  | 143  |  | 11.93  | 03.00   |  |  |  |                     |
|    | 2.4 (V21C/V21W)  | 82   |  | 12.90  | 03.00   |  | 24.0118-0140.1   | 418140   | 315 18,0 16,4 +B    |
|  | 2.4 (V41W)   | 82   |  | 12.90  | 03.00   |  |  |  |                     |
|  | 2.5 TD (V24C/V24W)   | 73   |  | 12.90  | 03.00   |  |  |  |                     |
|  | 2.5 TD (V44W)  | 73   |  | 12.90  | 03.00   |  |  |  |                     |
|  | 2.8 D 4x4 (V26W)   | 71   |  | 11.93  | 03.00   |  |  |  |                     |
|  | 2.8 TD (V46W)  | 92   |  | 11.93  | 03.00   |  |  |  |                     |
|  | 3.0 V6 (V23C/V23W)   |  |  | 12.90  | 03.00   |  |  |  |                     |
|  | 3.0 V6 (V43W)  | 130  |  | 12.90  | 03.00   |  |  |  |                     |
|  | 3.5 V6 (V25W)  | 153  |  | 11.93  | 03.00   |  |  |  |                     |
|  | 3.5 V6 (V45W)  | 143  |  | 11.93  | 03.00   |  |  |  |                     |
|    | 2.4 (V21C/V21W)  | 82   |  | 12.90  | 03.00   |  | 03.0137-0390.2   | 650390   | 196 x 40            |
|  | 2.4 (V41W)   | 82   |  | 12.90  | 03.00   |  | 03.0137-9275.2   | 669275   | Bremsbacken-Zubehör |
|  | 2.5 TD (V24C/V24W)   | 73   |  | 12.90  | 03.00   |  |  |  |                     |
|  | 2.5 TD (V44W)  | 73   |  | 12.90  | 03.00   |  |  |  |                     |
|  | 2.8 D 4x4 (V26W)   | 71   |  | 11.93  | 03.00   |  |  |  |                     |
|  | 2.8 TD (V46W)  | 92   |  | 11.93  | 03.00   |  |  |  |                     |
|  | 3.0 V6 (V23C/V23W)   |  |  | 12.90  | 03.00   |  |  |  |                     |
|  | 3.0 V6 (V43W)  | 130  |  | 12.90  | 03.00   |  |  |  |                     |
|  | 3.5 V6 (V25W)  | 153  |  | 11.93  | 03.00   |  |  |  |                     |
|  | 3.5 V6 (V45W)  | 143  |  | 11.93  | 03.00   |  |  |  |                     |
| <b>MITSUBISHI PAJERO (00-07)</b>   |  |  |  |  |   |  |  |  |                     |
|  | 2.5 TDiC (V64W)  | 73   |  | 04.00  | 01.07   |  | 13.0460-5958.2   | 605958   | 21363 15,8 +/-WK    |
|  | 2.5 TDiC (V64W)  | 85   |  | 04.00  | 01.07   |  | 13.0460-0235.2   | 610235   | Belagsatz-Zubehör   |
|  | 3.2 DiD (V68W)   | 118  |  | 10.01  | 08.06   |  |  |  |                     |
|  | 3.2 DiD (V68W)   | 121  |  | 04.00  | 09.01   |  |  |  |                     |
|  | 3.5 i V6 GDI (V65W)  | 149  |  | 04.00  | 08.06   |  |  |  |                     |
|  | 2.5 TDiC (V64W)  | 73   |  | 04.00  | 01.07   |  | 13.0460-5853.2   | 605853   | 23488 15,4 /WK      |
|  | 2.5 TDiC (V64W)  | 73   |  | 04.00  | 01.07   | + 15" Rad 1)   | 24.0124-0140.1   | 424140   | 276 24,0 22,4 V +B  |
|  | 2.5 TDiC (V64W)  | 85   |  | 04.00  | 01.07   | + 15" Rad 1)   |  |  |                     |
|  | 3.2 DiD (V68W)   | 118  |  | 10.01  | 08.06   | + 15" Rad 1)   |  |  |                     |
|  | 3.2 DiD (V68W)   | 121  |  | 04.00  | 09.01   | + 15" Rad 1)   |  |  |                     |
|  | 3.5 i V6 GDI (V65W)  | 149  |  | 04.00  | 08.06   | + 15" Rad 1)   |  |  |                     |
|  | 2.5 TDiC (V64W)  | 73   |  | 04.00  | 01.07   | + 16" Rad 2)   | 24.0126-0145.1   | 426145   | 290 26,0 24,4 V +B  |
|  | 2.5 TDiC (V64W)  | 85   |  | 04.00  | 01.07   |  | 13.0460-5855.2   | 605855   | 23582 16,0 +        |
|  | 2.5 TDiC (V64W)  | 85   |  | 04.00  | 01.07   |  | 13.0460-0137.2   | 610137   | Belagsatz-Zubehör   |
|  | 3.2 DiD (V68W)   | 118  |  | 10.01  | 08.06   |  |  |  |                     |
|  | 3.2 DiD (V68W)   | 121  |  | 04.00  | 09.01   |  |  |  |                     |
|  | 3.5 i V6 GDI (V65W)  | 149  |  | 04.00  | 08.06   |  |  |  |                     |
|  | 2.5 TDiC (V64W)  | 73   |  | 04.00  | 01.07   |  | 24.0122-0724.1   | 422724   | 300 22,0 20,4 V +B  |
|  | 3.2 DiD (V68W)   | 118  |  | 10.01  | 08.06   |  |  |  |                     |
|  | 3.2 DiD (V68W)   | 121  |  | 04.00  | 09.01   |  |  |  |                     |
|  | 3.5 i V6 GDI (V65W)  | 149  |  | 04.00  | 08.06   |  |  |  |                     |
|  | 2.5 TDiC (V64W)  | 85   |  | 04.00  | 01.07   |  | 24.0118-0140.1   | 418140   | 315 18,0 16,4 +B    |
|  | 2.5 TDiC (V64W)  | 73   |  | 04.00  | 01.07   |  | 03.0137-3003.2   | 653003   | 198 x 34            |
|  | 2.5 TDiC (V64W)  | 85   |  | 04.00  | 01.07   |  |  |  |                     |
|  | 3.2 DiD (V68W)   | 118  |  | 10.01  | 08.06   |  |  |  |                     |
|  | 3.2 DiD (V68W)   | 121  |  | 04.00  | 09.01   |  |  |  |                     |
|  | 3.5 i V6 GDI (V65W)  | 149  |  | 04.00  | 08.06   |  |  |  |                     |
|  | 2.5 TDiC (V64W)  | 73   |  | 04.00  | 01.07   |  |  |  |                     |
|  | 2.5 TDiC (V64W)  | 85   |  | 04.00  | 01.07   |  |  |  |                     |
|  | 3.2 DiD (V68W)   | 118  |  | 10.01  | 08.06   |  |  |  |                     |
| <b>MITSUBISHI PAJERO (07-)</b>   |  |  |  |  |   |  |  |  |                     |
|  | 3.2 DI-D (V88W)  | 118  |  | 02.07  |   |  | 13.0460-5853.2   | 605853   | 23488 15,4 /WK      |
|  | 3.2 DI-D (V88W)  | 125  |  | 02.07  |   |  |  |  |                     |
|  | 3.2 DI-D 4x4 (V88W)  | 140  |  | 02.07  |   |  |  |  |                     |
|  | 3.2 TD 4x4 (V88W)  | 147  |  | 01.09  |   |  |  |  |                     |
|  | 3.8 i V6 (V87W)  | 182  |  | 02.10  |   |  |  |  |                     |
|  | 3.8 i V6 (V87W)  | 184  |  | 02.07  |   |  |  |  |                     |

1) + 15" wheel / + ruota 15" / + roue 15" / + rueda 15"





























2) + 16" wheel / + ruota 16" / + roue 16" / + rueda 16"

|     |    |  |                          |    |  |    |  |  |
|--|--|--|--|--|---|--|--|--|
| <b>MITSUBISHI PAJERO (07-)</b>   |  |  |  |  |   |  |  |  |
|    | 3.0 i V6 (V93W) 131<br>3.2 DI-D (V98W) 118<br>3.2 DI-D (V98W) 125<br>3.2 TD 4x4 (V98W) 147<br>3.8 i V6 (V97W) 182<br>3.8 i V6 (V97W) 184   |  | 02.07<br>02.07<br>02.07<br>01.09<br>02.10<br>02.07   |  | 13.0460-5747.2 605747   |  |  | 24024 17,0 +WK   |
|    | 3.2 DI-D (V88W) 118<br>3.2 DI-D (V88W) 125<br>3.2 DI-D 4x4 (V88W) 140<br>3.2 TD 4x4 (V88W) 147<br>3.8 i V6 (V87W) 182<br>3.8 i V6 (V87W) 184   |  | 02.07<br>02.07<br>02.07<br>01.09<br>02.10<br>02.07   |  | 24.0126-0145.1 426145   |  |  | 290 26,0 24,4 V +B   |
|  | 3.0 i V6 (V93W) 131<br>3.2 DI-D (V98W) 118<br>3.2 DI-D (V98W) 125<br>3.2 TD 4x4 (V98W) 147<br>3.8 i V6 (V97W) 182<br>3.8 i V6 (V97W) 184   |  | 02.07<br>02.07<br>02.07<br>01.09<br>02.10<br>02.07   |  | 24.0128-0215.1 428215   |  |  | 332 28,0 26,0 V +B   |
|    | 3.0 i V6 (V93W) 131<br>3.2 DI-D (V88W) 118<br>3.2 DI-D (V88W) 125<br>3.2 DI-D (V98W) 118<br>3.2 DI-D (V98W) 125<br>3.2 DI-D 4x4 (V88W) 140<br>3.2 TD 4x4 (V88W) 147<br>3.2 TD 4x4 (V98W) 147<br>3.8 i V6 (V87W) 182<br>3.8 i V6 (V87W) 184<br>3.8 i V6 (V97W) 182<br>3.8 i V6 (V97W) 184 |  | 02.07<br>02.07<br>02.07<br>02.07<br>02.07<br>02.07<br>01.09<br>01.09<br>02.10<br>02.07<br>02.10<br>02.07 |  | 24.0710-5005.4 360337<br>24.0710-5006.4 360338                                    | <br>     |  | Radsensor L=920<br>Radsensor L=936   |
|    | 3.2 DI-D (V88W) 118<br>3.2 DI-D (V88W) 125<br>3.2 DI-D 4x4 (V88W) 140<br>3.2 TD 4x4 (V88W) 147<br>3.8 i V6 (V87W) 182<br>3.8 i V6 (V87W) 184   |  | 02.07<br>02.07<br>02.07<br>01.09<br>02.10<br>02.07   |  | 13.0460-5855.2 605855<br>13.0460-0137.2 610137                                    |  |  | 23582 16,0 +<br>Belagsatz-Zubehör  |
|  | 3.0 i V6 (V93W) 131<br>3.2 DI-D (V98W) 118<br>3.2 DI-D (V98W) 125<br>3.2 TD 4x4 (V98W) 147<br>3.8 i V6 (V97W) 182<br>3.8 i V6 (V97W) 184   |  | 02.07<br>02.07<br>02.07<br>01.09<br>02.10<br>02.07   |  | 13.0460-5744.2 605744   |  |  | 21947 15,4   |
|  | 3.2 DI-D (V88W) 118<br>3.2 DI-D (V88W) 125<br>3.2 DI-D 4x4 (V88W) 140<br>3.2 TD 4x4 (V88W) 147<br>3.8 i V6 (V87W) 182<br>3.8 i V6 (V87W) 184   |  | 02.07<br>02.07<br>02.07<br>01.09<br>02.10<br>02.07   |  | 24.0122-0724.1 422724   |  |  | 300 22,0 20,4 V +B   |
|  | 3.0 i V6 (V93W) 131<br>3.2 DI-D (V98W) 118<br>3.2 DI-D (V98W) 125<br>3.2 TD 4x4 (V98W) 147<br>3.8 i V6 (V97W) 182<br>3.8 i V6 (V97W) 184   |  | 02.07<br>02.07<br>02.07<br>01.09<br>02.10<br>02.07   |  | 24.0118-0146.1 418146   |  |  | 332 18,0 16,0 V +B   |
|  | 3.0 i V6 (V93W) 131<br>3.2 DI-D (V88W) 118<br>3.2 DI-D (V88W) 125<br>3.2 DI-D (V98W) 118<br>3.2 DI-D (V98W) 125<br>3.2 DI-D 4x4 (V88W) 140<br>3.2 TD 4x4 (V88W) 147<br>3.2 TD 4x4 (V98W) 147<br>3.8 i V6 (V87W) 182<br>3.8 i V6 (V87W) 184<br>3.8 i V6 (V97W) 182<br>3.8 i V6 (V97W) 184 |  | 02.07<br>02.07<br>02.07<br>02.07<br>02.07<br>02.07<br>01.09<br>01.09<br>02.10<br>02.07<br>02.10<br>02.07 |  | 24.0710-5003.4 360335<br>24.0710-5004.4 360336                                    | <br> |  | Radsensor L=984<br>Radsensor L=952   |
|  | 3.0 i V6 (V93W) 131<br>3.2 DI-D (V88W) 118<br>3.2 DI-D (V88W) 125<br>3.2 DI-D 4x4 (V88W) 140<br>3.2 TD 4x4 (V88W) 147<br>3.8 i V6 (V87W) 182<br>3.8 i V6 (V87W) 184  |  | 02.07<br>02.07<br>02.07<br>02.07<br>01.09<br>02.10<br>02.07  | langer Radstand <sup>1)</sup><br>kurzer Radstand <sup>2)</sup><br>kurzer Radstand <sup>2)</sup><br>kurzer Radstand <sup>2)</sup><br>kurzer Radstand <sup>2)</sup><br>kurzer Radstand <sup>2)</sup> | 03.0137-3003.2 653003   |  |  | 198 x 34   |
| <b>MITSUBISHI PAJERO PININ / SHOGUN PININ (GB) (99-05)</b>                         |  |  |  |  |   |  |  |  |
|  | 1.8 i 16V (H67W) 84<br>1.8 i 16V GDi (H66W) 88<br>2.0 16V GDi (H77W) 95  |  | 11.01 02.05<br>10.99 10.01<br>09.00 02.05  |  | 13.0460-5854.2 605854   |  |  | 23487 15,5 <b>SUM</b>  |
|  | 1.8 i 16V (H67W) 84<br>1.8 i 16V GDi (H66W) 88<br>2.0 16V GDi (H77W) 95  |  | 11.01 02.05<br>10.99 10.01<br>09.00 02.05  |  | 24.0122-0230.1 422230   |  |  | 285 22,0 20,4 V +B   |
|  | 1.8 i 16V (H67W) 84<br>1.8 i 16V GDi (H66W) 88<br>2.0 16V GDi (H77W) 95  |  | 11.01 02.05<br>10.99 10.01<br>09.00 02.05  |  | 13.0460-5980.2 605980<br>13.0460-0150.2 610150                                    |  |  | 21706 15,5 +WK <b>AKE</b><br>Belagsatz-Zubehör <b>AKE</b>                          |

<sup>1)</sup> long wheel base / passo lungo / empattement long / distancia larga entre ejes  
<sup>2)</sup> short wheel base / passo corto / empattement court / distancia corta entre ejes































|     |                        |  |  |  |  |  |  |  |  |                          |            |
|--|--|--|--|--|---|--|--|--|--|--------------------------|------------|
| <b>MITSUBISHI PAJERO PININ / SHOGUN PININ (GB) (99-05)</b>                         |  |  |  |  |   |  |  |  |  |                          |            |
|    | 1.8 i 16V (H67W)<br>1.8 i 16V GDi (H66W)<br>2.0 16V GDi (H77W)   | 84<br>88<br>95   |  | 11.01<br>10.99<br>09.00  | 02.05<br>10.01<br>02.05   |  | 24.0110-0281.1   | 410281   | 262 9,5 8,4                              |                          |            |
|    | 1.8 i 16V GDi (H66W)   | 88   |  | 10.99  | 10.01   |  | 03.0137-0389.2   | 650389   | 167 x 32                                 |                          |            |
| <b>MITSUBISHI PAJERO SPORT / MONTERO (USA) (98-09)</b>                             |  |  |  |  |   |  |  |  |  |                          |            |
|    | 2.5 TDCi (K94W)<br>2.5 TDCi (K94W)<br>2.5 TDCi (K94W)<br>2.8 TDI<br>3.0 i V6 (K96W)<br>3.0 i V6 (K96W) | 73<br>85<br>98<br>87<br>125<br>130   |  | 11.98<br>07.02<br>08.03<br>11.98<br>06.00<br>11.98                               | 02.09<br>02.09<br>02.09<br>02.09<br>02.09<br>09.01                                |  | 13.0460-5958.2<br>13.0460-0235.2   | 605958<br>610235   | 21363 15,8 +/WK<br>Belagsatz-Zubehör     | <b>AKE</b>               |            |
|    | 2.5 TDCi (K94W)<br>2.5 TDCi (K94W)<br>2.5 TDCi (K94W)<br>2.8 TDI<br>3.0 i V6 (K96W)<br>3.0 i V6 (K96W) | 73<br>85<br>98<br>87<br>125<br>130   |  | 11.98<br>07.02<br>08.03<br>11.98<br>06.00<br>11.98                               | 02.09<br>02.09<br>02.09<br>02.09<br>02.09<br>09.01                                |  | 24.0124-0140.1   | 424140   | 276 24,0 22,4 V +B                       |                          |            |
|    | 2.5 TDCi (K94W)<br>2.5 TDCi (K94W)<br>2.5 TDCi (K94W)<br>2.8 TDI<br>3.0 i V6 (K96W)<br>3.0 i V6 (K96W) | 73<br>85<br>98<br>87<br>125<br>130   |  | 11.98<br>07.02<br>08.03<br>11.98<br>06.00<br>11.98                               | 02.09<br>02.09<br>02.09<br>02.09<br>02.09<br>09.01                                |  | 24.0118-0140.1   | 418140   | 315 18,0 16,4 +B                         |                          |            |
| <b>MITSUBISHI PAJERO SPORT (KH_) (09-)</b>   |  |  |  |  |   |  |  |  |  |                          |            |
|    | 2.4<br>2.5 DI-D<br>2.5 DI-D 4WD<br>3.0 V6 4WD<br>3.2 DI-D  | 94<br>131<br>131<br>162<br>121   |  | 11.09<br>11.09<br>11.09<br>11.09<br>11.09  |   |  | 13.0460-5631.2   | 605631   |  | 24529 16,0 +/WK          |            |
|    | 2.4<br>2.5 DI-D<br>2.5 DI-D 4WD<br>3.0 V6 4WD  | 94<br>131<br>131<br>162  |  | 11.09<br>11.09<br>11.09<br>11.09   |   |  | 03.0137-0390.2   | 650390   |  | 196 x 40                 |            |
| <b>MITSUBISHI SANTAMO (99-04)</b>  |  |  |  |  |   |  |  |  |  |                          |            |
|   | 2.0 i 16V<br>2.0 i 16V 4WD   | 102<br>102   |  | 05.99<br>05.99   | 12.04<br>12.04  |  | 13.0460-5952.2   | 605952   |  | 21647 16,0 +/WK          | <b>SUM</b> |
|  | 2.0 i 16V<br>2.0 i 16V 4WD<br>2.0 i 16V<br>2.0 i 16V 4WD   | 102<br>102<br>102<br>102   |  | 05.99<br>05.99<br>05.99<br>05.99   | 12.04<br>12.04<br>12.04<br>12.04  | - ABS<br>- ABS<br>+ ABS<br>+ ABS   | 24.0124-0136.1<br>24.0124-0146.1   | 424136<br>424146   | 256 24,0 21,5 V +B<br>256 24,0 22,4 V +B |                          |            |
|  | 2.0 i 16V<br>2.0 i 16V 4WD   | 102<br>102   |  | 05.99<br>05.99   | 12.04<br>12.04  | + ABS<br>+ ABS   | 13.0460-5980.2   | 605980   |  | 21706 15,5 +/WK          | <b>AKE</b> |
|  | 2.0 i 16V<br>2.0 i 16V 4WD   | 102<br>102   |  | 05.99<br>05.99   | 12.04<br>12.04  | + ABS<br>+ ABS   | 24.0110-0240.1   | 410240   | 262 10,0 8,4 +B                          |                          |            |
|  | 2.0 i 16V<br>2.0 i 16V 4WD   | 102<br>102   |  | 05.99<br>05.99   | 12.04<br>12.04  | - ABS<br>- ABS   | 03.0137-0288.2   | 650288   | 229 x 42                                 |                          |            |
| <b>MITSUBISHI SPACE GEAR (95-02)</b>   |  |  |  |  |   |  |  |  |  |                          |            |
|  | 2.0 i<br>2.0 i 16V<br>2.4 i<br>2.5 TDiC  | 83<br>85<br>97<br>73   |  | 08.96<br>05.95<br>05.95<br>05.95   | 10.02<br>05.00<br>10.02<br>05.00  |  | 13.0460-5890.2   | 605890   |  | 23290 15,5 /WK           | <b>AKE</b> |
|  | 2.4 i 4x4<br>2.5 TDiC 4x4  | 97<br>73   |  | 05.95<br>05.95   | 05.00<br>05.00  |  | 13.0460-5958.2<br>13.0460-0235.2   | 605958<br>610235   | 21363 15,8 +/WK<br>Belagsatz-Zubehör     | <b>AKE</b>               |            |
|  | 2.4 i 4x4<br>2.5 TDiC 4x4  | 97<br>73   |  | 05.95<br>05.95   | 05.00<br>05.00  |  | 24.0124-0202.1   | 424202   | 276 24,0 22,4 V                          |                          |            |
|  | 2.4 i 4x4<br>2.5 TDiC 4x4  | 97<br>73   |  | 05.95<br>05.95   | 05.00<br>05.00  |  | 13.0460-5980.2   | 605980   |  | 21706 15,5 +/WK          | <b>AKE</b> |
|  | 2.4 i 4x4<br>2.5 TDiC 4x4  | 97<br>73   |  | 05.95<br>05.95   | 05.00<br>05.00  |  | 24.0118-0140.1   | 418140   | 315 18,0 16,4 +B                         |                          |            |
|  | 2.0 i<br>2.0 i 16V<br>2.4 i<br>2.5 TDiC  | 83<br>85<br>97<br>73   |  | 08.96<br>05.95<br>05.95<br>05.95   | 10.02<br>05.00<br>10.02<br>05.00  |  | 03.0137-0482.2   | 650482   | 254 x 52                                 |                          |            |
| <b>MITSUBISHI SPACE RUNNER (91-99)</b>   |  |  |  |  |   |  |  |  |  |                          |            |
|  | 1.8 (N11W)<br>1.8 4x4 (N21W)<br>2.0 TD (N18W)  | 85<br>90<br>60   |  | 06.91<br>06.91<br>06.92  | 08.99<br>08.99<br>08.99   |  | 13.0460-5952.2<br>13.0460-0442.2   | 605952<br>610442   | 21647 16,0 +/WK<br>Belagsatz-Zubehör     | <b>SUM</b><br><b>SUM</b> |            |





















1) - Europe / - Europa / - Europe / - Europa



|     |  |  |  |  |  |  |  |  |
|--|--|--|--|--|---|--|--|--|
| <b>MITSUBISHI SPACE RUNNER (91-99)</b>   |  |  |  |  |   |  |  |  |
|    | 1.8 (N11W)   | 85   | 06.91  | 08.99  | - ABS/ + HA-Trommelbremse 1)  | 24.0124-0136.1   | 424136   | 256 24,0 21,5 V +B   |
|  | 1.8 4x4 (N21W)   | 90   | 06.91  | 08.99  | - ABS/ + HA-Trommelbremse 1)  |  |  |  |
|    | 2.0 TD (N18W)  | 60   | 06.92  | 08.99  | - ABS   |  |  |  |
|  | 1.8 (N11W)   | 85   | 06.91  | 08.99  | + ABS/ + HA-Scheibenbremse 2)   | 24.0124-0146.1   | 424146   | 256 24,0 22,4 V +B   |
|    | 1.8 4x4 (N21W)   | 90   | 06.91  | 08.99  | + ABS/ + HA-Scheibenbremse 2)   |  |  |  |
|  | 1.8 (N11W)   | 85   | 06.91  | 08.99  |   | 13.0460-5980.2   | 605980   | 21706 15,5 +/WK AKE  |
|    | 1.8 4x4 (N21W)   | 90   | 06.91  | 08.99  |   |  |  |  |
|  | 1.8 (N11W)   | 85   | 06.91  | 08.99  |   | 24.0110-0240.1   | 410240   | 262 10,0 8,4 +B  |
|    | 1.8 4x4 (N21W)   | 90   | 06.91  | 08.99  |   |  |  |  |
|  | 1.8 (N11W)   | 85   | 06.91  | 08.99  |   | 03.0137-0289.2   | 650289   | 203 x 37   |
|    | 2.0 TD (N18W)  | 60   | 06.92  | 08.99  |   | 03.0137-9192.2   | 669192   | Bremsbacken-Zubehör  |
|  | 1.8 4x4 (N21W)   | 90   | 06.91  | 08.99  |   | 03.0137-0288.2   | 650288   | 229 x 42   |
|    | 1.8 (N11W)   | 85   | 06.91  | 08.99  |   | 03.0137-0389.2   | 650389   | 167 x 32   |
| <b>MITSUBISHI SPACE RUNNER (99-03)</b>   |  |  |  |  |   |  |  |  |
|  | 2.0 16V (N63W)   | 100  | 09.99  | 04.00  |   | 13.0460-5958.2   | 605958   | 21363 15,8 +/WK AKE  |
|  | 2.4 16V GDI (N64W)   | 110  | 09.99  | 04.00  |   | 13.0460-0235.2   | 610235   | Belagsatz-Zubehör  |
|  | 2.0 16V (N63W)   | 100  | 05.00  | 04.03  |   | 13.0460-5760.2   | 605760   | 23584 16,4 /WK AKE   |
|  | 2.4 16V GDI (N64W)   | 110  | 05.00  | 04.03  |   |  |  |  |
|  | 2.0 16V (N63W)   | 100  | 09.99  | 04.00  |   | 24.0124-0182.1   | 424182   | 276 24,0 22,4 V  |
|  | 2.4 16V GDI (N64W)   | 110  | 09.99  | 04.00  |   |  |  |  |
|  | 2.0 16V (N63W)   | 100  | 05.00  | 04.03  |   | 24.0126-0134.1   | 426134   | 276 26,0 24,4 V +B   |
|  | 2.4 16V GDI (N64W)   | 110  | 05.00  | 04.03  |   |  |  |  |
|  | 2.0 16V (N63W)   | 100  | 09.99  | 04.03  |   | 13.0460-5980.2   | 605980   | 21706 15,5 +/WK AKE  |
|  | 2.4 16V GDI (N64W)   | 110  | 09.99  | 04.03  |   | 13.0460-0150.2   | 610150   | Belagsatz-Zubehör AKE  |
|  | 2.0 16V (N63W)   | 100  | 09.99  | 04.03  |   | 24.0110-0704.1   | 410704   | 262 10,0 8,4 +B  |
|  | 2.4 16V GDI (N64W)   | 110  | 09.99  | 04.03  |   |  |  |  |
|  | 2.0 16V (N63W)   | 100  | 09.99  | 04.03  |   | 03.0137-0389.2   | 650389   | 167 x 32   |
|  | 2.4 16V GDI (N64W)   | 110  | 09.99  | 04.03  |   |  |  |  |
| <b>MITSUBISHI SPACE STAR (98-06)</b>   |  |  |  |  |   |  |  |  |
|  | 1.3 i (DG1A)   | 60   | 08.00  | 03.06  |   | 13.0460-2830.2   | 602830   | 21920 14,6 /WK/Zub/S TRW   |
|  | 1.3 i (DG1A)   | 61   | 12.98  | 03.06  |   |  |  |  |
|  | 1.3 i (DG1A)   | 63   | 06.98  | 07.00  |   |  |  |  |
|  | 1.6 i 16V (DG3A)   | 72   | 09.01  | 03.06  |   |  |  |  |
|  | 1.8 GDI (DG5A)   | 82   | 10.02  | 03.06  |   |  |  |  |
|  | 1.8 GDI (DG5A)   | 90   | 06.98  | 03.06  |   |  |  |  |
|  | 1.9 DI-D (DG4A)  | 75   | 02.01  | 03.06  |   |  |  |  |
|  | 1.9 DI-D (DG4A)  | 85   | 10.02  | 03.06  |   |  |  |  |
|  | 1.3 i (DG1A)   | 60   | 08.00  | 03.06  |   | 24.0124-0136.1   | 424136   | 256 24,0 21,5 V +B   |
|  | 1.3 i (DG1A)   | 61   | 12.98  | 03.06  |   |  |  |  |
|  | 1.3 i (DG1A)   | 63   | 06.98  | 07.00  |   |  |  |  |
|  | 1.6 i 16V (DG3A)   | 72   | 09.01  | 03.06  |   |  |  |  |
|  | 1.8 GDI (DG5A)   | 82   | 10.02  | 03.06  |   |  |  |  |
|  | 1.8 GDI (DG5A)   | 90   | 06.98  | 03.06  |   |  |  |  |
|  | 1.9 DI-D (DG4A)  | 75   | 02.01  | 03.06  |   |  |  |  |
|  | 1.9 DI-D (DG4A)  | 85   | 10.02  | 03.06  |   |  |  |  |
|  | 1.3 i (DG1A)   | 60   | 08.00  | 03.06  | + ABS   | 13.0460-2831.2   | 602831   | 21861 15,2 /WK/S TRW   |
|  | 1.3 i (DG1A)   | 61   | 12.98  | 03.06  | + ABS   |  |  |  |
|  | 1.3 i (DG1A)   | 63   | 06.98  | 07.00  | + ABS   |  |  |  |
|  | 1.6 i 16V (DG3A)   | 72   | 09.01  | 03.06  |   |  |  |  |
|  | 1.8 GDI (DG5A)   | 82   | 10.02  | 03.06  | + ABS   |  |  |  |
|  | 1.8 GDI (DG5A)   | 90   | 06.98  | 03.06  | + ABS   |  |  |  |
|  | 1.9 DI-D (DG4A)  | 75   | 02.01  | 03.06  |   |  |  |  |
|  | 1.9 DI-D (DG4A)  | 85   | 10.02  | 03.06  |   |  |  |  |
|  | 1.3 i (DG1A)   | 60   | 08.00  | 03.06  | + ABS   | 24.0110-0229.1   | 410229   | 260 10,0 8,4 +B  |
|  | 1.3 i (DG1A)   | 61   | 12.98  | 03.06  | + ABS   |  |  |  |
|  | 1.3 i (DG1A)   | 63   | 06.98  | 07.00  | + ABS   |  |  |  |
|  | 1.6 i 16V (DG3A)   | 72   | 09.01  | 03.06  |   |  |  |  |
|  | 1.8 GDI (DG5A)   | 82   | 10.02  | 03.06  | + ABS   |  |  |  |
|  | 1.8 GDI (DG5A)   | 90   | 06.98  | 03.06  | + ABS   |  |  |  |
|  | 1.9 DI-D (DG4A)  | 75   | 02.01  | 03.06  |   |  |  |  |
|  | 1.9 DI-D (DG4A)  | 85   | 10.02  | 03.06  |   |  |  |  |
|  | 1.3 i (DG1A)   | 63   | 06.98  | 09.98  | - ABS   | 03.0137-0289.2   | 650289   | 203 x 37   |
|  | 1.3 i (DG1A)   | 60   | 08.00  | 03.06  | - ABS   | 03.0137-0428.2   | 650428   | 203 x 39 HEB   |
|  | 1.3 i (DG1A)   | 61   | 12.98  | 03.06  | - ABS   | 03.0137-9257.2   | 669257   | Bremsbacken-Zubehör  |
|  | 1.3 i (DG1A)   | 63   | 10.98  | 07.00  | - ABS   |  |  |  |
|  | 1.8 GDI (DG5A)   | 82   | 10.02  | 03.06  | - ABS   |  |  |  |
|  | 1.8 GDI (DG5A)   | 90   | 06.98  | 03.06  | - ABS   |  |  |  |
|  | 1.3 i (DG1A)   | 60   | 08.00  | 03.06  | - ABS   | 24.0220-3028.1   | 480169   | 203/205 x 41,  |
|  | 1.3 i (DG1A)   | 61   | 12.98  | 03.06  | - ABS   |  |  |  |
|  | 1.3 i (DG1A)   | 63   | 06.98  | 07.00  | - ABS   |  |  |  |
|  | 1.8 GDI (DG5A)   | 82   | 10.02  | 03.06  | - ABS   |  |  |  |
| 1.8 GDI (DG5A)   | 90   | 06.98  | 03.06  | - ABS  |   |  |  |  |





















1) - ABS/ + RA drum brake / - ABS/ + P freno a tamburo / - ABS/ + fr. à tambour essieu AR / - ABS/ + ET tambores de freno

2) + ABS/ + RA disc brake / + ABS/ + P disco freno / + ABS / + fr. à disque essieu AR / + ABS/ + ET disco de freno























|     |                                  |  |    |  |  |  |  |  |
|--|--|--|--|--|---|--|--|--|
| <b>MITSUBISHI SPACE STAR (A05A) (12-)</b>  |  |  |  |  |   |  |  |  |
|    | 1.0 12V<br>1.2 12V<br>1.2 12V  | 52<br>57<br>59   | 05.12<br>05.12<br>10.12  |  | 13.0460-5709.2  | 605709   |  | 24229 14,8 +/WK/Zub AKE  |
| <b>MITSUBISHI SPACE WAGON (91-98)</b>  |  |  |  |  |   |  |  |  |
|    | 1.8 (N31W)<br>1.8 4x4 (N41W)<br>1.8 TD (N35W)<br>2.0 (N33W)<br>2.0 4x4 (N43W)<br>2.0 TD (N38W)<br>2.4 (N34W)     |  | 05.91 05.92<br>05.91 05.92<br>05.91 05.92<br>06.92 10.98<br>06.92 10.98<br>06.92 10.98<br>06.92 05.96  |  | 13.0460-5952.2<br>13.0460-0442.2  | 605952<br>610442   |  | 21647 16,0 +/WK<br>Belagsatz-Zubehör SUM<br>SUM                                    |
|    | 1.8 (N31W)<br>1.8 4x4 (N41W)<br>1.8 TD (N35W)<br>2.0 (N33W)<br>2.0 4x4 (N43W)<br>2.0 TD (N38W)<br>2.4 (N34W)     |  | 05.91 05.92 + HA-Trommelbremse 1)<br>05.91 05.92 + HA-Trommelbremse 1)<br>05.91 05.92 + HA-Trommelbremse 1)<br>06.92 10.98 + HA-Trommelbremse 1)<br>06.92 10.98 + HA-Trommelbremse 1)<br>06.92 10.98 + HA-Trommelbremse 1)<br>06.92 05.96 + HA-Trommelbremse 1)        |  | 24.0124-0136.1  | 424136   |  | 256 24,0 21,5 V +B   |
|  | 1.8 (N31W)<br>1.8 4x4 (N41W)<br>1.8 TD (N35W)<br>2.0 (N33W)<br>2.0 4x4 (N43W)<br>2.0 TD (N38W)<br>2.4 (N34W)     |  | 05.91 05.92 + HA-Scheibenbremse 2)<br>05.91 05.92 + HA-Scheibenbremse 2)<br>05.91 05.92 + HA-Scheibenbremse 2)<br>06.92 10.98 + HA-Scheibenbremse 2)<br>06.92 10.98 + HA-Scheibenbremse 2)<br>06.92 10.98 + HA-Scheibenbremse 2)<br>06.92 05.96 + HA-Scheibenbremse 2) |  | 24.0124-0146.1  | 424146   |  | 256 24,0 22,4 V +B   |
|    | 1.8 (N31W)<br>1.8 4x4 (N41W)<br>1.8 TD (N35W)<br>2.0 (N33W)<br>2.0 4x4 (N43W)<br>2.0 TD (N38W)<br>2.4 (N34W)     |  | 05.91 05.92<br>05.91 05.92<br>05.91 05.92<br>06.92 10.98<br>06.92 10.98<br>06.92 10.98<br>06.92 05.96  |  | 13.0460-5980.2  | 605980   |  | 21706 15,5 +/WK AKE  |
|    | 1.8 (N31W)<br>1.8 4x4 (N41W)<br>1.8 TD (N35W)<br>2.0 (N33W)<br>2.0 4x4 (N43W)<br>2.0 TD (N38W)<br>2.4 (N34W)     |  | 05.91 05.92<br>05.91 05.92<br>05.91 05.92<br>06.92 10.98<br>06.92 10.98<br>06.92 10.98<br>06.92 05.96  |  | 24.0110-0240.1  | 410240   |  | 262 10,0 8,4 +B  |
|  | 1.8 (N31W)<br>1.8 4x4 (N41W)<br>1.8 TD (N35W)<br>2.0 (N33W)<br>2.0 4x4 (N43W)<br>2.0 TD (N38W)<br>2.4 (N34W)     |  | 05.91 05.92<br>05.91 05.92<br>05.91 05.92<br>06.92 10.98<br>06.92 10.98<br>06.92 10.98<br>06.92 05.96  |  | 03.0137-0288.2  | 650288   |  | 229 x 42   |
|  | 1.8 (N31W)<br>1.8 TD (N35W)<br>2.0 (N33W)<br>2.0 TD (N38W)<br>2.4 (N34W)   |  | 05.91 05.92<br>05.91 05.92<br>06.92 10.98<br>06.92 10.98<br>06.92 05.96  |  | 03.0137-0389.2  | 650389   |  | 167 x 32   |
| <b>MITSUBISHI SPACE WAGON (98-05)</b>  |  |  |  |  |   |  |  |  |
|  | 2.0 GDi (N83W)<br>2.0 GLX (N83W)<br>2.4 GDi (N84W)<br>2.4 GDi (N84W)<br>2.4 GDi 4x4 (N94W)<br>2.4 GDi 4x4 (N94W) | 98<br>80<br>108<br>110<br>108<br>110   | 05.02 08.05<br>10.98 04.02<br>09.00 08.03<br>10.98 08.03<br>09.00 08.03<br>10.98 08.03   |  | 13.0460-5958.2<br>13.0460-0235.2  | 605958<br>610235   |  | 21363 15,8 +/WK<br>Belagsatz-Zubehör AKE   |
|  | 2.0 GDi (N83W)<br>2.0 GLX (N83W)<br>2.4 GDi (N84W)<br>2.4 GDi (N84W)<br>2.4 GDi 4x4 (N94W)<br>2.4 GDi 4x4 (N94W) | 98<br>80<br>108<br>110<br>108<br>110   | 05.02 08.05<br>10.98 04.02<br>09.00 08.03<br>10.98 08.03<br>09.00 08.03<br>10.98 08.03   |  | 24.0124-0182.1  | 424182   |  | 276 24,0 22,4 V  |
|  | 2.0 GDi (N83W)<br>2.0 GLX (N83W)<br>2.4 GDi (N84W)<br>2.4 GDi (N84W)<br>2.4 GDi 4x4 (N94W)<br>2.4 GDi 4x4 (N94W) | 98<br>80<br>108<br>110<br>108<br>110   | 05.02 08.05<br>10.98 04.02<br>09.00 08.03<br>10.98 08.03<br>09.00 08.03<br>10.98 08.03   |  | 03.0137-0389.2  | 650389   |  | 167 x 32   |
| <b>NISSAN 200 SX (S14) (94-99)</b>   |  |  |  |  |   |  |  |  |
|  | 2.0 i 16V Turbo  | 147  | 04.94 12.99  |  | 24.0109-0147.1  | 409147   |  | 258 9,0 8,0  |
| <b>NISSAN 350 Z (Z33) (02-09)</b>  |  |  |  |  |   |  |  |  |
|  | 3.5 i V6<br>3.5 i V6<br>3.5 i V6<br>3.5 i V6   | 206<br>214<br>221<br>230   | 10.03 05.09<br>11.04 01.07<br>09.02 05.09<br>09.05 05.09   |  | 13.0460-4818.2  | 604818   |  | 23142 15,1 +/WK/Zub BRE  |











1) + RA drum brake / + P freno a tamburo / + frein à tambour essieu AR / + ET-tambores de freno

2) + RA disc brake / + P disco freno / + frein à disque essieu AR / + ET-disco de freno

|     |    kW                   |  |  |        |   |  |  |  |
|--|---|--|--|--|--|--|--|--|
| <b>NISSAN 350 Z (Z33) (02-09)</b>  |   |  |  |  |  |  |  |  |
|    | 3.5 i V6<br>3.5 i V6<br>3.5 i V6<br>3.5 i V6  | 206<br>214<br>221<br>230   |  | 10.03<br>11.04<br>09.02<br>09.05   | 05.09<br>01.07<br>05.09<br>05.09   | 24.0130-0215.1   | 430215   | 324 30,0 28,4 V L +B   |
|    | 3.5 i V6<br>3.5 i V6<br>3.5 i V6<br>3.5 i V6  | 206<br>214<br>221<br>230   |  | 10.03<br>11.04<br>09.02<br>09.05   | 05.09<br>01.07<br>05.09<br>05.09   | 13.0460-4974.2   | 604974   | 21580 14,6 +/WK BRE  |
|    | 3.5 i V6<br>3.5 i V6<br>3.5 i V6<br>3.5 i V6  | 206<br>214<br>221<br>230   |  | 10.03<br>11.04<br>09.02<br>09.05   | 05.09<br>01.07<br>05.09<br>05.09   | 24.0122-0268.1   | 422268   | 322 22,0 20,2 V +B   |
|    | 3.5 i V6<br>3.5 i V6<br>3.5 i V6<br>3.5 i V6  | 206<br>214<br>221<br>230   |  | 10.03<br>11.04<br>09.02<br>09.05   | 05.09<br>01.07<br>05.09<br>05.09   | 03.0137-3006.2   | 653006   | 172 x 32   |
| <b>NISSAN ALMERA (N15) (95-00)</b>   |   |  |  |  |  |  |  |  |
|    | 1.4 i<br>1.6 i<br>2.0 D   |  |  | 07.95<br>07.95<br>07.95  | 04.00 - ABS<br>12.97 - ABS<br>04.00 - ABS  | 13.0460-5988.2<br>13.0460-0283.2   | 605988<br>610283   | 23004 15,9 +/WK AKE<br>Belagsatz-Zubehör   |
|  | 1.6 i   |  |  | 01.98  | 04.00 - ABS  | 13.0460-5717.2<br>13.0460-0285.2   | 605717<br>610285   | 23502 16,0 +/WK<br>Belagsatz-Zubehör   |
|  | 1.4 i<br>1.6 i<br>2.0 D   |  |  | 07.95<br>07.95<br>07.95  | 04.00 + ABS<br>04.00 + ABS<br>04.00 + ABS  | 13.0460-5717.2<br>13.0460-0285.2   | 605717<br>610285   | 23502 16,0 +/WK<br>Belagsatz-Zubehör   |
|  | 2.0 i   |  |  | 04.96  | 04.00  | 13.0460-0294.2   | 610294   | Belagsatz-Zubehör  |
|    | 1.4 i<br>1.4 i<br>1.6 i<br>2.0 D  |  |  | 07.95<br>01.98<br>07.95<br>07.95   | 12.97 - ABS<br>04.00 - ABS<br>04.00 - ABS<br>04.00 - ABS   | 24.0118-0118.1<br>24.0118-0117.1   | 418118<br>418117   | 232 18,0 16,0 V<br>247 18,0 16,0 V   |
|  | 1.4 i<br>1.6 i<br>2.0 D   |  |  | 07.95<br>07.95<br>07.95  | 04.00 + ABS<br>04.00 + ABS<br>04.00 + ABS  | 24.0120-0203.1   | 420203   | 252 20,0 18,0 V +B   |
|  | 2.0 i   |  |  | 04.96  | 04.00  | 24.0126-0112.1   | 426112   | 257 26,0 24,0 V  |
|   | 1.4 i<br>1.6 i<br>2.0 D   |  |  | 07.95<br>07.95<br>07.95  | 12.97 + ABS<br>12.97 + ABS<br>12.97 + ABS  | 13.0460-5841.2<br>13.0460-0284.2   | 605841<br>610284   | 23023 14,8 +/WK SUM<br>Belagsatz-Zubehör   |
|  | 1.4 i<br>1.6 i<br>2.0 D<br>2.0 i  |  |  | 01.98<br>01.98<br>01.98<br>04.96   | 04.00 + ABS<br>04.00 + ABS<br>04.00 + ABS<br>04.00   | 13.0460-5983.2<br>13.0460-0332.2   | 605983<br>610332   | 21713 16,5<br>Belagsatz-Zubehör  |
|  | 1.4 i<br>1.6 i<br>2.0 D   |  |  | 07.95<br>07.95<br>07.95  | 12.97 + ABS<br>12.97 + ABS<br>12.97 + ABS  | 24.0107-0108.1   | 407108   | 234 7,0 6,0  |
|  | 1.4 i<br>1.6 i<br>2.0 D   |  |  | 07.95<br>07.95<br>07.95  | 04.00 - ABS<br>04.00 - ABS<br>04.00 - ABS  | 03.0137-0265.2<br>03.0137-9165.2   | 650265<br>669165   | 180 x 31<br>Bremsbacken-Zubehör  |
|  | 1.4 i<br>1.6 i<br>2.0 D   |  |  | 07.95<br>07.95<br>07.95  | 04.00 - ABS<br>04.00 - ABS<br>04.00 - ABS  | 24.0218-0025.1   | 480082   | 180/181 x 37,5   |
| <b>NISSAN ALMERA (N16) (00-06)</b>   |   |  |  |  |  |  |  |  |
|  | 1.5 dCi<br>1.5 i<br>1.5 i<br>1.5 i  | 60<br>66<br>66<br>72   |  | 01.03<br>03.00<br>02.00<br>10.02   | 11.06 - ABS<br>11.06 - ABS/ Produktionsland ⬇<br>11.06 - ABS<br>11.06 - ABS  | 13.0460-5950.2   | 605950   | 21546 16,7 TRW   |
|  | 1.5 dCi<br>1.5 i<br>1.5 i<br>1.5 i<br>1.8 i<br>1.8 i<br>1.8 i<br>2.2 dCi<br>2.2 dCi<br>2.2 Di<br>2.2 Di | 60<br>66<br>66<br>72<br>84<br>84<br>85<br>82<br>100<br>81<br>81                  |  | 01.03<br>03.00<br>02.00<br>10.02<br>03.00<br>02.00<br>09.03<br>09.03<br>03.00<br>02.00 | 11.06 + ABS<br>11.06 + ABS/ Produktionsland ⬇<br>11.06 + ABS<br>11.06 + ABS<br>11.06 Produktionsland ⬇<br>11.06<br>11.06<br>11.06 Produktionsland ⬇<br>11.06 | 13.0460-5807.2<br>13.0460-0148.2   | 605807<br>610148   | 23463 16,6 + TRW<br>Belagsatz-Zubehör TRW  |
|  | 1.5 dCi<br>1.5 i<br>1.5 i<br>1.5 i  | 60<br>66<br>66<br>72   |  | 01.03<br>03.00<br>02.00<br>10.02   | 11.06 - ABS<br>11.06 - ABS/ Produktionsland ⬇<br>11.06 - ABS<br>11.06 - ABS  | 24.0122-0146.1   | 422146   | 257 22,0 20,0 V +B   |
|  | 1.5 dCi<br>1.5 i<br>1.5 i<br>1.5 i<br>1.8 i<br>1.8 i<br>1.8 i<br>2.2 dCi<br>2.2 dCi<br>2.2 Di<br>2.2 Di | 60<br>66<br>66<br>72<br>84<br>84<br>85<br>82<br>100<br>81<br>81                  |  | 01.03<br>03.00<br>02.00<br>10.02<br>03.00<br>02.00<br>09.03<br>09.03<br>03.00<br>02.00 | 11.06 + ABS<br>11.06 + ABS/ Produktionsland ⬇<br>11.06 + ABS<br>11.06 + ABS<br>11.06 Produktionsland ⬇<br>11.06<br>11.06<br>11.06 Produktionsland ⬇<br>11.06 | 24.0122-0179.1   | 422179   | 280 22,0 20,0 V +B   |

























| <b>NISSAN ALMERA (N16) (00-06)</b>       |  |     |       |       |                 |                        |   |                |        |   |  |  |  |           |                    |  |                   |
|--|--|-----|-------|-------|-----------------|------------------------|---|----------------|--------|---|--|--|--|-----------|--------------------|--|-------------------|
|  | 1.5 dCi                                | 60  |       | 01.03 | 11.06           | + ABS                  |   | 13.0460-5986.2 | 605986 |   |  |  |  | 21545     | 14,9               |  | TRW               |
|  | 1.5 i                                  | 66  |       | 02.00 | 11.06           | + ABS                  |   |                |        |   |  |  |  |           |                    |  |                   |
|  | 1.5 i                                  | 72  |       | 10.02 | 11.06           | + ABS                  |   |                |        |   |  |  |  |           |                    |  |                   |
|  | 1.8 i                                  | 84  |       | 02.00 | 11.06           |                        |   |                |        |   |  |  |  |           |                    |  |                   |
|  | 1.8 i                                  | 85  |       | 10.02 | 11.06           |                        |   |                |        |   |  |  |  |           |                    |  |                   |
|  | 2.2 dCi                                | 82  |       | 09.03 | 11.06           |                        |   |                |        |   |  |  |  |           |                    |  |                   |
|  | 2.2 dCi                                | 100 |       | 09.03 | 11.06           |                        |   |                |        |   |  |  |  |           |                    |  |                   |
|  | 2.2 Di                                 | 81  |       | 02.00 | 11.06           |                        |   |                |        |   |  |  |  |           |                    |  |                   |
|  | 1.5 i                                  | 66  |       | 03.00 | 03.01           | + ABS/ Produktionsland | ⬇ | 13.0460-5983.2 | 605983 |   |  |  |  | 21713     | 16,5               |  |                   |
|  | 1.8 i                                  | 84  |       | 03.00 | 03.01           | Produktionsland        | ⬇ |                |        |   |  |  |  |           |                    |  |                   |
| 2.2 Di                                   | 81                                     |     | 03.00 | 03.01 | Produktionsland | ⬇                      |   |                |        |   |  |  |  |           |                    |  |                   |
|  | 1.5 dCi                                | 60  |       | 01.03 | 11.06           | + ABS                  |   | 24.0110-0215.1 | 410215 |   |  |  |  | 258       | 10,0 9,0 +B        |  |                   |
|  | 1.5 i                                  | 66  |       | 03.00 | 03.01           | + ABS/ Produktionsland | ⬇ |                |        |   |  |  |  |           |                    |  |                   |
|  | 1.5 i                                  | 66  |       | 02.00 | 11.06           | + ABS                  |   |                |        |   |  |  |  |           |                    |  |                   |
|  | 1.5 i                                  | 72  |       | 10.02 | 11.06           | + ABS                  |   |                |        |   |  |  |  |           |                    |  |                   |
|  | 1.8 i                                  | 84  |       | 03.00 | 03.01           | Produktionsland        | ⬇ |                |        |   |  |  |  |           |                    |  |                   |
|  | 1.8 i                                  | 84  |       | 02.00 | 11.06           |                        |   |                |        |   |  |  |  |           |                    |  |                   |
|  | 1.8 i                                  | 85  |       | 10.02 | 11.06           |                        |   |                |        |   |  |  |  |           |                    |  |                   |
|  | 2.2 dCi                                | 82  |       | 09.03 | 11.06           |                        |   |                |        |   |  |  |  |           |                    |  |                   |
|  | 2.2 dCi                                | 100 |       | 09.03 | 11.06           |                        |   |                |        |   |  |  |  |           |                    |  |                   |
|  | 2.2 Di                                 | 81  |       | 03.00 | 03.01           | Produktionsland        | ⬇ |                |        |   |  |  |  |           |                    |  |                   |
| 2.2 Di                                   | 81                                     |     | 02.00 | 11.06 |                 |                        |   |                |        |   |  |  |  |           |                    |  |                   |
|  | 1.5 dCi                                | 60  |       | 01.03 | 11.06           | - ABS                  |   | 03.0137-0443.2 | 650443 |   |  |  |  | 203       | x 37               |  |                   |
|  | 1.5 i                                  | 66  |       | 03.00 | 03.01           | - ABS/ Produktionsland | ⬇ |                |        |   |  |  |  |           |                    |  |                   |
|  | 1.5 i                                  | 66  |       | 02.00 | 11.06           | - ABS                  |   |                |        |   |  |  |  |           |                    |  |                   |
|  | 1.5 i                                  | 72  |       | 10.02 | 11.06           | - ABS                  |   |                |        |   |  |  |  |           |                    |  |                   |
|  | 1.5 dCi                                | 60  |       | 01.03 | 11.06           | - ABS                  |   | 24.0220-3034.1 | 480190 |   |  |  |  | 203/205,5 | x 43               |  |                   |
|  | 1.5 i                                  | 66  |       | 03.00 | 03.01           | - ABS/ Produktionsland | ⬇ |                |        |   |  |  |  |           |                    |  |                   |
|  | 1.5 i                                  | 66  |       | 02.00 | 11.06           | - ABS                  |   |                |        |   |  |  |  |           |                    |  |                   |
|  | 1.5 i                                  | 72  |       | 10.02 | 11.06           | - ABS                  |   |                |        |   |  |  |  |           |                    |  |                   |
| <b>NISSAN ALMERA TINO (V10M) (00-05)</b> |  |     |       |       |                 |                        |   |                |        |   |  |  |  |           |                    |  |                   |
|  | 1.8 i 16V                              | 84  |       | 08.00 | 01.03           |                        |   | 13.0460-5825.2 | 605825 |   |  |  |  | 23094     | 16,5 +/WK/Zub/STRW |  | Belagsatz-Zubehör |
|  | 2.0 i 16V                              | 100 |       | 08.00 | 01.03           |                        |   | 13.0460-0282.2 | 610282 |   |  |  |  |           |                    |  |                   |
|  | 2.2 Di                                 | 84  |       | 08.00 | 01.03           |                        |   |                |        |   |  |  |  |           |                    |  |                   |
|  | 1.8 i 16V                              | 84  |       | 02.03 | 11.05           |                        |   | 13.0460-5825.2 | 605825 |   |  |  |  | 23094     | 16,5 +/WK/Zub/STRW |  | Belagsatz-Zubehör |
|  | 1.8 i 16V                              | 85  |       | 12.02 | 11.05           |                        |   | 13.0460-0282.2 | 610282 |   |  |  |  |           |                    |  |                   |
|  | 2.0 i 16V                              | 100 |       | 02.03 | 08.03           |                        |   |                |        |   |  |  |  |           |                    |  |                   |
|  | 2.2 dCi                                | 82  |       | 09.03 | 11.05           |                        |   |                |        |   |  |  |  |           |                    |  |                   |
|  | 2.2 dCi                                | 100 |       | 09.03 | 11.05           |                        |   |                |        |   |  |  |  |           |                    |  |                   |
|  | 2.2 Di                                 | 84  |       | 02.03 | 08.03           |                        |   |                |        |   |  |  |  |           |                    |  |                   |
|  | 1.8 i 16V                              | 84  |       | 08.00 | 11.05           |                        |   | 24.0128-0140.1 | 428140 |   |  |  |  | 280       | 28,0 26,0 V +B     |  |                   |
|  | 1.8 i 16V                              | 85  |       | 12.02 | 11.05           |                        |   |                |        |   |  |  |  |           |                    |  |                   |
|  | 2.0 i 16V                              | 100 |       | 08.00 | 08.03           |                        |   |                |        |   |  |  |  |           |                    |  |                   |
|  | 2.2 dCi                                | 82  |       | 09.03 | 11.05           |                        |   |                |        |   |  |  |  |           |                    |  |                   |
|  | 2.2 dCi                                | 100 |       | 09.03 | 11.05           |                        |   |                |        |   |  |  |  |           |                    |  |                   |
|  | 2.2 Di                                 | 84  |       | 08.00 | 08.03           |                        |   |                |        |   |  |  |  |           |                    |  |                   |
|  | 1.8 i 16V                              | 84  |       | 08.00 | 11.05           |                        |   | 13.0460-5986.2 | 605986 |   |  |  |  | 21545     | 14,9               |  | TRW               |
|  | 1.8 i 16V                              | 85  |       | 12.02 | 11.05           |                        |   |                |        |   |  |  |  |           |                    |  |                   |
|  | 2.0 i 16V                              | 100 |       | 08.00 | 08.03           |                        |   |                |        |   |  |  |  |           |                    |  |                   |
|  | 2.2 dCi                                | 82  |       | 09.03 | 11.05           |                        |   |                |        |   |  |  |  |           |                    |  |                   |
|  | 2.2 dCi                                | 100 |       | 09.03 | 11.05           |                        |   |                |        |   |  |  |  |           |                    |  |                   |
|  | 2.2 Di                                 | 84  |       | 08.00 | 08.03           |                        |   |                |        |   |  |  |  |           |                    |  |                   |
|  | 1.8 i 16V                              | 84  |       | 08.00 | 11.05           |                        |   | 24.0110-0285.1 | 410285 |   |  |  |  | 278       | 10,0 9,0 +B        |  |                   |
|  | 1.8 i 16V                              | 85  |       | 12.02 | 11.05           |                        |   |                |        |   |  |  |  |           |                    |  |                   |
|  | 2.0 i 16V                              | 100 |       | 08.00 | 08.03           |                        |   |                |        |   |  |  |  |           |                    |  |                   |
| <b>NISSAN CABSTAR E (F23E) (92-07)</b>   |  |     |       |       |                 |                        |   |                |        |   |  |  |  |           |                    |  |                   |
|  | 2.5 TD                                 | 55  |       | 01.92 | 12.00           |                        |   | 13.0460-3856.2 | 603856 |   |  |  |  | 23435     | 18,0 +/WK/S        |  | BOS               |
|  | 2.7 TD                                 | 66  |       | 10.00 | 04.04           |                        |   |                |        |   |  |  |  |           |                    |  |                   |
|  | 3.0 TD                                 | 81  |       | 10.00 | 04.04           |                        |   |                |        |   |  |  |  |           |                    |  |                   |
|  | 35 DI 3.0                              | 92  |       | 01.04 | 12.06           |                        |   |                |        |   |  |  |  |           |                    |  |                   |
|  | 2.5 TD                                 | 55  |       | 01.92 | 12.00           |                        |   | 24.0124-0229.1 | 424229 |   |  |  |  | 263       | 24,0 22,0 V +B     |  |                   |
|  | 2.7 TD                                 | 66  |       | 10.00 | 04.04           |                        |   |                |        |   |  |  |  |           |                    |  |                   |
|  | 35 DI 3.0                              | 92  |       | 01.04 | 12.06           |                        |   |                |        |   |  |  |  |           |                    |  |                   |
|  | <b>NISSAN CABSTAR E (F24E) (06-13)</b> |     |       |       |                 |                        |   |                |        |   |  |  |  |           |                    |  |                   |
|  | 2.5 TDiC                               | 96  |       | 09.06 | 12.13           |                        |   | 13.0460-4866.2 | 604866 |   |  |  |  | 29229     | 20,7 +/WK/Zub/SBRE |  |                   |
|  | 3.0 TDi                                | 110 |       | 09.06 | 12.13           |                        |   | 13.0460-4865.2 | 604865 |   |  |  |  | 29160     | 20,3 +/WK/Zub/SBRE |  |                   |
|  | 2.5 TDiC                               | 96  |       | 09.06 | 12.13           |                        |   | 24.0126-0163.1 | 426163 |   |  |  |  | 290       | 26,0 23,0 V +B     |  |                   |
|  |  |     |       |       |                 |                        |   |                |        |   |  |  |  |           |                    |  |                   |
|  | 2.5 TDiC                               | 96  |       | 09.06 | 12.13           |                        |   | 13.0460-4861.2 | 604861 |   |  |  |  | 29121     | 20,3 +/WK/Zub/SBRE |  |                   |
|  |  |     |       |       |                 |                        |   |                |        |   |  |  |  |           |                    |  |                   |
|  | 2.5 TDiC                               | 96  |       | 09.06 | 12.13           | + 3,5 t                |   | 24.0711-6202.3 | 360362 | 2 |  |  |  |           |                    |  | Radsensor L=532   |
|  | 2.5 TDiC                               | 96  |       | 09.06 | 12.13           | + 4,5 t                |   | 24.0711-6203.3 | 360363 | 2 |  |  |  |           |                    |  |                   |

|     |    kW |  |  |  |  |  |  |  |
|--|---|--|--|--|---|--|--|--|
| <b>NISSAN CUBE (Z12) (10-11)</b>   |   |  |  |  |   |  |  |  |
|    | 1.5 dCi<br>1.5 dCi<br>1.6 i 16V   | 78<br>81<br>81   |  | 03.10<br>03.10<br>03.10  | 03.11<br>03.11<br>03.11   | 13.0460-5716.2   | 605716   | 21561 17,0 +/WK/Zub  |
|    | 1.5 dCi<br>1.5 dCi<br>1.6 i 16V   | 78<br>81<br>81   |  | 03.10<br>03.10<br>03.10  | 03.11<br>03.11<br>03.11   | 24.0124-0238.1   | 424238   | 280 24,0 22,0 V +B   |
|    | 1.5 dCi<br>1.5 dCi<br>1.6 i 16V   | 78<br>81<br>81   |  | 03.10<br>03.10<br>03.10  | 06.10<br>06.10<br>06.10   | 13.0460-5843.2   | 605843   | 23871 14,3 +/WK <b>AKE</b>   |
|  | 1.5 dCi<br>1.5 dCi<br>1.6 i 16V   | 78<br>81<br>81   |  | 07.10<br>07.10<br>07.10  | 03.11<br>03.11<br>03.11   | 13.0460-5843.2   | 605843   | 23871 14,3 +/WK <b>AKE</b>   |
|    | 1.5 dCi<br>1.5 dCi<br>1.6 i 16V   | 78<br>81<br>81   |  | 03.10<br>03.10<br>03.10  | 03.11<br>03.11<br>03.11   | 24.0109-0166.1   | 409166   | 292 9,0 8,0 +B   |
|    | 1.5 dCi   | 78   |  | 03.10  | 03.11   | 03.0137-3012.2   | 653012   | 172 x 32   |
|  | 1.5 dCi   | 81   |  | 03.10  | 03.11   |  |  |  |
|  | 1.6 i 16V   | 81   |  | 03.10  | 03.11   |  |  |  |
| <b>NISSAN GT-R (R35) (09-)</b>   |   |  |  |  |   |  |  |  |
|    | 3.8 V6 4WD  | 353  |  | 02.09  |   | 03.0137-3041.2   | 653041   | 190 x 33/20  |
|  | 3.8 V6 4WD  | 357  |  | 02.09  |   |  |  |  |
|  | 3.8 V6 4WD  | 390  |  | 02.11  |   |  |  |  |
|  | 3.8 V6 4WD  | 404  |  | 02.12  |   |  |  |  |
|  | 3.8 V6 4WD  | 441  |  | 07.14  |   |  |  |  |
| <b>NISSAN INTERSTAR (X70) (02-10)</b>  |   |  |  |  |   |  |  |  |
|    | 1.9 dCi   | 60   |  | 07.02  | 08.06   | 13.0460-3800.2   | 603800   | 23613 17,7<br>Belagsatz-Zubehör <b>BOS</b>   |
|  | 2.2 dCi   | 66   |  | 07.02  | 08.06   |  |  |  |
|  | 2.5 dCi   | 73   |  | 11.03  | 06.10   |  |  |  |
|  | 2.5 dCi   | 74   |  | 04.06  | 06.10   |  |  |  |
|  | 2.5 dCi   | 84   |  | 07.02  | 08.06   |  |  |  |
|  | 2.5 dCi   | 88   |  | 09.06  | 06.10   |  |  |  |
|  | 2.5 dCi   | 107  |  | 09.06  | 06.10   |  |  |  |
|  | 3.0 dCi   | 100  |  | 11.03  | 08.06   |  |  |  |
|  |       | 1.9 dCi  | 60   |  | 07.02   |  |  |  |
| 2.2 dCi  |   | 66   |  | 07.02  | 08.06   |  |  |  |
| 2.5 dCi  |   | 73   |  | 11.03  | 06.10   |  |  |  |
| 2.5 dCi  |   | 74   |  | 04.06  | 06.10   |  |  |  |
| 2.5 dCi  |   | 84   |  | 07.02  | 08.06   |  |  |  |
| 2.5 dCi  |   | 88   |  | 09.06  | 06.10   |  |  |  |
| 2.5 dCi  |   | 107  |  | 09.06  | 06.10   |  |  |  |
| 3.0 dCi  |   | 100  |  | 11.03  | 08.06   |  |  |  |
|    |   | 1.9 dCi  | 60   |  | 07.02   | 08.06  | 13.0460-3806.2   | 603806   |
|  | 2.2 dCi   | 66   |  | 07.02  | 08.06   |  |  |  |
|  | 2.5 dCi   | 73   |  | 11.03  | 06.10   |  |  |  |
|  | 2.5 dCi   | 74   |  | 04.06  | 06.10   |  |  |  |
|  | 2.5 dCi   | 84   |  | 07.02  | 08.06   |  |  |  |
|  | 2.5 dCi   | 88   |  | 09.06  | 06.10   |  |  |  |
|  | 2.5 dCi   | 107  |  | 09.06  | 06.10   |  |  |  |
|  | 3.0 dCi   | 100  |  | 11.03  | 08.06   |  |  |  |
|  |      | 1.9 dCi  | 60   |  | 07.02   | 08.06  |  |  |
| 2.2 dCi  |   | 66   |  | 07.02  | 08.06   |  |  |  |
| 2.5 dCi  |   | 73   |  | 11.03  | 06.10   |  |  |  |
| 2.5 dCi  |   | 74   |  | 04.06  | 06.10   |  |  |  |
| 2.5 dCi  |   | 84   |  | 07.02  | 08.06   |  |  |  |
| 2.5 dCi  |   | 88   |  | 09.06  | 06.10   |  |  |  |
| 2.5 dCi  |   | 107  |  | 09.06  | 06.10   |  |  |  |
| 3.0 dCi  |   | 100  |  | 11.03  | 08.06   |  |  |  |
| <b>NISSAN JUKE (F15) (10-)</b>   |   |  |  |  |   |  |  |  |
|  | 1.2 DIG-T   | 85   |  | 05.14  |   | 13.0460-5716.2   | 605716   | 21561 17,0 +/WK/Zub  |
|  | 1.5 dCi   | 81   |  | 06.10  |   |  |  |  |
|  | 1.6 16V   | 69   |  | 01.13  |   |  |  |  |
|  | 1.6 16V   | 86   |  | 06.10  |   |  |  |  |
|  | 1.6 DIG-T   | 140  |  | 06.10  |   |  |  |  |
|  | 1.6 DIG-T   | 147  |  | 11.12  |   |  |  |  |
|  | 1.6 DIG-T   | 160  |  | 08.14  |   |  |  |  |
|  | 1.6 DIG-T 4x4   | 140  |  | 06.10  |   |  |  |  |
|  | 1.6 DIG-T Nismo 4x4   | 147  |  | 02.13  |   |  |  |  |
|  | 1.6 DIG-T NismoRS 4x4   | 157  |  | 08.14  |   |  |  |  |
|  |     | 1.2 DIG-T  | 85   |  | 05.14   |  |  |  |
| 1.5 dCi  |   | 81   |  | 06.10  |   |  |  |  |
| 1.6 16V  |   | 69   |  | 01.13  |   |  |  |  |
| 1.6 16V  |   | 86   |  | 06.10  |   |  |  |  |
| 1.6 DIG-T  |   | 140  |  | 06.10  |   |  |  |  |
| 1.6 DIG-T  |   | 147  |  | 11.12  |   |  |  |  |
|  | 1.6 DIG-T   | 140  |  | 06.10  |   | 24.0126-0177.1   | 426177   | 296 26,0 24,0 V +B   |
|  | 1.6 DIG-T   | 147  |  | 11.12  |   |  |  |  |
|  | 1.6 DIG-T   | 160  |  | 08.14  |   |  |  |  |
|  | 1.6 DIG-T 4x4   | 140  |  | 06.10  |   |  |  |  |
|  | 1.6 DIG-T Nismo 4x4   | 147  |  | 02.13  |   |  |  |  |
|  | 1.6 DIG-T NismoRS 4x4   | 157  |  | 08.14  |   |  |  |  |
|  | 1.2 DIG-T   | 85   |  | 05.14  |   | 13.0460-5843.2   | 605843   | 23871 14,3 +/WK <b>AKE</b>   |
|  | 1.5 dCi   | 81   |  | 06.10  |   |  |  |  |
|  | 1.6 16V   | 69   |  | 01.13  |   |  |  |  |
|  | 1.6 16V   | 86   |  | 06.10  |   |  |  |  |
| ↓  | ↓   |  |  |  |   |  |  |  |

| NISSAN JUKE (F15) (10-)  |  | NISSAN KUBISTAR (X76) Kombi (03-09)  |   |  |
|--|--|--|---|--|
|    | 1.6 DIG-T 140<br>1.6 DIG-T 147<br>1.6 DIG-T 160<br>1.6 DIG-T 4x4 140<br>1.6 DIG-T Nismo 4x4 147<br>1.6 DIG-T NismoRS 4x4 157   | 06.10<br>11.12<br>08.14<br>06.10<br>02.13<br>08.14   | 13.0460-5843.2 605843   | 23871 14,3 +WK AKE                             |
|    | 1.2 DIG-T 85<br>1.5 dCi 81<br>1.6 16V 69<br>1.6 16V 86<br>1.6 DIG-T 140<br>1.6 DIG-T 147<br>1.6 DIG-T 160<br>1.6 DIG-T 4x4 140   | 05.14<br>06.10<br>01.13<br>06.10<br>11.12<br>08.14<br>06.10  | 24.0109-0157.1 409157<br>Produktionsland <br>Produktionsland  | 292 9,0 8,0 +B                                 |
|    | 1.2 DIG-T 85<br>1.5 dCi 81<br>1.6 16V 69<br>1.6 16V 86<br>1.6 DIG-T 140<br>1.6 DIG-T 147<br>1.6 DIG-T 160<br>1.6 DIG-T 4x4 140<br>1.6 DIG-T Nismo 4x4 147<br>1.6 DIG-T NismoRS 4x4 157 | 05.14<br>06.10<br>01.13<br>06.10<br>11.12<br>08.14<br>06.10<br>02.13<br>08.14  | 03.0137-3012.2 653012   | 172 x 32                                       |
|    | 1.2 44<br>1.2 55<br>1.4 55<br>1.5 dCi 42<br>1.5 dCi 44<br>1.5 dCi 48<br>1.5 dCi 51<br>1.5 dCi 60<br>1.5 dCi 66<br>1.6 i 16V 70   | 08.03 08.05<br>08.03 10.09<br>08.03 10.09<br>08.03 08.05<br>09.05 10.09<br>08.03 08.05<br>09.05 10.09<br>08.03 08.05<br>09.05 10.09<br>08.03 10.09 | 13.0460-3977.2 603977   | 21980 18,0 +/WE/S BOS                          |
|    | 1.2 44<br>1.2 55<br>1.4 55<br>1.5 dCi 42<br>1.5 dCi 44<br>1.5 dCi 48<br>1.5 dCi 51<br>1.5 dCi 60<br>1.5 dCi 66<br>1.6 i 16V 70   | 08.03 08.05<br>08.03 10.09<br>08.03 10.09<br>08.03 08.05<br>09.05 10.09<br>08.03 08.05<br>09.05 10.09<br>08.03 08.05<br>09.05 10.09<br>08.03 10.09 | 24.0121-0106.1 421106<br>+ ABS  | 259 20,6 17,7 V +S +B                          |
|  | 1.2 44<br>1.2 55<br>1.4 55<br>1.5 dCi 42<br>1.5 dCi 44<br>1.5 dCi 48<br>1.5 dCi 51<br>1.5 dCi 60<br>1.5 dCi 66<br>1.6 i 16V 70   | 08.03 08.05<br>08.03 10.09<br>08.03 10.09<br>08.03 08.05<br>09.05 10.09<br>08.03 08.05<br>09.05 10.09<br>08.03 08.05<br>09.05 10.09<br>08.03 10.09 | 24.0120-0125.1 420125<br>- ABS  | 238 20,1 17,7 V +S +B                          |
|  | 1.2 44<br>1.2 55<br>1.4 55<br>1.5 dCi 42<br>1.5 dCi 44<br>1.5 dCi 48<br>1.5 dCi 51<br>1.5 dCi 60<br>1.5 dCi 66<br>1.6 i 16V 70   | 08.03 08.05<br>08.03 10.09<br>08.03 10.09<br>08.03 08.05<br>09.05 10.09<br>08.03 08.05<br>09.05 10.09<br>08.03 08.05<br>09.05 10.09<br>08.03 10.09 | 03.0137-0350.2 650350<br>03.0137-9233.2 669233<br>- erhöhte Zuladung <sup>1)</sup><br>- erhöhte Zuladung <sup>1)</sup>  | 203 x 39 HEB<br>Bremsbacken-Zubehör            |
|  | 1.2 44<br>1.2 55<br>1.4 55<br>1.5 dCi 42<br>1.5 dCi 44<br>1.5 dCi 48<br>1.5 dCi 51<br>1.5 dCi 60<br>1.5 dCi 66<br>1.6 i 16V 70   | 08.03 08.05<br>08.03 10.09<br>08.03 10.09<br>08.03 08.05<br>09.05 10.09<br>08.03 08.05<br>09.05 10.09<br>08.03 08.05<br>09.05 10.09<br>08.03 10.09 | 03.0137-0351.2 650351<br>03.0137-9228.2 669228<br>+ erhöhte Zuladung <sup>2)</sup><br>+ erhöhte Zuladung <sup>2)</sup>  | 229 x 42 HEB<br>Bremsbacken-Zubehör BDX<br>BDX |
|  | 1.2 44<br>1.2 55<br>1.4 55<br>1.5 dCi 42<br>1.5 dCi 44<br>1.5 dCi 48<br>1.5 dCi 51<br>1.5 dCi 60<br>1.5 dCi 66<br>1.6 i 16V 70   | 08.03 08.05<br>08.03 10.09<br>08.03 10.09<br>08.03 08.05<br>09.05 10.09<br>08.03 08.05<br>09.05 10.09<br>08.03 08.05<br>09.05 10.09<br>08.03 10.09 | 24.0220-3010.1 480081<br>- erhöhte Zuladung <sup>1)</sup>   | 203/204,5 x 50,5                               |















1) - increased payload / - carico utile maggiorato / - charge utile augmentée / - incremento de carga  
2) + increased payload / + carico utile maggiorato / + charge utile augmentée / + incremento de carga























|     |  |  |  |  |  |  |  |  |                         |
|--|--|--|--|--|---|--|--|--|-------------------------|
| <b>NISSAN KUBISTAR (X76) Kombi (03-09)</b>   |  |  |  |  |   |  |  |  |                         |
|    | 1.2  | 44   |  | 08.03  | 08.05   | 03.0520-5722.3   | 695722   | - erhöhte Zuladung <sup>1)</sup>   | 22,20/203x39 TopKit BDX |
|  | 1.2  | 55   |  | 08.03  | 10.09   |  |  |  |                         |
|  | 1.4  | 55   |  | 08.03  | 10.09   |  |  |  |                         |
|  | 1.5 dCi  | 42   |  | 08.03  | 08.05   |  |  |  |                         |
|  | 1.5 dCi  | 44   |  | 09.05  | 10.09   |  |  |  |                         |
|  | 1.5 dCi  | 48   |  | 08.03  | 08.05   |  |  |  |                         |
|  | 1.5 dCi  | 51   |  | 09.05  | 10.09   |  |  |  |                         |
|  | 1.5 dCi  | 60   |  | 08.03  | 08.05   |  |  |  |                         |
|  | 1.5 dCi  | 66   |  | 09.05  | 10.09   |  |  |  |                         |
|  | 1.6 i 16V  | 70   |  | 08.03  | 10.09   |  |  |  |                         |
|  | 1.2  | 44   |  | 08.03  | 08.05   | 03.0520-5622.3   | 695622   | + erhöhte Zuladung <sup>2)</sup>   | 22,20/229x42 TopKit BDX |
|  | 1.2  | 55   |  | 08.03  | 10.09   |  |  |  |                         |
|  | 1.4  | 55   |  | 08.03  | 10.09   |  |  |  |                         |
|  | 1.5 dCi  | 42   |  | 08.03  | 08.05   |  |  |  |                         |
|  | 1.5 dCi  | 44   |  | 09.05  | 10.09   |  |  |  |                         |
|  | 1.5 dCi  | 48   |  | 08.03  | 08.05   |  |  |  |                         |
|  | 1.5 dCi  | 51   |  | 09.05  | 10.09   |  |  |  |                         |
|  | 1.5 dCi  | 60   |  | 08.03  | 08.05   |  |  |  |                         |
|  | 1.5 dCi  | 66   |  | 09.05  | 10.09   |  |  |  |                         |
|  | 1.6 i 16V  | 70   |  | 08.03  | 10.09   |  |  |  |                         |
| <b>NISSAN LEAF (EM61) (10-)</b>  |  |  |  |  |   |  |  |  |                         |
|    | Electric   | 80   |  | 11.10  |   | 13.0460-5783.2   | 605783   |  | 24227 16,7 +WK TOK      |
|    | Electric   | 80   |  | 11.10  |   | 13.0460-5843.2   | 605843   |  | 23871 14,3 +WK AKE      |
|    | Electric   | 80   |  | 11.10  |   | 24.0116-0119.1   | 416119   |  | 292 16,0 14,0 V +B      |
|    | Electric   | 80   |  | 11.10  |   | 03.0137-3012.2   | 653012   |  | 172 x 32                |
| <b>NISSAN MAXIMA (A32) (94-99)</b>   |  |  |  |  |   |  |  |  |                         |
|   | 2.0 i V6   | 103  |  | 10.94  | 12.99   | 24.0122-0174.1   | 422174   |  | 280 22,0 20,0 V         |
| <b>NISSAN MAXIMA (CA33) (00-03)</b>  |  |  |  |  |   |  |  |  |                         |
|  | 2.0 i V6   | 103  |  | 03.00  | 11.03   | 13.0460-5880.2   | 605880   |  | 23184 14,8 +WK          |
|  | 2.5 i V6   | 154  |  | 03.00  | 11.03   | 13.0460-0112.2   | 610112   |  | Belagsatz-Zubehör       |
|  | 3.0 i V6   | 147  |  | 03.00  | 11.03   |  |  |  |                         |
|  | 2.0 i V6   | 103  |  | 03.00  | 11.03   | 24.0128-0140.1   | 428140   |  | 280 28,0 26,0 V +B      |
|  | 2.5 i V6   | 154  |  | 03.00  | 11.03   |  |  |  |                         |
|  | 3.0 i V6   | 147  |  | 03.00  | 11.03   |  |  |  |                         |
|  | 2.0 i V6   | 103  |  | 03.00  | 11.03   | 13.0460-5626.2   | 605626   |  | 21713 17,1 +WK/S        |
|  | 2.5 i V6   | 154  |  | 03.00  | 11.03   | 13.0460-0295.2   | 610295   |  | Belagsatz-Zubehör       |
|  | 3.0 i V6   | 147  |  | 03.00  | 11.03   |  |  |  |                         |
| <b>NISSAN MICRA (K11E) (92-02)</b>   |  |  |  |  |   |  |  |  |                         |
|  | 1.0 i 16V  | 40   |  | 08.92  | 07.00   | 13.0460-5956.2   | 605956   |  | 21626 15,0              |
|  | 1.0 i 16V  | 44   |  | 08.00  | 12.02   | 13.0460-0452.2   | 610452   | + ABS  | Belagsatz-Zubehör       |
|  | 1.3 i 16V  | 55   |  | 08.92  | 07.00   |  |  |  |                         |
|  | 1.4 i 16V  | 60   |  | 08.00  | 12.02   |  |  |  |                         |
|  | 1.5 D  | 42   |  | 02.98  | 12.02   |  |  |  |                         |
|  | 1.0 i 16V  | 40   |  | 08.92  | 07.00   | 24.0112-0137.1   | 412137   |  | 234 12,0 10,0 +B        |
|  | 1.0 i 16V  | 44   |  | 08.00  | 12.02   |  |  |  |                         |
|  | 1.3 i 16V  | 55   |  | 08.92  | 07.00   |  |  |  |                         |
|  | 1.4 i 16V  | 60   |  | 08.00  | 12.02   |  |  |  |                         |
|  | 1.5 D  | 42   |  | 02.98  | 12.02   |  |  |  |                         |
|  | 1.0 i 16V  | 44   |  | 08.00  | 12.02   | 24.0118-0139.1   | 418139   |  | 238 18,0 16,0 V +B      |
|  | 1.4 i 16V  | 60   |  | 08.00  | 12.02   |  |  |  |                         |
|  | 1.5 D  | 42   |  | 08.00  | 12.02   |  |  |  |                         |
|  | 1.0 i 16V  | 40   |  | 08.92  | 08.00   | 13.0460-5989.2   | 605989   |  | 23454 14,9              |
|  | 1.0 i 16V  | 44   |  | 09.00  | 12.02   | 13.0460-0248.2   | 610248   |  | Belagsatz-Zubehör       |
|  | 1.3 i 16V  | 55   |  | 08.92  | 08.00   |  |  |  |                         |
|  | 1.4 i 16V  | 60   |  | 09.00  | 12.02   |  |  |  |                         |
|  | 1.0 i 16V  | 40   |  | 08.92  | 08.00   | 24.0107-0109.1   | 407109   |  | 240 7,0 6,0 +B          |
|  | 1.0 i 16V  | 44   |  | 09.00  | 12.02   |  |  |  |                         |
|  | 1.3 i 16V  | 55   |  | 08.92  | 08.00   |  |  |  |                         |
|  | 1.4 i 16V  | 60   |  | 09.00  | 12.02   |  |  |  |                         |
|  | 1.0 i 16V  | 40   |  | 08.92  | 01.98   | 03.0137-0275.2   | 650275   |  | 180 x 27 HEB            |
|  | 1.3 i 16V  | 55   |  | 08.92  | 01.98   | 03.0137-9180.2   | 669180   |  | Bremsbacken-Zubehör     |
|  | 1.0 i 16V  | 40   |  | 02.98  | 08.00   | 03.0137-0413.2   | 650413   |  | 180 x 27 HEB            |
|  | 1.0 i 16V  | 44   |  | 09.00  | 12.02   | 03.0137-9180.2   | 669180   |  | Bremsbacken-Zubehör     |
|  | 1.3 i 16V  | 55   |  | 02.98  | 08.00   |  |  |  |                         |
|  | 1.4 i 16V  | 60   |  | 09.00  | 12.02   |  |  |  |                         |
|  | 1.5 D  | 42   |  | 02.98  | 12.02   |  |  |  |                         |
|  | 1.0 i 16V  | 40   |  | 08.92  | 08.00   | 24.0218-0028.1   | 480100   | + Leichtmetallfelgen <sup>3)</sup>   | 180/181 x 32            |
|  | 1.0 i 16V  | 44   |  | 09.00  | 12.02   | 24.0218-0043.1   | 480165   | - Leichtmetallfelgen <sup>4)</sup>   | 180/181 x 38,6          |
|  | 1.3 i 16V  | 55   |  | 08.92  | 08.00   |  |  |  |                         |
|  | 1.4 i 16V  | 60   |  | 09.00  | 12.02   |  |  |  |                         |
|  | 1.5 D  | 42   |  | 02.98  | 12.02   |  |  |  |                         |

1) - increased payload / - carico utile maggiorato / - charge utile augmentée / - incremento de carga  
2) + increased payload / + carico utile maggiorato / + charge utile augmentée / + incremento de carga  
3) + light alloy rims / + cerchi in lega / + jantes en alliage léger / + Llantas de aleación ligera  
4) - light alloy rims / - cerchi in lega / - jantes en alliage léger / - Llantas de aleación ligera



| NISSAN MICRA (K11E) (92-02)  |   | NISSAN MICRA (K12E) (03-10)                        |   | NISSAN MICRA C+C (CK12E) (05-10)  |                                  | NISSAN MICRA (K13K) (10-)                          |                            |   |
|--|---|--|---|---|----------------------------------|--|----------------------------|---|
|    | 1.0 i 16V<br>1.3 i 16V  | 40<br>55   | 08.92<br>08.92  | 01.98<br>01.98  | - ABS<br>- ABS                   | 03.0420-3317.3<br>03.0520-3317.3                   | 683317<br>693317           | 17,78/180x27 Kit<br>17,78/180x27 TopKit                               |
|    | 1.0 i 16V<br>1.0 i 16V<br>1.3 i 16V<br>1.4 i 16V<br>1.5 D   | 40<br>44<br>55<br>60<br>42                         | 02.98<br>09.00<br>02.98<br>09.00<br>02.98                                     | 08.00<br>12.02<br>08.00<br>12.02<br>12.02                                     | - ABS<br>- ABS<br>- ABS<br>- ABS | 03.0520-4217.3                                     | 694217                     | 17,78/180x27 TopKit BOS   |
|    | 1.0 i 16V<br>1.2 i 16V<br>1.2 i 16V<br>1.4 i 16V<br>1.5 dCi<br>1.5 dCi<br>1.5 dCi<br>1.5 dCi<br>1.6 i 16V | 48<br>48<br>59<br>65<br>48<br>50<br>60<br>63<br>81 | 01.03<br>01.03<br>01.03<br>01.03<br>01.03<br>06.05<br>09.03<br>01.03<br>05.05 | 06.10<br>06.10<br>06.10<br>06.10<br>06.10<br>06.10<br>06.10<br>06.10<br>06.10 |                                  | 13.0460-5801.2<br>13.0460-0291.2                   | 605801<br>610291           | 23973 17,4 /S<br>Belagsatz-Zubehör TRW                                |
|    | 1.0 i 16V<br>1.2 i 16V<br>1.2 i 16V<br>1.4 i 16V<br>1.5 dCi<br>1.5 dCi<br>1.5 dCi<br>1.5 dCi<br>1.6 i 16V | 48<br>48<br>59<br>65<br>48<br>50<br>60<br>63<br>81 | 01.03<br>01.03<br>01.03<br>01.03<br>01.03<br>06.05<br>09.03<br>01.03<br>05.05 | 06.10<br>06.10<br>06.10<br>06.10<br>06.10<br>06.10<br>06.10<br>06.10<br>06.10 |                                  | 24.0122-0216.1                                     | 422216                     | 260 22,0 19,8 V L +S +B   |
|    | 1.0 i 16V<br>1.2 i 16V<br>1.2 i 16V<br>1.4 i 16V<br>1.5 dCi<br>1.5 dCi<br>1.5 dCi<br>1.5 dCi<br>1.6 i 16V | 48<br>48<br>59<br>65<br>48<br>50<br>60<br>63<br>81 | 01.03<br>01.03<br>01.03<br>01.03<br>01.03<br>06.05<br>09.03<br>01.03<br>05.05 | 06.10<br>06.10<br>06.10<br>06.10<br>06.10<br>06.10<br>06.10<br>06.10<br>06.10 |                                  | 03.0137-0454.2<br>03.0137-9280.2                   | 650454<br>669280           | 203 x 38 HEB<br>Bremsbacken-Zubehör                                   |
|   | 1.0 i 16V<br>1.2 i 16V<br>1.2 i 16V<br>1.4 i 16V<br>1.5 dCi<br>1.5 dCi<br>1.5 dCi<br>1.5 dCi<br>1.6 i 16V | 48<br>48<br>59<br>65<br>48<br>50<br>60<br>63<br>81 | 01.03<br>01.03<br>01.03<br>01.03<br>01.03<br>06.05<br>09.03<br>01.03<br>05.05 | 06.10<br>06.10<br>06.10<br>06.10<br>06.10<br>06.10<br>06.10<br>06.10<br>06.10 |                                  | 24.0220-3030.1                                     | 480180                     | ohne Sensorring <sup>1)</sup><br>203/204,5 x 50,5                     |
|  | 1.0 i 16V<br>1.2 i 16V<br>1.2 i 16V<br>1.4 i 16V<br>1.5 dCi<br>1.5 dCi<br>1.5 dCi<br>1.5 dCi<br>1.6 i 16V | 48<br>48<br>59<br>65<br>48<br>50<br>60<br>63<br>81 | 01.03<br>01.03<br>01.03<br>01.03<br>01.03<br>06.05<br>09.03<br>01.03<br>05.05 | 06.10<br>06.10<br>06.10<br>06.10<br>06.10<br>06.10<br>06.10<br>06.10<br>06.10 |                                  | 03.0520-6419.3                                     | 696419                     | 19,05/203x38 TopKit AP  |
|  | 1.4 i 16V<br>1.6 i 16V  | 65<br>81   | 08.05<br>08.05  | 12.10<br>12.10  |                                  | 13.0460-5801.2<br>13.0460-0291.2                   | 605801<br>610291           | 23973 17,4 /S<br>Belagsatz-Zubehör TRW                                |
|  | 1.4 i 16V<br>1.6 i 16V  | 65<br>81   | 08.05<br>08.05  | 12.10<br>12.10  |                                  | 24.0122-0216.1                                     | 422216                     | 260 22,0 19,8 V L +S +B   |
|  | 1.4 i 16V<br>1.6 i 16V  | 65<br>81   | 08.05<br>08.05  | 12.10<br>12.10  |                                  | 03.0137-0454.2<br>03.0137-9280.2                   | 650454<br>669280           | 203 x 38 HEB<br>Bremsbacken-Zubehör                                   |
|  | 1.4 i 16V<br>1.6 i 16V  | 65<br>81   | 08.05<br>08.05  | 12.10<br>12.10  |                                  | 24.0220-3030.1                                     | 480180                     | ohne Sensorring <sup>1)</sup><br>203/204,5 x 50,5                     |
|  | 1.4 i 16V<br>1.6 i 16V  | 65<br>81   | 08.05<br>08.05  | 12.10<br>12.10  |                                  | 03.0520-6419.3                                     | 696419                     | 19,05/203x38 TopKit AP  |
|  | 1.2 DIG<br>1.2 i<br>1.2 i   | 72<br>56<br>59                                     | 04.11<br>05.10<br>05.10   |   |                                  | 13.0460-2774.2                                     | 602774                     | 24403 17,4 +/-WK TRW  |
|  | 1.2 DIG<br>1.2 i<br>1.2 i   | 72<br>56<br>59                                     | 04.11<br>05.10<br>05.10   |   |                                  | 24.0122-0277.1                                     | 422277                     | 260 22,0 20,0 V +B  |
|  | 1.2 DIG<br>1.2 i<br>1.2 i   | 72<br>56<br>59                                     | 04.11<br>05.10<br>05.10   |   |                                  | 03.0137-0423.2<br>03.0137-0510.2<br>03.0137-9274.2 | 650423<br>650510<br>669274 | 203 x 39 HEB<br>203 x 39 HEB<br>Bremsbacken-Zubehör BOS<br>BOS<br>BOS |

<sup>1)</sup> without sensor ring / senza sensori / sans secours ABS / sin anillo sensor ABS

|     |                            |  |  |  |  |  |  |  |            |
|--|--|--|--|--|---|--|--|--|------------|
| <b>NISSAN MURANO (Z50) (03-08)</b>   |  |  |  |  |   |  |  |  |            |
|    | 3.5 i V6<br>3.5 i V6<br>3.5 i V6<br>3.5 i V6 4x4<br>3.5 i V6 4x4<br>3.5 i V6 4x4                           | 172<br>180<br>198<br>172<br>180<br>198   | 08.03<br>08.03<br>09.06<br>08.03<br>11.04<br>09.06                               | 06.08<br>06.08<br>06.08<br>06.08<br>06.08<br>06.08                               | 13.0460-5778.2<br>13.0460-0017.2  | 605778<br>610017   |  | 23698 16,8 +/WK<br>Belagsatz-Zubehör   | <b>SUM</b> |
|    | 3.5 i V6<br>3.5 i V6<br>3.5 i V6<br>3.5 i V6 4x4<br>3.5 i V6 4x4<br>3.5 i V6 4x4                           | 172<br>180<br>198<br>172<br>180<br>198   | 08.03<br>08.03<br>09.06<br>08.03<br>11.04<br>09.06                               | 06.08<br>06.08<br>06.08<br>06.08<br>06.08<br>06.08                               | 24.0128-0153.1  | 428153   |  | 320 28,0 26,0 V L +B   |            |
|    | 3.5 i V6<br>3.5 i V6<br>3.5 i V6 4x4<br>3.5 i V6 4x4   | 172<br>180<br>172<br>180   | 08.03<br>08.03<br>08.03<br>11.04   | 07.05<br>07.05<br>07.05<br>07.05   | 13.0460-5843.2<br>13.0460-0341.2  | 605843<br>610341   |  | 23871 14,3 +/WK<br>Belagsatz-Zubehör   | <b>AKE</b> |
|    | 3.5 i V6<br>3.5 i V6<br>3.5 i V6<br>3.5 i V6 4x4<br>3.5 i V6 4x4<br>3.5 i V6 4x4                           | 172<br>180<br>198<br>172<br>180<br>198   | 08.03<br>08.03<br>09.06<br>08.03<br>11.04<br>09.06                               | 06.08<br>06.08<br>06.08<br>06.08<br>06.08<br>06.08                               | 24.0116-0122.1  | 416122   |  | 308 16,0 14,0 V +B   |            |
| <b>NISSAN MURANO (Z51) (07-)</b>   |  |  |  |  |   |  |  |  |            |
|    | 2.5 D 4x4<br>3.5 i 4x4<br>3.5 i V6<br>3.5 i V6<br>3.5 i V6<br>3.5 i V6 4x4<br>3.5 i V6 4x4<br>3.5 i V6 4x4 | 140<br>183<br>172<br>191<br>195<br>188<br>191<br>195                             | 01.10<br>12.10<br>11.07<br>01.11<br>11.07<br>10.08<br>01.11<br>11.07             |  | 13.0460-5778.2  | 605778   |  | 23698 16,8 +/WK  | <b>SUM</b> |
|    | 2.5 D 4x4<br>3.5 i 4x4<br>3.5 i V6<br>3.5 i V6<br>3.5 i V6<br>3.5 i V6 4x4<br>3.5 i V6 4x4<br>3.5 i V6 4x4 | 140<br>183<br>172<br>191<br>195<br>188<br>191<br>195                             | 01.10<br>12.10<br>11.07<br>01.11<br>11.07<br>10.08<br>01.11<br>11.07             |  | 24.0128-0153.1  | 428153   |  | 320 28,0 26,0 V L +B   |            |
|  | 2.5 D 4x4<br>3.5 i 4x4<br>3.5 i V6<br>3.5 i V6<br>3.5 i V6<br>3.5 i V6 4x4<br>3.5 i V6 4x4<br>3.5 i V6 4x4 | 140<br>183<br>172<br>191<br>195<br>188<br>191<br>195                             | 08.10<br>12.10<br>08.10<br>01.11<br>08.10<br>08.10<br>01.11<br>08.10             |  | 13.0460-5843.2  | 605843   |  | 23871 14,3 +/WK  | <b>AKE</b> |
|  | 2.5 D 4x4<br>3.5 i 4x4<br>3.5 i V6<br>3.5 i V6<br>3.5 i V6<br>3.5 i V6 4x4<br>3.5 i V6 4x4<br>3.5 i V6 4x4 | 140<br>183<br>172<br>191<br>195<br>188<br>191<br>195                             | 01.10<br>12.10<br>11.07<br>01.11<br>11.07<br>10.08<br>01.11<br>11.07             |  | 24.0116-0122.1  | 416122   |  | 308 16,0 14,0 V +B   |            |
|  | 2.5 D 4x4<br>3.5 i 4x4<br>3.5 i V6<br>3.5 i V6<br>3.5 i V6<br>3.5 i V6 4x4<br>3.5 i V6 4x4<br>3.5 i V6 4x4 | 140<br>183<br>172<br>191<br>195<br>188<br>191<br>195                             | 01.10<br>12.10<br>11.07<br>01.11<br>11.07<br>10.08<br>01.11<br>11.07             |  | 03.0137-3041.2  | 653041   |  | 190 x 33/20  |            |
| <b>NISSAN NAVARA (D40M) (05-)</b>  |  |  |  |  |   |  |  |  |            |
|  | 2.5 dCi<br>2.5 dCi<br>2.5 dCi<br>2.5 dCi 4WD<br>2.5 dCi 4WD<br>2.5 dCi 4WD<br>2.5 dCi 4WD                  | 106<br>120<br>128<br>106<br>126<br>128<br>140                                    | 07.05<br>10.06<br>12.05<br>10.08<br>10.06<br>07.05<br>12.09                      |  | 13.0460-5783.2<br>13.0460-0017.2  | 605783<br>610017   | + 16" Rad <sup>1)</sup><br>+ 16" Rad <sup>1)</sup>                                 | 24227 16,7 +/WK<br>Belagsatz-Zubehör   | <b>TOK</b> |
|  | 2.5 dCi<br>2.5 dCi<br>2.5 dCi<br>2.5 dCi 4WD<br>2.5 dCi 4WD<br>2.5 dCi 4WD<br>3.0 dCi 4WD                  | 106<br>120<br>128<br>106<br>126<br>128<br>170                                    | 07.05<br>10.06<br>12.05<br>10.08<br>10.06<br>07.05<br>12.09                      |  | 13.0460-5778.2  | 605778   | + 17" Rad <sup>2)</sup>  | 23698 16,8 +/WK  | <b>SUM</b> |
|  | 2.5 dCi<br>2.5 dCi<br>2.5 dCi<br>2.5 dCi 4WD<br>2.5 dCi 4WD  | 106<br>120<br>128<br>106<br>126  | 07.05<br>10.06<br>12.05<br>10.08<br>10.06  |  | 24.0128-0241.1  | 428241   | + 16" Rad <sup>1)</sup>  | 296 28,0 26,0 V L +B   |            |
|  |  |  |  |  |   |  |  |  |            |

<sup>1)</sup> + 16" wheel / + ruota 16" / + roue 16" / + rueda 16"

<sup>2)</sup> + 17" wheel / + ruota 17" / + roue 17" / + rueda 17"



| NISSAN NAVARA (D40M) (05-) |             |     |  |       |  |  |                |        |                         |                      |
|----------------------------|-------------|-----|--|-------|--|--|----------------|--------|-------------------------|----------------------|
|                            | 2.5 dCi 4WD | 128 |  | 07.05 |  |  | 24.0128-0241.1 | 428241 | + 16" Rad <sup>1)</sup> | 296 28,0 26,0 V L +B |
|                            | 2.5 dCi 4WD | 140 |  | 12.09 |  |  |                |        |                         |                      |
|                            | 2.5 dCi     | 106 |  | 07.05 |  |  | 24.0128-0240.1 | 428240 | + 17" Rad <sup>2)</sup> | 320 28,0 26,0 V L +B |
|                            | 2.5 dCi     | 120 |  | 10.06 |  |  |                |        |                         |                      |
|                            | 2.5 dCi     | 128 |  | 12.05 |  |  |                |        |                         |                      |
|                            | 2.5 dCi 4WD | 106 |  | 10.08 |  |  |                |        |                         |                      |
|                            | 2.5 dCi 4WD | 126 |  | 10.06 |  |  |                |        |                         |                      |
|                            | 2.5 dCi 4WD | 128 |  | 07.05 |  |  |                |        |                         |                      |
|                            | 2.5 dCi 4WD | 140 |  | 12.09 |  |  |                |        |                         |                      |
|                            | 3.0 dCi 4WD | 170 |  | 02.10 |  |  | 24.0128-0240.1 | 428240 |                         | 320 28,0 26,0 V L +B |
|                            | 2.5 dCi     | 106 |  | 07.05 |  |  | 03.0137-0519.2 | 650519 |                         | 294 x 56             |
|                            | 2.5 dCi     | 120 |  | 10.06 |  |  |                |        |                         |                      |
|                            | 2.5 dCi     | 128 |  | 12.05 |  |  |                |        |                         |                      |
|                            | 2.5 dCi 4WD | 106 |  | 10.08 |  |  |                |        |                         |                      |
|                            | 2.5 dCi 4WD | 126 |  | 10.06 |  |  |                |        |                         |                      |
|                            | 2.5 dCi 4WD | 128 |  | 07.05 |  |  |                |        |                         |                      |
|                            | 2.5 dCi 4WD | 140 |  | 12.09 |  |  |                |        |                         |                      |
|                            | 3.0 dCi 4WD | 170 |  | 02.10 |  |  |                |        |                         |                      |

























| NISSAN NAVARA Pick-up (D23) (15-) |             |     |  |       |  |  |                |        |  |          |
|-----------------------------------|-------------|-----|--|-------|--|--|----------------|--------|--|----------|
|                                   | 2.3 dCi     | 120 |  | 10.15 |  |  | 03.0137-0519.2 | 650519 |  | 294 x 56 |
|                                   | 2.3 dCi     | 140 |  | 10.15 |  |  |                |        |  |          |
|                                   | 2.3 dCi 4x4 | 120 |  | 10.15 |  |  |                |        |  |          |
|                                   | 2.3 dCi 4x4 | 140 |  | 10.15 |  |  |                |        |  |          |

| NISSAN NOTE (E11E) (06-13) |         |    |  |       |       |  |                |        |                               |                         |
|----------------------------|---------|----|--|-------|-------|--|----------------|--------|-------------------------------|-------------------------|
|                            | 1.4     | 65 |  | 03.06 | 05.13 |  | 13.0460-2709.2 | 602709 |                               | 23973 17,4 /Zub/S TRW   |
|                            | 1.5 dCi | 50 |  | 03.06 | 05.13 |  | 13.0470-2709.2 | LD2709 |                               | 23973 17,4 /Zub/S TRW   |
|                            | 1.5 dCi | 63 |  | 03.06 | 05.13 |  |                |        |                               |                         |
|                            | 1.5 dCi | 66 |  | 09.10 | 05.13 |  |                |        |                               |                         |
|                            | 1.5 dCi | 76 |  | 07.08 | 05.13 |  |                |        |                               |                         |
|                            | 1.6     | 81 |  | 03.06 | 05.13 |  |                |        |                               |                         |
|                            | 1.4     | 65 |  | 03.06 | 05.13 |  | 24.0122-0216.1 | 422216 |                               | 260 22,0 19,8 V L +S +B |
|                            | 1.5 dCi | 50 |  | 03.06 | 05.13 |  |                |        |                               |                         |
|                            | 1.5 dCi | 63 |  | 03.06 | 05.13 |  |                |        |                               |                         |
|                            | 1.5 dCi | 66 |  | 09.10 | 05.13 |  |                |        |                               |                         |
|                            | 1.5 dCi | 76 |  | 07.08 | 05.13 |  |                |        |                               |                         |
|                            | 1.6     | 81 |  | 03.06 | 05.13 |  |                |        |                               |                         |
|                            | 1.4     | 65 |  | 03.06 | 05.13 |  | 03.0137-0454.2 | 650454 |                               | 203 x 38 HEB            |
|                            | 1.5 dCi | 50 |  | 03.06 | 05.13 |  | 03.0137-9280.2 | 669280 |                               | Bremsbacken-Zubehör     |
|                            | 1.5 dCi | 63 |  | 03.06 | 05.13 |  |                |        |                               |                         |
|                            | 1.5 dCi | 66 |  | 09.10 | 05.13 |  |                |        |                               |                         |
|                            | 1.5 dCi | 76 |  | 07.08 | 05.13 |  |                |        |                               |                         |
|                            | 1.6     | 81 |  | 03.06 | 05.13 |  |                |        |                               |                         |
|                            | 1.4     | 65 |  | 03.06 | 05.13 |  | 24.0220-3030.1 | 480180 | ohne Sensorring <sup>3)</sup> | 203/204,5 x 50,5        |
|                            | 1.5 dCi | 50 |  | 03.06 | 05.13 |  |                |        |                               |                         |
|                            | 1.5 dCi | 63 |  | 03.06 | 05.13 |  |                |        |                               |                         |
|                            | 1.5 dCi | 66 |  | 09.10 | 05.13 |  |                |        |                               |                         |
|                            | 1.5 dCi | 76 |  | 07.08 | 05.13 |  |                |        |                               |                         |
|                            | 1.6     | 81 |  | 03.06 | 05.13 |  |                |        |                               |                         |
|                            | 1.4     | 65 |  | 03.06 | 05.13 |  | 03.0520-6419.3 | 696419 |                               | 19,05/203x38 TopKit AP  |
|                            | 1.5 dCi | 50 |  | 03.06 | 05.13 |  |                |        |                               |                         |
|                            | 1.5 dCi | 63 |  | 03.06 | 05.13 |  |                |        |                               |                         |
|                            | 1.5 dCi | 66 |  | 09.10 | 05.13 |  |                |        |                               |                         |
|                            | 1.5 dCi | 76 |  | 07.08 | 05.13 |  |                |        |                               |                         |
|                            | 1.6     | 81 |  | 03.06 | 05.13 |  |                |        |                               |                         |

| NISSAN NOTE (E12E) (13-) |         |    |  |       |  |  |                |        |  |                     |
|--------------------------|---------|----|--|-------|--|--|----------------|--------|--|---------------------|
|                          | 1.2     | 59 |  | 06.13 |  |  | 13.0460-2774.2 | 602774 |  | 24403 17,4 +/WK TRW |
|                          | 1.2 DIG | 72 |  | 06.13 |  |  |                |        |  |                     |
|                          | 1.2 LPG | 59 |  | 06.13 |  |  |                |        |  |                     |
|                          | 1.5 dCi | 66 |  | 06.13 |  |  |                |        |  |                     |
|                          | 1.2     | 59 |  | 06.13 |  |  | 24.0122-0277.1 | 422277 |  | 260 22,0 20,0 V +B  |
|                          | 1.2 DIG | 72 |  | 06.13 |  |  |                |        |  |                     |
|                          | 1.2 LPG | 59 |  | 06.13 |  |  |                |        |  |                     |
|                          | 1.5 dCi | 66 |  | 06.13 |  |  |                |        |  |                     |
|                          | 1.2     | 59 |  | 06.13 |  |  | 03.0137-0423.2 | 650423 |  | 203 x 39 HEB BOS    |
|                          | 1.2 DIG | 72 |  | 06.13 |  |  |                |        |  |                     |
|                          | 1.2 LPG | 59 |  | 06.13 |  |  |                |        |  |                     |
|                          | 1.5 dCi | 66 |  | 06.13 |  |  |                |        |  |                     |

| NISSAN NP 300 (D40M) (08-) |             |    |  |       |  |  |                |        |  |                      |
|----------------------------|-------------|----|--|-------|--|--|----------------|--------|--|----------------------|
|                            | 2.5 dCi     | 98 |  | 04.08 |  |  | 13.0460-5783.2 | 605783 |  | 24227 16,7 +/WK TOK  |
|                            | 2.5 dCi 4x4 | 98 |  | 04.08 |  |  |                |        |  |                      |
|                            | 2.5 dCi     | 98 |  | 04.08 |  |  | 24.0128-0241.1 | 428241 |  | 296 28,0 26,0 V L +B |
|                            | 2.5 dCi 4x4 | 98 |  | 04.08 |  |  |                |        |  |                      |
|                            | 2.5 dCi     | 98 |  | 04.08 |  |  | 03.0137-0519.2 | 650519 |  | 294 x 56             |
|                            | 2.5 dCi 4x4 | 98 |  | 04.08 |  |  |                |        |  |                      |























1) + 16" wheel / + ruota 16" / + roue 16" / + rueda 16"  
2) + 17" wheel / + ruota 17" / + roue 17" / + rueda 17"  
3) without sensor ring / senza sensori / sans secours ABS / sin anillo sensor ABS

|     |  |  |  |  |  |  |  |  |
|--|--|--|--|--|---|--|--|--|
| <b>NISSAN NV 200 (M20) Kasten (10-)</b>  |  |  |  |  |   |  |  |  |
|    | e-NV   | 80   |  | 05.14  |   | 13.0460-5783.2   | 605783   | 24227 16,7 +/WK TOK  |
|    | 1.5 dCi  | 63   |  | 02.10  |   | 24.0126-0175.1   | 426175   | 257 26,0 24,0 V +B   |
|  | 1.5 dCi  | 66   |  | 04.11  |   |  |  |  |
|  | 1.5 dCi  | 81   |  | 04.11  |   |  |  |  |
|  | 1.6 i 16V  | 81   |  | 02.10  |   |  |  |  |
|    | e-NV   | 80   |  | 05.14  |   | 13.0460-5843.2   | 605843   | 23871 14,3 +/WK AKE  |
|    | e-NV   | 80   |  | 05.14  |   | 24.0109-0157.1   | 409157   | 292 9,0 8,0 +B   |
| <b>NISSAN NV 200 EVALIA (M20) Bus (10-)</b>  |  |  |  |  |   |  |  |  |
|    | e-NV   | 80   |  | 07.14  |   | 13.0460-5783.2   | 605783   | 24227 16,7 +/WK TOK  |
|    | 1.5 dCi  | 63   |  | 07.10  |   | 24.0126-0175.1   | 426175   | 257 26,0 24,0 V +B   |
|  | 1.5 dCi  | 66   |  | 04.11  |   |  |  |  |
|  | 1.5 dCi  | 81   |  | 04.11  |   |  |  |  |
|  | 1.6 i 16V  | 81   |  | 07.10  |   |  |  |  |
|    | e-NV   | 80   |  |  |   | 13.0460-5843.2   | 605843   | 23871 14,3 +/WK AKE  |
|    | e-NV   | 80   |  | 07.14  |   | 24.0109-0157.1   | 409157   | 292 9,0 8,0 +B   |
| <b>NISSAN NV 400 (X62) Bus (11-)</b>   |  |  |  |  |   |  |  |  |
|    | 2.3 dCi  | 74   |  | 11.11  |   | 24.0128-0252.1   | 428252   | 302 28,0 24,5 V +S +B  |
|  | 2.3 dCi  | 92   |  | 11.11  |   |  |  |  |
|  | 2.3 dCi  | 107  |  | 11.11  |   |  |  |  |
|  | 2.3 dCi  | 110  |  | 02.14  |   |  |  |  |
|    | 2.3 dCi  | 74   |  | 11.11  |   | 13.0460-4858.2   | 604858   | 25112 18,4 +/WK BRE  |
|  | 2.3 dCi  | 92   |  | 11.11  |   |  |  |  |
|  | 2.3 dCi  | 107  |  | 11.11  |   |  |  |  |
|  | 2.3 dCi  | 110  |  | 02.14  |   |  |  |  |
|   | 2.3 dCi  | 74   |  | 11.11  |   | 24.0112-0191.1   | 412191   | 305 12,0 10,0 L +S +B  |
|  | 2.3 dCi  | 92   |  | 11.11  |   |  |  |  |
|  | 2.3 dCi  | 107  |  | 11.11  |   |  |  |  |
|  | 2.3 dCi  | 110  |  | 02.14  |   |  |  |  |
| <b>NISSAN NV 400 (X62) Kasten (11-)</b>  |  |  |  |  |   |  |  |  |
|  | 2.3 dCi FWD  | 74   |  | 11.11  |   | 24.0128-0252.1   | 428252   | 302 28,0 24,5 V +S +B  |
|  | 2.3 dCi FWD  | 92   |  | 11.11  |   |  |  |  |
|  | 2.3 dCi FWD  | 107  |  | 11.11  |   |  |  |  |
|  | 2.3 dCi FWD  | 110  |  | 02.14  |   |  |  |  |
|  | 2.3 dCi FWD  | 120  |  | 06.14  |   |  |  |  |
|  | 2.3 dCi RWD  | 92   |  | 11.11  |   |  |  |  |
|  | 2.3 dCi RWD  | 107  |  | 11.11  |   |  |  |  |
|  | 2.3 dCi RWD  | 110  |  | 02.14  |   |  |  |  |
|  | 2.3 dCi RWD  | 120  |  | 06.14  |   |  |  |  |
|  | 2.3 dCi FWD  | 74   |  | 11.11  |   | 13.0460-4858.2   | 604858   | 25112 18,4 +/WK BRE  |
|  | 2.3 dCi FWD  | 92   |  | 11.11  |   |  |  |  |
|  | 2.3 dCi FWD  | 107  |  | 11.11  |   |  |  |  |
|  | 2.3 dCi FWD  | 110  |  | 02.14  |   |  |  |  |
|  | 2.3 dCi FWD  | 120  |  | 06.14  |   |  |  |  |
|  | 2.3 dCi FWD  | 74   |  | 11.11  |   | 24.0112-0191.1   | 412191   | 305 12,0 10,0 L +S +B  |
|  | 2.3 dCi FWD  | 92   |  | 11.11  |   |  |  |  |
|  | 2.3 dCi FWD  | 107  |  | 11.11  |   |  |  |  |
|  | 2.3 dCi FWD  | 110  |  | 02.14  |   |  |  |  |
|  | 2.3 dCi FWD  | 120  |  | 06.14  |   |  |  |  |
|  | 2.3 dCi RWD  | 92   |  | 11.11  |   | 24.0118-0153.1   | 418153   | + Doppelbereifung <sup>1)</sup>  |
|  | 2.3 dCi RWD  | 107  |  | 11.11  |   | 24.0112-0190.1   | 412190   | + Einfachbereifung <sup>2)</sup>   |
|  | 2.3 dCi RWD  | 110  |  | 02.14  |   |  |  | 302 18,0 15,0 +B   |
|  | 2.3 dCi RWD  | 120  |  | 06.14  |   |  |  | 305 12,0 10,0 L +S +B  |
| <b>NISSAN NV 400 (X62) Pritsche/Fahrgestell (11-)</b>                              |  |  |  |  |   |  |  |  |
|  | 2.3 dCi FWD  | 74   |  | 11.11  |   | 24.0128-0252.1   | 428252   | 302 28,0 24,5 V +S +B  |
|  | 2.3 dCi FWD  | 92   |  | 11.11  |   |  |  |  |
|  | 2.3 dCi FWD  | 107  |  | 11.11  |   |  |  |  |
|  | 2.3 dCi FWD  | 110  |  | 08.14  |   |  |  |  |
|  | 2.3 dCi FWD  | 120  |  | 06.14  |   |  |  |  |
|  | 2.3 dCi RWD  | 92   |  | 11.11  |   |  |  |  |
|  | 2.3 dCi RWD  | 107  |  | 11.11  |   |  |  |  |
|  | 2.3 dCi RWD  | 110  |  | 08.14  |   |  |  |  |
|  | 2.3 dCi RWD  | 120  |  | 06.14  |   |  |  |  |
|  | 2.3 dCi FWD  | 74   |  | 11.11  |   | 13.0460-4858.2   | 604858   | 25112 18,4 +/WK BRE  |
|  | 2.3 dCi FWD  | 92   |  | 11.11  |   |  |  |  |
|  | 2.3 dCi FWD  | 107  |  | 11.11  |   |  |  |  |
|  | 2.3 dCi FWD  | 110  |  | 08.14  |   |  |  |  |
|  | 2.3 dCi FWD  | 120  |  | 06.14  |   |  |  |  |
|  | 2.3 dCi RWD  | 92   |  | 11.11  |   |  |  |  |
|  | 2.3 dCi RWD  | 107  |  | 11.11  |   |  |  |  |

<sup>1)</sup> + twin tyres / + ruote gemellate / + roue jumelée / + cubierta doble























<sup>2)</sup> + single tyre / + ruota singola / + roue simple / + cubierta simple























|     |                  |  |  |  |  |  |  |  |
|--|--|--|--|--|---|--|--|--|
| <b>NISSAN NV 400 (X62) Pritsche/Fahrgestell (11-)</b>                              |  |  |  |  |   |  |  |  |
|    | 2.3 dCi RWD<br>2.3 dCi RWD   | 110<br>120   | 08.14<br>06.14   |  | 13.0460-4858.2<br>604858  |  |  | 25112 18,4 +/WK <b>BRE</b>   |
|    | 2.3 dCi FWD<br>2.3 dCi FWD<br>2.3 dCi FWD<br>2.3 dCi FWD<br>2.3 dCi FWD                          | 74<br>92<br>107<br>110<br>120  | 11.11<br>11.11<br>11.11<br>08.14<br>06.14  |  | 24.0112-0191.1<br>412191  |  |  | 305 12,0 10,0 L +S +B  |
|  | 2.3 dCi RWD<br>2.3 dCi RWD<br>2.3 dCi RWD<br>2.3 dCi RWD   | 92<br>107<br>110<br>120  | 11.11<br>11.11<br>08.14<br>06.14   |  | 24.0118-0153.1<br>418153<br>24.0112-0190.1<br>412190                              |  | + Doppelbereifung <sup>1)</sup><br>+ Einfachbereifung <sup>2)</sup>                | 302 18,0 15,0 +B<br>305 12,0 10,0 L +S +B  |
| <b>NISSAN PATHFINDER (R50) (97-04)</b>   |  |  |  |  |   |  |  |  |
|    | 3.3 i V6 4WD<br>3.3 i V6 4WD<br>3.5 i V6 4WD   | 110<br>125<br>162  | 03.98<br>09.97<br>11.00  | 10.00<br>12.04<br>12.04  | 24.0128-0166.1<br>428166  |  |  | 300 28,0 26,0 V  |
|    | 3.3 i V6 4WD<br>3.3 i V6 4WD<br>3.5 i V6 4WD   | 110<br>125<br>162  | 03.98<br>09.97<br>11.00  | 10.00<br>12.04<br>12.04  | 03.0137-0319.2<br>650319<br>03.0137-9290.2<br>669290                              |  |  | 295 x 52<br>Bremsbacken-Zubehör  |
| <b>NISSAN PATHFINDER (R51M) (05-)</b>  |  |  |  |  |   |  |  |  |
|    | 2.5 dCi<br>2.5 dCi 4WD<br>2.5 dCi 4WD<br>2.5 dCi 4WD   | 128<br>120<br>126<br>128   | 01.05<br>01.05<br>10.06<br>03.05   |  | 13.0460-5783.2<br>605783<br>13.0460-0017.2<br>610017                              |  | + 16" Rad <sup>3)</sup><br>+ 16" Rad <sup>3)</sup>                                 | 24227 16,7 +/WK <b>TOK</b><br>Belagsatz-Zubehör                                    |
|  | 2.5 dCi<br>2.5 dCi 4WD<br>2.5 dCi 4WD<br>2.5 dCi 4WD<br>4.0<br>4.0 4WD<br>3.0 dCi                | 128<br>120<br>126<br>128<br>198<br>198<br>170                                    | 01.05<br>01.05<br>10.06<br>03.05<br>01.05<br>09.05<br>08.10                      |  | 13.0460-5778.2<br>605778  |  | + 17" Rad <sup>4)</sup>  | 23698 16,8 +/WK <b>SUM</b>   |
|    | 2.5 dCi<br>2.5 dCi 4WD<br>2.5 dCi 4WD<br>2.5 dCi 4WD<br>2.5 dCi 4WD                              | 128<br>120<br>126<br>128<br>140  | 01.05<br>01.05<br>10.06<br>03.05<br>08.10  |  | 24.0128-0241.1<br>428241  |  | + 16" Rad <sup>3)</sup>  | 296 28,0 26,0 V L +B   |
|  | 2.5 dCi<br>2.5 dCi 4WD<br>2.5 dCi 4WD<br>2.5 dCi 4WD<br>2.5 dCi 4WD<br>4.0<br>4.0 4WD<br>3.0 dCi | 128<br>120<br>126<br>128<br>140<br>198<br>198<br>170                             | 01.05<br>01.05<br>10.06<br>03.05<br>08.10<br>01.05<br>09.05<br>08.10             |  | 24.0128-0240.1<br>428240  |  | + 17" Rad <sup>4)</sup>  | 320 28,0 26,0 V L +B   |
|  | 2.5 dCi<br>2.5 dCi 4WD<br>2.5 dCi 4WD<br>2.5 dCi 4WD<br>2.5 dCi 4WD<br>3.0 dCi<br>4.0<br>4.0 4WD | 128<br>120<br>126<br>128<br>140<br>170<br>198<br>198                             | 01.05<br>01.05<br>10.06<br>03.05<br>08.10<br>08.10<br>01.05<br>09.05             |  | 13.0460-5784.2<br>605784  |  |  | 24240 16,6 +/WK  |
|  | 2.5 dCi<br>2.5 dCi 4WD<br>2.5 dCi 4WD<br>2.5 dCi 4WD<br>2.5 dCi 4WD<br>3.0 dCi<br>4.0<br>4.0 4WD | 128<br>120<br>126<br>128<br>140<br>170<br>198<br>198                             | 01.05<br>01.05<br>10.06<br>03.05<br>08.10<br>08.10<br>01.05<br>09.05             |  | 24.0118-0724.1<br>418724  |  |  | 308 18,0 16,0 V +B   |
|  | 2.5 dCi<br>2.5 dCi 4WD<br>2.5 dCi 4WD<br>2.5 dCi 4WD<br>2.5 dCi 4WD<br>3.0 dCi<br>4.0<br>4.0 4WD | 128<br>120<br>126<br>128<br>140<br>170<br>198<br>198                             | 01.05<br>01.05<br>10.06<br>03.05<br>08.10<br>08.10<br>01.05<br>09.05             |  | 03.0137-3042.2<br>653042  |  |  | 190 x 33/25  |
| <b>NISSAN PATROL GR I (Y60) (88-97)</b>  |  |  |  |  |   |  |  |  |
|  | 2.8 TD<br>4.2 i  | 85<br>121  | 09.88<br>10.91   | 06.97<br>06.97   | 13.0460-5960.2<br>605960<br>13.0460-0448.2<br>610448                              |  |  | 20863 16,5 <b>SUM</b><br>Belagsatz-Zubehör   |
|  | 2.8 TD<br>4.2 i  | 85<br>121  | 09.88<br>10.91   | 06.97<br>06.97   | 24.0120-0119.1<br>420119  |  |  | 295 20,0 18,0 V  |
|  | 2.8 TD<br>4.2 i  | 85<br>121  | 10.91<br>10.91   | 06.97<br>06.97   | 24.0118-0136.1<br>418136  |  |  | 316 18,0 16,0 V  |
|  | 2.8 TD   | 85   | 09.88  | 09.91  | 03.0137-0297.2<br>650297  |  |  | 270 x 52   |















1) + twin tyres / + ruote gemellate / + roue jumelée / + cubierta doble  
2) + single tyre / + ruota singola / + roue simple / + cubierta simple  
3) + 16" wheel / + ruota 16" / + roue 16" / + rueda 16"  
4) + 17" wheel / + ruota 17" / + roue 17" / + rueda 17"











|     |  |  |  |  |  |  |  |  |                     |     |
|--|--|--|--|--|---|--|--|--|---------------------|-----|
| <b>NISSAN PATROL GR II (Y61) (97-10)</b>   |  |  |  |  |   |  |  |  |                     |     |
|    | 2.8 TD   | 95   |  | 06.97  | 04.00   |  | 13.0460-5879.2   | 605879   | 23611 18,8 +/WK     | AKE |
|  | 2.8 TDiC   | 96   |  | 10.97  | 02.00   |  |  |  |                     |     |
|  | 3.0 D  | 116  |  | 05.00  | 09.04   |  |  |  |                     |     |
|  | 3.0 D 4x4  | 118  |  | 10.04  | 03.10   |  |  |  |                     |     |
|  | 3.0 DTi  | 116  |  | 05.00  | 08.04   |  |  |  |                     |     |
|  | 3.0 DTi  | 118  |  | 05.00  | 03.10   |  |  |  |                     |     |
|  | 4.8 i V6   | 180  |  | 05.00  | 03.10   |  | 13.0460-5879.2   | 605879   | 23611 18,8 +/WK     | AKE |
|  |  |  |  |  |   |  | 13.0460-0117.2   | 610117   | Belagsatz-Zubehör   |     |
|    | 2.8 TD   | 95   |  | 06.97  | 04.00   |  | 13.0460-5751.2   | 605751   | 23502 16,0 +/WK     |     |
|  | 2.8 TDiC   | 96   |  | 10.97  | 02.00   |  |  |  |                     |     |
|  | 3.0 D  | 116  |  | 05.00  | 09.04   |  |  |  |                     |     |
|  | 3.0 D 4x4  | 118  |  | 10.04  | 03.10   |  |  |  |                     |     |
|  | 3.0 DTi  | 116  |  | 05.00  | 08.04   |  |  |  |                     |     |
|  | 3.0 DTi  | 118  |  | 05.00  | 03.10   |  |  |  |                     |     |
|  | 4.8 i V6   | 180  |  | 05.00  | 03.10   |  | 13.0460-0203.2   | 610203   | Belagsatz-Zubehör   |     |
|    | 2.8 TD   | 95   |  | 06.97  | 04.00   |  | 24.0118-0136.1   | 418136   | 316 18,0 16,0 V     |     |
|  | 2.8 TDiC   | 96   |  | 10.97  | 02.00   |  |  |  |                     |     |
|  | 3.0 D  | 116  |  | 05.00  | 09.04   |  |  |  |                     |     |
|  | 3.0 D 4x4  | 118  |  | 10.04  | 03.10   |  |  |  |                     |     |
|  | 3.0 DTi  | 116  |  | 05.00  | 08.04   |  |  |  |                     |     |
|  | 3.0 DTi  | 118  |  | 05.00  | 03.10   |  |  |  |                     |     |
| <b>NISSAN PICK-UP (D21) (85-97)</b>  |  |  |  |  |   |  |  |  |                     |     |
|    | 2.0  |  |  | 09.85  | 08.91   |  | 13.0460-5937.2   | 605937   | 21119 17,0 +/WK     | AKE |
|  | 2.3 D  |  |  | 09.85  | 08.88   |  | 13.0460-0322.2   | 610322   | Belagsatz-Zubehör   | AKE |
|  | 2.4 i 4WD  |  |  | 03.86  | 02.98   |  |  |  |                     |     |
|  | 2.5 D  |  |  | 09.87  | 02.98   |  |  |  |                     |     |
|  | 2.5 D 4WD  |  |  | 09.85  | 02.98   |  |  |  |                     |     |
|    | 2.4 i 4WD  |  |  | 03.86  | 02.98   |  | 24.0122-0180.1   | 422180   | 267 22,0 20,0 V     |     |
|  | 2.5 D 4WD  |  |  | 09.85  | 02.98   |  |  |  |                     |     |
|    | 2.0  |  |  | 10.88  | 08.91   |  | 03.0137-0310.2   | 650310   | 260 x 52            |     |
|  |  |  |  |  |   |  | 03.0137-9273.2   | 669273   | Bremsbacken-Zubehör |     |
|  | 2.4 i 4WD  |  |  | 10.88  | 02.98   |  | 03.0137-0319.2   | 650319   | 295 x 52            |     |
|  |  |  |  |  |   |  | 03.0137-9290.2   | 669290   | Bremsbacken-Zubehör |     |
| <b>NISSAN PICK-UP (D22) (98-07)</b>  |  |  |  |  |   |  |  |  |                     |     |
|   | 2.4 i  | 88   |  | 02.98  | 10.01   |  | 13.0460-5957.2   | 605957   | 21347 17,0 +/WK     | AKE |
|  | 2.4 i  | 98   |  | 11.01  | 04.05   |  | 13.0460-0289.2   | 610289   | Belagsatz-Zubehör   |     |
|  | 2.4 i  | 110  |  | 01.03  | 12.07   |  |  |  |                     |     |
|  | 2.4 i 4WD  | 88   |  | 02.98  | 10.01   |  |  |  |                     |     |
|  | 2.5 D  | 61   |  | 02.98  | 10.01   |  |  |  |                     |     |
|  | 2.5 TD 4WD   | 76   |  | 05.98  | 10.01   |  |  |  |                     |     |
|  | 2.5 TDi  | 98   |  | 11.01  | 04.05   |  |  |  |                     |     |
|  | 3.2 TD 4WD   | 76   |  | 10.98  | 10.01   |  |  |  |                     |     |
|  | 2.4 i 4WD  | 98   |  | 11.01  | 04.05   |  | 13.0460-5632.2   | 605632   | 23970 16,8 +/WK     |     |
|  | 2.4 i 4WD  | 110  |  | 11.01  | 04.05   |  |  |  |                     |     |
|  | 2.5 TDi 4WD  | 98   |  | 11.01  | 04.05   |  |  |  |                     |     |
|  | 3.2 TD 4WD   | 76   |  | 11.01  | 12.07   |  |  |  |                     |     |
|  | 2.4 i 4WD  | 88   |  | 02.98  | 03.01   |  | 24.0126-0109.1   | 426109   | 277 26,0 24,0 V +B  |     |
|  | 2.5 TD 4WD   | 76   |  | 05.98  | 03.01   |  |  |  |                     |     |
|  | 2.4 i 4WD  | 98   |  | 11.01  | 04.05   |  | 24.0128-0166.1   | 428166   | 300 28,0 26,0 V     |     |
|  | 2.4 i 4WD  | 110  |  | 11.01  | 04.05   |  |  |  |                     |     |
|  | 2.5 TDi 4WD  | 98   |  | 11.01  | 04.05   |  |  |  |                     |     |
|  | 3.2 TD 4WD   | 76   |  | 11.01  | 12.07   |  |  |  |                     |     |
|  | 2.4 i  | 88   |  | 02.98  | 10.01   |  | 03.0137-0310.2   | 650310   | 260 x 52            |     |
|  | 2.4 i  | 98   |  | 11.01  | 04.05   |  | 03.0137-9273.2   | 669273   | Bremsbacken-Zubehör |     |
|  | 2.4 i  | 110  |  | 01.03  | 12.07   |  |  |  |                     |     |
|  | 2.5 D  | 61   |  | 02.98  | 10.01   |  |  |  |                     |     |
|  | 2.5 TDi  | 98   |  | 11.01  | 04.05   |  |  |  |                     |     |
|  | 2.4 i 4WD  | 88   |  | 02.98  | 10.01   |  | 03.0137-0319.2   | 650319   | 295 x 52            |     |
|  | 2.4 i 4WD  | 98   |  | 11.01  | 04.05   |  | 03.0137-9290.2   | 669290   | Bremsbacken-Zubehör |     |
|  | 2.4 i 4WD  | 110  |  | 11.04  | 04.05   |  |  |  |                     |     |
|  | 2.5 TD 4WD   | 76   |  | 05.98  | 10.01   |  |  |  |                     |     |
|  | 2.5 TDi 4WD  | 98   |  | 11.01  | 04.05   |  |  |  |                     |     |
|  | 3.2 TD 4WD   | 76   |  | 10.98  | 12.07   |  |  |  |                     |     |
| <b>NISSAN PICK-UP (D22S) (06-)</b>   |  |  |  |  |   |  |  |  |                     |     |
|  | 2.5 DDTi   |  |  | 01.06  |   |  | 13.0460-5957.2   | 605957   | 21347 17,0 +/WK     | AKE |
|  | 2.5 DDTi 4WD   |  |  | 01.06  |   |  | 13.0460-0289.2   | 610289   | Belagsatz-Zubehör   |     |
|  | 2.5 DDTi 4WD   |  |  | 01.06  |   |  | 13.0460-5632.2   | 605632   | 23970 16,8 +/WK     |     |
|  |  |  |  |  |   |  | 24.0128-0166.1   | 428166   | 300 28,0 26,0 V     |     |
|  | 2.5 DDTi   |  |  | 01.06  |   |  | 03.0137-0310.2   | 650310   | 260 x 52            |     |
|  |  |  |  |  |   |  | 03.0137-9273.2   | 669273   | Bremsbacken-Zubehör |     |
|  | 2.5 DDTi 4WD   |  |  | 01.06  |   |  | 03.0137-0319.2   | 650319   | 295 x 52            |     |
|  |  |  |  |  |   |  | 03.0137-9290.2   | 669290   | Bremsbacken-Zubehör |     |
| <b>NISSAN PIXO (K10B) (09-13)</b>  |  |  |  |  |   |  |  |  |                     |     |
|  | 1.0 i 12V  | 50   |  | 06.09  | 04.13   |  | 13.0460-5887.2   | 605887   | 23507 15,2 +/WK     | SUM |



















|     |  |  |  |  |  |  |  |  |  |
|--|--|--|--|--|---|--|--|--|--|
| <b>NISSAN PIXO (K10B) (09-13)</b>  |  |  |  |  |   |  |  |  |  |
|    | 1.0 i 12V  | 50   |  | 06.09  | 04.13   |  | 24.0120-0225.1   | 420225   | 231 20,0 18,0 VL +B                                      |
|    | 1.0 i 12V  | 50   |  | 06.09  | 04.13   |  | 03.0137-0503.2   | 650503   | 180 x 26   |
| <b>NISSAN PRIMASTAR (X83) Bus (01-)</b>  |  |  |  |  |   |  |  |  |  |
|    | 1.9 dCi (100)  | 74   |  | 03.01  | 08.06   |  | 13.0460-2870.2   | 602870   | 23099 18,4 /S TRW  |
|  | 1.9 dCi (80)   | 60   |  | 03.01  | 08.06   |  |  |  |  |
|  | 2.0 dCi (115)  | 84   |  | 09.08  |   |  |  |  |  |
|  | 2.0 dCi (120)  | 84   |  | 09.06  |   |  |  |  |  |
|  | 2.0 dCi (90)   | 66   |  | 09.06  |   |  |  |  |  |
|  | 2.0 i 16V  | 88   |  | 03.01  |   |  |  |  |  |
|  | 2.5 dCi (140)  | 99   |  | 07.03  | 08.06   |  |  |  |  |
|  | 2.5 dCi (150)  | 107  |  | 09.06  |   |  |  |  |  |
|    | 1.9 dCi (100)  | 74   |  | 03.01  | 08.06   |  | 24.0128-0132.1   | 428132   | 305 28,0 24,0 VL +S +B                                   |
|  | 1.9 dCi (80)   | 60   |  | 03.01  | 08.06   |  |  |  |  |
|  | 2.0 dCi (115)  | 84   |  | 09.08  |   |  |  |  |  |
|  | 2.0 dCi (120)  | 84   |  | 09.06  |   |  |  |  |  |
|  | 2.0 dCi (90)   | 66   |  | 09.06  |   |  |  |  |  |
|  | 2.0 i 16V  | 88   |  | 03.01  |   |  |  |  |  |
|  | 2.5 dCi (140)  | 99   |  | 07.03  | 08.06   |  |  |  |  |
|  | 2.5 dCi (150)  | 107  |  | 09.06  |   |  |  |  |  |
|    | 1.9 dCi (100)  | 74   |  | 03.01  | 08.06   |  | 13.0460-2840.2   | 602840   | 23980 16,5 /WE/S TRW                                     |
|  | 1.9 dCi (80)   | 60   |  | 03.01  | 08.06   |  |  |  |  |
|  | 2.0 dCi (115)  | 84   |  | 09.08  |   |  |  |  |  |
|  | 2.0 dCi (120)  | 84   |  | 09.06  |   |  |  |  |  |
|  | 2.0 dCi (90)   | 66   |  | 09.06  |   |  |  |  |  |
|  | 2.0 i 16V  | 88   |  | 03.01  |   |  |  |  |  |
|  | 2.5 dCi (140)  | 99   |  | 07.03  | 08.06   |  |  |  |  |
|  | 2.5 dCi (150)  | 107  |  | 09.06  |   |  |  |  |  |
|    | 1.9 dCi (100)  | 74   |  | 03.01  | 08.06   |  | 24.0112-0177.2   | 412177   | mit Lager/ mit Sensorring <sup>1)</sup> 280 12,0 10,0 +B |
|  | 1.9 dCi (80)   | 60   |  | 03.01  | 08.06   |  |  |  |  |
|  | 2.0 dCi (115)  | 84   |  | 09.08  |   |  |  |  |  |
|  | 2.0 dCi (120)  | 84   |  | 09.06  |   |  |  |  |  |
|  | 2.0 dCi (90)   | 66   |  | 09.06  |   |  |  |  |  |
|  | 2.0 i 16V  | 88   |  | 03.01  |   |  |  |  |  |
|  | 2.5 dCi (140)  | 99   |  | 07.03  | 08.06   |  |  |  |  |
|  | 2.5 dCi (150)  | 107  |  | 09.06  |   |  |  |  |  |
| <b>NISSAN PRIMASTAR (X83) Kasten/Pritsche (02-)</b>                                |  |  |  |  |   |  |  |  |  |
|  | 1.9 dCi (100)  | 74   |  | 07.02  | 08.06   |  | 13.0460-2870.2   | 602870   | 23099 18,4 /S TRW  |
|  | 1.9 dCi (80)   | 60   |  | 07.02  | 08.06   |  |  |  |  |
|  | 2.0 dCi (115)  | 84   |  | 09.08  |   |  |  |  |  |
|  | 2.0 dCi (120)  | 84   |  | 09.06  |   |  |  |  |  |
|  | 2.0 dCi (90)   | 66   |  | 09.06  |   |  |  |  |  |
|  | 2.0 i 16V  | 88   |  | 07.02  |   |  |  |  |  |
|  | 2.5 dCi (140)  | 99   |  | 07.03  | 08.06   |  |  |  |  |
|  | 2.5 dCi (150)  | 107  |  | 09.06  |   |  |  |  |  |
|  | 1.9 dCi (100)  | 74   |  | 07.02  | 08.06   |  | 24.0128-0132.1   | 428132   | 305 28,0 24,0 VL +S +B                                   |
|  | 1.9 dCi (80)   | 60   |  | 07.02  | 08.06   |  |  |  |  |
|  | 2.0 dCi (115)  | 84   |  | 09.08  |   |  |  |  |  |
|  | 2.0 dCi (120)  | 84   |  | 09.06  |   |  |  |  |  |
|  | 2.0 dCi (90)   | 66   |  | 09.06  |   |  |  |  |  |
|  | 2.0 i 16V  | 88   |  | 07.02  |   |  |  |  |  |
|  | 2.5 dCi (140)  | 99   |  | 07.03  | 08.06   |  |  |  |  |
|  | 2.5 dCi (150)  | 107  |  | 09.06  |   |  |  |  |  |
|  | 1.9 dCi (100)  | 74   |  | 07.02  | 08.06   |  | 13.0460-2840.2   | 602840   | 23980 16,5 /WE/S TRW                                     |
|  | 1.9 dCi (80)   | 60   |  | 07.02  | 08.06   |  |  |  |  |
|  | 2.0 dCi (115)  | 84   |  | 09.08  |   |  |  |  |  |
|  | 2.0 dCi (120)  | 84   |  | 09.06  |   |  |  |  |  |
|  | 2.0 dCi (90)   | 66   |  | 09.06  |   |  |  |  |  |
|  | 2.0 i 16V  | 88   |  | 07.02  |   |  |  |  |  |
|  | 2.5 dCi (140)  | 99   |  | 07.03  | 08.06   |  |  |  |  |
|  | 2.5 dCi (150)  | 107  |  | 09.06  |   |  |  |  |  |
|  | 1.9 dCi (100)  | 74   |  | 07.02  | 08.06   |  | 24.0112-0177.2   | 412177   | mit Lager/ mit Sensorring <sup>1)</sup> 280 12,0 10,0 +B |
|  | 1.9 dCi (80)   | 60   |  | 07.02  | 08.06   |  |  |  |  |
|  | 2.0 dCi (115)  | 84   |  | 09.08  |   |  |  |  |  |
|  | 2.0 dCi (120)  | 84   |  | 09.06  |   |  |  |  |  |
|  | 2.0 dCi (90)   | 66   |  | 09.06  |   |  |  |  |  |
|  | 2.0 i 16V  | 88   |  | 07.02  |   |  |  |  |  |
|  | 2.5 dCi (140)  | 99   |  | 07.03  | 08.06   |  |  |  |  |
|  | 2.5 dCi (150)  | 107  |  | 09.06  |   |  |  |  |  |
| <b>NISSAN PRIMERA (P11E) Limousine (96-02)</b>                                     |  |  |  |  |   |  |  |  |  |
|  | 1.6 i 16V  |  |  | 06.96  | 03.98   |  | 13.0460-5950.2   | 605950   | 21546 16,7 TRW   |
|  | 2.0 i 16V  | 85   |  | 06.96  | 03.98   |  |  |  |  |
|  | 2.0 i 16V  | 96   |  | 06.96  | 03.98   |  |  |  |  |
|  | 2.0 TD   | 66   |  | 06.96  | 03.98   |  |  |  |  |
|  | 1.6 i 16V  |  |  | 04.98  | 02.02   |  | 13.0460-5807.2   | 605807   | 23463 16,6 + TRW   |
|  | 1.8 i 16V  | 84   |  | 06.99  | 02.02   |  | 13.0460-0148.2   | 610148   | Belagsatz-Zubehör TRW                                    |
|  | 2.0 i 16V  | 85   |  | 04.98  | 02.02   |  |  |  |  |
|  | 2.0 i 16V  | 96   |  | 04.98  | 02.02   |  |  |  |  |
|  | 2.0 i 16V  | 103  |  | 06.99  | 02.02   |  |  |  |  |
|  | 2.0 i 16V  | 110  |  | 06.96  | 02.02   |  |  |  |  |
| ↓  | ↓  |  |  |  |   |  |  |  |  |

















<sup>1)</sup> with bearing/ with sensor ring / con supporto/+ anell.sens.ABS / avec palier de secours ABS / con apoyo/+ anillo sensor ABS

|   |  |  |  |  |  |  |  |  |            |
|--|--|--|--|--|---|--|--|--|------------|
| <b>NISSAN PRIMERA (P11E) Limousine (96-02)</b>                                   |  |  |  |  |   |  |  |  |            |
|  | 2.0 TD   | 66   |  | 04.98  | 02.02   | 13.0460-5807.2   | 605807   | 23463 16,6 +<br>Belagsatz-Zubehör  | TRW<br>TRW |
|  | 2.0 i 16V  | 103  |  | 06.99  | 02.02   | 13.0460-0148.2   | 610148   |  |            |
|  | 2.0 i 16V  | 110  |  | 06.96  | 02.02   |  | 605727   | 23160 17,3 +   | ATE        |
|  | 1.6 i 16V  |  |  | 06.96  | 05.99   | 24.0122-0146.1   | 422146   | 257 22,0 20,0 V +B   |            |
|  | 2.0 i 16V  | 85   |  | 06.96  | 05.99   |  |  |  |            |
|  | 2.0 i 16V  | 96   |  | 06.96  | 05.99   |  |  |  |            |
|  | 2.0 TD   | 66   |  | 06.96  | 05.99   |  |  |  |            |
|  | 1.6 i 16V  |  |  | 06.99  | 02.02   | 24.0122-0179.1   | 422179   | 280 22,0 20,0 V +B   |            |
|  | 1.8 i 16V  | 84   |  | 06.99  | 02.02   |  |  |  |            |
|  | 2.0 i 16V  | 85   |  | 06.99  | 02.02   |  |  |  |            |
|  | 2.0 i 16V  | 96   |  | 06.99  | 02.02   |  |  |  |            |
|  | 2.0 i 16V  | 103  |  | 06.99  | 02.02   |  |  |  |            |
|  | 2.0 i 16V  | 110  |  | 06.96  | 02.02   |  |  |  |            |
|  | 2.0 TD   | 66   |  | 06.99  | 02.02   |  |  |  |            |
|  | 1.8 i 16V  | 84   |  | 06.99  | 02.02   | 13.0460-5986.2   | 605986   | 21545 14,9   | TRW        |
|  | 2.0 i 16V  | 85   |  | 06.96  | 02.02   |  |  |  |            |
|  | 2.0 i 16V  | 96   |  | 06.96  | 02.02   |  |  |  |            |
|  | 2.0 i 16V  | 103  |  | 06.99  | 02.02   |  |  |  |            |
|  | 2.0 i 16V  | 110  |  | 06.96  | 02.02   |  |  |  |            |
|  | 2.0 i 16V  | 85   |  | 06.96  | 05.99   | 24.0110-0215.1   | 410215   | 258 10,0 9,0 +B  |            |
|  | 2.0 i 16V  | 96   |  | 06.96  | 05.99   |  |  |  |            |
|  | 2.0 i 16V  | 103  |  | 06.99  | 02.02   |  |  |  |            |
|  | 2.0 i 16V  | 110  |  | 06.96  | 05.99   |  |  |  |            |
|  | 1.8 i 16V  | 84   |  | 06.99  | 02.02   | 24.0110-0310.1   | 410310   | 278 10,0 9,0 +B  |            |
|  | 2.0 i 16V  | 85   |  | 06.99  | 02.02   |  |  |  |            |
|  | 2.0 i 16V  | 96   |  | 06.99  | 02.02   |  |  |  |            |
|  | 2.0 i 16V  | 103  |  | 06.99  | 02.02   |  |  |  |            |
|  | 2.0 i 16V  | 110  |  | 06.99  | 02.02   |  |  |  |            |
|  | 1.6 i 16V  |  |  | 06.96  | 02.02   | 03.0137-0351.2   | 650351   | 229 x 42 HEB   | BDX        |
|  | 2.0 TD   | 66   |  | 06.96  | 02.02   | 03.0137-9228.2   | 669228   | Bremsbacken-Zubehör  | BDX        |
|  | 1.6 i 16V  |  |  | 06.96  | 02.02   | 03.0520-7520.3   | 697520   | 20,64/230x42 TopKit  | BDX        |
|  | 2.0 TD   | 66   |  | 06.96  | 02.02   |  |  |  |            |

|  |         |     |  |       |       |                |        |   |     |
|--|---------|-----|--|-------|-------|----------------|--------|---|-----|
| <b>NISSAN PRIMERA (P12E) Limousine (02-08)</b>                                     |         |     |  |       |       |                |        |   |     |
|   | 1.6     | 78  |  | 03.02 | 10.08 | 13.0460-5825.2 | 605825 | 23094 16,5 +/WK/Zub/STRW<br>Belagsatz-Zubehör |     |
|  | 1.6     | 80  |  | 03.02 | 04.06 | 13.0460-0282.2 | 610282 |   |     |
|  | 1.8     | 85  |  | 03.02 | 10.08 |                |        |   |     |
|  | 1.9 dCi | 88  |  | 04.03 | 10.07 |                |        |   |     |
|  | 2.0     | 103 |  | 03.02 | 10.08 |                |        |   |     |
|  | 2.2 dCi | 102 |  | 04.03 | 10.07 |                |        |   |     |
|  | 2.2 Di  | 93  |  | 03.02 | 04.03 |                |        |   |     |
|  | 2.5     | 125 |  | 03.02 | 04.06 |                |        |   |     |
|  | 1.6     | 78  |  | 03.02 | 10.08 | 24.0128-0140.1 | 428140 | 280 28,0 26,0 V +B                            |     |
|  | 1.6     | 80  |  | 03.02 | 04.06 |                |        |   |     |
|  | 1.8     | 85  |  | 03.02 | 10.08 |                |        |   |     |
|  | 1.9 dCi | 88  |  | 04.03 | 10.07 |                |        |   |     |
|  | 2.0     | 103 |  | 03.02 | 10.08 |                |        |   |     |
|  | 2.2 dCi | 102 |  | 04.03 | 10.07 |                |        |   |     |
|  | 2.2 Di  | 93  |  | 03.02 | 04.03 |                |        |   |     |
|  | 2.5     | 125 |  | 03.02 | 04.06 |                |        |   |     |
|  | 1.6     | 78  |  | 03.02 | 10.08 | 13.0460-7137.2 | 607137 | 23482 15,8 +<br>23482 15,8 +                  | ATE |
|  | 1.6     | 80  |  | 03.02 | 04.06 | 13.0470-7137.2 | LD7137 |   |     |
|  | 1.8     | 85  |  | 03.02 | 10.08 |                |        |   |     |
|  | 1.9 dCi | 88  |  | 04.03 | 10.07 |                |        |   |     |
|  | 2.0     | 103 |  | 03.02 | 10.08 |                |        |   |     |
|  | 2.2 dCi | 102 |  | 04.03 | 10.07 |                |        |   |     |
|  | 2.2 Di  | 93  |  | 03.02 | 04.03 |                |        |   |     |
|  | 2.5     | 125 |  | 03.02 | 04.06 |                |        |   |     |
|  | 1.6     | 78  |  | 03.02 | 10.08 | 24.0110-0285.1 | 410285 | 278 10,0 9,0 +B                               |     |
|  | 1.6     | 80  |  | 03.02 | 04.06 |                |        |   |     |
|  | 1.8     | 85  |  | 03.02 | 10.08 |                |        |   |     |
|  | 1.9 dCi | 88  |  | 04.03 | 10.07 |                |        |   |     |
|  | 2.0     | 103 |  | 03.02 | 10.08 |                |        |   |     |
|  | 2.2 dCi | 102 |  | 04.03 | 10.07 |                |        |   |     |
|  | 2.2 Di  | 93  |  | 03.02 | 04.03 |                |        |   |     |
|  | 2.5     | 125 |  | 03.02 | 04.06 |                |        |   |     |



























|  |       |  |  |       |       |                |        |                    |     |
|--|-------|--|--|-------|-------|----------------|--------|--------------------|-----|
| <b>NISSAN PRIMERA (W10) Kombi (90-98)</b>  |       |  |  |       |       |                |        |                    |     |
|  | 1.6   |  |  | 07.90 | 03.98 | 13.0460-5933.2 | 605933 | 21725 16,8 +/WK    | AKE |
|  | 2.0 D |  |  | 07.90 | 12.95 |                |        |                    |     |
|  | 2.0 i |  |  | 07.90 | 12.95 |                |        |                    |     |
|  | 1.6   |  |  | 07.90 | 03.98 | 24.0122-0146.1 | 422146 | 257 22,0 20,0 V +B |     |
|  | 2.0 D |  |  | 07.90 | 12.95 |                |        |                    |     |
|  | 2.0 i |  |  | 07.90 | 12.95 |                |        |                    |     |
|  | 1.6   |  |  | 07.90 | 03.98 | 13.0460-5983.2 | 605983 | 21713 16,5         |     |
|  | 2.0 D |  |  | 07.90 | 12.95 |                |        |                    |     |
|  | 2.0 i |  |  | 07.90 | 12.95 |                |        |                    |     |
|  | 1.6   |  |  | 07.90 | 03.98 | 24.0109-0129.1 | 409129 | 258 9,0 8,0        |     |
|  | 2.0 D |  |  | 07.90 | 12.95 |                |        |                    |     |
|  | 2.0 i |  |  | 07.90 | 12.95 |                |        |                    |     |
|  |       |  |  |       |       |                |        |                    |     |

|     |   |  |  |  |  |  |  |  |                                  |  |  |  |  |  |  |  |   |                     |  |
|--|---|--|--|--|--|--|--|--|----------------------------------|---|--|--|--|--|--|--|---|---------------------|--|
| <b>NISSAN PRIMERA (W10) Kombi (90-98)</b>  |   |  |  |  |  |  |  |  |                                  |   |  |  |  |  |  |  |   |                     |  |
|    | 1.6<br>2.0 D  |  |  | 07.90<br>07.90   | 03.98<br>12.95   | - ABS<br>- ABS   |  |  | 03.0137-0210.2<br>03.0137-9112.2 | 650210<br>669112  |  |  |  |  |  |  | 229 x 41<br>Bremsbacken-Zubehör               |                     |  |
| <b>NISSAN PRIMERA (W11) Kombi (98-02)</b>  |   |  |  |  |  |  |  |  |                                  |   |  |  |  |  |  |  |   |                     |  |
|    | 1.6 i 16V<br>1.6 i 16V<br>1.6 i 16V<br>1.8 i 16V<br>2.0 i 16V<br>2.0 i 16V<br>2.0 TD              | 66<br>73<br>81<br>84<br>85<br>96<br>66   |  | 04.98<br>04.98<br>04.98<br>08.99<br>04.98<br>04.98<br>04.98                      | 02.02<br>02.02<br>02.02<br>02.02<br>06.99<br>06.99<br>02.02          |  |  | 13.0460-5807.2<br>13.0460-0148.2   | 605807<br>610148                 |   |  |  |  |  |  | 23463 16,6 +<br>Belagsatz-Zubehör  | TRW<br>TRW                                    |                     |  |
|  | 2.0 i 16V<br>2.0 i 16V<br>2.0 i 16V   | 85<br>96<br>103  |  | 07.99<br>07.99<br>08.99  | 02.02<br>02.02<br>02.02  |  |  | 13.0460-5727.2   | 605727                           |   |  |  |  |  |  |  | 23160 17,3 +                                  | ATE                 |  |
|    | 1.6 i 16V<br>1.6 i 16V<br>1.6 i 16V<br>1.8 i 16V<br>2.0 i 16V<br>2.0 i 16V<br>2.0 i 16V<br>2.0 TD | 66<br>73<br>81<br>84<br>85<br>96<br>103<br>66                                    |  | 04.98<br>04.98<br>04.98<br>08.99<br>04.98<br>04.98<br>08.99<br>04.98             | 02.02<br>02.02<br>02.02<br>02.02<br>02.02<br>02.02<br>02.02<br>02.02 |  |  | 24.0122-0179.1   | 422179                           |   |  |  |  |  |  |  | 280 22,0 20,0 V +B                            |                     |  |
|    | 1.6 i 16V<br>1.6 i 16V<br>1.6 i 16V<br>1.8 i 16V<br>2.0 i 16V<br>2.0 i 16V<br>2.0 i 16V<br>2.0 TD | 66<br>73<br>81<br>84<br>85<br>96<br>103<br>66                                    |  | 04.98<br>04.98<br>04.98<br>08.99<br>04.98<br>04.98<br>08.99<br>04.98             | 02.02<br>02.02<br>02.02<br>02.02<br>02.02<br>02.02<br>02.02<br>02.02 |  |  | 13.0460-5986.2   | 605986                           |   |  |  |  |  |  |  | 21545 14,9                                    | TRW                 |  |
|    | 1.6 i 16V<br>1.6 i 16V<br>1.6 i 16V<br>1.8 i 16V<br>2.0 i 16V<br>2.0 i 16V<br>2.0 i 16V<br>2.0 TD | 66<br>73<br>81<br>84<br>85<br>96<br>103<br>66                                    |  | 04.98<br>04.98<br>04.98<br>08.99<br>04.98<br>04.98<br>08.99<br>04.98             | 03.01<br>03.01<br>03.01<br>03.01<br>03.01<br>03.01<br>03.01<br>03.01 |  |  | 24.0110-0310.1   | 410310                           |   |  |  |  |  |  |  | 278 10,0 9,0 +B                               |                     |  |
|  | 1.6 i 16V<br>1.6 i 16V<br>1.6 i 16V<br>1.8 i 16V<br>2.0 i 16V<br>2.0 i 16V<br>2.0 i 16V<br>2.0 TD | 66<br>73<br>81<br>84<br>85<br>96<br>103<br>66                                    |  | 04.01<br>04.01<br>04.01<br>04.01<br>04.01<br>04.01<br>04.01<br>04.01             | 02.02<br>02.02<br>02.02<br>02.02<br>02.02<br>02.02<br>02.02<br>02.02 |  |  | 24.0110-0215.1   | 410215                           |   |  |  |  |  |  |  | 258 10,0 9,0 +B                               |                     |  |
| <b>NISSAN PRIMERA (W12) Kombi (02-08)</b>  |   |  |  |  |  |  |  |  |                                  |   |  |  |  |  |  |  |   |                     |  |
|  | 1.6<br>1.8<br>1.9 dCi<br>2.0<br>2.2 dCi<br>2.2 Di<br>2.5  | 80<br>85<br>88<br>103<br>102<br>93<br>125  |  | 03.02<br>03.02<br>04.03<br>03.02<br>04.03<br>03.02<br>03.02                      | 04.06<br>10.08<br>10.07<br>10.08<br>10.07<br>04.03<br>04.06          |  |  | 13.0460-5825.2<br>13.0460-0282.2   | 605825<br>610282                 |   |  |  |  |  |  |  | 23094 16,5 +/WK/Zub/STRW<br>Belagsatz-Zubehör |                     |  |
|  | 1.6<br>1.8<br>1.9 dCi<br>2.0<br>2.2 dCi<br>2.2 Di<br>2.5  | 80<br>85<br>88<br>103<br>102<br>93<br>125  |  | 03.02<br>03.02<br>04.03<br>03.02<br>04.03<br>03.02<br>03.02                      | 04.06<br>10.08<br>10.07<br>10.08<br>10.07<br>04.03<br>04.06          |  |  | 24.0128-0140.1   | 428140                           |   |  |  |  |  |  |  | 280 28,0 26,0 V +B                            |                     |  |
|  | 1.6<br>1.8<br>1.9 dCi<br>2.0<br>2.2 dCi<br>2.2 Di<br>2.5  | 80<br>85<br>88<br>103<br>102<br>93<br>125  |  | 03.02<br>03.02<br>04.03<br>03.02<br>04.03<br>03.02<br>03.02                      | 04.06<br>10.08<br>10.07<br>10.08<br>10.07<br>04.03<br>04.06          |  |  | 13.0460-7137.2<br>13.0470-7137.2   | 607137<br>LD7137                 |   |  |  |  |  |  |  | 23482 15,8 +<br>23482 15,8 +                  | ATE<br>ATE          |  |
|  | 1.6<br>1.8<br>1.9 dCi<br>2.0<br>2.2 dCi<br>2.2 Di<br>2.5  | 80<br>85<br>88<br>103<br>102<br>93<br>125  |  | 03.02<br>03.02<br>04.03<br>03.02<br>04.03<br>03.02<br>03.02                      | 04.06<br>10.08<br>10.07<br>10.08<br>10.07<br>04.03<br>04.06          |  |  | 24.0110-0285.1   | 410285                           |   |  |  |  |  |  |  | 278 10,0 9,0 +B                               |                     |  |
| <b>NISSAN PULSAR (14-)</b>   |   |  |  |  |  |  |  |  |                                  |   |  |  |  |  |  |  |   |                     |  |
|  | 1.2 DIG-T<br>1.5 dCi<br>1.6 DIG-T   | 85<br>81<br>140  |  | 10.14<br>10.14<br>02.15  |  |  |  | 13.0460-5716.2   | 605716                           |   |  |  |  |  |  |  |   | 21561 17,0 +/WK/Zub |  |

|     |   |  |                          |                                   |  |  |                  |  |
|--|---|--|--|---|---|--|--|--|
| <b>NISSAN PULSAR (14-)</b>   |   |  |  |   |   |  |  |  |
|    | 1.2 DIG-T<br>1.5 dCi<br>1.6 DIG-T   | 85<br>81<br>140  | 10.14<br>10.14<br>02.15  |   | 24.0124-0247.1<br>24.0126-0177.1<br>13.0460-5843.2                                | 424247<br>426177<br>605843   |  | 280 24,0 22,0 V +B<br>296 26,0 24,0 V +B<br>23871 14,3 +/WK <b>AKE</b>             |
|    | 1.2 DIG-T<br>1.5 dCi<br>1.6 DIG-T   | 85<br>81<br>140  | 10.14<br>10.14<br>02.15  |   | 24.0109-0157.1  | 409157   |  | 292 9,0 8,0 +B   |
|    | 1.2 DIG-T<br>1.5 dCi<br>1.6 DIG-T   | 85<br>81<br>140  | 10.14<br>10.14<br>02.15  |   | 24.0109-0157.1  | 409157   |  | 292 9,0 8,0 +B   |
| <b>NISSAN QASHQAI / QASHQAI +2 (J10,JJ10) (07-14)</b>                              |   |  |  |   |   |  |  |  |
|    | 1.5 dCi<br>1.5 dCi<br>1.5 dCi<br>1.6 dCi<br>1.6 dCi Allrad<br>1.6 i 16V<br>1.6 i 16V<br>2.0 dCi<br>2.0 dCi Allrad<br>2.0 i 16V<br>2.0 i 16V<br>2.0 i 16V Allrad<br>2.0 i 16V Allrad | 76<br>78<br>81<br>96<br>96<br>84<br>86<br>110<br>110<br>102<br>104<br>102<br>104 | 07.08<br>02.07<br>11.10<br>10.11<br>10.11<br>02.07<br>11.10<br>02.07<br>02.07<br>11.10<br>02.07<br>11.10 | 01.14<br>01.14<br>01.14<br>01.14<br>01.14<br>01.14<br>01.14<br>01.14<br>01.14<br>01.14<br>01.14<br>01.14<br>01.14 | 13.0460-5752.2<br>13.0470-5752.2<br>13.0460-0212.2                                | 605752<br>LD5752<br>610212   | kurze Ausführung <sup>1)</sup><br>kurze Ausführung <sup>1)</sup><br>kurze Ausführung <sup>1)</sup> | 24632 17,0<br>24632 17,0<br>Belagsatz-Zubehör                                      |
|  | 1.6 dCi<br>1.6 dCi Allrad<br>2.0 dCi<br>2.0 dCi Allrad<br>2.0 i 16V Allrad  | 96<br>96<br>110<br>110<br>104  | 07.11<br>07.11<br>08.08<br>08.08<br>08.08  | 01.14<br>01.14<br>01.14<br>01.14<br>01.14   | 13.0460-5778.2  | 605778   | lange Ausführung <sup>2)</sup>   | 23698 16,8 +/WK <b>SUM</b>   |
|    | 1.5 dCi<br>1.5 dCi<br>1.5 dCi<br>1.6 dCi<br>1.6 dCi Allrad<br>1.6 i 16V<br>1.6 i 16V<br>2.0 dCi<br>2.0 dCi Allrad<br>2.0 i 16V<br>2.0 i 16V<br>2.0 i 16V Allrad<br>2.0 i 16V Allrad | 76<br>78<br>81<br>96<br>96<br>84<br>86<br>110<br>110<br>102<br>104<br>102<br>104 | 07.08<br>02.07<br>11.10<br>10.11<br>10.11<br>02.07<br>11.10<br>02.07<br>02.07<br>11.10<br>02.07<br>11.10 | 01.14<br>01.14<br>01.14<br>01.14<br>01.14<br>01.14<br>01.14<br>01.14<br>01.14<br>01.14<br>01.14<br>01.14<br>01.14 | 24.0126-0154.1  | 426154   | kurze Ausführung <sup>1)</sup>   | 296 26,0 24,0 V +B   |
|  | 1.6 dCi<br>1.6 dCi Allrad<br>2.0 dCi<br>2.0 dCi Allrad<br>2.0 i 16V Allrad  | 96<br>96<br>110<br>110<br>104  | 07.11<br>07.11<br>08.08<br>08.08<br>08.08  | 01.14<br>01.14<br>01.14<br>01.14<br>01.14   | 24.0128-0242.1  | 428242   | lange Ausführung <sup>2)</sup>   | 320 28,0 26,0 V +B   |
|  | 1.5 dCi<br>1.5 dCi<br>1.5 dCi<br>1.6 dCi<br>1.6 dCi Allrad<br>1.6 i 16V<br>1.6 i 16V<br>2.0 dCi<br>2.0 dCi Allrad<br>2.0 i 16V<br>2.0 i 16V<br>2.0 i 16V Allrad<br>2.0 i 16V Allrad | 76<br>78<br>81<br>96<br>96<br>84<br>86<br>110<br>110<br>102<br>104<br>102<br>104 | 07.08<br>02.07<br>11.10<br>10.11<br>10.11<br>02.07<br>11.10<br>02.07<br>02.07<br>11.10<br>02.07<br>11.10 | 01.14<br>01.14<br>01.14<br>01.14<br>01.14<br>01.14<br>01.14<br>01.14<br>01.14<br>01.14<br>01.14<br>01.14<br>01.14 | 13.0460-5843.2<br>13.0460-0213.2  | 605843<br>610213   |  | 23871 14,3 +/WK <b>AKE</b><br>Belagsatz-Zubehör                                    |
|  | 1.5 dCi<br>1.5 dCi<br>1.5 dCi<br>1.6 dCi<br>1.6 dCi Allrad<br>1.6 i 16V<br>1.6 i 16V<br>2.0 dCi<br>2.0 dCi Allrad<br>2.0 i 16V<br>2.0 i 16V<br>2.0 i 16V Allrad<br>2.0 i 16V Allrad | 76<br>78<br>81<br>96<br>96<br>84<br>86<br>110<br>110<br>102<br>104<br>102<br>104 | 07.08<br>02.07<br>11.10<br>10.11<br>10.11<br>02.07<br>11.10<br>02.07<br>02.07<br>11.10<br>02.07<br>11.10 | 01.14<br>01.14<br>01.14<br>01.14<br>01.14<br>01.14<br>01.14<br>01.14<br>01.14<br>01.14<br>01.14<br>01.14<br>01.14 | 24.0109-0157.1  | 409157   | kurze Ausführung <sup>1)</sup>   | 292 9,0 8,0 +B   |
|  | 1.5 dCi<br>1.5 dCi<br>1.5 dCi<br>1.6 dCi<br>1.6 dCi Allrad<br>1.6 i 16V<br>1.6 i 16V<br>2.0 dCi<br>2.0 dCi Allrad<br>2.0 i 16V<br>2.0 i 16V<br>2.0 i 16V Allrad                     | 76<br>78<br>81<br>96<br>96<br>84<br>86<br>110<br>110<br>104<br>104<br>104        | 08.08<br>08.08<br>02.10<br>07.11<br>07.11<br>08.08<br>02.10<br>08.08<br>08.08<br>08.08<br>08.08          | 01.14<br>01.14<br>01.14<br>01.14<br>01.14<br>01.14<br>01.14<br>01.14<br>01.14<br>01.14<br>01.14<br>01.14          | 24.0116-0119.1  | 416119   | lange Ausführung <sup>2)</sup>   | 292 16,0 14,0 V +B   |





























<sup>1)</sup> short version / versione corto / version court / versión corta



















<sup>2)</sup> long version / versione lunga / version longue / versión larga

|     |   |  |  |                                   |   |                  |  |  |                                     |
|--|---|--|--|---|--|--|--|--|-------------------------------------|
| <b>NISSAN QASHQAI / QASHQAI +2 (J10, JJ10) (07-14)</b>                             |   |  |  |   |  |  |  |  |                                     |
|    | 1.5 dCi<br>1.5 dCi<br>1.5 dCi<br>1.6 dCi<br>1.6 dCi Allrad<br>1.6 i 16V<br>1.6 i 16V<br>2.0 dCi<br>2.0 dCi Allrad<br>2.0 i 16V<br>2.0 i 16V<br>2.0 i 16V Allrad<br>2.0 i 16V Allrad | 76<br>78<br>81<br>96<br>96<br>84<br>86<br>110<br>110<br>102<br>104<br>102<br>104 |  | 07.08<br>02.07<br>11.10<br>10.11<br>10.11<br>02.07<br>11.10<br>02.07<br>02.07<br>02.07<br>11.10<br>02.07<br>11.10 | 01.14<br>01.14<br>01.14<br>01.14<br>01.14<br>01.14<br>01.14<br>01.14<br>01.14<br>01.14<br>01.14<br>01.14<br>01.14<br>01.14 | 03.0137-3012.2   | 653012   | 172 x 32   |                                     |
| <b>NISSAN QASHQAI (J11E) (14-)</b>   |   |  |  |   |  |  |  |  |                                     |
|    | 1.2 DIG-T<br>1.5 dCi<br>1.6 dCi<br>1.6 dCi 4x4<br>1.6 DIG-T<br>2.0 4x4 (J11R)   | 85<br>81<br>96<br>96<br>120<br>106   |  | 02.14<br>02.14<br>02.14<br>02.14<br>10.14<br>10.15  |  | 24.0126-0185.1   | 426185   | 296 26,0 24,0 V L +B   |                                     |
|    | 1.2 DIG-T<br>1.5 dCi<br>1.6 dCi<br>1.6 dCi 4x4<br>1.6 DIG-T<br>2.0 4x4 (J11R)   | 85<br>81<br>96<br>96<br>120<br>106   |  | 02.14<br>02.14<br>02.14<br>02.14<br>10.14<br>10.15  |  | 13.0460-2600.2   | 602600   | 25965 15,0 +/-WK TRW   |                                     |
|    | 1.2 DIG-T<br>1.5 dCi<br>1.6 dCi<br>1.6 dCi 4x4<br>1.6 DIG-T<br>2.0 4x4 (J11R)   | 85<br>81<br>96<br>96<br>120<br>106   |  | 02.14<br>02.14<br>02.14<br>02.14<br>10.14<br>10.15  |  | 24.0113-0200.1   | 413200   | 290 13,0 11,0 +B   |                                     |
| <b>NISSAN SERENA/VANETTE CARGO (C23M/963) (92-01)</b>                              |   |  |  |   |  |  |  |  |                                     |
|    | 1.6 i 16V<br>2.0 D<br>2.3 D   | 71<br>49<br>55   |  | 07.92<br>07.92<br>09.94   | 11.01<br>08.94<br>11.01  | + 1-Kolbensattel <sup>1)</sup><br>+ 1-Kolbensattel <sup>1)</sup><br>+ 1-Kolbensattel <sup>1)</sup> | 13.0460-5881.2<br>13.0460-0322.2   | 605881<br>610322   | 21099 17,0<br>Belagsatz-Zubehör AKE |
|   | 1.6 i 16V<br>2.0 D<br>2.0 i 16V<br>2.3 D  | 71<br>49<br>93<br>55   |  | 07.92<br>07.92<br>07.92<br>09.94  | 11.01<br>08.94<br>11.01<br>11.01   | + 2-Kolbensattel <sup>2)</sup><br>+ 2-Kolbensattel <sup>2)</sup><br>+ 2-Kolbensattel <sup>2)</sup> | 13.0460-5959.2   | 605959   | 21481 15,5 TRW                      |
|  | 1.6 i 16V<br>2.0 D<br>2.3 D   | 71<br>49<br>55   |  | 07.92<br>07.92<br>09.94   | 11.01<br>08.94<br>11.01  | + 1-Kolbensattel <sup>1)</sup><br>+ 1-Kolbensattel <sup>1)</sup><br>+ 1-Kolbensattel <sup>1)</sup> | 24.0122-0193.1   | 422193   | 250 22,0 20,0 V                     |
|  | 1.6 i 16V<br>2.0 D<br>2.0 i 16V<br>2.3 D  | 71<br>49<br>93<br>55   |  | 07.92<br>07.92<br>07.92<br>09.94  | 11.01<br>08.94<br>11.01<br>11.01   | + 2-Kolbensattel <sup>2)</sup><br>+ 2-Kolbensattel <sup>2)</sup><br>+ 2-Kolbensattel <sup>2)</sup> | 24.0126-0108.1   | 426108   | 257 26,0 24,0 V +B                  |
|  | 1.6 i 16V<br>2.0 D<br>2.0 i 16V<br>2.3 D  | 71<br>49<br>93<br>55   |  | 07.92<br>07.92<br>07.92<br>09.94  | 09.95<br>08.94<br>09.95<br>09.95   | - Hochdach <sup>3)</sup><br>- Hochdach <sup>3)</sup><br>- Hochdach <sup>3)</sup>                   | 03.0137-0269.2<br>03.0137-9169.2   | 650269<br>669169   | 254 x 57 HEB<br>Bremsbacken-Zubehör |
|  | 1.6 i 16V<br>2.0 i 16V<br>2.3 D   | 71<br>93<br>55   |  | 10.95<br>10.95<br>10.95   | 05.96<br>05.96<br>05.96  | - Hochdach <sup>3)</sup><br>- Hochdach <sup>3)</sup><br>- Hochdach <sup>3)</sup>                   | 03.0137-9169.2   | 669169   | Bremsbacken-Zubehör                 |
|  | 1.6 i 16V<br>2.0 i 16V<br>2.3 D   | 71<br>93<br>55   |  | 06.96<br>06.96<br>06.96   | 11.01<br>11.01<br>11.01  | - Hochdach <sup>3)</sup><br>- Hochdach <sup>3)</sup><br>- Hochdach <sup>3)</sup>                   | 03.0137-0361.2<br>03.0137-9169.2   | 650361<br>669169   | 254 x 57 HEB<br>Bremsbacken-Zubehör |
|  | 1.6 i 16V<br>2.3 D  | 71<br>55   |  | 12.94<br>12.94  | 05.96<br>05.96   | + Hochdach <sup>4)</sup><br>+ Hochdach <sup>4)</sup>   | 03.0137-0376.2<br>03.0137-9169.2   | 650376<br>669169   | 254 x 58 HEB<br>Bremsbacken-Zubehör |
|  | 1.6 i 16V<br>2.3 D  | 71<br>55   |  | 06.96<br>06.96  | 11.01<br>11.01   | + Hochdach <sup>4)</sup><br>+ Hochdach <sup>4)</sup>   | 03.0137-9169.2   | 669169   | Bremsbacken-Zubehör                 |
|  | 1.6 i 16V<br>2.0 D<br>2.0 i 16V<br>2.3 D  | 71<br>49<br>93<br>55   |  | 07.92<br>07.92<br>07.92<br>09.94  | 11.01<br>08.94<br>11.01<br>11.01   |  | 24.0225-4012.1   | 480153   | 254/255,5 x 67                      |
| <b>NISSAN SUNNY (Y10) Kombi (90-00)</b>  |   |  |  |   |  |  |  |  |                                     |
|  | 1.6 16V<br>1.6 16V 4x4<br>1.7 D<br>2.0 D  |  |  | 11.90<br>11.90<br>11.90<br>11.90  | 03.00<br>03.00<br>03.00<br>03.00   |  | 13.0460-5808.2   | 605808   | 21716 16,0 +/-WK                    |
|  | 1.6 16V<br>1.6 16V 4x4<br>1.7 D<br>2.0 D  |  |  | 11.90<br>11.90<br>11.90<br>11.90  | 03.00<br>03.00<br>03.00<br>03.00   |  | 24.0118-0107.1   | 418107   | 240 18,0 16,0 V +B                  |
|  | 1.6 16V<br>1.6 16V 4x4<br>1.7 D<br>2.0 D  |  |  | 11.90<br>11.90<br>11.90<br>11.90  | 03.00<br>03.00<br>03.00<br>03.00   |  | 03.0137-0210.2<br>03.0137-9112.2   | 650210<br>669112   | 229 x 41<br>Bremsbacken-Zubehör     |
|  | 1.6 16V<br>1.6 16V 4x4<br>1.7 D<br>2.0 D  |  |  | 11.90<br>11.90<br>11.90<br>11.90  | 06.95<br>06.95<br>06.95<br>06.95   |  | 24.0222-8021.1   | 480092   | 229/230 x 54,5                      |



















1) + 1 piston caliper / + pinza freno a 1 pistone / + étrier à 1 piston / + mordaza de freno  
2) + 2 piston caliper / + pinza freno a 2 pistoni / + étrier à 2 pistons / + pinza de dos pistones  
3) - high roof / - tetto rialzato / - toit surélevé / - techo sobrealzado  
4) + high roof / + tetto rialzato / + toit surélevé / + techo sobrealzado



|     |  |  |  |  |  |  |  |  |
|--|--|--|--|--|---|--|--|--|
| <b>NISSAN TEANA (J31) (03-08)</b>  |  |  |  |  |   |  |  |  |
|    | 2.0 i 16V<br>2.3 i V6<br>3.5 i V6  | 103<br>127<br>170  |  | 10.03<br>10.03<br>10.03  | 06.08<br>06.08<br>06.08   | - ⊖<br>- ⊖<br>- ⊖  | 13.0460-5716.2<br>605716   | 21561 17,0 +/WK/Zub  |
|    | 2.0 i 16V<br>2.3 i V6<br>3.5 i V6  | 103<br>127<br>170  |  | 10.03<br>10.03<br>10.03  | 06.08<br>06.08<br>06.08   | - ⊖<br>- ⊖<br>- ⊖  | 13.0460-5843.2<br>605843   | 23871 14,3 +/WK AKE  |
| <b>NISSAN TEANA (J32) (08-)</b>  |  |  |  |  |   |  |  |  |
|    | 2.3<br>2.5 V6<br>3.5 V6  | 127<br>134<br>183  |  | 07.08<br>07.08<br>07.08  | 06.10<br>06.10<br>06.10   | - ⊖<br>- ⊖<br>- ⊖  | 13.0460-5843.2<br>605843   | 23871 14,3 +/WK AKE  |
|    | 2.3<br>2.5 V6<br>3.5 V6  | 127<br>134<br>183  |  | 07.10<br>07.10<br>07.10  | - ⊖<br>- ⊖<br>- ⊖   |  | 13.0460-5843.2<br>605843   | 23871 14,3 +/WK AKE  |
| <b>NISSAN TERRANO I (WD21) (87-97)</b>   |  |  |  |  |   |  |  |  |
|    | 2.4 i 4WD<br>2.7 TD 4WD<br>3.0 i V6 4WD  | 76<br>73<br>109  |  | 08.87<br>08.87<br>01.90  | 10.93<br>10.93<br>09.97   |  | 13.0460-5957.2<br>605957<br>13.0460-0289.2<br>610289                               | 21347 17,0 +/WK AKE<br>Belagsatz-Zubehör   |
|    | 2.4 i 4WD<br>2.7 TD 4WD<br>3.0 i V6 4WD  | 76<br>73<br>109  |  | 08.87<br>08.87<br>01.90  | 10.93<br>10.93<br>09.97   |  | 24.0126-0109.1<br>426109   | 277 26,0 24,0 V +B   |
|    | 2.4 i 4WD<br>2.7 TD 4WD  | 76<br>73   |  | 08.87<br>08.87   | 10.93<br>10.93  |  | 03.0137-0310.2<br>650310<br>03.0137-9273.2<br>669273                               | 260 x 52<br>Bremsbacken-Zubehör  |
| <b>NISSAN TERRANO II (R20) (93-06)</b>   |  |  |  |  |   |  |  |  |
|    | 2.4 i 4WD<br>2.4 i 4WD<br>2.7 TD 4WD<br>2.7 TDi 4WD<br>3.0 Di 4WD                | 87<br>91<br>74<br>92<br>113  |  | 05.96<br>02.93<br>02.93<br>05.96<br>05.02  | 11.05<br>04.96<br>01.02<br>11.05<br>04.06   |  | 13.0460-5959.2<br>605959   | 21481 15,5 TRW   |
|    | 2.4 i 4WD<br>2.4 i 4WD<br>2.7 TD 4WD<br>2.7 TDi 4WD<br>3.0 Di 4WD                | 87<br>91<br>74<br>92<br>113  |  | 05.96<br>02.93<br>02.93<br>05.96<br>05.02  | 11.05<br>04.96<br>01.02<br>11.05<br>04.06   |  | 24.0126-0109.1<br>426109   | 277 26,0 24,0 V +B   |
|   | 2.4 i 4WD<br>2.4 i 4WD<br>2.7 TD 4WD<br>2.7 TDi 4WD                              | 87<br>91<br>74<br>92   |  | 05.96<br>02.93<br>02.93<br>05.96   | 09.99<br>04.96<br>09.99<br>09.99  |  | 03.0137-0376.2<br>650376<br>03.0137-9169.2<br>669169                               | 254 x 58 HEB<br>Bremsbacken-Zubehör  |
|  | 2.4 i 4WD<br>2.4 i 4WD<br>2.7 TD 4WD<br>2.7 TDi 4WD<br>3.0 Di 4WD                | 87<br>91<br>74<br>92<br>113  |  | 10.99<br>10.99<br>10.99<br>05.02   | 11.05<br>01.02<br>11.05<br>04.06  |  | 03.0137-0469.2<br>650469<br>03.0137-9268.2<br>669268                               | 280 x 65 HEB<br>Bremsbacken-Zubehör  |
|  | 2.4 i 4WD<br>2.4 i 4WD<br>2.7 TD 4WD<br>2.7 TDi 4WD                              | 87<br>91<br>74<br>92   |  | 05.96<br>02.93<br>02.93<br>05.96   | 09.99<br>04.96<br>09.99<br>09.99  |  | 24.0225-4014.1<br>480155   | 254/255,5 x 65   |
| <b>NISSAN TIIDA Schrägheck (C11X) (07-11)</b>                                      |  |  |  |  |   |  |  |  |
|  | 1.5 dCi<br>1.6 i 16V<br>1.8 i 16V<br>1.8 i 16V Flex                              | 78<br>81<br>93<br>92   |  | 09.07<br>09.07<br>09.07<br>05.09   | 04.11<br>04.11<br>04.11<br>04.11  |  | 13.0460-5716.2<br>605716<br>13.0460-0170.2<br>610170                               | 21561 17,0 +/WK/Zub<br>Belagsatz-Zubehör   |
|  | 1.5 dCi<br>1.6 i 16V<br>1.8 i 16V<br>1.8 i 16V Flex                              | 78<br>81<br>93<br>92   |  | 09.07<br>09.07<br>09.07<br>05.09   | 04.11<br>04.11<br>04.11<br>04.11  |  | 24.0124-0238.1<br>424238   | 280 24,0 22,0 V +B   |
|  | 1.5 dCi<br>1.6 i 16V<br>1.8 i 16V<br>1.8 i 16V Flex                              | 78<br>81<br>93<br>92   |  | 09.07<br>09.07<br>09.07<br>05.09   | 05.10<br>05.10<br>05.10<br>05.10  |  | 13.0460-5843.2<br>605843<br>13.0460-0213.2<br>610213                               | 23871 14,3 +/WK AKE<br>Belagsatz-Zubehör   |
|  | 1.5 dCi<br>1.6 i 16V<br>1.8 i 16V<br>1.8 i 16V Flex                              | 78<br>81<br>93<br>92   |  | 06.10<br>06.10<br>06.10<br>06.10   | 04.11<br>04.11<br>04.11<br>04.11  |  | 13.0460-5843.2<br>605843   | 23871 14,3 +/WK AKE  |
|  | 1.5 dCi<br>1.6 i 16V<br>1.8 i 16V<br>1.8 i 16V Flex                              | 78<br>81<br>93<br>92   |  | 09.07<br>09.07<br>09.07<br>05.09   | 04.11<br>04.11<br>04.11<br>04.11  |  | 24.0109-0166.1<br>409166   | 292 9,0 8,0 +B   |
| <b>NISSAN TIIDA Stufenheck (SC11X) (07-11)</b>                                     |  |  |  |  |   |  |  |  |
|  | 1.5 dCi<br>1.5 dCi<br>1.6 i 16V<br>1.8 i 16V<br>1.8 i 16V<br>1.8 i 16V Flex      | 76<br>78<br>81<br>78<br>93<br>95<br>93   |  | 01.07<br>09.07<br>09.07<br>01.07<br>09.07<br>01.07<br>07.10                      | 04.11<br>04.11<br>04.11<br>04.11<br>04.11<br>04.11<br>04.11                       |  | 13.0460-5716.2<br>605716<br>13.0460-0170.2<br>610170                               | 21561 17,0 +/WK/Zub<br>Belagsatz-Zubehör   |
|  | 1.5 dCi<br>1.5 dCi<br>1.6 i 16V<br>1.8 i 16V<br>1.8 i 16V                        | 76<br>78<br>81<br>78<br>93   |  | 01.07<br>09.07<br>09.07<br>01.07<br>09.07  | 04.11<br>04.11<br>04.11<br>04.11<br>04.11   |  | 24.0124-0238.1<br>424238   | 280 24,0 22,0 V +B   |
|  | ↓  |  |  |  |   |  |  |  |

|     |   |             |  |    |   |  |  |  |
|--|---|---|--|--|--|--|--|--|
| <b>NISSAN TIIDA Stufenheck (SC11X) (07-11)</b>                                     |   |   |  |  |  |  |  |  |
|    | 1.8 i 16V<br>1.8 i 16V Flex   | 95<br>93  |  | 01.07<br>07.10   | 04.11<br>04.11   |  | 24.0124-0238.1<br>424238   | 280 24,0 22,0 V +B   |
|    | 1.5 dCi<br>1.5 dCi<br>1.6 i 16V<br>1.8 i 16V<br>1.8 i 16V<br>1.8 i 16V  | 76<br>78<br>81<br>78<br>93<br>95  |  | 01.07<br>09.07<br>09.07<br>01.07<br>09.07<br>01.07   | 05.10<br>05.10<br>05.10<br>05.10<br>05.10<br>05.10   |  | 13.0460-5843.2<br>13.0460-0213.2<br>605843<br>610213                               | 23871 14,3 +/WK<br>Belagsatz-Zubehör <b>AKE</b>                                    |
|    | 1.5 dCi<br>1.5 dCi<br>1.6 i 16V<br>1.8 i 16V<br>1.8 i 16V<br>1.8 i 16V<br>1.8 i 16V Flex  | 76<br>78<br>81<br>78<br>93<br>95<br>93  |  | 06.10<br>06.10<br>06.10<br>06.10<br>06.10<br>06.10<br>07.10  | 04.11<br>04.11<br>04.11<br>04.11<br>04.11<br>04.11<br>04.11  |  | 13.0460-5843.2<br>605843   | 23871 14,3 +/WK <b>AKE</b>   |
|    | 1.5 dCi<br>1.5 dCi<br>1.6 i 16V<br>1.8 i 16V<br>1.8 i 16V<br>1.8 i 16V<br>1.8 i 16V Flex  | 76<br>78<br>81<br>78<br>93<br>95<br>93  |  | 01.07<br>09.07<br>09.07<br>01.07<br>09.07<br>01.07<br>07.10  | 04.11<br>04.11<br>04.11<br>04.11<br>04.11<br>04.11<br>04.11  |  | 24.0109-0166.1<br>409166   | 292 9,0 8,0 +B   |
| <b>NISSAN URVAN (E24) (87-97)</b>  |   |   |  |  |  |  |  |  |
|    | 2.0<br>2.3 TD<br>2.4<br>2.5 TD  |   |  | 02.87<br>02.87<br>05.89<br>01.89   | 05.97<br>12.88<br>05.97<br>05.97   |  | 13.0460-5957.2<br>605957   | 21347 17,0 +/WK <b>AKE</b>   |
|    | 2.0<br>2.3 TD<br>2.4<br>2.5 TD  |   |  | 02.87<br>02.87<br>05.89<br>01.89   | 05.97<br>12.88<br>05.97<br>05.97   |  | 03.0137-0310.2<br>03.0137-9273.2<br>650310<br>669273                               | 260 x 52<br>Bremsbacken-Zubehör  |
| <b>NISSAN X-TRAIL (T30) (01-07)</b>  |   |   |  |  |  |  |  |  |
|    | 2.0 i 16V<br>2.0 i 16V<br>2.0 i 16V 4x4<br>2.0 i 16V 4x4<br>2.0 i 16V 4x4<br>2.2 DCi<br>2.2 dCi<br>2.2 dCi 4x4<br>2.2 DCi FWD<br>2.2 Di 4x4<br>2.5 i 16V 4x4<br>2.5 i 16V 4x4<br>2.5 i 16V 4x4<br>2.5 i 16V FWD | 103<br>110<br>103<br>110<br>206<br>84<br>100<br>100<br>84<br>84<br>121<br>132<br>134<br>131 |  | 07.01<br>09.01<br>07.01<br>09.01<br>06.01<br>10.04<br>12.03<br>12.03<br>07.01<br>07.01<br>01.03<br>11.02<br>09.01<br>11.02 | 02.07<br>02.07<br>02.07<br>02.07<br>02.07<br>02.07<br>02.07<br>02.07<br>09.03<br>09.03<br>02.07<br>02.07<br>02.07<br>02.07 |  | 13.0460-5842.2<br>13.0460-0340.2<br>605842<br>610340                               | 23420 16,5<br>Belagsatz-Zubehör  |
|  | 2.0 i 16V<br>2.0 i 16V<br>2.0 i 16V 4x4<br>2.0 i 16V 4x4<br>2.0 i 16V 4x4<br>2.2 DCi<br>2.2 dCi<br>2.2 dCi 4x4<br>2.2 DCi FWD<br>2.2 Di 4x4<br>2.5 i 16V 4x4<br>2.5 i 16V 4x4<br>2.5 i 16V 4x4<br>2.5 i 16V FWD | 103<br>110<br>103<br>110<br>206<br>84<br>100<br>100<br>84<br>84<br>121<br>132<br>134<br>131 |  | 07.01<br>09.01<br>07.01<br>09.01<br>06.01<br>10.04<br>12.03<br>12.03<br>07.01<br>07.01<br>01.03<br>11.02<br>09.01<br>11.02 | 02.07<br>02.07<br>02.07<br>02.07<br>02.07<br>02.07<br>02.07<br>02.07<br>09.03<br>09.03<br>02.07<br>02.07<br>02.07<br>02.07 |  | 24.0128-0140.1<br>428140   | 280 28,0 26,0 V +B   |
|  | 2.0 i 16V<br>2.0 i 16V<br>2.0 i 16V 4x4<br>2.0 i 16V 4x4<br>2.0 i 16V 4x4<br>2.2 DCi<br>2.2 dCi<br>2.2 dCi 4x4<br>2.2 DCi FWD<br>2.2 Di 4x4<br>2.5 i 16V 4x4<br>2.5 i 16V 4x4<br>2.5 i 16V 4x4<br>2.5 i 16V FWD | 103<br>110<br>103<br>110<br>206<br>84<br>100<br>100<br>84<br>84<br>121<br>132<br>134<br>131 |  | 07.01<br>09.01<br>07.01<br>09.01<br>06.01<br>10.04<br>12.03<br>12.03<br>07.01<br>07.01<br>01.03<br>11.02<br>09.01<br>11.02 | 02.07<br>02.07<br>02.07<br>02.07<br>02.07<br>02.07<br>02.07<br>02.07<br>09.03<br>09.03<br>02.07<br>02.07<br>02.07<br>02.07 |  | 13.0460-5843.2<br>13.0460-0341.2<br>605843<br>610341                               | 23871 14,3 +/WK<br>Belagsatz-Zubehör <b>AKE</b>                                    |
|  | 2.0 i 16V<br>2.0 i 16V<br>2.0 i 16V 4x4<br>2.0 i 16V 4x4<br>2.0 i 16V 4x4<br>2.2 DCi<br>2.2 dCi<br>2.2 dCi 4x4<br>2.2 DCi FWD   | 103<br>110<br>103<br>110<br>206<br>84<br>100<br>100<br>84                                   |  | 07.01<br>09.01<br>07.01<br>09.01<br>06.01<br>10.04<br>12.03<br>12.03<br>07.01  | 02.07<br>02.07<br>02.07<br>02.07<br>02.07<br>02.07<br>02.07<br>02.07<br>09.03  |  | 24.0116-0119.1<br>416119   | 292 16,0 14,0 V +B   |
| ↓  | ↓   |   |  |  |  |  |  |  |



|     |   |  |                          |   |  |  |                        |                  |
|--|---|--|--|---|---|--|--|--|
| <b>NISSAN X-TRAIL (T32) (13-)</b>  |   |  |  |   |   |  |  |  |
|    | 1.6 dCi<br>1.6 dCi 4x4  | 96<br>96   | 12.13<br>12.13   |   | 24.0126-0185.1<br>24.0128-0291.1  | 426185<br>428291   | - 3. Sitzreihe <sup>1)</sup><br>+ 3. Sitzreihe <sup>2)</sup>   | 296 26,0 24,0 V L +B<br>320 28,0 26,0 V +B   |
| <b>OPEL ADAM / Vauxhall Adam (13-)</b>   |   |  |  |   |   |  |  |  |
|    | 1.0<br>1.0 ECOTEC DIT<br>1.0 ECOTEC DIT<br>1.2<br>1.2 ecoFLEX<br>1.4 ecoFLEX<br>1.4 ecoFLEX<br>1.4 LPG<br>1.4 T ecoFlex | 50<br>66<br>85<br>69<br>51<br>64<br>74<br>64<br>110                              | 07.13<br>07.14<br>07.14<br>07.13<br>01.13<br>01.13<br>01.13<br>07.13<br>11.14                            | + Bremsscheibendurchm. 257 mm <sup>3)</sup><br>+ Bremsscheibendurchm. 257 mm <sup>3)</sup><br>+ Bremsscheibendurchm. 257 mm <sup>3)</sup><br>+ Bremsscheibendurchm. 257 mm <sup>3)</sup><br>+ Bremsscheibendurchm. 257 mm <sup>3)</sup><br>+ Bremsscheibendurchm. 257 mm <sup>3)</sup><br>+ Bremsscheibendurchm. 257 mm <sup>3)</sup>   | 13.0460-3839.2<br>13.0470-3839.2  | 603839<br>LD3839   |  | 23982 18,1 +/WK/Zub/SBOS<br>23982 18,1 +/WK/Zub/SBOS   |
|    | 1.0<br>1.0 ECOTEC DIT<br>1.0 ECOTEC DIT<br>1.2<br>1.2 ecoFLEX<br>1.4 ecoFLEX<br>1.4 ecoFLEX<br>1.4 LPG<br>1.4 T ecoFlex | 50<br>66<br>85<br>69<br>51<br>64<br>74<br>64<br>110                              | 07.13<br>07.14<br>07.14<br>07.13<br>01.13<br>01.13<br>01.13<br>07.13<br>11.14                            | + Bremsscheibendurchm. 308 mm <sup>4)</sup><br>+ Bremsscheibendurchm. 308 mm <sup>4)</sup><br>+ Bremsscheibendurchm. 308 mm <sup>4)</sup><br>+ Bremsscheibendurchm. 308 mm <sup>4)</sup><br>+ Bremsscheibendurchm. 308 mm <sup>4)</sup><br>+ Bremsscheibendurchm. 308 mm <sup>4)</sup><br>+ Bremsscheibendurchm. 308 mm <sup>4)</sup><br>+ Bremsscheibendurchm. 308 mm <sup>4)</sup><br>+ Bremsscheibendurchm. 308 mm <sup>4)</sup> | 13.0460-7179.2<br>13.0470-7179.2  | 607179<br>LD7179   |  | 23832 20,2 +/WK<br>23832 20,2 +/WK<br>ATE<br>ATE   |
|  | 1.0<br>1.0 ECOTEC DIT<br>1.0 ECOTEC DIT<br>1.2<br>1.2 ecoFLEX<br>1.4 ecoFLEX<br>1.4 ecoFLEX<br>1.4 LPG<br>1.4 T ecoFlex | 50<br>66<br>85<br>69<br>51<br>64<br>74<br>64<br>110                              | 07.13<br>07.14<br>07.14<br>07.13<br>01.13<br>01.13<br>01.13<br>07.13<br>11.14                            |   | 24.0122-0231.1<br>24.0322-0231.1  | 422231<br>522231   |  | 257 22,0 20,0 V +S +B<br>257 22,0 20,0 V +S +B PD  |
|  | 1.0<br>1.0 ECOTEC DIT<br>1.0 ECOTEC DIT<br>1.2<br>1.2 ecoFLEX<br>1.4 ecoFLEX<br>1.4 ecoFLEX<br>1.4 LPG<br>1.4 T ecoFlex | 50<br>66<br>85<br>69<br>51<br>64<br>74<br>64<br>110                              | 07.13<br>07.14<br>07.14<br>07.13<br>01.13<br>01.13<br>01.13<br>07.13<br>11.14                            |   | 24.0125-0142.1<br>24.0325-0142.1  | 425142<br>525142   |  | 308 25,0 22,0 V L +S +B<br>308 25,0 22,0 V L +S +B PD  |
|  | 1.0<br>1.0 ECOTEC DIT<br>1.0 ECOTEC DIT<br>1.2<br>1.2 ecoFLEX<br>1.4 ecoFLEX<br>1.4 ecoFLEX<br>1.4 LPG<br>1.4 T ecoFlex | 50<br>66<br>85<br>69<br>51<br>64<br>74<br>64<br>110                              | E6999999<br>E6999999<br>E6999999<br>E6999999<br>E6999999<br>E6999999<br>E6999999<br>E6999999<br>E6999999 | 07.13<br>07.14<br>07.14<br>07.13<br>01.13<br>01.13<br>01.13<br>07.13<br>11.14   | 03.0137-0479.2<br>03.0137-9310.2<br>03.0137-0478.2<br>03.0137-9309.2              | 650479<br>669310<br>650478<br>669309   | 8" Bremse <sup>5)</sup><br>8" Bremse <sup>5)</sup><br>9" Bremse <sup>6)</sup><br>9" Bremse <sup>6)</sup> | 203 x 38 HEB<br>Bremsbacken-Zubehör<br>228 x 42 HEB<br>Bremsbacken-Zubehör<br>AP<br>AP<br>AP<br>AP |
|  | 1.0<br>1.0 ECOTEC DIT<br>1.0 ECOTEC DIT<br>1.2<br>1.2 ecoFLEX<br>1.4 ecoFLEX<br>1.4 ecoFLEX<br>1.4 LPG<br>1.4 T ecoFlex | 50<br>66<br>85<br>69<br>51<br>64<br>74<br>64<br>110                              | F6000001<br>F6000001<br>F6000001<br>F6000001<br>F6000001<br>F6000001<br>F6000001<br>F6000001<br>F6000001 |   | 03.0137-0479.2<br>03.0137-9310.2<br>03.0137-0478.2<br>03.0137-9309.2              | 650479<br>669310<br>650478<br>669309   | 8" Bremse <sup>5)</sup><br>8" Bremse <sup>5)</sup><br>9" Bremse <sup>6)</sup><br>9" Bremse <sup>6)</sup> | 203 x 38 HEB<br>Bremsbacken-Zubehör<br>228 x 42 HEB<br>Bremsbacken-Zubehör<br>AP<br>AP<br>AP<br>AP |
|  | 1.0<br>1.0 ECOTEC DIT<br>1.0 ECOTEC DIT<br>1.2<br>1.2 ecoFLEX<br>1.4 ecoFLEX<br>1.4 ecoFLEX<br>1.4 LPG<br>1.4 T ecoFlex | 50<br>66<br>85<br>69<br>51<br>64<br>74<br>64<br>110                              | E6999999<br>E6999999<br>E6999999<br>E6999999<br>E6999999<br>E6999999<br>E6999999<br>E6999999<br>E6999999 | 07.13<br>07.14<br>07.14<br>07.13<br>01.13<br>01.13<br>01.13<br>07.13<br>11.14   | 03.0520-6819.3  | 696819   | 9" Bremse <sup>6)</sup>  | 19,05/228x42 TopKit AP   |
| <b>OPEL AGILA / Vauxhall Agila Mk I (00-07)</b>                                    |   |  |  |   |   |  |  |  |
|  | 1.0<br>1.0 12V<br>1.2 16V<br>1.2 16V Twinport<br>1.3 CDTI   | 44<br>43<br>55<br>59<br>51   | 08.03<br>09.00<br>09.00<br>07.04<br>08.03  | 07.07<br>07.07<br>07.07<br>07.07  | 13.0460-3995.2  | 603995   |  | 23605 15,7 +/WK/Zub/SBOS   |

<sup>1)</sup> - 3rd seat row / - 3a fila di sedili / - 3ème rangée de sièges / - 3a fila de asientos

<sup>2)</sup> + 3rd seat row / + 3a fila di sedili / + 3ème rangée de sièges / + 3a fila de asientos

<sup>3)</sup> + brake disc diameter 257mm / + diametro dischi freno 257mm / + diamètre disques frein 257mm / + diámetro disco freno 257mm

<sup>4)</sup> + brake disc diameter 308mm / + diametro dischi freno 308mm / + diamètre disques frein 308mm / + diámetro disco freno 308mm

<sup>5)</sup> 8" brake / servofreno da 8" / frein de 8" / freno de 8"

<sup>6)</sup> 9" brake / servofreno da 9" / frein de 9" / freno de 9"



### OPEL AGILA / Vauxhall Agila Mk I (00-07)

|  |                  |    |           |       |       |                |        |                               |                     |
|--|------------------|----|-----------|-------|-------|----------------|--------|-------------------------------|---------------------|
|  | 1.0              | 44 | 3G002367  | 08.03 |       | 24.0112-0153.1 | 412153 |                               | 247 12,0 10,5 +B    |
|  | 1.0 12V          | 43 | 3G002367  | 09.00 |       |                |        |                               |                     |
|  | 1.2 16V          | 55 | 3G002367  | 09.00 |       |                |        |                               |                     |
|  | 1.2 16V Twinport | 59 | 3G002367  | 07.04 |       |                |        |                               |                     |
|  | 1.3 CDTI         | 51 | 3G002367  | 08.03 |       |                |        |                               |                     |
|  | 1.0              | 44 | 3G002368  |       | 07.07 | 24.0117-0106.1 | 417106 |                               | 253 17,0 15,0 V +B  |
|  | 1.0 12V          | 43 | 3G002368  |       | 07.07 |                |        |                               |                     |
|  | 1.2 16V          | 55 | 3G002368  |       | 07.07 |                |        |                               |                     |
|  | 1.2 16V Twinport | 59 | 3G002368  |       | 07.07 |                |        |                               |                     |
|  | 1.3 CDTI         | 51 | 3G002368  |       | 07.07 |                |        |                               |                     |
|  | 1.0 12V          | 43 | 2G999999  | 09.00 |       | 03.0137-0399.2 | 650399 |                               | 180 x 26 HEB        |
|  | 1.2 16V          | 55 | 2G999999  | 09.00 |       | 03.0137-9286.2 | 669286 |                               | Bremsbacken-Zubehör |
|  | 1.0              | 44 |           | 08.03 | 07.07 | 03.0137-0465.2 | 650465 |                               | 200 x 29 HEB        |
|  | 1.0 12V          | 43 | 3G0000001 |       | 07.07 | 03.0137-9300.2 | 669300 |                               | Bremsbacken-Zubehör |
|  | 1.2 16V          | 55 | 3G0000001 |       | 07.07 |                |        |                               |                     |
|  | 1.2 16V Twinport | 59 |           | 07.04 | 07.07 |                |        |                               |                     |
|  | 1.3 CDTI         | 51 |           | 08.03 | 07.07 |                |        |                               |                     |
|  | 1.0 12V          | 43 | 2G999999  | 09.00 |       | 24.0218-0039.1 | 480160 | ohne Sensorring <sup>1)</sup> | 180/182 x 34,5      |
|  | 1.2 16V          | 55 | 2G999999  | 09.00 |       |                |        |                               |                     |
|  | 1.0              | 44 | 4G000001  |       | 07.07 | 24.0220-0045.1 | 480189 | ohne Sensorring <sup>1)</sup> | 200/202 x 38        |
|  | 1.0 12V          | 43 | 4G000001  |       | 07.07 |                |        |                               |                     |
|  | 1.2 16V          | 55 | 4G000001  |       | 07.07 |                |        |                               |                     |
|  | 1.2 16V Twinport | 59 | 4G000001  |       | 07.07 |                |        |                               |                     |
|  | 1.3 CDTI         | 51 | 4G000001  |       | 07.07 |                |        |                               |                     |
|  | 1.0 12V          | 43 | 2G999999  | 09.00 |       | 03.0520-1315.3 | 691315 |                               | 15,87/180x26 TopKit |
|  | 1.2 16V          | 55 | 2G999999  | 09.00 |       |                |        |                               |                     |
|  | 1.0              | 44 |           | 08.03 | 07.07 | 03.0520-1415.3 | 691415 |                               | 15,87/200x29 TopKit |
|  | 1.0 12V          | 43 | 3G0000001 |       | 07.07 |                |        |                               |                     |
|  | 1.2 16V          | 55 | 3G0000001 |       | 07.07 |                |        |                               |                     |
|  | 1.3 CDTI         | 51 |           | 08.03 | 07.07 |                |        |                               |                     |













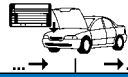









### OPEL AGILA / Vauxhall Agila Mk II (08-)

|  |          |    |  |       |  |                |        |  |                         |
|--|----------|----|--|-------|--|----------------|--------|--|-------------------------|
|  | 1.0      | 48 |  | 01.08 |  | 13.0460-5700.2 | 605700 |  | 23973 17,0 +/WK/S TRW   |
|  | 1.0      | 50 |  | 07.11 |  |                |        |  |                         |
|  | 1.2      | 63 |  | 01.08 |  |                |        |  |                         |
|  | 1.2      | 69 |  | 11.10 |  |                |        |  |                         |
|  | 1.3 CDTI | 55 |  | 01.08 |  |                |        |  |                         |
|  | 1.0      | 48 |  | 01.08 |  | 24.0120-0211.1 | 420211 |  | 252 20,0 18,0 V +S +B   |
|  | 1.0      | 50 |  | 07.11 |  |                |        |  |                         |
|  | 1.2      | 63 |  | 01.08 |  |                |        |  |                         |
|  | 1.2      | 69 |  | 11.10 |  |                |        |  |                         |
|  | 1.3 CDTI | 55 |  | 01.08 |  |                |        |  |                         |
|  | 1.0      | 48 |  | 01.08 |  | 24.0710-5007.3 | 360339 |  | Radsensor L=720         |
|  | 1.0      | 50 |  | 07.11 |  | 24.0710-5008.3 | 360340 |  | Radsensor L=720         |
|  | 1.2      | 63 |  | 01.08 |  |                |        |  |                         |
|  | 1.2      | 69 |  | 11.10 |  |                |        |  |                         |
|  | 1.3 CDTI | 55 |  | 01.08 |  |                |        |  |                         |
|  | 1.0      | 48 |  | 01.08 |  | 24.0710-5009.3 | 360341 |  | Radsensor L=1285        |
|  | 1.0      | 50 |  | 07.11 |  | 24.0710-5010.3 | 360342 |  | Radsensor L=1285        |
|  | 1.2      | 63 |  | 01.08 |  |                |        |  |                         |
|  | 1.2      | 69 |  | 11.10 |  |                |        |  |                         |
|  | 1.3 CDTI | 55 |  | 01.08 |  |                |        |  |                         |
|  | 1.0      | 48 |  | 01.08 |  | 03.0137-0466.2 | 650466 |  | 200 x 32 HEB BOS        |
|  | 1.0      | 50 |  | 07.11 |  | 03.0137-9287.2 | 669287 |  | Bremsbacken-Zubehör BOS |
|  | 1.2      | 63 |  | 01.08 |  |                |        |  |                         |
|  | 1.2      | 69 |  | 11.10 |  |                |        |  |                         |
|  | 1.3 CDTI | 55 |  | 01.08 |  |                |        |  |                         |
|  | 1.0      | 48 |  | 01.08 |  | 03.0520-6919.3 | 696919 |  | 19,05/200x32 TopKit BOS |
|  | 1.0      | 50 |  | 07.11 |  |                |        |  |                         |
|  | 1.2      | 63 |  | 01.08 |  |                |        |  |                         |
|  | 1.2      | 69 |  | 11.10 |  |                |        |  |                         |
|  | 1.3 CDTI | 55 |  | 01.08 |  |                |        |  |                         |

### OPEL ANTARA / Vauxhall Antara (06-)

|        |              |     |       |       |  |                |        |  |                      |
|--------|--------------|-----|-------|-------|--|----------------|--------|--|----------------------|
|        | 2.0 CDTi 4x4 | 93  |       | 03.07 |  | 13.0460-5785.2 | 605785 |  | 24510 17,0 +/WK      |
|        | 2.0 CDTi 4x4 | 110 |       | 07.06 |  |                |        |  |                      |
|        | 2.0 CDTi 4x4 | 125 |       | 01.16 |  |                |        |  |                      |
|        | 2.0 CDTi FWD | 93  |       | 09.08 |  |                |        |  |                      |
|        | 2.0 CDTi FWD | 110 |       | 08.06 |  |                |        |  |                      |
|        | 2.0 CDTi FWD | 125 |       | 01.16 |  |                |        |  |                      |
|        | 2.2 CDTi 4x4 | 120 |       | 12.10 |  |                |        |  |                      |
|        | 2.2 CDTi 4x4 | 135 |       | 12.10 |  |                |        |  |                      |
|        | 2.2 CDTi FWD | 120 |       | 12.10 |  |                |        |  |                      |
|        | 2.4          | 104 |       | 07.06 |  |                |        |  |                      |
|        | 2.4 4x4      | 103 |       | 01.07 |  |                |        |  |                      |
|        | 2.4 4x4      | 123 |       | 12.10 |  |                |        |  |                      |
|        | 2.4 FWD      | 103 |       | 09.08 |  |                |        |  |                      |
|        | 2.4 FWD      | 123 |       | 12.10 |  |                |        |  |                      |
|        | 3.0 4x4      | 190 |       | 12.10 |  |                |        |  |                      |
| 3.2 V6 | 167          |     | 07.06 |       |  |                |        |  |                      |
|        | 2.0 CDTi 4x4 | 93  |       | 03.07 |  | 24.0129-0101.1 | 429101 |  | 296 29,0 27,5 V L +B |
|        | 2.0 CDTi 4x4 | 110 |       | 07.06 |  |                |        |  |                      |
|        | 2.0 CDTi 4x4 | 125 |       | 01.16 |  |                |        |  |                      |
|        | 2.0 CDTi FWD | 93  |       | 09.08 |  |                |        |  |                      |
|        | 2.0 CDTi FWD | 110 |       | 08.06 |  |                |        |  |                      |

<sup>1)</sup> without sensor ring / senza sensori / sans secours ABS / sin anillo sensor ABS













|     |    |                            |  |    |  |  |       |  |
|--|--|--|--|--|---|--|---|--|
| <b>OPEL ANTARA / Vauxhall Antara (06-)</b>   |  |  |  |  |   |  |   |  |
|    | 2.0 CDTi FWD<br>2.2 CDTi 4x4<br>2.2 CDTi 4x4<br>2.2 CDTi FWD<br>2.4<br>2.4 4x4<br>2.4 4x4<br>2.4 FWD<br>2.4 FWD<br>3.0 4X4<br>3.2 V6   | 125<br>120<br>135<br>120<br>104<br>103<br>123<br>103<br>123<br>190<br>167                                  |  | 01.16<br>12.10<br>12.10<br>12.10<br>07.06<br>01.07<br>12.10<br>09.08<br>12.10<br>12.10<br>07.06  | 24.0129-0101.1  | 429101   |   | 296 29,0 27,5 V L +B   |
|    | 2.0 CDTi 4x4<br>2.0 CDTi 4x4<br>2.0 CDTi 4x4<br>2.0 CDTi FWD<br>2.0 CDTi FWD<br>2.0 CDTi FWD<br>2.2 CDTi 4x4<br>2.2 CDTi 4x4<br>2.2 CDTi FWD<br>2.4<br>2.4 4x4<br>2.4 4x4<br>2.4 FWD<br>2.4 FWD<br>3.0 4X4<br>3.2 V6 | 93<br>110<br>125<br>93<br>110<br>125<br>120<br>135<br>120<br>104<br>103<br>123<br>103<br>123<br>190<br>167 |  | 03.07<br>07.06<br>01.16<br>09.08<br>08.06<br>01.16<br>12.10<br>12.10<br>12.10<br>07.06<br>01.07<br>12.10<br>09.08<br>12.10<br>12.10<br>07.06 | 13.0460-5788.2<br>13.0460-0135.2  | 605788<br>610135   |   | 24498 14,7 +/WK/Zub<br>Belagsatz-Zubehör   |
|    | 2.0 CDTi 4x4<br>2.0 CDTi 4x4<br>2.0 CDTi 4x4<br>2.0 CDTi FWD<br>2.0 CDTi FWD<br>2.0 CDTi FWD<br>2.2 CDTi 4x4<br>2.2 CDTi 4x4<br>2.2 CDTi FWD<br>2.4<br>2.4 4x4<br>2.4 4x4<br>2.4 FWD<br>2.4 FWD<br>3.0 4X4<br>3.2 V6 | 93<br>110<br>125<br>93<br>110<br>125<br>120<br>135<br>120<br>104<br>103<br>123<br>103<br>123<br>190<br>167 |  | 03.07<br>07.06<br>01.16<br>09.08<br>08.06<br>01.16<br>12.10<br>12.10<br>12.10<br>07.06<br>01.07<br>12.10<br>09.08<br>12.10<br>12.10<br>07.06 | 24.0120-0209.1  | 420209   |   | 303 20,0 18,4 V L +B   |
|  | 2.0 CDTi 4x4<br>2.0 CDTi 4x4<br>2.0 CDTi 4x4<br>2.0 CDTi FWD<br>2.0 CDTi FWD<br>2.0 CDTi FWD<br>2.2 CDTi 4x4<br>2.2 CDTi 4x4<br>2.2 CDTi FWD<br>2.4<br>2.4 4x4<br>2.4 4x4<br>2.4 FWD<br>2.4 FWD<br>3.0 4X4<br>3.2 V6 | 93<br>110<br>125<br>93<br>110<br>125<br>120<br>135<br>120<br>104<br>103<br>123<br>103<br>123<br>190<br>167 |  | 03.07<br>07.06<br>01.16<br>09.08<br>08.06<br>01.16<br>12.10<br>12.10<br>12.10<br>07.06<br>01.07<br>12.10<br>09.08<br>12.10<br>12.10<br>07.06 | 03.0137-3011.2  | 653011   |   | 188 x 26   |
| <b>OPEL AMPERA / Vauxhall Ampera (11-)</b>   |  |  |  |  |   |  |   |  |
|  | EV 150   | 111  |  | 11.11  | 13.0460-7263.2  | 607263   |   | 24034 19,1 +/WK/Zub  |
|  | EV 150   | 111  |  | 11.11  | 24.0126-0166.1<br>24.0326-0166.1  | 426166<br>526166   |   | 300 26,0 23,0 V L +S +B<br>300 26,0 23,0 V L +S +B PD                              |
|  | EV 150   | 111  |  | 11.11  | 24.0711-5348.3  | 360351   | 2  | Radsensor L=800  |
|  | EV 150   | 111  |  | 11.11  | 13.0460-7264.2<br>13.0470-7264.2  | 607264<br>LD7264   | elektrische Feststellbremse <sup>1)</sup><br>elektrische Feststellbremse <sup>1)</sup>  | 25096 17,0 +/WK/Zub ATE<br>25096 17,0 +/WK/Zub ATE                                 |
|  | EV 150   | 111  |  | 11.11  | 24.0112-0189.1<br>24.0312-0189.1  | 412189<br>512189   | elektrische Feststellbremse <sup>1)</sup><br>elektrische Feststellbremse <sup>1)</sup>  | 292 12,0 10,0 +S +B<br>292 12,0 10,0 +S +B PD                                      |
|  | EV 150   | 111  |  | 11.11  | 24.0711-5366.3  | 360355   | 2  | Radsensor L=574  |
| <b>OPEL ARENA / Vauxhall Arena (97-01)</b>   |  |  |  |  |   |  |   |  |
|  | 1.9 D<br>2.5 D   |  |  | 03.98<br>03.98   | 09.01<br>09.01  | 13.0460-3969.2   | 603969  | 20926 18,5 /WK BDX   |

<sup>1)</sup> electric parking brake / fr.di stazionamento elettrico / frein à main électrique / freno de mano eléctrico







| OPEL ASTRA F / Vauxhall Astra MKIII (91-01)  |                   |    |          |       |       |                                   |                |        |   |                            |
|--|-------------------|----|----------|-------|-------|-----------------------------------|----------------|--------|---|----------------------------|
|    | 2.0 Limousine     | 85 | R2500000 | 10.91 |       |                                   | 03.0520-3717.3 | 693717 |   | 17,46/200x46 TopKit        |
|  | 1.4 Cabrio        |    | R2500001 |       | 03.01 |                                   | 03.0420-4019.3 | 684019 |   | 19,05/200x46 Kit DEL       |
|  | 1.4 Caravan       |    | SP999999 | 10.91 |       |                                   | 03.0520-4019.3 | 694019 |   | 19,05/200x46 TopKit DEL    |
|  | 1.4 N Limousine   |    | T2500001 |       | 09.98 |                                   |                |        |   |                            |
|  | 1.4 S Limousine   |    | T2500001 |       | 09.98 | + Schaltgetriebe <sup>1)</sup>    |                |        |   |                            |
|  | 1.4 S Limousine   |    |          | 10.91 | 09.98 | + Automatikgetriebe <sup>2)</sup> |                |        |   |                            |
|  | 1.6 16V Limousine |    |          | 02.93 | 09.98 |                                   |                |        |   |                            |
|  | 1.6 Cabrio        |    | R2500001 |       | 03.01 |                                   |                |        |   |                            |
|  | 1.6 Caravan       |    | SP999999 | 10.91 |       |                                   |                |        |   |                            |
|  | 1.6 N Limousine   |    | T2500001 |       | 09.98 | + Schaltgetriebe <sup>1)</sup>    |                |        |   |                            |
|  | 1.6 N Limousine   |    |          | 10.91 | 09.98 | + Automatikgetriebe <sup>2)</sup> |                |        |   |                            |
|  | 1.6 S Limousine   |    |          | 10.91 | 09.98 |                                   |                |        |   |                            |
|  | 1.7 D Caravan     |    | SP999999 | 10.91 |       |                                   |                |        |   |                            |
|  | 1.7 D Limousine   |    | T2500001 |       | 09.98 | + Schaltgetriebe <sup>1)</sup>    |                |        |   |                            |
|  | 1.7 D Limousine   |    |          | 10.91 | 09.98 | + Automatikgetriebe <sup>2)</sup> |                |        |   |                            |
|  | 1.7 TD Caravan    |    | SP999999 | 10.91 |       |                                   |                |        |   |                            |
|  | 1.7 TD Limousine  |    | R2500001 |       | 09.98 |                                   |                |        |   |                            |
|  | 1.8 16V Cabrio    | 85 |          | 11.94 | 03.01 |                                   |                |        |   |                            |
|  | 1.8 16V Caravan   | 85 | SP999999 | 07.94 |       |                                   |                |        |   |                            |
|  | 1.8 16V Limousine | 85 |          | 11.94 | 09.98 |                                   |                |        |   |                            |
|  | 1.8 Cabrio        |    | R2500001 |       | 03.01 |                                   |                |        |   |                            |
|  | 1.8 Caravan       |    | SP999999 | 10.91 |       |                                   |                |        |   |                            |
|  | 1.8 Limousine     | 66 | R2500001 |       | 09.98 |                                   |                |        |   |                            |
|  | 2.0 Cabrio        |    | R2500001 |       | 03.01 |                                   |                |        |   |                            |
|  | 2.0 Caravan       |    | SP999999 | 10.91 |       |                                   |                |        |   |                            |
|  | 2.0 Limousine     | 85 | R2500001 |       | 09.98 |                                   |                |        |   |                            |
|  | 1.4 Caravan       |    | T2500001 |       | 09.98 |                                   | 03.0520-5719.3 | 695719 |   | 19,05/230x42 TopKit TRW    |
|  | 1.6 Caravan       |    | T2500001 |       | 09.98 |                                   |                |        |   |                            |
|  | 1.7 D Caravan     |    | T2500001 |       | 09.98 |                                   |                |        |   |                            |
|  | 1.7 TD Caravan    |    | T2500001 |       | 09.98 |                                   |                |        |   |                            |
|  | 1.8 16V Caravan   | 85 | T2500001 |       | 01.98 |                                   |                |        |   |                            |
|  | 1.8 Caravan       |    | T2500001 |       | 09.98 |                                   |                |        |   |                            |
|  | 2.0 Caravan       |    | T2500001 |       | 09.98 |                                   |                |        |   |                            |
|    | 1.8 16V           |    |          | 10.91 | 09.98 |                                   | 03.0137-0172.2 | 650172 |   | 160 x 25                   |
|  | 2.0 GSi           |    |          | 10.91 | 09.98 |                                   | 03.0137-9243.2 | 669243 |   | Bremsbacken-Zubehör        |
|  | 2.0 GSi 16V       |    |          | 10.91 | 09.98 |                                   |                |        |   |                            |
| OPEL ASTRA F CLASSIC (98-02)   |                   |    |          |       |       |                                   |                |        |   |                            |
|   | 1.4 i             | 44 |          | 01.98 | 12.02 |                                   | 13.0460-7051.2 | 607051 |   | 20547 16,5 +/WE ATE        |
|  | 1.6 i             | 55 |          | 01.98 | 01.05 |                                   | 24.8190-0707.2 | 620707 | 2   | Warnkontakt L=685mm        |
|  | 1.6 i 16V         | 74 |          | 01.98 | 12.02 |                                   | 13.0460-7052.2 | 607052 |   | 21190 17,5 +/WE ATE        |
|  |                   |    |          |       |       |                                   | 24.8190-0707.2 | 620707 | 2  | Warnkontakt L=685mm        |
|  | 1.4 i             | 44 |          | 01.98 | 12.02 |                                   | 24.0113-0161.1 | 413161 |   | 236 12,7 9,7 +S +B         |
|  |                   |    |          |       |       |                                   | 24.0313-0161.1 | 513161 |   | 236 12,7 9,7 +S +B PD      |
|  | 1.6 i             | 55 |          | 01.98 | 12.02 |                                   | 24.0120-0115.1 | 420115 |   | 236 20,0 17,0 V L +S +B    |
|  |                   |    |          |       |       |                                   | 24.0320-0115.1 | 520115 |   | 236 20,0 17,0 V L +S +B PD |
|  | 1.6 i 16V         | 74 |          | 01.98 | 12.02 |                                   | 24.0124-0115.1 | 424115 |   | 256 24,0 21,0 V L +S +B    |
|  |                   |    |          |       |       |                                   | 24.0324-0115.1 | 524115 |   | 256 24,0 21,0 V L +S +B PD |
|  | 1.4 i             | 44 |          | 01.98 | 12.02 |                                   | 03.0137-0267.2 | 650267 |   | 200 x 46 HEB               |
|  | 1.6 i             | 55 |          | 01.98 | 12.02 |                                   | 03.0137-9167.2 | 669167 |   | Bremsbacken-Zubehör        |
|  | 1.6 i 16V         | 74 |          | 01.98 | 12.02 |                                   |                |        |   |                            |
|  | 1.4 i             | 44 |          | 01.98 | 12.02 |                                   | 24.0220-0001.2 | 480013 |   | 200/201 x 53,5             |
|  | 1.6 i             | 55 |          | 01.98 | 12.02 |                                   |                |        |   |                            |
|  | 1.6 i 16V         | 74 |          | 01.98 | 12.02 |                                   |                |        |   |                            |
| OPEL ASTRA F CLASSIC Caravan (98-05)   |                   |    |          |       |       |                                   |                |        |   |                            |
|  | 1.4 i             | 44 |          | 01.98 | 01.05 |                                   | 13.0460-7051.2 | 607051 |   | 20547 16,5 +/WE ATE        |
|  | 1.4 i 16V         | 66 |          | 09.03 | 01.05 |                                   |                |        |   |                            |
|  | 1.6 i             | 55 |          | 01.98 | 01.05 |                                   |                |        |   |                            |
|  | 1.6 i 16V         | 74 |          | 01.98 | 01.05 |                                   | 13.0460-7052.2 | 607052 |   | 21190 17,5 +/WE ATE        |
|  | 1.4 i             | 44 |          | 01.98 | 01.05 |                                   | 24.0113-0161.1 | 413161 |   | 236 12,7 9,7 +S +B         |
|  | 1.4 i 16V         | 66 |          | 09.03 | 01.05 |                                   |                |        |   |                            |
|  | 1.6 i             | 55 |          | 01.98 | 01.05 |                                   | 24.0120-0115.1 | 420115 |   | 236 20,0 17,0 V L +S +B    |
|  | 1.6 i 16V         | 74 |          | 01.98 | 01.05 |                                   | 24.0124-0115.1 | 424115 |   | 256 24,0 21,0 V L +S +B    |
|  | 1.4 i             | 44 |          | 01.98 | 01.05 |                                   | 03.0137-0322.2 | 650322 |   | 230 x 42                   |
|  | 1.4 i 16V         | 66 |          | 09.03 | 01.05 |                                   | 03.0137-9215.2 | 669215 |   | Bremsbacken-Zubehör        |
|  | 1.6 i             | 55 |          | 01.98 | 01.05 |                                   |                |        |   |                            |
|  | 1.6 i 16V         | 74 |          | 01.98 | 01.05 |                                   |                |        |   |                            |
|  | 1.4 i             | 44 |          | 01.98 | 01.05 |                                   | 24.0223-0013.2 | 480061 |   | 230/231 x 50               |
|  | 1.4 i 16V         | 66 |          | 09.03 | 01.05 |                                   |                |        |   |                            |
|  | 1.6 i             | 55 |          | 01.98 | 01.05 |                                   |                |        |   |                            |
|  | 1.6 i 16V         | 74 |          | 01.98 | 01.05 |                                   |                |        |   |                            |
| OPEL ASTRA G / Vauxhall Astra MKIV (98-05)   |                   |    |          |       |       |                                   |                |        |   |                            |
|  | 1.2 16V           |    |          | 04.98 |       |                                   | 13.0460-7115.2 | 607115 |   | 23063 17,5 +/WK ATE        |
|  | 1.4 16V           |    |          | 04.98 |       |                                   | 13.0470-7115.2 | LD7115 |   | 23063 17,5 +/WK ATE        |
|  | 1.4 Caravan       | 66 |          | 09.07 |       |                                   | 24.8190-0718.2 | 620718 | 2   | Warnkontakt L=720mm        |
|  | 1.4 Limousine     | 66 |          | 09.07 |       |                                   | 24.8190-0018.2 | 620018 | 2   | Warnkontakt L=755mm        |
|  | 1.6               |    |          | 04.98 |       |                                   |                |        |   |                            |
|  | 1.6 16V           |    |          | 04.98 |       |                                   |                |        |   |                            |
|  | 1.6 16V Cabrio    |    |          | 03.01 |       |                                   |                |        |   |                            |
|  | 1.7 CDTI          |    |          | 04.03 |       |                                   |                |        |   |                            |
|  | 1.7 DTI           |    |          | 02.00 |       |                                   |                |        |   |                            |
|  | 1.7 TD            |    |          | 04.98 |       |                                   |                |        |   |                            |
|  | 1.8 16V           |    |          | 04.98 |       | - ABS                             |                |        |   |                            |

<sup>1)</sup> + manual transmission / + scatola cambio velocità / + transmission mécanique / + cambio de velocidad

<sup>2)</sup> + autom.transmission / + scatola cambio automatico / + transmission automatique / + cambio automático

<sup>3)</sup> up to chassis: 42187758 / fino no.telaio: 42187758 / jusqu'au de châssis: 42187758 / hasta no.de chasis: 42187758

<sup>4)</sup> from chassis no.:42187759 / dal no.telaio:42187759 / du no.châssis:42187759 / desde no.chasis.:42187759



**OPEL ASTRA G / Vauxhall Astra MKIV (98-05)**

|                    |                    |          |          |       |                                   |                |        |   |                            |     |
|--------------------|--------------------|----------|----------|-------|-----------------------------------|----------------|--------|---|----------------------------|-----|
|                    | 1.8 16V Cabrio     |          | 03.01    | - ABS | 13.0460-7115.2                    | 607115         |        | 2 bis Fgst.Nr.: 42187758 <sup>1)</sup><br>ab Fgst.Nr.: 42187759 <sup>2)</sup> | 23063 17,5 +WK             | ATE |
|                    | 1.8 16V Caravan    |          | 04.98    | - ABS | 13.0470-7115.2                    | LD7115         |        |   | 23063 17,5 +WK             | ATE |
|                    | 2.0 DI             |          | 04.98    | - ABS | 24.8190-0718.2                    | 620718         |        |   | Warnkontakt L=720mm        |     |
|                    | 1.6 CNG            |          | 03.03    |       | 13.0460-7116.2                    | 607116         |        |   | 23057 20,2 +WE             | ATE |
|                    | 1.8 16V            |          | 04.98    | + ABS | 13.0470-7116.2                    | LD7116         |        |   | 23057 20,2 +WE             | ATE |
|                    | 1.8 16V Cabrio     |          | 03.01    | + ABS | 24.8190-0718.2                    | 620718         |        | 2 bis Fgst.Nr.: 42187758 <sup>1)</sup><br>ab Fgst.Nr.: 42187759 <sup>2)</sup> | Warnkontakt L=720mm        |     |
|                    | 1.8 16V Caravan    |          | 04.98    | + ABS | 24.8190-0718.2                    | 620018         |        |   | Warnkontakt L=755mm        |     |
|                    | 1.8 16V Coupe      |          | 03.00    |       |                                   |                |        |   |                            |     |
|                    | 2.0 16V            |          | 04.98    |       |                                   |                |        |   |                            |     |
|                    | 2.0 DI             |          | 04.98    | + ABS |                                   |                |        |   |                            |     |
|                    | 2.0 DTI 16V        |          | 08.99    |       |                                   |                |        |   |                            |     |
|                    | 2.2 16V            |          | 09.00    |       |                                   |                |        |   |                            |     |
|                    | 2.2 16V Cabrio     |          | 03.01    |       |                                   |                |        |   |                            |     |
|                    | 2.2 16V Coupe      |          | 09.00    |       |                                   |                |        |   |                            |     |
|                    | 2.2 DTI 16V        |          | 09.02    |       |                                   |                |        |   |                            |     |
| 2.2 DTI 16V Cabrio |                    | 09.02    |          |       |                                   |                |        |   |                            |     |
| 2.2 DTI 16V Coupe  |                    | 09.02    |          |       |                                   |                |        |   |                            |     |
| 2.0 16V OPC        |                    | 10.99    |          |       | 13.0460-7173.2                    | 607173         |        |   | 23116 20,3 +WK             | ATE |
| 2.0 16V OPC Cabrio |                    | 03.02    |          |       | 24.8190-0718.2                    | 620718         | 2      | bis Fgst.Nr.: 42187758 <sup>1)</sup><br>ab Fgst.Nr.: 42187759 <sup>2)</sup>   | Warnkontakt L=720mm        |     |
| 2.0 Turbo          |                    | 03.00    |          |       | 24.8190-0018.2                    | 620018         | 2      |   | Warnkontakt L=755mm        |     |
|                    | 1.2 16V            |          | 18999999 | 04.98 | + HA-Trommelbremse <sup>3)</sup>  | 24.0111-0141.1 | 411141 |   | 256 10,8 8,0               |     |
|                    | 1.2 16V            |          | 18999999 | 04.98 | + HA-Scheibenbremse <sup>4)</sup> | 24.0124-0152.1 | 424152 |   | 256 23,8 21,0 V L +S +B    |     |
|                    | 1.4 16V            | 22000001 |          | 04.98 |                                   | 24.0324-0152.1 | 524152 | für 4-Loch-Felge <sup>5)</sup><br>für 4-Loch-Felge <sup>5)</sup>              | 256 10,8 8,0 +B PD         |     |
|                    | 1.4 Caravan        | 66       |          | 09.07 |                                   |                |        |   |                            |     |
|                    | 1.4 Limousine      | 66       |          | 09.07 |                                   |                |        |   |                            |     |
|                    | 1.6                |          |          | 04.98 |                                   |                |        |   |                            |     |
|                    | 1.6 16V            |          |          | 04.98 |                                   |                |        |   |                            |     |
|                    | 1.6 16V Cabrio     |          |          | 03.01 |                                   |                |        |   |                            |     |
|                    | 1.7 CDTI           |          |          | 04.03 |                                   |                |        |   |                            |     |
|                    | 1.7 DTI            |          |          | 02.00 |                                   |                |        |   |                            |     |
|                    | 1.7 TD             |          |          | 04.98 |                                   |                |        |   |                            |     |
|                    | 1.8 16V            |          |          | 04.98 | - ABS                             |                |        |   |                            |     |
|                    | 1.8 16V Cabrio     |          |          | 03.01 | - ABS                             |                |        |   |                            |     |
|                    | 1.8 16V Caravan    |          |          | 04.98 | - ABS                             |                |        |   |                            |     |
|                    | 2.0 DI             |          |          | 04.98 | - ABS                             |                |        |   |                            |     |
|                    | 1.6                |          |          | 04.98 |                                   | 24.0125-0131.1 | 425131 | für 5-Loch-Felge <sup>6)</sup><br>für 5-Loch-Felge <sup>6)</sup>              | 280 24,8 22,0 V L +S +B    |     |
|                    | 1.6 16V            |          |          | 04.98 |                                   | 24.0325-0131.1 | 525131 |   | 280 24,8 22,0 V L +S +B PD |     |
|                    | 1.6 CNG            |          |          | 03.03 |                                   |                |        |   |                            |     |
|                    | 1.8 16V            |          |          | 04.98 | + ABS                             |                |        |   |                            |     |
|                    | 1.8 16V Cabrio     |          |          | 03.01 | + ABS                             |                |        |   |                            |     |
|                    | 1.8 16V Caravan    |          |          | 04.98 | + ABS                             |                |        |   |                            |     |
|                    | 1.8 16V Coupe      |          |          | 03.00 |                                   |                |        |   |                            |     |
|                    | 2.0 16V            |          |          | 04.98 |                                   |                |        |   |                            |     |
|                    | 2.0 DI             |          |          | 04.98 | + ABS                             |                |        |   |                            |     |
|                    | 2.0 DTI 16V        |          |          | 08.99 |                                   |                |        |   |                            |     |
|                    | 2.2 16V            |          |          | 09.00 |                                   |                |        |   |                            |     |
|                    | 2.2 16V Cabrio     |          |          | 03.01 |                                   |                |        |   |                            |     |
|                    | 2.2 16V Coupe      |          |          | 09.00 |                                   |                |        |   |                            |     |
|                    | 2.2 DTI 16V        |          |          | 09.02 |                                   |                |        |   |                            |     |
|                    | 2.2 DTI 16V Cabrio |          |          | 09.02 |                                   |                |        |   |                            |     |
| 2.2 DTI 16V Coupe  |                    |          | 09.02    |       |                                   |                |        |   |                            |     |
| 2.0 16V OPC        |                    |          | 10.99    |       | 24.0125-0142.1                    | 425142         |        | 308 25,0 22,0 V L +S +B   |                            |     |
| 2.0 16V OPC Cabrio |                    |          | 03.02    |       | 24.0325-0142.1                    | 525142         |        | 308 25,0 22,0 V L +S +B PD  |                            |     |
| 2.0 Turbo          |                    |          | 03.00    |       |                                   |                |        |   |                            |     |
|                    | 1.2 16V            |          |          | 04.98 |                                   | 13.0460-3976.2 | 603976 |   | 23258 16,5 +WK/Zub/SBOS    |     |
|                    | 1.4 16V            |          |          | 04.98 |                                   | 13.0460-2868.2 | 602868 |   | 23417 15,3 +WK/Zub/STRW    |     |
|                    | 1.4 Caravan        | 66       |          | 09.07 |                                   | 13.0470-2868.2 | LD2868 |   | 23417 15,3 +WK/Zub/STRW    |     |
|                    | 1.4 Limousine      | 66       |          | 09.07 |                                   |                |        |   |                            |     |
|                    | 1.6                |          |          | 04.98 |                                   |                |        |   |                            |     |
|                    | 1.6 16V            |          |          | 04.98 |                                   |                |        |   |                            |     |
|                    | 1.6 16V Cabrio     |          |          | 03.01 |                                   |                |        |   |                            |     |
|                    | 1.6 16V Caravan    |          |          | 04.98 |                                   |                |        |   |                            |     |
|                    | 1.6 CNG            |          |          | 03.03 |                                   |                |        |   |                            |     |
|                    | 1.7 CDTI           |          |          | 04.03 |                                   |                |        |   |                            |     |
|                    | 1.7 DTI            |          |          | 02.00 |                                   |                |        |   |                            |     |
|                    | 1.7 TD             |          |          | 04.98 |                                   |                |        |   |                            |     |
|                    | 1.8 16V            |          |          | 04.98 |                                   |                |        |   |                            |     |
|                    | 1.8 16V Cabrio     |          |          | 03.01 |                                   |                |        |   |                            |     |
|                    | 1.8 16V Coupe      |          |          | 03.00 |                                   |                |        |   |                            |     |
| 2.0 16V            |                    |          | 04.98    |       |                                   |                |        |   |                            |     |
| 2.0 16V OPC        |                    |          | 10.99    |       |                                   |                |        |   |                            |     |
| 2.0 16V OPC Cabrio |                    |          | 03.02    |       |                                   |                |        |   |                            |     |
| 2.0 DI             |                    |          | 04.98    |       |                                   |                |        |   |                            |     |
| 2.0 DTI 16V        |                    |          | 08.99    |       |                                   |                |        |   |                            |     |
| 2.0 Turbo          |                    |          | 03.00    |       |                                   |                |        |   |                            |     |
| 2.2 16V            |                    |          | 09.00    |       |                                   |                |        |   |                            |     |
| 2.2 16V Cabrio     |                    |          | 03.01    |       |                                   |                |        |   |                            |     |
| 2.2 16V Coupe      |                    |          | 09.00    |       |                                   |                |        |   |                            |     |
| 2.2 DTI 16V        |                    |          | 09.02    |       |                                   |                |        |   |                            |     |
| 2.2 DTI 16V Cabrio |                    |          | 09.02    |       |                                   |                |        |   |                            |     |
| 2.2 DTI 16V Coupe  |                    |          | 09.02    |       |                                   |                |        |   |                            |     |

<sup>1)</sup> up to chassis: 42187758 / fino no.telaio: 42187758 / jusqu'au de châssis: 42187758 / hasta no.de chasis: 42187758

<sup>2)</sup> from chassis no.:42187759 / dal no.telaio:42187759 / du no.châssis:42187759 / desde no.chasis:42187759

<sup>3)</sup> + RA drum brake / + P freno a tamburo / + frein à tambour essieu AR / + ET-tambores de freno

<sup>4)</sup> + RA disc brake / + P disco freno / + frein à disque essieu AR / + ET-disco de freno

<sup>5)</sup> for 4 bore wheel rim / per cerchione a 4 fori / pour jante à 4 trous / para Liantas de 4 taladros

<sup>6)</sup> for 5 bore wheel rim / per cerchione a 5 fori / pour jante à 5 trous / para Liantas de 5 taladros



**OPEL ASTRA G / Vauxhall Astra MKIV (98-05)**

|                    |                   |          |          |       |                |        |  |  |
|--------------------|-------------------|----------|----------|-------|----------------|--------|--|--|
|                    | 1.2 16V           |          | 04.98    |       | 24.0110-0251.1 | 410251 | für 4-Loch-Felge <sup>1)</sup><br>für 4-Loch-Felge <sup>1)</sup> | 240 9,8 8,0 +S +B<br><b>240 9,8 8,0 +S +B PD</b> |
|                    | 1.4 16V           |          | 04.98    |       | 24.0310-0251.1 | 510251 |  |  |
|                    | 1.4 Caravan       | 66       | 09.07    |       |                |        |  |  |
|                    | 1.4 Limousine     | 66       | 09.07    |       |                |        |  |  |
|                    | 1.6               |          | 04.98    |       |                |        |  |  |
|                    | 1.6 16V           |          | 04.98    |       |                |        |  |  |
|                    | 1.6 16V Cabrio    |          | 03.01    |       |                |        |  |  |
|                    | 1.7 CDTI          |          | 04.03    |       |                |        |  |  |
|                    | 1.7 DTI           |          | 02.00    |       |                |        |  |  |
|                    | 1.7 TD            |          | 04.98    |       |                |        |  |  |
|                    | 1.8 16V           |          | 04.98    | - ABS |                |        |  |  |
|                    | 1.8 16V Cabrio    |          | 03.01    | - ABS |                |        |  |  |
|                    | 1.8 16V Caravan   |          | 04.98    | - ABS |                |        |  |  |
|                    | 2.0 DI            |          | 04.98    | - ABS |                |        |  |  |
|                    | 1.6 16V           |          | 04.98    |       | 24.0110-0250.1 | 410250 | für 5-Loch-Felge <sup>2)</sup><br>für 5-Loch-Felge <sup>2)</sup> | 264 9,8 8,0 +S +B<br><b>264 9,8 8,0 +S +B PD</b> |
|                    | 1.6 CNG           |          | 03.03    |       | 24.0310-0250.1 | 510250 |  |  |
|                    | 1.8 16V           |          | 04.98    | + ABS |                |        |  |  |
|                    | 1.8 16V Cabrio    |          | 03.01    | + ABS |                |        |  |  |
|                    | 1.8 16V Caravan   |          | 04.98    | + ABS |                |        |  |  |
|                    | 1.8 16V Coupe     |          | 03.00    |       |                |        |  |  |
| 2.0 16V            |                   | 04.98    |          |       |                |        |  |  |
| 2.0 16V OPC        |                   | 10.99    |          |       |                |        |  |  |
| 2.0 16V OPC Cabrio |                   | 03.02    |          |       |                |        |  |  |
| 2.0 DI             |                   | 04.98    | + ABS    |       |                |        |  |  |
| 2.0 DTI 16V        |                   | 08.99    |          |       |                |        |  |  |
| 2.0 Turbo          |                   | 03.00    |          |       |                |        |  |  |
| 2.2 16V            |                   | 09.00    |          |       |                |        |  |  |
| 2.2 16V Cabrio     |                   | 03.01    |          |       |                |        |  |  |
| 2.2 16V Coupe      |                   | 09.00    |          |       |                |        |  |  |
| 2.2 DTI 16V        |                   | 09.02    |          |       |                |        |  |  |
| 2.2 DTI 16V Cabrio |                   | 09.02    |          |       |                |        |  |  |
| 2.2 DTI 16V Coupe  |                   | 09.02    |          |       |                |        |  |  |
|                    | 1.2 16V Limousine |          | 04.98    |       | 03.0137-0267.2 | 650267 |  | 200 x 46 HEB<br>Bremsbacken-Zubehör              |
|                    | 1.2 16V Caravan   |          | 18999999 | 04.98 | 03.0137-9167.2 | 669167 |  |  |
|                    | 1.4 16V           |          | 18999999 | 04.98 | 03.0137-0322.2 | 650322 |  | 230 x 42<br>Bremsbacken-Zubehör                  |
|                    | 1.6               |          | 18999999 | 04.98 | 03.0137-9215.2 | 669215 |  |  |
|                    | 1.6 16V           |          | 18999999 | 04.98 |                |        |  |  |
|                    | 1.6 CNG           |          | 18999999 | 03.03 |                |        |  |  |
|                    | 1.7 DTI           |          | 18999999 | 02.00 |                |        |  |  |
|                    | 1.7 TD            |          | 04.98    |       |                |        |  |  |
|                    | 1.2 16V Caravan   | 22000001 |          |       | 03.0137-0424.2 | 650424 |  | 230 x 42 HEB<br>Bremsbacken-Zubehör              |
|                    | 1.4 16V           | 22000001 |          |       | 03.0137-9215.2 | 669215 |  |  |
| 1.4 Caravan        | 66                | 09.07    |          |       |                |        |  |  |
| 1.4 Limousine      | 66                | 09.07    |          |       |                |        |  |  |
| 1.6                | 22000001          |          |          |       |                |        |  |  |
| 1.6 16V            | 22000001          |          |          |       |                |        |  |  |
| 1.6 CNG            | 22000001          |          |          |       |                |        |  |  |
| 1.7 DTI            | 22000001          |          |          |       |                |        |  |  |
|                    | 1.2 16V Limousine |          | 04.98    |       | 24.0220-0001.2 | 480013 |  | 200/201 x 53,5                                   |
|                    | 1.2 16V Caravan   |          | 04.98    |       | 24.0223-0013.2 | 480061 |  | 230/231 x 50                                     |
|                    | 1.4 16V           |          | 04.98    |       |                |        |  |  |
|                    | 1.4 Caravan       | 66       | 09.07    |       |                |        |  |  |
|                    | 1.4 Limousine     | 66       | 09.07    |       |                |        |  |  |
|                    | 1.6               |          | 04.98    |       |                |        |  |  |
|                    | 1.6 16V           |          | 04.98    |       |                |        |  |  |
|                    | 1.6 CNG           |          | 03.03    |       |                |        |  |  |
|                    | 1.7 DTI           |          | 02.00    |       |                |        |  |  |
|                    | 1.7 TD            |          | 04.98    |       |                |        |  |  |
|                    | 1.2 16V Caravan   |          | 18999999 | 04.98 | 03.0520-5719.3 | 695719 |  | 19,05/230x42 TopKit TRW                          |
|                    | 1.4 16V           |          | 18999999 | 04.98 |                |        |  |  |
|                    | 1.6               |          | 18999999 | 04.98 |                |        |  |  |
|                    | 1.6 16V           |          | 18999999 | 04.98 |                |        |  |  |
|                    | 1.6 CNG           |          | 18999999 | 03.03 |                |        |  |  |
|                    | 1.7 DTI           |          | 18999999 | 02.00 |                |        |  |  |
|                    | 1.7 TD            |          | 04.98    |       |                |        |  |  |
|                    | 1.2 16V Caravan   | 22000001 |          |       | 03.0520-6019.3 | 696019 |  | 19,05/230x42 TopKit                              |
|                    | 1.4 16V           | 22000001 |          |       |                |        |  |  |
|                    | 1.4 Caravan       | 66       | 09.07    |       |                |        |  |  |
| 1.4 Limousine      | 66                | 09.07    |          |       |                |        |  |  |
| 1.6                | 22000001          |          |          |       |                |        |  |  |
| 1.6 16V            | 22000001          |          |          |       |                |        |  |  |
| 1.6 CNG            | 22000001          |          |          |       |                |        |  |  |
| 1.7 DTI            | 22000001          |          |          |       |                |        |  |  |















**OPEL ASTRA H / GTC / Vauxhall Astra Mk V (04-10)**

|  |           |     |       |       |                |        |   |   |            |
|--|-----------|-----|-------|-------|----------------|--------|---|---|------------|
|  | 1.2       |     | 08.05 | 11.10 | 13.0460-7179.2 | 607179 | 1 | 23832 20,2 +/WK<br>23832 20,2 +/WK<br>Warnkontakt L=287mm | ATE<br>ATE |
|  | 1.3 CDTI  | 66  | 08.05 | 11.10 | 13.0470-7179.2 | LD7179 |   |   |            |
|  | 1.4       |     | 01.04 | 11.10 | 24.8190-0720.2 | 620720 |   |   |            |
|  | 1.6       | 77  | 01.04 | 11.10 |                |        |   |   |            |
|  | 1.6       | 85  | 01.07 | 11.10 |                |        |   |   |            |
|  | 1.6 Turbo | 132 | 01.07 | 11.10 |                |        |   |   |            |
|  | 1.7 CDTI  | 59  | 01.04 | 11.10 |                |        |   |   |            |
|  | 1.7 CDTI  | 74  | 01.04 | 11.10 |                |        |   |   |            |
|  | 1.7 CDTI  | 81  | 04.07 | 11.10 |                |        |   |   |            |
|  | 1.7 CDTI  | 92  | 04.07 | 11.10 |                |        |   |   |            |

<sup>1)</sup> for 4 bore wheel rim / per cerchione a 4 fori / pour jante à 4 trous / para Llantas de 4 taladros

<sup>2)</sup> for 5 bore wheel rim / per cerchione a 5 fori / pour jante à 5 trous / para Llantas de 5 taladros



|     |  |  |  |  |  |  |  |  |   |                            |     |
|--|--|--|--|--|---|--|--|--|---|----------------------------|-----|
| <b>OPEL ASTRA H / GTC / Vauxhall Astra Mk V (04-10)</b>                            |  |  |  |  |   |  |  |  |   |                            |     |
|    | 1.8  | 92   |  | 01.04  | 11.10   | 13.0460-7179.2   | 607179   |  | 23832 20,2 +/WK                                 | ATE                        |     |
|  | 1.8  | 103  |  | 01.06  | 11.10   | 13.0470-7179.2   | LD7179   |  | 23832 20,2 +/WK                                 | ATE                        |     |
|  | 1.9 CDTI   | 74   |  | 09.05  | 11.10   | 24.8190-0720.2   | 620720   | 1  | Warnkontakt L=287mm                             |                            |     |
|  | 1.9 CDTI   | 88   |  | 09.04  | 11.10   |  |  |  |   |                            |     |
|  | 1.9 CDTI   | 110  |  | 09.04  | 11.10   |  |  |  |   |                            |     |
|  | 2.0 Turbo  | 125  |  | 01.04  | 11.10   |  |  |  |   |                            |     |
|  | 2.0 Turbo  | 147  |  | 09.04  | 11.10   |  |  |  |   |                            |     |
|  | 2.0 Turbo OPC  | 177  |  | 03.05  | 11.10   |  |  |  |   |                            |     |
|  |  |  |  |  |   | 13.0460-7212.2   | 607212   |  | f. Bremssattel m.Stahlkolben <sup>1)</sup>      | 23738 20,1 +/WE            | ATE |
|  |  |  |  |  |   | 13.0460-7172.2   | 607172   |  | f. Bremssattel m.Kunststoffkolben <sup>2)</sup> | 23402 20,1 +/WE            | ATE |
|  |  |  |  |  |   | 13.0470-7172.2   | LD7172   |  | f. Bremssattel m.Kunststoffkolben <sup>2)</sup> | 23402 20,1 +/WE            | ATE |
|  |  |  |  |  |   | 24.8190-0720.2   | 620720   | 1  | Warnkontakt L=287mm                             |                            |     |
|    | 1.2  |  |  | 08.05  | 11.10   | 24.0125-0198.1   | 425198   |  | für 4-Loch-Felge <sup>3)</sup>                  | 280 25,0 22,0 V L +S +B    |     |
|  | 1.3 CDTI   | 66   |  | 08.05  | 11.10   | 24.0325-0198.1   | 525198   |  | für 4-Loch-Felge <sup>3)</sup>                  | 280 25,0 22,0 V L +S +B PD |     |
|  | 1.4  |  |  | 01.04  | 11.10   |  |  |  |   |                            |     |
|  | 1.6  | 77   |  | 01.04  | 11.10   |  |  |  |   |                            |     |
|  | 1.6  | 85   |  | 01.07  | 11.10   |  |  |  |   |                            |     |
|  | 1.6 Turbo  | 132  |  | 01.07  | 11.10   |  |  |  |   |                            |     |
|  | 1.7 CDTI   | 59   |  | 01.04  | 11.10   |  |  |  |   |                            |     |
|  | 1.7 CDTI   | 74   |  | 01.04  | 11.10   |  |  |  |   |                            |     |
|  | 1.7 CDTI   | 81   |  | 04.07  | 11.10   |  |  |  |   |                            |     |
|  | 1.7 CDTI   | 92   |  | 04.07  | 11.10   |  |  |  |   |                            |     |
|  | 1.8  | 92   |  | 01.04  | 11.10   |  |  |  |   |                            |     |
|  | 1.8  | 103  |  | 01.06  | 11.10   |  |  |  |   |                            |     |
|  | 1.9 CDTI   | 74   |  | 09.05  | 11.10   |  |  |  |   |                            |     |
|  | 1.9 CDTI   | 88   |  | 09.04  | 11.10   |  |  |  |   |                            |     |
|  | 1.9 CDTI   | 110  |  | 09.04  | 11.10   |  |  |  |   |                            |     |
|  | 2.0 Turbo  | 125  |  | 01.04  | 11.10   |  |  |  |   |                            |     |
|  | 2.0 Turbo  | 147  |  | 09.04  | 11.10   |  |  |  |   |                            |     |
|  | 1.2  |  |  | 08.05  | 11.10   | 24.0125-0131.1   | 425131   |  | für 5-Loch-Felge <sup>4)</sup>                  | 280 24,8 22,0 V L +S +B    |     |
|  | 1.3 CDTI   | 66   |  | 08.05  | 11.10   | 24.0325-0131.1   | 525131   |  | für 5-Loch-Felge <sup>4)</sup>                  | 280 24,8 22,0 V L +S +B PD |     |
|  | 1.4  |  |  | 01.04  | 11.10   |  |  |  |   |                            |     |
|  | 1.6  | 77   |  | 01.04  | 11.10   |  |  |  |   |                            |     |
|  | 1.6  | 85   |  | 01.07  | 11.10   |  |  |  |   |                            |     |
|  | 1.7 CDTI   | 59   |  | 01.04  | 11.10   |  |  |  |   |                            |     |
|  | 1.7 CDTI   | 74   |  | 01.04  | 11.10   |  |  |  |   |                            |     |
|  | 1.7 CDTI   | 81   |  | 04.07  | 11.10   |  |  |  |   |                            |     |
|  | 1.8  | 92   |  | 01.04  | 11.10   |  |  |  |   |                            |     |
|  | 1.8  | 103  |  | 01.06  | 11.10   |  |  |  |   |                            |     |
|  | 1.6 Turbo  | 132  |  | 01.07  | 11.10   | 24.0125-0142.1   | 425142   |  | für 5-Loch-Felge <sup>4)</sup>                  | 308 25,0 22,0 V L +S +B    |     |
|  | 1.7 CDTI   | 92   |  | 04.07  | 11.10   | 24.0325-0142.1   | 525142   |  | für 5-Loch-Felge <sup>4)</sup>                  | 308 25,0 22,0 V L +S +B PD |     |
|  | 1.9 CDTI   | 74   |  | 09.05  | 11.10   |  |  |  |   |                            |     |
|  | 1.9 CDTI   | 88   |  | 09.04  | 11.10   |  |  |  |   |                            |     |
|  | 1.9 CDTI   | 110  |  | 09.04  | 11.10   |  |  |  |   |                            |     |
|  | 2.0 Turbo  | 125  |  | 01.04  | 11.10   |  |  |  |   |                            |     |
|  | 2.0 Turbo  | 147  |  | 09.04  | 11.10   |  |  |  |   |                            |     |
|  | 2.0 Turbo OPC  | 177  |  | 03.05  | 11.10   | 24.0128-0201.1   | 428201   |  | für 5-Loch-Felge <sup>4)</sup>                  | 321 28,0 25,0 V L +B       |     |
|  | 1.2  |  |  | 08.05  | 11.10   | 13.0460-2868.2   | 602868   |  |   | 23417 15,3 +/WK/Zub/STRW   |     |
|  | 1.3 CDTI   | 66   |  | 08.05  | 11.10   | 13.0470-2868.2   | LD2868   |  |   | 23417 15,3 +/WK/Zub/STRW   |     |
|  | 1.4  |  |  | 01.04  | 11.10   |  |  |  |   |                            |     |
|  | 1.6  | 77   |  | 01.04  | 11.10   |  |  |  |   |                            |     |
|  | 1.6  | 85   |  | 01.07  | 11.10   |  |  |  |   |                            |     |
|  | 1.6 Turbo  | 132  |  | 01.07  | 11.10   |  |  |  |   |                            |     |
|  | 1.7 CDTI   | 59   |  | 01.04  | 11.10   |  |  |  |   |                            |     |
|  | 1.7 CDTI   | 74   |  | 01.04  | 11.10   |  |  |  |   |                            |     |
|  | 1.7 CDTI   | 81   |  | 04.07  | 11.10   |  |  |  |   |                            |     |
|  | 1.7 CDTI   | 92   |  | 04.07  | 11.10   |  |  |  |   |                            |     |
|  | 1.8  | 92   |  | 01.04  | 11.10   |  |  |  |   |                            |     |
|  | 1.8  | 103  |  | 01.06  | 11.10   |  |  |  |   |                            |     |
|  | 1.9 CDTI   | 74   |  | 09.05  | 11.10   |  |  |  |   |                            |     |
|  | 1.9 CDTI   | 88   |  | 09.04  | 11.10   |  |  |  |   |                            |     |
|  | 1.9 CDTI   | 110  |  | 09.04  | 11.10   |  |  |  |   |                            |     |
|  | 2.0 Turbo  | 125  |  | 01.04  | 11.10   |  |  |  |   |                            |     |
|  | 2.0 Turbo  | 147  |  | 09.04  | 11.10   |  |  |  |   |                            |     |
|  | 2.0 Turbo OPC  | 177  |  | 03.05  | 11.10   |  |  |  |   |                            |     |
|  | 1.2  |  |  | 08.05  | 11.10   | 24.0110-0251.1   | 410251   |  | für 4-Loch-Felge <sup>3)</sup>                  | 240 9,8 8,0 +S +B          |     |
|  | 1.3 CDTI   | 66   |  | 08.05  | 11.10   | 24.0310-0251.1   | 510251   |  | für 4-Loch-Felge <sup>3)</sup>                  | 240 9,8 8,0 +S +B PD       |     |
|  | 1.4  |  |  | 01.04  | 11.10   | 24.0110-0250.1   | 410250   |  | für 5-Loch-Felge <sup>4)</sup>                  | 264 9,8 8,0 +S +B          |     |
|  | 1.6  | 77   |  | 01.04  | 11.10   | 24.0310-0250.1   | 510250   |  | für 5-Loch-Felge <sup>4)</sup>                  | 264 9,8 8,0 +S +B PD       |     |
|  | 1.6  | 85   |  | 01.07  | 11.10   |  |  |  |   |                            |     |
|  | 1.6 Turbo  | 132  |  | 01.07  | 11.10   |  |  |  |   |                            |     |
|  | 1.7 CDTI   | 59   |  | 01.04  | 11.10   |  |  |  |   |                            |     |
|  | 1.7 CDTI   | 74   |  | 01.04  | 11.10   |  |  |  |   |                            |     |
|  | 1.7 CDTI   | 81   |  | 04.07  | 11.10   |  |  |  |   |                            |     |
|  | 1.7 CDTI   | 92   |  | 04.07  | 11.10   |  |  |  |   |                            |     |
|  | 1.8  | 92   |  | 01.04  | 11.10   |  |  |  |   |                            |     |
|  | 1.8  | 103  |  | 01.06  | 11.10   |  |  |  |   |                            |     |
|  | 1.9 CDTI   | 74   |  | 09.05  | 11.10   |  |  |  |   |                            |     |
|  | 1.9 CDTI   | 88   |  | 09.04  | 11.10   |  |  |  |   |                            |     |
|  | 1.9 CDTI   | 110  |  | 09.04  | 11.10   |  |  |  |   |                            |     |
|  | 2.0 Turbo  | 125  |  | 01.04  | 11.10   |  |  |  |   |                            |     |
|  | 2.0 Turbo  | 147  |  | 09.04  | 11.10   |  |  |  |   |                            |     |
|  | 2.0 Turbo OPC  | 177  |  | 03.05  | 11.10   | 24.0110-0339.1   | 410339   |  |   | 278 10,0 8,0 +S +B         |     |
|  | 1.2  |  |  | 08.05  | 07.06   | 03.0137-0424.2   | 650424   |  |   | 230 x 42 HEB               |     |
|  | 1.4  |  |  | 01.04  | 07.06   | 03.0137-9215.2   | 669215   |  |   | Bremsbacken-Zubehör        |     |
|  | 1.6  | 77   |  | 01.04  | 07.06   |  |  |  |   |                            |     |
|  | 1.7 CDTI   | 59   |  | 01.04  | 07.06   |  |  |  |   |                            |     |

















<sup>1)</sup> for br.caliper +steel piston / per pinza fr. +pistone acciaio / pour étrier f. +piston en acier / para pinza fr. +pistón de acero

<sup>2)</sup> for br.caliper +plastic piston / per pinza fr. +pistone plastica / pour étrier fr. +piston plastique / para pinza fr. +pistón plástico

<sup>3)</sup> for 4 bore wheel rim / per cerchione a 4 fori / pour jante à 4 trous / para Liantas de 4 taladros

<sup>4)</sup> for 5 bore wheel rim / per cerchione a 5 fori / pour jante à 5 trous / para Liantas de 5 taladros



|     |  |  |  |  |  |  |  |  |
|--|--|--|--|--|---|--|--|--|
| <b>OPEL ASTRA H / GTC / Vauxhall Astra Mk V (04-10)</b>                            |  |  |  |  |   |  |  |  |
|    | 1.7 CDTI   | 74   | 01.04  | 07.06  | 03.0137-0424.2  | 650424   |  | 230 x 42 HEB   |
|  |  |  |  |  | 03.0137-9215.2  | 669215   |  | Bremsbacken-Zubehör  |
|  | 1.2  |  | 08.06  | 11.10  | 03.0137-9309.2  | 669309   |  | Bremsbacken-Zubehör <b>AP</b>  |
|  | 1.4  |  | 08.06  | 11.10  |   |  |  |  |
|  | 1.6  | 77   | 08.06  | 11.10  |   |  |  |  |
|  | 1.7 CDTI   | 59   | 08.06  | 11.10  |   |  |  |  |
|  | 1.7 CDTI   | 74   | 08.06  | 11.10  |   |  |  |  |
|    | 1.2  |  | 08.05  | 11.10  | 24.0223-0021.1  | 480186   |  | 230/231 x 50   |
|  | 1.4  |  | 01.04  | 11.10  |   |  |  |  |
|  | 1.6  | 77   | 01.04  | 11.10  |   |  |  |  |
|  | 1.7 CDTI   | 59   | 01.04  | 11.10  |   |  |  |  |
|  | 1.7 CDTI   | 74   | 01.04  | 11.10  |   |  |  |  |
|    | 1.2  |  | 08.05  | 07.06  | 03.0520-8720.3  | 698720   |  | 20,64/230x42 TopKit  |
|  | 1.4  |  | 01.04  | 07.06  |   |  |  |  |
|  | 1.6  | 77   | 01.04  | 07.06  |   |  |  |  |
|  | 1.7 CDTI   | 59   | 01.04  | 07.06  |   |  |  |  |
|  | 1.7 CDTI   | 74   | 01.04  | 07.06  |   |  |  |  |
| <b>OPEL ASTRA H Caravan/Vau. Astra MKV Estate (04-10)</b>                          |  |  |  |  |   |  |  |  |
|    | 1.2  | 59   | 08.05  | 11.10  | 13.0460-7179.2  | 607179   |  | 23832 20,2 +/WK <b>ATE</b>   |
|  | 1.3 CDTI   | 66   | 08.05  | 11.10  | 13.0470-7179.2  | LD7179   |  | 23832 20,2 +/WK <b>ATE</b>   |
|  | 1.4  |  | 08.04  | 11.10  | 24.8190-0720.2  | 620720   | 1  | Warnkontakt L=287mm  |
|  | 1.6  | 77   | 08.04  | 11.10  |   |  |  |  |
|  | 1.6  | 85   | 01.07  | 11.10  |   |  |  |  |
|  | 1.6 LPG  | 85   | 08.09  | 11.10  |   |  |  |  |
|  | 1.6 Turbo  | 132  | 01.07  | 11.10  |   |  |  |  |
|  | 1.7 CDTI   | 59   | 08.04  | 11.10  |   |  |  |  |
|  | 1.7 CDTI   | 74   | 08.04  | 11.10  |   |  |  |  |
|  | 1.7 CDTI   | 81   | 04.07  | 11.10  |   |  |  |  |
|  | 1.7 CDTI   | 92   | 04.07  | 11.10  |   |  |  |  |
|  | 1.7 TD   | 79   | 08.04  | 11.10  |   |  |  |  |
|  | 1.8  | 92   | 09.04  | 11.10  |   |  |  |  |
|  | 1.8  | 103  | 08.05  | 11.10  |   |  |  |  |
|  | 1.9 CDTI   | 74   | 09.05  | 11.10  |   |  |  |  |
|  | 1.9 CDTI   | 88   | 08.04  | 11.10  |   |  |  |  |
|  | 1.9 CDTI   | 110  | 09.04  | 11.10  |   |  |  |  |
|  | 2.0 Turbo  | 125  | 08.04  | 11.10  |   |  |  |  |
|  | 2.0 Turbo  | 147  | 09.04  | 11.10  |   |  |  |  |
|   | 1.2  | 59   | 08.05  | 11.10  | 24.0125-0198.1  | 425198   | für 4-Loch-Felge <sup>1)</sup>   | 280 25,0 22,0 V L +S +B  |
|  | 1.3 CDTI   | 66   | 08.05  | 11.10  | 24.0325-0198.1  | 525198   | für 4-Loch-Felge <sup>1)</sup>   | 280 25,0 22,0 V L +S +B <b>PD</b>  |
|  | 1.4  |  | 08.04  | 11.10  |   |  |  |  |
|  | 1.6  | 77   | 08.04  | 11.10  |   |  |  |  |
|  | 1.6  | 85   | 01.07  | 11.10  |   |  |  |  |
|  | 1.6 LPG  | 85   | 08.09  | 11.10  |   |  |  |  |
|  | 1.6 Turbo  | 132  | 01.07  | 11.10  |   |  |  |  |
|  | 1.7 CDTI   | 59   | 08.04  | 11.10  |   |  |  |  |
|  | 1.7 CDTI   | 74   | 08.04  | 11.10  |   |  |  |  |
|  | 1.7 CDTI   | 81   | 04.07  | 11.10  |   |  |  |  |
|  | 1.7 CDTI   | 92   | 04.07  | 11.10  |   |  |  |  |
|  | 1.7 TD   | 79   | 08.04  | 11.10  |   |  |  |  |
|  | 1.8  | 92   | 09.04  | 11.10  |   |  |  |  |
|  | 1.8  | 103  | 08.05  | 11.10  |   |  |  |  |
|  | 1.9 CDTI   | 74   | 09.05  | 11.10  |   |  |  |  |
|  | 1.9 CDTI   | 88   | 08.04  | 11.10  |   |  |  |  |
|  | 1.9 CDTI   | 110  | 09.04  | 11.10  |   |  |  |  |
|  | 2.0 Turbo  | 125  | 08.04  | 11.10  |   |  |  |  |
|  | 2.0 Turbo  | 147  | 09.04  | 11.10  |   |  |  |  |
|  | 1.8  | 92   | 09.04  | 11.10  | 24.0125-0131.1  | 425131   | für 5-Loch-Felge <sup>2)</sup>   | 280 24,8 22,0 V L +S +B  |
|  |  |  |  |  | 24.0325-0131.1  | 525131   | für 5-Loch-Felge <sup>2)</sup>   | 280 24,8 22,0 V L +S +B <b>PD</b>  |
|  | 1.2  | 59   | 08.05  | 11.10  | 24.0125-0131.1  | 425131   | für 5-Loch-Felge <sup>2)</sup>   | 280 24,8 22,0 V L +S +B  |
|  | 1.3 CDTI   | 66   | 08.05  | 11.10  |   |  |  |  |
|  | 1.4  |  | 08.04  | 11.10  |   |  |  |  |
|  | 1.6  | 77   | 08.04  | 11.10  |   |  |  |  |
|  | 1.6  | 85   | 01.07  | 11.10  |   |  |  |  |
|  | 1.6 LPG  | 85   | 08.09  | 11.10  |   |  |  |  |
|  | 1.7 CDTI   | 59   | 08.04  | 11.10  |   |  |  |  |
|  | 1.7 CDTI   | 74   | 08.04  | 11.10  |   |  |  |  |
|  | 1.7 CDTI   | 81   | 04.07  | 11.10  |   |  |  |  |
|  | 1.7 TD   | 79   | 08.04  | 11.10  |   |  |  |  |
|  | 1.8  | 103  | 08.05  | 11.10  |   |  |  |  |
|  | 1.6 Turbo  | 132  | 01.07  | 11.10  | 24.0125-0142.1  | 425142   | für 5-Loch-Felge <sup>2)</sup>   | 308 25,0 22,0 V L +S +B  |
|  | 1.7 CDTI   | 92   | 04.07  | 11.10  | 24.0325-0142.1  | 525142   | für 5-Loch-Felge <sup>2)</sup>   | 308 25,0 22,0 V L +S +B <b>PD</b>  |
|  | 1.9 CDTI   | 74   | 09.05  | 11.10  |   |  |  |  |
|  | 1.9 CDTI   | 88   | 08.04  | 11.10  |   |  |  |  |
|  | 1.9 CDTI   | 110  | 09.04  | 11.10  |   |  |  |  |
|  | 2.0 Turbo  | 125  | 08.04  | 11.10  |   |  |  |  |
|  | 2.0 Turbo  | 147  | 09.04  | 11.10  |   |  |  |  |
|  | 1.2  | 59   | 08.05  | 11.10  | 13.0460-2868.2  | 602868   |  | 23417 15,3 +/WK/Zub/STRW   |
|  | 1.3 CDTI   | 66   | 08.05  | 11.10  | 13.0470-2868.2  | LD2868   |  | 23417 15,3 +/WK/Zub/STRW   |
|  | 1.4  |  | 08.04  | 11.10  |   |  |  |  |
|  | 1.6  | 77   | 08.04  | 11.10  |   |  |  |  |
|  | 1.6  | 85   | 01.07  | 11.10  |   |  |  |  |
|  | 1.6 LPG  | 85   | 08.09  | 11.10  |   |  |  |  |
|  | 1.6 Turbo  | 132  | 01.07  | 11.10  |   |  |  |  |
|  | 1.7 CDTI   | 59   | 08.04  | 11.10  |   |  |  |  |
|  | 1.7 CDTI   | 74   | 08.04  | 11.10  |   |  |  |  |
|  |  |  |  |  |   |  |  |  |

<sup>1)</sup> for 4 bore wheel rim / per cerchione a 4 fori / pour jante à 4 trous / para Llantas de 4 taladros

<sup>2)</sup> for 5 bore wheel rim / per cerchione a 5 fori / pour jante à 5 trous / para Llantas de 5 taladros



**OPEL ASTRA H Caravan/Vau. Astra MKV Estate (04-10)**

|  |  |   |  |   |   |  |  |                                      |  |  |  |
|--|--|---|--|---|---|--|--|--------------------------------------|--|--|--|
|  | 1.7 CDTI<br>1.7 CDTI<br>1.7 TD<br>1.8<br>1.8<br>1.9 CDTI<br>1.9 CDTI<br>1.9 CDTI<br>2.0 Turbo<br>2.0 Turbo   | 81<br>92<br>79<br>92<br>103<br>74<br>88<br>110<br>125<br>147  |  | 04.07<br>04.07<br>08.04<br>09.04<br>08.05<br>09.05<br>08.04<br>09.04<br>08.04<br>09.04  | 11.10<br>11.10<br>11.10<br>11.10<br>11.10<br>11.10<br>11.10<br>11.10<br>11.10<br>11.10  |  | 13.0460-2868.2<br>13.0470-2868.2                                     | 602868<br>LD2868                     |  |  | 23417 15,3 +WK/Zub/STRW<br>23417 15,3 +WK/Zub/STRW |
|  | 1.2<br>1.3 CDTI<br>1.4<br>1.6<br>1.6<br>1.6 LPG<br>1.6 Turbo<br>1.7 CDTI<br>1.7 CDTI<br>1.7 CDTI<br>1.7 CDTI<br>1.7 TD<br>1.8<br>1.8<br>1.9 CDTI<br>1.9 CDTI<br>1.9 CDTI<br>2.0 Turbo<br>2.0 Turbo | 59<br>66<br>77<br>85<br>85<br>132<br>59<br>74<br>81<br>92<br>79<br>92<br>103<br>74<br>88<br>110<br>125<br>147 |  | 08.05<br>08.05<br>08.04<br>08.04<br>01.07<br>08.09<br>01.07<br>08.04<br>08.04<br>04.07<br>04.07<br>08.04<br>09.04<br>08.05<br>09.05<br>08.04<br>09.04<br>08.04<br>09.04 | 11.10<br>11.10<br>11.10<br>11.10<br>11.10<br>11.10<br>11.10<br>11.10<br>11.10<br>11.10<br>11.10<br>11.10<br>11.10<br>11.10<br>11.10<br>11.10<br>11.10<br>11.10<br>11.10 |  | 24.0110-0251.1<br>24.0310-0251.1<br>24.0110-0250.1<br>24.0310-0250.1 | 410251<br>510251<br>410250<br>510250 | für 4-Loch-Felge <sup>1)</sup><br>für 4-Loch-Felge <sup>1)</sup><br>für 5-Loch-Felge <sup>2)</sup><br>für 5-Loch-Felge <sup>2)</sup> | 240 9,8 8,0 +S +B<br>240 9,8 8,0 +S +B PD<br>264 9,8 8,0 +S +B<br>264 9,8 8,0 +S +B PD |  |
|  | 1.2<br>1.4<br>1.6<br>1.7 CDTI<br>1.7 CDTI<br>1.7 TD  | 59<br>77<br>59<br>74<br>79  |  | 08.05<br>08.04<br>08.04<br>08.04<br>08.04   | 07.06<br>07.06<br>07.06<br>07.06<br>07.06   |  | 03.0137-0424.2<br>03.0137-9215.2                                     | 650424<br>669215                     |  | 230 x 42 HEB<br>Bremsbacken-Zubehör  |  |
|  | 1.2<br>1.4<br>1.6<br>1.7 CDTI<br>1.7 CDTI<br>1.7 TD  | 59<br>77<br>59<br>74<br>79  |  | 08.06<br>08.06<br>08.06<br>08.06<br>08.06   | 11.10<br>11.10<br>11.10<br>11.10<br>11.10   |  | 03.0137-9309.2   | 669309                               |  | Bremsbacken-Zubehör <b>AP</b>  |  |
|  | 1.2<br>1.4<br>1.6<br>1.7 CDTI<br>1.7 CDTI<br>1.7 TD  | 59<br>77<br>59<br>74<br>79  |  | 08.05<br>08.04<br>08.04<br>08.04<br>08.04   | 11.10<br>11.10<br>11.10<br>11.10<br>11.10   |  | 24.0223-0021.1   | 480186                               |  | 230/231 x 50   |  |
|  | 1.2<br>1.4<br>1.6<br>1.7 CDTI<br>1.7 CDTI<br>1.7 TD  | 59<br>77<br>59<br>74<br>79  |  | 08.05<br>08.04<br>08.04<br>08.04<br>08.04   | 07.06<br>07.06<br>07.06<br>07.06<br>07.06   |  | 03.0520-8720.3   | 698720                               |  | 20,64/230x42 TopKit  |  |

**OPEL ASTRA H TwinTop (06-10)**

|  |  |                                      |  |   |   |  |  |                            |  |   |                          |
|--|--|--------------------------------------|--|---|---|--|--|----------------------------|--|---|--------------------------|
|  | 1.6<br>1.6<br>1.6 Turbo<br>1.8<br>1.9 CDTI<br>2.0 Turbo<br>2.0 Turbo | 77<br>85<br>132<br>110<br>125<br>147 |  | 03.06<br>12.06<br>02.07<br>03.06<br>03.06<br>03.06<br>03.06 | 11.10<br>11.10<br>11.10<br>11.10<br>11.10<br>11.10<br>11.10 |  | 13.0460-7179.2<br>13.0470-7179.2<br>24.8190-0720.2 | 607179<br>LD7179<br>620720 | 1  | 23832 20,2 +WK<br>23832 20,2 +WK<br>Warnkontakt L=287mm | <b>ATE</b><br><b>ATE</b> |
|  | 1.6<br>1.6<br>1.6 Turbo<br>1.8<br>1.9 CDTI<br>2.0 Turbo<br>2.0 Turbo | 77<br>85<br>132<br>110<br>125<br>147 |  | 03.06<br>12.06<br>02.07<br>03.06<br>03.06<br>03.06<br>03.06 | 11.10<br>11.10<br>11.10<br>11.10<br>11.10<br>11.10<br>11.10 |  | 24.0125-0198.1<br>24.0325-0198.1                   | 425198<br>525198           | für 4-Loch-Felge <sup>1)</sup><br>für 4-Loch-Felge <sup>1)</sup> | 280 25,0 22,0 V L +S +B<br>280 25,0 22,0 V L +S +B PD   |                          |
|  | 1.6<br>1.6<br>1.8  | 77<br>85                             |  | 03.06<br>12.06<br>03.06                                     | 11.10<br>11.10<br>11.10                                     |  | 24.0125-0131.1<br>24.0325-0131.1                   | 425131<br>525131           | für 5-Loch-Felge <sup>2)</sup><br>für 5-Loch-Felge <sup>2)</sup> | 280 24,8 22,0 V L +S +B<br>280 24,8 22,0 V L +S +B PD   |                          |
|  | 1.6 Turbo<br>1.9 CDTI<br>2.0 Turbo<br>2.0 Turbo                      | 132<br>110<br>125<br>147             |  | 02.07<br>03.06<br>03.06<br>03.06                            | 11.10<br>11.10<br>11.10<br>11.10                            |  | 24.0125-0142.1<br>24.0325-0142.1                   | 425142<br>525142           | für 5-Loch-Felge <sup>2)</sup><br>für 5-Loch-Felge <sup>2)</sup> | 308 25,0 22,0 V L +S +B<br>308 25,0 22,0 V L +S +B PD   |                          |
|  | 1.6<br>1.6<br>1.6 Turbo<br>1.8<br>1.9 CDTI<br>2.0 Turbo<br>2.0 Turbo | 77<br>85<br>132<br>110<br>125<br>147 |  | 03.06<br>12.06<br>02.07<br>03.06<br>03.06<br>03.06          | 11.10<br>11.10<br>11.10<br>11.10<br>11.10<br>11.10<br>11.10 |  | 13.0460-2868.2<br>13.0470-2868.2                   | 602868<br>LD2868           |  | 23417 15,3 +WK/Zub/STRW<br>23417 15,3 +WK/Zub/STRW      |                          |

<sup>1)</sup> for 4 bore wheel rim / per cerchione a 4 fori / pour jante à 4 trous / para Llantas de 4 taladros

<sup>2)</sup> for 5 bore wheel rim / per cerchione a 5 fori / pour jante à 5 trous / para Llantas de 5 taladros



### OPEL ASTRA H TwinTop (06-10)

|           |           |     |       |       |       |                |        |  |  |                                |                   |
|-----------|-----------|-----|-------|-------|-------|----------------|--------|--|--|--------------------------------|-------------------|
|           | 1.6       | 77  |       | 03.06 | 11.10 | 24.0110-0291.1 | 410291 | für 4-Loch-Felge <sup>1)</sup><br>für 4-Loch-Felge <sup>1)</sup> | 264 10,0 8,0 +S +B<br><b>264 10,0 8,0 +S +B PD</b> |                                |                   |
|           | 1.6       | 85  |       | 12.06 | 11.10 | 24.0310-0291.1 | 510291 |  |  |                                |                   |
|           | 1.6 Turbo | 132 |       | 02.07 | 11.10 |                |        |  |  |                                |                   |
|           | 1.8       |     |       | 03.06 | 11.10 |                |        |  |  |                                |                   |
|           | 1.9 CDTi  | 110 |       | 03.06 | 11.10 |                |        |  |  |                                |                   |
|           | 2.0 Turbo | 125 |       | 03.06 | 11.10 |                |        |  |  |                                |                   |
|           | 2.0 Turbo | 147 |       | 03.06 | 11.10 |                |        |  |  |                                |                   |
|           | 1.6       | 77  |       | 03.06 | 11.10 | 24.0110-0250.1 | 410250 |  |  | für 5-Loch-Felge <sup>2)</sup> | 264 9,8 8,0 +S +B |
|           | 1.6       | 85  |       | 12.06 | 11.10 |                |        |  |  |                                |                   |
|           | 1.6 Turbo | 132 |       | 02.07 | 11.10 |                |        |  |  |                                |                   |
| 1.8       |           |     | 03.06 | 11.10 |       |                |        |  |  |                                |                   |
| 1.9 CDTi  | 110       |     | 03.06 | 11.10 |       |                |        |  |  |                                |                   |
| 2.0 Turbo | 125       |     | 03.06 | 11.10 |       |                |        |  |  |                                |                   |
| 2.0 Turbo | 147       |     | 03.06 | 11.10 |       |                |        |  |  |                                |                   |

### OPEL ASTRA J / GTC / Vauxhall Astra MK VI (09-)

|                       |                       |     |       |       |                |                |        |   |   |                              |  |
|-----------------------|-----------------------|-----|-------|-------|----------------|----------------|--------|---|---|------------------------------|--|
|                       | 1.3 CDTi ECOTEC       | 70  |       | 12.09 |                | 13.0460-7262.2 | 607262 |   | 25031 19,1 +WK/Zub<br><b>25031 19,1 +WK/Zub ATE</b> |                              |  |
|                       | 1.4 ecoFLEX           | 64  |       | 12.09 |                | 13.0470-7262.2 | LD7262 |   |   |                              |  |
|                       | 1.4 ecoFLEX           | 74  |       | 12.09 |                |                |        |   |   |                              |  |
|                       | 1.4 LPG Turbo ecoFLEX | 103 |       | 01.12 |                |                |        |   |   |                              |  |
|                       | 1.4 Turbo ECOTEC      | 88  |       | 11.10 |                |                |        |   |   |                              |  |
|                       | 1.4 Turbo ECOTEC      | 103 |       | 12.09 |                |                |        |   |   |                              |  |
|                       | 1.6 CDTi              | 81  |       | 02.14 |                |                |        |   |   |                              |  |
|                       | 1.6 CDTi              | 100 |       | 01.14 |                |                |        |   |   |                              |  |
|                       | 1.6 SIDI              | 125 |       | 12.12 |                |                |        |   |   |                              |  |
|                       | 1.6 SIDI              | 147 |       | 07.13 |                |                |        |   |   |                              |  |
|                       | 1.6 Turbo ECOTEC      | 85  |       | 12.09 |                |                |        |   |   |                              |  |
|                       | 1.6 Turbo ECOTEC      | 132 |       | 12.09 |                |                |        |   |   |                              |  |
|                       | 1.7 CDTi ECOTEC       | 81  |       | 12.09 |                |                |        |   |   |                              |  |
|                       | 1.7 CDTi ECOTEC       | 96  |       | 12.09 |                |                |        |   |   |                              |  |
|                       | 1.8                   | 103 |       | 10.11 |                |                |        |   |   |                              |  |
|                       | 2.0 CDTi BiTurbo      | 143 |       | 12.12 |                |                |        |   |   |                              |  |
|                       | 2.0 CDTi ECOTEC       |     |       | 12.09 |                |                |        |   |   |                              |  |
|                       | 1.3 CDTi ECOTEC       | 70  |       | 12.09 |                | 13.0460-7263.2 | 607263 |   |   |                              | 24034 19,1 +WK/Zub<br><b>24034 19,1 +WK/Zub ATE</b>      |
|                       | 1.4 ecoFLEX           | 64  |       | 12.09 |                | 13.0470-7263.2 | LD7263 |   |   |                              |  |
|                       | 1.4 ecoFLEX           | 74  |       | 12.09 |                |                |        |   |   |                              |  |
| 1.4 LPG Turbo ecoFLEX | 103                   |     | 01.12 |       |                |                |        |   |   |                              |  |
| 1.4 Turbo ECOTEC      | 88                    |     | 11.10 |       |                |                |        |   |   |                              |  |
| 1.4 Turbo ECOTEC      | 103                   |     | 12.09 |       |                |                |        |   |   |                              |  |
| 1.6 CDTi              | 81                    |     | 02.14 |       |                |                |        |   |   |                              |  |
| 1.6 CDTi              | 100                   |     | 01.14 |       |                |                |        |   |   |                              |  |
| 1.6 SIDI              | 125                   |     | 12.12 |       |                |                |        |   |   |                              |  |
| 1.6 SIDI              | 147                   |     | 07.13 |       |                |                |        |   |   |                              |  |
| 1.6 Turbo ECOTEC      | 85                    |     | 12.09 |       |                |                |        |   |   |                              |  |
| 1.6 Turbo ECOTEC      | 132                   |     | 12.09 |       |                |                |        |   |   |                              |  |
| 1.7 CDTi ECOTEC       | 81                    |     | 12.09 |       |                |                |        |   |   |                              |  |
| 1.7 CDTi ECOTEC       | 96                    |     | 12.09 |       |                |                |        |   |   |                              |  |
| 1.8                   | 103                   |     | 10.11 |       |                |                |        |   |   |                              |  |
| 2.0 CDTi BiTurbo      | 143                   |     | 12.12 |       |                |                |        |   |   |                              |  |
| 2.0 CDTi ECOTEC       |                       |     | 12.09 |       |                |                |        |   |   |                              |  |
| 1.3 CDTi ECOTEC       | 70                    |     | 12.09 |       | 13.0460-5612.2 | 605612         |        | 24412 19,0 +WK/Zub<br><b>24412 19,0 +WK/Zub MAN</b> |   |                              |  |
| 1.4 ecoFLEX           | 64                    |     | 12.09 |       | 13.0470-5612.2 | LD5612         |        |   |   |                              |  |
| 1.4 ecoFLEX           | 74                    |     | 12.09 |       |                |                |        |   |   |                              |  |
| 1.4 LPG Turbo ecoFLEX | 103                   |     | 01.12 |       |                |                |        |   |   |                              |  |
| 1.4 Turbo ECOTEC      | 88                    |     | 11.10 |       |                |                |        |   |   |                              |  |
| 1.4 Turbo ECOTEC      | 103                   |     | 12.09 |       |                |                |        |   |   |                              |  |
| 1.6 CDTi              | 81                    |     | 02.14 |       |                |                |        |   |   |                              |  |
| 1.6 CDTi              | 100                   |     | 01.14 |       |                |                |        |   |   |                              |  |
| 1.6 SIDI              | 125                   |     | 12.12 |       |                |                |        |   |   |                              |  |
| 1.6 SIDI              | 147                   |     | 07.13 |       |                |                |        |   |   |                              |  |
| 1.6 Turbo ECOTEC      | 85                    |     | 12.09 |       |                |                |        |   |   |                              |  |
| 1.6 Turbo ECOTEC      | 132                   |     | 12.09 |       |                |                |        |   |   |                              |  |
| 1.7 CDTi ECOTEC       | 81                    |     | 12.09 |       |                |                |        |   |   |                              |  |
| 1.7 CDTi ECOTEC       | 96                    |     | 12.09 |       |                |                |        |   |   |                              |  |
| 1.8                   | 103                   |     | 10.11 |       |                |                |        |   |   |                              |  |
| 2.0 CDTi BiTurbo      | 143                   |     | 12.12 |       |                |                |        |   |   |                              |  |
| 2.0 CDTi ECOTEC       |                       |     | 12.09 |       |                |                |        |   |   |                              |  |
| 2.0 OPC               | 206                   |     | 06.12 |       | 13.0460-4855.2 | 604855         |        |   |   | 23325 16,4 /WK<br><b>BRE</b> |  |
|                       | 1.3 CDTi ECOTEC       | 70  |       | 12.09 |                | 24.0126-0165.1 |        |   | 426165  |                              | 276 26,0 23,0 V +S +B<br><b>276 26,0 23,0 V +S +B PD</b> |
|                       | 1.4 ecoFLEX           | 64  |       | 12.09 |                | 24.0326-0165.1 |        |   | 526165  |                              |  |
|                       | 1.4 ecoFLEX           | 74  |       | 12.09 |                |                |        |   |   |                              |  |
|                       | 1.4 LPG Turbo ecoFLEX | 103 |       | 01.12 |                |                |        |   |   |                              |  |
|                       | 1.4 Turbo ECOTEC      | 88  |       | 11.10 |                |                |        |   |   |                              |  |
|                       | 1.4 Turbo ECOTEC      | 103 |       | 12.09 |                |                |        |   |   |                              |  |
|                       | 1.6 CDTi              | 81  |       | 02.14 |                |                |        |   |   |                              |  |
|                       | 1.6 CDTi              | 100 |       | 01.14 |                |                |        |   |   |                              |  |
|                       | 1.6 SIDI              | 125 |       | 12.12 |                |                |        |   |   |                              |  |
|                       | 1.6 SIDI              | 147 |       | 07.13 |                |                |        |   |   |                              |  |
|                       | 1.6 Turbo ECOTEC      | 85  |       | 12.09 |                |                |        |   |   |                              |  |
|                       | 1.6 Turbo ECOTEC      | 132 |       | 12.09 |                |                |        |   |   |                              |  |
|                       | 1.7 CDTi ECOTEC       | 81  |       | 12.09 |                |                |        |   |   |                              |  |
|                       | 1.7 CDTi ECOTEC       | 96  |       | 12.09 |                |                |        |   |   |                              |  |
|                       | 1.8                   | 103 |       | 10.11 |                |                |        |   |   |                              |  |
|                       | 2.0 CDTi BiTurbo      | 143 |       | 12.12 |                |                |        |   |   |                              |  |
|                       | 2.0 CDTi ECOTEC       |     |       | 12.09 |                |                |        |   |   |                              |  |

<sup>1)</sup> for 4 bore wheel rim / per cerchione a 4 fori / pour jante à 4 trous / para Llantas de 4 taladros

<sup>2)</sup> for 5 bore wheel rim / per cerchione a 5 fori / pour jante à 5 trous / para Llantas de 5 taladros

<sup>3)</sup> + brake disc diameter 276 mm / + disco fr.diam. 276mm / + disques fr.diam. 276mm / + disco fr.diam. 276mm

<sup>4)</sup> + brake disc diameter 300mm / + diametro dischi freno 300mm / + diamètre disques frein 300mm / + diámetro disco freno 300mm

<sup>5)</sup> + brake disc diameter 321mm / + diametro dischi freno 321mm / + diamètre disques frein 321mm / + diámetro disco freno 321mm





**OPEL ASTRA J / GTC / Vauxhall Astra MK VI (09-)**

|                  |                       |       |   |   |                |                                      |   |                           |
|------------------|-----------------------|-------|---|---|----------------|--------------------------------------|---|---------------------------|
|                  | 1.3 CDTi ECOTEC       | 70    | 12.09                                       | + Bremsscheibendurchm. 300 mm <sup>1)</sup> | 24.0126-0166.1 | 426166                               |   | 300 26,0 23,0 VL +S +B    |
|                  | 1.4 ecoFLEX           | 64    | 12.09                                       | + Bremsscheibendurchm. 300 mm <sup>1)</sup> | 24.0326-0166.1 | 526166                               |   | 300 26,0 23,0 VL +S +B PD |
|                  | 1.4 ecoFLEX           | 74    | 12.09                                       | + Bremsscheibendurchm. 300 mm <sup>1)</sup> |                |                                      |   |                           |
|                  | 1.4 LPG Turbo ecoFLEX | 103   | 01.12                                       | + Bremsscheibendurchm. 300 mm <sup>1)</sup> |                |                                      |   |                           |
|                  | 1.4 Turbo ECOTEC      | 88    | 11.10                                       | + Bremsscheibendurchm. 300 mm <sup>1)</sup> |                |                                      |   |                           |
|                  | 1.4 Turbo ECOTEC      | 103   | 12.09                                       | + Bremsscheibendurchm. 300 mm <sup>1)</sup> |                |                                      |   |                           |
|                  | 1.6 CDTi              | 81    | 02.14                                       | + Bremsscheibendurchm. 300 mm <sup>1)</sup> |                |                                      |   |                           |
|                  | 1.6 CDTi              | 100   | 01.14                                       | + Bremsscheibendurchm. 300 mm <sup>1)</sup> |                |                                      |   |                           |
|                  | 1.6 SIDI              | 125   | 12.12                                       | + Bremsscheibendurchm. 300 mm <sup>1)</sup> |                |                                      |   |                           |
|                  | 1.6 SIDI              | 147   | 07.13                                       | + Bremsscheibendurchm. 300 mm <sup>1)</sup> |                |                                      |   |                           |
|                  | 1.6 Turbo ECOTEC      | 85    | 12.09                                       | + Bremsscheibendurchm. 300 mm <sup>1)</sup> |                |                                      |   |                           |
|                  | 1.6 Turbo ECOTEC      | 132   | 12.09                                       | + Bremsscheibendurchm. 300 mm <sup>1)</sup> |                |                                      |   |                           |
|                  | 1.7 CDTi ECOTEC       | 81    | 12.09                                       | + Bremsscheibendurchm. 300 mm <sup>1)</sup> |                |                                      |   |                           |
| 1.7 CDTi ECOTEC  | 96                    | 12.09 | + Bremsscheibendurchm. 300 mm <sup>1)</sup> |   |                |                                      |   |                           |
| 1.8              | 103                   | 10.11 | + Bremsscheibendurchm. 300 mm <sup>1)</sup> |   |                |                                      |   |                           |
| 2.0 CDTi BiTurbo | 143                   | 12.12 | + Bremsscheibendurchm. 300 mm <sup>1)</sup> |   |                |                                      |   |                           |
| 2.0 CDTi ECOTEC  |                       | 12.09 | + Bremsscheibendurchm. 300 mm <sup>1)</sup> |   |                |                                      |   |                           |
|                  | 1.3 CDTi ECOTEC       | 70    | 12.09                                       | + Bremsscheibendurchm. 321 mm <sup>2)</sup> | 24.0130-0224.1 | 430224                               |   | 321 30,0 27,0 VL +S +B    |
|                  | 1.4 ecoFLEX           | 64    | 12.09                                       | + Bremsscheibendurchm. 321 mm <sup>2)</sup> |                |                                      |   |                           |
|                  | 1.4 ecoFLEX           | 74    | 12.09                                       | + Bremsscheibendurchm. 321 mm <sup>2)</sup> |                |                                      |   |                           |
|                  | 1.4 LPG Turbo ecoFLEX | 103   | 01.12                                       | + Bremsscheibendurchm. 321 mm <sup>2)</sup> |                |                                      |   |                           |
|                  | 1.4 Turbo ECOTEC      | 88    | 11.10                                       | + Bremsscheibendurchm. 321 mm <sup>2)</sup> |                |                                      |   |                           |
|                  | 1.4 Turbo ECOTEC      | 103   | 12.09                                       | + Bremsscheibendurchm. 321 mm <sup>2)</sup> |                |                                      |   |                           |
|                  | 1.6 CDTi              | 81    | 02.14                                       | + Bremsscheibendurchm. 321 mm <sup>2)</sup> |                |                                      |   |                           |
|                  | 1.6 CDTi              | 100   | 01.14                                       | + Bremsscheibendurchm. 321 mm <sup>2)</sup> |                |                                      |   |                           |
|                  | 1.6 SIDI              | 125   | 12.12                                       | + Bremsscheibendurchm. 321 mm <sup>2)</sup> |                |                                      |   |                           |
|                  | 1.6 SIDI              | 147   | 07.13                                       | + Bremsscheibendurchm. 321 mm <sup>2)</sup> |                |                                      |   |                           |
|                  | 1.6 Turbo ECOTEC      | 85    | 12.09                                       | + Bremsscheibendurchm. 321 mm <sup>2)</sup> |                |                                      |   |                           |
|                  | 1.6 Turbo ECOTEC      | 132   | 12.09                                       | + Bremsscheibendurchm. 321 mm <sup>2)</sup> |                |                                      |   |                           |
|                  | 1.7 CDTi ECOTEC       | 81    | 12.09                                       | + Bremsscheibendurchm. 321 mm <sup>2)</sup> |                |                                      |   |                           |
| 1.7 CDTi ECOTEC  | 96                    | 12.09 | + Bremsscheibendurchm. 321 mm <sup>2)</sup> |   |                |                                      |   |                           |
| 1.8              | 103                   | 10.11 | + Bremsscheibendurchm. 321 mm <sup>2)</sup> |   |                |                                      |   |                           |
| 2.0 CDTi BiTurbo | 143                   | 12.12 | + Bremsscheibendurchm. 321 mm <sup>2)</sup> |   |                |                                      |   |                           |
| 2.0 CDTi ECOTEC  |                       | 12.09 | + Bremsscheibendurchm. 321 mm <sup>2)</sup> |   |                |                                      |   |                           |
|                  | 1.3 CDTi ECOTEC       | 70    | 12.09                                       |   | 24.0711-5377.3 | 360379                               | 2  - Flexride Fahrwerk/ 3-türig <sup>3)</sup> | Radsensor L=930           |
|                  | 1.4 ecoFLEX           | 64    | 12.09                                       |   | 24.0711-5348.3 | 360351                               | 2  - Flexride Fahrwerk/ 5-türig <sup>4)</sup> | Radsensor L=800           |
|                  | 1.4 ecoFLEX           | 74    | 12.09                                       |   |                |                                      |   |                           |
|                  | 1.4 LPG Turbo ecoFLEX | 103   | 01.12                                       |   |                |                                      |   |                           |
|                  | 1.4 Turbo ECOTEC      | 88    | 11.10                                       |   |                |                                      |   |                           |
|                  | 1.4 Turbo ECOTEC      | 103   | 12.09                                       |   |                |                                      |   |                           |
|                  | 1.6 CDTi              | 81    | 02.14                                       |   |                |                                      |   |                           |
|                  | 1.6 CDTi              | 100   | 01.14                                       |   |                |                                      |   |                           |
|                  | 1.6 SIDI              | 125   | 12.12                                       |   |                |                                      |   |                           |
|                  | 1.6 SIDI              | 147   | 07.13                                       |   |                |                                      |   |                           |
|                  | 1.6 Turbo ECOTEC      | 85    | 12.09                                       |   |                |                                      |   |                           |
|                  | 1.6 Turbo ECOTEC      | 132   | 12.09                                       |   |                |                                      |   |                           |
|                  | 1.7 CDTi ECOTEC       | 81    | 12.09                                       |   |                |                                      |   |                           |
| 1.7 CDTi ECOTEC  | 96                    | 12.09 |   |   |                |                                      |   |                           |
| 1.8              | 103                   | 10.11 |   |   |                |                                      |   |                           |
| 2.0 CDTi BiTurbo | 143                   | 12.12 |   |   |                |                                      |   |                           |
| 2.0 CDTi ECOTEC  |                       | 12.09 |   |   |                |                                      |   |                           |
| 2.0 OPC          | 206                   | 06.12 |   | 24.0711-5377.3                              | 360379         | 2  - Flexride Fahrwerk <sup>5)</sup> | Radsensor L=930                               |                           |
|                  | 1.3 CDTi ECOTEC       | 70    | 12.09                                       |   | 13.0460-7264.2 | 607264                               |   | 25096 17,0 +WK/Zub ATE    |
|                  | 1.4 ecoFLEX           | 64    | 12.09                                       |   | 13.0470-7264.2 | LD7264                               |   | 25096 17,0 +WK/Zub ATE    |
|                  | 1.4 ecoFLEX           | 74    | 12.09                                       |   |                |                                      |   |                           |
|                  | 1.4 LPG Turbo ecoFLEX | 103   | 01.12                                       |   |                |                                      |   |                           |
|                  | 1.4 Turbo ECOTEC      | 88    | 11.10                                       |   |                |                                      |   |                           |
|                  | 1.4 Turbo ECOTEC      | 103   | 12.09                                       |   |                |                                      |   |                           |
|                  | 1.6 CDTi              | 81    | 02.14                                       |   |                |                                      |   |                           |
|                  | 1.6 CDTi              | 100   | 01.14                                       |   |                |                                      |   |                           |
|                  | 1.6 SIDI              | 125   | 12.12                                       |   |                |                                      |   |                           |
|                  | 1.6 SIDI              | 147   | 07.13                                       |   |                |                                      |   |                           |
|                  | 1.6 Turbo ECOTEC      | 85    | 12.09                                       |   |                |                                      |   |                           |
|                  | 1.6 Turbo ECOTEC      | 132   | 12.09                                       |   |                |                                      |   |                           |
|                  | 1.7 CDTi ECOTEC       | 81    | 12.09                                       |   |                |                                      |   |                           |
| 1.7 CDTi ECOTEC  | 96                    | 12.09 |   |   |                |                                      |   |                           |
| 1.8              | 103                   | 10.11 |   |   |                |                                      |   |                           |
| 2.0 CDTi BiTurbo | 143                   | 12.12 |   |   |                |                                      |   |                           |
| 2.0 CDTi ECOTEC  |                       | 12.09 |   |   |                |                                      |   |                           |
|                  | 1.3 CDTi ECOTEC       | 70    | 12.09                                       | + Bremsscheibendurchm. 268 mm <sup>6)</sup> | 24.0112-0188.1 | 412188                               |   | 268 12,0 10,0 +S +B       |
|                  | 1.4 ecoFLEX           | 64    | 12.09                                       | + Bremsscheibendurchm. 268 mm <sup>6)</sup> | 24.0312-0188.1 | 512188                               |   | 268 12,0 10,0 +S +B PD    |
|                  | 1.4 ecoFLEX           | 74    | 12.09                                       | + Bremsscheibendurchm. 268 mm <sup>6)</sup> |                |                                      |   |                           |
|                  | 1.4 LPG Turbo ecoFLEX | 103   | 01.12                                       | + Bremsscheibendurchm. 268 mm <sup>6)</sup> |                |                                      |   |                           |
|                  | 1.4 Turbo ECOTEC      | 88    | 11.10                                       | + Bremsscheibendurchm. 268 mm <sup>6)</sup> |                |                                      |   |                           |
|                  | 1.4 Turbo ECOTEC      | 103   | 12.09                                       | + Bremsscheibendurchm. 268 mm <sup>6)</sup> |                |                                      |   |                           |
|                  | 1.6 CDTi              | 81    | 02.14                                       | + Bremsscheibendurchm. 268 mm <sup>6)</sup> |                |                                      |   |                           |
|                  | 1.6 CDTi              | 100   | 01.14                                       | + Bremsscheibendurchm. 268 mm <sup>6)</sup> |                |                                      |   |                           |
|                  | 1.6 SIDI              | 125   | 12.12                                       | + Bremsscheibendurchm. 268 mm <sup>6)</sup> |                |                                      |   |                           |
|                  | 1.6 SIDI              | 147   | 07.13                                       | + Bremsscheibendurchm. 268 mm <sup>6)</sup> |                |                                      |   |                           |
|                  | 1.6 Turbo ECOTEC      | 85    | 12.09                                       | + Bremsscheibendurchm. 268 mm <sup>6)</sup> |                |                                      |   |                           |
|                  | 1.6 Turbo ECOTEC      | 132   | 12.09                                       | + Bremsscheibendurchm. 268 mm <sup>6)</sup> |                |                                      |   |                           |
|                  | 1.7 CDTi ECOTEC       | 81    | 12.09                                       | + Bremsscheibendurchm. 268 mm <sup>6)</sup> |                |                                      |   |                           |
| 1.7 CDTi ECOTEC  | 96                    | 12.09 | + Bremsscheibendurchm. 268 mm <sup>6)</sup> |   |                |                                      |   |                           |
| 1.8              | 103                   | 10.11 | + Bremsscheibendurchm. 268 mm <sup>6)</sup> |   |                |                                      |   |                           |
| 2.0 CDTi BiTurbo | 143                   | 12.12 | + Bremsscheibendurchm. 268 mm <sup>6)</sup> |   |                |                                      |   |                           |
| 2.0 CDTi ECOTEC  |                       | 12.09 | + Bremsscheibendurchm. 268 mm <sup>6)</sup> |   |                |                                      |   |                           |

<sup>1)</sup> + brake disc diameter 300mm / + diametro dischi freno 300mm / + diamètre disques frein 300mm / + diámetro disco freno 300mm  
<sup>2)</sup> + brake disc diameter 321mm / + diametro dischi freno 321mm / + diamètre disques frein 321mm / + diámetro disco freno 321mm  
<sup>3)</sup> - flexride suspension/ 3 door / - autotelaio flexride/ 3 porte / - châssis de flexride / 3 portes / - suspensión flexride/ 3 puertas  
<sup>4)</sup> - flexride suspension/ 5 door / - autotelaio flexride/ 5 porte / - châssis de flexride / 5 portes / - suspensión flexride/ 5 puertas  
<sup>5)</sup> - flexride suspension / - autotelaio flexride / - châssis de flexride / - suspensión flexride  
<sup>6)</sup> + brake disc diameter 268 mm / + disco fr.diam. 268mm / + disques fr.diam. 268mm / + disco fr.diam. 268mm

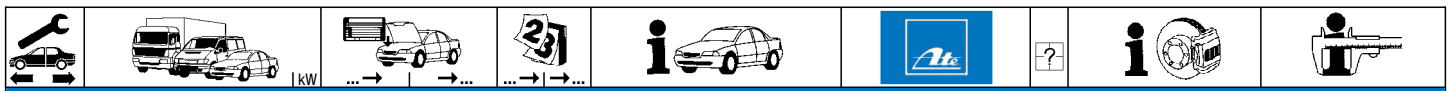

**OPEL ASTRA J / GTC / Vauxhall Astra MK VI (09-)**

|                  |                       |       |  |  |                |        |                                      |   |
|------------------|-----------------------|-------|--|--|----------------|--------|--------------------------------------|---|
|                  | 1.3 CDTi ECOTEC       | 70    | 12.09                                      | + Bremsscheibendurchm. 292mm <sup>1)</sup> | 24.0112-0189.1 | 412189 |                                      | 292 12,0 10,0 +S +B<br>292 12,0 10,0 +S +B PD |
|                  | 1.4 ecoFLEX           | 64    | 12.09                                      | + Bremsscheibendurchm. 292mm <sup>1)</sup> | 24.0312-0189.1 | 512189 |                                      |   |
|                  | 1.4 ecoFLEX           | 74    | 12.09                                      | + Bremsscheibendurchm. 292mm <sup>1)</sup> |                |        |                                      |   |
|                  | 1.4 LPG Turbo ecoFLEX | 103   | 01.12                                      | + Bremsscheibendurchm. 292mm <sup>1)</sup> |                |        |                                      |   |
|                  | 1.4 Turbo ECOTEC      | 88    | 11.10                                      | + Bremsscheibendurchm. 292mm <sup>1)</sup> |                |        |                                      |   |
|                  | 1.4 Turbo ECOTEC      | 103   | 12.09                                      | + Bremsscheibendurchm. 292mm <sup>1)</sup> |                |        |                                      |   |
|                  | 1.6 CDTi              | 81    | 02.14                                      | + Bremsscheibendurchm. 292mm <sup>1)</sup> |                |        |                                      |   |
|                  | 1.6 CDTi              | 100   | 01.14                                      | + Bremsscheibendurchm. 292mm <sup>1)</sup> |                |        |                                      |   |
|                  | 1.6 SIDI              | 125   | 12.12                                      | + Bremsscheibendurchm. 292mm <sup>1)</sup> |                |        |                                      |   |
|                  | 1.6 SIDI              | 147   | 07.13                                      | + Bremsscheibendurchm. 292mm <sup>1)</sup> |                |        |                                      |   |
|                  | 1.6 Turbo ECOTEC      | 85    | 12.09                                      | + Bremsscheibendurchm. 292mm <sup>1)</sup> |                |        |                                      |   |
|                  | 1.6 Turbo ECOTEC      | 132   | 12.09                                      | + Bremsscheibendurchm. 292mm <sup>1)</sup> |                |        |                                      |   |
|                  | 1.7 CDTi ECOTEC       | 81    | 12.09                                      | + Bremsscheibendurchm. 292mm <sup>1)</sup> |                |        |                                      |   |
|                  | 1.7 CDTi ECOTEC       | 96    | 12.09                                      | + Bremsscheibendurchm. 292mm <sup>1)</sup> |                |        |                                      |   |
|                  | 1.8                   | 103   | 10.11                                      | + Bremsscheibendurchm. 292mm <sup>1)</sup> |                |        |                                      |   |
| 2.0 CDTi BiTurbo | 143                   | 12.12 | + Bremsscheibendurchm. 292mm <sup>1)</sup> |  |                |        |                                      |   |
| 2.0 CDTi ECOTEC  |                       | 12.09 | + Bremsscheibendurchm. 292mm <sup>1)</sup> |  |                |        |                                      |   |
|                  | 1.3 CDTi ECOTEC       | 70    | 12.09                                      |  | 24.0711-5366.3 | 360355 | 2  - Flexride Fahrwerk <sup>2)</sup> | Radsensor L=574                               |
|                  | 1.4 ecoFLEX           | 64    | 12.09                                      |  |                |        |                                      |   |
|                  | 1.4 ecoFLEX           | 74    | 12.09                                      |  |                |        |                                      |   |
|                  | 1.4 LPG Turbo ecoFLEX | 103   | 01.12                                      |  |                |        |                                      |   |
|                  | 1.4 Turbo ECOTEC      | 88    | 11.10                                      |  |                |        |                                      |   |
|                  | 1.4 Turbo ECOTEC      | 103   | 12.09                                      |  |                |        |                                      |   |
|                  | 1.6 CDTi              | 81    | 02.14                                      |  |                |        |                                      |   |
|                  | 1.6 CDTi              | 100   | 01.14                                      |  |                |        |                                      |   |
|                  | 1.6 SIDI              | 125   | 12.12                                      |  |                |        |                                      |   |
|                  | 1.6 SIDI              | 147   | 07.13                                      |  |                |        |                                      |   |
|                  | 1.6 Turbo ECOTEC      | 85    | 12.09                                      |  |                |        |                                      |   |
|                  | 1.6 Turbo ECOTEC      | 132   | 12.09                                      |  |                |        |                                      |   |
|                  | 1.7 CDTi ECOTEC       | 81    | 12.09                                      |  |                |        |                                      |   |
|                  | 1.7 CDTi ECOTEC       | 96    | 12.09                                      |  |                |        |                                      |   |
|                  | 1.8                   | 103   | 10.11                                      |  |                |        |                                      |   |
| 2.0 CDTi BiTurbo | 143                   | 12.12 |  |  |                |        |                                      |   |
| 2.0 CDTi ECOTEC  |                       | 12.09 |  |  |                |        |                                      |   |
| 2.0 OPC          | 206                   | 06.12 |  |  |                |        |                                      |   |

**OPEL ASTRA J Sports Tourer/Vau.Astra Sports Tourer (10-)**

|                 |                       |       |   |   |                |        |  |  |
|-----------------|-----------------------|-------|---|---|----------------|--------|--|--|
|                 | 1.3 CDTi ECOTEC       | 70    | 11.10                                       | + Bremsscheibendurchm. 276 mm <sup>3)</sup> | 13.0460-7262.2 | 607262 |  | 25031 19,1 +/WK/Zub<br>25031 19,1 +/WK/Zub ATE     |
|                 | 1.4 ecoFLEX           | 64    | 11.10                                       | + Bremsscheibendurchm. 276 mm <sup>3)</sup> | 13.0470-7262.2 | LD7262 |  |  |
|                 | 1.4 ecoFLEX           | 74    | 11.10                                       | + Bremsscheibendurchm. 276 mm <sup>3)</sup> |                |        |  |  |
|                 | 1.4 LPG Turbo ecoFLEX | 103   | 01.12                                       | + Bremsscheibendurchm. 276 mm <sup>3)</sup> |                |        |  |  |
|                 | 1.4 Turbo ECOTEC      | 88    | 11.10                                       | + Bremsscheibendurchm. 276 mm <sup>3)</sup> |                |        |  |  |
|                 | 1.4 Turbo ECOTEC      | 103   | 11.10                                       | + Bremsscheibendurchm. 276 mm <sup>3)</sup> |                |        |  |  |
|                 | 1.6 CDTi              | 81    | 02.14                                       | + Bremsscheibendurchm. 276 mm <sup>3)</sup> |                |        |  |  |
|                 | 1.6 CDTi              | 100   | 01.14                                       | + Bremsscheibendurchm. 276 mm <sup>3)</sup> |                |        |  |  |
|                 | 1.6 ECOTEC            | 85    | 11.10                                       | + Bremsscheibendurchm. 276 mm <sup>3)</sup> |                |        |  |  |
|                 | 1.6 LPG               | 84    | 10.12                                       | + Bremsscheibendurchm. 276 mm <sup>3)</sup> |                |        |  |  |
|                 | 1.6 SIDI              | 125   | 12.12                                       | + Bremsscheibendurchm. 276 mm <sup>3)</sup> |                |        |  |  |
|                 | 1.6 Turbo ECOTEC      | 132   | 11.10                                       | + Bremsscheibendurchm. 276 mm <sup>3)</sup> |                |        |  |  |
|                 | 1.7 CDTi ECOTEC       |       | 11.10                                       | + Bremsscheibendurchm. 276 mm <sup>3)</sup> |                |        |  |  |
|                 | 1.7 CDTi ECOTEC       | 92    | 11.10                                       | + Bremsscheibendurchm. 276 mm <sup>3)</sup> |                |        |  |  |
|                 | 2.0 CDTi BiTurbo      | 143   | 12.12                                       | + Bremsscheibendurchm. 276 mm <sup>3)</sup> |                |        |  |  |
| 2.0 CDTi ECOTEC |                       | 11.10 | + Bremsscheibendurchm. 276 mm <sup>3)</sup> |   |                |        |  |  |
|                 | 1.3 CDTi ECOTEC       | 70    | 11.10                                       | + Bremsscheibendurchm. 300 mm <sup>4)</sup> | 13.0460-7263.2 | 607263 |  | 24034 19,1 +/WK/Zub<br>24034 19,1 +/WK/Zub ATE     |
|                 | 1.4 ecoFLEX           | 64    | 11.10                                       | + Bremsscheibendurchm. 300 mm <sup>4)</sup> | 13.0470-7263.2 | LD7263 |  |  |
|                 | 1.4 ecoFLEX           | 74    | 11.10                                       | + Bremsscheibendurchm. 300 mm <sup>4)</sup> |                |        |  |  |
|                 | 1.4 LPG Turbo ecoFLEX | 103   | 01.12                                       | + Bremsscheibendurchm. 300 mm <sup>4)</sup> |                |        |  |  |
|                 | 1.4 Turbo ECOTEC      | 88    | 11.10                                       | + Bremsscheibendurchm. 300 mm <sup>4)</sup> |                |        |  |  |
|                 | 1.4 Turbo ECOTEC      | 103   | 11.10                                       | + Bremsscheibendurchm. 300 mm <sup>4)</sup> |                |        |  |  |
|                 | 1.6 CDTi              | 81    | 02.14                                       | + Bremsscheibendurchm. 300 mm <sup>4)</sup> |                |        |  |  |
|                 | 1.6 CDTi              | 100   | 01.14                                       | + Bremsscheibendurchm. 300 mm <sup>4)</sup> |                |        |  |  |
|                 | 1.6 ECOTEC            | 85    | 11.10                                       | + Bremsscheibendurchm. 300 mm <sup>4)</sup> |                |        |  |  |
|                 | 1.6 LPG               | 84    | 10.12                                       | + Bremsscheibendurchm. 300 mm <sup>4)</sup> |                |        |  |  |
|                 | 1.6 SIDI              | 125   | 12.12                                       | + Bremsscheibendurchm. 300 mm <sup>4)</sup> |                |        |  |  |
|                 | 1.6 Turbo ECOTEC      | 132   | 11.10                                       | + Bremsscheibendurchm. 300 mm <sup>4)</sup> |                |        |  |  |
|                 | 1.7 CDTi ECOTEC       |       | 11.10                                       | + Bremsscheibendurchm. 300 mm <sup>4)</sup> |                |        |  |  |
|                 | 1.7 CDTi ECOTEC       | 92    | 11.10                                       | + Bremsscheibendurchm. 300 mm <sup>4)</sup> |                |        |  |  |
|                 | 2.0 CDTi BiTurbo      | 143   | 12.12                                       | + Bremsscheibendurchm. 300 mm <sup>4)</sup> |                |        |  |  |
| 2.0 CDTi ECOTEC |                       | 11.10 | + Bremsscheibendurchm. 300 mm <sup>4)</sup> |   |                |        |  |  |
|                 | 1.3 CDTi ECOTEC       | 70    | 11.10                                       | + Bremsscheibendurchm. 321 mm <sup>5)</sup> | 13.0460-5612.2 | 605612 |  | 24412 19,0 +/WK/Zub MAN<br>24412 19,0 +/WK/Zub MAN |
|                 | 1.4 ecoFLEX           | 64    | 11.10                                       | + Bremsscheibendurchm. 321 mm <sup>5)</sup> | 13.0470-5612.2 | LD5612 |  |  |
|                 | 1.4 ecoFLEX           | 74    | 11.10                                       | + Bremsscheibendurchm. 321 mm <sup>5)</sup> |                |        |  |  |
|                 | 1.4 LPG Turbo ecoFLEX | 103   | 01.12                                       | + Bremsscheibendurchm. 321 mm <sup>5)</sup> |                |        |  |  |
|                 | 1.4 Turbo ECOTEC      | 88    | 11.10                                       | + Bremsscheibendurchm. 321 mm <sup>5)</sup> |                |        |  |  |
|                 | 1.4 Turbo ECOTEC      | 103   | 11.10                                       | + Bremsscheibendurchm. 321 mm <sup>5)</sup> |                |        |  |  |
|                 | 1.6 CDTi              | 81    | 02.14                                       | + Bremsscheibendurchm. 321 mm <sup>5)</sup> |                |        |  |  |
|                 | 1.6 CDTi              | 100   | 01.14                                       | + Bremsscheibendurchm. 321 mm <sup>5)</sup> |                |        |  |  |
|                 | 1.6 ECOTEC            | 85    | 11.10                                       | + Bremsscheibendurchm. 321 mm <sup>5)</sup> |                |        |  |  |
|                 | 1.6 LPG               | 84    | 10.12                                       | + Bremsscheibendurchm. 321 mm <sup>5)</sup> |                |        |  |  |
|                 | 1.6 SIDI              | 125   | 12.12                                       | + Bremsscheibendurchm. 321 mm <sup>5)</sup> |                |        |  |  |
|                 | 1.6 Turbo ECOTEC      | 132   | 11.10                                       | + Bremsscheibendurchm. 321 mm <sup>5)</sup> |                |        |  |  |
|                 | 1.7 CDTi ECOTEC       |       | 11.10                                       | + Bremsscheibendurchm. 321 mm <sup>5)</sup> |                |        |  |  |
|                 | 1.7 CDTi ECOTEC       | 92    | 11.10                                       | + Bremsscheibendurchm. 321 mm <sup>5)</sup> |                |        |  |  |
|                 | 2.0 CDTi BiTurbo      | 143   | 12.12                                       | + Bremsscheibendurchm. 321 mm <sup>5)</sup> |                |        |  |  |
| 2.0 CDTi ECOTEC |                       | 11.10 | + Bremsscheibendurchm. 321 mm <sup>5)</sup> |   |                |        |  |  |

<sup>1)</sup> + brake disc diameter 292mm / + diametro dischi freno 292mm / + diamètre disques frein 292mm / + diámetro disco freno 292mm

<sup>2)</sup> - flexride suspension / - autotelaio flexride / - châssis de flexride / - suspensión flexride

<sup>3)</sup> + brake disc diameter 276 mm / + disco fr.diam. 276mm / + disques fr.diam. 276mm / + disco fr.diam. 276mm

<sup>4)</sup> + brake disc diameter 300mm / + diametro dischi freno 300mm / + diamètre disques frein 300mm / + diámetro disco freno 300mm

<sup>5)</sup> + brake disc diameter 321mm / + diametro dischi freno 321mm / + diamètre disques frein 321mm / + diámetro disco freno 321mm







**OPEL ASTRA J Sports Tourer/Vau.Astra Sports Tourer (10-)**

|                       |                       |                 |   |   |   |                         |        |   |   |  |  |
|-----------------------|-----------------------|-----------------|---|---|---|-------------------------|--------|---|---|--|--|
|                       | 1.3 CDTi ECOTEC       | 70              | 11.10                                       | + Bremsscheibendurchm. 276 mm <sup>1)</sup> | 24.0126-0165.1                              | 426165                  |        | 276 26,0 23,0 V +S +B<br>276 26,0 23,0 V +S +B PD |   |  |  |
|                       | 1.4 ecoFLEX           | 64              | 11.10                                       | + Bremsscheibendurchm. 276 mm <sup>1)</sup> | 24.0326-0165.1                              | 526165                  |        |   |   |  |  |
|                       | 1.4 ecoFLEX           | 74              | 11.10                                       | + Bremsscheibendurchm. 276 mm <sup>1)</sup> |   |                         |        |   |   |  |  |
|                       | 1.4 LPG Turbo ecoFLEX | 103             | 01.12                                       | + Bremsscheibendurchm. 276 mm <sup>1)</sup> |   |                         |        |   |   |  |  |
|                       | 1.4 Turbo ECOTEC      | 88              | 11.10                                       | + Bremsscheibendurchm. 276 mm <sup>1)</sup> |   |                         |        |   |   |  |  |
|                       | 1.4 Turbo ECOTEC      | 103             | 11.10                                       | + Bremsscheibendurchm. 276 mm <sup>1)</sup> |   |                         |        |   |   |  |  |
|                       | 1.6 CDTi              | 81              | 02.14                                       | + Bremsscheibendurchm. 276 mm <sup>1)</sup> |   |                         |        |   |   |  |  |
|                       | 1.6 CDTi              | 100             | 01.14                                       | + Bremsscheibendurchm. 276 mm <sup>1)</sup> |   |                         |        |   |   |  |  |
|                       | 1.6 ECOTEC            | 85              | 11.10                                       | + Bremsscheibendurchm. 276 mm <sup>1)</sup> |   |                         |        |   |   |  |  |
|                       | 1.6 LPG               | 84              | 10.12                                       | + Bremsscheibendurchm. 276 mm <sup>1)</sup> |   |                         |        |   |   |  |  |
|                       | 1.6 SIDI              | 125             | 12.12                                       | + Bremsscheibendurchm. 276 mm <sup>1)</sup> |   |                         |        |   |   |  |  |
|                       | 1.6 Turbo ECOTEC      | 132             | 11.10                                       | + Bremsscheibendurchm. 276 mm <sup>1)</sup> |   |                         |        |   |   |  |  |
|                       | 1.7 CDTi ECOTEC       |                 | 11.10                                       | + Bremsscheibendurchm. 276 mm <sup>1)</sup> |   |                         |        |   |   |  |  |
|                       | 1.7 CDTi ECOTEC       | 92              | 11.10                                       | + Bremsscheibendurchm. 276 mm <sup>1)</sup> |   |                         |        |   |   |  |  |
|                       | 2.0 CDTi BiTurbo      | 143             | 12.12                                       | + Bremsscheibendurchm. 276 mm <sup>1)</sup> |   |                         |        |   |   |  |  |
|                       | 2.0 CDTi ECOTEC       |                 | 11.10                                       | + Bremsscheibendurchm. 276 mm <sup>1)</sup> |   |                         |        |   |   |  |  |
|                       | 1.3 CDTi ECOTEC       | 70              | 11.10                                       | + Bremsscheibendurchm. 300 mm <sup>2)</sup> | 24.0126-0166.1                              | 426166                  |        |   | 300 26,0 23,0 V L +S +B<br>300 26,0 23,0 V L +S +B PD |  |  |
|                       | 1.4 ecoFLEX           | 64              | 11.10                                       | + Bremsscheibendurchm. 300 mm <sup>2)</sup> | 24.0326-0166.1                              | 526166                  |        |   |   |  |  |
|                       | 1.4 ecoFLEX           | 74              | 11.10                                       | + Bremsscheibendurchm. 300 mm <sup>2)</sup> |   |                         |        |   |   |  |  |
| 1.4 LPG Turbo ecoFLEX | 103                   | 01.12           | + Bremsscheibendurchm. 300 mm <sup>2)</sup> |   |   |                         |        |   |   |  |  |
| 1.4 Turbo ECOTEC      | 88                    | 11.10           | + Bremsscheibendurchm. 300 mm <sup>2)</sup> |   |   |                         |        |   |   |  |  |
| 1.4 Turbo ECOTEC      | 103                   | 11.10           | + Bremsscheibendurchm. 300 mm <sup>2)</sup> |   |   |                         |        |   |   |  |  |
| 1.6 CDTi              | 81                    | 02.14           | + Bremsscheibendurchm. 300 mm <sup>2)</sup> |   |   |                         |        |   |   |  |  |
| 1.6 CDTi              | 100                   | 01.14           | + Bremsscheibendurchm. 300 mm <sup>2)</sup> |   |   |                         |        |   |   |  |  |
| 1.6 ECOTEC            | 85                    | 11.10           | + Bremsscheibendurchm. 300 mm <sup>2)</sup> |   |   |                         |        |   |   |  |  |
| 1.6 LPG               | 84                    | 10.12           | + Bremsscheibendurchm. 300 mm <sup>2)</sup> |   |   |                         |        |   |   |  |  |
| 1.6 SIDI              | 125                   | 12.12           | + Bremsscheibendurchm. 300 mm <sup>2)</sup> |   |   |                         |        |   |   |  |  |
| 1.6 Turbo ECOTEC      | 132                   | 11.10           | + Bremsscheibendurchm. 300 mm <sup>2)</sup> |   |   |                         |        |   |   |  |  |
| 1.7 CDTi ECOTEC       |                       | 11.10           | + Bremsscheibendurchm. 300 mm <sup>2)</sup> |   |   |                         |        |   |   |  |  |
| 1.7 CDTi ECOTEC       | 92                    | 11.10           | + Bremsscheibendurchm. 300 mm <sup>2)</sup> |   |   |                         |        |   |   |  |  |
| 2.0 CDTi BiTurbo      | 143                   | 12.12           | + Bremsscheibendurchm. 300 mm <sup>2)</sup> |   |   |                         |        |   |   |  |  |
| 2.0 CDTi ECOTEC       |                       | 11.10           | + Bremsscheibendurchm. 300 mm <sup>2)</sup> |   |   |                         |        |   |   |  |  |
| 1.3 CDTi ECOTEC       | 70                    | 11.10           | + Bremsscheibendurchm. 321 mm <sup>3)</sup> | 24.0130-0224.1                              | 430224                                      | 321 30,0 27,0 V L +S +B |        |   |   |  |  |
| 1.4 ecoFLEX           | 64                    | 11.10           | + Bremsscheibendurchm. 321 mm <sup>3)</sup> |   |   |                         |        |   |   |  |  |
| 1.4 ecoFLEX           | 74                    | 11.10           | + Bremsscheibendurchm. 321 mm <sup>3)</sup> |   |   |                         |        |   |   |  |  |
| 1.4 LPG Turbo ecoFLEX | 103                   | 01.12           | + Bremsscheibendurchm. 321 mm <sup>3)</sup> |   |   |                         |        |   |   |  |  |
| 1.4 Turbo ECOTEC      | 88                    | 11.10           | + Bremsscheibendurchm. 321 mm <sup>3)</sup> |   |   |                         |        |   |   |  |  |
| 1.4 Turbo ECOTEC      | 103                   | 11.10           | + Bremsscheibendurchm. 321 mm <sup>3)</sup> |   |   |                         |        |   |   |  |  |
| 1.6 CDTi              | 81                    | 02.14           | + Bremsscheibendurchm. 321 mm <sup>3)</sup> |   |   |                         |        |   |   |  |  |
| 1.6 CDTi              | 100                   | 01.14           | + Bremsscheibendurchm. 321 mm <sup>3)</sup> |   |   |                         |        |   |   |  |  |
| 1.6 ECOTEC            | 85                    | 11.10           | + Bremsscheibendurchm. 321 mm <sup>3)</sup> |   |   |                         |        |   |   |  |  |
| 1.6 LPG               | 84                    | 10.12           | + Bremsscheibendurchm. 321 mm <sup>3)</sup> |   |   |                         |        |   |   |  |  |
| 1.6 SIDI              | 125                   | 12.12           | + Bremsscheibendurchm. 321 mm <sup>3)</sup> |   |   |                         |        |   |   |  |  |
| 1.6 Turbo ECOTEC      | 132                   | 11.10           | + Bremsscheibendurchm. 321 mm <sup>3)</sup> |   |   |                         |        |   |   |  |  |
| 1.7 CDTi ECOTEC       |                       | 11.10           | + Bremsscheibendurchm. 321 mm <sup>3)</sup> |   |   |                         |        |   |   |  |  |
| 1.7 CDTi ECOTEC       | 92                    | 11.10           | + Bremsscheibendurchm. 321 mm <sup>3)</sup> |   |   |                         |        |   |   |  |  |
| 2.0 CDTi BiTurbo      | 143                   | 12.12           | + Bremsscheibendurchm. 321 mm <sup>3)</sup> |   |   |                         |        |   |   |  |  |
| 2.0 CDTi ECOTEC       |                       | 11.10           | + Bremsscheibendurchm. 321 mm <sup>3)</sup> |   |   |                         |        |   |   |  |  |
|                       | 1.3 CDTi ECOTEC       | 70              | 11.10                                       |   | 24.0711-5348.3                              |                         | 360351 | 2  - Flexride Fahrwerk <sup>4)</sup>              | Radsensor L=800                                       |  |  |
|                       | 1.4 ecoFLEX           | 64              | 11.10                                       |   |   |                         |        |   |   |  |  |
|                       | 1.4 ecoFLEX           | 74              | 11.10                                       |   |   |                         |        |   |   |  |  |
|                       | 1.4 LPG Turbo ecoFLEX | 103             | 01.12                                       |   |   |                         |        |   |   |  |  |
|                       | 1.4 Turbo ECOTEC      | 88              | 11.10                                       |   |   |                         |        |   |   |  |  |
|                       | 1.4 Turbo ECOTEC      | 103             | 11.10                                       |   |   |                         |        |   |   |  |  |
|                       | 1.6 CDTi              | 81              | 02.14                                       |   |   |                         |        |   |   |  |  |
|                       | 1.6 CDTi              | 100             | 01.14                                       |   |   |                         |        |   |   |  |  |
|                       | 1.6 ECOTEC            | 85              | 11.10                                       |   |   |                         |        |   |   |  |  |
|                       | 1.6 LPG               | 84              | 10.12                                       |   |   |                         |        |   |   |  |  |
|                       | 1.6 SIDI              | 125             | 12.12                                       |   |   |                         |        |   |   |  |  |
|                       | 1.6 Turbo ECOTEC      | 132             | 11.10                                       |   |   |                         |        |   |   |  |  |
|                       | 1.7 CDTi ECOTEC       |                 | 11.10                                       |   |   |                         |        |   |   |  |  |
|                       | 1.7 CDTi ECOTEC       | 92              | 11.10                                       |   |   |                         |        |   |   |  |  |
|                       | 2.0 CDTi BiTurbo      | 143             | 12.12                                       |   |   |                         |        |   |   |  |  |
|                       | 2.0 CDTi ECOTEC       |                 | 11.10                                       |   |   |                         |        |   |   |  |  |
|                       |                       | 1.3 CDTi ECOTEC | 70  | 11.10                                       |   | 13.0460-7264.2          | 607264 |   |   |  | 25096 17,0 +/WK/Zub ATE<br>25096 17,0 +/WK/Zub ATE |
|                       |                       | 1.4 ecoFLEX     | 64  | 11.10                                       |   | 13.0470-7264.2          | LD7264 |   |   |  |  |
|                       |                       | 1.4 ecoFLEX     | 74  | 11.10                                       |   |                         |        |   |   |  |  |
| 1.4 LPG Turbo ecoFLEX |                       | 103             | 01.12                                       |   |   |                         |        |   |   |  |  |
| 1.4 Turbo ECOTEC      |                       | 88              | 11.10                                       |   |   |                         |        |   |   |  |  |
| 1.4 Turbo ECOTEC      |                       | 103             | 11.10                                       |   |   |                         |        |   |   |  |  |
| 1.6 CDTi              |                       | 81              | 02.14                                       |   |   |                         |        |   |   |  |  |
| 1.6 CDTi              |                       | 100             | 01.14                                       |   |   |                         |        |   |   |  |  |
| 1.6 ECOTEC            |                       | 85              | 11.10                                       |   |   |                         |        |   |   |  |  |
| 1.6 LPG               |                       | 84              | 10.12                                       |   |   |                         |        |   |   |  |  |
| 1.6 SIDI              |                       | 125             | 12.12                                       |   |   |                         |        |   |   |  |  |
| 1.6 Turbo ECOTEC      |                       | 132             | 11.10                                       |   |   |                         |        |   |   |  |  |
| 1.7 CDTi ECOTEC       |                       |                 | 11.10                                       |   |   |                         |        |   |   |  |  |
| 1.7 CDTi ECOTEC       |                       | 92              | 11.10                                       |   |   |                         |        |   |   |  |  |
| 2.0 CDTi BiTurbo      |                       | 143             | 12.12                                       |   |   |                         |        |   |   |  |  |
| 2.0 CDTi ECOTEC       |                       |                 | 11.10                                       |   |   |                         |        |   |   |  |  |
|                       |                       | 1.3 CDTi ECOTEC | 70  | 11.10                                       | + Bremsscheibendurchm. 268 mm <sup>5)</sup> | 24.0112-0188.1          | 412188 |   | 268 12,0 10,0 +S +B<br>268 12,0 10,0 +S +B PD         |  |  |
|                       |                       | 1.4 ecoFLEX     | 64  | 11.10                                       | + Bremsscheibendurchm. 268 mm <sup>5)</sup> | 24.0312-0188.1          | 512188 |   |   |  |  |
|                       |                       | 1.4 ecoFLEX     | 74  | 11.10                                       | + Bremsscheibendurchm. 268 mm <sup>5)</sup> |                         |        |   |   |  |  |
|                       | 1.4 LPG Turbo ecoFLEX | 103             | 01.12                                       | + Bremsscheibendurchm. 268 mm <sup>5)</sup> |   |                         |        |   |   |  |  |
|                       | 1.4 Turbo ECOTEC      | 88              | 11.10                                       | + Bremsscheibendurchm. 268 mm <sup>5)</sup> |   |                         |        |   |   |  |  |
|                       | 1.4 Turbo ECOTEC      | 103             | 11.10                                       | + Bremsscheibendurchm. 268 mm <sup>5)</sup> |   |                         |        |   |   |  |  |
| 1.6 CDTi              | 81                    | 02.14           | + Bremsscheibendurchm. 268 mm <sup>5)</sup> |   |   |                         |        |   |   |  |  |

<sup>1)</sup> + brake disc diameter 276 mm / + disco fr.diam. 276mm / + disques fr.diam. 276mm / + disco fr.diam. 276mm  
<sup>2)</sup> + brake disc diameter 300mm / + diametro dischi freno 300mm / + diamètre disques frein 300mm / + diametro disco freno 300mm  
<sup>3)</sup> + brake disc diameter 321mm / + diametro dischi freno 321mm / + diamètre disques frein 321mm / + diametro disco freno 321mm  
<sup>4)</sup> - flexride suspension / - autoteleia flexride / - châssis de flexride / - suspensión flexride  
<sup>5)</sup> + brake disc diameter 268 mm / + disco fr.diam. 268mm / + disques fr.diam. 268mm / + disco fr.diam. 268mm





**OPEL ASTRA J Sports Tourer/Vau.Astra Sports Tourer (10-)**

|                       |                       |       |  |   |                |        |                                      |                        |
|-----------------------|-----------------------|-------|--|---|----------------|--------|--------------------------------------|------------------------|
|                       | 1.6 CDTi              | 100   | 01.14                                      | + Bremsscheibendurchm. 268 mm <sup>1)</sup> | 24.0112-0188.1 | 412188 |                                      | 268 12,0 10,0 +S +B    |
|                       | 1.6 ECOTEC            | 85    | 11.10                                      | + Bremsscheibendurchm. 268 mm <sup>1)</sup> | 24.0312-0188.1 | 512188 |                                      | 268 12,0 10,0 +S +B PD |
|                       | 1.6 LPG               | 84    | 10.12                                      | + Bremsscheibendurchm. 268 mm <sup>1)</sup> |                |        |                                      |                        |
|                       | 1.6 SIDI              | 125   | 12.12                                      | + Bremsscheibendurchm. 268 mm <sup>1)</sup> |                |        |                                      |                        |
|                       | 1.6 Turbo ECOTEC      | 132   | 11.10                                      | + Bremsscheibendurchm. 268 mm <sup>1)</sup> |                |        |                                      |                        |
|                       | 1.7 CDTi ECOTEC       |       | 11.10                                      | + Bremsscheibendurchm. 268 mm <sup>1)</sup> |                |        |                                      |                        |
|                       | 1.7 CDTi ECOTEC       | 92    | 11.10                                      | + Bremsscheibendurchm. 268 mm <sup>1)</sup> |                |        |                                      |                        |
|                       | 2.0 CDTi BiTurbo      | 143   | 12.12                                      | + Bremsscheibendurchm. 268 mm <sup>1)</sup> |                |        |                                      |                        |
|                       | 2.0 CDTi ECOTEC       |       | 11.10                                      | + Bremsscheibendurchm. 268 mm <sup>1)</sup> |                |        |                                      |                        |
|                       | 1.3 CDTi ECOTEC       | 70    | 11.10                                      | + Bremsscheibendurchm. 292mm <sup>2)</sup>  | 24.0112-0189.1 | 412189 |                                      | 292 12,0 10,0 +S +B    |
| 1.4 ecoFLEX           | 64                    | 11.10 | + Bremsscheibendurchm. 292mm <sup>2)</sup> | 24.0312-0189.1                              | 512189         |        | 292 12,0 10,0 +S +B PD               |                        |
| 1.4 ecoFLEX           | 74                    | 11.10 | + Bremsscheibendurchm. 292mm <sup>2)</sup> |   |                |        |                                      |                        |
| 1.4 LPG Turbo ecoFLEX | 103                   | 01.12 | + Bremsscheibendurchm. 292mm <sup>2)</sup> |   |                |        |                                      |                        |
| 1.4 Turbo ECOTEC      | 88                    | 11.10 | + Bremsscheibendurchm. 292mm <sup>2)</sup> |   |                |        |                                      |                        |
| 1.4 Turbo ECOTEC      | 103                   | 11.10 | + Bremsscheibendurchm. 292mm <sup>2)</sup> |   |                |        |                                      |                        |
| 1.6 CDTi              | 81                    | 02.14 | + Bremsscheibendurchm. 292mm <sup>2)</sup> |   |                |        |                                      |                        |
| 1.6 CDTi              | 100                   | 01.14 | + Bremsscheibendurchm. 292mm <sup>2)</sup> |   |                |        |                                      |                        |
| 1.6 ECOTEC            | 85                    | 11.10 | + Bremsscheibendurchm. 292mm <sup>2)</sup> |   |                |        |                                      |                        |
| 1.6 LPG               | 84                    | 10.12 | + Bremsscheibendurchm. 292mm <sup>2)</sup> |   |                |        |                                      |                        |
| 1.6 SIDI              | 125                   | 12.12 | + Bremsscheibendurchm. 292mm <sup>2)</sup> |   |                |        |                                      |                        |
| 1.6 Turbo ECOTEC      | 132                   | 11.10 | + Bremsscheibendurchm. 292mm <sup>2)</sup> |   |                |        |                                      |                        |
| 1.7 CDTi ECOTEC       |                       | 11.10 | + Bremsscheibendurchm. 292mm <sup>2)</sup> |   |                |        |                                      |                        |
| 1.7 CDTi ECOTEC       | 92                    | 11.10 | + Bremsscheibendurchm. 292mm <sup>2)</sup> |   |                |        |                                      |                        |
| 2.0 CDTi BiTurbo      | 143                   | 12.12 | + Bremsscheibendurchm. 292mm <sup>2)</sup> |   |                |        |                                      |                        |
| 2.0 CDTi ECOTEC       |                       | 11.10 | + Bremsscheibendurchm. 292mm <sup>2)</sup> |   |                |        |                                      |                        |
|                       | 1.3 CDTi ECOTEC       | 70    | 11.10                                      |   | 24.0711-5366.3 | 360355 | 2  - Flexride Fahrwerk <sup>3)</sup> | Radsensor L=574        |
|                       | 1.4 ecoFLEX           | 64    | 11.10                                      |   |                |        |                                      |                        |
|                       | 1.4 ecoFLEX           | 74    | 11.10                                      |   |                |        |                                      |                        |
|                       | 1.4 LPG Turbo ecoFLEX | 103   | 01.12                                      |   |                |        |                                      |                        |
|                       | 1.4 Turbo ECOTEC      | 88    | 11.10                                      |   |                |        |                                      |                        |
|                       | 1.4 Turbo ECOTEC      | 103   | 11.10                                      |   |                |        |                                      |                        |
|                       | 1.6 CDTi              | 81    | 02.14                                      |   |                |        |                                      |                        |
|                       | 1.6 CDTi              | 100   | 01.14                                      |   |                |        |                                      |                        |
|                       | 1.6 ECOTEC            | 85    | 11.10                                      |   |                |        |                                      |                        |
|                       | 1.6 LPG               | 84    | 10.12                                      |   |                |        |                                      |                        |
|                       | 1.6 SIDI              | 125   | 12.12                                      |   |                |        |                                      |                        |
|                       | 1.6 Turbo ECOTEC      | 132   | 11.10                                      |   |                |        |                                      |                        |
|                       | 1.7 CDTi ECOTEC       |       | 11.10                                      |   |                |        |                                      |                        |
|                       | 1.7 CDTi ECOTEC       | 92    | 11.10                                      |   |                |        |                                      |                        |
|                       | 2.0 CDTi BiTurbo      | 143   | 12.12                                      |   |                |        |                                      |                        |
| 2.0 CDTi ECOTEC       |                       | 11.10 |  |   |                |        |                                      |                        |

**OPEL CALIBRA / Vauxhall Calibra (89-97)**























|  |             |          |          |       |                |        |   |                            |
|--|-------------|----------|----------|-------|----------------|--------|---|----------------------------|
|  | 2.0         |          | 09.89    | 07.97 | 13.0460-7052.2 | 607052 |   | 21190 17,5 +/WE ATE        |
|  | 2.0 16V     |          | 09.89    | 07.97 | 24.8190-0705.2 | 620705 | 2 | Warnkontakt L=670mm        |
|  | 2.0 16V 4x4 |          | 09.89    | 07.97 |                |        |   |                            |
|  | 2.0 4x4     |          | 09.89    | 07.97 |                |        |   |                            |
|  | 2.0 Turbo   |          | S9999999 | 03.92 | 13.0460-7080.2 | 607080 |   | 21411 17,5 + ATE           |
|  | 2.5         |          | S9999999 | 02.93 | 24.8190-0707.2 | 620707 | 2 | Warnkontakt L=685mm        |
|  | 2.0 Turbo   | T1000001 |          | 07.97 | 13.0460-7091.2 | 607091 |   | 21829 20,3 +/WE ATE        |
|  | 2.5         | T1000001 |          | 07.97 | 24.8190-0713.2 | 620713 | 2 | Warnkontakt L=685mm        |
|  | 2.0         |          | 09.89    | 07.97 | 24.0124-0115.1 | 424115 |   | 256 24,0 21,0 V L +S +B    |
|  | 2.0 16V     |          | 09.89    | 07.97 | 24.0324-0115.1 | 524115 |   | 256 24,0 21,0 V L +S +B PD |
|  | 2.0 16V 4x4 |          | 09.89    | 07.97 |                |        |   |                            |
|  | 2.0 4x4     |          | 09.89    | 07.97 |                |        |   |                            |
|  | 2.0 Turbo   |          | S9999999 | 03.92 | 24.0124-0133.1 | 424133 |   | 284 24,0 21,0 V L          |
|  | 2.5         |          | S9999999 | 02.93 |                |        |   |                            |
|  | 2.0 Turbo   | T1000001 |          | 07.97 | 24.0125-0119.1 | 425119 |   | 288 25,0 22,0 V L +S +B    |
|  | 2.5         | T1000001 |          | 07.97 | 24.0325-0119.1 | 525119 |   | 288 25,0 22,0 V L +S +B PD |
|  | 2.0         |          | 09.89    | 07.97 | 13.0460-4043.2 | 604043 |   | 21140 15,0 ATE             |
|  | 2.0 16V     |          | 09.89    | 07.97 | 13.0460-0217.2 | 610217 |   | Belagsatz-Zubehör ATE      |
|  | 2.0 16V 4x4 |          | 09.89    | 07.97 |                |        |   |                            |
|  | 2.0 4x4     |          | 09.89    | 07.97 |                |        |   |                            |
|  | 2.0 Turbo   |          | 03.92    | 07.97 |                |        |   |                            |
|  | 2.5         | T1000001 |          | 07.97 | 13.0460-4040.2 | 604040 |   | 21050 15,8 ATE             |
|  |             |          |          |       | 13.0460-0347.2 | 610347 |   | Belagsatz-Zubehör          |
|  | 2.0         |          | 09.89    | 07.97 | 24.0110-0205.1 | 410205 |   | 270 9,9 8,0 +B             |
|  | 2.0 16V     |          | 09.89    | 07.97 |                |        |   |                            |
|  | 2.0 16V 4x4 |          | 09.89    | 07.97 |                |        |   |                            |
|  | 2.0 4x4     |          | 09.89    | 07.97 |                |        |   |                            |
|  | 2.0 Turbo   |          | 03.92    | 07.97 | 24.0110-0253.1 | 410253 |   | 270 10,0 8,0               |
|  | 2.5         |          | 02.93    | 07.97 |                |        |   |                            |
|  | 2.0         |          | 09.89    | 07.97 | 03.0137-0172.2 | 650172 |   | 160 x 25                   |
|  | 2.0 16V     |          | 09.89    | 07.97 | 03.0137-9092.2 | 669092 |   | Bremsbacken-Zubehör        |
|  | 2.0 16V 4x4 |          | 09.89    | 07.97 |                |        |   |                            |
|  | 2.0 4x4     |          | 09.89    | 07.97 |                |        |   |                            |
|  | 2.0 Turbo   |          | 03.92    | 07.97 |                |        |   |                            |
|  | 2.5         |          | 02.93    | 07.97 | 03.0137-0172.2 | 650172 |   | 160 x 25                   |
|  |             |          |          |       | 03.0137-9243.2 | 669243 |   | Bremsbacken-Zubehör        |

<sup>1)</sup> + brake disc diameter 268 mm / + disco fr.diam. 268mm / + disques fr.diam. 268mm / + disco fr.diam. 268mm































<sup>2)</sup> + brake disc diameter 292mm / + diametro dischi freno 292mm / + diamètre disques frein 292mm / + diametro disco freno 292mm

<sup>3)</sup> - flexride suspension / - autotelaio flexride / - châssis de flexride / - suspensión flexride



|     |   |    |  |    |  |  |   |  |
|--|---|--|--|--|---|--|---|--|
| <b>OPEL CAMPO (97-01)</b>  |   |  |  |  |   |  |   |  |
|    | 2.5 DTI<br>2.5 DTI 4x4<br>3.1 TD<br>3.1 TD 4x4  |  | 09.96<br>09.96<br>09.96<br>09.96   |  | 13.0460-5942.2<br>13.0460-0337.2  | 605942<br>610337   |   | 21544 16,5 +WK<br>Belagsatz-Zubehör<br><b>AKE</b><br><b>AKE</b>                    |
|    | 2.5 DTI<br>2.5 DTI 4x4<br>3.1 TD<br>3.1 TD 4x4  |  | 09.96<br>09.96<br>09.96<br>09.96   |  | 24.0122-0156.1  | 422156   |   | 257 22,0 20,6 V  |
|    | 2.5 DTI 4x4<br>3.1 TD 4x4   |  | 09.96<br>09.96   |  | 03.0137-0445.2  | 650445   |   | 294 x 47   |
| <b>OPEL CASCADA / Vauxhall Cascada (13-)</b>                                       |   |  |  |  |   |  |   |  |
|    | 1.4 Turbo ECOTEC<br>1.4 Turbo ECOTEC<br>1.6 DI Turbo<br>1.6 SIDI Turbo<br>2.0 CDTi<br>2.0 CDTi BiTurbo<br>2.0 CDTi ECOTEC | 88<br>103<br>147<br>125<br>125<br>143<br>121   | 01.13<br>01.13<br>11.13<br>01.13<br>07.15<br>01.13<br>01.13                      |  | 13.0460-5612.2<br>13.0470-5612.2  | 605612<br>LD5612   |   | 24412 19,0 +WK/Zub<br>24412 19,0 +WK/Zub<br><b>MAN</b><br><b>MAN</b>               |
|    | 1.4 Turbo ECOTEC<br>1.4 Turbo ECOTEC<br>1.6 DI Turbo<br>1.6 SIDI Turbo<br>2.0 CDTi<br>2.0 CDTi BiTurbo<br>2.0 CDTi ECOTEC | 88<br>103<br>147<br>125<br>125<br>143<br>121   | 01.13<br>01.13<br>11.13<br>01.13<br>07.15<br>01.13<br>01.13                      |  | 24.0130-0224.1  | 430224   |   | 321 30,0 27,0 V L +S +B  |
|    | 1.4 Turbo ECOTEC<br>1.4 Turbo ECOTEC<br>1.6 DI Turbo<br>1.6 SIDI Turbo<br>2.0 CDTi<br>2.0 CDTi BiTurbo<br>2.0 CDTi ECOTEC | 88<br>103<br>147<br>125<br>125<br>143<br>121   | 01.13<br>01.13<br>11.13<br>01.13<br>07.15<br>01.13<br>01.13                      |  | 24.0711-5377.3  | 360379   | 2  - Flexride Fahrwerk <sup>1)</sup>   | Radsensor L=930  |
|    | 1.4 Turbo ECOTEC<br>1.4 Turbo ECOTEC<br>1.6 DI Turbo<br>1.6 SIDI Turbo<br>2.0 CDTi<br>2.0 CDTi BiTurbo<br>2.0 CDTi ECOTEC | 88<br>103<br>147<br>125<br>125<br>143<br>121   | 01.13<br>01.13<br>11.13<br>01.13<br>07.15<br>01.13<br>01.13                      |  | 13.0460-7264.2<br>13.0470-7264.2  | 607264<br>LD7264   |   | 25096 17,0 +WK/Zub<br>25096 17,0 +WK/Zub<br><b>ATE</b><br><b>ATE</b>               |
|  | 1.4 Turbo ECOTEC<br>1.4 Turbo ECOTEC<br>1.6 DI Turbo<br>1.6 SIDI Turbo<br>2.0 CDTi<br>2.0 CDTi BiTurbo<br>2.0 CDTi ECOTEC | 88<br>103<br>147<br>125<br>125<br>143<br>121   | 01.13<br>01.13<br>11.13<br>01.13<br>07.15<br>01.13<br>01.13                      |  | 24.0112-0189.1<br>24.0312-0189.1  | 412189<br>512189   |   | 292 12,0 10,0 +S +B<br>292 12,0 10,0 +S +B PD                                      |
|  | 1.4 Turbo ECOTEC<br>1.4 Turbo ECOTEC<br>1.6 DI Turbo<br>1.6 SIDI Turbo<br>2.0 CDTi<br>2.0 CDTi BiTurbo<br>2.0 CDTi ECOTEC | 88<br>103<br>147<br>125<br>125<br>143<br>121   | 01.13<br>01.13<br>11.13<br>01.13<br>07.15<br>01.13<br>01.13                      |  | 24.0711-5366.3  | 360355   | 2  - Flexride Fahrwerk <sup>1)</sup> | Radsensor L=574  |
| <b>OPEL COMBO / Vauxhall Combo (01-11)</b>   |   |  |  |  |   |  |   |  |
|  | 1.3 CDTi<br>1.4 16V<br>1.6<br>1.7 DI 16V<br>1.7 DTI 16V   |  | 06.03<br>10.01<br>10.01<br>10.01<br>10.01  | 10.11 - erhöhte Zuladung <sup>2)</sup><br>10.11 - erhöhte Zuladung <sup>2)</sup><br>10.11 - erhöhte Zuladung <sup>2)</sup><br>10.11 - erhöhte Zuladung <sup>2)</sup><br>10.11 - erhöhte Zuladung <sup>2)</sup>   | 13.0460-2857.2<br>13.0470-2857.2  | 602857<br>LD2857   |   | 23225 17,0 +WK/Zub/STRW<br>23225 17,0 +WK/Zub/STRW                                 |
|  | 1.3 CDTi<br>1.4 16V<br>1.6<br>1.7 DI 16V<br>1.7 DTI 16V   | 43033898, 53000000<br>43033898, 53000000<br>43033898, 53000000<br>43033898, 53000000<br>43033898, 53000000                       | 06.03<br>10.01<br>10.01<br>10.01<br>10.01  | + erhöhte Zuladung <sup>3)</sup><br>+ erhöhte Zuladung <sup>3)</sup><br>+ erhöhte Zuladung <sup>3)</sup><br>+ erhöhte Zuladung <sup>3)</sup><br>+ erhöhte Zuladung <sup>3)</sup>   | 13.0460-2857.2<br>13.0470-2857.2  | 602857<br>LD2857   |   | 23225 17,0 +WK/Zub/STRW<br>23225 17,0 +WK/Zub/STRW                                 |
|  | 1.3 CDTi<br>1.4 16V<br>1.6<br>1.6 CNG<br>1.7 CDTi 16V<br>1.7 DI 16V<br>1.7 DTI 16V  | 43033899, 53000001<br>43033899, 53000001<br>43033899, 53000001<br>43033899, 53000001<br>43033899, 53000001<br>43033899, 53000001 | 06.03<br>10.11<br>10.11<br>04.05<br>06.04<br>10.11<br>10.11                      | + erhöhte Zuladung <sup>3)</sup><br>+ erhöhte Zuladung <sup>3)</sup><br>+ erhöhte Zuladung <sup>3)</sup><br>+ erhöhte Zuladung <sup>3)</sup><br>+ erhöhte Zuladung <sup>3)</sup><br>+ erhöhte Zuladung <sup>3)</sup><br>+ erhöhte Zuladung <sup>3)</sup> | 13.0460-7179.2<br>13.0470-7179.2  | 607179<br>LD7179   |   | 23832 20,2 +WK<br>23832 20,2 +WK<br><b>ATE</b><br><b>ATE</b>                       |
|  | 1.3 CDTi<br>1.4 16V<br>1.6<br>1.7 DI 16V<br>1.7 DTI 16V   |  | 06.03<br>10.01<br>10.01<br>10.01<br>10.01  | 10.11 - erhöhte Zuladung <sup>2)</sup><br>10.11 - erhöhte Zuladung <sup>2)</sup><br>10.11 - erhöhte Zuladung <sup>2)</sup><br>10.11 - erhöhte Zuladung <sup>2)</sup><br>10.11 - erhöhte Zuladung <sup>2)</sup>   | 24.0124-0166.1<br>24.0324-0166.1  | 424166<br>524166   |   | 260 24,0 21,0 V L +S +B<br>260 24,0 21,0 V L +B PD                                 |
|  | 1.3 CDTi<br>1.4 16V<br>1.6<br>1.7 DI 16V<br>1.7 DTI 16V   | 43033898, 53000000<br>43033898, 53000000<br>43033898, 53000000<br>43033898, 53000000<br>43033898, 53000000                       | 06.03<br>10.01<br>10.01<br>10.01<br>10.01  | + erhöhte Zuladung <sup>3)</sup><br>+ erhöhte Zuladung <sup>3)</sup><br>+ erhöhte Zuladung <sup>3)</sup><br>+ erhöhte Zuladung <sup>3)</sup><br>+ erhöhte Zuladung <sup>3)</sup>   | 24.0124-0166.1<br>24.0324-0166.1  | 424166<br>524166   |   | 260 24,0 21,0 V L +S +B<br>260 24,0 21,0 V L +B PD                                 |















1) - flexride suspension / - autotelaio flexride / - châssis de flexride / - suspensión flexride  
2) - increased payload / - carico utile maggiorato / - charge utile augmentée / - incremento de carga  
3) + increased payload / + carico utile maggiorato / + charge utile augmentée / + incremento de carga

|     |  |  |  |  |  |  |  |     |                            |
|--|--|--|--|--|---|--|--|---|----------------------------|
| <b>OPEL COMBO / Vauxhall Combo (01-11)</b>   |  |  |  |  |   |  |  |   |                            |
|    | 1.3 CDTi   | 43033899, 53000001   |  | 10.11  | + erhöhte Zuladung <sup>1)</sup>  | 24.0125-0148.1   | 425148   |   | 280 25,0 22,0 V L +S +B    |
|  | 1.4 16V  | 43033899, 53000001   |  | 10.11  | + erhöhte Zuladung <sup>1)</sup>  | 24.0325-0148.1   | 525148   |   | 280 25,0 22,0 V L +S +B PD |
|    | 1.6  | 43033899, 53000001   | 04.05  | 10.11  | + erhöhte Zuladung <sup>1)</sup>  |  |  |   |                            |
|  | 1.6 CNG  |  |  | 10.11  | + erhöhte Zuladung <sup>1)</sup>  |  |  |   |                            |
|    | 1.7 DI 16V   | 43033899, 53000001   |  | 10.11  | + erhöhte Zuladung <sup>1)</sup>  |  |  |   |                            |
|  | 1.7 DTi 16V  | 43033899, 53000001   |  | 10.11  | + erhöhte Zuladung <sup>1)</sup>  |  |  |   |                            |
|    | 1.7 CDTi 16V   |  | 06.04  | 10.11  |   | 24.0125-0131.1   | 425131   |   | 280 24,8 22,0 V L +S +B    |
|  |  |  |  |  |   | 24.0325-0131.1   | 525131   |   | 280 24,8 22,0 V L +S +B PD |
|    | 1.3 CDTi   |  | 06.03  | 10.11  |   | 24.0710-1002.1   | 360206   | 2  | Radsensor L=452            |
|  | 1.4 16V  |  | 10.01  | 10.11  |   |  |  |   |                            |
|   | 1.6  |  | 10.01  | 10.11  |   |  |  |   |                            |
|  | 1.6 CNG  |  | 04.05  | 10.11  |   |  |  |   |                            |
|  | 1.7 CDTi 16V   |  | 06.03  | 10.11  |   |  |  |   |                            |
|  | 1.7 DI 16V   |  | 10.01  | 10.11  |   |  |  |   |                            |
|  | 1.7 DTi 16V  |  | 10.01  | 10.11  |   |  |  |   |                            |
|  |  |  |  |  |   |  |  |   |                            |
|  | 1.3 CDTi   |  | 06.03  | 10.11  |   | 13.0460-2868.2   | 602868   |   | 23417 15,3 +/WK/Zub/STRW   |
|  | 1.4 16V  |  | 10.01  | 10.11  |   | 13.0470-2868.2   | LD2868   |   | 23417 15,3 +/WK/Zub/STRW   |
|  | 1.6  |  | 10.01  | 10.11  |   |  |  |   |                            |
|  | 1.6 CNG  |  | 04.05  | 10.11  |   |  |  |   |                            |
|  | 1.7 CDTi 16V   |  | 06.04  | 10.11  |   |  |  |   |                            |
|  | 1.7 DI 16V   |  | 10.01  | 10.11  |   |  |  |   |                            |
|  | 1.7 DTi 16V  |  | 10.01  | 10.11  |   |  |  |   |                            |
|  |  |  |  |  |   |  |  |   |                            |
|  | 1.3 CDTi   |  | 06.03  | 10.11  |   | 24.0110-0291.1   | 410291   |   | 264 10,0 8,0 +S +B         |
|  | 1.4 16V  |  | 10.01  | 10.11  |   | 24.0310-0291.1   | 510291   |   | 264 10,0 8,0 +S +B PD      |
|  | 1.6  |  | 10.01  | 10.11  |   |  |  |   |                            |
|  | 1.6 CNG  |  | 04.05  | 10.11  |   |  |  |   |                            |
|  | 1.7 CDTi 16V   |  | 06.04  | 10.11  |   | 24.0110-0250.1   | 410250   |   | 264 9,8 8,0 +S +B          |
|  | 1.7 DI 16V   |  | 10.01  | 10.11  |   |  |  |   |                            |
|  | 1.7 DTi 16V  |  | 10.01  | 10.11  |   |  |  |   |                            |
|  |  |  |  |  |   |  |  |   |                            |
|  | 1.3 CDTi   |  | 06.03  | 10.11  |   | 03.0137-0424.2   | 650424   |   | 230 x 42 HEB               |
|  | 1.4 16V  |  | 10.01  | 10.11  |   | 03.0137-9215.2   | 669215   |   | Bremsbacken-Zubehör        |
|  | 1.6  |  | 10.01  | 10.11  |   |  |  |   |                            |
|  | 1.6 CNG  |  | 04.05  | 10.11  |   |  |  |   |                            |
|  | 1.7 CDTi 16V   |  | 06.04  | 10.11  |   |  |  |   |                            |
|  | 1.7 DI 16V   |  | 10.01  | 10.11  |   |  |  |   |                            |
|  | 1.7 DTi 16V  |  | 10.01  | 10.11  |   |  |  |   |                            |
|  |  |  |  |  |   |  |  |   |                            |
|  | 1.3 CDTi   | 36999999   | 06.03  |  |   | 24.0223-0013.2   | 480061   |   | 230/231 x 50               |
|  | 1.4 16V  | 36999999   | 10.01  |  |   |  |  |   |                            |
|  | 1.6  | 36999999   | 10.01  |  |   |  |  |   |                            |
|  | 1.6 CNG  | 36999999   | 04.05  |  |   |  |  |   |                            |
|  | 1.7 CDTi 16V   | 36999999   | 06.04  |  |   |  |  |   |                            |
|  | 1.7 DI 16V   | 36999999   | 10.01  |  |   |  |  |   |                            |
|  | 1.7 DTi 16V  | 36999999   | 10.01  |  |   |  |  |   |                            |
|  |  |  |  |  |   |  |  |   |                            |
|  | 1.3 CDTi   | 43000001   |  | 10.11  |   | 24.0223-0021.1   | 480186   |   | 230/231 x 50               |
|  | 1.4 16V  | 43000001   |  | 10.11  |   |  |  |   |                            |
|  | 1.6  | 43000001   |  | 10.11  |   |  |  |   |                            |
|  | 1.6 CNG  | 43000001   |  | 10.11  |   |  |  |   |                            |
|  | 1.7 CDTi 16V   | 43000001   |  | 10.11  |   |  |  |   |                            |
|  | 1.7 DI 16V   | 43000001   |  | 10.11  |   |  |  |   |                            |
|  | 1.7 DTi 16V  | 43000001   |  | 10.11  |   |  |  |   |                            |
|  |  |  |  |  |   |  |  |   |                            |
|  | 1.3 CDTi   |  | 06.03  | 10.11  |   | 03.0520-6019.3   | 696019   |   | 19,05/230x42 TopKit        |
|  | 1.4 16V  |  | 10.01  | 10.11  |   |  |  |   |                            |
|  | 1.6  |  | 10.01  | 10.11  |   |  |  |   |                            |
|  | 1.6 CNG  |  | 04.05  | 10.11  |   |  |  |   |                            |
|  | 1.7 CDTi 16V   |  | 06.04  | 10.11  |   |  |  |   |                            |
|  | 1.7 DI 16V   |  | 10.01  | 10.11  |   |  |  |   |                            |
|  | 1.7 DTi 16V  |  | 10.01  | 10.11  |   |  |  |   |                            |
|  |  |  |  |  |   |  |  |   |                            |
| <b>OPEL COMBO D / Vauxhall Combo D (11-)</b>                                       |  |  |  |  |   |  |  |   |                            |
|  | 1.3 CDTi   | 55   | 03.15  |  | + Bremsscheibendurchm. 284 mm <sup>2)</sup>                                       | 13.0460-3827.2   | 603827   | bis 11.2013   | 23709 19,6 +/WK/Zub/SBOS   |
|  | 1.3 CDTi   | 66   | 11.11  |  | + Bremsscheibendurchm. 284 mm <sup>2)</sup>                                       | 13.0470-3827.2   | LD3827   | bis 11.2013   | 23709 19,6 +/WK/Zub/SBOS   |
|  | 1.3 CDTi   | 70   | 03.16  |  | + Bremsscheibendurchm. 284 mm <sup>2)</sup>                                       |  |  |   |                            |
|  | 1.4  | 70   | 11.11  |  | + Bremsscheibendurchm. 284 mm <sup>2)</sup>                                       |  |  |   |                            |
|  | 1.4 CNG  | 88   | 11.11  |  | + Bremsscheibendurchm. 284 mm <sup>2)</sup>                                       |  |  |   |                            |
|  | 1.6 CDTi   | 66   | 11.11  |  | + Bremsscheibendurchm. 284 mm <sup>2)</sup>                                       |  |  |   |                            |
|  | 1.6 CDTi   | 70   | 03.15  |  | + Bremsscheibendurchm. 284 mm <sup>2)</sup>                                       |  |  |   |                            |
|  | 1.6 CDTi   | 74   | 11.11  |  | + Bremsscheibendurchm. 284 mm <sup>2)</sup>                                       |  |  |   |                            |
|  | 1.6 CDTi   | 77   | 11.11  |  | + Bremsscheibendurchm. 284 mm <sup>2)</sup>                                       |  |  |   |                            |
|  | 1.6 CDTi   | 88   | 03.15  |  | + Bremsscheibendurchm. 284 mm <sup>2)</sup>                                       |  |  |   |                            |
|  | 2.0 CDTi   | 99   | 11.11  |  | + Bremsscheibendurchm. 284 mm <sup>2)</sup>                                       |  |  |   |                            |
|  |  |  |  |  |   |  |  |   |                            |
|  | 1.3 CDTi   | 55   | 03.15  |  | + Bremsscheibendurchm. 305 mm <sup>3)</sup>                                       | 13.0460-7265.2   | 607265   | bis 11.2013   | 24727 20,7 +/WK ATE        |
|  | 1.3 CDTi   | 66   | 11.11  |  | + Bremsscheibendurchm. 305 mm <sup>3)</sup>                                       |  |  |   |                            |
|  | 1.3 CDTi   | 70   | 03.16  |  | + Bremsscheibendurchm. 305 mm <sup>3)</sup>                                       |  |  |   |                            |
|  | 1.4  | 70   | 11.11  |  | + Bremsscheibendurchm. 305 mm <sup>3)</sup>                                       |  |  |   |                            |
|  | 1.4 CNG  | 88   | 11.11  |  | + Bremsscheibendurchm. 305 mm <sup>3)</sup>                                       |  |  |   |                            |
|  | 1.6 CDTi   | 66   | 11.11  |  | + Bremsscheibendurchm. 305 mm <sup>3)</sup>                                       |  |  |   |                            |
|  | 1.6 CDTi   | 70   | 03.15  |  | + Bremsscheibendurchm. 305 mm <sup>3)</sup>                                       |  |  |   |                            |
|  | 1.6 CDTi   | 74   | 11.11  |  | + Bremsscheibendurchm. 305 mm <sup>3)</sup>                                       |  |  |   |                            |
|  | 1.6 CDTi   | 77   | 11.11  |  | + Bremsscheibendurchm. 305 mm <sup>3)</sup>                                       |  |  |   |                            |
|  | 1.6 CDTi   | 88   | 03.15  |  | + Bremsscheibendurchm. 305 mm <sup>3)</sup>                                       |  |  |   |                            |
|  | 2.0 CDTi   | 99   | 11.11  |  | + Bremsscheibendurchm. 305 mm <sup>3)</sup>                                       |  |  |   |                            |
|  |  |  |  |  |   |  |  |   |                            |
|  | 1.3 CDTi   | 55   | 03.15  |  | + Bremsscheibendurchm. 284 mm <sup>2)</sup>                                       | 24.0122-0145.1   | 422145   |   | 284 22,0 20,2 V +B         |
|  | 1.3 CDTi   | 66   | 11.11  |  | + Bremsscheibendurchm. 284 mm <sup>2)</sup>                                       |  |  |   |                            |
|  | 1.3 CDTi   | 70   | 03.16  |  | + Bremsscheibendurchm. 284 mm <sup>2)</sup>                                       |  |  |   |                            |
|  | 1.4  | 70   | 11.11  |  | + Bremsscheibendurchm. 284 mm <sup>2)</sup>                                       |  |  |   |                            |
|  | 1.4 CNG  | 88   | 11.11  |  | + Bremsscheibendurchm. 284 mm <sup>2)</sup>                                       |  |  |   |                            |
|  |  |  |  |  |   |  |  |   |                            |

<sup>1)</sup> + increased payload / + carico utile maggiorato / + charge utile augmentée / + incremento de carga

<sup>2)</sup> + brake disc diameter 284mm / + diametro dischi freno 284mm / + diamètre disques frein 284mm / + diámetro disco freno 284mm

<sup>3)</sup> + brake disc diameter 305mm / + diametro dischi freno 305mm / + diamètre disques frein 305mm / + diámetro disco freno 305mm

|     |  |  |  |  |  |  |  |  |
|--|--|--|--|--|---|--|--|--|
| <b>OPEL COMBO D / Vauxhall Combo D (11-)</b>                                       |  |  |  |  |   |  |  |  |
|    | 1.6 CDTi   | 66   | 11.11  | + Bremsscheibendurchm. 284 mm <sup>1)</sup>                                      | 24.0122-0145.1  | 422145   |  | 284 22,0 20,2 V +B   |
|  | 1.6 CDTi   | 70   | 03.15  | + Bremsscheibendurchm. 284 mm <sup>1)</sup>                                      |   |  |  |  |
|  | 1.6 CDTi   | 74   | 11.11  | + Bremsscheibendurchm. 284 mm <sup>1)</sup>                                      |   |  |  |  |
|  | 1.6 CDTi   | 77   | 11.11  | + Bremsscheibendurchm. 284 mm <sup>1)</sup>                                      |   |  |  |  |
|  | 1.6 CDTi   | 88   | 03.15  | + Bremsscheibendurchm. 284 mm <sup>1)</sup>                                      |   |  |  |  |
|  | 2.0 CDTi   | 99   | 11.11  | + Bremsscheibendurchm. 284 mm <sup>1)</sup>                                      |   |  |  |  |
|  | 1.3 CDTi   | 55   | 03.15  | + Bremsscheibendurchm. 305 mm <sup>2)</sup>                                      | 24.0128-0253.1  | 428253   |  | 305 28,0 26,0 V L +B   |
|  | 1.3 CDTi   | 66   | 11.11  | + Bremsscheibendurchm. 305 mm <sup>2)</sup>                                      |   |  |  |  |
|  | 1.3 CDTi   | 70   | 03.16  | + Bremsscheibendurchm. 305 mm <sup>2)</sup>                                      |   |  |  |  |
|  | 1.4  | 78   | 11.11  | + Bremsscheibendurchm. 305 mm <sup>2)</sup>                                      |   |  |  |  |
|  | 1.4 CNG  | 88   | 11.11  | + Bremsscheibendurchm. 305 mm <sup>2)</sup>                                      |   |  |  |  |
|  | 1.6 CDTi   | 66   | 11.11  | + Bremsscheibendurchm. 305 mm <sup>2)</sup>                                      |   |  |  |  |
|  | 1.6 CDTi   | 70   | 03.15  | + Bremsscheibendurchm. 305 mm <sup>2)</sup>                                      |   |  |  |  |
|  | 1.6 CDTi   | 74   | 11.11  | + Bremsscheibendurchm. 305 mm <sup>2)</sup>                                      |   |  |  |  |
| 1.6 CDTi   | 77   | 11.11  | + Bremsscheibendurchm. 305 mm <sup>2)</sup>                                      |  |   |  |  |  |
| 1.6 CDTi   | 88   | 03.15  | + Bremsscheibendurchm. 305 mm <sup>2)</sup>                                      |  |   |  |  |  |
| 2.0 CDTi   | 99   | 11.11  | + Bremsscheibendurchm. 305 mm <sup>2)</sup>                                      |  |   |  |  |  |
|    | 1.4  | 70   | 11.11  | + 10" Bremse <sup>3)</sup>   | 03.0137-0505.2  | 650505   |  | 254 x 57 HEB AP  |
|  | 1.4 CNG  | 88   | 11.11  | + 10" Bremse <sup>3)</sup>   |   |  |  |  |
|  | 2.0 CDTi   | 99   | 11.11  | + 10" Bremse <sup>3)</sup>   |   |  |  |  |
|  | 1.3 CDTi   | 55   | 03.15  | + 10" Bremse <sup>3)</sup>   | 03.0137-0505.2  | 650505   | + langer Radstand <sup>4)</sup>  | 254 x 57 HEB AP  |
|  | 1.3 CDTi   | 66   | 11.11  | + 10" Bremse <sup>3)</sup>   |   |  |  |  |
|  | 1.3 CDTi   | 70   | 03.16  | + 10" Bremse <sup>3)</sup>   |   |  |  |  |
|  | 1.6 CDTi   | 66   | 11.11  | + 10" Bremse <sup>3)</sup>   |   |  |  |  |
|  | 1.6 CDTi   | 70   | 03.15  | + 10" Bremse <sup>3)</sup>   |   |  |  |  |
|  | 1.6 CDTi   | 74   | 11.11  | + 10" Bremse <sup>3)</sup>   |   |  |  |  |
|  | 1.6 CDTi   | 77   | 11.11  | + 10" Bremse <sup>3)</sup>   |   |  |  |  |
|  | 1.6 CDTi   | 88   | 03.15  | + 10" Bremse <sup>3)</sup>   |   |  |  |  |
|  | 1.3 CDTi   | 55   | 03.15  | + 9" Bremse <sup>5)</sup>  | 03.0137-0457.2  | 650457   | + kurzer Radstand <sup>6)</sup>  | 228 x 42 HEB AP  |
|  | 1.3 CDTi   | 66   | 11.11  | + 9" Bremse <sup>5)</sup>  |   |  |  |  |
|  | 1.3 CDTi   | 70   | 03.16  | + 9" Bremse <sup>5)</sup>  |   |  |  |  |
| 1.6 CDTi   | 66   | 11.11  | + 9" Bremse <sup>5)</sup>  |  |   |  |  |  |
| 1.6 CDTi   | 70   | 03.15  | + 9" Bremse <sup>5)</sup>  |  |   |  |  |  |
| 1.6 CDTi   | 74   | 11.11  | + 9" Bremse <sup>5)</sup>  |  |   |  |  |  |
| 1.6 CDTi   | 77   | 11.11  | + 9" Bremse <sup>5)</sup>  |  |   |  |  |  |
| 1.6 CDTi   | 88   | 03.15  | + 9" Bremse <sup>5)</sup>  |  |   |  |  |  |
| <b>OPEL CORSA B / Vauxhall Corsa (93-00)</b>                                       |  |  |  |  |   |  |  |  |
|   | 1.0 12V  |  | 11.96  | 09.00  | 13.0460-7051.2  | 607051   |  | 20547 16,5 +WE ATE   |
|  | 1.2  |  | 03.93  | 09.00  |   |  |  |  |
|  | 1.2 16V  |  | 04.98  | 09.00  |   |  |  |  |
|  | 1.4  |  | 03.93  | 09.00  |   |  |  |  |
|  | 1.4 i 16V  |  | 03.93  | 09.00  |   |  |  |  |
|  | 1.4 Si   | 60   | 03.93  | 09.00  |   |  |  |  |
|  | 1.5 D  |  | 03.93  | 09.00  |   |  |  |  |
|  | 1.5 TD   |  | 03.93  | 09.00  |   |  |  |  |
|  | 1.6 GSI 16V  | 109  | 09.93  | 09.00  |   |  |  |  |
|  | 1.6 i 16V  |  | 09.93  | 09.00  |   |  |  |  |
|  | 1.7 D  |  | 09.93  | 09.00  |   |  |  |  |
| Combo  |  | 09.93  | 09.00  |  |   |  |  |  |
|  | 1.0 12V  |  | 11.96  | 09.00  | 24.0113-0161.1  | 413161   |  | 236 12,7 9,7 +S +B   |
|  | 1.2  |  | 03.93  | 09.00  | 24.0313-0161.1  | 513161   |  | 236 12,7 9,7 +S +B PD  |
|  | 1.2 16V  |  | 04.98  | 09.00  | - Sport/ + Automatikgetr./ - Klimaanlage <sup>7)</sup>                            |  |  |  |
|  | 1.2 16V  |  | 04.98  | 09.00  | - Sport/ + Schaltgetriebe <sup>8)</sup>   |  |  |  |
|  | 1.4  |  | 03.93  | 09.00  | - Sport/ + Automatikgetr./ - Klimaanlage <sup>7)</sup>                            |  |  |  |
|  | 1.4  |  | 03.93  | 09.00  | - Sport/ + Schaltgetriebe <sup>8)</sup>   |  |  |  |
|  | 1.5 D  |  | 03.93  | 09.00  |   |  |  |  |
|  | 1.5 TD   |  | 03.93  | 09.00  |   |  |  |  |
|  | 1.7 D  |  | 09.93  | 09.00  |   |  |  |  |
|  | 1.2 16V  |  | 04.98  | 09.00  | + Sport <sup>9)</sup>   | 24.0120-0115.1   | 420115   | 236 20,0 17,0 V L +S +B  |
|  | 1.2 16V  |  | 04.98  | 09.00  | - Sport/ + Automatikgetr./ + Klimaanlage <sup>10)</sup>                           | 24.0320-0115.1   | 520115   | 236 20,0 17,0 V L +S +B PD   |
|  | 1.4  |  | 03.93  | 09.00  | + Sport <sup>9)</sup>   |  |  |  |
|  | 1.4  |  | 03.93  | 09.00  | - Sport/ + Automatikgetr./ + Klimaanlage <sup>10)</sup>                           |  |  |  |
|  | 1.4 i 16V  |  | 09.93  | 09.00  |   |  |  |  |
| 1.4 Si   | 60   | 03.93  | 09.00  |  |   |  |  |  |
| Combo  |  | 09.93  | 09.00  |  |   |  |  |  |
| 1.6 GSI 16V  | 109  | 09.93  | 09.00  |  | 24.0120-0140.1  | 420140   | 256 20,0 17,0 V L +S +B  |  |
| 1.6 i 16V  |  | 09.93  | 09.00  |  |   |  |  |  |
|  | 1.0 12V  |  | 11.96  | 09.00  | 03.0137-0266.2  | 650266   |  | 200 x 29 HEB   |
|  | 1.2  |  | 03.93  | 09.00  | 03.0137-9166.2  | 669166   |  | Bremsbacken-Zubehör  |
|  | 1.2 16V  |  | 04.98  | 09.00  |   |  |  |  |
|  | 1.4  |  | 03.93  | 09.00  |   |  |  |  |
|  | 1.4 i 16V  |  | 03.93  | 09.00  |   |  |  |  |
|  | 1.4 Si   | 60   | 03.93  | 09.00  |   |  |  |  |
|  | 1.5 D  |  | 03.93  | 09.00  |   |  |  |  |
|  | 1.5 TD   |  | 03.93  | 09.00  |   |  |  |  |
|  | 1.6 GSI 16V  | 109  | 09.93  | 09.00  |   |  |  |  |
|  | 1.6 i 16V  |  | 09.93  | 09.00  |   |  |  |  |
|  | 1.7 D  |  | 09.93  | 09.00  |   |  |  |  |
| Combo  |  | 09.93  | 09.00  |  |   |  |  |  |
| 1.0 12V  |  | 11.96  | 09.00  | - ABS  | 24.0220-0012.1  | 480017   | 230 x 51 HEB TRW   |  |
| 1.2  |  | 03.93  | 09.00  | - ABS  | 24.0220-0712.2  | 480208   | 200/201 x 35 - Lager TRW   |  |
| 1.2 16V  |  | 04.98  | 09.00  | - ABS  |   |  | 200/201 x 35 + Lager   |  |
| 1.4  |  | 03.93  | 09.00  | - ABS  |   |  |  |  |
| 1.4 i 16V  |  | 03.93  | 09.00  | - ABS  |   |  |  |  |

<sup>1)</sup> + brake disc diameter 284mm / + diametro dischi freno 284mm / + diamètre disques frein 284mm / + diámetro disco freno 284mm

<sup>2)</sup> + brake disc diameter 305mm / + diametro dischi freno 305mm / + diamètre disques frein 305mm / + diámetro disco freno 305mm

<sup>3)</sup> + 10" brake / + freno 10" / + frein de 10" / + freno de 10"

<sup>4)</sup> + long wheel base / + passo lungo / + empattement long / + distancia larga entre ejes

<sup>5)</sup> + 9" brake / + servofreno da 9" / + frein de 9" / + freno de 9"

<sup>6)</sup> + short wheel base / + passo lungo / + empattement court / + distancia corta entre ejes

<sup>7)</sup> - Sport/+ auto.transm./- air condit. / - Sport/+ scatola.auto./- aria condiz. / - Sport/+ transm.auto./- air condit. / - Sport/+ cambio auto./- aire acond.

<sup>8)</sup> - Sport/ + manual transm. / - Sport/ + cambio velocità / - Sport/ + transm. mécanique / - Sport/ + cambio velocidad

<sup>9)</sup> + Sport / + Sportivo / + Sport / + Deportivo

<sup>10)</sup> - Sport/+ auto.transm./+ air condit. / - Sport/+ scatola.auto./+ aria condiz. / - Sport/+ transm.auto./+ air condit. / - Sport/+ cambio auto./+ aire acond.

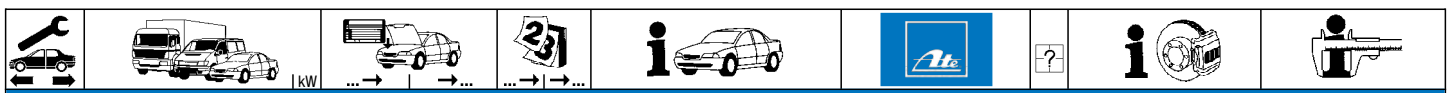

**OPEL CORSA B / Vauxhall Corsa (93-00)**

|             |             |     |       |       |       |                |                |        |  |                         |                         |              |
|-------------|-------------|-----|-------|-------|-------|----------------|----------------|--------|--|-------------------------|-------------------------|--------------|
|             | 1.4 Si      | 60  |       | 03.93 | 09.00 | - ABS          | 24.0220-0012.1 | 480017 |  |                         | 200/201 x 35 - Lager    |              |
|             | 1.5 D       |     |       | 03.93 | 09.00 | + ABS          | 24.0220-0712.2 | 480208 |  |                         | 200/201 x 35 + Lager    |              |
|             | 1.5 TD      |     |       | 03.93 | 09.00 | - ABS          |                |        |  |                         |                         |              |
|             | 1.6 GSI 16V | 109 |       | 09.93 | 09.00 | - ABS          |                |        |  |                         |                         |              |
|             | 1.6 i 16V   |     |       | 09.93 | 09.00 | - ABS          |                |        |  |                         |                         |              |
|             | 1.7 D       |     |       | 09.93 | 09.00 | - ABS          |                |        |  |                         |                         |              |
|             | 1.0 12V     |     |       | 11.96 | 09.00 | + ABS          | 24.0220-0033.2 | 480132 |  | mit Sensoring 1)        |                         | 200/201 x 35 |
|             | 1.2         |     |       | 03.93 | 09.00 | + ABS          |                |        |  |                         |                         |              |
|             | 1.2 16V     |     |       | 04.98 | 09.00 | + ABS          |                |        |  |                         |                         |              |
|             | 1.4         |     |       | 03.93 | 09.00 | + ABS          |                |        |  |                         |                         |              |
| 1.4 i 16V   |             |     | 03.93 | 09.00 | + ABS |                |                |        |  |                         |                         |              |
| 1.4 Si      | 60          |     | 03.93 | 09.00 | + ABS |                |                |        |  |                         |                         |              |
| 1.5 D       |             |     | 03.93 | 09.00 | + ABS |                |                |        |  |                         |                         |              |
| 1.5 TD      |             |     | 03.93 | 09.00 | + ABS |                |                |        |  |                         |                         |              |
| 1.6 GSI 16V | 109         |     | 09.93 | 09.00 | + ABS |                |                |        |  |                         |                         |              |
| 1.6 i 16V   |             |     | 09.93 | 09.00 | + ABS |                |                |        |  |                         |                         |              |
| 1.7 D       |             |     | 09.93 | 09.00 | + ABS |                |                |        |  |                         |                         |              |
| Combo       |             |     | 09.93 | 09.00 |       | 24.0223-0008.2 | 480038         |        |  |                         | 230/231 x 60            |              |
|             | 1.0 12V     |     |       | 11.96 | 09.00 |                | 03.0420-1019.3 | 681019 |  |                         | 19,05/200x29 Kit TRW    |              |
|             | 1.2         |     |       | 03.93 | 09.00 |                | 03.0520-1019.3 | 691019 |  |                         | 19,05/200x29 TopKit TRW |              |
|             | 1.2 16V     |     |       | 04.98 | 09.00 |                |                |        |  |                         |                         |              |
|             | 1.4         |     |       | 03.93 | 09.00 |                |                |        |  |                         |                         |              |
|             | 1.4 i 16V   |     |       | 03.93 | 09.00 |                |                |        |  |                         |                         |              |
|             | 1.4 Si      | 60  |       | 03.93 | 09.00 |                |                |        |  |                         |                         |              |
|             | 1.5 D       |     |       | 03.93 | 09.00 |                |                |        |  |                         |                         |              |
|             | 1.5 TD      |     |       | 03.93 | 09.00 |                |                |        |  |                         |                         |              |
|             | 1.6 GSI 16V | 109 |       | 09.93 | 09.00 |                |                |        |  |                         |                         |              |
|             | 1.6 i 16V   |     |       | 09.93 | 09.00 |                |                |        |  |                         |                         |              |
| 1.7 D       |             |     | 09.93 | 09.00 |       |                |                |        |  |                         |                         |              |
| Combo       |             |     | 09.93 | 09.00 |       | 03.0520-5819.3 | 695819         |        |  | 19,05/230x51 TopKit TRW |                         |              |

















**OPEL CORSA C / Vauxhall Corsa MK II (00-06)**

|             |             |  |       |       |       |                |                |        |   |                            |                            |
|-------------|-------------|--|-------|-------|-------|----------------|----------------|--------|---|----------------------------|----------------------------|
|             | 1.0 12V     |  |       | 09.00 | 09.06 |                | 13.0460-2857.2 | 602857 |   |                            | 23225 17,0 +/WK/Zub/STRW   |
|             | 1.2 16V     |  |       | 09.00 | 09.06 |                | 13.0470-2857.2 | LD2857 |   |                            | 23225 17,0 +/WK/Zub/STRW   |
|             | 1.3 CDTI    |  |       | 06.03 | 09.06 |                |                |        |   |                            |                            |
|             | 1.4 16V     |  |       | 09.00 | 09.06 |                |                |        |   |                            |                            |
|             | 1.6         |  |       | 09.01 | 09.06 |                |                |        |   |                            |                            |
|             | 1.7 DI 16V  |  |       | 09.00 | 09.06 |                |                |        |   |                            |                            |
|             | 1.7 DTI 16V |  |       | 09.00 | 09.06 |                |                |        |   |                            |                            |
|             | 1.8 16V     |  |       | 09.00 | 09.06 |                |                |        |   |                            |                            |
|             | 1.7 CDTI    |  |       | 06.03 | 09.06 |                | 13.0460-7179.2 | 607179 |   |                            | 23832 20,2 +/WK ATE        |
|             |             |  |       |       |       | 13.0470-7179.2 | LD7179         |        |   | 23832 20,2 +/WK ATE        |                            |
|             | 1.0 12V     |  |       | 09.00 | 09.06 | - ABS          | 24.0111-0152.1 | 411152 |   |                            | 240 11,0 8,0 +B            |
|             | 1.2 16V     |  |       | 09.00 | 09.06 | - ABS          |                |        |   |                            |                            |
|             | 1.0 12V     |  |       | 09.00 | 09.06 | + ABS          | 24.0120-0174.1 | 420174 |   |                            | 240 20,0 17,0 V +S +B      |
|             | 1.2 16V     |  |       | 09.00 | 09.06 | + ABS          |                |        |   |                            |                            |
|             | 1.7 DI 16V  |  |       | 09.00 | 09.06 |                |                |        |   |                            |                            |
|             | 1.3 CDTI    |  |       | 06.03 | 09.06 |                | 24.0124-0166.1 | 424166 |   |                            | 260 24,0 21,0 V L +S +B    |
|             | 1.4 16V     |  |       | 09.00 | 09.06 |                | 24.0324-0166.1 | 524166 |   |                            | 260 24,0 21,0 V L +S +B PD |
|             | 1.6         |  |       | 09.01 | 09.06 |                |                |        |   |                            |                            |
|             | 1.7 DTI 16V |  |       | 09.00 | 09.06 |                |                |        |   |                            |                            |
| 1.8 16V     |             |  | 09.00 | 09.06 |       |                |                |        |   |                            |                            |
| 1.7 CDTI    |             |  | 06.03 | 09.06 |       | 24.0125-0131.1 | 425131         |        |   | 280 24,8 22,0 V L +S +B    |                            |
|             |             |  |       |       |       | 24.0325-0131.1 | 525131         |        |   | 280 24,8 22,0 V L +S +B PD |                            |
|             | 1.0 12V     |  |       | 09.00 | 09.06 |                | 24.0710-1002.1 | 360206 | 2 |                            | Radsensor L=452            |
|             | 1.2 16V     |  |       | 09.00 | 09.06 |                |                |        |   |                            |                            |
|             | 1.3 CDTI    |  |       | 06.03 | 09.06 |                |                |        |   |                            |                            |
|             | 1.4 16V     |  |       | 09.00 | 09.06 |                |                |        |   |                            |                            |
|             | 1.6         |  |       | 09.01 | 09.06 |                |                |        |   |                            |                            |
|             | 1.7 CDTI    |  |       | 06.03 | 09.06 |                |                |        |   |                            |                            |
|             | 1.7 DI 16V  |  |       | 09.00 | 09.06 |                |                |        |   |                            |                            |
|             | 1.7 DTI 16V |  |       | 09.00 | 09.06 |                |                |        |   |                            |                            |
|             | 1.8 16V     |  |       | 09.00 | 09.06 |                |                |        |   |                            |                            |
|             | 1.4 16V     |  |       | 09.00 | 09.06 |                | 13.0460-2858.2 | 602858 |   |                            | 23284 14,0 /WK/S TRW       |
|             | 1.8 16V     |  |       | 09.00 | 09.06 |                | 13.0470-2858.2 | LD2858 |   |                            | 23284 14,0 /WK/S TRW       |
|             | 1.4 16V     |  |       | 09.00 | 09.06 |                | 24.0110-0268.1 | 410268 |   |                            | 240 10,2 8,2 +B            |
|             | 1.8 16V     |  |       | 09.00 | 09.06 |                |                |        |   |                            |                            |
|             | 1.0 12V     |  |       | 09.00 | 09.06 | - ABS          | 03.0137-0395.2 | 650395 |   |                            | 200 x 29 HEB               |
|             | 1.2 16V     |  |       | 09.00 | 09.06 | - ABS          | 03.0137-9166.2 | 669166 |   |                            | Bremsbacken-Zubehör        |
|             | 1.3 CDTI    |  |       | 06.03 | 09.06 | - ABS          |                |        |   |                            |                            |
|             | 1.4 16V     |  |       | 09.00 | 09.06 | - ABS          |                |        |   |                            |                            |
|             | 1.6         |  |       | 09.01 | 09.06 | - ABS          |                |        |   |                            |                            |
|             | 1.7 CDTI    |  |       | 06.03 | 09.06 | - ABS          |                |        |   |                            |                            |
|             | 1.7 DI 16V  |  |       | 09.00 | 09.06 | - ABS          |                |        |   |                            |                            |
|             | 1.7 DTI 16V |  |       | 09.00 | 09.06 | - ABS          |                |        |   |                            |                            |
|             | 1.0 12V     |  |       | 09.00 | 09.06 | + ABS          | 03.0137-0396.2 | 650396 |   |                            | 200 x 46 HEB               |
|             | 1.2 16V     |  |       | 09.00 | 09.06 | + ABS          | 03.0137-9167.2 | 669167 |   |                            | Bremsbacken-Zubehör        |
| 1.3 CDTI    |             |  | 06.03 | 09.06 | + ABS |                |                |        |   |                            |                            |
| 1.4 16V     |             |  | 09.00 | 09.06 | + ABS |                |                |        |   |                            |                            |
| 1.6         |             |  | 09.01 | 09.06 | + ABS |                |                |        |   |                            |                            |
| 1.7 CDTI    |             |  | 06.03 | 09.06 | + ABS |                |                |        |   |                            |                            |
| 1.7 DI 16V  |             |  | 09.00 | 09.06 | + ABS |                |                |        |   |                            |                            |
| 1.7 DTI 16V |             |  | 09.00 | 09.06 | + ABS |                |                |        |   |                            |                            |

1) with sensor ring / con sensori / avec secours ABS / con anillo sensor ABS





|     |  |  |  |  |  |  |  |  |                          |
|--|--|--|--|--|---|--|--|--|--------------------------|
| <b>OPEL CORSA C / Vauxhall Corsa MK II (00-06)</b>                                 |  |  |  |  |   |  |  |  |                          |
|    | 1.0 12V  |  | 09.00  | 09.06  | - ABS   | 24.0220-0039.1   | 480163   |  | 200/201 x 35             |
|  | 1.2 16V  |  | 09.00  | 09.06  | - ABS   |  |  |  |                          |
|  | 1.3 CDTI   |  | 06.03  | 09.06  | - ABS   |  |  |  |                          |
|  | 1.4 16V  |  | 09.00  | 09.06  | - ABS   |  |  |  |                          |
|  | 1.6  |  | 09.01  | 09.06  | - ABS   |  |  |  |                          |
|  | 1.7 DI 16V   |  | 09.00  | 09.06  | - ABS   |  |  |  |                          |
|  | 1.7 DTI 16V  |  | 09.00  | 09.06  | - ABS   |  |  |  |                          |
|  | 1.0 12V  |  | 09.00  | 09.06  | + ABS   | 24.0220-0038.1   | 480162   | ohne Sensorring <sup>1)</sup><br>ohne Sensorring <sup>1)</sup>                     | 200/201 x 54 - Lager     |
|  | 1.2 16V  |  | 09.00  | 09.06  | + ABS   | 24.0220-0738.2   | 480214   |  | 200/201 x 54 + Lager     |
|  | 1.3 CDTI   |  | 06.03  | 09.06  | + ABS   |  |  |  |                          |
|  | 1.4 16V  |  | 09.00  | 09.06  | + ABS   |  |  |  |                          |
|  | 1.6  |  | 09.01  | 09.06  | + ABS   |  |  |  |                          |
|  | 1.7 DI 16V   |  | 09.00  | 09.06  | + ABS   |  |  |  |                          |
|  | 1.7 DTI 16V  |  | 09.00  | 09.06  | + ABS   |  |  |  |                          |
|    | 1.0 12V  |  | 09.00  | 09.06  | - ABS   | 03.0520-5119.3   | 695119   |  | 19,05/200x29 TopKit      |
|  | 1.2 16V  |  | 09.00  | 09.06  | - ABS   |  |  |  |                          |
|  | 1.3 CDTI   |  | 06.03  | 09.06  | - ABS   |  |  |  |                          |
|  | 1.4 16V  |  | 09.00  | 09.06  | - ABS   |  |  |  |                          |
|  | 1.6  |  | 09.01  | 09.06  | - ABS   |  |  |  |                          |
|  | 1.7 DI 16V   |  | 09.00  | 09.06  | - ABS   |  |  |  |                          |
|  | 1.7 DTI 16V  |  | 09.00  | 09.06  | - ABS   |  |  |  |                          |
|  | 1.0 12V  |  | 09.00  | 09.06  | + ABS   | 03.0520-5219.3   | 695219   |  | 19,05/200x46 TopKit      |
|  | 1.2 16V  |  | 09.00  | 09.06  | + ABS   |  |  |  |                          |
|  | 1.3 CDTI   |  | 06.03  | 09.06  | + ABS   |  |  |  |                          |
|  | 1.4 16V  |  | 09.00  | 09.06  | + ABS   |  |  |  |                          |
|  | 1.6  |  | 09.01  | 09.06  | + ABS   |  |  |  |                          |
|  | 1.7 DI 16V   |  | 09.00  | 09.06  | + ABS   |  |  |  |                          |
|  | 1.7 DTI 16V  |  | 09.00  | 09.06  | + ABS   |  |  |  |                          |
| <b>OPEL CORSA D / Vauxhall Corsa MK III (06-)</b>                                  |  |  |  |  |   |  |  |  |                          |
|    | 1.0 i  |  | 10.06  |  | - belüftete Scheiben <sup>2)</sup>  | 13.0460-3839.2   | 603839   |  | 23982 18,1 +/WK/Zub/SBOS |
|  | 1.0 i  |  | 10.06  |  | + belüftete Scheiben <sup>3)</sup>  | 13.0460-3839.2   | 603839   |  | 23982 18,1 +/WK/Zub/SBOS |
|  | 1.2  | 51   | 06.10  |  |   | 13.0470-3839.2   | LD3839   |  | 23982 18,1 +/WK/Zub/SBOS |
|  | 1.2  | 63   | 06.10  |  |   |  |  |  |                          |
|  | 1.2 i 16V  | 59   | 10.06  |  |   |  |  |  |                          |
|  | 1.2 LPG  |  | 09.09  |  |   |  |  |  |                          |
|  | 1.3 CDTI   | 55   | 10.06  |  | + Bremsscheibe 257mm <sup>4)</sup>  |  |  |  |                          |
|  | 1.3 CDTi   | 70   | 06.10  |  | + Bremsscheibe 257mm <sup>4)</sup>  |  |  |  |                          |
|  | 1.4  | 64   | 09.09  |  |   |  |  |  |                          |
|  | 1.4  | 74   | 06.10  |  |   |  |  |  |                          |
|  | 1.4 i 16V  | 66   | 10.06  |  |   |  |  |  |                          |
|  | 1.3 CDTI   | 55   | 10.06  |  | + Bremsscheibe 284mm <sup>5)</sup>  | 13.0460-3840.2   | 603840   |  | 23981 19,6 +/WK/Zub/SBOS |
|  | 1.3 CDTI   | 66   | 10.06  |  |   | 13.0470-3840.2   | LD3840   |  | 23981 19,6 +/WK/Zub/SBOS |
|  | 1.3 CDTi   | 70   | 06.10  |  | + Bremsscheibe 284mm <sup>5)</sup>  |  |  |  |                          |
| 1.4 Turbo ecoFLEX  | 88   | 06.12  |  |  | 13.0460-3841.2  | 603841   |  | 24550 19,5 +/WK/Zub/SBOS   |                          |
| 1.7 CDTI   | 92   | 10.06  |  |  |   |  |  |  |                          |
| 1.7 CDTi   | 96   | 06.10  |  |  |   |  |  |  |                          |
| 1.6 Turbo GSI  | 110  | 06.07  |  |  | 13.0460-7179.2  | 607179   |  | 23832 20,2 +/WK ATE  |                          |
| 1.6 Turbo OPC  |  | 03.07  |  |  | 13.0470-7179.2  | LD7179   |  | 23832 20,2 +/WK ATE  |                          |
|  | 1.0 i  |  | 10.06  |  |   | 24.0112-0184.1   | 412184   |  | 257 12,0 10,0 +S +B      |
|  | 1.0 i  |  | 10.06  |  |   | 24.0122-0231.1   | 422231   |  | 257 22,0 20,0 V +S +B    |
|  | 1.2  | 51   | 06.10  |  |   | 24.0322-0231.1   | 522231   |  | 257 22,0 20,0 V +S +B PD |
|  | 1.2  | 63   | 06.10  |  |   |  |  |  |                          |
|  | 1.2 i 16V  | 59   | 10.06  |  |   |  |  |  |                          |
|  | 1.2 LPG  |  | 09.09  |  |   |  |  |  |                          |
|  | 1.3 CDTI   | 55   | 10.06  |  | + Bremsscheibe 257mm <sup>4)</sup>  |  |  |  |                          |
|  | 1.3 CDTi   | 70   | 06.10  |  | + Bremsscheibe 257mm <sup>4)</sup>  |  |  |  |                          |
|  | 1.4  | 64   | 09.09  |  |   |  |  |  |                          |
|  | 1.4  | 74   | 06.10  |  |   |  |  |  |                          |
|  | 1.4 i 16V  | 66   | 10.06  |  |   |  |  |  |                          |
|  | 1.3 CDTI   | 55   | 10.06  |  | + Bremsscheibe 284mm <sup>5)</sup>  | 24.0122-0241.1   | 422241   |  | 284 22,0 20,0 V +S +B    |
|  | 1.3 CDTI   | 66   | 10.06  |  |   |  |  |  |                          |
|  | 1.3 CDTi   | 70   | 06.10  |  | + Bremsscheibe 284mm <sup>5)</sup>  |  |  |  |                          |
| 1.4 Turbo ecoFLEX  | 88   | 06.12  |  |  | 24.0126-0146.1  | 426146   |  | 278 26,0 23,0 V L +B   |                          |
| 1.7 CDTI   | 92   | 10.06  |  |  |   |  |  |  |                          |
| 1.7 CDTi   | 96   | 06.10  |  |  |   |  |  |  |                          |
| 1.6 Turbo GSI  | 110  | 06.07  |  |  | 24.0125-0142.1  | 425142   |  | 308 25,0 22,0 V L +S +B  |                          |
| 1.6 Turbo OPC  |  | 03.07  |  | - Nuerburgring Edition <sup>6)</sup>   | 24.0325-0142.1  | 525142   |  | 308 25,0 22,0 V L +S +B PD   |                          |
|  | 1.4 Turbo ecoFLEX  | 88   | 06.12  |  |   | 13.0460-3848.2   | 603848   |  | 24349 17,6 /Zub BOS      |
|  | 1.6 Turbo GSI  | 110  | 06.07  |  |   |  |  |  |                          |
|  | 1.6 Turbo OPC  |  | 03.07  |  |   |  |  |  |                          |
|  | 1.7 CDTI   | 92   | 10.06  |  |   |  |  |  |                          |
|  | 1.7 CDTi   | 96   | 06.10  |  |   |  |  |  |                          |
|  | 1.4 Turbo ecoFLEX  | 88   | 06.12  |  |   | 24.0110-0347.1   | 410347   |  | 264 10,0 8,0 +B          |
|  | 1.6 Turbo GSI  | 110  | 06.07  |  |   |  |  |  |                          |
|  | 1.6 Turbo OPC  |  | 03.07  |  |   |  |  |  |                          |
|  | 1.7 CDTI   | 92   | 10.06  |  |   |  |  |  |                          |
|  | 1.7 CDTi   | 96   | 06.10  |  |   |  |  |  |                          |
|  | 1.0 i  |  | 10.06  |  |   | 03.0137-0479.2   | 650479   | + 3 türig <sup>7)</sup>  | 203 x 38 HEB             |
|  | 1.2  | 51   | 06.10  |  |   | 03.0137-9310.2   | 669310   |  | Bremsbacken-Zubehör      |
|  | 1.2  | 63   | 06.10  |  |   |  |  |  | AP                       |
|  | 1.2 i 16V  | 59   | 10.06  |  |   |  |  |  |                          |
|  | 1.2 LPG  |  | 09.09  |  |   |  |  |  |                          |
| 1.3 CDTI   | 55   | 10.06  |  |  |   |  |  |  |                          |

<sup>1)</sup> without sensor ring / senza sensori / sans secours ABS / sin anillo sensor ABS

<sup>2)</sup> - ventilated discs / - dischi ventilati / - disques ventilés / - disco ventilado

<sup>3)</sup> + ventilated discs / + dischi ventilati / + disques ventilés / + disco ventilado

















<sup>4)</sup> + brake disc 257mm / + dischi freno 257mm / + disque de frein 257mm / + disco de freno 257mm

<sup>5)</sup> + brake disc 284mm / + dischi freno 284mm / + disque de frein 284mm / + disco de freno 284mm

<sup>6)</sup> - Nürburgring edition / - edizione Nürburgring / - édition Nürburgring / - edición Nürburgring

<sup>7)</sup> + 3 door / + 3 porte / + 3 portes / + 3 puertas



|     |    |  |  |  |  |  |  |  |                            |     |
|--|--|--|--|--|---|--|--|--|----------------------------|-----|
| <b>OPEL CORSA D / Vauxhall Corsa MK III (06-)</b>                                  |  |  |  |  |   |  |  |  |                            |     |
|    | 1.3 CDTi   | 66   | 10.06  |  | 03.0137-0479.2  | 650479   | + 3 türig <sup>1)</sup>  | 203 x 38 HEB   | AP                         |     |
|  | 1.3 CDTi   | 70   | 06.10  |  | 03.0137-9310.2  | 669310   |  | Bremsbacken-Zubehör  | AP                         |     |
|  | 1.4  | 64   | 09.09  |  |   |  |  |  |                            |     |
|  | 1.4  | 74   | 06.10  |  |   |  |  |  |                            |     |
|  | 1.4 i 16V  | 66   | 10.06  |  |   |  |  |  |                            |     |
|  | 1.0 i  |  | 10.06  |  | 03.0137-0478.2  | 650478   | + 5 türig <sup>2)</sup>  | 228 x 42 HEB   | AP                         |     |
|  | 1.2  | 51   | 06.10  |  | 03.0137-9309.2  | 669309   |  | Bremsbacken-Zubehör  | AP                         |     |
|  | 1.2  | 63   | 06.10  |  |   |  |  |  |                            |     |
|  | 1.2 i 16V  | 59   | 10.06  |  |   |  |  |  |                            |     |
|  | 1.2 LPG  |  | 09.09  |  |   |  |  |  |                            |     |
|  | 1.3 CDTi   | 55   | 10.06  |  |   |  |  |  |                            |     |
|  | 1.3 CDTi   | 66   | 10.06  |  |   |  |  |  |                            |     |
|  | 1.3 CDTi   | 70   | 06.10  |  |   |  |  |  |                            |     |
|  | 1.4  | 64   | 09.09  |  |   |  |  |  |                            |     |
| 1.4  | 74   | 06.10  |  |  |   |  |  |  |                            |     |
| 1.4 i 16V  | 66   | 10.06  |  |  |   |  |  |  |                            |     |
|    | 1.0 i  |  | 10.06  |  | 24.0220-3035.1  | 480300   | + 3 türig <sup>1)</sup>  | 203/204,7 x 47   |                            |     |
|  | 1.2  | 51   | 06.10  |  | 24.0222-8037.1  | 480302   | + 5 türig <sup>2)</sup>  | 228/230 x 48   |                            |     |
|  | 1.2  | 63   | 06.10  |  |   |  |  |  |                            |     |
|  | 1.2 i 16V  | 59   | 10.06  |  |   |  |  |  |                            |     |
|  | 1.2 LPG  |  | 09.09  |  |   |  |  |  |                            |     |
|  | 1.3 CDTi   | 55   | 10.06  | + ecoFlex  | 24.0220-3035.1  | 480300   |  | 203/204,7 x 47   |                            |     |
|  | 1.3 CDTi   | 55   | 10.06  | - ecoFlex  | 24.0222-8037.1  | 480302   |  | 228/230 x 48   |                            |     |
|  | 1.3 CDTi   | 66   | 10.06  |  |   |  |  |  |                            |     |
|  | 1.3 CDTi   | 70   | 06.10  |  |   |  |  |  |                            |     |
|  | 1.4  | 64   | 09.09  |  |   |  |  |  |                            |     |
|  | 1.4  | 74   | 06.10  |  |   |  |  |  |                            |     |
|  | 1.4 i 16V  | 66   | 10.06  |  |   |  |  |  |                            |     |
|  |    | 1.0 i  |  | 10.06  |   | 03.0520-6719.3   | 696719   | + Quick Fit/ + 3 türig <sup>3)</sup>   | 19,05/203x38 TopKit        | AP  |
|  |  | 1.2  | 51   | 06.10  |   | 03.0520-6819.3   | 696819   | + Quick Fit/ + 5 türig <sup>4)</sup>   | 19,05/228x42 TopKit        | AP  |
| 1.2  |  | 63   | 06.10  |  |   |  |  |  |                            |     |
| 1.2 i 16V  |  | 59   | 10.06  |  |   |  |  |  |                            |     |
| 1.2 LPG  |  |  | 09.09  |  |   |  |  |  |                            |     |
| 1.3 CDTi   |  | 55   | 10.06  |  | 03.0520-6819.3  | 696819   | + Quick Fit  | 19,05/228x42 TopKit  | AP                         |     |
| 1.3 CDTi   |  | 66   | 10.06  |  |   |  |  |  |                            |     |
| 1.3 CDTi   |  | 70   | 06.10  |  |   |  |  |  |                            |     |
| 1.4  |  | 64   | 09.09  |  |   |  |  |  |                            |     |
| 1.4  |  | 74   | 06.10  |  |   |  |  |  |                            |     |
| 1.4 i 16V  |  | 66   | 10.06  |  |   |  |  |  |                            |     |
| <b>OPEL CORSA E / Vauxhall Corsa Mk IV (14-)</b>                                   |  |  |  |  |   |  |  |  |                            |     |
|  |  | 1.0  | 66   | 11.14  | + Bremsscheibendurchm. 308 mm <sup>5)</sup>                                       | 13.0460-7179.2   | 607179   |  | 23832 20,2 +/WK            | ATE |
|  |  | 1.0  | 85   | 11.14  | + Bremsscheibendurchm. 308 mm <sup>5)</sup>                                       | 13.0470-7179.2   | LD7179   |  | 23832 20,2 +/WK            | ATE |
|  | 1.2  | 51   | 11.14  | + Bremsscheibendurchm. 308 mm <sup>5)</sup>                                      |   |  |  |  |                            |     |
|  | 1.3 CDTi   | 55   | 11.14  | + Bremsscheibendurchm. 308 mm <sup>5)</sup>                                      |   |  |  |  |                            |     |
|  | 1.3 CDTi   | 70   | 11.14  | + Bremsscheibendurchm. 308 mm <sup>5)</sup>                                      |   |  |  |  |                            |     |
|  | 1.4  | 55   | 11.14  | + Bremsscheibendurchm. 308 mm <sup>5)</sup>                                      |   |  |  |  |                            |     |
|  | 1.4  | 66   | 11.14  | + Bremsscheibendurchm. 308 mm <sup>5)</sup>                                      |   |  |  |  |                            |     |
|  | 1.4 LPG  | 66   | 03.15  | + Bremsscheibendurchm. 308 mm <sup>5)</sup>                                      |   |  |  |  |                            |     |
|  | 1.4 Turbo  | 74   | 11.14  | + Bremsscheibendurchm. 308 mm <sup>5)</sup>                                      |   |  |  |  |                            |     |
|  | 1.4 Turbo  | 110  | 03.15  | + Bremsscheibendurchm. 308 mm <sup>5)</sup>                                      |   |  |  |  |                            |     |
|  |  | 1.0  | 66   | 11.14  |   | 24.0122-0231.1   | 422231   |  | 257 22,0 20,0 V +S +B      |     |
|  |  | 1.0  | 85   | 11.14  |   | 24.0322-0231.1   | 522231   |  | 257 22,0 20,0 V +S +B PD   |     |
|  |  | 1.2  | 51   | 11.14  |   |  |  |  |                            |     |
|  |  | 1.3 CDTi   | 55   | 11.14  |   |  |  |  |                            |     |
| 1.3 CDTi   |  | 70   | 11.14  |  |   |  |  |  |                            |     |
| 1.4  |  | 55   | 11.14  |  |   |  |  |  |                            |     |
| 1.4  |  | 66   | 11.14  |  |   |  |  |  |                            |     |
| 1.4 LPG  |  | 66   | 03.15  |  |   |  |  |  |                            |     |
| 1.4 Turbo  |  | 74   | 11.14  |  |   |  |  |  |                            |     |
| 1.4 Turbo  |  | 110  | 03.15  |  |   |  |  |  |                            |     |
|  |  | 1.0  | 66   | 11.14  |   | 24.0122-0241.1   | 422241   |  | 284 22,0 20,0 V +S +B      |     |
|  |  | 1.0  | 85   | 11.14  |   |  |  |  |                            |     |
|  |  | 1.2  | 51   | 11.14  |   |  |  |  |                            |     |
|  |  | 1.3 CDTi   | 55   | 11.14  |   |  |  |  |                            |     |
|  | 1.3 CDTi   | 70   | 11.14  |  |   |  |  |  |                            |     |
|  | 1.4  | 55   | 11.14  |  |   |  |  |  |                            |     |
|  | 1.4  | 66   | 11.14  |  |   |  |  |  |                            |     |
|  | 1.4 LPG  | 66   | 03.15  |  |   |  |  |  |                            |     |
|  | 1.4 Turbo  | 74   | 11.14  |  |   |  |  |  |                            |     |
|  | 1.4 Turbo  | 110  | 03.15  |  |   |  |  |  |                            |     |
|  |  | 1.0  | 66   | 11.14  |   | 24.0125-0142.1   | 425142   |  | 308 25,0 22,0 V L +S +B    |     |
|  |  | 1.0  | 85   | 11.14  |   | 24.0325-0142.1   | 525142   |  | 308 25,0 22,0 V L +S +B PD |     |
|  |  | 1.2  | 51   | 11.14  |   |  |  |  |                            |     |
|  |  | 1.3 CDTi   | 55   | 11.14  |   |  |  |  |                            |     |
| 1.3 CDTi   |  | 70   | 11.14  |  |   |  |  |  |                            |     |
| 1.4  |  | 55   | 11.14  |  |   |  |  |  |                            |     |
| 1.4  |  | 66   | 11.14  |  |   |  |  |  |                            |     |
| 1.4 LPG  |  | 66   | 03.15  |  |   |  |  |  |                            |     |
| 1.4 Turbo  |  | 74   | 11.14  |  |   |  |  |  |                            |     |
| 1.4 Turbo  |  | 110  | 03.15  |  |   |  |  |  |                            |     |
|  |  | 1.0  | 66   | 11.14  |   | 13.0460-2793.2   | 602793   |  | 25973 17,2 +/WK/Zub/STRW   |     |
|  |  | 1.0  | 85   | 11.14  |   |  |  |  |                            |     |
|  |  | 1.2  | 51   | 11.14  |   |  |  |  |                            |     |
|  |  | 1.3 CDTi   | 55   | 11.14  |   |  |  |  |                            |     |
|  | 1.3 CDTi   | 70   | 11.14  |  |   |  |  |  |                            |     |
|  | ↓  |  |  |  |   |  |  |  |                            |     |

<sup>1)</sup> + 3 door / + 3 porte / + 3 portes / + 3 puertas

<sup>2)</sup> + 5 door / + 5 porte / + 5 portes / + 5 puertas

<sup>3)</sup> + Quick Fit/ + 3 door / + Quick Fit/ + 3 porte / + Quick Fit/ + 3 portes / + Quick Fit/ + 3 puertas

<sup>4)</sup> + Quick Fit/ + 5 door / + Quick Fit/ + 5 porte / + Quick Fit/ + 5 portes / + Quick Fit/ + 5 puertas

<sup>5)</sup> + brake disc diameter 308mm / + diametro discos freno 308mm / + diamètre disques frein 308mm / + diametro disco freno 308mm





### OPEL CORSA E / Vauxhall Corsa Mk IV (14-)

|  |   |  |  |   |  |  |  |  |                                     |          |
|--|---|--|--|---|--|--|--|--|-------------------------------------|----------|
|  | 1.4<br>1.4<br>1.4 LPG<br>1.4 Turbo<br>1.4 Turbo<br>1.6 Turbo  | 55<br>66<br>66<br>74<br>110<br>152                               |  | 11.14<br>11.14<br>03.15<br>11.14<br>03.15<br>03.15  |  | 13.0460-2793.2<br>602793                             |  |  | 25973 17,2 +WK/Zub/STRW             |          |
|  | 1.0<br>1.0<br>1.2<br>1.3 CDTi<br>1.3 CDTi<br>1.4<br>1.4<br>1.4 LPG<br>1.4 Turbo<br>1.4 Turbo<br>1.6 Turbo | 66<br>85<br>51<br>55<br>70<br>55<br>66<br>66<br>74<br>110<br>152 |  | 11.14<br>11.14<br>11.14<br>11.14<br>11.14<br>11.14<br>11.14<br>03.15<br>11.14<br>03.15<br>03.15 |  | 24.0110-0347.1<br>24.0110-0323.1<br>410347<br>410323 |  | + POC J7A<br>+ POC J67                                 | 264 10,0 8,0 +B<br>264 10,0 8,0 +B  |          |
|  | 1.0<br>1.0<br>1.2<br>1.3 CDTi<br>1.3 CDTi<br>1.4<br>1.4<br>1.4 LPG<br>1.4 Turbo<br>1.4 Turbo              | 66<br>85<br>51<br>55<br>70<br>55<br>66<br>66<br>74<br>110        |  | 11.14<br>11.14<br>11.14<br>11.14<br>11.14<br>11.14<br>11.14<br>03.15<br>11.14<br>03.15          |  | 03.0137-0478.2<br>03.0137-9309.2<br>650478<br>669309 |  | + 9" Bremse <sup>1)</sup><br>+ 9" Bremse <sup>1)</sup> | 228 x 42 HEB<br>Bremsbacken-Zubehör | AP<br>AP |

### OPEL FRONTERA A (92-98)

|  |  |  |  |  |  |  |  |  |                                     |            |
|--|--|--|--|--|--|--|--|--|-------------------------------------|------------|
|  | 2.0<br>2.2 16V<br>2.3 TD<br>2.4<br>2.5 TDS<br>2.8 TD |  | SV720102<br>SV720102<br>SV720102<br>SV720102<br>SV720102<br>SV720102 | 03.92<br>03.95<br>03.92<br>03.92<br>09.96<br>03.95                                     |  | 13.0460-5942.2<br>13.0460-0337.2<br>605942<br>610337 |  |  | 21544 16,5 +WK<br>Belagsatz-Zubehör | AKE<br>AKE |
|  | 2.0<br>2.2 16V<br>2.3 TD<br>2.4<br>2.5 TDS<br>2.8 TD | SV720103<br>SV720103<br>SV720103<br>SV720103<br>SV720103<br>SV720103 |  | 10.98<br>10.98<br>10.98<br>10.98<br>10.98<br>10.98                                     |  | 13.0460-5926.2<br>13.0460-0446.2<br>605926<br>610446 |  |  | 21845 16,5 +WK<br>Belagsatz-Zubehör | AKE<br>AKE |
|  | 2.0<br>2.2 16V<br>2.3 TD<br>2.4<br>2.5 TDS<br>2.8 TD |  | SV720102<br>SV720102<br>SV720102<br>SV720102<br>SV720102<br>SV720102 | 03.92<br>03.95<br>03.92<br>03.92<br>09.96<br>03.95                                     |  | 24.0122-0156.1<br>422156                             |  |  | 257 22,0 20,6 V                     |            |
|  | 2.0<br>2.2 16V<br>2.3 TD<br>2.4<br>2.5 TDS<br>2.8 TD | SV720103<br>SV720103<br>SV720103<br>SV720103<br>SV720103<br>SV720103 |  | 10.98 - ABS<br>10.98 - ABS<br>10.98 - ABS<br>10.98 - ABS<br>10.98 - ABS<br>10.98 - ABS |  | 24.0126-0111.1<br>426111                             |  |  | 280 26,0 24,6 V +B                  |            |
|  | 2.0<br>2.2 16V<br>2.3 TD<br>2.4<br>2.5 TDS<br>2.8 TD | SV720103<br>SV720103<br>SV720103<br>SV720103<br>SV720103<br>SV720103 |  | 10.98 + ABS<br>10.98 + ABS<br>10.98 + ABS<br>10.98 + ABS<br>10.98 + ABS<br>10.98 + ABS |  | 24.0126-0111.1<br>426111                             |  |  | 280 26,0 24,6 V +B                  |            |
|  | 2.0<br>2.2 16V<br>2.3 TD<br>2.4<br>2.5 TDS<br>2.8 TD | SV720103<br>SV720103<br>SV720103<br>SV720103<br>SV720103<br>SV720103 |  | 10.98<br>10.98<br>10.98<br>10.98<br>10.98<br>10.98                                     |  | 13.0460-5927.2<br>13.0460-0447.2<br>605927<br>610447 |  |  | 21875 16,0 +WK<br>Belagsatz-Zubehör | AKE<br>AKE |
|  | 2.0<br>2.2 16V<br>2.3 TD<br>2.4<br>2.5 TDS<br>2.8 TD | SV720103<br>SV720103<br>SV720103<br>SV720103<br>SV720103<br>SV720103 |  | 10.98<br>10.98<br>10.98<br>10.98<br>10.98<br>10.98                                     |  | 24.0118-0122.1<br>418122                             |  |  | 313 18,0 16,6 V +B                  |            |
|  | 2.0<br>2.2 16V<br>2.3 TD<br>2.4<br>2.5 TDS<br>2.8 TD |  | SV720102<br>SV720102<br>SV720102<br>SV720102<br>SV720102<br>SV720102 | 03.92<br>03.95<br>03.92<br>03.92<br>09.96<br>03.95                                     |  | 03.0137-0283.2<br>03.0137-9245.2<br>650283<br>669245 |  |  | 254 x 52<br>Bremsbacken-Zubehör     |            |
|  | 2.0<br>2.2 16V<br>2.3 TD<br>2.4<br>2.5 TDS<br>2.8 TD | SV720103<br>SV720103<br>SV720103<br>SV720103<br>SV720103<br>SV720103 |  | 10.98<br>10.98<br>10.98<br>10.98<br>10.98<br>10.98                                     |  | 03.0137-0430.2<br>650430                             |  |  | 210 x 32                            |            |

<sup>1)</sup> + 9" brake / + servofreno da 9" / + frein de 9" / + freno de 9"











**OPEL INSIGNIA / Vauxhall Insignia (08-)**

|  |  |  |  |  |  |  |  |   |
|--|--|--|--|--|--|--|--|---|
|  | 2.0 CDTI 81<br>2.0 CDTI 88<br>2.0 CDTI 96<br>2.0 CDTi 103<br>2.0 CDTI 118<br>2.0 CDTI 120<br>2.0 CDTI 4x4 118<br>2.0 CDTI 4x4 120<br>2.0 Turbo 162<br>2.0 Turbo 184<br>2.0 Turbo 4x4 162<br>2.0 Turbo 4x4 184<br>2.8 V6 T 4x4 OPC 239<br>2.8 V6 Turbo 4x4 191                              |  | 07.08<br>03.13<br>07.08<br>07.13<br>07.08<br>07.13<br>06.10<br>07.13<br>07.08<br>04.14<br>07.08<br>09.11<br>07.09<br>07.08 | + Bremsscheibendurchm. 315mm <sup>1)</sup><br>+ Bremsscheibendurchm. 315mm <sup>1)</sup><br>+ Bremsscheibendurchm. 315mm <sup>1)</sup><br>+ Bremsscheibendurchm. 315mm <sup>1)</sup><br>+ Bremsscheibendurchm. 315mm <sup>1)</sup><br>+ Bremsscheibendurchm. 315mm <sup>1)</sup><br>+ Bremsscheibendurchm. 315mm <sup>1)</sup><br>+ Bremsscheibendurchm. 315mm <sup>1)</sup><br>+ Bremsscheibendurchm. 315mm <sup>1)</sup><br>+ Bremsscheibendurchm. 315mm <sup>1)</sup><br>+ Bremsscheibendurchm. 315mm <sup>1)</sup><br>+ Bremsscheibendurchm. 315mm <sup>1)</sup> | 24.0123-0114.1 423114<br>24.0323-0114.1 523114   |  |  | 315 22,9 21,5 V +S +B<br>315 22,9 21,5 V +S +B PD |
|  | 1.4 Turbo ecoFLEX 103<br>1.6 85<br>1.6 Turbo 132<br>1.8 103<br>2.0 BiTurbo CDTI<br>2.0 CDTI 81<br>2.0 CDTI 96<br>2.0 CDTI 118<br>2.0 Turbo 162   | B1999999<br>B1999999<br>B1999999<br>B1999999<br>B1999999<br>B1999999<br>B1999999<br>B1999999<br>B1999999   | 06.11<br>07.08<br>10.08<br>07.08<br>07.08<br>07.08<br>07.08<br>07.08   |  | 24.0711-5332.3 360327<br>24.0710-5021.3 360412<br>24.0710-5022.3 360413                          | 2  - Flexride Fahrwerk <sup>2)</sup><br>+ Flexride Fahrwerk <sup>3)</sup><br>+ Flexride Fahrwerk <sup>3)</sup>                                   | Radsensor L=766<br>Radsensor L=1417<br>Radsensor L=1674                      |   |
|  | 1.4 Turbo ecoFLEX 103<br>1.4 Turbo LPG ecoFLEX 103<br>1.6 85<br>1.6 SIDI 125<br>1.6 Turbo 132<br>1.8 103<br>2.0 BiTurbo CDTI<br>2.0 CDTI 81<br>2.0 CDTI 88<br>2.0 CDTI 96<br>2.0 CDTI 118<br>2.0 Turbo 162   | C1000001<br>D1999999<br>C1000001<br>D1999999<br>C1000001<br>D1999999<br>C1000001<br>D1999999<br>C1000001<br>D1999999<br>C1000001<br>D1999999<br>D1999999                                     | 07.12<br>03.13<br>03.13  |  | 24.0711-5395.3 360381<br>24.0711-5396.3 360382<br>24.0710-5021.3 360412<br>24.0710-5022.3 360413 | - Flexride Fahrwerk <sup>2)</sup><br>- Flexride Fahrwerk <sup>2)</sup><br>+ Flexride Fahrwerk <sup>3)</sup><br>+ Flexride Fahrwerk <sup>3)</sup> | Radsensor L=1417<br>Radsensor L=1674<br>Radsensor L=1417<br>Radsensor L=1674 |   |
|  | 1.4 Turbo ecoFLEX 103<br>1.4 Turbo LPG ecoFLEX 103<br>1.6 85<br>1.6 CDTi 88<br>1.6 CDTi 100<br>1.6 SIDI 125<br>1.6 Turbo 132<br>1.8 103<br>2.0 BiTurbo CDTI<br>2.0 CDTI 81<br>2.0 CDTI 88<br>2.0 CDTI 96<br>2.0 CDTi 103<br>2.0 CDTI 118<br>2.0 CDTi 120<br>2.0 Turbo 162<br>2.0 Turbo 184 | E1000001<br>E1000001<br>E1000001<br>E1000001<br>E1000001<br>E1000001<br>E1000001<br>E1000001<br>E1000001<br>E1000001<br>E1000001<br>E1000001<br>E1000001<br>E1000001<br>E1000001<br>E1000001 | 07.15<br>07.15<br>07.13<br>07.13   |  | 24.0710-5019.3 360410<br>24.0710-5020.3 360411<br>24.0710-5021.3 360412<br>24.0710-5022.3 360413 | - Flexride Fahrwerk <sup>2)</sup><br>- Flexride Fahrwerk <sup>2)</sup><br>+ Flexride Fahrwerk <sup>3)</sup><br>+ Flexride Fahrwerk <sup>3)</sup> | Radsensor L=1438<br>Radsensor L=1841<br>Radsensor L=1417<br>Radsensor L=1674 |   |
|  | 2.0 BiTurbo CDTI 4x4<br>2.0 CDTI 4x4<br>2.0 Turbo 4x4<br>2.8 V6 Turbo 4x4  | A1000001<br>A1000001<br>A1000001<br>A1000001   | 07.08<br>06.10<br>07.08<br>07.08   |  | 24.0711-5294.3 360325  | 2  - Flexride Fahrwerk <sup>2)</sup>   | Radsensor L=1245   |   |
|  | 2.0 BiTurbo CDTI 4x4<br>2.0 CDTI 4x4<br>2.0 CDTi 4x4<br>2.0 Turbo 4x4<br>2.0 Turbo 4x4<br>2.8 V6 Turbo 4x4   | B1000001<br>B1000001<br>B1000001<br>B1000001<br>B1000001<br>B1000001   | 07.13<br>09.11   |  | 24.0711-5294.3 360325  | 2  - Flexride Fahrwerk <sup>2)</sup>   | Radsensor L=1245   |   |
|  | 2.0 BiTurbo CDTI 4x4<br>2.0 CDTI 4x4<br>2.0 CDTi 4x4<br>2.0 Turbo 4x4<br>2.0 Turbo 4x4<br>2.8 V6 Turbo 4x4   | E1000001<br>E1000001<br>E1000001<br>E1000001<br>E1000001<br>E1000001   |  |  | 24.0711-5294.3 360325  | 2  - Flexride Fahrwerk <sup>2)</sup>   | Radsensor L=1245   |   |
|  | 2.8 V6 T 4x4 OPC   | 239  | 07.09  |  | 24.0711-5342.3 360414  | 2  | Radsensor L=1245   |   |

**OPEL INSIGNIA Country Tourer (13-)**

|  |  |  |                         |  |  |  |   |
|--|--|--|-------------------------|--|--|--|---|
|  | 2.0 CDTI 4x4 120<br>2.0 SIDI Turbo 4x4 184<br>2.0 SIDI Turbo 4x4 184 |  | 09.13<br>09.13<br>09.13 | + Bremsscheibendurchm. 296mm <sup>4)</sup><br>+ Bremsscheibendurchm. 296mm <sup>4)</sup><br>+ Bremsscheibendurchm. 296mm <sup>4)</sup> | 13.0460-5611.2 605611<br>13.0470-5611.2 LD5611 |  | 24415 19,1 +/WK/Zub MAN<br>24415 19,1 +/WK/Zub MAN    |
|  | 2.0 CDTI 4x4 120<br>2.0 SIDI Turbo 4x4 184<br>2.0 SIDI Turbo 4x4 184 |  | 09.13<br>09.13<br>09.13 | + Bremsscheibendurchm. 321mm <sup>5)</sup><br>+ Bremsscheibendurchm. 321mm <sup>5)</sup><br>+ Bremsscheibendurchm. 321mm <sup>5)</sup> | 13.0460-5612.2 605612<br>13.0470-5612.2 LD5612 |  | 24412 19,0 +/WK/Zub MAN<br>24412 19,0 +/WK/Zub MAN    |
|  | 2.0 CDTI 4x4 120<br>2.0 SIDI Turbo 4x4 184<br>2.0 SIDI Turbo 4x4 184 |  | 09.13<br>09.13<br>09.13 | + Bremsscheibendurchm. 337mm <sup>6)</sup><br>+ Bremsscheibendurchm. 337mm <sup>6)</sup><br>+ Bremsscheibendurchm. 337mm <sup>6)</sup> | 13.0460-2754.2 602754                          |  | 24418 17,0 +/WK/Zub TRW                               |
|  | 2.0 CDTI 4x4 120<br>2.0 SIDI Turbo 4x4 184<br>2.0 SIDI Turbo 4x4 184 |  | 09.13<br>09.13<br>09.13 | + Bremsscheibendurchm. 296mm <sup>4)</sup><br>+ Bremsscheibendurchm. 296mm <sup>4)</sup><br>+ Bremsscheibendurchm. 296mm <sup>4)</sup> | 24.0130-0207.1 430207<br>24.0330-0207.1 530207 |  | 296 30,0 27,0 V L +S +B<br>296 30,0 27,0 V L +S +B PD |
|  | 2.0 CDTI 4x4 120<br>2.0 SIDI Turbo 4x4 184<br>2.0 SIDI Turbo 4x4 184 |  | 09.13<br>09.13<br>09.13 | + Bremsscheibendurchm. 321mm <sup>5)</sup><br>+ Bremsscheibendurchm. 321mm <sup>5)</sup><br>+ Bremsscheibendurchm. 321mm <sup>5)</sup> | 24.0130-0209.1 430209<br>24.0330-0209.1 530209 |  | 321 30,0 27,0 V L +S +B<br>321 30,0 27,0 V L +S +B PD |

<sup>1)</sup> + brake disc diameter 315mm / + diametro dischi freno 315mm / + diamètre disques frein 315mm / + diámetro disco freno 315mm

<sup>2)</sup> - flexride suspension / - autotelaio flexride / - châssis de flexride / - suspensión flexride

<sup>3)</sup> + flexride suspension / + autotelaio flexride / + châssis de flexride / + suspensión flexride

<sup>4)</sup> + brake disc diameter 296mm / + diametro dischi freno 296mm / + diamètre disques frein 296mm / + diámetro disco freno 296mm

<sup>5)</sup> + brake disc diameter 321mm / + diametro dischi freno 321mm / + diamètre disques frein 321mm / + diámetro disco freno 321mm

<sup>6)</sup> + brake disc diameter 337mm / + diametro dischi freno 337mm / + diamètre disques frein 337mm / + diámetro disco freno 337mm







**OPEL INSIGNIA Sports Tourer / Vauxh. Insignia SportsTourer (08-)**

|  |                       |     |       |   |                |        |                                      |                         |     |
|--|-----------------------|-----|-------|---|----------------|--------|--------------------------------------|-------------------------|-----|
|  | 2.8 V6 Turbo 4x4      | 191 | 07.08 | + Bremsscheibendurchm. 337 mm <sup>1)</sup> | 13.0460-2754.2 | 602754 |                                      | 24418 17,0 +WK/Zub      | TRW |
|  | 2.8 V6 T 4x4 OPC      | 239 | 07.09 |   | 13.0460-4855.2 | 604855 |                                      | 23325 16,4 /WK          | BRE |
|  | 1.4 Turbo ecoFLEX     | 103 | 06.11 | + Bremsscheibendurchm. 296mm <sup>2)</sup>  | 24.0130-0207.1 | 430207 |                                      | 296 30,0 27,0 V L +S +B | PD  |
|  | 1.4 Turbo LPG ecoFLEX | 103 | 07.12 | + Bremsscheibendurchm. 296mm <sup>2)</sup>  | 24.0330-0207.1 | 530207 |                                      | 296 30,0 27,0 V L +S +B |     |
|  | 1.6                   | 85  | 07.08 | + Bremsscheibendurchm. 296mm <sup>2)</sup>  |                |        |                                      |                         |     |
|  | 1.6 CDTi              | 88  | 07.15 | + Bremsscheibendurchm. 296mm <sup>2)</sup>  |                |        |                                      |                         |     |
|  | 1.6 CDTi              | 100 | 07.15 | + Bremsscheibendurchm. 296mm <sup>2)</sup>  |                |        |                                      |                         |     |
|  | 1.6 SIDI              | 125 | 03.13 | + Bremsscheibendurchm. 296mm <sup>2)</sup>  |                |        |                                      |                         |     |
|  | 1.6 Turbo             | 132 | 10.08 | + Bremsscheibendurchm. 296mm <sup>2)</sup>  |                |        |                                      |                         |     |
|  | 1.8                   | 103 | 07.08 | + Bremsscheibendurchm. 296mm <sup>2)</sup>  |                |        |                                      |                         |     |
|  | 2.0 BiTurbo CDTI      |     | 07.08 | + Bremsscheibendurchm. 296mm <sup>2)</sup>  |                |        |                                      |                         |     |
|  | 2.0 BiTurbo CDTI 4x4  |     | 07.08 | + Bremsscheibendurchm. 296mm <sup>2)</sup>  |                |        |                                      |                         |     |
|  | 2.0 CDTI              | 81  | 07.08 | + Bremsscheibendurchm. 296mm <sup>2)</sup>  |                |        |                                      |                         |     |
|  | 2.0 CDTI              | 88  | 03.13 | + Bremsscheibendurchm. 296mm <sup>2)</sup>  |                |        |                                      |                         |     |
|  | 2.0 CDTI              | 96  | 07.08 | + Bremsscheibendurchm. 296mm <sup>2)</sup>  |                |        |                                      |                         |     |
|  | 2.0 CDTi              | 103 | 07.13 | + Bremsscheibendurchm. 296mm <sup>2)</sup>  |                |        |                                      |                         |     |
|  | 2.0 CDTi              | 118 | 07.08 | + Bremsscheibendurchm. 296mm <sup>2)</sup>  |                |        |                                      |                         |     |
|  | 2.0 CDTi              | 120 | 07.13 | + Bremsscheibendurchm. 296mm <sup>2)</sup>  |                |        |                                      |                         |     |
|  | 2.0 CDTI 4x4          | 118 | 06.10 | + Bremsscheibendurchm. 296mm <sup>2)</sup>  |                |        |                                      |                         |     |
|  | 2.0 CDTi 4x4          | 120 | 07.13 | + Bremsscheibendurchm. 296mm <sup>2)</sup>  |                |        |                                      |                         |     |
|  | 2.0 Turbo             | 162 | 07.08 | + Bremsscheibendurchm. 296mm <sup>2)</sup>  |                |        |                                      |                         |     |
|  | 2.0 Turbo             | 184 | 04.14 | + Bremsscheibendurchm. 296mm <sup>2)</sup>  |                |        |                                      |                         |     |
|  | 2.0 Turbo 4x4         | 162 | 07.08 | + Bremsscheibendurchm. 296mm <sup>2)</sup>  |                |        |                                      |                         |     |
|  | 2.0 Turbo 4x4         | 184 | 09.11 | + Bremsscheibendurchm. 296mm <sup>2)</sup>  |                |        |                                      |                         |     |
|  | 1.4 Turbo ecoFLEX     | 103 | 06.11 | + Bremsscheibendurchm. 321 mm <sup>3)</sup> | 24.0130-0209.1 | 430209 |                                      | 321 30,0 27,0 V L +S +B | PD  |
|  | 1.4 Turbo LPG ecoFLEX | 103 | 07.12 | + Bremsscheibendurchm. 321 mm <sup>3)</sup> | 24.0330-0209.1 | 530209 |                                      | 321 30,0 27,0 V L +S +B |     |
|  | 1.6                   | 85  | 07.08 | + Bremsscheibendurchm. 321 mm <sup>3)</sup> |                |        |                                      |                         |     |
|  | 1.6 CDTi              | 88  | 07.15 | + Bremsscheibendurchm. 321 mm <sup>3)</sup> |                |        |                                      |                         |     |
|  | 1.6 CDTi              | 100 | 07.15 | + Bremsscheibendurchm. 321 mm <sup>3)</sup> |                |        |                                      |                         |     |
|  | 1.6 SIDI              | 125 | 03.13 | + Bremsscheibendurchm. 321 mm <sup>3)</sup> |                |        |                                      |                         |     |
|  | 1.6 Turbo             | 132 | 10.08 | + Bremsscheibendurchm. 321 mm <sup>3)</sup> |                |        |                                      |                         |     |
|  | 1.8                   | 103 | 07.08 | + Bremsscheibendurchm. 321 mm <sup>3)</sup> |                |        |                                      |                         |     |
|  | 2.0 BiTurbo CDTI      |     | 07.08 | + Bremsscheibendurchm. 321 mm <sup>3)</sup> |                |        |                                      |                         |     |
|  | 2.0 BiTurbo CDTI 4x4  |     | 07.08 | + Bremsscheibendurchm. 321 mm <sup>3)</sup> |                |        |                                      |                         |     |
|  | 2.0 CDTI              | 81  | 07.08 | + Bremsscheibendurchm. 321 mm <sup>3)</sup> |                |        |                                      |                         |     |
|  | 2.0 CDTI              | 88  | 03.13 | + Bremsscheibendurchm. 321 mm <sup>3)</sup> |                |        |                                      |                         |     |
|  | 2.0 CDTI              | 96  | 07.08 | + Bremsscheibendurchm. 321 mm <sup>3)</sup> |                |        |                                      |                         |     |
|  | 2.0 CDTi              | 103 | 07.13 | + Bremsscheibendurchm. 321 mm <sup>3)</sup> |                |        |                                      |                         |     |
|  | 2.0 CDTi              | 118 | 07.08 | + Bremsscheibendurchm. 321 mm <sup>3)</sup> |                |        |                                      |                         |     |
|  | 2.0 CDTi              | 120 | 07.13 | + Bremsscheibendurchm. 321 mm <sup>3)</sup> |                |        |                                      |                         |     |
|  | 2.0 CDTI 4x4          | 118 | 06.10 | + Bremsscheibendurchm. 321 mm <sup>3)</sup> |                |        |                                      |                         |     |
|  | 2.0 CDTi 4x4          | 120 | 07.13 | + Bremsscheibendurchm. 321 mm <sup>3)</sup> |                |        |                                      |                         |     |
|  | 2.0 Turbo             | 162 | 07.08 | + Bremsscheibendurchm. 321 mm <sup>3)</sup> |                |        |                                      |                         |     |
|  | 2.0 Turbo             | 184 | 04.14 | + Bremsscheibendurchm. 321 mm <sup>3)</sup> |                |        |                                      |                         |     |
|  | 2.0 Turbo 4x4         | 162 | 07.08 | + Bremsscheibendurchm. 321 mm <sup>3)</sup> |                |        |                                      |                         |     |
|  | 2.0 Turbo 4x4         | 184 | 09.11 | + Bremsscheibendurchm. 321 mm <sup>3)</sup> |                |        |                                      |                         |     |
|  | 1.4 Turbo ecoFLEX     | 103 | 06.11 | + Bremsscheibendurchm. 337 mm <sup>1)</sup> | 24.0130-0208.1 | 430208 |                                      | 337 30,0 27,0 V L +S +B |     |
|  | 1.4 Turbo LPG ecoFLEX | 103 | 07.12 | + Bremsscheibendurchm. 337 mm <sup>1)</sup> |                |        |                                      |                         |     |
|  | 1.6                   | 85  | 07.08 | + Bremsscheibendurchm. 337 mm <sup>1)</sup> |                |        |                                      |                         |     |
|  | 1.6 CDTi              | 88  | 07.15 | + Bremsscheibendurchm. 337 mm <sup>1)</sup> |                |        |                                      |                         |     |
|  | 1.6 CDTi              | 100 | 07.15 | + Bremsscheibendurchm. 337 mm <sup>1)</sup> |                |        |                                      |                         |     |
|  | 1.6 SIDI              | 125 | 03.13 | + Bremsscheibendurchm. 337 mm <sup>1)</sup> |                |        |                                      |                         |     |
|  | 1.6 Turbo             | 132 | 10.08 | + Bremsscheibendurchm. 337 mm <sup>1)</sup> |                |        |                                      |                         |     |
|  | 1.8                   | 103 | 07.08 | + Bremsscheibendurchm. 337 mm <sup>1)</sup> |                |        |                                      |                         |     |
|  | 2.0 BiTurbo CDTI      |     | 07.08 | + Bremsscheibendurchm. 337 mm <sup>1)</sup> |                |        |                                      |                         |     |
|  | 2.0 BiTurbo CDTI 4x4  |     | 07.08 | + Bremsscheibendurchm. 337 mm <sup>1)</sup> |                |        |                                      |                         |     |
|  | 2.0 CDTI              | 81  | 07.08 | + Bremsscheibendurchm. 337 mm <sup>1)</sup> |                |        |                                      |                         |     |
|  | 2.0 CDTI              | 88  | 03.13 | + Bremsscheibendurchm. 337 mm <sup>1)</sup> |                |        |                                      |                         |     |
|  | 2.0 CDTI              | 96  | 07.08 | + Bremsscheibendurchm. 337 mm <sup>1)</sup> |                |        |                                      |                         |     |
|  | 2.0 CDTi              | 103 | 07.13 | + Bremsscheibendurchm. 337 mm <sup>1)</sup> |                |        |                                      |                         |     |
|  | 2.0 CDTi              | 118 | 07.08 | + Bremsscheibendurchm. 337 mm <sup>1)</sup> |                |        |                                      |                         |     |
|  | 2.0 CDTi              | 120 | 07.13 | + Bremsscheibendurchm. 337 mm <sup>1)</sup> |                |        |                                      |                         |     |
|  | 2.0 CDTI 4x4          | 118 | 06.10 | + Bremsscheibendurchm. 337 mm <sup>1)</sup> |                |        |                                      |                         |     |
|  | 2.0 CDTi 4x4          | 120 | 07.13 | + Bremsscheibendurchm. 337 mm <sup>1)</sup> |                |        |                                      |                         |     |
|  | 2.0 Turbo             | 162 | 07.08 | + Bremsscheibendurchm. 337 mm <sup>1)</sup> |                |        |                                      |                         |     |
|  | 2.0 Turbo             | 184 | 04.14 | + Bremsscheibendurchm. 337 mm <sup>1)</sup> |                |        |                                      |                         |     |
|  | 2.0 Turbo 4x4         | 162 | 07.08 | + Bremsscheibendurchm. 337 mm <sup>1)</sup> |                |        |                                      |                         |     |
|  | 2.0 Turbo 4x4         | 184 | 09.11 | + Bremsscheibendurchm. 337 mm <sup>1)</sup> |                |        |                                      |                         |     |
|  | 2.8 V6 Turbo 4x4      | 191 | 07.08 | + Bremsscheibendurchm. 337 mm <sup>1)</sup> |                |        |                                      |                         |     |
|  | 1.4 Turbo ecoFLEX     | 103 | 06.11 |   | 24.0710-5015.3 | 360403 | 2  - Flexride Fahrwerk <sup>4)</sup> | Radsensor L=740         |     |
|  | 1.4 Turbo LPG ecoFLEX | 103 | 07.12 |   |                |        |                                      |                         |     |
|  | 1.6                   | 85  | 07.08 |   |                |        |                                      |                         |     |
|  | 1.6 CDTi              | 88  | 07.15 |   |                |        |                                      |                         |     |
|  | 1.6 CDTi              | 100 | 07.15 |   |                |        |                                      |                         |     |
|  | 1.6 SIDI              | 125 | 03.13 |   |                |        |                                      |                         |     |
|  | 1.6 Turbo             | 132 | 10.08 |   |                |        |                                      |                         |     |
|  | 1.8                   | 103 | 07.08 |   |                |        |                                      |                         |     |
|  | 2.0 BiTurbo CDTI      |     | 07.08 |   |                |        |                                      |                         |     |
|  | 2.0 BiTurbo CDTI 4x4  |     | 07.08 |   |                |        |                                      |                         |     |
|  | 2.0 CDTI              | 81  | 07.08 |   |                |        |                                      |                         |     |
|  | 2.0 CDTI              | 88  | 03.13 |   |                |        |                                      |                         |     |
|  | 2.0 CDTI              | 96  | 07.08 |   |                |        |                                      |                         |     |
|  | 2.0 CDTi              | 103 | 07.13 |   |                |        |                                      |                         |     |
|  | 2.0 CDTi              | 118 | 07.08 |   |                |        |                                      |                         |     |
|  | 2.0 CDTi              | 120 | 07.13 |   |                |        |                                      |                         |     |
|  | 2.0 CDTI 4x4          | 118 | 06.10 |   |                |        |                                      |                         |     |

<sup>1)</sup> + brake disc diameter 337mm / + diametro dischi freno 337mm / + diamètre disques frein 337mm / + diámetro disco freno 337mm

<sup>2)</sup> + brake disc diameter 296mm / + diametro dischi freno 296mm / + diamètre disques frein 296mm / + diámetro disco freno 296mm

<sup>3)</sup> + brake disc diameter 321mm / + diametro dischi freno 321mm / + diamètre disques frein 321mm / + diámetro disco freno 321mm

<sup>4)</sup> - flexride suspension / - autotelaio flexride / - châssis de flexride / - suspensión flexride



**OPEL INSIGNIA Sports Tourer / Vauxh. Insignia SportsTourer (08-)**

|                      |                       |       |  |  |                |        |   |                                   |                          |
|----------------------|-----------------------|-------|--|--|----------------|--------|---|-----------------------------------|--------------------------|
|                      | 2.0 CDTi 4x4          | 120   | 07.13                                      |  | 24.0710-5015.3 | 360403 | 2 | - Flexride Fahrwerk <sup>1)</sup> | Radsensor L=740          |
|                      | 2.0 Turbo             | 162   | 07.08                                      |  |                |        |   |                                   |                          |
|                      | 2.0 Turbo             | 184   | 04.14                                      |  |                |        |   |                                   |                          |
|                      | 2.0 Turbo 4x4         | 162   | 07.08                                      |  |                |        |   |                                   |                          |
|                      | 2.0 Turbo 4x4         | 184   | 09.11                                      |  |                |        |   |                                   |                          |
|                      | 2.8 V6 T 4x4 OPC      | 239   | 07.09                                      |  | 24.0710-5011.4 | 360353 | 2 | - Flexride Fahrwerk <sup>1)</sup> | Radsensor                |
|                      | 2.8 V6 Turbo 4x4      | 191   | 07.08                                      |  |                |        |   |                                   |                          |
|                      | 1.4 Turbo ecoFLEX     | 103   | 06.11                                      | + Bremsscheibendurchm. 292mm <sup>2)</sup> | 13.0460-2758.2 | 602758 |   |                                   | 24421 17,2 +WK/Zub TRW   |
|                      | 1.4 Turbo LPG ecoFLEX | 103   | 07.12                                      | + Bremsscheibendurchm. 292mm <sup>2)</sup> | 13.0470-2758.2 | LD2758 |   |                                   | 24421 17,2 +WK/Zub TRW   |
|                      | 1.6                   | 85    | 07.08                                      | + Bremsscheibendurchm. 292mm <sup>2)</sup> |                |        |   |                                   |                          |
|                      | 1.6 CDTi              | 88    | 07.15                                      | + Bremsscheibendurchm. 292mm <sup>2)</sup> |                |        |   |                                   |                          |
|                      | 1.6 CDTi              | 100   | 07.15                                      | + Bremsscheibendurchm. 292mm <sup>2)</sup> |                |        |   |                                   |                          |
|                      | 1.6 SIDI              | 125   | 03.13                                      | + Bremsscheibendurchm. 292mm <sup>2)</sup> |                |        |   |                                   |                          |
|                      | 1.6 Turbo             | 132   | 10.08                                      | + Bremsscheibendurchm. 292mm <sup>2)</sup> |                |        |   |                                   |                          |
|                      | 1.8                   | 103   | 07.08                                      | + Bremsscheibendurchm. 292mm <sup>2)</sup> |                |        |   |                                   |                          |
|                      | 2.0 BiTurbo CDTi      |       | 07.08                                      | + Bremsscheibendurchm. 292mm <sup>2)</sup> |                |        |   |                                   |                          |
|                      | 2.0 BiTurbo CDTi 4x4  |       | 07.08                                      | + Bremsscheibendurchm. 292mm <sup>2)</sup> |                |        |   |                                   |                          |
|                      | 2.0 CDTi              | 81    | 07.08                                      | + Bremsscheibendurchm. 292mm <sup>2)</sup> |                |        |   |                                   |                          |
|                      | 2.0 CDTi              | 88    | 03.13                                      | + Bremsscheibendurchm. 292mm <sup>2)</sup> |                |        |   |                                   |                          |
|                      | 2.0 CDTi              | 96    | 07.08                                      | + Bremsscheibendurchm. 292mm <sup>2)</sup> |                |        |   |                                   |                          |
|                      | 2.0 CDTi              | 103   | 07.13                                      | + Bremsscheibendurchm. 292mm <sup>2)</sup> |                |        |   |                                   |                          |
|                      | 2.0 CDTi              | 118   | 07.08                                      | + Bremsscheibendurchm. 292mm <sup>2)</sup> |                |        |   |                                   |                          |
|                      | 2.0 CDTi              | 120   | 07.13                                      | + Bremsscheibendurchm. 292mm <sup>2)</sup> |                |        |   |                                   |                          |
|                      | 2.0 CDTi 4x4          | 118   | 06.10                                      | + Bremsscheibendurchm. 292mm <sup>2)</sup> |                |        |   |                                   |                          |
|                      | 2.0 CDTi 4x4          | 120   | 07.13                                      | + Bremsscheibendurchm. 292mm <sup>2)</sup> |                |        |   |                                   |                          |
|                      | 2.0 Turbo             | 162   | 07.08                                      | + Bremsscheibendurchm. 292mm <sup>2)</sup> |                |        |   |                                   |                          |
|                      | 2.0 Turbo             | 184   | 04.14                                      | + Bremsscheibendurchm. 292mm <sup>2)</sup> |                |        |   |                                   |                          |
|                      | 2.0 Turbo 4x4         | 162   | 07.08                                      | + Bremsscheibendurchm. 292mm <sup>2)</sup> |                |        |   |                                   |                          |
|                      | 2.0 Turbo 4x4         | 184   | 09.11                                      | + Bremsscheibendurchm. 292mm <sup>2)</sup> |                |        |   |                                   |                          |
|                      | 1.4 Turbo ecoFLEX     | 103   | 06.11                                      | + Bremsscheibendurchm. 315mm <sup>3)</sup> | 13.0460-2755.2 | 602755 |   |                                   | 24421 17,2 +WK/Zub TRW   |
|                      | 1.4 Turbo LPG ecoFLEX | 103   | 07.12                                      | + Bremsscheibendurchm. 315mm <sup>3)</sup> | 13.0470-2755.2 | LD2755 |   |                                   | 24421 17,2 +WK/Zub TRW   |
|                      | 1.6                   | 85    | 07.08                                      | + Bremsscheibendurchm. 315mm <sup>3)</sup> |                |        |   |                                   |                          |
|                      | 1.6 CDTi              | 88    | 07.15                                      | + Bremsscheibendurchm. 315mm <sup>3)</sup> |                |        |   |                                   |                          |
|                      | 1.6 CDTi              | 100   | 07.15                                      | + Bremsscheibendurchm. 315mm <sup>3)</sup> |                |        |   |                                   |                          |
|                      | 1.6 SIDI              | 125   | 03.13                                      | + Bremsscheibendurchm. 315mm <sup>3)</sup> |                |        |   |                                   |                          |
|                      | 1.6 Turbo             | 132   | 10.08                                      | + Bremsscheibendurchm. 315mm <sup>3)</sup> |                |        |   |                                   |                          |
|                      | 1.8                   | 103   | 07.08                                      | + Bremsscheibendurchm. 315mm <sup>3)</sup> |                |        |   |                                   |                          |
|                      | 2.0 BiTurbo CDTi      |       | 07.08                                      | + Bremsscheibendurchm. 315mm <sup>3)</sup> |                |        |   |                                   |                          |
|                      | 2.0 BiTurbo CDTi 4x4  |       | 07.08                                      | + Bremsscheibendurchm. 315mm <sup>3)</sup> |                |        |   |                                   |                          |
|                      | 2.0 CDTi              | 81    | 07.08                                      | + Bremsscheibendurchm. 315mm <sup>3)</sup> |                |        |   |                                   |                          |
|                      | 2.0 CDTi              | 88    | 03.13                                      | + Bremsscheibendurchm. 315mm <sup>3)</sup> |                |        |   |                                   |                          |
| 2.0 CDTi             | 96                    | 07.08 | + Bremsscheibendurchm. 315mm <sup>3)</sup> |  |                |        |   |                                   |                          |
| 2.0 CDTi             | 103                   | 07.13 | + Bremsscheibendurchm. 315mm <sup>3)</sup> |  |                |        |   |                                   |                          |
| 2.0 CDTi             | 118                   | 07.08 | + Bremsscheibendurchm. 315mm <sup>3)</sup> |  |                |        |   |                                   |                          |
| 2.0 CDTi             | 120                   | 07.13 | + Bremsscheibendurchm. 315mm <sup>3)</sup> |  |                |        |   |                                   |                          |
| 2.0 CDTi 4x4         | 118                   | 06.10 | + Bremsscheibendurchm. 315mm <sup>3)</sup> |  |                |        |   |                                   |                          |
| 2.0 CDTi 4x4         | 120                   | 07.13 | + Bremsscheibendurchm. 315mm <sup>3)</sup> |  |                |        |   |                                   |                          |
| 2.0 Turbo            | 162                   | 07.08 | + Bremsscheibendurchm. 315mm <sup>3)</sup> |  |                |        |   |                                   |                          |
| 2.0 Turbo            | 184                   | 04.14 | + Bremsscheibendurchm. 315mm <sup>3)</sup> |  |                |        |   |                                   |                          |
| 2.0 Turbo 4x4        | 162                   | 07.08 | + Bremsscheibendurchm. 315mm <sup>3)</sup> |  |                |        |   |                                   |                          |
| 2.0 Turbo 4x4        | 184                   | 09.11 | + Bremsscheibendurchm. 315mm <sup>3)</sup> |  |                |        |   |                                   |                          |
| 2.8 V6 T 4x4 OPC     | 239                   | 07.09 | + Bremsscheibendurchm. 315mm <sup>3)</sup> |  |                |        |   |                                   |                          |
| 2.8 V6 Turbo 4x4     | 191                   | 07.08 | + Bremsscheibendurchm. 315mm <sup>3)</sup> |  |                |        |   |                                   |                          |
|                      | 1.4 Turbo ecoFLEX     | 103   | 06.11                                      | + Bremsscheibendurchm. 292mm <sup>2)</sup> | 24.0112-0187.1 | 412187 |   |                                   | 292 12,0 10,5 +S +B      |
|                      | 1.4 Turbo LPG ecoFLEX | 103   | 07.12                                      | + Bremsscheibendurchm. 292mm <sup>2)</sup> | 24.0312-0187.1 | 512187 |   |                                   | 292 12,0 10,5 +S +B PD   |
|                      | 1.6                   | 85    | 07.08                                      | + Bremsscheibendurchm. 292mm <sup>2)</sup> |                |        |   |                                   |                          |
|                      | 1.6 CDTi              | 88    | 07.15                                      | + Bremsscheibendurchm. 292mm <sup>2)</sup> |                |        |   |                                   |                          |
|                      | 1.6 CDTi              | 100   | 07.15                                      | + Bremsscheibendurchm. 292mm <sup>2)</sup> |                |        |   |                                   |                          |
|                      | 1.6 SIDI              | 125   | 03.13                                      | + Bremsscheibendurchm. 292mm <sup>2)</sup> |                |        |   |                                   |                          |
|                      | 1.6 Turbo             | 132   | 10.08                                      | + Bremsscheibendurchm. 292mm <sup>2)</sup> |                |        |   |                                   |                          |
|                      | 1.8                   | 103   | 07.08                                      | + Bremsscheibendurchm. 292mm <sup>2)</sup> |                |        |   |                                   |                          |
|                      | 2.0 BiTurbo CDTi      |       | 07.08                                      | + Bremsscheibendurchm. 292mm <sup>2)</sup> |                |        |   |                                   |                          |
|                      | 2.0 BiTurbo CDTi 4x4  |       | 07.08                                      | + Bremsscheibendurchm. 292mm <sup>2)</sup> |                |        |   |                                   |                          |
|                      | 2.0 CDTi              | 81    | 07.08                                      | + Bremsscheibendurchm. 292mm <sup>2)</sup> |                |        |   |                                   |                          |
|                      | 2.0 CDTi              | 88    | 03.13                                      | + Bremsscheibendurchm. 292mm <sup>2)</sup> |                |        |   |                                   |                          |
|                      | 2.0 CDTi              | 96    | 07.08                                      | + Bremsscheibendurchm. 292mm <sup>2)</sup> |                |        |   |                                   |                          |
|                      | 2.0 CDTi              | 103   | 07.13                                      | + Bremsscheibendurchm. 292mm <sup>2)</sup> |                |        |   |                                   |                          |
|                      | 2.0 CDTi              | 118   | 07.08                                      | + Bremsscheibendurchm. 292mm <sup>2)</sup> |                |        |   |                                   |                          |
|                      | 2.0 CDTi              | 120   | 07.13                                      | + Bremsscheibendurchm. 292mm <sup>2)</sup> |                |        |   |                                   |                          |
|                      | 2.0 CDTi 4x4          | 118   | 06.10                                      | + Bremsscheibendurchm. 292mm <sup>2)</sup> |                |        |   |                                   |                          |
|                      | 2.0 CDTi 4x4          | 120   | 07.13                                      | + Bremsscheibendurchm. 292mm <sup>2)</sup> |                |        |   |                                   |                          |
|                      | 2.0 Turbo             | 162   | 07.08                                      | + Bremsscheibendurchm. 292mm <sup>2)</sup> |                |        |   |                                   |                          |
|                      | 2.0 Turbo             | 184   | 04.14                                      | + Bremsscheibendurchm. 292mm <sup>2)</sup> |                |        |   |                                   |                          |
|                      | 2.0 Turbo 4x4         | 162   | 07.08                                      | + Bremsscheibendurchm. 292mm <sup>2)</sup> |                |        |   |                                   |                          |
|                      | 2.0 Turbo 4x4         | 184   | 09.11                                      | + Bremsscheibendurchm. 292mm <sup>2)</sup> |                |        |   |                                   |                          |
|                      | 1.4 Turbo ecoFLEX     | 103   | 06.11                                      | + Bremsscheibendurchm. 315mm <sup>3)</sup> | 24.0123-0114.1 | 423114 |   |                                   | 315 22,9 21,5 V +S +B    |
|                      | 1.4 Turbo LPG ecoFLEX | 103   | 07.12                                      | + Bremsscheibendurchm. 315mm <sup>3)</sup> | 24.0323-0114.1 | 523114 |   |                                   | 315 22,9 21,5 V +S +B PD |
| 1.6                  | 85                    | 07.08 | + Bremsscheibendurchm. 315mm <sup>3)</sup> |  |                |        |   |                                   |                          |
| 1.6 CDTi             | 88                    | 07.15 | + Bremsscheibendurchm. 315mm <sup>3)</sup> |  |                |        |   |                                   |                          |
| 1.6 CDTi             | 100                   | 07.15 | + Bremsscheibendurchm. 315mm <sup>3)</sup> |  |                |        |   |                                   |                          |
| 1.6 SIDI             | 125                   | 03.13 | + Bremsscheibendurchm. 315mm <sup>3)</sup> |  |                |        |   |                                   |                          |
| 1.6 Turbo            | 132                   | 10.08 | + Bremsscheibendurchm. 315mm <sup>3)</sup> |  |                |        |   |                                   |                          |
| 1.8                  | 103                   | 07.08 | + Bremsscheibendurchm. 315mm <sup>3)</sup> |  |                |        |   |                                   |                          |
| 2.0 BiTurbo CDTi     |                       | 07.08 | + Bremsscheibendurchm. 315mm <sup>3)</sup> |  |                |        |   |                                   |                          |
| 2.0 BiTurbo CDTi 4x4 |                       | 07.08 | + Bremsscheibendurchm. 315mm <sup>3)</sup> |  |                |        |   |                                   |                          |
| 2.0 CDTi             | 81                    | 07.08 | + Bremsscheibendurchm. 315mm <sup>3)</sup> |  |                |        |   |                                   |                          |
| 2.0 CDTi             | 88                    | 03.13 | + Bremsscheibendurchm. 315mm <sup>3)</sup> |  |                |        |   |                                   |                          |

<sup>1)</sup> - flexride suspension / - autotelaio flexride / - châssis de flexride / - suspensión flexride

<sup>2)</sup> + brake disc diameter 292mm / + diametro dischi freno 292mm / + diamètre disques frein 292mm / + diámetro disco freno 292mm

<sup>3)</sup> + brake disc diameter 315mm / + diametro dischi freno 315mm / + diamètre disques frein 315mm / + diámetro disco freno 315mm





**OPEL INSIGNIA Sports Tourer / Vauxh. Insignia SportsTourer (08-)**

|  |                       |     |          |       |  |                |        |   |                                   |                          |
|--|-----------------------|-----|----------|-------|--|----------------|--------|---|-----------------------------------|--------------------------|
|  | 2.0 CDTI              | 96  |          | 07.08 | + Bremsscheibendurchm. 315mm <sup>1)</sup> | 24.0123-0114.1 | 423114 |   |                                   | 315 22,9 21,5 V +S +B    |
|  | 2.0 CDTi              | 103 |          | 07.13 | + Bremsscheibendurchm. 315mm <sup>1)</sup> | 24.0323-0114.1 | 523114 |   |                                   | 315 22,9 21,5 V +S +B PD |
|  | 2.0 CDTI              | 118 |          | 07.08 | + Bremsscheibendurchm. 315mm <sup>1)</sup> |                |        |   |                                   |                          |
|  | 2.0 CDTi              | 120 |          | 07.13 | + Bremsscheibendurchm. 315mm <sup>1)</sup> |                |        |   |                                   |                          |
|  | 2.0 CDTI 4x4          | 118 |          | 06.10 | + Bremsscheibendurchm. 315mm <sup>1)</sup> |                |        |   |                                   |                          |
|  | 2.0 CDTI 4x4          | 120 |          | 07.13 | + Bremsscheibendurchm. 315mm <sup>1)</sup> |                |        |   |                                   |                          |
|  | 2.0 Turbo             | 162 |          | 07.08 | + Bremsscheibendurchm. 315mm <sup>1)</sup> |                |        |   |                                   |                          |
|  | 2.0 Turbo             | 184 |          | 04.14 | + Bremsscheibendurchm. 315mm <sup>1)</sup> |                |        |   |                                   |                          |
|  | 2.0 Turbo 4x4         | 162 |          | 07.08 | + Bremsscheibendurchm. 315mm <sup>1)</sup> |                |        |   |                                   |                          |
|  | 2.0 Turbo 4x4         | 184 |          | 09.11 | + Bremsscheibendurchm. 315mm <sup>1)</sup> |                |        |   |                                   |                          |
|  | 2.8 V6 T 4x4 OPC      | 239 |          | 07.09 | + Bremsscheibendurchm. 315mm <sup>1)</sup> |                |        |   |                                   |                          |
|  | 2.8 V6 Turbo 4x4      | 191 |          | 07.08 | + Bremsscheibendurchm. 315mm <sup>1)</sup> |                |        |   |                                   |                          |
|  | 1.4 Turbo ecoFLEX     | 103 | B1999999 | 06.11 |  | 24.0711-5332.3 | 360327 | 2 | - Flexride Fahrwerk <sup>2)</sup> | Radsensor L=766          |
|  | 1.6                   | 85  | B1999999 | 07.08 |  | 24.0710-5021.3 | 360412 |   | + Flexride Fahrwerk <sup>3)</sup> | Radsensor L=1417         |
|  | 1.6 Turbo             | 132 | B1999999 | 10.08 |  | 24.0710-5022.3 | 360413 |   | + Flexride Fahrwerk <sup>3)</sup> | Radsensor L=1674         |
|  | 1.8                   | 103 | B1999999 | 07.08 |  |                |        |   |                                   |                          |
|  | 2.0 BiTurbo CDTI      |     | B1999999 | 07.08 |  |                |        |   |                                   |                          |
|  | 2.0 CDTI              | 81  | B1999999 | 07.08 |  |                |        |   |                                   |                          |
|  | 2.0 CDTI              | 96  | B1999999 | 07.08 |  |                |        |   |                                   |                          |
|  | 2.0 CDTI              | 118 | B1999999 | 07.08 |  |                |        |   |                                   |                          |
|  | 2.0 Turbo             | 162 | B1999999 | 07.08 |  |                |        |   |                                   |                          |
|  | 1.4 Turbo ecoFLEX     | 103 | C1000001 |       |  | 24.0711-5395.3 | 360381 |   | - Flexride Fahrwerk <sup>2)</sup> | Radsensor L=1417         |
|  | 1.4 Turbo LPG ecoFLEX | 103 | D1999999 | 07.12 |  | 24.0711-5396.3 | 360382 |   | - Flexride Fahrwerk <sup>2)</sup> | Radsensor L=1674         |
|  | 1.6                   | 85  | C1000001 |       |  | 24.0710-5021.3 | 360412 |   | + Flexride Fahrwerk <sup>3)</sup> | Radsensor L=1417         |
|  | 1.6 SIDI              | 125 |          | 03.13 |  | 24.0710-5022.3 | 360413 |   | + Flexride Fahrwerk <sup>3)</sup> | Radsensor L=1674         |
|  | 1.6 Turbo             | 132 | C1000001 |       |  |                |        |   |                                   |                          |
|  | 1.8                   | 103 | C1000001 |       |  |                |        |   |                                   |                          |
|  | 2.0 BiTurbo CDTI      |     | C1000001 |       |  |                |        |   |                                   |                          |
|  | 2.0 CDTI              | 81  | C1000001 |       |  |                |        |   |                                   |                          |
|  | 2.0 CDTI              | 88  |          | 03.13 |  |                |        |   |                                   |                          |
|  | 2.0 CDTI              | 96  | C1000001 |       |  |                |        |   |                                   |                          |
|  | 2.0 CDTI              | 118 | C1000001 |       |  |                |        |   |                                   |                          |
|  | 2.0 Turbo             | 162 | C1000001 |       |  |                |        |   |                                   |                          |
|  | 1.4 Turbo ecoFLEX     | 103 | E1000001 |       |  | 24.0710-5019.3 | 360410 |   | - Flexride Fahrwerk <sup>2)</sup> | Radsensor L=1438         |
|  | 1.4 Turbo LPG ecoFLEX | 103 | E1000001 |       |  | 24.0710-5020.3 | 360411 |   | - Flexride Fahrwerk <sup>2)</sup> | Radsensor L=1841         |
|  | 1.6                   | 85  | E1000001 |       |  | 24.0710-5021.3 | 360412 |   | + Flexride Fahrwerk <sup>3)</sup> | Radsensor L=1417         |
|  | 1.6 SIDI              | 125 | E1000001 |       |  | 24.0710-5022.3 | 360413 |   | + Flexride Fahrwerk <sup>3)</sup> | Radsensor L=1674         |
|  | 1.6 Turbo             | 132 | E1000001 |       |  |                |        |   |                                   |                          |
|  | 1.8                   | 103 | E1000001 |       |  |                |        |   |                                   |                          |
|  | 2.0 BiTurbo CDTI      |     | E1000001 |       |  |                |        |   |                                   |                          |
|  | 2.0 CDTI              | 81  | E1000001 |       |  |                |        |   |                                   |                          |
|  | 2.0 CDTI              | 88  | E1000001 |       |  |                |        |   |                                   |                          |
|  | 2.0 CDTI              | 96  | E1000001 |       |  |                |        |   |                                   |                          |
|  | 2.0 CDTi              | 103 |          | 07.13 |  |                |        |   |                                   |                          |
|  | 2.0 CDTI              | 118 | E1000001 |       |  |                |        |   |                                   |                          |
|  | 2.0 CDTi              | 120 |          | 07.13 |  |                |        |   |                                   |                          |
|  | 2.0 Turbo             | 162 | E1000001 |       |  |                |        |   |                                   |                          |
|  | 2.0 Turbo             | 184 |          | 04.14 |  |                |        |   |                                   |                          |
|  | 2.0 BiTurbo CDTI 4x4  |     | A1000001 | 07.08 |  | 24.0711-5294.3 | 360325 | 2 | - Flexride Fahrwerk <sup>2)</sup> | Radsensor L=1245         |
|  | 2.0 CDTI 4x4          | 118 | A1000001 | 06.10 |  |                |        |   |                                   |                          |
|  | 2.0 Turbo 4x4         | 162 | A1000001 | 07.08 |  |                |        |   |                                   |                          |
|  | 2.8 V6 Turbo 4x4      | 191 | A1000001 | 07.08 |  |                |        |   |                                   |                          |
|  | 2.0 BiTurbo CDTI 4x4  |     | B1000001 |       |  | 24.0711-5294.3 | 360325 | 2 | - Flexride Fahrwerk <sup>2)</sup> | Radsensor L=1245         |
|  | 2.0 CDTI 4x4          | 118 | B1000001 |       |  |                |        |   |                                   |                          |
|  | 2.0 CDTI 4x4          | 120 |          | 07.13 |  |                |        |   |                                   |                          |
|  | 2.0 Turbo 4x4         | 162 | B1000001 |       |  |                |        |   |                                   |                          |
|  | 2.0 Turbo 4x4         | 184 |          | 09.11 |  |                |        |   |                                   |                          |
|  | 2.8 V6 Turbo 4x4      | 191 | B1000001 |       |  |                |        |   |                                   |                          |
|  | 2.0 BiTurbo CDTI 4x4  |     | E1000001 |       |  | 24.0711-5294.3 | 360325 | 2 | - Flexride Fahrwerk <sup>2)</sup> | Radsensor L=1245         |
|  | 2.0 CDTI 4x4          | 118 | E1000001 |       |  |                |        |   |                                   |                          |
|  | 2.0 CDTI 4x4          | 120 | E1000001 |       |  |                |        |   |                                   |                          |
|  | 2.0 Turbo 4x4         | 162 | E1000001 |       |  |                |        |   |                                   |                          |
|  | 2.0 Turbo 4x4         | 184 | E1000001 |       |  |                |        |   |                                   |                          |
|  | 2.8 V6 Turbo 4x4      | 191 | E1000001 |       |  |                |        |   |                                   |                          |
|  | 2.8 V6 T 4x4 OPC      | 239 |          | 07.09 |  | 24.0711-5342.3 | 360414 | 2 |                                   | Radsensor L=1245         |

**OPEL KARL / Vauxhall Viva (15-)**

|  |         |    |  |       |  |                |        |  |  |                     |
|--|---------|----|--|-------|--|----------------|--------|--|--|---------------------|
|  | 1.0     | 55 |  | 01.15 |  | 03.0137-9314.2 | 669314 |  |  | Bremsbacken-Zubehör |
|  | 1.0 LPG | 54 |  | 02.15 |  |                |        |  |  |                     |

**OPEL MERIVA A / Vauxhall Meriva Mk I (03-10)**

|  |               |     |  |       |                                    |                |        |  |  |                         |
|--|---------------|-----|--|-------|------------------------------------|----------------|--------|--|--|-------------------------|
|  | 1.4 16V       | 66  |  | 07.04 | 05.10 + 4-Loch Felge <sup>4)</sup> | 13.0460-2857.2 | 602857 |  |  | 23225 17,0 +WK/Zub/STRW |
|  | 1.4 LPG       | 66  |  | 07.04 | 05.10 + 4-Loch Felge <sup>4)</sup> | 13.0470-2857.2 | LD2857 |  |  | 23225 17,0 +WK/Zub/STRW |
|  | 1.6           | 64  |  | 05.03 | 05.10                              |                |        |  |  |                         |
|  | 1.3 CDTI      | 51  |  | 04.05 | 05.10                              | 13.0460-7179.2 | 607179 |  |  | 23832 20,2 +WK ATE      |
|  | 1.3 CDTI      | 55  |  | 09.03 | 05.10                              | 13.0470-7179.2 | LD7179 |  |  | 23832 20,2 +WK ATE      |
|  | 1.4 16V       | 66  |  | 07.04 | 05.10 + 5-Loch Felge <sup>5)</sup> |                |        |  |  |                         |
|  | 1.4 LPG       | 66  |  | 07.04 | 05.10 + 5-Loch Felge <sup>5)</sup> |                |        |  |  |                         |
|  | 1.6           | 77  |  | 01.06 | 05.10                              |                |        |  |  |                         |
|  | 1.6 16V       | 74  |  | 05.03 | 05.10                              |                |        |  |  |                         |
|  | 1.6 Turbo OPC | 132 |  | 09.05 | 05.10                              |                |        |  |  |                         |
|  | 1.7 CDTI      | 74  |  | 09.03 | 05.10                              |                |        |  |  |                         |
|  | 1.7 CDTI      | 92  |  | 09.06 | 05.10                              |                |        |  |  |                         |
|  | 1.7 DTI       | 48  |  | 05.03 | 05.10                              |                |        |  |  |                         |
|  | 1.7 DTI 16V   | 55  |  | 09.02 | 05.10                              |                |        |  |  |                         |

















<sup>1)</sup> + brake disc diameter 315mm / + diametro dischi freno 315mm / + diamètre disques frein 315mm / + diámetro disco freno 315mm

<sup>2)</sup> - flexride suspension / - autotelaio flexride / - châssis de flexride / - suspensión flexride

<sup>3)</sup> + flexride suspension / + autotelaio flexride / + châssis de flexride / + suspensión flexride

<sup>4)</sup> + 4 bore wheel rim / + cerchione a 4 fori / + jante à 4 trous / + Llantas de 4 taladros

















<sup>5)</sup> + 5 bore wheel rim / + cerchione a 5 fori / + jante à 5 trous / + Llantas de 5 taladros

|     |    |  |  |  |  |  |     |  |   |  |
|--|--|--|--|--|---|--|---|--|---|--|
| <b>OPEL MERIVA A / Vauxhall Meriva Mk I (03-10)</b>                                |  |  |  |  |   |  |   |  |   |  |
|    | 1.8 16V  | 92   | 09.02  | 05.10  | 13.0460-7179.2<br>13.0470-7179.2  | 607179<br>LD7179   |   | 23832 20,2 +/WK<br>23832 20,2 +/WK   | ATE<br>ATE                                |  |
|    | 1.4 16V  | 66   | 07.04  | 05.10  | 24.0124-0166.1  | 424166   | für 4-Loch-Felge <sup>1)</sup>  | 260 24,0 21,0 V L +S +B  |   |  |
|  | 1.4 LPG  | 66   | 07.04  | 05.10  | 24.0324-0166.1  | 524166   | für 4-Loch-Felge <sup>1)</sup>  | 260 24,0 21,0 V L +S +B PD   |   |  |
|  | 1.6  | 64   | 05.03  | 05.10  |   |  |   |  |   |  |
|  | 1.3 CDTI   | 51   | 04.05  | 05.10  | 24.0125-0148.1  | 425148   | für 4-Loch-Felge <sup>1)</sup>  | 280 25,0 22,0 V L +S +B  |   |  |
|  | 1.3 CDTI   | 55   | 09.03  | 05.10  | 24.0325-0148.1  | 525148   | für 4-Loch-Felge <sup>1)</sup>  | 280 25,0 22,0 V L +S +B PD   |   |  |
|  | 1.6  | 77   | 01.06  | 05.10  |   |  |   |  |   |  |
|  | 1.6 16V  | 74   | 05.03  | 05.10  |   |  |   |  |   |  |
|  | 1.7 DTI  | 48   | 05.03  | 05.10  |   |  |   |  |   |  |
|  | 1.7 DTI 16V  | 55   | 05.03  | 05.10  |   |  |   |  |   |  |
|  | 1.8 16V  | 92   | 05.03  | 05.10  |   |  |   |  |   |  |
|  | 1.3 CDTI   | 51   | 04.05  | 05.10  | 24.0125-0131.1  | 425131   | für 5-Loch-Felge <sup>2)</sup>  | 280 24,8 22,0 V L +S +B  |   |  |
|  | 1.3 CDTI   | 55   | 09.03  | 05.10  | 24.0325-0131.1  | 525131   | für 5-Loch-Felge <sup>2)</sup>  | 280 24,8 22,0 V L +S +B PD   |   |  |
|  | 1.4 16V  | 66   | 07.04  | 05.10  |   |  |   |  |   |  |
|  | 1.4 LPG  | 66   | 07.04  | 05.10  |   |  |   |  |   |  |
|  | 1.6  | 64   | 05.03  | 05.10  |   |  |   |  |   |  |
| 1.6  | 77   | 01.06  | 05.10  |  |   |  |   |  |   |  |
| 1.6 16V  | 74   | 05.03  | 05.10  |  |   |  |   |  |   |  |
| 1.7 CDTI   | 74   | 09.03  | 05.10  |  |   |  |   |  |   |  |
| 1.7 CDTI   | 92   | 09.06  | 05.10  |  |   |  |   |  |   |  |
| 1.7 DTI  | 48   | 05.03  | 05.10  |  |   |  |   |  |   |  |
| 1.7 DTI 16V  | 55   | 05.03  | 05.10  |  |   |  |   |  |   |  |
| 1.8 16V  | 92   | 05.03  | 05.10  |  |   |  |   |  |   |  |
| 1.6 Turbo OPC  | 132  | 09.05  | 05.10  | 24.0125-0142.1<br>24.0325-0142.1   | 425142<br>525142  |  |   | 308 25,0 22,0 V L +S +B<br>308 25,0 22,0 V L +S +B PD                              |   |  |
|    | 1.3 CDTI   | 51   | 04.05  | 05.10  | 24.0710-1002.1  | 360206   | 2  | Radsensor L=452  |   |  |
|  | 1.3 CDTI   | 55   | 09.03  | 05.10  |   |  |   |  |   |  |
|  | 1.4 16V  | 66   | 07.04  | 05.10  |   |  |   |  |   |  |
|  | 1.4 LPG  | 66   | 07.04  | 05.10  |   |  |   |  |   |  |
|  | 1.6  | 64   | 05.03  | 05.10  |   |  |   |  |   |  |
|  | 1.6  | 77   | 01.06  | 05.10  |   |  |   |  |   |  |
|  | 1.6 16V  | 74   | 05.03  | 05.10  |   |  |   |  |   |  |
|  | 1.6 Turbo OPC  | 132  | 09.05  | 05.10  |   |  |   |  |   |  |
|  | 1.7 CDTI   | 74   | 09.03  | 05.10  |   |  |   |  |   |  |
|  | 1.7 CDTI   | 92   | 09.06  | 05.10  |   |  |   |  |   |  |
|  | 1.7 DTI  | 48   | 05.03  | 05.10  |   |  |   |  |   |  |
|  | 1.7 DTI 16V  | 55   | 05.03  | 05.10  |   |  |   |  |   |  |
| 1.8 16V  | 92   | 05.03  | 05.10  |  |   |  |   |  |   |  |
|  | 1.3 CDTI   | 51   | 04.05  | 05.10  | 13.0460-2868.2<br>13.0470-2868.2  | 602868<br>LD2868   |   | 23417 15,3 +/WK/Zub/STRW<br>23417 15,3 +/WK/Zub/STRW                               |   |  |
|  | 1.3 CDTI   | 55   | 09.03  | 05.10  |   |  |   |  |   |  |
|  | 1.4 16V  | 66   | 07.04  | 05.10  |   |  |   |  |   |  |
|  | 1.4 LPG  | 66   | 07.04  | 05.10  |   |  |   |  |   |  |
|  | 1.6  | 64   | 05.03  | 05.10  |   |  |   |  |   |  |
|  | 1.6  | 77   | 01.06  | 05.10  |   |  |   |  |   |  |
|  | 1.6 16V  | 74   | 05.03  | 05.10  |   |  |   |  |   |  |
|  | 1.6 Turbo OPC  | 132  | 09.05  | 05.10  |   |  |   |  |   |  |
|  | 1.7 CDTI   | 74   | 09.03  | 05.10  |   |  |   |  |   |  |
|  | 1.7 CDTI   | 92   | 09.06  | 05.10  |   |  |   |  |   |  |
|  | 1.7 DTI  | 48   | 05.03  | 05.10  |   |  |   |  |   |  |
|  | 1.7 DTI 16V  | 55   | 05.03  | 05.10  |   |  |   |  |   |  |
|  | 1.8 16V  | 92   | 05.03  | 05.10  |   |  |   |  |   |  |
|  |  | 1.4 16V  | 66   | 07.04  | 05.10   | 24.0110-0251.1<br>24.0310-0251.1   | 410251<br>510251  | für 4-Loch-Felge <sup>1)</sup><br>für 4-Loch-Felge <sup>1)</sup>                   | 240 9,8 8,0 +S +B<br>240 9,8 8,0 +S +B PD |  |
|  |  | 1.4 LPG  | 66   | 07.04  | 05.10   |  |   |  |   |  |
| 1.6  |  | 64   | 05.03  | 05.10  |   |  |   |  |   |  |
| 1.3 CDTI   |  | 51   | 04.05  | 05.10  | 24.0110-0291.1  | 410291   | für 4-Loch-Felge <sup>1)</sup>  | 264 10,0 8,0 +S +B   |   |  |
| 1.3 CDTI   |  | 55   | 09.03  | 05.10  | 24.0310-0291.1  | 510291   | für 4-Loch-Felge <sup>1)</sup>  | 264 10,0 8,0 +S +B PD  |   |  |
| 1.6  |  | 77   | 01.06  | 05.10  |   |  |   |  |   |  |
| 1.6 16V  |  | 74   | 05.03  | 05.10  |   |  |   |  |   |  |
| 1.7 DTI  |  | 48   | 05.03  | 05.10  |   |  |   |  |   |  |
| 1.7 DTI 16V  |  | 55   | 05.03  | 05.10  |   |  |   |  |   |  |
| 1.8 16V  |  | 92   | 05.03  | 05.10  |   |  |   |  |   |  |
| 1.3 CDTI   |  | 51   | 04.05  | 05.10  | 24.0110-0250.1  | 410250   | für 5-Loch-Felge <sup>2)</sup>  | 264 9,8 8,0 +S +B  |   |  |
| 1.3 CDTI   |  | 55   | 09.03  | 05.10  | 24.0310-0250.1  | 510250   | für 5-Loch-Felge <sup>2)</sup>  | 264 9,8 8,0 +S +B PD   |   |  |
| 1.4 16V  |  | 66   | 07.04  | 05.10  |   |  |   |  |   |  |
| 1.4 LPG  |  | 66   | 07.04  | 05.10  |   |  |   |  |   |  |
| 1.6  |  | 64   | 05.03  | 05.10  |   |  |   |  |   |  |
| 1.6  | 77   | 01.06  | 05.10  |  |   |  |   |  |   |  |
| 1.6 16V  | 74   | 05.03  | 05.10  |  |   |  |   |  |   |  |
| 1.6 Turbo OPC  | 132  | 09.05  | 05.10  |  |   |  |   |  |   |  |
| 1.7 CDTI   | 74   | 09.03  | 05.10  |  |   |  |   |  |   |  |
| 1.7 CDTI   | 92   | 09.06  | 05.10  |  |   |  |   |  |   |  |
| 1.7 DTI  | 48   | 05.03  | 05.10  |  |   |  |   |  |   |  |
| 1.7 DTI 16V  | 55   | 05.03  | 05.10  |  |   |  |   |  |   |  |
| 1.8 16V  | 92   | 05.03  | 05.10  |  |   |  |   |  |   |  |
| <b>OPEL MERIVA B / Vauxhall Meriva Mk II (10-)</b>                                 |  |  |  |  |   |  |   |  |   |  |
|  | 1.3 CDTI   | 55   | 06.10  |  | 13.0460-7179.2<br>13.0470-7179.2  | 607179<br>LD7179   |   | 23832 20,2 +/WK<br>23832 20,2 +/WK   | ATE<br>ATE                                |  |
|  | 1.3 CDTI   | 70   | 06.10  |  |   |  |   |  |   |  |
|  | 1.4  | 74   | 06.10  |  |   |  |   |  |   |  |
|  | 1.4  | 103  | 06.10  |  |   |  |   |  |   |  |
|  | 1.4 ecoFLEX  | 88   | 06.10  |  |   |  |   |  |   |  |
|  | 1.6 CDTi   | 70   | 03.14  |  |   |  |   |  |   |  |
|  | 1.6 CDTi   | 81   | 03.14  |  |   |  |   |  |   |  |
|  | 1.6 CDTi   | 100  | 08.13  |  |   |  |   |  |   |  |
| ↓  | ↓  |  |  |  |   |  |   |  |   |  |





















<sup>1)</sup> for 4 bore wheel rim / per cerchione a 4 fori / pour jante à 4 trous / para Llantas de 4 taladros

<sup>2)</sup> for 5 bore wheel rim / per cerchione a 5 fori / pour jante à 5 trous / para Llantas de 5 taladros

















|     |   |  |                 |  |  |  |  |  |            |
|--|---|--|---|--|---|--|--|--|------------|
| <b>OPEL MERIVA B / Vauxhall Meriva Mk II (10-)</b>                                 |   |  |   |  |   |  |  |  |            |
|    | 1.7 CDTi<br>1.7 CDTi<br>1.7 CDTi  | 74<br>81<br>96   | 06.10<br>06.10<br>06.10   |  | 13.0460-7179.2<br>13.0470-7179.2  | 607179<br>LD7179   |  | 23832 20,2 +/WK<br>23832 20,2 +/WK   | ATE<br>ATE |
|    | 1.3 CDTi<br>1.3 CDTi<br>1.4<br>1.4 ecoFLEX<br>1.7 CDTi<br>1.7 CDTi<br>1.7 CDTi  | 55<br>70<br>74<br>88<br>74<br>81<br>96   | 06.10<br>06.10<br>06.10<br>06.10<br>06.10<br>06.10<br>06.10                                     |  | 24.0125-0131.1<br>24.0325-0131.1  | 425131<br>525131   |  | 280 24,8 22,0 V L +S +B<br>280 24,8 22,0 V L +S +B PD                              |            |
|  | 1.4<br>1.4 ecoFLEX<br>1.6 CDTi<br>1.6 CDTi<br>1.6 CDTi<br>1.7 CDTi<br>1.7 CDTi<br>1.7 CDTi                                | 103<br>88<br>70<br>81<br>100<br>74<br>81<br>96                                   | 06.10<br>06.10<br>03.14<br>03.14<br>08.13<br>06.10<br>06.10<br>06.10                            |  | 24.0125-0142.1  | 425142   |  | 308 25,0 22,0 V L +S +B  |            |
|    | 1.3 CDTi<br>1.3 CDTi<br>1.4<br>1.4<br>1.4 ecoFLEX<br>1.6 CDTi<br>1.6 CDTi<br>1.6 CDTi<br>1.7 CDTi<br>1.7 CDTi<br>1.7 CDTi | 55<br>70<br>74<br>103<br>88<br>70<br>81<br>100<br>74<br>81<br>96                 | 06.10<br>06.10<br>06.10<br>06.10<br>06.10<br>03.14<br>03.14<br>08.13<br>06.10<br>06.10<br>06.10 |  | 13.0460-2868.2<br>13.0470-2868.2  | 602868<br>LD2868   |  | 23417 15,3 +/WK/Zub/STRW<br>23417 15,3 +/WK/Zub/STRW                               |            |
|    | 1.3 CDTi<br>1.3 CDTi<br>1.4<br>1.4<br>1.4 ecoFLEX<br>1.6 CDTi<br>1.6 CDTi<br>1.6 CDTi<br>1.7 CDTi<br>1.7 CDTi<br>1.7 CDTi | 55<br>70<br>74<br>103<br>88<br>70<br>81<br>100<br>74<br>81<br>96                 | 06.10<br>06.10<br>06.10<br>06.10<br>06.10<br>03.14<br>03.14<br>08.13<br>06.10<br>06.10<br>06.10 |  | 24.0110-0250.1<br>24.0310-0250.1  | 410250<br>510250   |  | 264 9,8 8,0 +S +B<br>264 9,8 8,0 +S +B PD  |            |
| <b>OPEL MOKKA / Vauxhall Mokka (12-)</b>   |   |  |   |  |   |  |  |  |            |
|  | 1.4<br>1.4 4x4<br>1.4 4x4<br>1.6<br>1.6 CDTi<br>1.6 CDTi<br>1.6 CDTi 4x4<br>1.7 CDTi<br>1.7 CDTi 4x4<br>1.8<br>1.8 4x4    | 103<br>103<br>112<br>85<br>81<br>100<br>100<br>96<br>96<br>103<br>103            | 04.13<br>06.12<br>06.16<br>06.12<br>06.15<br>01.15<br>01.15<br>06.12<br>06.12<br>01.13<br>01.13 |  | 13.0460-7263.2<br>13.0470-7263.2  | 607263<br>LD7263   |  | 24034 19,1 +/WK/Zub<br>24034 19,1 +/WK/Zub   | ATE<br>ATE |
|  | 1.4<br>1.4 4x4<br>1.4 4x4<br>1.6<br>1.6 CDTi<br>1.6 CDTi<br>1.6 CDTi 4x4<br>1.7 CDTi<br>1.7 CDTi 4x4<br>1.8<br>1.8 4x4    | 103<br>103<br>112<br>85<br>81<br>100<br>100<br>96<br>96<br>103<br>103            | 04.13<br>06.12<br>06.16<br>06.12<br>06.15<br>01.15<br>01.15<br>06.12<br>06.12<br>01.13<br>01.13 |  | 24.0126-0182.1  | 426182   |  | 300 26,0 23,0 V L +S +B  |            |
|  | 1.4<br>1.4 4x4<br>1.4 4x4<br>1.6<br>1.6 CDTi<br>1.6 CDTi<br>1.6 CDTi 4x4<br>1.7 CDTi<br>1.7 CDTi 4x4<br>1.8<br>1.8 4x4    | 103<br>103<br>112<br>85<br>81<br>100<br>100<br>96<br>96<br>103<br>103            | 04.13<br>06.12<br>06.16<br>06.12<br>06.15<br>01.15<br>01.15<br>06.12<br>06.12<br>01.13<br>01.13 |  | 13.0460-7264.2<br>13.0470-7264.2  | 607264<br>LD7264   |  | 25096 17,0 +/WK/Zub<br>25096 17,0 +/WK/Zub   | ATE<br>ATE |
|  | 1.4<br>1.4 4x4<br>1.4 4x4<br>1.6<br>1.6 CDTi<br>1.6 CDTi<br>1.6 CDTi 4x4<br>1.7 CDTi<br>1.7 CDTi 4x4<br>1.8<br>1.8 4x4    | 103<br>103<br>112<br>85<br>81<br>100<br>100<br>96<br>96<br>103<br>103            | 04.13<br>06.12<br>06.16<br>06.12<br>06.15<br>01.15<br>01.15<br>06.12<br>06.12<br>01.13<br>01.13 |  | 24.0112-0188.1<br>24.0312-0188.1  | 412188<br>512188   |  | 268 12,0 10,0 +S +B<br>268 12,0 10,0 +S +B PD                                      |            |









|     |                      |  |  |  |  |   |  |  |   |                          |
|--|--|--|--|--|---|---|--|--|---|--------------------------|
| <b>OPEL MONTEREY (92-98)</b>   |  |  |  |  |   |   |  |  |   |                          |
|    | 3.1 TD<br>3.2  |  |  | 09.91<br>05.92   | 07.98<br>07.98  | 13.0460-5926.2<br>13.0460-0446.2  | 605926<br>610446   | 21845 16,5 +/WK<br>Belagsatz-Zubehör   | <b>AKE</b><br><b>AKE</b>                          |                          |
|    | 3.1 TD<br>3.2  |  |  | 09.91<br>05.92   | 07.98<br>07.98  | - ABS<br>- ABS  | 24.0126-0111.1   | 426111   | 280 26,0 24,6 V +B                                |                          |
|  | 3.1 TD<br>3.2  |  |  | 09.91<br>05.92   | 07.98<br>07.98  | + ABS<br>+ ABS  | 24.0126-0111.1   | 426111   | 280 26,0 24,6 V +B                                |                          |
|    | 3.1 TD<br>3.2  |  |  | 09.91<br>05.92   | 07.98<br>07.98  |   | 13.0460-5927.2<br>13.0460-0447.2   | 605927<br>610447   | 21875 16,0 +/WK<br>Belagsatz-Zubehör              | <b>AKE</b><br><b>AKE</b> |
|    | 3.1 TD<br>3.2  |  |  | 09.91<br>05.92   | 07.98<br>07.98  |   | 24.0118-0122.1   | 418122   | 313 18,0 16,6 V +B                                |                          |
| <b>OPEL MONTEREY (98-99)</b>   |  |  |  |  |   |   |  |  |   |                          |
|    | 3.0 DTI<br>3.5 V6  |  |  | 07.98<br>07.98   | 08.99<br>08.99  |   | 13.0460-5926.2<br>13.0460-0446.2   | 605926<br>610446   | 21845 16,5 +/WK<br>Belagsatz-Zubehör              | <b>AKE</b><br><b>AKE</b> |
|    | 3.0 DTI<br>3.5 V6  |  |  | 07.98<br>07.98   | 08.99<br>08.99  | - ABS<br>- ABS  | 24.0126-0111.1   | 426111   | 280 26,0 24,6 V +B                                |                          |
|  | 3.0 DTI<br>3.5 V6  |  |  | 07.98<br>07.98   | 08.99<br>08.99  | + ABS<br>+ ABS  | 24.0126-0111.1   | 426111   | 280 26,0 24,6 V +B                                |                          |
|    | 3.0 DTI<br>3.5 V6  |  |  | 07.98<br>07.98   | 08.99<br>08.99  |   | 13.0460-5927.2<br>13.0460-0447.2   | 605927<br>610447   | 21875 16,0 +/WK<br>Belagsatz-Zubehör              | <b>AKE</b><br><b>AKE</b> |
|    | 3.0 DTI<br>3.5 V6  |  |  | 07.98<br>07.98   | 08.99<br>08.99  |   | 24.0118-0122.1   | 418122   | 313 18,0 16,6 V +B                                |                          |
| <b>OPEL MOVANO A (98-10)</b>   |  |  |  |  |   |   |  |  |   |                          |
|    | 1.9 DTI<br>2.2 DTI 16V<br>2.5 CDTI<br>2.5 CDTI<br>2.5 CDTI<br>2.5 D<br>2.5 DTI<br>2.8 DTI<br>3.0 DTI | 66<br>74<br>88<br>107<br>59  |  | 09.00<br>09.00<br>09.06<br>09.06<br>09.06<br>07.98<br>10.01<br>07.98<br>10.03    | 01.10<br>01.10<br>01.10<br>01.10<br>01.10<br>09.00<br>01.10<br>01.10<br>01.10     | + 15" Rad <sup>1)</sup><br>+ 15" Rad <sup>1)</sup><br>+ 15" Rad <sup>1)</sup><br>+ 15" Rad <sup>1)</sup><br>+ 15" Rad <sup>1)</sup><br>+ 15" Rad <sup>1)</sup><br>+ 15" Rad <sup>1)</sup><br>+ 15" Rad <sup>1)</sup><br>+ 15" Rad <sup>1)</sup> | 13.0460-3946.2   | 603946   | 23302 18,0 /WE                                    | <b>BDX</b>               |
|  | 1.9 DTI<br>2.2 DTI 16V<br>2.5 CDTI<br>2.5 CDTI<br>2.5 CDTI<br>2.5 D<br>2.5 DTI<br>2.8 DTI<br>3.0 DTI | 66<br>74<br>88<br>107<br>59  |  | 09.00<br>09.00<br>09.06<br>09.06<br>09.06<br>07.98<br>10.01<br>07.98<br>10.03    | 01.10<br>01.10<br>01.10<br>01.10<br>01.10<br>09.00<br>01.10<br>01.10<br>01.10     | + 16" Rad <sup>2)</sup><br>+ 16" Rad <sup>2)</sup><br>+ 16" Rad <sup>2)</sup><br>+ 16" Rad <sup>2)</sup><br>+ 16" Rad <sup>2)</sup><br>+ 16" Rad <sup>2)</sup><br>+ 16" Rad <sup>2)</sup><br>+ 16" Rad <sup>2)</sup><br>+ 16" Rad <sup>2)</sup> | 13.0460-3800.2<br>13.0460-0344.2   | 603800<br>610344   | 23613 17,7<br>Belagsatz-Zubehör                   | <b>BOS</b>               |
|  | 1.9 DTI<br>2.2 DTI 16V<br>2.5 CDTI<br>2.5 CDTI<br>2.5 CDTI<br>2.5 D<br>2.5 DTI<br>2.8 DTI<br>3.0 DTI | 66<br>74<br>88<br>107<br>59  |  | 09.00<br>09.00<br>09.06<br>09.06<br>09.06<br>07.98<br>10.01<br>07.98<br>10.03    | 01.10<br>01.10<br>01.10<br>01.10<br>01.10<br>09.00<br>01.10<br>01.10<br>01.10     | + 15" Rad <sup>1)</sup><br>+ 15" Rad <sup>1)</sup><br>+ 15" Rad <sup>1)</sup><br>+ 15" Rad <sup>1)</sup><br>+ 15" Rad <sup>1)</sup><br>+ 15" Rad <sup>1)</sup><br>+ 15" Rad <sup>1)</sup><br>+ 15" Rad <sup>1)</sup><br>+ 15" Rad <sup>1)</sup> | 24.0124-0162.1   | 424162   | 280 24,0 21,0 V +B                                |                          |
|  | 1.9 DTI<br>2.2 DTI 16V<br>2.5 CDTI<br>2.5 CDTI<br>2.5 CDTI<br>2.5 D<br>2.5 DTI<br>2.8 DTI<br>3.0 DTI | 66<br>74<br>88<br>107<br>59  |  | 09.00<br>09.00<br>09.06<br>09.06<br>09.06<br>07.98<br>10.01<br>07.98<br>10.03    | 01.10<br>01.10<br>01.10<br>01.10<br>01.10<br>09.00<br>01.10<br>01.10<br>01.10     | + 16" Rad <sup>2)</sup><br>+ 16" Rad <sup>2)</sup><br>+ 16" Rad <sup>2)</sup><br>+ 16" Rad <sup>2)</sup><br>+ 16" Rad <sup>2)</sup><br>+ 16" Rad <sup>2)</sup><br>+ 16" Rad <sup>2)</sup><br>+ 16" Rad <sup>2)</sup><br>+ 16" Rad <sup>2)</sup> | 24.0128-0129.1<br>24.0328-0129.1   | 428129<br>528129   | 306 28,0 25,0 V +S +B<br>306 28,0 25,0 V +S +B PD |                          |
|  | 1.9 DTI<br>2.2 DTI 16V<br>2.5 CDTI<br>2.5 CDTI<br>2.5 CDTI<br>2.5 D<br>2.5 DTI<br>2.8 DTI<br>3.0 DTI | 66<br>74<br>88<br>107<br>59  |  | 09.00<br>09.00<br>09.06<br>09.06<br>09.06<br>07.98<br>10.01<br>07.98<br>10.03    | 01.10<br>01.10<br>01.10<br>01.10<br>01.10<br>09.00<br>01.10<br>01.10<br>01.10     |   | 13.0460-3806.2   | 603806   | 23669 16,8 /S                                     | <b>BOS</b>               |
|  | 1.9 DTI<br>2.2 DTI 16V<br>2.5 CDTI<br>2.5 CDTI<br>2.5 CDTI<br>2.5 D<br>2.5 DTI<br>2.8 DTI<br>3.0 DTI | 66<br>74<br>88<br>107<br>59  |  | 09.00<br>09.00<br>09.06<br>09.06<br>09.06<br>07.98<br>10.01<br>07.98<br>10.03    | 01.10<br>01.10<br>01.10<br>01.10<br>01.10<br>09.00<br>01.10<br>01.10<br>01.10     |   | 24.0112-0155.1   | 412155   | 305 12,0 10,5 +S +B                               |                          |

<sup>1)</sup> + 15" wheel / + ruota 15" / + roue 15" / + rueda 15"

<sup>2)</sup> + 16" wheel / + ruota 16" / + roue 16" / + rueda 16"

|     |    |    |  |                                   |   |  |  |  |
|--|--|--|--|---|--|--|--|--|
| <b>OPEL MOVANO A (98-10)</b>   |  |  |  |   |  |  |  |  |
|    | 1.9 DTI<br>2.2 DTI 16V<br>2.5 D<br>2.5 DTI<br>2.8 DTI  | 66<br>59   |  | 09.00<br>09.00<br>07.98<br>10.01<br>07.98   | 01.10<br>01.10<br>09.00<br>01.10<br>10.01  | 03.0137-0382.2<br>03.0137-9240.2   | 650382<br>669240   | 280 x 65<br>Bremsbacken-Zubehör  |
|    | 1.9 DTI<br>2.2 DTI 16V<br>2.5 D<br>2.5 DTI<br>2.8 DTI  | 66<br>59   |  | 09.00<br>09.00<br>07.98<br>10.01<br>07.98   | 01.10<br>01.10<br>09.00<br>01.10<br>10.01  | 24.0228-0002.1   | 480159   | 280/282 x 69,5   |
| <b>OPEL MOVANO B (10-)</b>   |  |  |  |   |  |  |  |  |
|    | 2.3 CDTI FWD<br>2.3 CDTI FWD<br>2.3 CDTI FWD<br>2.3 CDTI FWD<br>2.3 CDTI FWD<br>2.3 CDTI FWD<br>2.3 CDTI FWD<br>2.3 CDTI RWD<br>2.3 CDTI RWD<br>2.3 CDTI RWD<br>2.3 CDTI RWD<br>2.3 CDTI RWD<br>2.3 CDTI RWD<br>2.3 CDTI RWD | 74<br>81<br>92<br>100<br>107<br>110<br>120<br>74<br>92<br>100<br>107<br>110<br>120 |  | 02.10<br>05.14<br>02.10<br>05.14<br>05.10<br>01.13<br>05.14<br>02.10<br>02.10<br>05.14<br>05.10<br>01.13<br>05.14 |  | 13.0460-4856.2   | 604856   | 25147 18,4 +WK<br><b>BRE</b>   |
|    | 2.3 CDTI FWD<br>2.3 CDTI FWD<br>2.3 CDTI FWD<br>2.3 CDTI FWD<br>2.3 CDTI FWD<br>2.3 CDTI FWD<br>2.3 CDTI FWD<br>2.3 CDTI RWD<br>2.3 CDTI RWD<br>2.3 CDTI RWD<br>2.3 CDTI RWD<br>2.3 CDTI RWD<br>2.3 CDTI RWD<br>2.3 CDTI RWD | 74<br>81<br>92<br>100<br>107<br>110<br>120<br>74<br>92<br>100<br>107<br>110<br>120 |  | 02.10<br>05.14<br>02.10<br>05.14<br>05.10<br>01.13<br>05.14<br>02.10<br>02.10<br>05.14<br>05.10<br>01.13<br>05.14 |  | 24.0128-0252.1   | 428252   | 302 28,0 24,5 V +S +B  |
|   | 2.3 CDTI FWD<br>2.3 CDTI FWD<br>2.3 CDTI FWD<br>2.3 CDTI FWD<br>2.3 CDTI FWD<br>2.3 CDTI FWD<br>2.3 CDTI FWD<br>2.3 CDTI RWD<br>2.3 CDTI RWD<br>2.3 CDTI RWD<br>2.3 CDTI RWD<br>2.3 CDTI RWD<br>2.3 CDTI RWD<br>2.3 CDTI RWD | 74<br>81<br>92<br>100<br>107<br>110<br>120<br>74<br>92<br>100<br>107<br>110<br>120 |  | 02.10<br>05.14<br>02.10<br>05.14<br>05.10<br>01.13<br>05.14<br>02.10<br>02.10<br>05.14<br>05.10<br>01.13<br>05.14 | + Einfachbereifung <sup>1)</sup><br>+ Einfachbereifung <sup>1)</sup><br>+ Einfachbereifung <sup>1)</sup><br>+ Einfachbereifung <sup>1)</sup><br>+ Einfachbereifung <sup>1)</sup><br>+ Einfachbereifung <sup>1)</sup><br>+ Einfachbereifung <sup>1)</sup><br>+ Einfachbereifung <sup>1)</sup><br>+ Einfachbereifung <sup>1)</sup><br>+ Einfachbereifung <sup>1)</sup><br>+ Einfachbereifung <sup>1)</sup><br>+ Einfachbereifung <sup>1)</sup><br>+ Einfachbereifung <sup>1)</sup> | 13.0460-4858.2   | 604858   | 25112 18,4 +WK<br><b>BRE</b>   |
|  | 2.3 CDTI FWD<br>2.3 CDTI FWD<br>2.3 CDTI FWD<br>2.3 CDTI FWD<br>2.3 CDTI FWD<br>2.3 CDTI FWD<br>2.3 CDTI FWD<br>2.3 CDTI RWD<br>2.3 CDTI RWD<br>2.3 CDTI RWD<br>2.3 CDTI RWD<br>2.3 CDTI RWD<br>2.3 CDTI RWD                 | 74<br>81<br>92<br>100<br>107<br>110<br>120<br>74<br>92<br>100<br>107<br>110<br>120 |  | 02.10<br>05.14<br>02.10<br>05.14<br>05.10<br>01.13<br>05.14<br>02.10<br>02.10<br>05.14<br>05.10<br>01.13<br>05.14 | + Doppelbereifung <sup>2)</sup><br>+ Doppelbereifung <sup>2)</sup><br>+ Doppelbereifung <sup>2)</sup><br>+ Doppelbereifung <sup>2)</sup><br>+ Doppelbereifung <sup>2)</sup><br>+ Doppelbereifung <sup>2)</sup><br>+ Doppelbereifung <sup>2)</sup><br>+ Doppelbereifung <sup>2)</sup><br>+ Doppelbereifung <sup>2)</sup><br>+ Doppelbereifung <sup>2)</sup><br>+ Doppelbereifung <sup>2)</sup><br>+ Doppelbereifung <sup>2)</sup>   | 13.0460-4857.2   | 604857   | 25172 18,4 +WK<br><b>BRE</b>   |
|  | 2.3 CDTI FWD<br>2.3 CDTI FWD<br>2.3 CDTI FWD<br>2.3 CDTI FWD<br>2.3 CDTI FWD<br>2.3 CDTI FWD<br>2.3 CDTI FWD   | 74<br>81<br>92<br>100<br>107<br>110<br>120   |  | 02.10<br>05.14<br>02.10<br>05.14<br>05.10<br>01.13<br>05.14   |  | 24.0112-0191.1   | 412191   | 305 12,0 10,0 L +S +B  |
|  | 2.3 CDTI RWD<br>2.3 CDTI RWD<br>2.3 CDTI RWD<br>2.3 CDTI RWD<br>2.3 CDTI RWD   | 74<br>92<br>100<br>107<br>110  |  | 02.10<br>02.10<br>05.14<br>05.10<br>01.13   | + Einfachbereifung <sup>1)</sup><br>+ Einfachbereifung <sup>1)</sup><br>+ Einfachbereifung <sup>1)</sup><br>+ Einfachbereifung <sup>1)</sup>   | 24.0112-0190.1   | 412190   | 305 12,0 10,0 L +S +B  |
|  | 2.3 CDTI RWD<br>2.3 CDTI RWD<br>2.3 CDTI RWD   | 74<br>92<br>100  |  | 02.10<br>02.10<br>05.14   | + Doppelbereifung <sup>2)</sup><br>+ Doppelbereifung <sup>2)</sup><br>+ Doppelbereifung <sup>2)</sup>  | 24.0118-0153.1   | 418153   | 302 18,0 15,0 +B   |

<sup>1)</sup> + single tyre / + ruota singola / + roue simple / + cubierta simple  
<sup>2)</sup> + twin tyres / + ruote gemellate / + roue jumelée / + cubierta doble

| OPEL MOVANO B (10-)  |  |  |   |   |  |        |  |  |
|--|--|--|---|---|--|--------|--|--|
|    | 2.3 CDTI RWD 110<br>2.3 CDTI RWD 120   |  | 01.13<br>05.14  | + Doppelbereifung <sup>1)</sup><br>+ Doppelbereifung <sup>1)</sup>  | 24.0118-0153.1<br>418153   |        | 302 18,0 15,0 +B   |  |
| OPEL OMEGA B / Vauxhall Omega (94-03)  |  |  |   |   |  |        |  |  |
|    | 2.0<br>2.0 16V   |  | V1999999<br>03.94<br>V1999999<br>03.94  | - Sonderfahrzeuge/ - Polizei <sup>2)</sup><br>- Sonderfahrzeuge/ - Polizei <sup>2)</sup>  | 13.0460-7080.2<br>607080<br>24.8190-0710.2<br>620710   | 2      | 21411 17,5 +<br>Warnkontakt L=730mm  | ATE  |
|  | 2.0<br>2.0 16V<br>2.0 DTI 16V<br>2.2 16V<br>2.2 DTI 16V<br>2.5 DTI<br>2.5 TD<br>2.5 V6<br>2.6 V6<br>3.0 V6<br>3.2 V6 | W1000001<br>W1000001   |   | 09.99<br>09.99<br>09.97 08.00<br>10.99 08.03<br>09.00 08.03<br>09.01 08.03<br>04.94 08.03<br>03.94 09.00<br>09.00 08.03<br>04.94 01.01<br>02.01 08.03             | 13.0460-2815.2<br>602815<br>24.8190-0711.2<br>620711   | 2      | 21368 18,3 /WE/S<br>Warnkontakt L=730mm  | TRW  |
|    | 2.0<br>2.0 16V   |  | V1999999<br>03.94<br>V1999999<br>03.94  | - Sonderfahrzeuge/ - Polizei <sup>2)</sup><br>- Sonderfahrzeuge/ - Polizei <sup>2)</sup>  | 24.0124-0119.1<br>424119   |        | 286 24,0 21,0 V L +B   |  |
|  | 2.0<br>2.0 16V<br>2.0 DTI 16V<br>2.2 16V<br>2.2 DTI 16V<br>2.5 DTI<br>2.5 TD<br>2.5 V6<br>2.6 V6<br>3.0 V6<br>3.2 V6 | W1000001<br>W1000001   |   | 09.99<br>09.99<br>09.97 08.00<br>10.99 08.03<br>09.00 08.03<br>09.01 08.03<br>04.94 08.03<br>03.94 09.00<br>09.00 08.03<br>04.94 01.01<br>02.01 08.03             | 24.0128-0104.1<br>428104   |        | 296 28,0 25,0 V L +S +B  |  |
|    | 2.0<br>2.0 16V<br>2.0 DTI 16V<br>2.2 16V<br>2.2 DTI 16V<br>2.5 DTI<br>2.5 TD<br>2.5 V6<br>2.6 V6<br>3.0 V6<br>3.2 V6 |  |   | 03.94 09.99<br>03.94 09.99<br>09.97 08.00<br>10.99 08.03<br>09.00 08.03<br>09.01 08.03<br>04.94 08.03<br>03.94 08.03<br>09.00 08.03<br>04.94 01.01<br>02.01 08.03 | 13.0460-4040.2<br>604040<br>13.0460-0246.2<br>610246   |        | - belüftete Scheiben <sup>3)</sup><br>Belagsatz-Zubehör  | 21050 15,8<br>ATE  |
|  | 2.0<br>2.0 16V<br>2.0 DTI 16V<br>2.2 16V<br>2.2 DTI 16V<br>2.5 DTI<br>2.5 TD<br>2.5 V6<br>2.6 V6<br>3.0 V6<br>3.2 V6 |  |   | 03.94 09.99<br>03.94 09.99<br>09.97 08.00<br>10.99 08.03<br>09.00 08.03<br>09.01 08.03<br>04.94 08.03<br>03.94 09.00<br>09.00 08.03<br>04.94 01.01<br>02.01 08.03 | 24.0112-0131.1<br>412131<br>24.0120-0171.1<br>420171   |        | 286 12,0 10,0 +B<br>286 20,0 18,0 V +B   |  |
|  | 2.0<br>2.0 16V<br>2.5 TD<br>2.5 V6<br>3.0 V6   |  | V1169750<br>03.94<br>V1169750<br>03.94<br>V1169750<br>04.94<br>V1169750<br>03.94<br>V1169750<br>04.94 |   | 03.0137-0172.2<br>650172<br>03.0137-9092.2<br>669092   |        | 160 x 25<br>Bremsbacken-Zubehör  |  |
|  | 2.0<br>2.0 16V<br>2.0 DTI 16V<br>2.2 16V<br>2.2 DTI 16V<br>2.5 DTI<br>2.5 TD<br>2.5 V6<br>2.6 V6<br>3.0 V6<br>3.2 V6 | V1169751<br>V1169751<br>V1169751<br>V1169751<br>V1169751<br>V1169751<br>V1169751<br>V1169751<br>V1169751 |   | 09.99<br>09.99<br>08.00<br>08.03<br>08.03<br>09.01 08.03<br>08.03<br>09.00<br>08.03<br>01.01<br>02.01 08.03   | 03.0137-0172.2<br>650172<br>03.0137-9242.2<br>669242   |        | 160 x 25<br>Bremsbacken-Zubehör  |  |
| OPEL SIGNUM / Vauxhall Signum (03-08)  |  |  |   |   |  |        |  |  |
|  | 1.8<br>1.8<br>1.9 CDTI<br>1.9 CDTI<br>1.9 CDTI<br>2.0 DTI<br>2.0 Turbo<br>2.2<br>2.2 DTI<br>3.0 V6 CDTI<br>3.2 V6    | 90<br>103<br>74<br>88<br>110   |   | 05.03 05.08<br>09.05 05.08<br>08.05 05.08<br>04.04 05.08<br>04.04 05.08<br>05.03 05.08<br>05.03 05.08<br>03.03 05.08<br>05.03 05.08<br>05.03 05.08<br>05.03       | 13.0460-7212.2<br>607212<br>13.0460-7172.2<br>607172<br>13.0470-7172.2<br>LD7172<br>24.8190-0719.2<br>620719<br>24.8190-0720.2<br>620720 | 1<br>1 | f. Bremssattel m.Stahlkolben <sup>4)</sup><br>f. Bremssattel m.Kunststoffkolben <sup>5)</sup><br>f. Bremssattel m.Kunststoffkolben <sup>5)</sup><br>- 08.2004<br>09.2004 -<br>Warnkontakt L=686mm<br>Warnkontakt L=287mm | 23738 20,1 +/WE<br>23402 20,1 +/WE<br>23402 20,1 +/WE<br>ATE<br>ATE<br>ATE |
|  | 2.8 V6 Turbo<br>2.8 V6 Turbo<br>3.0 V6 CDTI<br>3.0 V6 CDTI   | 169 61000001<br>130 31068239<br>135 61000001   | 31068238<br>31068238  | 03.06 05.08<br>05.08<br>05.08<br>05.08  | 13.0460-7199.2<br>607199<br>24.8190-0721.2<br>620721<br>24.8190-0722.2<br>620722   | 1<br>1 | ChNr. -41048790<br>ChNr. 41048791-<br>Warnkontakt L=700mm<br>Warnkontakt L=302mm   | 23404 20,6 +/WE<br>ATE   |

<sup>1)</sup> + twin tyres / + ruote gemellate / + roue jumelée / + cubierta doble

<sup>2)</sup> - special vehicles/ - Police / - veicoli speciali/ - Polizia / - véhicule spécial/ - Police / - vehiculo especial/ - Police































<sup>3)</sup> - ventilated discs / - dischi ventilati / - disques ventilés / - disco ventilado

<sup>4)</sup> for br.caliper +steel piston / per pinza fr. +pistone acciaio / pour étrier f. +piston en acier / para pinza fr. +pistón de acero

<sup>5)</sup> for br.caliper +plastic piston / per pinza fr. +pistone plastica / pour étrier fr. +piston plastique / para pinza fr. + pistón plástico

| OPEL SIGNUM / Vauxhall Signum (03-08) |              |          |                     |       |       |  |                |        |                 |                            |
|---------------------------------------|--------------|----------|---------------------|-------|-------|--|----------------|--------|-----------------|----------------------------|
|                                       | 3.2 V6       | 31068239 |                     | 05.08 |       | 13.0460-7199.2                           | 607199         | 1      | ChNr. -41048790 | 23404 20,6 +WE ATE         |
|                                       |              |          |                     |       |       | 24.8190-0721.2                           | 620721         | 1      | ChNr. 41048791- | Warnkontakt L=700mm        |
|                                       |              |          |                     |       |       | 24.8190-0722.2                           | 620722         |        |                 | Warnkontakt L=302mm        |
|                                       | 1.8          | 90       |                     | 05.03 | 05.08 | - Sportfahrwerk <sup>1)</sup>            | 24.0125-0141.1 | 425141 |                 | 285 24,9 22,0 V L +S +B    |
|                                       | 1.8          | 103      |                     | 09.05 | 05.08 | + Sportfahrwerk/ - Polizei <sup>2)</sup> | 24.0325-0141.1 | 525141 |                 | 285 24,9 22,0 V L +S +B PD |
|                                       | 1.9 CDTI     | 74       |                     | 08.05 | 05.08 | - Polizei <sup>3)</sup>                  |                |        |                 |                            |
|                                       | 1.9 CDTI     | 88       |                     | 04.04 | 05.08 | - Sportfahrwerk <sup>1)</sup>            |                |        |                 |                            |
|                                       | 1.9 CDTI     | 110      |                     | 04.04 | 05.08 | - Sportfahrwerk <sup>1)</sup>            |                |        |                 |                            |
|                                       | 2.0 DTI      |          |                     | 05.03 | 05.08 | - Sportfahrwerk <sup>1)</sup>            |                |        |                 |                            |
|                                       | 2.2          |          |                     | 03.03 | 05.08 | - Sportfahrwerk <sup>1)</sup>            |                |        |                 |                            |
|                                       | 2.2 DTI      |          |                     | 05.03 | 05.08 | - Sportfahrwerk <sup>1)</sup>            |                |        |                 |                            |
|                                       | 1.8          | 90       |                     | 05.03 | 05.08 | + Sportfahrwerk <sup>4)</sup>            | 24.0128-0137.1 | 428137 |                 | 302 28,0 25,0 V L +S +B    |
|                                       | 1.8          | 103      |                     | 09.05 | 05.08 | + Sportfahrwerk/ + Polizei <sup>5)</sup> | 24.0328-0137.1 | 528137 |                 | 302 28,0 25,0 V L +S +B PD |
|                                       | 1.9 CDTI     | 74       |                     | 08.05 | 05.08 | + Polizei <sup>6)</sup>                  |                |        |                 |                            |
|                                       | 1.9 CDTI     | 88       |                     | 04.04 | 05.08 | + Sportfahrwerk <sup>4)</sup>            |                |        |                 |                            |
|                                       | 1.9 CDTI     | 110      |                     | 04.04 | 05.08 | + Sportfahrwerk <sup>4)</sup>            |                |        |                 |                            |
|                                       | 2.0 DTI      |          |                     | 05.03 | 05.08 | + Sportfahrwerk <sup>4)</sup>            |                |        |                 |                            |
|                                       | 2.0 Turbo    |          |                     | 05.03 | 05.08 |  |                |        |                 |                            |
|                                       | 2.2          |          |                     | 03.03 | 05.08 | + Sportfahrwerk <sup>4)</sup>            |                |        |                 |                            |
|                                       | 2.2 DTI      |          |                     | 05.03 | 05.08 | + Sportfahrwerk <sup>4)</sup>            |                |        |                 |                            |
|                                       | 3.0 V6 CDTI  | 130      | 31068238            | 05.03 |       |  |                |        |                 |                            |
|                                       | 3.2 V6       |          | 31068238            | 05.03 |       |  |                |        |                 |                            |
|                                       | 2.8 V6 Turbo |          |                     | 03.06 | 05.08 |  | 24.0128-0164.1 | 428164 |                 | 314 28,0 25,0 V L +S +B    |
|                                       | 2.8 V6 Turbo | 169      | 61000001            |       | 05.08 |  |                |        |                 |                            |
|                                       | 3.0 V6 CDTI  | 130      | 31068239            |       | 05.08 |  |                |        |                 |                            |
|                                       | 3.0 V6 CDTI  | 135      | 61000001            |       | 05.08 |  |                |        |                 |                            |
|                                       | 3.2 V6       |          | 31068239            |       | 05.08 |  |                |        |                 |                            |
|                                       | 1.8          | 90       | 41096248 / 48091178 | 05.03 |       |  | 13.0460-7194.2 | 607194 |                 | 23482 16,6 + ATE           |
|                                       | 1.9 CDTI     | 88       | 41096248 / 48091178 | 04.04 |       |  | 13.0470-7194.2 | LD7194 |                 | 23482 16,6 + ATE           |
|                                       | 1.9 CDTI     | 110      | 41096248 / 48091178 | 04.04 |       |  |                |        |                 |                            |
|                                       | 2.0 DTI      |          | 41096248 / 48091178 | 05.03 |       |  |                |        |                 |                            |
|                                       | 2.0 Turbo    |          | 41096248 / 48091178 | 05.03 |       |  |                |        |                 |                            |
|                                       | 2.2          |          | 41096248 / 48091178 | 03.03 |       |  |                |        |                 |                            |
|                                       | 2.2 DTI      |          | 41096248 / 48091178 | 05.03 |       |  |                |        |                 |                            |
|                                       | 3.0 V6 CDTI  | 130      | 41096248 / 48091178 | 05.03 |       |  |                |        |                 |                            |
|                                       | 3.2 V6       |          | 41096248 / 48091178 | 05.03 |       |  |                |        |                 |                            |
|                                       | 1.8          | 90       | 41096249 / 48091179 |       | 05.08 |  | 13.0460-7195.2 | 607195 |                 | 23482 16,6 + ATE           |
|                                       | 1.8          | 103      |                     | 09.05 | 05.08 |  | 13.0470-7195.2 | LD7195 |                 | 23482 16,6 + ATE           |
|                                       | 1.9 CDTI     | 74       |                     | 08.05 | 05.08 |  | 13.0460-7194.2 | 607194 |                 | 23482 16,6 + ATE           |
|                                       | 1.9 CDTI     | 88       | 41096249 / 48091179 |       | 05.08 |  | 13.0470-7194.2 | LD7194 |                 | 23482 16,6 + ATE           |
|                                       | 1.9 CDTI     | 110      | 41096249 / 48091179 |       | 05.08 |  |                |        |                 |                            |
|                                       | 2.0 DTI      |          | 41096249 / 48091179 |       | 05.08 |  |                |        |                 |                            |
|                                       | 2.0 Turbo    |          | 41096249 / 48091179 |       | 05.08 |  |                |        |                 |                            |
|                                       | 2.2          |          | 41096249 / 48091179 |       | 05.08 |  |                |        |                 |                            |
|                                       | 2.2 DTI      |          | 41096249 / 48091179 |       | 05.08 |  |                |        |                 |                            |
|                                       | 2.8 V6 Turbo |          |                     | 03.06 | 05.08 |  |                |        |                 |                            |
|                                       | 2.8 V6 Turbo | 169      |                     | 09.05 | 05.08 |  |                |        |                 |                            |
|                                       | 3.0 V6 CDTI  | 130      | 41096249 / 48091179 |       | 05.08 |  |                |        |                 |                            |
|                                       | 3.0 V6 CDTI  | 135      |                     | 09.05 | 05.08 |  |                |        |                 |                            |
|                                       | 3.2 V6       |          | 41096249 / 48091179 |       | 05.08 |  |                |        |                 |                            |
|                                       | 1.8          | 90       |                     | 05.03 | 05.08 |  | 24.0112-0157.1 | 412157 |                 | 278 11,9 10,0 +S +B        |
|                                       | 1.8          | 103      |                     | 09.05 | 05.08 |  | 24.0312-0157.1 | 512157 |                 | 278 11,9 10,0 +S +B PD     |
|                                       | 1.9 CDTI     | 74       |                     | 08.05 | 05.08 |  |                |        |                 |                            |
|                                       | 1.9 CDTI     | 88       |                     | 04.04 | 05.08 |  |                |        |                 |                            |
|                                       | 1.9 CDTI     | 110      |                     | 04.04 | 05.08 |  |                |        |                 |                            |
|                                       | 2.0 DTI      |          |                     | 05.03 | 05.08 |  |                |        |                 |                            |
|                                       | 2.2          |          |                     | 03.03 | 05.08 |  |                |        |                 |                            |
|                                       | 2.2 DTI      |          |                     | 05.03 | 05.08 |  |                |        |                 |                            |
|                                       | 2.8 V6 Turbo |          |                     | 03.06 | 05.08 |  |                |        |                 |                            |
|                                       | 2.8 V6 Turbo | 169      |                     | 09.05 | 05.08 |  |                |        |                 |                            |
|                                       | 3.0 V6 CDTI  | 135      |                     | 09.05 | 05.08 |  |                |        |                 |                            |
|                                       | 1.8          | 90       |                     | 05.03 | 05.08 |  | 24.0120-0173.1 | 420173 |                 | 292 19,9 18,0 V +S +B      |
|                                       | 1.8          | 103      |                     | 09.05 | 05.08 |  | 24.0320-0173.1 | 520173 |                 | 292 19,9 18,0 V +S +B PD   |
|                                       | 1.9 CDTI     | 74       |                     | 08.05 | 05.08 |  |                |        |                 |                            |
|                                       | 1.9 CDTI     | 88       |                     | 04.04 | 05.08 |  |                |        |                 |                            |
|                                       | 1.9 CDTI     | 110      |                     | 04.04 | 05.08 |  |                |        |                 |                            |
|                                       | 2.0 DTI      |          |                     | 05.03 | 05.08 |  |                |        |                 |                            |
|                                       | 2.0 Turbo    |          |                     | 05.03 | 05.08 |  |                |        |                 |                            |
|                                       | 2.2          |          |                     | 03.03 | 05.08 |  |                |        |                 |                            |
|                                       | 2.2 DTI      |          |                     | 05.03 | 05.08 |  |                |        |                 |                            |
|                                       | 2.8 V6 Turbo |          |                     | 03.06 | 05.08 |  |                |        |                 |                            |
|                                       | 2.8 V6 Turbo | 169      |                     | 09.05 | 05.08 |  |                |        |                 |                            |
|                                       | 3.0 V6 CDTI  | 130      |                     | 05.03 | 05.08 |  |                |        |                 |                            |
|                                       | 3.0 V6 CDTI  | 135      |                     | 09.05 | 05.08 |  |                |        |                 |                            |
|                                       | 3.2 V6       |          |                     | 05.03 | 05.08 |  |                |        |                 |                            |
| OPEL SINTRA / Vauxhall Sintra (97-99) |              |          |                     |       |       |  |                |        |                 |                            |
|                                       | 2.2 16V      |          |                     | 11.96 | 04.99 |  | 13.0460-8002.2 | 608002 |                 | 23358 18,0 +WK             |
|                                       | 2.2 DTI      |          |                     | 07.97 | 04.99 |  |                |        |                 |                            |
|                                       | 3.0 V6       |          |                     | 11.96 | 04.99 |  |                |        |                 |                            |
|                                       | 2.2 16V      |          |                     | 11.96 | 04.99 |  | 24.0132-0110.1 | 432110 |                 | 278 32,2 30,7 V            |
|                                       | 2.2 DTI      |          |                     | 07.97 | 04.99 |  |                |        |                 |                            |
|                                       | 3.0 V6       |          |                     | 11.96 | 04.99 |  |                |        |                 |                            |

<sup>1)</sup> - sports suspension / - sospensione sportiva / - châssis de sport / - suspensión deportiva  
<sup>2)</sup> + sports suspension / - Police / + sospensione sportiva/ - Polizia / + châssis de sport/ - Police / + suspensión deportiva/ - Police  
<sup>3)</sup> - Police / - Polizia / - voiture de police / - Police  
<sup>4)</sup> + sports suspension / + sospensione sportiva / + châssis de sport / + suspensión deportiva  
<sup>5)</sup> + sports suspension/ + Police / + sospensione sportiva/ + Polizia / + châssis de sport/ + Police / + suspensión deportiva/ + Police  
<sup>6)</sup> + Police / + Polizia / + voiture de police / + Police

|     |    |  |  |  |                |  |  |                              |
|--|--|--|--|--|---|--|--|--|
| <b>OPEL SINTRA / Vauxhall Sintra (97-99)</b>                                       |  |  |  |  |   |  |  |  |
|    | 2.2 16V<br>2.2 DTI<br>3.0 V6   |  |  | 11.96<br>07.97<br>11.96  | 04.99<br>04.99<br>04.99   | 13.0460-8011.2   | 608011   | 23361 14,8 +WK   |
|    | 2.2 16V<br>2.2 DTI<br>3.0 V6   |  |  | 11.96<br>07.97<br>11.96  | 04.99<br>04.99<br>04.99   | 24.0111-0133.1   | 411133   | 278 11,0 9,0 +B  |
| <b>OPEL SPEEDSTER / Vauxhall VX220 (00-05)</b>                                     |  |  |  |  |   |  |  |  |
|    | 2.0 Turbo<br>2.2 16V   |  |  | 04.03<br>09.00   | 09.05<br>09.05  | 24.0125-0119.1<br>24.0325-0119.1   | 425119<br>525119   | 288 25,0 22,0 V L +S +B<br>288 25,0 22,0 V L +S +B PD  |
|    | 2.0 Turbo<br>2.2 16V   |  |  | 04.03<br>09.00   | 09.05<br>09.05  | 24.0125-0119.1<br>24.0325-0119.1   | 425119<br>525119   | 288 25,0 22,0 V L +S +B<br>288 25,0 22,0 V L +S +B PD  |
| <b>OPEL TIGRA / Vauxhall Tigra (94-00)</b>   |  |  |  |  |   |  |  |  |
|    | 1.4 16V<br>1.6 16V   |  |  | 07.94<br>07.94   | 12.00<br>08.98  | 13.0460-7051.2   | 607051   | 20547 16,5 +WE ATE   |
|    | 1.4 16V<br>1.6 16V   |  |  | 07.94<br>07.94   | 12.00<br>08.98  | 24.0120-0140.1   | 420140   | 256 20,0 17,0 V L +S +B  |
|    | 1.4 16V<br>1.6 16V   |  |  | 07.94<br>07.94   | 12.00<br>08.98  | 03.0137-0266.2<br>03.0137-9166.2   | 650266<br>669166   | 200 x 29 HEB<br>Bremsbacken-Zubehör  |
|    | 1.4 16V<br>1.6 16V   |  |  | 07.94<br>07.94   | 12.00<br>08.98  | 24.0220-0012.1<br>24.0220-0712.2   | 480017<br>480208   | 200/201 x 35 - Lager<br>200/201 x 35 + Lager   |
|    | 1.4 16V<br>1.6 16V   |  |  | 07.94<br>07.94   | 12.00<br>08.98  | 24.0220-0033.2   | 480132   | mit Sensorring <sup>1)</sup><br>200/201 x 35   |
|    | 1.4 16V<br>1.6 16V   |  |  | 07.94<br>07.94   | 12.00<br>08.98  | 03.0420-1019.3<br>03.0520-1019.3   | 681019<br>691019   | 19,05/200x29 Kit TRW<br>19,05/200x29 TopKit TRW  |
| <b>OPEL TIGRA TWIN TOP / Vau. Tigra Twin Top (04-09)</b>                           |  |  |  |  |   |  |  |  |
|    | 1.3 CDTI<br>1.4<br>1.8   | 51<br>66<br>92   |  | 06.04<br>06.04<br>06.04  | 08.09<br>08.09<br>08.09   | 13.0460-2857.2<br>13.0470-2857.2   | 602857<br>LD2857   | 23225 17,0 +WK/Zub/STRW<br>23225 17,0 +WK/Zub/STRW   |
|   | 1.3 CDTI<br>1.4<br>1.8   | 51<br>66<br>92   |  | 06.04<br>06.04<br>06.04  | 08.09<br>08.09<br>08.09   | 24.0124-0166.1<br>24.0324-0166.1   | 424166<br>524166   | 260 24,0 21,0 V L +S +B<br>260 24,0 21,0 V L +B PD   |
|  | 1.3 CDTI<br>1.4<br>1.8   | 51<br>66<br>92   |  | 06.04<br>06.04<br>06.04  | 08.09<br>08.09<br>08.09   | 24.0710-1002.1   | 360206   | 2 <br>Radsensor L=452     |
|  | 1.3 CDTI<br>1.4<br>1.8   | 51<br>66<br>92   | ORGA 6E999999<br>ORGA 6E999999<br>ORGA 6E999999                                  | 06.04<br>06.04<br>06.04  |   | 13.0460-2858.2<br>13.0470-2858.2   | 602858<br>LD2858   | 23284 14,0 /WK/S TRW<br>23284 14,0 /WK/S TRW   |
|  | 1.3 CDTI<br>1.4<br>1.8   | 51<br>66<br>92   | ORGA 7E000001<br>ORGA 7E000001<br>ORGA 7E000001                                  |  | 08.09<br>08.09<br>08.09   | 13.0460-2858.2<br>13.0470-2858.2   | 602858<br>LD2858   | 23284 14,0 /WK/S TRW<br>23284 14,0 /WK/S TRW   |
|  | 1.3 CDTI<br>1.4<br>1.8   | 51<br>66<br>92   |  | 06.04<br>06.04<br>06.04  | 08.09<br>08.09<br>08.09   | 24.0110-0268.1   | 410268   | 240 10,2 8,2 +B  |
|  | 1.3 CDTI<br>1.4<br>1.8   | 51<br>66<br>92   |  | 06.04<br>06.04<br>06.04  | 08.09<br>08.09<br>08.09   | 03.0137-0396.2<br>03.0137-9167.2   | 650396<br>669167   | 200 x 46 HEB<br>Bremsbacken-Zubehör  |
|  | 1.3 CDTI<br>1.4<br>1.8   | 51<br>66<br>92   |  | 06.04<br>06.04<br>06.04  | 08.09<br>08.09<br>08.09   | 24.0220-0038.1<br>24.0220-0738.2   | 480162<br>480214   | ohne Sensorring <sup>2)</sup><br>ohne Sensorring <sup>2)</sup><br>200/201 x 54 - Lager<br>200/201 x 54 + Lager |
| <b>OPEL VECTRA B / Vauxhall Vectra (96-02)</b>                                     |  |  |  |  |   |  |  |  |
|  | 1.6<br>1.6 16V<br>1.7 TD<br>1.8 i 16V<br>2.0 DI 16V<br>2.0 DTI 16V   |  | W7999999<br>W7999999<br>W7999999<br>W7999999<br>W7999999                         | 09.95<br>09.95<br>09.95<br>11.96<br>06.97  |   | 13.0460-7052.2<br>24.8190-0715.2   | 607052<br>620715   | 2<br>21190 17,5 +WE ATE<br>Warnkontakt L=660mm   |
|  | 1.6<br>1.6 16V<br>1.8 i 16V<br>2.0 16V<br>2.0 DI 16V<br>2.0 DTI 16V<br>2.2 16V<br>2.2 DTI 16V<br>2.5 V6<br>2.6 V6<br>i 500 2.5 | X1000001<br>X1000001<br>X1000001<br>X1000001<br>X1000001<br>X1000001             |  |  | 04.02<br>04.02<br>04.02<br>09.95<br>04.02<br>04.02<br>09.00<br>04.02<br>09.95<br>09.00<br>09.00 | 13.0460-7091.2<br>24.8190-0714.2   | 607091<br>620714   | 2<br>21829 20,3 +WE ATE<br>Warnkontakt L=660mm   |
|  | 1.6<br>1.6 16V<br>1.7 TD<br>1.8 i 16V<br>2.0 DI 16V<br>2.0 DTI 16V   |  | W7999999<br>W7999999<br>W7999999<br>W7999999<br>W7999999                         | 09.95<br>09.95<br>09.95<br>11.96<br>06.97  |   | 24.0124-0115.1<br>24.0324-0115.1   | 424115<br>524115   | 256 24,0 21,0 V L +S +B<br>256 24,0 21,0 V L +S +B PD  |

<sup>1)</sup> with sensor ring / con sensori / avec secours ABS / con anillo sensor ABS  
<sup>2)</sup> without sensor ring / senza sensori / sans secours ABS / sin anillo sensor ABS





| OPEL VECTRA B / Vauxhall Vectra (96-02) |                      |          |          |       |                |                |        |                         |                            |
|---|----------------------|----------|----------|-------|----------------|----------------|--------|-------------------------|----------------------------|
|   | 1.6                  | X1000001 |          | 04.02 |                | 24.0125-0119.1 | 425119 |                         | 288 25,0 22,0 V L +S +B    |
|   | 1.6 16V              | X1000001 |          | 04.02 |                | 24.0325-0119.1 | 525119 |                         | 288 25,0 22,0 V L +S +B PD |
|   | 1.8 i 16V            | X1000001 |          | 04.02 |                |                |        |                         |                            |
|   | 2.0 16V              |          | 09.95    | 04.02 |                |                |        |                         |                            |
|   | 2.0 DI 16V           | X1000001 |          | 04.02 |                |                |        |                         |                            |
|   | 2.0 DTI 16V          | X1000001 |          | 04.02 |                |                |        |                         |                            |
|   | 2.2 16V              |          | 09.00    | 04.02 |                |                |        |                         |                            |
|   | 2.2 DTI 16V          |          | 09.00    | 04.02 |                |                |        |                         |                            |
|   | 2.5 V6               |          | 09.95    | 09.00 |                |                |        |                         |                            |
| 2.6 V6                                  |                      | 09.00    | 04.02    |       |                |                |        |                         |                            |
| i 500 2.5                               | 143                  |          | 05.98    | 09.00 |                | 24.0125-0142.1 | 425142 |                         | 308 25,0 22,0 V L +S +B    |
|   |                      |          |          |       |                | 24.0325-0142.1 | 525142 |                         | 308 25,0 22,0 V L +S +B PD |
|   | 1.6 16V              |          |          | 09.95 | 04.02          |                |        |                         | 21050 15,8 ATE             |
|   | 1.7 TD               |          |          | 09.95 | 11.96          | 13.0460-4040.2 | 604040 |                         | Belagsatz-Zubehör          |
|   | 1.8 i 16V            |          |          | 09.95 | 04.02          | 13.0460-0347.2 | 610347 |                         |                            |
|   | 2.0 16V              |          |          | 09.95 | 04.02          |                |        |                         |                            |
|   | 2.0 DI 16V Caravan   |          |          | 11.96 | 04.02          |                |        |                         |                            |
|   | 2.0 DTI 16V          |          |          | 06.97 | 04.02          |                |        |                         |                            |
|   | 2.2 16V              |          |          | 09.00 | 04.02          |                |        |                         |                            |
|   | 2.2 DTI 16V          |          |          | 09.00 | 04.02          |                |        |                         |                            |
|   | 2.5 V6               |          |          | 09.95 | 09.00          |                |        |                         |                            |
| 2.6 V6                                  |                      |          | 09.00    | 04.02 |                |                |        |                         |                            |
| i 500 2.5                               | 143                  |          | 05.98    | 09.00 |                |                |        |                         |                            |
|   | 1.6 16V              |          | W7999999 | 09.95 |                | 24.0110-0225.1 | 410225 |                         | 270 10,0 8,0 +S +B         |
|   | 1.7 TD               |          |          | 09.95 | 11.96          | 24.0310-0225.1 | 510225 |                         | 270 10,0 8,0 +S +B PD      |
|   | 1.8 i 16V            |          | W7999999 | 09.95 |                |                |        |                         |                            |
|   | 2.0 DI 16V Caravan   |          | W7999999 | 11.96 |                |                |        |                         |                            |
|   | 2.0 DTI 16V          |          | W7999999 | 06.97 |                |                |        |                         |                            |
|   | 1.6 16V              | X1000001 |          | 04.02 |                | 24.0110-0226.1 | 410226 |                         | 286 10,0 8,0 +S +B         |
|   | 1.8 i 16V            | X1000001 |          | 04.02 |                | 24.0310-0226.1 | 510226 |                         | 286 10,0 8,0 +S +B PD      |
|   | 2.0 16V              |          | 09.95    | 04.02 |                |                |        |                         |                            |
|   | 2.0 DI 16V Caravan   | X1000001 |          | 04.02 |                |                |        |                         |                            |
| 2.0 DTI 16V                             | X1000001             |          | 04.02    |       |                |                |        |                         |                            |
| 2.2 16V                                 |                      | 09.00    | 04.02    |       |                |                |        |                         |                            |
| 2.2 DTI 16V                             |                      | 09.00    | 04.02    |       |                |                |        |                         |                            |
| 2.5 V6                                  |                      | 09.95    | 09.00    |       |                |                |        |                         |                            |
| 2.6 V6                                  |                      | 09.00    | 04.02    |       |                |                |        |                         |                            |
| i 500 2.5                               | 143                  |          | 05.98    | 09.00 |                |                |        |                         |                            |
|   | 1.6                  |          |          | 09.95 | 04.02          | 03.0137-0322.2 | 650322 |                         | 230 x 42                   |
|   | 2.0 DI 16V Limousine |          |          | 11.96 | 04.02          | 03.0137-9215.2 | 669215 |                         | Bremsbacken-Zubehör        |
|   | 1.6                  |          | W7999999 | 09.95 |                | 24.0223-0013.2 | 480061 |                         | 230/231 x 50               |
|   | 2.0 DI 16V Limousine |          | W7999999 | 11.96 |                |                |        |                         |                            |
|   | 1.6                  | X1000001 |          | 04.02 |                | 24.0223-0018.2 | 480136 |                         | 230/231 x 49,3             |
|   | 2.0 DI 16V Limousine | X1000001 |          | 04.02 |                |                |        |                         |                            |
|   | 1.6                  | W7154259 | W7999999 |       |                | 03.0520-5719.3 | 695719 |                         | 19,05/230x42 TopKit TRW    |
|   | 1.6                  | W5276826 | W5999999 |       |                |                |        |                         |                            |
|   | 1.6                  | W1238519 | W1999999 |       |                |                |        |                         |                            |
|   | 2.0 DI 16V Limousine | W7154259 | W7999999 |       |                |                |        |                         |                            |
|   | 2.0 DI 16V Limousine | W5276826 | W5999999 |       |                |                |        |                         |                            |
|   | 2.0 DI 16V Limousine | W1238519 | W1999999 |       |                |                |        |                         |                            |
| 1.6                                     | X1000001             |          | 04.02    |       | 03.0520-7320.3 | 697320         |        | 20,64/230x42 TopKit TRW |                            |
| 2.0 DI 16V Limousine                    | X1000001             |          | 04.02    |       |                |                |        |                         |                            |
|   | 1.6 16V              |          |          | 09.95 | 04.02          | 03.0137-0172.2 | 650172 |                         | 160 x 25                   |
|   | 1.7 TD               |          |          | 09.95 | 11.96          | 03.0137-9243.2 | 669243 |                         | Bremsbacken-Zubehör        |
|   | 1.8 i 16V            |          |          | 09.95 | 04.02          |                |        |                         |                            |
|   | 2.0 16V              |          |          | 09.95 | 04.02          |                |        |                         |                            |
|   | 2.0 DI 16V Caravan   |          |          | 11.96 | 04.02          |                |        |                         |                            |
|   | 2.0 DTI 16V          |          |          | 06.97 | 04.02          |                |        |                         |                            |
|   | 2.2 16V              |          |          | 09.00 | 04.02          |                |        |                         |                            |
|   | 2.2 DTI 16V          |          |          | 09.00 | 04.02          |                |        |                         |                            |
|   | 2.5 V6               |          |          | 09.95 | 09.00          |                |        |                         |                            |
| 2.6 V6                                  |                      |          | 09.00    | 04.02 |                |                |        |                         |                            |













  

| OPEL VECTRA C (F68,F69)/Vau. Vectra MK II (02-08) |                  |     |       |       |       |                |        |                                      |                     |     |
|---|------------------|-----|-------|-------|-------|----------------|--------|--------------------------------------|---------------------|-----|
|   | 1.6              | 74  |       | 08.05 | 10.08 | 13.0460-7212.2 | 607212 | f. Bremssattel m.Stahlkolben 1)      | 23738 20,1 +/WE     | ATE |
|   | 1.6              | 77  |       | 01.06 | 10.08 | 13.0460-7172.2 | 607172 | f. Bremssattel m.Kunststoffkolben 2) | 23402 20,1 +/WE     | ATE |
|   | 1.6 16V          |     |       | 04.02 | 10.08 | 13.0470-7172.2 | LD7172 | f. Bremssattel m.Kunststoffkolben 2) | 23402 20,1 +/WE     | ATE |
|   | 1.8              | 81  |       | 04.02 | 10.08 | 24.8190-0719.2 | 620719 | Ch. - 48045597                       | Warnkontakt L=686mm |     |
|   | 1.8              | 103 |       | 01.06 | 10.08 | 24.8190-0720.2 | 620720 | Ch. 48045598-                        | Warnkontakt L=287mm |     |
|   | 1.8 16V          | 90  |       | 04.02 | 10.08 |                |        |                                      |                     |     |
|   | 1.9 CDTI         | 74  |       | 10.05 | 10.08 |                |        |                                      |                     |     |
|   | 1.9 CDTI         | 88  |       | 04.04 | 10.08 |                |        |                                      |                     |     |
|   | 1.9 CDTI         | 110 |       | 04.04 | 10.08 |                |        |                                      |                     |     |
|   | 2.0 DTI 16V      |     |       | 04.02 | 10.08 |                |        |                                      |                     |     |
|   | 2.0 Turbo        |     |       | 03.03 | 10.08 |                |        |                                      |                     |     |
|   | 2.2 16V          | 108 |       | 04.02 | 10.08 |                |        |                                      |                     |     |
|   | 2.2 direct       | 114 |       | 10.03 | 10.08 |                |        |                                      |                     |     |
|   | 2.2 DTI 16V      |     |       | 04.02 | 10.08 |                |        |                                      |                     |     |
|   | 2.8 V6 Turbo     | 169 |       | 08.05 | 10.08 | 13.0460-7199.2 | 607199 |                                      | 23404 20,6 +/WE     | ATE |
|   | 2.8 V6 Turbo     | 184 |       | 08.06 | 10.08 | 24.8190-0721.2 | 620721 | Ch. - 48045597                       | Warnkontakt L=700mm |     |
|   | 3.0 CDTI         |     |       | 05.03 | 10.08 | 24.8190-0722.2 | 620722 | Ch. 48045598-                        | Warnkontakt L=302mm |     |
|   | 3.0 V6 CDTI      | 135 |       | 08.05 | 10.08 |                |        |                                      |                     |     |
|   | 3.2 V6           |     |       | 04.02 | 10.08 |                |        |                                      |                     |     |
|   | 2.8 V6 Turbo OPC | 188 |       | 08.05 | 10.08 | 24.8190-0722.2 | 620722 |                                      | Warnkontakt L=302mm |     |
| 2.8 V6 Turbo OPC                                  | 206              |     | 08.06 | 10.08 |       |                |        |                                      |                     |     |

1) for br.caliper +steel piston / per pinza fr. +pistone acciaio / pour étrier f. +piston en acier / para pinza fr. +pistón de acero

2) for br.caliper +plastic piston / per pinza fr. +pistone plastica / pour étrier fr. +piston plastique / para pinza fr. + pistón plástico



|     |                  |  |                     |  |       |  |                               |  |        |  |  |  |  |  |  |  |                            |                         |
|--|------------------|--|---------------------|--|-------|--|-------------------------------|--|--------|---|--|--|--|--|--|--|----------------------------|-------------------------|
| <b>OPEL VECTRA C (F68,F69)/Vau. Vectra MK II (02-08)</b>                           |                  |  |                     |  |       |  |                               |  |        |   |  |  |  |  |  |  |                            |                         |
|    | 1.6              | 74   |                     | 08.05  | 10.08 |  | 24.0125-0141.1                | 425141   |        |   |  |  |  |  |  |  | 285 24,9 22,0 V L +S +B    |                         |
|  | 1.6              | 77   |                     | 01.06  | 10.08 |  | 24.0325-0141.1                | 525141   |        |   |  |  |  |  |  |  | 285 24,9 22,0 V L +S +B PD |                         |
|  | 1.6 16V          |  |                     | 04.02  | 10.08 |  |                               |  |        |   |  |  |  |  |  |  |                            |                         |
|  | 1.8              | 81   |                     | 04.02  | 10.08 | - Sportfahrwerk <sup>1)</sup>  |                               |  |        |   |  |  |  |  |  |  |                            |                         |
|  | 1.8              | 103  |                     | 01.06  | 10.08 | + Sportfahrwerk/ - Polizei <sup>2)</sup>   |                               |  |        |   |  |  |  |  |  |  |                            |                         |
|  | 1.8 16V          | 90   |                     | 04.02  | 10.08 | - Sportfahrwerk <sup>1)</sup>  |                               |  |        |   |  |  |  |  |  |  |                            |                         |
|  | 1.9 CDTI         | 74   |                     | 10.05  | 10.08 | - Polizei <sup>3)</sup>  |                               |  |        |   |  |  |  |  |  |  |                            |                         |
|  | 1.9 CDTI         | 88   |                     | 04.04  | 10.08 |  |                               |  |        |   |  |  |  |  |  |  |                            |                         |
|  | 1.9 CDTI         | 110  |                     | 04.04  | 10.08 |  |                               |  |        |   |  |  |  |  |  |  |                            |                         |
|  | 2.0 DTI 16V      |  |                     | 04.02  | 10.08 |  |                               |  |        |   |  |  |  |  |  |  |                            |                         |
|  | 2.2 16V          | 108  |                     | 04.02  | 10.08 | - Sportfahrwerk <sup>1)</sup>  |                               |  |        |   |  |  |  |  |  |  |                            |                         |
|  | 2.2 direct       | 114  |                     | 10.03  | 10.08 | - Sportfahrwerk <sup>1)</sup>  |                               |  |        |   |  |  |  |  |  |  |                            |                         |
|  | 2.2 DTI 16V      |  |                     | 04.02  | 10.08 | - Sportfahrwerk <sup>1)</sup>  |                               |  |        |   |  |  |  |  |  |  |                            |                         |
|  |                  | 1.8  | 81                  |  | 04.02 | 10.08  | + Sportfahrwerk <sup>4)</sup> | 24.0128-0137.1   | 428137 |   |  |  |  |  |  |  |                            | 302 28,0 25,0 V L +S +B |
| 1.8  |                  | 103  |                     | 01.06  | 10.08 | + Sportfahrwerk/ + Polizei <sup>5)</sup>   | 24.0328-0137.1                | 528137   |        |   |  |  |  |  |  |  | 302 28,0 25,0 V L +S +B PD |                         |
| 1.8 16V  |                  | 90   |                     | 04.02  | 10.08 | + Sportfahrwerk <sup>4)</sup>  |                               |  |        |   |  |  |  |  |  |  |                            |                         |
| 1.9 CDTI   |                  | 74   |                     | 10.05  | 10.08 | + Polizei <sup>6)</sup>  |                               |  |        |   |  |  |  |  |  |  |                            |                         |
| 2.0 Turbo  |                  |  |                     | 03.03  | 10.08 |  |                               |  |        |   |  |  |  |  |  |  |                            |                         |
| 2.2 16V  |                  | 108  |                     | 04.02  | 10.08 | + Sportfahrwerk <sup>4)</sup>  |                               |  |        |   |  |  |  |  |  |  |                            |                         |
| 2.2 direct   |                  | 114  |                     | 10.03  | 10.08 | + Sportfahrwerk <sup>4)</sup>  |                               |  |        |   |  |  |  |  |  |  |                            |                         |
| 2.2 DTI 16V  |                  |  |                     | 04.02  | 10.08 | + Sportfahrwerk <sup>4)</sup>  |                               |  |        |   |  |  |  |  |  |  |                            |                         |
| 3.0 CDTI   |                  |  | 31070293            | 05.03  |       |  |                               |  |        |   |  |  |  |  |  |  |                            |                         |
| 3.2 V6   |                  |  | 31070293            | 04.02  |       |  |                               |  |        |   |  |  |  |  |  |  |                            |                         |
|  | 2.8 V6 Turbo     | 169  | 61000001            |  | 10.08 |  | 24.0128-0164.1                | 428164   |        |   |  |  |  |  |  |  | 314 28,0 25,0 V L +S +B    |                         |
|  | 2.8 V6 Turbo     | 184  |                     | 08.06  | 10.08 |  |                               |  |        |   |  |  |  |  |  |  |                            |                         |
|  | 3.0 CDTI         |  | 31070294            |  | 10.08 |  |                               |  |        |   |  |  |  |  |  |  |                            |                         |
|  | 3.0 V6 CDTI      | 135  | 61000001            |  | 10.08 |  |                               |  |        |   |  |  |  |  |  |  |                            |                         |
|  | 3.2 V6           |  | 31070294            |  | 10.08 |  |                               |  |        |   |  |  |  |  |  |  |                            |                         |
|  | 2.8 V6 Turbo OPC | 188  | 61000001            |  | 10.08 |  | 24.0130-0189.1                | 430189   |        |   |  |  |  |  |  |  | 345 29,9 27,5 V L +B       |                         |
|  | 2.8 V6 Turbo OPC | 206  | 61000001            |  | 10.08 |  |                               |  |        |   |  |  |  |  |  |  |                            |                         |
|    | 1.6 16V          |  |                     | 41096248 / 48091178  | 04.02 |  | 13.0460-7194.2                | 607194   |        |   |  |  |  |  |  |  | 23482 16,6 +               |                         |
|  | 1.8              | 81   |                     | 41096248 / 48091178  | 04.02 |  | 13.0470-7194.2                | LD7194   |        |   |  |  |  |  |  |  | ATE                        |                         |
|  | 1.8 16V          | 90   |                     | 41096248 / 48091178  | 04.02 |  |                               |  |        |   |  |  |  |  |  |  | ATE                        |                         |
|  | 1.9 CDTI         | 88   |                     | 41096248 / 48091178  | 04.04 |  |                               |  |        |   |  |  |  |  |  |  |                            |                         |
|  | 1.9 CDTI         | 110  |                     | 41096248 / 48091178  | 04.04 |  |                               |  |        |   |  |  |  |  |  |  |                            |                         |
|  | 2.0 DTI 16V      |  |                     | 41096248 / 48091178  | 04.02 |  |                               |  |        |   |  |  |  |  |  |  |                            |                         |
|  | 2.0 Turbo        |  |                     | 41096248 / 48091178  | 03.03 |  |                               |  |        |   |  |  |  |  |  |  |                            |                         |
|  | 2.2 16V          | 108  |                     | 41096248 / 48091178  | 04.02 |  |                               |  |        |   |  |  |  |  |  |  |                            |                         |
|  | 2.2 direct       | 114  |                     | 41096248 / 48091178  | 10.03 |  |                               |  |        |   |  |  |  |  |  |  |                            |                         |
|  | 2.2 DTI 16V      |  |                     | 41096248 / 48091178  | 04.02 |  |                               |  |        |   |  |  |  |  |  |  |                            |                         |
|  | 3.0 CDTI         |  |                     | 41096248 / 48091178  | 05.03 |  |                               |  |        |   |  |  |  |  |  |  |                            |                         |
|  | 3.2 V6           |  |                     | 41096248 / 48091178  | 04.02 |  |                               |  |        |   |  |  |  |  |  |  |                            |                         |
|  | 1.6              | 74   |                     |  | 08.05 | 10.08  |                               | 13.0460-7194.2   | 607194 |   |  |  |  |  |  |  | 23482 16,6 +               |                         |
|  | 1.6              | 77   |                     |  | 01.06 | 10.08  |                               | 13.0470-7194.2   | LD7194 |   |  |  |  |  |  |  | ATE                        |                         |
|  | 1.6 16V          |  | 41096248 / 48091179 |  |       | 10.08  |                               | 13.0460-7195.2   | 607195 |   |  |  |  |  |  |  | ATE                        |                         |
|  | 1.8              | 81   | 41096248 / 48091179 |  |       | 10.08  |                               | 13.0470-7195.2   | LD7195 |   |  |  |  |  |  |  | ATE                        |                         |
|  | 1.8              | 103  |                     |  | 01.06 | 10.08  |                               |  |        |   |  |  |  |  |  |  |                            |                         |
|  | 1.8 16V          | 90   | 41096248 / 48091179 |  |       | 10.08  |                               |  |        |   |  |  |  |  |  |  |                            |                         |
|  | 1.9 CDTI         | 74   |                     |  | 10.05 | 10.08  |                               |  |        |   |  |  |  |  |  |  |                            |                         |
|  | 1.9 CDTI         | 88   | 41096248 / 48091179 |  |       | 10.08  |                               |  |        |   |  |  |  |  |  |  |                            |                         |
|  | 1.9 CDTI         | 110  | 41096248 / 48091179 |  |       | 10.08  |                               |  |        |   |  |  |  |  |  |  |                            |                         |
|  | 2.0 DTI 16V      |  | 41096248 / 48091179 |  |       | 10.08  |                               |  |        |   |  |  |  |  |  |  |                            |                         |
|  | 2.0 Turbo        |  | 41096248 / 48091179 |  |       | 10.08  |                               |  |        |   |  |  |  |  |  |  |                            |                         |
|  | 2.2 16V          | 108  | 41096248 / 48091179 |  |       | 10.08  |                               |  |        |   |  |  |  |  |  |  |                            |                         |
|  | 2.2 direct       | 114  | 41096248 / 48091179 |  |       | 10.08  |                               |  |        |   |  |  |  |  |  |  |                            |                         |
|  | 2.2 DTI 16V      |  | 41096248 / 48091179 |  |       | 10.08  |                               |  |        |   |  |  |  |  |  |  |                            |                         |
|  | 2.8 V6 Turbo     | 169  |                     |  | 08.05 | 10.08  |                               |  |        |   |  |  |  |  |  |  |                            |                         |
|  | 2.8 V6 Turbo     | 184  |                     |  | 08.06 | 10.08  |                               |  |        |   |  |  |  |  |  |  |                            |                         |
| 2.8 V6 Turbo OPC   | 188              |  |                     | 08.05  | 10.08 |  |                               |  |        |   |  |  |  |  |  |  |                            |                         |
| 2.8 V6 Turbo OPC   | 206              |  |                     | 08.06  | 10.08 |  |                               |  |        |   |  |  |  |  |  |  |                            |                         |
| 3.0 CDTI   |                  | 41096248 / 48091179  |                     |  | 10.08 |  |                               |  |        |   |  |  |  |  |  |  |                            |                         |
| 3.0 V6 CDTI  | 135              |  |                     | 08.05  | 10.08 |  |                               |  |        |   |  |  |  |  |  |  |                            |                         |
| 3.2 V6   |                  | 41096248 / 48091179  |                     |  | 10.08 |  |                               |  |        |   |  |  |  |  |  |  |                            |                         |
|  | 1.6              | 74   |                     |  | 08.05 | 10.08  | 24.0112-0157.1                | 412157   |        |   |  |  |  |  |  |  | 278 11,9 10,0 +S +B        |                         |
|  | 1.6              | 77   |                     |  | 01.06 | 10.08  | 24.0312-0157.1                | 512157   |        |   |  |  |  |  |  |  | 278 11,9 10,0 +S +B PD     |                         |
|  | 1.6 16V          |  |                     |  | 04.02 | 10.08  | 24.0120-0173.1                | 420173   |        |   |  |  |  |  |  |  | 292 19,9 18,0 V +S +B      |                         |
|  | 1.8              | 81   |                     |  | 04.02 | 10.08  | 24.0320-0173.1                | 520173   |        |   |  |  |  |  |  |  | 292 19,9 18,0 V +S +B PD   |                         |
|  | 1.8              | 103  |                     |  | 01.06 | 10.08  |                               |  |        |   |  |  |  |  |  |  |                            |                         |
|  | 1.8 16V          | 90   |                     |  | 04.02 | 10.08  |                               |  |        |   |  |  |  |  |  |  |                            |                         |
|  | 1.9 CDTI         | 74   |                     |  | 10.05 | 10.08  |                               |  |        |   |  |  |  |  |  |  |                            |                         |
|  | 1.9 CDTI         | 88   |                     |  | 04.04 | 10.08  |                               |  |        |   |  |  |  |  |  |  |                            |                         |
|  | 1.9 CDTI         | 110  |                     |  | 04.04 | 10.08  |                               |  |        |   |  |  |  |  |  |  |                            |                         |
|  | 2.0 DTI 16V      |  |                     |  | 04.02 | 10.08  |                               |  |        |   |  |  |  |  |  |  |                            |                         |
|  | 2.0 Turbo        |  |                     |  | 03.03 | 10.08  |                               |  |        |   |  |  |  |  |  |  |                            |                         |
|  | 2.2 16V          | 108  |                     |  | 04.02 | 10.08  |                               |  |        |   |  |  |  |  |  |  |                            |                         |
|  | 2.2 direct       | 114  |                     |  | 10.03 | 10.08  |                               |  |        |   |  |  |  |  |  |  |                            |                         |
|  | 2.2 DTI 16V      |  |                     |  | 04.02 | 10.08  |                               |  |        |   |  |  |  |  |  |  |                            |                         |
|  | 2.8 V6 Turbo     | 169  |                     |  | 08.05 | 10.08  |                               |  |        |   |  |  |  |  |  |  |                            |                         |
|  | 2.8 V6 Turbo     | 184  |                     |  | 08.06 | 10.08  |                               |  |        |   |  |  |  |  |  |  |                            |                         |
|  | 2.8 V6 Turbo OPC | 188  |                     |  | 08.05 | 10.08  |                               |  |        |   |  |  |  |  |  |  |                            |                         |
| 2.8 V6 Turbo OPC   | 206              |  |                     | 08.06  | 10.08 |  |                               |  |        |   |  |  |  |  |  |  |                            |                         |
| 3.0 CDTI   |                  |  |                     | 05.03  | 10.08 |  |                               |  |        |   |  |  |  |  |  |  |                            |                         |
| 3.0 V6 CDTI  | 135              |  |                     | 08.05  | 10.08 |  |                               |  |        |   |  |  |  |  |  |  |                            |                         |
| 3.2 V6   |                  |  |                     | 04.02  | 10.08 |  |                               |  |        |   |  |  |  |  |  |  |                            |                         |

<sup>1)</sup> - sports suspension / - sospensione sportiva / - châssis de sport / - suspensión deportiva  
<sup>2)</sup> - sports suspension / - Police / + sospensione sportiva/ - Polizia / + châssis de sport/ - Police / + suspensión deportiva/ - Police  
<sup>3)</sup> - Police / - Polizia / - voiture de police / - Police  
<sup>4)</sup> + sports suspension / + sospensione sportiva / + châssis de sport / + suspensión deportiva  
<sup>5)</sup> + sports suspension/ + Police / + sospensione sportiva/ + Polizia / + châssis de sport/ + Police / + suspensión deportiva/ + Police  
<sup>6)</sup> + Police / + Polizia / + voiture de police / + Police



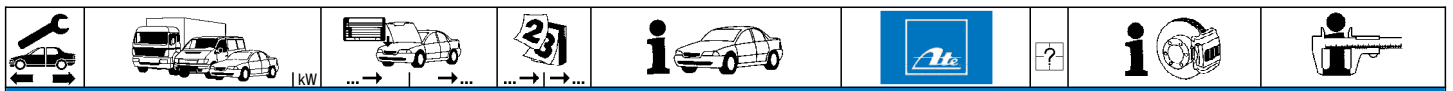

















**OPEL VECTRA C Caravan (F35) / Vau. MK II (03-08)**

|                  |              |                     |                     |       |       |                |                |                 |   |       |           |           |     |
|------------------|--------------|---------------------|---------------------|-------|-------|----------------|----------------|-----------------|---|-------|-----------|-----------|-----|
|                  | 1.6          | 77                  |                     | 06.06 | 10.08 |                | 13.0460-7212.2 | 607212          | f. Bremssattel m.Stahlkolben <sup>1)</sup>      | 23738 | 20,1 +/WE | ATE       |     |
|                  | 1.6 16V      | 74                  |                     | 10.03 | 10.08 |                | 13.0460-7172.2 | 607172          | f. Bremssattel m.Kunststoffkolben <sup>2)</sup> | 23402 | 20,1 +/WE | ATE       |     |
|                  | 1.8          | 81                  |                     | 04.04 | 10.08 |                | 13.0470-7172.2 | LD7172          | f. Bremssattel m.Kunststoffkolben <sup>2)</sup> | 23402 | 20,1 +/WE | ATE       |     |
|                  | 1.8          | 103                 |                     | 01.06 | 10.08 |                | 24.8190-0719.2 | 620719          | Ch. - 48045597                                  |       |           |           |     |
|                  | 1.8 16V      | 90                  |                     | 10.03 | 10.08 |                | 24.8190-0720.2 | 620720          | Ch. 48045598-                                   |       |           |           |     |
|                  | 1.9 CDTI     | 74                  |                     | 10.05 | 10.08 |                |                |                 |   |       |           |           |     |
|                  | 1.9 CDTI     | 88                  |                     | 04.04 | 10.08 |                |                |                 |   |       |           |           |     |
|                  | 1.9 CDTI     | 110                 |                     | 04.04 | 10.08 |                |                |                 |   |       |           |           |     |
|                  | 2.0 DTI 16V  | 74                  |                     | 10.03 | 10.08 |                |                |                 |   |       |           |           |     |
|                  | 2.0 Turbo    | 129                 |                     | 10.03 | 10.08 |                |                |                 |   |       |           |           |     |
|                  | 2.2 16V      | 108                 |                     | 10.03 | 10.08 |                |                |                 |   |       |           |           |     |
|                  | 2.2 direct   | 114                 |                     | 10.03 | 10.08 |                |                |                 |   |       |           |           |     |
|                  | 2.2 DTI 16V  | 92                  |                     | 10.03 | 10.08 |                |                |                 |   |       |           |           |     |
|                  | 2.8 V6 Turbo | 169                 |                     | 08.05 | 10.08 |                | 13.0460-7199.2 | 607199          |   |       | 23404     | 20,6 +/WE | ATE |
|                  | 2.8 V6 Turbo | 184                 |                     | 11.06 | 10.08 |                | 24.8190-0721.2 | 620721          | 1 Ch. - 48045597                                |       |           |           |     |
| 3.0 V6 CDTI      | 130          |                     | 10.03               | 10.08 |       | 24.8190-0722.2 | 620722         | 1 Ch. 48045598- |   |       |           |           |     |
| 3.0 V6 CDTI      | 135          |                     | 08.05               | 10.08 |       |                |                |                 |   |       |           |           |     |
| 3.2 V6           | 155          |                     | 10.03               | 10.08 |       |                |                |                 |   |       |           |           |     |
| 2.8 V6 Turbo OPC | 188          |                     | 08.05               | 10.08 |       | 24.8190-0722.2 | 620722         | 1               |   |       |           |           |     |
| 2.8 V6 Turbo OPC | 206          |                     | 06.06               | 10.08 |       |                |                |                 |   |       |           |           |     |
|                  | 1.6          | 77                  |                     | 06.06 | 10.08 |                | 24.0125-0141.1 | 425141          |   |       |           |           |     |
|                  | 1.6 16V      | 74                  |                     | 10.03 | 10.08 |                | 24.0325-0141.1 | 525141          |   |       |           |           |     |
|                  | 1.8          | 81                  |                     | 04.02 | 10.08 |                |                |                 |   |       |           |           |     |
|                  | 1.8          | 103                 |                     | 01.06 | 10.08 |                |                |                 |   |       |           |           |     |
|                  | 1.8 16V      | 90                  |                     | 10.03 | 10.08 |                |                |                 |   |       |           |           |     |
|                  | 1.9 CDTI     | 74                  |                     | 10.05 | 10.08 |                |                |                 |   |       |           |           |     |
|                  | 1.9 CDTI     | 88                  |                     | 04.04 | 10.08 |                |                |                 |   |       |           |           |     |
|                  | 1.9 CDTI     | 110                 |                     | 04.04 | 10.08 |                |                |                 |   |       |           |           |     |
|                  | 2.0 DTI 16V  | 74                  |                     | 10.03 | 10.08 |                |                |                 |   |       |           |           |     |
|                  | 2.2 16V      | 108                 |                     | 10.03 | 10.08 |                |                |                 |   |       |           |           |     |
|                  | 2.2 direct   | 114                 |                     | 10.03 | 10.08 |                |                |                 |   |       |           |           |     |
|                  | 2.2 DTI 16V  | 92                  |                     | 10.03 | 10.08 |                |                |                 |   |       |           |           |     |
|                  | 1.8          | 81                  |                     | 04.02 | 10.08 |                | 24.0128-0137.1 | 428137          |   |       |           |           |     |
|                  | 1.8          | 103                 |                     | 01.06 | 10.08 |                | 24.0328-0137.1 | 528137          |   |       |           |           |     |
|                  | 1.8 16V      | 90                  |                     | 10.03 | 10.08 |                |                |                 |   |       |           |           |     |
| 1.9 CDTI         | 74           |                     | 10.05               | 10.08 |       |                |                |                 |   |       |           |           |     |
| 1.9 CDTI         | 88           |                     | 04.04               | 10.08 |       |                |                |                 |   |       |           |           |     |
| 1.9 CDTI         | 110          |                     | 04.04               | 10.08 |       |                |                |                 |   |       |           |           |     |
| 2.0 Turbo        | 129          |                     | 10.03               | 10.08 |       |                |                |                 |   |       |           |           |     |
| 2.2 16V          | 108          |                     | 10.03               | 10.08 |       |                |                |                 |   |       |           |           |     |
| 2.2 direct       | 114          |                     | 10.03               | 10.08 |       |                |                |                 |   |       |           |           |     |
| 2.2 DTI 16V      | 92           |                     | 10.03               | 10.08 |       |                |                |                 |   |       |           |           |     |
| 3.0 V6 CDTI      | 130          | 31070293            | 10.03               | 10.08 |       |                |                |                 |   |       |           |           |     |
| 3.2 V6           | 155          | 31070293            | 10.03               | 10.08 |       |                |                |                 |   |       |           |           |     |
| 2.8 V6 Turbo     | 169          | 61000001            |                     | 10.08 |       | 24.0128-0164.1 | 428164         |                 |   |       |           |           |     |
| 2.8 V6 Turbo     | 184          |                     | 11.06               | 10.08 |       |                |                |                 |   |       |           |           |     |
| 3.0 V6 CDTI      | 130          | 31070294            |                     | 10.08 |       |                |                |                 |   |       |           |           |     |
| 3.0 V6 CDTI      | 135          |                     | 08.05               | 10.08 |       |                |                |                 |   |       |           |           |     |
| 3.2 V6           | 155          | 31070294            |                     | 10.08 |       |                |                |                 |   |       |           |           |     |
| 2.8 V6 Turbo OPC | 188          | 61000001            |                     | 10.08 |       | 24.0130-0189.1 | 430189         |                 |   |       |           |           |     |
| 2.8 V6 Turbo OPC | 206          |                     | 06.06               | 10.08 |       |                |                |                 |   |       |           |           |     |
|                  | 1.6          | 77                  | 41096248 / 48091178 | 06.06 | 10.08 |                | 13.0460-7194.2 | 607194          |   |       |           |           |     |
|                  | 1.6 16V      | 74                  | 41096248 / 48091178 | 10.03 | 10.08 |                | 13.0470-7194.2 | LD7194          |   |       |           |           |     |
|                  | 1.8          | 81                  | 41096248 / 48091178 | 04.02 | 10.08 |                |                |                 |   |       |           |           |     |
|                  | 1.8          | 103                 | 41096248 / 48091178 | 01.06 | 10.08 |                |                |                 |   |       |           |           |     |
|                  | 1.8 16V      | 90                  | 41096248 / 48091178 | 10.03 | 10.08 |                |                |                 |   |       |           |           |     |
|                  | 1.9 CDTI     | 74                  | 41096248 / 48091178 | 10.05 | 10.08 |                |                |                 |   |       |           |           |     |
|                  | 1.9 CDTI     | 88                  | 41096248 / 48091178 | 04.04 | 10.08 |                |                |                 |   |       |           |           |     |
|                  | 1.9 CDTI     | 110                 | 41096248 / 48091178 | 04.04 | 10.08 |                |                |                 |   |       |           |           |     |
|                  | 2.0 DTI 16V  | 74                  | 41096248 / 48091178 | 10.03 | 10.08 |                |                |                 |   |       |           |           |     |
|                  | 2.0 Turbo    | 129                 | 41096248 / 48091178 | 10.03 | 10.08 |                |                |                 |   |       |           |           |     |
|                  | 2.2 16V      | 108                 | 41096248 / 48091178 | 10.03 | 10.08 |                |                |                 |   |       |           |           |     |
|                  | 2.2 direct   | 114                 | 41096248 / 48091178 | 10.03 | 10.08 |                |                |                 |   |       |           |           |     |
|                  | 2.2 DTI 16V  | 92                  | 41096248 / 48091178 | 10.03 | 10.08 |                |                |                 |   |       |           |           |     |
|                  | 2.8 V6 Turbo | 169                 | 41096248 / 48091178 | 08.05 | 10.08 |                |                |                 |   |       |           |           |     |
|                  | 2.8 V6 Turbo | 184                 | 41096248 / 48091178 | 11.06 | 10.08 |                |                |                 |   |       |           |           |     |
| 2.8 V6 Turbo OPC | 188          | 41096248 / 48091178 | 08.05               | 10.08 |       |                |                |                 |   |       |           |           |     |
| 2.8 V6 Turbo OPC | 206          | 41096248 / 48091178 | 06.06               | 10.08 |       |                |                |                 |   |       |           |           |     |
| 3.0 V6 CDTI      | 130          | 41096248 / 48091178 | 10.03               | 10.08 |       |                |                |                 |   |       |           |           |     |
| 3.0 V6 CDTI      | 135          | 41096248 / 48091178 | 08.05               | 10.08 |       |                |                |                 |   |       |           |           |     |
| 3.2 V6           | 155          | 41096248 / 48091178 | 10.03               | 10.08 |       |                |                |                 |   |       |           |           |     |
| 1.6              | 77           | 41096248 / 48091179 |                     | 10.08 |       | 13.0460-7195.2 | 607195         |                 |   |       |           |           |     |
| 1.6 16V          | 74           | 41096248 / 48091179 |                     | 10.08 |       | 13.0470-7195.2 | LD7195         |                 |   |       |           |           |     |
| 1.8              | 81           | 41096248 / 48091179 |                     | 10.08 |       |                |                |                 |   |       |           |           |     |
| 1.8              | 103          | 41096248 / 48091179 |                     | 10.08 |       |                |                |                 |   |       |           |           |     |
| 1.8 16V          | 90           | 41096248 / 48091179 |                     | 10.08 |       |                |                |                 |   |       |           |           |     |
| 1.9 CDTI         | 74           | 41096248 / 48091179 |                     | 10.08 |       |                |                |                 |   |       |           |           |     |
| 1.9 CDTI         | 88           | 41096248 / 48091179 |                     | 10.08 |       |                |                |                 |   |       |           |           |     |
| 1.9 CDTI         | 110          | 41096248 / 48091179 |                     | 10.08 |       |                |                |                 |   |       |           |           |     |
| 2.0 DTI 16V      | 74           | 41096248 / 48091179 |                     | 10.08 |       |                |                |                 |   |       |           |           |     |
| 2.0 Turbo        | 129          | 41096248 / 48091179 |                     | 10.08 |       |                |                |                 |   |       |           |           |     |
| 2.2 16V          | 108          | 41096248 / 48091179 |                     | 10.08 |       |                |                |                 |   |       |           |           |     |
| 2.2 direct       | 114          | 41096248 / 48091179 |                     | 10.08 |       |                |                |                 |   |       |           |           |     |
| 2.2 DTI 16V      | 92           | 41096248 / 48091179 |                     | 10.08 |       |                |                |                 |   |       |           |           |     |
| 2.8 V6 Turbo     | 169          | 41096248 / 48091179 |                     | 10.08 |       |                |                |                 |   |       |           |           |     |
| 2.8 V6 Turbo     | 184          | 41096248 / 48091179 |                     | 10.08 |       |                |                |                 |   |       |           |           |     |

<sup>1)</sup> for br.caliper +steel piston / per pinza fr. +pistone acciaio / pour étrier f. +piston en acier / para pinza fr. +pistón de acero  
<sup>2)</sup> for br.caliper +plastic piston / per pinza fr. +pistone plastica / pour étrier f. +piston plastique / para pinza fr. +pistón plástico  
<sup>3)</sup> - sports suspension / - sospensione sportiva / - châssis de sport / - suspensión deportiva  
<sup>4)</sup> + sports suspension / - Police / + sospensione sportiva/ - Polizia / + châssis de sport/ - Police / + suspensión deportiva/ - Police  
<sup>5)</sup> - sports suspens./ - Police / - sospensione sportiva/ - Polizia / - châssis de sport/ - Police / - suspens.deportiva/ - Police  
<sup>6)</sup> + sports suspension / + sospensione sportiva / + châssis de sport/ + suspensión deportiva  
<sup>7)</sup> + sports suspension/ + Police / + sospensione sportiva/ + Polizia / + châssis de sport/ + Police / + suspensión deportiva/ + Police

|     |   |    |                                 |   |   |  |  |    |  |
|--|---|--|---|---|--|--|--|--|--|
| <b>OPEL VECTRA C Caravan (F35) / Vau. MK II (03-08)</b>                            |   |  |   |   |  |  |  |  |  |
|    | 2.8 V6 Turbo OPC<br>2.8 V6 Turbo OPC<br>3.0 V6 CDTI<br>3.0 V6 CDTI<br>3.2 V6  | 188<br>206<br>130<br>135<br>155  | 41096249 / 48091179<br>41096249 / 48091179<br>41096249 / 48091179<br>41096249 / 48091179<br>41096249 / 48091179 | 10.08<br>10.08<br>10.08<br>10.08<br>10.08   | 13.0460-7195.2<br>13.0470-7195.2   | 607195<br>LD7195   |  | 23482 16,6 +<br>23482 16,6 +   | ATE<br>ATE   |
|    | 1.6<br>1.6 16V<br>1.8<br>1.8<br>1.8 16V<br>1.9 CDTI<br>1.9 CDTI<br>1.9 CDTI<br>1.9 CDTI<br>2.0 DTI 16V<br>2.0 Turbo<br>2.2 16V<br>2.2 direct<br>2.2 DTI 16V<br>2.8 V6 Turbo<br>2.8 V6 Turbo<br>2.8 V6 Turbo OPC<br>2.8 V6 Turbo OPC<br>3.0 V6 CDTI<br>3.0 V6 CDTI<br>3.2 V6 | 77<br>74<br>81<br>103<br>90<br>74<br>88<br>110<br>74<br>129<br>108<br>114<br>92<br>169<br>184<br>188<br>206<br>130<br>135<br>155 |   | 06.06<br>10.03<br>04.02<br>01.06<br>10.03<br>10.05<br>04.04<br>04.04<br>10.03<br>10.03<br>10.03<br>10.03<br>08.05<br>11.06<br>08.05<br>06.06<br>10.03<br>08.05<br>10.03 | 10.08<br>10.08<br>10.08<br>10.08<br>10.08<br>10.08<br>10.08<br>10.08<br>10.08<br>10.08<br>10.08<br>10.08<br>10.08<br>10.08<br>10.08<br>10.08<br>10.08<br>10.08<br>10.08<br>10.08<br>10.08<br>10.08 | 24.0112-0157.1<br>24.0312-0157.1<br>24.0120-0173.1<br>24.0320-0173.1               | 412157<br>512157<br>420173<br>520173   | - belüftete Scheiben <sup>1)</sup><br>- belüftete Scheiben <sup>1)</sup><br>+ belüftete Scheiben <sup>2)</sup><br>+ belüftete Scheiben <sup>2)</sup> | 278 11,9 10,0 +S +B<br>278 11,9 10,0 +S +B PD<br>292 19,9 18,0 V +S +B<br>292 19,9 18,0 V +S +B PD |
| <b>OPEL VIVARO (01-14)</b>   |   |  |   |   |  |  |  |  |  |
|    | 1.9 CDTI<br>1.9 CDTI<br>1.9 Di<br>2.0<br>2.0 16V<br>2.0 CDTI<br>2.0 CDTI<br>2.5 CDTI<br>2.5 CDTI<br>2.5 CDTI<br>2.5 DTi   | 60<br>74<br>60<br>86<br>88<br>66<br>84<br>84<br>99<br>107<br>99  |   | 08.01<br>08.01<br>08.06<br>08.06<br>08.01<br>08.06<br>08.06<br>08.06<br>05.03<br>08.06<br>08.06   | 06.14<br>06.14<br>06.14<br>06.14<br>06.14<br>06.14<br>06.14<br>06.14<br>06.14<br>06.14<br>06.14  | 13.0460-2870.2   | 602870   | 23099 18,4 /S  | TRW  |
|   | 1.9 CDTI<br>1.9 CDTI<br>1.9 Di<br>2.0<br>2.0 16V<br>2.0 CDTI<br>2.0 CDTI<br>2.5 CDTI<br>2.5 CDTI<br>2.5 CDTI<br>2.5 DTi   | 60<br>74<br>60<br>86<br>88<br>66<br>84<br>84<br>99<br>107<br>99  |   | 08.01<br>08.01<br>08.06<br>08.06<br>08.01<br>08.06<br>08.06<br>08.06<br>05.03<br>08.06<br>08.06   | 06.14<br>06.14<br>06.14<br>06.14<br>06.14<br>06.14<br>06.14<br>06.14<br>06.14<br>06.14<br>06.14  | 24.0128-0132.1   | 428132   | 305 28,0 24,0 VL +S +B   |  |
|  | 1.9 CDTI<br>1.9 CDTI<br>1.9 Di<br>2.0<br>2.0 16V<br>2.0 CDTI<br>2.0 CDTI<br>2.5 CDTI<br>2.5 CDTI<br>2.5 CDTI<br>2.5 DTi   | 60<br>74<br>60<br>86<br>88<br>66<br>84<br>84<br>99<br>107<br>99  |   | 08.01<br>08.01<br>08.06<br>08.06<br>08.01<br>08.06<br>08.06<br>08.06<br>05.03<br>08.06<br>08.06   | 06.14<br>06.14<br>06.14<br>06.14<br>06.14<br>06.14<br>06.14<br>06.14<br>06.14<br>06.14<br>06.14  | 13.0460-2840.2<br>13.0460-0072.2   | 602840<br>610072   | 23980 16,5 /WE/S<br>Belagsatz-Zubehör  | TRW<br>TRW   |
|  | 1.9 CDTI<br>1.9 CDTI<br>1.9 Di<br>2.0<br>2.0 16V<br>2.0 CDTI<br>2.0 CDTI<br>2.5 CDTI<br>2.5 CDTI<br>2.5 CDTI<br>2.5 DTi   | 60<br>74<br>60<br>86<br>88<br>66<br>84<br>84<br>99<br>107<br>99  |   | 08.01<br>08.01<br>08.06<br>08.06<br>08.01<br>08.06<br>08.06<br>08.06<br>05.03<br>08.06<br>08.06   | 06.14<br>06.14<br>06.14<br>06.14<br>06.14<br>06.14<br>06.14<br>06.14<br>06.14<br>06.14<br>06.14  | 24.0112-0177.2   | 412177   | mit Lager/ mit Sensorring <sup>3)</sup>  | 280 12,0 10,0 +B   |
| <b>OPEL VIVARO B (14-)</b>   |   |  |   |   |  |  |  |  |  |
|  | 1.6 BiTurbo CDTI<br>1.6 CDTI<br>1.6 CDTi<br>1.6 CDTI<br>1.6 CDTI<br>1.6 CDTi<br>1.6 CDTi  | 103<br>66<br>70<br>85<br>88<br>92<br>107   |   | 07.14<br>07.14<br>04.15<br>07.14<br>07.14<br>04.15<br>04.15   |  | 13.0460-2840.2   | 602840   | 23980 16,5 /WE/S   | TRW  |
| <b>OPEL ZAFIRA I / Vauxhall Zafira I (99-05)</b>                                   |   |  |   |   |  |  |  |  |  |
|  |   |  |   |   |  |  |  |  |  |

<sup>1)</sup> - ventilated discs / - dischi ventilati / - disques ventilés / - disco ventilado

<sup>2)</sup> + ventilated discs / + dischi ventilati / + disques ventilés / + disco ventilado

<sup>3)</sup> with bearing/ with sensor ring / con supporto/+ anell.sens.ABS / avec palier de secours ABS / con apoyo/+ anillo sensor ABS



### OPEL ZAFIRA I / Vauxhall Zafira I (99-05)

|  |             |  |          |       |       |          |                |        |       |  |   |            |
|--|-------------|--|----------|-------|-------|----------|----------------|--------|-------|--|---|------------|
|  | 1.6 16V     |  |          | 04.99 | 06.05 |          | 13.0460-7116.2 | 607116 | + ABS | 23057 20,2 +/WE<br>23057 20,2 +/WE<br>23063 17,5 +/WK<br>23063 17,5 +/WK<br>Warnkontakt L=720mm<br>Warnkontakt L=755mm | ATE<br>ATE<br>ATE<br>ATE                                      |            |
|  | 1.8 16V     |  |          | 04.99 | 06.05 |          | 13.0470-7116.2 | LD7116 | + ABS |  |   |            |
|  | 2.0 DI 16V  |  |          | 10.99 | 06.05 |          | 13.0460-7115.2 | 607115 | - ABS |  |   |            |
|  | 2.0 DTI 16V |  |          | 06.00 | 06.05 |          | 13.0470-7115.2 | LD7115 | - ABS | 2<br>2<br>bis Fgst.Nr.: 42187758 <sup>1)</sup><br>ab Fgst.Nr.: 42187759 <sup>2)</sup>                                  | 24.8190-0718.2 620718<br>24.8190-0018.2 620018                | 2          |
|  | 2.2 16V     |  |          | 09.00 | 06.05 |          | 13.0460-7116.2 | 607116 |       |  |   |            |
|  | 2.2 DTI 16V |  |          | 01.02 | 06.05 |          | 13.0470-7116.2 | LD7116 |       |  |   |            |
|  | 2.0 16V OPC |  |          | 09.01 | 06.05 |          | 13.0460-7173.2 | 607173 |       | 2<br>2<br>bis Fgst.Nr.: 42187758 <sup>1)</sup><br>ab Fgst.Nr.: 42187759 <sup>2)</sup>                                  | 23116 20,3 +/WK<br>Warnkontakt L=720mm<br>Warnkontakt L=755mm | ATE<br>ATE |
|  | 2.0 16V OPC |  |          | 09.01 | 06.05 |          | 24.8190-0718.2 | 620718 |       |  |   |            |
|  | 2.0 16V OPC |  |          | 09.01 | 06.05 |          | 24.8190-0018.2 | 620018 |       |  |   |            |
|  | 1.6 16V     |  |          | 04.99 | 06.05 |          | 24.0125-0131.1 | 425131 |       | 280 24,8 22,0 V L +S +B<br>280 24,8 22,0 V L +S +B PD  |   |            |
|  | 1.8 16V     |  |          | 04.99 | 06.05 |          | 24.0325-0131.1 | 525131 |       |  |   |            |
|  | 2.0 DI 16V  |  |          | 10.99 | 06.05 |          |                |        |       |  |   |            |
|  | 2.0 DTI 16V |  |          | 06.00 | 06.05 |          |                |        |       |  |   |            |
|  | 2.2 16V     |  |          | 09.00 | 06.05 |          |                |        |       |  |   |            |
|  | 2.2 DTI 16V |  |          | 01.02 | 06.05 |          |                |        |       |  |   |            |
|  | 2.0 16V OPC |  |          | 09.01 | 06.05 |          | 24.0125-0142.1 | 425142 |       | 308 25,0 22,0 V L +S +B<br>308 25,0 22,0 V L +S +B PD  |   |            |
|  | 2.0 16V OPC |  |          | 09.01 | 06.05 |          | 24.0325-0142.1 | 525142 |       |  |   |            |
|  | 1.6 16V     |  |          | 04.99 | 06.05 | + D A CH | 13.0460-3976.2 | 603976 |       | 23258 16,5 +/WK/Zub/SBOS<br>23417 15,3 +/WK/Zub/STRW<br>23417 15,3 +/WK/Zub/STRW                                       |   |            |
|  | 1.8 16V     |  |          | 04.99 | 06.05 |          | 13.0460-2868.2 | 602868 |       |  |   |            |
|  | 2.0 16V OPC |  |          | 09.01 | 06.05 |          | 13.0470-2868.2 | LD2868 |       |  |   |            |
|  | 2.0 DI 16V  |  |          | 10.99 | 06.05 |          |                |        |       |  |   |            |
|  | 2.0 DTI 16V |  |          | 06.00 | 06.05 |          |                |        |       |  |   |            |
|  | 2.2 16V     |  |          | 09.00 | 06.05 |          |                |        |       |  |   |            |
|  | 2.2 DTI 16V |  |          | 01.02 | 06.05 |          |                |        |       |  |   |            |
|  | 1.6 16V     |  |          | 04.99 | 06.05 | + D A CH | 24.0110-0250.1 | 410250 |       | 264 9,8 8,0 +S +B<br>264 9,8 8,0 +S +B PD  |   |            |
|  | 1.8 16V     |  |          | 04.99 | 06.05 |          | 24.0310-0250.1 | 510250 |       |  |   |            |
|  | 2.0 16V OPC |  |          | 09.01 | 06.05 |          |                |        |       |  |   |            |
|  | 2.0 DI 16V  |  |          | 10.99 | 06.05 |          |                |        |       |  |   |            |
|  | 2.0 DTI 16V |  |          | 06.00 | 06.05 |          |                |        |       |  |   |            |
|  | 2.2 16V     |  |          | 09.00 | 06.05 |          |                |        |       |  |   |            |
|  | 2.2 DTI 16V |  |          | 01.02 | 06.05 |          |                |        |       |  |   |            |
|  | 1.6 16V     |  | 12999999 | 04.99 |       | - D A CH | 03.0137-0322.2 | 650322 |       | 230 x 42<br>Bremsbacken-Zubehör  |   |            |
|  | 1.6 16V     |  | 22000001 | 06.05 |       | - D A CH | 03.0137-9215.2 | 669215 |       |  |   |            |
|  | 1.6 16V     |  |          | 06.05 |       | - D A CH | 03.0137-0424.2 | 650424 |       | 230 x 42 HEB<br>Bremsbacken-Zubehör  |   |            |
|  | 1.6 16V     |  |          | 06.05 |       | - D A CH | 03.0137-9215.2 | 669215 |       |  |   |            |
|  | 1.6 16V     |  |          | 04.99 | 06.05 | - D A CH | 24.0223-0018.2 | 480136 |       | 230/231 x 49,3   |   |            |
|  | 1.6 16V     |  | 12999999 | 04.99 |       | - D A CH | 03.0520-7320.3 | 697320 |       | 20,64/230x42 TopKit  | TRW   |            |

### OPEL ZAFIRA II / Vauxhall Zafira II (05-)

|           |               |     |       |       |  |   |                |        |   |  |                          |
|-----------|---------------|-----|-------|-------|--|---|----------------|--------|---|--|--------------------------|
|           | 1.6           | 77  |       | 07.05 |  |   | 13.0460-7179.2 | 607179 |   | 23738 20,1 +/WE<br>23402 20,1 +/WE<br>23402 20,1 +/WE<br>Warnkontakt L=287mm   | ATE<br>ATE<br>ATE<br>ATE |
|           | 1.6           | 85  |       | 12.07 |  |   | 13.0470-7179.2 | LD7179 |   |  |                          |
|           | 1.6 CNG       | 69  |       | 01.06 |  |   | 24.8190-0720.2 | 620720 | 1 |  |                          |
|           | 1.6 CNG Turbo | 110 |       | 02.09 |  |   |                |        |   |  |                          |
|           | 1.7 CDTI      | 81  |       | 12.07 |  |   |                |        |   |  |                          |
|           | 1.7 CDTI      | 92  |       | 12.07 |  |   |                |        |   |  |                          |
|           | 1.8           | 88  |       | 06.13 |  |   |                |        |   |  |                          |
|           | 1.8           | 103 |       | 07.05 |  |   |                |        |   |  |                          |
|           | 1.9 CDTI      | 74  |       | 07.05 |  |   |                |        |   |  |                          |
|           | 1.9 CDTI      | 88  |       | 07.05 |  |   |                |        |   |  |                          |
|           | 1.9 CDTI      | 110 |       | 07.05 |  |   |                |        |   |  |                          |
|           | 2.0           | 125 |       | 07.05 |  |   |                |        |   |  |                          |
|           | 2.0 Turbo     | 147 |       | 07.05 |  |   |                |        |   |  |                          |
|           | 2.2           | 110 |       | 07.05 |  |   |                |        |   |  |                          |
|           | 2.0 OPC       | 177 |       | 09.05 |  |   | 13.0460-7212.2 | 607212 |   | f. Bremssattel m.Stahlkolben <sup>3)</sup><br>f. Bremssattel m.Kunststoffkolben <sup>4)</sup><br>f. Bremssattel m.Kunststoffkolben <sup>4)</sup> |                          |
|           |               |     |       |       |  |   | 13.0460-7172.2 | 607172 |   |  |                          |
|           |               |     |       |       |  |   | 13.0470-7172.2 | LD7172 |   |  |                          |
|           |               |     |       |       |  |   | 24.8190-0720.2 | 620720 | 1 |  |                          |
|           | 1.6           | 77  |       | 07.05 |  |   | 24.0125-0131.1 | 425131 |   | 280 24,8 22,0 V L +S +B<br>280 24,8 22,0 V L +S +B PD  |                          |
|           | 1.6           | 85  |       | 12.07 |  |   | 24.0325-0131.1 | 525131 |   |  |                          |
|           | 1.8           | 88  |       | 06.13 |  | + Bremsscheibendurchm. 280 mm               |                |        |   |  |                          |
|           | 1.8           | 103 |       | 07.05 |  | + Bremsscheibendurchm. 280 mm               |                |        |   |  |                          |
|           | 1.6 CNG       | 69  |       | 01.06 |  |   | 24.0125-0142.1 | 425142 |   |  |                          |
|           | 1.6 CNG Turbo | 110 |       | 02.09 |  |   | 24.0325-0142.1 | 525142 |   |  |                          |
|           | 1.7 CDTI      | 81  |       | 12.07 |  |   |                |        |   |  |                          |
|           | 1.7 CDTI      | 92  |       | 12.07 |  |   |                |        |   |  |                          |
|           | 1.8           | 88  |       | 06.13 |  | + Bremsscheibendurchm. 308 mm <sup>5)</sup> |                |        |   |  |                          |
|           | 1.8           | 103 |       | 07.05 |  | + Bremsscheibendurchm. 308 mm <sup>5)</sup> |                |        |   |  |                          |
|           | 1.9 CDTI      | 74  |       | 07.05 |  |   |                |        |   |  |                          |
|           | 1.9 CDTI      | 88  |       | 07.05 |  |   |                |        |   |  |                          |
|           | 1.9 CDTI      | 110 |       | 07.05 |  |   |                |        |   |  |                          |
|           | 2.0           | 125 |       | 07.05 |  |   |                |        |   |  |                          |
| 2.0 Turbo | 147           |     | 07.05 |       |  |   |                |        |   |  |                          |
| 2.2       | 110           |     | 07.05 |       |  |   |                |        |   |  |                          |
|           | 2.0 OPC       | 177 |       | 09.05 |  |   | 24.0128-0201.1 | 428201 |   | 321 28,0 25,0 V L +B   |                          |
|           | 1.6           | 77  |       | 07.05 |  |   | 13.0460-2868.2 | 602868 |   | 23417 15,3 +/WK/Zub/STRW<br>23417 15,3 +/WK/Zub/STRW   |                          |
|           | 1.6           | 85  |       | 12.07 |  |   | 13.0470-2868.2 | LD2868 |   |  |                          |
|           | 1.6 CNG       | 69  |       | 01.06 |  |   |                |        |   |  |                          |
|           | 1.6 CNG Turbo | 110 |       | 02.09 |  |   |                |        |   |  |                          |
|           | 1.7 CDTI      | 81  |       | 12.07 |  |   |                |        |   |  |                          |

<sup>1)</sup> up to chassis: 42187758 / fino no.telaio: 42187758 / jusqu'au de châssis: 42187758 / hasta no.de chasis: 42187758  
<sup>2)</sup> from chassis no.:42187759 / dal no.telaio:42187759 / du no.châssis:42187759 / desde no.chasis.:42187759  
<sup>3)</sup> for br.caliper +steel piston / per pinza fr. +pistone acciaio / pour étrier f. +piston en acier / para pinza fr. +pistón de acero  
<sup>4)</sup> for br.caliper +plastic piston / per pinza fr. +pistone plastica / pour étrier fr. +piston plastique / para pinza fr. +pistón plástico  
<sup>5)</sup> + brake disc diameter 308mm / + diametro dischi freno 308mm / + diamètre disques frein 308mm / + diametro disco freno 308mm



**OPEL ZAFIRA II / Vauxhall Zafira II (05-)**

|           |           |          |          |                        |                        |                |        |  |  |                    |
|-----------|-----------|----------|----------|------------------------|------------------------|----------------|--------|--|--|--------------------|
|           | 1.7 CDTi  | 92       |          | 12.07                  |                        | 13.0460-2868.2 | 602868 |  | 23417 15,3 +WK/Zub/STRW<br>23417 15,3 +WK/Zub/STRW |                    |
|           | 1.8       | 88       |          | 06.13                  |                        | 13.0470-2868.2 | LD2868 |  |  |                    |
|           | 1.8       | 103      |          | 07.05                  |                        |                |        |  |  |                    |
|           | 1.9 CDTi  | 74       |          | 07.05                  |                        |                |        |  |  |                    |
|           | 1.9 CDTi  | 88       |          | 07.05                  |                        |                |        |  |  |                    |
|           | 1.9 CDTi  | 110      |          | 07.05                  |                        |                |        |  |  |                    |
|           | 2.0       | 125      |          | 07.05                  |                        |                |        |  |  |                    |
|           | 2.0 OPC   | 177      |          | 09.05                  |                        |                |        |  |  |                    |
|           | 2.0 Turbo | 147      |          | 07.05                  |                        |                |        |  |  |                    |
|           | 2.2       | 110      |          | 07.05                  |                        |                |        |  |  |                    |
|           | 1.6       | 77       |          | 07.05                  |                        | 24.0110-0250.1 | 410250 |  | 264 9,8 8,0 +S +B<br>264 9,8 8,0 +S +B PD          |                    |
|           | 1.6       | 85       |          | 12.07                  |                        | 24.0310-0250.1 | 510250 |  |  |                    |
|           | 1.7 CDTi  | 81       |          | 12.07                  | - verstärkte Bremse 1) |                |        |  |  |                    |
|           | 1.7 CDTi  | 92       |          | 12.07                  | - verstärkte Bremse 1) |                |        |  |  |                    |
|           | 1.8       | 88       |          | 06.13                  | - verstärkte Bremse 1) |                |        |  |  |                    |
|           | 1.8       | 103      |          | 07.05                  | - verstärkte Bremse 1) |                |        |  |  |                    |
|           | 1.9 CDTi  | 74       |          | 07.05                  | - verstärkte Bremse 1) |                |        |  |  |                    |
|           | 1.9 CDTi  | 88       |          | 07.05                  | - verstärkte Bremse 1) |                |        |  |  |                    |
|           | 1.9 CDTi  | 110      |          | 07.05                  | - verstärkte Bremse 1) |                |        |  |  |                    |
|           | 2.0       | 125      |          | 07.05                  | - verstärkte Bremse 1) |                |        |  |  |                    |
|           | 2.0 Turbo | 147      | 52999999 | 07.05                  |                        |                |        |  |  |                    |
|           | 2.2       | 110      |          | 07.05                  | - verstärkte Bremse 1) |                |        |  |  |                    |
|           | 1.7 CDTi  | 81       |          | 12.07                  | + verstärkte Bremse 2) | 24.0110-0339.1 | 410339 |  |  | 278 10,0 8,0 +S +B |
|           | 1.7 CDTi  | 92       |          | 12.07                  | + verstärkte Bremse 2) |                |        |  |  |                    |
|           | 1.8       | 88       |          | 06.13                  | + verstärkte Bremse 2) |                |        |  |  |                    |
| 1.8       | 103       |          | 07.05    | + verstärkte Bremse 2) |                        |                |        |  |  |                    |
| 1.9 CDTi  | 74        |          | 07.05    | + verstärkte Bremse 2) |                        |                |        |  |  |                    |
| 1.9 CDTi  | 88        |          | 07.05    | + verstärkte Bremse 2) |                        |                |        |  |  |                    |
| 1.9 CDTi  | 110       |          | 07.05    | + verstärkte Bremse 2) |                        |                |        |  |  |                    |
| 2.0 OPC   | 177       |          | 09.05    | + verstärkte Bremse 2) |                        |                |        |  |  |                    |
| 2.0 Turbo | 147       | 62000001 | 07.05    |                        |                        |                |        |  |  |                    |
| 2.2       | 110       |          | 07.05    | + verstärkte Bremse 2) |                        |                |        |  |  |                    |





**OPEL ZAFIRA III Tourer / Vauxhall Zafira III Tourer (11-)**

|                  |                  |     |       |                                  |                                  |                |        |  |   |   |
|------------------|------------------|-----|-------|----------------------------------|----------------------------------|----------------|--------|--|---|---|
|                  | 1.4 T            | 88  |       | 11.11                            | + Bremsscheibendurchm. 300 mm 3) | 13.0460-7263.2 | 607263 |  | 24034 19,1 +WK/Zub<br>24034 19,1 +WK/Zub<br>ATE       |   |
|                  | 1.4 T            | 103 |       | 11.11                            | + Bremsscheibendurchm. 300 mm 3) | 13.0470-7263.2 | LD7263 |  |   |   |
|                  | 1.4 T LPG        | 103 |       | 11.11                            | + Bremsscheibendurchm. 300 mm 3) |                |        |  |   |   |
|                  | 1.6 CDTi ecoFLEX | 88  |       | 07.14                            | + Bremsscheibendurchm. 300 mm 3) |                |        |  |   |   |
|                  | 1.6 CDTi ecoFLEX | 100 |       | 03.13                            | + Bremsscheibendurchm. 300 mm 3) |                |        |  |   |   |
|                  | 1.6 SIDI         | 125 |       | 12.12                            | + Bremsscheibendurchm. 300 mm 3) |                |        |  |   |   |
|                  | 1.6 SIDI         | 147 |       | 07.13                            | + Bremsscheibendurchm. 300 mm 3) |                |        |  |   |   |
|                  | 1.6 T CNG        | 110 |       | 11.11                            | + Bremsscheibendurchm. 300 mm 3) |                |        |  |   |   |
|                  | 1.8              |     |       | 11.11                            | + Bremsscheibendurchm. 300 mm 3) |                |        |  |   |   |
|                  | 1.8              | 103 |       | 11.11                            | + Bremsscheibendurchm. 300 mm 3) |                |        |  |   |   |
|                  | 1.8 LPG          | 101 |       | 11.11                            | + Bremsscheibendurchm. 300 mm 3) |                |        |  |   |   |
|                  | 2.0 CDTi         |     |       | 11.11                            | + Bremsscheibendurchm. 300 mm 3) |                |        |  |   |   |
|                  | 2.0 CDTi         | 81  |       | 11.11                            | + Bremsscheibendurchm. 300 mm 3) |                |        |  |   |   |
|                  | 2.0 CDTi         | 96  |       | 11.11                            | + Bremsscheibendurchm. 300 mm 3) |                |        |  |   |   |
|                  | 2.0 CDTi         | 125 |       | 01.15                            | + Bremsscheibendurchm. 300 mm 3) |                |        |  |   |   |
|                  | 2.0 CDTi BiTurbo | 143 |       | 12.12                            | + Bremsscheibendurchm. 300 mm 3) |                |        |  |   |   |
|                  | 1.4 T            | 88  |       | 11.11                            | + Bremsscheibendurchm. 321 mm 4) | 13.0460-5612.2 | 605612 |  |   | 24412 19,0 +WK/Zub<br>24412 19,0 +WK/Zub<br>MAN |
|                  | 1.4 T            | 103 |       | 11.11                            | + Bremsscheibendurchm. 321 mm 4) | 13.0470-5612.2 | LD5612 |  |   |   |
|                  | 1.4 T LPG        | 103 |       | 11.11                            | + Bremsscheibendurchm. 321 mm 4) |                |        |  |   |   |
|                  | 1.6 CDTi ecoFLEX | 88  |       | 07.14                            | + Bremsscheibendurchm. 321 mm 4) |                |        |  |   |   |
| 1.6 CDTi ecoFLEX | 100              |     | 03.13 | + Bremsscheibendurchm. 321 mm 4) |                                  |                |        |  |   |   |
| 1.6 SIDI         | 125              |     | 12.12 | + Bremsscheibendurchm. 321 mm 4) |                                  |                |        |  |   |   |
| 1.6 SIDI         | 147              |     | 07.13 | + Bremsscheibendurchm. 321 mm 4) |                                  |                |        |  |   |   |
| 1.6 T CNG        | 110              |     | 11.11 | + Bremsscheibendurchm. 321 mm 4) |                                  |                |        |  |   |   |
| 1.8              |                  |     | 11.11 | + Bremsscheibendurchm. 321 mm 4) |                                  |                |        |  |   |   |
| 1.8              | 103              |     | 11.11 | + Bremsscheibendurchm. 321 mm 4) |                                  |                |        |  |   |   |
| 1.8 LPG          | 101              |     | 11.11 | + Bremsscheibendurchm. 321 mm 4) |                                  |                |        |  |   |   |
| 2.0 CDTi         |                  |     | 11.11 | + Bremsscheibendurchm. 321 mm 4) |                                  |                |        |  |   |   |
| 2.0 CDTi         | 81               |     | 11.11 | + Bremsscheibendurchm. 321 mm 4) |                                  |                |        |  |   |   |
| 2.0 CDTi         | 96               |     | 11.11 | + Bremsscheibendurchm. 321 mm 4) |                                  |                |        |  |   |   |
| 2.0 CDTi         | 125              |     | 01.15 | + Bremsscheibendurchm. 321 mm 4) |                                  |                |        |  |   |   |
| 2.0 CDTi BiTurbo | 143              |     | 12.12 | + Bremsscheibendurchm. 321 mm 4) |                                  |                |        |  |   |   |
|                  | 1.4 T            | 88  |       | 11.11                            | + Bremsscheibendurchm. 300 mm 3) | 24.0126-0166.1 | 426166 |  | 300 26,0 23,0 V L +S +B<br>300 26,0 23,0 V L +S +B PD |   |
|                  | 1.4 T            | 103 |       | 11.11                            | + Bremsscheibendurchm. 300 mm 3) | 24.0326-0166.1 | 526166 |  |   |   |
|                  | 1.4 T LPG        | 103 |       | 11.11                            | + Bremsscheibendurchm. 300 mm 3) |                |        |  |   |   |
|                  | 1.6 CDTi ecoFLEX | 88  |       | 07.14                            | + Bremsscheibendurchm. 300 mm 3) |                |        |  |   |   |
|                  | 1.6 CDTi ecoFLEX | 100 |       | 03.13                            | + Bremsscheibendurchm. 300 mm 3) |                |        |  |   |   |
|                  | 1.6 SIDI         | 125 |       | 12.12                            | + Bremsscheibendurchm. 300 mm 3) |                |        |  |   |   |
|                  | 1.6 SIDI         | 147 |       | 07.13                            | + Bremsscheibendurchm. 300 mm 3) |                |        |  |   |   |
|                  | 1.6 T CNG        | 110 |       | 11.11                            | + Bremsscheibendurchm. 300 mm 3) |                |        |  |   |   |
|                  | 1.8              |     |       | 11.11                            | + Bremsscheibendurchm. 300 mm 3) |                |        |  |   |   |
|                  | 1.8              | 103 |       | 11.11                            | + Bremsscheibendurchm. 300 mm 3) |                |        |  |   |   |
|                  | 1.8 LPG          | 101 |       | 11.11                            | + Bremsscheibendurchm. 300 mm 3) |                |        |  |   |   |
|                  | 2.0 CDTi         |     |       | 11.11                            | + Bremsscheibendurchm. 300 mm 3) |                |        |  |   |   |
|                  | 2.0 CDTi         | 81  |       | 11.11                            | + Bremsscheibendurchm. 300 mm 3) |                |        |  |   |   |
|                  | 2.0 CDTi         | 96  |       | 11.11                            | + Bremsscheibendurchm. 300 mm 3) |                |        |  |   |   |
|                  | 2.0 CDTi         | 125 |       | 01.15                            | + Bremsscheibendurchm. 300 mm 3) |                |        |  |   |   |
|                  | 2.0 CDTi BiTurbo | 143 |       | 12.12                            | + Bremsscheibendurchm. 300 mm 3) |                |        |  |   |   |
|                  | 1.4 T            | 88  |       | 11.11                            | + Bremsscheibendurchm. 321 mm 4) | 24.0130-0224.1 | 430224 |  |   | 321 30,0 27,0 V L +S +B                         |
|                  | 1.4 T            | 103 |       | 11.11                            | + Bremsscheibendurchm. 321 mm 4) |                |        |  |   |   |
|                  | 1.4 T LPG        | 103 |       | 11.11                            | + Bremsscheibendurchm. 321 mm 4) |                |        |  |   |   |
|                  | 1.6 CDTi ecoFLEX | 88  |       | 07.14                            | + Bremsscheibendurchm. 321 mm 4) |                |        |  |   |   |
| 1.6 CDTi ecoFLEX | 100              |     | 03.13 | + Bremsscheibendurchm. 321 mm 4) |                                  |                |        |  |   |   |

1) - heavy duty brake / - freno rinforzato / - frein renforcé / - freno reforzado  
 2) + heavy duty brake / + freno rinforzato / + frein renforcé / + freno reforzado  
 3) + brake disc diameter 300mm / + diametro dischi freno 300mm / + diamètre disques frein 300mm / + diámetro disco freno 300mm  
 4) + brake disc diameter 321mm / + diametro dischi freno 321mm / + diamètre disques frein 321mm / + diámetro disco freno 321mm





| OPEL ZAFIRA III Tourer / Vauxhall Zafira III Tourer (11-)                          |                  |     |          |       |  |                |        |   |                         |
|--|------------------|-----|----------|-------|--|----------------|--------|---|-------------------------|
|    | 1.6 SIDI         | 125 |          | 12.12 | + Bremsscheibendurchm. 321mm <sup>1)</sup> | 24.0130-0224.1 | 430224 |   | 321 30,0 27,0 VL +S +B  |
|  | 1.6 SIDI         | 147 |          | 07.13 | + Bremsscheibendurchm. 321mm <sup>1)</sup> |                |        |   |                         |
|  | 1.6 T CNG        | 110 |          | 11.11 | + Bremsscheibendurchm. 321mm <sup>1)</sup> |                |        |   |                         |
|  | 1.8              |     |          | 11.11 | + Bremsscheibendurchm. 321mm <sup>1)</sup> |                |        |   |                         |
|  | 1.8              | 103 |          | 11.11 | + Bremsscheibendurchm. 321mm <sup>1)</sup> |                |        |   |                         |
|  | 1.8 LPG          | 101 |          | 11.11 | + Bremsscheibendurchm. 321mm <sup>1)</sup> |                |        |   |                         |
|  | 2.0 CDTi         |     |          | 11.11 | + Bremsscheibendurchm. 321mm <sup>1)</sup> |                |        |   |                         |
|  | 2.0 CDTi         | 81  |          | 11.11 | + Bremsscheibendurchm. 321mm <sup>1)</sup> |                |        |   |                         |
|  | 2.0 CDTi         | 96  |          | 11.11 | + Bremsscheibendurchm. 321mm <sup>1)</sup> |                |        |   |                         |
|  | 2.0 CDTi         | 125 |          | 01.15 | + Bremsscheibendurchm. 321mm <sup>1)</sup> |                |        |   |                         |
|  | 2.0 CDTi BiTurbo | 143 |          | 12.12 | + Bremsscheibendurchm. 321mm <sup>1)</sup> |                |        |   |                         |
|    | 1.4 T            | 88  |          | 11.11 |  | 24.0711-5348.3 | 360351 | 2  - Flexride Fahrwerk <sup>2)</sup> | Radsensor L=800         |
|  | 1.4 T            | 103 |          | 11.11 |  |                |        |   |                         |
|  | 1.4 T LPG        | 103 |          | 11.11 |  |                |        |   |                         |
|  | 1.6 CDTi ecoFLEX | 88  |          | 07.14 |  |                |        |   |                         |
|  | 1.6 CDTi ecoFLEX | 100 |          | 03.13 |  |                |        |   |                         |
|  | 1.6 SIDI         | 125 |          | 12.12 |  |                |        |   |                         |
|  | 1.6 SIDI         | 147 |          | 07.13 |  |                |        |   |                         |
|  | 1.6 T CNG        | 110 |          | 11.11 |  |                |        |   |                         |
|  | 1.8              |     |          | 11.11 |  |                |        |   |                         |
|  | 1.8              | 103 |          | 11.11 |  |                |        |   |                         |
|  | 1.8 LPG          | 101 |          | 11.11 |  |                |        |   |                         |
|  | 2.0 CDTi         |     |          | 11.11 |  |                |        |   |                         |
|  | 2.0 CDTi         | 81  |          | 11.11 |  |                |        |   |                         |
|  | 2.0 CDTi         | 96  |          | 11.11 |  |                |        |   |                         |
|  | 2.0 CDTi         | 125 |          | 01.15 |  |                |        |   |                         |
|  | 2.0 CDTi BiTurbo | 143 |          | 12.12 |  |                |        |   |                         |
|    | 1.4 T            | 88  | E9999999 | 11.11 | + Bremsscheibendurchm. 292mm <sup>3)</sup> | 13.0460-7264.2 | 607264 |   | 25096 17,0 +/WK/Zub ATE |
|  | 1.4 T            | 103 | E9999999 | 11.11 | + Bremsscheibendurchm. 292mm <sup>3)</sup> | 13.0470-7264.2 | LD7264 |   | 25096 17,0 +/WK/Zub ATE |
|  | 1.4 T LPG        | 103 | E9999999 | 11.11 | + Bremsscheibendurchm. 292mm <sup>3)</sup> |                |        |   |                         |
|  | 1.6 CDTi ecoFLEX | 100 | E9999999 | 03.13 | + Bremsscheibendurchm. 292mm <sup>3)</sup> |                |        |   |                         |
|  | 1.6 SIDI         | 125 | E9999999 | 12.12 | + Bremsscheibendurchm. 292mm <sup>3)</sup> |                |        |   |                         |
|  | 1.6 SIDI         | 147 | E9999999 | 07.13 | + Bremsscheibendurchm. 292mm <sup>3)</sup> |                |        |   |                         |
|  | 1.6 T CNG        | 110 | E9999999 | 11.11 | + Bremsscheibendurchm. 292mm <sup>3)</sup> |                |        |   |                         |
|  | 1.8              |     | E9999999 | 11.11 | + Bremsscheibendurchm. 292mm <sup>3)</sup> |                |        |   |                         |
|  | 1.8              | 103 | E9999999 | 11.11 | + Bremsscheibendurchm. 292mm <sup>3)</sup> |                |        |   |                         |
|  | 1.8 LPG          | 101 | E9999999 | 11.11 | + Bremsscheibendurchm. 292mm <sup>3)</sup> |                |        |   |                         |
|  | 2.0 CDTi         |     | E9999999 | 11.11 | + Bremsscheibendurchm. 292mm <sup>3)</sup> |                |        |   |                         |
|  | 2.0 CDTi         | 81  | E9999999 | 11.11 | + Bremsscheibendurchm. 292mm <sup>3)</sup> |                |        |   |                         |
|  | 2.0 CDTi         | 96  | E9999999 | 11.11 | + Bremsscheibendurchm. 292mm <sup>3)</sup> |                |        |   |                         |
|  | 2.0 CDTi BiTurbo | 143 | E9999999 | 12.12 | + Bremsscheibendurchm. 292mm <sup>3)</sup> |                |        |   |                         |
|  | 1.4 T            | 88  | F0000001 |       | + Bremsscheibendurchm. 292mm <sup>3)</sup> | 13.0460-7264.2 | 607264 |   | 25096 17,0 +/WK/Zub ATE |
|  | 1.4 T            | 103 | F0000001 |       | + Bremsscheibendurchm. 292mm <sup>3)</sup> | 13.0470-7264.2 | LD7264 |   | 25096 17,0 +/WK/Zub ATE |
|  | 1.4 T LPG        | 103 | F0000001 |       | + Bremsscheibendurchm. 292mm <sup>3)</sup> |                |        |   |                         |
|  | 1.6 CDTi ecoFLEX | 88  |          | 07.14 | + Bremsscheibendurchm. 292mm <sup>3)</sup> |                |        |   |                         |
|  | 1.6 CDTi ecoFLEX | 100 | F0000001 |       | + Bremsscheibendurchm. 292mm <sup>3)</sup> |                |        |   |                         |
|  | 1.6 SIDI         | 125 | F0000001 |       | + Bremsscheibendurchm. 292mm <sup>3)</sup> |                |        |   |                         |
|  | 1.6 SIDI         | 147 | F0000001 |       | + Bremsscheibendurchm. 292mm <sup>3)</sup> |                |        |   |                         |
|  | 1.6 T CNG        | 110 | F0000001 |       | + Bremsscheibendurchm. 292mm <sup>3)</sup> |                |        |   |                         |
|  | 1.8              |     | F0000001 |       | + Bremsscheibendurchm. 292mm <sup>3)</sup> |                |        |   |                         |
|  | 1.8              | 103 | F0000001 |       | + Bremsscheibendurchm. 292mm <sup>3)</sup> |                |        |   |                         |
|  | 1.8 LPG          | 101 | F0000001 |       | + Bremsscheibendurchm. 292mm <sup>3)</sup> |                |        |   |                         |
|  | 2.0 CDTi         |     | F0000001 |       | + Bremsscheibendurchm. 292mm <sup>3)</sup> |                |        |   |                         |
|  | 2.0 CDTi         | 81  | F0000001 |       | + Bremsscheibendurchm. 292mm <sup>3)</sup> |                |        |   |                         |
|  | 2.0 CDTi         | 96  | F0000001 |       | + Bremsscheibendurchm. 292mm <sup>3)</sup> |                |        |   |                         |
|  | 2.0 CDTi         | 125 |          | 01.15 | + Bremsscheibendurchm. 292mm <sup>3)</sup> |                |        |   |                         |
|  | 2.0 CDTi BiTurbo | 143 | F0000001 |       | + Bremsscheibendurchm. 292mm <sup>3)</sup> |                |        |   |                         |
|  | 1.4 T            | 88  |          | 11.11 | + Bremsscheibendurchm. 292mm <sup>3)</sup> | 24.0112-0189.1 | 412189 |   | 292 12,0 10,0 +S +B     |
|  | 1.4 T            | 103 |          | 11.11 | + Bremsscheibendurchm. 292mm <sup>3)</sup> | 24.0312-0189.1 | 512189 |   | 292 12,0 10,0 +S +B PD  |
|  | 1.4 T LPG        | 103 |          | 11.11 | + Bremsscheibendurchm. 292mm <sup>3)</sup> |                |        |   |                         |
|  | 1.6 CDTi ecoFLEX | 88  |          | 07.14 | + Bremsscheibendurchm. 292mm <sup>3)</sup> |                |        |   |                         |
|  | 1.6 CDTi ecoFLEX | 100 |          | 03.13 | + Bremsscheibendurchm. 292mm <sup>3)</sup> |                |        |   |                         |
|  | 1.6 SIDI         | 125 |          | 12.12 | + Bremsscheibendurchm. 292mm <sup>3)</sup> |                |        |   |                         |
|  | 1.6 SIDI         | 147 |          | 07.13 | + Bremsscheibendurchm. 292mm <sup>3)</sup> |                |        |   |                         |
|  | 1.6 T CNG        | 110 |          | 11.11 | + Bremsscheibendurchm. 292mm <sup>3)</sup> |                |        |   |                         |
|  | 1.8              |     |          | 11.11 | + Bremsscheibendurchm. 292mm <sup>3)</sup> |                |        |   |                         |
|  | 1.8              | 103 |          | 11.11 | + Bremsscheibendurchm. 292mm <sup>3)</sup> |                |        |   |                         |
|  | 1.8 LPG          | 101 |          | 11.11 | + Bremsscheibendurchm. 292mm <sup>3)</sup> |                |        |   |                         |
|  | 2.0 CDTi         |     |          | 11.11 | + Bremsscheibendurchm. 292mm <sup>3)</sup> |                |        |   |                         |
|  | 2.0 CDTi         | 81  |          | 11.11 | + Bremsscheibendurchm. 292mm <sup>3)</sup> |                |        |   |                         |
|  | 2.0 CDTi         | 96  |          | 11.11 | + Bremsscheibendurchm. 292mm <sup>3)</sup> |                |        |   |                         |
|  | 2.0 CDTi         | 125 |          | 01.15 | + Bremsscheibendurchm. 292mm <sup>3)</sup> |                |        |   |                         |
|  | 2.0 CDTi BiTurbo | 143 |          | 12.12 | + Bremsscheibendurchm. 292mm <sup>3)</sup> |                |        |   |                         |
|  | 1.4 T            | 88  |          | 11.11 | + Bremsscheibendurchm. 315mm <sup>4)</sup> | 24.0123-0116.1 | 423116 |   | 315 23,0 20,0 V +S +B   |
|  | 1.4 T            | 103 |          | 11.11 | + Bremsscheibendurchm. 315mm <sup>4)</sup> |                |        |   |                         |
|  | 1.4 T LPG        | 103 |          | 11.11 | + Bremsscheibendurchm. 315mm <sup>4)</sup> |                |        |   |                         |
|  | 1.6 CDTi ecoFLEX | 88  |          | 07.14 | + Bremsscheibendurchm. 315mm <sup>4)</sup> |                |        |   |                         |
|  | 1.6 CDTi ecoFLEX | 100 |          | 03.13 | + Bremsscheibendurchm. 315mm <sup>4)</sup> |                |        |   |                         |
|  | 1.6 SIDI         | 125 |          | 12.12 | + Bremsscheibendurchm. 315mm <sup>4)</sup> |                |        |   |                         |
|  | 1.6 SIDI         | 147 |          | 07.13 | + Bremsscheibendurchm. 315mm <sup>4)</sup> |                |        |   |                         |
|  | 1.6 T CNG        | 110 |          | 11.11 | + Bremsscheibendurchm. 315mm <sup>4)</sup> |                |        |   |                         |
|  | 1.8              |     |          | 11.11 | + Bremsscheibendurchm. 315mm <sup>4)</sup> |                |        |   |                         |
|  | 1.8              | 103 |          | 11.11 | + Bremsscheibendurchm. 315mm <sup>4)</sup> |                |        |   |                         |
|  | 1.8 LPG          | 101 |          | 11.11 | + Bremsscheibendurchm. 315mm <sup>4)</sup> |                |        |   |                         |
|  | 2.0 CDTi         |     |          | 11.11 | + Bremsscheibendurchm. 315mm <sup>4)</sup> |                |        |   |                         |
|  | 2.0 CDTi         | 81  |          | 11.11 | + Bremsscheibendurchm. 315mm <sup>4)</sup> |                |        |   |                         |
|  | 2.0 CDTi         | 96  |          | 11.11 | + Bremsscheibendurchm. 315mm <sup>4)</sup> |                |        |   |                         |

1) + brake disc diameter 321mm / + diametro dischi freno 321mm / + diamètre disques frein 321mm / + diámetro disco freno 321mm  
2) - flexride suspension / - autotelaio flexride / - châssis de flexride / - suspensión flexride  
3) + brake disc diameter 292mm / + diametro dischi freno 292mm / + diamètre disques frein 292mm / + diámetro disco freno 292mm  
4) + brake disc diameter 315mm / + diametro dischi freno 315mm / + diamètre disques frein 315mm / + diámetro disco freno 315mm





**OPEL ZAFIRA III Tourer / Vauxhall Zafira III Tourer (11-)**

|  |                  |     |  |       |  |                |        |   |  |                       |
|--|------------------|-----|--|-------|--|----------------|--------|---|--|-----------------------|
|  | 2.0 CDTi         | 125 |  | 01.15 | + Bremsscheibendurchm. 315mm <sup>1)</sup> | 24.0123-0116.1 | 423116 |   |  | 315 23,0 20,0 V +S +B |
|  | 2.0 CDTi BiTurbo | 143 |  | 12.12 | + Bremsscheibendurchm. 315mm <sup>1)</sup> |                |        |   |  |                       |
|  | 1.4 T            | 88  |  | 11.11 |  | 24.0711-5328.3 | 360371 | 2 |  | Radsensor L=530       |
|  | 1.4 T            | 103 |  | 11.11 |  |                |        |   |  |                       |
|  | 1.4 T LPG        | 103 |  | 11.11 |  |                |        |   |  |                       |
|  | 1.6 CDTi ecoFLEX | 88  |  | 07.14 |  |                |        |   |  |                       |
|  | 1.6 CDTi ecoFLEX | 100 |  | 03.13 |  |                |        |   |  |                       |
|  | 1.6 SIDI         | 125 |  | 12.12 |  |                |        |   |  |                       |
|  | 1.6 SIDI         | 147 |  | 07.13 |  |                |        |   |  |                       |
|  | 1.6 T CNG        | 110 |  | 11.11 |  |                |        |   |  |                       |
|  | 1.8              |     |  | 11.11 |  |                |        |   |  |                       |
|  | 1.8              | 103 |  | 11.11 |  |                |        |   |  |                       |
|  | 1.8 LPG          | 101 |  | 11.11 |  |                |        |   |  |                       |
|  | 2.0 CDTi         |     |  | 11.11 |  |                |        |   |  |                       |
|  | 2.0 CDTi         | 81  |  | 11.11 |  |                |        |   |  |                       |
|  | 2.0 CDTi         | 96  |  | 11.11 |  |                |        |   |  |                       |
|  | 2.0 CDTi         | 125 |  | 01.15 |  |                |        |   |  |                       |
|  | 2.0 CDTi BiTurbo | 143 |  | 12.12 |  |                |        |   |  |                       |

**PEUGEOT 106 (96-04)**

|  |          |    |            |       |       |                |        |   |                                |                                   |                 |
|--|----------|----|------------|-------|-------|----------------|--------|---|--------------------------------|-----------------------------------|-----------------|
|  | 1.0 i    | 33 |            | 05.96 | 03.04 | 13.0460-4042.2 | 604042 |   | für 3-Loch-Felge <sup>2)</sup> | 21191 16,8 +/WK                   | ATE             |
|  | 1.0 i    | 37 |            | 01.97 | 03.04 | 13.0460-4066.2 | 604066 |   | für 3-Loch-Felge <sup>2)</sup> | 21857 17,7                        | ATE             |
|  | 1.1      | 42 |            | 09.00 | 10.02 | 13.0460-3943.2 | 603943 |   | für 4-Loch-Felge <sup>3)</sup> | 20906 18,0 +/WK                   | BDX             |
|  | 1.1 i    | 40 |            | 01.97 | 03.04 | 13.0460-3962.2 | 603962 |   | für 4-Loch-Felge <sup>3)</sup> | 20905 18,0 +/WE                   | BDX             |
|  | 1.1 i    | 44 |            | 05.96 | 03.04 | 13.0460-0424.2 | 610424 |   |                                | Belagsatz-Zubehör                 | ATE             |
|  |          |    |            |       |       | 13.0460-0406.2 | 610406 |   |                                | Belagsatz-Zubehör                 | BDX             |
|  | 1.4 i    | 55 |            | 05.96 | 03.04 | 13.0460-3943.2 | 603943 |   |                                | 20906 18,0 +/WK                   | BDX             |
|  | 1.5 D    | 40 |            | 05.96 | 03.04 | 13.0460-3962.2 | 603962 |   |                                | 20905 18,0 +/WE                   | BDX             |
|  | 1.5 D    | 42 |            | 10.00 | 03.04 | 13.0460-0403.2 | 610403 |   |                                | Belagsatz-Zubehör                 | BDX             |
|  | 1.6      | 65 |            | 05.96 | 03.04 |                |        |   |                                |                                   |                 |
|  | 1.6      | 74 |            | 05.96 | 03.04 | 13.0460-7088.2 | 607088 |   |                                | 21827 17,3 +                      | ATE             |
|  | 1.6 16V  | 87 |            | 05.96 | 03.04 |                |        |   |                                |                                   |                 |
|  | 1.0 i    | 33 |            | 05.96 | 03.04 | 24.0108-0107.1 | 408107 |   | für 3-Loch-Felge <sup>2)</sup> | 238 8,0 6,0 +S +B                 |                 |
|  | 1.0 i    | 37 |            | 01.97 | 03.04 | 24.0110-0187.1 | 410187 |   | für 4-Loch-Felge <sup>3)</sup> | 247 10,0 9,0 +S +B                |                 |
|  | 1.1      | 42 |            | 09.00 | 10.02 |                |        |   |                                |                                   |                 |
|  | 1.1 i    | 40 |            | 01.97 | 03.04 |                |        |   |                                |                                   |                 |
|  | 1.1 i    | 44 |            | 05.96 | 03.04 |                |        |   |                                |                                   |                 |
|  | 1.4 i    | 55 |            | 05.96 | 03.04 | 24.0110-0187.1 | 410187 |   |                                | 247 10,0 9,0 +S +B                |                 |
|  | 1.5 D    | 40 |            | 05.96 | 03.04 |                |        |   |                                |                                   |                 |
|  | 1.5 D    | 42 |            | 10.00 | 03.04 |                |        |   |                                |                                   |                 |
|  | 1.6      | 65 |            | 05.96 | 03.04 |                |        |   |                                |                                   |                 |
|  | Electric | 20 |            | 04.96 | 07.04 |                |        |   |                                |                                   |                 |
|  | 1.6      | 74 |            | 05.96 | 03.04 | 24.0120-0132.1 | 420132 |   |                                | 247 20,4 18,5 V +S +B             |                 |
|  | 1.6 16V  | 87 |            | 05.96 | 03.04 | 24.0320-0132.1 | 520132 |   |                                | 247 20,4 18,5 V +S +B PD          |                 |
|  | 1.0 i    | 33 |            | 05.96 | 03.04 | 24.0751-1128.3 | 360094 | 2 |                                | Radsensor L=515                   |                 |
|  | 1.0 i    | 37 |            | 01.97 | 03.04 |                |        |   |                                |                                   |                 |
|  | 1.1      | 42 |            | 09.00 | 10.02 |                |        |   |                                |                                   |                 |
|  | 1.1 i    | 40 |            | 01.97 | 03.04 |                |        |   |                                |                                   |                 |
|  | 1.1 i    | 44 |            | 05.96 | 03.04 |                |        |   |                                |                                   |                 |
|  | 1.4 i    | 55 |            | 05.96 | 03.04 |                |        |   |                                |                                   |                 |
|  | 1.5 D    | 40 |            | 05.96 | 03.04 |                |        |   |                                |                                   |                 |
|  | 1.5 D    | 42 |            | 10.00 | 03.04 |                |        |   |                                |                                   |                 |
|  | 1.6      | 65 |            | 05.96 | 03.04 |                |        |   |                                |                                   |                 |
|  | 1.6      | 74 |            | 05.96 | 03.04 |                |        |   |                                |                                   |                 |
|  | 1.6 16V  | 87 |            | 05.96 | 03.04 |                |        |   |                                |                                   |                 |
|  | Electric | 20 |            | 04.96 | 07.04 |                |        |   |                                |                                   |                 |
|  | 1.6      | 74 |            | 05.96 | 03.04 | 13.0460-3954.2 | 603954 |   |                                | 20973 11,0 +                      | BDX             |
|  | 1.6 16V  | 87 |            | 05.96 | 03.04 | 13.0460-0435.2 | 610435 |   |                                | Belagsatz-Zubehör                 | BDX             |
|  | 1.6      | 74 |            | 05.96 | 03.04 | 24.0108-0106.1 | 408106 |   |                                | 247 8,0 6,0 +S +B                 |                 |
|  | 1.6 16V  | 87 |            | 05.96 | 03.04 |                |        |   |                                |                                   |                 |
|  | 1.0 i    | 33 | ORGA 08056 | 05.96 |       | 24.0721-1187.3 | 360090 | 2 |                                | + HA-Trommelbremse <sup>4)</sup>  | Radsensor L=715 |
|  | 1.0 i    | 37 | ORGA 08056 | 01.97 |       |                |        |   |                                |                                   |                 |
|  | 1.1 i    | 40 | ORGA 08056 | 01.97 |       |                |        |   |                                |                                   |                 |
|  | 1.1 i    | 44 | ORGA 08056 | 05.96 |       |                |        |   |                                |                                   |                 |
|  | 1.4 i    | 55 | ORGA 08056 | 05.96 |       |                |        |   |                                |                                   |                 |
|  | 1.5 D    | 40 | ORGA 08056 | 05.96 |       |                |        |   |                                |                                   |                 |
|  | 1.5 D    | 42 | ORGA 08056 | 05.96 |       |                |        |   |                                |                                   |                 |
|  | 1.6      | 65 | ORGA 08056 | 05.96 |       |                |        |   |                                |                                   |                 |
|  | 1.6      | 74 | ORGA 08056 | 05.96 |       |                |        |   |                                |                                   |                 |
|  | Electric | 20 | ORGA 08056 | 04.96 |       |                |        |   |                                |                                   |                 |
|  | 1.0 i    | 33 | ORGA 08057 |       | 03.04 | 24.0721-1199.3 | 360292 | 2 |                                | + HA-Trommelbremse <sup>4)</sup>  | Radsensor L=715 |
|  | 1.0 i    | 37 | ORGA 08057 |       | 03.04 |                |        |   |                                |                                   |                 |
|  | 1.1      | 42 |            | 09.00 | 10.02 |                |        |   |                                |                                   |                 |
|  | 1.1 i    | 40 | ORGA 08057 |       | 03.04 |                |        |   |                                |                                   |                 |
|  | 1.1 i    | 44 | ORGA 08057 |       | 03.04 |                |        |   |                                |                                   |                 |
|  | 1.4 i    | 55 | ORGA 08057 |       | 03.04 |                |        |   |                                |                                   |                 |
|  | 1.5 D    | 40 | ORGA 08057 |       | 03.04 |                |        |   |                                |                                   |                 |
|  | 1.5 D    | 42 |            | 10.00 | 03.04 |                |        |   |                                |                                   |                 |
|  | 1.6      | 65 | ORGA 08057 |       | 03.04 |                |        |   |                                |                                   |                 |
|  | 1.6      | 74 | ORGA 08057 |       | 03.04 |                |        |   |                                |                                   |                 |
|  | Electric | 20 | ORGA 08057 |       | 07.04 |                |        |   |                                |                                   |                 |
|  | 1.6      | 74 | ORGA 08056 | 05.96 |       | 24.0751-1132.3 | 360294 | 2 |                                | + HA-Scheibenbremse <sup>5)</sup> | Radsensor L=740 |
|  | 1.6 16V  | 87 | ORGA 08056 | 05.96 |       |                |        |   |                                |                                   |                 |
|  | 1.6      | 74 | ORGA 08057 |       | 03.04 | 24.0751-1190.3 | 360299 | 2 |                                | + HA-Scheibenbremse <sup>5)</sup> | Radsensor L=740 |
|  | 1.6 16V  | 87 | ORGA 08057 |       | 03.04 |                |        |   |                                |                                   |                 |

<sup>1)</sup> + brake disc diameter 315mm / + diametro dischi freno 315mm / + diamètre disques frein 315mm / + diámetro disco freno 315mm



<sup>2)</sup> for 3 bore wheel rim / per cerchione a 3 fori / pour jante à 3 trous / para Liantas de 3 taladros

<sup>3)</sup> for 4 bore wheel rim / per cerchione a 4 fori / pour jante à 4 trous / para Liantas de 4 taladros





<sup>4)</sup> + RA drum brake / + P freno a tamburo / + frein à tambour essieu AR / + ET-tambores de freno

<sup>5)</sup> + RA disc brake / + P disco freno / + frein à disque essieu AR / + ET-disco de freno



| PEUGEOT 106 (96-04)  |          | KW |            | ...   |       | ...   |            | ...            |        | ... |   | ...                    |  | ... |  | ... |  | ... |     |
|--|----------|----|------------|-------|-------|-------|------------|----------------|--------|-----|---|------------------------|--|-----|--|-----|--|-----|-----|
|    | 1.0 i    | 33 |            | 05.96 | 03.04 | - ABS |            | 03.0137-0195.2 | 650195 |     | für 3-Loch-Felge <sup>1)</sup>              | 164 x 32 AUT           |  |     |  |     |  |     |     |
|  | 1.0 i    | 37 |            | 01.97 | 03.04 | - ABS |            | 03.0137-0196.2 | 650196 |     | für 4-Loch-Felge <sup>2)</sup>              | 180 x 32 AUT           |  |     |  |     |  |     | BDX |
|  | 1.1      | 42 |            | 09.00 | 10.02 | - ABS |            | 03.0137-9079.2 | 669079 |     | für 3-Loch-Felge <sup>1)</sup>              | Bremsbacken-Zubehör    |  |     |  |     |  |     |     |
|  | 1.1 i    | 40 |            | 01.97 | 03.04 | - ABS |            | 03.0137-9055.2 | 669055 |     | für 4-Loch-Felge <sup>2)</sup>              | Bremsbacken-Zubehör    |  |     |  |     |  |     | BDX |
|  | 1.1 i    | 44 |            | 05.96 | 03.04 | - ABS |            |                |        |     |   |                        |  |     |  |     |  |     |     |
|  | 1.0 i    | 33 |            | 05.96 | 03.04 | + ABS |            | 03.0137-0312.2 | 650312 |     |   | 203 x 38 HEB           |  |     |  |     |  |     | TRW |
|  | 1.0 i    | 37 |            | 01.97 | 03.04 | + ABS |            | 03.0137-9158.2 | 669158 |     |   | Bremsbacken-Zubehör    |  |     |  |     |  |     | TRW |
|  | 1.1      | 42 |            | 09.00 | 10.02 | + ABS |            |                |        |     |   |                        |  |     |  |     |  |     |     |
|  | 1.1 i    | 40 |            | 01.97 | 03.04 | + ABS |            |                |        |     |   |                        |  |     |  |     |  |     |     |
|  | 1.1 i    | 44 |            | 05.96 | 03.04 | + ABS |            |                |        |     |   |                        |  |     |  |     |  |     |     |
|  | 1.4 i    | 55 |            | 05.96 | 03.04 | - ABS |            | 03.0137-0196.2 | 650196 |     |   | 180 x 32 AUT           |  |     |  |     |  |     | BDX |
|  | 1.5 D    | 40 |            | 05.96 | 03.04 | - ABS |            | 03.0137-9055.2 | 669055 |     |   | Bremsbacken-Zubehör    |  |     |  |     |  |     | BDX |
|  | 1.5 D    | 42 |            | 10.00 | 03.04 | - ABS |            |                |        |     |   |                        |  |     |  |     |  |     |     |
|  | 1.6      | 65 |            | 05.96 | 03.04 | - ABS |            |                |        |     |   |                        |  |     |  |     |  |     |     |
|  | 1.4 i    | 55 |            | 05.96 | 03.04 | + ABS |            | 03.0137-0312.2 | 650312 |     |   | 203 x 38 HEB           |  |     |  |     |  |     | TRW |
|  | 1.5 D    | 40 |            | 05.96 | 03.04 | + ABS |            | 03.0137-9158.2 | 669158 |     |   | Bremsbacken-Zubehör    |  |     |  |     |  |     | TRW |
|  | 1.5 D    | 42 |            | 10.00 | 03.04 | + ABS |            |                |        |     |   |                        |  |     |  |     |  |     |     |
|  | 1.6      | 65 |            | 05.96 | 03.04 | + ABS |            |                |        |     |   |                        |  |     |  |     |  |     |     |
|  | Electric | 20 |            | 04.96 | 07.04 |       |            | 03.0137-0196.2 | 650196 |     |   | 180 x 32 AUT           |  |     |  |     |  |     | BDX |
|  |          |    |            |       |       |       |            | 03.0137-9055.2 | 669055 |     |   | Bremsbacken-Zubehör    |  |     |  |     |  |     | BDX |
|    | 1.0 i    | 33 |            | 05.96 | 03.04 | - ABS |            | 24.0216-5001.1 | 480001 |     | für 3-Loch-Felge/- Sensorring <sup>3)</sup> | 165/166 x 38,5 - Lager |  |     |  |     |  |     |     |
|  | 1.0 i    | 37 |            | 01.97 | 03.04 | - ABS |            | 24.0216-5701.2 | 480212 |     | für 3-Loch-Felge/- Sensorring <sup>3)</sup> | 165/166 x 38,5 + Lager |  |     |  |     |  |     |     |
|  | 1.1      | 42 |            | 09.00 | 10.02 | - ABS |            | 24.0218-0020.1 | 480074 |     | für 4-Loch-Felge <sup>2)</sup>              | 180/181 x 46 - Lager   |  |     |  |     |  |     |     |
|  | 1.1 i    | 40 |            | 01.97 | 03.04 | - ABS |            | 24.0218-0720.2 | 480205 |     | für 4-Loch-Felge <sup>2)</sup>              | 180/181 x 46 + Lager   |  |     |  |     |  |     |     |
|  | 1.1 i    | 44 |            | 05.96 | 03.04 | - ABS |            |                |        |     |   |                        |  |     |  |     |  |     |     |
|  | 1.0 i    | 33 |            | 05.96 | 03.04 | + ABS |            | 24.0220-3013.1 | 480089 |     |   | 203/204,5 x 46,5       |  |     |  |     |  |     |     |
|  | 1.0 i    | 37 |            | 01.97 | 03.04 | + ABS |            |                |        |     |   |                        |  |     |  |     |  |     |     |
|  | 1.1      | 42 |            | 09.00 | 10.02 | + ABS |            |                |        |     |   |                        |  |     |  |     |  |     |     |
|  | 1.1 i    | 40 |            | 01.97 | 03.04 | + ABS |            |                |        |     |   |                        |  |     |  |     |  |     |     |
|  | 1.1 i    | 44 |            | 05.96 | 03.04 | + ABS |            |                |        |     |   |                        |  |     |  |     |  |     |     |
|  | 1.4 i    | 55 |            | 05.96 | 03.04 | - ABS |            | 24.0218-0020.1 | 480074 |     |   | 180/181 x 46 - Lager   |  |     |  |     |  |     |     |
|  | 1.5 D    | 40 |            | 05.96 | 03.04 | - ABS |            | 24.0218-0720.2 | 480205 |     |   | 180/181 x 46 + Lager   |  |     |  |     |  |     |     |
|  | 1.5 D    | 42 |            | 10.00 | 03.04 | - ABS |            |                |        |     |   |                        |  |     |  |     |  |     |     |
|  | 1.6      | 65 |            | 05.96 | 03.04 | - ABS |            |                |        |     |   |                        |  |     |  |     |  |     |     |
|  | Electric | 20 |            | 04.96 | 07.04 | - ABS |            |                |        |     |   |                        |  |     |  |     |  |     |     |
|  | 1.4 i    | 55 |            | 05.96 | 03.04 | + ABS |            | 24.0220-3013.1 | 480089 |     |   | 203/204,5 x 46,5       |  |     |  |     |  |     |     |
|  | 1.5 D    | 40 |            | 05.96 | 03.04 | + ABS |            |                |        |     |   |                        |  |     |  |     |  |     |     |
|  | 1.5 D    | 42 |            | 10.00 | 03.04 | + ABS |            |                |        |     |   |                        |  |     |  |     |  |     |     |
|  | 1.6      | 65 |            | 05.96 | 03.04 | + ABS |            |                |        |     |   |                        |  |     |  |     |  |     |     |
|  | 1.0 i    | 33 |            | 05.96 | 03.04 | - ABS |            | 03.0420-0519.3 | 680519 |     | für 3-Loch-Felge <sup>1)</sup>              | 19,05/164x32 Kit       |  |     |  |     |  |     | BDX |
|  | 1.0 i    | 37 |            | 01.97 | 03.04 | - ABS |            | 03.0520-0519.3 | 690519 |     | für 3-Loch-Felge <sup>1)</sup>              | 19,05/164x32 TopKit    |  |     |  |     |  |     | BDX |
|  | 1.1      | 42 |            | 09.00 | 10.02 | - ABS |            | 03.0420-1619.3 | 681619 |     | für 4-Loch-Felge <sup>2)</sup>              | 19,05/180x32 Kit       |  |     |  |     |  |     | BDX |
|  | 1.1 i    | 40 |            | 01.97 | 03.04 | - ABS |            | 03.0520-1619.3 | 691619 |     | für 4-Loch-Felge <sup>2)</sup>              | 19,05/180x32 TopKit    |  |     |  |     |  |     | BDX |
|  | 1.1 i    | 44 |            | 05.96 | 03.04 | - ABS |            |                |        |     |   |                        |  |     |  |     |  |     |     |
|  | 1.0 i    | 33 |            | 05.96 |       | + ABS | ORGA 08056 | 03.0520-5720.3 | 695720 |     | + GG <sup>4)</sup>                          | 20,64/203x39 TopKit    |  |     |  |     |  |     | TRW |
|  | 1.0 i    | 37 |            | 01.97 |       | + ABS | ORGA 08056 |                |        |     |   |                        |  |     |  |     |  |     |     |
|  | 1.1 i    | 40 |            | 01.97 |       | + ABS | ORGA 08056 |                |        |     |   |                        |  |     |  |     |  |     |     |
|  | 1.1 i    | 44 |            | 05.96 |       | + ABS | ORGA 08056 |                |        |     |   |                        |  |     |  |     |  |     |     |
|  | 1.0 i    | 33 | ORGA 08057 |       |       | + ABS |            | 03.0520-6420.3 | 696420 |     |   | 20,64/203x39 TopKit    |  |     |  |     |  |     | TRW |
|  | 1.0 i    | 37 | ORGA 08057 |       |       | + ABS |            |                |        |     |   |                        |  |     |  |     |  |     |     |
|  | 1.1      | 42 | ORGA 08057 |       |       | + ABS |            |                |        |     |   |                        |  |     |  |     |  |     |     |
|  | 1.1 i    | 40 | ORGA 08057 |       |       | + ABS |            |                |        |     |   |                        |  |     |  |     |  |     |     |
|  | 1.1 i    | 44 | ORGA 08057 |       |       | + ABS |            |                |        |     |   |                        |  |     |  |     |  |     |     |
|  | 1.4 i    | 55 |            | 05.96 | 03.04 | - ABS |            | 03.0420-1619.3 | 681619 |     |   | 19,05/180x32 Kit       |  |     |  |     |  |     | BDX |
|  | 1.5 D    | 40 |            | 05.96 | 03.04 | - ABS |            | 03.0520-1619.3 | 691619 |     |   | 19,05/180x32 TopKit    |  |     |  |     |  |     | BDX |
|  | 1.5 D    | 42 |            | 10.00 | 03.04 | - ABS |            |                |        |     |   |                        |  |     |  |     |  |     |     |
|  | 1.6      | 65 |            | 05.96 | 03.04 | - ABS |            |                |        |     |   |                        |  |     |  |     |  |     |     |
|  | 1.4 i    | 55 |            | 05.96 |       | + ABS | ORGA 08056 | 03.0520-5720.3 | 695720 |     | + GG <sup>4)</sup>                          | 20,64/203x39 TopKit    |  |     |  |     |  |     | TRW |
|  | 1.5 D    | 40 |            | 05.96 |       | + ABS | ORGA 08056 |                |        |     |   |                        |  |     |  |     |  |     |     |
|  | 1.6      | 65 |            | 05.96 |       | + ABS | ORGA 08056 |                |        |     |   |                        |  |     |  |     |  |     |     |
|  | 1.4 i    | 55 | ORGA 08057 |       |       | + ABS |            | 03.0520-6420.3 | 696420 |     |   | 20,64/203x39 TopKit    |  |     |  |     |  |     | TRW |
|  | 1.5 D    | 40 | ORGA 08057 |       |       | + ABS |            |                |        |     |   |                        |  |     |  |     |  |     |     |
|  | 1.5 D    | 42 |            | 10.00 |       | + ABS |            |                |        |     |   |                        |  |     |  |     |  |     |     |
|  | 1.6      | 65 | ORGA 08057 |       |       | + ABS |            |                |        |     |   |                        |  |     |  |     |  |     |     |

### PEUGEOT 107 (05-14)

|  |         |    |  |       |       |  |  |                |        |  |  |                       |  |  |  |  |  |  |     |
|--|---------|----|--|-------|-------|--|--|----------------|--------|--|--|-----------------------|--|--|--|--|--|--|-----|
|  | 1.0     | 50 |  | 06.05 | 05.14 |  |  | 13.0460-3829.2 | 603829 |  |  | 23959 17,0 /Zub/S     |  |  |  |  |  |  | BOS |
|  | 1.4 HDi | 40 |  | 06.05 | 05.14 |  |  |                |        |  |  |                       |  |  |  |  |  |  |     |
|  | 1.0     | 50 |  | 06.05 | 05.14 |  |  | 24.0120-0180.1 | 420180 |  |  | 247 20,0 18,0 V +S +B |  |  |  |  |  |  |     |
|  | 1.4 HDi | 40 |  | 06.05 | 05.14 |  |  |                |        |  |  |                       |  |  |  |  |  |  |     |
|  | 1.0     | 50 |  | 06.05 | 05.14 |  |  | 03.0137-0466.2 | 650466 |  |  | 200 x 32 HEB          |  |  |  |  |  |  | BOS |
|  | 1.4 HDi | 40 |  | 06.05 | 05.14 |  |  | 03.0137-9287.2 | 669287 |  |  | Bremsbacken-Zubehör   |  |  |  |  |  |  | BOS |
|  | 1.0     | 50 |  | 06.05 | 05.14 |  |  | 24.0220-0046.1 | 480193 |  |  | 200/201 x 44          |  |  |  |  |  |  |     |
|  | 1.4 HDi | 40 |  | 06.05 | 05.14 |  |  |                |        |  |  |                       |  |  |  |  |  |  |     |
|  | 1.0     | 50 |  | 06.05 | 05.14 |  |  | 03.0520-4117.3 | 694117 |  |  | 17,46/200x32 TopKit   |  |  |  |  |  |  | BOS |
|  | 1.4 HDi | 40 |  | 06.05 | 05.14 |  |  |                |        |  |  |                       |  |  |  |  |  |  |     |

<sup>1)</sup> for 3 bore wheel rim / per cerchione a 3 fori / pour jante à 3 trous / para Llantas de 3 taladros

<sup>2)</sup> for 4 bore wheel rim / per cerchione a 4 fori / pour jante à 4 trous / para Llantas de 4 taladros

<sup>3)</sup> f.3 bore wheel rim/-sensorring / p.cerchione a 3 fori/- sensore / p.jant.à 3 trous/- secours ABS / Llant.3 tala./-anillo sens.ABS

<sup>4)</sup> + cast iron / + ghisa / + fonte grise / + fundición de gris

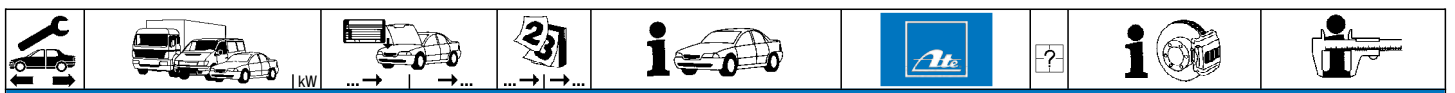











### PEUGEOT 108 (14-)

|  |                          |          |  |                |  |                                  |                  |  |                                     |                          |
|--|--------------------------|----------|--|----------------|--|----------------------------------|------------------|--|-------------------------------------|--------------------------|
|  | 1.0 68 VTi<br>1.2 82 VTi | 51<br>60 |  | 05.14<br>05.14 |  | 13.0460-3829.2                   | 603829           |  | 23959 17,0 /Zub/S                   | <b>BOS</b>               |
|  | 1.0 68 VTi<br>1.2 82 VTi | 51<br>60 |  | 05.14<br>05.14 |  | 24.0120-0180.1                   | 420180           |  | 247 20,0 18,0 V +S +B               |                          |
|  | 1.0 68 VTi<br>1.2 82 VTi | 51<br>60 |  | 05.14<br>05.14 |  | 03.0137-0466.2<br>03.0137-9287.2 | 650466<br>669287 |  | 200 x 32 HEB<br>Bremsbacken-Zubehör | <b>BOS</b><br><b>BOS</b> |
|  | 1.0 68 VTi<br>1.2 82 VTi | 51<br>60 |  | 05.14<br>05.14 |  | 24.0220-0046.1                   | 480193           |  | 200/201 x 44                        |                          |

### PEUGEOT 205 (91-98)

















|  |   |  |  |   |   |  |                                      |  |  |  |
|--|---|--|--|---|---|--|--------------------------------------|--|--|--|
|  | 1.0<br>1.1<br>1.4<br>1.6<br>1.7 D<br>1.9 D                                  | 33<br><br><br><br>44<br>47                   |  | 09.90<br>09.90<br>09.90<br>09.90<br>03.94<br>09.90                            | 09.98<br>09.98<br>09.98<br>09.98<br>09.98<br>09.98                            | 13.0460-3911.2<br>13.0460-2956.2<br>13.0460-0060.2<br>13.0460-0402.2 | 603911<br>602956<br>610060<br>610402 |  | 20905 18,0 +/WK<br>20989 17,7 +/WK<br>Belagsatz-Zubehör<br>Belagsatz-Zubehör | <b>BDX</b><br><b>TRW</b><br><b>TRW</b><br><b>BDX</b> |
|  | 1.1 i<br>1.4 i<br>1.6 i<br>1.9 GTI/CTI<br>1.7 TD                            | 44<br>55<br>66<br>75<br>57                   |  | 09.90<br>09.90<br>09.90<br>09.90<br>09.90                                     | 09.98<br>09.98<br>09.98<br>07.94<br>09.98                                     | 13.0460-3911.2<br>13.0460-2956.2<br>13.0460-0060.2<br>13.0460-0404.2 | 603911<br>602956<br>610060<br>610404 |  | 20905 18,0 +/WK<br>20989 17,7 +/WK<br>Belagsatz-Zubehör<br>Belagsatz-Zubehör | <b>BDX</b><br><b>TRW</b><br><b>TRW</b><br><b>BDX</b> |
|  | 1.9 GTI<br>1.9 GTI  | 88<br>94                                     |  | 09.90<br>09.90  | 10.94<br>09.98  | 13.0460-7058.2<br>13.0460-3911.2<br>13.0460-0402.2                   | 607058<br>603911<br>610402           |  | 21430 17,3 +/WK<br>20905 18,0 +/WK<br>Belagsatz-Zubehör                      | <b>ATE</b><br><b>BDX</b><br><b>BDX</b>               |
|  | 1.0<br>1.1<br>1.1 i<br>1.4<br>1.7 D<br>1.7 TD<br>1.9 D                      | 33<br><br>44<br><br>44<br>57<br>47           |  | 09.90<br>09.90<br>09.90<br>09.90<br>09.90<br>09.90                            | 09.98<br>09.98<br>09.98<br>09.98<br>09.98<br>09.98                            | 24.0110-0187.1   | 410187                               |  | 247 10,0 9,0 +S +B   |  |
|  | 1.1 i<br>1.4 i<br>1.6<br>1.6 i<br>1.9 GTI/CTI                               | 44<br>55<br><br>66<br>75                     |  | 09.90<br>09.90<br>09.90<br>09.90<br>09.90                                     | 09.98<br>09.98<br>09.98<br>09.98<br>07.94                                     | 24.0120-0131.1   | 420131                               |  | 247 20,4 18,5 V  |  |
|  | 1.7 TD<br>1.9 GTI<br>1.9 GTI  | 57<br>88<br>94                               |  | 01.91<br>09.90<br>09.90   | 09.98<br>10.94<br>09.98   | 24.0120-0132.1<br>24.0320-0132.1                                     | 420132<br>520132                     |  | 247 20,4 18,5 V +S +B<br>247 20,4 18,5 V +S +B PD                            |  |
|  | 1.9 GTI<br>1.9 GTI  | 88<br>94                                     |  | 09.90<br>09.90  | 10.94<br>09.98  | 13.0460-3954.2<br>13.0460-0435.2                                     | 603954<br>610435                     |  | 20973 11,0 +<br>Belagsatz-Zubehör  | <b>BDX</b><br><b>BDX</b>                             |
|  | 1.9 GTI<br>1.9 GTI  | 88<br>94                                     |  | 09.90<br>09.90  | 10.94<br>09.98  | 24.0108-0105.1   | 408105                               |  | 248 8,0 6,5  |  |
|  | 1.0<br>1.1<br>1.1 i<br>1.4<br>1.4 i<br>1.6<br>1.6 i<br>1.7 TD<br>1.9 D Lim. | 33<br><br>44<br><br>55<br><br>66<br>57<br>47 |  | 09.90<br>09.90<br>09.90<br>09.90<br>09.90<br>09.90<br>09.90<br>09.90<br>09.90 | 09.98<br>09.98<br>09.98<br>09.98<br>09.98<br>09.98<br>09.98<br>09.98<br>09.98 | 03.0137-0196.2<br>03.0137-0197.2<br>03.0137-9055.2<br>03.0137-9175.2 | 650196<br>650197<br>669055<br>669175 |  | 180 x 32 AUT<br>180 x 32 HEB<br>Bremsbacken-Zubehör<br>Bremsbacken-Zubehör   | <b>BDX</b><br><b>TRW</b><br><b>BDX</b><br><b>TRW</b> |
|  | 1.7 D<br>1.7 TD<br>1.9 D Kombi<br>1.9 GTI/CTI                               | 44<br>57<br>47<br>75                         |  | 03.94<br>09.90<br>09.90<br>09.90  | 09.98<br>09.98 + ABS<br>09.98<br>07.94  | 03.0137-0201.2<br>03.0137-9056.2                                     | 650201<br>669056                     |  | 180 x 41 HEB<br>Bremsbacken-Zubehör  | <b>TRW</b><br><b>TRW</b>                             |
|  | 1.0<br>1.1<br>1.1 i<br>1.4<br>1.4 i<br>1.6<br>1.6 i<br>1.7 TD<br>1.9 D Lim. | 33<br><br>44<br><br>55<br><br>66<br>57<br>47 |  | 09.90<br>09.90<br>09.90<br>09.90<br>09.90<br>09.90<br>09.90<br>09.90<br>09.90 | 09.98<br>09.98<br>09.98<br>09.98<br>09.98<br>09.98<br>09.98<br>09.98<br>09.98 | 24.0218-0014.1   | 480009                               |  | 180/181 x 43 - Lager   |  |
|  | 1.7 D<br>1.7 TD<br>1.9 D Kombi<br>1.9 GTI/CTI                               | 44<br>57<br>47<br>75                         |  | 03.94<br>09.90<br>09.90<br>09.90  | 09.98<br>09.98 + ABS<br>09.98<br>07.94  | 24.0218-0015.1   | 480010                               |  | 180/181 x 53,5 - Lager   |  |
|  | 1.0<br>1.1<br>1.1 i<br>1.4<br>1.4 i<br>1.6<br>1.6 i<br>1.7 TD               | 33<br><br>44<br><br>55<br><br>66<br>57       |  | 09.90<br>09.90<br>09.90<br>09.90<br>09.90<br>09.90<br>09.90                   | 09.98<br>09.98<br>09.98<br>12.97<br>09.98<br>09.98<br>09.98                   | 03.0520-0619.3<br>03.0520-0419.3                                     | 690619<br>690419                     |  | 19,05/180x32 TopKit<br>19,05/180x32 TopKit                                   | <b>BDX</b><br><b>TRW</b>                             |



| PEUGEOT 205 (91-98)  |  |            |       |            |                                    |                |                                    |                |                          |     |                     |     |     |    |            |       |       |           |                |        |  |                        |     |             |    |            |       |       |           |                |        |  |                     |     |         |    |            |       |       |  |                |        |  |                     |     |             |    |  |       |       |  |  |  |  |  |  |                |    |            |       |       |       |                |        |  |                     |     |         |    |            |       |       |           |  |  |  |  |  |                   |    |            |       |       |       |                |        |       |                    |  |         |    |            |       |       |       |                |        |       |                     |  |       |    |            |       |       |       |                |        |       |                        |  |         |    |            |       |       |                                    |                |        |  |                       |     |         |    |            |       |       |  |                |        |  |                          |  |         |    |  |       |       |  |  |  |  |  |  |         |     |            |       |       |  |  |  |  |  |  |                |    |            |       |       |  |                |        |  |                   |     |                |    |            |       |       |  |                |        |  |                   |     |                   |    |  |       |       |  |                |        |  |                   |     |         |    |            |       |       |  |  |  |  |  |  |             |     |            |       |       |  |  |  |  |  |  |         |    |            |       |       |  |                |        |  |                       |     |         |     |            |       |       |  |                |        |  |                          |  |         |     |            |       |       |  |                |        |  |                   |     |         |     |            |       |  |  |                |        |  |                   |     |  |   |     |       |       |       |                |                                    |                |                       |  |                     |    |            |    |       |       |       |           |                |        |  |                        |    |     |       |       |       |       |           |  |  |  |         |    |            |    |       |       |       |  |  |  |  |         |     |            |    |       |       |       |  |  |  |  |        |     |                |       |       |       |                |        |  |                       |  |  |  |         |    |  |       |                |           |  |                          |  |  |  |     |  |            |       |  |       |                |        |       |                    |  |     |    |            |       |  |       |                |        |       |                     |  |         |    |            |       |  |       |                |        |       |                        |  |         |    |            |       |       |                                    |                |        |  |                       |  |     |    |  |       |       |  |                |        |  |                          |  |         |    |            |       |       |  |  |  |  |  |  |         |    |            |       |       |  |  |  |  |  |  |                |    |            |       |       |  |  |  |  |  |  |         |    |            |       |       |  |  |  |  |  |  |                   |    |            |       |       |  |                |        |   |                 |  |     |    |  |       |       |  |  |  |  |  |  |       |    |            |       |       |  |  |  |  |  |  |         |    |            |       |       |  |                |        |  |                       |  |         |    |            |       |       |  |                |        |  |                          |  |         |    |            |       |       |  |  |  |  |  |  |                |     |            |       |       |  |  |  |  |  |  |         |    |  |       |       |  |                |        |  |                       |  |         |    |            |  |       |  |  |  |  |  |  |             |    |  |       |       |  |  |  |  |  |  |         |    |            |  |       |  |  |  |  |  |  |         |     |            |       |       |  |  |  |  |  |  |         |     |            |       |       |  |                |        |  |                       |  |  |  |  |  |  |  |                |        |  |                          |  |  |  |     |  |            |       |  |  |                |        |   |                 |  |     |    |            |       |  |  |  |  |  |  |  |         |    |            |       |  |  |  |  |  |  |  |         |    |            |       |  |  |  |  |  |  |  |     |    |  |       |       |  |  |  |  |  |  |         |    |            |       |  |  |  |  |  |  |  |       |    |            |       |  |  |  |  |  |  |  |         |    |            |       |  |  |  |  |  |  |  |         |    |            |       |  |  |  |  |  |  |  |     |  |            |  |       |  |                |        |   |                 |  |     |    |  |       |       |  |  |  |  |  |  |     |    |            |  |       |  |  |  |  |  |  |         |    |  |       |       |  |  |  |  |  |  |         |    |            |  |       |  |  |  |  |  |  |         |    |            |  |       |  |  |  |  |  |  |                |    |  |       |       |  |  |  |  |  |  |         |    |  |       |       |  |  |  |  |  |  |         |    |            |  |       |  |  |  |  |  |  |             |    |  |       |       |  |  |  |  |  |  |         |    |            |  |       |  |  |  |  |  |  |        |     |  |       |       |  |  |  |  |  |  |         |     |            |  |       |  |  |  |  |  |  |
|--|--|------------|-------|------------|------------------------------------|----------------|------------------------------------|----------------|--------------------------|-----|---------------------|-----|-----|----|------------|-------|-------|-----------|----------------|--------|--|------------------------|-----|-------------|----|------------|-------|-------|-----------|----------------|--------|--|---------------------|-----|---------|----|------------|-------|-------|--|----------------|--------|--|---------------------|-----|-------------|----|--|-------|-------|--|--|--|--|--|--|----------------|----|------------|-------|-------|-------|----------------|--------|--|---------------------|-----|---------|----|------------|-------|-------|-----------|--|--|--|--|--|-------------------|----|------------|-------|-------|-------|----------------|--------|-------|--------------------|--|---------|----|------------|-------|-------|-------|----------------|--------|-------|---------------------|--|-------|----|------------|-------|-------|-------|----------------|--------|-------|------------------------|--|---------|----|------------|-------|-------|------------------------------------|----------------|--------|--|-----------------------|-----|---------|----|------------|-------|-------|--|----------------|--------|--|--------------------------|--|---------|----|--|-------|-------|--|--|--|--|--|--|---------|-----|------------|-------|-------|--|--|--|--|--|--|----------------|----|------------|-------|-------|--|----------------|--------|--|-------------------|-----|----------------|----|------------|-------|-------|--|----------------|--------|--|-------------------|-----|-------------------|----|--|-------|-------|--|----------------|--------|--|-------------------|-----|---------|----|------------|-------|-------|--|--|--|--|--|--|-------------|-----|------------|-------|-------|--|--|--|--|--|--|---------|----|------------|-------|-------|--|----------------|--------|--|-----------------------|-----|---------|-----|------------|-------|-------|--|----------------|--------|--|--------------------------|--|---------|-----|------------|-------|-------|--|----------------|--------|--|-------------------|-----|---------|-----|------------|-------|--|--|----------------|--------|--|-------------------|-----|--|---|-----|-------|-------|-------|----------------|------------------------------------|----------------|-----------------------|--|---------------------|----|------------|----|-------|-------|-------|-----------|----------------|--------|--|------------------------|----|-----|-------|-------|-------|-------|-----------|--|--|--|---------|----|------------|----|-------|-------|-------|--|--|--|--|---------|-----|------------|----|-------|-------|-------|--|--|--|--|--------|-----|----------------|-------|-------|-------|----------------|--------|--|-----------------------|--|--|--|---------|----|--|-------|----------------|-----------|--|--------------------------|--|--|--|-----|--|------------|-------|--|-------|----------------|--------|-------|--------------------|--|-----|----|------------|-------|--|-------|----------------|--------|-------|---------------------|--|---------|----|------------|-------|--|-------|----------------|--------|-------|------------------------|--|---------|----|------------|-------|-------|------------------------------------|----------------|--------|--|-----------------------|--|-----|----|--|-------|-------|--|----------------|--------|--|--------------------------|--|---------|----|------------|-------|-------|--|--|--|--|--|--|---------|----|------------|-------|-------|--|--|--|--|--|--|----------------|----|------------|-------|-------|--|--|--|--|--|--|---------|----|------------|-------|-------|--|--|--|--|--|--|-------------------|----|------------|-------|-------|--|----------------|--------|---|-----------------|--|-----|----|--|-------|-------|--|--|--|--|--|--|-------|----|------------|-------|-------|--|--|--|--|--|--|---------|----|------------|-------|-------|--|----------------|--------|--|-----------------------|--|---------|----|------------|-------|-------|--|----------------|--------|--|--------------------------|--|---------|----|------------|-------|-------|--|--|--|--|--|--|----------------|-----|------------|-------|-------|--|--|--|--|--|--|---------|----|--|-------|-------|--|----------------|--------|--|-----------------------|--|---------|----|------------|--|-------|--|--|--|--|--|--|-------------|----|--|-------|-------|--|--|--|--|--|--|---------|----|------------|--|-------|--|--|--|--|--|--|---------|-----|------------|-------|-------|--|--|--|--|--|--|---------|-----|------------|-------|-------|--|----------------|--------|--|-----------------------|--|--|--|--|--|--|--|----------------|--------|--|--------------------------|--|--|--|-----|--|------------|-------|--|--|----------------|--------|---|-----------------|--|-----|----|------------|-------|--|--|--|--|--|--|--|---------|----|------------|-------|--|--|--|--|--|--|--|---------|----|------------|-------|--|--|--|--|--|--|--|-----|----|--|-------|-------|--|--|--|--|--|--|---------|----|------------|-------|--|--|--|--|--|--|--|-------|----|------------|-------|--|--|--|--|--|--|--|---------|----|------------|-------|--|--|--|--|--|--|--|---------|----|------------|-------|--|--|--|--|--|--|--|-----|--|------------|--|-------|--|----------------|--------|---|-----------------|--|-----|----|--|-------|-------|--|--|--|--|--|--|-----|----|------------|--|-------|--|--|--|--|--|--|---------|----|--|-------|-------|--|--|--|--|--|--|---------|----|------------|--|-------|--|--|--|--|--|--|---------|----|------------|--|-------|--|--|--|--|--|--|----------------|----|--|-------|-------|--|--|--|--|--|--|---------|----|--|-------|-------|--|--|--|--|--|--|---------|----|------------|--|-------|--|--|--|--|--|--|-------------|----|--|-------|-------|--|--|--|--|--|--|---------|----|------------|--|-------|--|--|--|--|--|--|--------|-----|--|-------|-------|--|--|--|--|--|--|---------|-----|------------|--|-------|--|--|--|--|--|--|
|    | <table border="1"> <tr> <td>1.9 D Lim.</td> <td>47</td> <td></td> <td>09.90</td> <td>09.98</td> <td></td> <td>03.0520-0619.3</td> <td>690619</td> <td></td> <td>19,05/180x32 TopKit</td> <td>BDX</td> </tr> <tr> <td></td> <td></td> <td></td> <td></td> <td></td> <td></td> <td>03.0520-0419.3</td> <td>690419</td> <td></td> <td>19,05/180x32 TopKit</td> <td>TRW</td> </tr> <tr> <td>1.9 GTI/CTI</td> <td>75</td> <td></td> <td>09.90</td> <td>07.94</td> <td></td> <td>03.0520-0919.3</td> <td>690919</td> <td></td> <td>19,05/180x41 TopKit</td> <td>TRW</td> </tr> <tr> <td>1.7 D</td> <td>44</td> <td></td> <td>03.94</td> <td>09.98</td> <td></td> <td>03.0520-3120.3</td> <td>693120</td> <td></td> <td>20,64/180x41 TopKit</td> <td>TRW</td> </tr> <tr> <td>1.9 D Kombi</td> <td>47</td> <td></td> <td>09.90</td> <td>09.98</td> <td></td> <td></td> <td></td> <td></td> <td></td> <td></td> </tr> <tr> <td>1.7 TD</td> <td>57</td> <td></td> <td>09.90</td> <td>09.98</td> <td>+ ABS</td> <td>03.0520-0919.3</td> <td>690919</td> <td></td> <td>19,05/180x41 TopKit</td> <td>TRW</td> </tr> </table>  | 1.9 D Lim. | 47    |            | 09.90                              | 09.98          |                                    | 03.0520-0619.3 | 690619                   |     | 19,05/180x32 TopKit | BDX |     |    |            |       |       |           | 03.0520-0419.3 | 690419 |  | 19,05/180x32 TopKit    | TRW | 1.9 GTI/CTI | 75 |            | 09.90 | 07.94 |           | 03.0520-0919.3 | 690919 |  | 19,05/180x41 TopKit | TRW | 1.7 D   | 44 |            | 03.94 | 09.98 |  | 03.0520-3120.3 | 693120 |  | 20,64/180x41 TopKit | TRW | 1.9 D Kombi | 47 |  | 09.90 | 09.98 |  |  |  |  |  |  | 1.7 TD         | 57 |            | 09.90 | 09.98 | + ABS | 03.0520-0919.3 | 690919 |  | 19,05/180x41 TopKit | TRW |         |    |            |       |       |           |  |  |  |  |  |                   |    |            |       |       |       |                |        |       |                    |  |         |    |            |       |       |       |                |        |       |                     |  |       |    |            |       |       |       |                |        |       |                        |  |         |    |            |       |       |                                    |                |        |  |                       |     |         |    |            |       |       |  |                |        |  |                          |  |         |    |  |       |       |  |  |  |  |  |  |         |     |            |       |       |  |  |  |  |  |  |                |    |            |       |       |  |                |        |  |                   |     |                |    |            |       |       |  |                |        |  |                   |     |                   |    |  |       |       |  |                |        |  |                   |     |         |    |            |       |       |  |  |  |  |  |  |             |     |            |       |       |  |  |  |  |  |  |         |    |            |       |       |  |                |        |  |                       |     |         |     |            |       |       |  |                |        |  |                          |  |         |     |            |       |       |  |                |        |  |                   |     |         |     |            |       |  |  |                |        |  |                   |     |  |   |     |       |       |       |                |                                    |                |                       |  |                     |    |            |    |       |       |       |           |                |        |  |                        |    |     |       |       |       |       |           |  |  |  |         |    |            |    |       |       |       |  |  |  |  |         |     |            |    |       |       |       |  |  |  |  |        |     |                |       |       |       |                |        |  |                       |  |  |  |         |    |  |       |                |           |  |                          |  |  |  |     |  |            |       |  |       |                |        |       |                    |  |     |    |            |       |  |       |                |        |       |                     |  |         |    |            |       |  |       |                |        |       |                        |  |         |    |            |       |       |                                    |                |        |  |                       |  |     |    |  |       |       |  |                |        |  |                          |  |         |    |            |       |       |  |  |  |  |  |  |         |    |            |       |       |  |  |  |  |  |  |                |    |            |       |       |  |  |  |  |  |  |         |    |            |       |       |  |  |  |  |  |  |                   |    |            |       |       |  |                |        |   |                 |  |     |    |  |       |       |  |  |  |  |  |  |       |    |            |       |       |  |  |  |  |  |  |         |    |            |       |       |  |                |        |  |                       |  |         |    |            |       |       |  |                |        |  |                          |  |         |    |            |       |       |  |  |  |  |  |  |                |     |            |       |       |  |  |  |  |  |  |         |    |  |       |       |  |                |        |  |                       |  |         |    |            |  |       |  |  |  |  |  |  |             |    |  |       |       |  |  |  |  |  |  |         |    |            |  |       |  |  |  |  |  |  |         |     |            |       |       |  |  |  |  |  |  |         |     |            |       |       |  |                |        |  |                       |  |  |  |  |  |  |  |                |        |  |                          |  |  |  |     |  |            |       |  |  |                |        |   |                 |  |     |    |            |       |  |  |  |  |  |  |  |         |    |            |       |  |  |  |  |  |  |  |         |    |            |       |  |  |  |  |  |  |  |     |    |  |       |       |  |  |  |  |  |  |         |    |            |       |  |  |  |  |  |  |  |       |    |            |       |  |  |  |  |  |  |  |         |    |            |       |  |  |  |  |  |  |  |         |    |            |       |  |  |  |  |  |  |  |     |  |            |  |       |  |                |        |   |                 |  |     |    |  |       |       |  |  |  |  |  |  |     |    |            |  |       |  |  |  |  |  |  |         |    |  |       |       |  |  |  |  |  |  |         |    |            |  |       |  |  |  |  |  |  |         |    |            |  |       |  |  |  |  |  |  |                |    |  |       |       |  |  |  |  |  |  |         |    |  |       |       |  |  |  |  |  |  |         |    |            |  |       |  |  |  |  |  |  |             |    |  |       |       |  |  |  |  |  |  |         |    |            |  |       |  |  |  |  |  |  |        |     |  |       |       |  |  |  |  |  |  |         |     |            |  |       |  |  |  |  |  |  |
| 1.9 D Lim.   | 47   |            | 09.90 | 09.98      |                                    | 03.0520-0619.3 | 690619                             |                | 19,05/180x32 TopKit      | BDX |                     |     |     |    |            |       |       |           |                |        |  |                        |     |             |    |            |       |       |           |                |        |  |                     |     |         |    |            |       |       |  |                |        |  |                     |     |             |    |  |       |       |  |  |  |  |  |  |                |    |            |       |       |       |                |        |  |                     |     |         |    |            |       |       |           |  |  |  |  |  |                   |    |            |       |       |       |                |        |       |                    |  |         |    |            |       |       |       |                |        |       |                     |  |       |    |            |       |       |       |                |        |       |                        |  |         |    |            |       |       |                                    |                |        |  |                       |     |         |    |            |       |       |  |                |        |  |                          |  |         |    |  |       |       |  |  |  |  |  |  |         |     |            |       |       |  |  |  |  |  |  |                |    |            |       |       |  |                |        |  |                   |     |                |    |            |       |       |  |                |        |  |                   |     |                   |    |  |       |       |  |                |        |  |                   |     |         |    |            |       |       |  |  |  |  |  |  |             |     |            |       |       |  |  |  |  |  |  |         |    |            |       |       |  |                |        |  |                       |     |         |     |            |       |       |  |                |        |  |                          |  |         |     |            |       |       |  |                |        |  |                   |     |         |     |            |       |  |  |                |        |  |                   |     |  |   |     |       |       |       |                |                                    |                |                       |  |                     |    |            |    |       |       |       |           |                |        |  |                        |    |     |       |       |       |       |           |  |  |  |         |    |            |    |       |       |       |  |  |  |  |         |     |            |    |       |       |       |  |  |  |  |        |     |                |       |       |       |                |        |  |                       |  |  |  |         |    |  |       |                |           |  |                          |  |  |  |     |  |            |       |  |       |                |        |       |                    |  |     |    |            |       |  |       |                |        |       |                     |  |         |    |            |       |  |       |                |        |       |                        |  |         |    |            |       |       |                                    |                |        |  |                       |  |     |    |  |       |       |  |                |        |  |                          |  |         |    |            |       |       |  |  |  |  |  |  |         |    |            |       |       |  |  |  |  |  |  |                |    |            |       |       |  |  |  |  |  |  |         |    |            |       |       |  |  |  |  |  |  |                   |    |            |       |       |  |                |        |   |                 |  |     |    |  |       |       |  |  |  |  |  |  |       |    |            |       |       |  |  |  |  |  |  |         |    |            |       |       |  |                |        |  |                       |  |         |    |            |       |       |  |                |        |  |                          |  |         |    |            |       |       |  |  |  |  |  |  |                |     |            |       |       |  |  |  |  |  |  |         |    |  |       |       |  |                |        |  |                       |  |         |    |            |  |       |  |  |  |  |  |  |             |    |  |       |       |  |  |  |  |  |  |         |    |            |  |       |  |  |  |  |  |  |         |     |            |       |       |  |  |  |  |  |  |         |     |            |       |       |  |                |        |  |                       |  |  |  |  |  |  |  |                |        |  |                          |  |  |  |     |  |            |       |  |  |                |        |   |                 |  |     |    |            |       |  |  |  |  |  |  |  |         |    |            |       |  |  |  |  |  |  |  |         |    |            |       |  |  |  |  |  |  |  |     |    |  |       |       |  |  |  |  |  |  |         |    |            |       |  |  |  |  |  |  |  |       |    |            |       |  |  |  |  |  |  |  |         |    |            |       |  |  |  |  |  |  |  |         |    |            |       |  |  |  |  |  |  |  |     |  |            |  |       |  |                |        |   |                 |  |     |    |  |       |       |  |  |  |  |  |  |     |    |            |  |       |  |  |  |  |  |  |         |    |  |       |       |  |  |  |  |  |  |         |    |            |  |       |  |  |  |  |  |  |         |    |            |  |       |  |  |  |  |  |  |                |    |  |       |       |  |  |  |  |  |  |         |    |  |       |       |  |  |  |  |  |  |         |    |            |  |       |  |  |  |  |  |  |             |    |  |       |       |  |  |  |  |  |  |         |    |            |  |       |  |  |  |  |  |  |        |     |  |       |       |  |  |  |  |  |  |         |     |            |  |       |  |  |  |  |  |  |
|  |  |            |       |            |                                    | 03.0520-0419.3 | 690419                             |                | 19,05/180x32 TopKit      | TRW |                     |     |     |    |            |       |       |           |                |        |  |                        |     |             |    |            |       |       |           |                |        |  |                     |     |         |    |            |       |       |  |                |        |  |                     |     |             |    |  |       |       |  |  |  |  |  |  |                |    |            |       |       |       |                |        |  |                     |     |         |    |            |       |       |           |  |  |  |  |  |                   |    |            |       |       |       |                |        |       |                    |  |         |    |            |       |       |       |                |        |       |                     |  |       |    |            |       |       |       |                |        |       |                        |  |         |    |            |       |       |                                    |                |        |  |                       |     |         |    |            |       |       |  |                |        |  |                          |  |         |    |  |       |       |  |  |  |  |  |  |         |     |            |       |       |  |  |  |  |  |  |                |    |            |       |       |  |                |        |  |                   |     |                |    |            |       |       |  |                |        |  |                   |     |                   |    |  |       |       |  |                |        |  |                   |     |         |    |            |       |       |  |  |  |  |  |  |             |     |            |       |       |  |  |  |  |  |  |         |    |            |       |       |  |                |        |  |                       |     |         |     |            |       |       |  |                |        |  |                          |  |         |     |            |       |       |  |                |        |  |                   |     |         |     |            |       |  |  |                |        |  |                   |     |  |   |     |       |       |       |                |                                    |                |                       |  |                     |    |            |    |       |       |       |           |                |        |  |                        |    |     |       |       |       |       |           |  |  |  |         |    |            |    |       |       |       |  |  |  |  |         |     |            |    |       |       |       |  |  |  |  |        |     |                |       |       |       |                |        |  |                       |  |  |  |         |    |  |       |                |           |  |                          |  |  |  |     |  |            |       |  |       |                |        |       |                    |  |     |    |            |       |  |       |                |        |       |                     |  |         |    |            |       |  |       |                |        |       |                        |  |         |    |            |       |       |                                    |                |        |  |                       |  |     |    |  |       |       |  |                |        |  |                          |  |         |    |            |       |       |  |  |  |  |  |  |         |    |            |       |       |  |  |  |  |  |  |                |    |            |       |       |  |  |  |  |  |  |         |    |            |       |       |  |  |  |  |  |  |                   |    |            |       |       |  |                |        |   |                 |  |     |    |  |       |       |  |  |  |  |  |  |       |    |            |       |       |  |  |  |  |  |  |         |    |            |       |       |  |                |        |  |                       |  |         |    |            |       |       |  |                |        |  |                          |  |         |    |            |       |       |  |  |  |  |  |  |                |     |            |       |       |  |  |  |  |  |  |         |    |  |       |       |  |                |        |  |                       |  |         |    |            |  |       |  |  |  |  |  |  |             |    |  |       |       |  |  |  |  |  |  |         |    |            |  |       |  |  |  |  |  |  |         |     |            |       |       |  |  |  |  |  |  |         |     |            |       |       |  |                |        |  |                       |  |  |  |  |  |  |  |                |        |  |                          |  |  |  |     |  |            |       |  |  |                |        |   |                 |  |     |    |            |       |  |  |  |  |  |  |  |         |    |            |       |  |  |  |  |  |  |  |         |    |            |       |  |  |  |  |  |  |  |     |    |  |       |       |  |  |  |  |  |  |         |    |            |       |  |  |  |  |  |  |  |       |    |            |       |  |  |  |  |  |  |  |         |    |            |       |  |  |  |  |  |  |  |         |    |            |       |  |  |  |  |  |  |  |     |  |            |  |       |  |                |        |   |                 |  |     |    |  |       |       |  |  |  |  |  |  |     |    |            |  |       |  |  |  |  |  |  |         |    |  |       |       |  |  |  |  |  |  |         |    |            |  |       |  |  |  |  |  |  |         |    |            |  |       |  |  |  |  |  |  |                |    |  |       |       |  |  |  |  |  |  |         |    |  |       |       |  |  |  |  |  |  |         |    |            |  |       |  |  |  |  |  |  |             |    |  |       |       |  |  |  |  |  |  |         |    |            |  |       |  |  |  |  |  |  |        |     |  |       |       |  |  |  |  |  |  |         |     |            |  |       |  |  |  |  |  |  |
| 1.9 GTI/CTI  | 75   |            | 09.90 | 07.94      |                                    | 03.0520-0919.3 | 690919                             |                | 19,05/180x41 TopKit      | TRW |                     |     |     |    |            |       |       |           |                |        |  |                        |     |             |    |            |       |       |           |                |        |  |                     |     |         |    |            |       |       |  |                |        |  |                     |     |             |    |  |       |       |  |  |  |  |  |  |                |    |            |       |       |       |                |        |  |                     |     |         |    |            |       |       |           |  |  |  |  |  |                   |    |            |       |       |       |                |        |       |                    |  |         |    |            |       |       |       |                |        |       |                     |  |       |    |            |       |       |       |                |        |       |                        |  |         |    |            |       |       |                                    |                |        |  |                       |     |         |    |            |       |       |  |                |        |  |                          |  |         |    |  |       |       |  |  |  |  |  |  |         |     |            |       |       |  |  |  |  |  |  |                |    |            |       |       |  |                |        |  |                   |     |                |    |            |       |       |  |                |        |  |                   |     |                   |    |  |       |       |  |                |        |  |                   |     |         |    |            |       |       |  |  |  |  |  |  |             |     |            |       |       |  |  |  |  |  |  |         |    |            |       |       |  |                |        |  |                       |     |         |     |            |       |       |  |                |        |  |                          |  |         |     |            |       |       |  |                |        |  |                   |     |         |     |            |       |  |  |                |        |  |                   |     |  |   |     |       |       |       |                |                                    |                |                       |  |                     |    |            |    |       |       |       |           |                |        |  |                        |    |     |       |       |       |       |           |  |  |  |         |    |            |    |       |       |       |  |  |  |  |         |     |            |    |       |       |       |  |  |  |  |        |     |                |       |       |       |                |        |  |                       |  |  |  |         |    |  |       |                |           |  |                          |  |  |  |     |  |            |       |  |       |                |        |       |                    |  |     |    |            |       |  |       |                |        |       |                     |  |         |    |            |       |  |       |                |        |       |                        |  |         |    |            |       |       |                                    |                |        |  |                       |  |     |    |  |       |       |  |                |        |  |                          |  |         |    |            |       |       |  |  |  |  |  |  |         |    |            |       |       |  |  |  |  |  |  |                |    |            |       |       |  |  |  |  |  |  |         |    |            |       |       |  |  |  |  |  |  |                   |    |            |       |       |  |                |        |   |                 |  |     |    |  |       |       |  |  |  |  |  |  |       |    |            |       |       |  |  |  |  |  |  |         |    |            |       |       |  |                |        |  |                       |  |         |    |            |       |       |  |                |        |  |                          |  |         |    |            |       |       |  |  |  |  |  |  |                |     |            |       |       |  |  |  |  |  |  |         |    |  |       |       |  |                |        |  |                       |  |         |    |            |  |       |  |  |  |  |  |  |             |    |  |       |       |  |  |  |  |  |  |         |    |            |  |       |  |  |  |  |  |  |         |     |            |       |       |  |  |  |  |  |  |         |     |            |       |       |  |                |        |  |                       |  |  |  |  |  |  |  |                |        |  |                          |  |  |  |     |  |            |       |  |  |                |        |   |                 |  |     |    |            |       |  |  |  |  |  |  |  |         |    |            |       |  |  |  |  |  |  |  |         |    |            |       |  |  |  |  |  |  |  |     |    |  |       |       |  |  |  |  |  |  |         |    |            |       |  |  |  |  |  |  |  |       |    |            |       |  |  |  |  |  |  |  |         |    |            |       |  |  |  |  |  |  |  |         |    |            |       |  |  |  |  |  |  |  |     |  |            |  |       |  |                |        |   |                 |  |     |    |  |       |       |  |  |  |  |  |  |     |    |            |  |       |  |  |  |  |  |  |         |    |  |       |       |  |  |  |  |  |  |         |    |            |  |       |  |  |  |  |  |  |         |    |            |  |       |  |  |  |  |  |  |                |    |  |       |       |  |  |  |  |  |  |         |    |  |       |       |  |  |  |  |  |  |         |    |            |  |       |  |  |  |  |  |  |             |    |  |       |       |  |  |  |  |  |  |         |    |            |  |       |  |  |  |  |  |  |        |     |  |       |       |  |  |  |  |  |  |         |     |            |  |       |  |  |  |  |  |  |
| 1.7 D  | 44   |            | 03.94 | 09.98      |                                    | 03.0520-3120.3 | 693120                             |                | 20,64/180x41 TopKit      | TRW |                     |     |     |    |            |       |       |           |                |        |  |                        |     |             |    |            |       |       |           |                |        |  |                     |     |         |    |            |       |       |  |                |        |  |                     |     |             |    |  |       |       |  |  |  |  |  |  |                |    |            |       |       |       |                |        |  |                     |     |         |    |            |       |       |           |  |  |  |  |  |                   |    |            |       |       |       |                |        |       |                    |  |         |    |            |       |       |       |                |        |       |                     |  |       |    |            |       |       |       |                |        |       |                        |  |         |    |            |       |       |                                    |                |        |  |                       |     |         |    |            |       |       |  |                |        |  |                          |  |         |    |  |       |       |  |  |  |  |  |  |         |     |            |       |       |  |  |  |  |  |  |                |    |            |       |       |  |                |        |  |                   |     |                |    |            |       |       |  |                |        |  |                   |     |                   |    |  |       |       |  |                |        |  |                   |     |         |    |            |       |       |  |  |  |  |  |  |             |     |            |       |       |  |  |  |  |  |  |         |    |            |       |       |  |                |        |  |                       |     |         |     |            |       |       |  |                |        |  |                          |  |         |     |            |       |       |  |                |        |  |                   |     |         |     |            |       |  |  |                |        |  |                   |     |  |   |     |       |       |       |                |                                    |                |                       |  |                     |    |            |    |       |       |       |           |                |        |  |                        |    |     |       |       |       |       |           |  |  |  |         |    |            |    |       |       |       |  |  |  |  |         |     |            |    |       |       |       |  |  |  |  |        |     |                |       |       |       |                |        |  |                       |  |  |  |         |    |  |       |                |           |  |                          |  |  |  |     |  |            |       |  |       |                |        |       |                    |  |     |    |            |       |  |       |                |        |       |                     |  |         |    |            |       |  |       |                |        |       |                        |  |         |    |            |       |       |                                    |                |        |  |                       |  |     |    |  |       |       |  |                |        |  |                          |  |         |    |            |       |       |  |  |  |  |  |  |         |    |            |       |       |  |  |  |  |  |  |                |    |            |       |       |  |  |  |  |  |  |         |    |            |       |       |  |  |  |  |  |  |                   |    |            |       |       |  |                |        |   |                 |  |     |    |  |       |       |  |  |  |  |  |  |       |    |            |       |       |  |  |  |  |  |  |         |    |            |       |       |  |                |        |  |                       |  |         |    |            |       |       |  |                |        |  |                          |  |         |    |            |       |       |  |  |  |  |  |  |                |     |            |       |       |  |  |  |  |  |  |         |    |  |       |       |  |                |        |  |                       |  |         |    |            |  |       |  |  |  |  |  |  |             |    |  |       |       |  |  |  |  |  |  |         |    |            |  |       |  |  |  |  |  |  |         |     |            |       |       |  |  |  |  |  |  |         |     |            |       |       |  |                |        |  |                       |  |  |  |  |  |  |  |                |        |  |                          |  |  |  |     |  |            |       |  |  |                |        |   |                 |  |     |    |            |       |  |  |  |  |  |  |  |         |    |            |       |  |  |  |  |  |  |  |         |    |            |       |  |  |  |  |  |  |  |     |    |  |       |       |  |  |  |  |  |  |         |    |            |       |  |  |  |  |  |  |  |       |    |            |       |  |  |  |  |  |  |  |         |    |            |       |  |  |  |  |  |  |  |         |    |            |       |  |  |  |  |  |  |  |     |  |            |  |       |  |                |        |   |                 |  |     |    |  |       |       |  |  |  |  |  |  |     |    |            |  |       |  |  |  |  |  |  |         |    |  |       |       |  |  |  |  |  |  |         |    |            |  |       |  |  |  |  |  |  |         |    |            |  |       |  |  |  |  |  |  |                |    |  |       |       |  |  |  |  |  |  |         |    |  |       |       |  |  |  |  |  |  |         |    |            |  |       |  |  |  |  |  |  |             |    |  |       |       |  |  |  |  |  |  |         |    |            |  |       |  |  |  |  |  |  |        |     |  |       |       |  |  |  |  |  |  |         |     |            |  |       |  |  |  |  |  |  |
| 1.9 D Kombi  | 47   |            | 09.90 | 09.98      |                                    |                |                                    |                |                          |     |                     |     |     |    |            |       |       |           |                |        |  |                        |     |             |    |            |       |       |           |                |        |  |                     |     |         |    |            |       |       |  |                |        |  |                     |     |             |    |  |       |       |  |  |  |  |  |  |                |    |            |       |       |       |                |        |  |                     |     |         |    |            |       |       |           |  |  |  |  |  |                   |    |            |       |       |       |                |        |       |                    |  |         |    |            |       |       |       |                |        |       |                     |  |       |    |            |       |       |       |                |        |       |                        |  |         |    |            |       |       |                                    |                |        |  |                       |     |         |    |            |       |       |  |                |        |  |                          |  |         |    |  |       |       |  |  |  |  |  |  |         |     |            |       |       |  |  |  |  |  |  |                |    |            |       |       |  |                |        |  |                   |     |                |    |            |       |       |  |                |        |  |                   |     |                   |    |  |       |       |  |                |        |  |                   |     |         |    |            |       |       |  |  |  |  |  |  |             |     |            |       |       |  |  |  |  |  |  |         |    |            |       |       |  |                |        |  |                       |     |         |     |            |       |       |  |                |        |  |                          |  |         |     |            |       |       |  |                |        |  |                   |     |         |     |            |       |  |  |                |        |  |                   |     |  |   |     |       |       |       |                |                                    |                |                       |  |                     |    |            |    |       |       |       |           |                |        |  |                        |    |     |       |       |       |       |           |  |  |  |         |    |            |    |       |       |       |  |  |  |  |         |     |            |    |       |       |       |  |  |  |  |        |     |                |       |       |       |                |        |  |                       |  |  |  |         |    |  |       |                |           |  |                          |  |  |  |     |  |            |       |  |       |                |        |       |                    |  |     |    |            |       |  |       |                |        |       |                     |  |         |    |            |       |  |       |                |        |       |                        |  |         |    |            |       |       |                                    |                |        |  |                       |  |     |    |  |       |       |  |                |        |  |                          |  |         |    |            |       |       |  |  |  |  |  |  |         |    |            |       |       |  |  |  |  |  |  |                |    |            |       |       |  |  |  |  |  |  |         |    |            |       |       |  |  |  |  |  |  |                   |    |            |       |       |  |                |        |   |                 |  |     |    |  |       |       |  |  |  |  |  |  |       |    |            |       |       |  |  |  |  |  |  |         |    |            |       |       |  |                |        |  |                       |  |         |    |            |       |       |  |                |        |  |                          |  |         |    |            |       |       |  |  |  |  |  |  |                |     |            |       |       |  |  |  |  |  |  |         |    |  |       |       |  |                |        |  |                       |  |         |    |            |  |       |  |  |  |  |  |  |             |    |  |       |       |  |  |  |  |  |  |         |    |            |  |       |  |  |  |  |  |  |         |     |            |       |       |  |  |  |  |  |  |         |     |            |       |       |  |                |        |  |                       |  |  |  |  |  |  |  |                |        |  |                          |  |  |  |     |  |            |       |  |  |                |        |   |                 |  |     |    |            |       |  |  |  |  |  |  |  |         |    |            |       |  |  |  |  |  |  |  |         |    |            |       |  |  |  |  |  |  |  |     |    |  |       |       |  |  |  |  |  |  |         |    |            |       |  |  |  |  |  |  |  |       |    |            |       |  |  |  |  |  |  |  |         |    |            |       |  |  |  |  |  |  |  |         |    |            |       |  |  |  |  |  |  |  |     |  |            |  |       |  |                |        |   |                 |  |     |    |  |       |       |  |  |  |  |  |  |     |    |            |  |       |  |  |  |  |  |  |         |    |  |       |       |  |  |  |  |  |  |         |    |            |  |       |  |  |  |  |  |  |         |    |            |  |       |  |  |  |  |  |  |                |    |  |       |       |  |  |  |  |  |  |         |    |  |       |       |  |  |  |  |  |  |         |    |            |  |       |  |  |  |  |  |  |             |    |  |       |       |  |  |  |  |  |  |         |    |            |  |       |  |  |  |  |  |  |        |     |  |       |       |  |  |  |  |  |  |         |     |            |  |       |  |  |  |  |  |  |
| 1.7 TD   | 57   |            | 09.90 | 09.98      | + ABS                              | 03.0520-0919.3 | 690919                             |                | 19,05/180x41 TopKit      | TRW |                     |     |     |    |            |       |       |           |                |        |  |                        |     |             |    |            |       |       |           |                |        |  |                     |     |         |    |            |       |       |  |                |        |  |                     |     |             |    |  |       |       |  |  |  |  |  |  |                |    |            |       |       |       |                |        |  |                     |     |         |    |            |       |       |           |  |  |  |  |  |                   |    |            |       |       |       |                |        |       |                    |  |         |    |            |       |       |       |                |        |       |                     |  |       |    |            |       |       |       |                |        |       |                        |  |         |    |            |       |       |                                    |                |        |  |                       |     |         |    |            |       |       |  |                |        |  |                          |  |         |    |  |       |       |  |  |  |  |  |  |         |     |            |       |       |  |  |  |  |  |  |                |    |            |       |       |  |                |        |  |                   |     |                |    |            |       |       |  |                |        |  |                   |     |                   |    |  |       |       |  |                |        |  |                   |     |         |    |            |       |       |  |  |  |  |  |  |             |     |            |       |       |  |  |  |  |  |  |         |    |            |       |       |  |                |        |  |                       |     |         |     |            |       |       |  |                |        |  |                          |  |         |     |            |       |       |  |                |        |  |                   |     |         |     |            |       |  |  |                |        |  |                   |     |  |   |     |       |       |       |                |                                    |                |                       |  |                     |    |            |    |       |       |       |           |                |        |  |                        |    |     |       |       |       |       |           |  |  |  |         |    |            |    |       |       |       |  |  |  |  |         |     |            |    |       |       |       |  |  |  |  |        |     |                |       |       |       |                |        |  |                       |  |  |  |         |    |  |       |                |           |  |                          |  |  |  |     |  |            |       |  |       |                |        |       |                    |  |     |    |            |       |  |       |                |        |       |                     |  |         |    |            |       |  |       |                |        |       |                        |  |         |    |            |       |       |                                    |                |        |  |                       |  |     |    |  |       |       |  |                |        |  |                          |  |         |    |            |       |       |  |  |  |  |  |  |         |    |            |       |       |  |  |  |  |  |  |                |    |            |       |       |  |  |  |  |  |  |         |    |            |       |       |  |  |  |  |  |  |                   |    |            |       |       |  |                |        |   |                 |  |     |    |  |       |       |  |  |  |  |  |  |       |    |            |       |       |  |  |  |  |  |  |         |    |            |       |       |  |                |        |  |                       |  |         |    |            |       |       |  |                |        |  |                          |  |         |    |            |       |       |  |  |  |  |  |  |                |     |            |       |       |  |  |  |  |  |  |         |    |  |       |       |  |                |        |  |                       |  |         |    |            |  |       |  |  |  |  |  |  |             |    |  |       |       |  |  |  |  |  |  |         |    |            |  |       |  |  |  |  |  |  |         |     |            |       |       |  |  |  |  |  |  |         |     |            |       |       |  |                |        |  |                       |  |  |  |  |  |  |  |                |        |  |                          |  |  |  |     |  |            |       |  |  |                |        |   |                 |  |     |    |            |       |  |  |  |  |  |  |  |         |    |            |       |  |  |  |  |  |  |  |         |    |            |       |  |  |  |  |  |  |  |     |    |  |       |       |  |  |  |  |  |  |         |    |            |       |  |  |  |  |  |  |  |       |    |            |       |  |  |  |  |  |  |  |         |    |            |       |  |  |  |  |  |  |  |         |    |            |       |  |  |  |  |  |  |  |     |  |            |  |       |  |                |        |   |                 |  |     |    |  |       |       |  |  |  |  |  |  |     |    |            |  |       |  |  |  |  |  |  |         |    |  |       |       |  |  |  |  |  |  |         |    |            |  |       |  |  |  |  |  |  |         |    |            |  |       |  |  |  |  |  |  |                |    |  |       |       |  |  |  |  |  |  |         |    |  |       |       |  |  |  |  |  |  |         |    |            |  |       |  |  |  |  |  |  |             |    |  |       |       |  |  |  |  |  |  |         |    |            |  |       |  |  |  |  |  |  |        |     |  |       |       |  |  |  |  |  |  |         |     |            |  |       |  |  |  |  |  |  |
| PEUGEOT 206 Limousine (98-09)  |  |            |       |            |                                    |                |                                    |                |                          |     |                     |     |     |    |            |       |       |           |                |        |  |                        |     |             |    |            |       |       |           |                |        |  |                     |     |         |    |            |       |       |  |                |        |  |                     |     |             |    |  |       |       |  |  |  |  |  |  |                |    |            |       |       |       |                |        |  |                     |     |         |    |            |       |       |           |  |  |  |  |  |                   |    |            |       |       |       |                |        |       |                    |  |         |    |            |       |       |       |                |        |       |                     |  |       |    |            |       |       |       |                |        |       |                        |  |         |    |            |       |       |                                    |                |        |  |                       |     |         |    |            |       |       |  |                |        |  |                          |  |         |    |  |       |       |  |  |  |  |  |  |         |     |            |       |       |  |  |  |  |  |  |                |    |            |       |       |  |                |        |  |                   |     |                |    |            |       |       |  |                |        |  |                   |     |                   |    |  |       |       |  |                |        |  |                   |     |         |    |            |       |       |  |  |  |  |  |  |             |     |            |       |       |  |  |  |  |  |  |         |    |            |       |       |  |                |        |  |                       |     |         |     |            |       |       |  |                |        |  |                          |  |         |     |            |       |       |  |                |        |  |                   |     |         |     |            |       |  |  |                |        |  |                   |     |  |   |     |       |       |       |                |                                    |                |                       |  |                     |    |            |    |       |       |       |           |                |        |  |                        |    |     |       |       |       |       |           |  |  |  |         |    |            |    |       |       |       |  |  |  |  |         |     |            |    |       |       |       |  |  |  |  |        |     |                |       |       |       |                |        |  |                       |  |  |  |         |    |  |       |                |           |  |                          |  |  |  |     |  |            |       |  |       |                |        |       |                    |  |     |    |            |       |  |       |                |        |       |                     |  |         |    |            |       |  |       |                |        |       |                        |  |         |    |            |       |       |                                    |                |        |  |                       |  |     |    |  |       |       |  |                |        |  |                          |  |         |    |            |       |       |  |  |  |  |  |  |         |    |            |       |       |  |  |  |  |  |  |                |    |            |       |       |  |  |  |  |  |  |         |    |            |       |       |  |  |  |  |  |  |                   |    |            |       |       |  |                |        |   |                 |  |     |    |  |       |       |  |  |  |  |  |  |       |    |            |       |       |  |  |  |  |  |  |         |    |            |       |       |  |                |        |  |                       |  |         |    |            |       |       |  |                |        |  |                          |  |         |    |            |       |       |  |  |  |  |  |  |                |     |            |       |       |  |  |  |  |  |  |         |    |  |       |       |  |                |        |  |                       |  |         |    |            |  |       |  |  |  |  |  |  |             |    |  |       |       |  |  |  |  |  |  |         |    |            |  |       |  |  |  |  |  |  |         |     |            |       |       |  |  |  |  |  |  |         |     |            |       |       |  |                |        |  |                       |  |  |  |  |  |  |  |                |        |  |                          |  |  |  |     |  |            |       |  |  |                |        |   |                 |  |     |    |            |       |  |  |  |  |  |  |  |         |    |            |       |  |  |  |  |  |  |  |         |    |            |       |  |  |  |  |  |  |  |     |    |  |       |       |  |  |  |  |  |  |         |    |            |       |  |  |  |  |  |  |  |       |    |            |       |  |  |  |  |  |  |  |         |    |            |       |  |  |  |  |  |  |  |         |    |            |       |  |  |  |  |  |  |  |     |  |            |  |       |  |                |        |   |                 |  |     |    |  |       |       |  |  |  |  |  |  |     |    |            |  |       |  |  |  |  |  |  |         |    |  |       |       |  |  |  |  |  |  |         |    |            |  |       |  |  |  |  |  |  |         |    |            |  |       |  |  |  |  |  |  |                |    |  |       |       |  |  |  |  |  |  |         |    |  |       |       |  |  |  |  |  |  |         |    |            |  |       |  |  |  |  |  |  |             |    |  |       |       |  |  |  |  |  |  |         |    |            |  |       |  |  |  |  |  |  |        |     |  |       |       |  |  |  |  |  |  |         |     |            |  |       |  |  |  |  |  |  |
|    | <table border="1"> <tr> <td>1.1</td> <td></td> <td></td> <td>09.98</td> <td>02.09</td> <td></td> <td>13.0460-3975.2</td> <td>603975</td> <td></td> <td>23597 18,0 +/S</td> <td>BOS</td> </tr> <tr> <td>1.4</td> <td>55</td> <td></td> <td>03.07</td> <td>02.09</td> <td></td> <td></td> <td></td> <td></td> <td></td> <td></td> </tr> <tr> <td>1.4</td> <td>55</td> <td></td> <td>09.98</td> <td>02.09</td> <td></td> <td></td> <td></td> <td></td> <td></td> <td></td> </tr> <tr> <td>1.4 HDi</td> <td>50</td> <td></td> <td>09.01</td> <td>02.09</td> <td></td> <td></td> <td></td> <td></td> <td></td> <td></td> </tr> <tr> <td>1.4 HDi</td> <td>51</td> <td></td> <td>09.02</td> <td>02.07</td> <td></td> <td></td> <td></td> <td></td> <td></td> <td></td> </tr> <tr> <td>1.4 HDi eco 70</td> <td>50</td> <td></td> <td>09.08</td> <td>02.09</td> <td></td> <td></td> <td></td> <td></td> <td></td> <td></td> </tr> <tr> <td>1.4 LPG</td> <td>55</td> <td></td> <td>05.06</td> <td>09.07</td> <td></td> <td></td> <td></td> <td></td> <td></td> <td></td> </tr> <tr> <td>1.4 Roland Garros</td> <td>55</td> <td></td> <td>09.98</td> <td>02.09</td> <td>- ABS</td> <td></td> <td></td> <td></td> <td></td> <td></td> </tr> <tr> <td>1.6</td> <td>65</td> <td></td> <td>09.98</td> <td>12.00</td> <td>- ABS</td> <td></td> <td></td> <td></td> <td></td> <td></td> </tr> <tr> <td>1.9 D</td> <td>51</td> <td></td> <td>09.98</td> <td>02.09</td> <td>- ABS</td> <td></td> <td></td> <td></td> <td></td> <td></td> </tr> <tr> <td>1.6 16V</td> <td>80</td> <td>ORGA 09078</td> <td>12.00</td> <td></td> <td></td> <td>13.0460-3978.2</td> <td>603978</td> <td></td> <td>23332 18,0 +/Zub/S</td> <td>BOS</td> </tr> <tr> <td>2.0 HDi</td> <td>66</td> <td>ORGA 09078</td> <td>12.99</td> <td></td> <td></td> <td></td> <td></td> <td></td> <td></td> <td></td> </tr> <tr> <td>2.0 S16</td> <td>99</td> <td></td> <td>04.99</td> <td>10.00</td> <td></td> <td></td> <td></td> <td></td> <td></td> <td></td> </tr> <tr> <td>2.0 S16</td> <td>100</td> <td>ORGA 09078</td> <td>10.00</td> <td></td> <td></td> <td></td> <td></td> <td></td> <td></td> <td></td> </tr> <tr> <td>1.4 16V</td> <td>65</td> <td></td> <td>10.03</td> <td>02.09</td> <td></td> <td>13.0460-3994.2</td> <td>603994</td> <td></td> <td>23599 19,0 /Zub/S</td> <td>BOS</td> </tr> <tr> <td>1.6 16V</td> <td>80</td> <td>ORGA 09079</td> <td></td> <td>02.09</td> <td></td> <td>13.0470-3994.2</td> <td>LD3994</td> <td></td> <td>23599 19,0 /Zub/S</td> <td>BOS</td> </tr> <tr> <td>1.6 HDi 110</td> <td>80</td> <td></td> <td>05.04</td> <td>02.09</td> <td></td> <td>13.0460-0454.2</td> <td>610454</td> <td></td> <td>Belagsatz-Zubehör</td> <td>BOS</td> </tr> <tr> <td>2.0 HDi</td> <td>66</td> <td>ORGA 09079</td> <td></td> <td>02.09</td> <td></td> <td></td> <td></td> <td></td> <td></td> <td></td> </tr> <tr> <td>2.0 S16</td> <td>100</td> <td>ORGA 09079</td> <td></td> <td>02.09</td> <td></td> <td></td> <td></td> <td></td> <td></td> <td></td> </tr> <tr> <td>1.6 16V</td> <td>80</td> <td>ORGA 10950</td> <td></td> <td>02.09</td> <td></td> <td>13.0460-2862.2</td> <td>602862</td> <td></td> <td>23346 19,0 /WE/S</td> <td>TRW</td> </tr> <tr> <td>2.0 HDi</td> <td>66</td> <td>ORGA 10892</td> <td></td> <td>02.09</td> <td></td> <td></td> <td></td> <td></td> <td></td> <td></td> </tr> <tr> <td>2.0 RC</td> <td>130</td> <td></td> <td>07.03</td> <td>02.09</td> <td></td> <td>13.0460-3966.2</td> <td>603966</td> <td></td> <td>23600 19,4 /Zub/S</td> <td>BOS</td> </tr> <tr> <td></td> <td></td> <td></td> <td></td> <td></td> <td></td> <td>13.0470-3966.2</td> <td>LD3966</td> <td></td> <td>23600 19,4 /Zub/S</td> <td>BOS</td> </tr> <tr> <td></td> <td> <table border="1"> <tr> <td>1.1</td> <td></td> <td></td> <td>09.98</td> <td>02.09</td> <td>- belüftete Scheiben <sup>1)</sup></td> <td>24.0113-0185.1</td> <td>413185</td> <td></td> <td>248 13,0 11,0 +S +B</td> <td></td> </tr> <tr> <td>1.4</td> <td>55</td> <td></td> <td>03.07</td> <td>02.09</td> <td>- ROL GAR</td> <td>24.0313-0185.1</td> <td>513185</td> <td></td> <td>248 13,0 11,0 +S +B PD</td> <td></td> </tr> <tr> <td>1.4</td> <td>55</td> <td></td> <td>09.98</td> <td>02.09</td> <td>- ROL GAR</td> <td></td> <td></td> <td></td> <td></td> <td></td> </tr> <tr> <td>1.4 HDi</td> <td>50</td> <td></td> <td>09.01</td> <td>02.09</td> <td></td> <td></td> <td></td> <td></td> <td></td> <td></td> </tr> <tr> <td>1.4 HDi</td> <td>51</td> <td></td> <td>09.02</td> <td>02.07</td> <td></td> <td></td> <td></td> <td></td> <td></td> <td></td> </tr> <tr> <td>1.4 HDi eco 70</td> <td>50</td> <td></td> <td>09.08</td> <td>02.09</td> <td></td> <td></td> <td></td> <td></td> <td></td> <td></td> </tr> <tr> <td>1.4 LPG</td> <td>55</td> <td></td> <td>05.06</td> <td>09.07</td> <td>- ROL GAR</td> <td></td> <td></td> <td></td> <td></td> <td></td> </tr> <tr> <td>1.1</td> <td></td> <td>ORGA 08988</td> <td>09.98</td> <td></td> <td>- ABS</td> <td>24.0110-0187.1</td> <td>410187</td> <td>- ABS</td> <td>247 10,0 9,0 +S +B</td> <td></td> </tr> <tr> <td>1.1</td> <td></td> <td>ORGA 08989</td> <td></td> <td></td> <td>- ABS</td> <td>24.0113-0185.1</td> <td>413185</td> <td>- ABS</td> <td>248 13,0 11,0 +S +B</td> <td></td> </tr> <tr> <td></td> <td></td> <td>ORGA 09974</td> <td></td> <td></td> <td>- ABS</td> <td>24.0313-0185.1</td> <td>513185</td> <td>- ABS</td> <td>248 13,0 11,0 +S +B PD</td> <td></td> </tr> <tr> <td>1.1</td> <td></td> <td>ORGA 09975</td> <td></td> <td>02.09</td> <td>+ belüftete Scheiben <sup>2)</sup></td> <td>24.0120-0132.1</td> <td>420132</td> <td></td> <td>247 20,4 18,5 V +S +B</td> <td></td> </tr> <tr> <td>1.4</td> <td>55</td> <td></td> <td>03.07</td> <td>02.09</td> <td></td> <td>24.0320-0132.1</td> <td>520132</td> <td></td> <td>247 20,4 18,5 V +S +B PD</td> <td></td> </tr> <tr> <td>1.4 HDi</td> <td>50</td> <td></td> <td>09.01</td> <td>02.09</td> <td></td> <td></td> <td></td> <td></td> <td></td> <td></td> </tr> <tr> <td>1.4 HDi</td> <td>51</td> <td></td> <td>09.02</td> <td>02.07</td> <td></td> <td></td> <td></td> <td></td> <td></td> <td></td> </tr> <tr> <td>1.4 HDi eco 70</td> <td>50</td> <td></td> <td>09.08</td> <td>02.09</td> <td></td> <td></td> <td></td> <td></td> <td></td> <td></td> </tr> <tr> <td>1.4 LPG</td> <td>55</td> <td></td> <td>05.06</td> <td>09.07</td> <td></td> <td></td> <td></td> <td></td> <td></td> <td></td> </tr> <tr> <td>1.4 Roland Garros</td> <td>55</td> <td></td> <td>09.98</td> <td>02.09</td> <td></td> <td></td> <td></td> <td></td> <td></td> <td></td> </tr> <tr> <td>1.6</td> <td>65</td> <td></td> <td>09.98</td> <td>12.00</td> <td></td> <td></td> <td></td> <td></td> <td></td> <td></td> </tr> <tr> <td>1.9 D</td> <td>51</td> <td></td> <td>09.98</td> <td>02.09</td> <td></td> <td></td> <td></td> <td></td> <td></td> <td></td> </tr> <tr> <td>1.6 16V</td> <td>80</td> <td>ORGA 09078</td> <td>12.00</td> <td></td> <td></td> <td>24.0120-0133.1</td> <td>420133</td> <td></td> <td>266 20,5 18,5 V +S +B</td> <td></td> </tr> <tr> <td>2.0 HDi</td> <td>66</td> <td>ORGA 09078</td> <td>12.99</td> <td></td> <td></td> <td>24.0320-0133.1</td> <td>520133</td> <td></td> <td>266 20,5 18,5 V +S +B PD</td> <td></td> </tr> <tr> <td>2.0 S16</td> <td>99</td> <td></td> <td>04.99</td> <td>10.00</td> <td></td> <td></td> <td></td> <td></td> <td></td> <td></td> </tr> <tr> <td>2.0 S16</td> <td>100</td> <td>ORGA 09078</td> <td>10.00</td> <td></td> <td></td> <td></td> <td></td> <td></td> <td></td> <td></td> </tr> <tr> <td>1.4 16V</td> <td>65</td> <td></td> <td>10.03</td> <td>02.09</td> <td></td> <td>24.0122-0194.1</td> <td>422194</td> <td></td> <td>266 22,0 20,0 V +S +B</td> <td></td> </tr> <tr> <td>1.6 16V</td> <td>80</td> <td>ORGA 09079</td> <td></td> <td>02.09</td> <td></td> <td></td> <td></td> <td></td> <td></td> <td></td> </tr> <tr> <td>1.6 HDi 110</td> <td>80</td> <td></td> <td>05.04</td> <td>02.09</td> <td></td> <td></td> <td></td> <td></td> <td></td> <td></td> </tr> <tr> <td>2.0 HDi</td> <td>66</td> <td>ORGA 09079</td> <td></td> <td>02.09</td> <td></td> <td></td> <td></td> <td></td> <td></td> <td></td> </tr> <tr> <td>2.0 S16</td> <td>100</td> <td>ORGA 09079</td> <td></td> <td>02.09</td> <td></td> <td></td> <td></td> <td></td> <td></td> <td></td> </tr> <tr> <td>2.0 RC</td> <td>130</td> <td></td> <td>07.03</td> <td>02.09</td> <td></td> <td>24.0126-0120.1</td> <td>426120</td> <td></td> <td>283 26,0 24,0 V +S +B</td> <td></td> </tr> <tr> <td></td> <td></td> <td></td> <td></td> <td></td> <td></td> <td>24.0326-0120.1</td> <td>526120</td> <td></td> <td>283 26,0 24,0 V +S +B PD</td> <td></td> </tr> <tr> <td></td> <td> <table border="1"> <tr> <td>1.1</td> <td></td> <td>ORGA 09456</td> <td>09.98</td> <td></td> <td></td> <td>24.0713-1115.3</td> <td>360035</td> <td>2</td> <td>Radsensor L=815</td> <td></td> </tr> <tr> <td>1.4</td> <td>55</td> <td>ORGA 09456</td> <td>09.98</td> <td></td> <td></td> <td></td> <td></td> <td></td> <td></td> <td></td> </tr> <tr> <td>1.4 HDi</td> <td>50</td> <td>ORGA 09456</td> <td>09.01</td> <td></td> <td></td> <td></td> <td></td> <td></td> <td></td> <td></td> </tr> <tr> <td>1.4 HDi</td> <td>51</td> <td>ORGA 09456</td> <td>09.02</td> <td></td> <td></td> <td></td> <td></td> <td></td> <td></td> <td></td> </tr> <tr> <td>1.6</td> <td>65</td> <td></td> <td>09.98</td> <td>12.00</td> <td></td> <td></td> <td></td> <td></td> <td></td> <td></td> </tr> <tr> <td>1.6 16V</td> <td>80</td> <td>ORGA 09456</td> <td>12.00</td> <td></td> <td></td> <td></td> <td></td> <td></td> <td></td> <td></td> </tr> <tr> <td>1.9 D</td> <td>51</td> <td>ORGA 09456</td> <td>09.98</td> <td></td> <td></td> <td></td> <td></td> <td></td> <td></td> <td></td> </tr> <tr> <td>2.0 HDi</td> <td>66</td> <td>ORGA 09456</td> <td>12.99</td> <td></td> <td></td> <td></td> <td></td> <td></td> <td></td> <td></td> </tr> <tr> <td>2.0 S16</td> <td>99</td> <td>ORGA 09456</td> <td>04.99</td> <td></td> <td></td> <td></td> <td></td> <td></td> <td></td> <td></td> </tr> <tr> <td>1.1</td> <td></td> <td>ORGA 09457</td> <td></td> <td>02.09</td> <td></td> <td>24.0711-6205.3</td> <td>360229</td> <td>2</td> <td>Radsensor L=815</td> <td></td> </tr> <tr> <td>1.4</td> <td>55</td> <td></td> <td>03.07</td> <td>02.09</td> <td></td> <td></td> <td></td> <td></td> <td></td> <td></td> </tr> <tr> <td>1.4</td> <td>55</td> <td>ORGA 09457</td> <td></td> <td>02.09</td> <td></td> <td></td> <td></td> <td></td> <td></td> <td></td> </tr> <tr> <td>1.4 16V</td> <td>65</td> <td></td> <td>10.03</td> <td>02.09</td> <td></td> <td></td> <td></td> <td></td> <td></td> <td></td> </tr> <tr> <td>1.4 HDi</td> <td>50</td> <td>ORGA 09457</td> <td></td> <td>02.09</td> <td></td> <td></td> <td></td> <td></td> <td></td> <td></td> </tr> <tr> <td>1.4 HDi</td> <td>51</td> <td>ORGA 09457</td> <td></td> <td>02.09</td> <td></td> <td></td> <td></td> <td></td> <td></td> <td></td> </tr> <tr> <td>1.4 HDi eco 70</td> <td>50</td> <td></td> <td>09.08</td> <td>02.09</td> <td></td> <td></td> <td></td> <td></td> <td></td> <td></td> </tr> <tr> <td>1.4 LPG</td> <td>55</td> <td></td> <td>05.06</td> <td>09.07</td> <td></td> <td></td> <td></td> <td></td> <td></td> <td></td> </tr> <tr> <td>1.6 16V</td> <td>80</td> <td>ORGA 09457</td> <td></td> <td>02.09</td> <td></td> <td></td> <td></td> <td></td> <td></td> <td></td> </tr> <tr> <td>1.6 HDi 110</td> <td>80</td> <td></td> <td>05.04</td> <td>02.09</td> <td></td> <td></td> <td></td> <td></td> <td></td> <td></td> </tr> <tr> <td>2.0 HDi</td> <td>66</td> <td>ORGA 09457</td> <td></td> <td>02.09</td> <td></td> <td></td> <td></td> <td></td> <td></td> <td></td> </tr> <tr> <td>2.0 RC</td> <td>130</td> <td></td> <td>07.03</td> <td>02.09</td> <td></td> <td></td> <td></td> <td></td> <td></td> <td></td> </tr> <tr> <td>2.0 S16</td> <td>100</td> <td>ORGA 09457</td> <td></td> <td>02.09</td> <td></td> <td></td> <td></td> <td></td> <td></td> <td></td> </tr> </table> </td> </tr> </table></td></tr></table> | 1.1        |       |            | 09.98                              | 02.09          |                                    | 13.0460-3975.2 | 603975                   |     | 23597 18,0 +/S      | BOS | 1.4 | 55 |            | 03.07 | 02.09 |           |                |        |  |                        |     | 1.4         | 55 |            | 09.98 | 02.09 |           |                |        |  |                     |     | 1.4 HDi | 50 |            | 09.01 | 02.09 |  |                |        |  |                     |     | 1.4 HDi     | 51 |  | 09.02 | 02.07 |  |  |  |  |  |  | 1.4 HDi eco 70 | 50 |            | 09.08 | 02.09 |       |                |        |  |                     |     | 1.4 LPG | 55 |            | 05.06 | 09.07 |           |  |  |  |  |  | 1.4 Roland Garros | 55 |            | 09.98 | 02.09 | - ABS |                |        |       |                    |  | 1.6     | 65 |            | 09.98 | 12.00 | - ABS |                |        |       |                     |  | 1.9 D | 51 |            | 09.98 | 02.09 | - ABS |                |        |       |                        |  | 1.6 16V | 80 | ORGA 09078 | 12.00 |       |                                    | 13.0460-3978.2 | 603978 |  | 23332 18,0 +/Zub/S    | BOS | 2.0 HDi | 66 | ORGA 09078 | 12.99 |       |  |                |        |  |                          |  | 2.0 S16 | 99 |  | 04.99 | 10.00 |  |  |  |  |  |  | 2.0 S16 | 100 | ORGA 09078 | 10.00 |       |  |  |  |  |  |  | 1.4 16V        | 65 |            | 10.03 | 02.09 |  | 13.0460-3994.2 | 603994 |  | 23599 19,0 /Zub/S | BOS | 1.6 16V        | 80 | ORGA 09079 |       | 02.09 |  | 13.0470-3994.2 | LD3994 |  | 23599 19,0 /Zub/S | BOS | 1.6 HDi 110       | 80 |  | 05.04 | 02.09 |  | 13.0460-0454.2 | 610454 |  | Belagsatz-Zubehör | BOS | 2.0 HDi | 66 | ORGA 09079 |       | 02.09 |  |  |  |  |  |  | 2.0 S16     | 100 | ORGA 09079 |       | 02.09 |  |  |  |  |  |  | 1.6 16V | 80 | ORGA 10950 |       | 02.09 |  | 13.0460-2862.2 | 602862 |  | 23346 19,0 /WE/S      | TRW | 2.0 HDi | 66  | ORGA 10892 |       | 02.09 |  |                |        |  |                          |  | 2.0 RC  | 130 |            | 07.03 | 02.09 |  | 13.0460-3966.2 | 603966 |  | 23600 19,4 /Zub/S | BOS |         |     |            |       |  |  | 13.0470-3966.2 | LD3966 |  | 23600 19,4 /Zub/S | BOS |  | <table border="1"> <tr> <td>1.1</td> <td></td> <td></td> <td>09.98</td> <td>02.09</td> <td>- belüftete Scheiben <sup>1)</sup></td> <td>24.0113-0185.1</td> <td>413185</td> <td></td> <td>248 13,0 11,0 +S +B</td> <td></td> </tr> <tr> <td>1.4</td> <td>55</td> <td></td> <td>03.07</td> <td>02.09</td> <td>- ROL GAR</td> <td>24.0313-0185.1</td> <td>513185</td> <td></td> <td>248 13,0 11,0 +S +B PD</td> <td></td> </tr> <tr> <td>1.4</td> <td>55</td> <td></td> <td>09.98</td> <td>02.09</td> <td>- ROL GAR</td> <td></td> <td></td> <td></td> <td></td> <td></td> </tr> <tr> <td>1.4 HDi</td> <td>50</td> <td></td> <td>09.01</td> <td>02.09</td> <td></td> <td></td> <td></td> <td></td> <td></td> <td></td> </tr> <tr> <td>1.4 HDi</td> <td>51</td> <td></td> <td>09.02</td> <td>02.07</td> <td></td> <td></td> <td></td> <td></td> <td></td> <td></td> </tr> <tr> <td>1.4 HDi eco 70</td> <td>50</td> <td></td> <td>09.08</td> <td>02.09</td> <td></td> <td></td> <td></td> <td></td> <td></td> <td></td> </tr> <tr> <td>1.4 LPG</td> <td>55</td> <td></td> <td>05.06</td> <td>09.07</td> <td>- ROL GAR</td> <td></td> <td></td> <td></td> <td></td> <td></td> </tr> <tr> <td>1.1</td> <td></td> <td>ORGA 08988</td> <td>09.98</td> <td></td> <td>- ABS</td> <td>24.0110-0187.1</td> <td>410187</td> <td>- ABS</td> <td>247 10,0 9,0 +S +B</td> <td></td> </tr> <tr> <td>1.1</td> <td></td> <td>ORGA 08989</td> <td></td> <td></td> <td>- ABS</td> <td>24.0113-0185.1</td> <td>413185</td> <td>- ABS</td> <td>248 13,0 11,0 +S +B</td> <td></td> </tr> <tr> <td></td> <td></td> <td>ORGA 09974</td> <td></td> <td></td> <td>- ABS</td> <td>24.0313-0185.1</td> <td>513185</td> <td>- ABS</td> <td>248 13,0 11,0 +S +B PD</td> <td></td> </tr> <tr> <td>1.1</td> <td></td> <td>ORGA 09975</td> <td></td> <td>02.09</td> <td>+ belüftete Scheiben <sup>2)</sup></td> <td>24.0120-0132.1</td> <td>420132</td> <td></td> <td>247 20,4 18,5 V +S +B</td> <td></td> </tr> <tr> <td>1.4</td> <td>55</td> <td></td> <td>03.07</td> <td>02.09</td> <td></td> <td>24.0320-0132.1</td> <td>520132</td> <td></td> <td>247 20,4 18,5 V +S +B PD</td> <td></td> </tr> <tr> <td>1.4 HDi</td> <td>50</td> <td></td> <td>09.01</td> <td>02.09</td> <td></td> <td></td> <td></td> <td></td> <td></td> <td></td> </tr> <tr> <td>1.4 HDi</td> <td>51</td> <td></td> <td>09.02</td> <td>02.07</td> <td></td> <td></td> <td></td> <td></td> <td></td> <td></td> </tr> <tr> <td>1.4 HDi eco 70</td> <td>50</td> <td></td> <td>09.08</td> <td>02.09</td> <td></td> <td></td> <td></td> <td></td> <td></td> <td></td> </tr> <tr> <td>1.4 LPG</td> <td>55</td> <td></td> <td>05.06</td> <td>09.07</td> <td></td> <td></td> <td></td> <td></td> <td></td> <td></td> </tr> <tr> <td>1.4 Roland Garros</td> <td>55</td> <td></td> <td>09.98</td> <td>02.09</td> <td></td> <td></td> <td></td> <td></td> <td></td> <td></td> </tr> <tr> <td>1.6</td> <td>65</td> <td></td> <td>09.98</td> <td>12.00</td> <td></td> <td></td> <td></td> <td></td> <td></td> <td></td> </tr> <tr> <td>1.9 D</td> <td>51</td> <td></td> <td>09.98</td> <td>02.09</td> <td></td> <td></td> <td></td> <td></td> <td></td> <td></td> </tr> <tr> <td>1.6 16V</td> <td>80</td> <td>ORGA 09078</td> <td>12.00</td> <td></td> <td></td> <td>24.0120-0133.1</td> <td>420133</td> <td></td> <td>266 20,5 18,5 V +S +B</td> <td></td> </tr> <tr> <td>2.0 HDi</td> <td>66</td> <td>ORGA 09078</td> <td>12.99</td> <td></td> <td></td> <td>24.0320-0133.1</td> <td>520133</td> <td></td> <td>266 20,5 18,5 V +S +B PD</td> <td></td> </tr> <tr> <td>2.0 S16</td> <td>99</td> <td></td> <td>04.99</td> <td>10.00</td> <td></td> <td></td> <td></td> <td></td> <td></td> <td></td> </tr> <tr> <td>2.0 S16</td> <td>100</td> <td>ORGA 09078</td> <td>10.00</td> <td></td> <td></td> <td></td> <td></td> <td></td> <td></td> <td></td> </tr> <tr> <td>1.4 16V</td> <td>65</td> <td></td> <td>10.03</td> <td>02.09</td> <td></td> <td>24.0122-0194.1</td> <td>422194</td> <td></td> <td>266 22,0 20,0 V +S +B</td> <td></td> </tr> <tr> <td>1.6 16V</td> <td>80</td> <td>ORGA 09079</td> <td></td> <td>02.09</td> <td></td> <td></td> <td></td> <td></td> <td></td> <td></td> </tr> <tr> <td>1.6 HDi 110</td> <td>80</td> <td></td> <td>05.04</td> <td>02.09</td> <td></td> <td></td> <td></td> <td></td> <td></td> <td></td> </tr> <tr> <td>2.0 HDi</td> <td>66</td> <td>ORGA 09079</td> <td></td> <td>02.09</td> <td></td> <td></td> <td></td> <td></td> <td></td> <td></td> </tr> <tr> <td>2.0 S16</td> <td>100</td> <td>ORGA 09079</td> <td></td> <td>02.09</td> <td></td> <td></td> <td></td> <td></td> <td></td> <td></td> </tr> <tr> <td>2.0 RC</td> <td>130</td> <td></td> <td>07.03</td> <td>02.09</td> <td></td> <td>24.0126-0120.1</td> <td>426120</td> <td></td> <td>283 26,0 24,0 V +S +B</td> <td></td> </tr> <tr> <td></td> <td></td> <td></td> <td></td> <td></td> <td></td> <td>24.0326-0120.1</td> <td>526120</td> <td></td> <td>283 26,0 24,0 V +S +B PD</td> <td></td> </tr> <tr> <td></td> <td> <table border="1"> <tr> <td>1.1</td> <td></td> <td>ORGA 09456</td> <td>09.98</td> <td></td> <td></td> <td>24.0713-1115.3</td> <td>360035</td> <td>2</td> <td>Radsensor L=815</td> <td></td> </tr> <tr> <td>1.4</td> <td>55</td> <td>ORGA 09456</td> <td>09.98</td> <td></td> <td></td> <td></td> <td></td> <td></td> <td></td> <td></td> </tr> <tr> <td>1.4 HDi</td> <td>50</td> <td>ORGA 09456</td> <td>09.01</td> <td></td> <td></td> <td></td> <td></td> <td></td> <td></td> <td></td> </tr> <tr> <td>1.4 HDi</td> <td>51</td> <td>ORGA 09456</td> <td>09.02</td> <td></td> <td></td> <td></td> <td></td> <td></td> <td></td> <td></td> </tr> <tr> <td>1.6</td> <td>65</td> <td></td> <td>09.98</td> <td>12.00</td> <td></td> <td></td> <td></td> <td></td> <td></td> <td></td> </tr> <tr> <td>1.6 16V</td> <td>80</td> <td>ORGA 09456</td> <td>12.00</td> <td></td> <td></td> <td></td> <td></td> <td></td> <td></td> <td></td> </tr> <tr> <td>1.9 D</td> <td>51</td> <td>ORGA 09456</td> <td>09.98</td> <td></td> <td></td> <td></td> <td></td> <td></td> <td></td> <td></td> </tr> <tr> <td>2.0 HDi</td> <td>66</td> <td>ORGA 09456</td> <td>12.99</td> <td></td> <td></td> <td></td> <td></td> <td></td> <td></td> <td></td> </tr> <tr> <td>2.0 S16</td> <td>99</td> <td>ORGA 09456</td> <td>04.99</td> <td></td> <td></td> <td></td> <td></td> <td></td> <td></td> <td></td> </tr> <tr> <td>1.1</td> <td></td> <td>ORGA 09457</td> <td></td> <td>02.09</td> <td></td> <td>24.0711-6205.3</td> <td>360229</td> <td>2</td> <td>Radsensor L=815</td> <td></td> </tr> <tr> <td>1.4</td> <td>55</td> <td></td> <td>03.07</td> <td>02.09</td> <td></td> <td></td> <td></td> <td></td> <td></td> <td></td> </tr> <tr> <td>1.4</td> <td>55</td> <td>ORGA 09457</td> <td></td> <td>02.09</td> <td></td> <td></td> <td></td> <td></td> <td></td> <td></td> </tr> <tr> <td>1.4 16V</td> <td>65</td> <td></td> <td>10.03</td> <td>02.09</td> <td></td> <td></td> <td></td> <td></td> <td></td> <td></td> </tr> <tr> <td>1.4 HDi</td> <td>50</td> <td>ORGA 09457</td> <td></td> <td>02.09</td> <td></td> <td></td> <td></td> <td></td> <td></td> <td></td> </tr> <tr> <td>1.4 HDi</td> <td>51</td> <td>ORGA 09457</td> <td></td> <td>02.09</td> <td></td> <td></td> <td></td> <td></td> <td></td> <td></td> </tr> <tr> <td>1.4 HDi eco 70</td> <td>50</td> <td></td> <td>09.08</td> <td>02.09</td> <td></td> <td></td> <td></td> <td></td> <td></td> <td></td> </tr> <tr> <td>1.4 LPG</td> <td>55</td> <td></td> <td>05.06</td> <td>09.07</td> <td></td> <td></td> <td></td> <td></td> <td></td> <td></td> </tr> <tr> <td>1.6 16V</td> <td>80</td> <td>ORGA 09457</td> <td></td> <td>02.09</td> <td></td> <td></td> <td></td> <td></td> <td></td> <td></td> </tr> <tr> <td>1.6 HDi 110</td> <td>80</td> <td></td> <td>05.04</td> <td>02.09</td> <td></td> <td></td> <td></td> <td></td> <td></td> <td></td> </tr> <tr> <td>2.0 HDi</td> <td>66</td> <td>ORGA 09457</td> <td></td> <td>02.09</td> <td></td> <td></td> <td></td> <td></td> <td></td> <td></td> </tr> <tr> <td>2.0 RC</td> <td>130</td> <td></td> <td>07.03</td> <td>02.09</td> <td></td> <td></td> <td></td> <td></td> <td></td> <td></td> </tr> <tr> <td>2.0 S16</td> <td>100</td> <td>ORGA 09457</td> <td></td> <td>02.09</td> <td></td> <td></td> <td></td> <td></td> <td></td> <td></td> </tr> </table> </td> </tr> </table> | 1.1 |       |       | 09.98 | 02.09          | - belüftete Scheiben <sup>1)</sup> | 24.0113-0185.1 | 413185                |  | 248 13,0 11,0 +S +B |    | 1.4        | 55 |       | 03.07 | 02.09 | - ROL GAR | 24.0313-0185.1 | 513185 |  | 248 13,0 11,0 +S +B PD |    | 1.4 | 55    |       | 09.98 | 02.09 | - ROL GAR |  |  |  |         |    | 1.4 HDi    | 50 |       | 09.01 | 02.09 |  |  |  |  |         |     | 1.4 HDi    | 51 |       | 09.02 | 02.07 |  |  |  |  |        |     | 1.4 HDi eco 70 | 50    |       | 09.08 | 02.09          |        |  |                       |  |  |  | 1.4 LPG | 55 |  | 05.06 | 09.07          | - ROL GAR |  |                          |  |  |  | 1.1 |  | ORGA 08988 | 09.98 |  | - ABS | 24.0110-0187.1 | 410187 | - ABS | 247 10,0 9,0 +S +B |  | 1.1 |    | ORGA 08989 |       |  | - ABS | 24.0113-0185.1 | 413185 | - ABS | 248 13,0 11,0 +S +B |  |         |    | ORGA 09974 |       |  | - ABS | 24.0313-0185.1 | 513185 | - ABS | 248 13,0 11,0 +S +B PD |  | 1.1     |    | ORGA 09975 |       | 02.09 | + belüftete Scheiben <sup>2)</sup> | 24.0120-0132.1 | 420132 |  | 247 20,4 18,5 V +S +B |  | 1.4 | 55 |  | 03.07 | 02.09 |  | 24.0320-0132.1 | 520132 |  | 247 20,4 18,5 V +S +B PD |  | 1.4 HDi | 50 |            | 09.01 | 02.09 |  |  |  |  |  |  | 1.4 HDi | 51 |            | 09.02 | 02.07 |  |  |  |  |  |  | 1.4 HDi eco 70 | 50 |            | 09.08 | 02.09 |  |  |  |  |  |  | 1.4 LPG | 55 |            | 05.06 | 09.07 |  |  |  |  |  |  | 1.4 Roland Garros | 55 |            | 09.98 | 02.09 |  |                |        |   |                 |  | 1.6 | 65 |  | 09.98 | 12.00 |  |  |  |  |  |  | 1.9 D | 51 |            | 09.98 | 02.09 |  |  |  |  |  |  | 1.6 16V | 80 | ORGA 09078 | 12.00 |       |  | 24.0120-0133.1 | 420133 |  | 266 20,5 18,5 V +S +B |  | 2.0 HDi | 66 | ORGA 09078 | 12.99 |       |  | 24.0320-0133.1 | 520133 |  | 266 20,5 18,5 V +S +B PD |  | 2.0 S16 | 99 |            | 04.99 | 10.00 |  |  |  |  |  |  | 2.0 S16        | 100 | ORGA 09078 | 10.00 |       |  |  |  |  |  |  | 1.4 16V | 65 |  | 10.03 | 02.09 |  | 24.0122-0194.1 | 422194 |  | 266 22,0 20,0 V +S +B |  | 1.6 16V | 80 | ORGA 09079 |  | 02.09 |  |  |  |  |  |  | 1.6 HDi 110 | 80 |  | 05.04 | 02.09 |  |  |  |  |  |  | 2.0 HDi | 66 | ORGA 09079 |  | 02.09 |  |  |  |  |  |  | 2.0 S16 | 100 | ORGA 09079 |       | 02.09 |  |  |  |  |  |  | 2.0 RC  | 130 |            | 07.03 | 02.09 |  | 24.0126-0120.1 | 426120 |  | 283 26,0 24,0 V +S +B |  |  |  |  |  |  |  | 24.0326-0120.1 | 526120 |  | 283 26,0 24,0 V +S +B PD |  |  | <table border="1"> <tr> <td>1.1</td> <td></td> <td>ORGA 09456</td> <td>09.98</td> <td></td> <td></td> <td>24.0713-1115.3</td> <td>360035</td> <td>2</td> <td>Radsensor L=815</td> <td></td> </tr> <tr> <td>1.4</td> <td>55</td> <td>ORGA 09456</td> <td>09.98</td> <td></td> <td></td> <td></td> <td></td> <td></td> <td></td> <td></td> </tr> <tr> <td>1.4 HDi</td> <td>50</td> <td>ORGA 09456</td> <td>09.01</td> <td></td> <td></td> <td></td> <td></td> <td></td> <td></td> <td></td> </tr> <tr> <td>1.4 HDi</td> <td>51</td> <td>ORGA 09456</td> <td>09.02</td> <td></td> <td></td> <td></td> <td></td> <td></td> <td></td> <td></td> </tr> <tr> <td>1.6</td> <td>65</td> <td></td> <td>09.98</td> <td>12.00</td> <td></td> <td></td> <td></td> <td></td> <td></td> <td></td> </tr> <tr> <td>1.6 16V</td> <td>80</td> <td>ORGA 09456</td> <td>12.00</td> <td></td> <td></td> <td></td> <td></td> <td></td> <td></td> <td></td> </tr> <tr> <td>1.9 D</td> <td>51</td> <td>ORGA 09456</td> <td>09.98</td> <td></td> <td></td> <td></td> <td></td> <td></td> <td></td> <td></td> </tr> <tr> <td>2.0 HDi</td> <td>66</td> <td>ORGA 09456</td> <td>12.99</td> <td></td> <td></td> <td></td> <td></td> <td></td> <td></td> <td></td> </tr> <tr> <td>2.0 S16</td> <td>99</td> <td>ORGA 09456</td> <td>04.99</td> <td></td> <td></td> <td></td> <td></td> <td></td> <td></td> <td></td> </tr> <tr> <td>1.1</td> <td></td> <td>ORGA 09457</td> <td></td> <td>02.09</td> <td></td> <td>24.0711-6205.3</td> <td>360229</td> <td>2</td> <td>Radsensor L=815</td> <td></td> </tr> <tr> <td>1.4</td> <td>55</td> <td></td> <td>03.07</td> <td>02.09</td> <td></td> <td></td> <td></td> <td></td> <td></td> <td></td> </tr> <tr> <td>1.4</td> <td>55</td> <td>ORGA 09457</td> <td></td> <td>02.09</td> <td></td> <td></td> <td></td> <td></td> <td></td> <td></td> </tr> <tr> <td>1.4 16V</td> <td>65</td> <td></td> <td>10.03</td> <td>02.09</td> <td></td> <td></td> <td></td> <td></td> <td></td> <td></td> </tr> <tr> <td>1.4 HDi</td> <td>50</td> <td>ORGA 09457</td> <td></td> <td>02.09</td> <td></td> <td></td> <td></td> <td></td> <td></td> <td></td> </tr> <tr> <td>1.4 HDi</td> <td>51</td> <td>ORGA 09457</td> <td></td> <td>02.09</td> <td></td> <td></td> <td></td> <td></td> <td></td> <td></td> </tr> <tr> <td>1.4 HDi eco 70</td> <td>50</td> <td></td> <td>09.08</td> <td>02.09</td> <td></td> <td></td> <td></td> <td></td> <td></td> <td></td> </tr> <tr> <td>1.4 LPG</td> <td>55</td> <td></td> <td>05.06</td> <td>09.07</td> <td></td> <td></td> <td></td> <td></td> <td></td> <td></td> </tr> <tr> <td>1.6 16V</td> <td>80</td> <td>ORGA 09457</td> <td></td> <td>02.09</td> <td></td> <td></td> <td></td> <td></td> <td></td> <td></td> </tr> <tr> <td>1.6 HDi 110</td> <td>80</td> <td></td> <td>05.04</td> <td>02.09</td> <td></td> <td></td> <td></td> <td></td> <td></td> <td></td> </tr> <tr> <td>2.0 HDi</td> <td>66</td> <td>ORGA 09457</td> <td></td> <td>02.09</td> <td></td> <td></td> <td></td> <td></td> <td></td> <td></td> </tr> <tr> <td>2.0 RC</td> <td>130</td> <td></td> <td>07.03</td> <td>02.09</td> <td></td> <td></td> <td></td> <td></td> <td></td> <td></td> </tr> <tr> <td>2.0 S16</td> <td>100</td> <td>ORGA 09457</td> <td></td> <td>02.09</td> <td></td> <td></td> <td></td> <td></td> <td></td> <td></td> </tr> </table> | 1.1 |  | ORGA 09456 | 09.98 |  |  | 24.0713-1115.3 | 360035 | 2 | Radsensor L=815 |  | 1.4 | 55 | ORGA 09456 | 09.98 |  |  |  |  |  |  |  | 1.4 HDi | 50 | ORGA 09456 | 09.01 |  |  |  |  |  |  |  | 1.4 HDi | 51 | ORGA 09456 | 09.02 |  |  |  |  |  |  |  | 1.6 | 65 |  | 09.98 | 12.00 |  |  |  |  |  |  | 1.6 16V | 80 | ORGA 09456 | 12.00 |  |  |  |  |  |  |  | 1.9 D | 51 | ORGA 09456 | 09.98 |  |  |  |  |  |  |  | 2.0 HDi | 66 | ORGA 09456 | 12.99 |  |  |  |  |  |  |  | 2.0 S16 | 99 | ORGA 09456 | 04.99 |  |  |  |  |  |  |  | 1.1 |  | ORGA 09457 |  | 02.09 |  | 24.0711-6205.3 | 360229 | 2 | Radsensor L=815 |  | 1.4 | 55 |  | 03.07 | 02.09 |  |  |  |  |  |  | 1.4 | 55 | ORGA 09457 |  | 02.09 |  |  |  |  |  |  | 1.4 16V | 65 |  | 10.03 | 02.09 |  |  |  |  |  |  | 1.4 HDi | 50 | ORGA 09457 |  | 02.09 |  |  |  |  |  |  | 1.4 HDi | 51 | ORGA 09457 |  | 02.09 |  |  |  |  |  |  | 1.4 HDi eco 70 | 50 |  | 09.08 | 02.09 |  |  |  |  |  |  | 1.4 LPG | 55 |  | 05.06 | 09.07 |  |  |  |  |  |  | 1.6 16V | 80 | ORGA 09457 |  | 02.09 |  |  |  |  |  |  | 1.6 HDi 110 | 80 |  | 05.04 | 02.09 |  |  |  |  |  |  | 2.0 HDi | 66 | ORGA 09457 |  | 02.09 |  |  |  |  |  |  | 2.0 RC | 130 |  | 07.03 | 02.09 |  |  |  |  |  |  | 2.0 S16 | 100 | ORGA 09457 |  | 02.09 |  |  |  |  |  |  |
| 1.1  |  |            | 09.98 | 02.09      |                                    | 13.0460-3975.2 | 603975                             |                | 23597 18,0 +/S           | BOS |                     |     |     |    |            |       |       |           |                |        |  |                        |     |             |    |            |       |       |           |                |        |  |                     |     |         |    |            |       |       |  |                |        |  |                     |     |             |    |  |       |       |  |  |  |  |  |  |                |    |            |       |       |       |                |        |  |                     |     |         |    |            |       |       |           |  |  |  |  |  |                   |    |            |       |       |       |                |        |       |                    |  |         |    |            |       |       |       |                |        |       |                     |  |       |    |            |       |       |       |                |        |       |                        |  |         |    |            |       |       |                                    |                |        |  |                       |     |         |    |            |       |       |  |                |        |  |                          |  |         |    |  |       |       |  |  |  |  |  |  |         |     |            |       |       |  |  |  |  |  |  |                |    |            |       |       |  |                |        |  |                   |     |                |    |            |       |       |  |                |        |  |                   |     |                   |    |  |       |       |  |                |        |  |                   |     |         |    |            |       |       |  |  |  |  |  |  |             |     |            |       |       |  |  |  |  |  |  |         |    |            |       |       |  |                |        |  |                       |     |         |     |            |       |       |  |                |        |  |                          |  |         |     |            |       |       |  |                |        |  |                   |     |         |     |            |       |  |  |                |        |  |                   |     |  |   |     |       |       |       |                |                                    |                |                       |  |                     |    |            |    |       |       |       |           |                |        |  |                        |    |     |       |       |       |       |           |  |  |  |         |    |            |    |       |       |       |  |  |  |  |         |     |            |    |       |       |       |  |  |  |  |        |     |                |       |       |       |                |        |  |                       |  |  |  |         |    |  |       |                |           |  |                          |  |  |  |     |  |            |       |  |       |                |        |       |                    |  |     |    |            |       |  |       |                |        |       |                     |  |         |    |            |       |  |       |                |        |       |                        |  |         |    |            |       |       |                                    |                |        |  |                       |  |     |    |  |       |       |  |                |        |  |                          |  |         |    |            |       |       |  |  |  |  |  |  |         |    |            |       |       |  |  |  |  |  |  |                |    |            |       |       |  |  |  |  |  |  |         |    |            |       |       |  |  |  |  |  |  |                   |    |            |       |       |  |                |        |   |                 |  |     |    |  |       |       |  |  |  |  |  |  |       |    |            |       |       |  |  |  |  |  |  |         |    |            |       |       |  |                |        |  |                       |  |         |    |            |       |       |  |                |        |  |                          |  |         |    |            |       |       |  |  |  |  |  |  |                |     |            |       |       |  |  |  |  |  |  |         |    |  |       |       |  |                |        |  |                       |  |         |    |            |  |       |  |  |  |  |  |  |             |    |  |       |       |  |  |  |  |  |  |         |    |            |  |       |  |  |  |  |  |  |         |     |            |       |       |  |  |  |  |  |  |         |     |            |       |       |  |                |        |  |                       |  |  |  |  |  |  |  |                |        |  |                          |  |  |  |     |  |            |       |  |  |                |        |   |                 |  |     |    |            |       |  |  |  |  |  |  |  |         |    |            |       |  |  |  |  |  |  |  |         |    |            |       |  |  |  |  |  |  |  |     |    |  |       |       |  |  |  |  |  |  |         |    |            |       |  |  |  |  |  |  |  |       |    |            |       |  |  |  |  |  |  |  |         |    |            |       |  |  |  |  |  |  |  |         |    |            |       |  |  |  |  |  |  |  |     |  |            |  |       |  |                |        |   |                 |  |     |    |  |       |       |  |  |  |  |  |  |     |    |            |  |       |  |  |  |  |  |  |         |    |  |       |       |  |  |  |  |  |  |         |    |            |  |       |  |  |  |  |  |  |         |    |            |  |       |  |  |  |  |  |  |                |    |  |       |       |  |  |  |  |  |  |         |    |  |       |       |  |  |  |  |  |  |         |    |            |  |       |  |  |  |  |  |  |             |    |  |       |       |  |  |  |  |  |  |         |    |            |  |       |  |  |  |  |  |  |        |     |  |       |       |  |  |  |  |  |  |         |     |            |  |       |  |  |  |  |  |  |
| 1.4  | 55   |            | 03.07 | 02.09      |                                    |                |                                    |                |                          |     |                     |     |     |    |            |       |       |           |                |        |  |                        |     |             |    |            |       |       |           |                |        |  |                     |     |         |    |            |       |       |  |                |        |  |                     |     |             |    |  |       |       |  |  |  |  |  |  |                |    |            |       |       |       |                |        |  |                     |     |         |    |            |       |       |           |  |  |  |  |  |                   |    |            |       |       |       |                |        |       |                    |  |         |    |            |       |       |       |                |        |       |                     |  |       |    |            |       |       |       |                |        |       |                        |  |         |    |            |       |       |                                    |                |        |  |                       |     |         |    |            |       |       |  |                |        |  |                          |  |         |    |  |       |       |  |  |  |  |  |  |         |     |            |       |       |  |  |  |  |  |  |                |    |            |       |       |  |                |        |  |                   |     |                |    |            |       |       |  |                |        |  |                   |     |                   |    |  |       |       |  |                |        |  |                   |     |         |    |            |       |       |  |  |  |  |  |  |             |     |            |       |       |  |  |  |  |  |  |         |    |            |       |       |  |                |        |  |                       |     |         |     |            |       |       |  |                |        |  |                          |  |         |     |            |       |       |  |                |        |  |                   |     |         |     |            |       |  |  |                |        |  |                   |     |  |   |     |       |       |       |                |                                    |                |                       |  |                     |    |            |    |       |       |       |           |                |        |  |                        |    |     |       |       |       |       |           |  |  |  |         |    |            |    |       |       |       |  |  |  |  |         |     |            |    |       |       |       |  |  |  |  |        |     |                |       |       |       |                |        |  |                       |  |  |  |         |    |  |       |                |           |  |                          |  |  |  |     |  |            |       |  |       |                |        |       |                    |  |     |    |            |       |  |       |                |        |       |                     |  |         |    |            |       |  |       |                |        |       |                        |  |         |    |            |       |       |                                    |                |        |  |                       |  |     |    |  |       |       |  |                |        |  |                          |  |         |    |            |       |       |  |  |  |  |  |  |         |    |            |       |       |  |  |  |  |  |  |                |    |            |       |       |  |  |  |  |  |  |         |    |            |       |       |  |  |  |  |  |  |                   |    |            |       |       |  |                |        |   |                 |  |     |    |  |       |       |  |  |  |  |  |  |       |    |            |       |       |  |  |  |  |  |  |         |    |            |       |       |  |                |        |  |                       |  |         |    |            |       |       |  |                |        |  |                          |  |         |    |            |       |       |  |  |  |  |  |  |                |     |            |       |       |  |  |  |  |  |  |         |    |  |       |       |  |                |        |  |                       |  |         |    |            |  |       |  |  |  |  |  |  |             |    |  |       |       |  |  |  |  |  |  |         |    |            |  |       |  |  |  |  |  |  |         |     |            |       |       |  |  |  |  |  |  |         |     |            |       |       |  |                |        |  |                       |  |  |  |  |  |  |  |                |        |  |                          |  |  |  |     |  |            |       |  |  |                |        |   |                 |  |     |    |            |       |  |  |  |  |  |  |  |         |    |            |       |  |  |  |  |  |  |  |         |    |            |       |  |  |  |  |  |  |  |     |    |  |       |       |  |  |  |  |  |  |         |    |            |       |  |  |  |  |  |  |  |       |    |            |       |  |  |  |  |  |  |  |         |    |            |       |  |  |  |  |  |  |  |         |    |            |       |  |  |  |  |  |  |  |     |  |            |  |       |  |                |        |   |                 |  |     |    |  |       |       |  |  |  |  |  |  |     |    |            |  |       |  |  |  |  |  |  |         |    |  |       |       |  |  |  |  |  |  |         |    |            |  |       |  |  |  |  |  |  |         |    |            |  |       |  |  |  |  |  |  |                |    |  |       |       |  |  |  |  |  |  |         |    |  |       |       |  |  |  |  |  |  |         |    |            |  |       |  |  |  |  |  |  |             |    |  |       |       |  |  |  |  |  |  |         |    |            |  |       |  |  |  |  |  |  |        |     |  |       |       |  |  |  |  |  |  |         |     |            |  |       |  |  |  |  |  |  |
| 1.4  | 55   |            | 09.98 | 02.09      |                                    |                |                                    |                |                          |     |                     |     |     |    |            |       |       |           |                |        |  |                        |     |             |    |            |       |       |           |                |        |  |                     |     |         |    |            |       |       |  |                |        |  |                     |     |             |    |  |       |       |  |  |  |  |  |  |                |    |            |       |       |       |                |        |  |                     |     |         |    |            |       |       |           |  |  |  |  |  |                   |    |            |       |       |       |                |        |       |                    |  |         |    |            |       |       |       |                |        |       |                     |  |       |    |            |       |       |       |                |        |       |                        |  |         |    |            |       |       |                                    |                |        |  |                       |     |         |    |            |       |       |  |                |        |  |                          |  |         |    |  |       |       |  |  |  |  |  |  |         |     |            |       |       |  |  |  |  |  |  |                |    |            |       |       |  |                |        |  |                   |     |                |    |            |       |       |  |                |        |  |                   |     |                   |    |  |       |       |  |                |        |  |                   |     |         |    |            |       |       |  |  |  |  |  |  |             |     |            |       |       |  |  |  |  |  |  |         |    |            |       |       |  |                |        |  |                       |     |         |     |            |       |       |  |                |        |  |                          |  |         |     |            |       |       |  |                |        |  |                   |     |         |     |            |       |  |  |                |        |  |                   |     |  |   |     |       |       |       |                |                                    |                |                       |  |                     |    |            |    |       |       |       |           |                |        |  |                        |    |     |       |       |       |       |           |  |  |  |         |    |            |    |       |       |       |  |  |  |  |         |     |            |    |       |       |       |  |  |  |  |        |     |                |       |       |       |                |        |  |                       |  |  |  |         |    |  |       |                |           |  |                          |  |  |  |     |  |            |       |  |       |                |        |       |                    |  |     |    |            |       |  |       |                |        |       |                     |  |         |    |            |       |  |       |                |        |       |                        |  |         |    |            |       |       |                                    |                |        |  |                       |  |     |    |  |       |       |  |                |        |  |                          |  |         |    |            |       |       |  |  |  |  |  |  |         |    |            |       |       |  |  |  |  |  |  |                |    |            |       |       |  |  |  |  |  |  |         |    |            |       |       |  |  |  |  |  |  |                   |    |            |       |       |  |                |        |   |                 |  |     |    |  |       |       |  |  |  |  |  |  |       |    |            |       |       |  |  |  |  |  |  |         |    |            |       |       |  |                |        |  |                       |  |         |    |            |       |       |  |                |        |  |                          |  |         |    |            |       |       |  |  |  |  |  |  |                |     |            |       |       |  |  |  |  |  |  |         |    |  |       |       |  |                |        |  |                       |  |         |    |            |  |       |  |  |  |  |  |  |             |    |  |       |       |  |  |  |  |  |  |         |    |            |  |       |  |  |  |  |  |  |         |     |            |       |       |  |  |  |  |  |  |         |     |            |       |       |  |                |        |  |                       |  |  |  |  |  |  |  |                |        |  |                          |  |  |  |     |  |            |       |  |  |                |        |   |                 |  |     |    |            |       |  |  |  |  |  |  |  |         |    |            |       |  |  |  |  |  |  |  |         |    |            |       |  |  |  |  |  |  |  |     |    |  |       |       |  |  |  |  |  |  |         |    |            |       |  |  |  |  |  |  |  |       |    |            |       |  |  |  |  |  |  |  |         |    |            |       |  |  |  |  |  |  |  |         |    |            |       |  |  |  |  |  |  |  |     |  |            |  |       |  |                |        |   |                 |  |     |    |  |       |       |  |  |  |  |  |  |     |    |            |  |       |  |  |  |  |  |  |         |    |  |       |       |  |  |  |  |  |  |         |    |            |  |       |  |  |  |  |  |  |         |    |            |  |       |  |  |  |  |  |  |                |    |  |       |       |  |  |  |  |  |  |         |    |  |       |       |  |  |  |  |  |  |         |    |            |  |       |  |  |  |  |  |  |             |    |  |       |       |  |  |  |  |  |  |         |    |            |  |       |  |  |  |  |  |  |        |     |  |       |       |  |  |  |  |  |  |         |     |            |  |       |  |  |  |  |  |  |
| 1.4 HDi  | 50   |            | 09.01 | 02.09      |                                    |                |                                    |                |                          |     |                     |     |     |    |            |       |       |           |                |        |  |                        |     |             |    |            |       |       |           |                |        |  |                     |     |         |    |            |       |       |  |                |        |  |                     |     |             |    |  |       |       |  |  |  |  |  |  |                |    |            |       |       |       |                |        |  |                     |     |         |    |            |       |       |           |  |  |  |  |  |                   |    |            |       |       |       |                |        |       |                    |  |         |    |            |       |       |       |                |        |       |                     |  |       |    |            |       |       |       |                |        |       |                        |  |         |    |            |       |       |                                    |                |        |  |                       |     |         |    |            |       |       |  |                |        |  |                          |  |         |    |  |       |       |  |  |  |  |  |  |         |     |            |       |       |  |  |  |  |  |  |                |    |            |       |       |  |                |        |  |                   |     |                |    |            |       |       |  |                |        |  |                   |     |                   |    |  |       |       |  |                |        |  |                   |     |         |    |            |       |       |  |  |  |  |  |  |             |     |            |       |       |  |  |  |  |  |  |         |    |            |       |       |  |                |        |  |                       |     |         |     |            |       |       |  |                |        |  |                          |  |         |     |            |       |       |  |                |        |  |                   |     |         |     |            |       |  |  |                |        |  |                   |     |  |   |     |       |       |       |                |                                    |                |                       |  |                     |    |            |    |       |       |       |           |                |        |  |                        |    |     |       |       |       |       |           |  |  |  |         |    |            |    |       |       |       |  |  |  |  |         |     |            |    |       |       |       |  |  |  |  |        |     |                |       |       |       |                |        |  |                       |  |  |  |         |    |  |       |                |           |  |                          |  |  |  |     |  |            |       |  |       |                |        |       |                    |  |     |    |            |       |  |       |                |        |       |                     |  |         |    |            |       |  |       |                |        |       |                        |  |         |    |            |       |       |                                    |                |        |  |                       |  |     |    |  |       |       |  |                |        |  |                          |  |         |    |            |       |       |  |  |  |  |  |  |         |    |            |       |       |  |  |  |  |  |  |                |    |            |       |       |  |  |  |  |  |  |         |    |            |       |       |  |  |  |  |  |  |                   |    |            |       |       |  |                |        |   |                 |  |     |    |  |       |       |  |  |  |  |  |  |       |    |            |       |       |  |  |  |  |  |  |         |    |            |       |       |  |                |        |  |                       |  |         |    |            |       |       |  |                |        |  |                          |  |         |    |            |       |       |  |  |  |  |  |  |                |     |            |       |       |  |  |  |  |  |  |         |    |  |       |       |  |                |        |  |                       |  |         |    |            |  |       |  |  |  |  |  |  |             |    |  |       |       |  |  |  |  |  |  |         |    |            |  |       |  |  |  |  |  |  |         |     |            |       |       |  |  |  |  |  |  |         |     |            |       |       |  |                |        |  |                       |  |  |  |  |  |  |  |                |        |  |                          |  |  |  |     |  |            |       |  |  |                |        |   |                 |  |     |    |            |       |  |  |  |  |  |  |  |         |    |            |       |  |  |  |  |  |  |  |         |    |            |       |  |  |  |  |  |  |  |     |    |  |       |       |  |  |  |  |  |  |         |    |            |       |  |  |  |  |  |  |  |       |    |            |       |  |  |  |  |  |  |  |         |    |            |       |  |  |  |  |  |  |  |         |    |            |       |  |  |  |  |  |  |  |     |  |            |  |       |  |                |        |   |                 |  |     |    |  |       |       |  |  |  |  |  |  |     |    |            |  |       |  |  |  |  |  |  |         |    |  |       |       |  |  |  |  |  |  |         |    |            |  |       |  |  |  |  |  |  |         |    |            |  |       |  |  |  |  |  |  |                |    |  |       |       |  |  |  |  |  |  |         |    |  |       |       |  |  |  |  |  |  |         |    |            |  |       |  |  |  |  |  |  |             |    |  |       |       |  |  |  |  |  |  |         |    |            |  |       |  |  |  |  |  |  |        |     |  |       |       |  |  |  |  |  |  |         |     |            |  |       |  |  |  |  |  |  |
| 1.4 HDi  | 51   |            | 09.02 | 02.07      |                                    |                |                                    |                |                          |     |                     |     |     |    |            |       |       |           |                |        |  |                        |     |             |    |            |       |       |           |                |        |  |                     |     |         |    |            |       |       |  |                |        |  |                     |     |             |    |  |       |       |  |  |  |  |  |  |                |    |            |       |       |       |                |        |  |                     |     |         |    |            |       |       |           |  |  |  |  |  |                   |    |            |       |       |       |                |        |       |                    |  |         |    |            |       |       |       |                |        |       |                     |  |       |    |            |       |       |       |                |        |       |                        |  |         |    |            |       |       |                                    |                |        |  |                       |     |         |    |            |       |       |  |                |        |  |                          |  |         |    |  |       |       |  |  |  |  |  |  |         |     |            |       |       |  |  |  |  |  |  |                |    |            |       |       |  |                |        |  |                   |     |                |    |            |       |       |  |                |        |  |                   |     |                   |    |  |       |       |  |                |        |  |                   |     |         |    |            |       |       |  |  |  |  |  |  |             |     |            |       |       |  |  |  |  |  |  |         |    |            |       |       |  |                |        |  |                       |     |         |     |            |       |       |  |                |        |  |                          |  |         |     |            |       |       |  |                |        |  |                   |     |         |     |            |       |  |  |                |        |  |                   |     |  |   |     |       |       |       |                |                                    |                |                       |  |                     |    |            |    |       |       |       |           |                |        |  |                        |    |     |       |       |       |       |           |  |  |  |         |    |            |    |       |       |       |  |  |  |  |         |     |            |    |       |       |       |  |  |  |  |        |     |                |       |       |       |                |        |  |                       |  |  |  |         |    |  |       |                |           |  |                          |  |  |  |     |  |            |       |  |       |                |        |       |                    |  |     |    |            |       |  |       |                |        |       |                     |  |         |    |            |       |  |       |                |        |       |                        |  |         |    |            |       |       |                                    |                |        |  |                       |  |     |    |  |       |       |  |                |        |  |                          |  |         |    |            |       |       |  |  |  |  |  |  |         |    |            |       |       |  |  |  |  |  |  |                |    |            |       |       |  |  |  |  |  |  |         |    |            |       |       |  |  |  |  |  |  |                   |    |            |       |       |  |                |        |   |                 |  |     |    |  |       |       |  |  |  |  |  |  |       |    |            |       |       |  |  |  |  |  |  |         |    |            |       |       |  |                |        |  |                       |  |         |    |            |       |       |  |                |        |  |                          |  |         |    |            |       |       |  |  |  |  |  |  |                |     |            |       |       |  |  |  |  |  |  |         |    |  |       |       |  |                |        |  |                       |  |         |    |            |  |       |  |  |  |  |  |  |             |    |  |       |       |  |  |  |  |  |  |         |    |            |  |       |  |  |  |  |  |  |         |     |            |       |       |  |  |  |  |  |  |         |     |            |       |       |  |                |        |  |                       |  |  |  |  |  |  |  |                |        |  |                          |  |  |  |     |  |            |       |  |  |                |        |   |                 |  |     |    |            |       |  |  |  |  |  |  |  |         |    |            |       |  |  |  |  |  |  |  |         |    |            |       |  |  |  |  |  |  |  |     |    |  |       |       |  |  |  |  |  |  |         |    |            |       |  |  |  |  |  |  |  |       |    |            |       |  |  |  |  |  |  |  |         |    |            |       |  |  |  |  |  |  |  |         |    |            |       |  |  |  |  |  |  |  |     |  |            |  |       |  |                |        |   |                 |  |     |    |  |       |       |  |  |  |  |  |  |     |    |            |  |       |  |  |  |  |  |  |         |    |  |       |       |  |  |  |  |  |  |         |    |            |  |       |  |  |  |  |  |  |         |    |            |  |       |  |  |  |  |  |  |                |    |  |       |       |  |  |  |  |  |  |         |    |  |       |       |  |  |  |  |  |  |         |    |            |  |       |  |  |  |  |  |  |             |    |  |       |       |  |  |  |  |  |  |         |    |            |  |       |  |  |  |  |  |  |        |     |  |       |       |  |  |  |  |  |  |         |     |            |  |       |  |  |  |  |  |  |
| 1.4 HDi eco 70   | 50   |            | 09.08 | 02.09      |                                    |                |                                    |                |                          |     |                     |     |     |    |            |       |       |           |                |        |  |                        |     |             |    |            |       |       |           |                |        |  |                     |     |         |    |            |       |       |  |                |        |  |                     |     |             |    |  |       |       |  |  |  |  |  |  |                |    |            |       |       |       |                |        |  |                     |     |         |    |            |       |       |           |  |  |  |  |  |                   |    |            |       |       |       |                |        |       |                    |  |         |    |            |       |       |       |                |        |       |                     |  |       |    |            |       |       |       |                |        |       |                        |  |         |    |            |       |       |                                    |                |        |  |                       |     |         |    |            |       |       |  |                |        |  |                          |  |         |    |  |       |       |  |  |  |  |  |  |         |     |            |       |       |  |  |  |  |  |  |                |    |            |       |       |  |                |        |  |                   |     |                |    |            |       |       |  |                |        |  |                   |     |                   |    |  |       |       |  |                |        |  |                   |     |         |    |            |       |       |  |  |  |  |  |  |             |     |            |       |       |  |  |  |  |  |  |         |    |            |       |       |  |                |        |  |                       |     |         |     |            |       |       |  |                |        |  |                          |  |         |     |            |       |       |  |                |        |  |                   |     |         |     |            |       |  |  |                |        |  |                   |     |  |   |     |       |       |       |                |                                    |                |                       |  |                     |    |            |    |       |       |       |           |                |        |  |                        |    |     |       |       |       |       |           |  |  |  |         |    |            |    |       |       |       |  |  |  |  |         |     |            |    |       |       |       |  |  |  |  |        |     |                |       |       |       |                |        |  |                       |  |  |  |         |    |  |       |                |           |  |                          |  |  |  |     |  |            |       |  |       |                |        |       |                    |  |     |    |            |       |  |       |                |        |       |                     |  |         |    |            |       |  |       |                |        |       |                        |  |         |    |            |       |       |                                    |                |        |  |                       |  |     |    |  |       |       |  |                |        |  |                          |  |         |    |            |       |       |  |  |  |  |  |  |         |    |            |       |       |  |  |  |  |  |  |                |    |            |       |       |  |  |  |  |  |  |         |    |            |       |       |  |  |  |  |  |  |                   |    |            |       |       |  |                |        |   |                 |  |     |    |  |       |       |  |  |  |  |  |  |       |    |            |       |       |  |  |  |  |  |  |         |    |            |       |       |  |                |        |  |                       |  |         |    |            |       |       |  |                |        |  |                          |  |         |    |            |       |       |  |  |  |  |  |  |                |     |            |       |       |  |  |  |  |  |  |         |    |  |       |       |  |                |        |  |                       |  |         |    |            |  |       |  |  |  |  |  |  |             |    |  |       |       |  |  |  |  |  |  |         |    |            |  |       |  |  |  |  |  |  |         |     |            |       |       |  |  |  |  |  |  |         |     |            |       |       |  |                |        |  |                       |  |  |  |  |  |  |  |                |        |  |                          |  |  |  |     |  |            |       |  |  |                |        |   |                 |  |     |    |            |       |  |  |  |  |  |  |  |         |    |            |       |  |  |  |  |  |  |  |         |    |            |       |  |  |  |  |  |  |  |     |    |  |       |       |  |  |  |  |  |  |         |    |            |       |  |  |  |  |  |  |  |       |    |            |       |  |  |  |  |  |  |  |         |    |            |       |  |  |  |  |  |  |  |         |    |            |       |  |  |  |  |  |  |  |     |  |            |  |       |  |                |        |   |                 |  |     |    |  |       |       |  |  |  |  |  |  |     |    |            |  |       |  |  |  |  |  |  |         |    |  |       |       |  |  |  |  |  |  |         |    |            |  |       |  |  |  |  |  |  |         |    |            |  |       |  |  |  |  |  |  |                |    |  |       |       |  |  |  |  |  |  |         |    |  |       |       |  |  |  |  |  |  |         |    |            |  |       |  |  |  |  |  |  |             |    |  |       |       |  |  |  |  |  |  |         |    |            |  |       |  |  |  |  |  |  |        |     |  |       |       |  |  |  |  |  |  |         |     |            |  |       |  |  |  |  |  |  |
| 1.4 LPG  | 55   |            | 05.06 | 09.07      |                                    |                |                                    |                |                          |     |                     |     |     |    |            |       |       |           |                |        |  |                        |     |             |    |            |       |       |           |                |        |  |                     |     |         |    |            |       |       |  |                |        |  |                     |     |             |    |  |       |       |  |  |  |  |  |  |                |    |            |       |       |       |                |        |  |                     |     |         |    |            |       |       |           |  |  |  |  |  |                   |    |            |       |       |       |                |        |       |                    |  |         |    |            |       |       |       |                |        |       |                     |  |       |    |            |       |       |       |                |        |       |                        |  |         |    |            |       |       |                                    |                |        |  |                       |     |         |    |            |       |       |  |                |        |  |                          |  |         |    |  |       |       |  |  |  |  |  |  |         |     |            |       |       |  |  |  |  |  |  |                |    |            |       |       |  |                |        |  |                   |     |                |    |            |       |       |  |                |        |  |                   |     |                   |    |  |       |       |  |                |        |  |                   |     |         |    |            |       |       |  |  |  |  |  |  |             |     |            |       |       |  |  |  |  |  |  |         |    |            |       |       |  |                |        |  |                       |     |         |     |            |       |       |  |                |        |  |                          |  |         |     |            |       |       |  |                |        |  |                   |     |         |     |            |       |  |  |                |        |  |                   |     |  |   |     |       |       |       |                |                                    |                |                       |  |                     |    |            |    |       |       |       |           |                |        |  |                        |    |     |       |       |       |       |           |  |  |  |         |    |            |    |       |       |       |  |  |  |  |         |     |            |    |       |       |       |  |  |  |  |        |     |                |       |       |       |                |        |  |                       |  |  |  |         |    |  |       |                |           |  |                          |  |  |  |     |  |            |       |  |       |                |        |       |                    |  |     |    |            |       |  |       |                |        |       |                     |  |         |    |            |       |  |       |                |        |       |                        |  |         |    |            |       |       |                                    |                |        |  |                       |  |     |    |  |       |       |  |                |        |  |                          |  |         |    |            |       |       |  |  |  |  |  |  |         |    |            |       |       |  |  |  |  |  |  |                |    |            |       |       |  |  |  |  |  |  |         |    |            |       |       |  |  |  |  |  |  |                   |    |            |       |       |  |                |        |   |                 |  |     |    |  |       |       |  |  |  |  |  |  |       |    |            |       |       |  |  |  |  |  |  |         |    |            |       |       |  |                |        |  |                       |  |         |    |            |       |       |  |                |        |  |                          |  |         |    |            |       |       |  |  |  |  |  |  |                |     |            |       |       |  |  |  |  |  |  |         |    |  |       |       |  |                |        |  |                       |  |         |    |            |  |       |  |  |  |  |  |  |             |    |  |       |       |  |  |  |  |  |  |         |    |            |  |       |  |  |  |  |  |  |         |     |            |       |       |  |  |  |  |  |  |         |     |            |       |       |  |                |        |  |                       |  |  |  |  |  |  |  |                |        |  |                          |  |  |  |     |  |            |       |  |  |                |        |   |                 |  |     |    |            |       |  |  |  |  |  |  |  |         |    |            |       |  |  |  |  |  |  |  |         |    |            |       |  |  |  |  |  |  |  |     |    |  |       |       |  |  |  |  |  |  |         |    |            |       |  |  |  |  |  |  |  |       |    |            |       |  |  |  |  |  |  |  |         |    |            |       |  |  |  |  |  |  |  |         |    |            |       |  |  |  |  |  |  |  |     |  |            |  |       |  |                |        |   |                 |  |     |    |  |       |       |  |  |  |  |  |  |     |    |            |  |       |  |  |  |  |  |  |         |    |  |       |       |  |  |  |  |  |  |         |    |            |  |       |  |  |  |  |  |  |         |    |            |  |       |  |  |  |  |  |  |                |    |  |       |       |  |  |  |  |  |  |         |    |  |       |       |  |  |  |  |  |  |         |    |            |  |       |  |  |  |  |  |  |             |    |  |       |       |  |  |  |  |  |  |         |    |            |  |       |  |  |  |  |  |  |        |     |  |       |       |  |  |  |  |  |  |         |     |            |  |       |  |  |  |  |  |  |
| 1.4 Roland Garros  | 55   |            | 09.98 | 02.09      | - ABS                              |                |                                    |                |                          |     |                     |     |     |    |            |       |       |           |                |        |  |                        |     |             |    |            |       |       |           |                |        |  |                     |     |         |    |            |       |       |  |                |        |  |                     |     |             |    |  |       |       |  |  |  |  |  |  |                |    |            |       |       |       |                |        |  |                     |     |         |    |            |       |       |           |  |  |  |  |  |                   |    |            |       |       |       |                |        |       |                    |  |         |    |            |       |       |       |                |        |       |                     |  |       |    |            |       |       |       |                |        |       |                        |  |         |    |            |       |       |                                    |                |        |  |                       |     |         |    |            |       |       |  |                |        |  |                          |  |         |    |  |       |       |  |  |  |  |  |  |         |     |            |       |       |  |  |  |  |  |  |                |    |            |       |       |  |                |        |  |                   |     |                |    |            |       |       |  |                |        |  |                   |     |                   |    |  |       |       |  |                |        |  |                   |     |         |    |            |       |       |  |  |  |  |  |  |             |     |            |       |       |  |  |  |  |  |  |         |    |            |       |       |  |                |        |  |                       |     |         |     |            |       |       |  |                |        |  |                          |  |         |     |            |       |       |  |                |        |  |                   |     |         |     |            |       |  |  |                |        |  |                   |     |  |   |     |       |       |       |                |                                    |                |                       |  |                     |    |            |    |       |       |       |           |                |        |  |                        |    |     |       |       |       |       |           |  |  |  |         |    |            |    |       |       |       |  |  |  |  |         |     |            |    |       |       |       |  |  |  |  |        |     |                |       |       |       |                |        |  |                       |  |  |  |         |    |  |       |                |           |  |                          |  |  |  |     |  |            |       |  |       |                |        |       |                    |  |     |    |            |       |  |       |                |        |       |                     |  |         |    |            |       |  |       |                |        |       |                        |  |         |    |            |       |       |                                    |                |        |  |                       |  |     |    |  |       |       |  |                |        |  |                          |  |         |    |            |       |       |  |  |  |  |  |  |         |    |            |       |       |  |  |  |  |  |  |                |    |            |       |       |  |  |  |  |  |  |         |    |            |       |       |  |  |  |  |  |  |                   |    |            |       |       |  |                |        |   |                 |  |     |    |  |       |       |  |  |  |  |  |  |       |    |            |       |       |  |  |  |  |  |  |         |    |            |       |       |  |                |        |  |                       |  |         |    |            |       |       |  |                |        |  |                          |  |         |    |            |       |       |  |  |  |  |  |  |                |     |            |       |       |  |  |  |  |  |  |         |    |  |       |       |  |                |        |  |                       |  |         |    |            |  |       |  |  |  |  |  |  |             |    |  |       |       |  |  |  |  |  |  |         |    |            |  |       |  |  |  |  |  |  |         |     |            |       |       |  |  |  |  |  |  |         |     |            |       |       |  |                |        |  |                       |  |  |  |  |  |  |  |                |        |  |                          |  |  |  |     |  |            |       |  |  |                |        |   |                 |  |     |    |            |       |  |  |  |  |  |  |  |         |    |            |       |  |  |  |  |  |  |  |         |    |            |       |  |  |  |  |  |  |  |     |    |  |       |       |  |  |  |  |  |  |         |    |            |       |  |  |  |  |  |  |  |       |    |            |       |  |  |  |  |  |  |  |         |    |            |       |  |  |  |  |  |  |  |         |    |            |       |  |  |  |  |  |  |  |     |  |            |  |       |  |                |        |   |                 |  |     |    |  |       |       |  |  |  |  |  |  |     |    |            |  |       |  |  |  |  |  |  |         |    |  |       |       |  |  |  |  |  |  |         |    |            |  |       |  |  |  |  |  |  |         |    |            |  |       |  |  |  |  |  |  |                |    |  |       |       |  |  |  |  |  |  |         |    |  |       |       |  |  |  |  |  |  |         |    |            |  |       |  |  |  |  |  |  |             |    |  |       |       |  |  |  |  |  |  |         |    |            |  |       |  |  |  |  |  |  |        |     |  |       |       |  |  |  |  |  |  |         |     |            |  |       |  |  |  |  |  |  |
| 1.6  | 65   |            | 09.98 | 12.00      | - ABS                              |                |                                    |                |                          |     |                     |     |     |    |            |       |       |           |                |        |  |                        |     |             |    |            |       |       |           |                |        |  |                     |     |         |    |            |       |       |  |                |        |  |                     |     |             |    |  |       |       |  |  |  |  |  |  |                |    |            |       |       |       |                |        |  |                     |     |         |    |            |       |       |           |  |  |  |  |  |                   |    |            |       |       |       |                |        |       |                    |  |         |    |            |       |       |       |                |        |       |                     |  |       |    |            |       |       |       |                |        |       |                        |  |         |    |            |       |       |                                    |                |        |  |                       |     |         |    |            |       |       |  |                |        |  |                          |  |         |    |  |       |       |  |  |  |  |  |  |         |     |            |       |       |  |  |  |  |  |  |                |    |            |       |       |  |                |        |  |                   |     |                |    |            |       |       |  |                |        |  |                   |     |                   |    |  |       |       |  |                |        |  |                   |     |         |    |            |       |       |  |  |  |  |  |  |             |     |            |       |       |  |  |  |  |  |  |         |    |            |       |       |  |                |        |  |                       |     |         |     |            |       |       |  |                |        |  |                          |  |         |     |            |       |       |  |                |        |  |                   |     |         |     |            |       |  |  |                |        |  |                   |     |  |   |     |       |       |       |                |                                    |                |                       |  |                     |    |            |    |       |       |       |           |                |        |  |                        |    |     |       |       |       |       |           |  |  |  |         |    |            |    |       |       |       |  |  |  |  |         |     |            |    |       |       |       |  |  |  |  |        |     |                |       |       |       |                |        |  |                       |  |  |  |         |    |  |       |                |           |  |                          |  |  |  |     |  |            |       |  |       |                |        |       |                    |  |     |    |            |       |  |       |                |        |       |                     |  |         |    |            |       |  |       |                |        |       |                        |  |         |    |            |       |       |                                    |                |        |  |                       |  |     |    |  |       |       |  |                |        |  |                          |  |         |    |            |       |       |  |  |  |  |  |  |         |    |            |       |       |  |  |  |  |  |  |                |    |            |       |       |  |  |  |  |  |  |         |    |            |       |       |  |  |  |  |  |  |                   |    |            |       |       |  |                |        |   |                 |  |     |    |  |       |       |  |  |  |  |  |  |       |    |            |       |       |  |  |  |  |  |  |         |    |            |       |       |  |                |        |  |                       |  |         |    |            |       |       |  |                |        |  |                          |  |         |    |            |       |       |  |  |  |  |  |  |                |     |            |       |       |  |  |  |  |  |  |         |    |  |       |       |  |                |        |  |                       |  |         |    |            |  |       |  |  |  |  |  |  |             |    |  |       |       |  |  |  |  |  |  |         |    |            |  |       |  |  |  |  |  |  |         |     |            |       |       |  |  |  |  |  |  |         |     |            |       |       |  |                |        |  |                       |  |  |  |  |  |  |  |                |        |  |                          |  |  |  |     |  |            |       |  |  |                |        |   |                 |  |     |    |            |       |  |  |  |  |  |  |  |         |    |            |       |  |  |  |  |  |  |  |         |    |            |       |  |  |  |  |  |  |  |     |    |  |       |       |  |  |  |  |  |  |         |    |            |       |  |  |  |  |  |  |  |       |    |            |       |  |  |  |  |  |  |  |         |    |            |       |  |  |  |  |  |  |  |         |    |            |       |  |  |  |  |  |  |  |     |  |            |  |       |  |                |        |   |                 |  |     |    |  |       |       |  |  |  |  |  |  |     |    |            |  |       |  |  |  |  |  |  |         |    |  |       |       |  |  |  |  |  |  |         |    |            |  |       |  |  |  |  |  |  |         |    |            |  |       |  |  |  |  |  |  |                |    |  |       |       |  |  |  |  |  |  |         |    |  |       |       |  |  |  |  |  |  |         |    |            |  |       |  |  |  |  |  |  |             |    |  |       |       |  |  |  |  |  |  |         |    |            |  |       |  |  |  |  |  |  |        |     |  |       |       |  |  |  |  |  |  |         |     |            |  |       |  |  |  |  |  |  |
| 1.9 D  | 51   |            | 09.98 | 02.09      | - ABS                              |                |                                    |                |                          |     |                     |     |     |    |            |       |       |           |                |        |  |                        |     |             |    |            |       |       |           |                |        |  |                     |     |         |    |            |       |       |  |                |        |  |                     |     |             |    |  |       |       |  |  |  |  |  |  |                |    |            |       |       |       |                |        |  |                     |     |         |    |            |       |       |           |  |  |  |  |  |                   |    |            |       |       |       |                |        |       |                    |  |         |    |            |       |       |       |                |        |       |                     |  |       |    |            |       |       |       |                |        |       |                        |  |         |    |            |       |       |                                    |                |        |  |                       |     |         |    |            |       |       |  |                |        |  |                          |  |         |    |  |       |       |  |  |  |  |  |  |         |     |            |       |       |  |  |  |  |  |  |                |    |            |       |       |  |                |        |  |                   |     |                |    |            |       |       |  |                |        |  |                   |     |                   |    |  |       |       |  |                |        |  |                   |     |         |    |            |       |       |  |  |  |  |  |  |             |     |            |       |       |  |  |  |  |  |  |         |    |            |       |       |  |                |        |  |                       |     |         |     |            |       |       |  |                |        |  |                          |  |         |     |            |       |       |  |                |        |  |                   |     |         |     |            |       |  |  |                |        |  |                   |     |  |   |     |       |       |       |                |                                    |                |                       |  |                     |    |            |    |       |       |       |           |                |        |  |                        |    |     |       |       |       |       |           |  |  |  |         |    |            |    |       |       |       |  |  |  |  |         |     |            |    |       |       |       |  |  |  |  |        |     |                |       |       |       |                |        |  |                       |  |  |  |         |    |  |       |                |           |  |                          |  |  |  |     |  |            |       |  |       |                |        |       |                    |  |     |    |            |       |  |       |                |        |       |                     |  |         |    |            |       |  |       |                |        |       |                        |  |         |    |            |       |       |                                    |                |        |  |                       |  |     |    |  |       |       |  |                |        |  |                          |  |         |    |            |       |       |  |  |  |  |  |  |         |    |            |       |       |  |  |  |  |  |  |                |    |            |       |       |  |  |  |  |  |  |         |    |            |       |       |  |  |  |  |  |  |                   |    |            |       |       |  |                |        |   |                 |  |     |    |  |       |       |  |  |  |  |  |  |       |    |            |       |       |  |  |  |  |  |  |         |    |            |       |       |  |                |        |  |                       |  |         |    |            |       |       |  |                |        |  |                          |  |         |    |            |       |       |  |  |  |  |  |  |                |     |            |       |       |  |  |  |  |  |  |         |    |  |       |       |  |                |        |  |                       |  |         |    |            |  |       |  |  |  |  |  |  |             |    |  |       |       |  |  |  |  |  |  |         |    |            |  |       |  |  |  |  |  |  |         |     |            |       |       |  |  |  |  |  |  |         |     |            |       |       |  |                |        |  |                       |  |  |  |  |  |  |  |                |        |  |                          |  |  |  |     |  |            |       |  |  |                |        |   |                 |  |     |    |            |       |  |  |  |  |  |  |  |         |    |            |       |  |  |  |  |  |  |  |         |    |            |       |  |  |  |  |  |  |  |     |    |  |       |       |  |  |  |  |  |  |         |    |            |       |  |  |  |  |  |  |  |       |    |            |       |  |  |  |  |  |  |  |         |    |            |       |  |  |  |  |  |  |  |         |    |            |       |  |  |  |  |  |  |  |     |  |            |  |       |  |                |        |   |                 |  |     |    |  |       |       |  |  |  |  |  |  |     |    |            |  |       |  |  |  |  |  |  |         |    |  |       |       |  |  |  |  |  |  |         |    |            |  |       |  |  |  |  |  |  |         |    |            |  |       |  |  |  |  |  |  |                |    |  |       |       |  |  |  |  |  |  |         |    |  |       |       |  |  |  |  |  |  |         |    |            |  |       |  |  |  |  |  |  |             |    |  |       |       |  |  |  |  |  |  |         |    |            |  |       |  |  |  |  |  |  |        |     |  |       |       |  |  |  |  |  |  |         |     |            |  |       |  |  |  |  |  |  |
| 1.6 16V  | 80   | ORGA 09078 | 12.00 |            |                                    | 13.0460-3978.2 | 603978                             |                | 23332 18,0 +/Zub/S       | BOS |                     |     |     |    |            |       |       |           |                |        |  |                        |     |             |    |            |       |       |           |                |        |  |                     |     |         |    |            |       |       |  |                |        |  |                     |     |             |    |  |       |       |  |  |  |  |  |  |                |    |            |       |       |       |                |        |  |                     |     |         |    |            |       |       |           |  |  |  |  |  |                   |    |            |       |       |       |                |        |       |                    |  |         |    |            |       |       |       |                |        |       |                     |  |       |    |            |       |       |       |                |        |       |                        |  |         |    |            |       |       |                                    |                |        |  |                       |     |         |    |            |       |       |  |                |        |  |                          |  |         |    |  |       |       |  |  |  |  |  |  |         |     |            |       |       |  |  |  |  |  |  |                |    |            |       |       |  |                |        |  |                   |     |                |    |            |       |       |  |                |        |  |                   |     |                   |    |  |       |       |  |                |        |  |                   |     |         |    |            |       |       |  |  |  |  |  |  |             |     |            |       |       |  |  |  |  |  |  |         |    |            |       |       |  |                |        |  |                       |     |         |     |            |       |       |  |                |        |  |                          |  |         |     |            |       |       |  |                |        |  |                   |     |         |     |            |       |  |  |                |        |  |                   |     |  |   |     |       |       |       |                |                                    |                |                       |  |                     |    |            |    |       |       |       |           |                |        |  |                        |    |     |       |       |       |       |           |  |  |  |         |    |            |    |       |       |       |  |  |  |  |         |     |            |    |       |       |       |  |  |  |  |        |     |                |       |       |       |                |        |  |                       |  |  |  |         |    |  |       |                |           |  |                          |  |  |  |     |  |            |       |  |       |                |        |       |                    |  |     |    |            |       |  |       |                |        |       |                     |  |         |    |            |       |  |       |                |        |       |                        |  |         |    |            |       |       |                                    |                |        |  |                       |  |     |    |  |       |       |  |                |        |  |                          |  |         |    |            |       |       |  |  |  |  |  |  |         |    |            |       |       |  |  |  |  |  |  |                |    |            |       |       |  |  |  |  |  |  |         |    |            |       |       |  |  |  |  |  |  |                   |    |            |       |       |  |                |        |   |                 |  |     |    |  |       |       |  |  |  |  |  |  |       |    |            |       |       |  |  |  |  |  |  |         |    |            |       |       |  |                |        |  |                       |  |         |    |            |       |       |  |                |        |  |                          |  |         |    |            |       |       |  |  |  |  |  |  |                |     |            |       |       |  |  |  |  |  |  |         |    |  |       |       |  |                |        |  |                       |  |         |    |            |  |       |  |  |  |  |  |  |             |    |  |       |       |  |  |  |  |  |  |         |    |            |  |       |  |  |  |  |  |  |         |     |            |       |       |  |  |  |  |  |  |         |     |            |       |       |  |                |        |  |                       |  |  |  |  |  |  |  |                |        |  |                          |  |  |  |     |  |            |       |  |  |                |        |   |                 |  |     |    |            |       |  |  |  |  |  |  |  |         |    |            |       |  |  |  |  |  |  |  |         |    |            |       |  |  |  |  |  |  |  |     |    |  |       |       |  |  |  |  |  |  |         |    |            |       |  |  |  |  |  |  |  |       |    |            |       |  |  |  |  |  |  |  |         |    |            |       |  |  |  |  |  |  |  |         |    |            |       |  |  |  |  |  |  |  |     |  |            |  |       |  |                |        |   |                 |  |     |    |  |       |       |  |  |  |  |  |  |     |    |            |  |       |  |  |  |  |  |  |         |    |  |       |       |  |  |  |  |  |  |         |    |            |  |       |  |  |  |  |  |  |         |    |            |  |       |  |  |  |  |  |  |                |    |  |       |       |  |  |  |  |  |  |         |    |  |       |       |  |  |  |  |  |  |         |    |            |  |       |  |  |  |  |  |  |             |    |  |       |       |  |  |  |  |  |  |         |    |            |  |       |  |  |  |  |  |  |        |     |  |       |       |  |  |  |  |  |  |         |     |            |  |       |  |  |  |  |  |  |
| 2.0 HDi  | 66   | ORGA 09078 | 12.99 |            |                                    |                |                                    |                |                          |     |                     |     |     |    |            |       |       |           |                |        |  |                        |     |             |    |            |       |       |           |                |        |  |                     |     |         |    |            |       |       |  |                |        |  |                     |     |             |    |  |       |       |  |  |  |  |  |  |                |    |            |       |       |       |                |        |  |                     |     |         |    |            |       |       |           |  |  |  |  |  |                   |    |            |       |       |       |                |        |       |                    |  |         |    |            |       |       |       |                |        |       |                     |  |       |    |            |       |       |       |                |        |       |                        |  |         |    |            |       |       |                                    |                |        |  |                       |     |         |    |            |       |       |  |                |        |  |                          |  |         |    |  |       |       |  |  |  |  |  |  |         |     |            |       |       |  |  |  |  |  |  |                |    |            |       |       |  |                |        |  |                   |     |                |    |            |       |       |  |                |        |  |                   |     |                   |    |  |       |       |  |                |        |  |                   |     |         |    |            |       |       |  |  |  |  |  |  |             |     |            |       |       |  |  |  |  |  |  |         |    |            |       |       |  |                |        |  |                       |     |         |     |            |       |       |  |                |        |  |                          |  |         |     |            |       |       |  |                |        |  |                   |     |         |     |            |       |  |  |                |        |  |                   |     |  |   |     |       |       |       |                |                                    |                |                       |  |                     |    |            |    |       |       |       |           |                |        |  |                        |    |     |       |       |       |       |           |  |  |  |         |    |            |    |       |       |       |  |  |  |  |         |     |            |    |       |       |       |  |  |  |  |        |     |                |       |       |       |                |        |  |                       |  |  |  |         |    |  |       |                |           |  |                          |  |  |  |     |  |            |       |  |       |                |        |       |                    |  |     |    |            |       |  |       |                |        |       |                     |  |         |    |            |       |  |       |                |        |       |                        |  |         |    |            |       |       |                                    |                |        |  |                       |  |     |    |  |       |       |  |                |        |  |                          |  |         |    |            |       |       |  |  |  |  |  |  |         |    |            |       |       |  |  |  |  |  |  |                |    |            |       |       |  |  |  |  |  |  |         |    |            |       |       |  |  |  |  |  |  |                   |    |            |       |       |  |                |        |   |                 |  |     |    |  |       |       |  |  |  |  |  |  |       |    |            |       |       |  |  |  |  |  |  |         |    |            |       |       |  |                |        |  |                       |  |         |    |            |       |       |  |                |        |  |                          |  |         |    |            |       |       |  |  |  |  |  |  |                |     |            |       |       |  |  |  |  |  |  |         |    |  |       |       |  |                |        |  |                       |  |         |    |            |  |       |  |  |  |  |  |  |             |    |  |       |       |  |  |  |  |  |  |         |    |            |  |       |  |  |  |  |  |  |         |     |            |       |       |  |  |  |  |  |  |         |     |            |       |       |  |                |        |  |                       |  |  |  |  |  |  |  |                |        |  |                          |  |  |  |     |  |            |       |  |  |                |        |   |                 |  |     |    |            |       |  |  |  |  |  |  |  |         |    |            |       |  |  |  |  |  |  |  |         |    |            |       |  |  |  |  |  |  |  |     |    |  |       |       |  |  |  |  |  |  |         |    |            |       |  |  |  |  |  |  |  |       |    |            |       |  |  |  |  |  |  |  |         |    |            |       |  |  |  |  |  |  |  |         |    |            |       |  |  |  |  |  |  |  |     |  |            |  |       |  |                |        |   |                 |  |     |    |  |       |       |  |  |  |  |  |  |     |    |            |  |       |  |  |  |  |  |  |         |    |  |       |       |  |  |  |  |  |  |         |    |            |  |       |  |  |  |  |  |  |         |    |            |  |       |  |  |  |  |  |  |                |    |  |       |       |  |  |  |  |  |  |         |    |  |       |       |  |  |  |  |  |  |         |    |            |  |       |  |  |  |  |  |  |             |    |  |       |       |  |  |  |  |  |  |         |    |            |  |       |  |  |  |  |  |  |        |     |  |       |       |  |  |  |  |  |  |         |     |            |  |       |  |  |  |  |  |  |
| 2.0 S16  | 99   |            | 04.99 | 10.00      |                                    |                |                                    |                |                          |     |                     |     |     |    |            |       |       |           |                |        |  |                        |     |             |    |            |       |       |           |                |        |  |                     |     |         |    |            |       |       |  |                |        |  |                     |     |             |    |  |       |       |  |  |  |  |  |  |                |    |            |       |       |       |                |        |  |                     |     |         |    |            |       |       |           |  |  |  |  |  |                   |    |            |       |       |       |                |        |       |                    |  |         |    |            |       |       |       |                |        |       |                     |  |       |    |            |       |       |       |                |        |       |                        |  |         |    |            |       |       |                                    |                |        |  |                       |     |         |    |            |       |       |  |                |        |  |                          |  |         |    |  |       |       |  |  |  |  |  |  |         |     |            |       |       |  |  |  |  |  |  |                |    |            |       |       |  |                |        |  |                   |     |                |    |            |       |       |  |                |        |  |                   |     |                   |    |  |       |       |  |                |        |  |                   |     |         |    |            |       |       |  |  |  |  |  |  |             |     |            |       |       |  |  |  |  |  |  |         |    |            |       |       |  |                |        |  |                       |     |         |     |            |       |       |  |                |        |  |                          |  |         |     |            |       |       |  |                |        |  |                   |     |         |     |            |       |  |  |                |        |  |                   |     |  |   |     |       |       |       |                |                                    |                |                       |  |                     |    |            |    |       |       |       |           |                |        |  |                        |    |     |       |       |       |       |           |  |  |  |         |    |            |    |       |       |       |  |  |  |  |         |     |            |    |       |       |       |  |  |  |  |        |     |                |       |       |       |                |        |  |                       |  |  |  |         |    |  |       |                |           |  |                          |  |  |  |     |  |            |       |  |       |                |        |       |                    |  |     |    |            |       |  |       |                |        |       |                     |  |         |    |            |       |  |       |                |        |       |                        |  |         |    |            |       |       |                                    |                |        |  |                       |  |     |    |  |       |       |  |                |        |  |                          |  |         |    |            |       |       |  |  |  |  |  |  |         |    |            |       |       |  |  |  |  |  |  |                |    |            |       |       |  |  |  |  |  |  |         |    |            |       |       |  |  |  |  |  |  |                   |    |            |       |       |  |                |        |   |                 |  |     |    |  |       |       |  |  |  |  |  |  |       |    |            |       |       |  |  |  |  |  |  |         |    |            |       |       |  |                |        |  |                       |  |         |    |            |       |       |  |                |        |  |                          |  |         |    |            |       |       |  |  |  |  |  |  |                |     |            |       |       |  |  |  |  |  |  |         |    |  |       |       |  |                |        |  |                       |  |         |    |            |  |       |  |  |  |  |  |  |             |    |  |       |       |  |  |  |  |  |  |         |    |            |  |       |  |  |  |  |  |  |         |     |            |       |       |  |  |  |  |  |  |         |     |            |       |       |  |                |        |  |                       |  |  |  |  |  |  |  |                |        |  |                          |  |  |  |     |  |            |       |  |  |                |        |   |                 |  |     |    |            |       |  |  |  |  |  |  |  |         |    |            |       |  |  |  |  |  |  |  |         |    |            |       |  |  |  |  |  |  |  |     |    |  |       |       |  |  |  |  |  |  |         |    |            |       |  |  |  |  |  |  |  |       |    |            |       |  |  |  |  |  |  |  |         |    |            |       |  |  |  |  |  |  |  |         |    |            |       |  |  |  |  |  |  |  |     |  |            |  |       |  |                |        |   |                 |  |     |    |  |       |       |  |  |  |  |  |  |     |    |            |  |       |  |  |  |  |  |  |         |    |  |       |       |  |  |  |  |  |  |         |    |            |  |       |  |  |  |  |  |  |         |    |            |  |       |  |  |  |  |  |  |                |    |  |       |       |  |  |  |  |  |  |         |    |  |       |       |  |  |  |  |  |  |         |    |            |  |       |  |  |  |  |  |  |             |    |  |       |       |  |  |  |  |  |  |         |    |            |  |       |  |  |  |  |  |  |        |     |  |       |       |  |  |  |  |  |  |         |     |            |  |       |  |  |  |  |  |  |
| 2.0 S16  | 100  | ORGA 09078 | 10.00 |            |                                    |                |                                    |                |                          |     |                     |     |     |    |            |       |       |           |                |        |  |                        |     |             |    |            |       |       |           |                |        |  |                     |     |         |    |            |       |       |  |                |        |  |                     |     |             |    |  |       |       |  |  |  |  |  |  |                |    |            |       |       |       |                |        |  |                     |     |         |    |            |       |       |           |  |  |  |  |  |                   |    |            |       |       |       |                |        |       |                    |  |         |    |            |       |       |       |                |        |       |                     |  |       |    |            |       |       |       |                |        |       |                        |  |         |    |            |       |       |                                    |                |        |  |                       |     |         |    |            |       |       |  |                |        |  |                          |  |         |    |  |       |       |  |  |  |  |  |  |         |     |            |       |       |  |  |  |  |  |  |                |    |            |       |       |  |                |        |  |                   |     |                |    |            |       |       |  |                |        |  |                   |     |                   |    |  |       |       |  |                |        |  |                   |     |         |    |            |       |       |  |  |  |  |  |  |             |     |            |       |       |  |  |  |  |  |  |         |    |            |       |       |  |                |        |  |                       |     |         |     |            |       |       |  |                |        |  |                          |  |         |     |            |       |       |  |                |        |  |                   |     |         |     |            |       |  |  |                |        |  |                   |     |  |   |     |       |       |       |                |                                    |                |                       |  |                     |    |            |    |       |       |       |           |                |        |  |                        |    |     |       |       |       |       |           |  |  |  |         |    |            |    |       |       |       |  |  |  |  |         |     |            |    |       |       |       |  |  |  |  |        |     |                |       |       |       |                |        |  |                       |  |  |  |         |    |  |       |                |           |  |                          |  |  |  |     |  |            |       |  |       |                |        |       |                    |  |     |    |            |       |  |       |                |        |       |                     |  |         |    |            |       |  |       |                |        |       |                        |  |         |    |            |       |       |                                    |                |        |  |                       |  |     |    |  |       |       |  |                |        |  |                          |  |         |    |            |       |       |  |  |  |  |  |  |         |    |            |       |       |  |  |  |  |  |  |                |    |            |       |       |  |  |  |  |  |  |         |    |            |       |       |  |  |  |  |  |  |                   |    |            |       |       |  |                |        |   |                 |  |     |    |  |       |       |  |  |  |  |  |  |       |    |            |       |       |  |  |  |  |  |  |         |    |            |       |       |  |                |        |  |                       |  |         |    |            |       |       |  |                |        |  |                          |  |         |    |            |       |       |  |  |  |  |  |  |                |     |            |       |       |  |  |  |  |  |  |         |    |  |       |       |  |                |        |  |                       |  |         |    |            |  |       |  |  |  |  |  |  |             |    |  |       |       |  |  |  |  |  |  |         |    |            |  |       |  |  |  |  |  |  |         |     |            |       |       |  |  |  |  |  |  |         |     |            |       |       |  |                |        |  |                       |  |  |  |  |  |  |  |                |        |  |                          |  |  |  |     |  |            |       |  |  |                |        |   |                 |  |     |    |            |       |  |  |  |  |  |  |  |         |    |            |       |  |  |  |  |  |  |  |         |    |            |       |  |  |  |  |  |  |  |     |    |  |       |       |  |  |  |  |  |  |         |    |            |       |  |  |  |  |  |  |  |       |    |            |       |  |  |  |  |  |  |  |         |    |            |       |  |  |  |  |  |  |  |         |    |            |       |  |  |  |  |  |  |  |     |  |            |  |       |  |                |        |   |                 |  |     |    |  |       |       |  |  |  |  |  |  |     |    |            |  |       |  |  |  |  |  |  |         |    |  |       |       |  |  |  |  |  |  |         |    |            |  |       |  |  |  |  |  |  |         |    |            |  |       |  |  |  |  |  |  |                |    |  |       |       |  |  |  |  |  |  |         |    |  |       |       |  |  |  |  |  |  |         |    |            |  |       |  |  |  |  |  |  |             |    |  |       |       |  |  |  |  |  |  |         |    |            |  |       |  |  |  |  |  |  |        |     |  |       |       |  |  |  |  |  |  |         |     |            |  |       |  |  |  |  |  |  |
| 1.4 16V  | 65   |            | 10.03 | 02.09      |                                    | 13.0460-3994.2 | 603994                             |                | 23599 19,0 /Zub/S        | BOS |                     |     |     |    |            |       |       |           |                |        |  |                        |     |             |    |            |       |       |           |                |        |  |                     |     |         |    |            |       |       |  |                |        |  |                     |     |             |    |  |       |       |  |  |  |  |  |  |                |    |            |       |       |       |                |        |  |                     |     |         |    |            |       |       |           |  |  |  |  |  |                   |    |            |       |       |       |                |        |       |                    |  |         |    |            |       |       |       |                |        |       |                     |  |       |    |            |       |       |       |                |        |       |                        |  |         |    |            |       |       |                                    |                |        |  |                       |     |         |    |            |       |       |  |                |        |  |                          |  |         |    |  |       |       |  |  |  |  |  |  |         |     |            |       |       |  |  |  |  |  |  |                |    |            |       |       |  |                |        |  |                   |     |                |    |            |       |       |  |                |        |  |                   |     |                   |    |  |       |       |  |                |        |  |                   |     |         |    |            |       |       |  |  |  |  |  |  |             |     |            |       |       |  |  |  |  |  |  |         |    |            |       |       |  |                |        |  |                       |     |         |     |            |       |       |  |                |        |  |                          |  |         |     |            |       |       |  |                |        |  |                   |     |         |     |            |       |  |  |                |        |  |                   |     |  |   |     |       |       |       |                |                                    |                |                       |  |                     |    |            |    |       |       |       |           |                |        |  |                        |    |     |       |       |       |       |           |  |  |  |         |    |            |    |       |       |       |  |  |  |  |         |     |            |    |       |       |       |  |  |  |  |        |     |                |       |       |       |                |        |  |                       |  |  |  |         |    |  |       |                |           |  |                          |  |  |  |     |  |            |       |  |       |                |        |       |                    |  |     |    |            |       |  |       |                |        |       |                     |  |         |    |            |       |  |       |                |        |       |                        |  |         |    |            |       |       |                                    |                |        |  |                       |  |     |    |  |       |       |  |                |        |  |                          |  |         |    |            |       |       |  |  |  |  |  |  |         |    |            |       |       |  |  |  |  |  |  |                |    |            |       |       |  |  |  |  |  |  |         |    |            |       |       |  |  |  |  |  |  |                   |    |            |       |       |  |                |        |   |                 |  |     |    |  |       |       |  |  |  |  |  |  |       |    |            |       |       |  |  |  |  |  |  |         |    |            |       |       |  |                |        |  |                       |  |         |    |            |       |       |  |                |        |  |                          |  |         |    |            |       |       |  |  |  |  |  |  |                |     |            |       |       |  |  |  |  |  |  |         |    |  |       |       |  |                |        |  |                       |  |         |    |            |  |       |  |  |  |  |  |  |             |    |  |       |       |  |  |  |  |  |  |         |    |            |  |       |  |  |  |  |  |  |         |     |            |       |       |  |  |  |  |  |  |         |     |            |       |       |  |                |        |  |                       |  |  |  |  |  |  |  |                |        |  |                          |  |  |  |     |  |            |       |  |  |                |        |   |                 |  |     |    |            |       |  |  |  |  |  |  |  |         |    |            |       |  |  |  |  |  |  |  |         |    |            |       |  |  |  |  |  |  |  |     |    |  |       |       |  |  |  |  |  |  |         |    |            |       |  |  |  |  |  |  |  |       |    |            |       |  |  |  |  |  |  |  |         |    |            |       |  |  |  |  |  |  |  |         |    |            |       |  |  |  |  |  |  |  |     |  |            |  |       |  |                |        |   |                 |  |     |    |  |       |       |  |  |  |  |  |  |     |    |            |  |       |  |  |  |  |  |  |         |    |  |       |       |  |  |  |  |  |  |         |    |            |  |       |  |  |  |  |  |  |         |    |            |  |       |  |  |  |  |  |  |                |    |  |       |       |  |  |  |  |  |  |         |    |  |       |       |  |  |  |  |  |  |         |    |            |  |       |  |  |  |  |  |  |             |    |  |       |       |  |  |  |  |  |  |         |    |            |  |       |  |  |  |  |  |  |        |     |  |       |       |  |  |  |  |  |  |         |     |            |  |       |  |  |  |  |  |  |
| 1.6 16V  | 80   | ORGA 09079 |       | 02.09      |                                    | 13.0470-3994.2 | LD3994                             |                | 23599 19,0 /Zub/S        | BOS |                     |     |     |    |            |       |       |           |                |        |  |                        |     |             |    |            |       |       |           |                |        |  |                     |     |         |    |            |       |       |  |                |        |  |                     |     |             |    |  |       |       |  |  |  |  |  |  |                |    |            |       |       |       |                |        |  |                     |     |         |    |            |       |       |           |  |  |  |  |  |                   |    |            |       |       |       |                |        |       |                    |  |         |    |            |       |       |       |                |        |       |                     |  |       |    |            |       |       |       |                |        |       |                        |  |         |    |            |       |       |                                    |                |        |  |                       |     |         |    |            |       |       |  |                |        |  |                          |  |         |    |  |       |       |  |  |  |  |  |  |         |     |            |       |       |  |  |  |  |  |  |                |    |            |       |       |  |                |        |  |                   |     |                |    |            |       |       |  |                |        |  |                   |     |                   |    |  |       |       |  |                |        |  |                   |     |         |    |            |       |       |  |  |  |  |  |  |             |     |            |       |       |  |  |  |  |  |  |         |    |            |       |       |  |                |        |  |                       |     |         |     |            |       |       |  |                |        |  |                          |  |         |     |            |       |       |  |                |        |  |                   |     |         |     |            |       |  |  |                |        |  |                   |     |  |   |     |       |       |       |                |                                    |                |                       |  |                     |    |            |    |       |       |       |           |                |        |  |                        |    |     |       |       |       |       |           |  |  |  |         |    |            |    |       |       |       |  |  |  |  |         |     |            |    |       |       |       |  |  |  |  |        |     |                |       |       |       |                |        |  |                       |  |  |  |         |    |  |       |                |           |  |                          |  |  |  |     |  |            |       |  |       |                |        |       |                    |  |     |    |            |       |  |       |                |        |       |                     |  |         |    |            |       |  |       |                |        |       |                        |  |         |    |            |       |       |                                    |                |        |  |                       |  |     |    |  |       |       |  |                |        |  |                          |  |         |    |            |       |       |  |  |  |  |  |  |         |    |            |       |       |  |  |  |  |  |  |                |    |            |       |       |  |  |  |  |  |  |         |    |            |       |       |  |  |  |  |  |  |                   |    |            |       |       |  |                |        |   |                 |  |     |    |  |       |       |  |  |  |  |  |  |       |    |            |       |       |  |  |  |  |  |  |         |    |            |       |       |  |                |        |  |                       |  |         |    |            |       |       |  |                |        |  |                          |  |         |    |            |       |       |  |  |  |  |  |  |                |     |            |       |       |  |  |  |  |  |  |         |    |  |       |       |  |                |        |  |                       |  |         |    |            |  |       |  |  |  |  |  |  |             |    |  |       |       |  |  |  |  |  |  |         |    |            |  |       |  |  |  |  |  |  |         |     |            |       |       |  |  |  |  |  |  |         |     |            |       |       |  |                |        |  |                       |  |  |  |  |  |  |  |                |        |  |                          |  |  |  |     |  |            |       |  |  |                |        |   |                 |  |     |    |            |       |  |  |  |  |  |  |  |         |    |            |       |  |  |  |  |  |  |  |         |    |            |       |  |  |  |  |  |  |  |     |    |  |       |       |  |  |  |  |  |  |         |    |            |       |  |  |  |  |  |  |  |       |    |            |       |  |  |  |  |  |  |  |         |    |            |       |  |  |  |  |  |  |  |         |    |            |       |  |  |  |  |  |  |  |     |  |            |  |       |  |                |        |   |                 |  |     |    |  |       |       |  |  |  |  |  |  |     |    |            |  |       |  |  |  |  |  |  |         |    |  |       |       |  |  |  |  |  |  |         |    |            |  |       |  |  |  |  |  |  |         |    |            |  |       |  |  |  |  |  |  |                |    |  |       |       |  |  |  |  |  |  |         |    |  |       |       |  |  |  |  |  |  |         |    |            |  |       |  |  |  |  |  |  |             |    |  |       |       |  |  |  |  |  |  |         |    |            |  |       |  |  |  |  |  |  |        |     |  |       |       |  |  |  |  |  |  |         |     |            |  |       |  |  |  |  |  |  |
| 1.6 HDi 110  | 80   |            | 05.04 | 02.09      |                                    | 13.0460-0454.2 | 610454                             |                | Belagsatz-Zubehör        | BOS |                     |     |     |    |            |       |       |           |                |        |  |                        |     |             |    |            |       |       |           |                |        |  |                     |     |         |    |            |       |       |  |                |        |  |                     |     |             |    |  |       |       |  |  |  |  |  |  |                |    |            |       |       |       |                |        |  |                     |     |         |    |            |       |       |           |  |  |  |  |  |                   |    |            |       |       |       |                |        |       |                    |  |         |    |            |       |       |       |                |        |       |                     |  |       |    |            |       |       |       |                |        |       |                        |  |         |    |            |       |       |                                    |                |        |  |                       |     |         |    |            |       |       |  |                |        |  |                          |  |         |    |  |       |       |  |  |  |  |  |  |         |     |            |       |       |  |  |  |  |  |  |                |    |            |       |       |  |                |        |  |                   |     |                |    |            |       |       |  |                |        |  |                   |     |                   |    |  |       |       |  |                |        |  |                   |     |         |    |            |       |       |  |  |  |  |  |  |             |     |            |       |       |  |  |  |  |  |  |         |    |            |       |       |  |                |        |  |                       |     |         |     |            |       |       |  |                |        |  |                          |  |         |     |            |       |       |  |                |        |  |                   |     |         |     |            |       |  |  |                |        |  |                   |     |  |   |     |       |       |       |                |                                    |                |                       |  |                     |    |            |    |       |       |       |           |                |        |  |                        |    |     |       |       |       |       |           |  |  |  |         |    |            |    |       |       |       |  |  |  |  |         |     |            |    |       |       |       |  |  |  |  |        |     |                |       |       |       |                |        |  |                       |  |  |  |         |    |  |       |                |           |  |                          |  |  |  |     |  |            |       |  |       |                |        |       |                    |  |     |    |            |       |  |       |                |        |       |                     |  |         |    |            |       |  |       |                |        |       |                        |  |         |    |            |       |       |                                    |                |        |  |                       |  |     |    |  |       |       |  |                |        |  |                          |  |         |    |            |       |       |  |  |  |  |  |  |         |    |            |       |       |  |  |  |  |  |  |                |    |            |       |       |  |  |  |  |  |  |         |    |            |       |       |  |  |  |  |  |  |                   |    |            |       |       |  |                |        |   |                 |  |     |    |  |       |       |  |  |  |  |  |  |       |    |            |       |       |  |  |  |  |  |  |         |    |            |       |       |  |                |        |  |                       |  |         |    |            |       |       |  |                |        |  |                          |  |         |    |            |       |       |  |  |  |  |  |  |                |     |            |       |       |  |  |  |  |  |  |         |    |  |       |       |  |                |        |  |                       |  |         |    |            |  |       |  |  |  |  |  |  |             |    |  |       |       |  |  |  |  |  |  |         |    |            |  |       |  |  |  |  |  |  |         |     |            |       |       |  |  |  |  |  |  |         |     |            |       |       |  |                |        |  |                       |  |  |  |  |  |  |  |                |        |  |                          |  |  |  |     |  |            |       |  |  |                |        |   |                 |  |     |    |            |       |  |  |  |  |  |  |  |         |    |            |       |  |  |  |  |  |  |  |         |    |            |       |  |  |  |  |  |  |  |     |    |  |       |       |  |  |  |  |  |  |         |    |            |       |  |  |  |  |  |  |  |       |    |            |       |  |  |  |  |  |  |  |         |    |            |       |  |  |  |  |  |  |  |         |    |            |       |  |  |  |  |  |  |  |     |  |            |  |       |  |                |        |   |                 |  |     |    |  |       |       |  |  |  |  |  |  |     |    |            |  |       |  |  |  |  |  |  |         |    |  |       |       |  |  |  |  |  |  |         |    |            |  |       |  |  |  |  |  |  |         |    |            |  |       |  |  |  |  |  |  |                |    |  |       |       |  |  |  |  |  |  |         |    |  |       |       |  |  |  |  |  |  |         |    |            |  |       |  |  |  |  |  |  |             |    |  |       |       |  |  |  |  |  |  |         |    |            |  |       |  |  |  |  |  |  |        |     |  |       |       |  |  |  |  |  |  |         |     |            |  |       |  |  |  |  |  |  |
| 2.0 HDi  | 66   | ORGA 09079 |       | 02.09      |                                    |                |                                    |                |                          |     |                     |     |     |    |            |       |       |           |                |        |  |                        |     |             |    |            |       |       |           |                |        |  |                     |     |         |    |            |       |       |  |                |        |  |                     |     |             |    |  |       |       |  |  |  |  |  |  |                |    |            |       |       |       |                |        |  |                     |     |         |    |            |       |       |           |  |  |  |  |  |                   |    |            |       |       |       |                |        |       |                    |  |         |    |            |       |       |       |                |        |       |                     |  |       |    |            |       |       |       |                |        |       |                        |  |         |    |            |       |       |                                    |                |        |  |                       |     |         |    |            |       |       |  |                |        |  |                          |  |         |    |  |       |       |  |  |  |  |  |  |         |     |            |       |       |  |  |  |  |  |  |                |    |            |       |       |  |                |        |  |                   |     |                |    |            |       |       |  |                |        |  |                   |     |                   |    |  |       |       |  |                |        |  |                   |     |         |    |            |       |       |  |  |  |  |  |  |             |     |            |       |       |  |  |  |  |  |  |         |    |            |       |       |  |                |        |  |                       |     |         |     |            |       |       |  |                |        |  |                          |  |         |     |            |       |       |  |                |        |  |                   |     |         |     |            |       |  |  |                |        |  |                   |     |  |   |     |       |       |       |                |                                    |                |                       |  |                     |    |            |    |       |       |       |           |                |        |  |                        |    |     |       |       |       |       |           |  |  |  |         |    |            |    |       |       |       |  |  |  |  |         |     |            |    |       |       |       |  |  |  |  |        |     |                |       |       |       |                |        |  |                       |  |  |  |         |    |  |       |                |           |  |                          |  |  |  |     |  |            |       |  |       |                |        |       |                    |  |     |    |            |       |  |       |                |        |       |                     |  |         |    |            |       |  |       |                |        |       |                        |  |         |    |            |       |       |                                    |                |        |  |                       |  |     |    |  |       |       |  |                |        |  |                          |  |         |    |            |       |       |  |  |  |  |  |  |         |    |            |       |       |  |  |  |  |  |  |                |    |            |       |       |  |  |  |  |  |  |         |    |            |       |       |  |  |  |  |  |  |                   |    |            |       |       |  |                |        |   |                 |  |     |    |  |       |       |  |  |  |  |  |  |       |    |            |       |       |  |  |  |  |  |  |         |    |            |       |       |  |                |        |  |                       |  |         |    |            |       |       |  |                |        |  |                          |  |         |    |            |       |       |  |  |  |  |  |  |                |     |            |       |       |  |  |  |  |  |  |         |    |  |       |       |  |                |        |  |                       |  |         |    |            |  |       |  |  |  |  |  |  |             |    |  |       |       |  |  |  |  |  |  |         |    |            |  |       |  |  |  |  |  |  |         |     |            |       |       |  |  |  |  |  |  |         |     |            |       |       |  |                |        |  |                       |  |  |  |  |  |  |  |                |        |  |                          |  |  |  |     |  |            |       |  |  |                |        |   |                 |  |     |    |            |       |  |  |  |  |  |  |  |         |    |            |       |  |  |  |  |  |  |  |         |    |            |       |  |  |  |  |  |  |  |     |    |  |       |       |  |  |  |  |  |  |         |    |            |       |  |  |  |  |  |  |  |       |    |            |       |  |  |  |  |  |  |  |         |    |            |       |  |  |  |  |  |  |  |         |    |            |       |  |  |  |  |  |  |  |     |  |            |  |       |  |                |        |   |                 |  |     |    |  |       |       |  |  |  |  |  |  |     |    |            |  |       |  |  |  |  |  |  |         |    |  |       |       |  |  |  |  |  |  |         |    |            |  |       |  |  |  |  |  |  |         |    |            |  |       |  |  |  |  |  |  |                |    |  |       |       |  |  |  |  |  |  |         |    |  |       |       |  |  |  |  |  |  |         |    |            |  |       |  |  |  |  |  |  |             |    |  |       |       |  |  |  |  |  |  |         |    |            |  |       |  |  |  |  |  |  |        |     |  |       |       |  |  |  |  |  |  |         |     |            |  |       |  |  |  |  |  |  |
| 2.0 S16  | 100  | ORGA 09079 |       | 02.09      |                                    |                |                                    |                |                          |     |                     |     |     |    |            |       |       |           |                |        |  |                        |     |             |    |            |       |       |           |                |        |  |                     |     |         |    |            |       |       |  |                |        |  |                     |     |             |    |  |       |       |  |  |  |  |  |  |                |    |            |       |       |       |                |        |  |                     |     |         |    |            |       |       |           |  |  |  |  |  |                   |    |            |       |       |       |                |        |       |                    |  |         |    |            |       |       |       |                |        |       |                     |  |       |    |            |       |       |       |                |        |       |                        |  |         |    |            |       |       |                                    |                |        |  |                       |     |         |    |            |       |       |  |                |        |  |                          |  |         |    |  |       |       |  |  |  |  |  |  |         |     |            |       |       |  |  |  |  |  |  |                |    |            |       |       |  |                |        |  |                   |     |                |    |            |       |       |  |                |        |  |                   |     |                   |    |  |       |       |  |                |        |  |                   |     |         |    |            |       |       |  |  |  |  |  |  |             |     |            |       |       |  |  |  |  |  |  |         |    |            |       |       |  |                |        |  |                       |     |         |     |            |       |       |  |                |        |  |                          |  |         |     |            |       |       |  |                |        |  |                   |     |         |     |            |       |  |  |                |        |  |                   |     |  |   |     |       |       |       |                |                                    |                |                       |  |                     |    |            |    |       |       |       |           |                |        |  |                        |    |     |       |       |       |       |           |  |  |  |         |    |            |    |       |       |       |  |  |  |  |         |     |            |    |       |       |       |  |  |  |  |        |     |                |       |       |       |                |        |  |                       |  |  |  |         |    |  |       |                |           |  |                          |  |  |  |     |  |            |       |  |       |                |        |       |                    |  |     |    |            |       |  |       |                |        |       |                     |  |         |    |            |       |  |       |                |        |       |                        |  |         |    |            |       |       |                                    |                |        |  |                       |  |     |    |  |       |       |  |                |        |  |                          |  |         |    |            |       |       |  |  |  |  |  |  |         |    |            |       |       |  |  |  |  |  |  |                |    |            |       |       |  |  |  |  |  |  |         |    |            |       |       |  |  |  |  |  |  |                   |    |            |       |       |  |                |        |   |                 |  |     |    |  |       |       |  |  |  |  |  |  |       |    |            |       |       |  |  |  |  |  |  |         |    |            |       |       |  |                |        |  |                       |  |         |    |            |       |       |  |                |        |  |                          |  |         |    |            |       |       |  |  |  |  |  |  |                |     |            |       |       |  |  |  |  |  |  |         |    |  |       |       |  |                |        |  |                       |  |         |    |            |  |       |  |  |  |  |  |  |             |    |  |       |       |  |  |  |  |  |  |         |    |            |  |       |  |  |  |  |  |  |         |     |            |       |       |  |  |  |  |  |  |         |     |            |       |       |  |                |        |  |                       |  |  |  |  |  |  |  |                |        |  |                          |  |  |  |     |  |            |       |  |  |                |        |   |                 |  |     |    |            |       |  |  |  |  |  |  |  |         |    |            |       |  |  |  |  |  |  |  |         |    |            |       |  |  |  |  |  |  |  |     |    |  |       |       |  |  |  |  |  |  |         |    |            |       |  |  |  |  |  |  |  |       |    |            |       |  |  |  |  |  |  |  |         |    |            |       |  |  |  |  |  |  |  |         |    |            |       |  |  |  |  |  |  |  |     |  |            |  |       |  |                |        |   |                 |  |     |    |  |       |       |  |  |  |  |  |  |     |    |            |  |       |  |  |  |  |  |  |         |    |  |       |       |  |  |  |  |  |  |         |    |            |  |       |  |  |  |  |  |  |         |    |            |  |       |  |  |  |  |  |  |                |    |  |       |       |  |  |  |  |  |  |         |    |  |       |       |  |  |  |  |  |  |         |    |            |  |       |  |  |  |  |  |  |             |    |  |       |       |  |  |  |  |  |  |         |    |            |  |       |  |  |  |  |  |  |        |     |  |       |       |  |  |  |  |  |  |         |     |            |  |       |  |  |  |  |  |  |
| 1.6 16V  | 80   | ORGA 10950 |       | 02.09      |                                    | 13.0460-2862.2 | 602862                             |                | 23346 19,0 /WE/S         | TRW |                     |     |     |    |            |       |       |           |                |        |  |                        |     |             |    |            |       |       |           |                |        |  |                     |     |         |    |            |       |       |  |                |        |  |                     |     |             |    |  |       |       |  |  |  |  |  |  |                |    |            |       |       |       |                |        |  |                     |     |         |    |            |       |       |           |  |  |  |  |  |                   |    |            |       |       |       |                |        |       |                    |  |         |    |            |       |       |       |                |        |       |                     |  |       |    |            |       |       |       |                |        |       |                        |  |         |    |            |       |       |                                    |                |        |  |                       |     |         |    |            |       |       |  |                |        |  |                          |  |         |    |  |       |       |  |  |  |  |  |  |         |     |            |       |       |  |  |  |  |  |  |                |    |            |       |       |  |                |        |  |                   |     |                |    |            |       |       |  |                |        |  |                   |     |                   |    |  |       |       |  |                |        |  |                   |     |         |    |            |       |       |  |  |  |  |  |  |             |     |            |       |       |  |  |  |  |  |  |         |    |            |       |       |  |                |        |  |                       |     |         |     |            |       |       |  |                |        |  |                          |  |         |     |            |       |       |  |                |        |  |                   |     |         |     |            |       |  |  |                |        |  |                   |     |  |   |     |       |       |       |                |                                    |                |                       |  |                     |    |            |    |       |       |       |           |                |        |  |                        |    |     |       |       |       |       |           |  |  |  |         |    |            |    |       |       |       |  |  |  |  |         |     |            |    |       |       |       |  |  |  |  |        |     |                |       |       |       |                |        |  |                       |  |  |  |         |    |  |       |                |           |  |                          |  |  |  |     |  |            |       |  |       |                |        |       |                    |  |     |    |            |       |  |       |                |        |       |                     |  |         |    |            |       |  |       |                |        |       |                        |  |         |    |            |       |       |                                    |                |        |  |                       |  |     |    |  |       |       |  |                |        |  |                          |  |         |    |            |       |       |  |  |  |  |  |  |         |    |            |       |       |  |  |  |  |  |  |                |    |            |       |       |  |  |  |  |  |  |         |    |            |       |       |  |  |  |  |  |  |                   |    |            |       |       |  |                |        |   |                 |  |     |    |  |       |       |  |  |  |  |  |  |       |    |            |       |       |  |  |  |  |  |  |         |    |            |       |       |  |                |        |  |                       |  |         |    |            |       |       |  |                |        |  |                          |  |         |    |            |       |       |  |  |  |  |  |  |                |     |            |       |       |  |  |  |  |  |  |         |    |  |       |       |  |                |        |  |                       |  |         |    |            |  |       |  |  |  |  |  |  |             |    |  |       |       |  |  |  |  |  |  |         |    |            |  |       |  |  |  |  |  |  |         |     |            |       |       |  |  |  |  |  |  |         |     |            |       |       |  |                |        |  |                       |  |  |  |  |  |  |  |                |        |  |                          |  |  |  |     |  |            |       |  |  |                |        |   |                 |  |     |    |            |       |  |  |  |  |  |  |  |         |    |            |       |  |  |  |  |  |  |  |         |    |            |       |  |  |  |  |  |  |  |     |    |  |       |       |  |  |  |  |  |  |         |    |            |       |  |  |  |  |  |  |  |       |    |            |       |  |  |  |  |  |  |  |         |    |            |       |  |  |  |  |  |  |  |         |    |            |       |  |  |  |  |  |  |  |     |  |            |  |       |  |                |        |   |                 |  |     |    |  |       |       |  |  |  |  |  |  |     |    |            |  |       |  |  |  |  |  |  |         |    |  |       |       |  |  |  |  |  |  |         |    |            |  |       |  |  |  |  |  |  |         |    |            |  |       |  |  |  |  |  |  |                |    |  |       |       |  |  |  |  |  |  |         |    |  |       |       |  |  |  |  |  |  |         |    |            |  |       |  |  |  |  |  |  |             |    |  |       |       |  |  |  |  |  |  |         |    |            |  |       |  |  |  |  |  |  |        |     |  |       |       |  |  |  |  |  |  |         |     |            |  |       |  |  |  |  |  |  |
| 2.0 HDi  | 66   | ORGA 10892 |       | 02.09      |                                    |                |                                    |                |                          |     |                     |     |     |    |            |       |       |           |                |        |  |                        |     |             |    |            |       |       |           |                |        |  |                     |     |         |    |            |       |       |  |                |        |  |                     |     |             |    |  |       |       |  |  |  |  |  |  |                |    |            |       |       |       |                |        |  |                     |     |         |    |            |       |       |           |  |  |  |  |  |                   |    |            |       |       |       |                |        |       |                    |  |         |    |            |       |       |       |                |        |       |                     |  |       |    |            |       |       |       |                |        |       |                        |  |         |    |            |       |       |                                    |                |        |  |                       |     |         |    |            |       |       |  |                |        |  |                          |  |         |    |  |       |       |  |  |  |  |  |  |         |     |            |       |       |  |  |  |  |  |  |                |    |            |       |       |  |                |        |  |                   |     |                |    |            |       |       |  |                |        |  |                   |     |                   |    |  |       |       |  |                |        |  |                   |     |         |    |            |       |       |  |  |  |  |  |  |             |     |            |       |       |  |  |  |  |  |  |         |    |            |       |       |  |                |        |  |                       |     |         |     |            |       |       |  |                |        |  |                          |  |         |     |            |       |       |  |                |        |  |                   |     |         |     |            |       |  |  |                |        |  |                   |     |  |   |     |       |       |       |                |                                    |                |                       |  |                     |    |            |    |       |       |       |           |                |        |  |                        |    |     |       |       |       |       |           |  |  |  |         |    |            |    |       |       |       |  |  |  |  |         |     |            |    |       |       |       |  |  |  |  |        |     |                |       |       |       |                |        |  |                       |  |  |  |         |    |  |       |                |           |  |                          |  |  |  |     |  |            |       |  |       |                |        |       |                    |  |     |    |            |       |  |       |                |        |       |                     |  |         |    |            |       |  |       |                |        |       |                        |  |         |    |            |       |       |                                    |                |        |  |                       |  |     |    |  |       |       |  |                |        |  |                          |  |         |    |            |       |       |  |  |  |  |  |  |         |    |            |       |       |  |  |  |  |  |  |                |    |            |       |       |  |  |  |  |  |  |         |    |            |       |       |  |  |  |  |  |  |                   |    |            |       |       |  |                |        |   |                 |  |     |    |  |       |       |  |  |  |  |  |  |       |    |            |       |       |  |  |  |  |  |  |         |    |            |       |       |  |                |        |  |                       |  |         |    |            |       |       |  |                |        |  |                          |  |         |    |            |       |       |  |  |  |  |  |  |                |     |            |       |       |  |  |  |  |  |  |         |    |  |       |       |  |                |        |  |                       |  |         |    |            |  |       |  |  |  |  |  |  |             |    |  |       |       |  |  |  |  |  |  |         |    |            |  |       |  |  |  |  |  |  |         |     |            |       |       |  |  |  |  |  |  |         |     |            |       |       |  |                |        |  |                       |  |  |  |  |  |  |  |                |        |  |                          |  |  |  |     |  |            |       |  |  |                |        |   |                 |  |     |    |            |       |  |  |  |  |  |  |  |         |    |            |       |  |  |  |  |  |  |  |         |    |            |       |  |  |  |  |  |  |  |     |    |  |       |       |  |  |  |  |  |  |         |    |            |       |  |  |  |  |  |  |  |       |    |            |       |  |  |  |  |  |  |  |         |    |            |       |  |  |  |  |  |  |  |         |    |            |       |  |  |  |  |  |  |  |     |  |            |  |       |  |                |        |   |                 |  |     |    |  |       |       |  |  |  |  |  |  |     |    |            |  |       |  |  |  |  |  |  |         |    |  |       |       |  |  |  |  |  |  |         |    |            |  |       |  |  |  |  |  |  |         |    |            |  |       |  |  |  |  |  |  |                |    |  |       |       |  |  |  |  |  |  |         |    |  |       |       |  |  |  |  |  |  |         |    |            |  |       |  |  |  |  |  |  |             |    |  |       |       |  |  |  |  |  |  |         |    |            |  |       |  |  |  |  |  |  |        |     |  |       |       |  |  |  |  |  |  |         |     |            |  |       |  |  |  |  |  |  |
| 2.0 RC   | 130  |            | 07.03 | 02.09      |                                    | 13.0460-3966.2 | 603966                             |                | 23600 19,4 /Zub/S        | BOS |                     |     |     |    |            |       |       |           |                |        |  |                        |     |             |    |            |       |       |           |                |        |  |                     |     |         |    |            |       |       |  |                |        |  |                     |     |             |    |  |       |       |  |  |  |  |  |  |                |    |            |       |       |       |                |        |  |                     |     |         |    |            |       |       |           |  |  |  |  |  |                   |    |            |       |       |       |                |        |       |                    |  |         |    |            |       |       |       |                |        |       |                     |  |       |    |            |       |       |       |                |        |       |                        |  |         |    |            |       |       |                                    |                |        |  |                       |     |         |    |            |       |       |  |                |        |  |                          |  |         |    |  |       |       |  |  |  |  |  |  |         |     |            |       |       |  |  |  |  |  |  |                |    |            |       |       |  |                |        |  |                   |     |                |    |            |       |       |  |                |        |  |                   |     |                   |    |  |       |       |  |                |        |  |                   |     |         |    |            |       |       |  |  |  |  |  |  |             |     |            |       |       |  |  |  |  |  |  |         |    |            |       |       |  |                |        |  |                       |     |         |     |            |       |       |  |                |        |  |                          |  |         |     |            |       |       |  |                |        |  |                   |     |         |     |            |       |  |  |                |        |  |                   |     |  |   |     |       |       |       |                |                                    |                |                       |  |                     |    |            |    |       |       |       |           |                |        |  |                        |    |     |       |       |       |       |           |  |  |  |         |    |            |    |       |       |       |  |  |  |  |         |     |            |    |       |       |       |  |  |  |  |        |     |                |       |       |       |                |        |  |                       |  |  |  |         |    |  |       |                |           |  |                          |  |  |  |     |  |            |       |  |       |                |        |       |                    |  |     |    |            |       |  |       |                |        |       |                     |  |         |    |            |       |  |       |                |        |       |                        |  |         |    |            |       |       |                                    |                |        |  |                       |  |     |    |  |       |       |  |                |        |  |                          |  |         |    |            |       |       |  |  |  |  |  |  |         |    |            |       |       |  |  |  |  |  |  |                |    |            |       |       |  |  |  |  |  |  |         |    |            |       |       |  |  |  |  |  |  |                   |    |            |       |       |  |                |        |   |                 |  |     |    |  |       |       |  |  |  |  |  |  |       |    |            |       |       |  |  |  |  |  |  |         |    |            |       |       |  |                |        |  |                       |  |         |    |            |       |       |  |                |        |  |                          |  |         |    |            |       |       |  |  |  |  |  |  |                |     |            |       |       |  |  |  |  |  |  |         |    |  |       |       |  |                |        |  |                       |  |         |    |            |  |       |  |  |  |  |  |  |             |    |  |       |       |  |  |  |  |  |  |         |    |            |  |       |  |  |  |  |  |  |         |     |            |       |       |  |  |  |  |  |  |         |     |            |       |       |  |                |        |  |                       |  |  |  |  |  |  |  |                |        |  |                          |  |  |  |     |  |            |       |  |  |                |        |   |                 |  |     |    |            |       |  |  |  |  |  |  |  |         |    |            |       |  |  |  |  |  |  |  |         |    |            |       |  |  |  |  |  |  |  |     |    |  |       |       |  |  |  |  |  |  |         |    |            |       |  |  |  |  |  |  |  |       |    |            |       |  |  |  |  |  |  |  |         |    |            |       |  |  |  |  |  |  |  |         |    |            |       |  |  |  |  |  |  |  |     |  |            |  |       |  |                |        |   |                 |  |     |    |  |       |       |  |  |  |  |  |  |     |    |            |  |       |  |  |  |  |  |  |         |    |  |       |       |  |  |  |  |  |  |         |    |            |  |       |  |  |  |  |  |  |         |    |            |  |       |  |  |  |  |  |  |                |    |  |       |       |  |  |  |  |  |  |         |    |  |       |       |  |  |  |  |  |  |         |    |            |  |       |  |  |  |  |  |  |             |    |  |       |       |  |  |  |  |  |  |         |    |            |  |       |  |  |  |  |  |  |        |     |  |       |       |  |  |  |  |  |  |         |     |            |  |       |  |  |  |  |  |  |
|  |  |            |       |            |                                    | 13.0470-3966.2 | LD3966                             |                | 23600 19,4 /Zub/S        | BOS |                     |     |     |    |            |       |       |           |                |        |  |                        |     |             |    |            |       |       |           |                |        |  |                     |     |         |    |            |       |       |  |                |        |  |                     |     |             |    |  |       |       |  |  |  |  |  |  |                |    |            |       |       |       |                |        |  |                     |     |         |    |            |       |       |           |  |  |  |  |  |                   |    |            |       |       |       |                |        |       |                    |  |         |    |            |       |       |       |                |        |       |                     |  |       |    |            |       |       |       |                |        |       |                        |  |         |    |            |       |       |                                    |                |        |  |                       |     |         |    |            |       |       |  |                |        |  |                          |  |         |    |  |       |       |  |  |  |  |  |  |         |     |            |       |       |  |  |  |  |  |  |                |    |            |       |       |  |                |        |  |                   |     |                |    |            |       |       |  |                |        |  |                   |     |                   |    |  |       |       |  |                |        |  |                   |     |         |    |            |       |       |  |  |  |  |  |  |             |     |            |       |       |  |  |  |  |  |  |         |    |            |       |       |  |                |        |  |                       |     |         |     |            |       |       |  |                |        |  |                          |  |         |     |            |       |       |  |                |        |  |                   |     |         |     |            |       |  |  |                |        |  |                   |     |  |   |     |       |       |       |                |                                    |                |                       |  |                     |    |            |    |       |       |       |           |                |        |  |                        |    |     |       |       |       |       |           |  |  |  |         |    |            |    |       |       |       |  |  |  |  |         |     |            |    |       |       |       |  |  |  |  |        |     |                |       |       |       |                |        |  |                       |  |  |  |         |    |  |       |                |           |  |                          |  |  |  |     |  |            |       |  |       |                |        |       |                    |  |     |    |            |       |  |       |                |        |       |                     |  |         |    |            |       |  |       |                |        |       |                        |  |         |    |            |       |       |                                    |                |        |  |                       |  |     |    |  |       |       |  |                |        |  |                          |  |         |    |            |       |       |  |  |  |  |  |  |         |    |            |       |       |  |  |  |  |  |  |                |    |            |       |       |  |  |  |  |  |  |         |    |            |       |       |  |  |  |  |  |  |                   |    |            |       |       |  |                |        |   |                 |  |     |    |  |       |       |  |  |  |  |  |  |       |    |            |       |       |  |  |  |  |  |  |         |    |            |       |       |  |                |        |  |                       |  |         |    |            |       |       |  |                |        |  |                          |  |         |    |            |       |       |  |  |  |  |  |  |                |     |            |       |       |  |  |  |  |  |  |         |    |  |       |       |  |                |        |  |                       |  |         |    |            |  |       |  |  |  |  |  |  |             |    |  |       |       |  |  |  |  |  |  |         |    |            |  |       |  |  |  |  |  |  |         |     |            |       |       |  |  |  |  |  |  |         |     |            |       |       |  |                |        |  |                       |  |  |  |  |  |  |  |                |        |  |                          |  |  |  |     |  |            |       |  |  |                |        |   |                 |  |     |    |            |       |  |  |  |  |  |  |  |         |    |            |       |  |  |  |  |  |  |  |         |    |            |       |  |  |  |  |  |  |  |     |    |  |       |       |  |  |  |  |  |  |         |    |            |       |  |  |  |  |  |  |  |       |    |            |       |  |  |  |  |  |  |  |         |    |            |       |  |  |  |  |  |  |  |         |    |            |       |  |  |  |  |  |  |  |     |  |            |  |       |  |                |        |   |                 |  |     |    |  |       |       |  |  |  |  |  |  |     |    |            |  |       |  |  |  |  |  |  |         |    |  |       |       |  |  |  |  |  |  |         |    |            |  |       |  |  |  |  |  |  |         |    |            |  |       |  |  |  |  |  |  |                |    |  |       |       |  |  |  |  |  |  |         |    |  |       |       |  |  |  |  |  |  |         |    |            |  |       |  |  |  |  |  |  |             |    |  |       |       |  |  |  |  |  |  |         |    |            |  |       |  |  |  |  |  |  |        |     |  |       |       |  |  |  |  |  |  |         |     |            |  |       |  |  |  |  |  |  |
|    | <table border="1"> <tr> <td>1.1</td> <td></td> <td></td> <td>09.98</td> <td>02.09</td> <td>- belüftete Scheiben <sup>1)</sup></td> <td>24.0113-0185.1</td> <td>413185</td> <td></td> <td>248 13,0 11,0 +S +B</td> <td></td> </tr> <tr> <td>1.4</td> <td>55</td> <td></td> <td>03.07</td> <td>02.09</td> <td>- ROL GAR</td> <td>24.0313-0185.1</td> <td>513185</td> <td></td> <td>248 13,0 11,0 +S +B PD</td> <td></td> </tr> <tr> <td>1.4</td> <td>55</td> <td></td> <td>09.98</td> <td>02.09</td> <td>- ROL GAR</td> <td></td> <td></td> <td></td> <td></td> <td></td> </tr> <tr> <td>1.4 HDi</td> <td>50</td> <td></td> <td>09.01</td> <td>02.09</td> <td></td> <td></td> <td></td> <td></td> <td></td> <td></td> </tr> <tr> <td>1.4 HDi</td> <td>51</td> <td></td> <td>09.02</td> <td>02.07</td> <td></td> <td></td> <td></td> <td></td> <td></td> <td></td> </tr> <tr> <td>1.4 HDi eco 70</td> <td>50</td> <td></td> <td>09.08</td> <td>02.09</td> <td></td> <td></td> <td></td> <td></td> <td></td> <td></td> </tr> <tr> <td>1.4 LPG</td> <td>55</td> <td></td> <td>05.06</td> <td>09.07</td> <td>- ROL GAR</td> <td></td> <td></td> <td></td> <td></td> <td></td> </tr> <tr> <td>1.1</td> <td></td> <td>ORGA 08988</td> <td>09.98</td> <td></td> <td>- ABS</td> <td>24.0110-0187.1</td> <td>410187</td> <td>- ABS</td> <td>247 10,0 9,0 +S +B</td> <td></td> </tr> <tr> <td>1.1</td> <td></td> <td>ORGA 08989</td> <td></td> <td></td> <td>- ABS</td> <td>24.0113-0185.1</td> <td>413185</td> <td>- ABS</td> <td>248 13,0 11,0 +S +B</td> <td></td> </tr> <tr> <td></td> <td></td> <td>ORGA 09974</td> <td></td> <td></td> <td>- ABS</td> <td>24.0313-0185.1</td> <td>513185</td> <td>- ABS</td> <td>248 13,0 11,0 +S +B PD</td> <td></td> </tr> <tr> <td>1.1</td> <td></td> <td>ORGA 09975</td> <td></td> <td>02.09</td> <td>+ belüftete Scheiben <sup>2)</sup></td> <td>24.0120-0132.1</td> <td>420132</td> <td></td> <td>247 20,4 18,5 V +S +B</td> <td></td> </tr> <tr> <td>1.4</td> <td>55</td> <td></td> <td>03.07</td> <td>02.09</td> <td></td> <td>24.0320-0132.1</td> <td>520132</td> <td></td> <td>247 20,4 18,5 V +S +B PD</td> <td></td> </tr> <tr> <td>1.4 HDi</td> <td>50</td> <td></td> <td>09.01</td> <td>02.09</td> <td></td> <td></td> <td></td> <td></td> <td></td> <td></td> </tr> <tr> <td>1.4 HDi</td> <td>51</td> <td></td> <td>09.02</td> <td>02.07</td> <td></td> <td></td> <td></td> <td></td> <td></td> <td></td> </tr> <tr> <td>1.4 HDi eco 70</td> <td>50</td> <td></td> <td>09.08</td> <td>02.09</td> <td></td> <td></td> <td></td> <td></td> <td></td> <td></td> </tr> <tr> <td>1.4 LPG</td> <td>55</td> <td></td> <td>05.06</td> <td>09.07</td> <td></td> <td></td> <td></td> <td></td> <td></td> <td></td> </tr> <tr> <td>1.4 Roland Garros</td> <td>55</td> <td></td> <td>09.98</td> <td>02.09</td> <td></td> <td></td> <td></td> <td></td> <td></td> <td></td> </tr> <tr> <td>1.6</td> <td>65</td> <td></td> <td>09.98</td> <td>12.00</td> <td></td> <td></td> <td></td> <td></td> <td></td> <td></td> </tr> <tr> <td>1.9 D</td> <td>51</td> <td></td> <td>09.98</td> <td>02.09</td> <td></td> <td></td> <td></td> <td></td> <td></td> <td></td> </tr> <tr> <td>1.6 16V</td> <td>80</td> <td>ORGA 09078</td> <td>12.00</td> <td></td> <td></td> <td>24.0120-0133.1</td> <td>420133</td> <td></td> <td>266 20,5 18,5 V +S +B</td> <td></td> </tr> <tr> <td>2.0 HDi</td> <td>66</td> <td>ORGA 09078</td> <td>12.99</td> <td></td> <td></td> <td>24.0320-0133.1</td> <td>520133</td> <td></td> <td>266 20,5 18,5 V +S +B PD</td> <td></td> </tr> <tr> <td>2.0 S16</td> <td>99</td> <td></td> <td>04.99</td> <td>10.00</td> <td></td> <td></td> <td></td> <td></td> <td></td> <td></td> </tr> <tr> <td>2.0 S16</td> <td>100</td> <td>ORGA 09078</td> <td>10.00</td> <td></td> <td></td> <td></td> <td></td> <td></td> <td></td> <td></td> </tr> <tr> <td>1.4 16V</td> <td>65</td> <td></td> <td>10.03</td> <td>02.09</td> <td></td> <td>24.0122-0194.1</td> <td>422194</td> <td></td> <td>266 22,0 20,0 V +S +B</td> <td></td> </tr> <tr> <td>1.6 16V</td> <td>80</td> <td>ORGA 09079</td> <td></td> <td>02.09</td> <td></td> <td></td> <td></td> <td></td> <td></td> <td></td> </tr> <tr> <td>1.6 HDi 110</td> <td>80</td> <td></td> <td>05.04</td> <td>02.09</td> <td></td> <td></td> <td></td> <td></td> <td></td> <td></td> </tr> <tr> <td>2.0 HDi</td> <td>66</td> <td>ORGA 09079</td> <td></td> <td>02.09</td> <td></td> <td></td> <td></td> <td></td> <td></td> <td></td> </tr> <tr> <td>2.0 S16</td> <td>100</td> <td>ORGA 09079</td> <td></td> <td>02.09</td> <td></td> <td></td> <td></td> <td></td> <td></td> <td></td> </tr> <tr> <td>2.0 RC</td> <td>130</td> <td></td> <td>07.03</td> <td>02.09</td> <td></td> <td>24.0126-0120.1</td> <td>426120</td> <td></td> <td>283 26,0 24,0 V +S +B</td> <td></td> </tr> <tr> <td></td> <td></td> <td></td> <td></td> <td></td> <td></td> <td>24.0326-0120.1</td> <td>526120</td> <td></td> <td>283 26,0 24,0 V +S +B PD</td> <td></td> </tr> <tr> <td></td> <td> <table border="1"> <tr> <td>1.1</td> <td></td> <td>ORGA 09456</td> <td>09.98</td> <td></td> <td></td> <td>24.0713-1115.3</td> <td>360035</td> <td>2</td> <td>Radsensor L=815</td> <td></td> </tr> <tr> <td>1.4</td> <td>55</td> <td>ORGA 09456</td> <td>09.98</td> <td></td> <td></td> <td></td> <td></td> <td></td> <td></td> <td></td> </tr> <tr> <td>1.4 HDi</td> <td>50</td> <td>ORGA 09456</td> <td>09.01</td> <td></td> <td></td> <td></td> <td></td> <td></td> <td></td> <td></td> </tr> <tr> <td>1.4 HDi</td> <td>51</td> <td>ORGA 09456</td> <td>09.02</td> <td></td> <td></td> <td></td> <td></td> <td></td> <td></td> <td></td> </tr> <tr> <td>1.6</td> <td>65</td> <td></td> <td>09.98</td> <td>12.00</td> <td></td> <td></td> <td></td> <td></td> <td></td> <td></td> </tr> <tr> <td>1.6 16V</td> <td>80</td> <td>ORGA 09456</td> <td>12.00</td> <td></td> <td></td> <td></td> <td></td> <td></td> <td></td> <td></td> </tr> <tr> <td>1.9 D</td> <td>51</td> <td>ORGA 09456</td> <td>09.98</td> <td></td> <td></td> <td></td> <td></td> <td></td> <td></td> <td></td> </tr> <tr> <td>2.0 HDi</td> <td>66</td> <td>ORGA 09456</td> <td>12.99</td> <td></td> <td></td> <td></td> <td></td> <td></td> <td></td> <td></td> </tr> <tr> <td>2.0 S16</td> <td>99</td> <td>ORGA 09456</td> <td>04.99</td> <td></td> <td></td> <td></td> <td></td> <td></td> <td></td> <td></td> </tr> <tr> <td>1.1</td> <td></td> <td>ORGA 09457</td> <td></td> <td>02.09</td> <td></td> <td>24.0711-6205.3</td> <td>360229</td> <td>2</td> <td>Radsensor L=815</td> <td></td> </tr> <tr> <td>1.4</td> <td>55</td> <td></td> <td>03.07</td> <td>02.09</td> <td></td> <td></td> <td></td> <td></td> <td></td> <td></td> </tr> <tr> <td>1.4</td> <td>55</td> <td>ORGA 09457</td> <td></td> <td>02.09</td> <td></td> <td></td> <td></td> <td></td> <td></td> <td></td> </tr> <tr> <td>1.4 16V</td> <td>65</td> <td></td> <td>10.03</td> <td>02.09</td> <td></td> <td></td> <td></td> <td></td> <td></td> <td></td> </tr> <tr> <td>1.4 HDi</td> <td>50</td> <td>ORGA 09457</td> <td></td> <td>02.09</td> <td></td> <td></td> <td></td> <td></td> <td></td> <td></td> </tr> <tr> <td>1.4 HDi</td> <td>51</td> <td>ORGA 09457</td> <td></td> <td>02.09</td> <td></td> <td></td> <td></td> <td></td> <td></td> <td></td> </tr> <tr> <td>1.4 HDi eco 70</td> <td>50</td> <td></td> <td>09.08</td> <td>02.09</td> <td></td> <td></td> <td></td> <td></td> <td></td> <td></td> </tr> <tr> <td>1.4 LPG</td> <td>55</td> <td></td> <td>05.06</td> <td>09.07</td> <td></td> <td></td> <td></td> <td></td> <td></td> <td></td> </tr> <tr> <td>1.6 16V</td> <td>80</td> <td>ORGA 09457</td> <td></td> <td>02.09</td> <td></td> <td></td> <td></td> <td></td> <td></td> <td></td> </tr> <tr> <td>1.6 HDi 110</td> <td>80</td> <td></td> <td>05.04</td> <td>02.09</td> <td></td> <td></td> <td></td> <td></td> <td></td> <td></td> </tr> <tr> <td>2.0 HDi</td> <td>66</td> <td>ORGA 09457</td> <td></td> <td>02.09</td> <td></td> <td></td> <td></td> <td></td> <td></td> <td></td> </tr> <tr> <td>2.0 RC</td> <td>130</td> <td></td> <td>07.03</td> <td>02.09</td> <td></td> <td></td> <td></td> <td></td> <td></td> <td></td> </tr> <tr> <td>2.0 S16</td> <td>100</td> <td>ORGA 09457</td> <td></td> <td>02.09</td> <td></td> <td></td> <td></td> <td></td> <td></td> <td></td> </tr> </table> </td> </tr> </table>  | 1.1        |       |            | 09.98                              | 02.09          | - belüftete Scheiben <sup>1)</sup> | 24.0113-0185.1 | 413185                   |     | 248 13,0 11,0 +S +B |     | 1.4 | 55 |            | 03.07 | 02.09 | - ROL GAR | 24.0313-0185.1 | 513185 |  | 248 13,0 11,0 +S +B PD |     | 1.4         | 55 |            | 09.98 | 02.09 | - ROL GAR |                |        |  |                     |     | 1.4 HDi | 50 |            | 09.01 | 02.09 |  |                |        |  |                     |     | 1.4 HDi     | 51 |  | 09.02 | 02.07 |  |  |  |  |  |  | 1.4 HDi eco 70 | 50 |            | 09.08 | 02.09 |       |                |        |  |                     |     | 1.4 LPG | 55 |            | 05.06 | 09.07 | - ROL GAR |  |  |  |  |  | 1.1               |    | ORGA 08988 | 09.98 |       | - ABS | 24.0110-0187.1 | 410187 | - ABS | 247 10,0 9,0 +S +B |  | 1.1     |    | ORGA 08989 |       |       | - ABS | 24.0113-0185.1 | 413185 | - ABS | 248 13,0 11,0 +S +B |  |       |    | ORGA 09974 |       |       | - ABS | 24.0313-0185.1 | 513185 | - ABS | 248 13,0 11,0 +S +B PD |  | 1.1     |    | ORGA 09975 |       | 02.09 | + belüftete Scheiben <sup>2)</sup> | 24.0120-0132.1 | 420132 |  | 247 20,4 18,5 V +S +B |     | 1.4     | 55 |            | 03.07 | 02.09 |  | 24.0320-0132.1 | 520132 |  | 247 20,4 18,5 V +S +B PD |  | 1.4 HDi | 50 |  | 09.01 | 02.09 |  |  |  |  |  |  | 1.4 HDi | 51  |            | 09.02 | 02.07 |  |  |  |  |  |  | 1.4 HDi eco 70 | 50 |            | 09.08 | 02.09 |  |                |        |  |                   |     | 1.4 LPG        | 55 |            | 05.06 | 09.07 |  |                |        |  |                   |     | 1.4 Roland Garros | 55 |  | 09.98 | 02.09 |  |                |        |  |                   |     | 1.6     | 65 |            | 09.98 | 12.00 |  |  |  |  |  |  | 1.9 D       | 51  |            | 09.98 | 02.09 |  |  |  |  |  |  | 1.6 16V | 80 | ORGA 09078 | 12.00 |       |  | 24.0120-0133.1 | 420133 |  | 266 20,5 18,5 V +S +B |     | 2.0 HDi | 66  | ORGA 09078 | 12.99 |       |  | 24.0320-0133.1 | 520133 |  | 266 20,5 18,5 V +S +B PD |  | 2.0 S16 | 99  |            | 04.99 | 10.00 |  |                |        |  |                   |     | 2.0 S16 | 100 | ORGA 09078 | 10.00 |  |  |                |        |  |                   |     | 1.4 16V  | 65  |     | 10.03 | 02.09 |       | 24.0122-0194.1 | 422194                             |                | 266 22,0 20,0 V +S +B |  | 1.6 16V             | 80 | ORGA 09079 |    | 02.09 |       |       |           |                |        |  | 1.6 HDi 110            | 80 |     | 05.04 | 02.09 |       |       |           |  |  |  | 2.0 HDi | 66 | ORGA 09079 |    | 02.09 |       |       |  |  |  |  | 2.0 S16 | 100 | ORGA 09079 |    | 02.09 |       |       |  |  |  |  | 2.0 RC | 130 |                | 07.03 | 02.09 |       | 24.0126-0120.1 | 426120 |  | 283 26,0 24,0 V +S +B |  |  |  |         |    |  |       | 24.0326-0120.1 | 526120    |  | 283 26,0 24,0 V +S +B PD |  |  | <table border="1"> <tr> <td>1.1</td> <td></td> <td>ORGA 09456</td> <td>09.98</td> <td></td> <td></td> <td>24.0713-1115.3</td> <td>360035</td> <td>2</td> <td>Radsensor L=815</td> <td></td> </tr> <tr> <td>1.4</td> <td>55</td> <td>ORGA 09456</td> <td>09.98</td> <td></td> <td></td> <td></td> <td></td> <td></td> <td></td> <td></td> </tr> <tr> <td>1.4 HDi</td> <td>50</td> <td>ORGA 09456</td> <td>09.01</td> <td></td> <td></td> <td></td> <td></td> <td></td> <td></td> <td></td> </tr> <tr> <td>1.4 HDi</td> <td>51</td> <td>ORGA 09456</td> <td>09.02</td> <td></td> <td></td> <td></td> <td></td> <td></td> <td></td> <td></td> </tr> <tr> <td>1.6</td> <td>65</td> <td></td> <td>09.98</td> <td>12.00</td> <td></td> <td></td> <td></td> <td></td> <td></td> <td></td> </tr> <tr> <td>1.6 16V</td> <td>80</td> <td>ORGA 09456</td> <td>12.00</td> <td></td> <td></td> <td></td> <td></td> <td></td> <td></td> <td></td> </tr> <tr> <td>1.9 D</td> <td>51</td> <td>ORGA 09456</td> <td>09.98</td> <td></td> <td></td> <td></td> <td></td> <td></td> <td></td> <td></td> </tr> <tr> <td>2.0 HDi</td> <td>66</td> <td>ORGA 09456</td> <td>12.99</td> <td></td> <td></td> <td></td> <td></td> <td></td> <td></td> <td></td> </tr> <tr> <td>2.0 S16</td> <td>99</td> <td>ORGA 09456</td> <td>04.99</td> <td></td> <td></td> <td></td> <td></td> <td></td> <td></td> <td></td> </tr> <tr> <td>1.1</td> <td></td> <td>ORGA 09457</td> <td></td> <td>02.09</td> <td></td> <td>24.0711-6205.3</td> <td>360229</td> <td>2</td> <td>Radsensor L=815</td> <td></td> </tr> <tr> <td>1.4</td> <td>55</td> <td></td> <td>03.07</td> <td>02.09</td> <td></td> <td></td> <td></td> <td></td> <td></td> <td></td> </tr> <tr> <td>1.4</td> <td>55</td> <td>ORGA 09457</td> <td></td> <td>02.09</td> <td></td> <td></td> <td></td> <td></td> <td></td> <td></td> </tr> <tr> <td>1.4 16V</td> <td>65</td> <td></td> <td>10.03</td> <td>02.09</td> <td></td> <td></td> <td></td> <td></td> <td></td> <td></td> </tr> <tr> <td>1.4 HDi</td> <td>50</td> <td>ORGA 09457</td> <td></td> <td>02.09</td> <td></td> <td></td> <td></td> <td></td> <td></td> <td></td> </tr> <tr> <td>1.4 HDi</td> <td>51</td> <td>ORGA 09457</td> <td></td> <td>02.09</td> <td></td> <td></td> <td></td> <td></td> <td></td> <td></td> </tr> <tr> <td>1.4 HDi eco 70</td> <td>50</td> <td></td> <td>09.08</td> <td>02.09</td> <td></td> <td></td> <td></td> <td></td> <td></td> <td></td> </tr> <tr> <td>1.4 LPG</td> <td>55</td> <td></td> <td>05.06</td> <td>09.07</td> <td></td> <td></td> <td></td> <td></td> <td></td> <td></td> </tr> <tr> <td>1.6 16V</td> <td>80</td> <td>ORGA 09457</td> <td></td> <td>02.09</td> <td></td> <td></td> <td></td> <td></td> <td></td> <td></td> </tr> <tr> <td>1.6 HDi 110</td> <td>80</td> <td></td> <td>05.04</td> <td>02.09</td> <td></td> <td></td> <td></td> <td></td> <td></td> <td></td> </tr> <tr> <td>2.0 HDi</td> <td>66</td> <td>ORGA 09457</td> <td></td> <td>02.09</td> <td></td> <td></td> <td></td> <td></td> <td></td> <td></td> </tr> <tr> <td>2.0 RC</td> <td>130</td> <td></td> <td>07.03</td> <td>02.09</td> <td></td> <td></td> <td></td> <td></td> <td></td> <td></td> </tr> <tr> <td>2.0 S16</td> <td>100</td> <td>ORGA 09457</td> <td></td> <td>02.09</td> <td></td> <td></td> <td></td> <td></td> <td></td> <td></td> </tr> </table> | 1.1 |  | ORGA 09456 | 09.98 |  |       | 24.0713-1115.3 | 360035 | 2     | Radsensor L=815    |  | 1.4 | 55 | ORGA 09456 | 09.98 |  |       |                |        |       |                     |  | 1.4 HDi | 50 | ORGA 09456 | 09.01 |  |       |                |        |       |                        |  | 1.4 HDi | 51 | ORGA 09456 | 09.02 |       |                                    |                |        |  |                       |  | 1.6 | 65 |  | 09.98 | 12.00 |  |                |        |  |                          |  | 1.6 16V | 80 | ORGA 09456 | 12.00 |       |  |  |  |  |  |  | 1.9 D   | 51 | ORGA 09456 | 09.98 |       |  |  |  |  |  |  | 2.0 HDi        | 66 | ORGA 09456 | 12.99 |       |  |  |  |  |  |  | 2.0 S16 | 99 | ORGA 09456 | 04.99 |       |  |  |  |  |  |  | 1.1               |    | ORGA 09457 |       | 02.09 |  | 24.0711-6205.3 | 360229 | 2 | Radsensor L=815 |  | 1.4 | 55 |  | 03.07 | 02.09 |  |  |  |  |  |  | 1.4   | 55 | ORGA 09457 |       | 02.09 |  |  |  |  |  |  | 1.4 16V | 65 |            | 10.03 | 02.09 |  |                |        |  |                       |  | 1.4 HDi | 50 | ORGA 09457 |       | 02.09 |  |                |        |  |                          |  | 1.4 HDi | 51 | ORGA 09457 |       | 02.09 |  |  |  |  |  |  | 1.4 HDi eco 70 | 50  |            | 09.08 | 02.09 |  |  |  |  |  |  | 1.4 LPG | 55 |  | 05.06 | 09.07 |  |                |        |  |                       |  | 1.6 16V | 80 | ORGA 09457 |  | 02.09 |  |  |  |  |  |  | 1.6 HDi 110 | 80 |  | 05.04 | 02.09 |  |  |  |  |  |  | 2.0 HDi | 66 | ORGA 09457 |  | 02.09 |  |  |  |  |  |  | 2.0 RC  | 130 |            | 07.03 | 02.09 |  |  |  |  |  |  | 2.0 S16 | 100 | ORGA 09457 |       | 02.09 |  |                |        |  |                       |  |  |  |  |  |  |  |                |        |  |                          |  |  |  |     |  |            |       |  |  |                |        |   |                 |  |     |    |            |       |  |  |  |  |  |  |  |         |    |            |       |  |  |  |  |  |  |  |         |    |            |       |  |  |  |  |  |  |  |     |    |  |       |       |  |  |  |  |  |  |         |    |            |       |  |  |  |  |  |  |  |       |    |            |       |  |  |  |  |  |  |  |         |    |            |       |  |  |  |  |  |  |  |         |    |            |       |  |  |  |  |  |  |  |     |  |            |  |       |  |                |        |   |                 |  |     |    |  |       |       |  |  |  |  |  |  |     |    |            |  |       |  |  |  |  |  |  |         |    |  |       |       |  |  |  |  |  |  |         |    |            |  |       |  |  |  |  |  |  |         |    |            |  |       |  |  |  |  |  |  |                |    |  |       |       |  |  |  |  |  |  |         |    |  |       |       |  |  |  |  |  |  |         |    |            |  |       |  |  |  |  |  |  |             |    |  |       |       |  |  |  |  |  |  |         |    |            |  |       |  |  |  |  |  |  |        |     |  |       |       |  |  |  |  |  |  |         |     |            |  |       |  |  |  |  |  |  |
| 1.1  |  |            | 09.98 | 02.09      | - belüftete Scheiben <sup>1)</sup> | 24.0113-0185.1 | 413185                             |                | 248 13,0 11,0 +S +B      |     |                     |     |     |    |            |       |       |           |                |        |  |                        |     |             |    |            |       |       |           |                |        |  |                     |     |         |    |            |       |       |  |                |        |  |                     |     |             |    |  |       |       |  |  |  |  |  |  |                |    |            |       |       |       |                |        |  |                     |     |         |    |            |       |       |           |  |  |  |  |  |                   |    |            |       |       |       |                |        |       |                    |  |         |    |            |       |       |       |                |        |       |                     |  |       |    |            |       |       |       |                |        |       |                        |  |         |    |            |       |       |                                    |                |        |  |                       |     |         |    |            |       |       |  |                |        |  |                          |  |         |    |  |       |       |  |  |  |  |  |  |         |     |            |       |       |  |  |  |  |  |  |                |    |            |       |       |  |                |        |  |                   |     |                |    |            |       |       |  |                |        |  |                   |     |                   |    |  |       |       |  |                |        |  |                   |     |         |    |            |       |       |  |  |  |  |  |  |             |     |            |       |       |  |  |  |  |  |  |         |    |            |       |       |  |                |        |  |                       |     |         |     |            |       |       |  |                |        |  |                          |  |         |     |            |       |       |  |                |        |  |                   |     |         |     |            |       |  |  |                |        |  |                   |     |  |   |     |       |       |       |                |                                    |                |                       |  |                     |    |            |    |       |       |       |           |                |        |  |                        |    |     |       |       |       |       |           |  |  |  |         |    |            |    |       |       |       |  |  |  |  |         |     |            |    |       |       |       |  |  |  |  |        |     |                |       |       |       |                |        |  |                       |  |  |  |         |    |  |       |                |           |  |                          |  |  |  |     |  |            |       |  |       |                |        |       |                    |  |     |    |            |       |  |       |                |        |       |                     |  |         |    |            |       |  |       |                |        |       |                        |  |         |    |            |       |       |                                    |                |        |  |                       |  |     |    |  |       |       |  |                |        |  |                          |  |         |    |            |       |       |  |  |  |  |  |  |         |    |            |       |       |  |  |  |  |  |  |                |    |            |       |       |  |  |  |  |  |  |         |    |            |       |       |  |  |  |  |  |  |                   |    |            |       |       |  |                |        |   |                 |  |     |    |  |       |       |  |  |  |  |  |  |       |    |            |       |       |  |  |  |  |  |  |         |    |            |       |       |  |                |        |  |                       |  |         |    |            |       |       |  |                |        |  |                          |  |         |    |            |       |       |  |  |  |  |  |  |                |     |            |       |       |  |  |  |  |  |  |         |    |  |       |       |  |                |        |  |                       |  |         |    |            |  |       |  |  |  |  |  |  |             |    |  |       |       |  |  |  |  |  |  |         |    |            |  |       |  |  |  |  |  |  |         |     |            |       |       |  |  |  |  |  |  |         |     |            |       |       |  |                |        |  |                       |  |  |  |  |  |  |  |                |        |  |                          |  |  |  |     |  |            |       |  |  |                |        |   |                 |  |     |    |            |       |  |  |  |  |  |  |  |         |    |            |       |  |  |  |  |  |  |  |         |    |            |       |  |  |  |  |  |  |  |     |    |  |       |       |  |  |  |  |  |  |         |    |            |       |  |  |  |  |  |  |  |       |    |            |       |  |  |  |  |  |  |  |         |    |            |       |  |  |  |  |  |  |  |         |    |            |       |  |  |  |  |  |  |  |     |  |            |  |       |  |                |        |   |                 |  |     |    |  |       |       |  |  |  |  |  |  |     |    |            |  |       |  |  |  |  |  |  |         |    |  |       |       |  |  |  |  |  |  |         |    |            |  |       |  |  |  |  |  |  |         |    |            |  |       |  |  |  |  |  |  |                |    |  |       |       |  |  |  |  |  |  |         |    |  |       |       |  |  |  |  |  |  |         |    |            |  |       |  |  |  |  |  |  |             |    |  |       |       |  |  |  |  |  |  |         |    |            |  |       |  |  |  |  |  |  |        |     |  |       |       |  |  |  |  |  |  |         |     |            |  |       |  |  |  |  |  |  |
| 1.4  | 55   |            | 03.07 | 02.09      | - ROL GAR                          | 24.0313-0185.1 | 513185                             |                | 248 13,0 11,0 +S +B PD   |     |                     |     |     |    |            |       |       |           |                |        |  |                        |     |             |    |            |       |       |           |                |        |  |                     |     |         |    |            |       |       |  |                |        |  |                     |     |             |    |  |       |       |  |  |  |  |  |  |                |    |            |       |       |       |                |        |  |                     |     |         |    |            |       |       |           |  |  |  |  |  |                   |    |            |       |       |       |                |        |       |                    |  |         |    |            |       |       |       |                |        |       |                     |  |       |    |            |       |       |       |                |        |       |                        |  |         |    |            |       |       |                                    |                |        |  |                       |     |         |    |            |       |       |  |                |        |  |                          |  |         |    |  |       |       |  |  |  |  |  |  |         |     |            |       |       |  |  |  |  |  |  |                |    |            |       |       |  |                |        |  |                   |     |                |    |            |       |       |  |                |        |  |                   |     |                   |    |  |       |       |  |                |        |  |                   |     |         |    |            |       |       |  |  |  |  |  |  |             |     |            |       |       |  |  |  |  |  |  |         |    |            |       |       |  |                |        |  |                       |     |         |     |            |       |       |  |                |        |  |                          |  |         |     |            |       |       |  |                |        |  |                   |     |         |     |            |       |  |  |                |        |  |                   |     |  |   |     |       |       |       |                |                                    |                |                       |  |                     |    |            |    |       |       |       |           |                |        |  |                        |    |     |       |       |       |       |           |  |  |  |         |    |            |    |       |       |       |  |  |  |  |         |     |            |    |       |       |       |  |  |  |  |        |     |                |       |       |       |                |        |  |                       |  |  |  |         |    |  |       |                |           |  |                          |  |  |  |     |  |            |       |  |       |                |        |       |                    |  |     |    |            |       |  |       |                |        |       |                     |  |         |    |            |       |  |       |                |        |       |                        |  |         |    |            |       |       |                                    |                |        |  |                       |  |     |    |  |       |       |  |                |        |  |                          |  |         |    |            |       |       |  |  |  |  |  |  |         |    |            |       |       |  |  |  |  |  |  |                |    |            |       |       |  |  |  |  |  |  |         |    |            |       |       |  |  |  |  |  |  |                   |    |            |       |       |  |                |        |   |                 |  |     |    |  |       |       |  |  |  |  |  |  |       |    |            |       |       |  |  |  |  |  |  |         |    |            |       |       |  |                |        |  |                       |  |         |    |            |       |       |  |                |        |  |                          |  |         |    |            |       |       |  |  |  |  |  |  |                |     |            |       |       |  |  |  |  |  |  |         |    |  |       |       |  |                |        |  |                       |  |         |    |            |  |       |  |  |  |  |  |  |             |    |  |       |       |  |  |  |  |  |  |         |    |            |  |       |  |  |  |  |  |  |         |     |            |       |       |  |  |  |  |  |  |         |     |            |       |       |  |                |        |  |                       |  |  |  |  |  |  |  |                |        |  |                          |  |  |  |     |  |            |       |  |  |                |        |   |                 |  |     |    |            |       |  |  |  |  |  |  |  |         |    |            |       |  |  |  |  |  |  |  |         |    |            |       |  |  |  |  |  |  |  |     |    |  |       |       |  |  |  |  |  |  |         |    |            |       |  |  |  |  |  |  |  |       |    |            |       |  |  |  |  |  |  |  |         |    |            |       |  |  |  |  |  |  |  |         |    |            |       |  |  |  |  |  |  |  |     |  |            |  |       |  |                |        |   |                 |  |     |    |  |       |       |  |  |  |  |  |  |     |    |            |  |       |  |  |  |  |  |  |         |    |  |       |       |  |  |  |  |  |  |         |    |            |  |       |  |  |  |  |  |  |         |    |            |  |       |  |  |  |  |  |  |                |    |  |       |       |  |  |  |  |  |  |         |    |  |       |       |  |  |  |  |  |  |         |    |            |  |       |  |  |  |  |  |  |             |    |  |       |       |  |  |  |  |  |  |         |    |            |  |       |  |  |  |  |  |  |        |     |  |       |       |  |  |  |  |  |  |         |     |            |  |       |  |  |  |  |  |  |
| 1.4  | 55   |            | 09.98 | 02.09      | - ROL GAR                          |                |                                    |                |                          |     |                     |     |     |    |            |       |       |           |                |        |  |                        |     |             |    |            |       |       |           |                |        |  |                     |     |         |    |            |       |       |  |                |        |  |                     |     |             |    |  |       |       |  |  |  |  |  |  |                |    |            |       |       |       |                |        |  |                     |     |         |    |            |       |       |           |  |  |  |  |  |                   |    |            |       |       |       |                |        |       |                    |  |         |    |            |       |       |       |                |        |       |                     |  |       |    |            |       |       |       |                |        |       |                        |  |         |    |            |       |       |                                    |                |        |  |                       |     |         |    |            |       |       |  |                |        |  |                          |  |         |    |  |       |       |  |  |  |  |  |  |         |     |            |       |       |  |  |  |  |  |  |                |    |            |       |       |  |                |        |  |                   |     |                |    |            |       |       |  |                |        |  |                   |     |                   |    |  |       |       |  |                |        |  |                   |     |         |    |            |       |       |  |  |  |  |  |  |             |     |            |       |       |  |  |  |  |  |  |         |    |            |       |       |  |                |        |  |                       |     |         |     |            |       |       |  |                |        |  |                          |  |         |     |            |       |       |  |                |        |  |                   |     |         |     |            |       |  |  |                |        |  |                   |     |  |   |     |       |       |       |                |                                    |                |                       |  |                     |    |            |    |       |       |       |           |                |        |  |                        |    |     |       |       |       |       |           |  |  |  |         |    |            |    |       |       |       |  |  |  |  |         |     |            |    |       |       |       |  |  |  |  |        |     |                |       |       |       |                |        |  |                       |  |  |  |         |    |  |       |                |           |  |                          |  |  |  |     |  |            |       |  |       |                |        |       |                    |  |     |    |            |       |  |       |                |        |       |                     |  |         |    |            |       |  |       |                |        |       |                        |  |         |    |            |       |       |                                    |                |        |  |                       |  |     |    |  |       |       |  |                |        |  |                          |  |         |    |            |       |       |  |  |  |  |  |  |         |    |            |       |       |  |  |  |  |  |  |                |    |            |       |       |  |  |  |  |  |  |         |    |            |       |       |  |  |  |  |  |  |                   |    |            |       |       |  |                |        |   |                 |  |     |    |  |       |       |  |  |  |  |  |  |       |    |            |       |       |  |  |  |  |  |  |         |    |            |       |       |  |                |        |  |                       |  |         |    |            |       |       |  |                |        |  |                          |  |         |    |            |       |       |  |  |  |  |  |  |                |     |            |       |       |  |  |  |  |  |  |         |    |  |       |       |  |                |        |  |                       |  |         |    |            |  |       |  |  |  |  |  |  |             |    |  |       |       |  |  |  |  |  |  |         |    |            |  |       |  |  |  |  |  |  |         |     |            |       |       |  |  |  |  |  |  |         |     |            |       |       |  |                |        |  |                       |  |  |  |  |  |  |  |                |        |  |                          |  |  |  |     |  |            |       |  |  |                |        |   |                 |  |     |    |            |       |  |  |  |  |  |  |  |         |    |            |       |  |  |  |  |  |  |  |         |    |            |       |  |  |  |  |  |  |  |     |    |  |       |       |  |  |  |  |  |  |         |    |            |       |  |  |  |  |  |  |  |       |    |            |       |  |  |  |  |  |  |  |         |    |            |       |  |  |  |  |  |  |  |         |    |            |       |  |  |  |  |  |  |  |     |  |            |  |       |  |                |        |   |                 |  |     |    |  |       |       |  |  |  |  |  |  |     |    |            |  |       |  |  |  |  |  |  |         |    |  |       |       |  |  |  |  |  |  |         |    |            |  |       |  |  |  |  |  |  |         |    |            |  |       |  |  |  |  |  |  |                |    |  |       |       |  |  |  |  |  |  |         |    |  |       |       |  |  |  |  |  |  |         |    |            |  |       |  |  |  |  |  |  |             |    |  |       |       |  |  |  |  |  |  |         |    |            |  |       |  |  |  |  |  |  |        |     |  |       |       |  |  |  |  |  |  |         |     |            |  |       |  |  |  |  |  |  |
| 1.4 HDi  | 50   |            | 09.01 | 02.09      |                                    |                |                                    |                |                          |     |                     |     |     |    |            |       |       |           |                |        |  |                        |     |             |    |            |       |       |           |                |        |  |                     |     |         |    |            |       |       |  |                |        |  |                     |     |             |    |  |       |       |  |  |  |  |  |  |                |    |            |       |       |       |                |        |  |                     |     |         |    |            |       |       |           |  |  |  |  |  |                   |    |            |       |       |       |                |        |       |                    |  |         |    |            |       |       |       |                |        |       |                     |  |       |    |            |       |       |       |                |        |       |                        |  |         |    |            |       |       |                                    |                |        |  |                       |     |         |    |            |       |       |  |                |        |  |                          |  |         |    |  |       |       |  |  |  |  |  |  |         |     |            |       |       |  |  |  |  |  |  |                |    |            |       |       |  |                |        |  |                   |     |                |    |            |       |       |  |                |        |  |                   |     |                   |    |  |       |       |  |                |        |  |                   |     |         |    |            |       |       |  |  |  |  |  |  |             |     |            |       |       |  |  |  |  |  |  |         |    |            |       |       |  |                |        |  |                       |     |         |     |            |       |       |  |                |        |  |                          |  |         |     |            |       |       |  |                |        |  |                   |     |         |     |            |       |  |  |                |        |  |                   |     |  |   |     |       |       |       |                |                                    |                |                       |  |                     |    |            |    |       |       |       |           |                |        |  |                        |    |     |       |       |       |       |           |  |  |  |         |    |            |    |       |       |       |  |  |  |  |         |     |            |    |       |       |       |  |  |  |  |        |     |                |       |       |       |                |        |  |                       |  |  |  |         |    |  |       |                |           |  |                          |  |  |  |     |  |            |       |  |       |                |        |       |                    |  |     |    |            |       |  |       |                |        |       |                     |  |         |    |            |       |  |       |                |        |       |                        |  |         |    |            |       |       |                                    |                |        |  |                       |  |     |    |  |       |       |  |                |        |  |                          |  |         |    |            |       |       |  |  |  |  |  |  |         |    |            |       |       |  |  |  |  |  |  |                |    |            |       |       |  |  |  |  |  |  |         |    |            |       |       |  |  |  |  |  |  |                   |    |            |       |       |  |                |        |   |                 |  |     |    |  |       |       |  |  |  |  |  |  |       |    |            |       |       |  |  |  |  |  |  |         |    |            |       |       |  |                |        |  |                       |  |         |    |            |       |       |  |                |        |  |                          |  |         |    |            |       |       |  |  |  |  |  |  |                |     |            |       |       |  |  |  |  |  |  |         |    |  |       |       |  |                |        |  |                       |  |         |    |            |  |       |  |  |  |  |  |  |             |    |  |       |       |  |  |  |  |  |  |         |    |            |  |       |  |  |  |  |  |  |         |     |            |       |       |  |  |  |  |  |  |         |     |            |       |       |  |                |        |  |                       |  |  |  |  |  |  |  |                |        |  |                          |  |  |  |     |  |            |       |  |  |                |        |   |                 |  |     |    |            |       |  |  |  |  |  |  |  |         |    |            |       |  |  |  |  |  |  |  |         |    |            |       |  |  |  |  |  |  |  |     |    |  |       |       |  |  |  |  |  |  |         |    |            |       |  |  |  |  |  |  |  |       |    |            |       |  |  |  |  |  |  |  |         |    |            |       |  |  |  |  |  |  |  |         |    |            |       |  |  |  |  |  |  |  |     |  |            |  |       |  |                |        |   |                 |  |     |    |  |       |       |  |  |  |  |  |  |     |    |            |  |       |  |  |  |  |  |  |         |    |  |       |       |  |  |  |  |  |  |         |    |            |  |       |  |  |  |  |  |  |         |    |            |  |       |  |  |  |  |  |  |                |    |  |       |       |  |  |  |  |  |  |         |    |  |       |       |  |  |  |  |  |  |         |    |            |  |       |  |  |  |  |  |  |             |    |  |       |       |  |  |  |  |  |  |         |    |            |  |       |  |  |  |  |  |  |        |     |  |       |       |  |  |  |  |  |  |         |     |            |  |       |  |  |  |  |  |  |
| 1.4 HDi  | 51   |            | 09.02 | 02.07      |                                    |                |                                    |                |                          |     |                     |     |     |    |            |       |       |           |                |        |  |                        |     |             |    |            |       |       |           |                |        |  |                     |     |         |    |            |       |       |  |                |        |  |                     |     |             |    |  |       |       |  |  |  |  |  |  |                |    |            |       |       |       |                |        |  |                     |     |         |    |            |       |       |           |  |  |  |  |  |                   |    |            |       |       |       |                |        |       |                    |  |         |    |            |       |       |       |                |        |       |                     |  |       |    |            |       |       |       |                |        |       |                        |  |         |    |            |       |       |                                    |                |        |  |                       |     |         |    |            |       |       |  |                |        |  |                          |  |         |    |  |       |       |  |  |  |  |  |  |         |     |            |       |       |  |  |  |  |  |  |                |    |            |       |       |  |                |        |  |                   |     |                |    |            |       |       |  |                |        |  |                   |     |                   |    |  |       |       |  |                |        |  |                   |     |         |    |            |       |       |  |  |  |  |  |  |             |     |            |       |       |  |  |  |  |  |  |         |    |            |       |       |  |                |        |  |                       |     |         |     |            |       |       |  |                |        |  |                          |  |         |     |            |       |       |  |                |        |  |                   |     |         |     |            |       |  |  |                |        |  |                   |     |  |   |     |       |       |       |                |                                    |                |                       |  |                     |    |            |    |       |       |       |           |                |        |  |                        |    |     |       |       |       |       |           |  |  |  |         |    |            |    |       |       |       |  |  |  |  |         |     |            |    |       |       |       |  |  |  |  |        |     |                |       |       |       |                |        |  |                       |  |  |  |         |    |  |       |                |           |  |                          |  |  |  |     |  |            |       |  |       |                |        |       |                    |  |     |    |            |       |  |       |                |        |       |                     |  |         |    |            |       |  |       |                |        |       |                        |  |         |    |            |       |       |                                    |                |        |  |                       |  |     |    |  |       |       |  |                |        |  |                          |  |         |    |            |       |       |  |  |  |  |  |  |         |    |            |       |       |  |  |  |  |  |  |                |    |            |       |       |  |  |  |  |  |  |         |    |            |       |       |  |  |  |  |  |  |                   |    |            |       |       |  |                |        |   |                 |  |     |    |  |       |       |  |  |  |  |  |  |       |    |            |       |       |  |  |  |  |  |  |         |    |            |       |       |  |                |        |  |                       |  |         |    |            |       |       |  |                |        |  |                          |  |         |    |            |       |       |  |  |  |  |  |  |                |     |            |       |       |  |  |  |  |  |  |         |    |  |       |       |  |                |        |  |                       |  |         |    |            |  |       |  |  |  |  |  |  |             |    |  |       |       |  |  |  |  |  |  |         |    |            |  |       |  |  |  |  |  |  |         |     |            |       |       |  |  |  |  |  |  |         |     |            |       |       |  |                |        |  |                       |  |  |  |  |  |  |  |                |        |  |                          |  |  |  |     |  |            |       |  |  |                |        |   |                 |  |     |    |            |       |  |  |  |  |  |  |  |         |    |            |       |  |  |  |  |  |  |  |         |    |            |       |  |  |  |  |  |  |  |     |    |  |       |       |  |  |  |  |  |  |         |    |            |       |  |  |  |  |  |  |  |       |    |            |       |  |  |  |  |  |  |  |         |    |            |       |  |  |  |  |  |  |  |         |    |            |       |  |  |  |  |  |  |  |     |  |            |  |       |  |                |        |   |                 |  |     |    |  |       |       |  |  |  |  |  |  |     |    |            |  |       |  |  |  |  |  |  |         |    |  |       |       |  |  |  |  |  |  |         |    |            |  |       |  |  |  |  |  |  |         |    |            |  |       |  |  |  |  |  |  |                |    |  |       |       |  |  |  |  |  |  |         |    |  |       |       |  |  |  |  |  |  |         |    |            |  |       |  |  |  |  |  |  |             |    |  |       |       |  |  |  |  |  |  |         |    |            |  |       |  |  |  |  |  |  |        |     |  |       |       |  |  |  |  |  |  |         |     |            |  |       |  |  |  |  |  |  |
| 1.4 HDi eco 70   | 50   |            | 09.08 | 02.09      |                                    |                |                                    |                |                          |     |                     |     |     |    |            |       |       |           |                |        |  |                        |     |             |    |            |       |       |           |                |        |  |                     |     |         |    |            |       |       |  |                |        |  |                     |     |             |    |  |       |       |  |  |  |  |  |  |                |    |            |       |       |       |                |        |  |                     |     |         |    |            |       |       |           |  |  |  |  |  |                   |    |            |       |       |       |                |        |       |                    |  |         |    |            |       |       |       |                |        |       |                     |  |       |    |            |       |       |       |                |        |       |                        |  |         |    |            |       |       |                                    |                |        |  |                       |     |         |    |            |       |       |  |                |        |  |                          |  |         |    |  |       |       |  |  |  |  |  |  |         |     |            |       |       |  |  |  |  |  |  |                |    |            |       |       |  |                |        |  |                   |     |                |    |            |       |       |  |                |        |  |                   |     |                   |    |  |       |       |  |                |        |  |                   |     |         |    |            |       |       |  |  |  |  |  |  |             |     |            |       |       |  |  |  |  |  |  |         |    |            |       |       |  |                |        |  |                       |     |         |     |            |       |       |  |                |        |  |                          |  |         |     |            |       |       |  |                |        |  |                   |     |         |     |            |       |  |  |                |        |  |                   |     |  |   |     |       |       |       |                |                                    |                |                       |  |                     |    |            |    |       |       |       |           |                |        |  |                        |    |     |       |       |       |       |           |  |  |  |         |    |            |    |       |       |       |  |  |  |  |         |     |            |    |       |       |       |  |  |  |  |        |     |                |       |       |       |                |        |  |                       |  |  |  |         |    |  |       |                |           |  |                          |  |  |  |     |  |            |       |  |       |                |        |       |                    |  |     |    |            |       |  |       |                |        |       |                     |  |         |    |            |       |  |       |                |        |       |                        |  |         |    |            |       |       |                                    |                |        |  |                       |  |     |    |  |       |       |  |                |        |  |                          |  |         |    |            |       |       |  |  |  |  |  |  |         |    |            |       |       |  |  |  |  |  |  |                |    |            |       |       |  |  |  |  |  |  |         |    |            |       |       |  |  |  |  |  |  |                   |    |            |       |       |  |                |        |   |                 |  |     |    |  |       |       |  |  |  |  |  |  |       |    |            |       |       |  |  |  |  |  |  |         |    |            |       |       |  |                |        |  |                       |  |         |    |            |       |       |  |                |        |  |                          |  |         |    |            |       |       |  |  |  |  |  |  |                |     |            |       |       |  |  |  |  |  |  |         |    |  |       |       |  |                |        |  |                       |  |         |    |            |  |       |  |  |  |  |  |  |             |    |  |       |       |  |  |  |  |  |  |         |    |            |  |       |  |  |  |  |  |  |         |     |            |       |       |  |  |  |  |  |  |         |     |            |       |       |  |                |        |  |                       |  |  |  |  |  |  |  |                |        |  |                          |  |  |  |     |  |            |       |  |  |                |        |   |                 |  |     |    |            |       |  |  |  |  |  |  |  |         |    |            |       |  |  |  |  |  |  |  |         |    |            |       |  |  |  |  |  |  |  |     |    |  |       |       |  |  |  |  |  |  |         |    |            |       |  |  |  |  |  |  |  |       |    |            |       |  |  |  |  |  |  |  |         |    |            |       |  |  |  |  |  |  |  |         |    |            |       |  |  |  |  |  |  |  |     |  |            |  |       |  |                |        |   |                 |  |     |    |  |       |       |  |  |  |  |  |  |     |    |            |  |       |  |  |  |  |  |  |         |    |  |       |       |  |  |  |  |  |  |         |    |            |  |       |  |  |  |  |  |  |         |    |            |  |       |  |  |  |  |  |  |                |    |  |       |       |  |  |  |  |  |  |         |    |  |       |       |  |  |  |  |  |  |         |    |            |  |       |  |  |  |  |  |  |             |    |  |       |       |  |  |  |  |  |  |         |    |            |  |       |  |  |  |  |  |  |        |     |  |       |       |  |  |  |  |  |  |         |     |            |  |       |  |  |  |  |  |  |
| 1.4 LPG  | 55   |            | 05.06 | 09.07      | - ROL GAR                          |                |                                    |                |                          |     |                     |     |     |    |            |       |       |           |                |        |  |                        |     |             |    |            |       |       |           |                |        |  |                     |     |         |    |            |       |       |  |                |        |  |                     |     |             |    |  |       |       |  |  |  |  |  |  |                |    |            |       |       |       |                |        |  |                     |     |         |    |            |       |       |           |  |  |  |  |  |                   |    |            |       |       |       |                |        |       |                    |  |         |    |            |       |       |       |                |        |       |                     |  |       |    |            |       |       |       |                |        |       |                        |  |         |    |            |       |       |                                    |                |        |  |                       |     |         |    |            |       |       |  |                |        |  |                          |  |         |    |  |       |       |  |  |  |  |  |  |         |     |            |       |       |  |  |  |  |  |  |                |    |            |       |       |  |                |        |  |                   |     |                |    |            |       |       |  |                |        |  |                   |     |                   |    |  |       |       |  |                |        |  |                   |     |         |    |            |       |       |  |  |  |  |  |  |             |     |            |       |       |  |  |  |  |  |  |         |    |            |       |       |  |                |        |  |                       |     |         |     |            |       |       |  |                |        |  |                          |  |         |     |            |       |       |  |                |        |  |                   |     |         |     |            |       |  |  |                |        |  |                   |     |  |   |     |       |       |       |                |                                    |                |                       |  |                     |    |            |    |       |       |       |           |                |        |  |                        |    |     |       |       |       |       |           |  |  |  |         |    |            |    |       |       |       |  |  |  |  |         |     |            |    |       |       |       |  |  |  |  |        |     |                |       |       |       |                |        |  |                       |  |  |  |         |    |  |       |                |           |  |                          |  |  |  |     |  |            |       |  |       |                |        |       |                    |  |     |    |            |       |  |       |                |        |       |                     |  |         |    |            |       |  |       |                |        |       |                        |  |         |    |            |       |       |                                    |                |        |  |                       |  |     |    |  |       |       |  |                |        |  |                          |  |         |    |            |       |       |  |  |  |  |  |  |         |    |            |       |       |  |  |  |  |  |  |                |    |            |       |       |  |  |  |  |  |  |         |    |            |       |       |  |  |  |  |  |  |                   |    |            |       |       |  |                |        |   |                 |  |     |    |  |       |       |  |  |  |  |  |  |       |    |            |       |       |  |  |  |  |  |  |         |    |            |       |       |  |                |        |  |                       |  |         |    |            |       |       |  |                |        |  |                          |  |         |    |            |       |       |  |  |  |  |  |  |                |     |            |       |       |  |  |  |  |  |  |         |    |  |       |       |  |                |        |  |                       |  |         |    |            |  |       |  |  |  |  |  |  |             |    |  |       |       |  |  |  |  |  |  |         |    |            |  |       |  |  |  |  |  |  |         |     |            |       |       |  |  |  |  |  |  |         |     |            |       |       |  |                |        |  |                       |  |  |  |  |  |  |  |                |        |  |                          |  |  |  |     |  |            |       |  |  |                |        |   |                 |  |     |    |            |       |  |  |  |  |  |  |  |         |    |            |       |  |  |  |  |  |  |  |         |    |            |       |  |  |  |  |  |  |  |     |    |  |       |       |  |  |  |  |  |  |         |    |            |       |  |  |  |  |  |  |  |       |    |            |       |  |  |  |  |  |  |  |         |    |            |       |  |  |  |  |  |  |  |         |    |            |       |  |  |  |  |  |  |  |     |  |            |  |       |  |                |        |   |                 |  |     |    |  |       |       |  |  |  |  |  |  |     |    |            |  |       |  |  |  |  |  |  |         |    |  |       |       |  |  |  |  |  |  |         |    |            |  |       |  |  |  |  |  |  |         |    |            |  |       |  |  |  |  |  |  |                |    |  |       |       |  |  |  |  |  |  |         |    |  |       |       |  |  |  |  |  |  |         |    |            |  |       |  |  |  |  |  |  |             |    |  |       |       |  |  |  |  |  |  |         |    |            |  |       |  |  |  |  |  |  |        |     |  |       |       |  |  |  |  |  |  |         |     |            |  |       |  |  |  |  |  |  |
| 1.1  |  | ORGA 08988 | 09.98 |            | - ABS                              | 24.0110-0187.1 | 410187                             | - ABS          | 247 10,0 9,0 +S +B       |     |                     |     |     |    |            |       |       |           |                |        |  |                        |     |             |    |            |       |       |           |                |        |  |                     |     |         |    |            |       |       |  |                |        |  |                     |     |             |    |  |       |       |  |  |  |  |  |  |                |    |            |       |       |       |                |        |  |                     |     |         |    |            |       |       |           |  |  |  |  |  |                   |    |            |       |       |       |                |        |       |                    |  |         |    |            |       |       |       |                |        |       |                     |  |       |    |            |       |       |       |                |        |       |                        |  |         |    |            |       |       |                                    |                |        |  |                       |     |         |    |            |       |       |  |                |        |  |                          |  |         |    |  |       |       |  |  |  |  |  |  |         |     |            |       |       |  |  |  |  |  |  |                |    |            |       |       |  |                |        |  |                   |     |                |    |            |       |       |  |                |        |  |                   |     |                   |    |  |       |       |  |                |        |  |                   |     |         |    |            |       |       |  |  |  |  |  |  |             |     |            |       |       |  |  |  |  |  |  |         |    |            |       |       |  |                |        |  |                       |     |         |     |            |       |       |  |                |        |  |                          |  |         |     |            |       |       |  |                |        |  |                   |     |         |     |            |       |  |  |                |        |  |                   |     |  |   |     |       |       |       |                |                                    |                |                       |  |                     |    |            |    |       |       |       |           |                |        |  |                        |    |     |       |       |       |       |           |  |  |  |         |    |            |    |       |       |       |  |  |  |  |         |     |            |    |       |       |       |  |  |  |  |        |     |                |       |       |       |                |        |  |                       |  |  |  |         |    |  |       |                |           |  |                          |  |  |  |     |  |            |       |  |       |                |        |       |                    |  |     |    |            |       |  |       |                |        |       |                     |  |         |    |            |       |  |       |                |        |       |                        |  |         |    |            |       |       |                                    |                |        |  |                       |  |     |    |  |       |       |  |                |        |  |                          |  |         |    |            |       |       |  |  |  |  |  |  |         |    |            |       |       |  |  |  |  |  |  |                |    |            |       |       |  |  |  |  |  |  |         |    |            |       |       |  |  |  |  |  |  |                   |    |            |       |       |  |                |        |   |                 |  |     |    |  |       |       |  |  |  |  |  |  |       |    |            |       |       |  |  |  |  |  |  |         |    |            |       |       |  |                |        |  |                       |  |         |    |            |       |       |  |                |        |  |                          |  |         |    |            |       |       |  |  |  |  |  |  |                |     |            |       |       |  |  |  |  |  |  |         |    |  |       |       |  |                |        |  |                       |  |         |    |            |  |       |  |  |  |  |  |  |             |    |  |       |       |  |  |  |  |  |  |         |    |            |  |       |  |  |  |  |  |  |         |     |            |       |       |  |  |  |  |  |  |         |     |            |       |       |  |                |        |  |                       |  |  |  |  |  |  |  |                |        |  |                          |  |  |  |     |  |            |       |  |  |                |        |   |                 |  |     |    |            |       |  |  |  |  |  |  |  |         |    |            |       |  |  |  |  |  |  |  |         |    |            |       |  |  |  |  |  |  |  |     |    |  |       |       |  |  |  |  |  |  |         |    |            |       |  |  |  |  |  |  |  |       |    |            |       |  |  |  |  |  |  |  |         |    |            |       |  |  |  |  |  |  |  |         |    |            |       |  |  |  |  |  |  |  |     |  |            |  |       |  |                |        |   |                 |  |     |    |  |       |       |  |  |  |  |  |  |     |    |            |  |       |  |  |  |  |  |  |         |    |  |       |       |  |  |  |  |  |  |         |    |            |  |       |  |  |  |  |  |  |         |    |            |  |       |  |  |  |  |  |  |                |    |  |       |       |  |  |  |  |  |  |         |    |  |       |       |  |  |  |  |  |  |         |    |            |  |       |  |  |  |  |  |  |             |    |  |       |       |  |  |  |  |  |  |         |    |            |  |       |  |  |  |  |  |  |        |     |  |       |       |  |  |  |  |  |  |         |     |            |  |       |  |  |  |  |  |  |
| 1.1  |  | ORGA 08989 |       |            | - ABS                              | 24.0113-0185.1 | 413185                             | - ABS          | 248 13,0 11,0 +S +B      |     |                     |     |     |    |            |       |       |           |                |        |  |                        |     |             |    |            |       |       |           |                |        |  |                     |     |         |    |            |       |       |  |                |        |  |                     |     |             |    |  |       |       |  |  |  |  |  |  |                |    |            |       |       |       |                |        |  |                     |     |         |    |            |       |       |           |  |  |  |  |  |                   |    |            |       |       |       |                |        |       |                    |  |         |    |            |       |       |       |                |        |       |                     |  |       |    |            |       |       |       |                |        |       |                        |  |         |    |            |       |       |                                    |                |        |  |                       |     |         |    |            |       |       |  |                |        |  |                          |  |         |    |  |       |       |  |  |  |  |  |  |         |     |            |       |       |  |  |  |  |  |  |                |    |            |       |       |  |                |        |  |                   |     |                |    |            |       |       |  |                |        |  |                   |     |                   |    |  |       |       |  |                |        |  |                   |     |         |    |            |       |       |  |  |  |  |  |  |             |     |            |       |       |  |  |  |  |  |  |         |    |            |       |       |  |                |        |  |                       |     |         |     |            |       |       |  |                |        |  |                          |  |         |     |            |       |       |  |                |        |  |                   |     |         |     |            |       |  |  |                |        |  |                   |     |  |   |     |       |       |       |                |                                    |                |                       |  |                     |    |            |    |       |       |       |           |                |        |  |                        |    |     |       |       |       |       |           |  |  |  |         |    |            |    |       |       |       |  |  |  |  |         |     |            |    |       |       |       |  |  |  |  |        |     |                |       |       |       |                |        |  |                       |  |  |  |         |    |  |       |                |           |  |                          |  |  |  |     |  |            |       |  |       |                |        |       |                    |  |     |    |            |       |  |       |                |        |       |                     |  |         |    |            |       |  |       |                |        |       |                        |  |         |    |            |       |       |                                    |                |        |  |                       |  |     |    |  |       |       |  |                |        |  |                          |  |         |    |            |       |       |  |  |  |  |  |  |         |    |            |       |       |  |  |  |  |  |  |                |    |            |       |       |  |  |  |  |  |  |         |    |            |       |       |  |  |  |  |  |  |                   |    |            |       |       |  |                |        |   |                 |  |     |    |  |       |       |  |  |  |  |  |  |       |    |            |       |       |  |  |  |  |  |  |         |    |            |       |       |  |                |        |  |                       |  |         |    |            |       |       |  |                |        |  |                          |  |         |    |            |       |       |  |  |  |  |  |  |                |     |            |       |       |  |  |  |  |  |  |         |    |  |       |       |  |                |        |  |                       |  |         |    |            |  |       |  |  |  |  |  |  |             |    |  |       |       |  |  |  |  |  |  |         |    |            |  |       |  |  |  |  |  |  |         |     |            |       |       |  |  |  |  |  |  |         |     |            |       |       |  |                |        |  |                       |  |  |  |  |  |  |  |                |        |  |                          |  |  |  |     |  |            |       |  |  |                |        |   |                 |  |     |    |            |       |  |  |  |  |  |  |  |         |    |            |       |  |  |  |  |  |  |  |         |    |            |       |  |  |  |  |  |  |  |     |    |  |       |       |  |  |  |  |  |  |         |    |            |       |  |  |  |  |  |  |  |       |    |            |       |  |  |  |  |  |  |  |         |    |            |       |  |  |  |  |  |  |  |         |    |            |       |  |  |  |  |  |  |  |     |  |            |  |       |  |                |        |   |                 |  |     |    |  |       |       |  |  |  |  |  |  |     |    |            |  |       |  |  |  |  |  |  |         |    |  |       |       |  |  |  |  |  |  |         |    |            |  |       |  |  |  |  |  |  |         |    |            |  |       |  |  |  |  |  |  |                |    |  |       |       |  |  |  |  |  |  |         |    |  |       |       |  |  |  |  |  |  |         |    |            |  |       |  |  |  |  |  |  |             |    |  |       |       |  |  |  |  |  |  |         |    |            |  |       |  |  |  |  |  |  |        |     |  |       |       |  |  |  |  |  |  |         |     |            |  |       |  |  |  |  |  |  |
|  |  | ORGA 09974 |       |            | - ABS                              | 24.0313-0185.1 | 513185                             | - ABS          | 248 13,0 11,0 +S +B PD   |     |                     |     |     |    |            |       |       |           |                |        |  |                        |     |             |    |            |       |       |           |                |        |  |                     |     |         |    |            |       |       |  |                |        |  |                     |     |             |    |  |       |       |  |  |  |  |  |  |                |    |            |       |       |       |                |        |  |                     |     |         |    |            |       |       |           |  |  |  |  |  |                   |    |            |       |       |       |                |        |       |                    |  |         |    |            |       |       |       |                |        |       |                     |  |       |    |            |       |       |       |                |        |       |                        |  |         |    |            |       |       |                                    |                |        |  |                       |     |         |    |            |       |       |  |                |        |  |                          |  |         |    |  |       |       |  |  |  |  |  |  |         |     |            |       |       |  |  |  |  |  |  |                |    |            |       |       |  |                |        |  |                   |     |                |    |            |       |       |  |                |        |  |                   |     |                   |    |  |       |       |  |                |        |  |                   |     |         |    |            |       |       |  |  |  |  |  |  |             |     |            |       |       |  |  |  |  |  |  |         |    |            |       |       |  |                |        |  |                       |     |         |     |            |       |       |  |                |        |  |                          |  |         |     |            |       |       |  |                |        |  |                   |     |         |     |            |       |  |  |                |        |  |                   |     |  |   |     |       |       |       |                |                                    |                |                       |  |                     |    |            |    |       |       |       |           |                |        |  |                        |    |     |       |       |       |       |           |  |  |  |         |    |            |    |       |       |       |  |  |  |  |         |     |            |    |       |       |       |  |  |  |  |        |     |                |       |       |       |                |        |  |                       |  |  |  |         |    |  |       |                |           |  |                          |  |  |  |     |  |            |       |  |       |                |        |       |                    |  |     |    |            |       |  |       |                |        |       |                     |  |         |    |            |       |  |       |                |        |       |                        |  |         |    |            |       |       |                                    |                |        |  |                       |  |     |    |  |       |       |  |                |        |  |                          |  |         |    |            |       |       |  |  |  |  |  |  |         |    |            |       |       |  |  |  |  |  |  |                |    |            |       |       |  |  |  |  |  |  |         |    |            |       |       |  |  |  |  |  |  |                   |    |            |       |       |  |                |        |   |                 |  |     |    |  |       |       |  |  |  |  |  |  |       |    |            |       |       |  |  |  |  |  |  |         |    |            |       |       |  |                |        |  |                       |  |         |    |            |       |       |  |                |        |  |                          |  |         |    |            |       |       |  |  |  |  |  |  |                |     |            |       |       |  |  |  |  |  |  |         |    |  |       |       |  |                |        |  |                       |  |         |    |            |  |       |  |  |  |  |  |  |             |    |  |       |       |  |  |  |  |  |  |         |    |            |  |       |  |  |  |  |  |  |         |     |            |       |       |  |  |  |  |  |  |         |     |            |       |       |  |                |        |  |                       |  |  |  |  |  |  |  |                |        |  |                          |  |  |  |     |  |            |       |  |  |                |        |   |                 |  |     |    |            |       |  |  |  |  |  |  |  |         |    |            |       |  |  |  |  |  |  |  |         |    |            |       |  |  |  |  |  |  |  |     |    |  |       |       |  |  |  |  |  |  |         |    |            |       |  |  |  |  |  |  |  |       |    |            |       |  |  |  |  |  |  |  |         |    |            |       |  |  |  |  |  |  |  |         |    |            |       |  |  |  |  |  |  |  |     |  |            |  |       |  |                |        |   |                 |  |     |    |  |       |       |  |  |  |  |  |  |     |    |            |  |       |  |  |  |  |  |  |         |    |  |       |       |  |  |  |  |  |  |         |    |            |  |       |  |  |  |  |  |  |         |    |            |  |       |  |  |  |  |  |  |                |    |  |       |       |  |  |  |  |  |  |         |    |  |       |       |  |  |  |  |  |  |         |    |            |  |       |  |  |  |  |  |  |             |    |  |       |       |  |  |  |  |  |  |         |    |            |  |       |  |  |  |  |  |  |        |     |  |       |       |  |  |  |  |  |  |         |     |            |  |       |  |  |  |  |  |  |
| 1.1  |  | ORGA 09975 |       | 02.09      | + belüftete Scheiben <sup>2)</sup> | 24.0120-0132.1 | 420132                             |                | 247 20,4 18,5 V +S +B    |     |                     |     |     |    |            |       |       |           |                |        |  |                        |     |             |    |            |       |       |           |                |        |  |                     |     |         |    |            |       |       |  |                |        |  |                     |     |             |    |  |       |       |  |  |  |  |  |  |                |    |            |       |       |       |                |        |  |                     |     |         |    |            |       |       |           |  |  |  |  |  |                   |    |            |       |       |       |                |        |       |                    |  |         |    |            |       |       |       |                |        |       |                     |  |       |    |            |       |       |       |                |        |       |                        |  |         |    |            |       |       |                                    |                |        |  |                       |     |         |    |            |       |       |  |                |        |  |                          |  |         |    |  |       |       |  |  |  |  |  |  |         |     |            |       |       |  |  |  |  |  |  |                |    |            |       |       |  |                |        |  |                   |     |                |    |            |       |       |  |                |        |  |                   |     |                   |    |  |       |       |  |                |        |  |                   |     |         |    |            |       |       |  |  |  |  |  |  |             |     |            |       |       |  |  |  |  |  |  |         |    |            |       |       |  |                |        |  |                       |     |         |     |            |       |       |  |                |        |  |                          |  |         |     |            |       |       |  |                |        |  |                   |     |         |     |            |       |  |  |                |        |  |                   |     |  |   |     |       |       |       |                |                                    |                |                       |  |                     |    |            |    |       |       |       |           |                |        |  |                        |    |     |       |       |       |       |           |  |  |  |         |    |            |    |       |       |       |  |  |  |  |         |     |            |    |       |       |       |  |  |  |  |        |     |                |       |       |       |                |        |  |                       |  |  |  |         |    |  |       |                |           |  |                          |  |  |  |     |  |            |       |  |       |                |        |       |                    |  |     |    |            |       |  |       |                |        |       |                     |  |         |    |            |       |  |       |                |        |       |                        |  |         |    |            |       |       |                                    |                |        |  |                       |  |     |    |  |       |       |  |                |        |  |                          |  |         |    |            |       |       |  |  |  |  |  |  |         |    |            |       |       |  |  |  |  |  |  |                |    |            |       |       |  |  |  |  |  |  |         |    |            |       |       |  |  |  |  |  |  |                   |    |            |       |       |  |                |        |   |                 |  |     |    |  |       |       |  |  |  |  |  |  |       |    |            |       |       |  |  |  |  |  |  |         |    |            |       |       |  |                |        |  |                       |  |         |    |            |       |       |  |                |        |  |                          |  |         |    |            |       |       |  |  |  |  |  |  |                |     |            |       |       |  |  |  |  |  |  |         |    |  |       |       |  |                |        |  |                       |  |         |    |            |  |       |  |  |  |  |  |  |             |    |  |       |       |  |  |  |  |  |  |         |    |            |  |       |  |  |  |  |  |  |         |     |            |       |       |  |  |  |  |  |  |         |     |            |       |       |  |                |        |  |                       |  |  |  |  |  |  |  |                |        |  |                          |  |  |  |     |  |            |       |  |  |                |        |   |                 |  |     |    |            |       |  |  |  |  |  |  |  |         |    |            |       |  |  |  |  |  |  |  |         |    |            |       |  |  |  |  |  |  |  |     |    |  |       |       |  |  |  |  |  |  |         |    |            |       |  |  |  |  |  |  |  |       |    |            |       |  |  |  |  |  |  |  |         |    |            |       |  |  |  |  |  |  |  |         |    |            |       |  |  |  |  |  |  |  |     |  |            |  |       |  |                |        |   |                 |  |     |    |  |       |       |  |  |  |  |  |  |     |    |            |  |       |  |  |  |  |  |  |         |    |  |       |       |  |  |  |  |  |  |         |    |            |  |       |  |  |  |  |  |  |         |    |            |  |       |  |  |  |  |  |  |                |    |  |       |       |  |  |  |  |  |  |         |    |  |       |       |  |  |  |  |  |  |         |    |            |  |       |  |  |  |  |  |  |             |    |  |       |       |  |  |  |  |  |  |         |    |            |  |       |  |  |  |  |  |  |        |     |  |       |       |  |  |  |  |  |  |         |     |            |  |       |  |  |  |  |  |  |
| 1.4  | 55   |            | 03.07 | 02.09      |                                    | 24.0320-0132.1 | 520132                             |                | 247 20,4 18,5 V +S +B PD |     |                     |     |     |    |            |       |       |           |                |        |  |                        |     |             |    |            |       |       |           |                |        |  |                     |     |         |    |            |       |       |  |                |        |  |                     |     |             |    |  |       |       |  |  |  |  |  |  |                |    |            |       |       |       |                |        |  |                     |     |         |    |            |       |       |           |  |  |  |  |  |                   |    |            |       |       |       |                |        |       |                    |  |         |    |            |       |       |       |                |        |       |                     |  |       |    |            |       |       |       |                |        |       |                        |  |         |    |            |       |       |                                    |                |        |  |                       |     |         |    |            |       |       |  |                |        |  |                          |  |         |    |  |       |       |  |  |  |  |  |  |         |     |            |       |       |  |  |  |  |  |  |                |    |            |       |       |  |                |        |  |                   |     |                |    |            |       |       |  |                |        |  |                   |     |                   |    |  |       |       |  |                |        |  |                   |     |         |    |            |       |       |  |  |  |  |  |  |             |     |            |       |       |  |  |  |  |  |  |         |    |            |       |       |  |                |        |  |                       |     |         |     |            |       |       |  |                |        |  |                          |  |         |     |            |       |       |  |                |        |  |                   |     |         |     |            |       |  |  |                |        |  |                   |     |  |   |     |       |       |       |                |                                    |                |                       |  |                     |    |            |    |       |       |       |           |                |        |  |                        |    |     |       |       |       |       |           |  |  |  |         |    |            |    |       |       |       |  |  |  |  |         |     |            |    |       |       |       |  |  |  |  |        |     |                |       |       |       |                |        |  |                       |  |  |  |         |    |  |       |                |           |  |                          |  |  |  |     |  |            |       |  |       |                |        |       |                    |  |     |    |            |       |  |       |                |        |       |                     |  |         |    |            |       |  |       |                |        |       |                        |  |         |    |            |       |       |                                    |                |        |  |                       |  |     |    |  |       |       |  |                |        |  |                          |  |         |    |            |       |       |  |  |  |  |  |  |         |    |            |       |       |  |  |  |  |  |  |                |    |            |       |       |  |  |  |  |  |  |         |    |            |       |       |  |  |  |  |  |  |                   |    |            |       |       |  |                |        |   |                 |  |     |    |  |       |       |  |  |  |  |  |  |       |    |            |       |       |  |  |  |  |  |  |         |    |            |       |       |  |                |        |  |                       |  |         |    |            |       |       |  |                |        |  |                          |  |         |    |            |       |       |  |  |  |  |  |  |                |     |            |       |       |  |  |  |  |  |  |         |    |  |       |       |  |                |        |  |                       |  |         |    |            |  |       |  |  |  |  |  |  |             |    |  |       |       |  |  |  |  |  |  |         |    |            |  |       |  |  |  |  |  |  |         |     |            |       |       |  |  |  |  |  |  |         |     |            |       |       |  |                |        |  |                       |  |  |  |  |  |  |  |                |        |  |                          |  |  |  |     |  |            |       |  |  |                |        |   |                 |  |     |    |            |       |  |  |  |  |  |  |  |         |    |            |       |  |  |  |  |  |  |  |         |    |            |       |  |  |  |  |  |  |  |     |    |  |       |       |  |  |  |  |  |  |         |    |            |       |  |  |  |  |  |  |  |       |    |            |       |  |  |  |  |  |  |  |         |    |            |       |  |  |  |  |  |  |  |         |    |            |       |  |  |  |  |  |  |  |     |  |            |  |       |  |                |        |   |                 |  |     |    |  |       |       |  |  |  |  |  |  |     |    |            |  |       |  |  |  |  |  |  |         |    |  |       |       |  |  |  |  |  |  |         |    |            |  |       |  |  |  |  |  |  |         |    |            |  |       |  |  |  |  |  |  |                |    |  |       |       |  |  |  |  |  |  |         |    |  |       |       |  |  |  |  |  |  |         |    |            |  |       |  |  |  |  |  |  |             |    |  |       |       |  |  |  |  |  |  |         |    |            |  |       |  |  |  |  |  |  |        |     |  |       |       |  |  |  |  |  |  |         |     |            |  |       |  |  |  |  |  |  |
| 1.4 HDi  | 50   |            | 09.01 | 02.09      |                                    |                |                                    |                |                          |     |                     |     |     |    |            |       |       |           |                |        |  |                        |     |             |    |            |       |       |           |                |        |  |                     |     |         |    |            |       |       |  |                |        |  |                     |     |             |    |  |       |       |  |  |  |  |  |  |                |    |            |       |       |       |                |        |  |                     |     |         |    |            |       |       |           |  |  |  |  |  |                   |    |            |       |       |       |                |        |       |                    |  |         |    |            |       |       |       |                |        |       |                     |  |       |    |            |       |       |       |                |        |       |                        |  |         |    |            |       |       |                                    |                |        |  |                       |     |         |    |            |       |       |  |                |        |  |                          |  |         |    |  |       |       |  |  |  |  |  |  |         |     |            |       |       |  |  |  |  |  |  |                |    |            |       |       |  |                |        |  |                   |     |                |    |            |       |       |  |                |        |  |                   |     |                   |    |  |       |       |  |                |        |  |                   |     |         |    |            |       |       |  |  |  |  |  |  |             |     |            |       |       |  |  |  |  |  |  |         |    |            |       |       |  |                |        |  |                       |     |         |     |            |       |       |  |                |        |  |                          |  |         |     |            |       |       |  |                |        |  |                   |     |         |     |            |       |  |  |                |        |  |                   |     |  |   |     |       |       |       |                |                                    |                |                       |  |                     |    |            |    |       |       |       |           |                |        |  |                        |    |     |       |       |       |       |           |  |  |  |         |    |            |    |       |       |       |  |  |  |  |         |     |            |    |       |       |       |  |  |  |  |        |     |                |       |       |       |                |        |  |                       |  |  |  |         |    |  |       |                |           |  |                          |  |  |  |     |  |            |       |  |       |                |        |       |                    |  |     |    |            |       |  |       |                |        |       |                     |  |         |    |            |       |  |       |                |        |       |                        |  |         |    |            |       |       |                                    |                |        |  |                       |  |     |    |  |       |       |  |                |        |  |                          |  |         |    |            |       |       |  |  |  |  |  |  |         |    |            |       |       |  |  |  |  |  |  |                |    |            |       |       |  |  |  |  |  |  |         |    |            |       |       |  |  |  |  |  |  |                   |    |            |       |       |  |                |        |   |                 |  |     |    |  |       |       |  |  |  |  |  |  |       |    |            |       |       |  |  |  |  |  |  |         |    |            |       |       |  |                |        |  |                       |  |         |    |            |       |       |  |                |        |  |                          |  |         |    |            |       |       |  |  |  |  |  |  |                |     |            |       |       |  |  |  |  |  |  |         |    |  |       |       |  |                |        |  |                       |  |         |    |            |  |       |  |  |  |  |  |  |             |    |  |       |       |  |  |  |  |  |  |         |    |            |  |       |  |  |  |  |  |  |         |     |            |       |       |  |  |  |  |  |  |         |     |            |       |       |  |                |        |  |                       |  |  |  |  |  |  |  |                |        |  |                          |  |  |  |     |  |            |       |  |  |                |        |   |                 |  |     |    |            |       |  |  |  |  |  |  |  |         |    |            |       |  |  |  |  |  |  |  |         |    |            |       |  |  |  |  |  |  |  |     |    |  |       |       |  |  |  |  |  |  |         |    |            |       |  |  |  |  |  |  |  |       |    |            |       |  |  |  |  |  |  |  |         |    |            |       |  |  |  |  |  |  |  |         |    |            |       |  |  |  |  |  |  |  |     |  |            |  |       |  |                |        |   |                 |  |     |    |  |       |       |  |  |  |  |  |  |     |    |            |  |       |  |  |  |  |  |  |         |    |  |       |       |  |  |  |  |  |  |         |    |            |  |       |  |  |  |  |  |  |         |    |            |  |       |  |  |  |  |  |  |                |    |  |       |       |  |  |  |  |  |  |         |    |  |       |       |  |  |  |  |  |  |         |    |            |  |       |  |  |  |  |  |  |             |    |  |       |       |  |  |  |  |  |  |         |    |            |  |       |  |  |  |  |  |  |        |     |  |       |       |  |  |  |  |  |  |         |     |            |  |       |  |  |  |  |  |  |
| 1.4 HDi  | 51   |            | 09.02 | 02.07      |                                    |                |                                    |                |                          |     |                     |     |     |    |            |       |       |           |                |        |  |                        |     |             |    |            |       |       |           |                |        |  |                     |     |         |    |            |       |       |  |                |        |  |                     |     |             |    |  |       |       |  |  |  |  |  |  |                |    |            |       |       |       |                |        |  |                     |     |         |    |            |       |       |           |  |  |  |  |  |                   |    |            |       |       |       |                |        |       |                    |  |         |    |            |       |       |       |                |        |       |                     |  |       |    |            |       |       |       |                |        |       |                        |  |         |    |            |       |       |                                    |                |        |  |                       |     |         |    |            |       |       |  |                |        |  |                          |  |         |    |  |       |       |  |  |  |  |  |  |         |     |            |       |       |  |  |  |  |  |  |                |    |            |       |       |  |                |        |  |                   |     |                |    |            |       |       |  |                |        |  |                   |     |                   |    |  |       |       |  |                |        |  |                   |     |         |    |            |       |       |  |  |  |  |  |  |             |     |            |       |       |  |  |  |  |  |  |         |    |            |       |       |  |                |        |  |                       |     |         |     |            |       |       |  |                |        |  |                          |  |         |     |            |       |       |  |                |        |  |                   |     |         |     |            |       |  |  |                |        |  |                   |     |  |   |     |       |       |       |                |                                    |                |                       |  |                     |    |            |    |       |       |       |           |                |        |  |                        |    |     |       |       |       |       |           |  |  |  |         |    |            |    |       |       |       |  |  |  |  |         |     |            |    |       |       |       |  |  |  |  |        |     |                |       |       |       |                |        |  |                       |  |  |  |         |    |  |       |                |           |  |                          |  |  |  |     |  |            |       |  |       |                |        |       |                    |  |     |    |            |       |  |       |                |        |       |                     |  |         |    |            |       |  |       |                |        |       |                        |  |         |    |            |       |       |                                    |                |        |  |                       |  |     |    |  |       |       |  |                |        |  |                          |  |         |    |            |       |       |  |  |  |  |  |  |         |    |            |       |       |  |  |  |  |  |  |                |    |            |       |       |  |  |  |  |  |  |         |    |            |       |       |  |  |  |  |  |  |                   |    |            |       |       |  |                |        |   |                 |  |     |    |  |       |       |  |  |  |  |  |  |       |    |            |       |       |  |  |  |  |  |  |         |    |            |       |       |  |                |        |  |                       |  |         |    |            |       |       |  |                |        |  |                          |  |         |    |            |       |       |  |  |  |  |  |  |                |     |            |       |       |  |  |  |  |  |  |         |    |  |       |       |  |                |        |  |                       |  |         |    |            |  |       |  |  |  |  |  |  |             |    |  |       |       |  |  |  |  |  |  |         |    |            |  |       |  |  |  |  |  |  |         |     |            |       |       |  |  |  |  |  |  |         |     |            |       |       |  |                |        |  |                       |  |  |  |  |  |  |  |                |        |  |                          |  |  |  |     |  |            |       |  |  |                |        |   |                 |  |     |    |            |       |  |  |  |  |  |  |  |         |    |            |       |  |  |  |  |  |  |  |         |    |            |       |  |  |  |  |  |  |  |     |    |  |       |       |  |  |  |  |  |  |         |    |            |       |  |  |  |  |  |  |  |       |    |            |       |  |  |  |  |  |  |  |         |    |            |       |  |  |  |  |  |  |  |         |    |            |       |  |  |  |  |  |  |  |     |  |            |  |       |  |                |        |   |                 |  |     |    |  |       |       |  |  |  |  |  |  |     |    |            |  |       |  |  |  |  |  |  |         |    |  |       |       |  |  |  |  |  |  |         |    |            |  |       |  |  |  |  |  |  |         |    |            |  |       |  |  |  |  |  |  |                |    |  |       |       |  |  |  |  |  |  |         |    |  |       |       |  |  |  |  |  |  |         |    |            |  |       |  |  |  |  |  |  |             |    |  |       |       |  |  |  |  |  |  |         |    |            |  |       |  |  |  |  |  |  |        |     |  |       |       |  |  |  |  |  |  |         |     |            |  |       |  |  |  |  |  |  |
| 1.4 HDi eco 70   | 50   |            | 09.08 | 02.09      |                                    |                |                                    |                |                          |     |                     |     |     |    |            |       |       |           |                |        |  |                        |     |             |    |            |       |       |           |                |        |  |                     |     |         |    |            |       |       |  |                |        |  |                     |     |             |    |  |       |       |  |  |  |  |  |  |                |    |            |       |       |       |                |        |  |                     |     |         |    |            |       |       |           |  |  |  |  |  |                   |    |            |       |       |       |                |        |       |                    |  |         |    |            |       |       |       |                |        |       |                     |  |       |    |            |       |       |       |                |        |       |                        |  |         |    |            |       |       |                                    |                |        |  |                       |     |         |    |            |       |       |  |                |        |  |                          |  |         |    |  |       |       |  |  |  |  |  |  |         |     |            |       |       |  |  |  |  |  |  |                |    |            |       |       |  |                |        |  |                   |     |                |    |            |       |       |  |                |        |  |                   |     |                   |    |  |       |       |  |                |        |  |                   |     |         |    |            |       |       |  |  |  |  |  |  |             |     |            |       |       |  |  |  |  |  |  |         |    |            |       |       |  |                |        |  |                       |     |         |     |            |       |       |  |                |        |  |                          |  |         |     |            |       |       |  |                |        |  |                   |     |         |     |            |       |  |  |                |        |  |                   |     |  |   |     |       |       |       |                |                                    |                |                       |  |                     |    |            |    |       |       |       |           |                |        |  |                        |    |     |       |       |       |       |           |  |  |  |         |    |            |    |       |       |       |  |  |  |  |         |     |            |    |       |       |       |  |  |  |  |        |     |                |       |       |       |                |        |  |                       |  |  |  |         |    |  |       |                |           |  |                          |  |  |  |     |  |            |       |  |       |                |        |       |                    |  |     |    |            |       |  |       |                |        |       |                     |  |         |    |            |       |  |       |                |        |       |                        |  |         |    |            |       |       |                                    |                |        |  |                       |  |     |    |  |       |       |  |                |        |  |                          |  |         |    |            |       |       |  |  |  |  |  |  |         |    |            |       |       |  |  |  |  |  |  |                |    |            |       |       |  |  |  |  |  |  |         |    |            |       |       |  |  |  |  |  |  |                   |    |            |       |       |  |                |        |   |                 |  |     |    |  |       |       |  |  |  |  |  |  |       |    |            |       |       |  |  |  |  |  |  |         |    |            |       |       |  |                |        |  |                       |  |         |    |            |       |       |  |                |        |  |                          |  |         |    |            |       |       |  |  |  |  |  |  |                |     |            |       |       |  |  |  |  |  |  |         |    |  |       |       |  |                |        |  |                       |  |         |    |            |  |       |  |  |  |  |  |  |             |    |  |       |       |  |  |  |  |  |  |         |    |            |  |       |  |  |  |  |  |  |         |     |            |       |       |  |  |  |  |  |  |         |     |            |       |       |  |                |        |  |                       |  |  |  |  |  |  |  |                |        |  |                          |  |  |  |     |  |            |       |  |  |                |        |   |                 |  |     |    |            |       |  |  |  |  |  |  |  |         |    |            |       |  |  |  |  |  |  |  |         |    |            |       |  |  |  |  |  |  |  |     |    |  |       |       |  |  |  |  |  |  |         |    |            |       |  |  |  |  |  |  |  |       |    |            |       |  |  |  |  |  |  |  |         |    |            |       |  |  |  |  |  |  |  |         |    |            |       |  |  |  |  |  |  |  |     |  |            |  |       |  |                |        |   |                 |  |     |    |  |       |       |  |  |  |  |  |  |     |    |            |  |       |  |  |  |  |  |  |         |    |  |       |       |  |  |  |  |  |  |         |    |            |  |       |  |  |  |  |  |  |         |    |            |  |       |  |  |  |  |  |  |                |    |  |       |       |  |  |  |  |  |  |         |    |  |       |       |  |  |  |  |  |  |         |    |            |  |       |  |  |  |  |  |  |             |    |  |       |       |  |  |  |  |  |  |         |    |            |  |       |  |  |  |  |  |  |        |     |  |       |       |  |  |  |  |  |  |         |     |            |  |       |  |  |  |  |  |  |
| 1.4 LPG  | 55   |            | 05.06 | 09.07      |                                    |                |                                    |                |                          |     |                     |     |     |    |            |       |       |           |                |        |  |                        |     |             |    |            |       |       |           |                |        |  |                     |     |         |    |            |       |       |  |                |        |  |                     |     |             |    |  |       |       |  |  |  |  |  |  |                |    |            |       |       |       |                |        |  |                     |     |         |    |            |       |       |           |  |  |  |  |  |                   |    |            |       |       |       |                |        |       |                    |  |         |    |            |       |       |       |                |        |       |                     |  |       |    |            |       |       |       |                |        |       |                        |  |         |    |            |       |       |                                    |                |        |  |                       |     |         |    |            |       |       |  |                |        |  |                          |  |         |    |  |       |       |  |  |  |  |  |  |         |     |            |       |       |  |  |  |  |  |  |                |    |            |       |       |  |                |        |  |                   |     |                |    |            |       |       |  |                |        |  |                   |     |                   |    |  |       |       |  |                |        |  |                   |     |         |    |            |       |       |  |  |  |  |  |  |             |     |            |       |       |  |  |  |  |  |  |         |    |            |       |       |  |                |        |  |                       |     |         |     |            |       |       |  |                |        |  |                          |  |         |     |            |       |       |  |                |        |  |                   |     |         |     |            |       |  |  |                |        |  |                   |     |  |   |     |       |       |       |                |                                    |                |                       |  |                     |    |            |    |       |       |       |           |                |        |  |                        |    |     |       |       |       |       |           |  |  |  |         |    |            |    |       |       |       |  |  |  |  |         |     |            |    |       |       |       |  |  |  |  |        |     |                |       |       |       |                |        |  |                       |  |  |  |         |    |  |       |                |           |  |                          |  |  |  |     |  |            |       |  |       |                |        |       |                    |  |     |    |            |       |  |       |                |        |       |                     |  |         |    |            |       |  |       |                |        |       |                        |  |         |    |            |       |       |                                    |                |        |  |                       |  |     |    |  |       |       |  |                |        |  |                          |  |         |    |            |       |       |  |  |  |  |  |  |         |    |            |       |       |  |  |  |  |  |  |                |    |            |       |       |  |  |  |  |  |  |         |    |            |       |       |  |  |  |  |  |  |                   |    |            |       |       |  |                |        |   |                 |  |     |    |  |       |       |  |  |  |  |  |  |       |    |            |       |       |  |  |  |  |  |  |         |    |            |       |       |  |                |        |  |                       |  |         |    |            |       |       |  |                |        |  |                          |  |         |    |            |       |       |  |  |  |  |  |  |                |     |            |       |       |  |  |  |  |  |  |         |    |  |       |       |  |                |        |  |                       |  |         |    |            |  |       |  |  |  |  |  |  |             |    |  |       |       |  |  |  |  |  |  |         |    |            |  |       |  |  |  |  |  |  |         |     |            |       |       |  |  |  |  |  |  |         |     |            |       |       |  |                |        |  |                       |  |  |  |  |  |  |  |                |        |  |                          |  |  |  |     |  |            |       |  |  |                |        |   |                 |  |     |    |            |       |  |  |  |  |  |  |  |         |    |            |       |  |  |  |  |  |  |  |         |    |            |       |  |  |  |  |  |  |  |     |    |  |       |       |  |  |  |  |  |  |         |    |            |       |  |  |  |  |  |  |  |       |    |            |       |  |  |  |  |  |  |  |         |    |            |       |  |  |  |  |  |  |  |         |    |            |       |  |  |  |  |  |  |  |     |  |            |  |       |  |                |        |   |                 |  |     |    |  |       |       |  |  |  |  |  |  |     |    |            |  |       |  |  |  |  |  |  |         |    |  |       |       |  |  |  |  |  |  |         |    |            |  |       |  |  |  |  |  |  |         |    |            |  |       |  |  |  |  |  |  |                |    |  |       |       |  |  |  |  |  |  |         |    |  |       |       |  |  |  |  |  |  |         |    |            |  |       |  |  |  |  |  |  |             |    |  |       |       |  |  |  |  |  |  |         |    |            |  |       |  |  |  |  |  |  |        |     |  |       |       |  |  |  |  |  |  |         |     |            |  |       |  |  |  |  |  |  |
| 1.4 Roland Garros  | 55   |            | 09.98 | 02.09      |                                    |                |                                    |                |                          |     |                     |     |     |    |            |       |       |           |                |        |  |                        |     |             |    |            |       |       |           |                |        |  |                     |     |         |    |            |       |       |  |                |        |  |                     |     |             |    |  |       |       |  |  |  |  |  |  |                |    |            |       |       |       |                |        |  |                     |     |         |    |            |       |       |           |  |  |  |  |  |                   |    |            |       |       |       |                |        |       |                    |  |         |    |            |       |       |       |                |        |       |                     |  |       |    |            |       |       |       |                |        |       |                        |  |         |    |            |       |       |                                    |                |        |  |                       |     |         |    |            |       |       |  |                |        |  |                          |  |         |    |  |       |       |  |  |  |  |  |  |         |     |            |       |       |  |  |  |  |  |  |                |    |            |       |       |  |                |        |  |                   |     |                |    |            |       |       |  |                |        |  |                   |     |                   |    |  |       |       |  |                |        |  |                   |     |         |    |            |       |       |  |  |  |  |  |  |             |     |            |       |       |  |  |  |  |  |  |         |    |            |       |       |  |                |        |  |                       |     |         |     |            |       |       |  |                |        |  |                          |  |         |     |            |       |       |  |                |        |  |                   |     |         |     |            |       |  |  |                |        |  |                   |     |  |   |     |       |       |       |                |                                    |                |                       |  |                     |    |            |    |       |       |       |           |                |        |  |                        |    |     |       |       |       |       |           |  |  |  |         |    |            |    |       |       |       |  |  |  |  |         |     |            |    |       |       |       |  |  |  |  |        |     |                |       |       |       |                |        |  |                       |  |  |  |         |    |  |       |                |           |  |                          |  |  |  |     |  |            |       |  |       |                |        |       |                    |  |     |    |            |       |  |       |                |        |       |                     |  |         |    |            |       |  |       |                |        |       |                        |  |         |    |            |       |       |                                    |                |        |  |                       |  |     |    |  |       |       |  |                |        |  |                          |  |         |    |            |       |       |  |  |  |  |  |  |         |    |            |       |       |  |  |  |  |  |  |                |    |            |       |       |  |  |  |  |  |  |         |    |            |       |       |  |  |  |  |  |  |                   |    |            |       |       |  |                |        |   |                 |  |     |    |  |       |       |  |  |  |  |  |  |       |    |            |       |       |  |  |  |  |  |  |         |    |            |       |       |  |                |        |  |                       |  |         |    |            |       |       |  |                |        |  |                          |  |         |    |            |       |       |  |  |  |  |  |  |                |     |            |       |       |  |  |  |  |  |  |         |    |  |       |       |  |                |        |  |                       |  |         |    |            |  |       |  |  |  |  |  |  |             |    |  |       |       |  |  |  |  |  |  |         |    |            |  |       |  |  |  |  |  |  |         |     |            |       |       |  |  |  |  |  |  |         |     |            |       |       |  |                |        |  |                       |  |  |  |  |  |  |  |                |        |  |                          |  |  |  |     |  |            |       |  |  |                |        |   |                 |  |     |    |            |       |  |  |  |  |  |  |  |         |    |            |       |  |  |  |  |  |  |  |         |    |            |       |  |  |  |  |  |  |  |     |    |  |       |       |  |  |  |  |  |  |         |    |            |       |  |  |  |  |  |  |  |       |    |            |       |  |  |  |  |  |  |  |         |    |            |       |  |  |  |  |  |  |  |         |    |            |       |  |  |  |  |  |  |  |     |  |            |  |       |  |                |        |   |                 |  |     |    |  |       |       |  |  |  |  |  |  |     |    |            |  |       |  |  |  |  |  |  |         |    |  |       |       |  |  |  |  |  |  |         |    |            |  |       |  |  |  |  |  |  |         |    |            |  |       |  |  |  |  |  |  |                |    |  |       |       |  |  |  |  |  |  |         |    |  |       |       |  |  |  |  |  |  |         |    |            |  |       |  |  |  |  |  |  |             |    |  |       |       |  |  |  |  |  |  |         |    |            |  |       |  |  |  |  |  |  |        |     |  |       |       |  |  |  |  |  |  |         |     |            |  |       |  |  |  |  |  |  |
| 1.6  | 65   |            | 09.98 | 12.00      |                                    |                |                                    |                |                          |     |                     |     |     |    |            |       |       |           |                |        |  |                        |     |             |    |            |       |       |           |                |        |  |                     |     |         |    |            |       |       |  |                |        |  |                     |     |             |    |  |       |       |  |  |  |  |  |  |                |    |            |       |       |       |                |        |  |                     |     |         |    |            |       |       |           |  |  |  |  |  |                   |    |            |       |       |       |                |        |       |                    |  |         |    |            |       |       |       |                |        |       |                     |  |       |    |            |       |       |       |                |        |       |                        |  |         |    |            |       |       |                                    |                |        |  |                       |     |         |    |            |       |       |  |                |        |  |                          |  |         |    |  |       |       |  |  |  |  |  |  |         |     |            |       |       |  |  |  |  |  |  |                |    |            |       |       |  |                |        |  |                   |     |                |    |            |       |       |  |                |        |  |                   |     |                   |    |  |       |       |  |                |        |  |                   |     |         |    |            |       |       |  |  |  |  |  |  |             |     |            |       |       |  |  |  |  |  |  |         |    |            |       |       |  |                |        |  |                       |     |         |     |            |       |       |  |                |        |  |                          |  |         |     |            |       |       |  |                |        |  |                   |     |         |     |            |       |  |  |                |        |  |                   |     |  |   |     |       |       |       |                |                                    |                |                       |  |                     |    |            |    |       |       |       |           |                |        |  |                        |    |     |       |       |       |       |           |  |  |  |         |    |            |    |       |       |       |  |  |  |  |         |     |            |    |       |       |       |  |  |  |  |        |     |                |       |       |       |                |        |  |                       |  |  |  |         |    |  |       |                |           |  |                          |  |  |  |     |  |            |       |  |       |                |        |       |                    |  |     |    |            |       |  |       |                |        |       |                     |  |         |    |            |       |  |       |                |        |       |                        |  |         |    |            |       |       |                                    |                |        |  |                       |  |     |    |  |       |       |  |                |        |  |                          |  |         |    |            |       |       |  |  |  |  |  |  |         |    |            |       |       |  |  |  |  |  |  |                |    |            |       |       |  |  |  |  |  |  |         |    |            |       |       |  |  |  |  |  |  |                   |    |            |       |       |  |                |        |   |                 |  |     |    |  |       |       |  |  |  |  |  |  |       |    |            |       |       |  |  |  |  |  |  |         |    |            |       |       |  |                |        |  |                       |  |         |    |            |       |       |  |                |        |  |                          |  |         |    |            |       |       |  |  |  |  |  |  |                |     |            |       |       |  |  |  |  |  |  |         |    |  |       |       |  |                |        |  |                       |  |         |    |            |  |       |  |  |  |  |  |  |             |    |  |       |       |  |  |  |  |  |  |         |    |            |  |       |  |  |  |  |  |  |         |     |            |       |       |  |  |  |  |  |  |         |     |            |       |       |  |                |        |  |                       |  |  |  |  |  |  |  |                |        |  |                          |  |  |  |     |  |            |       |  |  |                |        |   |                 |  |     |    |            |       |  |  |  |  |  |  |  |         |    |            |       |  |  |  |  |  |  |  |         |    |            |       |  |  |  |  |  |  |  |     |    |  |       |       |  |  |  |  |  |  |         |    |            |       |  |  |  |  |  |  |  |       |    |            |       |  |  |  |  |  |  |  |         |    |            |       |  |  |  |  |  |  |  |         |    |            |       |  |  |  |  |  |  |  |     |  |            |  |       |  |                |        |   |                 |  |     |    |  |       |       |  |  |  |  |  |  |     |    |            |  |       |  |  |  |  |  |  |         |    |  |       |       |  |  |  |  |  |  |         |    |            |  |       |  |  |  |  |  |  |         |    |            |  |       |  |  |  |  |  |  |                |    |  |       |       |  |  |  |  |  |  |         |    |  |       |       |  |  |  |  |  |  |         |    |            |  |       |  |  |  |  |  |  |             |    |  |       |       |  |  |  |  |  |  |         |    |            |  |       |  |  |  |  |  |  |        |     |  |       |       |  |  |  |  |  |  |         |     |            |  |       |  |  |  |  |  |  |
| 1.9 D  | 51   |            | 09.98 | 02.09      |                                    |                |                                    |                |                          |     |                     |     |     |    |            |       |       |           |                |        |  |                        |     |             |    |            |       |       |           |                |        |  |                     |     |         |    |            |       |       |  |                |        |  |                     |     |             |    |  |       |       |  |  |  |  |  |  |                |    |            |       |       |       |                |        |  |                     |     |         |    |            |       |       |           |  |  |  |  |  |                   |    |            |       |       |       |                |        |       |                    |  |         |    |            |       |       |       |                |        |       |                     |  |       |    |            |       |       |       |                |        |       |                        |  |         |    |            |       |       |                                    |                |        |  |                       |     |         |    |            |       |       |  |                |        |  |                          |  |         |    |  |       |       |  |  |  |  |  |  |         |     |            |       |       |  |  |  |  |  |  |                |    |            |       |       |  |                |        |  |                   |     |                |    |            |       |       |  |                |        |  |                   |     |                   |    |  |       |       |  |                |        |  |                   |     |         |    |            |       |       |  |  |  |  |  |  |             |     |            |       |       |  |  |  |  |  |  |         |    |            |       |       |  |                |        |  |                       |     |         |     |            |       |       |  |                |        |  |                          |  |         |     |            |       |       |  |                |        |  |                   |     |         |     |            |       |  |  |                |        |  |                   |     |  |   |     |       |       |       |                |                                    |                |                       |  |                     |    |            |    |       |       |       |           |                |        |  |                        |    |     |       |       |       |       |           |  |  |  |         |    |            |    |       |       |       |  |  |  |  |         |     |            |    |       |       |       |  |  |  |  |        |     |                |       |       |       |                |        |  |                       |  |  |  |         |    |  |       |                |           |  |                          |  |  |  |     |  |            |       |  |       |                |        |       |                    |  |     |    |            |       |  |       |                |        |       |                     |  |         |    |            |       |  |       |                |        |       |                        |  |         |    |            |       |       |                                    |                |        |  |                       |  |     |    |  |       |       |  |                |        |  |                          |  |         |    |            |       |       |  |  |  |  |  |  |         |    |            |       |       |  |  |  |  |  |  |                |    |            |       |       |  |  |  |  |  |  |         |    |            |       |       |  |  |  |  |  |  |                   |    |            |       |       |  |                |        |   |                 |  |     |    |  |       |       |  |  |  |  |  |  |       |    |            |       |       |  |  |  |  |  |  |         |    |            |       |       |  |                |        |  |                       |  |         |    |            |       |       |  |                |        |  |                          |  |         |    |            |       |       |  |  |  |  |  |  |                |     |            |       |       |  |  |  |  |  |  |         |    |  |       |       |  |                |        |  |                       |  |         |    |            |  |       |  |  |  |  |  |  |             |    |  |       |       |  |  |  |  |  |  |         |    |            |  |       |  |  |  |  |  |  |         |     |            |       |       |  |  |  |  |  |  |         |     |            |       |       |  |                |        |  |                       |  |  |  |  |  |  |  |                |        |  |                          |  |  |  |     |  |            |       |  |  |                |        |   |                 |  |     |    |            |       |  |  |  |  |  |  |  |         |    |            |       |  |  |  |  |  |  |  |         |    |            |       |  |  |  |  |  |  |  |     |    |  |       |       |  |  |  |  |  |  |         |    |            |       |  |  |  |  |  |  |  |       |    |            |       |  |  |  |  |  |  |  |         |    |            |       |  |  |  |  |  |  |  |         |    |            |       |  |  |  |  |  |  |  |     |  |            |  |       |  |                |        |   |                 |  |     |    |  |       |       |  |  |  |  |  |  |     |    |            |  |       |  |  |  |  |  |  |         |    |  |       |       |  |  |  |  |  |  |         |    |            |  |       |  |  |  |  |  |  |         |    |            |  |       |  |  |  |  |  |  |                |    |  |       |       |  |  |  |  |  |  |         |    |  |       |       |  |  |  |  |  |  |         |    |            |  |       |  |  |  |  |  |  |             |    |  |       |       |  |  |  |  |  |  |         |    |            |  |       |  |  |  |  |  |  |        |     |  |       |       |  |  |  |  |  |  |         |     |            |  |       |  |  |  |  |  |  |
| 1.6 16V  | 80   | ORGA 09078 | 12.00 |            |                                    | 24.0120-0133.1 | 420133                             |                | 266 20,5 18,5 V +S +B    |     |                     |     |     |    |            |       |       |           |                |        |  |                        |     |             |    |            |       |       |           |                |        |  |                     |     |         |    |            |       |       |  |                |        |  |                     |     |             |    |  |       |       |  |  |  |  |  |  |                |    |            |       |       |       |                |        |  |                     |     |         |    |            |       |       |           |  |  |  |  |  |                   |    |            |       |       |       |                |        |       |                    |  |         |    |            |       |       |       |                |        |       |                     |  |       |    |            |       |       |       |                |        |       |                        |  |         |    |            |       |       |                                    |                |        |  |                       |     |         |    |            |       |       |  |                |        |  |                          |  |         |    |  |       |       |  |  |  |  |  |  |         |     |            |       |       |  |  |  |  |  |  |                |    |            |       |       |  |                |        |  |                   |     |                |    |            |       |       |  |                |        |  |                   |     |                   |    |  |       |       |  |                |        |  |                   |     |         |    |            |       |       |  |  |  |  |  |  |             |     |            |       |       |  |  |  |  |  |  |         |    |            |       |       |  |                |        |  |                       |     |         |     |            |       |       |  |                |        |  |                          |  |         |     |            |       |       |  |                |        |  |                   |     |         |     |            |       |  |  |                |        |  |                   |     |  |   |     |       |       |       |                |                                    |                |                       |  |                     |    |            |    |       |       |       |           |                |        |  |                        |    |     |       |       |       |       |           |  |  |  |         |    |            |    |       |       |       |  |  |  |  |         |     |            |    |       |       |       |  |  |  |  |        |     |                |       |       |       |                |        |  |                       |  |  |  |         |    |  |       |                |           |  |                          |  |  |  |     |  |            |       |  |       |                |        |       |                    |  |     |    |            |       |  |       |                |        |       |                     |  |         |    |            |       |  |       |                |        |       |                        |  |         |    |            |       |       |                                    |                |        |  |                       |  |     |    |  |       |       |  |                |        |  |                          |  |         |    |            |       |       |  |  |  |  |  |  |         |    |            |       |       |  |  |  |  |  |  |                |    |            |       |       |  |  |  |  |  |  |         |    |            |       |       |  |  |  |  |  |  |                   |    |            |       |       |  |                |        |   |                 |  |     |    |  |       |       |  |  |  |  |  |  |       |    |            |       |       |  |  |  |  |  |  |         |    |            |       |       |  |                |        |  |                       |  |         |    |            |       |       |  |                |        |  |                          |  |         |    |            |       |       |  |  |  |  |  |  |                |     |            |       |       |  |  |  |  |  |  |         |    |  |       |       |  |                |        |  |                       |  |         |    |            |  |       |  |  |  |  |  |  |             |    |  |       |       |  |  |  |  |  |  |         |    |            |  |       |  |  |  |  |  |  |         |     |            |       |       |  |  |  |  |  |  |         |     |            |       |       |  |                |        |  |                       |  |  |  |  |  |  |  |                |        |  |                          |  |  |  |     |  |            |       |  |  |                |        |   |                 |  |     |    |            |       |  |  |  |  |  |  |  |         |    |            |       |  |  |  |  |  |  |  |         |    |            |       |  |  |  |  |  |  |  |     |    |  |       |       |  |  |  |  |  |  |         |    |            |       |  |  |  |  |  |  |  |       |    |            |       |  |  |  |  |  |  |  |         |    |            |       |  |  |  |  |  |  |  |         |    |            |       |  |  |  |  |  |  |  |     |  |            |  |       |  |                |        |   |                 |  |     |    |  |       |       |  |  |  |  |  |  |     |    |            |  |       |  |  |  |  |  |  |         |    |  |       |       |  |  |  |  |  |  |         |    |            |  |       |  |  |  |  |  |  |         |    |            |  |       |  |  |  |  |  |  |                |    |  |       |       |  |  |  |  |  |  |         |    |  |       |       |  |  |  |  |  |  |         |    |            |  |       |  |  |  |  |  |  |             |    |  |       |       |  |  |  |  |  |  |         |    |            |  |       |  |  |  |  |  |  |        |     |  |       |       |  |  |  |  |  |  |         |     |            |  |       |  |  |  |  |  |  |
| 2.0 HDi  | 66   | ORGA 09078 | 12.99 |            |                                    | 24.0320-0133.1 | 520133                             |                | 266 20,5 18,5 V +S +B PD |     |                     |     |     |    |            |       |       |           |                |        |  |                        |     |             |    |            |       |       |           |                |        |  |                     |     |         |    |            |       |       |  |                |        |  |                     |     |             |    |  |       |       |  |  |  |  |  |  |                |    |            |       |       |       |                |        |  |                     |     |         |    |            |       |       |           |  |  |  |  |  |                   |    |            |       |       |       |                |        |       |                    |  |         |    |            |       |       |       |                |        |       |                     |  |       |    |            |       |       |       |                |        |       |                        |  |         |    |            |       |       |                                    |                |        |  |                       |     |         |    |            |       |       |  |                |        |  |                          |  |         |    |  |       |       |  |  |  |  |  |  |         |     |            |       |       |  |  |  |  |  |  |                |    |            |       |       |  |                |        |  |                   |     |                |    |            |       |       |  |                |        |  |                   |     |                   |    |  |       |       |  |                |        |  |                   |     |         |    |            |       |       |  |  |  |  |  |  |             |     |            |       |       |  |  |  |  |  |  |         |    |            |       |       |  |                |        |  |                       |     |         |     |            |       |       |  |                |        |  |                          |  |         |     |            |       |       |  |                |        |  |                   |     |         |     |            |       |  |  |                |        |  |                   |     |  |   |     |       |       |       |                |                                    |                |                       |  |                     |    |            |    |       |       |       |           |                |        |  |                        |    |     |       |       |       |       |           |  |  |  |         |    |            |    |       |       |       |  |  |  |  |         |     |            |    |       |       |       |  |  |  |  |        |     |                |       |       |       |                |        |  |                       |  |  |  |         |    |  |       |                |           |  |                          |  |  |  |     |  |            |       |  |       |                |        |       |                    |  |     |    |            |       |  |       |                |        |       |                     |  |         |    |            |       |  |       |                |        |       |                        |  |         |    |            |       |       |                                    |                |        |  |                       |  |     |    |  |       |       |  |                |        |  |                          |  |         |    |            |       |       |  |  |  |  |  |  |         |    |            |       |       |  |  |  |  |  |  |                |    |            |       |       |  |  |  |  |  |  |         |    |            |       |       |  |  |  |  |  |  |                   |    |            |       |       |  |                |        |   |                 |  |     |    |  |       |       |  |  |  |  |  |  |       |    |            |       |       |  |  |  |  |  |  |         |    |            |       |       |  |                |        |  |                       |  |         |    |            |       |       |  |                |        |  |                          |  |         |    |            |       |       |  |  |  |  |  |  |                |     |            |       |       |  |  |  |  |  |  |         |    |  |       |       |  |                |        |  |                       |  |         |    |            |  |       |  |  |  |  |  |  |             |    |  |       |       |  |  |  |  |  |  |         |    |            |  |       |  |  |  |  |  |  |         |     |            |       |       |  |  |  |  |  |  |         |     |            |       |       |  |                |        |  |                       |  |  |  |  |  |  |  |                |        |  |                          |  |  |  |     |  |            |       |  |  |                |        |   |                 |  |     |    |            |       |  |  |  |  |  |  |  |         |    |            |       |  |  |  |  |  |  |  |         |    |            |       |  |  |  |  |  |  |  |     |    |  |       |       |  |  |  |  |  |  |         |    |            |       |  |  |  |  |  |  |  |       |    |            |       |  |  |  |  |  |  |  |         |    |            |       |  |  |  |  |  |  |  |         |    |            |       |  |  |  |  |  |  |  |     |  |            |  |       |  |                |        |   |                 |  |     |    |  |       |       |  |  |  |  |  |  |     |    |            |  |       |  |  |  |  |  |  |         |    |  |       |       |  |  |  |  |  |  |         |    |            |  |       |  |  |  |  |  |  |         |    |            |  |       |  |  |  |  |  |  |                |    |  |       |       |  |  |  |  |  |  |         |    |  |       |       |  |  |  |  |  |  |         |    |            |  |       |  |  |  |  |  |  |             |    |  |       |       |  |  |  |  |  |  |         |    |            |  |       |  |  |  |  |  |  |        |     |  |       |       |  |  |  |  |  |  |         |     |            |  |       |  |  |  |  |  |  |
| 2.0 S16  | 99   |            | 04.99 | 10.00      |                                    |                |                                    |                |                          |     |                     |     |     |    |            |       |       |           |                |        |  |                        |     |             |    |            |       |       |           |                |        |  |                     |     |         |    |            |       |       |  |                |        |  |                     |     |             |    |  |       |       |  |  |  |  |  |  |                |    |            |       |       |       |                |        |  |                     |     |         |    |            |       |       |           |  |  |  |  |  |                   |    |            |       |       |       |                |        |       |                    |  |         |    |            |       |       |       |                |        |       |                     |  |       |    |            |       |       |       |                |        |       |                        |  |         |    |            |       |       |                                    |                |        |  |                       |     |         |    |            |       |       |  |                |        |  |                          |  |         |    |  |       |       |  |  |  |  |  |  |         |     |            |       |       |  |  |  |  |  |  |                |    |            |       |       |  |                |        |  |                   |     |                |    |            |       |       |  |                |        |  |                   |     |                   |    |  |       |       |  |                |        |  |                   |     |         |    |            |       |       |  |  |  |  |  |  |             |     |            |       |       |  |  |  |  |  |  |         |    |            |       |       |  |                |        |  |                       |     |         |     |            |       |       |  |                |        |  |                          |  |         |     |            |       |       |  |                |        |  |                   |     |         |     |            |       |  |  |                |        |  |                   |     |  |   |     |       |       |       |                |                                    |                |                       |  |                     |    |            |    |       |       |       |           |                |        |  |                        |    |     |       |       |       |       |           |  |  |  |         |    |            |    |       |       |       |  |  |  |  |         |     |            |    |       |       |       |  |  |  |  |        |     |                |       |       |       |                |        |  |                       |  |  |  |         |    |  |       |                |           |  |                          |  |  |  |     |  |            |       |  |       |                |        |       |                    |  |     |    |            |       |  |       |                |        |       |                     |  |         |    |            |       |  |       |                |        |       |                        |  |         |    |            |       |       |                                    |                |        |  |                       |  |     |    |  |       |       |  |                |        |  |                          |  |         |    |            |       |       |  |  |  |  |  |  |         |    |            |       |       |  |  |  |  |  |  |                |    |            |       |       |  |  |  |  |  |  |         |    |            |       |       |  |  |  |  |  |  |                   |    |            |       |       |  |                |        |   |                 |  |     |    |  |       |       |  |  |  |  |  |  |       |    |            |       |       |  |  |  |  |  |  |         |    |            |       |       |  |                |        |  |                       |  |         |    |            |       |       |  |                |        |  |                          |  |         |    |            |       |       |  |  |  |  |  |  |                |     |            |       |       |  |  |  |  |  |  |         |    |  |       |       |  |                |        |  |                       |  |         |    |            |  |       |  |  |  |  |  |  |             |    |  |       |       |  |  |  |  |  |  |         |    |            |  |       |  |  |  |  |  |  |         |     |            |       |       |  |  |  |  |  |  |         |     |            |       |       |  |                |        |  |                       |  |  |  |  |  |  |  |                |        |  |                          |  |  |  |     |  |            |       |  |  |                |        |   |                 |  |     |    |            |       |  |  |  |  |  |  |  |         |    |            |       |  |  |  |  |  |  |  |         |    |            |       |  |  |  |  |  |  |  |     |    |  |       |       |  |  |  |  |  |  |         |    |            |       |  |  |  |  |  |  |  |       |    |            |       |  |  |  |  |  |  |  |         |    |            |       |  |  |  |  |  |  |  |         |    |            |       |  |  |  |  |  |  |  |     |  |            |  |       |  |                |        |   |                 |  |     |    |  |       |       |  |  |  |  |  |  |     |    |            |  |       |  |  |  |  |  |  |         |    |  |       |       |  |  |  |  |  |  |         |    |            |  |       |  |  |  |  |  |  |         |    |            |  |       |  |  |  |  |  |  |                |    |  |       |       |  |  |  |  |  |  |         |    |  |       |       |  |  |  |  |  |  |         |    |            |  |       |  |  |  |  |  |  |             |    |  |       |       |  |  |  |  |  |  |         |    |            |  |       |  |  |  |  |  |  |        |     |  |       |       |  |  |  |  |  |  |         |     |            |  |       |  |  |  |  |  |  |
| 2.0 S16  | 100  | ORGA 09078 | 10.00 |            |                                    |                |                                    |                |                          |     |                     |     |     |    |            |       |       |           |                |        |  |                        |     |             |    |            |       |       |           |                |        |  |                     |     |         |    |            |       |       |  |                |        |  |                     |     |             |    |  |       |       |  |  |  |  |  |  |                |    |            |       |       |       |                |        |  |                     |     |         |    |            |       |       |           |  |  |  |  |  |                   |    |            |       |       |       |                |        |       |                    |  |         |    |            |       |       |       |                |        |       |                     |  |       |    |            |       |       |       |                |        |       |                        |  |         |    |            |       |       |                                    |                |        |  |                       |     |         |    |            |       |       |  |                |        |  |                          |  |         |    |  |       |       |  |  |  |  |  |  |         |     |            |       |       |  |  |  |  |  |  |                |    |            |       |       |  |                |        |  |                   |     |                |    |            |       |       |  |                |        |  |                   |     |                   |    |  |       |       |  |                |        |  |                   |     |         |    |            |       |       |  |  |  |  |  |  |             |     |            |       |       |  |  |  |  |  |  |         |    |            |       |       |  |                |        |  |                       |     |         |     |            |       |       |  |                |        |  |                          |  |         |     |            |       |       |  |                |        |  |                   |     |         |     |            |       |  |  |                |        |  |                   |     |  |   |     |       |       |       |                |                                    |                |                       |  |                     |    |            |    |       |       |       |           |                |        |  |                        |    |     |       |       |       |       |           |  |  |  |         |    |            |    |       |       |       |  |  |  |  |         |     |            |    |       |       |       |  |  |  |  |        |     |                |       |       |       |                |        |  |                       |  |  |  |         |    |  |       |                |           |  |                          |  |  |  |     |  |            |       |  |       |                |        |       |                    |  |     |    |            |       |  |       |                |        |       |                     |  |         |    |            |       |  |       |                |        |       |                        |  |         |    |            |       |       |                                    |                |        |  |                       |  |     |    |  |       |       |  |                |        |  |                          |  |         |    |            |       |       |  |  |  |  |  |  |         |    |            |       |       |  |  |  |  |  |  |                |    |            |       |       |  |  |  |  |  |  |         |    |            |       |       |  |  |  |  |  |  |                   |    |            |       |       |  |                |        |   |                 |  |     |    |  |       |       |  |  |  |  |  |  |       |    |            |       |       |  |  |  |  |  |  |         |    |            |       |       |  |                |        |  |                       |  |         |    |            |       |       |  |                |        |  |                          |  |         |    |            |       |       |  |  |  |  |  |  |                |     |            |       |       |  |  |  |  |  |  |         |    |  |       |       |  |                |        |  |                       |  |         |    |            |  |       |  |  |  |  |  |  |             |    |  |       |       |  |  |  |  |  |  |         |    |            |  |       |  |  |  |  |  |  |         |     |            |       |       |  |  |  |  |  |  |         |     |            |       |       |  |                |        |  |                       |  |  |  |  |  |  |  |                |        |  |                          |  |  |  |     |  |            |       |  |  |                |        |   |                 |  |     |    |            |       |  |  |  |  |  |  |  |         |    |            |       |  |  |  |  |  |  |  |         |    |            |       |  |  |  |  |  |  |  |     |    |  |       |       |  |  |  |  |  |  |         |    |            |       |  |  |  |  |  |  |  |       |    |            |       |  |  |  |  |  |  |  |         |    |            |       |  |  |  |  |  |  |  |         |    |            |       |  |  |  |  |  |  |  |     |  |            |  |       |  |                |        |   |                 |  |     |    |  |       |       |  |  |  |  |  |  |     |    |            |  |       |  |  |  |  |  |  |         |    |  |       |       |  |  |  |  |  |  |         |    |            |  |       |  |  |  |  |  |  |         |    |            |  |       |  |  |  |  |  |  |                |    |  |       |       |  |  |  |  |  |  |         |    |  |       |       |  |  |  |  |  |  |         |    |            |  |       |  |  |  |  |  |  |             |    |  |       |       |  |  |  |  |  |  |         |    |            |  |       |  |  |  |  |  |  |        |     |  |       |       |  |  |  |  |  |  |         |     |            |  |       |  |  |  |  |  |  |
| 1.4 16V  | 65   |            | 10.03 | 02.09      |                                    | 24.0122-0194.1 | 422194                             |                | 266 22,0 20,0 V +S +B    |     |                     |     |     |    |            |       |       |           |                |        |  |                        |     |             |    |            |       |       |           |                |        |  |                     |     |         |    |            |       |       |  |                |        |  |                     |     |             |    |  |       |       |  |  |  |  |  |  |                |    |            |       |       |       |                |        |  |                     |     |         |    |            |       |       |           |  |  |  |  |  |                   |    |            |       |       |       |                |        |       |                    |  |         |    |            |       |       |       |                |        |       |                     |  |       |    |            |       |       |       |                |        |       |                        |  |         |    |            |       |       |                                    |                |        |  |                       |     |         |    |            |       |       |  |                |        |  |                          |  |         |    |  |       |       |  |  |  |  |  |  |         |     |            |       |       |  |  |  |  |  |  |                |    |            |       |       |  |                |        |  |                   |     |                |    |            |       |       |  |                |        |  |                   |     |                   |    |  |       |       |  |                |        |  |                   |     |         |    |            |       |       |  |  |  |  |  |  |             |     |            |       |       |  |  |  |  |  |  |         |    |            |       |       |  |                |        |  |                       |     |         |     |            |       |       |  |                |        |  |                          |  |         |     |            |       |       |  |                |        |  |                   |     |         |     |            |       |  |  |                |        |  |                   |     |  |   |     |       |       |       |                |                                    |                |                       |  |                     |    |            |    |       |       |       |           |                |        |  |                        |    |     |       |       |       |       |           |  |  |  |         |    |            |    |       |       |       |  |  |  |  |         |     |            |    |       |       |       |  |  |  |  |        |     |                |       |       |       |                |        |  |                       |  |  |  |         |    |  |       |                |           |  |                          |  |  |  |     |  |            |       |  |       |                |        |       |                    |  |     |    |            |       |  |       |                |        |       |                     |  |         |    |            |       |  |       |                |        |       |                        |  |         |    |            |       |       |                                    |                |        |  |                       |  |     |    |  |       |       |  |                |        |  |                          |  |         |    |            |       |       |  |  |  |  |  |  |         |    |            |       |       |  |  |  |  |  |  |                |    |            |       |       |  |  |  |  |  |  |         |    |            |       |       |  |  |  |  |  |  |                   |    |            |       |       |  |                |        |   |                 |  |     |    |  |       |       |  |  |  |  |  |  |       |    |            |       |       |  |  |  |  |  |  |         |    |            |       |       |  |                |        |  |                       |  |         |    |            |       |       |  |                |        |  |                          |  |         |    |            |       |       |  |  |  |  |  |  |                |     |            |       |       |  |  |  |  |  |  |         |    |  |       |       |  |                |        |  |                       |  |         |    |            |  |       |  |  |  |  |  |  |             |    |  |       |       |  |  |  |  |  |  |         |    |            |  |       |  |  |  |  |  |  |         |     |            |       |       |  |  |  |  |  |  |         |     |            |       |       |  |                |        |  |                       |  |  |  |  |  |  |  |                |        |  |                          |  |  |  |     |  |            |       |  |  |                |        |   |                 |  |     |    |            |       |  |  |  |  |  |  |  |         |    |            |       |  |  |  |  |  |  |  |         |    |            |       |  |  |  |  |  |  |  |     |    |  |       |       |  |  |  |  |  |  |         |    |            |       |  |  |  |  |  |  |  |       |    |            |       |  |  |  |  |  |  |  |         |    |            |       |  |  |  |  |  |  |  |         |    |            |       |  |  |  |  |  |  |  |     |  |            |  |       |  |                |        |   |                 |  |     |    |  |       |       |  |  |  |  |  |  |     |    |            |  |       |  |  |  |  |  |  |         |    |  |       |       |  |  |  |  |  |  |         |    |            |  |       |  |  |  |  |  |  |         |    |            |  |       |  |  |  |  |  |  |                |    |  |       |       |  |  |  |  |  |  |         |    |  |       |       |  |  |  |  |  |  |         |    |            |  |       |  |  |  |  |  |  |             |    |  |       |       |  |  |  |  |  |  |         |    |            |  |       |  |  |  |  |  |  |        |     |  |       |       |  |  |  |  |  |  |         |     |            |  |       |  |  |  |  |  |  |
| 1.6 16V  | 80   | ORGA 09079 |       | 02.09      |                                    |                |                                    |                |                          |     |                     |     |     |    |            |       |       |           |                |        |  |                        |     |             |    |            |       |       |           |                |        |  |                     |     |         |    |            |       |       |  |                |        |  |                     |     |             |    |  |       |       |  |  |  |  |  |  |                |    |            |       |       |       |                |        |  |                     |     |         |    |            |       |       |           |  |  |  |  |  |                   |    |            |       |       |       |                |        |       |                    |  |         |    |            |       |       |       |                |        |       |                     |  |       |    |            |       |       |       |                |        |       |                        |  |         |    |            |       |       |                                    |                |        |  |                       |     |         |    |            |       |       |  |                |        |  |                          |  |         |    |  |       |       |  |  |  |  |  |  |         |     |            |       |       |  |  |  |  |  |  |                |    |            |       |       |  |                |        |  |                   |     |                |    |            |       |       |  |                |        |  |                   |     |                   |    |  |       |       |  |                |        |  |                   |     |         |    |            |       |       |  |  |  |  |  |  |             |     |            |       |       |  |  |  |  |  |  |         |    |            |       |       |  |                |        |  |                       |     |         |     |            |       |       |  |                |        |  |                          |  |         |     |            |       |       |  |                |        |  |                   |     |         |     |            |       |  |  |                |        |  |                   |     |  |   |     |       |       |       |                |                                    |                |                       |  |                     |    |            |    |       |       |       |           |                |        |  |                        |    |     |       |       |       |       |           |  |  |  |         |    |            |    |       |       |       |  |  |  |  |         |     |            |    |       |       |       |  |  |  |  |        |     |                |       |       |       |                |        |  |                       |  |  |  |         |    |  |       |                |           |  |                          |  |  |  |     |  |            |       |  |       |                |        |       |                    |  |     |    |            |       |  |       |                |        |       |                     |  |         |    |            |       |  |       |                |        |       |                        |  |         |    |            |       |       |                                    |                |        |  |                       |  |     |    |  |       |       |  |                |        |  |                          |  |         |    |            |       |       |  |  |  |  |  |  |         |    |            |       |       |  |  |  |  |  |  |                |    |            |       |       |  |  |  |  |  |  |         |    |            |       |       |  |  |  |  |  |  |                   |    |            |       |       |  |                |        |   |                 |  |     |    |  |       |       |  |  |  |  |  |  |       |    |            |       |       |  |  |  |  |  |  |         |    |            |       |       |  |                |        |  |                       |  |         |    |            |       |       |  |                |        |  |                          |  |         |    |            |       |       |  |  |  |  |  |  |                |     |            |       |       |  |  |  |  |  |  |         |    |  |       |       |  |                |        |  |                       |  |         |    |            |  |       |  |  |  |  |  |  |             |    |  |       |       |  |  |  |  |  |  |         |    |            |  |       |  |  |  |  |  |  |         |     |            |       |       |  |  |  |  |  |  |         |     |            |       |       |  |                |        |  |                       |  |  |  |  |  |  |  |                |        |  |                          |  |  |  |     |  |            |       |  |  |                |        |   |                 |  |     |    |            |       |  |  |  |  |  |  |  |         |    |            |       |  |  |  |  |  |  |  |         |    |            |       |  |  |  |  |  |  |  |     |    |  |       |       |  |  |  |  |  |  |         |    |            |       |  |  |  |  |  |  |  |       |    |            |       |  |  |  |  |  |  |  |         |    |            |       |  |  |  |  |  |  |  |         |    |            |       |  |  |  |  |  |  |  |     |  |            |  |       |  |                |        |   |                 |  |     |    |  |       |       |  |  |  |  |  |  |     |    |            |  |       |  |  |  |  |  |  |         |    |  |       |       |  |  |  |  |  |  |         |    |            |  |       |  |  |  |  |  |  |         |    |            |  |       |  |  |  |  |  |  |                |    |  |       |       |  |  |  |  |  |  |         |    |  |       |       |  |  |  |  |  |  |         |    |            |  |       |  |  |  |  |  |  |             |    |  |       |       |  |  |  |  |  |  |         |    |            |  |       |  |  |  |  |  |  |        |     |  |       |       |  |  |  |  |  |  |         |     |            |  |       |  |  |  |  |  |  |
| 1.6 HDi 110  | 80   |            | 05.04 | 02.09      |                                    |                |                                    |                |                          |     |                     |     |     |    |            |       |       |           |                |        |  |                        |     |             |    |            |       |       |           |                |        |  |                     |     |         |    |            |       |       |  |                |        |  |                     |     |             |    |  |       |       |  |  |  |  |  |  |                |    |            |       |       |       |                |        |  |                     |     |         |    |            |       |       |           |  |  |  |  |  |                   |    |            |       |       |       |                |        |       |                    |  |         |    |            |       |       |       |                |        |       |                     |  |       |    |            |       |       |       |                |        |       |                        |  |         |    |            |       |       |                                    |                |        |  |                       |     |         |    |            |       |       |  |                |        |  |                          |  |         |    |  |       |       |  |  |  |  |  |  |         |     |            |       |       |  |  |  |  |  |  |                |    |            |       |       |  |                |        |  |                   |     |                |    |            |       |       |  |                |        |  |                   |     |                   |    |  |       |       |  |                |        |  |                   |     |         |    |            |       |       |  |  |  |  |  |  |             |     |            |       |       |  |  |  |  |  |  |         |    |            |       |       |  |                |        |  |                       |     |         |     |            |       |       |  |                |        |  |                          |  |         |     |            |       |       |  |                |        |  |                   |     |         |     |            |       |  |  |                |        |  |                   |     |  |   |     |       |       |       |                |                                    |                |                       |  |                     |    |            |    |       |       |       |           |                |        |  |                        |    |     |       |       |       |       |           |  |  |  |         |    |            |    |       |       |       |  |  |  |  |         |     |            |    |       |       |       |  |  |  |  |        |     |                |       |       |       |                |        |  |                       |  |  |  |         |    |  |       |                |           |  |                          |  |  |  |     |  |            |       |  |       |                |        |       |                    |  |     |    |            |       |  |       |                |        |       |                     |  |         |    |            |       |  |       |                |        |       |                        |  |         |    |            |       |       |                                    |                |        |  |                       |  |     |    |  |       |       |  |                |        |  |                          |  |         |    |            |       |       |  |  |  |  |  |  |         |    |            |       |       |  |  |  |  |  |  |                |    |            |       |       |  |  |  |  |  |  |         |    |            |       |       |  |  |  |  |  |  |                   |    |            |       |       |  |                |        |   |                 |  |     |    |  |       |       |  |  |  |  |  |  |       |    |            |       |       |  |  |  |  |  |  |         |    |            |       |       |  |                |        |  |                       |  |         |    |            |       |       |  |                |        |  |                          |  |         |    |            |       |       |  |  |  |  |  |  |                |     |            |       |       |  |  |  |  |  |  |         |    |  |       |       |  |                |        |  |                       |  |         |    |            |  |       |  |  |  |  |  |  |             |    |  |       |       |  |  |  |  |  |  |         |    |            |  |       |  |  |  |  |  |  |         |     |            |       |       |  |  |  |  |  |  |         |     |            |       |       |  |                |        |  |                       |  |  |  |  |  |  |  |                |        |  |                          |  |  |  |     |  |            |       |  |  |                |        |   |                 |  |     |    |            |       |  |  |  |  |  |  |  |         |    |            |       |  |  |  |  |  |  |  |         |    |            |       |  |  |  |  |  |  |  |     |    |  |       |       |  |  |  |  |  |  |         |    |            |       |  |  |  |  |  |  |  |       |    |            |       |  |  |  |  |  |  |  |         |    |            |       |  |  |  |  |  |  |  |         |    |            |       |  |  |  |  |  |  |  |     |  |            |  |       |  |                |        |   |                 |  |     |    |  |       |       |  |  |  |  |  |  |     |    |            |  |       |  |  |  |  |  |  |         |    |  |       |       |  |  |  |  |  |  |         |    |            |  |       |  |  |  |  |  |  |         |    |            |  |       |  |  |  |  |  |  |                |    |  |       |       |  |  |  |  |  |  |         |    |  |       |       |  |  |  |  |  |  |         |    |            |  |       |  |  |  |  |  |  |             |    |  |       |       |  |  |  |  |  |  |         |    |            |  |       |  |  |  |  |  |  |        |     |  |       |       |  |  |  |  |  |  |         |     |            |  |       |  |  |  |  |  |  |
| 2.0 HDi  | 66   | ORGA 09079 |       | 02.09      |                                    |                |                                    |                |                          |     |                     |     |     |    |            |       |       |           |                |        |  |                        |     |             |    |            |       |       |           |                |        |  |                     |     |         |    |            |       |       |  |                |        |  |                     |     |             |    |  |       |       |  |  |  |  |  |  |                |    |            |       |       |       |                |        |  |                     |     |         |    |            |       |       |           |  |  |  |  |  |                   |    |            |       |       |       |                |        |       |                    |  |         |    |            |       |       |       |                |        |       |                     |  |       |    |            |       |       |       |                |        |       |                        |  |         |    |            |       |       |                                    |                |        |  |                       |     |         |    |            |       |       |  |                |        |  |                          |  |         |    |  |       |       |  |  |  |  |  |  |         |     |            |       |       |  |  |  |  |  |  |                |    |            |       |       |  |                |        |  |                   |     |                |    |            |       |       |  |                |        |  |                   |     |                   |    |  |       |       |  |                |        |  |                   |     |         |    |            |       |       |  |  |  |  |  |  |             |     |            |       |       |  |  |  |  |  |  |         |    |            |       |       |  |                |        |  |                       |     |         |     |            |       |       |  |                |        |  |                          |  |         |     |            |       |       |  |                |        |  |                   |     |         |     |            |       |  |  |                |        |  |                   |     |  |   |     |       |       |       |                |                                    |                |                       |  |                     |    |            |    |       |       |       |           |                |        |  |                        |    |     |       |       |       |       |           |  |  |  |         |    |            |    |       |       |       |  |  |  |  |         |     |            |    |       |       |       |  |  |  |  |        |     |                |       |       |       |                |        |  |                       |  |  |  |         |    |  |       |                |           |  |                          |  |  |  |     |  |            |       |  |       |                |        |       |                    |  |     |    |            |       |  |       |                |        |       |                     |  |         |    |            |       |  |       |                |        |       |                        |  |         |    |            |       |       |                                    |                |        |  |                       |  |     |    |  |       |       |  |                |        |  |                          |  |         |    |            |       |       |  |  |  |  |  |  |         |    |            |       |       |  |  |  |  |  |  |                |    |            |       |       |  |  |  |  |  |  |         |    |            |       |       |  |  |  |  |  |  |                   |    |            |       |       |  |                |        |   |                 |  |     |    |  |       |       |  |  |  |  |  |  |       |    |            |       |       |  |  |  |  |  |  |         |    |            |       |       |  |                |        |  |                       |  |         |    |            |       |       |  |                |        |  |                          |  |         |    |            |       |       |  |  |  |  |  |  |                |     |            |       |       |  |  |  |  |  |  |         |    |  |       |       |  |                |        |  |                       |  |         |    |            |  |       |  |  |  |  |  |  |             |    |  |       |       |  |  |  |  |  |  |         |    |            |  |       |  |  |  |  |  |  |         |     |            |       |       |  |  |  |  |  |  |         |     |            |       |       |  |                |        |  |                       |  |  |  |  |  |  |  |                |        |  |                          |  |  |  |     |  |            |       |  |  |                |        |   |                 |  |     |    |            |       |  |  |  |  |  |  |  |         |    |            |       |  |  |  |  |  |  |  |         |    |            |       |  |  |  |  |  |  |  |     |    |  |       |       |  |  |  |  |  |  |         |    |            |       |  |  |  |  |  |  |  |       |    |            |       |  |  |  |  |  |  |  |         |    |            |       |  |  |  |  |  |  |  |         |    |            |       |  |  |  |  |  |  |  |     |  |            |  |       |  |                |        |   |                 |  |     |    |  |       |       |  |  |  |  |  |  |     |    |            |  |       |  |  |  |  |  |  |         |    |  |       |       |  |  |  |  |  |  |         |    |            |  |       |  |  |  |  |  |  |         |    |            |  |       |  |  |  |  |  |  |                |    |  |       |       |  |  |  |  |  |  |         |    |  |       |       |  |  |  |  |  |  |         |    |            |  |       |  |  |  |  |  |  |             |    |  |       |       |  |  |  |  |  |  |         |    |            |  |       |  |  |  |  |  |  |        |     |  |       |       |  |  |  |  |  |  |         |     |            |  |       |  |  |  |  |  |  |
| 2.0 S16  | 100  | ORGA 09079 |       | 02.09      |                                    |                |                                    |                |                          |     |                     |     |     |    |            |       |       |           |                |        |  |                        |     |             |    |            |       |       |           |                |        |  |                     |     |         |    |            |       |       |  |                |        |  |                     |     |             |    |  |       |       |  |  |  |  |  |  |                |    |            |       |       |       |                |        |  |                     |     |         |    |            |       |       |           |  |  |  |  |  |                   |    |            |       |       |       |                |        |       |                    |  |         |    |            |       |       |       |                |        |       |                     |  |       |    |            |       |       |       |                |        |       |                        |  |         |    |            |       |       |                                    |                |        |  |                       |     |         |    |            |       |       |  |                |        |  |                          |  |         |    |  |       |       |  |  |  |  |  |  |         |     |            |       |       |  |  |  |  |  |  |                |    |            |       |       |  |                |        |  |                   |     |                |    |            |       |       |  |                |        |  |                   |     |                   |    |  |       |       |  |                |        |  |                   |     |         |    |            |       |       |  |  |  |  |  |  |             |     |            |       |       |  |  |  |  |  |  |         |    |            |       |       |  |                |        |  |                       |     |         |     |            |       |       |  |                |        |  |                          |  |         |     |            |       |       |  |                |        |  |                   |     |         |     |            |       |  |  |                |        |  |                   |     |  |   |     |       |       |       |                |                                    |                |                       |  |                     |    |            |    |       |       |       |           |                |        |  |                        |    |     |       |       |       |       |           |  |  |  |         |    |            |    |       |       |       |  |  |  |  |         |     |            |    |       |       |       |  |  |  |  |        |     |                |       |       |       |                |        |  |                       |  |  |  |         |    |  |       |                |           |  |                          |  |  |  |     |  |            |       |  |       |                |        |       |                    |  |     |    |            |       |  |       |                |        |       |                     |  |         |    |            |       |  |       |                |        |       |                        |  |         |    |            |       |       |                                    |                |        |  |                       |  |     |    |  |       |       |  |                |        |  |                          |  |         |    |            |       |       |  |  |  |  |  |  |         |    |            |       |       |  |  |  |  |  |  |                |    |            |       |       |  |  |  |  |  |  |         |    |            |       |       |  |  |  |  |  |  |                   |    |            |       |       |  |                |        |   |                 |  |     |    |  |       |       |  |  |  |  |  |  |       |    |            |       |       |  |  |  |  |  |  |         |    |            |       |       |  |                |        |  |                       |  |         |    |            |       |       |  |                |        |  |                          |  |         |    |            |       |       |  |  |  |  |  |  |                |     |            |       |       |  |  |  |  |  |  |         |    |  |       |       |  |                |        |  |                       |  |         |    |            |  |       |  |  |  |  |  |  |             |    |  |       |       |  |  |  |  |  |  |         |    |            |  |       |  |  |  |  |  |  |         |     |            |       |       |  |  |  |  |  |  |         |     |            |       |       |  |                |        |  |                       |  |  |  |  |  |  |  |                |        |  |                          |  |  |  |     |  |            |       |  |  |                |        |   |                 |  |     |    |            |       |  |  |  |  |  |  |  |         |    |            |       |  |  |  |  |  |  |  |         |    |            |       |  |  |  |  |  |  |  |     |    |  |       |       |  |  |  |  |  |  |         |    |            |       |  |  |  |  |  |  |  |       |    |            |       |  |  |  |  |  |  |  |         |    |            |       |  |  |  |  |  |  |  |         |    |            |       |  |  |  |  |  |  |  |     |  |            |  |       |  |                |        |   |                 |  |     |    |  |       |       |  |  |  |  |  |  |     |    |            |  |       |  |  |  |  |  |  |         |    |  |       |       |  |  |  |  |  |  |         |    |            |  |       |  |  |  |  |  |  |         |    |            |  |       |  |  |  |  |  |  |                |    |  |       |       |  |  |  |  |  |  |         |    |  |       |       |  |  |  |  |  |  |         |    |            |  |       |  |  |  |  |  |  |             |    |  |       |       |  |  |  |  |  |  |         |    |            |  |       |  |  |  |  |  |  |        |     |  |       |       |  |  |  |  |  |  |         |     |            |  |       |  |  |  |  |  |  |
| 2.0 RC   | 130  |            | 07.03 | 02.09      |                                    | 24.0126-0120.1 | 426120                             |                | 283 26,0 24,0 V +S +B    |     |                     |     |     |    |            |       |       |           |                |        |  |                        |     |             |    |            |       |       |           |                |        |  |                     |     |         |    |            |       |       |  |                |        |  |                     |     |             |    |  |       |       |  |  |  |  |  |  |                |    |            |       |       |       |                |        |  |                     |     |         |    |            |       |       |           |  |  |  |  |  |                   |    |            |       |       |       |                |        |       |                    |  |         |    |            |       |       |       |                |        |       |                     |  |       |    |            |       |       |       |                |        |       |                        |  |         |    |            |       |       |                                    |                |        |  |                       |     |         |    |            |       |       |  |                |        |  |                          |  |         |    |  |       |       |  |  |  |  |  |  |         |     |            |       |       |  |  |  |  |  |  |                |    |            |       |       |  |                |        |  |                   |     |                |    |            |       |       |  |                |        |  |                   |     |                   |    |  |       |       |  |                |        |  |                   |     |         |    |            |       |       |  |  |  |  |  |  |             |     |            |       |       |  |  |  |  |  |  |         |    |            |       |       |  |                |        |  |                       |     |         |     |            |       |       |  |                |        |  |                          |  |         |     |            |       |       |  |                |        |  |                   |     |         |     |            |       |  |  |                |        |  |                   |     |  |   |     |       |       |       |                |                                    |                |                       |  |                     |    |            |    |       |       |       |           |                |        |  |                        |    |     |       |       |       |       |           |  |  |  |         |    |            |    |       |       |       |  |  |  |  |         |     |            |    |       |       |       |  |  |  |  |        |     |                |       |       |       |                |        |  |                       |  |  |  |         |    |  |       |                |           |  |                          |  |  |  |     |  |            |       |  |       |                |        |       |                    |  |     |    |            |       |  |       |                |        |       |                     |  |         |    |            |       |  |       |                |        |       |                        |  |         |    |            |       |       |                                    |                |        |  |                       |  |     |    |  |       |       |  |                |        |  |                          |  |         |    |            |       |       |  |  |  |  |  |  |         |    |            |       |       |  |  |  |  |  |  |                |    |            |       |       |  |  |  |  |  |  |         |    |            |       |       |  |  |  |  |  |  |                   |    |            |       |       |  |                |        |   |                 |  |     |    |  |       |       |  |  |  |  |  |  |       |    |            |       |       |  |  |  |  |  |  |         |    |            |       |       |  |                |        |  |                       |  |         |    |            |       |       |  |                |        |  |                          |  |         |    |            |       |       |  |  |  |  |  |  |                |     |            |       |       |  |  |  |  |  |  |         |    |  |       |       |  |                |        |  |                       |  |         |    |            |  |       |  |  |  |  |  |  |             |    |  |       |       |  |  |  |  |  |  |         |    |            |  |       |  |  |  |  |  |  |         |     |            |       |       |  |  |  |  |  |  |         |     |            |       |       |  |                |        |  |                       |  |  |  |  |  |  |  |                |        |  |                          |  |  |  |     |  |            |       |  |  |                |        |   |                 |  |     |    |            |       |  |  |  |  |  |  |  |         |    |            |       |  |  |  |  |  |  |  |         |    |            |       |  |  |  |  |  |  |  |     |    |  |       |       |  |  |  |  |  |  |         |    |            |       |  |  |  |  |  |  |  |       |    |            |       |  |  |  |  |  |  |  |         |    |            |       |  |  |  |  |  |  |  |         |    |            |       |  |  |  |  |  |  |  |     |  |            |  |       |  |                |        |   |                 |  |     |    |  |       |       |  |  |  |  |  |  |     |    |            |  |       |  |  |  |  |  |  |         |    |  |       |       |  |  |  |  |  |  |         |    |            |  |       |  |  |  |  |  |  |         |    |            |  |       |  |  |  |  |  |  |                |    |  |       |       |  |  |  |  |  |  |         |    |  |       |       |  |  |  |  |  |  |         |    |            |  |       |  |  |  |  |  |  |             |    |  |       |       |  |  |  |  |  |  |         |    |            |  |       |  |  |  |  |  |  |        |     |  |       |       |  |  |  |  |  |  |         |     |            |  |       |  |  |  |  |  |  |
|  |  |            |       |            |                                    | 24.0326-0120.1 | 526120                             |                | 283 26,0 24,0 V +S +B PD |     |                     |     |     |    |            |       |       |           |                |        |  |                        |     |             |    |            |       |       |           |                |        |  |                     |     |         |    |            |       |       |  |                |        |  |                     |     |             |    |  |       |       |  |  |  |  |  |  |                |    |            |       |       |       |                |        |  |                     |     |         |    |            |       |       |           |  |  |  |  |  |                   |    |            |       |       |       |                |        |       |                    |  |         |    |            |       |       |       |                |        |       |                     |  |       |    |            |       |       |       |                |        |       |                        |  |         |    |            |       |       |                                    |                |        |  |                       |     |         |    |            |       |       |  |                |        |  |                          |  |         |    |  |       |       |  |  |  |  |  |  |         |     |            |       |       |  |  |  |  |  |  |                |    |            |       |       |  |                |        |  |                   |     |                |    |            |       |       |  |                |        |  |                   |     |                   |    |  |       |       |  |                |        |  |                   |     |         |    |            |       |       |  |  |  |  |  |  |             |     |            |       |       |  |  |  |  |  |  |         |    |            |       |       |  |                |        |  |                       |     |         |     |            |       |       |  |                |        |  |                          |  |         |     |            |       |       |  |                |        |  |                   |     |         |     |            |       |  |  |                |        |  |                   |     |  |   |     |       |       |       |                |                                    |                |                       |  |                     |    |            |    |       |       |       |           |                |        |  |                        |    |     |       |       |       |       |           |  |  |  |         |    |            |    |       |       |       |  |  |  |  |         |     |            |    |       |       |       |  |  |  |  |        |     |                |       |       |       |                |        |  |                       |  |  |  |         |    |  |       |                |           |  |                          |  |  |  |     |  |            |       |  |       |                |        |       |                    |  |     |    |            |       |  |       |                |        |       |                     |  |         |    |            |       |  |       |                |        |       |                        |  |         |    |            |       |       |                                    |                |        |  |                       |  |     |    |  |       |       |  |                |        |  |                          |  |         |    |            |       |       |  |  |  |  |  |  |         |    |            |       |       |  |  |  |  |  |  |                |    |            |       |       |  |  |  |  |  |  |         |    |            |       |       |  |  |  |  |  |  |                   |    |            |       |       |  |                |        |   |                 |  |     |    |  |       |       |  |  |  |  |  |  |       |    |            |       |       |  |  |  |  |  |  |         |    |            |       |       |  |                |        |  |                       |  |         |    |            |       |       |  |                |        |  |                          |  |         |    |            |       |       |  |  |  |  |  |  |                |     |            |       |       |  |  |  |  |  |  |         |    |  |       |       |  |                |        |  |                       |  |         |    |            |  |       |  |  |  |  |  |  |             |    |  |       |       |  |  |  |  |  |  |         |    |            |  |       |  |  |  |  |  |  |         |     |            |       |       |  |  |  |  |  |  |         |     |            |       |       |  |                |        |  |                       |  |  |  |  |  |  |  |                |        |  |                          |  |  |  |     |  |            |       |  |  |                |        |   |                 |  |     |    |            |       |  |  |  |  |  |  |  |         |    |            |       |  |  |  |  |  |  |  |         |    |            |       |  |  |  |  |  |  |  |     |    |  |       |       |  |  |  |  |  |  |         |    |            |       |  |  |  |  |  |  |  |       |    |            |       |  |  |  |  |  |  |  |         |    |            |       |  |  |  |  |  |  |  |         |    |            |       |  |  |  |  |  |  |  |     |  |            |  |       |  |                |        |   |                 |  |     |    |  |       |       |  |  |  |  |  |  |     |    |            |  |       |  |  |  |  |  |  |         |    |  |       |       |  |  |  |  |  |  |         |    |            |  |       |  |  |  |  |  |  |         |    |            |  |       |  |  |  |  |  |  |                |    |  |       |       |  |  |  |  |  |  |         |    |  |       |       |  |  |  |  |  |  |         |    |            |  |       |  |  |  |  |  |  |             |    |  |       |       |  |  |  |  |  |  |         |    |            |  |       |  |  |  |  |  |  |        |     |  |       |       |  |  |  |  |  |  |         |     |            |  |       |  |  |  |  |  |  |
|  | <table border="1"> <tr> <td>1.1</td> <td></td> <td>ORGA 09456</td> <td>09.98</td> <td></td> <td></td> <td>24.0713-1115.3</td> <td>360035</td> <td>2</td> <td>Radsensor L=815</td> <td></td> </tr> <tr> <td>1.4</td> <td>55</td> <td>ORGA 09456</td> <td>09.98</td> <td></td> <td></td> <td></td> <td></td> <td></td> <td></td> <td></td> </tr> <tr> <td>1.4 HDi</td> <td>50</td> <td>ORGA 09456</td> <td>09.01</td> <td></td> <td></td> <td></td> <td></td> <td></td> <td></td> <td></td> </tr> <tr> <td>1.4 HDi</td> <td>51</td> <td>ORGA 09456</td> <td>09.02</td> <td></td> <td></td> <td></td> <td></td> <td></td> <td></td> <td></td> </tr> <tr> <td>1.6</td> <td>65</td> <td></td> <td>09.98</td> <td>12.00</td> <td></td> <td></td> <td></td> <td></td> <td></td> <td></td> </tr> <tr> <td>1.6 16V</td> <td>80</td> <td>ORGA 09456</td> <td>12.00</td> <td></td> <td></td> <td></td> <td></td> <td></td> <td></td> <td></td> </tr> <tr> <td>1.9 D</td> <td>51</td> <td>ORGA 09456</td> <td>09.98</td> <td></td> <td></td> <td></td> <td></td> <td></td> <td></td> <td></td> </tr> <tr> <td>2.0 HDi</td> <td>66</td> <td>ORGA 09456</td> <td>12.99</td> <td></td> <td></td> <td></td> <td></td> <td></td> <td></td> <td></td> </tr> <tr> <td>2.0 S16</td> <td>99</td> <td>ORGA 09456</td> <td>04.99</td> <td></td> <td></td> <td></td> <td></td> <td></td> <td></td> <td></td> </tr> <tr> <td>1.1</td> <td></td> <td>ORGA 09457</td> <td></td> <td>02.09</td> <td></td> <td>24.0711-6205.3</td> <td>360229</td> <td>2</td> <td>Radsensor L=815</td> <td></td> </tr> <tr> <td>1.4</td> <td>55</td> <td></td> <td>03.07</td> <td>02.09</td> <td></td> <td></td> <td></td> <td></td> <td></td> <td></td> </tr> <tr> <td>1.4</td> <td>55</td> <td>ORGA 09457</td> <td></td> <td>02.09</td> <td></td> <td></td> <td></td> <td></td> <td></td> <td></td> </tr> <tr> <td>1.4 16V</td> <td>65</td> <td></td> <td>10.03</td> <td>02.09</td> <td></td> <td></td> <td></td> <td></td> <td></td> <td></td> </tr> <tr> <td>1.4 HDi</td> <td>50</td> <td>ORGA 09457</td> <td></td> <td>02.09</td> <td></td> <td></td> <td></td> <td></td> <td></td> <td></td> </tr> <tr> <td>1.4 HDi</td> <td>51</td> <td>ORGA 09457</td> <td></td> <td>02.09</td> <td></td> <td></td> <td></td> <td></td> <td></td> <td></td> </tr> <tr> <td>1.4 HDi eco 70</td> <td>50</td> <td></td> <td>09.08</td> <td>02.09</td> <td></td> <td></td> <td></td> <td></td> <td></td> <td></td> </tr> <tr> <td>1.4 LPG</td> <td>55</td> <td></td> <td>05.06</td> <td>09.07</td> <td></td> <td></td> <td></td> <td></td> <td></td> <td></td> </tr> <tr> <td>1.6 16V</td> <td>80</td> <td>ORGA 09457</td> <td></td> <td>02.09</td> <td></td> <td></td> <td></td> <td></td> <td></td> <td></td> </tr> <tr> <td>1.6 HDi 110</td> <td>80</td> <td></td> <td>05.04</td> <td>02.09</td> <td></td> <td></td> <td></td> <td></td> <td></td> <td></td> </tr> <tr> <td>2.0 HDi</td> <td>66</td> <td>ORGA 09457</td> <td></td> <td>02.09</td> <td></td> <td></td> <td></td> <td></td> <td></td> <td></td> </tr> <tr> <td>2.0 RC</td> <td>130</td> <td></td> <td>07.03</td> <td>02.09</td> <td></td> <td></td> <td></td> <td></td> <td></td> <td></td> </tr> <tr> <td>2.0 S16</td> <td>100</td> <td>ORGA 09457</td> <td></td> <td>02.09</td> <td></td> <td></td> <td></td> <td></td> <td></td> <td></td> </tr> </table>   | 1.1        |       | ORGA 09456 | 09.98                              |                |                                    | 24.0713-1115.3 | 360035                   | 2   | Radsensor L=815     |     | 1.4 | 55 | ORGA 09456 | 09.98 |       |           |                |        |  |                        |     | 1.4 HDi     | 50 | ORGA 09456 | 09.01 |       |           |                |        |  |                     |     | 1.4 HDi | 51 | ORGA 09456 | 09.02 |       |  |                |        |  |                     |     | 1.6         | 65 |  | 09.98 | 12.00 |  |  |  |  |  |  | 1.6 16V        | 80 | ORGA 09456 | 12.00 |       |       |                |        |  |                     |     | 1.9 D   | 51 | ORGA 09456 | 09.98 |       |           |  |  |  |  |  | 2.0 HDi           | 66 | ORGA 09456 | 12.99 |       |       |                |        |       |                    |  | 2.0 S16 | 99 | ORGA 09456 | 04.99 |       |       |                |        |       |                     |  | 1.1   |    | ORGA 09457 |       | 02.09 |       | 24.0711-6205.3 | 360229 | 2     | Radsensor L=815        |  | 1.4     | 55 |            | 03.07 | 02.09 |                                    |                |        |  |                       |     | 1.4     | 55 | ORGA 09457 |       | 02.09 |  |                |        |  |                          |  | 1.4 16V | 65 |  | 10.03 | 02.09 |  |  |  |  |  |  | 1.4 HDi | 50  | ORGA 09457 |       | 02.09 |  |  |  |  |  |  | 1.4 HDi        | 51 | ORGA 09457 |       | 02.09 |  |                |        |  |                   |     | 1.4 HDi eco 70 | 50 |            | 09.08 | 02.09 |  |                |        |  |                   |     | 1.4 LPG           | 55 |  | 05.06 | 09.07 |  |                |        |  |                   |     | 1.6 16V | 80 | ORGA 09457 |       | 02.09 |  |  |  |  |  |  | 1.6 HDi 110 | 80  |            | 05.04 | 02.09 |  |  |  |  |  |  | 2.0 HDi | 66 | ORGA 09457 |       | 02.09 |  |                |        |  |                       |     | 2.0 RC  | 130 |            | 07.03 | 02.09 |  |                |        |  |                          |  | 2.0 S16 | 100 | ORGA 09457 |       | 02.09 |  |                |        |  |                   |     |         |     |            |       |  |  |                |        |  |                   |     |  |   |     |       |       |       |                |                                    |                |                       |  |                     |    |            |    |       |       |       |           |                |        |  |                        |    |     |       |       |       |       |           |  |  |  |         |    |            |    |       |       |       |  |  |  |  |         |     |            |    |       |       |       |  |  |  |  |        |     |                |       |       |       |                |        |  |                       |  |  |  |         |    |  |       |                |           |  |                          |  |  |  |     |  |            |       |  |       |                |        |       |                    |  |     |    |            |       |  |       |                |        |       |                     |  |         |    |            |       |  |       |                |        |       |                        |  |         |    |            |       |       |                                    |                |        |  |                       |  |     |    |  |       |       |  |                |        |  |                          |  |         |    |            |       |       |  |  |  |  |  |  |         |    |            |       |       |  |  |  |  |  |  |                |    |            |       |       |  |  |  |  |  |  |         |    |            |       |       |  |  |  |  |  |  |                   |    |            |       |       |  |                |        |   |                 |  |     |    |  |       |       |  |  |  |  |  |  |       |    |            |       |       |  |  |  |  |  |  |         |    |            |       |       |  |                |        |  |                       |  |         |    |            |       |       |  |                |        |  |                          |  |         |    |            |       |       |  |  |  |  |  |  |                |     |            |       |       |  |  |  |  |  |  |         |    |  |       |       |  |                |        |  |                       |  |         |    |            |  |       |  |  |  |  |  |  |             |    |  |       |       |  |  |  |  |  |  |         |    |            |  |       |  |  |  |  |  |  |         |     |            |       |       |  |  |  |  |  |  |         |     |            |       |       |  |                |        |  |                       |  |  |  |  |  |  |  |                |        |  |                          |  |  |  |     |  |            |       |  |  |                |        |   |                 |  |     |    |            |       |  |  |  |  |  |  |  |         |    |            |       |  |  |  |  |  |  |  |         |    |            |       |  |  |  |  |  |  |  |     |    |  |       |       |  |  |  |  |  |  |         |    |            |       |  |  |  |  |  |  |  |       |    |            |       |  |  |  |  |  |  |  |         |    |            |       |  |  |  |  |  |  |  |         |    |            |       |  |  |  |  |  |  |  |     |  |            |  |       |  |                |        |   |                 |  |     |    |  |       |       |  |  |  |  |  |  |     |    |            |  |       |  |  |  |  |  |  |         |    |  |       |       |  |  |  |  |  |  |         |    |            |  |       |  |  |  |  |  |  |         |    |            |  |       |  |  |  |  |  |  |                |    |  |       |       |  |  |  |  |  |  |         |    |  |       |       |  |  |  |  |  |  |         |    |            |  |       |  |  |  |  |  |  |             |    |  |       |       |  |  |  |  |  |  |         |    |            |  |       |  |  |  |  |  |  |        |     |  |       |       |  |  |  |  |  |  |         |     |            |  |       |  |  |  |  |  |  |
| 1.1  |  | ORGA 09456 | 09.98 |            |                                    | 24.0713-1115.3 | 360035                             | 2              | Radsensor L=815          |     |                     |     |     |    |            |       |       |           |                |        |  |                        |     |             |    |            |       |       |           |                |        |  |                     |     |         |    |            |       |       |  |                |        |  |                     |     |             |    |  |       |       |  |  |  |  |  |  |                |    |            |       |       |       |                |        |  |                     |     |         |    |            |       |       |           |  |  |  |  |  |                   |    |            |       |       |       |                |        |       |                    |  |         |    |            |       |       |       |                |        |       |                     |  |       |    |            |       |       |       |                |        |       |                        |  |         |    |            |       |       |                                    |                |        |  |                       |     |         |    |            |       |       |  |                |        |  |                          |  |         |    |  |       |       |  |  |  |  |  |  |         |     |            |       |       |  |  |  |  |  |  |                |    |            |       |       |  |                |        |  |                   |     |                |    |            |       |       |  |                |        |  |                   |     |                   |    |  |       |       |  |                |        |  |                   |     |         |    |            |       |       |  |  |  |  |  |  |             |     |            |       |       |  |  |  |  |  |  |         |    |            |       |       |  |                |        |  |                       |     |         |     |            |       |       |  |                |        |  |                          |  |         |     |            |       |       |  |                |        |  |                   |     |         |     |            |       |  |  |                |        |  |                   |     |  |   |     |       |       |       |                |                                    |                |                       |  |                     |    |            |    |       |       |       |           |                |        |  |                        |    |     |       |       |       |       |           |  |  |  |         |    |            |    |       |       |       |  |  |  |  |         |     |            |    |       |       |       |  |  |  |  |        |     |                |       |       |       |                |        |  |                       |  |  |  |         |    |  |       |                |           |  |                          |  |  |  |     |  |            |       |  |       |                |        |       |                    |  |     |    |            |       |  |       |                |        |       |                     |  |         |    |            |       |  |       |                |        |       |                        |  |         |    |            |       |       |                                    |                |        |  |                       |  |     |    |  |       |       |  |                |        |  |                          |  |         |    |            |       |       |  |  |  |  |  |  |         |    |            |       |       |  |  |  |  |  |  |                |    |            |       |       |  |  |  |  |  |  |         |    |            |       |       |  |  |  |  |  |  |                   |    |            |       |       |  |                |        |   |                 |  |     |    |  |       |       |  |  |  |  |  |  |       |    |            |       |       |  |  |  |  |  |  |         |    |            |       |       |  |                |        |  |                       |  |         |    |            |       |       |  |                |        |  |                          |  |         |    |            |       |       |  |  |  |  |  |  |                |     |            |       |       |  |  |  |  |  |  |         |    |  |       |       |  |                |        |  |                       |  |         |    |            |  |       |  |  |  |  |  |  |             |    |  |       |       |  |  |  |  |  |  |         |    |            |  |       |  |  |  |  |  |  |         |     |            |       |       |  |  |  |  |  |  |         |     |            |       |       |  |                |        |  |                       |  |  |  |  |  |  |  |                |        |  |                          |  |  |  |     |  |            |       |  |  |                |        |   |                 |  |     |    |            |       |  |  |  |  |  |  |  |         |    |            |       |  |  |  |  |  |  |  |         |    |            |       |  |  |  |  |  |  |  |     |    |  |       |       |  |  |  |  |  |  |         |    |            |       |  |  |  |  |  |  |  |       |    |            |       |  |  |  |  |  |  |  |         |    |            |       |  |  |  |  |  |  |  |         |    |            |       |  |  |  |  |  |  |  |     |  |            |  |       |  |                |        |   |                 |  |     |    |  |       |       |  |  |  |  |  |  |     |    |            |  |       |  |  |  |  |  |  |         |    |  |       |       |  |  |  |  |  |  |         |    |            |  |       |  |  |  |  |  |  |         |    |            |  |       |  |  |  |  |  |  |                |    |  |       |       |  |  |  |  |  |  |         |    |  |       |       |  |  |  |  |  |  |         |    |            |  |       |  |  |  |  |  |  |             |    |  |       |       |  |  |  |  |  |  |         |    |            |  |       |  |  |  |  |  |  |        |     |  |       |       |  |  |  |  |  |  |         |     |            |  |       |  |  |  |  |  |  |
| 1.4  | 55   | ORGA 09456 | 09.98 |            |                                    |                |                                    |                |                          |     |                     |     |     |    |            |       |       |           |                |        |  |                        |     |             |    |            |       |       |           |                |        |  |                     |     |         |    |            |       |       |  |                |        |  |                     |     |             |    |  |       |       |  |  |  |  |  |  |                |    |            |       |       |       |                |        |  |                     |     |         |    |            |       |       |           |  |  |  |  |  |                   |    |            |       |       |       |                |        |       |                    |  |         |    |            |       |       |       |                |        |       |                     |  |       |    |            |       |       |       |                |        |       |                        |  |         |    |            |       |       |                                    |                |        |  |                       |     |         |    |            |       |       |  |                |        |  |                          |  |         |    |  |       |       |  |  |  |  |  |  |         |     |            |       |       |  |  |  |  |  |  |                |    |            |       |       |  |                |        |  |                   |     |                |    |            |       |       |  |                |        |  |                   |     |                   |    |  |       |       |  |                |        |  |                   |     |         |    |            |       |       |  |  |  |  |  |  |             |     |            |       |       |  |  |  |  |  |  |         |    |            |       |       |  |                |        |  |                       |     |         |     |            |       |       |  |                |        |  |                          |  |         |     |            |       |       |  |                |        |  |                   |     |         |     |            |       |  |  |                |        |  |                   |     |  |   |     |       |       |       |                |                                    |                |                       |  |                     |    |            |    |       |       |       |           |                |        |  |                        |    |     |       |       |       |       |           |  |  |  |         |    |            |    |       |       |       |  |  |  |  |         |     |            |    |       |       |       |  |  |  |  |        |     |                |       |       |       |                |        |  |                       |  |  |  |         |    |  |       |                |           |  |                          |  |  |  |     |  |            |       |  |       |                |        |       |                    |  |     |    |            |       |  |       |                |        |       |                     |  |         |    |            |       |  |       |                |        |       |                        |  |         |    |            |       |       |                                    |                |        |  |                       |  |     |    |  |       |       |  |                |        |  |                          |  |         |    |            |       |       |  |  |  |  |  |  |         |    |            |       |       |  |  |  |  |  |  |                |    |            |       |       |  |  |  |  |  |  |         |    |            |       |       |  |  |  |  |  |  |                   |    |            |       |       |  |                |        |   |                 |  |     |    |  |       |       |  |  |  |  |  |  |       |    |            |       |       |  |  |  |  |  |  |         |    |            |       |       |  |                |        |  |                       |  |         |    |            |       |       |  |                |        |  |                          |  |         |    |            |       |       |  |  |  |  |  |  |                |     |            |       |       |  |  |  |  |  |  |         |    |  |       |       |  |                |        |  |                       |  |         |    |            |  |       |  |  |  |  |  |  |             |    |  |       |       |  |  |  |  |  |  |         |    |            |  |       |  |  |  |  |  |  |         |     |            |       |       |  |  |  |  |  |  |         |     |            |       |       |  |                |        |  |                       |  |  |  |  |  |  |  |                |        |  |                          |  |  |  |     |  |            |       |  |  |                |        |   |                 |  |     |    |            |       |  |  |  |  |  |  |  |         |    |            |       |  |  |  |  |  |  |  |         |    |            |       |  |  |  |  |  |  |  |     |    |  |       |       |  |  |  |  |  |  |         |    |            |       |  |  |  |  |  |  |  |       |    |            |       |  |  |  |  |  |  |  |         |    |            |       |  |  |  |  |  |  |  |         |    |            |       |  |  |  |  |  |  |  |     |  |            |  |       |  |                |        |   |                 |  |     |    |  |       |       |  |  |  |  |  |  |     |    |            |  |       |  |  |  |  |  |  |         |    |  |       |       |  |  |  |  |  |  |         |    |            |  |       |  |  |  |  |  |  |         |    |            |  |       |  |  |  |  |  |  |                |    |  |       |       |  |  |  |  |  |  |         |    |  |       |       |  |  |  |  |  |  |         |    |            |  |       |  |  |  |  |  |  |             |    |  |       |       |  |  |  |  |  |  |         |    |            |  |       |  |  |  |  |  |  |        |     |  |       |       |  |  |  |  |  |  |         |     |            |  |       |  |  |  |  |  |  |
| 1.4 HDi  | 50   | ORGA 09456 | 09.01 |            |                                    |                |                                    |                |                          |     |                     |     |     |    |            |       |       |           |                |        |  |                        |     |             |    |            |       |       |           |                |        |  |                     |     |         |    |            |       |       |  |                |        |  |                     |     |             |    |  |       |       |  |  |  |  |  |  |                |    |            |       |       |       |                |        |  |                     |     |         |    |            |       |       |           |  |  |  |  |  |                   |    |            |       |       |       |                |        |       |                    |  |         |    |            |       |       |       |                |        |       |                     |  |       |    |            |       |       |       |                |        |       |                        |  |         |    |            |       |       |                                    |                |        |  |                       |     |         |    |            |       |       |  |                |        |  |                          |  |         |    |  |       |       |  |  |  |  |  |  |         |     |            |       |       |  |  |  |  |  |  |                |    |            |       |       |  |                |        |  |                   |     |                |    |            |       |       |  |                |        |  |                   |     |                   |    |  |       |       |  |                |        |  |                   |     |         |    |            |       |       |  |  |  |  |  |  |             |     |            |       |       |  |  |  |  |  |  |         |    |            |       |       |  |                |        |  |                       |     |         |     |            |       |       |  |                |        |  |                          |  |         |     |            |       |       |  |                |        |  |                   |     |         |     |            |       |  |  |                |        |  |                   |     |  |   |     |       |       |       |                |                                    |                |                       |  |                     |    |            |    |       |       |       |           |                |        |  |                        |    |     |       |       |       |       |           |  |  |  |         |    |            |    |       |       |       |  |  |  |  |         |     |            |    |       |       |       |  |  |  |  |        |     |                |       |       |       |                |        |  |                       |  |  |  |         |    |  |       |                |           |  |                          |  |  |  |     |  |            |       |  |       |                |        |       |                    |  |     |    |            |       |  |       |                |        |       |                     |  |         |    |            |       |  |       |                |        |       |                        |  |         |    |            |       |       |                                    |                |        |  |                       |  |     |    |  |       |       |  |                |        |  |                          |  |         |    |            |       |       |  |  |  |  |  |  |         |    |            |       |       |  |  |  |  |  |  |                |    |            |       |       |  |  |  |  |  |  |         |    |            |       |       |  |  |  |  |  |  |                   |    |            |       |       |  |                |        |   |                 |  |     |    |  |       |       |  |  |  |  |  |  |       |    |            |       |       |  |  |  |  |  |  |         |    |            |       |       |  |                |        |  |                       |  |         |    |            |       |       |  |                |        |  |                          |  |         |    |            |       |       |  |  |  |  |  |  |                |     |            |       |       |  |  |  |  |  |  |         |    |  |       |       |  |                |        |  |                       |  |         |    |            |  |       |  |  |  |  |  |  |             |    |  |       |       |  |  |  |  |  |  |         |    |            |  |       |  |  |  |  |  |  |         |     |            |       |       |  |  |  |  |  |  |         |     |            |       |       |  |                |        |  |                       |  |  |  |  |  |  |  |                |        |  |                          |  |  |  |     |  |            |       |  |  |                |        |   |                 |  |     |    |            |       |  |  |  |  |  |  |  |         |    |            |       |  |  |  |  |  |  |  |         |    |            |       |  |  |  |  |  |  |  |     |    |  |       |       |  |  |  |  |  |  |         |    |            |       |  |  |  |  |  |  |  |       |    |            |       |  |  |  |  |  |  |  |         |    |            |       |  |  |  |  |  |  |  |         |    |            |       |  |  |  |  |  |  |  |     |  |            |  |       |  |                |        |   |                 |  |     |    |  |       |       |  |  |  |  |  |  |     |    |            |  |       |  |  |  |  |  |  |         |    |  |       |       |  |  |  |  |  |  |         |    |            |  |       |  |  |  |  |  |  |         |    |            |  |       |  |  |  |  |  |  |                |    |  |       |       |  |  |  |  |  |  |         |    |  |       |       |  |  |  |  |  |  |         |    |            |  |       |  |  |  |  |  |  |             |    |  |       |       |  |  |  |  |  |  |         |    |            |  |       |  |  |  |  |  |  |        |     |  |       |       |  |  |  |  |  |  |         |     |            |  |       |  |  |  |  |  |  |
| 1.4 HDi  | 51   | ORGA 09456 | 09.02 |            |                                    |                |                                    |                |                          |     |                     |     |     |    |            |       |       |           |                |        |  |                        |     |             |    |            |       |       |           |                |        |  |                     |     |         |    |            |       |       |  |                |        |  |                     |     |             |    |  |       |       |  |  |  |  |  |  |                |    |            |       |       |       |                |        |  |                     |     |         |    |            |       |       |           |  |  |  |  |  |                   |    |            |       |       |       |                |        |       |                    |  |         |    |            |       |       |       |                |        |       |                     |  |       |    |            |       |       |       |                |        |       |                        |  |         |    |            |       |       |                                    |                |        |  |                       |     |         |    |            |       |       |  |                |        |  |                          |  |         |    |  |       |       |  |  |  |  |  |  |         |     |            |       |       |  |  |  |  |  |  |                |    |            |       |       |  |                |        |  |                   |     |                |    |            |       |       |  |                |        |  |                   |     |                   |    |  |       |       |  |                |        |  |                   |     |         |    |            |       |       |  |  |  |  |  |  |             |     |            |       |       |  |  |  |  |  |  |         |    |            |       |       |  |                |        |  |                       |     |         |     |            |       |       |  |                |        |  |                          |  |         |     |            |       |       |  |                |        |  |                   |     |         |     |            |       |  |  |                |        |  |                   |     |  |   |     |       |       |       |                |                                    |                |                       |  |                     |    |            |    |       |       |       |           |                |        |  |                        |    |     |       |       |       |       |           |  |  |  |         |    |            |    |       |       |       |  |  |  |  |         |     |            |    |       |       |       |  |  |  |  |        |     |                |       |       |       |                |        |  |                       |  |  |  |         |    |  |       |                |           |  |                          |  |  |  |     |  |            |       |  |       |                |        |       |                    |  |     |    |            |       |  |       |                |        |       |                     |  |         |    |            |       |  |       |                |        |       |                        |  |         |    |            |       |       |                                    |                |        |  |                       |  |     |    |  |       |       |  |                |        |  |                          |  |         |    |            |       |       |  |  |  |  |  |  |         |    |            |       |       |  |  |  |  |  |  |                |    |            |       |       |  |  |  |  |  |  |         |    |            |       |       |  |  |  |  |  |  |                   |    |            |       |       |  |                |        |   |                 |  |     |    |  |       |       |  |  |  |  |  |  |       |    |            |       |       |  |  |  |  |  |  |         |    |            |       |       |  |                |        |  |                       |  |         |    |            |       |       |  |                |        |  |                          |  |         |    |            |       |       |  |  |  |  |  |  |                |     |            |       |       |  |  |  |  |  |  |         |    |  |       |       |  |                |        |  |                       |  |         |    |            |  |       |  |  |  |  |  |  |             |    |  |       |       |  |  |  |  |  |  |         |    |            |  |       |  |  |  |  |  |  |         |     |            |       |       |  |  |  |  |  |  |         |     |            |       |       |  |                |        |  |                       |  |  |  |  |  |  |  |                |        |  |                          |  |  |  |     |  |            |       |  |  |                |        |   |                 |  |     |    |            |       |  |  |  |  |  |  |  |         |    |            |       |  |  |  |  |  |  |  |         |    |            |       |  |  |  |  |  |  |  |     |    |  |       |       |  |  |  |  |  |  |         |    |            |       |  |  |  |  |  |  |  |       |    |            |       |  |  |  |  |  |  |  |         |    |            |       |  |  |  |  |  |  |  |         |    |            |       |  |  |  |  |  |  |  |     |  |            |  |       |  |                |        |   |                 |  |     |    |  |       |       |  |  |  |  |  |  |     |    |            |  |       |  |  |  |  |  |  |         |    |  |       |       |  |  |  |  |  |  |         |    |            |  |       |  |  |  |  |  |  |         |    |            |  |       |  |  |  |  |  |  |                |    |  |       |       |  |  |  |  |  |  |         |    |  |       |       |  |  |  |  |  |  |         |    |            |  |       |  |  |  |  |  |  |             |    |  |       |       |  |  |  |  |  |  |         |    |            |  |       |  |  |  |  |  |  |        |     |  |       |       |  |  |  |  |  |  |         |     |            |  |       |  |  |  |  |  |  |
| 1.6  | 65   |            | 09.98 | 12.00      |                                    |                |                                    |                |                          |     |                     |     |     |    |            |       |       |           |                |        |  |                        |     |             |    |            |       |       |           |                |        |  |                     |     |         |    |            |       |       |  |                |        |  |                     |     |             |    |  |       |       |  |  |  |  |  |  |                |    |            |       |       |       |                |        |  |                     |     |         |    |            |       |       |           |  |  |  |  |  |                   |    |            |       |       |       |                |        |       |                    |  |         |    |            |       |       |       |                |        |       |                     |  |       |    |            |       |       |       |                |        |       |                        |  |         |    |            |       |       |                                    |                |        |  |                       |     |         |    |            |       |       |  |                |        |  |                          |  |         |    |  |       |       |  |  |  |  |  |  |         |     |            |       |       |  |  |  |  |  |  |                |    |            |       |       |  |                |        |  |                   |     |                |    |            |       |       |  |                |        |  |                   |     |                   |    |  |       |       |  |                |        |  |                   |     |         |    |            |       |       |  |  |  |  |  |  |             |     |            |       |       |  |  |  |  |  |  |         |    |            |       |       |  |                |        |  |                       |     |         |     |            |       |       |  |                |        |  |                          |  |         |     |            |       |       |  |                |        |  |                   |     |         |     |            |       |  |  |                |        |  |                   |     |  |   |     |       |       |       |                |                                    |                |                       |  |                     |    |            |    |       |       |       |           |                |        |  |                        |    |     |       |       |       |       |           |  |  |  |         |    |            |    |       |       |       |  |  |  |  |         |     |            |    |       |       |       |  |  |  |  |        |     |                |       |       |       |                |        |  |                       |  |  |  |         |    |  |       |                |           |  |                          |  |  |  |     |  |            |       |  |       |                |        |       |                    |  |     |    |            |       |  |       |                |        |       |                     |  |         |    |            |       |  |       |                |        |       |                        |  |         |    |            |       |       |                                    |                |        |  |                       |  |     |    |  |       |       |  |                |        |  |                          |  |         |    |            |       |       |  |  |  |  |  |  |         |    |            |       |       |  |  |  |  |  |  |                |    |            |       |       |  |  |  |  |  |  |         |    |            |       |       |  |  |  |  |  |  |                   |    |            |       |       |  |                |        |   |                 |  |     |    |  |       |       |  |  |  |  |  |  |       |    |            |       |       |  |  |  |  |  |  |         |    |            |       |       |  |                |        |  |                       |  |         |    |            |       |       |  |                |        |  |                          |  |         |    |            |       |       |  |  |  |  |  |  |                |     |            |       |       |  |  |  |  |  |  |         |    |  |       |       |  |                |        |  |                       |  |         |    |            |  |       |  |  |  |  |  |  |             |    |  |       |       |  |  |  |  |  |  |         |    |            |  |       |  |  |  |  |  |  |         |     |            |       |       |  |  |  |  |  |  |         |     |            |       |       |  |                |        |  |                       |  |  |  |  |  |  |  |                |        |  |                          |  |  |  |     |  |            |       |  |  |                |        |   |                 |  |     |    |            |       |  |  |  |  |  |  |  |         |    |            |       |  |  |  |  |  |  |  |         |    |            |       |  |  |  |  |  |  |  |     |    |  |       |       |  |  |  |  |  |  |         |    |            |       |  |  |  |  |  |  |  |       |    |            |       |  |  |  |  |  |  |  |         |    |            |       |  |  |  |  |  |  |  |         |    |            |       |  |  |  |  |  |  |  |     |  |            |  |       |  |                |        |   |                 |  |     |    |  |       |       |  |  |  |  |  |  |     |    |            |  |       |  |  |  |  |  |  |         |    |  |       |       |  |  |  |  |  |  |         |    |            |  |       |  |  |  |  |  |  |         |    |            |  |       |  |  |  |  |  |  |                |    |  |       |       |  |  |  |  |  |  |         |    |  |       |       |  |  |  |  |  |  |         |    |            |  |       |  |  |  |  |  |  |             |    |  |       |       |  |  |  |  |  |  |         |    |            |  |       |  |  |  |  |  |  |        |     |  |       |       |  |  |  |  |  |  |         |     |            |  |       |  |  |  |  |  |  |
| 1.6 16V  | 80   | ORGA 09456 | 12.00 |            |                                    |                |                                    |                |                          |     |                     |     |     |    |            |       |       |           |                |        |  |                        |     |             |    |            |       |       |           |                |        |  |                     |     |         |    |            |       |       |  |                |        |  |                     |     |             |    |  |       |       |  |  |  |  |  |  |                |    |            |       |       |       |                |        |  |                     |     |         |    |            |       |       |           |  |  |  |  |  |                   |    |            |       |       |       |                |        |       |                    |  |         |    |            |       |       |       |                |        |       |                     |  |       |    |            |       |       |       |                |        |       |                        |  |         |    |            |       |       |                                    |                |        |  |                       |     |         |    |            |       |       |  |                |        |  |                          |  |         |    |  |       |       |  |  |  |  |  |  |         |     |            |       |       |  |  |  |  |  |  |                |    |            |       |       |  |                |        |  |                   |     |                |    |            |       |       |  |                |        |  |                   |     |                   |    |  |       |       |  |                |        |  |                   |     |         |    |            |       |       |  |  |  |  |  |  |             |     |            |       |       |  |  |  |  |  |  |         |    |            |       |       |  |                |        |  |                       |     |         |     |            |       |       |  |                |        |  |                          |  |         |     |            |       |       |  |                |        |  |                   |     |         |     |            |       |  |  |                |        |  |                   |     |  |   |     |       |       |       |                |                                    |                |                       |  |                     |    |            |    |       |       |       |           |                |        |  |                        |    |     |       |       |       |       |           |  |  |  |         |    |            |    |       |       |       |  |  |  |  |         |     |            |    |       |       |       |  |  |  |  |        |     |                |       |       |       |                |        |  |                       |  |  |  |         |    |  |       |                |           |  |                          |  |  |  |     |  |            |       |  |       |                |        |       |                    |  |     |    |            |       |  |       |                |        |       |                     |  |         |    |            |       |  |       |                |        |       |                        |  |         |    |            |       |       |                                    |                |        |  |                       |  |     |    |  |       |       |  |                |        |  |                          |  |         |    |            |       |       |  |  |  |  |  |  |         |    |            |       |       |  |  |  |  |  |  |                |    |            |       |       |  |  |  |  |  |  |         |    |            |       |       |  |  |  |  |  |  |                   |    |            |       |       |  |                |        |   |                 |  |     |    |  |       |       |  |  |  |  |  |  |       |    |            |       |       |  |  |  |  |  |  |         |    |            |       |       |  |                |        |  |                       |  |         |    |            |       |       |  |                |        |  |                          |  |         |    |            |       |       |  |  |  |  |  |  |                |     |            |       |       |  |  |  |  |  |  |         |    |  |       |       |  |                |        |  |                       |  |         |    |            |  |       |  |  |  |  |  |  |             |    |  |       |       |  |  |  |  |  |  |         |    |            |  |       |  |  |  |  |  |  |         |     |            |       |       |  |  |  |  |  |  |         |     |            |       |       |  |                |        |  |                       |  |  |  |  |  |  |  |                |        |  |                          |  |  |  |     |  |            |       |  |  |                |        |   |                 |  |     |    |            |       |  |  |  |  |  |  |  |         |    |            |       |  |  |  |  |  |  |  |         |    |            |       |  |  |  |  |  |  |  |     |    |  |       |       |  |  |  |  |  |  |         |    |            |       |  |  |  |  |  |  |  |       |    |            |       |  |  |  |  |  |  |  |         |    |            |       |  |  |  |  |  |  |  |         |    |            |       |  |  |  |  |  |  |  |     |  |            |  |       |  |                |        |   |                 |  |     |    |  |       |       |  |  |  |  |  |  |     |    |            |  |       |  |  |  |  |  |  |         |    |  |       |       |  |  |  |  |  |  |         |    |            |  |       |  |  |  |  |  |  |         |    |            |  |       |  |  |  |  |  |  |                |    |  |       |       |  |  |  |  |  |  |         |    |  |       |       |  |  |  |  |  |  |         |    |            |  |       |  |  |  |  |  |  |             |    |  |       |       |  |  |  |  |  |  |         |    |            |  |       |  |  |  |  |  |  |        |     |  |       |       |  |  |  |  |  |  |         |     |            |  |       |  |  |  |  |  |  |
| 1.9 D  | 51   | ORGA 09456 | 09.98 |            |                                    |                |                                    |                |                          |     |                     |     |     |    |            |       |       |           |                |        |  |                        |     |             |    |            |       |       |           |                |        |  |                     |     |         |    |            |       |       |  |                |        |  |                     |     |             |    |  |       |       |  |  |  |  |  |  |                |    |            |       |       |       |                |        |  |                     |     |         |    |            |       |       |           |  |  |  |  |  |                   |    |            |       |       |       |                |        |       |                    |  |         |    |            |       |       |       |                |        |       |                     |  |       |    |            |       |       |       |                |        |       |                        |  |         |    |            |       |       |                                    |                |        |  |                       |     |         |    |            |       |       |  |                |        |  |                          |  |         |    |  |       |       |  |  |  |  |  |  |         |     |            |       |       |  |  |  |  |  |  |                |    |            |       |       |  |                |        |  |                   |     |                |    |            |       |       |  |                |        |  |                   |     |                   |    |  |       |       |  |                |        |  |                   |     |         |    |            |       |       |  |  |  |  |  |  |             |     |            |       |       |  |  |  |  |  |  |         |    |            |       |       |  |                |        |  |                       |     |         |     |            |       |       |  |                |        |  |                          |  |         |     |            |       |       |  |                |        |  |                   |     |         |     |            |       |  |  |                |        |  |                   |     |  |   |     |       |       |       |                |                                    |                |                       |  |                     |    |            |    |       |       |       |           |                |        |  |                        |    |     |       |       |       |       |           |  |  |  |         |    |            |    |       |       |       |  |  |  |  |         |     |            |    |       |       |       |  |  |  |  |        |     |                |       |       |       |                |        |  |                       |  |  |  |         |    |  |       |                |           |  |                          |  |  |  |     |  |            |       |  |       |                |        |       |                    |  |     |    |            |       |  |       |                |        |       |                     |  |         |    |            |       |  |       |                |        |       |                        |  |         |    |            |       |       |                                    |                |        |  |                       |  |     |    |  |       |       |  |                |        |  |                          |  |         |    |            |       |       |  |  |  |  |  |  |         |    |            |       |       |  |  |  |  |  |  |                |    |            |       |       |  |  |  |  |  |  |         |    |            |       |       |  |  |  |  |  |  |                   |    |            |       |       |  |                |        |   |                 |  |     |    |  |       |       |  |  |  |  |  |  |       |    |            |       |       |  |  |  |  |  |  |         |    |            |       |       |  |                |        |  |                       |  |         |    |            |       |       |  |                |        |  |                          |  |         |    |            |       |       |  |  |  |  |  |  |                |     |            |       |       |  |  |  |  |  |  |         |    |  |       |       |  |                |        |  |                       |  |         |    |            |  |       |  |  |  |  |  |  |             |    |  |       |       |  |  |  |  |  |  |         |    |            |  |       |  |  |  |  |  |  |         |     |            |       |       |  |  |  |  |  |  |         |     |            |       |       |  |                |        |  |                       |  |  |  |  |  |  |  |                |        |  |                          |  |  |  |     |  |            |       |  |  |                |        |   |                 |  |     |    |            |       |  |  |  |  |  |  |  |         |    |            |       |  |  |  |  |  |  |  |         |    |            |       |  |  |  |  |  |  |  |     |    |  |       |       |  |  |  |  |  |  |         |    |            |       |  |  |  |  |  |  |  |       |    |            |       |  |  |  |  |  |  |  |         |    |            |       |  |  |  |  |  |  |  |         |    |            |       |  |  |  |  |  |  |  |     |  |            |  |       |  |                |        |   |                 |  |     |    |  |       |       |  |  |  |  |  |  |     |    |            |  |       |  |  |  |  |  |  |         |    |  |       |       |  |  |  |  |  |  |         |    |            |  |       |  |  |  |  |  |  |         |    |            |  |       |  |  |  |  |  |  |                |    |  |       |       |  |  |  |  |  |  |         |    |  |       |       |  |  |  |  |  |  |         |    |            |  |       |  |  |  |  |  |  |             |    |  |       |       |  |  |  |  |  |  |         |    |            |  |       |  |  |  |  |  |  |        |     |  |       |       |  |  |  |  |  |  |         |     |            |  |       |  |  |  |  |  |  |
| 2.0 HDi  | 66   | ORGA 09456 | 12.99 |            |                                    |                |                                    |                |                          |     |                     |     |     |    |            |       |       |           |                |        |  |                        |     |             |    |            |       |       |           |                |        |  |                     |     |         |    |            |       |       |  |                |        |  |                     |     |             |    |  |       |       |  |  |  |  |  |  |                |    |            |       |       |       |                |        |  |                     |     |         |    |            |       |       |           |  |  |  |  |  |                   |    |            |       |       |       |                |        |       |                    |  |         |    |            |       |       |       |                |        |       |                     |  |       |    |            |       |       |       |                |        |       |                        |  |         |    |            |       |       |                                    |                |        |  |                       |     |         |    |            |       |       |  |                |        |  |                          |  |         |    |  |       |       |  |  |  |  |  |  |         |     |            |       |       |  |  |  |  |  |  |                |    |            |       |       |  |                |        |  |                   |     |                |    |            |       |       |  |                |        |  |                   |     |                   |    |  |       |       |  |                |        |  |                   |     |         |    |            |       |       |  |  |  |  |  |  |             |     |            |       |       |  |  |  |  |  |  |         |    |            |       |       |  |                |        |  |                       |     |         |     |            |       |       |  |                |        |  |                          |  |         |     |            |       |       |  |                |        |  |                   |     |         |     |            |       |  |  |                |        |  |                   |     |  |   |     |       |       |       |                |                                    |                |                       |  |                     |    |            |    |       |       |       |           |                |        |  |                        |    |     |       |       |       |       |           |  |  |  |         |    |            |    |       |       |       |  |  |  |  |         |     |            |    |       |       |       |  |  |  |  |        |     |                |       |       |       |                |        |  |                       |  |  |  |         |    |  |       |                |           |  |                          |  |  |  |     |  |            |       |  |       |                |        |       |                    |  |     |    |            |       |  |       |                |        |       |                     |  |         |    |            |       |  |       |                |        |       |                        |  |         |    |            |       |       |                                    |                |        |  |                       |  |     |    |  |       |       |  |                |        |  |                          |  |         |    |            |       |       |  |  |  |  |  |  |         |    |            |       |       |  |  |  |  |  |  |                |    |            |       |       |  |  |  |  |  |  |         |    |            |       |       |  |  |  |  |  |  |                   |    |            |       |       |  |                |        |   |                 |  |     |    |  |       |       |  |  |  |  |  |  |       |    |            |       |       |  |  |  |  |  |  |         |    |            |       |       |  |                |        |  |                       |  |         |    |            |       |       |  |                |        |  |                          |  |         |    |            |       |       |  |  |  |  |  |  |                |     |            |       |       |  |  |  |  |  |  |         |    |  |       |       |  |                |        |  |                       |  |         |    |            |  |       |  |  |  |  |  |  |             |    |  |       |       |  |  |  |  |  |  |         |    |            |  |       |  |  |  |  |  |  |         |     |            |       |       |  |  |  |  |  |  |         |     |            |       |       |  |                |        |  |                       |  |  |  |  |  |  |  |                |        |  |                          |  |  |  |     |  |            |       |  |  |                |        |   |                 |  |     |    |            |       |  |  |  |  |  |  |  |         |    |            |       |  |  |  |  |  |  |  |         |    |            |       |  |  |  |  |  |  |  |     |    |  |       |       |  |  |  |  |  |  |         |    |            |       |  |  |  |  |  |  |  |       |    |            |       |  |  |  |  |  |  |  |         |    |            |       |  |  |  |  |  |  |  |         |    |            |       |  |  |  |  |  |  |  |     |  |            |  |       |  |                |        |   |                 |  |     |    |  |       |       |  |  |  |  |  |  |     |    |            |  |       |  |  |  |  |  |  |         |    |  |       |       |  |  |  |  |  |  |         |    |            |  |       |  |  |  |  |  |  |         |    |            |  |       |  |  |  |  |  |  |                |    |  |       |       |  |  |  |  |  |  |         |    |  |       |       |  |  |  |  |  |  |         |    |            |  |       |  |  |  |  |  |  |             |    |  |       |       |  |  |  |  |  |  |         |    |            |  |       |  |  |  |  |  |  |        |     |  |       |       |  |  |  |  |  |  |         |     |            |  |       |  |  |  |  |  |  |
| 2.0 S16  | 99   | ORGA 09456 | 04.99 |            |                                    |                |                                    |                |                          |     |                     |     |     |    |            |       |       |           |                |        |  |                        |     |             |    |            |       |       |           |                |        |  |                     |     |         |    |            |       |       |  |                |        |  |                     |     |             |    |  |       |       |  |  |  |  |  |  |                |    |            |       |       |       |                |        |  |                     |     |         |    |            |       |       |           |  |  |  |  |  |                   |    |            |       |       |       |                |        |       |                    |  |         |    |            |       |       |       |                |        |       |                     |  |       |    |            |       |       |       |                |        |       |                        |  |         |    |            |       |       |                                    |                |        |  |                       |     |         |    |            |       |       |  |                |        |  |                          |  |         |    |  |       |       |  |  |  |  |  |  |         |     |            |       |       |  |  |  |  |  |  |                |    |            |       |       |  |                |        |  |                   |     |                |    |            |       |       |  |                |        |  |                   |     |                   |    |  |       |       |  |                |        |  |                   |     |         |    |            |       |       |  |  |  |  |  |  |             |     |            |       |       |  |  |  |  |  |  |         |    |            |       |       |  |                |        |  |                       |     |         |     |            |       |       |  |                |        |  |                          |  |         |     |            |       |       |  |                |        |  |                   |     |         |     |            |       |  |  |                |        |  |                   |     |  |   |     |       |       |       |                |                                    |                |                       |  |                     |    |            |    |       |       |       |           |                |        |  |                        |    |     |       |       |       |       |           |  |  |  |         |    |            |    |       |       |       |  |  |  |  |         |     |            |    |       |       |       |  |  |  |  |        |     |                |       |       |       |                |        |  |                       |  |  |  |         |    |  |       |                |           |  |                          |  |  |  |     |  |            |       |  |       |                |        |       |                    |  |     |    |            |       |  |       |                |        |       |                     |  |         |    |            |       |  |       |                |        |       |                        |  |         |    |            |       |       |                                    |                |        |  |                       |  |     |    |  |       |       |  |                |        |  |                          |  |         |    |            |       |       |  |  |  |  |  |  |         |    |            |       |       |  |  |  |  |  |  |                |    |            |       |       |  |  |  |  |  |  |         |    |            |       |       |  |  |  |  |  |  |                   |    |            |       |       |  |                |        |   |                 |  |     |    |  |       |       |  |  |  |  |  |  |       |    |            |       |       |  |  |  |  |  |  |         |    |            |       |       |  |                |        |  |                       |  |         |    |            |       |       |  |                |        |  |                          |  |         |    |            |       |       |  |  |  |  |  |  |                |     |            |       |       |  |  |  |  |  |  |         |    |  |       |       |  |                |        |  |                       |  |         |    |            |  |       |  |  |  |  |  |  |             |    |  |       |       |  |  |  |  |  |  |         |    |            |  |       |  |  |  |  |  |  |         |     |            |       |       |  |  |  |  |  |  |         |     |            |       |       |  |                |        |  |                       |  |  |  |  |  |  |  |                |        |  |                          |  |  |  |     |  |            |       |  |  |                |        |   |                 |  |     |    |            |       |  |  |  |  |  |  |  |         |    |            |       |  |  |  |  |  |  |  |         |    |            |       |  |  |  |  |  |  |  |     |    |  |       |       |  |  |  |  |  |  |         |    |            |       |  |  |  |  |  |  |  |       |    |            |       |  |  |  |  |  |  |  |         |    |            |       |  |  |  |  |  |  |  |         |    |            |       |  |  |  |  |  |  |  |     |  |            |  |       |  |                |        |   |                 |  |     |    |  |       |       |  |  |  |  |  |  |     |    |            |  |       |  |  |  |  |  |  |         |    |  |       |       |  |  |  |  |  |  |         |    |            |  |       |  |  |  |  |  |  |         |    |            |  |       |  |  |  |  |  |  |                |    |  |       |       |  |  |  |  |  |  |         |    |  |       |       |  |  |  |  |  |  |         |    |            |  |       |  |  |  |  |  |  |             |    |  |       |       |  |  |  |  |  |  |         |    |            |  |       |  |  |  |  |  |  |        |     |  |       |       |  |  |  |  |  |  |         |     |            |  |       |  |  |  |  |  |  |
| 1.1  |  | ORGA 09457 |       | 02.09      |                                    | 24.0711-6205.3 | 360229                             | 2              | Radsensor L=815          |     |                     |     |     |    |            |       |       |           |                |        |  |                        |     |             |    |            |       |       |           |                |        |  |                     |     |         |    |            |       |       |  |                |        |  |                     |     |             |    |  |       |       |  |  |  |  |  |  |                |    |            |       |       |       |                |        |  |                     |     |         |    |            |       |       |           |  |  |  |  |  |                   |    |            |       |       |       |                |        |       |                    |  |         |    |            |       |       |       |                |        |       |                     |  |       |    |            |       |       |       |                |        |       |                        |  |         |    |            |       |       |                                    |                |        |  |                       |     |         |    |            |       |       |  |                |        |  |                          |  |         |    |  |       |       |  |  |  |  |  |  |         |     |            |       |       |  |  |  |  |  |  |                |    |            |       |       |  |                |        |  |                   |     |                |    |            |       |       |  |                |        |  |                   |     |                   |    |  |       |       |  |                |        |  |                   |     |         |    |            |       |       |  |  |  |  |  |  |             |     |            |       |       |  |  |  |  |  |  |         |    |            |       |       |  |                |        |  |                       |     |         |     |            |       |       |  |                |        |  |                          |  |         |     |            |       |       |  |                |        |  |                   |     |         |     |            |       |  |  |                |        |  |                   |     |  |   |     |       |       |       |                |                                    |                |                       |  |                     |    |            |    |       |       |       |           |                |        |  |                        |    |     |       |       |       |       |           |  |  |  |         |    |            |    |       |       |       |  |  |  |  |         |     |            |    |       |       |       |  |  |  |  |        |     |                |       |       |       |                |        |  |                       |  |  |  |         |    |  |       |                |           |  |                          |  |  |  |     |  |            |       |  |       |                |        |       |                    |  |     |    |            |       |  |       |                |        |       |                     |  |         |    |            |       |  |       |                |        |       |                        |  |         |    |            |       |       |                                    |                |        |  |                       |  |     |    |  |       |       |  |                |        |  |                          |  |         |    |            |       |       |  |  |  |  |  |  |         |    |            |       |       |  |  |  |  |  |  |                |    |            |       |       |  |  |  |  |  |  |         |    |            |       |       |  |  |  |  |  |  |                   |    |            |       |       |  |                |        |   |                 |  |     |    |  |       |       |  |  |  |  |  |  |       |    |            |       |       |  |  |  |  |  |  |         |    |            |       |       |  |                |        |  |                       |  |         |    |            |       |       |  |                |        |  |                          |  |         |    |            |       |       |  |  |  |  |  |  |                |     |            |       |       |  |  |  |  |  |  |         |    |  |       |       |  |                |        |  |                       |  |         |    |            |  |       |  |  |  |  |  |  |             |    |  |       |       |  |  |  |  |  |  |         |    |            |  |       |  |  |  |  |  |  |         |     |            |       |       |  |  |  |  |  |  |         |     |            |       |       |  |                |        |  |                       |  |  |  |  |  |  |  |                |        |  |                          |  |  |  |     |  |            |       |  |  |                |        |   |                 |  |     |    |            |       |  |  |  |  |  |  |  |         |    |            |       |  |  |  |  |  |  |  |         |    |            |       |  |  |  |  |  |  |  |     |    |  |       |       |  |  |  |  |  |  |         |    |            |       |  |  |  |  |  |  |  |       |    |            |       |  |  |  |  |  |  |  |         |    |            |       |  |  |  |  |  |  |  |         |    |            |       |  |  |  |  |  |  |  |     |  |            |  |       |  |                |        |   |                 |  |     |    |  |       |       |  |  |  |  |  |  |     |    |            |  |       |  |  |  |  |  |  |         |    |  |       |       |  |  |  |  |  |  |         |    |            |  |       |  |  |  |  |  |  |         |    |            |  |       |  |  |  |  |  |  |                |    |  |       |       |  |  |  |  |  |  |         |    |  |       |       |  |  |  |  |  |  |         |    |            |  |       |  |  |  |  |  |  |             |    |  |       |       |  |  |  |  |  |  |         |    |            |  |       |  |  |  |  |  |  |        |     |  |       |       |  |  |  |  |  |  |         |     |            |  |       |  |  |  |  |  |  |
| 1.4  | 55   |            | 03.07 | 02.09      |                                    |                |                                    |                |                          |     |                     |     |     |    |            |       |       |           |                |        |  |                        |     |             |    |            |       |       |           |                |        |  |                     |     |         |    |            |       |       |  |                |        |  |                     |     |             |    |  |       |       |  |  |  |  |  |  |                |    |            |       |       |       |                |        |  |                     |     |         |    |            |       |       |           |  |  |  |  |  |                   |    |            |       |       |       |                |        |       |                    |  |         |    |            |       |       |       |                |        |       |                     |  |       |    |            |       |       |       |                |        |       |                        |  |         |    |            |       |       |                                    |                |        |  |                       |     |         |    |            |       |       |  |                |        |  |                          |  |         |    |  |       |       |  |  |  |  |  |  |         |     |            |       |       |  |  |  |  |  |  |                |    |            |       |       |  |                |        |  |                   |     |                |    |            |       |       |  |                |        |  |                   |     |                   |    |  |       |       |  |                |        |  |                   |     |         |    |            |       |       |  |  |  |  |  |  |             |     |            |       |       |  |  |  |  |  |  |         |    |            |       |       |  |                |        |  |                       |     |         |     |            |       |       |  |                |        |  |                          |  |         |     |            |       |       |  |                |        |  |                   |     |         |     |            |       |  |  |                |        |  |                   |     |  |   |     |       |       |       |                |                                    |                |                       |  |                     |    |            |    |       |       |       |           |                |        |  |                        |    |     |       |       |       |       |           |  |  |  |         |    |            |    |       |       |       |  |  |  |  |         |     |            |    |       |       |       |  |  |  |  |        |     |                |       |       |       |                |        |  |                       |  |  |  |         |    |  |       |                |           |  |                          |  |  |  |     |  |            |       |  |       |                |        |       |                    |  |     |    |            |       |  |       |                |        |       |                     |  |         |    |            |       |  |       |                |        |       |                        |  |         |    |            |       |       |                                    |                |        |  |                       |  |     |    |  |       |       |  |                |        |  |                          |  |         |    |            |       |       |  |  |  |  |  |  |         |    |            |       |       |  |  |  |  |  |  |                |    |            |       |       |  |  |  |  |  |  |         |    |            |       |       |  |  |  |  |  |  |                   |    |            |       |       |  |                |        |   |                 |  |     |    |  |       |       |  |  |  |  |  |  |       |    |            |       |       |  |  |  |  |  |  |         |    |            |       |       |  |                |        |  |                       |  |         |    |            |       |       |  |                |        |  |                          |  |         |    |            |       |       |  |  |  |  |  |  |                |     |            |       |       |  |  |  |  |  |  |         |    |  |       |       |  |                |        |  |                       |  |         |    |            |  |       |  |  |  |  |  |  |             |    |  |       |       |  |  |  |  |  |  |         |    |            |  |       |  |  |  |  |  |  |         |     |            |       |       |  |  |  |  |  |  |         |     |            |       |       |  |                |        |  |                       |  |  |  |  |  |  |  |                |        |  |                          |  |  |  |     |  |            |       |  |  |                |        |   |                 |  |     |    |            |       |  |  |  |  |  |  |  |         |    |            |       |  |  |  |  |  |  |  |         |    |            |       |  |  |  |  |  |  |  |     |    |  |       |       |  |  |  |  |  |  |         |    |            |       |  |  |  |  |  |  |  |       |    |            |       |  |  |  |  |  |  |  |         |    |            |       |  |  |  |  |  |  |  |         |    |            |       |  |  |  |  |  |  |  |     |  |            |  |       |  |                |        |   |                 |  |     |    |  |       |       |  |  |  |  |  |  |     |    |            |  |       |  |  |  |  |  |  |         |    |  |       |       |  |  |  |  |  |  |         |    |            |  |       |  |  |  |  |  |  |         |    |            |  |       |  |  |  |  |  |  |                |    |  |       |       |  |  |  |  |  |  |         |    |  |       |       |  |  |  |  |  |  |         |    |            |  |       |  |  |  |  |  |  |             |    |  |       |       |  |  |  |  |  |  |         |    |            |  |       |  |  |  |  |  |  |        |     |  |       |       |  |  |  |  |  |  |         |     |            |  |       |  |  |  |  |  |  |
| 1.4  | 55   | ORGA 09457 |       | 02.09      |                                    |                |                                    |                |                          |     |                     |     |     |    |            |       |       |           |                |        |  |                        |     |             |    |            |       |       |           |                |        |  |                     |     |         |    |            |       |       |  |                |        |  |                     |     |             |    |  |       |       |  |  |  |  |  |  |                |    |            |       |       |       |                |        |  |                     |     |         |    |            |       |       |           |  |  |  |  |  |                   |    |            |       |       |       |                |        |       |                    |  |         |    |            |       |       |       |                |        |       |                     |  |       |    |            |       |       |       |                |        |       |                        |  |         |    |            |       |       |                                    |                |        |  |                       |     |         |    |            |       |       |  |                |        |  |                          |  |         |    |  |       |       |  |  |  |  |  |  |         |     |            |       |       |  |  |  |  |  |  |                |    |            |       |       |  |                |        |  |                   |     |                |    |            |       |       |  |                |        |  |                   |     |                   |    |  |       |       |  |                |        |  |                   |     |         |    |            |       |       |  |  |  |  |  |  |             |     |            |       |       |  |  |  |  |  |  |         |    |            |       |       |  |                |        |  |                       |     |         |     |            |       |       |  |                |        |  |                          |  |         |     |            |       |       |  |                |        |  |                   |     |         |     |            |       |  |  |                |        |  |                   |     |  |   |     |       |       |       |                |                                    |                |                       |  |                     |    |            |    |       |       |       |           |                |        |  |                        |    |     |       |       |       |       |           |  |  |  |         |    |            |    |       |       |       |  |  |  |  |         |     |            |    |       |       |       |  |  |  |  |        |     |                |       |       |       |                |        |  |                       |  |  |  |         |    |  |       |                |           |  |                          |  |  |  |     |  |            |       |  |       |                |        |       |                    |  |     |    |            |       |  |       |                |        |       |                     |  |         |    |            |       |  |       |                |        |       |                        |  |         |    |            |       |       |                                    |                |        |  |                       |  |     |    |  |       |       |  |                |        |  |                          |  |         |    |            |       |       |  |  |  |  |  |  |         |    |            |       |       |  |  |  |  |  |  |                |    |            |       |       |  |  |  |  |  |  |         |    |            |       |       |  |  |  |  |  |  |                   |    |            |       |       |  |                |        |   |                 |  |     |    |  |       |       |  |  |  |  |  |  |       |    |            |       |       |  |  |  |  |  |  |         |    |            |       |       |  |                |        |  |                       |  |         |    |            |       |       |  |                |        |  |                          |  |         |    |            |       |       |  |  |  |  |  |  |                |     |            |       |       |  |  |  |  |  |  |         |    |  |       |       |  |                |        |  |                       |  |         |    |            |  |       |  |  |  |  |  |  |             |    |  |       |       |  |  |  |  |  |  |         |    |            |  |       |  |  |  |  |  |  |         |     |            |       |       |  |  |  |  |  |  |         |     |            |       |       |  |                |        |  |                       |  |  |  |  |  |  |  |                |        |  |                          |  |  |  |     |  |            |       |  |  |                |        |   |                 |  |     |    |            |       |  |  |  |  |  |  |  |         |    |            |       |  |  |  |  |  |  |  |         |    |            |       |  |  |  |  |  |  |  |     |    |  |       |       |  |  |  |  |  |  |         |    |            |       |  |  |  |  |  |  |  |       |    |            |       |  |  |  |  |  |  |  |         |    |            |       |  |  |  |  |  |  |  |         |    |            |       |  |  |  |  |  |  |  |     |  |            |  |       |  |                |        |   |                 |  |     |    |  |       |       |  |  |  |  |  |  |     |    |            |  |       |  |  |  |  |  |  |         |    |  |       |       |  |  |  |  |  |  |         |    |            |  |       |  |  |  |  |  |  |         |    |            |  |       |  |  |  |  |  |  |                |    |  |       |       |  |  |  |  |  |  |         |    |  |       |       |  |  |  |  |  |  |         |    |            |  |       |  |  |  |  |  |  |             |    |  |       |       |  |  |  |  |  |  |         |    |            |  |       |  |  |  |  |  |  |        |     |  |       |       |  |  |  |  |  |  |         |     |            |  |       |  |  |  |  |  |  |
| 1.4 16V  | 65   |            | 10.03 | 02.09      |                                    |                |                                    |                |                          |     |                     |     |     |    |            |       |       |           |                |        |  |                        |     |             |    |            |       |       |           |                |        |  |                     |     |         |    |            |       |       |  |                |        |  |                     |     |             |    |  |       |       |  |  |  |  |  |  |                |    |            |       |       |       |                |        |  |                     |     |         |    |            |       |       |           |  |  |  |  |  |                   |    |            |       |       |       |                |        |       |                    |  |         |    |            |       |       |       |                |        |       |                     |  |       |    |            |       |       |       |                |        |       |                        |  |         |    |            |       |       |                                    |                |        |  |                       |     |         |    |            |       |       |  |                |        |  |                          |  |         |    |  |       |       |  |  |  |  |  |  |         |     |            |       |       |  |  |  |  |  |  |                |    |            |       |       |  |                |        |  |                   |     |                |    |            |       |       |  |                |        |  |                   |     |                   |    |  |       |       |  |                |        |  |                   |     |         |    |            |       |       |  |  |  |  |  |  |             |     |            |       |       |  |  |  |  |  |  |         |    |            |       |       |  |                |        |  |                       |     |         |     |            |       |       |  |                |        |  |                          |  |         |     |            |       |       |  |                |        |  |                   |     |         |     |            |       |  |  |                |        |  |                   |     |  |   |     |       |       |       |                |                                    |                |                       |  |                     |    |            |    |       |       |       |           |                |        |  |                        |    |     |       |       |       |       |           |  |  |  |         |    |            |    |       |       |       |  |  |  |  |         |     |            |    |       |       |       |  |  |  |  |        |     |                |       |       |       |                |        |  |                       |  |  |  |         |    |  |       |                |           |  |                          |  |  |  |     |  |            |       |  |       |                |        |       |                    |  |     |    |            |       |  |       |                |        |       |                     |  |         |    |            |       |  |       |                |        |       |                        |  |         |    |            |       |       |                                    |                |        |  |                       |  |     |    |  |       |       |  |                |        |  |                          |  |         |    |            |       |       |  |  |  |  |  |  |         |    |            |       |       |  |  |  |  |  |  |                |    |            |       |       |  |  |  |  |  |  |         |    |            |       |       |  |  |  |  |  |  |                   |    |            |       |       |  |                |        |   |                 |  |     |    |  |       |       |  |  |  |  |  |  |       |    |            |       |       |  |  |  |  |  |  |         |    |            |       |       |  |                |        |  |                       |  |         |    |            |       |       |  |                |        |  |                          |  |         |    |            |       |       |  |  |  |  |  |  |                |     |            |       |       |  |  |  |  |  |  |         |    |  |       |       |  |                |        |  |                       |  |         |    |            |  |       |  |  |  |  |  |  |             |    |  |       |       |  |  |  |  |  |  |         |    |            |  |       |  |  |  |  |  |  |         |     |            |       |       |  |  |  |  |  |  |         |     |            |       |       |  |                |        |  |                       |  |  |  |  |  |  |  |                |        |  |                          |  |  |  |     |  |            |       |  |  |                |        |   |                 |  |     |    |            |       |  |  |  |  |  |  |  |         |    |            |       |  |  |  |  |  |  |  |         |    |            |       |  |  |  |  |  |  |  |     |    |  |       |       |  |  |  |  |  |  |         |    |            |       |  |  |  |  |  |  |  |       |    |            |       |  |  |  |  |  |  |  |         |    |            |       |  |  |  |  |  |  |  |         |    |            |       |  |  |  |  |  |  |  |     |  |            |  |       |  |                |        |   |                 |  |     |    |  |       |       |  |  |  |  |  |  |     |    |            |  |       |  |  |  |  |  |  |         |    |  |       |       |  |  |  |  |  |  |         |    |            |  |       |  |  |  |  |  |  |         |    |            |  |       |  |  |  |  |  |  |                |    |  |       |       |  |  |  |  |  |  |         |    |  |       |       |  |  |  |  |  |  |         |    |            |  |       |  |  |  |  |  |  |             |    |  |       |       |  |  |  |  |  |  |         |    |            |  |       |  |  |  |  |  |  |        |     |  |       |       |  |  |  |  |  |  |         |     |            |  |       |  |  |  |  |  |  |
| 1.4 HDi  | 50   | ORGA 09457 |       | 02.09      |                                    |                |                                    |                |                          |     |                     |     |     |    |            |       |       |           |                |        |  |                        |     |             |    |            |       |       |           |                |        |  |                     |     |         |    |            |       |       |  |                |        |  |                     |     |             |    |  |       |       |  |  |  |  |  |  |                |    |            |       |       |       |                |        |  |                     |     |         |    |            |       |       |           |  |  |  |  |  |                   |    |            |       |       |       |                |        |       |                    |  |         |    |            |       |       |       |                |        |       |                     |  |       |    |            |       |       |       |                |        |       |                        |  |         |    |            |       |       |                                    |                |        |  |                       |     |         |    |            |       |       |  |                |        |  |                          |  |         |    |  |       |       |  |  |  |  |  |  |         |     |            |       |       |  |  |  |  |  |  |                |    |            |       |       |  |                |        |  |                   |     |                |    |            |       |       |  |                |        |  |                   |     |                   |    |  |       |       |  |                |        |  |                   |     |         |    |            |       |       |  |  |  |  |  |  |             |     |            |       |       |  |  |  |  |  |  |         |    |            |       |       |  |                |        |  |                       |     |         |     |            |       |       |  |                |        |  |                          |  |         |     |            |       |       |  |                |        |  |                   |     |         |     |            |       |  |  |                |        |  |                   |     |  |   |     |       |       |       |                |                                    |                |                       |  |                     |    |            |    |       |       |       |           |                |        |  |                        |    |     |       |       |       |       |           |  |  |  |         |    |            |    |       |       |       |  |  |  |  |         |     |            |    |       |       |       |  |  |  |  |        |     |                |       |       |       |                |        |  |                       |  |  |  |         |    |  |       |                |           |  |                          |  |  |  |     |  |            |       |  |       |                |        |       |                    |  |     |    |            |       |  |       |                |        |       |                     |  |         |    |            |       |  |       |                |        |       |                        |  |         |    |            |       |       |                                    |                |        |  |                       |  |     |    |  |       |       |  |                |        |  |                          |  |         |    |            |       |       |  |  |  |  |  |  |         |    |            |       |       |  |  |  |  |  |  |                |    |            |       |       |  |  |  |  |  |  |         |    |            |       |       |  |  |  |  |  |  |                   |    |            |       |       |  |                |        |   |                 |  |     |    |  |       |       |  |  |  |  |  |  |       |    |            |       |       |  |  |  |  |  |  |         |    |            |       |       |  |                |        |  |                       |  |         |    |            |       |       |  |                |        |  |                          |  |         |    |            |       |       |  |  |  |  |  |  |                |     |            |       |       |  |  |  |  |  |  |         |    |  |       |       |  |                |        |  |                       |  |         |    |            |  |       |  |  |  |  |  |  |             |    |  |       |       |  |  |  |  |  |  |         |    |            |  |       |  |  |  |  |  |  |         |     |            |       |       |  |  |  |  |  |  |         |     |            |       |       |  |                |        |  |                       |  |  |  |  |  |  |  |                |        |  |                          |  |  |  |     |  |            |       |  |  |                |        |   |                 |  |     |    |            |       |  |  |  |  |  |  |  |         |    |            |       |  |  |  |  |  |  |  |         |    |            |       |  |  |  |  |  |  |  |     |    |  |       |       |  |  |  |  |  |  |         |    |            |       |  |  |  |  |  |  |  |       |    |            |       |  |  |  |  |  |  |  |         |    |            |       |  |  |  |  |  |  |  |         |    |            |       |  |  |  |  |  |  |  |     |  |            |  |       |  |                |        |   |                 |  |     |    |  |       |       |  |  |  |  |  |  |     |    |            |  |       |  |  |  |  |  |  |         |    |  |       |       |  |  |  |  |  |  |         |    |            |  |       |  |  |  |  |  |  |         |    |            |  |       |  |  |  |  |  |  |                |    |  |       |       |  |  |  |  |  |  |         |    |  |       |       |  |  |  |  |  |  |         |    |            |  |       |  |  |  |  |  |  |             |    |  |       |       |  |  |  |  |  |  |         |    |            |  |       |  |  |  |  |  |  |        |     |  |       |       |  |  |  |  |  |  |         |     |            |  |       |  |  |  |  |  |  |
| 1.4 HDi  | 51   | ORGA 09457 |       | 02.09      |                                    |                |                                    |                |                          |     |                     |     |     |    |            |       |       |           |                |        |  |                        |     |             |    |            |       |       |           |                |        |  |                     |     |         |    |            |       |       |  |                |        |  |                     |     |             |    |  |       |       |  |  |  |  |  |  |                |    |            |       |       |       |                |        |  |                     |     |         |    |            |       |       |           |  |  |  |  |  |                   |    |            |       |       |       |                |        |       |                    |  |         |    |            |       |       |       |                |        |       |                     |  |       |    |            |       |       |       |                |        |       |                        |  |         |    |            |       |       |                                    |                |        |  |                       |     |         |    |            |       |       |  |                |        |  |                          |  |         |    |  |       |       |  |  |  |  |  |  |         |     |            |       |       |  |  |  |  |  |  |                |    |            |       |       |  |                |        |  |                   |     |                |    |            |       |       |  |                |        |  |                   |     |                   |    |  |       |       |  |                |        |  |                   |     |         |    |            |       |       |  |  |  |  |  |  |             |     |            |       |       |  |  |  |  |  |  |         |    |            |       |       |  |                |        |  |                       |     |         |     |            |       |       |  |                |        |  |                          |  |         |     |            |       |       |  |                |        |  |                   |     |         |     |            |       |  |  |                |        |  |                   |     |  |   |     |       |       |       |                |                                    |                |                       |  |                     |    |            |    |       |       |       |           |                |        |  |                        |    |     |       |       |       |       |           |  |  |  |         |    |            |    |       |       |       |  |  |  |  |         |     |            |    |       |       |       |  |  |  |  |        |     |                |       |       |       |                |        |  |                       |  |  |  |         |    |  |       |                |           |  |                          |  |  |  |     |  |            |       |  |       |                |        |       |                    |  |     |    |            |       |  |       |                |        |       |                     |  |         |    |            |       |  |       |                |        |       |                        |  |         |    |            |       |       |                                    |                |        |  |                       |  |     |    |  |       |       |  |                |        |  |                          |  |         |    |            |       |       |  |  |  |  |  |  |         |    |            |       |       |  |  |  |  |  |  |                |    |            |       |       |  |  |  |  |  |  |         |    |            |       |       |  |  |  |  |  |  |                   |    |            |       |       |  |                |        |   |                 |  |     |    |  |       |       |  |  |  |  |  |  |       |    |            |       |       |  |  |  |  |  |  |         |    |            |       |       |  |                |        |  |                       |  |         |    |            |       |       |  |                |        |  |                          |  |         |    |            |       |       |  |  |  |  |  |  |                |     |            |       |       |  |  |  |  |  |  |         |    |  |       |       |  |                |        |  |                       |  |         |    |            |  |       |  |  |  |  |  |  |             |    |  |       |       |  |  |  |  |  |  |         |    |            |  |       |  |  |  |  |  |  |         |     |            |       |       |  |  |  |  |  |  |         |     |            |       |       |  |                |        |  |                       |  |  |  |  |  |  |  |                |        |  |                          |  |  |  |     |  |            |       |  |  |                |        |   |                 |  |     |    |            |       |  |  |  |  |  |  |  |         |    |            |       |  |  |  |  |  |  |  |         |    |            |       |  |  |  |  |  |  |  |     |    |  |       |       |  |  |  |  |  |  |         |    |            |       |  |  |  |  |  |  |  |       |    |            |       |  |  |  |  |  |  |  |         |    |            |       |  |  |  |  |  |  |  |         |    |            |       |  |  |  |  |  |  |  |     |  |            |  |       |  |                |        |   |                 |  |     |    |  |       |       |  |  |  |  |  |  |     |    |            |  |       |  |  |  |  |  |  |         |    |  |       |       |  |  |  |  |  |  |         |    |            |  |       |  |  |  |  |  |  |         |    |            |  |       |  |  |  |  |  |  |                |    |  |       |       |  |  |  |  |  |  |         |    |  |       |       |  |  |  |  |  |  |         |    |            |  |       |  |  |  |  |  |  |             |    |  |       |       |  |  |  |  |  |  |         |    |            |  |       |  |  |  |  |  |  |        |     |  |       |       |  |  |  |  |  |  |         |     |            |  |       |  |  |  |  |  |  |
| 1.4 HDi eco 70   | 50   |            | 09.08 | 02.09      |                                    |                |                                    |                |                          |     |                     |     |     |    |            |       |       |           |                |        |  |                        |     |             |    |            |       |       |           |                |        |  |                     |     |         |    |            |       |       |  |                |        |  |                     |     |             |    |  |       |       |  |  |  |  |  |  |                |    |            |       |       |       |                |        |  |                     |     |         |    |            |       |       |           |  |  |  |  |  |                   |    |            |       |       |       |                |        |       |                    |  |         |    |            |       |       |       |                |        |       |                     |  |       |    |            |       |       |       |                |        |       |                        |  |         |    |            |       |       |                                    |                |        |  |                       |     |         |    |            |       |       |  |                |        |  |                          |  |         |    |  |       |       |  |  |  |  |  |  |         |     |            |       |       |  |  |  |  |  |  |                |    |            |       |       |  |                |        |  |                   |     |                |    |            |       |       |  |                |        |  |                   |     |                   |    |  |       |       |  |                |        |  |                   |     |         |    |            |       |       |  |  |  |  |  |  |             |     |            |       |       |  |  |  |  |  |  |         |    |            |       |       |  |                |        |  |                       |     |         |     |            |       |       |  |                |        |  |                          |  |         |     |            |       |       |  |                |        |  |                   |     |         |     |            |       |  |  |                |        |  |                   |     |  |   |     |       |       |       |                |                                    |                |                       |  |                     |    |            |    |       |       |       |           |                |        |  |                        |    |     |       |       |       |       |           |  |  |  |         |    |            |    |       |       |       |  |  |  |  |         |     |            |    |       |       |       |  |  |  |  |        |     |                |       |       |       |                |        |  |                       |  |  |  |         |    |  |       |                |           |  |                          |  |  |  |     |  |            |       |  |       |                |        |       |                    |  |     |    |            |       |  |       |                |        |       |                     |  |         |    |            |       |  |       |                |        |       |                        |  |         |    |            |       |       |                                    |                |        |  |                       |  |     |    |  |       |       |  |                |        |  |                          |  |         |    |            |       |       |  |  |  |  |  |  |         |    |            |       |       |  |  |  |  |  |  |                |    |            |       |       |  |  |  |  |  |  |         |    |            |       |       |  |  |  |  |  |  |                   |    |            |       |       |  |                |        |   |                 |  |     |    |  |       |       |  |  |  |  |  |  |       |    |            |       |       |  |  |  |  |  |  |         |    |            |       |       |  |                |        |  |                       |  |         |    |            |       |       |  |                |        |  |                          |  |         |    |            |       |       |  |  |  |  |  |  |                |     |            |       |       |  |  |  |  |  |  |         |    |  |       |       |  |                |        |  |                       |  |         |    |            |  |       |  |  |  |  |  |  |             |    |  |       |       |  |  |  |  |  |  |         |    |            |  |       |  |  |  |  |  |  |         |     |            |       |       |  |  |  |  |  |  |         |     |            |       |       |  |                |        |  |                       |  |  |  |  |  |  |  |                |        |  |                          |  |  |  |     |  |            |       |  |  |                |        |   |                 |  |     |    |            |       |  |  |  |  |  |  |  |         |    |            |       |  |  |  |  |  |  |  |         |    |            |       |  |  |  |  |  |  |  |     |    |  |       |       |  |  |  |  |  |  |         |    |            |       |  |  |  |  |  |  |  |       |    |            |       |  |  |  |  |  |  |  |         |    |            |       |  |  |  |  |  |  |  |         |    |            |       |  |  |  |  |  |  |  |     |  |            |  |       |  |                |        |   |                 |  |     |    |  |       |       |  |  |  |  |  |  |     |    |            |  |       |  |  |  |  |  |  |         |    |  |       |       |  |  |  |  |  |  |         |    |            |  |       |  |  |  |  |  |  |         |    |            |  |       |  |  |  |  |  |  |                |    |  |       |       |  |  |  |  |  |  |         |    |  |       |       |  |  |  |  |  |  |         |    |            |  |       |  |  |  |  |  |  |             |    |  |       |       |  |  |  |  |  |  |         |    |            |  |       |  |  |  |  |  |  |        |     |  |       |       |  |  |  |  |  |  |         |     |            |  |       |  |  |  |  |  |  |
| 1.4 LPG  | 55   |            | 05.06 | 09.07      |                                    |                |                                    |                |                          |     |                     |     |     |    |            |       |       |           |                |        |  |                        |     |             |    |            |       |       |           |                |        |  |                     |     |         |    |            |       |       |  |                |        |  |                     |     |             |    |  |       |       |  |  |  |  |  |  |                |    |            |       |       |       |                |        |  |                     |     |         |    |            |       |       |           |  |  |  |  |  |                   |    |            |       |       |       |                |        |       |                    |  |         |    |            |       |       |       |                |        |       |                     |  |       |    |            |       |       |       |                |        |       |                        |  |         |    |            |       |       |                                    |                |        |  |                       |     |         |    |            |       |       |  |                |        |  |                          |  |         |    |  |       |       |  |  |  |  |  |  |         |     |            |       |       |  |  |  |  |  |  |                |    |            |       |       |  |                |        |  |                   |     |                |    |            |       |       |  |                |        |  |                   |     |                   |    |  |       |       |  |                |        |  |                   |     |         |    |            |       |       |  |  |  |  |  |  |             |     |            |       |       |  |  |  |  |  |  |         |    |            |       |       |  |                |        |  |                       |     |         |     |            |       |       |  |                |        |  |                          |  |         |     |            |       |       |  |                |        |  |                   |     |         |     |            |       |  |  |                |        |  |                   |     |  |   |     |       |       |       |                |                                    |                |                       |  |                     |    |            |    |       |       |       |           |                |        |  |                        |    |     |       |       |       |       |           |  |  |  |         |    |            |    |       |       |       |  |  |  |  |         |     |            |    |       |       |       |  |  |  |  |        |     |                |       |       |       |                |        |  |                       |  |  |  |         |    |  |       |                |           |  |                          |  |  |  |     |  |            |       |  |       |                |        |       |                    |  |     |    |            |       |  |       |                |        |       |                     |  |         |    |            |       |  |       |                |        |       |                        |  |         |    |            |       |       |                                    |                |        |  |                       |  |     |    |  |       |       |  |                |        |  |                          |  |         |    |            |       |       |  |  |  |  |  |  |         |    |            |       |       |  |  |  |  |  |  |                |    |            |       |       |  |  |  |  |  |  |         |    |            |       |       |  |  |  |  |  |  |                   |    |            |       |       |  |                |        |   |                 |  |     |    |  |       |       |  |  |  |  |  |  |       |    |            |       |       |  |  |  |  |  |  |         |    |            |       |       |  |                |        |  |                       |  |         |    |            |       |       |  |                |        |  |                          |  |         |    |            |       |       |  |  |  |  |  |  |                |     |            |       |       |  |  |  |  |  |  |         |    |  |       |       |  |                |        |  |                       |  |         |    |            |  |       |  |  |  |  |  |  |             |    |  |       |       |  |  |  |  |  |  |         |    |            |  |       |  |  |  |  |  |  |         |     |            |       |       |  |  |  |  |  |  |         |     |            |       |       |  |                |        |  |                       |  |  |  |  |  |  |  |                |        |  |                          |  |  |  |     |  |            |       |  |  |                |        |   |                 |  |     |    |            |       |  |  |  |  |  |  |  |         |    |            |       |  |  |  |  |  |  |  |         |    |            |       |  |  |  |  |  |  |  |     |    |  |       |       |  |  |  |  |  |  |         |    |            |       |  |  |  |  |  |  |  |       |    |            |       |  |  |  |  |  |  |  |         |    |            |       |  |  |  |  |  |  |  |         |    |            |       |  |  |  |  |  |  |  |     |  |            |  |       |  |                |        |   |                 |  |     |    |  |       |       |  |  |  |  |  |  |     |    |            |  |       |  |  |  |  |  |  |         |    |  |       |       |  |  |  |  |  |  |         |    |            |  |       |  |  |  |  |  |  |         |    |            |  |       |  |  |  |  |  |  |                |    |  |       |       |  |  |  |  |  |  |         |    |  |       |       |  |  |  |  |  |  |         |    |            |  |       |  |  |  |  |  |  |             |    |  |       |       |  |  |  |  |  |  |         |    |            |  |       |  |  |  |  |  |  |        |     |  |       |       |  |  |  |  |  |  |         |     |            |  |       |  |  |  |  |  |  |
| 1.6 16V  | 80   | ORGA 09457 |       | 02.09      |                                    |                |                                    |                |                          |     |                     |     |     |    |            |       |       |           |                |        |  |                        |     |             |    |            |       |       |           |                |        |  |                     |     |         |    |            |       |       |  |                |        |  |                     |     |             |    |  |       |       |  |  |  |  |  |  |                |    |            |       |       |       |                |        |  |                     |     |         |    |            |       |       |           |  |  |  |  |  |                   |    |            |       |       |       |                |        |       |                    |  |         |    |            |       |       |       |                |        |       |                     |  |       |    |            |       |       |       |                |        |       |                        |  |         |    |            |       |       |                                    |                |        |  |                       |     |         |    |            |       |       |  |                |        |  |                          |  |         |    |  |       |       |  |  |  |  |  |  |         |     |            |       |       |  |  |  |  |  |  |                |    |            |       |       |  |                |        |  |                   |     |                |    |            |       |       |  |                |        |  |                   |     |                   |    |  |       |       |  |                |        |  |                   |     |         |    |            |       |       |  |  |  |  |  |  |             |     |            |       |       |  |  |  |  |  |  |         |    |            |       |       |  |                |        |  |                       |     |         |     |            |       |       |  |                |        |  |                          |  |         |     |            |       |       |  |                |        |  |                   |     |         |     |            |       |  |  |                |        |  |                   |     |  |   |     |       |       |       |                |                                    |                |                       |  |                     |    |            |    |       |       |       |           |                |        |  |                        |    |     |       |       |       |       |           |  |  |  |         |    |            |    |       |       |       |  |  |  |  |         |     |            |    |       |       |       |  |  |  |  |        |     |                |       |       |       |                |        |  |                       |  |  |  |         |    |  |       |                |           |  |                          |  |  |  |     |  |            |       |  |       |                |        |       |                    |  |     |    |            |       |  |       |                |        |       |                     |  |         |    |            |       |  |       |                |        |       |                        |  |         |    |            |       |       |                                    |                |        |  |                       |  |     |    |  |       |       |  |                |        |  |                          |  |         |    |            |       |       |  |  |  |  |  |  |         |    |            |       |       |  |  |  |  |  |  |                |    |            |       |       |  |  |  |  |  |  |         |    |            |       |       |  |  |  |  |  |  |                   |    |            |       |       |  |                |        |   |                 |  |     |    |  |       |       |  |  |  |  |  |  |       |    |            |       |       |  |  |  |  |  |  |         |    |            |       |       |  |                |        |  |                       |  |         |    |            |       |       |  |                |        |  |                          |  |         |    |            |       |       |  |  |  |  |  |  |                |     |            |       |       |  |  |  |  |  |  |         |    |  |       |       |  |                |        |  |                       |  |         |    |            |  |       |  |  |  |  |  |  |             |    |  |       |       |  |  |  |  |  |  |         |    |            |  |       |  |  |  |  |  |  |         |     |            |       |       |  |  |  |  |  |  |         |     |            |       |       |  |                |        |  |                       |  |  |  |  |  |  |  |                |        |  |                          |  |  |  |     |  |            |       |  |  |                |        |   |                 |  |     |    |            |       |  |  |  |  |  |  |  |         |    |            |       |  |  |  |  |  |  |  |         |    |            |       |  |  |  |  |  |  |  |     |    |  |       |       |  |  |  |  |  |  |         |    |            |       |  |  |  |  |  |  |  |       |    |            |       |  |  |  |  |  |  |  |         |    |            |       |  |  |  |  |  |  |  |         |    |            |       |  |  |  |  |  |  |  |     |  |            |  |       |  |                |        |   |                 |  |     |    |  |       |       |  |  |  |  |  |  |     |    |            |  |       |  |  |  |  |  |  |         |    |  |       |       |  |  |  |  |  |  |         |    |            |  |       |  |  |  |  |  |  |         |    |            |  |       |  |  |  |  |  |  |                |    |  |       |       |  |  |  |  |  |  |         |    |  |       |       |  |  |  |  |  |  |         |    |            |  |       |  |  |  |  |  |  |             |    |  |       |       |  |  |  |  |  |  |         |    |            |  |       |  |  |  |  |  |  |        |     |  |       |       |  |  |  |  |  |  |         |     |            |  |       |  |  |  |  |  |  |
| 1.6 HDi 110  | 80   |            | 05.04 | 02.09      |                                    |                |                                    |                |                          |     |                     |     |     |    |            |       |       |           |                |        |  |                        |     |             |    |            |       |       |           |                |        |  |                     |     |         |    |            |       |       |  |                |        |  |                     |     |             |    |  |       |       |  |  |  |  |  |  |                |    |            |       |       |       |                |        |  |                     |     |         |    |            |       |       |           |  |  |  |  |  |                   |    |            |       |       |       |                |        |       |                    |  |         |    |            |       |       |       |                |        |       |                     |  |       |    |            |       |       |       |                |        |       |                        |  |         |    |            |       |       |                                    |                |        |  |                       |     |         |    |            |       |       |  |                |        |  |                          |  |         |    |  |       |       |  |  |  |  |  |  |         |     |            |       |       |  |  |  |  |  |  |                |    |            |       |       |  |                |        |  |                   |     |                |    |            |       |       |  |                |        |  |                   |     |                   |    |  |       |       |  |                |        |  |                   |     |         |    |            |       |       |  |  |  |  |  |  |             |     |            |       |       |  |  |  |  |  |  |         |    |            |       |       |  |                |        |  |                       |     |         |     |            |       |       |  |                |        |  |                          |  |         |     |            |       |       |  |                |        |  |                   |     |         |     |            |       |  |  |                |        |  |                   |     |  |   |     |       |       |       |                |                                    |                |                       |  |                     |    |            |    |       |       |       |           |                |        |  |                        |    |     |       |       |       |       |           |  |  |  |         |    |            |    |       |       |       |  |  |  |  |         |     |            |    |       |       |       |  |  |  |  |        |     |                |       |       |       |                |        |  |                       |  |  |  |         |    |  |       |                |           |  |                          |  |  |  |     |  |            |       |  |       |                |        |       |                    |  |     |    |            |       |  |       |                |        |       |                     |  |         |    |            |       |  |       |                |        |       |                        |  |         |    |            |       |       |                                    |                |        |  |                       |  |     |    |  |       |       |  |                |        |  |                          |  |         |    |            |       |       |  |  |  |  |  |  |         |    |            |       |       |  |  |  |  |  |  |                |    |            |       |       |  |  |  |  |  |  |         |    |            |       |       |  |  |  |  |  |  |                   |    |            |       |       |  |                |        |   |                 |  |     |    |  |       |       |  |  |  |  |  |  |       |    |            |       |       |  |  |  |  |  |  |         |    |            |       |       |  |                |        |  |                       |  |         |    |            |       |       |  |                |        |  |                          |  |         |    |            |       |       |  |  |  |  |  |  |                |     |            |       |       |  |  |  |  |  |  |         |    |  |       |       |  |                |        |  |                       |  |         |    |            |  |       |  |  |  |  |  |  |             |    |  |       |       |  |  |  |  |  |  |         |    |            |  |       |  |  |  |  |  |  |         |     |            |       |       |  |  |  |  |  |  |         |     |            |       |       |  |                |        |  |                       |  |  |  |  |  |  |  |                |        |  |                          |  |  |  |     |  |            |       |  |  |                |        |   |                 |  |     |    |            |       |  |  |  |  |  |  |  |         |    |            |       |  |  |  |  |  |  |  |         |    |            |       |  |  |  |  |  |  |  |     |    |  |       |       |  |  |  |  |  |  |         |    |            |       |  |  |  |  |  |  |  |       |    |            |       |  |  |  |  |  |  |  |         |    |            |       |  |  |  |  |  |  |  |         |    |            |       |  |  |  |  |  |  |  |     |  |            |  |       |  |                |        |   |                 |  |     |    |  |       |       |  |  |  |  |  |  |     |    |            |  |       |  |  |  |  |  |  |         |    |  |       |       |  |  |  |  |  |  |         |    |            |  |       |  |  |  |  |  |  |         |    |            |  |       |  |  |  |  |  |  |                |    |  |       |       |  |  |  |  |  |  |         |    |  |       |       |  |  |  |  |  |  |         |    |            |  |       |  |  |  |  |  |  |             |    |  |       |       |  |  |  |  |  |  |         |    |            |  |       |  |  |  |  |  |  |        |     |  |       |       |  |  |  |  |  |  |         |     |            |  |       |  |  |  |  |  |  |
| 2.0 HDi  | 66   | ORGA 09457 |       | 02.09      |                                    |                |                                    |                |                          |     |                     |     |     |    |            |       |       |           |                |        |  |                        |     |             |    |            |       |       |           |                |        |  |                     |     |         |    |            |       |       |  |                |        |  |                     |     |             |    |  |       |       |  |  |  |  |  |  |                |    |            |       |       |       |                |        |  |                     |     |         |    |            |       |       |           |  |  |  |  |  |                   |    |            |       |       |       |                |        |       |                    |  |         |    |            |       |       |       |                |        |       |                     |  |       |    |            |       |       |       |                |        |       |                        |  |         |    |            |       |       |                                    |                |        |  |                       |     |         |    |            |       |       |  |                |        |  |                          |  |         |    |  |       |       |  |  |  |  |  |  |         |     |            |       |       |  |  |  |  |  |  |                |    |            |       |       |  |                |        |  |                   |     |                |    |            |       |       |  |                |        |  |                   |     |                   |    |  |       |       |  |                |        |  |                   |     |         |    |            |       |       |  |  |  |  |  |  |             |     |            |       |       |  |  |  |  |  |  |         |    |            |       |       |  |                |        |  |                       |     |         |     |            |       |       |  |                |        |  |                          |  |         |     |            |       |       |  |                |        |  |                   |     |         |     |            |       |  |  |                |        |  |                   |     |  |   |     |       |       |       |                |                                    |                |                       |  |                     |    |            |    |       |       |       |           |                |        |  |                        |    |     |       |       |       |       |           |  |  |  |         |    |            |    |       |       |       |  |  |  |  |         |     |            |    |       |       |       |  |  |  |  |        |     |                |       |       |       |                |        |  |                       |  |  |  |         |    |  |       |                |           |  |                          |  |  |  |     |  |            |       |  |       |                |        |       |                    |  |     |    |            |       |  |       |                |        |       |                     |  |         |    |            |       |  |       |                |        |       |                        |  |         |    |            |       |       |                                    |                |        |  |                       |  |     |    |  |       |       |  |                |        |  |                          |  |         |    |            |       |       |  |  |  |  |  |  |         |    |            |       |       |  |  |  |  |  |  |                |    |            |       |       |  |  |  |  |  |  |         |    |            |       |       |  |  |  |  |  |  |                   |    |            |       |       |  |                |        |   |                 |  |     |    |  |       |       |  |  |  |  |  |  |       |    |            |       |       |  |  |  |  |  |  |         |    |            |       |       |  |                |        |  |                       |  |         |    |            |       |       |  |                |        |  |                          |  |         |    |            |       |       |  |  |  |  |  |  |                |     |            |       |       |  |  |  |  |  |  |         |    |  |       |       |  |                |        |  |                       |  |         |    |            |  |       |  |  |  |  |  |  |             |    |  |       |       |  |  |  |  |  |  |         |    |            |  |       |  |  |  |  |  |  |         |     |            |       |       |  |  |  |  |  |  |         |     |            |       |       |  |                |        |  |                       |  |  |  |  |  |  |  |                |        |  |                          |  |  |  |     |  |            |       |  |  |                |        |   |                 |  |     |    |            |       |  |  |  |  |  |  |  |         |    |            |       |  |  |  |  |  |  |  |         |    |            |       |  |  |  |  |  |  |  |     |    |  |       |       |  |  |  |  |  |  |         |    |            |       |  |  |  |  |  |  |  |       |    |            |       |  |  |  |  |  |  |  |         |    |            |       |  |  |  |  |  |  |  |         |    |            |       |  |  |  |  |  |  |  |     |  |            |  |       |  |                |        |   |                 |  |     |    |  |       |       |  |  |  |  |  |  |     |    |            |  |       |  |  |  |  |  |  |         |    |  |       |       |  |  |  |  |  |  |         |    |            |  |       |  |  |  |  |  |  |         |    |            |  |       |  |  |  |  |  |  |                |    |  |       |       |  |  |  |  |  |  |         |    |  |       |       |  |  |  |  |  |  |         |    |            |  |       |  |  |  |  |  |  |             |    |  |       |       |  |  |  |  |  |  |         |    |            |  |       |  |  |  |  |  |  |        |     |  |       |       |  |  |  |  |  |  |         |     |            |  |       |  |  |  |  |  |  |
| 2.0 RC   | 130  |            | 07.03 | 02.09      |                                    |                |                                    |                |                          |     |                     |     |     |    |            |       |       |           |                |        |  |                        |     |             |    |            |       |       |           |                |        |  |                     |     |         |    |            |       |       |  |                |        |  |                     |     |             |    |  |       |       |  |  |  |  |  |  |                |    |            |       |       |       |                |        |  |                     |     |         |    |            |       |       |           |  |  |  |  |  |                   |    |            |       |       |       |                |        |       |                    |  |         |    |            |       |       |       |                |        |       |                     |  |       |    |            |       |       |       |                |        |       |                        |  |         |    |            |       |       |                                    |                |        |  |                       |     |         |    |            |       |       |  |                |        |  |                          |  |         |    |  |       |       |  |  |  |  |  |  |         |     |            |       |       |  |  |  |  |  |  |                |    |            |       |       |  |                |        |  |                   |     |                |    |            |       |       |  |                |        |  |                   |     |                   |    |  |       |       |  |                |        |  |                   |     |         |    |            |       |       |  |  |  |  |  |  |             |     |            |       |       |  |  |  |  |  |  |         |    |            |       |       |  |                |        |  |                       |     |         |     |            |       |       |  |                |        |  |                          |  |         |     |            |       |       |  |                |        |  |                   |     |         |     |            |       |  |  |                |        |  |                   |     |  |   |     |       |       |       |                |                                    |                |                       |  |                     |    |            |    |       |       |       |           |                |        |  |                        |    |     |       |       |       |       |           |  |  |  |         |    |            |    |       |       |       |  |  |  |  |         |     |            |    |       |       |       |  |  |  |  |        |     |                |       |       |       |                |        |  |                       |  |  |  |         |    |  |       |                |           |  |                          |  |  |  |     |  |            |       |  |       |                |        |       |                    |  |     |    |            |       |  |       |                |        |       |                     |  |         |    |            |       |  |       |                |        |       |                        |  |         |    |            |       |       |                                    |                |        |  |                       |  |     |    |  |       |       |  |                |        |  |                          |  |         |    |            |       |       |  |  |  |  |  |  |         |    |            |       |       |  |  |  |  |  |  |                |    |            |       |       |  |  |  |  |  |  |         |    |            |       |       |  |  |  |  |  |  |                   |    |            |       |       |  |                |        |   |                 |  |     |    |  |       |       |  |  |  |  |  |  |       |    |            |       |       |  |  |  |  |  |  |         |    |            |       |       |  |                |        |  |                       |  |         |    |            |       |       |  |                |        |  |                          |  |         |    |            |       |       |  |  |  |  |  |  |                |     |            |       |       |  |  |  |  |  |  |         |    |  |       |       |  |                |        |  |                       |  |         |    |            |  |       |  |  |  |  |  |  |             |    |  |       |       |  |  |  |  |  |  |         |    |            |  |       |  |  |  |  |  |  |         |     |            |       |       |  |  |  |  |  |  |         |     |            |       |       |  |                |        |  |                       |  |  |  |  |  |  |  |                |        |  |                          |  |  |  |     |  |            |       |  |  |                |        |   |                 |  |     |    |            |       |  |  |  |  |  |  |  |         |    |            |       |  |  |  |  |  |  |  |         |    |            |       |  |  |  |  |  |  |  |     |    |  |       |       |  |  |  |  |  |  |         |    |            |       |  |  |  |  |  |  |  |       |    |            |       |  |  |  |  |  |  |  |         |    |            |       |  |  |  |  |  |  |  |         |    |            |       |  |  |  |  |  |  |  |     |  |            |  |       |  |                |        |   |                 |  |     |    |  |       |       |  |  |  |  |  |  |     |    |            |  |       |  |  |  |  |  |  |         |    |  |       |       |  |  |  |  |  |  |         |    |            |  |       |  |  |  |  |  |  |         |    |            |  |       |  |  |  |  |  |  |                |    |  |       |       |  |  |  |  |  |  |         |    |  |       |       |  |  |  |  |  |  |         |    |            |  |       |  |  |  |  |  |  |             |    |  |       |       |  |  |  |  |  |  |         |    |            |  |       |  |  |  |  |  |  |        |     |  |       |       |  |  |  |  |  |  |         |     |            |  |       |  |  |  |  |  |  |
| 2.0 S16  | 100  | ORGA 09457 |       | 02.09      |                                    |                |                                    |                |                          |     |                     |     |     |    |            |       |       |           |                |        |  |                        |     |             |    |            |       |       |           |                |        |  |                     |     |         |    |            |       |       |  |                |        |  |                     |     |             |    |  |       |       |  |  |  |  |  |  |                |    |            |       |       |       |                |        |  |                     |     |         |    |            |       |       |           |  |  |  |  |  |                   |    |            |       |       |       |                |        |       |                    |  |         |    |            |       |       |       |                |        |       |                     |  |       |    |            |       |       |       |                |        |       |                        |  |         |    |            |       |       |                                    |                |        |  |                       |     |         |    |            |       |       |  |                |        |  |                          |  |         |    |  |       |       |  |  |  |  |  |  |         |     |            |       |       |  |  |  |  |  |  |                |    |            |       |       |  |                |        |  |                   |     |                |    |            |       |       |  |                |        |  |                   |     |                   |    |  |       |       |  |                |        |  |                   |     |         |    |            |       |       |  |  |  |  |  |  |             |     |            |       |       |  |  |  |  |  |  |         |    |            |       |       |  |                |        |  |                       |     |         |     |            |       |       |  |                |        |  |                          |  |         |     |            |       |       |  |                |        |  |                   |     |         |     |            |       |  |  |                |        |  |                   |     |  |   |     |       |       |       |                |                                    |                |                       |  |                     |    |            |    |       |       |       |           |                |        |  |                        |    |     |       |       |       |       |           |  |  |  |         |    |            |    |       |       |       |  |  |  |  |         |     |            |    |       |       |       |  |  |  |  |        |     |                |       |       |       |                |        |  |                       |  |  |  |         |    |  |       |                |           |  |                          |  |  |  |     |  |            |       |  |       |                |        |       |                    |  |     |    |            |       |  |       |                |        |       |                     |  |         |    |            |       |  |       |                |        |       |                        |  |         |    |            |       |       |                                    |                |        |  |                       |  |     |    |  |       |       |  |                |        |  |                          |  |         |    |            |       |       |  |  |  |  |  |  |         |    |            |       |       |  |  |  |  |  |  |                |    |            |       |       |  |  |  |  |  |  |         |    |            |       |       |  |  |  |  |  |  |                   |    |            |       |       |  |                |        |   |                 |  |     |    |  |       |       |  |  |  |  |  |  |       |    |            |       |       |  |  |  |  |  |  |         |    |            |       |       |  |                |        |  |                       |  |         |    |            |       |       |  |                |        |  |                          |  |         |    |            |       |       |  |  |  |  |  |  |                |     |            |       |       |  |  |  |  |  |  |         |    |  |       |       |  |                |        |  |                       |  |         |    |            |  |       |  |  |  |  |  |  |             |    |  |       |       |  |  |  |  |  |  |         |    |            |  |       |  |  |  |  |  |  |         |     |            |       |       |  |  |  |  |  |  |         |     |            |       |       |  |                |        |  |                       |  |  |  |  |  |  |  |                |        |  |                          |  |  |  |     |  |            |       |  |  |                |        |   |                 |  |     |    |            |       |  |  |  |  |  |  |  |         |    |            |       |  |  |  |  |  |  |  |         |    |            |       |  |  |  |  |  |  |  |     |    |  |       |       |  |  |  |  |  |  |         |    |            |       |  |  |  |  |  |  |  |       |    |            |       |  |  |  |  |  |  |  |         |    |            |       |  |  |  |  |  |  |  |         |    |            |       |  |  |  |  |  |  |  |     |  |            |  |       |  |                |        |   |                 |  |     |    |  |       |       |  |  |  |  |  |  |     |    |            |  |       |  |  |  |  |  |  |         |    |  |       |       |  |  |  |  |  |  |         |    |            |  |       |  |  |  |  |  |  |         |    |            |  |       |  |  |  |  |  |  |                |    |  |       |       |  |  |  |  |  |  |         |    |  |       |       |  |  |  |  |  |  |         |    |            |  |       |  |  |  |  |  |  |             |    |  |       |       |  |  |  |  |  |  |         |    |            |  |       |  |  |  |  |  |  |        |     |  |       |       |  |  |  |  |  |  |         |     |            |  |       |  |  |  |  |  |  |























<sup>1)</sup> - ventilated discs / - dischi ventilati / - disques ventilés / - disco ventilado

<sup>2)</sup> + ventilated discs / + dischi ventilati / + disques ventilés / + disco ventilado

|     |                                |  |    |                 |  |  |  |                                    |  |            |
|--|--|--|--|---|---|--|--|--|--|------------|
| <b>PEUGEOT 206 Limousine (98-09)</b>   |  |  |  |   |   |  |  |  |  |            |
|    | 1.4 16V<br>1.6 16V<br>1.6 HDi 110<br>2.0 RC<br>2.0 S16<br>2.0 S16  | 65<br>80<br>80<br>130<br>99<br>100   |  | 10.03<br>12.00<br>05.04<br>07.03<br>04.99<br>10.00  | 02.09<br>02.09<br>02.09<br>02.09<br>10.00<br>02.09                                | 13.0460-3823.2<br>13.0460-0435.2   | 603823<br>610435   | 20974 11,0<br>Belagsatz-Zubehör  | BOS<br>BDX                                       |            |
|    | 1.4 16V<br>1.6 16V<br>1.6 HDi 110<br>2.0 RC<br>2.0 S16<br>2.0 S16  | 65<br>80<br>80<br>130<br>99<br>100   |  | 10.03<br>12.00<br>05.04<br>07.03<br>04.99<br>10.00  | 02.09<br>02.09<br>02.09<br>02.09<br>10.00<br>02.09                                | 24.0108-0106.1   | 408106   | 247 8,0 6,0 +S +B  |  |            |
|    | 1.1<br>1.4<br>1.4 HDi<br>1.4 HDi<br>1.6<br>1.6 16V<br>1.9 D<br>2.0 HDi<br>2.0 S16<br>2.0 S16                   | 55<br>50<br>51<br>65<br>80<br>51<br>66<br>99<br>100                              | ORGA 09456<br>ORGA 09456<br>ORGA 09456<br>ORGA 09456<br>ORGA 09456<br>ORGA 09456<br>ORGA 09456<br>ORGA 09456<br>ORGA 09456 | 09.98<br>10.98<br>09.01<br>09.02<br>10.98<br>12.00<br>10.98<br>12.00<br>12.99<br>04.99<br>10.00 | 02.09<br>02.09<br>02.09<br>02.09<br>12.00<br>12.00<br>10.00<br>10.00              | 24.0741-1116.3   | 360043   | 2                                 | Radsensor L=826                                  |            |
|  | 1.1<br>1.4<br>1.4<br>1.4 HDi<br>1.4 HDi<br>1.4 HDi eco 70<br>1.4 LPG<br>2.0 HDi                                | 55<br>55<br>50<br>51<br>50<br>55<br>66   | ORGA 09457<br>ORGA 09457<br>ORGA 09457<br>ORGA 09457<br>ORGA 09457<br>ORGA 09457   | 03.07<br>02.09<br>02.09<br>02.09<br>02.09<br>09.08<br>05.06                                     | 02.09<br>02.09<br>02.09<br>02.09<br>02.09<br>02.09<br>02.09                       | 24.0711-5136.3   | 360109   | 2  + Trommelbremse <sup>1)</sup>  | Radsensor L=846                                  |            |
|  | 1.4 16V<br>1.6 16V<br>1.6 HDi 110<br>2.0 RC<br>2.0 S16   | 65<br>80<br>80<br>130<br>100   | ORGA 09457<br>ORGA 09457<br>ORGA 09457   | 10.03<br>05.04<br>07.03   | 02.09<br>02.09<br>02.09   | 24.0711-5135.3   | 360108   | 2  + Scheibenbremse <sup>2)</sup> | Radsensor L=846                                  |            |
|    | 1.1<br>1.4<br>1.4<br>1.4 HDi<br>1.4 HDi<br>1.4 HDi eco 70<br>1.4 LPG<br>1.6<br>1.9 D                           | 55<br>55<br>50<br>51<br>50<br>55<br>65<br>51                                     |  | 09.98<br>03.07<br>09.98<br>09.01<br>09.02<br>09.08<br>05.06<br>09.98<br>09.98                   | 02.09<br>02.09<br>02.09<br>02.09<br>02.07<br>02.09<br>02.09<br>12.00<br>02.09     | 03.0137-0354.2<br>03.0137-9088.2   | 650354<br>669088   | - ABS<br>- ABS<br>- ABS<br>- ABS<br>- ABS<br>- ABS<br>- ABS<br>- ABS<br>- ABS  | 180 x 32 HEB<br>Bremsbacken-Zubehör              | BDX<br>BDX |
|  | 1.1<br>1.4<br>1.4 HDi<br>1.4 HDi<br>1.6<br>1.9 D<br>2.0 HDi  | 55<br>50<br>51<br>65<br>51<br>66   | ORGA 09456<br>ORGA 09456<br>ORGA 09456<br>ORGA 09456<br>ORGA 09456<br>ORGA 09456   | 09.98<br>09.98<br>09.01<br>09.02<br>09.98<br>09.98<br>12.99                                     | + ABS<br>+ ABS<br>+ ABS<br>+ ABS<br>+ ABS<br>+ ABS                                | 03.0137-0312.2<br>03.0137-9158.2   | 650312<br>669158   |  | 203 x 38 HEB<br>Bremsbacken-Zubehör              | TRW<br>TRW |
|  | 1.1<br>1.4<br>1.4<br>1.4 16V<br>1.4 HDi<br>1.4 HDi<br>1.4 HDi eco 70<br>1.4 LPG<br>1.6 16V<br>1.9 D<br>2.0 HDi | 55<br>55<br>50<br>65<br>51<br>50<br>55<br>80<br>51<br>66                         | ORGA 09457<br>ORGA 09457<br>ORGA 09457<br>ORGA 09457<br>ORGA 09457   | 03.07<br>10.03<br>02.09<br>02.09<br>02.07<br>09.08<br>05.06<br>12.00                            | + ABS<br>+ ABS<br>+ ABS<br>+ ABS<br>+ ABS<br>+ ABS<br>+ ABS<br>+ ABS              | 03.0137-0446.2<br>03.0137-9278.2   | 650446<br>669278   |  | 203 x 39<br>Bremsbacken-Zubehör                  | TRW<br>TRW |
|  | 1.1<br>1.4<br>1.4<br>1.4 HDi<br>1.4 HDi<br>1.4 HDi eco 70<br>1.4 LPG<br>1.6<br>1.9 D                           | 55<br>55<br>50<br>51<br>50<br>55<br>65<br>51                                     |  | 09.98<br>03.07<br>09.98<br>09.01<br>09.02<br>09.08<br>05.06<br>09.98<br>09.98                   | 02.09<br>02.09<br>02.09<br>02.09<br>02.09<br>02.09<br>02.09<br>12.00<br>02.09     | 24.0218-0020.1<br>24.0218-0720.2   | 480074<br>480205   | - ABS<br>- ABS<br>- ABS<br>- ABS<br>- ABS<br>- ABS<br>- ABS<br>- ABS<br>- ABS  | 180/181 x 46 - Lager<br>180/181 x 46 + Lager     |            |
|  | 1.1<br>1.4<br>1.4 16V<br>1.4 HDi<br>1.4 HDi<br>1.6<br>1.6 16V<br>1.9 D<br>2.0 HDi                              | 55<br>65<br>50<br>51<br>65<br>80<br>51<br>66                                     | ORGA 10254<br>ORGA 10254<br>ORGA 10254<br>ORGA 10254   | 09.98<br>09.98<br>10.03<br>09.01<br>09.02<br>09.98<br>12.00<br>09.98<br>12.99                   | + ABS<br>+ ABS<br>02.09<br>+ ABS<br>+ ABS<br>+ ABS<br>+ ABS<br>+ ABS              | 24.0220-3013.1   | 480089   |  | 203/204,5 x 46,5                                 |            |
|  | 1.1<br>1.4<br>1.4<br>1.4 HDi<br>1.4 HDi<br>1.6<br>1.6 16V<br>1.9 D<br>2.0 HDi                                  | 55<br>55<br>50<br>51<br>65<br>80<br>51<br>66                                     | ORGA 10255<br>ORGA 10255<br>ORGA 10255<br>ORGA 10255   | 03.07<br>02.09<br>02.09<br>02.09<br>02.09<br>02.09<br>02.09<br>12.99                            | + ABS<br>+ ABS<br>+ ABS<br>+ ABS<br>+ ABS<br>+ ABS<br>+ ABS                       | 24.0220-3029.1<br>24.0220-3729.2   | 480179<br>480217   | ohne Sensorring <sup>3)</sup><br>mit Sensorring <sup>4)</sup>  | 203/204,5 x 42 - Lager<br>203/204,5 x 42 + Lager |            |

1) + drum brake / + freno a tamburo / + freins à tambour / + tambores de freno  
2) + disc brake / + disco freno / + disques de frein / + disco de freno  
3) without sensor ring / senza sensori / sans secours ABS / sin anillo sensor ABS  
4) with sensor ring / con sensori / avec secours ABS / con anillo sensor ABS



|     |                                |  |                |  |  |           |  |  |   |   |
|--|--|--|--|--|---|---|--|--|---|---|
| <b>PEUGEOT 206 Limousine (98-09)</b>   |  |  |  |  |   |   |  |  |   |   |
|    | 1.4 LPG  | 55   |  | 05.06  | 09.07   | + ABS   | 24.0220-3029.1<br>24.0220-3729.2   | 480179<br>480217   | ohne Sensorring <sup>1)</sup><br>mit Sensorring <sup>2)</sup>                           | 203/204,5 x 42 - Lager<br>203/204,5 x 42 + Lager  |
|    | 1.1<br>1.4<br>1.4 HDi<br>1.4 HDi<br>1.4 HDi eco 70<br>1.6<br>1.9 D   | 55<br>50<br>51<br>50<br>65<br>51   |  | 09.98<br>09.98<br>09.01<br>09.02<br>09.08<br>09.98<br>09.98                      | 02.09<br>02.09<br>02.09<br>02.07<br>02.09<br>12.00<br>02.09                       | - ABS<br>- ABS<br>- ABS<br>- ABS<br>- ABS<br>- ABS/ + Schaltgetriebe <sup>4)</sup><br>- ABS | 03.0520-4819.3   | 694819   | - integriertem Regler <sup>3)</sup>   | 19,05/180x32 TopKit BDX   |
|  | 1.1<br>1.4<br>1.4 HDi<br>1.4 HDi<br>1.4 HDi eco 70<br>1.6  | 55<br>50<br>51<br>50<br>65   |  | 09.98<br>09.98<br>09.01<br>09.02<br>09.08<br>09.98                               | 02.09<br>02.09<br>02.09<br>02.09<br>02.09<br>12.00                                | - ABS<br>- ABS<br>- ABS<br>- ABS<br>- ABS<br>- ABS/ + Schaltgetriebe <sup>4)</sup>          | 03.0520-6520.3   | 696520   |   | 20,64/180x32 TopKit BDX   |
|  | 1.1<br>1.4<br>1.4 HDi<br>1.4 HDi<br>1.6<br>1.9 D<br>2.0 HDi  | 55<br>50<br>51<br>50<br>65<br>51<br>66   | ORGA 09456<br>ORGA 09456<br>ORGA 09456<br>ORGA 09456<br>ORGA 09456<br>ORGA 09456               | 09.98<br>09.98<br>09.01<br>09.02<br>09.98<br>12.99                               |   | + ABS<br>+ ABS<br>+ ABS<br>+ ABS<br>+ ABS<br>+ ABS  | 03.0520-6420.3   | 696420   |   | 20,64/203x39 TopKit TRW   |
|  | 1.1<br>1.4<br>1.4<br>1.4 16V<br>1.4 HDi<br>1.4 HDi<br>1.4 HDi eco 70<br>1.4 LPG<br>1.6 16V<br>1.9 D<br>2.0 HDi | 55<br>55<br>65<br>50<br>51<br>50<br>55<br>80<br>51<br>66                         | ORGA 09457<br>ORGA 09457<br>ORGA 09457<br>ORGA 09457<br>ORGA 09457<br>ORGA 09457<br>ORGA 09457 | 03.07<br>10.03<br>09.08<br>05.06<br>12.00  | 02.09<br>02.09<br>02.09<br>02.09<br>02.09<br>09.07<br>02.09                       | + ABS<br>+ ABS<br>+ ABS<br>+ ABS<br>+ ABS<br>+ ABS<br>+ ABS                                 | 03.0520-7720.3   | 697720   |   | 20,64/203x39 TopKit TRW   |
| <b>PEUGEOT 206 CC (00-07)</b>  |  |  |  |  |   |   |  |  |   |   |
|    | 1.6 16V<br>2.0 16V   | 80<br>100  | ORGA 09078<br>ORGA 09078   | 09.00<br>09.00   |   |   | 13.0460-3978.2   | 603978   |   | 23332 18,0 +/Zub/S BOS  |
|  | 1.6 16V<br>1.6 HDi 110<br>2.0 16V<br>1.6 16V   | 80<br>80<br>100<br>80  | ORGA 09079<br>ORGA 09079<br>ORGA 09079<br>ORGA 10950   | 09.00<br>04.05<br>01.07<br>01.07   |   |   | 13.0460-3994.2<br>13.0470-3994.2<br>13.0460-0454.2                                 | 603994<br>LD3994<br>610454   |   | 23599 19,0 /Zub/S BOS<br>23599 19,0 /Zub/S BOS<br>Belagsatz-Zubehör BOS<br>23346 19,0 /WE/S TRW |
|  | 1.6 16V<br>2.0 16V   | 80<br>100  | ORGA 09078<br>ORGA 09078   | 09.00<br>09.00   |   |   | 24.0120-0133.1<br>24.0320-0133.1   | 420133<br>520133   |   | 266 20,5 18,5 V +S +B<br>266 20,5 18,5 V +S +B PD   |
|  | 1.6 16V<br>1.6 HDi 110<br>2.0 16V  | 80<br>80<br>100  | ORGA 09079<br>ORGA 09079<br>ORGA 09079   | 04.05<br>01.07<br>01.07  |   |   | 24.0122-0194.1   | 422194   |   | 266 22,0 20,0 V +S +B   |
|  | 1.6 16V<br>2.0 16V   | 80<br>100  | ORGA 09456<br>ORGA 09456   | 09.00<br>09.00   |   |   | 24.0713-1115.3   | 360035   | 2  | Radsensor L=815   |
|  | 1.6 16V<br>1.6 HDi 110<br>2.0 16V  | 80<br>80<br>100  | ORGA 09457   | 09.00<br>04.05<br>09.02  | 01.07<br>01.07<br>01.07   |   | 24.0711-6205.3   | 360229   | 2  | Radsensor L=815   |
|  | 1.6 16V<br>1.6 HDi 110<br>2.0 16V  | 80<br>80<br>100  |  | 09.00<br>04.05<br>09.00  | 01.07<br>01.07<br>01.07   |   | 13.0460-3823.2<br>13.0460-0435.2   | 603823<br>610435   |   | 20974 11,0 BOS<br>Belagsatz-Zubehör BDX   |
|  | 1.6 16V<br>1.6 HDi 110<br>2.0 16V  | 80<br>80<br>100  |  | 09.00<br>04.05<br>09.00  | 01.07<br>01.07<br>01.07   |   | 24.0108-0106.1   | 408106   |   | 247 8,0 6,0 +S +B   |
|  | 1.6 16V<br>2.0 16V   | 80<br>100  | ORGA 09456<br>ORGA 09456   | 09.00<br>09.00   |   |   | 24.0741-1116.3   | 360043   | 2  | Radsensor L=826   |
|  | 1.6 16V<br>1.6 HDi 110<br>2.0 16V  | 80<br>80<br>100  | ORGA 09457<br>ORGA 09457   | 04.05<br>01.07<br>01.07  | 01.07<br>01.07<br>01.07   |   | 24.0711-5135.3   | 360108   | 2  | Radsensor L=846   |
| <b>PEUGEOT 206 SW (02-07)</b>  |  |  |  |  |   |   |  |  |   |   |
|  | 1.1<br>1.4<br>1.4 HDi  | 44<br>55<br>50   |  | 07.02<br>07.02<br>07.02  | 05.07<br>05.07<br>05.07   |   | 13.0460-3975.2   | 603975   |   | 23597 18,0 +/S BOS  |
|  | 1.4 16V<br>1.6 16V<br>1.6 HDi 110<br>2.0 HDi<br>2.0 S16  | 65<br>80<br>80<br>66<br>100  | ORGA 10808<br>ORGA 10808   | 10.03<br>07.02<br>05.04<br>07.02<br>07.02  | 05.07<br>05.07<br>05.07<br>05.07<br>05.07   |   | 13.0460-3994.2<br>13.0470-3994.2<br>13.0460-0454.2                                 | 603994<br>LD3994<br>610454   |   | 23599 19,0 /Zub/S BOS<br>23599 19,0 /Zub/S BOS<br>Belagsatz-Zubehör BOS                         |
|  | 1.6 16V<br>2.0 HDi   | 80<br>66   | ORGA 10809<br>ORGA 10809   | 05.07<br>05.07   | 05.07<br>05.07  |   | 13.0460-2862.2   | 602862   |   | 23346 19,0 /WE/S TRW  |
|  | 1.1<br>1.4<br>1.4 HDi  | 44<br>55<br>50   |  | 07.02<br>07.02<br>07.02  | 05.07<br>05.07<br>05.07   | - belüftete Scheiben <sup>5)</sup><br>- belüftete Scheiben <sup>5)</sup>                    | 24.0113-0185.1<br>24.0313-0185.1   | 413185<br>513185   |   | 248 13,0 11,0 +S +B<br>248 13,0 11,0 +S +B PD   |
|  | 1.4<br>1.4 HDi   | 55<br>50   |  | 07.02<br>07.02   | 05.07<br>05.07  | + belüftete Scheiben <sup>6)</sup><br>+ belüftete Scheiben <sup>6)</sup>                    | 24.0120-0132.1   | 420132   |   | 247 20,4 18,5 V +S +B   |
|  | 1.4 16V<br>1.6 16V<br>1.6 HDi 110<br>2.0 HDi   | 65<br>80<br>80<br>66   |  | 10.03<br>07.02<br>05.04<br>07.02   | 05.07<br>05.07<br>05.07<br>05.07  |   | 24.0122-0194.1   | 422194   |   | 266 22,0 20,0 V +S +B   |

<sup>1)</sup> without sensor ring / senza sensori / sans secours ABS / sin anillo sensor ABS

<sup>2)</sup> with sensor ring / con sensori / avec secours ABS / con anillo sensor ABS



























<sup>3)</sup> - built-in corrector / - regolatore incorporato / - correcteur intégré / - regulador integrado

<sup>4)</sup> - ABS/ + manual transmission / - ABS/+ scatola camb.velocità / - ABS/ + transmission mécanique / - ABS/ + cambio de velocidad

<sup>5)</sup> - ventilated discs / - dischi ventilati / - disques ventilés / - disco ventilado























<sup>6)</sup> + ventilated discs / + dischi ventilati / + disques ventilés / + disco ventilado



|     |  |  |  |  |  |  |  |  |   |                          |
|--|--|--|--|--|---|--|--|--|---|--------------------------|
| <b>PEUGEOT 206 SW (02-07)</b>  |  |  |  |  |   |  |  |  |   |                          |
|    | 2.0 S16  | 100  |  | 07.02  | 05.07   |  | 24.0122-0194.1   | 422194   | 266 22,0 20,0 V +S +B   |                          |
|    | 1.1  | 44   | ORGA 09456   | 07.02  |   |  | 24.0713-1115.3   | 360035   | 2    | Radsensor L=815          |
|  | 1.4  | 55   | ORGA 09456   | 07.02  |   |  |  |  |   |                          |
|  | 1.4 HDi  | 50   | ORGA 09456   | 07.02  |   |  |  |  |   |                          |
|  | 1.6 16V  | 80   | ORGA 09456   | 07.02  |   |  |  |  |   |                          |
|  | 2.0 HDi  | 66   | ORGA 09456   | 07.02  |   |  |  |  |   |                          |
|  | 2.0 S16  | 100  | ORGA 09456   | 07.02  |   |  |  |  |   |                          |
|  | 1.1  | 44   | ORGA 09457   |  | 05.07   |  | 24.0711-6205.3   | 360229   | 2    | Radsensor L=815          |
|  | 1.4  | 55   | ORGA 09457   |  | 05.07   |  |  |  |   |                          |
|  | 1.4 16V  | 65   |  | 10.03  | 05.07   |  |  |  |   |                          |
|  | 1.4 HDi  | 50   | ORGA 09457   |  | 05.07   |  |  |  |   |                          |
|  | 1.6 16V  | 80   | ORGA 09457   |  | 05.07   |  |  |  |   |                          |
|  | 1.6 HDi 110  | 80   |  | 05.04  | 05.07   |  |  |  |   |                          |
|  | 2.0 HDi  | 66   | ORGA 09457   |  | 05.07   |  |  |  |   |                          |
|  | 2.0 S16  | 100  | ORGA 09457   |  | 05.07   |  |  |  |   |                          |
|    | 1.4 16V  | 65   |  | 10.03  | 05.07   |  | 13.0460-3823.2   | 603823   |   | 20974 11,0 BOS           |
|  | 1.6 16V  | 80   |  | 07.02  | 05.07   |  | 13.0460-0435.2   | 610435   |   | Belagsatz-Zubehör BDX    |
|  | 1.6 HDi 110  | 80   |  | 05.04  | 05.07   |  |  |  |   |                          |
|  | 2.0 S16  | 100  |  | 07.02  | 05.07   |  |  |  |   |                          |
|    | 1.4 16V  | 65   |  | 10.03  | 05.07   |  | 24.0108-0106.1   | 408106   |   | 247 8,0 6,0 +S +B        |
|  | 1.6 16V  | 80   |  | 07.02  | 05.07   |  |  |  |   |                          |
|  | 1.6 HDi 110  | 80   |  | 05.04  | 05.07   |  |  |  |   |                          |
|  | 2.0 S16  | 100  |  | 07.02  | 05.07   |  |  |  |   |                          |
|    | 1.1  | 44   | ORGA 09456   | 07.02  |   |  | 24.0741-1116.3   | 360043   | 2    | Radsensor L=826          |
|  | 1.4  | 55   | ORGA 09456   | 07.02  |   |  |  |  |   |                          |
|  | 1.4 HDi  | 50   | ORGA 09456   | 07.02  |   |  |  |  |   |                          |
|  | 1.6 16V  | 80   | ORGA 09456   | 07.02  |   |  |  |  |   |                          |
|  | 2.0 HDi  | 66   | ORGA 09456   | 07.02  |   |  |  |  |   |                          |
|  | 2.0 S16  | 100  | ORGA 09456   | 07.02  |   |  |  |  |   |                          |
|  | 1.1  | 44   | ORGA 09457   |  | 05.07   |  | 24.0711-5136.3   | 360109   | 2    | Radsensor L=846          |
|  | 1.4  | 55   | ORGA 09457   |  | 05.07   |  |  |  |   |                          |
|  | 1.4 16V  | 65   |  | 10.03  | 05.07   |  |  |  |   |                          |
|  | 1.4 HDi  | 50   | ORGA 09457   |  | 05.07   |  |  |  |   |                          |
|  | 2.0 HDi  | 66   | ORGA 09457   |  | 05.07   |  |  |  |   |                          |
|  | 1.6 16V  | 80   | ORGA 09457   |  | 05.07   |  | 24.0711-5135.3   | 360108   | 2    | Radsensor L=846          |
|  | 1.6 HDi 110  | 80   |  | 05.04  | 05.07   |  |  |  |   |                          |
|  | 2.0 S16  | 100  | ORGA 09457   |  | 05.07   |  |  |  |   |                          |
|  | 1.1  | 44   | ORGA 09456   | 07.02  |   |  | 03.0137-0312.2   | 650312   |   | 203 x 38 HEB TRW         |
|  | 1.4  | 55   | ORGA 09456   | 07.02  |   |  | 03.0137-9158.2   | 669158   |   | Bremsbacken-Zubehör TRW  |
|  | 1.4 HDi  | 50   | ORGA 09456   | 07.02  |   |  |  |  |   |                          |
|  | 2.0 HDi  | 66   | ORGA 09456   | 07.02  |   |  |  |  |   |                          |
|  | 1.1  | 44   | ORGA 09457   |  | 05.07   |  | 03.0137-0446.2   | 650446   |   | 203 x 39 TRW             |
|  | 1.4  | 55   | ORGA 09457   |  | 05.07   |  | 03.0137-9278.2   | 669278   |   | Bremsbacken-Zubehör TRW  |
|  | 1.4 HDi  | 50   | ORGA 09457   |  | 05.07   |  |  |  |   |                          |
|  | 2.0 HDi  | 66   | ORGA 09457   |  | 05.07   |  |  |  |   |                          |
|  | 1.1  | 44   | ORGA 10254   | 07.02  |   |  | 24.0220-3013.1   | 480089   |   | 203/204,5 x 46,5         |
|  | 1.4  | 55   | ORGA 10254   | 07.02  |   |  |  |  |   |                          |
|  | 1.4 HDi  | 50   | ORGA 10254   | 07.02  |   |  |  |  |   |                          |
|  | 2.0 HDi  | 66   | ORGA 10254   | 07.02  |   |  |  |  |   |                          |
|  | 1.1  | 44   | ORGA 10255   |  | 05.07   |  | 24.0220-3029.1   | 480179   | ohne Sensorring <sup>1)</sup>   | 203/204,5 x 42 - Lager   |
|  | 1.4  | 55   | ORGA 10255   |  | 05.07   |  | 24.0220-3729.2   | 480217   | mit Sensorring <sup>2)</sup>  | 203/204,5 x 42 + Lager   |
|  | 1.4 HDi  | 50   | ORGA 10255   |  | 05.07   |  |  |  |   |                          |
|  | 2.0 HDi  | 66   | ORGA 10255   |  | 05.07   |  |  |  |   |                          |
|  | 1.1  | 44   | ORGA 09456   | 07.02  |   |  | 03.0520-6420.3   | 696420   |   | 20,64/203x39 TopKit TRW  |
|  | 1.4  | 55   | ORGA 09456   | 07.02  |   |  |  |  |   |                          |
|  | 1.4 HDi  | 50   | ORGA 09456   | 07.02  |   |  |  |  |   |                          |
|  | 2.0 HDi  | 66   | ORGA 09456   | 07.02  |   |  |  |  |   |                          |
|  | 1.1  | 44   | ORGA 09457   |  | 05.07   |  | 03.0520-7720.3   | 697720   |   | 20,64/203x39 TopKit TRW  |
|  | 1.4  | 55   | ORGA 09457   |  | 05.07   |  |  |  |   |                          |
|  | 1.4 HDi  | 50   | ORGA 09457   |  | 05.07   |  |  |  |   |                          |
|  | 2.0 HDi  | 66   | ORGA 09457   |  | 05.07   |  |  |  |   |                          |
| <b>PEUGEOT 206 PLUS (09-13)</b>  |  |  |  |  |   |  |  |  |   |                          |
|  | 1.1  | 44   |  | 01.09  | 05.13   | + ⊕  | 13.0460-3975.2   | 603975   |   | 23597 18,0 +/-S BOS      |
|  | 1.4 HDi eco 70   | 50   |  | 01.09  | 05.13   | + ⊕  |  |  |   |                          |
|  | 1.4 i  | 54   |  | 09.10  | 05.13   | + ⊕  |  |  |   |                          |
|  | 1.4 i  | 55   |  | 01.09  | 05.13   | + ⊕  |  |  |   |                          |
|  | 1.6 16V  | 80   |  | 07.10  | 05.13   |  | 13.0460-3994.2   | 603994   |   | 23599 19,0 /Zub/S BOS    |
|  |  |  |  |  |   |  | 13.0470-3994.2   | LD3994   |   | 23599 19,0 /Zub/S BOS    |
|  | 1.1  | 44   |  | 01.09  | 05.13   | + ⊕  | 24.0120-0132.1   | 420132   |   | 247 20,4 18,5 V +S +B    |
|  | 1.4 HDi eco 70   | 50   |  | 01.09  | 05.13   | + ⊕  | 24.0320-0132.1   | 520132   |   | 247 20,4 18,5 V +S +B PD |
|  | 1.4 i  | 54   |  | 09.10  | 05.13   | + ⊕  |  |  |   |                          |
|  | 1.4 i  | 55   |  | 01.09  | 05.13   | + ⊕  |  |  |   |                          |
|  | 1.1  | 44   |  | 01.09  | 05.13   | - ⊖  | 24.0113-0185.1   | 413185   |   | 248 13,0 11,0 +S +B      |
|  | 1.4 HDi eco 70   | 50   |  | 01.09  | 05.13   | - ⊖  | 24.0313-0185.1   | 513185   |   | 248 13,0 11,0 +S +B PD   |
|  | 1.4 i  | 54   |  | 09.10  | 05.13   | - ⊖  |  |  |   |                          |
|  | 1.4 i  | 55   |  | 01.09  | 05.13   | - ⊖  |  |  |   |                          |
|  | 1.6 16V  | 80   |  | 07.10  | 05.13   |  | 24.0122-0194.1   | 422194   |   | 266 22,0 20,0 V +S +B    |
|  | 1.1  | 44   |  | 01.09  | 05.13   |  | 24.0711-6205.3   | 360229   | 2  | Radsensor L=815          |
|  | 1.4 HDi eco 70   | 50   |  | 01.09  | 05.13   |  |  |  |   |                          |
|  | 1.4 i  | 54   |  | 09.10  | 05.13   |  |  |  |   |                          |
|  | 1.4 i  | 55   |  | 01.09  | 05.13   |  |  |  |   |                          |
|  | 1.6 16V  | 80   |  | 07.10  | 05.13   |  |  |  |   |                          |

<sup>1)</sup> without sensor ring / senza sensori / sans secours ABS / sin anillo sensor ABS





















<sup>2)</sup> with sensor ring / con sensori / avec secours ABS / con anillo sensor ABS

|     |   |     |  |    |  |  |  |       |   |            |
|--|---|---|--|--|---|--|--|---|---|------------|
| <b>PEUGEOT 206 PLUS (09-13)</b>  |   |   |  |  |   |  |  |   |   |            |
|    | 1.1<br>1.4 HDi eco 70<br>1.4 i<br>1.4 i<br>1.6 16V  | 44<br>50<br>54<br>55<br>80  |  | 01.09 05.13<br>01.09 05.13<br>09.10 05.13<br>01.09 05.13<br>07.10 05.13  |   | 24.0711-5136.3   | 360109   | 2    | Radsensor L=846                                   |            |
|    | 1.1<br>1.4 HDi eco 70<br>1.4 i<br>1.4 i<br>1.6 16V  | 44<br>50<br>54<br>55<br>80  |  | 01.09 05.13 + ABS/ + Elektronische Bremslastverteilung <sup>1)</sup><br>01.09 05.13 + ABS/ + Elektronische Bremslastverteilung <sup>1)</sup><br>09.10 05.13 + ABS/ + Elektronische Bremslastverteilung <sup>1)</sup><br>01.09 05.13 + ABS/ + Elektronische Bremslastverteilung <sup>1)</sup><br>07.10 05.13 + ABS/ + Elektronische Bremslastverteilung <sup>1)</sup> |   | 03.0137-0446.2<br>03.0137-9278.2   | 650446<br>669278   |   | 203 x 39<br>Bremsbacken-Zubehör                   | TRW<br>TRW |
|    | 1.1<br>1.4 HDi eco 70<br>1.4 i<br>1.4 i<br>1.6 16V  | 44<br>50<br>54<br>55<br>80  |  | 01.09 05.13 - ABS<br>01.09 05.13 - ABS<br>09.10 05.13 - ABS<br>01.09 05.13 - ABS<br>07.10 05.13 - ABS  |   | 03.0137-0354.2<br>03.0137-9088.2   | 650354<br>669088   |   | 180 x 32 HEB<br>Bremsbacken-Zubehör               | BDX<br>BDX |
|    | 1.1<br>1.4 HDi eco 70<br>1.4 i<br>1.4 i<br>1.6 16V  | 44<br>50<br>54<br>55<br>80  |  | 01.09 05.13 + ABS/ + Elektronische Bremslastverteilung <sup>1)</sup><br>01.09 05.13 + ABS/ + Elektronische Bremslastverteilung <sup>1)</sup><br>09.10 05.13 + ABS/ + Elektronische Bremslastverteilung <sup>1)</sup><br>01.09 05.13 + ABS/ + Elektronische Bremslastverteilung <sup>1)</sup><br>07.10 05.13 + ABS/ + Elektronische Bremslastverteilung <sup>1)</sup> |   | 24.0220-3029.1<br>24.0220-3729.2   | 480179<br>480217   |   | 203/204,5 x 42 - Lager<br>203/204,5 x 42 + Lager  |            |
|    | 1.1<br>1.4 HDi eco 70<br>1.4 i<br>1.4 i<br>1.6 16V  | 44<br>50<br>54<br>55<br>80  |  | 01.09 05.13 + ABS<br>01.09 05.13 + ABS<br>09.10 05.13 + ABS<br>01.09 05.13 + ABS<br>07.10 05.13 + ABS  |   | 24.0220-3013.1   | 480089   |   | 203/204,5 x 46,5                                  |            |
|    | 1.1<br>1.4 HDi eco 70<br>1.4 i<br>1.4 i<br>1.6 16V  | 44<br>50<br>54<br>55<br>80  |  | 01.09 05.13 - ABS<br>01.09 05.13 - ABS<br>09.10 05.13 - ABS<br>01.09 05.13 - ABS<br>07.10 05.13 - ABS  |   | 24.0218-0720.2<br>24.0218-0020.1   | 480205<br>480074   |   | 180/181 x 46 + Lager<br>180/181 x 46 - Lager      |            |
|    | 1.1<br>1.4 HDi eco 70<br>1.4 i<br>1.4 i<br>1.6 16V  | 44<br>50<br>54<br>55<br>80  |  | 01.09 05.13 + ABS/ + Elektronische Bremslastverteilung <sup>1)</sup><br>01.09 05.13 + ABS/ + Elektronische Bremslastverteilung <sup>1)</sup><br>09.10 05.13 + ABS/ + Elektronische Bremslastverteilung <sup>1)</sup><br>01.09 05.13 + ABS/ + Elektronische Bremslastverteilung <sup>1)</sup><br>07.10 05.13 + ABS/ + Elektronische Bremslastverteilung <sup>1)</sup> |   | 03.0520-7720.3   | 697720   |   | 20,64/203x39 TopKit                               | TRW        |
| <b>PEUGEOT 207 Limousine (06-12)</b>   |   |   |  |  |   |  |  |   |   |            |
|   | 1.4<br>1.4<br>1.4 16V<br>1.4 HDi<br>1.6 HDi<br>1.6 HDi<br>1.6 16V RC  | 53<br>55<br>65<br>50<br>66<br>68<br>128   |  | 02.06 06.12<br>09.07 06.12<br>02.06 06.12<br>02.06 06.12 + Bremsscheibendurchm. 266 mm <sup>2)</sup><br>11.09 06.12<br>10.06 06.12   |   | 13.0460-3994.2<br>13.0470-3994.2   | 603994<br>LD3994   |   | 23599 19,0 /Zub/S<br>23599 19,0 /Zub/S            | BOS<br>BOS |
|  | 1.4 16V VTI<br>1.6 16V<br>1.6 16V Turbo<br>1.6 16V Turbo<br>1.6 16V VTI<br>1.6 HDi<br>1.6 HDi<br>1.6 HDi 110  | 70<br>80<br>110<br>115<br>88<br>66<br>80<br>82                                      |  | 08.07 06.12<br>02.06 06.12<br>02.06 06.12<br>01.10 06.12<br>02.07 06.12<br>02.06 06.12 + Bremsscheibendurchm. 283 mm <sup>3)</sup><br>02.06 06.12<br>08.09 06.12   |   | 13.0460-7202.2<br>13.0470-7202.2   | 607202<br>LD7202   |   | 23589 19,1 +<br>23589 19,1 +                      | ATE<br>ATE |
|  | 1.4 16V VTI<br>1.6 16V<br>1.6 16V Turbo<br>1.6 16V Turbo<br>1.6 16V VTI<br>1.6 HDi<br>1.6 HDi<br>1.6 HDi 110<br>1.6 16V RC  | 70<br>80<br>110<br>115<br>88<br>66<br>80<br>82<br>128                               |  | 08.07 06.12<br>02.06 06.12<br>02.06 06.12<br>01.10 06.12<br>10.06 06.12<br>02.06 06.12<br>02.06 06.12<br>08.09 06.12<br>10.06 06.12  |   | 24.0122-0194.1   | 422194   |   | 266 22,0 20,0 V +S +B                             |            |
|  | 1.4 16V VTI<br>1.6 16V<br>1.6 16V Turbo<br>1.6 16V Turbo<br>1.6 16V VTI<br>1.6 HDi<br>1.6 HDi<br>1.6 HDi 110<br>1.6 16V RC  | 70<br>80<br>110<br>115<br>88<br>66<br>80<br>82<br>128                               |  | 08.07 06.12<br>02.06 06.12<br>02.06 06.12<br>01.10 06.12<br>10.06 06.12<br>02.06 06.12<br>02.06 06.12<br>08.09 06.12<br>10.06 06.12  |   | 24.0126-0120.1<br>24.0326-0120.1   | 426120<br>526120   |   | 283 26,0 24,0 V +S +B<br>283 26,0 24,0 V +S +B PD |            |
|  | 1.4<br>1.4<br>1.4 16V<br>1.4 16V VTI<br>1.4 HDi<br>1.6 16V<br>1.6 16V RC<br>1.6 16V Turbo<br>1.6 16V Turbo<br>1.6 16V VTI<br>1.6 HDi<br>1.6 HDi<br>1.6 HDi<br>1.6 HDi 110 | 53<br>55<br>65<br>70<br>50<br>80<br>128<br>110<br>115<br>88<br>66<br>68<br>80<br>82 |  | 02.06 06.12<br>09.07 06.12<br>02.06 06.12<br>08.07 06.12<br>02.06 06.12<br>02.06 06.12<br>10.06 06.12<br>02.06 06.12<br>10.09 06.12<br>10.06 06.12<br>02.06 06.12<br>11.09 06.12<br>02.06 06.12<br>08.09 06.12   |   | 24.0711-5256.3   | 360320   | 2  | Radsensor L=1029                                  |            |

<sup>1)</sup> + ABS/+ electr.br.force distribution / + ABS/+ ripartiz.eletr.di frenata / + ABS/+ répartition électr.de freinage / + ABS/+ distrib.electr.la carga frenado

<sup>2)</sup> + brake disc diameter 266 mm / + disco fr.diam. 266mm / + disques fr.diam. 266mm / + disco fr.diam. 266mm

<sup>3)</sup> + brake disc diameter 283 mm / + disco fr.diam. 283mm / + disques fr.diam. 283mm / + disco fr.diam. 283mm

|     |  |  |  |  |  |  |  |       |                          |     |
|--|--|--|--|--|---|--|--|---|--------------------------|-----|
| <b>PEUGEOT 207 Limousine (06-12)</b>   |  |  |  |  |   |  |  |   |                          |     |
|    | 1.6 16V  | 80   | ORGA 11634   | 02.06  |   | 13.0460-3813.2   | 603813   |   | 24150 17,6 /S            | BOS |
|  | 1.6 16V Turbo  | 110  | ORGA 11634   | 02.06  |   | 13.0470-3813.2   | LD3813   |   | 24150 17,6 /Zub/S        | BOS |
|  | 1.6 16V Turbo  | 115  | ORGA 11634   | 10.09  |   | 13.0460-3851.2   | 603851   |   | 24150 17,6 /Zub          | BOS |
|  | 1.6 16V VTi  | 88   | ORGA 11634   | 10.06  |   |  |  |   |                          |     |
|  | 1.6 HDi  | 66   | ORGA 11634   | 02.06  |   |  |  |   |                          |     |
|  | 1.6 HDi  | 80   | ORGA 11634   | 02.06  |   |  |  |   |                          |     |
|  | 1.6 HDi 110  | 82   | ORGA 11634   | 08.09  |   |  |  |   |                          |     |
|  | 1.6 16V RC   | 128  | ORGA 11627   | 02.07  |   | 13.0460-3851.2   | 603851   |   | 24150 17,6 /Zub          | BOS |
|  | 1.6 16V  | 80   | ORGA 11635   |  | 06.12   | 13.0460-2740.2   | 602740   |   | 23554 17,2 /Zub/S        | TRW |
|  | 1.6 16V RC   | 128  | ORGA 11628   |  | 06.12   | 13.0470-2740.2   | LD2740   |   | 23554 17,2 /Zub/S        | TRW |
|  | 1.6 16V Turbo  | 110  | ORGA 11635   |  | 06.12   |  |  |   |                          |     |
|  | 1.6 16V Turbo  | 115  | ORGA 11635   |  | 06.12   |  |  |   |                          |     |
|  | 1.6 16V VTi  | 88   | ORGA 11635   |  | 06.12   |  |  |   |                          |     |
|  | 1.6 HDi  | 66   | ORGA 11635   |  | 06.12   |  |  |   |                          |     |
| 1.6 HDi  | 80   | ORGA 11635   |  | 06.12  |   |  |  |   |                          |     |
| 1.6 HDi 110  | 82   | ORGA 11635   |  | 06.12  |   |  |  |   |                          |     |
|    | 1.6 16V  | 80   |  | 02.06  | 06.12   | 24.0109-0100.2   | 409100   | mit Lager/ mit Sensorring <sup>1)</sup>   | 249 9,0 7,0 +B           |     |
|  | 1.6 16V RC   | 128  |  | 10.06  | 06.12   |  |  |   |                          |     |
|  | 1.6 16V Turbo  | 110  |  | 02.06  | 06.12   |  |  |   |                          |     |
|  | 1.6 16V Turbo  | 115  |  | 10.09  | 06.12   |  |  |   |                          |     |
|  | 1.6 16V VTi  | 88   |  | 10.06  | 06.12   |  |  |   |                          |     |
|  | 1.6 HDi  | 66   |  | 02.06  | 06.12   |  |  |   |                          |     |
|  | 1.6 HDi  | 80   |  | 02.06  | 06.12   |  |  |   |                          |     |
|  | 1.6 HDi 110  | 82   |  | 08.09  | 06.12   |  |  |   |                          |     |
|    | 1.4  | 53   |  | 02.06  | 06.12   | 03.0137-0491.2   | 650491   |   | 228 x 42 HEB             | BOS |
|  | 1.4  | 55   |  | 09.07  | 06.12   | 03.0137-9228.2   | 669228   |   | Bremsbacken-Zubehör      |     |
|  | 1.4 16V  | 65   |  | 02.06  | 06.12   |  |  |   |                          |     |
|  | 1.4 16V VTi  | 70   |  | 08.07  | 06.12   |  |  |   |                          |     |
|  | 1.4 HDi  | 50   |  | 02.06  | 06.12   |  |  |   |                          |     |
|  | 1.6 HDi  | 66   |  | 02.06  | 06.12   |  |  |   |                          |     |
|  | 1.6 HDi  | 68   |  | 11.09  | 06.12   |  |  |   |                          |     |
|  | 1.4  | 53   |  | 02.06  | 06.12 + ABS   | 03.0520-9420.3   | 699420   |   | 20,64/228x42 TopKit      | BOS |
| 1.4  | 55   |  | 09.07  | 06.12 + ABS  |   |  |  |   |                          |     |
| 1.4 16V  | 65   |  | 02.06  | 06.12  |   |  |  |   |                          |     |
| 1.4 16V VTi  | 70   |  | 08.07  | 06.12  |   |  |  |   |                          |     |
| 1.4 HDi  | 50   |  | 02.06  | 06.12 + ABS  |   |  |  |   |                          |     |
| 1.6 HDi  | 66   |  | 02.06  | 06.12  |   |  |  |   |                          |     |
| 1.6 HDi  | 68   |  | 11.09  | 06.12  |   |  |  |   |                          |     |
| <b>PEUGEOT 207 CC (07-15)</b>  |  |  |  |  |   |  |  |   |                          |     |
|  | 1.6 16V  | 88   |  | 02.07  |   | 13.0460-3966.2   | 603966   |   | 23600 19,4 /Zub/S        | BOS |
|  | 1.6 16V Turbo  | 110  |  | 02.07  |   | 13.0470-3966.2   | LD3966   |   | 23600 19,4 /Zub/S        | BOS |
|  | 1.6 16V Turbo  | 115  |  | 10.09  |   |  |  |   |                          |     |
|  | 1.6 HDi  | 80   |  | 02.07  |   |  |  |   |                          |     |
|  | 1.6 HDi  | 82   |  | 08.09  |   |  |  |   |                          |     |
|  | 1.6 16V  | 88   |  | 02.07  |   | 24.0126-0120.1   | 426120   |   | 283 26,0 24,0 V +S +B    |     |
|  | 1.6 16V Turbo  | 110  |  | 02.07  |   | 24.0326-0120.1   | 526120   |   | 283 26,0 24,0 V +S +B PD |     |
|  | 1.6 16V Turbo  | 115  |  | 10.09  |   |  |  |   |                          |     |
|  | 1.6 HDi  | 80   |  | 02.07  |   |  |  |   |                          |     |
|  | 1.6 HDi  | 82   |  | 08.09  |   |  |  |   |                          |     |
|  | 1.6 16V  | 88   |  | 02.07  |   | 24.0711-5256.3   | 360320   | 2  | Radsensor L=1029         |     |
|  | 1.6 16V Turbo  | 110  |  | 02.07  |   |  |  |   |                          |     |
|  | 1.6 16V Turbo  | 115  |  | 10.09  |   |  |  |   |                          |     |
|  | 1.6 HDi  | 80   |  | 02.07  |   |  |  |   |                          |     |
|  | 1.6 HDi  | 82   |  | 08.09  |   |  |  |   |                          |     |
|  | 1.6 16V  | 88   | ORGA 1164182   | 02.07  |   | 13.0460-3851.2   | 603851   |   | 24150 17,6 /Zub          | BOS |
|  | 1.6 16V Turbo  | 110  | ORGA 1163482   | 02.07  |   |  |  |   |                          |     |
|  | 1.6 16V Turbo  | 115  | ORGA 1163482   | 10.09  |   |  |  |   |                          |     |
|  | 1.6 HDi  | 80   | ORGA 1163482   | 02.07  |   |  |  |   |                          |     |
|  | 1.6 16V  | 88   | ORGA 1164282   |  |   | 13.0460-2740.2   | 602740   |   | 23554 17,2 /Zub/S        | TRW |
| 1.6 16V Turbo  | 110  | ORGA 1163582   |  |  | 13.0470-2740.2  | LD2740   |  | 23554 17,2 /Zub/S   | TRW                      |     |
| 1.6 16V Turbo  | 115  | ORGA 1163582   |  |  |   |  |  |   |                          |     |
| 1.6 HDi  | 80   | ORGA 1163582   |  |  |   |  |  |   |                          |     |
| 1.6 HDi  | 82   |  | 08.09  |  |   |  |  |   |                          |     |
|  | 1.6 16V  | 88   |  | 02.07  |   | 24.0109-0100.2   | 409100   | mit Lager/ mit Sensorring <sup>1)</sup>   | 249 9,0 7,0 +B           |     |
|  | 1.6 16V Turbo  | 110  |  | 02.07  |   |  |  |   |                          |     |
|  | 1.6 16V Turbo  | 115  |  | 10.09  |   |  |  |   |                          |     |
|  | 1.6 HDi  | 80   |  | 02.07  |   |  |  |   |                          |     |
|  | 1.6 HDi  | 82   |  | 08.09  |   |  |  |   |                          |     |
| <b>PEUGEOT 207 SW (07-13)</b>  |  |  |  |  |   |  |  |   |                          |     |
|  | 1.4 i  | 54   |  | 06.07  | 07.13   | 13.0460-3994.2   | 603994   |   | 23599 19,0 /Zub/S        | BOS |
|  | 1.4 i 16V  | 70   |  | 06.07  | 07.13   | 13.0470-3994.2   | LD3994   |   | 23599 19,0 /Zub/S        | BOS |
|  | 1.6 16V Turbo  | 110  |  | 02.07  | 07.13   | 13.0460-3966.2   | 603966   |   | 23600 19,4 /Zub/S        | BOS |
|  | 1.6 HDi  | 68   |  | 11.09  | 07.13   | 13.0470-3966.2   | LD3966   |   | 23600 19,4 /Zub/S        | BOS |
|  | 1.6 HDi  | 82   |  | 08.09  | 07.13   |  |  |   |                          |     |
|  | 1.6 HDi FAP 110  | 80   |  | 06.07  | 07.13   |  |  |   |                          |     |
|  | 1.6 HDi FAP 90   | 66   |  | 06.07  | 07.13   |  |  |   |                          |     |
|  | 1.6 i 16V  | 88   |  | 06.07  | 07.13   |  |  |   |                          |     |
| 1.6 16V RC   | 128  |  | 11.07  | 07.13  | 13.0460-7202.2  | 607202   |  | 23589 19,1 +  | ATE                      |     |
|  |  |  |  |  | 13.0470-7202.2  | LD7202   |  | 23589 19,1 +  | ATE                      |     |
|  | 1.4 i  | 54   |  | 06.07  | 07.13   | 24.0122-0194.1   | 422194   |   | 266 22,0 20,0 V +S +B    |     |
|  |  |  |  |  |   |  |  |   |                          |     |

<sup>1)</sup> with bearing/ with sensor ring / con supporto/+ anell.sens.ABS / avec palier de secours ABS / con apoyo/+ anillo sensor ABS



**PEUGEOT 207 SW (07-13)**

|  |   |  |  |   |   |                                  |                  |   |  |
|--|---|--|--|---|---|----------------------------------|------------------|---|--|
|  | 1.4 i 16V<br>1.6 16V Turbo<br>1.6 HDi<br>1.6 HDi<br>1.6 HDi FAP 110<br>1.6 HDi FAP 90<br>1.6 i 16V<br>1.6 16V RC          | 70<br>110<br>68<br>82<br>80<br>66<br>88<br>128       |  | 06.07<br>02.07<br>11.09<br>08.09<br>06.07<br>06.07<br>06.07<br>11.07          | 07.13<br>07.13<br>07.13<br>07.13<br>07.13<br>07.13<br>07.13<br>07.13          | 24.0126-0120.1<br>24.0326-0120.1 | 426120<br>526120 |   | 283 26,0 24,0 V +S +B<br>283 26,0 24,0 V +S +B PD            |
|  | 1.4 i<br>1.4 i 16V<br>1.6 16V RC<br>1.6 16V Turbo<br>1.6 HDi<br>1.6 HDi<br>1.6 HDi FAP 110<br>1.6 HDi FAP 90<br>1.6 i 16V | 54<br>70<br>128<br>110<br>68<br>82<br>80<br>66<br>88 |  | 06.07<br>06.07<br>11.07<br>02.07<br>11.09<br>08.09<br>06.07<br>06.07<br>06.07 | 07.13<br>07.13<br>07.13<br>07.13<br>07.13<br>07.13<br>07.13<br>07.13<br>07.13 | 24.0711-5256.3                   | 360320           | 2                                       | Radsensor L=1029   |
|  | 1.6 16V RC<br>1.6 16V Turbo<br>1.6 HDi<br>1.6 HDi FAP 110<br>1.6 HDi FAP 90<br>1.6 i 16V                                  | 128<br>110<br>82<br>80<br>66<br>88                   | ORGA 11627<br>ORGA 11627<br>ORGA 11631<br>ORGA 11634<br>ORGA 11634<br>ORGA 11627 | 11.07<br>02.07<br>08.09<br>06.07<br>06.07<br>06.07                            |   | 13.0460-3851.2                   | 603851           |   | 24150 17,6 /Zub <b>BOS</b>                                   |
|  | 1.6 16V RC<br>1.6 16V Turbo<br>1.6 HDi<br>1.6 HDi<br>1.6 HDi FAP 110<br>1.6 HDi FAP 90<br>1.6 i 16V                       | 128<br>110<br>68<br>82<br>80<br>66<br>88             | ORGA 11628<br>ORGA 11628<br>ORGA 11631<br>ORGA 11635<br>ORGA 11634<br>ORGA 11628 |   | 07.13<br>07.13<br>11.09<br>07.13<br>07.13<br>07.13<br>07.13                   | 13.0460-2740.2<br>13.0470-2740.2 | 602740<br>LD2740 |   | 23554 17,2 /Zub/S <b>TRW</b><br>23554 17,2 /Zub/S <b>TRW</b> |
|  | 1.6 16V RC<br>1.6 16V Turbo<br>1.6 HDi<br>1.6 HDi<br>1.6 HDi FAP 110<br>1.6 HDi FAP 90<br>1.6 i 16V                       | 128<br>110<br>68<br>82<br>80<br>66<br>88             |  | 06.07<br>02.07<br>11.09<br>08.09<br>06.07<br>06.07<br>06.07                   | 07.13<br>07.13<br>07.13<br>07.13<br>07.13<br>07.13<br>07.13                   | 24.0109-0100.2                   | 409100           | mit Lager/ mit Sensorring <sup>1)</sup> | 249 9,0 7,0 +B   |
|  | 1.4 i<br>1.4 i 16V<br>1.6 HDi<br>1.6 HDi FAP 90   | 54<br>70<br>68<br>66                                 |  | 06.07<br>06.07<br>11.09<br>06.07  | 07.13<br>07.13<br>07.13<br>07.13  | 03.0137-0491.2<br>03.0137-9228.2 | 650491<br>669228 |   | 228 x 42 HEB <b>BOS</b><br>Bremsbacken-Zubehör               |
|  | 1.4 i<br>1.4 i 16V<br>1.6 HDi<br>1.6 HDi FAP 90   | 54<br>70<br>68<br>66                                 |  | 06.07<br>06.07<br>11.09<br>06.07  | 07.13<br>07.13<br>07.13<br>07.13  | 03.0520-9420.3                   | 699420           | + ABS                                   | 20,64/228x42 TopKit <b>BOS</b>                               |















**PEUGEOT 208 (12-)**

|  |   |  |  |   |   |                                  |                  |  |  |
|--|---|--|--|---|---|----------------------------------|------------------|--|--|
|  | 1.0 VTI<br>1.2 THP<br>1.2 VTI<br>1.4 HDi<br>1.4 VTI<br>1.4 VTI GPL<br>1.6 BlueHDi 100<br>1.6 BlueHDi 120<br>1.6 e-HDi<br>1.6 e-HDi<br>1.6 HDi<br>1.6 HDi<br>1.6 THP<br>1.6 THP 163<br>1.6 VTI | 50<br>81<br>60<br>50<br>70<br>70<br>73<br>88<br>68<br>84<br>55<br>85<br>115<br>120<br>88 |  | 01.12<br>01.13<br>01.12<br>01.12<br>01.12<br>10.13<br>01.15<br>11.13<br>01.12<br>01.12<br>01.13<br>04.14<br>01.12<br>03.15<br>01.12 | + Bremsscheibendurchm. 266 mm <sup>2)</sup><br>+ Bremsscheibendurchm. 266 mm <sup>2)</sup><br>+ Bremsscheibendurchm. 266 mm <sup>2)</sup><br>+ Bremsscheibendurchm. 266 mm <sup>2)</sup><br>+ Bremsscheibendurchm. 266 mm <sup>2)</sup><br>+ Bremsscheibendurchm. 266 mm <sup>2)</sup><br>+ Bremsscheibendurchm. 266 mm <sup>2)</sup><br>+ Bremsscheibendurchm. 266 mm <sup>2)</sup><br>+ Bremsscheibendurchm. 266 mm <sup>2)</sup><br>+ Bremsscheibendurchm. 266 mm <sup>2)</sup><br>+ Bremsscheibendurchm. 266 mm <sup>2)</sup><br>+ Bremsscheibendurchm. 266 mm <sup>2)</sup><br>+ Bremsscheibendurchm. 266 mm <sup>2)</sup><br>+ Bremsscheibendurchm. 266 mm <sup>2)</sup><br>+ Bremsscheibendurchm. 266 mm <sup>2)</sup> | 13.0460-3994.2<br>13.0470-3994.2 | 603994<br>LD3994 |  | 23599 19,0 /Zub/S <b>BOS</b><br>23599 19,0 /Zub/S <b>BOS</b> |
|  | 1.0 VTI<br>1.2 THP<br>1.2 VTI<br>1.4 HDi<br>1.4 VTI<br>1.4 VTI GPL<br>1.6 BlueHDi 100<br>1.6 BlueHDi 120<br>1.6 e-HDi<br>1.6 e-HDi<br>1.6 HDi<br>1.6 HDi<br>1.6 THP<br>1.6 THP 163<br>1.6 VTI | 50<br>81<br>60<br>50<br>70<br>70<br>73<br>88<br>68<br>84<br>55<br>85<br>115<br>120<br>88 |  | 01.12<br>01.13<br>01.12<br>01.12<br>01.12<br>10.13<br>01.15<br>11.13<br>01.12<br>01.12<br>01.13<br>04.14<br>01.12<br>03.15<br>01.12 | + Bremsscheibendurchm. 302 mm <sup>3)</sup><br>+ Bremsscheibendurchm. 302 mm <sup>3)</sup><br>+ Bremsscheibendurchm. 302 mm <sup>3)</sup><br>+ Bremsscheibendurchm. 302 mm <sup>3)</sup><br>+ Bremsscheibendurchm. 302 mm <sup>3)</sup><br>+ Bremsscheibendurchm. 302 mm <sup>3)</sup><br>+ Bremsscheibendurchm. 302 mm <sup>3)</sup><br>+ Bremsscheibendurchm. 302 mm <sup>3)</sup><br>+ Bremsscheibendurchm. 302 mm <sup>3)</sup><br>+ Bremsscheibendurchm. 302 mm <sup>3)</sup><br>+ Bremsscheibendurchm. 302 mm <sup>3)</sup><br>+ Bremsscheibendurchm. 302 mm <sup>3)</sup><br>+ Bremsscheibendurchm. 302 mm <sup>3)</sup><br>+ Bremsscheibendurchm. 302 mm <sup>3)</sup><br>+ Bremsscheibendurchm. 302 mm <sup>3)</sup> | 13.0460-7202.2<br>13.0470-7202.2 | 607202<br>LD7202 |  | 23589 19,1 + <b>ATE</b><br>23589 19,1 + <b>ATE</b>           |
|  | 1.0 VTI<br>1.2 THP<br>1.2 VTI<br>1.4 HDi<br>1.4 VTI<br>1.4 VTI GPL<br>1.6 BlueHDi 100<br>1.6 BlueHDi 120<br>1.6 e-HDi   | 50<br>81<br>60<br>50<br>70<br>70<br>73<br>88<br>68                                       |  | 01.12<br>01.13<br>01.12<br>01.12<br>01.12<br>10.13<br>01.15<br>11.13<br>01.12   |   | 24.0122-0194.1                   | 422194           |  | 266 22,0 20,0 V +S +B  |

<sup>1)</sup> with bearing/ with sensor ring / con supporto/+ anell.sens.ABS / avec palier de secours ABS / con apoyo/+ anillo sensor ABS

<sup>2)</sup> + brake disc diameter 266 mm / + disco fr.diam. 266mm / + disques fr.diam. 266mm / + disco fr.diam. 266mm

<sup>3)</sup> + brake disc diameter 302 mm / + disco fr.diam. 302mm / + disques fr.diam. 302mm / + disco fr.diam. 302mm

|     |   |  |   |  |  |  |     |  |
|--|---|--|---|--|---|--|---|--|
| <b>PEUGEOT 208 (12-)</b>   |   |  |   |  |   |  |   |  |
|    | 1.6 e-HDi 84<br>1.6 HDi 55<br>1.6 HDi 85<br>1.6 THP 115<br>1.6 THP 163 120<br>1.6 VTi 88  |  | 01.12<br>01.13<br>04.14<br>01.12<br>03.15<br>01.12  |  | 24.0122-0194.1  | 422194   |   | 266 22,0 20,0 V +S +B  |
|  | 1.0 VTi 50<br>1.2 THP 81<br>1.2 VTi 60<br>1.4 HDi 50<br>1.4 VTi 70<br>1.4 VTi GPL 70<br>1.6 BlueHDi 100 73<br>1.6 BlueHDi 120 88<br>1.6 e-HDi 68<br>1.6 e-HDi 84<br>1.6 GTi 147<br>1.6 HDi 55<br>1.6 HDi 85<br>1.6 THP 115<br>1.6 THP 163 120<br>1.6 VTi 88                     |  | 01.12<br>01.13<br>01.12<br>01.12<br>01.12<br>10.13<br>01.15<br>11.13<br>01.12<br>01.12<br>03.13<br>01.13<br>04.14<br>01.12<br>03.15<br>01.12          |  | 24.0126-0159.1  | 426159   |   | 302 26,0 24,0 V +S +B  |
|    | 1.0 VTi 50<br>1.2 THP 81<br>1.2 VTi 60<br>1.4 HDi 50<br>1.4 VTi 70<br>1.4 VTi GPL 70<br>1.6 BlueHDi 100 73<br>1.6 BlueHDi 120 88<br>1.6 e-HDi 68<br>1.6 e-HDi 84<br>1.6 GTi 147<br>1.6 GTi 30th 153<br>1.6 HDi 55<br>1.6 HDi 85<br>1.6 THP 115<br>1.6 THP 163 120<br>1.6 VTi 88 |  | 01.12<br>01.13<br>01.12<br>01.12<br>01.12<br>10.13<br>01.15<br>11.13<br>01.12<br>01.12<br>03.13<br>10.14<br>01.13<br>04.14<br>01.12<br>03.15<br>01.12 |  | 24.0711-5256.3  | 360320   | 2  | Radsensor L=1029   |
|   | 1.0 VTi 50<br>1.2 THP 81<br>1.2 VTi 60<br>1.4 HDi 50<br>1.4 VTi 70<br>1.4 VTi GPL 70<br>1.6 BlueHDi 100 73<br>1.6 BlueHDi 120 88<br>1.6 e-HDi 68<br>1.6 e-HDi 84<br>1.6 GTi 147<br>1.6 GTi 30th 153<br>1.6 HDi 55<br>1.6 HDi 85<br>1.6 THP 115<br>1.6 THP 163 120<br>1.6 VTi 88 |  | 01.12<br>01.13<br>01.12<br>01.12<br>01.12<br>10.13<br>01.15<br>11.13<br>01.12<br>01.12<br>03.13<br>10.14<br>01.13<br>04.14<br>01.12<br>03.15<br>01.12 |  | 13.0460-2740.2<br>13.0470-2740.2  | 602740<br>LD2740   |   | 23554 17,2 /Zub/S TRW<br>23554 17,2 /Zub/S TRW                                     |
|  | 1.0 VTi 50<br>1.2 THP 81<br>1.2 VTi 60<br>1.4 HDi 50<br>1.4 VTi 70<br>1.4 VTi GPL 70<br>1.6 BlueHDi 100 73<br>1.6 BlueHDi 120 88<br>1.6 e-HDi 68<br>1.6 e-HDi 84<br>1.6 GTi 147<br>1.6 GTi 30th 153<br>1.6 HDi 55<br>1.6 HDi 85<br>1.6 THP 115<br>1.6 THP 163 120<br>1.6 VTi 88 |  | 01.12<br>01.13<br>01.12<br>01.12<br>01.12<br>10.13<br>01.15<br>11.13<br>01.12<br>01.12<br>03.13<br>10.14<br>01.13<br>04.14<br>01.12<br>03.15<br>01.12 |  | 24.0109-0100.2  | 409100   |   | 249 9,0 7,0 +B   |
|  | 1.0 VTi 50<br>1.2 THP 81<br>1.2 VTi 60<br>1.4 HDi 50<br>1.4 VTi 70<br>1.4 VTi GPL 70<br>1.6 BlueHDi 100 73<br>1.6 BlueHDi 120 88<br>1.6 e-HDi 68<br>1.6 e-HDi 84<br>1.6 HDi 55<br>1.6 HDi 85<br>1.6 THP 115<br>1.6 THP 163 120<br>1.6 VTi 88                                    |  | 01.12<br>01.13<br>01.12<br>01.12<br>01.12<br>10.13<br>01.15<br>11.13<br>01.12<br>01.12<br>01.13<br>04.14<br>01.12<br>03.15<br>01.12                   |  | 03.0137-0504.2<br>03.0137-9281.2  | 650504<br>669281   |   | 203 x 39 HEB BOS<br>Bremsbacken-Zubehör  |
| ↓  | ↓   |  |   |  |   |  |   |  |







| PEUGEOT 208 (12-) |                 |     |  |       |  |                |        |  |                     |     |
|-------------------|-----------------|-----|--|-------|--|----------------|--------|--|---------------------|-----|
|                   | 1.6 VTi         | 88  |  | 01.12 |  | 03.0137-0504.2 | 650504 |  | 203 x 39 HEB        | BOS |
|                   |                 |     |  |       |  | 03.0137-9281.2 | 669281 |  | Bremsbacken-Zubehör |     |
|                   | 1.0 VTi         | 50  |  | 01.12 |  | 03.0520-9720.3 | 699720 |  | 20,64/203x39 TopKit | BOS |
|                   | 1.2 THP         | 81  |  | 01.13 |  |                |        |  |                     |     |
|                   | 1.2 VTi         | 60  |  | 01.12 |  |                |        |  |                     |     |
|                   | 1.4 HDi         | 50  |  | 01.12 |  |                |        |  |                     |     |
|                   | 1.4 VTi         | 70  |  | 01.12 |  |                |        |  |                     |     |
|                   | 1.4 VTi GPL     | 70  |  | 10.13 |  |                |        |  |                     |     |
|                   | 1.6 BlueHDi 100 | 73  |  | 01.15 |  |                |        |  |                     |     |
|                   | 1.6 BlueHDi 120 | 88  |  | 11.13 |  |                |        |  |                     |     |
|                   | 1.6 e-HDi       | 68  |  | 01.12 |  |                |        |  |                     |     |
|                   | 1.6 e-HDi       | 84  |  | 01.12 |  |                |        |  |                     |     |
|                   | 1.6 HDi         | 55  |  | 01.13 |  |                |        |  |                     |     |
|                   | 1.6 HDi         | 85  |  | 04.14 |  |                |        |  |                     |     |
|                   | 1.6 THP         | 115 |  | 01.12 |  |                |        |  |                     |     |
|                   | 1.6 THP 163     | 120 |  | 03.15 |  |                |        |  |                     |     |
|                   | 1.6 VTi         | 88  |  | 01.12 |  |                |        |  |                     |     |

| PEUGEOT 301 (12-) |                 |    |  |       |  |                |        |                                    |                        |     |
|-------------------|-----------------|----|--|-------|--|----------------|--------|------------------------------------|------------------------|-----|
|                   | 1.2 VTi 72      | 53 |  | 11.12 |  | 13.0460-3867.2 | 603867 | - belüftete Scheiben <sup>1)</sup> | 25250 18,9 +/Zub/S     | MAN |
|                   | 1.2 VTi 82      | 60 |  | 12.14 |  | 13.0460-3994.2 | 603994 | + belüftete Scheiben <sup>2)</sup> | 23599 19,0 /Zub/S      | BOS |
|                   | 1.6 BlueHDi 100 | 73 |  | 04.14 |  | 13.0470-3994.2 | LD3994 | + belüftete Scheiben <sup>2)</sup> | 23599 19,0 /Zub/S      | BOS |
|                   | 1.6 HDi 92      | 68 |  | 11.12 |  |                |        |                                    |                        |     |
|                   | 1.6 VTi 115     | 85 |  | 11.12 |  |                |        |                                    |                        |     |
|                   | 1.2 VTi 72      | 53 |  | 11.12 |  | 24.0113-0184.1 | 413184 |                                    | 266 13,0 11,0 +S +B    |     |
|                   | 1.2 VTi 82      | 60 |  | 12.14 |  | 24.0313-0184.1 | 513184 |                                    | 266 13,0 11,0 +S +B PD |     |
|                   | 1.6 BlueHDi 100 | 73 |  | 04.14 |  | 24.0122-0194.1 | 422194 |                                    | 266 22,0 20,0 V +S +B  |     |
|                   | 1.6 HDi 92      | 68 |  | 11.12 |  |                |        |                                    |                        |     |
|                   | 1.6 VTi 115     | 85 |  | 11.12 |  |                |        |                                    |                        |     |
|                   | 1.2 VTi 72      | 53 |  | 11.12 |  | 24.0711-5256.3 | 360320 | 2                                  | Radsensor L=1029       |     |
|                   | 1.2 VTi 82      | 60 |  | 12.14 |  |                |        |                                    |                        |     |
|                   | 1.6 BlueHDi 100 | 73 |  | 04.14 |  |                |        |                                    |                        |     |
|                   | 1.6 HDi 92      | 68 |  | 11.12 |  |                |        |                                    |                        |     |
|                   | 1.6 VTi 115     | 85 |  | 11.12 |  |                |        |                                    |                        |     |
|                   | 1.2 VTi 72      | 53 |  | 11.12 |  | 03.0137-0504.2 | 650504 | + ABS                              | 203 x 39 HEB           | BOS |
|                   | 1.2 VTi 82      | 60 |  | 12.14 |  |                |        |                                    |                        |     |
|                   | 1.6 BlueHDi 100 | 73 |  | 04.14 |  |                |        |                                    |                        |     |
|                   | 1.6 HDi 92      | 68 |  | 11.12 |  |                |        |                                    |                        |     |
|                   | 1.6 VTi 115     | 85 |  | 11.12 |  |                |        |                                    |                        |     |
|                   | 1.2 VTi 72      | 53 |  | 11.12 |  | 03.0520-9720.3 | 699720 | + ABS                              | 20,64/203x39 TopKit    | BOS |
|                   | 1.2 VTi 82      | 60 |  | 12.14 |  |                |        |                                    |                        |     |
|                   | 1.6 BlueHDi 100 | 73 |  | 04.14 |  |                |        |                                    |                        |     |
|                   | 1.6 HDi 92      | 68 |  | 11.12 |  |                |        |                                    |                        |     |
|                   | 1.6 VTi 115     | 85 |  | 11.12 |  |                |        |                                    |                        |     |

| PEUGEOT 306 Limousine (3/5-tuerig) (93-01) |                  |     |            |       |       |                     |                |        |                    |     |
|--|------------------|-----|------------|-------|-------|---------------------|----------------|--------|--------------------|-----|
|  | 1.1              | 44  |            | 03.94 | 04.97 | - ABS               | 13.0460-3952.2 | 603952 | 20905 18,0 +/WK    | BDX |
|  | 1.4              | 55  |            | 03.93 | 04.97 | - ABS               | 13.0460-0403.2 | 610403 | Belagsatz-Zubehör  | BDX |
|  | 1.4              | 55  |            | 05.97 | 05.01 | - ABS               | 13.0460-3975.2 | 603975 | 23597 18,0 +/S     | BOS |
|  | 1.1              | 44  |            | 03.94 | 04.97 | + ABS               | 13.0460-7058.2 | 607058 | 21430 17,3 +/WK    | ATE |
|  | 1.4              | 55  | ORGA 08575 | 03.93 | 05.01 | + ABS/ - Entreprise | 13.0460-7088.2 | 607088 | 21827 17,3 +       | ATE |
|  | 1.4 Entreprise   | 55  |            | 03.93 | 05.01 |                     |                |        |                    |     |
|  | 1.6              | 65  | ORGA 08575 | 03.93 | 05.01 |                     |                |        |                    |     |
|  | 1.6              | 65  |            | 05.00 | 10.00 | - ABS               |                |        |                    |     |
|  | 1.6              | 72  |            | 10.00 | 05.01 | - ABS               |                |        |                    |     |
|  | 1.8              | 74  | ORGA 08575 | 03.93 | 05.01 | - ABS               |                |        |                    |     |
|  | 1.8              | 74  | ORGA 08576 | 05.01 | 05.01 | - ABS               |                |        |                    |     |
|  | 1.8 D            | 43  |            | 03.93 | 05.01 |                     |                |        |                    |     |
|  | 1.9 D            | 47  |            | 05.93 | 05.01 |                     |                |        |                    |     |
|  | 1.9 D            | 50  |            | 06.94 | 05.01 |                     |                |        |                    |     |
|  | 1.9 D            | 51  | ORGA 08575 | 04.93 | 05.01 |                     |                |        |                    |     |
|  | 1.9 D            | 51  | ORGA 08576 | 05.01 | 05.01 | - ABS               |                |        |                    |     |
|  | 1.9 D            | 55  |            | 03.98 | 05.01 | + ABS               |                |        |                    |     |
|  | 1.9 D Entreprise | 55  |            | 09.98 | 10.00 | + ABS               |                |        |                    |     |
|  | 1.9 TD           | 66  |            | 10.93 | 05.01 |                     |                |        |                    |     |
|  | 1.4              | 55  | ORGA 08576 | 05.01 | 05.01 | + ABS               | 13.0460-3978.2 | 603978 | 23332 18,0 +/Zub/S | BOS |
|  | 1.6              | 65  | ORGA 08576 | 10.00 | 10.00 | + ABS               | 13.0460-2829.2 | 602829 | 23124 19,0 +/WK/S  | TRW |
|  | 1.6              | 72  |            | 10.00 | 05.01 | + ABS               |                |        |                    |     |
|  | 1.8              | 74  | ORGA 08576 | 05.01 | 05.01 | + ABS               |                |        |                    |     |
|  | 1.8 16V          | 81  |            | 03.97 | 05.01 |                     |                |        |                    |     |
|  | 1.9 D            | 51  |            | 05.00 | 05.01 | + ABS/ - Entreprise |                |        |                    |     |
|  | 1.9 D Entreprise | 51  |            | 10.00 | 05.01 | + ABS               |                |        |                    |     |
|  | 2.0              | 89  |            | 05.97 | 05.01 |                     |                |        |                    |     |
|  | 2.0 16V          | 89  |            | 03.97 | 05.01 |                     |                |        |                    |     |
|  | 2.0 HDi          | 66  |            | 06.99 | 05.01 |                     |                |        |                    |     |
|  | 2.0 S16          | 110 |            | 05.97 | 05.01 |                     |                |        |                    |     |
|  | 2.0 S16          | 112 |            | 05.97 | 05.01 |                     |                |        |                    |     |
|  | 2.0              | 89  |            | 03.94 | 04.97 |                     | 13.0460-2869.2 | 602869 | 23169 19,4 /WK/S   | TRW |
|  | 2.0 16V          | 89  |            | 03.97 | 04.97 |                     |                |        |                    |     |
|  | 2.0 S16          | 110 |            | 03.94 | 04.97 |                     | 13.0460-2817.2 | 602817 | 21674 19,0 +/WK/S  | TRW |
|  | 2.0 S16          | 112 |            | 07.94 | 04.97 |                     |                |        |                    |     |
|  | 2.0 S16          | 120 |            | 03.96 | 05.01 |                     |                |        |                    |     |

1) - ventilated discs / - dischi ventilati / - disques ventilés / - disco ventilado  
 2) + ventilated discs / + dischi ventilati / + disques ventilés / + disco ventilado

















| PEUGEOT 306 Limousine (3/5-tuerig) (93-01)   |                                | KW  |            | 231          |              | i  |  | Atc                   |        | ? |  | i |  | i                   |                             |
|--|--------------------------------|-----|------------|--------------|--------------|--|--|-----------------------|--------|---|--|---|--|---------------------|-----------------------------|
|    | 1.1                            | 44  |            | <b>03.94</b> | <b>04.97</b> | - ABS  |  | <b>24.0110-0187.1</b> | 410187 |   |  |   |  | 247                 | 10,0 9,0 +S +B              |
|  | 1.4                            | 55  |            | <b>03.93</b> | <b>04.97</b> | - ABS  |  |                       |        |   |  |   |  |                     |                             |
|  | 1.4                            | 55  |            | <b>05.97</b> | <b>05.01</b> | - ABS  |  | <b>24.0113-0185.1</b> | 413185 |   |  |   |  | 248                 | 13,0 11,0 +S +B             |
|  |                                |     |            |              |              |  |  | <b>24.0313-0185.1</b> | 513185 |   |  |   |  | <b>248</b>          | <b>13,0 11,0 +S +B PD</b>   |
|  | 1.1                            | 44  |            | <b>03.94</b> | <b>04.97</b> | + ABS  |  | <b>24.0120-0132.1</b> | 420132 |   |  |   |  | 247                 | 20,4 18,5 V +S +B           |
|  | 1.4                            | 55  | ORGA 08575 | <b>03.93</b> |              | + ABS/ - Entreprise                          |  | <b>24.0320-0132.1</b> | 520132 |   |  |   |  | <b>247</b>          | <b>20,4 18,5 V +S +B PD</b> |
|  | 1.4 <b>Entreprise</b>          | 55  |            | <b>03.93</b> | <b>05.01</b> |  |  |                       |        |   |  |   |  |                     |                             |
|  | 1.6                            | 65  | ORGA 08575 | <b>03.93</b> |              |  |  |                       |        |   |  |   |  |                     |                             |
|  | 1.6                            | 65  | ORGA 08576 |              | <b>10.00</b> | - ABS  |  |                       |        |   |  |   |  |                     |                             |
|  | 1.6                            | 72  |            |              | <b>10.00</b> | - ABS  |  |                       |        |   |  |   |  |                     |                             |
|  | 1.8                            | 74  | ORGA 08575 | <b>03.93</b> |              |  |  |                       |        |   |  |   |  |                     |                             |
|  | 1.8                            | 74  | ORGA 08576 |              | <b>05.01</b> | - ABS  |  |                       |        |   |  |   |  |                     |                             |
|  | 1.8 <b>D</b>                   | 43  |            | <b>03.93</b> | <b>05.01</b> |  |  |                       |        |   |  |   |  |                     |                             |
|  | 1.9 <b>D</b>                   | 47  |            | <b>05.93</b> | <b>05.01</b> |  |  |                       |        |   |  |   |  |                     |                             |
|  | 1.9 <b>D</b>                   | 50  |            | <b>06.94</b> | <b>05.01</b> |  |  |                       |        |   |  |   |  |                     |                             |
|  | 1.9 <b>D</b>                   | 51  | ORGA 08575 | <b>09.98</b> |              |  |  |                       |        |   |  |   |  |                     |                             |
|  | 1.9 <b>D</b>                   | 51  |            | <b>09.98</b> |              | + ABS  |  |                       |        |   |  |   |  |                     |                             |
|  | 1.9 <b>D</b>                   | 51  | ORGA 08576 |              | <b>05.01</b> | - ABS  |  |                       |        |   |  |   |  |                     |                             |
|  | 1.9 <b>D</b>                   | 55  |            | <b>03.98</b> | <b>05.01</b> |  |  |                       |        |   |  |   |  |                     |                             |
|  | 1.9 <b>TD</b>                  | 66  |            | <b>10.93</b> | <b>05.01</b> |  |  |                       |        |   |  |   |  |                     |                             |
|  | 1.4                            | 55  | ORGA 08576 |              | <b>05.01</b> | + ABS  |  | <b>24.0120-0133.1</b> | 420133 |   |  |   |  | 266                 | 20,5 18,5 V +S +B           |
|  | 1.6                            | 65  | ORGA 08576 |              | <b>10.00</b> | + ABS  |  | <b>24.0320-0133.1</b> | 520133 |   |  |   |  | <b>266</b>          | <b>20,5 18,5 V +S +B PD</b> |
|  | 1.6                            | 72  |            | <b>10.00</b> | <b>05.01</b> | + ABS  |  |                       |        |   |  |   |  |                     |                             |
|  | 1.8                            | 74  | ORGA 08576 |              | <b>05.01</b> | + ABS  |  |                       |        |   |  |   |  |                     |                             |
|  | 1.8 <b>16V</b>                 | 81  |            | <b>03.97</b> | <b>05.01</b> |  |  |                       |        |   |  |   |  |                     |                             |
|  | 1.9 <b>D</b>                   | 51  | ORGA 08576 |              | <b>05.01</b> | + ABS/ - Entreprise                          |  |                       |        |   |  |   |  |                     |                             |
|  | 1.9 <b>D</b> <b>Entreprise</b> |     |            | <b>10.00</b> | <b>05.01</b> | + ABS  |  |                       |        |   |  |   |  |                     |                             |
|  | 2.0                            | 89  |            | <b>03.94</b> | <b>05.01</b> |  |  |                       |        |   |  |   |  |                     |                             |
|  | 2.0 <b>16V</b>                 |     |            | <b>03.97</b> | <b>05.01</b> |  |  |                       |        |   |  |   |  |                     |                             |
|  | 2.0 <b>Hdi</b>                 | 66  |            | <b>06.99</b> | <b>05.01</b> |  |  |                       |        |   |  |   |  |                     |                             |
|  | 2.0 <b>S16</b>                 | 110 |            | <b>05.97</b> | <b>05.01</b> |  |  |                       |        |   |  |   |  |                     |                             |
|  | 2.0 <b>S16</b>                 | 112 |            | <b>05.97</b> | <b>05.01</b> |  |  |                       |        |   |  |   |  |                     |                             |
|  | 2.0 <b>S16</b>                 | 110 |            | <b>03.94</b> | <b>04.97</b> |  |  | <b>24.0122-0142.1</b> | 422142 |   |  |   |  | 283                 | 22,0 20,0 V L +B            |
|  | 2.0 <b>S16</b>                 | 112 |            | <b>07.94</b> | <b>04.97</b> |  |  |                       |        |   |  |   |  |                     |                             |
|  | 2.0 <b>S16</b>                 | 120 |            | <b>03.96</b> | <b>05.01</b> |  |  |                       |        |   |  |   |  |                     |                             |
|    | 1.8 <b>16V</b>                 | 81  |            | <b>03.97</b> | <b>05.01</b> |  |  | <b>13.0460-3954.2</b> | 603954 |   |  |   |  | <b>20973</b>        | 11,0 + <b>BDX</b>           |
|  | 2.0                            | 89  |            | <b>03.94</b> | <b>05.01</b> |  |  | <b>13.0460-3823.2</b> | 603823 |   |  |   |  | <b>20974</b>        | 11,0 <b>BOS</b>             |
|  | 2.0 <b>16V</b>                 |     |            | <b>03.97</b> | <b>05.01</b> |  |  | <b>13.0460-0435.2</b> | 610435 |   |  |   |  |                     | <b>BDX</b>                  |
|  | 2.0 <b>Hdi</b>                 | 66  |            | <b>06.99</b> | <b>05.01</b> |  |  |                       |        |   |  |   |  |                     | Belagsatz-Zubehör           |
|  | 2.0 <b>S16</b>                 | 110 |            | <b>03.94</b> | <b>05.01</b> |  |  |                       |        |   |  |   |  |                     |                             |
|  | 2.0 <b>S16</b>                 | 112 |            | <b>07.94</b> | <b>05.01</b> |  |  |                       |        |   |  |   |  |                     |                             |
|  | 2.0 <b>S16</b>                 | 120 |            | <b>03.96</b> | <b>05.01</b> |  |  |                       |        |   |  |   |  |                     |                             |
|  | 1.8 <b>16V</b>                 | 81  |            | <b>03.97</b> | <b>05.01</b> |  |  | <b>24.0108-0106.1</b> | 408106 |   |  |   |  | 247                 | 8,0 6,0 +S +B               |
|  | 2.0                            | 89  |            | <b>03.94</b> | <b>05.01</b> |  |  |                       |        |   |  |   |  |                     |                             |
|  | 2.0 <b>16V</b>                 |     |            | <b>03.97</b> | <b>05.01</b> |  |  |                       |        |   |  |   |  |                     |                             |
|  | 2.0 <b>Hdi</b>                 | 66  |            | <b>06.99</b> | <b>05.01</b> |  |  |                       |        |   |  |   |  |                     |                             |
|  | 2.0 <b>S16</b>                 | 110 |            | <b>03.94</b> | <b>05.01</b> |  |  |                       |        |   |  |   |  |                     |                             |
|  | 2.0 <b>S16</b>                 | 112 |            | <b>07.94</b> | <b>05.01</b> |  |  |                       |        |   |  |   |  |                     |                             |
|  | 2.0 <b>S16</b>                 | 120 |            | <b>03.96</b> | <b>05.01</b> |  |  |                       |        |   |  |   |  |                     |                             |
|  | 1.1                            | 44  |            | <b>03.94</b> | <b>04.97</b> | - ABS  |  | <b>03.0137-0261.2</b> | 650261 |   |  |   |  | 180 x 32            | <b>BDX</b>                  |
|  | 1.4                            | 55  |            | <b>05.97</b> | <b>05.01</b> | - ABS  |  | <b>03.0137-0197.2</b> | 650197 |   |  |   |  | 180 x 32 <b>HEB</b> | <b>TRW</b>                  |
|  | 1.4                            | 55  |            | <b>03.93</b> | <b>04.97</b> | - ABS/-verst.Fahrw./+ 5 türig <sup>1)</sup>  |  | <b>03.0137-9086.2</b> | 669086 |   |  |   |  | Bremsbacken-Zubehör | <b>BDX</b>                  |
|  | 1.6                            | 65  |            | <b>03.93</b> | <b>10.00</b> | - ABS  |  | <b>03.0137-9175.2</b> | 669175 |   |  |   |  | Bremsbacken-Zubehör | <b>TRW</b>                  |
|  | 1.6                            | 72  |            | <b>10.00</b> | <b>05.01</b> | - ABS  |  |                       |        |   |  |   |  |                     |                             |
|  | 1.8                            | 74  |            | <b>03.93</b> | <b>05.01</b> | - ABS  |  |                       |        |   |  |   |  |                     |                             |
|  | 1.8 <b>D</b>                   | 43  |            | <b>05.97</b> | <b>05.01</b> | - ABS  |  |                       |        |   |  |   |  |                     |                             |
|  | 1.8 <b>D</b>                   | 43  |            | <b>03.93</b> | <b>04.97</b> | - ABS/-verst.Fahrw./+ 5 türig <sup>1)</sup>  |  |                       |        |   |  |   |  |                     |                             |
|  | 1.9 <b>D</b>                   |     |            | <b>05.97</b> | <b>05.01</b> | - ABS  |  |                       |        |   |  |   |  |                     |                             |
|  | 1.9 <b>D</b>                   |     |            | <b>05.93</b> | <b>04.97</b> | - ABS/-verst.Fahrw./+ 5 türig <sup>1)</sup>  |  |                       |        |   |  |   |  |                     |                             |
|  | 1.9 <b>TD</b>                  | 66  |            | <b>10.93</b> | <b>05.01</b> | - ABS/-verst.Fahrw./+ 5 türig <sup>1)</sup>  |  |                       |        |   |  |   |  |                     |                             |
|  | 1.1                            | 44  |            | <b>03.94</b> | <b>04.97</b> | + ABS  |  | <b>03.0137-0370.2</b> | 650370 |   |  |   |  | 229 x 42 <b>HEB</b> | <b>BDX</b>                  |
|  | 1.4                            | 55  |            | <b>03.93</b> | <b>04.97</b> | + ABS/ - verstärktes Fahrwerk <sup>2)</sup>  |  | <b>03.0137-9228.2</b> | 669228 |   |  |   |  | Bremsbacken-Zubehör | <b>BDX</b>                  |
|  | 1.4                            | 55  |            | <b>03.93</b> | <b>04.97</b> | - ABS/+ verst.Fahrw./+ 3 türig <sup>3)</sup> |  |                       |        |   |  |   |  |                     |                             |
|  | 1.4 <b>Entreprise</b>          | 55  |            | <b>05.97</b> | <b>05.01</b> |  |  |                       |        |   |  |   |  |                     |                             |
|  | 1.8 <b>D</b>                   | 43  |            | <b>03.93</b> | <b>04.97</b> | + ABS/ - verstärktes Fahrwerk <sup>2)</sup>  |  |                       |        |   |  |   |  |                     |                             |
|  | 1.8 <b>D</b>                   | 43  |            | <b>03.93</b> | <b>04.97</b> | - ABS/+ verst.Fahrw./+ 3 türig <sup>3)</sup> |  |                       |        |   |  |   |  |                     |                             |
|  | 1.8 <b>D</b> <b>Entreprise</b> | 43  |            | <b>05.97</b> | <b>05.01</b> |  |  |                       |        |   |  |   |  |                     |                             |
|  | 1.9 <b>D</b>                   |     |            | <b>05.93</b> | <b>04.97</b> | + ABS/ - verstärktes Fahrwerk <sup>2)</sup>  |  |                       |        |   |  |   |  |                     |                             |
|  | 1.9 <b>D</b>                   |     |            | <b>05.93</b> | <b>04.97</b> | - ABS/+ verst.Fahrw./+ 3 türig <sup>3)</sup> |  |                       |        |   |  |   |  |                     |                             |
|  | 1.9 <b>D</b> <b>Entreprise</b> |     |            | <b>05.97</b> | <b>05.01</b> | + ABS/ - verstärktes Fahrwerk <sup>2)</sup>  |  |                       |        |   |  |   |  |                     |                             |
|  | 1.9 <b>TD</b>                  | 66  |            | <b>10.93</b> | <b>05.01</b> | + ABS/ - verstärktes Fahrwerk <sup>2)</sup>  |  |                       |        |   |  |   |  |                     |                             |
|  | 1.9 <b>TD</b>                  | 66  |            | <b>10.93</b> | <b>05.01</b> | - ABS/+ verst.Fahrw./+ 3 türig <sup>3)</sup> |  |                       |        |   |  |   |  |                     |                             |
|  | 1.1                            | 44  |            | <b>03.94</b> | <b>08.95</b> | + ABS  |  | <b>03.0137-0197.2</b> | 650197 |   |  |   |  | 180 x 32 <b>HEB</b> | <b>TRW</b>                  |
|  | 1.4                            | 55  |            | <b>03.93</b> | <b>08.95</b> | + ABS  |  | <b>03.0137-9175.2</b> | 669175 |   |  |   |  | Bremsbacken-Zubehör | <b>TRW</b>                  |
|  | 1.6                            | 65  |            | <b>03.93</b> | <b>08.95</b> | + ABS  |  |                       |        |   |  |   |  |                     |                             |
|  | 1.8                            | 74  |            | <b>03.93</b> | <b>08.95</b> | + ABS  |  |                       |        |   |  |   |  |                     |                             |
|  | 1.8 <b>D</b>                   | 43  |            | <b>03.93</b> | <b>08.95</b> | + ABS  |  |                       |        |   |  |   |  |                     |                             |
|  | 1.9 <b>D</b>                   |     |            | <b>05.93</b> | <b>08.95</b> | + ABS  |  |                       |        |   |  |   |  |                     |                             |
|  | 1.9 <b>TD</b>                  | 66  |            | <b>10.93</b> | <b>08.95</b> | + ABS  |  |                       |        |   |  |   |  |                     |                             |
|  | 1.1                            | 44  |            | <b>09.95</b> | <b>04.97</b> | + ABS  |  | <b>03.0137-0312.2</b> | 650312 |   |  |   |  | 203 x 38 <b>HEB</b> | <b>TRW</b>                  |
|  | 1.4                            | 55  |            | <b>09.95</b> | <b>05.01</b> | + ABS  |  | <b>03.0137-9158.2</b> | 669158 |   |  |   |  | Bremsbacken-Zubehör | <b>TRW</b>                  |
|  | 1.6                            | 65  |            | <b>09.95</b> | <b>10.00</b> | + ABS  |  |                       |        |   |  |   |  |                     |                             |
|  | 1.6                            | 72  |            | <b>10.00</b> | <b>05.01</b> | + ABS  |  |                       |        |   |  |   |  |                     |                             |
|  | 1.8                            | 74  |            | <b>09.95</b> | <b>05.01</b> | + ABS  |  |                       |        |   |  |   |  |                     |                             |
|  | 1.8 <b>D</b>                   | 43  |            | <b>09.95</b> | <b>05.01</b> | + ABS  |  |                       |        |   |  |   |  |                     |                             |
|  | 1.9 <b>D</b>                   |     |            | <b>09.95</b> | <b>05.01</b> | + ABS  |  |                       |        |   |  |   |  |                     |                             |

1) - ABS/- reinforced susp./+ 5 door / - ABS/- sospens.rinforzata/+ 5 porte / - ABS/- châssis renforcé/+ 5 portes / - ABS/- suspens.reforzada/+ 5 puertas

2) + ABS/- reinforced suspension / + ABS/- sospensione rinforzata / + ABS/- châssis renforcé / + ABS/- suspensión reforzada

3) - ABS/+ reinforced susp./+3 door / - ABS/+ sospens.rinforzata/ + 3 porte / - ABS/+ châssis renforcé/+ 3 portes / - ABS/+ suspensión reforzada/+3 puertas

|     |   |  |  |                          |                         |    |  |  |  |  |     |
|--|---|--|--|--|--|--|--|--|--|--|-----|
| <b>PEUGEOT 306 Limousine (3/5-tuerig) (93-01)</b>                                  |   |  |  |  |  |  |  |  |  |  |     |
|    | 1.9 TD  | 66   |  | 09.95  | 05.01  |  | 03.0137-0312.2<br>03.0137-9158.2   | 650312<br>669158   | 203 x 38 HEB<br>Bremsbacken-Zubehör              | TRW<br>TRW                                       |     |
|    | 1.1<br>1.4<br>1.4<br>1.6<br>1.6<br>1.8<br>1.8 D<br>1.8 D<br>1.9 D<br>1.9 D<br>1.9 TD  | 44<br>55<br>55<br>65<br>72<br>74<br>43<br>43<br>66                               |  | 03.94<br>05.97<br>03.93<br>03.93<br>10.00<br>03.93<br>05.97<br>03.93<br>05.97<br>05.93<br>10.93          | 04.97<br>05.01<br>04.97<br>10.00<br>05.01<br>05.01<br>05.01<br>04.97<br>05.01<br>04.97<br>05.01          | - ABS<br>- ABS<br>- ABS/-verst.Fahrw./+ 5 türig <sup>1)</sup><br>- ABS<br>- ABS<br>- ABS<br>- ABS<br>- ABS/-verst.Fahrw./+ 5 türig <sup>1)</sup><br>- ABS<br>- ABS/-verst.Fahrw./+ 5 türig <sup>1)</sup><br>- ABS/-verst.Fahrw./+ 5 türig <sup>1)</sup>  | 24.0218-0016.1<br>24.0218-0716.2   | 480011<br>480203   | 180/181 x 44,5 - Lager<br>180/181 x 44,5 + Lager |  |     |
|  | 1.1<br>1.4<br>1.4<br>1.4 Enterprise<br>1.8 D<br>1.8 D<br>1.8 D Enterprise<br>1.9 D<br>1.9 D<br>1.9 D Enterprise<br>1.9 TD<br>1.9 TD | 44<br>55<br>55<br>55<br>43<br>43<br>43<br>66<br>66                               |  | 03.94<br>03.93<br>03.93<br>05.97<br>03.93<br>03.93<br>05.97<br>05.93<br>05.93<br>05.97<br>10.93<br>10.93 | 04.97<br>04.97<br>04.97<br>05.01<br>04.97<br>04.97<br>05.01<br>04.97<br>04.97<br>05.01<br>05.01<br>05.01 | + ABS<br>+ ABS/- verstärktes Fahrwerk <sup>3)</sup><br>- ABS/+ verst.Fahrw./+ 3 türig <sup>4)</sup><br>+ ABS/- verstärktes Fahrwerk <sup>3)</sup><br>- ABS/+ verst.Fahrw./+ 3 türig <sup>4)</sup><br>+ ABS/- verstärktes Fahrwerk <sup>3)</sup><br>- ABS/+ verst.Fahrw./+ 3 türig <sup>4)</sup><br>+ ABS/- verstärktes Fahrwerk <sup>3)</sup><br>- ABS/+ verst.Fahrw./+ 3 türig <sup>4)</sup>  | 24.0222-8017.1   | 480071   | für BENDIX-System <sup>2)</sup>                  | 229/230 x 50,8                                   |     |
|  | 1.1<br>1.4<br>1.6<br>1.8<br>1.8 D<br>1.9 D<br>1.9 TD  | 44<br>55<br>65<br>74<br>43<br>66   |  | 03.94<br>03.93<br>03.93<br>03.93<br>05.93<br>10.93   | 08.95<br>08.95<br>08.95<br>08.95<br>08.95<br>08.95   | + ABS<br>+ ABS<br>+ ABS<br>+ ABS<br>+ ABS<br>+ ABS   | 24.0218-0016.1<br>24.0218-0716.2   | 480011<br>480203   | für TRW-System<br>für TRW-System                 | 180/181 x 44,5 - Lager<br>180/181 x 44,5 + Lager |     |
|  | 1.1<br>1.4<br>1.6<br>1.6<br>1.8<br>1.8 D<br>1.9 D<br>1.9 TD   | 44<br>55<br>65<br>72<br>74<br>43<br>66   |  | 09.95<br>09.95<br>09.95<br>10.00<br>09.95<br>09.95<br>09.95<br>09.95                                     | 04.97<br>05.01<br>10.00<br>05.01<br>05.01<br>05.01<br>05.01  | + ABS<br>+ ABS<br>+ ABS<br>+ ABS<br>+ ABS<br>+ ABS<br>+ ABS  | 24.0220-3014.1   | 480090   |  | 203/204,4 x 46,5                                 |     |
|  | 1.1<br>1.4<br>1.4<br>1.6<br>1.6<br>1.8<br>1.8 D<br>1.8 D<br>1.9 D<br>1.9 D<br>1.9 TD  | 44<br>55<br>55<br>65<br>72<br>74<br>43<br>43<br>66                               |  | 03.94<br>05.97<br>03.93<br>03.93<br>10.00<br>03.93<br>05.97<br>03.93<br>05.97<br>05.93<br>10.93          | 04.97<br>05.01<br>04.97<br>10.00<br>05.01<br>05.01<br>05.01<br>04.97<br>05.01<br>04.97<br>05.01          | - ABS<br>- ABS<br>- ABS/-verst.Fahrw./+ 5 türig <sup>1)</sup><br>- ABS<br>- ABS<br>- ABS<br>- ABS<br>- ABS<br>- ABS/-verst.Fahrw./+ 5 türig <sup>1)</sup><br>- ABS<br>- ABS/-verst.Fahrw./+ 5 türig <sup>1)</sup><br>- ABS/-verst.Fahrw./+ 5 türig <sup>1)</sup>   | 03.0520-2620.3<br>03.0520-2520.3   | 692620<br>692520   | 20,64/180x32 TopKit<br>20,64/180x32 TopKit       | BDX<br>TRW                                       |     |
|  | 1.1<br>1.4<br>1.4<br>1.4 Enterprise<br>1.8 D<br>1.8 D<br>1.8 D Enterprise<br>1.9 D<br>1.9 D<br>1.9 D Enterprise<br>1.9 TD<br>1.9 TD | 44<br>55<br>55<br>55<br>43<br>43<br>43<br>66<br>66                               |  | 03.94<br>03.93<br>03.93<br>05.97<br>03.93<br>03.93<br>05.97<br>05.93<br>05.93<br>05.97<br>10.93<br>10.93 | 04.97<br>04.97<br>04.97<br>05.01<br>04.97<br>04.97<br>05.01<br>04.97<br>04.97<br>05.01<br>05.01<br>05.01 | - verstärktes Fahrwerk <sup>5)</sup><br>+ verstärktes Fahrw./+ 3 türig <sup>6)</sup><br>- verstärktes Fahrwerk <sup>5)</sup><br>+ verstärktes Fahrw./+ 3 türig <sup>6)</sup><br>- verstärktes Fahrwerk <sup>5)</sup><br>+ verstärktes Fahrw./+ 3 türig <sup>6)</sup><br>- verstärktes Fahrwerk <sup>5)</sup><br>+ verstärktes Fahrw./+ 3 türig <sup>6)</sup><br>- verstärktes Fahrwerk <sup>5)</sup><br>+ verstärktes Fahrw./+ 3 türig <sup>6)</sup> | 03.0520-3220.3   | 693220   | + ABS  | 20,64/229x42 TopKit                              | BDX |
|  | 1.1<br>1.4<br>1.6<br>1.8<br>1.8 D<br>1.9 D<br>1.9 TD  | 44<br>55<br>65<br>74<br>43<br>66   | ORGA 08729   | 09.95<br>09.95<br>09.95<br>09.95<br>09.95<br>09.95   | + ABS<br>+ ABS<br>+ ABS<br>+ ABS<br>+ ABS<br>+ ABS   |  | 03.0520-5720.3   | 695720   | + GG <sup>7)</sup>                               | 20,64/203x39 TopKit                              | TRW |
|  | 1.4<br>1.6<br>1.8<br>1.8 D<br>1.9 D<br>1.9 TD   | 55<br>72<br>74<br>43<br>66   | ORGA 08730   | 05.01<br>05.01<br>05.01<br>05.01<br>05.01  | + ABS<br>+ ABS<br>+ ABS<br>+ ABS<br>+ ABS  |  | 03.0520-6420.3   | 696420   |  | 20,64/203x39 TopKit                              | TRW |
| <b>PEUGEOT 306 Limousine (4-tuerig) (94-01)</b>                                    |   |  |  |  |  |  |  |  |  |  |     |
|  | 1.4   | 55   |  | 10.94  | 04.97  | - ABS  | 13.0460-3952.2<br>13.0460-0403.2   | 603952<br>610403   | 20905 18,0 +/WK<br>Belagsatz-Zubehör             | BDX<br>BDX                                       |     |
|  | 1.4   | 55   |  | 05.97  | 05.01  | - ABS  | 13.0460-3975.2   | 603975   | 23597 18,0 +/S                                   | BOS  |     |
|  | 1.4<br>1.6<br>1.6<br>1.6  | 55<br>65<br>65<br>72   | ORGA 08575<br>ORGA 08575   | 10.94<br>10.94   |  | + ABS  | 13.0460-7058.2<br>13.0460-7088.2   | 607058<br>607088   | 21430 17,3 +/WK<br>21827 17,3 +                  | ATE<br>ATE                                       |     |
|  | 1.6   | 72   |  | 10.00  | 05.01  | - ABS  |  |  |  |  |     |

<sup>1)</sup> - ABS/- reinforced susp./+ 5 door / - ABS/- sospens.rinforzata/+ 5 porte / - ABS/- châssis renforcé/+ 5 portes / - ABS/- suspens.reforzada/+ 5 puertas

<sup>2)</sup> for BENDIX system / per sistema BENDIX / pour système BENDIX / para sistema BENDIX

<sup>3)</sup> + ABS/- reinforced suspension / + ABS/- sospensione rinforzata / + ABS/- châssis renforcé / + ABS/- suspensión reforzada

<sup>4)</sup> - ABS/+ reinforced susp./+3 door / - ABS/+ sospens.rinforzata/ + 3 porte / - ABS/+ châssis renforcé/+ 3 portes / - ABS/+ suspensión reforzada/+3 puertas

<sup>5)</sup> - reinforced suspension / - sospensione rinforzata / - châssis renforcé / - suspensión reforzada

<sup>6)</sup> + reinforced suspension/+ 3 door / + sospensione rinforzata/ + 3 porte / + châssis renforcé/ + 3 portes / + suspensión reforzada/ + 3 puertas

<sup>7)</sup> + cast iron / + ghisa / + fonte grise / + fundición de gris

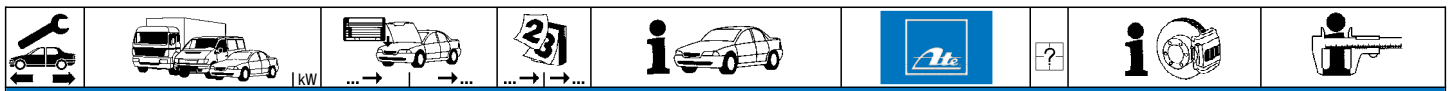

**PEUGEOT 306 Limousine (4-tuerig) (94-01)**

|         |         |            |            |            |       |       |       |                |                |        |  |                          |                    |     |
|---------|---------|------------|------------|------------|-------|-------|-------|----------------|----------------|--------|--|--------------------------|--------------------|-----|
|         | 1.8     | 74         |            | ORGA 08575 | 04.94 |       |       | 13.0460-7058.2 | 607058         |        |  | 21430 17,3 +WK           | ATE                |     |
|         | 1.8     | 74         | ORGA 08576 |            |       | 05.01 | - ABS | 13.0460-7088.2 | 607088         |        |  | 21827 17,3 +             | ATE                |     |
|         | 1.9 D   | 47         |            |            | 10.94 | 05.01 |       |                |                |        |  |                          |                    |     |
|         | 1.9 D   | 50         |            |            | 10.94 | 05.01 |       |                |                |        |  |                          |                    |     |
|         | 1.9 D   | 51         |            | ORGA 08575 | 09.98 |       |       |                |                |        |  |                          |                    |     |
|         | 1.9 D   | 51         | ORGA 08576 |            |       | 05.01 | - ABS |                |                |        |  |                          |                    |     |
|         | 1.9 D   | 55         |            |            | 03.98 | 05.01 |       |                |                |        |  |                          |                    |     |
|         | 1.9 TD  | 66         |            |            | 10.94 | 05.01 |       |                |                |        |  |                          |                    |     |
|         | 1.4     | 55         | ORGA 08576 |            |       | 05.01 | + ABS |                | 13.0460-3978.2 | 603978 |  |                          | 23332 18,0 +/Zub/S | BOS |
|         | 1.6     | 65         | ORGA 08576 |            |       | 10.00 | + ABS |                | 13.0460-2829.2 | 602829 |  |                          | 23124 19,0 +WK/S   | TRW |
| 1.6     | 72      |            |            |            | 10.00 | + ABS |       |                |                |        |  |                          |                    |     |
| 1.8     | 74      | ORGA 08576 |            |            | 05.01 | + ABS |       |                |                |        |  |                          |                    |     |
| 1.8 16V | 81      |            |            | 03.97      | 05.01 |       |       |                |                |        |  |                          |                    |     |
| 1.9 D   | 51      | ORGA 08576 |            |            | 05.01 | + ABS |       |                |                |        |  |                          |                    |     |
| 2.0     | 89      |            |            | 05.97      | 05.01 |       |       |                |                |        |  |                          |                    |     |
| 2.0 16V | 97      |            |            | 03.97      | 05.01 |       |       |                |                |        |  |                          |                    |     |
| 2.0 HDi | 66      |            |            | 06.99      | 05.01 |       |       |                |                |        |  |                          |                    |     |
| 2.0 S16 | 110     |            |            | 05.97      | 05.01 |       |       |                |                |        |  |                          |                    |     |
| 2.0 S16 | 112     |            |            | 05.97      | 05.01 |       |       |                |                |        |  |                          |                    |     |
| 2.0     | 89      |            |            | 04.94      | 04.97 |       |       | 13.0460-2869.2 | 602869         |        |  | 23169 19,4 /WK/S         | TRW                |     |
| 2.0 S16 | 110     |            |            | 04.94      | 04.97 |       |       |                |                |        |  |                          |                    |     |
| 2.0 S16 | 112     |            |            | 07.94      | 04.97 |       |       |                |                |        |  |                          |                    |     |
|         | 1.4     | 55         |            |            | 10.94 | 04.97 | - ABS | 24.0110-0187.1 | 410187         |        |  | 247 10,0 9,0 +S +B       |                    |     |
|         | 1.4     | 55         |            |            | 05.97 | 05.01 | - ABS | 24.0113-0185.1 | 413185         |        |  | 248 13,0 11,0 +S +B      |                    |     |
|         |         |            |            |            |       |       |       | 24.0313-0185.1 | 513185         |        |  | 248 13,0 11,0 +S +B PD   |                    |     |
|         | 1.4     | 55         | ORGA 08575 |            | 10.94 |       | + ABS | 24.0120-0132.1 | 420132         |        |  | 247 20,4 18,5 V +S +B    |                    |     |
|         | 1.6     | 65         | ORGA 08576 |            |       | 10.00 | - ABS | 24.0320-0132.1 | 520132         |        |  | 247 20,4 18,5 V +S +B PD |                    |     |
|         | 1.6     | 65         |            |            | 10.94 | 05.00 |       |                |                |        |  |                          |                    |     |
|         | 1.6     | 72         |            |            | 10.00 | 05.01 | - ABS |                |                |        |  |                          |                    |     |
|         | 1.8     | 74         |            | ORGA 08575 | 04.94 |       |       |                |                |        |  |                          |                    |     |
|         | 1.8     | 74         | ORGA 08576 |            |       | 05.01 | - ABS |                |                |        |  |                          |                    |     |
|         | 1.9 D   | 47         |            |            | 10.94 | 05.01 |       |                |                |        |  |                          |                    |     |
| 1.9 D   | 50      |            |            | 10.94      | 05.01 |       |       |                |                |        |  |                          |                    |     |
| 1.9 D   | 51      |            | ORGA 08575 | 09.98      |       |       |       |                |                |        |  |                          |                    |     |
| 1.9 D   | 51      | ORGA 08576 |            |            | 05.01 | - ABS |       |                |                |        |  |                          |                    |     |
| 1.9 D   | 55      |            |            | 03.98      | 05.01 |       |       |                |                |        |  |                          |                    |     |
| 1.9 TD  | 66      |            |            | 10.94      | 05.01 |       |       |                |                |        |  |                          |                    |     |
| 1.4     | 55      |            |            | 05.00      | 05.01 | + ABS |       | 24.0120-0133.1 | 420133         |        |  | 266 20,5 18,5 V +S +B    |                    |     |
| 1.6     | 65      |            |            | 05.00      | 10.00 | + ABS |       | 24.0320-0133.1 | 520133         |        |  | 266 20,5 18,5 V +S +B PD |                    |     |
| 1.6     | 72      |            |            | 10.00      | 05.01 | + ABS |       |                |                |        |  |                          |                    |     |
| 1.8     | 74      |            |            | 05.00      | 05.01 | + ABS |       |                |                |        |  |                          |                    |     |
| 1.8 16V | 81      |            |            | 03.97      | 05.01 |       |       |                |                |        |  |                          |                    |     |
| 1.9 D   | 51      |            |            | 05.00      | 05.01 | + ABS |       |                |                |        |  |                          |                    |     |
| 2.0     | 89      |            |            | 04.94      | 05.01 |       |       |                |                |        |  |                          |                    |     |
| 2.0 16V | 97      |            |            | 03.97      | 05.01 |       |       |                |                |        |  |                          |                    |     |
| 2.0 HDi | 66      |            |            | 06.99      | 05.01 |       |       |                |                |        |  |                          |                    |     |
| 2.0 S16 | 110     |            |            | 05.97      | 05.01 |       |       |                |                |        |  |                          |                    |     |
| 2.0 S16 | 112     |            |            | 05.97      | 05.01 |       |       |                |                |        |  |                          |                    |     |
| 2.0 S16 | 110     |            |            | 06.94      | 04.97 |       |       | 24.0122-0142.1 | 422142         |        |  | 283 22,0 20,0 V L +B     |                    |     |
| 2.0 S16 | 112     |            |            | 07.94      | 04.97 |       |       |                |                |        |  |                          |                    |     |
|         | 1.8 16V | 81         |            |            | 03.97 | 05.01 |       | 13.0460-3954.2 | 603954         |        |  | 20973 11,0 +             | BDX                |     |
|         | 2.0     | 89         |            |            | 04.94 | 05.01 |       | 13.0460-3823.2 | 603823         |        |  | 20974 11,0               | BOS                |     |
|         | 2.0 16V | 97         |            |            | 03.97 | 05.01 |       | 13.0460-0435.2 | 610435         |        |  | Belagsatz-Zubehör        | BDX                |     |
|         | 2.0 HDi | 66         |            |            | 06.99 | 05.01 |       |                |                |        |  |                          |                    |     |
|         | 2.0 S16 | 110        |            |            | 06.94 | 05.01 |       |                |                |        |  |                          |                    |     |
|         | 2.0 S16 | 112        |            |            | 07.94 | 05.01 |       |                |                |        |  |                          |                    |     |
|         | 1.8 16V | 81         |            |            | 03.97 | 05.01 |       | 24.0108-0106.1 | 408106         |        |  | 247 8,0 6,0 +S +B        |                    |     |
|         | 2.0     | 89         |            |            | 04.94 | 05.01 |       |                |                |        |  |                          |                    |     |
|         | 2.0 16V | 97         |            |            | 03.97 | 05.01 |       |                |                |        |  |                          |                    |     |
|         | 2.0 HDi | 66         |            |            | 06.99 | 05.01 |       |                |                |        |  |                          |                    |     |
|         | 2.0 S16 | 110        |            |            | 06.94 | 05.01 |       |                |                |        |  |                          |                    |     |
|         | 2.0 S16 | 112        |            |            | 07.94 | 05.01 |       |                |                |        |  |                          |                    |     |
|         | 1.4     | 55         |            |            | 10.94 | 05.01 | - ABS | 03.0137-0261.2 | 650261         |        |  | 180 x 32                 | BDX                |     |
|         | 1.6     | 65         |            |            | 10.94 | 10.00 | - ABS | 03.0137-0197.2 | 650197         |        |  | 180 x 32 HEB             | TRW                |     |
|         | 1.6     | 72         |            |            | 10.00 | 05.01 | - ABS | 03.0137-9086.2 | 669086         |        |  | Bremsbacken-Zubehör      | BDX                |     |
|         | 1.8     | 74         |            |            | 04.94 | 05.01 | - ABS | 03.0137-9175.2 | 669175         |        |  | Bremsbacken-Zubehör      | TRW                |     |
|         | 1.9 D   | 50         |            |            | 10.94 | 05.01 | - ABS |                |                |        |  |                          |                    |     |
|         | 1.9 TD  | 66         |            |            | 10.94 | 08.95 | - ABS |                |                |        |  |                          |                    |     |
|         | 1.4     | 55         |            |            | 10.94 | 05.01 | + ABS | 03.0137-0370.2 | 650370         |        |  | 229 x 42 HEB             | BDX                |     |
|         | 1.6     | 65         |            |            | 10.94 | 10.00 | + ABS | 03.0137-9228.2 | 669228         |        |  | Bremsbacken-Zubehör      | BDX                |     |
|         | 1.8     | 74         |            |            | 04.94 | 05.01 | + ABS |                |                |        |  |                          |                    |     |
|         | 1.9 D   | 50         |            |            | 10.94 | 05.01 | + ABS |                |                |        |  |                          |                    |     |
|         | 1.9 TD  | 66         |            |            | 10.94 | 05.01 | + ABS |                |                |        |  |                          |                    |     |
|         | 1.4     | 55         |            |            | 10.94 | 08.95 | + ABS | 03.0137-0197.2 | 650197         |        |  | 180 x 32 HEB             | TRW                |     |
|         | 1.6     | 65         |            |            | 10.94 | 08.95 | + ABS | 03.0137-9175.2 | 669175         |        |  | Bremsbacken-Zubehör      | TRW                |     |
|         | 1.8     | 74         |            |            | 04.94 | 08.95 | + ABS |                |                |        |  |                          |                    |     |
|         | 1.9 D   | 50         |            |            | 10.94 | 08.95 | + ABS |                |                |        |  |                          |                    |     |
|         | 1.9 TD  | 66         |            |            | 10.94 | 08.95 | + ABS |                |                |        |  |                          |                    |     |
|         | 1.4     | 55         |            |            | 09.95 | 05.01 | + ABS | 03.0137-0312.2 | 650312         |        |  | 203 x 38 HEB             | TRW                |     |
|         | 1.6     | 65         |            |            | 09.95 | 10.00 | + ABS | 03.0137-9158.2 | 669158         |        |  | Bremsbacken-Zubehör      | TRW                |     |
| 1.6     | 72      |            |            | 10.00      | 05.01 | + ABS |       |                |                |        |  |                          |                    |     |
| 1.8     | 74      |            |            | 09.95      | 05.01 | + ABS |       |                |                |        |  |                          |                    |     |
| 1.9 D   | 50      |            |            | 09.95      | 05.01 | + ABS |       |                |                |        |  |                          |                    |     |
| 1.9 TD  | 66      |            |            | 09.95      | 05.01 |       |       |                |                |        |  |                          |                    |     |





**PEUGEOT 306 Limousine (4-tuerig) (94-01)**

|        |        |            |            |       |       |                |                |        |  |                         |                         |
|--------|--------|------------|------------|-------|-------|----------------|----------------|--------|--|-------------------------|-------------------------|
|        | 1.4    | 55         |            | 10.94 | 05.01 | - ABS          | 24.0218-0016.1 | 480011 |  |                         | 180/181 x 44,5 - Lager  |
|        | 1.6    | 65         |            | 10.94 | 10.00 | - ABS          | 24.0218-0716.2 | 480203 |  |                         | 180/181 x 44,5 + Lager  |
|        | 1.6    | 72         |            | 10.00 | 05.01 | - ABS          |                |        |  |                         |                         |
|        | 1.8    | 74         |            | 04.94 | 05.01 | - ABS          |                |        |  |                         |                         |
|        | 1.9 D  |            |            | 10.94 | 05.01 | - ABS          |                |        |  |                         |                         |
|        | 1.9 TD | 66         |            | 10.94 | 08.95 | - ABS          |                |        |  |                         |                         |
|        | 1.4    | 55         |            | 10.94 | 08.95 | + ABS          | 24.0222-8017.1 | 480071 |  |                         | 229/230 x 50,8          |
|        | 1.6    | 65         |            | 10.94 | 08.95 | + ABS          |                |        |  |                         |                         |
|        | 1.8    | 74         |            | 04.94 | 08.95 | + ABS          |                |        |  |                         |                         |
|        | 1.9 D  |            |            | 10.94 | 08.95 | + ABS          |                |        |  |                         |                         |
|        | 1.9 TD | 66         |            | 10.94 | 08.95 | + ABS          |                |        |  |                         |                         |
|        | 1.4    | 55         |            | 10.94 | 08.95 | + ABS          | 24.0218-0016.1 | 480011 |  |                         | 180/181 x 44,5 - Lager  |
|        | 1.6    | 65         |            | 10.94 | 08.95 | + ABS          | 24.0218-0716.2 | 480203 |  |                         | 180/181 x 44,5 + Lager  |
|        | 1.8    | 74         |            | 04.94 | 08.95 | + ABS          |                |        |  |                         |                         |
|        | 1.9 D  |            |            | 10.94 | 08.95 | + ABS          |                |        |  |                         |                         |
| 1.9 TD | 66     |            | 10.94      | 08.95 | + ABS |                |                |        |  |                         |                         |
| 1.4    | 55     |            | 09.95      | 05.01 | + ABS | 24.0220-3014.1 | 480090         |        |  | 203/204,4 x 46,5        |                         |
| 1.6    | 65     |            | 09.95      | 10.00 | + ABS |                |                |        |  |                         |                         |
| 1.6    | 72     |            | 10.00      | 05.01 | + ABS |                |                |        |  |                         |                         |
| 1.8    | 74     |            | 09.95      | 05.01 | + ABS |                |                |        |  |                         |                         |
| 1.9 D  |        |            | 09.95      | 05.01 | + ABS |                |                |        |  |                         |                         |
| 1.9 TD | 66     |            | 09.95      | 05.01 |       |                |                |        |  |                         |                         |
|        | 1.4    | 55         |            | 10.94 | 05.01 | - ABS          | 03.0520-2620.3 | 692620 |  |                         | 20,64/180x32 TopKit BDX |
|        | 1.6    | 65         |            | 10.94 | 10.00 | - ABS          | 03.0520-2520.3 | 692520 |  |                         | 20,64/180x32 TopKit TRW |
|        | 1.6    | 72         |            | 10.00 | 05.01 | - ABS          |                |        |  |                         |                         |
|        | 1.8    | 74         |            | 04.94 | 05.01 | - ABS          |                |        |  |                         |                         |
|        | 1.9 D  |            |            | 10.94 | 05.01 | - ABS          |                |        |  |                         |                         |
|        | 1.9 TD | 66         |            | 10.94 | 08.95 | - ABS          |                |        |  |                         |                         |
|        | 1.4    | 55         |            | 10.94 | 05.01 | + ABS          | 03.0520-3220.3 | 693220 |  |                         | 20,64/229x42 TopKit BDX |
|        | 1.6    | 65         |            | 10.94 | 10.00 | + ABS          |                |        |  |                         |                         |
|        | 1.8    | 74         |            | 04.94 | 05.01 | + ABS          |                |        |  |                         |                         |
|        | 1.9 D  |            |            | 10.94 | 05.01 | + ABS          |                |        |  |                         |                         |
|        | 1.9 TD | 66         |            | 10.94 | 05.01 | + ABS          |                |        |  |                         |                         |
|        | 1.4    | 55         | ORGA 08729 | 09.95 |       | + ABS          | 03.0520-5720.3 | 695720 |  | + GG 1)                 | 20,64/203x39 TopKit TRW |
|        | 1.6    | 65         | ORGA 08729 | 09.95 |       | + ABS          |                |        |  |                         |                         |
|        | 1.8    | 74         | ORGA 08729 | 09.95 |       | + ABS          |                |        |  |                         |                         |
|        | 1.9 D  |            | ORGA 08729 | 09.95 |       | + ABS          |                |        |  |                         |                         |
| 1.9 TD | 66     | ORGA 08729 | 09.95      |       |       |                |                |        |  |                         |                         |
| 1.4    | 55     | ORGA 08730 |            | 05.01 | + ABS | 03.0520-6420.3 | 696420         |        |  | 20,64/203x39 TopKit TRW |                         |
| 1.6    | 65     | ORGA 08730 |            | 10.00 | + ABS |                |                |        |  |                         |                         |
| 1.6    | 72     | ORGA 08730 |            | 05.01 | + ABS |                |                |        |  |                         |                         |
| 1.8    | 74     | ORGA 08730 |            | 05.01 | + ABS |                |                |        |  |                         |                         |
| 1.9 D  |        | ORGA 08730 |            | 05.01 | + ABS |                |                |        |  |                         |                         |
| 1.9 TD | 66     | ORGA 08730 |            | 05.01 |       |                |                |        |  |                         |                         |

**PEUGEOT 306 Cabriolet (94-03)**

|         |         |    |            |       |       |       |                |        |  |  |                          |
|---------|---------|----|------------|-------|-------|-------|----------------|--------|--|--|--------------------------|
|         | 1.6     | 65 | ORGA 08575 | 04.96 |       |       | 13.0460-7058.2 | 607058 |  |  | 21430 17,3 +/WK ATE      |
|         | 1.6     | 65 |            | 10.00 | - ABS |       | 13.0460-7088.2 | 607088 |  |  | 21827 17,3 + ATE         |
|         | 1.8     | 74 | ORGA 08575 | 03.94 |       |       |                |        |  |  |                          |
|         | 1.8     | 74 |            | 05.00 | 10.00 | - ABS |                |        |  |  |                          |
|         | 1.8 16V | 81 | ORGA 08575 | 07.00 |       |       |                |        |  |  |                          |
|         | 1.8 16V | 81 |            | 07.00 | 04.02 | - ABS |                |        |  |  |                          |
|         | 1.6     | 65 | ORGA 08576 |       | 10.00 | + ABS | 13.0460-3978.2 | 603978 |  |  | 23332 18,0 +/Zub/S BOS   |
|         | 1.6     | 72 |            | 10.00 | 07.03 |       | 13.0460-2829.2 | 602829 |  |  | 23124 19,0 +/WK/S TRW    |
|         | 1.8     | 74 | ORGA 08576 |       | 10.00 | + ABS |                |        |  |  |                          |
|         | 1.8 16V | 81 |            | 07.00 | 04.02 |       |                |        |  |  |                          |
| 2.0     | 89      |    | 03.94      | 04.97 |       |       |                |        |  |  |                          |
| 2.0 16V | 97      |    | 03.97      | 10.00 |       |       |                |        |  |  |                          |
| 2.0 16V | 99      |    | 03.97      | 04.02 |       |       |                |        |  |  |                          |
|         | 1.6     | 65 | ORGA 08575 | 04.96 |       |       | 24.0120-0132.1 | 420132 |  |  | 247 20,4 18,5 V +S +B    |
|         | 1.6     | 65 | ORGA 08576 |       | 10.00 | - ABS | 24.0320-0132.1 | 520132 |  |  | 247 20,4 18,5 V +S +B PD |
|         | 1.8     | 74 | ORGA 08575 | 03.94 |       |       |                |        |  |  |                          |
|         | 1.8     | 74 | ORGA 08576 |       | 10.00 | - ABS |                |        |  |  |                          |
|         | 1.6     | 65 | ORGA 08576 |       | 10.00 | + ABS | 24.0120-0133.1 | 420133 |  |  | 266 20,5 18,5 V +S +B    |
|         | 1.6     | 72 |            | 10.00 | 07.03 |       | 24.0320-0133.1 | 520133 |  |  | 266 20,5 18,5 V +S +B PD |
|         | 1.8     | 74 | ORGA 08576 |       | 10.00 | + ABS |                |        |  |  |                          |
|         | 1.8 16V | 81 |            | 07.00 | 07.03 |       |                |        |  |  |                          |
|         | 2.0     | 89 |            | 03.94 | 04.97 |       |                |        |  |  |                          |
|         | 2.0 16V | 97 |            | 03.97 | 10.00 |       |                |        |  |  |                          |
| 2.0 16V | 99      |    | 03.97      | 04.02 |       |       |                |        |  |  |                          |
|         | 1.8 16V | 81 |            | 07.00 | 07.03 |       | 13.0460-3954.2 | 603954 |  |  | 20973 11,0 + BDX         |
|         | 2.0     | 89 |            | 03.94 | 04.97 |       | 13.0460-3823.2 | 603823 |  |  | 20974 11,0 BOS           |
|         | 2.0 16V | 97 |            | 03.97 | 10.00 |       | 13.0460-0435.2 | 610435 |  |  | Belagsatz-Zubehör BDX    |
|         | 2.0 16V | 99 |            | 03.97 | 04.02 |       |                |        |  |  |                          |
|         | 1.8 16V | 81 |            | 07.00 | 07.03 |       | 24.0108-0106.1 | 408106 |  |  | 247 8,0 6,0 +S +B        |
| 2.0     | 89      |    | 03.94      | 04.97 |       |       |                |        |  |  |                          |
| 2.0 16V | 97      |    | 03.97      | 10.00 |       |       |                |        |  |  |                          |
| 2.0 16V | 99      |    | 03.97      | 04.02 |       |       |                |        |  |  |                          |
|         | 1.6     | 65 |            | 04.96 | 10.00 | - ABS | 03.0137-0261.2 | 650261 |  |  | 180 x 32 BDX             |
|         | 1.6     | 72 |            | 10.00 | 07.03 | - ABS | 03.0137-0197.2 | 650197 |  |  | 180 x 32 HEB TRW         |
|         | 1.8     | 74 |            | 03.94 | 10.00 | - ABS | 03.0137-9086.2 | 669086 |  |  | Bremsbacken-Zubehör BDX  |
|         |         |    |            |       |       |       | 03.0137-9175.2 | 669175 |  |  | Bremsbacken-Zubehör TRW  |
|         | 1.6     | 65 |            | 04.96 | 05.00 | + ABS | 03.0137-0370.2 | 650370 |  |  | 229 x 42 HEB BDX         |
|         | 1.8     | 74 |            | 03.94 | 10.00 | + ABS | 03.0137-9228.2 | 669228 |  |  | Bremsbacken-Zubehör BDX  |

1) + cast iron / + ghisa / + fonte grise / + fundición de gris

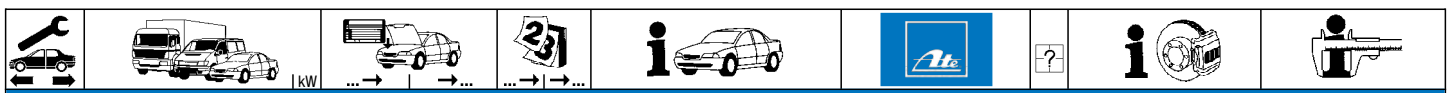

**PEUGEOT 306 Cabriolet (94-03)**

|  |         |    |            |       |             |                |        |         |                        |     |
|--|---------|----|------------|-------|-------------|----------------|--------|---------|------------------------|-----|
|  | 1.8     | 74 |            | 03.94 | 08.95 + ABS | 03.0137-0197.2 | 650197 |         | 180 x 32 HEB           | TRW |
|  | 1.6     | 65 |            | 04.96 | 10.00 + ABS | 03.0137-9175.2 | 669175 |         | Bremsbacken-Zubehör    | TRW |
|  | 1.6     | 72 |            | 10.00 | 07.03 + ABS | 03.0137-0312.2 | 650312 |         | 203 x 38 HEB           | TRW |
|  | 1.8     | 74 |            | 09.95 | 10.00 + ABS | 03.0137-9158.2 | 669158 |         | Bremsbacken-Zubehör    | TRW |
|  | 1.6     | 65 |            | 04.96 | 10.00 - ABS | 24.0218-0016.1 | 480011 |         | 180/181 x 44,5 - Lager |     |
|  | 1.6     | 72 |            | 10.00 | 07.03 - ABS | 24.0218-0716.2 | 480203 |         | 180/181 x 44,5 + Lager |     |
|  | 1.8     | 74 |            | 03.94 | 08.95 + ABS |                |        |         |                        |     |
|  | 1.8     | 74 |            | 03.94 | 10.00 - ABS |                |        |         |                        |     |
|  | 1.6     | 65 |            | 04.96 | 10.00 + ABS | 24.0220-3014.1 | 480090 |         | 203/204,4 x 46,5       |     |
|  | 1.6     | 72 |            | 10.00 | 07.03 + ABS |                |        |         |                        |     |
|  | 1.8     | 74 |            | 09.95 | 10.00 + ABS |                |        |         |                        |     |
|  | 1.8 16V | 81 |            | 07.00 | 04.02 + ABS |                |        |         |                        |     |
|  | 1.6     | 65 |            | 04.96 | 10.00 - ABS | 03.0520-2620.3 | 692620 |         | 20,64/180x32 TopKit    | BDX |
|  | 1.6     | 72 |            | 10.00 | 07.03 - ABS | 03.0520-2520.3 | 692520 |         | 20,64/180x32 TopKit    | TRW |
|  | 1.8     | 74 |            | 03.94 | 10.00 - ABS |                |        |         |                        |     |
|  | 1.8 16V | 81 |            | 07.00 | 04.02 - ABS |                |        |         |                        |     |
|  | 1.6     | 65 | ORGA 08729 | 04.96 | + ABS       | 03.0520-5720.3 | 695720 | + GG 1) | 20,64/203x39 TopKit    | TRW |
|  | 1.8     | 74 | ORGA 08729 | 09.95 | + ABS       |                |        |         |                        |     |
|  | 1.6     | 65 | ORGA 08730 |       | 10.00 + ABS | 03.0520-6420.3 | 696420 |         | 20,64/203x39 TopKit    | TRW |
|  | 1.6     | 72 |            | 10.00 | 07.03 + ABS |                |        |         |                        |     |
|  | 1.8     | 74 | ORGA 08730 |       | 10.00 + ABS |                |        |         |                        |     |

**PEUGEOT 306 Kombi (97-02)**

|  |         |    |  |       |             |                |        |  |                          |     |
|--|---------|----|--|-------|-------------|----------------|--------|--|--------------------------|-----|
|  | 1.4     | 55 |  | 03.97 | 03.02 - ABS | 13.0460-7088.2 | 607088 |  | 21827 17,3 +             | ATE |
|  | 1.6     | 65 |  | 03.97 | 10.00 - ABS |                |        |  |                          |     |
|  | 1.6     | 72 |  | 10.00 | 03.02 - ABS |                |        |  |                          |     |
|  | 1.8 D   |    |  | 03.97 | 03.02 - ABS |                |        |  |                          |     |
|  | 1.9 D   | 51 |  | 03.97 | 03.02 - ABS |                |        |  |                          |     |
|  | 1.4     | 55 |  | 03.97 | 03.02 + ABS | 13.0460-3978.2 | 603978 |  | 23332 18,0 +/Zub/S       | BOS |
|  | 1.6     | 65 |  | 03.97 | 10.00 + ABS | 13.0460-2829.2 | 602829 |  | 23124 19,0 +/WK/S        | TRW |
|  | 1.6     | 72 |  | 10.00 | 03.02 + ABS |                |        |  |                          |     |
|  | 1.8     | 74 |  | 03.97 | 03.02       |                |        |  |                          |     |
|  | 1.8 16V | 81 |  | 03.97 | 03.02       |                |        |  |                          |     |
|  | 1.8 D   |    |  | 03.97 | 03.02 + ABS |                |        |  |                          |     |
|  | 1.9 D   | 51 |  | 03.97 | 03.02 + ABS |                |        |  |                          |     |
|  | 1.9 TD  | 66 |  | 03.97 | 03.02       |                |        |  |                          |     |
|  | 2.0 16V | 97 |  | 03.97 | 03.02       |                |        |  |                          |     |
|  | 2.0 HDi | 66 |  | 06.99 | 03.02       |                |        |  |                          |     |
|  | 1.4     | 55 |  | 03.97 | 03.02 - ABS | 24.0120-0132.1 | 420132 |  | 247 20,4 18,5 V +S +B    |     |
|  | 1.6     | 65 |  | 03.97 | 10.00 - ABS | 24.0320-0132.1 | 520132 |  | 247 20,4 18,5 V +S +B PD |     |
|  | 1.6     | 72 |  | 10.00 | 03.02 - ABS |                |        |  |                          |     |
|  | 1.8 D   |    |  | 03.97 | 03.02 - ABS |                |        |  |                          |     |
|  | 1.9 D   | 51 |  | 03.97 | 03.02 - ABS |                |        |  |                          |     |
|  | 1.4     | 55 |  | 03.97 | 03.02 + ABS | 24.0120-0133.1 | 420133 |  | 266 20,5 18,5 V +S +B    |     |
|  | 1.6     | 65 |  | 03.97 | 10.00 + ABS | 24.0320-0133.1 | 520133 |  | 266 20,5 18,5 V +S +B PD |     |
|  | 1.6     | 72 |  | 10.00 | 03.02 + ABS |                |        |  |                          |     |
|  | 1.8     | 74 |  | 03.97 | 03.02       |                |        |  |                          |     |
|  | 1.8 16V | 81 |  | 03.97 | 03.02       |                |        |  |                          |     |
|  | 1.8 D   |    |  | 03.97 | 03.02 + ABS |                |        |  |                          |     |
|  | 1.9 D   | 51 |  | 03.97 | 03.02 + ABS |                |        |  |                          |     |
|  | 1.9 TD  | 66 |  | 03.97 | 03.02       |                |        |  |                          |     |
|  | 2.0 16V | 97 |  | 03.97 | 03.02       |                |        |  |                          |     |
|  | 2.0 HDi | 66 |  | 06.99 | 03.02       |                |        |  |                          |     |
|  | 1.8 16V | 81 |  | 03.97 | 03.02       | 13.0460-3954.2 | 603954 |  | 20973 11,0 +             | BDX |
|  | 2.0 16V | 97 |  | 03.97 | 03.02       | 13.0460-3823.2 | 603823 |  | 20974 11,0               | BOS |
|  | 2.0 HDi | 66 |  | 06.99 | 03.02       | 13.0460-0435.2 | 610435 |  | Belagsatz-Zubehör        | BDX |
|  | 1.8 16V | 81 |  | 03.97 | 03.02       | 24.0108-0106.1 | 408106 |  | 247 8,0 6,0 +S +B        |     |
|  | 2.0 16V | 97 |  | 03.97 | 03.02       |                |        |  |                          |     |
|  | 2.0 HDi | 66 |  | 06.99 | 03.02       |                |        |  |                          |     |
|  | 1.4     | 55 |  | 03.97 | 03.02       | 03.0137-0370.2 | 650370 |  | 229 x 42 HEB             | BDX |
|  | 1.6     | 65 |  | 03.97 | 10.00       | 03.0137-9228.2 | 669228 |  | Bremsbacken-Zubehör      | BDX |
|  | 1.6     | 72 |  | 10.00 | 03.02       |                |        |  |                          |     |
|  | 1.8     | 74 |  | 03.97 | 03.02       |                |        |  |                          |     |
|  | 1.8 D   |    |  | 03.97 | 03.02       |                |        |  |                          |     |
|  | 1.9 D   | 51 |  | 03.97 | 03.02       |                |        |  |                          |     |
|  | 1.9 TD  | 66 |  | 03.97 | 03.02       |                |        |  |                          |     |
|  | 1.4     | 55 |  | 03.97 | 03.02       | 24.0222-8017.1 | 480071 |  | 229/230 x 50,8           |     |
|  | 1.6     | 65 |  | 03.97 | 10.00       |                |        |  |                          |     |
|  | 1.6     | 72 |  | 10.00 | 03.02       |                |        |  |                          |     |
|  | 1.8     | 74 |  | 03.97 | 03.02       |                |        |  |                          |     |
|  | 1.8 D   |    |  | 03.97 | 03.02       |                |        |  |                          |     |
|  | 1.9 D   | 51 |  | 03.97 | 03.02       |                |        |  |                          |     |
|  | 1.9 TD  | 66 |  | 03.97 | 03.02       |                |        |  |                          |     |
|  | 1.4     | 55 |  | 03.97 | 03.02 - ABS | 03.0520-6720.3 | 696720 |  | 20,64/229x42 TopKit      | BDX |
|  | 1.6     | 65 |  | 03.97 | 10.00 - ABS |                |        |  |                          |     |
|  | 1.6     | 72 |  | 10.00 | 03.02 - ABS |                |        |  |                          |     |
|  | 1.8 D   |    |  | 03.97 | 03.02 - ABS |                |        |  |                          |     |
|  | 1.9 D   | 51 |  | 03.97 | 03.02 - ABS |                |        |  |                          |     |
|  | 1.4     | 55 |  | 03.97 | 03.02 + ABS | 03.0520-5822.3 | 695822 |  | 22,20/229x42 TopKit      | BDX |
|  | 1.6     | 65 |  | 03.97 | 10.00 + ABS |                |        |  |                          |     |
|  | 1.6     | 72 |  | 10.00 | 03.02 + ABS |                |        |  |                          |     |
|  | 1.8     | 74 |  | 03.97 | 03.02 + ABS |                |        |  |                          |     |
|  | 1.8 D   |    |  | 03.97 | 03.02 + ABS |                |        |  |                          |     |
|  | 1.9 D   | 51 |  | 03.97 | 03.02 + ABS |                |        |  |                          |     |

1) + cast iron / + ghisa / + fonte grise / + fundición de gris





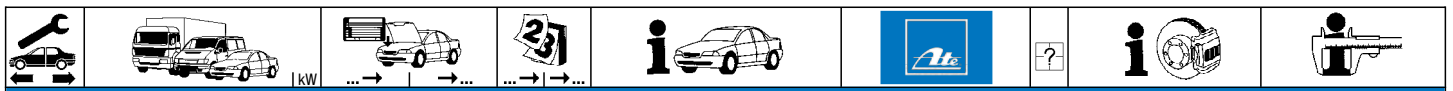

**PEUGEOT 306 Kombi (97-02)**

|  |        |    |  |       |       |  |                |        |  |                     |     |
|--|--------|----|--|-------|-------|--|----------------|--------|--|---------------------|-----|
|  | 1.9 TD | 66 |  | 03.97 | 03.02 |  | 03.0520-5822.3 | 695822 |  | 22,20/229x42 TopKit | BDX |
|--|--------|----|--|-------|-------|--|----------------|--------|--|---------------------|-----|

**PEUGEOT 307 Limousine (00-07)**

|             |             |            |            |       |       |                                       |                |        |   |                   |                   |                   |                 |
|-------------|-------------|------------|------------|-------|-------|---------------------------------------|----------------|--------|---|-------------------|-------------------|-------------------|-----------------|
|             | 1.4         | 55         |            | 08.00 | 07.07 |                                       | 13.0460-3994.2 | 603994 |   | 23599             | 19,0 /Zub/S       | BOS               |                 |
|             | 1.4 16V     | 65         | ORGA 10551 |       | 07.07 | + ESP                                 | 13.0470-3994.2 | LD3994 |   | 23599             | 19,0 /Zub/S       | BOS               |                 |
|             | 1.4 16V     | 65         |            | 11.03 | 07.07 | - ESP                                 |                |        |   |                   |                   |                   |                 |
|             | 1.4 HDi     | 50         |            | 10.01 | 07.07 |                                       |                |        |   |                   |                   |                   |                 |
|             | 1.6         | 81         |            | 07.06 | 07.07 | + ESP/ + Schaltgetriebe <sup>1)</sup> |                |        |   |                   |                   |                   |                 |
|             | 1.6 16V     | 80         | ORGA 10551 |       | 07.07 | + ESP/ + Schaltgetriebe <sup>1)</sup> |                |        |   |                   |                   |                   |                 |
|             | 1.6 16V     | 80         |            | 08.00 | 07.07 | - ESP/ + Schaltgetriebe <sup>2)</sup> |                |        |   |                   |                   |                   |                 |
|             | 1.6 HDi 90  | 66         | ORGA 10551 |       | 07.07 | + ESP                                 |                |        |   |                   |                   |                   |                 |
|             | 1.6 HDi 90  | 66         |            | 04.05 | 07.07 | - ESP                                 |                |        |   |                   |                   |                   |                 |
|             | 2.0 HDi 90  | 66         | ORGA 09520 |       | 07.07 | - ESP                                 |                |        |   |                   |                   |                   |                 |
|             | 1.4 16V     | 65         | ORGA 10550 | 11.03 |       | + ESP                                 | 13.0460-3966.2 | 603966 |   |                   | 23600             | 19,4 /Zub/S       | BOS             |
|             | 1.6         | 81         |            | 07.06 | 07.07 | + Automatikgetriebe <sup>3)</sup>     | 13.0470-3966.2 | LD3966 |   |                   | 23600             | 19,4 /Zub/S       | BOS             |
|             | 1.6 16V     | 80         | ORGA 10550 | 08.00 |       | + ESP/ + Schaltgetriebe <sup>1)</sup> | 13.0460-0454.2 | 610454 |   |                   |                   | Belagsatz-Zubehör | BOS             |
|             | 1.6 16V     | 80         |            | 08.00 | 07.07 | + Automatikgetriebe <sup>3)</sup>     |                |        |   |                   |                   |                   |                 |
|             | 1.6 BioFlex | 80         |            | 09.07 |       |                                       |                |        |   |                   |                   |                   |                 |
| 1.6 HDi 110 | 80          |            | 02.04      | 07.07 |       |                                       |                |        |   |                   |                   |                   |                 |
| 1.6 HDi 90  | 66          | ORGA 10550 | 04.05      |       | + ESP |                                       |                |        |   |                   |                   |                   |                 |
| 2.0 16V     | 100         |            | 08.00      | 07.07 |       |                                       |                |        |   |                   |                   |                   |                 |
| 2.0 16V     | 103         |            | 03.05      | 07.07 |       |                                       |                |        |   |                   |                   |                   |                 |
| 2.0 HDi 110 | 79          |            | 08.00      | 07.07 |       |                                       |                |        |   |                   |                   |                   |                 |
| 2.0 HDi 90  | 66          | ORGA 09519 | 08.00      |       |       |                                       |                |        |   |                   |                   |                   |                 |
| 2.0 HDi 90  | 66          | ORGA 09520 |            | 07.07 |       |                                       |                |        |   |                   |                   |                   |                 |
| 2.0 16V     | 130         |            | 06.05      | 07.07 |       | 13.0460-7202.2                        | 607202         |        |   | 23589             | 19,1 +            | ATE               |                 |
| 2.0 HDi 135 | 100         |            | 10.03      | 07.07 |       | 13.0470-7202.2                        | LD7202         |        |   | 23589             | 19,1 +            | ATE               |                 |
|             | 1.4         | 55         |            | 08.00 | 07.07 |                                       | 24.0122-0194.1 | 422194 |   |                   | 266               | 22,0 20,0 V +S +B |                 |
|             | 1.4 16V     | 65         | ORGA 10551 |       | 07.07 | + ESP                                 |                |        |   |                   |                   |                   |                 |
|             | 1.4 16V     | 65         |            | 11.03 | 07.07 | - ESP                                 |                |        |   |                   |                   |                   |                 |
|             | 1.4 HDi     | 50         |            | 10.01 | 07.07 |                                       |                |        |   |                   |                   |                   |                 |
|             | 1.6         | 81         |            | 07.06 | 07.07 | + ESP/ + Schaltgetriebe <sup>1)</sup> |                |        |   |                   |                   |                   |                 |
|             | 1.6 16V     | 80         | ORGA 10551 |       | 07.07 | + ESP/ + Schaltgetriebe <sup>1)</sup> |                |        |   |                   |                   |                   |                 |
|             | 1.6 16V     | 80         |            | 08.00 | 07.07 | - ESP/ + Schaltgetriebe <sup>2)</sup> |                |        |   |                   |                   |                   |                 |
|             | 1.6 HDi 90  | 66         | ORGA 10551 |       | 07.07 | + ESP                                 |                |        |   |                   |                   |                   |                 |
|             | 1.6 HDi 90  | 66         |            | 04.05 | 07.07 | - ESP                                 |                |        |   |                   |                   |                   |                 |
|             | 2.0 HDi 90  | 66         | ORGA 09520 |       | 07.07 | - ESP                                 |                |        |   |                   |                   |                   |                 |
|             | 1.4 16V     | 65         | ORGA 10550 | 11.03 |       | + ESP                                 | 24.0126-0120.1 | 426120 |   |                   | 283               | 26,0 24,0 V +S +B |                 |
|             | 1.6         | 81         |            | 07.06 | 07.07 | + Automatikgetriebe <sup>3)</sup>     | 24.0326-0120.1 | 526120 |   |                   | 283               | 26,0 24,0 V +S +B | PD              |
|             | 1.6 16V     | 80         |            | 08.00 | 07.07 | + Automatikgetriebe <sup>3)</sup>     |                |        |   |                   |                   |                   |                 |
|             | 1.6 16V     | 80         |            | 08.00 | 07.07 | + ESP/ + Schaltgetriebe <sup>1)</sup> |                |        |   |                   |                   |                   |                 |
|             | 1.6 BioFlex | 80         |            | 09.07 |       |                                       |                |        |   |                   |                   |                   |                 |
| 1.6 HDi 110 | 80          |            | 02.04      | 07.07 |       |                                       |                |        |   |                   |                   |                   |                 |
| 1.6 HDi 90  | 66          | ORGA 10550 | 04.05      |       | + ESP |                                       |                |        |   |                   |                   |                   |                 |
| 2.0 16V     | 100         |            | 08.00      | 07.07 |       |                                       |                |        |   |                   |                   |                   |                 |
| 2.0 16V     | 103         |            | 03.05      | 07.07 |       |                                       |                |        |   |                   |                   |                   |                 |
| 2.0 HDi 110 | 79          |            | 08.00      | 07.07 |       |                                       |                |        |   |                   |                   |                   |                 |
| 2.0 HDi 90  | 66          | ORGA 09519 | 08.00      |       |       |                                       |                |        |   |                   |                   |                   |                 |
| 2.0 HDi 90  | 66          | ORGA 09520 |            | 07.07 | + ESP |                                       |                |        |   |                   |                   |                   |                 |
| 2.0 16V     | 130         |            | 06.05      | 07.07 |       | 24.0126-0140.1                        | 426140         |        |   | 302               | 26,0 24,0 V +S +B |                   |                 |
| 2.0 HDi 135 | 100         |            | 10.03      | 07.07 |       |                                       |                |        |   |                   |                   |                   |                 |
|             | 1.4         | 55         | ORGA 09862 | 08.00 |       |                                       | 24.0710-2015.1 | 360222 | 2 |                   |                   | Radsensor L=675   |                 |
|             | 1.4 HDi     | 50         | ORGA 09862 | 10.01 |       |                                       |                |        |   |                   |                   |                   |                 |
|             | 1.6 16V     | 80         | ORGA 09862 | 08.00 |       |                                       |                |        |   |                   |                   |                   |                 |
|             | 2.0 16V     | 100        | ORGA 09862 | 08.00 |       |                                       |                |        |   |                   |                   |                   |                 |
|             | 2.0 HDi 110 | 79         | ORGA 09862 | 08.00 |       |                                       |                |        |   |                   |                   |                   |                 |
|             | 2.0 HDi 135 | 100        | ORGA 09862 | 10.03 |       |                                       |                |        |   |                   |                   |                   |                 |
|             | 2.0 HDi 90  | 66         | ORGA 09862 | 08.00 |       |                                       |                |        |   |                   |                   |                   |                 |
|             | 1.4         | 55         |            | 08.00 | 07.07 | + ESP                                 | 24.0710-2017.1 | 360224 | 2 |                   | + ABS (Bosch) 8.0 |                   | Radsensor L=675 |
|             | 1.4         | 55         | ORGA 09863 |       | 07.07 | - ESP                                 |                |        |   |                   |                   |                   |                 |
|             | 1.4 16V     | 65         |            | 11.03 | 07.07 | + ESP                                 |                |        |   |                   |                   |                   |                 |
|             | 1.4 16V     | 65         | ORGA 09863 |       | 07.07 | - ESP                                 |                |        |   |                   |                   |                   |                 |
|             | 1.4 HDi     | 50         |            | 10.01 | 07.07 | + ESP                                 |                |        |   |                   |                   |                   |                 |
|             | 1.4 HDi     | 50         | ORGA 09863 |       | 07.07 | - ESP                                 |                |        |   |                   |                   |                   |                 |
|             | 1.6         | 81         |            | 07.06 | 07.07 |                                       |                |        |   |                   |                   |                   |                 |
|             | 1.6 16V     | 80         |            | 08.00 | 07.07 | + ESP                                 |                |        |   |                   |                   |                   |                 |
| 1.6 16V     | 80          | ORGA 09863 |            | 07.07 | - ESP |                                       |                |        |   |                   |                   |                   |                 |
| 1.6 HDi 110 | 80          |            | 02.04      | 07.07 | + ESP |                                       |                |        |   |                   |                   |                   |                 |
| 1.6 HDi 90  | 66          |            | 04.05      | 07.07 |       |                                       |                |        |   |                   |                   |                   |                 |
| 2.0 16V     | 100         |            | 08.00      | 07.07 | + ESP |                                       |                |        |   |                   |                   |                   |                 |
| 2.0 16V     | 100         | ORGA 09863 |            | 07.07 | - ESP |                                       |                |        |   |                   |                   |                   |                 |
| 2.0 16V     | 103         |            | 03.05      | 07.07 |       |                                       |                |        |   |                   |                   |                   |                 |
| 2.0 16V     | 130         |            | 06.05      | 07.07 |       |                                       |                |        |   |                   |                   |                   |                 |
| 2.0 HDi 110 | 79          |            | 08.00      | 07.07 | + ESP |                                       |                |        |   |                   |                   |                   |                 |
| 2.0 HDi 110 | 79          | ORGA 09863 |            | 07.07 | - ESP |                                       |                |        |   |                   |                   |                   |                 |
| 2.0 HDi 135 | 100         |            | 10.03      | 07.07 | + ESP |                                       |                |        |   |                   |                   |                   |                 |
| 2.0 HDi 135 | 100         | ORGA 09863 |            | 07.07 | - ESP |                                       |                |        |   |                   |                   |                   |                 |
| 2.0 HDi 90  | 66          |            | 08.00      | 07.07 | + ESP |                                       |                |        |   |                   |                   |                   |                 |
| 2.0 HDi 90  | 66          | ORGA 09863 |            | 07.07 | - ESP |                                       |                |        |   |                   |                   |                   |                 |
| 1.4         | 55          | ORGA 10892 |            | 07.07 |       | 24.0711-5325.3                        | 360350         | 2      |   | + ABS (Bosch) 8.1 |                   | Radsensor L=680   |                 |
| 1.4 16V     | 65          | ORGA 10892 |            | 07.07 |       |                                       |                |        |   |                   |                   |                   |                 |
| 1.4 HDi     | 50          | ORGA 10892 |            | 07.07 |       |                                       |                |        |   |                   |                   |                   |                 |
| 1.6         | 81          | ORGA 10892 |            | 07.07 |       |                                       |                |        |   |                   |                   |                   |                 |
| 1.6 16V     | 80          | ORGA 10892 |            | 07.07 |       |                                       |                |        |   |                   |                   |                   |                 |

<sup>1)</sup> + ESP/ + manual transm. / + ESP/+ scatola cambio velocità / + ESP/ + transmission mécanique / + ESP/ + cambio de velocidad  
<sup>2)</sup> - ESP/ + manual transm. / - ESP/+ scatola cambio velocità / - ESP/ + transmission mécanique / - ESP/ + cambio de velocidad  
<sup>3)</sup> + autom.transmission / + scatola cambio automatico / + transmission automatique / + cambio automático



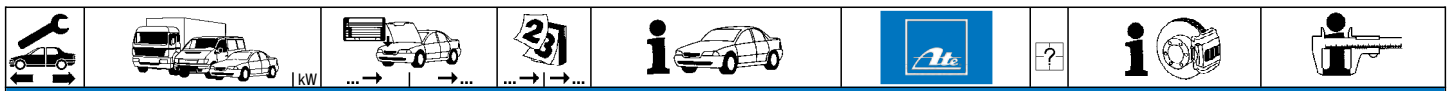

**PEUGEOT 307 Limousine (00-07)**

















|  |   |   |  |   |   |  |                              |   |                   |
|--|---|---|--|---|---|--|------------------------------|---|-------------------|
|  | 1.6 BioFlex<br>1.6 HDi 110<br>1.6 HDi 90<br>2.0 16V<br>2.0 16V<br>2.0 16V<br>2.0 HDi 110<br>2.0 HDi 135<br>2.0 HDi 90                                 | 80<br>80 ORGA 10892<br>66 ORGA 10892<br>100 ORGA 10892<br>103 ORGA 10892<br>130 ORGA 10892<br>79 ORGA 10892<br>100 ORGA 10892<br>66 ORGA 10892  |  | 09.07<br>07.07<br>07.07<br>07.07<br>07.07<br>07.07<br>07.07<br>07.07<br>07.07                                     | 24.0711-5325.3<br>360350  | 2  + ABS (Bosch) 8.1                               | Radsensor L=680              |   |                   |
|  | 1.4<br>1.4 16V<br>1.4 HDi<br>1.6<br>1.6 16V<br>1.6 HDi 110<br>1.6 HDi 90<br>2.0 16V<br>2.0 16V<br>2.0 16V<br>2.0 HDi 110<br>2.0 HDi 135<br>2.0 HDi 90 | 55<br>65<br>50<br>81<br>80<br>80<br>66<br>100<br>103<br>130<br>79<br>100<br>66  |  | 08.00<br>11.03<br>10.01<br>07.06<br>08.00<br>02.04<br>04.05<br>08.00<br>03.05<br>06.05<br>08.00<br>10.03<br>08.00 | 07.07<br>07.07<br>07.07<br>07.07<br>07.07<br>07.07<br>07.07<br>07.07<br>07.07<br>07.07<br>07.07<br>07.07<br>07.07 | 13.0460-2823.2<br>13.0470-2823.2<br>13.0460-0072.2 | 602823<br>LD2823<br>610072   | 23554 17,2 /S<br>23554 17,2 /S<br>Belagsatz-Zubehör | TRW<br>TRW<br>TRW |
|  | 1.4<br>1.4 16V<br>1.4 HDi<br>1.6<br>1.6 16V<br>1.6 HDi 110<br>1.6 HDi 90<br>2.0 16V<br>2.0 16V<br>2.0 16V<br>2.0 HDi 110<br>2.0 HDi 135<br>2.0 HDi 90 | 55<br>65<br>50<br>80<br>80<br>66<br>100<br>103<br>130<br>79<br>100<br>66  | ORGA 10656<br>ORGA 10656<br>ORGA 10656<br>ORGA 10656<br>ORGA 10656<br>ORGA 10656<br>ORGA 10656<br>ORGA 10656<br>ORGA 10656<br>ORGA 10656<br>ORGA 10656<br>ORGA 10656<br>ORGA 10656 | 08.00<br>11.03<br>10.01<br>08.00<br>02.04<br>04.05<br>08.00<br>03.05<br>06.05<br>08.00<br>10.03<br>08.00          | 07.07<br>07.07<br>07.07<br>07.07<br>07.07<br>07.07<br>07.07<br>07.07<br>07.07<br>07.07<br>07.07<br>07.07<br>07.07 | 13.0460-3813.2<br>13.0470-3813.2                   | 603813<br>LD3813             | 24150 17,6 /S<br>24150 17,6 /Zub/S                  | BOS<br>BOS        |
|  | 1.4<br>1.4 16V<br>1.4 HDi<br>1.6<br>1.6 16V<br>1.6 HDi 110<br>1.6 HDi 90<br>2.0 16V<br>2.0 16V<br>2.0 16V<br>2.0 HDi 110<br>2.0 HDi 135<br>2.0 HDi 90 | 55<br>65<br>50<br>81<br>80<br>80<br>66<br>100<br>103<br>130<br>79<br>100<br>66  | ORGA 10897<br>ORGA 10897<br>ORGA 10897<br>ORGA 10897<br>ORGA 10897<br>ORGA 10897<br>ORGA 10897<br>ORGA 10897<br>ORGA 10897<br>ORGA 10897<br>ORGA 10897<br>ORGA 10897               | 08.00<br>11.03<br>10.01<br>07.06<br>08.00<br>02.04<br>04.05<br>08.00<br>03.05<br>08.00<br>10.03<br>08.00          | 07.07<br>07.07<br>07.07<br>07.07<br>07.07<br>07.07<br>07.07<br>07.07<br>07.07<br>07.07<br>07.07<br>07.07          | 24.0109-0150.2                                     | 409150                       | mit Sensorring <sup>1)</sup>                        | 249 9,0 8,0 +B    |
|  | 1.4<br>1.4 16V<br>1.4 HDi<br>1.6<br>1.6 16V<br>1.6 HDi 110<br>1.6 HDi 90<br>2.0 16V<br>2.0 16V<br>2.0 16V<br>2.0 HDi 110<br>2.0 HDi 135<br>2.0 HDi 90 | 55 ORGA 10898<br>65 ORGA 10898<br>50 ORGA 10898<br>81 ORGA 10898<br>80 ORGA 10898<br>80 ORGA 10898<br>66 ORGA 10898<br>100 ORGA 10898<br>103 ORGA 10898<br>79 ORGA 10898<br>100 ORGA 10898<br>66 ORGA 10898 |  | 07.07<br>07.07<br>07.07<br>07.07<br>07.07<br>07.07<br>07.07<br>07.07<br>07.07<br>07.07<br>07.07<br>07.07          | 24.0109-0100.2  | 409100   | mit Sensorring <sup>1)</sup> | 249 9,0 7,0 +B                                      |                   |
|  | 1.4<br>1.4 16V<br>1.4 HDi<br>1.6<br>1.6 16V<br>1.6 HDi 110<br>1.6 HDi 90<br>2.0 16V<br>2.0 16V<br>2.0 16V<br>2.0 HDi 110<br>2.0 HDi 135<br>2.0 HDi 90 | 55<br>65<br>50<br>81<br>80<br>80<br>66<br>100<br>103<br>130<br>79<br>100<br>66  |  | 08.00<br>11.03<br>10.01<br>07.06<br>08.00<br>02.04<br>04.05<br>08.00<br>03.05<br>06.05<br>08.00<br>10.03<br>08.00 | 07.07<br>07.07<br>07.07<br>07.07<br>07.07<br>07.07<br>07.07<br>07.07<br>07.07<br>07.07<br>07.07<br>07.07<br>07.07 | 24.0109-0137.1                                     | 409137                       | ohne Sensorring <sup>2)</sup>                       | 247 9,0 8,0 +S +B |

**PEUGEOT 307 Break (02-08)**

|  |  |  |                          |  |  |                                  |  |  |   |                   |
|--|--|--|--------------------------|--|--|----------------------------------|--|--|---|-------------------|
|  | 1.4<br>1.4 16V<br>1.6 16V<br>1.6 BioFlex<br>1.6 HDi 110<br>1.6 HDi 90<br>2.0 16V<br>2.0 16V<br>2.0 HDi 110<br>2.0 HDi 90 | 55<br>65<br>80<br>80<br>80<br>66<br>100<br>103<br>79<br>66 | ORGA 10550<br>ORGA 10550 | 04.02<br>11.03<br>03.02<br>09.07<br>02.04<br>04.05<br>03.02<br>03.05<br>03.02<br>03.02 | 07.07<br>07.07<br>04.08<br>04.08<br>04.08<br>04.08<br>04.08<br>04.08<br>04.08<br>04.08 | + ESP<br>+ ESP                   | 13.0460-3966.2<br>13.0470-3966.2<br>13.0460-0454.2 | 603966<br>LD3966<br>610454             | 23600 19,4 /Zub/S<br>23600 19,4 /Zub/S<br>Belagsatz-Zubehör | BOS<br>BOS<br>BOS |
|  | 1.4<br>1.4<br>1.4 16V<br>1.4 16V   | 55 ORGA 10551<br>55<br>65 ORGA 10551<br>65                 |                          | 04.02<br>09.03<br>04.08<br>11.03   | + ESP<br>- ESP<br>+ ESP<br>- ESP   | 13.0460-3994.2<br>13.0470-3994.2 | 603994<br>LD3994                                   | 23599 19,0 /Zub/S<br>23599 19,0 /Zub/S | BOS<br>BOS  |                   |

<sup>1)</sup> with sensor ring / con sensori / avec secours ABS / con anillo sensor ABS  
<sup>2)</sup> without sensor ring / senza sensori / sans secours ABS / sin anillo sensor ABS



|     |  |  |  |  |  |  |  |  |   |                          |
|--|--|--|--|--|---|--|--|--|---|--------------------------|
| <b>PEUGEOT 307 Break (02-08)</b>   |  |  |  |  |   |  |  |  |   |                          |
|    | 1.4 HDi  | 50   |  | 03.02  | 04.08   |  | 13.0460-3994.2<br>13.0470-3994.2   | 603994<br>LD3994   | 23599 19,0 /Zub/S<br>23599 19,0 /Zub/S  | BOS<br>BOS               |
|  | 2.0 16V  | 130  |  | 06.05  | 04.08   |  | 13.0460-7202.2<br>13.0470-7202.2   | 607202<br>LD7202   | 23589 19,1 +<br>23589 19,1 +  | ATE<br>ATE               |
|  | 2.0 HDi 135  | 100  |  | 02.04  | 04.08   |  |  |  |   |                          |
|    | 1.4  | 55   | ORGA 10551   |  | 04.08   | + ESP  | 24.0122-0194.1   | 422194   |   | 266 22,0 20,0 V +S +B    |
|  | 1.4  | 55   |  | 04.02  | 09.03   | - ESP  |  |  |   |                          |
|  | 1.4 16V  | 65   | ORGA 10551   |  | 04.08   | + ESP  |  |  |   |                          |
|  | 1.4 16V  | 65   |  | 11.03  | 04.08   | - ESP  |  |  |   |                          |
|  | 1.4 HDi  | 50   |  | 03.02  | 04.08   |  |  |  |   |                          |
|  | 1.4  | 55   | ORGA 10550   | 04.02  |   | + ESP  | 24.0126-0120.1   | 426120   |   | 283 26,0 24,0 V +S +B    |
|  | 1.4 16V  | 65   | ORGA 10550   | 11.03  |   | + ESP  | 24.0326-0120.1   | 526120   |   | 283 26,0 24,0 V +S +B PD |
|  | 1.6 16V  | 80   |  | 03.02  | 04.08   |  |  |  |   |                          |
|  | 1.6 BioFlex  | 80   |  | 09.07  | 04.08   |  |  |  |   |                          |
|  | 1.6 HDi 110  | 80   |  | 02.04  | 04.08   |  |  |  |   |                          |
|  | 1.6 HDi 90   | 66   |  | 04.05  | 04.08   |  |  |  |   |                          |
|  | 2.0 16V  | 100  |  | 03.02  | 04.08   |  |  |  |   |                          |
|  | 2.0 16V  | 103  |  | 03.05  | 04.08   |  |  |  |   |                          |
|  | 2.0 HDi 110  | 79   |  | 03.02  | 04.08   |  |  |  |   |                          |
|  | 2.0 HDi 90   | 66   |  | 03.02  | 04.08   |  |  |  |   |                          |
|  | 2.0 16V  | 130  |  | 06.05  | 04.08   |  | 24.0126-0140.1   | 426140   |   | 302 26,0 24,0 V +S +B    |
|  | 2.0 HDi 135  | 100  |  | 02.04  | 04.08   |  |  |  |   |                          |
|    | 1.4  | 55   | ORGA 09862   | 04.02  |   |  | 24.0710-2015.1   | 360222   | 2    | Radsensor L=675          |
|  | 1.4 16V  | 65   | ORGA 09862   | 11.03  |   |  |  |  |   |                          |
|  | 1.4 HDi  | 50   | ORGA 09862   | 03.02  |   |  |  |  |   |                          |
|  | 1.6 16V  | 80   | ORGA 09862   | 03.02  |   |  |  |  |   |                          |
|  | 1.6 BioFlex  | 80   | ORGA 09862   | 09.07  |   |  |  |  |   |                          |
|  | 2.0 16V  | 100  | ORGA 09862   | 03.02  |   |  |  |  |   |                          |
|  | 2.0 HDi 110  | 79   | ORGA 09862   | 03.02  |   |  |  |  |   |                          |
|  | 2.0 HDi 90   | 66   | ORGA 09862   | 03.02  |   |  |  |  |   |                          |
|  | 1.4  | 55   |  | 04.02  | 09.03   | + ESP  | 24.0710-2017.1   | 360224   | 2    | + ABS (Bosch) 8.0        |
|  | 1.4  | 55   | ORGA 09863   |  | 04.08   | - ESP  |  |  |   |                          |
|  | 1.4 16V  | 65   |  | 11.03  | 04.08   | + ESP  |  |  |   |                          |
|  | 1.4 16V  | 65   | ORGA 09863   |  | 04.08   | - ESP  |  |  |   |                          |
|  | 1.4 HDi  | 50   |  | 03.02  | 04.08   | + ESP  |  |  |   |                          |
|  | 1.4 HDi  | 50   | ORGA 09863   |  | 04.08   | - ESP  |  |  |   |                          |
|  | 1.6 16V  | 80   |  | 03.02  | 04.08   | + ESP  |  |  |   |                          |
|  | 1.6 16V  | 80   | ORGA 09863   |  | 04.08   | - ESP  |  |  |   |                          |
|  | 1.6 BioFlex  | 80   |  | 09.07  | 04.08   | + ESP  |  |  |   |                          |
|  | 1.6 BioFlex  | 80   | ORGA 09863   |  | 04.08   | - ESP  |  |  |   |                          |
|  | 1.6 HDi 110  | 80   |  | 02.04  | 04.08   |  |  |  |   |                          |
|  | 1.6 HDi 90   | 66   |  | 04.05  | 04.08   |  |  |  |   |                          |
|  | 2.0 16V  | 100  |  | 03.02  | 04.08   | + ESP  |  |  |   |                          |
|  | 2.0 16V  | 100  | ORGA 09863   |  | 04.08   | - ESP  |  |  |   |                          |
|  | 2.0 16V  | 103  |  | 03.05  | 04.08   |  |  |  |   |                          |
|  | 2.0 16V  | 130  |  | 06.05  | 04.08   |  |  |  |   |                          |
|  | 2.0 HDi 110  | 79   |  | 03.02  | 04.08   | + ESP  |  |  |   |                          |
|  | 2.0 HDi 110  | 79   | ORGA 09863   |  | 04.08   | - ESP  |  |  |   |                          |
|  | 2.0 HDi 135  | 100  |  | 02.04  | 04.08   |  |  |  |   |                          |
|  | 2.0 HDi 90   | 66   |  | 03.02  | 04.08   | + ESP  |  |  |   |                          |
|  | 2.0 HDi 90   | 66   | ORGA 09863   |  | 04.08   | - ESP  |  |  |   |                          |
|  | 1.4  | 55   | ORGA 10892   |  | 04.08   |  | 24.0711-5325.3   | 360350   | 2  | + ABS (Bosch) 8.1        |
|  | 1.4 16V  | 65   | ORGA 10892   |  | 04.08   |  |  |  |   |                          |
|  | 1.4 HDi  | 50   | ORGA 10892   |  | 04.08   |  |  |  |   |                          |
|  | 1.6 16V  | 80   | ORGA 10892   |  | 04.08   |  |  |  |   |                          |
|  | 1.6 BioFlex  | 80   | ORGA 10892   |  | 04.08   |  |  |  |   |                          |
|  | 1.6 HDi 110  | 80   | ORGA 10892   |  | 04.08   |  |  |  |   |                          |
|  | 1.6 HDi 90   | 66   | ORGA 10892   |  | 04.08   |  |  |  |   |                          |
|  | 2.0 16V  | 100  | ORGA 10892   |  | 04.08   |  |  |  |   |                          |
|  | 2.0 16V  | 103  | ORGA 10892   |  | 04.08   |  |  |  |   |                          |
|  | 2.0 16V  | 130  | ORGA 10892   |  | 04.08   |  |  |  |   |                          |
|  | 2.0 HDi 110  | 79   | ORGA 10892   |  | 04.08   |  |  |  |   |                          |
|  | 2.0 HDi 135  | 100  | ORGA 10892   |  | 04.08   |  |  |  |   |                          |
|  | 2.0 HDi 90   | 66   | ORGA 10892   |  | 04.08   |  |  |  |   |                          |
|  | 1.4  | 55   | ORGA 12056   | 04.02  |   |  | 13.0460-2823.2<br>13.0470-2823.2   | 602823<br>LD2823   | 23554 17,2 /S<br>23554 17,2 /S  | TRW<br>TRW               |
|  | 1.4 16V  | 65   | ORGA 12056   | 11.03  |   |  | 13.0460-0072.2   | 610072   |   | Belagsatz-Zubehör        |
|  | 1.4 HDi  | 50   | ORGA 12056   | 03.02  |   |  |  |  |   |                          |
|  | 1.6 16V  | 80   | ORGA 12056   | 03.02  |   |  |  |  |   |                          |
|  | 1.6 BioFlex  | 80   | ORGA 12056   | 09.07  |   |  |  |  |   |                          |
|  | 1.6 HDi 110  | 80   | ORGA 12056   | 02.04  |   |  |  |  |   |                          |
|  | 1.6 HDi 90   | 66   | ORGA 12056   | 04.05  |   |  |  |  |   |                          |
|  | 2.0 16V  | 100  | ORGA 12056   | 03.02  |   |  |  |  |   |                          |
|  | 2.0 16V  | 103  | ORGA 12056   | 03.05  |   |  |  |  |   |                          |
|  | 2.0 16V  | 130  | ORGA 12056   | 06.05  |   |  |  |  |   |                          |
|  | 2.0 HDi 110  | 79   | ORGA 12056   | 03.02  |   |  |  |  |   |                          |
|  | 2.0 HDi 135  | 100  | ORGA 12056   | 02.04  |   |  |  |  |   |                          |
|  | 2.0 HDi 90   | 66   | ORGA 12056   | 03.02  |   |  |  |  |   |                          |
|  | 1.4  | 55   | ORGA 10656   | 04.02  |   |  | 13.0460-3813.2<br>13.0470-3813.2   | 603813<br>LD3813   | 24150 17,6 /S<br>24150 17,6 /Zub/S  | BOS<br>BOS               |
|  | 1.4 16V  | 65   | ORGA 10656   | 11.03  |   |  |  |  |   |                          |
|  | 1.4 HDi  | 50   | ORGA 10656   | 03.02  |   |  |  |  |   |                          |
|  | 1.6 16V  | 80   | ORGA 10656   | 03.02  |   |  |  |  |   |                          |
|  | 1.6 HDi 110  | 80   | ORGA 10656   | 02.04  |   |  |  |  |   |                          |
|  | 1.6 HDi 90   | 66   | ORGA 10656   | 04.05  |   |  |  |  |   |                          |
|  | 2.0 16V  | 100  | ORGA 10656   | 03.02  |   |  |  |  |   |                          |
|  | 2.0 16V  | 103  | ORGA 10656   | 03.05  |   |  |  |  |   |                          |
|  | 2.0 16V  | 130  | ORGA 10656   | 06.05  |   |  |  |  |   |                          |
|  | 2.0 HDi 110  | 79   | ORGA 10656   | 03.02  |   |  |  |  |   |                          |



### PEUGEOT 307 Break (02-08)

|             |             |            |            |       |       |                |        |                               |                   |     |
|-------------|-------------|------------|------------|-------|-------|----------------|--------|-------------------------------|-------------------|-----|
|             | 2.0 HDi 135 | 100        | ORGA 10656 | 02.04 |       | 13.0460-3813.2 | 603813 |                               | 24150 17,6 /S     | BOS |
|             | 2.0 HDi 90  | 66         | ORGA 10656 | 03.02 |       | 13.0470-3813.2 | LD3813 |                               | 24150 17,6 /Zub/S | BOS |
|             | 1.4         | 55         | ORGA 12057 |       | 04.08 | 13.0460-3813.2 | 603813 |                               | 24150 17,6 /S     | BOS |
|             | 1.4 16V     | 65         | ORGA 12057 |       | 04.08 | 13.0470-3813.2 | LD3813 |                               | 24150 17,6 /Zub/S | BOS |
|             | 1.4 HDi     | 50         | ORGA 12057 |       | 04.08 |                |        |                               |                   |     |
|             | 1.6 16V     | 80         | ORGA 12057 |       | 04.08 |                |        |                               |                   |     |
|             | 1.6 HDi 110 | 80         | ORGA 12057 |       | 04.08 |                |        |                               |                   |     |
|             | 1.6 HDi 90  | 66         | ORGA 12057 |       | 04.08 |                |        |                               |                   |     |
|             | 2.0 16V     | 100        | ORGA 12057 |       | 04.08 |                |        |                               |                   |     |
|             | 2.0 16V     | 103        | ORGA 12057 |       | 04.08 |                |        |                               |                   |     |
| 2.0 16V     | 130         | ORGA 12057 |            | 04.08 |       |                |        |                               |                   |     |
| 2.0 HDi 110 | 79          | ORGA 12057 |            | 04.08 |       |                |        |                               |                   |     |
| 2.0 HDi 135 | 100         | ORGA 12057 |            | 04.08 |       |                |        |                               |                   |     |
| 2.0 HDi 90  | 66          | ORGA 12057 |            | 04.08 |       |                |        |                               |                   |     |
|             | 1.4         | 55         | ORGA 10897 | 04.02 |       | 24.0109-0150.2 | 409150 | mit Sensorring <sup>1)</sup>  | 249 9,0 8,0 +B    |     |
|             | 1.4 16V     | 65         | ORGA 10897 | 03.02 |       |                |        |                               |                   |     |
|             | 1.4 HDi     | 50         | ORGA 10897 | 03.02 |       |                |        |                               |                   |     |
|             | 1.6 16V     | 80         | ORGA 10897 | 03.02 |       |                |        |                               |                   |     |
|             | 1.6 BioFlex | 80         | ORGA 10897 | 09.07 |       |                |        |                               |                   |     |
|             | 1.6 HDi 110 | 80         | ORGA 10897 | 02.04 |       |                |        |                               |                   |     |
|             | 1.6 HDi 90  | 66         | ORGA 10897 | 04.05 |       |                |        |                               |                   |     |
|             | 2.0 16V     | 100        | ORGA 10897 | 03.02 |       |                |        |                               |                   |     |
|             | 2.0 16V     | 103        | ORGA 10897 | 03.05 |       |                |        |                               |                   |     |
|             | 2.0 HDi 110 | 79         | ORGA 10897 | 03.02 |       |                |        |                               |                   |     |
| 2.0 HDi 135 | 100         | ORGA 10897 | 02.04      |       |       |                |        |                               |                   |     |
| 2.0 HDi 90  | 66          | ORGA 10897 | 03.02      |       |       |                |        |                               |                   |     |
|             | 1.4         | 55         | ORGA 10898 |       | 04.08 | 24.0109-0100.2 | 409100 | mit Sensorring <sup>1)</sup>  | 249 9,0 7,0 +B    |     |
|             | 1.4 16V     | 65         | ORGA 10898 |       | 04.08 |                |        |                               |                   |     |
|             | 1.4 HDi     | 50         | ORGA 10898 |       | 04.08 |                |        |                               |                   |     |
|             | 1.6 16V     | 80         | ORGA 10898 |       | 04.08 |                |        |                               |                   |     |
|             | 1.6 BioFlex | 80         | ORGA 10898 |       | 04.08 |                |        |                               |                   |     |
|             | 1.6 HDi 110 | 80         | ORGA 10898 |       | 04.08 |                |        |                               |                   |     |
|             | 1.6 HDi 90  | 66         | ORGA 10898 |       | 04.08 |                |        |                               |                   |     |
|             | 2.0 16V     | 100        | ORGA 10898 |       | 04.08 |                |        |                               |                   |     |
|             | 2.0 16V     | 103        | ORGA 10898 |       | 04.08 |                |        |                               |                   |     |
|             | 2.0 HDi 110 | 79         | ORGA 10898 |       | 04.08 |                |        |                               |                   |     |
| 2.0 HDi 135 | 100         | ORGA 10898 |            | 04.08 |       |                |        |                               |                   |     |
| 2.0 HDi 90  | 66          | ORGA 10898 |            | 04.08 |       |                |        |                               |                   |     |
|             | 1.4         | 55         |            | 04.02 | 04.08 | 24.0109-0137.1 | 409137 | ohne Sensorring <sup>2)</sup> | 247 9,0 8,0 +S +B |     |
|             | 1.4 16V     | 65         |            | 03.02 | 04.08 |                |        |                               |                   |     |
|             | 1.4 HDi     | 50         |            | 03.02 | 04.08 |                |        |                               |                   |     |
|             | 1.6 16V     | 80         |            | 03.02 | 04.08 |                |        |                               |                   |     |
|             | 1.6 BioFlex | 80         |            | 09.07 | 04.08 |                |        |                               |                   |     |
|             | 1.6 HDi 110 | 80         |            | 02.04 | 04.08 |                |        |                               |                   |     |
|             | 1.6 HDi 90  | 66         |            | 04.05 | 04.08 |                |        |                               |                   |     |
|             | 2.0 16V     | 100        |            | 03.02 | 04.08 |                |        |                               |                   |     |
|             | 2.0 16V     | 103        |            | 03.05 | 04.08 |                |        |                               |                   |     |
|             | 2.0 16V     | 130        |            | 06.05 | 04.08 |                |        |                               |                   |     |
| 2.0 HDi 110 | 79          |            | 03.02      | 04.08 |       |                |        |                               |                   |     |
| 2.0 HDi 135 | 100         |            | 02.04      | 04.08 |       |                |        |                               |                   |     |
| 2.0 HDi 90  | 66          |            | 03.02      | 04.08 |       |                |        |                               |                   |     |

### PEUGEOT 307 CC (03-09)

|            |            |            |            |       |       |                |        |   |                          |     |
|------------|------------|------------|------------|-------|-------|----------------|--------|---|--------------------------|-----|
|            | CC 110     | 80         |            | 03.05 | 02.09 | 13.0460-3966.2 | 603966 |   | 23600 19,4 /Zub/S        | BOS |
|            | CC 135     | 100        |            | 10.03 | 02.09 | 13.0470-3966.2 | LD3966 |   | 23600 19,4 /Zub/S        | BOS |
|            | CC 140     | 103        |            | 03.05 | 02.09 | 13.0460-0454.2 | 610454 |   | Belagsatz-Zubehör        | BOS |
|            | CC 180     | 130        |            | 10.03 | 02.09 | 13.0460-7202.2 | 607202 |   | 23589 19,1 +             | ATE |
|            | CC HDi 135 | 100        |            | 06.05 | 02.09 | 13.0470-7202.2 | LD7202 |   | 23589 19,1 +             | ATE |
|            | CC 110     | 80         |            | 03.05 | 02.09 | 24.0126-0120.1 | 426120 |   | 283 26,0 24,0 V +S +B    |     |
|            | CC 135     | 100        |            | 10.03 | 02.09 | 24.0326-0120.1 | 526120 |   | 283 26,0 24,0 V +S +B PD |     |
|            | CC 140     | 103        |            | 03.05 | 02.09 |                |        |   |                          |     |
|            | CC 180     | 130        |            | 10.03 | 02.09 | 24.0126-0140.1 | 426140 |   | 302 26,0 24,0 V +S +B    |     |
|            | CC HDi 135 | 100        |            | 06.05 | 02.09 |                |        |   |                          |     |
|            | CC 135     | 100        | ORGA 09862 | 10.03 |       | 24.0710-2015.1 | 360222 | 2 | Radsensor L=675          |     |
|            | CC 180     | 130        | ORGA 09862 | 10.03 |       |                |        |   |                          |     |
|            | CC 110     | 80         |            | 03.05 | 02.09 | 24.0710-2017.1 | 360224 | 2 | Radsensor L=675          |     |
|            | CC 135     | 100        |            | 10.03 | 02.09 |                |        |   |                          |     |
|            | CC 135     | 100        | ORGA 09863 | 02.09 | + ESP |                |        |   |                          |     |
|            | CC 140     | 103        |            | 03.05 | 02.09 |                |        |   |                          |     |
|            | CC 180     | 130        |            | 10.03 | 02.09 |                |        |   |                          |     |
| CC 180     | 130        | ORGA 09863 | 02.09      | + ESP |       |                |        |   |                          |     |
| CC HDi 135 | 100        |            | 06.05      | 02.09 |       |                |        |   |                          |     |
|            | CC 110     | 80         | ORGA 10892 |       | 02.09 | 24.0711-5325.3 | 360350 | 2 | Radsensor L=680          |     |
|            | CC 135     | 100        | ORGA 10892 |       | 02.09 |                |        |   |                          |     |
|            | CC 140     | 103        | ORGA 10892 |       | 02.09 |                |        |   |                          |     |
|            | CC 180     | 130        | ORGA 10892 |       | 02.09 |                |        |   |                          |     |
|            | CC HDi 135 | 100        | ORGA 10892 |       | 02.09 |                |        |   |                          |     |
|            | CC 110     | 80         | ORGA 12056 | 03.05 |       | 13.0460-2823.2 | 602823 |   | 23554 17,2 /S            | TRW |
|            | CC 135     | 100        | ORGA 12056 | 10.03 |       | 13.0470-2823.2 | LD2823 |   | 23554 17,2 /S            | TRW |
|            | CC 140     | 103        | ORGA 12056 | 03.05 |       | 13.0460-0072.2 | 610072 |   | Belagsatz-Zubehör        | TRW |
|            | CC 180     | 130        | ORGA 12056 | 10.03 |       |                |        |   |                          |     |
|            | CC HDi 135 | 100        | ORGA 12056 | 06.05 |       |                |        |   |                          |     |
|            | CC 110     | 80         | ORGA 10656 | 03.05 |       | 13.0460-3813.2 | 603813 |   | 24150 17,6 /S            | BOS |
|            | CC 135     | 100        | ORGA 10656 | 10.03 |       | 13.0470-3813.2 | LD3813 |   | 24150 17,6 /Zub/S        | BOS |
|            | CC 140     | 103        | ORGA 10656 | 03.05 |       |                |        |   |                          |     |

<sup>1)</sup> with sensor ring / con sensori / avec secours ABS / con anillo sensor ABS

<sup>2)</sup> without sensor ring / senza sensori / sans secours ABS / sin anillo sensor ABS



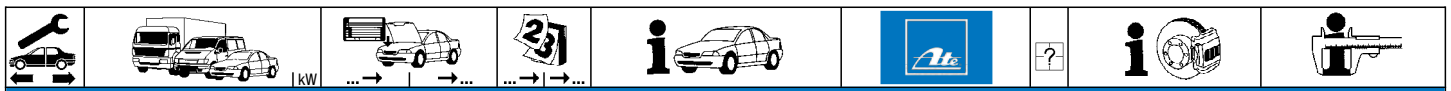

**PEUGEOT 307 CC (03-09)**

|  |            |     |            |       |       |                |        |                    |                   |     |
|--|------------|-----|------------|-------|-------|----------------|--------|--------------------|-------------------|-----|
|  | CC 180     | 130 | ORGA 10656 | 10.03 |       | 13.0460-3813.2 | 603813 |                    | 24150 17,6 /S     | BOS |
|  | CC HDi 135 | 100 | ORGA 10656 | 06.05 |       | 13.0470-3813.2 | LD3813 |                    | 24150 17,6 /Zub/S | BOS |
|  | CC 110     | 80  | ORGA 12057 |       | 02.09 | 13.0460-3813.2 | 603813 |                    | 24150 17,6 /S     | BOS |
|  | CC 135     | 100 | ORGA 12057 |       | 02.09 | 13.0470-3813.2 | LD3813 |                    | 24150 17,6 /Zub/S | BOS |
|  | CC 140     | 103 | ORGA 12057 |       | 02.09 |                |        |                    |                   |     |
|  | CC 180     | 130 | ORGA 12057 |       | 02.09 |                |        |                    |                   |     |
|  | CC HDi 135 | 100 | ORGA 12057 |       | 02.09 |                |        |                    |                   |     |
|  | CC 110     | 80  |            | 03.05 | 02.09 | 24.0109-0137.1 | 409137 | ohne Sensorring 1) | 247 9,0 8,0 +S +B |     |
|  | CC 135     | 100 |            | 10.03 | 02.09 |                |        |                    |                   |     |
|  | CC 140     | 103 |            | 03.05 | 02.09 |                |        |                    |                   |     |
|  | CC 180     | 130 |            | 10.03 | 02.09 |                |        |                    |                   |     |
|  | CC HDi 135 | 100 |            | 06.05 | 02.09 |                |        |                    |                   |     |
|  |            |     |            |       |       |                |        |                    |                   |     |
|  | CC 110     | 80  | ORGA 10897 | 03.05 |       | 24.0109-0150.2 | 409150 | mit Sensorring 2)  | 249 9,0 8,0 +B    |     |
|  | CC 135     | 100 | ORGA 10897 | 10.03 |       |                |        |                    |                   |     |
|  | CC 140     | 103 | ORGA 10897 | 03.05 |       |                |        |                    |                   |     |
|  | CC HDi 135 | 100 | ORGA 10897 | 06.05 |       |                |        |                    |                   |     |
|  |            |     |            |       |       |                |        |                    |                   |     |
|  | CC 110     | 80  | ORGA 10898 |       | 02.09 | 24.0109-0100.2 | 409100 | mit Sensorring 2)  | 249 9,0 7,0 +B    |     |
|  | CC 135     | 100 | ORGA 10898 |       | 02.09 |                |        |                    |                   |     |
|  | CC 140     | 103 | ORGA 10898 |       | 02.09 |                |        |                    |                   |     |
|  | CC HDi 135 | 100 | ORGA 10898 |       | 02.09 |                |        |                    |                   |     |
|  |            |     |            |       |       |                |        |                    |                   |     |

**PEUGEOT 307 SW (02-08)**

|             |             |            |            |       |       |       |                |                |        |                       |                          |                 |
|-------------|-------------|------------|------------|-------|-------|-------|----------------|----------------|--------|-----------------------|--------------------------|-----------------|
|             | 1.4         | 55         | ORGA 10551 |       | 04.08 | + ESP |                | 13.0460-3994.2 | 603994 |                       | 23599 19,0 /Zub/S        | BOS             |
|             | 1.4         | 55         |            | 04.02 | 04.08 | - ESP |                | 13.0470-3994.2 | LD3994 |                       | 23599 19,0 /Zub/S        | BOS             |
|             | 1.4 16V     | 65         | ORGA 10551 |       | 04.08 | + ESP |                |                |        |                       |                          |                 |
|             | 1.4 16V     | 65         |            | 11.03 | 04.08 | - ESP |                |                |        |                       |                          |                 |
|             | 1.4 HDi     | 50         |            | 03.02 | 01.05 |       |                |                |        |                       |                          |                 |
|             | 1.4         | 55         | ORGA 10550 | 04.02 |       | + ESP |                | 13.0460-3966.2 | 603966 |                       | 23600 19,4 /Zub/S        | BOS             |
|             | 1.4 16V     | 65         | ORGA 10550 | 11.03 |       | + ESP |                | 13.0470-3966.2 | LD3966 |                       | 23600 19,4 /Zub/S        | BOS             |
|             | 1.6 16V     | 80         |            | 03.02 | 04.08 |       |                | 13.0460-0454.2 | 610454 |                       | Belagsatz-Zubehör        | BOS             |
|             | 1.6 BioFlex | 80         |            | 09.07 | 04.08 |       |                |                |        |                       |                          |                 |
|             | 1.6 D       | 66         |            | 12.06 | 04.08 |       |                |                |        |                       |                          |                 |
|             | 1.6 HDi 110 | 80         |            | 02.04 | 04.08 |       |                |                |        |                       |                          |                 |
|             | 2.0 16V     | 100        |            | 03.02 | 04.08 |       |                |                |        |                       |                          |                 |
|             | 2.0 16V     | 103        |            | 03.05 | 04.08 |       |                |                |        |                       |                          |                 |
|             | 2.0 HDi 110 | 79         |            | 03.02 | 04.08 |       |                |                |        |                       |                          |                 |
|             | 2.0 HDi 90  | 66         |            | 03.02 | 04.08 |       |                |                |        |                       |                          |                 |
|             | 2.0 HDi 135 | 100        |            | 02.04 | 04.08 |       |                | 13.0460-7202.2 | 607202 |                       | 23589 19,1 +             | ATE             |
|             |             |            |            |       |       |       |                | 13.0470-7202.2 | LD7202 |                       | 23589 19,1 +             | ATE             |
|             | 1.4         | 55         | ORGA 10551 |       | 04.08 | + ESP |                | 24.0122-0194.1 | 422194 |                       | 266 22,0 20,0 V +S +B    |                 |
|             | 1.4         | 55         |            | 04.02 | 04.08 | - ESP |                |                |        |                       |                          |                 |
|             | 1.4 16V     | 65         | ORGA 10551 |       | 04.08 | + ESP |                |                |        |                       |                          |                 |
| 1.4 16V     | 65          |            | 11.03      | 04.08 | - ESP |       |                |                |        |                       |                          |                 |
| 1.4 HDi     | 50          |            | 03.02      | 01.05 |       |       |                |                |        |                       |                          |                 |
|             | 1.4         | 55         | ORGA 10550 | 04.02 |       | + ESP |                | 24.0126-0120.1 | 426120 |                       | 283 26,0 24,0 V +S +B    |                 |
|             | 1.4 16V     | 65         | ORGA 10550 | 11.03 |       | + ESP |                | 24.0326-0120.1 | 526120 |                       | 283 26,0 24,0 V +S +B PD |                 |
|             | 1.6 16V     | 80         |            | 03.02 | 04.08 |       |                |                |        |                       |                          |                 |
|             | 1.6 BioFlex | 80         |            | 09.07 | 04.08 |       |                |                |        |                       |                          |                 |
|             | 1.6 D       | 66         |            | 12.06 | 04.08 |       |                |                |        |                       |                          |                 |
|             | 1.6 HDi 110 | 80         |            | 02.04 | 04.08 |       |                |                |        |                       |                          |                 |
|             | 2.0 16V     | 100        |            | 03.02 | 04.08 |       |                |                |        |                       |                          |                 |
|             | 2.0 16V     | 103        |            | 03.05 | 04.08 |       |                |                |        |                       |                          |                 |
|             | 2.0 HDi 110 | 79         |            | 03.02 | 04.08 |       |                |                |        |                       |                          |                 |
|             | 2.0 HDi 90  | 66         |            | 03.02 | 04.08 |       |                |                |        |                       |                          |                 |
| 2.0 HDi 135 | 100         |            | 02.04      | 04.08 |       |       | 24.0126-0140.1 | 426140         |        | 302 26,0 24,0 V +S +B |                          |                 |
|             | 1.4         | 55         | ORGA 09862 | 04.02 |       |       |                | 24.0710-2015.1 | 360222 | 2                     |                          | Radsensor L=675 |
|             | 1.4 16V     | 65         | ORGA 09862 | 11.03 |       |       |                |                |        |                       |                          |                 |
|             | 1.4 HDi     | 50         | ORGA 09862 | 03.02 |       |       |                |                |        |                       |                          |                 |
|             | 1.6 16V     | 80         | ORGA 09862 | 03.02 |       |       |                |                |        |                       |                          |                 |
|             | 1.6 BioFlex | 80         | ORGA 09862 | 09.07 |       |       |                |                |        |                       |                          |                 |
|             | 2.0 16V     | 100        | ORGA 09862 | 03.02 |       |       |                |                |        |                       |                          |                 |
|             | 2.0 HDi 110 | 79         | ORGA 09862 | 03.02 |       |       |                |                |        |                       |                          |                 |
|             | 2.0 HDi 90  | 66         | ORGA 09862 | 03.02 |       |       |                |                |        |                       |                          |                 |
|             | 1.4         | 55         |            | 04.02 | 04.08 | + ESP |                | 24.0710-2017.1 | 360224 | 2                     | + ABS (Bosch) 8.0        | Radsensor L=675 |
|             | 1.4         | 55         | ORGA 09863 |       | 04.08 | - ESP |                |                |        |                       |                          |                 |
| 1.4 16V     | 65          |            | 11.03      | 04.08 | + ESP |       |                |                |        |                       |                          |                 |
| 1.4 16V     | 65          | ORGA 09863 |            | 04.08 | - ESP |       |                |                |        |                       |                          |                 |
| 1.4 HDi     | 50          |            | 03.02      | 01.05 | + ESP |       |                |                |        |                       |                          |                 |
| 1.4 HDi     | 50          | ORGA 09863 |            | 01.05 | - ESP |       |                |                |        |                       |                          |                 |
| 1.6 16V     | 80          |            | 03.02      | 04.08 | + ESP |       |                |                |        |                       |                          |                 |
| 1.6 16V     | 80          | ORGA 09863 |            | 04.08 | - ESP |       |                |                |        |                       |                          |                 |
| 1.6 BioFlex | 80          |            | 09.07      | 04.08 | + ESP |       |                |                |        |                       |                          |                 |
| 1.6 BioFlex | 80          | ORGA 09863 |            | 04.08 | - ESP |       |                |                |        |                       |                          |                 |
| 1.6 HDi 110 | 80          |            | 02.04      | 04.08 |       |       |                |                |        |                       |                          |                 |
| 2.0 16V     | 100         |            | 03.02      | 04.08 | + ESP |       |                |                |        |                       |                          |                 |
| 2.0 16V     | 100         | ORGA 09863 |            | 04.08 | - ESP |       |                |                |        |                       |                          |                 |
| 2.0 16V     | 103         |            | 03.05      | 04.08 |       |       |                |                |        |                       |                          |                 |
| 2.0 HDi 110 | 79          |            | 03.02      | 04.08 | + ESP |       |                |                |        |                       |                          |                 |
| 2.0 HDi 110 | 79          | ORGA 09863 |            | 04.08 | - ESP |       |                |                |        |                       |                          |                 |
| 2.0 HDi 135 | 100         |            | 02.04      | 04.08 |       |       |                |                |        |                       |                          |                 |
| 2.0 HDi 90  | 66          |            | 03.02      | 04.08 | + ESP |       |                |                |        |                       |                          |                 |
| 2.0 HDi 90  | 66          | ORGA 09863 |            | 04.08 | - ESP |       |                |                |        |                       |                          |                 |
| 1.4         | 55          | ORGA 10892 |            | 04.08 |       |       |                | 24.0711-5325.3 | 360350 | 2                     | + ABS (Bosch) 8.1        | Radsensor L=680 |
| 1.4 16V     | 65          | ORGA 10892 |            | 04.08 |       |       |                |                |        |                       |                          |                 |
| 1.6 16V     | 80          | ORGA 10892 |            | 04.08 |       |       |                |                |        |                       |                          |                 |
| 1.6 BioFlex | 80          | ORGA 10892 |            | 04.08 |       |       |                |                |        |                       |                          |                 |

1) without sensor ring / senza sensori / sans secours ABS / sin anillo sensor ABS  
 2) with sensor ring / con sensori / avec secours ABS / con anillo sensor ABS

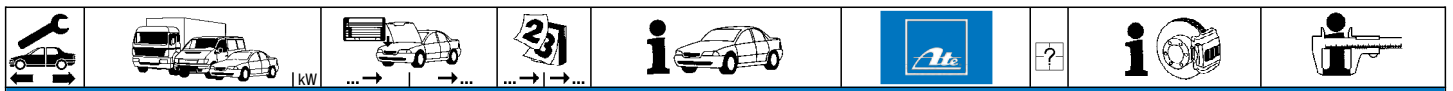

**PEUGEOT 307 SW (02-08)**

|  |   |  |  |  |  |  |                             |   |                   |
|--|---|--|--|--|--|--|-----------------------------|---|-------------------|
|  | 1.6 D<br>1.6 HDi 110<br>2.0 16V<br>2.0 16V<br>2.0 HDi 110<br>2.0 HDi 135<br>2.0 HDi 90  | 66<br>80 ORGA 10892<br>100 ORGA 10892<br>103 ORGA 10892<br>79 ORGA 10892<br>100 ORGA 10892<br>66 ORGA 10892  |  | 12.06<br>04.08<br>04.08<br>04.08<br>04.08<br>04.08<br>04.08  |  | 24.0711-5325.3<br>360350                           | 2  + ABS (Bosch) 8.1        | Radsensor L=680                                     |                   |
|  | 1.4<br>1.4 16V<br>1.4 HDi<br>1.6 16V<br>1.6 BioFlex<br>1.6 D<br>1.6 HDi 110<br>2.0 16V<br>2.0 16V<br>2.0 HDi 110<br>2.0 HDi 135<br>2.0 HDi 90 | 55<br>65<br>50<br>80<br>80<br>66<br>80<br>100<br>103<br>79<br>100<br>66  | ORGA 12056<br>ORGA 12056<br>ORGA 12056<br>ORGA 12056<br>ORGA 12056<br>ORGA 12056<br>ORGA 12056<br>ORGA 12056<br>ORGA 12056<br>ORGA 12056<br>ORGA 12056<br>ORGA 12056 | 04.02<br>11.03<br>03.02<br>03.02<br>09.07<br>12.06<br>02.04<br>03.02<br>03.05<br>03.02<br>02.04<br>03.02 | 04.08<br>01.05   | 13.0460-2823.2<br>13.0470-2823.2<br>13.0460-0072.2 | 602823<br>LD2823<br>610072  | 23554 17,2 /S<br>23554 17,2 /S<br>Belagsatz-Zubehör | TRW<br>TRW<br>TRW |
|  | 1.4<br>1.4 16V<br>1.4 HDi<br>1.6 16V<br>1.6 BioFlex<br>1.6 D<br>1.6 HDi 110<br>2.0 16V<br>2.0 16V<br>2.0 HDi 110<br>2.0 HDi 135<br>2.0 HDi 90 | 55<br>65<br>50<br>80<br>80<br>66<br>80<br>100<br>103<br>79<br>100<br>66  | ORGA 10656<br>ORGA 10656<br>ORGA 10656<br>ORGA 10656<br>ORGA 10656<br>ORGA 10656<br>ORGA 10656<br>ORGA 10656<br>ORGA 10656<br>ORGA 10656<br>ORGA 10656<br>ORGA 10656 | 04.02<br>11.03<br>03.02<br>03.02<br>09.07<br>12.06<br>02.04<br>03.02<br>03.05<br>03.02<br>02.04<br>03.02 | 04.08<br>01.05   | 13.0460-3813.2<br>13.0470-3813.2                   | 603813<br>LD3813            | 24150 17,6 /S<br>24150 17,6 /Zub/S                  | BOS<br>BOS        |
|  | 1.4 16V<br>1.6 16V<br>1.6 BioFlex<br>1.6 D<br>1.6 HDi 110<br>2.0 16V<br>2.0 16V<br>2.0 HDi 110<br>2.0 HDi 135<br>2.0 HDi 90                   | 65 ORGA 12057<br>80 ORGA 12057<br>80 ORGA 12057<br>66 ORGA 12057<br>80 ORGA 12057<br>100 ORGA 12057<br>103 ORGA 12057<br>79 ORGA 12057<br>100 ORGA 12057<br>66 ORGA 12057                  |  | 04.08<br>04.08<br>04.08<br>04.08<br>04.08<br>04.08<br>04.08<br>04.08<br>04.08<br>04.08                   |  | 13.0460-3813.2<br>13.0470-3813.2                   | 603813<br>LD3813            | 24150 17,6 /S<br>24150 17,6 /Zub/S                  | BOS<br>BOS        |
|  | 1.4<br>1.4 16V<br>1.4 HDi<br>1.6 16V<br>1.6 D<br>1.6 HDi 110<br>2.0 16V<br>2.0 16V<br>2.0 HDi 110<br>2.0 HDi 135<br>2.0 HDi 90                | 55<br>65<br>50<br>80<br>66<br>80<br>100<br>103<br>79<br>100<br>66  | ORGA 10897<br>ORGA 10897<br>ORGA 10897<br>ORGA 10897<br>ORGA 10897<br>ORGA 10897<br>ORGA 10897<br>ORGA 10897<br>ORGA 10897<br>ORGA 10897<br>ORGA 10897               | 04.02<br>03.02<br>03.02<br>03.02<br>12.06<br>02.04<br>03.02<br>03.05<br>03.02<br>02.04<br>03.02          |  | 24.0109-0150.2<br>409150                           | mit Sensoring <sup>1)</sup> | 249 9,0 8,0 +B                                      |                   |
|  | 1.4<br>1.4 16V<br>1.4 HDi<br>1.6 16V<br>1.6 D<br>1.6 HDi 110<br>2.0 16V<br>2.0 16V<br>2.0 HDi 110<br>2.0 HDi 135<br>2.0 HDi 90                | 55 ORGA 10898<br>65 ORGA 10898<br>50 ORGA 10898<br>80 ORGA 10898<br>66 ORGA 10898<br>80 ORGA 10898<br>100 ORGA 10898<br>103 ORGA 10898<br>79 ORGA 10898<br>100 ORGA 10898<br>66 ORGA 10898 |  | 04.08<br>04.08<br>01.05<br>04.08<br>04.08<br>04.08<br>04.08<br>04.08<br>04.08<br>04.08<br>04.08          |  | 24.0109-0100.2<br>409100                           | mit Sensoring <sup>1)</sup> | 249 9,0 7,0 +B                                      |                   |
|  | 1.4<br>1.4 16V<br>1.4 HDi<br>1.6 16V<br>1.6 BioFlex<br>1.6 D<br>1.6 HDi 110<br>2.0 16V<br>2.0 16V<br>2.0 HDi 110<br>2.0 HDi 135<br>2.0 HDi 90 | 55<br>65<br>50<br>80<br>80<br>66<br>80<br>100<br>103<br>79<br>100<br>66  |  | 04.02<br>03.02<br>03.02<br>03.02<br>09.07<br>12.06<br>02.04<br>03.02<br>03.05<br>03.02<br>02.04<br>03.02 | 04.08<br>04.08<br>01.05<br>04.08<br>04.08<br>04.08<br>04.08<br>04.08<br>04.08<br>04.08<br>04.08<br>04.08 | 24.0109-0137.1<br>409137                           |                             | 247 9,0 8,0 +S +B                                   |                   |

**PEUGEOT 308 Limousine (07-13)**

|  |   |   |  |  |  |                                  |                  |  |            |
|--|---|---|--|--|--|----------------------------------|------------------|--|------------|
|  | 1.4 16V<br>1.4 VTI<br>1.6 140 THP<br>1.6 150 THP<br>1.6 16V<br>1.6 BioFlex<br>1.6 HDi 110<br>1.6 HDi 112<br>1.6 HDi 115<br>1.6 HDi 90 | 72<br>70<br>103<br>110<br>115<br>80<br>80<br>82<br>84<br>66 |  | 12.09<br>08.07<br>08.07<br>08.07<br>10.09<br>04.08<br>08.07<br>12.09<br>03.13<br>08.07 | 07.13<br>07.13<br>07.13<br>07.13<br>07.13<br>07.13<br>07.13<br>07.13<br>07.13<br>07.13 | 13.0460-3847.2<br>13.0470-3847.2 | 603847<br>LD3847 | 24660 17,8 /Zub/S<br>24660 17,8 /Zub/S | BOS<br>BOS |
|--|---|---|--|--|--|----------------------------------|------------------|--|------------|

<sup>1)</sup> with sensor ring / con sensori / avec secours ABS / con anillo sensor ABS



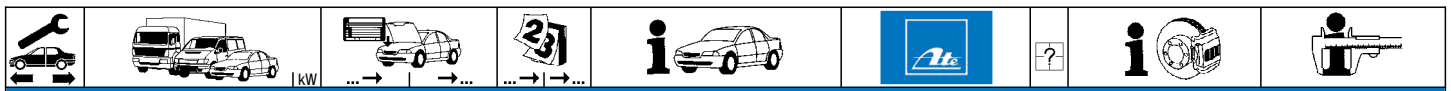

**PEUGEOT 308 Limousine (07-13)**

|                 |                 |     |            |       |                |                |        |                         |                          |     |
|-----------------|-----------------|-----|------------|-------|----------------|----------------|--------|-------------------------|--------------------------|-----|
|                 | 1.6 HDi 92      | 68  |            | 11.09 | 07.13          | 13.0460-3847.2 | 603847 |                         | 24660 17,8 /Zub/S        | BOS |
|                 | 1.6 VTi         | 88  |            | 08.07 | 07.13          | 13.0470-3847.2 | LD3847 |                         | 24660 17,8 /Zub/S        | BOS |
|                 | 2.0 HDi 135     | 100 | ORGA 11678 |       | 07.13          |                |        |                         |                          |     |
|                 | 2.0 HDi FAP 140 | 103 |            | 12.08 | 07.13          |                |        |                         |                          |     |
|                 | 1.6 16V         | 115 |            | 10.09 | 07.13          | 13.0460-7202.2 | 607202 |                         | 23589 19,1 +             | ATE |
|                 | 1.6 175 THP     | 128 |            | 03.08 | 07.13          | 13.0470-7202.2 | LD7202 |                         | 23589 19,1 +             | ATE |
|                 | 2.0 HDi 135     | 100 | ORGA 11678 | 08.07 |                |                |        |                         |                          |     |
| 2.0 HDi 163     | 120             |     | 04.12      | 07.13 |                |                |        |                         |                          |     |
| 1.6 GTi         | 147             |     | 07.10      | 07.13 | 13.0460-7279.2 | 607279         |        | 25069 17,3 +/WK         | ATE                      |     |
|                 | 1.4 16V         | 72  |            | 12.09 | 07.13          | 24.0126-0120.1 | 426120 |                         | 283 26,0 24,0 V +S +B    |     |
|                 | 1.4 VTi         | 70  |            | 08.07 | 07.13          | 24.0326-0120.1 | 526120 |                         | 283 26,0 24,0 V +S +B PD |     |
|                 | 1.6 140 THP     | 103 |            | 08.07 | 07.13          |                |        |                         |                          |     |
|                 | 1.6 150 THP     | 110 |            | 08.07 | 07.13          |                |        |                         |                          |     |
|                 | 1.6 BioFlex     | 80  |            | 04.08 | 07.13          |                |        |                         |                          |     |
|                 | 1.6 HDi 110     | 80  |            | 08.07 | 07.13          |                |        |                         |                          |     |
|                 | 1.6 HDi 112     | 82  |            | 12.09 | 07.13          |                |        |                         |                          |     |
|                 | 1.6 HDi 115     | 84  |            | 03.13 | 07.13          |                |        |                         |                          |     |
|                 | 1.6 HDi 90      | 66  |            | 08.07 | 07.13          |                |        |                         |                          |     |
|                 | 1.6 HDi 92      | 68  |            | 11.09 | 07.13          |                |        |                         |                          |     |
|                 | 1.6 VTi         | 88  |            | 08.07 | 07.13          |                |        |                         |                          |     |
|                 | 2.0 HDi 135     | 100 | ORGA 11678 | 08.07 | 07.13          |                |        |                         |                          |     |
|                 | 2.0 HDi 135     | 100 |            | 08.07 | 07.13          |                |        |                         |                          |     |
|                 | 2.0 HDi FAP 140 | 103 |            | 12.08 | 07.13          |                |        |                         |                          |     |
|                 | 1.6 16V         | 115 |            | 10.09 | 07.13          | 24.0126-0159.1 | 426159 |                         | 302 26,0 24,0 V +S +B    |     |
|                 | 1.6 175 THP     | 128 |            | 03.08 | 07.13          |                |        |                         |                          |     |
|                 | 2.0 HDi 135     | 100 | ORGA 11678 | 08.07 |                |                |        |                         |                          |     |
| 2.0 HDi 163     | 120             |     | 04.12      | 07.13 |                |                |        |                         |                          |     |
| 1.6 GTi         | 147             |     | 07.10      | 07.13 | 24.0130-0230.1 | 430230         |        | 340 30,0 28,0 V L +S +B |                          |     |
|                 | 1.4 16V         | 72  |            | 12.09 | 07.13          | 24.0711-5325.3 | 360350 | 2                       | Radsensor L=680          |     |
|                 | 1.4 VTi         | 70  |            | 08.07 | 07.13          |                |        |                         |                          |     |
|                 | 1.6 140 THP     | 103 |            | 08.07 | 07.13          |                |        |                         |                          |     |
|                 | 1.6 150 THP     | 110 |            | 08.07 | 07.13          |                |        |                         |                          |     |
|                 | 1.6 16V         | 115 |            | 10.09 | 07.13          |                |        |                         |                          |     |
|                 | 1.6 175 THP     | 128 |            | 03.08 | 07.13          |                |        |                         |                          |     |
|                 | 1.6 BioFlex     | 80  |            | 04.08 | 07.13          |                |        |                         |                          |     |
|                 | 1.6 GTi         | 147 |            | 07.10 | 07.13          |                |        |                         |                          |     |
|                 | 1.6 HDi 110     | 80  |            | 08.07 | 07.13          |                |        |                         |                          |     |
|                 | 1.6 HDi 112     | 82  |            | 12.09 | 07.13          |                |        |                         |                          |     |
|                 | 1.6 HDi 115     | 84  |            | 03.13 | 07.13          |                |        |                         |                          |     |
|                 | 1.6 HDi 90      | 66  |            | 08.07 | 07.13          |                |        |                         |                          |     |
|                 | 1.6 HDi 92      | 68  |            | 11.09 | 07.13          |                |        |                         |                          |     |
|                 | 1.6 VTi         | 88  |            | 08.07 | 07.13          |                |        |                         |                          |     |
|                 | 2.0 HDi 135     | 100 |            | 08.07 | 07.13          |                |        |                         |                          |     |
|                 | 2.0 HDi 163     | 120 |            | 04.12 | 07.13          |                |        |                         |                          |     |
|                 | 2.0 HDi FAP 140 | 103 |            | 12.08 | 07.13          |                |        |                         |                          |     |
|                 | 1.4 16V         | 72  |            | 12.09 | 07.13          | 13.0460-2740.2 | 602740 |                         | 23554 17,2 /Zub/S        | TRW |
|                 | 1.4 VTi         | 70  |            | 08.07 | 07.13          | 13.0470-2740.2 | LD2740 |                         | 23554 17,2 /Zub/S        | TRW |
|                 | 1.6             | 120 |            | 01.12 | 07.13          |                |        |                         |                          |     |
|                 | 1.6 140 THP     | 103 |            | 08.07 | 07.13          |                |        |                         |                          |     |
|                 | 1.6 150 THP     | 110 |            | 08.07 | 07.13          |                |        |                         |                          |     |
|                 | 1.6 16V         | 115 |            | 10.09 | 07.13          |                |        |                         |                          |     |
|                 | 1.6 175 THP     | 128 |            | 03.08 | 07.13          |                |        |                         |                          |     |
|                 | 1.6 BioFlex     | 80  |            | 04.08 | 07.13          |                |        |                         |                          |     |
|                 | 1.6 HDi 110     | 80  |            | 08.07 | 07.13          |                |        |                         |                          |     |
|                 | 1.6 HDi 112     | 82  |            | 12.09 | 07.13          |                |        |                         |                          |     |
|                 | 1.6 HDi 115     | 84  |            | 03.13 | 07.13          |                |        |                         |                          |     |
|                 | 1.6 HDi 90      | 66  |            | 08.07 | 07.13          |                |        |                         |                          |     |
|                 | 1.6 HDi 92      | 68  |            | 11.09 | 07.13          |                |        |                         |                          |     |
|                 | 1.6 VTi         | 88  |            | 08.07 | 07.13          |                |        |                         |                          |     |
|                 | 2.0 HDi         | 110 |            | 10.11 | 07.13          |                |        |                         |                          |     |
|                 | 2.0 HDi 135     | 100 |            | 08.07 | 07.13          |                |        |                         |                          |     |
|                 | 2.0 HDi 163     | 120 |            | 04.12 | 07.13          |                |        |                         |                          |     |
| 2.0 HDi FAP 140 | 103             |     | 12.08      | 07.13 |                |                |        |                         |                          |     |
| 1.6 GTi         | 147             |     | 07.10      | 07.13 | 13.0460-2761.2 | 602761         |        | 24922 17,5 /Zub/S       | TRW                      |     |
|                 | 1.4 16V         | 72  |            | 12.09 | 07.13          | 24.0109-0171.2 | 409171 |                         | 249 9,0 8,0 +B           |     |
|                 | 1.4 VTi         | 70  |            | 08.07 | 07.13          |                |        |                         |                          |     |
|                 | 1.6             | 120 |            | 01.12 | 07.13          |                |        |                         |                          |     |
|                 | 1.6 140 THP     | 103 |            | 08.07 | 07.13          |                |        |                         |                          |     |
|                 | 1.6 150 THP     | 110 |            | 08.07 | 07.13          |                |        |                         |                          |     |
|                 | 1.6 16V         | 115 |            | 10.09 | 07.13          |                |        |                         |                          |     |
|                 | 1.6 175 THP     | 128 |            | 03.08 | 07.13          |                |        |                         |                          |     |
|                 | 1.6 BioFlex     | 80  |            | 04.08 | 07.13          |                |        |                         |                          |     |
|                 | 1.6 HDi 110     | 80  |            | 08.07 | 07.13          |                |        |                         |                          |     |
|                 | 1.6 HDi 112     | 82  |            | 12.09 | 07.13          |                |        |                         |                          |     |
|                 | 1.6 HDi 115     | 84  |            | 03.13 | 07.13          |                |        |                         |                          |     |
|                 | 1.6 HDi 90      | 66  |            | 08.07 | 07.13          |                |        |                         |                          |     |
|                 | 1.6 HDi 92      | 68  |            | 11.09 | 07.13          |                |        |                         |                          |     |
|                 | 1.6 VTi         | 88  |            | 08.07 | 07.13          |                |        |                         |                          |     |
|                 | 2.0 HDi         | 110 |            | 10.11 | 07.13          |                |        |                         |                          |     |
|                 | 2.0 HDi 135     | 100 |            | 08.07 | 07.13          |                |        |                         |                          |     |
|                 | 2.0 HDi 163     | 120 |            | 04.12 | 07.13          |                |        |                         |                          |     |
| 2.0 HDi FAP 140 | 103             |     | 12.08      | 07.13 |                |                |        |                         |                          |     |
| 1.6 GTi         | 147             |     | 07.10      | 07.13 | 24.0112-0198.1 | 412198         |        | 290 12,0 10,0 +S +B     |                          |     |





















**PEUGEOT 308 SW (08-14)**

|  |  |   |  |  |  |  |                |        |  |                   |     |
|--|--|---|--|--|--|--|----------------|--------|--|-------------------|-----|
|  | 2.0 BioFlex<br>2.0 HDi<br>2.0 HDi 135<br>2.0 HDi 140<br>2.0 HDi 150  | 103<br>120<br>100<br>103<br>110   |  | 05.08<br>06.09<br>05.08<br>12.08<br>04.11  | 04.14<br>04.14<br>04.14<br>04.14<br>04.14  | + Break Loisirs<br>+ Break Loisirs<br>+ Break Loisirs<br>+ Break Loisirs<br>+ Break Loisirs  | 13.0460-2745.2 | 602745 |  | 24765 16,5 /Zub/S | TRW |
|  | 1.4 16V<br>1.4 16V<br>1.6 16V<br>1.6 16V<br>1.6 16V<br>1.6 16V<br>1.6 16V<br>1.6 Bioflex<br>1.6 HDi 110<br>1.6 HDi 112<br>1.6 HDi 115<br>1.6 HDi 90<br>1.6 HDi 92<br>2.0 BioFlex<br>2.0 HDi<br>2.0 HDi 135<br>2.0 HDi 140<br>2.0 HDi 150 | 70<br>72<br>88<br>103<br>110<br>115<br>128<br>82<br>80<br>82<br>84<br>66<br>68<br>103<br>120<br>100<br>103<br>110 |  | 05.08<br>12.09<br>05.08<br>05.08<br>05.08<br>10.09<br>05.08<br>03.09<br>05.08<br>12.09<br>03.13<br>05.08<br>11.09<br>05.08<br>06.09<br>05.08<br>12.08<br>04.11 | 04.14<br>04.14<br>04.14<br>04.14<br>04.14<br>04.14<br>04.14<br>04.14<br>04.14<br>04.14<br>04.14<br>04.14<br>04.14<br>04.14<br>04.14<br>04.14<br>04.14<br>04.14 | - Break Loisirs<br>- Break Loisirs<br>- Break Loisirs<br>- Break Loisirs<br>- Break Loisirs<br>- Break Loisirs<br>- Break Loisirs<br>- Break Loisirs<br>- Break Loisirs<br>- Break Loisirs<br>- Break Loisirs<br>- Break Loisirs<br>- Break Loisirs<br>- Break Loisirs<br>- Break Loisirs<br>- Break Loisirs<br>- Break Loisirs<br>- Break Loisirs | 24.0109-0171.2 | 409171 |  | 249 9,0 8,0 +B    |     |
|  | 1.4 16V<br>1.4 16V<br>1.6 16V<br>1.6 16V<br>1.6 16V<br>1.6 16V<br>1.6 16V<br>1.6 Bioflex<br>1.6 HDi 110<br>1.6 HDi 112<br>1.6 HDi 115<br>1.6 HDi 90<br>1.6 HDi 92<br>2.0 BioFlex<br>2.0 HDi<br>2.0 HDi 135<br>2.0 HDi 140<br>2.0 HDi 150 | 70<br>72<br>88<br>103<br>110<br>115<br>128<br>82<br>80<br>82<br>84<br>66<br>68<br>103<br>120<br>100<br>103<br>110 |  | 05.08<br>12.09<br>05.08<br>05.08<br>05.08<br>10.09<br>05.08<br>03.09<br>05.08<br>12.09<br>03.13<br>05.08<br>11.09<br>05.08<br>06.09<br>05.08<br>12.08<br>04.11 | 04.14<br>04.14<br>04.14<br>04.14<br>04.14<br>04.14<br>04.14<br>04.14<br>04.14<br>04.14<br>04.14<br>04.14<br>04.14<br>04.14<br>04.14<br>04.14<br>04.14<br>04.14 | + Break Loisirs<br>+ Break Loisirs<br>+ Break Loisirs<br>+ Break Loisirs<br>+ Break Loisirs<br>+ Break Loisirs<br>+ Break Loisirs<br>+ Break Loisirs<br>+ Break Loisirs<br>+ Break Loisirs<br>+ Break Loisirs<br>+ Break Loisirs<br>+ Break Loisirs<br>+ Break Loisirs<br>+ Break Loisirs<br>+ Break Loisirs<br>+ Break Loisirs<br>+ Break Loisirs | 24.0112-0194.2 | 412194 |  | 268 12,0 10,0 +B  |     |

**PEUGEOT 308 CC (09-15)**

|  |  |   |  |  |  |  |                                  |                  |   |   |            |
|--|--|---|--|--|--|--|----------------------------------|------------------|---|---|------------|
|  | 1.6 16V<br>1.6 16V<br>1.6 THP<br>2.0 HDi<br>2.0 HDi<br>2.0 HDi FAP 140   | 103<br>115<br>110<br>100<br>120<br>103                          |  | 06.09<br>09.09<br>06.09<br>04.09<br>06.09<br>03.09                                     |  |  | 13.0460-7202.2<br>13.0470-7202.2 | 607202<br>LD7202 |   | 23589 19,1 +<br>23589 19,1 +                      | ATE<br>ATE |
|  | 1.6 HDi<br>1.6 HDi 115<br>1.6 VTi<br>1.6 THP   | 82<br>84<br>88<br>147   |  | 03.09<br>03.13<br>03.09<br>10.10   |  |  | 13.0460-3847.2<br>13.0470-3847.2 | 603847<br>LD3847 |   | 24660 17,8 /Zub/S<br>24660 17,8 /Zub/S            | BOS<br>BOS |
|  | 1.6 16V<br>1.6 16V<br>1.6 THP<br>2.0 HDi<br>2.0 HDi<br>2.0 HDi FAP 140   | 103<br>115<br>110<br>100<br>120<br>103                          |  | 06.09<br>09.09<br>06.09<br>04.09<br>06.09<br>03.09                                     |  |  | 24.0126-0159.1                   | 426159           |   | 302 26,0 24,0 V +S +B                             |            |
|  | 1.6 HDi<br>1.6 HDi 115<br>1.6 VTi<br>1.6 THP   | 82<br>84<br>88<br>147   |  | 03.09<br>03.13<br>03.09<br>10.10   |  |  | 24.0126-0120.1<br>24.0326-0120.1 | 426120<br>526120 |   | 283 26,0 24,0 V +S +B<br>283 26,0 24,0 V +S +B PD |            |
|  | 1.6 16V<br>1.6 16V<br>1.6 HDi<br>1.6 HDi 115<br>1.6 THP<br>1.6 THP<br>1.6 VTi<br>2.0 HDi<br>2.0 HDi<br>2.0 HDi FAP 140 | 103<br>115<br>82<br>84<br>110<br>147<br>88<br>100<br>120<br>103 |  | 06.09<br>09.09<br>03.09<br>03.13<br>06.09<br>10.10<br>03.09<br>04.09<br>06.09<br>03.09 |  |  | 24.0711-5325.3                   | 360350           | 2 | Radsensor L=680                                   |            |
|  | 1.6 16V<br>1.6 16V<br>1.6 HDi<br>1.6 HDi 115<br>1.6 THP<br>1.6 VTi<br>2.0 HDi<br>2.0 HDi<br>2.0 HDi FAP 140            | 103<br>115<br>82<br>84<br>110<br>88<br>100<br>120<br>103        |  | 06.09<br>09.09<br>03.09<br>03.13<br>06.09<br>03.09<br>04.09<br>06.09<br>03.09          |  |  | 13.0460-2740.2<br>13.0470-2740.2 | 602740<br>LD2740 |   | 23554 17,2 /Zub/S<br>23554 17,2 /Zub/S            | TRW<br>TRW |
|  | 1.6 THP  | 147   |  | 10.10  |  |  | 13.0460-2761.2                   | 602761           |   | 24922 17,5 /Zub/S                                 | TRW        |

|     |  |  |  |  |  |  |  |       |                         |
|--|--|--|--|--|---|--|--|---|-------------------------|
| <b>PEUGEOT 308 CC (09-15)</b>  |  |  |  |  |   |  |  |   |                         |
|    | 1.6 16V  | 103  |  | 06.09  |   | 24.0109-0171.2   | 409171   |   | 249 9,0 8,0 +B          |
|  | 1.6 16V  | 115  |  | 09.09  |   |  |  |   |                         |
|  | 1.6 HDi  | 82   |  | 03.09  |   |  |  |   |                         |
|  | 1.6 HDi 115  | 84   |  | 03.13  |   |  |  |   |                         |
|  | 1.6 THP  | 110  |  | 06.09  |   |  |  |   |                         |
|  | 1.6 VTi  | 88   |  | 03.09  |   |  |  |   |                         |
|  | 2.0 HDi  | 100  |  | 04.09  |   |  |  |   |                         |
|  | 2.0 HDi  | 120  |  | 06.09  |   |  |  |   |                         |
|  | 2.0 HDi FAP 140  | 103  |  | 03.09  |   |  |  |   |                         |
|  | 1.6 THP  | 147  |  | 10.10  |   | 24.0112-0198.1   | 412198   |   | 290 12,0 10,0 +S +B     |
| <b>PEUGEOT 308 II (T9) (13-)</b>   |  |  |  |  |   |  |  |   |                         |
|    | 1.2 THP 110  | 81   |  | 11.13  |   | 13.0460-3870.2   | 603870   |   | 25895 18,5 +/Zub/S BOS  |
|  | 1.2 THP 130  | 96   |  | 11.13  |   | 13.0470-3870.2   | LD3870   |   | 25895 18,5 +/Zub/S BOS  |
|  | 1.2 VTi 82   | 60   |  | 09.13  |   |  |  |   |                         |
|  | 1.6 GT 205   | 151  |  | 06.14  |   |  |  |   |                         |
|  | 1.6 GTi 250  | 184  |  | 08.15  |   |  |  |   |                         |
|  | 1.6 GTi 270  | 200  |  | 06.15  |   |  |  |   |                         |
|  | 1.6 HDi 100  | 73   |  | 04.14  |   |  |  |   |                         |
|  | 1.6 HDi 115  | 85   |  | 09.13  |   |  |  |   |                         |
|  | 1.6 HDi 120  | 88   |  | 11.13  |   |  |  |   |                         |
|  | 1.6 HDi 92   | 68   |  | 09.13  |   |  |  |   |                         |
|  | 1.6 THP 125  | 92   |  | 09.13  |   |  |  |   |                         |
|  | 1.6 THP 150  | 110  |  | 03.14  |   |  |  |   |                         |
|  | 1.6 THP 155  | 115  |  | 09.13  |   |  |  |   |                         |
|  | 1.6 THP 163  | 120  |  | 06.14  |   |  |  |   |                         |
|  | 1.6 VTi  | 85   |  | 03.14  |   |  |  |   |                         |
|  | 2.0 GT HDi 180   | 133  |  | 06.14  |   |  |  |   |                         |
|  | 2.0 HDi 150  | 110  |  | 11.13  |   |  |  |   |                         |
|  | 1.2 THP 110  | 81   |  | 11.13  |   | 13.0460-7300.2   | 607300   |   | 25833 17,3 +/WE ATE     |
|  | 1.2 THP 130  | 96   |  | 11.13  |   | 13.0470-7300.2   | LD7300   |   | 25702 18,2 + ATE        |
|  | 1.2 VTi 82   | 60   |  | 09.13  |   |  |  |   |                         |
|  | 1.6 GT 205   | 151  |  | 06.14  |   |  |  |   |                         |
|  | 1.6 GTi 250  | 184  |  | 08.15  |   |  |  |   |                         |
|  | 1.6 GTi 270  | 200  |  | 06.15  |   |  |  |   |                         |
|  | 1.6 HDi 100  | 73   |  | 04.14  |   |  |  |   |                         |
|  | 1.6 HDi 115  | 85   |  | 09.13  |   |  |  |   |                         |
|  | 1.6 HDi 120  | 88   |  | 11.13  |   |  |  |   |                         |
|  | 1.6 HDi 92   | 68   |  | 09.13  |   |  |  |   |                         |
|  | 1.6 THP 125  | 92   |  | 09.13  |   |  |  |   |                         |
|  | 1.6 THP 150  | 110  |  | 03.14  |   |  |  |   |                         |
|  | 1.6 THP 155  | 115  |  | 09.13  |   |  |  |   |                         |
|  | 1.6 THP 163  | 120  |  | 06.14  |   |  |  |   |                         |
|  | 1.6 VTi  | 85   |  | 03.14  |   |  |  |   |                         |
|  | 2.0 GT HDi 180   | 133  |  | 06.14  |   |  |  |   |                         |
|  | 2.0 HDi 150  | 110  |  | 11.13  |   |  |  |   |                         |
|  | 1.2 THP 110  | 81   |  | 11.13  |   | 24.0126-0183.1   | 426183   |   | 283 26,0 24,0 V L +S +B |
|  | 1.2 THP 130  | 96   |  | 11.13  |   |  |  |   |                         |
|  | 1.2 VTi 82   | 60   |  | 09.13  |   |  |  |   |                         |
|  | 1.6 GT 205   | 151  |  | 06.14  |   |  |  |   |                         |
|  | 1.6 GTi 250  | 184  |  | 08.15  |   |  |  |   |                         |
|  | 1.6 GTi 270  | 200  |  | 06.15  |   |  |  |   |                         |
|  | 1.6 HDi 100  | 73   |  | 04.14  |   |  |  |   |                         |
|  | 1.6 HDi 115  | 85   |  | 09.13  |   |  |  |   |                         |
|  | 1.6 HDi 120  | 88   |  | 11.13  |   |  |  |   |                         |
|  | 1.6 HDi 92   | 68   |  | 09.13  |   |  |  |   |                         |
|  | 1.6 THP 125  | 92   |  | 09.13  |   |  |  |   |                         |
|  | 1.6 THP 150  | 110  |  | 03.14  |   |  |  |   |                         |
|  | 1.6 THP 155  | 115  |  | 09.13  |   |  |  |   |                         |
|  | 1.6 THP 163  | 120  |  | 06.14  |   |  |  |   |                         |
|  | 1.6 VTi  | 85   |  | 03.14  |   |  |  |   |                         |
|  | 2.0 GT HDi 180   | 133  |  | 06.14  |   |  |  |   |                         |
|  | 2.0 HDi 150  | 110  |  | 11.13  |   |  |  |   |                         |
|  | 1.2 THP 110  | 81   |  | 11.13  |   | 24.0128-0269.1   | 428269   |   | 304 28,0 26,0 V L +S +B |
|  | 1.2 THP 130  | 96   |  | 11.13  |   |  |  |   |                         |
|  | 1.2 VTi 82   | 60   |  | 09.13  |   |  |  |   |                         |
|  | 1.6 GT 205   | 151  |  | 06.14  |   |  |  |   |                         |
|  | 1.6 GTi 250  | 184  |  | 08.15  |   |  |  |   |                         |
|  | 1.6 GTi 270  | 200  |  | 06.15  |   |  |  |   |                         |
|  | 1.6 HDi 100  | 73   |  | 04.14  |   |  |  |   |                         |
|  | 1.6 HDi 115  | 85   |  | 09.13  |   |  |  |   |                         |
|  | 1.6 HDi 120  | 88   |  | 11.13  |   |  |  |   |                         |
|  | 1.6 HDi 92   | 68   |  | 09.13  |   |  |  |   |                         |
|  | 1.6 THP 125  | 92   |  | 09.13  |   |  |  |   |                         |
|  | 1.6 THP 150  | 110  |  | 03.14  |   |  |  |   |                         |
|  | 1.6 THP 155  | 115  |  | 09.13  |   |  |  |   |                         |
|  | 1.6 THP 163  | 120  |  | 06.14  |   |  |  |   |                         |
|  | 1.6 VTi  | 85   |  | 03.14  |   |  |  |   |                         |
|  | 2.0 GT HDi 180   | 133  |  | 06.14  |   |  |  |   |                         |
|  | 2.0 HDi 150  | 110  |  | 11.13  |   |  |  |   |                         |
|  | 1.2 THP 110  | 81   |  | 11.13  |   | 24.0711-5379.3   | 360422   | 2  | Radsensor L=877         |
|  | 1.2 THP 130  | 96   |  | 11.13  |   |  |  |   |                         |
|  | 1.2 VTi 82   | 60   |  | 09.13  |   |  |  |   |                         |
|  | 1.6 GT 205   | 151  |  | 06.14  |   |  |  |   |                         |
|  | 1.6 GTi 250  | 184  |  | 08.15  |   |  |  |   |                         |
|  | 1.6 GTi 270  | 200  |  | 06.15  |   |  |  |   |                         |
|  | 1.6 HDi 100  | 73   |  | 04.14  |   |  |  |   |                         |

1) + brake disc diameter 283 mm / + disco fr.diam. 283mm / + disques fr.diam. 283mm / + disco fr.diam. 283mm















2) + brake disc diameter 304 mm / + disco fr.diam. 304mm / + disques fr.diam. 304mm / + disco fr.diam. 304mm



**PEUGEOT 308 II (T9) (13-)**

|  |   |  |  |  |   |                                  |                  |  |  |            |
|--|---|--|--|--|---|----------------------------------|------------------|--|--|------------|
|  | 1.6 HDi 115<br>1.6 HDi 120<br>1.6 HDi 92<br>1.6 THP 125<br>1.6 THP 150<br>1.6 THP 155<br>1.6 THP 163<br>1.6 VTi<br>2.0 GT HDi 180<br>2.0 HDi 150  | 85<br>88<br>68<br>92<br>110<br>115<br>120<br>85<br>133<br>110  |  | 09.13<br>11.13<br>09.13<br>09.13<br>03.14<br>09.13<br>06.14<br>03.14<br>06.14<br>11.13   |   | 24.0711-5379.3<br>360422         | 2                | Radsensor L=877  |  |            |
|  | 1.2 THP 110<br>1.2 THP 130<br>1.2 VTi 82<br>1.6 GT 205<br>1.6 GTi 250<br>1.6 GTi 270<br>1.6 HDi 100<br>1.6 HDi 115<br>1.6 HDi 120<br>1.6 HDi 92<br>1.6 THP 125<br>1.6 THP 150<br>1.6 THP 155<br>1.6 THP 163<br>1.6 VTi<br>2.0 GT HDi 180<br>2.0 HDi 150 | 81<br>96<br>60<br>151<br>184<br>200<br>73<br>85<br>88<br>68<br>92<br>110<br>115<br>120<br>85<br>133<br>110 |  | 11.13<br>11.13<br>09.13<br>06.14<br>08.15<br>06.15<br>04.14<br>09.13<br>11.13<br>09.13<br>03.14<br>09.13<br>06.14<br>03.14<br>06.14<br>11.13 | + Bremsscheibendurchm. 249 mm <sup>1)</sup><br>+ Bremsscheibendurchm. 249 mm <sup>1)</sup><br>+ Bremsscheibendurchm. 249 mm <sup>1)</sup><br>+ Bremsscheibendurchm. 249 mm <sup>1)</sup><br>+ Bremsscheibendurchm. 249 mm <sup>1)</sup><br>+ Bremsscheibendurchm. 249 mm <sup>1)</sup><br>+ Bremsscheibendurchm. 249 mm <sup>1)</sup><br>+ Bremsscheibendurchm. 249 mm <sup>1)</sup><br>+ Bremsscheibendurchm. 249 mm <sup>1)</sup><br>+ Bremsscheibendurchm. 249 mm <sup>1)</sup><br>+ Bremsscheibendurchm. 249 mm <sup>1)</sup><br>+ Bremsscheibendurchm. 249 mm <sup>1)</sup><br>+ Bremsscheibendurchm. 249 mm <sup>1)</sup><br>+ Bremsscheibendurchm. 249 mm <sup>1)</sup><br>+ Bremsscheibendurchm. 249 mm <sup>1)</sup><br>+ Bremsscheibendurchm. 249 mm <sup>1)</sup>  | 13.0460-7301.2<br>13.0470-7301.2 | 607301<br>LD7301 | - elektrische Feststellbremse <sup>2)</sup><br>- elektrische Feststellbremse <sup>2)</sup> | 25841 16,1 +<br>25841 16,1 +             | ATE<br>ATE |
|  | 1.2 THP 110<br>1.2 THP 130<br>1.2 VTi 82<br>1.6 GT 205<br>1.6 GTi 250<br>1.6 GTi 270<br>1.6 HDi 100<br>1.6 HDi 115<br>1.6 HDi 120<br>1.6 HDi 92<br>1.6 THP 125<br>1.6 THP 150<br>1.6 THP 155<br>1.6 THP 163<br>1.6 VTi<br>2.0 GT HDi 180<br>2.0 HDi 150 | 81<br>96<br>60<br>151<br>184<br>200<br>73<br>85<br>88<br>68<br>92<br>110<br>115<br>120<br>85<br>133<br>110 |  | 11.13<br>11.13<br>09.13<br>06.14<br>08.15<br>06.15<br>04.14<br>09.13<br>11.13<br>09.13<br>03.14<br>09.13<br>06.14<br>03.14<br>06.14<br>11.13 | + Bremsscheibendurchm. 268 mm <sup>3)</sup><br>+ Bremsscheibendurchm. 268 mm <sup>3)</sup><br>+ Bremsscheibendurchm. 268 mm <sup>3)</sup><br>+ Bremsscheibendurchm. 268 mm <sup>3)</sup><br>+ Bremsscheibendurchm. 268 mm <sup>3)</sup><br>+ Bremsscheibendurchm. 268 mm <sup>3)</sup><br>+ Bremsscheibendurchm. 268 mm <sup>3)</sup><br>+ Bremsscheibendurchm. 268 mm <sup>3)</sup><br>+ Bremsscheibendurchm. 268 mm <sup>3)</sup><br>+ Bremsscheibendurchm. 268 mm <sup>3)</sup><br>+ Bremsscheibendurchm. 268 mm <sup>3)</sup><br>+ Bremsscheibendurchm. 268 mm <sup>3)</sup><br>+ Bremsscheibendurchm. 268 mm <sup>3)</sup><br>+ Bremsscheibendurchm. 268 mm <sup>3)</sup><br>+ Bremsscheibendurchm. 268 mm <sup>3)</sup><br>+ Bremsscheibendurchm. 268 mm <sup>3)</sup><br>+ Bremsscheibendurchm. 268 mm <sup>3)</sup> | 13.0460-7295.2<br>13.0470-7295.2 | 607295<br>LD7295 | - elektrische Feststellbremse <sup>2)</sup><br>- elektrische Feststellbremse <sup>2)</sup> | 25968 16,1 +<br>25968 16,1 +             | ATE<br>ATE |
|  | 1.2 THP 110<br>1.2 THP 130<br>1.2 VTi 82<br>1.6 GT 205<br>1.6 GTi 250<br>1.6 GTi 270<br>1.6 HDi 100<br>1.6 HDi 115<br>1.6 HDi 120<br>1.6 HDi 92<br>1.6 THP 125<br>1.6 THP 150<br>1.6 THP 155<br>1.6 THP 163<br>1.6 VTi<br>2.0 GT HDi 180<br>2.0 HDi 150 | 81<br>96<br>60<br>151<br>184<br>200<br>73<br>85<br>88<br>68<br>92<br>110<br>115<br>120<br>85<br>133<br>110 |  | 11.13<br>11.13<br>09.13<br>06.14<br>08.15<br>06.15<br>04.14<br>09.13<br>11.13<br>09.13<br>03.14<br>09.13<br>06.14<br>03.14<br>06.14<br>11.13 | + Bremsscheibendurchm. 268 mm <sup>3)</sup><br>+ Bremsscheibendurchm. 268 mm <sup>3)</sup><br>+ Bremsscheibendurchm. 268 mm <sup>3)</sup><br>+ Bremsscheibendurchm. 268 mm <sup>3)</sup><br>+ Bremsscheibendurchm. 268 mm <sup>3)</sup><br>+ Bremsscheibendurchm. 268 mm <sup>3)</sup><br>+ Bremsscheibendurchm. 268 mm <sup>3)</sup><br>+ Bremsscheibendurchm. 268 mm <sup>3)</sup><br>+ Bremsscheibendurchm. 268 mm <sup>3)</sup><br>+ Bremsscheibendurchm. 268 mm <sup>3)</sup><br>+ Bremsscheibendurchm. 268 mm <sup>3)</sup><br>+ Bremsscheibendurchm. 268 mm <sup>3)</sup><br>+ Bremsscheibendurchm. 268 mm <sup>3)</sup><br>+ Bremsscheibendurchm. 268 mm <sup>3)</sup><br>+ Bremsscheibendurchm. 268 mm <sup>3)</sup><br>+ Bremsscheibendurchm. 268 mm <sup>3)</sup><br>+ Bremsscheibendurchm. 268 mm <sup>3)</sup> | 13.0460-3871.2<br>13.0470-3871.2 | 603871<br>LD3871 | + elektrische Feststellbremse <sup>4)</sup><br>+ elektrische Feststellbremse <sup>4)</sup> | 25839 17,8 +/Zub/S<br>25839 17,8 +/Zub/S | BOS<br>BOS |
|  | 1.2 THP 110<br>1.2 THP 130<br>1.2 VTi 82<br>1.6 GT 205<br>1.6 GTi 250<br>1.6 GTi 270<br>1.6 HDi 100<br>1.6 HDi 115<br>1.6 HDi 120<br>1.6 HDi 92<br>1.6 THP 125<br>1.6 THP 150<br>1.6 THP 155<br>1.6 THP 163<br>1.6 VTi<br>2.0 GT HDi 180<br>2.0 HDi 150 | 81<br>96<br>60<br>151<br>184<br>200<br>73<br>85<br>88<br>68<br>92<br>110<br>115<br>120<br>85<br>133<br>110 |  | 11.13<br>11.13<br>09.13<br>06.14<br>08.15<br>06.15<br>04.14<br>09.13<br>11.13<br>09.13<br>03.14<br>09.13<br>06.14<br>03.14<br>06.14<br>11.13 | + Bremsscheibendurchm. 290 mm <sup>5)</sup><br>+ Bremsscheibendurchm. 290 mm <sup>5)</sup><br>+ Bremsscheibendurchm. 290 mm <sup>5)</sup><br>+ Bremsscheibendurchm. 290 mm <sup>5)</sup><br>+ Bremsscheibendurchm. 290 mm <sup>5)</sup><br>+ Bremsscheibendurchm. 290 mm <sup>5)</sup><br>+ Bremsscheibendurchm. 290 mm <sup>5)</sup><br>+ Bremsscheibendurchm. 290 mm <sup>5)</sup><br>+ Bremsscheibendurchm. 290 mm <sup>5)</sup><br>+ Bremsscheibendurchm. 290 mm <sup>5)</sup><br>+ Bremsscheibendurchm. 290 mm <sup>5)</sup><br>+ Bremsscheibendurchm. 290 mm <sup>5)</sup><br>+ Bremsscheibendurchm. 290 mm <sup>5)</sup><br>+ Bremsscheibendurchm. 290 mm <sup>5)</sup><br>+ Bremsscheibendurchm. 290 mm <sup>5)</sup><br>+ Bremsscheibendurchm. 290 mm <sup>5)</sup><br>+ Bremsscheibendurchm. 290 mm <sup>5)</sup> | 13.0460-3872.2<br>13.0470-3872.2 | 603872<br>LD3872 |  | 25827 17,7 +/Zub/S<br>25827 17,7 +/Zub/S | BOS<br>BOS |
|  | 1.2 THP 110<br>1.2 THP 130<br>1.2 VTi 82<br>1.6 GT 205<br>1.6 GTi 250<br>1.6 GTi 270<br>1.6 HDi 100<br>1.6 HDi 115<br>1.6 HDi 120<br>1.6 HDi 92   | 81<br>96<br>60<br>151<br>184<br>200<br>73<br>85<br>88<br>68  |  | 11.13<br>11.13<br>09.13<br>06.14<br>08.15<br>06.15<br>04.14<br>09.13<br>11.13<br>09.13   | + Bremsscheibendurchm. 268 mm <sup>3)</sup><br>+ Bremsscheibendurchm. 268 mm <sup>3)</sup><br>+ Bremsscheibendurchm. 268 mm <sup>3)</sup><br>+ Bremsscheibendurchm. 268 mm <sup>3)</sup><br>+ Bremsscheibendurchm. 268 mm <sup>3)</sup><br>+ Bremsscheibendurchm. 268 mm <sup>3)</sup><br>+ Bremsscheibendurchm. 268 mm <sup>3)</sup><br>+ Bremsscheibendurchm. 268 mm <sup>3)</sup><br>+ Bremsscheibendurchm. 268 mm <sup>3)</sup><br>+ Bremsscheibendurchm. 268 mm <sup>3)</sup>  | 24.0112-0211.1                   | 412211           |  | 268 12,0 10,0 +S +B                      |            |

<sup>1)</sup> + brake disc diameter 249mm / + diametro dischi freno 249mm / + diamètre disques frein 249mm / + diámetro disco freno 249mm  
<sup>2)</sup> - electric parking brake / - freno a mano elettrico / - frein à main électrique / - freno de mano eléctrico  
<sup>3)</sup> + brake disc diameter 268 mm / + disco fr.diam. 268mm / + disques fr.diam. 268mm / + disco fr.diam. 268mm  
<sup>4)</sup> + electric parking brake / + freno a mano elettrico / + frein à main électrique / + freno de mano eléctrico  
<sup>5)</sup> + brake disc diameter 290mm / + diametro dischi freno 290mm / + diamètre disques frein 290mm / + diámetro disco freno 290mm

|     |  |  |  |  |  |  |                                |  |                |        |  |                     |
|--|--|--|--|--|---|--|--|--|----------------|--------|--|---------------------|
| <b>PEUGEOT 308 II (T9) (13-)</b>   |  |  |  |  |   |  |  |  |                |        |  |                     |
|    | 1.6 HDi 92   | 68   | 09.13  | + Bremsscheibendurchm. 268 mm <sup>1)</sup>                                      | 24.0112-0211.1  | 412211   |  | 268 12,0 10,0 +S +B  |                |        |  |                     |
|  | 1.6 THP 125  | 92   | 09.13  | + Bremsscheibendurchm. 268 mm <sup>1)</sup>                                      |   |  |  |  |                |        |  |                     |
|  | 1.6 THP 150  | 110  | 03.14  | + Bremsscheibendurchm. 268 mm <sup>1)</sup>                                      |   |  |  |  |                |        |  |                     |
|  | 1.6 THP 155  | 115  | 09.13  | + Bremsscheibendurchm. 268 mm <sup>1)</sup>                                      |   |  |  |  |                |        |  |                     |
|  | 1.6 THP 163  | 120  | 06.14  | + Bremsscheibendurchm. 268 mm <sup>1)</sup>                                      |   |  |  |  |                |        |  |                     |
|  | 1.6 VTi  | 85   | 03.14  | + Bremsscheibendurchm. 268 mm <sup>1)</sup>                                      |   |  |  |  |                |        |  |                     |
|  | 2.0 GT HDi 180   | 133  | 06.14  | + Bremsscheibendurchm. 268 mm <sup>1)</sup>                                      |   |  |  |  |                |        |  |                     |
|  | 2.0 HDi 150  | 110  | 11.13  | + Bremsscheibendurchm. 268 mm <sup>1)</sup>                                      |   |  |  |  |                |        |  |                     |
|  | 1.2 THP 110  | 81   | 11.13  | + Bremsscheibendurchm. 290 mm <sup>2)</sup>                                      |   |  |  |  | 24.0112-0212.1 | 412212 |  | 290 12,0 10,0 +S +B |
|  | 1.2 THP 130  | 96   | 11.13  | + Bremsscheibendurchm. 290 mm <sup>2)</sup>                                      |   |  |  |  |                |        |  |                     |
|  | 1.2 VTi 82   | 60   | 09.13  | + Bremsscheibendurchm. 290 mm <sup>2)</sup>                                      |   |  |  |  |                |        |  |                     |
|  | 1.6 GT 205   | 151  | 06.14  | + Bremsscheibendurchm. 290 mm <sup>2)</sup>                                      |   |  |  |  |                |        |  |                     |
|  | 1.6 GTi 250  | 184  | 08.15  | + Bremsscheibendurchm. 290 mm <sup>2)</sup>                                      |   |  |  |  |                |        |  |                     |
|  | 1.6 GTi 270  | 200  | 06.15  | + Bremsscheibendurchm. 290 mm <sup>2)</sup>                                      |   |  |  |  |                |        |  |                     |
| 1.6 HDi 100  | 73   | 04.14  | + Bremsscheibendurchm. 290 mm <sup>2)</sup>                                      |  |   |  |  |  |                |        |  |                     |
| 1.6 HDi 115  | 85   | 09.13  | + Bremsscheibendurchm. 290 mm <sup>2)</sup>                                      |  |   |  |  |  |                |        |  |                     |
| 1.6 HDi 120  | 88   | 11.13  | + Bremsscheibendurchm. 290 mm <sup>2)</sup>                                      |  |   |  |  |  |                |        |  |                     |
| 1.6 HDi 92   | 68   | 09.13  | + Bremsscheibendurchm. 290 mm <sup>2)</sup>                                      |  |   |  |  |  |                |        |  |                     |
| 1.6 THP 125  | 92   | 09.13  | + Bremsscheibendurchm. 290 mm <sup>2)</sup>                                      |  |   |  |  |  |                |        |  |                     |
| 1.6 THP 150  | 110  | 03.14  | + Bremsscheibendurchm. 290 mm <sup>2)</sup>                                      |  |   |  |  |  |                |        |  |                     |
| 1.6 THP 155  | 115  | 09.13  | + Bremsscheibendurchm. 290 mm <sup>2)</sup>                                      |  |   |  |  |  |                |        |  |                     |
| 1.6 THP 163  | 120  | 06.14  | + Bremsscheibendurchm. 290 mm <sup>2)</sup>                                      |  |   |  |  |  |                |        |  |                     |
| 1.6 VTi  | 85   | 03.14  | + Bremsscheibendurchm. 290 mm <sup>2)</sup>                                      |  |   |  |  |  |                |        |  |                     |
| 2.0 GT HDi 180   | 133  | 06.14  | + Bremsscheibendurchm. 290 mm <sup>2)</sup>                                      |  |   |  |  |  |                |        |  |                     |
| 2.0 HDi 150  | 110  | 11.13  | + Bremsscheibendurchm. 290 mm <sup>2)</sup>                                      |  |   |  |  |  |                |        |  |                     |
|    | 1.2 THP 110  | 81   | 11.13  |  | 24.0711-6342.3  | 360443   | 2  - Einparkhilfe <sup>3)</sup> | Radsensor  |                |        |  |                     |
|  | 1.2 THP 130  | 96   | 11.13  |  |   |  |  |  |                |        |  |                     |
|  | 1.2 VTi 82   | 60   | 09.13  |  |   |  |  |  |                |        |  |                     |
|  | 1.6 GT 205   | 151  | 06.14  |  |   |  |  |  |                |        |  |                     |
|  | 1.6 GTi 250  | 184  | 08.15  |  |   |  |  |  |                |        |  |                     |
|  | 1.6 GTi 270  | 200  | 06.15  |  |   |  |  |  |                |        |  |                     |
|  | 1.6 HDi 100  | 73   | 04.14  |  |   |  |  |  |                |        |  |                     |
|  | 1.6 HDi 115  | 85   | 09.13  |  |   |  |  |  |                |        |  |                     |
|  | 1.6 HDi 120  | 88   | 11.13  |  |   |  |  |  |                |        |  |                     |
|  | 1.6 HDi 92   | 68   | 09.13  |  |   |  |  |  |                |        |  |                     |
|  | 1.6 THP 125  | 92   | 09.13  |  |   |  |  |  |                |        |  |                     |
|  | 1.6 THP 150  | 110  | 03.14  |  |   |  |  |  |                |        |  |                     |
|  | 1.6 THP 155  | 115  | 09.13  |  |   |  |  |  |                |        |  |                     |
|  | 1.6 THP 163  | 120  | 06.14  |  |   |  |  |  |                |        |  |                     |
| 1.6 VTi  | 85   | 03.14  |  |  |   |  |  |  |                |        |  |                     |
| 2.0 GT HDi 180   | 133  | 06.14  |  |  |   |  |  |  |                |        |  |                     |
| 2.0 HDi 150  | 110  | 11.13  |  |  |   |  |  |  |                |        |  |                     |
| <b>PEUGEOT 308 II SW (T9) (14-)</b>  |  |  |  |  |   |  |  |  |                |        |  |                     |
|  | 1.2 e-THP  | 81   | 08.14  | + Bremsscheibendurchm. 283 mm <sup>5)</sup>                                      | 13.0460-3870.2  | 603870   |  | 25895 18,5 +/Zub/S BOS<br>25895 18,5 +/Zub/S BOS                                   |                |        |  |                     |
|  | 1.2 e-THP  | 96   | 03.14  | + Bremsscheibendurchm. 283 mm <sup>5)</sup>                                      |   |  |  |  |                |        |  |                     |
|  | 1.6 BlueHDi  | 73   | 03.14  | + Bremsscheibendurchm. 283 mm <sup>5)</sup>                                      |   |  |  |  |                |        |  |                     |
|  | 1.6 BlueHDi  | 88   | 03.14  | + Bremsscheibendurchm. 283 mm <sup>5)</sup>                                      |   |  |  |  |                |        |  |                     |
|  | 1.6 e-HDi  | 85   | 03.14  | + Bremsscheibendurchm. 283 mm <sup>5)</sup>                                      |   |  |  |  |                |        |  |                     |
|  | 1.6 GT 205   | 151  | 06.14  | + Bremsscheibendurchm. 283 mm <sup>5)</sup>                                      |   |  |  |  |                |        |  |                     |
|  | 1.6 HDi  | 68   | 03.14  | + Bremsscheibendurchm. 283 mm <sup>5)</sup>                                      |   |  |  |  |                |        |  |                     |
|  | 1.6 THP  | 115  | 03.14  | + Bremsscheibendurchm. 283 mm <sup>5)</sup>                                      |   |  |  |  |                |        |  |                     |
|  | 1.6 THP 125  | 92   | 03.14  | + Bremsscheibendurchm. 283 mm <sup>5)</sup>                                      |   |  |  |  |                |        |  |                     |
|  | 1.6 THP 150  | 110  | 03.14  | + Bremsscheibendurchm. 283 mm <sup>5)</sup>                                      |   |  |  |  |                |        |  |                     |
|  | 1.6 THP 163  | 120  | 06.14  | + Bremsscheibendurchm. 283 mm <sup>5)</sup>                                      |   |  |  |  |                |        |  |                     |
|  | 1.6 VTi  | 85   | 03.14  | + Bremsscheibendurchm. 283 mm <sup>5)</sup>                                      |   |  |  |  |                |        |  |                     |
|  | 2.0 BlueHDi  | 110  | 03.14  | + Bremsscheibendurchm. 283 mm <sup>5)</sup>                                      |   |  |  |  |                |        |  |                     |
|  | 2.0 BlueHDi 180  | 132  | 06.14  | + Bremsscheibendurchm. 283 mm <sup>5)</sup>                                      |   |  |  |  |                |        |  |                     |
| 2.0 GT HDi 180   | 133  | 06.14  | + Bremsscheibendurchm. 283 mm <sup>5)</sup>                                      |  |   |  |  |  |                |        |  |                     |
|  | 1.2 e-THP  | 81   | 08.14  | + Bremsscheibendurchm. 304 mm <sup>6)</sup>                                      | 13.0460-7300.2  | 607300   |  | 25833 17,3 +/WE ATE<br>25702 18,2 + ATE  |                |        |  |                     |
|  | 1.2 e-THP  | 96   | 03.14  | + Bremsscheibendurchm. 304 mm <sup>6)</sup>                                      |   |  |  |  |                |        |  |                     |
|  | 1.6 BlueHDi  | 73   | 03.14  | + Bremsscheibendurchm. 304 mm <sup>6)</sup>                                      |   |  |  |  |                |        |  |                     |
|  | 1.6 BlueHDi  | 88   | 03.14  | + Bremsscheibendurchm. 304 mm <sup>6)</sup>                                      |   |  |  |  |                |        |  |                     |
|  | 1.6 e-HDi  | 85   | 03.14  | + Bremsscheibendurchm. 304 mm <sup>6)</sup>                                      |   |  |  |  |                |        |  |                     |
|  | 1.6 GT 205   | 151  | 06.14  | + Bremsscheibendurchm. 304 mm <sup>6)</sup>                                      |   |  |  |  |                |        |  |                     |
|  | 1.6 HDi  | 68   | 03.14  | + Bremsscheibendurchm. 304 mm <sup>6)</sup>                                      |   |  |  |  |                |        |  |                     |
|  | 1.6 THP  | 115  | 03.14  | + Bremsscheibendurchm. 304 mm <sup>6)</sup>                                      |   |  |  |  |                |        |  |                     |
|  | 1.6 THP 125  | 92   | 03.14  | + Bremsscheibendurchm. 304 mm <sup>6)</sup>                                      |   |  |  |  |                |        |  |                     |
|  | 1.6 THP 150  | 110  | 03.14  | + Bremsscheibendurchm. 304 mm <sup>6)</sup>                                      |   |  |  |  |                |        |  |                     |
|  | 1.6 THP 163  | 120  | 06.14  | + Bremsscheibendurchm. 304 mm <sup>6)</sup>                                      |   |  |  |  |                |        |  |                     |
|  | 1.6 VTi  | 85   | 03.14  | + Bremsscheibendurchm. 304 mm <sup>6)</sup>                                      |   |  |  |  |                |        |  |                     |
|  | 2.0 BlueHDi  | 110  | 03.14  | + Bremsscheibendurchm. 304 mm <sup>6)</sup>                                      |   |  |  |  |                |        |  |                     |
|  | 2.0 BlueHDi 180  | 132  | 06.14  | + Bremsscheibendurchm. 304 mm <sup>6)</sup>                                      |   |  |  |  |                |        |  |                     |
| 2.0 GT HDi 180   | 133  | 06.14  | + Bremsscheibendurchm. 304 mm <sup>6)</sup>                                      |  |   |  |  |  |                |        |  |                     |
|  | 1.2 e-THP  | 81   | 08.14  | + Bremsscheibendurchm. 283 mm <sup>5)</sup>                                      | 24.0126-0183.1  | 426183   |  | 283 26,0 24,0 VL +S +B   |                |        |  |                     |
|  | 1.2 e-THP  | 96   | 03.14  | + Bremsscheibendurchm. 283 mm <sup>5)</sup>                                      |   |  |  |  |                |        |  |                     |
|  | 1.6 BlueHDi  | 73   | 03.14  | + Bremsscheibendurchm. 283 mm <sup>5)</sup>                                      |   |  |  |  |                |        |  |                     |
|  | 1.6 BlueHDi  | 88   | 03.14  | + Bremsscheibendurchm. 283 mm <sup>5)</sup>                                      |   |  |  |  |                |        |  |                     |
|  | 1.6 e-HDi  | 85   | 03.14  | + Bremsscheibendurchm. 283 mm <sup>5)</sup>                                      |   |  |  |  |                |        |  |                     |
|  | 1.6 GT 205   | 151  | 06.14  | + Bremsscheibendurchm. 283 mm <sup>5)</sup>                                      |   |  |  |  |                |        |  |                     |
|  | 1.6 HDi  | 68   | 03.14  | + Bremsscheibendurchm. 283 mm <sup>5)</sup>                                      |   |  |  |  |                |        |  |                     |
|  | 1.6 THP  | 115  | 03.14  | + Bremsscheibendurchm. 283 mm <sup>5)</sup>                                      |   |  |  |  |                |        |  |                     |
|  | 1.6 THP 125  | 92   | 03.14  | + Bremsscheibendurchm. 283 mm <sup>5)</sup>                                      |   |  |  |  |                |        |  |                     |
|  | 1.6 THP 150  | 110  | 03.14  | + Bremsscheibendurchm. 283 mm <sup>5)</sup>                                      |   |  |  |  |                |        |  |                     |
|  | 1.6 THP 163  | 120  | 06.14  | + Bremsscheibendurchm. 283 mm <sup>5)</sup>                                      |   |  |  |  |                |        |  |                     |
|  | 1.6 VTi  | 85   | 03.14  | + Bremsscheibendurchm. 283 mm <sup>5)</sup>                                      |   |  |  |  |                |        |  |                     |
|  | 2.0 BlueHDi  | 110  | 03.14  | + Bremsscheibendurchm. 283 mm <sup>5)</sup>                                      |   |  |  |  |                |        |  |                     |
|  | 2.0 BlueHDi 180  | 132  | 06.14  | + Bremsscheibendurchm. 283 mm <sup>5)</sup>                                      |   |  |  |  |                |        |  |                     |
| 2.0 GT HDi 180   | 133  | 03.14  | + Bremsscheibendurchm. 283 mm <sup>5)</sup>                                      |  |   |  |  |  |                |        |  |                     |

<sup>1)</sup> + brake disc diameter 268 mm / + disco fr.diam. 268mm / + disques fr.diam. 268mm / + disco fr.diam. 268mm

<sup>2)</sup> + brake disc diameter 290mm / + diametro dischi freno 290mm / + diamètre disques frein 290mm / + diametro disco freno 290mm

<sup>3)</sup> - parking aid / - assistente di parcheggio / - aide au stationnement / - asistente de aparcamiento

<sup>4)</sup> + parking aid / + assistente di parcheggio / + aide au stationnement / + asistente de aparcamiento

<sup>5)</sup> + brake disc diameter 283 mm / + disco fr.diam. 283mm / + disques fr.diam. 283mm / + disco fr.diam. 283mm

<sup>6)</sup> + brake disc diameter 304 mm / + disco fr.diam. 304mm / + disques fr.diam. 304mm / + disco fr.diam. 304mm





**PEUGEOT 308 II SW (T9) (14-)**

|                 |                 |       |   |   |                |        |   |                        |
|-----------------|-----------------|-------|---|---|----------------|--------|---|------------------------|
|                 | 2.0 BlueHdi 180 | 132   | 06.14                                       | + Bremsscheibendurchm. 283 mm <sup>1)</sup> | 24.0126-0183.1 | 426183 |   | 283 26,0 24,0 VL +S +B |
|                 | 2.0 GT HDi 180  | 133   | 06.14                                       | + Bremsscheibendurchm. 283 mm <sup>1)</sup> |                |        |   |                        |
|                 | 1.2 e-THP       | 81    | 08.14                                       | + Bremsscheibendurchm. 304 mm <sup>2)</sup> | 24.0128-0269.1 | 428269 |   | 304 28,0 26,0 VL +S +B |
|                 | 1.2 e-THP       | 96    | 03.14                                       | + Bremsscheibendurchm. 304 mm <sup>2)</sup> |                |        |   |                        |
|                 | 1.6 BlueHdi     | 73    | 03.14                                       | + Bremsscheibendurchm. 304 mm <sup>2)</sup> |                |        |   |                        |
|                 | 1.6 BlueHdi     | 88    | 03.14                                       | + Bremsscheibendurchm. 304 mm <sup>2)</sup> |                |        |   |                        |
|                 | 1.6 e-HDi       | 85    | 03.14                                       | + Bremsscheibendurchm. 304 mm <sup>2)</sup> |                |        |   |                        |
|                 | 1.6 GT 205      | 151   | 06.14                                       | + Bremsscheibendurchm. 304 mm <sup>2)</sup> |                |        |   |                        |
|                 | 1.6 HDi         | 68    | 03.14                                       | + Bremsscheibendurchm. 304 mm <sup>2)</sup> |                |        |   |                        |
|                 | 1.6 THP         | 115   | 03.14                                       | + Bremsscheibendurchm. 304 mm <sup>2)</sup> |                |        |   |                        |
|                 | 1.6 THP 125     | 92    | 03.14                                       | + Bremsscheibendurchm. 304 mm <sup>2)</sup> |                |        |   |                        |
|                 | 1.6 THP 150     | 110   | 03.14                                       | + Bremsscheibendurchm. 304 mm <sup>2)</sup> |                |        |   |                        |
|                 | 1.6 THP 163     | 120   | 06.14                                       | + Bremsscheibendurchm. 304 mm <sup>2)</sup> |                |        |   |                        |
| 1.6 VTi         | 85              | 03.14 | + Bremsscheibendurchm. 304 mm <sup>2)</sup> |   |                |        |   |                        |
| 2.0 BlueHdi     | 110             | 03.14 | + Bremsscheibendurchm. 304 mm <sup>2)</sup> |   |                |        |   |                        |
| 2.0 BlueHdi 180 | 132             | 06.14 | + Bremsscheibendurchm. 304 mm <sup>2)</sup> |   |                |        |   |                        |
| 2.0 GT HDi 180  | 133             | 06.14 | + Bremsscheibendurchm. 304 mm <sup>2)</sup> |   |                |        |   |                        |
|                 | 1.2 e-THP       | 81    | 08.14                                       |   | 24.0711-5379.3 | 360422 | 2   | Radsensor L=877        |
|                 | 1.2 e-THP       | 96    | 03.14                                       |   |                |        |   |                        |
|                 | 1.6 BlueHdi     | 73    | 03.14                                       |   |                |        |   |                        |
|                 | 1.6 BlueHdi     | 88    | 03.14                                       |   |                |        |   |                        |
|                 | 1.6 e-HDi       | 85    | 03.14                                       |   |                |        |   |                        |
|                 | 1.6 GT 205      | 151   | 06.14                                       |   |                |        |   |                        |
|                 | 1.6 HDi         | 68    | 03.14                                       |   |                |        |   |                        |
|                 | 1.6 THP         | 115   | 03.14                                       |   |                |        |   |                        |
|                 | 1.6 THP 125     | 92    | 03.14                                       |   |                |        |   |                        |
|                 | 1.6 THP 150     | 110   | 03.14                                       |   |                |        |   |                        |
|                 | 1.6 THP 163     | 120   | 06.14                                       |   |                |        |   |                        |
|                 | 1.6 VTi         | 85    | 03.14                                       |   |                |        |   |                        |
|                 | 2.0 BlueHdi     | 110   | 03.14                                       |   |                |        |   |                        |
| 2.0 BlueHdi 180 | 132             | 06.14 |   |   |                |        |   |                        |
| 2.0 GT HDi 180  | 133             | 06.14 |   |   |                |        |   |                        |
|                 | 1.2 e-THP       | 81    | 08.14                                       | + Bremsscheibendurchm. 249 mm <sup>3)</sup> | 13.0460-7301.2 | 607301 |   | 25841 16,1 +           |
|                 | 1.2 e-THP       | 96    | 03.14                                       | + Bremsscheibendurchm. 249 mm <sup>3)</sup> | 13.0470-7301.2 | LD7301 |   | 25841 16,1 +           |
|                 | 1.6 BlueHdi     | 73    | 03.14                                       | + Bremsscheibendurchm. 249 mm <sup>3)</sup> |                |        |   |                        |
|                 | 1.6 BlueHdi     | 88    | 03.14                                       | + Bremsscheibendurchm. 249 mm <sup>3)</sup> |                |        |   |                        |
|                 | 1.6 e-HDi       | 85    | 03.14                                       | + Bremsscheibendurchm. 249 mm <sup>3)</sup> |                |        |   |                        |
|                 | 1.6 GT 205      | 151   | 06.14                                       | + Bremsscheibendurchm. 249 mm <sup>3)</sup> |                |        |   |                        |
|                 | 1.6 HDi         | 68    | 03.14                                       | + Bremsscheibendurchm. 249 mm <sup>3)</sup> |                |        |   |                        |
|                 | 1.6 THP         | 115   | 03.14                                       | + Bremsscheibendurchm. 249 mm <sup>3)</sup> |                |        |   |                        |
|                 | 1.6 THP 125     | 92    | 03.14                                       | + Bremsscheibendurchm. 249 mm <sup>3)</sup> |                |        |   |                        |
|                 | 1.6 THP 150     | 110   | 03.14                                       | + Bremsscheibendurchm. 249 mm <sup>3)</sup> |                |        |   |                        |
|                 | 1.6 THP 163     | 120   | 06.14                                       | + Bremsscheibendurchm. 249 mm <sup>3)</sup> |                |        |   |                        |
|                 | 1.6 VTi         | 85    | 03.14                                       | + Bremsscheibendurchm. 249 mm <sup>3)</sup> |                |        |   |                        |
|                 | 2.0 BlueHdi     | 110   | 03.14                                       | + Bremsscheibendurchm. 249 mm <sup>3)</sup> |                |        |   |                        |
| 2.0 BlueHdi 180 | 132             | 06.14 | + Bremsscheibendurchm. 249 mm <sup>3)</sup> |   |                |        |   |                        |
| 2.0 GT HDi 180  | 133             | 09.14 | + Bremsscheibendurchm. 249 mm <sup>3)</sup> |   |                |        |   |                        |
|                 | 1.2 e-THP       | 81    | 08.14                                       | + Bremsscheibendurchm. 268 mm <sup>4)</sup> | 13.0460-7295.2 | 607295 |   | 25968 16,1 +           |
|                 | 1.2 e-THP       | 96    | 03.14                                       | + Bremsscheibendurchm. 268 mm <sup>4)</sup> | 13.0470-7295.2 | LD7295 | - elektrische Feststellbremse <sup>5)</sup> | 25968 16,1 +           |
|                 | 1.6 BlueHdi     | 73    | 03.14                                       | + Bremsscheibendurchm. 268 mm <sup>4)</sup> |                |        | - elektrische Feststellbremse <sup>5)</sup> | 25968 16,1 +           |
|                 | 1.6 BlueHdi     | 88    | 03.14                                       | + Bremsscheibendurchm. 268 mm <sup>4)</sup> |                |        |   |                        |
|                 | 1.6 e-HDi       | 85    | 03.14                                       | + Bremsscheibendurchm. 268 mm <sup>4)</sup> |                |        |   |                        |
|                 | 1.6 GT 205      | 151   | 06.14                                       | + Bremsscheibendurchm. 268 mm <sup>4)</sup> |                |        |   |                        |
|                 | 1.6 HDi         | 68    | 03.14                                       | + Bremsscheibendurchm. 268 mm <sup>4)</sup> |                |        |   |                        |
|                 | 1.6 THP         | 115   | 03.14                                       | + Bremsscheibendurchm. 268 mm <sup>4)</sup> |                |        |   |                        |
|                 | 1.6 THP 125     | 92    | 03.14                                       | + Bremsscheibendurchm. 268 mm <sup>4)</sup> |                |        |   |                        |
|                 | 1.6 THP 150     | 110   | 03.14                                       | + Bremsscheibendurchm. 268 mm <sup>4)</sup> |                |        |   |                        |
|                 | 1.6 THP 163     | 120   | 06.14                                       | + Bremsscheibendurchm. 268 mm <sup>4)</sup> |                |        |   |                        |
|                 | 1.6 VTi         | 85    | 03.14                                       | + Bremsscheibendurchm. 268 mm <sup>4)</sup> |                |        |   |                        |
|                 | 2.0 BlueHdi     | 110   | 03.14                                       | + Bremsscheibendurchm. 268 mm <sup>4)</sup> |                |        |   |                        |
| 2.0 BlueHdi 180 | 132             | 06.14 | + Bremsscheibendurchm. 268 mm <sup>4)</sup> |   |                |        |   |                        |
| 2.0 GT HDi 180  | 133             | 06.14 | + Bremsscheibendurchm. 268 mm <sup>4)</sup> |   |                |        |   |                        |
|                 | 1.2 e-THP       | 81    | 08.14                                       | + Bremsscheibendurchm. 268 mm <sup>4)</sup> | 13.0460-3871.2 | 603871 | + elektrische Feststellbremse <sup>6)</sup> | 25839 17,8 +/Zub/S     |
|                 | 1.2 e-THP       | 96    | 03.14                                       | + Bremsscheibendurchm. 268 mm <sup>4)</sup> | 13.0470-3871.2 | LD3871 | + elektrische Feststellbremse <sup>6)</sup> | 25839 17,8 +/Zub/S     |
|                 | 1.6 BlueHdi     | 73    | 03.14                                       | + Bremsscheibendurchm. 268 mm <sup>4)</sup> |                |        |   |                        |
|                 | 1.6 BlueHdi     | 88    | 03.14                                       | + Bremsscheibendurchm. 268 mm <sup>4)</sup> |                |        |   |                        |
|                 | 1.6 e-HDi       | 85    | 03.14                                       | + Bremsscheibendurchm. 268 mm <sup>4)</sup> |                |        |   |                        |
|                 | 1.6 GT 205      | 151   | 06.14                                       | + Bremsscheibendurchm. 268 mm <sup>4)</sup> |                |        |   |                        |
|                 | 1.6 HDi         | 68    | 03.14                                       | + Bremsscheibendurchm. 268 mm <sup>4)</sup> |                |        |   |                        |
|                 | 1.6 THP         | 115   | 03.14                                       | + Bremsscheibendurchm. 268 mm <sup>4)</sup> |                |        |   |                        |
|                 | 1.6 THP 125     | 92    | 03.14                                       | + Bremsscheibendurchm. 268 mm <sup>4)</sup> |                |        |   |                        |
|                 | 1.6 THP 150     | 110   | 03.14                                       | + Bremsscheibendurchm. 268 mm <sup>4)</sup> |                |        |   |                        |
|                 | 1.6 THP 163     | 120   | 06.14                                       | + Bremsscheibendurchm. 268 mm <sup>4)</sup> |                |        |   |                        |
|                 | 1.6 VTi         | 85    | 03.14                                       | + Bremsscheibendurchm. 268 mm <sup>4)</sup> |                |        |   |                        |
|                 | 2.0 BlueHdi     | 110   | 03.14                                       | + Bremsscheibendurchm. 268 mm <sup>4)</sup> |                |        |   |                        |
| 2.0 BlueHdi 180 | 132             | 06.14 | + Bremsscheibendurchm. 268 mm <sup>4)</sup> |   |                |        |   |                        |
| 2.0 GT HDi 180  | 133             | 06.14 | + Bremsscheibendurchm. 268 mm <sup>4)</sup> |   |                |        |   |                        |
|                 | 1.2 e-THP       | 81    | 08.14                                       | + Bremsscheibendurchm. 290 mm <sup>7)</sup> | 13.0460-3872.2 | 603872 |   | 25827 17,7 +/Zub/S     |
|                 | 1.2 e-THP       | 96    | 03.14                                       | + Bremsscheibendurchm. 290 mm <sup>7)</sup> | 13.0470-3872.2 | LD3872 |   | 25827 17,7 +/Zub/S     |
|                 | 1.6 BlueHdi     | 73    | 03.14                                       | + Bremsscheibendurchm. 290 mm <sup>7)</sup> |                |        |   |                        |
|                 | 1.6 BlueHdi     | 88    | 03.14                                       | + Bremsscheibendurchm. 290 mm <sup>7)</sup> |                |        |   |                        |
|                 | 1.6 e-HDi       | 85    | 03.14                                       | + Bremsscheibendurchm. 290 mm <sup>7)</sup> |                |        |   |                        |
|                 | 1.6 GT 205      | 151   | 06.14                                       | + Bremsscheibendurchm. 290 mm <sup>7)</sup> |                |        |   |                        |
|                 | 1.6 HDi         | 68    | 03.14                                       | + Bremsscheibendurchm. 290 mm <sup>7)</sup> |                |        |   |                        |
| 1.6 THP         | 115             | 03.14 | + Bremsscheibendurchm. 290 mm <sup>7)</sup> |   |                |        |   |                        |
| 1.6 THP 125     | 92              | 03.14 | + Bremsscheibendurchm. 290 mm <sup>7)</sup> |   |                |        |   |                        |
| 1.6 THP 150     | 110             | 03.14 | + Bremsscheibendurchm. 290 mm <sup>7)</sup> |   |                |        |   |                        |

<sup>1)</sup> + brake disc diameter 283 mm / + disco fr.diam. 283mm / + disques fr.diam. 283mm / + disco fr.diam. 283mm  
<sup>2)</sup> + brake disc diameter 304 mm / + disco fr.diam. 304mm / + disques fr.diam. 304mm / + disco fr.diam. 304mm  
<sup>3)</sup> + brake disc diameter 249mm / + diametro dischi freno 249mm / + diamètre disques frein 249mm / + diametro disco freno 249mm  
<sup>4)</sup> + brake disc diameter 268 mm / + disco fr.diam. 268mm / + disques fr.diam. 268mm / + disco fr.diam. 268mm  
<sup>5)</sup> - electric parking brake / - freno a mano elettrico / - frein à main électrique / - freno de mano eléctrico  
<sup>6)</sup> + electric parking brake / + freno a mano elettrico / + frein à main électrique / + freno de mano eléctrico  
<sup>7)</sup> + brake disc diameter 290mm / + diametro dischi freno 290mm / + diamètre disques frein 290mm / + diametro disco freno 290mm



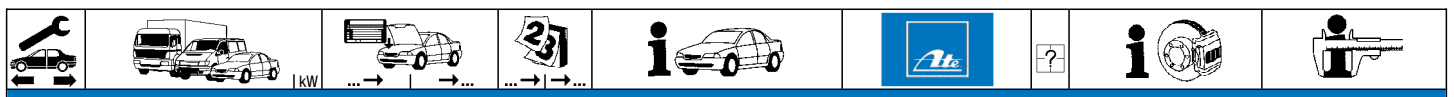

### PEUGEOT 308 II SW (T9) (14-)

|  |   |   |   |   |                                  |                  |  |  |            |
|--|---|---|---|---|----------------------------------|------------------|--|--|------------|
|  | 1.6 THP 163<br>1.6 VTi<br>2.0 BlueHdi<br>2.0 BlueHdi 180<br>2.0 GT HDi 180  | 120<br>85<br>110<br>132<br>133  | 06.14<br>03.14<br>03.14<br>06.14<br>06.14   | + Bremsscheibendurchm. 290 mm <sup>1)</sup><br>+ Bremsscheibendurchm. 290 mm <sup>1)</sup><br>+ Bremsscheibendurchm. 290 mm <sup>1)</sup><br>+ Bremsscheibendurchm. 290 mm <sup>1)</sup><br>+ Bremsscheibendurchm. 290 mm <sup>1)</sup>   | 13.0460-3872.2<br>13.0470-3872.2 | 603872<br>LD3872 |  | 25827 17,7 +/Zub/S<br>25827 17,7 +/Zub/S | BOS<br>BOS |
|  | 1.2 e-THP<br>1.2 e-THP<br>1.6 BlueHdi<br>1.6 BlueHdi<br>1.6 e-HDi<br>1.6 GT 205<br>1.6 HDi<br>1.6 THP<br>1.6 THP 125<br>1.6 THP 150<br>1.6 THP 163<br>1.6 VTi<br>2.0 BlueHdi<br>2.0 BlueHdi 180<br>2.0 GT HDi 180 | 81<br>96<br>73<br>88<br>85<br>151<br>68<br>115<br>92<br>110<br>120<br>85<br>110<br>132<br>133 | 08.14<br>03.14<br>03.14<br>03.14<br>03.14<br>06.14<br>03.14<br>03.14<br>03.14<br>03.14<br>06.14<br>03.14<br>03.14<br>06.14<br>09.14 | + Bremsscheibendurchm. 268 mm <sup>2)</sup><br>+ Bremsscheibendurchm. 268 mm <sup>2)</sup><br>+ Bremsscheibendurchm. 268 mm <sup>2)</sup><br>+ Bremsscheibendurchm. 268 mm <sup>2)</sup><br>+ Bremsscheibendurchm. 268 mm <sup>2)</sup><br>+ Bremsscheibendurchm. 268 mm <sup>2)</sup><br>+ Bremsscheibendurchm. 268 mm <sup>2)</sup><br>+ Bremsscheibendurchm. 268 mm <sup>2)</sup><br>+ Bremsscheibendurchm. 268 mm <sup>2)</sup><br>+ Bremsscheibendurchm. 268 mm <sup>2)</sup><br>+ Bremsscheibendurchm. 268 mm <sup>2)</sup><br>+ Bremsscheibendurchm. 268 mm <sup>2)</sup><br>+ Bremsscheibendurchm. 268 mm <sup>2)</sup><br>+ Bremsscheibendurchm. 268 mm <sup>2)</sup><br>+ Bremsscheibendurchm. 268 mm <sup>2)</sup> | 24.0112-0211.1                   | 412211           |  | 268 12,0 10,0 +S +B                      |            |
|  | 1.2 e-THP<br>1.2 e-THP<br>1.6 BlueHdi<br>1.6 BlueHdi<br>1.6 e-HDi<br>1.6 GT 205<br>1.6 HDi<br>1.6 THP<br>1.6 THP 125<br>1.6 THP 150<br>1.6 THP 163<br>1.6 VTi<br>2.0 BlueHdi<br>2.0 BlueHdi 180<br>2.0 GT HDi 180 | 81<br>96<br>73<br>88<br>85<br>151<br>68<br>115<br>92<br>110<br>120<br>85<br>110<br>132<br>133 | 03.14<br>03.14<br>03.14<br>03.14<br>03.14<br>06.14<br>03.14<br>03.14<br>03.14<br>03.14<br>06.14<br>03.14<br>03.14<br>06.14<br>06.14 | + Bremsscheibendurchm. 290 mm <sup>1)</sup><br>+ Bremsscheibendurchm. 290 mm <sup>1)</sup><br>+ Bremsscheibendurchm. 290 mm <sup>1)</sup><br>+ Bremsscheibendurchm. 290 mm <sup>1)</sup><br>+ Bremsscheibendurchm. 290 mm <sup>1)</sup><br>+ Bremsscheibendurchm. 290 mm <sup>1)</sup><br>+ Bremsscheibendurchm. 290 mm <sup>1)</sup><br>+ Bremsscheibendurchm. 290 mm <sup>1)</sup><br>+ Bremsscheibendurchm. 290 mm <sup>1)</sup><br>+ Bremsscheibendurchm. 290 mm <sup>1)</sup><br>+ Bremsscheibendurchm. 290 mm <sup>1)</sup><br>+ Bremsscheibendurchm. 290 mm <sup>1)</sup><br>+ Bremsscheibendurchm. 290 mm <sup>1)</sup><br>+ Bremsscheibendurchm. 290 mm <sup>1)</sup><br>+ Bremsscheibendurchm. 290 mm <sup>1)</sup> | 24.0112-0212.1                   | 412212           |  | 290 12,0 10,0 +S +B                      |            |
|  | 1.2 e-THP<br>1.2 e-THP<br>1.6 BlueHdi<br>1.6 BlueHdi<br>1.6 e-HDi<br>1.6 GT 205<br>1.6 HDi<br>1.6 THP<br>1.6 THP 125<br>1.6 THP 150<br>1.6 THP 163<br>1.6 VTi<br>2.0 BlueHdi<br>2.0 BlueHdi 180<br>2.0 GT HDi 180 | 81<br>96<br>73<br>88<br>85<br>151<br>68<br>115<br>92<br>110<br>120<br>85<br>110<br>132<br>133 | 08.14<br>03.14<br>03.14<br>03.14<br>03.14<br>06.14<br>03.14<br>03.14<br>03.14<br>03.14<br>06.14<br>03.14<br>03.14<br>06.14<br>06.14 |   | 24.0711-6342.3<br>24.0711-6343.3 | 360443<br>360444 | 2  - Einparkhilfe <sup>3)</sup><br>2  + Einparkhilfe <sup>4)</sup> | Radsensor<br>Radsensor                   |            |

### PEUGEOT 406 Limousine (95-04)

|  |   |   |   |  |                                  |                  |  |   |     |
|--|---|---|---|--|----------------------------------|------------------|--|---|-----|
|  | 1.6 i<br>1.8 16V<br>1.8 16V<br>1.8 i<br>1.9 D   | 65<br>81<br>85<br>66<br>55  | 10.95<br>10.95<br>10.00<br>05.97<br>10.96   | 04.04<br>10.00<br>04.04<br>04.04<br>04.04  | 13.0460-2816.2                   | 602816           |  | 21724 19,3 +WK/S                                  | TRW |
|  | 1.9 TD<br>1.9 TD<br>2.0 16V<br>2.0 16V<br>2.0 16V<br>2.0 16V<br>2.0 16V HPi<br>2.0 HDi 110<br>2.0 HDi 110 FAP<br>2.0 HDi 90<br>2.0 Turbo<br>2.1 TD<br>2.2 HDi<br>2.2 i<br>3.0 24V<br>3.0 V6 | 66<br>68<br>97<br>99<br>100<br>103<br>80<br>79<br>66<br>80<br>98<br>116<br>140<br>152 | 01.96<br>01.96<br>10.95<br>01.99<br>08.00<br>05.01<br>02.99<br>08.01<br>02.99<br>04.96<br>10.95<br>03.00<br>07.00<br>10.96<br>03.00 | 04.04<br>04.04<br>04.04<br>08.00<br>04.04<br>04.04<br>08.01<br>04.04<br>04.04<br>04.04<br>04.04<br>04.04<br>04.04<br>04.04<br>04.04<br>04.04 | 13.0460-2817.2                   | 602817           |  | 21674 19,0 +WK/S                                  | TRW |
|  | 1.6 i<br>1.8 16V<br>1.8 16V<br>1.8 i<br>1.9 D   | 65<br>81<br>85<br>66<br>55  | 10.95<br>10.95<br>10.00<br>05.97<br>10.96   | 04.04<br>10.00<br>04.04<br>04.04<br>04.04  | 24.0124-0139.1                   | 424139           |  | 260 24,0 22,0 V +S +B                             |     |
|  | 1.9 TD<br>1.9 TD<br>2.0 16V<br>2.0 16V<br>2.0 16V<br>2.0 16V HPi<br>2.0 HDi 110<br>2.0 HDi 110 FAP<br>2.0 HDi 90<br>2.0 Turbo   | 66<br>68<br>97<br>99<br>100<br>103<br>80<br>79<br>66                                  | 01.96<br>01.96<br>10.95<br>01.99<br>08.00<br>05.01<br>02.99<br>08.01<br>02.99<br>04.96  | 04.04<br>04.04<br>04.04<br>08.00<br>04.04<br>04.04<br>08.01<br>04.04<br>04.04<br>04.04   | 24.0126-0106.1<br>24.0326-0106.1 | 426106<br>526106 |  | 283 26,0 24,2 V +S +B<br>283 26,0 24,2 V +S +B PD |     |

















<sup>1)</sup> + brake disc diameter 290mm / + diametro dischi freno 290mm / + diamètre disques frein 290mm / + diámetro disco freno 290mm

<sup>2)</sup> + brake disc diameter 268 mm / + disco fr.diam. 268mm / + disques fr.diam. 268mm / + disco fr.diam. 268mm

<sup>3)</sup> - parking aid / - assistente di parcheggio / - aide au stationnement / - asistente de aparcamiento















<sup>4)</sup> + parking aid / + assistente di parcheggio / + aide au stationnement / + asistente de aparcamiento



|     |   |    |    |    |  |                |  |  |
|--|---|--|--|--|---|--|--|--|
| <b>PEUGEOT 406 Limousine (95-04)</b>   |   |  |  |  |   |  |  |  |
|    | 2.1 TD<br>2.2 HDi<br>2.2 i<br>3.0 24V<br>3.0 V6   | 80<br>98<br>116<br>140<br>152  |  | 10.95 04.04<br>03.00 04.04<br>07.00 04.04<br>10.96 04.04<br>03.00 04.04  |   | 24.0126-0106.1 426106<br>24.0326-0106.1 526106   |  | 283 26,0 24,2 V +S +B<br>283 26,0 24,2 V +S +B PD                                  |
|    | 1.8 16V<br>2.0 16V<br>2.0 16V<br>2.0 16V<br>2.0 16V HPi<br>2.0 HDi 110<br>2.0 HDi 110 FAP<br>2.0 HDi 90<br>2.0 Turbo<br>2.1 TD<br>2.2 HDi<br>2.2 i<br>3.0 24V<br>3.0 V6 | 85<br>97<br>99<br>100<br>103<br>80<br>79<br>66<br>80<br>98<br>116<br>140<br>152  | S 80012040<br>S 80012040<br>S 80012040<br>S 80012040<br>S 80012040<br>S 80012040<br>S 80012040<br>S 80012040<br>S 80012040<br>S 80012040<br>S 80012040<br>S 80012040<br>S 80012040 | 10.00 04.04<br>10.95 04.04<br>01.99 08.00<br>08.00 04.04<br>05.01 04.04<br>02.99 08.01<br>08.01 04.04<br>02.99 04.04<br>04.96 04.04<br>10.95 04.04<br>03.00 04.04<br>07.00 04.04<br>10.96 04.04<br>03.00 04.04 |   | 13.0460-4059.2 604059<br>13.0460-0409.2 610409   |  | 21278 16,4 +/-WK ATE<br>Belagsatz-Zubehör ATE                                      |
|  | 1.8 16V<br>2.0 16V<br>2.0 16V<br>2.0 16V HPi<br>2.0 HDi 110 FAP<br>2.0 HDi 90<br>2.0 Turbo<br>2.1 TD<br>2.2 HDi<br>2.2 i<br>3.0 24V<br>3.0 V6                           | 85 S 80012041<br>97 S 80012041<br>100 S 80012041<br>103 S 80012041<br>79 S 80012041<br>66 S 80012041<br>S 80012041<br>80 S 80012041<br>98 S 80012041<br>116 S 80012041<br>140 S 80012041<br>152 S 80012041 |  | 04.04<br>04.04<br>04.04<br>04.04<br>04.04<br>04.04<br>04.04<br>04.04<br>04.04<br>04.04<br>04.04<br>04.04   |   | 13.0460-7134.2 607134  |  | 21278 16,4 ATE   |
|    | 1.8 16V<br>2.0 16V<br>2.0 16V<br>2.0 16V<br>2.0 16V HPi<br>2.0 HDi 110<br>2.0 HDi 110 FAP<br>2.0 HDi 90<br>2.0 Turbo<br>2.1 TD<br>2.2 HDi<br>2.2 i<br>3.0 24V<br>3.0 V6 | 85<br>97<br>99<br>100<br>103<br>80<br>79<br>66<br>80<br>98<br>116<br>140<br>152  |  | 10.00 04.04<br>10.95 04.04<br>01.99 08.00<br>08.00 04.04<br>05.01 04.04<br>02.99 08.01<br>08.01 04.04<br>02.99 04.04<br>04.96 04.04<br>10.95 04.04<br>03.00 04.04<br>07.00 04.04<br>10.96 04.04<br>03.00 04.04 |   | 24.0110-0230.1 410230  |  | 291 10,0 8,0 +B  |
|  | 1.6 i<br>1.8 16V<br>1.8 i<br>1.9 D<br>1.9 TD<br>1.9 TD  | 65<br>81<br>66<br>55<br>66<br>68   |  | 10.95 04.04<br>10.95 10.00<br>05.97 04.04<br>10.96 04.04<br>10.95 04.04<br>01.96 04.04   |   | 03.0137-0340.2 650340<br>03.0137-9228.2 669228   |  | 229 x 42 HEB BDX<br>Bremsbacken-Zubehör BDX  |
|  | 1.6 i<br>1.8 16V<br>1.8 i<br>1.9 D<br>1.9 TD<br>1.9 TD  | 65<br>81<br>66<br>55<br>66<br>68   |  | 10.95 04.04<br>10.95 10.00<br>05.97 04.04<br>10.96 04.04<br>10.95 04.04<br>01.96 04.04   |   | 24.0222-8017.1 480071  |  | 229/230 x 50,8   |
|  | 1.6 i<br>1.8 16V<br>1.8 i<br>1.9 D<br>1.9 TD<br>1.9 TD  | 65<br>81<br>66<br>55<br>66<br>68   |  | 10.95 04.04 - ABS<br>10.95 10.00 - ABS<br>05.97 04.04 - ABS<br>10.96 04.04 - ABS<br>10.95 04.04 - ABS<br>01.96 04.04 - ABS   |   | 03.0520-5820.3 695820<br>03.0520-5920.3 695920   | - integriertem Regler 1)<br>+ integriertem Regler 2)                               | 20,64/229x42 TopKit BDX<br>20,64/229x42 TopKit BDX                                 |
|  | 1.6 i<br>1.8 16V<br>1.8 i<br>1.9 D<br>1.9 TD<br>1.9 TD  | 65<br>81<br>66<br>55<br>66<br>68   |  | 10.95 04.04 + ABS<br>10.95 10.00 + ABS<br>05.97 04.04 + ABS<br>10.96 04.04 + ABS<br>10.95 04.04 + ABS<br>01.96 04.04 + ABS   |   | 03.0520-5820.3 695820  | - integriertem Regler 1)   | 20,64/229x42 TopKit BDX  |
|  | 1.8 16V<br>2.0 16V<br>2.0 16V<br>2.0 16V<br>2.0 16V HPi<br>2.0 HDi 110<br>2.0 HDi 110 FAP<br>2.0 HDi 90<br>2.0 Turbo<br>2.1 TD<br>2.2 HDi<br>2.2 i<br>3.0 24V<br>3.0 V6 | 85<br>97<br>99<br>100<br>103<br>80<br>79<br>66<br>80<br>98<br>116<br>140<br>152  |  | 10.00 04.04<br>10.95 04.04<br>01.99 08.00<br>08.00 04.04<br>05.01 04.04<br>02.99 08.01<br>08.01 04.04<br>02.99 04.04<br>04.96 04.04<br>10.95 04.04<br>03.00 04.04<br>07.00 04.04<br>10.96 04.04<br>03.00 04.04 |   | 03.0137-4010.2 654010<br>03.0137-9249.2 669249<br>03.0137-9700.2 669700<br>03.0137-9702.2 669702 |  | 180 x 30 /Zub<br>Bremsbacken-Zubehör<br>Bremsbacken-Zubehör<br>Spreizschloß Satz   |

1) - built-in corrector / - regolatore incorporato / - correcteur intégré / - regulador integrado

2) + built-in corrector / + regolatore incorporato / + correcteur intégré / + regulador integrado

|     |   |  |    |    |   |  |  |  |
|--|---|--|--|--|--|--|--|--|
| <b>PEUGEOT 406 Kombi (96-04)</b>   |   |  |  |  |  |  |  |  |
|    | 1.8<br>1.8 16V<br>1.8 16V<br>1.9 D  | 66<br>81<br>85<br>55   |  | 05.97<br>10.95<br>10.96<br>10.96   | 04.04<br>10.00<br>04.04<br>04.04   | 13.0460-2816.2   | 602816   | 21724 19,3 +/WK/S TRW  |
|  | 1.9 TD<br>2.0 16V<br>2.0 16V<br>2.0 16V<br>2.0 16V HPi<br>2.0 HDi 110<br>2.0 HDi 110 FAP<br>2.0 HDi 90<br>2.0 Turbo<br>2.1 TD<br>2.2<br>2.2 HDi<br>3.0 24V<br>3.0 V6  | 66<br>97<br>99<br>100<br>103<br>80<br>79<br>66<br>80<br>116<br>98<br>140<br>152  |  | 10.95<br>10.96<br>01.99<br>10.00<br>05.01<br>02.99<br>08.01<br>02.99<br>10.96<br>10.96<br>07.00<br>03.00<br>10.96<br>03.00 | 04.04<br>04.04<br>10.00<br>04.04<br>04.04<br>08.01<br>04.04<br>04.04<br>04.04<br>04.04<br>04.04<br>04.04<br>04.04<br>04.04 | 13.0460-2817.2   | 602817   | 21674 19,0 +/WK/S TRW  |
|    | 1.8<br>1.8 16V<br>1.8 16V<br>1.9 D  | 66<br>81<br>85<br>55   |  | 05.97<br>10.95<br>10.96<br>10.96   | 04.04<br>10.00<br>04.04<br>04.04   | 24.0124-0139.1   | 424139   | 260 24,0 22,0 V +S +B  |
|  | 1.9 TD<br>2.0 16V<br>2.0 16V<br>2.0 16V<br>2.0 16V HPi<br>2.0 HDi 110<br>2.0 HDi 110 FAP<br>2.0 HDi 90<br>2.0 Turbo<br>2.1 TD<br>2.2<br>2.2 HDi<br>3.0 24V<br>3.0 V6  | 66<br>97<br>99<br>100<br>103<br>80<br>79<br>66<br>80<br>116<br>98<br>140<br>152  |  | 10.95<br>10.96<br>01.99<br>10.00<br>05.01<br>02.99<br>08.01<br>02.99<br>10.96<br>10.96<br>07.00<br>03.00<br>10.96<br>03.00 | 04.04<br>04.04<br>10.00<br>04.04<br>04.04<br>08.01<br>04.04<br>04.04<br>04.04<br>04.04<br>04.04<br>04.04<br>04.04<br>04.04 | 24.0126-0106.1<br>24.0326-0106.1   | 426106<br>526106   | 283 26,0 24,2 V +S +B<br>283 26,0 24,2 V +S +B PD                                  |
|    | 1.8 16V<br>2.0 16V<br>2.0 16V<br>2.0 16V<br>2.0 16V HPi<br>2.0 HDi 110<br>2.0 HDi 110 FAP<br>2.0 HDi 90<br>2.0 Turbo<br>2.1 TD<br>2.2<br>2.2 HDi<br>3.0 24V<br>3.0 V6 | 85<br>97<br>99<br>100<br>103<br>80<br>79<br>66<br>80<br>116<br>98<br>140<br>152  | S 80012040<br>S 80012040<br>S 80012040<br>S 80012040<br>S 80012040<br>S 80012040<br>S 80012040<br>S 80012040<br>S 80012040<br>S 80012040<br>S 80012040<br>S 80012040<br>S 80012040 | 10.00<br>10.96<br>01.99<br>10.00<br>05.01<br>02.99<br>08.01<br>02.99<br>10.96<br>10.96<br>07.00<br>03.00<br>10.96<br>03.00 | 04.04<br>10.00<br>10.00<br>08.01   | 13.0460-4059.2<br>13.0460-0409.2   | 604059<br>610409   | 21278 16,4 +/WK<br>Belagsatz-Zubehör ATE   |
|  | 1.8 16V<br>2.0 16V<br>2.0 16V<br>2.0 16V HPi<br>2.0 HDi 110 FAP<br>2.0 HDi 90<br>2.0 Turbo<br>2.1 TD<br>2.2<br>2.2 HDi<br>3.0 24V<br>3.0 V6                           | 85<br>97<br>100<br>103<br>79<br>66<br>80<br>116<br>98<br>140<br>152              | S 80012041<br>S 80012041<br>S 80012041<br>S 80012041<br>S 80012041<br>S 80012041<br>S 80012041<br>S 80012041<br>S 80012041<br>S 80012041<br>S 80012041                             | 10.00<br>10.00<br>10.00<br>05.01<br>02.99<br>08.01<br>02.99<br>10.96<br>10.96<br>07.00<br>03.00<br>10.96<br>03.00          | 04.04<br>04.04<br>04.04<br>04.04<br>04.04<br>04.04<br>04.04<br>04.04<br>04.04<br>04.04<br>04.04<br>04.04<br>04.04          | 13.0460-7134.2   | 607134   | 21278 16,4 ATE   |
|  | 1.8 16V<br>2.0 16V<br>2.0 16V<br>2.0 16V<br>2.0 16V HPi<br>2.0 HDi 110<br>2.0 HDi 110 FAP<br>2.0 HDi 90<br>2.0 Turbo<br>2.1 TD<br>2.2<br>2.2 HDi<br>3.0 24V<br>3.0 V6 | 85<br>97<br>99<br>100<br>103<br>80<br>79<br>66<br>80<br>116<br>98<br>140<br>152  |  | 10.00<br>10.96<br>01.99<br>10.00<br>05.01<br>02.99<br>08.01<br>02.99<br>10.96<br>10.96<br>07.00<br>03.00<br>10.96<br>03.00 | 04.04<br>04.04<br>10.00<br>04.04<br>04.04<br>08.01<br>04.04<br>04.04<br>04.04<br>04.04<br>04.04<br>04.04<br>04.04<br>04.04 | 24.0110-0230.1   | 410230   | 291 10,0 8,0 +B  |
|  | 1.8<br>1.8 16V<br>1.9 D<br>1.9 TD   | 66<br>81<br>55<br>66   |  | 05.97<br>10.95<br>10.96<br>10.96   | 04.04<br>10.00<br>04.04<br>04.04   | 03.0137-0340.2<br>03.0137-9228.2   | 650340<br>669228   | 229 x 42 HEB<br>Bremsbacken-Zubehör BDX BDX  |
|  | 1.8<br>1.8 16V<br>1.9 D<br>1.9 TD   | 66<br>81<br>55<br>66   |  | 05.97<br>10.95<br>10.96<br>10.96   | 04.04<br>10.00<br>04.04<br>04.04   | 24.0222-8017.1   | 480071   | 229/230 x 50,8   |



| PEUGEOT 406 Kombi (96-04) |                 |     |       |       |       |       |                |        |                          |  |
|---------------------------|-----------------|-----|-------|-------|-------|-------|----------------|--------|--------------------------|--|
|                           | 1.8             | 66  |       | 05.97 | 04.04 | - ABS | 03.0520-5820.3 | 695820 | - integriertem Regler 1) | 20,64/229x42 TopKit BDX<br>20,64/229x42 TopKit BDX                               |
|                           | 1.8 16V         | 81  |       | 10.95 | 10.00 | - ABS | 03.0520-5920.3 | 695920 | + integriertem Regler 2) |  |
|                           | 1.9 D           | 55  |       | 10.96 | 04.04 | - ABS |                |        |                          |  |
|                           | 1.9 TD          | 66  |       | 10.96 | 04.04 | - ABS |                |        |                          |  |
|                           | 1.8             | 66  |       | 05.97 | 04.04 | + ABS | 03.0520-5820.3 | 695820 | - integriertem Regler 1) | 20,64/229x42 TopKit BDX  |
|                           | 1.8 16V         | 81  |       | 10.95 | 10.00 | + ABS |                |        |                          |  |
|                           | 1.9 D           | 55  |       | 10.96 | 04.04 | + ABS |                |        |                          |  |
|                           | 1.9 TD          | 66  |       | 10.96 | 04.04 | + ABS |                |        |                          |  |
|                           | 1.8 16V         | 85  |       | 10.00 | 04.04 |       | 03.0137-4010.2 | 654010 |                          | 180 x 30 /Zub<br>Bremsbacken-Zubehör<br>Bremsbacken-Zubehör<br>Spreizschloß Satz |
|                           | 2.0 16V         | 97  |       | 10.96 | 04.04 |       | 03.0137-9249.2 | 669249 |                          |  |
|                           | 2.0 16V         | 99  |       | 01.99 | 10.00 |       | 03.0137-9700.2 | 669700 |                          |  |
|                           | 2.0 16V         | 100 |       | 10.00 | 04.04 |       | 03.0137-9702.2 | 669702 |                          |  |
|                           | 2.0 16V HPi     | 103 |       | 05.01 | 04.04 |       |                |        |                          |  |
|                           | 2.0 HDi 110     | 80  |       | 02.99 | 08.01 |       |                |        |                          |  |
|                           | 2.0 HDi 110 FAP | 79  |       | 08.01 | 04.04 |       |                |        |                          |  |
|                           | 2.0 HDi 90      | 66  |       | 02.99 | 04.04 |       |                |        |                          |  |
|                           | 2.0 Turbo       |     |       | 10.96 | 04.04 |       |                |        |                          |  |
|                           | 2.1 TD          | 80  |       | 10.96 | 04.04 |       |                |        |                          |  |
|                           | 2.2             | 116 |       | 07.00 | 04.04 |       |                |        |                          |  |
|                           | 2.2 HDi         | 98  |       | 03.00 | 04.04 |       |                |        |                          |  |
|                           | 3.0 24V         | 140 |       | 10.96 | 04.04 |       |                |        |                          |  |
| 3.0 V6                    | 152             |     | 03.00 | 04.04 |       |       |                |        |                          |  |

| PEUGEOT 406 Coupe (97-05) |         |            |            |       |       |                |                |        |                 |  |
|---------------------------|---------|------------|------------|-------|-------|----------------|----------------|--------|-----------------|--|
|                           | 2.0 16V | 97         |            | 03.97 | 09.05 |                | 13.0460-2817.2 | 602817 |                 | 21674 19,0 +/WK/S TRW  |
|                           | 2.0 16V | 99         |            | 01.99 | 10.00 |                |                |        |                 |  |
|                           | 2.0 16V | 100        |            | 10.00 | 09.05 |                |                |        |                 |  |
|                           | 2.2     | 116        |            | 03.02 | 09.05 |                |                |        |                 |  |
|                           | 2.2 HDi | 98         |            | 06.02 | 09.05 |                |                |        |                 |  |
|                           | 2.2 HDi | 98         |            | 03.00 | 06.02 |                | 13.0460-4969.2 | 604969 |                 |  |
|                           | 3.0 24V | 140        |            | 03.97 | 09.05 |                |                |        |                 |  |
|                           | 3.0 V6  | 152        |            | 03.00 | 09.05 |                |                |        |                 |  |
|                           | 2.0 16V | 97         |            | 03.97 | 09.05 |                | 24.0126-0106.1 | 426106 |                 | 283 26,0 24,2 V +S +B<br>283 26,0 24,2 V +S +B PD                                |
|                           | 2.0 16V | 99         |            | 01.99 | 10.00 |                | 24.0326-0106.1 | 526106 |                 |  |
|                           | 2.0 16V | 100        |            | 10.00 | 09.05 |                |                |        |                 |  |
|                           | 2.2     | 116        |            | 03.02 | 09.05 |                |                |        |                 |  |
| 2.2 HDi                   | 98      |            | 06.02      | 09.05 |       |                |                |        |                 |  |
| 2.2 HDi                   | 98      |            | 03.00      | 06.02 |       | 24.0128-0143.1 | 428143         |        | 305 28,0 26,0 V |  |
|                           | 3.0 24V | 140        |            | 03.97 | 09.05 |                |                |        |                 |  |
|                           | 3.0 V6  | 152        |            | 03.00 | 09.05 |                |                |        |                 |  |
|                           | 2.0 16V | 97         |            | 03.97 | 09.05 |                | 13.0460-4059.2 | 604059 |                 | 21278 16,4 +/WK ATE<br>Belagsatz-Zubehör ATE                                     |
|                           | 2.0 16V | 99         | S 80012040 | 01.99 | 10.00 |                | 13.0460-0409.2 | 610409 |                 |  |
|                           | 2.0 16V | 100        | S 80012040 | 10.00 |       |                |                |        |                 |  |
|                           | 2.2     | 116        | S 80012040 | 03.02 |       |                |                |        |                 |  |
| 2.2 HDi                   | 98      | S 80012040 | 03.00      |       |       |                |                |        |                 |  |
| 3.0 24V                   | 140     | S 80012040 | 03.97      |       |       |                |                |        |                 |  |
|                           | 3.0 V6  | 152        | S 80012040 | 03.00 |       |                |                |        |                 |  |
|                           | 2.0 16V | 97         | S 80012041 | 09.05 |       |                | 13.0460-7134.2 | 607134 |                 | 21278 16,4 ATE   |
|                           | 2.0 16V | 100        | S 80012041 | 09.05 |       |                |                |        |                 |  |
|                           | 2.2     | 116        | S 80012041 | 09.05 |       |                |                |        |                 |  |
|                           | 2.2 HDi | 98         | S 80012041 | 09.05 |       |                |                |        |                 |  |
|                           | 3.0 24V | 140        | S 80012041 | 09.05 |       |                |                |        |                 |  |
| 3.0 V6                    | 152     | S 80012041 | 09.05      |       |       |                |                |        |                 |  |
|                           | 2.0 16V | 97         |            | 03.97 | 09.05 |                | 24.0110-0230.1 | 410230 |                 | 291 10,0 8,0 +B  |
|                           | 2.0 16V | 99         |            | 01.99 | 10.00 |                |                |        |                 |  |
|                           | 2.0 16V | 100        |            | 10.00 | 09.05 |                |                |        |                 |  |
|                           | 2.2     | 116        |            | 03.02 | 09.05 |                |                |        |                 |  |
|                           | 2.2 HDi | 98         |            | 03.00 | 09.05 |                |                |        |                 |  |
|                           | 3.0 24V | 140        |            | 03.97 | 09.05 |                |                |        |                 |  |
|                           | 3.0 V6  | 152        |            | 03.00 | 09.05 |                |                |        |                 |  |
|                           | 2.0 16V | 97         |            | 03.97 | 09.05 |                | 03.0137-4010.2 | 654010 |                 | 180 x 30 /Zub<br>Bremsbacken-Zubehör<br>Bremsbacken-Zubehör<br>Spreizschloß Satz |
|                           | 2.0 16V | 99         |            | 01.99 | 10.00 |                | 03.0137-9249.2 | 669249 |                 |  |
|                           | 2.0 16V | 100        |            | 10.00 | 09.05 |                | 03.0137-9700.2 | 669700 |                 |  |
|                           | 2.2     | 116        |            | 03.02 | 09.05 |                | 03.0137-9702.2 | 669702 |                 |  |
|                           | 2.2 HDi | 98         |            | 03.00 | 09.05 |                |                |        |                 |  |
| 3.0 24V                   | 140     |            | 03.97      | 09.05 |       |                |                |        |                 |  |
|                           | 3.0 V6  | 152        |            | 03.00 | 09.05 |                |                |        |                 |  |

| PEUGEOT 407 Limousine / SW (04-11) |             |            |            |       |       |  |                |        |  |  |  |
|------------------------------------|-------------|------------|------------|-------|-------|--|----------------|--------|--|--|--|
|                                    | 1.6 HDi 110 | 80         |            | 05.04 | 02.11 |  | 13.0460-2891.2 | 602891 |  | 23134 19,6 +/WK/S TRW<br>23134 19,6 +/WK/S TRW |  |
|                                    | 1.8 16V     | 85         |            | 05.04 | 02.11 |  | 13.0470-2891.2 | LD2891 |  |  |  |
|                                    | 1.8 16V     | 92         |            | 09.05 | 02.11 |  |                |        |  |  |  |
|                                    | 2.0 16V     | 100        |            | 05.04 | 02.11 |  |                |        |  |  |  |
|                                    | 2.0 16V     | 103        |            | 09.05 | 02.11 |  |                |        |  |  |  |
|                                    | 2.0 Bioflex | 103        |            | 09.07 | 02.11 |  |                |        |  |  |  |
|                                    | 2.0 HDi 135 | 100        | ORGA 11682 | 05.04 |       |  |                |        |  |  |  |
|                                    | 2.2 16V     | 116        |            | 05.04 | 02.11 |  | 13.0460-2892.2 | 602892 |  |  | 24133 18,6 +/WK/Zub/STRW<br>24133 18,6 +/WK/Zub/STRW |
|                                    | 2.2 16V     | 120        |            | 09.05 | 02.11 |  | 13.0470-2892.2 | LD2892 |  |  |  |
|                                    | 2.2 HDi     | 120        |            | 06.08 | 02.11 |  |                |        |  |  |  |
| 2.2 HDi 170                        | 125         |            | 05.06      | 02.11 |       |  |                |        |  |  |  |
|                                    | 2.7 HDi     | 150        |            | 10.05 | 02.11 |  |                |        |  |  |  |
|                                    | 3.0 V6      | 155        | ORGA 12410 | 05.04 |       |  |                |        |  |  |  |
|                                    | 2.0 HDi     | 110        |            | 10.10 | 02.11 |  | 13.0460-7252.2 | 607252 |  | 24332 18,3 +/WK ATE<br>24332 18,3 +/WK ATE     |  |
|                                    | 2.0 HDi     | 120        |            | 07.09 | 02.11 |  | 13.0470-7252.2 | LD7252 |  |  |  |
| 2.0 HDi 135                        | 100         | ORGA 11683 | 02.11      |       |       |  |                |        |  |  |  |
|                                    | 2.0 HDi 140 | 103        |            | 08.08 | 02.11 |  |                |        |  |  |  |

1) - built-in corrector / - regolatore incorporato / - correcteur intégré / - regulador integrado  
2) + built-in corrector / + regolatore incorporato / + correcteur intégré / + regulador integrado

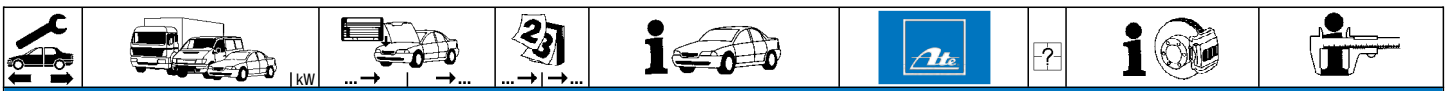

**PEUGEOT 407 Limousine / SW (04-11)**

|  |             |     |            |            |       |       |                |        |   |       |          |                     |     |
|--|-------------|-----|------------|------------|-------|-------|----------------|--------|---|-------|----------|---------------------|-----|
|  | 3.0 V6      | 155 | ORGA 12411 |            | 02.11 |       | 13.0460-7279.2 | 607279 |   | 25069 | 17,3 +WK | ATE                 |     |
|  | 1.6 HDi 110 | 80  |            |            | 05.04 | 02.11 | 24.0126-0121.1 | 426121 |   |       | 283      | 26,0 24,0 V L +S +B |     |
|  | 1.8 16V     | 85  |            |            | 05.04 | 02.11 |                |        |   |       |          |                     |     |
|  | 1.8 16V     | 92  |            |            | 09.05 | 02.11 |                |        |   |       |          |                     |     |
|  | 2.0 16V     | 100 |            |            | 05.04 | 02.11 |                |        |   |       |          |                     |     |
|  | 2.0 16V     | 103 |            |            | 09.05 | 02.11 |                |        |   |       |          |                     |     |
|  | 2.0 Bioflex | 103 |            |            | 09.07 | 02.11 |                |        |   |       |          |                     |     |
|  | 2.0 HDi 135 | 100 | ORGA 11682 |            | 05.04 |       |                |        |   |       |          |                     |     |
|  | 2.2 16V     | 116 | ORGA 11193 |            | 05.04 |       | 24.0130-0181.1 | 430181 |   |       | 330      | 30,0 28,0 V +S +B   |     |
|  | 2.2 16V     | 120 | ORGA 11193 |            | 09.05 |       |                |        |   |       |          |                     |     |
|  | 2.2 HDi     | 120 | ORGA 11193 |            | 06.08 |       |                |        |   |       |          |                     |     |
|  | 2.2 HDi 170 | 125 | ORGA 11193 |            | 05.06 |       |                |        |   |       |          |                     |     |
|  | 2.7 HDi     | 150 | ORGA 11193 |            | 10.05 |       |                |        |   |       |          |                     |     |
|  | 3.0 V6      | 155 | ORGA 11193 |            | 05.04 |       |                |        |   |       |          |                     |     |
|  | 2.2 16V     | 116 | ORGA 11194 |            |       | 02.11 | 24.0130-0206.1 | 430206 |   |       | 330      | 30,0 28,0 V L +S +B |     |
|  | 2.2 16V     | 120 | ORGA 11194 |            |       | 02.11 |                |        |   |       |          |                     |     |
|  | 2.2 HDi     | 120 | ORGA 11194 |            |       | 02.11 |                |        |   |       |          |                     |     |
|  | 2.2 HDi 170 | 125 | ORGA 11194 |            |       | 02.11 |                |        |   |       |          |                     |     |
|  | 2.7 HDi     | 150 | ORGA 11194 |            |       | 02.11 |                |        |   |       |          |                     |     |
|  | 3.0 V6      | 155 | ORGA 11194 | ORGA 12410 |       |       |                |        |   |       |          |                     |     |
|  | 2.0 HDi     | 110 |            |            | 10.10 | 02.11 | 24.0128-0216.1 | 428216 |   |       | 304      | 28,0 26,0 V +S +B   |     |
|  | 2.0 HDi 135 | 100 | ORGA 11683 |            |       | 02.11 |                |        |   |       |          |                     |     |
|  | 2.0 HDi 140 | 103 |            |            | 08.08 | 02.11 |                |        |   |       |          |                     |     |
|  | 2.0 HDi     | 120 |            |            | 07.09 | 02.11 | 24.0128-0269.1 | 428269 |   |       | 304      | 28,0 26,0 V L +S +B |     |
|  | 3.0 V6      | 155 | ORGA 12411 |            |       | 02.11 | 24.0130-0227.1 | 430227 |   |       | 340      | 30,0 28,0 V L +S +B |     |
|  | 1.6 HDi 110 | 80  | ORGA 11073 |            | 05.04 |       | 24.0710-2018.1 | 360225 | 2 |       |          | Radsensor L=1259    |     |
|  | 1.8 16V     | 85  | ORGA 11073 |            | 05.04 |       |                |        |   |       |          |                     |     |
|  | 1.8 16V     | 92  | ORGA 11073 |            | 09.05 |       |                |        |   |       |          |                     |     |
|  | 2.0 16V     | 100 | ORGA 11073 |            | 05.04 |       |                |        |   |       |          |                     |     |
|  | 2.0 16V     | 103 | ORGA 11073 |            | 09.05 |       |                |        |   |       |          |                     |     |
|  | 2.0 HDi 135 | 100 | ORGA 11073 |            | 05.04 |       |                |        |   |       |          |                     |     |
|  | 2.2 16V     | 116 | ORGA 11073 |            | 05.04 |       |                |        |   |       |          |                     |     |
|  | 2.2 16V     | 120 | ORGA 11073 |            | 09.05 |       |                |        |   |       |          |                     |     |
|  | 2.2 HDi 170 | 125 | ORGA 11073 |            | 05.06 |       |                |        |   |       |          |                     |     |
|  | 2.7 HDi     | 150 | ORGA 11073 |            | 10.05 |       |                |        |   |       |          |                     |     |
|  | 3.0 V6      | 155 | ORGA 11073 |            | 05.04 |       |                |        |   |       |          |                     |     |
|  | 1.6 HDi 110 | 80  | ORGA 11683 |            |       | 02.11 | 24.0711-5215.3 | 360317 | 2 |       |          | Radsensor L=1259    |     |
|  | 1.8 16V     | 85  | ORGA 11683 |            |       | 02.11 | 24.0711-5345.3 | 360372 | 2 |       |          | Radsensor L=1259    |     |
|  | 1.8 16V     | 92  | ORGA 11683 |            |       | 02.11 |                |        |   |       |          |                     |     |
|  | 2.0 16V     | 100 | ORGA 11683 |            |       | 02.11 |                |        |   |       |          |                     |     |
|  | 2.0 16V     | 103 | ORGA 11683 |            |       | 02.11 |                |        |   |       |          |                     |     |
|  | 2.0 Bioflex | 103 | ORGA 11683 |            |       | 02.11 |                |        |   |       |          |                     |     |
|  | 2.0 HDi     | 110 |            |            | 02.10 | 02.11 |                |        |   |       |          |                     |     |
|  | 2.0 HDi     | 120 |            |            | 07.09 | 02.11 |                |        |   |       |          |                     |     |
|  | 2.0 HDi 135 | 100 | ORGA 11683 |            |       | 02.11 |                |        |   |       |          |                     |     |
|  | 2.0 HDi 140 | 103 | ORGA 11683 |            |       | 02.11 |                |        |   |       |          |                     |     |
|  | 2.2 16V     | 116 | ORGA 11683 |            |       | 02.11 |                |        |   |       |          |                     |     |
|  | 2.2 16V     | 120 | ORGA 11683 |            |       | 02.11 |                |        |   |       |          |                     |     |
|  | 2.2 HDi     | 120 | ORGA 11683 |            |       | 02.11 |                |        |   |       |          |                     |     |
|  | 2.2 HDi 170 | 125 | ORGA 11683 |            |       | 02.11 |                |        |   |       |          |                     |     |
|  | 2.7 HDi     | 150 | ORGA 11683 |            |       | 02.11 |                |        |   |       |          |                     |     |
|  | 3.0 V6      | 155 | ORGA 11683 |            |       | 02.11 |                |        |   |       |          |                     |     |
|  | 1.6 HDi 110 | 80  |            |            | 05.04 | 02.11 | 13.0460-2893.2 | 602893 |   |       | 24135    | 17,7 /S             | TRW |
|  | 1.8 16V     | 85  |            |            | 05.04 | 02.11 | 13.0470-2893.2 | LD2893 |   |       | 24135    | 17,7 /S             | TRW |
|  | 1.8 16V     | 92  |            |            | 09.05 | 02.11 |                |        |   |       |          |                     |     |
|  | 2.0 16V     | 100 |            |            | 05.04 | 02.11 |                |        |   |       |          |                     |     |
|  | 2.0 16V     | 103 |            |            | 09.05 | 02.11 |                |        |   |       |          |                     |     |
|  | 2.0 Bioflex | 103 |            |            | 09.07 | 02.11 |                |        |   |       |          |                     |     |
|  | 2.0 HDi     | 110 |            |            | 02.10 | 02.11 |                |        |   |       |          |                     |     |
|  | 2.0 HDi     | 120 |            |            | 07.09 | 02.11 |                |        |   |       |          |                     |     |
|  | 2.0 HDi 135 | 100 |            |            | 05.04 | 02.11 |                |        |   |       |          |                     |     |
|  | 2.0 HDi 140 | 103 |            |            | 08.08 | 02.11 |                |        |   |       |          |                     |     |
|  | 2.2 16V     | 116 |            |            | 05.04 | 02.11 |                |        |   |       |          |                     |     |
|  | 2.2 16V     | 120 |            |            | 09.05 | 02.11 |                |        |   |       |          |                     |     |
|  | 2.2 HDi     | 120 |            |            | 06.08 | 02.11 |                |        |   |       |          |                     |     |
|  | 2.2 HDi 170 | 125 |            |            | 05.06 | 02.11 |                |        |   |       |          |                     |     |
|  | 2.7 HDi     | 150 |            |            | 10.05 | 02.11 |                |        |   |       |          |                     |     |
|  | 3.0 V6      | 155 |            |            | 05.04 | 02.11 |                |        |   |       |          |                     |     |
|  | 1.6 HDi 110 | 80  |            |            | 05.04 | 02.11 | 24.0112-0162.1 | 412162 |   |       | 290      | 12,0 10,0 +S +B     |     |
|  | 1.8 16V     | 85  |            |            | 05.04 | 02.11 |                |        |   |       |          |                     |     |
|  | 1.8 16V     | 92  |            |            | 09.05 | 02.11 |                |        |   |       |          |                     |     |
|  | 2.0 16V     | 100 |            |            | 05.04 | 02.11 |                |        |   |       |          |                     |     |
|  | 2.0 16V     | 103 |            |            | 09.05 | 02.11 |                |        |   |       |          |                     |     |
|  | 2.0 Bioflex | 103 |            |            | 09.07 | 02.11 |                |        |   |       |          |                     |     |
|  | 2.0 HDi     | 110 |            |            | 02.10 | 02.11 |                |        |   |       |          |                     |     |
|  | 2.0 HDi     | 120 |            |            | 07.09 | 02.11 |                |        |   |       |          |                     |     |
|  | 2.0 HDi 135 | 100 |            |            | 05.04 | 02.11 |                |        |   |       |          |                     |     |
|  | 2.0 HDi 140 | 103 |            |            | 08.08 | 02.11 |                |        |   |       |          |                     |     |
|  | 2.2 16V     | 116 |            |            | 05.04 | 02.11 |                |        |   |       |          |                     |     |
|  | 2.2 16V     | 120 |            |            | 09.05 | 02.11 |                |        |   |       |          |                     |     |
|  | 2.2 HDi     | 120 |            |            | 06.08 | 02.11 |                |        |   |       |          |                     |     |
|  | 2.2 HDi 170 | 125 |            |            | 05.06 | 02.11 |                |        |   |       |          |                     |     |
|  | 2.7 HDi     | 150 |            |            | 10.05 | 02.11 |                |        |   |       |          |                     |     |
|  | 3.0 V6      | 155 |            |            | 05.04 | 02.11 |                |        |   |       |          |                     |     |







**PEUGEOT 407 Limousine / SW (04-11)**

|        |             |            |            |       |       |                |        |   |  |                  |
|--------|-------------|------------|------------|-------|-------|----------------|--------|---|--|------------------|
|        | 1.6 HDi 110 | 80         | ORGA 11073 | 05.04 |       | 24.0710-2019.1 | 360226 | 2 |  | Radsensor L=1762 |
|        | 1.8 16V     | 85         | ORGA 11073 | 05.04 |       |                |        |   |  |                  |
|        | 1.8 16V     | 92         | ORGA 11073 | 09.05 |       |                |        |   |  |                  |
|        | 2.0 16V     | 100        | ORGA 11073 | 05.04 |       |                |        |   |  |                  |
|        | 2.0 16V     | 103        | ORGA 11073 | 09.05 |       |                |        |   |  |                  |
|        | 2.0 HDi 135 | 100        | ORGA 11073 | 05.04 |       |                |        |   |  |                  |
|        | 2.2 16V     | 116        | ORGA 11073 | 05.04 |       |                |        |   |  |                  |
|        | 2.2 16V     | 120        | ORGA 11073 | 09.05 |       |                |        |   |  |                  |
|        | 2.2 HDi 170 | 125        | ORGA 11073 | 05.06 |       |                |        |   |  |                  |
|        | 2.7 HDi     | 150        | ORGA 11073 | 10.05 |       |                |        |   |  |                  |
| 3.0 V6 | 155         | ORGA 11073 | 05.04      |       |       |                |        |   |  |                  |
|        | 1.6 HDi 110 | 80         | ORGA 11683 | 02.11 |       | 24.0711-5216.3 | 360318 | 2 |  | Radsensor L=1762 |
|        | 1.8 16V     | 85         | ORGA 11683 | 02.11 |       |                |        |   |  |                  |
|        | 1.8 16V     | 92         | ORGA 11683 | 02.11 |       |                |        |   |  |                  |
|        | 2.0 16V     | 100        | ORGA 11683 | 02.11 |       |                |        |   |  |                  |
|        | 2.0 16V     | 103        | ORGA 11683 | 02.11 |       |                |        |   |  |                  |
|        | 2.0 Bioflex | 103        | ORGA 11683 | 02.11 |       |                |        |   |  |                  |
|        | 2.0 HDi     | 110        |            | 02.10 | 02.11 |                |        |   |  |                  |
|        | 2.0 HDi     | 120        |            | 07.09 | 02.11 |                |        |   |  |                  |
|        | 2.0 HDi 135 | 100        | ORGA 11683 | 02.11 |       |                |        |   |  |                  |
|        | 2.0 HDi 140 | 103        | ORGA 11683 | 02.11 |       |                |        |   |  |                  |
|        | 2.2 16V     | 116        | ORGA 11683 | 02.11 |       |                |        |   |  |                  |
|        | 2.2 16V     | 120        | ORGA 11683 | 02.11 |       |                |        |   |  |                  |
|        | 2.2 HDi     | 120        | ORGA 11683 | 02.11 |       |                |        |   |  |                  |
|        | 2.2 HDi 170 | 125        | ORGA 11683 | 02.11 |       |                |        |   |  |                  |
|        | 2.7 HDi     | 150        | ORGA 11683 | 02.11 |       |                |        |   |  |                  |
| 3.0 V6 | 155         | ORGA 11683 | 02.11      |       |       |                |        |   |  |                  |

**PEUGEOT 407 Coupe (05-11)**

|  |             |     |            |       |       |                |        |   |  |                          |
|--|-------------|-----|------------|-------|-------|----------------|--------|---|--|--------------------------|
|  | 2.0 HDi 135 | 100 |            | 07.07 | 12.11 | 13.0460-2892.2 | 602892 |   |  | 24133 18,6 +/WK/Zub/STRW |
|  | 2.2 16V     | 120 |            | 10.05 | 12.11 | 13.0470-2892.2 | LD2892 |   |  | 24133 18,6 +/WK/Zub/STRW |
|  | 2.7 HDi     | 150 |            | 10.05 | 12.11 |                |        |   |  |                          |
|  | 3.0 V6      | 155 | ORGA 12410 | 10.05 |       |                |        |   |  |                          |
|  | 3.0 HDi     | 177 |            | 06.09 | 12.11 | 13.0460-7279.2 | 607279 |   |  | 25069 17,3 +/WK ATE      |
|  | 3.0 V6      | 155 | ORGA 12411 |       | 12.11 |                |        |   |  |                          |
|  | 2.0 HDi     | 110 |            | 02.10 | 12.11 | 13.0460-7252.2 | 607252 |   |  | 24332 18,3 +/WK ATE      |
|  | 2.0 HDi     | 120 |            | 06.09 | 12.11 | 13.0470-7252.2 | LD7252 |   |  | 24332 18,3 +/WK ATE      |
|  | 2.2 16V     | 120 | ORGA 11193 | 10.05 |       | 24.0130-0181.1 | 430181 |   |  | 330 30,0 28,0 V +S +B    |
|  | 2.7 HDi     | 150 | ORGA 11193 | 10.05 |       |                |        |   |  |                          |
|  | 3.0 V6      | 155 | ORGA 11193 | 10.05 |       |                |        |   |  |                          |
|  | 2.0 HDi 135 | 100 |            | 07.07 | 12.11 | 24.0130-0206.1 | 430206 |   |  | 330 30,0 28,0 V L +S +B  |
|  | 2.2 16V     | 120 | ORGA 11194 |       | 12.11 |                |        |   |  |                          |
|  | 2.7 HDi     | 150 | ORGA 11194 |       | 12.11 |                |        |   |  |                          |
|  | 3.0 V6      | 155 | ORGA 11194 |       | 12.11 |                |        |   |  |                          |
|  | 2.0 HDi     | 110 |            | 02.10 | 12.11 | 24.0128-0216.1 | 428216 |   |  | 304 28,0 26,0 V +S +B    |
|  | 2.0 HDi     | 120 |            | 06.09 | 12.11 |                |        |   |  |                          |
|  | 3.0 HDi     | 177 |            | 06.09 | 12.11 | 24.0130-0227.1 | 430227 |   |  | 340 30,0 28,0 V L +S +B  |
|  | 3.0 V6      | 155 | ORGA 12411 |       | 12.11 |                |        |   |  |                          |
|  | 2.0 HDi 135 | 100 | ORGA 11192 | 07.07 |       | 24.0710-2018.1 | 360225 | 2 |  | Radsensor L=1259         |
|  | 2.2 16V     | 120 | ORGA 11283 | 10.05 |       |                |        |   |  |                          |
|  | 2.7 HDi     | 150 | ORGA 11283 | 10.05 |       |                |        |   |  |                          |
|  | 3.0 V6      | 155 | ORGA 11283 | 10.05 |       |                |        |   |  |                          |
|  | 2.0 HDi     | 110 |            | 02.10 | 12.11 | 24.0711-5215.3 | 360317 | 2 |  | Radsensor L=1259         |
|  | 2.0 HDi     | 120 |            | 06.09 | 12.11 | 24.0711-5345.3 | 360372 | 2 |  | Radsensor L=1259         |
|  | 2.0 HDi 135 | 100 | ORGA 11683 |       | 12.11 |                |        |   |  |                          |
|  | 2.2 16V     | 120 | ORGA 11683 |       | 12.11 |                |        |   |  |                          |
|  | 2.7 HDi     | 150 | ORGA 11683 |       | 12.11 |                |        |   |  |                          |
|  | 3.0 HDi     | 177 |            | 06.09 | 12.11 |                |        |   |  |                          |
|  | 3.0 V6      | 155 | ORGA 11683 |       | 12.11 |                |        |   |  |                          |
|  | 2.0 HDi     | 110 |            | 02.10 | 12.11 | 13.0460-2893.2 | 602893 |   |  | 24135 17,7 /S TRW        |
|  | 2.0 HDi     | 120 |            | 06.09 | 12.11 | 13.0470-2893.2 | LD2893 |   |  | 24135 17,7 /S TRW        |
|  | 2.0 HDi 135 | 100 |            | 07.07 | 12.11 |                |        |   |  |                          |
|  | 2.2 16V     | 120 |            | 10.05 | 12.11 |                |        |   |  |                          |
|  | 2.7 HDi     | 150 |            | 10.05 | 12.11 |                |        |   |  |                          |
|  | 3.0 HDi     | 177 |            | 06.09 | 12.11 |                |        |   |  |                          |
|  | 3.0 V6      | 155 |            | 10.05 | 12.11 |                |        |   |  |                          |
|  | 2.0 HDi     | 110 |            | 02.10 | 12.11 | 24.0112-0174.1 | 412174 |   |  | 290 12,0 10,0 +B         |
|  | 2.0 HDi     | 120 |            | 06.09 | 12.11 |                |        |   |  |                          |
|  | 2.0 HDi 135 | 100 |            | 07.07 | 12.11 |                |        |   |  |                          |
|  | 2.2 16V     | 120 |            | 10.05 | 12.11 |                |        |   |  |                          |
|  | 2.7 HDi     | 150 |            | 10.05 | 12.11 |                |        |   |  |                          |
|  | 3.0 HDi     | 177 |            | 06.09 | 12.11 |                |        |   |  |                          |
|  | 3.0 V6      | 155 |            | 10.05 | 12.11 |                |        |   |  |                          |
|  | 2.0 HDi     | 120 |            | 06.09 | 12.11 | 24.0112-0162.1 | 412162 |   |  | 290 12,0 10,0 +S +B      |
|  | 2.0 HDi 135 | 100 |            | 07.07 | 12.11 |                |        |   |  |                          |
|  | 3.0 HDi     | 177 |            | 06.09 | 12.11 |                |        |   |  |                          |
|  | 2.0 HDi 135 | 100 | ORGA 11192 | 07.07 |       | 24.0710-2019.1 | 360226 | 2 |  | Radsensor L=1762         |
|  | 2.2 16V     | 120 | ORGA 11283 | 10.05 |       |                |        |   |  |                          |
|  | 2.7 HDi     | 150 | ORGA 11283 | 10.05 |       |                |        |   |  |                          |
|  | 3.0 V6      | 155 | ORGA 11283 | 10.05 |       |                |        |   |  |                          |
|  | 2.0 HDi     | 110 |            | 02.10 | 12.11 | 24.0711-5216.3 | 360318 | 2 |  | Radsensor L=1762         |
|  | 2.0 HDi     | 120 |            | 06.09 | 12.11 |                |        |   |  |                          |
|  | 2.0 HDi 135 | 100 | ORGA 11683 |       | 12.11 |                |        |   |  |                          |
|  | 2.2 16V     | 120 | ORGA 11683 |       | 12.11 |                |        |   |  |                          |
|  | 2.7 HDi     | 150 | ORGA 11683 |       | 12.11 |                |        |   |  |                          |



| PEUGEOT 407 Coupe (05-11)  |  |                        |            |  |       |  |                |        |                        |     |
|--|--|------------------------|------------|--|-------|--|----------------|--------|------------------------|-----|
|    | 3.0 HDi<br>3.0 V6  | 177<br>155             | ORGA 11683 | 06.09<br>12.11   | 12.11 | 24.0711-5216.3   | 360318         | 2      | Radsensor L=1762       |     |
| PEUGEOT 508 (10-)  |  |                        |            |  |       |  |                |        |                        |     |
|    | 1.6 BlueHdi 120<br>1.6 HDi<br>1.6 HDi<br>1.6 THP<br>1.6 THP 150<br>1.6 THP 163<br>1.6 VTi<br>2.0 HDi<br>2.0 HDi<br>2.0 HDi 150<br>2.0 HDi 180<br>2.0 HDi Hybrid4<br>2.0 HDi Hybrid4 AWC<br>2.2 HDi | 88<br>82<br>115<br>110 |            | 03.14<br>02.12<br>11.10<br>11.10<br>11.10<br>11.10<br>11.10<br>11.10<br>04.14<br>04.14<br>06.12<br>11.10<br>11.10          |       | + Bremsscheibendurchm. 283 mm / + Bremsscheibendicke 26 mm <sup>1)</sup><br>+ Bremsscheibendurchm. 283 mm / + Bremsscheibendicke 26 mm <sup>1)</sup><br>+ Bremsscheibendurchm. 283 mm / + Bremsscheibendicke 26 mm <sup>1)</sup><br>+ Bremsscheibendurchm. 283 mm / + Bremsscheibendicke 26 mm <sup>1)</sup><br>+ Bremsscheibendurchm. 283 mm / + Bremsscheibendicke 26 mm <sup>1)</sup><br>+ Bremsscheibendurchm. 283 mm / + Bremsscheibendicke 26 mm <sup>1)</sup><br>+ Bremsscheibendurchm. 283 mm / + Bremsscheibendicke 26 mm <sup>1)</sup><br>+ Bremsscheibendurchm. 283 mm / + Bremsscheibendicke 26 mm <sup>1)</sup><br>+ Bremsscheibendurchm. 283 mm / + Bremsscheibendicke 26 mm <sup>1)</sup><br>+ Bremsscheibendurchm. 283 mm / + Bremsscheibendicke 26 mm <sup>1)</sup><br>+ Bremsscheibendurchm. 283 mm / + Bremsscheibendicke 26 mm <sup>1)</sup><br>+ Bremsscheibendurchm. 283 mm / + Bremsscheibendicke 26 mm <sup>1)</sup><br>+ Bremsscheibendurchm. 283 mm / + Bremsscheibendicke 26 mm <sup>1)</sup><br>+ Bremsscheibendurchm. 283 mm / + Bremsscheibendicke 26 mm <sup>1)</sup>   | 13.0460-7276.2 | 607276 | 25222 17,3 +/WK        | ATE |
|  | 1.6 BlueHdi 120<br>1.6 HDi<br>1.6 HDi<br>1.6 THP<br>1.6 THP 150<br>1.6 THP 163<br>1.6 VTi<br>2.0 HDi<br>2.0 HDi<br>2.0 HDi 150<br>2.0 HDi 180<br>2.0 HDi Hybrid4<br>2.0 HDi Hybrid4 AWC<br>2.2 HDi | 88<br>82<br>115<br>110 |            | 03.14<br>02.12<br>11.10<br>11.10<br>11.10<br>09.11<br>11.10<br>11.10<br>11.10<br>04.14<br>04.14<br>06.12<br>11.10<br>11.10 |       | + Bremsscheibendurchm. 304 mm / + Bremsscheibendicke 28 mm <sup>2)</sup><br>+ Bremsscheibendurchm. 304 mm / + Bremsscheibendicke 28 mm <sup>2)</sup><br>+ Bremsscheibendurchm. 304 mm / + Bremsscheibendicke 28 mm <sup>2)</sup><br>+ Bremsscheibendurchm. 304 mm / + Bremsscheibendicke 28 mm <sup>2)</sup><br>+ Bremsscheibendurchm. 304 mm / + Bremsscheibendicke 28 mm <sup>2)</sup><br>+ Bremsscheibendurchm. 304 mm / + Bremsscheibendicke 28 mm <sup>2)</sup><br>+ Bremsscheibendurchm. 304 mm / + Bremsscheibendicke 28 mm <sup>2)</sup><br>+ Bremsscheibendurchm. 304 mm / + Bremsscheibendicke 28 mm <sup>2)</sup><br>+ Bremsscheibendurchm. 304 mm / + Bremsscheibendicke 28 mm <sup>2)</sup><br>+ Bremsscheibendurchm. 304 mm / + Bremsscheibendicke 28 mm <sup>2)</sup><br>+ Bremsscheibendurchm. 304 mm / + Bremsscheibendicke 28 mm <sup>2)</sup><br>+ Bremsscheibendurchm. 304 mm / + Bremsscheibendicke 28 mm <sup>2)</sup><br>+ Bremsscheibendurchm. 304 mm / + Bremsscheibendicke 28 mm <sup>2)</sup><br>+ Bremsscheibendurchm. 304 mm / + Bremsscheibendicke 28 mm <sup>2)</sup><br>+ Bremsscheibendurchm. 304 mm / + Bremsscheibendicke 28 mm <sup>2)</sup> | 13.0460-7277.2 | 607277 | 24332 18,3 +/WK        | ATE |
|  | 1.6 BlueHdi 120<br>1.6 HDi<br>1.6 HDi<br>1.6 THP<br>1.6 THP 150<br>1.6 THP 163<br>1.6 VTi<br>2.0 HDi<br>2.0 HDi<br>2.0 HDi 150<br>2.0 HDi 180<br>2.0 HDi Hybrid4<br>2.0 HDi Hybrid4 AWC<br>2.2 HDi | 88<br>82<br>115<br>110 |            | 03.14<br>02.12<br>11.10<br>11.10<br>11.10<br>09.11<br>11.10<br>11.10<br>11.10<br>04.14<br>04.14<br>06.12<br>11.10<br>11.10 |       | + Bremsscheibendurchm. 340 mm / + Bremsscheibendicke 30 mm <sup>3)</sup><br>+ Bremsscheibendurchm. 340 mm / + Bremsscheibendicke 30 mm <sup>3)</sup><br>+ Bremsscheibendurchm. 340 mm / + Bremsscheibendicke 30 mm <sup>3)</sup><br>+ Bremsscheibendurchm. 340 mm / + Bremsscheibendicke 30 mm <sup>3)</sup><br>+ Bremsscheibendurchm. 340 mm / + Bremsscheibendicke 30 mm <sup>3)</sup><br>+ Bremsscheibendurchm. 340 mm / + Bremsscheibendicke 30 mm <sup>3)</sup><br>+ Bremsscheibendurchm. 340 mm / + Bremsscheibendicke 30 mm <sup>3)</sup><br>+ Bremsscheibendurchm. 340 mm / + Bremsscheibendicke 30 mm <sup>3)</sup><br>+ Bremsscheibendurchm. 340 mm / + Bremsscheibendicke 30 mm <sup>3)</sup><br>+ Bremsscheibendurchm. 340 mm / + Bremsscheibendicke 30 mm <sup>3)</sup><br>+ Bremsscheibendurchm. 340 mm / + Bremsscheibendicke 30 mm <sup>3)</sup><br>+ Bremsscheibendurchm. 340 mm / + Bremsscheibendicke 30 mm <sup>3)</sup><br>+ Bremsscheibendurchm. 340 mm / + Bremsscheibendicke 30 mm <sup>3)</sup><br>+ Bremsscheibendurchm. 340 mm / + Bremsscheibendicke 30 mm <sup>3)</sup><br>+ Bremsscheibendurchm. 340 mm / + Bremsscheibendicke 30 mm <sup>3)</sup> | 13.0460-7279.2 | 607279 | 25069 17,3 +/WK        | ATE |
|  | 1.6 BlueHdi 120<br>1.6 HDi<br>1.6 HDi<br>1.6 THP<br>1.6 THP 150<br>1.6 THP 163<br>1.6 VTi<br>2.0 HDi<br>2.0 HDi<br>2.0 HDi 150<br>2.0 HDi 180<br>2.0 HDi Hybrid4<br>2.0 HDi Hybrid4 AWC<br>2.2 HDi | 88<br>82<br>115<br>110 |            | 03.14<br>02.12<br>11.10<br>11.10<br>11.10<br>09.11<br>11.10<br>11.10<br>11.10<br>04.14<br>04.14<br>06.12<br>11.10<br>11.10 |       |  |                |        | 283 26,0 24,0 VL +S +B |     |
|  | 1.6 BlueHdi 120<br>1.6 HDi<br>1.6 HDi<br>1.6 THP<br>1.6 THP 150<br>1.6 THP 163<br>1.6 VTi<br>2.0 HDi<br>2.0 HDi<br>2.0 HDi 150<br>2.0 HDi 180<br>2.0 HDi Hybrid4<br>2.0 HDi Hybrid4 AWC<br>2.2 HDi | 88<br>82<br>115<br>110 |            | 03.14<br>02.12<br>11.10<br>11.10<br>11.10<br>09.11<br>11.10<br>11.10<br>11.10<br>04.14<br>04.14<br>06.12<br>11.10<br>11.10 |       |  |                |        | 304 28,0 26,0 VL +S +B |     |
|  | 1.6 BlueHdi 120<br>1.6 HDi<br>1.6 HDi<br>1.6 THP<br>1.6 THP 150<br>1.6 THP 163<br>1.6 VTi<br>2.0 HDi<br>2.0 HDi<br>2.0 HDi 150<br>2.0 HDi 180<br>2.0 HDi Hybrid4                                   | 88<br>82<br>115<br>110 |            | 03.14<br>02.12<br>11.10<br>11.10<br>11.10<br>09.11<br>11.10<br>11.10<br>11.10<br>04.14<br>04.14<br>06.12                   |       |  |                |        | 340 30,0 28,0 VL +S +B |     |

1) + br.disc diam. 283mm /+ br.disc thickness 26mm / + disco fr.diam. 283mm /+ disco fr.spessore 26mm / + disques fr.diam. 283mm /+ disques fr.épaisseur 26mm / + disco fr.diam. 283mm /+ disco fr.espesor 26mm  
2) + br.disc diam. 304mm /+ br.disc thickness 28mm / + disco fr.diam. 304mm /+ disco fr.spessore 28mm / + disques fr.diam. 304mm /+ disques fr.épaisseur 28mm / + disco fr.diam. 304mm /+ disco fr.espesor 28mm  
3) + br.disc diam. 340mm /+ br.disc thickness 30mm / + disco fr.diam. 340mm /+ disco fr.spessore 30mm / + disques fr.diam. 340mm /+ disques fr.épaisseur 30mm / + disco fr.diam. 340mm /+ disco fr.espesor 30mm





**PEUGEOT 508 (10-)**

|  |  |  |  |  |  |                                  |                  |   |  |
|--|--|--|--|--|--|----------------------------------|------------------|---|--|
|  | 2.0 HDi Hybrid4 AWC<br>2.2 HDi   | 120<br>150   |  | 11.10<br>11.10   |  | 24.0130-0227.1                   | 430227           |   | 340 30,0 28,0 VL +S +B   |
|  | 1.6 BlueHDi 120<br>1.6 HDi<br>1.6 HDi<br>1.6 THP<br>1.6 THP 150<br>1.6 THP 163<br>1.6 VTi<br>2.0 HDi<br>2.0 HDi<br>2.0 HDi 150<br>2.0 HDi 180<br>2.0 HDi Hybrid4<br>2.0 HDi Hybrid4 AWC<br>2.2 HDi | 88<br>82<br>115<br>110<br>110<br>110<br>120<br>110<br>133<br>147<br>120<br>150 |  | 03.14<br>02.12<br>11.10<br>11.10<br>11.10<br>09.11<br>11.10<br>11.10<br>11.10<br>04.14<br>04.14<br>06.12<br>11.10<br>11.10 |  | 24.0711-5375.3                   | 360397           | 2 | Radsensor L=1233   |
|  | 1.6 BlueHDi 120<br>1.6 HDi<br>1.6 HDi<br>1.6 THP<br>1.6 THP 150<br>1.6 THP 163<br>1.6 VTi<br>2.0 HDi<br>2.0 HDi<br>2.0 HDi 150<br>2.0 HDi 180<br>2.2 HDi<br>2.0 HDi Hybrid4<br>2.0 HDi Hybrid4 AWC | 88<br>82<br>115<br>110<br>110<br>110<br>120<br>110<br>133<br>150<br>147<br>120 |  | 03.14<br>02.12<br>11.10<br>11.10<br>11.10<br>09.11<br>11.10<br>11.10<br>11.10<br>04.14<br>04.14<br>11.10<br>06.12<br>11.10 |  | 13.0460-7278.2                   | 607278           |   | 25218 16,6 + <b>ATE</b>  |
|  | 1.6 BlueHDi 120<br>1.6 HDi<br>1.6 HDi<br>1.6 THP<br>1.6 THP 150<br>1.6 THP 163<br>1.6 VTi<br>2.0 HDi<br>2.0 HDi<br>2.0 HDi 150<br>2.0 HDi 180<br>2.0 HDi Hybrid4<br>2.0 HDi Hybrid4 AWC            | 88<br>82<br>115<br>110<br>110<br>110<br>120<br>110<br>133<br>147<br>120<br>150 |  | 03.14<br>02.12<br>11.10<br>11.10<br>11.10<br>09.11<br>11.10<br>11.10<br>11.10<br>04.14<br>04.14<br>06.12<br>11.10<br>11.10 |  | 24.0112-0197.1                   | 412197           |   | 290 12,0 10,0 +S +B  |
|  | 1.6 BlueHDi 120<br>1.6 HDi<br>1.6 HDi<br>1.6 THP<br>1.6 THP 150<br>1.6 THP 163<br>1.6 VTi<br>2.0 HDi<br>2.0 HDi<br>2.0 HDi 150<br>2.0 HDi 180<br>2.2 HDi   | 88<br>82<br>115<br>110<br>110<br>110<br>120<br>110<br>133<br>150               |  | 03.14<br>02.12<br>11.10<br>11.10<br>11.10<br>09.11<br>11.10<br>11.10<br>11.10<br>04.14<br>04.14<br>11.10                   |  | 24.0711-5346.3                   | 360373           | 2 | Radsensor L=1762   |
|  | 2.0 HDi Hybrid4<br>2.0 HDi Hybrid4 AWC<br>2.2 HDi  | 147<br>120<br>150  |  | 06.12<br>11.10<br>11.10  |  | 13.0460-2761.2                   | 602761           |   | 24922 17,5 /Zub/S <b>TRW</b>   |
|  | 2.0 HDi Hybrid4<br>2.0 HDi Hybrid4 AWC<br>2.2 HDi  | 147<br>120<br>150  |  | 06.12<br>11.10<br>11.10  |  | 24.0112-0197.1<br>24.0112-0162.1 | 412197<br>412162 |   | - elektrische Feststellbremse 1)<br>+ elektrische Feststellbremse 2)<br>290 12,0 10,0 +S +B<br>290 12,0 10,0 +S +B |

**PEUGEOT 508 SW (10-)**

|  |  |  |  |  |  |                |        |  |                             |
|--|--|--|--|--|--|----------------|--------|--|-----------------------------|
|  | 1.6 HDi<br>1.6 HDi<br>1.6 THP<br>1.6 THP<br>1.6 THP 150<br>1.6 VTi<br>2.0 HDi<br>2.0 HDi<br>2.0 HDi Hybrid4 AWC<br>2.2 HDi   | 82<br>115<br>121<br>110<br>120<br>120<br>150       | ORGA 12774<br>ORGA 12774<br>ORGA 12774<br>ORGA 12774<br>ORGA 12774<br>ORGA 12774<br>ORGA 12774<br>ORGA 12774<br>ORGA 12774<br>ORGA 12774   | 02.12<br>11.10<br>11.10<br>02.12<br>11.10<br>11.10<br>11.10<br>11.10<br>11.10<br>11.10 |  | 13.0460-7276.2 | 607276 |  | 25222 17,3 +/-WK <b>ATE</b> |
|  | 1.6 BlueHDi 120<br>1.6 HDi<br>1.6 HDi<br>1.6 THP<br>1.6 THP<br>1.6 THP 150<br>1.6 VTi<br>2.0 HDi<br>2.0 HDi<br>2.0 HDi 150<br>2.0 HDi 180<br>2.0 HDi 180 RXH<br>2.0 HDi Hybrid4 AWC<br>2.2 HDi | 88<br>82<br>115<br>121<br>110<br>120<br>120<br>150 | ORGA 12775<br>ORGA 12775<br>ORGA 12775<br>ORGA 12775<br>ORGA 12775<br>ORGA 12775<br>ORGA 12775<br>ORGA 12775<br>ORGA 12775<br>ORGA 12775<br>ORGA 12775<br>ORGA 12775<br>ORGA 12775 | 03.14<br>04.14<br>04.14<br>10.14   |  | 13.0460-7276.2 | 607276 |  | 25222 17,3 +/-WK <b>ATE</b> |
|  | 1.6 HDi<br>1.6 HDi<br>1.6 THP  | 82<br>115  | ORGA 12774<br>ORGA 12774<br>ORGA 12774   | 02.12<br>11.10<br>11.10  |  | 13.0460-7277.2 | 607277 |  | 24332 18,3 +/-WK <b>ATE</b> |

1) - electric parking brake / - freno a mano elettrico / - frein à main électrique / - freno de mano eléctrico  
 2) + electric parking brake / + freno a mano elettrico / + frein à main électrique / + freno de mano eléctrico  
 3) + br.disc diam. 283mm /+ br.disc thickness 26mm / + disco fr.diam. 283mm /+ disco fr.spessore 26mm / + disques fr.diam. 283mm /+ disques fr.épaisseur 26mm / + disco fr.diam. 283mm /+ disco fr.espesor 26mm  
 4) + br.disc diam. 304mm /+ br.disc thickness 28mm / + disco fr.diam. 304mm /+ disco fr.spessore 28mm / + disques fr.diam. 304mm /+ disques fr.épaisseur 28mm / + disco fr.diam. 304mm /+ disco fr.espesor 28mm





**PEUGEOT 508 SW (10-)**

|  |  |  |  |  |                              |                                |                         |
|--|--|--|--|--|------------------------------|--------------------------------|-------------------------|
|  | <p>1.6 THP 121<br/>1.6 THP 150 110<br/>1.6 VTi<br/>2.0 HDi<br/>2.0 HDi 120<br/>2.0 HDi Hybrid4 AWC 120<br/>2.2 HDi 150</p>   | <p>ORGA 12774<br/>ORGA 12774<br/>ORGA 12774<br/>ORGA 12774<br/>ORGA 12774<br/>ORGA 12774</p> | <p>02.12<br/>11.10<br/>11.10<br/>11.10<br/>11.10<br/>11.10</p>   | <p>+ Bremsscheibendurchm. 304 mm / + Bremsscheibendicke 28 mm<sup>1)</sup><br/>+ Bremsscheibendurchm. 304 mm / + Bremsscheibendicke 28 mm<sup>1)</sup><br/>+ Bremsscheibendurchm. 304 mm / + Bremsscheibendicke 28 mm<sup>1)</sup><br/>+ Bremsscheibendurchm. 304 mm / + Bremsscheibendicke 28 mm<sup>1)</sup><br/>+ Bremsscheibendurchm. 304 mm / + Bremsscheibendicke 28 mm<sup>1)</sup><br/>+ Bremsscheibendurchm. 304 mm / + Bremsscheibendicke 28 mm<sup>1)</sup></p>   | <p>13.0460-7277.2 607277</p> | <p>24332 18,3 +WK</p>          | <p>ATE</p>              |
|  | <p>1.6 BlueHdi 120 88<br/>1.6 Hdi ORGA 12775<br/>1.6 Hdi 82 ORGA 12775<br/>1.6 THP 115 ORGA 12775<br/>1.6 THP 121 ORGA 12775<br/>1.6 THP 150 110 ORGA 12775<br/>1.6 VTi ORGA 12775<br/>2.0 HDi ORGA 12775<br/>2.0 HDi 120 ORGA 12775<br/>2.0 HDi 150 110<br/>2.0 HDi 180 133<br/>2.0 HDi 180 RXH 133<br/>2.0 HDi Hybrid4 AWC 120 ORGA 12775<br/>2.2 HDi 150 ORGA 12775</p> |  | <p>03.14<br/>04.14<br/>04.14<br/>10.14</p>   | <p>+ Bremsscheibendurchm. 304 mm / + Bremsscheibendicke 28 mm<sup>1)</sup><br/>+ Bremsscheibendurchm. 304 mm / + Bremsscheibendicke 28 mm<sup>1)</sup><br/>+ Bremsscheibendurchm. 304 mm / + Bremsscheibendicke 28 mm<sup>1)</sup><br/>+ Bremsscheibendurchm. 304 mm / + Bremsscheibendicke 28 mm<sup>1)</sup><br/>+ Bremsscheibendurchm. 304 mm / + Bremsscheibendicke 28 mm<sup>1)</sup><br/>+ Bremsscheibendurchm. 304 mm / + Bremsscheibendicke 28 mm<sup>1)</sup><br/>+ Bremsscheibendurchm. 304 mm / + Bremsscheibendicke 28 mm<sup>1)</sup><br/>+ Bremsscheibendurchm. 304 mm / + Bremsscheibendicke 28 mm<sup>1)</sup><br/>+ Bremsscheibendurchm. 304 mm / + Bremsscheibendicke 28 mm<sup>1)</sup><br/>+ Bremsscheibendurchm. 304 mm / + Bremsscheibendicke 28 mm<sup>1)</sup><br/>+ Bremsscheibendurchm. 304 mm / + Bremsscheibendicke 28 mm<sup>1)</sup><br/>+ Bremsscheibendurchm. 304 mm / + Bremsscheibendicke 28 mm<sup>1)</sup><br/>+ Bremsscheibendurchm. 304 mm / + Bremsscheibendicke 28 mm<sup>1)</sup><br/>+ Bremsscheibendurchm. 304 mm / + Bremsscheibendicke 28 mm<sup>1)</sup><br/>+ Bremsscheibendurchm. 304 mm / + Bremsscheibendicke 28 mm<sup>1)</sup><br/>+ Bremsscheibendurchm. 304 mm / + Bremsscheibendicke 28 mm<sup>1)</sup></p> | <p>13.0460-7277.2 607277</p> | <p>24332 18,3 +WK</p>          | <p>ATE</p>              |
|  | <p>1.6 BlueHdi 120 88<br/>1.6 Hdi<br/>1.6 Hdi 82<br/>1.6 THP 115<br/>1.6 THP 121<br/>1.6 THP 150 110<br/>1.6 VTi<br/>2.0 HDi<br/>2.0 HDi 120<br/>2.0 HDi 150 110<br/>2.0 HDi 180 133<br/>2.0 HDi 180 RXH 133<br/>2.0 HDi Hybrid4 AWC 120<br/>2.2 HDi 150</p>   |  | <p>03.14<br/>02.12<br/>11.10<br/>11.10<br/>02.12<br/>11.10<br/>11.10<br/>11.10<br/>11.10<br/>04.14<br/>04.14<br/>10.14<br/>11.10<br/>11.10</p> | <p>+ Bremsscheibendurchm. 340 mm / + Bremsscheibendicke 30 mm<sup>2)</sup><br/>+ Bremsscheibendurchm. 340 mm / + Bremsscheibendicke 30 mm<sup>2)</sup><br/>+ Bremsscheibendurchm. 340 mm / + Bremsscheibendicke 30 mm<sup>2)</sup><br/>+ Bremsscheibendurchm. 340 mm / + Bremsscheibendicke 30 mm<sup>2)</sup><br/>+ Bremsscheibendurchm. 340 mm / + Bremsscheibendicke 30 mm<sup>2)</sup><br/>+ Bremsscheibendurchm. 340 mm / + Bremsscheibendicke 30 mm<sup>2)</sup><br/>+ Bremsscheibendurchm. 340 mm / + Bremsscheibendicke 30 mm<sup>2)</sup><br/>+ Bremsscheibendurchm. 340 mm / + Bremsscheibendicke 30 mm<sup>2)</sup><br/>+ Bremsscheibendurchm. 340 mm / + Bremsscheibendicke 30 mm<sup>2)</sup><br/>+ Bremsscheibendurchm. 340 mm / + Bremsscheibendicke 30 mm<sup>2)</sup><br/>+ Bremsscheibendurchm. 340 mm / + Bremsscheibendicke 30 mm<sup>2)</sup><br/>+ Bremsscheibendurchm. 340 mm / + Bremsscheibendicke 30 mm<sup>2)</sup><br/>+ Bremsscheibendurchm. 340 mm / + Bremsscheibendicke 30 mm<sup>2)</sup><br/>+ Bremsscheibendurchm. 340 mm / + Bremsscheibendicke 30 mm<sup>2)</sup><br/>+ Bremsscheibendurchm. 340 mm / + Bremsscheibendicke 30 mm<sup>2)</sup><br/>+ Bremsscheibendurchm. 340 mm / + Bremsscheibendicke 30 mm<sup>2)</sup></p> | <p>13.0460-7279.2 607279</p> | <p>25069 17,3 +WK</p>          | <p>ATE</p>              |
|  | <p>1.6 BlueHdi 120 88<br/>1.6 Hdi<br/>1.6 Hdi 82<br/>1.6 THP 115<br/>1.6 THP 121<br/>1.6 THP 150 110<br/>1.6 VTi<br/>2.0 HDi<br/>2.0 HDi 120<br/>2.0 HDi 150 110<br/>2.0 HDi 180 133<br/>2.0 HDi 180 RXH 133<br/>2.0 HDi Hybrid4 AWC 120<br/>2.2 HDi 150</p>   |  | <p>03.14<br/>02.12<br/>11.10<br/>11.10<br/>02.12<br/>11.10<br/>11.10<br/>11.10<br/>11.10<br/>04.14<br/>04.14<br/>10.14<br/>11.10<br/>11.10</p> |  | <p>24.0126-0121.1 426121</p> | <p>283 26,0 24,0 V L +S +B</p> |                         |
|  | <p>1.6 BlueHdi 120 88<br/>1.6 Hdi<br/>1.6 Hdi 82<br/>1.6 THP 115<br/>1.6 THP 121<br/>1.6 THP 150 110<br/>1.6 VTi<br/>2.0 HDi<br/>2.0 HDi 120<br/>2.0 HDi 150 110<br/>2.0 HDi 180 133<br/>2.0 HDi 180 RXH 133<br/>2.0 HDi Hybrid4 AWC 120<br/>2.2 HDi 150</p>   |  | <p>03.14<br/>02.12<br/>11.10<br/>11.10<br/>02.12<br/>11.10<br/>11.10<br/>11.10<br/>11.10<br/>04.14<br/>04.14<br/>10.14<br/>11.10<br/>11.10</p> |  | <p>24.0128-0269.1 428269</p> | <p>304 28,0 26,0 V L +S +B</p> |                         |
|  | <p>1.6 BlueHdi 120 88<br/>1.6 Hdi<br/>1.6 Hdi 82<br/>1.6 THP 115<br/>1.6 THP 121<br/>1.6 THP 150 110<br/>1.6 VTi<br/>2.0 HDi<br/>2.0 HDi 120<br/>2.0 HDi 150 110<br/>2.0 HDi 180 133<br/>2.0 HDi 180 RXH 133<br/>2.0 HDi Hybrid4 AWC 120<br/>2.2 HDi 150</p>   |  | <p>03.14<br/>02.12<br/>11.10<br/>11.10<br/>02.12<br/>11.10<br/>11.10<br/>11.10<br/>11.10<br/>04.14<br/>04.14<br/>10.14<br/>11.10<br/>11.10</p> |  | <p>24.0130-0227.1 430227</p> | <p>340 30,0 28,0 V L +S +B</p> |                         |
|  | <p>1.6 BlueHdi 120 88<br/>1.6 Hdi<br/>1.6 Hdi 82<br/>1.6 THP 115<br/>1.6 THP 121<br/>1.6 THP 150 110<br/>1.6 VTi<br/>2.0 HDi<br/>2.0 HDi 120<br/>2.0 HDi 150 110</p>   |  | <p>03.14<br/>02.12<br/>11.10<br/>11.10<br/>02.12<br/>11.10<br/>11.10<br/>11.10<br/>11.10<br/>04.14</p>   |  | <p>24.0711-5375.3 360397</p> | <p>2</p>                       | <p>Radsensor L=1233</p> |

1) + br.disc diam. 304mm /+ br.disc thickness 28mm / + disco fr.diam. 304mm /+ disco fr.spessore 28mm / + disques fr.diam. 304mm /+ disques fr.épaisseur 28mm / + disco fr.diam. 304mm /+ disco fr.espesor 28mm  
2) + br.disc diam. 340mm /+ br.disc thickness 30mm / + disco fr.diam. 340mm /+ disco fr.spessore 30mm / + disques fr.diam. 340mm /+ disques fr.épaisseur 30mm / + disco fr.diam. 340mm /+ disco fr.espesor 30mm



**PEUGEOT 508 SW (10-)**

|  |  |   |  |   |  |                                  |                  |   |  |  |
|--|--|---|--|---|--|----------------------------------|------------------|---|--|--|
|  | 2.0 HDi 180<br>2.0 HDi 180 RXH<br>2.0 HDi Hybrid4 AWC<br>2.2 HDi   | 133<br>133<br>120<br>150  |  | 04.14<br>10.14<br>11.10<br>11.10  |  | 24.0711-5375.3                   | 360397           | 2 |  | Radsensor L=1233                           |
|  | 1.6 BlueHDi 120<br>1.6 HDi<br>1.6 HDi<br>1.6 THP<br>1.6 THP<br>1.6 THP 150<br>1.6 VTi<br>2.0 HDi<br>2.0 HDi<br>2.0 HDi 150<br>2.0 HDi 180<br>2.2 HDi<br>2.0 HDi 180 RXH<br>2.0 HDi Hybrid4 AWC | 88<br>82<br>82<br>115<br>121<br>110<br>120<br>110<br>133<br>150 |  | 03.14<br>02.12<br>11.10<br>11.10<br>02.12<br>11.10<br>11.10<br>11.10<br>04.14<br>04.14<br>11.10 |  | 13.0460-7278.2                   | 607278           |   |  | 25218 16,6 + ATE                           |
|  | 1.6 BlueHDi 120<br>1.6 HDi<br>1.6 HDi<br>1.6 THP<br>1.6 THP<br>1.6 THP 150<br>1.6 VTi<br>2.0 HDi<br>2.0 HDi<br>2.0 HDi 150<br>2.2 HDi<br>2.0 HDi 180 RXH<br>2.0 HDi Hybrid4 AWC                | 88<br>82<br>82<br>115<br>121<br>110<br>120<br>110<br>133<br>120 |  | 03.14<br>02.12<br>11.10<br>11.10<br>02.12<br>11.10<br>11.10<br>11.10<br>10.14<br>11.10          |  | 13.0460-2761.2                   | 602761           |   | elektrische Feststellbremse 1)                                       | 24922 17,5 /Zub/S TRW                      |
|  | 1.6 BlueHDi 120<br>1.6 HDi<br>1.6 HDi<br>1.6 THP<br>1.6 THP<br>1.6 THP 150<br>1.6 VTi<br>2.0 HDi<br>2.0 HDi<br>2.0 HDi 150<br>2.2 HDi<br>2.0 HDi 180 RXH<br>2.0 HDi Hybrid4 AWC                | 88<br>82<br>82<br>115<br>121<br>110<br>120<br>110<br>133<br>120 |  | 03.14<br>02.12<br>11.10<br>11.10<br>02.12<br>11.10<br>11.10<br>11.10<br>10.14<br>11.10          |  | 24.0112-0197.1                   | 412197           |   |  | 290 12,0 10,0 +S +B                        |
|  | 1.6 BlueHDi 120<br>1.6 HDi<br>1.6 HDi<br>1.6 THP<br>1.6 THP<br>1.6 THP 150<br>1.6 VTi<br>2.0 HDi<br>2.0 HDi<br>2.0 HDi 150<br>2.2 HDi<br>2.0 HDi 180 RXH<br>2.0 HDi Hybrid4 AWC                | 88<br>82<br>82<br>115<br>121<br>110<br>120<br>110<br>133<br>120 |  | 03.14<br>02.12<br>11.10<br>11.10<br>02.12<br>11.10<br>11.10<br>11.10<br>10.14<br>11.10          |  | 24.0112-0197.1<br>24.0112-0162.1 | 412197<br>412162 |   | - elektrische Feststellbremse 2)<br>+ elektrische Feststellbremse 3) | 290 12,0 10,0 +S +B<br>290 12,0 10,0 +S +B |
|  | 1.6 BlueHDi 120<br>1.6 HDi<br>1.6 HDi<br>1.6 THP<br>1.6 THP<br>1.6 THP 150<br>1.6 VTi<br>2.0 HDi<br>2.0 HDi<br>2.0 HDi 150<br>2.2 HDi<br>2.0 HDi 180 RXH<br>2.0 HDi Hybrid4 AWC                | 88<br>82<br>82<br>115<br>121<br>110<br>120<br>110<br>133<br>120 |  | 03.14<br>02.12<br>11.10<br>11.10<br>02.12<br>11.10<br>11.10<br>11.10<br>10.14<br>11.10          |  | 24.0711-5346.3                   | 360373           | 2 |  | Radsensor L=1762                           |

**PEUGEOT 605 (90-99)**

|  |  |   |  |   |     |                                  |                  |  |  |  |
|--|--|---|--|---|-----|----------------------------------|------------------|--|--|--|
|  | 2.0<br>2.0 i<br>2.0 Turbo<br>2.1 D<br>2.1 TD<br>3.0 V6<br>3.0 V6                                   |   | S 90807683<br>S 90807683<br>S 90807683<br>S 90807683<br>S 90807683<br>S 90807683<br>S 90807683 | 04.90<br>04.90<br>12.92<br>04.90<br>10.90<br>04.90<br>04.90                   | - ⊕ | 13.0460-3902.2<br>13.0460-0206.2 | 603902<br>610206 |  |  | 21299 17,0 +/WK<br>Belagsatz-Zubehör BDX BDX |
|  | 2.0<br>2.0 16V<br>2.0 i<br>2.0 Turbo<br>2.0 Turbo<br>2.1 D<br>2.1 TD<br>2.5 TD<br>3.0 V6           | S 90807684<br>97<br>89 S 90807684<br>104 S 90807684<br>108<br>60 S 90807684<br>80 S 90807684<br>95<br>123 S 90807684                          |  | 09.94<br>12.99<br>12.99<br>08.94<br>12.99<br>08.94<br>12.99<br>12.99          | - ⊕ | 13.0460-3948.2                   | 603948           |  |  | 21508 17,0 +/WK BDX                          |
|  | 2.0<br>2.0 i<br>2.0 Turbo<br>2.1 D<br>2.1 TD<br>3.0 V6<br>3.0 V6                                   | 89<br>104<br>60<br>80<br>123<br>147   | S 90807683<br>S 90807683<br>S 90807683<br>S 90807683<br>S 90807683<br>S 90807683<br>S 90807683 | 04.90<br>04.90<br>12.92<br>04.90<br>10.90<br>04.90<br>04.90                   | - ⊕ | 24.0122-0141.1                   | 422141           |  |  | 276 22,0 20,0 V                              |
|  | 2.0<br>2.0 16V<br>2.0 i<br>2.0 Turbo<br>2.0 Turbo<br>2.1 D<br>2.1 TD<br>2.5 TD<br>3.0 V6<br>3.0 V6 | S 90807684<br>97<br>89 S 90807684<br>104 S 90807684<br>108<br>60 S 90807684<br>80 S 90807684<br>95<br>123 S 90807684<br>140<br>147 S 90807684 |  | 09.94<br>12.99<br>12.99<br>08.94<br>12.99<br>08.94<br>12.99<br>12.99<br>12.99 | - ⊕ | 24.0126-0100.1                   | 426100           |  |  | 283 26,0 24,0 V L                            |
|  | 2.0<br>2.0 16V<br>2.0 i<br>2.0 Turbo<br>2.0 Turbo<br>2.1 D   | 89<br>97<br>89<br>104<br>108<br>60  | S 91036112<br>S 91036112<br>S 91036112<br>S 91036112<br>S 91036112                             | 04.90<br>09.94<br>04.90<br>12.92<br>09.94<br>04.90                            | - ⊕ | 13.0460-4014.2<br>13.0460-0409.2 | 604014<br>610409 |  |  | 21278 16,4 +/WK<br>Belagsatz-Zubehör ATE ATE |

1) electric parking brake / fr.di stazionamento elettrico / frein à main électrique / freno de mano eléctrico  
 2) - electric parking brake / - freno a mano elettrico / - frein à main électrique / - freno de mano eléctrico  
 3) + electric parking brake / + freno a mano elettrico / + frein à main électrique / + freno de mano eléctrico



**PEUGEOT 605 (90-99)**

|        |           |            |            |       |       |                |                |        |                     |              |
|--------|-----------|------------|------------|-------|-------|----------------|----------------|--------|---------------------|--------------|
|        | 2.1 TD    | 80         | S 91036112 | 10.90 |       | 13.0460-4014.2 | 604014         |        | 21278 16,4 +/WK     | ATE          |
|        | 2.5 TD    | 95         | S 91036112 | 09.94 |       | 13.0460-0409.2 | 610409         |        | Belagsatz-Zubehör   | ATE          |
|        | 3.0 V6    | 123        | S 91036112 | 04.90 |       |                |                |        |                     |              |
|        | 3.0 V6    | 147        | S 91036112 | 04.90 |       |                |                |        |                     |              |
|        | 2.0       | S 91036113 |            | 12.99 | - ⊕   | 13.0460-7107.2 | 607107         |        | 21278 16,4          | ATE          |
|        | 2.0 16V   | 97         | S 91036113 | 12.99 |       |                |                |        |                     |              |
|        | 2.0 i     | 89         | S 91036113 | 12.99 |       |                |                |        |                     |              |
|        | 2.0 Turbo | 108        | S 91036113 | 12.99 |       |                |                |        |                     |              |
|        | 2.1 TD    | 80         | S 91036113 | 12.99 |       |                |                |        |                     |              |
|        | 2.5 TD    | 95         | S 91036113 | 12.99 |       |                |                |        |                     |              |
| 3.0 V6 | 123       | S 91036113 | 12.99      |       |       |                |                |        |                     |              |
| 3.0 V6 | 140       |            | 04.97      | 12.99 |       |                |                |        |                     |              |
| 3.0 V6 | 147       | S 91036113 | 12.99      |       |       |                |                |        |                     |              |
|        | 2.0       |            |            | 04.90 | 12.99 | - ⊕            | 24.0110-0231.1 | 410231 |                     | 290 10,0 8,0 |
|        | 2.0 16V   | 97         |            | 09.94 | 12.99 |                |                |        |                     |              |
|        | 2.0 i     | 89         |            | 04.90 | 12.99 |                |                |        |                     |              |
|        | 2.0 Turbo | 104        |            | 12.92 | 08.94 |                |                |        |                     |              |
|        | 2.0 Turbo | 108        |            | 09.94 | 12.99 |                |                |        |                     |              |
|        | 2.1 D     | 60         |            | 04.90 | 08.94 |                |                |        |                     |              |
|        | 2.1 TD    | 80         |            | 10.90 | 12.99 |                |                |        |                     |              |
|        | 2.5 TD    | 95         |            | 09.94 | 12.99 |                |                |        |                     |              |
|        | 3.0 V6    | 123        |            | 04.90 | 12.99 |                |                |        |                     |              |
|        | 3.0 V6    | 140        |            | 04.97 | 12.99 |                |                |        |                     |              |
| 3.0 V6 | 147       |            | 04.90      | 12.99 |       |                |                |        |                     |              |
|        | 2.0       |            |            | 04.90 | 12.99 | - ⊕            | 03.0137-0409.2 | 650409 | 186 x 20            |              |
|        | 2.0 16V   | 97         |            | 09.94 | 12.99 |                | 03.0137-9701.2 | 669701 | Bremsbacken-Zubehör |              |
|        | 2.0 i     | 89         |            | 04.90 | 12.99 |                |                |        |                     |              |
|        | 2.0 Turbo | 104        |            | 12.92 | 08.94 |                |                |        |                     |              |
|        | 2.0 Turbo | 108        |            | 09.94 | 12.99 |                |                |        |                     |              |
|        | 2.1 D     | 60         |            | 04.90 | 08.94 |                |                |        |                     |              |
|        | 2.1 TD    | 80         |            | 10.90 | 12.99 |                |                |        |                     |              |
|        | 2.5 TD    | 95         |            | 09.94 | 12.99 |                |                |        |                     |              |
|        | 3.0 V6    | 123        |            | 04.90 | 12.99 |                |                |        |                     |              |
|        | 3.0 V6    | 140        |            | 04.97 | 12.99 |                |                |        |                     |              |
| 3.0 V6 | 147       |            | 04.90      | 12.99 |       |                |                |        |                     |              |

**PEUGEOT 607 (00-10)**

|             |            |     |       |       |       |  |                |        |                   |                          |
|-------------|------------|-----|-------|-------|-------|--|----------------|--------|-------------------|--------------------------|
|             | 2.0        | 100 |       | 02.00 | 11.04 |  | 13.0460-2844.2 | 602844 |                   | 21674 19,4 +/WK/Zub/STRW |
|             | 2.0 HDi    | 79  |       | 03.01 | 07.04 |  |                |        |                   |                          |
|             | 2.0 HDi    | 80  |       | 05.00 | 11.04 |  |                |        |                   |                          |
|             | 2.2 16V    | 116 |       | 02.00 | 11.04 |  |                |        |                   |                          |
|             | 2.2 HDi    | 98  |       | 02.00 | 11.04 |  |                |        |                   |                          |
|             | 3.0 V6 24V | 152 |       | 02.00 | 11.04 |  | 13.0460-4972.2 | 604972 |                   | 23575 16,0 +/WK/Zub BRE  |
|             | 2.0        | 100 |       | 12.04 | 12.10 |  | 13.0460-2892.2 | 602892 |                   | 24133 18,6 +/WK/Zub/STRW |
|             | 2.0 HDi    | 80  |       | 12.04 | 12.10 |  | 13.0470-2892.2 | LD2892 |                   | 24133 18,6 +/WK/Zub/STRW |
|             | 2.0 HDi    | 100 |       | 09.05 | 12.10 |  |                |        |                   |                          |
|             | 2.2 16V    | 116 |       | 12.04 | 12.10 |  |                |        |                   |                          |
| 2.2 16V     | 120        |     | 09.05 | 12.10 |       |  |                |        |                   |                          |
| 2.2 HDi     | 98         |     | 12.04 | 12.10 |       |  |                |        |                   |                          |
| 2.2 HDi     | 125        |     | 05.06 | 12.10 |       |  |                |        |                   |                          |
| 2.7 HDi 24V | 150        |     | 12.04 | 12.10 |       |  |                |        |                   |                          |
| 3.0 V6 24V  | 155        |     | 03.04 | 12.10 |       |  |                |        |                   |                          |
|             | 2.0        | 100 |       | 02.00 | 11.04 |  | 24.0126-0121.1 | 426121 |                   | 283 26,0 24,0 V L +S +B  |
|             | 2.0 HDi    | 79  |       | 03.01 | 07.04 |  |                |        |                   |                          |
|             | 2.0 HDi    | 80  |       | 05.00 | 11.04 |  |                |        |                   |                          |
|             | 2.2 16V    | 116 |       | 02.00 | 11.04 |  |                |        |                   |                          |
|             | 2.2 HDi    | 98  |       | 02.00 | 11.04 |  |                |        |                   |                          |
|             | 3.0 V6 24V | 152 |       | 02.00 | 11.04 |  | 24.0132-0152.1 | 432152 |                   | 309 32,0 30,0 V          |
|             | 2.0        | 100 |       | 12.04 | 12.10 |  | 24.0130-0181.1 | 430181 |                   | 330 30,0 28,0 V +S +B    |
|             | 2.0 HDi    | 80  |       | 12.04 | 12.10 |  |                |        |                   |                          |
|             | 2.0 HDi    | 100 |       | 09.05 | 12.10 |  |                |        |                   |                          |
|             | 2.2 16V    | 116 |       | 12.04 | 12.10 |  |                |        |                   |                          |
| 2.2 16V     | 120        |     | 09.05 | 12.10 |       |  |                |        |                   |                          |
| 2.2 HDi     | 98         |     | 12.04 | 12.10 |       |  |                |        |                   |                          |
| 2.2 HDi     | 125        |     | 05.06 | 12.10 |       |  |                |        |                   |                          |
| 2.7 HDi 24V | 150        |     | 12.04 | 12.10 |       |  |                |        |                   |                          |
| 3.0 V6 24V  | 155        |     | 03.04 | 12.10 |       |  |                |        |                   |                          |
|             | 2.0        | 100 |       | 02.00 | 11.04 |  | 13.0460-7134.2 | 607134 | 21278 16,4        | ATE                      |
|             | 2.0 HDi    | 79  |       | 03.01 | 07.04 |  | 13.0460-0409.2 | 610409 | Belagsatz-Zubehör | ATE                      |
|             | 2.0 HDi    | 80  |       | 05.00 | 11.04 |  |                |        |                   |                          |
|             | 2.2 16V    | 116 |       | 02.00 | 11.04 |  |                |        |                   |                          |
|             | 2.2 HDi    | 98  |       | 02.00 | 11.04 |  |                |        |                   |                          |
|             | 3.0 V6 24V | 152 |       | 02.00 | 11.04 |  |                |        |                   |                          |
|             | 2.0        | 100 |       | 12.04 | 12.10 |  | 13.0460-2893.2 | 602893 | 24135 17,7 /S     | TRW                      |
|             | 2.0 HDi    | 80  |       | 12.04 | 12.10 |  | 13.0470-2893.2 | LD2893 | 24135 17,7 /S     | TRW                      |
|             | 2.0 HDi    | 100 |       | 09.05 | 12.10 |  |                |        |                   |                          |
|             | 2.2 16V    | 116 |       | 12.04 | 12.10 |  |                |        |                   |                          |
| 2.2 16V     | 120        |     | 09.05 | 12.10 |       |  |                |        |                   |                          |
| 2.2 HDi     | 98         |     | 12.04 | 12.10 |       |  |                |        |                   |                          |
| 2.2 HDi     | 125        |     | 05.06 | 12.10 |       |  |                |        |                   |                          |
| 2.7 HDi 24V | 150        |     | 12.04 | 12.10 |       |  |                |        |                   |                          |
| 3.0 V6 24V  | 155        |     | 03.04 | 12.10 |       |  |                |        |                   |                          |



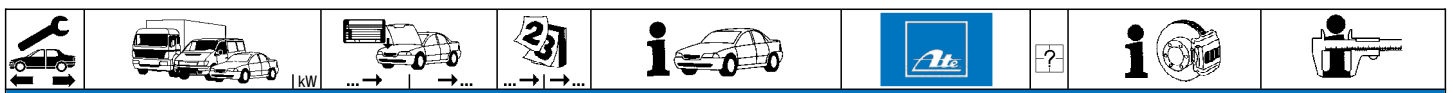

**PEUGEOT 607 (00-10)**

|             |            |     |       |       |       |                |        |  |  |                |        |  |                     |
|-------------|------------|-----|-------|-------|-------|----------------|--------|--|--|----------------|--------|--|---------------------|
|             | 2.0        | 100 |       | 02.00 | 11.04 | 24.0110-0272.1 | 410272 |  | 290 10,0 8,0   |                |        |  |                     |
|             | 2.0 HDi    | 79  |       | 03.01 | 07.04 |                |        |  |  |                |        |  |                     |
|             | 2.0 HDi    | 80  |       | 05.00 | 11.04 |                |        |  |  |                |        |  |                     |
|             | 2.2 16V    | 116 |       | 02.00 | 11.04 |                |        |  |  |                |        |  |                     |
|             | 2.2 HDi    | 98  |       | 02.00 | 11.04 |                |        |  |  |                |        |  |                     |
|             | 3.0 V6 24V | 152 |       | 02.00 | 11.04 |                |        |  |  |                |        |  |                     |
|             | 2.0        | 100 |       | 12.04 | 12.10 |                |        |  |  | 24.0112-0162.1 | 412162 |  | 290 12,0 10,0 +S +B |
|             | 2.0 HDi    | 80  |       | 12.04 | 12.10 |                |        |  |  |                |        |  |                     |
|             | 2.0 HDi    | 100 |       | 09.05 | 12.10 |                |        |  |  |                |        |  |                     |
|             | 2.2 16V    | 116 |       | 12.04 | 12.10 |                |        |  |  |                |        |  |                     |
| 2.2 16V     | 120        |     | 09.05 | 12.10 |       |                |        |  |  |                |        |  |                     |
| 2.2 HDi     | 98         |     | 12.04 | 12.10 |       |                |        |  |  |                |        |  |                     |
| 2.2 HDi     | 125        |     | 05.06 | 12.10 |       |                |        |  |  |                |        |  |                     |
| 2.7 HDi 24V | 150        |     | 12.04 | 12.10 |       |                |        |  |  |                |        |  |                     |
| 3.0 V6 24V  | 155        |     | 03.04 | 12.10 |       |                |        |  |  |                |        |  |                     |
|             | 2.0        | 100 |       | 02.00 | 11.04 | 03.0137-4010.2 | 654010 |  | 180 x 30 /Zub<br>Bremsbacken-Zubehör<br>Bremsbacken-Zubehör<br>Spreizschloß Satz |                |        |  |                     |
|             | 2.0 HDi    | 79  |       | 03.01 | 07.04 |                |        |  |  |                |        |  |                     |
|             | 2.0 HDi    | 80  |       | 05.00 | 11.04 |                |        |  |  |                |        |  |                     |
|             | 2.2 16V    | 116 |       | 02.00 | 11.04 |                |        |  |  |                |        |  |                     |
|             | 2.2 HDi    | 98  |       | 02.00 | 11.04 |                |        |  |  |                |        |  |                     |
|             | 3.0 V6 24V | 152 |       | 02.00 | 11.04 |                |        |  |  |                |        |  |                     |
|             |            |     |       |       |       |                |        |  |  |                |        |  |                     |

**PEUGEOT 806 (94-02)**

|  |           |     |  |       |       |                |        |  |  |            |
|--|-----------|-----|--|-------|-------|----------------|--------|--|--|------------|
|  | 1.8 i     | 73  |  | 10.96 | 06.02 | 13.0460-3957.2 | 603957 |  | 23042 19,0 /WK/Zub   | <b>BDX</b> |
|  | 1.9 TD    |     |  | 07.95 | 06.02 |                |        |  |  |            |
|  | 2.0 16V   |     |  | 10.98 | 06.02 |                |        |  |  |            |
|  | 2.0 HDi   | 80  |  | 08.99 | 06.02 |                |        |  |  |            |
|  | 2.0 i     | 89  |  | 08.94 | 06.02 |                |        |  |  |            |
|  | 2.0 Turbo | 108 |  | 08.94 | 06.02 |                |        |  |  |            |
|  | 2.1 TD    | 80  |  | 06.96 | 06.02 |                |        |  |  |            |
|  | 1.8 i     | 73  |  | 10.96 | 06.02 | 24.0120-0155.1 | 420155 |  | 258 20,0 18,2 V L +B   |            |
|  | 1.9 TD    |     |  | 07.95 | 06.02 |                |        |  |  |            |
|  | 2.0 16V   |     |  | 10.98 | 06.02 |                |        |  |  |            |
|  | 2.0 HDi   | 80  |  | 08.99 | 06.02 |                |        |  |  |            |
|  | 2.0 i     | 89  |  | 08.94 | 06.02 |                |        |  |  |            |
|  | 2.0 Turbo | 108 |  | 08.94 | 06.02 |                |        |  |  |            |
|  | 2.1 TD    | 80  |  | 06.96 | 06.02 |                |        |  |  |            |
|  | 1.8 i     | 73  |  | 10.96 | 06.02 | 13.0460-7061.2 | 607061 |  | 21275 17,0 +/WK  | <b>ATE</b> |
|  | 1.9 TD    |     |  | 07.95 | 06.02 |                |        |  |  |            |
|  | 2.0 16V   |     |  | 10.98 | 06.02 |                |        |  |  |            |
|  | 2.0 HDi   | 80  |  | 08.99 | 06.02 |                |        |  |  |            |
|  | 2.0 i     | 89  |  | 08.94 | 06.02 |                |        |  |  |            |
|  | 2.0 Turbo | 108 |  | 08.94 | 06.02 |                |        |  |  |            |
|  | 2.1 TD    | 80  |  | 06.96 | 06.02 |                |        |  |  |            |
|  | 1.8 i     | 73  |  | 10.96 | 06.02 | 24.0110-0218.1 | 410218 |  | 295 10,0 8,0 +B  |            |
|  | 1.9 TD    |     |  | 07.95 | 06.02 |                |        |  |  |            |
|  | 2.0 16V   |     |  | 10.98 | 06.02 |                |        |  |  |            |
|  | 2.0 HDi   | 80  |  | 08.99 | 06.02 |                |        |  |  |            |
|  | 2.0 i     | 89  |  | 08.94 | 06.02 |                |        |  |  |            |
|  | 2.0 Turbo | 108 |  | 08.94 | 06.02 |                |        |  |  |            |
|  | 2.1 TD    | 80  |  | 06.96 | 06.02 |                |        |  |  |            |
|  | 1.8 i     | 73  |  | 10.96 | 06.02 | 03.0137-0314.2 | 650314 |  | 255 x 61<br>Bremsbacken-Zubehör  |            |
|  | 1.9 TD    |     |  | 07.95 | 06.02 |                |        |  |  |            |
|  | 2.0 HDi   | 80  |  | 08.99 | 06.02 |                |        |  |  |            |
|  | 2.0 i     | 89  |  | 08.94 | 06.02 |                |        |  |  |            |
|  | 1.8 i     | 73  |  | 10.96 | 06.02 | 24.0225-5003.1 | 480066 |  | 255/256 x 67   |            |
|  | 1.9 TD    |     |  | 07.95 | 06.02 |                |        |  |  |            |
|  | 2.0 HDi   | 80  |  | 08.99 | 06.02 |                |        |  |  |            |
|  | 2.0 i     | 89  |  | 08.94 | 06.02 |                |        |  |  |            |
|  | 1.8 i     | 73  |  | 10.96 | 06.02 | 03.0520-2619.3 | 692619 |  | 19,05/255x61 TopKit  | <b>BDX</b> |
|  | 1.9 TD    |     |  | 07.95 | 06.02 |                |        |  |  |            |
|  | 2.0 HDi   | 80  |  | 08.99 | 06.02 |                |        |  |  |            |
|  | 2.0 i     | 89  |  | 08.94 | 06.02 |                |        |  |  |            |
|  | 1.8 i     | 73  |  | 10.96 | 06.02 | 03.0137-4018.2 | 654018 |  | 180 x 30 /Zub<br>Bremsbacken-Zubehör<br>Bremsbacken-Zubehör<br>Spreizschloß Satz |            |
|  | 1.9 TD    |     |  | 07.95 | 06.02 |                |        |  |  |            |
|  | 2.0 16V   |     |  | 10.98 | 06.02 |                |        |  |  |            |
|  | 2.0 HDi   | 80  |  | 08.99 | 06.02 |                |        |  |  |            |
|  | 2.0 i     | 89  |  | 08.94 | 06.02 |                |        |  |  |            |
|  | 2.0 Turbo | 108 |  | 08.94 | 06.02 |                |        |  |  |            |
|  | 2.1 TD    | 80  |  | 06.96 | 06.02 |                |        |  |  |            |

**PEUGEOT 807 (02-14)**

|         |         |     |       |       |                |                |        |                 |                   |            |
|---------|---------|-----|-------|-------|----------------|----------------|--------|-----------------|-------------------|------------|
|         | 2.0 16V | 100 |       | 06.02 | 06.14          | 13.0460-2863.2 | 602863 |                 | 20261 19,0 +/WK/S | <b>TRW</b> |
|         | 2.0 16V | 103 |       | 09.05 | 06.14          |                |        |                 |                   |            |
|         | 2.0 HDi | 79  |       | 06.02 | 06.14          |                |        |                 |                   |            |
|         | 2.0 HDi | 80  |       | 04.04 | 05.06          |                |        |                 |                   |            |
|         | 2.0 HDi | 88  |       | 11.06 | 06.14          |                |        |                 |                   |            |
|         | 2.0 HDi | 100 |       | 06.06 | 06.14          |                |        |                 |                   |            |
|         | 2.2 16V | 116 |       | 06.02 | 06.14          |                |        |                 |                   |            |
|         | 2.2 HDi | 94  |       | 06.02 | 06.14          |                |        |                 |                   |            |
|         | 2.2 HDi | 100 |       | 04.04 | 06.14          |                |        |                 |                   |            |
|         | 2.0 HDi | 120 |       | 06.09 | 06.14          |                |        |                 |                   |            |
| 2.2 HDi |         |     | 01.07 | 06.14 |                |                |        |                 |                   |            |
| 3.0 V6  | 150     |     | 06.02 | 06.14 | 13.0460-4995.2 | 604995         |        | 23575 15,6 +/WK | <b>BRE</b>        |            |













**PEUGEOT 807 (02-14)**

|  |         |     |  |       |       |  |                |        |   |  |                       |
|--|---------|-----|--|-------|-------|--|----------------|--------|---|--|-----------------------|
|  | 2.0 16V | 100 |  | 06.02 | 06.14 |  | 24.0128-0136.1 | 428136 |   |  | 285 28,0 26,0 V +B    |
|  | 2.0 16V | 103 |  | 09.05 | 06.14 |  | 24.0328-0136.1 | 528136 |   |  | 285 28,0 26,0 V +B PD |
|  | 2.0 HDi | 79  |  | 06.02 | 06.14 |  |                |        |   |  |                       |
|  | 2.0 HDi | 80  |  | 04.04 | 05.06 |  |                |        |   |  |                       |
|  | 2.0 HDi | 88  |  | 11.06 | 06.14 |  |                |        |   |  |                       |
|  | 2.0 HDi | 100 |  | 06.06 | 06.14 |  |                |        |   |  |                       |
|  | 2.0 HDi | 120 |  | 06.09 | 06.14 |  |                |        |   |  |                       |
|  | 2.2 16V | 116 |  | 06.02 | 06.14 |  |                |        |   |  |                       |
|  | 2.2 HDi | 94  |  | 06.02 | 06.14 |  |                |        |   |  |                       |
|  | 2.2 HDi | 100 |  | 04.04 | 06.14 |  |                |        |   |  |                       |
|  | 2.2 HDi |     |  | 10.07 | 06.14 |  | 24.0132-0126.1 | 432126 |   |  | 310 32,0 30,0 V       |
|  | 3.0 V6  | 150 |  | 06.02 | 06.14 |  |                |        |   |  |                       |
|  | 2.0 16V | 100 |  | 06.02 | 06.14 |  | 13.0460-2819.2 | 602819 |   |  | 20961 17,6 /S         |
|  | 2.0 16V | 103 |  | 09.05 | 06.14 |  | 13.0460-0072.2 | 610072 |   |  | Belagsatz-Zubehör     |
|  | 2.0 HDi | 79  |  | 06.02 | 06.14 |  |                |        |   |  | TRW                   |
|  | 2.0 HDi | 80  |  | 04.04 | 05.06 |  |                |        |   |  | TRW                   |
|  | 2.0 HDi | 88  |  | 11.06 | 06.14 |  |                |        |   |  |                       |
|  | 2.0 HDi | 100 |  | 06.06 | 06.14 |  |                |        |   |  |                       |
|  | 2.0 HDi | 120 |  | 06.09 | 06.14 |  |                |        |   |  |                       |
|  | 2.2 16V | 116 |  | 06.02 | 06.14 |  |                |        |   |  |                       |
|  | 2.2 HDi |     |  | 10.07 | 06.14 |  |                |        |   |  |                       |
|  | 2.2 HDi | 94  |  | 06.02 | 06.14 |  |                |        |   |  |                       |
|  | 2.2 HDi | 100 |  | 04.04 | 06.14 |  |                |        |   |  |                       |
|  | 3.0 V6  | 150 |  | 06.02 | 06.14 |  |                |        |   |  |                       |
|  | 2.0 16V | 100 |  | 06.02 | 06.14 |  | 24.0112-0156.1 | 412156 |   |  | 272 12,0 10,0 +B      |
|  | 2.0 16V | 103 |  | 09.05 | 06.14 |  |                |        |   |  |                       |
|  | 2.0 HDi | 79  |  | 06.02 | 06.14 |  |                |        |   |  |                       |
|  | 2.0 HDi | 80  |  | 04.04 | 05.06 |  |                |        |   |  |                       |
|  | 2.0 HDi | 88  |  | 11.06 | 06.14 |  |                |        |   |  |                       |
|  | 2.0 HDi | 100 |  | 06.06 | 06.14 |  |                |        |   |  |                       |
|  | 2.0 HDi | 120 |  | 06.09 | 06.14 |  |                |        |   |  |                       |
|  | 2.2 16V | 116 |  | 06.02 | 06.14 |  |                |        |   |  |                       |
|  | 2.2 HDi |     |  | 10.07 | 06.14 |  |                |        |   |  |                       |
|  | 2.2 HDi | 94  |  | 06.02 | 06.14 |  |                |        |   |  |                       |
|  | 2.2 HDi | 100 |  | 04.04 | 06.14 |  |                |        |   |  |                       |
|  | 3.0 V6  | 150 |  | 06.02 | 06.14 |  |                |        |   |  |                       |
|  | 2.0 16V | 100 |  | 06.02 | 06.14 |  | 24.0711-6066.3 | 360130 | 2 |  | Radsensor L=955       |
|  | 2.0 16V | 103 |  | 09.05 | 06.14 |  |                |        |   |  |                       |
|  | 2.0 HDi | 79  |  | 06.02 | 06.14 |  |                |        |   |  |                       |
|  | 2.0 HDi | 80  |  | 04.04 | 05.06 |  |                |        |   |  |                       |
|  | 2.0 HDi | 88  |  | 11.06 | 06.14 |  |                |        |   |  |                       |
|  | 2.0 HDi | 100 |  | 06.06 | 06.14 |  |                |        |   |  |                       |
|  | 2.0 HDi | 120 |  | 06.09 | 06.14 |  |                |        |   |  |                       |
|  | 2.2 16V | 116 |  | 06.02 | 06.14 |  |                |        |   |  |                       |
|  | 2.2 HDi |     |  | 10.07 | 06.14 |  |                |        |   |  |                       |
|  | 2.2 HDi | 94  |  | 06.02 | 06.14 |  |                |        |   |  |                       |
|  | 2.2 HDi | 100 |  | 04.04 | 06.14 |  |                |        |   |  |                       |
|  | 3.0 V6  | 150 |  | 06.02 | 06.14 |  |                |        |   |  |                       |

**PEUGEOT 1007 (05-11)**























|  |             |    |  |       |       |  |                |        |   |  |                          |     |
|--|-------------|----|--|-------|-------|--|----------------|--------|---|--|--------------------------|-----|
|  | 1.4         | 54 |  | 04.05 | 02.11 |  | 13.0460-3994.2 | 603994 |   |  | 23599 19,0 /Zub/S        | BOS |
|  | 1.4 16V     | 65 |  | 10.05 | 02.11 |  | 13.0470-3994.2 | LD3994 |   |  | 23599 19,0 /Zub/S        | BOS |
|  | 1.4 HDi     | 50 |  | 04.05 | 02.11 |  |                |        |   |  |                          |     |
|  | 1.6 16V     | 80 |  | 04.05 | 02.11 |  |                |        |   |  |                          |     |
|  | 1.6 HDi 110 | 80 |  | 04.07 | 02.11 |  | 13.0460-3966.2 | 603966 |   |  | 23600 19,4 /Zub/S        | BOS |
|  |             |    |  |       |       |  | 13.0470-3966.2 | LD3966 |   |  | 23600 19,4 /Zub/S        | BOS |
|  | 1.4         | 54 |  | 04.05 | 02.11 |  | 24.0122-0194.1 | 422194 |   |  | 266 22,0 20,0 V +S +B    |     |
|  | 1.4 16V     | 65 |  | 10.05 | 02.11 |  |                |        |   |  |                          |     |
|  | 1.4 HDi     | 50 |  | 04.05 | 02.11 |  |                |        |   |  |                          |     |
|  | 1.6 16V     | 80 |  | 04.05 | 02.11 |  |                |        |   |  |                          |     |
|  | 1.6 HDi 110 | 80 |  | 04.07 | 02.11 |  | 24.0126-0120.1 | 426120 |   |  | 283 26,0 24,0 V +S +B    |     |
|  |             |    |  |       |       |  | 24.0326-0120.1 | 526120 |   |  | 283 26,0 24,0 V +S +B PD |     |
|  | 1.4         | 54 |  | 04.05 | 02.11 |  | 24.0711-5124.3 | 360066 | 2 |  | Radsensor L=1120         |     |
|  | 1.4 16V     | 65 |  | 10.05 | 02.11 |  |                |        |   |  |                          |     |
|  | 1.4 HDi     | 50 |  | 04.05 | 02.11 |  |                |        |   |  |                          |     |
|  | 1.6 16V     | 80 |  | 04.05 | 02.11 |  |                |        |   |  |                          |     |
|  | 1.6 HDi 110 | 80 |  | 04.07 | 02.11 |  |                |        |   |  |                          |     |
|  | 1.6 16V     | 80 |  | 04.05 | 02.11 |  | 13.0460-2823.2 | 602823 |   |  | 23554 17,2 /S            | TRW |
|  | 1.6 HDi 110 | 80 |  | 04.07 | 02.11 |  | 13.0470-2823.2 | LD2823 |   |  | 23554 17,2 /S            | TRW |
|  | 1.6 16V     | 80 |  | 04.05 | 02.11 |  | 24.0109-0137.1 | 409137 |   |  | 247 9,0 8,0 +S +B        |     |
|  | 1.6 HDi 110 | 80 |  | 04.07 | 02.11 |  |                |        |   |  |                          |     |
|  | 1.4         | 54 |  | 04.05 | 02.11 |  | 24.0711-5093.3 | 360063 | 2 |  | Radsensor L=757          |     |
|  | 1.4 16V     | 65 |  | 10.05 | 02.11 |  |                |        |   |  |                          |     |
|  | 1.4 HDi     | 50 |  | 04.05 | 02.11 |  |                |        |   |  |                          |     |
|  | 1.6 16V     | 80 |  | 04.05 | 02.11 |  |                |        |   |  |                          |     |
|  | 1.6 HDi 110 | 80 |  | 04.07 | 02.11 |  |                |        |   |  |                          |     |
|  | 1.4         | 54 |  | 04.05 | 02.11 |  | 03.0137-0439.2 | 650439 |   |  | 203 x 39 HEB             |     |
|  | 1.4 16V     | 65 |  | 10.05 | 02.11 |  | 03.0137-0426.2 | 650426 |   |  | 203 x 38 HEB             | TRW |
|  | 1.4 HDi     | 50 |  | 04.05 | 02.11 |  | 03.0137-9281.2 | 669281 |   |  | Bremsbacken-Zubehör      |     |
|  |             |    |  |       |       |  | 03.0137-9267.2 | 669267 |   |  | Bremsbacken-Zubehör      | TRW |
|  | 1.4         | 54 |  | 04.05 | 02.11 |  | 24.0220-3029.1 | 480179 |   |  | 203/204,5 x 42 - Lager   |     |
|  | 1.4 16V     | 65 |  | 10.05 | 02.11 |  | 24.0220-3729.2 | 480217 |   |  | 203/204,5 x 42 + Lager   |     |
|  | 1.4 HDi     | 50 |  | 04.05 | 02.11 |  |                |        |   |  |                          |     |



| PEUGEOT 1007 (05-11)   |   | PEUGEOT 2008 (13-)   |   |   |  |  |
|--|---|--|---|---|--|--|
|    | 1.4<br>1.4 16V<br>1.4 HDi   | 54<br>65<br>50   | 04.05 02.11<br>10.05 02.11<br>04.05 02.11   | 03.0520-8520.3 698520<br>03.0520-7620.3 697620  |  | 20,64/203x39 TopKit BOS<br>20,64/203x38 TopKit TRW   |
|    | 1.2 THP 110<br>1.2 THP 130<br>1.2 VTI 82<br>1.4 HDi 68<br>1.6 BlueHDi 100<br>1.6 BlueHDi 120<br>1.6 BlueHDi 75<br>1.6 e-HDi 115<br>1.6 e-HDi 92<br>1.6 HDi 115<br>1.6 VTI 120 | 81<br>96<br>60<br>50<br>73<br>88<br>55<br>84<br>68<br>85<br>88 | 01.15<br>01.15<br>03.13<br>03.13<br>01.15<br>07.14<br>01.15<br>03.13<br>03.13<br>07.14<br>03.13 | + Bremsscheibendurchm. 266 mm <sup>1)</sup><br>+ Bremsscheibendurchm. 266 mm <sup>1)</sup><br>+ Bremsscheibendurchm. 266 mm <sup>1)</sup><br>+ Bremsscheibendurchm. 266 mm <sup>1)</sup><br>+ Bremsscheibendurchm. 266 mm <sup>1)</sup><br>+ Bremsscheibendurchm. 266 mm <sup>1)</sup><br>+ Bremsscheibendurchm. 266 mm <sup>1)</sup><br>+ Bremsscheibendurchm. 266 mm <sup>1)</sup><br>+ Bremsscheibendurchm. 266 mm <sup>1)</sup><br>+ Bremsscheibendurchm. 266 mm <sup>1)</sup><br>+ Bremsscheibendurchm. 266 mm <sup>1)</sup> | 13.0460-3994.2 603994<br>13.0470-3994.2 LD3994 | 23599 19,0 /Zub/S BOS<br>23599 19,0 /Zub/S BOS   |
|    | 1.2 THP 110<br>1.2 THP 130<br>1.2 VTI 82<br>1.4 HDi 68<br>1.6 BlueHDi 100<br>1.6 BlueHDi 120<br>1.6 BlueHDi 75<br>1.6 e-HDi 115<br>1.6 e-HDi 92<br>1.6 HDi 115<br>1.6 VTI 120 | 81<br>96<br>60<br>50<br>73<br>88<br>55<br>84<br>68<br>85<br>88 | 01.15<br>01.15<br>03.13<br>03.13<br>01.15<br>07.14<br>01.15<br>03.13<br>03.13<br>07.14<br>03.13 | + Bremsscheibendurchm. 283 mm <sup>2)</sup><br>+ Bremsscheibendurchm. 283 mm <sup>2)</sup><br>+ Bremsscheibendurchm. 283 mm <sup>2)</sup><br>+ Bremsscheibendurchm. 283 mm <sup>2)</sup><br>+ Bremsscheibendurchm. 283 mm <sup>2)</sup><br>+ Bremsscheibendurchm. 283 mm <sup>2)</sup><br>+ Bremsscheibendurchm. 283 mm <sup>2)</sup><br>+ Bremsscheibendurchm. 283 mm <sup>2)</sup><br>+ Bremsscheibendurchm. 283 mm <sup>2)</sup><br>+ Bremsscheibendurchm. 283 mm <sup>2)</sup><br>+ Bremsscheibendurchm. 283 mm <sup>2)</sup> | 13.0460-3855.2 603855                          | 24883 18,0 +/Zub/S BOS   |
|  | 1.2 THP 110<br>1.2 THP 130<br>1.2 VTI 82<br>1.4 HDi 68<br>1.6 BlueHDi 100<br>1.6 BlueHDi 120<br>1.6 BlueHDi 75<br>1.6 e-HDi 115<br>1.6 e-HDi 92<br>1.6 HDi 115<br>1.6 VTI 120 | 81<br>96<br>60<br>50<br>73<br>88<br>55<br>84<br>68<br>85<br>88 | 01.15<br>01.15<br>03.13<br>03.13<br>01.15<br>07.14<br>01.15<br>03.13<br>03.13<br>07.14<br>03.13 |   | 24.0122-0194.1 422194                          | 266 22,0 20,0 V +S +B  |
|  | 1.2 THP 110<br>1.2 THP 130<br>1.2 VTI 82<br>1.4 HDi 68<br>1.6 BlueHDi 100<br>1.6 BlueHDi 120<br>1.6 BlueHDi 75<br>1.6 e-HDi 115<br>1.6 e-HDi 92<br>1.6 HDi 115<br>1.6 VTI 120 | 81<br>96<br>60<br>50<br>73<br>88<br>55<br>84<br>68<br>85<br>88 | 01.15<br>01.15<br>03.13<br>03.13<br>01.15<br>07.14<br>01.15<br>03.13<br>03.13<br>07.14<br>03.13 |   | 24.0126-0120.1 426120<br>24.0326-0120.1 526120 | 283 26,0 24,0 V +S +B<br>283 26,0 24,0 V +S +B PD  |
|  | 1.2 THP 110<br>1.2 THP 130<br>1.2 VTI 82<br>1.4 HDi 68<br>1.6 BlueHDi 100<br>1.6 BlueHDi 120<br>1.6 BlueHDi 75<br>1.6 e-HDi 115<br>1.6 e-HDi 92<br>1.6 HDi 115<br>1.6 VTI 120 | 81<br>96<br>60<br>50<br>73<br>88<br>55<br>84<br>68<br>85<br>88 | 01.15<br>01.15<br>03.13<br>03.13<br>01.15<br>07.14<br>01.15<br>03.13<br>03.13<br>07.14<br>03.13 |   | 24.0711-5256.3 360320                          | 2  Radsensor L=1029 |
|  | 1.2 THP 110<br>1.2 THP 130<br>1.2 VTI 82<br>1.4 HDi 68<br>1.6 BlueHDi 100<br>1.6 BlueHDi 120<br>1.6 BlueHDi 75<br>1.6 e-HDi 115<br>1.6 e-HDi 92<br>1.6 HDi 115<br>1.6 VTI 120 | 81<br>96<br>60<br>50<br>73<br>88<br>55<br>84<br>68<br>85<br>88 | 01.15<br>01.15<br>03.13<br>03.13<br>01.15<br>07.14<br>01.15<br>03.13<br>03.13<br>07.14<br>03.13 |   | 13.0460-2740.2 602740<br>13.0470-2740.2 LD2740 | 23554 17,2 /Zub/S TRW<br>23554 17,2 /Zub/S TRW   |
|  | 1.2 THP 110<br>1.2 THP 130<br>1.2 VTI 82<br>1.4 HDi 68<br>1.6 BlueHDi 100<br>1.6 BlueHDi 120<br>1.6 BlueHDi 75<br>1.6 e-HDi 115<br>1.6 e-HDi 92<br>1.6 HDi 115<br>1.6 VTI 120 | 81<br>96<br>60<br>50<br>73<br>88<br>55<br>84<br>68<br>85<br>88 | 01.15<br>01.15<br>03.13<br>03.13<br>01.15<br>07.14<br>01.15<br>03.13<br>03.13<br>07.14<br>03.13 |   | 24.0109-0100.2 409100                          | 249 9,0 7,0 +B   |

<sup>1)</sup> + brake disc diameter 266 mm / + disco fr.diam. 266mm / + disques fr.diam. 266mm / + disco fr.diam. 266mm

<sup>2)</sup> + brake disc diameter 283 mm / + disco fr.diam. 283mm / + disques fr.diam. 283mm / + disco fr.diam. 283mm

|     |  |  |  |  |  |  |   |  |            |
|--|--|--|--|--|---|--|---|--|------------|
| <b>PEUGEOT 3008 (09-)</b>  |  |  |  |  |   |  |   |  |            |
|    | 1.2  | 96   |  | 01.15  |   | 13.0460-3847.2 603847<br>13.0470-3847.2 LD3847                                     |   | 24660 17,8 /Zub/S<br>24660 17,8 /Zub/S   | BOS<br>BOS |
|  | 1.6 HDi  | 80   |  | 06.09  |   | 13.0460-3847.2 603847<br>13.0470-3847.2 LD3847                                     |   | 24660 17,8 /Zub/S<br>24660 17,8 /Zub/S   | BOS<br>BOS |
|  | 1.6 HDi  | 82   |  | 08.10  |   |  |   |  |            |
|  | 1.6 HDi 115  | 84   |  | 11.12  |   |  |   |  |            |
|  | 1.6 HDi 120  | 88   |  | 05.14  |   |  |   |  |            |
|  | 1.6 VTi  | 88   |  | 06.09  |   |  |   |  |            |
|  | 1.6 THP  |  |  | 06.09  |   | 13.0460-7202.2 607202<br>13.0470-7202.2 LD7202                                     |   | 23589 19,1 +<br>23589 19,1 +   | ATE<br>ATE |
|  | 1.6 THP 16V 163  | 121  |  | 05.14  |   |  |   |  |            |
|  | 2.0 HDi  |  |  | 06.09  |   |  |   |  |            |
|  | 2.0 HDi  | 100  |  | 09.11  |   |  |   |  |            |
| 2.0 HDi Hybrid4  |  |  | 02.11  |  | 13.0460-7230.2 607230<br>13.0470-7230.2 LD7230                                    |  | 24557 19,4 +<br>24557 19,4 +  | ATE<br>ATE   |            |
|    | 1.2  | 96   |  | 01.15  |   | 24.0126-0120.1 426120<br>24.0326-0120.1 526120                                     |   | 283 26,0 24,0 V +S +B<br>283 26,0 24,0 V +S +B PD                                  |            |
|  | 1.6 HDi  | 80   |  | 06.09  |   |  |   |  |            |
|  | 1.6 HDi  | 82   |  | 08.10  |   |  |   |  |            |
|  | 1.6 HDi 115  | 84   |  | 11.12  |   |  |   |  |            |
|  | 1.6 HDi 120  | 88   |  | 05.14  |   |  |   |  |            |
|  | 1.6 VTi  | 88   |  | 06.09  |   |  |   |  |            |
|  | 1.6 THP  |  |  | 06.09  |   | 24.0126-0159.1 426159  |   | 302 26,0 24,0 V +S +B  |            |
|  | 2.0 HDi  |  |  | 06.09  |   |  |   |  |            |
|  | 2.0 HDi  | 100  |  | 09.11  |   |  |   |  |            |
|  | 2.0 HDi Hybrid4  |  |  | 02.11  |   |  |   |  |            |
| 1.6 THP 16V 163  | 121  |  | 05.14  |  | 24.0126-0140.1 426140   |  | 302 26,0 24,0 V +S +B   |  |            |
|    | 1.2  | 96   |  | 01.15  |   | 24.0711-5325.3 360350  | 2  | Radsensor L=680  |            |
|  | 1.6 HDi  | 80   |  | 06.09  |   |  |   |  |            |
|  | 1.6 HDi  | 82   |  | 08.10  |   |  |   |  |            |
|  | 1.6 HDi 115  | 84   |  | 11.12  |   |  |   |  |            |
|  | 1.6 HDi 120  | 88   |  | 05.14  |   |  |   |  |            |
|  | 1.6 THP  |  |  | 06.09  |   |  |   |  |            |
|  | 1.6 THP 16V 163  | 121  |  | 05.14  |   |  |   |  |            |
|  | 1.6 VTi  | 88   |  | 06.09  |   |  |   |  |            |
|  | 2.0 HDi  |  |  | 06.09  |   |  |   |  |            |
|  | 2.0 HDi  | 100  |  | 09.11  |   |  |   |  |            |
| 2.0 HDi Hybrid4  |  |  | 02.11  |  |   |  |   |  |            |
|    | 1.2  | 96   |  | 01.15  |   | 13.0460-2761.2 602761  |   | 24922 17,5 /Zub/S  | TRW        |
|  | 1.6 HDi  | 80   |  | 06.09  |   |  |   |  |            |
|  | 1.6 HDi  | 82   |  | 08.10  |   |  |   |  |            |
|  | 1.6 HDi 115  | 84   |  | 11.12  |   |  |   |  |            |
|  | 1.6 HDi 120  | 88   |  | 05.14  |   |  |   |  |            |
|  | 1.6 THP  |  |  | 06.09  |   |  |   |  |            |
|  | 1.6 THP 16V 163  | 121  |  | 05.14  |   |  |   |  |            |
|  | 1.6 VTi  | 88   |  | 06.09  |   |  |   |  |            |
|  | 2.0 HDi  |  |  | 06.09  |   |  |   |  |            |
|  | 2.0 HDi  | 100  |  | 09.11  |   |  |   |  |            |
| 2.0 HDi Hybrid4  |  |  | 02.11  |  |   |  |   |  |            |
|  | 1.2  | 96   |  | 01.15  |   | 24.0112-0194.2 412194  |   | 268 12,0 10,0 +B   |            |
|  | 1.6 HDi  | 80   |  | 06.09  |   |  |   |  |            |
|  | 1.6 HDi  | 82   |  | 08.10  |   |  |   |  |            |
|  | 1.6 HDi 115  | 84   |  | 11.12  |   |  |   |  |            |
|  | 1.6 HDi 120  | 88   |  | 05.14  |   |  |   |  |            |
|  | 1.6 THP  |  |  | 06.09  |   |  |   |  |            |
|  | 1.6 THP 16V 163  | 121  |  | 06.09  |   |  |   |  |            |
|  | 1.6 VTi  | 88   |  | 06.09  |   |  |   |  |            |
|  | 2.0 HDi  |  |  | 06.09  |   |  |   |  |            |
|  | 2.0 HDi  | 100  |  | 09.11  |   |  |   |  |            |
| 2.0 HDi Hybrid4  |  |  | 02.11  |  | 24.0112-0198.1 412198   |  | 290 12,0 10,0 +S +B   |  |            |
| <b>PEUGEOT 4007 (07-12)</b>  |  |  |  |  |   |  |   |  |            |
|  | 2.0  | 108  |  | 11.10  | 11.12   | 13.0460-5958.2 605958<br>13.0460-0235.2 610235                                     |   | 21363 15,8 +/WK<br>Belagsatz-Zubehör   | AKE        |
|  | 2.0 4x4  | 108  |  | 11.10  | 11.12   |  |   |  |            |
|  | 2.2 HDi 4x4  | 115  |  | 02.07  | 11.12   |  |   |  |            |
|  | 2.4 16V 4x4  | 125  |  | 07.07  | 11.12   |  |   |  |            |
|  | 2.0  | 108  |  | 11.10  | 11.12   | 24.0124-0215.1 424215  |   | 294 24,0 22,4 V +B   |            |
|  | 2.0 4x4  | 108  |  | 11.10  | 11.12   |  |   |  |            |
|  | 2.2 HDi 4x4  | 115  |  | 02.07  | 11.12   |  |   |  |            |
|  | 2.4 16V 4x4  | 125  |  | 07.07  | 11.12   |  |   |  |            |
|  | 2.0  | 108  |  | 11.10  | 11.12   | 13.0460-5855.2 605855<br>13.0460-0137.2 610137                                     |   | 23582 16,0 +<br>Belagsatz-Zubehör  |            |
|  | 2.0 4x4  | 108  |  | 11.10  | 11.12   |  |   |  |            |
|  | 2.2 HDi 4x4  | 115  |  | 02.07  | 11.12   |  |   |  |            |
|  | 2.4 16V 4x4  | 125  |  | 07.07  | 11.12   |  |   |  |            |
|  | 2.2 HDi 4x4  | 115  |  | 02.07  | 11.12   | 24.0110-0330.1 410330  |   | 302 10,0 8,4 +B  |            |
|  | 2.4 16V 4x4  | 125  |  | 07.07  | 11.12   |  |   |  |            |
|  | 2.0  | 108  |  | 11.10  | 11.12   | 24.0110-0360.1 410360  |   | 302 10,0 8,4 +B  |            |
|  | 2.0 4x4  | 108  |  | 11.10  | 11.12   |  |   |  |            |
|  | 2.2 HDi 4x4  | 115  |  | 02.07  | 11.12   | 03.0137-3015.2 653015<br>03.0137-9307.2 669307                                     |   | 190 x 32<br>Bremsbacken-Zubehör  |            |
|  | 2.4 16V 4x4  | 125  |  | 07.07  | 11.12   |  |   |  |            |
|  | 2.0  | 108  |  | 11.10  | 11.12   | 03.0137-3023.2 653023<br>03.0137-9307.2 669307                                     |   | 170 x 32<br>Bremsbacken-Zubehör  |            |
|  | 2.0 4x4  | 108  |  | 11.10  | 11.12   |  |   |  |            |

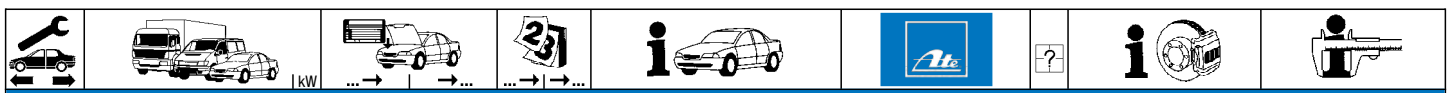

### PEUGEOT 4008 (12-)

|  |  |                                     |  |  |  |                |        |  |                    |     |
|--|--|-------------------------------------|--|--|--|----------------|--------|--|--------------------|-----|
|  | 1.6<br>1.6 HDi<br>1.6 HDi AWC<br>1.8 HDi<br>1.8 HDi AWC<br>2.0 | 86<br>84<br>84<br>110<br>110<br>113 |  | 04.12<br>05.12<br>04.12<br>05.12<br>04.12<br>04.12 |  | 13.0460-5760.2 | 605760 |  | 23584 16,4 /WK     | AKE |
|  | 1.6<br>1.6 HDi<br>1.6 HDi AWC<br>1.8 HDi<br>1.8 HDi AWC<br>2.0 | 86<br>84<br>84<br>110<br>110<br>113 |  | 04.12<br>05.12<br>04.12<br>05.12<br>04.12<br>04.12 |  | 24.0126-0170.1 | 426170 |  | 294 26,0 24,4 V +B |     |
|  | 1.6<br>1.6 HDi<br>1.6 HDi AWC<br>1.8 HDi<br>1.8 HDi AWC<br>2.0 | 86<br>84<br>84<br>110<br>110<br>113 | ORGA 13114<br>ORGA 13114<br>ORGA 13114<br>ORGA 13114<br>ORGA 13114<br>ORGA 13114 | 04.12<br>05.12<br>04.12<br>05.12<br>04.12<br>04.12 |  | 13.0460-5855.2 | 605855 |  | 23582 16,0 +       |     |
|  | 1.6<br>1.6 HDi<br>1.6 HDi AWC<br>1.8 HDi<br>1.8 HDi AWC<br>2.0 | 86<br>84<br>84<br>110<br>110<br>113 | ORGA 13114<br>ORGA 13114<br>ORGA 13114<br>ORGA 13114<br>ORGA 13114<br>ORGA 13114 | 04.12<br>05.12<br>04.12<br>05.12<br>04.12<br>04.12 |  | 24.0110-0360.1 | 410360 |  | 302 10,0 8,4 +B    |     |
|  | 1.6<br>1.6 HDi<br>1.6 HDi AWC<br>1.8 HDi<br>1.8 HDi AWC<br>2.0 | 86<br>84<br>84<br>110<br>110<br>113 |  | 04.12<br>05.12<br>04.12<br>05.12<br>04.12<br>04.12 |  | 03.0137-3023.2 | 653023 |  | 170 x 32           |     |

### PEUGEOT 5008 (09-)

|  |  |  |  |  |  |                                  |                  |   |   |            |
|--|--|--|--|--|--|----------------------------------|------------------|---|---|------------|
|  | 1.6 16V<br>1.6 HDi<br>1.6 HDi<br>1.6 HDi 115   | 88<br>80<br>82<br>84   |  | 09.09<br>09.09<br>08.10<br>11.12   |  | 13.0460-7229.2<br>13.0470-7229.2 | 607229<br>LD7229 |   | 24538 18,5 +<br>24538 18,5 +                      | ATE<br>ATE |
|  | 1.2<br>1.6 16V<br>1.6 HDi 120<br>1.6 THP 150<br>1.6 THP 163<br>2.0 HDi<br>2.0 HDi<br>2.0 HDi   | 96<br>115<br>88<br>110<br>120<br>100<br>110<br>120                         |  | 01.15<br>09.09<br>05.14<br>02.12<br>02.12<br>02.12<br>09.09<br>09.09                                     |  | 13.0460-7230.2<br>13.0470-7230.2 | 607230<br>LD7230 |   | 24557 19,4 +<br>24557 19,4 +                      | ATE<br>ATE |
|  | 1.6 16V<br>1.6 HDi<br>1.6 HDi<br>1.6 HDi 115   | 88<br>80<br>82<br>84   |  | 09.09<br>09.09<br>08.10<br>11.12   |  | 24.0126-0120.1<br>24.0326-0120.1 | 426120<br>526120 |   | 283 26,0 24,0 V +S +B<br>283 26,0 24,0 V +S +B PD |            |
|  | 1.2<br>1.6 16V<br>1.6 HDi 120<br>1.6 THP 150<br>1.6 THP 163<br>2.0 HDi<br>2.0 HDi<br>2.0 HDi   | 96<br>115<br>88<br>110<br>120<br>100<br>110<br>120                         |  | 01.15<br>09.09<br>05.14<br>02.12<br>02.12<br>02.12<br>09.09<br>09.09                                     |  | 24.0126-0159.1                   | 426159           |   | 302 26,0 24,0 V +S +B                             |            |
|  | 1.2<br>1.6 16V<br>1.6 16V<br>1.6 HDi<br>1.6 HDi<br>1.6 HDi 115<br>1.6 HDi 120<br>1.6 THP 150<br>1.6 THP 163<br>2.0 HDi<br>2.0 HDi<br>2.0 HDi | 96<br>88<br>115<br>80<br>82<br>84<br>88<br>110<br>120<br>100<br>110<br>120 |  | 01.15<br>09.09<br>09.09<br>09.09<br>08.10<br>11.12<br>05.14<br>02.12<br>02.12<br>02.12<br>09.09<br>09.09 |  | 24.0711-5325.3                   | 360350           | 2 | Radsensor L=680                                   |            |
|  | 1.2<br>1.6 16V<br>1.6 16V<br>1.6 HDi<br>1.6 HDi<br>1.6 HDi 115<br>1.6 HDi 120<br>1.6 THP 150<br>1.6 THP 163<br>2.0 HDi<br>2.0 HDi<br>2.0 HDi | 96<br>88<br>115<br>80<br>82<br>84<br>88<br>110<br>120<br>100<br>110<br>120 |  | 01.15<br>09.09<br>09.09<br>09.09<br>08.10<br>11.12<br>05.14<br>02.12<br>02.12<br>02.12<br>09.09<br>09.09 |  | 13.0460-2761.2                   | 602761           |   | 24922 17,5 /Zub/S                                 | TRW        |
|  | 1.2<br>1.6 16V<br>1.6 16V<br>1.6 HDi<br>1.6 HDi<br>1.6 HDi 115   | 96<br>88<br>115<br>80<br>82<br>84  |  | 01.15<br>09.09<br>09.09<br>09.09<br>08.10<br>11.12   |  | 24.0112-0194.2                   | 412194           |   | 268 12,0 10,0 +B                                  |            |



**PEUGEOT 5008 (09-)**

|  |             |     |  |       |  |                |        |  |                  |
|--|-------------|-----|--|-------|--|----------------|--------|--|------------------|
|  | 1.6 HDi 120 | 88  |  | 05.14 |  | 24.0112-0194.2 | 412194 |  | 268 12,0 10,0 +B |
|  | 1.6 THP 150 | 110 |  | 02.12 |  |                |        |  |                  |
|  | 1.6 THP 163 | 120 |  | 02.12 |  |                |        |  |                  |
|  | 2.0 HDi     | 100 |  | 02.12 |  |                |        |  |                  |
|  | 2.0 HDi     | 110 |  | 09.09 |  |                |        |  |                  |
|  | 2.0 HDi     | 120 |  | 09.09 |  |                |        |  |                  |

**PEUGEOT BIPPER (08-15)**

|  |            |    |  |       |                                     |                |        |  |                          |
|--|------------|----|--|-------|-------------------------------------|----------------|--------|--|--------------------------|
|  | 1.4 HDi    | 50 |  | 02.08 |                                     | 13.0460-3818.2 | 603818 |  | 23706 18,1 +/WK/S BOS    |
|  | 1.4 i      | 54 |  | 02.08 |                                     |                |        |  |                          |
|  | 1.3 HDi 75 | 55 |  | 10.10 |                                     | 13.0460-3863.2 | 603863 |  | 23706 18,0 +/WK/Zub/SBOS |
|  | 1.4 HDi    | 50 |  | 02.08 | + automatisiertes Schaltgetriebe 1) | 24.0122-0147.1 | 422147 |  | 284 22,0 20,2 V +B       |
|  | 1.3 HDi 75 | 55 |  | 10.10 |                                     | 24.0122-0197.1 | 422197 |  | 258 22,0 20,2 V +B       |
|  | 1.4 HDi    | 50 |  | 02.08 | + Schaltgetriebe 2)                 | 24.0322-0197.1 | 522197 |  | 258 22,0 20,2 V +B PD    |
|  | 1.4 i      | 54 |  | 02.08 |                                     |                |        |  |                          |
|  | 1.4 HDi    | 50 |  | 10.10 |                                     | 03.0137-0479.2 | 650479 |  | 203 x 38 HEB AP          |
|  | 1.4 i      | 54 |  | 02.08 |                                     | 03.0137-9310.2 | 669310 |  | Bremsbacken-Zubehör AP   |
|  | 1.3 HDi 75 | 55 |  | 10.10 |                                     | 03.0137-0493.2 | 650493 |  | 228 x 42 HEB AP          |
|  | 1.4 HDi    | 50 |  | 02.08 | 09.10                               |                |        |  |                          |
|  | 1.4 i      | 54 |  | 02.08 |                                     | 24.0220-2001.1 | 480307 |  | 203/204,7 x 48,5         |
|  | 1.3 HDi 75 | 55 |  | 10.10 |                                     | 24.0222-8038.1 | 480316 |  | 228/230 x 48             |
|  | 1.4 HDi    | 50 |  | 02.08 |                                     |                |        |  |                          |
|  | 1.4 HDi    | 50 |  | 10.10 |                                     | 03.0520-9220.3 | 699220 |  | 20,64/203x38 TopKit AP   |
|  | 1.4 i      | 54 |  | 02.08 |                                     |                |        |  |                          |

















**PEUGEOT BOXER Bus (94-02)**

|  |                     |    |            |       |       |                |        |  |                         |
|--|---------------------|----|------------|-------|-------|----------------|--------|--|-------------------------|
|  | 1.9 D (10)          | 51 |            | 02.94 | 12.99 | 13.0460-2976.2 | 602976 |  | 21797 19,7 +/WK/S TRW   |
|  | 1.9 TD (10/14)      | 66 |            | 08.94 | 12.99 |                |        |  |                         |
|  | 1.9 TD (10/14)      | 68 |            | 02.94 | 12.99 |                |        |  |                         |
|  | 2.0 i (10/14)       | 80 |            | 02.94 | 12.99 |                |        |  |                         |
|  | 2.5 D (14)          | 63 |            | 08.94 | 12.99 |                |        |  |                         |
|  | 2.5 TD (14)         | 76 |            | 08.94 | 12.99 |                |        |  |                         |
|  | 2.5 TDi (14)        | 79 |            | 01.97 | 12.99 |                |        |  |                         |
|  | 2.8 D (14)          | 64 | S 16206253 | 01.99 |       |                |        |  |                         |
|  | 2.8 HDi 4X4 (10/14) |    | S 16206253 | 10.00 |       |                |        |  |                         |
|  | 1.9 D (10)          | 51 |            | 01.00 | 10.01 | 13.0460-2850.2 | 602850 |  | 23602 19,7 +/WK/S TRW   |
|  | 1.9 TD (10/14)      | 66 |            | 01.00 | 10.01 |                |        |  |                         |
|  | 1.9 TD (10/14)      | 68 |            | 01.00 | 10.01 |                |        |  |                         |
|  | 2.0 i (10/14)       | 80 |            | 01.00 | 10.01 |                |        |  |                         |
|  | 2.5 D (14)          | 63 |            | 01.00 | 10.01 |                |        |  |                         |
|  | 2.5 TD (14)         | 76 |            | 01.00 | 10.01 |                |        |  |                         |
|  | 2.5 TDi (14)        | 79 |            | 01.00 | 10.01 |                |        |  |                         |
|  | 2.8 D (14)          | 64 | S 16206253 | 01.99 |       |                |        |  |                         |
|  | 2.8 HDi (14)        | 94 |            | 11.00 | 10.01 |                |        |  |                         |
|  | 2.8 HDi 4X4 (10/14) |    | S 16206253 | 10.00 |       |                |        |  |                         |
|  | 1.9 D (10)          | 51 |            | 11.01 | 03.02 | 13.0460-4978.2 | 604978 |  | 23917 19,3 +/WK/Zub BRE |
|  | 1.9 TD (10/14)      | 66 |            | 11.01 | 03.02 |                |        |  |                         |
|  | 1.9 TD (10/14)      | 68 |            | 11.01 | 03.02 |                |        |  |                         |
|  | 2.0 i (10/14)       | 80 |            | 11.01 | 03.02 |                |        |  |                         |
|  | 2.5 D (14)          | 63 |            | 11.01 | 03.02 |                |        |  |                         |
|  | 2.5 TD (14)         | 76 |            | 11.01 | 03.02 |                |        |  |                         |
|  | 2.5 TDi (14)        | 79 |            | 11.01 | 03.02 |                |        |  |                         |
|  | 2.8 D (14)          | 64 | S 16204256 |       | 02.02 |                |        |  |                         |
|  | 2.8 HDi (14)        | 94 |            | 11.01 | 03.02 |                |        |  |                         |
|  | 2.8 HDi 4X4 (10/14) |    | S 16204256 |       | 03.02 |                |        |  |                         |
|  | 2.0 i (18)          | 80 |            | 02.94 | 12.99 | 13.0460-2977.2 | 602977 |  | 21799 19,7 +/WK/S TRW   |
|  | 2.5 D (18)          | 63 |            | 08.94 | 12.99 |                |        |  |                         |
|  | 2.5 TD (18)         | 76 |            | 08.94 | 12.99 |                |        |  |                         |
|  | 2.5 TDi (18)        | 79 |            | 01.97 | 12.99 |                |        |  |                         |
|  | 2.8 D (18)          | 64 | S 16205352 | 01.99 |       |                |        |  |                         |
|  | 2.8 HDi 4X4 (18)    |    | S 16205352 | 10.00 |       |                |        |  |                         |
|  | 2.0 i (18)          | 80 |            | 01.00 | 10.01 | 13.0460-2852.2 | 602852 |  | 23603 19,7 +/WK/S TRW   |
|  | 2.5 D (18)          | 63 |            | 01.00 | 10.01 |                |        |  |                         |
|  | 2.5 TD (18)         | 76 |            | 01.00 | 10.01 |                |        |  |                         |
|  | 2.5 TDi (18)        | 79 |            | 01.00 | 10.01 |                |        |  |                         |
|  | 2.8 HDi (18)        | 94 |            | 11.00 | 10.01 |                |        |  |                         |
|  | 2.8 HDi 4X4 (18)    |    | S 16205352 | 10.00 |       |                |        |  |                         |
|  | 2.0 i (18)          | 80 |            | 11.01 | 03.02 | 13.0460-4979.2 | 604979 |  | 23919 19,3 +/WK/Zub BRE |
|  | 2.5 D (18)          | 63 |            | 11.01 | 03.02 |                |        |  |                         |
|  | 2.5 TD (18)         | 76 |            | 11.01 | 03.02 |                |        |  |                         |
|  | 2.5 TDi (18)        | 79 |            | 11.01 | 03.02 |                |        |  |                         |
|  | 2.8 D (18)          | 64 | S 16194400 |       | 02.02 |                |        |  |                         |
|  | 2.8 HDi (18)        | 94 |            | 11.01 | 03.02 |                |        |  |                         |
|  | 2.8 HDi 4X4 (18)    |    | S 16194400 |       | 03.02 |                |        |  |                         |
|  | 1.9 D (10)          | 51 |            | 02.94 | 03.02 | 24.0118-0108.1 | 418108 |  | 280 18,0 15,9 +B        |
|  | 1.9 TD (10/14)      | 66 |            | 08.94 | 03.02 |                |        |  |                         |
|  | 1.9 TD (10/14)      | 68 |            | 02.94 | 03.02 |                |        |  |                         |
|  | 2.0 i (10/14)       | 80 |            | 02.94 | 03.02 |                |        |  |                         |
|  | 2.5 D (14)          | 63 |            | 08.94 | 03.02 |                |        |  |                         |
|  | 2.8 D (14)          | 64 | S 16206253 | 01.99 |       |                |        |  |                         |
|  | 2.8 HDi 4X4 (10/14) |    | S 16206253 | 10.00 |       |                |        |  |                         |
|  | 2.5 TD (14)         | 76 |            | 08.94 | 03.02 | 24.0124-0127.1 | 424127 |  | 280 24,0 21,9 V +B      |
|  | 2.5 TDi (14)        | 79 |            | 01.97 | 03.02 |                |        |  |                         |
|  | 2.8 D (14)          | 64 | S 16204256 |       | 02.02 |                |        |  |                         |

1) + autom.manual transmission / + scatola camb.velocità autom. / + transm.mécanique autom. / + cambio de velocidad autom.

2) + manual transmission / + scatola cambio velocità / + transmission mécanique / + cambio de velocidad



|     |   |        |  |                 |                |  |  |  |
|--|---|--|--|---|---|--|--|--|
| <b>PEUGEOT BOXER Bus (94-02)</b>   |   |  |  |   |   |  |  |  |
|    | 2.8 HDi (14)<br>2.8 HDi 4X4 (10/14)   | 94<br>S 16204256   |  | 11.00<br>03.02  | 03.02   | 24.0124-0127.1   | 424127   | 280 24,0 21,9 V +B   |
|  | 2.0 i (18)<br>2.5 D (18)<br>2.5 TD (18)<br>2.5 TDi (18)<br>2.8 D (18)<br>2.8 HDi 4X4 (18)   | 80<br>63<br>76<br>79<br>64   |  | 02.94<br>08.94<br>08.94<br>01.97<br>01.99<br>10.00  | 03.02<br>03.02<br>03.02<br>03.02<br>02.02<br>03.02  | 24.0124-0138.1   | 424138   | 300 24,0 21,9 V +B   |
|    | 1.9 D (10)<br>1.9 TD (10/14)<br>1.9 TD (10/14)<br>2.0 i (10/14/18)<br>2.5 D (14/18)<br>2.5 TD (14/18)<br>2.5 TDi (14/18)<br>2.8 D (14/18)<br>2.8 HDi (14/18)<br>2.8 HDi 4X4 (10/14)<br>2.8 HDi 4X4 (18) | 51<br>66<br>68<br>80<br>63<br>76<br>79<br>64<br>S 16194400<br>S 16194400<br>S 16194400 |  | 11.01<br>11.01<br>11.01<br>11.01<br>11.01<br>11.01<br>11.01<br>11.01<br>11.01<br>11.01<br>10.00 | 03.02<br>03.02<br>03.02<br>03.02<br>03.02<br>03.02<br>03.02<br>02.02<br>03.02<br>03.02<br>03.02 | 13.0460-4980.2   | 604980   | 23921 20,3 /Zub <b>BRE</b>   |
|    | 1.9 D (10)<br>1.9 TD (10/14)<br>1.9 TD (10/14)<br>2.0 i (10/14)<br>2.5 D (14)<br>2.5 TD (14)<br>2.5 TDi (14)<br>2.8 D (14)<br>2.8 HDi (14)<br>2.8 HDi 4X4 (10/14)                                       | 51<br>66<br>68<br>80<br>63<br>76<br>79<br>64<br>S 16194400<br>94<br>S 16194400         |  | 11.01<br>11.01<br>11.01<br>11.01<br>11.01<br>11.01<br>11.01<br>11.01<br>11.01<br>11.01          | 03.02<br>03.02<br>03.02<br>03.02<br>03.02<br>03.02<br>03.02<br>02.02<br>03.02<br>03.02          | 24.0116-0124.1   | 416124   | 280 16,0 14,2 +B   |
|  | 2.0 i (18)<br>2.5 D (18)<br>2.5 TD (18)<br>2.5 TDi (18)<br>2.8 D (18)<br>2.8 HDi (18)<br>2.8 HDi 4X4 (18)   | 80<br>63<br>76<br>79<br>64<br>S 16194400<br>S 16194400                                 |  | 11.01<br>11.01<br>11.01<br>11.01<br>11.01<br>11.01<br>10.00                                     | 03.02<br>03.02<br>03.02<br>03.02<br>02.02<br>03.02<br>03.02                                     | 24.0116-0125.1   | 416125   | 280 16,0 14,2 +B   |
|   | 1.9 D (10)<br>1.9 TD (10/14)<br>1.9 TD (10/14)<br>2.0 i (10/14)<br>2.5 D (14)<br>2.5 TD (14)<br>2.5 TDi (14)<br>2.8 D (14)<br>2.8 HDi (14)<br>2.8 HDi 4X4 (10/14)                                       | 51<br>66<br>68<br>80<br>63<br>76<br>79<br>64<br>94<br>S 16206253<br>S 16206253         |  | 02.94<br>08.94<br>02.94<br>02.94<br>08.94<br>08.94<br>01.97<br>01.99<br>11.00<br>10.00          | 10.01<br>10.01<br>10.01<br>10.01<br>10.01<br>10.01<br>10.01<br>10.01<br>10.01<br>10.01          | 03.0137-0333.2<br>03.0137-9219.2   | 650333<br>669219   | - Wohnmobil<br>254 x 57 HEB<br>Bremsbacken-Zubehör <b>TRW</b>                      |
|  | 1.9 D (10)<br>1.9 TD (10/14)<br>1.9 TD (10/14)<br>2.0 i (10/14)<br>2.5 D (14)<br>2.5 TD (14)<br>2.5 TDi (14)<br>2.8 D (14)<br>2.8 HDi (14)<br>2.8 HDi 4X4 (10/14)                                       | 51<br>66<br>68<br>80<br>63<br>76<br>79<br>64<br>S 16204256<br>94<br>S 16204256         |  | 11.01<br>11.01<br>11.01<br>11.01<br>11.01<br>11.01<br>11.01<br>11.01<br>11.01<br>10.00          | 03.02<br>03.02<br>03.02<br>03.02<br>03.02<br>03.02<br>03.02<br>02.02<br>03.02<br>03.02          | 03.0137-0432.2<br>03.0137-9285.2   | 650432<br>669285   | - Quick Fit<br>254 x 57 HEB<br>Bremsbacken-Zubehör <b>AP</b>                       |
|  | 2.0 i (18)<br>2.5 D (18)<br>2.5 TD (18)<br>2.5 TDi (18)<br>2.8 D (18)<br>2.8 HDi (18)<br>2.8 HDi 4X4 (18)   | 80<br>63<br>76<br>79<br>64<br>94<br>S 16209999<br>S 16209999                           |  | 02.94<br>08.94<br>08.94<br>01.97<br>01.99<br>11.00<br>10.00                                     | 10.01<br>10.01<br>10.01<br>10.01<br>10.01<br>10.01<br>10.01                                     | 03.0137-0334.2<br>03.0137-9219.2   | 650334<br>669219   | - Wohnmobil<br>254 x 57 HEB<br>Bremsbacken-Zubehör <b>TRW</b>                      |
|  | 1.9 D (10)<br>1.9 TD (10/14)<br>1.9 TD (10/14)<br>2.0 i (10/14)<br>2.5 D (14)<br>2.5 TD (14)<br>2.5 TDi (14)<br>2.8 D (14)<br>2.8 HDi (14)<br>2.8 HDi 4X4 (10/14)                                       | 51<br>66<br>68<br>80<br>63<br>76<br>79<br>64<br>94                                     |  | 02.94<br>08.94<br>02.94<br>02.94<br>08.94<br>08.94<br>01.97<br>01.99<br>11.00<br>10.00          | 03.02<br>03.02<br>03.02<br>03.02<br>03.02<br>03.02<br>03.02<br>02.02<br>03.02<br>03.02          | 24.0225-4002.1   | 480048   | 254/255,6 x 63,5   |
|  | 2.0 i (18)<br>2.5 D (18)<br>2.5 TD (18)<br>2.5 TDi (18)<br>2.8 D (18)<br>2.8 HDi (18)<br>2.8 HDi 4X4 (18)   | 80<br>63<br>76<br>79<br>64<br>94<br>S 16209999<br>S 16209999                           |  | 02.94<br>08.94<br>08.94<br>01.97<br>01.99<br>11.00<br>10.00                                     | 10.01<br>10.01<br>10.01<br>10.01<br>10.01<br>10.01<br>10.01                                     | 24.0225-4005.1   | 480070   | 254/255,6 x 64,5   |
|  | 1.9 D (10)<br>1.9 TD (10/14)<br>1.9 TD (10/14)<br>2.0 i (10/14)<br>2.5 D (14)   | 51<br>66<br>68<br>80<br>63   |  | 02.94<br>08.94<br>02.94<br>02.94<br>08.94   | 10.01<br>10.01<br>10.01<br>10.01<br>10.01   | 03.0520-0925.3   | 690925   | - Wohnmobil<br>25,40/254x57 TopKit <b>TRW</b>                                      |
|  | 2.5 TD (14)   | 76   |  | 08.94   | 10.01   | 03.0520-0226.3   | 690226   | - Wohnmobil<br>26,99/254x57 TopKit <b>TRW</b>                                      |





**PEUGEOT BOXER Bus (94-02)**

|              |                |    |       |       |                |                |             |                     |                     |     |                |        |             |                     |    |
|--------------|----------------|----|-------|-------|----------------|----------------|-------------|---------------------|---------------------|-----|----------------|--------|-------------|---------------------|----|
|              | 2.5 TDi (14)   | 79 |       | 01.97 | 10.01          | 03.0520-0226.3 | 690226      | - Wohnmobil         | 26,99/254x57 TopKit | TRW |                |        |             |                     |    |
|              | 2.8 HDi (14)   | 94 |       | 11.00 | 10.01          |                |             |                     |                     |     |                |        |             |                     |    |
|              | 1.9 D (10)     | 51 |       | 11.01 | 03.02          |                |             |                     |                     |     | 03.0520-0326.3 | 690326 | + Quick Fit | 26,99/254x57 TopKit | AP |
|              | 1.9 TD (10/14) | 66 |       | 11.01 | 03.02          |                |             |                     |                     |     |                |        |             |                     |    |
|              | 1.9 TD (10/14) | 68 |       | 11.01 | 03.02          |                |             |                     |                     |     |                |        |             |                     |    |
|              | 2.0 i (10/14)  | 80 |       | 11.01 | 03.02          |                |             |                     |                     |     |                |        |             |                     |    |
|              | 2.5 D (14)     | 63 |       | 11.01 | 03.02          |                |             |                     |                     |     |                |        |             |                     |    |
|              | 2.5 TD (14)    | 76 |       | 11.01 | 03.02          |                |             |                     |                     |     |                |        |             |                     |    |
|              | 2.5 TDi (14)   | 79 |       | 11.01 | 03.02          |                |             |                     |                     |     |                |        |             |                     |    |
|              | 2.8 HDi (14)   | 94 |       | 11.01 | 03.02          |                |             |                     |                     |     |                |        |             |                     |    |
| 2.0 i (18)   | 80             |    | 02.94 | 10.01 | 03.0520-0728.3 | 690728         | - Wohnmobil | 28,57/254x57 TopKit | TRW                 |     |                |        |             |                     |    |
| 2.5 D (18)   | 63             |    | 08.94 | 10.01 |                |                |             |                     |                     |     |                |        |             |                     |    |
| 2.5 TD (18)  | 76             |    | 08.94 | 10.01 |                |                |             |                     |                     |     |                |        |             |                     |    |
| 2.5 TDi (18) | 79             |    | 01.97 | 10.01 |                |                |             |                     |                     |     |                |        |             |                     |    |
| 2.8 HDi (18) | 94             |    | 11.00 | 10.01 |                |                |             |                     |                     |     |                |        |             |                     |    |

**PEUGEOT BOXER Kasten (94-02)**

|                    |                    |            |       |       |                |                |        |                     |                   |                |        |  |                     |
|--------------------|--------------------|------------|-------|-------|----------------|----------------|--------|---------------------|-------------------|----------------|--------|--|---------------------|
|                    | 1.9 D (10)         | 50         |       | 07.99 | 12.99          | 13.0460-2976.2 | 602976 |                     | 21797 19,7 +/WK/S | TRW            |        |  |                     |
|                    | 1.9 D (10)         | 51         |       | 02.94 | 12.99          |                |        |                     |                   |                |        |  |                     |
|                    | 1.9 DT 4X4 (10/14) | 66         |       | 03.96 | 12.99          |                |        |                     |                   |                |        |  |                     |
|                    | 1.9 TD (10/14)     | 66         |       | 07.99 | 12.99          |                |        |                     |                   |                |        |  |                     |
|                    | 1.9 TD (10/14)     | 68         |       | 02.94 | 12.99          |                |        |                     |                   |                |        |  |                     |
|                    | 2.0 i (10/14)      | 80         |       | 02.94 | 12.99          |                |        |                     |                   |                |        |  |                     |
|                    | 2.0 i 4x4 (10/14)  | 80         |       | 03.96 | 12.99          |                |        |                     |                   |                |        |  |                     |
|                    | 2.5 D/DT (14)      | 63         |       | 02.94 | 12.99          |                |        |                     |                   |                |        |  |                     |
|                    | 2.5 TD (14)        | 76         |       | 02.94 | 12.99          |                |        |                     |                   |                |        |  |                     |
|                    | 2.5 TDi (14)       | 79         |       | 01.97 | 12.99          |                |        |                     |                   |                |        |  |                     |
| 2.8 D (14)         | 64                 | S 16206253 | 01.99 |       |                |                |        |                     |                   |                |        |  |                     |
| 1.9 D (10)         | 50                 |            | 01.00 | 10.01 | 13.0460-2850.2 | 602850         |        | 23602 19,7 +/WK/S   | TRW               |                |        |  |                     |
| 1.9 D (10)         | 51                 |            | 01.00 | 10.01 |                |                |        |                     |                   |                |        |  |                     |
| 1.9 DT 4X4 (10/14) | 66                 |            | 01.00 | 10.01 |                |                |        |                     |                   |                |        |  |                     |
| 1.9 TD (10/14)     | 66                 |            | 01.00 | 10.01 |                |                |        |                     |                   |                |        |  |                     |
| 1.9 TD (10/14)     | 68                 |            | 01.00 | 10.01 |                |                |        |                     |                   |                |        |  |                     |
| 2.0 HDi (10/14)    | 62                 |            | 08.01 | 10.01 |                |                |        |                     |                   |                |        |  |                     |
| 2.0 i (10/14)      | 80                 |            | 01.00 | 10.01 |                |                |        |                     |                   |                |        |  |                     |
| 2.5 D/DT (14)      | 63                 |            | 01.00 | 10.01 |                |                |        |                     |                   |                |        |  |                     |
| 2.5 TD (14)        | 76                 |            | 01.00 | 10.01 |                |                |        |                     |                   |                |        |  |                     |
| 2.5 TDi (14)       | 79                 |            | 01.00 | 10.01 |                |                |        |                     |                   |                |        |  |                     |
| 2.8 D (14)         | 64                 | S 16206253 | 01.99 |       |                |                |        |                     |                   |                |        |  |                     |
| 2.8 HDi (14)       | 94                 |            | 11.00 | 10.01 |                |                |        |                     |                   |                |        |  |                     |
| 2.8 HDi 4x4 (14)   | 94                 |            | 10.00 | 10.01 |                |                |        |                     |                   |                |        |  |                     |
| 1.9 D (10)         | 50                 |            | 11.01 | 03.02 | 13.0460-4978.2 | 604978         |        | 23917 19,3 +/WK/Zub | BRE               |                |        |  |                     |
| 1.9 D (10)         | 51                 |            | 11.01 | 03.02 |                |                |        |                     |                   |                |        |  |                     |
| 1.9 DT 4X4 (10/14) | 66                 |            | 11.01 | 03.02 |                |                |        |                     |                   |                |        |  |                     |
| 1.9 TD (10/14)     | 66                 |            | 11.01 | 03.02 |                |                |        |                     |                   |                |        |  |                     |
| 1.9 TD (10/14)     | 68                 |            | 11.01 | 03.02 |                |                |        |                     |                   |                |        |  |                     |
| 2.0 HDi (10/14)    | 62                 |            | 11.01 | 03.02 |                |                |        |                     |                   |                |        |  |                     |
| 2.0 i (10/14)      | 80                 |            | 11.01 | 03.02 |                |                |        |                     |                   |                |        |  |                     |
| 2.0 i 4x4 (10/14)  | 80                 |            | 11.01 | 03.02 |                |                |        |                     |                   |                |        |  |                     |
| 2.5 D/DT (14)      | 63                 |            | 11.01 | 03.02 |                |                |        |                     |                   |                |        |  |                     |
| 2.5 TD (14)        | 76                 |            | 11.01 | 03.02 |                |                |        |                     |                   |                |        |  |                     |
| 2.5 TDi (14)       | 79                 |            | 11.01 | 03.02 |                |                |        |                     |                   |                |        |  |                     |
| 2.8 D (14)         | 64                 | S 16204256 | 02.02 |       |                |                |        |                     |                   |                |        |  |                     |
| 2.8 HDi (14)       | 94                 |            | 11.01 | 03.02 |                |                |        |                     |                   |                |        |  |                     |
| 2.0 i (18)         | 80                 |            | 02.94 | 12.99 | 13.0460-2977.2 | 602977         |        | 21799 19,7 +/WK/S   | TRW               |                |        |  |                     |
| 2.0 i 4x4 (18)     | 80                 |            | 03.96 | 12.99 |                |                |        |                     |                   |                |        |  |                     |
| 2.5 D/DT (18)      | 63                 |            | 02.94 | 12.99 |                |                |        |                     |                   |                |        |  |                     |
| 2.5 TD (18)        | 76                 |            | 02.94 | 12.99 |                |                |        |                     |                   |                |        |  |                     |
| 2.5 TDi (18)       | 79                 |            | 01.97 | 12.99 |                |                |        |                     |                   |                |        |  |                     |
| 2.8 D (18)         | 64                 | S 16205352 | 01.99 |       |                |                |        |                     |                   |                |        |  |                     |
| 2.0 i (18)         | 80                 |            | 01.00 | 10.01 | 13.0460-2852.2 | 602852         |        | 23603 19,7 +/WK/S   | TRW               |                |        |  |                     |
| 2.0 i 4x4 (18)     | 80                 |            | 01.00 | 10.01 |                |                |        |                     |                   |                |        |  |                     |
| 2.5 D/DT (18)      | 63                 |            | 01.00 | 10.01 |                |                |        |                     |                   |                |        |  |                     |
| 2.5 TD (18)        | 76                 |            | 01.00 | 10.01 |                |                |        |                     |                   |                |        |  |                     |
| 2.5 TDi (18)       | 79                 |            | 01.00 | 10.01 |                |                |        |                     |                   |                |        |  |                     |
| 2.8 D (18)         | 64                 | S 16205352 | 01.99 |       |                |                |        |                     |                   |                |        |  |                     |
| 2.8 HDi (18)       | 94                 |            | 11.00 | 10.01 |                |                |        |                     |                   |                |        |  |                     |
| 2.8 HDi 4x4 (18)   | 94                 |            | 10.00 | 10.01 |                |                |        |                     |                   |                |        |  |                     |
| 2.0 i (18)         | 80                 |            | 11.01 | 03.02 |                |                |        |                     |                   | 13.0460-4979.2 | 604979 |  | 23919 19,3 +/WK/Zub |
| 2.0 i 4x4 (18)     | 80                 |            | 11.01 | 03.02 |                |                |        |                     |                   |                |        |  |                     |
| 2.5 D/DT (18)      | 63                 |            | 11.01 | 03.02 |                |                |        |                     |                   |                |        |  |                     |
| 2.5 TD (18)        | 76                 |            | 11.01 | 03.02 |                |                |        |                     |                   |                |        |  |                     |
| 2.5 TDi (18)       | 79                 |            | 11.01 | 03.02 |                |                |        |                     |                   |                |        |  |                     |
| 2.8 D (18)         | 64                 | S 16194400 | 02.02 |       |                |                |        |                     |                   |                |        |  |                     |
| 2.8 HDi (18)       | 94                 |            | 11.01 | 03.02 |                |                |        |                     |                   |                |        |  |                     |
| 2.8 HDi 4x4 (18)   | 94                 |            | 11.01 | 03.02 |                |                |        |                     |                   |                |        |  |                     |
| 1.9 D (10)         | 50                 |            | 07.99 | 03.02 | 24.0118-0108.1 | 418108         |        | 280 18,0 15,9 +B    |                   |                |        |  |                     |
| 1.9 D (10)         | 51                 |            | 02.94 | 03.02 |                |                |        |                     |                   |                |        |  |                     |
| 1.9 DT 4X4 (10/14) | 66                 |            | 03.96 | 03.02 |                |                |        |                     |                   |                |        |  |                     |
| 1.9 TD (10/14)     | 66                 |            | 07.99 | 03.02 |                |                |        |                     |                   |                |        |  |                     |
| 1.9 TD (10/14)     | 68                 |            | 02.94 | 03.02 |                |                |        |                     |                   |                |        |  |                     |
| 2.0 i (10/14)      | 80                 |            | 02.94 | 03.02 |                |                |        |                     |                   |                |        |  |                     |
| 2.0 i 4x4 (10/14)  | 80                 |            | 03.96 | 03.02 |                |                |        |                     |                   |                |        |  |                     |
| 2.5 D/DT (14)      | 63                 |            | 02.94 | 03.02 |                |                |        |                     |                   |                |        |  |                     |
| 2.8 D (14)         | 64                 | S 16206253 | 01.99 |       |                |                |        |                     |                   |                |        |  |                     |
| 2.5 TD (14)        | 76                 |            | 02.94 | 03.02 | 24.0124-0127.1 | 424127         |        | 280 24,0 21,9 V +B  |                   |                |        |  |                     |



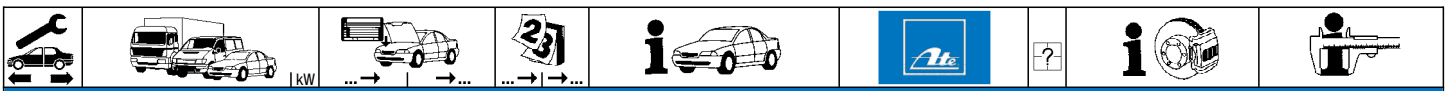

**PEUGEOT BOXER Kasten (94-02)**

|                      |                    |                    |       |       |       |                |        |             |                         |       |                |        |             |                            |
|----------------------|--------------------|--------------------|-------|-------|-------|----------------|--------|-------------|-------------------------|-------|----------------|--------|-------------|----------------------------|
|                      | 2.5 TDi (14)       | 79                 |       | 01.97 | 03.02 | 24.0124-0127.1 | 424127 |             | 280 24,0 21,9 V +B      |       |                |        |             |                            |
|                      | 2.8 D (14)         | 64 S 16204256      |       |       | 02.02 |                |        |             |                         |       |                |        |             |                            |
|                      | 2.8 HDi (14)       | 94                 |       | 11.00 | 03.02 |                |        |             |                         |       |                |        |             |                            |
|                      | 2.8 HDi 4x4 (14)   | 94                 |       | 10.00 | 03.02 |                |        |             |                         |       |                |        |             |                            |
|                      | 2.0 HDi (18)       | 62                 |       | 08.01 | 03.02 |                |        |             |                         |       |                |        |             |                            |
|                      | 2.0 i (18)         | 80                 |       | 02.94 | 03.02 | 24.0124-0138.1 | 424138 |             | 300 24,0 21,9 V +B      |       |                |        |             |                            |
|                      | 2.0 i 4x4 (18)     | 80                 |       | 03.96 | 03.02 |                |        |             |                         |       |                |        |             |                            |
|                      | 2.5 D/DT (18)      | 63                 |       | 02.94 | 03.02 |                |        |             |                         |       |                |        |             |                            |
|                      | 2.5 TD (18)        | 76                 |       | 02.94 | 03.02 |                |        |             |                         |       |                |        |             |                            |
|                      | 2.5 TDi (18)       | 79                 |       | 01.97 | 03.02 |                |        |             |                         |       |                |        |             |                            |
|                      | 2.8 D (18)         | 64                 |       | 01.99 | 02.02 |                |        |             |                         |       |                |        |             |                            |
|                      | 2.8 HDi (18)       | 94                 |       | 11.00 | 03.02 |                |        |             |                         |       |                |        |             |                            |
|                      | 2.8 HDi 4x4 (18)   | 94                 |       | 10.00 | 03.02 |                |        |             |                         |       |                |        |             |                            |
|                      |                    | 1.9 D (10)         | 50    |       | 11.01 |                |        |             |                         | 03.02 | 13.0460-4980.2 | 604980 |             | 23921 20,3 /Zub <b>BRE</b> |
|                      |                    | 1.9 D (10)         | 51    |       | 11.01 |                |        |             |                         | 03.02 |                |        |             |                            |
|                      |                    | 1.9 DT 4X4 (10/14) | 66    |       | 11.01 |                |        |             |                         | 03.02 |                |        |             |                            |
|                      |                    | 1.9 TD (10/14)     | 66    |       | 11.01 |                |        |             |                         | 03.02 |                |        |             |                            |
|                      |                    | 1.9 TD (10/14)     | 68    |       | 11.01 |                |        |             |                         | 03.02 |                |        |             |                            |
| 2.0 HDi (10/14/18)   |                    | 62                 |       | 11.01 | 03.02 |                |        |             |                         |       |                |        |             |                            |
| 2.0 i (10/14/18)     |                    | 80                 |       | 11.01 | 03.02 |                |        |             |                         |       |                |        |             |                            |
| 2.0 i 4x4 (10/14/18) |                    | 80                 |       | 11.01 | 03.02 |                |        |             |                         |       |                |        |             |                            |
| 2.5 D/DT (14/18)     |                    | 63                 |       | 11.01 | 03.02 |                |        |             |                         |       |                |        |             |                            |
| 2.5 TDi (14/18)      |                    | 79                 |       | 11.01 | 03.02 |                |        |             |                         |       |                |        |             |                            |
| 2.5 TDi (14/18)      |                    | 79                 |       | 11.01 | 03.02 |                |        |             |                         |       |                |        |             |                            |
| 2.8 D (14/18)        |                    | 64 S 16194400      |       |       | 02.02 |                |        |             |                         |       |                |        |             |                            |
| 2.8 HDi (14/18)      |                    | 94                 |       | 11.01 | 03.02 |                |        |             |                         |       |                |        |             |                            |
| 2.8 HDi 4x4 (14/18)  |                    | 94                 |       | 11.01 | 03.02 |                |        |             |                         |       |                |        |             |                            |
|                      | 1.9 D (10)         | 50                 |       | 11.01 | 03.02 | 24.0116-0124.1 | 416124 |             | 280 16,0 14,2 +B        |       |                |        |             |                            |
|                      | 1.9 D (10)         | 51                 |       | 11.01 | 03.02 |                |        |             |                         |       |                |        |             |                            |
|                      | 1.9 DT 4X4 (10/14) | 66                 |       | 11.01 | 03.02 |                |        |             |                         |       |                |        |             |                            |
|                      | 1.9 TD (10/14)     | 66                 |       | 11.01 | 03.02 |                |        |             |                         |       |                |        |             |                            |
|                      | 1.9 TD (10/14)     | 68                 |       | 11.01 | 03.02 |                |        |             |                         |       |                |        |             |                            |
|                      | 2.0 HDi (10/14)    | 62                 |       | 11.01 | 03.02 |                |        |             |                         |       |                |        |             |                            |
|                      | 2.0 i (10/14)      | 80                 |       | 11.01 | 03.02 |                |        |             |                         |       |                |        |             |                            |
|                      | 2.0 i 4x4 (10/14)  | 80                 |       | 11.01 | 03.02 |                |        |             |                         |       |                |        |             |                            |
|                      | 2.5 D/DT (14)      | 63                 |       | 11.01 | 03.02 |                |        |             |                         |       |                |        |             |                            |
|                      | 2.5 TD (14)        | 76                 |       | 11.01 | 03.02 |                |        |             |                         |       |                |        |             |                            |
|                      | 2.5 TDi (14)       | 79                 |       | 11.01 | 03.02 |                |        |             |                         |       |                |        |             |                            |
|                      | 2.8 D (14)         | 64 S 16194400      |       |       | 02.02 |                |        |             |                         |       |                |        |             |                            |
|                      | 2.8 HDi (14)       | 94                 |       | 11.01 | 03.02 |                |        |             |                         |       |                |        |             |                            |
|                      | 2.8 HDi 4x4 (14)   | 94                 |       | 11.01 | 03.02 |                |        |             |                         |       |                |        |             |                            |
|                      | 2.0 i (18)         | 80                 |       | 11.01 | 03.02 | 24.0116-0125.1 | 416125 |             | 280 16,0 14,2 +B        |       |                |        |             |                            |
|                      | 2.0 i 4x4 (18)     | 80                 |       | 11.01 | 03.02 |                |        |             |                         |       |                |        |             |                            |
|                      | 2.5 D/DT (18)      | 63                 |       | 11.01 | 03.02 |                |        |             |                         |       |                |        |             |                            |
|                      | 2.5 TD (18)        | 76                 |       | 11.01 | 03.02 |                |        |             |                         |       |                |        |             |                            |
|                      | 2.5 TDi (18)       | 79                 |       | 11.01 | 03.02 |                |        |             |                         |       |                |        |             |                            |
|                      | 2.8 D (18)         | 64 S 16194400      |       |       | 02.02 |                |        |             |                         |       |                |        |             |                            |
|                      | 2.8 HDi (18)       | 94                 |       | 11.01 | 03.02 |                |        |             |                         |       |                |        |             |                            |
|                      | 2.8 HDi 4x4 (18)   | 94                 |       | 11.01 | 03.02 |                |        |             |                         |       |                |        |             |                            |
|                      |                    | 1.9 D (10)         | 50    |       | 07.99 |                |        |             |                         | 10.01 | 03.0137-0333.2 | 650333 | - Wohnmobil | 254 x 57 HEB <b>TRW</b>    |
|                      |                    | 1.9 D (10)         | 51    |       | 02.94 |                |        |             |                         | 10.01 |                |        |             |                            |
|                      |                    | 1.9 DT 4X4 (10/14) | 66    |       | 03.96 |                |        |             |                         | 10.01 |                |        |             |                            |
|                      |                    | 1.9 TD (10/14)     | 66    |       | 07.99 |                |        |             |                         | 10.01 |                |        |             |                            |
|                      |                    | 1.9 TD (10/14)     | 68    |       | 02.94 |                |        |             |                         | 10.01 |                |        |             |                            |
|                      |                    | 2.0 HDi (10/14)    | 62    |       | 08.01 |                |        |             |                         | 10.01 |                |        |             |                            |
| 2.0 i (10/14)        |                    | 80                 |       | 02.94 | 10.01 |                |        |             |                         |       |                |        |             |                            |
| 2.0 i 4x4 (10/14)    |                    | 80                 |       | 03.96 | 10.01 |                |        |             |                         |       |                |        |             |                            |
| 2.5 D/DT (14)        |                    | 63                 |       | 02.94 | 10.01 |                |        |             |                         |       |                |        |             |                            |
| 2.5 TD (14)          |                    | 76                 |       | 02.94 | 10.01 |                |        |             |                         |       |                |        |             |                            |
| 2.5 TDi (14)         |                    | 79                 |       | 01.97 | 10.01 |                |        |             |                         |       |                |        |             |                            |
| 2.8 D (14)           |                    | 64 S 16206253      |       |       | 01.99 |                |        |             |                         |       |                |        |             |                            |
| 2.8 HDi (14)         |                    | 94                 |       | 11.00 | 10.01 |                |        |             |                         |       |                |        |             |                            |
| 2.8 HDi 4x4 (14)     |                    | 94                 |       | 10.00 | 10.01 |                |        |             |                         |       |                |        |             |                            |
|                      | 1.9 D (10)         | 50                 |       | 11.01 | 03.02 | 03.0137-0432.2 | 650432 | - Quick Fit | 254 x 57 HEB <b>AP</b>  |       |                |        |             |                            |
|                      | 1.9 D (10)         | 51                 |       | 11.01 | 03.02 |                |        |             |                         |       |                |        |             |                            |
|                      | 1.9 DT 4X4 (10/14) | 66                 |       | 11.01 | 03.02 |                |        |             |                         |       |                |        |             |                            |
|                      | 1.9 TD (10/14)     | 66                 |       | 11.01 | 03.02 |                |        |             |                         |       |                |        |             |                            |
|                      | 1.9 TD (10/14)     | 68                 |       | 11.01 | 03.02 |                |        |             |                         |       |                |        |             |                            |
|                      | 2.0 HDi (10/14)    | 62                 |       | 11.01 | 03.02 |                |        |             |                         |       |                |        |             |                            |
|                      | 2.0 i (10/14)      | 80                 |       | 11.01 | 03.02 |                |        |             |                         |       |                |        |             |                            |
|                      | 2.0 i 4x4 (10/14)  | 80                 |       | 11.01 | 03.02 |                |        |             |                         |       |                |        |             |                            |
|                      | 2.5 D/DT (14)      | 63                 |       | 11.01 | 03.02 |                |        |             |                         |       |                |        |             |                            |
|                      | 2.5 TD (14)        | 76                 |       | 11.01 | 03.02 |                |        |             |                         |       |                |        |             |                            |
|                      | 2.5 TDi (14)       | 79                 |       | 11.01 | 03.02 |                |        |             |                         |       |                |        |             |                            |
|                      | 2.8 D (14)         | 64 S 16204256      |       |       | 02.02 |                |        |             |                         |       |                |        |             |                            |
|                      | 2.8 HDi (14)       | 94                 |       | 11.01 | 03.02 |                |        |             |                         |       |                |        |             |                            |
|                      | 2.8 HDi 4x4 (14)   | 94                 |       | 11.01 | 03.02 |                |        |             |                         |       |                |        |             |                            |
|                      | 2.0 HDi (18)       | 62                 |       | 08.01 | 10.01 | 03.0137-0334.2 | 650334 | - Wohnmobil | 254 x 57 HEB <b>TRW</b> |       |                |        |             |                            |
|                      | 2.0 i (18)         | 80                 |       | 02.94 | 10.01 |                |        |             |                         |       |                |        |             |                            |
|                      | 2.0 i 4x4 (18)     | 80                 |       | 03.96 | 10.01 |                |        |             |                         |       |                |        |             |                            |
|                      | 2.5 D/DT (18)      | 63                 |       | 02.94 | 10.01 |                |        |             |                         |       |                |        |             |                            |
|                      | 2.5 TD (18)        | 76                 |       | 02.94 | 10.01 |                |        |             |                         |       |                |        |             |                            |
|                      | 2.5 TDi (18)       | 79                 |       | 01.97 | 10.01 |                |        |             |                         |       |                |        |             |                            |
|                      | 2.8 D (18)         | 64 S 16209999      |       |       | 01.99 |                |        |             |                         |       |                |        |             |                            |
|                      | 2.8 HDi (18)       | 94                 |       | 11.00 | 10.01 |                |        |             |                         |       |                |        |             |                            |
| 2.8 HDi 4x4 (18)     | 94                 |                    | 10.00 | 10.01 |       |                |        |             |                         |       |                |        |             |                            |



**PEUGEOT BOXER Kasten (94-02)**

|                   |                    |            |            |       |       |                |        |  |             |                         |
|-------------------|--------------------|------------|------------|-------|-------|----------------|--------|--|-------------|-------------------------|
|                   | 1.9 D (10)         | 50         |            | 07.99 | 03.02 | 24.0225-4002.1 | 480048 |  |             | 254/255,6 x 63,5        |
|                   | 1.9 D (10)         | 51         |            | 02.94 | 03.02 |                |        |  |             |                         |
|                   | 1.9 DT 4X4 (10/14) | 66         |            | 03.96 | 03.02 |                |        |  |             |                         |
|                   | 1.9 TD (10/14)     | 66         |            | 07.99 | 03.02 |                |        |  |             |                         |
|                   | 1.9 TD (10/14)     | 68         |            | 02.94 | 03.02 |                |        |  |             |                         |
|                   | 2.0 HDi (10/14)    | 62         |            | 08.01 | 03.02 |                |        |  |             |                         |
|                   | 2.0 i (10/14)      | 80         |            | 02.94 | 03.02 |                |        |  |             |                         |
|                   | 2.0 i 4x4 (10/14)  | 80         |            | 03.96 | 03.02 |                |        |  |             |                         |
|                   | 2.5 D/DT (14)      | 63         |            | 02.94 | 03.02 |                |        |  |             |                         |
|                   | 2.5 TD (14)        | 76         |            | 02.94 | 03.02 |                |        |  |             |                         |
|                   | 2.5 TDi (14)       | 79         |            | 01.97 | 03.02 |                |        |  |             |                         |
|                   | 2.8 D (14)         | 64         |            | 01.99 | 02.02 |                |        |  |             |                         |
|                   | 2.8 HDi (14)       | 94         |            | 11.00 | 03.02 |                |        |  |             |                         |
|                   | 2.8 HDi 4x4 (14)   | 94         |            | 10.00 | 03.02 |                |        |  |             |                         |
|                   | 2.0 HDi (18)       | 62         |            | 08.01 | 10.01 |                |        |  |             |                         |
|                   | 2.0 i (18)         | 80         |            | 02.94 | 10.01 |                |        |  |             |                         |
|                   | 2.0 i 4x4 (18)     | 80         |            | 03.96 | 10.01 |                |        |  |             |                         |
|                   | 2.5 D/DT (18)      | 63         |            | 02.94 | 10.01 |                |        |  |             |                         |
|                   | 2.5 TD (18)        | 76         |            | 02.94 | 10.01 |                |        |  |             |                         |
| 2.5 TDi (18)      | 79                 |            | 01.97      | 10.01 |       |                |        |  |             |                         |
| 2.8 D (18)        | 64                 | S 16209999 | 01.99      | 10.01 |       |                |        |  |             |                         |
| 2.8 HDi (18)      | 94                 |            | 11.00      | 10.01 |       |                |        |  |             |                         |
| 2.8 HDi 4x4 (18)  | 94                 |            | 10.00      | 10.01 |       |                |        |  |             |                         |
|                   | 1.9 D (10)         | 50         |            | 07.99 | 10.01 | 03.0520-0925.3 | 690925 |  | - Wohnmobil | 25,40/254x57 TopKit TRW |
|                   | 1.9 D (10)         | 51         |            | 02.94 | 10.01 |                |        |  |             |                         |
|                   | 1.9 DT 4X4 (10/14) | 66         |            | 03.96 | 10.01 |                |        |  |             |                         |
|                   | 1.9 TD (10/14)     | 66         |            | 07.99 | 10.01 |                |        |  |             |                         |
|                   | 1.9 TD (10/14)     | 68         |            | 02.94 | 10.01 |                |        |  |             |                         |
|                   | 2.0 HDi (10/14)    | 62         |            | 08.01 | 10.01 |                |        |  |             |                         |
|                   | 2.0 i (10/14)      | 80         |            | 02.94 | 10.01 |                |        |  |             |                         |
|                   | 2.0 i 4x4 (10/14)  | 80         |            | 03.96 | 10.01 |                |        |  |             |                         |
|                   | 2.5 D/DT (14)      | 63         |            | 02.94 | 10.01 |                |        |  |             |                         |
|                   | 2.5 TD (14)        | 76         |            | 02.94 | 10.01 |                |        |  |             |                         |
|                   | 2.5 TDi (14)       | 79         |            | 01.97 | 10.01 |                |        |  |             |                         |
|                   | 2.8 HDi (14)       | 94         |            | 11.00 | 10.01 |                |        |  |             |                         |
|                   | 2.8 HDi 4x4 (14)   | 94         |            | 10.00 | 10.01 |                |        |  |             |                         |
|                   | 1.9 D (10)         | 50         |            | 11.01 | 03.02 |                |        |  |             |                         |
|                   | 1.9 D (10)         | 51         |            | 11.01 | 03.02 |                |        |  |             |                         |
|                   | 1.9 DT 4X4 (10/14) | 66         |            | 11.01 | 03.02 |                |        |  |             |                         |
|                   | 1.9 TD (10/14)     | 66         |            | 11.01 | 03.02 |                |        |  |             |                         |
|                   | 1.9 TD (10/14)     | 68         |            | 11.01 | 03.02 |                |        |  |             |                         |
|                   | 2.0 HDi (10/14)    | 62         |            | 11.01 | 03.02 |                |        |  |             |                         |
| 2.0 i (10/14)     | 80                 |            | 11.01      | 03.02 |       |                |        |  |             |                         |
| 2.0 i 4x4 (10/14) | 80                 |            | 11.01      | 03.02 |       |                |        |  |             |                         |
| 2.5 D/DT (14)     | 63                 |            | 11.01      | 03.02 |       |                |        |  |             |                         |
| 2.5 TD (14)       | 76                 |            | 11.01      | 03.02 |       |                |        |  |             |                         |
| 2.5 TDi (14)      | 79                 |            | 11.01      | 03.02 |       |                |        |  |             |                         |
| 2.8 HDi (14)      | 94                 |            | 11.01      | 03.02 |       |                |        |  |             |                         |
| 2.8 HDi 4x4 (14)  | 94                 |            | 11.01      | 03.02 |       |                |        |  |             |                         |
|                   | 2.0 HDi (18)       | 62         |            | 08.01 | 10.01 | 03.0520-0728.3 | 690728 |  | - Wohnmobil | 28,57/254x57 TopKit TRW |
|                   | 2.0 i (18)         | 80         |            | 02.94 | 10.01 |                |        |  |             |                         |
|                   | 2.0 i 4x4 (18)     | 80         |            | 03.96 | 10.01 |                |        |  |             |                         |
|                   | 2.5 D/DT (18)      | 63         |            | 02.94 | 10.01 |                |        |  |             |                         |
|                   | 2.5 TD (18)        | 76         |            | 02.94 | 10.01 |                |        |  |             |                         |
|                   | 2.5 TDi (18)       | 79         |            | 01.97 | 10.01 |                |        |  |             |                         |
|                   | 2.8 HDi (18)       | 94         |            | 11.00 | 10.01 |                |        |  |             |                         |
|                   | 2.8 HDi 4x4 (18)   | 94         |            | 10.00 | 10.01 |                |        |  |             |                         |
|                   | 1.9 D (10/14)      | 51         | S 16206253 | 03.94 |       |                |        |  |             |                         |
|                   | 1.9 TD (10/14)     | 66         |            | 12.98 | 12.99 |                |        |  |             |                         |
|                   | 1.9 TD (10/14)     | 68         |            | 07.96 | 12.99 |                |        |  |             |                         |
|                   | 2.0 i (10/14)      |            |            | 06.94 | 12.99 |                |        |  |             |                         |
|                   | 2.5 D (14)         | 63         |            | 02.94 | 12.99 |                |        |  |             |                         |
|                   | 2.5 TD (14)        | 76         |            | 02.94 | 12.99 |                |        |  |             |                         |
|                   | 2.5 TDi (14)       | 79         |            | 01.97 | 12.99 |                |        |  |             |                         |
|                   | 2.8 D (14)         | 64         | S 16206253 | 01.99 |       |                |        |  |             |                         |
|                   | 1.9 D (10/14)      | 51         | S 16206253 | 03.94 |       |                |        |  |             |                         |
|                   | 1.9 TD (10/14)     | 66         |            | 01.00 | 10.01 |                |        |  |             |                         |
|                   | 1.9 TD (10/14)     | 68         |            | 01.00 | 10.01 |                |        |  |             |                         |
| 2.0 i (10/14)     |                    |            | 01.00      | 10.01 |       |                |        |  |             |                         |
| 2.5 D (14)        | 63                 |            | 01.00      | 10.01 |       |                |        |  |             |                         |
| 2.5 TD (14)       | 76                 |            | 01.00      | 10.01 |       |                |        |  |             |                         |
| 2.5 TDi (14)      | 79                 |            | 01.00      | 10.01 |       |                |        |  |             |                         |
| 2.8 D (14)        | 64                 | S 16206253 | 01.99      |       |       |                |        |  |             |                         |
| 2.8 HDi (14)      | 94                 |            | 11.00      | 10.01 |       |                |        |  |             |                         |
| 2.8 HDi 4X4 (14)  | 93                 |            | 10.00      | 10.01 |       |                |        |  |             |                         |
|                   | 1.9 D (10/14)      | 51         | S 16204256 |       | 04.02 | 13.0460-4978.2 | 604978 |  |             | 23917 19,3 +/WK/Zub BRE |
|                   | 1.9 TD (10/14)     | 66         |            | 11.01 | 03.02 |                |        |  |             |                         |
|                   | 1.9 TD (10/14)     | 68         |            | 11.01 | 03.02 |                |        |  |             |                         |
|                   | 2.0 i (10/14)      |            |            | 11.01 | 03.02 |                |        |  |             |                         |
|                   | 2.5 D (14)         | 63         |            | 11.01 | 03.02 |                |        |  |             |                         |
|                   | 2.5 TD (14)        | 76         |            | 11.01 | 03.02 |                |        |  |             |                         |
|                   | 2.5 TDi (14)       | 79         |            | 11.01 | 03.02 |                |        |  |             |                         |
|                   | 2.8 D (14)         | 64         | S 16204256 |       | 02.02 |                |        |  |             |                         |
|                   | 2.8 HDi (14)       | 94         |            | 11.01 | 03.02 |                |        |  |             |                         |

**PEUGEOT BOXER Pritsche/Fahrgestell (94-02)**

|                  |                |            |            |       |       |                |        |  |  |                         |
|------------------|----------------|------------|------------|-------|-------|----------------|--------|--|--|-------------------------|
|                  | 1.9 D (10/14)  | 51         | S 16206253 | 03.94 |       | 13.0460-2976.2 | 602976 |  |  | 21797 19,7 +/WK/S TRW   |
|                  | 1.9 TD (10/14) | 66         |            | 12.98 | 12.99 |                |        |  |  |                         |
|                  | 1.9 TD (10/14) | 68         |            | 07.96 | 12.99 |                |        |  |  |                         |
|                  | 2.0 i (10/14)  |            |            | 06.94 | 12.99 |                |        |  |  |                         |
|                  | 2.5 D (14)     | 63         |            | 02.94 | 12.99 |                |        |  |  |                         |
|                  | 2.5 TD (14)    | 76         |            | 02.94 | 12.99 |                |        |  |  |                         |
|                  | 2.5 TDi (14)   | 79         |            | 01.97 | 12.99 |                |        |  |  |                         |
|                  | 2.8 D (14)     | 64         | S 16206253 | 01.99 |       |                |        |  |  |                         |
|                  | 1.9 D (10/14)  | 51         | S 16206253 | 03.94 |       |                |        |  |  |                         |
| 1.9 TD (10/14)   | 66             |            | 01.00      | 10.01 |       |                |        |  |  |                         |
| 1.9 TD (10/14)   | 68             |            | 01.00      | 10.01 |       |                |        |  |  |                         |
| 2.0 i (10/14)    |                |            | 01.00      | 10.01 |       |                |        |  |  |                         |
| 2.5 D (14)       | 63             |            | 01.00      | 10.01 |       |                |        |  |  |                         |
| 2.5 TD (14)      | 76             |            | 01.00      | 10.01 |       |                |        |  |  |                         |
| 2.5 TDi (14)     | 79             |            | 01.00      | 10.01 |       |                |        |  |  |                         |
| 2.8 D (14)       | 64             | S 16206253 | 01.99      |       |       |                |        |  |  |                         |
| 2.8 HDi (14)     | 94             |            | 11.00      | 10.01 |       |                |        |  |  |                         |
| 2.8 HDi 4X4 (14) | 93             |            | 10.00      | 10.01 |       |                |        |  |  |                         |
|                  | 1.9 D (10/14)  | 51         | S 16204256 |       | 04.02 | 13.0460-4978.2 | 604978 |  |  | 23917 19,3 +/WK/Zub BRE |
|                  | 1.9 TD (10/14) | 66         |            | 11.01 | 03.02 |                |        |  |  |                         |
|                  | 1.9 TD (10/14) | 68         |            | 11.01 | 03.02 |                |        |  |  |                         |
|                  | 2.0 i (10/14)  |            |            | 11.01 | 03.02 |                |        |  |  |                         |
|                  | 2.5 D (14)     | 63         |            | 11.01 | 03.02 |                |        |  |  |                         |
|                  | 2.5 TD (14)    | 76         |            | 11.01 | 03.02 |                |        |  |  |                         |
|                  | 2.5 TDi (14)   | 79         |            | 11.01 | 03.02 |                |        |  |  |                         |
|                  | 2.8 D (14)     | 64         | S 16204256 |       | 02.02 |                |        |  |  |                         |
|                  | 2.8 HDi (14)   | 94         |            | 11.01 | 03.02 |                |        |  |  |                         |





**PEUGEOT BOXER Pritsche/Fahrgestell (94-02)**

|  |                     |    |            |       |       |  |                |        |  |             |                     |            |
|--|---------------------|----|------------|-------|-------|--|----------------|--------|--|-------------|---------------------|------------|
|  | 2.8 HDi 4X4 (14)    | 93 |            | 11.01 | 11.01 |  | 13.0460-4978.2 | 604978 |  |             | 23917 19,3 +/WK/Zub | <b>BRE</b> |
|  | 2.0 i (18)          |    |            | 06.94 | 12.99 |  | 13.0460-2977.2 | 602977 |  |             | 21799 19,7 +/WK/S   | <b>TRW</b> |
|  | 2.5 D (18)          | 63 |            | 02.94 | 12.99 |  |                |        |  |             |                     |            |
|  | 2.5 TD (18)         | 76 |            | 02.94 | 12.99 |  |                |        |  |             |                     |            |
|  | 2.5 TDi (18)        | 79 |            | 01.97 | 12.99 |  |                |        |  |             |                     |            |
|  | 2.8 D (18)          | 64 | S 16205352 | 01.99 |       |  |                |        |  |             |                     |            |
|  | 2.0 i (18)          |    |            | 01.00 | 10.01 |  | 13.0460-2852.2 | 602852 |  |             | 23603 19,7 +/WK/S   | <b>TRW</b> |
|  | 2.5 D (18)          | 63 |            | 01.00 | 10.01 |  |                |        |  |             |                     |            |
|  | 2.5 TD (18)         | 76 |            | 01.00 | 10.01 |  |                |        |  |             |                     |            |
|  | 2.5 TDi (18)        | 79 |            | 01.00 | 10.01 |  |                |        |  |             |                     |            |
|  | 2.8 HDi (18)        | 94 |            | 11.00 | 10.01 |  |                |        |  |             |                     |            |
|  | 2.8 HDi 4X4 (18)    | 93 |            | 10.00 | 10.01 |  |                |        |  |             |                     |            |
|  | 2.0 i (18)          |    |            | 11.01 | 03.02 |  | 13.0460-4979.2 | 604979 |  |             | 23919 19,3 +/WK/Zub | <b>BRE</b> |
|  | 2.5 D (18)          | 63 |            | 11.01 | 03.02 |  |                |        |  |             |                     |            |
|  | 2.5 TD (18)         | 76 |            | 11.01 | 03.02 |  |                |        |  |             |                     |            |
|  | 2.5 TDi (18)        | 79 |            | 11.01 | 03.02 |  |                |        |  |             |                     |            |
|  | 2.8 D (18)          | 64 | S 16194400 |       | 02.02 |  |                |        |  |             |                     |            |
|  | 2.8 HDi (18)        | 94 |            | 11.01 | 03.02 |  |                |        |  |             |                     |            |
|  | 2.8 HDi 4X4 (18)    | 93 |            | 11.01 | 11.01 |  |                |        |  |             |                     |            |
|  | 1.9 D (10/14)       | 51 | S 16206253 | 03.94 |       |  | 24.0118-0108.1 | 418108 |  |             | 280 18,0 15,9 +B    |            |
|  | 1.9 TD (10/14)      | 66 |            | 12.98 | 12.99 |  |                |        |  |             |                     |            |
|  | 1.9 TD (10/14)      | 68 |            | 07.96 | 12.99 |  |                |        |  |             |                     |            |
|  | 2.0 i (10/14)       |    |            | 06.94 | 12.99 |  |                |        |  |             |                     |            |
|  | 2.5 D (14)          | 63 |            | 02.94 | 12.99 |  |                |        |  |             |                     |            |
|  | 2.8 D (14)          | 64 | S 16206253 | 01.99 |       |  |                |        |  |             |                     |            |
|  | 1.9 D (10/14)       | 51 | S 16204256 |       | 04.02 |  | 24.0124-0127.1 | 424127 |  |             | 280 24,0 21,9 V +B  |            |
|  | 2.5 TD (14)         | 76 |            | 02.94 | 03.02 |  |                |        |  |             |                     |            |
|  | 2.5 TDi (14)        | 79 |            | 01.97 | 03.02 |  |                |        |  |             |                     |            |
|  | 2.8 D (14)          | 64 | S 16204256 |       | 02.02 |  |                |        |  |             |                     |            |
|  | 2.8 HDi (14)        | 94 |            | 11.00 | 03.02 |  |                |        |  |             |                     |            |
|  | 2.8 HDi 4X4 (14)    | 93 |            | 10.00 | 11.01 |  |                |        |  |             |                     |            |
|  | 2.0 i (18)          |    |            | 06.94 | 03.02 |  | 24.0124-0138.1 | 424138 |  |             | 300 24,0 21,9 V +B  |            |
|  | 2.5 D (18)          | 63 |            | 02.94 | 03.02 |  |                |        |  |             |                     |            |
|  | 2.5 TD (18)         | 76 |            | 02.94 | 03.02 |  |                |        |  |             |                     |            |
|  | 2.5 TDi (18)        | 79 |            | 01.97 | 03.02 |  |                |        |  |             |                     |            |
|  | 2.8 D (18)          | 64 |            | 01.99 | 02.02 |  |                |        |  |             |                     |            |
|  | 2.8 HDi (18)        | 94 |            | 11.00 | 03.02 |  |                |        |  |             |                     |            |
|  | 2.8 HDi 4X4 (18)    | 93 |            | 10.00 | 11.01 |  |                |        |  |             |                     |            |
|  | 1.9 D (10/14)       | 51 | S 16194400 |       | 04.02 |  | 13.0460-4980.2 | 604980 |  |             | 23921 20,3 /Zub     | <b>BRE</b> |
|  | 1.9 TD (10/14)      | 66 |            | 11.01 | 03.02 |  |                |        |  |             |                     |            |
|  | 1.9 TD (10/14)      | 68 |            | 11.01 | 03.02 |  |                |        |  |             |                     |            |
|  | 2.0 i (10/14/18)    |    |            | 11.01 | 03.02 |  |                |        |  |             |                     |            |
|  | 2.5 D (14/18)       | 63 |            | 11.01 | 03.02 |  |                |        |  |             |                     |            |
|  | 2.5 TD (14/18)      | 76 |            | 11.01 | 03.02 |  |                |        |  |             |                     |            |
|  | 2.5 TDi (14/18)     | 79 |            | 11.01 | 03.02 |  |                |        |  |             |                     |            |
|  | 2.8 D (14/18)       | 64 | S 16194400 |       | 02.02 |  |                |        |  |             |                     |            |
|  | 2.8 HDi (14/18)     | 94 |            | 11.01 | 03.02 |  |                |        |  |             |                     |            |
|  | 2.8 HDi 4X4 (14/18) | 93 |            | 11.01 | 11.01 |  |                |        |  |             |                     |            |
|  | 1.9 D (10/14)       | 51 | S 16194400 |       | 04.02 |  | 24.0116-0124.1 | 416124 |  |             | 280 16,0 14,2 +B    |            |
|  | 1.9 TD (10/14)      | 66 |            | 11.01 | 03.02 |  |                |        |  |             |                     |            |
|  | 1.9 TD (10/14)      | 68 |            | 11.01 | 03.02 |  |                |        |  |             |                     |            |
|  | 2.0 i (10/14)       |    |            | 11.01 | 03.02 |  |                |        |  |             |                     |            |
|  | 2.5 D (14)          | 63 |            | 11.01 | 03.02 |  |                |        |  |             |                     |            |
|  | 2.5 TD (14)         | 76 |            | 11.01 | 03.02 |  |                |        |  |             |                     |            |
|  | 2.5 TDi (14)        | 79 |            | 11.01 | 03.02 |  |                |        |  |             |                     |            |
|  | 2.8 D (14)          | 64 | S 16194400 |       | 02.02 |  |                |        |  |             |                     |            |
|  | 2.8 HDi (14)        | 94 |            | 11.01 | 03.02 |  |                |        |  |             |                     |            |
|  | 2.8 HDi 4X4 (14)    | 93 |            | 11.01 | 11.01 |  |                |        |  |             |                     |            |
|  | 2.0 i (18)          |    |            | 11.01 | 03.02 |  | 24.0116-0125.1 | 416125 |  |             | 280 16,0 14,2 +B    |            |
|  | 2.5 D (18)          | 63 |            | 11.01 | 03.02 |  |                |        |  |             |                     |            |
|  | 2.5 TD (18)         | 76 |            | 11.01 | 03.02 |  |                |        |  |             |                     |            |
|  | 2.5 TDi (18)        | 79 |            | 11.01 | 03.02 |  |                |        |  |             |                     |            |
|  | 2.8 D (18)          | 64 | S 16194400 |       | 02.02 |  |                |        |  |             |                     |            |
|  | 2.8 HDi (18)        | 94 |            | 11.01 | 03.02 |  |                |        |  |             |                     |            |
|  | 1.9 D (10/14)       | 51 | S 16206253 | 03.94 |       |  | 03.0137-0333.2 | 650333 |  | - Wohnmobil | 254 x 57 HEB        | <b>TRW</b> |
|  | 1.9 TD (10/14)      | 66 |            | 12.98 | 10.01 |  | 03.0137-9219.2 | 669219 |  |             | Bremsbacken-Zubehör | <b>TRW</b> |
|  | 1.9 TD (10/14)      | 68 |            | 07.96 | 10.01 |  |                |        |  |             |                     |            |
|  | 2.0 i (10/14)       |    |            | 06.94 | 10.01 |  |                |        |  |             |                     |            |
|  | 2.5 D (14)          | 63 |            | 02.94 | 10.01 |  |                |        |  |             |                     |            |
|  | 2.5 TD (14)         | 76 |            | 02.94 | 10.01 |  |                |        |  |             |                     |            |
|  | 2.5 TDi (14)        | 79 |            | 01.97 | 10.01 |  |                |        |  |             |                     |            |
|  | 2.8 D (14)          | 64 | S 16206253 | 01.99 |       |  |                |        |  |             |                     |            |
|  | 2.8 HDi (14)        | 94 |            | 11.00 | 10.01 |  |                |        |  |             |                     |            |
|  | 2.8 HDi 4X4 (14)    | 93 |            | 10.00 | 10.01 |  |                |        |  |             |                     |            |
|  | 1.9 D (10/14)       | 51 | S 16204256 |       | 04.02 |  | 03.0137-0432.2 | 650432 |  | - Quick Fit | 254 x 57 HEB        | <b>AP</b>  |
|  | 1.9 TD (10/14)      | 66 |            | 11.01 | 03.02 |  | 03.0137-9285.2 | 669285 |  |             | Bremsbacken-Zubehör | <b>AP</b>  |
|  | 1.9 TD (10/14)      | 68 |            | 11.01 | 03.02 |  |                |        |  |             |                     |            |
|  | 2.0 i (10/14)       |    |            | 11.01 | 03.02 |  |                |        |  |             |                     |            |
|  | 2.5 D (14)          | 63 |            | 11.01 | 03.02 |  |                |        |  |             |                     |            |
|  | 2.5 TD (14)         | 76 |            | 11.01 | 03.02 |  |                |        |  |             |                     |            |
|  | 2.5 TDi (14)        | 79 |            | 11.01 | 03.02 |  |                |        |  |             |                     |            |
|  | 2.8 D (14)          | 64 | S 16204256 |       | 02.02 |  |                |        |  |             |                     |            |
|  | 2.8 HDi (14)        | 94 |            | 11.01 | 03.02 |  |                |        |  |             |                     |            |
|  | 2.8 HDi 4X4 (14)    | 93 |            | 11.01 | 11.01 |  |                |        |  |             |                     |            |



**PEUGEOT BOXER Pritsche/Fahrgestell (94-02)**

|  |   |  |            |  |  |                                  |                  |             |                                     |            |
|--|---|--|------------|--|--|----------------------------------|------------------|-------------|-------------------------------------|------------|
|  | 2.0 i (18)<br>2.5 D (18)<br>2.5 TD (18)<br>2.5 TDi (18)<br>2.8 D (18)<br>2.8 HDi (18)<br>2.8 HDi 4X4 (18)   | 63<br>76<br>79<br>64<br>94<br>93                   | S 16209999 | 06.94<br>02.94<br>02.94<br>01.97<br>01.99<br>11.00<br>10.00                            | 10.01<br>10.01<br>10.01<br>10.01<br>10.01<br>10.01<br>10.01                            | 03.0137-0334.2<br>03.0137-9219.2 | 650334<br>669219 | - Wohnmobil | 254 x 57 HEB<br>Bremsbacken-Zubehör | TRW<br>TRW |
|  | 1.9 D (10/14)<br>1.9 TD (10/14)<br>1.9 TD (10/14)<br>2.0 i (10/14)<br>2.5 D (14)<br>2.5 TD (14)<br>2.5 TDi (14)<br>2.8 D (14)<br>2.8 HDi (14)<br>2.8 HDi 4X4 (14) | 51<br>66<br>68<br>63<br>76<br>79<br>64<br>94<br>93 |            | 03.94<br>12.98<br>07.96<br>06.94<br>02.94<br>02.94<br>01.97<br>01.99<br>11.00<br>10.00 | 04.02<br>03.02<br>03.02<br>03.02<br>03.02<br>03.02<br>03.02<br>02.02<br>03.02<br>11.01 | 24.0225-4002.1                   | 480048           |             | 254/255,6 x 63,5                    |            |
|  | 2.0 i (18)<br>2.5 D (18)<br>2.5 TD (18)<br>2.5 TDi (18)<br>2.8 D (18)<br>2.8 HDi (18)<br>2.8 HDi 4X4 (18)   | 63<br>76<br>79<br>64<br>94<br>93                   | S 16209999 | 06.94<br>02.94<br>02.94<br>01.97<br>01.99<br>11.00<br>10.00                            | 10.01<br>10.01<br>10.01<br>10.01<br>10.01<br>10.01<br>11.01                            | 24.0225-4005.1                   | 480070           |             | 254/255,6 x 64,5                    |            |
|  | 1.9 TD (10/14)<br>1.9 TD (10/14)<br>2.0 i (10/14)<br>2.5 D (14)   | 66<br>68<br>63                                     |            | 12.98<br>07.96<br>06.94<br>02.94   | 10.01<br>10.01<br>10.01<br>10.01   | 03.0520-0925.3                   | 690925           | - Wohnmobil | 25,40/254x57 TopKit                 | TRW        |
|  | 2.5 TD (14)<br>2.5 TDi (14)<br>2.8 HDi (14)<br>2.8 HDi 4X4 (14)   | 76<br>79<br>94<br>93                               |            | 02.94<br>01.97<br>11.00<br>10.00   | 10.01<br>10.01<br>10.01<br>10.01   | 03.0520-0226.3                   | 690226           | - Wohnmobil | 26,99/254x57 TopKit                 | TRW        |
|  | 1.9 TD (10/14)<br>1.9 TD (10/14)<br>2.0 i (10/14)<br>2.5 D (14)<br>2.5 TD (14)<br>2.5 TDi (14)<br>2.8 HDi (14)<br>2.8 HDi 4X4 (14)                                | 66<br>68<br>63<br>76<br>79<br>94<br>93             |            | 11.01<br>11.01<br>11.01<br>11.01<br>11.01<br>11.01<br>11.01<br>11.01                   | 03.02<br>03.02<br>03.02<br>03.02<br>03.02<br>03.02<br>03.02<br>11.01                   | 03.0520-0326.3                   | 690326           | + Quick Fit | 26,99/254x57 TopKit                 | AP         |
|  | 2.0 i (18)<br>2.5 D (18)<br>2.5 TD (18)<br>2.5 TDi (18)<br>2.8 HDi (18)<br>2.8 HDi 4X4 (18)   | 63<br>76<br>79<br>94<br>93                         |            | 06.94<br>02.94<br>02.94<br>01.97<br>11.00<br>10.00                                     | 10.01<br>10.01<br>10.01<br>10.01<br>10.01<br>10.01                                     | 03.0520-0728.3                   | 690728           | - Wohnmobil | 28,57/254x57 TopKit                 | TRW        |

**PEUGEOT BOXER (02-06)**

|  |  |                |  |                                  |                                  |                                  |                  |             |                                     |          |
|--|--|----------------|--|----------------------------------|----------------------------------|----------------------------------|------------------|-------------|-------------------------------------|----------|
|  | 2.0 HDi (10/14)<br>2.0 i (10/14)<br>2.2 HDi (10/14)<br>2.8 HDi (10/14)             | 62<br>81<br>74 |  | 04.02<br>04.02<br>04.02<br>04.02 | 03.06<br>03.06<br>03.06<br>03.06 | 13.0460-4978.2                   | 604978           |             | 23917 19,3 +/WK/Zub                 | BRE      |
|  | 2.0 HDi (18)<br>2.0 i (18)<br>2.2 HDi (18)<br>2.8 HDi (18)                         | 62<br>81<br>74 |  | 04.02<br>04.02<br>04.02<br>04.02 | 03.06<br>03.06<br>03.06<br>03.06 | 13.0460-4979.2                   | 604979           |             | 23919 19,3 +/WK/Zub                 | BRE      |
|  | 2.0 HDi (10/14)<br>2.0 i (10/14)<br>2.2 HDi (10/14)<br>2.8 HDi (10/14)             | 62<br>81<br>74 |  | 04.02<br>04.02<br>04.02<br>04.02 | 03.06<br>03.06<br>03.06<br>03.06 | 24.0124-0127.1                   | 424127           |             | 280 24,0 21,9 V +B                  |          |
|  | 2.0 HDi (18)<br>2.0 i (18)<br>2.2 HDi (18)<br>2.8 HDi (18)                         | 62<br>81<br>74 |  | 04.02<br>04.02<br>04.02<br>04.02 | 03.06<br>03.06<br>03.06<br>03.06 | 24.0124-0138.1                   | 424138           |             | 300 24,0 21,9 V +B                  |          |
|  | 2.0 HDi (10/14/18)<br>2.0 i (10/14/18)<br>2.2 HDi (10/14/18)<br>2.8 HDi (10/14/18) | 62<br>81<br>74 |  | 04.02<br>04.02<br>04.02<br>04.02 | 03.06<br>03.06<br>03.06<br>03.06 | 13.0460-4980.2                   | 604980           |             | 23921 20,3 /Zub                     | BRE      |
|  | 2.0 HDi (10/14)<br>2.0 i (10/14)<br>2.2 HDi (10/14)<br>2.8 HDi (10/14)             | 62<br>81<br>74 |  | 04.02<br>04.02<br>04.02<br>04.02 | 03.06<br>03.06<br>03.06<br>03.06 | 24.0116-0124.1                   | 416124           |             | 280 16,0 14,2 +B                    |          |
|  | 2.0 HDi (18)<br>2.0 i (18)<br>2.2 HDi (18)<br>2.8 HDi (18)                         | 62<br>81<br>74 |  | 04.02<br>04.02<br>04.02<br>04.02 | 03.06<br>03.06<br>03.06<br>03.06 | 24.0116-0125.1                   | 416125           |             | 280 16,0 14,2 +B                    |          |
|  | 2.0 HDi (10/14)<br>2.0 i (10/14)<br>2.2 HDi (10/14)<br>2.8 HDi (10/14)             | 62<br>81<br>74 |  | 04.02<br>04.02<br>04.02<br>04.02 | 03.06<br>03.06<br>03.06<br>03.06 | 03.0137-0432.2<br>03.0137-9285.2 | 650432<br>669285 | - Quick Fit | 254 x 57 HEB<br>Bremsbacken-Zubehör | AP<br>AP |
|  | 2.0 HDi (10/14)<br>2.0 i (10/14)<br>2.2 HDi (10/14)<br>2.8 HDi (10/14)             | 62<br>81<br>74 |  | 04.02<br>04.02<br>04.02<br>04.02 | 03.06<br>03.06<br>03.06<br>03.06 | 24.0225-4002.1                   | 480048           |             | 254/255,6 x 63,5                    |          |



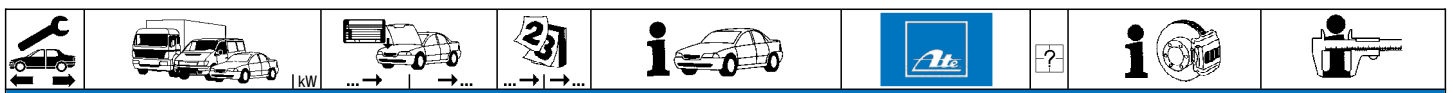

### PEUGEOT BOXER (02-06)

|  |                       |    |  |       |       |                |        |                 |                     |    |
|--|-----------------------|----|--|-------|-------|----------------|--------|-----------------|---------------------|----|
|  | 2.0 HDi (10/14)       | 62 |  | 04.02 | 03.06 | 03.0520-0326.3 | 690326 | + Quick Fit     | 26,99/254x57 TopKit | AP |
|  | 2.0 i (10/14)         | 81 |  | 04.02 | 03.06 |                |        |                 |                     |    |
|  | 2.2 HDi (10/14)       | 74 |  | 04.02 | 03.06 |                |        |                 |                     |    |
|  | 2.8 HDi (10/14)       |    |  | 04.02 | 03.06 |                |        |                 |                     |    |
|  | 2.0 Bifuel (10/14/18) | 81 |  | 02.03 | 03.06 | 03.0137-4002.2 | 654002 | - Stützlager 1) | 172 x 42 /Zub       |    |
|  | 2.0 HDi (10/14/18)    | 62 |  | 04.02 | 03.06 |                |        |                 |                     |    |
|  | 2.0 i (10/14/18)      | 81 |  | 04.02 | 03.06 |                |        |                 |                     |    |
|  | 2.2 HDi (10/14/18)    | 74 |  | 04.02 | 03.06 |                |        |                 |                     |    |
|  | 2.8 HDi (10/14/18)    |    |  | 04.02 | 03.06 |                |        |                 |                     |    |

### PEUGEOT BOXER (06-)

|  |                 |     |  |       |                        |                |        |  |                      |     |
|--|-----------------|-----|--|-------|------------------------|----------------|--------|--|----------------------|-----|
|  | 2.0 BlueHDi 110 | 81  |  | 07.15 | Nutzlast 120/140 2)    | 13.0460-4807.2 | 604807 |  | 24468 19,1 +/-WK/Zub | BRE |
|  | 2.0 BlueHDi 130 | 96  |  | 07.15 | Nutzlast 120/140 2)    |                |        |  |                      |     |
|  | 2.0 BlueHDi 160 | 120 |  | 07.15 | Nutzlast 120/140 2)    |                |        |  |                      |     |
|  | 2.2 HDi 100     | 74  |  | 04.06 | Nutzlast 120/140 2)    |                |        |  |                      |     |
|  | 2.2 HDi 110     | 81  |  | 03.11 | Nutzlast 120/140 2)    |                |        |  |                      |     |
|  | 2.2 HDi 120     | 88  |  | 04.06 | Nutzlast 120/140 2)    |                |        |  |                      |     |
|  | 2.2 HDi 130     | 96  |  | 03.11 | Nutzlast 120/140 2)    |                |        |  |                      |     |
|  | 2.2 HDi 150     | 110 |  | 03.11 | Nutzlast 120/140 2)    |                |        |  |                      |     |
|  | 3.0 HDi 145     | 107 |  | 04.10 | Nutzlast 120/140 2)    |                |        |  |                      |     |
|  | 3.0 HDi 160     | 116 |  | 04.06 | Nutzlast 120/140 2)    |                |        |  |                      |     |
|  | 3.0 HDi 175     | 130 |  | 03.11 | Nutzlast 120/140 2)    |                |        |  |                      |     |
|  | 2.2 HDi 100     | 74  |  | 04.06 | Nutzlast leicht 160 3) | 13.0460-4809.2 | 604809 |  | 24468 19,1 +/-WK/Zub | BRE |
|  | 2.2 HDi 110     | 81  |  | 03.11 | Nutzlast leicht 160 3) |                |        |  |                      |     |
|  | 2.2 HDi 120     | 88  |  | 04.06 | Nutzlast leicht 160 3) |                |        |  |                      |     |
|  | 2.2 HDi 130     | 96  |  | 03.11 | Nutzlast leicht 160 3) |                |        |  |                      |     |
|  | 2.2 HDi 150     | 110 |  | 03.11 | Nutzlast leicht 160 3) |                |        |  |                      |     |
|  | 3.0 HDi 145     | 107 |  | 04.10 | Nutzlast leicht 160 3) |                |        |  |                      |     |
|  | 3.0 HDi 160     | 116 |  | 04.06 | Nutzlast leicht 160 3) |                |        |  |                      |     |
|  | 3.0 HDi 175     | 130 |  | 03.11 | Nutzlast leicht 160 3) |                |        |  |                      |     |
|  | 2.0 BlueHDi 110 | 81  |  | 07.15 | Nutzlast leicht 160 3) | 13.0460-4809.2 | 604809 |  | 24468 19,1 +/-WK/Zub | BRE |
|  | 2.0 BlueHDi 130 | 96  |  | 07.15 | Nutzlast leicht 160 3) |                |        |  |                      |     |
|  | 2.0 BlueHDi 160 | 120 |  | 07.15 | Nutzlast leicht 160 3) |                |        |  |                      |     |
|  | 2.2 HDi 100     | 74  |  | 04.06 | Nutzlast schwer 160 4) | 13.0460-4810.2 | 604810 |  | 24466 19,1 +/-WK/Zub | BRE |
|  | 2.2 HDi 110     | 81  |  | 03.11 | Nutzlast schwer 160 4) |                |        |  |                      |     |
|  | 2.2 HDi 120     | 88  |  | 04.06 | Nutzlast schwer 160 4) |                |        |  |                      |     |
|  | 2.2 HDi 130     | 96  |  | 03.11 | Nutzlast schwer 160 4) |                |        |  |                      |     |
|  | 2.2 HDi 150     | 110 |  | 03.11 | Nutzlast schwer 160 4) |                |        |  |                      |     |
|  | 3.0 HDi 145     | 107 |  | 04.10 | Nutzlast schwer 160 4) |                |        |  |                      |     |
|  | 3.0 HDi 160     | 116 |  | 04.06 | Nutzlast schwer 160 4) |                |        |  |                      |     |
|  | 3.0 HDi 175     | 130 |  | 03.11 | Nutzlast schwer 160 4) |                |        |  |                      |     |
|  | 2.0 BlueHDi 110 | 81  |  | 07.15 | Nutzlast schwer 160 4) | 13.0460-4811.2 | 604811 |  | 24466 19,1 +/-WK/Zub | BRE |
|  | 2.0 BlueHDi 110 | 81  |  | 07.15 | Nutzlast 200 5)        |                |        |  |                      |     |
|  | 2.0 BlueHDi 130 | 96  |  | 07.15 | Nutzlast schwer 160 4) |                |        |  |                      |     |
|  | 2.0 BlueHDi 130 | 96  |  | 07.15 | Nutzlast 200 5)        |                |        |  |                      |     |
|  | 2.0 BlueHDi 160 | 120 |  | 07.15 | Nutzlast schwer 160 4) |                |        |  |                      |     |
|  | 2.0 BlueHDi 160 | 120 |  | 07.15 | Nutzlast 200 5)        |                |        |  |                      |     |
|  | 2.2 HDi 100     | 74  |  | 04.06 | Nutzlast 200 5)        |                |        |  |                      |     |
|  | 2.2 HDi 110     | 81  |  | 03.11 | Nutzlast 200 5)        |                |        |  |                      |     |
|  | 2.2 HDi 120     | 88  |  | 04.06 | Nutzlast 200 5)        |                |        |  |                      |     |
|  | 2.2 HDi 130     | 96  |  | 03.11 | Nutzlast 200 5)        |                |        |  |                      |     |
|  | 2.2 HDi 150     | 110 |  | 03.11 | Nutzlast 200 5)        |                |        |  |                      |     |
|  | 3.0 HDi 145     | 107 |  | 04.10 | Nutzlast 200 5)        |                |        |  |                      |     |
|  | 3.0 HDi 160     | 116 |  | 04.06 | Nutzlast 200 5)        |                |        |  |                      |     |
|  | 3.0 HDi 175     | 130 |  | 03.11 | Nutzlast 200 5)        |                |        |  |                      |     |
|  | 2.0 BlueHDi 110 | 81  |  | 07.15 | Nutzlast leicht 120    | 24.0124-0127.1 | 424127 |  | 280 24,0 21,9 V +B   |     |
|  | 2.0 BlueHDi 130 | 96  |  | 07.15 | Nutzlast leicht 120    |                |        |  |                      |     |
|  | 2.0 BlueHDi 160 | 120 |  | 07.15 | Nutzlast leicht 120    |                |        |  |                      |     |
|  | 2.2 HDi 100     | 74  |  | 04.06 | Nutzlast 120/140 2)    |                |        |  |                      |     |
|  | 2.2 HDi 110     | 81  |  | 03.11 | Nutzlast 120/140 2)    |                |        |  |                      |     |
|  | 2.2 HDi 120     | 88  |  | 04.06 | Nutzlast 120/140 2)    |                |        |  |                      |     |
|  | 2.2 HDi 130     | 96  |  | 03.11 | Nutzlast 120/140 2)    |                |        |  |                      |     |
|  | 2.2 HDi 150     | 110 |  | 03.11 | Nutzlast 120/140 2)    |                |        |  |                      |     |
|  | 3.0 HDi 145     | 107 |  | 04.10 | Nutzlast 120/140 2)    |                |        |  |                      |     |
|  | 3.0 HDi 160     | 116 |  | 04.06 | Nutzlast 120/140 2)    |                |        |  |                      |     |
|  | 3.0 HDi 175     | 130 |  | 03.11 | Nutzlast 120/140 2)    |                |        |  |                      |     |
|  | 2.2 HDi 100     | 74  |  | 04.06 | Nutzlast leicht 160 3) | 24.0128-0213.1 | 428213 |  | 280 28,0 25,9 V +B   |     |
|  | 2.2 HDi 110     | 81  |  | 03.11 | Nutzlast leicht 160 3) |                |        |  |                      |     |
|  | 2.2 HDi 120     | 88  |  | 04.06 | Nutzlast leicht 160 3) |                |        |  |                      |     |
|  | 2.2 HDi 130     | 96  |  | 03.11 | Nutzlast leicht 160 3) |                |        |  |                      |     |
|  | 2.2 HDi 150     | 110 |  | 03.11 | Nutzlast leicht 160 3) |                |        |  |                      |     |
|  | 3.0 HDi 145     | 107 |  | 04.10 | Nutzlast leicht 160 3) |                |        |  |                      |     |
|  | 3.0 HDi 160     | 116 |  | 04.06 | Nutzlast leicht 160 3) |                |        |  |                      |     |
|  | 3.0 HDi 175     | 130 |  | 03.11 | Nutzlast leicht 160 3) |                |        |  |                      |     |
|  | 2.2 HDi 100     | 74  |  | 04.06 | Nutzlast schwer 160 4) | 24.0124-0138.1 | 424138 |  | 300 24,0 21,9 V +B   |     |
|  | 2.2 HDi 110     | 81  |  | 03.11 | Nutzlast schwer 160 4) |                |        |  |                      |     |
|  | 2.2 HDi 120     | 88  |  | 04.06 | Nutzlast schwer 160 4) |                |        |  |                      |     |
|  | 2.2 HDi 130     | 96  |  | 03.11 | Nutzlast schwer 160 4) |                |        |  |                      |     |
|  | 2.2 HDi 150     | 110 |  | 03.11 | Nutzlast schwer 160 4) |                |        |  |                      |     |
|  | 3.0 HDi 145     | 107 |  | 04.10 | Nutzlast schwer 160 4) |                |        |  |                      |     |
|  | 3.0 HDi 160     | 116 |  | 04.06 | Nutzlast schwer 160 4) |                |        |  |                      |     |
|  | 3.0 HDi 175     | 130 |  | 03.11 | Nutzlast schwer 160 4) |                |        |  |                      |     |
|  | 2.2 HDi 100     | 74  |  | 04.06 | Nutzlast 200 5)        | 24.0132-0131.1 | 432131 |  | 300 32,0 29,9 V +B   |     |
|  | 2.2 HDi 110     | 81  |  | 03.11 | Nutzlast 200 5)        |                |        |  |                      |     |
|  | 2.2 HDi 120     | 88  |  | 04.06 | Nutzlast 200 5)        |                |        |  |                      |     |
|  | 2.2 HDi 130     | 96  |  | 03.11 | Nutzlast 200 5)        |                |        |  |                      |     |

1) - support bearing / - cuscinetto di spinta / - palier d'appui / - soporte de apoyo  
2) payload 120/140 / carico utile 120/140 / charge utile 120/140 / carga útil 120/140  
3) light payload 160 / carico utile leggero 160 / charge utile légère 160 / carga útil ligera 160  
4) heavy payload 160 / carico utile pesante 160 / charge utile lourde 160 / carga útil pesada 160  
5) payload 200 / carico utile 200 / charge utile 200 / carga útil 200





### PEUGEOT BOXER (06-)

|  |   |   |  |   |  |                |        |  |                       |
|--|---|---|--|---|--|----------------|--------|--|-----------------------|
|  | 2.2 HDi 150<br>3.0 HDi 145<br>3.0 HDi 160<br>3.0 HDi 175  | 110<br>107<br>116<br>130  |  | 03.11<br>04.10<br>04.06<br>03.11  | Nutzlast 200 <sup>1)</sup><br>Nutzlast 200 <sup>1)</sup><br>Nutzlast 200 <sup>1)</sup><br>Nutzlast 200 <sup>1)</sup>   | 24.0132-0131.1 | 432131 |  | 300 32,0 29,9 V +B    |
|  | 2.2 HDi 100<br>2.2 HDi 110<br>2.2 HDi 120<br>2.2 HDi 130<br>2.2 HDi 150<br>3.0 HDi 145<br>3.0 HDi 160<br>3.0 HDi 175  | 74<br>81<br>88<br>96<br>110<br>107<br>116<br>130                    |  | 04.06<br>03.11<br>04.06<br>03.11<br>03.11<br>04.10<br>04.06<br>03.11                            |  | 13.0460-4812.2 | 604812 |  | 24465 19,2 /Zub/S BRE |
|  | 2.0 BlueHDi 110<br>2.0 BlueHDi 130<br>2.0 BlueHDi 160<br>2.2 HDi 100<br>2.2 HDi 110<br>2.2 HDi 120<br>2.2 HDi 130<br>2.2 HDi 150<br>3.0 HDi 145<br>3.0 HDi 160<br>3.0 HDi 175 | 81<br>96<br>120<br>74<br>81<br>88<br>96<br>110<br>107<br>116<br>130 |  | 07.15<br>07.15<br>07.15<br>04.06<br>03.11<br>04.06<br>03.11<br>03.11<br>04.10<br>04.06<br>03.11 | Nutzlast 120/140+ leicht 16Q <sup>2)</sup><br>Nutzlast 120/140+ leicht 16Q <sup>2)</sup><br>Nutzlast 120/140+ leicht 16Q <sup>2)</sup><br>Nutzlast 120/140+ leicht 16Q <sup>2)</sup><br>Nutzlast 120/140+ leicht 16Q <sup>2)</sup><br>Nutzlast 120/140+ leicht 16Q <sup>2)</sup><br>Nutzlast 120/140+ leicht 16Q <sup>2)</sup><br>Nutzlast 120/140+ leicht 16Q <sup>2)</sup><br>Nutzlast 120/140+ leicht 16Q <sup>2)</sup><br>Nutzlast 120/140+ leicht 16Q <sup>2)</sup><br>Nutzlast 120/140+ leicht 16Q <sup>2)</sup> | 24.0116-0124.1 | 416124 |  | 280 16,0 14,2 +B      |
|  | 2.0 BlueHDi 110<br>2.0 BlueHDi 130<br>2.0 BlueHDi 160<br>2.2 HDi 100<br>2.2 HDi 110<br>2.2 HDi 120<br>2.2 HDi 130<br>2.2 HDi 150<br>3.0 HDi 145<br>3.0 HDi 160<br>3.0 HDi 175 | 81<br>96<br>120<br>74<br>81<br>88<br>96<br>110<br>107<br>116<br>130 |  | 07.15<br>07.15<br>07.15<br>04.06<br>03.11<br>04.06<br>03.11<br>03.11<br>04.10<br>04.06<br>03.11 | Nutzlast schwer 16Q <sup>3)</sup><br>Nutzlast schwer 16Q <sup>3)</sup><br>Nutzlast schwer 16Q <sup>3)</sup><br>Nutzlast schwer 16Q <sup>3)</sup><br>Nutzlast schwer 16Q <sup>3)</sup><br>Nutzlast schwer 16Q <sup>3)</sup><br>Nutzlast schwer 16Q <sup>3)</sup><br>Nutzlast schwer 16Q <sup>3)</sup><br>Nutzlast schwer 16Q <sup>3)</sup><br>Nutzlast schwer 16Q <sup>3)</sup><br>Nutzlast schwer 16Q <sup>3)</sup>  | 24.0116-0125.1 | 416125 |  | 280 16,0 14,2 +B      |
|  | 2.2 HDi 100<br>2.2 HDi 110<br>2.2 HDi 120<br>2.2 HDi 130<br>2.2 HDi 150<br>3.0 HDi 145<br>3.0 HDi 160<br>3.0 HDi 175  | 74<br>81<br>88<br>96<br>110<br>107<br>116<br>130                    |  | 04.06<br>03.11<br>04.06<br>03.11<br>03.11<br>04.10<br>04.06<br>03.11                            | Nutzlast 200 <sup>1)</sup><br>Nutzlast 200 <sup>1)</sup><br>Nutzlast 200 <sup>1)</sup><br>Nutzlast 200 <sup>1)</sup><br>Nutzlast 200 <sup>1)</sup><br>Nutzlast 200 <sup>1)</sup><br>Nutzlast 200 <sup>1)</sup><br>Nutzlast 200 <sup>1)</sup>   | 24.0116-0123.1 | 416123 |  | 300 16,0 14,2 +B      |
|  | 2.0 BlueHDi 110<br>2.0 BlueHDi 130<br>2.0 BlueHDi 160<br>2.2 HDi 100<br>2.2 HDi 110<br>2.2 HDi 120<br>2.2 HDi 130<br>2.2 HDi 150<br>3.0 HDi 145<br>3.0 HDi 160<br>3.0 HDi 175 | 81<br>96<br>120<br>74<br>81<br>88<br>96<br>110<br>107<br>116<br>130 |  | 07.15<br>07.15<br>07.15<br>04.06<br>03.11<br>04.06<br>03.11<br>03.11<br>04.10<br>04.06<br>03.11 |  | 03.0137-4004.2 | 654004 |  | 172 x 42 /Zub         |

### PEUGEOT EXPERT Kombi (95-06)

|  |  |   |  |  |       |                |        |  |                        |
|--|--|---|--|--|-------|----------------|--------|--|------------------------|
|  | 1.6<br>1.8<br>1.9 D<br>1.9 TD<br>1.9 TD<br>2.0 16V<br>2.0 HDi<br>2.0 HDi | 58<br>74<br>51<br>66<br>68<br>100<br>69<br>80 | ORGA 09792<br>ORGA 09792<br>ORGA 09155<br>ORGA 09792<br>ORGA 09792<br>ORGA 09792<br>ORGA 09792<br>ORGA 09792 | 10.95<br>10.96<br>10.95<br>04.96<br>07.00<br>07.00<br>07.00          |       | 13.0460-2978.2 | 602978 |  | 21801 19,0 +/-WK/S TRW |
|  | 1.6<br>1.9 D   | 58<br>51                                      | ORGA 09155<br>ORGA 09156   | 01.96  | 12.06 | 13.0460-3957.2 | 603957 |  | 23042 19,0 /WK/Zub BDX |
|  | 1.6<br>1.8<br>1.9 TD<br>1.9 TD<br>2.0 16V<br>2.0 HDi<br>2.0 HDi          | 58<br>74<br>66<br>68<br>100<br>69<br>80       | ORGA 09793<br>ORGA 09793<br>ORGA 09793<br>ORGA 09793<br>ORGA 09793<br>ORGA 09793<br>ORGA 09793               | 12.06<br>12.06<br>12.06<br>12.06<br>12.06<br>12.06<br>12.06          |       | 13.0460-2863.2 | 602863 |  | 20261 19,0 +/-WK/S TRW |
|  | 1.6<br>1.8<br>1.9 D<br>1.9 TD<br>1.9 TD<br>2.0 16V<br>2.0 HDi<br>2.0 HDi | 58<br>74<br>51<br>66<br>68<br>100<br>69<br>80 | ORGA 09155<br>ORGA 09155<br>ORGA 09155<br>ORGA 09155<br>ORGA 09155<br>ORGA 09155<br>ORGA 09155<br>ORGA 09155 | 10.95<br>10.96<br>10.95<br>10.95<br>04.96<br>07.00<br>07.00<br>07.00 |       | 24.0120-0155.1 | 420155 |  | 258 20,0 18,2 V L +B   |
|  | 1.6<br>1.8<br>1.9 D<br>1.9 TD<br>1.9 TD<br>2.0 16V                       | 58<br>74<br>51<br>66<br>68<br>100             | ORGA 09792<br>ORGA 09792<br>ORGA 09792<br>ORGA 09792<br>ORGA 09792<br>ORGA 09792                             | 10.95<br>10.96<br>10.95<br>04.96<br>07.00                            |       | 24.0126-0104.1 | 426104 |  | 281 26,0 24,2 V +B     |

<sup>1)</sup> payload 200 / carico utile 200 / charge utile 200 / carga útil 200

<sup>2)</sup> payload 120/140+ light 16Q / carico utile 120/140+ leggero 16Q / charge utile 120/140+ légère 16Q / carga útil 120/140+ ligera 16Q

<sup>3)</sup> heavy payload 16Q / carico utile pesante 16Q / charge utile lourde 16Q / carga útil pesada 16Q

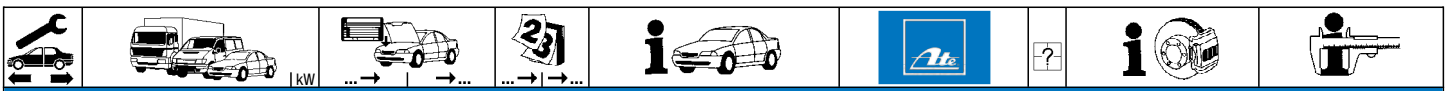

**PEUGEOT EXPERT Kombi (95-06)**

|  |         |     |            |              |              |                |        |  |                              |
|--|---------|-----|------------|--------------|--------------|----------------|--------|--|------------------------------|
|  | 2.0 HDi | 69  | ORGA 09792 | <b>07.00</b> |              | 24.0126-0104.1 | 426104 |  | 281 26,0 24,2 V +B           |
|  | 2.0 HDi | 80  | ORGA 09792 | <b>07.00</b> |              |                |        |  |                              |
|  | 1.6     | 58  | ORGA 09793 |              | <b>12.06</b> | 24.0128-0136.1 | 428136 |  | 285 28,0 26,0 V +B           |
|  | 1.8     | 74  | ORGA 09793 |              | <b>12.06</b> | 24.0328-0136.1 | 528136 |  | <b>285 28,0 26,0 V +B PD</b> |
|  | 1.9 D   | 51  | ORGA 09793 |              | <b>12.06</b> |                |        |  |                              |
|  | 1.9 TD  | 66  | ORGA 09793 |              | <b>12.06</b> |                |        |  |                              |
|  | 1.9 TD  | 68  | ORGA 09793 |              | <b>12.06</b> |                |        |  |                              |
|  | 2.0 16V | 100 | ORGA 09793 |              | <b>12.06</b> |                |        |  |                              |
|  | 2.0 HDi | 69  | ORGA 09793 |              | <b>12.06</b> |                |        |  |                              |
|  | 2.0 HDi | 80  | ORGA 09793 |              | <b>12.06</b> |                |        |  |                              |
|  | 1.6     | 58  |            |              | <b>10.95</b> | <b>12.06</b>   |        |  | 255 x 61                     |
|  | 1.8     | 74  |            |              | <b>10.96</b> | <b>12.06</b>   |        |  | Bremsbacken-Zubehör          |
|  | 1.9 D   | 51  |            |              | <b>10.95</b> | <b>12.06</b>   |        |  |                              |
|  | 1.9 TD  | 66  |            |              | <b>10.95</b> | <b>12.06</b>   |        |  |                              |
|  | 1.9 TD  | 68  |            |              | <b>04.96</b> | <b>12.06</b>   |        |  |                              |
|  | 2.0 16V | 100 |            |              | <b>07.00</b> | <b>12.06</b>   |        |  |                              |
|  | 2.0 HDi | 69  |            |              | <b>07.00</b> | <b>12.06</b>   |        |  |                              |
|  | 2.0 HDi | 80  |            |              | <b>07.00</b> | <b>12.06</b>   |        |  |                              |
|  | 1.6     | 58  |            |              | <b>10.95</b> | <b>12.06</b>   |        |  | 255/256 x 67                 |
|  | 1.8     | 74  |            |              | <b>10.96</b> | <b>12.06</b>   |        |  |                              |
|  | 1.9 D   | 51  |            |              | <b>10.95</b> | <b>12.06</b>   |        |  |                              |
|  | 1.9 TD  | 66  |            |              | <b>10.95</b> | <b>12.06</b>   |        |  |                              |
|  | 1.9 TD  | 68  |            |              | <b>04.96</b> | <b>12.06</b>   |        |  |                              |
|  | 2.0 16V | 100 |            |              | <b>07.00</b> | <b>12.06</b>   |        |  |                              |
|  | 2.0 HDi | 69  |            |              | <b>07.00</b> | <b>12.06</b>   |        |  |                              |
|  | 2.0 HDi | 80  |            |              | <b>07.00</b> | <b>12.06</b>   |        |  |                              |
|  | 1.6     | 58  |            |              | <b>10.95</b> | <b>12.06</b>   |        |  | 19,05/255x61 TopKit BDX      |
|  | 1.8     | 74  |            |              | <b>10.96</b> | <b>12.06</b>   |        |  |                              |
|  | 1.9 D   | 51  |            |              | <b>10.95</b> | <b>12.06</b>   |        |  |                              |
|  | 1.9 TD  | 66  |            |              | <b>10.95</b> | <b>12.06</b>   |        |  |                              |
|  | 1.9 TD  | 68  |            |              | <b>04.96</b> | <b>12.06</b>   |        |  |                              |
|  | 2.0 16V | 100 |            |              | <b>07.00</b> | <b>12.06</b>   |        |  |                              |
|  | 2.0 HDi | 69  |            |              | <b>07.00</b> | <b>12.06</b>   |        |  |                              |
|  | 2.0 HDi | 80  |            |              | <b>07.00</b> | <b>12.06</b>   |        |  |                              |

**PEUGEOT EXPERT Kasten (95-06)**

|  |         |     |            |              |              |                |                |        |                        |
|--|---------|-----|------------|--------------|--------------|----------------|----------------|--------|------------------------|
|  | 1.6     | 58  | ORGA 09155 | <b>10.95</b> | + 0,8 t      | 13.0460-3957.2 | 603957         |        | 23042 19,0 /WK/Zub BDX |
|  | 1.8     | 74  | ORGA 09155 | <b>10.96</b> | + 0,8 t      |                |                |        |                        |
|  | 1.9 D   | 51  | ORGA 09155 | <b>10.95</b> | + 0,8 t      |                |                |        |                        |
|  | 1.9 TD  | 66  | ORGA 09155 | <b>10.95</b> | + 0,8 t      |                |                |        |                        |
|  | 1.9 TD  | 68  | ORGA 09155 | <b>04.96</b> | + 0,8 t      |                |                |        |                        |
|  | 2.0 16V | 100 | ORGA 09155 | <b>07.00</b> | + 0,8 t      |                |                |        |                        |
|  | 2.0 HDi | 69  | ORGA 09155 | <b>07.00</b> | + 0,8 t      |                |                |        |                        |
|  | 2.0 HDi | 80  | ORGA 09155 | <b>07.00</b> | + 0,8 t      |                |                |        |                        |
|  | 1.6     | 58  | ORGA 09156 | <b>10.95</b> | + 0,9 t      | 13.0460-2978.2 | 602978         |        | 21801 19,0 +/WK/S TRW  |
|  | 1.6     | 58  | ORGA 09156 |              | + 0,8 t      |                |                |        |                        |
|  | 1.8     | 74  | ORGA 09156 | <b>10.96</b> | + 0,9 t      |                |                |        |                        |
|  | 1.8     | 74  | ORGA 09156 |              | + 0,8 t      |                |                |        |                        |
|  | 1.9 D   | 51  | ORGA 09156 | <b>10.95</b> | + 0,9 t      |                |                |        |                        |
|  | 1.9 D   | 51  | ORGA 09156 |              | + 0,8 t      |                |                |        |                        |
|  | 1.9 TD  | 66  | ORGA 09156 | <b>10.95</b> | + 0,9 t      |                |                |        |                        |
|  | 1.9 TD  | 66  | ORGA 09156 |              | + 0,8 t      |                |                |        |                        |
|  | 1.9 TD  | 68  | ORGA 09156 | <b>04.96</b> | + 0,9 t      |                |                |        |                        |
|  | 1.9 TD  | 68  | ORGA 09156 |              | + 0,8 t      |                |                |        |                        |
|  | 2.0 16V | 100 | ORGA 09156 | <b>07.00</b> | + 0,9 t      |                |                |        |                        |
|  | 2.0 16V | 100 | ORGA 09156 |              | + 0,8 t      |                |                |        |                        |
|  | 2.0 HDi | 69  | ORGA 09156 | <b>07.00</b> | + 0,9 t      |                |                |        |                        |
|  | 2.0 HDi | 69  | ORGA 09156 |              | + 0,8 t      |                |                |        |                        |
|  | 2.0 HDi | 80  | ORGA 09156 | <b>07.00</b> | + 0,9 t      |                |                |        |                        |
|  | 2.0 HDi | 80  | ORGA 09156 |              | + 0,8 t      |                |                |        |                        |
|  | 1.6     | 58  | ORGA 09793 |              | <b>12.06</b> | + 0,8/0,9 t    | 13.0460-2863.2 | 602863 | 20261 19,0 +/WK/S TRW  |
|  | 1.8     | 74  | ORGA 09793 |              | <b>12.06</b> | + 0,8/0,9 t    |                |        |                        |
|  | 1.9 D   | 51  | ORGA 09793 |              | <b>12.06</b> | + 0,8/0,9 t    |                |        |                        |
|  | 1.9 TD  | 66  | ORGA 09793 |              | <b>12.06</b> | + 0,8/0,9 t    |                |        |                        |
|  | 1.9 TD  | 68  | ORGA 09793 |              | <b>12.06</b> | + 0,8/0,9 t    |                |        |                        |
|  | 2.0 16V | 100 | ORGA 09793 |              | <b>12.06</b> | + 0,8/0,9 t    |                |        |                        |
|  | 2.0 HDi | 69  | ORGA 09793 |              | <b>12.06</b> | + 0,8/0,9 t    |                |        |                        |
|  | 2.0 HDi | 80  | ORGA 09793 |              | <b>12.06</b> | + 0,8/0,9 t    |                |        |                        |
|  | 1.6     | 58  | ORGA 09155 | <b>10.95</b> | + 0,8 t      | 24.0120-0155.1 | 420155         |        | 258 20,0 18,2 V L +B   |
|  | 1.8     | 74  | ORGA 09155 | <b>10.96</b> | + 0,8 t      |                |                |        |                        |
|  | 1.9 D   | 51  | ORGA 09155 | <b>10.95</b> | + 0,8 t      |                |                |        |                        |
|  | 1.9 TD  | 66  | ORGA 09155 | <b>10.95</b> | + 0,8 t      |                |                |        |                        |
|  | 1.9 TD  | 68  | ORGA 09155 | <b>04.96</b> | + 0,8 t      |                |                |        |                        |
|  | 2.0 16V | 100 | ORGA 09155 | <b>07.00</b> | + 0,8 t      |                |                |        |                        |
|  | 2.0 HDi | 69  | ORGA 09155 | <b>07.00</b> | + 0,8 t      |                |                |        |                        |
|  | 2.0 HDi | 80  | ORGA 09155 | <b>07.00</b> | + 0,8 t      |                |                |        |                        |
|  | 1.6     | 58  | ORGA 09792 | <b>10.95</b> | + 0,9 t      | 24.0126-0104.1 | 426104         |        | 281 26,0 24,2 V +B     |
|  | 1.6     | 58  | ORGA 09156 |              | + 0,8 t      |                |                |        |                        |
|  | 1.8     | 74  | ORGA 09792 | <b>10.96</b> | + 0,9 t      |                |                |        |                        |
|  | 1.8     | 74  | ORGA 09156 |              | + 0,8 t      |                |                |        |                        |
|  | 1.9 D   | 51  | ORGA 09792 | <b>10.95</b> | + 0,9 t      |                |                |        |                        |
|  | 1.9 D   | 51  | ORGA 09156 |              | + 0,8 t      |                |                |        |                        |
|  | 1.9 TD  | 66  | ORGA 09792 | <b>10.95</b> | + 0,9 t      |                |                |        |                        |
|  | 1.9 TD  | 66  | ORGA 09156 |              | + 0,8 t      |                |                |        |                        |
|  | 1.9 TD  | 68  | ORGA 09792 | <b>04.96</b> | + 0,9 t      |                |                |        |                        |
|  | 1.9 TD  | 68  | ORGA 09156 |              | + 0,8 t      |                |                |        |                        |



**PEUGEOT EXPERT Kasten (95-06)**

|         |         |     |            |            |       |         |                |                |        |                         |
|---------|---------|-----|------------|------------|-------|---------|----------------|----------------|--------|-------------------------|
|         | 2.0 16V | 100 |            | ORGA 09792 | 07.00 | + 0,9 t | 24.0126-0104.1 | 426104         |        | 281 26,0 24,2 V +B      |
|         | 2.0 16V | 100 | ORGA 09156 | ORGA 09792 |       | + 0,8 t |                |                |        |                         |
|         | 2.0 HDi | 69  |            | ORGA 09792 | 07.00 | + 0,9 t |                |                |        |                         |
|         | 2.0 HDi | 69  | ORGA 09156 | ORGA 09792 |       | + 0,8 t |                |                |        |                         |
|         | 2.0 HDi | 80  |            | ORGA 09792 | 07.00 | + 0,9 t |                |                |        |                         |
|         | 2.0 HDi | 80  | ORGA 09156 | ORGA 09792 |       | + 0,8 t |                |                |        |                         |
|         | 1.6     | 58  | ORGA 09793 |            | 12.06 | + 0,9 t | 24.0128-0136.1 | 428136         |        | 285 28,0 26,0 V +B      |
|         | 1.6     | 58  | ORGA 09793 |            | 12.06 | + 0,8 t |                |                |        |                         |
|         | 1.8     | 74  | ORGA 09793 |            | 12.06 | + 0,9 t |                |                |        |                         |
|         | 1.8     | 74  | ORGA 09793 |            | 12.06 | + 0,8 t |                |                |        |                         |
|         | 1.9 D   | 51  | ORGA 09793 |            | 12.06 | + 0,9 t |                |                |        |                         |
|         | 1.9 D   | 51  | ORGA 09793 |            | 12.06 | + 0,8 t |                |                |        |                         |
|         | 1.9 TD  | 66  | ORGA 09793 |            | 12.06 | + 0,9 t |                |                |        |                         |
|         | 1.9 TD  | 66  | ORGA 09793 |            | 12.06 | + 0,8 t |                |                |        |                         |
|         | 1.9 TD  | 68  | ORGA 09793 |            | 12.06 | + 0,9 t |                |                |        |                         |
|         | 1.9 TD  | 68  | ORGA 09793 |            | 12.06 | + 0,8 t |                |                |        |                         |
|         | 2.0 16V | 100 | ORGA 09793 |            | 12.06 | + 0,9 t |                |                |        |                         |
|         | 2.0 16V | 100 | ORGA 09793 |            | 12.06 | + 0,8 t |                |                |        |                         |
|         | 2.0 HDi | 69  | ORGA 09793 |            | 12.06 | + 0,9 t |                |                |        |                         |
|         | 2.0 HDi | 69  | ORGA 09793 |            | 12.06 | + 0,8 t |                |                |        |                         |
|         | 2.0 HDi | 80  | ORGA 09793 |            | 12.06 | + 0,9 t |                |                |        |                         |
|         | 2.0 HDi | 80  | ORGA 09793 |            | 12.06 | + 0,8 t |                |                |        |                         |
|         |         | 1.6 | 58         |            |       | 10.95   | 12.06          | 03.0137-0314.2 | 650314 |                         |
| 1.8     |         | 74  |            |            | 10.96 | 12.06   | 03.0137-9208.2 |                |        |                         |
| 1.9 D   |         | 51  |            |            | 10.95 | 12.06   |                |                |        |                         |
| 1.9 TD  |         | 66  |            |            | 10.95 | 12.06   |                |                |        |                         |
| 1.9 TD  |         | 68  |            |            | 04.96 | 12.06   |                |                |        |                         |
| 2.0 16V |         | 100 |            |            | 07.00 | 12.06   |                |                |        |                         |
| 2.0 HDi |         | 69  |            |            | 07.00 | 12.06   |                |                |        |                         |
| 2.0 HDi |         | 80  |            |            | 07.00 | 12.06   |                |                |        |                         |
|         | 1.6     | 58  |            |            | 10.95 | 12.06   | 24.0225-5003.1 | 480066         |        | 255/256 x 67            |
|         | 1.8     | 74  |            |            | 10.96 | 12.06   |                |                |        |                         |
|         | 1.9 D   | 51  |            |            | 10.95 | 12.06   |                |                |        |                         |
|         | 1.9 TD  | 66  |            |            | 10.95 | 12.06   |                |                |        |                         |
|         | 1.9 TD  | 68  |            |            | 04.96 | 12.06   |                |                |        |                         |
|         | 2.0 16V | 100 |            |            | 07.00 | 12.06   |                |                |        |                         |
|         | 2.0 HDi | 69  |            |            | 07.00 | 12.06   |                |                |        |                         |
|         | 2.0 HDi | 80  |            |            | 07.00 | 12.06   |                |                |        |                         |
|         | 1.6     | 58  |            |            | 10.95 | 12.06   | 03.0520-2619.3 | 692619         |        | 19,05/255x61 TopKit BDX |
|         | 1.8     | 74  |            |            | 10.96 | 12.06   |                |                |        |                         |
|         | 1.9 D   | 51  |            |            | 10.95 | 12.06   |                |                |        |                         |
|         | 1.9 TD  | 66  |            |            | 10.95 | 12.06   |                |                |        |                         |
|         | 1.9 TD  | 68  |            |            | 04.96 | 12.06   |                |                |        |                         |
|         | 2.0 16V | 100 |            |            | 07.00 | 12.06   |                |                |        |                         |
|         | 2.0 HDi | 69  |            |            | 07.00 | 12.06   |                |                |        |                         |
|         | 2.0 HDi | 80  |            |            | 07.00 | 12.06   |                |                |        |                         |

**PEUGEOT EXPERT Pritsche/Fahrgestell (95-06)**

|  |         |    |            |            |       |       |                |        |  |                                 |                |        |
|--|---------|----|------------|------------|-------|-------|----------------|--------|--|---------------------------------|----------------|--------|
|  | 1.6     | 58 |            | ORGA 09792 | 10.95 |       | 13.0460-2978.2 | 602978 |  | 21801 19,0 +/WK/S TRW           |                |        |
|  | 1.9 D   | 51 |            | ORGA 09792 | 10.95 |       |                |        |  |                                 |                |        |
|  | 1.9 TD  | 66 |            | ORGA 09792 | 10.95 |       |                |        |  |                                 |                |        |
|  | 1.9 TD  | 68 |            | ORGA 09792 | 04.96 |       |                |        |  |                                 |                |        |
|  | 2.0 HDi | 80 |            | ORGA 09792 | 10.00 |       |                |        |  |                                 |                |        |
|  | 1.6     | 58 | ORGA 09793 |            | 12.06 |       | 13.0460-2863.2 | 602863 |  | 20261 19,0 +/WK/S TRW           |                |        |
|  | 1.9 D   | 51 | ORGA 09793 |            | 12.06 |       |                |        |  |                                 |                |        |
|  | 1.9 TD  | 66 | ORGA 09793 |            | 12.06 |       |                |        |  |                                 |                |        |
|  | 1.9 TD  | 68 | ORGA 09793 |            | 12.06 |       |                |        |  |                                 |                |        |
|  | 2.0 HDi | 80 | ORGA 09793 |            | 12.06 |       |                |        |  |                                 |                |        |
|  | 1.6     | 58 |            | ORGA 09792 | 10.95 |       | 24.0126-0104.1 | 426104 |  | 281 26,0 24,2 V +B              |                |        |
|  | 1.9 D   | 51 |            | ORGA 09792 | 10.95 |       |                |        |  |                                 |                |        |
|  | 1.9 TD  | 66 |            | ORGA 09792 | 10.95 |       |                |        |  |                                 |                |        |
|  | 1.9 TD  | 68 |            | ORGA 09792 | 04.96 |       |                |        |  |                                 |                |        |
|  | 2.0 HDi | 80 |            | ORGA 09792 | 10.00 |       |                |        |  |                                 |                |        |
|  |         |    |            |            |       |       |                |        |  |                                 |                |        |
|  | 1.6     | 58 | ORGA 09793 |            | 12.06 |       | 24.0128-0136.1 | 428136 |  | 285 28,0 26,0 V +B              |                |        |
|  | 1.9 D   | 51 | ORGA 09793 |            | 12.06 |       |                |        |  |                                 | 24.0328-0136.1 | 528136 |
|  | 1.9 TD  | 66 | ORGA 09793 |            | 12.06 |       |                |        |  |                                 |                |        |
|  | 1.9 TD  | 68 | ORGA 09793 |            | 12.06 |       |                |        |  |                                 |                |        |
|  | 2.0 HDi | 80 | ORGA 09793 |            | 12.06 |       |                |        |  |                                 |                |        |
|  |         |    |            |            |       |       |                |        |  |                                 |                |        |
|  |         |    |            |            |       |       |                |        |  |                                 |                |        |
|  | 1.6     | 58 |            |            | 10.95 | 12.06 | 03.0137-0314.2 | 650314 |  | 255 x 61<br>Bremsbacken-Zubehör |                |        |
|  | 1.9 D   | 51 |            |            | 10.95 | 12.06 |                |        |  |                                 | 03.0137-9208.2 | 669208 |
|  | 1.9 TD  | 66 |            |            | 10.95 | 12.06 |                |        |  |                                 |                |        |
|  | 1.9 TD  | 68 |            |            | 04.96 | 12.06 |                |        |  |                                 |                |        |
|  | 2.0 HDi | 80 |            |            | 10.00 | 12.06 |                |        |  |                                 |                |        |
|  |         |    |            |            |       |       |                |        |  |                                 |                |        |
|  | 1.6     | 58 |            |            | 10.95 | 12.06 | 24.0225-5003.1 | 480066 |  | 255/256 x 67                    |                |        |
|  | 1.9 D   | 51 |            |            | 10.95 | 12.06 |                |        |  |                                 |                |        |
|  | 1.9 TD  | 66 |            |            | 10.95 | 12.06 |                |        |  |                                 |                |        |
|  | 1.9 TD  | 68 |            |            | 04.96 | 12.06 |                |        |  |                                 |                |        |
|  | 2.0 HDi | 80 |            |            | 10.00 | 12.06 |                |        |  |                                 |                |        |
|  | 1.6     | 58 |            |            | 10.95 | 12.06 | 03.0520-2619.3 | 692619 |  | 19,05/255x61 TopKit BDX         |                |        |
|  | 1.9 D   | 51 |            |            | 10.95 | 12.06 |                |        |  |                                 |                |        |
|  | 1.9 TD  | 66 |            |            | 10.95 | 12.06 |                |        |  |                                 |                |        |
|  | 1.9 TD  | 68 |            |            | 04.96 | 12.06 |                |        |  |                                 |                |        |
|  | 2.0 HDi | 80 |            |            | 10.00 | 12.06 |                |        |  |                                 |                |        |





### PEUGEOT EXPERT / Expert Tepee (07-15)

|  |  |   |  |   |                                  |                  |  |             |  |
|--|--|---|--|---|----------------------------------|------------------|--|-------------|--|
|  | 1.6 HDi 90<br>2.0 HDi 100<br>2.0 HDi 120<br>2.0 HDi 120 4x4<br>2.0 HDi 130<br>2.0 HDi 130 4x4<br>2.0 HDi 140<br>2.0 HDi 165<br>2.0 i 16V               | 66<br>72<br>88<br>88<br>94<br>94<br>100<br>120<br>103       | 01.07<br>03.11<br>01.07<br>01.07<br>03.11<br>03.11<br>01.07<br>09.09<br>01.07          |   | 13.0460-2738.2                   | 602738           |  |             | 24595 18,5 +WK/Zub/STRW                        |
|  | 1.6 HDi 90<br>1.6 HDi 90<br>2.0 HDi 100<br>2.0 HDi 120<br>2.0 HDi 120 4x4<br>2.0 HDi 130<br>2.0 HDi 130 4x4<br>2.0 HDi 140<br>2.0 HDi 165<br>2.0 i 16V | 66<br>66<br>72<br>88<br>88<br>94<br>94<br>100<br>120<br>103 | 01.07<br>01.07<br>03.11<br>01.07<br>01.07<br>03.11<br>03.11<br>01.07<br>09.09<br>01.07 | + HA-Trommelbremse <sup>1)</sup><br>+ HA-Scheibenbremse <sup>2)</sup> | 24.0128-0214.1<br>24.0128-0216.1 | 428214<br>428216 |  |             | 280 28,0 26,0 V +S +B<br>304 28,0 26,0 V +S +B |
|  | 1.6 HDi 90<br>2.0 HDi 100<br>2.0 HDi 120<br>2.0 HDi 120 4x4<br>2.0 HDi 130<br>2.0 HDi 130 4x4<br>2.0 HDi 140<br>2.0 HDi 165<br>2.0 i 16V               | 66<br>72<br>88<br>88<br>94<br>94<br>100<br>120<br>103       | 01.07<br>03.11<br>01.07<br>01.07<br>03.11<br>03.11<br>01.07<br>09.09<br>01.07          |   | 13.0460-2739.2                   | 602739           |  |             | 24578 16,5 /Zub/S TRW                          |
|  | 1.6 HDi 90<br>2.0 HDi 100<br>2.0 HDi 120<br>2.0 HDi 120 4x4<br>2.0 HDi 130<br>2.0 HDi 130 4x4<br>2.0 HDi 140<br>2.0 HDi 165<br>2.0 i 16V               | 66<br>72<br>88<br>88<br>94<br>94<br>100<br>120<br>103       | 01.07<br>03.11<br>01.07<br>01.07<br>03.11<br>03.11<br>01.07<br>09.09<br>01.07          |   | 24.0114-0116.1                   | 414116           |  |             | 290 14,0 12,0 +S +B                            |
|  | 1.6 HDi 90   | 66  | 01.07  |   | 03.0137-0334.2<br>03.0137-9219.2 | 650334<br>669219 |  | - Wohnmobil | 254 x 57 HEB<br>Bremsbacken-Zubehör TRW        |
|  | 1.6 HDi 90   | 66  | 01.07  |   | 24.0225-4021.1                   | 480311           |  |             | 254/256,2 x 68                                 |
|  | 1.6 HDi 90   | 66  | 01.07  |   | 03.0520-7122.3                   | 697122           |  | - Wohnmobil | 22,20/254x57 TopKit TRW                        |

### PEUGEOT EXPERT (K0) Kasten (16-)

|  |  |                              |   |  |                |        |  |  |                     |
|--|--|------------------------------|---|--|----------------|--------|--|--|---------------------|
|  | 1.6 BlueHDi 115<br>1.6 BlueHDi 95<br>2.0 BlueHDi 120<br>2.0 BlueHDi 150<br>2.0 BlueHDi 180 | 85<br>70<br>90<br>110<br>130 | 04.16<br>04.16<br>04.16<br>04.16<br>04.16 |  | 24.0112-0212.1 | 412212 |  |  | 290 12,0 10,0 +S +B |
|--|--|------------------------------|---|--|----------------|--------|--|--|---------------------|

### PEUGEOT iON (10-)

|  |                      |          |                |  |                |        |  |  |                  |
|--|----------------------|----------|----------------|--|----------------|--------|--|--|------------------|
|  | Electric<br>Electric | 47<br>49 | 11.10<br>10.14 |  | 13.0460-5621.2 | 605621 |  |  | 24423 14,6 /Zub  |
|  | Electric<br>Electric | 47<br>49 | 11.10<br>10.14 |  | 24.0117-0110.1 | 417110 |  |  | 257 17,0 15,0 +B |

### PEUGEOT PARTNER Kombi (96-08)

|  |   |  |  |   |  |                                  |                  |  |  |
|--|---|--|--|---|--|----------------------------------|------------------|--|--|
|  | 1.1 i<br>1.4<br>1.4 i<br>1.6 16V<br>1.8 i<br>1.9 D<br>1.9 D<br>2.0 HDi 90<br>Electric   | 44<br>54<br>55<br>80<br>66<br>50<br>51<br>66<br>28   | 07.96<br>11.02<br>07.96<br>07.01<br>05.97<br>07.96<br>12.98<br>02.00<br>01.98  | 09.02<br>03.08<br>09.02   |  | 13.0460-2829.2                   | 602829           |  | 23124 19,0 +/WK/S TRW                          |
|  | 1.1 i<br>1.4<br>1.4 i<br>1.6 16V<br>1.6 HDi 75<br>1.6 HDi 90<br>1.8 i<br>1.9 D<br>1.9 D<br>1.9 D 4X4<br>2.0 HDi 90<br>1.6 16V<br>1.6 HDi 75 | 44<br>54<br>55<br>80 ORGA 09128<br>55<br>66<br>66 ORGA 09128<br>50 ORGA 09128<br>51 ORGA 09128<br>51<br>66 ORGA 09128<br>80 ORGA 09128<br>55 | 10.02<br>11.02<br>10.02<br>03.08<br>02.06<br>02.06<br>03.08<br>03.08<br>03.08<br>04.04<br>03.08<br>03.08<br>03.08<br>02.06 | 03.08<br>03.08<br>03.08<br>- ESP<br>- ESP<br>- ESP<br>03.08<br>03.08<br>03.08<br>03.08<br>- ESP<br>03.08 + ESP<br>03.08 + ESP |  | 13.0460-3994.2<br>13.0470-3994.2 | 603994<br>LD3994 |  | 23599 19,0 /Zub/S BOS<br>23599 19,0 /Zub/S BOS |
|  | 1.6 HDi 75  | 55   | 02.06  | 03.08   |  | 13.0460-3811.2                   | 603811           |  | 23708 19,2 /S BOS                              |

<sup>1)</sup> + RA drum brake / + P freno a tamburo / + frein à tambour essieu AR / + ET-tambores de freno

<sup>2)</sup> + RA disc brake / + P disco freno / + frein à disque essieu AR / + ET-disco de freno

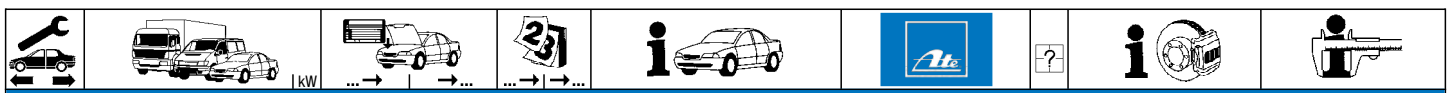

**PEUGEOT PARTNER Kombi (96-08)**

|  |  |  |  |  |  |  |                                      |  |            |
|--|--|--|--|--|--|--|--------------------------------------|--|------------|
|  | 1.6 HDi 90<br>2.0 HDi 90   | 66<br>66 ORGA 09128  |  | 02.06<br>03.08   | 03.08 + ESP<br>03.08 + ESP   | 13.0460-3811.2<br>603811   |                                      | 23708 19,2 /S  | BOS        |
|  | 1.1 i<br>1.4 i<br>1.4 i<br>1.6 16V<br>1.8 i<br>1.9 D<br>1.9 D<br>2.0 HDi 90<br>Electric                            | 44<br>55<br>55<br>80<br>66<br>50<br>51<br>66<br>28   |  | 07.96<br>07.96<br>10.02<br>07.01<br>05.97<br>07.96<br>12.98<br>02.00<br>01.98          | 09.02<br>09.02<br>03.08<br>03.08<br>03.08<br>03.08<br>03.08<br>12.01   | 24.0113-0184.1<br>24.0313-0184.1<br>24.0120-0133.1<br>24.0320-0133.1 | 413184<br>513184<br>420133<br>520133 | 266 13,0 11,0 +S +B<br>266 13,0 11,0 +S +B PD<br>266 20,5 18,5 V +S +B<br>266 20,5 18,5 V +S +B PD |            |
|  | 1.1 i<br>1.4<br>1.4 i<br>1.6 16V<br>1.6 HDi 75<br>1.6 HDi 90<br>1.8 i<br>1.9 D<br>1.9 D<br>1.9 D 4X4<br>2.0 HDi 90 | 44<br>54<br>55 ORGA 09128<br>80 ORGA 09128<br>55<br>66<br>66 ORGA 09128<br>50 ORGA 09128<br>51 ORGA 09128<br>51<br>66 ORGA 09128 |  | 10.02<br>11.02<br>03.08<br>03.08<br>02.06<br>02.06<br>03.08<br>04.04                   | 03.08<br>03.08<br>03.08 - ESP<br>03.08 - ESP<br>03.08<br>03.08<br>03.08<br>03.08 - ESP                         | 24.0122-0194.1   | 422194                               | 266 22,0 20,0 V +S +B  |            |
|  | 1.6 16V<br>1.6 HDi 75<br>1.6 HDi 90<br>2.0 HDi 90  | 80 ORGA 09128<br>55<br>66<br>66 ORGA 09128   |  | 02.06<br>02.06<br>03.08<br>03.08   | 03.08 + ESP<br>03.08 + ESP<br>03.08 + ESP<br>03.08 + ESP   | 24.0126-0120.1<br>24.0326-0120.1                                     | 426120<br>526120                     | 283 26,0 24,0 V +S +B<br>283 26,0 24,0 V +S +B PD  |            |
|  | 1.6 16V<br>1.6 HDi 75<br>1.6 HDi 90<br>2.0 HDi 90  | 80<br>55<br>66<br>66   |  | 07.01<br>02.06<br>02.06<br>02.00   | 03.08 + ESP<br>03.08 + ESP<br>03.08 + ESP<br>03.08 + ESP   | 13.0460-2823.2<br>13.0470-2823.2                                     | 602823<br>LD2823                     | 23554 17,2 /S<br>23554 17,2 /S   | TRW<br>TRW |
|  | 1.6 16V<br>1.6 HDi 75<br>1.6 HDi 90<br>2.0 HDi 90  | 80<br>55<br>66<br>66   |  | 07.01<br>02.06<br>02.06<br>02.00   | 03.08 + ESP<br>03.08 + ESP<br>03.08 + ESP<br>03.08 + ESP   | 24.0109-0137.1   | 409137                               | 247 9,0 8,0 +S +B  |            |
|  | 1.1 i<br>1.4 i<br>1.6 16V<br>1.6 HDi 75<br>1.6 HDi 90<br>1.8 i<br>1.9 D<br>1.9 D<br>2.0 HDi 90<br>Electric         | 44<br>55<br>80<br>55<br>66<br>66<br>50<br>51<br>66<br>28   |  | 07.96<br>07.96<br>07.01<br>02.06<br>02.06<br>05.97<br>07.96<br>12.98<br>02.00<br>01.91 | 03.08<br>03.08<br>03.08 - ESP<br>03.08 - ESP<br>03.08 - ESP<br>03.08<br>03.08<br>03.08 - ESP<br>12.01          | 03.0137-0341.2<br>03.0137-9220.2                                     | 650341<br>669220                     | 229 x 42 HEB<br>Bremsbacken-Zubehör  | TRW<br>TRW |
|  | 1.1 i<br>1.4 i<br>1.6 16V<br>1.6 HDi 75<br>1.6 HDi 90<br>1.8 i<br>1.9 D<br>1.9 D<br>2.0 HDi 90<br>Electric         | 44<br>55<br>80<br>55<br>66<br>66<br>50<br>51<br>66<br>28   |  | 07.96<br>07.96<br>07.01<br>02.06<br>02.06<br>05.97<br>07.96<br>12.98<br>02.00<br>01.98 | 03.08<br>03.08<br>03.08 - ESP<br>03.08 - ESP<br>03.08 - ESP<br>03.08<br>03.08<br>03.08 - ESP<br>12.01          | 24.0222-8017.1   | 480071                               | 229/230 x 50,8   |            |
|  | 1.1 i<br>1.4 i<br>1.8 i<br>1.9 D<br>1.9 D<br>Electric  | 44<br>55<br>66<br>50<br>51<br>28   | ORGA 08000<br>ORGA 08000<br>ORGA 08000<br>ORGA 08000<br>ORGA 08000 | 07.96<br>07.96<br>05.97<br>07.96<br>12.98<br>01.98                                     |  | 03.0520-6322.3   | 696322                               | 22,20/229x42 TopKit  | TRW        |
|  | 1.1 i<br>1.4 i<br>1.6 16V<br>1.6 HDi 75<br>1.6 HDi 90<br>1.8 i<br>1.9 D<br>1.9 D<br>2.0 HDi 90<br>Electric         | 44 ORGA 08001<br>55 ORGA 08001<br>80<br>55<br>66<br>66 ORGA 08001<br>50 ORGA 08001<br>51 ORGA 08001<br>66<br>28 ORGA 08001       |  | 07.96<br>07.96<br>07.01<br>02.06<br>02.06<br>03.08<br>03.08<br>03.08<br>02.00<br>12.01 | 03.08<br>03.08<br>03.08 - ESP<br>03.08 - ESP<br>03.08 - ESP<br>03.08<br>03.08<br>03.08<br>03.08 - ESP<br>12.01 | 03.0520-6322.3   | 696322                               | 22,20/229x42 TopKit  | TRW        |

**PEUGEOT PARTNER Kasten (96-08)**

|  |   |  |  |  |  |                                  |                  |  |            |
|--|---|--|--|--|--|----------------------------------|------------------|--|------------|
|  | 1.1 i<br>1.4 i<br>1.8<br>1.8 D<br>1.8 D<br>1.9 D<br>1.9 D<br>2.0 HDi 90 | 44<br>55<br>66<br>43<br>44<br>50<br>51<br>66 |  | 07.96<br>07.96<br>03.97<br>07.96<br>11.96<br>05.96<br>07.96<br>04.00 | 09.02<br>09.02<br>08.00<br>03.08<br>03.08<br>03.08<br>03.08<br>04.00 | 13.0460-2829.2                   | 602829           | 23124 19,0 +/-WK/S                     | TRW        |
|  | 1.1 i<br>1.4 i<br>1.6<br>1.6 HDi 75<br>1.6 HDi 90                       | 44<br>55<br>80<br>55<br>66                   |  | 10.02<br>10.02<br>09.00<br>02.06<br>02.06                            | 03.08<br>03.08<br>03.08<br>03.08<br>03.08                            | 13.0460-3994.2<br>13.0470-3994.2 | 603994<br>LD3994 | 23599 19,0 /Zub/S<br>23599 19,0 /Zub/S | BOS<br>BOS |





**PEUGEOT PARTNER Kasten (96-08)**

|            |            |            |            |            |       |                |                |                |        |                      |                      |        |
|------------|------------|------------|------------|------------|-------|----------------|----------------|----------------|--------|----------------------|----------------------|--------|
|            | 1.8 D      | 43         | ORGA 09128 |            | 03.08 |                | 13.0460-3994.2 | 603994         |        | 23599                | 19,0 /Zub/S          | BOS    |
|            | 1.8 D      | 44         | ORGA 09128 |            | 02.98 |                | 13.0470-3994.2 | LD3994         |        | 23599                | 19,0 /Zub/S          | BOS    |
|            | 1.9 D      | 50         | ORGA 09128 |            | 12.98 |                |                |                |        |                      |                      |        |
|            | 1.9 D      | 51         | ORGA 09128 |            | 03.08 |                |                |                |        |                      |                      |        |
|            | 2.0 HDi 90 | 66         | ORGA 09128 |            | 03.08 | - ESP          |                |                |        |                      |                      |        |
|            | Electric   | 25         |            |            | 01.98 | 03.08          |                |                |        |                      |                      |        |
|            | 2.0 HDi 90 | 66         | ORGA 09128 |            | 03.08 | + ESP          | 13.0460-3811.2 | 603811         |        | 23708                | 19,2 /S              | BOS    |
|            | 1.1 i      | 44         |            |            | 07.96 | 09.02          | 24.0113-0184.1 | 413184         |        | 266                  | 13,0 11,0 +S +B      |        |
|            | 1.4 i      | 55         |            |            | 07.96 | 09.02          | 24.0313-0184.1 | 513184         |        | 266                  | 13,0 11,0 +S +B PD   |        |
|            | 1.8        | 66         |            |            | 03.97 | 08.00          |                |                |        |                      |                      |        |
|            | 1.8        | 66         |            |            | 03.97 | 08.00          | 24.0120-0133.1 | 420133         |        | 266                  | 20,5 18,5 V +S +B    |        |
|            | 1.8 D      | 43         | ORGA 09127 |            | 07.96 |                | 24.0320-0133.1 | 520133         |        | 266                  | 20,5 18,5 V +S +B PD |        |
|            | 1.8 D      | 44         | ORGA 09127 |            | 11.96 |                |                |                |        |                      |                      |        |
|            | 1.9 D      | 50         | ORGA 09127 |            | 05.96 |                |                |                |        |                      |                      |        |
|            | 1.9 D      | 51         | ORGA 09127 |            | 07.96 |                |                |                |        |                      |                      |        |
|            | 2.0 HDi 90 | 66         | ORGA 09127 |            | 04.00 |                |                |                |        |                      |                      |        |
|            | 1.1 i      | 44         |            |            | 10.02 | 03.08          | 24.0122-0194.1 | 422194         |        | 266                  | 22,0 20,0 V +S +B    |        |
|            | 1.4 i      | 55         |            |            | 10.02 | 03.08          |                |                |        |                      |                      |        |
| 1.6        | 80         |            |            | 09.00      | 03.08 |                |                |                |        |                      |                      |        |
| 1.6 HDi 75 | 55         |            |            | 02.06      | 03.08 |                |                |                |        |                      |                      |        |
| 1.6 HDi 90 | 66         |            |            | 02.06      | 03.08 |                |                |                |        |                      |                      |        |
| 1.8 D      | 43         | ORGA 09128 |            | 07.96      | 03.08 |                |                |                |        |                      |                      |        |
| 1.8 D      | 44         | ORGA 09128 |            | 11.96      | 02.98 |                |                |                |        |                      |                      |        |
| 1.9 D      | 50         | ORGA 09128 |            | 05.96      | 12.98 |                |                |                |        |                      |                      |        |
| 1.9 D      | 51         | ORGA 09128 |            | 07.96      | 03.08 |                |                |                |        |                      |                      |        |
| 2.0 HDi 90 | 66         | ORGA 09128 |            | 04.00      | 03.08 | - ESP          |                |                |        |                      |                      |        |
| Electric   | 25         |            |            | 01.98      | 03.08 |                |                |                |        |                      |                      |        |
| 2.0 HDi 90 | 66         | ORGA 09128 |            | 03.08      | + ESP | 24.0126-0120.1 | 426120         |                | 283    | 26,0 24,0 V +S +B    |                      |        |
|            |            |            |            |            |       | 24.0326-0120.1 | 526120         |                | 283    | 26,0 24,0 V +S +B PD |                      |        |
|            | 2.0 HDi 90 | 66         |            | 04.00      | 03.08 | + ESP          | 13.0460-2823.2 | 602823         |        | 23554                | 17,2 /S              | TRW    |
|            |            |            |            |            |       |                | 13.0470-2823.2 | LD2823         |        | 23554                | 17,2 /S              | TRW    |
|            | 2.0 HDi 90 | 66         |            | 04.00      | 03.08 | + ESP          | 24.0109-0137.1 | 409137         |        | 247                  | 9,0 8,0 +S +B        |        |
|            |            |            |            |            |       |                |                |                |        |                      |                      |        |
|            | 1.1 i      | 44         |            |            | 07.96 | 03.08          | 03.0137-0341.2 | 650341         |        | 229 x 42             | HEB                  | TRW    |
|            | 1.4 i      | 55         |            |            | 07.96 | 03.08          | 03.0137-9220.2 | 669220         |        | Bremsbacken-Zubehör  |                      | TRW    |
|            | 1.6 HDi 75 | 55         |            |            | 02.06 | 03.08          |                |                |        |                      |                      |        |
|            | 1.6 HDi 90 | 66         |            |            | 02.06 | 03.08          |                |                |        |                      |                      |        |
|            | 1.8        | 66         |            |            | 03.97 | 08.00          |                |                |        |                      |                      |        |
|            | 1.8 D      | 43         |            |            | 07.96 | 03.08          |                |                |        |                      |                      |        |
|            | 1.8 D      | 44         |            |            | 11.96 | 02.98          |                |                |        |                      |                      |        |
|            | 1.9 D      | 50         |            |            | 05.96 | 12.98          |                |                |        |                      |                      |        |
|            | 1.9 D      | 51         |            |            | 07.96 | 03.08          |                |                |        |                      |                      |        |
|            | 2.0 HDi 90 | 66         |            |            | 04.00 | 03.08          | - ESP          |                |        |                      |                      |        |
|            | 1.1 i      | 44         |            |            | 07.96 | 03.08          | 24.0222-8017.1 | 480071         |        | 229/230 x 50,8       |                      |        |
|            | 1.4 i      | 55         |            |            | 07.96 | 03.08          |                |                |        |                      |                      |        |
|            | 1.6 HDi 75 | 55         |            |            | 02.06 | 03.08          |                |                |        |                      |                      |        |
|            | 1.6 HDi 90 | 66         |            |            | 02.06 | 03.08          |                |                |        |                      |                      |        |
|            | 1.8        | 66         |            |            | 03.97 | 08.00          |                |                |        |                      |                      |        |
|            | 1.8 D      | 43         |            |            | 07.96 | 03.08          |                |                |        |                      |                      |        |
|            | 1.8 D      | 44         |            |            | 11.96 | 02.98          |                |                |        |                      |                      |        |
|            | 1.9 D      | 50         |            |            | 05.96 | 12.98          |                |                |        |                      |                      |        |
|            | 1.9 D      | 51         |            |            | 07.96 | 03.08          |                |                |        |                      |                      |        |
|            | 2.0 HDi 90 | 66         |            |            | 04.00 | 03.08          | - ESP          |                |        |                      |                      |        |
|            | Electric   | 25         |            |            | 01.98 | 03.08          |                |                |        |                      |                      |        |
|            |            | 1.1 i      | 44         | ORGA 08000 |       | 07.96          |                | 03.0520-6322.3 | 696322 |                      | 22,20/229x42         | TopKit |
| 1.4 i      |            | 55         | ORGA 08000 |            | 07.96 |                |                |                |        |                      |                      |        |
| 1.8        |            | 66         |            |            | 03.97 | 08.00          |                |                |        |                      |                      |        |
| 1.8 D      |            | 43         | ORGA 08000 |            | 07.96 |                |                |                |        |                      |                      |        |
| 1.8 D      |            | 44         | ORGA 08000 |            | 11.96 |                |                |                |        |                      |                      |        |
| 1.9 D      |            | 50         | ORGA 08000 |            | 05.96 |                |                |                |        |                      |                      |        |
| 1.9 D      |            | 51         | ORGA 08000 |            | 07.96 |                |                |                |        |                      |                      |        |
| Electric   |            | 25         | ORGA 08000 |            | 01.98 |                |                |                |        |                      |                      |        |
|            | 1.1 i      | 44         | ORGA 08001 |            | 03.08 |                | 03.0520-6322.3 | 696322         |        | 22,20/229x42         | TopKit               | TRW    |
|            | 1.4 i      | 55         | ORGA 08001 |            | 03.08 |                |                |                |        |                      |                      |        |
|            | 1.6 HDi 75 | 55         |            |            | 02.06 | 03.08          |                |                |        |                      |                      |        |
|            | 1.6 HDi 90 | 66         |            |            | 02.06 | 03.08          |                |                |        |                      |                      |        |
|            | 1.8 D      | 43         | ORGA 08001 |            | 03.08 |                |                |                |        |                      |                      |        |
|            | 1.8 D      | 44         | ORGA 08001 |            | 02.98 |                |                |                |        |                      |                      |        |
|            | 1.9 D      | 50         | ORGA 08001 |            | 12.98 |                |                |                |        |                      |                      |        |
|            | 1.9 D      | 51         | ORGA 08001 |            | 03.08 |                |                |                |        |                      |                      |        |
|            | 2.0 HDi 90 | 66         |            |            | 04.00 | 03.08          | - ESP          |                |        |                      |                      |        |
| Electric   | 25         | ORGA 08001 |            | 03.08      |       |                |                |                |        |                      |                      |        |

**PEUGEOT PARTNER Tepee/Kasten/Pritsche (B9) (08-)**

|  |                 |    |  |  |       |  |                |        |  |       |        |     |
|--|-----------------|----|--|--|-------|--|----------------|--------|--|-------|--------|-----|
|  | 1.2 THP 110     | 81 |  |  | 02.16 |  | 13.0460-7229.2 | 607229 |  | 24538 | 18,5 + | ATE |
|  | 1.6             | 72 |  |  | 08.10 |  | 13.0470-7229.2 | LD7229 |  | 24538 | 18,5 + | ATE |
|  | 1.6             | 88 |  |  | 04.10 |  |                |        |  |       |        |     |
|  | 1.6 BlueHdi 100 | 73 |  |  | 12.14 |  |                |        |  |       |        |     |
|  | 1.6 BlueHdi 120 | 88 |  |  | 12.14 |  |                |        |  |       |        |     |
|  | 1.6 BlueHdi 75  | 55 |  |  | 01.15 |  |                |        |  |       |        |     |
|  | 1.6 HDi         | 55 |  |  | 04.08 |  |                |        |  |       |        |     |
|  | 1.6 HDi         | 66 |  |  | 04.08 |  |                |        |  |       |        |     |
|  | 1.6 HDi         | 80 |  |  | 04.08 |  |                |        |  |       |        |     |
|  | 1.6 HDi         | 82 |  |  | 08.10 |  |                |        |  |       |        |     |
|  | ↓               |    |  |  |       |  |                |        |  |       |        |     |
|  | ↓               |    |  |  |       |  |                |        |  |       |        |     |





**PEUGEOT PARTNER Tepee/Kasten/Pritsche (B9) (08-)**

|  |                 |    |       |  |                |        |  |                          |     |
|--|-----------------|----|-------|--|----------------|--------|--|--------------------------|-----|
|  | 1.6 HDi 115     | 84 | 03.13 |  | 13.0460-7229.2 | 607229 |  | 24538 18,5 +             | ATE |
|  | 1.6 HDi 4x4     | 66 | 04.12 |  | 13.0470-7229.2 | LD7229 |  | 24538 18,5 +             | ATE |
|  | 1.6 HDi 90      | 68 | 04.10 |  |                |        |  |                          |     |
|  | 1.6 i 16V       | 66 | 04.08 |  |                |        |  |                          |     |
|  | 1.6 i 16V       | 80 | 04.08 |  |                |        |  |                          |     |
|  | Electrique      | 49 | 06.13 |  |                |        |  |                          |     |
|  | 1.2 THP 110     | 81 | 02.16 |  | 24.0126-0120.1 | 426120 |  | 283 26,0 24,0 V +S +B    |     |
|  | 1.6             | 72 | 08.10 |  | 24.0326-0120.1 | 526120 |  | 283 26,0 24,0 V +S +B PD |     |
|  | 1.6             | 88 | 04.10 |  |                |        |  |                          |     |
|  | 1.6 BlueHDi 100 | 73 | 12.14 |  |                |        |  |                          |     |
|  | 1.6 BlueHDi 120 | 88 | 12.14 |  |                |        |  |                          |     |
|  | 1.6 BlueHDi 75  | 55 | 01.15 |  |                |        |  |                          |     |
|  | 1.6 HDi         | 55 | 04.08 |  |                |        |  |                          |     |
|  | 1.6 HDi         | 66 | 04.08 |  |                |        |  |                          |     |
|  | 1.6 HDi         | 80 | 04.08 |  |                |        |  |                          |     |
|  | 1.6 HDi         | 82 | 08.10 |  |                |        |  |                          |     |
|  | 1.6 HDi 115     | 84 | 03.13 |  |                |        |  |                          |     |
|  | 1.6 HDi 4x4     | 66 | 04.12 |  |                |        |  |                          |     |
|  | 1.6 HDi 90      | 68 | 04.10 |  |                |        |  |                          |     |
|  | 1.6 i 16V       | 66 | 04.08 |  |                |        |  |                          |     |
|  | Electrique      | 49 | 06.13 |  |                |        |  |                          |     |
|  | 1.2 THP 110     | 81 | 02.16 |  | 13.0460-2745.2 | 602745 |  | 24765 16,5 /Zub/S        | TRW |
|  | 1.6             | 72 | 08.10 |  |                |        |  |                          |     |
|  | 1.6             | 88 | 04.10 |  |                |        |  |                          |     |
|  | 1.6 BlueHDi 100 | 73 | 12.14 |  |                |        |  |                          |     |
|  | 1.6 BlueHDi 120 | 88 | 12.14 |  |                |        |  |                          |     |
|  | 1.6 BlueHDi 75  | 55 | 01.15 |  |                |        |  |                          |     |
|  | 1.6 HDi         | 55 | 04.08 |  |                |        |  |                          |     |
|  | 1.6 HDi         | 66 | 04.08 |  |                |        |  |                          |     |
|  | 1.6 HDi         | 80 | 04.08 |  |                |        |  |                          |     |
|  | 1.6 HDi         | 82 | 08.10 |  |                |        |  |                          |     |
|  | 1.6 HDi 115     | 84 | 03.13 |  |                |        |  |                          |     |
|  | 1.6 HDi 4x4     | 66 | 04.12 |  |                |        |  |                          |     |
|  | 1.6 HDi 90      | 68 | 04.10 |  |                |        |  |                          |     |
|  | 1.6 i 16V       | 66 | 04.08 |  |                |        |  |                          |     |
|  | Electrique      | 49 | 06.13 |  |                |        |  |                          |     |
|  | 1.2 THP 110     | 81 | 02.16 |  | 24.0112-0194.2 | 412194 |  | 268 12,0 10,0 +B         |     |
|  | 1.6             | 72 | 08.10 |  |                |        |  |                          |     |
|  | 1.6             | 88 | 04.10 |  |                |        |  |                          |     |
|  | 1.6 BlueHDi 100 | 73 | 12.14 |  |                |        |  |                          |     |
|  | 1.6 BlueHDi 120 | 88 | 12.14 |  |                |        |  |                          |     |
|  | 1.6 BlueHDi 75  | 55 | 01.15 |  |                |        |  |                          |     |
|  | 1.6 HDi         | 55 | 04.08 |  |                |        |  |                          |     |
|  | 1.6 HDi         | 66 | 04.08 |  |                |        |  |                          |     |
|  | 1.6 HDi         | 80 | 04.08 |  |                |        |  |                          |     |
|  | 1.6 HDi         | 82 | 08.10 |  |                |        |  |                          |     |
|  | 1.6 HDi 115     | 84 | 03.13 |  |                |        |  |                          |     |
|  | 1.6 HDi 4x4     | 66 | 04.12 |  |                |        |  |                          |     |
|  | 1.6 HDi 90      | 68 | 04.10 |  |                |        |  |                          |     |
|  | 1.6 i 16V       | 66 | 04.08 |  |                |        |  |                          |     |
|  | Electrique      | 49 | 06.13 |  |                |        |  |                          |     |

**PEUGEOT RCZ (10-15)**

|  |             |     |       |                         |                |        |   |                         |     |
|--|-------------|-----|-------|-------------------------|----------------|--------|---|-------------------------|-----|
|  | 1.6 16V     | 115 | 03.10 |                         | 13.0460-7202.2 | 607202 |   | 23589 19,1 +            | ATE |
|  | 1.6 THP 150 | 110 | 03.11 |                         | 13.0470-7202.2 | LD7202 |   | 23589 19,1 +            | ATE |
|  | 2.0 HDi     | 120 | 03.10 | + 18" Rad <sup>1)</sup> |                |        |   |                         |     |
|  | 1.6 16V     | 147 | 06.10 |                         | 13.0460-7279.2 | 607279 |   | 25069 17,3 +/-WK        | ATE |
|  | 2.0 HDi     | 120 | 03.10 | + 19" Rad <sup>2)</sup> |                |        |   |                         |     |
|  | 1.6 16V     | 115 | 03.10 |                         | 24.0126-0176.1 | 426176 |   | 302 26,0 24,0 V L +S +B |     |
|  | 1.6 THP 150 | 110 | 03.11 |                         |                |        |   |                         |     |
|  | 2.0 HDi     | 120 | 03.10 | + 18" Rad <sup>1)</sup> |                |        |   |                         |     |
|  | 1.6 16V     | 147 | 06.10 |                         | 24.0130-0229.1 | 430229 |   | 340 30,0 28,0 V L +S +B |     |
|  | 2.0 HDi     | 120 | 03.10 | + 19" Rad <sup>2)</sup> |                |        |   |                         |     |
|  | 1.6 16V     | 115 | 03.10 |                         | 24.0711-5325.3 | 360350 | 2 | Radsensor L=680         |     |
|  | 1.6 16V     | 147 | 06.10 |                         |                |        |   |                         |     |
|  | 1.6 THP 150 | 110 | 03.11 |                         |                |        |   |                         |     |
|  | 2.0 HDi     | 120 | 03.10 |                         |                |        |   |                         |     |
|  | R           | 199 | 10.13 |                         |                |        |   |                         |     |
|  | 1.6 16V     | 115 | 03.10 |                         | 13.0460-2761.2 | 602761 |   | 24922 17,5 /Zub/S       | TRW |
|  | 1.6 16V     | 147 | 03.10 |                         |                |        |   |                         |     |
|  | 1.6 THP 150 | 110 | 03.11 |                         |                |        |   |                         |     |
|  | 2.0 HDi     | 120 | 03.10 |                         |                |        |   |                         |     |
|  | R           | 199 | 10.13 |                         |                |        |   |                         |     |
|  | 1.6 16V     | 115 | 03.10 |                         | 24.0112-0162.1 | 412162 |   | 290 12,0 10,0 +S +B     |     |
|  | 1.6 16V     | 147 | 06.10 |                         |                |        |   |                         |     |
|  | 1.6 THP 150 | 110 | 03.11 |                         |                |        |   |                         |     |
|  | 2.0 HDi     | 120 | 03.10 |                         |                |        |   |                         |     |
|  | R           | 199 | 10.13 |                         |                |        |   |                         |     |

<sup>1)</sup> + 18" wheel / + ruota 18" / + roue 18" / + rueda 18"

<sup>2)</sup> + 19" wheel / + ruota 19" / + roue 19" / + rueda 19"





| PEUGEOT TRAVELLER (16-)          |                  |     |  |       |       |  |                |        |   |   |
|----------------------------------|------------------|-----|--|-------|-------|--|----------------|--------|---|---|
|                                  | 1.6 BlueHDi 115  | 85  |  | 04.16 |       |  | 24.0112-0212.1 | 412212 |   | 290 12,0 10,0 +S +B                       |
|                                  | 1.6 BlueHDi 95   | 70  |  | 04.16 |       |  |                |        |   |   |
|                                  | 2.0 BlueHDi 150  | 110 |  | 04.16 |       |  |                |        |   |   |
|                                  | 2.0 BlueHDi 180  | 130 |  | 04.16 |       |  |                |        |   |   |
| PONTIAC TRANS SPORT (97-05)      |                  |     |  |       |       |  |                |        |   |   |
|                                  | 3.4              |     |  | 03.97 | 12.05 |  | 13.0460-8002.2 | 608002 |   | 23358 18,0 +/WK                           |
|                                  | 3.4              |     |  | 03.97 | 12.05 |  | 24.0132-0110.1 | 432110 |   | 278 32,2 30,7 V                           |
|                                  | 3.4              |     |  | 03.97 | 12.05 |  | 24.0111-0133.1 | 411133 |   | 278 11,0 9,0 +B                           |
| PORSCHE 911 (993) (93-97)        |                  |     |  |       |       |  |                |        |   |   |
|                                  | 3.6 CARRERA      |     |  | 10.93 | 09.97 |  | 24.8190-0917.2 | 620917 | 2 | Warnkontakt L=518mm                       |
|                                  | 3.6 CARRERA 4    |     |  | 07.94 | 09.97 |  |                |        |   |   |
|                                  | 3.8 CARRERA      | 210 |  | 06.95 | 09.97 |  |                |        |   |   |
|                                  | 3.8 CARRERA 4    | 210 |  | 06.95 | 09.97 |  |                |        |   |   |
|                                  | 3.6 TURBO 4      | 300 |  | 03.95 | 09.97 |  | 13.0460-4056.2 | 604056 | 2 | 21402 17,5 /WE BRE<br>Warnkontakt L=475mm |
|                                  | 3.6 TURBO GT2    | 316 |  | 03.95 | 09.97 |  | 24.8190-0926.2 | 620926 |   |   |
|                                  | 3.6 TURBO GT2 4  |     |  | 08.95 | 09.97 |  |                |        |   |   |
|                                  | 3.8 CARRERA RS   | 221 |  | 06.95 | 09.97 |  |                |        |   |   |
|                                  | 3.8 CARRERA RS 4 | 221 |  | 08.95 | 09.97 |  |                |        |   |   |
|                                  | 3.6 CARRERA      |     |  | 10.93 | 09.97 |  | 24.0132-0142.1 | 432142 |   | 304 32,0 30,0 V L +B                      |
|                                  | 3.6 CARRERA 4    |     |  | 07.94 | 09.97 |  | 24.0132-0143.1 | 432143 |   | 304 32,0 30,0 V L +B                      |
|                                  | 3.8 CARRERA      | 210 |  | 06.95 | 09.97 |  |                |        |   |   |
|                                  | 3.8 CARRERA 4    | 210 |  | 06.95 | 09.97 |  |                |        |   |   |
|                                  | 3.6 TURBO 4      | 300 |  | 03.95 | 09.97 |  | 24.0132-0163.2 | 432163 |   | 322 32,0 30,0 V L +B                      |
|                                  | 3.6 TURBO GT2    | 316 |  | 03.95 | 09.97 |  | 24.0132-0164.2 | 432164 |   | 322 32,0 30,0 V L +B                      |
|                                  | 3.6 TURBO GT2 4  |     |  | 08.95 | 09.97 |  |                |        |   |   |
|                                  | 3.8 CARRERA RS   | 221 |  | 06.95 | 09.97 |  |                |        |   |   |
|                                  | 3.8 CARRERA RS 4 | 221 |  | 08.95 | 09.97 |  |                |        |   |   |
|                                  | 3.6 CARRERA      |     |  | 10.93 | 09.97 |  | 24.8190-0920.2 | 620920 | 2 | Warnkontakt L=698mm                       |
|                                  | 3.6 CARRERA 4    |     |  | 07.94 | 09.97 |  |                |        |   |   |
|                                  | 3.8 CARRERA      | 210 |  | 06.95 | 09.97 |  |                |        |   |   |
|                                  | 3.8 CARRERA 4    | 210 |  | 06.95 | 09.97 |  |                |        |   |   |
|                                  | 3.6 TURBO 4      | 300 |  | 03.95 | 09.97 |  | 24.8190-0920.2 | 620920 | 2 | Warnkontakt L=698mm                       |
|                                  | 3.6 TURBO GT2    | 316 |  | 03.95 | 09.97 |  |                |        |   |   |
|                                  | 3.6 TURBO GT2 4  |     |  | 08.95 | 09.97 |  |                |        |   |   |
|                                  | 3.8 CARRERA RS   | 221 |  | 06.95 | 09.97 |  |                |        |   |   |
|                                  | 3.8 CARRERA RS 4 | 221 |  | 08.95 | 09.97 |  |                |        |   |   |
|                                  | 3.6 CARRERA      |     |  | 10.93 | 09.97 |  | 24.0124-0183.1 | 424183 |   | 299 24,0 22,0 V L +B                      |
|                                  | 3.6 CARRERA 4    |     |  | 07.94 | 09.97 |  |                |        |   |   |
|                                  | 3.8 CARRERA      | 210 |  | 06.95 | 09.97 |  |                |        |   |   |
|                                  | 3.8 CARRERA 4    | 210 |  | 06.95 | 09.97 |  |                |        |   |   |
| PORSCHE 911 TARGA (993) (95-97)  |                  |     |  |       |       |  |                |        |   |   |
|                                  | 3.6 CARRERA      | 210 |  | 08.95 | 09.97 |  | 24.8190-0917.2 | 620917 | 2 | Warnkontakt L=518mm                       |
|                                  | 3.6 CARRERA      | 210 |  | 08.95 | 09.97 |  | 24.0132-0142.1 | 432142 |   | 304 32,0 30,0 V L +B                      |
|                                  |                  |     |  |       |       |  | 24.0132-0143.1 | 432143 |   | 304 32,0 30,0 V L +B                      |
|                                  | 3.6 CARRERA      | 210 |  | 08.95 | 09.97 |  | 24.8190-0920.2 | 620920 | 2 | Warnkontakt L=698mm                       |
|                                  | 3.6 CARRERA      | 210 |  | 08.95 | 09.97 |  | 24.0124-0183.1 | 424183 |   | 299 24,0 22,0 V L +B                      |
| PORSCHE 911 CABRIO (993) (94-97) |                  |     |  |       |       |  |                |        |   |   |
|                                  | 3.6 CARRERA      |     |  | 07.94 | 09.97 |  | 24.8190-0917.2 | 620917 | 2 | Warnkontakt L=518mm                       |
|                                  | 3.6 CARRERA 4    |     |  | 07.94 | 09.97 |  |                |        |   |   |
|                                  | 3.8 CARRERA      | 210 |  | 06.95 | 09.97 |  |                |        |   |   |
|                                  | 3.8 CARRERA 4    | 210 |  | 06.95 | 09.97 |  |                |        |   |   |
|                                  | 3.8 CARRERA RS   | 221 |  | 08.95 | 09.97 |  | 13.0460-4056.2 | 604056 | 2 | 21402 17,5 /WE BRE<br>Warnkontakt L=475mm |
|                                  | 3.8 CARRERA RS 4 | 221 |  | 08.95 | 09.97 |  | 24.8190-0926.2 | 620926 |   |   |
|                                  | 3.6 CARRERA      |     |  | 07.94 | 09.97 |  | 24.0132-0142.1 | 432142 |   | 304 32,0 30,0 V L +B                      |
|                                  | 3.6 CARRERA 4    |     |  | 07.94 | 09.97 |  | 24.0132-0143.1 | 432143 |   | 304 32,0 30,0 V L +B                      |
|                                  | 3.8 CARRERA      | 210 |  | 06.95 | 09.97 |  |                |        |   |   |
|                                  | 3.8 CARRERA 4    | 210 |  | 06.95 | 09.97 |  |                |        |   |   |
|                                  | 3.6 CARRERA      |     |  | 07.94 | 09.97 |  | 24.8190-0920.2 | 620920 | 2 | Warnkontakt L=698mm                       |
|                                  | 3.6 CARRERA 4    |     |  | 07.94 | 09.97 |  |                |        |   |   |
|                                  | 3.8 CARRERA      | 210 |  | 06.95 | 09.97 |  |                |        |   |   |
|                                  | 3.8 CARRERA 4    | 210 |  | 06.95 | 09.97 |  |                |        |   |   |
|                                  | 3.8 CARRERA RS   | 221 |  | 08.95 | 09.97 |  | 24.8190-0920.2 | 620920 | 2 | Warnkontakt L=698mm                       |
|                                  | 3.8 CARRERA RS 4 | 221 |  | 08.95 | 09.97 |  |                |        |   |   |
|                                  | 3.6 CARRERA      |     |  | 07.94 | 09.97 |  | 24.0124-0183.1 | 424183 |   | 299 24,0 22,0 V L +B                      |
|                                  | 3.6 CARRERA 4    |     |  | 07.94 | 09.97 |  |                |        |   |   |
|                                  | 3.8 CARRERA      | 210 |  | 06.95 | 09.97 |  |                |        |   |   |
|                                  | 3.8 CARRERA 4    | 210 |  | 06.95 | 09.97 |  |                |        |   |   |

<sup>1)</sup> two-piece brake disc/ with ABE / disco frenante in due parti/ con ABE / disque d.fr.en deux parties/ avec ABE / disco de fr.de dos piezas/ con ABE

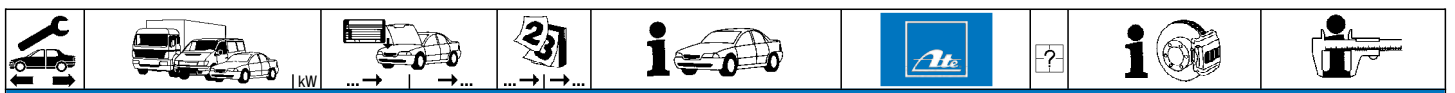

### PORSCHE 911 (996) (97-05)

|               |               |       |       |                |                |        |                               |  |  |            |
|---------------|---------------|-------|-------|----------------|----------------|--------|-------------------------------|--|--|------------|
|               | 3.4 CARRERA   |       | 09.97 | 09.01          | 13.0460-4987.2 | 604987 | 2                             |  | 23329 17,0 /WE<br>Warnkontakt L=440mm        | <b>BRE</b> |
|               | 3.4 CARRERA 4 |       | 06.97 | 09.01          | 24.8190-0921.2 | 620921 |                               |  |  |            |
|               | 3.6 CARRERA   |       | 10.01 | 08.05          |                |        |                               |  |  |            |
|               | 3.6 CARRERA 4 |       | 10.01 | 08.05          | 13.0460-4999.2 | 604999 |                               |  |  |            |
|               | 3.6 S         |       | 08.04 | 08.05          | 24.8190-0921.2 | 620921 |                               |  |  |            |
| 3.6 TURBO 4   |               | 06.00 | 08.05 |                |                |        | - Keramikbremse <sup>1)</sup> | 23330 17,0 /WE<br>Warnkontakt L=440mm        | <b>BRE</b>                                   |            |
| 3.6 GT3       |               | 03.99 | 12.02 | 24.8190-0921.2 | 620921         | 2      | - Keramikbremse <sup>1)</sup> | Warnkontakt L=440mm                          |  |            |
| 3.6 GT3       |               | 01.03 | 08.05 | 24.8190-0921.2 | 620921         | 2      | - Keramikbremse <sup>1)</sup> | Warnkontakt L=440mm                          |  |            |
|               | 3.4 CARRERA   |       | 09.97 | 09.01          | 24.0128-0131.1 | 428131 |                               |  | 318 28,0 26,0 V L +B<br>318 28,0 26,0 V L +B |            |
|               | 3.4 CARRERA 4 |       | 09.97 | 09.01          | 24.0128-0130.1 | 428130 |                               |  |  |            |
|               | 3.6 CARRERA   |       | 10.01 | 08.05          |                |        |                               |  |  |            |
|               | 3.6 CARRERA 4 |       | 10.01 | 08.05          |                |        |                               |  |  |            |
|               | 3.6 CARRERA   |       | 01.02 | 08.05          | 24.0134-0101.1 | 434101 |                               |  |  |            |
| 3.6 CARRERA 4 |               | 01.02 | 08.05 | 24.0134-0102.1 | 434102         |        | - Keramikbremse <sup>1)</sup> | 330 34,0 32,0 V L +B<br>330 34,0 32,0 V L +B |  |            |
| 3.6 TURBO 4   |               | 06.00 | 08.05 |                |                |        | - Keramikbremse <sup>1)</sup> |  |  |            |
|               | 3.4 CARRERA   |       | 09.97 | 09.01          | 13.0460-4988.2 | 604988 | 2                             |  | 21792 15,5 /WE<br>Warnkontakt L=440mm        | <b>BRE</b> |
|               | 3.4 CARRERA 4 |       | 06.97 | 09.01          | 24.8190-0921.2 | 620921 |                               |  |  |            |
|               | 3.6 CARRERA   |       | 10.01 | 08.05          |                |        |                               |  |  |            |
|               | 3.6 CARRERA 4 |       | 10.01 | 08.05          |                |        |                               |  |  |            |
|               | 3.6 CARRERA   |       | 01.02 | 08.05          | 13.0460-4987.2 | 604987 |                               |  |  |            |
| 3.6 CARRERA 4 |               | 01.02 | 08.05 | 24.8190-0921.2 | 620921         | 2      | - Keramikbremse <sup>1)</sup> | 23329 17,0 /WE<br>Warnkontakt L=440mm        | <b>BRE</b>                                   |            |
| 3.6 S         |               | 08.04 | 08.05 |                |                |        | - Keramikbremse <sup>1)</sup> |  |  |            |
| 3.6 TURBO 4   |               | 01.02 | 08.08 |                |                |        |                               |  |  |            |
| 3.6 GT3       |               | 03.99 | 08.05 | 13.0460-4987.2 | 604987         | 2      | - Keramikbremse <sup>1)</sup> | 23329 17,0 /WE<br>Warnkontakt L=440mm        | <b>BRE</b>                                   |            |
|               | 3.4 CARRERA   |       | 09.97 | 09.01          | 24.0124-0176.1 | 424176 |                               |  | 299 24,0 22,0 V L +B                         |            |
|               | 3.4 CARRERA 4 |       | 06.97 | 09.01          |                |        |                               |  |  |            |
|               | 3.6 CARRERA   |       | 10.01 | 08.05          |                |        |                               |  |  |            |
|               | 3.6 CARRERA 4 |       | 10.01 | 08.05          |                |        |                               |  |  |            |
|               | 3.6 CARRERA   |       | 01.02 | 08.05          | 24.0128-0197.1 | 428197 |                               |  |  |            |
| 3.6 CARRERA 4 |               | 01.02 | 08.05 | 24.0128-0196.1 | 428196         |        | - Keramikbremse <sup>1)</sup> | 330 28,0 26,0 V L +B<br>330 28,0 26,0 V L +B |  |            |
| 3.6 S         |               | 08.04 | 08.05 |                |                |        | - Keramikbremse <sup>1)</sup> |  |  |            |
| 3.6 TURBO 4   |               | 06.00 | 08.05 |                |                |        |                               |  |  |            |
| 3.6 GT2       |               | 04.01 | 08.05 | 24.0128-0197.1 | 428197         |        | - Keramikbremse <sup>1)</sup> | 330 28,0 26,0 V L +B                         |  |            |
| 3.6 GT3       |               | 03.99 | 08.05 | 24.0128-0196.1 | 428196         |        | - Keramikbremse <sup>1)</sup> | 330 28,0 26,0 V L +B                         |  |            |
|               | 3.6 CARRERA   |       | 01.03 | 08.05          | 03.0137-3002.2 | 653002 |                               |  | 180 x 25                                     |            |
|               | 3.6 CARRERA 4 |       | 01.03 | 08.05          |                |        |                               |  |  |            |
|               | 3.6 GT2       |       | 01.03 | 08.05          |                |        |                               |  |  |            |
|               | 3.6 GT3       |       | 01.03 | 08.05          |                |        |                               |  |  |            |
|               | 3.6 S         |       | 08.04 | 08.05          |                |        |                               |  |  |            |
| 3.6 TURBO 4   |               | 01.03 | 08.05 |                |                |        |                               |  |  |            |

### PORSCHE 911 TARGA (996) (01-05)

|  |     |     |  |       |       |                |        |   |  |  |            |
|--|-----|-----|--|-------|-------|----------------|--------|---|--|--|------------|
|  | 3.6 | 235 |  | 12.01 | 08.05 | 13.0460-4987.2 | 604987 | 2 |  | 23329 17,0 /WE<br>Warnkontakt L=440mm        | <b>BRE</b> |
|  | 3.6 | 235 |  | 12.01 | 08.05 | 24.0128-0131.1 | 428131 |   |  | 318 28,0 26,0 V L +B<br>318 28,0 26,0 V L +B |            |
|  | 3.6 | 235 |  | 12.01 | 08.05 | 13.0460-4988.2 | 604988 | 2 |  | 21792 15,5 /WE<br>Warnkontakt L=440mm        | <b>BRE</b> |
|  | 3.6 | 235 |  | 12.01 | 08.05 | 24.0124-0176.1 | 424176 |   |  | 299 24,0 22,0 V L +B                         |            |
|  | 3.6 | 235 |  | 01.03 | 08.05 | 03.0137-3002.2 | 653002 |   |  | 180 x 25                                     |            |

### PORSCHE 911 CABRIO (996) (98-05)

|               |               |       |       |                |                |        |                               |  |  |            |
|---------------|---------------|-------|-------|----------------|----------------|--------|-------------------------------|--|--|------------|
|               | 3.4 CARRERA   |       | 02.98 | 09.01          | 13.0460-4987.2 | 604987 | 2                             |  | 23329 17,0 /WE<br>Warnkontakt L=440mm        | <b>BRE</b> |
|               | 3.4 CARRERA 4 |       | 02.98 | 09.01          | 24.8190-0921.2 | 620921 |                               |  |  |            |
|               | 3.6 CARRERA   |       | 10.01 | 08.05          |                |        |                               |  |  |            |
|               | 3.6 CARRERA 4 |       | 10.01 | 08.05          |                |        |                               |  |  |            |
|               | 3.6 CARRERA   |       | 01.02 | 08.05          | 13.0460-4999.2 | 604999 |                               |  |  |            |
| 3.6 CARRERA 4 |               | 01.02 | 08.05 | 24.8190-0921.2 | 620921         | 2      | - Keramikbremse <sup>1)</sup> | 23330 17,0 /WE<br>Warnkontakt L=440mm        | <b>BRE</b>                                   |            |
| 3.6 TURBO 4   |               | 10.03 | 08.05 |                |                |        | - Keramikbremse <sup>1)</sup> |  |  |            |
|               | 3.4 CARRERA   |       | 02.98 | 09.01          | 24.0128-0131.1 | 428131 |                               |  | 318 28,0 26,0 V L +B<br>318 28,0 26,0 V L +B |            |
|               | 3.4 CARRERA 4 |       | 02.98 | 09.01          | 24.0128-0130.1 | 428130 |                               |  |  |            |
|               | 3.6 CARRERA   |       | 10.01 | 08.05          |                |        |                               |  |  |            |
|               | 3.6 CARRERA 4 |       | 10.01 | 08.05          |                |        |                               |  |  |            |
|               | 3.6 CARRERA   |       | 01.02 | 08.05          | 24.0134-0101.1 | 434101 |                               |  |  |            |
| 3.6 CARRERA 4 |               | 01.02 | 08.05 | 24.0134-0102.1 | 434102         |        | - Keramikbremse <sup>1)</sup> | 330 34,0 32,0 V L +B<br>330 34,0 32,0 V L +B |  |            |
| 3.6 TURBO 4   |               | 10.03 | 08.05 |                |                |        | - Keramikbremse <sup>1)</sup> |  |  |            |
|               | 3.4 CARRERA   |       | 02.98 | 09.01          | 13.0460-4988.2 | 604988 | 2                             |  | 21792 15,5 /WE<br>Warnkontakt L=440mm        | <b>BRE</b> |
|               | 3.4 CARRERA 4 |       | 02.98 | 09.01          | 24.8190-0921.2 | 620921 |                               |  |  |            |
|               | 3.6 CARRERA   |       | 10.01 | 08.05          |                |        |                               |  |  |            |
|               | 3.6 CARRERA 4 |       | 10.01 | 08.05          |                |        |                               |  |  |            |
|               | 3.4 CARRERA   |       | 02.98 | 09.01          | 13.0460-4987.2 | 604987 |                               |  |  |            |
| 3.4 CARRERA 4 |               | 02.98 | 09.01 | 24.8190-0921.2 | 620921         | 2      | - Keramikbremse <sup>1)</sup> | 23329 17,0 /WE<br>Warnkontakt L=440mm        | <b>BRE</b>                                   |            |
| 3.6 CARRERA   |               | 10.01 | 08.05 |                |                |        | - Keramikbremse <sup>1)</sup> |  |  |            |
| 3.6 CARRERA 4 |               | 10.01 | 08.05 |                |                |        |                               |  |  |            |
| 3.6 TURBO 4   |               | 10.03 | 08.05 |                |                |        |                               |  |  |            |

<sup>1)</sup> - ceramic brake / - freno in ceramica / - frein de céramique / - freno de cerámica





### PORSCHE 911 CABRIO (996) (98-05)

|  |               |  |  |       |       |  |                |        |  |                      |
|--|---------------|--|--|-------|-------|--|----------------|--------|--|----------------------|
|  | 3.4 CARRERA   |  |  | 02.98 | 09.01 |  | 24.0124-0176.1 | 424176 |  | 299 24,0 22,0 V L +B |
|  | 3.4 CARRERA 4 |  |  | 02.98 | 09.01 |  |                |        |  |                      |
|  | 3.6 CARRERA   |  |  | 10.01 | 08.05 |  |                |        |  |                      |
|  | 3.6 CARRERA 4 |  |  | 10.01 | 08.05 |  |                |        |  |                      |
|  | 3.6 CARRERA   |  |  | 01.02 | 08.05 |  | 24.0128-0197.1 | 428197 |  | 330 28,0 26,0 V L +B |
|  | 3.6 CARRERA 4 |  |  | 01.02 | 08.05 |  | 24.0128-0196.1 | 428196 |  | 330 28,0 26,0 V L +B |
|  | 3.6 TURBO 4   |  |  | 10.03 | 08.05 |  |                |        |  |                      |
|  | 3.6 CARRERA   |  |  | 01.03 | 08.05 |  | 03.0137-3002.2 | 653002 |  | 180 x 25             |
|  | 3.6 CARRERA 4 |  |  | 01.03 | 08.05 |  |                |        |  |                      |
|  | 3.6 TURBO 4   |  |  | 10.03 | 08.05 |  |                |        |  |                      |

### PORSCHE 911 COUPE (997) (04-13)

|  |                  |     |  |       |       |                               |                |        |   |                       |
|--|------------------|-----|--|-------|-------|-------------------------------|----------------|--------|---|-----------------------|
|  | 3.6 Carrera      | 239 |  | 07.04 | 09.13 | - Keramikbremse <sup>1)</sup> | 13.0460-4842.2 | 604842 |   | 24049 17,0 /WE BRE    |
|  |                  |     |  |       |       |                               | 24.8190-0025.2 | 620025 |   | Warnkontakt L=349,6mm |
|  | 3.6 Carrera      | 254 |  | 06.08 | 09.13 | - Keramikbremse <sup>1)</sup> | 24.8190-0016.2 | 620016 | 2 | Warnkontakt L=359,6mm |
|  | 3.6 Carrera 4    | 239 |  | 07.04 | 09.13 | - Keramikbremse <sup>1)</sup> | 13.0460-4842.2 | 604842 |   | 24049 17,0 /WE BRE    |
|  |                  |     |  |       |       |                               | 24.8190-0938.2 | 620938 | 2 | Warnkontakt L=495mm   |
|  | 3.6 Carrera 4    | 254 |  | 06.08 | 09.13 | - Keramikbremse <sup>1)</sup> | 24.8190-0938.2 | 620938 | 2 | Warnkontakt L=495mm   |
|  | 3.8 Carrera S    | 261 |  | 07.04 | 09.13 | - Keramikbremse <sup>1)</sup> | 13.0460-4999.2 | 604999 |   | 23330 17,0 /WE BRE    |
|  | 3.8 Carrera S    | 280 |  | 08.05 | 09.13 | - Keramikbremse <sup>1)</sup> | 24.8190-0933.2 | 620933 |   | Warnkontakt L=305mm   |
|  |                  |     |  |       |       |                               | 24.8190-0931.2 | 620931 |   | Warnkontakt L=336mm   |
|  | 3.8 Carrera GTS  | 300 |  | 06.09 | 09.13 | - Keramikbremse <sup>1)</sup> | 24.8190-0933.2 | 620933 |   | Warnkontakt L=305mm   |
|  | 3.8 Carrera S    | 283 |  | 06.08 | 09.13 | - Keramikbremse <sup>1)</sup> | 24.8190-0931.2 | 620931 |   | Warnkontakt L=336mm   |
|  | 3.8 Carrera 4S   | 261 |  | 07.04 | 09.13 | - Keramikbremse <sup>1)</sup> | 13.0460-4999.2 | 604999 |   | 23330 17,0 /WE BRE    |
|  | 3.8 Carrera 4S   | 280 |  | 08.05 | 09.13 | - Keramikbremse <sup>1)</sup> | 24.8190-0950.2 | 620950 | 2 | Warnkontakt L=525mm   |
|  | 3.8 Carrera 4GTS | 300 |  | 06.09 | 09.13 | - Keramikbremse <sup>1)</sup> | 24.8190-0950.2 | 620950 | 2 | Warnkontakt L=525mm   |
|  | 3.8 Carrera 4S   | 283 |  | 06.08 | 09.13 | - Keramikbremse <sup>1)</sup> |                |        |   |                       |
|  | 3.6 Carrera      | 239 |  | 07.04 | 09.13 | + Keramikbremse <sup>2)</sup> | 24.8190-0957.2 | 620957 |   | Warnkontakt L=394,6mm |
|  | 3.6 Carrera S    | 261 |  | 07.04 | 09.13 | + Keramikbremse <sup>2)</sup> | 24.8190-0956.2 | 620956 |   | Warnkontakt L=454,6mm |
|  | 3.6 Carrera S    | 280 |  | 08.05 | 09.13 | + Keramikbremse <sup>2)</sup> |                |        |   |                       |
|  | 3.6 Carrera 4    | 239 |  | 07.04 | 09.13 | + Keramikbremse <sup>2)</sup> | 24.8190-0938.2 | 620938 | 2 | Warnkontakt L=495mm   |
|  | 3.8 Carrera 4S   | 261 |  | 07.04 | 09.13 | + Keramikbremse <sup>2)</sup> |                |        |   |                       |
|  | 3.8 Carrera 4S   | 280 |  | 08.05 | 09.13 | + Keramikbremse <sup>2)</sup> |                |        |   |                       |
|  | 3.6 Carrera      | 254 |  | 06.08 | 09.13 | + Keramikbremse <sup>2)</sup> | 24.8190-0957.2 | 620957 |   | Warnkontakt L=394,6mm |
|  | 3.8 Carrera 4GTS | 300 |  | 06.09 | 09.13 | + Keramikbremse <sup>2)</sup> | 24.8190-0956.2 | 620956 |   | Warnkontakt L=454,6mm |
|  | 3.8 Carrera GTS  | 300 |  | 06.09 | 09.13 | + Keramikbremse <sup>2)</sup> |                |        |   |                       |
|  | 3.8 Carrera S    | 283 |  | 06.08 | 09.13 | + Keramikbremse <sup>2)</sup> |                |        |   |                       |
|  | 3.6 Carrera 4    | 254 |  | 06.08 | 09.13 | + Keramikbremse <sup>2)</sup> | 24.8190-0938.2 | 620938 | 2 | Warnkontakt L=495mm   |
|  | 3.8 Carrera 4S   | 283 |  | 06.08 | 09.13 | + Keramikbremse <sup>2)</sup> |                |        |   |                       |
|  | 3.8 Turbo        | 368 |  | 01.11 | 09.13 | + Keramikbremse <sup>2)</sup> |                |        |   |                       |
|  | 3.8 Turbo 4S     | 390 |  | 01.11 | 09.13 | + Keramikbremse <sup>2)</sup> |                |        |   |                       |
|  | 3.6 Turbo        | 353 |  | 03.06 | 09.13 | - Keramikbremse <sup>1)</sup> | 24.8190-0938.2 | 620938 | 2 | Warnkontakt L=495mm   |
|  | 3.8 Turbo        | 368 |  | 09.09 | 09.13 | - Keramikbremse <sup>1)</sup> |                |        |   |                       |
|  | 3.6 Turbo        | 353 |  | 03.06 | 09.13 | + Keramikbremse <sup>2)</sup> | 24.8190-0938.2 | 620938 | 2 | Warnkontakt L=495mm   |
|  | 3.8 Turbo        | 368 |  | 09.09 | 12.10 | + Keramikbremse <sup>2)</sup> |                |        |   |                       |
|  | 3.8 Turbo 4S     | 390 |  | 02.10 | 12.10 | + Keramikbremse <sup>2)</sup> |                |        |   |                       |
|  | 3.6 GT2          | 390 |  | 09.07 | 09.13 |                               | 24.8190-0938.2 | 620938 | 2 | Warnkontakt L=495mm   |
|  | 3.8 GT3          | 320 |  | 05.09 | 09.13 | + Keramikbremse <sup>2)</sup> |                |        |   |                       |
|  | 3.6 GT2 RS       | 456 |  | 05.10 | 09.13 |                               | 24.8190-0951.2 | 620951 | 2 | Warnkontakt L=500mm   |
|  | 3.8 GT3 RS       | 331 |  | 08.09 | 09.13 | + Keramikbremse <sup>2)</sup> |                |        |   |                       |
|  | 4.0 GT3 RS       | 368 |  | 07.11 | 09.13 | + Keramikbremse <sup>2)</sup> |                |        |   |                       |
|  | 3.6 GT3          | 305 |  | 03.06 | 12.08 |                               | 24.8190-0951.2 | 620951 | 2 | Warnkontakt L=500mm   |
|  | 3.8 GT3          | 320 |  | 05.09 | 09.13 | - Keramikbremse <sup>1)</sup> | 24.8190-0951.2 | 620951 | 2 | Warnkontakt L=500mm   |
|  | 3.8 GT3 RS       | 331 |  | 08.09 | 09.13 | - Keramikbremse <sup>1)</sup> |                |        |   |                       |
|  | 4.0 GT3 RS       | 368 |  | 07.11 | 09.13 | - Keramikbremse <sup>1)</sup> |                |        |   |                       |
|  | 3.6 Carrera      | 239 |  | 07.04 | 09.13 | - Keramikbremse <sup>1)</sup> | 24.0128-0131.1 | 428131 |   | 318 28,0 26,0 V L +B  |
|  | 3.6 Carrera 4    | 239 |  | 07.04 | 09.13 | - Keramikbremse <sup>1)</sup> | 24.0128-0130.1 | 428130 |   | 318 28,0 26,0 V L +B  |
|  | 3.6 Carrera      | 254 |  | 06.08 | 09.13 | - Keramikbremse <sup>1)</sup> | 24.0128-0247.1 | 428247 |   | 330 28,0 26,0 V L +B  |
|  | 3.6 Carrera 4    | 254 |  | 06.08 | 09.13 | - Keramikbremse <sup>1)</sup> | 24.0128-0246.1 | 428246 |   | 330 28,0 26,0 V L +B  |
|  | 3.8 Carrera 4S   | 261 |  | 07.04 | 09.13 | - Keramikbremse <sup>1)</sup> | 24.0134-0101.1 | 434101 |   | 330 34,0 32,0 V L +B  |
|  | 3.8 Carrera 4S   | 280 |  | 08.05 | 09.13 | - Keramikbremse <sup>1)</sup> | 24.0134-0102.1 | 434102 |   | 330 34,0 32,0 V L +B  |
|  | 3.8 Carrera 4S   | 283 |  | 06.08 | 12.10 | - Keramikbremse <sup>1)</sup> |                |        |   |                       |
|  | 3.8 Carrera S    | 261 |  | 07.04 | 09.13 | - Keramikbremse <sup>1)</sup> |                |        |   |                       |
|  | 3.8 Carrera S    | 280 |  | 08.05 | 09.13 | - Keramikbremse <sup>1)</sup> |                |        |   |                       |
|  | 3.8 Carrera S    | 283 |  | 06.08 | 12.10 | - Keramikbremse <sup>1)</sup> |                |        |   |                       |
|  | 3.8 Carrera 4GTS | 300 |  | 06.09 | 09.13 | - Keramikbremse <sup>1)</sup> | 24.0134-0101.1 | 434101 |   | 330 34,0 32,0 V L +B  |
|  | 3.8 Carrera 4S   | 283 |  | 01.11 | 09.13 | - Keramikbremse <sup>1)</sup> | 24.0134-0102.1 | 434102 |   | 330 34,0 32,0 V L +B  |
|  | 3.8 Carrera GTS  | 300 |  | 06.09 | 09.13 | - Keramikbremse <sup>1)</sup> |                |        |   |                       |
|  | 3.8 Carrera S    | 283 |  | 01.11 | 09.13 | - Keramikbremse <sup>1)</sup> |                |        |   |                       |
|  | 3.6 GT3          | 305 |  | 03.06 | 09.13 |                               | 24.0134-0105.1 | 434105 |   | 350 34,0 32,0 V L +B  |
|  |                  |     |  |       |       |                               | 24.0134-0106.1 | 434106 |   | 350 34,0 32,0 V L +B  |
|  | 3.6 Carrera      | 239 |  | 07.04 | 09.13 | - Keramikbremse <sup>1)</sup> | 13.0460-4988.2 | 604988 |   | 21792 15,5 /WE BRE    |
|  | 3.6 Carrera 4    | 239 |  | 07.04 | 09.13 | - Keramikbremse <sup>1)</sup> | 24.8190-0921.2 | 620921 | 2 | Warnkontakt L=440mm   |
|  | 3.6 Carrera      | 254 |  | 06.08 | 09.13 | - Keramikbremse <sup>1)</sup> | 24.8190-0023.2 | 620023 | 2 | Warnkontakt L=484,6mm |
|  | 3.6 Carrera 4    | 254 |  | 06.08 | 09.13 | - Keramikbremse <sup>1)</sup> |                |        |   |                       |
|  | 3.8 Carrera 4S   | 261 |  | 07.04 | 09.13 | - Keramikbremse <sup>1)</sup> | 13.0460-4842.2 | 604842 |   | 24049 17,0 /WE BRE    |
|  | 3.8 Carrera 4S   | 280 |  | 08.05 | 09.13 | - Keramikbremse <sup>1)</sup> | 24.8190-0943.2 | 620943 | 2 | Warnkontakt L=504,6mm |
|  | 3.8 Carrera S    | 261 |  | 07.04 | 09.13 | - Keramikbremse <sup>1)</sup> |                |        |   |                       |
|  | 3.8 Carrera S    | 280 |  | 08.05 | 09.13 | - Keramikbremse <sup>1)</sup> |                |        |   |                       |
|  | 3.8 Carrera 4GTS | 300 |  | 06.09 | 09.13 | - Keramikbremse <sup>1)</sup> | 24.8190-0943.2 | 620943 | 2 | Warnkontakt L=504,6mm |
|  | 3.8 Carrera 4S   | 283 |  | 06.08 | 09.13 | - Keramikbremse <sup>1)</sup> |                |        |   |                       |

<sup>1)</sup> - ceramic brake / - freno in ceramica / - frein de céramique / - freno de cerámica  
<sup>2)</sup> + ceramic brake / + freno di ceramica / + frein de céramique / + freno de cerámica





**PORSCHE 911 COUPE (997) (04-13)**

|              |                  |       |       |                               |                               |                |        |   |                               |                       |
|--------------|------------------|-------|-------|-------------------------------|-------------------------------|----------------|--------|---|-------------------------------|-----------------------|
|              | 3.8 Carrera GTS  | 300   | 06.09 | 09.13                         | - Keramikbremse <sup>1)</sup> | 24.8190-0943.2 | 620943 | 2 |                               | Warnkontakt L=504,6mm |
|              | 3.8 Carrera S    | 283   | 06.08 | 09.13                         | - Keramikbremse <sup>1)</sup> |                |        |   |                               |                       |
|              | 3.6 Carrera      | 239   | 07.04 | 09.13                         | + Keramikbremse <sup>2)</sup> | 24.8190-0943.2 | 620943 | 2 |                               | Warnkontakt L=504,6mm |
|              | 3.6 Carrera      | 254   | 06.08 | 09.13                         | + Keramikbremse <sup>2)</sup> |                |        |   |                               |                       |
|              | 3.6 Carrera 4    | 239   | 07.04 | 09.13                         | + Keramikbremse <sup>2)</sup> |                |        |   |                               |                       |
|              | 3.6 Carrera 4    | 254   | 06.08 | 09.13                         | + Keramikbremse <sup>2)</sup> |                |        |   |                               |                       |
|              | 3.8 Carrera 4S   | 261   | 07.04 | 09.13                         | + Keramikbremse <sup>2)</sup> |                |        |   |                               |                       |
|              | 3.8 Carrera 4S   | 280   | 08.05 | 09.13                         | + Keramikbremse <sup>2)</sup> |                |        |   |                               |                       |
|              | 3.8 Carrera 4S   | 283   | 06.08 | 09.13                         | + Keramikbremse <sup>2)</sup> |                |        |   |                               |                       |
|              | 3.8 Carrera S    | 261   | 07.04 | 09.13                         | + Keramikbremse <sup>2)</sup> |                |        |   |                               |                       |
|              | 3.8 Carrera S    | 280   | 08.05 | 09.13                         | + Keramikbremse <sup>2)</sup> |                |        |   |                               |                       |
|              | 3.8 Carrera S    | 283   | 06.08 | 09.13                         | + Keramikbremse <sup>2)</sup> |                |        |   |                               |                       |
|              | 3.6 GT3          | 305   | 03.06 | 12.06                         | - Keramikbremse <sup>1)</sup> | 24.8190-0023.2 | 620023 | 2 |                               | Warnkontakt L=484,6mm |
|              | 3.6 Turbo        | 353   | 03.06 | 09.13                         | - Keramikbremse <sup>1)</sup> |                |        |   |                               |                       |
|              | 3.6 Turbo        | 353   | 03.06 | 09.13                         | + Keramikbremse <sup>2)</sup> | 24.8190-0023.2 | 620023 | 2 |                               | Warnkontakt L=484,6mm |
|              | 3.8 Turbo        | 368   | 09.09 | 09.13                         | + Keramikbremse <sup>2)</sup> |                |        |   |                               |                       |
|              | 3.8 Turbo 4S     | 390   | 02.10 | 09.13                         | + Keramikbremse <sup>2)</sup> |                |        |   |                               |                       |
|              | 3.6 GT2          | 390   | 09.07 | 09.13                         |                               | 24.8190-0023.2 | 620023 | 2 |                               | Warnkontakt L=484,6mm |
|              | 3.6 GT2 RS       | 456   | 05.10 | 09.13                         |                               |                |        |   |                               |                       |
| 3.6 GT3      | 305              | 03.06 | 09.13 | + Keramikbremse <sup>2)</sup> |                               |                |        |   |                               |                       |
| 3.8 GT3      | 320              | 05.09 | 09.13 | + Keramikbremse <sup>2)</sup> |                               |                |        |   |                               |                       |
| 3.8 GT3 RS   | 331              | 08.09 | 09.13 | + Keramikbremse <sup>2)</sup> |                               |                |        |   |                               |                       |
| 4.0 GT3 RS   | 368              | 07.11 | 09.13 | + Keramikbremse <sup>2)</sup> |                               |                |        |   |                               |                       |
| 3.8 Turbo    | 368              | 09.09 | 09.13 | - Keramikbremse <sup>1)</sup> | 24.8190-0023.2                | 620023         | 2      |   | Warnkontakt L=484,6mm         |                       |
| 3.8 Turbo 4S | 390              | 02.10 | 09.13 | - Keramikbremse <sup>1)</sup> |                               |                |        |   |                               |                       |
| 3.6 GT3      | 305              | 01.07 | 12.07 | - Keramikbremse <sup>1)</sup> | 24.8190-0023.2                | 620023         | 2      |   | Warnkontakt L=484,6mm         |                       |
| 3.8 GT3      | 320              | 05.09 | 09.13 | - Keramikbremse <sup>1)</sup> | 24.8190-0023.2                | 620023         | 2      |   | Warnkontakt L=484,6mm         |                       |
| 3.8 GT3 RS   | 331              | 08.09 | 09.13 | - Keramikbremse <sup>1)</sup> |                               |                |        |   |                               |                       |
| 4.0 GT3 RS   | 368              | 07.11 | 09.13 | - Keramikbremse <sup>1)</sup> |                               |                |        |   |                               |                       |
|              | 3.6 Carrera      | 239   | 07.04 | 09.13                         |                               | 24.0124-0176.1 | 424176 |   | - Keramikbremse <sup>1)</sup> | 299 24,0 22,0 V L + B |
|              | 3.6 Carrera 4    | 239   | 07.04 | 09.13                         |                               | 24.0124-0176.1 | 424176 |   | - Keramikbremse <sup>1)</sup> | 299 24,0 22,0 V L + B |
|              | 3.6 Carrera      | 254   | 06.08 | 12.10                         |                               | 24.0128-0197.1 | 428197 |   | - Keramikbremse <sup>1)</sup> | 330 28,0 26,0 V L + B |
|              | 3.6 Carrera 4    | 254   | 06.08 | 12.10                         |                               | 24.0128-0196.1 | 428196 |   | - Keramikbremse <sup>1)</sup> | 330 28,0 26,0 V L + B |
|              | 3.8 Carrera 4S   | 283   | 06.08 | 12.10                         |                               |                |        |   |                               |                       |
|              | 3.8 Carrera S    | 283   | 06.08 | 12.10                         |                               |                |        |   |                               |                       |
|              | 3.6 Carrera      | 254   | 01.11 | 09.13                         |                               | 24.0128-0197.1 | 428197 |   | - Keramikbremse <sup>1)</sup> | 330 28,0 26,0 V L + B |
|              | 3.6 Carrera 4    | 254   | 01.11 | 09.13                         |                               | 24.0128-0196.1 | 428196 |   | - Keramikbremse <sup>1)</sup> | 330 28,0 26,0 V L + B |
|              | 3.8 Carrera 4S   | 283   | 01.11 | 09.13                         |                               |                |        |   |                               |                       |
|              | 3.8 Carrera S    | 283   | 01.11 | 09.13                         |                               |                |        |   |                               |                       |
|              | 3.8 Carrera 4GTS | 300   | 06.09 | 09.13                         |                               | 24.0128-0197.1 | 428197 |   | - Keramikbremse <sup>1)</sup> | 330 28,0 26,0 V L + B |
|              | 3.8 Carrera GTS  | 300   | 06.09 | 09.13                         |                               | 24.0128-0196.1 | 428196 |   | - Keramikbremse <sup>1)</sup> | 330 28,0 26,0 V L + B |
|              | 3.8 Carrera S    | 261   | 07.04 | 09.13                         |                               |                |        |   |                               |                       |
|              | 3.8 Carrera S    | 280   | 08.05 | 09.13                         |                               |                |        |   |                               |                       |
|              | 3.8 Carrera 4S   | 261   | 07.04 | 09.13                         |                               | 24.0128-0197.1 | 428197 |   | - Keramikbremse <sup>1)</sup> | 330 28,0 26,0 V L + B |
|              | 3.8 Carrera 4S   | 280   | 08.05 | 09.13                         |                               | 24.0128-0196.1 | 428196 |   | - Keramikbremse <sup>1)</sup> | 330 28,0 26,0 V L + B |
|              | 3.6 GT3          | 305   | 03.06 | 09.13                         |                               | 24.0128-0265.1 | 428265 |   | - Keramikbremse <sup>1)</sup> | 350 28,0 26,0 V L + B |
|              | 3.6 Turbo        | 353   | 03.06 | 09.13                         |                               | 24.0128-0264.1 | 428264 |   | - Keramikbremse <sup>1)</sup> | 350 28,0 26,0 V L + B |
|              | 3.8 Turbo        | 368   | 09.09 | 09.13                         |                               |                |        |   |                               |                       |
| 3.8 Turbo 4S | 390              | 02.10 | 09.13 |                               |                               |                |        |   |                               |                       |
|              | 3.6 Carrera      | 239   | 07.04 | 09.13                         |                               | 03.0137-3002.2 | 653002 |   |                               | 180 x 25              |
|              | 3.6 Carrera 4    | 239   | 07.04 | 09.13                         |                               |                |        |   |                               |                       |
|              | 3.8 Carrera 4S   | 261   | 07.04 | 09.13                         |                               |                |        |   |                               |                       |
|              | 3.8 Carrera S    | 261   | 07.04 | 09.13                         |                               |                |        |   |                               |                       |

**PORSCHE 911 CABRIO (997) (05-13)**

|                |                  |       |       |       |                |                |        |                               |  |   |                          |
|----------------|------------------|-------|-------|-------|----------------|----------------|--------|-------------------------------|--|---|--------------------------|
|                | 3.6 Carrera      | 239   | 04.05 | 09.13 |                | 13.0460-4987.2 | 604987 | 2                             | - Sportausführung/- Keramikbr. <sup>3)</sup><br>+ Sportausführung/- Keramikbr. <sup>4)</sup> | 23329 17,0 /WE<br>24049 17,0 /WE<br>Warnkontakt L=336mm | <b>BRE</b><br><b>BRE</b> |
|                | 3.6 Carrera 4    | 239   | 04.05 | 09.13 |                | 13.0460-4842.2 | 604842 | 2                             | - Keramikbremse <sup>1)</sup>  | 24049 17,0 /WE<br>Warnkontakt L=495mm                   | <b>BRE</b>               |
|                | 3.6 Carrera 4    | 254   | 06.08 | 09.13 |                | 24.8190-0938.2 | 620938 | 2                             | - Keramikbremse <sup>1)</sup>  |   |                          |
|                | 3.6 Turbo        | 353   | 09.07 | 09.13 |                |                |        |                               |  |   |                          |
|                | 3.8 Carrera GTS  | 300   | 06.09 | 09.13 |                |                |        |                               |  |   |                          |
|                | 3.8 Turbo        | 368   | 09.09 | 09.13 |                |                |        |                               |  |   |                          |
|                | 3.8 Turbo 4S     | 390   | 02.10 | 09.13 |                |                |        |                               |  |   |                          |
|                | 3.6 Carrera      | 254   | 06.08 | 09.13 |                | 24.8190-0016.2 | 620016 | 2                             | - Keramikbremse <sup>1)</sup>  | Warnkontakt L=359,6mm                                   |                          |
|                | 3.8 Carrera 4GTS | 300   | 06.09 | 09.13 |                | 13.0460-4999.2 | 604999 | 1                             | - Keramikbremse <sup>1)</sup>  | 23330 17,0 /WE  | <b>BRE</b>               |
|                | 3.8 Carrera S    | 261   | 04.05 | 09.13 |                | 24.8190-0933.2 | 620933 | 1                             | - Keramikbremse <sup>1)</sup>  | Warnkontakt L=305mm                                     |                          |
|                | 3.8 Carrera S    | 280   | 08.05 | 09.13 |                | 24.8190-0931.2 | 620931 | 1                             | - Keramikbremse <sup>1)</sup>  | Warnkontakt L=336mm                                     |                          |
|                | 3.8 Carrera S    | 283   | 06.08 | 09.13 |                |                |        |                               |  |   |                          |
|                | 3.8 Carrera 4S   | 261   | 04.05 | 09.13 |                | 13.0460-4999.2 | 604999 | 2                             | - Keramikbremse <sup>1)</sup>  | 23330 17,0 /WE  | <b>BRE</b>               |
| 3.8 Carrera 4S | 280              | 08.05 | 09.13 |       | 24.8190-0950.2 | 620950         | 2      | - Keramikbremse <sup>1)</sup> | Warnkontakt L=525mm  |   |                          |
| 3.8 Carrera 4S | 283              | 06.08 | 09.13 |       |                |                |        |                               |  |   |                          |
|                | 3.6 Carrera      | 239   | 04.05 | 09.13 |                | 24.0128-0131.1 | 428131 |                               | - Keramikbremse <sup>1)</sup>  | 318 28,0 26,0 V L + B                                   |                          |
|                | 3.6 Carrera 4    | 239   | 04.05 | 09.13 |                | 24.0128-0130.1 | 428130 |                               | - Keramikbremse <sup>1)</sup>  | 318 28,0 26,0 V L + B                                   |                          |
|                | 3.6 Carrera      | 254   | 06.08 | 09.13 |                | 24.0128-0247.1 | 428247 |                               | - Keramikbremse <sup>1)</sup>  | 330 28,0 26,0 V L + B                                   |                          |
|                | 3.6 Carrera 4    | 254   | 06.08 | 09.13 |                | 24.0128-0246.1 | 428246 |                               | - Keramikbremse <sup>1)</sup>  | 330 28,0 26,0 V L + B                                   |                          |
|                | 3.8 Carrera 4GTS | 300   | 06.09 | 09.13 |                | 24.0134-0101.1 | 434101 |                               | - Keramikbremse <sup>1)</sup>  | 330 34,0 32,0 V L + B                                   |                          |
|                | 3.8 Carrera GTS  | 300   | 06.09 | 09.13 |                | 24.0134-0102.1 | 434102 |                               | - Keramikbremse <sup>1)</sup>  | 330 34,0 32,0 V L + B                                   |                          |
|                | 3.8 Carrera S    | 261   | 04.05 | 09.13 |                |                |        |                               |  |   |                          |
|                | 3.8 Carrera 4S   | 261   | 04.05 | 09.13 |                | 24.0134-0101.1 | 434101 |                               | - Keramikbremse <sup>1)</sup>  | 330 34,0 32,0 V L + B                                   |                          |
| 3.6 Turbo      | 353              | 09.07 | 09.13 |       | 24.0134-0101.1 | 434101         |        | - Keramikbremse <sup>1)</sup> | 330 34,0 32,0 V L + B  |   |                          |
| 3.8 Carrera 4S | 280              | 08.05 | 09.13 |       | 24.0134-0102.1 | 434102         |        | - Keramikbremse <sup>1)</sup> | 330 34,0 32,0 V L + B  |   |                          |

1) - ceramic brake / - freno in ceramica / - frein de céramique / - freno de cerámica  
 2) + ceramic brake / + freno di ceramica / + frein de céramique / + freno de cerámica  
 3) - sport design/- ceramic brake / - versio.sportiva/-fr.ceramica / - réalis.sport/-fr.d.céramique / - realiz.deporte/- fr.cerámica  
 4) + sport design / - ceramic br. / + realiz.sportivo/-fr.ceramica / + réalis.sport/-fr.d.céramique / + realiz.deporte/- fr.cerámica





**PORSCHE 911 CABRIO (997) (05-13)**

|  |                  |     |  |       |       |                |        |   |  |   |
|--|------------------|-----|--|-------|-------|----------------|--------|---|--|---|
|  | 3.8 Carrera 4S   | 283 |  | 06.08 | 09.13 | 24.0134-0101.1 | 434101 |   | - Keramikbremse <sup>1)</sup>  | 330 34,0 32,0 V L +B                                    |
|  | 3.8 Carrera S    | 280 |  | 08.05 | 09.13 | 24.0134-0102.1 | 434102 |   | - Keramikbremse <sup>1)</sup>  | 330 34,0 32,0 V L +B                                    |
|  | 3.8 Carrera S    | 283 |  | 06.08 | 09.13 |                |        |   |  |   |
|  | 3.8 Turbo        | 368 |  | 09.09 | 09.13 |                |        |   |  |   |
|  | 3.8 Turbo 4S     | 390 |  | 02.10 | 09.13 |                |        |   |  |   |
|  | 3.6 Carrera      | 239 |  | 04.05 | 09.13 | 13.0460-4988.2 | 604988 |   | - Sportausführung/- Keramikbr. <sup>2)</sup><br>+ Sportausführung/- Keramikbr. <sup>3)</sup><br>- Sportausführung/- Keramikbr. <sup>2)</sup> | 21792 15,5 /WE<br>XXXXX 15,5 /WE<br>Warnkontakt L=440mm |
|  | 3.6 Carrera 4    | 239 |  | 04.05 | 09.13 | 13.0460-4988.2 | 604988 | 2 | - Keramikbremse <sup>1)</sup><br>- Keramikbremse <sup>1)</sup>   | 21792 15,5 /WE<br>Warnkontakt L=440mm                   |
|  | 3.6 Carrera      | 254 |  | 06.08 | 09.13 | 24.8190-0023.2 | 620023 | 2 | - Keramikbremse <sup>1)</sup>  | Warnkontakt L=484,6mm                                   |
|  | 3.6 Carrera 4    | 254 |  | 06.08 | 09.13 | 24.8190-0023.2 | 620023 | 2 | - Keramikbremse <sup>1)</sup>  | Warnkontakt L=484,6mm                                   |
|  | 3.8 Carrera 4S   | 261 |  | 04.05 | 09.13 | 13.0460-4842.2 | 604842 |   | - Keramikbremse <sup>1)</sup>  | 24049 17,0 /WE<br>Warnkontakt L=504,6mm                 |
|  | 3.8 Carrera S    | 261 |  | 04.05 | 09.13 | 24.8190-0943.2 | 620943 | 2 | - Keramikbremse <sup>1)</sup>  | Warnkontakt L=504,6mm                                   |
|  | 3.6 Turbo        | 353 |  | 09.07 | 09.13 | 24.8190-0943.2 | 620943 | 2 |  | Warnkontakt L=504,6mm                                   |
|  | 3.8 Carrera 4S   | 280 |  | 08.05 | 09.13 |                |        |   |  |   |
|  | 3.8 Carrera 4S   | 283 |  | 06.08 | 09.13 |                |        |   |  |   |
|  | 3.8 Carrera GTS  | 300 |  | 06.09 | 09.13 |                |        |   |  |   |
|  | 3.8 Carrera S    | 280 |  | 08.05 | 09.13 |                |        |   |  |   |
|  | 3.8 Carrera S    | 283 |  | 06.08 | 09.13 |                |        |   |  |   |
|  | 3.8 Turbo        | 368 |  | 09.09 | 09.13 |                |        |   |  |   |
|  | 3.8 Turbo 4S     | 390 |  | 02.10 | 09.13 |                |        |   |  |   |
|  | 3.6 Carrera      | 239 |  | 04.05 | 09.13 | 24.0124-0176.1 | 424176 |   | - Keramikbremse <sup>1)</sup>  | 299 24,0 22,0 V L +B                                    |
|  | 3.6 Carrera 4    | 239 |  | 04.05 | 09.13 | 24.0124-0176.1 | 424176 |   | - Keramikbremse <sup>1)</sup>  | 299 24,0 22,0 V L +B                                    |
|  | 3.6 Carrera      | 254 |  | 06.08 | 09.13 | 24.0128-0197.1 | 428197 |   | - Keramikbremse <sup>1)</sup>  | 330 28,0 26,0 V L +B                                    |
|  | 3.6 Carrera 4    | 254 |  | 06.08 | 09.13 | 24.0128-0196.1 | 428196 |   | - Keramikbremse <sup>1)</sup>  | 330 28,0 26,0 V L +B                                    |
|  | 3.8 Carrera 4S   | 280 |  | 08.05 | 09.13 |                |        |   |  |   |
|  | 3.8 Carrera 4S   | 283 |  | 06.08 | 09.13 |                |        |   |  |   |
|  | 3.8 Carrera S    | 280 |  | 08.05 | 09.13 |                |        |   |  |   |
|  | 3.8 Carrera S    | 283 |  | 06.08 | 09.13 |                |        |   |  |   |
|  | 3.8 Turbo        | 368 |  | 09.09 | 09.13 |                |        |   |  |   |
|  | 3.8 Turbo 4S     | 390 |  | 02.10 | 09.13 |                |        |   |  |   |
|  | 3.8 Carrera 4GTS | 300 |  | 06.09 | 09.13 | 24.0128-0197.1 | 428197 |   | - Keramikbremse <sup>1)</sup>  | 330 28,0 26,0 V L +B                                    |
|  | 3.8 Carrera GTS  | 300 |  | 06.09 | 09.13 | 24.0128-0196.1 | 428196 |   | - Keramikbremse <sup>1)</sup>  | 330 28,0 26,0 V L +B                                    |
|  | 3.8 Carrera S    | 261 |  | 04.05 | 09.13 |                |        |   |  |   |
|  | 3.6 Turbo        | 353 |  | 09.07 | 09.13 | 24.0128-0265.1 | 428265 |   | - Keramikbremse <sup>1)</sup>  | 350 28,0 26,0 V L +B                                    |
|  |                  |     |  |       |       | 24.0128-0264.1 | 428264 |   | - Keramikbremse <sup>1)</sup>  | 350 28,0 26,0 V L +B                                    |
|  | 3.8 Carrera 4S   | 261 |  | 04.05 | 09.13 | 24.0128-0197.1 | 428197 |   | - Keramikbremse <sup>1)</sup>  | 330 28,0 26,0 V L +B                                    |
|  |                  |     |  |       |       | 24.0128-0196.1 | 428196 |   | - Keramikbremse <sup>1)</sup>  | 330 28,0 26,0 V L +B                                    |
|  | 3.6 Carrera      | 239 |  | 04.05 | 09.13 | 03.0137-3002.2 | 653002 |   |  | 180 x 25  |
|  | 3.6 Carrera 4    | 239 |  | 04.05 | 09.13 |                |        |   |  |   |
|  | 3.8 Carrera 4S   | 261 |  | 04.05 | 09.13 |                |        |   |  |   |
|  | 3.8 Carrera 4S   | 280 |  | 08.05 | 09.13 |                |        |   |  |   |
|  | 3.8 Carrera S    | 261 |  | 04.05 | 09.13 |                |        |   |  |   |
|  | 3.8 Carrera S    | 280 |  | 08.05 | 09.13 |                |        |   |  |   |

**PORSCHE 911 TARGA (997) (06-13)**



























|  |                |     |  |       |       |                |        |   |                               |                       |
|--|----------------|-----|--|-------|-------|----------------|--------|---|-------------------------------|-----------------------|
|  | 3.6 Carrera 4  | 239 |  | 11.06 | 09.13 | 24.8190-0027.2 | 620027 | 2 | - Keramikbremse <sup>1)</sup> | Warnkontakt L=514,6mm |
|  | 3.6 TARGA 4    | 254 |  | 06.08 | 09.13 |                |        |   |                               |                       |
|  | 3.8 Carrera 4S | 261 |  | 11.06 | 09.13 |                |        |   |                               |                       |
|  | 3.8 TARGA 4S   | 283 |  | 06.08 | 09.13 | 24.8190-0950.2 | 620950 | 2 | - Keramikbremse <sup>1)</sup> | Warnkontakt L=525mm   |
|  | 3.6 Carrera 4  | 239 |  | 11.06 | 09.13 | 24.0128-0247.1 | 428247 |   | - Keramikbremse <sup>1)</sup> | 330 28,0 26,0 V L +B  |
|  | 3.6 TARGA 4    | 254 |  | 06.08 | 09.13 | 24.0128-0246.1 | 428246 |   | - Keramikbremse <sup>1)</sup> | 330 28,0 26,0 V L +B  |
|  | 3.8 Carrera 4S | 261 |  | 11.06 | 09.13 |                |        |   |                               |                       |
|  | 3.8 TARGA 4S   | 283 |  | 06.08 | 09.13 | 24.0134-0101.1 | 434101 |   | - Keramikbremse <sup>1)</sup> | 330 34,0 32,0 V L +B  |
|  |                |     |  |       |       | 24.0134-0102.1 | 434102 |   | - Keramikbremse <sup>1)</sup> | 330 34,0 32,0 V L +B  |
|  |                |     |  |       |       | 24.8190-0023.2 | 620023 | 2 | - Keramikbremse <sup>1)</sup> | Warnkontakt L=484,6mm |
|  | 3.6 Carrera 4  | 239 |  | 11.06 | 09.13 | 24.8190-0023.2 | 620023 | 2 | - Keramikbremse <sup>1)</sup> | Warnkontakt L=484,6mm |
|  | 3.6 TARGA 4    | 254 |  | 06.08 | 09.13 | 24.0124-0176.1 | 424176 |   | - Keramikbremse <sup>1)</sup> | 299 24,0 22,0 V L +B  |
|  | 3.8 Carrera 4S | 261 |  | 11.06 | 09.13 |                |        |   |                               |                       |
|  | 3.8 TARGA 4S   | 283 |  | 06.08 | 09.13 | 24.0128-0197.1 | 428197 |   | - Keramikbremse <sup>1)</sup> | 330 28,0 26,0 V L +B  |
|  |                |     |  |       |       | 24.0128-0196.1 | 428196 |   | - Keramikbremse <sup>1)</sup> | 330 28,0 26,0 V L +B  |

**PORSCHE 911 COUPE (991) (11-)**

|  |                |     |  |       |  |                |        |   |                               |                     |
|--|----------------|-----|--|-------|--|----------------|--------|---|-------------------------------|---------------------|
|  | 3.4 Carrera    | 257 |  | 12.11 |  | 24.8190-0069.2 | 620069 | 2 | - Keramikbremse <sup>1)</sup> | Warnkontakt L=248mm |
|  |                |     |  |       |  | 24.8190-0952.2 | 620952 | 2 | + Keramikbremse <sup>4)</sup> | Warnkontakt L=300mm |
|  | 3.8 Carrera S  | 294 |  | 12.11 |  | 24.8190-0952.2 | 620952 | 2 | + Keramikbremse <sup>4)</sup> | Warnkontakt L=300mm |
|  | 3.8 Carrera S  | 316 |  | 07.12 |  |                |        |   |                               |                     |
|  | 3.4 Carrera 4S | 257 |  | 11.12 |  | 24.8190-0952.2 | 620952 | 2 | + Keramikbremse <sup>4)</sup> | Warnkontakt L=300mm |
|  | 3.8 Carrera 4S |     |  | 11.12 |  |                |        |   |                               |                     |
|  | 3.8 Turbo      |     |  | 09.13 |  | 24.8190-0952.2 | 620952 | 2 |                               | Warnkontakt L=300mm |
|  | 3.8 Turbo S    | 412 |  | 09.13 |  |                |        |   |                               |                     |
|  | 3.8 GT3        | 350 |  | 08.13 |  | 24.8190-0952.2 | 620952 | 2 | + Keramikbremse <sup>4)</sup> | Warnkontakt L=300mm |
|  | 4.0 GT3 RS     | 368 |  | 04.15 |  |                |        |   |                               |                     |
|  | 3.0 Carrera    | 272 |  | 11.15 |  | 24.8190-0952.2 | 620952 | 2 | + Keramikbremse <sup>4)</sup> | Warnkontakt L=300mm |
|  | 3.0 Carrera 4  | 272 |  | 11.15 |  |                |        |   |                               |                     |
|  | 3.0 Carrera 4S | 309 |  | 11.15 |  |                |        |   |                               |                     |
|  | 3.0 Carrera S  | 309 |  | 11.15 |  |                |        |   |                               |                     |

1) - ceramic brake / - freno de cerámica / - frein de céramique / - freno de cerámica  
 2) - sport design/- ceramic brake / - versio.sportiva/-fr.ceramica / - réalis.sport/-fr.d.céramique / - realiz.deporte/- fr.cerámica  
 3) + sport design / - ceramic br. / + realiz.sportivo/-fr.ceramica / + réalis.sport/-fr.d.céramique / + realiz.deporte/- fr.cerámica  
 4) + ceramic brake / + freno de cerámica / + frein de céramique / + freno de cerámica



























|     |    kW |  |  |  |  |  |    |  |
|--|---|--|--|--|---|--|--|--|
| <b>PORSCHE 911 COUPE (991) (11-)</b>   |   |  |  |  |   |  |  |  |
|    | 3.4 Carrera   | 257  |  | 12.11  |   | 24.0128-0247.1 428247<br>24.0128-0246.1 428246                                     |  - Keramikbremse <sup>1)</sup><br> - Keramikbremse <sup>1)</sup>     | 330 28,0 26,0 V L +B<br>330 28,0 26,0 V L +B                                       |
|    | 3.8 Carrera S   | 294  |  | 12.11  |   | 24.8190-0953.2 620953  | 2  | Warnkontakt L=215mm  |
|  | 3.8 Carrera S   | 316  |  | 07.12  |   |  |  |  |
|  | 3.4 Carrera   | 257  |  | 12.11  |   | 24.8190-0953.2 620953  | 2  | Warnkontakt L=215mm  |
|  | 3.4 Carrera 4S  | 257  |  | 11.12  |   | 24.8190-0953.2 620953  | 2  | Warnkontakt L=215mm  |
|  | 3.8 Carrera 4S  |  |  | 11.12  |   |  |  |  |
|  | 3.8 Turbo   |  |  | 09.13  |   | 24.8190-0953.2 620953  | 2  | + Keramikbremse <sup>2)</sup>  |
|  | 3.8 Turbo S   | 412  |  | 09.13  |   |  |  | Warnkontakt L=215mm  |
|  | 3.8 GT3   | 350  |  | 08.13  |   | 24.8190-0953.2 620953  | 2  | - Keramikbremse <sup>1)</sup>  |
|  | 4.0 GT3 RS  | 368  |  | 04.15  |   |  |  | Warnkontakt L=215mm  |
|  | 3.0 Carrera   | 272  |  | 11.15  |   | 24.8190-0953.2 620953  | 2  |  |
| 3.0 Carrera 4  | 272   |  | 11.15  |  |   |  |  |  |
| 3.0 Carrera 4S   | 309   |  | 11.15  |  |   |  |  |  |
| 3.0 Carrera S  | 309   |  | 11.15  |  |   |  |  |  |
|    | 3.4 Carrera 4S  | 257  |  | 11.12  |   | 24.0128-0197.1 428197<br>24.0128-0196.1 428196                                     |  - Keramikbremse <sup>1)</sup><br> - Keramikbremse <sup>1)</sup>     | 330 28,0 26,0 V L +B<br>330 28,0 26,0 V L +B                                       |
|  | 3.8 Carrera 4S  |  |  | 11.12  |   |  |  |  |
|  | 3.8 Carrera S   | 294  |  | 12.11  |   |  |  |  |
|  | 3.8 Carrera S   | 316  |  | 07.12  |   |  |  |  |
|    | 3.0 Carrera   | 272  |  | 11.15  |   | 03.0137-9700.2 669700  |  | Bremsbacken-Zubehör  |
|  | 3.0 Carrera 4   | 272  |  | 11.15  |   |  |  |  |
|  | 3.0 Carrera 4S  | 309  |  | 11.15  |   |  |  |  |
|  | 3.0 Carrera S   | 309  |  | 11.15  |   |  |  |  |
|  | 3.4 Carrera   | 257  |  | 12.11  |   |  |  |  |
|  | 3.4 Carrera 4S  | 257  |  | 11.12  |   |  |  |  |
|  | 3.8 Carrera 4S  |  |  | 11.12  |   |  |  |  |
|  | 3.8 Carrera S   | 294  |  | 12.11  |   |  |  |  |
|  | 3.8 Carrera S   | 316  |  | 07.12  |   |  |  |  |
|  | 3.8 GT3   | 350  |  | 08.13  |   |  |  |  |
|  | 3.8 Turbo   |  |  | 09.13  |   |  |  |  |
|  | 3.8 Turbo S   | 412  |  | 09.13  |   |  |  |  |
|  | 4.0 GT3 RS  | 368  |  | 04.15  |   |  |  |  |
| <b>PORSCHE 911 CABRIO (991) (12-)</b>  |   |  |  |  |   |  |  |  |
|    | 3.4 Carrera   | 257  |  | 03.12  |   | 24.8190-0069.2 620069<br>24.8190-0952.2 620952                                     | 2<br>2   | - Keramikbremse <sup>1)</sup><br>+ Keramikbremse <sup>2)</sup>                     |
|  | 3.8 Turbo   | 383  |  | 12.13  |   | 24.8190-0069.2 620069<br>24.8190-0952.2 620952                                     | 2<br>2   | - Keramikbremse <sup>1)</sup><br>+ Keramikbremse <sup>2)</sup>                     |
|  | 3.8 Carrera S   | 294  |  | 03.12  |   | 24.8190-0952.2 620952  | 2  | + Keramikbremse <sup>2)</sup>  |
|  | 3.8 Carrera S   | 316  |  | 07.12  |   |  |  | Warnkontakt L=300mm  |
|  | 3.0 Carrera   | 272  |  | 11.15  |   | 24.8190-0952.2 620952  | 2  | + Keramikbremse <sup>2)</sup>  |
|  | 3.0 Carrera 4   | 272  |  | 11.15  |   |  |  |  |
|  | 3.0 Carrera 4S  | 309  |  | 11.15  |   |  |  |  |
|  | 3.0 Carrera S   | 309  |  | 11.15  |   |  |  |  |
|  | 3.4 Carrera   | 257  |  | 12.11  |   | 24.0128-0247.1 428247<br>24.0128-0246.1 428246                                     |  - Keramikbremse <sup>1)</sup><br> - Keramikbremse <sup>1)</sup> | 330 28,0 26,0 V L +B<br>330 28,0 26,0 V L +B                                       |
|  | 3.8 Turbo   | 383  |  | 12.13  |   |  |  |  |
|  | 3.4 Carrera   | 257  |  | 03.12  |   | 24.8190-0953.2 620953  | 2  | Warnkontakt L=215mm  |
|  | 3.8 Turbo   | 383  |  | 12.13  |   |  |  |  |
|  | 3.8 Carrera S   | 294  |  | 03.12  |   | 24.8190-0953.2 620953  | 2  | Warnkontakt L=215mm  |
|  | 3.8 Carrera S   | 316  |  | 07.12  |   |  |  |  |
|  | 3.4 Carrera 4S  | 257  |  | 11.12  |   | 24.8190-0953.2 620953  | 2  | Warnkontakt L=215mm  |
|  | 3.8 Carrera 4S  |  |  | 11.12  |   |  |  |  |
|  | 3.8 Turbo S   | 412  |  | 12.13  |   |  |  |  |
|  | 3.0 Carrera   | 272  |  | 11.15  |   | 24.8190-0953.2 620953  | 2  | Warnkontakt L=215mm  |
|  | 3.0 Carrera 4   | 272  |  | 11.15  |   |  |  |  |
|  | 3.0 Carrera 4S  | 309  |  | 11.15  |   |  |  |  |
| 3.0 Carrera S  | 309   |  | 11.15  |  |   |  |  |  |
|  | 3.4 Carrera 4S  | 257  |  | 11.12  |   | 24.0128-0197.1 428197<br>24.0128-0196.1 428196                                     |  - Keramikbremse <sup>1)</sup><br> - Keramikbremse <sup>1)</sup> | 330 28,0 26,0 V L +B<br>330 28,0 26,0 V L +B                                       |
|  | 3.8 Carrera 4S  |  |  | 11.12  |   |  |  |  |
|  | 3.8 Carrera S   | 294  |  | 03.12  |   |  |  |  |
|  | 3.8 Turbo S   | 412  |  | 12.13  |   |  |  |  |
|  | 3.0 Carrera   | 272  |  | 11.15  |   | 03.0137-9700.2 669700  |  | Bremsbacken-Zubehör  |
|  | 3.0 Carrera 4   | 272  |  | 11.15  |   |  |  |  |
|  | 3.0 Carrera 4S  | 309  |  | 11.15  |   |  |  |  |
|  | 3.0 Carrera S   | 309  |  | 11.15  |   |  |  |  |
|  | 3.4 Carrera   | 257  |  | 03.12  |   |  |  |  |
|  | 3.4 Carrera 4S  | 257  |  | 11.12  |   |  |  |  |
|  | 3.8 Carrera 4S  |  |  | 11.12  |   |  |  |  |
|  | 3.8 Carrera S   | 294  |  | 03.12  |   |  |  |  |
|  | 3.8 Carrera S   | 316  |  | 07.12  |   |  |  |  |
|  | 3.8 Turbo   | 383  |  | 12.13  |   |  |  |  |
| 3.8 Turbo S  | 412   |  | 12.13  |  |   |  |  |  |
| <b>PORSCHE 911 TARGA (991) (14-)</b>   |   |  |  |  |   |  |  |  |
|  | 3.4 Carrera 4   | 257  |  | 05.14  |   | 24.8190-0069.2 620069<br>24.8190-0952.2 620952                                     | 2<br>2   | - Keramikbremse <sup>1)</sup><br>+ Keramikbremse <sup>2)</sup>                     |
|  | 3.8 Carrera 4S  | 294  |  | 05.14  |   | 24.8190-0952.2 620952  | 2  | + Keramikbremse <sup>2)</sup>  |
|  | 3.8 Carrera 4S  | 316  |  | 05.14  |   |  |  | Warnkontakt L=300mm  |
|  | 3.0 Carrera 4   | 272  |  | 11.15  |   | 24.8190-0952.2 620952  | 2  | + Keramikbremse <sup>2)</sup>  |
|  | 3.0 Carrera 4S  | 309  |  | 11.15  |   |  |  | Warnkontakt L=300mm  |













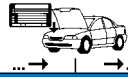













<sup>1)</sup> - ceramic brake / - freno in ceramica / - frein de céramique / - freno de cerámica

<sup>2)</sup> + ceramic brake / + freno di ceramica / + frein de céramique / + freno de cerámica



|     |  |  |  |  |  |  |                                |  |
|--|--|--|--|--|---|--|--|--|
| <b>PORSCHE 911 TARGA (991) (14-)</b>   |  |  |  |  |   |  |  |  |
|    | 3.4 Carrera 4  | 257  |  | 05.14  |   | 24.0128-0247.1 428247<br>24.0128-0246.1 428246                                     | <input type="checkbox"/> - Keramikbremse <sup>1)</sup><br><input type="checkbox"/> - Keramikbremse <sup>1)</sup> | 330 28,0 26,0 V L +B<br>330 28,0 26,0 V L +B                                       |
|    | 3.4 Carrera 4  | 257  |  | 05.14  |   | 24.8190-0953.2 620953  | 2  | Warnkontakt L=215mm  |
|  | 3.8 Carrera 4S   | 294  |  | 05.14  |   | 24.8190-0953.2 620953  | 2  | Warnkontakt L=215mm  |
|  | 3.8 Carrera 4S   | 316  |  | 05.14  |   |  |  |  |
|  | 3.0 Carrera 4  | 272  |  | 11.15  |   | 24.8190-0953.2 620953  | 2  | + Keramikbremse <sup>2)</sup> Warnkontakt L=215mm                                  |
|  | 3.0 Carrera 4S   | 309  |  | 11.15  |   |  |  |  |
|    | 3.8 Carrera 4S   | 294  |  | 05.14  |   | 24.0128-0197.1 428197<br>24.0128-0196.1 428196                                     | <input type="checkbox"/> - Keramikbremse <sup>1)</sup><br><input type="checkbox"/> - Keramikbremse <sup>1)</sup> | 330 28,0 26,0 V L +B<br>330 28,0 26,0 V L +B                                       |
|  | 3.8 Carrera 4S   | 316  |  | 05.14  |   |  |  |  |
|    | 3.0 Carrera 4  | 272  |  | 11.15  |   | 03.0137-9700.2 669700  |  | Bremsbacken-Zubehör  |
|  | 3.0 Carrera 4S   | 309  |  | 11.15  |   |  |  |  |
|  | 3.4 Carrera 4  | 257  |  | 05.14  |   |  |  |  |
|  | 3.8 Carrera 4S   | 294  |  | 05.14  |   |  |  |  |
|  | 3.8 Carrera 4S   | 316  |  | 05.14  |   |  |  |  |
| <b>PORSCHE CARRERA GT (980) (03-07)</b>  |  |  |  |  |   |  |  |  |
|    | 5.7 V10  | 450  |  | 07.03  | 05.07   | 24.0711-5271.3 360301<br>24.0711-5272.3 360302                                     | <input type="checkbox"/><br><input type="checkbox"/>   | Radsensor<br>Radsensor   |
|    | 5.7 V10  | 450  |  | 07.03  | 05.07   | 24.8190-0938.2 620938  | 2  | Warnkontakt L=495mm  |
|    | 5.7 V10  | 450  |  | 07.03  | 05.07   | 24.0711-5271.3 360301<br>24.0711-5272.3 360302                                     | <input type="checkbox"/><br><input type="checkbox"/>   | Radsensor<br>Radsensor   |
| <b>PORSCHE BOXSTER (986) (96-04)</b>   |  |  |  |  |   |  |  |  |
|    | 2.5  | 150  |  | 09.96  | 07.99   | 13.0460-4814.2 604814  |  | 21937 15,5 /WE BRE   |
|  | 2.7  | 162  |  | 08.99  | 06.02   | 13.0470-4814.2 LD4814  |  | 21937 15,5 /WE BRE   |
|  | 2.7  | 168  |  | 07.02  | 12.04   | 24.8190-0921.2 620921  | 2  | Warnkontakt L=440mm  |
|  | 3.2 S  | 185  |  | 08.99  | 06.02   | 13.0460-4987.2 604987  |  | 23329 17,0 /WE BRE   |
|  | 3.2 S  | 191  |  | 07.02  | 12.04   | 24.8190-0921.2 620921  | 2  | Warnkontakt L=440mm  |
|  | 3.2 S  | 196  |  | 01.04  | 12.04   |  |  |  |
|    | 2.5  | 150  |  | 09.96  | 07.99   | 24.0124-0165.1 424165  |  | 298 24,0 22,0 V L +B   |
|  | 2.7  | 162  |  | 08.99  | 06.02   |  |  |  |
|  | 2.7  | 168  |  | 07.02  | 12.04   |  |  |  |
|  | 3.2 S  | 185  |  | 08.99  | 06.02   | 24.0128-0131.1 428131  | <input type="checkbox"/>   | 318 28,0 26,0 V L +B   |
|  | 3.2 S  | 191  |  | 07.02  | 12.04   | 24.0128-0130.1 428130  | <input type="checkbox"/>   | 318 28,0 26,0 V L +B   |
|  | 3.2 S  | 196  |  | 01.04  | 12.04   |  |  |  |
|  | 2.5  | 150  |  | 09.96  | 07.99   | 13.0460-4988.2 604988  |  | 21792 15,5 /WE BRE   |
|  | 2.7  | 162  |  | 08.99  | 06.02   | 24.8190-0922.2 620922  | 2  | Warnkontakt L=440mm  |
|  | 2.7  | 168  |  | 07.02  | 12.04   |  |  |  |
|  | 3.2 S  | 185  |  | 08.99  | 06.02   | 13.0460-4988.2 604988  |  | 21792 15,5 /WE BRE   |
|  | 3.2 S  | 191  |  | 07.02  | 12.04   | 24.8190-0922.2 620922  | 2  | Warnkontakt L=440mm  |
|  | 3.2 S  | 196  |  | 01.04  | 12.04   |  |  |  |
|  | 2.5  | 150  |  | 09.96  | 07.99   | 24.0120-0176.1 420176  |  | 292 20,0 18,0 V L +B   |
|  | 2.7  | 162  |  | 08.99  | 06.02   |  |  |  |
|  | 2.7  | 168  |  | 07.02  | 12.04   |  |  |  |
|  | 3.2 S  | 185  |  | 08.99  | 06.02   | 24.0124-0194.1 424194  |  | 299 24,0 22,0 V L +B   |
|  | 3.2 S  | 191  |  | 07.02  | 12.04   |  |  |  |
|  | 3.2 S  | 196  |  | 01.04  | 12.04   |  |  |  |
|  | 2.5  | 150  |  | 09.96  | 07.99   | 03.0137-0421.2 650421  |  | 164 x 20   |
|  | 2.7  | 162  |  | 08.99  | 06.02   |  |  |  |
|  | 2.7  | 168  |  | 07.02  | 12.04   |  |  |  |
|  | 3.2 S  | 191  |  | 07.02  | 12.04   | 03.0137-3002.2 653002  |  | 180 x 25   |
|  | 3.2 S  | 196  |  | 01.04  | 12.04   |  |  |  |
| <b>PORSCHE BOXSTER (987) (05-11)</b>   |  |  |  |  |   |  |  |  |
|  | 2.7  | 176  |  | 11.04  | 07.06   | 13.0460-4815.2 604815  |  | 21937 15,5 /WE BRE   |
|  | 2.7  | 180  |  | 06.06  | 09.11   | 13.0470-4814.2 LD4814  |  | 21937 15,5 /WE BRE   |
|  |  |  |  |  |   | 24.8190-0934.2 620934  | 1 <input type="checkbox"/>   | Warnkontakt L=295mm  |
|  |  |  |  |  |   | 24.8190-0933.2 620933  | 1 <input type="checkbox"/>   | Warnkontakt L=305mm  |
|  | 2.9  | 188  |  | 06.09  | 09.11   | 24.8190-0025.2 620025  | 1 <input type="checkbox"/> - Keramikbremse <sup>1)</sup>   | Warnkontakt L=349,6mm  |
|  | 3.2 S  | 206  |  | 11.04  | 07.06   | 24.8190-0024.2 620024  | 1 <input type="checkbox"/> - Keramikbremse <sup>1)</sup>   | Warnkontakt L=369,6mm  |
|  | 3.4 RS 60 SPYDER   | 223  |  | 08.08  | 09.11   |  |  |  |
|  | 3.4 S  | 217  |  | 06.06  | 09.11   |  |  |  |
|  | 3.4 S  | 228  |  | 06.09  | 09.11   | 24.8190-0025.2 620025  | 1 <input type="checkbox"/> - Keramikbremse <sup>1)</sup>   | Warnkontakt L=349,6mm  |
|  | Spyder 3.4   | 235  |  | 06.10  | 09.11   | 24.8190-0024.2 620024  | 1 <input type="checkbox"/> - Keramikbremse <sup>1)</sup>   | Warnkontakt L=369,6mm  |
|  | 2.7  | 176  |  | 11.04  | 07.06   | 24.0124-0211.1 424211  | <input type="checkbox"/>   | 298 24,0 22,0 V L +B   |
|  | 2.7  | 180  |  | 06.06  | 09.11   | 24.0124-0210.1 424210  | <input type="checkbox"/>   | 298 24,0 22,0 V L +B   |
|  | 2.9  | 188  |  | 06.09  | 09.11   | 24.0128-0131.1 428131  | <input type="checkbox"/> - Keramikbremse <sup>1)</sup>   | 318 28,0 26,0 V L +B   |
|  | 3.2 S  | 206  |  | 11.04  | 07.06   | 24.0128-0130.1 428130  | <input type="checkbox"/> - Keramikbremse <sup>1)</sup>   | 318 28,0 26,0 V L +B   |
|  | 3.4 RS 60 SPYDER   | 223  |  | 08.08  | 09.11   |  |  |  |
|  | 3.4 S  | 217  |  | 06.06  | 09.11   |  |  |  |
|  | 3.4 S  | 228  |  | 06.09  | 09.11   |  |  |  |
|  | 2.7  | 176  |  | 11.04  | 07.06   | 13.0460-4816.2 604816  |  | 24541 15,5 +/WE BRE  |
|  | 2.7  | 180  |  | 06.06  | 09.11   | 24.8190-0932.2 620932  | 2  | Warnkontakt L=461mm  |
|  | 2.9  | 188  |  | 06.09  | 09.11   |  |  |  |
|  | 3.2 S  | 206  |  | 11.04  | 07.06   | 13.0460-4988.2 604988  |  | 21792 15,5 /WE BRE   |
|  | 3.4 RS 60 SPYDER   | 223  |  | 08.08  | 09.11   | 24.8190-0922.2 620922  | 2  | Warnkontakt L=440mm  |
|  | 3.4 S  | 217  |  | 06.06  | 09.11   |  |  |  |
|  | 3.4 S  | 228  |  | 06.06  | 09.11   |  |  |  |













<sup>1)</sup> - ceramic brake / - freno in ceramica / - frein de céramique / - freno de cerámica  
<sup>2)</sup> + ceramic brake / + freno de ceramica / + frein de céramique / + freno de cerámica

|     |  |  |  |  |  |  |  |  |  |  |            |
|--|--|--|--|--|---|--|--|--|--|--|------------|
| <b>PORSCHE BOXSTER (987) (05-11)</b>   |  |  |  |  |   |  |  |  |  |  |            |
|    | 3.4 S  | 228  |  | 06.09  | 09.11   |  | 13.0460-4988.2 604988<br>24.8190-0922.2 620922                                     | 2  | - Keramikbremse <sup>1)</sup><br>- Keramikbremse <sup>1)</sup> | 21792 15,5 /WE<br>Warnkontakt L=440mm        | <b>BRE</b> |
|    | 2.7  | 176  |  | 11.04  | 07.06   |  | 24.0120-0212.1 420212  |  |  | 299 20,0 18,0 V L +B                         |            |
|  | 2.7  | 180  |  | 06.06  | 09.11   |  |  |  |  |  |            |
|  | 2.9  | 188  |  | 06.09  | 09.11   |  |  |  |  |  |            |
|  | 3.2 S  | 206  |  | 11.04  | 07.06   |  | 24.0124-0194.1 424194  |  | - Keramikbremse <sup>1)</sup>                                  | 299 24,0 22,0 V L +B                         |            |
|  | 3.4 RS 60 SPYDER   | 223  |  | 08.08  | 09.11   |  |  |  |  |  |            |
|  | 3.4 S  | 217  |  | 06.06  | 09.11   |  |  |  |  |  |            |
|  | 3.4 S  | 228  |  | 06.09  | 09.11   |  |  |  |  |  |            |
|    | 2.7  | 176  |  | 11.04  | 07.06   |  | 03.0137-3002.2 653002  |  |  | 180 x 25                                     |            |
|  | 2.7  | 180  |  | 06.06  | 09.11   |  |  |  |  |  |            |
|  | 2.9  | 188  |  | 06.09  | 09.11   |  |  |  |  |  |            |
|  | 3.2 S  | 206  |  | 11.04  | 07.06   |  |  |  |  |  |            |
|  | 3.4 RS 60 SPYDER   | 223  |  | 08.08  | 09.11   |  |  |  |  |  |            |
|  | 3.4 S  | 217  |  | 06.06  | 09.11   |  |  |  |  |  |            |
|  | 3.4 S  | 228  |  | 06.09  | 09.11   |  |  |  |  |  |            |
| <b>PORSCHE BOXSTER (981) (12-)</b>   |  |  |  |  |   |  |  |  |  |  |            |
|    | 2.7  | 195  |  | 04.12  |   |  | 24.8190-0069.2 620069<br>24.8190-0952.2 620952                                     | 2  | - Keramikbremse <sup>1)</sup><br>+ Keramikbremse <sup>2)</sup> | Warnkontakt L=248mm<br>Warnkontakt L=300mm   |            |
|  | 3.4 GTS  | 243  |  | 02.14  |   |  | 24.8190-0069.2 620069  | 2  | - Keramikbremse <sup>1)</sup>                                  | Warnkontakt L=248mm                          |            |
|  | 3.4 S  | 232  |  | 04.12  |   |  | 24.8190-0952.2 620952  | 2  | + Keramikbremse <sup>2)</sup>                                  | Warnkontakt L=300mm                          |            |
|    | 2.7  | 195  |  | 04.12  |   |  | 24.0128-0273.1 428273<br>24.0128-0260.1 428260                                     |  | - Keramikbremse <sup>1)</sup><br>- Keramikbremse <sup>1)</sup> | 315 28,0 26,0 V L +B<br>315 28,0 26,0 V L +B |            |
|  | 3.4 GTS  | 243  |  | 02.14  |   |  | 24.0128-0247.1 428247  |  | - Keramikbremse <sup>1)</sup>                                  | 330 28,0 26,0 V L +B                         |            |
|  | 3.4 S  | 232  |  | 04.12  |   |  | 24.0128-0246.1 428246  |  | - Keramikbremse <sup>1)</sup>                                  | 330 28,0 26,0 V L +B                         |            |
|    | 2.7  | 195  |  | 04.12  |   |  | 13.0460-4816.2 604816  | 2  | - Keramikbremse <sup>1)</sup>                                  | 24541 15,5 +/WE                              | <b>BRE</b> |
|  | 3.4 GTS  | 243  |  | 02.14  |   |  | 24.8190-0070.2 620070  | 2  | + Keramikbremse <sup>2)</sup>                                  | Warnkontakt L=268mm                          |            |
|  | 3.4 S  | 232  |  | 04.12  |   |  |  |  |  |  |            |
|    | 2.7  | 195  |  | 04.12  |   |  | 24.0120-0212.1 420212  |  | - Keramikbremse <sup>1)</sup>                                  | 299 20,0 18,0 V L +B                         |            |
|    | 2.7  | 195  |  | 04.12  |   |  | 03.0137-9700.2 669700  |  |  | Bremsbacken-Zubehör                          |            |
|  | 3.4 GTS  | 243  |  | 02.14  |   |  |  |  |  |  |            |
|  | 3.4 S  | 232  |  | 04.12  |   |  |  |  |  |  |            |
| <b>PORSCHE BOXSTER Spyder (981) (15-)</b>  |  |  |  |  |   |  |  |  |  |  |            |
|   | 3.8  | 276  |  | 07.15  |   |  | 24.8190-0952.2 620952  | 2  | - Keramikbremse <sup>1)</sup>                                  | Warnkontakt L=300mm                          |            |
|  | 3.8  | 276  |  | 07.15  |   |  | 24.8190-0953.2 620953<br>24.8190-0952.2 620952                                     | 2  | - Keramikbremse <sup>1)</sup><br>+ Keramikbremse <sup>2)</sup> | Warnkontakt L=215mm<br>Warnkontakt L=300mm   |            |
|  | 3.8  | 276  |  | 07.15  |   |  | 03.0137-9700.2 669700  |  |  | Bremsbacken-Zubehör                          |            |
| <b>PORSCHE 718 BOXSTER (982) (16-)</b>   |  |  |  |  |   |  |  |  |  |  |            |
|  | 2.0  | 220  |  | 04.16  |   |  | 24.8190-0952.2 620952  | 2  | + Keramikbremse <sup>2)</sup>                                  | Warnkontakt L=300mm                          |            |
|  | S 2.5  | 257  |  | 04.16  |   |  |  |  |  |  |            |
|  | 2.0  | 220  |  | 04.16  |   |  | 24.0128-0247.1 428247<br>24.0128-0246.1 428246                                     |  | - Keramikbremse <sup>1)</sup><br>- Keramikbremse <sup>1)</sup> | 330 28,0 26,0 V L +B<br>330 28,0 26,0 V L +B |            |
|  | 2.0  | 220  |  | 04.16  |   |  | 13.0460-4816.2 604816  | 2  | - Keramikbremse <sup>1)</sup>                                  | 24541 15,5 +/WE                              | <b>BRE</b> |
|  | S 2.5  | 257  |  | 04.16  |   |  | 24.8190-0070.2 620070  | 2  | - Keramikbremse <sup>1)</sup>                                  | Warnkontakt L=268mm                          |            |
|  | 2.0  | 220  |  | 04.16  |   |  | 24.8190-0070.2 620070  | 2  | + Keramikbremse <sup>2)</sup>                                  | Warnkontakt L=268mm                          |            |
|  | S 2.5  | 257  |  | 04.16  |   |  |  |  |  |  |            |
|  | 2.0  | 220  |  | 04.16  |   |  | 24.0120-0212.1 420212  |  | - Keramikbremse <sup>1)</sup>                                  | 299 20,0 18,0 V L +B                         |            |
|  | S 2.5  | 257  |  | 04.16  |   |  |  |  |  |  |            |
|  | 2.0  | 220  |  | 04.16  |   |  | 03.0137-9700.2 669700  |  |  | Bremsbacken-Zubehör                          |            |
|  | S 2.5  | 257  |  | 04.16  |   |  |  |  |  |  |            |
| <b>PORSCHE CAYENNE I (03-10)</b>   |  |  |  |  |   |  |  |  |  |  |            |
|  | 3.0 TDI  | 176  |  | 02.09  | 04.10 + 17" Rad/ + schwarzer Sattel <sup>3)</sup>                                 |  | 13.0460-4992.2 604992  |  |  | 23692 16,6 /WE                               | <b>BRE</b> |
|  | 3.2  | 184  |  | 10.03  | 12.06 + 17" Rad/ + schwarzer Sattel <sup>3)</sup>                                 |  | 13.0470-4992.2 LD4992  |  |  | 23692 16,6 /WE                               | <b>BRE</b> |
|  | 3.6  | 213  |  | 01.07  | 04.10 + 17" Rad/ + schwarzer Sattel <sup>3)</sup>                                 |  | 13.0460-0279.2 610279<br>24.8190-0929.2 620929                                     | 2  |  | Belagsatz-Zubehör<br>Warnkontakt L=417,4mm   |            |
|  | GTS 4.8  | 298  |  | 10.07  | 04.10 + 17" Rad/ + schwarzer Sattel <sup>3)</sup>                                 |  | 13.0460-4992.2 604992  |  |  | 23692 16,6 /WE                               | <b>BRE</b> |
|  | S 4.5  | 250  |  | 09.02  | 12.06 + 17" Rad/ + schwarzer Sattel <sup>3)</sup>                                 |  | 13.0460-0279.2 610279  |  |  | Belagsatz-Zubehör                            |            |
|  | S 4.8  | 283  |  | 01.07  | 04.10 + 17" Rad/ + schwarzer Sattel <sup>3)</sup>                                 |  | 24.8190-0929.2 620929  | 2  |  | Warnkontakt L=417,4mm                        |            |
|  | Turbo 4.5  | 331  |  | 09.02  | 12.06 + 17" Rad/ + schwarzer Sattel <sup>3)</sup>                                 |  |  |  |  |  |            |
|  | Turbo S 4.5  | 368  |  | 01.04  | 04.10 + 17" Rad/ + schwarzer Sattel <sup>3)</sup>                                 |  |  |  |  |  |            |
|  | Turbo S 4.5  | 383  |  | 01.04  | 04.10 + 17" Rad/ + schwarzer Sattel <sup>3)</sup>                                 |  |  |  |  |  |            |
|  | Turbo S 4.8  | 368  |  | 01.07  | 04.10 + 17" Rad/ + schwarzer Sattel <sup>3)</sup>                                 |  |  |  |  |  |            |
|  | Turbo S 4.8  | 397  |  | 02.07  | 12.09 + 17" Rad/ + schwarzer Sattel <sup>3)</sup>                                 |  |  |  |  |  |            |
|  | Turbo S 4.8  | 404  |  | 08.08  | 04.10 + 17" Rad/ + schwarzer Sattel <sup>3)</sup>                                 |  |  |  |  |  |            |

<sup>1)</sup> - ceramic brake / - freno in ceramica / - frein de céramique / - freno de cerámica

<sup>2)</sup> + ceramic brake / + freno di ceramica / + frein de céramique / + freno de cerámica

<sup>3)</sup> + 17" wheel/ + black caliper / + ruota 17"/ + pinza nero / + roue 17"/ + étrier noir / + rueda 17"/ + pinza negro

|     |  |  |  |  |  |  |  |  |  |            |  |  |  |
|--|--|--|--|--|---|--|--|--|--|------------|--|--|--|
| <b>PORSCHE CAYENNE I (03-10)</b>   |  |  |  |  |   |  |  |  |  |            |  |  |  |
|    | 3.0 TDI  | 176  | 02.09  | 04.10  | + 18" Rad/ + silberner Sattel <sup>1)</sup>                                       | 13.0460-4993.2   | 604993   | 2  | 23693 16,6 /WE<br>23693 16,6 /WE<br>Belagsatz-Zubehör<br>Warnkontakt L=417,4mm | <b>BRE</b> |  |  |  |
|  | 3.2  | 184  | 10.03  | 12.06  | + 18" Rad/ + silberner Sattel <sup>1)</sup>                                       | 13.0470-4993.2   | LD4993   |  |  |            |  |  |  |
|  | 3.6  | 213  | 01.07  | 04.10  | + 18" Rad/ + silberner Sattel <sup>1)</sup>                                       | 13.0460-0279.2   | 610279   |  |  |            |  |  |  |
|  | GTS 4.8  | 298  | 10.07  | 04.10  | + 18" Rad/ + silberner Sattel <sup>1)</sup>                                       | 13.0460-4993.2   | 604993   |  |  |            |  |  |  |
|  | S 4.5  | 250  | 09.02  | 12.06  | + 18" Rad/ + silberner Sattel <sup>1)</sup>                                       | 13.0460-0279.2   | 610279   |  |  |            |  |  |  |
|  | S 4.8  | 283  | 01.07  | 04.10  | + 18" Rad/ + silberner Sattel <sup>1)</sup>                                       | 24.8190-0929.2   | 620929   |  |  |            |  |  |  |
|  | Turbo 4.5  | 331  | 09.02  | 12.06  | + 18" Rad/ + silberner Sattel <sup>1)</sup>                                       |  |  |  |  |            |  |  |  |
|  | Turbo S 4.5  | 368  | 01.04  | 04.10  | + 18" Rad/ + silberner Sattel <sup>1)</sup>                                       |  |  |  |  |            |  |  |  |
|  | Turbo S 4.5  | 383  | 01.04  | 04.10  | + 18" Rad/ + silberner Sattel <sup>1)</sup>                                       |  |  |  |  |            |  |  |  |
|  | Turbo S 4.8  | 368  | 01.07  | 01.07  | + 18" Rad/ + silberner Sattel <sup>1)</sup>                                       |  |  |  |  |            |  |  |  |
|  | Turbo S 4.8  | 397  | 02.07  | 04.10  | + 18" Rad/ + silberner Sattel <sup>1)</sup>                                       |  |  |  |  |            |  |  |  |
|  | Turbo S 4.8  | 404  | 08.08  | 04.10  | + 18" Rad/ + silberner Sattel <sup>1)</sup>                                       |  |  |  |  |            |  |  |  |
|  | 3.0 TDI  | 176  | 02.09  | 04.10  | + 18" Rad/ + roter Sattel <sup>2)</sup>   | 13.0460-4993.2   | 604993   | 2  | 23693 16,6 /WE<br>Warnkontakt L=417,4mm  | <b>BRE</b> |  |  |  |
|  | 3.2  | 184  | 10.03  | 12.06  | + 18" Rad/ + roter Sattel <sup>2)</sup>   | 24.8190-0929.2   | 620929   |  |  |            |  |  |  |
|  | 3.6  | 213  | 01.07  | 04.10  | + 18" Rad/ + roter Sattel <sup>2)</sup>   |  |  |  |  |            |  |  |  |
|  | GTS 4.8  | 298  | 10.07  | 04.10  | + 18" Rad/ + roter Sattel <sup>2)</sup>   |  |  |  |  |            |  |  |  |
|  | S 4.5  | 250  | 09.02  | 04.10  | + 18" Rad/ + roter Sattel <sup>2)</sup>   |  |  |  |  |            |  |  |  |
|  | S 4.8  | 283  | 01.07  | 04.10  | + 18" Rad/ + roter Sattel <sup>2)</sup>   |  |  |  |  |            |  |  |  |
|  | Turbo 4.5  | 331  | 09.02  | 12.06  | + 18" Rad/ + roter Sattel <sup>2)</sup>   |  |  |  |  |            |  |  |  |
|  | Turbo S 4.5  | 368  | 01.04  | 04.10  | + 18" Rad/ + roter Sattel <sup>2)</sup>   |  |  |  |  |            |  |  |  |
|  | Turbo S 4.5  | 383  | 01.04  | 04.10  | + 18" Rad/ + roter Sattel <sup>2)</sup>   |  |  |  |  |            |  |  |  |
|  | Turbo S 4.8  | 368  | 01.07  | 04.10  | + 18" Rad/ + roter Sattel <sup>2)</sup>   |  |  |  |  |            |  |  |  |
|  | Turbo S 4.8  | 397  | 02.07  | 04.10  | + 18" Rad/ + roter Sattel <sup>2)</sup>   |  |  |  |  |            |  |  |  |
|  | Turbo S 4.8  | 404  | 08.08  | 04.10  | + 18" Rad/ + roter Sattel <sup>2)</sup>   |  |  |  |  |            |  |  |  |
|  | 3.0 TDI  | 176  | 02.09  | 04.10  | + 18" Rad/ + roter Sattel <sup>2)</sup>   | 13.0460-4852.2   | 604852   | 2  | 24553 15,8 /WE<br>Warnkontakt L=367,4mm  | <b>BRE</b> |  |  |  |
|  | 3.2  | 184  | 10.03  | 12.06  | + 18" Rad/ + roter Sattel <sup>2)</sup>   | 24.8190-0936.2   | 620936   |  |  |            |  |  |  |
|  | 3.6  | 213  | 01.07  | 04.10  | + 18" Rad/ + roter Sattel <sup>2)</sup>   |  |  |  |  |            |  |  |  |
|  | GTS 4.8  | 298  | 10.07  | 04.10  | + 18" Rad/ + roter Sattel <sup>2)</sup>   |  |  |  |  |            |  |  |  |
|  | S 4.5  | 250  | 08.02  | 12.06  | + 18" Rad/ + roter Sattel <sup>2)</sup>   |  |  |  |  |            |  |  |  |
|  | S 4.8  | 283  | 01.07  | 04.10  | + 18" Rad/ + roter Sattel <sup>2)</sup>   |  |  |  |  |            |  |  |  |
|  | Turbo 4.5  | 331  | 09.02  | 12.06  | + 18" Rad/ + roter Sattel <sup>2)</sup>   |  |  |  |  |            |  |  |  |
|  | Turbo S 4.5  | 368  | 01.04  | 04.10  | + 18" Rad/ + roter Sattel <sup>2)</sup>   |  |  |  |  |            |  |  |  |
|  | Turbo S 4.5  | 383  | 01.04  | 04.10  | + 18" Rad/ + roter Sattel <sup>2)</sup>   |  |  |  |  |            |  |  |  |
|  | Turbo S 4.8  | 368  | 01.07  | 04.10  | + 18" Rad/ + roter Sattel <sup>2)</sup>   |  |  |  |  |            |  |  |  |
|  | Turbo S 4.8  | 397  | 02.07  | 04.10  | + 18" Rad/ + roter Sattel <sup>2)</sup>   |  |  |  |  |            |  |  |  |
|  | Turbo S 4.8  | 404  | 08.08  | 04.10  | + 18" Rad/ + roter Sattel <sup>2)</sup>   |  |  |  |  |            |  |  |  |
|  | 3.0 TDI  | 176  | 02.09  | 04.10  | + 19" Rad/ + roter Sattel <sup>3)</sup>   | 13.0460-4840.2   | 604840   | 2  | 23961 16,8 /WE<br>Warnkontakt L=397,4mm  | <b>BRE</b> |  |  |  |
|  | 3.2  | 184  | 01.05  | 12.06  | + 19" Rad/ + roter Sattel <sup>3)</sup>   | 24.8190-0066.2   | 620066   |  |  |            |  |  |  |
|  | 3.6  | 213  | 01.07  | 04.10  | + 19" Rad/ + roter Sattel <sup>3)</sup>   |  |  |  |  |            |  |  |  |
|  | GTS 4.8  | 298  | 10.07  | 04.10  | + 19" Rad/ + roter Sattel <sup>3)</sup>   |  |  |  |  |            |  |  |  |
|  | S 4.5  | 250  | 01.05  | 12.06  | + 19" Rad/ + roter Sattel <sup>3)</sup>   |  |  |  |  |            |  |  |  |
|  | S 4.8  | 283  | 01.07  | 04.10  | + 19" Rad/ + roter Sattel <sup>3)</sup>   |  |  |  |  |            |  |  |  |
|  | Turbo 4.5  | 331  | 01.05  | 12.06  | + 19" Rad/ + roter Sattel <sup>3)</sup>   |  |  |  |  |            |  |  |  |
|  | Turbo S 4.5  | 368  | 01.04  | 04.10  | + 19" Rad/ + roter Sattel <sup>3)</sup>   |  |  |  |  |            |  |  |  |
|  | Turbo S 4.5  | 383  | 01.04  | 04.10  | + 19" Rad/ + roter Sattel <sup>3)</sup>   |  |  |  |  |            |  |  |  |
|  | Turbo S 4.8  | 368  | 01.07  | 04.10  | + 19" Rad/ + roter Sattel <sup>3)</sup>   |  |  |  |  |            |  |  |  |
|  | Turbo S 4.8  | 397  | 02.07  | 04.10  | + 19" Rad/ + roter Sattel <sup>3)</sup>   |  |  |  |  |            |  |  |  |
|  | Turbo S 4.8  | 404  | 08.08  | 04.10  | + 19" Rad/ + roter Sattel <sup>3)</sup>   |  |  |  |  |            |  |  |  |
|  | 3.0 TDI  | 176  | 02.09  | 04.10  | + 20" Rad/ + gelber Sattel <sup>4)</sup>  | 24.8190-0954.2   | 620954   | 2  | Warnkontakt L=365mm  |            |  |  |  |
|  | 3.2  | 184  | 01.05  | 12.06  | + 20" Rad/ + gelber Sattel <sup>4)</sup>  |  |  |  |  |            |  |  |  |
|  | 3.6  | 213  | 01.07  | 04.10  | + 20" Rad/ + gelber Sattel <sup>4)</sup>  |  |  |  |  |            |  |  |  |
|  | GTS 4.8  | 298  | 10.07  | 04.10  | + 20" Rad/ + gelber Sattel <sup>4)</sup>  |  |  |  |  |            |  |  |  |
|  | S 4.5  | 250  | 01.05  | 12.06  | + 20" Rad/ + gelber Sattel <sup>4)</sup>  |  |  |  |  |            |  |  |  |
|  | S 4.8  | 283  | 01.07  | 04.10  | + 20" Rad/ + gelber Sattel <sup>4)</sup>  |  |  |  |  |            |  |  |  |
|  | Turbo 4.5  | 331  | 01.05  | 12.06  | + 20" Rad/ + gelber Sattel <sup>4)</sup>  |  |  |  |  |            |  |  |  |
|  | Turbo S 4.5  | 368  | 01.04  | 04.10  | + 20" Rad/ + gelber Sattel <sup>4)</sup>  |  |  |  |  |            |  |  |  |
|  | Turbo S 4.5  | 383  | 01.04  | 04.10  | + 20" Rad/ + gelber Sattel <sup>4)</sup>  |  |  |  |  |            |  |  |  |
|  | Turbo S 4.8  | 368  | 01.07  | 04.10  | + 20" Rad/ + gelber Sattel <sup>4)</sup>  |  |  |  |  |            |  |  |  |
|  | Turbo S 4.8  | 397  | 02.07  | 04.10  | + 20" Rad/ + gelber Sattel <sup>4)</sup>  |  |  |  |  |            |  |  |  |
|  | Turbo S 4.8  | 404  | 08.08  | 04.10  | + 20" Rad/ + gelber Sattel <sup>4)</sup>  |  |  |  |  |            |  |  |  |
|  | 3.0 TDI  | 176  | 02.09  | 04.10  | + 17" Rad <sup>5)</sup>   | 24.0132-0117.1   | 432117   |  | 330 32,0 30,0 V L +S +B<br>330 32,0 30,0 V L +S +B                             |            |  |  |  |
|  | 3.2  | 184  | 10.03  | 04.10  | + 17" Rad <sup>5)</sup>   | 24.0132-0118.1   | 432118   |  |  |            |  |  |  |
|  | 3.6  | 213  | 01.07  | 04.10  | + 17" Rad <sup>5)</sup>   |  |  |  |  |            |  |  |  |
|  | GTS 4.8  | 298  | 10.07  | 04.10  | + 17" Rad <sup>5)</sup>   |  |  |  |  |            |  |  |  |
|  | S 4.5  | 250  | 09.02  | 04.10  | + 17" Rad <sup>5)</sup>   |  |  |  |  |            |  |  |  |
|  | S 4.8  | 283  | 01.07  | 04.10  | + 17" Rad <sup>5)</sup>   |  |  |  |  |            |  |  |  |
|  | Turbo 4.5  | 331  | 09.02  | 04.10  | + 17" Rad <sup>5)</sup>   |  |  |  |  |            |  |  |  |
|  | Turbo S 4.8  | 368  | 01.07  | 04.10  | + 17" Rad <sup>5)</sup>   |  |  |  |  |            |  |  |  |
|  | 3.0 TDI  | 176  | 02.09  | 04.10  | + 18" Rad <sup>6)</sup>   | 24.0134-0123.1   | 434123   |  |  |            |  | 350 34,0 32,0 V L +B<br>350 34,0 32,0 V L +B |  |
|  | 3.2  | 184  | 10.03  | 04.10  | + 18" Rad <sup>6)</sup>   | 24.0134-0124.1   | 434124   |  |  |            |  |  |  |
|  | 3.6  | 213  | 01.07  | 04.10  | + 18" Rad <sup>6)</sup>   |  |  |  |  |            |  |  |  |
|  | GTS 4.8  | 298  | 10.07  | 04.10  | + 18" Rad <sup>6)</sup>   |  |  |  |  |            |  |  |  |
| S 4.5  | 250  | 09.02  | 04.10  | + 18" Rad <sup>6)</sup>  |   |  |  |  |  |            |  |  |  |
| S 4.8  | 283  | 01.07  | 04.10  | + 18" Rad <sup>6)</sup>  |   |  |  |  |  |            |  |  |  |
| Turbo 4.5  | 331  | 09.02  | 04.10  | + 18" Rad <sup>6)</sup>  |   |  |  |  |  |            |  |  |  |
| Turbo S 4.8  | 368  | 01.07  | 04.10  | + 18" Rad <sup>6)</sup>  |   |  |  |  |  |            |  |  |  |
| 3.0 TDI  | 176  | 02.09  | 04.10  | + 18" Rad/ + roter Sattel <sup>2)</sup>  | 24.0136-0111.1  | 436111   |  | 368 36,0 34,0 V L +B   |  |            |  |  |  |
| 3.6  | 213  | 01.07  | 04.10  | + 18" Rad/ + roter Sattel <sup>2)</sup>  |   |  |  |  |  |            |  |  |  |
| S 4.8  | 283  | 01.07  | 04.10  | + 18" Rad/ + roter Sattel <sup>2)</sup>  |   |  |  |  |  |            |  |  |  |
| Turbo S 4.8  | 368  | 01.07  | 04.10  | + 18" Rad/ + roter Sattel <sup>2)</sup>  |   |  |  |  |  |            |  |  |  |
|  | 3.0 TDI  | 176  | 02.09  | 04.10  |   | 24.0711-5401.3   | 360330   |  | Radsensor<br>Radsensor   |            |  |  |  |
|  | 3.2  | 184  | 10.03  | 12.06  |   | 24.0711-5402.3   | 360331   |  |  |            |  |  |  |
|  | 3.6  | 213  | 01.07  | 04.10  |   |  |  |  |  |            |  |  |  |
|  | GTS 4.8  | 298  | 10.07  | 04.10  |   |  |  |  |  |            |  |  |  |
|  | S 4.5  | 250  | 09.02  | 12.06  |   |  |  |  |  |            |  |  |  |
|  | S 4.8  | 283  | 01.07  | 04.10  |   |  |  |  |  |            |  |  |  |

<sup>1)</sup> + 18" wheel/ + silver caliper / + ruota 18"/ + pinza argento / + roue 18"/ + étrier argent / + rueda 18"/ + pinza plata  
<sup>2)</sup> + 18" wheel/ + red caliper / + ruota 18"/ + pinza rosso / + roue 18"/ + étrier rouge / + rueda 18"/ + pinza rojo  
<sup>3)</sup> + 19" wheel/ + red caliper / + ruota 19"/ + pinza rosso / + roue 19"/ + étrier rouge / + rueda 19"/ + pinza rojo  
<sup>4)</sup> + 20" wheel/ + yellow caliper / + ruota 20"/ + pinza giallo / + roue 20"/ + étrier jaune / + rueda 20"/ + pinza amarillo  
<sup>5)</sup> + 17" wheel / + ruota 17" / + roue 17" / + rueda 17"  
<sup>6)</sup> + 18" wheel / + ruota 18" / + roue 18" / + rueda 18"







**PORSCHE CAYENNE II (10-)**

|             |                |       |  |  |                |        |   |                         |
|-------------|----------------|-------|--|--|----------------|--------|---|-------------------------|
|             | 3.0 D          | 155   | 06.10  | + 18" Rad/ + schwarzer Sattel <sup>1)</sup>            | 24.8190-0014.2 | 620014 | 2 | Warnkontakt L=296mm     |
|             | 3.0 D          | 180   | 06.10  | + 18" Rad/ + schwarzer Sattel <sup>1)</sup>            |                |        |   |                         |
|             | 3.0 D          | 193   | 10.14  |  |                |        |   |                         |
|             | 3.0 S E-Hybrid | 245   | 06.10  | + 18" Rad/ + schwarzer Sattel <sup>1)</sup>            |                |        |   |                         |
|             | 3.0 S E-Hybrid | 306   | 10.14  |  |                |        |   |                         |
|             | 3.6            | 220   | 06.10  | + 18" Rad/ + schwarzer Sattel <sup>1)</sup>            |                |        |   |                         |
|             | 3.6 GTS        | 324   | 02.15  |  |                |        |   |                         |
|             | 3.6 S          | 309   | 10.14  |  |                |        |   |                         |
|             | 4.2 S Diesel   | 281   | 10.12  | + 18" Rad/ + schwarzer Sattel <sup>1)</sup>            |                |        |   |                         |
|             | 4.2 S Diesel   | 283   | 10.14  |  |                |        |   |                         |
|             | 4.8 GTS        | 309   | 06.12  | + 18" Rad/ + schwarzer Sattel <sup>1)</sup>            |                |        |   |                         |
|             | 4.8 S          | 294   | 06.10  | + 18" Rad/ + schwarzer Sattel <sup>1)</sup>            |                |        |   |                         |
|             | 4.8 Turbo      | 368   | 06.10  | + 18" Rad/ + schwarzer Sattel <sup>1)</sup>            |                |        |   |                         |
|             | 4.8 Turbo      | 382   | 10.14  |  |                |        |   |                         |
| 4.8 Turbo S | 405            | 10.12 | + 18" Rad/ + schwarzer Sattel <sup>1)</sup>            |  |                |        |   |                         |
| 4.8 Turbo S | 419            | 01.15 | + 18" Rad/ + schwarzer Sattel <sup>1)</sup>            |  |                |        |   |                         |
|             | 3.0 D          | 155   | 06.10  | + 18"/19" Rad/+ silb.+elox.+roter Sattel <sup>2)</sup> | 24.8190-0014.2 | 620014 | 2 | Warnkontakt L=296mm     |
|             | 3.0 D          | 180   | 06.10  | + 18"/19" Rad/+ silb.+elox.+roter Sattel <sup>2)</sup> |                |        |   |                         |
|             | 3.0 D          | 193   | 10.14  |  |                |        |   |                         |
|             | 3.0 S E-Hybrid | 245   | 06.10  | + 18"/19" Rad/+ silb.+elox.+roter Sattel <sup>2)</sup> |                |        |   |                         |
|             | 3.0 S E-Hybrid | 306   | 10.14  |  |                |        |   |                         |
|             | 3.6            | 220   | 06.10  | + 18"/19" Rad/+ silb.+elox.+roter Sattel <sup>2)</sup> |                |        |   |                         |
|             | 3.6 GTS        | 324   | 02.15  |  |                |        |   |                         |
|             | 3.6 S          | 309   | 10.14  |  |                |        |   |                         |
|             | 4.2 S Diesel   | 281   | 10.12  | + 18"/19" Rad/+ silb.+elox.+roter Sattel <sup>2)</sup> |                |        |   |                         |
|             | 4.2 S Diesel   | 283   | 10.14  |  |                |        |   |                         |
|             | 4.8 GTS        | 309   | 06.12  | + 18"/19" Rad/+ silb.+elox.+roter Sattel <sup>2)</sup> |                |        |   |                         |
|             | 4.8 S          | 294   | 06.10  | + 18"/19" Rad/+ silb.+elox.+roter Sattel <sup>2)</sup> |                |        |   |                         |
|             | 4.8 Turbo      | 368   | 06.10  | + 18"/19" Rad/+ silb.+elox.+roter Sattel <sup>2)</sup> |                |        |   |                         |
|             | 4.8 Turbo      | 382   | 10.14  |  |                |        |   |                         |
| 4.8 Turbo S | 405            | 10.12 | + 18"/19" Rad/+ silb.+elox.+roter Sattel <sup>2)</sup> |  |                |        |   |                         |
| 4.8 Turbo S | 419            | 01.15 | + 19" Rad/ + roter Sattel <sup>3)</sup>                |  |                |        |   |                         |
|             | 3.0 D          | 155   | 06.10  | + 19"/20" Rad/+ gelber Sattel <sup>4)</sup>            | 24.8190-0939.2 | 620939 | 2 | Warnkontakt L=372,4mm   |
|             | 3.0 D          | 180   | 06.10  | + 19"/20" Rad/+ gelber Sattel <sup>4)</sup>            |                |        |   |                         |
|             | 3.0 D          | 193   | 10.14  |  |                |        |   |                         |
|             | 3.0 S E-Hybrid | 245   | 06.10  | + 19"/20" Rad/+ gelber Sattel <sup>4)</sup>            |                |        |   |                         |
|             | 3.0 S E-Hybrid | 306   | 10.14  |  |                |        |   |                         |
|             | 3.6            | 220   | 06.10  | + 19"/20" Rad/+ gelber Sattel <sup>4)</sup>            |                |        |   |                         |
|             | 3.6 GTS        | 324   | 02.15  |  |                |        |   |                         |
|             | 3.6 S          | 309   | 10.14  |  |                |        |   |                         |
|             | 4.2 S Diesel   | 281   | 10.12  | + 19"/20" Rad/+ gelber Sattel <sup>4)</sup>            |                |        |   |                         |
|             | 4.2 S Diesel   | 283   | 10.14  |  |                |        |   |                         |
|             | 4.8 GTS        | 309   | 06.12  | + 19"/20" Rad/+ gelber Sattel <sup>4)</sup>            |                |        |   |                         |
|             | 4.8 S          | 294   | 06.10  | + 19"/20" Rad/+ gelber Sattel <sup>4)</sup>            |                |        |   |                         |
|             | 4.8 Turbo      | 368   | 06.10  | + 19"/20" Rad/+ gelber Sattel <sup>4)</sup>            |                |        |   |                         |
|             | 4.8 Turbo      | 382   | 10.14  |  |                |        |   |                         |
| 4.8 Turbo S | 405            | 10.12 | + 19"/20" Rad/+ gelber Sattel <sup>4)</sup>            |  |                |        |   |                         |
| 4.8 Turbo S | 419            | 01.15 | + 19"/20" Rad/+ gelber Sattel <sup>4)</sup>            |  |                |        |   |                         |
|             | 3.0 D          | 155   | 06.10  | + 18" Rad/ + grüner Sattel <sup>5)</sup>               | 24.8190-0014.2 | 620014 | 2 | Warnkontakt L=296mm     |
|             | 3.0 D          | 180   | 06.10  | + 18" Rad/ + grüner Sattel <sup>5)</sup>               |                |        |   |                         |
|             | 3.0 D          | 193   | 10.14  |  |                |        |   |                         |
|             | 3.0 S E-Hybrid | 245   | 06.10  | + 18" Rad/ + grüner Sattel <sup>5)</sup>               |                |        |   |                         |
|             | 3.0 S E-Hybrid | 306   | 10.14  |  |                |        |   |                         |
|             | 3.6            | 220   | 06.10  | + 18" Rad/ + grüner Sattel <sup>5)</sup>               |                |        |   |                         |
|             | 3.6 GTS        | 324   | 02.15  |  |                |        |   |                         |
|             | 3.6 S          | 309   | 10.14  |  |                |        |   |                         |
|             | 4.2 S Diesel   | 281   | 10.12  | + 18" Rad/ + grüner Sattel <sup>5)</sup>               |                |        |   |                         |
|             | 4.2 S Diesel   | 283   | 10.14  |  |                |        |   |                         |
|             | 4.8 GTS        | 309   | 06.12  | + 18" Rad/ + grüner Sattel <sup>5)</sup>               |                |        |   |                         |
|             | 4.8 S          | 294   | 06.10  | + 18" Rad/ + grüner Sattel <sup>5)</sup>               |                |        |   |                         |
|             | 4.8 Turbo      | 368   | 06.10  | + 18" Rad/ + grüner Sattel <sup>5)</sup>               |                |        |   |                         |
|             | 4.8 Turbo      | 382   | 10.14  |  |                |        |   |                         |
| 4.8 Turbo S | 405            | 10.12 | + 18" Rad/ + grüner Sattel <sup>5)</sup>               |  |                |        |   |                         |
| 4.8 Turbo S | 419            | 01.15 | + 18" Rad/ + grüner Sattel <sup>5)</sup>               |  |                |        |   |                         |
|             | 3.0 D          | 155   | 06.10  | + 18" Rad/ + schwarzer Sattel <sup>1)</sup>            | 24.0134-0123.1 | 434123 |   | 350 34,0 32,0 V L +B    |
|             | 3.0 D          | 180   | 06.10  | + 18" Rad/ + schwarzer Sattel <sup>1)</sup>            |                |        |   |                         |
|             | 3.0 D          | 193   | 10.14  |  |                |        |   |                         |
|             | 3.0 S E-Hybrid | 245   | 06.10  | + 18" Rad/ + schwarzer Sattel <sup>1)</sup>            |                |        |   |                         |
|             | 3.0 S E-Hybrid | 306   | 10.14  |  |                |        |   |                         |
|             | 3.6            | 220   | 06.10  | + 18" Rad/ + schwarzer Sattel <sup>1)</sup>            |                |        |   |                         |
|             | 3.6 GTS        | 324   | 02.15  |  |                |        |   |                         |
|             | 3.6 S          | 309   | 10.14  |  |                |        |   |                         |
|             | 4.2 S Diesel   | 281   | 10.12  | + 18" Rad/ + schwarzer Sattel <sup>1)</sup>            |                |        |   |                         |
|             | 4.2 S Diesel   | 283   | 10.14  |  |                |        |   |                         |
|             | 4.8 GTS        | 309   | 06.12  | + 18" Rad/ + schwarzer Sattel <sup>1)</sup>            |                |        |   |                         |
|             | 4.8 S          | 294   | 06.10  | + 18" Rad/ + schwarzer Sattel <sup>1)</sup>            |                |        |   |                         |
|             | 4.8 Turbo      | 368   | 06.10  | + 18" Rad/ + schwarzer Sattel <sup>1)</sup>            |                |        |   |                         |
|             | 4.8 Turbo      | 382   | 10.14  |  |                |        |   |                         |
| 4.8 Turbo S | 405            | 10.12 | + 18" Rad/ + schwarzer Sattel <sup>1)</sup>            |  |                |        |   |                         |
| 4.8 Turbo S | 419            | 01.15 | + 18" Rad/ + schwarzer Sattel <sup>1)</sup>            |  |                |        |   |                         |
|             | 3.0 D          | 155   | 06.10  | + 18" Rad/ + silb. + eloxierter Sattel <sup>6)</sup>   | 24.0136-0123.1 | 436123 |   | 360 36,0 34,0 V L +S +B |
|             | 3.0 D          | 180   | 06.10  | + 18" Rad/ + silb. + eloxierter Sattel <sup>6)</sup>   |                |        |   |                         |
|             | 3.0 D          | 193   | 10.14  |  |                |        |   |                         |
|             | 3.0 S E-Hybrid | 245   | 10.14  |  |                |        |   |                         |
|             | 3.0 S E-Hybrid | 245   | 06.10  | + 18" Rad/ + silb. + eloxierter Sattel <sup>6)</sup>   |                |        |   |                         |
|             | 3.6            | 220   | 06.10  | + 18" Rad/ + silb. + eloxierter Sattel <sup>6)</sup>   |                |        |   |                         |
| 3.6 GTS     | 324            | 02.15 |  |  |                |        |   |                         |

<sup>1)</sup> + 18" wheel/ + black caliper / + ruota 18" / + pinza nero / + roue 18" Rad/ + étrier noir / + rueda 18" / + pinza negro  
<sup>2)</sup> + 18"/19" wheel/ + silv.+elox.+red caliper / + ruota 18"/19"/+ arg.+elox.+pinza rosso / + roue 18"/19"/+ arg.+elox.+étrier rouge / + rueda 18"/19"/+ argent.+elox.+pinza rojo  
<sup>3)</sup> + 19" wheel/ + red caliper / + ruota 19"/ + pinza rosso / + roue 19"/ + étrier rouge / + rueda 19"/ + pinza rojo  
<sup>4)</sup> + 19"/20" wheel/ + yellow caliper / + ruota 19"/20"/+ pinza giallo / + roue 19"/20"/+ étrier jaune / + rueda 19"/20"/+ pinza amarillo  
<sup>5)</sup> + 18" wheel/ + green caliper / + ruota 18"/ + pinza verde / + roue 18"/ + étrier vert / + rueda 18"/ + pinza verde  
<sup>6)</sup> + 18" wheel/ + silv. + elox. caliper / + ruota 18" / + pinza argento + elox. / + roue 18" / + étrier argent + elox. / + rueda 18" / + pinza argenteria + elox.







**PORSCHE CAYENNE II (10-)**

|             |                |     |       |   |   |                |        |   |                                 |
|-------------|----------------|-----|-------|---|---|----------------|--------|---|---------------------------------|
|             | 4.8 Turbo S    | 419 |       | 01.15   | + 19" Rad/ + gelber Sattel <sup>1)</sup>                        | 24.8190-0940.2 | 620940 | 2 | Warnkontakt L=227,4mm           |
|             | 3.0 D          | 155 |       | 06.10   | + 17"/18" Rad/+ silb.+ silb.eloxiert+roter Sattel <sup>2)</sup> | 24.0128-0149.1 | 428149 |   | 330 28,0 26,0 V L +S +B         |
|             | 3.0 D          | 180 |       | 06.10   | + 17"/18" Rad/+ silb.+ silb.eloxiert+roter Sattel <sup>2)</sup> |                |        |   |                                 |
|             | 3.0 D          | 193 |       | 10.14   | + 17"/18" Rad/+ silb.+ silb.eloxiert+roter Sattel <sup>2)</sup> |                |        |   |                                 |
|             | 3.0 S E-Hybrid | 245 |       | 06.10   | + 17"/18" Rad/+ silb.+ silb.eloxiert+roter Sattel <sup>2)</sup> |                |        |   |                                 |
|             | 3.0 S E-Hybrid | 306 |       | 10.14   | + 17"/18" Rad/+ silb.+ silb.eloxiert+roter Sattel <sup>2)</sup> |                |        |   |                                 |
|             | 3.6            | 220 |       | 06.10   | + 17"/18" Rad/+ silb.+ silb.eloxiert+roter Sattel <sup>2)</sup> |                |        |   |                                 |
|             | 3.6 GTS        | 324 |       | 02.15   | + 17"/18" Rad/+ silb.+ silb.eloxiert+roter Sattel <sup>2)</sup> |                |        |   |                                 |
|             | 3.6 S          | 309 |       | 10.14   | + 17"/18" Rad/+ silb.+ silb.eloxiert+roter Sattel <sup>2)</sup> |                |        |   |                                 |
|             | 4.2 S Diesel   | 281 |       | 10.12   | + 17"/18" Rad/+ silb.+ silb.eloxiert+roter Sattel <sup>2)</sup> |                |        |   |                                 |
|             | 4.2 S Diesel   | 283 |       | 10.14   | + 17"/18" Rad/+ silb.+ silb.eloxiert+roter Sattel <sup>2)</sup> |                |        |   |                                 |
|             | 4.8 GTS        | 309 |       | 06.12   | + 17"/18" Rad/+ silb.+ silb.eloxiert+roter Sattel <sup>2)</sup> |                |        |   |                                 |
|             | 4.8 S          | 294 |       | 06.10   | + 17"/18" Rad/+ silb.+ silb.eloxiert+roter Sattel <sup>2)</sup> |                |        |   |                                 |
|             | 4.8 Turbo      | 368 |       | 06.10   | + 17"/18" Rad/+ silb.+ silb.eloxiert+roter Sattel <sup>2)</sup> |                |        |   |                                 |
|             | 4.8 Turbo S    | 382 |       | 10.14   | + 17"/18" Rad/+ silb.+ silb.eloxiert+roter Sattel <sup>2)</sup> |                |        |   |                                 |
| 4.8 Turbo S | 405            |     | 10.12 | + 17"/18" Rad/+ silb.+ silb.eloxiert+roter Sattel <sup>2)</sup> |   |                |        |   |                                 |
| 4.8 Turbo S | 419            |     | 01.15 | + 18" Rad <sup>3)</sup>   |   |                |        |   |                                 |
|             | 3.0 D          | 155 |       | 06.10   | + 18" plus Rad/ + roter Sattel <sup>4)</sup>                    | 24.0128-0169.1 | 428169 |   | 358 28,0 26,0 V L +B            |
|             | 3.0 D          | 180 |       | 06.10   | + 18" plus Rad/ + roter Sattel <sup>4)</sup>                    |                |        |   |                                 |
|             | 3.0 D          | 193 |       | 10.14   | + 18" plus Rad/ + roter Sattel <sup>4)</sup>                    |                |        |   |                                 |
|             | 3.0 S E-Hybrid | 245 |       | 06.10   | + 18" plus Rad/ + roter Sattel <sup>4)</sup>                    |                |        |   |                                 |
|             | 3.0 S E-Hybrid | 306 |       | 10.14   | + 18" plus Rad/ + roter Sattel <sup>4)</sup>                    |                |        |   |                                 |
|             | 3.6            | 220 |       | 06.10   | + 18" plus Rad/ + roter Sattel <sup>4)</sup>                    |                |        |   |                                 |
|             | 3.6 GTS        | 324 |       | 02.15   | + 18" plus Rad/ + roter Sattel <sup>4)</sup>                    |                |        |   |                                 |
|             | 3.6 S          | 309 |       | 10.14   | + 18" plus Rad/ + roter Sattel <sup>4)</sup>                    |                |        |   |                                 |
|             | 4.2 S Diesel   | 281 |       | 10.12   | + 18" plus Rad/ + roter Sattel <sup>4)</sup>                    |                |        |   |                                 |
|             | 4.2 S Diesel   | 283 |       | 10.14   | + 18" plus Rad/ + roter Sattel <sup>4)</sup>                    |                |        |   |                                 |
|             | 4.8 GTS        | 309 |       | 06.12   | + 18" plus Rad/ + roter Sattel <sup>4)</sup>                    |                |        |   |                                 |
|             | 4.8 S          | 294 |       | 06.10   | + 18" plus Rad/ + roter Sattel <sup>4)</sup>                    |                |        |   |                                 |
|             | 4.8 Turbo      | 368 |       | 06.10   | + 18" plus Rad/ + roter Sattel <sup>4)</sup>                    |                |        |   |                                 |
|             | 4.8 Turbo S    | 382 |       | 10.14   | + 18" plus Rad/ + roter Sattel <sup>4)</sup>                    |                |        |   |                                 |
| 4.8 Turbo S | 405            |     | 10.12 | + 18" plus Rad/ + roter Sattel <sup>4)</sup>                    |   |                |        |   |                                 |
| 4.8 Turbo S | 419            |     | 01.15 | + 18" plus Rad/ + roter Sattel <sup>4)</sup>                    |   |                |        |   |                                 |
|             | 3.0 D          | 155 |       | 06.10   |   | 24.0711-5403.3 | 360361 | 2 | Radsensor                       |
|             | 3.0 D          | 180 |       | 06.10   |   |                |        |   |                                 |
|             | 3.0 D          | 193 |       | 10.14   |   |                |        |   |                                 |
|             | 3.0 S E-Hybrid | 245 |       | 06.10   |   |                |        |   |                                 |
|             | 3.0 S E-Hybrid | 306 |       | 10.14   |   |                |        |   |                                 |
|             | 3.6            | 220 |       | 06.10   |   |                |        |   |                                 |
|             | 3.6 GTS        | 324 |       | 02.15   |   |                |        |   |                                 |
|             | 3.6 S          | 309 |       | 10.14   |   |                |        |   |                                 |
|             | 4.2 S Diesel   | 281 |       | 10.12   |   |                |        |   |                                 |
|             | 4.2 S Diesel   | 283 |       | 10.14   |   |                |        |   |                                 |
|             | 4.8 GTS        | 309 |       | 06.12   |   |                |        |   |                                 |
|             | 4.8 S          | 294 |       | 06.10   |   |                |        |   |                                 |
|             | 4.8 Turbo      | 368 |       | 06.10   |   |                |        |   |                                 |
|             | 4.8 Turbo      | 382 |       | 10.14   |   |                |        |   |                                 |
| 4.8 Turbo S | 405            |     | 10.12 |   |   |                |        |   |                                 |
| 4.8 Turbo S | 419            |     | 01.15 |   |   |                |        |   |                                 |
|             | 3.0 D          | 155 |       | 06.10   | 12.10   | 03.0137-3019.2 | 653019 |   | 210 x 30<br>Bremsbacken-Zubehör |
|             | 3.0 D          | 180 |       | 06.10   | 12.10   |                |        |   |                                 |
|             | 3.0 S E-Hybrid | 245 |       | 06.10   | 12.10   |                |        |   |                                 |
|             | 3.6            | 220 |       | 06.10   | 12.10   |                |        |   |                                 |
|             | 4.8 S          | 294 |       | 06.10   | 12.10   |                |        |   |                                 |
|             | 4.8 Turbo      | 368 |       | 06.10   | 12.10   |                |        |   |                                 |
|             | 3.0 D          | 155 |       | 01.11   |   | 03.0137-3019.2 | 653019 |   | 210 x 30                        |
|             | 3.0 D          | 180 |       | 01.11   |   |                |        |   |                                 |
|             | 3.0 D          | 193 |       | 10.14   |   |                |        |   |                                 |
|             | 3.0 S E-Hybrid | 245 |       | 01.11   |   |                |        |   |                                 |
|             | 3.0 S E-Hybrid | 306 |       | 10.14   |   |                |        |   |                                 |
|             | 3.6            | 220 |       | 01.11   |   |                |        |   |                                 |
|             | 3.6 GTS        | 324 |       | 02.15   |   |                |        |   |                                 |
|             | 3.6 S          | 309 |       | 10.14   |   |                |        |   |                                 |
|             | 4.2 S Diesel   | 281 |       | 10.12   |   |                |        |   |                                 |
|             | 4.2 S Diesel   | 283 |       | 10.14   |   |                |        |   |                                 |
|             | 4.8 GTS        | 309 |       | 06.12   |   |                |        |   |                                 |
|             | 4.8 S          | 294 |       | 01.11   |   |                |        |   |                                 |
|             | 4.8 Turbo      | 368 |       | 01.11   |   |                |        |   |                                 |
|             | 4.8 Turbo      | 382 |       | 10.14   |   |                |        |   |                                 |
| 4.8 Turbo S | 405            |     | 10.12 |   |   |                |        |   |                                 |
| 4.8 Turbo S | 419            |     | 01.15 |   |   |                |        |   |                                 |

**PORSCHE CAYMAN (987C) (05-12)**

|  |       |     |  |       |       |                |        |   |                               |   |
|--|-------|-----|--|-------|-------|----------------|--------|---|-------------------------------|---|
|  | 2.7   | 180 |  | 05.06 | 05.12 | 13.0460-4815.2 | 604815 | 1 | - Keramikbremse <sup>5)</sup> | 21937 15,5 /WE<br>BRE<br>Warnkontakt L=295mm<br>Warnkontakt L=305mm |
|  |       |     |  |       |       | 13.0470-4814.2 | LD4814 |   |                               |   |
|  |       |     |  |       |       | 24.8190-0934.2 | 620934 |   |                               |   |
|  |       |     |  |       |       | 24.8190-0933.2 | 620933 |   |                               |   |
|  | 2.9   | 195 |  | 02.09 | 05.12 | 24.8190-0025.2 | 620025 | 1 |                               | Warnkontakt L=349,6mm   |
|  |       |     |  |       |       | 24.8190-0024.2 | 620024 | 1 |                               | Warnkontakt L=369,6mm   |
|  | 3.4 S | 217 |  | 11.05 | 05.12 | 24.8190-0025.2 | 620025 | 1 | - Keramikbremse <sup>5)</sup> | Warnkontakt L=349,6mm   |
|  |       |     |  |       |       | 24.8190-0024.2 | 620024 | 1 | - Keramikbremse <sup>5)</sup> | Warnkontakt L=369,6mm   |
|  |       |     |  |       |       | 24.8190-0935.2 | 620935 | 1 | - Keramikbremse <sup>5)</sup> | Warnkontakt L=315mm   |



























<sup>1)</sup> + 19" wheel/ + yellow caliper / + ruota 19" / + pinza giallo / + roue 19" / + étrier jaune / + rueda 19" / + pinza amarillo

<sup>2)</sup> + 17"/18" wheel/ + silv.+elox.+red caliper / + ruota 17"/18"/ + pinza argento+elox.+rosso / + roue 17"/18"/ + étrier arg.+elox.+rouge / + rueda 17"/18"/ + pinza argent.+elox.+rojo

<sup>3)</sup> + 18" wheel/ + ruota 18" / + roue 18" / + rueda 18"

<sup>4)</sup> + 18" plus wheel/ + red caliper / + ruota 18" plus / + pinza rosso / + roue 18" plus / + étrier rouge / + rueda 18" plus / + pinza rojo

<sup>5)</sup> - ceramic brake / - freno in ceramica / - frein de céramique / - freno de cerámica

|     |  |  |  |  |  |  |  |  |                       |
|--|--|--|--|--|---|--|--|--|-----------------------|
| <b>PORSCHE CAYMAN (987C) (05-12)</b>   |  |  |  |  |   |  |  |  |                       |
|    | 3.4 S  | 235  | 02.09  | 05.12  | 24.8190-0025.2  | 620025   | 1  | - Keramikbremse <sup>1)</sup>  | Warnkontakt L=349,6mm |
|  | 3.4 S Sport  | 223  | 08.08  | 05.12  | 24.8190-0024.2  | 620024   | 1  | - Keramikbremse <sup>1)</sup>  | Warnkontakt L=369,6mm |
|  | R 3.4  | 243  | 11.10  | 05.12  | 24.8190-0935.2  | 620935   | 1  | - Keramikbremse <sup>1)</sup>  | Warnkontakt L=315mm   |
|    | 3.4 S  | 235  | 02.09  | 05.12  | 24.8190-0957.2  | 620957   | 1  | + Keramikbremse <sup>2)</sup>  | Warnkontakt L=394,6mm |
|  | 3.4 S Sport  | 223  | 08.08  | 05.12  | 24.8190-0956.2  | 620956   | 1  | + Keramikbremse <sup>2)</sup>  | Warnkontakt L=454,6mm |
|  | R 3.4  | 243  | 11.10  | 05.12  |   |  |  |  |                       |
|    | 2.7  | 180  | 05.06  | 05.12  | 24.0124-0211.1  | 424211   |  |  | 298 24,0 22,0 V L + B |
|  | 2.9  | 195  | 02.09  | 05.12  | 24.0124-0210.1  | 424210   |  |  | 298 24,0 22,0 V L + B |
|  | 3.4 S  | 217  | 11.05  | 05.12  | 24.0128-0131.1  | 428131   |  | - Keramikbremse <sup>1)</sup>  | 318 28,0 26,0 V L + B |
|  | 3.4 S  | 235  | 02.09  | 05.12  | 24.0128-0130.1  | 428130   |  | - Keramikbremse <sup>1)</sup>  | 318 28,0 26,0 V L + B |
|  | 3.4 S Sport  | 223  | 08.08  | 05.12  |   |  |  |  |                       |
|    | 2.7  | 180  | 05.06  | 05.12  | 13.0460-4816.2  | 604816   | 2  |  | 24541 15,5 +/WE BRE   |
|  | 2.9  | 195  | 02.09  | 05.12  | 24.8190-0932.2  | 620932   | 2  |  | Warnkontakt L=461mm   |
|  | 3.4 S  | 235  | 02.09  | 05.12  |   |  |  |  |                       |
|  | 3.4 S Sport  | 223  | 08.08  | 05.12  |   |  |  |  |                       |
|  | R 3.4  | 243  | 11.10  | 05.12  | 13.0460-4816.2  | 604816   | 2  | - Keramikbremse <sup>1)</sup>  | 24541 15,5 +/WE BRE   |
|    | 3.4 S  | 217  | 11.05  | 05.12  | 24.8190-0922.2  | 620922   | 2  | - Keramikbremse <sup>1)</sup>  | Warnkontakt L=440mm   |
|  | 2.7  | 180  | 05.06  | 05.12  | 13.0460-4988.2  | 604988   | 2  | - Keramikbremse <sup>1)</sup>  | 21792 15,5 /WE BRE    |
|  | 2.9  | 195  | 02.09  | 05.12  | 24.8190-0922.2  | 620922   | 2  | - Keramikbremse <sup>1)</sup>  | Warnkontakt L=440mm   |
|  | 3.4 S  | 217  | 11.05  | 05.12  | 24.0120-0212.1  | 420212   |  |  | 299 20,0 18,0 V L + B |
|  | 3.4 S  | 217  | 11.05  | 05.12  | 24.0124-0194.1  | 424194   |  | - Keramikbremse <sup>1)</sup>  | 299 24,0 22,0 V L + B |
|    | 2.7  | 180  | 05.06  | 05.12  | 03.0137-3002.2  | 653002   |  |  | 180 x 25              |
|  | 3.4 S  | 217  | 11.05  | 05.12  |   |  |  |  |                       |
| <b>PORSCHE CAYMAN (981C) (13-)</b>   |  |  |  |  |   |  |  |  |                       |
|    | 2.7  | 202  | 03.13  |  | 24.8190-0069.2  | 620069   | 2  | - Keramikbremse <sup>1)</sup>  | Warnkontakt L=248mm   |
|  | 3.4 GTS  | 250  | 02.14  |  | 24.8190-0069.2  | 620069   | 2  | - Keramikbremse <sup>1)</sup>  | Warnkontakt L=248mm   |
|  | 3.4 S  | 239  | 03.13  |  |   |  |  |  |                       |
|  | 2.7  | 202  | 03.13  |  | 24.8190-0952.2  | 620952   | 2  | + Keramikbremse <sup>2)</sup>  | Warnkontakt L=300mm   |
|  | 3.4 GTS  | 250  | 02.14  |  |   |  |  |  |                       |
|  | 3.4 S  | 239  | 03.13  |  |   |  |  |  |                       |
|    | 3.8 GT4  | 283  | 01.15  |  | 24.8190-0952.2  | 620952   | 2  |  | Warnkontakt L=300mm   |
|  | 3.8 GT4  | 283  | 01.15  |  | 24.8190-0952.2  | 620952   | 2  |  | Warnkontakt L=300mm   |
|  | 2.7  | 202  | 03.13  |  | 24.0128-0273.1  | 428273   |  | - Keramikbremse <sup>1)</sup>  | 315 28,0 26,0 V L + B |
|  | 3.4 GTS  | 250  | 02.14  |  | 24.0128-0260.1  | 428260   |  | - Keramikbremse <sup>1)</sup>  | 315 28,0 26,0 V L + B |
|  | 3.4 S  | 239  | 03.13  |  |   |  |  |  |                       |
|  | 2.7  | 202  | 03.13  |  | 13.0460-4816.2  | 604816   | 2  | - Keramikbremse <sup>1)</sup>  | 24541 15,5 +/WE BRE   |
|    | 3.4 GTS  | 250  | 02.14  |  | 24.8190-0070.2  | 620070   | 2  |  | Warnkontakt L=268mm   |
|  | 3.4 S  | 239  | 03.13  |  |   |  |  |  |                       |
|  | 3.8 GT4  | 283  | 01.15  |  | 24.8190-0952.2  | 620952   | 2  |  | Warnkontakt L=300mm   |
|  | 2.7  | 202  | 03.13  |  | 24.8190-0070.2  | 620070   | 2  |  | Warnkontakt L=268mm   |
|  | 3.4 GTS  | 250  | 02.14  |  |   |  |  |  |                       |
|  | 3.4 S  | 239  | 03.13  |  |   |  |  |  |                       |
|   | 2.7  | 202  | 03.13  |  | 24.0120-0212.1  | 420212   |  | - Keramikbremse <sup>1)</sup>  | 299 20,0 18,0 V L + B |
|  | 3.4 GTS  | 250  | 02.14  |  |   |  |  |  |                       |
|  | 3.4 S  | 239  | 03.13  |  |   |  |  |  |                       |
|  | 2.7  | 202  | 03.13  |  | 03.0137-9700.2  | 669700   |  |  | Bremsbacken-Zubehör   |
|  | 3.4 GTS  | 250  | 02.14  |  |   |  |  |  |                       |
|  | 3.4 S  | 239  | 03.13  |  |   |  |  |  |                       |
|  | 3.8 GT4  | 283  | 01.15  |  |   |  |  |  |                       |
| <b>PORSCHE 718 CAYMAN (982) (16-)</b>  |  |  |  |  |   |  |  |  |                       |
|  | 2.0  | 220  | 04.16  |  | 24.8190-0952.2  | 620952   | 2  | + Keramikbremse <sup>2)</sup>  | Warnkontakt L=300mm   |
|  | S 2.5  | 257  | 04.16  |  |   |  |  |  |                       |
|  | 2.0  | 220  | 04.16  |  | 24.0128-0247.1  | 428247   |  | - Keramikbremse <sup>1)</sup>  | 330 28,0 26,0 V L + B |
|  |  |  |  |  | 24.0128-0246.1  | 428246   |  | - Keramikbremse <sup>1)</sup>  | 330 28,0 26,0 V L + B |
|  | 2.0  | 220  | 04.16  |  | 13.0460-4816.2  | 604816   | 2  | - Keramikbremse <sup>1)</sup>  | 24541 15,5 +/WE BRE   |
|  | S 2.5  | 257  | 04.16  |  | 24.8190-0070.2  | 620070   | 2  | - Keramikbremse <sup>1)</sup>  | Warnkontakt L=268mm   |
|  | 2.0  | 220  | 04.16  |  | 24.8190-0070.2  | 620070   | 2  | + Keramikbremse <sup>2)</sup>  | Warnkontakt L=268mm   |
|  | S 2.5  | 257  | 04.16  |  |   |  |  |  |                       |
|  | 2.0  | 220  | 04.16  |  | 24.0120-0212.1  | 420212   |  | - Keramikbremse <sup>1)</sup>  | 299 20,0 18,0 V L + B |
|  | S 2.5  | 257  | 04.16  |  |   |  |  |  |                       |
|  | 2.0  | 220  | 04.16  |  | 03.0137-9700.2  | 669700   |  |  | Bremsbacken-Zubehör   |
|  | S 2.5  | 257  | 04.16  |  |   |  |  |  |                       |
| <b>PORSCHE MACAN (13-)</b>   |  |  |  |  |   |  |  |  |                       |
|  | 2.0  | 174  | 07.14  |  | 13.0460-4852.2  | 604852   |  |  | 24553 15,8 /WE BRE    |
|  | 2.0  | 185  | 10.15  |  |   |  |  |  |                       |
|  | 3.0 GTS  | 265  | 10.15  |  |   |  |  |  |                       |
|  | 3.0 S  | 250  | 11.13  |  |   |  |  |  |                       |
|  | 3.0 S Diesel   |  | 11.13  |  |   |  |  |  |                       |
|  | 3.6 Turbo  | 294  | 11.13  |  |   |  |  |  |                       |

<sup>1)</sup> - ceramic brake / - freno in ceramica / - frein de céramique / - freno de cerámica

<sup>2)</sup> + ceramic brake / + freno di ceramica / + frein de céramique / + freno de cerámica

<sup>3)</sup> + brake disc diameter 360mm / + diametro dischi freno 360mm / + diamètre disques frein 360mm / + diámetro disco freno 360mm



### PORSCHE MACAN (13-)

|  |              |     |       |   |                |        |   |                          |            |
|--|--------------|-----|-------|---|----------------|--------|---|--------------------------|------------|
|  | 2.0          | 174 | 07.14 | + Bremsscheibendurchm. 345 mm <sup>1)</sup> | 13.0460-4879.2 | 604879 |   | 25643 16,8 /WE           | <b>BRE</b> |
|  | 2.0          | 185 | 10.15 | + Bremsscheibendurchm. 345 mm <sup>1)</sup> | 13.0470-4879.2 | LD4879 |   | 25643 17,0 /WE           |            |
|  | 3.0 GTS      | 265 | 10.15 | + Bremsscheibendurchm. 345 mm <sup>1)</sup> |                |        |   |                          |            |
|  | 3.0 S        | 250 | 11.13 | + Bremsscheibendurchm. 345 mm <sup>1)</sup> |                |        |   |                          |            |
|  | 3.0 S Diesel | 250 | 11.13 | + Bremsscheibendurchm. 345 mm <sup>1)</sup> |                |        |   |                          |            |
|  | 3.6 Turbo    | 294 | 11.13 | + Bremsscheibendurchm. 345 mm <sup>1)</sup> |                |        |   |                          |            |
|  | 2.0          | 174 | 07.14 | + Bremsscheibendurchm. 345 mm <sup>1)</sup> | 24.0130-0222.1 | 430222 |   | 345 30,0 28,0 V L +S +B  |            |
|  | 2.0          | 185 | 10.15 | + Bremsscheibendurchm. 345 mm <sup>1)</sup> |                |        |   |                          |            |
|  | 3.0 GTS      | 265 | 10.15 | + Bremsscheibendurchm. 345 mm <sup>1)</sup> |                |        |   |                          |            |
|  | 3.0 S        | 250 | 11.13 | + Bremsscheibendurchm. 345 mm <sup>1)</sup> |                |        |   |                          |            |
|  | 3.0 S Diesel | 250 | 11.13 | + Bremsscheibendurchm. 345 mm <sup>1)</sup> |                |        |   |                          |            |
|  | 3.6 Turbo    | 294 | 11.13 | + Bremsscheibendurchm. 345 mm <sup>1)</sup> |                |        |   |                          |            |
|  | 2.0          | 174 | 07.14 | + Bremsscheibendurchm. 330 mm <sup>2)</sup> | 13.0460-2770.2 | 602770 |   | 25214 17,4 +/WK/Zub/STRW |            |
|  | 2.0          | 185 | 10.15 | + Bremsscheibendurchm. 330 mm <sup>2)</sup> | 13.0470-2770.2 | LD2770 | 2 | 25214 17,4 +/WK/Zub/STRW |            |
|  | 3.0 GTS      | 265 | 10.15 | + Bremsscheibendurchm. 330 mm <sup>2)</sup> | 24.8190-0313.2 | 620313 |   | Warnkontakt L=217mm      |            |
|  | 3.0 S        | 250 | 11.13 | + Bremsscheibendurchm. 330 mm <sup>2)</sup> |                |        |   |                          |            |
|  | 3.0 S Diesel | 250 | 11.13 | + Bremsscheibendurchm. 330 mm <sup>2)</sup> |                |        |   |                          |            |
|  | 3.6 Turbo    | 294 | 11.13 | + Bremsscheibendurchm. 330 mm <sup>2)</sup> |                |        |   |                          |            |
|  | 2.0          | 174 | 07.14 | + Bremsscheibendurchm. 356 mm <sup>3)</sup> | 24.8190-0313.2 | 620313 | 2 | Warnkontakt L=217mm      |            |
|  | 2.0          | 185 | 10.15 | + Bremsscheibendurchm. 356 mm <sup>3)</sup> |                |        |   |                          |            |
|  | 3.0 GTS      | 265 | 10.15 | + Bremsscheibendurchm. 356 mm <sup>3)</sup> |                |        |   |                          |            |
|  | 3.0 S        | 250 | 11.13 | + Bremsscheibendurchm. 356 mm <sup>3)</sup> |                |        |   |                          |            |
|  | 3.0 S Diesel | 250 | 11.13 | + Bremsscheibendurchm. 356 mm <sup>3)</sup> |                |        |   |                          |            |
|  | 3.6 Turbo    | 294 | 11.13 | + Bremsscheibendurchm. 356 mm <sup>3)</sup> |                |        |   |                          |            |
|  | 2.0          | 174 | 07.14 | + Bremsscheibendurchm. 330 mm <sup>2)</sup> | 24.0122-0272.1 | 422272 |   | 330 21,9 20,0 V L +S +B  |            |
|  | 2.0          | 185 | 10.15 | + Bremsscheibendurchm. 330 mm <sup>2)</sup> |                |        |   |                          |            |
|  | 3.0 GTS      | 265 | 10.15 | + Bremsscheibendurchm. 330 mm <sup>2)</sup> |                |        |   |                          |            |
|  | 3.0 S        | 250 | 11.13 | + Bremsscheibendurchm. 330 mm <sup>2)</sup> |                |        |   |                          |            |
|  | 3.0 S Diesel | 250 | 11.13 | + Bremsscheibendurchm. 330 mm <sup>2)</sup> |                |        |   |                          |            |
|  | 3.6 Turbo    | 294 | 11.13 | + Bremsscheibendurchm. 330 mm <sup>2)</sup> |                |        |   |                          |            |

### PORSCHE PANAMERA (10-)

|  |              |     |       |  |                |        |   |  |                         |
|--|--------------|-----|-------|--|----------------|--------|---|--|-------------------------|
|  | 3.0 D        | 155 | 08.11 |  | 24.8190-0014.2 | 620014 | 2 | - Keramikbremse <sup>4)</sup>                          | Warnkontakt L=296mm     |
|  | 3.0 D        | 184 | 08.11 |  |                |        |   |  |                         |
|  | 3.0 D        | 221 | 01.14 |  |                |        |   |  |                         |
|  | 3.0 S Hybrid |     | 03.11 |  |                |        |   |  |                         |
|  | 3.6          | 220 | 05.10 |  |                |        |   |  |                         |
|  | 3.6 4        | 220 | 05.10 |  |                |        |   |  |                         |
|  | 3.0 4S       | 309 | 07.13 |  | 24.8190-0014.2 | 620014 | 2 | - Keramikbremse <sup>4)</sup>                          | Warnkontakt L=296mm     |
|  | 3.0 S        | 309 | 07.13 |  |                |        |   |  |                         |
|  | 3.0 4S       | 309 | 07.13 |  | 24.8190-0939.2 | 620939 | 2 | + Keramikbremse <sup>5)</sup>                          | Warnkontakt L=372,4mm   |
|  | 3.0 D        | 155 | 08.11 |  |                |        |   |  |                         |
|  | 3.0 D        | 184 | 08.11 |  |                |        |   |  |                         |
|  | 3.0 D        | 221 | 01.14 |  |                |        |   |  |                         |
|  | 3.0 S        | 309 | 07.13 |  |                |        |   |  |                         |
|  | 3.0 S Hybrid |     | 03.11 |  |                |        |   |  |                         |
|  | 3.6          | 220 | 05.10 |  |                |        |   |  |                         |
|  | 3.6 4        | 220 | 05.10 |  |                |        |   |  |                         |
|  | 4.8 4S       | 294 | 09.09 |  | 13.0460-4852.2 | 604852 |   | - Keramikbremse <sup>4)</sup>                          | 24553 15,8 /WE          |
|  | 4.8 GTS      | 316 | 01.12 |  | 24.8190-0939.2 | 620939 | 2 | - Keramikbremse <sup>4)</sup>                          | Warnkontakt L=372,4mm   |
|  | 4.8 S        | 294 | 09.09 |  |                |        |   |  |                         |
|  | 4.8 Turbo    | 368 | 09.09 |  |                |        |   |  |                         |
|  | 4.8 Turbo S  | 404 | 05.11 |  |                |        |   |  |                         |
|  | 4.8 Turbo S  | 419 | 01.14 |  |                |        |   |  |                         |
|  | 4.8 4S       | 294 | 09.09 |  | 24.8190-0939.2 | 620939 | 2 | + Keramikbremse <sup>5)</sup>                          | Warnkontakt L=372,4mm   |
|  | 4.8 GTS      | 316 | 01.12 |  |                |        |   |  |                         |
|  | 4.8 S        | 294 | 09.09 |  |                |        |   |  |                         |
|  | 4.8 Turbo    | 368 | 09.09 |  |                |        |   |  |                         |
|  | 4.8 Turbo S  | 404 | 05.11 |  |                |        |   |  |                         |
|  | 4.8 Turbo S  | 419 | 01.14 |  |                |        |   |  |                         |
|  | 3.0 4S       | 309 | 07.13 |  | 24.0136-0128.1 | 436128 |   | <input type="checkbox"/> - Keramikbremse <sup>4)</sup> | 360 36,0 34,0 V L +S +B |
|  | 3.0 D        | 155 | 08.11 |  | 24.0136-0127.1 | 436127 |   | <input type="checkbox"/> - Keramikbremse <sup>4)</sup> | 360 36,0 34,0 V L +S +B |
|  | 3.0 D        | 184 | 08.11 |  |                |        |   |  |                         |
|  | 3.0 D        | 221 | 01.14 |  |                |        |   |  |                         |
|  | 3.0 S        | 309 | 07.13 |  |                |        |   |  |                         |
|  | 3.0 S Hybrid |     | 03.11 |  |                |        |   |  |                         |
|  | 3.6          | 220 | 05.10 |  |                |        |   |  |                         |
|  | 3.6 4        | 220 | 05.10 |  |                |        |   |  |                         |
|  | 3.0 4S       | 309 | 07.13 |  | 24.8190-0940.2 | 620940 | 2 |  | Warnkontakt L=227,4mm   |
|  | 3.0 S        | 309 | 07.13 |  |                |        |   |  |                         |
|  | 4.8 4S       | 294 | 09.09 |  |                |        |   |  |                         |
|  | 4.8 GTS      | 316 | 01.12 |  |                |        |   |  |                         |
|  | 4.8 S        | 294 | 09.09 |  |                |        |   |  |                         |
|  | 3.0 D        | 155 | 08.11 |  | 24.8190-0015.2 | 620015 | 2 |  | Warnkontakt L=138mm     |
|  | 3.0 D        | 184 | 08.11 |  |                |        |   |  |                         |
|  | 3.0 D        | 221 | 01.14 |  |                |        |   |  |                         |
|  | 3.0 S Hybrid |     | 03.11 |  |                |        |   |  |                         |
|  | 3.6          | 220 | 05.10 |  |                |        |   |  |                         |
|  | 3.6 4        | 220 | 05.10 |  |                |        |   |  |                         |
|  | 3.0 4S       | 309 | 07.13 |  | 24.8190-0015.2 | 620015 | 2 |  | Warnkontakt L=138mm     |
|  | 3.0 S        | 309 | 07.13 |  |                |        |   |  |                         |
|  | 4.8 Turbo    | 368 | 09.09 |  | 24.8190-0940.2 | 620940 | 2 |  | Warnkontakt L=227,4mm   |
|  | 4.8 Turbo S  | 404 | 05.11 |  |                |        |   |  |                         |
|  | 4.8 Turbo S  | 419 | 01.14 |  |                |        |   |  |                         |

























<sup>1)</sup> + brake disc diameter 345mm / + diametro dischi freno 345mm / + diamètre disques frein 345mm / + diámetro disco freno 345mm

<sup>2)</sup> + brake disc diameter 330mm / + diametro dischi freno 330mm / + diamètre disques frein 330mm / + diámetro disco freno 330mm

<sup>3)</sup> + brake disc diameter 356mm / + diametro dischi freno 356mm / + diamètre disques frein 356mm / + diámetro disco freno 356mm

<sup>4)</sup> - ceramic brake / - freno in ceramica / - frein de céramique / - freno de cerámica

















<sup>5)</sup> + ceramic brake / + freno di ceramica / + frein de céramique / + freno de cerámica

|     |    kW   |         |    |  |  |  |                                |                     |
|--|---|---|--|--|---|--|--|---|
| <b>PORSCHE PANAMERA (10-)</b>  |   |   |  |  |   |  |  |   |
|    | 3.0 4S<br>3.0 D<br>3.0 D<br>3.0 D<br>3.0 S<br>3.0 S Hybrid<br>3.6<br>3.6 4<br>4.8 4S<br>4.8 GTS<br>4.8 S<br>4.8 Turbo<br>4.8 Turbo S<br>4.8 Turbo S | 309<br>155<br>184<br>221<br>309<br>220<br>220<br>294<br>316<br>294<br>368<br>404<br>419 | 07.13<br>08.11<br>08.11<br>01.14<br>07.13<br>03.11<br>05.10<br>05.10<br>09.09<br>01.12<br>09.09<br>09.09<br>05.11<br>01.14 |  | 24.8190-0940.2<br>620940  | 2  |  | Warnkontakt L=227,4mm   |
|    | 3.0 4S<br>3.0 D<br>3.0 D<br>3.0 D<br>3.0 S<br>3.0 S Hybrid<br>3.6<br>3.6 4<br>4.8 4S<br>4.8 GTS<br>4.8 S  | 309<br>155<br>184<br>221<br>309<br>220<br>220<br>294<br>316<br>294                      | 07.13<br>08.11<br>08.11<br>01.14<br>07.13<br>03.11<br>05.10<br>05.10<br>09.09<br>01.12<br>09.09                            |  | 24.0128-0282.1<br>24.0128-0283.1  | 428282<br>428283   | <input type="checkbox"/> - Keramikbremse <sup>1)</sup><br><input type="checkbox"/> - Keramikbremse <sup>1)</sup> | 330 28,0 26,0 V L +S +B<br>330 28,0 26,0 V L +S +B  |
| <b>PROTON JUMBUCK Pick-up (02-)</b>  |   |   |  |  |   |  |  |   |
|    | 1.5   | 64  | 05.02  |  | 24.0118-0120.1  | 418120   |  | 236 18,0 16,4 V +B  |
| <b>PROTON PERSONA 300 / 400 (94-00)</b>  |   |   |  |  |   |  |  |   |
|    | 1.3 i<br>1.5 GLi<br>2.0 TD<br>1.6 GLX<br>1.8 GLX  | 55<br>66<br>83<br>85  | 01.94 07.00<br>01.94 07.00<br>09.96 07.00<br>01.94 07.00<br>05.96 07.00  |  | 13.0460-5953.2<br>13.0460-0233.2  | 605953<br>610233   |  | 21650 15,0<br>Belagsatz-Zubehör<br><b>SUM</b>   |
|    | 1.3 i<br>1.5 GLi<br>2.0 TD<br>1.6 GLX<br>1.8 GLX  | 55<br>66<br>83<br>85  | 01.94 07.00<br>01.94 07.00<br>09.96 07.00<br>01.94 07.00<br>05.96 07.00  |  | 24.0118-0120.1  | 418120   |  | 236 18,0 16,4 V +B  |
|  | 1.3 i<br>1.5 GLi<br>2.0 TD  | 55<br>66  | 01.94 07.00<br>01.94 07.00<br>09.96 07.00  |  | 03.0137-0216.2<br>03.0137-9107.2  | 650216<br>669107   |  | 180 x 37 HEB<br>Bremsbacken-Zubehör   |
| <b>PROTON SATRIA (00-)</b>   |   |   |  |  |   |  |  |   |
|  | 1.3 i 12V<br>1.5 i 12V<br>1.8 GTi 16V   | 55<br>64<br>103   | 08.00<br>07.00<br>08.00  |  | 13.0460-5953.2<br>13.0460-0233.2  | 605953<br>610233   |  | 21650 15,0<br>Belagsatz-Zubehör<br><b>SUM</b>   |
|  | 1.3 i 12V<br>1.5 i 12V  | 55<br>64  | 08.00<br>07.00   |  | 24.0113-0186.1<br>24.0118-0120.1  | 413186<br>418120   |  | 234 13,0 11,4<br>236 18,0 16,4 V +B   |
|  | 1.8 GTi 16V   | 103   | 08.00  |  | 13.0460-5826.2  | 605826   |  | 21872 14,5 +/WK<br><b>AKE</b>   |
| <b>PROTON WIRA (00-05)</b>   |   |   |  |  |   |  |  |   |
|  | 1.3 i 12V<br>1.5 i 12V  | 55<br>64  | 08.00 09.05<br>08.00 09.05   |  | 13.0460-5953.2<br>13.0460-0233.2  | 605953<br>610233   |  | 21650 15,0<br>Belagsatz-Zubehör<br><b>SUM</b>   |
|  | 1.3 i 12V<br>1.5 i 12V  | 55<br>64  | 08.00 09.05<br>08.00 09.05   |  | 24.0113-0186.1<br>24.0118-0120.1  | 413186<br>418120   |  | 234 13,0 11,4<br>236 18,0 16,4 V +B   |
| <b>RENAULT AVANTIME (01-03)</b>  |   |   |  |  |   |  |  |   |
|  | 2.0 16V Turbo<br>3.0 V6<br>2.2 dCi  | 120<br>152<br>110   | 11.01 06.03<br>09.01 06.03<br>05.02 06.03  |  | 13.0460-2870.2  | 602870   |  | 23099 18,4 /S<br><b>TRW</b>   |
|  | 2.0 16V Turbo<br>2.2 dCi<br>3.0 V6  | 120<br>110<br>152   | 11.01 06.03<br>05.02 06.03<br>09.01 06.03  |  | 24.0128-0134.1  | 428134   |  | 305 28,0 26,0 V +B  |
|  | 2.0 16V Turbo<br>2.2 dCi<br>3.0 V6  | 120<br>110<br>152   | 11.01 06.03<br>05.02 06.03<br>09.01 06.03  |  | 13.0460-2845.2<br>13.0470-2845.2<br>13.0460-0077.2                                | 602845<br>LD2845<br>610077   |  | 23554 16,4 /Zub/S<br>23554 16,4 /Zub/S<br>Belagsatz-Zubehör<br><b>TRW</b><br><b>TRW</b><br><b>TRW</b> |
|  | 2.0 16V Turbo<br>2.2 dCi<br>3.0 V6  | 120<br>110<br>152   | 11.01 06.03<br>05.02 06.03<br>09.01 06.03  |  | 24.0111-0151.1  | 411151   |  | 265 10,5 9,5 +B   |

<sup>1)</sup> - ceramic brake / - freno in ceramica / - frein de céramique / - freno de cerámica

<sup>2)</sup> remove sliding plates befor.installation / rimuovere le lamiere di scorrimento prima del montaggio / retirer l.plaques coulissantes avant le montage / elimine las chapas de deslizamiento antes del montaje



|     |  |  |  |  |  |  |  |  |                       |  |
|--|--|--|--|--|---|--|--|--|-----------------------|--|
| <b>RENAULT CAPTUR (J87) (13-)</b>  |  |  |  |  |   |  |  |  |                       |  |
|    | 0.9 TCe 90   | 66   |  | 06.13  |   | 13.0460-2709.2<br>13.0470-2709.2   | 602709<br>LD2709   | 23973 17,4 /Zub/S<br>23973 17,4 /Zub/S   | TRW<br>TRW            |  |
|  | 1.2 TCe 120  | 88   |  | 06.13  |   | 13.0460-7266.2   | 607266   | 24538 17,9 +   | ATE                   |  |
|  | 1.5 dCi 110  | 81   |  | 01.15  |   | 13.0470-7266.2   | LD7266   | 24538 17,9 +   | ATE                   |  |
|  | 1.5 dCi 90   | 66   |  | 06.13  |   |  |  |  |                       |  |
|    | 0.9 TCe 90   | 66   |  | 06.13  |   | 24.0122-0270.1   | 422270   | 258 22,0 19,8 V L +S +B  |                       |  |
|  | 1.2 TCe 120  | 88   |  | 06.13  |   | 24.0124-0253.1   | 424253   | 280 24,0 21,8 V L +S +B  |                       |  |
|  | 1.5 dCi 110  | 81   |  | 01.15  |   |  |  |  |                       |  |
|  | 1.5 dCi 90   | 66   |  | 06.13  |   |  |  |  |                       |  |
|    | 0.9 TCe 90   | 66   |  | 03.15  |   | 24.0711-5382.3   | 360423   | 2  | Radsensor L=650       |  |
|  | 1.2 TCe 120  | 88   |  | 03.15  |   |  |  |  |                       |  |
|  | 1.5 dCi 110  | 81   |  | 03.15  |   |  |  |  |                       |  |
|  | 1.5 dCi 90   | 66   |  | 03.15  |   |  |  |  |                       |  |
|    | 0.9 TCe 90   | 66   |  | 06.13  |   | 03.0137-0496.2   | 650496   | 228 x 42 HEB   | BDX                   |  |
|  | 1.2 TCe 120  | 88   |  | 06.13  |   | 03.0137-9228.2   | 669228   | Bremsbacken-Zubehör  | BDX                   |  |
|  | 1.5 dCi 110  | 81   |  | 01.15  |   |  |  |  |                       |  |
|  | 1.5 dCi 90   | 66   |  | 06.13  |   |  |  |  |                       |  |
|    | 0.9 TCe 90   | 66   |  | 06.13  |   | 03.0520-7919.3   | 697919   | 19,05/228x42 TopKit  |                       |  |
|  | 1.2 TCe 120  | 88   |  | 06.13  |   | 03.0520-7222.3   | 697222   | 22,20/228x42 TopKit  |                       |  |
|  | 1.5 dCi 110  | 81   |  | 01.15  |   |  |  |  |                       |  |
|  | 1.5 dCi 90   | 66   |  | 06.13  |   |  |  |  |                       |  |
| <b>RENAULT CLIO I Limousine (B/C 57_) (90-98)</b>                                  |  |  |  |  |   |  |  |  |                       |  |
|    | 1.1  |  |  | 01.91  | 04.92   | 13.0460-3955.2<br>13.0460-2834.2<br>13.0460-0423.2                                 | 603955<br>602834<br>610423   | 21097 15,0 +/WK<br>21463 18,0 /WK/S<br>Belagsatz-Zubehör                           | BDX<br>TRW<br>BDX     |  |
|  | 1.1  |  |  | 05.92  | 09.98   | 13.0460-3911.2   | 603911   | 20905 18,0 +/WK  | BDX                   |  |
|  | 1.2  | 44   |  | 05.90  | 03.96   | 13.0460-2834.2   | 602834   | 21463 18,0 /WK/S   | TRW                   |  |
|  | 1.2 (5/357F/J/L/R)   | 43   |  | 10.94  | 09.98   | 13.0460-0411.2   | 610411   | Belagsatz-Zubehör  | BDX                   |  |
|  | 1.2 (5/357K.5/357Y)  | 40   |  | 01.96  | 09.98   |  |  |  |                       |  |
|  | 1.2 (5/357K.5/357Y)  | 43   |  | 01.96  | 09.98   |  |  |  |                       |  |
|  | 1.2 (B/C 577)  | 40   |  | 01.96  | 12.96   |  |  |  |                       |  |
|  | 1.2 (B/C 57A/S)  | 43   |  | 05.90  | 09.98   |  |  |  |                       |  |
|  | 1.2 (B/C 57R)  | 40   |  | 01.91  | 01.96   |  |  |  |                       |  |
|  | 1.4  | 59   |  | 01.91  | 09.98   |  |  |  |                       |  |
|  | 1.4 (B/C 57J)  | 55   |  | 01.91  | 09.98   |  |  |  |                       |  |
|  | 1.4 (B/C 57T/Y)  | 58   |  | 01.91  | 09.98   |  |  |  |                       |  |
|  | 1.7  | 68   |  | 01.91  | 04.95   |  |  |  |                       |  |
|  | 1.8  | 70   |  | 01.91  | 09.98   |  |  |  |                       |  |
|  | 1.8 (B/C 578)  | 66   |  | 08.94  | 09.98   |  |  |  |                       |  |
|  | 1.8 (B/C 57C/U)  | 65   |  | 01.91  | 09.98   |  |  |  |                       |  |
|  | 1.8 16V  | 99   |  | 08.91  | 06.94   |  |  |  |                       |  |
|  | 1.8 Rsi (B/C 579)  | 80   |  | 01.93  | 08.95   |  |  |  |                       |  |
|  | 1.8 Rsi (B/C 57H)  | 79   |  | 08.95  | 09.98   |  |  |  |                       |  |
|  | 1.9 D  | 40   |  | 01.97  | 09.98   |  |  |  |                       |  |
|  | 1.9 D  | 47   |  | 01.91  | 09.98   |  |  |  |                       |  |
| Electric   | 21   |  | 05.96  | 02.98  |   |  |  |  |                       |  |
| Williams (B/C 57M)   | 108  |  | 01.94  | 09.98  |   |  |  |  |                       |  |
|  | 1.1  |  |  | 01.91  | 04.92   | 24.0108-0104.1   | 408104   | 238 8,2 7,0 +S +B  |                       |  |
|  | 1.1  |  |  | 05.92  | 09.98   | 24.0112-0116.1   | 412116   | 238 12,0 10,5 +S +B  |                       |  |
|  | 1.2  | 44   |  | 05.90  | 03.96   |  |  |  |                       |  |
|  | 1.2 (5/357F/J/L/R)   | 43   |  | 10.94  | 09.98   |  |  |  |                       |  |
|  | 1.2 (5/357K.5/357Y)  | 40   |  | 01.96  | 09.98   |  |  |  |                       |  |
|  | 1.2 (5/357K.5/357Y)  | 43   |  | 01.96  | 09.98   |  |  |  |                       |  |
|  | 1.2 (B/C 577)  | 40   |  | 01.96  | 12.96   |  |  |  |                       |  |
|  | 1.2 (B/C 57A/S)  | 43   |  | 05.90  | 09.98   |  |  |  |                       |  |
|  | 1.2 (B/C 57R)  | 40   |  | 01.91  | 01.96   |  |  |  |                       |  |
|  | 1.4  | 59   |  | 01.91  | 09.98   |  |  |  |                       |  |
|  | 1.4  | 59   |  | 01.91  | 03.96   | + Schaltgetriebe 1)  |  |  |                       |  |
|  | 1.4 (B/C 57J)  | 55   |  | 01.91  | 09.98   | + Automatikgetriebe 2)   |  |  |                       |  |
|  | 1.4 (B/C 57J)  | 55   |  | 01.91  | 09.98   | + Schaltgetriebe 1)  |  |  |                       |  |
|  | 1.4 (B/C 57T/Y)  | 58   |  | 01.91  | 03.96   | + Automatikgetriebe 2)   |  |  |                       |  |
|  | 1.4 (B/C 57T/Y)  | 58   |  | 01.91  | 09.98   | + Schaltgetriebe 1)  |  |  |                       |  |
|  | 1.4 (B/C 57T/Y)  | 58   |  | 01.91  | 03.96   | + Automatikgetriebe 2)   |  |  |                       |  |
|  | 1.9 D  | 47   |  | 01.91  | 01.94   |  |  |  |                       |  |
|  | Electric   | 21   |  | 05.96  | 02.98   |  |  |  |                       |  |
|  | 1.4  | 59   |  | 04.96  | 09.98   | + Automatikgetriebe 2)   | 24.0120-0125.1   | 420125   | 238 20,1 17,7 V +S +B |  |
|  | 1.4 (B/C 57J)  | 55   |  | 04.96  | 09.98   | + Automatikgetriebe 2)   |  |  |                       |  |
|  | 1.4 (B/C 57T/Y)  | 58   |  | 04.96  | 09.98   | + Automatikgetriebe 2)   |  |  |                       |  |
| 1.4 S  | 59   |  | 01.91  | 09.98  |   |  |  |  |                       |  |
| 1.4 S (B/C 57J)  | 55   |  | 01.91  | 09.98  |   |  |  |  |                       |  |
| 1.4 S (B/C 57T/Y)  | 58   |  | 01.91  | 09.98  |   |  |  |  |                       |  |
| 1.7  | 68   |  | 01.91  | 04.95  |   |  |  |  |                       |  |
| 1.8  | 70   |  | 01.91  | 09.98  |   |  |  |  |                       |  |
| 1.8 (B/C 578)  | 66   |  | 08.94  | 09.98  |   |  |  |  |                       |  |
| 1.8 (B/C 57C/U)  | 65   |  | 01.91  | 09.98  |   |  |  |  |                       |  |
| 1.8 Rsi (B/C 579)  | 80   |  | 01.93  | 08.95  |   |  |  |  |                       |  |
| 1.8 Rsi (B/C 57H)  | 79   |  | 08.95  | 09.98  |   |  |  |  |                       |  |
| 1.9 D  | 40   |  | 01.97  | 09.98  |   |  |  |  |                       |  |
| 1.9 D  | 47   |  | 02.94  | 09.98  |   |  |  |  |                       |  |
| 1.8 16V  | 99   |  | 08.91  | 06.94  |   | 24.0121-0106.1   | 421106   | 259 20,6 17,7 V +S +B  |                       |  |
| Williams (B/C 57M)   | 108  |  | 01.94  | 09.98  |   |  |  |  |                       |  |

1) + manual transmission / + scatola cambio velocità / + transmission mécanique / + cambio de velocidad  
2) + autom.transmission / + scatola cambio automatico / + transmission automatique / + cambio automático



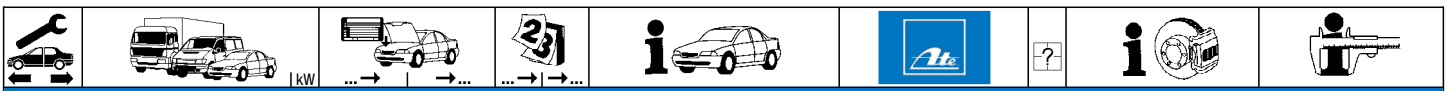

**RENAULT CLIO I Limousine (B/C 57\_) (90-98)**

|  |                     |     |       |       |       |                |        |  |                        |            |
|--|---------------------|-----|-------|-------|-------|----------------|--------|--|------------------------|------------|
|  | 1.2                 | 44  | 05.90 | 03.96 | + ABS | 13.0460-3822.2 | 603822 |  | 21597 11,0 +/S         | <b>BDX</b> |
|  | 1.2 (5/357F/J/L/R)  | 43  | 10.94 | 09.98 | + ABS |                |        |  |                        |            |
|  | 1.2 (5/357K.5/357Y) | 40  | 01.96 | 09.98 | + ABS |                |        |  |                        |            |
|  | 1.2 (5/357K.5/357Y) | 43  | 01.96 | 09.98 | + ABS |                |        |  |                        |            |
|  | 1.2 (B/C 577)       | 40  | 01.96 | 12.96 | + ABS |                |        |  |                        |            |
|  | 1.2 (B/C 57A/S)     | 43  | 05.90 | 09.98 | + ABS |                |        |  |                        |            |
|  | 1.2 (B/C 57R)       | 40  | 01.91 | 01.96 | + ABS |                |        |  |                        |            |
|  | 1.4                 | 59  | 01.91 | 09.98 | + ABS |                |        |  |                        |            |
|  | 1.4 (B/C 57J)       | 55  | 01.91 | 09.98 | + ABS |                |        |  |                        |            |
|  | 1.4 (B/C 57T/Y)     | 58  | 01.91 | 09.98 | + ABS |                |        |  |                        |            |
|  | 1.7                 | 68  | 12.93 | 04.95 | + ABS |                |        |  |                        |            |
|  | 1.8 (357A)          | 70  | 10.94 | 09.98 | + ABS |                |        |  |                        |            |
|  | 1.8 (357D)          | 70  | 10.94 | 04.96 | + ABS |                |        |  |                        |            |
|  | 1.8 (357E)          | 70  | 10.94 | 04.96 |       |                |        |  |                        |            |
|  | 1.8 (557A)          | 70  | 08.94 | 09.98 | + ABS |                |        |  |                        |            |
|  | 1.8 (557D)          | 70  | 08.94 | 04.96 | + ABS |                |        |  |                        |            |
|  | 1.8 (557U)          | 70  | 09.96 | 09.98 | + ABS |                |        |  |                        |            |
|  | 1.8 (B/C 578)       | 66  | 08.94 | 09.98 | + ABS |                |        |  |                        |            |
|  | 1.8 (B/C 57C/U)     | 65  | 12.93 | 09.98 | + ABS |                |        |  |                        |            |
|  | 1.8 16V             | 99  | 08.91 | 06.94 |       |                |        |  |                        |            |
|  | 1.8 Rsi (B/C 579)   | 80  | 01.93 | 08.95 |       |                |        |  |                        |            |
|  | 1.8 Rsi (B/C 57H)   | 79  | 08.95 | 09.98 |       |                |        |  |                        |            |
|  | 1.9 D               | 40  | 01.97 | 09.98 | + ABS |                |        |  |                        |            |
|  | 1.9 D               | 47  | 01.91 | 09.98 | + ABS |                |        |  |                        |            |
|  | Williams (B/C 57M)  | 108 | 01.94 | 09.98 |       |                |        |  |                        |            |
|  | 1.2                 | 44  | 05.90 | 03.96 | + ABS | 24.0108-0109.1 | 408109 |  | 238 8,0 7,0            |            |
|  | 1.2 (5/357F/J/L/R)  | 43  | 10.94 | 09.98 | + ABS |                |        |  |                        |            |
|  | 1.2 (5/357K.5/357Y) | 40  | 01.96 | 09.98 | + ABS |                |        |  |                        |            |
|  | 1.2 (5/357K.5/357Y) | 43  | 01.96 | 09.98 | + ABS |                |        |  |                        |            |
|  | 1.2 (B/C 577)       | 40  | 01.96 | 12.96 | + ABS |                |        |  |                        |            |
|  | 1.2 (B/C 57A/S)     | 43  | 05.90 | 09.98 | + ABS |                |        |  |                        |            |
|  | 1.2 (B/C 57R)       | 40  | 01.91 | 01.96 | + ABS |                |        |  |                        |            |
|  | 1.4                 | 59  | 01.91 | 09.98 | + ABS |                |        |  |                        |            |
|  | 1.4 (B/C 57J)       | 55  | 01.91 | 09.98 | + ABS |                |        |  |                        |            |
|  | 1.4 (B/C 57T/Y)     | 58  | 01.91 | 09.98 | + ABS |                |        |  |                        |            |
|  | 1.7                 | 68  | 12.93 | 04.95 | + ABS |                |        |  |                        |            |
|  | 1.8 (357A)          | 70  | 10.94 | 09.98 | + ABS |                |        |  |                        |            |
|  | 1.8 (357D)          | 70  | 10.94 | 04.96 | + ABS |                |        |  |                        |            |
|  | 1.8 (357E)          | 70  | 10.94 | 04.96 |       |                |        |  |                        |            |
|  | 1.8 (557A)          | 70  | 08.94 | 09.98 | + ABS |                |        |  |                        |            |
|  | 1.8 (557D)          | 70  | 08.94 | 04.96 | + ABS |                |        |  |                        |            |
|  | 1.8 (557U)          | 70  | 09.96 | 09.98 | + ABS |                |        |  |                        |            |
|  | 1.8 (B/C 578)       | 66  | 08.94 | 09.98 | + ABS |                |        |  |                        |            |
|  | 1.8 (B/C 57C/U)     | 65  | 12.93 | 09.98 | + ABS |                |        |  |                        |            |
|  | 1.8 16V             | 99  | 08.91 | 06.94 |       |                |        |  |                        |            |
|  | 1.8 Rsi (B/C 579)   | 80  | 01.93 | 08.95 |       |                |        |  |                        |            |
|  | 1.8 Rsi (B/C 57H)   | 79  | 08.95 | 09.98 |       |                |        |  |                        |            |
|  | 1.9 D               | 40  | 01.97 | 09.98 | + ABS |                |        |  |                        |            |
|  | 1.9 D               | 47  | 01.91 | 09.98 | + ABS |                |        |  |                        |            |
|  | Williams (B/C 57M)  | 108 | 01.94 | 09.98 |       |                |        |  |                        |            |
|  | 1.1                 | 44  | 01.91 | 09.98 |       | 03.0137-0209.2 | 650209 |  | 180 x 42               | <b>BDX</b> |
|  | 1.2                 | 44  | 05.90 | 03.96 | - ABS | 03.0137-9086.2 | 669086 |  | Bremsbacken-Zubehör    | <b>BDX</b> |
|  | 1.2 (5/357G)        | 43  | 01.94 | 04.96 |       | 03.0137-0201.2 | 650201 |  | 180 x 41 HEB           | <b>TRW</b> |
|  | 1.2 (5/357K.5/357Y) | 40  | 01.96 | 09.98 | - ABS | 03.0137-9056.2 | 669056 |  | Bremsbacken-Zubehör    | <b>TRW</b> |
|  | 1.2 (5/357K.5/357Y) | 43  | 01.96 | 09.98 | - ABS |                |        |  |                        |            |
|  | 1.2 (B 57N)         | 43  | 09.91 | 09.98 | - ABS |                |        |  |                        |            |
|  | 1.2 (B/C 577)       | 40  | 01.96 | 12.96 | - ABS |                |        |  |                        |            |
|  | 1.2 (B/C 57A/S)     | 43  | 05.90 | 09.98 | - ABS |                |        |  |                        |            |
|  | 1.2 (B/C 57R)       | 40  | 01.91 | 01.96 | - ABS |                |        |  |                        |            |
|  | 1.4                 | 59  | 01.91 | 09.98 | - ABS |                |        |  |                        |            |
|  | 1.4 (B/C 57J)       | 55  | 01.91 | 09.98 | - ABS |                |        |  |                        |            |
|  | 1.4 (B/C 57T/Y)     | 58  | 01.91 | 09.98 | - ABS |                |        |  |                        |            |
|  | 1.7                 | 68  | 01.91 | 04.95 | - ABS |                |        |  |                        |            |
|  | 1.8 (357A)          | 70  | 10.94 | 09.98 | - ABS |                |        |  |                        |            |
|  | 1.8 (357D)          | 70  | 10.94 | 04.96 | - ABS |                |        |  |                        |            |
|  | 1.8 (357E)          | 70  | 10.94 | 04.96 |       |                |        |  |                        |            |
|  | 1.8 (557A)          | 70  | 08.94 | 09.98 | - ABS |                |        |  |                        |            |
|  | 1.8 (557D)          | 70  | 08.94 | 09.98 | - ABS |                |        |  |                        |            |
|  | 1.8 (B/C 578)       | 66  | 08.94 | 09.98 | - ABS |                |        |  |                        |            |
|  | 1.8 (B/C 57C/U)     | 65  | 01.91 | 09.98 | - ABS |                |        |  |                        |            |
|  | 1.9 D               | 40  | 01.97 | 09.98 | - ABS |                |        |  |                        |            |
|  | 1.9 D               | 47  | 01.91 | 09.98 | - ABS |                |        |  |                        |            |
|  | Electric            | 21  | 05.96 | 02.98 |       | 03.0137-0271.2 | 650271 |  | 229 x 42 HEB           | <b>TRW</b> |
|  | 1.1                 | 44  | 01.91 | 09.98 |       | 24.0218-0032.1 | 480118 |  | 180/181 x 53,5 - Lager |            |
|  | 1.2                 | 44  | 05.90 | 03.96 | - ABS | 24.0218-0732.2 | 480207 |  | 180/181 x 53,2 + Lager |            |
|  | 1.2 (5/357G)        | 43  | 01.94 | 04.96 |       |                |        |  |                        |            |
|  | 1.2 (5/357K.5/357Y) | 40  | 01.96 | 09.98 | - ABS |                |        |  |                        |            |
|  | 1.2 (5/357K.5/357Y) | 43  | 01.96 | 09.98 | - ABS |                |        |  |                        |            |
|  | 1.2 (B 57N)         | 43  | 09.91 | 09.98 | - ABS |                |        |  |                        |            |
|  | 1.2 (B/C 577)       | 40  | 01.96 | 12.96 | - ABS |                |        |  |                        |            |
|  | 1.2 (B/C 57A/S)     | 43  | 05.90 | 09.98 | - ABS |                |        |  |                        |            |
|  | 1.2 (B/C 57R)       | 40  | 01.91 | 01.96 | - ABS |                |        |  |                        |            |
|  | 1.4                 | 59  | 01.91 | 09.98 | - ABS |                |        |  |                        |            |
|  | 1.4 (B/C 57J)       | 55  | 01.91 | 09.98 | - ABS |                |        |  |                        |            |
|  | 1.4 (B/C 57T/Y)     | 58  | 01.91 | 09.98 | - ABS |                |        |  |                        |            |
|  | 1.7                 | 68  | 01.91 | 04.95 | - ABS |                |        |  |                        |            |
|  | 1.8 (357A)          | 70  | 10.94 | 09.98 | - ABS |                |        |  |                        |            |





**RENAULT CLIO I Limousine (B/C 57\_) (90-98)**





|                 |                     |    |       |       |       |                |                |        |                  |  |
|-----------------|---------------------|----|-------|-------|-------|----------------|----------------|--------|------------------|--|
|                 | 1.8 (357D)          | 70 |       | 10.94 | 04.96 | - ABS          | 24.0218-0032.1 | 480118 |                  | 180/181 x 53,5 - Lager<br>180/181 x 53,2 + Lager |
|                 | 1.8 (357E)          | 70 |       | 10.94 | 04.96 |                | 24.0218-0732.2 | 480207 |                  |  |
|                 | 1.8 (557A)          | 70 |       | 08.94 | 09.98 | - ABS          |                |        |                  |  |
|                 | 1.8 (557D)          | 70 |       | 08.94 | 09.98 | - ABS          |                |        |                  |  |
|                 | 1.8 (B/C 578)       | 66 |       | 08.94 | 09.98 | - ABS          |                |        |                  |  |
|                 | 1.8 (B/C 57C/U)     | 65 |       | 01.91 | 09.98 | - ABS          |                |        |                  |  |
|                 | 1.9 D               | 40 |       | 01.97 | 09.98 | - ABS          |                |        |                  |  |
|                 | 1.9 D               | 47 |       | 01.91 | 09.98 | - ABS          |                |        |                  |  |
| Electric        | 21                  |    | 05.96 | 02.98 |       | 24.0222-8015.1 | 480055         |        | 229/229,5 x 52,5 |  |
|                 |                     |    |       |       |       | 24.0222-8019.2 | 480087         |        | 229/229,5 x 52,5 |  |
|                 | 1.1                 | 44 |       | 01.91 | 09.98 |                | 03.0420-1020.3 | 681020 |                  | 20,64/180x42 Kit BDX                             |
|                 | 1.2                 | 44 |       | 05.90 | 03.96 | - ABS          | 03.0520-1020.3 | 691020 |                  | 20,64/180x42 TopKit BDX                          |
|                 | 1.2 (5/357G)        | 43 |       | 01.94 | 04.96 |                | 03.0520-6320.3 | 696320 |                  | 20,64/180x41 TopKit TRW                          |
|                 | 1.2 (5/357K.5/357Y) | 40 |       | 01.96 | 09.98 | - ABS          |                |        |                  |  |
|                 | 1.2 (5/357K.5/357Y) | 43 |       | 01.96 | 09.98 | - ABS          |                |        |                  |  |
|                 | 1.2 (B 57N)         | 43 |       | 09.91 | 09.98 |                |                |        |                  |  |
|                 | 1.2 (B/C 577)       | 40 |       | 01.96 | 12.96 | - ABS          |                |        |                  |  |
|                 | 1.2 (B/C 57A/S)     | 43 |       | 01.91 | 09.98 | - ABS          |                |        |                  |  |
|                 | 1.2 (B/C 57R)       | 40 |       | 01.91 | 01.96 | - ABS          |                |        |                  |  |
|                 | 1.4                 | 59 |       | 01.91 | 09.98 | - ABS          |                |        |                  |  |
|                 | 1.4 (B/C 57J)       | 55 |       | 01.91 | 09.98 | - ABS          |                |        |                  |  |
|                 | 1.4 (B/C 57T/Y)     | 58 |       | 01.91 | 09.98 | - ABS          |                |        |                  |  |
|                 | 1.7                 | 68 |       | 04.91 | 04.95 | - ABS          |                |        |                  |  |
|                 | 1.8 (357A)          | 70 |       | 10.94 | 09.98 | - ABS          |                |        |                  |  |
|                 | 1.8 (357D)          | 70 |       | 10.94 | 04.96 | - ABS          |                |        |                  |  |
|                 | 1.8 (557A)          | 70 |       | 08.94 | 04.96 | - ABS          |                |        |                  |  |
|                 | 1.8 (557D)          | 70 |       | 08.94 | 04.96 | - ABS          |                |        |                  |  |
|                 | 1.8 (B/C 578)       | 66 |       | 08.94 | 09.98 | - ABS          |                |        |                  |  |
|                 | 1.8 (B/C 57C/U)     | 65 |       | 01.91 | 09.98 | - ABS          |                |        |                  |  |
|                 | 1.9 D (B/C 576)     | 47 |       | 01.91 | 09.98 | - ABS          |                |        |                  |  |
|                 | 1.9 D (B/C 57I)     | 47 |       | 07.92 | 09.98 | - ABS          |                |        |                  |  |
| 1.9 D (B/C 57L) | 47                  |    | 01.91 | 09.98 | - ABS |                |                |        |                  |  |

**RENAULT CLIO I Kasten (S 57\_) (91-98)**

|  |       |    |  |       |       |       |                |        |  |                         |
|--|-------|----|--|-------|-------|-------|----------------|--------|--|-------------------------|
|  | 1.1   | 34 |  | 01.91 | 04.92 |       | 13.0460-3955.2 | 603955 |  | 21097 15,0 +/WK BDX     |
|  |       |    |  |       |       |       | 13.0460-2834.2 | 602834 |  | 21463 18,0 /WK/S TRW    |
|  |       |    |  |       |       |       | 13.0460-0423.2 | 610423 |  | Belagsatz-Zubehör BDX   |
|  | 1.1   | 34 |  | 05.92 | 09.98 |       | 13.0460-3911.2 | 603911 |  | 20905 18,0 +/WK BDX     |
|  | 1.2   | 40 |  | 01.91 | 09.98 |       | 13.0460-2834.2 | 602834 |  | 21463 18,0 /WK/S TRW    |
|  | 1.2   | 44 |  | 01.91 | 09.98 |       | 13.0460-0411.2 | 610411 |  | Belagsatz-Zubehör BDX   |
|  | 1.9 D | 48 |  | 01.91 | 09.98 |       |                |        |  |                         |
|  | 1.1   | 34 |  | 01.91 | 04.92 |       | 24.0108-0104.1 | 408104 |  | 238 8,2 7,0 +S +B       |
|  | 1.1   | 34 |  | 05.92 | 09.98 |       | 24.0112-0116.1 | 412116 |  | 238 12,0 10,5 +S +B     |
|  | 1.2   | 40 |  | 01.91 | 09.98 |       |                |        |  |                         |
|  | 1.2   | 44 |  | 01.91 | 09.98 |       |                |        |  |                         |
|  | 1.9 D | 48 |  | 01.91 | 01.94 |       |                |        |  |                         |
|  | 1.9 D | 48 |  | 02.94 | 09.98 |       | 24.0120-0125.1 | 420125 |  | 238 20,1 17,7 V +S +B   |
|  | 1.2   | 40 |  | 01.91 | 09.98 | + ABS | 13.0460-3822.2 | 603822 |  | 21597 11,0 +/S BDX      |
|  | 1.2   | 44 |  | 01.91 | 09.98 | + ABS |                |        |  |                         |
|  | 1.9 D | 48 |  | 01.91 | 09.98 | + ABS |                |        |  |                         |
|  | 1.2   | 40 |  | 01.91 | 09.98 | + ABS | 24.0108-0109.1 | 408109 |  | 238 8,0 7,0             |
|  | 1.2   | 44 |  | 01.91 | 09.98 | + ABS |                |        |  |                         |
|  | 1.9 D | 48 |  | 01.91 | 09.98 | + ABS |                |        |  |                         |
|  | 1.1   | 34 |  | 01.91 | 09.98 |       | 03.0137-0209.2 | 650209 |  | 180 x 42 BDX            |
|  | 1.2   | 40 |  | 01.91 | 09.98 | - ABS | 03.0137-9086.2 | 669086 |  | Bremsbacken-Zubehör BDX |
|  | 1.2   | 44 |  | 01.91 | 09.98 | - ABS | 03.0137-0201.2 | 650201 |  | 180 x 41 HEB TRW        |
|  | 1.9 D | 48 |  | 01.91 | 09.98 | - ABS | 03.0137-9056.2 | 669056 |  | Bremsbacken-Zubehör TRW |
|  | 1.1   | 34 |  | 01.91 | 09.98 |       | 24.0218-0032.1 | 480118 |  | 180/181 x 53,5 - Lager  |
|  | 1.2   | 40 |  | 01.91 | 09.98 | - ABS | 24.0218-0732.2 | 480207 |  | 180/181 x 53,2 + Lager  |
|  | 1.2   | 44 |  | 01.91 | 09.98 | - ABS |                |        |  |                         |
|  | 1.9 D | 48 |  | 01.91 | 09.98 | - ABS |                |        |  |                         |
|  | 1.1   | 34 |  | 01.91 | 09.98 |       | 03.0420-1020.3 | 681020 |  | 20,64/180x42 Kit BDX    |
|  | 1.2   | 40 |  | 01.91 | 09.98 | - ABS | 03.0520-1020.3 | 691020 |  | 20,64/180x42 TopKit BDX |
|  | 1.2   | 44 |  | 01.91 | 09.98 | - ABS | 03.0520-6320.3 | 696320 |  | 20,64/180x41 TopKit TRW |
|  | 1.9 D | 48 |  | 01.91 | 09.98 | - ABS |                |        |  |                         |

**RENAULT CLIO II Limousine (BB\_/CB\_) (98-12)**

|  |          |    |  |       |       |  |                |        |  |                      |
|--|----------|----|--|-------|-------|--|----------------|--------|--|----------------------|
|  | 1.0      | 40 |  | 02.00 | 05.01 |  | 13.0460-2834.2 | 602834 |  | 21463 18,0 /WK/S TRW |
|  | 1.2      | 43 |  | 09.98 | 12.12 |  |                |        |  |                      |
|  | 1.2      | 44 |  | 03.99 | 05.01 |  |                |        |  |                      |
|  | 1.2 16V  | 55 |  | 06.01 | 12.12 |  |                |        |  |                      |
|  | 1.2 LPG  | 43 |  | 09.98 | 06.09 |  |                |        |  |                      |
|  | 1.4      | 55 |  | 09.98 | 05.05 |  |                |        |  |                      |
|  | 1.4 16V  | 70 |  | 10.99 | 07.00 |  |                |        |  |                      |
|  | 1.4 16V  | 72 |  | 08.00 | 12.12 |  |                |        |  |                      |
|  | 1.5 dCi  | 47 |  | 06.05 | 12.12 |  |                |        |  |                      |
|  | 1.5 dCi  | 48 |  | 06.01 | 12.12 |  |                |        |  |                      |
|  | 1.5 dCi  | 50 |  | 08.04 | 12.12 |  |                |        |  |                      |
|  | 1.5 dCi  | 59 |  | 06.01 | 10.03 |  |                |        |  |                      |
|  | 1.5 dCi  | 60 |  | 06.01 | 12.12 |  |                |        |  |                      |
|  | 1.5 dCi  | 62 |  | 02.07 | 12.12 |  |                |        |  |                      |
|  | 1.5 dCi  | 74 |  | 01.04 | 12.12 |  |                |        |  |                      |
|  | 1.6      | 66 |  | 09.98 | 05.05 |  |                |        |  |                      |
|  | 1.6 16V  | 79 |  | 09.98 | 12.12 |  |                |        |  |                      |
|  | 1.6 Flex | 81 |  | 05.00 | 12.06 |  |                |        |  |                      |
|  | 1.9 D    | 47 |  | 09.98 | 05.05 |  |                |        |  |                      |

| RENAULT CLIO II Limousine (BB /CB_) (98-12)  |  |  |  |   |  |   |                                  |                  |  |   |            |
|--|--|--|--|---|--|---|----------------------------------|------------------|--|---|------------|
|    | 1.9 D<br>1.9 dTi   | 48<br>59   |  | 02.00<br>02.00  | 05.05<br>05.05   |   | 13.0460-2834.2<br>602834         |                  | 21463 18,0 /WK/S   | TRW   |            |
|  | 2.0 16V Sport<br>2.0 16V Sport   | 124<br>132   |  | 02.00<br>01.04  | 12.12<br>12.12   |   | 13.0460-2895.2<br>13.0460-0262.2 | 602895<br>610262 | 23172 18,0 /WE/Zub/S<br>Belagsatz-Zubehör                                  | TRW<br>TRW  |            |
|    | 1.0<br>1.2<br>1.2<br>1.2 16V<br>1.2 LPG<br>1.4<br>1.4<br>1.5 dCi<br>1.5 dCi<br>1.9 D<br>1.9 D  | 40<br>43<br>44<br>55<br>43<br>55<br>55<br>47<br>62<br>47<br>48                               |  | 02.00<br>09.98<br>03.99<br>06.01<br>09.98<br>09.98<br>09.98<br>06.05<br>02.07<br>09.98<br>02.00                                     | 05.01<br>05.01<br>05.01<br>02.10<br>06.09<br>05.05<br>05.05<br>02.08<br>12.12<br>05.05<br>05.05  | - ABS<br>- ABS<br>- ABS<br>- ABS<br>- ABS<br>- ABS / + Schaltgetriebe <sup>1)</sup><br>- ABS<br>- ABS<br>- ABS / - Klimaanlage <sup>2)</sup><br>- ABS / - Klimaanlage <sup>2)</sup> | 24.0112-0116.1<br>412116         |                  | 238 12,0 10,5 +S +B  |   |            |
|  | 1.0<br>1.2<br>1.2<br>1.2 16V<br>1.2 LPG<br>1.4<br>1.4<br>1.4 16V<br>1.4 16V<br>1.5 dCi<br>1.5 dCi<br>1.6   | 40<br>43<br>44<br>55<br>43<br>55<br>55<br>70<br>72<br>47<br>62<br>66                         |  | 02.00<br>09.98<br>03.99<br>06.01<br>09.98<br>09.98<br>09.98<br>10.99<br>08.00<br>06.05<br>02.07<br>09.98                            | 05.01<br>05.01<br>05.01<br>12.12<br>06.09<br>05.05<br>05.05<br>07.00<br>12.12<br>02.08<br>12.12<br>05.05                                     | + ABS<br>+ ABS<br>+ ABS<br>+ ABS<br>+ ABS / + Schaltgetriebe <sup>3)</sup><br>- ABS / + Automatikgetriebe <sup>4)</sup><br>+ ABS<br>- ABS<br>+ ABS<br>+ ABS                         | 24.0120-0125.1<br>420125         |                  | 238 20,1 17,7 V +S +B  |   |            |
|  | 1.0<br>1.2<br>1.2 16V<br>1.2 LPG<br>1.4<br>1.4 16V<br>1.4 16V<br>1.5 dCi<br>1.5 dCi<br>1.5 dCi<br>1.5 dCi<br>1.6<br>1.6 16V<br>1.6 Flex<br>1.9 dTi | 40<br>43<br>55<br>43<br>55<br>70<br>72<br>48<br>50<br>59<br>60<br>74<br>66<br>79<br>81<br>59 |  | 02.00<br>06.01<br>09.98<br>09.98<br>10.99<br>08.00<br>06.01<br>08.04<br>06.01<br>06.01<br>01.04<br>09.98<br>09.98<br>05.00<br>02.00 | 05.01<br>12.12<br>12.12<br>06.09<br>05.05<br>07.00<br>12.12<br>12.12<br>10.03<br>12.12<br>12.12<br>12.12<br>05.05<br>12.12<br>12.06<br>05.05 | + ABS<br>+ ABS<br>+ ABS / + Automatikgetriebe <sup>5)</sup><br>+ ABS<br>+ ABS<br>+ ABS<br>+ ABS<br>+ ABS<br>+ ABS   | 24.0121-0106.1<br>421106         |                  | 259 20,6 17,7 V +S +B  |   |            |
|  | 1.9 D<br>1.9 D   | 47<br>48   |  | 09.98<br>02.00  | 05.05<br>05.05   |   | 24.0120-0125.1<br>24.0121-0106.1 | 420125<br>421106 | + ABS / - Klimaanlage <sup>6)</sup><br>+ ABS / + Klimaanlage <sup>7)</sup> | 238 20,1 17,7 V +S +B<br>259 20,6 17,7 V +S +B        |            |
|  | 2.0 16V Sport<br>2.0 16V Sport   | 124<br>132   |  | 02.00<br>01.04  | 12.12<br>12.12   |   | 24.0124-0158.1<br>24.0324-0158.1 | 424158<br>524158 |  | 280 24,0 21,8 V L +S +B<br>280 24,0 21,8 V L +S +B PD |            |
|  | 1.2<br>1.2 16V<br>1.4 16V<br>1.5 dCi<br>1.5 dCi<br>1.5 dCi<br>1.5 dCi<br>1.5 dCi<br>1.5 dCi<br>2.0 16V Sport<br>2.0 16V Sport                      | 43<br>55<br>72<br>48<br>50<br>59<br>60<br>62<br>74<br>124<br>132                             |  | 09.98<br>06.01<br>08.00<br>06.01<br>08.04<br>06.01<br>06.01<br>02.07<br>01.04<br>02.00<br>01.04                                     | 12.12<br>12.12<br>12.12<br>12.12<br>12.12<br>10.03<br>12.12<br>12.12<br>12.12<br>12.12<br>12.12  | + ABS<br>+ ABS<br>+ ABS<br>+ ABS<br>+ ABS<br>+ ABS<br>+ ABS<br>+ ABS<br>+ ABS   | 13.0460-3926.2<br>13.0460-0435.2 | 603926<br>610435 |  | 20974 10,8<br>Belagsatz-Zubehör                       | BDX<br>BDX |
|  | 1.2<br>1.2 16V<br>1.4 16V<br>1.5 dCi<br>1.5 dCi<br>1.5 dCi<br>1.5 dCi<br>1.5 dCi   | 43<br>55<br>72<br>48<br>50<br>59<br>60<br>62<br>74   |  | 09.98<br>06.01<br>08.00<br>06.01<br>08.04<br>06.01<br>06.01<br>02.07<br>01.04   | 12.12<br>12.12<br>11.02<br>12.12<br>12.12<br>11.02<br>12.12<br>12.12<br>12.12  | + ABS<br>+ ABS<br>+ ABS<br>+ ABS<br>+ ABS<br>+ ABS<br>+ ABS<br>+ ABS  | 24.0108-0117.2<br>408117         |                  | mit Lager/ mit Sensorring <sup>8)</sup>                                    | 238 8,0 7,0 +B  |            |
|  | 1.4 16V<br>1.5 dCi<br>2.0 16V Sport<br>2.0 16V Sport   | 72<br>59<br>124<br>132   |  | 12.02<br>12.02<br>02.00<br>01.04  | 12.12<br>10.03<br>12.12<br>12.12   | + ESP<br>+ ESP  | 24.0108-0108.1<br>408108         |                  | ohne Sensorring <sup>9)</sup>  | 238 8,0 7,0 +B  |            |
|  | 1.2 16V<br>1.2 LPG<br>1.5 dCi<br>1.5 dCi<br>1.5 dCi<br>1.5 dCi<br>1.5 dCi<br>1.5 dCi<br>1.5 dCi<br>2.0 16V Sport<br>2.0 16V Sport                  | 55<br>43<br>47<br>48<br>50<br>59<br>60<br>62<br>74<br>124<br>132                             |  | 06.01<br>09.98<br>06.05<br>06.01<br>08.04<br>06.01<br>06.01<br>02.07<br>01.04<br>02.00<br>01.04                                     | 12.12<br>06.09<br>12.12<br>12.12<br>12.12<br>10.03<br>12.12<br>12.12<br>12.12<br>12.12<br>12.12  | + ESP<br>+ ESP<br><br>+ ESP<br>+ ESP<br>+ ESP<br>+ ESP<br>+ ESP   | 24.0741-1129.1<br>360164         |                  |  | Radsensor L=798                                       |            |

1) - ABS/ + manual transmission / - ABS/+ scatola camb.velocità / - ABS/ + transmission mécanique / - ABS/ + cambio de velocidad  
2) - ABS/ - air conditioning / - ABS/ - aria condizionata / - ABS/ - air conditionné / - ABS/ - aire acondicionado  
3) + ABS/ + manual transm. / + ABS/+ scatola camb.velocità / + ABS/ + transmission mécanique / + ABS/ + cambio de velocidad  
4) - ABS/ + autom.transmission / - ABS/ + scatola cambio autom. / - ABS/ + transmission automatique / - ABS/ + cambio automático  
5) + ABS/ + autom.transmission / + ABS/ + scatola cambio autom. / + ABS/ + transmission automatique / + ABS/ + cambio automático

6) + ABS/ - air conditioning / + ABS/ - aria condizionata / + ABS/ - air conditionné / + ABS/ - aire acondicionado  
7) + ABS/ + air conditioning / + ABS/ + aria condizionata / + ABS/ + air conditionné / + ABS/ + aire acondicionado  
8) with bearing/ with sensor ring / con supporto/+ anell.sens.ABS / avec palier de secours ABS / con apoyo/+ anillo sensor ABS  
9) without sensor ring / senza sensori / sans secours ABS / sin anillo sensor ABS



**RENAULT CLIO II Limousine (BB /CB\_) (98-12)**

|          |          |       |       |                                    |  |                |        |  |  |                          |  |  |  |
|----------|----------|-------|-------|------------------------------------|--|----------------|--------|--|--|--------------------------|--|--|--|
|          | 1.0      | 40    | 02.00 | 05.01                              | - ABS                                    | 03.0137-0358.2 | 650358 |  | 180 x 42 HEB<br>Bremsbacken-Zubehör              | <b>BDX</b><br><b>BDX</b> |  |  |  |
|          | 1.2      | 43    | 09.98 | 12.12                              | - ABS                                    | 03.0137-9088.2 | 669088 |  |  |                          |  |  |  |
|          | 1.2      | 44    | 03.99 | 05.01                              | - ABS                                    |                |        |  |  |                          |  |  |  |
|          | 1.2 16V  | 55    | 06.01 | 12.12                              | - ABS                                    |                |        |  |  |                          |  |  |  |
|          | 1.4      | 55    | 09.98 | 05.05                              | - ABS/ + Schaltgetriebe <sup>1)</sup>    |                |        |  |  |                          |  |  |  |
|          | 1.4      | 55    | 09.98 | 05.05                              | - ABS                                    |                |        |  |  |                          |  |  |  |
|          | 1.5 dCi  | 47    | 06.05 | 12.12                              | - ABS                                    |                |        |  |  |                          |  |  |  |
|          | 1.5 dCi  | 62    | 02.07 | 12.12                              | - ABS                                    |                |        |  |  |                          |  |  |  |
|          | 1.9 D    | 47    | 09.98 | 05.05                              | - ABS/ - Klimaanlage <sup>2)</sup>       |                |        |  |  |                          |  |  |  |
|          | 1.9 D    | 48    | 02.00 | 05.05                              | - ABS/ - Klimaanlage <sup>2)</sup>       |                |        |  |  |                          |  |  |  |
|          | 1.0      | 40    | 02.00 | 05.01                              | + ABS                                    | 03.0137-0423.2 | 650423 |  | 203 x 39 HEB<br>Bremsbacken-Zubehör              | <b>BOS</b><br><b>BOS</b> |  |  |  |
|          | 1.2      | 43    | 09.98 | 12.12                              | + ABS                                    | 03.0137-9274.2 | 669274 |  |  |                          |  |  |  |
|          | 1.2      | 44    | 03.99 | 05.01                              | + ABS                                    |                |        |  |  |                          |  |  |  |
|          | 1.2 16V  | 55    | 06.01 | 12.12                              | + ABS                                    |                |        |  |  |                          |  |  |  |
|          | 1.2 LPG  | 43    | 09.98 | 06.09                              |  |                |        |  |  |                          |  |  |  |
|          | 1.4      | 55    | 09.98 | 05.05                              | + ABS/ + Schaltgetriebe <sup>3)</sup>    |                |        |  |  |                          |  |  |  |
|          | 1.4      | 55    | 09.98 | 05.05                              | + ABS/ + Automatikgetriebe <sup>4)</sup> |                |        |  |  |                          |  |  |  |
|          | 1.4 16V  | 70    | 10.99 | 07.00                              |  |                |        |  |  |                          |  |  |  |
|          | 1.4 16V  | 72    | 08.00 | 12.12                              |  |                |        |  |  |                          |  |  |  |
|          | 1.5 dCi  | 47    | 06.05 | 12.12                              | + ABS                                    |                |        |  |  |                          |  |  |  |
|          | 1.5 dCi  | 48    | 06.01 | 12.12                              |  |                |        |  |  |                          |  |  |  |
|          | 1.5 dCi  | 50    | 08.04 | 12.12                              |  |                |        |  |  |                          |  |  |  |
|          | 1.5 dCi  | 59    | 06.01 | 10.03                              |  |                |        |  |  |                          |  |  |  |
|          | 1.5 dCi  | 60    | 06.01 | 12.12                              |  |                |        |  |  |                          |  |  |  |
|          | 1.5 dCi  | 62    | 02.07 | 12.12                              | + ABS                                    |                |        |  |  |                          |  |  |  |
|          | 1.5 dCi  | 74    | 01.04 | 12.12                              |  |                |        |  |  |                          |  |  |  |
|          | 1.6      | 66    | 09.98 | 05.05                              |  |                |        |  |  |                          |  |  |  |
|          | 1.6 16V  | 79    | 09.98 | 12.12                              |  |                |        |  |  |                          |  |  |  |
|          | 1.6 Flex | 81    | 05.00 | 12.06                              |  |                |        |  |  |                          |  |  |  |
| 1.9 D    | 47       | 09.98 | 05.05 | + ABS/ + Klimaanlage <sup>5)</sup> |  |                |        |  |  |                          |  |  |  |
| 1.9 D    | 48       | 02.00 | 05.05 | + ABS/ + Klimaanlage <sup>5)</sup> |  |                |        |  |  |                          |  |  |  |
| 1.9 dTi  | 59       | 02.00 | 05.05 |                                    |  |                |        |  |  |                          |  |  |  |
|          | 1.0      | 40    | 02.00 | 05.01                              | + ABS                                    | 03.0137-0312.2 | 650312 |  | 203 x 38 HEB<br>Bremsbacken-Zubehör              | <b>TRW</b><br><b>TRW</b> |  |  |  |
|          | 1.2      | 43    | 09.98 | 10.07                              | + ABS                                    | 03.0137-9158.2 | 669158 |  |  |                          |  |  |  |
|          | 1.2      | 44    | 03.99 | 05.01                              | + ABS                                    |                |        |  |  |                          |  |  |  |
|          | 1.2 16V  | 55    | 06.01 | 10.07                              | + ABS                                    |                |        |  |  |                          |  |  |  |
|          | 1.2 LPG  | 43    | 09.98 | 06.09                              |  |                |        |  |  |                          |  |  |  |
|          | 1.4      | 55    | 09.98 | 05.05                              | + ABS/ + Schaltgetriebe <sup>3)</sup>    |                |        |  |  |                          |  |  |  |
|          | 1.4      | 55    | 09.98 | 05.05                              | + ABS/ + Automatikgetriebe <sup>4)</sup> |                |        |  |  |                          |  |  |  |
|          | 1.4 16V  | 70    | 10.99 | 07.00                              |  |                |        |  |  |                          |  |  |  |
|          | 1.4 16V  | 72    | 08.00 | 10.07                              |  |                |        |  |  |                          |  |  |  |
|          | 1.5 dCi  | 47    | 06.05 | 10.07                              | + ABS                                    |                |        |  |  |                          |  |  |  |
|          | 1.5 dCi  | 48    | 06.01 | 10.07                              |  |                |        |  |  |                          |  |  |  |
|          | 1.5 dCi  | 50    | 08.04 | 10.07                              |  |                |        |  |  |                          |  |  |  |
|          | 1.5 dCi  | 59    | 06.01 | 10.03                              |  |                |        |  |  |                          |  |  |  |
|          | 1.5 dCi  | 60    | 06.01 | 10.07                              |  |                |        |  |  |                          |  |  |  |
| 1.5 dCi  | 62       | 02.07 | 10.07 | + ABS                              |  |                |        |  |  |                          |  |  |  |
| 1.5 dCi  | 74       | 01.04 | 10.07 |                                    |  |                |        |  |  |                          |  |  |  |
| 1.6      | 66       | 09.98 | 05.05 |                                    |  |                |        |  |  |                          |  |  |  |
| 1.6 16V  | 79       | 09.98 | 10.07 |                                    |  |                |        |  |  |                          |  |  |  |
| 1.6 Flex | 81       | 05.00 | 12.06 |                                    |  |                |        |  |  |                          |  |  |  |
| 1.9 D    | 47       | 09.98 | 05.05 | + ABS/ + Klimaanlage <sup>5)</sup> |  |                |        |  |  |                          |  |  |  |
| 1.9 D    | 48       | 02.00 | 05.05 | + ABS/ + Klimaanlage <sup>5)</sup> |  |                |        |  |  |                          |  |  |  |
| 1.9 dTi  | 59       | 02.00 | 05.05 |                                    |  |                |        |  |  |                          |  |  |  |
|          | 1.2      | 43    | 11.07 | 12.12                              | + ABS                                    | 03.0137-0498.2 | 650498 |  | 203 x 38 HEB<br>Bremsbacken-Zubehör              | <b>TRW</b><br><b>TRW</b> |  |  |  |
|          | 1.2 16V  | 55    | 11.07 | 12.12                              | + ABS                                    | 03.0137-9278.2 | 669278 |  |  |                          |  |  |  |
|          | 1.4 16V  | 72    | 11.07 | 12.12                              |  |                |        |  |  |                          |  |  |  |
|          | 1.5 dCi  | 47    | 11.07 | 12.12                              | + ABS                                    |                |        |  |  |                          |  |  |  |
|          | 1.5 dCi  | 48    | 11.07 | 12.12                              |  |                |        |  |  |                          |  |  |  |
|          | 1.5 dCi  | 50    | 11.07 | 12.12                              |  |                |        |  |  |                          |  |  |  |
|          | 1.5 dCi  | 60    | 11.07 | 12.12                              |  |                |        |  |  |                          |  |  |  |
|          | 1.5 dCi  | 62    | 11.07 | 12.12                              | + ABS                                    |                |        |  |  |                          |  |  |  |
| 1.5 dCi  | 74       | 11.07 | 12.12 |                                    |  |                |        |  |  |                          |  |  |  |
| 1.6 16V  | 79       | 11.07 | 12.12 |                                    |  |                |        |  |  |                          |  |  |  |
|          | 1.0      | 40    | 02.00 | 05.01                              | - ABS                                    | 24.0218-0032.1 | 480118 |  | 180/181 x 53,5 - Lager<br>180/181 x 53,2 + Lager |                          |  |  |  |
|          | 1.2      | 43    | 09.98 | 12.12                              | - ABS                                    | 24.0218-0732.2 | 480207 |  |  |                          |  |  |  |
|          | 1.2      | 44    | 03.99 | 05.01                              | - ABS                                    |                |        |  |  |                          |  |  |  |
|          | 1.2 16V  | 55    | 06.01 | 12.12                              | - ABS                                    |                |        |  |  |                          |  |  |  |
|          | 1.2 LPG  | 43    | 09.98 | 06.09                              | - ABS                                    |                |        |  |  |                          |  |  |  |
|          | 1.4      | 55    | 09.98 | 05.05                              | - ABS/ + Schaltgetriebe <sup>1)</sup>    |                |        |  |  |                          |  |  |  |
|          | 1.4      | 55    | 09.98 | 05.05                              | - ABS                                    |                |        |  |  |                          |  |  |  |
|          | 1.5 dCi  | 47    | 06.05 | 12.12                              | - ABS                                    |                |        |  |  |                          |  |  |  |
|          | 1.5 dCi  | 62    | 02.07 | 12.12                              | - ABS                                    |                |        |  |  |                          |  |  |  |
|          | 1.9 D    | 47    | 09.98 | 05.05                              | - ABS/ - Klimaanlage <sup>2)</sup>       |                |        |  |  |                          |  |  |  |
| 1.9 D    | 48       | 02.00 | 05.05 | - ABS/ - Klimaanlage <sup>2)</sup> |  |                |        |  |  |                          |  |  |  |
|          | 1.0      | 40    | 02.00 | 05.01                              | + ABS                                    | 24.0220-3021.1 | 480127 |  | 203/204,5 x 48 - Lager                           |                          |  |  |  |
|          | 1.2      | 43    | 09.98 | 11.02                              | + ABS                                    |                |        |  |  |                          |  |  |  |
|          | 1.2      | 44    | 03.99 | 05.01                              | + ABS                                    |                |        |  |  |                          |  |  |  |
|          | 1.2 16V  | 55    | 06.01 | 11.02                              | + ABS                                    |                |        |  |  |                          |  |  |  |
|          | 1.2 LPG  | 43    | 09.98 | 11.02                              | + ABS                                    |                |        |  |  |                          |  |  |  |
|          | 1.4      | 55    | 09.98 | 11.02                              | + ABS/ + Schaltgetriebe <sup>3)</sup>    |                |        |  |  |                          |  |  |  |
|          | 1.4      | 55    | 09.98 | 11.02                              | + ABS/ + Automatikgetriebe <sup>4)</sup> |                |        |  |  |                          |  |  |  |
|          | 1.4 16V  | 70    | 10.99 | 07.00                              |  |                |        |  |  |                          |  |  |  |
|          | 1.4 16V  | 72    | 08.00 | 11.02                              |  |                |        |  |  |                          |  |  |  |
|          | 1.5 dCi  | 48    | 06.01 | 11.02                              |  |                |        |  |  |                          |  |  |  |
|          | 1.5 dCi  | 59    | 06.01 | 11.02                              |  |                |        |  |  |                          |  |  |  |
|          | 1.5 dCi  | 60    | 06.01 | 11.02                              |  |                |        |  |  |                          |  |  |  |
|          | ↓        |       |       |                                    |  |                |        |  |  |                          |  |  |  |
|          | ↓        |       |       |                                    |  |                |        |  |  |                          |  |  |  |

1) - ABS/ + manual transmission / - ABS/ + scatola camb.velocità / - ABS/ + transmission mécanique / - ABS/ + cambio de velocidad  
2) - ABS/ - air conditioning / - ABS/ - aria condizionata / - ABS/ - air conditionné / - ABS/ - aire acondicionado  
3) + ABS/ + manual transm. / + ABS/+ scatola camb.velocità / + ABS/ + transmission mécanique / + ABS/ + cambio de velocidad  
4) + ABS/ + autom.transmission / + ABS/ + scatola cambio autom. / + ABS/ + transmission automatique / + ABS/ + cambio automático  
5) + ABS/ + air conditioning / + ABS/ + aria condizionata / + ABS/ + air conditionné / + ABS/ + aire acondicionado



### RENAULT CLIO II Limousine (BB\_/CB\_) (98-12)

|          |          |       |                               |                                     |                |        |  |                         |                |        |  |                         |
|----------|----------|-------|-------------------------------|-------------------------------------|----------------|--------|--|-------------------------|----------------|--------|--|-------------------------|
|          | 1.6      | 66    | 09.98                         | 11.02                               | 24.0220-3021.1 | 480127 |  | 203/204,5 x 48 - Lager  |                |        |  |                         |
|          | 1.6 16V  | 79    | 09.98                         | 11.02                               |                |        |  |                         |                |        |  |                         |
|          | 1.6 Flex | 81    | 05.00                         | 11.02                               |                |        |  |                         |                |        |  |                         |
|          | 1.9 D    | 47    | 09.98                         | 11.02 + ABS/ + Klimaanlage 1)       |                |        |  |                         |                |        |  |                         |
|          | 1.9 D    | 48    | 02.00                         | 11.02 + ABS/ + Klimaanlage 1)       |                |        |  |                         |                |        |  |                         |
|          | 1.9 dTi  | 59    | 02.00                         | 11.02                               |                |        |  |                         |                |        |  |                         |
|          | 1.2      | 43    | 12.02                         | 01.04 + ABS                         |                |        |  |                         |                |        |  |                         |
|          | 1.2 16V  | 55    | 12.02                         | 01.04 + ABS                         |                |        |  |                         |                |        |  |                         |
|          | 1.2 LPG  | 43    | 12.02                         | 06.09 + ABS                         |                |        |  |                         |                |        |  |                         |
|          | 1.4      | 55    | 12.02                         | 01.04 + ABS/ + Schaltgetriebe 2)    |                |        |  |                         |                |        |  |                         |
|          | 1.4      | 55    | 12.02                         | 01.04 + ABS/ + Automatikgetriebe 3) |                |        |  |                         |                |        |  |                         |
|          | 1.4 16V  | 72    | 12.02                         | 01.04                               |                |        |  |                         |                |        |  |                         |
|          | 1.5 dCi  | 48    | 12.02                         | 01.04                               |                |        |  |                         |                |        |  |                         |
|          | 1.5 dCi  | 59    | 12.02                         | 01.04                               |                |        |  |                         |                |        |  |                         |
|          | 1.5 dCi  | 60    | 12.02                         | 01.04                               |                |        |  |                         |                |        |  |                         |
| 1.6      | 66       | 12.02 | 01.04                         |                                     |                |        |  |                         |                |        |  |                         |
| 1.6 16V  | 79       | 12.02 | 01.04                         |                                     |                |        |  |                         |                |        |  |                         |
| 1.6 Flex | 81       | 12.02 | 01.04                         |                                     |                |        |  |                         |                |        |  |                         |
| 1.9 D    | 47       | 12.02 | 01.04 + ABS/ + Klimaanlage 1) |                                     |                |        |  |                         |                |        |  |                         |
| 1.9 D    | 48       | 12.02 | 01.04 + ABS/ + Klimaanlage 1) |                                     |                |        |  |                         |                |        |  |                         |
| 1.9 dTi  | 59       | 12.02 | 01.04                         |                                     |                |        |  |                         |                |        |  |                         |
|          | 1.0      | 40    | 02.00                         | 05.01 - ABS                         | 03.0520-4719.3 | 694719 |  | 19,05/180x42 TopKit BDX |                |        |  |                         |
|          | 1.2      | 43    | 09.98                         | 12.12 - ABS                         |                |        |  |                         |                |        |  |                         |
|          | 1.2      | 44    | 03.99                         | 05.01 - ABS                         |                |        |  |                         |                |        |  |                         |
|          | 1.2 16V  | 55    | 06.01                         | 12.12 - ABS                         |                |        |  |                         |                |        |  |                         |
|          | 1.2 LPG  | 43    | 09.98                         | 06.09 - ABS                         |                |        |  |                         |                |        |  |                         |
|          | 1.4      | 55    | 09.98                         | 05.05 - ABS/ + Schaltgetriebe 4)    |                |        |  |                         |                |        |  |                         |
|          | 1.4      | 55    | 09.98                         | 05.05 - ABS                         |                |        |  |                         |                |        |  |                         |
|          | 1.5 dCi  | 47    | 06.05                         | 12.12 - ABS                         |                |        |  |                         |                |        |  |                         |
|          | 1.5 dCi  | 62    | 02.07                         | 12.12 - ABS                         |                |        |  |                         |                |        |  |                         |
|          | 1.9 D    | 47    | 09.98                         | 05.05 - ABS/ - Klimaanlage 5)       |                |        |  |                         |                |        |  |                         |
|          | 1.9 D    | 48    | 02.00                         | 05.05 - ABS/ - Klimaanlage 5)       |                |        |  |                         |                |        |  |                         |
|          | 1.0      | 40    | 02.00                         | 05.01 + ABS                         |                |        |  |                         | 03.0520-3817.3 | 693817 |  | 17,46/203x39 TopKit BOS |
|          | 1.2      | 43    | 09.98                         | 10.07 + ABS                         |                |        |  |                         |                |        |  |                         |
|          | 1.2      | 44    | 03.99                         | 05.01 + ABS                         |                |        |  |                         |                |        |  |                         |
|          | 1.2 16V  | 55    | 06.01                         | 10.07 + ABS                         |                |        |  |                         |                |        |  |                         |
|          | 1.2 LPG  | 43    | 09.98                         | 10.07 + ABS                         |                |        |  |                         |                |        |  |                         |
|          | 1.4      | 55    | 09.98                         | 05.05 + ABS/ + Schaltgetriebe 2)    |                |        |  |                         |                |        |  |                         |
|          | 1.4      | 55    | 09.98                         | 05.05 + ABS/ + Automatikgetriebe 3) |                |        |  |                         |                |        |  |                         |
|          | 1.4 16V  | 70    | 10.99                         | 07.00                               |                |        |  |                         |                |        |  |                         |
|          | 1.4 16V  | 72    | 08.00                         | 10.07                               |                |        |  |                         |                |        |  |                         |
|          | 1.5 dCi  | 47    | 06.05                         | 10.07 + ABS                         |                |        |  |                         |                |        |  |                         |
|          | 1.5 dCi  | 48    | 06.01                         | 10.07                               |                |        |  |                         |                |        |  |                         |
|          | 1.5 dCi  | 50    | 08.04                         | 10.07                               |                |        |  |                         |                |        |  |                         |
|          | 1.5 dCi  | 59    | 06.01                         | 10.03                               |                |        |  |                         |                |        |  |                         |
|          | 1.5 dCi  | 60    | 06.01                         | 10.07                               |                |        |  |                         |                |        |  |                         |
|          | 1.5 dCi  | 62    | 02.07                         | 10.07 + ABS                         |                |        |  |                         |                |        |  |                         |
|          | 1.5 dCi  | 74    | 01.04                         | 10.07                               |                |        |  |                         |                |        |  |                         |
| 1.6      | 66       | 09.98 | 05.05                         |                                     |                |        |  |                         |                |        |  |                         |
| 1.6 16V  | 79       | 09.98 | 10.07                         |                                     |                |        |  |                         |                |        |  |                         |
| 1.6 Flex | 81       | 05.00 | 12.06                         |                                     |                |        |  |                         |                |        |  |                         |
| 1.9 D    | 47       | 09.98 | 05.05 + ABS/ + Klimaanlage 1) |                                     |                |        |  |                         |                |        |  |                         |
| 1.9 D    | 48       | 02.00 | 05.05 + ABS/ + Klimaanlage 1) |                                     |                |        |  |                         |                |        |  |                         |
| 1.9 dTi  | 59       | 02.00 | 05.05                         |                                     |                |        |  |                         |                |        |  |                         |
|          | 1.2      | 43    | 11.07                         | 12.12 + ABS                         | 03.0520-4717.3 | 694717 |  | 17,46/203x38 TopKit     |                |        |  |                         |
|          | 1.2 16V  | 55    | 11.07                         | 12.12 + ABS                         |                |        |  |                         |                |        |  |                         |
|          | 1.2 LPG  | 43    | 11.07                         | 06.09 + ABS                         |                |        |  |                         |                |        |  |                         |
|          | 1.4 16V  | 72    | 11.07                         | 12.12                               |                |        |  |                         |                |        |  |                         |
|          | 1.5 dCi  | 47    | 11.07                         | 12.12 + ABS                         |                |        |  |                         |                |        |  |                         |
|          | 1.5 dCi  | 48    | 11.07                         | 12.12                               |                |        |  |                         |                |        |  |                         |
|          | 1.5 dCi  | 50    | 11.07                         | 12.12                               |                |        |  |                         |                |        |  |                         |
|          | 1.5 dCi  | 60    | 11.07                         | 12.12                               |                |        |  |                         |                |        |  |                         |
|          | 1.5 dCi  | 62    | 11.07                         | 12.12 + ABS                         |                |        |  |                         |                |        |  |                         |
|          | 1.5 dCi  | 74    | 11.07                         | 12.12                               |                |        |  |                         |                |        |  |                         |
|          | 1.6      | 66    | 11.07                         | 12.12                               |                |        |  |                         |                |        |  |                         |
|          | 1.6 16V  | 79    | 11.07                         | 12.12                               |                |        |  |                         |                |        |  |                         |

### RENAULT CLIO II Kasten (SB\_) (98-12)

|            |            |     |       |             |                |        |  |                       |                |                |        |  |                     |        |  |                       |
|------------|------------|-----|-------|-------------|----------------|--------|--|-----------------------|----------------|----------------|--------|--|---------------------|--------|--|-----------------------|
|            | 1.2        | 43  | 09.98 | 12.12       | 13.0460-2834.2 | 602834 |  | 21463 18,0 /WK/S TRW  |                |                |        |  |                     |        |  |                       |
|            | 1.2        | 44  | 03.99 | 10.03       |                |        |  |                       |                |                |        |  |                     |        |  |                       |
|            | 1.5 dCi    | 48  | 06.01 | 12.12       |                |        |  |                       |                |                |        |  |                     |        |  |                       |
|            | 1.5 dCi    | 59  | 06.01 | 10.04       |                |        |  |                       |                |                |        |  |                     |        |  |                       |
|            | 1.5 dCi    | 60  | 11.03 | 12.12       |                |        |  |                       |                |                |        |  |                     |        |  |                       |
|            | 1.9 D      | 40  | 03.99 | 01.00       |                |        |  |                       |                |                |        |  |                     |        |  |                       |
|            | 1.9 D      | 47  | 09.98 | 12.12       |                |        |  |                       |                |                |        |  |                     |        |  |                       |
|            | 1.9 D (SB) | 48  | 02.00 | 05.01       |                |        |  |                       |                |                |        |  |                     |        |  |                       |
|            | 1.9 dTi    | 59  | 02.00 | 05.01       |                |        |  |                       |                |                |        |  |                     |        |  |                       |
|            |            | 1.2 | 43    | 09.98       |                |        |  |                       | 12.12 - ABS    | 24.0112-0116.1 | 412116 |  | 238 12,0 10,5 +S +B |        |  |                       |
| 1.2        |            | 44  | 03.99 | 10.03 - ABS |                |        |  |                       |                |                |        |  |                     |        |  |                       |
| 1.2        |            | 43  | 09.98 | 12.12 + ABS | 24.0120-0125.1 | 420125 |  | 238 20,1 17,7 V +S +B |                |                |        |  |                     |        |  |                       |
| 1.9 D      |            | 40  | 03.99 | 01.00       |                |        |  |                       |                |                |        |  |                     |        |  |                       |
| 1.9 D      |            | 47  | 09.98 | 12.12       |                |        |  |                       |                |                |        |  |                     |        |  |                       |
| 1.9 D (SB) |            | 48  | 02.00 | 05.01 - ABS |                |        |  |                       |                |                |        |  |                     |        |  |                       |
| 1.5 dCi    |            | 48  | 06.01 | 12.12       |                |        |  |                       | 24.0121-0106.1 |                |        |  |                     | 421106 |  | 259 20,6 17,7 V +S +B |
| 1.5 dCi    |            | 59  | 06.01 | 10.04       |                |        |  |                       |                |                |        |  |                     |        |  |                       |
| 1.5 dCi    |            | 60  | 11.03 | 12.12       |                |        |  |                       |                |                |        |  |                     |        |  |                       |
| 1.9 D (SB) |            | 48  | 02.00 | 05.01 + ABS |                |        |  |                       |                |                |        |  |                     |        |  |                       |

1) + ABS/ + air conditioning / + ABS/ + aria condizionata / + ABS/ + air conditionné / + ABS/ + aire acondicionado

















2) + ABS/ + manual transm. / + ABS/+ scatola camb.velocità / + ABS/ + transmission mécanique / + ABS/ + cambio de velocidad

3) + ABS/ + autom.transmission / + ABS/ + scatola cambio autom. / + ABS/ + transmission automatique / + ABS/ + cambio automático















4) - ABS/ + manual transmission / - ABS/+ scatola camb.velocità / - ABS/ + transmission mécanique / - ABS/ + cambio de velocidad

5) - ABS/ - air conditioning / - ABS/ - aria condizionata / - ABS/ - air conditionné / - ABS/ - aire acondicionado











|     |  |  |  |  |  |  |  |  |                                |
|--|--|--|--|--|---|--|--|--|--------------------------------|
| <b>RENAULT CLIO II Kasten (SB_) (98-12)</b>  |  |  |  |  |   |  |  |  |                                |
|    | 1.9 dTi  | 59   |  | 02.00  | 05.01   |  | 24.0121-0106.1   | 421106   | 259 20,6 17,7 V +S +B          |
|    | 1.5 dCi  | 48   |  | 06.01  | 12.12   | + ESP  | 24.0741-1129.1   | 360164   | Radsensor L=798                |
|  | 1.5 dCi  | 59   |  | 06.01  | 10.04   | + ESP  |  |  |                                |
|  | 1.5 dCi  | 60   |  | 11.03  | 12.12   | + ESP  |  |  |                                |
|  | 1.9 D (SB)   | 48   |  | 02.00  | 05.01   | + ESP  |  |  |                                |
|    | 1.2  | 43   |  | 09.98  | 12.12   | - ABS  | 03.0137-0358.2   | 650358   | 180 x 42 HEB <b>BDX</b>        |
|  | 1.9 D (SJ)   | 47   |  | 09.98  | 12.12   |  | 03.0137-9088.2   | 669088   | Bremsbacken-Zubehör <b>BDX</b> |
|  | 1.2  | 43   |  | 09.98  | 12.12   | + ABS  | 03.0137-0312.2   | 650312   | 203 x 38 HEB <b>TRW</b>        |
|  | 1.5 dCi  | 48   |  | 06.01  | 12.12   |  | 03.0137-9158.2   | 669158   | Bremsbacken-Zubehör <b>TRW</b> |
|  | 1.5 dCi  | 59   |  | 06.01  | 10.04   |  | 03.0137-0423.2   | 650423   | 203 x 39 HEB <b>BOS</b>        |
|  | 1.5 dCi  | 60   |  | 11.03  | 12.12   |  | 03.0137-9274.2   | 669274   | Bremsbacken-Zubehör <b>BOS</b> |
|  | 1.9 D  | 40   |  | 03.99  | 01.00   |  |  |  |                                |
|  | 1.9 D  | 47   |  | 09.98  | 12.12   |  |  |  |                                |
|  | 1.9 D (SB)   | 48   |  | 02.00  | 05.01   |  |  |  |                                |
|  | 1.9 dTi  | 59   |  | 02.00  | 05.01   |  |  |  |                                |
|    | 1.2  | 43   |  | 09.98  | 12.12   | - ABS  | 24.0218-0032.1   | 480118   | 180/181 x 53,5 - Lager         |
|  | 1.9 D (SJ)   | 47   |  | 09.98  | 12.12   |  | 24.0218-0732.2   | 480207   | 180/181 x 53,2 + Lager         |
|  | 1.2  | 43   |  | 09.98  | 12.12   | + ABS  | 24.0220-3021.1   | 480127   | 203/204,5 x 48 - Lager         |
|  | 1.5 dCi  | 48   |  | 06.01  | 12.12   |  |  |  |                                |
|  | 1.5 dCi  | 59   |  | 06.01  | 10.04   |  |  |  |                                |
|  | 1.5 dCi  | 60   |  | 11.03  | 12.12   |  |  |  |                                |
|  | 1.9 D  | 40   |  | 03.99  | 01.00   |  |  |  |                                |
|  | 1.9 D  | 47   |  | 09.98  | 12.12   |  |  |  |                                |
|  | 1.9 D (SB)   | 48   |  | 02.00  | 05.01   |  |  |  |                                |
|  | 1.9 dTi  | 59   |  | 02.00  | 05.01   |  |  |  |                                |
|    | 1.2  | 43   |  | 09.98  | 06.05   | - ABS  | 03.0520-4719.3   | 694719   | 19,05/180x42 TopKit <b>BDX</b> |
|  | 1.9 D (SJ)   | 47   |  | 09.98  | 06.05   |  |  |  |                                |
|  | 1.2  | 43   |  | 09.98  | 06.05   | + ABS  | 03.0520-3817.3   | 693817   | 17,46/203x39 TopKit <b>BOS</b> |
|  | 1.5 dCi  | 48   |  | 06.01  | 06.05   |  | 03.0520-3517.3   | 693517   | 17,78/203x39 TopKit <b>TRW</b> |
|  | 1.5 dCi  | 59   |  | 06.01  | 10.04   |  |  |  |                                |
|  | 1.5 dCi  | 60   |  | 11.03  | 09.05   |  |  |  |                                |
|  | 1.9 D  | 40   |  | 03.99  | 01.00   |  |  |  |                                |
|  | 1.9 D  | 47   |  | 09.98  | 06.05   |  |  |  |                                |
|  | 1.9 D (SB)   | 48   |  | 02.00  | 05.01   |  |  |  |                                |
|  | 1.9 dTi  | 59   |  | 02.00  | 06.05   |  |  |  |                                |
| <b>RENAULT CLIO III (BR_/CR_) (05-12)</b>  |  |  |  |  |   |  |  |  |                                |
|  | 1.2 16V  | 43   |  | 06.06  | 12.12   |  | 13.0460-2709.2   | 602709   | 23973 17,4 /Zub/S <b>TRW</b>   |
|  | 1.2 16V  | 48   |  | 06.05  | 12.12   |  | 13.0470-2709.2   | LD2709   | 23973 17,4 /Zub/S <b>TRW</b>   |
|  | 1.2 16V  | 55   |  | 06.05  | 12.12   |  |  |  |                                |
|  | 1.2 16V  | 58   |  | 06.05  | 12.12   |  |  |  |                                |
|  | 1.2 16V  | 74   |  | 05.07  | 12.12   |  |  |  |                                |
|  | 1.2 16V  | 76   |  | 09.10  | 12.12   |  |  |  |                                |
|  | 1.2 16V Hi-Flex  | 55   |  | 07.08  | 12.12   |  |  |  |                                |
|  | 1.4 16V  | 72   |  | 06.05  | 12.12   |  |  |  |                                |
|  | 1.5 dCi  | 47   |  | 06.05  | 12.12   |  |  |  |                                |
|  | 1.5 dCi  | 48   |  | 05.05  | 10.06   |  |  |  |                                |
|  | 1.5 dCi  | 50   |  | 06.05  | 12.12   |  |  |  |                                |
|  | 1.5 dCi  | 55   |  | 08.10  | 12.12   |  |  |  |                                |
|  | 1.5 dCi  | 60   |  | 11.07  | 12.12   |  |  |  |                                |
|  | 1.5 dCi  | 63   |  | 06.05  | 12.12   |  |  |  |                                |
|  | 1.5 dCi  | 65   |  | 08.10  | 12.12   |  |  |  |                                |
|  | 1.5 dCi  | 76   |  | 06.05  | 12.12   |  |  |  |                                |
|  | 1.5 dCi  | 78   |  | 06.05  | 12.12   |  |  |  |                                |
|  | 1.6 16V  | 65   |  | 06.05  | 12.12   |  |  |  |                                |
|  | 1.6 16V  | 82   |  | 06.05  | 12.12   |  |  |  |                                |
|  | 1.6 16V GT   | 94   |  | 04.09  | 12.12   |  |  |  |                                |
|  | 1.6 Hi-Flex  | 86   |  | 05.05  | 02.10   |  |  |  |                                |
|  | 2.0 16V  | 102  |  | 09.06  | 12.12   |  | 13.0460-7221.2   | 607221   | 24535 18,3 + <b>ATE</b>        |
|  | 2.0 16V  | 110  |  | 11.07  | 12.12   |  | 13.0470-7221.2   | LD7221   | 24535 18,3 + <b>ATE</b>        |
|  | 2.0 16V Sport  | 145  |  | 02.06  | 12.12   |  | 13.0460-4805.2   | 604805   | 24162 15,2 <b>BRE</b>          |
|  | 2.0 16V Sport  | 148  |  | 04.09  | 12.12   |  |  |  |                                |
|  | 1.2 16V  | 43   |  | 06.06  | 12.12   |  | 24.0122-0216.1   | 422216   | 260 22,0 19,8 VL +S +B         |
|  | 1.2 16V  | 48   |  | 06.05  | 12.12   |  |  |  |                                |
|  | 1.2 16V  | 55   |  | 06.05  | 12.12   |  |  |  |                                |
|  | 1.2 16V  | 58   |  | 06.05  | 12.12   |  |  |  |                                |
|  | 1.2 16V  | 74   |  | 05.07  | 12.12   |  |  |  |                                |
|  | 1.2 16V  | 76   |  | 09.10  | 12.12   |  |  |  |                                |
|  | 1.2 16V Hi-Flex  | 55   |  | 07.08  | 12.12   |  |  |  |                                |
|  | 1.4 16V  | 72   |  | 06.05  | 12.12   |  |  |  |                                |
|  | 1.5 dCi  | 47   |  | 06.05  | 12.12   |  |  |  |                                |
|  | 1.5 dCi  | 48   |  | 05.05  | 10.06   |  |  |  |                                |
|  | 1.5 dCi  | 50   |  | 06.05  | 12.12   |  |  |  |                                |
|  | 1.5 dCi  | 55   |  | 08.10  | 12.12   |  |  |  |                                |
|  | 1.5 dCi  | 60   |  | 11.07  | 12.12   |  |  |  |                                |
|  | 1.5 dCi  | 63   |  | 06.05  | 12.12   |  |  |  |                                |
|  | 1.5 dCi  | 65   |  | 08.10  | 12.12   |  |  |  |                                |
|  | 1.5 dCi  | 76   |  | 06.05  | 12.12   |  |  |  |                                |
|  | 1.5 dCi  | 78   |  | 06.05  | 12.12   |  |  |  |                                |
|  | 1.6 16V  | 65   |  | 06.05  | 12.12   |  |  |  |                                |
|  | 1.6 16V  | 82   |  | 06.05  | 12.12   |  |  |  |                                |
|  | 1.6 16V GT   | 94   |  | 04.09  | 12.12   |  |  |  |                                |
|  | 1.6 Hi-Flex  | 86   |  | 05.05  | 02.10   |  |  |  |                                |































|     |  |  |  |  |  |  |  |  |
|--|--|--|--|--|---|--|--|--|
| <b>RENAULT CLIO III (BR_/CR_) (05-12)</b>  |  |  |  |  |   |  |  |  |
|    | 2.0 16V  | 102  |  | 09.06  | 12.12   | 24.0124-0158.1   | 424158   | 280 24,0 21,8 V L +S +B  |
|  | 2.0 16V  | 110  |  | 11.07  | 12.12   | 24.0324-0158.1   | 524158   | 280 24,0 21,8 V L +S +B PD   |
|  | 2.0 16V Sport  | 145  |  | 02.06  | 12.12   | 24.0128-0223.1   | 428223   | 313 28,0 26,0 V L +S +B  |
|  | 2.0 16V Sport  | 148  |  | 04.09  | 12.12   |  |  |  |
|    | 1.2 16V  | 43   |  | 06.06  | 12.12   | 13.0460-2845.2   | 602845   | 23554 16,4 /Zub/S TRW  |
|  | 1.2 16V  | 48   |  | 06.05  | 12.12   | 13.0470-2845.2   | LD2845   | 23554 16,4 /Zub/S TRW  |
|  | 1.2 16V  | 55   |  | 06.05  | 12.12   |  |  |  |
|  | 1.2 16V  | 58   |  | 06.05  | 12.12   |  |  |  |
|  | 1.2 16V  | 74   |  | 05.07  | 12.12   |  |  |  |
|  | 1.2 16V  | 76   |  | 09.10  | 12.12   |  |  |  |
|  | 1.2 16V Hi-Flex  | 55   |  | 07.08  | 12.12   |  |  |  |
|  | 1.4 16V  | 72   |  | 06.05  | 12.12   |  |  |  |
|  | 1.5 dCi  | 48   |  | 05.05  | 10.06   |  |  |  |
|  | 1.5 dCi  | 50   |  | 06.05  | 12.12   |  |  |  |
|  | 1.5 dCi  | 55   |  | 08.10  | 12.12   |  |  |  |
|  | 1.5 dCi  | 60   |  | 11.07  | 12.12   |  |  |  |
|  | 1.5 dCi  | 63   |  | 06.05  | 12.12   |  |  |  |
|  | 1.5 dCi  | 65   |  | 08.10  | 12.12   |  |  |  |
|  | 1.5 dCi  | 76   |  | 06.05  | 12.12   |  |  |  |
|  | 1.5 dCi  | 78   |  | 06.05  | 12.12   |  |  |  |
|  | 1.6 16V  | 65   |  | 06.05  | 12.12   |  |  |  |
|  | 1.6 16V  | 82   |  | 06.05  | 12.12   |  |  |  |
|  | 1.6 16V GT   | 94   |  | 04.09  | 12.12   |  |  |  |
|  | 1.6 Hi-Flex  | 86   |  | 05.05  | 02.10   |  |  |  |
| 2.0 16V  | 102  |  | 09.06  | 12.12  |   |  |  |  |
|    | 1.2 16V  | 43   |  | 06.06  | 12.12   | 24.0108-0114.2   | 408114   | mit Lager/ mit Sensorring <sup>1)</sup> 240 8,0 7,0 +B                             |
|  | 1.2 16V  | 48   |  | 06.05  | 12.12   |  |  |  |
|  | 1.2 16V  | 55   |  | 06.05  | 12.12   |  |  |  |
|  | 1.2 16V  | 58   |  | 06.05  | 12.12   |  |  |  |
|  | 1.2 16V  | 74   |  | 05.07  | 12.12   |  |  |  |
|  | 1.2 16V  | 76   |  | 09.10  | 12.12   |  |  |  |
|  | 1.2 16V Hi-Flex  | 55   |  | 07.08  | 12.12   |  |  |  |
|  | 1.4 16V  | 72   |  | 06.05  | 12.12   |  |  |  |
|  | 1.5 dCi  | 48   |  | 05.05  | 10.06   |  |  |  |
|  | 1.5 dCi  | 50   |  | 06.05  | 12.12   |  |  |  |
|  | 1.5 dCi  | 55   |  | 08.10  | 12.12   |  |  |  |
|  | 1.5 dCi  | 60   |  | 11.07  | 12.12   |  |  |  |
|  | 1.5 dCi  | 63   |  | 06.05  | 12.12   |  |  |  |
|  | 1.5 dCi  | 65   |  | 08.10  | 12.12   |  |  |  |
|  | 1.5 dCi  | 76   |  | 06.05  | 12.12   |  |  |  |
|  | 1.5 dCi  | 78   |  | 06.05  | 12.12   |  |  |  |
|  | 1.6 16V  | 65   |  | 06.05  | 12.12   |  |  |  |
|  | 1.6 16V  | 82   |  | 06.05  | 12.12   |  |  |  |
|  | 1.6 16V GT   | 94   |  | 04.09  | 12.12   |  |  |  |
|  | 1.6 Hi-Flex  | 86   |  | 05.05  | 02.10   |  |  |  |
| 2.0 16V  | 102  |  | 09.06  | 12.12  |   |  |  |  |
|  | 2.0 16V Sport  | 145  |  | 02.06  | 12.12   | 24.0111-0183.2   | 411183   | mit Lager/ mit Sensorring <sup>1)</sup> 300 11,0 9,5 +B                            |
|  | 2.0 16V Sport  | 148  |  | 04.09  | 12.12   |  |  |  |
|  | 1.2 16V  | 43   |  | 06.06  | 12.12   | 03.0137-0454.2   | 650454   | 203 x 38 HEB   |
|  | 1.2 16V  | 48   |  | 06.05  | 12.12   | 03.0137-9280.2   | 669280   | Bremsbacken-Zubehör  |
|  | 1.2 16V  | 55   |  | 06.05  | 12.12   |  |  |  |
|  | 1.2 16V  | 58   |  | 06.05  | 12.12   |  |  |  |
|  | 1.2 16V  | 74   |  | 05.07  | 12.12   |  |  |  |
|  | 1.2 16V  | 76   |  | 09.10  | 12.12   |  |  |  |
|  | 1.2 16V Hi-Flex  | 55   |  | 07.08  | 12.12   |  |  |  |
|  | 1.4 16V  | 72   |  | 06.05  | 12.12   |  |  |  |
|  | 1.5 dCi  | 48   |  | 05.05  | 10.06   |  |  |  |
|  | 1.5 dCi  | 50   |  | 06.05  | 12.12   |  |  |  |
|  | 1.5 dCi  | 55   |  | 08.10  | 12.12   |  |  |  |
|  | 1.5 dCi  | 60   |  | 11.07  | 12.12   |  |  |  |
|  | 1.5 dCi  | 63   |  | 06.05  | 12.12   |  |  |  |
|  | 1.5 dCi  | 65   |  | 08.10  | 12.12   |  |  |  |
|  | 1.5 dCi  | 76   |  | 06.05  | 12.12   |  |  |  |
|  | 1.2 16V  | 43   |  | 06.06  | 12.12   | 24.0220-3033.1   | 480195   | ohne Sensorring <sup>2)</sup> 203/204,5 x 50,5                                     |
|  | 1.2 16V  | 48   |  | 06.05  | 12.12   |  |  |  |
|  | 1.2 16V  | 55   |  | 06.05  | 12.12   |  |  |  |
|  | 1.2 16V  | 58   |  | 06.05  | 12.12   |  |  |  |
|  | 1.2 16V  | 74   |  | 05.07  | 12.12   |  |  |  |
|  | 1.2 16V  | 76   |  | 09.10  | 12.12   |  |  |  |
|  | 1.2 16V Hi-Flex  | 55   |  | 07.08  | 12.12   |  |  |  |
|  | 1.4 16V  | 72   |  | 06.05  | 12.12   |  |  |  |
|  | 1.5 dCi  | 48   |  | 05.05  | 10.06   |  |  |  |
|  | 1.5 dCi  | 50   |  | 06.05  | 12.12   |  |  |  |
|  | 1.5 dCi  | 55   |  | 08.10  | 12.12   |  |  |  |
|  | 1.5 dCi  | 60   |  | 11.07  | 12.12   |  |  |  |
|  | 1.5 dCi  | 63   |  | 06.05  | 12.12   |  |  |  |
|  | 1.5 dCi  | 65   |  | 08.10  | 12.12   |  |  |  |
|  | 1.5 dCi  | 76   |  | 06.05  | 12.12   |  |  |  |
|  | 1.2 16V  | 43   |  | 06.06  | 12.12   | 03.0520-6419.3   | 696419   | 19,05/203x38 TopKit AP   |
|  | 1.2 16V  | 48   |  | 06.05  | 12.12   |  |  |  |
|  | 1.2 16V  | 55   |  | 06.05  | 12.12   |  |  |  |
|  | 1.2 16V  | 58   |  | 06.05  | 12.12   |  |  |  |
|  | 1.2 16V  | 74   |  | 05.07  | 12.12   |  |  |  |
|  | 1.2 16V  | 76   |  | 09.10  | 12.12   |  |  |  |
|  | 1.2 16V Hi-Flex  | 55   |  | 07.08  | 12.12   |  |  |  |
|  | 1.4 16V  | 72   |  | 06.05  | 12.12   |  |  |  |

<sup>1)</sup> with bearing/ with sensor ring / con supporto/+ anell.sens.ABS / avec palier de secours ABS / con apoyo/+ anillo sensor ABS

<sup>2)</sup> without sensor ring / senza sensori / sans secours ABS / sin anillo sensor ABS

| RENAULT CLIO III (BR_/CR_) (05-12)   |   |         |             |                |             |  |                         |  |                         |     |         |    |       |             |                |        |       |                     |     |         |    |       |             |  |  |  |  |  |                 |    |       |             |  |  |  |  |  |         |    |       |             |  |  |  |  |  |         |    |       |             |  |  |  |  |  |         |    |       |             |  |  |  |  |  |         |    |       |             |  |  |  |  |  |         |    |       |             |  |  |  |  |  |         |    |       |             |  |  |  |  |  |         |    |       |             |  |  |  |  |  |         |    |       |             |  |  |  |  |  |
|--|---|---------|-------------|----------------|-------------|--|-------------------------|--|-------------------------|-----|---------|----|-------|-------------|----------------|--------|-------|---------------------|-----|---------|----|-------|-------------|--|--|--|--|--|-----------------|----|-------|-------------|--|--|--|--|--|---------|----|-------|-------------|--|--|--|--|--|---------|----|-------|-------------|--|--|--|--|--|---------|----|-------|-------------|--|--|--|--|--|---------|----|-------|-------------|--|--|--|--|--|---------|----|-------|-------------|--|--|--|--|--|---------|----|-------|-------------|--|--|--|--|--|---------|----|-------|-------------|--|--|--|--|--|---------|----|-------|-------------|--|--|--|--|--|
|    | <table border="1"> <tr><td>1.5 dCi</td><td>48</td><td>05.05</td><td>10.06</td><td>03.0520-6419.3</td><td>696419</td><td></td><td>19,05/203x38 TopKit</td><td>AP</td></tr> <tr><td>1.5 dCi</td><td>50</td><td>06.05</td><td>12.12</td><td></td><td></td><td></td><td></td><td></td></tr> <tr><td>1.5 dCi</td><td>55</td><td>08.10</td><td>12.12</td><td></td><td></td><td></td><td></td><td></td></tr> <tr><td>1.5 dCi</td><td>60</td><td>11.07</td><td>12.12</td><td></td><td></td><td></td><td></td><td></td></tr> <tr><td>1.5 dCi</td><td>63</td><td>06.05</td><td>12.12</td><td></td><td></td><td></td><td></td><td></td></tr> <tr><td>1.5 dCi</td><td>65</td><td>08.10</td><td>12.12</td><td></td><td></td><td></td><td></td><td></td></tr> <tr><td>1.5 dCi</td><td>76</td><td>06.05</td><td>12.12</td><td></td><td></td><td></td><td></td><td></td></tr> </table>  | 1.5 dCi | 48          | 05.05          | 10.06       | 03.0520-6419.3                         | 696419                  |  | 19,05/203x38 TopKit     | AP  | 1.5 dCi | 50 | 06.05 | 12.12       |                |        |       |                     |     | 1.5 dCi | 55 | 08.10 | 12.12       |  |  |  |  |  | 1.5 dCi         | 60 | 11.07 | 12.12       |  |  |  |  |  | 1.5 dCi | 63 | 06.05 | 12.12       |  |  |  |  |  | 1.5 dCi | 65 | 08.10 | 12.12       |  |  |  |  |  | 1.5 dCi | 76 | 06.05 | 12.12       |  |  |  |  |  |         |    |       |             |  |  |  |  |  |         |    |       |             |  |  |  |  |  |         |    |       |             |  |  |  |  |  |         |    |       |             |  |  |  |  |  |         |    |       |             |  |  |  |  |  |
| 1.5 dCi  | 48  | 05.05   | 10.06       | 03.0520-6419.3 | 696419      |  | 19,05/203x38 TopKit     | AP                                     |                         |     |         |    |       |             |                |        |       |                     |     |         |    |       |             |  |  |  |  |  |                 |    |       |             |  |  |  |  |  |         |    |       |             |  |  |  |  |  |         |    |       |             |  |  |  |  |  |         |    |       |             |  |  |  |  |  |         |    |       |             |  |  |  |  |  |         |    |       |             |  |  |  |  |  |         |    |       |             |  |  |  |  |  |         |    |       |             |  |  |  |  |  |         |    |       |             |  |  |  |  |  |
| 1.5 dCi  | 50  | 06.05   | 12.12       |                |             |  |                         |  |                         |     |         |    |       |             |                |        |       |                     |     |         |    |       |             |  |  |  |  |  |                 |    |       |             |  |  |  |  |  |         |    |       |             |  |  |  |  |  |         |    |       |             |  |  |  |  |  |         |    |       |             |  |  |  |  |  |         |    |       |             |  |  |  |  |  |         |    |       |             |  |  |  |  |  |         |    |       |             |  |  |  |  |  |         |    |       |             |  |  |  |  |  |         |    |       |             |  |  |  |  |  |
| 1.5 dCi  | 55  | 08.10   | 12.12       |                |             |  |                         |  |                         |     |         |    |       |             |                |        |       |                     |     |         |    |       |             |  |  |  |  |  |                 |    |       |             |  |  |  |  |  |         |    |       |             |  |  |  |  |  |         |    |       |             |  |  |  |  |  |         |    |       |             |  |  |  |  |  |         |    |       |             |  |  |  |  |  |         |    |       |             |  |  |  |  |  |         |    |       |             |  |  |  |  |  |         |    |       |             |  |  |  |  |  |         |    |       |             |  |  |  |  |  |
| 1.5 dCi  | 60  | 11.07   | 12.12       |                |             |  |                         |  |                         |     |         |    |       |             |                |        |       |                     |     |         |    |       |             |  |  |  |  |  |                 |    |       |             |  |  |  |  |  |         |    |       |             |  |  |  |  |  |         |    |       |             |  |  |  |  |  |         |    |       |             |  |  |  |  |  |         |    |       |             |  |  |  |  |  |         |    |       |             |  |  |  |  |  |         |    |       |             |  |  |  |  |  |         |    |       |             |  |  |  |  |  |         |    |       |             |  |  |  |  |  |
| 1.5 dCi  | 63  | 06.05   | 12.12       |                |             |  |                         |  |                         |     |         |    |       |             |                |        |       |                     |     |         |    |       |             |  |  |  |  |  |                 |    |       |             |  |  |  |  |  |         |    |       |             |  |  |  |  |  |         |    |       |             |  |  |  |  |  |         |    |       |             |  |  |  |  |  |         |    |       |             |  |  |  |  |  |         |    |       |             |  |  |  |  |  |         |    |       |             |  |  |  |  |  |         |    |       |             |  |  |  |  |  |         |    |       |             |  |  |  |  |  |
| 1.5 dCi  | 65  | 08.10   | 12.12       |                |             |  |                         |  |                         |     |         |    |       |             |                |        |       |                     |     |         |    |       |             |  |  |  |  |  |                 |    |       |             |  |  |  |  |  |         |    |       |             |  |  |  |  |  |         |    |       |             |  |  |  |  |  |         |    |       |             |  |  |  |  |  |         |    |       |             |  |  |  |  |  |         |    |       |             |  |  |  |  |  |         |    |       |             |  |  |  |  |  |         |    |       |             |  |  |  |  |  |         |    |       |             |  |  |  |  |  |
| 1.5 dCi  | 76  | 06.05   | 12.12       |                |             |  |                         |  |                         |     |         |    |       |             |                |        |       |                     |     |         |    |       |             |  |  |  |  |  |                 |    |       |             |  |  |  |  |  |         |    |       |             |  |  |  |  |  |         |    |       |             |  |  |  |  |  |         |    |       |             |  |  |  |  |  |         |    |       |             |  |  |  |  |  |         |    |       |             |  |  |  |  |  |         |    |       |             |  |  |  |  |  |         |    |       |             |  |  |  |  |  |         |    |       |             |  |  |  |  |  |
| RENAULT CLIO III Grandtour (KR_) (08-12)   |   |         |             |                |             |  |                         |  |                         |     |         |    |       |             |                |        |       |                     |     |         |    |       |             |  |  |  |  |  |                 |    |       |             |  |  |  |  |  |         |    |       |             |  |  |  |  |  |         |    |       |             |  |  |  |  |  |         |    |       |             |  |  |  |  |  |         |    |       |             |  |  |  |  |  |         |    |       |             |  |  |  |  |  |         |    |       |             |  |  |  |  |  |         |    |       |             |  |  |  |  |  |         |    |       |             |  |  |  |  |  |
|    | <table border="1"> <tr><td>1.2 16V</td><td>55</td><td>02.08</td><td>12.12</td><td>13.0460-2709.2</td><td>602709</td><td></td><td>23973 17,4 /Zub/S</td><td>TRW</td></tr> <tr><td>1.2 16V</td><td>57</td><td>02.08</td><td>12.12</td><td>13.0470-2709.2</td><td>LD2709</td><td></td><td>23973 17,4 /Zub/S</td><td>TRW</td></tr> <tr><td>1.2 16V</td><td>74</td><td>02.08</td><td>12.12</td><td></td><td></td><td></td><td></td><td></td></tr> <tr><td>1.2 16V Hi-Flex</td><td>55</td><td>07.08</td><td>12.12</td><td></td><td></td><td></td><td></td><td></td></tr> <tr><td>1.4 16V</td><td>72</td><td>02.10</td><td>12.12</td><td></td><td></td><td></td><td></td><td></td></tr> <tr><td>1.5 dCi</td><td>48</td><td>02.08</td><td>12.12</td><td></td><td></td><td></td><td></td><td></td></tr> <tr><td>1.5 dCi</td><td>50</td><td>02.08</td><td>12.12</td><td></td><td></td><td></td><td></td><td></td></tr> <tr><td>1.5 dCi</td><td>63</td><td>02.08</td><td>12.12</td><td></td><td></td><td></td><td></td><td></td></tr> <tr><td>1.5 dCi</td><td>76</td><td>02.08</td><td>12.12</td><td></td><td></td><td></td><td></td><td></td></tr> <tr><td>1.5 dCi</td><td>78</td><td>02.08</td><td>12.12</td><td></td><td></td><td></td><td></td><td></td></tr> <tr><td>1.6 16V</td><td>82</td><td>02.08</td><td>12.12</td><td></td><td></td><td></td><td></td><td></td></tr> <tr><td>1.6 16V</td><td>94</td><td>11.08</td><td>12.12</td><td></td><td></td><td></td><td></td><td></td></tr> </table>   | 1.2 16V | 55          | 02.08          | 12.12       | 13.0460-2709.2                         | 602709                  |  | 23973 17,4 /Zub/S       | TRW | 1.2 16V | 57 | 02.08 | 12.12       | 13.0470-2709.2 | LD2709 |       | 23973 17,4 /Zub/S   | TRW | 1.2 16V | 74 | 02.08 | 12.12       |  |  |  |  |  | 1.2 16V Hi-Flex | 55 | 07.08 | 12.12       |  |  |  |  |  | 1.4 16V | 72 | 02.10 | 12.12       |  |  |  |  |  | 1.5 dCi | 48 | 02.08 | 12.12       |  |  |  |  |  | 1.5 dCi | 50 | 02.08 | 12.12       |  |  |  |  |  | 1.5 dCi | 63 | 02.08 | 12.12       |  |  |  |  |  | 1.5 dCi | 76 | 02.08 | 12.12       |  |  |  |  |  | 1.5 dCi | 78 | 02.08 | 12.12       |  |  |  |  |  | 1.6 16V | 82 | 02.08 | 12.12       |  |  |  |  |  | 1.6 16V | 94 | 11.08 | 12.12       |  |  |  |  |  |
| 1.2 16V  | 55  | 02.08   | 12.12       | 13.0460-2709.2 | 602709      |  | 23973 17,4 /Zub/S       | TRW                                    |                         |     |         |    |       |             |                |        |       |                     |     |         |    |       |             |  |  |  |  |  |                 |    |       |             |  |  |  |  |  |         |    |       |             |  |  |  |  |  |         |    |       |             |  |  |  |  |  |         |    |       |             |  |  |  |  |  |         |    |       |             |  |  |  |  |  |         |    |       |             |  |  |  |  |  |         |    |       |             |  |  |  |  |  |         |    |       |             |  |  |  |  |  |         |    |       |             |  |  |  |  |  |
| 1.2 16V  | 57  | 02.08   | 12.12       | 13.0470-2709.2 | LD2709      |  | 23973 17,4 /Zub/S       | TRW                                    |                         |     |         |    |       |             |                |        |       |                     |     |         |    |       |             |  |  |  |  |  |                 |    |       |             |  |  |  |  |  |         |    |       |             |  |  |  |  |  |         |    |       |             |  |  |  |  |  |         |    |       |             |  |  |  |  |  |         |    |       |             |  |  |  |  |  |         |    |       |             |  |  |  |  |  |         |    |       |             |  |  |  |  |  |         |    |       |             |  |  |  |  |  |         |    |       |             |  |  |  |  |  |
| 1.2 16V  | 74  | 02.08   | 12.12       |                |             |  |                         |  |                         |     |         |    |       |             |                |        |       |                     |     |         |    |       |             |  |  |  |  |  |                 |    |       |             |  |  |  |  |  |         |    |       |             |  |  |  |  |  |         |    |       |             |  |  |  |  |  |         |    |       |             |  |  |  |  |  |         |    |       |             |  |  |  |  |  |         |    |       |             |  |  |  |  |  |         |    |       |             |  |  |  |  |  |         |    |       |             |  |  |  |  |  |         |    |       |             |  |  |  |  |  |
| 1.2 16V Hi-Flex  | 55  | 07.08   | 12.12       |                |             |  |                         |  |                         |     |         |    |       |             |                |        |       |                     |     |         |    |       |             |  |  |  |  |  |                 |    |       |             |  |  |  |  |  |         |    |       |             |  |  |  |  |  |         |    |       |             |  |  |  |  |  |         |    |       |             |  |  |  |  |  |         |    |       |             |  |  |  |  |  |         |    |       |             |  |  |  |  |  |         |    |       |             |  |  |  |  |  |         |    |       |             |  |  |  |  |  |         |    |       |             |  |  |  |  |  |
| 1.4 16V  | 72  | 02.10   | 12.12       |                |             |  |                         |  |                         |     |         |    |       |             |                |        |       |                     |     |         |    |       |             |  |  |  |  |  |                 |    |       |             |  |  |  |  |  |         |    |       |             |  |  |  |  |  |         |    |       |             |  |  |  |  |  |         |    |       |             |  |  |  |  |  |         |    |       |             |  |  |  |  |  |         |    |       |             |  |  |  |  |  |         |    |       |             |  |  |  |  |  |         |    |       |             |  |  |  |  |  |         |    |       |             |  |  |  |  |  |
| 1.5 dCi  | 48  | 02.08   | 12.12       |                |             |  |                         |  |                         |     |         |    |       |             |                |        |       |                     |     |         |    |       |             |  |  |  |  |  |                 |    |       |             |  |  |  |  |  |         |    |       |             |  |  |  |  |  |         |    |       |             |  |  |  |  |  |         |    |       |             |  |  |  |  |  |         |    |       |             |  |  |  |  |  |         |    |       |             |  |  |  |  |  |         |    |       |             |  |  |  |  |  |         |    |       |             |  |  |  |  |  |         |    |       |             |  |  |  |  |  |
| 1.5 dCi  | 50  | 02.08   | 12.12       |                |             |  |                         |  |                         |     |         |    |       |             |                |        |       |                     |     |         |    |       |             |  |  |  |  |  |                 |    |       |             |  |  |  |  |  |         |    |       |             |  |  |  |  |  |         |    |       |             |  |  |  |  |  |         |    |       |             |  |  |  |  |  |         |    |       |             |  |  |  |  |  |         |    |       |             |  |  |  |  |  |         |    |       |             |  |  |  |  |  |         |    |       |             |  |  |  |  |  |         |    |       |             |  |  |  |  |  |
| 1.5 dCi  | 63  | 02.08   | 12.12       |                |             |  |                         |  |                         |     |         |    |       |             |                |        |       |                     |     |         |    |       |             |  |  |  |  |  |                 |    |       |             |  |  |  |  |  |         |    |       |             |  |  |  |  |  |         |    |       |             |  |  |  |  |  |         |    |       |             |  |  |  |  |  |         |    |       |             |  |  |  |  |  |         |    |       |             |  |  |  |  |  |         |    |       |             |  |  |  |  |  |         |    |       |             |  |  |  |  |  |         |    |       |             |  |  |  |  |  |
| 1.5 dCi  | 76  | 02.08   | 12.12       |                |             |  |                         |  |                         |     |         |    |       |             |                |        |       |                     |     |         |    |       |             |  |  |  |  |  |                 |    |       |             |  |  |  |  |  |         |    |       |             |  |  |  |  |  |         |    |       |             |  |  |  |  |  |         |    |       |             |  |  |  |  |  |         |    |       |             |  |  |  |  |  |         |    |       |             |  |  |  |  |  |         |    |       |             |  |  |  |  |  |         |    |       |             |  |  |  |  |  |         |    |       |             |  |  |  |  |  |
| 1.5 dCi  | 78  | 02.08   | 12.12       |                |             |  |                         |  |                         |     |         |    |       |             |                |        |       |                     |     |         |    |       |             |  |  |  |  |  |                 |    |       |             |  |  |  |  |  |         |    |       |             |  |  |  |  |  |         |    |       |             |  |  |  |  |  |         |    |       |             |  |  |  |  |  |         |    |       |             |  |  |  |  |  |         |    |       |             |  |  |  |  |  |         |    |       |             |  |  |  |  |  |         |    |       |             |  |  |  |  |  |         |    |       |             |  |  |  |  |  |
| 1.6 16V  | 82  | 02.08   | 12.12       |                |             |  |                         |  |                         |     |         |    |       |             |                |        |       |                     |     |         |    |       |             |  |  |  |  |  |                 |    |       |             |  |  |  |  |  |         |    |       |             |  |  |  |  |  |         |    |       |             |  |  |  |  |  |         |    |       |             |  |  |  |  |  |         |    |       |             |  |  |  |  |  |         |    |       |             |  |  |  |  |  |         |    |       |             |  |  |  |  |  |         |    |       |             |  |  |  |  |  |         |    |       |             |  |  |  |  |  |
| 1.6 16V  | 94  | 11.08   | 12.12       |                |             |  |                         |  |                         |     |         |    |       |             |                |        |       |                     |     |         |    |       |             |  |  |  |  |  |                 |    |       |             |  |  |  |  |  |         |    |       |             |  |  |  |  |  |         |    |       |             |  |  |  |  |  |         |    |       |             |  |  |  |  |  |         |    |       |             |  |  |  |  |  |         |    |       |             |  |  |  |  |  |         |    |       |             |  |  |  |  |  |         |    |       |             |  |  |  |  |  |         |    |       |             |  |  |  |  |  |
|    | <table border="1"> <tr><td>1.2 16V</td><td>55</td><td>02.08</td><td>12.12</td><td>24.0122-0216.1</td><td>422216</td><td></td><td>260 22,0 19,8 V L +S +B</td><td></td></tr> <tr><td>1.2 16V</td><td>57</td><td>02.08</td><td>12.12</td><td></td><td></td><td></td><td></td><td></td></tr> <tr><td>1.2 16V</td><td>74</td><td>02.08</td><td>12.12</td><td></td><td></td><td></td><td></td><td></td></tr> <tr><td>1.2 16V Hi-Flex</td><td>55</td><td>07.08</td><td>12.12</td><td></td><td></td><td></td><td></td><td></td></tr> <tr><td>1.4 16V</td><td>72</td><td>02.10</td><td>12.12</td><td></td><td></td><td></td><td></td><td></td></tr> <tr><td>1.5 dCi</td><td>48</td><td>02.08</td><td>12.12</td><td></td><td></td><td></td><td></td><td></td></tr> <tr><td>1.5 dCi</td><td>50</td><td>02.08</td><td>12.12</td><td></td><td></td><td></td><td></td><td></td></tr> <tr><td>1.5 dCi</td><td>63</td><td>02.08</td><td>12.12</td><td></td><td></td><td></td><td></td><td></td></tr> <tr><td>1.5 dCi</td><td>76</td><td>02.08</td><td>12.12</td><td></td><td></td><td></td><td></td><td></td></tr> <tr><td>1.5 dCi</td><td>78</td><td>02.08</td><td>12.12</td><td></td><td></td><td></td><td></td><td></td></tr> <tr><td>1.6 16V</td><td>82</td><td>02.08</td><td>12.12</td><td></td><td></td><td></td><td></td><td></td></tr> <tr><td>1.6 16V</td><td>94</td><td>11.08</td><td>12.12</td><td></td><td></td><td></td><td></td><td></td></tr> </table>  | 1.2 16V | 55          | 02.08          | 12.12       | 24.0122-0216.1                         | 422216                  |  | 260 22,0 19,8 V L +S +B |     | 1.2 16V | 57 | 02.08 | 12.12       |                |        |       |                     |     | 1.2 16V | 74 | 02.08 | 12.12       |  |  |  |  |  | 1.2 16V Hi-Flex | 55 | 07.08 | 12.12       |  |  |  |  |  | 1.4 16V | 72 | 02.10 | 12.12       |  |  |  |  |  | 1.5 dCi | 48 | 02.08 | 12.12       |  |  |  |  |  | 1.5 dCi | 50 | 02.08 | 12.12       |  |  |  |  |  | 1.5 dCi | 63 | 02.08 | 12.12       |  |  |  |  |  | 1.5 dCi | 76 | 02.08 | 12.12       |  |  |  |  |  | 1.5 dCi | 78 | 02.08 | 12.12       |  |  |  |  |  | 1.6 16V | 82 | 02.08 | 12.12       |  |  |  |  |  | 1.6 16V | 94 | 11.08 | 12.12       |  |  |  |  |  |
| 1.2 16V  | 55  | 02.08   | 12.12       | 24.0122-0216.1 | 422216      |  | 260 22,0 19,8 V L +S +B |  |                         |     |         |    |       |             |                |        |       |                     |     |         |    |       |             |  |  |  |  |  |                 |    |       |             |  |  |  |  |  |         |    |       |             |  |  |  |  |  |         |    |       |             |  |  |  |  |  |         |    |       |             |  |  |  |  |  |         |    |       |             |  |  |  |  |  |         |    |       |             |  |  |  |  |  |         |    |       |             |  |  |  |  |  |         |    |       |             |  |  |  |  |  |         |    |       |             |  |  |  |  |  |
| 1.2 16V  | 57  | 02.08   | 12.12       |                |             |  |                         |  |                         |     |         |    |       |             |                |        |       |                     |     |         |    |       |             |  |  |  |  |  |                 |    |       |             |  |  |  |  |  |         |    |       |             |  |  |  |  |  |         |    |       |             |  |  |  |  |  |         |    |       |             |  |  |  |  |  |         |    |       |             |  |  |  |  |  |         |    |       |             |  |  |  |  |  |         |    |       |             |  |  |  |  |  |         |    |       |             |  |  |  |  |  |         |    |       |             |  |  |  |  |  |
| 1.2 16V  | 74  | 02.08   | 12.12       |                |             |  |                         |  |                         |     |         |    |       |             |                |        |       |                     |     |         |    |       |             |  |  |  |  |  |                 |    |       |             |  |  |  |  |  |         |    |       |             |  |  |  |  |  |         |    |       |             |  |  |  |  |  |         |    |       |             |  |  |  |  |  |         |    |       |             |  |  |  |  |  |         |    |       |             |  |  |  |  |  |         |    |       |             |  |  |  |  |  |         |    |       |             |  |  |  |  |  |         |    |       |             |  |  |  |  |  |
| 1.2 16V Hi-Flex  | 55  | 07.08   | 12.12       |                |             |  |                         |  |                         |     |         |    |       |             |                |        |       |                     |     |         |    |       |             |  |  |  |  |  |                 |    |       |             |  |  |  |  |  |         |    |       |             |  |  |  |  |  |         |    |       |             |  |  |  |  |  |         |    |       |             |  |  |  |  |  |         |    |       |             |  |  |  |  |  |         |    |       |             |  |  |  |  |  |         |    |       |             |  |  |  |  |  |         |    |       |             |  |  |  |  |  |         |    |       |             |  |  |  |  |  |
| 1.4 16V  | 72  | 02.10   | 12.12       |                |             |  |                         |  |                         |     |         |    |       |             |                |        |       |                     |     |         |    |       |             |  |  |  |  |  |                 |    |       |             |  |  |  |  |  |         |    |       |             |  |  |  |  |  |         |    |       |             |  |  |  |  |  |         |    |       |             |  |  |  |  |  |         |    |       |             |  |  |  |  |  |         |    |       |             |  |  |  |  |  |         |    |       |             |  |  |  |  |  |         |    |       |             |  |  |  |  |  |         |    |       |             |  |  |  |  |  |
| 1.5 dCi  | 48  | 02.08   | 12.12       |                |             |  |                         |  |                         |     |         |    |       |             |                |        |       |                     |     |         |    |       |             |  |  |  |  |  |                 |    |       |             |  |  |  |  |  |         |    |       |             |  |  |  |  |  |         |    |       |             |  |  |  |  |  |         |    |       |             |  |  |  |  |  |         |    |       |             |  |  |  |  |  |         |    |       |             |  |  |  |  |  |         |    |       |             |  |  |  |  |  |         |    |       |             |  |  |  |  |  |         |    |       |             |  |  |  |  |  |
| 1.5 dCi  | 50  | 02.08   | 12.12       |                |             |  |                         |  |                         |     |         |    |       |             |                |        |       |                     |     |         |    |       |             |  |  |  |  |  |                 |    |       |             |  |  |  |  |  |         |    |       |             |  |  |  |  |  |         |    |       |             |  |  |  |  |  |         |    |       |             |  |  |  |  |  |         |    |       |             |  |  |  |  |  |         |    |       |             |  |  |  |  |  |         |    |       |             |  |  |  |  |  |         |    |       |             |  |  |  |  |  |         |    |       |             |  |  |  |  |  |
| 1.5 dCi  | 63  | 02.08   | 12.12       |                |             |  |                         |  |                         |     |         |    |       |             |                |        |       |                     |     |         |    |       |             |  |  |  |  |  |                 |    |       |             |  |  |  |  |  |         |    |       |             |  |  |  |  |  |         |    |       |             |  |  |  |  |  |         |    |       |             |  |  |  |  |  |         |    |       |             |  |  |  |  |  |         |    |       |             |  |  |  |  |  |         |    |       |             |  |  |  |  |  |         |    |       |             |  |  |  |  |  |         |    |       |             |  |  |  |  |  |
| 1.5 dCi  | 76  | 02.08   | 12.12       |                |             |  |                         |  |                         |     |         |    |       |             |                |        |       |                     |     |         |    |       |             |  |  |  |  |  |                 |    |       |             |  |  |  |  |  |         |    |       |             |  |  |  |  |  |         |    |       |             |  |  |  |  |  |         |    |       |             |  |  |  |  |  |         |    |       |             |  |  |  |  |  |         |    |       |             |  |  |  |  |  |         |    |       |             |  |  |  |  |  |         |    |       |             |  |  |  |  |  |         |    |       |             |  |  |  |  |  |
| 1.5 dCi  | 78  | 02.08   | 12.12       |                |             |  |                         |  |                         |     |         |    |       |             |                |        |       |                     |     |         |    |       |             |  |  |  |  |  |                 |    |       |             |  |  |  |  |  |         |    |       |             |  |  |  |  |  |         |    |       |             |  |  |  |  |  |         |    |       |             |  |  |  |  |  |         |    |       |             |  |  |  |  |  |         |    |       |             |  |  |  |  |  |         |    |       |             |  |  |  |  |  |         |    |       |             |  |  |  |  |  |         |    |       |             |  |  |  |  |  |
| 1.6 16V  | 82  | 02.08   | 12.12       |                |             |  |                         |  |                         |     |         |    |       |             |                |        |       |                     |     |         |    |       |             |  |  |  |  |  |                 |    |       |             |  |  |  |  |  |         |    |       |             |  |  |  |  |  |         |    |       |             |  |  |  |  |  |         |    |       |             |  |  |  |  |  |         |    |       |             |  |  |  |  |  |         |    |       |             |  |  |  |  |  |         |    |       |             |  |  |  |  |  |         |    |       |             |  |  |  |  |  |         |    |       |             |  |  |  |  |  |
| 1.6 16V  | 94  | 11.08   | 12.12       |                |             |  |                         |  |                         |     |         |    |       |             |                |        |       |                     |     |         |    |       |             |  |  |  |  |  |                 |    |       |             |  |  |  |  |  |         |    |       |             |  |  |  |  |  |         |    |       |             |  |  |  |  |  |         |    |       |             |  |  |  |  |  |         |    |       |             |  |  |  |  |  |         |    |       |             |  |  |  |  |  |         |    |       |             |  |  |  |  |  |         |    |       |             |  |  |  |  |  |         |    |       |             |  |  |  |  |  |
|    | <table border="1"> <tr><td>1.2 16V</td><td>55</td><td>02.08</td><td>12.12 + ESP</td><td>13.0460-2845.2</td><td>602845</td><td></td><td>23554 16,4 /Zub/S</td><td>TRW</td></tr> <tr><td>1.2 16V</td><td>57</td><td>02.08</td><td>12.12 + ESP</td><td>13.0470-2845.2</td><td>LD2845</td><td></td><td>23554 16,4 /Zub/S</td><td>TRW</td></tr> <tr><td>1.2 16V</td><td>74</td><td>02.08</td><td>12.12 + ESP</td><td></td><td></td><td></td><td></td><td></td></tr> <tr><td>1.2 16V Hi-Flex</td><td>55</td><td>07.08</td><td>12.12 + ESP</td><td></td><td></td><td></td><td></td><td></td></tr> <tr><td>1.4 16V</td><td>72</td><td>02.10</td><td>12.12 + ESP</td><td></td><td></td><td></td><td></td><td></td></tr> <tr><td>1.5 dCi</td><td>48</td><td>02.08</td><td>12.12 + ESP</td><td></td><td></td><td></td><td></td><td></td></tr> <tr><td>1.5 dCi</td><td>50</td><td>02.08</td><td>12.12 + ESP</td><td></td><td></td><td></td><td></td><td></td></tr> <tr><td>1.5 dCi</td><td>63</td><td>02.08</td><td>12.12 + ESP</td><td></td><td></td><td></td><td></td><td></td></tr> <tr><td>1.5 dCi</td><td>76</td><td>02.08</td><td>12.12 + ESP</td><td></td><td></td><td></td><td></td><td></td></tr> <tr><td>1.5 dCi</td><td>78</td><td>02.08</td><td>12.12 + ESP</td><td></td><td></td><td></td><td></td><td></td></tr> <tr><td>1.6 16V</td><td>82</td><td>02.08</td><td>12.12 + ESP</td><td></td><td></td><td></td><td></td><td></td></tr> <tr><td>1.6 16V</td><td>94</td><td>11.08</td><td>12.12 + ESP</td><td></td><td></td><td></td><td></td><td></td></tr> </table> | 1.2 16V | 55          | 02.08          | 12.12 + ESP | 13.0460-2845.2                         | 602845                  |  | 23554 16,4 /Zub/S       | TRW | 1.2 16V | 57 | 02.08 | 12.12 + ESP | 13.0470-2845.2 | LD2845 |       | 23554 16,4 /Zub/S   | TRW | 1.2 16V | 74 | 02.08 | 12.12 + ESP |  |  |  |  |  | 1.2 16V Hi-Flex | 55 | 07.08 | 12.12 + ESP |  |  |  |  |  | 1.4 16V | 72 | 02.10 | 12.12 + ESP |  |  |  |  |  | 1.5 dCi | 48 | 02.08 | 12.12 + ESP |  |  |  |  |  | 1.5 dCi | 50 | 02.08 | 12.12 + ESP |  |  |  |  |  | 1.5 dCi | 63 | 02.08 | 12.12 + ESP |  |  |  |  |  | 1.5 dCi | 76 | 02.08 | 12.12 + ESP |  |  |  |  |  | 1.5 dCi | 78 | 02.08 | 12.12 + ESP |  |  |  |  |  | 1.6 16V | 82 | 02.08 | 12.12 + ESP |  |  |  |  |  | 1.6 16V | 94 | 11.08 | 12.12 + ESP |  |  |  |  |  |
| 1.2 16V  | 55  | 02.08   | 12.12 + ESP | 13.0460-2845.2 | 602845      |  | 23554 16,4 /Zub/S       | TRW                                    |                         |     |         |    |       |             |                |        |       |                     |     |         |    |       |             |  |  |  |  |  |                 |    |       |             |  |  |  |  |  |         |    |       |             |  |  |  |  |  |         |    |       |             |  |  |  |  |  |         |    |       |             |  |  |  |  |  |         |    |       |             |  |  |  |  |  |         |    |       |             |  |  |  |  |  |         |    |       |             |  |  |  |  |  |         |    |       |             |  |  |  |  |  |         |    |       |             |  |  |  |  |  |
| 1.2 16V  | 57  | 02.08   | 12.12 + ESP | 13.0470-2845.2 | LD2845      |  | 23554 16,4 /Zub/S       | TRW                                    |                         |     |         |    |       |             |                |        |       |                     |     |         |    |       |             |  |  |  |  |  |                 |    |       |             |  |  |  |  |  |         |    |       |             |  |  |  |  |  |         |    |       |             |  |  |  |  |  |         |    |       |             |  |  |  |  |  |         |    |       |             |  |  |  |  |  |         |    |       |             |  |  |  |  |  |         |    |       |             |  |  |  |  |  |         |    |       |             |  |  |  |  |  |         |    |       |             |  |  |  |  |  |
| 1.2 16V  | 74  | 02.08   | 12.12 + ESP |                |             |  |                         |  |                         |     |         |    |       |             |                |        |       |                     |     |         |    |       |             |  |  |  |  |  |                 |    |       |             |  |  |  |  |  |         |    |       |             |  |  |  |  |  |         |    |       |             |  |  |  |  |  |         |    |       |             |  |  |  |  |  |         |    |       |             |  |  |  |  |  |         |    |       |             |  |  |  |  |  |         |    |       |             |  |  |  |  |  |         |    |       |             |  |  |  |  |  |         |    |       |             |  |  |  |  |  |
| 1.2 16V Hi-Flex  | 55  | 07.08   | 12.12 + ESP |                |             |  |                         |  |                         |     |         |    |       |             |                |        |       |                     |     |         |    |       |             |  |  |  |  |  |                 |    |       |             |  |  |  |  |  |         |    |       |             |  |  |  |  |  |         |    |       |             |  |  |  |  |  |         |    |       |             |  |  |  |  |  |         |    |       |             |  |  |  |  |  |         |    |       |             |  |  |  |  |  |         |    |       |             |  |  |  |  |  |         |    |       |             |  |  |  |  |  |         |    |       |             |  |  |  |  |  |
| 1.4 16V  | 72  | 02.10   | 12.12 + ESP |                |             |  |                         |  |                         |     |         |    |       |             |                |        |       |                     |     |         |    |       |             |  |  |  |  |  |                 |    |       |             |  |  |  |  |  |         |    |       |             |  |  |  |  |  |         |    |       |             |  |  |  |  |  |         |    |       |             |  |  |  |  |  |         |    |       |             |  |  |  |  |  |         |    |       |             |  |  |  |  |  |         |    |       |             |  |  |  |  |  |         |    |       |             |  |  |  |  |  |         |    |       |             |  |  |  |  |  |
| 1.5 dCi  | 48  | 02.08   | 12.12 + ESP |                |             |  |                         |  |                         |     |         |    |       |             |                |        |       |                     |     |         |    |       |             |  |  |  |  |  |                 |    |       |             |  |  |  |  |  |         |    |       |             |  |  |  |  |  |         |    |       |             |  |  |  |  |  |         |    |       |             |  |  |  |  |  |         |    |       |             |  |  |  |  |  |         |    |       |             |  |  |  |  |  |         |    |       |             |  |  |  |  |  |         |    |       |             |  |  |  |  |  |         |    |       |             |  |  |  |  |  |
| 1.5 dCi  | 50  | 02.08   | 12.12 + ESP |                |             |  |                         |  |                         |     |         |    |       |             |                |        |       |                     |     |         |    |       |             |  |  |  |  |  |                 |    |       |             |  |  |  |  |  |         |    |       |             |  |  |  |  |  |         |    |       |             |  |  |  |  |  |         |    |       |             |  |  |  |  |  |         |    |       |             |  |  |  |  |  |         |    |       |             |  |  |  |  |  |         |    |       |             |  |  |  |  |  |         |    |       |             |  |  |  |  |  |         |    |       |             |  |  |  |  |  |
| 1.5 dCi  | 63  | 02.08   | 12.12 + ESP |                |             |  |                         |  |                         |     |         |    |       |             |                |        |       |                     |     |         |    |       |             |  |  |  |  |  |                 |    |       |             |  |  |  |  |  |         |    |       |             |  |  |  |  |  |         |    |       |             |  |  |  |  |  |         |    |       |             |  |  |  |  |  |         |    |       |             |  |  |  |  |  |         |    |       |             |  |  |  |  |  |         |    |       |             |  |  |  |  |  |         |    |       |             |  |  |  |  |  |         |    |       |             |  |  |  |  |  |
| 1.5 dCi  | 76  | 02.08   | 12.12 + ESP |                |             |  |                         |  |                         |     |         |    |       |             |                |        |       |                     |     |         |    |       |             |  |  |  |  |  |                 |    |       |             |  |  |  |  |  |         |    |       |             |  |  |  |  |  |         |    |       |             |  |  |  |  |  |         |    |       |             |  |  |  |  |  |         |    |       |             |  |  |  |  |  |         |    |       |             |  |  |  |  |  |         |    |       |             |  |  |  |  |  |         |    |       |             |  |  |  |  |  |         |    |       |             |  |  |  |  |  |
| 1.5 dCi  | 78  | 02.08   | 12.12 + ESP |                |             |  |                         |  |                         |     |         |    |       |             |                |        |       |                     |     |         |    |       |             |  |  |  |  |  |                 |    |       |             |  |  |  |  |  |         |    |       |             |  |  |  |  |  |         |    |       |             |  |  |  |  |  |         |    |       |             |  |  |  |  |  |         |    |       |             |  |  |  |  |  |         |    |       |             |  |  |  |  |  |         |    |       |             |  |  |  |  |  |         |    |       |             |  |  |  |  |  |         |    |       |             |  |  |  |  |  |
| 1.6 16V  | 82  | 02.08   | 12.12 + ESP |                |             |  |                         |  |                         |     |         |    |       |             |                |        |       |                     |     |         |    |       |             |  |  |  |  |  |                 |    |       |             |  |  |  |  |  |         |    |       |             |  |  |  |  |  |         |    |       |             |  |  |  |  |  |         |    |       |             |  |  |  |  |  |         |    |       |             |  |  |  |  |  |         |    |       |             |  |  |  |  |  |         |    |       |             |  |  |  |  |  |         |    |       |             |  |  |  |  |  |         |    |       |             |  |  |  |  |  |
| 1.6 16V  | 94  | 11.08   | 12.12 + ESP |                |             |  |                         |  |                         |     |         |    |       |             |                |        |       |                     |     |         |    |       |             |  |  |  |  |  |                 |    |       |             |  |  |  |  |  |         |    |       |             |  |  |  |  |  |         |    |       |             |  |  |  |  |  |         |    |       |             |  |  |  |  |  |         |    |       |             |  |  |  |  |  |         |    |       |             |  |  |  |  |  |         |    |       |             |  |  |  |  |  |         |    |       |             |  |  |  |  |  |         |    |       |             |  |  |  |  |  |
|  | <table border="1"> <tr><td>1.2 16V</td><td>55</td><td>02.08</td><td>12.12 + ESP</td><td>24.0108-0114.2</td><td>408114</td><td>mit Lager/ mit Sensoring <sup>1)</sup></td><td>240 8,0 7,0 +B</td><td></td></tr> <tr><td>1.2 16V</td><td>57</td><td>02.08</td><td>12.12 + ESP</td><td></td><td></td><td></td><td></td><td></td></tr> <tr><td>1.2 16V</td><td>74</td><td>02.08</td><td>12.12 + ESP</td><td></td><td></td><td></td><td></td><td></td></tr> <tr><td>1.2 16V Hi-Flex</td><td>55</td><td>07.08</td><td>12.12 + ESP</td><td></td><td></td><td></td><td></td><td></td></tr> <tr><td>1.4 16V</td><td>72</td><td>02.10</td><td>12.12 + ESP</td><td></td><td></td><td></td><td></td><td></td></tr> <tr><td>1.5 dCi</td><td>48</td><td>02.08</td><td>12.12 + ESP</td><td></td><td></td><td></td><td></td><td></td></tr> <tr><td>1.5 dCi</td><td>50</td><td>02.08</td><td>12.12 + ESP</td><td></td><td></td><td></td><td></td><td></td></tr> <tr><td>1.5 dCi</td><td>63</td><td>02.08</td><td>12.12 + ESP</td><td></td><td></td><td></td><td></td><td></td></tr> <tr><td>1.5 dCi</td><td>76</td><td>02.08</td><td>12.12 + ESP</td><td></td><td></td><td></td><td></td><td></td></tr> <tr><td>1.5 dCi</td><td>78</td><td>02.08</td><td>12.12 + ESP</td><td></td><td></td><td></td><td></td><td></td></tr> <tr><td>1.6 16V</td><td>82</td><td>02.08</td><td>12.12 + ESP</td><td></td><td></td><td></td><td></td><td></td></tr> <tr><td>1.6 16V</td><td>94</td><td>11.08</td><td>12.12 + ESP</td><td></td><td></td><td></td><td></td><td></td></tr> </table>         | 1.2 16V | 55          | 02.08          | 12.12 + ESP | 24.0108-0114.2                         | 408114                  | mit Lager/ mit Sensoring <sup>1)</sup> | 240 8,0 7,0 +B          |     | 1.2 16V | 57 | 02.08 | 12.12 + ESP |                |        |       |                     |     | 1.2 16V | 74 | 02.08 | 12.12 + ESP |  |  |  |  |  | 1.2 16V Hi-Flex | 55 | 07.08 | 12.12 + ESP |  |  |  |  |  | 1.4 16V | 72 | 02.10 | 12.12 + ESP |  |  |  |  |  | 1.5 dCi | 48 | 02.08 | 12.12 + ESP |  |  |  |  |  | 1.5 dCi | 50 | 02.08 | 12.12 + ESP |  |  |  |  |  | 1.5 dCi | 63 | 02.08 | 12.12 + ESP |  |  |  |  |  | 1.5 dCi | 76 | 02.08 | 12.12 + ESP |  |  |  |  |  | 1.5 dCi | 78 | 02.08 | 12.12 + ESP |  |  |  |  |  | 1.6 16V | 82 | 02.08 | 12.12 + ESP |  |  |  |  |  | 1.6 16V | 94 | 11.08 | 12.12 + ESP |  |  |  |  |  |
| 1.2 16V  | 55  | 02.08   | 12.12 + ESP | 24.0108-0114.2 | 408114      | mit Lager/ mit Sensoring <sup>1)</sup> | 240 8,0 7,0 +B          |  |                         |     |         |    |       |             |                |        |       |                     |     |         |    |       |             |  |  |  |  |  |                 |    |       |             |  |  |  |  |  |         |    |       |             |  |  |  |  |  |         |    |       |             |  |  |  |  |  |         |    |       |             |  |  |  |  |  |         |    |       |             |  |  |  |  |  |         |    |       |             |  |  |  |  |  |         |    |       |             |  |  |  |  |  |         |    |       |             |  |  |  |  |  |         |    |       |             |  |  |  |  |  |
| 1.2 16V  | 57  | 02.08   | 12.12 + ESP |                |             |  |                         |  |                         |     |         |    |       |             |                |        |       |                     |     |         |    |       |             |  |  |  |  |  |                 |    |       |             |  |  |  |  |  |         |    |       |             |  |  |  |  |  |         |    |       |             |  |  |  |  |  |         |    |       |             |  |  |  |  |  |         |    |       |             |  |  |  |  |  |         |    |       |             |  |  |  |  |  |         |    |       |             |  |  |  |  |  |         |    |       |             |  |  |  |  |  |         |    |       |             |  |  |  |  |  |
| 1.2 16V  | 74  | 02.08   | 12.12 + ESP |                |             |  |                         |  |                         |     |         |    |       |             |                |        |       |                     |     |         |    |       |             |  |  |  |  |  |                 |    |       |             |  |  |  |  |  |         |    |       |             |  |  |  |  |  |         |    |       |             |  |  |  |  |  |         |    |       |             |  |  |  |  |  |         |    |       |             |  |  |  |  |  |         |    |       |             |  |  |  |  |  |         |    |       |             |  |  |  |  |  |         |    |       |             |  |  |  |  |  |         |    |       |             |  |  |  |  |  |
| 1.2 16V Hi-Flex  | 55  | 07.08   | 12.12 + ESP |                |             |  |                         |  |                         |     |         |    |       |             |                |        |       |                     |     |         |    |       |             |  |  |  |  |  |                 |    |       |             |  |  |  |  |  |         |    |       |             |  |  |  |  |  |         |    |       |             |  |  |  |  |  |         |    |       |             |  |  |  |  |  |         |    |       |             |  |  |  |  |  |         |    |       |             |  |  |  |  |  |         |    |       |             |  |  |  |  |  |         |    |       |             |  |  |  |  |  |         |    |       |             |  |  |  |  |  |
| 1.4 16V  | 72  | 02.10   | 12.12 + ESP |                |             |  |                         |  |                         |     |         |    |       |             |                |        |       |                     |     |         |    |       |             |  |  |  |  |  |                 |    |       |             |  |  |  |  |  |         |    |       |             |  |  |  |  |  |         |    |       |             |  |  |  |  |  |         |    |       |             |  |  |  |  |  |         |    |       |             |  |  |  |  |  |         |    |       |             |  |  |  |  |  |         |    |       |             |  |  |  |  |  |         |    |       |             |  |  |  |  |  |         |    |       |             |  |  |  |  |  |
| 1.5 dCi  | 48  | 02.08   | 12.12 + ESP |                |             |  |                         |  |                         |     |         |    |       |             |                |        |       |                     |     |         |    |       |             |  |  |  |  |  |                 |    |       |             |  |  |  |  |  |         |    |       |             |  |  |  |  |  |         |    |       |             |  |  |  |  |  |         |    |       |             |  |  |  |  |  |         |    |       |             |  |  |  |  |  |         |    |       |             |  |  |  |  |  |         |    |       |             |  |  |  |  |  |         |    |       |             |  |  |  |  |  |         |    |       |             |  |  |  |  |  |
| 1.5 dCi  | 50  | 02.08   | 12.12 + ESP |                |             |  |                         |  |                         |     |         |    |       |             |                |        |       |                     |     |         |    |       |             |  |  |  |  |  |                 |    |       |             |  |  |  |  |  |         |    |       |             |  |  |  |  |  |         |    |       |             |  |  |  |  |  |         |    |       |             |  |  |  |  |  |         |    |       |             |  |  |  |  |  |         |    |       |             |  |  |  |  |  |         |    |       |             |  |  |  |  |  |         |    |       |             |  |  |  |  |  |         |    |       |             |  |  |  |  |  |
| 1.5 dCi  | 63  | 02.08   | 12.12 + ESP |                |             |  |                         |  |                         |     |         |    |       |             |                |        |       |                     |     |         |    |       |             |  |  |  |  |  |                 |    |       |             |  |  |  |  |  |         |    |       |             |  |  |  |  |  |         |    |       |             |  |  |  |  |  |         |    |       |             |  |  |  |  |  |         |    |       |             |  |  |  |  |  |         |    |       |             |  |  |  |  |  |         |    |       |             |  |  |  |  |  |         |    |       |             |  |  |  |  |  |         |    |       |             |  |  |  |  |  |
| 1.5 dCi  | 76  | 02.08   | 12.12 + ESP |                |             |  |                         |  |                         |     |         |    |       |             |                |        |       |                     |     |         |    |       |             |  |  |  |  |  |                 |    |       |             |  |  |  |  |  |         |    |       |             |  |  |  |  |  |         |    |       |             |  |  |  |  |  |         |    |       |             |  |  |  |  |  |         |    |       |             |  |  |  |  |  |         |    |       |             |  |  |  |  |  |         |    |       |             |  |  |  |  |  |         |    |       |             |  |  |  |  |  |         |    |       |             |  |  |  |  |  |
| 1.5 dCi  | 78  | 02.08   | 12.12 + ESP |                |             |  |                         |  |                         |     |         |    |       |             |                |        |       |                     |     |         |    |       |             |  |  |  |  |  |                 |    |       |             |  |  |  |  |  |         |    |       |             |  |  |  |  |  |         |    |       |             |  |  |  |  |  |         |    |       |             |  |  |  |  |  |         |    |       |             |  |  |  |  |  |         |    |       |             |  |  |  |  |  |         |    |       |             |  |  |  |  |  |         |    |       |             |  |  |  |  |  |         |    |       |             |  |  |  |  |  |
| 1.6 16V  | 82  | 02.08   | 12.12 + ESP |                |             |  |                         |  |                         |     |         |    |       |             |                |        |       |                     |     |         |    |       |             |  |  |  |  |  |                 |    |       |             |  |  |  |  |  |         |    |       |             |  |  |  |  |  |         |    |       |             |  |  |  |  |  |         |    |       |             |  |  |  |  |  |         |    |       |             |  |  |  |  |  |         |    |       |             |  |  |  |  |  |         |    |       |             |  |  |  |  |  |         |    |       |             |  |  |  |  |  |         |    |       |             |  |  |  |  |  |
| 1.6 16V  | 94  | 11.08   | 12.12 + ESP |                |             |  |                         |  |                         |     |         |    |       |             |                |        |       |                     |     |         |    |       |             |  |  |  |  |  |                 |    |       |             |  |  |  |  |  |         |    |       |             |  |  |  |  |  |         |    |       |             |  |  |  |  |  |         |    |       |             |  |  |  |  |  |         |    |       |             |  |  |  |  |  |         |    |       |             |  |  |  |  |  |         |    |       |             |  |  |  |  |  |         |    |       |             |  |  |  |  |  |         |    |       |             |  |  |  |  |  |
|  | <table border="1"> <tr><td>1.2 16V</td><td>55</td><td>02.08</td><td>12.12</td><td>03.0137-0454.2</td><td>650454</td><td>- ESP</td><td>203 x 38 HEB</td><td></td></tr> <tr><td>1.2 16V</td><td>57</td><td>02.08</td><td>12.12</td><td>03.0137-9280.2</td><td>669280</td><td>- ESP</td><td>Bremsbacken-Zubehör</td><td></td></tr> <tr><td>1.2 16V</td><td>74</td><td>02.08</td><td>12.12</td><td></td><td></td><td></td><td></td><td></td></tr> <tr><td>1.2 16V Hi-Flex</td><td>55</td><td>07.08</td><td>12.12</td><td></td><td></td><td></td><td></td><td></td></tr> <tr><td>1.4 16V</td><td>72</td><td>02.10</td><td>12.12</td><td></td><td></td><td></td><td></td><td></td></tr> <tr><td>1.5 dCi</td><td>48</td><td>02.08</td><td>12.12</td><td></td><td></td><td></td><td></td><td></td></tr> <tr><td>1.5 dCi</td><td>50</td><td>02.08</td><td>12.12</td><td></td><td></td><td></td><td></td><td></td></tr> <tr><td>1.5 dCi</td><td>63</td><td>02.08</td><td>12.12</td><td></td><td></td><td></td><td></td><td></td></tr> <tr><td>1.5 dCi</td><td>76</td><td>02.08</td><td>12.12</td><td></td><td></td><td></td><td></td><td></td></tr> <tr><td>1.5 dCi</td><td>78</td><td>02.08</td><td>12.12</td><td></td><td></td><td></td><td></td><td></td></tr> <tr><td>1.6 16V</td><td>82</td><td>02.08</td><td>12.12</td><td></td><td></td><td></td><td></td><td></td></tr> <tr><td>1.6 16V</td><td>94</td><td>11.08</td><td>12.12</td><td></td><td></td><td></td><td></td><td></td></tr> </table>  | 1.2 16V | 55          | 02.08          | 12.12       | 03.0137-0454.2                         | 650454                  | - ESP                                  | 203 x 38 HEB            |     | 1.2 16V | 57 | 02.08 | 12.12       | 03.0137-9280.2 | 669280 | - ESP | Bremsbacken-Zubehör |     | 1.2 16V | 74 | 02.08 | 12.12       |  |  |  |  |  | 1.2 16V Hi-Flex | 55 | 07.08 | 12.12       |  |  |  |  |  | 1.4 16V | 72 | 02.10 | 12.12       |  |  |  |  |  | 1.5 dCi | 48 | 02.08 | 12.12       |  |  |  |  |  | 1.5 dCi | 50 | 02.08 | 12.12       |  |  |  |  |  | 1.5 dCi | 63 | 02.08 | 12.12       |  |  |  |  |  | 1.5 dCi | 76 | 02.08 | 12.12       |  |  |  |  |  | 1.5 dCi | 78 | 02.08 | 12.12       |  |  |  |  |  | 1.6 16V | 82 | 02.08 | 12.12       |  |  |  |  |  | 1.6 16V | 94 | 11.08 | 12.12       |  |  |  |  |  |
| 1.2 16V  | 55  | 02.08   | 12.12       | 03.0137-0454.2 | 650454      | - ESP                                  | 203 x 38 HEB            |  |                         |     |         |    |       |             |                |        |       |                     |     |         |    |       |             |  |  |  |  |  |                 |    |       |             |  |  |  |  |  |         |    |       |             |  |  |  |  |  |         |    |       |             |  |  |  |  |  |         |    |       |             |  |  |  |  |  |         |    |       |             |  |  |  |  |  |         |    |       |             |  |  |  |  |  |         |    |       |             |  |  |  |  |  |         |    |       |             |  |  |  |  |  |         |    |       |             |  |  |  |  |  |
| 1.2 16V  | 57  | 02.08   | 12.12       | 03.0137-9280.2 | 669280      | - ESP                                  | Bremsbacken-Zubehör     |  |                         |     |         |    |       |             |                |        |       |                     |     |         |    |       |             |  |  |  |  |  |                 |    |       |             |  |  |  |  |  |         |    |       |             |  |  |  |  |  |         |    |       |             |  |  |  |  |  |         |    |       |             |  |  |  |  |  |         |    |       |             |  |  |  |  |  |         |    |       |             |  |  |  |  |  |         |    |       |             |  |  |  |  |  |         |    |       |             |  |  |  |  |  |         |    |       |             |  |  |  |  |  |
| 1.2 16V  | 74  | 02.08   | 12.12       |                |             |  |                         |  |                         |     |         |    |       |             |                |        |       |                     |     |         |    |       |             |  |  |  |  |  |                 |    |       |             |  |  |  |  |  |         |    |       |             |  |  |  |  |  |         |    |       |             |  |  |  |  |  |         |    |       |             |  |  |  |  |  |         |    |       |             |  |  |  |  |  |         |    |       |             |  |  |  |  |  |         |    |       |             |  |  |  |  |  |         |    |       |             |  |  |  |  |  |         |    |       |             |  |  |  |  |  |
| 1.2 16V Hi-Flex  | 55  | 07.08   | 12.12       |                |             |  |                         |  |                         |     |         |    |       |             |                |        |       |                     |     |         |    |       |             |  |  |  |  |  |                 |    |       |             |  |  |  |  |  |         |    |       |             |  |  |  |  |  |         |    |       |             |  |  |  |  |  |         |    |       |             |  |  |  |  |  |         |    |       |             |  |  |  |  |  |         |    |       |             |  |  |  |  |  |         |    |       |             |  |  |  |  |  |         |    |       |             |  |  |  |  |  |         |    |       |             |  |  |  |  |  |
| 1.4 16V  | 72  | 02.10   | 12.12       |                |             |  |                         |  |                         |     |         |    |       |             |                |        |       |                     |     |         |    |       |             |  |  |  |  |  |                 |    |       |             |  |  |  |  |  |         |    |       |             |  |  |  |  |  |         |    |       |             |  |  |  |  |  |         |    |       |             |  |  |  |  |  |         |    |       |             |  |  |  |  |  |         |    |       |             |  |  |  |  |  |         |    |       |             |  |  |  |  |  |         |    |       |             |  |  |  |  |  |         |    |       |             |  |  |  |  |  |
| 1.5 dCi  | 48  | 02.08   | 12.12       |                |             |  |                         |  |                         |     |         |    |       |             |                |        |       |                     |     |         |    |       |             |  |  |  |  |  |                 |    |       |             |  |  |  |  |  |         |    |       |             |  |  |  |  |  |         |    |       |             |  |  |  |  |  |         |    |       |             |  |  |  |  |  |         |    |       |             |  |  |  |  |  |         |    |       |             |  |  |  |  |  |         |    |       |             |  |  |  |  |  |         |    |       |             |  |  |  |  |  |         |    |       |             |  |  |  |  |  |
| 1.5 dCi  | 50  | 02.08   | 12.12       |                |             |  |                         |  |                         |     |         |    |       |             |                |        |       |                     |     |         |    |       |             |  |  |  |  |  |                 |    |       |             |  |  |  |  |  |         |    |       |             |  |  |  |  |  |         |    |       |             |  |  |  |  |  |         |    |       |             |  |  |  |  |  |         |    |       |             |  |  |  |  |  |         |    |       |             |  |  |  |  |  |         |    |       |             |  |  |  |  |  |         |    |       |             |  |  |  |  |  |         |    |       |             |  |  |  |  |  |
| 1.5 dCi  | 63  | 02.08   | 12.12       |                |             |  |                         |  |                         |     |         |    |       |             |                |        |       |                     |     |         |    |       |             |  |  |  |  |  |                 |    |       |             |  |  |  |  |  |         |    |       |             |  |  |  |  |  |         |    |       |             |  |  |  |  |  |         |    |       |             |  |  |  |  |  |         |    |       |             |  |  |  |  |  |         |    |       |             |  |  |  |  |  |         |    |       |             |  |  |  |  |  |         |    |       |             |  |  |  |  |  |         |    |       |             |  |  |  |  |  |
| 1.5 dCi  | 76  | 02.08   | 12.12       |                |             |  |                         |  |                         |     |         |    |       |             |                |        |       |                     |     |         |    |       |             |  |  |  |  |  |                 |    |       |             |  |  |  |  |  |         |    |       |             |  |  |  |  |  |         |    |       |             |  |  |  |  |  |         |    |       |             |  |  |  |  |  |         |    |       |             |  |  |  |  |  |         |    |       |             |  |  |  |  |  |         |    |       |             |  |  |  |  |  |         |    |       |             |  |  |  |  |  |         |    |       |             |  |  |  |  |  |
| 1.5 dCi  | 78  | 02.08   | 12.12       |                |             |  |                         |  |                         |     |         |    |       |             |                |        |       |                     |     |         |    |       |             |  |  |  |  |  |                 |    |       |             |  |  |  |  |  |         |    |       |             |  |  |  |  |  |         |    |       |             |  |  |  |  |  |         |    |       |             |  |  |  |  |  |         |    |       |             |  |  |  |  |  |         |    |       |             |  |  |  |  |  |         |    |       |             |  |  |  |  |  |         |    |       |             |  |  |  |  |  |         |    |       |             |  |  |  |  |  |
| 1.6 16V  | 82  | 02.08   | 12.12       |                |             |  |                         |  |                         |     |         |    |       |             |                |        |       |                     |     |         |    |       |             |  |  |  |  |  |                 |    |       |             |  |  |  |  |  |         |    |       |             |  |  |  |  |  |         |    |       |             |  |  |  |  |  |         |    |       |             |  |  |  |  |  |         |    |       |             |  |  |  |  |  |         |    |       |             |  |  |  |  |  |         |    |       |             |  |  |  |  |  |         |    |       |             |  |  |  |  |  |         |    |       |             |  |  |  |  |  |
| 1.6 16V  | 94  | 11.08   | 12.12       |                |             |  |                         |  |                         |     |         |    |       |             |                |        |       |                     |     |         |    |       |             |  |  |  |  |  |                 |    |       |             |  |  |  |  |  |         |    |       |             |  |  |  |  |  |         |    |       |             |  |  |  |  |  |         |    |       |             |  |  |  |  |  |         |    |       |             |  |  |  |  |  |         |    |       |             |  |  |  |  |  |         |    |       |             |  |  |  |  |  |         |    |       |             |  |  |  |  |  |         |    |       |             |  |  |  |  |  |
|  | <table border="1"> <tr><td>1.2 16V</td><td>55</td><td>02.08</td><td>12.12</td><td>24.0220-3033.1</td><td>480195</td><td>- ESP</td><td>203/204,5 x 50,5</td><td></td></tr> <tr><td>1.2 16V</td><td>57</td><td>02.08</td><td>12.12</td><td></td><td></td><td></td><td></td><td></td></tr> <tr><td>1.2 16V</td><td>74</td><td>02.08</td><td>12.12</td><td></td><td></td><td></td><td></td><td></td></tr> <tr><td>1.2 16V Hi-Flex</td><td>55</td><td>07.08</td><td>12.12</td><td></td><td></td><td></td><td></td><td></td></tr> <tr><td>1.5 dCi</td><td>48</td><td>02.08</td><td>12.12</td><td></td><td></td><td></td><td></td><td></td></tr> <tr><td>1.5 dCi</td><td>50</td><td>02.08</td><td>12.12</td><td></td><td></td><td></td><td></td><td></td></tr> <tr><td>1.5 dCi</td><td>63</td><td>02.08</td><td>12.12</td><td></td><td></td><td></td><td></td><td></td></tr> <tr><td>1.5 dCi</td><td>76</td><td>02.08</td><td>12.12</td><td></td><td></td><td></td><td></td><td></td></tr> <tr><td>1.5 dCi</td><td>78</td><td>02.08</td><td>12.12</td><td></td><td></td><td></td><td></td><td></td></tr> <tr><td>1.6 16V</td><td>82</td><td>02.08</td><td>12.12</td><td></td><td></td><td></td><td></td><td></td></tr> </table>  | 1.2 16V | 55          | 02.08          | 12.12       | 24.0220-3033.1                         | 480195                  | - ESP                                  | 203/204,5 x 50,5        |     | 1.2 16V | 57 | 02.08 | 12.12       |                |        |       |                     |     | 1.2 16V | 74 | 02.08 | 12.12       |  |  |  |  |  | 1.2 16V Hi-Flex | 55 | 07.08 | 12.12       |  |  |  |  |  | 1.5 dCi | 48 | 02.08 | 12.12       |  |  |  |  |  | 1.5 dCi | 50 | 02.08 | 12.12       |  |  |  |  |  | 1.5 dCi | 63 | 02.08 | 12.12       |  |  |  |  |  | 1.5 dCi | 76 | 02.08 | 12.12       |  |  |  |  |  | 1.5 dCi | 78 | 02.08 | 12.12       |  |  |  |  |  | 1.6 16V | 82 | 02.08 | 12.12       |  |  |  |  |  |         |    |       |             |  |  |  |  |  |         |    |       |             |  |  |  |  |  |
| 1.2 16V  | 55  | 02.08   | 12.12       | 24.0220-3033.1 | 480195      | - ESP                                  | 203/204,5 x 50,5        |  |                         |     |         |    |       |             |                |        |       |                     |     |         |    |       |             |  |  |  |  |  |                 |    |       |             |  |  |  |  |  |         |    |       |             |  |  |  |  |  |         |    |       |             |  |  |  |  |  |         |    |       |             |  |  |  |  |  |         |    |       |             |  |  |  |  |  |         |    |       |             |  |  |  |  |  |         |    |       |             |  |  |  |  |  |         |    |       |             |  |  |  |  |  |         |    |       |             |  |  |  |  |  |
| 1.2 16V  | 57  | 02.08   | 12.12       |                |             |  |                         |  |                         |     |         |    |       |             |                |        |       |                     |     |         |    |       |             |  |  |  |  |  |                 |    |       |             |  |  |  |  |  |         |    |       |             |  |  |  |  |  |         |    |       |             |  |  |  |  |  |         |    |       |             |  |  |  |  |  |         |    |       |             |  |  |  |  |  |         |    |       |             |  |  |  |  |  |         |    |       |             |  |  |  |  |  |         |    |       |             |  |  |  |  |  |         |    |       |             |  |  |  |  |  |
| 1.2 16V  | 74  | 02.08   | 12.12       |                |             |  |                         |  |                         |     |         |    |       |             |                |        |       |                     |     |         |    |       |             |  |  |  |  |  |                 |    |       |             |  |  |  |  |  |         |    |       |             |  |  |  |  |  |         |    |       |             |  |  |  |  |  |         |    |       |             |  |  |  |  |  |         |    |       |             |  |  |  |  |  |         |    |       |             |  |  |  |  |  |         |    |       |             |  |  |  |  |  |         |    |       |             |  |  |  |  |  |         |    |       |             |  |  |  |  |  |
| 1.2 16V Hi-Flex  | 55  | 07.08   | 12.12       |                |             |  |                         |  |                         |     |         |    |       |             |                |        |       |                     |     |         |    |       |             |  |  |  |  |  |                 |    |       |             |  |  |  |  |  |         |    |       |             |  |  |  |  |  |         |    |       |             |  |  |  |  |  |         |    |       |             |  |  |  |  |  |         |    |       |             |  |  |  |  |  |         |    |       |             |  |  |  |  |  |         |    |       |             |  |  |  |  |  |         |    |       |             |  |  |  |  |  |         |    |       |             |  |  |  |  |  |
| 1.5 dCi  | 48  | 02.08   | 12.12       |                |             |  |                         |  |                         |     |         |    |       |             |                |        |       |                     |     |         |    |       |             |  |  |  |  |  |                 |    |       |             |  |  |  |  |  |         |    |       |             |  |  |  |  |  |         |    |       |             |  |  |  |  |  |         |    |       |             |  |  |  |  |  |         |    |       |             |  |  |  |  |  |         |    |       |             |  |  |  |  |  |         |    |       |             |  |  |  |  |  |         |    |       |             |  |  |  |  |  |         |    |       |             |  |  |  |  |  |
| 1.5 dCi  | 50  | 02.08   | 12.12       |                |             |  |                         |  |                         |     |         |    |       |             |                |        |       |                     |     |         |    |       |             |  |  |  |  |  |                 |    |       |             |  |  |  |  |  |         |    |       |             |  |  |  |  |  |         |    |       |             |  |  |  |  |  |         |    |       |             |  |  |  |  |  |         |    |       |             |  |  |  |  |  |         |    |       |             |  |  |  |  |  |         |    |       |             |  |  |  |  |  |         |    |       |             |  |  |  |  |  |         |    |       |             |  |  |  |  |  |
| 1.5 dCi  | 63  | 02.08   | 12.12       |                |             |  |                         |  |                         |     |         |    |       |             |                |        |       |                     |     |         |    |       |             |  |  |  |  |  |                 |    |       |             |  |  |  |  |  |         |    |       |             |  |  |  |  |  |         |    |       |             |  |  |  |  |  |         |    |       |             |  |  |  |  |  |         |    |       |             |  |  |  |  |  |         |    |       |             |  |  |  |  |  |         |    |       |             |  |  |  |  |  |         |    |       |             |  |  |  |  |  |         |    |       |             |  |  |  |  |  |
| 1.5 dCi  | 76  | 02.08   | 12.12       |                |             |  |                         |  |                         |     |         |    |       |             |                |        |       |                     |     |         |    |       |             |  |  |  |  |  |                 |    |       |             |  |  |  |  |  |         |    |       |             |  |  |  |  |  |         |    |       |             |  |  |  |  |  |         |    |       |             |  |  |  |  |  |         |    |       |             |  |  |  |  |  |         |    |       |             |  |  |  |  |  |         |    |       |             |  |  |  |  |  |         |    |       |             |  |  |  |  |  |         |    |       |             |  |  |  |  |  |
| 1.5 dCi  | 78  | 02.08   | 12.12       |                |             |  |                         |  |                         |     |         |    |       |             |                |        |       |                     |     |         |    |       |             |  |  |  |  |  |                 |    |       |             |  |  |  |  |  |         |    |       |             |  |  |  |  |  |         |    |       |             |  |  |  |  |  |         |    |       |             |  |  |  |  |  |         |    |       |             |  |  |  |  |  |         |    |       |             |  |  |  |  |  |         |    |       |             |  |  |  |  |  |         |    |       |             |  |  |  |  |  |         |    |       |             |  |  |  |  |  |
| 1.6 16V  | 82  | 02.08   | 12.12       |                |             |  |                         |  |                         |     |         |    |       |             |                |        |       |                     |     |         |    |       |             |  |  |  |  |  |                 |    |       |             |  |  |  |  |  |         |    |       |             |  |  |  |  |  |         |    |       |             |  |  |  |  |  |         |    |       |             |  |  |  |  |  |         |    |       |             |  |  |  |  |  |         |    |       |             |  |  |  |  |  |         |    |       |             |  |  |  |  |  |         |    |       |             |  |  |  |  |  |         |    |       |             |  |  |  |  |  |
|  | <table border="1"> <tr><td>1.2 16V</td><td>55</td><td>02.08</td><td>12.12</td><td>03.0520-6419.3</td><td>696419</td><td>- ESP</td><td>19,05/203x38 TopKit</td><td>AP</td></tr> <tr><td>1.2 16V</td><td>57</td><td>02.08</td><td>12.12</td><td></td><td></td><td></td><td></td><td></td></tr> <tr><td>1.2 16V</td><td>74</td><td>02.08</td><td>12.12</td><td></td><td></td><td></td><td></td><td></td></tr> <tr><td>1.2 16V Hi-Flex</td><td>55</td><td>07.08</td><td>12.12</td><td></td><td></td><td></td><td></td><td></td></tr> <tr><td>1.4 16V</td><td>72</td><td>02.04</td><td>12.12</td><td></td><td></td><td></td><td></td><td></td></tr> <tr><td>1.5 dCi</td><td>48</td><td>02.08</td><td>12.12</td><td></td><td></td><td></td><td></td><td></td></tr> <tr><td>1.5 dCi</td><td>50</td><td>02.08</td><td>12.12</td><td></td><td></td><td></td><td></td><td></td></tr> <tr><td>1.5 dCi</td><td>63</td><td>02.08</td><td>12.12</td><td></td><td></td><td></td><td></td><td></td></tr> </table>   | 1.2 16V | 55          | 02.08          | 12.12       | 03.0520-6419.3                         | 696419                  | - ESP                                  | 19,05/203x38 TopKit     | AP  | 1.2 16V | 57 | 02.08 | 12.12       |                |        |       |                     |     | 1.2 16V | 74 | 02.08 | 12.12       |  |  |  |  |  | 1.2 16V Hi-Flex | 55 | 07.08 | 12.12       |  |  |  |  |  | 1.4 16V | 72 | 02.04 | 12.12       |  |  |  |  |  | 1.5 dCi | 48 | 02.08 | 12.12       |  |  |  |  |  | 1.5 dCi | 50 | 02.08 | 12.12       |  |  |  |  |  | 1.5 dCi | 63 | 02.08 | 12.12       |  |  |  |  |  |         |    |       |             |  |  |  |  |  |         |    |       |             |  |  |  |  |  |         |    |       |             |  |  |  |  |  |         |    |       |             |  |  |  |  |  |
| 1.2 16V  | 55  | 02.08   | 12.12       | 03.0520-6419.3 | 696419      | - ESP                                  | 19,05/203x38 TopKit     | AP                                     |                         |     |         |    |       |             |                |        |       |                     |     |         |    |       |             |  |  |  |  |  |                 |    |       |             |  |  |  |  |  |         |    |       |             |  |  |  |  |  |         |    |       |             |  |  |  |  |  |         |    |       |             |  |  |  |  |  |         |    |       |             |  |  |  |  |  |         |    |       |             |  |  |  |  |  |         |    |       |             |  |  |  |  |  |         |    |       |             |  |  |  |  |  |         |    |       |             |  |  |  |  |  |
| 1.2 16V  | 57  | 02.08   | 12.12       |                |             |  |                         |  |                         |     |         |    |       |             |                |        |       |                     |     |         |    |       |             |  |  |  |  |  |                 |    |       |             |  |  |  |  |  |         |    |       |             |  |  |  |  |  |         |    |       |             |  |  |  |  |  |         |    |       |             |  |  |  |  |  |         |    |       |             |  |  |  |  |  |         |    |       |             |  |  |  |  |  |         |    |       |             |  |  |  |  |  |         |    |       |             |  |  |  |  |  |         |    |       |             |  |  |  |  |  |
| 1.2 16V  | 74  | 02.08   | 12.12       |                |             |  |                         |  |                         |     |         |    |       |             |                |        |       |                     |     |         |    |       |             |  |  |  |  |  |                 |    |       |             |  |  |  |  |  |         |    |       |             |  |  |  |  |  |         |    |       |             |  |  |  |  |  |         |    |       |             |  |  |  |  |  |         |    |       |             |  |  |  |  |  |         |    |       |             |  |  |  |  |  |         |    |       |             |  |  |  |  |  |         |    |       |             |  |  |  |  |  |         |    |       |             |  |  |  |  |  |
| 1.2 16V Hi-Flex  | 55  | 07.08   | 12.12       |                |             |  |                         |  |                         |     |         |    |       |             |                |        |       |                     |     |         |    |       |             |  |  |  |  |  |                 |    |       |             |  |  |  |  |  |         |    |       |             |  |  |  |  |  |         |    |       |             |  |  |  |  |  |         |    |       |             |  |  |  |  |  |         |    |       |             |  |  |  |  |  |         |    |       |             |  |  |  |  |  |         |    |       |             |  |  |  |  |  |         |    |       |             |  |  |  |  |  |         |    |       |             |  |  |  |  |  |
| 1.4 16V  | 72  | 02.04   | 12.12       |                |             |  |                         |  |                         |     |         |    |       |             |                |        |       |                     |     |         |    |       |             |  |  |  |  |  |                 |    |       |             |  |  |  |  |  |         |    |       |             |  |  |  |  |  |         |    |       |             |  |  |  |  |  |         |    |       |             |  |  |  |  |  |         |    |       |             |  |  |  |  |  |         |    |       |             |  |  |  |  |  |         |    |       |             |  |  |  |  |  |         |    |       |             |  |  |  |  |  |         |    |       |             |  |  |  |  |  |
| 1.5 dCi  | 48  | 02.08   | 12.12       |                |             |  |                         |  |                         |     |         |    |       |             |                |        |       |                     |     |         |    |       |             |  |  |  |  |  |                 |    |       |             |  |  |  |  |  |         |    |       |             |  |  |  |  |  |         |    |       |             |  |  |  |  |  |         |    |       |             |  |  |  |  |  |         |    |       |             |  |  |  |  |  |         |    |       |             |  |  |  |  |  |         |    |       |             |  |  |  |  |  |         |    |       |             |  |  |  |  |  |         |    |       |             |  |  |  |  |  |
| 1.5 dCi  | 50  | 02.08   | 12.12       |                |             |  |                         |  |                         |     |         |    |       |             |                |        |       |                     |     |         |    |       |             |  |  |  |  |  |                 |    |       |             |  |  |  |  |  |         |    |       |             |  |  |  |  |  |         |    |       |             |  |  |  |  |  |         |    |       |             |  |  |  |  |  |         |    |       |             |  |  |  |  |  |         |    |       |             |  |  |  |  |  |         |    |       |             |  |  |  |  |  |         |    |       |             |  |  |  |  |  |         |    |       |             |  |  |  |  |  |
| 1.5 dCi  | 63  | 02.08   | 12.12       |                |             |  |                         |  |                         |     |         |    |       |             |                |        |       |                     |     |         |    |       |             |  |  |  |  |  |                 |    |       |             |  |  |  |  |  |         |    |       |             |  |  |  |  |  |         |    |       |             |  |  |  |  |  |         |    |       |             |  |  |  |  |  |         |    |       |             |  |  |  |  |  |         |    |       |             |  |  |  |  |  |         |    |       |             |  |  |  |  |  |         |    |       |             |  |  |  |  |  |         |    |       |             |  |  |  |  |  |























<sup>1)</sup> with bearing/ with sensor ring / con supporto/+ anell.sens.ABS / avec palier de secours ABS / con apoyo/+ anillo sensor ABS

|          |   |                            |  |   |   |  |                            |   |   |   |                   |
|--|---|----------------------------|--|---|---|--|----------------------------|---|---|---|-------------------|
| <b>RENAULT CLIO III Grandtour (KR_) (08-12)</b>  |   |                            |  |   |   |  |                            |   |   |   |                   |
|    | 1.5 dCi<br>1.5 dCi<br>1.6 16V<br>1.6 16V                            | 76<br>78<br>82<br>94       |  | 02.08<br>02.08<br>02.08<br>11.08          | 12.12<br>12.12<br>12.12<br>12.12          | 03.0520-6419.3                                     | 696419                     |   | - ESP   | 19,05/203x38 TopKit                                 | AP                |
| <b>RENAULT CLIO IV (B98_) (12-)</b>  |   |                            |  |   |   |  |                            |   |   |   |                   |
|    | 0.9 TCe 90<br>1.2 16V 75<br>1.2 TCe 120<br>1.5 dCi 75<br>1.5 dCi 90 | 66<br>54<br>88<br>55<br>66 |  | 09.12<br>09.12<br>03.13<br>09.12<br>09.12 | 03.15<br>03.15<br>03.15<br>03.15<br>03.15 | 13.0460-7298.2                                     | 607298                     |   |   | 25702 18,2 +  | ATE               |
|    | 0.9 TCe 90<br>1.2 16V 75<br>1.2 TCe 120<br>1.5 dCi 75<br>1.5 dCi 90 | 66<br>54<br>88<br>55<br>66 |  | 09.12<br>09.12<br>03.13<br>09.12<br>09.12 | 03.15<br>03.15<br>03.15<br>03.15<br>03.15 | 13.0460-2709.2<br>13.0470-2709.2                   | 602709<br>LD2709           |   |   | 23973 17,4 /Zub/S<br>23973 17,4 /Zub/S              | TRW<br>TRW        |
|    | 1.6 RS 200<br>1.6 RS Trophy   | 147<br>162                 |  | 03.13<br>03.15                            |   | 13.0460-7249.2<br>13.0470-7249.2                   | 607249<br>LD7249           |   |   | 24709 18,6 +<br>24709 18,6 +                        | ATE<br>ATE        |
|    | 0.9 TCe 90<br>1.2 16V 75<br>1.5 dCi 75<br>1.5 dCi 90                | 66<br>54<br>55<br>66       |  | 09.12<br>09.12<br>09.12<br>09.12          |   | 24.0122-0289.1                                     | 422289                     |   |   | 258 22,0 19,8 V L +S +B                             |                   |
|    | 1.2 TCe 120<br>1.5 dCi 90   | 88<br>66                   |  | 03.13<br>09.12                            |   | 24.0122-0270.1                                     | 422270                     |   | + Schaltgetriebe <sup>1)</sup><br>+ Automatikgetriebe <sup>2)</sup> | 258 22,0 19,8 V L +S +B                             |                   |
|    | 1.6 RS 200<br>1.6 RS Trophy   | 147<br>162                 |  | 03.13<br>03.15                            |   | 24.0128-0245.1                                     | 428245                     |   |   | 320 28,0 25,4 V L +S +B                             |                   |
|   | 0.9 TCe 90<br>1.2 16V 75<br>1.2 TCe 120<br>1.5 dCi 75<br>1.5 dCi 90 | 66<br>54<br>88<br>55<br>66 |  | 09.12<br>09.12<br>03.13<br>09.12<br>09.12 |   | 24.0711-5382.3                                     | 360423                     | 2 |   | Radsensor L=650                                     |                   |
|    | 1.6 RS 200<br>1.6 RS Trophy   | 147<br>162                 |  | 03.13<br>03.15                            |   | 13.0460-2740.2<br>13.0470-2740.2                   | 602740<br>LD2740           |   |   | 23554 17,2 /Zub/S<br>23554 17,2 /Zub/S              | TRW<br>TRW        |
|    | 1.6 RS 200<br>1.6 RS Trophy   | 147<br>162                 |  | 03.13<br>03.15                            |   | 24.0108-0118.2                                     | 408118                     |   | mit Lager/ mit Sensorring <sup>3)</sup>                             | 260 8,0 7,0 +B                                      |                   |
|    | 0.9 TCe 90<br>1.2 16V 75<br>1.5 dCi 75<br>1.5 dCi 90                | 66<br>54<br>55<br>66       |  | 09.12<br>09.12<br>09.12<br>09.12          |   | 24.0711-6324.3<br>24.0711-6325.3                   | 360399<br>360400           |   |   | Radsensor L=620<br>Radsensor L=620                  |                   |
|    | 0.9 TCe 90<br>1.2 16V 75<br>1.5 dCi 75<br>1.5 dCi 90                | 66<br>54<br>55<br>66       |  | 09.12<br>09.12<br>09.12<br>09.12          |   | 03.0137-0423.2<br>03.0137-0532.2<br>03.0137-9274.2 | 650423<br>650532<br>669274 |   |   | 203 x 39 HEB<br>203 x 39 HEB<br>Bremsbacken-Zubehör | BOS<br>BOS<br>BOS |
|    | 1.2 TCe 120<br>1.5 dCi 90   | 88<br>66                   |  | 03.13<br>09.12                            |   | 03.0137-0496.2<br>03.0137-9228.2                   | 650496<br>669228           |   |   | 228 x 42 HEB<br>Bremsbacken-Zubehör                 | BDX<br>BDX        |
|    | 0.9 TCe 90<br>1.2 16V 75<br>1.5 dCi 75<br>1.5 dCi 90                | 66<br>54<br>55<br>66       |  | 09.12<br>09.12<br>09.12<br>09.12          |   | 03.0520-3817.3<br>03.0520-5017.3                   | 693817<br>695017           |   |   | 17,46/203x39 TopKit<br>17,46/203x39 TopKit          | BOS<br>BOS        |
|    | 1.2 TCe 120<br>1.5 dCi 90   | 88<br>66                   |  | 03.13<br>09.12                            |   | 03.0520-7919.3                                     | 697919                     |   |   | 19,05/228x42 TopKit                                 |                   |
| <b>RENAULT CLIO IV Grandtour (K98_) (12-)</b>  |   |                            |  |   |   |  |                            |   |   |   |                   |
|    | 0.9 TCe 90<br>1.2 16V<br>1.2 TCe 120<br>1.5 dCi 75<br>1.5 dCi 90    | 66<br>54<br>88<br>55<br>66 |  | 11.12<br>11.12<br>03.13<br>11.12<br>11.12 |   | 13.0460-2709.2<br>13.0470-2709.2                   | 602709<br>LD2709           |   |   | 23973 17,4 /Zub/S<br>23973 17,4 /Zub/S              | TRW<br>TRW        |
|    | 0.9 TCe 90<br>1.2 16V<br>1.2 TCe 120<br>1.5 dCi 75<br>1.5 dCi 90    | 66<br>54<br>88<br>55<br>66 |  | 11.12<br>11.12<br>03.13<br>11.12<br>11.12 |   | 24.0122-0270.1                                     | 422270                     |   |   | 258 22,0 19,8 V L +S +B                             |                   |
|    | 0.9 TCe 90<br>1.2 16V<br>1.2 TCe 120<br>1.5 dCi 75<br>1.5 dCi 90    | 66<br>54<br>88<br>55<br>66 |  | 11.12<br>11.12<br>03.13<br>11.12<br>11.12 |   | 24.0711-5382.3                                     | 360423                     | 2 |   | Radsensor L=650                                     |                   |
|    | 0.9 TCe 90<br>1.2 16V<br>1.2 TCe 120<br>1.5 dCi 75<br>1.5 dCi 90    | 66<br>54<br>88<br>55<br>66 |  | 11.12<br>11.12<br>03.13<br>11.12<br>11.12 |   | 03.0137-0496.2<br>03.0137-9228.2                   | 650496<br>669228           |   |   | 228 x 42 HEB<br>Bremsbacken-Zubehör                 | BDX<br>BDX        |
|  | 0.9 TCe 90<br>1.2 16V<br>1.2 TCe 120<br>1.5 dCi 75<br>1.5 dCi 90    | 66<br>54<br>88<br>55<br>66 |  | 11.12<br>11.12<br>03.13<br>11.12<br>11.12 |   | 03.0520-7919.3                                     | 697919                     |   |   | 19,05/228x42 TopKit                                 |                   |

<sup>1)</sup> + manual transmission / + scatola cambio velocità / + transmission mécanique / + cambio de velocidad

<sup>2)</sup> + autom.transmission / + scatola cambio automatico / + transmission automatique / + cambio automático

<sup>3)</sup> with bearing/ with sensor ring / con supporto/+ anell.sens.ABS / avec palier de secours ABS / con apoyo/+ anillo sensor ABS

|     |  |  |  |  |  |  |  |     |                         |
|--|--|--|--|--|---|--|--|---|-------------------------|
| <b>RENAULT DOKKER (K67/F67) (12-)</b>  |  |  |  |  |   |  |  |   |                         |
|    | 1.5 dCi 75   | 55   |  | 11.12  | - ESP   | 13.0460-2709.2   | 602709   | 23973 17,4 /Zub/S   | TRW                     |
|  | 1.5 dCi 90   | 66   |  | 11.12  | - ESP   | 13.0470-2709.2   | LD2709   | 23973 17,4 /Zub/S   | TRW                     |
|  | 1.6 MPI  | 61   |  | 11.12  | - ESP   |  |  |   |                         |
|  | 1.2 TCe 115  | 85   |  | 01.13  |   | 13.0460-7266.2   | 607266   | 24538 17,9 +  | ATE                     |
|  | 1.5 dCi 75   | 55   |  | 11.12  | + ESP   | 13.0470-7266.2   | LD7266   | 24538 17,9 +  | ATE                     |
|  | 1.5 dCi 90   | 66   |  | 11.12  | + ESP   |  |  |   |                         |
| 1.6 MPI  | 61   |  | 11.12  | + ESP  |   |  |  |   |                         |
|    | 1.5 dCi 75   | 55   |  | 11.12  | - ESP   | 24.0122-0270.1   | 422270   | - erhöhte Zuladung <sup>1)</sup><br>+ erhöhte Zuladung <sup>2)</sup>                  | 258 22,0 19,8 V L +S +B |
|  | 1.5 dCi 90   | 66   |  | 11.12  | - ESP   | 24.0124-0253.1   | 424253   |   | 280 24,0 21,8 V L +S +B |
|  | 1.6 MPI  | 61   |  | 11.12  | - ESP   |  |  |   |                         |
|  | 1.2 TCe 115  | 85   |  | 01.13  |   | 24.0124-0253.1   | 424253   |   | 280 24,0 21,8 V L +S +B |
|  | 1.5 dCi 75   | 55   |  | 11.12  | + ESP   |  |  |   |                         |
|  | 1.5 dCi 90   | 66   |  | 11.12  | + ESP   |  |  |   |                         |
| 1.6 MPI  | 61   |  | 11.12  | + ESP  |   |  |  |   |                         |
|    | 1.2 TCe 115  | 85   |  | 01.13  |   | 24.0711-5369.3   | 360378   | 2  | Radsensor L=619         |
|  | 1.5 dCi 75   | 55   |  | 11.12  |   |  |  |   |                         |
|  | 1.5 dCi 90   | 66   |  | 11.12  |   |  |  |   |                         |
|  | 1.6 MPI  | 61   |  | 11.12  |   |  |  |   |                         |
|    | 1.2 TCe 115  | 85   |  | 01.13  |   | 03.0137-0496.2   | 650496   |   | 228 x 42 HEB            |
|  | 1.5 dCi 75   | 55   |  | 11.12  |   | 03.0137-9228.2   | 669228   |   | Bremsbacken-Zubehör     |
|  | 1.5 dCi 90   | 66   |  | 11.12  |   |  |  |   | BDX                     |
|  | 1.6 MPI  | 61   |  | 11.12  |   |  |  |   | BDX                     |
|    | 1.2 TCe 115  | 85   |  | 01.13  |   | 03.0520-7222.3   | 697222   |   | 22,20/228x42 TopKit     |
|  | 1.5 dCi 75   | 55   |  | 11.12  |   |  |  |   |                         |
|  | 1.5 dCi 90   | 66   |  | 11.12  |   |  |  |   |                         |
|  | 1.6 MPI  | 61   |  | 11.12  |   |  |  |   |                         |
| <b>RENAULT DUSTER (HS-) (11-)</b>  |  |  |  |  |   |  |  |   |                         |
|    | 1.5 dCi  | 66   |  | 06.11  | - ABS   | 13.0460-2709.2   | 602709   | 23973 17,4 /Zub/S   | TRW                     |
|  | 1.6 16V  | 75   |  | 06.11  | - ESP   | 13.0470-2709.2   | LD2709   | 23973 17,4 /Zub/S   | TRW                     |
|  | 1.6 16V 4x4  | 75   |  | 06.11  | - ESP   |  |  |   |                         |
|  | 2.0  | 98   |  | 02.12  | - ABS   |  |  |   |                         |
|  | 1.5 dCi 4x4  | 66   |  | 06.11  |   | 13.0460-7266.2   | 607266   | 24538 17,9 +  | ATE                     |
|  |  |  |  |  |   | 13.0470-7266.2   | LD7266   | 24538 17,9 +  | ATE                     |
|    | 1.5 dCi  | 66   |  | 06.11  |   | 13.0460-7266.2   | 607266   | 24538 17,9 +  | ATE                     |
|  | 1.5 dCi 4x4  | 66   |  | 06.11  |   | 13.0470-7266.2   | LD7266   | 24538 17,9 +  | ATE                     |
|  | 1.6 16V  | 75   |  | 06.11  | + ESP   |  |  |   |                         |
|  | 1.6 16V 4x4  | 75   |  | 06.11  | + ESP   |  |  |   |                         |
|  | 2.0  | 98   |  | 02.12  | + ABS   |  |  |   |                         |
|  | 2.0 4x4  | 99   |  | 02.12  | + ABS   |  |  |   |                         |
|  | 1.5 dCi  | 66   |  | 06.11  | - ABS   | 24.0123-0119.1   | 423119   |   | 269 22,5 19,8 V L +S +B |
|  | 1.6 16V  | 75   |  | 06.11  | - ESP   |  |  |   |                         |
|  | 1.6 16V 4x4  | 75   |  | 06.11  | - ESP   |  |  |   |                         |
|  | 2.0  | 98   |  | 02.12  | - ABS   |  |  |   |                         |
|  | 1.5 dCi  | 66   |  | 06.11  | + ABS   | 24.0124-0221.1   | 424221   |   | 280 24,0 21,8 V L +S +B |
|  | 1.5 dCi 4x4  | 66   |  | 06.11  |   |  |  |   |                         |
|  | 1.6 16V  | 75   |  | 06.11  | + ESP   |  |  |   |                         |
|  | 1.6 16V 4x4  | 75   |  | 06.11  | + ESP   |  |  |   |                         |
|  | 2.0  | 98   |  | 02.12  | + ABS   |  |  |   |                         |
|  | 2.0 4x4  | 99   |  | 02.12  | + ABS   |  |  |   |                         |
|  | 1.5 dCi  | 66   |  | 06.11  |   | 03.0137-0496.2   | 650496   |   | 228 x 42 HEB            |
|  | 1.6 16V  | 75   |  | 06.11  |   | 03.0137-9228.2   | 669228   |   | Bremsbacken-Zubehör     |
| 2.0  | 98   |  | 02.12  |  |   |  |  | BDX   |                         |
|  | 1.5 dCi 4x4  | 66   |  | 06.11  |   | 03.0137-9312.2   | 669312   |   | Bremsbacken-Zubehör     |
|  | 1.6 16V 4x4  | 75   |  | 06.11  |   |  |  |   |                         |
|  | 2.0 4x4  | 99   |  | 02.12  |   |  |  |   |                         |
|  | 1.5 dCi  | 66   |  | 06.11  |   | 03.0520-7919.3   | 697919   |   | 19,05/228x42 TopKit     |
| 1.6 16V  | 75   |  | 06.11  |  |   |  |  |   |                         |
| 2.0  | 98   |  | 02.12  |  |   |  |  |   |                         |
| <b>RENAULT ESPACE III (JE_) (96-02)</b>  |  |  |  |  |   |  |  |   |                         |
|  | 1.9 dTi  | 72   |  | 02.99  | 10.02   | 13.0460-2832.2   | 602832   | 21888 18,1 +/WK/S   | TRW                     |
|  | 2.0  | 84   |  | 11.96  | 10.00   |  |  |   |                         |
|  | 2.0  | 102  |  | 09.01  | 10.02   |  |  |   |                         |
|  | 2.0 16V  | 103  |  | 10.98  | 10.02   |  |  |   |                         |
|  | 2.2 D  | 84   |  | 11.97  | 01.00   |  |  |   |                         |
|  | 2.2 dT   | 83   |  | 11.96  | 10.00   |  |  |   |                         |
|  | 3.0 V6   | 123  |  | 11.96  | 10.98   |  |  |   |                         |
|  | 2.2 dCi  | 85   |  | 07.00  | 10.02   | 13.0460-2870.2   | 602870   | 23099 18,4 /S   | TRW                     |
|  | 2.2 dCi  | 95   |  | 10.00  | 10.02   |  |  |   |                         |
|  | 3.0 V6   | 140  |  | 07.00  | 10.02   |  |  |   |                         |
|  | 2.2 dCi  | 95   |  | 10.00  | 10.02   | 13.0460-2735.2   | 602735   | 23099 18,4 +/WK/Zub/STRW  |                         |
|  | 3.0 V6   | 140  |  | 10.98  | 06.00   |  |  |   |                         |
|  | 1.9 dTi  | 72   |  | 02.99  | 10.02   | 24.0124-0171.1   | 424171   | 280 24,0 21,8 V L +S +B   |                         |
|  | 2.0  | 84   |  | 11.96  | 10.00   | 24.0324-0171.1   | 524171   | 280 24,0 21,8 V L +S +B   | PD                      |
|  | 2.0  | 102  |  | 09.01  | 10.02   |  |  |   |                         |
|  | 2.0 16V  | 103  |  | 10.98  | 10.02   |  |  |   |                         |
|  | 2.2 D  | 84   |  | 11.97  | 01.00   |  |  |   |                         |
|  | 2.2 dT   | 83   |  | 11.96  | 10.00   |  |  |   |                         |
|  | 3.0 V6   | 123  |  | 11.96  | 10.98   |  |  |   |                         |
|  | 2.2 dCi  | 85   |  | 07.00  | 10.02   | 24.0128-0134.1   | 428134   | 305 28,0 26,0 V +B  |                         |
|  | 2.2 dCi  | 95   |  | 10.00  | 10.02   |  |  |   |                         |
|  | 3.0 V6   | 140  |  | 07.00  | 10.02   |  |  |   |                         |

1) - increased payload / - carico utile maggiorato / - charge utile augmentée / - incremento de carga

2) + increased payload / + carico utile maggiorato / + charge utile augmentée / + incremento de carga

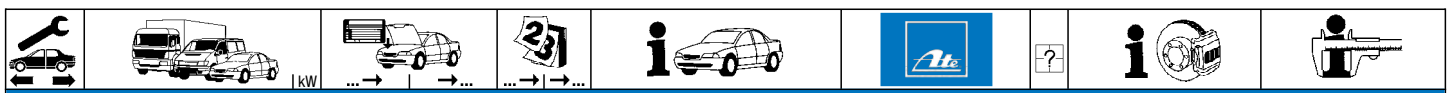

### RENAULT ESPACE III (JE\_) (96-02)





|  |   |                                |  |   |   |                                  |                  |  |  |            |
|--|---|--------------------------------|--|---|---|----------------------------------|------------------|--|--|------------|
|  | 2.0 16V<br>3.0 V6<br>3.0 V6                   | 103<br>123<br>140              |  | 10.98<br>11.96<br>10.98                   | 06.00<br>10.98<br>06.00                   | 13.0460-4957.2<br>13.0460-0438.2 | 604957<br>610438 |  | 20410 15,0 +<br>Belagsatz-Zubehör      | BRE<br>BRE |
|  | 2.0<br>2.0 16V<br>2.2 dCi<br>3.0 V6           | 102<br>103<br>95<br>140        |  | 09.01<br>07.00<br>10.00<br>07.00          | 10.02<br>10.02<br>10.02<br>10.02          | 13.0460-2845.2<br>13.0470-2845.2 | 602845<br>LD2845 |  | 23554 16,4 /Zub/S<br>23554 16,4 /Zub/S | TRW<br>TRW |
|  | 2.0<br>2.0 16V<br>2.2 dCi<br>3.0 V6<br>3.0 V6 | 102<br>103<br>95<br>123<br>140 |  | 09.01<br>10.98<br>10.00<br>11.96<br>10.98 | 10.02<br>10.02<br>10.02<br>10.98<br>10.02 | 24.0111-0151.1                   | 411151           |  | 265 10,5 9,5 +B                        |            |
|  | 1.9 dTi<br>2.0<br>2.2 D<br>2.2 dCi<br>2.2 dT  | 72<br>84<br>84<br>85<br>83     |  | 02.99<br>11.96<br>11.97<br>07.00<br>11.96 | 10.02<br>10.00<br>01.00<br>10.02<br>10.00 | 03.0137-0347.2<br>03.0137-9206.2 | 650347<br>669206 |  | 229 x 42 HEB<br>Bremsbacken-Zubehör    | TRW<br>TRW |
|  | 1.9 dTi<br>2.0<br>2.2 D<br>2.2 dCi<br>2.2 dT  | 72<br>84<br>84<br>85<br>83     |  | 02.99<br>11.96<br>11.97<br>07.00<br>11.96 | 10.02<br>10.00<br>01.00<br>10.02<br>10.00 | 24.0222-8032.1                   | 480170           |  | 229/229,5 x 52,5                       |            |
|  | 1.9 dTi<br>2.0<br>2.2 D<br>2.2 dCi<br>2.2 dT  | 72<br>84<br>84<br>85<br>83     |  | 02.99<br>11.96<br>11.97<br>07.00<br>11.96 | 10.02<br>10.00<br>01.00<br>10.02<br>10.00 | 03.0520-5522.3                   | 695522           |  | 22,20/229x41 TopKit                    | TRW        |

### RENAULT ESPACE IV (JK\_) (02-)

|  |  |   |  |  |  |   |                  |        |                              |                      |
|--|--|---|--|--|--|---|------------------|--------|------------------------------|----------------------|
|  | 1.9 dCi<br>1.9 dCi<br>2.0<br>2.0 dCi<br>2.0 dCi 110<br>2.0 dCi 130<br>2.0 i<br>2.0 Turbo<br>2.0 Turbo<br>2.2 dCi<br>2.2 dCi<br>3.0 dCi<br>3.0 dCi<br>3.0 dCi<br>3.5 V6 | 85<br>88<br>98<br>96<br>110<br>127<br>100<br>120<br>125<br>102<br>110<br>120<br>130<br>133<br>177 |  | 04.03<br>11.02<br>11.02<br>01.06<br>01.06<br>11.02<br>11.02<br>04.05<br>02.06<br>11.02<br>09.09<br>11.02<br>01.06<br>11.02 | 02.05  | 13.0460-7159.2<br>13.0470-7159.2  | 607159<br>LD7159 |        | 23248 18,3 +<br>23248 18,3 + | ATE<br>ATE           |
|  | 1.9 dCi<br>2.0<br>2.0 dCi 110<br>2.0 dCi 130<br>2.0 i<br>2.0 Turbo<br>2.0 Turbo<br>2.2 dCi<br>2.2 dCi<br>3.0 dCi<br>3.0 dCi<br>3.0 dCi<br>3.5 V6                       | 88<br>98<br>110<br>127<br>100<br>120<br>120<br>102<br>110<br>120<br>130<br>133<br>177             |  | 11.02<br>11.02<br>01.06<br>01.06<br>11.02<br>11.02<br>11.02<br>02.06<br>11.02<br>09.05<br>11.02<br>01.06<br>11.02          | 09.03<br>02.05<br><br><br>09.03<br>09.03<br>09.03    | + Leichtmetallfelgen 1)<br>+ Leichtmetallfelgen 1)<br><br><br>+ Leichtmetallfelgen 1)<br>+ 18" Leichtmetallfelgen 2)<br>+ 17" Leichtmetallfelgen 3)<br>+ Stahlfelgen 4) | 24.0128-0133.1   | 428133 |                              | 324 28,0 25,4 V L +B |
|  | 1.9 dCi<br>1.9 dCi<br>1.9 dCi<br>2.0<br>2.0 dCi<br>2.0 i<br>2.0 i<br>2.0 Turbo<br>2.0 Turbo<br>2.0 Turbo   | 85<br>88<br>88<br>98<br>96<br>100<br>100<br>120<br>120<br>125                                     |  | 04.03<br>10.03<br>11.02<br>11.02<br>01.06<br>10.03<br>11.02<br>10.03<br>10.03<br>04.05                                     | 02.05<br><br><br>02.05<br><br><br>02.05<br><br>02.05 | + Leichtmetallfelgen 1)<br>+ Stahlfelgen 4)<br>+ Stahlfelgen 4)<br><br>+ Leichtmetallfelgen 1)<br>+ Stahlfelgen 4)<br>+ 17" Leichtmetallfelgen 3)<br>+ Stahlfelgen 4)   | 24.0128-0135.1   | 428135 |                              | 308 28,0 25,8 V L +B |
|  | 1.9 dCi<br>1.9 dCi<br>2.0<br>2.0 dCi<br>2.0 dCi 110<br>2.0 dCi 130<br>2.0 i<br>2.0 Turbo<br>2.0 Turbo<br>2.2 dCi<br>2.2 dCi<br>3.0 dCi<br>3.0 dCi<br>3.0 dCi<br>3.5 V6 | 85<br>88<br>98<br>96<br>110<br>127<br>100<br>120<br>125<br>102<br>110<br>120<br>130<br>133<br>177 |  | 04.03<br>11.02<br>11.02<br>01.06<br>01.06<br>11.02<br>11.02<br>04.05   | 02.05<br>02.05                                       | 24.0711-5094.1  | 360064           | 2      | Radsensor L=557              |                      |

1) + light alloy rims / + cerchioni in lega / + jantes en alliage léger / + Llantas de aleación ligera  
 2) + 18" light alloy rims / + cerchioni in lega 18" / + jantes en alliage léger 18" / + Llantas aleación ligera 18"  
 3) + 17" alloy wheels / + cerchioni in lega 17" / + jantes en alliage léger 17" / + Llantas aleación ligera 17"  
 4) + steel rims / + cerchioni in acciaio / + jantes en acier / + Llantas acero



| RENAULT ESPACE IV (JK_) (02-)  |              |     |  |       |       |     |                |        |   |   |                         |
|--|--------------|-----|--|-------|-------|-----|----------------|--------|---|---|-------------------------|
|    | 1.9 dCi      | 85  |  | 04.03 | 02.05 |     | 13.0460-7137.2 | 607137 |   | 23482 15,8 +                            | ATE                     |
|  | 1.9 dCi      | 88  |  | 11.02 |       |     | 13.0470-7137.2 | LD7137 |   | 23482 15,8 +                            | ATE                     |
|  | 2.0          | 98  |  | 11.02 | 02.05 |     |                |        |   |   |                         |
|  | 2.0 dCi      | 96  |  | 01.06 |       |     |                |        |   |   |                         |
|  | 2.0 dCi 110  | 110 |  | 01.06 |       |     |                |        |   |   |                         |
|  | 2.0 dCi 130  | 127 |  | 01.06 |       |     |                |        |   |   |                         |
|  | 2.0 i        | 100 |  | 11.02 |       |     |                |        |   |   |                         |
|  | 2.0 Turbo    | 120 |  | 11.02 |       |     |                |        |   |   |                         |
|  | 2.0 Turbo    | 125 |  | 04.05 |       |     |                |        |   |   |                         |
|  | 2.2 dCi      | 102 |  | 02.06 |       |     |                |        |   |   |                         |
|  | 2.2 dCi      | 110 |  | 11.02 |       |     |                |        |   |   |                         |
|  | 3.0 dCi      | 120 |  | 09.05 |       |     |                |        |   |   |                         |
|  | 3.0 dCi      | 130 |  | 11.02 |       |     |                |        |   |   |                         |
|  | 3.0 dCi      | 133 |  | 01.06 |       |     |                |        |   |   |                         |
|  | 3.5 V6       | 177 |  | 11.02 |       |     |                |        |   |   |                         |
|    | 1.9 dCi      | 85  |  | 04.03 | 02.05 |     | 24.0111-0100.2 | 411100 |   | mit Lager/ mit Sensorring <sup>1)</sup> | 300 11,0 9,5 +B         |
|  | 1.9 dCi      | 88  |  | 11.02 |       |     |                |        |   |   |                         |
|  | 2.0          | 98  |  | 11.02 | 02.05 |     |                |        |   |   |                         |
|  | 2.0 dCi      | 96  |  | 01.06 |       |     |                |        |   |   |                         |
|  | 2.0 dCi 110  | 110 |  | 01.06 |       |     |                |        |   |   |                         |
|  | 2.0 dCi 130  | 127 |  | 01.06 |       |     |                |        |   |   |                         |
|  | 2.0 i        | 100 |  | 11.02 |       |     |                |        |   |   |                         |
|  | 2.0 Turbo    | 120 |  | 11.02 |       |     |                |        |   |   |                         |
|  | 2.0 Turbo    | 125 |  | 04.05 |       |     |                |        |   |   |                         |
|  | 2.2 dCi      | 102 |  | 02.06 |       |     |                |        |   |   |                         |
|  | 2.2 dCi      | 110 |  | 11.02 |       |     |                |        |   |   |                         |
|  | 3.0 dCi      | 120 |  | 09.05 |       |     |                |        |   |   |                         |
|  | 3.0 dCi      | 130 |  | 11.02 |       |     |                |        |   |   |                         |
|  | 3.0 dCi      | 133 |  | 01.06 |       |     |                |        |   |   |                         |
|  | 3.5 V6       | 177 |  | 11.02 |       |     |                |        |   |   |                         |
|    | 1.9 dCi      | 85  |  | 04.03 | 02.05 |     | 24.0711-5097.1 | 360198 | 2 |   | Radsensor L=636         |
|  | 1.9 dCi      | 88  |  | 11.02 | 05.06 |     |                |        |   |   |                         |
|  | 2.0          | 98  |  | 11.02 | 02.05 |     |                |        |   |   |                         |
|  | 2.0 dCi      | 96  |  | 01.06 | 05.06 |     |                |        |   |   |                         |
|  | 2.0 dCi 110  | 110 |  | 01.06 | 05.06 |     |                |        |   |   |                         |
|  | 2.0 dCi 130  | 127 |  | 01.06 | 05.06 |     |                |        |   |   |                         |
|  | 2.0 i        | 100 |  | 11.02 | 05.06 |     |                |        |   |   |                         |
|  | 2.0 Turbo    | 120 |  | 11.02 | 05.06 |     |                |        |   |   |                         |
|  | 2.0 Turbo    | 125 |  | 04.05 | 05.06 |     |                |        |   |   |                         |
|  | 2.2 dCi      | 102 |  | 02.06 | 05.06 |     |                |        |   |   |                         |
|  | 2.2 dCi      | 110 |  | 11.02 | 05.06 |     |                |        |   |   |                         |
|  | 3.0 dCi      | 120 |  | 09.05 | 05.06 |     |                |        |   |   |                         |
|  | 3.0 dCi      | 130 |  | 11.02 | 05.06 |     |                |        |   |   |                         |
|  | 3.0 dCi      | 133 |  | 01.06 | 05.06 |     |                |        |   |   |                         |
|  | 3.5 V6       | 177 |  | 11.02 | 05.06 |     |                |        |   |   |                         |
| RENAULT ESPACE V (JR_) (15-)   |              |     |  |       |       |     |                |        |   |   |                         |
|  | 1.6 dCi 130  | 96  |  | 06.15 |       |     | 24.0128-0245.1 | 428245 |   |   | 320 28,0 25,4 V L +S +B |
|  | 1.6 dCi 160  | 118 |  | 06.15 |       |     |                |        |   |   |                         |
|  | 1.6 Tce 200  | 147 |  | 02.15 |       |     |                |        |   |   |                         |
| RENAULT EXPRESS/RAPID (F40_) (85-98)   |              |     |  |       |       |     |                |        |   |   |                         |
|  | 1.0          | 31  |  | 09.85 | 05.88 |     | 13.0460-3955.2 | 603955 |   |   | 21097 15,0 +/WK         |
|  | 1.0 (F400)   | 27  |  | 01.86 | 05.88 |     | 13.0460-0423.2 | 610423 |   |   | Belagsatz-Zubehör       |
|  | 1.1          | 34  |  | 09.85 | 05.88 | - ⊖ |                |        |   |   | BDX                     |
|  | 1.1 (F401)   | 33  |  | 07.85 | 05.88 | - ⊖ |                |        |   |   |                         |
|  | 1.1 (F40H)   | 33  |  | 06.87 | 05.88 |     |                |        |   |   |                         |
|  | 1.6 (F404)   | 40  |  | 01.86 | 06.86 | + ⊕ |                |        |   |   |                         |
|  | 1.0          | 31  |  | 06.88 | 08.91 |     | 13.0460-3911.2 | 603911 |   |   | 20905 18,0 +/WK         |
|  | 1.0 (F400)   | 27  |  | 06.88 | 05.92 |     | 13.0460-2834.2 | 602834 |   |   | 21463 18,0 /WK/S        |
|  | 1.1          | 34  |  | 06.88 | 08.91 |     | 13.0460-0411.2 | 610411 |   |   | Belagsatz-Zubehör       |
|  | 1.1          | 34  |  | 09.85 | 05.88 | + ⊖ |                |        |   |   | BDX                     |
|  | 1.1 (F401)   | 33  |  | 06.88 | 04.95 | + ⊖ |                |        |   |   |                         |
|  | 1.1 (F401)   | 33  |  | 07.85 | 05.88 | + ⊖ |                |        |   |   |                         |
|  | 1.1 (F40H)   | 33  |  | 06.88 | 06.90 |     |                |        |   |   |                         |
|  | 1.1 (F40T)   | 33  |  | 09.91 | 03.98 |     |                |        |   |   |                         |
|  | 1.2          | 40  |  | 09.91 | 08.93 |     |                |        |   |   |                         |
|  | 1.2          | 48  |  | 05.95 | 11.98 |     |                |        |   |   |                         |
|  | 1.2 (F406)   | 40  |  | 10.92 | 03.98 |     |                |        |   |   |                         |
|  | 1.2 (F40F)   | 40  |  | 06.90 | 03.98 |     |                |        |   |   |                         |
|  | 1.4          | 43  |  | 09.91 | 08.93 |     |                |        |   |   |                         |
|  | 1.4          | 54  |  | 09.91 | 08.93 |     |                |        |   |   |                         |
|  | 1.4          | 59  |  | 05.95 | 08.97 |     |                |        |   |   |                         |
|  | 1.4 (F402)   | 43  |  | 01.86 | 06.90 |     |                |        |   |   |                         |
|  | 1.4 (F40A)   | 43  |  | 06.90 | 03.98 |     |                |        |   |   |                         |
|  | 1.4 (F40M)   | 44  |  | 06.87 | 06.90 |     |                |        |   |   |                         |
|  | 1.4 (F40Y)   | 43  |  | 09.91 | 03.98 |     |                |        |   |   |                         |
|  | 1.4 i (F407) | 43  |  | 01.86 | 03.98 |     |                |        |   |   |                         |
|  | 1.4 i (F40D) | 58  |  | 09.94 | 03.98 |     |                |        |   |   |                         |
|  | 1.4 i (F40U) | 55  |  | 09.91 | 03.98 |     |                |        |   |   |                         |
|  | 1.4 i (F40V) | 55  |  | 09.91 | 03.98 |     |                |        |   |   |                         |
|  | 1.6 (F404)   | 40  |  | 07.86 | 08.98 | + ⊕ |                |        |   |   |                         |
|  | 1.6 (F404)   | 40  |  | 01.86 | 08.98 | - ⊕ |                |        |   |   |                         |
|  | 1.9 (F40E)   | 47  |  | 09.92 | 03.98 |     |                |        |   |   |                         |
|  | 1.9 (F40N)   | 47  |  | 06.90 | 03.98 |     |                |        |   |   |                         |
|  | 1.9 (F40P)   | 47  |  | 09.91 | 03.98 |     |                |        |   |   |                         |

<sup>1)</sup> with bearing/ with sensor ring / con supporto/+ anell.sens.ABS / avec palier de secours ABS / con apoyo/+ anillo sensor ABS



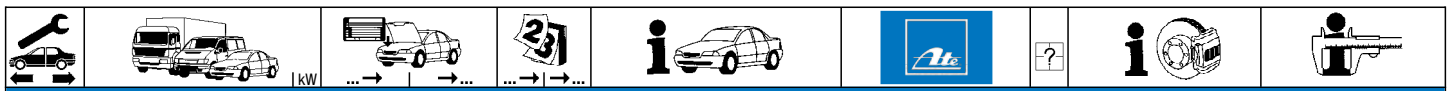

**RENAULT EXPRESS/RAPID (F40\_) (85-98)**

|  |              |    |  |       |  |                |        |  |       |                     |            |
|--|--------------|----|--|-------|--|----------------|--------|--|-------|---------------------|------------|
|  | 1.9 (F40R)   | 40 |  | 09.94 | 03.98                                  | 13.0460-3911.2 | 603911 |  | 20905 | 18,0 +WK            | <b>BDX</b> |
|  | 1.9 D (G40B) | 40 |  | 09.95 | 03.98                                  | 13.0460-0411.2 | 610411 |  |       | Belagsatz-Zubehör   | <b>BDX</b> |
|  | 1.9 D (G40C) | 40 |  | 09.95 | 03.98                                  |                |        |  |       |                     |            |
|  | 1.0          | 31 |  | 09.85 | 08.91 + ⊕                              | 24.0108-0104.1 | 408104 |  |       | 238 8,2 7,0 +S +B   |            |
|  | 1.0 (F400)   | 27 |  | 01.86 | 05.92 + ⊕                              |                |        |  |       |                     |            |
|  | 1.1          | 34 |  | 09.85 | 05.88 - ⊖                              |                |        |  |       |                     |            |
|  | 1.1 (F401)   | 33 |  | 07.85 | 05.88 - ⊖                              |                |        |  |       |                     |            |
|  | 1.1 (F40H)   | 33 |  | 06.87 | 05.88                                  |                |        |  |       |                     |            |
|  | 1.6 (F404)   | 40 |  | 01.86 | 06.86 + ⊕                              |                |        |  |       |                     |            |
|  | 1.0          | 31 |  | 09.85 | 08.91 - ⊖                              | 24.0112-0116.1 | 412116 |  |       | 238 12,0 10,5 +S +B |            |
|  | 1.0 (F400)   | 27 |  | 01.86 | 05.92 - ⊖                              |                |        |  |       |                     |            |
|  | 1.1 (F401)   | 33 |  | 01.86 | 04.95 + ⊖                              |                |        |  |       |                     |            |
|  | 1.1 (F401)   | 33 |  | 06.88 | 04.95 - ⊖                              |                |        |  |       |                     |            |
|  | 1.1 (F40H)   | 33 |  | 06.88 | 06.90                                  |                |        |  |       |                     |            |
|  | 1.1 (F40T)   | 33 |  | 09.91 | 03.98                                  |                |        |  |       |                     |            |
|  | 1.2          | 40 |  | 09.91 | 08.93                                  |                |        |  |       |                     |            |
|  | 1.2          | 48 |  | 05.95 | 11.98                                  |                |        |  |       |                     |            |
|  | 1.2 (F406)   | 40 |  | 10.92 | 03.98                                  |                |        |  |       |                     |            |
|  | 1.2 (F40F)   | 40 |  | 06.90 | 03.98                                  |                |        |  |       |                     |            |
|  | 1.4          | 43 |  | 09.91 | 08.93                                  |                |        |  |       |                     |            |
|  | 1.4          | 54 |  | 09.91 | 08.93                                  |                |        |  |       |                     |            |
|  | 1.4          | 59 |  | 05.95 | 08.97                                  |                |        |  |       |                     |            |
|  | 1.4 (F402)   | 43 |  | 01.86 | 06.90                                  |                |        |  |       |                     |            |
|  | 1.4 (F40A)   | 43 |  | 06.90 | 03.98                                  |                |        |  |       |                     |            |
|  | 1.4 (F40M)   | 44 |  | 06.87 | 06.90                                  |                |        |  |       |                     |            |
|  | 1.4 (F40Y)   | 43 |  | 09.91 | 03.98                                  |                |        |  |       |                     |            |
|  | 1.4 i (F407) | 43 |  | 01.86 | 03.98                                  |                |        |  |       |                     |            |
|  | 1.4 i (F40D) | 58 |  | 09.94 | 03.98                                  |                |        |  |       |                     |            |
|  | 1.4 i (F40U) | 55 |  | 09.91 | 03.98                                  |                |        |  |       |                     |            |
|  | 1.4 i (F40V) | 55 |  | 09.91 | 03.98                                  |                |        |  |       |                     |            |
|  | 1.6 (F404)   | 40 |  | 07.86 | 08.98 + ⊕                              |                |        |  |       |                     |            |
|  | 1.6 (F404)   | 40 |  | 01.86 | 08.98 - ⊕                              |                |        |  |       |                     |            |
|  | 1.9 (F40E)   | 47 |  | 09.92 | 03.98                                  |                |        |  |       |                     |            |
|  | 1.9 (F40N)   | 47 |  | 06.90 | 03.98                                  |                |        |  |       |                     |            |
|  | 1.9 (F40P)   | 47 |  | 09.91 | 03.98                                  |                |        |  |       |                     |            |
|  | 1.9 (F40R)   | 40 |  | 09.94 | 03.98                                  |                |        |  |       |                     |            |
|  | 1.9 D (G40B) | 40 |  | 09.95 | 03.98                                  |                |        |  |       |                     |            |
|  | 1.9 D (G40C) | 40 |  | 09.95 | 03.98                                  |                |        |  |       |                     |            |
|  | 1.0          | 31 |  | 09.85 | 08.91                                  | 03.0137-0209.2 | 650209 |  |       | 180 x 42            | <b>BDX</b> |
|  | 1.0 (F400)   | 27 |  | 01.86 | 05.92                                  | 03.0137-9086.2 | 669086 |  |       | 180 x 41 HEB        | <b>BDX</b> |
|  | 1.1          | 34 |  | 09.85 | 08.91                                  | 03.0137-0201.2 | 650201 |  |       |                     | <b>TRW</b> |
|  | 1.1 (F401)   | 33 |  | 07.85 | 04.95                                  | 03.0137-9056.2 | 669056 |  |       |                     | <b>TRW</b> |
|  | 1.1 (F40H)   | 33 |  | 06.87 | 06.90                                  |                |        |  |       |                     |            |
|  | 1.1 (F40T)   | 33 |  | 09.91 | 09.96                                  |                |        |  |       |                     |            |
|  | 1.6 (F404)   | 40 |  | 01.86 | 06.86 + ⊕                              |                |        |  |       |                     |            |
|  | 1.1 (F40T)   | 33 |  | 10.96 | 03.98                                  | 03.0137-0211.2 | 650211 |  |       | 203 x 39            | <b>BDX</b> |
|  | 1.2          | 40 |  | 09.91 | 08.93                                  | 03.0137-9125.2 | 669125 |  |       |                     | <b>BDX</b> |
|  | 1.2          | 48 |  | 05.95 | 11.98                                  |                |        |  |       |                     |            |
|  | 1.2 (F406)   | 40 |  | 10.92 | 03.98                                  |                |        |  |       |                     |            |
|  | 1.2 (F40F)   | 40 |  | 06.90 | 03.98                                  |                |        |  |       |                     |            |
|  | 1.4          | 43 |  | 09.91 | 08.93 - erhöhte Zuladung <sup>1)</sup> |                |        |  |       |                     |            |
|  | 1.4          | 54 |  | 09.91 | 08.93 - erhöhte Zuladung <sup>1)</sup> |                |        |  |       |                     |            |
|  | 1.4          | 59 |  | 05.95 | 08.97 - erhöhte Zuladung <sup>1)</sup> |                |        |  |       |                     |            |
|  | 1.4 (F402)   | 43 |  | 01.86 | 06.90                                  |                |        |  |       |                     |            |
|  | 1.4 (F40A)   | 43 |  | 06.90 | 03.98 - erhöhte Zuladung <sup>1)</sup> |                |        |  |       |                     |            |
|  | 1.4 (F40M)   | 44 |  | 06.87 | 08.91                                  |                |        |  |       |                     |            |
|  | 1.4 i (F407) | 43 |  | 01.86 | 03.98                                  |                |        |  |       |                     |            |
|  | 1.4 i (F40D) | 58 |  | 09.94 | 03.98 - erhöhte Zuladung <sup>1)</sup> |                |        |  |       |                     |            |
|  | 1.4 i (F40U) | 55 |  | 09.91 | 03.98 - erhöhte Zuladung <sup>1)</sup> |                |        |  |       |                     |            |
|  | 1.4 i (F40V) | 55 |  | 09.91 | 03.98 - erhöhte Zuladung <sup>1)</sup> |                |        |  |       |                     |            |
|  | 1.6 (F404)   | 40 |  | 07.86 | 08.98 - erhöhte Zuladung <sup>1)</sup> |                |        |  |       |                     |            |
|  | 1.6 (F404)   | 40 |  | 01.86 | 06.86 - ⊕                              |                |        |  |       |                     |            |
|  | 1.9 (F40E)   | 47 |  | 09.92 | 03.98 - erhöhte Zuladung <sup>1)</sup> |                |        |  |       |                     |            |
|  | 1.9 (F40N)   | 47 |  | 06.90 | 03.98 - erhöhte Zuladung <sup>1)</sup> |                |        |  |       |                     |            |
|  | 1.9 (F40P)   | 47 |  | 09.91 | 03.98 - erhöhte Zuladung <sup>1)</sup> |                |        |  |       |                     |            |
|  | 1.9 (F40R)   | 40 |  | 09.94 | 03.98 - erhöhte Zuladung <sup>1)</sup> |                |        |  |       |                     |            |
|  | 1.9 D (G40B) | 40 |  | 09.95 | 03.98 - erhöhte Zuladung <sup>1)</sup> |                |        |  |       |                     |            |
|  | 1.9 D (G40C) | 40 |  | 09.95 | 03.98 - erhöhte Zuladung <sup>1)</sup> |                |        |  |       |                     |            |
|  | 1.4          | 43 |  | 09.91 | 08.93 + erhöhte Zuladung <sup>2)</sup> | 03.0137-0271.2 | 650271 |  |       | 229 x 42 HEB        | <b>TRW</b> |
|  | 1.4          | 54 |  | 09.91 | 08.93 + erhöhte Zuladung <sup>2)</sup> | 03.0137-9027.2 | 669027 |  |       |                     | <b>TRW</b> |
|  | 1.4          | 59 |  | 05.95 | 08.97 + erhöhte Zuladung <sup>2)</sup> |                |        |  |       |                     |            |
|  | 1.4 (F40A)   | 43 |  | 06.90 | 03.98 + erhöhte Zuladung <sup>2)</sup> |                |        |  |       |                     |            |
|  | 1.4 (F40Y)   | 43 |  | 09.91 | 03.98                                  |                |        |  |       |                     |            |
|  | 1.4 i (F40D) | 58 |  | 09.94 | 03.98 + erhöhte Zuladung <sup>2)</sup> |                |        |  |       |                     |            |
|  | 1.4 i (F40U) | 55 |  | 09.91 | 03.98 + erhöhte Zuladung <sup>2)</sup> |                |        |  |       |                     |            |
|  | 1.4 i (F40V) | 55 |  | 09.91 | 03.98 + erhöhte Zuladung <sup>2)</sup> |                |        |  |       |                     |            |
|  | 1.6 (F404)   | 40 |  | 07.86 | 08.98 + erhöhte Zuladung <sup>2)</sup> |                |        |  |       |                     |            |
|  | 1.9 (F40E)   | 47 |  | 09.92 | 03.98 + erhöhte Zuladung <sup>2)</sup> |                |        |  |       |                     |            |
|  | 1.9 (F40N)   | 47 |  | 06.90 | 03.98 + erhöhte Zuladung <sup>2)</sup> |                |        |  |       |                     |            |
|  | 1.9 (F40P)   | 47 |  | 09.91 | 03.98 + erhöhte Zuladung <sup>2)</sup> |                |        |  |       |                     |            |
|  | 1.9 (F40R)   | 40 |  | 09.94 | 03.98 + erhöhte Zuladung <sup>2)</sup> |                |        |  |       |                     |            |
|  | 1.9 D (G40B) | 40 |  | 09.95 | 03.98 + erhöhte Zuladung <sup>2)</sup> |                |        |  |       |                     |            |
|  | 1.9 D (G40C) | 40 |  | 09.95 | 03.98 + erhöhte Zuladung <sup>2)</sup> |                |        |  |       |                     |            |

<sup>1)</sup> - increased payload / - carico utile maggiorato / - charge utile augmentée / - incremento de carga

<sup>2)</sup> + increased payload / + carico utile maggiorato / + charge utile augmentée / + incremento de carga



**RENAULT EXPRESS/RAPID (F40\_) (85-98)**









|              |              |    |              |              |   |   |                       |        |                         |                         |                       |        |  |                         |                       |        |  |                         |                       |        |  |                         |
|--------------|--------------|----|--------------|--------------|---|---|-----------------------|--------|-------------------------|-------------------------|-----------------------|--------|--|-------------------------|-----------------------|--------|--|-------------------------|-----------------------|--------|--|-------------------------|
|              | 1.0          | 31 |              | <b>09.85</b> | <b>08.91</b>                            | - (I)                                   | <b>24.0218-0013.1</b> | 480008 |                         | 180/181,3 x 53 - Lager  |                       |        |  |                         |                       |        |  |                         |                       |        |  |                         |
|              | 1.0 (F400)   | 27 |              | <b>01.86</b> | <b>05.92</b>                            | - (I)                                   |                       |        |                         |                         |                       |        |  |                         |                       |        |  |                         |                       |        |  |                         |
|              | 1.1          | 34 |              | <b>09.85</b> | <b>08.91</b>                            | - (I) (MA)                              |                       |        |                         |                         |                       |        |  |                         |                       |        |  |                         |                       |        |  |                         |
|              | 1.1 (F401)   | 33 |              | <b>07.85</b> | <b>04.95</b>                            | - (I) (MA)                              |                       |        |                         |                         |                       |        |  |                         |                       |        |  |                         |                       |        |  |                         |
|              | 1.1 (F40H)   | 33 |              | <b>06.87</b> | <b>06.90</b>                            |   |                       |        |                         |                         |                       |        |  |                         |                       |        |  |                         |                       |        |  |                         |
|              | 1.1 (F40T)   | 33 |              | <b>09.91</b> | <b>09.96</b>                            |   |                       |        |                         |                         |                       |        |  |                         |                       |        |  |                         |                       |        |  |                         |
|              | 1.2 (F40F)   | 40 |              | <b>06.90</b> | <b>03.98</b>                            |   |                       |        |                         |                         |                       |        |  |                         |                       |        |  |                         |                       |        |  |                         |
|              | 1.6 (F404)   | 40 |              | <b>01.86</b> | <b>06.86</b>                            | - erhöhte Zuladung/ + (P) <sup>1)</sup> |                       |        |                         |                         |                       |        |  |                         |                       |        |  |                         |                       |        |  |                         |
|              | 1.0          | 31 |              | <b>09.85</b> | <b>08.91</b>                            | + (I)                                   |                       |        |                         |                         | <b>24.0220-3005.1</b> | 480054 |  | 203/204,5 x 50,5        |                       |        |  |                         |                       |        |  |                         |
|              | 1.0 (F400)   | 27 |              | <b>01.86</b> | <b>05.92</b>                            | + (I)                                   |                       |        |                         |                         |                       |        |  |                         |                       |        |  |                         |                       |        |  |                         |
| 1.1          | 34           |    | <b>09.85</b> | <b>08.91</b> | + (I) (MA)                              |   |                       |        |                         |                         |                       |        |  |                         |                       |        |  |                         |                       |        |  |                         |
| 1.1 (F401)   | 33           |    | <b>07.85</b> | <b>04.95</b> | + (I) (MA)                              |   |                       |        |                         |                         |                       |        |  |                         |                       |        |  |                         |                       |        |  |                         |
| 1.1 (F40T)   | 33           |    | <b>10.96</b> | <b>03.98</b> |   |   |                       |        |                         |                         |                       |        |  |                         |                       |        |  |                         |                       |        |  |                         |
| 1.2          | 40           |    | <b>09.91</b> | <b>08.93</b> |   |   |                       |        |                         |                         |                       |        |  |                         |                       |        |  |                         |                       |        |  |                         |
| 1.2          | 48           |    | <b>05.95</b> | <b>11.98</b> |   |   |                       |        |                         |                         |                       |        |  |                         |                       |        |  |                         |                       |        |  |                         |
| 1.2 (F406)   | 40           |    | <b>10.92</b> | <b>03.98</b> |   |   |                       |        |                         |                         |                       |        |  |                         |                       |        |  |                         |                       |        |  |                         |
| 1.4          | 43           |    | <b>09.91</b> | <b>08.93</b> | - erhöhte Zuladung <sup>2)</sup>        |   |                       |        |                         |                         |                       |        |  |                         |                       |        |  |                         |                       |        |  |                         |
| 1.4          | 54           |    | <b>09.91</b> | <b>08.93</b> | - erhöhte Zuladung <sup>2)</sup>        |   |                       |        |                         |                         |                       |        |  |                         |                       |        |  |                         |                       |        |  |                         |
| 1.4          | 59           |    | <b>05.95</b> | <b>08.97</b> | - erhöhte Zuladung <sup>2)</sup>        |   |                       |        |                         |                         |                       |        |  |                         |                       |        |  |                         |                       |        |  |                         |
| 1.4 (F402)   | 43           |    | <b>01.86</b> | <b>06.90</b> |   |   |                       |        |                         |                         |                       |        |  |                         |                       |        |  |                         |                       |        |  |                         |
| 1.4 (F40A)   | 43           |    | <b>06.90</b> | <b>03.98</b> | - erhöhte Zuladung <sup>2)</sup>        |   |                       |        |                         |                         |                       |        |  |                         |                       |        |  |                         |                       |        |  |                         |
| 1.4 (F40M)   | 44           |    | <b>06.87</b> | <b>06.90</b> |   |   |                       |        |                         |                         |                       |        |  |                         |                       |        |  |                         |                       |        |  |                         |
| 1.4 i (F407) | 43           |    | <b>01.86</b> | <b>03.98</b> |   |   |                       |        |                         |                         |                       |        |  |                         |                       |        |  |                         |                       |        |  |                         |
| 1.4 i (F40D) | 58           |    | <b>09.94</b> | <b>03.98</b> | - erhöhte Zuladung <sup>2)</sup>        |   |                       |        |                         |                         |                       |        |  |                         |                       |        |  |                         |                       |        |  |                         |
| 1.4 i (F40U) | 55           |    | <b>09.91</b> | <b>03.98</b> | - erhöhte Zuladung <sup>2)</sup>        |   |                       |        |                         |                         |                       |        |  |                         |                       |        |  |                         |                       |        |  |                         |
| 1.4 i (F40V) | 55           |    | <b>09.91</b> | <b>03.98</b> | - erhöhte Zuladung <sup>2)</sup>        |   |                       |        |                         |                         |                       |        |  |                         |                       |        |  |                         |                       |        |  |                         |
| 1.6 (F404)   | 40           |    | <b>07.86</b> | <b>08.98</b> | - erhöhte Zuladung <sup>2)</sup>        |   |                       |        |                         |                         |                       |        |  |                         |                       |        |  |                         |                       |        |  |                         |
| 1.6 (F404)   | 40           |    | <b>01.86</b> | <b>06.86</b> | - erhöhte Zuladung/ - (P) <sup>3)</sup> |   |                       |        |                         |                         |                       |        |  |                         |                       |        |  |                         |                       |        |  |                         |
| 1.9 (F40E)   | 47           |    | <b>09.92</b> | <b>03.98</b> | - erhöhte Zuladung <sup>2)</sup>        |   |                       |        |                         |                         |                       |        |  |                         |                       |        |  |                         |                       |        |  |                         |
| 1.9 (F40N)   | 47           |    | <b>06.90</b> | <b>03.98</b> | - erhöhte Zuladung <sup>2)</sup>        |   |                       |        |                         |                         |                       |        |  |                         |                       |        |  |                         |                       |        |  |                         |
| 1.9 (F40P)   | 47           |    | <b>09.91</b> | <b>03.98</b> | - erhöhte Zuladung <sup>2)</sup>        |   |                       |        |                         |                         |                       |        |  |                         |                       |        |  |                         |                       |        |  |                         |
| 1.9 (F40R)   | 40           |    | <b>09.94</b> | <b>03.98</b> | - erhöhte Zuladung <sup>2)</sup>        |   |                       |        |                         |                         |                       |        |  |                         |                       |        |  |                         |                       |        |  |                         |
| 1.9 D (G40B) | 40           |    | <b>09.95</b> | <b>03.98</b> | - erhöhte Zuladung <sup>2)</sup>        |   |                       |        |                         |                         |                       |        |  |                         |                       |        |  |                         |                       |        |  |                         |
| 1.9 D (G40C) | 40           |    | <b>09.95</b> | <b>03.98</b> | - erhöhte Zuladung <sup>2)</sup>        |   |                       |        |                         |                         |                       |        |  |                         |                       |        |  |                         |                       |        |  |                         |
| 1.4          | 43           |    | <b>09.91</b> | <b>08.93</b> | + erhöhte Zuladung <sup>4)</sup>        | <b>24.0222-8019.2</b>                   | 480087                |        | 229/229,5 x 52,5        |                         |                       |        |  |                         |                       |        |  |                         |                       |        |  |                         |
| 1.4          | 54           |    | <b>09.91</b> | <b>08.93</b> | + erhöhte Zuladung <sup>4)</sup>        |   |                       |        |                         |                         |                       |        |  |                         |                       |        |  |                         |                       |        |  |                         |
| 1.4          | 59           |    | <b>05.95</b> | <b>08.97</b> | + erhöhte Zuladung <sup>4)</sup>        |   |                       |        |                         |                         |                       |        |  |                         |                       |        |  |                         |                       |        |  |                         |
| 1.4 (F40Y)   | 43           |    | <b>09.91</b> | <b>03.98</b> |   |   |                       |        |                         |                         |                       |        |  |                         |                       |        |  |                         |                       |        |  |                         |
| 1.4 i (F40D) | 58           |    | <b>09.94</b> | <b>03.98</b> | + erhöhte Zuladung <sup>4)</sup>        |   |                       |        |                         |                         |                       |        |  |                         |                       |        |  |                         |                       |        |  |                         |
| 1.4 i (F40U) | 55           |    | <b>09.91</b> | <b>03.98</b> | + erhöhte Zuladung <sup>4)</sup>        |   |                       |        |                         |                         |                       |        |  |                         |                       |        |  |                         |                       |        |  |                         |
| 1.4 i (F40V) | 55           |    | <b>09.91</b> | <b>03.98</b> | + erhöhte Zuladung <sup>4)</sup>        |   |                       |        |                         |                         |                       |        |  |                         |                       |        |  |                         |                       |        |  |                         |
| 1.6 (F404)   | 40           |    | <b>01.86</b> | <b>08.98</b> | + erhöhte Zuladung <sup>4)</sup>        |   |                       |        |                         |                         |                       |        |  |                         |                       |        |  |                         |                       |        |  |                         |
| 1.9 (F40E)   | 47           |    | <b>09.92</b> | <b>03.98</b> | + erhöhte Zuladung <sup>4)</sup>        |   |                       |        |                         |                         |                       |        |  |                         |                       |        |  |                         |                       |        |  |                         |
| 1.9 (F40N)   | 47           |    | <b>06.90</b> | <b>03.98</b> | + erhöhte Zuladung <sup>4)</sup>        |   |                       |        |                         |                         |                       |        |  |                         |                       |        |  |                         |                       |        |  |                         |
| 1.9 (F40P)   | 47           |    | <b>09.91</b> | <b>03.98</b> | + erhöhte Zuladung <sup>4)</sup>        |   |                       |        |                         |                         |                       |        |  |                         |                       |        |  |                         |                       |        |  |                         |
| 1.9 (F40R)   | 40           |    | <b>09.94</b> | <b>03.98</b> | + erhöhte Zuladung <sup>4)</sup>        |   |                       |        |                         |                         |                       |        |  |                         |                       |        |  |                         |                       |        |  |                         |
| 1.9 D (G40B) | 40           |    | <b>09.95</b> | <b>03.98</b> | + erhöhte Zuladung <sup>4)</sup>        |   |                       |        |                         |                         |                       |        |  |                         |                       |        |  |                         |                       |        |  |                         |
| 1.9 D (G40C) | 40           |    | <b>09.95</b> | <b>03.98</b> | + erhöhte Zuladung <sup>4)</sup>        |   |                       |        |                         |                         |                       |        |  |                         |                       |        |  |                         |                       |        |  |                         |
|              | 1.0          | 31 |              | <b>09.85</b> | <b>08.91</b>                            |   | <b>03.0520-1022.3</b> | 691022 |                         | 22,20/180x42 TopKit BDX |                       |        |  |                         |                       |        |  |                         |                       |        |  |                         |
|              | 1.0 (F400)   | 27 |              | <b>01.86</b> | <b>05.92</b>                            |   |                       |        |                         |                         |                       |        |  |                         |                       |        |  |                         |                       |        |  |                         |
|              | 1.1 (F40H)   | 33 |              | <b>06.87</b> | <b>06.90</b>                            |   |                       |        |                         |                         |                       |        |  |                         |                       |        |  |                         |                       |        |  |                         |
|              | 1.1 (F40T)   | 33 |              | <b>09.91</b> | <b>09.96</b>                            |   |                       |        |                         |                         |                       |        |  |                         |                       |        |  |                         |                       |        |  |                         |
|              | 1.1          | 34 |              | <b>09.85</b> | <b>08.91</b>                            | - (I)                                   |                       |        |                         |                         | <b>03.0520-1122.3</b> | 691122 |  | 22,20/180x41 TopKit TRW |                       |        |  |                         |                       |        |  |                         |
|              | 1.1 (F401)   | 33 |              | <b>07.85</b> | <b>04.95</b>                            | - (I)                                   |                       |        |                         |                         |                       |        |  |                         |                       |        |  |                         |                       |        |  |                         |
|              | 1.6 (F404)   | 40 |              | <b>01.86</b> | <b>06.86</b>                            | + (P)                                   |                       |        |                         |                         |                       |        |  |                         |                       |        |  |                         |                       |        |  |                         |
|              | 1.1          | 34 |              | <b>09.85</b> | <b>08.91</b>                            | + (I)                                   |                       |        |                         |                         |                       |        |  |                         | <b>03.0520-3020.3</b> | 693020 |  | 20,64/203x39 TopKit BDX |                       |        |  |                         |
|              | 1.1 (F401)   | 33 |              | <b>07.85</b> | <b>04.95</b>                            | + (I)                                   |                       |        |                         |                         |                       |        |  |                         |                       |        |  |                         |                       |        |  |                         |
|              | 1.4 (F402)   | 43 |              | <b>01.86</b> | <b>06.90</b>                            |   |                       |        |                         |                         |                       |        |  |                         |                       |        |  |                         |                       |        |  |                         |
|              | 1.4 (F40M)   | 44 |              | <b>06.87</b> | <b>08.91</b>                            |   |                       |        |                         |                         |                       |        |  |                         |                       |        |  |                         |                       |        |  |                         |
|              | 1.4 i (F407) | 43 |              | <b>01.86</b> | <b>03.98</b>                            |   |                       |        |                         |                         |                       |        |  |                         |                       |        |  |                         |                       |        |  |                         |
|              | 1.6 (F404)   | 40 |              | <b>01.86</b> | <b>06.86</b>                            | - (P)                                   |                       |        |                         |                         |                       |        |  |                         |                       |        |  |                         |                       |        |  |                         |
|              | 1.1          | 34 |              | <b>09.85</b> | <b>08.91</b>                            |   |                       |        |                         |                         |                       |        |  |                         |                       |        |  |                         | <b>03.0520-1122.3</b> | 691122 |  | 22,20/180x41 TopKit TRW |
|              | 1.1 (F401)   | 33 |              | <b>07.85</b> | <b>04.95</b>                            |   |                       |        |                         |                         |                       |        |  |                         |                       |        |  |                         |                       |        |  |                         |
|              | 1.6 (F404)   | 40 |              | <b>01.86</b> | <b>06.86</b>                            |   |                       |        |                         |                         |                       |        |  |                         |                       |        |  |                         |                       |        |  |                         |
|              | 1.1 (F40T)   | 33 |              | <b>10.96</b> | <b>03.98</b>                            |   |                       |        |                         |                         |                       |        |  |                         |                       |        |  |                         | <b>03.0520-3020.3</b> | 693020 |  | 20,64/203x39 TopKit BDX |
|              | 1.2          | 40 |              | <b>09.91</b> | <b>08.93</b>                            |   |                       |        |                         |                         |                       |        |  |                         |                       |        |  |                         |                       |        |  |                         |
|              | 1.2          | 48 |              | <b>05.95</b> | <b>11.98</b>                            |   |                       |        |                         |                         |                       |        |  |                         |                       |        |  |                         |                       |        |  |                         |
|              | 1.2 (F406)   | 40 |              | <b>10.92</b> | <b>03.98</b>                            |   |                       |        |                         |                         |                       |        |  |                         |                       |        |  |                         |                       |        |  |                         |
| 1.2 (F40F)   | 40           |    | <b>06.90</b> | <b>03.98</b> |   |   |                       |        |                         |                         |                       |        |  |                         |                       |        |  |                         |                       |        |  |                         |
| 1.4          | 43           |    | <b>09.91</b> | <b>08.93</b> | - erhöhte Zuladung <sup>2)</sup>        |   |                       |        |                         |                         |                       |        |  |                         |                       |        |  |                         |                       |        |  |                         |
| 1.4          | 54           |    | <b>09.91</b> | <b>08.93</b> | - erhöhte Zuladung <sup>2)</sup>        |   |                       |        |                         |                         |                       |        |  |                         |                       |        |  |                         |                       |        |  |                         |
| 1.4          | 59           |    | <b>05.95</b> | <b>08.97</b> | - erhöhte Zuladung <sup>2)</sup>        |   |                       |        |                         |                         |                       |        |  |                         |                       |        |  |                         |                       |        |  |                         |
| 1.4 (F40A)   | 43           |    | <b>06.90</b> | <b>03.98</b> | - erhöhte Zuladung <sup>2)</sup>        |   |                       |        |                         |                         |                       |        |  |                         |                       |        |  |                         |                       |        |  |                         |
| 1.4 i (F40D) | 58           |    | <b>09.94</b> | <b>03.98</b> | - erhöhte Zuladung <sup>2)</sup>        |   |                       |        |                         |                         |                       |        |  |                         |                       |        |  |                         |                       |        |  |                         |
| 1.4 i (F40U) | 55           |    | <b>09.91</b> | <b>03.98</b> | - erhöhte Zuladung <sup>2)</sup>        |   |                       |        |                         |                         |                       |        |  |                         |                       |        |  |                         |                       |        |  |                         |
| 1.4 i (F40V) | 55           |    | <b>09.91</b> | <b>03.98</b> | - erhöhte Zuladung <sup>2)</sup>        |   |                       |        |                         |                         |                       |        |  |                         |                       |        |  |                         |                       |        |  |                         |
| 1.6 (F404)   | 40           |    | <b>07.86</b> | <b>08.98</b> | - erhöhte Zuladung <sup>2)</sup>        |   |                       |        |                         |                         |                       |        |  |                         |                       |        |  |                         |                       |        |  |                         |
| 1.9 (F40E)   | 47           |    | <b>09.92</b> | <b>03.98</b> | - erhöhte Zuladung <sup>2)</sup>        |   |                       |        |                         |                         |                       |        |  |                         |                       |        |  |                         |                       |        |  |                         |
| 1.9 (F40N)   | 47           |    | <b>06.90</b> | <b>03.98</b> | - erhöhte Zuladung <sup>2)</sup>        |   |                       |        |                         |                         |                       |        |  |                         |                       |        |  |                         |                       |        |  |                         |
| 1.9 (F40P)   | 47           |    | <b>09.91</b> | <b>03.98</b> | - erhöhte Zuladung <sup>2)</sup>        |   |                       |        |                         |                         |                       |        |  |                         |                       |        |  |                         |                       |        |  |                         |
| 1.9 (F40R)   | 40           |    | <b>09.94</b> | <b>03.98</b> | - erhöhte Zuladung <sup>2)</sup>        |   |                       |        |                         |                         |                       |        |  |                         |                       |        |  |                         |                       |        |  |                         |
| 1.9 D (G40B) | 40           |    | <b>09.95</b> | <b>03.98</b> | - erhöhte Zuladung <sup>2)</sup>        |   |                       |        |                         |                         |                       |        |  |                         |                       |        |  |                         |                       |        |  |                         |
| 1.9 D (G40C) | 40           |    | <b>09.95</b> | <b>03.98</b> | - erhöhte Zuladung <sup>2)</sup>        |   |                       |        |                         |                         |                       |        |  |                         |                       |        |  |                         |                       |        |  |                         |
| 1.4          | 43           |    | <b>09.91</b> | <b>08.93</b> | + erhöhte Zuladung <sup>4)</sup>        | <b>03.0520-2422.3</b>                   | 692422                |        | 22,20/229x42 TopKit TRW |                         |                       |        |  |                         |                       |        |  |                         |                       |        |  |                         |
| 1.4          | 54           |    | <b>09.91</b> | <b>08.93</b> | + erhöhte Zuladung <sup>4)</sup>        |   |                       |        |                         |                         |                       |        |  |                         |                       |        |  |                         |                       |        |  |                         |
| 1.4          | 59           |    | <b>05.95</b> | <b>08.97</b> | + erhöhte Zuladung <sup>4)</sup>        |   |                       |        |                         |                         |                       |        |  |                         |                       |        |  |                         |                       |        |  |                         |

<sup>1)</sup> - increased payload/ + (P) / - carico utile maggiorato/ + (P) / - charge utile augmentée/ + (P) / - incremento de carga/ + (P)

<sup>2)</sup> - increased payload / - carico utile maggiorato / - charge utile augmentée / - incremento de carga

<sup>3)</sup> - increased payload/ - (P) / - carico utile maggiorato/ - (P) / - charge utile augmentée/ - (P) / - incremento de carga/ - (P)

<sup>4)</sup> + increased payload / + carico utile maggiorato / + charge utile augmentée / + incremento de carga

| RENAULT EXPRESS/RAPID (F40_) (85-98)   |  |             |   |                |   |   |                         |   |                         |     |             |    |       |   |                |        |  |                   |     |              |    |       |   |  |  |  |  |  |                 |    |       |   |  |  |  |  |  |              |    |       |   |  |  |  |  |  |            |    |       |   |  |  |  |  |  |            |    |       |   |  |  |  |  |  |            |    |       |   |  |  |  |  |  |            |     |       |   |  |  |  |  |  |            |     |       |   |  |  |  |  |  |              |    |       |  |                |        |   |                 |  |              |    |       |  |  |  |  |  |  |
|--|--|-------------|---|----------------|---|---|-------------------------|---|-------------------------|-----|-------------|----|-------|---|----------------|--------|--|-------------------|-----|--------------|----|-------|---|--|--|--|--|--|-----------------|----|-------|---|--|--|--|--|--|--------------|----|-------|---|--|--|--|--|--|------------|----|-------|---|--|--|--|--|--|------------|----|-------|---|--|--|--|--|--|------------|----|-------|---|--|--|--|--|--|------------|-----|-------|---|--|--|--|--|--|------------|-----|-------|---|--|--|--|--|--|--------------|----|-------|--|----------------|--------|---|-----------------|--|--------------|----|-------|--|--|--|--|--|--|
|    | <table border="1"> <tr><td>1.4 (F40A)</td><td>43</td><td>09.91</td><td>03.98 + erhöhte Zuladung <sup>1)</sup></td><td>03.0520-2422.3</td><td>692422</td><td></td><td>22,20/229x42 TopKit</td><td>TRW</td></tr> <tr><td>1.4 (F40Y)</td><td>43</td><td>09.91</td><td>03.98</td><td></td><td></td><td></td><td></td><td></td></tr> <tr><td>1.4 i (F40D)</td><td>58</td><td>09.94</td><td>03.98 + erhöhte Zuladung <sup>1)</sup></td><td></td><td></td><td></td><td></td><td></td></tr> <tr><td>1.4 i (F40U)</td><td>55</td><td>09.91</td><td>03.98 + erhöhte Zuladung <sup>1)</sup></td><td></td><td></td><td></td><td></td><td></td></tr> <tr><td>1.4 i (F40V)</td><td>55</td><td>09.91</td><td>03.98 + erhöhte Zuladung <sup>1)</sup></td><td></td><td></td><td></td><td></td><td></td></tr> <tr><td>1.6 (F404)</td><td>40</td><td>07.86</td><td>08.98 + erhöhte Zuladung <sup>1)</sup></td><td></td><td></td><td></td><td></td><td></td></tr> <tr><td>1.9 (F40E)</td><td>47</td><td>09.92</td><td>03.98 + erhöhte Zuladung <sup>1)</sup></td><td></td><td></td><td></td><td></td><td></td></tr> <tr><td>1.9 (F40N)</td><td>47</td><td>09.91</td><td>03.98 + erhöhte Zuladung <sup>1)</sup></td><td></td><td></td><td></td><td></td><td></td></tr> <tr><td>1.9 (F40P)</td><td>47</td><td>09.91</td><td>03.98 + erhöhte Zuladung <sup>1)</sup></td><td></td><td></td><td></td><td></td><td></td></tr> <tr><td>1.9 (F40R)</td><td>40</td><td>09.94</td><td>03.98 + erhöhte Zuladung <sup>1)</sup></td><td></td><td></td><td></td><td></td><td></td></tr> <tr><td>1.9 D (G40B)</td><td>40</td><td>09.95</td><td>03.98 + erhöhte Zuladung <sup>1)</sup></td><td></td><td></td><td></td><td></td><td></td></tr> <tr><td>1.9 D (G40C)</td><td>40</td><td>09.95</td><td>03.98 + erhöhte Zuladung <sup>1)</sup></td><td></td><td></td><td></td><td></td><td></td></tr> </table> | 1.4 (F40A)  | 43  | 09.91          | 03.98 + erhöhte Zuladung <sup>1)</sup>      | 03.0520-2422.3                          | 692422                  |   | 22,20/229x42 TopKit     | TRW | 1.4 (F40Y)  | 43 | 09.91 | 03.98                                       |                |        |  |                   |     | 1.4 i (F40D) | 58 | 09.94 | 03.98 + erhöhte Zuladung <sup>1)</sup>      |  |  |  |  |  | 1.4 i (F40U)    | 55 | 09.91 | 03.98 + erhöhte Zuladung <sup>1)</sup>      |  |  |  |  |  | 1.4 i (F40V) | 55 | 09.91 | 03.98 + erhöhte Zuladung <sup>1)</sup>      |  |  |  |  |  | 1.6 (F404) | 40 | 07.86 | 08.98 + erhöhte Zuladung <sup>1)</sup>      |  |  |  |  |  | 1.9 (F40E) | 47 | 09.92 | 03.98 + erhöhte Zuladung <sup>1)</sup>      |  |  |  |  |  | 1.9 (F40N) | 47 | 09.91 | 03.98 + erhöhte Zuladung <sup>1)</sup>      |  |  |  |  |  | 1.9 (F40P) | 47  | 09.91 | 03.98 + erhöhte Zuladung <sup>1)</sup>      |  |  |  |  |  | 1.9 (F40R) | 40  | 09.94 | 03.98 + erhöhte Zuladung <sup>1)</sup>      |  |  |  |  |  | 1.9 D (G40B) | 40 | 09.95 | 03.98 + erhöhte Zuladung <sup>1)</sup> |                |        |   |                 |  | 1.9 D (G40C) | 40 | 09.95 | 03.98 + erhöhte Zuladung <sup>1)</sup> |  |  |  |  |  |
| 1.4 (F40A)   | 43   | 09.91       | 03.98 + erhöhte Zuladung <sup>1)</sup>      | 03.0520-2422.3 | 692422                                      |   | 22,20/229x42 TopKit     | TRW                                     |                         |     |             |    |       |   |                |        |  |                   |     |              |    |       |   |  |  |  |  |  |                 |    |       |   |  |  |  |  |  |              |    |       |   |  |  |  |  |  |            |    |       |   |  |  |  |  |  |            |    |       |   |  |  |  |  |  |            |    |       |   |  |  |  |  |  |            |     |       |   |  |  |  |  |  |            |     |       |   |  |  |  |  |  |              |    |       |  |                |        |   |                 |  |              |    |       |  |  |  |  |  |  |
| 1.4 (F40Y)   | 43   | 09.91       | 03.98                                       |                |   |   |                         |   |                         |     |             |    |       |   |                |        |  |                   |     |              |    |       |   |  |  |  |  |  |                 |    |       |   |  |  |  |  |  |              |    |       |   |  |  |  |  |  |            |    |       |   |  |  |  |  |  |            |    |       |   |  |  |  |  |  |            |    |       |   |  |  |  |  |  |            |     |       |   |  |  |  |  |  |            |     |       |   |  |  |  |  |  |              |    |       |  |                |        |   |                 |  |              |    |       |  |  |  |  |  |  |
| 1.4 i (F40D)   | 58   | 09.94       | 03.98 + erhöhte Zuladung <sup>1)</sup>      |                |   |   |                         |   |                         |     |             |    |       |   |                |        |  |                   |     |              |    |       |   |  |  |  |  |  |                 |    |       |   |  |  |  |  |  |              |    |       |   |  |  |  |  |  |            |    |       |   |  |  |  |  |  |            |    |       |   |  |  |  |  |  |            |    |       |   |  |  |  |  |  |            |     |       |   |  |  |  |  |  |            |     |       |   |  |  |  |  |  |              |    |       |  |                |        |   |                 |  |              |    |       |  |  |  |  |  |  |
| 1.4 i (F40U)   | 55   | 09.91       | 03.98 + erhöhte Zuladung <sup>1)</sup>      |                |   |   |                         |   |                         |     |             |    |       |   |                |        |  |                   |     |              |    |       |   |  |  |  |  |  |                 |    |       |   |  |  |  |  |  |              |    |       |   |  |  |  |  |  |            |    |       |   |  |  |  |  |  |            |    |       |   |  |  |  |  |  |            |    |       |   |  |  |  |  |  |            |     |       |   |  |  |  |  |  |            |     |       |   |  |  |  |  |  |              |    |       |  |                |        |   |                 |  |              |    |       |  |  |  |  |  |  |
| 1.4 i (F40V)   | 55   | 09.91       | 03.98 + erhöhte Zuladung <sup>1)</sup>      |                |   |   |                         |   |                         |     |             |    |       |   |                |        |  |                   |     |              |    |       |   |  |  |  |  |  |                 |    |       |   |  |  |  |  |  |              |    |       |   |  |  |  |  |  |            |    |       |   |  |  |  |  |  |            |    |       |   |  |  |  |  |  |            |    |       |   |  |  |  |  |  |            |     |       |   |  |  |  |  |  |            |     |       |   |  |  |  |  |  |              |    |       |  |                |        |   |                 |  |              |    |       |  |  |  |  |  |  |
| 1.6 (F404)   | 40   | 07.86       | 08.98 + erhöhte Zuladung <sup>1)</sup>      |                |   |   |                         |   |                         |     |             |    |       |   |                |        |  |                   |     |              |    |       |   |  |  |  |  |  |                 |    |       |   |  |  |  |  |  |              |    |       |   |  |  |  |  |  |            |    |       |   |  |  |  |  |  |            |    |       |   |  |  |  |  |  |            |    |       |   |  |  |  |  |  |            |     |       |   |  |  |  |  |  |            |     |       |   |  |  |  |  |  |              |    |       |  |                |        |   |                 |  |              |    |       |  |  |  |  |  |  |
| 1.9 (F40E)   | 47   | 09.92       | 03.98 + erhöhte Zuladung <sup>1)</sup>      |                |   |   |                         |   |                         |     |             |    |       |   |                |        |  |                   |     |              |    |       |   |  |  |  |  |  |                 |    |       |   |  |  |  |  |  |              |    |       |   |  |  |  |  |  |            |    |       |   |  |  |  |  |  |            |    |       |   |  |  |  |  |  |            |    |       |   |  |  |  |  |  |            |     |       |   |  |  |  |  |  |            |     |       |   |  |  |  |  |  |              |    |       |  |                |        |   |                 |  |              |    |       |  |  |  |  |  |  |
| 1.9 (F40N)   | 47   | 09.91       | 03.98 + erhöhte Zuladung <sup>1)</sup>      |                |   |   |                         |   |                         |     |             |    |       |   |                |        |  |                   |     |              |    |       |   |  |  |  |  |  |                 |    |       |   |  |  |  |  |  |              |    |       |   |  |  |  |  |  |            |    |       |   |  |  |  |  |  |            |    |       |   |  |  |  |  |  |            |    |       |   |  |  |  |  |  |            |     |       |   |  |  |  |  |  |            |     |       |   |  |  |  |  |  |              |    |       |  |                |        |   |                 |  |              |    |       |  |  |  |  |  |  |
| 1.9 (F40P)   | 47   | 09.91       | 03.98 + erhöhte Zuladung <sup>1)</sup>      |                |   |   |                         |   |                         |     |             |    |       |   |                |        |  |                   |     |              |    |       |   |  |  |  |  |  |                 |    |       |   |  |  |  |  |  |              |    |       |   |  |  |  |  |  |            |    |       |   |  |  |  |  |  |            |    |       |   |  |  |  |  |  |            |    |       |   |  |  |  |  |  |            |     |       |   |  |  |  |  |  |            |     |       |   |  |  |  |  |  |              |    |       |  |                |        |   |                 |  |              |    |       |  |  |  |  |  |  |
| 1.9 (F40R)   | 40   | 09.94       | 03.98 + erhöhte Zuladung <sup>1)</sup>      |                |   |   |                         |   |                         |     |             |    |       |   |                |        |  |                   |     |              |    |       |   |  |  |  |  |  |                 |    |       |   |  |  |  |  |  |              |    |       |   |  |  |  |  |  |            |    |       |   |  |  |  |  |  |            |    |       |   |  |  |  |  |  |            |    |       |   |  |  |  |  |  |            |     |       |   |  |  |  |  |  |            |     |       |   |  |  |  |  |  |              |    |       |  |                |        |   |                 |  |              |    |       |  |  |  |  |  |  |
| 1.9 D (G40B)   | 40   | 09.95       | 03.98 + erhöhte Zuladung <sup>1)</sup>      |                |   |   |                         |   |                         |     |             |    |       |   |                |        |  |                   |     |              |    |       |   |  |  |  |  |  |                 |    |       |   |  |  |  |  |  |              |    |       |   |  |  |  |  |  |            |    |       |   |  |  |  |  |  |            |    |       |   |  |  |  |  |  |            |    |       |   |  |  |  |  |  |            |     |       |   |  |  |  |  |  |            |     |       |   |  |  |  |  |  |              |    |       |  |                |        |   |                 |  |              |    |       |  |  |  |  |  |  |
| 1.9 D (G40C)   | 40   | 09.95       | 03.98 + erhöhte Zuladung <sup>1)</sup>      |                |   |   |                         |   |                         |     |             |    |       |   |                |        |  |                   |     |              |    |       |   |  |  |  |  |  |                 |    |       |   |  |  |  |  |  |              |    |       |   |  |  |  |  |  |            |    |       |   |  |  |  |  |  |            |    |       |   |  |  |  |  |  |            |    |       |   |  |  |  |  |  |            |     |       |   |  |  |  |  |  |            |     |       |   |  |  |  |  |  |              |    |       |  |                |        |   |                 |  |              |    |       |  |  |  |  |  |  |
| RENAULT FLUENCE (L30_) (10-)   |  |             |   |                |   |   |                         |   |                         |     |             |    |       |   |                |        |  |                   |     |              |    |       |   |  |  |  |  |  |                 |    |       |   |  |  |  |  |  |              |    |       |   |  |  |  |  |  |            |    |       |   |  |  |  |  |  |            |    |       |   |  |  |  |  |  |            |    |       |   |  |  |  |  |  |            |     |       |   |  |  |  |  |  |            |     |       |   |  |  |  |  |  |              |    |       |  |                |        |   |                 |  |              |    |       |  |  |  |  |  |  |
|    | <table border="1"> <tr><td>1.5 dCi</td><td>63</td><td>02.10</td><td></td><td>13.0460-7266.2</td><td>607266</td><td></td><td>24538 17,9 +</td><td>ATE</td></tr> <tr><td>1.5 dCi</td><td>66</td><td>02.10</td><td></td><td>13.0470-7266.2</td><td>LD7266</td><td></td><td>24538 17,9 +</td><td>ATE</td></tr> <tr><td>1.5 dCi</td><td>70</td><td>07.14</td><td></td><td></td><td></td><td></td><td></td><td></td></tr> <tr><td>1.5 dCi</td><td>78</td><td>02.10</td><td></td><td></td><td></td><td></td><td></td><td></td></tr> <tr><td>1.5 dCi</td><td>81</td><td>02.10</td><td></td><td></td><td></td><td></td><td></td><td></td></tr> <tr><td>1.6 16V</td><td>81</td><td>02.10</td><td></td><td></td><td></td><td></td><td></td><td></td></tr> <tr><td>1.6 16V</td><td>82</td><td>02.10</td><td></td><td></td><td></td><td></td><td></td><td></td></tr> <tr><td>1.6 dCi</td><td>96</td><td>07.14</td><td></td><td></td><td></td><td></td><td></td><td></td></tr> <tr><td>2.0 16V</td><td>101</td><td>05.11</td><td></td><td></td><td></td><td></td><td></td><td></td></tr> <tr><td>2.0 16V</td><td>103</td><td>02.10</td><td></td><td></td><td></td><td></td><td></td><td></td></tr> <tr><td>Z.E.</td><td>70</td><td>02.12</td><td></td><td></td><td></td><td></td><td></td><td></td></tr> </table>  | 1.5 dCi     | 63  | 02.10          |   | 13.0460-7266.2                          | 607266                  |   | 24538 17,9 +            | ATE | 1.5 dCi     | 66 | 02.10 |   | 13.0470-7266.2 | LD7266 |  | 24538 17,9 +      | ATE | 1.5 dCi      | 70 | 07.14 |   |  |  |  |  |  | 1.5 dCi         | 78 | 02.10 |   |  |  |  |  |  | 1.5 dCi      | 81 | 02.10 |   |  |  |  |  |  | 1.6 16V    | 81 | 02.10 |   |  |  |  |  |  | 1.6 16V    | 82 | 02.10 |   |  |  |  |  |  | 1.6 dCi    | 96 | 07.14 |   |  |  |  |  |  | 2.0 16V    | 101 | 05.11 |   |  |  |  |  |  | 2.0 16V    | 103 | 02.10 |   |  |  |  |  |  | Z.E.         | 70 | 02.12 |  |                |        |   |                 |  |              |    |       |  |  |  |  |  |  |
| 1.5 dCi  | 63   | 02.10       |   | 13.0460-7266.2 | 607266                                      |   | 24538 17,9 +            | ATE                                     |                         |     |             |    |       |   |                |        |  |                   |     |              |    |       |   |  |  |  |  |  |                 |    |       |   |  |  |  |  |  |              |    |       |   |  |  |  |  |  |            |    |       |   |  |  |  |  |  |            |    |       |   |  |  |  |  |  |            |    |       |   |  |  |  |  |  |            |     |       |   |  |  |  |  |  |            |     |       |   |  |  |  |  |  |              |    |       |  |                |        |   |                 |  |              |    |       |  |  |  |  |  |  |
| 1.5 dCi  | 66   | 02.10       |   | 13.0470-7266.2 | LD7266                                      |   | 24538 17,9 +            | ATE                                     |                         |     |             |    |       |   |                |        |  |                   |     |              |    |       |   |  |  |  |  |  |                 |    |       |   |  |  |  |  |  |              |    |       |   |  |  |  |  |  |            |    |       |   |  |  |  |  |  |            |    |       |   |  |  |  |  |  |            |    |       |   |  |  |  |  |  |            |     |       |   |  |  |  |  |  |            |     |       |   |  |  |  |  |  |              |    |       |  |                |        |   |                 |  |              |    |       |  |  |  |  |  |  |
| 1.5 dCi  | 70   | 07.14       |   |                |   |   |                         |   |                         |     |             |    |       |   |                |        |  |                   |     |              |    |       |   |  |  |  |  |  |                 |    |       |   |  |  |  |  |  |              |    |       |   |  |  |  |  |  |            |    |       |   |  |  |  |  |  |            |    |       |   |  |  |  |  |  |            |    |       |   |  |  |  |  |  |            |     |       |   |  |  |  |  |  |            |     |       |   |  |  |  |  |  |              |    |       |  |                |        |   |                 |  |              |    |       |  |  |  |  |  |  |
| 1.5 dCi  | 78   | 02.10       |   |                |   |   |                         |   |                         |     |             |    |       |   |                |        |  |                   |     |              |    |       |   |  |  |  |  |  |                 |    |       |   |  |  |  |  |  |              |    |       |   |  |  |  |  |  |            |    |       |   |  |  |  |  |  |            |    |       |   |  |  |  |  |  |            |    |       |   |  |  |  |  |  |            |     |       |   |  |  |  |  |  |            |     |       |   |  |  |  |  |  |              |    |       |  |                |        |   |                 |  |              |    |       |  |  |  |  |  |  |
| 1.5 dCi  | 81   | 02.10       |   |                |   |   |                         |   |                         |     |             |    |       |   |                |        |  |                   |     |              |    |       |   |  |  |  |  |  |                 |    |       |   |  |  |  |  |  |              |    |       |   |  |  |  |  |  |            |    |       |   |  |  |  |  |  |            |    |       |   |  |  |  |  |  |            |    |       |   |  |  |  |  |  |            |     |       |   |  |  |  |  |  |            |     |       |   |  |  |  |  |  |              |    |       |  |                |        |   |                 |  |              |    |       |  |  |  |  |  |  |
| 1.6 16V  | 81   | 02.10       |   |                |   |   |                         |   |                         |     |             |    |       |   |                |        |  |                   |     |              |    |       |   |  |  |  |  |  |                 |    |       |   |  |  |  |  |  |              |    |       |   |  |  |  |  |  |            |    |       |   |  |  |  |  |  |            |    |       |   |  |  |  |  |  |            |    |       |   |  |  |  |  |  |            |     |       |   |  |  |  |  |  |            |     |       |   |  |  |  |  |  |              |    |       |  |                |        |   |                 |  |              |    |       |  |  |  |  |  |  |
| 1.6 16V  | 82   | 02.10       |   |                |   |   |                         |   |                         |     |             |    |       |   |                |        |  |                   |     |              |    |       |   |  |  |  |  |  |                 |    |       |   |  |  |  |  |  |              |    |       |   |  |  |  |  |  |            |    |       |   |  |  |  |  |  |            |    |       |   |  |  |  |  |  |            |    |       |   |  |  |  |  |  |            |     |       |   |  |  |  |  |  |            |     |       |   |  |  |  |  |  |              |    |       |  |                |        |   |                 |  |              |    |       |  |  |  |  |  |  |
| 1.6 dCi  | 96   | 07.14       |   |                |   |   |                         |   |                         |     |             |    |       |   |                |        |  |                   |     |              |    |       |   |  |  |  |  |  |                 |    |       |   |  |  |  |  |  |              |    |       |   |  |  |  |  |  |            |    |       |   |  |  |  |  |  |            |    |       |   |  |  |  |  |  |            |    |       |   |  |  |  |  |  |            |     |       |   |  |  |  |  |  |            |     |       |   |  |  |  |  |  |              |    |       |  |                |        |   |                 |  |              |    |       |  |  |  |  |  |  |
| 2.0 16V  | 101  | 05.11       |   |                |   |   |                         |   |                         |     |             |    |       |   |                |        |  |                   |     |              |    |       |   |  |  |  |  |  |                 |    |       |   |  |  |  |  |  |              |    |       |   |  |  |  |  |  |            |    |       |   |  |  |  |  |  |            |    |       |   |  |  |  |  |  |            |    |       |   |  |  |  |  |  |            |     |       |   |  |  |  |  |  |            |     |       |   |  |  |  |  |  |              |    |       |  |                |        |   |                 |  |              |    |       |  |  |  |  |  |  |
| 2.0 16V  | 103  | 02.10       |   |                |   |   |                         |   |                         |     |             |    |       |   |                |        |  |                   |     |              |    |       |   |  |  |  |  |  |                 |    |       |   |  |  |  |  |  |              |    |       |   |  |  |  |  |  |            |    |       |   |  |  |  |  |  |            |    |       |   |  |  |  |  |  |            |    |       |   |  |  |  |  |  |            |     |       |   |  |  |  |  |  |            |     |       |   |  |  |  |  |  |              |    |       |  |                |        |   |                 |  |              |    |       |  |  |  |  |  |  |
| Z.E.   | 70   | 02.12       |   |                |   |   |                         |   |                         |     |             |    |       |   |                |        |  |                   |     |              |    |       |   |  |  |  |  |  |                 |    |       |   |  |  |  |  |  |              |    |       |   |  |  |  |  |  |            |    |       |   |  |  |  |  |  |            |    |       |   |  |  |  |  |  |            |    |       |   |  |  |  |  |  |            |     |       |   |  |  |  |  |  |            |     |       |   |  |  |  |  |  |              |    |       |  |                |        |   |                 |  |              |    |       |  |  |  |  |  |  |
|    | <table border="1"> <tr><td>1.5 dCi</td><td>63</td><td>02.10</td><td></td><td>24.0124-0221.1</td><td>424221</td><td></td><td>280 24,0 21,8 V L +S +B</td><td></td></tr> <tr><td>1.5 dCi</td><td>66</td><td>02.10</td><td></td><td></td><td></td><td></td><td></td><td></td></tr> <tr><td>1.5 dCi</td><td>70</td><td>07.14</td><td></td><td></td><td></td><td></td><td></td><td></td></tr> <tr><td>1.5 dCi</td><td>78</td><td>02.10</td><td></td><td></td><td></td><td></td><td></td><td></td></tr> <tr><td>1.5 dCi</td><td>81</td><td>02.10</td><td></td><td></td><td></td><td></td><td></td><td></td></tr> <tr><td>1.6 16V</td><td>81</td><td>02.10</td><td></td><td></td><td></td><td></td><td></td><td></td></tr> <tr><td>1.6 16V</td><td>82</td><td>02.10</td><td></td><td></td><td></td><td></td><td></td><td></td></tr> <tr><td>1.6 dCi</td><td>96</td><td>07.14</td><td></td><td></td><td></td><td></td><td></td><td></td></tr> <tr><td>2.0 16V</td><td>101</td><td>05.11</td><td></td><td></td><td></td><td></td><td></td><td></td></tr> <tr><td>2.0 16V</td><td>103</td><td>02.10</td><td></td><td></td><td></td><td></td><td></td><td></td></tr> <tr><td>Z.E.</td><td>70</td><td>02.12</td><td></td><td></td><td></td><td></td><td></td><td></td></tr> </table>   | 1.5 dCi     | 63  | 02.10          |   | 24.0124-0221.1                          | 424221                  |   | 280 24,0 21,8 V L +S +B |     | 1.5 dCi     | 66 | 02.10 |   |                |        |  |                   |     | 1.5 dCi      | 70 | 07.14 |   |  |  |  |  |  | 1.5 dCi         | 78 | 02.10 |   |  |  |  |  |  | 1.5 dCi      | 81 | 02.10 |   |  |  |  |  |  | 1.6 16V    | 81 | 02.10 |   |  |  |  |  |  | 1.6 16V    | 82 | 02.10 |   |  |  |  |  |  | 1.6 dCi    | 96 | 07.14 |   |  |  |  |  |  | 2.0 16V    | 101 | 05.11 |   |  |  |  |  |  | 2.0 16V    | 103 | 02.10 |   |  |  |  |  |  | Z.E.         | 70 | 02.12 |  |                |        |   |                 |  |              |    |       |  |  |  |  |  |  |
| 1.5 dCi  | 63   | 02.10       |   | 24.0124-0221.1 | 424221                                      |   | 280 24,0 21,8 V L +S +B |   |                         |     |             |    |       |   |                |        |  |                   |     |              |    |       |   |  |  |  |  |  |                 |    |       |   |  |  |  |  |  |              |    |       |   |  |  |  |  |  |            |    |       |   |  |  |  |  |  |            |    |       |   |  |  |  |  |  |            |    |       |   |  |  |  |  |  |            |     |       |   |  |  |  |  |  |            |     |       |   |  |  |  |  |  |              |    |       |  |                |        |   |                 |  |              |    |       |  |  |  |  |  |  |
| 1.5 dCi  | 66   | 02.10       |   |                |   |   |                         |   |                         |     |             |    |       |   |                |        |  |                   |     |              |    |       |   |  |  |  |  |  |                 |    |       |   |  |  |  |  |  |              |    |       |   |  |  |  |  |  |            |    |       |   |  |  |  |  |  |            |    |       |   |  |  |  |  |  |            |    |       |   |  |  |  |  |  |            |     |       |   |  |  |  |  |  |            |     |       |   |  |  |  |  |  |              |    |       |  |                |        |   |                 |  |              |    |       |  |  |  |  |  |  |
| 1.5 dCi  | 70   | 07.14       |   |                |   |   |                         |   |                         |     |             |    |       |   |                |        |  |                   |     |              |    |       |   |  |  |  |  |  |                 |    |       |   |  |  |  |  |  |              |    |       |   |  |  |  |  |  |            |    |       |   |  |  |  |  |  |            |    |       |   |  |  |  |  |  |            |    |       |   |  |  |  |  |  |            |     |       |   |  |  |  |  |  |            |     |       |   |  |  |  |  |  |              |    |       |  |                |        |   |                 |  |              |    |       |  |  |  |  |  |  |
| 1.5 dCi  | 78   | 02.10       |   |                |   |   |                         |   |                         |     |             |    |       |   |                |        |  |                   |     |              |    |       |   |  |  |  |  |  |                 |    |       |   |  |  |  |  |  |              |    |       |   |  |  |  |  |  |            |    |       |   |  |  |  |  |  |            |    |       |   |  |  |  |  |  |            |    |       |   |  |  |  |  |  |            |     |       |   |  |  |  |  |  |            |     |       |   |  |  |  |  |  |              |    |       |  |                |        |   |                 |  |              |    |       |  |  |  |  |  |  |
| 1.5 dCi  | 81   | 02.10       |   |                |   |   |                         |   |                         |     |             |    |       |   |                |        |  |                   |     |              |    |       |   |  |  |  |  |  |                 |    |       |   |  |  |  |  |  |              |    |       |   |  |  |  |  |  |            |    |       |   |  |  |  |  |  |            |    |       |   |  |  |  |  |  |            |    |       |   |  |  |  |  |  |            |     |       |   |  |  |  |  |  |            |     |       |   |  |  |  |  |  |              |    |       |  |                |        |   |                 |  |              |    |       |  |  |  |  |  |  |
| 1.6 16V  | 81   | 02.10       |   |                |   |   |                         |   |                         |     |             |    |       |   |                |        |  |                   |     |              |    |       |   |  |  |  |  |  |                 |    |       |   |  |  |  |  |  |              |    |       |   |  |  |  |  |  |            |    |       |   |  |  |  |  |  |            |    |       |   |  |  |  |  |  |            |    |       |   |  |  |  |  |  |            |     |       |   |  |  |  |  |  |            |     |       |   |  |  |  |  |  |              |    |       |  |                |        |   |                 |  |              |    |       |  |  |  |  |  |  |
| 1.6 16V  | 82   | 02.10       |   |                |   |   |                         |   |                         |     |             |    |       |   |                |        |  |                   |     |              |    |       |   |  |  |  |  |  |                 |    |       |   |  |  |  |  |  |              |    |       |   |  |  |  |  |  |            |    |       |   |  |  |  |  |  |            |    |       |   |  |  |  |  |  |            |    |       |   |  |  |  |  |  |            |     |       |   |  |  |  |  |  |            |     |       |   |  |  |  |  |  |              |    |       |  |                |        |   |                 |  |              |    |       |  |  |  |  |  |  |
| 1.6 dCi  | 96   | 07.14       |   |                |   |   |                         |   |                         |     |             |    |       |   |                |        |  |                   |     |              |    |       |   |  |  |  |  |  |                 |    |       |   |  |  |  |  |  |              |    |       |   |  |  |  |  |  |            |    |       |   |  |  |  |  |  |            |    |       |   |  |  |  |  |  |            |    |       |   |  |  |  |  |  |            |     |       |   |  |  |  |  |  |            |     |       |   |  |  |  |  |  |              |    |       |  |                |        |   |                 |  |              |    |       |  |  |  |  |  |  |
| 2.0 16V  | 101  | 05.11       |   |                |   |   |                         |   |                         |     |             |    |       |   |                |        |  |                   |     |              |    |       |   |  |  |  |  |  |                 |    |       |   |  |  |  |  |  |              |    |       |   |  |  |  |  |  |            |    |       |   |  |  |  |  |  |            |    |       |   |  |  |  |  |  |            |    |       |   |  |  |  |  |  |            |     |       |   |  |  |  |  |  |            |     |       |   |  |  |  |  |  |              |    |       |  |                |        |   |                 |  |              |    |       |  |  |  |  |  |  |
| 2.0 16V  | 103  | 02.10       |   |                |   |   |                         |   |                         |     |             |    |       |   |                |        |  |                   |     |              |    |       |   |  |  |  |  |  |                 |    |       |   |  |  |  |  |  |              |    |       |   |  |  |  |  |  |            |    |       |   |  |  |  |  |  |            |    |       |   |  |  |  |  |  |            |    |       |   |  |  |  |  |  |            |     |       |   |  |  |  |  |  |            |     |       |   |  |  |  |  |  |              |    |       |  |                |        |   |                 |  |              |    |       |  |  |  |  |  |  |
| Z.E.   | 70   | 02.12       |   |                |   |   |                         |   |                         |     |             |    |       |   |                |        |  |                   |     |              |    |       |   |  |  |  |  |  |                 |    |       |   |  |  |  |  |  |              |    |       |   |  |  |  |  |  |            |    |       |   |  |  |  |  |  |            |    |       |   |  |  |  |  |  |            |    |       |   |  |  |  |  |  |            |     |       |   |  |  |  |  |  |            |     |       |   |  |  |  |  |  |              |    |       |  |                |        |   |                 |  |              |    |       |  |  |  |  |  |  |
|    | <table border="1"> <tr><td>1.5 dCi</td><td>63</td><td>02.10</td><td>- elektrische Feststellbremse <sup>2)</sup></td><td>13.0460-2740.2</td><td>602740</td><td></td><td>23554 17,2 /Zub/S</td><td>TRW</td></tr> <tr><td>1.5 dCi</td><td>66</td><td>02.10</td><td>- elektrische Feststellbremse <sup>2)</sup></td><td>13.0470-2740.2</td><td>LD2740</td><td></td><td>23554 17,2 /Zub/S</td><td>TRW</td></tr> <tr><td>1.5 dCi</td><td>70</td><td>07.14</td><td>- elektrische Feststellbremse <sup>2)</sup></td><td></td><td></td><td></td><td></td><td></td></tr> <tr><td>1.5 dCi</td><td>78</td><td>02.10</td><td>- elektrische Feststellbremse <sup>2)</sup></td><td></td><td></td><td></td><td></td><td></td></tr> <tr><td>1.5 dCi</td><td>81</td><td>02.10</td><td>- elektrische Feststellbremse <sup>2)</sup></td><td></td><td></td><td></td><td></td><td></td></tr> <tr><td>1.6 16V</td><td>81</td><td>02.10</td><td>- elektrische Feststellbremse <sup>2)</sup></td><td></td><td></td><td></td><td></td><td></td></tr> <tr><td>1.6 16V</td><td>82</td><td>02.10</td><td>- elektrische Feststellbremse <sup>2)</sup></td><td></td><td></td><td></td><td></td><td></td></tr> <tr><td>1.6 dCi</td><td>96</td><td>07.14</td><td>- elektrische Feststellbremse <sup>2)</sup></td><td></td><td></td><td></td><td></td><td></td></tr> <tr><td>2.0 16V</td><td>101</td><td>05.11</td><td>- elektrische Feststellbremse <sup>2)</sup></td><td></td><td></td><td></td><td></td><td></td></tr> <tr><td>2.0 16V</td><td>103</td><td>02.10</td><td>- elektrische Feststellbremse <sup>2)</sup></td><td></td><td></td><td></td><td></td><td></td></tr> </table>  | 1.5 dCi     | 63  | 02.10          | - elektrische Feststellbremse <sup>2)</sup> | 13.0460-2740.2                          | 602740                  |   | 23554 17,2 /Zub/S       | TRW | 1.5 dCi     | 66 | 02.10 | - elektrische Feststellbremse <sup>2)</sup> | 13.0470-2740.2 | LD2740 |  | 23554 17,2 /Zub/S | TRW | 1.5 dCi      | 70 | 07.14 | - elektrische Feststellbremse <sup>2)</sup> |  |  |  |  |  | 1.5 dCi         | 78 | 02.10 | - elektrische Feststellbremse <sup>2)</sup> |  |  |  |  |  | 1.5 dCi      | 81 | 02.10 | - elektrische Feststellbremse <sup>2)</sup> |  |  |  |  |  | 1.6 16V    | 81 | 02.10 | - elektrische Feststellbremse <sup>2)</sup> |  |  |  |  |  | 1.6 16V    | 82 | 02.10 | - elektrische Feststellbremse <sup>2)</sup> |  |  |  |  |  | 1.6 dCi    | 96 | 07.14 | - elektrische Feststellbremse <sup>2)</sup> |  |  |  |  |  | 2.0 16V    | 101 | 05.11 | - elektrische Feststellbremse <sup>2)</sup> |  |  |  |  |  | 2.0 16V    | 103 | 02.10 | - elektrische Feststellbremse <sup>2)</sup> |  |  |  |  |  |              |    |       |  |                |        |   |                 |  |              |    |       |  |  |  |  |  |  |
| 1.5 dCi  | 63   | 02.10       | - elektrische Feststellbremse <sup>2)</sup> | 13.0460-2740.2 | 602740                                      |   | 23554 17,2 /Zub/S       | TRW                                     |                         |     |             |    |       |   |                |        |  |                   |     |              |    |       |   |  |  |  |  |  |                 |    |       |   |  |  |  |  |  |              |    |       |   |  |  |  |  |  |            |    |       |   |  |  |  |  |  |            |    |       |   |  |  |  |  |  |            |    |       |   |  |  |  |  |  |            |     |       |   |  |  |  |  |  |            |     |       |   |  |  |  |  |  |              |    |       |  |                |        |   |                 |  |              |    |       |  |  |  |  |  |  |
| 1.5 dCi  | 66   | 02.10       | - elektrische Feststellbremse <sup>2)</sup> | 13.0470-2740.2 | LD2740                                      |   | 23554 17,2 /Zub/S       | TRW                                     |                         |     |             |    |       |   |                |        |  |                   |     |              |    |       |   |  |  |  |  |  |                 |    |       |   |  |  |  |  |  |              |    |       |   |  |  |  |  |  |            |    |       |   |  |  |  |  |  |            |    |       |   |  |  |  |  |  |            |    |       |   |  |  |  |  |  |            |     |       |   |  |  |  |  |  |            |     |       |   |  |  |  |  |  |              |    |       |  |                |        |   |                 |  |              |    |       |  |  |  |  |  |  |
| 1.5 dCi  | 70   | 07.14       | - elektrische Feststellbremse <sup>2)</sup> |                |   |   |                         |   |                         |     |             |    |       |   |                |        |  |                   |     |              |    |       |   |  |  |  |  |  |                 |    |       |   |  |  |  |  |  |              |    |       |   |  |  |  |  |  |            |    |       |   |  |  |  |  |  |            |    |       |   |  |  |  |  |  |            |    |       |   |  |  |  |  |  |            |     |       |   |  |  |  |  |  |            |     |       |   |  |  |  |  |  |              |    |       |  |                |        |   |                 |  |              |    |       |  |  |  |  |  |  |
| 1.5 dCi  | 78   | 02.10       | - elektrische Feststellbremse <sup>2)</sup> |                |   |   |                         |   |                         |     |             |    |       |   |                |        |  |                   |     |              |    |       |   |  |  |  |  |  |                 |    |       |   |  |  |  |  |  |              |    |       |   |  |  |  |  |  |            |    |       |   |  |  |  |  |  |            |    |       |   |  |  |  |  |  |            |    |       |   |  |  |  |  |  |            |     |       |   |  |  |  |  |  |            |     |       |   |  |  |  |  |  |              |    |       |  |                |        |   |                 |  |              |    |       |  |  |  |  |  |  |
| 1.5 dCi  | 81   | 02.10       | - elektrische Feststellbremse <sup>2)</sup> |                |   |   |                         |   |                         |     |             |    |       |   |                |        |  |                   |     |              |    |       |   |  |  |  |  |  |                 |    |       |   |  |  |  |  |  |              |    |       |   |  |  |  |  |  |            |    |       |   |  |  |  |  |  |            |    |       |   |  |  |  |  |  |            |    |       |   |  |  |  |  |  |            |     |       |   |  |  |  |  |  |            |     |       |   |  |  |  |  |  |              |    |       |  |                |        |   |                 |  |              |    |       |  |  |  |  |  |  |
| 1.6 16V  | 81   | 02.10       | - elektrische Feststellbremse <sup>2)</sup> |                |   |   |                         |   |                         |     |             |    |       |   |                |        |  |                   |     |              |    |       |   |  |  |  |  |  |                 |    |       |   |  |  |  |  |  |              |    |       |   |  |  |  |  |  |            |    |       |   |  |  |  |  |  |            |    |       |   |  |  |  |  |  |            |    |       |   |  |  |  |  |  |            |     |       |   |  |  |  |  |  |            |     |       |   |  |  |  |  |  |              |    |       |  |                |        |   |                 |  |              |    |       |  |  |  |  |  |  |
| 1.6 16V  | 82   | 02.10       | - elektrische Feststellbremse <sup>2)</sup> |                |   |   |                         |   |                         |     |             |    |       |   |                |        |  |                   |     |              |    |       |   |  |  |  |  |  |                 |    |       |   |  |  |  |  |  |              |    |       |   |  |  |  |  |  |            |    |       |   |  |  |  |  |  |            |    |       |   |  |  |  |  |  |            |    |       |   |  |  |  |  |  |            |     |       |   |  |  |  |  |  |            |     |       |   |  |  |  |  |  |              |    |       |  |                |        |   |                 |  |              |    |       |  |  |  |  |  |  |
| 1.6 dCi  | 96   | 07.14       | - elektrische Feststellbremse <sup>2)</sup> |                |   |   |                         |   |                         |     |             |    |       |   |                |        |  |                   |     |              |    |       |   |  |  |  |  |  |                 |    |       |   |  |  |  |  |  |              |    |       |   |  |  |  |  |  |            |    |       |   |  |  |  |  |  |            |    |       |   |  |  |  |  |  |            |    |       |   |  |  |  |  |  |            |     |       |   |  |  |  |  |  |            |     |       |   |  |  |  |  |  |              |    |       |  |                |        |   |                 |  |              |    |       |  |  |  |  |  |  |
| 2.0 16V  | 101  | 05.11       | - elektrische Feststellbremse <sup>2)</sup> |                |   |   |                         |   |                         |     |             |    |       |   |                |        |  |                   |     |              |    |       |   |  |  |  |  |  |                 |    |       |   |  |  |  |  |  |              |    |       |   |  |  |  |  |  |            |    |       |   |  |  |  |  |  |            |    |       |   |  |  |  |  |  |            |    |       |   |  |  |  |  |  |            |     |       |   |  |  |  |  |  |            |     |       |   |  |  |  |  |  |              |    |       |  |                |        |   |                 |  |              |    |       |  |  |  |  |  |  |
| 2.0 16V  | 103  | 02.10       | - elektrische Feststellbremse <sup>2)</sup> |                |   |   |                         |   |                         |     |             |    |       |   |                |        |  |                   |     |              |    |       |   |  |  |  |  |  |                 |    |       |   |  |  |  |  |  |              |    |       |   |  |  |  |  |  |            |    |       |   |  |  |  |  |  |            |    |       |   |  |  |  |  |  |            |    |       |   |  |  |  |  |  |            |     |       |   |  |  |  |  |  |            |     |       |   |  |  |  |  |  |              |    |       |  |                |        |   |                 |  |              |    |       |  |  |  |  |  |  |
|  | <table border="1"> <tr><td>1.5 dCi</td><td>63</td><td>02.10</td><td>+ elektrische Feststellbremse <sup>3)</sup></td><td>13.0460-2756.2</td><td>602756</td><td></td><td>24820 16,1 /Zub/S</td><td>TRW</td></tr> <tr><td>1.5 dCi</td><td>66</td><td>02.10</td><td>+ elektrische Feststellbremse <sup>3)</sup></td><td></td><td></td><td></td><td></td><td></td></tr> <tr><td>1.5 dCi</td><td>70</td><td>07.14</td><td>+ elektrische Feststellbremse <sup>3)</sup></td><td></td><td></td><td></td><td></td><td></td></tr> <tr><td>1.5 dCi</td><td>78</td><td>02.10</td><td>+ elektrische Feststellbremse <sup>3)</sup></td><td></td><td></td><td></td><td></td><td></td></tr> <tr><td>1.5 dCi</td><td>81</td><td>02.10</td><td>+ elektrische Feststellbremse <sup>3)</sup></td><td></td><td></td><td></td><td></td><td></td></tr> <tr><td>1.6 16V</td><td>81</td><td>02.10</td><td>+ elektrische Feststellbremse <sup>3)</sup></td><td></td><td></td><td></td><td></td><td></td></tr> <tr><td>1.6 16V</td><td>82</td><td>02.10</td><td>+ elektrische Feststellbremse <sup>3)</sup></td><td></td><td></td><td></td><td></td><td></td></tr> <tr><td>1.6 dCi</td><td>96</td><td>07.14</td><td>+ elektrische Feststellbremse <sup>3)</sup></td><td></td><td></td><td></td><td></td><td></td></tr> <tr><td>2.0 16V</td><td>101</td><td>05.11</td><td>+ elektrische Feststellbremse <sup>3)</sup></td><td></td><td></td><td></td><td></td><td></td></tr> <tr><td>2.0 16V</td><td>103</td><td>02.10</td><td>+ elektrische Feststellbremse <sup>3)</sup></td><td></td><td></td><td></td><td></td><td></td></tr> </table>  | 1.5 dCi     | 63  | 02.10          | + elektrische Feststellbremse <sup>3)</sup> | 13.0460-2756.2                          | 602756                  |   | 24820 16,1 /Zub/S       | TRW | 1.5 dCi     | 66 | 02.10 | + elektrische Feststellbremse <sup>3)</sup> |                |        |  |                   |     | 1.5 dCi      | 70 | 07.14 | + elektrische Feststellbremse <sup>3)</sup> |  |  |  |  |  | 1.5 dCi         | 78 | 02.10 | + elektrische Feststellbremse <sup>3)</sup> |  |  |  |  |  | 1.5 dCi      | 81 | 02.10 | + elektrische Feststellbremse <sup>3)</sup> |  |  |  |  |  | 1.6 16V    | 81 | 02.10 | + elektrische Feststellbremse <sup>3)</sup> |  |  |  |  |  | 1.6 16V    | 82 | 02.10 | + elektrische Feststellbremse <sup>3)</sup> |  |  |  |  |  | 1.6 dCi    | 96 | 07.14 | + elektrische Feststellbremse <sup>3)</sup> |  |  |  |  |  | 2.0 16V    | 101 | 05.11 | + elektrische Feststellbremse <sup>3)</sup> |  |  |  |  |  | 2.0 16V    | 103 | 02.10 | + elektrische Feststellbremse <sup>3)</sup> |  |  |  |  |  |              |    |       |  |                |        |   |                 |  |              |    |       |  |  |  |  |  |  |
| 1.5 dCi  | 63   | 02.10       | + elektrische Feststellbremse <sup>3)</sup> | 13.0460-2756.2 | 602756                                      |   | 24820 16,1 /Zub/S       | TRW                                     |                         |     |             |    |       |   |                |        |  |                   |     |              |    |       |   |  |  |  |  |  |                 |    |       |   |  |  |  |  |  |              |    |       |   |  |  |  |  |  |            |    |       |   |  |  |  |  |  |            |    |       |   |  |  |  |  |  |            |    |       |   |  |  |  |  |  |            |     |       |   |  |  |  |  |  |            |     |       |   |  |  |  |  |  |              |    |       |  |                |        |   |                 |  |              |    |       |  |  |  |  |  |  |
| 1.5 dCi  | 66   | 02.10       | + elektrische Feststellbremse <sup>3)</sup> |                |   |   |                         |   |                         |     |             |    |       |   |                |        |  |                   |     |              |    |       |   |  |  |  |  |  |                 |    |       |   |  |  |  |  |  |              |    |       |   |  |  |  |  |  |            |    |       |   |  |  |  |  |  |            |    |       |   |  |  |  |  |  |            |    |       |   |  |  |  |  |  |            |     |       |   |  |  |  |  |  |            |     |       |   |  |  |  |  |  |              |    |       |  |                |        |   |                 |  |              |    |       |  |  |  |  |  |  |
| 1.5 dCi  | 70   | 07.14       | + elektrische Feststellbremse <sup>3)</sup> |                |   |   |                         |   |                         |     |             |    |       |   |                |        |  |                   |     |              |    |       |   |  |  |  |  |  |                 |    |       |   |  |  |  |  |  |              |    |       |   |  |  |  |  |  |            |    |       |   |  |  |  |  |  |            |    |       |   |  |  |  |  |  |            |    |       |   |  |  |  |  |  |            |     |       |   |  |  |  |  |  |            |     |       |   |  |  |  |  |  |              |    |       |  |                |        |   |                 |  |              |    |       |  |  |  |  |  |  |
| 1.5 dCi  | 78   | 02.10       | + elektrische Feststellbremse <sup>3)</sup> |                |   |   |                         |   |                         |     |             |    |       |   |                |        |  |                   |     |              |    |       |   |  |  |  |  |  |                 |    |       |   |  |  |  |  |  |              |    |       |   |  |  |  |  |  |            |    |       |   |  |  |  |  |  |            |    |       |   |  |  |  |  |  |            |    |       |   |  |  |  |  |  |            |     |       |   |  |  |  |  |  |            |     |       |   |  |  |  |  |  |              |    |       |  |                |        |   |                 |  |              |    |       |  |  |  |  |  |  |
| 1.5 dCi  | 81   | 02.10       | + elektrische Feststellbremse <sup>3)</sup> |                |   |   |                         |   |                         |     |             |    |       |   |                |        |  |                   |     |              |    |       |   |  |  |  |  |  |                 |    |       |   |  |  |  |  |  |              |    |       |   |  |  |  |  |  |            |    |       |   |  |  |  |  |  |            |    |       |   |  |  |  |  |  |            |    |       |   |  |  |  |  |  |            |     |       |   |  |  |  |  |  |            |     |       |   |  |  |  |  |  |              |    |       |  |                |        |   |                 |  |              |    |       |  |  |  |  |  |  |
| 1.6 16V  | 81   | 02.10       | + elektrische Feststellbremse <sup>3)</sup> |                |   |   |                         |   |                         |     |             |    |       |   |                |        |  |                   |     |              |    |       |   |  |  |  |  |  |                 |    |       |   |  |  |  |  |  |              |    |       |   |  |  |  |  |  |            |    |       |   |  |  |  |  |  |            |    |       |   |  |  |  |  |  |            |    |       |   |  |  |  |  |  |            |     |       |   |  |  |  |  |  |            |     |       |   |  |  |  |  |  |              |    |       |  |                |        |   |                 |  |              |    |       |  |  |  |  |  |  |
| 1.6 16V  | 82   | 02.10       | + elektrische Feststellbremse <sup>3)</sup> |                |   |   |                         |   |                         |     |             |    |       |   |                |        |  |                   |     |              |    |       |   |  |  |  |  |  |                 |    |       |   |  |  |  |  |  |              |    |       |   |  |  |  |  |  |            |    |       |   |  |  |  |  |  |            |    |       |   |  |  |  |  |  |            |    |       |   |  |  |  |  |  |            |     |       |   |  |  |  |  |  |            |     |       |   |  |  |  |  |  |              |    |       |  |                |        |   |                 |  |              |    |       |  |  |  |  |  |  |
| 1.6 dCi  | 96   | 07.14       | + elektrische Feststellbremse <sup>3)</sup> |                |   |   |                         |   |                         |     |             |    |       |   |                |        |  |                   |     |              |    |       |   |  |  |  |  |  |                 |    |       |   |  |  |  |  |  |              |    |       |   |  |  |  |  |  |            |    |       |   |  |  |  |  |  |            |    |       |   |  |  |  |  |  |            |    |       |   |  |  |  |  |  |            |     |       |   |  |  |  |  |  |            |     |       |   |  |  |  |  |  |              |    |       |  |                |        |   |                 |  |              |    |       |  |  |  |  |  |  |
| 2.0 16V  | 101  | 05.11       | + elektrische Feststellbremse <sup>3)</sup> |                |   |   |                         |   |                         |     |             |    |       |   |                |        |  |                   |     |              |    |       |   |  |  |  |  |  |                 |    |       |   |  |  |  |  |  |              |    |       |   |  |  |  |  |  |            |    |       |   |  |  |  |  |  |            |    |       |   |  |  |  |  |  |            |    |       |   |  |  |  |  |  |            |     |       |   |  |  |  |  |  |            |     |       |   |  |  |  |  |  |              |    |       |  |                |        |   |                 |  |              |    |       |  |  |  |  |  |  |
| 2.0 16V  | 103  | 02.10       | + elektrische Feststellbremse <sup>3)</sup> |                |   |   |                         |   |                         |     |             |    |       |   |                |        |  |                   |     |              |    |       |   |  |  |  |  |  |                 |    |       |   |  |  |  |  |  |              |    |       |   |  |  |  |  |  |            |    |       |   |  |  |  |  |  |            |    |       |   |  |  |  |  |  |            |    |       |   |  |  |  |  |  |            |     |       |   |  |  |  |  |  |            |     |       |   |  |  |  |  |  |              |    |       |  |                |        |   |                 |  |              |    |       |  |  |  |  |  |  |
|  | <table border="1"> <tr><td>1.5 dCi</td><td>63</td><td>02.10</td><td></td><td>24.0108-0116.2</td><td>408116</td><td>mit Lager/ mit Sensorring <sup>4)</sup></td><td>260 8,0 7,0 +B</td><td></td></tr> <tr><td>1.5 dCi</td><td>66</td><td>02.10</td><td></td><td></td><td></td><td></td><td></td><td></td></tr> <tr><td>1.5 dCi</td><td>70</td><td>07.14</td><td></td><td></td><td></td><td></td><td></td><td></td></tr> <tr><td>1.5 dCi</td><td>78</td><td>02.10</td><td></td><td></td><td></td><td></td><td></td><td></td></tr> <tr><td>1.5 dCi</td><td>81</td><td>02.10</td><td></td><td></td><td></td><td></td><td></td><td></td></tr> <tr><td>1.6 16V</td><td>81</td><td>02.10</td><td></td><td></td><td></td><td></td><td></td><td></td></tr> <tr><td>1.6 16V</td><td>82</td><td>02.10</td><td></td><td></td><td></td><td></td><td></td><td></td></tr> <tr><td>1.6 dCi</td><td>96</td><td>07.14</td><td></td><td></td><td></td><td></td><td></td><td></td></tr> <tr><td>2.0 16V</td><td>101</td><td>05.11</td><td></td><td></td><td></td><td></td><td></td><td></td></tr> <tr><td>2.0 16V</td><td>103</td><td>02.10</td><td></td><td></td><td></td><td></td><td></td><td></td></tr> <tr><td>Z.E.</td><td>70</td><td>02.12</td><td></td><td>24.0111-0180.2</td><td>411180</td><td>mit Lager/ mit Sensorring <sup>4)</sup></td><td>274 11,0 9,5 +B</td><td></td></tr> </table>   | 1.5 dCi     | 63  | 02.10          |   | 24.0108-0116.2                          | 408116                  | mit Lager/ mit Sensorring <sup>4)</sup> | 260 8,0 7,0 +B          |     | 1.5 dCi     | 66 | 02.10 |   |                |        |  |                   |     | 1.5 dCi      | 70 | 07.14 |   |  |  |  |  |  | 1.5 dCi         | 78 | 02.10 |   |  |  |  |  |  | 1.5 dCi      | 81 | 02.10 |   |  |  |  |  |  | 1.6 16V    | 81 | 02.10 |   |  |  |  |  |  | 1.6 16V    | 82 | 02.10 |   |  |  |  |  |  | 1.6 dCi    | 96 | 07.14 |   |  |  |  |  |  | 2.0 16V    | 101 | 05.11 |   |  |  |  |  |  | 2.0 16V    | 103 | 02.10 |   |  |  |  |  |  | Z.E.         | 70 | 02.12 |  | 24.0111-0180.2 | 411180 | mit Lager/ mit Sensorring <sup>4)</sup> | 274 11,0 9,5 +B |  |              |    |       |  |  |  |  |  |  |
| 1.5 dCi  | 63   | 02.10       |   | 24.0108-0116.2 | 408116                                      | mit Lager/ mit Sensorring <sup>4)</sup> | 260 8,0 7,0 +B          |   |                         |     |             |    |       |   |                |        |  |                   |     |              |    |       |   |  |  |  |  |  |                 |    |       |   |  |  |  |  |  |              |    |       |   |  |  |  |  |  |            |    |       |   |  |  |  |  |  |            |    |       |   |  |  |  |  |  |            |    |       |   |  |  |  |  |  |            |     |       |   |  |  |  |  |  |            |     |       |   |  |  |  |  |  |              |    |       |  |                |        |   |                 |  |              |    |       |  |  |  |  |  |  |
| 1.5 dCi  | 66   | 02.10       |   |                |   |   |                         |   |                         |     |             |    |       |   |                |        |  |                   |     |              |    |       |   |  |  |  |  |  |                 |    |       |   |  |  |  |  |  |              |    |       |   |  |  |  |  |  |            |    |       |   |  |  |  |  |  |            |    |       |   |  |  |  |  |  |            |    |       |   |  |  |  |  |  |            |     |       |   |  |  |  |  |  |            |     |       |   |  |  |  |  |  |              |    |       |  |                |        |   |                 |  |              |    |       |  |  |  |  |  |  |
| 1.5 dCi  | 70   | 07.14       |   |                |   |   |                         |   |                         |     |             |    |       |   |                |        |  |                   |     |              |    |       |   |  |  |  |  |  |                 |    |       |   |  |  |  |  |  |              |    |       |   |  |  |  |  |  |            |    |       |   |  |  |  |  |  |            |    |       |   |  |  |  |  |  |            |    |       |   |  |  |  |  |  |            |     |       |   |  |  |  |  |  |            |     |       |   |  |  |  |  |  |              |    |       |  |                |        |   |                 |  |              |    |       |  |  |  |  |  |  |
| 1.5 dCi  | 78   | 02.10       |   |                |   |   |                         |   |                         |     |             |    |       |   |                |        |  |                   |     |              |    |       |   |  |  |  |  |  |                 |    |       |   |  |  |  |  |  |              |    |       |   |  |  |  |  |  |            |    |       |   |  |  |  |  |  |            |    |       |   |  |  |  |  |  |            |    |       |   |  |  |  |  |  |            |     |       |   |  |  |  |  |  |            |     |       |   |  |  |  |  |  |              |    |       |  |                |        |   |                 |  |              |    |       |  |  |  |  |  |  |
| 1.5 dCi  | 81   | 02.10       |   |                |   |   |                         |   |                         |     |             |    |       |   |                |        |  |                   |     |              |    |       |   |  |  |  |  |  |                 |    |       |   |  |  |  |  |  |              |    |       |   |  |  |  |  |  |            |    |       |   |  |  |  |  |  |            |    |       |   |  |  |  |  |  |            |    |       |   |  |  |  |  |  |            |     |       |   |  |  |  |  |  |            |     |       |   |  |  |  |  |  |              |    |       |  |                |        |   |                 |  |              |    |       |  |  |  |  |  |  |
| 1.6 16V  | 81   | 02.10       |   |                |   |   |                         |   |                         |     |             |    |       |   |                |        |  |                   |     |              |    |       |   |  |  |  |  |  |                 |    |       |   |  |  |  |  |  |              |    |       |   |  |  |  |  |  |            |    |       |   |  |  |  |  |  |            |    |       |   |  |  |  |  |  |            |    |       |   |  |  |  |  |  |            |     |       |   |  |  |  |  |  |            |     |       |   |  |  |  |  |  |              |    |       |  |                |        |   |                 |  |              |    |       |  |  |  |  |  |  |
| 1.6 16V  | 82   | 02.10       |   |                |   |   |                         |   |                         |     |             |    |       |   |                |        |  |                   |     |              |    |       |   |  |  |  |  |  |                 |    |       |   |  |  |  |  |  |              |    |       |   |  |  |  |  |  |            |    |       |   |  |  |  |  |  |            |    |       |   |  |  |  |  |  |            |    |       |   |  |  |  |  |  |            |     |       |   |  |  |  |  |  |            |     |       |   |  |  |  |  |  |              |    |       |  |                |        |   |                 |  |              |    |       |  |  |  |  |  |  |
| 1.6 dCi  | 96   | 07.14       |   |                |   |   |                         |   |                         |     |             |    |       |   |                |        |  |                   |     |              |    |       |   |  |  |  |  |  |                 |    |       |   |  |  |  |  |  |              |    |       |   |  |  |  |  |  |            |    |       |   |  |  |  |  |  |            |    |       |   |  |  |  |  |  |            |    |       |   |  |  |  |  |  |            |     |       |   |  |  |  |  |  |            |     |       |   |  |  |  |  |  |              |    |       |  |                |        |   |                 |  |              |    |       |  |  |  |  |  |  |
| 2.0 16V  | 101  | 05.11       |   |                |   |   |                         |   |                         |     |             |    |       |   |                |        |  |                   |     |              |    |       |   |  |  |  |  |  |                 |    |       |   |  |  |  |  |  |              |    |       |   |  |  |  |  |  |            |    |       |   |  |  |  |  |  |            |    |       |   |  |  |  |  |  |            |    |       |   |  |  |  |  |  |            |     |       |   |  |  |  |  |  |            |     |       |   |  |  |  |  |  |              |    |       |  |                |        |   |                 |  |              |    |       |  |  |  |  |  |  |
| 2.0 16V  | 103  | 02.10       |   |                |   |   |                         |   |                         |     |             |    |       |   |                |        |  |                   |     |              |    |       |   |  |  |  |  |  |                 |    |       |   |  |  |  |  |  |              |    |       |   |  |  |  |  |  |            |    |       |   |  |  |  |  |  |            |    |       |   |  |  |  |  |  |            |    |       |   |  |  |  |  |  |            |     |       |   |  |  |  |  |  |            |     |       |   |  |  |  |  |  |              |    |       |  |                |        |   |                 |  |              |    |       |  |  |  |  |  |  |
| Z.E.   | 70   | 02.12       |   | 24.0111-0180.2 | 411180                                      | mit Lager/ mit Sensorring <sup>4)</sup> | 274 11,0 9,5 +B         |   |                         |     |             |    |       |   |                |        |  |                   |     |              |    |       |   |  |  |  |  |  |                 |    |       |   |  |  |  |  |  |              |    |       |   |  |  |  |  |  |            |    |       |   |  |  |  |  |  |            |    |       |   |  |  |  |  |  |            |    |       |   |  |  |  |  |  |            |     |       |   |  |  |  |  |  |            |     |       |   |  |  |  |  |  |              |    |       |  |                |        |   |                 |  |              |    |       |  |  |  |  |  |  |
| RENAULT KADJAR (HFE) (15-)   |  |             |   |                |   |   |                         |   |                         |     |             |    |       |   |                |        |  |                   |     |              |    |       |   |  |  |  |  |  |                 |    |       |   |  |  |  |  |  |              |    |       |   |  |  |  |  |  |            |    |       |   |  |  |  |  |  |            |    |       |   |  |  |  |  |  |            |    |       |   |  |  |  |  |  |            |     |       |   |  |  |  |  |  |            |     |       |   |  |  |  |  |  |              |    |       |  |                |        |   |                 |  |              |    |       |  |  |  |  |  |  |
|  | <table border="1"> <tr><td>1.2 TCe 130</td><td>96</td><td>06.15</td><td></td><td>24.0126-0185.1</td><td>426185</td><td></td><td>296 26,0 24,0 V L +B</td><td></td></tr> <tr><td>1.5 dCi 110</td><td>81</td><td>06.15</td><td></td><td></td><td></td><td></td><td></td><td></td></tr> <tr><td>1.6 dCi 130</td><td>96</td><td>06.15</td><td></td><td></td><td></td><td></td><td></td><td></td></tr> <tr><td>1.6 dCi 130 4x4</td><td>96</td><td>06.15</td><td></td><td></td><td></td><td></td><td></td><td></td></tr> </table>  | 1.2 TCe 130 | 96  | 06.15          |   | 24.0126-0185.1                          | 426185                  |   | 296 26,0 24,0 V L +B    |     | 1.5 dCi 110 | 81 | 06.15 |   |                |        |  |                   |     | 1.6 dCi 130  | 96 | 06.15 |   |  |  |  |  |  | 1.6 dCi 130 4x4 | 96 | 06.15 |   |  |  |  |  |  |              |    |       |   |  |  |  |  |  |            |    |       |   |  |  |  |  |  |            |    |       |   |  |  |  |  |  |            |    |       |   |  |  |  |  |  |            |     |       |   |  |  |  |  |  |            |     |       |   |  |  |  |  |  |              |    |       |  |                |        |   |                 |  |              |    |       |  |  |  |  |  |  |
| 1.2 TCe 130  | 96   | 06.15       |   | 24.0126-0185.1 | 426185                                      |   | 296 26,0 24,0 V L +B    |   |                         |     |             |    |       |   |                |        |  |                   |     |              |    |       |   |  |  |  |  |  |                 |    |       |   |  |  |  |  |  |              |    |       |   |  |  |  |  |  |            |    |       |   |  |  |  |  |  |            |    |       |   |  |  |  |  |  |            |    |       |   |  |  |  |  |  |            |     |       |   |  |  |  |  |  |            |     |       |   |  |  |  |  |  |              |    |       |  |                |        |   |                 |  |              |    |       |  |  |  |  |  |  |
| 1.5 dCi 110  | 81   | 06.15       |   |                |   |   |                         |   |                         |     |             |    |       |   |                |        |  |                   |     |              |    |       |   |  |  |  |  |  |                 |    |       |   |  |  |  |  |  |              |    |       |   |  |  |  |  |  |            |    |       |   |  |  |  |  |  |            |    |       |   |  |  |  |  |  |            |    |       |   |  |  |  |  |  |            |     |       |   |  |  |  |  |  |            |     |       |   |  |  |  |  |  |              |    |       |  |                |        |   |                 |  |              |    |       |  |  |  |  |  |  |
| 1.6 dCi 130  | 96   | 06.15       |   |                |   |   |                         |   |                         |     |             |    |       |   |                |        |  |                   |     |              |    |       |   |  |  |  |  |  |                 |    |       |   |  |  |  |  |  |              |    |       |   |  |  |  |  |  |            |    |       |   |  |  |  |  |  |            |    |       |   |  |  |  |  |  |            |    |       |   |  |  |  |  |  |            |     |       |   |  |  |  |  |  |            |     |       |   |  |  |  |  |  |              |    |       |  |                |        |   |                 |  |              |    |       |  |  |  |  |  |  |
| 1.6 dCi 130 4x4  | 96   | 06.15       |   |                |   |   |                         |   |                         |     |             |    |       |   |                |        |  |                   |     |              |    |       |   |  |  |  |  |  |                 |    |       |   |  |  |  |  |  |              |    |       |   |  |  |  |  |  |            |    |       |   |  |  |  |  |  |            |    |       |   |  |  |  |  |  |            |    |       |   |  |  |  |  |  |            |     |       |   |  |  |  |  |  |            |     |       |   |  |  |  |  |  |              |    |       |  |                |        |   |                 |  |              |    |       |  |  |  |  |  |  |
|  | <table border="1"> <tr><td>1.2 TCe 130</td><td>96</td><td>06.15</td><td></td><td>13.0460-2600.2</td><td>602600</td><td></td><td>25965 15,0 +/-WK</td><td>TRW</td></tr> <tr><td>1.5 dCi 110</td><td>81</td><td>06.15</td><td></td><td></td><td></td><td></td><td></td><td></td></tr> <tr><td>1.6 dCi 130</td><td>96</td><td>06.15</td><td></td><td></td><td></td><td></td><td></td><td></td></tr> <tr><td>1.6 dCi 130 4x4</td><td>96</td><td>06.15</td><td></td><td></td><td></td><td></td><td></td><td></td></tr> </table>   | 1.2 TCe 130 | 96  | 06.15          |   | 13.0460-2600.2                          | 602600                  |   | 25965 15,0 +/-WK        | TRW | 1.5 dCi 110 | 81 | 06.15 |   |                |        |  |                   |     | 1.6 dCi 130  | 96 | 06.15 |   |  |  |  |  |  | 1.6 dCi 130 4x4 | 96 | 06.15 |   |  |  |  |  |  |              |    |       |   |  |  |  |  |  |            |    |       |   |  |  |  |  |  |            |    |       |   |  |  |  |  |  |            |    |       |   |  |  |  |  |  |            |     |       |   |  |  |  |  |  |            |     |       |   |  |  |  |  |  |              |    |       |  |                |        |   |                 |  |              |    |       |  |  |  |  |  |  |
| 1.2 TCe 130  | 96   | 06.15       |   | 13.0460-2600.2 | 602600                                      |   | 25965 15,0 +/-WK        | TRW                                     |                         |     |             |    |       |   |                |        |  |                   |     |              |    |       |   |  |  |  |  |  |                 |    |       |   |  |  |  |  |  |              |    |       |   |  |  |  |  |  |            |    |       |   |  |  |  |  |  |            |    |       |   |  |  |  |  |  |            |    |       |   |  |  |  |  |  |            |     |       |   |  |  |  |  |  |            |     |       |   |  |  |  |  |  |              |    |       |  |                |        |   |                 |  |              |    |       |  |  |  |  |  |  |
| 1.5 dCi 110  | 81   | 06.15       |   |                |   |   |                         |   |                         |     |             |    |       |   |                |        |  |                   |     |              |    |       |   |  |  |  |  |  |                 |    |       |   |  |  |  |  |  |              |    |       |   |  |  |  |  |  |            |    |       |   |  |  |  |  |  |            |    |       |   |  |  |  |  |  |            |    |       |   |  |  |  |  |  |            |     |       |   |  |  |  |  |  |            |     |       |   |  |  |  |  |  |              |    |       |  |                |        |   |                 |  |              |    |       |  |  |  |  |  |  |
| 1.6 dCi 130  | 96   | 06.15       |   |                |   |   |                         |   |                         |     |             |    |       |   |                |        |  |                   |     |              |    |       |   |  |  |  |  |  |                 |    |       |   |  |  |  |  |  |              |    |       |   |  |  |  |  |  |            |    |       |   |  |  |  |  |  |            |    |       |   |  |  |  |  |  |            |    |       |   |  |  |  |  |  |            |     |       |   |  |  |  |  |  |            |     |       |   |  |  |  |  |  |              |    |       |  |                |        |   |                 |  |              |    |       |  |  |  |  |  |  |
| 1.6 dCi 130 4x4  | 96   | 06.15       |   |                |   |   |                         |   |                         |     |             |    |       |   |                |        |  |                   |     |              |    |       |   |  |  |  |  |  |                 |    |       |   |  |  |  |  |  |              |    |       |   |  |  |  |  |  |            |    |       |   |  |  |  |  |  |            |    |       |   |  |  |  |  |  |            |    |       |   |  |  |  |  |  |            |     |       |   |  |  |  |  |  |            |     |       |   |  |  |  |  |  |              |    |       |  |                |        |   |                 |  |              |    |       |  |  |  |  |  |  |
|  | <table border="1"> <tr><td>1.2 TCe 130</td><td>96</td><td>06.15</td><td></td><td>24.0113-0200.1</td><td>413200</td><td></td><td>290 13,0 11,0 +B</td><td></td></tr> <tr><td>1.5 dCi 110</td><td>81</td><td>06.15</td><td></td><td></td><td></td><td></td><td></td><td></td></tr> <tr><td>1.6 dCi 130</td><td>96</td><td>06.15</td><td></td><td></td><td></td><td></td><td></td><td></td></tr> <tr><td>1.6 dCi 130 4x4</td><td>96</td><td>06.15</td><td></td><td></td><td></td><td></td><td></td><td></td></tr> </table>  | 1.2 TCe 130 | 96  | 06.15          |   | 24.0113-0200.1                          | 413200                  |   | 290 13,0 11,0 +B        |     | 1.5 dCi 110 | 81 | 06.15 |   |                |        |  |                   |     | 1.6 dCi 130  | 96 | 06.15 |   |  |  |  |  |  | 1.6 dCi 130 4x4 | 96 | 06.15 |   |  |  |  |  |  |              |    |       |   |  |  |  |  |  |            |    |       |   |  |  |  |  |  |            |    |       |   |  |  |  |  |  |            |    |       |   |  |  |  |  |  |            |     |       |   |  |  |  |  |  |            |     |       |   |  |  |  |  |  |              |    |       |  |                |        |   |                 |  |              |    |       |  |  |  |  |  |  |
| 1.2 TCe 130  | 96   | 06.15       |   | 24.0113-0200.1 | 413200                                      |   | 290 13,0 11,0 +B        |   |                         |     |             |    |       |   |                |        |  |                   |     |              |    |       |   |  |  |  |  |  |                 |    |       |   |  |  |  |  |  |              |    |       |   |  |  |  |  |  |            |    |       |   |  |  |  |  |  |            |    |       |   |  |  |  |  |  |            |    |       |   |  |  |  |  |  |            |     |       |   |  |  |  |  |  |            |     |       |   |  |  |  |  |  |              |    |       |  |                |        |   |                 |  |              |    |       |  |  |  |  |  |  |
| 1.5 dCi 110  | 81   | 06.15       |   |                |   |   |                         |   |                         |     |             |    |       |   |                |        |  |                   |     |              |    |       |   |  |  |  |  |  |                 |    |       |   |  |  |  |  |  |              |    |       |   |  |  |  |  |  |            |    |       |   |  |  |  |  |  |            |    |       |   |  |  |  |  |  |            |    |       |   |  |  |  |  |  |            |     |       |   |  |  |  |  |  |            |     |       |   |  |  |  |  |  |              |    |       |  |                |        |   |                 |  |              |    |       |  |  |  |  |  |  |
| 1.6 dCi 130  | 96   | 06.15       |   |                |   |   |                         |   |                         |     |             |    |       |   |                |        |  |                   |     |              |    |       |   |  |  |  |  |  |                 |    |       |   |  |  |  |  |  |              |    |       |   |  |  |  |  |  |            |    |       |   |  |  |  |  |  |            |    |       |   |  |  |  |  |  |            |    |       |   |  |  |  |  |  |            |     |       |   |  |  |  |  |  |            |     |       |   |  |  |  |  |  |              |    |       |  |                |        |   |                 |  |              |    |       |  |  |  |  |  |  |
| 1.6 dCi 130 4x4  | 96   | 06.15       |   |                |   |   |                         |   |                         |     |             |    |       |   |                |        |  |                   |     |              |    |       |   |  |  |  |  |  |                 |    |       |   |  |  |  |  |  |              |    |       |   |  |  |  |  |  |            |    |       |   |  |  |  |  |  |            |    |       |   |  |  |  |  |  |            |    |       |   |  |  |  |  |  |            |     |       |   |  |  |  |  |  |            |     |       |   |  |  |  |  |  |              |    |       |  |                |        |   |                 |  |              |    |       |  |  |  |  |  |  |

<sup>1)</sup> + increased payload / + carico utile maggiorato / + charge utile augmentée / + incremento de carga  
<sup>2)</sup> - electric parking brake / - freno a mano elettrico / - frein à main électrique / - freno de mano eléctrico  
<sup>3)</sup> + electric parking brake / + freno a mano elettrico / + frein à main électrique / + freno de mano eléctrico  
<sup>4)</sup> with bearing/ with sensor ring / con supporto/+ anell.sens.ABS / avec palier de secours ABS / con apoya/+ anillo sensor ABS





**RENAULT KANGOO I (KC\_) (98-07)**

|                      |                      |    |       |       |                                      |   |                |        |  |                              |                        |                   |     |
|----------------------|----------------------|----|-------|-------|--------------------------------------|---|----------------|--------|--|------------------------------|------------------------|-------------------|-----|
|                      | 1.2                  | 43 |       | 03.98 | 12.07                                |   | 13.0460-3977.2 | 603977 |  | - Postfahrzeug <sup>1)</sup> | 21980                  | 18,0 +WE/S        | BOS |
|                      | 1.2 16V              | 55 |       | 06.01 | 12.07                                |   |                |        |  |                              |                        |                   |     |
|                      | 1.4                  | 55 |       | 03.98 | 12.07                                |   |                |        |  |                              |                        |                   |     |
|                      | 1.5 dCi              | 42 |       | 07.03 | 12.07                                |   |                |        |  |                              |                        |                   |     |
|                      | 1.5 dCi              | 45 |       | 04.05 | 12.07                                |   |                |        |  |                              |                        |                   |     |
|                      | 1.5 dCi              | 62 |       | 06.05 | 12.07                                |   |                |        |  |                              |                        |                   |     |
|                      | 1.5 dCi (KC07)       |    |       | 12.01 | 12.07                                |   |                |        |  |                              |                        |                   |     |
|                      | 1.5 dCi (KC08/09)    | 60 |       | 07.02 | 12.07                                |   |                |        |  |                              |                        |                   |     |
|                      | 1.6                  | 66 |       | 09.99 | 06.01                                |   |                |        |  |                              |                        |                   |     |
|                      | 1.6 16V 2WD          | 70 |       | 06.01 | 12.07                                |   |                |        |  |                              |                        |                   |     |
|                      | 1.6 16V bivalent     | 60 |       | 06.05 | 12.07                                |   |                |        |  |                              |                        |                   |     |
|                      | 1.9 D                | 47 |       | 03.98 | 12.07                                |   |                |        |  |                              |                        |                   |     |
|                      | 1.9 D (KC0D)         | 40 |       | 03.98 | 12.07                                |   |                |        |  |                              |                        |                   |     |
|                      | 1.9 dTi (KC0U)       | 59 |       | 02.00 | 12.07                                |   |                |        |  |                              |                        |                   |     |
| 1.9 RXED             | 48                   |    | 09.99 | 06.01 |                                      |   |                |        |  |                              |                        |                   |     |
| Elektro              | 22                   |    | 01.02 | 12.04 |                                      |   |                |        |  |                              |                        |                   |     |
| 1.6 16V 4x4          | 70                   |    | 10.01 | 12.07 |                                      | 13.0460-3815.2                              | 603815         |        |  |                              | 23930                  | 18,2 /Zub/S       | BOS |
| 1.9 dCi 4x4          | 62                   |    | 10.03 | 12.07 |                                      | 13.0470-3815.2                              | LD3815         |        |  |                              | 23930                  | 18,2 /Zub/S       | BOS |
| 1.9 dCi 4x4 (KC0V)   | 59                   |    | 10.01 | 12.07 |                                      |   |                |        |  |                              |                        |                   |     |
|                      | 1.2                  | 43 |       | 03.98 | 12.07                                | - ABS                                       | 24.0120-0125.1 | 420125 |  |                              | 238                    | 20,1 17,7 V +S +B |     |
|                      | 1.2 16V              | 55 |       | 06.01 | 12.07                                | - ABS/ - verstärktes Fahrwerk <sup>2)</sup> |                |        |  |                              |                        |                   |     |
|                      | 1.4                  | 55 |       | 03.98 | 12.07                                | - ABS/ - verstärktes Fahrwerk <sup>2)</sup> |                |        |  |                              |                        |                   |     |
|                      | 1.5 dCi              | 45 |       | 04.05 | 12.07                                | - ABS                                       |                |        |  |                              |                        |                   |     |
|                      | 1.9 D                | 47 |       | 03.98 | 12.07                                | - ABS                                       |                |        |  |                              |                        |                   |     |
|                      | 1.9 D (KC0D)         | 40 |       | 03.98 | 12.07                                | - ABS                                       |                |        |  |                              |                        |                   |     |
|                      | 1.9 dTi (KC0U)       | 59 |       | 02.00 | 12.07                                | - ABS                                       |                |        |  |                              |                        |                   |     |
|                      | 1.9 RXED             | 48 |       | 09.99 | 06.01                                | - ABS                                       |                |        |  |                              |                        |                   |     |
|                      | Elektro              | 22 |       | 01.02 | 12.04                                |   |                |        |  |                              |                        |                   |     |
|                      | 1.2                  | 43 |       | 03.98 | 12.07                                | + ABS                                       | 24.0121-0106.1 | 421106 |  |                              | 259                    | 20,6 17,7 V +S +B |     |
|                      | 1.2 16V              | 55 |       | 06.01 | 12.07                                | + ABS/ + verstärktes Fahrwerk <sup>3)</sup> |                |        |  |                              |                        |                   |     |
|                      | 1.4                  | 55 |       | 03.98 | 12.07                                | + ABS/ + verstärktes Fahrwerk <sup>3)</sup> |                |        |  |                              |                        |                   |     |
|                      | 1.5 dCi              | 42 |       | 07.03 | 12.07                                |   |                |        |  |                              |                        |                   |     |
|                      | 1.5 dCi              | 45 |       | 04.05 | 12.07                                | + ABS                                       |                |        |  |                              |                        |                   |     |
| 1.5 dCi              | 62                   |    | 06.05 | 12.07 |                                      |   |                |        |  |                              |                        |                   |     |
| 1.5 dCi (KC07)       |                      |    | 12.01 | 12.07 |                                      |   |                |        |  |                              |                        |                   |     |
| 1.5 dCi (KC08/09)    | 60                   |    | 07.02 | 12.07 |                                      |   |                |        |  |                              |                        |                   |     |
| 1.6                  | 66                   |    | 09.99 | 06.01 |                                      |   |                |        |  |                              |                        |                   |     |
| 1.6 16V 2WD          | 70                   |    | 06.01 | 12.07 |                                      |   |                |        |  |                              |                        |                   |     |
| 1.6 16V bivalent     | 60                   |    | 06.05 | 12.07 |                                      |   |                |        |  |                              |                        |                   |     |
| 1.9 D                | 47                   |    | 03.98 | 12.07 | + ABS                                |   |                |        |  |                              |                        |                   |     |
| 1.9 D (KC0D)         | 40                   |    | 03.98 | 12.07 | + ABS                                |   |                |        |  |                              |                        |                   |     |
| 1.9 dTi (KC0U)       | 59                   |    | 02.00 | 12.07 | + ABS                                |   |                |        |  |                              |                        |                   |     |
| 1.9 RXED             | 48                   |    | 09.99 | 06.01 | + ABS                                |   |                |        |  |                              |                        |                   |     |
| 1.6 16V 4x4          | 70                   |    | 10.01 | 12.07 |                                      | 24.0124-0158.1                              | 424158         |        |  | 280                          | 24,0 21,8 V L +S +B    |                   |     |
| 1.9 dCi 4x4          | 62                   |    | 10.03 | 12.07 |                                      | 24.0324-0158.1                              | 524158         |        |  | 280                          | 24,0 21,8 V L +S +B PD |                   |     |
| 1.9 dCi 4x4 (KC0V)   | 59                   |    | 10.01 | 12.07 |                                      |   |                |        |  |                              |                        |                   |     |
|                      | 1.6 16V 4x4          | 70 |       | 10.01 | 12.07                                |   | 13.0460-3988.2 | 603988 |  |                              | 23557                  | 17,2 /S           | BOS |
|                      | 1.9 dCi 4x4          | 62 |       | 10.03 | 12.07                                |   | 13.0470-3988.2 | LD3988 |  |                              | 23557                  | 17,2 /S           | BOS |
|                      | 1.9 dCi 4x4 (KC0V)   | 59 |       | 10.01 | 12.07                                |   |                |        |  |                              |                        |                   |     |
|                      | 1.6 16V 4x4          | 70 |       | 10.01 | 12.07                                |   | 24.0112-0160.1 | 412160 |  |                              | 281                    | 12,0 11,0 +B      |     |
|                      | 1.9 dCi 4x4          | 62 |       | 10.03 | 12.07                                |   |                |        |  |                              |                        |                   |     |
|                      | 1.9 dCi 4x4 (KC0V)   | 59 |       | 10.01 | 12.07                                |   |                |        |  |                              |                        |                   |     |
|                      | 1.2 (KC01/0A/0F)     | 43 |       | 03.98 | 12.07                                | - verstärktes Fahrwerk <sup>4)</sup>        | 03.0137-0350.2 | 650350 |  |                              | 203 x 39 HEB           |                   |     |
|                      | 1.2 16V (KC05/0T/0W) | 55 |       | 06.01 | 12.07                                | - verstärktes Fahrwerk <sup>4)</sup>        | 03.0137-9233.2 | 669233 |  |                              | Bremsbacken-Zubehör    |                   |     |
|                      | 1.4                  | 55 |       | 03.98 | 12.07                                | - verstärktes Fahrwerk <sup>4)</sup>        |                |        |  |                              |                        |                   |     |
|                      | 1.5 dCi              | 42 |       | 07.03 | 12.07                                | - verstärktes Fahrwerk <sup>4)</sup>        |                |        |  |                              |                        |                   |     |
|                      | 1.5 dCi              | 45 |       | 04.05 | 12.07                                | - verstärktes Fahrwerk <sup>4)</sup>        |                |        |  |                              |                        |                   |     |
|                      | 1.5 dCi              | 62 |       | 06.05 | 12.07                                | - verstärktes Fahrwerk <sup>4)</sup>        |                |        |  |                              |                        |                   |     |
|                      | 1.5 dCi (KC07)       |    |       | 12.01 | 12.07                                | - verstärktes Fahrwerk <sup>4)</sup>        |                |        |  |                              |                        |                   |     |
|                      | 1.5 dCi (KC08/09)    | 60 |       | 07.02 | 12.07                                | - verstärktes Fahrwerk <sup>4)</sup>        |                |        |  |                              |                        |                   |     |
|                      | 1.6 16V 2WD          | 70 |       | 06.01 | 12.07                                | - verstärktes Fahrwerk <sup>4)</sup>        |                |        |  |                              |                        |                   |     |
|                      | 1.9 D                | 47 |       | 03.98 | 12.07                                | - verstärktes Fahrwerk <sup>4)</sup>        |                |        |  |                              |                        |                   |     |
|                      | 1.9 D (KC0D)         | 40 |       | 03.98 | 12.07                                | - verstärktes Fahrwerk <sup>4)</sup>        |                |        |  |                              |                        |                   |     |
|                      | 1.9 dCi 4x4          | 62 |       | 10.03 | 12.07                                |   |                |        |  |                              |                        |                   |     |
|                      | 1.9 dTi (KC0U)       | 59 |       | 02.00 | 12.07                                | - verstärktes Fahrwerk <sup>4)</sup>        |                |        |  |                              |                        |                   |     |
|                      | 1.9 RXED             | 48 |       | 09.99 | 06.01                                | - verstärktes Fahrwerk <sup>4)</sup>        |                |        |  |                              |                        |                   |     |
| 1.2 (KC01/0A/0F)     | 43                   |    | 03.98 | 12.07 | + verstärktes Fahrwerk <sup>5)</sup> | 03.0137-0351.2                              | 650351         |        |  | 229 x 42 HEB                 |                        | BDX               |     |
| 1.2 (KC0K)           | 43                   |    | 03.98 | 12.07 |                                      | 03.0137-9228.2                              | 669228         |        |  | Bremsbacken-Zubehör          |                        | BDX               |     |
| 1.2 16V (KC05/0T/0W) | 55                   |    | 06.01 | 12.07 | + verstärktes Fahrwerk <sup>5)</sup> |   |                |        |  |                              |                        |                   |     |
| 1.2 16V (KC06)       | 55                   |    | 06.01 | 12.07 |                                      |   |                |        |  |                              |                        |                   |     |
| 1.4                  | 55                   |    | 03.98 | 12.07 | + verstärktes Fahrwerk <sup>5)</sup> |   |                |        |  |                              |                        |                   |     |
| 1.5 dCi              | 42                   |    | 07.03 | 12.07 | + verstärktes Fahrwerk <sup>5)</sup> |   |                |        |  |                              |                        |                   |     |
| 1.5 dCi              | 62                   |    | 06.05 | 12.07 | + verstärktes Fahrwerk <sup>5)</sup> |   |                |        |  |                              |                        |                   |     |
| 1.5 dCi (KC07)       |                      |    | 12.01 | 12.07 | + verstärktes Fahrwerk <sup>5)</sup> |   |                |        |  |                              |                        |                   |     |
| 1.5 dCi (KC08/09)    | 60                   |    | 07.02 | 12.07 | + verstärktes Fahrwerk <sup>5)</sup> |   |                |        |  |                              |                        |                   |     |
| 1.6                  | 66                   |    | 09.99 | 06.01 |                                      |   |                |        |  |                              |                        |                   |     |
| 1.6 16V 2WD          | 70                   |    | 06.01 | 12.07 | + verstärktes Fahrwerk <sup>5)</sup> |   |                |        |  |                              |                        |                   |     |
| 1.9 D                | 47                   |    | 03.98 | 12.07 | + verstärktes Fahrwerk <sup>5)</sup> |   |                |        |  |                              |                        |                   |     |
| 1.9 D (KC0D)         | 40                   |    | 03.98 | 12.07 | + verstärktes Fahrwerk <sup>5)</sup> |   |                |        |  |                              |                        |                   |     |
| 1.9 dTi (KC0U)       | 59                   |    | 02.00 | 12.07 | + verstärktes Fahrwerk <sup>5)</sup> |   |                |        |  |                              |                        |                   |     |
| 1.9 RXED             | 48                   |    | 09.99 | 06.01 | + verstärktes Fahrwerk <sup>5)</sup> |   |                |        |  |                              |                        |                   |     |
| Elektro              | 22                   |    | 01.02 | 12.04 |                                      |   |                |        |  |                              |                        |                   |     |

<sup>1)</sup> - Postal vehicle / - Veicoli postali / - Véhicule postal / - Vehículo de correos

<sup>2)</sup> - ABS/ - reinforced suspension / - ABS/ - sospensione rinforzata / - ABS/ - châssis renforcé / - ABS/ - suspensión reforzada

<sup>3)</sup> + ABS/ + reinforced suspens. / + ABS/ + sospensione rinforzata / + ABS/ + châssis renforcé / + ABS/ + suspensión reforzada

<sup>4)</sup> - reinforced suspension / - sospensione rinforzata / - châssis renforcé / - suspensión reforzada

<sup>5)</sup> + reinforced suspension / + sospensione rinforzata / + châssis renforcé / + suspensión reforzada



### RENAULT KANGOO I (KC\_) (98-07)

|                   |                      |                      |       |                                      |                                      |                |        |  |                         |                                      |                |        |                  |                         |
|-------------------|----------------------|----------------------|-------|--------------------------------------|--------------------------------------|----------------|--------|--|-------------------------|--------------------------------------|----------------|--------|------------------|-------------------------|
|                   | 1.2 (KC01/OA/OF)     | 43                   | 03.98 | 12.07                                | - verstärktes Fahrwerk <sup>1)</sup> | 24.0220-3010.1 | 480081 |  | 203/204,5 x 50,5        |                                      |                |        |                  |                         |
|                   | 1.2 16V (KC05/OT/OW) | 55                   | 06.01 | 12.07                                | - verstärktes Fahrwerk <sup>1)</sup> |                |        |  |                         |                                      |                |        |                  |                         |
|                   | 1.4                  | 55                   | 03.98 | 12.07                                | - verstärktes Fahrwerk <sup>1)</sup> |                |        |  |                         |                                      |                |        |                  |                         |
|                   | 1.5 dCi              | 42                   | 07.03 | 12.07                                | - verstärktes Fahrwerk <sup>1)</sup> |                |        |  |                         |                                      |                |        |                  |                         |
|                   | 1.5 dCi              | 45                   | 04.05 | 12.07                                | - verstärktes Fahrwerk <sup>1)</sup> |                |        |  |                         |                                      |                |        |                  |                         |
|                   | 1.5 dCi              | 62                   | 06.05 | 12.07                                | - verstärktes Fahrwerk <sup>1)</sup> |                |        |  |                         |                                      |                |        |                  |                         |
|                   | 1.5 dCi (KC07)       |                      | 12.01 | 12.07                                | - verstärktes Fahrwerk <sup>1)</sup> |                |        |  |                         |                                      |                |        |                  |                         |
|                   | 1.5 dCi (KC08/09)    | 60                   | 07.02 | 12.07                                | - verstärktes Fahrwerk <sup>1)</sup> |                |        |  |                         |                                      |                |        |                  |                         |
|                   | 1.9 D                | 47                   | 03.98 | 12.07                                | - verstärktes Fahrwerk <sup>1)</sup> |                |        |  |                         |                                      |                |        |                  |                         |
|                   | 1.9 D (KC0D)         | 40                   | 03.98 | 12.07                                | - verstärktes Fahrwerk <sup>1)</sup> |                |        |  |                         |                                      |                |        |                  |                         |
|                   | 1.9 dTi (KC0U)       | 59                   | 02.00 | 12.07                                | - verstärktes Fahrwerk <sup>1)</sup> |                |        |  |                         |                                      |                |        |                  |                         |
|                   | 1.9 RXED             | 48                   | 09.99 | 06.01                                | - verstärktes Fahrwerk <sup>1)</sup> |                |        |  |                         |                                      |                |        |                  |                         |
|                   | 1.2 (KC01/OA/OF)     | 43                   | 03.98 | 12.07                                | + verstärktes Fahrwerk <sup>2)</sup> |                |        |  |                         | 24.0222-8015.1                       | 480055         |        | 229/229,5 x 52,5 |                         |
|                   | 1.2 (KC0K)           | 43                   | 03.98 | 12.07                                | + verstärktes Fahrwerk <sup>2)</sup> |                |        |  |                         |                                      |                |        |                  |                         |
|                   | 1.2 16V (KC05/OT/OW) | 55                   | 06.01 | 12.07                                | + verstärktes Fahrwerk <sup>2)</sup> |                |        |  |                         |                                      |                |        |                  |                         |
|                   | 1.2 16V (KC06)       | 55                   | 06.01 | 12.07                                | + verstärktes Fahrwerk <sup>2)</sup> |                |        |  |                         |                                      |                |        |                  |                         |
|                   | 1.4                  | 55                   | 03.98 | 12.07                                | + verstärktes Fahrwerk <sup>2)</sup> |                |        |  |                         |                                      |                |        |                  |                         |
| 1.5 dCi           | 42                   | 07.03                | 12.07 | + verstärktes Fahrwerk <sup>2)</sup> |                                      |                |        |  |                         |                                      |                |        |                  |                         |
| 1.5 dCi           | 62                   | 06.05                | 12.07 | + verstärktes Fahrwerk <sup>2)</sup> |                                      |                |        |  |                         |                                      |                |        |                  |                         |
| 1.5 dCi (KC07)    |                      | 12.01                | 12.07 | + verstärktes Fahrwerk <sup>2)</sup> |                                      |                |        |  |                         |                                      |                |        |                  |                         |
| 1.5 dCi (KC08/09) | 60                   | 07.02                | 12.07 | + verstärktes Fahrwerk <sup>2)</sup> |                                      |                |        |  |                         |                                      |                |        |                  |                         |
| 1.9 D             | 47                   | 03.98                | 12.07 | + verstärktes Fahrwerk <sup>2)</sup> |                                      |                |        |  |                         |                                      |                |        |                  |                         |
| 1.9 D (KC0D)      | 40                   | 03.98                | 12.07 | + verstärktes Fahrwerk <sup>2)</sup> |                                      |                |        |  |                         |                                      |                |        |                  |                         |
| 1.9 dTi (KC0U)    | 59                   | 02.00                | 12.07 | + verstärktes Fahrwerk <sup>2)</sup> |                                      |                |        |  |                         |                                      |                |        |                  |                         |
| 1.9 RXED          | 48                   | 09.99                | 06.01 | + verstärktes Fahrwerk <sup>2)</sup> |                                      |                |        |  |                         |                                      |                |        |                  |                         |
| Elektro           | 22                   | 01.02                | 12.07 |                                      |                                      |                |        |  |                         |                                      |                |        |                  |                         |
|                   | 1.2 (KC01/OA/OF)     | 43                   | 03.98 | 12.07                                | - verstärktes Fahrwerk <sup>1)</sup> | 03.0520-5722.3 | 695722 |  | 22,20/203x39 TopKit BDX |                                      |                |        |                  |                         |
|                   | 1.2 16V (KC05/OT/OW) | 55                   | 06.01 | 12.07                                | - verstärktes Fahrwerk <sup>1)</sup> |                |        |  |                         |                                      |                |        |                  |                         |
|                   | 1.4                  | 55                   | 03.98 | 12.07                                | - verstärktes Fahrwerk <sup>1)</sup> |                |        |  |                         |                                      |                |        |                  |                         |
|                   | 1.5 dCi              | 42                   | 07.03 | 12.07                                | - verstärktes Fahrwerk <sup>1)</sup> |                |        |  |                         |                                      |                |        |                  |                         |
|                   | 1.5 dCi              | 62                   | 06.05 | 12.07                                | - verstärktes Fahrwerk <sup>1)</sup> |                |        |  |                         |                                      |                |        |                  |                         |
|                   | 1.5 dCi (KC07)       |                      | 12.01 | 12.07                                | - verstärktes Fahrwerk <sup>1)</sup> |                |        |  |                         |                                      |                |        |                  |                         |
|                   | 1.5 dCi (KC08/09)    | 60                   | 07.02 | 12.07                                | - verstärktes Fahrwerk <sup>1)</sup> |                |        |  |                         |                                      |                |        |                  |                         |
|                   | 1.6 16V 2WD          | 70                   | 06.01 | 12.07                                | - verstärktes Fahrwerk <sup>1)</sup> |                |        |  |                         |                                      |                |        |                  |                         |
|                   | 1.9 D                | 47                   | 03.98 | 12.07                                | - verstärktes Fahrwerk <sup>1)</sup> |                |        |  |                         |                                      |                |        |                  |                         |
|                   | 1.9 D (KC0D)         | 40                   | 03.98 | 12.07                                | - verstärktes Fahrwerk <sup>1)</sup> |                |        |  |                         |                                      |                |        |                  |                         |
|                   | 1.9 dCi 4x4          | 62                   | 10.03 | 12.07                                |                                      |                |        |  |                         |                                      |                |        |                  |                         |
|                   | 1.9 dTi (KC0U)       | 59                   | 02.00 | 12.07                                | - verstärktes Fahrwerk <sup>1)</sup> |                |        |  |                         |                                      |                |        |                  |                         |
|                   | 1.9 RXED             | 48                   | 09.99 | 06.01                                | - verstärktes Fahrwerk <sup>1)</sup> |                |        |  |                         |                                      |                |        |                  |                         |
|                   | Elektro              | 22                   | 01.02 | 12.07                                |                                      |                |        |  |                         |                                      |                |        |                  |                         |
|                   |                      | 1.2 (KC01/OA/OF)     | 43    | 03.98                                | 12.07                                |                |        |  |                         | + verstärktes Fahrwerk <sup>2)</sup> | 03.0520-5622.3 | 695622 |                  | 22,20/229x42 TopKit BDX |
|                   |                      | 1.2 (KC0K)           | 43    | 03.98                                | 12.07                                |                |        |  |                         | + verstärktes Fahrwerk <sup>2)</sup> |                |        |                  |                         |
|                   |                      | 1.2 16V (KC05/OT/OW) | 55    | 06.01                                | 12.07                                |                |        |  |                         | + verstärktes Fahrwerk <sup>2)</sup> |                |        |                  |                         |
| 1.2 16V (KC06)    |                      | 55                   | 06.01 | 12.07                                | + verstärktes Fahrwerk <sup>2)</sup> |                |        |  |                         |                                      |                |        |                  |                         |
| 1.4               |                      | 55                   | 03.98 | 12.07                                | + verstärktes Fahrwerk <sup>2)</sup> |                |        |  |                         |                                      |                |        |                  |                         |
| 1.5 dCi           |                      | 42                   | 07.03 | 12.07                                | + verstärktes Fahrwerk <sup>2)</sup> |                |        |  |                         |                                      |                |        |                  |                         |
| 1.5 dCi           |                      | 62                   | 06.05 | 12.07                                | + verstärktes Fahrwerk <sup>2)</sup> |                |        |  |                         |                                      |                |        |                  |                         |
| 1.5 dCi (KC07)    |                      |                      | 12.01 | 12.07                                | + verstärktes Fahrwerk <sup>2)</sup> |                |        |  |                         |                                      |                |        |                  |                         |
| 1.5 dCi (KC08/09) |                      | 60                   | 07.02 | 12.07                                | + verstärktes Fahrwerk <sup>2)</sup> |                |        |  |                         |                                      |                |        |                  |                         |
| 1.6 16V 2WD       |                      | 70                   | 06.01 | 12.07                                | + verstärktes Fahrwerk <sup>2)</sup> |                |        |  |                         |                                      |                |        |                  |                         |
| 1.9 D             |                      | 47                   | 03.98 | 12.07                                | + verstärktes Fahrwerk <sup>2)</sup> |                |        |  |                         |                                      |                |        |                  |                         |
| 1.9 D (KC0D)      |                      | 40                   | 03.98 | 12.07                                | + verstärktes Fahrwerk <sup>2)</sup> |                |        |  |                         |                                      |                |        |                  |                         |
| 1.9 dTi (KC0U)    |                      | 59                   | 02.00 | 12.07                                | + verstärktes Fahrwerk <sup>2)</sup> |                |        |  |                         |                                      |                |        |                  |                         |
| 1.9 RXED          |                      | 48                   | 09.99 | 06.01                                | + verstärktes Fahrwerk <sup>2)</sup> |                |        |  |                         |                                      |                |        |                  |                         |
| Elektro           |                      | 22                   | 01.02 | 12.07                                |                                      |                |        |  |                         |                                      |                |        |                  |                         |









### RENAULT KANGOO II (KW\_) (08-)

|            |                 |       |       |  |  |                |        |  |                         |                |        |  |                         |                |        |  |                      |
|------------|-----------------|-------|-------|--|--|----------------|--------|--|-------------------------|----------------|--------|--|-------------------------|----------------|--------|--|----------------------|
|            | 1.2 TCe 115     | 84    | 05.13 |  |  | 13.0460-2741.2 | 602741 |  | 24693 18,5 /Zub/S TRW   |                |        |  |                         |                |        |  |                      |
|            | 1.5 dCi         | 50    | 02.08 |  |  |                |        |  |                         | 13.0460-2742.2 | 602742 |  | 24693 17,5 /Zub/S TRW   |                |        |  |                      |
|            | 1.5 dCi         | 63    | 02.08 |  |  |                |        |  |                         |                |        |  |                         | 13.0460-2743.2 | 602743 |  | 24693 17,5 +WK/S TRW |
|            | 1.5 dCi         | 76    | 02.08 |  |  |                |        |  |                         |                |        |  |                         |                |        |  |                      |
|            | 1.5 dCi 110     | 80    | 09.10 |  |  |                |        |  |                         |                |        |  |                         |                |        |  |                      |
|            | 1.5 dCi 110     | 81    | 03.13 |  |  |                |        |  |                         |                |        |  |                         |                |        |  |                      |
|            | 1.5 dCi 75      | 55    | 11.12 |  |  |                |        |  |                         |                |        |  |                         |                |        |  |                      |
|            | 1.5 dCi 90      | 66    | 11.12 |  |  |                |        |  |                         |                |        |  |                         |                |        |  |                      |
|            | 1.6             | 64    | 02.08 |  |  |                |        |  |                         |                |        |  |                         |                |        |  |                      |
|            | 1.6 16V         | 78    | 02.08 |  |  |                |        |  |                         |                |        |  |                         |                |        |  |                      |
|            | 1.6 16V Hi-Flex | 78    | 02.08 |  |  |                |        |  |                         |                |        |  |                         |                |        |  |                      |
|            | Z.E.            | 44    | 10.11 |  |  |                |        |  |                         |                |        |  |                         |                |        |  |                      |
|            | 1.2 TCe 115     | 84    | 05.13 |  |  | 24.0124-0222.1 | 424222 |  | 280 24,0 21,8 V L +S +B |                |        |  |                         |                |        |  |                      |
|            | 1.5 dCi         | 50    | 02.08 |  |  |                |        |  |                         | 24.0126-0186.1 | 426186 |  | 280 26,0 23,8 V L +S +B |                |        |  |                      |
|            | 1.5 dCi         | 63    | 02.08 |  |  |                |        |  |                         |                |        |  |                         |                |        |  |                      |
|            | 1.5 dCi         | 76    | 02.08 |  |  |                |        |  |                         |                |        |  |                         |                |        |  |                      |
|            | 1.5 dCi 110     | 80    | 06.09 |  |  |                |        |  |                         |                |        |  |                         |                |        |  |                      |
|            | 1.5 dCi 110     | 81    | 03.13 |  |  |                |        |  |                         |                |        |  |                         |                |        |  |                      |
|            | 1.5 dCi 75      | 55    | 11.12 |  |  |                |        |  |                         |                |        |  |                         |                |        |  |                      |
|            | 1.5 dCi 90      | 66    | 11.12 |  |  |                |        |  |                         |                |        |  |                         |                |        |  |                      |
|            | 1.6             | 64    | 02.08 |  |  |                |        |  |                         |                |        |  |                         |                |        |  |                      |
|            | 1.6 16V         | 78    | 02.08 |  |  |                |        |  |                         |                |        |  |                         |                |        |  |                      |
|            | 1.6 16V Hi-Flex | 78    | 02.08 |  |  |                |        |  |                         |                |        |  |                         |                |        |  |                      |
|            | Z.E.            | 44    | 10.11 |  |  |                |        |  |                         |                |        |  |                         |                |        |  |                      |
|            | 1.2 TCe 115     | 84    | 05.13 |  |  | 13.0460-2744.2 | 602744 |  | 24692 15,9 /Zub/S TRW   |                |        |  |                         |                |        |  |                      |
|            | 1.5 dCi         | 50    | 02.08 |  |  |                |        |  |                         |                |        |  |                         |                |        |  |                      |
|            | 1.5 dCi         | 63    | 02.08 |  |  |                |        |  |                         |                |        |  |                         |                |        |  |                      |
|            | 1.5 dCi         | 76    | 02.08 |  |  |                |        |  |                         |                |        |  |                         |                |        |  |                      |
|            | 1.5 dCi 110     | 80    | 09.10 |  |  |                |        |  |                         |                |        |  |                         |                |        |  |                      |
|            | 1.5 dCi 110     | 81    | 03.13 |  |  |                |        |  |                         |                |        |  |                         |                |        |  |                      |
| 1.5 dCi 75 | 55              | 11.12 |       |  |  |                |        |  |                         |                |        |  |                         |                |        |  |                      |

<sup>1)</sup> - reinforced suspension / - sospensione rinforzata / - châssis renforcé / - suspensión reforzada

<sup>2)</sup> + reinforced suspension / + sospensione rinforzata / + châssis renforcé / + suspensión reforzada



| RENAULT KANGOO II (KW_) (08-)  |  |  |  |   |  |  |
|--|--|--|--|---|--|--|
|    | 1.5 dCi 90 66<br>1.6 64<br>1.6 16V 78<br>1.6 16V Hi-Flex 78<br>Z.E. 44   | 11.12<br>02.08<br>02.08<br>02.08<br>10.11  |  | 13.0460-2744.2 602744   |  | 24692 15,9 /Zub/S TRW  |
|    | 1.5 dCi 50<br>1.5 dCi 63<br>1.5 dCi 76<br>1.5 dCi 110 80<br>1.6 64<br>1.6 16V 78<br>1.6 16V Hi-Flex 78   | 02.08 10.11<br>02.08 10.11<br>02.08 10.11<br>09.10 10.11<br>02.08 10.11<br>02.08 10.11<br>02.08 10.11  |  | 24.0111-0174.2 411174   |  | 274 11,0 9,5 +B  |
|  | 1.2 TCe 115 84<br>1.5 dCi 50<br>1.5 dCi 63<br>1.5 dCi 76<br>1.5 dCi 110 80<br>1.5 dCi 110 81<br>1.5 dCi 75 55<br>1.5 dCi 90 66<br>1.6 64<br>1.6 16V 78<br>1.6 16V Hi-Flex 78<br>Z.E. 44  | 05.13 11.11<br>11.11<br>11.11<br>11.11<br>03.13<br>11.12<br>11.11<br>11.11<br>11.11<br>11.11<br>11.11  |  | 24.0111-0182.2 411182   |  | 274 11,0 9,5 +B  |
| RENAULT KANGOO Be Bop (KWO_) (09-10)   |  |  |  |   |  |  |
|    | 1.5 dCi 55<br>1.5 dCi 66<br>1.5 dCi 76<br>1.5 dCi 80<br>1.6 16V 78   | 09.10 12.10 + 14" Rad <sup>1)</sup><br>06.09 12.10 + 14" Rad <sup>1)</sup><br>02.09 12.10 + 14" Rad <sup>1)</sup><br>06.09 12.10 + 14" Rad <sup>1)</sup><br>02.09 12.10 + 14" Rad <sup>1)</sup>  |  | 13.0460-2709.2 602709<br>13.0470-2709.2 LD2709                          |  | 23973 17,4 /Zub/S TRW<br>23973 17,4 /Zub/S TRW                         |
|  | 1.5 dCi 55<br>1.5 dCi 66<br>1.5 dCi 76<br>1.5 dCi 80<br>1.6 16V 78   | 09.10 12.10 + 15"/16" Rad <sup>2)</sup><br>06.09 12.10 + 15"/16" Rad <sup>2)</sup><br>02.09 12.10 + 15"/16" Rad <sup>2)</sup><br>06.09 12.10 + 15"/16" Rad <sup>2)</sup><br>02.09 12.10 + 15"/16" Rad <sup>2)</sup>  |  | 13.0460-2741.2 602741<br>13.0460-2742.2 602742<br>13.0460-2743.2 602743 |  | 24693 18,5 /Zub/S TRW<br>24693 17,5 /Zub/S TRW<br>24693 17,5 +WK/S TRW |
|   | 1.5 dCi 55<br>1.5 dCi 66<br>1.5 dCi 76<br>1.5 dCi 80<br>1.6 16V 78   | 09.10 12.10 + 14" Rad <sup>1)</sup><br>06.09 12.10 + 14" Rad <sup>1)</sup><br>02.09 12.10 + 14" Rad <sup>1)</sup><br>06.09 12.10 + 14" Rad <sup>1)</sup><br>02.09 12.10 + 14" Rad <sup>1)</sup>  |  | 24.0122-0270.1 422270   |  | 258 22,0 19,8 V L +S +B  |
|  | 1.5 dCi 55<br>1.5 dCi 66<br>1.5 dCi 76<br>1.5 dCi 80<br>1.6 16V 78   | 09.10 12.10 + 15"/16" Rad <sup>2)</sup><br>06.09 12.10 + 15"/16" Rad <sup>2)</sup><br>02.09 12.10 + 15"/16" Rad <sup>2)</sup><br>06.09 12.10 + 15"/16" Rad <sup>2)</sup><br>02.09 12.10 + 15"/16" Rad <sup>2)</sup>  |  | 24.0124-0222.1 424222<br>24.0126-0186.1 426186                          |  | 280 24,0 21,8 V L +S +B<br>280 26,0 23,8 V L +S +B                     |
|  | 1.5 dCi 55<br>1.5 dCi 66<br>1.5 dCi 76<br>1.5 dCi 80<br>1.6 16V 78   | 09.10 12.10 + 15"/16" Rad <sup>2)</sup><br>06.09 12.10 + 15"/16" Rad <sup>2)</sup><br>02.09 12.10 + 15"/16" Rad <sup>2)</sup><br>06.09 12.10 + 15"/16" Rad <sup>2)</sup><br>02.09 12.10 + 15"/16" Rad <sup>2)</sup>  |  | 13.0460-2744.2 602744   |  | 24692 15,9 /Zub/S TRW  |
|  | 1.5 dCi 55<br>1.5 dCi 66<br>1.5 dCi 76<br>1.5 dCi 80<br>1.6 16V 78   | 09.10 12.10 + 15"/16" Rad <sup>2)</sup><br>06.09 12.10 + 15"/16" Rad <sup>2)</sup><br>02.09 12.10 + 15"/16" Rad <sup>2)</sup><br>06.09 12.10 + 15"/16" Rad <sup>2)</sup><br>02.09 12.10 + 15"/16" Rad <sup>2)</sup>  |  | 24.0111-0174.2 411174   |  | 274 11,0 9,5 +B  |
|  | 1.5 dCi 55<br>1.5 dCi 66<br>1.5 dCi 76<br>1.5 dCi 80<br>1.6 16V 78   | 09.10 12.10 + 14" Rad <sup>1)</sup><br>06.09 12.10 + 14" Rad <sup>1)</sup><br>02.09 12.10 + 14" Rad <sup>1)</sup><br>06.09 12.10 + 14" Rad <sup>1)</sup><br>02.09 12.10 + 14" Rad <sup>1)</sup>  |  | 03.0137-0496.2 650496<br>03.0137-9228.2 669228                          |  | 228 x 42 HEB BDX<br>Bremsbacken-Zubehör BDX                            |
|  | 1.5 dCi 55<br>1.5 dCi 66<br>1.5 dCi 76<br>1.5 dCi 80<br>1.6 16V 78   | 09.10 12.10 + 14" Rad <sup>1)</sup><br>06.09 12.10 + 14" Rad <sup>1)</sup><br>02.09 12.10 + 14" Rad <sup>1)</sup><br>06.09 12.10 + 14" Rad <sup>1)</sup><br>02.09 12.10 + 14" Rad <sup>1)</sup>  |  | 03.0520-7222.3 697222   |  | 22,20/228x42 TopKit  |
| RENAULT KANGOO Express/Rapid (FC_) (98-07)   |  |  |  |   |  |  |
|  | 1.0 40<br>1.2 43<br>1.2 44<br>1.2 16V 55<br>1.2 BiFuel 43<br>1.4 55<br>1.5 dCi 42<br>1.5 dCi 50<br>1.5 dCi 62<br>1.5 dCi (FC07) 48<br>1.5 dCi (FC08/09) 60<br>1.6 16V 70<br>1.6 16V bivalent 60<br>1.9 D 47<br>1.9 D 48<br>1.9 D (FC0D) 40<br>1.9 dCi (FC0V) 62<br>1.9 dTi (FC0U) 59 | 07.03 12.07<br>03.98 12.07<br>07.98 07.01<br>10.01 12.07<br>07.98 07.01<br>03.98 12.07<br>12.02 12.07<br>06.05 12.07<br>06.05 12.07<br>12.01 12.07<br>04.03 12.07<br>10.01 12.07<br>06.05 12.07<br>03.98 12.07<br>09.99 06.03<br>03.98 12.07<br>07.03 12.07<br>02.00 12.07 |  | 13.0460-3977.2 603977   |  | 21980 18,0 +WE/S BOS   |

<sup>1)</sup> + 14" wheel / + ruota 14" / + roue 14" / + rueda 14"  
<sup>2)</sup> + 15"/16" wheel / + ruota 15"/16" / + roue 15"/16" / + rueda 15"/16"



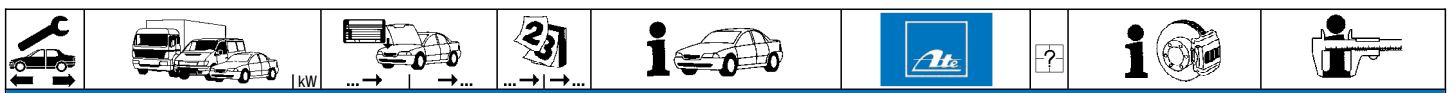

**RENAULT KANGOO Express/Rapid (FC\_) (98-07)**

|  |  |  |  |  |   |  |  |                                      |  |  |            |
|--|--|--|--|--|---|--|--|--------------------------------------|--|--|------------|
|  | 1.6 16V 4x4<br>1.9 dCi 4x4 (FCOV)  | 70<br>59   |  | 10.01<br>10.01   | 12.07<br>12.07  |  | 13.0460-3815.2<br>13.0470-3815.2                                     | 603815<br>LD3815                     |  | 23930 18,2 /Zub/S<br>23930 18,2 /Zub/S                                     | BOS<br>BOS |
|  | 1.0<br>1.2<br>1.2<br>1.2 BiFuel<br>1.4<br>1.5 dCi<br>1.5 dCi<br>1.5 dCi (FC07)<br>1.9 D<br>1.9 D (FCOD)<br>1.9 dTi (FCOU)  | 40<br>43<br>44<br>43<br>55<br>42<br>50<br>48<br>47<br>40<br>59   |  | 07.03<br>03.98<br>07.98<br>07.98<br>03.98<br>12.02<br>06.05<br>12.01<br>03.98<br>03.98<br>02.00  | 12.07<br>12.07<br>07.01<br>07.01<br>12.07<br>12.07<br>12.07<br>12.07<br>12.07<br>12.07<br>12.07   | - ABS<br>- ABS<br>- ABS<br>- ABS<br>- ABS / - verstärktes Fahrwerk <sup>1)</sup><br>- ABS<br>- ABS<br>- ABS<br>- ABS<br>- ABS                                | 24.0120-0125.1   | 420125                               |  | 238 20,1 17,7 V +S +B  |            |
|  | 1.0<br>1.2<br>1.2<br>1.2 16V<br>1.2 BiFuel<br>1.4<br>1.5 dCi<br>1.5 dCi<br>1.5 dCi<br>1.5 dCi (FC07)<br>1.5 dCi (FC08/09)<br>1.6 16V<br>1.6 16V bivalent<br>1.9 D<br>1.9 D<br>1.9 D (FCOD)<br>1.9 dCi (FCOV)<br>1.9 dCi 4x4 (FCOV)<br>1.9 dTi (FCOU) | 40<br>43<br>44<br>55<br>43<br>55<br>42<br>50<br>62<br>48<br>60<br>70<br>60<br>47<br>48<br>40<br>62<br>59<br>59 |  | 07.03<br>03.98<br>07.98<br>10.01<br>07.98<br>03.98<br>12.02<br>06.05<br>12.01<br>04.03<br>10.01<br>06.05<br>03.98<br>09.99<br>03.98<br>07.03<br>10.01<br>02.00 | 12.07<br>12.07<br>07.01<br>12.07<br>07.01<br>12.07<br>12.07<br>12.07<br>12.07<br>12.07<br>12.07<br>12.07<br>12.07<br>12.07<br>12.07<br>12.07<br>12.07<br>12.07<br>12.07 | + ABS<br>+ ABS / + verstärktes Fahrwerk <sup>2)</sup><br>+ ABS<br>+ ABS<br>+ ABS<br>+ ABS<br>+ ABS<br>+ ABS<br>+ ABS<br>+ ABS<br>+ ABS<br>+ ABS<br>+ ABS     | 24.0121-0106.1   | 421106                               |  | 259 20,6 17,7 V +S +B  |            |
|  | 1.6 16V 4x4<br>1.9 dCi 4x4 (FCOV)  | 70<br>59   |  | 10.01<br>10.01   | 12.07<br>12.07  |  | 24.0124-0158.1<br>24.0324-0158.1                                     | 424158<br>524158                     |  | 280 24,0 21,8 V L +S +B<br>280 24,0 21,8 V L +S +B PD                      |            |
|  | 1.6 16V 4x4<br>1.9 dCi 4x4 (FCOV)  | 70<br>59   |  | 10.01<br>10.01   | 12.07<br>12.07  |  | 13.0460-3988.2<br>13.0470-3988.2                                     | 603988<br>LD3988                     |  | 23557 17,2 /S<br>23557 17,2 /S   | BOS<br>BOS |
|  | 1.6 16V 4x4<br>1.9 dCi 4x4 (FCOV)  | 70<br>59   |  | 10.01<br>10.01   | 12.07<br>12.07  |  | 24.0112-0160.1   | 412160                               |  | 281 12,0 11,0 +B   |            |
|  | 1.0<br>1.2<br>1.2<br>1.2 16V<br>1.2 BiFuel<br>1.4<br>1.5 dCi<br>1.5 dCi<br>1.5 dCi<br>1.5 dCi (FC07)<br>1.5 dCi (FC08/09)<br>1.6 16V<br>1.6 16V bivalent<br>1.9 D<br>1.9 D<br>1.9 D (FCOD)<br>1.9 dCi (FCOV)<br>1.9 dTi (FCOU)                       | 40<br>43<br>44<br>55<br>43<br>55<br>42<br>50<br>62<br>48<br>60<br>70<br>60<br>47<br>48<br>40<br>62<br>59       |  | 07.03<br>03.98<br>07.98<br>10.01<br>07.98<br>03.98<br>12.02<br>06.05<br>12.01<br>04.03<br>10.01<br>06.05<br>03.98<br>09.99<br>03.98<br>07.03<br>02.00          | 12.07<br>12.07<br>07.01<br>12.07<br>07.01<br>12.07<br>12.07<br>12.07<br>12.07<br>12.07<br>12.07<br>12.07<br>12.07<br>12.07<br>12.07<br>12.07<br>12.07<br>12.07          | - verstärktes Fahrwerk <sup>3)</sup><br>- verstärktes Fahrwerk <sup>3)</sup><br>+ verstärktes Fahrwerk <sup>4)</sup><br>+ verstärktes Fahrwerk <sup>4)</sup> | 03.0137-0350.2<br>03.0137-9233.2<br>03.0137-0351.2<br>03.0137-9228.2 | 650350<br>669233<br>650351<br>669228 |  | 203 x 39 HEB<br>Bremsbacken-Zubehör<br>229 x 42 HEB<br>Bremsbacken-Zubehör | BDX<br>BDX |
|  | 1.0<br>1.2<br>1.2<br>1.2 16V<br>1.2 BiFuel<br>1.4<br>1.5 dCi<br>1.5 dCi<br>1.5 dCi<br>1.5 dCi (FC07)<br>1.5 dCi (FC08/09)<br>1.9 D<br>1.9 D<br>1.9 D (FCOD)<br>1.9 dCi (FCOV)<br>1.9 dTi (FCOU)  | 40<br>43<br>44<br>55<br>43<br>55<br>42<br>50<br>62<br>48<br>60<br>70<br>60<br>47<br>48<br>40<br>62<br>59       |  | 07.03<br>03.98<br>07.98<br>10.01<br>07.98<br>03.98<br>12.02<br>06.05<br>12.01<br>04.03<br>10.01<br>06.05<br>03.98<br>09.99<br>03.98<br>07.03<br>02.00          | 12.07<br>12.07<br>07.01<br>12.07<br>07.01<br>12.07<br>12.07<br>12.07<br>12.07<br>12.07<br>12.07<br>12.07<br>12.07<br>12.07<br>12.07<br>12.07<br>12.07                   | - verstärktes Fahrwerk <sup>3)</sup><br>+ verstärktes Fahrwerk <sup>4)</sup><br>+ verstärktes Fahrwerk <sup>4)</sup>   | 24.0220-3010.1<br>24.0222-8015.1<br>24.0222-8019.2                   | 480081<br>480055<br>480087           |  | 203/204,5 x 50,5<br>229/229,5 x 52,5<br>229/229,5 x 52,5                   |            |
|  | 1.0<br>1.2<br>1.2<br>1.2 16V<br>1.2 BiFuel<br>1.4<br>1.5 dCi<br>1.5 dCi<br>1.5 dCi<br>1.5 dCi (FC07)<br>1.5 dCi (FC08/09)  | 40<br>43<br>44<br>55<br>43<br>55<br>42<br>50<br>62<br>48<br>60   |  | 07.03<br>03.98<br>07.98<br>10.01<br>07.98<br>03.98<br>12.02<br>06.05<br>12.01<br>04.03   | 12.07<br>12.07<br>07.01<br>12.07<br>07.01<br>12.07<br>12.07<br>12.07<br>12.07<br>12.07  | - verstärktes Fahrwerk <sup>3)</sup><br>+ verstärktes Fahrwerk <sup>4)</sup>   | 03.0520-5722.3<br>03.0520-5622.3                                     | 695722<br>695622                     |  | 22,20/203x39 TopKit<br>22,20/229x42 TopKit                                 | BDX<br>BDX |

<sup>1)</sup> - ABS/ - reinforced suspension / - ABS/ - sospensione rinforzata / - ABS/ - châssis renforcé / - ABS/ - suspensión reforzada  
<sup>2)</sup> + ABS/ + reinforced suspens. / + ABS/ + sospensione rinforzata / + ABS/ + châssis renforcé / + ABS/ + suspensión reforzada  
<sup>3)</sup> - reinforced suspension / - sospensione rinforzata / - châssis renforcé / - suspensión reforzada  
<sup>4)</sup> + reinforced suspension / + sospensione rinforzata / + châssis renforcé / + suspensión reforzada



| <b>RENAULT KANGOO Express/Rapid (FC_) (98-07)</b> |                  |    |       |       |                             |                             |  |                |        |  |  |                                      |                         |     |  |
|---|------------------|----|-------|-------|-----------------------------|-----------------------------|--|----------------|--------|--|--|--------------------------------------|-------------------------|-----|--|
|   | 1.6 16V          | 70 |       | 10.01 | 12.07                       |                             |  | 03.0520-5722.3 | 695722 |  |  | - verstärktes Fahrwerk <sup>1)</sup> | 22,20/203x39 TopKit     | BDX |  |
|   | 1.6 16V bivalent | 60 |       | 06.05 | 12.07                       |                             |  | 03.0520-5622.3 | 695622 |  |  | + verstärktes Fahrwerk <sup>2)</sup> | 22,20/229x42 TopKit     | BDX |  |
|   | 1.9 D            | 47 |       | 03.98 | 12.07                       |                             |  |                |        |  |  |                                      |                         |     |  |
|   | 1.9 D            | 48 |       | 09.99 | 06.03                       |                             |  |                |        |  |  |                                      |                         |     |  |
|   | 1.9 D (FC0D)     | 40 |       | 03.98 | 12.07                       |                             |  |                |        |  |  |                                      |                         |     |  |
|   | 1.9 dCi (FC0V)   | 62 |       | 07.03 | 12.07                       |                             |  |                |        |  |  |                                      |                         |     |  |
|   | 1.9 dTi (FC0U)   | 59 |       | 02.00 | 12.07                       |                             |  |                |        |  |  |                                      |                         |     |  |
| <b>RENAULT KANGOO Express/Rapid (FW_) (08-)</b>   |                  |    |       |       |                             |                             |  |                |        |  |  |                                      |                         |     |  |
|   | 1.2 TCe 115      | 84 |       | 05.13 |                             | + 15"/16" Rad <sup>3)</sup> |  | 13.0460-2741.2 | 602741 |  |  |                                      | 24693 18,5 /Zub/S       | TRW |  |
|   | 1.5 dCi          | 50 |       | 02.08 |                             | + 15"/16" Rad <sup>3)</sup> |  | 13.0460-2742.2 | 602742 |  |  |                                      | 24693 17,5 /Zub/S       | TRW |  |
|   | 1.5 dCi          | 76 |       | 02.08 |                             | + 15"/16" Rad <sup>3)</sup> |  | 13.0460-2743.2 | 602743 |  |  |                                      | 24693 17,5 +/WK/S       | TRW |  |
|   | 1.5 dCi 110      | 80 |       | 09.10 |                             | + 15"/16" Rad <sup>3)</sup> |  |                |        |  |  |                                      |                         |     |  |
|   | 1.5 dCi 110      | 81 |       | 09.13 |                             | + 15"/16" Rad <sup>3)</sup> |  |                |        |  |  |                                      |                         |     |  |
|   | 1.5 dCi 75       | 55 |       | 09.10 |                             | + 15"/16" Rad <sup>3)</sup> |  |                |        |  |  |                                      |                         |     |  |
|   | 1.5 dCi 85       | 63 |       | 02.08 |                             | + 15"/16" Rad <sup>3)</sup> |  |                |        |  |  |                                      |                         |     |  |
|   | 1.5 dCi 90       | 66 |       | 06.09 |                             | + 15"/16" Rad <sup>3)</sup> |  |                |        |  |  |                                      |                         |     |  |
|   | 1.6              | 64 |       | 02.08 |                             | + 15"/16" Rad <sup>3)</sup> |  |                |        |  |  |                                      |                         |     |  |
|   | 1.6 16V          | 78 |       | 02.08 |                             | + 15"/16" Rad <sup>3)</sup> |  |                |        |  |  |                                      |                         |     |  |
|   | 1.6 16V LPG      | 72 |       | 02.08 |                             | + 15"/16" Rad <sup>3)</sup> |  |                |        |  |  |                                      |                         |     |  |
|   | 1.2 TCe 115      | 84 |       | 05.13 |                             | + 14" Rad <sup>4)</sup>     |  | 13.0460-2709.2 | 602709 |  |  |                                      | 23973 17,4 /Zub/S       | TRW |  |
|   | 1.5 dCi          | 50 |       | 02.08 |                             | + 14" Rad <sup>4)</sup>     |  | 13.0470-2709.2 | LD2709 |  |  |                                      | 23973 17,4 /Zub/S       | TRW |  |
|   | 1.5 dCi          | 76 |       | 02.08 |                             | + 14" Rad <sup>4)</sup>     |  |                |        |  |  |                                      |                         |     |  |
|   | 1.5 dCi 110      | 80 |       | 09.10 |                             | + 14" Rad <sup>4)</sup>     |  |                |        |  |  |                                      |                         |     |  |
| 1.5 dCi 110                                       | 81               |    | 09.13 |       | + 14" Rad <sup>4)</sup>     |                             |  |                |        |  |  |                                      |                         |     |  |
| 1.5 dCi 75  | 55               |    | 09.10 |       | + 14" Rad <sup>4)</sup>     |                             |  |                |        |  |  |                                      |                         |     |  |
| 1.5 dCi 85  | 63               |    | 02.08 |       | + 14" Rad <sup>4)</sup>     |                             |  |                |        |  |  |                                      |                         |     |  |
| 1.5 dCi 90  | 66               |    | 06.09 |       | + 14" Rad <sup>4)</sup>     |                             |  |                |        |  |  |                                      |                         |     |  |
| 1.6   | 64               |    | 02.08 |       | + 14" Rad <sup>4)</sup>     |                             |  |                |        |  |  |                                      |                         |     |  |
| 1.6 16V   | 78               |    | 02.08 |       | + 14" Rad <sup>4)</sup>     |                             |  |                |        |  |  |                                      |                         |     |  |
| 1.6 16V LPG                                       | 72               |    | 02.08 |       | + 14" Rad <sup>4)</sup>     |                             |  |                |        |  |  |                                      |                         |     |  |
| Z.E.  | 44               |    | 10.11 |       | + 14" Rad <sup>4)</sup>     |                             |  |                |        |  |  |                                      |                         |     |  |
|   | 1.2 TCe 115      | 84 |       | 05.13 |                             | + 14" Rad <sup>4)</sup>     |  | 24.0122-0270.1 | 422270 |  |  |                                      | 258 22,0 19,8 V L +S +B |     |  |
|   | 1.5 dCi          | 50 |       | 02.08 |                             | + 14" Rad <sup>4)</sup>     |  |                |        |  |  |                                      |                         |     |  |
|   | 1.5 dCi          | 76 |       | 02.08 |                             | + 14" Rad <sup>4)</sup>     |  |                |        |  |  |                                      |                         |     |  |
|   | 1.5 dCi 110      | 80 |       | 09.10 |                             | + 14" Rad <sup>4)</sup>     |  |                |        |  |  |                                      |                         |     |  |
|   | 1.5 dCi 110      | 81 |       | 09.13 |                             | + 14" Rad <sup>4)</sup>     |  |                |        |  |  |                                      |                         |     |  |
|   | 1.5 dCi 75       | 55 |       | 09.10 |                             | + 14" Rad <sup>4)</sup>     |  |                |        |  |  |                                      |                         |     |  |
|   | 1.5 dCi 85       | 63 |       | 02.08 |                             | + 14" Rad <sup>4)</sup>     |  |                |        |  |  |                                      |                         |     |  |
|   | 1.5 dCi 90       | 66 |       | 06.09 |                             | + 14" Rad <sup>4)</sup>     |  |                |        |  |  |                                      |                         |     |  |
|   | 1.6              | 64 |       | 02.08 |                             | + 14" Rad <sup>4)</sup>     |  |                |        |  |  |                                      |                         |     |  |
|   | 1.6 16V          | 78 |       | 02.08 |                             | + 14" Rad <sup>4)</sup>     |  |                |        |  |  |                                      |                         |     |  |
|   | 1.6 16V LPG      | 72 |       | 02.08 |                             | + 14" Rad <sup>4)</sup>     |  |                |        |  |  |                                      |                         |     |  |
|   | Z.E.             | 44 |       | 10.11 |                             | + 14" Rad <sup>4)</sup>     |  |                |        |  |  |                                      |                         |     |  |
|   | 1.2 TCe 115      | 84 |       | 05.13 |                             | + 15"/16" Rad <sup>3)</sup> |  | 24.0124-0222.1 | 424222 |  |  |                                      | 280 24,0 21,8 V L +S +B |     |  |
|   | 1.5 dCi          | 50 |       | 02.08 |                             | + 15"/16" Rad <sup>3)</sup> |  | 24.0126-0186.1 | 426186 |  |  |                                      | 280 26,0 23,8 V L +S +B |     |  |
|   | 1.5 dCi          | 76 |       | 02.08 |                             | + 15"/16" Rad <sup>3)</sup> |  |                |        |  |  |                                      |                         |     |  |
| 1.5 dCi 110                                       | 80               |    | 09.10 |       | + 15"/16" Rad <sup>3)</sup> |                             |  |                |        |  |  |                                      |                         |     |  |
| 1.5 dCi 110                                       | 81               |    | 09.13 |       | + 15"/16" Rad <sup>3)</sup> |                             |  |                |        |  |  |                                      |                         |     |  |
| 1.5 dCi 75  | 55               |    | 09.10 |       | + 15"/16" Rad <sup>3)</sup> |                             |  |                |        |  |  |                                      |                         |     |  |
| 1.5 dCi 85  | 63               |    | 02.08 |       | + 15"/16" Rad <sup>3)</sup> |                             |  |                |        |  |  |                                      |                         |     |  |
| 1.5 dCi 90  | 66               |    | 06.09 |       | + 15"/16" Rad <sup>3)</sup> |                             |  |                |        |  |  |                                      |                         |     |  |
| 1.6   | 64               |    | 02.08 |       | + 15"/16" Rad <sup>3)</sup> |                             |  |                |        |  |  |                                      |                         |     |  |
| 1.6 16V   | 78               |    | 02.08 |       | + 15"/16" Rad <sup>3)</sup> |                             |  |                |        |  |  |                                      |                         |     |  |
| 1.6 16V LPG                                       | 72               |    | 02.08 |       | + 15"/16" Rad <sup>3)</sup> |                             |  |                |        |  |  |                                      |                         |     |  |
| Z.E.  | 44               |    | 10.11 |       | + 15"/16" Rad <sup>3)</sup> |                             |  |                |        |  |  |                                      |                         |     |  |
|   | 1.5 dCi          | 50 |       | 02.08 | 10.11                       | + 15"/16" Rad <sup>3)</sup> |  | 24.0111-0174.2 | 411174 |  |  |                                      | 274 11,0 9,5 +B         |     |  |
|   | 1.5 dCi          | 76 |       | 02.08 | 10.11                       | + 15"/16" Rad <sup>3)</sup> |  |                |        |  |  |                                      |                         |     |  |
|   | 1.5 dCi 110      | 80 |       | 09.10 | 10.11                       | + 15"/16" Rad <sup>3)</sup> |  |                |        |  |  |                                      |                         |     |  |
|   | 1.5 dCi 75       | 55 |       | 09.10 | 10.11                       | + 15"/16" Rad <sup>3)</sup> |  |                |        |  |  |                                      |                         |     |  |
|   | 1.5 dCi 85       | 63 |       | 02.08 | 10.11                       | + 15"/16" Rad <sup>3)</sup> |  |                |        |  |  |                                      |                         |     |  |
|   | 1.5 dCi 90       | 66 |       | 06.09 | 10.11                       | + 15"/16" Rad <sup>3)</sup> |  |                |        |  |  |                                      |                         |     |  |
|   | 1.6              | 64 |       | 02.08 | 10.11                       | + 15"/16" Rad <sup>3)</sup> |  |                |        |  |  |                                      |                         |     |  |
|   | 1.6 16V          | 78 |       | 02.08 | 10.11                       | + 15"/16" Rad <sup>3)</sup> |  |                |        |  |  |                                      |                         |     |  |
|   | 1.6 16V LPG      | 72 |       | 02.08 | 10.11                       | + 15"/16" Rad <sup>3)</sup> |  |                |        |  |  |                                      |                         |     |  |
|   | Z.E.             | 44 |       | 10.11 |                             | + 15"/16" Rad <sup>3)</sup> |  |                |        |  |  |                                      |                         |     |  |
|   | 1.2 TCe 115      | 84 |       | 05.13 |                             | + 15"/16" Rad <sup>3)</sup> |  | 24.0111-0182.2 | 411182 |  |  |                                      | 274 11,0 9,5 +B         |     |  |
|   | 1.5 dCi          | 50 |       | 11.11 |                             | + 15"/16" Rad <sup>3)</sup> |  |                |        |  |  |                                      |                         |     |  |
|   | 1.5 dCi          | 76 |       | 11.11 |                             | + 15"/16" Rad <sup>3)</sup> |  |                |        |  |  |                                      |                         |     |  |
|   | 1.5 dCi 110      | 80 |       | 11.11 |                             | + 15"/16" Rad <sup>3)</sup> |  |                |        |  |  |                                      |                         |     |  |
|   | 1.5 dCi 110      | 81 |       | 09.13 |                             | + 15"/16" Rad <sup>3)</sup> |  |                |        |  |  |                                      |                         |     |  |
|   | 1.5 dCi 75       | 55 |       | 11.11 |                             | + 15"/16" Rad <sup>3)</sup> |  |                |        |  |  |                                      |                         |     |  |
|   | 1.5 dCi 85       | 63 |       | 11.11 |                             | + 15"/16" Rad <sup>3)</sup> |  |                |        |  |  |                                      |                         |     |  |
|   | 1.5 dCi 90       | 66 |       | 11.11 |                             | + 15"/16" Rad <sup>3)</sup> |  |                |        |  |  |                                      |                         |     |  |
|   | 1.6              | 64 |       | 11.11 |                             | + 15"/16" Rad <sup>3)</sup> |  |                |        |  |  |                                      |                         |     |  |
|   | 1.6 16V          | 78 |       | 11.11 |                             | + 15"/16" Rad <sup>3)</sup> |  |                |        |  |  |                                      |                         |     |  |
| 1.6 16V LPG                                       | 72               |    | 11.11 |       | + 15"/16" Rad <sup>3)</sup> |                             |  |                |        |  |  |                                      |                         |     |  |

1) - reinforced suspension / - sospensione rinforzata / - châssis renforcé / - suspensión reforzada  
2) + reinforced suspension / + sospensione rinforzata / + châssis renforcé / + suspensión reforzada  
3) + 15"/16" wheel / + ruota 15"/16" / + roue 15"/16" / + rueda 15"/16"  
4) + 14" wheel / + ruota 14" / + roue 14" / + rueda 14"



### RENAULT KANGOO Express/Rapid (FW\_) (08-)

|  |             |    |  |              |                             |                       |        |  |  |
|--|-------------|----|--|--------------|-----------------------------|-----------------------|--------|--|--|
|  | Z.E.        | 44 |  | <b>10.11</b> | + 15"/16" Rad <sup>1)</sup> | <b>24.0111-0182.2</b> | 411182 |  | 274 11,0 9,5 +B                                |
|  | 1.2 TCe 115 | 84 |  | <b>05.13</b> | + 14" Rad <sup>2)</sup>     | <b>03.0137-0496.2</b> | 650496 |  | 228 x 42 HEB<br>Bremsbacken-Zubehör <b>BDX</b> |
|  | 1.5 dCi     | 50 |  | <b>02.08</b> | + 14" Rad <sup>2)</sup>     | <b>03.0137-9228.2</b> | 669228 |  |  |
|  | 1.5 dCi     | 76 |  | <b>02.08</b> | + 14" Rad <sup>2)</sup>     |                       |        |  |  |
|  | 1.5 dCi 110 | 80 |  | <b>09.10</b> | + 14" Rad <sup>2)</sup>     |                       |        |  |  |
|  | 1.5 dCi 110 | 81 |  | <b>09.13</b> | + 14" Rad <sup>2)</sup>     |                       |        |  |  |
|  | 1.5 dCi 75  | 55 |  | <b>09.10</b> | + 14" Rad <sup>2)</sup>     |                       |        |  |  |
|  | 1.5 dCi 85  | 63 |  | <b>02.08</b> | + 14" Rad <sup>2)</sup>     |                       |        |  |  |
|  | 1.5 dCi 90  | 66 |  | <b>06.09</b> | + 14" Rad <sup>2)</sup>     |                       |        |  |  |
|  | 1.6         | 64 |  | <b>02.08</b> | + 14" Rad <sup>2)</sup>     |                       |        |  |  |
|  | 1.6 16V     | 78 |  | <b>02.08</b> | + 14" Rad <sup>2)</sup>     |                       |        |  |  |
|  | 1.6 16V LPG | 72 |  | <b>02.08</b> | + 14" Rad <sup>2)</sup>     |                       |        |  |  |
|  | Z.E.        | 44 |  | <b>10.11</b> | + 14" Rad <sup>2)</sup>     |                       |        |  |  |
|  | 1.2 TCe 115 | 84 |  | <b>05.13</b> | + 14" Rad <sup>2)</sup>     | <b>03.0520-7222.3</b> | 697222 |  | 22,20/228x42 TopKit                            |
|  | 1.5 dCi     | 50 |  | <b>02.08</b> | + 14" Rad <sup>2)</sup>     |                       |        |  |  |
|  | 1.5 dCi     | 76 |  | <b>02.08</b> | + 14" Rad <sup>2)</sup>     |                       |        |  |  |
|  | 1.5 dCi 110 | 80 |  | <b>09.10</b> | + 14" Rad <sup>2)</sup>     |                       |        |  |  |
|  | 1.5 dCi 110 | 81 |  | <b>09.13</b> | + 14" Rad <sup>2)</sup>     |                       |        |  |  |
|  | 1.5 dCi 75  | 55 |  | <b>09.10</b> | + 14" Rad <sup>2)</sup>     |                       |        |  |  |
|  | 1.5 dCi 85  | 63 |  | <b>02.08</b> | + 14" Rad <sup>2)</sup>     |                       |        |  |  |
|  | 1.5 dCi 90  | 66 |  | <b>06.09</b> | + 14" Rad <sup>2)</sup>     |                       |        |  |  |
|  | 1.6         | 64 |  | <b>02.08</b> | + 14" Rad <sup>2)</sup>     |                       |        |  |  |
|  | 1.6 16V     | 78 |  | <b>02.08</b> | + 14" Rad <sup>2)</sup>     |                       |        |  |  |
|  | 1.6 16V LPG | 72 |  | <b>02.08</b> | + 14" Rad <sup>2)</sup>     |                       |        |  |  |
|  | Z.E.        | 44 |  | <b>10.11</b> | + 14" Rad <sup>2)</sup>     |                       |        |  |  |

### RENAULT KOLEOS (HYO\_) (08-15)

|  |             |     |  |              |  |                       |        |  |                             |
|--|-------------|-----|--|--------------|--|-----------------------|--------|--|-----------------------------|
|  | 2.0 dCi     | 110 |  | <b>09.08</b> |  | <b>13.0460-5778.2</b> | 605778 |  | 23698 16,8 +/-WK <b>SUM</b> |
|  | 2.0 dCi     | 130 |  | <b>09.08</b> |  |                       |        |  |                             |
|  | 2.0 dCi 4x4 | 110 |  | <b>09.08</b> |  |                       |        |  |                             |
|  | 2.0 dCi 4x4 | 127 |  | <b>09.08</b> |  |                       |        |  |                             |
|  | 2.5 16V     | 126 |  | <b>09.08</b> |  |                       |        |  |                             |
|  | 2.5 16V 4x4 | 126 |  | <b>09.08</b> |  |                       |        |  |                             |
|  | 2.0 dCi     | 110 |  | <b>09.08</b> |  | <b>24.0128-0242.1</b> | 428242 |  | 320 28,0 26,0 V +B          |
|  | 2.0 dCi     | 130 |  | <b>09.08</b> |  |                       |        |  |                             |
|  | 2.0 dCi 4x4 | 110 |  | <b>09.08</b> |  |                       |        |  |                             |
|  | 2.0 dCi 4x4 | 127 |  | <b>09.08</b> |  |                       |        |  |                             |
|  | 2.5 16V     | 126 |  | <b>09.08</b> |  |                       |        |  |                             |
|  | 2.5 16V 4x4 | 126 |  | <b>09.08</b> |  |                       |        |  |                             |
|  | 2.0 dCi     | 110 |  | <b>09.08</b> |  | <b>13.0460-5843.2</b> | 605843 |  | 23871 14,3 +/-WK <b>AKE</b> |
|  | 2.0 dCi     | 130 |  | <b>09.08</b> |  |                       |        |  |                             |
|  | 2.0 dCi 4x4 | 110 |  | <b>09.08</b> |  |                       |        |  |                             |
|  | 2.0 dCi 4x4 | 127 |  | <b>09.08</b> |  |                       |        |  |                             |
|  | 2.5 16V     | 126 |  | <b>09.08</b> |  |                       |        |  |                             |
|  | 2.5 16V 4x4 | 126 |  | <b>09.08</b> |  |                       |        |  |                             |
|  | 2.0 dCi     | 110 |  | <b>09.08</b> |  | <b>24.0116-0119.1</b> | 416119 |  | 292 16,0 14,0 V +B          |
|  | 2.0 dCi     | 130 |  | <b>09.08</b> |  |                       |        |  |                             |
|  | 2.0 dCi 4x4 | 110 |  | <b>09.08</b> |  |                       |        |  |                             |
|  | 2.0 dCi 4x4 | 127 |  | <b>09.08</b> |  |                       |        |  |                             |
|  | 2.5 16V     | 126 |  | <b>09.08</b> |  |                       |        |  |                             |
|  | 2.5 16V 4x4 | 126 |  | <b>09.08</b> |  |                       |        |  |                             |
|  | 2.0 dCi     | 110 |  | <b>09.08</b> |  | <b>03.0137-3012.2</b> | 653012 |  | 172 x 32                    |
|  | 2.0 dCi     | 130 |  | <b>09.08</b> |  |                       |        |  |                             |
|  | 2.0 dCi 4x4 | 110 |  | <b>09.08</b> |  |                       |        |  |                             |
|  | 2.0 dCi 4x4 | 127 |  | <b>09.08</b> |  |                       |        |  |                             |
|  | 2.5 16V     | 126 |  | <b>09.08</b> |  |                       |        |  |                             |
|  | 2.5 16V 4x4 | 126 |  | <b>09.08</b> |  |                       |        |  |                             |















### RENAULT LAGUNA I Limousine (B56/556\_) (93-00)

|  |                      |     |  |              |                    |                       |        |  |  |  |
|--|----------------------|-----|--|--------------|--------------------|-----------------------|--------|--|--|--|
|  | 1.8 (B56A/B)         | 66  |  | <b>11.93</b> | <b>09.94</b> - ABS | <b>13.0460-2836.2</b> | 602836 |  | 21595 18,3 +/-WK/S <b>TRW</b>                        |  |
|  | 2.2 D (B56F/2)       | 61  |  | <b>11.93</b> | <b>02.94</b> - ABS |                       |        |  |  |  |
|  | 1.6 16V              | 79  |  | <b>11.97</b> | <b>03.99</b>       | <b>13.0460-2983.2</b> | 602983 |  | 21388 18,0 +/-WK/S <b>TRW</b>                        |  |
|  | 1.8                  |     |  | <b>04.95</b> | <b>02.01</b>       |                       |        |  |  |  |
|  | 1.8 (B56A/B)         | 66  |  | <b>11.93</b> | <b>02.01</b> + ABS |                       |        |  |  |  |
|  | 1.8 (B56S/T/0)       | 66  |  | <b>08.95</b> | <b>02.01</b>       |                       |        |  |  |  |
|  | 1.8 16V (B563,B564)  | 88  |  | <b>04.98</b> | <b>03.99</b>       |                       |        |  |  |  |
|  | 1.9 dTi              | 72  |  | <b>10.97</b> | <b>03.99</b>       |                       |        |  |  |  |
|  | 2.0                  | 84  |  | <b>06.95</b> | <b>03.99</b>       |                       |        |  |  |  |
|  | 2.0 (B56C/H/N)       | 83  |  | <b>11.93</b> | <b>02.01</b>       |                       |        |  |  |  |
|  | 2.0 (L)              | 70  |  | <b>06.95</b> | <b>03.99</b>       |                       |        |  |  |  |
|  | 2.0 16V              | 102 |  | <b>09.99</b> | <b>02.01</b>       |                       |        |  |  |  |
|  | 2.0 16V (B56D/M)     | 102 |  | <b>05.95</b> | <b>02.01</b>       |                       |        |  |  |  |
|  | 2.2 D (B56F/2)       | 61  |  | <b>11.93</b> | <b>02.01</b> + ABS |                       |        |  |  |  |
|  | 2.2 dT               | 83  |  | <b>03.96</b> | <b>08.99</b>       |                       |        |  |  |  |
|  | 3.0 V6               | 140 |  | <b>03.97</b> | <b>08.99</b>       |                       |        |  |  |  |
|  | 3.0 V6 (B56E/R,B565) | 123 |  | <b>11.93</b> | <b>02.01</b>       |                       |        |  |  |  |
|  | 1.6 16V              | 79  |  | <b>04.99</b> | <b>02.01</b>       | <b>13.0460-2895.2</b> | 602895 |  | 23172 18,0 /WE/Zub/S<br>Belagsatz-Zubehör <b>TRW</b> |  |
|  | 1.8 16V (B563,B564)  | 88  |  | <b>04.99</b> | <b>02.01</b>       | <b>13.0460-0262.2</b> | 610262 |  |  |  |
|  | 1.9 dCi              | 79  |  | <b>09.99</b> | <b>02.01</b>       |                       |        |  |  |  |
|  | 1.9 dTi              | 72  |  | <b>04.99</b> | <b>02.01</b>       |                       |        |  |  |  |
|  | 2.0                  | 84  |  | <b>04.99</b> | <b>02.01</b>       |                       |        |  |  |  |
|  | 2.0 (L)              | 70  |  | <b>04.99</b> | <b>02.01</b>       |                       |        |  |  |  |
|  | 2.0 (U)              | 80  |  | <b>04.99</b> | <b>02.01</b>       |                       |        |  |  |  |
|  | 2.0 16V (556A/B)     | 103 |  | <b>09.99</b> | <b>02.01</b>       |                       |        |  |  |  |
|  |                      |     |  |              |                    |                       |        |  |  |  |

<sup>1)</sup> + 15"/16" wheel / + ruota 15"/16" / + roue 15"/16" / + rueda 15"/16"

<sup>2)</sup> + 14" wheel / + ruota 14" / + roue 14" / + rueda 14"



|     |   |                    |  |    |    |  |       |  |
|--|---|--|--|--|---|--|---|--|
| RENAULT LAGUNA I Limousine (B56/556_) (93-00)                                      |   |  |  |  |   |  |   |  |
|    | 2.2 dT<br>3.0 V6  | 83<br>140  |  | 09.99 02.01<br>09.99 02.01   |   | 13.0460-2895.2 602895<br>13.0460-0262.2 610262                                     |   | 23172 18,0 /WE/Zub/S<br>Belagsatz-Zubehör TRW<br>TRW                               |
|    | 1.6 16V<br>1.8 (B56S/T/0)<br>1.8 16V (B563,B564)<br>1.9 dCi<br>1.9 dTi<br>2.0<br>2.0 (L)<br>2.0 (U)<br>2.0 16V<br>2.0 16V (556A/B)<br>2.0 16V (B56D/M)<br>2.2 dT<br>3.0 V6  | 79<br>66<br>88<br>79<br>72<br>84<br>70<br>80<br>102<br>103<br>102<br>83<br>140                     |  | 11.97 02.01<br>05.98 02.01<br>09.99 02.01<br>09.99 02.01<br>10.97 02.01<br>05.98 02.01<br>05.98 02.01<br>03.99 02.01<br>09.99 02.01<br>09.99 02.01<br>05.95 02.01<br>09.99 02.01<br>09.99 02.01  |   | 24.0124-0158.1 424158<br>24.0324-0158.1 524158                                     | für 4-Loch-Felge <sup>1)</sup><br>für 4-Loch-Felge <sup>1)</sup>                        | 280 24,0 21,8 V L +S +B<br>280 24,0 21,8 V L +S +B PD                              |
|  | 1.8<br>1.8 (B56A/B)<br>1.8 (B56S/T/0)<br>2.0<br>2.0 (B56C/H/N)<br>2.0 (L)<br>2.0 (L)<br>2.2 D (B56F/2)  | 66<br>66<br>84<br>83<br>70<br>70<br>61   |  | 04.95 02.01<br>11.93 02.01<br>08.95 04.98<br>06.95 04.98<br>11.93 02.01<br>06.95 04.98<br>06.95 02.01<br>11.93 02.01   | - Baccara<br>- Baccara<br>- Baccara<br>+ RN/Alize/Business  | 24.0122-0148.1 422148  | für 4-Loch-Felge <sup>1)</sup>  | 262 22,0 19,8 V L +S +B  |
|  | 1.8 16V (B563,B564)<br>1.9 dTi<br>2.0<br>2.0 (L)<br>2.0 (U)<br>2.0 16V<br>2.0 16V<br>2.0 16V (B56D/M)<br>2.2 dT<br>3.0 V6<br>3.0 V6 (B56E/R,B565)   | 88<br>72<br>84<br>70<br>80<br>102<br>103<br>102<br>83<br>140<br>123                                |  | 04.98 08.99<br>10.97 02.01<br>05.98 02.01<br>05.98 08.99<br>03.99 02.01<br>09.99 02.01<br>05.95 02.01<br>05.95 02.01<br>03.96 08.99<br>03.97 08.99<br>11.93 02.01  | + Initiale<br>+ Initiale<br>+ Initiale  | 24.0124-0171.1 424171<br>24.0324-0171.1 524171                                     | für 5-Loch-Felge <sup>2)</sup><br>für 5-Loch-Felge <sup>2)</sup>                        | 280 24,0 21,8 V L +S +B<br>280 24,0 21,8 V L +S +B PD                              |
|  | 2.0<br>2.0<br>2.0 (B56C/H/N)<br>2.0 (L)<br>2.0 (L)  | 84<br>84<br>83<br>70<br>70   |  | 06.95 04.98<br>06.95 02.01<br>11.93 02.01<br>06.95 04.98<br>06.95 02.01  | + Initiale<br>+ Baccara<br>+ Baccara<br>+ Initiale<br>+ Baccara   | 24.0122-0149.1 422149  | für 5-Loch-Felge <sup>2)</sup>  | 262 22,0 19,8 V L  |
|  | 1.6 16V<br>1.8<br>1.8 (B56A/B)<br>1.8 16V (B563,B564)<br>1.9 dCi<br>1.9 dTi<br>2.0 (B56C/H/N)<br>2.0 (L)<br>2.0 (U)<br>2.0 16V (556A/B)<br>2.0 16V (B56D/M)<br>2.2 D (B56F/2)<br>2.2 dT<br>3.0 V6<br>3.0 V6 (B56E/R,B565) | 79<br>66<br>88<br>79<br>72<br>83<br>70<br>80<br>103<br>102<br>61<br>83<br>140<br>123               |  | 03.98 02.01<br>02.97 02.01<br>02.97 02.01<br>04.98 02.01<br>09.99 02.01<br>10.97 02.01<br>02.97 02.01<br>02.97 02.01<br>03.99 02.01<br>09.99 02.01<br>02.97 02.01<br>02.97 02.01<br>02.97 02.01<br>03.97 02.01<br>02.97 02.01                |   | 24.0711-5002.3 360061  | 2  | Radsensor L=1088   |
|  | 1.8<br>1.8 (B56A/B)<br>1.8 (B56S/T/0)<br>2.0<br>2.0<br>2.0 (B56C/H/N)<br>2.0 (B56C/H/N)<br>2.0 (L)<br>2.0 (L)<br>2.0 16V (B56D/M)<br>2.0 16V (B56D/M)<br>2.2 D (B56F/2)<br>2.2 dT<br>2.2 dT<br>3.0 V6 (B56E/R,B565)       | 66<br>66<br>84<br>84<br>83<br>83<br>70<br>70<br>102<br>102<br>61<br>83<br>83<br>123                |  | 04.95 06.95<br>11.93 02.01<br>08.95 02.01<br>06.95 01.97<br>06.95 02.01<br>11.93 02.01<br>11.93 06.95<br>06.95 01.97<br>06.95 02.01<br>05.95 01.97<br>05.95 12.97<br>11.93 06.95<br>03.96 01.97<br>03.96 12.97<br>11.93 01.97                | + ABS<br>+ ABS<br>+ ABS<br>+ Initiale<br>+ Baccara<br>+ Baccara<br>+ ABS/ - Baccara<br>+ Initiale<br>+ Baccara<br>+ ABS<br>- ABS<br>+ ABS<br>+ ABS<br>- ABS | 13.0460-4957.2 604957<br>13.0460-0438.2 610438                                     |   | 20410 15,0 +<br>Belagsatz-Zubehör BRE<br>BRE                                       |
|  | 1.8 16V (B563,B564)<br>1.9 dCi<br>1.9 dTi<br>2.0<br>2.0<br>2.0 (L)<br>2.0 (L)<br>2.0 (U)<br>2.0 16V<br>2.0 16V (556A/B)<br>2.0 16V (B56D/M)<br>2.0 16V (B56D/M)<br>2.2 dT<br>2.2 dT<br>3.0 V6<br>3.0 V6 (B56E/R,B565)     | 88<br>79<br>72<br>84<br>84<br>70<br>70<br>80<br>102<br>103<br>102<br>102<br>83<br>83<br>140<br>123 |  | 04.98 02.01<br>09.99 02.01<br>10.97 02.01<br>02.97 02.01<br>06.95 02.01<br>02.97 02.01<br>06.95 02.01<br>03.99 02.01<br>09.99 02.01<br>09.99 02.01<br>02.97 02.01<br>01.98 02.01<br>02.97 02.01<br>01.98 02.01<br>03.97 02.01<br>02.97 02.01 | + Concorde<br>+ Initiale<br>- Baccara/Initiale<br>+ Initiale<br>- Baccara/Initiale<br>+ Fairway<br>+ ABS<br>- ABS<br>+ ABS<br>- ABS                         | 13.0460-4986.2 604986<br>13.0460-0438.2 610438                                     |   | 21965 15,0 +<br>Belagsatz-Zubehör BRE<br>BRE                                       |

<sup>1)</sup> for 4 bore wheel rim / per cerchione a 4 fori / pour jante à 4 trous / para Llantas de 4 taladros

<sup>2)</sup> for 5 bore wheel rim / per cerchione a 5 fori / pour jante à 5 trous / para Llantas de 5 taladros



**RENAULT LAGUNA I Limousine (B56/556\_) (93-00)**

|  |   |  |  |  |   |                                |   |
|--|---|--|--|--|---|--------------------------------|---|
|  | 1.8<br>1.8 (B56A/B) 66<br>1.8 (B56S/T/0) 66<br>1.8 16V (B563,B564) 88<br>1.9 dCi 79<br>2.0 84<br>2.0 (B56C/H/N) 83<br>2.0 (L) 70<br>2.0 16V 102<br>2.0 16V (556A/B) 103<br>2.0 16V (B56D/M) 102<br>2.2 D (B56F/2) 61<br>2.2 dT 83<br>3.0 V6 140 |  | 04.95 06.95 + ABS<br>11.93 02.01 + ABS<br>08.95 02.01 + ABS<br>04.98 08.99 + Initiale<br>09.99 02.01<br>09.99 02.01 + Initiale<br>11.93 06.95 + ABS/ - Baccara<br>09.99 02.01 + Initiale<br>09.99 02.01<br>05.95 02.01<br>11.93 06.95 + ABS<br>09.99 02.01<br>09.99 02.01  | 24.0110-0219.1 410219                          |   | für 4-Loch-Felge <sup>1)</sup> | 265 10,5 9,5 +B                             |
|  | 1.8 16V (B563,B564) 88<br>1.9 dTi 72<br>2.0 84<br>2.0 84<br>2.0 (B56C/H/N) 83<br>2.0 (L) 70<br>2.0 (L) 70<br>2.0 (U) 80<br>2.0 16V 102<br>2.0 16V (B56D/M) 102<br>2.2 dT 83<br>3.0 V6 140<br>3.0 V6 (B56E/R,B565) 123                           |  | 09.99 02.01 + Initiale<br>10.97 02.01 - Baccara<br>06.95 08.99 + Initiale<br>06.95 02.01 + Baccara<br>11.93 02.01 + Baccara<br>06.95 08.99 + Initiale<br>06.95 02.01 + Baccara<br>03.99 02.01 + Fairway<br>09.99 02.01<br>05.95 02.01<br>03.96 08.99<br>03.97 08.99<br>11.93 02.01   | 24.0110-0220.1 410220                          |   | für 5-Loch-Felge <sup>2)</sup> | 265 10,5 9,5 +B                             |
|  | 1.8<br>1.8 (B56A/B) 66<br>2.0 84<br>2.0 (B56C/H/N) 83<br>2.0 (B56C/H/N) 83<br>2.0 (L) 70<br>2.0 16V (B56D/M) 102<br>2.2 D (B56F/2) 61<br>2.2 dT 83<br>3.0 V6 (B56E/R,B565) 123  |  | 04.95 04.95<br>11.93 04.95<br>06.95 01.97 + Baccara/Initiale<br>11.93 01.97 + Baccara/Initiale<br>11.93 04.95 - Baccara<br>06.95 01.97 + Baccara/Initiale<br>05.95 02.01<br>11.93 04.95<br>03.96 01.97<br>11.93 01.97  | 24.0731-1199.1 360160                          | 2 |                                | Radsensor L=580                             |
|  | 1.6 16V 79<br>1.8<br>1.8 (B56A/B) 66<br>1.8 (B56S/T/0) 66<br>1.8 16V (B563,B564) 88<br>1.9 dTi 72<br>2.0 84<br>2.0 (B56C/H/N) 83<br>2.0 (L) 70<br>2.0 (U) 80<br>2.2 D (B56F/2) 61   |  | 03.98 02.01<br>02.97 02.01<br>02.97 02.01<br>02.97 02.01<br>04.98 02.01 - Initiale<br>10.97 02.01<br>02.97 02.01 - Baccara/Initiale<br>02.97 02.01 - Baccara/Initiale<br>02.97 02.01 - Baccara/Initiale<br>03.99 02.01<br>02.97 02.01  | 24.0711-5011.3 360070<br>24.0711-5012.3 360071 |   |                                | Radsensor L=507<br>Radsensor L=507          |
|  | 1.8 16V (B563,B564) 88<br>2.0 (B56C/H/N) 83<br>2.0 (L) 70<br>2.0 (L) 70<br>2.0 16V (B56D/M) 102<br>2.2 dT 83<br>3.0 V6 140<br>3.0 V6 (B56E/R,B565) 123  |  | 04.98 02.99 + Initiale<br>02.97 02.99 + Baccara/Initiale<br>02.97 02.99 + Baccara/Initiale<br>02.97 02.01 - Baccara/Initiale<br>02.97 02.99<br>02.97 02.99<br>03.97 02.99<br>02.97 02.01   | 24.0711-5001.3 360265                          | 2 |                                | Radsensor L=544                             |
|  | 1.8 16V (B563,B564) 88<br>1.9 dCi 79<br>2.0 (L) 70<br>2.0 16V (556A/B) 103<br>2.0 16V (B56D/M) 102<br>2.2 dT 83<br>3.0 V6 140   |  | 03.99 02.01 + Initiale<br>09.99 02.01<br>03.99 02.01 + Baccara/Initiale<br>09.99 02.01<br>03.99 02.01<br>03.99 02.01<br>03.99 02.01  | 24.0711-5027.3 360075                          | 2 |                                | Radsensor L=516                             |
|  | 1.6 16V 79<br>1.8<br>1.8<br>1.8 (B56A/B) 66<br>1.8 (B56S/T/0) 66<br>1.8 16V (B563,B564) 88<br>1.9 dTi 72<br>2.0 84<br>2.0 (B56C/H/N) 83<br>2.0 (B56C/H/N) 83<br>2.0 (B56C/H/N) 83<br>2.0 (L) 70<br>2.0 (U) 80<br>2.2 D (B56F/2) 61              |  | 11.97 02.01<br>07.95 02.01<br>04.95 06.95 - ABS<br>11.93 02.01 - ABS<br>08.95 02.01<br>04.98 02.01 - Fairway/Initiale<br>08.97 02.01 - Concorde<br>11.93 06.95 - ABS<br>07.95 02.01<br>07.95 02.01 - Baccara/Initiale<br>11.93 06.95 - ABS<br>07.95 02.01 - Baccara/Initiale<br>03.99 02.01 - Fairway<br>11.93 06.95 - ABS | 03.0137-0312.2 650312<br>03.0137-9158.2 669158 |   |                                | 203 x 38 HEB TRW<br>Bremsbacken-Zubehör TRW |
|  | 1.6 16V 79<br>1.8<br>1.8<br>1.8 (B56A/B) 66<br>1.8 (B56S/T/0) 66<br>1.8 16V (B563,B564) 88<br>1.9 dTi 72<br>2.0 84<br>2.0 (B56C/H/N) 83   |  | 11.97 02.01<br>07.95 02.01<br>04.95 06.95 - ABS<br>11.93 02.01 - ABS<br>08.95 02.01<br>04.98 02.01 - Fairway/Initiale<br>08.97 02.01 - Concorde<br>11.93 06.95 - ABS<br>07.95 02.01  | 24.0220-3012.1 480088                          |   |                                | 203/204,4 x 50                              |

<sup>1)</sup> for 4 bore wheel rim / per cerchione a 4 fori / pour jante à 4 trous / para Llantas de 4 taladros

<sup>2)</sup> for 5 bore wheel rim / per cerchione a 5 fori / pour jante à 5 trous / para Llantas de 5 taladros



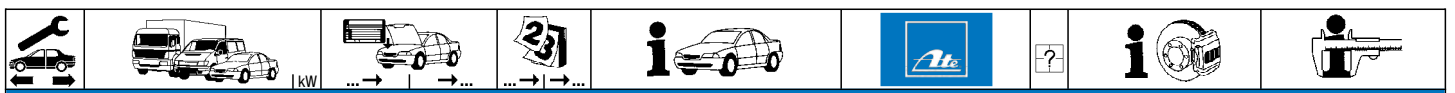

### RENAULT LAGUNA I Limousine (B56/556\_) (93-00)

|  |                     |    |       |       |                    |                |        |  |                         |
|--|---------------------|----|-------|-------|--------------------|----------------|--------|--|-------------------------|
|  | 2.0 (B56C/H/N)      | 83 | 07.95 | 02.01 | - Baccara/Initiale | 24.0220-3012.1 | 480088 |  | 203/204,4 x 50          |
|  | 2.0 (B56C/H/N)      | 83 | 11.93 | 06.95 | - ABS              |                |        |  |                         |
|  | 2.0 (L)             | 70 | 07.95 | 02.01 | - Baccara/Initiale |                |        |  |                         |
|  | 2.0 (U)             | 80 | 03.99 | 02.01 | - Fairway          |                |        |  |                         |
|  | 2.2 D (B56F/2)      | 61 | 11.93 | 06.95 | - ABS              |                |        |  |                         |
|  | 1.8                 |    | 07.95 | 02.01 |                    | 03.0520-2219.3 | 692219 |  | 19,05/203x39 TopKit TRW |
|  | 1.8                 |    | 04.95 | 06.95 | - ABS              |                |        |  |                         |
|  | 1.8 (B56A/B)        | 66 | 11.93 | 02.01 | - ABS              |                |        |  |                         |
|  | 1.8 (B56S/T/0)      | 66 | 08.95 | 04.98 |                    |                |        |  |                         |
|  | 2.0                 | 84 | 11.93 | 02.01 | - ABS              |                |        |  |                         |
|  | 2.0 (B56C/H/N)      | 83 | 07.95 | 02.01 |                    |                |        |  |                         |
|  | 2.0 (B56C/H/N)      | 83 | 07.95 | 02.01 | - Baccara/Initiale |                |        |  |                         |
|  | 2.0 (B56C/H/N)      | 83 | 11.93 | 06.95 | - ABS              |                |        |  |                         |
|  | 2.0 (L)             | 70 | 07.95 | 02.01 | - Baccara/Initiale |                |        |  |                         |
|  | 2.2 D (B56F/2)      | 61 | 11.93 | 06.95 | - ABS              |                |        |  |                         |
|  | 1.6 16V             | 79 | 11.97 | 02.01 |                    | 03.0520-7120.3 | 697120 |  | 20,64/203x39 TopKit TRW |
|  | 1.8 (B56S/T/0)      | 66 | 05.98 | 02.01 |                    |                |        |  |                         |
|  | 1.8 16V (B563,B564) | 88 | 04.98 | 02.01 | - Fairway/Initiale |                |        |  |                         |
|  | 1.9 dTi             | 72 | 10.97 | 02.01 | - Concorde         |                |        |  |                         |
|  | 2.0 (U)             | 80 | 03.99 | 02.01 | - Fairway          |                |        |  |                         |



















### RENAULT LAGUNA I Grandtour (K56\_) (95-00)

|  |             |     |                |        |           |                |        |                                |                            |
|--|-------------|-----|----------------|--------|-----------|----------------|--------|--------------------------------|----------------------------|
|  | 1.6 16V (8) | 79  | 11.97          | 02.01  |           | 13.0460-2983.2 | 602983 |                                | 21388 18,0 +/-WK/S TRW     |
|  | 1.8 (0)     | 66  | 06.95          | 02.01  |           |                |        |                                |                            |
|  | 1.8 (S)     | 66  | 06.95          | 02.01  |           |                |        |                                |                            |
|  | 1.8 (T)     | 66  | 07.95          | 02.01  |           |                |        |                                |                            |
|  | 1.8 (Z)     | 69  | 07.95          | 02.01  |           |                |        |                                |                            |
|  | 1.8 16V (3) | 88  | 02.99          | 02.01  |           |                |        |                                |                            |
|  | 1.8 16V (4) | 88  | 04.98          | 02.01  |           |                |        |                                |                            |
|  | 1.9 dTi     | 72  | 10.97          | 02.01  |           |                |        |                                |                            |
|  | 2.0         | 84  | 10.98          | 02.01  |           |                |        |                                |                            |
|  | 2.0 (C)     | 83  | 06.95          | 02.01  |           |                |        |                                |                            |
|  | 2.0 (H)     | 83  | 06.95          | 02.01  |           |                |        |                                |                            |
|  | 2.0 (L)     | 70  | 11.95          | 02.01  |           |                |        |                                |                            |
|  | 2.0 (N)     | 83  | 09.95          | 02.01  |           |                |        |                                |                            |
|  | 2.0 16V (D) | 102 | 09.95          | 02.01  |           |                |        |                                |                            |
|  | 2.0 16V (M) | 102 | 09.95          | 02.01  |           |                |        |                                |                            |
|  | 2.2 D       |     | 06.95          | 02.01  |           |                |        |                                |                            |
|  | 2.2 dT      |     | 03.96          | 02.01  |           |                |        |                                |                            |
|  | 3.0 V6      | 123 | 02.96          | 02.01  |           |                |        |                                |                            |
|  | 3.0 V6      | 140 | 03.97          | 02.01  |           |                |        |                                |                            |
|  | 1.6 16V (1) | 79  | 02.99          | 02.01  |           | 13.0460-2895.2 | 602895 |                                | 23172 18,0 /WE/Zub/S TRW   |
|  | 1.8 16V (Y) | 88  | 05.99          | 02.01  |           | 13.0460-0262.2 | 610262 |                                | Belagsatz-Zubehör TRW      |
|  | 1.9 dCi     | 79  | 09.99          | 02.01  |           |                |        |                                |                            |
|  | 2.0 16V     | 103 | 09.99          | 02.01  |           |                |        |                                |                            |
|  | 2.0 16V (A) | 102 | 09.99          | 02.01  |           |                |        |                                |                            |
|  | 2.0 16V (B) | 102 | 09.99          | 02.01  |           |                |        |                                |                            |
|  | 1.8 (0)     | 66  | 06.95          | 04.98  |           | 24.0122-0148.1 | 422148 | für 4-Loch-Felge <sup>1)</sup> | 262 22,0 19,8 V L +S +B    |
|  | 1.8 (S)     | 66  | 06.95          | 02.01  |           |                |        |                                |                            |
|  | 1.8 (T)     | 66  | 07.95          | 02.01  |           |                |        |                                |                            |
|  | 1.8 (Z)     | 69  | 07.95          | 02.01  |           |                |        |                                |                            |
|  | 2.0         | 84  | 10.98          | 02.01  |           |                |        |                                |                            |
|  | 2.0 (C)     | 83  | 06.95          | 02.01  |           |                |        |                                |                            |
|  | 2.0 (H)     | 83  | 06.95          | 02.01  |           |                |        |                                |                            |
|  | 2.0 (L)     | 70  | 11.95          | 04.98  |           |                |        |                                |                            |
|  | 2.0 (N)     | 83  | 09.95          | 02.01  |           |                |        |                                |                            |
|  | 2.2 D       |     | 06.95          | 02.01  |           |                |        |                                |                            |
|  | 1.6 16V     | 79  | 11.97          | 02.01  |           | 24.0124-0158.1 | 424158 | für 4-Loch-Felge <sup>1)</sup> | 280 24,0 21,8 V L +S +B    |
|  | 1.8 (0)     | 66  | 05.98          | 02.01  |           | 24.0324-0158.1 | 524158 | für 4-Loch-Felge <sup>1)</sup> | 280 24,0 21,8 V L +S +B PD |
|  | 1.8 16V (3) | 88  | 02.99          | 02.01  |           |                |        |                                |                            |
|  | 1.8 16V (4) | 88  | 04.98          | 02.01  | - Fairway |                |        |                                |                            |
|  | 1.8 16V (Y) | 88  | 05.99          | 02.01  |           |                |        |                                |                            |
|  | 1.9 dCi     | 79  | 09.99          | 02.01  |           |                |        |                                |                            |
|  | 1.9 dTi     | 72  | 10.97          | 02.01  |           |                |        |                                |                            |
|  | 2.0 (L)     | 70  | 05.98          | 02.01  |           |                |        |                                |                            |
|  | 2.0 16V     | 103 | 09.99          | 02.01  |           |                |        |                                |                            |
|  | 2.0 16V (A) | 102 | 09.99          | 02.01  |           |                |        |                                |                            |
|  | 2.0 16V (B) | 102 | 09.99          | 02.01  |           |                |        |                                |                            |
|  | 2.2 dT      |     | 03.96          | 02.01  |           |                |        |                                |                            |
|  | 3.0 V6      | 140 | 09.99          | 02.01  |           |                |        |                                |                            |
|  | 3.0 V6      | 140 | 09.99          | 02.01  |           |                |        |                                |                            |
|  | 1.8 16V (4) | 88  | 04.98          | 02.01  | + Fairway | 24.0124-0171.1 | 424171 | für 5-Loch-Felge <sup>2)</sup> | 280 24,0 21,8 V L +S +B    |
|  | 2.0 16V     | 103 | 09.99          | 02.01  |           | 24.0324-0171.1 | 524171 | für 5-Loch-Felge <sup>2)</sup> | 280 24,0 21,8 V L +S +B PD |
|  | 2.0 16V (D) | 102 | 09.95          | 02.01  |           |                |        |                                |                            |
|  | 2.0 16V (M) | 102 | 09.95          | 02.01  |           |                |        |                                |                            |
|  | 2.2 dT      |     | 03.96          | 02.01  |           |                |        |                                |                            |
|  | 3.0 V6      | 123 | 02.96          | 02.01  |           |                |        |                                |                            |
|  | 3.0 V6      | 140 | 03.97          | 08.99  |           | 24.0124-0171.1 | 424171 | für 5-Loch-Felge <sup>2)</sup> | 280 24,0 21,8 V L +S +B    |
|  |             |     | 24.0324-0171.1 | 524171 |           |                |        | für 5-Loch-Felge <sup>2)</sup> | 280 24,0 21,8 V L +S +B PD |
|  | 1.8 16V     | 88  | 04.98          | 02.01  | - Fairway | 24.0711-5002.3 | 360061 | 2                              | Radsensor L=1088           |
|  | 2.0 16V (A) | 102 | 09.99          | 02.01  |           |                |        |                                |                            |
|  | 2.0 16V (B) | 102 | 09.99          | 02.01  |           |                |        |                                |                            |
|  | 2.0 16V (M) | 102 | 02.97          | 02.01  |           |                |        |                                |                            |
|  | 2.2 dT      |     | 02.97          | 02.01  |           |                |        |                                |                            |
|  | 3.0 V6      | 140 | 03.97          | 02.01  |           |                |        |                                |                            |
|  | 3.0 V6 (5)  | 123 | 02.97          | 02.01  |           |                |        |                                |                            |

<sup>1)</sup> for 4 bore wheel rim / per cerchione a 4 fori / pour jante à 4 trous / para Llantas de 4 taladros

<sup>2)</sup> for 5 bore wheel rim / per cerchione a 5 fori / pour jante à 5 trous / para Llantas de 5 taladros



|     |  |  |  |  |  |       |       |  |            |
|--|--|--|--|--|---|---|---|--|------------|
| <b>RENAULT LAGUNA I Grandtour (K56_) (95-00)</b>                                   |  |  |  |  |   |   |   |  |            |
|    | 1.8 (O)  | 66   | 06.95  | 05.96 + ABS  | 13.0460-4957.2  | 604957  |   | 20410 15,0 + Belagsatz-Zubehör   | <b>BRE</b> |
|  | 1.8 (S)  | 66   | 06.95  | 05.96 + ABS  | 13.0460-0438.2  | 610438  |   |  | <b>BRE</b> |
|  | 1.8 (T)  | 66   | 07.95  | 05.96 + ABS  |   |   |   |  |            |
|  | 1.8 (Z)  | 69   | 07.95  | 05.96 + ABS  |   |   |   |  |            |
|  | 2.0  | 84   | 10.98  | 02.01 + ABS  |   |   |   |  |            |
|  | 2.0 (C)  | 83   | 06.95  | 05.96 + ABS  |   |   |   |  |            |
|  | 2.0 (H)  | 83   | 06.95  | 05.96 + ABS  |   |   |   |  |            |
|  | 2.0 (L)  | 70   | 11.95  | 05.96 + ABS  |   |   |   |  |            |
|  | 2.0 16V (D)  | 102  | 09.95  | 02.01  |   |   |   |  |            |
|  | 2.0 16V (M)  | 102  | 09.95  | 01.97  |   |   |   |  |            |
|  | 2.2 D  |  | 06.95  | 05.96 + ABS  |   |   |   |  |            |
|  | 2.2 dT   |  | 03.96  | 01.97  |   |   |   |  |            |
|  | 3.0 V6 (5)   | 123  | 03.96  | 02.01  |   |   |   |  |            |
|  | 3.0 V6 (R)   | 123  | 02.96  | 02.01  |   |   |   |  |            |
|  | 1.8 16V (4)  | 88   | 04.98  | 02.01 + Fairway  | 13.0460-4986.2  | 604986  |   | 21965 15,0 + Belagsatz-Zubehör   | <b>BRE</b> |
|  | 1.9 dCi  | 79   | 09.99  | 02.01  | 13.0460-0438.2  | 610438  |   |  | <b>BRE</b> |
|  | 1.9 dTi (KJ)   | 72   | 10.97  | 02.01 + Alize  |   |   |   |  |            |
|  | 2.0 16V  | 103  | 09.99  | 02.01  |   |   |   |  |            |
|  | 2.0 16V (A)  | 102  | 09.99  | 02.01  |   |   |   |  |            |
| 2.0 16V (B)  | 102  | 09.99  | 02.01  |  |   |   |   |  |            |
| 2.0 16V (M)  | 102  | 02.97  | 02.01  |  |   |   |   |  |            |
| 2.2 dT   |  | 02.97  | 02.01  |  |   |   |   |  |            |
| 3.0 V6   | 140  | 03.97  | 02.01  |  |   |   |   |  |            |
|    | 1.8 (O)  | 66   | 06.95  | 05.96 + ABS  | 24.0110-0219.1  | 410219  | für 4-Loch-Felge <sup>1)</sup>  | 265 10,5 9,5 +B  |            |
|  | 1.8 (S)  | 66   | 06.95  | 05.96 + ABS  |   |   |   |  |            |
|  | 1.8 (T)  | 66   | 07.95  | 05.96 + ABS  |   |   |   |  |            |
|  | 1.8 (Z)  | 69   | 07.95  | 05.96 + ABS  |   |   |   |  |            |
|  | 2.0  | 84   | 10.98  | 02.01 + ABS  |   |   |   |  |            |
|  | 2.0 (C)  | 83   | 06.95  | 05.96 + ABS  |   |   |   |  |            |
|  | 2.0 (H)  | 83   | 06.95  | 05.96 + ABS  |   |   |   |  |            |
|  | 2.0 (L)  | 70   | 11.95  | 05.96 + ABS  |   |   |   |  |            |
|  | 2.0 16V (A)  | 102  | 09.99  | 02.01  |   |   |   |  |            |
|  | 2.0 16V (B)  | 102  | 09.99  | 02.01  |   |   |   |  |            |
|  | 2.0 16V (D)  | 102  | 09.95  | 02.01  |   |   |   |  |            |
|  | 2.2 D  |  | 06.95  | 05.96 + ABS  |   |   |   |  |            |
|  | 2.2 dT   |  | 03.96  | 02.01  |   |   |   |  |            |
|  | 3.0 V6 (5)   | 123  | 03.96  | 02.01  |   |   |   |  |            |
|  | 3.0 V6 (R)   | 123  | 02.96  | 02.01  |   |   |   |  |            |
|  | 1.8 16V (4)  | 88   | 04.98  | 02.01 + Fairway  | 24.0110-0220.1  | 410220  | für 5-Loch-Felge <sup>2)</sup>  | 265 10,5 9,5 +B  |            |
|  | 1.9 dTi (KJ)   | 72   | 10.97  | 02.01 + Alize  |   |   |   |  |            |
|  | 2.0 16V  | 103  | 09.99  | 02.01  |   |   |   |  |            |
|  | 2.0 16V (M)  | 102  | 09.95  | 02.01  |   |   |   |  |            |
| 2.2 dT   |  | 03.96  | 02.01  |  |   |   |   |  |            |
| 3.0 V6   | 140  | 03.97  | 02.01  |  |   |   |   |  |            |
|  | 1.8 (O)  | 66   | 06.95  | 05.96  | 24.0731-1199.1  | 360160  | 2  | Radsensor L=580  |            |
|  | 1.8 (S)  | 66   | 06.95  | 05.96  |   |   |   |  |            |
|  | 1.8 (T)  | 66   | 07.95  | 05.96  |   |   |   |  |            |
|  | 1.8 (Z)  | 69   | 07.95  | 05.96  |   |   |   |  |            |
|  | 2.0 (C)  | 83   | 06.95  | 05.96  |   |   |   |  |            |
|  | 2.0 (H)  | 83   | 06.95  | 05.96  |   |   |   |  |            |
|  | 2.0 (L)  | 70   | 11.95  | 05.96  |   |   |   |  |            |
|  | 2.0 16V (D)  | 102  | 09.95  | 02.01  |   |   |   |  |            |
|  | 2.0 16V (M)  | 102  | 09.95  | 05.96  |   |   |   |  |            |
|  | 2.2 D  |  | 06.95  | 05.96  |   |   |   |  |            |
|  | 2.2 dT   |  | 03.96  | 05.96  |   |   |   |  |            |
|  | 3.0 V6 (5)   | 123  | 03.96  | 05.96  |   |   |   |  |            |
|  | 3.0 V6 (R)   | 123  | 02.96  | 02.01  |   |   |   |  |            |
|  | 1.6 16V  | 79   | 11.97  | 02.01  | 24.0711-5011.3  | 360070  |    | Radsensor L=507  |            |
|  | 1.8 (O)  | 66   | 02.97  | 02.01  | 24.0711-5012.3  | 360071  |    | Radsensor L=507  |            |
|  | 1.8 (S)  | 66   | 02.97  | 02.01  |   |   |   |  |            |
|  | 1.8 (T)  | 66   | 02.97  | 02.01  |   |   |   |  |            |
|  | 1.8 (Z)  | 69   | 02.97  | 02.01  |   |   |   |  |            |
|  | 1.8 16V  | 88   | 04.98  | 02.01 + Fairway  |   |   |   |  |            |
| 1.9 dTi  | 72   | 10.97  | 02.01  |  |   |   |   |  |            |
| 2.0  | 84   | 10.98  | 02.01  |  |   |   |   |  |            |
| 2.0 (C)  | 83   | 02.97  | 02.01  |  |   |   |   |  |            |
| 2.0 (H)  | 83   | 02.97  | 02.01  |  |   |   |   |  |            |
| 2.0 (L)  | 70   | 02.97  | 02.01  |  |   |   |   |  |            |
| 2.2 D  |  | 02.97  | 02.01  |  |   |   |   |  |            |
| 2.0 16V (M)  | 102  | 02.97  | 01.99  | 24.0711-5001.3   | 360265  | 2  | Radsensor L=544   |  |            |
| 2.2 dT   |  | 02.97  | 01.99  |  |   |   |   |  |            |
| 3.0 V6   | 140  | 03.97  | 01.99  |  |   |   |   |  |            |
| 3.0 V6 (5)   | 123  | 02.97  | 01.99  |  |   |   |   |  |            |
| 1.8 16V  | 88   | 04.98  | 02.01 - Fairway  | 24.0711-5027.3   | 360075  | 2  | Radsensor L=516   |  |            |
| 2.0 16V (A)  | 102  | 09.99  | 02.01  |  |   |   |   |  |            |
| 2.0 16V (B)  | 102  | 09.99  | 02.01  |  |   |   |   |  |            |
| 2.0 16V (M)  | 102  | 02.99  | 02.01  |  |   |   |   |  |            |
| 2.2 dT   |  | 02.99  | 02.01  |  |   |   |   |  |            |
| 3.0 V6   | 140  | 02.99  | 02.01  |  |   |   |   |  |            |
| 3.0 V6 (5)   | 123  | 02.99  | 02.01  |  |   |   |   |  |            |
|  | 1.6 16V  | 79   | 11.97  | 02.01  | 03.0137-0336.2  | 650336  |   | 229 x 42 HEB   | <b>TRW</b> |
|  | 1.8 (O)  | 66   | 06.96  | 02.01  | 03.0137-9220.2  | 669220  |   | Bremsbacken-Zubehör  | <b>TRW</b> |
|  | 1.8 (O)  | 66   | 06.95  | 05.96 - ABS  |   |   |   |  |            |
|  | 1.8 (S)  | 66   | 06.96  | 02.01  |   |   |   |  |            |
|  | 1.8 (S)  | 66   | 06.95  | 05.96 - ABS  |   |   |   |  |            |
| 1.8 (T)  | 66   | 06.96  | 02.01  |  |   |   |   |  |            |

<sup>1)</sup> for 4 bore wheel rim / per cerchione a 4 fori / pour jante à 4 trous / para Llantas de 4 taladros

<sup>2)</sup> for 5 bore wheel rim / per cerchione a 5 fori / pour jante à 5 trous / para Llantas de 5 taladros



## RENAULT LAGUNA I Grandtour (K56\_) (95-00)















|         |              |       |       |       |           |                |        |  |              |     |                |        |  |                     |           |                |        |  |                  |  |                |        |  |                  |  |  |  |  |  |  |  |  |  |  |  |  |  |  |  |  |  |  |  |  |  |  |  |  |  |  |  |  |  |  |       |                |        |  |                     |     |  |  |  |  |           |                |        |  |                     |     |  |  |  |  |  |  |  |  |  |  |
|---------|--------------|-------|-------|-------|-----------|----------------|--------|--|--------------|-----|----------------|--------|--|---------------------|-----------|----------------|--------|--|------------------|--|----------------|--------|--|------------------|--|--|--|--|--|--|--|--|--|--|--|--|--|--|--|--|--|--|--|--|--|--|--|--|--|--|--|--|--|--|-------|----------------|--------|--|---------------------|-----|--|--|--|--|-----------|----------------|--------|--|---------------------|-----|--|--|--|--|--|--|--|--|--|--|
|         | 1.8 (T)      | 66    | 07.95 | 05.96 | - ABS     | 03.0137-0336.2 | 650336 |  | 229 x 42 HEB | TRW |                |        |  |                     |           |                |        |  |                  |  |                |        |  |                  |  |  |  |  |  |  |  |  |  |  |  |  |  |  |  |  |  |  |  |  |  |  |  |  |  |  |  |  |  |  |       |                |        |  |                     |     |  |  |  |  |           |                |        |  |                     |     |  |  |  |  |  |  |  |  |  |  |
|         | 1.8 (Z)      | 69    | 06.96 | 02.01 |           |                |        |  |              |     | 03.0137-9220.2 | 669220 |  | Bremsbacken-Zubehör | TRW       |                |        |  |                  |  |                |        |  |                  |  |  |  |  |  |  |  |  |  |  |  |  |  |  |  |  |  |  |  |  |  |  |  |  |  |  |  |  |  |  |       |                |        |  |                     |     |  |  |  |  |           |                |        |  |                     |     |  |  |  |  |  |  |  |  |  |  |
|         | 1.8 (Z)      | 69    | 07.95 | 05.96 | - ABS     |                |        |  |              |     |                |        |  |                     |           |                |        |  |                  |  |                |        |  |                  |  |  |  |  |  |  |  |  |  |  |  |  |  |  |  |  |  |  |  |  |  |  |  |  |  |  |  |  |  |  |       |                |        |  |                     |     |  |  |  |  |           |                |        |  |                     |     |  |  |  |  |  |  |  |  |  |  |
|         | 1.8 16V (3)  | 88    | 02.99 | 02.01 |           |                |        |  |              |     |                |        |  |                     |           |                |        |  |                  |  |                |        |  |                  |  |  |  |  |  |  |  |  |  |  |  |  |  |  |  |  |  |  |  |  |  |  |  |  |  |  |  |  |  |  |       |                |        |  |                     |     |  |  |  |  |           |                |        |  |                     |     |  |  |  |  |  |  |  |  |  |  |
|         | 1.8 16V (4)  | 88    | 04.98 | 02.01 | - Fairway |                |        |  |              |     |                |        |  |                     |           |                |        |  |                  |  |                |        |  |                  |  |  |  |  |  |  |  |  |  |  |  |  |  |  |  |  |  |  |  |  |  |  |  |  |  |  |  |  |  |  |       |                |        |  |                     |     |  |  |  |  |           |                |        |  |                     |     |  |  |  |  |  |  |  |  |  |  |
|         | 1.8 16V (Y)  | 88    | 05.99 | 02.01 |           |                |        |  |              |     |                |        |  |                     |           |                |        |  |                  |  |                |        |  |                  |  |  |  |  |  |  |  |  |  |  |  |  |  |  |  |  |  |  |  |  |  |  |  |  |  |  |  |  |  |  |       |                |        |  |                     |     |  |  |  |  |           |                |        |  |                     |     |  |  |  |  |  |  |  |  |  |  |
|         | 1.9 dTi (KJ) | 72    | 10.97 | 02.01 | - Alize   |                |        |  |              |     |                |        |  |                     |           |                |        |  |                  |  |                |        |  |                  |  |  |  |  |  |  |  |  |  |  |  |  |  |  |  |  |  |  |  |  |  |  |  |  |  |  |  |  |  |  |       |                |        |  |                     |     |  |  |  |  |           |                |        |  |                     |     |  |  |  |  |  |  |  |  |  |  |
|         | 1.9 dTi (SJ) | 72    | 10.97 | 02.01 |           |                |        |  |              |     |                |        |  |                     |           |                |        |  |                  |  |                |        |  |                  |  |  |  |  |  |  |  |  |  |  |  |  |  |  |  |  |  |  |  |  |  |  |  |  |  |  |  |  |  |  |       |                |        |  |                     |     |  |  |  |  |           |                |        |  |                     |     |  |  |  |  |  |  |  |  |  |  |
|         | 2.0          | 84    | 10.98 | 02.01 |           |                |        |  |              |     |                |        |  |                     |           |                |        |  |                  |  |                |        |  |                  |  |  |  |  |  |  |  |  |  |  |  |  |  |  |  |  |  |  |  |  |  |  |  |  |  |  |  |  |  |  |       |                |        |  |                     |     |  |  |  |  |           |                |        |  |                     |     |  |  |  |  |  |  |  |  |  |  |
|         | 2.0 (C)      | 83    | 06.96 | 02.01 |           |                |        |  |              |     |                |        |  |                     |           |                |        |  |                  |  |                |        |  |                  |  |  |  |  |  |  |  |  |  |  |  |  |  |  |  |  |  |  |  |  |  |  |  |  |  |  |  |  |  |  |       |                |        |  |                     |     |  |  |  |  |           |                |        |  |                     |     |  |  |  |  |  |  |  |  |  |  |
|         | 2.0 (C)      | 83    | 06.95 | 05.96 | - ABS     |                |        |  |              |     |                |        |  |                     |           |                |        |  |                  |  |                |        |  |                  |  |  |  |  |  |  |  |  |  |  |  |  |  |  |  |  |  |  |  |  |  |  |  |  |  |  |  |  |  |  |       |                |        |  |                     |     |  |  |  |  |           |                |        |  |                     |     |  |  |  |  |  |  |  |  |  |  |
|         | 2.0 (H)      | 83    | 06.96 | 02.01 |           |                |        |  |              |     |                |        |  |                     |           |                |        |  |                  |  |                |        |  |                  |  |  |  |  |  |  |  |  |  |  |  |  |  |  |  |  |  |  |  |  |  |  |  |  |  |  |  |  |  |  |       |                |        |  |                     |     |  |  |  |  |           |                |        |  |                     |     |  |  |  |  |  |  |  |  |  |  |
|         | 2.0 (H)      | 83    | 06.95 | 05.96 | - ABS     |                |        |  |              |     |                |        |  |                     |           |                |        |  |                  |  |                |        |  |                  |  |  |  |  |  |  |  |  |  |  |  |  |  |  |  |  |  |  |  |  |  |  |  |  |  |  |  |  |  |  |       |                |        |  |                     |     |  |  |  |  |           |                |        |  |                     |     |  |  |  |  |  |  |  |  |  |  |
|         | 2.0 (L)      | 70    | 06.96 | 02.01 |           |                |        |  |              |     |                |        |  |                     |           |                |        |  |                  |  |                |        |  |                  |  |  |  |  |  |  |  |  |  |  |  |  |  |  |  |  |  |  |  |  |  |  |  |  |  |  |  |  |  |  |       |                |        |  |                     |     |  |  |  |  |           |                |        |  |                     |     |  |  |  |  |  |  |  |  |  |  |
|         | 2.0 (L)      | 70    | 11.95 | 05.96 | - ABS     |                |        |  |              |     |                |        |  |                     |           |                |        |  |                  |  |                |        |  |                  |  |  |  |  |  |  |  |  |  |  |  |  |  |  |  |  |  |  |  |  |  |  |  |  |  |  |  |  |  |  |       |                |        |  |                     |     |  |  |  |  |           |                |        |  |                     |     |  |  |  |  |  |  |  |  |  |  |
|         | 2.0 (N)      | 83    | 09.95 | 02.01 |           |                |        |  |              |     |                |        |  |                     |           |                |        |  |                  |  |                |        |  |                  |  |  |  |  |  |  |  |  |  |  |  |  |  |  |  |  |  |  |  |  |  |  |  |  |  |  |  |  |  |  |       |                |        |  |                     |     |  |  |  |  |           |                |        |  |                     |     |  |  |  |  |  |  |  |  |  |  |
| 2.2 D   |              | 06.96 | 02.01 |       |           |                |        |  |              |     |                |        |  |                     |           |                |        |  |                  |  |                |        |  |                  |  |  |  |  |  |  |  |  |  |  |  |  |  |  |  |  |  |  |  |  |  |  |  |  |  |  |  |  |  |  |       |                |        |  |                     |     |  |  |  |  |           |                |        |  |                     |     |  |  |  |  |  |  |  |  |  |  |
| 2.2 D   |              | 06.95 | 05.96 | - ABS |           |                |        |  |              |     |                |        |  |                     |           |                |        |  |                  |  |                |        |  |                  |  |  |  |  |  |  |  |  |  |  |  |  |  |  |  |  |  |  |  |  |  |  |  |  |  |  |  |  |  |  |       |                |        |  |                     |     |  |  |  |  |           |                |        |  |                     |     |  |  |  |  |  |  |  |  |  |  |
|         | 1.6 16V      | 79    | 11.97 | 02.01 |           |                |        |  |              |     |                |        |  |                     |           | 24.0222-8015.1 | 480055 |  | 229/229,5 x 52,5 |  |                |        |  |                  |  |  |  |  |  |  |  |  |  |  |  |  |  |  |  |  |  |  |  |  |  |  |  |  |  |  |  |  |  |  |       |                |        |  |                     |     |  |  |  |  |           |                |        |  |                     |     |  |  |  |  |  |  |  |  |  |  |
|         | 1.8 (O)      | 66    | 06.96 | 02.01 |           |                |        |  |              |     |                |        |  |                     |           |                |        |  |                  |  | 24.0222-8019.2 | 480087 |  | 229/229,5 x 52,5 |  |  |  |  |  |  |  |  |  |  |  |  |  |  |  |  |  |  |  |  |  |  |  |  |  |  |  |  |  |  |       |                |        |  |                     |     |  |  |  |  |           |                |        |  |                     |     |  |  |  |  |  |  |  |  |  |  |
|         | 1.8 (O)      | 66    | 06.95 | 05.96 |           |                |        |  |              |     |                |        |  |                     | - ABS     |                |        |  |                  |  |                |        |  |                  |  |  |  |  |  |  |  |  |  |  |  |  |  |  |  |  |  |  |  |  |  |  |  |  |  |  |  |  |  |  |       |                |        |  |                     |     |  |  |  |  |           |                |        |  |                     |     |  |  |  |  |  |  |  |  |  |  |
|         | 1.8 (S)      | 66    | 06.96 | 02.01 |           |                |        |  |              |     |                |        |  |                     |           |                |        |  |                  |  |                |        |  |                  |  |  |  |  |  |  |  |  |  |  |  |  |  |  |  |  |  |  |  |  |  |  |  |  |  |  |  |  |  |  |       |                |        |  |                     |     |  |  |  |  |           |                |        |  |                     |     |  |  |  |  |  |  |  |  |  |  |
|         | 1.8 (S)      | 66    | 06.95 | 05.96 |           |                |        |  |              |     |                |        |  |                     | - ABS     |                |        |  |                  |  |                |        |  |                  |  |  |  |  |  |  |  |  |  |  |  |  |  |  |  |  |  |  |  |  |  |  |  |  |  |  |  |  |  |  |       |                |        |  |                     |     |  |  |  |  |           |                |        |  |                     |     |  |  |  |  |  |  |  |  |  |  |
|         | 1.8 (T)      | 66    | 06.96 | 02.01 |           |                |        |  |              |     |                |        |  |                     |           |                |        |  |                  |  |                |        |  |                  |  |  |  |  |  |  |  |  |  |  |  |  |  |  |  |  |  |  |  |  |  |  |  |  |  |  |  |  |  |  |       |                |        |  |                     |     |  |  |  |  |           |                |        |  |                     |     |  |  |  |  |  |  |  |  |  |  |
|         | 1.8 (T)      | 66    | 07.95 | 05.96 |           |                |        |  |              |     |                |        |  |                     | - ABS     |                |        |  |                  |  |                |        |  |                  |  |  |  |  |  |  |  |  |  |  |  |  |  |  |  |  |  |  |  |  |  |  |  |  |  |  |  |  |  |  |       |                |        |  |                     |     |  |  |  |  |           |                |        |  |                     |     |  |  |  |  |  |  |  |  |  |  |
|         | 1.8 (Z)      | 69    | 06.96 | 02.01 |           |                |        |  |              |     |                |        |  |                     |           |                |        |  |                  |  |                |        |  |                  |  |  |  |  |  |  |  |  |  |  |  |  |  |  |  |  |  |  |  |  |  |  |  |  |  |  |  |  |  |  |       |                |        |  |                     |     |  |  |  |  |           |                |        |  |                     |     |  |  |  |  |  |  |  |  |  |  |
|         | 1.8 (Z)      | 69    | 07.95 | 05.96 |           |                |        |  |              |     |                |        |  |                     | - ABS     |                |        |  |                  |  |                |        |  |                  |  |  |  |  |  |  |  |  |  |  |  |  |  |  |  |  |  |  |  |  |  |  |  |  |  |  |  |  |  |  |       |                |        |  |                     |     |  |  |  |  |           |                |        |  |                     |     |  |  |  |  |  |  |  |  |  |  |
|         | 1.8 16V (3)  | 88    | 02.99 | 02.01 |           |                |        |  |              |     |                |        |  |                     |           |                |        |  |                  |  |                |        |  |                  |  |  |  |  |  |  |  |  |  |  |  |  |  |  |  |  |  |  |  |  |  |  |  |  |  |  |  |  |  |  |       |                |        |  |                     |     |  |  |  |  |           |                |        |  |                     |     |  |  |  |  |  |  |  |  |  |  |
|         | 1.8 16V (4)  | 88    | 04.98 | 02.01 |           |                |        |  |              |     |                |        |  |                     | - Fairway |                |        |  |                  |  |                |        |  |                  |  |  |  |  |  |  |  |  |  |  |  |  |  |  |  |  |  |  |  |  |  |  |  |  |  |  |  |  |  |  |       |                |        |  |                     |     |  |  |  |  |           |                |        |  |                     |     |  |  |  |  |  |  |  |  |  |  |
|         | 1.8 16V (Y)  | 88    | 05.99 | 02.01 |           |                |        |  |              |     |                |        |  |                     |           |                |        |  |                  |  |                |        |  |                  |  |  |  |  |  |  |  |  |  |  |  |  |  |  |  |  |  |  |  |  |  |  |  |  |  |  |  |  |  |  |       |                |        |  |                     |     |  |  |  |  |           |                |        |  |                     |     |  |  |  |  |  |  |  |  |  |  |
|         | 1.9 dTi (KJ) | 72    | 10.97 | 02.01 |           |                |        |  |              |     |                |        |  |                     | - Alize   |                |        |  |                  |  |                |        |  |                  |  |  |  |  |  |  |  |  |  |  |  |  |  |  |  |  |  |  |  |  |  |  |  |  |  |  |  |  |  |  |       |                |        |  |                     |     |  |  |  |  |           |                |        |  |                     |     |  |  |  |  |  |  |  |  |  |  |
|         | 1.9 dTi (SJ) | 72    | 10.97 | 02.01 |           |                |        |  |              |     |                |        |  |                     |           |                |        |  |                  |  |                |        |  |                  |  |  |  |  |  |  |  |  |  |  |  |  |  |  |  |  |  |  |  |  |  |  |  |  |  |  |  |  |  |  |       |                |        |  |                     |     |  |  |  |  |           |                |        |  |                     |     |  |  |  |  |  |  |  |  |  |  |
|         | 2.0          | 84    | 10.98 | 02.01 |           |                |        |  |              |     |                |        |  |                     |           |                |        |  |                  |  |                |        |  |                  |  |  |  |  |  |  |  |  |  |  |  |  |  |  |  |  |  |  |  |  |  |  |  |  |  |  |  |  |  |  |       |                |        |  |                     |     |  |  |  |  |           |                |        |  |                     |     |  |  |  |  |  |  |  |  |  |  |
|         | 2.0 (C)      | 83    | 06.96 | 02.01 |           |                |        |  |              |     |                |        |  |                     |           |                |        |  |                  |  |                |        |  |                  |  |  |  |  |  |  |  |  |  |  |  |  |  |  |  |  |  |  |  |  |  |  |  |  |  |  |  |  |  |  |       |                |        |  |                     |     |  |  |  |  |           |                |        |  |                     |     |  |  |  |  |  |  |  |  |  |  |
| 2.0 (C) | 83           | 06.95 | 05.96 | - ABS |           |                |        |  |              |     |                |        |  |                     |           |                |        |  |                  |  |                |        |  |                  |  |  |  |  |  |  |  |  |  |  |  |  |  |  |  |  |  |  |  |  |  |  |  |  |  |  |  |  |  |  |       |                |        |  |                     |     |  |  |  |  |           |                |        |  |                     |     |  |  |  |  |  |  |  |  |  |  |
| 2.0 (H) | 83           | 06.96 | 02.01 |       |           |                |        |  |              |     |                |        |  |                     |           |                |        |  |                  |  |                |        |  |                  |  |  |  |  |  |  |  |  |  |  |  |  |  |  |  |  |  |  |  |  |  |  |  |  |  |  |  |  |  |  |       |                |        |  |                     |     |  |  |  |  |           |                |        |  |                     |     |  |  |  |  |  |  |  |  |  |  |
| 2.0 (H) | 83           | 06.95 | 05.96 | - ABS |           |                |        |  |              |     |                |        |  |                     |           |                |        |  |                  |  |                |        |  |                  |  |  |  |  |  |  |  |  |  |  |  |  |  |  |  |  |  |  |  |  |  |  |  |  |  |  |  |  |  |  |       |                |        |  |                     |     |  |  |  |  |           |                |        |  |                     |     |  |  |  |  |  |  |  |  |  |  |
| 2.0 (L) | 70           | 06.96 | 02.01 |       |           |                |        |  |              |     |                |        |  |                     |           |                |        |  |                  |  |                |        |  |                  |  |  |  |  |  |  |  |  |  |  |  |  |  |  |  |  |  |  |  |  |  |  |  |  |  |  |  |  |  |  |       |                |        |  |                     |     |  |  |  |  |           |                |        |  |                     |     |  |  |  |  |  |  |  |  |  |  |
| 2.0 (L) | 70           | 11.95 | 05.96 | - ABS |           |                |        |  |              |     |                |        |  |                     |           |                |        |  |                  |  |                |        |  |                  |  |  |  |  |  |  |  |  |  |  |  |  |  |  |  |  |  |  |  |  |  |  |  |  |  |  |  |  |  |  |       |                |        |  |                     |     |  |  |  |  |           |                |        |  |                     |     |  |  |  |  |  |  |  |  |  |  |
| 2.0 (N) | 83           | 09.95 | 02.01 |       |           |                |        |  |              |     |                |        |  |                     |           |                |        |  |                  |  |                |        |  |                  |  |  |  |  |  |  |  |  |  |  |  |  |  |  |  |  |  |  |  |  |  |  |  |  |  |  |  |  |  |  |       |                |        |  |                     |     |  |  |  |  |           |                |        |  |                     |     |  |  |  |  |  |  |  |  |  |  |
| 2.2 D   |              | 06.96 | 02.01 |       |           |                |        |  |              |     |                |        |  |                     |           |                |        |  |                  |  |                |        |  |                  |  |  |  |  |  |  |  |  |  |  |  |  |  |  |  |  |  |  |  |  |  |  |  |  |  |  |  |  |  |  |       |                |        |  |                     |     |  |  |  |  |           |                |        |  |                     |     |  |  |  |  |  |  |  |  |  |  |
| 2.2 D   |              | 06.95 | 05.96 | - ABS |           |                |        |  |              |     |                |        |  |                     |           |                |        |  |                  |  |                |        |  |                  |  |  |  |  |  |  |  |  |  |  |  |  |  |  |  |  |  |  |  |  |  |  |  |  |  |  |  |  |  |  |       |                |        |  |                     |     |  |  |  |  |           |                |        |  |                     |     |  |  |  |  |  |  |  |  |  |  |
|         | 1.8 (O)      | 66    | 06.96 | 04.98 |           |                |        |  |              |     |                |        |  |                     |           |                |        |  |                  |  |                |        |  |                  |  |  |  |  |  |  |  |  |  |  |  |  |  |  |  |  |  |  |  |  |  |  |  |  |  |  |  |  |  |  |       | 03.0520-5520.3 | 695520 |  | 20,64/229x42 TopKit | TRW |  |  |  |  |           |                |        |  |                     |     |  |  |  |  |  |  |  |  |  |  |
|         | 1.8 (O)      | 66    | 06.95 | 05.96 |           |                |        |  |              |     |                |        |  |                     |           |                |        |  |                  |  |                |        |  |                  |  |  |  |  |  |  |  |  |  |  |  |  |  |  |  |  |  |  |  |  |  |  |  |  |  |  |  |  |  |  | - ABS |                |        |  |                     |     |  |  |  |  |           |                |        |  |                     |     |  |  |  |  |  |  |  |  |  |  |
|         | 1.8 (S)      | 66    | 06.96 | 02.01 |           |                |        |  |              |     |                |        |  |                     |           |                |        |  |                  |  |                |        |  |                  |  |  |  |  |  |  |  |  |  |  |  |  |  |  |  |  |  |  |  |  |  |  |  |  |  |  |  |  |  |  |       |                |        |  |                     |     |  |  |  |  |           |                |        |  |                     |     |  |  |  |  |  |  |  |  |  |  |
|         | 1.8 (S)      | 66    | 06.95 | 05.96 |           |                |        |  |              |     |                |        |  |                     |           |                |        |  |                  |  |                |        |  |                  |  |  |  |  |  |  |  |  |  |  |  |  |  |  |  |  |  |  |  |  |  |  |  |  |  |  |  |  |  |  | - ABS |                |        |  |                     |     |  |  |  |  |           |                |        |  |                     |     |  |  |  |  |  |  |  |  |  |  |
|         | 1.8 (T)      | 66    | 06.96 | 02.01 |           |                |        |  |              |     |                |        |  |                     |           |                |        |  |                  |  |                |        |  |                  |  |  |  |  |  |  |  |  |  |  |  |  |  |  |  |  |  |  |  |  |  |  |  |  |  |  |  |  |  |  |       |                |        |  |                     |     |  |  |  |  |           |                |        |  |                     |     |  |  |  |  |  |  |  |  |  |  |
|         | 1.8 (T)      | 66    | 07.95 | 05.96 |           |                |        |  |              |     |                |        |  |                     |           |                |        |  |                  |  |                |        |  |                  |  |  |  |  |  |  |  |  |  |  |  |  |  |  |  |  |  |  |  |  |  |  |  |  |  |  |  |  |  |  | - ABS |                |        |  |                     |     |  |  |  |  |           |                |        |  |                     |     |  |  |  |  |  |  |  |  |  |  |
|         | 1.8 (Z)      | 69    | 06.96 | 02.01 |           |                |        |  |              |     |                |        |  |                     |           |                |        |  |                  |  |                |        |  |                  |  |  |  |  |  |  |  |  |  |  |  |  |  |  |  |  |  |  |  |  |  |  |  |  |  |  |  |  |  |  |       |                |        |  |                     |     |  |  |  |  |           |                |        |  |                     |     |  |  |  |  |  |  |  |  |  |  |
|         | 1.8 (Z)      | 69    | 07.95 | 05.96 |           | - ABS          |        |  |              |     |                |        |  |                     |           |                |        |  |                  |  |                |        |  |                  |  |  |  |  |  |  |  |  |  |  |  |  |  |  |  |  |  |  |  |  |  |  |  |  |  |  |  |  |  |  |       |                |        |  |                     |     |  |  |  |  |           |                |        |  |                     |     |  |  |  |  |  |  |  |  |  |  |
|         | 2.0          | 84    | 10.98 | 02.01 |           |                |        |  |              |     |                |        |  |                     |           |                |        |  |                  |  |                |        |  |                  |  |  |  |  |  |  |  |  |  |  |  |  |  |  |  |  |  |  |  |  |  |  |  |  |  |  |  |  |  |  |       |                |        |  |                     |     |  |  |  |  |           |                |        |  |                     |     |  |  |  |  |  |  |  |  |  |  |
|         | 2.0 (C)      | 83    | 06.96 | 02.01 |           |                |        |  |              |     |                |        |  |                     |           |                |        |  |                  |  |                |        |  |                  |  |  |  |  |  |  |  |  |  |  |  |  |  |  |  |  |  |  |  |  |  |  |  |  |  |  |  |  |  |  |       |                |        |  |                     |     |  |  |  |  |           |                |        |  |                     |     |  |  |  |  |  |  |  |  |  |  |
|         | 2.0 (C)      | 83    | 06.95 | 05.96 | - ABS     |                |        |  |              |     |                |        |  |                     |           |                |        |  |                  |  |                |        |  |                  |  |  |  |  |  |  |  |  |  |  |  |  |  |  |  |  |  |  |  |  |  |  |  |  |  |  |  |  |  |  |       |                |        |  |                     |     |  |  |  |  |           |                |        |  |                     |     |  |  |  |  |  |  |  |  |  |  |
|         | 2.0 (H)      | 83    | 06.96 | 02.01 |           |                |        |  |              |     |                |        |  |                     |           |                |        |  |                  |  |                |        |  |                  |  |  |  |  |  |  |  |  |  |  |  |  |  |  |  |  |  |  |  |  |  |  |  |  |  |  |  |  |  |  |       |                |        |  |                     |     |  |  |  |  |           |                |        |  |                     |     |  |  |  |  |  |  |  |  |  |  |
|         | 2.0 (H)      | 83    | 06.95 | 05.96 | - ABS     |                |        |  |              |     |                |        |  |                     |           |                |        |  |                  |  |                |        |  |                  |  |  |  |  |  |  |  |  |  |  |  |  |  |  |  |  |  |  |  |  |  |  |  |  |  |  |  |  |  |  |       |                |        |  |                     |     |  |  |  |  |           |                |        |  |                     |     |  |  |  |  |  |  |  |  |  |  |
|         | 2.0 (L)      | 70    | 06.96 | 04.98 |           |                |        |  |              |     |                |        |  |                     |           |                |        |  |                  |  |                |        |  |                  |  |  |  |  |  |  |  |  |  |  |  |  |  |  |  |  |  |  |  |  |  |  |  |  |  |  |  |  |  |  |       |                |        |  |                     |     |  |  |  |  |           |                |        |  |                     |     |  |  |  |  |  |  |  |  |  |  |
|         | 2.0 (L)      | 70    | 11.95 | 05.96 | - ABS     |                |        |  |              |     |                |        |  |                     |           |                |        |  |                  |  |                |        |  |                  |  |  |  |  |  |  |  |  |  |  |  |  |  |  |  |  |  |  |  |  |  |  |  |  |  |  |  |  |  |  |       |                |        |  |                     |     |  |  |  |  |           |                |        |  |                     |     |  |  |  |  |  |  |  |  |  |  |
|         | 2.0 (N)      | 83    | 09.95 | 02.01 |           |                |        |  |              |     |                |        |  |                     |           |                |        |  |                  |  |                |        |  |                  |  |  |  |  |  |  |  |  |  |  |  |  |  |  |  |  |  |  |  |  |  |  |  |  |  |  |  |  |  |  |       |                |        |  |                     |     |  |  |  |  |           |                |        |  |                     |     |  |  |  |  |  |  |  |  |  |  |
| 2.2 D   |              | 06.96 | 02.01 |       |           |                |        |  |              |     |                |        |  |                     |           |                |        |  |                  |  |                |        |  |                  |  |  |  |  |  |  |  |  |  |  |  |  |  |  |  |  |  |  |  |  |  |  |  |  |  |  |  |  |  |  |       |                |        |  |                     |     |  |  |  |  |           |                |        |  |                     |     |  |  |  |  |  |  |  |  |  |  |
| 2.2 D   |              | 06.95 | 05.96 | - ABS |           |                |        |  |              |     |                |        |  |                     |           |                |        |  |                  |  |                |        |  |                  |  |  |  |  |  |  |  |  |  |  |  |  |  |  |  |  |  |  |  |  |  |  |  |  |  |  |  |  |  |  |       |                |        |  |                     |     |  |  |  |  |           |                |        |  |                     |     |  |  |  |  |  |  |  |  |  |  |
|         | 1.6 16V      | 79    | 11.97 | 02.01 |           |                |        |  |              |     |                |        |  |                     |           |                |        |  |                  |  |                |        |  |                  |  |  |  |  |  |  |  |  |  |  |  |  |  |  |  |  |  |  |  |  |  |  |  |  |  |  |  |  |  |  |       |                |        |  |                     |     |  |  |  |  |           | 03.0520-5922.3 | 695922 |  | 22,20/229x42 TopKit | TRW |  |  |  |  |  |  |  |  |  |  |
|         | 1.8 (O)      | 66    | 05.98 | 02.01 |           |                |        |  |              |     |                |        |  |                     |           |                |        |  |                  |  |                |        |  |                  |  |  |  |  |  |  |  |  |  |  |  |  |  |  |  |  |  |  |  |  |  |  |  |  |  |  |  |  |  |  |       |                |        |  |                     |     |  |  |  |  |           |                |        |  |                     |     |  |  |  |  |  |  |  |  |  |  |
|         | 1.8 16V (4)  | 88    | 04.98 | 02.01 |           |                |        |  |              |     |                |        |  |                     |           |                |        |  |                  |  |                |        |  |                  |  |  |  |  |  |  |  |  |  |  |  |  |  |  |  |  |  |  |  |  |  |  |  |  |  |  |  |  |  |  |       |                |        |  |                     |     |  |  |  |  | - Fairway |                |        |  |                     |     |  |  |  |  |  |  |  |  |  |  |
|         | 1.9 dTi (KJ) | 72    | 10.97 | 02.01 |           |                |        |  |              |     |                |        |  |                     |           |                |        |  |                  |  |                |        |  |                  |  |  |  |  |  |  |  |  |  |  |  |  |  |  |  |  |  |  |  |  |  |  |  |  |  |  |  |  |  |  |       |                |        |  |                     |     |  |  |  |  | - Alize   |                |        |  |                     |     |  |  |  |  |  |  |  |  |  |  |
|         | 1.9 dTi (SJ) | 72    | 10.97 | 02.01 |           |                |        |  |              |     |                |        |  |                     |           |                |        |  |                  |  |                |        |  |                  |  |  |  |  |  |  |  |  |  |  |  |  |  |  |  |  |  |  |  |  |  |  |  |  |  |  |  |  |  |  |       |                |        |  |                     |     |  |  |  |  |           |                |        |  |                     |     |  |  |  |  |  |  |  |  |  |  |
|         | 2.0 (L)      | 70    | 05.98 | 02.01 |           |                |        |  |              |     |                |        |  |                     |           |                |        |  |                  |  |                |        |  |                  |  |  |  |  |  |  |  |  |  |  |  |  |  |  |  |  |  |  |  |  |  |  |  |  |  |  |  |  |  |  |       |                |        |  |                     |     |  |  |  |  |           |                |        |  |                     |     |  |  |  |  |  |  |  |  |  |  |

## RENAULT LAGUNA II Limousine (BG\_) (01-07)

|                |                     |       |       |       |  |                |        |  |                                    |              |     |                |        |  |                                    |              |     |                |        |  |                                    |              |     |                |        |  |                                    |              |     |  |  |  |  |  |  |  |  |  |  |  |  |  |  |  |  |  |  |  |  |  |  |  |  |  |  |  |  |  |  |  |  |  |  |  |  |  |  |  |  |  |  |  |  |  |  |  |  |  |  |  |  |  |  |  |  |  |  |  |  |                |        |  |  |              |     |
|----------------|---------------------|-------|-------|-------|--|----------------|--------|--|------------------------------------|--------------|-----|----------------|--------|--|------------------------------------|--------------|-----|----------------|--------|--|------------------------------------|--------------|-----|----------------|--------|--|------------------------------------|--------------|-----|--|--|--|--|--|--|--|--|--|--|--|--|--|--|--|--|--|--|--|--|--|--|--|--|--|--|--|--|--|--|--|--|--|--|--|--|--|--|--|--|--|--|--|--|--|--|--|--|--|--|--|--|--|--|--|--|--|--|--|--|----------------|--------|--|--|--------------|-----|
|                | 1.6 16V             | 79    | 03.01 | 06.07 |  | 13.0460-7157.2 | 607157 |  | + Bremsscheibe 280mm <sup>1)</sup> | 23215 18,3 + | ATE |                |        |  |                                    |              |     |                |        |  |                                    |              |     |                |        |  |                                    |              |     |  |  |  |  |  |  |  |  |  |  |  |  |  |  |  |  |  |  |  |  |  |  |  |  |  |  |  |  |  |  |  |  |  |  |  |  |  |  |  |  |  |  |  |  |  |  |  |  |  |  |  |  |  |  |  |  |  |  |  |  |                |        |  |  |              |     |
|                | 1.6 16V             | 82    | 02.05 | 06.07 |  |                |        |  |                                    |              |     | 13.0470-7157.2 | LD7157 |  | + Bremsscheibe 280mm <sup>1)</sup> | 23215 18,3 + | ATE |                |        |  |                                    |              |     |                |        |  |                                    |              |     |  |  |  |  |  |  |  |  |  |  |  |  |  |  |  |  |  |  |  |  |  |  |  |  |  |  |  |  |  |  |  |  |  |  |  |  |  |  |  |  |  |  |  |  |  |  |  |  |  |  |  |  |  |  |  |  |  |  |  |  |                |        |  |  |              |     |
|                | 1.8 16V (04/06/0V)  | 89    | 03.01 | 06.07 |  |                |        |  |                                    |              |     |                |        |  |                                    |              |     | 13.0460-7158.2 | 607158 |  | + Bremsscheibe 300mm <sup>2)</sup> | 23245 18,3 + | ATE |                |        |  |                                    |              |     |  |  |  |  |  |  |  |  |  |  |  |  |  |  |  |  |  |  |  |  |  |  |  |  |  |  |  |  |  |  |  |  |  |  |  |  |  |  |  |  |  |  |  |  |  |  |  |  |  |  |  |  |  |  |  |  |  |  |  |  |                |        |  |  |              |     |
|                | 1.8 16V (0B/0C/0M)  | 88    | 03.01 | 06.07 |  |                |        |  |                                    |              |     |                |        |  |                                    |              |     |                |        |  |                                    |              |     | 13.0470-7158.2 | LD7158 |  | + Bremsscheibe 300mm <sup>2)</sup> | 23245 18,3 + | ATE |  |  |  |  |  |  |  |  |  |  |  |  |  |  |  |  |  |  |  |  |  |  |  |  |  |  |  |  |  |  |  |  |  |  |  |  |  |  |  |  |  |  |  |  |  |  |  |  |  |  |  |  |  |  |  |  |  |  |  |  |                |        |  |  |              |     |
|                | 1.8 16V (0J)        | 85    | 03.01 | 06.07 |  |                |        |  |                                    |              |     |                |        |  |                                    |              |     |                |        |  |                                    |              |     |                |        |  |                                    |              |     |  |  |  |  |  |  |  |  |  |  |  |  |  |  |  |  |  |  |  |  |  |  |  |  |  |  |  |  |  |  |  |  |  |  |  |  |  |  |  |  |  |  |  |  |  |  |  |  |  |  |  |  |  |  |  |  |  |  |  |  |                |        |  |  |              |     |
|                | 1.9 dCi             | 79    | 03.01 | 06.07 |  |                |        |  |                                    |              |     |                |        |  |                                    |              |     |                |        |  |                                    |              |     |                |        |  |                                    |              |     |  |  |  |  |  |  |  |  |  |  |  |  |  |  |  |  |  |  |  |  |  |  |  |  |  |  |  |  |  |  |  |  |  |  |  |  |  |  |  |  |  |  |  |  |  |  |  |  |  |  |  |  |  |  |  |  |  |  |  |  |                |        |  |  |              |     |
|                | 1.9 dCi             | 81    | 01.05 | 06.07 |  |                |        |  |                                    |              |     |                |        |  |                                    |              |     |                |        |  |                                    |              |     |                |        |  |                                    |              |     |  |  |  |  |  |  |  |  |  |  |  |  |  |  |  |  |  |  |  |  |  |  |  |  |  |  |  |  |  |  |  |  |  |  |  |  |  |  |  |  |  |  |  |  |  |  |  |  |  |  |  |  |  |  |  |  |  |  |  |  |                |        |  |  |              |     |
|                | 1.9 dCi             | 96    | 05.05 | 06.07 |  |                |        |  |                                    |              |     |                |        |  |                                    |              |     |                |        |  |                                    |              |     |                |        |  |                                    |              |     |  |  |  |  |  |  |  |  |  |  |  |  |  |  |  |  |  |  |  |  |  |  |  |  |  |  |  |  |  |  |  |  |  |  |  |  |  |  |  |  |  |  |  |  |  |  |  |  |  |  |  |  |  |  |  |  |  |  |  |  |                |        |  |  |              |     |
|                | 1.9 dCi (08/10)     | 68    | 03.04 | 06.07 |  |                |        |  |                                    |              |     |                |        |  |                                    |              |     |                |        |  |                                    |              |     |                |        |  |                                    |              |     |  |  |  |  |  |  |  |  |  |  |  |  |  |  |  |  |  |  |  |  |  |  |  |  |  |  |  |  |  |  |  |  |  |  |  |  |  |  |  |  |  |  |  |  |  |  |  |  |  |  |  |  |  |  |  |  |  |  |  |  |                |        |  |  |              |     |
|                | 1.9 dCi (0E)        | 77    | 06.01 | 06.07 |  |                |        |  |                                    |              |     |                |        |  |                                    |              |     |                |        |  |                                    |              |     |                |        |  |                                    |              |     |  |  |  |  |  |  |  |  |  |  |  |  |  |  |  |  |  |  |  |  |  |  |  |  |  |  |  |  |  |  |  |  |  |  |  |  |  |  |  |  |  |  |  |  |  |  |  |  |  |  |  |  |  |  |  |  |  |  |  |  |                |        |  |  |              |     |
|                | 1.9 dCi (0G)        | 88    | 03.01 | 06.07 |  |                |        |  |                                    |              |     |                |        |  |                                    |              |     |                |        |  |                                    |              |     |                |        |  |                                    |              |     |  |  |  |  |  |  |  |  |  |  |  |  |  |  |  |  |  |  |  |  |  |  |  |  |  |  |  |  |  |  |  |  |  |  |  |  |  |  |  |  |  |  |  |  |  |  |  |  |  |  |  |  |  |  |  |  |  |  |  |  |                |        |  |  |              |     |
|                | 1.9 dCi (0R)        | 74    | 10.01 | 06.07 |  |                |        |  |                                    |              |     |                |        |  |                                    |              |     |                |        |  |                                    |              |     |                |        |  |                                    |              |     |  |  |  |  |  |  |  |  |  |  |  |  |  |  |  |  |  |  |  |  |  |  |  |  |  |  |  |  |  |  |  |  |  |  |  |  |  |  |  |  |  |  |  |  |  |  |  |  |  |  |  |  |  |  |  |  |  |  |  |  |                |        |  |  |              |     |
|                | 2.0 16V (00/0K/0W)  | 99    | 08.02 | 06.07 |  |                |        |  |                                    |              |     |                |        |  |                                    |              |     |                |        |  |                                    |              |     |                |        |  |                                    |              |     |  |  |  |  |  |  |  |  |  |  |  |  |  |  |  |  |  |  |  |  |  |  |  |  |  |  |  |  |  |  |  |  |  |  |  |  |  |  |  |  |  |  |  |  |  |  |  |  |  |  |  |  |  |  |  |  |  |  |  |  |                |        |  |  |              |     |
|                | 2.0 16V IDE (0N/0P) | 103   | 04.01 | 06.07 |  |                |        |  |                                    |              |     |                |        |  |                                    |              |     |                |        |  |                                    |              |     |                |        |  |                                    |              |     |  |  |  |  |  |  |  |  |  |  |  |  |  |  |  |  |  |  |  |  |  |  |  |  |  |  |  |  |  |  |  |  |  |  |  |  |  |  |  |  |  |  |  |  |  |  |  |  |  |  |  |  |  |  |  |  |  |  |  |  |                |        |  |  |              |     |
|                | 2.2 dCi             | 102   | 05.05 | 06.07 |  |                |        |  |                                    |              |     |                |        |  |                                    |              |     |                |        |  |                                    |              |     |                |        |  |                                    |              |     |  |  |  |  |  |  |  |  |  |  |  |  |  |  |  |  |  |  |  |  |  |  |  |  |  |  |  |  |  |  |  |  |  |  |  |  |  |  |  |  |  |  |  |  |  |  |  |  |  |  |  |  |  |  |  |  |  |  |  |  | 13.0460-7158.2 | 607158 |  |  | 23245 18,3 + | ATE |
|                | 2.2 dCi             | 110   | 05.05 | 06.07 |  |                |        |  |                                    |              |     |                |        |  |                                    |              |     |                |        |  |                                    |              |     |                |        |  |                                    |              |     |  |  |  |  |  |  |  |  |  |  |  |  |  |  |  |  |  |  |  |  |  |  |  |  |  |  |  |  |  |  |  |  |  |  |  |  |  |  |  |  |  |  |  |  |  |  |  |  |  |  |  |  |  |  |  |  |  |  |  |  |                |        |  |  |              |     |
| 2.2 dCi        | 110                 | 10.01 | 11.01 |       |  |                |        |  |                                    |              |     |                |        |  |                                    |              |     |                |        |  |                                    |              |     |                |        |  |                                    |              |     |  |  |  |  |  |  |  |  |  |  |  |  |  |  |  |  |  |  |  |  |  |  |  |  |  |  |  |  |  |  |  |  |  |  |  |  |  |  |  |  |  |  |  |  |  |  |  |  |  |  |  |  |  |  |  |  |  |  |  |  |                |        |  |  |              |     |
| 2.2 dCi (BG09) | 85                  | 04.04 | 10.05 |       |  |                |        |  |                                    |              |     |                |        |  |                                    |              |     |                |        |  |                                    |              |     |                |        |  |                                    |              |     |  |  |  |  |  |  |  |  |  |  |  |  |  |  |  |  |  |  |  |  |  |  |  |  |  |  |  |  |  |  |  |  |  |  |  |  |  |  |  |  |  |  |  |  |  |  |  |  |  |  |  |  |  |  |  |  |  |  |  |  |                |        |  |  |              |     |

<sup>1)</sup> + brake disc 280mm / + dischi freno 280mm / + disques de frein 280mm / + disco de freno 280mm





<sup>2)</sup> + brake disc 300mm / + dischi freno 300mm / + disques de frein 300mm / + disco de freno 300mm

|     |  |  |  |  |  |  |  |     |                         |     |
|--|--|--|--|--|---|--|--|---|-------------------------|-----|
| <b>RENAULT LAGUNA II Limousine (BG_) (01-07)</b>                                   |  |  |  |  |   |  |  |   |                         |     |
|    | 2.0 16V  | 125  |  | 01.05  | 06.07   | 13.0460-7159.2   | 607159   |   | 23248 18,3 +            | ATE |
|  | 2.0 16V Sport  | 150  |  | 01.05  | 06.07   | 13.0470-7159.2   | LD7159   |   | 23248 18,3 +            | ATE |
|  | 2.0 16V Turbo  | 120  |  | 01.03  | 06.07   |  |  |   |                         |     |
|  | 2.0 dCi  | 110  |  | 08.05  | 06.07   |  |  |   |                         |     |
|  | 2.0 dCi 130  | 127  |  | 01.06  | 06.07   |  |  |   |                         |     |
|  | 2.2 dCi  | 110  |  | 12.01  | 04.05   |  |  |   |                         |     |
|  | 2.2 dCi (BG09)   | 85   |  | 04.04  | 10.05   |  |  |   |                         |     |
|  | 3.0 V6   | 152  |  | 03.01  | 06.07   |  |  |   |                         |     |
|    | 1.6 16V  | 79   |  | 03.01  | 06.07   | 24.0124-0169.1   | 424169   |   | 280 24,0 21,8 V L +B    |     |
|  | 1.6 16V  | 82   |  | 02.05  | 06.07   | 24.0126-0123.1   | 426123   |   | 300 26,0 22,8 V L +B    |     |
|  | 1.8 16V (04/06/OV)   | 89   |  | 03.01  | 06.07   | 24.0326-0123.1   | 526123   |   | 300 26,0 22,8 V L +B PD |     |
|  | 1.8 16V (0B/0C/0M)   | 88   |  | 03.01  | 06.07   |  |  |   |                         |     |
|  | 1.8 16V (0J)   | 85   |  | 03.01  | 06.07   |  |  |   |                         |     |
|  | 1.9 dCi  | 79   |  | 03.01  | 06.07   |  |  |   |                         |     |
|  | 1.9 dCi  | 81   |  | 01.05  | 06.07   |  |  |   |                         |     |
|  | 1.9 dCi  | 96   |  | 05.05  | 06.07   |  |  |   |                         |     |
|  | 1.9 dCi (08/10)  | 68   |  | 03.04  | 06.07   |  |  |   |                         |     |
|  | 1.9 dCi (0E)   | 77   |  | 06.01  | 06.07   |  |  |   |                         |     |
|  | 1.9 dCi (0G)   | 88   |  | 03.01  | 06.07   |  |  |   |                         |     |
|  | 1.9 dCi (0R)   | 74   |  | 10.01  | 06.07   |  |  |   |                         |     |
|  | 2.0 16V (00/0K/0W)   | 99   |  | 08.02  | 06.07   |  |  |   |                         |     |
|  | 2.0 16V IDE (0N/0P)  | 103  |  | 04.01  | 06.07   |  |  |   |                         |     |
|  | 2.2 dCi  | 102  |  | 05.05  | 06.07   | 24.0126-0123.1   | 426123   |   | 300 26,0 22,8 V L +B    |     |
|  | 2.2 dCi  | 110  |  | 05.05  | 06.07   | 24.0326-0123.1   | 526123   |   | 300 26,0 22,8 V L +B PD |     |
|  | 2.2 dCi  | 110  |  | 10.01  | 11.01   |  |  |   |                         |     |
|  | 2.2 dCi (BG09)   | 85   |  | 05.05  | 10.05   |  |  |   |                         |     |
|  | 2.0 16V  | 125  |  | 01.05  | 06.07   | 24.0128-0182.1   | 428182   |   | 308 28,0 25,4 V L +B    |     |
|  | 2.0 16V Sport  | 150  |  | 01.05  | 06.07   |  |  |   |                         |     |
|  | 2.0 16V Turbo  | 120  |  | 01.03  | 06.07   |  |  |   |                         |     |
|  | 2.0 dCi  | 110  |  | 08.05  | 06.07   |  |  |   |                         |     |
|  | 2.0 dCi 130  | 127  |  | 01.06  | 06.07   |  |  |   |                         |     |
|  | 2.2 dCi  | 110  |  | 11.02  | 04.05   |  |  |   |                         |     |
|  | 2.2 dCi (BG09)   | 85   |  | 04.04  | 04.05   |  |  |   |                         |     |
|  | 3.0 V6   | 152  |  | 03.01  | 06.01   |  |  |   |                         |     |
|  | 2.2 dCi  | 110  |  | 12.01  | 10.02   | 24.0128-0135.1   | 428135   |   | 308 28,0 25,8 V L +B    |     |
|  | 3.0 V6   | 152  |  | 07.01  | 06.07   |  |  |   |                         |     |
|    | 1.6 16V  | 79   |  | 03.01  | 06.07   | 24.0711-5094.1   | 360064   | 2  | Radsensor L=557         |     |
|  | 1.6 16V  | 82   |  | 02.05  | 06.07   |  |  |   |                         |     |
|  | 1.8 16V (04/06/OV)   | 89   |  | 03.01  | 06.07   |  |  |   |                         |     |
|  | 1.8 16V (0B/0C/0M)   | 88   |  | 03.01  | 06.07   |  |  |   |                         |     |
|  | 1.8 16V (0J)   | 85   |  | 03.01  | 06.07   |  |  |   |                         |     |
|  | 1.9 dCi  | 79   |  | 03.01  | 06.07   |  |  |   |                         |     |
|  | 1.9 dCi  | 81   |  | 01.05  | 06.07   |  |  |   |                         |     |
|  | 1.9 dCi  | 96   |  | 05.05  | 06.07   |  |  |   |                         |     |
|  | 1.9 dCi (08/10)  | 68   |  | 03.04  | 06.07   |  |  |   |                         |     |
|  | 1.9 dCi (0E)   | 77   |  | 06.01  | 06.07   |  |  |   |                         |     |
|  | 1.9 dCi (0G)   | 88   |  | 03.01  | 06.07   |  |  |   |                         |     |
|  | 1.9 dCi (0R)   | 74   |  | 10.01  | 06.07   |  |  |   |                         |     |
|  | 2.0 16V  | 125  |  | 01.05  | 06.07   |  |  |   |                         |     |
|  | 2.0 16V (00/0K/0W)   | 99   |  | 08.02  | 06.07   |  |  |   |                         |     |
|  | 2.0 16V IDE (0N/0P)  | 103  |  | 04.01  | 06.07   |  |  |   |                         |     |
|  | 2.0 16V Sport  | 150  |  | 01.05  | 06.07   |  |  |   |                         |     |
|  | 2.0 16V Turbo  | 120  |  | 01.03  | 06.07   |  |  |   |                         |     |
|  | 2.0 dCi  | 110  |  | 08.05  | 06.07   |  |  |   |                         |     |
|  | 2.0 dCi 130  | 127  |  | 01.06  | 06.07   |  |  |   |                         |     |
|  | 2.2 dCi  | 102  |  | 05.05  | 06.07   |  |  |   |                         |     |
|  | 2.2 dCi  | 110  |  | 10.01  | 06.07   |  |  |   |                         |     |
|  | 2.2 dCi (BG09)   | 85   |  | 04.04  | 10.05   |  |  |   |                         |     |
|  | 3.0 V6   | 152  |  | 03.01  | 06.07   |  |  |   |                         |     |
|  | 1.6 16V  | 79   |  | 03.01  | 06.07   | 13.0460-7137.2   | 607137   |   | 23482 15,8 +            | ATE |
|  | 1.6 16V  | 82   |  | 02.05  | 06.07   | 13.0470-7137.2   | LD7137   |   | 23482 15,8 +            | ATE |
|  | 1.8 16V (04/06/OV)   | 89   |  | 03.01  | 06.07   |  |  |   |                         |     |
|  | 1.8 16V (0B/0C/0M)   | 88   |  | 03.01  | 06.07   |  |  |   |                         |     |
|  | 1.8 16V (0J)   | 85   |  | 03.01  | 06.07   |  |  |   |                         |     |
|  | 1.9 dCi  | 79   |  | 03.01  | 06.07   |  |  |   |                         |     |
|  | 1.9 dCi  | 81   |  | 01.05  | 06.07   |  |  |   |                         |     |
|  | 1.9 dCi  | 96   |  | 05.05  | 06.07   |  |  |   |                         |     |
|  | 1.9 dCi (08/10)  | 68   |  | 03.04  | 06.07   |  |  |   |                         |     |
|  | 1.9 dCi (0E)   | 77   |  | 06.01  | 06.07   |  |  |   |                         |     |
|  | 1.9 dCi (0G)   | 88   |  | 03.01  | 06.07   |  |  |   |                         |     |
|  | 1.9 dCi (0R)   | 74   |  | 10.01  | 06.07   |  |  |   |                         |     |
|  | 2.0 16V  | 125  |  | 01.05  | 06.07   |  |  |   |                         |     |
|  | 2.0 16V (00/0K/0W)   | 99   |  | 08.02  | 06.07   |  |  |   |                         |     |
|  | 2.0 16V IDE (0N/0P)  | 103  |  | 04.01  | 06.07   |  |  |   |                         |     |
|  | 2.0 16V Sport  | 150  |  | 01.05  | 06.07   |  |  |   |                         |     |
|  | 2.0 16V Turbo  | 120  |  | 01.03  | 06.07   |  |  |   |                         |     |
|  | 2.0 dCi  | 110  |  | 08.05  | 06.07   |  |  |   |                         |     |
|  | 2.0 dCi 130  | 127  |  | 01.06  | 06.07   |  |  |   |                         |     |
|  | 2.2 dCi  | 102  |  | 05.05  | 06.07   |  |  |   |                         |     |
|  | 2.2 dCi  | 110  |  | 10.01  | 06.07   |  |  |   |                         |     |
|  | 2.2 dCi (BG09)   | 85   |  | 04.04  | 10.05   |  |  |   |                         |     |
|  | 3.0 V6   | 152  |  | 03.01  | 06.07   |  |  |   |                         |     |
|  | 1.6 16V  | 79   |  | 03.01  | 06.07   | 24.0111-0101.2   | 411101   | mit Lager/ mit Sensorring <sup>1)</sup>   | 274 10,9 9,5 +B         |     |
|  | 1.6 16V  | 82   |  | 02.05  | 06.07   |  |  |   |                         |     |
|  | 1.8 16V (04/06/OV)   | 89   |  | 03.01  | 06.07   |  |  |   |                         |     |
|  | 1.8 16V (0B/0C/0M)   | 88   |  | 03.01  | 06.07   |  |  |   |                         |     |

<sup>1)</sup> with bearing/ with sensor ring / con supporto/+ anell.sens.ABS / avec palier de secours ABS / con apoyo/+ anillo sensor ABS



### RENAULT LAGUNA II Limousine (BG\_) (01-07)

|  |  |  |   |                       |   |   |                 |
|--|--|--|---|-----------------------|---|---|-----------------|
|  | 1.8 16V (0J) 85<br>1.9 dCi 79<br>1.9 dCi 81<br>1.9 dCi 96<br>1.9 dCi (08/10) 68<br>1.9 dCi (0E) 77<br>1.9 dCi (0G) 88<br>1.9 dCi (0R) 74<br>2.0 16V 125<br>2.0 16V (00/0K/0W) 99<br>2.0 16V IDE (0N/0P) 103<br>2.0 16V Sport 150<br>2.0 16V Turbo 120<br>2.0 dCi 110<br>2.0 dCi 130 127<br>2.2 dCi 102<br>2.2 dCi 110<br>2.2 dCi (BG09) 85<br>3.0 V6 152   |  | 03.01 06.07<br>03.01 06.07<br>01.05 06.07<br>05.05 06.07<br>03.04 06.07<br>06.01 06.07<br>03.01 06.07<br>10.01 06.07<br>01.05 06.07<br>08.02 06.07<br>04.01 06.07<br>01.05 06.07<br>01.03 06.07<br>08.05 06.07<br>01.06 06.07<br>05.05 06.07<br>10.01 06.07<br>04.04 10.05<br>03.01 06.07   | 24.0111-0101.2 411101 |   | mit Lager/ mit Sensorring <sup>1)</sup> | 274 10,9 9,5 +B |
|  | 1.6 16V 79<br>1.6 16V 82<br>1.8 16V (04/06/0V) 89<br>1.8 16V (0B/0C/0M) 88<br>1.8 16V (0J) 85<br>1.9 dCi 79<br>1.9 dCi 81<br>1.9 dCi 96<br>1.9 dCi (08/10) 68<br>1.9 dCi (0E) 77<br>1.9 dCi (0G) 88<br>1.9 dCi (0R) 74<br>2.0 16V 125<br>2.0 16V (00/0K/0W) 99<br>2.0 16V IDE (0N/0P) 103<br>2.0 16V Sport 150<br>2.0 16V Turbo 120<br>2.0 dCi 110<br>2.0 dCi 130 127<br>2.2 dCi 102<br>2.2 dCi 110<br>2.2 dCi (BG09) 85<br>3.0 V6 152 |  | 03.01 02.06<br>02.05 02.06<br>03.01 02.06<br>03.01 02.06<br>03.01 02.06<br>01.05 02.06<br>05.05 02.06<br>03.04 02.06<br>06.01 02.06<br>03.01 02.06<br>10.01 02.06<br>01.05 02.06<br>08.02 02.06<br>04.01 02.06<br>01.05 02.06<br>01.03 02.06<br>08.05 02.06<br>01.06 02.06<br>05.05 02.06<br>10.01 02.06<br>04.04 10.05<br>03.01 02.06                | 24.0711-5095.1 360104 | 2    |   | Radsensor L=603 |
|  | 1.6 16V 79<br>1.6 16V 82<br>1.8 16V (04/06/0V) 89<br>1.8 16V (0B/0C/0M) 88<br>1.8 16V (0J) 85<br>1.9 dCi 79<br>1.9 dCi 81<br>1.9 dCi 96<br>1.9 dCi (08/10) 68<br>1.9 dCi (0E) 77<br>1.9 dCi (0G) 88<br>1.9 dCi (0R) 74<br>2.0 16V 125<br>2.0 16V (00/0K/0W) 99<br>2.0 16V IDE (0N/0P) 103<br>2.0 16V Sport 150<br>2.0 16V Turbo 120<br>2.0 dCi 110<br>2.0 dCi 130 127<br>2.2 dCi 102<br>2.2 dCi 110<br>3.0 V6 152                      |  | 03.06 06.07<br>03.06 06.07<br>03.06 06.07<br>03.06 06.07<br>03.06 06.07<br>03.06 06.07<br>03.06 06.07<br>03.06 06.07<br>03.06 06.07<br>03.06 06.07<br>03.06 06.07<br>03.06 06.07<br>03.06 06.07<br>03.06 06.07<br>03.06 06.07<br>03.06 06.07<br>03.06 06.07<br>03.06 06.07<br>03.06 06.07<br>03.06 06.07<br>03.06 06.07<br>03.06 06.07<br>03.06 06.07 | 24.0711-5201.1 360272 | 2  |   | Radsensor L=608 |

### RENAULT LAGUNA II Grandtour (KG\_) (01-07)















|  |   |  |   |  |  |  |  |                          |
|--|---|--|---|--|--|--|--|--------------------------|
|  | 1.6 16V 79<br>1.6 16V 82<br>1.6 FlexFuel 76<br>1.8 16V (04/06/0V) 89<br>1.8 16V (0B/0C/0M) 88<br>1.8 16V (0J) 85<br>1.9 dCi 79<br>1.9 dCi 81<br>1.9 dCi 96<br>1.9 dCi (08/10) 68<br>1.9 dCi (0E) 77<br>1.9 dCi (0G) 88<br>1.9 dCi (0R) 74<br>2.0 16V (00/0K/0W) 99<br>2.0 16V IDE (0N/0P) 103 |  | 03.01 06.07<br>02.05 06.07<br>06.01 10.03<br>03.01 06.07<br>03.01 06.07<br>03.01 06.07<br>03.01 06.07<br>01.05 06.07<br>05.05 06.07<br>03.04 06.07<br>06.01 06.07<br>03.01 06.07<br>10.01 06.07<br>08.02 06.07<br>04.01 06.07 | 13.0460-7157.2 607157<br>13.0470-7157.2 LD7157<br>13.0460-7158.2 607158<br>13.0470-7158.2 LD7158 |  | + Bremsscheibe 280mm <sup>2)</sup><br>+ Bremsscheibe 280mm <sup>2)</sup><br>+ Bremsscheibe 300mm <sup>3)</sup><br>+ Bremsscheibe 300mm <sup>3)</sup> | 23215 18,3 +<br>23215 18,3 +<br>23245 18,3 +<br>23245 18,3 + | ATE<br>ATE<br>ATE<br>ATE |
|  | 2.0 dCi 110<br>2.2 dCi 102<br>2.2 dCi 110<br>2.2 dCi 110<br>2.2 dCi (KG09) 85   |  | 08.05 06.07 + 16" Rad <sup>4)</sup><br>05.05 06.07<br>05.05 06.07<br>10.01 11.01<br>04.04 10.05   | 13.0460-7158.2 607158<br>13.0470-7158.2 LD7158   |  |  | 23245 18,3 +<br>23245 18,3 +                                 | ATE<br>ATE               |

<sup>1)</sup> with bearing/ with sensor ring / con supporto/+ anell.sens.ABS / avec palier de secours ABS / con apoyo/+ anillo sensor ABS

<sup>2)</sup> + brake disc 280mm / + dischi freno 280mm / + disques de frein 280mm / + disco de freno 280mm

<sup>3)</sup> + brake disc 300mm / + dischi freno 300mm / + disques de frein 300mm / + disco de freno 300mm

<sup>4)</sup> + 16" wheel / + ruota 16" / + roue 16" / + rueda 16"

|     |  |  |  |  |  |  |     |  |     |
|--|--|--|--|--|---|--|---|--|-----|
| <b>RENAULT LAGUNA II Grandtour (KG_) (01-07)</b>                                   |  |  |  |  |   |  |   |  |     |
|    | 2.0 16V  | 125  | 01.05  | 06.07  | 13.0460-7159.2  | 607159   |   | 23248 18,3 +   | ATE |
|  | 2.0 16V Sport  | 150  | 01.05  | 06.07  | 13.0470-7159.2  | LD7159   |   | 23248 18,3 +   | ATE |
|  | 2.0 16V Turbo  | 120  | 01.03  | 06.07  |   |  |   |  |     |
|  | 2.0 dCi  | 110  | 08.05  | 06.07  |   |  | + 17" Rad 1)  |  |     |
|  | 2.0 dCi 130  | 127  | 01.06  | 06.07  |   |  |   |  |     |
|  | 2.2 dCi  | 110  | 12.01  | 04.05  |   |  |   |  |     |
|  | 3.0 V6   | 152  | 03.01  | 06.07  |   |  |   |  |     |
|    | 1.6 16V  | 79   | 03.01  | 06.07  | 24.0124-0169.1  | 424169   |   | 280 24,0 21,8 V L +B   |     |
|  | 1.6 16V  | 82   | 02.05  | 06.07  | 24.0126-0123.1  | 426123   |   | 300 26,0 22,8 V L +B   |     |
|  | 1.6 FlexFuel   | 76   | 06.01  | 10.03  | 24.0326-0123.1  | 526123   |   | 300 26,0 22,8 V L +B PD  |     |
|  | 1.8 16V (04/06/0V)   | 89   | 03.01  | 06.07  |   |  |   |  |     |
|  | 1.8 16V (0B/0C/0M)   | 88   | 03.01  | 06.07  |   |  |   |  |     |
|  | 1.8 16V (0J)   | 85   | 03.01  | 06.07  |   |  |   |  |     |
|  | 1.9 dCi  | 79   | 03.01  | 06.07  |   |  |   |  |     |
|  | 1.9 dCi  | 81   | 01.05  | 06.07  |   |  |   |  |     |
|  | 1.9 dCi  | 96   | 05.05  | 06.07  |   |  |   |  |     |
|  | 1.9 dCi (08/10)  | 68   | 03.04  | 06.07  |   |  |   |  |     |
|  | 1.9 dCi (0E)   | 77   | 06.01  | 06.07  |   |  |   |  |     |
|  | 1.9 dCi (0G)   | 88   | 03.01  | 06.07  |   |  |   |  |     |
|  | 1.9 dCi (0R)   | 74   | 10.01  | 06.07  |   |  |   |  |     |
|  | 2.0 16V (00/0K/0W)   | 99   | 08.02  | 06.07  |   |  |   |  |     |
|  | 2.0 16V IDE (0N/0P)  | 103  | 04.01  | 06.07  |   |  |   |  |     |
|  | 2.0 dCi  | 110  | 08.05  | 06.07  |   |  | + 16" Rad 2)  | 300 26,0 22,8 V L +B   |     |
|  | 2.2 dCi  | 102  | 05.05  | 06.07  | 24.0126-0123.1  | 426123   |   | 300 26,0 22,8 V L +B PD  |     |
|  | 2.2 dCi  | 110  | 05.05  | 06.07  | 24.0326-0123.1  | 526123   |   |  |     |
|  | 2.2 dCi  | 110  | 10.01  | 11.01  |   |  |   |  |     |
|  | 2.2 dCi (KG09)   | 85   | 04.04  | 10.05  |   |  |   |  |     |
|  | 2.0 16V  | 125  | 01.05  | 06.07  | 24.0128-0182.1  | 428182   |   | 308 28,0 25,4 V L +B   |     |
|  | 2.0 16V Sport  | 150  | 01.05  | 06.07  |   |  |   |  |     |
|  | 2.0 16V Turbo  | 120  | 01.03  | 06.07  |   |  |   |  |     |
|  | 2.0 dCi  | 110  | 08.05  | 06.07  |   |  | + 17" Rad 1)  |  |     |
|  | 2.0 dCi 130  | 127  | 01.06  | 06.07  |   |  |   |  |     |
|  | 2.2 dCi  | 110  | 11.02  | 04.05  |   |  |   |  |     |
|  | 3.0 V6   | 152  | 03.01  | 06.01  |   |  |   |  |     |
|  | 2.2 dCi  | 110  | 12.01  | 10.02  | 24.0128-0135.1  | 428135   |   | 308 28,0 25,8 V L +B   |     |
|  | 3.0 V6   | 152  | 07.01  | 06.07  |   |  |   |  |     |
|    | 1.6 16V  | 79   | 03.01  | 06.07  | 24.0711-5094.1  | 360064   | 2  | Radsensor L=557  |     |
|  | 1.6 16V  | 82   | 02.05  | 06.07  |   |  |   |  |     |
|  | 1.6 FlexFuel   | 76   | 06.01  | 10.03  |   |  |   |  |     |
|  | 1.8 16V (04/06/0V)   | 89   | 03.01  | 06.07  |   |  |   |  |     |
|  | 1.8 16V (0B/0C/0M)   | 88   | 03.01  | 06.07  |   |  |   |  |     |
|  | 1.8 16V (0J)   | 85   | 03.01  | 06.07  |   |  |   |  |     |
|  | 1.9 dCi  | 79   | 03.01  | 06.07  |   |  |   |  |     |
|  | 1.9 dCi  | 81   | 01.05  | 06.07  |   |  |   |  |     |
|  | 1.9 dCi  | 96   | 05.05  | 06.07  |   |  |   |  |     |
|  | 1.9 dCi (08/10)  | 68   | 03.04  | 06.07  |   |  |   |  |     |
|  | 1.9 dCi (0E)   | 77   | 06.01  | 06.07  |   |  |   |  |     |
|  | 1.9 dCi (0G)   | 88   | 03.01  | 06.07  |   |  |   |  |     |
|  | 1.9 dCi (0R)   | 74   | 10.01  | 06.07  |   |  |   |  |     |
|  | 2.0 16V  | 125  | 01.05  | 06.07  |   |  |   |  |     |
|  | 2.0 16V (00/0K/0W)   | 99   | 08.02  | 06.07  |   |  |   |  |     |
|  | 2.0 16V IDE (0N/0P)  | 103  | 04.01  | 06.07  |   |  |   |  |     |
|  | 2.0 16V Sport  | 150  | 01.05  | 06.07  |   |  |   |  |     |
|  | 2.0 16V Turbo  | 120  | 01.03  | 06.07  |   |  |   |  |     |
|  | 2.0 dCi  | 110  | 08.05  | 06.07  |   |  |   |  |     |
|  | 2.0 dCi 130  | 127  | 01.06  | 06.07  |   |  |   |  |     |
|  | 2.2 dCi  | 102  | 05.05  | 06.07  |   |  |   |  |     |
|  | 2.2 dCi  | 110  | 10.01  | 06.07  |   |  |   |  |     |
|  | 2.2 dCi (KG09)   | 85   | 04.04  | 10.05  |   |  |   |  |     |
|  | 3.0 V6   | 152  | 03.01  | 06.07  |   |  |   |  |     |
|  | 1.6 16V  | 79   | 03.01  | 06.07  | 13.0460-7137.2  | 607137   |   | 23482 15,8 +   | ATE |
|  | 1.6 16V  | 82   | 02.05  | 06.07  | 13.0470-7137.2  | LD7137   |   | 23482 15,8 +   | ATE |
|  | 1.6 FlexFuel   | 76   | 06.01  | 10.03  |   |  |   |  |     |
|  | 1.8 16V (04/06/0V)   | 89   | 03.01  | 06.07  |   |  |   |  |     |
|  | 1.8 16V (0B/0C/0M)   | 88   | 03.01  | 06.07  |   |  |   |  |     |
|  | 1.8 16V (0J)   | 85   | 03.01  | 06.07  |   |  |   |  |     |
|  | 1.9 dCi  | 79   | 03.01  | 06.07  |   |  |   |  |     |
|  | 1.9 dCi  | 81   | 01.05  | 06.07  |   |  |   |  |     |
|  | 1.9 dCi  | 96   | 05.05  | 06.07  |   |  |   |  |     |
|  | 1.9 dCi (08/10)  | 68   | 03.04  | 06.07  |   |  |   |  |     |
|  | 1.9 dCi (0E)   | 77   | 06.01  | 06.07  |   |  |   |  |     |
|  | 1.9 dCi (0G)   | 88   | 03.01  | 06.07  |   |  |   |  |     |
|  | 1.9 dCi (0R)   | 74   | 10.01  | 06.07  |   |  |   |  |     |
|  | 2.0 16V  | 125  | 01.05  | 06.07  |   |  |   |  |     |
|  | 2.0 16V (00/0K/0W)   | 99   | 08.02  | 06.07  |   |  |   |  |     |
|  | 2.0 16V IDE (0N/0P)  | 103  | 04.01  | 06.07  |   |  |   |  |     |
|  | 2.0 16V Sport  | 150  | 01.05  | 06.07  |   |  |   |  |     |
|  | 2.0 16V Turbo  | 120  | 01.03  | 06.07  |   |  |   |  |     |
|  | 2.0 dCi  | 110  | 08.05  | 06.07  |   |  |   |  |     |
|  | 2.0 dCi 130  | 127  | 01.06  | 06.07  |   |  |   |  |     |
|  | 2.2 dCi  | 102  | 05.05  | 06.07  |   |  |   |  |     |
|  | 2.2 dCi  | 110  | 10.01  | 06.07  |   |  |   |  |     |
|  | 2.2 dCi (KG09)   | 85   | 04.04  | 10.05  |   |  |   |  |     |
|  | 3.0 V6   | 152  | 03.01  | 06.07  |   |  |   |  |     |

1) + 17" wheel / + ruota 17" / + roue 17" / + rueda 17"

2) + 16" wheel / + ruota 16" / + roue 16" / + rueda 16"



### RENAULT LAGUNA II Grandtour (KG\_) (01-07)

|  |  |   |  |  |                |        |   |   |                 |
|--|--|---|--|--|----------------|--------|---|---|-----------------|
|  | 1.6 16V<br>1.6 16V<br>1.6 FlexFuel<br>1.8 16V (04/06/OV)<br>1.8 16V (0B/0C/0M)<br>1.8 16V (0J)<br>1.9 dCi<br>1.9 dCi<br>1.9 dCi<br>1.9 dCi (08/10)<br>1.9 dCi (0E)<br>1.9 dCi (0G)<br>1.9 dCi (0R)<br>2.0 16V<br>2.0 16V (00/0K/0W)<br>2.0 16V IDE (0N/0P)<br>2.0 16V Sport<br>2.0 16V Turbo<br>2.0 dCi<br>2.0 dCi 130<br>2.2 dCi<br>2.2 dCi<br>2.2 dCi (KG09)<br>3.0 V6 | 79<br>82<br>76<br>89<br>88<br>85<br>79<br>81<br>96<br>68<br>77<br>88<br>74<br>125<br>99<br>103<br>150<br>120<br>110<br>127<br>102<br>110<br>85<br>152 | 03.01<br>02.05<br>06.01<br>03.01<br>03.01<br>03.01<br>01.05<br>05.05<br>03.04<br>06.01<br>03.01<br>10.01<br>01.05<br>08.02<br>04.01<br>01.05<br>01.03<br>08.05<br>01.06<br>05.05<br>10.01<br>04.04<br>03.01          | 06.07<br>06.07<br>10.03<br>06.07<br>06.07<br>06.07<br>06.07<br>06.07<br>06.07<br>06.07<br>06.07<br>06.07<br>06.07<br>06.07<br>06.07<br>06.07<br>06.07<br>06.07<br>06.07<br>06.07<br>06.07<br>10.05<br>06.07          | 24.0111-0101.2 | 411101 |   | mit Lager/ mit Sensorring <sup>1)</sup> | 274 10,9 9,5 +B |
|  | 1.6 16V<br>1.6 16V<br>1.6 FlexFuel<br>1.8 16V (04/06/OV)<br>1.8 16V (0B/0C/0M)<br>1.8 16V (0J)<br>1.9 dCi<br>1.9 dCi<br>1.9 dCi<br>1.9 dCi (08/10)<br>1.9 dCi (0E)<br>1.9 dCi (0G)<br>1.9 dCi (0R)<br>2.0 16V<br>2.0 16V (00/0K/0W)<br>2.0 16V IDE (0N/0P)<br>2.0 16V Sport<br>2.0 16V Turbo<br>2.0 dCi<br>2.0 dCi 130<br>2.2 dCi<br>2.2 dCi<br>2.2 dCi (KG09)<br>3.0 V6 | 79<br>82<br>76<br>89<br>88<br>85<br>79<br>81<br>96<br>68<br>77<br>88<br>74<br>125<br>99<br>103<br>150<br>120<br>110<br>127<br>102<br>110<br>85<br>152 | 03.01<br>02.05<br>06.01<br>03.01<br>03.01<br>03.01<br>01.05<br>05.05<br>03.04<br>06.01<br>03.01<br>10.01<br>01.05<br>08.02<br>04.01<br>01.05<br>01.03<br>08.05<br>01.06<br>05.05<br>10.01<br>04.04<br>03.01          | 02.06<br>02.06<br>10.03<br>02.06<br>02.06<br>02.06<br>02.06<br>02.06<br>02.06<br>02.06<br>02.06<br>02.06<br>02.06<br>02.06<br>02.06<br>02.06<br>02.06<br>02.06<br>02.06<br>02.06<br>02.06<br>10.05<br>02.06          | 24.0711-5095.1 | 360104 | 2 |   | Radsensor L=603 |
|  | 1.6 16V<br>1.6 16V<br>1.8 16V (04/06/OV)<br>1.8 16V (0B/0C/0M)<br>1.8 16V (0J)<br>1.9 dCi<br>1.9 dCi<br>1.9 dCi<br>1.9 dCi (08/10)<br>1.9 dCi (0E)<br>1.9 dCi (0G)<br>1.9 dCi (0R)<br>2.0 16V<br>2.0 16V (00/0K/0W)<br>2.0 16V IDE (0N/0P)<br>2.0 16V Sport<br>2.0 16V Turbo<br>2.0 dCi<br>2.0 dCi 130<br>2.2 dCi<br>2.2 dCi<br>2.2 dCi (KG09)<br>3.0 V6                 | 79<br>82<br>89<br>88<br>85<br>79<br>81<br>96<br>68<br>77<br>88<br>74<br>125<br>99<br>103<br>150<br>120<br>110<br>127<br>102<br>110<br>85<br>152       | 03.06<br>03.06<br>03.06<br>03.06<br>03.06<br>03.06<br>03.06<br>03.06<br>03.06<br>03.06<br>03.06<br>03.06<br>03.06<br>03.06<br>03.06<br>03.06<br>03.06<br>03.06<br>03.06<br>03.06<br>03.06<br>03.06<br>03.06<br>03.06 | 06.07<br>06.07<br>06.07<br>06.07<br>06.07<br>06.07<br>06.07<br>06.07<br>06.07<br>06.07<br>06.07<br>06.07<br>06.07<br>06.07<br>06.07<br>06.07<br>06.07<br>06.07<br>06.07<br>06.07<br>06.07<br>06.07<br>06.07<br>06.07 | 24.0711-5201.1 | 360272 | 2 |   | Radsensor L=608 |

### RENAULT LAGUNA III Limousine (BT0/1) (07-15)

|  |  |  |   |  |                                  |                  |  |  |                              |            |
|--|--|--|---|--|----------------------------------|------------------|--|--|------------------------------|------------|
|  | 1.5 dCi<br>1.6 16V   | 81<br>81                                     | 09.07<br>09.07  |  | 13.0460-7248.2                   | 607248           |  |  | 23215 17,5 +                 | ATE        |
|  | 2.0 16V<br>2.0 16V Hi-Flex<br>2.0 16V Turbo<br>2.0 dCi<br>2.0 dCi<br>2.0 dCi<br>2.0 dCi GT | 103<br>103<br>125<br>96<br>110<br>127<br>131 | 09.07<br>09.07<br>09.07<br>09.07<br>09.07<br>01.08<br>03.08 |  | 13.0460-7249.2<br>13.0470-7249.2 | 607249<br>LD7249 |  |  | 24709 18,6 +<br>24709 18,6 + | ATE<br>ATE |
|  | 2.0 16V Turbo GT<br>2.0 dCi<br>2.0 dCi<br>2.0 dCi<br>2.0 dCi GT<br>3.0 dCi                 | 150<br>96<br>110<br>127<br>131<br>173        | 03.08<br>09.07<br>09.07<br>01.08<br>03.08<br>09.08          |  | 13.0460-7250.2                   | 607250           |  | + 4-Rad Lenkung <sup>3)</sup><br>+ 4-Rad Lenkung <sup>3)</sup><br>+ 4-Rad Lenkung <sup>3)</sup><br>+ 4-Rad Lenkung <sup>3)</sup> | 24870 17,5 +                 | ATE        |

<sup>1)</sup> with bearing/ with sensor ring / con supporto/+ anell.sens.ABS / avec palier de secours ABS / con apoyo/+ anillo sensor ABS

<sup>2)</sup> - 4 wheel steering / - 4 ruote sterzanti / - 4 roues directionnelles / + dirección sobre cuatro ruedas

<sup>3)</sup> + 4 wheel steering / + 4 ruote sterzanti / + 4 roues directionnelles / + dirección sobre cuatro ruedas





### RENAULT LAGUNA III Limousine (BT0/1) (07-15)

|            |                  |     |       |                               |                               |                |        |   |                                    |     |
|------------|------------------|-----|-------|-------------------------------|-------------------------------|----------------|--------|---|------------------------------------|-----|
|            | 3.5 V6           | 175 |       | 04.08                         |                               | 13.0460-7250.2 | 607250 |   | 24870 17,5 +                       | ATE |
|            | 1.5 dCi          | 81  |       | 09.07                         |                               | 24.0124-0221.1 | 424221 |   | 280 24,0 21,8 V L +S +B            |     |
|            | 1.6 16V          | 81  |       | 09.07                         |                               |                |        |   |                                    |     |
|            | 2.0 16V          | 103 |       | 09.07                         |                               | 24.0126-0158.1 | 426158 |   | 296 26,0 23,4 V L +S +B            |     |
|            | 2.0 16V Hi-Flex  | 103 |       | 09.07                         |                               |                |        |   |                                    |     |
|            | 2.0 16V Turbo    | 125 |       | 09.07                         |                               |                |        |   |                                    |     |
|            | 2.0 dCi          | 96  |       | 09.07                         | - 4-Rad Lenkung <sup>1)</sup> |                |        |   |                                    |     |
|            | 2.0 dCi          | 110 |       | 09.07                         | - 4-Rad Lenkung <sup>1)</sup> |                |        |   |                                    |     |
|            | 2.0 dCi          | 127 |       | 01.08                         | - 4-Rad Lenkung <sup>1)</sup> |                |        |   |                                    |     |
|            | 2.0 dCi GT       | 131 |       | 03.08                         | - 4-Rad Lenkung <sup>1)</sup> |                |        |   |                                    |     |
|            | 2.0 16V Turbo GT | 150 |       | 03.08                         |                               | 24.0128-0245.1 | 428245 |   | 320 28,0 25,4 V L +S +B            |     |
| 2.0 dCi    | 96               |     | 09.07 | + 4-Rad Lenkung <sup>2)</sup> |                               |                |        |   |                                    |     |
| 2.0 dCi    | 110              |     | 09.07 | + 4-Rad Lenkung <sup>2)</sup> |                               |                |        |   |                                    |     |
| 2.0 dCi    | 127              |     | 01.08 | + 4-Rad Lenkung <sup>2)</sup> |                               |                |        |   |                                    |     |
| 2.0 dCi GT | 131              |     | 03.08 | + 4-Rad Lenkung <sup>2)</sup> |                               |                |        |   |                                    |     |
| 3.0 dCi    | 173              |     | 09.08 |                               |                               |                |        |   |                                    |     |
| 3.5 V6     | 175              |     | 04.08 |                               |                               |                |        |   |                                    |     |
|            | 1.5 dCi          | 81  |       | 09.07                         |                               | 24.0711-5194.3 | 360268 |   | Radsensor L=655<br>Radsensor L=615 |     |
|            | 1.6 16V          | 81  |       | 09.07                         |                               | 24.0711-5195.3 | 360269 |   |                                    |     |
|            | 2.0 16V          | 103 |       | 09.07                         |                               |                |        |   |                                    |     |
|            | 2.0 16V Hi-Flex  | 103 |       | 09.07                         |                               |                |        |   |                                    |     |
|            | 2.0 16V Turbo    | 125 |       | 09.07                         |                               |                |        |   |                                    |     |
|            | 2.0 16V Turbo GT | 150 |       | 03.08                         |                               |                |        |   |                                    |     |
|            | 2.0 dCi          | 96  |       | 09.07                         |                               |                |        |   |                                    |     |
|            | 2.0 dCi          | 110 |       | 09.07                         |                               |                |        |   |                                    |     |
|            | 2.0 dCi          | 127 |       | 01.08                         |                               |                |        |   |                                    |     |
|            | 2.0 dCi GT       | 131 |       | 03.08                         |                               |                |        |   |                                    |     |
| 3.0 dCi    | 173              |     | 09.08 |                               |                               |                |        |   |                                    |     |
| 3.5 V6     | 175              |     | 04.08 |                               |                               |                |        |   |                                    |     |
|            | 1.5 dCi          | 81  |       | 09.07                         |                               | 13.0460-7251.2 | 607251 |   | 24137 15,8 +                       | ATE |
|            | 1.6 16V          | 81  |       | 09.07                         |                               | 13.0470-7251.2 | LD7251 |   | 24137 15,8 +                       | ATE |
|            | 2.0 16V          | 103 |       | 09.07                         |                               |                |        |   |                                    |     |
|            | 2.0 16V Hi-Flex  | 103 |       | 09.07                         |                               |                |        |   |                                    |     |
|            | 2.0 16V Turbo    | 125 |       | 09.07                         |                               |                |        |   |                                    |     |
|            | 2.0 16V Turbo GT | 150 |       | 03.08                         |                               |                |        |   |                                    |     |
|            | 2.0 dCi          | 96  |       | 09.07                         |                               |                |        |   |                                    |     |
|            | 2.0 dCi          | 110 |       | 09.07                         |                               |                |        |   |                                    |     |
|            | 2.0 dCi          | 127 |       | 01.08                         |                               |                |        |   |                                    |     |
|            | 2.0 dCi GT       | 131 |       | 03.08                         |                               |                |        |   |                                    |     |
| 3.0 dCi    | 173              |     | 09.08 |                               |                               |                |        |   |                                    |     |
| 3.5 V6     | 175              |     | 04.08 |                               |                               |                |        |   |                                    |     |
|            | 1.5 dCi          | 81  |       | 09.07                         |                               | 24.0111-0173.2 | 411173 |   | 300 11,0 9,5 +B                    |     |
|            | 1.6 16V          | 81  |       | 09.07                         |                               |                |        |   |                                    |     |
|            | 2.0 16V          | 103 |       | 09.07                         |                               |                |        |   |                                    |     |
|            | 2.0 16V Hi-Flex  | 103 |       | 09.07                         |                               |                |        |   |                                    |     |
|            | 2.0 16V Turbo    | 125 |       | 09.07                         |                               |                |        |   |                                    |     |
|            | 2.0 16V Turbo GT | 150 |       | 03.08                         |                               |                |        |   |                                    |     |
|            | 2.0 dCi          | 96  |       | 09.07                         |                               |                |        |   |                                    |     |
|            | 2.0 dCi          | 110 |       | 09.07                         |                               |                |        |   |                                    |     |
|            | 2.0 dCi          | 127 |       | 01.08                         |                               |                |        |   |                                    |     |
|            | 2.0 dCi GT       | 131 |       | 03.08                         |                               |                |        |   |                                    |     |
| 3.0 dCi    | 173              |     | 09.08 |                               |                               |                |        |   |                                    |     |
| 3.5 V6     | 175              |     | 04.08 |                               |                               |                |        |   |                                    |     |
|            | 1.5 dCi          | 81  |       | 09.07                         |                               | 24.0711-5197.3 | 360270 | 2 | Radsensor L=645<br>Radsensor L=632 |     |
|            | 1.6 16V          | 81  |       | 09.07                         |                               | 24.0711-5196.3 | 360370 | 2 |                                    |     |
|            | 2.0 16V          | 103 |       | 09.07                         |                               |                |        |   |                                    |     |
|            | 2.0 16V Hi-Flex  | 103 |       | 09.07                         |                               |                |        |   |                                    |     |
|            | 2.0 16V Turbo    | 125 |       | 09.07                         |                               |                |        |   |                                    |     |
|            | 2.0 16V Turbo GT | 150 |       | 03.08                         |                               |                |        |   |                                    |     |
|            | 2.0 dCi          | 96  |       | 09.07                         |                               |                |        |   |                                    |     |
|            | 2.0 dCi          | 110 |       | 09.07                         |                               |                |        |   |                                    |     |
|            | 2.0 dCi          | 127 |       | 01.08                         |                               |                |        |   |                                    |     |
|            | 2.0 dCi GT       | 131 |       | 03.08                         |                               |                |        |   |                                    |     |
| 3.0 dCi    | 173              |     | 09.08 |                               |                               |                |        |   |                                    |     |
| 3.5 V6     | 175              |     | 04.08 |                               |                               |                |        |   |                                    |     |

### RENAULT LAGUNA III Coupe (DT0/1) (07-15)

|  |                  |     |  |       |                               |                |        |  |                         |     |
|--|------------------|-----|--|-------|-------------------------------|----------------|--------|--|-------------------------|-----|
|  | 1.5 dCi          | 81  |  | 03.12 |                               | 13.0460-7248.2 | 607248 |  | 23215 17,5 +            | ATE |
|  | 2.0 16V Turbo    | 125 |  | 09.08 |                               | 13.0460-7249.2 | 607249 |  | 24709 18,6 +            | ATE |
|  | 2.0 dCi          | 110 |  | 10.07 | - 4-Rad Lenkung <sup>1)</sup> | 13.0470-7249.2 | LD7249 |  | 24709 18,6 +            | ATE |
|  | 2.0 dCi          | 127 |  | 09.08 | - 4-Rad Lenkung <sup>1)</sup> |                |        |  |                         |     |
|  | 2.0 dCi GT       | 131 |  | 03.08 | - 4-Rad Lenkung <sup>1)</sup> |                |        |  |                         |     |
|  | 2.0 16V Turbo GT | 150 |  | 03.08 |                               | 13.0460-7250.2 | 607250 |  | 24870 17,5 +            | ATE |
|  | 2.0 dCi          | 110 |  | 10.07 | + 4-Rad Lenkung <sup>2)</sup> |                |        |  |                         |     |
|  | 2.0 dCi          | 127 |  | 09.08 | + 4-Rad Lenkung <sup>2)</sup> |                |        |  |                         |     |
|  | 2.0 dCi GT       | 131 |  | 03.08 | + 4-Rad Lenkung <sup>2)</sup> |                |        |  |                         |     |
|  | 3.0 dCi          | 173 |  | 09.08 |                               |                |        |  |                         |     |
|  | 3.5 V6           | 175 |  | 09.08 |                               |                |        |  |                         |     |
|  | 1.5 dCi          | 81  |  | 03.12 |                               | 24.0124-0221.1 | 424221 |  | 280 24,0 21,8 V L +S +B |     |
|  | 2.0 16V Turbo    | 125 |  | 09.08 |                               | 24.0126-0158.1 | 426158 |  | 296 26,0 23,4 V L +S +B |     |
|  | 2.0 dCi          | 110 |  | 10.07 | - 4-Rad Lenkung <sup>1)</sup> |                |        |  |                         |     |
|  | 2.0 dCi          | 127 |  | 09.08 | - 4-Rad Lenkung <sup>1)</sup> |                |        |  |                         |     |

<sup>1)</sup> - 4 wheel steering / - 4 route sterzanti / - 4 roues directionnelles / + dirección sobre cuatro ruedas

<sup>2)</sup> + 4 wheel steering / + 4 route sterzanti / + 4 roues directionnelles / + dirección sobre cuatro ruedas



### RENAULT LAGUNA III Coupe (DT0/1) (07-15)























|  |                  |     |       |                               |                |        |   |                         |
|--|------------------|-----|-------|-------------------------------|----------------|--------|---|-------------------------|
|  | 2.0 dCi GT       | 131 | 03.08 | - 4-Rad Lenkung <sup>1)</sup> | 24.0126-0158.1 | 426158 |   | 296 26,0 23,4 V L +S +B |
|  | 2.0 16V Turbo GT | 150 | 03.08 |                               | 24.0128-0245.1 | 428245 |   | 320 28,0 25,4 V L +S +B |
|  | 2.0 dCi          | 110 | 10.07 | + 4-Rad Lenkung <sup>2)</sup> |                |        |   |                         |
|  | 2.0 dCi          | 127 | 09.08 | + 4-Rad Lenkung <sup>2)</sup> |                |        |   |                         |
|  | 2.0 dCi GT       | 131 | 03.08 | + 4-Rad Lenkung <sup>2)</sup> |                |        |   |                         |
|  | 3.0 dCi          | 173 | 09.08 |                               |                |        |   |                         |
|  | 3.0 dCi          | 177 | 01.12 |                               |                |        |   |                         |
|  | 3.5 V6           | 175 | 09.08 |                               |                |        |   |                         |
|  | 1.5 dCi          | 81  | 03.12 |                               | 24.0711-5194.3 | 360268 |   | Radsensor L=655         |
|  | 2.0 16V Turbo    | 125 | 09.08 |                               | 24.0711-5195.3 | 360269 |   | Radsensor L=615         |
|  | 2.0 16V Turbo GT | 150 | 03.08 |                               |                |        |   |                         |
|  | 2.0 dCi          | 110 | 10.07 |                               |                |        |   |                         |
|  | 2.0 dCi          | 127 | 09.08 |                               |                |        |   |                         |
|  | 2.0 dCi GT       | 131 | 03.08 |                               |                |        |   |                         |
|  | 3.0 dCi          | 173 | 09.08 |                               |                |        |   |                         |
|  | 3.0 dCi          | 177 | 01.12 |                               |                |        |   |                         |
|  | 3.5 V6           | 175 | 09.08 |                               |                |        |   |                         |
|  | 1.5 dCi          | 81  | 03.12 |                               | 13.0460-7251.2 | 607251 |   | 24137 15,8 + ATE        |
|  | 2.0 16V Turbo    | 125 | 09.08 |                               | 13.0470-7251.2 | LD7251 |   | 24137 15,8 + ATE        |
|  | 2.0 16V Turbo GT | 150 | 03.08 |                               |                |        |   |                         |
|  | 2.0 dCi          | 110 | 10.07 |                               |                |        |   |                         |
|  | 2.0 dCi          | 127 | 09.08 |                               |                |        |   |                         |
|  | 2.0 dCi GT       | 131 | 03.08 |                               |                |        |   |                         |
|  | 3.0 dCi          | 173 | 09.08 |                               |                |        |   |                         |
|  | 3.0 dCi          | 177 | 01.12 |                               |                |        |   |                         |
|  | 3.5 V6           | 175 | 09.08 |                               |                |        |   |                         |
|  | 1.5 dCi          | 81  | 03.12 |                               | 24.0111-0181.2 | 411181 |   | 300 11,0 9,5 +B         |
|  | 2.0 16V Turbo    | 125 | 09.08 |                               |                |        |   |                         |
|  | 2.0 16V Turbo GT | 150 | 03.08 |                               |                |        |   |                         |
|  | 2.0 dCi          | 110 | 10.07 |                               |                |        |   |                         |
|  | 2.0 dCi          | 127 | 09.08 |                               |                |        |   |                         |
|  | 2.0 dCi GT       | 131 | 03.08 |                               |                |        |   |                         |
|  | 3.0 dCi          | 173 | 09.08 |                               |                |        |   |                         |
|  | 3.0 dCi          | 177 | 01.12 |                               |                |        |   |                         |
|  | 3.5 V6           | 175 | 09.08 |                               |                |        |   |                         |
|  | 1.5 dCi          | 81  | 03.12 |                               | 24.0711-5197.3 | 360270 | 2 | Radsensor L=645         |
|  | 2.0 16V Turbo    | 125 | 09.08 |                               | 24.0711-5196.3 | 360370 | 2 | Radsensor L=632         |
|  | 2.0 16V Turbo GT | 150 | 03.08 |                               |                |        |   |                         |
|  | 2.0 dCi          | 110 | 10.07 |                               |                |        |   |                         |
|  | 2.0 dCi          | 127 | 09.08 |                               |                |        |   |                         |
|  | 2.0 dCi GT       | 131 | 03.08 |                               |                |        |   |                         |
|  | 3.0 dCi          | 173 | 09.08 |                               |                |        |   |                         |
|  | 3.0 dCi          | 177 | 01.12 |                               |                |        |   |                         |
|  | 3.5 V6           | 175 | 09.08 |                               |                |        |   |                         |

### RENAULT LAGUNA III Grandtour (KT0/1) (07-15)

|  |                  |     |       |                               |                |        |  |                         |
|--|------------------|-----|-------|-------------------------------|----------------|--------|--|-------------------------|
|  | 1.5 dCi          | 81  | 09.07 |                               | 13.0460-7248.2 | 607248 |  | 23215 17,5 + ATE        |
|  | 1.6 16V          | 81  | 09.07 |                               |                |        |  |                         |
|  | 2.0 16V          | 103 | 09.07 |                               | 13.0460-7249.2 | 607249 |  | 24709 18,6 + ATE        |
|  | 2.0 16V Hi-Flex  | 103 | 09.07 |                               | 13.0470-7249.2 | LD7249 |  | 24709 18,6 + ATE        |
|  | 2.0 16V Turbo    | 125 | 09.07 |                               |                |        |  |                         |
|  | 2.0 dCi          | 96  | 09.07 | - 4-Rad Lenkung <sup>1)</sup> |                |        |  |                         |
|  | 2.0 dCi          | 110 | 09.07 | - 4-Rad Lenkung <sup>1)</sup> |                |        |  |                         |
|  | 2.0 dCi          | 127 | 09.07 | - 4-Rad Lenkung <sup>1)</sup> |                |        |  |                         |
|  | 2.0 dCi GT       | 131 | 03.08 | - 4-Rad Lenkung <sup>1)</sup> |                |        |  |                         |
|  | 2.0 16V Turbo GT | 150 | 03.08 |                               | 13.0460-7250.2 | 607250 |  | 24870 17,5 + ATE        |
|  | 2.0 dCi          | 96  | 09.07 | + 4-Rad Lenkung <sup>2)</sup> |                |        |  |                         |
|  | 2.0 dCi          | 110 | 09.07 | + 4-Rad Lenkung <sup>2)</sup> |                |        |  |                         |
|  | 2.0 dCi          | 127 | 09.07 | + 4-Rad Lenkung <sup>2)</sup> |                |        |  |                         |
|  | 2.0 dCi GT       | 131 | 03.08 | + 4-Rad Lenkung <sup>2)</sup> |                |        |  |                         |
|  | 3.0 dCi V6       | 173 | 09.08 |                               |                |        |  |                         |
|  | 3.5 V6           | 175 | 04.08 |                               |                |        |  |                         |
|  | 1.5 dCi          | 81  | 09.07 |                               | 24.0124-0221.1 | 424221 |  | 280 24,0 21,8 V L +S +B |
|  | 1.6 16V          | 81  | 09.07 |                               |                |        |  |                         |
|  | 2.0 16V          | 103 | 09.07 |                               | 24.0126-0158.1 | 426158 |  | 296 26,0 23,4 V L +S +B |
|  | 2.0 16V Hi-Flex  | 103 | 09.07 |                               |                |        |  |                         |
|  | 2.0 16V Turbo    | 125 | 09.07 |                               |                |        |  |                         |
|  | 2.0 dCi          | 96  | 09.07 | - 4-Rad Lenkung <sup>1)</sup> |                |        |  |                         |
|  | 2.0 dCi          | 110 | 09.07 | - 4-Rad Lenkung <sup>1)</sup> |                |        |  |                         |
|  | 2.0 dCi          | 127 | 09.07 | - 4-Rad Lenkung <sup>1)</sup> |                |        |  |                         |
|  | 2.0 dCi GT       | 131 | 03.08 | - 4-Rad Lenkung <sup>1)</sup> |                |        |  |                         |
|  | 2.0 16V Turbo GT | 150 | 03.08 |                               | 24.0128-0245.1 | 428245 |  | 320 28,0 25,4 V L +S +B |
|  | 2.0 dCi          | 96  | 09.07 | + 4-Rad Lenkung <sup>2)</sup> |                |        |  |                         |
|  | 2.0 dCi          | 110 | 09.07 | + 4-Rad Lenkung <sup>2)</sup> |                |        |  |                         |
|  | 2.0 dCi          | 127 | 09.07 | + 4-Rad Lenkung <sup>2)</sup> |                |        |  |                         |
|  | 2.0 dCi GT       | 131 | 03.08 | + 4-Rad Lenkung <sup>2)</sup> |                |        |  |                         |
|  | 3.0 dCi V6       | 173 | 09.08 |                               |                |        |  |                         |
|  | 3.5 V6           | 175 | 04.08 |                               |                |        |  |                         |
|  | 1.5 dCi          | 81  | 09.07 |                               | 24.0711-5194.3 | 360268 |  | Radsensor L=655         |
|  | 1.6 16V          | 81  | 09.07 |                               | 24.0711-5195.3 | 360269 |  | Radsensor L=615         |
|  | 2.0 16V          | 103 | 09.07 |                               |                |        |  |                         |
|  | 2.0 16V Hi-Flex  | 103 | 09.07 |                               |                |        |  |                         |
|  | 2.0 16V Turbo    | 125 | 09.07 |                               |                |        |  |                         |
|  | 2.0 16V Turbo GT | 150 | 03.08 |                               |                |        |  |                         |
|  | 2.0 dCi          | 96  | 09.07 |                               |                |        |  |                         |
|  | 2.0 dCi          | 110 | 09.07 |                               |                |        |  |                         |





























<sup>1)</sup> - 4 wheel steering / - 4 route sterzanti / - 4 roues directionnelles / + dirección sobre cuatro ruedas

<sup>2)</sup> + 4 wheel steering / + 4 route sterzanti / + 4 roues directionnelles / + dirección sobre cuatro ruedas

|     |    |  |                                      |  |  |  |    |  |
|--|--|--|--|--|---|--|--|--|
| <b>RENAULT LAGUNA III Grandtour (KT0/1) (07-15)</b>                                |  |  |  |  |   |  |  |  |
|    | 2.0 dCi<br>2.0 dCi GT<br>3.0 dCi V6<br>3.5 V6  | 127<br>131<br>173<br>175   | 09.07<br>03.08<br>09.08<br>04.08   |  | 24.0711-5194.3<br>24.0711-5195.3  | 360268<br>360269   |   | Radsensor L=655<br>Radsensor L=615   |
|    | 1.5 dCi<br>1.6 16V<br>2.0 16V<br>2.0 16V Hi-Flex<br>2.0 16V Turbo<br>2.0 16V Turbo GT<br>2.0 dCi<br>2.0 dCi<br>2.0 dCi<br>2.0 dCi GT<br>3.0 dCi V6<br>3.5 V6 | 81<br>81<br>103<br>103<br>125<br>150<br>96<br>110<br>127<br>131<br>173<br>175    | 09.07<br>09.07<br>09.07<br>09.07<br>03.08<br>09.07<br>09.07<br>09.07<br>03.08<br>09.08<br>04.08                      |  | 13.0460-7251.2<br>13.0470-7251.2  | 607251<br>LD7251   |  | 24137 15,8 +<br>24137 15,8 +<br>ATE<br>ATE   |
|    | 1.5 dCi<br>1.6 16V<br>2.0 16V<br>2.0 16V Hi-Flex<br>2.0 16V Turbo<br>2.0 16V Turbo GT<br>2.0 dCi<br>2.0 dCi<br>2.0 dCi<br>2.0 dCi GT<br>3.0 dCi V6<br>3.5 V6 | 81<br>81<br>103<br>103<br>125<br>150<br>96<br>110<br>127<br>131<br>173<br>175    | 09.07<br>09.07<br>09.07<br>09.07<br>03.08<br>09.07<br>09.07<br>09.07<br>03.08<br>09.08<br>04.08                      |  | 24.0111-0173.2  | 411173   |  | 300 11,0 9,5 +B  |
|    | 1.5 dCi<br>1.6 16V<br>2.0 16V<br>2.0 16V Hi-Flex<br>2.0 16V Turbo<br>2.0 16V Turbo GT<br>2.0 dCi<br>2.0 dCi<br>2.0 dCi<br>2.0 dCi GT<br>3.0 dCi V6<br>3.5 V6 | 81<br>81<br>103<br>103<br>125<br>150<br>96<br>110<br>127<br>131<br>173<br>175    | 09.07<br>09.07<br>09.07<br>09.07<br>03.08<br>09.07<br>09.07<br>09.07<br>03.08<br>09.08<br>04.08                      |  | 24.0711-5197.3<br>24.0711-5196.3  | 360270<br>360370   | 2  - 4-Rad Lenkung <sup>1)</sup><br>2  + 4-Rad Lenkung <sup>2)</sup> | Radsensor L=645<br>Radsensor L=632   |
| <b>RENAULT LATITUDE (L70_) (11-13)</b>   |  |  |  |  |   |  |  |  |
|  | 1.5 dCi<br>2.0 16V<br>2.0 16V eco2<br>2.0 dCi 150<br>2.5 dCi<br>2.0 dCi<br>2.0 dCi 175<br>3.0 dCi 240  | 81<br>103<br>103<br>110<br>130<br>127<br>177                                     | 02.11 06.13<br>02.11 06.13<br>02.11 06.13<br>02.11 06.13<br>05.11 06.13<br>02.11 06.13<br>05.11 06.13<br>02.11 06.13 |  | 13.0460-7249.2<br>13.0470-7249.2  | 607249<br>LD7249   |  | 24709 18,6 +<br>24709 18,6 +<br>ATE<br>ATE   |
|  | 1.5 dCi<br>2.0 16V<br>2.0 16V eco2<br>2.0 dCi<br>2.0 dCi 150<br>2.0 dCi 175<br>2.5 dCi   | 81<br>103<br>103<br>130<br>110<br>127<br>177                                     | 02.11 06.13<br>02.11 06.13<br>02.11 06.13<br>02.11 06.13<br>02.11 06.13<br>05.11 06.13<br>05.11 06.13                |  | 13.0460-5716.2  | 605716   |  | 21561 17,0 +/WK/Zub<br>24870 17,5 +<br>ATE   |
|  | 1.5 dCi<br>2.0 16V<br>2.0 16V eco2<br>2.0 dCi<br>2.0 dCi 150<br>2.0 dCi 175<br>2.5 dCi<br>3.0 dCi 240  | 81<br>103<br>103<br>130<br>110<br>127<br>177                                     | 02.11 06.13<br>02.11 06.13<br>02.11 06.13<br>02.11 06.13<br>02.11 06.13<br>05.11 06.13<br>05.11 06.13<br>02.11 06.13 |  | 13.0460-7287.2  | 607287   |  | 25265 16,6 +/WE<br>ATE   |
|  | 1.5 dCi<br>2.0 16V<br>2.0 16V eco2<br>2.0 dCi<br>2.0 dCi 150<br>2.0 dCi 175<br>2.5 dCi<br>3.0 dCi 240  | 81<br>103<br>103<br>130<br>110<br>127<br>177                                     | 02.11 06.13<br>02.11 06.13<br>02.11 06.13<br>02.11 06.13<br>02.11 06.13<br>05.11 06.13<br>05.11 06.13<br>02.11 06.13 |  | 24.0111-0173.2  | 411173   |  | 300 11,0 9,5 +B  |
| <b>RENAULT LOGAN (LS_) (04-13)</b>   |  |  |  |  |   |  |  |  |
|  | 1.4<br>1.5 dCi<br>1.5 dCi<br>1.6<br>1.6  | 55<br>50<br>63<br>64<br>77   | 09.04 04.13<br>04.07 04.13<br>02.08 04.13<br>09.04 04.13<br>04.07 04.13  |  | 13.0460-2834.2  | 602834   |  | 21463 18,0 /WK/S<br>TRW  |
|  | 1.4<br>1.6<br>1.5 dCi<br>1.5 dCi<br>1.6  | 55<br>64<br>50<br>63<br>77   | 09.04 04.13<br>09.04 04.13<br>04.07 04.13<br>02.08 04.13<br>04.07 04.13  |  | 24.0112-0116.1<br>24.0112-0171.1<br>24.0121-0106.1                                | 412116<br>412171<br>421106   | - ABS<br>+ ABS   | 238 12,0 10,5 +S +B<br>259 12,0 10,6 +S +B<br>259 20,6 17,7 V +S +B                |























<sup>1)</sup> - 4 wheel steering / - 4 route sterzanti / - 4 roues directionnelles / + dirección sobre cuatro ruedas

















<sup>2)</sup> + 4 wheel steering / + 4 route sterzanti / + 4 roues directionnelles / + dirección sobre cuatro ruedas

|     |  |  |  |  |  |  |          |  |                          |
|--|--|--|--|--|---|--|--|--|--------------------------|
| <b>RENAULT LOGAN (LS_) (04-13)</b>   |  |  |  |  |   |  |  |  |                          |
|    | 1.4<br>1.5 dCi<br>1.5 dCi<br>1.6<br>1.6  | 55<br>50<br>63<br>64<br>77   | 09.04<br>04.07<br>02.08<br>09.04<br>04.07  | 04.13<br>04.13<br>04.13<br>04.13<br>04.13  | 03.0137-0312.2<br>03.0137-9278.2<br>03.0137-0358.2<br>03.0137-9088.2              | 650312<br>669278<br>650358<br>669088   |  | 203 x 38 HEB<br>Bremsbacken-Zubehör<br>180 x 42 HEB<br>Bremsbacken-Zubehör         | TRW<br>TRW<br>BDX<br>BDX |
|    | 1.4<br>1.5 dCi<br>1.5 dCi<br>1.6<br>1.6  | 55<br>50<br>63<br>64<br>77   | 09.04<br>04.07<br>02.08<br>09.04<br>04.07  | 04.13<br>04.13<br>04.13<br>04.13<br>04.13  | 24.0218-0032.1<br>24.0220-3021.1<br>24.0220-3036.1                                | 480118<br>480127<br>480301   | + Trommeldurchmesser 180 mm <sup>1)</sup><br>- ABS<br>+ ABS/ ohne Sensorring <sup>2)</sup> | 180/181 x 53,5 - Lager<br>203/204,5 x 48 - Lager<br>203/204,5 x 50,5 - Lager       |                          |
|    | 1.4<br>1.5 dCi<br>1.5 dCi<br>1.6<br>1.6  | 55<br>50<br>63<br>64<br>77   | 09.04<br>04.07<br>02.08<br>09.04<br>04.07  | 04.13<br>04.13<br>04.13<br>04.13<br>04.13  | 03.0520-4719.3<br>03.0520-3517.3  | 694719<br>693517   |  | 19,05/180x42 TopKit<br>17,78/203x39 TopKit   | BDX<br>TRW               |
| <b>RENAULT LOGAN Kombi (KS_) (04-13)</b>   |  |  |  |  |   |  |  |  |                          |
|    | 1.4<br>1.5 dCi<br>1.5 dCi<br>1.6<br>1.6  | 55<br>50<br>63<br>64<br>77   | 10.07<br>04.07<br>02.08<br>04.07<br>04.07  | 04.13<br>04.13<br>04.13<br>04.13<br>04.13  | 13.0460-2834.2  | 602834   |  | 21463 18,0 /WK/S   | TRW                      |
|    | 1.4<br>1.6<br>1.5 dCi<br>1.5 dCi<br>1.6  | 55<br>64<br>50<br>63<br>77   | 10.07<br>04.07<br>04.07<br>02.08<br>04.07  | 04.13<br>04.13<br>04.13<br>04.13<br>04.13  | 24.0112-0116.1<br>24.0112-0171.1<br>24.0121-0106.1                                | 412116<br>412171<br>421106   | - ABS<br>+ ABS   | 238 12,0 10,5 +S +B<br>259 12,0 10,6 +S +B<br>259 20,6 17,7 V +S +B                |                          |
|    | 1.4<br>1.5 dCi<br>1.5 dCi<br>1.6<br>1.6  | 55<br>50<br>63<br>64<br>77   | 10.07<br>04.07<br>02.08<br>04.07<br>04.07  | 04.13<br>04.13<br>04.13<br>04.13<br>04.13  | 03.0137-0312.2<br>03.0137-9278.2<br>03.0137-0358.2<br>03.0137-9088.2              | 650312<br>669278<br>650358<br>669088   |  | 203 x 38 HEB<br>Bremsbacken-Zubehör<br>180 x 42 HEB<br>Bremsbacken-Zubehör         | TRW<br>TRW<br>BDX<br>BDX |
|    | 1.4<br>1.5 dCi<br>1.5 dCi<br>1.6<br>1.6  | 55<br>50<br>63<br>64<br>77   | 10.07<br>04.07<br>02.08<br>04.07<br>04.07  | 04.13<br>04.13<br>04.13<br>04.13<br>04.13  | 24.0218-0032.1<br>24.0220-3021.1<br>24.0220-3036.1                                | 480118<br>480127<br>480301   | + Trommeldurchmesser 180 mm <sup>1)</sup><br>- ABS<br>+ ABS/ ohne Sensorring <sup>2)</sup> | 180/181 x 53,5 - Lager<br>203/204,5 x 48 - Lager<br>203/204,5 x 50,5 - Lager       |                          |
|   | 1.4<br>1.5 dCi<br>1.5 dCi<br>1.6<br>1.6  | 55<br>50<br>63<br>64<br>77   | 10.07<br>04.07<br>02.08<br>04.07<br>04.07  | 04.13<br>04.13<br>04.13<br>04.13<br>04.13  | 03.0520-4719.3<br>03.0520-3517.3  | 694719<br>693517   |  | 19,05/180x42 TopKit<br>17,78/203x39 TopKit   | BDX<br>TRW               |
| <b>RENAULT LOGAN Express (07-13)</b>   |  |  |  |  |   |  |  |  |                          |
|  | 1.5 dCi<br>1.6<br>1.5 dCi<br>1.6   | 50<br>64<br>50<br>64   | 04.07<br>04.07<br>04.07<br>04.07   | 04.13<br>04.13<br>04.13<br>04.13   | 13.0460-7270.2  | 607270   |  | 24673 17,5 +   | ATE                      |
|  | 1.5 dCi<br>1.6   | 50<br>64   | 04.07<br>04.07   | 04.13<br>04.13   | 13.0460-2709.2<br>13.0470-2709.2  | 602709<br>LD2709   |  | 23973 17,4 /Zub/S<br>23973 17,4 /Zub/S   | TRW<br>TRW               |
|  | 1.5 dCi<br>1.6   | 50<br>64   | 04.07<br>04.07   | 04.13<br>04.13   | 24.0122-0216.1  | 422216   |  | 260 22,0 19,8 V L +S +B  |                          |
|  | 1.5 dCi<br>1.6   | 50<br>64   | 04.07<br>04.07   | 04.13<br>04.13   | 03.0137-0496.2  | 650496   |  | 228 x 42 HEB   | BDX                      |
|  | 1.5 dCi<br>1.6   | 50<br>64   | 04.07<br>04.07   | 04.13<br>04.13   | 03.0520-7222.3  | 697222   |  | 22,20/228x42 TopKit  |                          |
| <b>RENAULT LOGAN II (L52) (13-)</b>  |  |  |  |  |   |  |  |  |                          |
|  | 1.2<br>1.6<br>1.6  | 55<br>60<br>75   | 11.13<br>04.14<br>04.14  |  | 13.0460-7298.2  | 607298   |  | 25702 18,2 +   | ATE                      |
|  | 1.2<br>1.6<br>1.6  | 55<br>60<br>75   | 11.13<br>04.14<br>04.14  |  | 24.0112-0171.1<br>24.0122-0289.1  | 412171<br>422289   |  | 259 12,0 10,6 +S +B<br>258 22,0 19,8 V L +S +B                                     |                          |
|  | 1.2<br>1.6<br>1.6  | 55<br>60<br>75   | 11.13<br>04.14<br>04.14  |  | 24.0711-5369.3  | 360378   | 2     | Radsensor L=619  |                          |
|  | 1.2<br>1.6<br>1.6  | 55<br>60<br>75   | 11.13<br>04.14<br>04.14  |  | 03.0137-0532.2<br>03.0137-9274.2  | 650532<br>669274   |  | 203 x 39 HEB<br>Bremsbacken-Zubehör  | BOS<br>BOS               |
|  | 1.2<br>1.6<br>1.6  | 55<br>60<br>75   | 11.13<br>04.14<br>04.14  |  | 03.0137-0496.2<br>03.0137-9228.2  | 650496<br>669228   |  | 228 x 42 HEB<br>Bremsbacken-Zubehör  | BDX<br>BDX               |
|  | 1.2<br>1.6<br>1.6  | 55<br>60<br>75   | 11.13<br>04.14<br>04.14  |  | 03.0520-7919.3  | 697919   | + ABS  | 19,05/228x42 TopKit  |                          |
| <b>RENAULT LOGAN II Kombi (L52) (13-)</b>  |  |  |  |  |   |  |  |  |                          |
|  | 1.2 16V<br>1.2 16V LPG<br>1.5 dCi<br>1.6   | 54<br>53<br>62<br>59   | 12.13<br>12.13<br>12.13<br>12.13   |  | 13.0460-7298.2  | 607298   |  | 25702 18,2 +   | ATE                      |

<sup>1)</sup> + drum diameter 180 mm / + tamburi diametro 180 mm / + tambour diamètre 180 mm / + tambores diámetro 180 mm

<sup>2)</sup> + ABS/ without sensor ring / + ABS/ senza sensore / + ABS/ sans secours ABS / + ABS/ sin anillo sensor ABS

|     |   |        |  |    |  |  |  |                     |
|--|---|--|--|--|---|--|--|---|
| <b>RENAULT LOGAN II Kombi (L52) (13-)</b>  |   |  |  |  |   |  |  |   |
|    | 1.2 16V<br>1.2 16V LPG<br>1.5 dCi<br>1.6  | 54<br>53<br>62<br>59   |  | 12.13<br>12.13<br>12.13<br>12.13   |   | 24.0122-0289.1   | 422289   | 258 22,0 19,8 V L +S +B   |
|    | 1.2 16V<br>1.2 16V LPG<br>1.5 dCi<br>1.6  | 54<br>53<br>62<br>59   |  | 12.13<br>12.13<br>12.13<br>12.13   |   | 24.0711-5369.3   | 360378   | 2  Radsensor L=619 |
|    | 1.2 16V<br>1.2 16V LPG<br>1.5 dCi<br>1.6  | 54<br>53<br>62<br>59   |  | 12.13<br>12.13<br>12.13<br>12.13   |   | 03.0137-0532.2<br>03.0137-9274.2   | 650532<br>669274   | 203 x 39 HEB <b>BOS</b><br>Bremsbacken-Zubehör <b>BOS</b>   |
|    | 1.2 16V<br>1.2 16V LPG<br>1.5 dCi<br>1.6  | 54<br>53<br>62<br>59   |  | 12.13<br>12.13<br>12.13<br>12.13   |   | 03.0137-0496.2<br>03.0137-9228.2   | 650496<br>669228   | 228 x 42 HEB <b>BDX</b><br>Bremsbacken-Zubehör <b>BDX</b>   |
|    | 1.2 16V<br>1.2 16V LPG<br>1.5 dCi<br>1.6  | 54<br>53<br>62<br>59   |  | 12.13<br>12.13<br>12.13<br>12.13   |   | 03.0520-7919.3   | 697919   | + ABS<br><b>19,05/228x42 TopKit</b>   |
| <b>RENAULT MASCOTT (99-04)</b>   |   |  |  |  |   |  |  |   |
|    | 110.35<br>110.50<br>130.35<br>140.35<br>150.35  | 78<br>78<br>92<br>103<br>107   |  | 01.99 06.04<br>01.99 06.04<br>01.99 06.04<br>01.99 06.04<br>01.99 06.04  |   | 13.0460-4847.2   | 604847   | <b>29160</b> 20,3 /WE/Zub/S <b>BRE</b>  |
|    | 110.55<br>110.60<br>130.55<br>130.65<br>140.55<br>140.65<br>150.55<br>150.65<br>90.35   | 78<br>78<br>92<br>92<br>103<br>103<br>107<br>107<br>63                                 |  | 01.99 06.04<br>01.99 06.04<br>01.99 06.04<br>01.99 06.04<br>01.99 06.04<br>01.99 06.04<br>01.99 06.04<br>01.99 06.04<br>01.99 06.01  |   | 13.0460-4860.2   | 604860   | <b>29121</b> 20,3 +/WK/Zub <b>BRE</b>   |
|    | 110.35<br>110.50<br>130.35<br>140.35<br>150.35<br>90.35   | 78<br>78<br>92<br>103<br>107<br>63   |  | 01.99 06.04<br>01.99 06.04<br>01.99 06.04<br>01.99 06.04<br>01.99 06.04<br>01.99 06.01   |   | 24.0122-0266.1   | 422266   | 290 22,0 19,0 V L +B  |
|    | 110.55<br>110.60<br>130.55<br>130.65<br>140.55<br>140.65<br>150.55<br>150.65  | 78<br>78<br>92<br>92<br>103<br>103<br>107<br>107                                       |  | 01.99 06.04<br>01.99 06.04<br>01.99 06.04<br>01.99 06.04<br>01.99 06.04<br>01.99 06.04<br>01.99 06.04<br>01.99 06.04   |   | 24.0126-0161.1   | 426161   | 290 26,0 23,0 V L +B  |
|    | 110.35<br>110.50<br>110.55<br>110.60<br>130.35<br>130.55<br>130.65<br>140.35<br>140.55<br>140.65<br>150.35<br>150.55<br>150.65<br>90.35 | 78<br>78<br>78<br>78<br>92<br>92<br>92<br>103<br>103<br>103<br>107<br>107<br>107<br>63 |  | 01.99 06.04<br>01.99 06.04<br>01.99 06.04<br>01.99 06.04<br>01.99 06.04<br>01.99 06.04<br>01.99 06.04<br>01.99 06.04<br>01.99 06.04<br>01.01 06.04<br>01.99 06.04<br>01.99 06.04<br>10.01 06.04<br>01.99 06.01 |   | 13.0460-4860.2   | 604860   | <b>29121</b> 20,3 +/WK/Zub <b>BRE</b>   |
|  | 110.35<br>110.50<br>110.55<br>110.60<br>130.35<br>130.55<br>130.65<br>140.35<br>140.55<br>140.65<br>150.35<br>150.55<br>150.65<br>90.35 | 78<br>78<br>78<br>78<br>92<br>92<br>92<br>103<br>103<br>103<br>107<br>107<br>107<br>63 |  | 01.99 06.04<br>01.99 06.04<br>01.99 06.04<br>01.99 06.04<br>01.99 06.04<br>01.99 06.04<br>01.99 06.04<br>01.99 06.04<br>01.99 06.04<br>01.01 06.04<br>01.99 06.04<br>01.99 06.04<br>10.01 06.04<br>01.99 06.01 |   | 13.0460-4966.2   | 604966   | <b>29121</b> 20,3 /WE/S <b>BRE</b>  |
|  | 110.35<br>110.50<br>110.55<br>110.60<br>130.35<br>130.55<br>130.65<br>140.35<br>140.55<br>140.65<br>150.35<br>150.55                    | 78<br>78<br>78<br>78<br>92<br>92<br>92<br>103<br>103<br>103<br>107<br>107              |  | 01.99 06.04<br>01.99 06.04<br>01.99 06.04<br>01.99 06.04<br>01.99 06.04<br>01.99 06.04<br>01.99 06.04<br>01.99 06.04<br>01.99 06.04<br>01.01 06.04<br>01.99 06.04<br>01.99 06.04                               |   | 24.0122-0267.1   | 422267   | 290 22,0 19,0 V L +B  |
|  | 110.35<br>110.50<br>110.55<br>110.60<br>130.35<br>130.55<br>130.65<br>140.35<br>140.55<br>140.65<br>150.35<br>150.55                    | 78<br>78<br>78<br>78<br>92<br>92<br>92<br>103<br>103<br>103<br>107<br>107              |  | 01.99 06.04<br>01.99 06.04<br>01.99 06.04<br>01.99 06.04<br>01.99 06.04<br>01.99 06.04<br>01.99 06.04<br>01.99 06.04<br>01.99 06.04<br>01.01 06.04<br>01.99 06.04<br>01.99 06.04                               |   |  |  |   |

|     |   |                    |  |   |    |  |  |  |
|--|---|--|--|---|---|--|--|--|
| <b>RENAULT MASCOTT (99-04)</b>   |   |  |  |   |   |  |  |  |
|    | 150.65<br>90.35   | 107<br>63  |  | 10.01<br>01.99  | 06.04<br>06.01  | 24.0122-0267.1   | 422267   | 290 22,0 19,0 V L +B   |
| <b>RENAULT MASCOTT (04-10)</b>   |   |  |  |   |   |  |  |  |
|    | 120.35<br>120.55<br>160.35<br>160.55  | 85<br>85<br>115<br>115   |  | 05.04<br>05.04<br>05.04<br>05.04  | 12.10<br>12.10<br>12.10<br>12.10  | 13.0460-4966.2   | 604966   | 29121 20,3 /WE/S BRE   |
|    | 120.35<br>120.55<br>120.65<br>160.35<br>160.55<br>160.65  | 85<br>85<br>85<br>115<br>115<br>115  |  | 05.04<br>05.04<br>05.04<br>05.04<br>05.04<br>05.04  | 12.10<br>12.10<br>12.10<br>12.10<br>12.10<br>12.10  | 13.0460-4966.2   | 604966   | 29121 20,3 /WE/S BRE   |
| <b>RENAULT MASTER I Bus (80-98)</b>  |   |  |  |   |   |  |  |  |
|    | 2.0<br>2.0<br>2.1 D<br>2.2<br>2.4 D<br>2.4 D<br>2.5 D<br>2.5 TD<br>2.5 TD   | 58<br>59<br>44<br>67<br>52<br>53<br>55<br>69<br>72   |  | 10.86<br>08.80<br>08.80<br>08.80<br>08.80<br>09.86<br>08.89<br>08.89<br>08.89   | 07.98<br>09.86<br>07.98<br>07.98<br>08.89<br>10.89<br>07.98<br>07.98<br>07.98   | 13.0460-2824.2   | 602824   | 20380 15,6 +/-WK TRW   |
|    | 2.0<br>2.0<br>2.1 D<br>2.2<br>2.4 D<br>2.4 D<br>2.5 D<br>2.5 TD<br>2.5 TD   | 58<br>59<br>44<br>67<br>52<br>53<br>55<br>69<br>72   |  | 10.86<br>08.80<br>08.80<br>08.80<br>08.80<br>09.86<br>08.89<br>08.89<br>08.89   | 07.98<br>09.86<br>07.98<br>07.98<br>08.89<br>10.89<br>07.98<br>07.98<br>07.98   | 24.0124-0137.1   | 424137   | 278 24,0 22,0 V  |
|    | 2.0 (Q--)<br>2.0 (Q--)<br>2.0 (R--)<br>2.0 (R--)<br>2.1 D (Q--)<br>2.1 D (R--)<br>2.2 (Q--)<br>2.2 (R--)<br>2.4 D<br>2.4 D (Q--)<br>2.4 D (R--)<br>2.5 D (Q--)<br>2.5 D (R--)<br>2.5 TD (Q--)<br>2.5 TD (Q--)<br>2.5 TD (R--)<br>2.5 TD (R--) | 58<br>59<br>58<br>59<br>44<br>44<br>67<br>67<br>53<br>52<br>52<br>55<br>55<br>69<br>72<br>69<br>72 |  | 10.86<br>08.80<br>10.86<br>08.80<br>08.80<br>08.80<br>08.80<br>08.80<br>09.86<br>08.80<br>08.80<br>08.89<br>08.89<br>08.89<br>08.89<br>08.89<br>08.89 | 07.98<br>09.86<br>08.94<br>09.86<br>07.98<br>08.94<br>07.98<br>08.94<br>10.89<br>08.89<br>08.89<br>07.98<br>08.94<br>07.98<br>08.94<br>08.94<br>08.94 | 03.0137-0036.2<br>03.0137-9013.2   | 650036<br>669013   | 254 x 57<br>Bremsbacken-Zubehör TRW  |
|  | 2.0 (R--)<br>2.1 D (R--)<br>2.2 (R--)<br>2.5 D (R--)<br>2.5 TD (R--)<br>2.5 TD (R--)  | 58<br>44<br>67<br>55<br>69<br>72   |  | 09.94<br>09.94<br>09.94<br>09.94<br>09.94<br>09.94  | 07.98<br>07.98<br>07.98<br>07.98<br>07.98<br>07.98  | 03.0137-0330.2<br>03.0137-9216.2   | 650330<br>669216   | 254 x 57 HEB<br>Bremsbacken-Zubehör TRW  |
|  | 2.0 (Q--)<br>2.0 (Q--)<br>2.0 (R--)<br>2.0 (R--)<br>2.1 D (Q--)<br>2.1 D (R--)<br>2.2 (Q--)<br>2.2 (R--)<br>2.4 D<br>2.4 D (Q--)<br>2.4 D (R--)<br>2.5 D (Q--)<br>2.5 D (R--)<br>2.5 TD (Q--)<br>2.5 TD (Q--)<br>2.5 TD (R--)<br>2.5 TD (R--) | 58<br>59<br>58<br>59<br>44<br>44<br>67<br>67<br>53<br>52<br>52<br>55<br>55<br>69<br>72<br>69<br>72 |  | 10.86<br>08.80<br>10.86<br>08.80<br>08.80<br>08.80<br>08.80<br>08.80<br>09.86<br>08.80<br>08.80<br>08.89<br>08.89<br>08.89<br>08.89<br>08.89<br>08.89 | 07.98<br>09.86<br>08.94<br>09.86<br>07.98<br>08.94<br>07.98<br>08.94<br>10.89<br>08.89<br>08.89<br>07.98<br>08.94<br>07.98<br>07.98<br>08.94<br>08.94 | 03.0520-0125.3   | 690125   | 25,40/254x57 TopKit TRW  |
|  | 2.0 (R--)<br>2.1 D (R--)<br>2.2 (R--)<br>2.5 D (R--)<br>2.5 TD (R--)<br>2.5 TD (R--)  | 58<br>44<br>67<br>55<br>69<br>72   |  | 09.94<br>09.94<br>09.94<br>09.94<br>09.94<br>09.94  | 07.98<br>07.98<br>07.98<br>07.98<br>07.98<br>07.98  | 03.0520-0125.3   | 690125   | 25,40/254x57 TopKit TRW  |



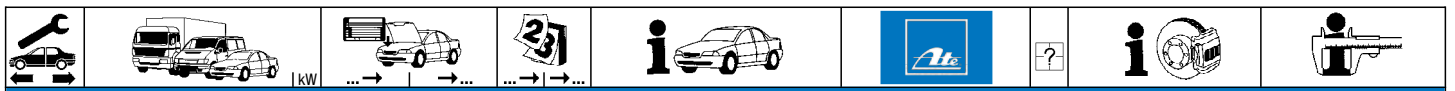

**RENAULT MASTER I Kasten (80-98)**

|  |  |  |  |  |  |  |  |                                     |            |
|--|--|--|--|--|--|--|--|-------------------------------------|------------|
|  | 2.0<br>2.0<br>2.1 D<br>2.2<br>2.4 D<br>2.5 D<br>2.5 TD<br>2.5 TD   | 58<br>59<br>44<br>67<br>52<br>55<br>69<br>72   |  | 10.86 07.98<br>08.80 09.86<br>08.80 07.98<br>08.80 07.98<br>08.80 08.89<br>08.89 07.98<br>08.89 07.98<br>08.89 07.98   | 13.0460-2824.2 602824                          |  |  | 20380 15,6 +WK                      | TRW        |
|  | 2.0<br>2.0<br>2.1 D<br>2.2<br>2.4 D<br>2.5 D<br>2.5 TD<br>2.5 TD   | 58<br>59<br>44<br>67<br>52<br>55<br>69<br>72   |  | 10.86 07.98<br>08.80 09.86<br>08.80 07.98<br>08.80 07.98<br>08.80 08.89<br>08.89 07.98<br>08.89 07.98<br>08.89 07.98   | 24.0124-0137.1 424137                          |  |  | 278 24,0 22,0 V                     |            |
|  | 2.0 (Q--)<br>2.0 (Q--)<br>2.0 (R--)<br>2.0 (R--)<br>2.1 D (Q--)<br>2.1 D (R--)<br>2.2 (Q--)<br>2.2 (R--)<br>2.4 D (Q--)<br>2.4 D (R--)<br>2.5 D (Q--)<br>2.5 D (R--)<br>2.5 TD (Q--)<br>2.5 TD (Q--)<br>2.5 TD (R--)<br>2.5 TD (R--) | 58<br>59<br>58<br>59<br>44<br>44<br>67<br>67<br>52<br>52<br>55<br>55<br>69<br>72<br>69<br>72 |  | 10.86 07.98<br>08.80 09.86<br>10.86 08.94<br>08.80 09.86<br>08.80 07.98<br>08.80 08.94<br>08.80 07.98<br>08.80 08.94<br>08.80 08.89<br>08.80 08.89<br>08.89 07.98<br>08.89 08.94<br>08.89 07.98<br>08.89 07.98<br>08.89 08.94<br>08.89 08.94 | 03.0137-0036.2 650036<br>03.0137-9013.2 669013 |  |  | 254 x 57<br>Bremsbacken-Zubehör     | TRW<br>TRW |
|  | 2.0 (R--)<br>2.1 D (R--)<br>2.2 (R--)<br>2.5 D (R--)<br>2.5 TD (R--)<br>2.5 TD (R--)   | 58<br>44<br>67<br>55<br>69<br>72   |  | 09.94 07.98<br>09.94 07.98<br>09.94 07.98<br>09.94 07.98<br>09.94 07.98<br>09.94 07.98   | 03.0137-0330.2 650330<br>03.0137-9216.2 669216 |  |  | 254 x 57 HEB<br>Bremsbacken-Zubehör | TRW<br>TRW |
|  | 2.0 (Q--)<br>2.0 (Q--)<br>2.0 (R--)<br>2.0 (R--)<br>2.1 D (Q--)<br>2.1 D (R--)<br>2.2 (Q--)<br>2.2 (R--)<br>2.4 D (Q--)<br>2.4 D (R--)<br>2.5 D (Q--)<br>2.5 D (R--)<br>2.5 TD (Q--)<br>2.5 TD (Q--)<br>2.5 TD (R--)<br>2.5 TD (R--) | 58<br>59<br>58<br>59<br>44<br>44<br>67<br>67<br>52<br>52<br>55<br>55<br>69<br>72<br>69<br>72 |  | 10.86 07.98<br>08.80 09.86<br>10.86 08.94<br>08.80 09.86<br>08.80 07.98<br>08.80 08.94<br>08.80 07.98<br>08.80 08.94<br>08.80 08.89<br>08.80 08.89<br>08.89 07.98<br>08.89 08.94<br>08.89 07.98<br>08.89 07.98<br>08.89 08.94<br>08.89 08.94 | 03.0520-0125.3 690125                          |  |  | 25,40/254x57 TopKit                 | TRW        |
|  | 2.0 (R--)<br>2.1 D (R--)<br>2.2 (R--)<br>2.5 D (R--)<br>2.5 TD (R--)<br>2.5 TD (R--)   | 58<br>44<br>67<br>55<br>69<br>72   |  | 09.94 07.98<br>09.94 07.98<br>09.94 07.98<br>09.94 07.98<br>09.94 07.98<br>09.94 07.98   | 03.0520-0125.3 690125                          |  |  | 25,40/254x57 TopKit                 | TRW        |

**RENAULT MASTER I Pritsche/Fahrgestell (80-98)**

|  |  |                                  |  |  |  |  |  |                                     |            |
|--|--|----------------------------------|--|--|--|--|--|-------------------------------------|------------|
|  | 2.0<br>2.0<br>2.5 D  | 58<br>59<br>55                   |  | 10.86 07.98<br>10.82 09.86<br>08.89 07.98  | 13.0460-2824.2 602824                          |  |  | 20380 15,6 +WK                      | TRW        |
|  | 2.0<br>2.0<br>2.5 D  | 58<br>59<br>55                   |  | 10.86 07.98<br>10.82 09.86<br>08.89 07.98  | 24.0124-0137.1 424137                          |  |  | 278 24,0 22,0 V                     |            |
|  | 2.0 (Q--)<br>2.0 (Q--)<br>2.0 (R--)<br>2.0 (R--)<br>2.5 D (Q--)<br>2.5 D (R--) | 58<br>59<br>58<br>59<br>55<br>55 |  | 10.86 07.98<br>10.82 09.86<br>10.86 08.94<br>10.82 09.86<br>08.89 07.98<br>08.89 08.94 | 03.0137-0036.2 650036<br>03.0137-9013.2 669013 |  |  | 254 x 57<br>Bremsbacken-Zubehör     | TRW<br>TRW |
|  | 2.0 (R--)<br>2.5 D (R--)   | 58<br>55                         |  | 09.94 07.98<br>09.94 07.98   | 03.0137-0330.2 650330<br>03.0137-9216.2 669216 |  |  | 254 x 57 HEB<br>Bremsbacken-Zubehör | TRW<br>TRW |
|  | 2.0 (Q--)<br>2.0 (Q--)<br>2.0 (R--)<br>2.0 (R--)<br>2.5 D (Q--)<br>2.5 D (R--) | 58<br>59<br>58<br>59<br>55<br>55 |  | 10.86 07.98<br>10.82 09.86<br>10.86 08.94<br>10.82 09.86<br>08.89 07.98<br>08.89 08.94 | 03.0520-0125.3 690125                          |  |  | 25,40/254x57 TopKit                 | TRW        |
|  | 2.0 (R--)<br>2.5 D (R--)   | 58<br>55                         |  | 09.94 07.98<br>09.94 07.98   | 03.0520-0125.3 690125                          |  |  | 25,40/254x57 TopKit                 | TRW        |





### RENAULT MASTER II Bus (JD/ND\_) (98-06)

|             |             |    |       |       |       |                |                |        |   |                         |                          |            |
|-------------|-------------|----|-------|-------|-------|----------------|----------------|--------|---|-------------------------|--------------------------|------------|
|             | 2.5 D       | 59 |       | 07.98 | 07.00 |                | 13.0460-3946.2 | 603946 |   |                         | 23302 18,0 /WE           | <b>BDX</b> |
|             | 2.8 dTi     | 84 |       | 07.98 | 07.00 |                |                |        |   |                         |                          |            |
|             | 1.9 dCi 80  | 60 |       | 11.01 | 08.06 |                | 13.0460-3800.2 | 603800 |   |                         | 23613 17,7               | <b>BOS</b> |
|             | 1.9 dTi     | 59 |       | 09.00 | 08.06 |                |                |        |   |                         |                          |            |
|             | 2.2 dCi 90  | 66 |       | 09.00 | 08.06 |                |                |        |   |                         |                          |            |
|             | 2.5 D       | 59 |       | 08.00 | 01.01 |                |                |        |   |                         |                          |            |
|             | 2.5 dCi 100 | 73 |       | 10.03 | 08.06 |                |                |        |   |                         |                          |            |
|             | 2.5 dCi 120 | 84 |       | 10.01 | 08.06 |                |                |        |   |                         |                          |            |
| 2.8 dTi     | 84          |    | 08.00 | 10.01 |       |                |                |        |   |                         |                          |            |
|             | 2.5 D       | 59 |       | 07.98 | 07.00 |                | 24.0124-0162.1 | 424162 |   | + 15" Rad <sup>1)</sup> | 280 24,0 21,0 V +B       |            |
|             | 2.8 dTi     | 84 |       | 07.98 | 07.00 |                |                |        |   |                         |                          |            |
|             | 1.9 dCi 80  | 60 |       | 11.01 | 08.06 |                | 24.0128-0129.1 | 428129 |   | + 16" Rad <sup>2)</sup> | 306 28,0 25,0 V +S +B    |            |
|             | 1.9 dTi     | 59 |       | 09.00 | 08.06 |                | 24.0328-0129.1 | 528129 |   | + 16" Rad <sup>2)</sup> | 306 28,0 25,0 V +S +B PD |            |
|             | 2.2 dCi 90  | 66 |       | 09.00 | 08.06 |                |                |        |   |                         |                          |            |
|             | 2.5 D       | 59 |       | 08.00 | 01.01 |                |                |        |   |                         |                          |            |
|             | 2.5 dCi 100 | 73 |       | 10.03 | 08.06 |                |                |        |   |                         |                          |            |
|             | 2.5 dCi 120 | 84 |       | 10.01 | 08.06 |                |                |        |   |                         |                          |            |
| 2.8 dTi     | 84          |    | 08.00 | 10.01 |       |                |                |        |   |                         |                          |            |
|             | 1.9 dCi 80  | 60 |       | 11.01 | 10.02 |                | 24.0711-6004.3 | 360231 | 2 |                         | Radsensor L=476          |            |
|             | 1.9 dTi     | 59 |       | 09.00 | 10.02 |                |                |        |   |                         |                          |            |
|             | 2.2 dCi 90  | 66 |       | 09.00 | 10.02 |                |                |        |   |                         |                          |            |
|             | 2.5 D       | 59 |       | 07.98 | 01.01 |                |                |        |   |                         |                          |            |
|             | 2.5 dCi 100 | 73 |       | 10.01 | 10.02 |                |                |        |   |                         |                          |            |
|             | 2.5 dCi 120 | 84 |       | 07.98 | 10.01 |                |                |        |   |                         |                          |            |
|             | 2.8 dTi     | 84 |       | 07.98 | 10.01 |                |                |        |   |                         |                          |            |
|             | 1.9 dCi 80  | 60 |       | 11.02 | 08.06 |                | 24.0711-6161.3 | 360138 | 2 |                         | Radsensor L=486          |            |
| 1.9 dTi     | 59          |    | 11.02 | 08.06 |       |                |                |        |   |                         |                          |            |
| 2.2 dCi 90  | 66          |    | 11.02 | 08.06 |       |                |                |        |   |                         |                          |            |
| 2.5 D       | 59          |    | 10.03 | 08.06 |       |                |                |        |   |                         |                          |            |
| 2.5 dCi 100 | 73          |    | 10.03 | 08.06 |       |                |                |        |   |                         |                          |            |
| 2.5 dCi 120 | 84          |    | 11.02 | 08.06 |       |                |                |        |   |                         |                          |            |
|             | 1.9 dCi 80  | 60 |       | 11.01 | 08.06 |                | 13.0460-3806.2 | 603806 |   |                         | 23669 16,8 /S            | <b>BOS</b> |
|             | 1.9 dTi     | 59 |       | 09.00 | 08.06 |                |                |        |   |                         |                          |            |
|             | 2.2 dCi 90  | 66 |       | 09.00 | 08.06 |                |                |        |   |                         |                          |            |
|             | 2.5 D       | 59 |       | 07.98 | 01.01 |                |                |        |   |                         |                          |            |
|             | 2.5 dCi 100 | 73 |       | 10.03 | 08.06 |                |                |        |   |                         |                          |            |
|             | 2.5 dCi 120 | 84 |       | 10.01 | 08.06 |                |                |        |   |                         |                          |            |
|             | 2.8 dTi     | 84 |       | 07.98 | 10.01 |                |                |        |   |                         |                          |            |
|             | 1.9 dCi 80  | 60 |       | 11.01 | 08.06 |                | 24.0112-0155.1 | 412155 |   |                         | 305 12,0 10,5 +S +B      |            |
| 1.9 dTi     | 59          |    | 09.00 | 08.06 |       |                |                |        |   |                         |                          |            |
| 2.2 dCi 90  | 66          |    | 09.00 | 08.06 |       |                |                |        |   |                         |                          |            |
| 2.5 D       | 59          |    | 07.98 | 01.01 |       |                |                |        |   |                         |                          |            |
| 2.5 dCi 100 | 73          |    | 10.03 | 08.06 |       |                |                |        |   |                         |                          |            |
| 2.5 dCi 120 | 84          |    | 10.01 | 08.06 |       |                |                |        |   |                         |                          |            |
| 2.8 dTi     | 84          |    | 07.98 | 10.01 |       |                |                |        |   |                         |                          |            |
|             | 1.9 dCi 80  | 60 |       | 11.01 | 08.06 |                | 24.0711-5161.3 | 360112 | 2 |                         | Radsensor L=1086         |            |
|             | 1.9 dTi     | 59 |       | 09.00 | 08.06 |                |                |        |   |                         |                          |            |
|             | 2.2 dCi 90  | 66 |       | 09.00 | 08.06 |                |                |        |   |                         |                          |            |
|             | 2.5 D       | 59 |       | 07.99 | 01.01 |                |                |        |   |                         |                          |            |
|             | 2.5 dCi 100 | 73 |       | 10.03 | 08.06 |                |                |        |   |                         |                          |            |
|             | 2.5 dCi 120 | 84 |       | 10.01 | 08.06 |                |                |        |   |                         |                          |            |
|             | 2.8 dTi     | 84 |       | 07.99 | 10.01 |                |                |        |   |                         |                          |            |
|             | 2.5 D       | 59 |       | 07.98 | 07.00 |                | 03.0137-0382.2 | 650382 |   |                         | 280 x 65                 |            |
| 2.8 dTi     | 84          |    | 07.98 | 07.00 |       | 03.0137-9240.2 | 669240         |        |   | Bremsbacken-Zubehör     |                          |            |
|             | 2.5 D       | 59 |       | 07.98 | 07.00 |                | 24.0228-0002.1 | 480159 |   |                         | 280/282 x 69,5           |            |
|             | 2.8 dTi     | 84 |       | 07.98 | 07.00 |                |                |        |   |                         |                          |            |

### RENAULT MASTER II Kasten (FD\_) (98-06)

|             |             |    |       |       |       |  |                |        |  |  |                          |            |
|-------------|-------------|----|-------|-------|-------|--|----------------|--------|--|--|--------------------------|------------|
|             | 2.5 D       | 59 |       | 07.98 | 07.00 |  | 13.0460-3946.2 | 603946 |  |  | 23302 18,0 /WE           | <b>BDX</b> |
|             | 2.8 dTi     | 84 |       | 07.98 | 07.00 |  |                |        |  |  |                          |            |
|             | 1.9 dCi 80  | 60 |       | 11.01 | 08.06 |  | 13.0460-3800.2 | 603800 |  |  | 23613 17,7               | <b>BOS</b> |
|             | 1.9 dTi     | 59 |       | 11.01 | 08.06 |  |                |        |  |  |                          |            |
|             | 2.2 dCi 90  | 65 |       | 11.01 | 08.06 |  |                |        |  |  |                          |            |
|             | 2.5 D       | 59 |       | 08.00 | 01.01 |  |                |        |  |  |                          |            |
|             | 2.5 dCi 100 | 73 |       | 10.03 | 08.06 |  |                |        |  |  |                          |            |
|             | 2.5 dCi 120 | 84 |       | 10.01 | 08.06 |  |                |        |  |  |                          |            |
|             | 2.8 dTi     | 84 |       | 08.00 | 10.01 |  |                |        |  |  |                          |            |
|             | 3.0 dCi 120 | 85 |       | 06.05 | 08.06 |  |                |        |  |  |                          |            |
| 3.0 dCi 140 | 100         |    | 10.03 | 08.06 |       |  |                |        |  |  |                          |            |
| 3.0 dCi 160 | 115         |    | 06.05 | 08.06 |       |  |                |        |  |  |                          |            |
|             | 2.5 D       | 59 |       | 07.98 | 07.00 |  | 24.0124-0162.1 | 424162 |  |  | 280 24,0 21,0 V +B       |            |
|             | 2.8 dTi     | 84 |       | 07.98 | 07.00 |  |                |        |  |  |                          |            |
|             | 1.9 dCi 80  | 60 |       | 11.01 | 08.06 |  | 24.0128-0129.1 | 428129 |  |  | 306 28,0 25,0 V +S +B    |            |
|             | 1.9 dTi     | 59 |       | 09.00 | 08.06 |  | 24.0328-0129.1 | 528129 |  |  | 306 28,0 25,0 V +S +B PD |            |
|             | 2.2 dCi 90  | 65 |       | 09.00 | 08.06 |  |                |        |  |  |                          |            |
|             | 2.5 D       | 59 |       | 08.00 | 01.01 |  |                |        |  |  |                          |            |
|             | 2.5 dCi 100 | 73 |       | 10.03 | 08.06 |  |                |        |  |  |                          |            |
|             | 2.5 dCi 120 | 84 |       | 10.01 | 08.06 |  |                |        |  |  |                          |            |
|             | 2.8 dTi     | 84 |       | 08.00 | 10.01 |  |                |        |  |  |                          |            |
|             | 3.0 dCi 120 | 85 |       | 06.05 | 08.06 |  |                |        |  |  |                          |            |
| 3.0 dCi 140 | 100         |    | 10.03 | 08.06 |       |  |                |        |  |  |                          |            |
| 3.0 dCi 160 | 115         |    | 06.05 | 08.06 |       |  |                |        |  |  |                          |            |

<sup>1)</sup> + 15" wheel / + ruota 15" / + roue 15" / + rueda 15"

<sup>2)</sup> + 16" wheel / + ruota 16" / + roue 16" / + rueda 16"







































**RENAULT MASTER II Kasten (FD\_) (98-06)**

















|             |             |    |       |       |       |                |        |   |  |                                 |
|-------------|-------------|----|-------|-------|-------|----------------|--------|---|--|---------------------------------|
|             | 1.9 dCi 80  | 60 |       | 11.01 | 10.02 | 24.0711-6004.3 | 360231 | 2 |  | Radsensor L=476                 |
|             | 1.9 dTi     | 59 |       | 09.00 | 10.02 |                |        |   |  |                                 |
|             | 2.2 dCi 90  | 65 |       | 09.00 | 10.02 |                |        |   |  |                                 |
|             | 2.5 D       | 59 |       | 07.98 | 01.01 |                |        |   |  |                                 |
|             | 2.5 dCi 120 | 84 |       | 10.01 | 10.02 |                |        |   |  |                                 |
|             | 2.8 dTi     | 84 |       | 07.98 | 10.01 |                |        |   |  |                                 |
|             | 1.9 dCi 80  | 60 |       | 11.02 | 08.06 |                |        |   |  |                                 |
| 1.9 dTi     | 59          |    | 11.02 | 08.06 |       |                |        |   |  |                                 |
| 2.2 dCi 90  | 65          |    | 11.02 | 08.06 |       |                |        |   |  |                                 |
| 2.5 dCi 100 | 73          |    | 10.03 | 08.06 |       |                |        |   |  |                                 |
| 2.5 dCi 120 | 84          |    | 11.02 | 08.06 |       |                |        |   |  |                                 |
| 3.0 dCi 120 | 85          |    | 06.05 | 08.06 |       |                |        |   |  |                                 |
| 3.0 dCi 140 | 100         |    | 10.03 | 08.06 |       |                |        |   |  |                                 |
| 3.0 dCi 160 | 115         |    | 06.05 | 08.06 |       |                |        |   |  |                                 |
|             | 1.9 dCi 80  | 60 |       | 11.01 | 08.06 | 13.0460-3806.2 | 603806 |   |  | 23669 16,8 /S <b>BOS</b>        |
|             | 1.9 dTi     | 59 |       | 09.00 | 08.06 |                |        |   |  |                                 |
|             | 2.2 dCi 90  | 65 |       | 09.00 | 08.06 |                |        |   |  |                                 |
|             | 2.5 D       | 59 |       | 08.00 | 01.01 |                |        |   |  |                                 |
|             | 2.5 dCi 100 | 73 |       | 10.03 | 08.06 |                |        |   |  |                                 |
|             | 2.5 dCi 120 | 84 |       | 10.01 | 08.06 |                |        |   |  |                                 |
|             | 2.8 dTi     | 84 |       | 08.00 | 10.01 |                |        |   |  |                                 |
| 3.0 dCi 120 | 85          |    | 06.05 | 08.06 |       |                |        |   |  |                                 |
| 3.0 dCi 140 | 100         |    | 10.03 | 08.06 |       |                |        |   |  |                                 |
| 3.0 dCi 160 | 115         |    | 06.05 | 08.06 |       |                |        |   |  |                                 |
|             | 1.9 dCi 80  | 60 |       | 11.01 | 08.06 | 24.0112-0155.1 | 412155 |   |  | 305 12,0 10,5 +S +B             |
|             | 1.9 dTi     | 59 |       | 09.00 | 08.06 |                |        |   |  |                                 |
|             | 2.2 dCi 90  | 65 |       | 09.00 | 08.06 |                |        |   |  |                                 |
|             | 2.5 D       | 59 |       | 08.00 | 01.01 |                |        |   |  |                                 |
|             | 2.5 dCi 100 | 73 |       | 10.03 | 08.06 |                |        |   |  |                                 |
|             | 2.5 dCi 120 | 84 |       | 10.01 | 08.06 |                |        |   |  |                                 |
|             | 2.8 dTi     | 84 |       | 08.00 | 10.01 |                |        |   |  |                                 |
| 3.0 dCi 120 | 85          |    | 06.05 | 08.06 |       |                |        |   |  |                                 |
| 3.0 dCi 140 | 100         |    | 10.03 | 08.06 |       |                |        |   |  |                                 |
| 3.0 dCi 160 | 115         |    | 06.05 | 08.06 |       |                |        |   |  |                                 |
|             | 1.9 dCi 80  | 60 |       | 11.03 | 08.06 | 24.0711-5161.3 | 360112 | 2 |  | Radsensor L=1086                |
|             | 1.9 dTi     | 59 |       | 11.01 | 08.06 |                |        |   |  |                                 |
|             | 2.2 dCi 90  | 65 |       | 09.00 | 08.06 |                |        |   |  |                                 |
|             | 2.5 D       | 59 |       | 07.99 | 01.01 |                |        |   |  |                                 |
|             | 2.5 dCi 100 | 73 |       | 10.03 | 08.06 |                |        |   |  |                                 |
|             | 2.5 dCi 120 | 84 |       | 10.01 | 08.06 |                |        |   |  |                                 |
|             | 2.8 dTi     | 84 |       | 07.99 | 10.01 |                |        |   |  |                                 |
| 3.0 dCi 120 | 85          |    | 06.05 | 08.06 |       |                |        |   |  |                                 |
| 3.0 dCi 140 | 100         |    | 10.03 | 08.06 |       |                |        |   |  |                                 |
| 3.0 dCi 160 | 115         |    | 06.05 | 08.06 |       |                |        |   |  |                                 |
|             | 2.5 D       | 59 |       | 07.98 | 07.00 | 03.0137-0382.2 | 650382 |   |  | 280 x 65<br>Bremsbacken-Zubehör |
|             | 2.8 dTi     | 84 |       | 07.98 | 07.00 |                |        |   |  |                                 |
|             | 2.5 D       | 59 |       | 07.98 | 07.00 | 24.0228-0002.1 | 480159 |   |  | 280/282 x 69,5                  |
|             | 2.8 dTi     | 84 |       | 07.98 | 07.00 |                |        |   |  |                                 |

**RENAULT MASTER II Pritsche/Fahrgestell (ED/HD/UD\_) (98-06)**

|             |             |     |       |       |       |                |        |   |  |                           |
|-------------|-------------|-----|-------|-------|-------|----------------|--------|---|--|---------------------------|
|             | 2.2 dCi 90  | 66  |       | 09.00 | 10.01 | 13.0460-3946.2 | 603946 |   |  | 23302 18,0 /WE <b>BDX</b> |
|             | 2.5 D       | 59  |       | 07.98 | 01.01 |                |        |   |  |                           |
|             | 2.8 dTi     | 84  |       | 07.98 | 10.01 |                |        |   |  |                           |
|             | 2.2 dCi 90  | 66  |       | 11.01 | 08.06 | 13.0460-3800.2 | 603800 |   |  | 23613 17,7 <b>BOS</b>     |
|             | 2.5 dCi 100 | 73  |       | 10.03 | 08.06 |                |        |   |  |                           |
|             | 2.5 dCi 120 | 84  |       | 10.01 | 08.06 |                |        |   |  |                           |
|             | 3.0 dCi 120 | 85  |       | 06.05 | 08.06 |                |        |   |  |                           |
|             | 3.0 dCi 140 | 100 |       | 10.03 | 08.06 |                |        |   |  |                           |
|             | 3.0 dCi 160 | 115 |       | 06.05 | 08.06 |                |        |   |  |                           |
|             | 2.2 dCi 90  | 66  |       | 11.01 | 08.06 |                |        |   |  |                           |
| 2.5 D       | 59          |     | 07.98 | 01.01 |       |                |        |   |  |                           |
| 2.8 dTi     | 84          |     | 07.98 | 07.00 |       |                |        |   |  |                           |
| 2.2 dCi 90  | 66          |     | 11.01 | 08.06 |       |                |        |   |  |                           |
| 2.5 dCi 100 | 73          |     | 10.03 | 08.06 |       |                |        |   |  |                           |
| 2.5 dCi 120 | 84          |     | 10.01 | 08.06 |       |                |        |   |  |                           |
| 2.8 dTi     | 84          |     | 08.00 | 08.01 |       |                |        |   |  |                           |
| 3.0 dCi 120 | 85          |     | 06.05 | 08.06 |       |                |        |   |  |                           |
| 3.0 dCi 140 | 100         |     | 10.03 | 08.06 |       |                |        |   |  |                           |
| 3.0 dCi 160 | 115         |     | 06.05 | 08.06 |       |                |        |   |  |                           |
|             | 2.2 dCi 90  | 66  |       | 09.00 | 10.02 | 24.0711-6004.3 | 360231 | 2 |  | Radsensor L=476           |
|             | 2.5 D       | 59  |       | 07.98 | 01.01 |                |        |   |  |                           |
|             | 2.5 dCi 120 | 84  |       | 10.01 | 10.02 |                |        |   |  |                           |
|             | 2.8 dTi     | 84  |       | 07.98 | 10.01 |                |        |   |  |                           |
|             | 2.2 dCi 90  | 66  |       | 11.02 | 08.06 | 24.0711-6161.3 | 360138 | 2 |  | Radsensor L=486           |
|             | 2.5 dCi 100 | 73  |       | 10.03 | 08.06 |                |        |   |  |                           |
|             | 2.5 dCi 120 | 84  |       | 11.02 | 08.06 |                |        |   |  |                           |
|             | 3.0 dCi 120 | 85  |       | 06.05 | 08.06 |                |        |   |  |                           |
|             | 3.0 dCi 140 | 100 |       | 10.03 | 08.06 |                |        |   |  |                           |
| 3.0 dCi 160 | 115         |     | 06.05 | 08.06 |       |                |        |   |  |                           |
|             | 2.2 dCi 90  | 66  |       | 09.00 | 08.06 | 13.0460-3806.2 | 603806 |   |  | 23669 16,8 /S <b>BOS</b>  |
|             | 2.5 D       | 59  |       | 08.00 | 01.01 |                |        |   |  |                           |
|             | 2.5 dCi 100 | 73  |       | 10.03 | 08.06 |                |        |   |  |                           |
|             | 2.5 dCi 120 | 84  |       | 10.01 | 08.06 |                |        |   |  |                           |
| ↓           | ↓           |     |       |       |       |                |        |   |  |                           |



|     |                           |  |  |  |  |  |       |  |
|--|---|--|--|--|---|--|---|--|
| <b>RENAULT MASTER II Pritsche/Fahrgestell (ED/HD/UD_) (98-06)</b>                  |   |  |  |  |   |  |   |  |
|    | 2.8 dTi<br>3.0 dCi 120<br>3.0 dCi 140<br>3.0 dCi 160  | 84<br>85<br>100<br>115   | 08.00<br>06.05<br>10.03<br>06.05   | 10.01<br>08.06<br>08.06<br>08.06   | 13.0460-3806.2  | 603806   |   | 23669 16,8 / S <b>BOS</b>  |
|    | 2.2 dCi 90<br>2.5 D<br>2.5 dCi 100<br>2.5 dCi 120<br>2.8 dTi<br>3.0 dCi 120<br>3.0 dCi 140<br>3.0 dCi 160 | 66<br>59<br>73<br>84<br>84<br>85<br>100<br>115                                   | 09.00<br>08.00<br>10.03<br>10.01<br>08.00<br>06.05<br>10.03<br>06.05             | 08.06<br>01.01<br>08.06<br>08.06<br>10.01<br>08.06<br>08.06<br>08.06             | 24.0112-0155.1  | 412155   |   | 305 12,0 10,5 +S +B  |
|    | 2.2 dCi 90<br>2.5 dCi 100<br>2.5 dCi 120<br>3.0 dCi 120<br>3.0 dCi 140<br>3.0 dCi 160                     | 66<br>73<br>84<br>85<br>100<br>115   | 09.00<br>10.03<br>10.01<br>06.05<br>10.03<br>06.05                               | 08.06<br>08.06<br>08.06<br>08.06<br>08.06<br>08.06                               | 24.0711-5161.3  | 360112   | 2    | Radsensor L=1086   |
|    | 2.5 D<br>2.8 dTi  | 59<br>84   | 07.98<br>07.98   | 07.00<br>07.00   | 03.0137-0382.2<br>03.0137-9240.2  | 650382<br>669240   |   | 280 x 65<br>Bremsbacken-Zubehör  |
|    | 2.5 D<br>2.8 dTi  | 59<br>84   | 07.98<br>07.98   | 07.00<br>07.00   | 24.0228-0002.1  | 480159   |   | 280/282 x 69,5   |
| <b>RENAULT MASTER II Bus (JD_) (06-10)</b>   |   |  |  |  |   |  |   |  |
|    | 2.5 dCi<br>2.5 dCi<br>2.5 dCi   | 74<br>88<br>107  | 08.06<br>08.06<br>08.06  | 12.10<br>12.10<br>12.10  | 13.0460-3800.2<br>13.0460-0344.2  | 603800<br>610344   |   | 23613 17,7 <b>BOS</b><br>Belagsatz-Zubehör   |
|    | 2.5 dCi<br>2.5 dCi<br>2.5 dCi   | 74<br>88<br>107  | 08.06<br>08.06<br>08.06  | 12.10<br>12.10<br>12.10  | 24.0128-0129.1<br>24.0328-0129.1  | 428129<br>528129   |   | 306 28,0 25,0 V +S +B<br>306 28,0 25,0 V +S +B PD                                  |
|    | 2.5 dCi<br>2.5 dCi<br>2.5 dCi   | 74<br>88<br>107  | 08.06<br>08.06<br>08.06  | 12.10<br>12.10<br>12.10  | 24.0711-6161.3  | 360138   | 2    | Radsensor L=486  |
|    | 2.5 dCi<br>2.5 dCi<br>2.5 dCi   | 74<br>88<br>107  | 08.06<br>08.06<br>08.06  | 12.10<br>12.10<br>12.10  | 13.0460-3806.2  | 603806   |   | 23669 16,8 / S <b>BOS</b>  |
|   | 2.5 dCi<br>2.5 dCi<br>2.5 dCi   | 74<br>88<br>107  | 08.06<br>08.06<br>08.06  | 12.10<br>12.10<br>12.10  | 24.0112-0155.1  | 412155   |   | 305 12,0 10,5 +S +B  |
|  | 2.5 dCi<br>2.5 dCi<br>2.5 dCi   | 74<br>88<br>107  | 08.06<br>08.06<br>08.06  | 12.10<br>12.10<br>12.10  | 24.0711-5161.3  | 360112   | 2  | Radsensor L=1086   |
| <b>RENAULT MASTER II Kasten (FD_) (06-10)</b>                                      |   |  |  |  |   |  |   |  |
|  | 2.5 dCi<br>2.5 dCi<br>2.5 dCi   | 74<br>88<br>107  | 08.06<br>08.06<br>08.06  | 12.10<br>12.10<br>12.10  | 13.0460-3800.2<br>13.0460-0344.2  | 603800<br>610344   |   | 23613 17,7 <b>BOS</b><br>Belagsatz-Zubehör   |
|  | 2.5 dCi<br>2.5 dCi<br>2.5 dCi   | 74<br>88<br>107  | 08.06<br>08.06<br>08.06  | 12.10<br>12.10<br>12.10  | 24.0128-0129.1<br>24.0328-0129.1  | 428129<br>528129   |   | 306 28,0 25,0 V +S +B<br>306 28,0 25,0 V +S +B PD                                  |
|  | 2.5 dCi<br>2.5 dCi<br>2.5 dCi   | 74<br>88<br>107  | 08.06<br>08.06<br>08.06  | 12.10<br>12.10<br>12.10  | 24.0711-6161.3  | 360138   | 2  | Radsensor L=486  |
|  | 2.5 dCi<br>2.5 dCi<br>2.5 dCi   | 74<br>88<br>107  | 08.06<br>08.06<br>08.06  | 12.10<br>12.10<br>12.10  | 13.0460-3806.2  | 603806   |   | 23669 16,8 / S <b>BOS</b>  |
|  | 2.5 dCi<br>2.5 dCi<br>2.5 dCi   | 74<br>88<br>107  | 08.06<br>08.06<br>08.06  | 12.10<br>12.10<br>12.10  | 24.0112-0155.1  | 412155   |   | 305 12,0 10,5 +S +B  |
|  | 2.5 dCi<br>2.5 dCi<br>2.5 dCi   | 74<br>88<br>107  | 08.06<br>08.06<br>08.06  | 12.10<br>12.10<br>12.10  | 24.0711-5161.3  | 360112   | 2  | Radsensor L=1086   |
| <b>RENAULT MASTER II Pritsche/Fahrgestell (ED/HD/UD_) (06-10)</b>                  |   |  |  |  |   |  |   |  |
|  | 2.5 dCi<br>2.5 dCi<br>2.5 dCi   | 74<br>88<br>107  | 08.06<br>08.06<br>08.06  | 12.10<br>12.10<br>12.10  | 13.0460-3800.2<br>13.0460-0344.2  | 603800<br>610344   |   | 23613 17,7 <b>BOS</b><br>Belagsatz-Zubehör   |
|  | 2.5 dCi<br>2.5 dCi<br>2.5 dCi   | 74<br>88<br>107  | 08.06<br>08.06<br>08.06  | 12.10<br>12.10<br>12.10  | 24.0128-0129.1<br>24.0328-0129.1  | 428129<br>528129   |   | 306 28,0 25,0 V +S +B<br>306 28,0 25,0 V +S +B PD                                  |
|  | 2.5 dCi<br>2.5 dCi<br>2.5 dCi   | 74<br>88<br>107  | 08.06<br>08.06<br>08.06  | 12.10<br>12.10<br>12.10  | 24.0711-6161.3  | 360138   | 2  | Radsensor L=486  |
|  | 2.5 dCi<br>2.5 dCi<br>2.5 dCi   | 74<br>88<br>107  | 08.06<br>08.06<br>08.06  | 12.10<br>12.10<br>12.10  | 13.0460-3806.2  | 603806   |   | 23669 16,8 / S <b>BOS</b>  |
|  | 2.5 dCi<br>2.5 dCi<br>2.5 dCi   | 74<br>88<br>107  | 08.06<br>08.06<br>08.06  | 12.10<br>12.10<br>12.10  | 24.0112-0155.1  | 412155   |   | 305 12,0 10,5 +S +B  |

|     |   |           |    |    |  |  |  |  |
|--|---|---|--|--|---|--|--|--|
| <b>RENAULT MASTER II Pritsche/Fahrgestell (ED/HD/UD_) (06-10)</b>                  |   |   |  |  |   |  |  |  |
|    | 2.5 dCi<br>2.5 dCi<br>2.5 dCi   | 74<br>88<br>107   | 08.06<br>12.10<br>08.06  | 12.10<br>12.10<br>12.10  | 24.0711-5161.3  | 360112   | 2  | Radsensor L=1086   |
| <b>RENAULT MASTER III Kasten/Bus (FV/JV) (10-)</b>                                 |   |   |  |  |   |  |  |  |
|    | 2.3 dCi FWD<br>2.3 dCi FWD<br>2.3 dCi FWD<br>2.3 dCi FWD<br>2.3 dCi FWD<br>2.3 dCi FWD<br>2.3 dCi FWD<br>2.3 dCi RWD<br>2.3 dCi RWD<br>2.3 dCi RWD<br>2.3 dCi RWD<br>2.3 dCi RWD<br>2.3 dCi RWD<br>2.3 dCi RWD<br>2.3 dCi RWD | 74<br>81<br>92<br>100<br>107<br>110<br>120<br>74<br>92<br>100<br>107<br>110<br>120<br>125 | 02.10<br>09.14<br>02.10<br>07.14<br>02.10<br>01.13<br>07.14<br>02.10<br>02.10<br>07.14<br>02.10<br>01.13<br>07.14<br>07.15 |  | 13.0460-4856.2  | 604856   |  | 25147 18,4 +/WK <b>BRE</b>   |
|    | 2.3 dCi FWD<br>2.3 dCi FWD<br>2.3 dCi FWD<br>2.3 dCi FWD<br>2.3 dCi FWD<br>2.3 dCi FWD<br>2.3 dCi FWD<br>2.3 dCi RWD<br>2.3 dCi RWD<br>2.3 dCi RWD<br>2.3 dCi RWD<br>2.3 dCi RWD<br>2.3 dCi RWD<br>2.3 dCi RWD<br>2.3 dCi RWD | 74<br>81<br>92<br>100<br>107<br>110<br>120<br>74<br>92<br>100<br>107<br>110<br>120<br>125 | 02.10<br>09.14<br>02.10<br>07.14<br>02.10<br>01.13<br>07.14<br>02.10<br>02.10<br>07.14<br>02.10<br>01.13<br>07.14<br>07.15 |  | 24.0128-0252.1  | 428252   |  | 302 28,0 24,5 V +S +B  |
|    | 2.3 dCi FWD<br>2.3 dCi FWD<br>2.3 dCi FWD<br>2.3 dCi FWD<br>2.3 dCi FWD<br>2.3 dCi FWD<br>2.3 dCi FWD<br>2.3 dCi RWD<br>2.3 dCi RWD<br>2.3 dCi RWD<br>2.3 dCi RWD<br>2.3 dCi RWD<br>2.3 dCi RWD<br>2.3 dCi RWD<br>2.3 dCi RWD | 74<br>81<br>92<br>100<br>107<br>110<br>120<br>74<br>92<br>100<br>107<br>110<br>120<br>125 | 02.10<br>09.14<br>02.10<br>07.14<br>02.10<br>01.13<br>07.14<br>02.10<br>02.10<br>07.14<br>02.10<br>01.13<br>07.14<br>07.15 |  | 24.0711-5251.3  | 360343   | 2  | Radsensor L=703  |
|  | 2.3 dCi FWD<br>2.3 dCi FWD<br>2.3 dCi FWD<br>2.3 dCi FWD<br>2.3 dCi FWD<br>2.3 dCi FWD<br>2.3 dCi FWD<br>2.3 dCi RWD<br>2.3 dCi RWD<br>2.3 dCi RWD<br>2.3 dCi RWD<br>2.3 dCi RWD<br>2.3 dCi RWD<br>2.3 dCi RWD<br>2.3 dCi RWD | 74<br>81<br>92<br>100<br>107<br>110<br>120<br>74<br>92<br>100<br>107<br>110<br>120<br>125 | 02.10<br>09.14<br>02.10<br>07.14<br>02.10<br>01.13<br>07.14<br>02.10<br>02.10<br>07.14<br>02.10<br>01.13<br>07.14<br>07.15 | + Einfachbereifung <sup>1)</sup><br>+ Einfachbereifung <sup>1)</sup><br>+ Einfachbereifung <sup>1)</sup><br>+ Einfachbereifung <sup>1)</sup><br>+ Einfachbereifung <sup>1)</sup><br>+ Einfachbereifung <sup>1)</sup><br>+ Einfachbereifung <sup>1)</sup><br>+ Einfachbereifung <sup>1)</sup><br>+ Einfachbereifung <sup>1)</sup><br>+ Einfachbereifung <sup>1)</sup><br>+ Einfachbereifung <sup>1)</sup><br>+ Einfachbereifung <sup>1)</sup><br>+ Einfachbereifung <sup>1)</sup><br>+ Einfachbereifung <sup>1)</sup><br>+ Einfachbereifung <sup>1)</sup> | 13.0460-4858.2  | 604858   |  | 25112 18,4 +/WK <b>BRE</b>   |
|  | 2.3 dCi FWD<br>2.3 dCi FWD<br>2.3 dCi FWD<br>2.3 dCi FWD<br>2.3 dCi FWD<br>2.3 dCi FWD<br>2.3 dCi FWD<br>2.3 dCi RWD<br>2.3 dCi RWD<br>2.3 dCi RWD<br>2.3 dCi RWD<br>2.3 dCi RWD<br>2.3 dCi RWD<br>2.3 dCi RWD<br>2.3 dCi RWD | 74<br>81<br>92<br>100<br>107<br>110<br>120<br>74<br>92<br>100<br>107<br>110<br>120<br>125 | 02.10<br>09.14<br>02.10<br>07.14<br>02.10<br>01.13<br>07.14<br>02.10<br>02.10<br>07.14<br>02.10<br>01.13<br>07.14<br>07.15 | + Doppelbereifung <sup>2)</sup><br>+ Doppelbereifung <sup>2)</sup><br>+ Doppelbereifung <sup>2)</sup><br>+ Doppelbereifung <sup>2)</sup><br>+ Doppelbereifung <sup>2)</sup><br>+ Doppelbereifung <sup>2)</sup><br>+ Doppelbereifung <sup>2)</sup><br>+ Doppelbereifung <sup>2)</sup><br>+ Doppelbereifung <sup>2)</sup><br>+ Doppelbereifung <sup>2)</sup><br>+ Doppelbereifung <sup>2)</sup><br>+ Doppelbereifung <sup>2)</sup><br>+ Doppelbereifung <sup>2)</sup><br>+ Doppelbereifung <sup>2)</sup><br>+ Doppelbereifung <sup>2)</sup>                | 13.0460-4857.2  | 604857   |  | 25172 18,4 +/WK <b>BRE</b>   |
|  | 2.3 dCi FWD<br>2.3 dCi FWD<br>2.3 dCi FWD<br>2.3 dCi FWD<br>2.3 dCi FWD<br>2.3 dCi FWD  | 74<br>81<br>92<br>100<br>107<br>110<br>120  | 02.10<br>09.14<br>02.10<br>07.14<br>02.10<br>01.13<br>07.14  |  | 24.0112-0191.1  | 412191   |  | 305 12,0 10,0 L +S +B  |

1) + single tyre / + ruota singola / + roue simple / + cubierta simple  
2) + twin tyres / + ruote gemellate / + roue jumelée / + cubierta doble



**RENAULT MASTER III Kasten/Bus (FV/JV) (10-)**

|  |             |     |  |       |                                  |                |        |   |                       |
|--|-------------|-----|--|-------|----------------------------------|----------------|--------|---|-----------------------|
|  | 2.3 dCi FWD | 125 |  | 07.15 |                                  | 24.0112-0191.1 | 412191 |   | 305 12,0 10,0 L +S +B |
|  | 2.3 dCi RWD | 74  |  | 02.10 | + Einfachbereifung <sup>1)</sup> | 24.0112-0190.1 | 412190 |   | 305 12,0 10,0 L +S +B |
|  | 2.3 dCi RWD | 92  |  | 02.10 | + Einfachbereifung <sup>1)</sup> |                |        |   |                       |
|  | 2.3 dCi RWD | 100 |  | 07.14 | + Einfachbereifung <sup>1)</sup> |                |        |   |                       |
|  | 2.3 dCi RWD | 107 |  | 02.10 | + Einfachbereifung <sup>1)</sup> |                |        |   |                       |
|  | 2.3 dCi RWD | 110 |  | 01.13 | + Einfachbereifung <sup>1)</sup> |                |        |   |                       |
|  | 2.3 dCi RWD | 120 |  | 07.14 | + Einfachbereifung <sup>1)</sup> |                |        |   |                       |
|  | 2.3 dCi RWD | 125 |  | 07.15 | + Einfachbereifung <sup>1)</sup> |                |        |   |                       |
|  | 2.3 dCi RWD | 74  |  | 02.10 | + Doppelbereifung <sup>2)</sup>  | 24.0118-0153.1 | 418153 |   | 302 18,0 15,0 +B      |
|  | 2.3 dCi RWD | 92  |  | 02.10 | + Doppelbereifung <sup>2)</sup>  |                |        |   |                       |
|  | 2.3 dCi RWD | 100 |  | 07.14 | + Doppelbereifung <sup>2)</sup>  |                |        |   |                       |
|  | 2.3 dCi RWD | 107 |  | 02.10 | + Doppelbereifung <sup>2)</sup>  |                |        |   |                       |
|  | 2.3 dCi RWD | 110 |  | 01.13 | + Doppelbereifung <sup>2)</sup>  |                |        |   |                       |
|  | 2.3 dCi RWD | 120 |  | 07.14 | + Doppelbereifung <sup>2)</sup>  |                |        |   |                       |
|  | 2.3 dCi RWD | 125 |  | 07.15 | + Doppelbereifung <sup>2)</sup>  |                |        |   |                       |
|  | 2.3 dCi FWD | 74  |  | 02.10 | - Sonderfahrzeuge <sup>3)</sup>  | 24.0711-5252.3 | 360344 | 2 | Radsensor L=643       |
|  | 2.3 dCi FWD | 81  |  | 09.14 | - Sonderfahrzeuge <sup>3)</sup>  | 24.0711-5253.3 | 360345 | 2 | Radsensor L=851       |
|  | 2.3 dCi FWD | 92  |  | 02.10 | - Sonderfahrzeuge <sup>3)</sup>  |                |        |   |                       |
|  | 2.3 dCi FWD | 100 |  | 07.14 | - Sonderfahrzeuge <sup>3)</sup>  |                |        |   |                       |
|  | 2.3 dCi FWD | 107 |  | 02.10 | - Sonderfahrzeuge <sup>3)</sup>  |                |        |   |                       |
|  | 2.3 dCi FWD | 110 |  | 01.13 | - Sonderfahrzeuge <sup>3)</sup>  |                |        |   |                       |
|  | 2.3 dCi FWD | 125 |  | 07.15 | - Sonderfahrzeuge <sup>3)</sup>  |                |        |   |                       |
|  | 2.3 dCi RWD | 74  |  | 02.10 | - Sonderfahrzeuge <sup>3)</sup>  |                |        |   |                       |
|  | 2.3 dCi RWD | 92  |  | 02.10 | - Sonderfahrzeuge <sup>3)</sup>  |                |        |   |                       |
|  | 2.3 dCi RWD | 100 |  | 07.14 | - Sonderfahrzeuge <sup>3)</sup>  |                |        |   |                       |
|  | 2.3 dCi RWD | 107 |  | 02.10 | - Sonderfahrzeuge <sup>3)</sup>  |                |        |   |                       |
|  | 2.3 dCi RWD | 120 |  | 07.14 | - Sonderfahrzeuge <sup>3)</sup>  |                |        |   |                       |
|  | 2.3 dCi RWD | 120 |  | 07.14 | - Sonderfahrzeuge <sup>3)</sup>  |                |        |   |                       |
|  | 2.3 dCi RWD | 125 |  | 07.15 | - Sonderfahrzeuge <sup>3)</sup>  |                |        |   |                       |

**RENAULT MASTER III Pritsche/Fahrgestell (EV/UV) (10-)**

|  |             |     |  |       |                                  |                |        |   |                       |
|--|-------------|-----|--|-------|----------------------------------|----------------|--------|---|-----------------------|
|  | 2.3 dCi FWD | 74  |  | 02.10 |                                  | 13.0460-4856.2 | 604856 |   | 25147 18,4 +/-WK BRE  |
|  | 2.3 dCi FWD | 81  |  | 09.14 |                                  |                |        |   |                       |
|  | 2.3 dCi FWD | 92  |  | 02.10 |                                  |                |        |   |                       |
|  | 2.3 dCi FWD | 107 |  | 02.10 |                                  |                |        |   |                       |
|  | 2.3 dCi FWD | 110 |  | 01.13 |                                  |                |        |   |                       |
|  | 2.3 dCi FWD | 120 |  | 07.14 |                                  |                |        |   |                       |
|  | 2.3 dCi RWD | 74  |  | 02.10 |                                  |                |        |   |                       |
|  | 2.3 dCi RWD | 92  |  | 02.10 |                                  |                |        |   |                       |
|  | 2.3 dCi RWD | 100 |  | 07.14 |                                  |                |        |   |                       |
|  | 2.3 dCi RWD | 107 |  | 02.10 |                                  |                |        |   |                       |
|  | 2.3 dCi RWD | 110 |  | 01.13 |                                  |                |        |   |                       |
|  | 2.3 dCi RWD | 120 |  | 07.14 |                                  |                |        |   |                       |
|  | 2.3 dCi FWD | 74  |  | 02.10 |                                  | 24.0128-0252.1 | 428252 |   | 302 28,0 24,5 V +S +B |
|  | 2.3 dCi FWD | 81  |  | 09.14 |                                  |                |        |   |                       |
|  | 2.3 dCi FWD | 92  |  | 02.10 |                                  |                |        |   |                       |
|  | 2.3 dCi FWD | 107 |  | 02.10 |                                  |                |        |   |                       |
|  | 2.3 dCi FWD | 110 |  | 01.13 |                                  |                |        |   |                       |
|  | 2.3 dCi FWD | 120 |  | 07.14 |                                  |                |        |   |                       |
|  | 2.3 dCi RWD | 74  |  | 02.10 |                                  |                |        |   |                       |
|  | 2.3 dCi RWD | 92  |  | 02.10 |                                  |                |        |   |                       |
|  | 2.3 dCi RWD | 100 |  | 07.14 |                                  |                |        |   |                       |
|  | 2.3 dCi RWD | 107 |  | 02.10 |                                  |                |        |   |                       |
|  | 2.3 dCi RWD | 110 |  | 01.13 |                                  |                |        |   |                       |
|  | 2.3 dCi RWD | 120 |  | 07.14 |                                  |                |        |   |                       |
|  | 2.3 dCi FWD | 74  |  | 02.10 |                                  | 24.0711-5251.3 | 360343 | 2 | Radsensor L=703       |
|  | 2.3 dCi FWD | 81  |  | 09.14 |                                  |                |        |   |                       |
|  | 2.3 dCi FWD | 92  |  | 02.10 |                                  |                |        |   |                       |
|  | 2.3 dCi FWD | 107 |  | 02.10 |                                  |                |        |   |                       |
|  | 2.3 dCi FWD | 110 |  | 01.13 |                                  |                |        |   |                       |
|  | 2.3 dCi FWD | 120 |  | 07.14 |                                  |                |        |   |                       |
|  | 2.3 dCi RWD | 74  |  | 02.10 |                                  |                |        |   |                       |
|  | 2.3 dCi RWD | 92  |  | 02.10 |                                  |                |        |   |                       |
|  | 2.3 dCi RWD | 100 |  | 07.14 |                                  |                |        |   |                       |
|  | 2.3 dCi RWD | 107 |  | 02.10 |                                  |                |        |   |                       |
|  | 2.3 dCi RWD | 110 |  | 01.13 |                                  |                |        |   |                       |
|  | 2.3 dCi RWD | 120 |  | 07.14 |                                  |                |        |   |                       |
|  | 2.3 dCi FWD | 74  |  | 02.10 | + Einfachbereifung <sup>1)</sup> | 13.0460-4858.2 | 604858 |   | 25112 18,4 +/-WK BRE  |
|  | 2.3 dCi FWD | 81  |  | 09.14 | + Einfachbereifung <sup>1)</sup> |                |        |   |                       |
|  | 2.3 dCi FWD | 92  |  | 02.10 | + Einfachbereifung <sup>1)</sup> |                |        |   |                       |
|  | 2.3 dCi FWD | 107 |  | 02.10 | + Einfachbereifung <sup>1)</sup> |                |        |   |                       |
|  | 2.3 dCi FWD | 110 |  | 01.13 | + Einfachbereifung <sup>1)</sup> |                |        |   |                       |
|  | 2.3 dCi FWD | 120 |  | 07.14 | + Einfachbereifung <sup>1)</sup> |                |        |   |                       |
|  | 2.3 dCi RWD | 74  |  | 02.10 | + Einfachbereifung <sup>1)</sup> |                |        |   |                       |
|  | 2.3 dCi RWD | 92  |  | 02.10 | + Einfachbereifung <sup>1)</sup> |                |        |   |                       |
|  | 2.3 dCi RWD | 100 |  | 07.14 | + Einfachbereifung <sup>1)</sup> |                |        |   |                       |
|  | 2.3 dCi RWD | 107 |  | 02.10 | + Einfachbereifung <sup>1)</sup> |                |        |   |                       |
|  | 2.3 dCi RWD | 110 |  | 01.13 | + Einfachbereifung <sup>1)</sup> |                |        |   |                       |
|  | 2.3 dCi RWD | 120 |  | 07.14 | + Einfachbereifung <sup>1)</sup> |                |        |   |                       |
|  | 2.3 dCi FWD | 74  |  | 02.10 | + Doppelbereifung <sup>2)</sup>  | 13.0460-4857.2 | 604857 |   | 25172 18,4 +/-WK BRE  |
|  | 2.3 dCi FWD | 81  |  | 09.14 | + Doppelbereifung <sup>2)</sup>  |                |        |   |                       |
|  | 2.3 dCi FWD | 92  |  | 02.10 | + Doppelbereifung <sup>2)</sup>  |                |        |   |                       |
|  | 2.3 dCi FWD | 107 |  | 02.10 | + Doppelbereifung <sup>2)</sup>  |                |        |   |                       |
|  | 2.3 dCi FWD | 110 |  | 01.13 | + Doppelbereifung <sup>2)</sup>  |                |        |   |                       |
|  | 2.3 dCi FWD | 120 |  | 07.14 | + Doppelbereifung <sup>2)</sup>  |                |        |   |                       |
|  | 2.3 dCi RWD | 74  |  | 02.10 | + Doppelbereifung <sup>2)</sup>  |                |        |   |                       |

1) + single tyre / + ruota singola / + roue simple / + cubierta simple  
 2) + twin tyres / + ruote gemellate / + roue jumelée / + cubierta doble  
 3) - special vehicles / - veicoli speciali / - véhicules spécial / - vehículo especial





### RENAULT MASTER III Pritsche/Fahrgestell (EV/UV) (10-)

|  |             |     |       |                                 |                |        |                                     |                       |     |
|--|-------------|-----|-------|---------------------------------|----------------|--------|-------------------------------------|-----------------------|-----|
|  | 2.3 dCi RWD | 92  | 02.10 | + Doppelbereifung <sup>1)</sup> | 13.0460-4857.2 | 604857 |                                     | 25172 18,4 +/WK       | BRE |
|  | 2.3 dCi RWD | 100 | 07.14 | + Doppelbereifung <sup>1)</sup> |                |        |                                     |                       |     |
|  | 2.3 dCi RWD | 107 | 02.10 | + Doppelbereifung <sup>1)</sup> |                |        |                                     |                       |     |
|  | 2.3 dCi RWD | 110 | 01.13 | + Doppelbereifung <sup>1)</sup> |                |        |                                     |                       |     |
|  | 2.3 dCi RWD | 120 | 07.14 | + Doppelbereifung <sup>1)</sup> |                |        |                                     |                       |     |
|  | 2.3 dCi FWD | 74  | 02.10 |                                 | 24.0112-0191.1 | 412191 |                                     | 305 12,0 10,0 L +S +B |     |
|  | 2.3 dCi FWD | 81  | 09.14 |                                 |                |        |                                     |                       |     |
|  | 2.3 dCi FWD | 92  | 02.10 |                                 |                |        |                                     |                       |     |
|  | 2.3 dCi FWD | 107 | 02.10 |                                 |                |        |                                     |                       |     |
|  | 2.3 dCi FWD | 110 | 01.13 |                                 |                |        |                                     |                       |     |
|  | 2.3 dCi FWD | 120 | 07.14 |                                 |                |        |                                     |                       |     |
|  | 2.3 dCi RWD | 74  | 02.10 |                                 | 24.0112-0190.1 | 412190 | + Einfachbereifung <sup>2)</sup>    | 305 12,0 10,0 L +S +B |     |
|  | 2.3 dCi RWD | 92  | 02.10 |                                 | 24.0118-0153.1 | 418153 | + Doppelbereifung <sup>1)</sup>     | 302 18,0 15,0 +B      |     |
|  | 2.3 dCi RWD | 100 | 07.14 |                                 |                |        |                                     |                       |     |
|  | 2.3 dCi RWD | 107 | 02.10 |                                 |                |        |                                     |                       |     |
|  | 2.3 dCi RWD | 110 | 01.13 |                                 |                |        |                                     |                       |     |
|  | 2.3 dCi RWD | 120 | 07.14 |                                 |                |        |                                     |                       |     |
|  | 2.3 dCi FWD | 74  | 02.10 | - Sonderfahrzeuge <sup>3)</sup> | 24.0711-5252.3 | 360344 | 2  + Einfachbereifung <sup>2)</sup> | Radsensor L=643       |     |
|  | 2.3 dCi FWD | 81  | 09.14 | - Sonderfahrzeuge <sup>3)</sup> | 24.0711-5253.3 | 360345 | 2  + Doppelbereifung <sup>1)</sup>  | Radsensor L=851       |     |
|  | 2.3 dCi FWD | 92  | 02.10 | - Sonderfahrzeuge <sup>3)</sup> |                |        |                                     |                       |     |
|  | 2.3 dCi FWD | 107 | 02.10 | - Sonderfahrzeuge <sup>3)</sup> |                |        |                                     |                       |     |
|  | 2.3 dCi FWD | 110 | 01.13 | - Sonderfahrzeuge <sup>3)</sup> |                |        |                                     |                       |     |
|  | 2.3 dCi FWD | 120 | 07.14 | - Sonderfahrzeuge <sup>3)</sup> |                |        |                                     |                       |     |
|  | 2.3 dCi RWD | 74  | 02.10 | - Sonderfahrzeuge <sup>3)</sup> |                |        |                                     |                       |     |
|  | 2.3 dCi RWD | 92  | 02.10 | - Sonderfahrzeuge <sup>3)</sup> |                |        |                                     |                       |     |
|  | 2.3 dCi RWD | 100 | 07.14 | - Sonderfahrzeuge <sup>3)</sup> |                |        |                                     |                       |     |
|  | 2.3 dCi RWD | 107 | 02.10 | - Sonderfahrzeuge <sup>3)</sup> |                |        |                                     |                       |     |
|  | 2.3 dCi RWD | 110 | 01.13 | - Sonderfahrzeuge <sup>3)</sup> |                |        |                                     |                       |     |
|  | 2.3 dCi RWD | 120 | 07.14 | - Sonderfahrzeuge <sup>3)</sup> |                |        |                                     |                       |     |

### RENAULT MAXITY (SHF/SHT) (06-)

|  |         |     |       |           |                |        |  |                          |  |
|--|---------|-----|-------|-----------|----------------|--------|--|--------------------------|--|
|  | 2.5 DXI | 81  | 12.06 |           | 13.0460-4866.2 | 604866 |  | 29229 20,7 +/WK/Zub/SBRE |  |
|  | 2.5 DXI | 96  | 12.06 |           |                |        |  |                          |  |
|  | 3.0 DXI | 110 | 12.06 |           |                |        |  |                          |  |
|  | 2.5 DXI | 81  | 12.06 | + 3500 kg | 24.0128-0244.1 | 428244 |  | 276 28,0 26,0 V L +B     |  |
|  | 2.5 DXI | 96  | 12.06 | + 3500 kg |                |        |  |                          |  |
|  | 3.0 DXI | 110 | 12.06 | + 3500 kg |                |        |  |                          |  |
|  | 2.5 DXI | 81  | 12.06 | + 4500 kg | 24.0126-0163.1 | 426163 |  | 290 26,0 23,0 V +B       |  |
|  | 2.5 DXI | 96  | 12.06 | + 4500 kg |                |        |  |                          |  |
|  | 3.0 DXI | 110 | 12.06 | + 4500 kg |                |        |  |                          |  |
|  | 2.5 DXI | 81  | 12.06 |           | 13.0460-4859.2 | 604859 |  | 23921 20,1 +/WK/Zub/SBRE |  |
|  | 3.0 DXI | 110 | 12.06 |           |                |        |  |                          |  |
|  | 2.5 DXI | 96  | 12.06 |           | 13.0460-4861.2 | 604861 |  | 29121 20,3 +/WK/Zub/SBRE |  |
|  | 2.5 DXI | 81  | 12.06 |           | 24.0116-0132.1 | 416132 |  | 280 16,0 13,0 +B         |  |
|  | 3.0 DXI | 110 | 12.06 |           | 24.0122-0264.1 | 422264 |  | 290 22,0 19,0 V +B       |  |

### RENAULT MEGANE I Limousine 3/5-tuerig (BA/SA\_) (96-02)

|  |                     |     |       |       |                                      |                |        |                       |     |
|--|---------------------|-----|-------|-------|--------------------------------------|----------------|--------|-----------------------|-----|
|  | 1.4 16V (D)         | 70  | 03.99 | 12.02 | 13.0460-2834.2                       | 602834         |        | 21463 18,0 /WK/S      | TRW |
|  | 1.4 16V (W)         | 70  | 06.98 | 12.02 |                                      |                |        |                       |     |
|  | 1.4 e               | 55  | 01.96 | 12.02 |                                      |                |        |                       |     |
|  | 1.4 Eco (T)         | 52  | 01.96 | 03.99 |                                      |                |        |                       |     |
|  | 1.6 16V (4)         | 79  | 04.98 | 12.02 | + verstärktes Fahrwerk <sup>4)</sup> |                |        |                       |     |
|  | 1.6 e               | 66  | 01.96 | 03.99 |                                      |                |        |                       |     |
|  | 1.6 i               | 55  | 01.96 | 03.99 |                                      |                |        |                       |     |
|  | 1.9 D (9)           | 47  | 01.96 | 12.02 |                                      |                |        |                       |     |
|  | 1.9 D (A)           | 47  | 01.96 | 12.02 |                                      |                |        |                       |     |
|  | 1.9 D (R)           | 47  | 06.98 | 12.02 |                                      |                |        |                       |     |
|  | 1.9 D (U)           | 47  | 01.96 | 12.02 |                                      |                |        |                       |     |
|  | 1.9 dT              | 66  | 01.96 | 12.02 |                                      |                |        |                       |     |
|  | 1.9 dTi (8)         | 72  | 03.97 | 02.01 |                                      |                |        |                       |     |
|  | 1.9 dTi (BAON/SAON) | 72  | 03.97 | 03.99 |                                      |                |        |                       |     |
|  | 1.9 TDI             | 69  | 09.96 | 12.02 |                                      |                |        |                       |     |
|  | 2.0 i               |     | 01.96 | 12.02 |                                      |                |        |                       |     |
|  | 1.6 16V (4)         | 79  | 04.98 | 02.99 | - verstärktes Fahrwerk <sup>5)</sup> | 13.0460-2983.2 | 602983 | 21388 18,0 +/WK/S     | TRW |
|  | 2.0 16V             | 108 | 07.96 | 12.02 |                                      |                |        |                       |     |
|  | 1.6 16V (11)        | 79  | 03.99 | 12.02 | 13.0460-2895.2                       | 602895         |        | 23172 18,0 /WE/Zub/S  | TRW |
|  | 1.6 16V (1J)        | 79  | 03.99 | 12.02 | 13.0460-0262.2                       | 610262         |        | Belagsatz-Zubehör     | TRW |
|  | 1.6 16V (4)         | 79  | 03.99 | 12.02 | + verstärktes Fahrwerk <sup>5)</sup> |                |        |                       |     |
|  | 1.6 16V (B)         | 79  | 03.99 | 12.02 |                                      |                |        |                       |     |
|  | 1.8 16V             | 85  | 01.01 | 12.02 |                                      |                |        |                       |     |
|  | 1.9 dCi             |     | 09.98 | 12.02 |                                      |                |        |                       |     |
|  | 1.9 dTi (1U)        | 59  | 02.01 | 12.02 |                                      |                |        |                       |     |
|  | 1.9 dTi (BAON/SAON) | 72  | 04.99 | 02.01 |                                      |                |        |                       |     |
|  | 1.4 e (E)           | 55  | 01.96 | 10.97 | 24.0112-0116.1                       | 412116         |        | 238 12,0 10,5 +S +B   |     |
|  | 1.4 Eco (T)         | 52  | 01.96 | 10.97 |                                      |                |        |                       |     |
|  | 1.6 i               | 55  | 01.96 | 10.97 |                                      |                |        |                       |     |
|  | 1.9 D (A/U)         | 47  | 01.96 | 10.97 |                                      |                |        |                       |     |
|  | 1.4 e (E)           | 55  | 11.97 | 09.98 | 24.0120-0125.1                       | 420125         |        | 238 20,1 17,7 V +S +B |     |
|  | 1.4 Eco (T)         | 52  | 11.97 | 03.99 |                                      |                |        |                       |     |
|  | 1.6 e               | 66  | 01.96 | 09.98 |                                      |                |        |                       |     |
|  | 1.6 i               | 55  | 11.97 | 09.98 |                                      |                |        |                       |     |
|  | 1.9 D (A)           | 47  | 11.97 | 09.98 |                                      |                |        |                       |     |
|  | 1.9 D (U)           | 47  | 11.97 | 12.02 |                                      |                |        |                       |     |
|  | 1.4 16V (D)         | 70  | 03.99 | 12.02 | 24.0121-0106.1                       | 421106         |        | 259 20,6 17,7 V +S +B |     |

<sup>1)</sup> + twin tyres / + ruote gemellate / + roue jumelée / + cubierta doble





















<sup>2)</sup> + single tyre / + ruota singola / + roue simple / + cubierta simple

<sup>3)</sup> - special vehicles / - veicoli speciali / - véhicules spéciaux / - vehículo especial

<sup>4)</sup> + reinforced suspension / + sospensione rinforzata / + châssis renforcé / + suspensión reforzada

<sup>5)</sup> - reinforced suspension / - sospensione rinforzata / - châssis renforcé / - suspensión reforzada



|     |  |  |  |  |  |  |     |  |
|--|--|--|--|--|---|--|---|--|
| <b>RENAULT MEGANE I Limousine 3/5-tuerig (BA/SA_) (96-02)</b>                      |  |  |  |  |   |  |   |  |
|    | 1.4 16V (W)  | 70   | 06.98  | 12.02  | 24.0121-0106.1  | 421106   |   | 259 20,6 17,7 V +S +B  |
|  | 1.4 e (E)  | 55   | 10.98  | 12.02  |   |  |   |  |
|  | 1.4 e (V)  | 55   | 06.98  | 12.02  |   |  |   |  |
|  | 1.6 e  | 66   | 10.98  | 03.99  |   |  |   |  |
|  | 1.6 i  | 55   | 10.98  | 03.99  |   |  |   |  |
|  | 1.9 D (9)  | 47   | 01.96  | 12.02  |   |  |   |  |
|  | 1.9 D (A)  | 47   | 10.98  | 12.02  |   |  |   |  |
|  | 1.9 D (R)  | 47   | 06.98  | 12.02  |   |  |   |  |
|  | 1.9 dT   | 66   | 01.96  | 12.02  |   |  |   |  |
|  | 1.9 dTi (8)  | 72   | 03.97  | 02.01  |   |  |   |  |
|  | 1.9 dTi (BAON/SAON)  | 72   | 03.97  | 02.99  |   |  |   |  |
|  | 1.9 TDI  | 69   | 09.96  | 12.02  |   |  |   |  |
|  | 2.0 i  |  | 01.96  | 12.02  |   |  |   |  |
|  | 2.0 16V  | 108  | 07.96  | 09.98  | 24.0122-0148.1  | 422148   |   | 262 22,0 19,8 V L +S +B  |
|  | 1.6 16V (11)   | 79   | 03.99  | 12.02  | 24.0124-0158.1  | 424158   |   | 280 24,0 21,8 V L +S +B  |
|  | 1.6 16V (1J)   | 79   | 03.99  | 12.02  | 24.0324-0158.1  | 524158   |   | 280 24,0 21,8 V L +S +B PD   |
|  | 1.6 16V (4)  | 79   | 04.98  | 12.02  |   |  |   |  |
|  | 1.6 16V (B)  | 79   | 03.99  | 12.02  |   |  |   |  |
|  | 1.8 16V  | 85   | 01.01  | 12.02  |   |  |   |  |
|  | 1.9 dCi  |  | 09.98  | 12.02  |   |  |   |  |
|  | 1.9 dTi (1U)   | 59   | 02.01  | 12.02  |   |  |   |  |
|  | 1.9 dTi (BAON/SAON)  | 72   | 03.99  | 02.01  |   |  |   |  |
|  | 2.0 16V  | 108  | 10.98  | 12.02  |   |  |   |  |
|    | 1.4 16V  | 70   | 03.99  | 12.02  | 24.0713-1109.1  | 360145   | 2  | Radsensor L=625  |
|  | 1.4 e  | 55   | 01.96  | 12.02  |   |  |   |  |
|  | 1.6 e  | 66   | 01.96  | 03.99  |   |  |   |  |
|  | 1.6 i  | 55   | 01.96  | 03.99  |   |  |   |  |
|  | 1.9 D (9)  | 47   | 01.96  | 12.02  |   |  |   |  |
|  | 1.9 D (A)  | 47   | 01.96  | 12.02  |   |  |   |  |
|  | 1.9 D (R)  | 47   | 06.98  | 12.02  |   |  |   |  |
|  | 1.9 D (U)  | 47   | 01.96  | 12.02  |   |  |   |  |
|  | 1.9 dT   | 66   | 01.96  | 12.02  |   |  |   |  |
|  | 1.9 dTi  | 72   | 03.97  | 02.01  |   |  |   |  |
|  | 1.9 dTi (1U)   | 59   | 02.01  | 12.02  |   |  |   |  |
|  | 2.0 i  |  | 01.96  | 12.02  |   |  |   |  |
|    | 1.4 16V (D)  | 70   | 03.99  | 12.02 + ASR  | 13.0460-3954.2  | 603954   |   | 20973 11,0 + BDX   |
|  | 1.6 16V (B)  | 79   | 03.99  | 12.02 + ASR  | 13.0460-0435.2  | 610435   |   | Belagsatz-Zubehör BDX  |
|  | 1.8 16V (12)   | 85   | 01.01  | 12.02 + ASR  |   |  |   |  |
|  | 1.8 16V (1A)   | 85   | 01.01  | 12.02  |   |  |   |  |
|  | 1.8 16V (1M)   | 85   | 01.01  | 12.02 + ASR  |   |  |   |  |
|  | 1.8 16V (1R)   | 85   | 01.01  | 12.02  |   |  |   |  |
|  | 1.9 dCi (F)  | 75   | 02.01  | 12.02 + ASR  |   |  |   |  |
|  | 2.0 16V  | 108  | 07.96  | 12.02  |   |  |   |  |
|  | 1.4 16V (D)  | 70   | 03.99  | 12.02 + ASR  | 24.0108-0108.1  | 408108   | ohne Sensorring <sup>1)</sup>   | 238 8,0 7,0 +B   |
|  | 1.6 16V (B)  | 79   | 03.99  | 12.02 + ASR  |   |  |   |  |
|  | 1.8 16V (12)   | 85   | 01.01  | 12.02 + ASR  |   |  |   |  |
|  | 1.8 16V (1A)   | 85   | 01.01  | 12.02  |   |  |   |  |
|  | 1.8 16V (1M)   | 85   | 01.01  | 12.02 + ASR  |   |  |   |  |
|  | 1.8 16V (1R)   | 85   | 01.01  | 12.02  |   |  |   |  |
|  | 1.9 dCi (F)  | 75   | 02.01  | 12.02 + ASR  |   |  |   |  |
|  | 2.0 16V  | 108  | 07.96  | 12.02  |   |  |   |  |
|  | 1.4 e  | 55   | 01.96  | 12.02  | 24.0721-1171.1  | 360146   |  | Radsensor L=580  |
|  | 1.6 e  | 66   | 01.96  | 03.99  | 24.0721-1172.1  | 360147   |  | Radsensor L=475  |
|  | 1.6 i  | 55   | 01.96  | 03.99  |   |  |   |  |
|  | 1.9 D (A)  | 47   | 01.96  | 12.02  |   |  |   |  |
|  | 1.9 D (R)  | 47   | 06.98  | 12.02  |   |  |   |  |
|  | 1.9 D (U)  | 47   | 01.96  | 12.02  |   |  |   |  |
|  | 1.4 16V  | 70   | 03.99  | 12.02  | 24.0721-1175.1  | 360088   |  | Radsensor L=560  |
|  | 1.9 D (9)  | 47   | 01.96  | 12.02  | 24.0721-1176.1  | 360089   |  | Radsensor L=450  |
|  | 1.9 dT   | 66   | 01.96  | 12.02  |   |  |   |  |
|  | 1.9 dTi  | 72   | 03.97  | 02.01  |   |  |   |  |
|  | 1.9 dTi (1U)   | 59   | 02.01  | 12.02  |   |  |   |  |
|  | 2.0 i  |  | 01.96  | 12.02  |   |  |   |  |
|  | 1.4 16V  | 70   | 06.98  | 12.02  | 03.0137-0335.2  | 650335   |   | 203 x 39 BDX   |
|  | 1.4 e (E)  | 55   | 01.96  | 12.02  | 03.0137-9125.2  | 669125   |   | Bremsbacken-Zubehör BDX  |
|  | 1.4 e (V)  | 55   | 06.98  | 12.02  |   |  |   |  |
|  | 1.4 Eco (T)  | 52   | 01.96  | 03.99  |   |  |   |  |
|  | 1.6 16V (11)   | 79   | 03.99  | 12.02  |   |  |   |  |
|  | 1.6 16V (1J)   | 79   | 03.99  | 12.02  |   |  |   |  |
|  | 1.6 16V (4)  | 79   | 04.98  | 12.02  |   |  |   |  |
|  | 1.6 16V (B)  | 79   | 03.99  | 12.02  |   |  |   |  |
|  | 1.6 e  | 66   | 01.96  | 03.99  |   |  |   |  |
|  | 1.6 i  | 55   | 01.96  | 03.99  |   |  |   |  |
|  | 1.8 16V (12)   | 85   | 01.01  | 12.02  |   |  |   |  |
|  | 1.8 16V (1M)   | 85   | 01.01  | 12.02  |   |  |   |  |
|  | 1.9 D (9)  | 47   | 01.96  | 12.02  |   |  |   |  |
|  | 1.9 D (A)  | 47   | 01.96  | 12.02  |   |  |   |  |
|  | 1.9 D (R)  | 47   | 06.98  | 12.02  |   |  |   |  |
|  | 1.9 D (U)  | 47   | 01.96  | 12.02  |   |  |   |  |
|  | 1.9 dCi  |  | 09.98  | 12.02  |   |  |   |  |
|  | 1.9 dT   | 66   | 01.96  | 12.02  |   |  |   |  |
|  | 1.9 dTi (1U)   | 59   | 02.01  | 12.02  |   |  |   |  |
|  | 1.9 dTi (8)  | 72   | 03.97  | 02.01  |   |  |   |  |
|  | 1.9 dTi (BAON/SAON)  | 72   | 03.97  | 02.01  |   |  |   |  |
|  | 1.9 TDI  | 69   | 09.96  | 12.02  |   |  |   |  |
|  | 2.0 i  |  | 01.96  | 12.02  |   |  |   |  |

<sup>1)</sup> without sensor ring / senza sensori / sans secours ABS / sin anillo sensor ABS



**RENAULT MEGANE I Limousine 3/5-tuerig (BA/SA\_) (96-02)**

|  |                     |    |       |       |                |        |  |                         |
|--|---------------------|----|-------|-------|----------------|--------|--|-------------------------|
|  | 1.4 16V             | 70 | 06.98 | 12.02 | 24.0220-3021.1 | 480127 |  | 203/204,5 x 48 - Lager  |
|  | 1.4 e               | 55 | 01.96 | 12.02 |                |        |  |                         |
|  | 1.4 Eco (T)         | 52 | 01.96 | 03.99 |                |        |  |                         |
|  | 1.6 16V             | 79 | 04.98 | 12.02 |                |        |  |                         |
|  | 1.6 e               | 66 | 01.96 | 03.99 |                |        |  |                         |
|  | 1.6 i               | 55 | 01.96 | 03.99 |                |        |  |                         |
|  | 1.8 16V (12)        | 85 | 01.01 | 12.02 |                |        |  |                         |
|  | 1.8 16V (1M)        | 85 | 01.01 | 12.02 |                |        |  |                         |
|  | 1.9 D               | 47 | 01.96 | 12.02 |                |        |  |                         |
|  | 1.9 dCi             |    | 09.98 | 12.02 |                |        |  |                         |
|  | 1.9 dT              | 66 | 01.96 | 12.02 |                |        |  |                         |
|  | 1.9 dTi             | 72 | 03.97 | 02.01 |                |        |  |                         |
|  | 1.9 dTi (1U)        | 59 | 02.01 | 12.02 |                |        |  |                         |
|  | 1.9 TDI             | 69 | 09.96 | 12.02 |                |        |  |                         |
|  | 2.0 i               |    | 01.96 | 12.02 |                |        |  |                         |
|  | 1.4 16V             | 70 | 06.98 | 12.02 | 03.0520-3217.3 | 693217 |  | 17,46/203x39 TopKit BDX |
|  | 1.4 e (E)           | 55 | 01.96 | 12.02 |                |        |  |                         |
|  | 1.4 e (V)           | 55 | 06.98 | 02.99 |                |        |  |                         |
|  | 1.4 e (V)           | 55 | 06.98 | 12.02 |                |        |  |                         |
|  | 1.4 Eco (T)         | 52 | 01.96 | 03.99 |                |        |  |                         |
|  | 1.6 16V (11)        | 79 | 03.99 | 12.02 |                |        |  |                         |
|  | 1.6 16V (1J)        | 79 | 03.99 | 12.02 |                |        |  |                         |
|  | 1.6 16V (4)         | 79 | 04.98 | 12.02 |                |        |  |                         |
|  | 1.6 16V (B)         | 79 | 03.99 | 12.02 |                |        |  |                         |
|  | 1.6 e               | 66 | 01.96 | 03.99 |                |        |  |                         |
|  | 1.6 i               | 55 | 01.96 | 03.99 |                |        |  |                         |
|  | 1.9 D (9)           | 47 | 01.96 | 12.02 |                |        |  |                         |
|  | 1.9 D (A)           | 47 | 01.96 | 12.02 |                |        |  |                         |
|  | 1.9 D (R)           | 47 | 06.98 | 12.02 |                |        |  |                         |
|  | 1.9 D (U)           | 47 | 01.96 | 12.02 |                |        |  |                         |
|  | 1.9 dCi             |    | 09.98 | 12.02 |                |        |  |                         |
|  | 1.9 dT              | 66 | 01.96 | 12.02 |                |        |  |                         |
|  | 1.9 dTi (1U)        | 59 | 02.01 | 12.02 |                |        |  |                         |
|  | 1.9 dTi (8)         | 72 | 03.97 | 02.01 |                |        |  |                         |
|  | 1.9 dTi (BAON/SAON) | 72 | 03.97 | 02.99 |                |        |  |                         |
|  | 1.9 dTi (BAON/SAON) | 72 | 03.97 | 02.01 |                |        |  |                         |
|  | 1.9 TDI             | 69 | 09.96 | 12.02 |                |        |  |                         |
|  | 2.0 i               |    | 01.96 | 12.02 |                |        |  |                         |
|  | 1.4 16V (D)         | 70 | 03.99 | 12.02 | 03.0520-5019.3 | 695019 |  | 19,05/203x39 TopKit BDX |
|  | 1.4 16V (W)         | 70 | 06.98 | 12.02 |                |        |  |                         |
|  | 1.4 e (V)           | 55 | 06.98 | 12.02 |                |        |  |                         |
|  | 1.6 16V (4)         | 79 | 04.98 | 12.02 |                |        |  |                         |
|  | 1.6 16V (B)         | 79 | 03.99 | 12.02 |                |        |  |                         |
|  | 1.8 16V (12)        | 85 | 01.01 | 12.02 |                |        |  |                         |
|  | 1.8 16V (1M)        | 85 | 01.01 | 12.02 |                |        |  |                         |
|  | 1.9 D (R)           | 47 | 06.98 | 12.02 |                |        |  |                         |
|  | 1.9 dCi (5)         | 75 | 09.98 | 12.02 |                |        |  |                         |
|  | 1.9 dCi (F)         | 75 | 02.01 | 12.02 |                |        |  |                         |
|  | 1.9 dTi (BAON/SAON) | 72 | 03.99 | 02.01 |                |        |  |                         |

**RENAULT MEGANE I Classic (LA\_) (96-02)**

|  |              |    |       |       |                |        |  |                          |
|--|--------------|----|-------|-------|----------------|--------|--|--------------------------|
|  | 1.4 16V (0W) | 70 | 06.98 | 12.02 | 13.0460-2834.2 | 602834 |  | 21463 18,0 /WK/S TRW     |
|  | 1.4 e (0E)   | 55 | 09.96 | 12.02 |                |        |  |                          |
|  | 1.4 e (0V)   | 55 | 04.98 | 12.02 |                |        |  |                          |
|  | 1.6 16V (1C) | 79 | 09.99 | 12.02 |                |        |  |                          |
|  | 1.6 16V (04) | 79 | 04.98 | 12.02 |                |        |  |                          |
|  | 1.6 e        | 66 | 09.96 | 03.99 |                |        |  |                          |
|  | 1.6 i        | 55 | 09.96 | 03.99 |                |        |  |                          |
|  | 1.9 D (0A)   | 47 | 09.96 | 12.02 |                |        |  |                          |
|  | 1.9 D (0R)   | 47 | 09.98 | 12.02 |                |        |  |                          |
|  | 1.9 D (0U)   | 47 | 09.96 | 12.02 |                |        |  |                          |
|  | 1.9 dT       | 66 | 09.96 | 12.02 |                |        |  |                          |
|  | 1.9 dTi (1U) | 59 | 02.01 | 12.02 |                |        |  |                          |
|  | 1.9 dTi (08) | 72 | 03.97 | 02.01 |                |        |  |                          |
|  | 1.9 dTi (0N) | 72 | 03.97 | 02.99 |                |        |  |                          |
|  | 1.9 TDI      | 69 | 09.96 | 12.02 |                |        |  |                          |
|  | 2.0 i (07)   | 84 | 09.96 | 12.02 |                |        |  |                          |
|  | 2.0 i (0G)   | 84 | 09.96 | 02.99 |                |        |  |                          |
|  | 1.6 16V (04) | 79 | 04.98 | 02.99 | 13.0460-2983.2 | 602983 |  | 21388 18,0 +/WK/S TRW    |
|  | 1.9 dTi (0N) | 72 | 03.97 | 02.99 |                |        |  |                          |
|  | 1.4 16V (0D) | 70 | 03.99 | 12.02 | 13.0460-2895.2 | 602895 |  | 23172 18,0 /WE/Zub/S TRW |
|  | 1.6 16V (11) | 79 | 03.99 | 12.02 | 13.0460-0262.2 | 610262 |  | Belagsatz-Zubehör TRW    |
|  | 1.6 16V (1J) | 79 | 03.99 | 12.02 |                |        |  |                          |
|  | 1.6 16V (04) | 79 | 03.99 | 12.02 |                |        |  |                          |
|  | 1.6 16V (0B) | 79 | 03.99 | 12.02 |                |        |  |                          |
|  | 1.8 16V      | 85 | 01.01 | 12.02 |                |        |  |                          |
|  | 1.9 dCi      | 75 | 09.98 | 12.02 |                |        |  |                          |
|  | 1.9 dTi (1U) | 59 | 02.01 | 12.02 |                |        |  |                          |
|  | 1.9 dTi (0N) | 72 | 03.99 | 02.01 |                |        |  |                          |
|  | 2.0 i        | 80 | 03.99 | 12.02 |                |        |  |                          |
|  | 2.0 i (0G)   | 84 | 03.99 | 12.02 |                |        |  |                          |
|  | 1.4 e (0E)   | 55 | 09.96 | 10.97 | 24.0112-0116.1 | 412116 |  | 238 12,0 10,5 +S +B      |
|  | 1.6 i        | 55 | 09.96 | 10.97 |                |        |  |                          |
|  | 1.9 D (0A)   | 47 | 09.96 | 10.97 |                |        |  |                          |
|  | 1.9 D (0U)   | 47 | 09.96 | 10.97 |                |        |  |                          |
|  | 1.4 e (0E)   | 55 | 11.97 | 09.98 | 24.0120-0125.1 | 420125 |  | 238 20,1 17,7 V +S +B    |
|  | 1.6 e        | 66 | 09.96 | 10.97 |                |        |  |                          |

1) + reinforced suspension / + sospensione rinforzata / + châssis renforcé / + suspensión reforzada

2) - reinforced suspension / - sospensione rinforzata / - châssis renforcé / - suspensión reforzada





**RENAULT MEGANE I Classic (LA\_) (96-02)**













|  |   |  |  |   |  |                                  |                  |                               |   |
|--|---|--|--|---|--|----------------------------------|------------------|-------------------------------|---|
|  | 1.6 i<br>1.9 D (OA)<br>1.9 D (OU)   | 55<br>47<br>47   |  | 11.97<br>11.97<br>11.97   | 09.98<br>09.98<br>12.02  | 24.0120-0125.1                   | 420125           |                               | 238 20,1 17,7 V +S +B                                 |
|  | 1.4 16V (OD)<br>1.4 16V (OW)<br>1.4 e (OE)<br>1.4 e (OV)<br>1.6 16V (1C)<br>1.6 e<br>1.6 i<br>1.9 D (OA)<br>1.9 D (OR)<br>1.9 dT<br>1.9 dTi (O8)<br>1.9 dTi (ON)<br>1.9 TDI<br>2.0 i (O7)<br>2.0 i (OG)                                   | 70<br>70<br>55<br>55<br>79<br>66<br>55<br>47<br>47<br>66<br>72<br>72<br>69<br>84<br>84             |  | 03.99<br>06.98<br>10.98<br>04.98<br>09.99<br>11.97<br>10.98<br>10.98<br>09.96<br>03.97<br>03.97<br>09.96<br>09.96<br>09.96                            | 12.02<br>12.02<br>12.02<br>12.02<br>12.02<br>03.99<br>03.99<br>12.02<br>12.02<br>02.01<br>02.99<br>12.02<br>12.02<br>02.99   | 24.0121-0106.1                   | 421106           |                               | 259 20,6 17,7 V +S +B                                 |
|  | 1.6 16V (11)<br>1.6 16V (1J)<br>1.6 16V (O4)<br>1.6 16V (OB)<br>1.8 16V<br>1.9 dCi<br>1.9 dTi (1U)<br>1.9 dTi (ON)<br>2.0 i<br>2.0 i (OG)   | 79<br>79<br>79<br>79<br>85<br>75<br>59<br>72<br>80<br>84   |  | 03.99<br>03.99<br>03.99<br>03.99<br>01.01<br>09.98<br>02.01<br>03.99<br>03.99<br>03.99  | 12.02<br>12.02<br>12.02<br>12.02<br>12.02<br>12.02<br>12.02<br>02.01<br>12.02<br>12.02   | 24.0124-0158.1<br>24.0324-0158.1 | 424158<br>524158 |                               | 280 24,0 21,8 V L +S +B<br>280 24,0 21,8 V L +S +B PD |
|  | 1.4 16V (OD)<br>1.4 16V (OW)<br>1.4 e (OE)<br>1.4 e (OV)<br>1.6 16V (O4)<br>1.6 16V (O4)<br>1.6 16V (OB)<br>1.6 e (OF)<br>1.6 i<br>1.9 D<br>1.9 D (OR)<br>1.9 dCi<br>1.9 dT<br>1.9 dTi (1U)<br>1.9 dTi (O8)<br>1.9 dTi (ON)<br>2.0 i (OG) | 70<br>70<br>55<br>55<br>79<br>79<br>79<br>66<br>55<br>47<br>47<br>75<br>66<br>59<br>72<br>72<br>84 |  | 03.99<br>06.98<br>09.96<br>04.98<br>09.00<br>04.98<br>09.98<br>09.96<br>09.96<br>09.96<br>09.00<br>09.98<br>09.96<br>02.01<br>03.97<br>09.00<br>09.96 | 12.02<br>12.02<br>12.02<br>12.02<br>12.02<br>12.02<br>12.02<br>03.99<br>03.99<br>12.02<br>12.02<br>12.02<br>12.02<br>02.01<br>02.01<br>02.01<br>12.02  | 24.0713-1109.1                   | 360145           | 2                             | Radsensor L=625                                       |
|  | 1.4 16V (OD)<br>1.6 16V (OB)<br>1.8 16V (12)<br>1.8 16V (1A)<br>1.8 16V (1M)<br>1.8 16V (1R)<br>1.9 dCi (1F)  | 70<br>79<br>85<br>85<br>85<br>85<br>75   |  | 03.99<br>09.98<br>01.01<br>01.01<br>01.01<br>01.01<br>02.01   | 12.02 + ASR<br>12.02<br>12.02 + ASR<br>12.02<br>12.02 + ASR<br>12.02<br>12.02  | 13.0460-3954.2<br>13.0460-0435.2 | 603954<br>610435 |                               | 20973 11,0 + BDX<br>Belagsatz-Zubehör BDX             |
|  | 1.4 16V (OD)<br>1.6 16V (OB)<br>1.8 16V (12)<br>1.8 16V (1A)<br>1.8 16V (1M)<br>1.8 16V (1R)<br>1.9 dCi (1F)  | 70<br>79<br>85<br>85<br>85<br>85<br>75   |  | 03.99<br>09.98<br>01.01<br>01.01<br>01.01<br>01.01<br>02.01   | 12.02 + ASR<br>12.02<br>12.02 + ASR<br>12.02<br>12.02 + ASR<br>12.02<br>12.02  | 24.0108-0108.1                   | 408108           | ohne Sensorring <sup>1)</sup> | 238 8,0 7,0 +B  |
|  | 1.4 16V (OD)<br>1.4 16V (OW)<br>1.4 e (OE)<br>1.4 e (OV)<br>1.6 16V (O4)<br>1.6 16V (OB)<br>1.6 e (OF)<br>1.6 i<br>1.9 D<br>1.9 D (OR)<br>1.9 dCi<br>1.9 dT<br>1.9 dTi (1U)<br>1.9 dTi (O8)<br>1.9 dTi (ON)<br>2.0 i (OG)                 | 70<br>70<br>55<br>55<br>79<br>79<br>66<br>55<br>47<br>47<br>75<br>66<br>59<br>72<br>72<br>84       |  | 03.99<br>06.98<br>09.96<br>04.98<br>04.98<br>09.98<br>09.96<br>09.96<br>09.96<br>09.00<br>09.98<br>09.96<br>02.01<br>03.97<br>09.00<br>09.96          | 12.02 - ASR/ + verstärktes Fahrwerk <sup>2)</sup><br>12.02 - verstärktes Fahrwerk <sup>3)</sup><br>12.02 - verstärktes Fahrwerk <sup>3)</sup><br>12.02<br>12.02 - verstärktes Fahrwerk <sup>3)</sup><br>12.02<br>03.99 - verstärktes Fahrwerk <sup>3)</sup><br>03.99 - verstärktes Fahrwerk <sup>3)</sup><br>12.02 - verstärktes Fahrwerk <sup>3)</sup><br>12.02 - ASR/ + verstärktes Fahrwerk <sup>2)</sup><br>12.02<br>12.02<br>02.01<br>02.01 - ASR<br>12.02 - verstärktes Fahrwerk <sup>3)</sup> | 24.0721-1175.1<br>24.0721-1176.1 | 360088<br>360089 | <br>                          | Radsensor L=560<br>Radsensor L=450                    |
|  | 1.6 16V (11)<br>1.6 16V (1C)<br>1.6 16V (O4)<br>1.6 e (OF)<br>1.6 i<br>1.9 D (OA)<br>1.9 D (OR)<br>1.9 D (OU)<br>1.9 dTi (ON)<br>2.0 i (OG)   | 79<br>79<br>79<br>66<br>55<br>47<br>47<br>47<br>72<br>84   |  | 09.99<br>09.99<br>04.98<br>09.96<br>09.96<br>09.96<br>09.98<br>09.96<br>03.97<br>09.96  | 12.02<br>12.02<br>12.02 - ASR/ + verstärktes Fahrwerk <sup>2)</sup><br>12.02 + verstärktes Fahrwerk <sup>4)</sup><br>12.02 + verstärktes Fahrwerk <sup>4)</sup><br>12.02 + verstärktes Fahrwerk <sup>4)</sup><br>08.00 - ASR/ + verstärktes Fahrwerk <sup>2)</sup><br>12.02 + verstärktes Fahrwerk <sup>4)</sup><br>08.00 - ASR<br>12.02 + verstärktes Fahrwerk <sup>4)</sup>  | 24.0721-1171.1<br>24.0721-1172.1 | 360146<br>360147 | <br>                          | Radsensor L=580<br>Radsensor L=475                    |



















<sup>1)</sup> without sensor ring / senza sensori / sans secours ABS / sin anillo sensor ABS

<sup>2)</sup> - ASR/ + reinforced suspens. / - ASR/+ sospensione rinforzata / - ASR/+ châssis renforcé / - ASR/+ suspensión reforzada

<sup>3)</sup> - reinforced suspension / - sospensione rinforzata / - châssis renforcé / - suspensión reforzada





















<sup>4)</sup> + reinforced suspension / + sospensione rinforzata / + châssis renforcé / + suspensión reforzada

|     |  |  |  |  |  |  |  |  |            |
|--|--|--|--|--|---|--|--|--|------------|
| <b>RENAULT MEGANE I Classic (LA_) (96-02)</b>                                      |  |  |  |  |   |  |  |  |            |
|    | 1.4 16V (10)   | 70   | 03.99  | 12.02  | 03.0137-0335.2  | 650335   |  | 203 x 39   | <b>BDX</b> |
|  | 1.4 16V (1H)   | 70   | 03.99  | 12.02  | 03.0137-9125.2  | 669125   |  | Bremsbacken-Zubehör  | <b>BDX</b> |
|  | 1.4 16V (OD)   | 70   | 03.99  | 12.02  |   |  |  |  |            |
|  | 1.4 16V (OW)   | 70   | 06.98  | 12.02  |   |  |  |  |            |
|  | 1.4 e (OE)   | 55   | 09.96  | 12.02  |   |  |  |  |            |
|  | 1.4 e (OV)   | 55   | 04.98  | 12.02  |   |  |  |  |            |
|  | 1.6 16V (11)   | 79   | 09.99  | 12.02  |   |  |  |  |            |
|  | 1.6 16V (1C)   | 79   | 09.99  | 12.02  |   |  |  |  |            |
|  | 1.6 16V (O4)   | 79   | 04.98  | 12.02  |   |  |  |  |            |
|  | 1.6 e  | 66   | 09.96  | 03.99  |   |  |  |  |            |
|  | 1.6 i  | 55   | 09.96  | 03.99  |   |  |  |  |            |
|  | 1.8 16V (12)   | 85   | 01.01  | 12.02  |   |  |  |  |            |
|  | 1.8 16V (1M)   | 85   | 01.01  | 12.02  |   |  |  |  |            |
|  | 1.9 D  | 47   | 09.96  | 12.02  |   |  |  |  |            |
|  | 1.9 dCi  | 75   | 09.98  | 12.02  |   |  |  |  |            |
|  | 1.9 dT   | 66   | 09.96  | 12.02  |   |  |  |  |            |
|  | 1.9 dTi (1U)   | 59   | 02.01  | 12.02  |   |  |  |  |            |
|  | 1.9 dTi (O8)   | 72   | 03.97  | 02.01  |   |  |  |  |            |
|  | 1.9 dTi (ON)   | 72   | 03.97  | 02.01  |   |  |  |  |            |
|  | 2.0 i (O7)   | 84   | 09.96  | 12.02  |   |  |  |  |            |
|  | 2.0 i (O6)   | 84   | 09.96  | 12.02  |   |  |  |  |            |
|    | 1.4 16V  | 70   | 06.98  | 12.02  | 24.0220-3021.1  | 480127   |  | 203/204,5 x 48 - Lager   |            |
|  | 1.4 e  | 55   | 09.96  | 12.02  |   |  |  |  |            |
|  | 1.6 16V  | 79   | 04.98  | 12.02  |   |  |  |  |            |
|  | 1.6 e  | 66   | 09.96  | 03.99  |   |  |  |  |            |
|  | 1.6 i  | 55   | 09.96  | 03.99  |   |  |  |  |            |
|  | 1.8 16V (12)   | 85   | 01.01  | 12.01  |   |  |  |  |            |
|  | 1.8 16V (1M)   | 85   | 01.01  | 12.02  |   |  |  |  |            |
|  | 1.9 D  | 47   | 09.96  | 12.02  |   |  |  |  |            |
|  | 1.9 dCi  | 75   | 09.98  | 12.02  |   |  |  |  |            |
|  | 1.9 dT   | 66   | 09.96  | 12.02  |   |  |  |  |            |
|  | 1.9 dTi  | 72   | 03.97  | 02.01  |   |  |  |  |            |
|  | 1.9 dTi (1U)   | 59   | 02.01  | 12.02  |   |  |  |  |            |
|  | 2.0 i  | 84   | 09.96  | 12.02  |   |  |  |  |            |
|    | 1.4 16V (OD)   | 70   | 03.99  | 12.02  | 03.0520-3217.3  | 693217   |  | 17,46/203x39 TopKit  | <b>BDX</b> |
|  | 1.4 16V (OW)   | 70   | 06.98  | 12.02  |   |  |  |  |            |
|  | 1.4 e (OE)   | 55   | 09.96  | 12.02  |   |  |  |  |            |
|  | 1.4 e (OV)   | 55   | 04.98  | 02.99  |   |  |  |  |            |
|  | 1.4 e (OV)   | 55   | 04.98  | 12.02  |   |  |  |  |            |
|  | 1.6 16V (11)   | 79   | 09.99  | 12.02  |   |  |  |  |            |
|  | 1.6 16V (1C)   | 79   | 09.99  | 12.02  |   |  |  |  |            |
|  | 1.6 16V (O4)   | 79   | 04.98  | 12.02  |   |  |  |  |            |
|  | 1.6 e  | 66   | 09.96  | 03.99  |   |  |  |  |            |
|  | 1.6 i  | 55   | 09.96  | 03.99  |   |  |  |  |            |
|  | 1.9 D  | 47   | 09.96  | 12.02  |   |  |  |  |            |
|  | 1.9 dCi  | 75   | 09.98  | 12.02  |   |  |  |  |            |
|  | 1.9 dT   | 66   | 09.96  | 12.02  |   |  |  |  |            |
|  | 1.9 dTi (1U)   | 59   | 02.01  | 12.02  |   |  |  |  |            |
|  | 1.9 dTi (O8)   | 72   | 03.97  | 02.01  |   |  |  |  |            |
|  | 1.9 dTi (ON)   | 72   | 03.97  | 02.99  |   |  |  |  |            |
|  | 1.9 dTi (ON)   | 72   | 03.97  | 02.01  |   |  |  |  |            |
|  | 2.0 i (O7)   | 84   | 09.96  | 12.02  |   |  |  |  |            |
|  | 2.0 i (O6)   | 84   | 09.96  | 02.99  |   |  |  |  |            |
|  | 2.0 i (O6)   | 84   | 09.96  | 12.02  |   |  |  |  |            |
|  | 1.4 16V (OD)   | 70   | 03.99  | 12.02  | 03.0520-5019.3  | 695019   |  | 19,05/203x39 TopKit  | <b>BDX</b> |
|  | 1.4 16V (OW)   | 70   | 06.98  | 12.02  |   |  |  |  |            |
|  | 1.4 e (OV)   | 55   | 03.99  | 12.02  |   |  |  |  |            |
|  | 1.6 16V (O4)   | 79   | 04.98  | 12.02  |   |  |  |  |            |
|  | 1.8 16V (12)   | 85   | 01.01  | 12.02  |   |  |  |  |            |
|  | 1.8 16V (1M)   | 85   | 01.01  | 12.02  |   |  |  |  |            |
|  | 1.9 dCi  | 75   | 09.98  | 12.02  |   |  |  |  |            |
|  | 1.9 dTi (1U)   | 59   | 02.01  | 12.02  |   |  |  |  |            |
|  | 1.9 dTi (O8)   | 72   | 03.97  | 02.01  |   |  |  |  |            |
|  | 1.9 dTi (ON)   | 72   | 03.99  | 02.01  |   |  |  |  |            |
|  | 2.0 i (O6)   | 84   | 03.99  | 12.02  |   |  |  |  |            |
|  | 2.0 i (O6)   | 84   | 03.99  | 12.02  |   |  |  |  |            |
| <b>RENAULT MEGANE I Coach (DA_) (95-03)</b>  |  |  |  |  |   |  |  |  |            |
|  | 1.4 16V (OW)   | 70   | 06.98  | 02.03  | 13.0460-2834.2  | 602834   |  | 21463 18,0 /WK/S   | <b>TRW</b> |
|  | 1.6 e  | 66   | 09.95  | 02.03  |   |  |  |  |            |
|  | 1.9 dTi  | 72   | 05.97  | 02.99  |   |  |  |  |            |
|  | 2.0 i  |  | 09.95  | 02.03  |   |  |  |  |            |
|  | 1.6 16V (O4)   | 79   | 04.98  | 04.99  | 13.0460-2983.2  | 602983   |  | 21388 18,0 +/WK/S  | <b>TRW</b> |
|  | 1.9 dTi  | 72   | 03.99  | 04.99  |   |  |  |  |            |
|  | 2.0 16V (O3)   | 103  | 07.98  | 08.98  |   |  |  |  |            |
|  | 2.0 16V (OH)   | 108  | 09.95  | 08.98  |   |  |  |  |            |
|  | 1.4 16V (OD)   | 70   | 10.00  | 02.03  | 13.0460-2895.2  | 602895   |  | 23172 18,0 /WE/Zub/S   | <b>TRW</b> |
|  | 1.6 16V  | 79   | 04.98  | 02.03  | 13.0460-0262.2  | 610262   |  | Belagsatz-Zubehör  | <b>TRW</b> |
|  | 1.9 dCi  |  | 10.00  | 02.03  |   |  |  |  |            |
|  | 1.9 dTi  | 72   | 03.99  | 02.03  |   |  |  |  |            |
|  | 2.0 16V  | 102  | 01.02  | 02.03  |   |  |  |  |            |
|  | 2.0 16V (O3)   | 103  | 09.98  | 02.03  |   |  |  |  |            |
|  | 2.0 16V (OH)   | 108  | 09.98  | 02.03  |   |  |  |  |            |
|  | 2.0 16V (OP)   | 103  | 10.00  | 02.03  |   |  |  |  |            |

|     |  |  |  |  |  |  |  |  |
|--|--|--|--|--|---|--|--|--|
| <b>RENAULT MEGANE I Coach (DA_) (95-03)</b>  |  |  |  |  |   |  |  |  |
|    | 1.6 e  | 66   | 09.95  | 10.97  | 24.0120-0125.1  | 420125   |  | 238 20,1 17,7 V +S +B  |
|  | 1.4 16V (OD)   | 70   | 10.00  | 02.03  | 24.0121-0106.1  | 421106   |  | 259 20,6 17,7 V +S +B  |
|  | 1.4 16V (OW)   | 70   | 06.98  | 02.03  |   |  |  |  |
|  | 1.6 e  | 66   | 11.97  | 02.03  |   |  |  |  |
|  | 1.9 dTi  | 72   | 05.97  | 02.99  |   |  |  |  |
|  | 2.0 i  |  | 09.95  | 02.03  |   |  |  |  |
|  | 1.6 16V  | 79   | 04.98  | 02.03  | 24.0124-0158.1  | 424158   |  | 280 24,0 21,8 V L +S +B  |
|  | 1.9 dCi  |  | 10.00  | 02.03  | 24.0324-0158.1  | 524158   |  | 280 24,0 21,8 V L +S +B PD   |
|  | 1.9 dTi  | 72   | 03.99  | 02.03  |   |  |  |  |
|  | 2.0 16V  | 102  | 01.02  | 02.03  |   |  |  |  |
|  | 2.0 16V (03)   | 103  | 07.98  | 02.03  |   |  |  |  |
|  | 2.0 16V (0H)   | ▶108   | 09.95  | 02.03  |   |  |  |  |
|  | 2.0 16V (OH)   | ◀108   | 09.98  | 02.03  |   |  |  |  |
|  | 2.0 16V (OP)   | 103  | 10.00  | 02.03  |   |  |  |  |
|  | 2.0 16V (OH)   | ◀108   | 09.95  | 08.98  | 24.0122-0148.1  | 422148   |  | 262 22,0 19,8 V L +S +B  |
|    | 1.4 16V  | 70   | 06.98  | 02.03  | 24.0713-1109.1  | 360145   | 2  | Radsensor L=625  |
|  | 1.6 16V  | 79   | 04.98  | 02.03  |   |  |  |  |
|  | 1.6 e  | 66   | 01.96  | 02.03  |   |  |  |  |
|  | 1.9 dTi  | 72   | 05.97  | 02.03  |   |  |  |  |
|  | 2.0 16V  | 102  | 01.02  | 02.03  |   |  |  |  |
|  | 2.0 16V (03)   | 103  | 07.98  | 02.03  |   |  |  |  |
|  | 2.0 16V (OH)   | 108  | 09.98  | 02.03  |   |  |  |  |
|  | 2.0 16V (OP)   | 103  | 10.00  | 02.03  |   |  |  |  |
|  | 2.0 i  |  | 01.96  | 02.03  |   |  |  |  |
|    | 1.4 16V (OD)   | 70   | 10.00  | 02.03  | 13.0460-3954.2  | 603954   |  | 20973 11,0 + BDX   |
|  | 1.6 16V (OB)   | 79   | 10.00  | 02.03  | 13.0460-0435.2  | 610435   |  | Belagsatz-Zubehör BDX  |
|  | 1.9 dCi (1F)   | 75   | 10.00  | 02.03  |   |  |  |  |
|  | 2.0 16V  | 102  | 01.02  | 02.03  |   |  |  |  |
|  | 2.0 16V (03)   | 103  | 07.98  | 02.03  |   |  |  |  |
|  | 2.0 16V (OH)   | 108  | 09.95  | 02.03  |   |  |  |  |
|  | 2.0 16V (OP)   | 103  | 10.00  | 02.03  |   |  |  |  |
|    | 1.4 16V (OD)   | 70   | 10.00  | 02.03  | 24.0108-0108.1  | 408108   |  | ohne Sensorring <sup>1)</sup>  |
|  | 1.6 16V (OB)   | 79   | 10.00  | 02.03  |   |  |  | 238 8,0 7,0 +B   |
|  | 1.9 dCi (1F)   | 75   | 10.00  | 02.03  |   |  |  |  |
|  | 2.0 16V  | 102  | 01.02  | 02.03  |   |  |  |  |
|  | 2.0 16V (03)   | 103  | 07.98  | 02.03  |   |  |  |  |
|  | 2.0 16V (OH)   | 108  | 09.95  | 02.03  |   |  |  |  |
|  | 2.0 16V (OP)   | 103  | 10.00  | 02.03  |   |  |  |  |
|   | 1.4 16V  | 70   | 06.98  | 02.03  | 24.0721-1175.1  | 360088   |  | Radsensor L=560  |
|  | 1.6 16V (04)   | 79   | 04.98  | 02.03  | 24.0721-1176.1  | 360089   |  | Radsensor L=450  |
|  | 1.6 e  | 66   | 01.96  | 02.03  |   |  |  |  |
|  | 1.9 dTi  | 72   | 05.97  | 02.03  |   |  |  |  |
|  | 2.0 16V (03)   | 103  | 09.00  | 02.03  |   |  |  |  |
|  | 2.0 i  |  | 01.96  | 02.03  |   |  |  |  |
|  | 1.6 e  | 66   | 01.96  | 02.03  | 24.0721-1171.1  | 360146   |  | Radsensor L=580  |
|  |  |  |  |  | 24.0721-1172.1  | 360147   |  | Radsensor L=475  |
|  | 1.4 16V (OD)   | 70   | 10.00  | 02.03  | 03.0137-0335.2  | 650335   |  | 203 x 39 BDX   |
|  | 1.4 16V (OW)   | 70   | 06.98  | 02.03  | 03.0137-9125.2  | 669125   |  | Bremsbacken-Zubehör BDX  |
|  | 1.6 16V (04)   | 79   | 04.98  | 02.03  |   |  |  |  |
|  | 1.6 16V (OB)   | 79   | 10.00  | 02.03  |   |  |  |  |
|  | 1.6 e  | 66   | 09.95  | 02.03  |   |  |  |  |
|  | 1.9 dCi (1F)   | 75   | 10.00  | 02.03  |   |  |  |  |
|  | 1.9 dCi (05)   | 75   | 10.00  | 02.03  |   |  |  |  |
|  | 1.9 dTi  | 72   | 05.97  | 02.03  |   |  |  |  |
|  | 2.0 i  |  | 09.95  | 02.03  |   |  |  |  |
|  | 1.4 16V (OD)   | 70   | 10.00  | 02.03  | 24.0220-3021.1  | 480127   |  | 203/204,5 x 48 - Lager   |
|  | 1.4 16V (OW)   | 70   | 06.98  | 02.03  |   |  |  |  |
|  | 1.6 16V  | 79   | 04.98  | 02.03  |   |  |  |  |
|  | 1.6 e  | 66   | 09.95  | 02.03  |   |  |  |  |
|  | 1.9 dCi  |  | 10.00  | 02.03  |   |  |  |  |
|  | 1.9 dTi  | 72   | 05.97  | 02.03  |   |  |  |  |
|  | 2.0 i  |  | 09.95  | 02.03  |   |  |  |  |
|  | 1.4 16V (OW)   | 70   | 06.98  | 02.03  | 03.0520-3217.3  | 693217   |  | 17,46/203x39 TopKit BDX  |
|  | 1.6 16V (04)   | 79   | 09.95  | 02.03  |   |  |  |  |
|  | 1.6 e  | 66   | 09.95  | 02.03  |   |  |  |  |
|  | 1.9 dCi (05)   | 75   | 10.00  | 02.03  |   |  |  |  |
|  | 1.9 dTi  | 72   | 03.99  | 02.03  |   |  |  |  |
|  | 1.9 dTi  | 72   | 05.97  | 02.99  |   |  |  |  |
|  | 2.0 i  |  | 09.95  | 02.03  |   |  |  |  |
|  | 1.4 16V (OD)   | 70   | 10.00  | 02.03  | 03.0520-5019.3  | 695019   |  | 19,05/203x39 TopKit BDX  |
|  | 1.4 16V (OW)   | 70   | 06.98  | 02.03  |   |  |  |  |
|  | 1.6 16V (04)   | 79   | 04.98  | 02.03  |   |  |  |  |
|  | 1.6 16V (OB)   | 79   | 10.00  | 02.03  |   |  |  |  |
|  | 1.9 dCi (1F)   | 75   | 10.00  | 02.03  |   |  |  |  |
|  | 1.9 dCi (05)   | 75   | 10.00  | 02.03  |   |  |  |  |
|  | 1.9 dTi  | 72   | 03.99  | 02.03  |   |  |  |  |
|  | 1.9 dTi  | 72   | 03.99  | 02.03  |   |  |  |  |
| <b>RENAULT MEGANE I Cabrio (EA_) (96-03)</b>                                       |  |  |  |  |   |  |  |  |
|  | 1.4 16V (W)  | 70   | 06.98  | 10.03  | 13.0460-2834.2  | 602834   |  | 21463 18,0 /WK/S TRW   |
|  | 1.6 e  | 66   | 08.96  | 10.03  |   |  |  |  |
|  | 2.0 i  |  | 12.96  | 10.03  |   |  |  |  |
|  | 1.4 16V (D)  | 70   | 10.00  | 10.03  | 13.0460-2895.2  | 602895   |  | 23172 18,0 /WE/Zub/S TRW   |
|  | 1.6 16V  | 79   | 09.98  | 10.03  | 13.0460-0262.2  | 610262   |  | Belagsatz-Zubehör TRW  |
|  | 2.0 16V  | 102  | 01.02  | 10.03  |   |  |  |  |
|  | 2.0 16V (3)  | 103  | 09.98  | 10.03  |   |  |  |  |
| ↓  | ↓  |  |  |  |   |  |  |  |

<sup>1)</sup> without sensor ring / senza sensori / sans secours ABS / sin anillo sensor ABS



|     |  |  |  |  |  |  |  |  |                         |
|--|--|--|--|--|---|--|--|--|-------------------------|
| <b>RENAULT MEGANE I Cabrio (EA_) (96-03)</b>                                       |  |  |  |  |   |  |  |  |                         |
|    | 2.0 16V (P)  | 103  |  | 10.00  | 10.03   | 13.0460-2895.2   | 602895   | 23172 18,0 /WE/Zub/S<br>Belagsatz-Zubehör  | TRW                     |
|  | 2.0 16V (H)  | 108  |  | 08.96  | 10.03   | 13.0460-0262.2   | 610262   |  | TRW                     |
|    | 1.6 e  | 66   |  | 08.96  | 10.97   | 24.0120-0125.1   | 420125   | 238 20,1 17,7 V +S +B  |                         |
|  | 1.4 16V (D)  | 70   |  | 10.00  | 10.03   | 24.0121-0106.1   | 421106   | 259 20,6 17,7 V +S +B  |                         |
|  | 1.4 16V (W)  | 70   |  | 06.98  | 10.03   |  |  |  |                         |
|  | 1.6 e  | 66   |  | 11.97  | 10.03   |  |  |  |                         |
|  | 2.0 i  |  |  | 12.96  | 10.03   |  |  |  |                         |
|  | 1.6 16V  | 79   |  | 09.98  | 10.03   | 24.0124-0158.1   | 424158   | 280 24,0 21,8 V L +S +B  |                         |
|  | 2.0 16V  | 102  |  | 01.02  | 10.03   | 24.0324-0158.1   | 524158   | 280 24,0 21,8 V L +S +B PD   |                         |
|  | 2.0 16V (3)  | 103  |  | 09.98  | 10.03   |  |  |  |                         |
|  | 2.0 16V (H)  | 108  |  | 08.96  | 10.03   |  |  |  |                         |
|  | 2.0 16V (H)  | 108  |  | 09.98  | 10.03   |  |  |  |                         |
|  | 2.0 16V (P)  | 103  |  | 10.00  | 10.03   |  |  |  |                         |
|  | 2.0 16V (H)  | 108  |  | 08.96  | 08.98   | 24.0122-0148.1   | 422148   | 262 22,0 19,8 V L +S +B  |                         |
|    | 1.4 16V  | 70   |  | 06.98  | 10.03   | 24.0713-1109.1   | 360145   | 2  | Radsensor L=625         |
|  | 1.6 16V  | 79   |  | 04.98  | 10.03   |  |  |  |                         |
|  | 1.6 e  | 66   |  | 08.96  | 10.03   |  |  |  |                         |
|  | 2.0 16V  | 102  |  | 01.02  | 10.03   |  |  |  |                         |
|  | 2.0 16V (3)  | 103  |  | 09.98  | 10.03   |  |  |  |                         |
|  | 2.0 16V (H)  | 108  |  | 09.98  | 10.03   |  |  |  |                         |
|  | 2.0 16V (P)  | 103  |  | 10.00  | 10.03   |  |  |  |                         |
|  | 2.0 i  |  |  | 12.96  | 10.03   |  |  |  |                         |
|    | 1.4 16V (D)  | 70   |  | 10.00  | 10.03 + ASR   | 13.0460-3954.2   | 603954   | 20973 11,0 +<br>Belagsatz-Zubehör  | BDX                     |
|  | 1.6 16V (B)  | 79   |  | 10.00  | 10.03 + ASR   | 13.0460-0435.2   | 610435   |  | BDX                     |
|  | 2.0 16V  | 102  |  | 01.02  | 10.03   |  |  |  |                         |
|  | 2.0 16V (3)  | 103  |  | 09.98  | 10.03   |  |  |  |                         |
|  | 2.0 16V (H)  | 108  |  | 08.96  | 10.03   |  |  |  |                         |
|  | 2.0 16V (P)  | 103  |  | 10.00  | 10.03   |  |  |  |                         |
|    | 1.4 16V (D)  | 70   |  | 10.00  | 10.03 + ASR   | 24.0108-0108.1   | 408108   | ohne Sensorring <sup>1)</sup>  | 238 8,0 7,0 +B          |
|  | 1.6 16V (B)  | 79   |  | 10.00  | 10.03 + ASR   |  |  |  |                         |
|  | 2.0 16V  | 102  |  | 01.02  | 10.03   |  |  |  |                         |
|  | 2.0 16V (3)  | 103  |  | 09.98  | 10.03   |  |  |  |                         |
|  | 2.0 16V (H)  | 108  |  | 08.96  | 10.03   |  |  |  |                         |
|  | 2.0 16V (P)  | 103  |  | 10.00  | 10.03   |  |  |  |                         |
|    | 1.4 16V  | 70   |  | 06.98  | 10.03   | 24.0721-1175.1   | 360088   | 2  | Radsensor L=560         |
|  | 1.6 16V  | 79   |  | 09.98  | 10.03   | 24.0721-1176.1   | 360089   | 2  | Radsensor L=450         |
|  | 1.6 e  | 66   |  | 08.96  | 10.03   |  |  |  |                         |
|  | 2.0 16V  | 102  |  | 01.02  | 10.03   |  |  |  |                         |
|  | 2.0 16V (3)  | 103  |  | 09.00  | 10.03   |  |  |  |                         |
|  | 2.0 i  |  |  | 12.96  | 10.03   |  |  |  |                         |
|  | 1.4 16V (D)  | 70   |  | 10.00  | 10.03   | 03.0137-0335.2   | 650335   | 203 x 39   | BDX                     |
|  | 1.4 16V (W)  | 70   |  | 06.98  | 10.03   | 03.0137-9125.2   | 669125   | Bremsbacken-Zubehör  | BDX                     |
|  | 1.6 16V (4)  | 79   |  | 09.98  | 10.03   |  |  |  |                         |
|  | 1.6 16V (B)  | 79   |  | 10.00  | 10.03   |  |  |  |                         |
|  | 1.6 e  | 66   |  | 08.96  | 10.03   |  |  |  |                         |
|  | 2.0 i  |  |  | 12.96  | 10.03   |  |  |  |                         |
|  | 1.4 16V  | 70   |  | 06.98  | 10.03   | 24.0220-3021.1   | 480127   |  | 203/204,5 x 48 - Lager  |
|  | 1.6 16V  | 79   |  | 09.98  | 10.03   |  |  |  |                         |
|  | 1.6 e  | 66   |  | 08.96  | 10.03   |  |  |  |                         |
|  | 2.0 i  |  |  | 12.96  | 10.03   |  |  |  |                         |
|  | 1.4 16V (W)  | 70   |  | 06.98  | 10.03 - ABS   | 03.0520-3217.3   | 693217   |  | 17,46/203x39 TopKit BDX |
|  | 1.6 16V (4)  | 79   |  | 09.98  | 10.03 - ABS   |  |  |  |                         |
|  | 1.6 e  | 66   |  | 08.96  | 10.03   |  |  |  |                         |
|  | 2.0 i  |  |  | 12.96  | 10.03   |  |  |  |                         |
|  | 1.4 16V (D)  | 70   |  | 10.00  | 10.03 + ABS/ - ASR  | 03.0520-5019.3   | 695019   |  | 19,05/203x39 TopKit BDX |
|  | 1.4 16V (W)  | 70   |  | 06.98  | 10.03 + ABS   |  |  |  |                         |
|  | 1.6 16V (4)  | 79   |  | 09.98  | 10.03 + ABS   |  |  |  |                         |
|  | 1.6 16V (B)  | 79   |  | 10.00  | 10.03 + ABS/ - ASR  |  |  |  |                         |
| <b>RENAULT MEGANE I Grandtour (KA_) (98-03)</b>                                    |  |  |  |  |   |  |  |  |                         |
|  | 1.4 16V  | 70   |  | 09.98  | 12.03   | 13.0460-2834.2   | 602834   | 21463 18,0 /WK/S   | TRW                     |
|  | 1.4 e  | 55   |  | 09.98  | 12.03   |  |  |  |                         |
|  | 1.6 e  | 66   |  | 09.98  | 12.03   |  |  |  |                         |
|  | 1.9 D  | 47   |  | 03.99  | 12.03   |  |  |  |                         |
|  | 1.9 dTi (ON)   | 72   |  | 01.99  | 12.03   | 13.0460-2983.2   | 602983   | 21388 18,0 +/WK/S  | TRW                     |
|  | 1.6 16V  | 79   |  | 09.98  | 12.03   | 13.0460-2895.2   | 602895   | 23172 18,0 /WE/Zub/S   | TRW                     |
|  | 1.8 16V  | 85   |  | 01.01  | 12.03   | 13.0460-0262.2   | 610262   | Belagsatz-Zubehör  | TRW                     |
|  | 1.9 dCi  | 75   |  | 01.01  | 12.03   |  |  |  |                         |
|  | 1.9 dTi (1U)   | 59   |  | 02.01  | 12.03   |  |  |  |                         |
|  | 1.4 16V  | 70   |  | 09.98  | 12.03   | 24.0121-0106.1   | 421106   | 259 20,6 17,7 V +S +B  |                         |
|  | 1.4 e  | 55   |  | 09.98  | 12.03   |  |  |  |                         |
|  | 1.6 e  | 66   |  | 09.98  | 12.03   |  |  |  |                         |
|  | 1.9 D  | 47   |  | 03.99  | 12.03   |  |  |  |                         |
|  | 1.6 16V  | 79   |  | 09.98  | 12.03   | 24.0124-0158.1   | 424158   | 280 24,0 21,8 V L +S +B  |                         |
|  | 1.8 16V  | 85   |  | 01.01  | 12.03   | 24.0324-0158.1   | 524158   | 280 24,0 21,8 V L +S +B PD   |                         |
|  | 1.9 dCi  | 75   |  | 02.01  | 12.03   |  |  |  |                         |
|  | 1.9 dTi (1U)   | 59   |  | 02.01  | 12.03   |  |  |  |                         |
|  | 1.9 dTi (ON)   | 72   |  | 01.99  | 12.03   |  |  |  |                         |
|  | 1.4 16V  | 70   |  | 09.98  | 12.03   | 24.0713-1109.1   | 360145   | 2  | Radsensor L=625         |
|  | 1.4 e  | 55   |  | 09.98  | 12.03   |  |  |  |                         |
|  | 1.6 e  | 66   |  | 09.98  | 12.03   |  |  |  |                         |
|  | 1.8 16V  | 85   |  | 09.98  | 12.03   |  |  |  |                         |
|  | 1.9 D  | 47   |  | 03.99  | 12.03   |  |  |  |                         |

<sup>1)</sup> without sensor ring / senza sensori / sans secours ABS / sin anillo sensor ABS

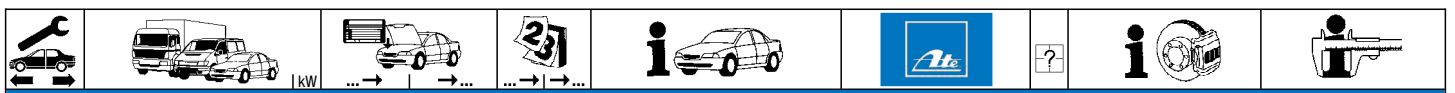



















### RENAULT MEGANE I Grandtour (KA\_) (98-03)

|  |  |                                  |  |  |  |  |                            |   |   |   |                   |
|--|--|----------------------------------|--|--|--|--|----------------------------|---|---|---|-------------------|
|  | 1.9 dCi<br>1.9 dTi (1U)<br>1.9 dTi (ON)  | 75<br>59<br>72                   |  | 02.01<br>02.01<br>01.99                            | 12.03<br>12.03<br>12.03                            | 24.0713-1109.1                                     | 360145                     | 2 |   | Radsensor L=625   |                   |
|  | 1.4 16V (OD)<br>1.6 16V (O4)<br>1.8 16V<br>1.9 dCi<br>1.9 dTi (1U)<br>1.9 dTi (ON) | 70<br>79<br>85<br>75<br>59<br>72 |  | 03.99<br>07.99<br>01.01<br>02.01<br>02.01<br>07.99 | 12.03<br>12.03<br>12.03<br>12.03<br>12.03<br>02.01 | 13.0460-2845.2<br>13.0470-2845.2<br>13.0460-0072.2 | 602845<br>LD2845<br>610072 |   |   | 23554 16,4 /Zub/S<br>23554 16,4 /Zub/S<br>Belagsatz-Zubehör | TRW<br>TRW<br>TRW |
|  | 1.4 16V (OD)<br>1.6 16V (O4)<br>1.8 16V<br>1.9 dCi<br>1.9 dTi (1U)<br>1.9 dTi (ON) | 70<br>79<br>85<br>75<br>59<br>72 |  | 03.99<br>07.99<br>01.01<br>02.01<br>02.01<br>07.99 | 12.03<br>12.03<br>12.03<br>12.03<br>12.03<br>02.01 | 24.0111-0166.2                                     | 411166                     |   | mit Lager/ mit Sensorring <sup>1)</sup> | 274 10,9 9,5 +B   |                   |
|  | 1.4 16V<br>1.4 e<br>1.6 16V<br>1.6 e<br>1.9 D                                      | 70<br>55<br>79<br>66<br>47       |  | 09.98<br>09.98<br>09.98<br>09.98<br>03.99          | 12.03<br>12.03<br>09.99<br>12.03<br>12.03          | 24.0721-1943.1                                     | 360153                     |   |   | Radsensor L=615   |                   |
|  | 1.6 16V<br>1.9 dCi<br>1.9 dTi (1U)<br>1.9 dTi (ON)                                 | 79<br>75<br>59<br>72             |  | 10.99<br>02.01<br>02.01<br>01.99                   | 04.01<br>04.01<br>04.01<br>04.01                   | 24.0741-1125.1<br>24.0741-1126.1                   | 360162<br>360163           |   |   | Radsensor L=645<br>Radsensor L=500                          |                   |
|  | 1.6 16V<br>1.9 dCi<br>1.9 dTi (1U)<br>1.9 dTi (ON)                                 | 79<br>75<br>59<br>72             |  | 05.01<br>05.01<br>05.01<br>05.01                   | 12.03<br>12.03<br>12.03<br>12.03                   | 24.0721-1175.1<br>24.0721-1176.1                   | 360088<br>360089           |   | - ESP<br>- ESP<br>- ESP<br>- ESP        | Radsensor L=560<br>Radsensor L=450                          |                   |
|  | 1.4 16V (OW)<br>1.4 e<br>1.6 16V (O4)<br>1.6 e<br>1.9 D<br>1.9 dTi (ON)            | 70<br>55<br>79<br>66<br>47<br>72 |  | 09.98<br>09.98<br>09.98<br>09.98<br>03.99<br>01.99 | 12.03<br>12.03<br>06.99<br>12.03<br>12.03<br>06.99 | 03.0137-0336.2<br>03.0137-9220.2                   | 650336<br>669220           |   |   | 229 x 42 HEB<br>Bremsbacken-Zubehör                         | TRW<br>TRW        |
|  | 1.4 16V (OW)<br>1.4 e<br>1.6 16V (O4)<br>1.6 e<br>1.9 D<br>1.9 dTi (ON)            | 70<br>55<br>79<br>66<br>47<br>72 |  | 09.98<br>09.98<br>09.98<br>09.98<br>03.99<br>01.99 | 12.03<br>12.03<br>06.99<br>12.03<br>12.03<br>06.99 | 24.0222-8019.2                                     | 480087                     |   |   | 229/229,5 x 52,5  |                   |
|  | 1.4 16V (OW)<br>1.4 e<br>1.6 16V (O4)<br>1.6 e<br>1.9 D<br>1.9 dTi (ON)            | 70<br>55<br>79<br>66<br>47<br>72 |  | 09.98<br>09.98<br>09.98<br>09.98<br>03.99<br>01.99 | 12.03<br>12.03<br>06.99<br>12.03<br>12.03<br>06.99 | 03.0520-5520.3                                     | 695520                     |   |   | 20,64/229x42 TopKit   | TRW               |





### RENAULT MEGANE II Limousine 3/5-tuerig (BM/CM\_) (02-08)

|  |  |   |  |   |  |  |                            |  |  |  |            |
|--|--|---|--|---|--|--|----------------------------|--|--|--|------------|
|  | 1.4 16V  | 72  |  | 11.02   | 09.05  | 13.0460-3814.2<br>13.0470-3814.2                   | 603814<br>LD3814           |  |  | 23934 18,2 /Zub/S<br>23934 18,2 /S   | BOS<br>BOS |
|  | 1.5 dCi<br>1.5 dCi<br>1.6 16V<br>1.9 dCi<br>2.0 16V<br>2.0 16V Turbo   | 60<br>63<br>83<br>88<br>99<br>120   |  | 11.02<br>05.05<br>11.02<br>11.02<br>11.02<br>05.04  | 09.05<br>09.05<br>09.05<br>09.05<br>09.05<br>09.05   | 13.0460-3815.2<br>13.0470-3815.2                   | 603815<br>LD3815           |  |  | 23930 18,2 /Zub/S<br>23930 18,2 /Zub/S   | BOS<br>BOS |
|  | 1.4 16V<br>1.5 dCi<br>1.5 dCi<br>1.5 dCi<br>1.5 dCi<br>1.6 16V<br>1.6 16V<br>1.6 FlexFuel<br>1.9 dCi<br>1.9 dCi<br>1.9 dCi<br>2.0 16V<br>2.0 16V<br>2.0 16V Turbo<br>2.0 dCi | 72<br>60<br>63<br>76<br>78<br>77<br>83<br>77<br>85<br>88<br>96<br>99<br>102<br>120<br>110 |  | 10.05<br>10.05<br>10.05<br>01.07<br>05.05<br>06.05<br>10.05<br>01.07<br>01.06<br>10.05<br>05.05<br>10.05<br>06.06<br>10.05<br>09.05 | 11.08<br>11.08<br>11.08<br>11.08<br>11.08<br>11.08<br>11.08<br>11.08<br>11.08<br>11.08<br>11.08<br>12.10<br>11.08<br>11.08 | 13.0460-7221.2<br>13.0470-7221.2                   | 607221<br>LD7221           |  |  | 24535 18,3 +<br>24535 18,3 +   | ATE<br>ATE |
|  | 2.0 16V<br>2.0 16V Sport<br>2.0 dCi  | 169<br>165<br>127   |  | 08.06<br>05.04<br>01.07   | 11.08<br>11.08<br>11.08  | 13.0460-4805.2                                     | 604805                     |  |  | 24162 15,2   | BRE        |
|  | 1.4 16V<br>1.5 dCi<br>1.5 dCi<br>1.5 dCi<br>1.6 16V<br>1.6 16V<br>1.6 FlexFuel<br>1.9 dCi<br>1.9 dCi<br>1.9 dCi  | 72<br>60<br>63<br>76<br>77<br>83<br>77<br>85<br>88<br>96                                  |  | 11.02<br>11.02<br>05.05<br>01.07<br>06.05<br>11.02<br>01.07<br>01.06<br>10.05<br>05.05  | 11.08<br>11.08<br>11.08<br>11.08<br>11.08<br>11.08<br>11.08<br>11.08<br>11.08<br>11.08                                     | 24.0122-0216.1<br>24.0124-0158.1<br>24.0324-0158.1 | 422216<br>424158<br>524158 |  |  | 260 22,0 19,8 V L +S +B<br>280 24,0 21,8 V L +S +B<br>280 24,0 21,8 V L +S +B PD |            |















<sup>1)</sup> with bearing/ with sensor ring / con supporto/+ anell.sens.ABS / avec palier de secours ABS / con apoyo/+ anillo sensor ABS

|     |  |  |  |  |  |  |  |      |                            |
|--|--|--|--|--|---|--|--|--|----------------------------|
| <b>RENAULT MEGANE II Limousine 3/5-tuerig (BM/CM ) (02-08)</b>                     |  |  |  |  |   |  |  |  |                            |
|    | 2.0 16V  | 99   |  | 11.02  | 11.08   | 24.0124-0158.1   | 424158   |  | 280 24,0 21,8 V L +S +B    |
|  | 2.0 16V  | 102  |  | 06.06  | 12.10   | 24.0324-0158.1   | 524158   |  | 280 24,0 21,8 V L +S +B PD |
|  | 2.0 16V Turbo  | 120  |  | 04.04  | 11.08   |  |  |  |                            |
|  | 2.0 dCi  | 110  |  | 09.05  | 11.08   | 24.0124-0223.1   | 424223   |  | 280 24,0 21,8 V L +S +B    |
|  | 2.0 16V  | 169  |  | 08.06  | 11.08   | 24.0128-0223.1   | 428223   |  | 313 28,0 26,0 V L +S +B    |
|  | 2.0 16V Sport  | 165  |  | 05.04  | 11.08   |  |  |  |                            |
|  | 2.0 dCi  | 127  |  | 01.07  | 11.08   |  |  |  |                            |
|    | 1.4 16V  | 72   |  | 11.02  | 01.05   | 24.0711-5151.3   | 360175   | 2   | Radsensor L=485            |
|  | 1.5 dCi  | 60   |  | 11.02  | 01.05   |  |  |  |                            |
|  | 1.6 16V  | 83   |  | 11.02  | 01.05   |  |  |  |                            |
|  | 1.9 dCi  | 88   |  | 11.02  | 01.05   |  |  |  |                            |
|  | 2.0 16V  | 99   |  | 11.02  | 01.05   |  |  |  |                            |
|  | 2.0 16V Turbo  | 120  |  | 05.04  | 01.05   |  |  |  |                            |
|  | 1.4 16V  | 72   |  | 02.05  | 12.05   | 24.0711-5190.3   | 360177   | 2   | Radsensor L=720            |
|  | 1.5 dCi  | 60   |  | 02.05  | 12.05   |  |  |  |                            |
|  | 1.5 dCi  | 63   |  | 05.05  | 12.05   |  |  |  |                            |
|  | 1.6 16V  | 83   |  | 02.05  | 12.05   |  |  |  |                            |
|  | 1.9 dCi  | 88   |  | 02.05  | 12.05   |  |  |  |                            |
|  | 2.0 16V  | 99   |  | 02.05  | 12.05   |  |  |  |                            |
|  | 2.0 16V Turbo  | 120  |  | 02.05  | 12.05   |  |  |  |                            |
|  | 2.0 dCi  | 110  |  | 09.05  | 12.05   |  |  |  |                            |
|  | 1.4 16V  | 72   |  | 01.06  | 11.08   | 24.0711-5180.3   | 360236   | 2   | Radsensor L=720            |
|  | 1.5 dCi  | 60   |  | 01.06  | 11.08   |  |  |  |                            |
|  | 1.5 dCi  | 63   |  | 01.06  | 11.08   |  |  |  |                            |
|  | 1.5 dCi  | 76   |  | 01.07  | 11.08   |  |  |  |                            |
|  | 1.5 dCi  | 78   |  | 05.05  | 11.08   |  |  |  |                            |
|  | 1.6 16V  | 77   |  | 06.05  | 11.08   |  |  |  |                            |
|  | 1.6 16V  | 83   |  | 01.06  | 11.08   |  |  |  |                            |
|  | 1.6 FlexFuel   | 77   |  | 01.07  | 11.08   |  |  |  |                            |
|  | 1.9 dCi  | 85   |  | 01.06  | 11.08   |  |  |  |                            |
|  | 1.9 dCi  | 88   |  | 01.06  | 11.08   |  |  |  |                            |
|  | 1.9 dCi  | 96   |  | 05.05  | 11.08   |  |  |  |                            |
|  | 2.0 16V  | 99   |  | 01.06  | 11.08   |  |  |  |                            |
|  | 2.0 16V  | 102  |  | 06.06  | 12.10   |  |  |  |                            |
|  | 2.0 16V Turbo  | 120  |  | 01.06  | 11.08   |  |  |  |                            |
|  | 2.0 dCi  | 110  |  | 01.06  | 11.08   |  |  |  |                            |
|  | 2.0 dCi  | 127  |  | 01.07  | 11.08   |  |  |  |                            |
|  | 2.0 16V Sport  | 165  |  | 05.04  | 01.05   | 24.0711-5177.3   | 360117   | 2   | Radsensor L=779            |
|  | 2.0 16V Sport  | 165  |  | 02.05  | 01.06   | 24.0711-5199.3   | 360271   | 2  | Radsensor L=1081           |
|  | 1.4 16V  | 72   |  | 11.02  | 11.08   | 13.0460-2845.2   | 602845   |  | 23554 16,4 /Zub/S TRW      |
|  | 1.5 dCi  | 60   |  | 11.02  | 11.08   | 13.0470-2845.2   | LD2845   |  | 23554 16,4 /Zub/S TRW      |
|  | 1.5 dCi  | 63   |  | 05.05  | 11.08   | 13.0460-0077.2   | 610077   |  | Belagsatz-Zubehör TRW      |
|  | 1.5 dCi  | 76   |  | 01.07  | 11.08   |  |  |  |                            |
|  | 1.5 dCi  | 78   |  | 05.05  | 11.08   |  |  |  |                            |
|  | 1.6 16V  | 77   |  | 06.05  | 11.08   |  |  |  |                            |
|  | 1.6 16V  | 83   |  | 11.02  | 11.08   |  |  |  |                            |
|  | 1.6 FlexFuel   | 77   |  | 01.07  | 11.08   |  |  |  |                            |
|  | 1.9 dCi  | 85   |  | 01.06  | 11.08   |  |  |  |                            |
|  | 1.9 dCi  | 88   |  | 11.02  | 11.08   |  |  |  |                            |
|  | 1.9 dCi  | 96   |  | 05.05  | 11.08   |  |  |  |                            |
|  | 2.0 16V  | 99   |  | 11.02  | 11.08   |  |  |  |                            |
|  | 2.0 16V  | 102  |  | 06.06  | 12.10   |  |  |  |                            |
|  | 2.0 16V  | 169  |  | 08.06  | 11.08   |  |  |  |                            |
|  | 2.0 16V Sport  | 165  |  | 05.04  | 11.08   |  |  |  |                            |
|  | 2.0 16V Turbo  | 120  |  | 05.04  | 11.08   |  |  |  |                            |
|  | 2.0 dCi  | 110  |  | 09.05  | 11.08   |  |  |  |                            |
|  | 1.4 16V  | 72   |  | 11.02  | 11.08   | 13.0460-7137.2   | 607137   | PR 1334  | 23482 15,8 + ATE           |
|  | 1.5 dCi  | 60   |  | 11.02  | 11.08   | 13.0470-7137.2   | LD7137   | PR 1334  | 23482 15,8 + ATE           |
|  | 1.5 dCi  | 63   |  | 05.05  | 11.08   |  |  |  |                            |
|  | 1.5 dCi  | 76   |  | 01.07  | 11.08   |  |  |  |                            |
|  | 1.5 dCi  | 78   |  | 05.05  | 11.08   |  |  |  |                            |
|  | 1.6 16V  | 77   |  | 06.05  | 11.08   |  |  |  |                            |
|  | 1.6 16V  | 83   |  | 11.02  | 11.08   |  |  |  |                            |
|  | 1.6 FlexFuel   | 77   |  | 01.07  | 11.08   |  |  |  |                            |
|  | 1.9 dCi  | 85   |  | 01.06  | 11.08   |  |  |  |                            |
|  | 1.9 dCi  | 88   |  | 11.02  | 11.08   |  |  |  |                            |
|  | 1.9 dCi  | 96   |  | 05.05  | 11.08   |  |  |  |                            |
|  | 2.0 16V  | 99   |  | 11.02  | 11.08   |  |  |  |                            |
|  | 2.0 16V  | 102  |  | 06.06  | 12.10   |  |  |  |                            |
|  | 2.0 16V  | 169  |  | 08.06  | 11.08   |  |  |  |                            |
|  | 2.0 16V Sport  | 165  |  | 05.04  | 11.08   |  |  |  |                            |
|  | 2.0 16V Turbo  | 120  |  | 05.04  | 11.08   |  |  |  |                            |
|  | 2.0 dCi  | 110  |  | 09.05  | 11.08   |  |  |  |                            |
|  | 1.4 16V  | 72   |  | 11.02  | 11.08   | 24.0108-0114.2   | 408114   | mit Lager/ mit Sensorring <sup>1)</sup>  | 240 8,0 7,0 +B             |
|  | 1.5 dCi  | 60   |  | 11.02  | 11.08   |  |  |  |                            |
|  | 1.5 dCi  | 63   |  | 05.05  | 11.08   |  |  |  |                            |
|  | 1.5 dCi  | 76   |  | 01.07  | 11.08   |  |  |  |                            |
|  | 1.5 dCi  | 78   |  | 05.05  | 11.08   |  |  |  |                            |
|  | 1.6 16V  | 77   |  | 06.05  | 11.08   |  |  |  |                            |
|  | 1.6 16V  | 83   |  | 11.02  | 11.08   |  |  |  |                            |
|  | 1.6 FlexFuel   | 77   |  | 01.07  | 11.08   |  |  |  |                            |
|  | 1.9 dCi  | 85   |  | 01.06  | 11.08   |  |  |  |                            |
|  | 1.9 dCi  | 88   |  | 11.02  | 11.08   |  |  |  |                            |
|  | 1.9 dCi  | 96   |  | 05.05  | 11.08   |  |  |  |                            |
|  | 2.0 16V  | 99   |  | 11.02  | 11.08   |  |  |  |                            |
|  | 2.0 16V  | 102  |  | 06.06  | 12.10   |  |  |  |                            |
|  | 2.0 16V  | 169  |  | 08.06  | 11.08   |  |  |  |                            |
|  | 2.0 16V  | 165  |  | 05.04  | 11.08   |  |  |  |                            |
|  | 2.0 16V Turbo  | 120  |  | 05.04  | 11.08   |  |  |  |                            |
|  | 2.0 16V  | 102  |  | 06.06  | 12.10   |  |  |  |                            |

<sup>1)</sup> with bearing/ with sensor ring / con supporto/+ anell.sens.ABS / avec palier de secours ABS / con apoyo/+ anillo sensor ABS





















| RENAULT MEGANE II Limousine 3/5-tuerig (BM/CM_) (02-08)                            |               |     |  |       |       |  |                |        |   |   |                            |
|--|---------------|-----|--|-------|-------|--|----------------|--------|---|---|----------------------------|
|    | 2.0 16V Turbo | 120 |  | 05.04 | 11.08 |  | 24.0108-0114.2 | 408114 |   | mit Lager/ mit Sensorring <sup>1)</sup> | 240 8,0 7,0 +B             |
|  | 2.0 dCi       | 110 |  | 09.05 | 11.08 |  | 24.0110-0389.2 | 410389 |   |   | 270 10,0 9,0 +B            |
|  | 2.0 dCi       | 127 |  | 01.07 | 11.08 |  | 24.0111-0183.2 | 411183 |   | mit Lager/ mit Sensorring <sup>1)</sup> | 300 11,0 9,5 +B            |
|    | 1.4 16V       | 72  |  | 11.02 | 12.05 |  | 24.0711-5152.3 | 360176 | 2 |   | Radsensor L=810            |
|  | 1.5 dCi       | 60  |  | 11.02 | 12.05 |  |                |        |   |   |                            |
|  | 1.5 dCi       | 63  |  | 05.05 | 12.05 |  |                |        |   |   |                            |
|  | 1.6 16V       | 83  |  | 11.02 | 12.05 |  |                |        |   |   |                            |
|  | 1.9 dCi       | 88  |  | 11.02 | 12.05 |  |                |        |   |   |                            |
|  | 1.9 dCi       | 96  |  | 05.05 | 12.05 |  |                |        |   |   |                            |
|  | 2.0 16V       | 99  |  | 11.02 | 12.05 |  |                |        |   |   |                            |
|  | 2.0 16V Sport | 165 |  | 05.04 | 12.05 |  |                |        |   |   |                            |
|  | 2.0 16V Turbo | 120 |  | 05.04 | 12.05 |  |                |        |   |   |                            |
|  | 2.0 dCi       | 110 |  | 09.05 | 12.05 |  |                |        |   |   |                            |
|  | 1.4 16V       | 72  |  | 01.06 | 11.08 |  | 24.0711-5181.3 | 360237 | 2 |   | Radsensor L=810            |
|  | 1.5 dCi       | 60  |  | 01.06 | 11.08 |  |                |        |   |   |                            |
|  | 1.5 dCi       | 63  |  | 01.06 | 11.08 |  |                |        |   |   |                            |
|  | 1.5 dCi       | 76  |  | 01.07 | 11.08 |  |                |        |   |   |                            |
|  | 1.5 dCi       | 78  |  | 05.05 | 11.08 |  |                |        |   |   |                            |
|  | 1.6 16V       | 77  |  | 06.05 | 11.08 |  |                |        |   |   |                            |
|  | 1.6 16V       | 83  |  | 01.06 | 11.08 |  |                |        |   |   |                            |
|  | 1.6 FlexFuel  | 77  |  | 01.07 | 11.08 |  |                |        |   |   |                            |
|  | 1.9 dCi       | 85  |  | 01.06 | 11.08 |  |                |        |   |   |                            |
|  | 1.9 dCi       | 88  |  | 01.06 | 11.08 |  |                |        |   |   |                            |
|  | 1.9 dCi       | 96  |  | 01.06 | 11.08 |  |                |        |   |   |                            |
|  | 2.0 16V       | 99  |  | 01.06 | 11.08 |  |                |        |   |   |                            |
|  | 2.0 16V       | 102 |  | 06.06 | 12.10 |  |                |        |   |   |                            |
|  | 2.0 16V       | 169 |  | 08.06 | 11.08 |  |                |        |   |   |                            |
|  | 2.0 16V Sport | 165 |  | 01.06 | 11.08 |  |                |        |   |   |                            |
|  | 2.0 16V Turbo | 120 |  | 01.06 | 11.08 |  |                |        |   |   |                            |
|  | 2.0 dCi       | 110 |  | 01.06 | 11.08 |  |                |        |   |   |                            |
|  | 2.0 dCi       | 127 |  | 01.07 | 11.08 |  |                |        |   |   |                            |
| RENAULT MEGANE II Limousine 4-tuerig (LM_) (03-08)                                 |               |     |  |       |       |  |                |        |   |   |                            |
|    | 1.4 16V       | 60  |  | 09.03 | 08.06 |  | 13.0460-3814.2 | 603814 |   |   | 23934 18,2 /Zub/S BOS      |
|  | 1.4 16V       | 72  |  | 09.03 | 12.08 |  | 13.0470-3814.2 | LD3814 |   |   | 23934 18,2 /S BOS          |
|  | 1.5 dCi       | 60  |  | 09.03 | 09.05 |  | 13.0460-3815.2 | 603815 |   |   | 23930 18,2 /Zub/S BOS      |
|  | 1.5 dCi       | 63  |  | 05.05 | 09.05 |  | 13.0470-3815.2 | LD3815 |   |   | 23930 18,2 /Zub/S BOS      |
|  | 1.5 dCi       | 74  |  | 02.04 | 09.05 |  |                |        |   |   |                            |
|  | 1.5 dCi       | 78  |  | 05.05 | 09.05 |  |                |        |   |   |                            |
|  | 1.6 16V       | 75  |  | 09.03 | 09.05 |  |                |        |   |   |                            |
|  | 1.6 16V       | 77  |  | 05.05 | 09.05 |  |                |        |   |   |                            |
|  | 1.6 16V       | 81  |  | 09.03 | 09.05 |  |                |        |   |   |                            |
|  | 1.6 16V       | 83  |  | 09.03 | 09.05 |  |                |        |   |   |                            |
|  | 1.9 dCi       | 66  |  | 09.03 | 09.05 |  |                |        |   |   |                            |
|  | 1.9 dCi       | 68  |  | 03.04 | 09.05 |  |                |        |   |   |                            |
|  | 1.9 dCi       | 81  |  | 05.05 | 09.05 |  |                |        |   |   |                            |
|  | 1.9 dCi       | 88  |  | 09.03 | 09.05 |  |                |        |   |   |                            |
|  | 1.9 dCi       | 96  |  | 05.05 | 09.05 |  |                |        |   |   |                            |
|  | 2.0 16V       | 99  |  | 09.03 | 09.05 |  |                |        |   |   |                            |
|  | 1.5 dCi       | 60  |  | 10.05 | 12.08 |  | 13.0460-7221.2 | 607221 |   |   | 24535 18,3 + ATE           |
|  | 1.5 dCi       | 63  |  | 10.05 | 12.08 |  | 13.0470-7221.2 | LD7221 |   |   | 24535 18,3 + ATE           |
|  | 1.5 dCi       | 74  |  | 10.05 | 03.06 |  |                |        |   |   |                            |
|  | 1.5 dCi       | 76  |  | 01.07 | 12.08 |  |                |        |   |   |                            |
|  | 1.5 dCi       | 78  |  | 10.05 | 12.08 |  |                |        |   |   |                            |
|  | 1.6 16V       | 75  |  | 10.05 | 12.08 |  |                |        |   |   |                            |
|  | 1.6 16V       | 77  |  | 10.05 | 12.08 |  |                |        |   |   |                            |
|  | 1.6 16V       | 81  |  | 10.05 | 12.08 |  |                |        |   |   |                            |
|  | 1.6 16V       | 82  |  | 01.07 | 12.08 |  |                |        |   |   |                            |
|  | 1.6 16V       | 83  |  | 10.05 | 12.08 |  |                |        |   |   |                            |
|  | 1.9 dCi       | 66  |  | 10.05 | 12.05 |  |                |        |   |   |                            |
|  | 1.9 dCi       | 68  |  | 10.05 | 12.08 |  |                |        |   |   |                            |
|  | 1.9 dCi       | 81  |  | 10.05 | 12.08 |  |                |        |   |   |                            |
|  | 1.9 dCi       | 88  |  | 10.05 | 12.08 |  |                |        |   |   |                            |
|  | 1.9 dCi       | 96  |  | 10.05 | 12.08 |  |                |        |   |   |                            |
|  | 2.0 16V       | 99  |  | 10.05 | 12.08 |  |                |        |   |   |                            |
|  | 2.0 16V       | 101 |  | 04.06 | 11.10 |  |                |        |   |   |                            |
|  | 2.0 dCi       | 110 |  | 09.05 | 12.08 |  |                |        |   |   |                            |
|  | 1.4 16V       | 60  |  | 09.03 | 08.06 |  | 24.0122-0216.1 | 422216 |   |   | 260 22,0 19,8 V L +S +B    |
|  | 1.4 16V       | 72  |  | 09.03 | 12.08 |  |                |        |   |   |                            |
|  | 1.5 dCi       | 60  |  | 09.03 | 12.08 |  | 24.0124-0158.1 | 424158 |   |   | 280 24,0 21,8 V L +S +B    |
|  | 1.5 dCi       | 63  |  | 05.05 | 12.08 |  | 24.0324-0158.1 | 524158 |   |   | 280 24,0 21,8 V L +S +B PD |
|  | 1.5 dCi       | 74  |  | 02.04 | 03.06 |  |                |        |   |   |                            |
|  | 1.5 dCi       | 76  |  | 01.07 | 12.08 |  |                |        |   |   |                            |
|  | 1.5 dCi       | 78  |  | 05.05 | 12.08 |  |                |        |   |   |                            |
|  | 1.6 16V       | 75  |  | 09.03 | 12.08 |  |                |        |   |   |                            |
|  | 1.6 16V       | 77  |  | 05.05 | 12.08 |  |                |        |   |   |                            |
|  | 1.6 16V       | 81  |  | 09.03 | 12.08 |  |                |        |   |   |                            |
|  | 1.6 16V       | 82  |  | 01.07 | 12.08 |  |                |        |   |   |                            |
|  | 1.6 16V       | 83  |  | 09.03 | 12.08 |  |                |        |   |   |                            |
|  | 1.9 dCi       | 66  |  | 09.03 | 12.05 |  |                |        |   |   |                            |
|  | 1.9 dCi       | 68  |  | 03.04 | 12.08 |  |                |        |   |   |                            |
|  | 1.9 dCi       | 81  |  | 05.05 | 12.08 |  |                |        |   |   |                            |
|  | 1.9 dCi       | 88  |  | 09.03 | 12.08 |  |                |        |   |   |                            |
|  | 1.9 dCi       | 96  |  | 05.05 | 12.08 |  |                |        |   |   |                            |
|  | 2.0 16V       | 99  |  | 09.03 | 12.08 |  |                |        |   |   |                            |
|  | 2.0 16V       | 101 |  | 04.06 | 11.10 |  |                |        |   |   |                            |

<sup>1)</sup> with bearing/ with sensor ring / con supporto/+ anell.sens.ABS / avec palier de secours ABS / con apoyo/+ anillo sensor ABS

|     |  |  |  |  |  |  |  |     |                 |
|--|--|--|--|--|---|--|--|---|-----------------|
| <b>RENAULT MEGANE II Limousine 4-tuerig (LM) (03-08)</b>                           |  |  |  |  |   |  |  |   |                 |
|    | 2.0 dCi  | 110  |  | 09.05  | 12.08   | 24.0124-0223.1   | 424223   | 280 24,0 21,8 VL +S +B  |                 |
|    | 1.4 16V  | 60   |  | 09.03  | 01.05   | 24.0711-5151.3   | 360175   | 2  | Radsensor L=485 |
|  | 1.4 16V  | 72   |  | 09.03  | 01.05   |  |  |   |                 |
|  | 1.5 dCi  | 60   |  | 09.03  | 01.05   |  |  |   |                 |
|  | 1.5 dCi  | 74   |  | 02.04  | 01.05   |  |  |   |                 |
|  | 1.6 16V  | 75   |  | 09.03  | 01.05   |  |  |   |                 |
|  | 1.6 16V  | 81   |  | 09.03  | 01.05   |  |  |   |                 |
|  | 1.6 16V  | 83   |  | 09.03  | 01.05   |  |  |   |                 |
|  | 1.9 dCi  | 66   |  | 09.03  | 01.05   |  |  |   |                 |
|  | 1.9 dCi  | 68   |  | 03.04  | 01.05   |  |  |   |                 |
|  | 1.9 dCi  | 88   |  | 09.03  | 01.05   |  |  |   |                 |
|  | 2.0 16V  | 99   |  | 09.03  | 01.05   |  |  |   |                 |
|  | 1.4 16V  | 60   |  | 02.05  | 12.05   | 24.0711-5190.3   | 360177   | 2  | Radsensor L=720 |
|  | 1.4 16V  | 72   |  | 02.05  | 12.05   |  |  |   |                 |
|  | 1.5 dCi  | 60   |  | 02.05  | 12.05   |  |  |   |                 |
|  | 1.5 dCi  | 63   |  | 05.05  | 12.05   |  |  |   |                 |
|  | 1.5 dCi  | 74   |  | 02.05  | 12.05   |  |  |   |                 |
|  | 1.5 dCi  | 78   |  | 05.05  | 12.05   |  |  |   |                 |
|  | 1.6 16V  | 75   |  | 02.05  | 12.05   |  |  |   |                 |
|  | 1.6 16V  | 77   |  | 05.05  | 12.05   |  |  |   |                 |
|  | 1.6 16V  | 81   |  | 02.05  | 12.05   |  |  |   |                 |
|  | 1.6 16V  | 83   |  | 02.05  | 12.05   |  |  |   |                 |
|  | 1.9 dCi  | 66   |  | 02.05  | 12.05   |  |  |   |                 |
|  | 1.9 dCi  | 68   |  | 02.05  | 12.05   |  |  |   |                 |
|  | 1.9 dCi  | 81   |  | 05.05  | 12.05   |  |  |   |                 |
|  | 1.9 dCi  | 88   |  | 02.05  | 12.05   |  |  |   |                 |
|  | 1.9 dCi  | 96   |  | 05.05  | 12.05   |  |  |   |                 |
|  | 2.0 16V  | 99   |  | 02.05  | 12.05   |  |  |   |                 |
|  | 2.0 dCi  | 110  |  | 09.05  | 12.05   |  |  |   |                 |
|  | 1.4 16V  | 60   |  | 01.06  | 08.06   | 24.0711-5180.3   | 360236   | 2  | Radsensor L=720 |
|  | 1.4 16V  | 72   |  | 01.06  | 12.08   |  |  |   |                 |
|  | 1.5 dCi  | 60   |  | 01.06  | 12.08   |  |  |   |                 |
|  | 1.5 dCi  | 63   |  | 01.06  | 12.08   |  |  |   |                 |
|  | 1.5 dCi  | 74   |  | 01.06  | 03.06   |  |  |   |                 |
|  | 1.5 dCi  | 76   |  | 01.07  | 12.08   |  |  |   |                 |
|  | 1.5 dCi  | 78   |  | 01.06  | 12.08   |  |  |   |                 |
|  | 1.6 16V  | 75   |  | 01.06  | 12.08   |  |  |   |                 |
|  | 1.6 16V  | 77   |  | 01.06  | 12.08   |  |  |   |                 |
|  | 1.6 16V  | 81   |  | 01.06  | 12.08   |  |  |   |                 |
|  | 1.6 16V  | 82   |  | 01.07  | 12.08   |  |  |   |                 |
|  | 1.6 16V  | 83   |  | 01.06  | 12.08   |  |  |   |                 |
|  | 1.9 dCi  | 68   |  | 01.06  | 12.08   |  |  |   |                 |
|  | 1.9 dCi  | 81   |  | 01.06  | 12.08   |  |  |   |                 |
|  | 1.9 dCi  | 88   |  | 01.06  | 12.08   |  |  |   |                 |
|  | 1.9 dCi  | 96   |  | 01.06  | 12.08   |  |  |   |                 |
|  | 2.0 16V  | 99   |  | 01.06  | 12.08   |  |  |   |                 |
|  | 2.0 16V  | 101  |  | 04.06  | 11.10   |  |  |   |                 |
|  | 2.0 dCi  | 110  |  | 01.06  | 12.08   |  |  |   |                 |
|  | 1.4 16V  | 60   |  | 09.03  | 08.06   |  |  |   |                 |
|  | 1.4 16V  | 72   |  | 09.03  | 04.07   |  |  |   |                 |
|  | 1.5 dCi  | 60   |  | 09.03  | 04.07   |  |  |   |                 |
|  | 1.5 dCi  | 63   |  | 05.05  | 04.07   |  |  |   |                 |
|  | 1.5 dCi  | 74   |  | 02.04  | 03.06   |  |  |   |                 |
|  | 1.5 dCi  | 76   |  | 01.07  | 04.07   |  |  |   |                 |
|  | 1.5 dCi  | 78   |  | 05.05  | 04.07   |  |  |   |                 |
|  | 1.6 16V  | 75   |  | 09.03  | 04.07   |  |  |   |                 |
|  | 1.6 16V  | 77   |  | 05.05  | 04.07   |  |  |   |                 |
|  | 1.6 16V  | 81   |  | 09.03  | 04.07   |  |  |   |                 |
|  | 1.6 16V  | 82   |  | 01.07  | 04.07   |  |  |   |                 |
|  | 1.6 16V  | 83   |  | 09.03  | 04.07   |  |  |   |                 |
|  | 1.9 dCi  | 66   |  | 09.03  | 12.05   |  |  |   |                 |
|  | 1.9 dCi  | 68   |  | 03.04  | 04.07   |  |  |   |                 |
|  | 1.9 dCi  | 81   |  | 05.05  | 04.07   |  |  |   |                 |
|  | 1.9 dCi  | 88   |  | 09.03  | 04.07   |  |  |   |                 |
|  | 1.9 dCi  | 96   |  | 05.05  | 04.07   |  |  |   |                 |
|  | 2.0 16V  | 99   |  | 09.03  | 04.07   |  |  |   |                 |
|  | 2.0 16V  | 101  |  | 04.06  | 11.10   |  |  |   |                 |
|  | 2.0 dCi  | 110  |  | 09.05  | 04.07   |  |  |   |                 |
|  | 1.4 16V  | 60   |  | 09.03  | 08.06   | 13.0460-7137.2   | 607137   | PR 1334   | 23482 15,8 +    |
|  | 1.4 16V  | 72   |  | 09.03  | 12.08   |  |  |   |                 |
|  | 1.5 dCi  | 60   |  | 09.03  | 12.08   |  |  |   |                 |
|  | 1.5 dCi  | 63   |  | 05.05  | 12.08   |  |  |   |                 |
|  | 1.5 dCi  | 74   |  | 02.04  | 03.06   |  |  |   |                 |
|  | 1.5 dCi  | 76   |  | 01.07  | 12.08   |  |  |   |                 |
|  | 1.5 dCi  | 78   |  | 05.05  | 12.08   |  |  |   |                 |
|  | 1.6 16V  | 75   |  | 09.03  | 12.08   |  |  |   |                 |
|  | 1.6 16V  | 77   |  | 05.05  | 12.08   |  |  |   |                 |
|  | 1.6 16V  | 81   |  | 09.03  | 12.08   |  |  |   |                 |
|  | 1.6 16V  | 82   |  | 01.07  | 12.08   |  |  |   |                 |
|  | 1.6 16V  | 83   |  | 09.03  | 12.08   |  |  |   |                 |
|  | 1.9 dCi  | 66   |  | 09.03  | 12.05   |  |  |   |                 |
|  | 1.9 dCi  | 68   |  | 03.04  | 12.08   |  |  |   |                 |
|  | 1.9 dCi  | 81   |  | 05.05  | 12.08   |  |  |   |                 |
|  | 1.9 dCi  | 88   |  | 09.03  | 12.08   |  |  |   |                 |
|  | 1.9 dCi  | 88   |  | 09.03  | 12.08   |  |  |   |                 |
|  | 1.9 dCi  | 96   |  | 05.05  | 12.08   |  |  |   |                 |
|  | 1.9 dCi  | 96   |  | 05.05  | 12.08   |  |  |   |                 |

















|     |  |  |  |  |  |  |       |  |
|--|--|--|--|--|---|--|---|--|
| <b>RENAULT MEGANE II Coupe/Cabrio (EM_) (03-10)</b>                                |  |  |  |  |   |  |   |  |
|    | 1.6 16V  | 83   | 09.03  | 04.10  | 24.0124-0158.1  | 424158   |   | 280 24,0 21,8 V L +S +B  |
|  | 1.9 dCi  | 81   | 05.05  | 04.10  | 24.0324-0158.1  | 524158   |   | 280 24,0 21,8 V L +S +B PD   |
|  | 1.9 dCi  | 85   | 01.06  | 04.10  |   |  |   |  |
|  | 1.9 dCi  | 88   | 09.03  | 04.10  |   |  |   |  |
|  | 1.9 dCi  | 96   | 05.05  | 02.07  |   |  |   |  |
|  | 2.0 16V  | 99   | 09.03  | 03.07  |   |  |   |  |
|  | 2.0 16V Turbo  | 120  | 05.04  | 04.10  |   |  |   |  |
|  | 2.0 dCi  | 110  | 09.05  | 04.10  | 24.0124-0223.1  | 424223   |   | 280 24,0 21,8 V L +S +B  |
|    | 1.6 16V  | 83   | 09.03  | 01.05  | 24.0711-5151.3  | 360175   | 2    | Radsensor L=485  |
|  | 1.9 dCi  | 88   | 09.03  | 01.05  |   |  |   |  |
|  | 2.0 16V  | 99   | 09.03  | 01.05  |   |  |   |  |
|  | 1.5 dCi  | 63   | 05.05  | 12.05  | 24.0711-5190.3  | 360177   | 2    | Radsensor L=720  |
|  | 1.6 16V  | 77   | 06.05  | 12.05  |   |  |   |  |
|  | 1.6 16V  | 83   | 02.05  | 12.05  |   |  |   |  |
|  | 1.9 dCi  | 81   | 05.05  | 12.05  |   |  |   |  |
|  | 1.9 dCi  | 88   | 02.05  | 12.05  |   |  |   |  |
|  | 1.9 dCi  | 96   | 05.05  | 12.05  |   |  |   |  |
|  | 2.0 16V  | 99   | 02.05  | 12.05  |   |  |   |  |
|  | 2.0 dCi  | 110  | 09.05  | 12.05  |   |  |   |  |
|  | 1.5 dCi  | 63   | 01.06  | 04.10  | 24.0711-5180.3  | 360236   | 2    | Radsensor L=720  |
|  | 1.5 dCi  | 76   | 01.07  | 06.09  |   |  |   |  |
|  | 1.5 dCi  | 78   | 03.06  | 06.08  |   |  |   |  |
|  | 1.6 16V  | 77   | 01.06  | 04.10  |   |  |   |  |
|  | 1.6 16V  | 82   | 01.07  | 04.10  |   |  |   |  |
|  | 1.6 16V  | 83   | 01.06  | 04.10  |   |  |   |  |
|  | 1.9 dCi  | 81   | 01.06  | 04.10  |   |  |   |  |
|  | 1.9 dCi  | 85   | 01.06  | 04.10  |   |  |   |  |
|  | 1.9 dCi  | 88   | 01.06  | 04.10  |   |  |   |  |
|  | 1.9 dCi  | 96   | 01.06  | 02.07  |   |  |   |  |
|  | 2.0 16V  | 99   | 01.06  | 03.07  |   |  |   |  |
|  | 2.0 dCi  | 110  | 01.06  | 04.10  |   |  |   |  |
|  | 2.0 16V Turbo  | 120  | 05.04  | 12.04  | 24.0711-5177.3  | 360117   | 2    | Radsensor L=779  |
|  | 2.0 16V Turbo  | 120  | 01.05  | 04.10  | 24.0711-5199.3  | 360271   | 2    | Radsensor L=1081   |
|    | 1.5 dCi  | 63   | 05.05  | 04.07  | 13.0460-2845.2  | 602845   |   | 23554 16,4 /Zub/S TRW  |
|  | 1.5 dCi  | 76   | 01.07  | 04.07  | 13.0470-2845.2  | LD2845   |   | 23554 16,4 /Zub/S TRW  |
|  | 1.5 dCi  | 78   | 03.06  | 04.07  | 13.0460-0077.2  | 610077   |   | Belagsatz-Zubehör TRW  |
|  | 1.6 16V  | 77   | 06.05  | 04.07  |   |  |   |  |
|  | 1.6 16V  | 82   | 01.07  | 04.07  |   |  |   |  |
|  | 1.6 16V  | 83   | 09.03  | 04.07  |   |  |   |  |
|  | 1.9 dCi  | 81   | 05.05  | 04.07  |   |  |   |  |
|  | 1.9 dCi  | 85   | 01.06  | 04.07  |   |  |   |  |
|  | 1.9 dCi  | 88   | 09.03  | 04.07  |   |  |   |  |
|  | 1.9 dCi  | 96   | 05.05  | 02.07  |   |  |   |  |
|  | 2.0 16V  | 99   | 09.03  | 03.07  |   |  |   |  |
|  | 2.0 16V Turbo  | 120  | 05.04  | 04.07  |   |  |   |  |
|  | 2.0 dCi  | 110  | 09.05  | 04.07  |   |  |   |  |
|  | 1.5 dCi  | 63   | 05.05  | 04.10  | 24.0108-0114.2  | 408114   | mit Lager/ mit Sensorring <sup>1)</sup>   | 240 8,0 7,0 +B   |
|  | 1.5 dCi  | 76   | 01.07  | 06.09  |   |  |   |  |
|  | 1.5 dCi  | 78   | 03.06  | 06.08  |   |  |   |  |
|  | 1.6 16V  | 77   | 06.05  | 04.10  |   |  |   |  |
|  | 1.6 16V  | 82   | 01.07  | 04.10  |   |  |   |  |
|  | 1.6 16V  | 83   | 09.03  | 04.10  |   |  |   |  |
|  | 1.9 dCi  | 81   | 05.05  | 04.10  |   |  |   |  |
|  | 1.9 dCi  | 85   | 01.06  | 04.10  |   |  |   |  |
|  | 1.9 dCi  | 88   | 09.03  | 04.10  |   |  |   |  |
|  | 1.9 dCi  | 96   | 05.05  | 02.07  |   |  |   |  |
|  | 2.0 16V  | 99   | 09.03  | 03.07  |   |  |   |  |
|  | 2.0 16V Turbo  | 120  | 05.04  | 04.10  |   |  |   |  |
|  | 2.0 dCi  | 110  | 09.05  | 04.10  | 24.0110-0389.2  | 410389   |   | 270 10,0 9,0 +B  |
|  | 1.5 dCi  | 63   | 05.05  | 12.05  | 24.0711-5152.3  | 360176   | 2  | Radsensor L=810  |
|  | 1.6 16V  | 77   | 06.05  | 12.05  |   |  |   |  |
|  | 1.6 16V  | 83   | 09.03  | 12.05  |   |  |   |  |
|  | 1.9 dCi  | 81   | 05.05  | 12.05  |   |  |   |  |
|  | 1.9 dCi  | 88   | 09.03  | 12.05  |   |  |   |  |
|  | 1.9 dCi  | 96   | 05.05  | 12.05  |   |  |   |  |
|  | 2.0 16V  | 99   | 09.03  | 12.05  |   |  |   |  |
|  | 2.0 16V Turbo  | 120  | 05.04  | 12.05  |   |  |   |  |
|  | 2.0 dCi  | 110  | 09.05  | 12.05  |   |  |   |  |
|  | 1.5 dCi  | 63   | 01.06  | 04.10  | 24.0711-5181.3  | 360237   | 2  | Radsensor L=810  |
|  | 1.5 dCi  | 76   | 01.07  | 06.09  |   |  |   |  |
|  | 1.5 dCi  | 78   | 03.06  | 06.08  |   |  |   |  |
|  | 1.6 16V  | 77   | 01.06  | 04.10  |   |  |   |  |
|  | 1.6 16V  | 82   | 01.07  | 04.10  |   |  |   |  |
|  | 1.6 16V  | 83   | 01.06  | 04.10  |   |  |   |  |
|  | 1.9 dCi  | 81   | 01.06  | 04.10  |   |  |   |  |
|  | 1.9 dCi  | 85   | 01.06  | 04.10  |   |  |   |  |
|  | 1.9 dCi  | 88   | 01.06  | 04.10  |   |  |   |  |
|  | 1.9 dCi  | 96   | 01.06  | 02.07  |   |  |   |  |
|  | 2.0 16V  | 99   | 01.06  | 03.07  |   |  |   |  |
|  | 2.0 16V Turbo  | 120  | 01.06  | 04.10  |   |  |   |  |
|  | 2.0 dCi  | 110  | 01.06  | 04.10  |   |  |   |  |

<sup>1)</sup> with bearing/ with sensor ring / con supporto/+ anell.sens.ABS / avec palier de secours ABS / con apoyo/+ anillo sensor ABS















**RENAULT MEGANE II Grandtour (KM\_) (03-08)**

|              |              |    |       |       |       |  |  |                |                |        |  |                            |              |     |
|--------------|--------------|----|-------|-------|-------|--|--|----------------|----------------|--------|--|----------------------------|--------------|-----|
|              | 1.4 16V      | 72 |       | 09.03 | 09.05 |  |  | 13.0460-3815.2 | 603815         |        |  | 23930 18,2 /Zub/S          | BOS          |     |
|              | 1.5 dCi      | 60 |       | 09.03 | 09.05 |  |  | 13.0470-3815.2 | LD3815         |        |  | 23930 18,2 /Zub/S          | BOS          |     |
|              | 1.5 dCi      | 63 |       | 05.05 | 09.05 |  |  |                |                |        |  |                            |              |     |
|              | 1.5 dCi      | 74 |       | 02.04 | 09.05 |  |  |                |                |        |  |                            |              |     |
|              | 1.5 dCi      | 78 |       | 05.05 | 09.05 |  |  |                |                |        |  |                            |              |     |
|              | 1.6 16V      | 77 |       | 05.05 | 09.05 |  |  |                |                |        |  |                            |              |     |
|              | 1.6 16V      | 83 |       | 09.03 | 09.05 |  |  |                |                |        |  |                            |              |     |
|              | 1.9 dCi      | 68 |       | 03.04 | 09.05 |  |  |                |                |        |  |                            |              |     |
|              | 1.9 dCi      | 81 |       | 05.05 | 09.05 |  |  |                |                |        |  |                            |              |     |
|              | 1.9 dCi      | 88 |       | 09.03 | 09.05 |  |  |                |                |        |  |                            |              |     |
|              | 1.9 dCi      | 96 |       | 05.05 | 09.05 |  |  |                |                |        |  |                            |              |     |
|              | 2.0 16V      | 99 |       | 09.03 | 09.05 |  |  |                |                |        |  |                            |              |     |
|              | 1.4 16V      | 72 |       | 10.05 | 12.08 |  |  |                | 13.0460-7221.2 | 607221 |  |                            | 24535 18,3 + | ATE |
|              | 1.5 dCi      | 60 |       | 10.05 | 05.06 |  |  |                | 13.0470-7221.2 | LD7221 |  |                            | 24535 18,3 + | ATE |
| 1.5 dCi      | 63           |    | 10.05 | 12.08 |       |  |  |                |                |        |  |                            |              |     |
| 1.5 dCi      | 74           |    | 10.05 | 03.06 |       |  |  |                |                |        |  |                            |              |     |
| 1.5 dCi      | 76           |    | 01.07 | 12.08 |       |  |  |                |                |        |  |                            |              |     |
| 1.5 dCi      | 78           |    | 10.05 | 06.08 |       |  |  |                |                |        |  |                            |              |     |
| 1.6 16V      | 77           |    | 05.05 | 07.09 |       |  |  |                |                |        |  |                            |              |     |
| 1.6 16V      | 82           |    | 01.07 | 12.08 |       |  |  |                |                |        |  |                            |              |     |
| 1.6 16V      | 83           |    | 09.03 | 12.08 |       |  |  |                |                |        |  |                            |              |     |
| 1.6 FlexFuel | 77           |    | 02.08 | 12.08 |       |  |  |                |                |        |  |                            |              |     |
| 1.9 dCi      | 68           |    | 10.05 | 02.07 |       |  |  |                |                |        |  |                            |              |     |
| 1.9 dCi      | 81           |    | 10.05 | 12.08 |       |  |  |                |                |        |  |                            |              |     |
| 1.9 dCi      | 88           |    | 10.05 | 12.08 |       |  |  |                |                |        |  |                            |              |     |
| 1.9 dCi      | 96           |    | 10.05 | 02.07 |       |  |  |                |                |        |  |                            |              |     |
| 2.0 16V      | 99           |    | 10.05 | 12.08 |       |  |  |                |                |        |  |                            |              |     |
| 2.0 16V      | 102          |    | 12.06 | 01.11 |       |  |  |                |                |        |  |                            |              |     |
| 2.0 dCi      | 110          |    | 09.05 | 12.08 |       |  |  |                |                |        |  |                            |              |     |
|              | 1.4 16V      | 72 |       | 09.03 | 12.08 |  |  | 24.0124-0158.1 | 424158         |        |  | 280 24,0 21,8 V L +S +B    |              |     |
|              | 1.5 dCi      | 60 |       | 09.03 | 05.06 |  |  | 24.0324-0158.1 | 524158         |        |  | 280 24,0 21,8 V L +S +B PD |              |     |
|              | 1.5 dCi      | 63 |       | 05.05 | 12.08 |  |  |                |                |        |  |                            |              |     |
|              | 1.5 dCi      | 74 |       | 02.04 | 03.06 |  |  |                |                |        |  |                            |              |     |
|              | 1.5 dCi      | 76 |       | 01.07 | 12.08 |  |  |                |                |        |  |                            |              |     |
|              | 1.5 dCi      | 78 |       | 05.05 | 06.08 |  |  |                |                |        |  |                            |              |     |
|              | 1.6 16V      | 77 |       | 05.05 | 07.09 |  |  |                |                |        |  |                            |              |     |
|              | 1.6 16V      | 82 |       | 01.07 | 12.08 |  |  |                |                |        |  |                            |              |     |
|              | 1.6 16V      | 83 |       | 09.03 | 12.08 |  |  |                |                |        |  |                            |              |     |
|              | 1.6 FlexFuel | 77 |       | 02.08 | 12.08 |  |  |                |                |        |  |                            |              |     |
|              | 1.9 dCi      | 68 |       | 03.04 | 02.07 |  |  |                |                |        |  |                            |              |     |
|              | 1.9 dCi      | 81 |       | 05.05 | 12.08 |  |  |                |                |        |  |                            |              |     |
|              | 1.9 dCi      | 88 |       | 09.03 | 12.08 |  |  |                |                |        |  |                            |              |     |
|              | 1.9 dCi      | 96 |       | 05.05 | 02.07 |  |  |                |                |        |  |                            |              |     |
| 2.0 16V      | 99           |    | 09.03 | 12.08 |       |  |  |                |                |        |  |                            |              |     |
| 2.0 16V      | 102          |    | 12.06 | 01.11 |       |  |  |                |                |        |  |                            |              |     |
| 2.0 dCi      | 110          |    | 09.05 | 12.08 |       |  |  | 24.0124-0223.1 | 424223         |        |  | 280 24,0 21,8 V L +S +B    |              |     |
|              | 1.4 16V      | 72 |       | 09.03 | 01.05 |  |  | 24.0711-5151.3 | 360175         | 2      |  | Radsensor L=485            |              |     |
|              | 1.5 dCi      | 60 |       | 09.03 | 01.05 |  |  |                |                |        |  |                            |              |     |
|              | 1.5 dCi      | 74 |       | 02.04 | 01.05 |  |  |                |                |        |  |                            |              |     |
|              | 1.6 16V      | 83 |       | 09.03 | 01.05 |  |  |                |                |        |  |                            |              |     |
|              | 1.9 dCi      | 68 |       | 03.04 | 01.05 |  |  |                |                |        |  |                            |              |     |
|              | 1.9 dCi      | 88 |       | 09.03 | 01.05 |  |  |                |                |        |  |                            |              |     |
|              | 2.0 16V      | 99 |       | 09.03 | 01.05 |  |  |                |                |        |  |                            |              |     |
|              | 1.4 16V      | 72 |       | 02.05 | 12.05 |  |  | 24.0711-5190.3 | 360177         | 2      |  | Radsensor L=720            |              |     |
|              | 1.5 dCi      | 60 |       | 02.05 | 12.05 |  |  |                |                |        |  |                            |              |     |
|              | 1.5 dCi      | 63 |       | 05.05 | 12.05 |  |  |                |                |        |  |                            |              |     |
|              | 1.5 dCi      | 74 |       | 02.05 | 12.05 |  |  |                |                |        |  |                            |              |     |
|              | 1.5 dCi      | 78 |       | 05.05 | 12.05 |  |  |                |                |        |  |                            |              |     |
|              | 1.6 16V      | 77 |       | 05.05 | 12.05 |  |  |                |                |        |  |                            |              |     |
|              | 1.6 16V      | 83 |       | 02.05 | 12.05 |  |  |                |                |        |  |                            |              |     |
| 1.9 dCi      | 68           |    | 02.05 | 12.05 |       |  |  |                |                |        |  |                            |              |     |
| 1.9 dCi      | 81           |    | 05.05 | 12.05 |       |  |  |                |                |        |  |                            |              |     |
| 1.9 dCi      | 88           |    | 02.05 | 12.05 |       |  |  |                |                |        |  |                            |              |     |
| 1.9 dCi      | 96           |    | 05.05 | 12.05 |       |  |  |                |                |        |  |                            |              |     |
| 2.0 16V      | 99           |    | 02.05 | 12.05 |       |  |  |                |                |        |  |                            |              |     |
| 2.0 dCi      | 110          |    | 09.05 | 12.05 |       |  |  |                |                |        |  |                            |              |     |
|              | 1.4 16V      | 72 |       | 01.06 | 12.08 |  |  | 24.0711-5180.3 | 360236         | 2      |  | Radsensor L=720            |              |     |
|              | 1.5 dCi      | 60 |       | 01.06 | 05.06 |  |  |                |                |        |  |                            |              |     |
|              | 1.5 dCi      | 63 |       | 01.06 | 12.08 |  |  |                |                |        |  |                            |              |     |
|              | 1.5 dCi      | 74 |       | 01.06 | 03.06 |  |  |                |                |        |  |                            |              |     |
|              | 1.5 dCi      | 76 |       | 01.07 | 12.08 |  |  |                |                |        |  |                            |              |     |
|              | 1.5 dCi      | 78 |       | 01.06 | 06.08 |  |  |                |                |        |  |                            |              |     |
|              | 1.6 16V      | 77 |       | 01.06 | 07.09 |  |  |                |                |        |  |                            |              |     |
|              | 1.6 16V      | 82 |       | 01.07 | 12.08 |  |  |                |                |        |  |                            |              |     |
|              | 1.6 16V      | 83 |       | 01.06 | 12.08 |  |  |                |                |        |  |                            |              |     |
|              | 1.6 FlexFuel | 77 |       | 02.08 | 12.08 |  |  |                |                |        |  |                            |              |     |
|              | 1.9 dCi      | 68 |       | 01.06 | 02.07 |  |  |                |                |        |  |                            |              |     |
|              | 1.9 dCi      | 81 |       | 01.06 | 12.08 |  |  |                |                |        |  |                            |              |     |
|              | 1.9 dCi      | 88 |       | 01.06 | 12.08 |  |  |                |                |        |  |                            |              |     |
|              | 1.9 dCi      | 96 |       | 01.06 | 02.07 |  |  |                |                |        |  |                            |              |     |
| 2.0 16V      | 99           |    | 01.06 | 12.08 |       |  |  |                |                |        |  |                            |              |     |
| 2.0 16V      | 102          |    | 12.06 | 01.11 |       |  |  |                |                |        |  |                            |              |     |
| 2.0 dCi      | 110          |    | 01.06 | 12.08 |       |  |  |                |                |        |  |                            |              |     |

|     |  |  |  |  |  |  |  |  |                 |
|--|--|--|--|--|---|--|--|--|-----------------|
| <b>RENAULT MEGANE II Grandtour (KM_) (03-08)</b>                                   |  |  |  |  |   |  |  |  |                 |
|    | 1.4 16V  | 72   | 09.03  | 04.07  | 13.0460-2845.2  | 602845   |  | 23554 16,4 /Zub/S  | TRW             |
|  | 1.5 dCi  | 60   | 09.03  | 05.06  | 13.0470-2845.2  | LD2845   |  | 23554 16,4 /Zub/S  | TRW             |
|  | 1.5 dCi  | 63   | 05.05  | 04.07  | 13.0460-0077.2  | 610077   |  | Belagsatz-Zubehör  | TRW             |
|  | 1.5 dCi  | 74   | 02.04  | 03.06  |   |  |  |  |                 |
|  | 1.5 dCi  | 76   | 01.07  | 04.07  |   |  |  |  |                 |
|  | 1.5 dCi  | 78   | 05.05  | 04.07  |   |  |  |  |                 |
|  | 1.6 16V  | 77   | 05.05  | 04.07  |   |  |  |  |                 |
|  | 1.6 16V  | 82   | 01.07  | 04.07  |   |  |  |  |                 |
|  | 1.6 16V  | 83   | 09.03  | 04.07  |   |  |  |  |                 |
|  | 1.9 dCi  | 68   | 03.04  | 02.07  |   |  |  |  |                 |
|  | 1.9 dCi  | 81   | 05.05  | 04.07  |   |  |  |  |                 |
|  | 1.9 dCi  | 88   | 09.03  | 04.07  |   |  |  |  |                 |
|  | 1.9 dCi  | 96   | 05.05  | 02.07  |   |  |  |  |                 |
|  | 2.0 16V  | 99   | 09.03  | 04.07  |   |  |  |  |                 |
| 2.0 16V  | 102  | 12.06  | 04.07  |  |   |  |  |  |                 |
| 2.0 dCi  | 110  | 09.05  | 04.07  |  |   |  |  |  |                 |
|    | 1.4 16V  | 72   | 09.03  | 12.08  | 24.0110-0325.2  | 410325   |  | mit Lager/ mit Sensorring <sup>1)</sup>  | 270 10,0 9,0 +B |
|  | 1.5 dCi  | 60   | 09.03  | 05.06  |   |  |  |  |                 |
|  | 1.5 dCi  | 63   | 05.05  | 12.08  |   |  |  |  |                 |
|  | 1.5 dCi  | 74   | 02.04  | 03.06  |   |  |  |  |                 |
|  | 1.5 dCi  | 76   | 01.07  | 12.08  |   |  |  |  |                 |
|  | 1.5 dCi  | 78   | 05.05  | 06.08  |   |  |  |  |                 |
|  | 1.6 16V  | 77   | 05.05  | 07.09  |   |  |  |  |                 |
|  | 1.6 16V  | 82   | 01.07  | 12.08  |   |  |  |  |                 |
|  | 1.6 16V  | 83   | 09.03  | 12.08  |   |  |  |  |                 |
|  | 1.6 FlexFuel   | 77   | 02.08  | 12.08  |   |  |  |  |                 |
|  | 1.9 dCi  | 68   | 03.04  | 02.07  |   |  |  |  |                 |
|  | 1.9 dCi  | 81   | 05.05  | 12.08  |   |  |  |  |                 |
|  | 1.9 dCi  | 88   | 09.03  | 12.08  |   |  |  |  |                 |
|  | 1.9 dCi  | 96   | 05.05  | 02.07  |   |  |  |  |                 |
| 2.0 16V  | 99   | 09.03  | 12.08  |  |   |  |  |  |                 |
| 2.0 16V  | 102  | 12.06  | 01.11  |  |   |  |  |  |                 |
| 2.0 dCi  | 110  | 09.05  | 12.08  | 24.0110-0389.2   | 410389  |  |  | 270 10,0 9,0 +B  |                 |
|    | 1.4 16V  | 72   | 09.03  | 12.05  | 24.0711-5152.3  | 360176   | 2  |  | Radsensor L=810 |
|  | 1.5 dCi  | 60   | 09.03  | 12.05  |   |  |  |  |                 |
|  | 1.5 dCi  | 63   | 05.05  | 12.05  |   |  |  |  |                 |
|  | 1.5 dCi  | 74   | 02.04  | 12.05  |   |  |  |  |                 |
|  | 1.5 dCi  | 78   | 05.05  | 12.05  |   |  |  |  |                 |
|  | 1.6 16V  | 77   | 05.05  | 12.05  |   |  |  |  |                 |
|  | 1.6 16V  | 83   | 09.03  | 12.05  |   |  |  |  |                 |
|  | 1.9 dCi  | 68   | 03.04  | 12.05  |   |  |  |  |                 |
|  | 1.9 dCi  | 81   | 05.05  | 12.05  |   |  |  |  |                 |
|  | 1.9 dCi  | 88   | 09.03  | 12.05  |   |  |  |  |                 |
|  | 1.9 dCi  | 96   | 05.05  | 12.05  |   |  |  |  |                 |
|  | 2.0 16V  | 99   | 09.03  | 12.05  |   |  |  |  |                 |
|  | 2.0 dCi  | 110  | 09.05  | 12.05  |   |  |  |  |                 |
|  | 1.4 16V  | 72   | 01.06  | 12.08  | 24.0711-5181.3  | 360237   | 2  |  | Radsensor L=810 |
| 1.5 dCi  | 60   | 01.06  | 05.06  |  |   |  |  |  |                 |
| 1.5 dCi  | 63   | 01.06  | 12.08  |  |   |  |  |  |                 |
| 1.5 dCi  | 74   | 01.06  | 03.06  |  |   |  |  |  |                 |
| 1.5 dCi  | 76   | 01.07  | 12.08  |  |   |  |  |  |                 |
| 1.5 dCi  | 78   | 01.06  | 06.08  |  |   |  |  |  |                 |
| 1.6 16V  | 77   | 01.06  | 07.09  |  |   |  |  |  |                 |
| 1.6 16V  | 82   | 01.07  | 12.08  |  |   |  |  |  |                 |
| 1.6 16V  | 83   | 01.06  | 12.08  |  |   |  |  |  |                 |
| 1.6 FlexFuel   | 77   | 02.08  | 12.08  |  |   |  |  |  |                 |
| 1.9 dCi  | 68   | 01.06  | 02.07  |  |   |  |  |  |                 |
| 1.9 dCi  | 81   | 01.06  | 12.08  |  |   |  |  |  |                 |
| 1.9 dCi  | 88   | 01.06  | 12.08  |  |   |  |  |  |                 |
| 1.9 dCi  | 96   | 01.06  | 02.07  |  |   |  |  |  |                 |
| 2.0 16V  | 99   | 01.06  | 12.08  |  |   |  |  |  |                 |
| 2.0 16V  | 102  | 12.06  | 01.11  |  |   |  |  |  |                 |
| 2.0 dCi  | 110  | 01.06  | 12.08  |  |   |  |  |  |                 |
| <b>RENAULT MEGANE III Schrägheck (BZ0_) (08-)</b>                                  |  |  |  |  |   |  |  |  |                 |
|  | 1.2 TCe  | 85   | 03.12  |  | 13.0460-7266.2  | 607266   |  | 24538 17,9 +   | ATE             |
|  | 1.2 TCe  | 97   | 01.13  |  | 13.0470-7266.2  | LD7266   |  | 24538 17,9 +   | ATE             |
|  | 1.4  | 96   | 04.09  |  |   |  |  |  |                 |
|  | 1.5 dCi  | 63   | 12.09  |  |   |  |  |  |                 |
|  | 1.5 dCi  | 66   | 11.08  |  |   |  |  |  |                 |
|  | 1.5 dCi  | 70   | 11.13  |  |   |  |  |  |                 |
|  | 1.5 dCi  | 78   | 02.09  |  |   |  |  |  |                 |
|  | 1.5 dCi  | 81   | 02.09  |  |   |  |  |  |                 |
|  | 1.5 dCi  | 96   | 11.08  |  |   |  |  |  |                 |
|  | 1.6  | 74   | 11.08  |  |   |  |  |  |                 |
|  | 1.6  | 81   | 11.08  |  |   |  |  |  |                 |
|  | 1.6 16V Bifuel   | 81   | 11.08  |  |   |  |  |  |                 |
|  | 1.6 dCi  | 96   | 04.11  |  |   |  |  |  |                 |
|  | 1.9 dCi  | 96   | 11.08  |  |   |  |  |  |                 |
| 2.0  | 103  | 02.09  |  |  |   |  |  |  |                 |
| 2.0  | 105  | 01.11  |  |  |   |  |  |  |                 |
| 2.0 dCi  | 110  | 10.10  |  | 13.0460-7249.2   | 607249  |  |  | 24709 18,6 +   | ATE             |
| 2.0 dCi  | 118  | 04.09  |  | 13.0470-7249.2   | LD7249  |  |  | 24709 18,6 +   | ATE             |
| 2.0 dCi  | 120  | 07.12  |  |  |   |  |  |  |                 |
| 2.0 TCe  | 132  | 11.08  |  |  |   |  |  |  |                 |
| 2.0 TCe  | 140  | 06.12  |  |  |   |  |  |  |                 |
| 2.0 TCe 220  | 162  | 11.13  |  |  |   |  |  |  |                 |

<sup>1)</sup> with bearing/ with sensor ring / con supporto/+ anell.sens.ABS / avec palier de secours ABS / con apoyo/+ anillo sensor ABS

|     |  |  |  |  |  |  |  |  |
|--|--|--|--|--|---|--|--|--|
| <b>RENAULT MEGANE III Schrägheck (BZO_) (08-)</b>                                  |  |  |  |  |   |  |  |  |
|    | 1.2 TCe  | 85   | 03.12  | 24.0124-0221.1   | 424221  |  |  | 280 24,0 21,8 VL +S +B   |
|  | 1.2 TCe  | 97   | 01.13  |  |   |  |  |  |
|  | 1.4  | 96   | 04.09  |  |   |  |  |  |
|  | 1.5 dCi  | 63   | 12.09  |  |   |  |  |  |
|  | 1.5 dCi  | 66   | 11.08  |  |   |  |  |  |
|  | 1.5 dCi  | 70   | 11.13  |  |   |  |  |  |
|  | 1.5 dCi  | 78   | 02.09  |  |   |  |  |  |
|  | 1.5 dCi  | 81   | 02.09  |  |   |  |  |  |
|  | 1.5 dCi  | 96   | 11.08  |  |   |  |  |  |
|  | 1.6  | 74   | 11.08  |  |   |  |  |  |
|  | 1.6  | 81   | 11.08  |  |   |  |  |  |
|  | 1.6 16V Bifuel   | 81   | 11.08  |  |   |  |  |  |
|  | 1.6 dCi  | 96   | 04.11  |  |   |  |  |  |
|  | 1.9 dCi  | 96   | 11.08  |  |   |  |  |  |
|  | 2.0  | 103  | 02.09  |  |   |  |  |  |
|  | 2.0  | 105  | 01.11  |  |   |  |  |  |
|  | 2.0 dCi  | 110  | 10.10  | 24.0126-0158.1   | 426158  |  |  | 296 26,0 23,4 VL +S +B   |
|  | 2.0 dCi  | 118  | 04.09  |  |   |  |  |  |
|  | 2.0 dCi  | 120  | 07.12  |  |   |  |  |  |
|  | 2.0 TCe  | 132  | 11.08  |  |   |  |  |  |
|  | 2.0 TCe  | 140  | 06.12  |  |   |  |  |  |
|  | 2.0 TCe 220  | 162  | 11.13  |  |   |  |  |  |
|    | 1.2 TCe  | 85   | 03.12  | 13.0460-2740.2   | 602740  |  | - elektrische Feststellbremse <sup>1)</sup>  | 23554 17,2 /Zub/S TRW  |
|  | 1.2 TCe  | 97   | 01.13  | 13.0470-2740.2   | LD2740  |  | - elektrische Feststellbremse <sup>1)</sup>  | 23554 17,2 /Zub/S TRW  |
|  | 1.4  | 96   | 04.09  |  |   |  |  |  |
|  | 1.5 dCi  | 63   | 12.09  |  |   |  |  |  |
|  | 1.5 dCi  | 66   | 11.08  |  |   |  |  |  |
|  | 1.5 dCi  | 70   | 11.13  |  |   |  |  |  |
|  | 1.5 dCi  | 78   | 02.09  |  |   |  |  |  |
|  | 1.5 dCi  | 81   | 02.09  |  |   |  |  |  |
|  | 1.5 dCi  | 96   | 11.08  |  |   |  |  |  |
|  | 1.6  | 74   | 11.08  |  |   |  |  |  |
|  | 1.6  | 81   | 11.08  |  |   |  |  |  |
|  | 1.6 16V Bifuel   | 81   | 11.08  |  |   |  |  |  |
|  | 1.6 dCi  | 96   | 04.11  |  |   |  |  |  |
|  | 1.9 dCi  | 96   | 11.08  |  |   |  |  |  |
|  | 2.0  | 103  | 02.09  |  |   |  |  |  |
|  | 2.0  | 105  | 01.11  |  |   |  |  |  |
|  | 2.0 dCi  | 110  | 10.10  |  |   |  |  |  |
|  | 2.0 dCi  | 118  | 04.09  |  |   |  |  |  |
|  | 2.0 TCe  | 132  | 11.08  |  |   |  |  |  |
|  | 2.0 TCe  | 140  | 06.12  |  |   |  |  |  |
|  | 2.0 TCe 220  | 162  | 11.13  |  |   |  |  |  |
|  | 1.2 TCe  | 85   | 03.12  | 13.0460-2756.2   | 602756  |  | + elektrische Feststellbremse <sup>2)</sup>  | 24820 16,1 /Zub/S TRW  |
|  | 1.2 TCe  | 97   | 01.13  |  |   |  |  |  |
|  | 1.4  | 96   | 04.09  |  |   |  |  |  |
|  | 1.5 dCi  | 63   | 12.09  |  |   |  |  |  |
|  | 1.5 dCi  | 66   | 11.08  |  |   |  |  |  |
|  | 1.5 dCi  | 70   | 11.13  |  |   |  |  |  |
|  | 1.5 dCi  | 78   | 02.09  |  |   |  |  |  |
|  | 1.5 dCi  | 81   | 02.09  |  |   |  |  |  |
|  | 1.5 dCi  | 96   | 11.08  |  |   |  |  |  |
|  | 1.6  | 74   | 11.08  |  |   |  |  |  |
|  | 1.6  | 81   | 11.08  |  |   |  |  |  |
|  | 1.6 16V Bifuel   | 81   | 11.08  |  |   |  |  |  |
|  | 1.6 dCi  | 96   | 04.11  |  |   |  |  |  |
|  | 1.9 dCi  | 96   | 11.08  |  |   |  |  |  |
|  | 2.0  | 103  | 02.09  |  |   |  |  |  |
|  | 2.0  | 105  | 01.11  |  |   |  |  |  |
|  | 2.0 dCi  | 110  | 10.10  |  |   |  |  |  |
|  | 2.0 dCi  | 118  | 04.09  |  |   |  |  |  |
|  | 2.0 TCe  | 132  | 11.08  |  |   |  |  |  |
|  | 2.0 TCe  | 140  | 06.12  |  |   |  |  |  |
|  | 2.0 TCe 220  | 162  | 11.13  |  |   |  |  |  |
|  | 1.2 TCe  | 85   | 03.12  | 24.0108-0116.2   | 408116  |  | mit Lager/ mit Sensorring <sup>3)</sup>  | 260 8,0 7,0 +B   |
|  | 1.2 TCe  | 97   | 01.13  |  |   |  |  |  |
|  | 1.4  | 96   | 04.09  |  |   |  |  |  |
|  | 1.5 dCi  | 63   | 12.09  |  |   |  |  |  |
|  | 1.5 dCi  | 66   | 11.08  |  |   |  |  |  |
|  | 1.5 dCi  | 70   | 11.13  |  |   |  |  |  |
|  | 1.5 dCi  | 78   | 02.09  |  |   |  |  |  |
|  | 1.5 dCi  | 81   | 02.09  |  |   |  |  |  |
|  | 1.5 dCi  | 96   | 11.08  |  |   |  |  |  |
|  | 1.6  | 74   | 11.08  |  |   |  |  |  |
|  | 1.6  | 81   | 11.08  |  |   |  |  |  |
|  | 1.6 16V Bifuel   | 81   | 11.08  |  |   |  |  |  |
|  | 1.6 dCi  | 96   | 04.11  |  |   |  |  |  |
|  | 1.9 dCi  | 96   | 11.08  |  |   |  |  |  |
|  | 2.0  | 103  | 02.09  |  |   |  |  |  |
|  | 2.0  | 105  | 01.11  |  |   |  |  |  |
|  | 2.0 dCi  | 110  | 07.12  |  |   |  |  |  |
|  | 2.0 dCi  | 110  | 10.10  |  |   |  |  |  |
|  | 2.0 dCi  | 118  | 04.09  |  |   |  |  |  |
|  | 2.0 TCe  | 132  | 11.08  |  |   |  |  |  |
|  | 2.0 TCe  | 140  | 06.12  |  |   |  |  |  |
|  | 2.0 TCe 220  | 162  | 11.13  |  |   |  |  |  |

<sup>1)</sup> - electric parking brake / - freno a mano elettrico / - frein à main électrique / - freno de mano eléctrico

<sup>2)</sup> + electric parking brake / + freno a mano elettrico / + frein à main électrique / + freno de mano eléctrico

<sup>3)</sup> with bearing/ with sensor ring / con supporto/+ anell.sens.ABS / avec palier de secours ABS / con apoyo/+ anillo sensor ABS



### RENAULT MEGANE III CC (EZO\_) (10-)

|         |                    |       |   |   |                |        |   |                         |     |
|---------|--------------------|-------|---|---|----------------|--------|---|-------------------------|-----|
|         | 1.2 TCe            | 97    | 04.13                                       |   | 13.0460-7266.2 | 607266 |   | 24538 17,9 +            | ATE |
|         | 1.4 16V            | 96    | 06.10                                       |   | 13.0470-7266.2 | LD7266 |   | 24538 17,9 +            | ATE |
|         | 1.5 dCi            | 78    | 06.10                                       |   |                |        |   |                         |     |
|         | 1.5 dCi            | 81    | 06.10                                       |   |                |        |   |                         |     |
|         | 1.6 16V            | 81    | 06.10                                       |   |                |        |   |                         |     |
|         | 1.6 16V Bio-Petrol | 81    | 06.10                                       |   |                |        |   |                         |     |
|         | 1.6 dCi            | 96    | 04.11                                       |   |                |        |   |                         |     |
|         | 1.9 dCi            | 96    | 06.10                                       |   |                |        |   |                         |     |
|         | 2.0 16V            | 103   | 06.10                                       |   |                |        |   |                         |     |
|         | 2.0 dCi            | 118   | 06.10                                       |   | 13.0460-7249.2 | 607249 |   | 24709 18,6 +            | ATE |
| 2.0 TCe | 132                | 06.10 |   | 13.0470-7249.2                              | LD7249         |        | 24709 18,6 +                            | ATE                     |     |
|         | 1.2 TCe            | 97    | 04.13                                       |   | 24.0124-0221.1 | 424221 |   | 280 24,0 21,8 V L +S +B |     |
|         | 1.4 16V            | 96    | 06.10                                       |   |                |        |   |                         |     |
|         | 1.5 dCi            | 78    | 06.10                                       |   |                |        |   |                         |     |
|         | 1.5 dCi            | 81    | 06.10                                       |   |                |        |   |                         |     |
|         | 1.6 16V            | 81    | 06.10                                       |   |                |        |   |                         |     |
|         | 1.6 16V Bio-Petrol | 81    | 06.10                                       |   |                |        |   |                         |     |
|         | 1.6 dCi            | 96    | 04.11                                       |   |                |        |   |                         |     |
|         | 1.9 dCi            | 96    | 06.10                                       |   |                |        |   |                         |     |
|         | 2.0 16V            | 103   | 06.10                                       |   |                |        |   |                         |     |
|         | 2.0 dCi            | 118   | 06.10                                       |   | 24.0126-0158.1 | 426158 |   | 296 26,0 23,4 V L +S +B |     |
| 2.0 TCe | 132                | 06.10 |   |   |                |        |   |                         |     |
|         | 1.2 TCe            | 97    | 04.13                                       | - elektrische Feststellbremse <sup>1)</sup> | 13.0460-2740.2 | 602740 |   | 23554 17,2 /Zub/S       | TRW |
|         | 1.4 16V            | 96    | 06.10                                       | - elektrische Feststellbremse <sup>1)</sup> | 13.0470-2740.2 | LD2740 |   | 23554 17,2 /Zub/S       | TRW |
|         | 1.5 dCi            | 78    | 06.10                                       | - elektrische Feststellbremse <sup>1)</sup> |                |        |   |                         |     |
|         | 1.5 dCi            | 81    | 06.10                                       | - elektrische Feststellbremse <sup>1)</sup> |                |        |   |                         |     |
|         | 1.6 16V            | 81    | 06.10                                       | - elektrische Feststellbremse <sup>1)</sup> |                |        |   |                         |     |
|         | 1.6 16V Bio-Petrol | 81    | 06.10                                       | - elektrische Feststellbremse <sup>1)</sup> |                |        |   |                         |     |
|         | 1.6 dCi            | 96    | 06.10                                       | - elektrische Feststellbremse <sup>1)</sup> |                |        |   |                         |     |
|         | 1.9 dCi            | 96    | 06.10                                       | - elektrische Feststellbremse <sup>1)</sup> |                |        |   |                         |     |
|         | 2.0 16V            | 103   | 06.10                                       | - elektrische Feststellbremse <sup>1)</sup> |                |        |   |                         |     |
|         | 2.0 dCi            | 118   | 06.10                                       | - elektrische Feststellbremse <sup>1)</sup> |                |        |   |                         |     |
| 2.0 TCe | 132                | 06.10 | - elektrische Feststellbremse <sup>1)</sup> |   |                |        |   |                         |     |
|         | 1.2 TCe            | 97    | 04.13                                       | + elektrische Feststellbremse <sup>2)</sup> | 13.0460-2756.2 | 602756 |   | 24820 16,1 /Zub/S       | TRW |
|         | 1.4 16V            | 96    | 06.10                                       | + elektrische Feststellbremse <sup>2)</sup> |                |        |   |                         |     |
|         | 1.5 dCi            | 78    | 06.10                                       | + elektrische Feststellbremse <sup>2)</sup> |                |        |   |                         |     |
|         | 1.5 dCi            | 81    | 06.10                                       | + elektrische Feststellbremse <sup>2)</sup> |                |        |   |                         |     |
|         | 1.6 16V            | 81    | 06.10                                       | + elektrische Feststellbremse <sup>2)</sup> |                |        |   |                         |     |
|         | 1.6 16V Bio-Petrol | 81    | 06.10                                       | + elektrische Feststellbremse <sup>2)</sup> |                |        |   |                         |     |
|         | 1.6 dCi            | 96    | 04.11                                       | + elektrische Feststellbremse <sup>2)</sup> |                |        |   |                         |     |
|         | 1.9 dCi            | 96    | 06.10                                       | + elektrische Feststellbremse <sup>2)</sup> |                |        |   |                         |     |
|         | 2.0 16V            | 103   | 06.10                                       | + elektrische Feststellbremse <sup>2)</sup> |                |        |   |                         |     |
|         | 2.0 dCi            | 118   | 06.10                                       | + elektrische Feststellbremse <sup>2)</sup> |                |        |   |                         |     |
| 2.0 TCe | 132                | 06.10 | + elektrische Feststellbremse <sup>2)</sup> |   |                |        |   |                         |     |
|         | 1.4 16V            | 96    | 06.10                                       |   | 24.0108-0116.2 | 408116 | mit Lager/ mit Sensorring <sup>3)</sup> | 260 8,0 7,0 +B          |     |
|         | 1.5 dCi            | 78    | 06.10                                       |   |                |        |   |                         |     |
|         | 1.5 dCi            | 81    | 06.10                                       |   |                |        |   |                         |     |
|         | 1.6 16V            | 81    | 06.10                                       |   |                |        |   |                         |     |
|         | 1.6 16V Bio-Petrol | 81    | 06.10                                       |   |                |        |   |                         |     |
|         | 1.9 dCi            | 96    | 06.10                                       |   |                |        |   |                         |     |
|         | 2.0 16V            | 103   | 06.10                                       |   |                |        |   |                         |     |
|         | 2.0 dCi            | 118   | 06.10                                       |   |                |        |   |                         |     |
| 2.0 TCe | 132                | 06.10 |   |   |                |        |   |                         |     |
|         | 1.2 TCe            | 97    | 04.13                                       |   | 24.0108-0118.2 | 408118 | mit Lager/ mit Sensorring <sup>3)</sup> | 260 8,0 7,0 +B          |     |
|         | 1.6 dCi            | 96    | 04.11                                       |   |                |        |   |                         |     |

### RENAULT MEGANE III Coupe (DZO\_) (08-)

|                |                  |       |       |  |                |        |  |                         |     |
|----------------|------------------|-------|-------|--|----------------|--------|--|-------------------------|-----|
|                | 1.2 TCe          | 85    | 03.12 |  | 13.0460-7266.2 | 607266 |  | 24538 17,9 +            | ATE |
|                | 1.2 TCe          | 97    | 01.13 |  | 13.0470-7266.2 | LD7266 |  | 24538 17,9 +            | ATE |
|                | 1.4 16V          | 96    | 04.09 |  |                |        |  |                         |     |
|                | 1.5 dCi          | 63    | 11.08 |  |                |        |  |                         |     |
|                | 1.5 dCi          | 66    | 11.08 |  |                |        |  |                         |     |
|                | 1.5 dCi          | 70    | 07.14 |  |                |        |  |                         |     |
|                | 1.5 dCi          | 78    | 11.08 |  |                |        |  |                         |     |
|                | 1.5 dCi          | 81    | 02.09 |  |                |        |  |                         |     |
|                | 1.6 16V          | 74    | 11.08 |  |                |        |  |                         |     |
|                | 1.6 16V          | 81    | 11.08 |  |                |        |  |                         |     |
| 1.6 16V Bifuel | 81               | 11.08 |       |  |                |        |  |                         |     |
| 1.6 dCi        | 96               | 04.11 |       |  |                |        |  |                         |     |
| 1.9 dCi        | 96               | 11.08 |       |  |                |        |  |                         |     |
| 2.0 16V        | 103              | 05.09 |       |  |                |        |  |                         |     |
|                | 2.0 dCi          | 110   | 04.09 |  | 13.0460-7249.2 | 607249 |  | 24709 18,6 +            | ATE |
|                | 2.0 dCi          | 118   | 04.09 |  | 13.0470-7249.2 | LD7249 |  | 24709 18,6 +            | ATE |
|                | 2.0 dCi          | 120   | 07.12 |  |                |        |  |                         |     |
|                | 2.0 TCe          | 132   | 11.08 |  |                |        |  |                         |     |
|                | 2.0 TCe          | 140   | 06.12 |  |                |        |  |                         |     |
|                | 2.0 TCe 220      | 162   | 11.13 |  |                |        |  |                         |     |
|                | 2.0 R.S. TCe 265 | 195   | 08.11 |  | 13.0460-4804.2 | 604804 |  | 23092 15,6              | BRE |
|                | 2.0 TCe 250      | 184   | 05.09 |  |                |        |  |                         |     |
|                | 1.2 TCe          | 85    | 03.12 |  | 24.0124-0221.1 | 424221 |  | 280 24,0 21,8 V L +S +B |     |
|                | 1.2 TCe          | 97    | 01.13 |  |                |        |  |                         |     |
|                | 1.4 16V          | 96    | 04.09 |  |                |        |  |                         |     |
|                | 1.5 dCi          | 63    | 11.08 |  |                |        |  |                         |     |
|                | 1.5 dCi          | 66    | 11.08 |  |                |        |  |                         |     |
|                | 1.5 dCi          | 70    | 07.14 |  |                |        |  |                         |     |
|                | 1.5 dCi          | 78    | 11.08 |  |                |        |  |                         |     |
| 1.5 dCi        | 81               | 02.09 |       |  |                |        |  |                         |     |

<sup>1)</sup> - electric parking brake / - freno a mano elettrico / - frein à main électrique / - freno de mano eléctrico

<sup>2)</sup> + electric parking brake / + freno a mano elettrico / + frein à main électrique / + freno de mano eléctrico

<sup>3)</sup> with bearing/ with sensor ring / con supporto/+ anell.sens.ABS / avec palier de secours ABS / con apoyo/+ anillo sensor ABS

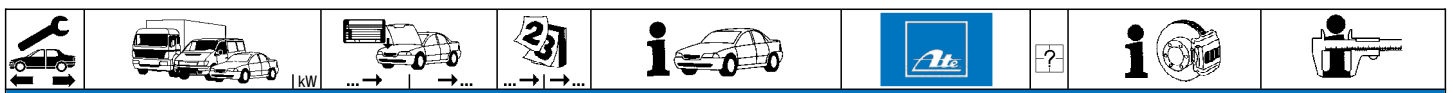

### RENAULT MEGANE III Coupe (DZO\_) (08-)

|                  |                  |     |       |                |                |        |                             |   |   |                |        |  |   |   |
|------------------|------------------|-----|-------|----------------|----------------|--------|-----------------------------|---|---|----------------|--------|--|---|---|
|                  | 1.6 16V          | 74  |       | 11.08          | 24.0124-0221.1 | 424221 |                             |   | 280 24,0 21,8 V L +S +B   |                |        |  |   |   |
|                  | 1.6 16V          | 81  |       | 11.08          |                |        |                             |   |   |                |        |  |   |   |
|                  | 1.6 16V Bifuel   | 81  |       | 11.08          |                |        |                             |   |   |                |        |  |   |   |
|                  | 1.6 dCi          | 96  |       | 04.11          |                |        |                             |   |   |                |        |  |   |   |
|                  | 1.9 dCi          | 96  |       | 11.08          |                |        |                             |   |   |                |        |  |   |   |
|                  | 2.0 16V          | 103 |       | 05.09          |                |        |                             |   |   |                |        |  |   |   |
|                  | 2.0 dCi          | 110 |       | 04.09          |                |        |                             |   |   |                |        |  |   |   |
|                  | 2.0 dCi          | 118 |       | 04.09          |                |        |                             |   |   |                |        |  |   |   |
|                  | 2.0 dCi          | 120 |       | 07.12          |                |        |                             |   |   |                |        |  |   |   |
|                  | 2.0 TCe          | 132 |       | 11.08          |                |        |                             |   |   |                |        |  |   |   |
| 2.0 TCe          | 140              |     | 06.12 |                |                |        |                             |   |   |                |        |  |   |   |
| 2.0 TCe 220      | 162              |     | 11.13 |                |                |        |                             |   |   |                |        |  |   |   |
| 2.0 R.S. TCe 265 | 195              |     | 08.11 | 24.0128-0288.1 | 428288         |        | + CUP Edition <sup>1)</sup> | 340 28,0 26,0 V L +S +B   |   |                |        |  |   |   |
| 2.0 TCe 250      | 184              |     | 05.09 |                |                |        |                             |   |   |                |        |  |   |   |
|                  | 1.2 TCe          | 85  |       | 03.12          | 13.0460-2740.2 | 602740 |                             |   | - elektrische Feststellbremse <sup>2)</sup> <b>23554</b> 17,2 /Zub/S <b>TRW</b> |                |        |  |   |   |
|                  | 1.2 TCe          | 97  |       | 01.13          |                |        |                             |   |   |                |        |  |   |   |
|                  | 1.4 16V          | 96  |       | 04.09          |                |        |                             |   |   |                |        |  |   |   |
|                  | 1.5 dCi          | 63  |       | 11.08          |                |        |                             |   |   |                |        |  |   |   |
|                  | 1.5 dCi          | 66  |       | 11.08          |                |        |                             |   |   |                |        |  |   |   |
|                  | 1.5 dCi          | 70  |       | 07.14          |                |        |                             |   |   |                |        |  |   |   |
|                  | 1.5 dCi          | 78  |       | 11.08          |                |        |                             |   |   |                |        |  |   |   |
|                  | 1.5 dCi          | 81  |       | 02.09          |                |        |                             |   |   |                |        |  |   |   |
|                  | 1.6 16V          | 74  |       | 11.08          |                |        |                             |   |   |                |        |  |   |   |
|                  | 1.6 16V          | 81  |       | 11.08          |                |        |                             |   |   |                |        |  |   |   |
|                  | 1.6 16V Bifuel   | 81  |       | 11.08          |                |        |                             |   |   |                |        |  |   |   |
|                  | 1.6 dCi          | 96  |       | 04.11          |                |        |                             |   |   |                |        |  |   |   |
|                  | 1.9 dCi          | 96  |       | 11.08          |                |        |                             |   |   |                |        |  |   |   |
|                  | 2.0 16V          | 103 |       | 05.09          |                |        |                             |   |   |                |        |  |   |   |
|                  | 2.0 dCi          | 110 |       | 04.09          |                |        |                             |   |   |                |        |  |   |   |
|                  | 2.0 dCi          | 118 |       | 04.09          |                |        |                             |   |   |                |        |  |   |   |
|                  | 2.0 TCe          | 132 |       | 11.08          |                |        |                             |   |   |                |        |  |   |   |
|                  | 2.0 TCe          | 140 |       | 06.12          |                |        |                             |   |   |                |        |  |   |   |
|                  | 2.0 TCe 220      | 162 |       | 11.13          |                |        |                             |   |   |                |        |  |   |   |
|                  | 2.0 R.S. TCe 265 | 195 |       | 08.11          |                |        |                             |   |   | 13.0460-2756.2 | 602756 |  | + elektrische Feststellbremse <sup>3)</sup> | <b>24820</b> 16,1 /Zub/S <b>TRW</b>   |
|                  | 2.0 TCe 250      | 184 |       | 05.09          |                |        |                             |   |   |                |        |  |   |   |
|                  | 1.2 TCe          | 85  |       | 03.12          |                |        |                             |   |   | 13.0460-2753.2 | 602753 |  |   | - elektrische Feststellbremse <sup>2)</sup> <b>23554</b> 16,0 /Zub/S <b>TRW</b> |
|                  | 1.2 TCe          | 97  |       | 01.13          |                |        |                             |   |   |                |        |  |   |   |
|                  | 1.4 16V          | 96  |       | 04.09          |                |        |                             |   |   |                |        |  |   |   |
|                  | 1.5 dCi          | 63  |       | 11.08          |                |        |                             |   |   |                |        |  |   |   |
|                  | 1.5 dCi          | 66  |       | 11.08          |                |        |                             |   |   |                |        |  |   |   |
|                  | 1.5 dCi          | 70  |       | 07.14          |                |        |                             |   |   |                |        |  |   |   |
|                  | 1.5 dCi          | 78  |       | 11.08          |                |        |                             |   |   |                |        |  |   |   |
|                  | 1.5 dCi          | 81  |       | 02.09          |                |        |                             |   |   |                |        |  |   |   |
|                  | 1.6 16V          | 74  |       | 11.08          |                |        |                             |   |   |                |        |  |   |   |
|                  | 1.6 16V          | 81  |       | 11.08          |                |        |                             |   |   |                |        |  |   |   |
|                  | 1.6 16V Bifuel   | 81  |       | 11.08          |                |        |                             |   |   |                |        |  |   |   |
|                  | 1.6 dCi          | 96  |       | 04.11          |                |        |                             |   |   |                |        |  |   |   |
|                  | 1.9 dCi          | 96  |       | 11.08          |                |        |                             |   |   |                |        |  |   |   |
| 2.0 16V          | 103              |     | 05.09 |                |                |        |                             |   |   |                |        |  |   |   |
| 2.0 dCi          | 110              |     | 04.09 |                |                |        |                             |   |   |                |        |  |   |   |
| 2.0 dCi          | 118              |     | 04.09 |                |                |        |                             |   |   |                |        |  |   |   |
| 2.0 TCe          | 132              |     | 11.08 |                |                |        |                             |   |   |                |        |  |   |   |
| 2.0 TCe          | 140              |     | 06.12 |                |                |        |                             |   |   |                |        |  |   |   |
| 2.0 TCe 220      | 162              |     | 11.13 |                |                |        |                             |   |   |                |        |  |   |   |
| 2.0 R.S. TCe 265 | 195              |     | 08.11 | 13.0460-2753.2 | 602753         |        |                             | - elektrische Feststellbremse <sup>2)</sup> <b>23554</b> 16,0 /Zub/S <b>TRW</b> |   |                |        |  |   |   |
| 2.0 TCe 250      | 184              |     | 05.09 |                |                |        |                             |   |   |                |        |  |   |   |
|                  | 1.2 TCe          | 85  |       | 03.12          | 24.0108-0116.2 | 408116 |                             |   | mit Lager/ mit Sensorring <sup>4)</sup>   |                |        |  |   |   |
|                  | 1.2 TCe          | 97  |       | 01.13          |                |        |                             |   |   |                |        |  |   |   |
|                  | 1.4 16V          | 96  |       | 04.09          |                |        |                             |   |   |                |        |  |   |   |
|                  | 1.5 dCi          | 63  |       | 11.08          |                |        |                             |   |   |                |        |  |   |   |
|                  | 1.5 dCi          | 66  |       | 11.08          |                |        |                             |   |   |                |        |  |   |   |
|                  | 1.5 dCi          | 70  |       | 07.14          |                |        |                             |   |   |                |        |  |   |   |
|                  | 1.5 dCi          | 78  |       | 11.08          |                |        |                             |   |   |                |        |  |   |   |
|                  | 1.5 dCi          | 81  |       | 02.09          |                |        |                             |   |   |                |        |  |   |   |
|                  | 1.6 16V          | 74  |       | 11.08          |                |        |                             |   |   |                |        |  |   |   |
|                  | 1.6 16V          | 81  |       | 11.08          |                |        |                             |   |   |                |        |  |   |   |
|                  | 1.6 16V Bifuel   | 81  |       | 11.08          |                |        |                             |   |   |                |        |  |   |   |
|                  | 1.6 dCi          | 96  |       | 04.11          |                |        |                             |   |   |                |        |  |   |   |
|                  | 1.9 dCi          | 96  |       | 11.08          |                |        |                             |   |   |                |        |  |   |   |
|                  | 2.0 16V          | 103 |       | 05.09          |                |        |                             |   |   |                |        |  |   |   |
|                  | 2.0 dCi          | 110 |       | 04.09          |                |        |                             |   |   |                |        |  |   |   |
|                  | 2.0 dCi          | 118 |       | 04.09          |                |        |                             |   |   |                |        |  |   |   |
|                  | 2.0 dCi          | 120 |       | 07.12          |                |        |                             |   |   |                |        |  |   |   |
| 2.0 TCe          | 132              |     | 11.08 |                |                |        |                             |   |   |                |        |  |   |   |
| 2.0 TCe          | 140              |     | 06.12 |                |                |        |                             |   |   |                |        |  |   |   |
| 2.0 TCe 220      | 162              |     | 11.13 |                |                |        |                             |   |   |                |        |  |   |   |

### RENAULT MEGANE III Grandtour (KZ\_) (08-)

|  |                |    |  |       |                |        |  |  |                                |  |  |  |  |  |  |
|--|----------------|----|--|-------|----------------|--------|--|--|--------------------------------|--|--|--|--|--|--|
|  | 1.2 TCe        | 85 |  | 03.12 | 13.0460-7266.2 | 607266 |  |  | <b>24538</b> 17,9 + <b>ATE</b> |  |  |  |  |  |  |
|  | 1.2 TCe        | 97 |  | 01.13 |                |        |  |  |                                |  |  |  |  |  |  |
|  | 1.4 16V        | 96 |  | 05.09 |                |        |  |  |                                |  |  |  |  |  |  |
|  | 1.5 dCi        | 63 |  | 08.09 |                |        |  |  |                                |  |  |  |  |  |  |
|  | 1.5 dCi        | 66 |  | 05.09 |                |        |  |  |                                |  |  |  |  |  |  |
|  | 1.5 dCi        | 70 |  | 11.13 |                |        |  |  |                                |  |  |  |  |  |  |
|  | 1.5 dCi        | 78 |  | 05.09 |                |        |  |  |                                |  |  |  |  |  |  |
|  | 1.5 dCi        | 81 |  | 02.09 |                |        |  |  |                                |  |  |  |  |  |  |
|  | 1.6 16V        | 74 |  | 05.09 |                |        |  |  |                                |  |  |  |  |  |  |
|  | 1.6 16V        | 81 |  | 05.09 |                |        |  |  |                                |  |  |  |  |  |  |
|  | 1.6 16V Bifuel | 81 |  | 11.08 |                |        |  |  |                                |  |  |  |  |  |  |
|  | 1.6 dCi        | 96 |  | 04.11 |                |        |  |  |                                |  |  |  |  |  |  |
|  |                |    |  |       |                |        |  |  |                                |  |  |  |  |  |  |
|  |                |    |  |       |                |        |  |  |                                |  |  |  |  |  |  |
|  |                |    |  |       |                |        |  |  |                                |  |  |  |  |  |  |
|  |                |    |  |       |                |        |  |  |                                |  |  |  |  |  |  |
|  |                |    |  |       |                |        |  |  |                                |  |  |  |  |  |  |
|  |                |    |  |       |                |        |  |  |                                |  |  |  |  |  |  |















<sup>1)</sup> + CUP edition / + edizione CUP / + édition CUP / + edición CUP

<sup>2)</sup> - electric parking brake / - freno a mano elettrico / - frein à main électrique / - freno de mano eléctrico

<sup>3)</sup> + electric parking brake / + freno a mano elettrico / + frein à main électrique / + freno de mano eléctrico

<sup>4)</sup> with bearing/ with sensor ring / con supporto/+ anell.sens.ABS / avec palier de secours ABS / con apoyo/+ anillo sensor ABS



















|     |    |  |  |  |  |  |  |  |                   |     |
|--|--|--|--|--|---|--|--|--|-------------------|-----|
| <b>RENAULT MEGANE III Grandtour (KZ_) (08-)</b>                                    |  |  |  |  |   |  |  |  |                   |     |
|    | 1.9 dCi  | 96   | 05.09  |  | 13.0460-7266.2  | 607266   |  | 24538 17,9 +   | ATE               |     |
|  | 2.0 16V  | 103  | 05.09  |  | 13.0470-7266.2  | LD7266   |  | 24538 17,9 +   | ATE               |     |
|  | 2.0 dCi  | 110  | 08.09  |  | 13.0460-7249.2  | 607249   |  | 24709 18,6 +   | ATE               |     |
|  | 2.0 dCi  | 118  | 04.09  |  | 13.0470-7249.2  | LD7249   |  | 24709 18,6 +   | ATE               |     |
|  | 2.0 dCi  | 120  | 07.12  |  |   |  |  |  |                   |     |
|  | 2.0 TCe  | 132  | 05.09  |  |   |  |  |  |                   |     |
|  | 2.0 TCe  | 140  | 09.12  |  |   |  |  |  |                   |     |
|    | 1.2 TCe  | 85   | 03.12  |  | 24.0124-0221.1  | 424221   |  | 280 24,0 21,8 V L +S +B  |                   |     |
|  | 1.2 TCe  | 97   | 01.13  |  |   |  |  |  |                   |     |
|  | 1.4 16V  | 96   | 05.09  |  |   |  |  |  |                   |     |
|  | 1.5 dCi  | 63   | 08.09  |  |   |  |  |  |                   |     |
|  | 1.5 dCi  | 66   | 05.09  |  |   |  |  |  |                   |     |
|  | 1.5 dCi  | 70   | 11.13  |  |   |  |  |  |                   |     |
|  | 1.5 dCi  | 78   | 05.09  |  |   |  |  |  |                   |     |
|  | 1.5 dCi  | 81   | 02.09  |  |   |  |  |  |                   |     |
|  | 1.6 16V  | 74   | 05.09  |  |   |  |  |  |                   |     |
|  | 1.6 16V  | 81   | 05.09  |  |   |  |  |  |                   |     |
|  | 1.6 16V Bifuel   | 81   | 11.08  |  |   |  |  |  |                   |     |
|  | 1.6 dCi  | 96   | 04.11  |  |   |  |  |  |                   |     |
|  | 1.9 dCi  | 96   | 05.09  |  |   |  |  |  |                   |     |
|  | 2.0 16V  | 103  | 05.09  |  |   |  |  |  |                   |     |
|  | 2.0 dCi  | 110  | 08.09  |  | 24.0126-0158.1  | 426158   |  | 296 26,0 23,4 V L +S +B  |                   |     |
|  | 2.0 dCi  | 118  | 04.09  |  |   |  |  |  |                   |     |
|  | 2.0 dCi  | 120  | 07.12  |  |   |  |  |  |                   |     |
| 2.0 TCe  | 132  | 05.09  |  |  |   |  |  |  |                   |     |
| 2.0 TCe  | 140  | 09.12  |  |  |   |  |  |  |                   |     |
| 2.0 TCe  | 162  | 09.12  |  |  |   |  |  |  |                   |     |
|    | 1.2 TCe  | 85   | 03.12  |  | 13.0460-2740.2  | 602740   | - elektrische Feststellbremse <sup>1)</sup>  | 23554 17,2 /Zub/S  | TRW               |     |
|  | 1.2 TCe  | 97   | 01.13  |  | 13.0470-2740.2  | LD2740   | - elektrische Feststellbremse <sup>1)</sup>  | 23554 17,2 /Zub/S  | TRW               |     |
|  | 1.4 16V  | 96   | 05.09  |  |   |  |  |  |                   |     |
|  | 1.5 dCi  | 63   | 08.09  |  |   |  |  |  |                   |     |
|  | 1.5 dCi  | 66   | 05.09  |  |   |  |  |  |                   |     |
|  | 1.5 dCi  | 70   | 11.13  |  |   |  |  |  |                   |     |
|  | 1.5 dCi  | 78   | 05.09  |  |   |  |  |  |                   |     |
|  | 1.5 dCi  | 81   | 02.09  |  |   |  |  |  |                   |     |
|  | 1.6 16V  | 74   | 05.09  |  |   |  |  |  |                   |     |
|  | 1.6 16V  | 81   | 05.09  |  |   |  |  |  |                   |     |
|  | 1.6 16V Bifuel   | 81   | 11.08  |  |   |  |  |  |                   |     |
|  | 1.6 dCi  | 96   | 04.11  |  |   |  |  |  |                   |     |
|  | 1.9 dCi  | 96   | 05.09  |  |   |  |  |  |                   |     |
|  | 2.0 16V  | 103  | 05.09  |  |   |  |  |  |                   |     |
|  | 2.0 dCi  | 110  | 08.09  |  |   |  |  |  |                   |     |
|  | 2.0 dCi  | 118  | 04.09  |  |   |  |  |  |                   |     |
|  | 2.0 TCe  | 132  | 05.09  |  |   |  |  |  |                   |     |
|  | 2.0 TCe  | 140  | 09.12  |  |   |  |  |  |                   |     |
|  | 2.0 TCe  | 162  | 09.12  |  |   |  |  |  |                   |     |
|  |  | 1.2 TCe  | 85   | 03.12  |   | 13.0460-2756.2   | 602756   | + elektrische Feststellbremse <sup>2)</sup>  | 24820 16,1 /Zub/S | TRW |
|  |  | 1.4 16V  | 96   | 05.09  |   |  |  |  |                   |     |
| 1.5 dCi  |  | 63   | 08.09  |  |   |  |  |  |                   |     |
| 1.5 dCi  |  | 66   | 05.09  |  |   |  |  |  |                   |     |
| 1.5 dCi  |  | 70   | 11.13  |  |   |  |  |  |                   |     |
| 1.5 dCi  |  | 78   | 05.09  |  |   |  |  |  |                   |     |
| 1.5 dCi  |  | 81   | 02.09  |  |   |  |  |  |                   |     |
| 1.6 16V  |  | 74   | 05.09  |  |   |  |  |  |                   |     |
| 1.6 16V  |  | 81   | 05.09  |  |   |  |  |  |                   |     |
| 1.6 16V Bifuel   |  | 81   | 11.08  |  |   |  |  |  |                   |     |
| 1.6 dCi  |  | 96   | 04.11  |  |   |  |  |  |                   |     |
| 1.9 dCi  |  | 96   | 05.09  |  |   |  |  |  |                   |     |
| 2.0 16V  |  | 103  | 05.09  |  |   |  |  |  |                   |     |
| 2.0 dCi  |  | 110  | 08.09  |  |   |  |  |  |                   |     |
| 2.0 dCi  |  | 118  | 04.09  |  |   |  |  |  |                   |     |
| 2.0 dCi  |  | 120  | 07.12  |  |   |  |  |  |                   |     |
| 2.0 TCe  |  | 132  | 05.09  |  |   |  |  |  |                   |     |
| 2.0 TCe  |  | 140  | 09.12  |  |   |  |  |  |                   |     |
| 2.0 TCe  |  | 162  | 09.12  |  |   |  |  |  |                   |     |
|  |  | 1.2 TCe  | 85   | 03.12  |   | 24.0108-0118.2   | 408118   | mit Lager/ mit Sensorring <sup>3)</sup>  | 260 8,0 7,0 +B    |     |
|  |  | 1.4 16V  | 96   | 05.09  |   |  |  |  |                   |     |
|  | 1.5 dCi  | 63   | 08.09  |  |   |  |  |  |                   |     |
|  | 1.5 dCi  | 66   | 05.09  |  |   |  |  |  |                   |     |
|  | 1.5 dCi  | 70   | 11.13  |  |   |  |  |  |                   |     |
|  | 1.5 dCi  | 78   | 05.09  |  |   |  |  |  |                   |     |
|  | 1.5 dCi  | 81   | 02.09  |  |   |  |  |  |                   |     |
|  | 1.6 16V  | 74   | 05.09  |  |   |  |  |  |                   |     |
|  | 1.6 16V  | 81   | 05.09  |  |   |  |  |  |                   |     |
|  | 1.6 16V Bifuel   | 81   | 11.08  |  |   |  |  |  |                   |     |
|  | 1.6 dCi  | 96   | 04.11  |  |   |  |  |  |                   |     |
|  | 1.9 dCi  | 96   | 05.09  |  |   |  |  |  |                   |     |
|  | 2.0 16V  | 103  | 05.09  |  |   |  |  |  |                   |     |
|  | 2.0 dCi  | 110  | 08.09  |  |   |  |  |  |                   |     |
|  | 2.0 dCi  | 118  | 04.09  |  |   |  |  |  |                   |     |
|  | 2.0 dCi  | 120  | 07.12  |  |   |  |  |  |                   |     |
|  | 2.0 TCe  | 132  | 05.09  |  |   |  |  |  |                   |     |
| 2.0 TCe  | 140  | 09.12  |  |  |   |  |  |  |                   |     |
| 2.0 TCe  | 162  | 09.12  |  |  |   |  |  |  |                   |     |
|  | 1.2 TCe  | 97   | 01.13  |  | 24.0108-0116.2  | 408116   | mit Lager/ mit Sensorring <sup>3)</sup>  | 260 8,0 7,0 +B   |                   |     |
|  | 2.0 TCe  | 140  | 06.12  |  |   |  |  |  |                   |     |

<sup>1)</sup> - electric parking brake / - freno a mano elettrico / - frein à main électrique / - freno de mano eléctrico

<sup>2)</sup> + electric parking brake / + freno a mano elettrico / + frein à main électrique / + freno de mano eléctrico

<sup>3)</sup> with bearing/ with sensor ring / con supporto/+ anell.sens.ABS / avec palier de secours ABS / con apoyo/+ anillo sensor ABS

|     |    |  |                                   |    |                          |  |  |  |   |            |
|--|--|--|---|--|---|--|--|--|---|------------|
| <b>RENAULT MEGANE IV (B9_) (15-)</b>   |  |  |   |  |   |  |  |  |   |            |
|    | 1.2 TCe 100<br>1.5 dCi 90  | 74<br>66   | 11.15<br>11.15  |  | 13.0460-2709.2<br>13.0470-2709.2  | 602709<br>LD2709   |  | 23973 17,4 /Zub/S<br>23973 17,4 /Zub/S   | TRW<br>TRW  |            |
|    | 1.2 TCe 130<br>1.5 dCi 110<br>1.5 dCi 90<br>1.6 dCi 165<br>1.6 TCe 205   | 97<br>81<br>66<br>118<br>151   | 11.15<br>11.15<br>11.15<br>11.15<br>11.15   |  | 24.0124-0221.1  | 424221   |  | 280 24,0 21,8 V L +S +B<br>320 28,0 25,4 V L +S +B                                 |   |            |
|    | 1.2 TCe 100<br>1.2 TCe 130<br>1.5 dCi 110<br>1.5 dCi 90<br>1.6 dCi 130<br>1.6 dCi 165  | 74<br>97<br>81<br>66<br>96<br>118  | 11.15<br>11.15<br>11.15<br>11.15<br>11.15<br>11.15  | - elektrische Feststellbremse <sup>1)</sup><br>- elektrische Feststellbremse <sup>1)</sup><br>- elektrische Feststellbremse <sup>1)</sup><br>- elektrische Feststellbremse <sup>1)</sup><br>- elektrische Feststellbremse <sup>1)</sup><br>- elektrische Feststellbremse <sup>1)</sup> | 13.0460-2740.2<br>13.0470-2740.2  | 602740<br>LD2740   |  | 23554 17,2 /Zub/S<br>23554 17,2 /Zub/S   | TRW<br>TRW  |            |
|  | 1.2 TCe 100<br>1.2 TCe 130<br>1.5 dCi 110<br>1.5 dCi 90<br>1.6 dCi 130   | 74<br>97<br>81<br>66<br>96   | 11.15<br>11.15<br>11.15<br>11.15<br>11.15   | + elektrische Feststellbremse <sup>2)</sup><br>+ elektrische Feststellbremse <sup>2)</sup><br>+ elektrische Feststellbremse <sup>2)</sup><br>+ elektrische Feststellbremse <sup>2)</sup><br>+ elektrische Feststellbremse <sup>2)</sup>  | 13.0460-2756.2  | 602756   |  | 24820 16,1 /Zub/S  | TRW   |            |
| <b>RENAULT MEGANE IV Grandtour (K9_) (15-)</b>                                     |  |  |   |  |   |  |  |  |   |            |
|    | 1.5 dCi 90   | 66   | 04.16   |  | 13.0460-2709.2<br>13.0470-2709.2  | 602709<br>LD2709   |  | 23973 17,4 /Zub/S<br>23973 17,4 /Zub/S   | TRW<br>TRW  |            |
|    | 1.2 TCe 100<br>1.2 TCe 130<br>1.5 dCi 110<br>1.5 dCi 90  | 74<br>97<br>81<br>66   | 04.16<br>04.16<br>04.16<br>04.16  |  | 24.0124-0221.1  | 424221   |  | 280 24,0 21,8 V L +S +B  |   |            |
|    | 1.2 TCe 100<br>1.2 TCe 130<br>1.5 dCi 110<br>1.5 dCi 90<br>1.6 dCi 130   | 74<br>97<br>81<br>66<br>96   | 04.16<br>04.16<br>04.16<br>04.16<br>04.16   | - elektrische Feststellbremse <sup>1)</sup><br>- elektrische Feststellbremse <sup>1)</sup><br>- elektrische Feststellbremse <sup>1)</sup><br>- elektrische Feststellbremse <sup>1)</sup><br>- elektrische Feststellbremse <sup>1)</sup>  | 13.0460-2740.2<br>13.0470-2740.2  | 602740<br>LD2740   |  | 23554 17,2 /Zub/S<br>23554 17,2 /Zub/S   | TRW<br>TRW  |            |
|  | 1.2 TCe 100<br>1.2 TCe 130<br>1.5 dCi 110<br>1.5 dCi 90<br>1.6 dCi 130   | 74<br>97<br>81<br>66<br>96   | 04.16<br>04.16<br>04.16<br>04.16<br>04.16   | + elektrische Feststellbremse <sup>2)</sup><br>+ elektrische Feststellbremse <sup>2)</sup><br>+ elektrische Feststellbremse <sup>2)</sup><br>+ elektrische Feststellbremse <sup>2)</sup><br>+ elektrische Feststellbremse <sup>2)</sup>  | 13.0460-2756.2  | 602756   |  | 24820 16,1 /Zub/S  | TRW   |            |
| <b>RENAULT MEGANE SCENIC (JA_) (96-99)</b>   |  |  |   |  |   |  |  |  |   |            |
|  | 1.4 i<br>1.6 e<br>1.6 i  | 51<br>66<br>55   | 11.96<br>11.96<br>11.96   | 09.98<br>09.98<br>09.98  |   |  | 13.0460-2834.2   | 602834   | 21463 18,0 /WK/S                                      | TRW        |
|  | 1.4 i<br>1.6 16V<br>1.6 e<br>1.6 e<br>1.6 i<br>1.9 D (FAOJ)<br>1.9 D (FAOY)<br>1.9 D (JAOY)<br>1.9 dT<br>1.9 dT<br>1.9 dTi (FAON)<br>1.9 dTi (JAON)<br>2.0 i | 51<br>79<br>66<br>66<br>55<br>47<br>47<br>47<br>66<br>69<br>72<br>72<br>84       | 10.98<br>04.98<br>10.98<br>11.96<br>10.98<br>11.96<br>11.96<br>11.96<br>11.96<br>03.97<br>03.98<br>04.97<br>11.96 | 09.99<br>03.99<br>12.98<br>09.98<br>09.99<br>09.98<br>09.99<br>12.97<br>08.99<br>09.99<br>09.99<br>09.99<br>09.99  | + Schaltgetriebe <sup>3)</sup><br><br>+ Schaltgetriebe <sup>3)</sup><br>+ Automatikgetriebe <sup>4)</sup> | 13.0460-2983.2   | 602983   |  | 21388 18,0 +/-WK/S                                    | TRW        |
|  | 1.6 16V<br>1.6 e<br>1.6 e<br>1.9 D (FAOJ)<br>1.9 D (JAOJ)<br>1.9 dTi (JAON)  | 79<br>66<br>66<br>47<br>47<br>72   | 04.99<br>01.99<br>01.99<br>10.98<br>11.96<br>10.98  | 09.99<br>09.99<br>09.99<br>09.99<br>09.99<br>09.99   | + Schaltgetriebe <sup>3)</sup><br>+ Automatikgetriebe <sup>4)</sup>                                       | 13.0460-2895.2<br>13.0460-0262.2   | 602895<br>610262   |  | 23172 18,0 /WE/Zub/S<br>Belagsatz-Zubehör             | TRW<br>TRW |
|  | 1.4 i<br>1.6 e<br>1.6 i  | 51<br>66<br>55   | 11.96<br>11.96<br>11.96   | 09.98<br>09.98<br>09.98  |   |  | 24.0121-0106.1   | 421106   | 259 20,6 17,7 V +S +B                                 |            |
|  | 1.6 16V<br>1.6 e<br>1.9 D (FAOJ)<br>1.9 D (JAOJ)<br>1.9 D (FAOY)<br>1.9 D (JAOY)<br>1.9 dT<br>1.9 dT<br>1.9 dTi (FAON)<br>1.9 dTi (JAON)<br>2.0 i            | 79<br>66<br>47<br>47<br>47<br>47<br>66<br>69<br>72<br>72<br>84                   | 04.98<br>11.96<br>11.96<br>11.96<br>11.96<br>11.96<br>11.96<br>03.97<br>03.98<br>04.97<br>11.96                   | 09.98<br>09.98<br>09.98<br>09.98<br>09.98<br>09.99<br>12.97<br>08.99<br>09.98<br>09.98<br>09.98  | + Automatikgetriebe <sup>4)</sup>   | 24.0122-0148.1   | 422148   |  | 262 22,0 19,8 V L +S +B                               |            |
|  | 1.4 i<br>1.6 16V<br>1.6 e<br>1.6 i<br>1.9 D (FAOJ)<br>1.9 D (JAOJ)<br>1.9 D (FAOY)<br>1.9 dTi (FAON)<br>1.9 dTi (JAON)                                       | 51<br>79<br>66<br>55<br>47<br>47<br>47<br>72<br>72                               | 10.98<br>10.98<br>10.98<br>10.98<br>10.98<br>10.98<br>10.98<br>10.98<br>10.98                                     | 09.99<br>09.99<br>09.99<br>09.99<br>09.99<br>09.99<br>09.99<br>09.99<br>09.99  |   | 24.0124-0158.1<br>24.0324-0158.1   | 424158<br>524158   |  | 280 24,0 21,8 V L +S +B<br>280 24,0 21,8 V L +S +B PD |            |

1) - electric parking brake / - freno a mano elettrico / - frein à main électrique / - freno de mano eléctrico  
2) + electric parking brake / + freno a mano elettrico / + frein à main électrique / + freno de mano eléctrico  
3) + manual transmission / + scatola cambio velocità / + transmission mécanique / + cambio de velocidad  
4) + autom.transmission / + scatola cambio automatico / + transmission automatique / + cambio automático



### RENAULT MEGANE SCENIC (JA\_) (96-99)

|  |                  |    |  |       |       |                                   |                |        |   |  |   |                 |
|--|------------------|----|--|-------|-------|-----------------------------------|----------------|--------|---|--|---|-----------------|
|  | 2.0 i            | 84 |  | 10.98 | 09.99 |                                   | 24.0124-0158.1 | 424158 |   |  | 280 24,0 21,8 V L +S +B                 |                 |
|  |                  |    |  |       |       |                                   | 24.0324-0158.1 | 524158 |   |  | 280 24,0 21,8 V L +S +B PD              |                 |
|  | 1.4 i            | 51 |  | 11.96 | 09.99 |                                   | 24.0713-1109.1 | 360145 | 2 |  | Radsensor L=625                         |                 |
|  | 1.6 16V          | 79 |  | 04.98 | 09.99 |                                   |                |        |   |  |   |                 |
|  | 1.6 e            | 66 |  | 11.96 | 09.99 | + Schaltgetriebe <sup>1)</sup>    |                |        |   |  |   |                 |
|  | 1.6 e            | 66 |  | 07.98 | 09.99 | + Automatikgetriebe <sup>2)</sup> |                |        |   |  |   |                 |
|  | 1.6 i            | 55 |  | 11.96 | 09.99 |                                   |                |        |   |  |   |                 |
|  | 1.9 D (F/JA0J)   | 47 |  | 07.98 | 09.99 |                                   |                |        |   |  |   |                 |
|  | 1.9 D (FA0Y)     | 47 |  | 07.98 | 09.99 |                                   |                |        |   |  |   |                 |
|  | 1.9 dTi (F/JAON) | 72 |  | 07.98 | 09.99 |                                   |                |        |   |  |   |                 |
|  | 2.0 i            | 84 |  | 07.98 | 09.99 |                                   |                |        |   |  |   |                 |
|  | 1.6 16V          | 79 |  | 04.98 | 09.99 |                                   | 13.0460-2845.2 | 602845 |   |  | 23554 16,4 /Zub/S                       | TRW             |
|  | 1.9 dTi (JAON)   | 72 |  | 04.97 | 09.99 | + ABS                             | 13.0470-2845.2 | LD2845 |   |  | 23554 16,4 /Zub/S                       | TRW             |
|  |                  |    |  |       |       |                                   | 13.0460-0077.2 | 610077 |   |  | Belagsatz-Zubehör                       | TRW             |
|  | 1.6 16V          | 79 |  | 04.98 | 09.99 |                                   | 24.0111-0166.2 | 411166 |   |  | mit Lager/ mit Sensorring <sup>3)</sup> | 274 10,9 9,5 +B |
|  | 1.9 dTi (JAON)   | 72 |  | 04.97 | 09.99 | + ABS                             |                |        |   |  |   |                 |
|  | 1.4 i            | 51 |  | 11.96 | 09.99 |                                   | 24.0721-1943.1 | 360153 |   |  | Radsensor L=615                         |                 |
|  | 1.6 16V          | 79 |  | 04.98 | 09.99 |                                   |                |        |   |  |   |                 |
|  | 1.6 e            | 66 |  | 11.96 | 09.99 |                                   |                |        |   |  |   |                 |
|  | 1.6 i            | 55 |  | 11.96 | 09.99 |                                   |                |        |   |  |   |                 |
|  | 1.9 D            | 47 |  | 11.96 | 09.99 |                                   |                |        |   |  |   |                 |
|  | 1.9 dT           | 66 |  | 11.96 | 12.97 |                                   |                |        |   |  |   |                 |
|  | 1.9 dT           | 69 |  | 03.97 | 08.99 |                                   |                |        |   |  |   |                 |
|  | 1.9 dTi (F/JAON) | 72 |  | 04.97 | 09.99 |                                   |                |        |   |  |   |                 |
|  | 2.0 i            | 84 |  | 11.96 | 09.99 |                                   |                |        |   |  |   |                 |
|  | 1.4 i            | 51 |  | 11.96 | 09.99 |                                   | 03.0137-0336.2 | 650336 |   |  | 229 x 42 HEB                            | TRW             |
|  | 1.6 16V          | 79 |  | 04.98 | 09.99 |                                   | 03.0137-9220.2 | 669220 |   |  | Bremsbacken-Zubehör                     | TRW             |
|  | 1.6 e            | 66 |  | 11.96 | 09.99 |                                   |                |        |   |  |   |                 |
|  | 1.6 i            | 55 |  | 11.96 | 09.99 |                                   |                |        |   |  |   |                 |
|  | 1.9 D (F/JA0J)   | 47 |  | 11.96 | 09.99 |                                   |                |        |   |  |   |                 |
|  | 1.9 dT           | 66 |  | 11.96 | 09.99 |                                   |                |        |   |  |   |                 |
|  | 1.9 dT           | 69 |  | 03.97 | 08.99 |                                   |                |        |   |  |   |                 |
|  | 1.9 dTi (F/JAON) | 72 |  | 04.97 | 09.99 | - ABS                             |                |        |   |  |   |                 |
|  | 2.0 i            | 84 |  | 11.96 | 09.99 |                                   |                |        |   |  |   |                 |
|  | 1.4 i            | 51 |  | 11.96 | 09.99 |                                   | 24.0222-8019.2 | 480087 |   |  | 229/229,5 x 52,5                        |                 |
|  | 1.6 16V          | 79 |  | 04.98 | 09.99 |                                   |                |        |   |  |   |                 |
|  | 1.6 e            | 66 |  | 11.96 | 09.99 |                                   |                |        |   |  |   |                 |
|  | 1.6 i            | 55 |  | 11.96 | 09.99 |                                   |                |        |   |  |   |                 |
|  | 1.9 D (F/JA0J)   | 47 |  | 11.96 | 09.99 |                                   |                |        |   |  |   |                 |
|  | 1.9 dT           | 66 |  | 11.96 | 09.99 |                                   |                |        |   |  |   |                 |
|  | 1.9 dT           | 69 |  | 03.97 | 08.99 |                                   |                |        |   |  |   |                 |
|  | 1.9 dTi (F/JAON) | 72 |  | 04.97 | 09.99 | - ABS                             |                |        |   |  |   |                 |
|  | 2.0 i            | 84 |  | 11.96 | 09.99 |                                   |                |        |   |  |   |                 |
|  | 1.4 i            | 51 |  | 11.96 | 09.99 |                                   | 03.0520-5520.3 | 695520 |   |  | 20,64/229x42 TopKit                     | TRW             |
|  | 1.6 16V          | 79 |  | 04.98 | 09.99 |                                   |                |        |   |  |   |                 |
|  | 1.6 e            | 66 |  | 11.96 | 09.99 |                                   |                |        |   |  |   |                 |
|  | 1.6 i            | 55 |  | 11.96 | 09.99 |                                   |                |        |   |  |   |                 |
|  | 1.9 D (F/JA0J)   | 47 |  | 11.96 | 09.99 |                                   |                |        |   |  |   |                 |
|  | 1.9 dT           | 66 |  | 11.96 | 09.99 |                                   |                |        |   |  |   |                 |
|  | 1.9 dT           | 69 |  | 03.97 | 08.99 |                                   |                |        |   |  |   |                 |
|  | 1.9 dTi (F/JAON) | 72 |  | 04.97 | 09.99 | - ABS                             |                |        |   |  |   |                 |
|  | 2.0 i            | 84 |  | 11.96 | 09.99 |                                   |                |        |   |  |   |                 |

### RENAULT MODUS/GRAND MODUS (JPO\_) (04-13)

|  |                 |    |  |       |       |  |                |        |  |  |                         |     |
|--|-----------------|----|--|-------|-------|--|----------------|--------|--|--|-------------------------|-----|
|  | 1.2             | 58 |  | 12.04 | 06.13 |  | 13.0460-2709.2 | 602709 |  |  | 23973 17,4 /Zub/S       | TRW |
|  | 1.2             | 76 |  | 04.11 | 06.13 |  | 13.0470-2709.2 | LD2709 |  |  | 23973 17,4 /Zub/S       | TRW |
|  | 1.2 16V         | 48 |  | 05.05 | 06.13 |  |                |        |  |  |                         |     |
|  | 1.2 16V         | 55 |  | 08.04 | 06.13 |  |                |        |  |  |                         |     |
|  | 1.2 16V         | 74 |  | 05.07 | 06.13 |  |                |        |  |  |                         |     |
|  | 1.2 16V Hi-Flex | 55 |  | 10.08 | 06.13 |  |                |        |  |  |                         |     |
|  | 1.4 16V         | 72 |  | 08.04 | 06.13 |  |                |        |  |  |                         |     |
|  | 1.5 dCi         | 48 |  | 12.04 | 06.13 |  |                |        |  |  |                         |     |
|  | 1.5 dCi         | 50 |  | 08.04 | 06.13 |  |                |        |  |  |                         |     |
|  | 1.5 dCi         | 60 |  | 09.04 | 06.13 |  |                |        |  |  |                         |     |
|  | 1.5 dCi         | 63 |  | 08.04 | 06.13 |  |                |        |  |  |                         |     |
|  | 1.5 dCi         | 76 |  | 05.07 | 06.13 |  |                |        |  |  |                         |     |
|  | 1.5 dCi         | 78 |  | 05.05 | 06.13 |  |                |        |  |  |                         |     |
|  | 1.5 dCi 75      | 55 |  | 10.10 | 06.13 |  |                |        |  |  |                         |     |
|  | 1.5 dCi 90      | 65 |  | 10.10 | 06.13 |  |                |        |  |  |                         |     |
|  | 1.6 16V         | 65 |  | 08.04 | 06.13 |  |                |        |  |  |                         |     |
|  | 1.6 16V         | 82 |  | 08.04 | 06.13 |  |                |        |  |  |                         |     |
|  | 1.2             | 58 |  | 12.04 | 06.13 |  | 24.0122-0216.1 | 422216 |  |  | 260 22,0 19,8 V L +S +B |     |
|  | 1.2             | 76 |  | 04.11 | 06.13 |  |                |        |  |  |                         |     |
|  | 1.2 16V         | 48 |  | 05.05 | 06.13 |  |                |        |  |  |                         |     |
|  | 1.2 16V         | 55 |  | 08.04 | 06.13 |  |                |        |  |  |                         |     |
|  | 1.2 16V         | 74 |  | 05.07 | 06.13 |  |                |        |  |  |                         |     |
|  | 1.2 16V Hi-Flex | 55 |  | 10.08 | 06.13 |  |                |        |  |  |                         |     |
|  | 1.4 16V         | 72 |  | 08.04 | 06.13 |  |                |        |  |  |                         |     |
|  | 1.5 dCi         | 48 |  | 12.04 | 06.13 |  |                |        |  |  |                         |     |
|  | 1.5 dCi         | 50 |  | 08.04 | 06.13 |  |                |        |  |  |                         |     |
|  | 1.5 dCi         | 60 |  | 09.04 | 06.13 |  |                |        |  |  |                         |     |
|  | 1.5 dCi         | 63 |  | 08.04 | 06.13 |  |                |        |  |  |                         |     |
|  | 1.5 dCi         | 76 |  | 05.07 | 06.13 |  |                |        |  |  |                         |     |
|  | 1.5 dCi         | 78 |  | 05.05 | 06.13 |  |                |        |  |  |                         |     |

<sup>1)</sup> + manual transmission / + scatola cambio velocità / + transmission mécanique / + cambio de velocidad

<sup>2)</sup> + autom.transmission / + scatola cambio automatico / + transmission automatique / + cambio automático

<sup>3)</sup> with bearing/ with sensor ring / con supporto/+ anell.sens.ABS / avec palier de secours ABS / con apoyo/+ anillo sensor ABS





### RENAULT MODUS/GRAND MODUS (JPO\_) (04-13)

|  |   |  |   |  |                                  |                  |   |                  |
|--|---|--|---|--|----------------------------------|------------------|---|------------------|
|  | 1.5 dCi 75<br>1.5 dCi 90<br>1.6 16V<br>1.6 16V  | 55<br>65<br>65<br>82   | 10.10<br>10.10<br>08.04<br>08.04  | 06.13<br>06.13<br>06.13<br>06.13   | 24.0122-0216.1<br>422216         |                  | 260 22,0 19,8 V L +S +B                 |                  |
|  | 1.2<br>1.2<br>1.2 16V<br>1.2 16V<br>1.2 16V<br>1.2 16V Hi-Flex<br>1.4 16V<br>1.5 dCi<br>1.5 dCi<br>1.5 dCi<br>1.5 dCi<br>1.5 dCi<br>1.5 dCi<br>1.5 dCi 75<br>1.5 dCi 90<br>1.6 16V<br>1.6 16V | 58<br>76<br>48<br>55<br>74<br>55<br>72<br>48<br>50<br>60<br>63<br>76<br>78<br>55<br>65<br>65<br>82 | 12.04<br>04.11<br>05.05<br>08.04<br>05.07<br>10.08<br>08.04<br>12.04<br>08.04<br>09.04<br>08.04<br>05.07<br>05.05<br>10.10<br>10.10<br>08.04<br>08.04 | 06.13<br>06.13<br>06.13 + ESP<br>06.13 + ESP<br>06.13 + ESP<br>06.13 + ESP<br>06.13<br>06.13 + ESP<br>06.13 + ESP<br>06.13 + ESP<br>06.13<br>06.13<br>06.13 + ESP<br>06.13 + ESP<br>06.13<br>06.13 | 13.0460-2845.2<br>13.0470-2845.2 | 602845<br>LD2845 | 23554 16,4 /Zub/S<br>23554 16,4 /Zub/S  | TRW<br>TRW       |
|  | 1.2<br>1.2 16V<br>1.2 16V<br>1.2 16V<br>1.2 16V Hi-Flex<br>1.4 16V<br>1.5 dCi<br>1.5 dCi<br>1.5 dCi<br>1.5 dCi<br>1.5 dCi<br>1.5 dCi<br>1.5 dCi 75<br>1.5 dCi 90<br>1.6 16V<br>1.6 16V        | 58<br>48<br>55<br>74<br>55<br>72<br>48<br>50<br>60<br>63<br>76<br>78<br>55<br>65<br>65<br>82       | 12.04<br>05.05<br>08.04<br>05.07<br>10.08<br>08.04<br>12.04<br>08.04<br>09.04<br>08.04<br>05.07<br>05.05<br>10.10<br>10.10<br>08.04<br>08.04          | 06.13<br>06.13 + ESP<br>06.13 + ESP<br>06.13 + ESP<br>06.13 + ESP<br>06.13<br>06.13 + ESP<br>06.13 + ESP<br>06.13 + ESP<br>06.13<br>06.13<br>06.13 + ESP<br>06.13 + ESP<br>06.13<br>06.13          | 24.0108-0114.2<br>408114         |                  | mit Lager/ mit Sensorring <sup>1)</sup> | 240 8,0 7,0 +B   |
|  | 1.2 16V<br>1.2 16V<br>1.2 16V Hi-Flex<br>1.5 dCi<br>1.5 dCi<br>1.5 dCi<br>1.5 dCi<br>1.5 dCi<br>1.5 dCi<br>1.5 dCi 75<br>1.5 dCi 90<br>1.6 16V<br>1.6 16V                                     | 48<br>55<br>55<br>48<br>50<br>60<br>63<br>76<br>78<br>55<br>65<br>65<br>82                         | 05.05<br>08.04<br>10.08<br>12.04<br>08.04<br>09.05<br>12.04<br>10.10<br>10.10   | 06.13 - ESP<br>06.13 - ESP<br>06.13 - ESP<br>06.13 - ESP<br>06.13 - ESP<br>06.13 - ESP<br>06.13 - ESP<br>06.13 - ESP<br>06.13 - ESP  | 03.0137-0454.2<br>03.0137-9280.2 | 650454<br>669280 | 203 x 38 HEB<br>Bremsbacken-Zubehör     |                  |
|  | 1.2 16V<br>1.2 16V<br>1.2 16V Hi-Flex<br>1.5 dCi<br>1.5 dCi<br>1.5 dCi<br>1.5 dCi<br>1.5 dCi<br>1.5 dCi 75<br>1.5 dCi 90  | 48<br>55<br>55<br>48<br>50<br>60<br>63<br>65   | 05.05<br>08.04<br>10.08<br>12.04<br>08.04<br>09.05<br>12.04<br>10.10<br>10.10   | 06.13 - ESP<br>06.13 - ESP<br>06.13 - ESP<br>06.13 - ESP<br>06.13 - ESP<br>06.13 - ESP<br>06.13 - ESP<br>06.13 - ESP   | 24.0220-3033.1<br>480195         |                  | ohne Sensorring <sup>2)</sup>           | 203/204,5 x 50,5 |
|  | 1.2 16V<br>1.2 16V<br>1.2 16V Hi-Flex<br>1.5 dCi<br>1.5 dCi<br>1.5 dCi<br>1.5 dCi<br>1.5 dCi<br>1.5 dCi 75<br>1.5 dCi 90  | 48<br>55<br>55<br>48<br>50<br>60<br>63<br>65   | 05.05<br>08.04<br>10.08<br>12.04<br>08.04<br>09.05<br>12.04<br>10.10<br>10.10   | 06.13 - ESP<br>06.13 - ESP<br>06.13 - ESP<br>06.13 - ESP<br>06.13 - ESP<br>06.13 - ESP<br>06.13 - ESP<br>06.13 - ESP   | 03.0520-6419.3<br>696419         |                  | 19,05/203x38 TopKit                     | AP               |

### RENAULT SAFRANE (B54\_) (92-00)

|  |  |  |   |   |  |                  |   |            |
|--|--|--|---|---|--|------------------|---|------------|
|  | 2.0 i (B540)<br>2.0 i (B542)<br>2.0 i (B54L)<br>2.1 dT<br>2.2 dT<br>2.2 i (B541)<br>2.2 i (B543)<br>2.5 20V<br>2.5 dT<br>3.0 V6<br>3.0 V6 (B544/B/J)<br>3.0 V6 | 77<br>97<br>100<br>65<br>83<br>79<br>101<br>121<br>83<br>123<br>123<br>140 | 09.92<br>04.92<br>08.96<br>11.93<br>08.96<br>04.92<br>04.92<br>08.96<br>12.92<br>08.96<br>12.92 | 07.96<br>07.96<br>12.00<br>07.96<br>12.00<br>07.96<br>07.96<br>12.00<br>07.96<br>12.00<br>07.96 | 13.0460-2983.2<br>602983                                     |                  | 21388 18,0 +WK/S                          | TRW        |
|  | 2.0 i (B540)<br>2.0 i (B542/E)<br>2.1 dT<br>2.2 i (B541)<br>2.2 i (B541)<br>2.2 i (B543)<br>2.0 i (B542/E)   | 77<br>97<br>65<br>79<br>79<br>101<br>97                                    | 09.92<br>04.92<br>11.93<br>04.92<br>02.95<br>04.92<br>02.95                                     | 07.96<br>01.95<br>07.96<br>07.96<br>01.95 + ⊕<br>01.95 - ⊖<br>09.96                             | 13.0460-2895.2<br>13.0460-0262.2<br>24.0122-0148.1<br>422148 | 602895<br>610262 | 23172 18,0 /WE/Zub/S<br>Belagsatz-Zubehör | TRW<br>TRW |
|  | 2.0 i (B542/E)   | 97   | 02.95   | 09.96   | 24.0122-0149.1<br>422149                                     |                  | 262 22,0 19,8 V L                         |            |

<sup>1)</sup> with bearing/ with sensor ring / con supporto/+ anell.sens.ABS / avec palier de secours ABS / con apoyo/+ anillo sensor ABS

<sup>2)</sup> without sensor ring / senza sensori / sans secours ABS / sin anillo sensor ABS

| RENAULT SAFRANE (B54_) (92-00) |                 |       |       |                              |                |        |                            |                            |                   |
|--------------------------------|-----------------|-------|-------|------------------------------|----------------|--------|----------------------------|----------------------------|-------------------|
|                                | 2.0 i (B54L)    | 100   | 08.96 | 12.97                        | 24.0122-0149.1 | 422149 |                            |                            | 262 22,0 19,8 V L |
|                                | 2.2 i (B541)    | 79    | 02.95 | 07.96 + ⊕                    |                |        |                            |                            |                   |
|                                | 2.2 i (B543)    | 101   | 02.95 | 07.96                        |                |        |                            |                            |                   |
|                                | 2.5 dT          | 83    | 09.92 | 05.94 + Schaltgetriebe 1)    |                |        |                            |                            |                   |
|                                | 2.5 dT          | 83    | 09.92 | 06.93 + Automatikgetriebe 2) |                |        |                            |                            |                   |
|                                | 2.0 i (B54L)    | 100   | 01.98 | 12.00                        | 24.0124-0171.1 | 424171 |                            | 280 24,0 21,8 V L +S +B    |                   |
|                                | 2.2 dT          | 83    | 08.96 | 12.00                        | 24.0324-0171.1 | 524171 |                            | 280 24,0 21,8 V L +S +B PD |                   |
|                                | 2.5 20V         | 121   | 08.96 | 12.00                        |                |        |                            |                            |                   |
|                                | 2.5 dT          | 83    | 06.94 | 07.96 + Schaltgetriebe 1)    |                |        |                            |                            |                   |
|                                | 2.5 dT          | 83    | 07.93 | 07.96 + Automatikgetriebe 2) |                |        |                            |                            |                   |
| 3.0 V6                         | 123             | 08.96 | 12.00 |                              |                |        |                            |                            |                   |
| 3.0 V6 (B544/B/J)              | 123             | 12.92 | 07.96 |                              |                |        |                            |                            |                   |
| 3.0 V6                         | 140             | 03.99 | 12.00 | 24.0124-0171.1               | 424171         |        | 280 24,0 21,8 V L +S +B    |                            |                   |
|                                |                 |       |       | 24.0324-0171.1               | 524171         |        | 280 24,0 21,8 V L +S +B PD |                            |                   |
|                                | 2.0 i (B540)    | 77    | 02.95 | 07.96                        | 13.0460-4957.2 | 604957 |                            | 20410 15,0 + BRE           |                   |
|                                | 2.0 i (B540)    | 77    | 09.92 | 01.95 + ABS                  | 13.0460-0438.2 | 610438 |                            | Belagsatz-Zubehör BRE      |                   |
|                                | 2.0 i (B542/E)  | 97    | 04.92 | 07.96                        |                |        |                            |                            |                   |
|                                | 2.0 i (B54L)    | 100   | 08.96 | 12.00                        |                |        |                            |                            |                   |
|                                | 2.1 dT          | 65    | 02.95 | 07.96                        |                |        |                            |                            |                   |
|                                | 2.1 dT          | 65    | 11.93 | 01.95 + ABS                  |                |        |                            |                            |                   |
|                                | 2.2 dT          | 83    | 08.96 | 12.00                        |                |        |                            |                            |                   |
|                                | 2.2 i (B541)    | 79    | 02.95 | 07.96                        |                |        |                            |                            |                   |
|                                | 2.2 i (B541)    | 79    | 04.92 | 01.95 + ABS                  |                |        |                            |                            |                   |
|                                | 2.2 i (B543)    | 101   | 04.92 | 07.96                        |                |        |                            |                            |                   |
|                                | 2.5 20V         | 121   | 08.96 | 12.00                        |                |        |                            |                            |                   |
|                                | 2.5 dT          | 83    | 12.92 | 07.96                        |                |        |                            |                            |                   |
|                                | 3.0 V6          | 123   | 08.96 | 12.00                        |                |        |                            |                            |                   |
|                                | 3.0 V6          | 140   | 03.99 | 12.00                        |                |        |                            |                            |                   |
|                                | 3.0 V6 (B544)   | 123   | 12.92 | 07.96                        |                |        |                            |                            |                   |
|                                | 3.0 V6 (B54B/J) | 123   | 12.92 | 07.96                        |                |        |                            |                            |                   |
| 3.0 V6 4x4 (B544)              | 123             | 02.93 | 07.96 | 13.0460-0423.2               | 610423         |        | Belagsatz-Zubehör BDX      |                            |                   |
| 3.0 V6 Biturbo                 | 193             | 01.93 | 07.96 |                              |                |        |                            |                            |                   |
|                                | 2.0 i (B540)    | 77    | 02.95 | 07.96                        | 24.0110-0219.1 | 410219 |                            | 265 10,5 9,5 +B            |                   |
|                                | 2.0 i (B540)    | 77    | 09.92 | 01.95 + ABS                  |                |        |                            |                            |                   |
|                                | 2.0 i (B542/E)  | 97    | 04.92 | 01.95                        |                |        |                            |                            |                   |
|                                | 2.1 dT          | 65    | 02.95 | 07.96                        |                |        |                            |                            |                   |
|                                | 2.1 dT          | 65    | 11.93 | 01.95 + ABS                  |                |        |                            |                            |                   |
|                                | 2.2 i (B541)    | 79    | 02.95 | 07.96 - ⊕                    |                |        |                            |                            |                   |
|                                | 2.2 i (B541)    | 79    | 04.92 | 01.95 + ABS                  |                |        |                            |                            |                   |
|                                | 2.2 i (B543)    | 101   | 04.92 | 01.95                        |                |        |                            |                            |                   |
|                                | 2.0 i (B542/E)  | 97    | 02.95 | 07.96                        | 24.0110-0220.1 | 410220 |                            | 265 10,5 9,5 +B            |                   |
|                                | 2.0 i (B54L)    | 100   | 08.96 | 12.00                        |                |        |                            |                            |                   |
|                                | 2.2 dT          | 83    | 08.96 | 12.00                        |                |        |                            |                            |                   |
|                                | 2.2 i (B541)    | 79    | 02.95 | 07.96 + ⊕                    |                |        |                            |                            |                   |
|                                | 2.2 i (B543)    | 101   | 02.95 | 07.96                        |                |        |                            |                            |                   |
|                                | 2.5 20V         | 121   | 08.96 | 12.00                        |                |        |                            |                            |                   |
| 2.5 dT                         | 83              | 12.92 | 07.96 |                              |                |        |                            |                            |                   |
| 3.0 V6                         | 123             | 08.96 | 12.00 |                              |                |        |                            |                            |                   |
| 3.0 V6                         | 140             | 03.99 | 12.00 |                              |                |        |                            |                            |                   |
| 3.0 V6 (B544)                  | 123             | 12.92 | 07.96 |                              |                |        |                            |                            |                   |
| 3.0 V6 (B54B/J)                | 123             | 12.92 | 07.96 |                              |                |        |                            |                            |                   |
| 3.0 V6 4x4 (B544)              | 123             | 02.93 | 07.96 | 24.0111-0144.1               | 411144         |        | 265 10,5 9,5 +B            |                            |                   |
| 3.0 V6 Biturbo                 | 193             | 01.93 | 07.96 |                              |                |        |                            |                            |                   |
|                                | 2.0 i (B540)    | 77    | 09.92 | 01.95 - ABS                  | 03.0137-0151.2 | 650151 |                            | 229 x 42 HEB TRW           |                   |
|                                | 2.1 dT          | 65    | 11.93 | 01.95 - ABS                  | 03.0137-9027.2 | 669027 |                            | 229/229,5 x 52,5 TRW       |                   |
|                                | 2.2 i (B541)    | 79    | 04.92 | 01.95 - ABS                  |                |        |                            |                            |                   |
|                                | 2.0 i (B540)    | 77    | 09.92 | 01.95 - ABS                  | 24.0222-8019.2 | 480087 |                            | 229/229,5 x 52,5           |                   |
|                                | 2.1 dT          | 65    | 11.93 | 01.95 - ABS                  |                |        |                            |                            |                   |
|                                | 2.2 i (B541)    | 79    | 04.92 | 01.95 - ABS                  |                |        |                            |                            |                   |
| RENAULT SANDERO (BS0_) (07-)   |                 |       |       |                              |                |        |                            |                            |                   |
|                                | 1.4             | 55    | 02.09 |                              | 13.0460-2834.2 | 602834 |                            | 21463 18,0 /WK/S TRW       |                   |
|                                | 1.6             | 62    | 11.10 |                              |                |        |                            |                            |                   |
|                                | 1.6             | 64    | 02.09 |                              |                |        |                            |                            |                   |
|                                | 1.6             | 66    | 05.09 |                              |                |        |                            |                            |                   |
|                                | 1.6             | 75    | 12.07 |                              |                |        |                            |                            |                   |
|                                | 1.4             | 55    | 02.09 | - ABS                        | 24.0112-0116.1 | 412116 |                            | 238 12,0 10,5 +S +B        |                   |
|                                | 1.6             | 62    | 11.10 | - ABS                        |                |        |                            |                            |                   |
|                                | 1.6             | 64    | 02.09 | - ABS                        |                |        |                            |                            |                   |
|                                | 1.6             | 66    | 05.09 | - ABS                        |                |        |                            |                            |                   |
|                                | 1.6             | 75    | 12.07 | - ABS                        |                |        |                            |                            |                   |
|                                | 1.4             | 55    | 02.09 | + ABS                        | 24.0112-0171.1 | 412171 |                            | 259 12,0 10,6 +S +B        |                   |
|                                | 1.6             | 62    | 11.10 | + ABS                        |                |        |                            |                            |                   |
|                                | 1.6             | 64    | 02.09 | + ABS                        |                |        |                            |                            |                   |
|                                | 1.6             | 66    | 05.09 | + ABS                        |                |        |                            |                            |                   |
|                                | 1.6             | 75    | 12.07 | + ABS                        |                |        |                            |                            |                   |
| 1.4                            | 55              | 02.09 |       | 24.0121-0106.1               | 421106         |        | 259 20,6 17,7 V +S +B      |                            |                   |
| 1.6                            | 62              | 11.10 |       |                              |                |        |                            |                            |                   |
| 1.6                            | 64              | 02.09 |       |                              |                |        |                            |                            |                   |
| 1.6                            | 66              | 05.09 |       |                              |                |        |                            |                            |                   |
| 1.6                            | 75              | 12.07 |       |                              |                |        |                            |                            |                   |
|                                | 1.4             | 55    | 02.09 |                              | 03.0137-0312.2 | 650312 |                            | 203 x 38 HEB TRW           |                   |
|                                | 1.6             | 62    | 11.10 |                              |                |        |                            |                            |                   |
|                                | 1.6             | 64    | 02.09 |                              |                |        |                            |                            |                   |
|                                | 1.6             | 66    | 05.09 |                              |                |        |                            |                            |                   |

1) + manual transmission / + scatola cambio velocità / + transmission mécanique / + cambio de velocidad  
2) + autom.transmission / + scatola cambio automatico / + transmission automatique / + cambio automático



### RENAULT SANDERO (BSO\_) (07-)

|  |     |    |  |       |  |                |        |       |                        |     |
|--|-----|----|--|-------|--|----------------|--------|-------|------------------------|-----|
|  | 1.6 | 75 |  | 12.07 |  | 03.0137-0312.2 | 650312 |       | 203 x 38 HEB           | TRW |
|  | 1.4 | 55 |  | 02.09 |  | 03.0137-0358.2 | 650358 | - ABS | 180 x 42 HEB           | BDX |
|  | 1.6 | 62 |  | 11.10 |  | 03.0137-9088.2 | 669088 |       | Bremsbacken-Zubehör    | BDX |
|  | 1.6 | 64 |  | 02.09 |  |                |        |       |                        |     |
|  | 1.6 | 66 |  | 05.09 |  |                |        |       |                        |     |
|  | 1.6 | 75 |  | 12.07 |  |                |        |       |                        |     |
|  | 1.4 | 55 |  | 02.09 |  | 03.0137-0423.2 | 650423 | + ABS | 203 x 39 HEB           | BOS |
|  | 1.6 | 62 |  | 11.10 |  | 03.0137-0532.2 | 650532 | + ABS | 203 x 39 HEB           | BOS |
|  | 1.6 | 64 |  | 02.09 |  | 03.0137-9274.2 | 669274 |       | Bremsbacken-Zubehör    | BOS |
|  | 1.6 | 66 |  | 05.09 |  |                |        |       |                        |     |
|  | 1.6 | 75 |  | 12.07 |  |                |        |       |                        |     |
|  | 1.6 | 62 |  | 11.10 |  | 24.0220-3021.1 | 480127 | - ABS | 203/204,5 x 48 - Lager |     |
|  | 1.6 | 64 |  | 02.09 |  |                |        |       |                        |     |
|  | 1.6 | 66 |  | 05.09 |  |                |        |       |                        |     |
|  | 1.6 | 75 |  | 12.07 |  |                |        |       |                        |     |
|  | 1.4 | 55 |  | 02.09 |  | 03.0520-4719.3 | 694719 | - ABS | 19,05/180x42 TopKit    | BDX |
|  | 1.6 | 62 |  | 11.10 |  | 03.0520-3817.3 | 693817 | + ABS | 17,46/203x39 TopKit    | BOS |
|  | 1.6 | 64 |  | 02.09 |  | 03.0520-3517.3 | 693517 | + ABS | 17,78/203x39 TopKit    | TRW |
|  | 1.6 | 66 |  | 05.09 |  |                |        |       |                        |     |
|  | 1.6 | 75 |  | 12.07 |  |                |        |       |                        |     |



















### RENAULT SANDERO II (13-)

|  |             |    |  |       |  |                |        |       |                         |     |
|--|-------------|----|--|-------|--|----------------|--------|-------|-------------------------|-----|
|  | 1.2 16V     | 54 |  | 12.13 |  | 13.0460-7298.2 | 607298 |       | 25702 18,2 +            | ATE |
|  | 1.2 16V LPG | 53 |  | 12.13 |  |                |        |       |                         |     |
|  | 1.6         | 59 |  | 11.13 |  |                |        |       |                         |     |
|  | 1.6         | 75 |  | 04.14 |  |                |        |       |                         |     |
|  | 1.2 16V     | 54 |  | 12.13 |  | 24.0112-0171.1 | 412171 |       | 259 12,0 10,6 +S +B     |     |
|  | 1.2 16V LPG | 53 |  | 12.13 |  |                |        |       |                         |     |
|  | 1.6         | 59 |  | 11.13 |  |                |        |       |                         |     |
|  | 1.6         | 75 |  | 04.14 |  |                |        |       |                         |     |
|  | 1.5 dCi     | 62 |  | 12.13 |  | 24.0122-0289.1 | 422289 |       | 258 22,0 19,8 V L +S +B |     |
|  | 1.2 16V     | 54 |  | 12.13 |  | 24.0711-5369.3 | 360378 | 2     | Radsensor L=619         |     |
|  | 1.2 16V LPG | 53 |  | 12.13 |  |                |        |       |                         |     |
|  | 1.5 dCi     | 62 |  | 12.13 |  |                |        |       |                         |     |
|  | 1.6         | 59 |  | 11.13 |  |                |        |       |                         |     |
|  | 1.6         | 75 |  | 04.14 |  |                |        |       |                         |     |
|  | 1.2 16V     | 54 |  | 12.13 |  | 03.0137-0423.2 | 650423 |       | 203 x 39 HEB            | BOS |
|  | 1.2 16V LPG | 53 |  | 12.13 |  | 03.0137-0532.2 | 650532 |       | 203 x 39 HEB            | BOS |
|  | 1.5 dCi     | 62 |  | 12.13 |  | 03.0137-0496.2 | 650496 |       | 228 x 42 HEB            | BDX |
|  | 1.6         | 59 |  | 11.13 |  |                |        |       |                         |     |
|  | 1.6         | 75 |  | 04.14 |  |                |        |       |                         |     |
|  | 1.2 16V     | 54 |  | 12.13 |  | 03.0520-3817.3 | 693817 |       | 17,46/203x39 TopKit     | BOS |
|  | 1.2 16V LPG | 53 |  | 12.13 |  | 03.0520-5017.3 | 695017 |       | 17,46/203x39 TopKit     | BOS |
|  | 1.5 dCi     | 62 |  | 12.13 |  | 03.0520-7919.3 | 697919 | + ABS | 19,05/228x42 TopKit     |     |
|  | 1.6         | 59 |  | 11.13 |  |                |        |       |                         |     |
|  | 1.6         | 75 |  |       |  |                |        |       |                         |     |

### RENAULT SCENIC I (JA\_) (99-03)

















|  |                       |     |  |       |       |                |        |   |                            |     |
|--|-----------------------|-----|--|-------|-------|----------------|--------|---|----------------------------|-----|
|  | 1.4 16V (0D,1H,0W,10) | 70  |  | 09.99 | 06.03 | 13.0460-2895.2 | 602895 |   | 23172 18,0 /WE/Zub/S       | TRW |
|  | 1.6 16V (JA00,15,16)  | 79  |  | 09.99 | 06.03 | 13.0460-0262.2 | 610262 |   | Belagsatz-Zubehör          | TRW |
|  | 1.8 16V (12,1R,1M,1A) | 85  |  | 01.01 | 06.03 |                |        |   |                            |     |
|  | 1.8 16V 4x4           | 85  |  | 07.00 | 06.03 |                |        |   |                            |     |
|  | 1.9 D                 | 47  |  | 09.99 | 03.01 |                |        |   |                            |     |
|  | 1.9 dCi (JA01,05,1F)  | 75  |  | 09.99 | 06.03 |                |        |   |                            |     |
|  | 1.9 dCi RX4           | 75  |  | 11.00 | 03.02 |                |        |   |                            |     |
|  | 1.9 dTi (JA0N)        | 72  |  | 09.99 | 06.03 |                |        |   |                            |     |
|  | 1.9 dTi (JA1U)        | 59  |  | 01.01 | 06.03 |                |        |   |                            |     |
|  | 2.0 16V (1B,1D,0C)    | 102 |  | 06.00 | 06.03 |                |        |   |                            |     |
|  | 2.0 16V IDE           | 103 |  | 09.99 | 06.03 |                |        |   |                            |     |
|  | 2.0 16V RX4           | 102 |  | 06.00 | 03.02 |                |        |   |                            |     |
|  | 1.9 dCi RX4           | 75  |  | 04.02 | 03.06 | 13.0460-7158.2 | 607158 |   | 23245 18,3 +               | ATE |
|  | 2.0 16V RX4           | 102 |  | 04.02 | 03.06 | 13.0470-7158.2 | LD7158 |   | 23245 18,3 +               | ATE |
|  | 1.4 16V (0D,1H,0W,10) | 70  |  | 09.99 | 06.03 | 24.0124-0158.1 | 424158 |   | 280 24,0 21,8 V L +S +B    |     |
|  | 1.6 16V (JA00,15,16)  | 79  |  | 09.99 | 06.03 | 24.0324-0158.1 | 524158 |   | 280 24,0 21,8 V L +S +B PD |     |
|  | 1.8 16V (12,1R,1M,1A) | 85  |  | 01.01 | 06.03 |                |        |   |                            |     |
|  | 1.8 16V 4x4           | 85  |  | 07.00 | 06.03 |                |        |   |                            |     |
|  | 1.9 D                 | 47  |  | 09.99 | 03.01 |                |        |   |                            |     |
|  | 1.9 dCi (JA01,05,1F)  | 75  |  | 09.99 | 06.03 |                |        |   |                            |     |
|  | 1.9 dTi (JA0N)        | 72  |  | 09.99 | 06.03 |                |        |   |                            |     |
|  | 1.9 dTi (JA1U)        | 59  |  | 01.01 | 06.03 |                |        |   |                            |     |
|  | 2.0 16V (1B,1D,0C)    | 102 |  | 06.00 | 06.03 |                |        |   |                            |     |
|  | 2.0 16V IDE           | 103 |  | 09.99 | 06.03 |                |        |   |                            |     |
|  | 1.9 dCi RX4           | 75  |  | 11.00 | 02.02 | 24.0124-0171.1 | 424171 |   | 280 24,0 21,8 V L +S +B    |     |
|  | 2.0 16V RX4           | 102 |  | 06.00 | 02.02 | 24.0324-0171.1 | 524171 |   | 280 24,0 21,8 V L +S +B PD |     |
|  | 1.9 dCi RX4           | 75  |  | 03.02 | 06.03 | 24.0126-0142.1 | 426142 |   | 300 26,0 22,8 V L          |     |
|  | 2.0 16V RX4           | 102 |  | 03.02 | 06.03 |                |        |   |                            |     |
|  | 1.4 16V (0D,1H,0W,10) | 70  |  | 09.99 | 06.03 | 24.0713-1109.1 | 360145 | 2 | Radsensor L=625            |     |
|  | 1.6 16V (JA00,15,16)  | 79  |  | 09.99 | 06.03 |                |        |   |                            |     |
|  | 1.8 16V (12,1R,1M,1A) | 85  |  | 01.01 | 06.03 |                |        |   |                            |     |
|  | 1.8 16V 4x4           | 85  |  | 07.00 | 06.03 |                |        |   |                            |     |
|  | 1.9 D                 | 47  |  | 09.99 | 03.01 |                |        |   |                            |     |
|  | 1.9 dCi (JA01,05,1F)  | 75  |  | 09.99 | 06.03 |                |        |   |                            |     |
|  | 1.9 dCi RX4           | 75  |  | 11.00 | 06.03 |                |        |   |                            |     |
|  | 1.9 dTi (JA0N)        | 72  |  | 09.99 | 06.03 |                |        |   |                            |     |
|  | 1.9 dTi (JA1U)        | 59  |  | 01.01 | 06.03 |                |        |   |                            |     |



|     |  |  |  |  |  |  |  |   |  |                |                |   |   |                                     |        |
|--|--|--|--|--|---|--|--|---|--|----------------|----------------|---|---|-------------------------------------|--------|
| <b>RENAULT SCENIC I (JA_) (99-03)</b>  |  |  |  |  |   |  |  |   |  |                |                |   |   |                                     |        |
|    | 1.4 16V (0D,1H,0W,10)  | 70   | 09.99  | 06.03  | + ABS   | 13.0460-2845.2   | 602845   | 23554 16,4 /Zub/S<br>23554 16,4 /Zub/S<br>Belagsatz-Zubehör                         | TRW<br>TRW<br>TRW                      |                |                |   |   |                                     |        |
|  | 1.6 16V (JA00,15,16)   | 79   | 09.99  | 06.03  | + ABS   | 13.0470-2845.2   | LD2845   |   |  |                |                |   |   |                                     |        |
|  | 1.8 16V (12,1R,1M,1A)  | 85   | 01.01  | 06.03  |   | 13.0460-0077.2   | 610077   |   |  |                |                |   |   |                                     |        |
|  | 1.8 16V 4x4  | 85   | 07.00  | 04.01  |   |  |  |   |  |                |                |   |   |                                     |        |
|  | 1.9 D  | 47   | 09.99  | 03.01  |   |  |  |   |  |                |                |   |   |                                     |        |
|  | 1.9 dCi (JA01,05,1F)   | 75   | 09.99  | 06.03  |   |  |  |   |  |                |                |   |   |                                     |        |
|  | 1.9 dCi RX4  | 75   | 11.00  | 06.03  |   |  |  |   |  |                |                |   |   |                                     |        |
|  | 1.9 dTi (JA0N)   | 72   | 09.99  | 06.03  | + ABS   |  |  |   |  |                |                |   |   |                                     |        |
|  | 1.9 dTi (JA1U)   | 59   | 01.01  | 06.03  |   |  |  |   |  |                |                |   |   |                                     |        |
|  | 2.0 16V (1B,1D,0C)   | 102  | 06.00  | 06.03  |   |  |  |   |  |                |                |   |   |                                     |        |
|  | 2.0 16V IDE  | 103  | 09.99  | 06.03  |   |  |  |   |  |                |                |   |   |                                     |        |
| 2.0 16V RX4  | 102  | 06.00  | 06.03  |  |   |  |  |   |  |                |                |   |   |                                     |        |
|    | 1.4 16V (0D,1H,0W,10)  | 70   | 09.99  | 06.03  | + ABS   | 24.0111-0166.2   | 411166   | mit Lager/ mit Sensorring <sup>1)</sup>   | 274 10,9 9,5 +B                        |                |                |   |   |                                     |        |
|  | 1.6 16V (JA00,15,16)   | 79   | 09.99  | 06.03  | + ABS   |  |  |   |  |                |                |   |   |                                     |        |
|  | 1.8 16V (12,1R,1M,1A)  | 85   | 01.01  | 06.03  |   |  |  |   |  |                |                |   |   |                                     |        |
|  | 1.8 16V 4x4  | 85   | 07.00  | 06.03  |   |  |  |   |  |                |                |   |   |                                     |        |
|  | 1.9 D  | 47   | 09.99  | 03.01  |   |  |  |   |  |                |                |   |   |                                     |        |
|  | 1.9 dCi (JA01,05,1F)   | 75   | 09.99  | 06.03  |   |  |  |   |  |                |                |   |   |                                     |        |
|  | 1.9 dTi (JA0N)   | 72   | 09.99  | 06.03  | + ABS   |  |  |   |  |                |                |   |   |                                     |        |
|  | 1.9 dTi (JA1U)   | 59   | 01.01  | 06.03  |   |  |  |   |  |                |                |   |   |                                     |        |
|  | 2.0 16V (1B,1D,0C)   | 102  | 06.00  | 06.03  |   |  |  |   |  |                |                |   |   |                                     |        |
|  | 2.0 16V IDE  | 103  | 09.99  | 06.03  |   |  |  |   |  |                |                |   |   |                                     |        |
|  | 1.9 dCi RX4  | 75   | 11.00  | 06.03  |   |  |  |   |  | 24.0111-0144.1 | 411144         | 265 10,5 9,5 +B   |   |                                     |        |
| 2.0 16V RX4  | 102  | 06.00  | 06.03  |  |   |  |  |   |  |                |                |   |   |                                     |        |
|    | 1.4 16V (0D,1H,0W,10)  | 70   | 09.99  | 06.03  |   | 24.0741-1125.1   | 360162   |  | Radsensor L=645<br>Radsensor L=500     |                |                |   |   |                                     |        |
|  | 1.6 16V (JA00,15,16)   | 79   | 10.99  | 06.03  |   |  |  |   |  | 24.0741-1126.1 | 360163         |   |   |                                     |        |
|  | 1.8 16V (12,1R,1M,1A)  | 85   | 01.01  | 06.03  |   |  |  |   |  |                |                |   |   |                                     |        |
|  | 1.9 D  | 47   | 09.99  | 03.01  |   |  |  |   |  |                |                |   |   |                                     |        |
|  | 1.9 dCi (JA01,05,1F)   | 75   | 09.99  | 06.03  |   |  |  |   |  |                |                |   |   |                                     |        |
|  | 1.9 dTi (JA0N)   | 72   | 09.99  | 06.03  |   |  |  |   |  |                |                |   |   |                                     |        |
|  | 1.9 dTi (JA1U)   | 59   | 01.01  | 06.03  |   |  |  |   |  |                |                |   |   |                                     |        |
|  | 2.0 16V (1B,1D,0C)   | 102  | 06.00  | 06.03  |   |  |  |   |  |                |                |   |   |                                     |        |
|  | 2.0 16V IDE  | 103  | 09.99  | 06.03  |   |  |  |   |  |                |                |   |   |                                     |        |
|  | 1.6 16V (JA00,15,16)   | 79   | 07.99  | 09.99  |   |  |  |   |  | 24.0721-1943.1 | 360153         |  | Radsensor L=615                                       |                                     |        |
|  |  | 1.4 16V (0D,1H,0W,10)  | 70   | 09.99  | 06.03   |  |  |   |  | - ABS          | 03.0137-0336.2 | 650336  |   | 229 x 42 HEB<br>Bremsbacken-Zubehör |        |
| 1.6 16V (JA00,15,16)   |  | 79   | 09.99  | 06.03  | - ABS   | 03.0137-9220.2   | 669220   |   |  |                |                |   |   |                                     |        |
| 1.9 dTi (JA0N)   |  | 72   | 09.99  | 06.03  | - ABS   |  |  |   |  |                |                |   |   |                                     |        |
|    | 1.4 16V (0D,1H,0W,10)  | 70   | 09.99  | 06.03  | - ABS   | 24.0222-8019.2   | 480087   |   | 229/229,5 x 52,5                       |                |                |   |   |                                     |        |
|  | 1.6 16V (JA00,15,16)   | 79   | 09.99  | 06.03  | - ABS   |  |  |   |  |                |                |   |   |                                     |        |
|  | 1.9 dTi (JA0N)   | 72   | 09.99  | 06.03  | - ABS   |  |  |   |  |                |                |   |   |                                     |        |
|  | 1.4 16V (0D,1H,0W,10)  | 70   | 09.99  | 06.03  | - ABS   | 03.0520-5520.3   | 695520   |   | 20,64/229x42 TopKit                    |                |                |   |   |                                     |        |
|  | 1.6 16V (JA00,15,16)   | 79   | 09.99  | 06.03  | - ABS   |  |  |   |  |                |                |   |   |                                     |        |
|  | 1.9 dTi (JA0N)   | 72   | 09.99  | 06.03  | - ABS   |  |  |   |  |                |                |   |   |                                     |        |
| <b>RENAULT SCENIC II (JM_) (03-09)</b>   |  |  |  |  |   |  |  |   |  |                |                |   |   |                                     |        |
|  | 1.4 16V  | 72   | 06.03  | 09.05  |   | 13.0460-3815.2   | 603815   |   | 23930 18,2 /Zub/S<br>23930 18,2 /Zub/S |                |                |   |   |                                     |        |
|  | 1.5 dCi  | 60   | 06.03  | 09.05  |   |  |  |   |  | 13.0470-3815.2 | LD3815         |   |   |                                     |        |
|  | 1.5 dCi  | 63   | 05.05  | 09.05  |   |  |  |   |  |                |                |   |   |                                     |        |
|  | 1.5 dCi  | 74   | 11.03  | 09.05  |   |  |  |   |  |                |                |   |   |                                     |        |
|  | 1.5 dCi  | 78   | 05.05  | 09.05  |   |  |  |   |  |                |                |   |   |                                     |        |
|  | 1.6 16V  | 83   | 06.03  | 09.05  |   |  |  |   |  |                |                |   |   |                                     |        |
|  | 1.6 Hi-Flex  | 81   | 03.05  | 09.05  |   |  |  |   |  |                |                |   |   |                                     |        |
|  | 1.9 dCi  | 81   | 05.05  | 09.05  |   |  |  |   |  |                |                |   |   |                                     |        |
|  | 1.9 dCi  | 88   | 06.03  | 09.05  |   |  |  |   |  |                |                |   |   |                                     |        |
|  | 1.9 dCi  | 92   | 06.03  | 09.05  |   |  |  |   |  |                |                |   |   |                                     |        |
|  | 1.9 dCi  | 96   | 05.05  | 09.05  |   |  |  |   |  |                |                |   |   |                                     |        |
|  | 2.0 16V  | 99   | 06.03  | 09.05  |   |  |  |   |  |                |                |   |   |                                     |        |
|  | 2.0 16V Turbo  | 120  | 05.04  | 09.05  |   |  |  |   |  |                |                |   |   |                                     |        |
|  | 1.4 16V  | 72   | 10.05  | 03.09  |   |  |  |   |  | 13.0460-7221.2 | 607221         |   | 24535 18,3 +<br>24535 18,3 +                          |                                     |        |
|  | 1.5 dCi  | 60   | 10.05  | 03.09  |   |  |  |   |  |                |                |   |   | 13.0470-7221.2                      | LD7221 |
|  | 1.5 dCi  | 63   | 10.05  | 03.09  |   |  |  |   |  |                |                |   |   |                                     |        |
|  | 1.5 dCi  | 74   | 10.05  | 03.09  |   |  |  |   |  |                |                |   |   |                                     |        |
| 1.5 dCi  | 76   | 01.07  | 03.09  |  |   |  |  |   |  |                |                |   |   |                                     |        |
| 1.5 dCi  | 78   | 10.05  | 03.09  |  |   |  |  |   |  |                |                |   |   |                                     |        |
| 1.6 16V  | 77   | 06.06  | 03.09  |  |   |  |  |   |  |                |                |   |   |                                     |        |
| 1.6 16V  | 82   | 01.07  | 03.09  |  |   |  |  |   |  |                |                |   |   |                                     |        |
| 1.6 16V  | 83   | 10.05  | 03.09  |  |   |  |  |   |  |                |                |   |   |                                     |        |
| 1.6 Hi-Flex  | 81   | 10.05  | 07.10  |  |   |  |  |   |  |                |                |   |   |                                     |        |
| 1.9 D  | 85   | 06.06  | 03.09  |  | 13.0460-7222.2  | 607222   |  | 23245 18,3 +  |  |                |                |   |   |                                     |        |
| 1.9 dCi  | 81   | 10.05  | 03.09  |  |   |  |  |   |  |                |                |   |   |                                     |        |
| 1.9 dCi  | 88   | 10.05  | 03.09  |  |   |  |  |   |  |                |                |   |   |                                     |        |
| 1.9 dCi  | 92   | 10.05  | 03.09  |  |   |  |  |   |  |                |                |   |   |                                     |        |
| 1.9 dCi  | 96   | 10.05  | 03.09  |  |   |  |  |   |  |                |                |   |   |                                     |        |
| 2.0 16V  | 99   | 10.05  | 03.09  |  |   |  |  |   |  |                |                |   |   |                                     |        |
| 2.0 16V Turbo  | 120  | 10.05  | 03.09  |  |   |  |  |   |  |                |                |   |   |                                     |        |
| 2.0 dCi  | 110  | 09.05  | 03.09  |  |   |  |  |   |  |                |                |   |   |                                     |        |
|  | 1.4 16V  | 72   | 06.03  | 03.09  |   |  |  |   |  | 24.0124-0158.1 | 424158         |   | 280 24,0 21,8 V L +S +B<br>280 24,0 21,8 V L +S +B PD |                                     |        |
|  | 1.5 dCi  | 60   | 06.03  | 03.09  |   |  |  |   |  |                |                |   |   | 24.0324-0158.1                      | 524158 |
|  | 1.5 dCi  | 63   | 05.05  | 03.09  |   |  |  |   |  |                |                |   |   |                                     |        |
|  | 1.5 dCi  | 74   | 11.03  | 03.09  |   |  |  |   |  |                |                |   |   |                                     |        |
|  | 1.5 dCi  | 76   | 01.07  | 03.09  |   |  |  |   |  |                |                |   |   |                                     |        |
|  | 1.5 dCi  | 78   | 05.05  | 03.09  |   |  |  |   |  |                |                |   |   |                                     |        |
|  | 1.6 16V  | 77   | 06.06  | 03.09  |   |  |  |   |  |                |                |   |   |                                     |        |
|  | 1.6 16V  | 82   | 01.07  | 03.09  |   |  |  |   |  |                |                |   |   |                                     |        |
|  | 1.6 16V  | 83   | 06.03  | 03.09  |   |  |  |   |  |                |                |   |   |                                     |        |
|  | 1.6 Hi-Flex  | 81   | 03.05  | 07.10  |   |  |  |   |  |                |                |   |   |                                     |        |

<sup>1)</sup> with bearing/ with sensor ring / con supporto/+ anell.sens.ABS / avec palier de secours ABS / con apoyo/+ anillo sensor ABS



|     |  |  |  |  |  |  |     |  |
|--|--|--|--|--|---|--|---|--|
| <b>RENAULT SCENIC II (JM_) (03-09)</b>   |  |  |  |  |   |  |   |  |
|    | 1.9 D 85   |  | 06.06 03.09  |  | 24.0124-0191.1  | 424191   |   | 300 24,0 21,8 V L +S +B  |
|  | 1.9 dCi 81   |  | 05.05 03.09  |  |   |  |   |  |
|  | 1.9 dCi 88   |  | 06.03 03.09  |  |   |  |   |  |
|  | 1.9 dCi 92   |  | 06.03 03.09  |  |   |  |   |  |
|  | 1.9 dCi 96   |  | 05.05 03.09  |  |   |  |   |  |
|  | 2.0 16V 99   |  | 06.03 03.09  |  |   |  |   |  |
|  | 2.0 dCi 110  |  | 09.05 03.09  |  | 24.0124-0224.1  | 424224   |   | 300 24,0 21,8 V L +S +B  |
|    | 1.4 16V 72   |  | 06.03 01.05  |  | 24.0711-5151.3  | 360175   | 2  | Radsensor L=485  |
|  | 1.5 dCi 60   |  | 06.03 01.05  |  |   |  |   |  |
|  | 1.5 dCi 74   |  | 11.03 01.05  |  |   |  |   |  |
|  | 1.6 16V 83   |  | 06.03 01.05  |  |   |  |   |  |
|  | 1.9 dCi 88   |  | 06.03 01.05  |  |   |  |   |  |
|  | 1.9 dCi 92   |  | 06.03 01.05  |  |   |  |   |  |
|  | 2.0 16V 99   |  | 06.03 01.05  |  |   |  |   |  |
|  | 2.0 16V Turbo 120  |  | 05.04 01.05  |  |   |  |   |  |
|  | 1.4 16V 72   |  | 02.05 12.05  |  | 24.0711-5190.3  | 360177   | 2  | Radsensor L=720  |
|  | 1.5 dCi 60   |  | 02.05 12.05  |  |   |  |   |  |
|  | 1.5 dCi 63   |  | 05.05 12.05  |  |   |  |   |  |
|  | 1.5 dCi 74   |  | 02.05 12.05  |  |   |  |   |  |
|  | 1.5 dCi 78   |  | 05.05 12.05  |  |   |  |   |  |
|  | 1.6 16V 83   |  | 02.05 12.05  |  |   |  |   |  |
|  | 1.6 Hi-Flex 81   |  | 03.05 12.05  |  |   |  |   |  |
|  | 1.9 dCi 81   |  | 05.05 12.05  |  |   |  |   |  |
|  | 1.9 dCi 88   |  | 02.05 12.05  |  |   |  |   |  |
|  | 1.9 dCi 92   |  | 02.05 12.05  |  |   |  |   |  |
|  | 1.9 dCi 96   |  | 05.05 12.05  |  |   |  |   |  |
|  | 2.0 16V 99   |  | 02.05 12.05  |  |   |  |   |  |
|  | 2.0 16V Turbo 120  |  | 02.05 12.05  |  |   |  |   |  |
|  | 2.0 dCi 110  |  | 09.05 12.05  |  |   |  |   |  |
|  | 1.4 16V 72   |  | 01.06 03.09  |  | 24.0711-5180.3  | 360236   | 2  | Radsensor L=720  |
|  | 1.5 dCi 60   |  | 01.06 03.09  |  |   |  |   |  |
|  | 1.5 dCi 63   |  | 01.06 03.09  |  |   |  |   |  |
|  | 1.5 dCi 74   |  | 01.06 03.09  |  |   |  |   |  |
|  | 1.5 dCi 76   |  | 01.07 03.09  |  |   |  |   |  |
|  | 1.5 dCi 78   |  | 01.06 03.09  |  |   |  |   |  |
|  | 1.6 16V 77   |  | 06.06 03.09  |  |   |  |   |  |
|  | 1.6 16V 82   |  | 01.07 03.09  |  |   |  |   |  |
|  | 1.6 16V 83   |  | 01.06 03.09  |  |   |  |   |  |
|  | 1.6 Hi-Flex 81   |  | 01.06 07.10  |  |   |  |   |  |
|  | 1.9 D 85   |  | 06.06 03.09  |  |   |  |   |  |
|  | 1.9 dCi 81   |  | 01.06 03.09  |  |   |  |   |  |
|  | 1.9 dCi 88   |  | 01.06 03.09  |  |   |  |   |  |
|  | 1.9 dCi 92   |  | 01.06 03.09  |  |   |  |   |  |
|  | 1.9 dCi 96   |  | 01.06 03.09  |  |   |  |   |  |
|  | 2.0 16V 99   |  | 01.06 03.09  |  |   |  |   |  |
|  | 2.0 16V Turbo 120  |  | 01.06 03.09  |  |   |  |   |  |
|  | 2.0 dCi 110  |  | 01.06 03.09  |  |   |  |   |  |
|  | 1.4 16V 72   |  | 06.03 03.09  |  | 13.0460-2845.2  | 602845   |   | 23554 16,4 /Zub/S TRW  |
|  | 1.5 dCi 60   |  | 06.03 03.09  |  | 13.0470-2845.2  | LD2845   |   | 23554 16,4 /Zub/S TRW  |
|  | 1.5 dCi 63   |  | 05.05 03.09  |  | 13.0460-0077.2  | 610077   |   | Belagsatz-Zubehör TRW  |
|  | 1.5 dCi 74   |  | 11.03 03.09  |  |   |  |   |  |
|  | 1.5 dCi 76   |  | 01.07 03.09  |  |   |  |   |  |
|  | 1.5 dCi 78   |  | 05.05 03.09  |  |   |  |   |  |
|  | 1.6 16V 77   |  | 06.06 03.09  |  |   |  |   |  |
|  | 1.6 16V 82   |  | 01.07 03.09  |  |   |  |   |  |
|  | 1.6 16V 83   |  | 06.03 03.09  |  |   |  |   |  |
|  | 1.6 Hi-Flex 81   |  | 03.05 07.10  |  |   |  |   |  |
|  | 1.9 D 85   |  | 06.06 03.09  |  |   |  |   |  |
|  | 1.9 dCi 81   |  | 05.05 03.09  |  |   |  |   |  |
|  | 1.9 dCi 88   |  | 06.03 03.09  |  |   |  |   |  |
|  | 1.9 dCi 92   |  | 06.03 03.09  |  |   |  |   |  |
|  | 1.9 dCi 96   |  | 05.05 03.09  |  |   |  |   |  |
|  | 2.0 16V 99   |  | 06.03 03.09  |  |   |  |   |  |
|  | 2.0 16V Turbo 120  |  | 05.04 03.09  |  |   |  |   |  |
|  | 2.0 dCi 110  |  | 09.05 03.09  |  |   |  |   |  |
|  | 1.4 16V 72   |  | 06.03 03.09  |  | 24.0110-0325.2  | 410325   | mit Lager/ mit Sensorring <sup>1)</sup>   | 270 10,0 9,0 +B  |
|  | 1.5 dCi 60   |  | 06.03 03.09  |  |   |  |   |  |
|  | 1.5 dCi 63   |  | 05.05 03.09  |  |   |  |   |  |
|  | 1.5 dCi 74   |  | 11.03 03.09  |  |   |  |   |  |
|  | 1.5 dCi 76   |  | 01.07 03.09  |  |   |  |   |  |
|  | 1.5 dCi 78   |  | 05.05 03.09  |  |   |  |   |  |
|  | 1.6 16V 77   |  | 06.06 03.09  |  |   |  |   |  |
|  | 1.6 16V 82   |  | 01.07 03.09  |  |   |  |   |  |
|  | 1.6 16V 83   |  | 06.03 03.09  |  |   |  |   |  |
|  | 1.6 Hi-Flex 81   |  | 03.05 07.10  |  |   |  |   |  |
|  | 1.9 D 85   |  | 06.06 03.09  |  |   |  |   |  |
|  | 1.9 dCi 81   |  | 05.05 03.09  |  |   |  |   |  |
|  | 1.9 dCi 88   |  | 06.03 03.09  |  |   |  |   |  |
|  | 1.9 dCi 92   |  | 06.03 03.09  |  |   |  |   |  |
|  | 1.9 dCi 96   |  | 05.05 03.09  |  |   |  |   |  |
|  | 2.0 16V 99   |  | 06.03 03.09  |  |   |  |   |  |
|  | 2.0 16V Turbo 120  |  | 05.04 03.09  |  |   |  |   |  |
|  | 2.0 dCi 110  |  | 09.05 03.09  |  | 24.0111-0101.2  | 411101   | mit Lager/ mit Sensorring <sup>1)</sup>   | 274 10,9 9,5 +B  |

<sup>1)</sup> with bearing/ with sensor ring / con supporto/+ anell.sens.ABS / avec palier de secours ABS / con apoyo/+ anillo sensor ABS



### RENAULT SCENIC II (JM\_) (03-09)

|  |               |     |  |       |       |                |        |   |  |                 |
|--|---------------|-----|--|-------|-------|----------------|--------|---|--|-----------------|
|  | 1.4 16V       | 72  |  | 06.03 | 12.05 | 24.0711-5152.3 | 360176 | 2 |  | Radsensor L=810 |
|  | 1.5 dCi       | 60  |  | 06.03 | 12.05 |                |        |   |  |                 |
|  | 1.5 dCi       | 63  |  | 05.05 | 12.05 |                |        |   |  |                 |
|  | 1.5 dCi       | 74  |  | 11.03 | 12.05 |                |        |   |  |                 |
|  | 1.5 dCi       | 78  |  | 05.05 | 12.05 |                |        |   |  |                 |
|  | 1.6 16V       | 83  |  | 06.03 | 12.05 |                |        |   |  |                 |
|  | 1.6 Hi-Flex   | 81  |  | 03.05 | 12.05 |                |        |   |  |                 |
|  | 1.9 dCi       | 81  |  | 05.05 | 12.05 |                |        |   |  |                 |
|  | 1.9 dCi       | 88  |  | 06.03 | 12.05 |                |        |   |  |                 |
|  | 1.9 dCi       | 92  |  | 06.03 | 12.05 |                |        |   |  |                 |
|  | 1.9 dCi       | 96  |  | 05.05 | 12.05 |                |        |   |  |                 |
|  | 2.0 16V       | 99  |  | 06.03 | 12.05 |                |        |   |  |                 |
|  | 2.0 16V Turbo | 120 |  | 05.04 | 12.05 |                |        |   |  |                 |
|  | 2.0 dCi       | 110 |  | 09.05 | 12.05 |                |        |   |  |                 |
|  | 1.4 16V       | 72  |  | 01.06 | 03.09 | 24.0711-5181.3 | 360237 | 2 |  | Radsensor L=810 |
|  | 1.5 dCi       | 60  |  | 01.06 | 03.09 |                |        |   |  |                 |
|  | 1.5 dCi       | 63  |  | 01.06 | 03.09 |                |        |   |  |                 |
|  | 1.5 dCi       | 74  |  | 01.06 | 03.09 |                |        |   |  |                 |
|  | 1.5 dCi       | 76  |  | 01.07 | 03.09 |                |        |   |  |                 |
|  | 1.5 dCi       | 78  |  | 01.06 | 03.09 |                |        |   |  |                 |
|  | 1.6 16V       | 77  |  | 06.06 | 03.09 |                |        |   |  |                 |
|  | 1.6 16V       | 82  |  | 01.07 | 03.09 |                |        |   |  |                 |
|  | 1.6 16V       | 83  |  | 01.06 | 03.09 |                |        |   |  |                 |
|  | 1.6 Hi-Flex   | 81  |  | 01.06 | 07.10 |                |        |   |  |                 |
|  | 1.9 D         | 85  |  | 06.06 | 03.09 |                |        |   |  |                 |
|  | 1.9 dCi       | 81  |  | 01.06 | 03.09 |                |        |   |  |                 |
|  | 1.9 dCi       | 88  |  | 01.06 | 03.09 |                |        |   |  |                 |
|  | 1.9 dCi       | 92  |  | 01.06 | 03.09 |                |        |   |  |                 |
|  | 1.9 dCi       | 96  |  | 01.06 | 03.09 |                |        |   |  |                 |
|  | 2.0 16V       | 99  |  | 01.06 | 03.09 |                |        |   |  |                 |
|  | 2.0 16V Turbo | 120 |  | 01.06 | 03.09 |                |        |   |  |                 |
|  | 2.0 dCi       | 110 |  | 01.06 | 03.09 |                |        |   |  |                 |

### RENAULT SCENIC III (JZ\_) (09-)















|  |         |     |  |       |   |                |        |  |  |                         |     |
|--|---------|-----|--|-------|---|----------------|--------|--|--|-------------------------|-----|
|  | 1.5 dCi | 63  |  | 04.09 | + 15" Rad <sup>1)</sup>                     | 13.0460-7266.2 | 607266 |  |  | 24538 17,9 +            | ATE |
|  | 1.5 dCi | 70  |  | 11.10 | + 15" Rad <sup>1)</sup>                     | 13.0470-7266.2 | LD7266 |  |  | 24538 17,9 +            | ATE |
|  | 1.5 dCi | 78  |  | 04.09 | + 15" Rad <sup>1)</sup>                     |                |        |  |  |                         |     |
|  | 1.5 dCi | 81  |  | 04.09 | + 15" Rad <sup>1)</sup>                     |                |        |  |  |                         |     |
|  | 1.6 16V | 81  |  | 04.09 | + 15" Rad <sup>1)</sup>                     |                |        |  |  |                         |     |
|  | 1.6 E85 | 81  |  | 06.09 | + 15" Rad <sup>1)</sup>                     |                |        |  |  |                         |     |
|  | 1.2 TCe | 85  |  | 03.12 |   | 13.0460-7249.2 | 607249 |  |  | 24709 18,6 +            | ATE |
|  | 1.2 TCe | 97  |  | 03.13 |   | 13.0470-7249.2 | LD7249 |  |  | 24709 18,6 +            | ATE |
|  | 1.4 TCe | 96  |  | 04.09 |   |                |        |  |  |                         |     |
|  | 1.5 dCi | 70  |  | 11.10 | + 16"/17" Rad <sup>2)</sup>                 |                |        |  |  |                         |     |
|  | 1.5 dCi | 78  |  | 04.09 | + 16"/17" Rad <sup>2)</sup>                 |                |        |  |  |                         |     |
|  | 1.5 dCi | 81  |  | 04.09 | + 16"/17" Rad <sup>2)</sup>                 |                |        |  |  |                         |     |
|  | 1.6 16V | 81  |  | 04.09 | + 16"/17" Rad <sup>2)</sup>                 |                |        |  |  |                         |     |
|  | 1.6 dCi | 96  |  | 04.11 |   |                |        |  |  |                         |     |
|  | 1.6 E85 | 81  |  | 06.09 | + 16"/17" Rad <sup>2)</sup>                 |                |        |  |  |                         |     |
|  | 1.9 dCi | 96  |  | 04.09 |   |                |        |  |  |                         |     |
|  | 2.0 16V | 103 |  | 04.09 |   |                |        |  |  |                         |     |
|  | 2.0 dCi | 110 |  | 04.09 |   |                |        |  |  |                         |     |
|  | 2.0 dCi | 118 |  | 04.09 |   |                |        |  |  |                         |     |
|  | 1.5 dCi | 63  |  | 04.09 | + 15" Rad <sup>1)</sup>                     | 24.0124-0221.1 | 424221 |  |  | 280 24,0 21,8 V L +S +B |     |
|  | 1.5 dCi | 70  |  | 04.09 | + 15" Rad <sup>1)</sup>                     |                |        |  |  |                         |     |
|  | 1.5 dCi | 78  |  | 04.09 | + 15" Rad <sup>1)</sup>                     |                |        |  |  |                         |     |
|  | 1.5 dCi | 81  |  | 04.09 | + 15" Rad <sup>1)</sup>                     |                |        |  |  |                         |     |
|  | 1.6 16V | 81  |  | 04.09 | + 15" Rad <sup>1)</sup>                     |                |        |  |  |                         |     |
|  | 1.6 E85 | 81  |  | 06.09 | + 15" Rad <sup>1)</sup>                     |                |        |  |  |                         |     |
|  | 1.2 TCe | 85  |  | 03.12 |   | 24.0126-0158.1 | 426158 |  |  | 296 26,0 23,4 V L +S +B |     |
|  | 1.2 TCe | 97  |  | 03.13 |   |                |        |  |  |                         |     |
|  | 1.4 TCe | 96  |  | 04.09 |   |                |        |  |  |                         |     |
|  | 1.5 dCi | 70  |  | 11.10 | + 16"/17" Rad <sup>2)</sup>                 |                |        |  |  |                         |     |
|  | 1.5 dCi | 78  |  | 04.09 | + 16"/17" Rad <sup>2)</sup>                 |                |        |  |  |                         |     |
|  | 1.5 dCi | 81  |  | 04.09 | + 16"/17" Rad <sup>2)</sup>                 |                |        |  |  |                         |     |
|  | 1.6 16V | 81  |  | 04.09 | + 16"/17" Rad <sup>2)</sup>                 |                |        |  |  |                         |     |
|  | 1.6 dCi | 96  |  | 04.11 |   |                |        |  |  |                         |     |
|  | 1.6 E85 | 81  |  | 06.09 | + 16"/17" Rad <sup>2)</sup>                 |                |        |  |  |                         |     |
|  | 1.9 dCi | 96  |  | 04.09 |   |                |        |  |  |                         |     |
|  | 2.0 16V | 103 |  | 04.09 |   |                |        |  |  |                         |     |
|  | 2.0 dCi | 110 |  | 04.09 |   |                |        |  |  |                         |     |
|  | 2.0 dCi | 118 |  | 04.09 |   |                |        |  |  |                         |     |
|  | 1.2 TCe | 85  |  | 03.12 | - elektrische Feststellbremse <sup>3)</sup> | 13.0460-2740.2 | 602740 |  |  | 23554 17,2 /Zub/S       | TRW |
|  | 1.2 TCe | 97  |  | 03.13 | - elektrische Feststellbremse <sup>3)</sup> | 13.0470-2740.2 | LD2740 |  |  | 23554 17,2 /Zub/S       | TRW |
|  | 1.4 TCe | 96  |  | 04.09 | - elektrische Feststellbremse <sup>3)</sup> |                |        |  |  |                         |     |
|  | 1.5 dCi | 63  |  | 04.09 | - elektrische Feststellbremse <sup>3)</sup> |                |        |  |  |                         |     |
|  | 1.5 dCi | 70  |  | 11.10 | - elektrische Feststellbremse <sup>3)</sup> |                |        |  |  |                         |     |
|  | 1.5 dCi | 78  |  | 04.09 | - elektrische Feststellbremse <sup>3)</sup> |                |        |  |  |                         |     |
|  | 1.5 dCi | 81  |  | 04.09 | - elektrische Feststellbremse <sup>3)</sup> |                |        |  |  |                         |     |
|  | 1.6 16V | 81  |  | 04.09 | - elektrische Feststellbremse <sup>3)</sup> |                |        |  |  |                         |     |
|  | 1.6 dCi | 96  |  | 04.11 | - elektrische Feststellbremse <sup>3)</sup> |                |        |  |  |                         |     |
|  | 1.6 E85 | 81  |  | 06.09 | - elektrische Feststellbremse <sup>3)</sup> |                |        |  |  |                         |     |
|  | 1.9 dCi | 96  |  | 04.09 | - elektrische Feststellbremse <sup>3)</sup> |                |        |  |  |                         |     |
|  | 2.0 16V | 103 |  | 04.09 | - elektrische Feststellbremse <sup>3)</sup> |                |        |  |  |                         |     |
|  | 2.0 dCi | 110 |  | 04.09 | - elektrische Feststellbremse <sup>3)</sup> | 13.0460-2753.2 | 602753 |  |  | 23554 16,0 /Zub/S       | TRW |
|  | 2.0 dCi | 118 |  | 04.09 | - elektrische Feststellbremse <sup>3)</sup> |                |        |  |  |                         |     |

<sup>1)</sup> + 15" wheel / + ruota 15" / + roue 15" / + rueda 15"

<sup>2)</sup> + 16"/17" wheel / + ruota 16"/17" / + roue 16"/17" / + ruedas 16"/17"

















<sup>3)</sup> - electric parking brake / - freno a mano elettrico / - frein à main électrique / - freno de mano eléctrico



|          |  |         |       |   |   |                |                |        |   |                         |                 |
|--|--|---------|-------|---|---|----------------|----------------|--------|---|-------------------------|-----------------|
| <b>RENAULT SCENIC III (JZ_) (09-)</b>  |  |         |       |   |   |                |                |        |   |                         |                 |
|    | 1.2 Tce  | 85      |       | 03.12                                       | + elektrische Feststellbremse <sup>1)</sup> | 13.0460-2756.2 | 602756         |        |   | 24820 16,1 /Zub/S       | TRW             |
|  | 1.2 Tce  | 97      |       | 03.13                                       | + elektrische Feststellbremse <sup>1)</sup> | 13.0460-2757.2 | 602757         |        |   | 24820 16,1 /Zub/S       | TRW             |
|  | 1.4 Tce  | 96      |       | 04.09                                       | + elektrische Feststellbremse <sup>1)</sup> |                |                |        |   |                         |                 |
|  | 1.5 dCi  | 63      |       | 04.09                                       | + elektrische Feststellbremse <sup>1)</sup> |                |                |        |   |                         |                 |
|  | 1.5 dCi  | 70      |       | 11.10                                       | + elektrische Feststellbremse <sup>1)</sup> |                |                |        |   |                         |                 |
|  | 1.5 dCi  | 78      |       | 04.09                                       | + elektrische Feststellbremse <sup>1)</sup> |                |                |        |   |                         |                 |
|  | 1.5 dCi  | 81      |       | 04.09                                       | + elektrische Feststellbremse <sup>1)</sup> |                |                |        |   |                         |                 |
|  | 1.6 16V  | 81      |       | 04.09                                       | + elektrische Feststellbremse <sup>1)</sup> |                |                |        |   |                         |                 |
|  | 1.6 dCi  | 96      |       | 04.11                                       | + elektrische Feststellbremse <sup>1)</sup> |                |                |        |   |                         |                 |
|  | 1.6 E85  | 81      |       | 06.09                                       | + elektrische Feststellbremse <sup>1)</sup> |                |                |        |   |                         |                 |
|  | 1.9 dCi  | 96      |       | 04.09                                       | + elektrische Feststellbremse <sup>1)</sup> |                |                |        |   |                         |                 |
| 2.0 16V  | 103  |         | 04.09 | + elektrische Feststellbremse <sup>1)</sup> |   |                |                |        |   |                         |                 |
| 2.0 dCi  | 110  |         | 04.09 | + elektrische Feststellbremse <sup>1)</sup> |   |                |                |        |   |                         |                 |
| 2.0 dCi  | 118  |         | 04.09 | + elektrische Feststellbremse <sup>1)</sup> |   |                |                |        |   |                         |                 |
|    | 1.2 Tce  | 85      |       | 03.12                                       |   | 24.0108-0118.2 | 408118         |        | mit Lager/ mit Sensorring <sup>2)</sup> | 260 8,0 7,0 +B          |                 |
|  | 1.2 Tce  | 97      |       | 03.13                                       |   |                |                |        |   |                         |                 |
|  | 1.4 Tce  | 96      |       | 04.09                                       |   |                |                |        |   |                         |                 |
|  | 1.5 dCi  | 63      |       | 04.09                                       |   |                |                |        |   |                         |                 |
|  | 1.5 dCi  | 70      |       | 11.10                                       |   |                |                |        |   |                         |                 |
|  | 1.5 dCi  | 78      |       | 04.09                                       |   |                |                |        |   |                         |                 |
|  | 1.5 dCi  | 81      |       | 04.09                                       |   |                |                |        |   |                         |                 |
|  | 1.6 16V  | 81      |       | 04.09                                       |   |                |                |        |   |                         |                 |
|  | 1.6 dCi  | 96      |       | 04.11                                       |   |                |                |        |   |                         |                 |
|  | 1.6 E85  | 81      |       | 06.09                                       |   |                |                |        |   |                         |                 |
|  | 1.9 dCi  | 96      |       | 04.09                                       |   |                |                |        |   |                         |                 |
| 2.0 16V  | 103  |         | 04.09 |   |   |                |                |        |   |                         |                 |
| 2.0 dCi  | 110  |         | 04.09 |   |   | 24.0111-0180.2 | 411180         |        | mit Lager/ mit Sensorring <sup>2)</sup> | 274 11,0 9,5 +B         |                 |
| 2.0 dCi  | 118  |         | 04.09 |   |   |                |                |        |   |                         |                 |
| <b>RENAULT GRAND SCENIC (JM_) (04-09)</b>  |  |         |       |   |   |                |                |        |   |                         |                 |
|    | 1.5 dCi  | 60      |       | 04.04                                       | 09.05                                       | 13.0460-3815.2 | 603815         |        |   | 23930 18,2 /Zub/S       | BOS             |
|  | 1.5 dCi  | 74      |       | 04.04                                       | 09.05                                       | 13.0470-3815.2 | LD3815         |        |   | 23930 18,2 /Zub/S       | BOS             |
|  | 1.6  |         |       | 04.04                                       | 09.05                                       |                |                |        |   |                         |                 |
|  | 1.9 dCi  | 81      |       | 05.05                                       | 09.05                                       |                |                |        |   |                         |                 |
|  | 1.9 dCi  | 88      |       | 04.04                                       | 09.05                                       |                |                |        |   |                         |                 |
|  | 1.9 dCi  | 96      |       | 05.05                                       | 09.05                                       |                |                |        |   |                         |                 |
|  | 2.0 16V  | 99      |       | 04.04                                       | 09.05                                       |                |                |        |   |                         |                 |
|  | 2.0 16V Turbo  | 120     |       | 04.04                                       | 09.05                                       |                |                |        |   |                         |                 |
|  | 2.0 dCi  | 110     |       | 09.05                                       | 09.05                                       |                |                |        |   |                         |                 |
|  | 1.5 dCi  | 60      |       | 10.05                                       | 03.09                                       | 13.0460-7222.2 | 607222         |        |   | 23245 18,3 +            | ATE             |
|  | 1.5 dCi  | 74      |       | 10.05                                       | 03.09                                       |                |                |        |   |                         |                 |
| 1.5 dCi  | 76   |         | 06.06 | 03.09                                       |   |                |                |        |   |                         |                 |
| 1.6  |  |         | 10.05 | 03.09                                       |   |                |                |        |   |                         |                 |
| 1.9 dCi  | 81   |         | 10.05 | 03.09                                       |   |                |                |        |   |                         |                 |
| 1.9 dCi  | 88   |         | 10.05 | 03.09                                       |   |                |                |        |   |                         |                 |
| 1.9 dCi  | 96   |         | 10.05 | 03.09                                       |   |                |                |        |   |                         |                 |
| 2.0 16V  | 99   |         | 10.05 | 03.09                                       |   |                |                |        |   |                         |                 |
| 2.0 16V Turbo  | 120  |         | 10.05 | 03.09                                       |   |                |                |        |   |                         |                 |
| 2.0 dCi  | 110  |         | 10.05 | 03.09                                       |   |                |                |        |   |                         |                 |
|    | 1.5 dCi  | 60      |       | 04.04                                       | 03.09                                       | 24.0124-0191.1 | 424191         |        |   | 300 24,0 21,8 V L +S +B |                 |
|  | 1.5 dCi  | 74      |       | 04.04                                       | 03.09                                       |                |                |        |   |                         |                 |
|  | 1.5 dCi  | 76      |       | 06.06                                       | 03.09                                       |                |                |        |   |                         |                 |
|  | 1.6  |         |       | 04.04                                       | 03.09                                       |                |                |        |   |                         |                 |
|  | 1.9 dCi  | 81      |       | 05.05                                       | 03.09                                       |                |                |        |   |                         |                 |
|  | 1.9 dCi  | 88      |       | 04.04                                       | 03.09                                       |                |                |        |   |                         |                 |
|  | 1.9 dCi  | 96      |       | 05.05                                       | 03.09                                       |                |                |        |   |                         |                 |
|  | 2.0 16V  | 99      |       | 04.04                                       | 03.09                                       |                |                |        |   |                         |                 |
|  | 2.0 dCi  | 110     |       | 09.05                                       | 03.09                                       | 24.0124-0224.1 | 424224         |        |   | 300 24,0 21,8 V L +S +B |                 |
|  | 2.0 16V Turbo  | 120     |       | 04.04                                       | 03.09                                       | 24.0128-0223.1 | 428223         |        |   | 313 28,0 26,0 V L +S +B |                 |
|  |  | 1.5 dCi | 60    |   | 04.04                                       | 01.05          | 24.0711-5151.3 | 360175 | 2                                       | ■                       | Radsensor L=485 |
| 1.5 dCi  |  | 74      |       | 04.04                                       | 01.05                                       |                |                |        |   |                         |                 |
| 1.6  |  |         |       | 04.04                                       | 01.05                                       |                |                |        |   |                         |                 |
| 1.9 dCi  |  | 88      |       | 04.04                                       | 01.05                                       |                |                |        |   |                         |                 |
| 2.0 16V  |  | 99      |       | 04.04                                       | 01.05                                       |                |                |        |   |                         |                 |
| 2.0 16V Turbo  |  | 120     |       | 04.04                                       | 01.05                                       |                |                |        |   |                         |                 |
| 1.5 dCi  |  | 60      |       | 02.05                                       | 12.05                                       | 24.0711-5190.3 | 360177         | 2      | ■                                       | Radsensor L=720         |                 |
| 1.5 dCi  |  | 74      |       | 02.05                                       | 12.05                                       |                |                |        |   |                         |                 |
| 1.6  |  |         |       | 02.05                                       | 12.05                                       |                |                |        |   |                         |                 |
| 1.9 dCi  |  | 81      |       | 05.05                                       | 12.05                                       |                |                |        |   |                         |                 |
| 1.9 dCi  |  | 88      |       | 02.05                                       | 12.05                                       |                |                |        |   |                         |                 |
| 1.9 dCi  | 96   |         | 05.05 | 12.05                                       |   |                |                |        |   |                         |                 |
| 2.0 16V  | 99   |         | 02.05 | 12.05                                       |   |                |                |        |   |                         |                 |
| 2.0 16V Turbo  | 120  |         | 02.05 | 12.05                                       |   |                |                |        |   |                         |                 |
| 2.0 dCi  | 110  |         | 09.05 | 12.05                                       |   |                |                |        |   |                         |                 |
| 1.5 dCi  | 60   |         | 01.06 | 03.09                                       | 24.0711-5180.3                              | 360236         | 2              | ■      | Radsensor L=720                         |                         |                 |
| 1.5 dCi  | 74   |         | 01.06 | 03.09                                       |   |                |                |        |   |                         |                 |
| 1.5 dCi  | 76   |         | 06.06 | 03.09                                       |   |                |                |        |   |                         |                 |
| 1.6  |  |         | 01.06 | 03.09                                       |   |                |                |        |   |                         |                 |
| 1.9 dCi  | 81   |         | 01.06 | 03.09                                       |   |                |                |        |   |                         |                 |
| 1.9 dCi  | 88   |         | 01.06 | 03.09                                       |   |                |                |        |   |                         |                 |
| 1.9 dCi  | 96   |         | 01.06 | 03.09                                       |   |                |                |        |   |                         |                 |
| 2.0 16V  | 99   |         | 01.06 | 03.09                                       |   |                |                |        |   |                         |                 |
| 2.0 16V Turbo  | 120  |         | 01.06 | 03.09                                       |   |                |                |        |   |                         |                 |
| 2.0 dCi  | 110  |         | 01.06 | 03.09                                       |   |                |                |        |   |                         |                 |

<sup>1)</sup> + electric parking brake / + freno a mano elettrico / + frein à main électrique / + freno de mano eléctrico







<sup>2)</sup> with bearing/ with sensor ring / con supporto/+ anell.sens.ABS / avec palier de secours ABS / con apollo/+ anillo sensor ABS

|     |  |  |  |  |  |  |  |  |   |                 |
|--|--|--|--|--|---|--|--|--|---|-----------------|
| <b>RENAULT GRAND SCENIC (JM_) (04-09)</b>  |  |  |  |  |   |  |  |  |   |                 |
|    | 1.5 dCi  | 60   |  | 04.04  | 03.09   | 13.0460-2845.2   | 602845   |  | 23554 16,4 /Zub/S                       | TRW             |
|  | 1.5 dCi  | 74   |  | 04.04  | 03.09   | 13.0470-2845.2   | LD2845   |  | 23554 16,4 /Zub/S                       | TRW             |
|  | 1.5 dCi  | 76   |  | 06.06  | 03.09   | 13.0460-0072.2   | 610072   |  | Belagsatz-Zubehör                       | TRW             |
|  | 1.6  |  |  | 04.04  | 03.09   |  |  |  |   |                 |
|  | 1.9 dCi  | 81   |  | 05.05  | 03.09   |  |  |  |   |                 |
|  | 1.9 dCi  | 88   |  | 04.04  | 03.09   |  |  |  |   |                 |
|  | 1.9 dCi  | 96   |  | 05.05  | 03.09   |  |  |  |   |                 |
|  | 2.0 16V  | 99   |  | 04.04  | 03.09   |  |  |  |   |                 |
|  | 2.0 16V Turbo  | 120  |  | 04.04  | 03.09   |  |  |  |   |                 |
|  | 2.0 dCi  | 110  |  | 09.05  | 03.09   |  |  |  |   |                 |
|    | 1.5 dCi  | 60   |  | 04.04  | 03.09   | 24.0111-0148.2   | 411148   |  | mit Lager/ mit Sensorring <sup>1)</sup> | 274 10,9 9,5 +B |
|  | 1.5 dCi  | 74   |  | 04.04  | 03.09   |  |  |  |   |                 |
|  | 1.5 dCi  | 76   |  | 06.06  | 03.09   |  |  |  |   |                 |
|  | 1.6  |  |  | 04.04  | 03.09   |  |  |  |   |                 |
|  | 1.9 dCi  | 81   |  | 05.05  | 03.09   |  |  |  |   |                 |
|  | 1.9 dCi  | 88   |  | 04.04  | 03.09   |  |  |  |   |                 |
|  | 1.9 dCi  | 96   |  | 05.05  | 03.09   |  |  |  |   |                 |
|  | 2.0 16V  | 99   |  | 06.03  | 03.09   |  |  |  |   |                 |
|  | 2.0 16V Turbo  | 120  |  | 04.04  | 03.09   |  |  |  |   |                 |
|  | 2.0 dCi  | 110  |  | 09.05  | 03.09   | 24.0111-0101.2   | 411101   |  | mit Lager/ mit Sensorring <sup>1)</sup> | 274 10,9 9,5 +B |
|    | 1.5 dCi  | 60   |  | 04.04  | 12.05   | 24.0711-5152.3   | 360176   | 2  |   | Radsensor L=810 |
|  | 1.5 dCi  | 74   |  | 04.04  | 12.05   |  |  |  |   |                 |
|  | 1.6  |  |  | 04.04  | 12.05   |  |  |  |   |                 |
|  | 1.9 dCi  | 81   |  | 05.05  | 12.05   |  |  |  |   |                 |
|  | 1.9 dCi  | 88   |  | 04.04  | 12.05   |  |  |  |   |                 |
|  | 1.9 dCi  | 96   |  | 05.05  | 12.05   |  |  |  |   |                 |
|  | 2.0 16V  | 99   |  | 04.04  | 12.05   |  |  |  |   |                 |
|  | 2.0 16V Turbo  | 120  |  | 04.04  | 12.05   |  |  |  |   |                 |
|  | 2.0 dCi  | 110  |  | 09.05  | 12.05   |  |  |  |   |                 |
|  | 1.5 dCi  | 60   |  | 01.06  | 03.09   | 24.0711-5181.3   | 360237   | 2  |   | Radsensor L=810 |
| 1.5 dCi  | 74   |  | 01.06  | 03.09  |   |  |  |  |   |                 |
| 1.5 dCi  | 76   |  | 06.06  | 03.09  |   |  |  |  |   |                 |
| 1.6  |  |  | 01.06  | 03.09  |   |  |  |  |   |                 |
| 1.9 dCi  | 81   |  | 01.06  | 03.09  |   |  |  |  |   |                 |
| 1.9 dCi  | 88   |  | 01.06  | 03.09  |   |  |  |  |   |                 |
| 1.9 dCi  | 96   |  | 01.06  | 03.09  |   |  |  |  |   |                 |
| 2.0 16V  | 99   |  | 01.06  | 03.09  |   |  |  |  |   |                 |
| 2.0 16V Turbo  | 120  |  | 01.06  | 03.09  |   |  |  |  |   |                 |
| 2.0 dCi  | 110  |  | 01.06  | 03.09  |   |  |  |  |   |                 |
| <b>RENAULT GRAND SCENIC (JZ_) (09-)</b>  |  |  |  |  |   |  |  |  |   |                 |
|  | 1.5 dCi  | 63   |  | 04.09  |   | 13.0460-7266.2   | 607266   |  | 24538 17,9 +                            | ATE             |
|  |  |  |  |  |   | 13.0470-7266.2   | LD7266   |  | 24538 17,9 +                            | ATE             |
|  | 1.2 TCe  | 85   |  | 03.12  |   | 13.0460-7249.2   | 607249   |  | 24709 18,6 +                            | ATE             |
|  | 1.2 TCe  | 97   |  | 03.13  |   | 13.0470-7249.2   | LD7249   |  | 24709 18,6 +                            | ATE             |
|  | 1.4 16V  | 96   |  | 02.09  |   |  |  |  |   |                 |
|  | 1.5 dCi  | 70   |  | 11.10  |   |  |  |  |   |                 |
|  | 1.5 dCi  | 78   |  | 02.09  |   |  |  |  |   |                 |
|  | 1.5 dCi  | 81   |  | 04.09  |   |  |  |  |   |                 |
|  | 1.6 16V  | 81   |  | 02.09  |   |  |  |  |   |                 |
|  | 1.6 dCi  | 96   |  | 04.11  |   |  |  |  |   |                 |
| 1.9 dCi  | 96   |  | 02.09  |  |   |  |  |  |   |                 |
| 2.0 16V  | 103  |  | 02.09  |  |   |  |  |  |   |                 |
| 2.0 dCi  | 110  |  | 02.09  |  | 13.0460-7250.2  | 607250   |  | 24870 17,5 +   | ATE                                     |                 |
| 2.0 dCi  | 118  |  | 04.09  |  |   |  |  |  |   |                 |
|  | 1.5 dCi  | 63   |  | 04.09  |   | 24.0124-0221.1   | 424221   |  | 280 24,0 21,8 V L +S +B                 |                 |
|  | 1.2 TCe  | 85   |  | 03.12  |   | 24.0126-0158.1   | 426158   |  | 296 26,0 23,4 V L +S +B                 |                 |
|  | 1.2 TCe  | 97   |  | 03.13  |   |  |  |  |   |                 |
|  | 1.4 16V  | 96   |  | 02.09  |   |  |  |  |   |                 |
|  | 1.5 dCi  | 70   |  | 11.10  |   |  |  |  |   |                 |
|  | 1.5 dCi  | 78   |  | 02.09  |   |  |  |  |   |                 |
|  | 1.5 dCi  | 81   |  | 04.09  |   |  |  |  |   |                 |
|  | 1.6 16V  | 81   |  | 02.09  |   |  |  |  |   |                 |
|  | 1.6 dCi  | 96   |  | 04.11  |   |  |  |  |   |                 |
|  | 1.9 dCi  | 96   |  | 02.09  |   |  |  |  |   |                 |
| 2.0 16V  | 103  |  | 02.09  |  |   |  |  |  |   |                 |
| 2.0 dCi  | 110  |  | 02.09  |  | 24.0128-0245.1  | 428245   |  | 320 28,0 25,4 V L +S +B  |   |                 |
| 2.0 dCi  | 118  |  | 04.09  |  |   |  |  |  |   |                 |
|  | 1.2 TCe  | 85   |  | 03.12  |   | 13.0460-2753.2   | 602753   |  | 23554 16,0 /Zub/S                       | TRW             |
|  | 1.2 TCe  | 97   |  | 03.13  |   |  |  |  |   |                 |
|  | 1.4 16V  | 96   |  | 02.09  |   |  |  |  |   |                 |
|  | 1.5 dCi  | 70   |  | 11.10  |   |  |  |  |   |                 |
|  | 1.5 dCi  | 78   |  | 02.09  |   |  |  |  |   |                 |
|  | 1.5 dCi  | 81   |  | 04.09  |   |  |  |  |   |                 |
|  | 1.6 16V  | 81   |  | 02.09  |   |  |  |  |   |                 |
|  | 1.6 dCi  | 96   |  | 04.11  |   |  |  |  |   |                 |
|  | 1.9 dCi  | 96   |  | 02.09  |   |  |  |  |   |                 |
|  | 2.0 16V  | 103  |  | 02.09  |   |  |  |  |   |                 |
| 2.0 dCi  | 110  |  | 02.09  |  |   |  |  |  |   |                 |
| 2.0 dCi  | 118  |  | 04.09  |  |   |  |  |  |   |                 |
|  | 1.2 TCe  | 85   |  | 03.12  |   | 13.0460-2757.2   | 602757   |  | 24820 16,1 /Zub/S                       | TRW             |
|  | 1.2 TCe  | 97   |  | 03.13  |   |  |  |  |   |                 |
|  | 1.4 16V  | 96   |  | 02.09  |   |  |  |  |   |                 |
|  | 1.5 dCi  | 63   |  | 04.09  |   |  |  |  |   |                 |
|  | 1.5 dCi  | 70   |  | 11.10  |   |  |  |  |   |                 |
|  | 1.5 dCi  | 78   |  | 02.09  |   |  |  |  |   |                 |

<sup>1)</sup> with bearing/ with sensor ring / con supporto/+ anell.sens.ABS / avec palier de secours ABS / con apoyo/+ anillo sensor ABS

<sup>2)</sup> - electric parking brake / - freno a mano elettrico / - frein à main électrique / - freno de mano eléctrico

<sup>3)</sup> + electric parking brake / + freno a mano elettrico / + frein à main électrique / + freno de mano eléctrico













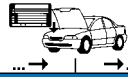





| RENAULT GRAND SCENIC (JZ_) (09-)   |         |     |  |       |       |   |                |        |   |                          |
|--|---------|-----|--|-------|-------|---|----------------|--------|---|--------------------------|
|    | 1.5 dCi | 81  |  | 04.09 |       | + elektrische Feststellbremse <sup>1)</sup> | 13.0460-2757.2 | 602757 |   | 24820 16,1 /Zub/S TRW    |
|  | 1.6 16V | 81  |  | 02.09 |       | + elektrische Feststellbremse <sup>1)</sup> |                |        |   |                          |
|  | 1.6 dCi | 96  |  | 04.11 |       | + elektrische Feststellbremse <sup>1)</sup> |                |        |   |                          |
|  | 1.9 dCi | 96  |  | 02.09 |       | + elektrische Feststellbremse <sup>1)</sup> |                |        |   |                          |
|  | 2.0 16V | 103 |  | 02.09 |       | + elektrische Feststellbremse <sup>1)</sup> |                |        |   |                          |
|  | 2.0 dCi | 110 |  | 02.09 |       | + elektrische Feststellbremse <sup>1)</sup> |                |        |   |                          |
|  | 2.0 dCi | 118 |  | 04.09 |       | + elektrische Feststellbremse <sup>1)</sup> |                |        |   |                          |
|    | 1.5 dCi | 63  |  | 04.09 |       |   | 24.0108-0118.2 | 408118 | mit Lager/ mit Sensorring <sup>2)</sup>   | 260 8,0 7,0 +B           |
|  | 1.2 TCe | 85  |  | 03.12 |       |   | 24.0111-0180.2 | 411180 | mit Lager/ mit Sensorring <sup>2)</sup>   | 274 11,0 9,5 +B          |
|  | 1.2 TCe | 97  |  | 03.13 |       |   |                |        |   |                          |
|  | 1.4 16V | 96  |  | 02.09 |       |   |                |        |   |                          |
|  | 1.5 dCi | 70  |  | 11.10 |       |   |                |        |   |                          |
|  | 1.5 dCi | 78  |  | 02.09 |       |   |                |        |   |                          |
|  | 1.5 dCi | 81  |  | 04.09 |       |   |                |        |   |                          |
|  | 1.6 16V | 81  |  | 02.09 |       |   |                |        |   |                          |
|  | 1.6 dCi | 96  |  | 04.11 |       |   |                |        |   |                          |
|  | 1.9 dCi | 96  |  | 02.09 |       |   |                |        |   |                          |
|  | 2.0 16V | 103 |  | 02.09 |       |   |                |        |   |                          |
|  | 2.0 dCi | 110 |  | 02.09 |       |   | 24.0111-0184.2 | 411184 | mit Lager/ mit Sensorring <sup>2)</sup>   | 290 11,0 9,5 +B          |
|  | 2.0 dCi | 118 |  | 04.09 |       |   |                |        |   |                          |
| RENAULT THALIA I (LB_) (98-)   |         |     |  |       |       |   |                |        |   |                          |
|    | 1.2 16V | 55  |  | 04.02 |       |   | 13.0460-2834.2 | 602834 |   | 21463 18,0 /WK/S TRW     |
|  | 1.4     | 55  |  | 08.00 |       |   |                |        |   |                          |
|  | 1.4 16V | 72  |  | 08.00 |       |   |                |        |   |                          |
|  | 1.5 dCi | 47  |  | 06.05 |       |   |                |        |   |                          |
|  | 1.5 dCi | 48  |  | 04.02 |       |   |                |        |   |                          |
|  | 1.5 dCi | 50  |  | 02.03 |       |   |                |        |   |                          |
|  | 1.5 dCi | 60  |  | 06.01 |       |   |                |        |   |                          |
|  | 1.6 16V | 79  |  | 04.02 |       |   |                |        |   |                          |
|  | 1.9 D   | 48  |  | 02.98 | 05.01 |   |                |        |   |                          |
|    | 1.2 16V | 55  |  | 04.02 |       |   | 24.0112-0116.1 | 412116 |   | 238 12,0 10,5 +S +B      |
|  | 1.4     | 55  |  | 08.00 |       |   |                |        |   |                          |
|  | 1.2 16V | 55  |  | 04.02 |       |   | 24.0120-0125.1 | 420125 |   | 238 20,1 17,7 V +S +B    |
|  | 1.4 16V | 72  |  | 08.00 |       |   |                |        |   |                          |
|  | 1.5 dCi | 47  |  | 06.05 |       |   |                |        |   |                          |
|  | 1.5 dCi | 48  |  | 04.02 |       |   |                |        |   |                          |
|  | 1.5 dCi | 50  |  | 02.03 |       |   |                |        |   |                          |
|  | 1.5 dCi | 60  |  | 06.01 |       |   |                |        |   |                          |
|  | 1.6 16V | 79  |  | 04.02 |       |   |                |        |   |                          |
|  | 1.9 D   | 48  |  | 02.98 | 05.01 |   |                |        |   |                          |
|  | 1.2 16V | 55  |  | 04.02 |       |   | 24.0741-1129.1 | 360164 | <input checked="" type="checkbox"/> + ESP | Radsensor L=798          |
|  | 1.4     | 55  |  | 08.00 |       |   |                |        |   |                          |
|  | 1.4 16V | 72  |  | 08.00 |       |   |                |        |   |                          |
|  | 1.5 dCi | 47  |  | 06.05 |       |   |                |        |   |                          |
|  | 1.5 dCi | 48  |  | 04.02 |       |   |                |        |   |                          |
|  | 1.5 dCi | 50  |  | 02.03 |       |   |                |        |   |                          |
|  | 1.5 dCi | 60  |  | 06.01 |       |   |                |        |   |                          |
|  | 1.2 16V | 55  |  | 04.02 |       | - ABS                                       | 03.0137-0358.2 | 650358 |   | 180 x 42 HEB BDX         |
|  | 1.4     | 55  |  | 08.00 |       |   | 03.0137-9088.2 | 669088 |   | Bremsbacken-Zubehör BDX  |
|  | 1.2 16V | 55  |  | 04.02 |       |   | 03.0137-0312.2 | 650312 |   | 203 x 38 HEB TRW         |
|  | 1.4     | 55  |  | 08.00 |       | - ABS                                       | 03.0137-9278.2 | 669278 |   | Bremsbacken-Zubehör TRW  |
|  | 1.4 16V | 72  |  | 08.00 |       |   |                |        |   |                          |
|  | 1.5 dCi | 47  |  | 06.05 |       |   |                |        |   |                          |
|  | 1.5 dCi | 48  |  | 04.02 |       |   |                |        |   |                          |
|  | 1.5 dCi | 50  |  | 02.03 |       |   |                |        |   |                          |
|  | 1.5 dCi | 60  |  | 06.01 |       |   |                |        |   |                          |
|  | 1.6 16V | 79  |  | 04.02 |       |   |                |        |   |                          |
|  | 1.9 D   | 48  |  | 02.98 | 05.01 |   |                |        |   |                          |
|  | 1.2 16V | 55  |  | 04.02 |       | + ABS                                       | 03.0137-0423.2 | 650423 |   | 203 x 39 HEB BOS         |
|  | 1.4     | 55  |  | 08.00 |       |   | 03.0137-9274.2 | 669274 |   | Bremsbacken-Zubehör BOS  |
|  | 1.4 16V | 72  |  | 08.00 |       | + ABS                                       |                |        |   |                          |
|  | 1.5 dCi | 47  |  | 06.05 |       |   |                |        |   |                          |
|  | 1.5 dCi | 48  |  | 04.02 |       |   |                |        |   |                          |
|  | 1.5 dCi | 50  |  | 02.03 |       |   |                |        |   |                          |
|  | 1.5 dCi | 60  |  | 06.01 |       |   |                |        |   |                          |
|  | 1.6 16V | 79  |  | 04.02 |       |   |                |        |   |                          |
|  | 1.9 D   | 48  |  | 02.98 | 05.01 |   |                |        |   |                          |
|  | 1.2 16V | 55  |  | 04.02 |       | - ABS                                       | 24.0218-0032.1 | 480118 |   | 180/181 x 53,5 - Lager   |
|  | 1.4     | 55  |  | 08.00 |       | - ABS                                       | 24.0218-0732.2 | 480207 |   | 180/181 x 53,2 + Lager   |
|  | 1.2 16V | 55  |  | 04.02 | 11.02 | + ABS                                       | 24.0220-3021.1 | 480127 |   | 203/204,5 x 48 - Lager   |
|  | 1.4     | 55  |  | 08.00 | 11.02 | + ABS                                       |                |        |   |                          |
|  | 1.4 16V | 72  |  | 08.00 | 11.02 |   |                |        |   |                          |
|  | 1.5 dCi | 48  |  | 04.02 | 11.02 |   |                |        |   |                          |
|  | 1.5 dCi | 60  |  | 06.01 | 11.02 |   |                |        |   |                          |
|  | 1.6 16V | 79  |  | 04.02 |       |   |                |        |   |                          |
|  | 1.9 D   | 48  |  | 02.98 | 05.01 |   |                |        |   |                          |
|  | 1.2 16V | 55  |  | 12.02 |       | + ABS                                       | 24.0220-3036.1 | 480301 | ohne Sensorring <sup>3)</sup>             | 203/204,5 x 50,5 - Lager |
|  | 1.4     | 55  |  | 12.02 |       | + ABS                                       |                |        |   |                          |
|  | 1.4 16V | 72  |  | 12.02 |       |   |                |        |   |                          |
|  | 1.5 dCi | 47  |  | 06.05 |       |   |                |        |   |                          |
|  | 1.5 dCi | 48  |  | 12.02 |       |   |                |        |   |                          |
|  | 1.5 dCi | 50  |  | 02.03 |       |   |                |        |   |                          |
|  | 1.5 dCi | 60  |  | 12.02 |       |   |                |        |   |                          |

<sup>1)</sup> + electric parking brake / + freno a mano elettrico / + frein à main électrique / + freno de mano eléctrico

<sup>2)</sup> with bearing/ with sensor ring / con supporto/+ anell.sens.ABS / avec palier de secours ABS / con apoyo/+ anillo sensor ABS

<sup>3)</sup> without sensor ring / senza sensori / sans secours ABS / sin anillo sensor ABS



|     |    |  |  |  |  |  |  |  |                    |
|--|--|--|--|--|---|--|--|--|--------------------|
| <b>RENAULT THALIA I (LB_) (98-)</b>  |  |  |  |  |   |  |  |  |                    |
|    | 1.2 16V  | 55   | 04.02  | - ABS  | 03.0520-4719.3  | 694719   |  | 19,05/180x42 TopKit BDX  |                    |
|  | 1.4  | 55   | 08.00  | - ABS  |   |  |  |  |                    |
|    | 1.2 16V  | 55   | 04.02  | + ABS  | 03.0520-3817.3  | 693817   |  | 17,46/203x39 TopKit BOS  |                    |
|  | 1.4  | 55   | 08.00  | + ABS  | 03.0520-3517.3  | 693517   |  | 17,78/203x39 TopKit TRW  |                    |
|  | 1.4 16V  | 72   | 08.00  |  |   |  |  |  |                    |
|  | 1.5 dCi  | 47   | 06.05  |  |   |  |  |  |                    |
|  | 1.5 dCi  | 48   | 04.02  |  |   |  |  |  |                    |
|  | 1.5 dCi  | 50   | 02.03  |  |   |  |  |  |                    |
|  | 1.5 dCi  | 60   | 06.01  |  |   |  |  |  |                    |
|  | 1.6 16V  | 79   | 04.02  |  |   |  |  |  |                    |
|  | 1.9 D  | 48   | 02.98  | 05.01  |   |  |  |  |                    |
| <b>RENAULT THALIA II / SYMBOL (LU_) (08-)</b>                                      |  |  |  |  |   |  |  |  |                    |
|    | 1.2 16V  | 55   | 09.08  |  | 13.0460-2834.2  | 602834   |  | 21463 18,0 /WK/S TRW   |                    |
|  | 1.5 dCi  | 47   | 09.08  |  |   |  |  |  |                    |
|  | 1.5 dCi  | 62   | 09.08  |  |   |  |  |  |                    |
|  | 1.6 16V  | 77   | 09.08  |  |   |  |  |  |                    |
|    | 1.2 16V  | 55   | 09.08  |  | 24.0112-0116.1  | 412116   |  | 238 12,0 10,5 +S +B  |                    |
|  | 1.5 dCi  | 47   | 09.08  |  | 24.0120-0125.1  | 420125   |  | 238 20,1 17,7 V +S +B  |                    |
|  | 1.5 dCi  | 62   | 09.08  |  |   |  |  |  |                    |
|  | 1.6 16V  | 77   | 09.08  |  | 24.0121-0106.1  | 421106   |  | 259 20,6 17,7 V +S +B  |                    |
|    | 1.2 16V  | 55   | 09.08  | 05.09  | 03.0137-0358.2  | 650358   |  | 180 x 42 HEB BDX   |                    |
|  | 1.5 dCi  | 47   | 09.08  | 05.09  | 03.0137-9088.2  | 669088   |  | Bremsbacken-Zubehör BDX  |                    |
|  | 1.5 dCi  | 62   | 09.08  | 05.09  |   |  |  |  |                    |
|  | 1.6 16V  | 77   | 09.08  | 05.09  |   |  |  |  |                    |
|  | 1.2 16V  | 55   | 06.09  | 09.12  | 03.0137-0423.2  | 650423   |  | 203 x 39 HEB BOS   |                    |
|  | 1.5 dCi  | 47   | 06.09  | 09.12  | 03.0137-0532.2  | 650532   |  | 203 x 39 HEB BOS   |                    |
|  | 1.5 dCi  | 62   | 06.09  | 09.12  | 03.0137-9274.2  | 669274   |  | Bremsbacken-Zubehör BOS  |                    |
|  | 1.6 16V  | 77   | 06.09  | 09.12  |   |  |  |  |                    |
|  | 1.2 16V  | 55   | 10.12  |  | 03.0137-9317.2  | 669317   |  | Bremsbacken-Zubehör  |                    |
|  | 1.5 dCi  | 47   | 10.12  |  |   |  |  |  |                    |
| 1.5 dCi  | 62   | 10.12  |  |  |   |  |  |  |                    |
| 1.6 16V  | 77   | 10.12  |  |  |   |  |  |  |                    |
|    | 1.2 16V  | 55   | 09.08  |  | 03.0137-0312.2  | 650312   |  | 203 x 38 HEB TRW   |                    |
|  | 1.5 dCi  | 47   | 09.08  |  | 03.0137-9278.2  | 669278   |  | Bremsbacken-Zubehör TRW  |                    |
|  | 1.5 dCi  | 62   | 09.08  |  |   |  |  |  |                    |
|  | 1.6 16V  | 77   | 09.08  |  |   |  |  |  |                    |
|    | 1.2 16V  | 55   | 09.08  |  | 24.0218-0032.1  | 480118   | - ABS  | 180/181 x 53,5 - Lager   |                    |
|  | 1.5 dCi  | 47   | 09.08  |  | 24.0218-0732.2  | 480207   | - ABS  | 180/181 x 53,2 + Lager   |                    |
|  | 1.5 dCi  | 62   | 09.08  |  | 24.0220-3036.1  | 480301   | + ABS  | 203/204,5 x 50,5 - Lager   |                    |
|  | 1.6 16V  | 77   | 09.08  |  |   |  |  |  |                    |
|   | 1.2 16V  | 55   | 09.08  | 05.09  | 03.0520-4719.3  | 694719   |  | 19,05/180x42 TopKit BDX  |                    |
|  | 1.5 dCi  | 47   | 09.08  | 05.09  |   |  |  |  |                    |
|  | 1.5 dCi  | 62   | 09.08  | 05.09  |   |  |  |  |                    |
|  | 1.6 16V  | 77   | 09.08  | 05.09  |   |  |  |  |                    |
|  | 1.2 16V  | 55   | 06.09  | 09.12  | 03.0520-3817.3  | 693817   |  | 17,46/203x39 TopKit BOS  |                    |
|  | 1.5 dCi  | 47   | 06.09  | 09.12  |   |  |  |  |                    |
|  | 1.5 dCi  | 62   | 06.09  | 09.12  |   |  |  |  |                    |
|  | 1.6 16V  | 77   | 06.09  | 09.12  |   |  |  |  |                    |
|  | 1.2 16V  | 55   | 10.12  |  | 03.0520-5017.3  | 695017   |  | 17,46/203x39 TopKit BOS  |                    |
|  | 1.5 dCi  | 47   | 10.12  |  |   |  |  |  |                    |
| 1.5 dCi  | 62   | 10.12  |  |  |   |  |  |  |                    |
| 1.6 16V  | 77   | 10.12  |  |  |   |  |  |  |                    |
| <b>RENAULT TRAFIC I Propulsion (PXX) (89-97)</b>                                   |  |  |  |  |   |  |  |  |                    |
|  | 1.7  | 50   | 05.89  | 08.94  | 13.0460-3969.2  | 603969   |  | 20926 18,5 /WK BDX   |                    |
|  | 2.0  | 59   | 05.89  | 10.97  |   |  |  |  |                    |
|  | 2.1 D  | 43   | 05.89  | 06.94  |   |  |  |  |                    |
|  | 2.1 D  | 47   | 06.94  | 10.97  |   |  |  |  |                    |
|  | 2.2  | 70   | 05.89  | 06.94  |   |  |  |  |                    |
|  | 2.2  | 74   | 09.94  | 12.97  |   |  |  |  |                    |
|  | 2.2 4x4  | 74   | 09.94  | 12.97  |   |  |  |  |                    |
|  | 2.5 D  | 51   | 05.89  | 12.97  |   |  |  |  |                    |
|  | 2.5 D  | 55   | 05.98  | 03.01  |   |  |  |  |                    |
|  | 2.5 D  | 56   | 03.89  | 08.94  |   |  |  |  |                    |
|  | 2.5 D  | 58   | 09.94  | 12.97  |   |  |  |  |                    |
|  | 2.5 D 4x4  | 56   | 03.89  | 08.94  |   |  |  |  |                    |
|  | 2.5 D 4x4  | 58   | 09.94  | 12.97  |   |  |  |  |                    |
|  |  | 1.7  | 50   | 05.89  | 08.94   | 24.0124-0103.1   | 424103   |  | 253 24,0 22,0 V +B |
|  |  | 2.0  | 59   | 05.89  | 10.97   |  |  |  |                    |
| 2.1 D  |  | 43   | 05.89  | 06.94  |   |  |  |  |                    |
| 2.1 D  |  | 47   | 06.94  | 10.97  |   |  |  |  |                    |
| 2.2  |  | 70   | 05.89  | 06.94  |   |  |  |  |                    |
| 2.2  |  | 74   | 09.94  | 12.97  |   |  |  |  |                    |
| 2.2 4x4  |  | 74   | 09.94  | 12.97  |   |  |  |  |                    |
| 2.5 D  |  | 51   | 05.89  | 12.97  |   |  |  |  |                    |
| 2.5 D  |  | 55   | 05.98  | 03.01  |   |  |  |  |                    |
| 2.5 D  |  | 56   | 03.89  | 08.94  |   |  |  |  |                    |
| 2.5 D  |  | 58   | 09.94  | 12.97  |   |  |  |  |                    |
| 2.5 D 4x4  |  | 56   | 03.89  | 08.94  |   |  |  |  |                    |
| 2.5 D 4x4  |  | 58   | 09.94  | 12.97  |   |  |  |  |                    |

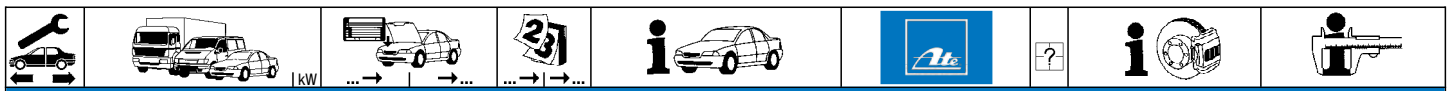















**RENAULT TRAFIC I Propulsion (PXX) (89-97)**

|       |       |       |       |                |                |              |                     |                |        |
|-------|-------|-------|-------|----------------|----------------|--------------|---------------------|----------------|--------|
|       | 1.7   | 50    | 05.89 | 08.94          | 03.0137-0036.2 | 650036       |                     | 254 x 57       | TRW    |
|       | 2.0   | 59    | 05.89 | 08.94          |                |              |                     |                |        |
|       | 2.1 D | 43    | 05.89 | 06.94          |                |              |                     |                |        |
|       | 2.1 D | 47    | 06.94 | 08.94          |                |              |                     |                |        |
| 2.0   | 59    | 09.94 | 10.97 | 03.0137-0330.2 | 650330         | 254 x 57 HEB | TRW                 |                |        |
| 2.1 D | 47    | 09.94 | 10.97 |                |                |              |                     | 03.0137-9216.2 | 669216 |
|       | 1.7   | 50    | 05.89 | 08.94          | 24.0225-4019.1 | 480305       | 254/254,8 x 70      |                |        |
|       | 2.0   | 59    | 05.89 | 10.97          |                |              |                     |                |        |
|       | 2.1 D | 43    | 05.89 | 06.94          |                |              |                     |                |        |
|       | 2.1 D | 47    | 06.94 | 10.97          |                |              |                     |                |        |
|       | 2.0   | 59    | 09.94 | 10.97          | 03.0520-0825.3 | 690825       | 25,40/254x57 TopKit | TRW            |        |
|       | 2.1 D | 47    | 09.94 | 10.97          |                |              |                     |                |        |

**RENAULT TRAFIC I Kasten (TXX) (89-01)**

|            |            |            |       |                |                |                |                     |                  |                |        |                |                     |          |                    |  |
|------------|------------|------------|-------|----------------|----------------|----------------|---------------------|------------------|----------------|--------|----------------|---------------------|----------|--------------------|--|
|            | 1.4        | 35         | 05.89 | 06.91          | 13.0460-3968.2 | 603968         |                     | 20488 18,5 +/-WK | BDX            |        |                |                     |          |                    |  |
|            | 1.7        | 50         | 05.89 | 08.94          |                |                |                     |                  |                |        |                |                     |          |                    |  |
|            | 2.0        | 59         | 05.89 | 08.90          |                |                |                     |                  |                |        |                |                     |          |                    |  |
|            | 2.1 D      | 43         | 05.89 | 06.94          |                |                |                     |                  |                |        |                |                     |          |                    |  |
|            | 2.1 D      | 47         | 06.94 | 08.94          |                |                |                     |                  |                |        |                |                     |          |                    |  |
|            | 1.9 D      | 44         | 06.97 | 03.01          | 13.0460-3969.2 | 603969         |                     | 20926 18,5 /WK   | BDX            |        |                |                     |          |                    |  |
|            | 2.1 D      | 47         | 09.94 | 10.97          |                |                |                     |                  |                |        |                |                     |          |                    |  |
|            | 2.2        | 70         | 05.89 | 06.94          |                |                |                     |                  |                |        |                |                     |          |                    |  |
|            | 2.2        | 74         | 06.94 | 10.97          |                |                |                     |                  |                |        |                |                     |          |                    |  |
|            | 2.5 D      | 55         | 05.89 | 03.01          |                |                |                     |                  |                |        |                |                     |          |                    |  |
|            |            | 1.4        | 35    | 05.89          |                |                |                     |                  |                | 06.91  | 24.0124-0103.1 | 424103              |          | 253 24,0 22,0 V +B |  |
|            |            | 1.7        | 50    | 05.89          |                |                |                     |                  |                | 08.94  |                |                     |          |                    |  |
| 1.9 D      |            | 44         | 06.97 | 03.01          |                |                |                     |                  |                |        |                |                     |          |                    |  |
| 2.0        |            | 59         | 05.89 | 08.90          |                |                |                     |                  |                |        |                |                     |          |                    |  |
| 2.1 D      |            | 43         | 05.89 | 06.94          |                |                |                     |                  |                |        |                |                     |          |                    |  |
| 2.1 D      |            | 47         | 06.94 | 10.97          |                |                |                     |                  |                |        |                |                     |          |                    |  |
| 2.2        |            | 70         | 05.89 | 06.94          |                |                |                     |                  |                |        |                |                     |          |                    |  |
| 2.2        |            | 74         | 06.94 | 10.97          |                |                |                     |                  |                |        |                |                     |          |                    |  |
| 2.5 D      |            | 55         | 05.89 | 03.01          |                |                |                     |                  |                |        |                |                     |          |                    |  |
|            |            | 1.4 (T1-0) | 35    | 05.89          | 06.91          | 03.0137-0153.2 | 650153              |                  | 255 x 46 AUT   | BDX    |                |                     |          |                    |  |
|            | 1.7 (T1-8) | 50         | 05.89 | 08.94          |                |                |                     |                  |                |        |                |                     |          |                    |  |
|            | 1.7 (T3-8) | 50         | 05.89 | 08.94          |                |                |                     |                  |                |        |                |                     |          |                    |  |
|            | 1.7 (T4-8) | 50         | 05.89 | 08.94          |                |                |                     |                  |                |        |                |                     |          |                    |  |
|            | 2.1 (T1-3) | 43         | 05.89 | 06.94          |                |                |                     |                  |                |        |                |                     |          |                    |  |
|            | 2.1 (T1-3) | 47         | 06.94 | 10.97          |                |                |                     |                  |                |        |                |                     |          |                    |  |
|            | 2.1 (T3-3) | 43         | 05.89 | 06.94          |                |                |                     |                  |                |        |                |                     |          |                    |  |
|            | 2.1 (T3-3) | 47         | 06.94 | 10.97          |                |                |                     |                  |                |        |                |                     |          |                    |  |
|            | 2.1 (T4-3) | 43         | 05.89 | 06.94          |                |                |                     |                  |                |        |                |                     |          |                    |  |
|            | 2.1 (T4-3) | 47         | 06.94 | 10.97          |                |                |                     |                  |                |        |                |                     |          |                    |  |
|            | 2.0        | 59         | 05.89 | 08.90          | 03.0137-0036.2 |                |                     |                  |                |        | 650036         |                     | 254 x 57 | TRW                |  |
|            | 2.0 4x4    | 59         | 05.89 | 08.90          |                |                |                     |                  |                |        |                |                     |          |                    |  |
|            | 2.1 D      | 43         | 05.89 | 06.94          |                |                |                     |                  |                |        |                |                     |          |                    |  |
|            | 2.1 D      | 47         | 06.94 | 08.94          |                |                |                     |                  |                |        |                |                     |          |                    |  |
|            | 2.1 D 4x4  | 43         | 05.89 | 06.94          |                |                |                     |                  |                |        |                |                     |          |                    |  |
|            | 2.1 D 4x4  | 47         | 06.94 | 08.94          |                |                |                     |                  |                |        |                |                     |          |                    |  |
|            | 2.2        | 70         | 05.89 | 06.94          |                |                |                     |                  |                |        |                |                     |          |                    |  |
|            | 2.2        | 74         | 06.94 | 08.94          |                |                |                     |                  |                |        |                |                     |          |                    |  |
|            | 2.2 4x4    | 70         | 05.89 | 06.94          |                |                |                     |                  |                |        |                |                     |          |                    |  |
| 2.2 4x4    | 74         | 06.94      | 08.94 |                |                |                |                     |                  |                |        |                |                     |          |                    |  |
| 2.5 D      | 55         | 05.89      | 08.94 |                |                |                |                     |                  |                |        |                |                     |          |                    |  |
| 2.5 D 4x4  | 55         | 05.89      | 08.94 |                |                |                |                     |                  |                |        |                |                     |          |                    |  |
| 1.9 D      | 44         | 06.97      | 03.01 | 03.0137-0330.2 |                | 650330         |                     | 254 x 57 HEB     | TRW            |        |                |                     |          |                    |  |
| 2.1 D      | 47         | 09.94      | 10.97 |                |                |                |                     |                  |                |        |                |                     |          |                    |  |
| 2.1 D 4x4  | 47         | 09.94      | 10.97 |                |                |                |                     |                  |                |        |                |                     |          |                    |  |
| 2.2        | 74         | 09.94      | 10.97 |                |                |                |                     |                  |                |        |                |                     |          |                    |  |
| 2.2 4x4    | 74         | 09.94      | 10.97 |                |                |                |                     |                  |                |        |                |                     |          |                    |  |
| 2.5 D      | 55         | 09.94      | 03.01 |                |                |                |                     |                  |                |        |                |                     |          |                    |  |
| 2.5 D 4x4  | 55         | 09.94      | 03.01 |                |                |                |                     |                  |                |        |                |                     |          |                    |  |
|            | 2.1 D      | 43         | 11.89 | 06.94          | 24.0225-4015.2 | 480178         |                     | 254/254,8 x 70   |                |        |                |                     |          |                    |  |
|            | 2.1 D      | 47         | 06.94 | 10.97          |                |                |                     |                  |                |        |                |                     |          |                    |  |
|            | 2.1 D 4x4  | 43         | 11.89 | 06.94          |                |                |                     |                  |                |        |                |                     |          |                    |  |
|            | 2.1 D 4x4  | 47         | 06.94 | 10.97          |                |                |                     |                  |                |        |                |                     |          |                    |  |
|            | 2.2        | 70         | 11.89 | 06.94          |                |                |                     |                  |                |        |                |                     |          |                    |  |
|            | 2.2        | 74         | 06.94 | 10.97          |                |                |                     |                  |                |        |                |                     |          |                    |  |
|            | 2.2 4x4    | 70         | 11.89 | 06.94          |                |                |                     |                  |                |        |                |                     |          |                    |  |
|            | 2.2 4x4    | 74         | 06.94 | 10.97          |                |                |                     |                  |                |        |                |                     |          |                    |  |
|            | 2.5 D      | 55         | 11.89 | 03.01          |                |                |                     |                  |                |        |                |                     |          |                    |  |
|            | 2.5 D 4x4  | 55         | 11.89 | 10.97          |                |                |                     |                  |                |        |                |                     |          |                    |  |
| 2.5 D 4x4  | 55         | 11.97      | 03.01 | 24.0225-4019.1 | 480305         |                | 254/254,8 x 70      |                  |                |        |                |                     |          |                    |  |
| 1.7 (T3-8) | ▶ 50       | 05.89      | 08.94 |                |                |                |                     |                  |                |        |                |                     |          |                    |  |
| 1.7 (T4-8) | ▶ 50       | 05.89      | 08.94 | 03.0520-0723.3 | 690723         |                | 23,81/255x45 TopKit | BDX              |                |        |                |                     |          |                    |  |
| 2.1 (T1-3) | ▶ 43       | 05.89      | 06.94 |                |                |                |                     |                  |                |        |                |                     |          |                    |  |
| 2.1 (T1-3) | ▶ 47       | 06.94      | 10.97 |                |                |                |                     |                  |                |        |                |                     |          |                    |  |
| 2.1 (T3-3) | ▶ 43       | 05.89      | 06.94 |                |                |                |                     |                  |                |        |                |                     |          |                    |  |
| 2.1 (T3-3) | ▶ 47       | 06.94      | 10.97 |                |                |                |                     |                  |                |        |                |                     |          |                    |  |
| 2.1 (T4-3) | ▶ 43       | 05.89      | 06.94 |                |                |                |                     |                  |                |        |                |                     |          |                    |  |
| 2.1 (T4-3) | ▶ 47       | 06.94      | 10.97 |                |                |                |                     |                  |                |        |                |                     |          |                    |  |
| 2.0        | 59         | 05.89      | 08.90 |                |                |                |                     |                  | 03.0520-0825.3 | 690825 |                | 25,40/254x57 TopKit | TRW      |                    |  |
| 2.0 4x4    | 59         | 05.89      | 08.90 |                |                |                |                     |                  |                |        |                |                     |          |                    |  |
| 2.1 D      | 43         | 05.89      | 06.94 |                |                |                |                     |                  |                |        |                |                     |          |                    |  |



|     |  |  |  |  |  |  |  |  |     |                |        |                     |     |
|--|--|--|--|--|---|--|--|--|-----|----------------|--------|---------------------|-----|
| <b>RENAULT TRAFIC I Kasten (TXX) (89-01)</b>                                       |  |  |  |  |   |  |  |  |     |                |        |                     |     |
|    | 2.1 D  | 47   |  | 06.94  | 08.94   | 03.0520-0825.3   | 690825   | 25,40/254x57 TopKit  | TRW |                |        |                     |     |
|  | 2.1 D 4x4  | 43   |  | 05.89  | 06.94   |  |  |  |     |                |        |                     |     |
|  | 2.1 D 4x4  | 47   |  | 06.94  | 08.94   |  |  |  |     |                |        |                     |     |
|  | 2.2  | 70   |  | 05.89  | 06.94   |  |  |  |     |                |        |                     |     |
|  | 2.2  | 74   |  | 06.94  | 08.94   |  |  |  |     |                |        |                     |     |
|  | 2.2 4x4  | 70   |  | 05.89  | 06.94   |  |  |  |     |                |        |                     |     |
|  | 2.2 4x4  | 74   |  | 06.94  | 08.94   |  |  |  |     |                |        |                     |     |
|  | 2.5 D  | 55   |  | 05.89  | 08.94   |  |  |  |     |                |        |                     |     |
|  | 2.5 D 4x4  | 55   |  | 05.89  | 08.94   |  |  |  |     |                |        |                     |     |
|  | 1.9 D  | 44   |  | 06.97  | 03.01   |  |  |  |     | 03.0520-0825.3 | 690825 | 25,40/254x57 TopKit | TRW |
| 2.1 D  | 47   |  | 09.94  | 10.97  |   |  |  |  |     |                |        |                     |     |
| 2.1 D 4x4  | 47   |  | 09.94  | 10.97  |   |  |  |  |     |                |        |                     |     |
| 2.2  | 74   |  | 09.94  | 10.97  |   |  |  |  |     |                |        |                     |     |
| 2.2 4x4  | 74   |  | 09.94  | 10.97  |   |  |  |  |     |                |        |                     |     |
| 2.5 D  | 55   |  | 09.94  | 03.01  |   |  |  |  |     |                |        |                     |     |
| 2.5 D 4x4  | 55   |  | 09.94  | 03.01  |   |  |  |  |     |                |        |                     |     |
| <b>RENAULT TRAFIC I Bus (TXW) (89-01)</b>  |  |  |  |  |   |  |  |  |     |                |        |                     |     |
|    | 1.7  | 50   |  | 05.89  | 08.94   | 13.0460-3969.2   | 603969   | 20926 18,5 /WK   | BDX |                |        |                     |     |
|  | 1.9 D  | 44   |  | 06.97  | 03.01   |  |  |  |     |                |        |                     |     |
|  | 2.0  | 59   |  | 05.89  | 08.90   |  |  |  |     |                |        |                     |     |
|  | 2.1 D  | 43   |  | 05.89  | 06.94   |  |  |  |     |                |        |                     |     |
|  | 2.1 D  | 47   |  | 06.94  | 10.97   |  |  |  |     |                |        |                     |     |
|  | 2.2  | 70   |  | 05.89  | 06.94   |  |  |  |     |                |        |                     |     |
|  | 2.2  | 74   |  | 06.94  | 10.97   |  |  |  |     |                |        |                     |     |
|  | 2.2 4x4  | 70   |  | 05.89  | 06.94   |  |  |  |     |                |        |                     |     |
|  | 2.2 4x4  | 74   |  | 06.94  | 10.97   |  |  |  |     |                |        |                     |     |
|  | 2.5 D  | 55   |  | 05.89  | 03.01   |  |  |  |     |                |        |                     |     |
| 2.5 D 4x4  | 55   |  | 08.89  | 03.01  |   |  |  |  |     |                |        |                     |     |
|    | 1.7  | 50   |  | 05.89  | 08.94   | 24.0124-0103.1   | 424103   | 253 24,0 22,0 V +B   |     |                |        |                     |     |
|  | 1.9 D  | 44   |  | 06.97  | 03.01   |  |  |  |     |                |        |                     |     |
|  | 2.0  | 59   |  | 05.89  | 08.90   |  |  |  |     |                |        |                     |     |
|  | 2.1 D  | 43   |  | 05.89  | 06.94   |  |  |  |     |                |        |                     |     |
|  | 2.1 D  | 47   |  | 06.94  | 10.97   |  |  |  |     |                |        |                     |     |
|  | 2.2  | 70   |  | 05.89  | 06.94   |  |  |  |     |                |        |                     |     |
|  | 2.2  | 74   |  | 06.94  | 10.97   |  |  |  |     |                |        |                     |     |
|  | 2.2 4x4  | 70   |  | 05.89  | 06.94   |  |  |  |     |                |        |                     |     |
|  | 2.2 4x4  | 74   |  | 06.94  | 10.97   |  |  |  |     |                |        |                     |     |
|  | 2.5 D  | 55   |  | 05.89  | 03.01   |  |  |  |     |                |        |                     |     |
| 2.5 D 4x4  | 55   |  | 08.89  | 03.01  |   |  |  |  |     |                |        |                     |     |
|  | 1.7  | 50   |  | 05.89  | 08.94   | 03.0137-0153.2   | 650153   | 255 x 46 AUT   | BDX |                |        |                     |     |
|  | 1.9 D  | 44   |  | 06.97  | 10.97   |  |  |  |     |                |        |                     |     |
|  | 2.0  | 59   |  | 05.89  | 08.90   |  |  |  |     |                |        |                     |     |
|  | 2.1 D  | 43   |  | 05.89  | 06.94   |  |  |  |     |                |        |                     |     |
|  | 2.1 D  | 47   |  | 06.94  | 10.97   |  |  |  |     |                |        |                     |     |
|  | 2.2  | 70   |  | 05.89  | 06.94   |  |  |  |     |                |        |                     |     |
|  | 2.2  | 74   |  | 06.94  | 10.97   |  |  |  |     |                |        |                     |     |
|  | 2.5 D  | 55   |  | 05.89  | 10.97   |  |  |  |     |                |        |                     |     |
|  | 2.5 D 4x4  | 55   |  | 08.89  | 10.97   |  |  |  |     |                |        |                     |     |
|  | 1.7  | 50   |  | 05.89  | 08.94   |  |  |  |     | 03.0137-0330.2 | 650330 | 254 x 57 HEB        | TRW |
| 1.9 D  | 44   |  | 11.97  | 03.01  |   |  |  |  |     |                |        |                     |     |
| 2.0  | 59   |  | 05.89  | 08.90  |   |  |  |  |     |                |        |                     |     |
| 2.1 D  | 43   |  | 05.89  | 06.94  |   |  |  |  |     |                |        |                     |     |
| 2.1 D  | 47   |  | 06.94  | 10.97  |   |  |  |  |     |                |        |                     |     |
| 2.2  | 70   |  | 05.89  | 06.94  |   |  |  |  |     |                |        |                     |     |
| 2.2  | 74   |  | 06.94  | 10.97  |   |  |  |  |     |                |        |                     |     |
| 2.5 D  | 55   |  | 11.97  | 03.01  |   |  |  |  |     |                |        |                     |     |
| 2.5 D 4x4  | 55   |  | 11.97  | 03.01  |   |  |  |  |     |                |        |                     |     |
| 2.2  | 70   |  | 05.89  | 06.94  | 03.0137-0036.2  | 650036   | 254 x 57   | TRW  |     |                |        |                     |     |
| 2.5 D  | 55   |  | 05.89  | 06.94  |   |  |  |  |     |                |        |                     |     |
| 2.5 D 4x4  | 55   |  | 08.89  | 06.94  |   |  |  |  |     |                |        |                     |     |
|  | 1.9 D  | 44   |  | 11.97  | 03.01   | 24.0225-4015.2   | 480178   | 254/254,8 x 70   |     |                |        |                     |     |
|  | 2.5 D  | 55   |  | 11.97  | 03.01   |  |  |  |     |                |        |                     |     |
|  | 2.5 D 4x4  | 55   |  | 11.97  | 03.01   |  |  |  |     |                |        |                     |     |
|  | 1.7  | 50   |  | 05.89  | 08.94   | 03.0520-0723.3   | 690723   | 23,81/255x45 TopKit  | BDX |                |        |                     |     |
|  | 1.9 D  | 44   |  | 06.97  | 10.97   |  |  |  |     |                |        |                     |     |
|  | 2.0  | 59   |  | 05.89  | 08.90   |  |  |  |     |                |        |                     |     |
|  | 2.1 D  | 43   |  | 05.89  | 06.94   |  |  |  |     |                |        |                     |     |
|  | 2.1 D  | 47   |  | 06.94  | 10.97   |  |  |  |     |                |        |                     |     |
|  | 2.2  | 70   |  | 05.89  | 06.94   |  |  |  |     |                |        |                     |     |
|  | 2.2  | 74   |  | 06.94  | 10.97   |  |  |  |     |                |        |                     |     |
|  | 2.5 D  | 55   |  | 05.89  | 10.97   |  |  |  |     |                |        |                     |     |
|  | 2.5 D 4x4  | 55   |  | 08.89  | 10.97   |  |  |  |     |                |        |                     |     |
|  | 1.7  | 50   |  | 05.89  | 08.94   |  |  |  |     | 03.0520-0825.3 | 690825 | 25,40/254x57 TopKit | TRW |
| 1.9 D  | 44   |  | 11.97  | 03.01  |   |  |  |  |     |                |        |                     |     |
| 2.0  | 59   |  | 05.89  | 08.90  |   |  |  |  |     |                |        |                     |     |
| 2.1 D  | 43   |  | 05.89  | 06.94  |   |  |  |  |     |                |        |                     |     |
| 2.1 D  | 47   |  | 06.94  | 10.97  |   |  |  |  |     |                |        |                     |     |
| 2.2  | 70   |  | 05.89  | 06.94  |   |  |  |  |     |                |        |                     |     |
| 2.2  | 74   |  | 06.94  | 10.97  |   |  |  |  |     |                |        |                     |     |
| 2.5 D  | 55   |  | 11.97  | 03.01  |   |  |  |  |     |                |        |                     |     |
| 2.5 D 4x4  | 55   |  | 11.97  | 03.01  |   |  |  |  |     |                |        |                     |     |
| 2.2  | 70   |  | 05.89  | 06.94  | 03.0520-0825.3  | 690825   | 25,40/254x57 TopKit  | TRW  |     |                |        |                     |     |
| 2.5 D  | 55   |  | 05.89  | 06.94  |   |  |  |  |     |                |        |                     |     |
| 2.5 D 4x4  | 55   |  | 08.89  | 06.94  |   |  |  |  |     |                |        |                     |     |



**RENAULT TRAFIC II (JL/FL/EL) (01-14)**

|  |             |     |  |       |       |  |  |                |        |  |   |       |         |                         |
|--|-------------|-----|--|-------|-------|--|--|----------------|--------|--|---|-------|---------|-------------------------|
|  | 1.9 dCi     | 59  |  | 04.01 | 07.03 |  |  | 13.0460-2870.2 | 602870 |  |   | 23099 | 18,4 /S | TRW                     |
|  | 1.9 dCi     | 75  |  | 03.01 | 08.14 |  |  |                |        |  |   |       |         |                         |
|  | 1.9 dCi 100 | 74  |  | 03.01 | 08.14 |  |  |                |        |  |   |       |         |                         |
|  | 1.9 dCi 80  | 60  |  | 03.01 | 08.14 |  |  |                |        |  |   |       |         |                         |
|  | 2.0 16V     | 86  |  | 08.06 | 08.14 |  |  |                |        |  |   |       |         |                         |
|  | 2.0 16V     | 88  |  | 03.01 | 08.14 |  |  |                |        |  |   |       |         |                         |
|  | 2.0 dCi 115 | 84  |  | 10.06 | 08.14 |  |  |                |        |  |   |       |         |                         |
|  | 2.0 dCi 90  | 66  |  | 10.06 | 08.14 |  |  |                |        |  |   |       |         |                         |
|  | 2.5 dCi     | 84  |  | 08.07 | 08.14 |  |  |                |        |  |   |       |         |                         |
|  | 2.5 dCi 115 | 84  |  | 02.08 | 08.14 |  |  |                |        |  |   |       |         |                         |
|  | 2.5 dCi 135 | 99  |  | 05.03 | 08.14 |  |  |                |        |  |   |       |         |                         |
|  | 2.5 dCi 145 | 107 |  | 10.06 | 08.14 |  |  |                |        |  |   |       |         |                         |
|  | 2.5 DTi     | 99  |  | 03.03 | 07.03 |  |  |                |        |  |   |       |         |                         |
|  | 1.9 dCi     | 59  |  | 04.01 | 07.03 |  |  | 24.0128-0132.1 | 428132 |  |   |       |         | 305 28,0 24,0 V L +S +B |
|  | 1.9 dCi     | 75  |  | 03.01 | 08.14 |  |  |                |        |  |   |       |         |                         |
|  | 1.9 dCi 100 | 74  |  | 03.01 | 08.14 |  |  |                |        |  |   |       |         |                         |
|  | 1.9 dCi 80  | 60  |  | 03.01 | 08.14 |  |  |                |        |  |   |       |         |                         |
|  | 2.0 16V     | 86  |  | 08.06 | 08.14 |  |  |                |        |  |   |       |         |                         |
|  | 2.0 16V     | 88  |  | 03.01 | 08.14 |  |  |                |        |  |   |       |         |                         |
|  | 2.0 dCi 115 | 84  |  | 10.06 | 08.14 |  |  |                |        |  |   |       |         |                         |
|  | 2.0 dCi 90  | 66  |  | 10.06 | 08.14 |  |  |                |        |  |   |       |         |                         |
|  | 2.5 dCi     | 84  |  | 08.07 | 08.14 |  |  |                |        |  |   |       |         |                         |
|  | 2.5 dCi 115 | 84  |  | 02.08 | 08.14 |  |  |                |        |  |   |       |         |                         |
|  | 2.5 dCi 135 | 99  |  | 05.03 | 08.14 |  |  |                |        |  |   |       |         |                         |
|  | 2.5 dCi 145 | 107 |  | 10.06 | 08.14 |  |  |                |        |  |   |       |         |                         |
|  | 2.5 DTi     | 99  |  | 03.03 | 07.03 |  |  |                |        |  |   |       |         |                         |
|  | 1.9 dCi     | 59  |  | 04.01 | 07.03 |  |  | 13.0460-2840.2 | 602840 |  |   |       |         | 23980 16,5 /WE/S TRW    |
|  | 1.9 dCi     | 75  |  | 03.01 | 08.14 |  |  | 13.0460-0072.2 | 610072 |  |   |       |         | TRW                     |
|  | 1.9 dCi 100 | 74  |  | 03.01 | 08.14 |  |  |                |        |  |   |       |         |                         |
|  | 1.9 dCi 80  | 60  |  | 03.01 | 08.14 |  |  |                |        |  |   |       |         |                         |
|  | 2.0 16V     | 86  |  | 08.06 | 08.14 |  |  |                |        |  |   |       |         |                         |
|  | 2.0 16V     | 88  |  | 03.01 | 08.14 |  |  |                |        |  |   |       |         |                         |
|  | 2.0 dCi 115 | 84  |  | 10.06 | 08.14 |  |  |                |        |  |   |       |         |                         |
|  | 2.0 dCi 90  | 66  |  | 10.06 | 08.14 |  |  |                |        |  |   |       |         |                         |
|  | 2.5 dCi     | 84  |  | 08.07 | 08.14 |  |  |                |        |  |   |       |         |                         |
|  | 2.5 dCi 115 | 84  |  | 02.08 | 08.14 |  |  |                |        |  |   |       |         |                         |
|  | 2.5 dCi 135 | 99  |  | 05.03 | 08.14 |  |  |                |        |  |   |       |         |                         |
|  | 2.5 dCi 145 | 107 |  | 10.06 | 08.14 |  |  |                |        |  |   |       |         |                         |
|  | 2.5 DTi     | 99  |  | 03.03 | 07.03 |  |  |                |        |  |   |       |         |                         |
|  | 1.9 dCi     | 59  |  | 04.01 | 07.03 |  |  | 24.0112-0177.2 | 412177 |  | mit Lager/ mit Sensorring <sup>1)</sup> |       |         | 280 12,0 10,0 +B        |
|  | 1.9 dCi     | 75  |  | 03.01 | 08.14 |  |  |                |        |  |   |       |         |                         |
|  | 1.9 dCi 100 | 74  |  | 03.01 | 08.14 |  |  |                |        |  |   |       |         |                         |
|  | 1.9 dCi 80  | 60  |  | 03.01 | 08.14 |  |  |                |        |  |   |       |         |                         |
|  | 2.0 16V     | 86  |  | 08.06 | 08.14 |  |  |                |        |  |   |       |         |                         |
|  | 2.0 16V     | 88  |  | 03.01 | 08.14 |  |  |                |        |  |   |       |         |                         |
|  | 2.0 dCi 115 | 84  |  | 10.06 | 08.14 |  |  |                |        |  |   |       |         |                         |
|  | 2.0 dCi 90  | 66  |  | 10.06 | 08.14 |  |  |                |        |  |   |       |         |                         |
|  | 2.5 dCi     | 84  |  | 08.07 | 08.14 |  |  |                |        |  |   |       |         |                         |
|  | 2.5 dCi 115 | 84  |  | 02.08 | 08.14 |  |  |                |        |  |   |       |         |                         |
|  | 2.5 dCi 135 | 99  |  | 05.03 | 08.14 |  |  |                |        |  |   |       |         |                         |
|  | 2.5 dCi 145 | 107 |  | 10.06 | 08.14 |  |  |                |        |  |   |       |         |                         |
|  | 2.5 DTi     | 99  |  | 03.03 | 07.03 |  |  |                |        |  |   |       |         |                         |

**RENAULT TRAFIC III (14-)**

|  |             |     |  |       |  |  |  |                |        |  |  |  |  |                      |
|--|-------------|-----|--|-------|--|--|--|----------------|--------|--|--|--|--|----------------------|
|  | 1.6 dCi 115 | 85  |  | 05.14 |  |  |  | 13.0460-2840.2 | 602840 |  |  |  |  | 23980 16,5 /WE/S TRW |
|  | 1.6 dCi 120 | 88  |  | 05.14 |  |  |  |                |        |  |  |  |  |                      |
|  | 1.6 dCi 125 | 92  |  | 07.15 |  |  |  |                |        |  |  |  |  |                      |
|  | 1.6 dCi 140 | 103 |  | 05.14 |  |  |  |                |        |  |  |  |  |                      |
|  | 1.6 dCi 145 | 107 |  | 07.15 |  |  |  |                |        |  |  |  |  |                      |
|  | 1.6 dCi 90  | 66  |  | 05.14 |  |  |  |                |        |  |  |  |  |                      |
|  | 1.6 dCi 95  | 70  |  | 07.15 |  |  |  |                |        |  |  |  |  |                      |

**RENAULT TWINGO I Limousine (C06\_) (93-07)**

|  |                      |    |  |       |       |                                      |  |                |        |  |  |  |  |                       |
|--|----------------------|----|--|-------|-------|--------------------------------------|--|----------------|--------|--|--|--|--|-----------------------|
|  | 1.2 (C063,C064)      | 40 |  | 03.93 | 10.96 |                                      |  | 13.0460-3953.2 | 603953 |  |  |  |  | 20634 15,0 BDX        |
|  | 1.2 (C066,C068)      | 43 |  | 05.96 | 09.98 | + Schaltgetriebe <sup>2)</sup>       |  | 13.0460-0423.2 | 610423 |  |  |  |  | Belagsatz-Zubehör BDX |
|  | 1.2 (C067)           | 40 |  | 05.96 | 09.98 | + Schaltgetriebe <sup>2)</sup>       |  | 13.0460-3955.2 | 603955 |  |  |  |  | 21097 15,0 +/WK BDX   |
|  | 1.2 (C060)           | 44 |  | 08.04 | 07.07 |                                      |  | 13.0460-2834.2 | 602834 |  |  |  |  | 21463 18,0 /WK/S TRW  |
|  | 1.2 (C066,C068)      | 43 |  | 10.98 | 07.07 | + Schaltgetriebe <sup>2)</sup>       |  |                |        |  |  |  |  |                       |
|  | 1.2 (C066,C068)      | 43 |  | 05.96 | 07.07 | + Automatikgetriebe <sup>3)</sup>    |  |                |        |  |  |  |  |                       |
|  | 1.2 (C067)           | 40 |  | 10.98 | 07.07 | + Schaltgetriebe <sup>2)</sup>       |  |                |        |  |  |  |  |                       |
|  | 1.2 (C067)           | 40 |  | 05.96 | 07.07 | + Automatikgetriebe <sup>3)</sup>    |  |                |        |  |  |  |  |                       |
|  | 1.2 (C06C,C06D,C06K) | 55 |  | 01.01 | 07.07 |                                      |  |                |        |  |  |  |  |                       |
|  | 1.2 (C063,C064)      | 40 |  | 03.93 | 10.96 |                                      |  | 24.0108-0104.1 | 408104 |  |  |  |  | 238 8,2 7,0 +S +B     |
|  | 1.2 (C066,C068)      | 43 |  | 05.96 | 09.98 | + Schaltgetriebe <sup>2)</sup>       |  |                |        |  |  |  |  |                       |
|  | 1.2 (C067)           | 40 |  | 05.96 | 09.98 | + Schaltgetriebe <sup>2)</sup>       |  |                |        |  |  |  |  |                       |
|  | 1.2 (C066,C068)      | 43 |  | 10.98 | 08.00 |                                      |  | 24.0112-0116.1 | 412116 |  |  |  |  | 238 12,0 10,5 +S +B   |
|  | 1.2 (C066,C068)      | 43 |  | 05.96 | 09.98 | + Automatikgetriebe <sup>3)</sup>    |  |                |        |  |  |  |  |                       |
|  | 1.2 (C067)           | 40 |  | 10.98 | 07.07 |                                      |  |                |        |  |  |  |  |                       |
|  | 1.2 (C067)           | 40 |  | 05.96 | 09.98 | + Automatikgetriebe <sup>3)</sup>    |  |                |        |  |  |  |  |                       |
|  | 1.2 (C06C,C06D,C06K) | 55 |  | 01.01 | 10.03 | + verstärktes Fahrwerk <sup>4)</sup> |  |                |        |  |  |  |  |                       |
|  | 1.2 (C060)           | 44 |  | 08.04 | 07.07 |                                      |  | 24.0121-0106.1 | 421106 |  |  |  |  | 259 20,6 17,7 V +S +B |
|  | 1.2 (C066,C068)      | 43 |  | 09.00 | 10.03 |                                      |  |                |        |  |  |  |  |                       |
|  | 1.2 (C06C,C06D,C06K) | 55 |  | 01.01 | 10.03 | - verstärktes Fahrwerk <sup>5)</sup> |  |                |        |  |  |  |  |                       |
|  | 1.2 (C066,C068)      | 43 |  | 11.03 | 07.07 |                                      |  | 24.0112-0171.1 | 412171 |  |  |  |  | 259 12,0 10,6 +S +B   |
|  | 1.2 (C06C,C06D,C06K) | 55 |  | 11.03 | 07.07 |                                      |  |                |        |  |  |  |  |                       |





























<sup>1)</sup> with bearing/ with sensor ring / con supporto/+ anell.sens.ABS / avec palier de secours ABS / con apoyo/+ anillo sensor ABS

<sup>2)</sup> + manual transmission / + scatola cambio velocità / + transmission mécanique / + cambio de velocidad

<sup>3)</sup> + autom.transmission / + scatola cambio automatico / + transmission automatique / + cambio automático

<sup>4)</sup> + reinforced suspension / + sospensione rinforzata / + châssis renforcé / + suspensión reforzada





















<sup>5)</sup> - reinforced suspension / - sospensione rinforzata / - châssis renforcé / - suspensión reforzada

|     |  |  |  |  |  |  |  |  |
|--|--|--|--|--|---|--|--|--|
| <b>RENAULT TWINGO I Limousine (C06_) (93-07)</b>                                   |  |  |  |  |   |  |  |  |
|    | 1.2 (C063,C064)  | 40   | 03.93  | 10.96  | 24.0731-1179.1  | 360157   | 2  | Radsensor L=475  |
|  | 1.2 (C066,C068)  | 43   | 05.96  | 02.01  |   |  |  |  |
|  | 1.2 (C067)   | 40   | 05.96  | 02.01  |   |  |  |  |
|  | 1.2 (C06C,C06D,C06K)   | 55   | 01.01  | 02.01  |   |  |  |  |
|    | 1.2 (C066,C068)  | 43   | 03.01  | 11.02  | 24.0751-3901.1  | 360300   | 2  | Radsensor L=578  |
|  | 1.2 (C067)   | 40   | 03.01  | 11.02  |   |  |  |  |
|  | 1.2 (C06C,C06D,C06K)   | 55   | 03.01  | 11.02  |   |  |  |  |
|  | 1.2 (C066,C068)  | 43   | 05.96  | 07.07  | 24.0713-1105.3  | 360286   |  | Radsensor L=420  |
|    | 1.2 (C067)   | 40   | 05.96  | 07.07  | 24.0713-1106.3  | 360287   |  | Radsensor L=420  |
|  | 1.2 (C06C,C06D,C06K)   | 55   | 01.01  | 07.07  | 24.0713-1105.3  | 360286   | 2  | Radsensor L=420  |
|  | 1.2 (C063,C064)  | 40   | 03.93  | 10.96  | 03.0137-0209.2  | 650209   |  | 180 x 42 BDX   |
|  | 1.2 (C066,C068)  | 43   | 05.96  | 07.07  | 03.0137-9086.2  | 669086   |  | Bremsbacken-Zubehör BDX  |
|    | 1.2 (C067)   | 40   | 05.96  | 07.07  | - ABS   |  |  |  |
|  | 1.2 (C066,C068)  | 43   | 05.96  | 06.98  | + ABS   | 03.0137-0209.2   | 650209   | 180 x 42 BDX   |
|  | 1.2 (C067)   | 40   | 05.96  | 06.98  | + ABS   | 03.0137-9086.2   | 669086   | Bremsbacken-Zubehör BDX  |
|  | 1.2 (C060)   | 44   | 08.04  | 07.07  |   | 03.0137-0312.2   | 650312   | 203 x 38 HEB TRW   |
|    | 1.2 (C066,C068)  | 43   | 07.98  | 07.07  | + ABS   | 03.0137-9158.2   | 669158   | Bremsbacken-Zubehör TRW  |
|  | 1.2 (C067)   | 40   | 07.98  | 07.07  | + ABS   |  |  |  |
|  | 1.2 (C06C,C06D,C06K)   | 55   | 01.01  | 07.07  |   |  |  |  |
|  | 1.2 (C063,C064)  | 40   | 03.93  | 10.96  |   | 24.0218-0032.1   | 480118   | 180/181 x 53,5 - Lager   |
|    | 1.2 (C066,C068)  | 43   | 05.96  | 07.07  |   | 24.0218-0732.2   | 480207   | 180/181 x 53,2 + Lager   |
|  | 1.2 (C067)   | 40   | 05.96  | 07.07  |   |  |  |  |
|  | 1.2 (C060)   | 44   | 08.04  | 07.07  |   | 24.0220-3036.1   | 480301   | ohne Sensorring 1)   |
|  | 1.2 (C06C,C06D,C06K)   | 55   | 01.01  | 07.07  |   | 24.0220-3021.1   | 480127   | 203/204,5 x 48 - Lager   |
|    | 1.2 (C063,C064)  | 40   | 03.93  | 10.96  | - ABS   | 03.0420-1020.3   | 681020   | 20,64/180x42 Kit BDX   |
|  | 1.2 (C066,C068)  | 43   | 05.96  | 07.07  | - ABS   | 03.0520-1020.3   | 691020   | 20,64/180x42 TopKit BDX  |
|  | 1.2 (C067)   | 40   | 05.96  | 07.07  | - ABS   |  |  |  |
|  | 1.2 (C060)   | 44   | 08.04  | 07.07  |   | 03.0520-3517.3   | 693517   | 17,78/203x39 TopKit TRW  |
|   | 1.2 (C066,C068)  | 43   | 05.96  | 07.07  | + ABS   |  |  |  |
|  | 1.2 (C067)   | 40   | 05.96  | 07.07  | + ABS   |  |  |  |
|  | 1.2 (C06C,C06D,C06K)   | 55   | 01.01  | 07.07  |   |  |  |  |
|  | 1.2 (S063,S064)  | 40   | 03.93  | 04.96  |   | 13.0460-3953.2   | 603953   | 20634 15,0 BDX   |
|  | 1.2 (S066,S068)  | 43   | 05.96  | 09.98  | + Schaltgetriebe 2)   | 13.0460-0423.2   | 610423   | Belagsatz-Zubehör BDX  |
|  | 1.2 (S066,S068)  | 43   | 10.98  | 07.07  | + Schaltgetriebe 2)   | 13.0460-2834.2   | 602834   | 21463 18,0 /WK/S TRW   |
|  | 1.2 (S066,S068)  | 43   | 05.96  | 07.07  | + Automatikgetriebe 3)  |  |  |  |
|  | 1.2 (S063,S064)  | 40   | 03.93  | 04.96  |   | 24.0108-0104.1   | 408104   | 238 8,2 7,0 +S +B  |
|  | 1.2 (S066,S068)  | 43   | 05.96  | 09.98  | + Schaltgetriebe 2)   | 24.0112-0116.1   | 412116   | 238 12,0 10,5 +S +B  |
|  | 1.2 (S066,S068)  | 43   | 10.98  | 08.00  | + Schaltgetriebe 2)   |  |  |  |
|  | 1.2 (S066,S068)  | 43   | 05.96  | 08.00  | + Automatikgetriebe 3)  |  |  |  |
|  | 1.2 (S066,S068)  | 43   | 09.00  | 07.07  | + Schaltgetriebe 2)   | 24.0121-0106.1   | 421106   | 259 20,6 17,7 V +S +B  |
|  | 1.2 (S066,S068)  | 43   | 09.00  | 07.07  | + Automatikgetriebe 3)  |  |  |  |
|  | 1.2 (S066,S068)  | 43   | 11.03  | 07.07  |   | 24.0112-0171.1   | 412171   | 259 12,0 10,6 +S +B  |
|  | 1.2 (S063,S064)  | 40   | 03.93  | 04.96  |   | 24.0731-1179.1   | 360157   | 2  |
|  | 1.2 (S066,S068)  | 43   | 05.96  | 07.07  |   |  |  | Radsensor L=475  |
|  | 1.2 (S066,S068)  | 43   | 05.96  | 07.07  |   | 24.0713-1105.3   | 360286   | Radsensor L=420  |
|  | 1.2 (S066,S068)  | 43   | 05.96  | 07.07  |   | 24.0713-1106.3   | 360287   | Radsensor L=420  |
|  | 1.2 (S063,S064)  | 40   | 03.93  | 04.96  | - ABS   | 03.0137-0209.2   | 650209   | 180 x 42 BDX   |
|  | 1.2 (S066,S068)  | 43   | 05.96  | 07.07  | - ABS   | 03.0137-9086.2   | 669086   | Bremsbacken-Zubehör BDX  |
|  | 1.2 (S063,S064)  | 40   | 03.93  | 04.96  | + ABS   | 03.0137-0209.2   | 650209   | 180 x 42 BDX   |
|  | 1.2 (S066,S068)  | 43   | 05.96  | 06.98  | + ABS   | 03.0137-9086.2   | 669086   | Bremsbacken-Zubehör BDX  |
|  | 1.2 (S066,S068)  | 43   | 07.98  | 07.07  | + ABS   | 03.0137-0312.2   | 650312   | 203 x 38 HEB TRW   |
|  | 1.2 (S066,S068)  | 43   | 07.98  | 07.07  | + ABS   | 03.0137-9158.2   | 669158   | Bremsbacken-Zubehör TRW  |
|  | 1.2 (S063,S064)  | 40   | 03.93  | 04.96  |   | 24.0218-0032.1   | 480118   | 180/181 x 53,5 - Lager   |
|  | 1.2 (S066,S068)  | 43   | 05.96  | 07.07  |   | 24.0218-0732.2   | 480207   | 180/181 x 53,2 + Lager   |
|  | 1.2 (S063,S064)  | 40   | 03.93  | 04.96  | - ABS   | 03.0420-1020.3   | 681020   | 20,64/180x42 Kit BDX   |
|  | 1.2 (S066,S068)  | 43   | 05.96  | 07.07  | - ABS   | 03.0520-1020.3   | 691020   | 20,64/180x42 TopKit BDX  |
|  | 1.2 (S066,S068)  | 43   | 05.96  | 07.07  | + ABS   | 03.0520-3517.3   | 693517   | 17,78/203x39 TopKit TRW  |
|  | 1.2  | 43   | 03.07  | 07.14  |   | 13.0460-2834.2   | 602834   | 21463 18,0 /WK/S TRW   |
|  | 1.2 16V  | 55   | 03.07  | 07.14  |   |  |  |  |
|  | 1.2 16V  | 56   | 03.07  | 07.14  |   |  |  |  |
|  | 1.2 TCe 100  | 75   | 02.11  | 07.14  |   |  |  |  |
|  | 1.2 Turbo  | 74   | 03.07  | 07.14  |   |  |  |  |
|  | 1.5 dCi  | 47   | 03.07  | 07.14  |   |  |  |  |
|  | 1.5 dCi  | 62   | 04.08  | 07.14  |   |  |  |  |
|  | 1.5 dCi 75   | 55   | 10.10  | 07.14  |   |  |  |  |
|  | 1.5 dCi 90   | 63   | 10.10  | 07.14  |   |  |  |  |
|  | 1.6 RS   | 98   | 05.08  | 07.14  |   | 13.0460-7248.2   | 607248   | 23215 17,5 + ATE   |
|  | 1.2  | 43   | 03.07  | 07.14  |   | 24.0112-0171.1   | 412171   | 259 12,0 10,6 +S +B  |
|  | 1.5 dCi  | 47   | 03.07  | 07.14  |   |  |  |  |
|  | 1.2  | 43   | 03.07  | 07.14  |   | 24.0121-0106.1   | 421106   | 259 20,6 17,7 V +S +B  |
|  | 1.2 16V  | 55   | 03.07  | 07.14  |   |  |  |  |
|  | 1.2 16V  | 56   | 03.07  | 07.14  |   |  |  |  |
|  | 1.2 TCe 100  | 75   | 02.11  | 07.14  |   |  |  |  |
|  | 1.2 Turbo  | 74   | 03.07  | 07.14  |   |  |  |  |
|  | 1.5 dCi  | 47   | 03.07  | 07.14  |   |  |  |  |
|  | ↓  | ↓  |  |  |   |  |  |  |

1) without sensor ring / senza sensori / sans secours ABS / sin anillo sensor ABS

2) + manual transmission / + scatola cambio velocità / + transmission mécanique / + cambio de velocidad

3) + autom.transmission / + scatola cambio automatico / + transmission automatique / + cambio automático





























|     |  |  |  |  |  |  |  |                       |
|--|--|--|--|--|---|--|--|---|
| <b>RENAULT TWINGO II (CNO_) (07-14)</b>  |  |  |  |  |   |  |  |   |
|    | 1.5 dCi  | 62   |  | 04.08  | 07.14   | 24.0121-0106.1   | 421106   | 259 20,6 17,7 V +S +B   |
|  | 1.5 dCi 75   | 55   |  | 10.10  | 07.14   |  |  |   |
|  | 1.5 dCi 90   | 63   |  | 10.10  | 07.14   |  |  |   |
|  | 1.6 RS   | 98   |  | 05.08  | 07.14   | 24.0124-0158.1   | 424158   | 280 24,0 21,8 V L +S +B   |
|  |  |  |  |  |   | 24.0324-0158.1   | 524158   | 280 24,0 21,8 V L +S +B PD  |
|    | 1.6 RS   | 98   |  | 05.08  | 07.14   | 24.0108-0114.2   | 408114   | mit Lager/ mit Sensorring <sup>1)</sup> 240 8,0 7,0 +B  |
|    | 1.2  | 43   |  | 03.07  | 09.12   | 03.0137-0498.2   | 650498   | 203 x 38 HEB <b>TRW</b>   |
|  | 1.2 16V  | 55   |  | 03.07  | 09.12   | 03.0137-9278.2   | 669278   | Bremsbacken-Zubehör <b>TRW</b>  |
|  | 1.2 16V  | 56   |  | 03.07  | 09.12   |  |  |   |
|  | 1.2 TCe 100  | 75   |  | 02.11  | 09.12   |  |  |   |
|  | 1.2 Turbo  | 74   |  | 03.07  | 09.12   |  |  |   |
|  | 1.5 dCi  | 47   |  | 03.07  | 09.12   |  |  |   |
|  | 1.5 dCi  | 62   |  | 04.08  | 09.12   |  |  |   |
|  | 1.5 dCi 75   | 55   |  | 10.10  | 09.12   |  |  |   |
|  | 1.5 dCi 90   | 63   |  | 10.10  | 09.12   |  |  |   |
|  | 1.2  | 43   |  | 10.12  | 07.14   | 03.0137-9317.2   | 669317   | Bremsbacken-Zubehör   |
|  | 1.2 16V  | 55   |  | 10.12  | 07.14   |  |  |   |
|  | 1.2 16V  | 56   |  | 10.12  | 07.14   |  |  |   |
|  | 1.2 TCe 100  | 75   |  | 10.12  | 07.14   |  |  |   |
|  | 1.2 Turbo  | 74   |  | 10.12  | 07.14   |  |  |   |
|  | 1.5 dCi  | 47   |  | 10.12  | 07.14   |  |  |   |
|  | 1.5 dCi  | 62   |  | 10.12  | 07.14   |  |  |   |
|  | 1.5 dCi 75   | 55   |  | 10.12  | 07.14   |  |  |   |
|  | 1.5 dCi 90   | 63   |  | 10.12  | 07.14   |  |  |   |
|    | 1.2  | 43   |  | 03.07  | 07.14   | 24.0220-3037.1   | 480308   | ohne Sensorring <sup>2)</sup> 203/204,5 x 48 - Lager  |
|  | 1.2 16V  | 55   |  | 03.07  | 07.14   | 24.0220-3737.2   | 480218   | mit Sensorring <sup>3)</sup> 203/204,5 x 48 + Lager   |
|  | 1.2 16V  | 56   |  | 03.07  | 07.14   |  |  |   |
|  | 1.2 TCe 100  | 75   |  | 02.11  | 07.14   |  |  |   |
|  | 1.2 Turbo  | 74   |  | 03.07  | 07.14   |  |  |   |
|  | 1.5 dCi  | 47   |  | 03.07  | 07.14   |  |  |   |
|  | 1.5 dCi  | 62   |  | 04.08  | 07.14   |  |  |   |
|  | 1.5 dCi 75   | 55   |  | 10.10  | 07.14   |  |  |   |
|  | 1.5 dCi 90   | 63   |  | 10.10  | 07.14   |  |  |   |
|    | 1.2  | 43   |  | 03.07  | 09.12   | 03.0520-4717.3   | 694717   | 17,46/203x38 TopKit   |
|  | 1.2 16V  | 55   |  | 03.07  | 09.12   |  |  |   |
|  | 1.2 16V  | 56   |  | 03.07  | 09.12   |  |  |   |
|  | 1.2 TCe 100  | 75   |  | 02.11  | 09.12   |  |  |   |
|  | 1.2 Turbo  | 74   |  | 03.07  | 09.12   |  |  |   |
|  | 1.5 dCi  | 47   |  | 03.07  | 09.12   |  |  |   |
|  | 1.5 dCi  | 62   |  | 04.08  | 09.12   |  |  |   |
|  | 1.5 dCi 75   | 55   |  | 10.10  | 09.12   |  |  |   |
|  | 1.5 dCi 90   | 63   |  | 10.10  | 09.12   |  |  |   |
| <b>RENAULT TWINGO III (14-)</b>  |  |  |  |  |   |  |  |   |
|  | 0.9 TCe 90   | 66   |  | 09.14  |   | 13.0460-7298.2   | 607298   | 25702 18,2 + <b>ATE</b>   |
|  | 1.0 SCe 70   | 51   |  | 09.15  |   |  |  |   |
|  | 1.0 SCe 70   | 52   |  | 09.14  |   |  |  |   |
|  | 0.9 TCe 90   | 66   |  | 09.14  |   | 24.0122-0289.1   | 422289   | 258 22,0 19,8 V L +S +B   |
|  | 1.0 SCe 70   | 51   |  | 09.15  |   |  |  |   |
|  | 1.0 SCe 70   | 52   |  | 09.14  |   |  |  |   |
| <b>RENAULT VEL SATIS (BJO_) (02-09)</b>  |  |  |  |  |   |  |  |   |
|  | 2.0  | 108  |  | 04.05  | 12.09   | 13.0460-7159.2   | 607159   | 23248 18,3 + <b>ATE</b>   |
|  | 2.0 16V Turbo  | 120  |  | 06.02  | 12.09   | 13.0470-7159.2   | LD7159   | 23248 18,3 + <b>ATE</b>   |
|  | 2.0 16V Turbo  | 125  |  | 04.04  | 12.09   |  |  |   |
|  | 2.0 dCi  | 110  |  | 08.05  | 12.09   |  |  |   |
|  | 2.0 dCi  | 127  |  | 01.06  | 12.09   |  |  |   |
|  | 2.2 dCi  | 85   |  | 04.04  | 12.09   |  |  |   |
|  | 2.2 dCi  | 102  |  | 09.04  | 12.09   |  |  |   |
|  | 2.2 dCi  | 110  |  | 06.02  | 12.09   |  |  |   |
|  | 3.0 dCi  | 130  |  | 06.02  | 12.09   |  |  |   |
|  | 3.0 dCi  | 133  |  | 06.06  | 12.09   |  |  |   |
|  | 3.5  | 170  |  | 10.04  | 12.09   |  |  |   |
|  | 3.5 V6   | 177  |  | 06.02  | 12.09   |  |  |   |
|  | 2.0  | 108  |  | 04.05  | 12.09   | 24.0128-0133.1   | 428133   | 324 28,0 25,4 V L +B  |
|  | 2.0 16V Turbo  | 120  |  | 06.02  | 12.09   |  |  |   |
|  | 2.0 16V Turbo  | 125  |  | 04.04  | 12.09   |  |  |   |
|  | 2.0 dCi  | 110  |  | 08.05  | 12.09   |  |  |   |
|  | 2.0 dCi  | 127  |  | 01.06  | 12.09   |  |  |   |
|  | 2.2 dCi  | 85   |  | 04.04  | 12.09   |  |  |   |
|  | 2.2 dCi  | 102  |  | 09.04  | 12.09   |  |  |   |
|  | 2.2 dCi  | 110  |  | 06.02  | 12.09   |  |  |   |
|  | 3.0 dCi  | 130  |  | 06.02  | 12.09   |  |  |   |
|  | 3.0 dCi  | 133  |  | 06.06  | 12.09   |  |  |   |
|  | 3.5  | 170  |  | 10.04  | 12.09   |  |  |   |
|  | 3.5 V6   | 177  |  | 06.02  | 12.09   |  |  |   |
|  | 2.0  | 108  |  | 04.05  | 12.09   | 24.0711-5094.1   | 360064   | 2  Radsensor L=557 |
|  | 2.0 16V Turbo  | 120  |  | 06.02  | 12.09   |  |  |   |
|  | 2.0 16V Turbo  | 125  |  | 04.04  | 12.09   |  |  |   |
|  | 2.0 dCi  | 110  |  | 08.05  | 12.09   |  |  |   |
|  | 2.0 dCi  | 127  |  | 01.06  | 12.09   |  |  |   |
|  | 2.2 dCi  | 85   |  | 04.04  | 12.09   |  |  |   |
|  | 2.2 dCi  | 102  |  | 09.04  | 12.09   |  |  |   |
|  | 2.2 dCi  | 110  |  | 06.02  | 12.09   |  |  |   |
| ↓  | ↓  |  |  |  |   |  |  |   |

<sup>1)</sup> with bearing/ with sensor ring / con supporto/+ anell.sens.ABS / avec palier de secours ABS / con apoyo/+ anillo sensor ABS

<sup>2)</sup> without sensor ring / senza sensori / sans secours ABS / sin anillo sensor ABS





















<sup>3)</sup> with sensor ring / con sensori / avec secours ABS / con anillo sensor ABS













































|     |   |  |                                      |                          |                         |  |  |    |  |
|--|---|--|--|--|--|--|--|--|--|
| <b>RENAULT VEL SATIS (BJO_) (02-09)</b>  |   |  |  |  |  |  |  |  |  |
|    | 3.0 dCi<br>3.0 dCi<br>3.5<br>3.5 V6   | 130<br>133<br>170<br>177   |  | 06.02<br>06.06<br>10.04<br>06.02   | 12.09<br>12.09<br>12.09<br>12.09   | 24.0711-5094.1   | 360064   | 2   | Radsensor L=557  |
|    | 2.0<br>2.0 16V Turbo<br>2.0 16V Turbo<br>2.0 dCi<br>2.0 dCi<br>2.2 dCi<br>2.2 dCi<br>2.2 dCi<br>3.0 dCi<br>3.0 dCi<br>3.5<br>3.5 V6 | 108<br>120<br>125<br>110<br>127<br>85<br>102<br>110<br>130<br>133<br>170<br>177  |  | 04.05<br>06.02<br>04.04<br>08.05<br>01.06<br>04.04<br>09.04<br>06.02<br>06.02<br>10.04<br>06.02          | 12.09<br>12.09<br>12.09<br>12.09<br>12.09<br>12.09<br>12.09<br>12.09<br>12.09<br>12.09<br>12.09<br>12.09 | 13.0460-7137.2<br>13.0470-7137.2   | 607137<br>LD7137   |  | 23482 15,8 +<br>23482 15,8 +<br><b>ATE</b><br><b>ATE</b> |
|    | 2.0 16V Turbo<br>2.2 dCi<br>3.0 dCi   | 120<br>110<br>130  | ORGA 020918<br>ORGA 020918<br>ORGA 020918  | 06.02<br>06.02<br>06.02  |  | 24.0111-0167.2   | 411167   | + Achszapfen D=30mm <sup>1)</sup>  | 300 11,0 9,5 +B  |
|    | 2.0<br>2.0 16V Turbo<br>2.0 16V Turbo<br>2.0 dCi<br>2.0 dCi<br>2.2 dCi<br>2.2 dCi<br>2.2 dCi<br>3.0 dCi<br>3.0 dCi<br>3.5<br>3.5 V6 | 108<br>120<br>125<br>110<br>127<br>85<br>102<br>110<br>130<br>133<br>170<br>177  | ORGA 020919<br>ORGA 020919<br>ORGA 020919<br>ORGA 020919<br>ORGA 020919<br>ORGA 020919<br>ORGA 020919<br>ORGA 020919 | 04.05<br>12.09<br>04.04<br>08.05<br>01.06<br>04.04<br>09.04<br>12.09<br>12.09<br>06.06<br>10.04<br>06.02 | 12.09<br>12.09<br>12.09<br>12.09<br>12.09<br>12.09<br>12.09<br>12.09<br>12.09<br>12.09<br>12.09<br>12.09 | 24.0111-0100.2   | 411100   | mit Lager/ mit Sensorring <sup>2)</sup>  | 300 11,0 9,5 +B  |
| <b>RENAULT WIND (E4M_) (10-13)</b>   |   |  |  |  |  |  |  |  |  |
|    | 1.2 16V Turbo<br>1.2 TCe 100<br>1.6 16V   | 74<br>75<br>98   |  | 07.10<br>02.11<br>07.10  | 09.13<br>09.13<br>09.13  | 13.0460-7248.2   | 607248   |  | 23215 17,5 +<br><b>ATE</b>                               |
|    | 1.2 16V Turbo<br>1.2 TCe 100<br>1.6 16V   | 74<br>75<br>98   |  | 07.10<br>02.11<br>07.10  | 09.13<br>09.13<br>09.13  | 24.0124-0158.1<br>24.0324-0158.1   | 424158<br>524158   |  | 280 24,0 21,8 V L +S +B<br>280 24,0 21,8 V L +S +B PD    |
|   | 1.2 16V Turbo<br>1.2 TCe 100<br>1.6 16V   | 74<br>75<br>98   |  | 07.10<br>02.11<br>07.10  | 09.13<br>09.13<br>09.13  | 24.0108-0114.2   | 408114   | mit Lager/ mit Sensorring <sup>2)</sup>  | 240 8,0 7,0 +B   |
| <b>RENAULT ZOE (12-)</b>   |   |  |  |  |  |  |  |  |  |
|  | Z.E.  | 65   |  | 06.12  |  | 24.0122-0270.1   | 422270   |  | 258 22,0 19,8 V L +S +B                                  |
|  | Z.E.  | 65   |  | 06.12  |  | 24.0711-5382.3   | 360423   | 2   | Radsensor L=650  |
|  | Z.E.  | 65   |  | 06.12  |  | 24.0711-6324.3<br>24.0711-6325.3   | 360399<br>360400   | <br> | Radsensor L=620<br>Radsensor L=620                       |
|  | Z.E.  | 65   |  | 06.12  |  | 03.0137-0496.2   | 650496   |  | 228 x 42 HEB <b>BDX</b>                                  |
| <b>ROLLS ROYCE SILVER SERAPH</b>   |   |  |  |  |  |  |  |  |  |
|  | 5.4   |  |  | 03.98  | 12.02  | 13.0460-7183.2   | 607183   |  | 21484 20,5 +/WE <b>ATE</b>                               |
| <b>ROVER 25-Serie (RF) (99-05)</b>   |   |  |  |  |  |  |  |  |  |
|  | 1.1 16V<br>1.4 16V<br>1.4 16V<br>1.6 16V<br>1.8 16V<br>1.8 16V<br>2.0 iDT<br>2.0 iDT  | 55<br>62<br>76<br>80<br>85<br>107<br>74<br>83                                    |  | 01.04<br>10.99<br>10.99<br>10.99<br>10.99<br>02.00<br>10.99<br>01.02                                     | 05.05<br>05.05<br>05.05<br>05.05<br>05.05<br>05.05<br>05.05<br>12.04                                     | 13.0460-2803.2<br>13.0460-0142.2   | 602803<br>610142   |  | 21515 17,5 +/WK/S <b>TRW</b><br>Belagsatz-Zubehör        |
|  | 1.1 16V<br>1.4 16V<br>1.4 16V<br>1.6 16V<br>1.8 16V<br>1.8 16V<br>2.0 iDT   | 55<br>62<br>76<br>80<br>85<br>107<br>74  |  | 01.04<br>10.99<br>10.99<br>10.99<br>10.99<br>02.00<br>10.99  | 05.05<br>05.05<br>05.05<br>05.05<br>05.05<br>05.05<br>05.05  | 24.0113-0198.1   | 413198   |  | 262 13,0 11,0 +B   |
|  | 1.1 16V<br>1.4 16V<br>1.4 16V<br>1.6 16V<br>1.8 16V<br>1.8 16V<br>2.0 iDT   | 55<br>62<br>76<br>80<br>85<br>107<br>74  |  | 01.04<br>10.99<br>10.99<br>10.99<br>10.99<br>02.00<br>10.99  | 05.05<br>05.05<br>05.05<br>05.05<br>05.05<br>05.05<br>05.05  | 24.0121-0105.1   | 421105   |  | 262 21,0 19,0 V +S +B                                    |

1) + axle stub D=30mm / + fusello D=30mm / + bout d'essieu D=30mm / + muñón del eje D=30mm

2) with bearing/ with sensor ring / con supporto/+ anell.sens.ABS / avec palier de secours ABS / con apoyo/+ anillo sensor ABS









|     |  |  |  |  |  |  |  |  |   |
|--|--|--|--|--|---|--|--|--|---|
| <b>ROVER 25-Serie (RF) (99-05)</b>   |  |  |  |  |   |  |  |  |   |
|    | 2.0 IDT  | 83   |  | 01.02  | 12.04   |  | 24.0121-0105.1   | 421105   | 262 21,0 19,0 V +S +B   |
|    | 1.1 16V  | 55   |  | 01.04  | 05.05   |  | 13.0460-5998.2   | 605998   | 21312 12,8 +/WK AKE   |
|  | 1.4 16V  | 62   |  | 10.99  | 05.05   |  |  |  |   |
|  | 1.4 16V  | 76   |  | 10.99  | 05.05   |  |  |  |   |
|  | 1.6 16V  | 80   |  | 10.99  | 05.05   |  |  |  |   |
|  | 1.8 16V  | 85   |  | 10.99  | 05.05   |  |  |  |   |
|  | 1.8 16V  | 107  |  | 02.00  | 05.05   |  |  |  |   |
|  | 2.0 IDT  | 74   |  | 10.99  | 05.05   |  |  |  |   |
|  | 2.0 IDT  | 83   |  | 01.02  | 12.04   |  |  |  |   |
|    | 1.1 16V  | 55   |  | 01.04  | 05.05   |  | 24.0110-0212.1   | 410212   | 239 10,0 8,0 +S +B  |
|  | 1.4 16V  | 62   |  | 10.99  | 05.05   |  |  |  |   |
|  | 1.4 16V  | 76   |  | 10.99  | 05.05   |  |  |  |   |
|  | 1.6 16V  | 80   |  | 10.99  | 05.05   |  |  |  |   |
|  | 1.8 16V  | 85   |  | 10.99  | 05.05   |  |  |  |   |
|  | 1.8 16V  | 107  |  | 02.00  | 05.05   |  |  |  |   |
|  | 2.0 IDT  | 74   |  | 10.99  | 05.05   |  |  |  |   |
|  | 2.0 IDT  | 83   |  | 01.02  | 12.04   |  |  |  |   |
|    | 1.1 16V  | 55   |  | 01.04  | 05.05   |  | 03.0137-0339.2   | 650339   | 203 x 38  |
|  | 1.4 16V  | 62   |  | 10.99  | 05.05   |  |  |  |   |
|  | 1.4 16V  | 76   |  | 10.99  | 05.05   |  |  |  |   |
|  | 1.6 16V  | 80   |  | 10.99  | 05.05   |  |  |  |   |
|  | 1.8 16V  | 85   |  | 10.99  | 05.05   |  |  |  |   |
|  | 1.8 16V  | 107  |  | 02.00  | 05.05   |  |  |  |   |
|  | 2.0 iDT  | 74   |  | 10.99  | 05.05   |  |  |  |   |
|  | 2.0 IDT  | 83   |  | 01.02  | 12.04   |  |  |  |   |
| <b>ROVER 45-Serie (RT) (00-05)</b>   |  |  |  |  |   |  |  |  |   |
|    | 1.4  | 76   |  | 02.00  | 05.05   |  | 13.0460-2803.2   | 602803   | 21515 17,5 +/WK/S TRW   |
|  | 1.6  | 80   |  | 02.00  | 05.05   |  | 13.0460-0142.2   | 610142   | Belagsatz-Zubehör   |
|  | 1.8  | 86   |  | 02.00  | 05.05   |  |  |  |   |
|  | 2.0 IDT  | 74   |  | 02.00  | 05.05   |  |  |  |   |
|  | 2.0 IDT  | 83   |  | 01.04  | 05.05   |  |  |  |   |
|  | 2.0 V6   | 110  |  | 02.00  | 05.05   |  |  |  |   |
|    | 1.4  | 76   |  | 02.00  | 05.05   |  | 24.0121-0105.1   | 421105   | 262 21,0 19,0 V +S +B   |
|  | 1.6  | 80   |  | 02.00  | 05.05   |  |  |  |   |
|  | 1.8  | 86   |  | 02.00  | 05.05   |  |  |  |   |
|  | 2.0 IDT  | 74   |  | 02.00  | 05.05   |  |  |  |   |
|  | 2.0 IDT  | 83   |  | 01.04  | 05.05   |  |  |  |   |
|  | 2.0 V6   | 110  |  | 02.00  | 05.05   |  |  |  |   |
|  | 1.4  | 76   |  | 02.00  | 05.05   |  | 13.0460-5998.2   | 605998   | 21312 12,8 +/WK AKE   |
|  | 1.6  | 80   |  | 02.00  | 05.05   |  |  |  |   |
|  | 1.8  | 86   |  | 02.00  | 05.05   |  |  |  |   |
|  | 2.0 IDT  | 74   |  | 02.00  | 05.05   |  |  |  |   |
|  | 2.0 IDT  | 83   |  | 01.04  | 05.05   |  |  |  |   |
|  | 2.0 V6   | 110  |  | 02.00  | 05.05   |  |  |  |   |
|  | 1.4  | 76   |  | 02.00  | 05.05   |  | 24.0110-0212.1   | 410212   | 239 10,0 8,0 +S +B  |
|  | 1.6  | 80   |  | 02.00  | 05.05   |  |  |  |   |
|  | 1.8  | 86   |  | 02.00  | 05.05   |  |  |  |   |
|  | 2.0 IDT  | 74   |  | 02.00  | 05.05   |  |  |  |   |
|  | 2.0 IDT  | 83   |  | 01.04  | 05.05   |  |  |  |   |
|  | 2.0 V6   | 110  |  | 02.00  | 05.05   |  |  |  |   |
|  | 1.4  | 76   |  | 02.00  | 05.05   |  | 03.0137-0339.2   | 650339   | 203 x 38  |
|  | 1.6  | 80   |  | 02.00  | 05.05   |  |  |  |   |
|  | 1.8  | 86   |  | 02.00  | 05.05   |  |  |  |   |
|  | 2.0 IDT  | 74   |  | 02.00  | 05.05   |  |  |  |   |
|  | 2.0 IDT  | 83   |  | 01.04  | 05.05   |  |  |  |   |
|  | 2.0 V6   | 110  |  | 02.00  | 05.05   |  |  |  |   |
| <b>ROVER 75-Serie (RJ/RX) (99-05)</b>  |  |  |  |  |   |  |  |  |   |
|  | 1.8  | 88   |  | 02.99  | 05.05   |  | 13.0460-7144.2   | 607144   | 23112 19,1 + ATE<br>Warnkontakt L=1103mm                          |
|  | 1.8 Turbo  | 110  |  | 05.03  | 05.05   |  | 24.8190-2801.2   | 622801   |   |
|  | 2.0 CDT  | 85   |  | 02.99  | 05.05   |  |  |  |   |
|  | 2.0 CDTI   | 96   |  | 02.03  | 05.05   |  |  |  |   |
|  | 2.0 V6   | 110  |  | 02.99  | 05.05   |  |  |  |   |
|  | 2.5 V6   | 129  |  | 02.99  | 10.01   |  |  |  |   |
|  | 2.5 V6   | 130  |  | 08.01  | 05.05   |  |  |  |   |
|  | 1.8  | 88   |  | 02.99  | 05.05   |  | 24.0122-0206.1   | 422206   | 284 22,0 19,0 V +B  |
|  | 1.8 Turbo  | 110  |  | 05.03  | 05.05   |  |  |  |   |
|  | 2.0 CDT  | 85   |  | 02.99  | 05.05   |  |  |  |   |
|  | 2.0 CDTI   | 96   |  | 02.03  | 05.05   |  |  |  |   |
|  | 2.0 V6   | 110  |  | 02.99  | 05.05   |  |  |  |   |
|  | 2.5 V6   | 129  |  | 02.99  | 10.01   |  |  |  |   |
|  | 2.5 V6   | 130  |  | 08.01  | 05.05   |  |  |  |   |
|  | 1.8  | 88   |  | 02.99  | 05.05   |  | 13.0460-3605.2   | 603605   | 20180 17,3 +/WE ATE<br>20180 17,3 +/WE ATE<br>Warnkontakt L=846mm |
|  | 1.8 Turbo  | 110  |  | 05.03  | 05.05   |  | 13.0470-3605.2   | LD3605   |   |
|  | 2.0 CDT  | 85   |  | 02.99  | 05.05   |  | 24.8190-2802.2   | 622802   |   |
|  | 2.0 CDTI   | 96   |  | 02.03  | 05.05   |  |  |  |   |
|  | 2.0 V6   | 110  |  | 02.99  | 05.05   |  |  |  |   |
|  | 2.5 V6   | 129  |  | 02.99  | 10.01   |  |  |  |   |
|  | 2.5 V6   | 130  |  | 08.01  | 05.05   |  |  |  |   |

|     |  |  |  |  |  |  |  |  |
|--|--|--|--|--|---|--|--|--|
| <b>ROVER 75-Serie (RJ/RX) (99-05)</b>  |  |  |  |  |   |  |  |  |
|    | 1.8<br>1.8 Turbo<br>2.0 CDT<br>2.0 CDTi<br>2.0 V6<br>2.5 V6<br>2.5 V6            | 88<br>110<br>85<br>96<br>110<br>129<br>130                                       | 02.99<br>05.03<br>02.99<br>02.03<br>02.99<br>02.99<br>08.01                      | 05.05<br>05.05<br>05.05<br>05.05<br>05.05<br>10.01<br>05.05                      |   | 24.0110-0270.1   | 410270   | 280 10,0 8,0 +B  |
|    | 1.8<br>1.8 Turbo<br>2.0 CDT<br>2.0 CDTi<br>2.0 V6<br>2.5 V6<br>2.5 V6            | 88<br>110<br>85<br>96<br>110<br>129<br>130                                       | 02.99<br>05.03<br>02.99<br>02.03<br>02.99<br>02.99<br>08.01                      | 05.05<br>05.05<br>05.05<br>05.05<br>05.05<br>10.01<br>05.05                      |   | 03.0137-0408.2<br>03.0137-9701.2<br>03.0137-9702.2                                 | 650408<br>669701<br>669702   | 160 x 20<br>Bremsbacken-Zubehör<br>Spreizschloß Satz                               |
| <b>ROVER 100-Serie (XP) (90-98)</b>  |  |  |  |  |   |  |  |  |
|    | 114<br>114 16V   |  | 05.90<br>05.90   | 12.98<br>12.98   |   | 13.0460-2804.2   | 602804   | 21518 17,0 TRW   |
|    | 111<br>114<br>114 16V  |  | 05.90<br>05.90<br>05.90  | 12.98<br>12.98<br>12.98  |   | 24.0113-0190.1<br>24.0122-0177.1   | 413190<br>422177   | 240 12,8 11,6<br>241 22,0 20,0 V +B  |
|    | 111<br>114<br>114 16V  |  | 05.90<br>05.90<br>05.90  | 12.98<br>12.98<br>12.98  |   | 03.0137-0080.2<br>03.0137-9200.2   | 650080<br>669200   | 178 x 32<br>Bremsbacken-Zubehör AP<br>AP   |
|    | 111<br>114<br>114 16V  |  | 05.90<br>05.90<br>05.90  | 12.98<br>12.98<br>12.98  |   | 03.0420-2417.3   | 682417   | 17,46/178x32 Kit AP  |
| <b>ROVER 200 II-Serie (RF) (95-00)</b>   |  |  |  |  |   |  |  |  |
|    | 211<br>214 i<br>214 Si<br>220 D<br>220 SDi                                       | 44   | 01.98<br>01.96<br>11.95<br>01.96<br>01.96  | 03.00<br>03.00<br>- ABS<br>03.00<br>- ABS  |   | 13.0460-2805.2   | 602805   | 21520 17,5 +/WK TRW  |
|  | 211<br>214 i<br>214 Si<br>216 Si<br>218 i 16V Vitesse<br>220 D<br>220 SDi        | 44   | 01.98<br>01.96<br>11.95<br>11.95<br>01.96<br>01.96<br>01.96                      | 03.00<br>03.00<br>+ ABS<br>+ ABS<br>03.00<br>03.00<br>+ ABS                      |   | 13.0460-2803.2<br>13.0460-0142.2   | 602803<br>610142   | 21515 17,5 +/WK/S TRW<br>Belagsatz-Zubehör   |
|  | 211<br>214 i<br>214 Si<br>220 D<br>220 SDi                                       | 44   | 01.98<br>01.96<br>11.95<br>01.96<br>01.96  | 03.00<br>03.00<br>- ABS<br>03.00<br>- ABS  |   | 24.0113-0198.1   | 413198   | 262 13,0 11,0 +B   |
|  | 211<br>214 i<br>214 Si<br>216 Si<br>218 i 16V Vitesse<br>220 D<br>220 SDi        | 44   | 01.98<br>01.96<br>11.95<br>11.95<br>01.96<br>01.96<br>01.96                      | 03.00<br>03.00<br>+ ABS<br>+ ABS<br>03.00<br>03.00<br>+ ABS                      |   | 24.0121-0105.1   | 421105   | 262 21,0 19,0 V +S +B  |
|  | 211<br>214 i<br>214 Si<br>216 Si<br>218 i 16V Vitesse<br>220 D<br>220 SDi        | 44   | 01.98<br>01.96<br>11.95<br>01.96<br>01.97<br>01.96<br>01.96                      | 03.00<br>+ ABS<br>+ ABS<br>+ ABS<br>+ ABS<br>+ ABS<br>+ ABS                      |   | 13.0460-5998.2   | 605998   | 21312 12,8 +/WK AKE  |
|  | 211<br>214 i<br>214 Si<br>216 Si<br>218 i 16V Vitesse<br>220 D<br>220 SDi        | 44   | 01.98<br>01.96<br>11.95<br>01.96<br>01.97<br>01.96<br>01.96                      | 03.00<br>+ ABS<br>+ ABS<br>+ ABS<br>+ ABS<br>+ ABS<br>+ ABS                      |   | 24.0110-0212.1   | 410212   | 239 10,0 8,0 +S +B   |
|  | 211<br>214 i<br>214 Si<br>216 Si<br>218 i 16V Vitesse<br>220 D<br>220 SDi        | 44   | 01.98<br>01.96<br>11.95<br>01.96<br>01.97<br>01.96<br>01.96                      | 03.00<br>- ABS<br>- ABS<br>- ABS<br>- ABS<br>- ABS<br>- ABS                      |   | 03.0137-0339.2   | 650339   | 203 x 38   |
|  | 211<br>214 i<br>214 Si<br>216 Si<br>218 i 16V Vitesse<br>220 D<br>220 SDi        | 44   | 01.98<br>01.96<br>11.95<br>01.96<br>01.97<br>01.96<br>01.96                      | 03.00<br>- ABS<br>- ABS<br>- ABS<br>- ABS<br>- ABS<br>- ABS                      |   | 03.0420-4519.3   | 684519   | 19,05/203x38 Kit   |

|     |    kW |  |                          |  |  |  |  |  |
|--|---|--|--|--|---|--|--|--|
| <b>ROVER 400-Serie (RT) (95-00)</b>  |   |  |  |  |   |  |  |  |
|    | 414 Si<br>416 Si<br>420 D 63<br>420 Di 77<br>420 Si 100                               |  | 05.95 03.00<br>06.95 03.00<br>11.95 03.00<br>05.95 03.00<br>12.95 03.00                                  |  | 13.0460-2803.2 602803<br>13.0460-0142.2 610142                                    |  |  | 21515 17,5 +/WK/S TRW<br>Belagsatz-Zubehör   |
|    | 414 Si<br>416 Si<br>420 D 63<br>420 Di 77<br>420 Si 100                               |  | 05.95 03.00 - ABS<br>06.95 03.00<br>11.95 03.00<br>05.95 03.00<br>06.95 03.00                            |  | 24.0113-0198.1 413198   |  |  | 262 13,0 11,0 +B   |
|  | 414 Si<br>416 Si<br>420 D 63<br>420 Di 77<br>420 Si 100                               |  | 06.95 03.00 + ABS<br>06.95 03.00<br>11.95 03.00<br>05.95 03.00<br>06.95 03.00                            |  | 24.0121-0105.1 421105   |  |  | 262 21,0 19,0 V +S +B  |
|    | 414 Si<br>416 Si<br>420 D 63<br>420 Di 77<br>420 Si 100                               |  | 05.95 03.00<br>06.95 03.00<br>11.95 03.00<br>05.95 03.00<br>12.95 03.00                                  |  | 13.0460-5998.2 605998<br>13.0460-0430.2 610430                                    |  |  | 21312 12,8 +/WK AKE<br>Belagsatz-Zubehör AKE                                       |
|    | 414 Si<br>416 Si<br>420 D 63<br>420 Di 77<br>420 Si 100                               |  | 06.95 03.00<br>06.95 03.00<br>11.95 03.00<br>05.95 03.00<br>12.95 03.00                                  |  | 24.0110-0212.1 410212   |  |  | 239 10,0 8,0 +S +B   |
|    | 414 Si<br>416 Si<br>420 D 63<br>420 Di 77<br>420 Si 100                               |  | 05.95 03.00<br>06.95 03.00<br>11.95 03.00<br>05.95 03.00<br>12.95 03.00                                  |  | 03.0137-0339.2 650339   |  |  | 203 x 38   |
|    | 414 Si  |  | 05.95 03.00 - ABS  |  | 03.0420-4519.3 684519   |  |  | 19,05/203x38 Kit   |
| <b>ROVER 600-Serie (RH) (93-99)</b>  |   |  |  |  |   |  |  |  |
|    | 618 i/Si<br>620 i<br>620 SDi<br>620 Si<br>620 Ti Vitesse<br>623 Si                    |  | 03.96 02.99<br>08.93 02.99<br>12.94 02.99<br>08.93 02.99<br>07.94 02.99<br>08.93 02.99                   |  | 13.0460-5955.2 605955<br>13.0460-0453.2 610453                                    |  |  | 21879 18,6 +/WK AKE<br>Belagsatz-Zubehör AKE                                       |
|  | 618 i/Si<br>620 i<br>620 SDi<br>620 Si  |  | 03.96 02.99<br>08.93 06.96 + 14" Rad <sup>1)</sup><br>12.94 02.99 + 14" Rad <sup>1)</sup><br>08.93 02.99 |  | 24.0123-0103.1 423103   |  |  | 260 23,0 21,0 V  |
|  | 620 i<br>620 SDi<br>620 Ti Vitesse<br>623 Si  |  | 08.93 02.99 + 15" Rad <sup>2)</sup><br>12.94 02.99 + 15" Rad <sup>2)</sup><br>07.94 02.99<br>08.93 02.99 |  | 24.0123-0102.1 423102   |  |  | 282 23,0 21,0 V  |
|  | 618 i/Si<br>620 i<br>620 SDi<br>620 Si<br>620 Ti Vitesse<br>623 Si                    |  | 03.96 02.99<br>08.93 02.99<br>12.94 02.99<br>08.93 02.99<br>07.94 02.99<br>08.93 02.99                   |  | 13.0460-5929.2 605929   |  |  | 21719 15,0 +/WK AKE  |
|  | 618 i/Si<br>620 i<br>620 SDi<br>620 Si<br>620 Ti Vitesse<br>623 Si                    |  | 03.96 02.99<br>08.93 02.99<br>12.94 02.99<br>08.93 02.99<br>07.94 02.99<br>08.93 02.99                   |  | 24.0110-0233.1 410233   |  |  | 260 10,0 8,0 +S +B   |
| <b>ROVER 800-Serie (XS/RS) (86-99)</b>   |   |  |  |  |   |  |  |  |
|  | 820<br>820 16V<br>825 D   |  | 09.88 12.91<br>01.92 02.99<br>01.92 02.99  |  | 24.0121-0110.1 421110   |  |  | 262 21,0 18,0 V  |
|  | 820 Turbo<br>825<br>827   |  | 01.92 02.99<br>10.86 02.99<br>02.88 02.99  |  | 24.0121-0100.1 421100   |  |  | 285 21,0 19,0 V  |
|  | 820<br>825<br>825 D<br>827  |  | 09.88 02.99<br>03.87 02.99<br>01.92 02.99<br>09.88 02.99   |  | 13.0460-2800.2 602800   |  |  | 20087 14,6 +/WK TRW  |
|  | 820<br>820 16V<br>820 Turbo<br>825<br>825 D<br>827                                    |  | 09.88 02.99<br>01.92 02.99<br>01.92 02.99<br>10.86 02.99<br>01.90 02.99<br>09.88 02.99                   |  | 24.0110-0255.1 410255   |  |  | 260 10,0 8,0   |

<sup>1)</sup> + 14" wheel / + ruota 14" / + roue 14" / + rueda 14"

<sup>2)</sup> + 15" wheel / + ruota 15" / + roue 15" / + rueda 15"

| ROVER STREETWISE (03-05)   |   |  |  |   |  |  |
|--|---|--|--|---|--|--|
|    | 1.4 62<br>1.4 76<br>1.8 86<br>2.0 TD 74   | 08.03 05.05<br>08.03 05.05<br>08.03 05.05<br>08.03 05.05   | 13.0460-2803.2 602803<br>13.0460-0142.2 610142   |   | 21515 17,5 +/WK/S TRW<br>Belagsatz-Zubehör   |  |
|    | 1.4 62<br>1.4 76<br>1.8 86<br>2.0 TD 74   | 08.03 05.05<br>08.03 05.05<br>08.03 05.05<br>08.03 05.05   | 24.0113-0198.1 413198  |   | 262 13,0 11,0 +B   |  |
|  | 1.4 62<br>1.4 76<br>1.8 86<br>2.0 TD 74   | 08.03 05.05<br>08.03 05.05<br>08.03 05.05<br>08.03 05.05   | 24.0121-0105.1 421105  |   | 262 21,0 19,0 V +S +B  |  |
| SAAB 9-3 (YS3D) (98-02)  |   |  |  |   |  |  |
|    | 2.0 i 96<br>2.0 SE Turbo 147<br>2.0 Turbo 110<br>2.0 Turbo 113<br>2.0 Turbo 136<br>2.0 Turbo 151<br>2.2 TiD 85<br>2.2 TiD 92<br>2.3 i 110<br>2.3 Turbo 165                      | 02.98 09.02<br>02.98 09.02<br>01.01 09.02<br>10.98 09.02<br>02.98 09.02<br>10.99 09.02<br>02.98 11.00<br>11.00 09.02<br>02.98 09.02<br>10.98 09.02   | 13.0460-7173.2 607173<br>24.8190-0718.2 620718   | 2 | 23116 20,3 +/WK ATE<br>Warnkontakt L=720mm   |  |
|    | 2.0 i 96<br>2.0 SE Turbo 147<br>2.0 Turbo 110<br>2.0 Turbo 113<br>2.0 Turbo 136<br>2.0 Turbo 151<br>2.2 TiD 85<br>2.2 TiD 92<br>2.3 i 110                                       | 02.98 09.02<br>02.98 09.02<br>01.01 09.02<br>10.98 09.02<br>02.98 09.02<br>10.99 09.02<br>02.98 11.00<br>11.00 09.02<br>02.98 09.02  | 24.0125-0119.1 425119<br>24.0325-0119.1 525119   |   | 288 25,0 22,0 V L +S +B<br>288 25,0 22,0 V L +S +B PD  |  |
|    | 2.0 i 96<br>2.0 SE Turbo 147<br>2.0 Turbo 110<br>2.0 Turbo 113<br>2.0 Turbo 136<br>2.0 Turbo 151<br>2.2 TiD 85<br>2.2 TiD 92<br>2.3 i 110<br>2.3 Turbo 165                      | 02.98 09.02<br>02.98 09.02<br>01.01 09.02<br>10.98 09.02<br>02.98 09.02<br>10.99 09.02<br>02.98 11.00<br>11.00 09.02<br>02.98 09.02<br>10.98 09.02   | 13.0460-4040.2 604040<br>13.0460-0347.2 610347   |   | 21050 15,8 ATE<br>Belagsatz-Zubehör  |  |
|  | 2.0 i 96<br>2.0 SE Turbo 147<br>2.0 Turbo 110<br>2.0 Turbo 113<br>2.0 Turbo 136<br>2.0 Turbo 151<br>2.2 TiD 85<br>2.2 TiD 92<br>2.3 i 110                                       | 02.98 09.02<br>02.98 09.02<br>01.01 09.02<br>10.98 09.02<br>02.98 09.02<br>10.99 09.02<br>02.98 11.00<br>11.00 09.02<br>02.98 09.02  | 24.0110-0226.1 410226<br>24.0310-0226.1 510226   |   | 286 10,0 8,0 +S +B<br>286 10,0 8,0 +S +B PD  |  |
|  | 2.0 i 96<br>2.0 SE Turbo 147<br>2.0 Turbo 110<br>2.0 Turbo 113<br>2.0 Turbo 136<br>2.0 Turbo 151<br>2.2 TiD 85<br>2.2 TiD 92<br>2.3 i 110<br>2.3 Turbo 165                      | 02.98 09.02<br>02.98 09.02<br>01.01 09.02<br>10.98 09.02<br>02.98 09.02<br>10.99 09.02<br>02.98 11.00<br>11.00 09.02<br>02.98 09.02<br>10.98 09.02   | 03.0137-0172.2 650172  |   | 160 x 25   |  |
| SAAB 9-3 Limousine (YS3F) (03-12)  |   |  |  |   |  |  |
|  | 1.8 i 90<br>1.8 i 90<br>1.8 t 110<br>1.8 t 110<br>1.9 TiD 88<br>1.9 TiD 88<br>1.9 TiD 110<br>1.9 TiD 110<br>2.0 t<br>2.0 t<br>2.0 Turbo Performance<br>2.2 TiD 92<br>2.2 TiD 92 | 03.04 12.05 + 16" Rad/ - Vector 1)<br>03.04 12.05 + 15" Rad 4)<br>09.02 12.05 + 16" Rad/ - Vector 1)<br>09.02 12.05 + 15" Rad 4)<br>07.04 12.05 + 16" Rad/ - Vector 1)<br>07.04 12.05 + 15" Rad 4)<br>07.04 12.05 + 16" Rad/ - Vector 1)<br>07.04 12.05 + 15" Rad 4)<br>09.02 12.05 + 16" Rad/ - Vector 1)<br>09.02 12.05 + 15" Rad 4)<br>04.04 12.05 + 15" Rad 4)<br>09.02 12.05 + 16" Rad/ - Vector 1)<br>09.02 12.05 + 15" Rad 4) | 13.0460-7212.2 607212<br>13.0460-7172.2 607172<br>13.0470-7172.2 LD7172                          |   | f. Bremssattel m.Stahlkolben 2)<br>f. Bremssattel m.Kunststoffkolben 3)<br>f. Bremssattel m.Kunststoffkolben 3)                              | 23738 20,1 +/WE ATE<br>23402 20,1 +/WE ATE<br>23402 20,1 +/WE ATE                        |
|  | 1.8 i 90<br>1.8 i Vector 90<br>1.8 t BioPower 110<br>1.9 TiD 88<br>1.9 TiD 110<br>1.9 TiD Vector 88<br>1.9 TiD Vector 110<br>1.9 TTiD<br>1.9 TTiD                               | 01.06 12.08 - Vector<br>09.02 12.08<br>01.07 12.08<br>01.06 12.08 - Vector<br>01.06 12.08 - Vector<br>07.04 12.08<br>07.04 12.08<br>07.07 12.08<br>07.07 12.08 - Vector  | 13.0460-7199.2 607199<br>13.0460-7212.2 607212<br>13.0460-7172.2 607172<br>13.0470-7172.2 LD7172 |   | + 16" Rad/ - USA 5)<br>+ 16" Rad/ + USA/+ Stahlkolben 6)<br>+ 16" Rad/ + USA/+ Kunststoffkolben 7)<br>+ 16" Rad/ + USA/+ Kunststoffkolben 7) | 23404 20,6 +/WE ATE<br>23738 20,1 +/WE ATE<br>23402 20,1 +/WE ATE<br>23402 20,1 +/WE ATE |

1) + 16" wheel/ - Vector / + ruota 16"/ - Vector / + roue 16"/ - Vector / + rueda 16"/ - Vector

2) for br.caliper + steel piston / per pinza fr. + pistone acciaio / pour étrier f. + piston en acier / para pinza fr. + pistón de acero

3) for br.caliper + plastic piston / per pinza fr. + pistone plastica / pour étrier fr. + piston plastique / para pinza fr. + pistón plástico

4) + 15" wheel / + ruota 15" / + roue 15" / + rueda 15"

5) + 16" wheel, - USA / + ruota 16", - USA / + roue 16", - USA / + rueda 16", - USA

6) + 16" wheel/ + USA/+ steel piston / + ruota 16" / + USA/+ pistone acciaio / + roue 16" / + USA/+ piston acier / + rueda 16" / + USA/+ pistón acero

7) + 16" wheel/ + USA/+ plastic piston / + ruota 16" / + USA/+ pistone plastica / + roue 16" / + USA/+ piston plastique / + rueda 16" / + USA/+ pistón plástico



**SAAB 9-3 Limousine (YS3F) (03-12)**

|                       |                       |       |       |          |                |                |                         |   |                            |     |
|-----------------------|-----------------------|-------|-------|----------|----------------|----------------|-------------------------|---|----------------------------|-----|
|                       | 2.0 t                 |       | 01.06 | 12.08    | - Vector       | 13.0460-7199.2 | 607199                  | + 16" Rad/ - USA <sup>1)</sup>                    | 23404 20,6 +/WE            | ATE |
|                       | 2.0 T Aero            | 154   | 09.02 | 12.08    |                | 13.0460-7212.2 | 607212                  | + 16" Rad/ + USA/+ Stahlkolben <sup>2)</sup>      | 23738 20,1 +/WE            | ATE |
|                       | 2.0 t BioPower        |       | 01.07 | 12.08    |                | 13.0460-7172.2 | 607172                  | + 16" Rad/ + USA/+ Kunststoffkolben <sup>3)</sup> | 23402 20,1 +/WE            | ATE |
|                       | 2.0 t BioPower        | 145   | 06.07 | 12.08    |                | 13.0470-7172.2 | LD7172                  | + 16" Rad/ + USA/+ Kunststoffkolben <sup>3)</sup> | 23402 20,1 +/WE            | ATE |
|                       | 2.0 t BioPower XWD    |       | 09.02 | 12.08    |                |                |                         |   |                            |     |
|                       | 2.0 t Vector          | 129   | 09.02 | 12.08    |                |                |                         |   |                            |     |
|                       | 2.0 t XWD             |       | 01.07 | 12.08    |                |                |                         |   |                            |     |
|                       | 2.0 Turbo Performance |       | 04.04 | 12.08    |                |                |                         |   |                            |     |
|                       | 2.2 TiD               | 92    | 01.06 | 12.08    | - Vector       |                |                         |   |                            |     |
|                       | 2.2 TiD Vector        | 92    | 09.02 | 12.08    |                |                |                         |   |                            |     |
|                       | 2.8 T Aero            | 184   | 03.05 | 12.08    |                |                |                         |   |                            |     |
|                       | 2.8 T Aero            | 188   | 07.07 | 12.08    |                |                |                         |   |                            |     |
|                       | 2.8 T Aero            | 206   | 07.07 | 12.08    |                |                |                         |   |                            |     |
|                       | 2.8 T Aero V6 XWD     | 206   | 04.08 | 12.08    |                |                |                         |   |                            |     |
|                       | 2.8 Turbo V6          |       | 04.08 | 12.08    |                |                |                         |   |                            |     |
|                       | 1.8 i                 | 90    | 01.09 | 06.12    | - Vector       | 13.0460-7204.2 | 607204                  | + 17" Rad <sup>4)</sup>                           | 23912 18,8 +               | ATE |
|                       | 1.8 i Vector          | 90    | 01.09 | 06.12    |                | 13.0470-7204.2 | LD7204                  | + 17" Rad <sup>4)</sup>                           | 23912 18,8 +               | ATE |
|                       | 1.8 t BioPower        | 110   | 01.09 | 06.12    |                |                |                         |   |                            |     |
|                       | 1.9 TiD               | 88    | 01.09 | 06.12    | - Vector       |                |                         |   |                            |     |
|                       | 1.9 TiD               | 110   | 01.09 | 06.12    | - Vector       |                |                         |   |                            |     |
| 1.9 TiD Vector        | 88                    | 01.09 | 06.12 |          |                |                |                         |   |                            |     |
| 1.9 TiD Vector        | 110                   | 01.09 | 06.12 |          |                |                |                         |   |                            |     |
| 1.9 TTiD              |                       | 01.09 | 06.12 |          |                |                |                         |   |                            |     |
| 1.9 TTiD              |                       | 01.09 | 06.12 | - Vector |                |                |                         |   |                            |     |
| 2.0 t                 |                       | 01.09 | 06.12 | - Vector |                |                |                         |   |                            |     |
| 2.0 T Aero            | 154                   | 01.09 | 06.12 |          |                |                |                         |   |                            |     |
| 2.0 t BioPower        |                       | 01.09 | 06.12 |          |                |                |                         |   |                            |     |
| 2.0 t BioPower        | 145                   | 01.09 | 06.12 |          |                |                |                         |   |                            |     |
| 2.0 t BioPower XWD    |                       | 01.09 | 06.12 |          |                |                |                         |   |                            |     |
| 2.0 t Vector          | 129                   | 01.09 | 06.12 |          |                |                |                         |   |                            |     |
| 2.0 t XWD             |                       | 01.09 | 06.12 |          |                |                |                         |   |                            |     |
| 2.0 Turbo Performance |                       | 01.09 | 06.12 |          |                |                |                         |   |                            |     |
| 2.2 TiD               | 92                    | 01.09 | 06.12 | - Vector |                |                |                         |   |                            |     |
| 2.2 TiD Vector        | 92                    | 01.09 | 06.12 |          |                |                |                         |   |                            |     |
| 2.8 T Aero            | 184                   | 01.09 | 06.12 |          |                |                |                         |   |                            |     |
| 2.8 T Aero            | 188                   | 01.09 | 06.12 |          |                |                |                         |   |                            |     |
| 2.8 T Aero            | 206                   | 01.09 | 06.12 |          |                |                |                         |   |                            |     |
| 2.8 T Aero V6 XWD     | 206                   | 01.09 | 06.12 |          |                |                |                         |   |                            |     |
| 2.8 Turbo V6          |                       | 01.09 | 06.12 |          |                |                |                         |   |                            |     |
|                       | 1.8 i                 | 90    | 03.04 | 06.12    |                | 24.0125-0141.1 | 425141                  | + 15" Rad <sup>5)</sup>                           | 285 24,9 22,0 V L +S +B    |     |
|                       | 1.8 t                 | 110   | 09.02 | 06.12    |                | 24.0325-0141.1 | 525141                  | + 15" Rad <sup>5)</sup>                           | 285 24,9 22,0 V L +S +B PD |     |
|                       | 1.8 t BioPower        | 110   | 01.07 | 06.12    |                |                |                         |   |                            |     |
|                       | 1.9 TiD               | 88    | 07.04 | 06.12    |                |                |                         |   |                            |     |
|                       | 1.9 TiD               | 110   | 07.04 | 06.12    |                |                |                         |   |                            |     |
|                       | 1.9 TTiD              |       | 07.07 | 06.12    |                |                |                         |   |                            |     |
|                       | 2.0 t Arc/Linear      | 129   | 09.02 | 06.12    |                |                |                         |   |                            |     |
|                       | 2.0 t BioPower        |       | 01.07 | 06.12    |                |                |                         |   |                            |     |
|                       | 2.0 t BioPower        | 145   | 06.07 | 06.12    |                |                |                         |   |                            |     |
|                       | 2.0 Turbo Performance |       | 04.04 | 06.12    |                |                |                         |   |                            |     |
|                       | 2.2 TiD               | 92    | 09.02 | 06.12    |                |                |                         |   |                            |     |
|                       | 2.0 T Aero            | 154   | 01.06 | 06.12    | + (USA)        | 24.0128-0164.1 | 428164                  | + 16" Rad <sup>6)</sup>                           | 314 28,0 25,0 V L +S +B    |     |
|                       | 2.0 T Aero            | 154   | 09.02 | 06.12    | - (USA)        |                |                         |   |                            |     |
|                       | 2.0 t BioPower XWD    |       | 09.02 | 06.12    |                |                |                         |   |                            |     |
|                       | 2.0 t Vector          | 129   | 09.02 | 06.12    |                |                |                         |   |                            |     |
|                       | 2.0 t XWD             |       | 01.07 | 06.12    |                |                |                         |   |                            |     |
|                       | 2.0 Turbo Performance |       | 04.04 | 06.12    |                |                |                         |   |                            |     |
|                       | 2.8 T Aero            | 184   | 01.06 | 06.12    | + (USA)        |                |                         |   |                            |     |
|                       | 2.8 T Aero            | 184   | 03.05 | 06.12    | - (USA)        |                |                         |   |                            |     |
|                       | 2.8 T Aero            | 188   | 07.07 | 06.12    |                |                |                         |   |                            |     |
| 2.8 T Aero            | 206                   | 07.07 | 06.12 |          |                |                |                         |   |                            |     |
| 2.8 T Aero V6 XWD     | 206                   | 04.08 | 06.12 |          |                |                |                         |   |                            |     |
| 2.8 Turbo V6          |                       | 04.08 | 06.12 |          |                |                |                         |   |                            |     |
| 2.0 T Aero            | 154                   | 09.02 | 12.05 |          | 24.0128-0137.1 | 428137         | + 16" Rad <sup>6)</sup> | 302 28,0 25,0 V L +S +B                           |                            |     |
| 2.8 T Aero            | 184                   | 03.05 | 12.05 |          | 24.0328-0137.1 | 528137         | + 16" Rad <sup>6)</sup> | 302 28,0 25,0 V L +S +B PD                        |                            |     |
| 1.8 i                 | 90                    | 03.04 | 06.12 | - Vector | 24.0130-0189.1 | 430189         | + 17" Rad <sup>4)</sup> | 345 29,9 27,5 V L +B                              |                            |     |
| 1.8 i Vector          | 90                    | 03.04 | 06.12 |          |                |                |                         |   |                            |     |
| 1.8 t BioPower        | 110                   | 01.07 | 06.12 |          |                |                |                         |   |                            |     |
| 1.9 TiD               | 88                    | 07.04 | 06.12 | - Vector |                |                |                         |   |                            |     |
| 1.9 TiD               | 110                   | 07.04 | 06.12 | - Vector |                |                |                         |   |                            |     |
| 1.9 TiD Vector        | 88                    | 07.04 | 06.12 |          |                |                |                         |   |                            |     |
| 1.9 TiD Vector        | 110                   | 07.04 | 06.12 |          |                |                |                         |   |                            |     |
| 1.9 TTiD              |                       | 07.07 | 06.12 |          |                |                |                         |   |                            |     |
| 1.9 TTiD              |                       | 07.07 | 06.12 | - Vector |                |                |                         |   |                            |     |
| 2.0 t                 |                       | 09.02 | 06.12 | - Vector |                |                |                         |   |                            |     |
| 2.0 T Aero            | 154                   | 09.02 | 06.12 |          |                |                |                         |   |                            |     |
| 2.0 t BioPower        |                       | 01.07 | 06.12 |          |                |                |                         |   |                            |     |
| 2.0 t BioPower        | 145                   | 06.07 | 06.12 |          |                |                |                         |   |                            |     |
| 2.0 t BioPower XWD    |                       | 09.02 | 06.12 |          |                |                |                         |   |                            |     |
| 2.0 t Vector          | 129                   | 09.02 | 06.12 |          |                |                |                         |   |                            |     |
| 2.0 t XWD             |                       | 01.07 | 06.12 |          |                |                |                         |   |                            |     |
| 2.0 Turbo Performance |                       | 04.04 | 06.12 |          |                |                |                         |   |                            |     |
| 2.2 TiD               | 92                    | 09.02 | 06.12 | - Vector |                |                |                         |   |                            |     |
| 2.2 TiD Vector        | 92                    | 09.02 | 06.12 |          |                |                |                         |   |                            |     |
| 2.8 T Aero            | 184                   | 03.05 | 06.12 |          |                |                |                         |   |                            |     |
| 2.8 T Aero            | 188                   | 07.07 | 06.12 |          |                |                |                         |   |                            |     |
| 2.8 T Aero            | 206                   | 07.07 | 06.12 |          |                |                |                         |   |                            |     |
| 2.8 T Aero V6 XWD     | 206                   | 05.08 | 06.12 |          |                |                |                         |   |                            |     |

<sup>1)</sup> + 16" wheel, - USA / + ruota 16", - USA / + roue 16", - USA / + rueda 16", - USA

<sup>2)</sup> + 16" wheel/ + USA/+ steel piston / + ruota 16" / + USA/+ pistone acciaio / + roue 16" / + USA/+ piston acier / + rueda 16" / + USA/+ pistón acero

<sup>3)</sup> + 16" wheel/ + USA/+ plastic piston / + ruota 16" / + USA/+ pistone plastica / + roue 16" / + USA/+ piston plastique / + rueda 16" / + USA/+ pistón plástico

<sup>4)</sup> + 17" wheel / + ruota 17" / + roue 17" / + rueda 17"

<sup>5)</sup> + 15" wheel / + ruota 15" / + roue 15" / + rueda 15"

<sup>6)</sup> + 16" wheel / + ruota 16" / + roue 16" / + rueda 16"



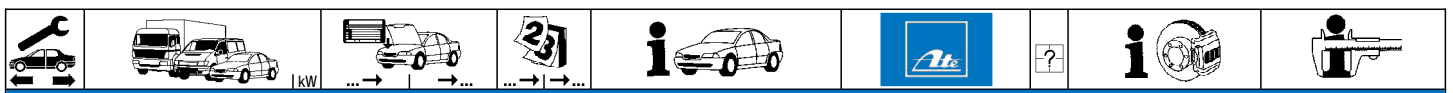

**SAAB 9-3 Limousine (YS3F) (03-12)**

|  |                       |     |          |       |       |  |                |        |  |                          |     |
|--|-----------------------|-----|----------|-------|-------|--|----------------|--------|--|--------------------------|-----|
|  | 2.8 Turbo V6          |     |          | 04.08 | 06.12 |  | 24.0130-0189.1 | 430189 | + 17" Rad <sup>1)</sup>                | 345 29,9 27,5 V L +B     |     |
|  | 1.8 i                 | 90  | 76001222 | 03.04 |       |  | 13.0460-7194.2 | 607194 | ersetzt Belag mit Federn <sup>2)</sup> | 23482 16,6 +             | ATE |
|  | 1.8 t                 | 110 | 76001222 | 09.02 |       |  | 13.0470-7194.2 | LD7194 | ersetzt Belag mit Federn <sup>2)</sup> | 23482 16,6 +             | ATE |
|  | 1.8 t BioPower        | 110 | 76001222 | 01.07 |       |  |                |        |  |                          |     |
|  | 1.9 TiD               | 88  | 76001222 | 07.04 |       |  |                |        |  |                          |     |
|  | 1.9 TiD               | 110 | 76001222 | 07.04 |       |  |                |        |  |                          |     |
|  | 1.9 TTiD              |     | 76001222 | 07.07 |       |  |                |        |  |                          |     |
|  | 2.0 t                 |     | 76001222 | 09.02 |       |  |                |        |  |                          |     |
|  | 2.0 T Aero            | 154 | 76001222 | 09.02 |       |  |                |        |  |                          |     |
|  | 2.0 t BioPower        |     | 76001222 | 01.07 |       |  |                |        |  |                          |     |
|  | 2.0 t BioPower        | 145 | 76001222 | 06.07 |       |  |                |        |  |                          |     |
|  | 2.0 t BioPower XWD    |     | 76001222 | 09.02 |       |  |                |        |  |                          |     |
|  | 2.0 t XWD             |     | 76001222 | 01.07 |       |  |                |        |  |                          |     |
|  | 2.0 Turbo Performance |     | 76001222 | 04.04 |       |  |                |        |  |                          |     |
|  | 2.2 TiD               | 92  | 76001222 | 09.02 |       |  |                |        |  |                          |     |
|  | 2.8 T Aero            | 184 | 76001222 | 03.05 |       |  |                |        |  |                          |     |
|  | 2.8 T Aero            | 188 | 76001222 | 07.07 |       |  |                |        |  |                          |     |
|  | 2.8 T Aero            | 206 | 76001222 | 07.07 |       |  |                |        |  |                          |     |
|  | 2.8 T Aero V6 XWD     | 206 | 76001222 | 04.08 |       |  |                |        |  |                          |     |
|  | 2.8 Turbo V6          |     | 76001222 | 04.08 |       |  |                |        |  |                          |     |
|  | 1.8 i                 | 90  | 76001223 | 06.12 |       |  | 13.0460-7195.2 | 607195 |  | 23482 16,6 +             | ATE |
|  | 1.8 t                 | 110 | 76001223 | 06.12 |       |  | 13.0470-7195.2 | LD7195 |  | 23482 16,6 +             | ATE |
|  | 1.8 t BioPower        | 110 | 76001223 | 06.12 |       |  |                |        |  |                          |     |
|  | 1.9 TiD               | 88  | 76001223 | 06.12 |       |  |                |        |  |                          |     |
|  | 1.9 TiD               | 110 | 76001223 | 06.12 |       |  |                |        |  |                          |     |
|  | 1.9 TTiD              |     | 76001223 | 06.12 |       |  |                |        |  |                          |     |
|  | 2.0 t                 |     | 76001223 | 06.12 |       |  |                |        |  |                          |     |
|  | 2.0 T Aero            | 154 | 76001223 | 06.12 |       |  |                |        |  |                          |     |
|  | 2.0 t BioPower        |     | 76001223 | 06.12 |       |  |                |        |  |                          |     |
|  | 2.0 t BioPower        | 145 | 76001223 | 06.12 |       |  |                |        |  |                          |     |
|  | 2.0 t BioPower XWD    |     | 76001223 | 06.12 |       |  |                |        |  |                          |     |
|  | 2.0 t XWD             |     | 76001223 | 06.12 |       |  |                |        |  |                          |     |
|  | 2.0 Turbo Performance |     | 76001223 | 06.12 |       |  |                |        |  |                          |     |
|  | 2.2 TiD               | 92  | 76001223 | 06.12 |       |  |                |        |  |                          |     |
|  | 2.8 T Aero            | 184 | 76001223 | 06.12 |       |  |                |        |  |                          |     |
|  | 2.8 T Aero            | 188 | 76001223 | 06.12 |       |  |                |        |  |                          |     |
|  | 2.8 T Aero            | 206 | 76001223 | 06.12 |       |  |                |        |  |                          |     |
|  | 2.8 T Aero V6 XWD     | 206 | 76001223 | 06.12 |       |  |                |        |  |                          |     |
|  | 2.8 Turbo V6          |     | 76001223 | 06.12 |       |  |                |        |  |                          |     |
|  | 1.8 i                 | 90  |          | 03.04 | 06.12 |  | 24.0112-0157.1 | 412157 | + 15" Rad <sup>3)</sup>                | 278 11,9 10,0 +S +B      |     |
|  | 1.8 t                 | 110 |          | 09.02 | 06.12 |  | 24.0312-0157.1 | 512157 | + 15" Rad <sup>3)</sup>                | 278 11,9 10,0 +S +B PD   |     |
|  | 1.8 t BioPower        | 110 |          | 01.07 | 06.12 |  | 24.0120-0173.1 | 420173 | + 16" Rad <sup>4)</sup>                | 292 19,9 18,0 V +S +B    |     |
|  | 1.9 TiD               | 88  |          | 07.04 | 06.12 |  | 24.0320-0173.1 | 520173 | + 16" Rad <sup>4)</sup>                | 292 19,9 18,0 V +S +B PD |     |
|  | 1.9 TiD               | 110 |          | 07.04 | 06.12 |  |                |        |  |                          |     |
|  | 1.9 TTiD              |     |          | 07.07 | 06.12 |  |                |        |  |                          |     |
|  | 2.0 t                 |     |          | 09.02 | 06.12 |  |                |        |  |                          |     |
|  | 2.0 T Aero            | 154 |          | 09.02 | 06.12 |  |                |        |  |                          |     |
|  | 2.0 t BioPower        |     |          | 01.07 | 06.12 |  |                |        |  |                          |     |
|  | 2.0 t BioPower        | 145 |          | 06.07 | 06.12 |  |                |        |  |                          |     |
|  | 2.0 Turbo Performance |     |          | 04.04 | 06.12 |  |                |        |  |                          |     |
|  | 2.2 TiD               | 92  |          | 09.02 | 06.12 |  |                |        |  |                          |     |
|  | 2.8 T Aero            | 184 |          | 03.05 | 06.12 |  |                |        |  |                          |     |
|  | 2.8 T Aero            | 188 |          | 07.07 | 06.12 |  |                |        |  |                          |     |
|  | 2.8 T Aero            | 206 |          | 07.07 | 06.12 |  |                |        |  |                          |     |
|  | 2.8 Turbo V6          |     |          | 04.08 | 06.12 |  |                |        |  |                          |     |

**SAAB 9-3 SportCombi (05-12)**

|  |                    |     |  |       |       |  |                |        |  |                 |     |
|--|--------------------|-----|--|-------|-------|--|----------------|--------|--|-----------------|-----|
|  | 1.8 i              | 90  |  | 03.05 | 06.12 |  | 13.0460-7212.2 | 607212 | + 15"/16" Rad/+ Stahlkolben <sup>5)</sup>      | 23738 20,1 +/WE | ATE |
|  | 1.8 t              | 110 |  | 03.05 | 06.12 |  | 13.0460-7172.2 | 607172 | + 15"/16" Rad/+ Kunststoffkolben <sup>6)</sup> | 23402 20,1 +/WE | ATE |
|  | 1.8 t BioPower     | 110 |  | 01.07 | 06.12 |  | 13.0470-7172.2 | LD7172 | + 15"/16" Rad/+ Kunststoffkolben <sup>6)</sup> | 23402 20,1 +/WE | ATE |
|  | 1.8 t BioPower     | 129 |  | 07.07 | 06.12 |  |                |        |  |                 |     |
|  | 1.9 TiD            | 88  |  | 03.05 | 06.12 |  |                |        |  |                 |     |
|  | 1.9 TiD            | 110 |  | 03.05 | 06.12 |  |                |        |  |                 |     |
|  | 1.9 TTiD           |     |  | 07.07 | 06.12 |  |                |        |  |                 |     |
|  | 2.0                |     |  | 04.06 | 09.07 |  |                |        |  |                 |     |
|  | 2.0 t              | 143 |  | 03.05 | 06.12 |  |                |        |  |                 |     |
|  | 2.0 t BioPower     |     |  | 01.07 | 06.12 |  |                |        |  |                 |     |
|  | 2.0 t BioPower     | 145 |  | 06.07 | 06.12 |  |                |        |  |                 |     |
|  | 2.0 t BioPower     | 147 |  | 07.07 | 06.12 |  |                |        |  |                 |     |
|  | 2.0 t BioPower     | 162 |  | 01.11 | 06.12 |  |                |        |  |                 |     |
|  | 2.0 t BioPower XWD |     |  | 01.07 | 06.12 |  |                |        |  |                 |     |
|  | 2.0 t BioPower XWD | 162 |  | 01.11 | 06.12 |  |                |        |  |                 |     |
|  | 2.0 t XWD          |     |  | 01.07 | 06.12 |  |                |        |  |                 |     |
|  | 2.0 T              |     |  | 03.05 | 12.08 |  | 13.0460-7199.2 | 607199 | + 16" plus Rad <sup>7)</sup>                   | 23404 20,6 +/WE | ATE |
|  | 2.0 T XWD          | 154 |  | 07.08 | 12.08 |  |                |        |  |                 |     |
|  | 2.8 T              | 184 |  | 03.05 | 12.08 |  |                |        |  |                 |     |
|  | 2.8 T              | 188 |  | 07.07 | 12.08 |  |                |        |  |                 |     |
|  | 2.8 T Aero         | 206 |  | 07.07 | 12.08 |  |                |        |  |                 |     |
|  | 2.8 T Aero V6 XWD  | 206 |  | 04.08 | 12.08 |  |                |        |  |                 |     |
|  | 2.8 Turbo V6       | 169 |  | 03.05 | 12.08 |  |                |        |  |                 |     |
|  | 2.8 Turbo V6       | 203 |  | 05.08 | 12.08 |  |                |        |  |                 |     |
|  | 2.0 T              |     |  | 01.09 | 06.12 |  | 13.0460-7204.2 | 607204 | + 17" Rad <sup>1)</sup>                        | 23912 18,8 +    | ATE |
|  | 2.0 T XWD          | 154 |  | 01.09 | 06.12 |  | 13.0470-7204.2 | LD7204 | + 17" Rad <sup>1)</sup>                        | 23912 18,8 +    | ATE |
|  | 2.0 T XWD          | 177 |  | 03.09 | 06.12 |  |                |        |  |                 |     |
|  | 2.8 T              | 184 |  | 01.09 | 06.12 |  |                |        |  |                 |     |

<sup>1)</sup> + 17" wheel / + ruota 17" / + roue 17" / + rueda 17"

<sup>2)</sup> replaces pad with springs / sostituisce la guarnizione con molle / remplace la garniture avec ressorts / sustituye guarnición con resortes

<sup>3)</sup> + 15" wheel / + ruota 15" / + roue 15" / + rueda 15"













<sup>4)</sup> + 16" wheel / + ruota 16" / + roue 16" / + rueda 16"

<sup>5)</sup> + 15"/16" wheel/+ steel piston / + ruota 15"/16" /+ pistone acciaio / + roue 15"/16" /+ piston acier / + rueda 15"/16" /+ pistón acero

<sup>6)</sup> + 15"/16" wheel/+ plastic piston / + ruota 15"/16" /+ pistone plastica / + roue 15"/16" /+ piston plastique / + rueda 15"/16" /+ pistón plástico

<sup>7)</sup> + 16" plus wheel / + ruota 16" plus / + roue 16" plus / + rueda 16" plus



|     |  |  |  |  |  |  |  |  |                            |     |
|--|--|--|--|--|---|--|--|--|----------------------------|-----|
| <b>SAAB 9-3 SportCombi (05-12)</b>   |  |  |  |  |   |  |  |  |                            |     |
|    | 2.8 T  | 188  |  | 01.09  | 06.12   | 13.0460-7204.2   | 607204   | + 17" Rad <sup>1)</sup>  | 23912 18,8 +               | ATE |
|  | 2.8 T Aero   | 206  |  | 01.09  | 06.12   | 13.0470-7204.2   | LD7204   | + 17" Rad <sup>1)</sup>  | 23912 18,8 +               | ATE |
|  | 2.8 T Aero V6 XWD  | 206  |  | 01.09  | 06.12   |  |  |  |                            |     |
|  | 2.8 Turbo V6   | 169  |  | 01.09  | 06.12   |  |  |  |                            |     |
|  | 2.8 Turbo V6   | 203  |  | 01.09  | 06.12   |  |  |  |                            |     |
|    | 1.8 i  | 90   |  | 03.05  | 06.12   | 24.0125-0141.1   | 425141   | + 15" Rad <sup>2)</sup>  | 285 24,9 22,0 V L +S +B    |     |
|  | 1.8 t  | 110  |  | 03.05  | 06.12   | 24.0325-0141.1   | 525141   | + 15" Rad <sup>2)</sup>  | 285 24,9 22,0 V L +S +B PD |     |
|  | 1.8 t BioPower   | 110  |  | 01.07  | 06.12   |  |  |  |                            |     |
|  | 1.8 t BioPower   | 129  |  | 07.07  | 06.12   |  |  |  |                            |     |
|  | 1.9 TiD  | 88   |  | 03.05  | 06.12   |  |  |  |                            |     |
|  | 1.9 TiD  | 110  |  | 03.05  | 06.12   |  |  |  |                            |     |
|  | 1.9 TTiD   |  |  | 07.07  | 06.12   |  |  |  |                            |     |
|  | 2.0  | 143  |  | 04.06  | 09.07   |  |  |  |                            |     |
|  | 2.0 t  |  |  | 03.05  | 06.12   |  |  |  |                            |     |
|  | 2.0 t BioPower   |  |  | 01.07  | 06.12   |  |  |  |                            |     |
|  | 2.0 t BioPower   | 145  |  | 06.07  | 06.12   |  |  |  |                            |     |
|  | 2.0 t BioPower   | 147  |  | 07.07  | 06.12   |  |  |  |                            |     |
|  | 2.0 t BioPower   | 162  |  | 01.11  | 06.12   |  |  |  |                            |     |
|  | 2.0 t BioPower XWD   |  |  | 01.07  | 06.12   |  |  |  |                            |     |
|  | 2.0 t BioPower XWD   | 162  |  | 01.11  | 06.12   |  |  |  |                            |     |
|  | 2.0 t XWD  |  |  | 01.07  | 06.12   |  |  |  |                            |     |
|  | 2.0 T  |  |  | 03.05  | 06.12   | 24.0128-0164.1   | 428164   | + 16" Rad <sup>3)</sup>  | 314 28,0 25,0 V L +S +B    |     |
|  | 2.0 T XWD  | 154  |  | 07.08  | 06.12   | 24.0128-0137.1   | 428137   | + 16" Rad <sup>3)</sup>  | 302 28,0 25,0 V L +S +B    |     |
|  | 2.0 T XWD  | 177  |  | 03.09  | 06.12   | 24.0328-0137.1   | 528137   | + 16" Rad <sup>3)</sup>  | 302 28,0 25,0 V L +S +B PD |     |
|  | 2.8 T  | 184  |  | 03.05  | 06.12   |  |  |  |                            |     |
|  | 2.8 T  | 188  |  | 07.07  | 06.12   |  |  |  |                            |     |
|  | 2.8 T Aero   | 206  |  | 07.07  | 06.12   |  |  |  |                            |     |
|  | 2.8 T Aero V6 XWD  | 206  |  | 04.08  | 06.12   |  |  |  |                            |     |
|  | 2.8 Turbo V6   | 169  |  | 03.05  | 06.12   |  |  |  |                            |     |
|  | 2.8 Turbo V6   | 203  |  | 05.08  | 06.12   |  |  |  |                            |     |
|  | 1.8 i  | 90   |  | 03.05  | 06.12   | 24.0130-0189.1   | 430189   | + 17" Rad <sup>1)</sup>  | 345 29,9 27,5 V L +B       |     |
|  | 1.8 t  | 110  |  | 03.05  | 06.12   |  |  |  |                            |     |
|  | 1.8 t BioPower   | 110  |  | 01.07  | 06.12   |  |  |  |                            |     |
|  | 1.8 t BioPower   | 129  |  | 07.07  | 06.12   |  |  |  |                            |     |
|  | 1.9 TiD  | 88   |  | 03.05  | 06.12   |  |  |  |                            |     |
|  | 1.9 TiD  | 110  |  | 03.05  | 06.12   |  |  |  |                            |     |
|  | 1.9 TTiD   |  |  | 07.07  | 06.12   |  |  |  |                            |     |
|  | 2.0  | 143  |  | 04.06  | 09.07   |  |  |  |                            |     |
|  | 2.0 t  |  |  | 03.05  | 06.12   |  |  |  |                            |     |
|  | 2.0 t BioPower   |  |  | 01.07  | 06.12   |  |  |  |                            |     |
|  | 2.0 t BioPower   | 145  |  | 06.07  | 06.12   |  |  |  |                            |     |
|  | 2.0 t BioPower   | 147  |  | 07.07  | 06.12   |  |  |  |                            |     |
|  | 2.0 t BioPower XWD   |  |  | 01.07  | 06.12   |  |  |  |                            |     |
|  | 2.0 t XWD  |  |  | 01.07  | 06.12   |  |  |  |                            |     |
|  | 1.8 i  | 90   | 76001222   | 03.05  |   | 13.0460-7194.2   | 607194   | ersetzt Belag mit Federn <sup>4)</sup>   | 23482 16,6 +               | ATE |
|  | 1.8 t  | 110  | 76001222   | 03.05  |   | 13.0470-7194.2   | LD7194   | ersetzt Belag mit Federn <sup>4)</sup>   | 23482 16,6 +               | ATE |
|  | 1.8 t BioPower   | 110  | 76001222   | 01.07  |   |  |  |  |                            |     |
|  | 1.8 t BioPower   | 129  | 76001222   | 07.07  |   |  |  |  |                            |     |
|  | 1.9 TiD  | 88   | 76001222   | 03.05  |   |  |  |  |                            |     |
|  | 1.9 TiD  | 110  | 76001222   | 03.05  |   |  |  |  |                            |     |
|  | 1.9 TTiD   |  | 76001222   | 07.07  |   |  |  |  |                            |     |
|  | 2.0  | 143  | 76001222   | 04.06  |   |  |  |  |                            |     |
|  | 2.0 t  |  | 76001222   | 03.05  |   |  |  |  |                            |     |
|  | 2.0 T  |  | 76001222   | 03.05  |   |  |  |  |                            |     |
|  | 2.0 t BioPower   |  | 76001222   | 01.07  |   |  |  |  |                            |     |
|  | 2.0 t BioPower   | 145  | 76001222   | 06.07  |   |  |  |  |                            |     |
|  | 2.0 t BioPower   | 147  | 76001222   | 07.07  |   |  |  |  |                            |     |
|  | 2.0 t BioPower   | 162  | 76001222   | 01.11  |   |  |  |  |                            |     |
|  | 2.0 t BioPower XWD   |  | 76001222   | 01.07  |   |  |  |  |                            |     |
|  | 2.0 t BioPower XWD   | 162  | 76001222   | 01.11  |   |  |  |  |                            |     |
|  | 2.0 t XWD  |  | 76001222   | 01.07  |   |  |  |  |                            |     |
|  | 2.0 T XWD  | 154  | 76001222   | 07.08  |   |  |  |  |                            |     |
|  | 2.0 T XWD  | 177  | 76001222   | 03.09  |   |  |  |  |                            |     |
|  | 2.8 T  | 184  | 76001222   | 03.05  |   |  |  |  |                            |     |
|  | 2.8 T  | 188  | 76001222   | 07.07  |   |  |  |  |                            |     |
|  | 2.8 T Aero   | 206  | 76001222   | 07.07  |   |  |  |  |                            |     |
|  | 2.8 T Aero V6 XWD  | 206  | 76001222   | 04.08  |   |  |  |  |                            |     |
|  | 2.8 Turbo V6   | 169  | 76001222   | 03.05  |   |  |  |  |                            |     |
|  | 2.8 Turbo V6   | 203  | 76001222   | 05.08  |   |  |  |  |                            |     |
|  | 1.8 i  | 90   | 76001223   |  | 06.12   | 13.0460-7195.2   | 607195   |  | 23482 16,6 +               | ATE |
|  | 1.8 t  | 110  | 76001223   |  | 06.12   | 13.0470-7195.2   | LD7195   |  | 23482 16,6 +               | ATE |
|  | 1.8 t BioPower   | 110  | 76001223   |  | 06.12   |  |  |  |                            |     |
|  | 1.8 t BioPower   | 129  | 76001223   |  | 06.12   |  |  |  |                            |     |
|  | 1.9 TiD  | 88   | 76001223   |  | 06.12   |  |  |  |                            |     |
|  | 1.9 TiD  | 110  | 76001223   |  | 06.12   |  |  |  |                            |     |
|  | 1.9 TTiD   |  | 76001223   |  | 06.12   |  |  |  |                            |     |
|  | 2.0 t  |  | 76001223   |  | 06.12   |  |  |  |                            |     |
|  | 2.0 T  |  | 76001223   |  | 06.12   |  |  |  |                            |     |
|  | 2.0 t BioPower   |  | 76001223   |  | 06.12   |  |  |  |                            |     |
|  | 2.0 t BioPower   | 145  | 76001223   |  | 06.12   |  |  |  |                            |     |
|  | 2.0 t BioPower   | 147  | 76001223   |  | 06.12   |  |  |  |                            |     |
|  | 2.0 t BioPower   | 162  | 76001223   |  | 06.12   |  |  |  |                            |     |
|  | 2.0 t BioPower XWD   |  | 76001223   |  | 06.12   |  |  |  |                            |     |
|  | 2.0 t BioPower XWD   | 162  | 76001223   |  | 06.12   |  |  |  |                            |     |
|  | 2.0 t XWD  |  | 76001223   |  | 06.12   |  |  |  |                            |     |
|  | 2.0 T XWD  | 154  | 76001223   |  | 06.12   |  |  |  |                            |     |
|  | 2.0 T XWD  | 177  | 76001223   |  | 06.12   |  |  |  |                            |     |

<sup>1)</sup> + 17" wheel / + ruota 17" / + roue 17" / + rueda 17"

<sup>2)</sup> + 15" wheel / + ruota 15" / + roue 15" / + rueda 15"

<sup>3)</sup> + 16" wheel / + ruota 16" / + roue 16" / + rueda 16"

<sup>4)</sup> replaces pad with springs / sostituisce la guarnizione con molle / remplace la garniture avec ressorts / sustituye guarnición con resortes



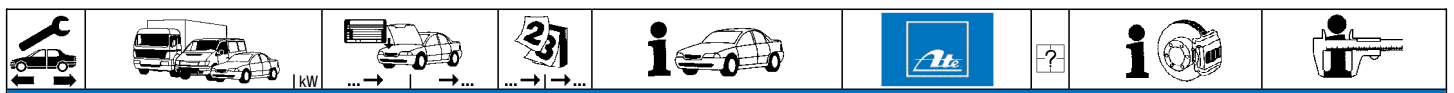

**SAAB 9-3 Cabriolet (YS3D) (98-03)**

|  |              |     |  |       |       |  |                |        |  |                              |
|--|--------------|-----|--|-------|-------|--|----------------|--------|--|------------------------------|
|  | 2.3 i        | 110 |  | 02.98 | 07.03 |  | 24.0110-0226.1 | 410226 |  | 286 10,0 8,0 +S +B           |
|  |              |     |  |       |       |  | 24.0310-0226.1 | 510226 |  | <b>286 10,0 8,0 +S +B PD</b> |
|  | 2.0 i        | 96  |  | 02.98 | 07.03 |  | 03.0137-0172.2 | 650172 |  | 160 x 25                     |
|  | 2.0 SE Turbo | 147 |  | 02.98 | 07.03 |  |                |        |  |                              |
|  | 2.0 T        | 113 |  | 10.98 | 07.03 |  |                |        |  |                              |
|  | 2.0 T        | 136 |  | 02.98 | 07.03 |  |                |        |  |                              |
|  | 2.0 T        | 151 |  | 10.99 | 07.03 |  |                |        |  |                              |
|  | 2.0 Turbo    | 110 |  | 01.01 | 07.03 |  |                |        |  |                              |
|  | 2.3 i        | 110 |  | 02.98 | 07.03 |  |                |        |  |                              |
|  | 2.3 i        | 165 |  | 10.99 | 07.03 |  |                |        |  |                              |

**SAAB 9-3 Cabriolet (YS3F) (03-12)**

|  |                       |     |  |       |       |             |                |        |  |                            |     |
|--|-----------------------|-----|--|-------|-------|-------------|----------------|--------|--|----------------------------|-----|
|  | 1.8 i                 | 90  |  | 01.04 | 06.12 |             | 13.0460-7212.2 | 607212 | + 15"/16" Rad/+ Stahlkolben <sup>1)</sup>      | 23738 20,1 +/WE            | ATE |
|  | 1.8 t                 | 110 |  | 08.03 | 06.12 |             | 13.0460-7172.2 | 607172 | + 15"/16" Rad/+ Kunststoffkolben <sup>2)</sup> | 23402 20,1 +/WE            | ATE |
|  | 1.8 t BioPower        | 110 |  | 01.07 | 06.12 |             | 13.0470-7172.2 | LD7172 | + 15"/16" Rad/+ Kunststoffkolben <sup>2)</sup> | 23402 20,1 +/WE            | ATE |
|  | 1.8 t BioPower        | 129 |  | 07.07 | 06.12 |             |                |        |  |                            |     |
|  | 1.9 TiD               | 88  |  | 09.04 | 06.12 |             |                |        |  |                            |     |
|  | 1.9 TiD               | 110 |  | 01.06 | 06.12 |             |                |        |  |                            |     |
|  | 1.9 TTD               |     |  | 07.07 | 06.12 |             |                |        |  |                            |     |
|  | 2.0                   | 143 |  | 04.06 | 09.07 |             |                |        |  |                            |     |
|  | 2.0 t                 |     |  | 08.03 | 06.12 |             |                |        |  |                            |     |
|  | 2.0 T                 |     |  | 08.03 | 06.12 | - USA       |                |        |  |                            |     |
|  | 2.0 t BioPower        |     |  | 06.07 | 06.12 |             |                |        |  |                            |     |
|  | 2.0 t BioPower        |     |  | 01.07 | 06.12 |             |                |        |  |                            |     |
|  | 2.0 t BioPower        | 147 |  | 07.07 | 06.12 |             |                |        |  |                            |     |
|  | 2.0 Turbo Performance | 185 |  | 04.04 | 06.12 |             |                |        |  |                            |     |
|  | 2.0 T                 |     |  | 08.03 | 06.12 | + USA + CDN | 13.0460-7212.2 | 607212 | + 16" Rad/+ Stahlkolben <sup>3)</sup>          | 23738 20,1 +/WE            | ATE |
|  | 2.0 Turbo Performance | 185 |  | 04.04 | 06.12 | + USA + CDN | 13.0460-7172.2 | 607172 | + 16" Rad/+ Kunststoffkolben <sup>4)</sup>     | 23402 20,1 +/WE            | ATE |
|  |                       |     |  |       |       |             | 13.0470-7172.2 | LD7172 | + 16" Rad/+ Kunststoffkolben <sup>4)</sup>     | 23402 20,1 +/WE            | ATE |
|  | 2.0 T                 |     |  | 08.03 | 12.08 | - USA + CDN | 13.0460-7199.2 | 607199 | + 16"/16plus" Rad <sup>5)</sup>                | 23404 20,6 +/WE            | ATE |
|  | 2.0 Turbo Performance | 185 |  | 04.04 | 12.08 | - USA + CDN |                |        |  |                            |     |
|  | 2.8 T                 | 184 |  | 02.06 | 12.08 |             |                |        |  |                            |     |
|  | 2.8 T                 | 221 |  | 10.08 | 12.08 |             |                |        |  |                            |     |
|  | 2.8 T Aero            | 188 |  | 07.07 | 12.08 |             |                |        |  |                            |     |
|  | 2.8 T V6 Aero         |     |  | 06.08 | 12.08 |             |                |        |  |                            |     |
|  | 2.0 T                 |     |  | 01.09 | 06.12 | - USA + CDN | 13.0460-7204.2 | 607204 | + 17" Rad <sup>6)</sup>                        | 23912 18,8 +               | ATE |
|  | 2.0 Turbo Performance | 185 |  | 01.09 | 06.12 | - USA + CDN | 13.0470-7204.2 | LD7204 | + 17" Rad <sup>6)</sup>                        | 23912 18,8 +               | ATE |
|  | 2.8 T                 | 184 |  | 01.09 | 06.12 |             |                |        |  |                            |     |
|  | 2.8 T                 | 221 |  | 01.09 | 06.12 |             |                |        |  |                            |     |
|  | 2.8 T Aero            | 188 |  | 01.09 | 06.12 |             |                |        |  |                            |     |
|  | 2.8 T V6 Aero         |     |  | 01.09 | 06.12 |             |                |        |  |                            |     |
|  | 1.8 i                 | 90  |  | 01.04 | 06.12 |             | 24.0125-0141.1 | 425141 | + 15" Rad <sup>7)</sup>                        | 285 24,9 22,0 V L +S +B    |     |
|  | 1.8 t                 | 110 |  | 08.03 | 06.12 |             | 24.0325-0141.1 | 525141 | + 15" Rad <sup>7)</sup>                        | 285 24,9 22,0 V L +S +B PD |     |
|  | 1.8 t BioPower        | 110 |  | 01.07 | 06.12 |             |                |        |  |                            |     |
|  | 1.8 t BioPower        | 129 |  | 07.07 | 06.12 |             |                |        |  |                            |     |
|  | 1.9 TiD               | 88  |  | 09.04 | 06.12 |             |                |        |  |                            |     |
|  | 1.9 TiD               | 110 |  | 01.06 | 06.12 |             |                |        |  |                            |     |
|  | 1.9 TTD               |     |  | 07.07 | 06.12 |             |                |        |  |                            |     |
|  | 2.0                   | 143 |  | 04.06 | 09.07 |             |                |        |  |                            |     |
|  | 2.0 t                 |     |  | 08.03 | 06.12 |             |                |        |  |                            |     |
|  | 2.0 T                 |     |  | 08.03 | 06.12 |             |                |        |  |                            |     |
|  | 2.0 t BioPower        |     |  | 06.07 | 06.12 |             |                |        |  |                            |     |
|  | 2.0 t BioPower        |     |  | 01.07 | 06.12 |             |                |        |  |                            |     |
|  | 2.0 t BioPower        | 147 |  | 07.07 | 06.12 |             |                |        |  |                            |     |
|  | 2.0 t Linear          | 129 |  | 08.03 | 06.12 |             |                |        |  |                            |     |
|  | 2.0 t Vector          | 129 |  | 08.03 | 06.12 |             |                |        |  |                            |     |
|  | 2.0 Turbo Performance | 185 |  | 04.04 | 06.12 |             |                |        |  |                            |     |
|  | 2.0 T                 |     |  | 08.03 | 06.12 |             | 24.0128-0137.1 | 428137 | + 16" Rad <sup>8)</sup>                        | 302 28,0 25,0 V L +S +B    |     |
|  | 2.0 t Vector          | 129 |  | 08.03 | 06.12 |             | 24.0328-0137.1 | 528137 | + 16" Rad <sup>8)</sup>                        | 302 28,0 25,0 V L +S +B PD |     |
|  | 2.0 Turbo Performance | 185 |  | 04.04 | 06.12 |             | 24.0128-0164.1 | 428164 | + 16" plus Rad <sup>9)</sup>                   | 314 28,0 25,0 V L +S +B    |     |
|  | 2.8 T                 | 184 |  | 02.06 | 06.12 |             |                |        |  |                            |     |
|  | 2.8 T                 | 221 |  | 10.08 | 06.12 |             |                |        |  |                            |     |
|  | 2.8 T Aero            | 188 |  | 07.07 | 06.12 |             |                |        |  |                            |     |
|  | 2.8 T V6 Aero         |     |  | 06.08 | 06.12 |             |                |        |  |                            |     |
|  | 1.8 i                 | 90  |  | 01.04 | 06.12 |             | 24.0130-0189.1 | 430189 | + 17" Rad <sup>6)</sup>                        | 345 29,9 27,5 V L +B       |     |
|  | 1.8 t                 | 110 |  | 08.03 | 06.12 |             |                |        |  |                            |     |
|  | 1.8 t BioPower        | 110 |  | 01.07 | 06.12 |             |                |        |  |                            |     |
|  | 1.8 t BioPower        | 129 |  | 07.07 | 06.12 |             |                |        |  |                            |     |
|  | 1.9 TiD               | 88  |  | 09.04 | 06.12 |             |                |        |  |                            |     |
|  | 1.9 TiD               | 110 |  | 01.06 | 06.12 |             |                |        |  |                            |     |
|  | 1.9 TTD               |     |  | 07.07 | 06.12 |             |                |        |  |                            |     |
|  | 2.0                   | 143 |  | 04.06 | 09.07 |             |                |        |  |                            |     |
|  | 2.0 t                 |     |  | 08.03 | 06.12 |             |                |        |  |                            |     |
|  | 2.0 T                 |     |  | 08.03 | 06.12 |             |                |        |  |                            |     |
|  | 2.0 t BioPower        |     |  | 06.07 | 06.12 |             |                |        |  |                            |     |
|  | 2.0 t BioPower        |     |  | 01.07 | 06.12 |             |                |        |  |                            |     |
|  | 2.0 t BioPower        | 147 |  | 07.07 | 06.12 |             |                |        |  |                            |     |
|  | 2.0 Turbo Performance | 185 |  | 04.04 | 06.12 |             |                |        |  |                            |     |
|  | 2.8 T                 | 184 |  | 02.06 | 06.12 |             |                |        |  |                            |     |
|  | 2.8 T                 | 221 |  | 10.08 | 06.12 |             |                |        |  |                            |     |
|  | 2.8 T Aero            | 188 |  | 07.07 | 06.12 |             |                |        |  |                            |     |
|  | 2.8 T V6 Aero         |     |  | 06.08 | 06.12 |             |                |        |  |                            |     |

<sup>1)</sup> + 15"/16" wheel/+ steel piston / + ruota 15"/16" /+ pistone acciaio / + roue 15"/16" /+ piston acier / + rueda 15"/16" /+ pistón acero

<sup>2)</sup> + 15"/16" wheel/+ plastic piston / + ruota 15"/16" /+ pistone plastica / + roue 15"/16" /+ piston plastique / + rueda 15"/16" /+ pistón plástico

<sup>3)</sup> + 16" wheel/+ steel piston / + ruota 16" /+ pistone in acciaio / + roue 16" /+ piston en acier / + rueda 16" /+ pistón de acero

<sup>4)</sup> + 16" wheel/+ plastic piston / + ruota 16" /+ pistone plastica / + roue 16" /+ piston plastique / + rueda 16" /+ pistón plástico

<sup>5)</sup> + 16"/16plus" wheel / + ruota 16"/16plus" / + roue 16"/16plus" / + rueda 16"/16plus"

<sup>6)</sup> + 17" wheel / + ruota 17" / + roue 17" / + rueda 17"

<sup>7)</sup> + 15" wheel / + ruota 15" / + roue 15" / + rueda 15"

<sup>8)</sup> + 16" wheel / + ruota 16" / + roue 16" / + rueda 16"

<sup>9)</sup> + 16" plus wheel / + ruota 16" plus / + roue 16" plus / + rueda 16" plus

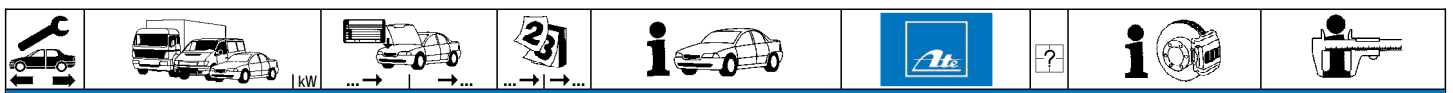

**SAAB 9-3 Cabriolet (YS3F) (03-12)**

|                       |                       |              |          |       |       |                |                |  |                          |     |                        |  |
|-----------------------|-----------------------|--------------|----------|-------|-------|----------------|----------------|--|--------------------------|-----|------------------------|--|
|                       | 1.8 i                 | 90           | 76001222 | 01.04 |       | 13.0460-7194.2 | 607194         | ersetzt Belag mit Federn <sup>1)</sup><br>ersetzt Belag mit Federn <sup>1)</sup> | 23482 16,6 +             | ATE |                        |  |
|                       | 1.8 t                 | 110          | 76001222 | 08.03 |       | 13.0470-7194.2 | LD7194         |  | 23482 16,6 +             | ATE |                        |  |
|                       | 1.8 t BioPower        | 110          | 76001222 | 01.07 |       |                |                |  |                          |     |                        |  |
|                       | 1.8 t BioPower        | 129          | 76001222 | 07.07 |       |                |                |  |                          |     |                        |  |
|                       | 1.9 TiD               | 88           | 76001222 | 09.04 |       |                |                |  |                          |     |                        |  |
|                       | 1.9 TiD               | 110          | 76001222 | 01.06 |       |                |                |  |                          |     |                        |  |
|                       | 1.9 TTiD              |              | 76001222 | 07.07 |       |                |                |  |                          |     |                        |  |
|                       | 2.0                   | 143          | 76001222 | 04.06 |       |                |                |  |                          |     |                        |  |
|                       | 2.0 t                 |              | 76001222 | 08.03 |       |                |                |  |                          |     |                        |  |
|                       | 2.0 T                 |              | 76001222 | 08.03 |       |                |                |  |                          |     |                        |  |
|                       | 2.0 t BioPower        |              | 76001222 | 06.07 |       |                |                |  |                          |     |                        |  |
|                       | 2.0 t BioPower        |              | 76001222 | 01.07 |       |                |                |  |                          |     |                        |  |
|                       | 2.0 t BioPower        | 147          | 76001222 | 07.07 |       |                |                |  |                          |     |                        |  |
|                       | 2.0 Turbo Performance | 185          | 76001222 | 04.04 |       |                |                |  |                          |     |                        |  |
| 2.8 T                 | 184                   | 76001222     | 02.06    |       |       |                |                |  |                          |     |                        |  |
| 2.8 T                 | 221                   | 76001222     | 10.08    |       |       |                |                |  |                          |     |                        |  |
| 2.8 T Aero            | 188                   | 76001222     | 07.07    |       |       |                |                |  |                          |     |                        |  |
| 2.8 T V6 Aero         |                       | 76001222     | 06.08    |       |       |                |                |  |                          |     |                        |  |
|                       | 1.8 i                 | 90           | 76001223 | 06.12 |       | 13.0460-7195.2 | 607195         |  | 23482 16,6 +             | ATE |                        |  |
|                       | 1.8 t                 | 110          | 76001223 | 06.12 |       | 13.0470-7195.2 | LD7195         |  | 23482 16,6 +             | ATE |                        |  |
|                       | 1.8 t BioPower        | 110          | 76001223 | 06.12 |       |                |                |  |                          |     |                        |  |
|                       | 1.8 t BioPower        | 129          | 76001223 | 06.12 |       |                |                |  |                          |     |                        |  |
|                       | 1.9 TiD               | 88           | 76001223 | 06.12 |       |                |                |  |                          |     |                        |  |
|                       | 1.9 TiD               | 110          | 76001223 | 06.12 |       |                |                |  |                          |     |                        |  |
|                       | 1.9 TTiD              |              | 76001223 | 06.12 |       |                |                |  |                          |     |                        |  |
|                       | 2.0                   | 143          | 76001223 | 09.07 |       |                |                |  |                          |     |                        |  |
|                       | 2.0 t                 |              | 76001223 | 06.12 |       |                |                |  |                          |     |                        |  |
|                       | 2.0 T                 |              | 76001223 | 06.12 |       |                |                |  |                          |     |                        |  |
|                       | 2.0 t BioPower        |              | 76001223 | 06.12 |       |                |                |  |                          |     |                        |  |
|                       | 2.0 t BioPower        |              | 76001223 | 06.12 |       |                |                |  |                          |     |                        |  |
|                       | 2.0 t BioPower        | 147          | 76001223 | 06.12 |       |                |                |  |                          |     |                        |  |
|                       | 2.0 Turbo Performance | 185          | 76001223 | 06.12 |       |                |                |  |                          |     |                        |  |
|                       | 2.8 T                 | 184          | 76001223 | 06.12 |       |                |                |  |                          |     |                        |  |
|                       | 2.8 T                 | 221          | 76001223 | 06.12 |       |                |                |  |                          |     |                        |  |
|                       | 2.8 T Aero            | 188          | 76001223 | 06.12 |       |                |                |  |                          |     |                        |  |
|                       | 2.8 T V6 Aero         |              | 76001223 | 06.12 |       |                |                |  |                          |     |                        |  |
|                       |                       | 1.8 t        | 110      |       | 08.03 | 08.05          | 24.0112-0157.1 |  | 412157                   |     | 278 11,9 10,0 +S +B    |  |
|                       |                       | 2.0 t Linear | 129      |       | 08.03 | 08.05          | 24.0312-0157.1 |  | 512157                   |     | 278 11,9 10,0 +S +B PD |  |
| 2.0 T                 |                       |              |          | 08.03 | 08.05 | 24.0120-0173.1 | 420173         | 292 19,9 18,0 V +S +B  |                          |     |                        |  |
| 2.0 t Vector          |                       | 129          |          | 08.03 | 08.05 | 24.0320-0173.1 | 520173         | 292 19,9 18,0 V +S +B PD   |                          |     |                        |  |
| 1.8 i                 |                       | 90           |          | 01.04 | 06.12 | 24.0112-0157.1 | 412157         | + 15" Rad <sup>2)</sup>  | 278 11,9 10,0 +S +B      |     |                        |  |
| 1.8 t                 |                       | 110          |          | 09.05 | 06.12 | 24.0312-0157.1 | 512157         | + 15" Rad <sup>2)</sup>  | 278 11,9 10,0 +S +B PD   |     |                        |  |
| 1.8 t BioPower        |                       | 110          |          | 01.07 | 06.12 | 24.0120-0173.1 | 420173         | + 16" Rad <sup>3)</sup>  | 292 19,9 18,0 V +S +B    |     |                        |  |
| 1.8 t BioPower        |                       | 129          |          | 07.07 | 06.12 | 24.0320-0173.1 | 520173         | + 16" Rad <sup>3)</sup>  | 292 19,9 18,0 V +S +B PD |     |                        |  |
| 1.9 TiD               |                       | 88           |          | 09.04 | 06.12 |                |                |  |                          |     |                        |  |
| 1.9 TiD               |                       | 110          |          | 01.06 | 06.12 |                |                |  |                          |     |                        |  |
| 1.9 TTiD              |                       |              |          | 07.07 | 06.12 |                |                |  |                          |     |                        |  |
| 2.0                   |                       | 143          |          | 04.06 | 09.07 |                |                |  |                          |     |                        |  |
| 2.0 t                 |                       |              |          | 09.05 | 06.12 |                |                |  |                          |     |                        |  |
| 2.0 T                 |                       |              |          | 09.05 | 06.12 |                |                |  |                          |     |                        |  |
| 2.0 t BioPower        |                       |              | 06.07    | 06.12 |       |                |                |  |                          |     |                        |  |
| 2.0 t BioPower        |                       |              | 01.07    | 06.12 |       |                |                |  |                          |     |                        |  |
| 2.0 t BioPower        | 147                   |              | 07.07    | 06.12 |       |                |                |  |                          |     |                        |  |
| 2.0 t Linear          | 129                   |              | 09.05    | 06.12 |       |                |                |  |                          |     |                        |  |
| 2.0 t Vector          | 129                   |              | 09.05    | 06.12 |       |                |                |  |                          |     |                        |  |
| 2.0 Turbo Performance | 185                   |              | 04.04    | 06.12 |       |                |                |  |                          |     |                        |  |
| 2.8 T                 | 184                   |              | 02.06    | 06.12 |       |                |                |  |                          |     |                        |  |
| 2.8 T                 | 221                   |              | 10.08    | 06.12 |       |                |                |  |                          |     |                        |  |
| 2.8 T Aero            | 188                   |              | 07.07    | 06.12 |       |                |                |  |                          |     |                        |  |
| 2.8 T V6 Aero         |                       |              | 06.08    | 06.12 |       |                |                |  |                          |     |                        |  |

**SAAB 9-3 X (09-12)**

|  |                    |     |  |       |       |                |        |   |                            |     |
|--|--------------------|-----|--|-------|-------|----------------|--------|---|----------------------------|-----|
|  | 1.9 TTiD           | 96  |  | 01.10 | 06.12 | 13.0460-7212.2 | 607212 | + 15"/16" Rad/+ Stahlkolben <sup>4)</sup><br>+ 15"/16" Rad/+ Kunststoffkolben <sup>5)</sup><br>+ 15"/16" Rad/+ Kunststoffkolben <sup>5)</sup> | 23738 20,1 +/WE            | ATE |
|  | 1.9 TTiD           | 132 |  | 03.09 | 06.12 | 13.0460-7172.2 | 607172 |   | 23402 20,1 +/WE            | ATE |
|  | 2.0 T BioPower XWD | 120 |  | 01.11 | 06.12 | 13.0470-7172.2 | LD7172 |   | 23402 20,1 +/WE            | ATE |
|  | 2.0 T BioPower XWD | 154 |  | 03.09 | 06.12 |                |        |   |                            |     |
|  | 2.0 T BioPower XWD | 162 |  | 01.11 | 06.12 |                |        |   |                            |     |
|  | 2.0 T XWD          | 154 |  | 03.09 | 06.12 |                |        |   |                            |     |
|  | 1.9 TTiD           | 96  |  | 01.10 | 06.12 | 13.0460-7199.2 | 607199 | + 16" plus Rad <sup>6)</sup>  | 23404 20,6 +/WE            | ATE |
|  | 1.9 TTiD           | 132 |  | 03.09 | 06.12 |                |        |   |                            |     |
|  | 2.0 T BioPower XWD | 120 |  | 01.11 | 06.12 |                |        |   |                            |     |
|  | 2.0 T BioPower XWD | 154 |  | 03.09 | 06.12 |                |        |   |                            |     |
|  | 2.0 T BioPower XWD | 162 |  | 01.11 | 06.12 |                |        |   |                            |     |
|  | 2.0 T XWD          | 154 |  | 03.09 | 06.12 |                |        |   |                            |     |
|  | 1.9 TTiD           | 96  |  | 01.10 | 06.12 | 13.0460-7204.2 | 607204 | + 17" Rad <sup>7)</sup><br>+ 17" Rad <sup>7)</sup>  | 23912 18,8 +               | ATE |
|  | 1.9 TTiD           | 132 |  | 03.09 | 06.12 | 13.0470-7204.2 | LD7204 |   | 23912 18,8 +               | ATE |
|  | 2.0 T BioPower XWD | 120 |  | 01.11 | 06.12 |                |        |   |                            |     |
|  | 2.0 T BioPower XWD | 154 |  | 03.09 | 06.12 |                |        |   |                            |     |
|  | 2.0 T BioPower XWD | 162 |  | 01.11 | 06.12 |                |        |   |                            |     |
|  | 2.0 T XWD          | 154 |  | 03.09 | 06.12 |                |        |   |                            |     |
|  | 1.9 TTiD           | 96  |  | 01.10 | 06.12 | 24.0125-0141.1 | 425141 | + 15" Rad <sup>2)</sup><br>+ 15" Rad <sup>2)</sup>  | 285 24,9 22,0 V L +S +B    |     |
|  | 1.9 TTiD           | 132 |  | 03.09 | 06.12 | 24.0325-0141.1 | 525141 |   | 285 24,9 22,0 V L +S +B PD |     |
|  | 2.0 T BioPower XWD | 120 |  | 01.11 | 06.12 |                |        |   |                            |     |
|  | 2.0 T BioPower XWD | 154 |  | 03.09 | 06.12 |                |        |   |                            |     |
|  | 2.0 T BioPower XWD | 162 |  | 01.11 | 06.12 |                |        |   |                            |     |
|  | 2.0 T XWD          | 154 |  | 03.09 | 06.12 |                |        |   |                            |     |

<sup>1)</sup> replaces pad with springs / sostituisce la guarnizione con molle / remplace la garniture avec ressorts / sustituye guarnición con resortes

<sup>2)</sup> + 15" wheel / + ruota 15" / + roue 15" / + rueda 15"

<sup>3)</sup> + 16" wheel / + ruota 16" / + roue 16" / + rueda 16"

<sup>4)</sup> + 15"/16" wheel+ steel piston / + ruota 15"/16"/+ pistone acciaio / + roue 15"/16"/+ piston acier / + rueda 15"/16"/+ pistón acero















<sup>5)</sup> + 15"/16" wheel+ plastic piston / + ruota 15"/16"/+ pistone plastica / + roue 15"/16"/+ piston plastique / + rueda 15"/16"/+ pistón plástico

<sup>6)</sup> + 16" plus wheel / + ruota 16" plus / + roue 16" plus / + rueda 16" plus

<sup>7)</sup> + 17" wheel / + ruota 17" / + roue 17" / + rueda 17"





|    |    |  |  |  |  |  |  |  |                            |                            |
|---|--|--|--|--|---|--|--|--|----------------------------|----------------------------|
| <b>SAAB 9-3 X (09-12)</b>   |  |  |  |  |   |  |  |  |                            |                            |
|   | 1.9 TTiD   | 96   |  | 01.10  | 06.12   | 24.0128-0137.1   | 428137   | + 16" Rad <sup>1)</sup>  | 302 28,0 25,0 V L +S +B    |                            |
|   | 1.9 TTiD   | 132  |  | 03.09  | 06.12   | 24.0328-0137.1   | 528137   | + 16" Rad <sup>1)</sup>  | 302 28,0 25,0 V L +S +B PD |                            |
|   | 2.0 T BioPower XWD   | 120  |  | 01.11  | 06.12   |  |  |  |                            |                            |
|   | 2.0 T BioPower XWD   | 154  |  | 03.09  | 06.12   |  |  |  |                            |                            |
|   | 2.0 T BioPower XWD   | 162  |  | 01.11  | 06.12   |  |  |  |                            |                            |
|   | 2.0 T XWD  | 154  |  | 03.09  | 06.12   |  |  |  |                            |                            |
|   | 1.9 TTiD   | 96   |  | 01.10  | 06.12   | 24.0128-0164.1   | 428164   | + 16" plus Rad <sup>2)</sup>   | 314 28,0 25,0 V L +S +B    |                            |
|   | 1.9 TTiD   | 132  |  | 03.09  | 06.12   |  |  |  |                            |                            |
|   | 2.0 T BioPower XWD   | 120  |  | 01.11  | 06.12   |  |  |  |                            |                            |
|   | 2.0 T BioPower XWD   | 154  |  | 03.09  | 06.12   |  |  |  |                            |                            |
|   | 2.0 T BioPower XWD   | 162  |  | 01.11  | 06.12   |  |  |  |                            |                            |
|   | 2.0 T XWD  | 154  |  | 03.09  | 06.12   |  |  |  |                            |                            |
|   | 1.9 TTiD   | 96   |  | 01.10  | 06.12   | 24.0130-0189.1   | 430189   | + 17" Rad <sup>3)</sup>  | 345 29,9 27,5 V L +B       |                            |
|   | 1.9 TTiD   | 132  |  | 03.09  | 06.12   |  |  |  |                            |                            |
|   | 2.0 T BioPower XWD   | 120  |  | 01.11  | 06.12   |  |  |  |                            |                            |
| 2.0 T BioPower XWD  | 154  |  | 03.09  | 06.12  |   |  |  |  |                            |                            |
| 2.0 T BioPower XWD  | 162  |  | 01.11  | 06.12  |   |  |  |  |                            |                            |
| 2.0 T XWD   | 154  |  | 03.09  | 06.12  |   |  |  |  |                            |                            |
|   | 1.9 TTiD   | 96   |  | 01.10  | 06.12   | 13.0460-7195.2   | 607195   |  | 23482 16,6 + ATE           |                            |
|   | 1.9 TTiD   | 132  |  | 03.09  | 06.12   | 13.0470-7195.2   | LD7195   |  | 23482 16,6 + ATE           |                            |
|   | 2.0 T BioPower XWD   | 120  |  | 01.11  | 06.12   |  |  |  |                            |                            |
|   | 2.0 T BioPower XWD   | 154  |  | 03.09  | 06.12   |  |  |  |                            |                            |
|   | 2.0 T BioPower XWD   | 162  |  | 01.11  | 06.12   |  |  |  |                            |                            |
|   | 2.0 T XWD  | 154  |  | 03.09  | 06.12   |  |  |  |                            |                            |
|   | 1.9 TTiD   | 96   |  | 01.10  | 06.12   | 24.0112-0157.1   | 412157   | + 15" Rad <sup>4)</sup>  | 278 11,9 10,0 +S +B        |                            |
|   | 1.9 TTiD   | 132  |  | 03.09  | 06.12   | 24.0312-0157.1   | 512157   | + 15" Rad <sup>4)</sup>  | 278 11,9 10,0 +S +B PD     |                            |
|   | 2.0 T BioPower XWD   | 120  |  | 01.11  | 06.12   |  |  |  |                            |                            |
|   | 2.0 T BioPower XWD   | 154  |  | 03.09  | 06.12   |  |  |  |                            |                            |
|   | 2.0 T BioPower XWD   | 162  |  | 01.11  | 06.12   |  |  |  |                            |                            |
|   | 2.0 T XWD  | 154  |  | 03.09  | 06.12   |  |  |  |                            |                            |
|   | 1.9 TTiD   | 96   |  | 01.10  | 06.12   | 24.0120-0173.1   | 420173   | - 15" Rad <sup>5)</sup>  | 292 19,9 18,0 V +S +B      |                            |
|   | 1.9 TTiD   | 132  |  | 03.09  | 06.12   | 24.0320-0173.1   | 520173   | - 15" Rad <sup>5)</sup>  | 292 19,9 18,0 V +S +B PD   |                            |
|   | 2.0 T BioPower XWD   | 120  |  | 01.11  | 06.12   |  |  |  |                            |                            |
|   | 2.0 T BioPower XWD   | 154  |  | 03.09  | 06.12   |  |  |  |                            |                            |
|   | 2.0 T BioPower XWD   | 162  |  | 01.11  | 06.12   |  |  |  |                            |                            |
|   | 2.0 T XWD  | 154  |  | 03.09  | 06.12   |  |  |  |                            |                            |
| <b>SAAB 9-5 Limousine (YS3E) (97-10)</b>  |  |  |  |  |   |  |  |  |                            |                            |
|  | 1.9 TiD  | 110  |  | 01.06  | 02.10   | 13.0460-7173.2   | 607173   | + 16" Rad <sup>1)</sup>  | 23116 20,3 +/WK ATE        |                            |
|   | 2.0  | 136  |  | 07.00  | 02.10   | 13.0460-7091.2   | 607091   |  | 21829 20,3 +/WE ATE        |                            |
|   | 2.0 t  | 110  |  | 09.97  | 02.10   | 24.8190-0718.2   | 620718   | 2  | Warnkontakt L=720mm        |                            |
|   | 2.0 T  | 129  |  | 10.98  | 02.10   |  |  |  |                            |                            |
|   | 2.0 t BioPower   | 110  |  | 01.05  | 02.10   |  |  |  |                            |                            |
|   | 2.0 t BioPower   | 132  |  | 06.06  | 02.10   |  |  |  |                            |                            |
|   | 2.0 Turbo SE   | 141  |  | 10.98  | 07.00   |  |  |  |                            |                            |
|   | 2.2 TiD  | 88   |  | 03.02  | 02.10   |  |  |  |                            |                            |
|   | 2.3 t  | 125  |  | 09.97  | 02.10   |  |  |  |                            |                            |
|   | 2.3 T  | 134  |  | 04.08  | 02.10   |  |  |  |                            |                            |
|   | 2.3 t  | 136  |  | 01.01  | 02.10   |  |  |  |                            |                            |
|   | 2.3 T  | 162  |  | 07.03  | 02.10   |  |  |  |                            |                            |
|   | 2.3 T  | 188  |  | 04.08  | 02.10   |  |  |  |                            |                            |
|   | 2.3 T  | 191  |  | 11.05  | 02.10   |  |  |  |                            |                            |
|   | 2.3 T Aero   | 169  |  | 01.00  | 09.01   |  |  |  |                            |                            |
|   | 2.3 T Aero   | 184  |  | 09.01  | 02.10   |  |  |  |                            |                            |
|   | 2.3 T Aero   | 225  |  | 04.03  | 03.04   |  |  |  |                            |                            |
|   | 2.3 t BioPower   | 136  |  | 01.07  | 02.10   |  |  |  |                            |                            |
|   | 2.3 t BioPower   | 152  |  | 11.06  | 02.10   |  |  |  |                            |                            |
|   | 2.3 t BioPower   | 154  |  | 01.07  | 02.10   |  |  |  |                            |                            |
|   | 3.0 t  | 147  |  | 01.98  | 02.10   |  |  |  |                            |                            |
|   | 3.0 TiD  | 130  |  | 07.01  | 02.10   |  |  |  |                            |                            |
|   |  | 1.9 TiD  | 110  |  | 01.06   | 02.10  | 24.0125-0119.1   | 425119   | + 15" Rad <sup>4)</sup>    | 288 25,0 22,0 V L +S +B    |
|   |  | 2.0  | 136  |  | 07.00   | 02.10  | 24.0325-0119.1   | 525119   | + 15" Rad <sup>4)</sup>    | 288 25,0 22,0 V L +S +B PD |
| 2.0 t   |  | 110  |  | 09.97  | 02.10   |  |  |  |                            |                            |
| 2.0 T   |  | 129  |  | 10.98  | 02.10   |  |  |  |                            |                            |
| 2.0 t BioPower  |  | 110  |  | 01.05  | 02.10   |  |  |  |                            |                            |
| 2.0 t BioPower  |  | 132  |  | 06.06  | 02.10   |  |  |  |                            |                            |
| 2.0 Turbo SE  |  | 141  |  | 10.98  | 07.00   |  |  |  |                            |                            |
| 2.2 TiD   |  | 88   |  | 03.02  | 02.10   |  |  |  |                            |                            |
| 2.3 t   |  | 125  |  | 09.97  | 02.10   |  |  |  |                            |                            |
| 2.3 T   |  | 134  |  | 04.08  | 02.10   |  |  |  |                            |                            |
| 2.3 t   |  | 136  |  | 01.01  | 02.10   |  |  |  |                            |                            |
| 2.3 T   |  | 162  | 43510123   | 02.10  | + USA   |  |  |  |                            |                            |
| 2.3 T   |  | 162  |  | 07.03  | 02.10   |  |  |  |                            |                            |
| 2.3 t BioPower  |  | 136  |  | 01.07  | 02.10   |  |  |  |                            |                            |
| 2.3 t BioPower  |  | 152  |  | 11.06  | 02.10   |  |  |  |                            |                            |
| 2.3 t BioPower  |  | 154  |  | 01.07  | 02.10   |  |  |  |                            |                            |
| 2.3 T   |  | 162  | 43510122   | 07.03  | + USA   | 24.0125-0142.1   | 425142   | + 16" Rad <sup>1)</sup>  | 308 25,0 22,0 V L +S +B    |                            |
| 2.3 T   |  | 188  |  | 04.08  | 02.10   | 24.0325-0142.1   | 525142   | + 16" Rad <sup>1)</sup>  | 308 25,0 22,0 V L +S +B PD |                            |
| 2.3 T   | 191  |  | 11.05  | 02.10  |   |  |  |  |                            |                            |
| 2.3 T Aero  | 169  |  | 10.99  | 09.01  |   |  |  |  |                            |                            |
| 2.3 T Aero  | 184  |  | 09.01  | 02.10  |   |  |  |  |                            |                            |
| 2.3 T Aero  | 225  |  | 04.03  | 03.04  |   |  |  |  |                            |                            |
| 3.0 t   | 147  |  | 01.98  | 02.10  |   |  |  |  |                            |                            |
| 3.0 TiD   | 130  |  | 07.01  | 02.10  |   |  |  |  |                            |                            |

<sup>1)</sup> + 16" wheel / + ruota 16" / + roue 16" / + rueda 16"

<sup>2)</sup> + 16" plus wheel / + ruota 16" plus / + roue 16" plus / + rueda 16" plus

<sup>3)</sup> + 17" wheel / + ruota 17" / + roue 17" / + rueda 17"

<sup>4)</sup> + 15" wheel / + ruota 15" / + roue 15" / + rueda 15"

<sup>5)</sup> - 15" wheel / - ruota 15" / - roue 15" / - rueda 15"



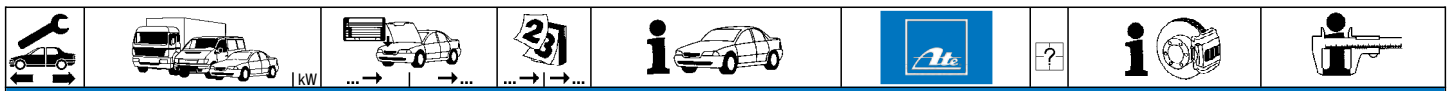

**SAAB 9-5 Limousine (YS3E) (97-10)**

|                |                |          |          |       |       |                |        |  |                       |     |
|----------------|----------------|----------|----------|-------|-------|----------------|--------|--|-----------------------|-----|
|                | 2.0 t          | 110      | X3025751 | 09.97 |       | 13.0460-4040.2 | 604040 |  | 21050 15,8            | ATE |
|                | 2.0 T          | 129      | X3025751 | 10.98 |       | 13.0460-0347.2 | 610347 |  | Belagsatz-Zubehör     |     |
|                | 2.0 Turbo SE   | 141      | X3025751 | 10.98 |       |                |        |  |                       |     |
|                | 2.3 t          | 125      | X3025751 | 09.97 |       |                |        |  |                       |     |
|                | 3.0 t          | 147      | X3025751 | 01.98 |       |                |        |  |                       |     |
|                | 1.9 TiD        | 110      |          | 01.06 | 02.10 | 13.0460-3605.2 | 603605 |  | 20180 17,3 +/WE       | ATE |
|                | 2.0            | 136      |          | 07.00 | 02.10 | 13.0470-3605.2 | LD3605 |  | 20180 17,3 +/WE       | ATE |
|                | 2.0 t          | 110      | X3025752 |       | 02.10 |                |        |  |                       |     |
|                | 2.0 T          | 129      | X3025752 |       | 02.10 |                |        |  |                       |     |
|                | 2.0 t BioPower | 110      |          | 01.05 | 02.10 |                |        |  |                       |     |
|                | 2.0 t BioPower | 132      |          | 06.06 | 02.10 |                |        |  |                       |     |
|                | 2.0 Turbo SE   | 141      | X3025752 |       | 07.00 |                |        |  |                       |     |
|                | 2.2 TiD        | 88       |          | 03.02 | 02.10 |                |        |  |                       |     |
|                | 2.3 t          | 125      | X3025752 |       | 02.10 |                |        |  |                       |     |
|                | 2.3 T          | 134      |          | 04.08 | 02.10 |                |        |  |                       |     |
|                | 2.3 t          | 136      |          | 01.01 | 02.10 |                |        |  |                       |     |
|                | 2.3 T          | 162      |          | 07.03 | 02.10 |                |        |  |                       |     |
| 2.3 T          | 188            |          | 04.08    | 02.10 |       |                |        |  |                       |     |
| 2.3 T          | 191            |          | 11.05    | 02.10 |       |                |        |  |                       |     |
| 2.3 T Aero     | 169            |          | 10.99    | 09.01 |       |                |        |  |                       |     |
| 2.3 T Aero     | 184            |          | 09.01    | 02.10 |       |                |        |  |                       |     |
| 2.3 T Aero     | 225            |          | 04.03    | 03.04 |       |                |        |  |                       |     |
| 2.3 t BioPower | 136            |          | 01.07    | 02.10 |       |                |        |  |                       |     |
| 2.3 t BioPower | 152            |          | 11.06    | 02.10 |       |                |        |  |                       |     |
| 2.3 t BioPower | 154            |          | 01.07    | 02.10 |       |                |        |  |                       |     |
| 3.0 t          | 147            | X3025752 |          | 02.10 |       |                |        |  |                       |     |
| 3.0 TiD        | 130            |          | 07.01    | 02.10 |       |                |        |  |                       |     |
|                | 2.0 t          | 110      | X3025751 | 09.97 |       | 24.0110-0226.1 | 410226 |  | 286 10,0 8,0 +S +B    |     |
|                | 2.0 T          | 129      | X3025751 | 10.98 |       | 24.0310-0226.1 | 510226 |  | 286 10,0 8,0 +S +B PD |     |
|                | 2.0 Turbo SE   | 141      | X3025751 | 10.98 |       |                |        |  |                       |     |
|                | 2.3 t          | 125      | X3025751 | 09.97 |       |                |        |  |                       |     |
|                | 3.0 t          | 147      | X3025751 | 01.98 |       |                |        |  |                       |     |
|                | 1.9 TiD        | 110      |          | 01.06 | 02.10 | 24.0110-0274.1 | 410274 |  | 286 10,0 8,0 +S +B    |     |
|                | 2.0            | 136      |          | 07.00 | 02.10 |                |        |  |                       |     |
|                | 2.0 t          | 110      | X3025752 |       | 02.10 |                |        |  |                       |     |
|                | 2.0 T          | 129      | X3025752 |       | 02.10 |                |        |  |                       |     |
|                | 2.0 t BioPower | 110      |          | 01.05 | 02.10 |                |        |  |                       |     |
|                | 2.0 t BioPower | 132      |          | 06.06 | 02.10 |                |        |  |                       |     |
|                | 2.0 Turbo SE   | 141      | X3025752 |       | 07.00 |                |        |  |                       |     |
|                | 2.2 TiD        | 88       |          | 03.02 | 02.10 |                |        |  |                       |     |
|                | 2.3 t          | 125      | X3025752 |       | 02.10 |                |        |  |                       |     |
|                | 2.3 T          | 134      |          | 04.08 | 02.10 |                |        |  |                       |     |
|                | 2.3 t          | 136      |          | 01.01 | 02.10 |                |        |  |                       |     |
|                | 2.3 T          | 162      |          | 07.03 | 02.10 |                |        |  |                       |     |
| 2.3 T Aero     | 169            |          | 10.99    | 09.01 |       |                |        |  |                       |     |
| 2.3 T Aero     | 184            |          | 09.01    | 12.01 |       |                |        |  |                       |     |
| 2.3 t BioPower | 136            |          | 01.07    | 02.10 |       |                |        |  |                       |     |
| 2.3 t BioPower | 152            |          | 11.06    | 02.10 |       |                |        |  |                       |     |
| 2.3 t BioPower | 154            |          | 01.07    | 02.10 |       |                |        |  |                       |     |
| 3.0 t          | 147            | X3025752 |          | 12.01 |       |                |        |  |                       |     |
| 3.0 TiD        | 130            |          | 07.01    | 12.01 |       |                |        |  |                       |     |
|                | 2.3 T          | 188      |          | 04.08 | 02.10 | 24.0120-0196.1 | 420196 |  | 300 20,0 18,0 V +S +B |     |
|                | 2.3 T          | 191      |          | 11.05 | 02.10 |                |        |  |                       |     |
|                | 2.3 T Aero     | 184      |          | 01.02 | 02.10 |                |        |  |                       |     |
|                | 2.3 T Aero     | 225      |          | 04.03 | 03.04 |                |        |  |                       |     |
|                | 3.0 t          | 147      |          | 01.02 | 02.10 |                |        |  |                       |     |
|                | 3.0 TiD        | 130      |          | 01.02 | 02.10 |                |        |  |                       |     |
|                | 1.9 TiD        | 110      |          | 01.06 | 02.10 | 03.0137-0172.2 | 650172 |  | 160 x 25              |     |
|                | 2.0            | 136      |          | 07.00 | 02.10 |                |        |  |                       |     |
|                | 2.0 t          | 110      |          | 09.97 | 02.10 |                |        |  |                       |     |
|                | 2.0 T          | 129      |          | 10.98 | 02.10 |                |        |  |                       |     |
|                | 2.0 t BioPower | 110      |          | 01.05 | 02.10 |                |        |  |                       |     |
|                | 2.0 t BioPower | 132      |          | 06.06 | 02.10 |                |        |  |                       |     |
|                | 2.0 Turbo SE   | 141      |          | 10.98 | 07.00 |                |        |  |                       |     |
|                | 2.2 TiD        | 88       |          | 03.02 | 02.10 |                |        |  |                       |     |
|                | 2.3 t          | 125      |          | 09.97 | 02.10 |                |        |  |                       |     |
|                | 2.3 T          | 134      |          | 04.08 | 02.10 |                |        |  |                       |     |
|                | 2.3 t          | 136      |          | 01.01 | 02.10 |                |        |  |                       |     |
|                | 2.3 T          | 162      |          | 07.03 | 02.10 |                |        |  |                       |     |
|                | 2.3 T          | 188      |          | 04.08 | 02.10 |                |        |  |                       |     |
|                | 2.3 T          | 191      |          | 11.05 | 02.10 |                |        |  |                       |     |
|                | 2.3 T Aero     | 169      |          | 10.99 | 09.01 |                |        |  |                       |     |
|                | 2.3 T Aero     | 184      |          | 09.01 | 02.10 |                |        |  |                       |     |
|                | 2.3 T Aero     | 225      |          | 04.03 | 03.04 |                |        |  |                       |     |
| 2.3 t BioPower | 136            |          | 01.07    | 02.10 |       |                |        |  |                       |     |
| 2.3 t BioPower | 152            |          | 11.06    | 02.10 |       |                |        |  |                       |     |
| 2.3 t BioPower | 154            |          | 01.07    | 02.10 |       |                |        |  |                       |     |
| 3.0 t          | 147            |          | 01.98    | 02.10 |       |                |        |  |                       |     |
| 3.0 TiD        | 130            |          | 07.01    | 02.10 |       |                |        |  |                       |     |

**SAAB 9-5 Kombi (YS3E) (98-10)**

|  |                |     |  |       |       |                |        |                         |                     |     |
|--|----------------|-----|--|-------|-------|----------------|--------|-------------------------|---------------------|-----|
|  | 1.9 TiD        | 110 |  | 01.06 | 02.10 | 13.0460-7173.2 | 607173 |                         | 23116 20,3 +/WK     | ATE |
|  | 1.9 TiD        | 129 |  | 01.07 | 02.10 | 13.0460-7091.2 | 607091 | + 16" Rad <sup>1)</sup> | 21829 20,3 +/WE     | ATE |
|  | 2.0            | 136 |  | 07.00 | 07.01 | 24.8190-0718.2 | 620718 | 2                       | Warnkontakt L=720mm |     |
|  | 2.0 t          | 110 |  | 10.98 | 02.10 |                |        |                         |                     |     |
|  | 2.0 t          | 141 |  | 10.98 | 02.10 |                |        |                         |                     |     |
|  | 2.0 t BioPower | 136 |  | 06.06 | 02.10 |                |        |                         |                     |     |
|  | ↓              |     |  |       |       |                |        |                         |                     |     |

<sup>1)</sup> + 16" wheel / + ruota 16" / + roue 16" / + rueda 16"



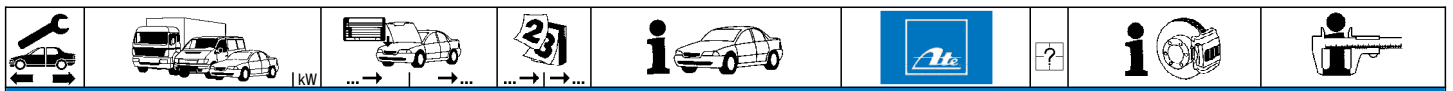

**SAAB 9-5 Kombi (YS3E) (98-10)**

|                |                |          |          |       |       |                |        |   |                              |   |            |  |  |                                  |            |
|----------------|----------------|----------|----------|-------|-------|----------------|--------|---|------------------------------|---|------------|--|--|----------------------------------|------------|
|                | 2.0 t BioPower | 110      |          | 01.06 | 02.10 | 13.0460-7173.2 | 607173 | 2 | + 16" Rad 1)                 | 23116 20,3 +WK<br>21829 20,3 +WE<br>Warnkontakt L=720mm | ATE<br>ATE |  |  |                                  |            |
|                | 2.2 TiD        | 88       |          | 03.02 | 02.10 | 13.0460-7091.2 | 607091 |   |                              |   |            |  |  |                                  |            |
|                | 2.3            | 224      |          | 06.03 | 08.05 | 24.8190-0718.2 | 620718 |   |                              |   |            |  |  |                                  |            |
|                | 2.3 t          | 125      |          | 10.98 | 02.10 |                |        |   |                              |   |            |  |  |                                  |            |
|                | 2.3 t          | 136      |          | 01.02 | 02.10 |                |        |   |                              |   |            |  |  |                                  |            |
|                | 2.3 T          | 162      |          | 07.03 | 02.10 |                |        |   |                              |   |            |  |  |                                  |            |
|                | 2.3 T          | 188      |          | 04.08 | 02.10 |                |        |   |                              |   |            |  |  |                                  |            |
|                | 2.3 T          | 191      |          | 01.06 | 02.10 |                |        |   |                              |   |            |  |  |                                  |            |
|                | 2.3 T Aero     | 169      |          | 10.99 | 09.01 |                |        |   |                              |   |            |  |  |                                  |            |
|                | 2.3 T Aero     | 184      |          | 09.01 | 02.10 |                |        |   |                              |   |            |  |  |                                  |            |
|                | 2.3 T Aero     | 225      |          | 04.03 | 03.04 |                |        |   |                              |   |            |  |  |                                  |            |
|                | 2.3 t BioPower | 136      |          | 01.07 | 02.10 |                |        |   |                              |   |            |  |  |                                  |            |
|                | 2.3 t BioPower | 152      |          | 11.06 | 02.10 |                |        |   |                              |   |            |  |  |                                  |            |
|                | 2.3 t BioPower | 154      |          | 01.07 | 02.10 |                |        |   |                              |   |            |  |  |                                  |            |
|                | 3.0 t          | 147      |          | 10.98 | 02.10 |                |        |   |                              |   |            |  |  |                                  |            |
| 3.0 TiD        | 130            |          | 07.01    | 02.10 |       |                |        |   |                              |   |            |  |  |                                  |            |
|                | 1.9 TiD        | 110      |          | 01.06 | 02.10 | 24.0125-0119.1 | 425119 |   | + 15" Rad 2)<br>+ 15" Rad 2) | 288 25,0 22,0 V L +S +B<br>288 25,0 22,0 V L +S +B PD   |            |  |  |                                  |            |
|                | 1.9 TiD        | 129      |          | 01.07 | 02.10 | 24.0325-0119.1 | 525119 |   |                              |   |            |  |  |                                  |            |
|                | 2.0            | 136      |          | 07.00 | 07.01 |                |        |   |                              |   |            |  |  |                                  |            |
|                | 2.0 t          | 110      |          | 10.98 | 02.10 |                |        |   |                              |   |            |  |  |                                  |            |
|                | 2.0 t          | 141      |          | 10.98 | 02.10 |                |        |   |                              |   |            |  |  |                                  |            |
|                | 2.0 t BioPower |          |          | 06.06 | 02.10 |                |        |   |                              |   |            |  |  |                                  |            |
|                | 2.0 t BioPower | 110      |          | 01.06 | 02.10 |                |        |   |                              |   |            |  |  |                                  |            |
|                | 2.2 TiD        | 88       |          | 03.02 | 02.10 |                |        |   |                              |   |            |  |  |                                  |            |
|                | 2.3 t          | 125      |          | 10.98 | 02.10 |                |        |   |                              |   |            |  |  |                                  |            |
|                | 2.3 t          | 136      |          | 01.01 | 02.10 |                |        |   |                              |   |            |  |  |                                  |            |
|                | 2.3 T          | 162      | 43510123 |       | 02.10 | + (USA)        |        |   |                              |   |            |  |  |                                  |            |
|                | 2.3 T          | 162      |          | 07.03 | 02.10 | - (USA)        |        |   |                              |   |            |  |  |                                  |            |
|                | 2.3 t BioPower | 136      |          | 01.07 | 02.10 |                |        |   |                              |   |            |  |  |                                  |            |
|                | 2.3 t BioPower | 152      |          | 11.06 | 02.10 |                |        |   |                              |   |            |  |  |                                  |            |
|                | 2.3 t BioPower | 154      |          | 01.07 | 02.10 |                |        |   |                              |   |            |  |  |                                  |            |
| 3.0 t          | 147            |          | 10.98    | 02.10 |       |                |        |   |                              |   |            |  |  |                                  |            |
|                | 2.0            | 136      |          | 07.00 | 07.01 | 24.0125-0142.1 | 425142 |   | + 16" Rad 1)<br>+ 16" Rad 1) | 308 25,0 22,0 V L +S +B<br>308 25,0 22,0 V L +S +B PD   |            |  |  |                                  |            |
|                | 2.0 t          | 110      |          | 10.98 | 02.10 | 24.0325-0142.1 | 525142 |   |                              |   |            |  |  |                                  |            |
|                | 2.0 t          | 141      |          | 10.98 | 02.10 |                |        |   |                              |   |            |  |  |                                  |            |
|                | 2.3            | 224      |          | 06.03 | 08.05 |                |        |   |                              |   |            |  |  |                                  |            |
|                | 2.3 t          | 125      |          | 10.98 | 02.10 |                |        |   |                              |   |            |  |  |                                  |            |
|                | 2.3 T          | 162      | 43510122 | 07.03 |       | + (USA)        |        |   |                              |   |            |  |  |                                  |            |
|                | 2.3 T          | 188      |          | 04.08 | 02.10 |                |        |   |                              |   |            |  |  |                                  |            |
|                | 2.3 T          | 191      |          | 01.06 | 02.10 |                |        |   |                              |   |            |  |  |                                  |            |
|                | 2.3 T Aero     | 169      |          | 10.99 | 09.01 |                |        |   |                              |   |            |  |  |                                  |            |
|                | 2.3 T Aero     | 184      |          | 09.01 | 02.10 |                |        |   |                              |   |            |  |  |                                  |            |
|                | 2.3 T Aero     | 225      |          | 04.03 | 03.04 |                |        |   |                              |   |            |  |  |                                  |            |
|                | 2.3 t BioPower | 136      |          | 01.07 | 02.10 |                |        |   |                              |   |            |  |  |                                  |            |
|                | 2.3 t BioPower | 152      |          | 11.06 | 02.10 |                |        |   |                              |   |            |  |  |                                  |            |
|                | 2.3 t BioPower | 154      |          | 01.07 | 02.10 |                |        |   |                              |   |            |  |  |                                  |            |
|                | 3.0 t          | 147      |          | 10.98 | 02.10 |                |        |   |                              |   |            |  |  |                                  |            |
| 3.0 TiD        | 130            |          | 07.01    | 02.10 |       |                |        |   |                              |   |            |  |  |                                  |            |
|                | 2.0            | 136      | X3025751 | 07.00 |       | 13.0460-4040.2 | 604040 |   |                              | 21050 15,8<br>Belagsatz-Zubehör                         | ATE        |  |  |                                  |            |
|                | 2.0 t          | 110      | X3025751 | 10.98 |       | 13.0460-0347.2 | 610347 |   |                              |   |            |  |  |                                  |            |
|                | 2.0 t          | 141      | X3025751 | 10.98 |       |                |        |   |                              |   |            |  |  |                                  |            |
|                | 2.0 t BioPower |          | X3025751 | 06.06 |       |                |        |   |                              |   |            |  |  |                                  |            |
|                | 2.0 t BioPower | 110      | X3025751 | 01.06 |       |                |        |   |                              |   |            |  |  |                                  |            |
|                | 2.3 t          | 125      | X3025751 | 10.98 |       |                |        |   |                              |   |            |  |  |                                  |            |
|                | 2.3 t BioPower | 136      | X3025751 | 01.07 |       |                |        |   |                              |   |            |  |  |                                  |            |
|                | 2.3 t BioPower | 152      | X3025751 | 11.06 |       |                |        |   |                              |   |            |  |  |                                  |            |
|                | 2.3 t BioPower | 154      | X3025751 | 01.07 |       |                |        |   |                              |   |            |  |  |                                  |            |
|                | 3.0 t          | 147      | X3025751 | 10.98 |       |                |        |   |                              |   |            |  |  |                                  |            |
|                | 1.9 TiD        | 110      |          | 01.06 | 02.10 | 13.0460-3605.2 | 603605 |   |                              |   |            |  |  | 20180 17,3 +WE<br>20180 17,3 +WE | ATE<br>ATE |
|                | 1.9 TiD        | 129      |          | 01.07 | 02.10 | 13.0470-3605.2 | LD3605 |   |                              |   |            |  |  |                                  |            |
|                | 2.0            | 136      | X3025752 |       | 07.01 |                |        |   |                              |   |            |  |  |                                  |            |
|                | 2.0 t          | 110      | X3025752 |       | 02.10 |                |        |   |                              |   |            |  |  |                                  |            |
|                | 2.0 t          | 141      | X3025752 |       | 02.10 |                |        |   |                              |   |            |  |  |                                  |            |
| 2.0 t BioPower |                | X3025752 |          | 02.10 |       |                |        |   |                              |   |            |  |  |                                  |            |
| 2.0 t BioPower | 110            | X3025752 |          | 02.10 |       |                |        |   |                              |   |            |  |  |                                  |            |
| 2.2 TiD        | 88             |          | 03.02    | 02.10 |       |                |        |   |                              |   |            |  |  |                                  |            |
| 2.3            | 224            |          | 06.03    | 08.05 |       |                |        |   |                              |   |            |  |  |                                  |            |
| 2.3 t          | 125            | X3025752 |          | 02.10 |       |                |        |   |                              |   |            |  |  |                                  |            |
| 2.3 t          | 136            |          | 01.01    | 02.10 |       |                |        |   |                              |   |            |  |  |                                  |            |
| 2.3 T          | 162            |          | 07.03    | 02.10 |       |                |        |   |                              |   |            |  |  |                                  |            |
| 2.3 T          | 188            |          | 04.08    | 02.10 |       |                |        |   |                              |   |            |  |  |                                  |            |
| 2.3 T          | 191            |          | 01.06    | 02.10 |       |                |        |   |                              |   |            |  |  |                                  |            |
| 2.3 T Aero     | 169            |          | 10.99    | 09.01 |       |                |        |   |                              |   |            |  |  |                                  |            |
| 2.3 T Aero     | 184            |          | 09.01    | 02.10 |       |                |        |   |                              |   |            |  |  |                                  |            |
| 2.3 T Aero     | 225            |          | 04.03    | 03.04 |       |                |        |   |                              |   |            |  |  |                                  |            |
| 2.3 t BioPower | 136            | X3025752 |          | 02.10 |       |                |        |   |                              |   |            |  |  |                                  |            |
| 2.3 t BioPower | 152            | X3025752 |          | 02.10 |       |                |        |   |                              |   |            |  |  |                                  |            |
| 2.3 t BioPower | 154            | X3025752 |          | 02.10 |       |                |        |   |                              |   |            |  |  |                                  |            |
| 3.0 t          | 147            | X3025752 |          | 02.10 |       |                |        |   |                              |   |            |  |  |                                  |            |
| 3.0 TiD        | 130            |          | 07.01    | 02.10 |       |                |        |   |                              |   |            |  |  |                                  |            |
|                | 2.0            | 136      | X3025751 | 07.00 |       | 24.0110-0226.1 | 410226 |   |                              | 286 10,0 8,0 +S +B<br>286 10,0 8,0 +S +B PD             |            |  |  |                                  |            |
|                | 2.0 t          | 110      | X3025751 | 10.98 |       | 24.0310-0226.1 | 510226 |   |                              |   |            |  |  |                                  |            |
|                | 2.0 t          | 141      | X3025751 | 10.98 |       |                |        |   |                              |   |            |  |  |                                  |            |
|                | 2.0 t BioPower |          | X3025751 | 06.06 |       |                |        |   |                              |   |            |  |  |                                  |            |
|                | 2.0 t BioPower | 110      | X3025751 | 01.06 |       |                |        |   |                              |   |            |  |  |                                  |            |
|                | 2.3 t          | 125      | X3025751 | 10.98 |       |                |        |   |                              |   |            |  |  |                                  |            |
| 2.3 t BioPower | 136            | X3025751 | 01.07    |       |       |                |        |   |                              |   |            |  |  |                                  |            |

1) + 16" wheel / + ruota 16" / + roue 16" / + rueda 16"

2) + 15" wheel / + ruota 15" / + roue 15" / + rueda 15"

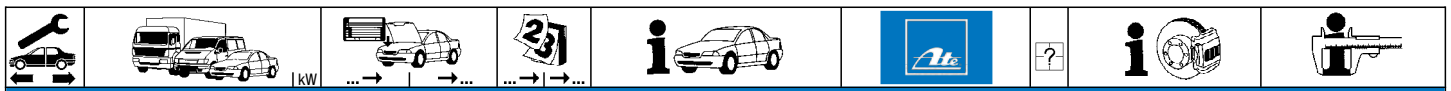

**SAAB 9-5 Kombi (YS3E) (98-10)**



















|                |                |          |          |       |                |                |        |                       |                       |
|----------------|----------------|----------|----------|-------|----------------|----------------|--------|-----------------------|-----------------------|
|                | 2.3 t BioPower | 152      | X3025751 | 11.06 |                | 24.0110-0226.1 | 410226 |                       | 286 10,0 8,0 +S +B    |
|                | 2.3 t BioPower | 154      | X3025751 | 01.07 |                | 24.0310-0226.1 | 510226 |                       | 286 10,0 8,0 +S +B PD |
|                | 3.0 t          | 147      | X3025751 | 10.98 |                |                |        |                       |                       |
|                | 1.9 TiD        | 110      |          | 01.06 | 02.10          | 24.0110-0274.1 | 410274 |                       | 286 10,0 8,0 +S +B    |
|                | 1.9 TiD        | 129      |          | 01.07 | 02.10          |                |        |                       |                       |
|                | 2.0            | 136      | X3025752 |       | 07.01          |                |        |                       |                       |
|                | 2.0 t          | 110      | X3025752 |       | 02.10          |                |        |                       |                       |
|                | 2.0 t          | 141      | X3025752 |       | 02.10          |                |        |                       |                       |
|                | 2.0 t BioPower |          | X3025752 |       | 02.10          |                |        |                       |                       |
|                | 2.0 t BioPower | 110      | X3025752 |       | 02.10          |                |        |                       |                       |
|                | 2.2 TiD        | 88       |          | 03.02 | 02.10          |                |        |                       |                       |
|                | 2.3 t          | 125      | X3025752 |       | 02.10          |                |        |                       |                       |
|                | 2.3 t          | 136      |          | 01.01 | 02.10          |                |        |                       |                       |
|                | 2.3 T          | 162      |          | 07.03 | 02.10          |                |        |                       |                       |
|                | 2.3 T Aero     | 169      |          | 10.99 | 09.01          |                |        |                       |                       |
| 2.3 T Aero     | 184            |          | 09.01    | 12.01 |                |                |        |                       |                       |
| 2.3 t BioPower | 136            | X3025752 |          | 02.10 |                |                |        |                       |                       |
| 2.3 t BioPower | 152            | X3025752 |          | 02.10 |                |                |        |                       |                       |
| 2.3 t BioPower | 154            | X3025752 |          | 02.10 |                |                |        |                       |                       |
| 3.0 t          | 147            | X3025752 |          | 12.01 |                |                |        |                       |                       |
| 3.0 TiD        | 130            |          | 07.01    | 12.01 |                |                |        |                       |                       |
| 2.3            | 224            |          | 06.03    | 08.05 | 24.0120-0196.1 | 420196         |        | 300 20,0 18,0 V +S +B |                       |
| 2.3 T          | 188            |          | 04.08    | 02.10 |                |                |        |                       |                       |
| 2.3 T          | 191            |          | 01.06    | 02.10 |                |                |        |                       |                       |
| 2.3 T Aero     | 184            |          | 01.02    | 02.10 |                |                |        |                       |                       |
| 2.3 T Aero     | 225            |          | 04.03    | 03.04 |                |                |        |                       |                       |
| 3.0 t          | 147            |          | 01.02    | 02.10 |                |                |        |                       |                       |
| 3.0 TiD        | 130            |          | 01.02    | 02.10 |                |                |        |                       |                       |
|                | 1.9 TiD        | 110      |          | 01.06 | 02.10          | 03.0137-0172.2 | 650172 |                       | 160 x 25              |
|                | 1.9 TiD        | 129      |          | 01.07 | 02.10          |                |        |                       |                       |
|                | 2.0            | 136      |          | 07.00 | 07.01          |                |        |                       |                       |
|                | 2.0 t          | 110      |          | 10.98 | 02.10          |                |        |                       |                       |
|                | 2.0 t          | 141      |          | 10.98 | 02.10          |                |        |                       |                       |
|                | 2.0 t BioPower |          |          | 06.06 | 02.10          |                |        |                       |                       |
|                | 2.0 t BioPower | 110      |          | 01.06 | 02.10          |                |        |                       |                       |
|                | 2.2 TiD        | 88       |          | 03.02 | 02.10          |                |        |                       |                       |
|                | 2.3            | 224      |          | 06.03 | 08.05          |                |        |                       |                       |
|                | 2.3 t          | 125      |          | 10.98 | 02.10          |                |        |                       |                       |
|                | 2.3 t          | 136      |          | 01.02 | 02.10          |                |        |                       |                       |
|                | 2.3 T          | 162      |          | 07.03 | 02.10          |                |        |                       |                       |
|                | 2.3 T          | 188      |          | 04.08 | 02.10          |                |        |                       |                       |
|                | 2.3 T          | 191      |          | 01.06 | 02.10          |                |        |                       |                       |
|                | 2.3 T Aero     | 169      |          | 10.99 | 09.01          |                |        |                       |                       |
|                | 2.3 T Aero     | 184      |          | 09.01 | 02.10          |                |        |                       |                       |
|                | 2.3 T Aero     | 225      |          | 04.03 | 03.04          |                |        |                       |                       |
|                | 2.3 t BioPower | 136      |          | 01.07 | 02.10          |                |        |                       |                       |
|                | 2.3 t BioPower | 152      |          | 11.06 | 02.10          |                |        |                       |                       |
|                | 2.3 t BioPower | 154      |          | 01.07 | 02.10          |                |        |                       |                       |
| 3.0 t          | 147            |          | 10.98    | 02.10 |                |                |        |                       |                       |
| 3.0 TiD        | 130            |          | 07.01    | 02.10 |                |                |        |                       |                       |

**SAAB 9-5 II (10-12)**

|                    |                    |     |       |       |                |                |                          |                         |                            |
|--------------------|--------------------|-----|-------|-------|----------------|----------------|--------------------------|-------------------------|----------------------------|
|                    | 1.6 T              | 132 |       | 03.10 | 06.12          | 13.0460-5611.2 | 605611                   | + 16" Rad <sup>1)</sup> | 24415 19,1 +/WK/Zub MAN    |
|                    | 2.0 T              | 162 |       | 03.10 | 06.12          | 13.0470-5611.2 | LD5611                   | + 16" Rad <sup>1)</sup> | 24415 19,1 +/WK/Zub MAN    |
|                    | 2.0 T BioPower     | 162 |       | 03.10 | 06.12          |                |                          |                         |                            |
|                    | 2.0 T BioPower XWD | 162 |       | 03.10 | 06.12          |                |                          |                         |                            |
|                    | 2.0 T XWD          | 162 |       | 03.10 | 06.12          |                |                          |                         |                            |
|                    | 2.0 TiD            | 118 |       | 03.10 | 06.12          |                |                          |                         |                            |
|                    | 2.0 TTiD           | 140 |       | 03.10 | 06.12          |                |                          |                         |                            |
|                    | 2.0 TTiD XWD       | 140 |       | 03.10 | 06.12          |                |                          |                         |                            |
|                    | 2.8 T V6 XWD       | 221 |       | 03.10 | 06.12          |                |                          |                         |                            |
|                    | 1.6 T              | 132 |       | 03.10 | 06.12          | 13.0460-5612.2 | 605612                   | + 17" Rad <sup>2)</sup> | 24412 19,0 +/WK/Zub MAN    |
|                    | 2.0 T              | 162 |       | 03.10 | 06.12          | 13.0470-5612.2 | LD5612                   | + 17" Rad <sup>2)</sup> | 24412 19,0 +/WK/Zub MAN    |
|                    | 2.0 T BioPower     | 162 |       | 03.10 | 06.12          |                |                          |                         |                            |
|                    | 2.0 T BioPower XWD | 162 |       | 03.10 | 06.12          |                |                          |                         |                            |
| 2.0 T XWD          | 162                |     | 03.10 | 06.12 |                |                |                          |                         |                            |
| 2.0 TiD            | 118                |     | 03.10 | 06.12 |                |                |                          |                         |                            |
| 2.0 TTiD           | 140                |     | 03.10 | 06.12 |                |                |                          |                         |                            |
| 2.0 TTiD XWD       | 140                |     | 03.10 | 06.12 |                |                |                          |                         |                            |
| 2.8 T V6 XWD       | 221                |     | 03.10 | 06.12 |                |                |                          |                         |                            |
| 1.6 T              | 132                |     | 03.10 | 06.12 | 13.0460-2754.2 | 602754         | + 17+" Rad <sup>3)</sup> | 24418 17,0 +/WK/Zub TRW |                            |
| 2.0 T              | 162                |     | 03.10 | 06.12 |                |                |                          |                         |                            |
| 2.0 T BioPower     | 162                |     | 03.10 | 06.12 |                |                |                          |                         |                            |
| 2.0 T BioPower XWD | 162                |     | 03.10 | 06.12 |                |                |                          |                         |                            |
| 2.0 T XWD          | 162                |     | 03.10 | 06.12 |                |                |                          |                         |                            |
| 2.0 TiD            | 118                |     | 03.10 | 06.12 |                |                |                          |                         |                            |
| 2.0 TTiD           | 140                |     | 03.10 | 06.12 |                |                |                          |                         |                            |
| 2.0 TTiD XWD       | 140                |     | 03.10 | 06.12 |                |                |                          |                         |                            |
| 2.8 T V6 XWD       | 221                |     | 03.10 | 06.12 |                |                |                          |                         |                            |
|                    | 1.6 T              | 132 |       | 03.10 | 06.12          | 24.0130-0207.1 | 430207                   | + 16" Rad <sup>1)</sup> | 296 30,0 27,0 V L +S +B    |
|                    | 2.0 T              | 162 |       | 03.10 | 06.12          | 24.0330-0207.1 | 530207                   | + 16" Rad <sup>1)</sup> | 296 30,0 27,0 V L +S +B PD |
|                    | 2.0 T BioPower     | 162 |       | 03.10 | 06.12          |                |                          |                         |                            |
|                    | 2.0 T BioPower XWD | 162 |       | 03.10 | 06.12          |                |                          |                         |                            |
|                    | 2.0 T XWD          | 162 |       | 03.10 | 06.12          |                |                          |                         |                            |
|                    | 2.0 TiD            | 118 |       | 03.10 | 06.12          |                |                          |                         |                            |
|                    | 2.0 TTiD           | 140 |       | 03.10 | 06.12          |                |                          |                         |                            |
| 2.0 TTiD XWD       | 140                |     | 03.10 | 06.12 |                |                |                          |                         |                            |

1) + 16" wheel / + ruota 16" / + roue 16" / + rueda 16"  
 2) + 17" wheel / + ruota 17" / + roue 17" / + rueda 17"  
 3) + 17+" wheel / + ruota 17+" / + roue 17+" / + rueda 17+"



|     |  |  |  |  |  |  |  |  |   |  |
|--|--|--|--|--|---|--|--|--|---|--|
| <b>SAAB 9-5 II (10-12)</b>   |  |  |  |  |   |  |  |  |   |  |
|    | 2.8 T V6 XWD   | 221  |  | 03.10  | 06.12   |  |  | 24.0130-0207.1 430207<br>24.0330-0207.1 530207                                     | + 16" Rad <sup>1)</sup><br>+ 16" Rad <sup>1)</sup>  | 296 30,0 27,0 V L +S +B<br><b>296 30,0 27,0 V L +S +B PD</b>     |
|  | 1.6 T  | 132  |  | 03.10  | 06.12   |  |  | 24.0130-0209.1 430209<br>24.0330-0209.1 530209                                     | + 17" Rad <sup>2)</sup><br>+ 17" Rad <sup>2)</sup>  | 321 30,0 27,0 V L +S +B<br><b>321 30,0 27,0 V L +S +B PD</b>     |
|  | 2.0 T  | 162  |  | 03.10  | 06.12   |  |  |  |   |  |
|  | 2.0 T BioPower   | 162  |  | 03.10  | 06.12   |  |  |  |   |  |
|  | 2.0 T BioPower XWD   | 162  |  | 03.10  | 06.12   |  |  |  |   |  |
|  | 2.0 T XWD  | 162  |  | 03.10  | 06.12   |  |  |  |   |  |
|  | 2.0 TiD  | 118  |  | 03.10  | 06.12   |  |  |  |   |  |
|  | 2.0 TTiD   | 140  |  | 03.10  | 06.12   |  |  |  |   |  |
|  | 2.0 TTiD XWD   | 140  |  | 03.10  | 06.12   |  |  |  |   |  |
|  | 2.8 T V6 XWD   | 221  |  | 03.10  | 06.12   |  |  |  |   |  |
| 1.6 T  | 132  |  | 03.10  | 06.12  |   |  | 24.0130-0208.1 430208  | + 17+" Rad <sup>3)</sup>   | 337 30,0 27,0 V L +S +B   |  |
| 2.0 T  | 162  |  | 03.10  | 06.12  |   |  |  |  |   |  |
| 2.0 T BioPower   | 162  |  | 03.10  | 06.12  |   |  |  |  |   |  |
| 2.0 T BioPower XWD   | 162  |  | 03.10  | 06.12  |   |  |  |  |   |  |
| 2.0 T XWD  | 162  |  | 03.10  | 06.12  |   |  |  |  |   |  |
| 2.0 TiD  | 118  |  | 03.10  | 06.12  |   |  |  |  |   |  |
| 2.0 TTiD   | 140  |  | 03.10  | 06.12  |   |  |  |  |   |  |
| 2.0 TTiD XWD   | 140  |  | 03.10  | 06.12  |   |  |  |  |   |  |
| 2.8 T V6 XWD   | 221  |  | 03.10  | 06.12  |   |  |  |  |   |  |
|    | 1.6 T  | 132  |  | 03.10  | 06.12   |  |  | 24.0710-5015.3 360403  | 2  - staeendige Daempfungsteuerung <sup>4)</sup>           | Radsensor L=740  |
|  | 2.0 T  | 162  |  | 03.10  | 06.12   |  |  |  |   |  |
|  | 2.0 T BioPower   | 162  |  | 03.10  | 06.12   |  |  |  |   |  |
|  | 2.0 T BioPower XWD   | 162  |  | 03.10  | 06.12   |  |  |  |   |  |
|  | 2.0 T XWD  | 162  |  | 03.10  | 06.12   |  |  |  |   |  |
|  | 2.0 TiD  | 118  |  | 03.10  | 06.12   |  |  |  |   |  |
|  | 2.0 TTiD   | 140  |  | 03.10  | 06.12   |  |  |  |   |  |
|  | 2.0 TTiD XWD   | 140  |  | 03.10  | 06.12   |  |  |  |   |  |
|  | 2.8 T V6 XWD   | 221  |  | 03.10  | 06.12   |  |  |  |   |  |
|  | 1.6 T  | 132  |  | 03.10  | 06.12   |  |  | 13.0460-2755.2 602755<br>13.0470-2755.2 LD2755                                     | + 16"/17" Rad <sup>5)</sup><br>+ 16"/17" Rad <sup>5)</sup>  | 24421 17,2 +/WK/Zub <b>TRW</b><br>24421 17,2 +/WK/Zub <b>TRW</b> |
| 2.0 T  | 162  |  | 03.10  | 06.12  |   |  |  |  |   |  |
| 2.0 T BioPower   | 162  |  | 03.10  | 06.12  |   |  |  |  |   |  |
| 2.0 T BioPower XWD   | 162  |  | 03.10  | 06.12  |   |  |  |  |   |  |
| 2.0 T XWD  | 162  |  | 03.10  | 06.12  |   |  |  |  |   |  |
| 2.0 TiD  | 118  |  | 03.10  | 06.12  |   |  |  |  |   |  |
| 2.0 TTiD   | 140  |  | 03.10  | 06.12  |   |  |  |  |   |  |
| 2.0 TTiD XWD   | 140  |  | 03.10  | 06.12  |   |  |  |  |   |  |
| 2.8 T V6 XWD   | 221  |  | 03.10  | 06.12  |   |  |  |  |   |  |
|   | 1.6 T  | 132  |  | 03.10  | 06.12   |  |  | 24.0112-0187.1 412187<br>24.0312-0187.1 512187                                     | + 16" Rad <sup>1)</sup><br>+ 16" Rad <sup>1)</sup>  | 292 12,0 10,5 +S +B<br><b>292 12,0 10,5 +S +B PD</b>             |
|  | 2.0 T  | 162  |  | 03.10  | 06.12   |  |  |  |   |  |
|  | 2.0 T BioPower   | 162  |  | 03.10  | 06.12   |  |  |  |   |  |
|  | 2.0 T BioPower XWD   | 162  |  | 03.10  | 06.12   |  |  |  |   |  |
|  | 2.0 T XWD  | 162  |  | 03.10  | 06.12   |  |  |  |   |  |
|  | 2.0 TiD  | 118  |  | 03.10  | 06.12   |  |  |  |   |  |
|  | 2.0 TTiD   | 140  |  | 03.10  | 06.12   |  |  |  |   |  |
|  | 2.0 TTiD XWD   | 140  |  | 03.10  | 06.12   |  |  |  |   |  |
|  | 2.8 T V6 XWD   | 221  |  | 03.10  | 06.12   |  |  |  |   |  |
|  | 1.6 T  | 132  |  | 03.10  | 06.12   |  |  | 24.0123-0114.1 423114<br>24.0323-0114.1 523114                                     | + 17" Rad <sup>2)</sup><br>+ 17" Rad <sup>2)</sup>  | 315 22,9 21,5 V +S +B<br><b>315 22,9 21,5 V +S +B PD</b>         |
| 2.0 T  | 162  |  | 03.10  | 06.12  |   |  |  |  |   |  |
| 2.0 T BioPower   | 162  |  | 03.10  | 06.12  |   |  |  |  |   |  |
| 2.0 T BioPower XWD   | 162  |  | 03.10  | 06.12  |   |  |  |  |   |  |
| 2.0 T XWD  | 162  |  | 03.10  | 06.12  |   |  |  |  |   |  |
| 2.0 TiD  | 118  |  | 03.10  | 06.12  |   |  |  |  |   |  |
| 2.0 TTiD   | 140  |  | 03.10  | 06.12  |   |  |  |  |   |  |
| 2.0 TTiD XWD   | 140  |  | 03.10  | 06.12  |   |  |  |  |   |  |
| 2.8 T V6 XWD   | 221  |  | 03.10  | 06.12  |   |  |  |  |   |  |
|  | 1.6 T  | 132  |  | 03.10  | 06.12   |  |  | 24.0711-5332.3 360327  | 2  - staeendige Daempfungsst./+HA 4-Lenker <sup>6)</sup> | Radsensor L=766  |
|  | 2.0 T  | 162  |  | 03.10  | 06.12   |  |  |  |   |  |
|  | 2.0 T BioPower   | 162  |  | 03.10  | 06.12   |  |  |  |   |  |
|  | 2.0 T BioPower XWD   | 162  |  | 03.10  | 06.12   |  |  |  |   |  |
|  | 2.0 T XWD  | 162  |  | 03.10  | 06.12   |  |  |  |   |  |
|  | 2.0 TiD  | 118  |  | 03.10  | 06.12   |  |  |  |   |  |
|  | 2.0 TTiD   | 140  |  | 03.10  | 06.12   |  |  |  |   |  |
|  | 2.0 TTiD XWD   | 140  |  | 03.10  | 06.12   |  |  |  |   |  |
|  | 2.8 T V6 XWD   | 221  |  | 03.10  | 06.12   |  |  |  |   |  |
|  | 1.6 T  | 132  |  | 03.10  | 06.12   |  |  | 24.0711-5342.3 360414  | 2    | Radsensor L=1245   |
| 2.0 T  | 162  |  | 03.10  | 06.12  |   |  |  |  |   |  |
| 2.0 T BioPower   | 162  |  | 03.10  | 06.12  |   |  |  |  |   |  |
| 2.0 T BioPower XWD   | 162  |  | 03.10  | 06.12  |   |  |  |  |   |  |
| 2.0 T XWD  | 162  |  | 03.10  | 06.12  |   |  |  |  |   |  |
| 2.0 TiD  | 118  |  | 03.10  | 06.12  |   |  |  |  |   |  |
| 2.0 TTiD   | 140  |  | 03.10  | 06.12  |   |  |  |  |   |  |
| 2.0 TTiD XWD   | 140  |  | 03.10  | 06.12  |   |  |  |  |   |  |
| 2.8 T V6 XWD   | 221  |  | 03.10  | 06.12  |   |  |  |  |   |  |
| <b>SAAB 900 (94-98)</b>  |  |  |  |  |   |  |  |  |   |  |
|  | 2.0 16V Turbo  |  |  | 09.93  | 08.96   |  |  | 13.0460-7080.2 607080  |   | 21411 17,5 + <b>ATE</b>  |
|  | 2.0 i  |  |  | 09.93  | 08.96   |  |  |  |   |  |
|  | 2.3 16V  |  |  | 09.93  | 08.96   |  |  |  |   |  |
|  | 2.5 V6   |  |  | 09.93  | 08.96   |  |  |  |   |  |
|  | 2.0 16V Turbo  |  |  | 09.96  | 03.98   |  |  | 13.0460-7091.2 607091<br>13.0460-7173.2 607173                                     |   | 21829 20,3 +/WE <b>ATE</b><br>23116 20,3 +/WK <b>ATE</b>         |
| 2.0 i  |  |  | 09.96  | 03.98  |   |  | 24.8190-0718.2 620718  | 2  | Warnkontakt L=720mm   |  |
| 2.3 16V  |  |  | 09.96  | 03.98  |   |  |  |  |   |  |
| 2.5 V6   |  |  | 09.96  | 03.98  |   |  |  |  |   |  |
|  | 2.0 16V Turbo  |  |  | 09.93  | 08.96   |  |  | 24.0124-0133.1 424133  |   | 284 24,0 21,0 V L  |
|  | 2.0 i  |  |  | 09.93  | 08.96   |  |  |  |   |  |
|  | 2.3 16V  |  |  | 09.93  | 08.96   |  |  |  |   |  |
|  | 2.5 V6   |  |  | 09.93  | 08.96   |  |  |  |   |  |
|  | 2.0 16V Turbo  |  |  | 09.96  | 03.98   |  |  | 24.0125-0119.1 425119<br>24.0325-0119.1 525119                                     |   | 288 25,0 22,0 V L +S +B<br><b>288 25,0 22,0 V L +S +B PD</b>     |
| 2.0 i  |  |  | 09.96  | 03.98  |   |  |  |  |   |  |
| 2.3 16V  |  |  | 09.96  | 03.98  |   |  |  |  |   |  |
| 2.5 V6   |  |  | 09.96  | 03.98  |   |  |  |  |   |  |

<sup>1)</sup> + 16" wheel / + ruota 16" / + roue 16" / + rueda 16"























<sup>2)</sup> + 17" wheel / + ruota 17" / + roue 17" / + rueda 17"



























<sup>3)</sup> + 17+" wheel / + ruota 17+" / + roue 17+" / + rueda 17+"

<sup>4)</sup> - continuous damping control / - smorzam.a controllo continuo / - contrôle d'amortissement.continuo / - control amortiguación continuo

<sup>5)</sup> + 16"/17" wheel / + ruota 16"/17" / + roue 16"/17" / + ruedas 16"/17"

<sup>6)</sup> - contin.damping contr./+4-link RA / - smorzam.contr.conti./P 4 bracci / - contr.d'amortissm.cont./EAR 4 bras / - contr.amortiguac.cont./ET cuatro brazos

|     |            |              |        |  |  |  |    |  |
|--|--|--|--|--|---|--|--|--|
| <b>SAAB 900 (94-98)</b>  |  |  |  |  |   |  |  |  |
|    | 2.0 16V Turbo<br>2.0 i<br>2.3 16V<br>2.5 V6  |  | 09.93<br>09.93<br>09.93<br>09.93   | 08.96<br>08.96<br>08.96<br>08.96   | 13.0460-4043.2<br>13.0460-0217.2  | 604043<br>610217   |  | 21140 15,0<br>Belagsatz-Zubehör<br><b>ATE</b><br><b>ATE</b>                        |
|  | 2.0 16V Turbo<br>2.0 i<br>2.3 16V<br>2.5 V6  |  | 09.96<br>09.96<br>09.96<br>09.96   | 03.98<br>03.98<br>03.98<br>03.98   | 13.0460-4040.2<br>13.0460-0347.2  | 604040<br>610347   |  | 21050 15,8<br>Belagsatz-Zubehör<br><b>ATE</b>                                      |
|    | 2.0 16V Turbo<br>2.0 16V Turbo<br>2.0 i<br>2.0 i<br>2.3 16V<br>2.3 16V<br>2.5 V6<br>2.5 V6 | V7004689<br>V2022961<br>V7004689<br>V2022961<br>V7004689<br>V2022961<br>V7004689<br>V2022961 | 09.93<br>09.93<br>09.93<br>09.93<br>09.93<br>09.93<br>09.93<br>09.93                   |  | 24.0110-0249.1  | 410249   |  | 260 10,0 8,0   |
|  | 2.0 16V Turbo<br>2.0 16V Turbo<br>2.0 i<br>2.0 i<br>2.3 16V<br>2.3 16V<br>2.5 V6<br>2.5 V6 | V7004690<br>V2022962<br>V7004690<br>V2022962<br>V7004690<br>V2022962<br>V7004690<br>V2022962 | 03.98<br>03.98<br>03.98<br>03.98<br>03.98<br>03.98<br>03.98<br>03.98                   |  | 24.0110-0226.1<br>24.0310-0226.1  | 410226<br>510226   |  | 286 10,0 8,0 +S +B<br><b>286 10,0 8,0 +S +B PD</b>                                 |
|    | 2.0 16V Turbo<br>2.0 i<br>2.3 16V<br>2.5 V6  |  | 09.93<br>09.93<br>09.93<br>09.93   | 03.98<br>03.98<br>03.98<br>03.98   | 03.0137-0172.2  | 650172   |  | 160 x 25   |
| <b>SAAB 9000 (94-98)</b>   |  |  |  |  |   |  |  |  |
|    | 2.0 16V<br>2.0 16V Turbo<br>2.3 16V<br>2.3 16V Turbo<br>3.0 V6                             |  | 09.93<br>09.93<br>09.93<br>09.93<br>09.94  | 05.98<br>05.98<br>05.98<br>05.98<br>05.98  | 13.0460-5703.2  | 605703   |  | 21154 19,5 +/WE<br><b>ATE</b>  |
|    | 2.0 16V<br>2.0 16V Turbo<br>2.3 16V<br>2.3 16V Turbo<br>3.0 V6                             |  | 09.93<br>09.93<br>09.93<br>09.93<br>09.94  | 05.98<br>05.98<br>05.98<br>05.98<br>05.98  | 24.0125-0125.1  | 425125   |  | 280 25,0 23,0 V  |
|  | 2.0 16V<br>2.0 16V Turbo<br>2.3 16V<br>2.3 16V Turbo<br>3.0 V6                             |  | 01.96<br>01.96<br>01.96<br>01.96<br>01.96  | 05.98<br>05.98<br>05.98<br>05.98<br>05.98  | 24.0751-1174.1<br>24.0751-1175.1  | 360049<br>360050   | <br> | Radsensor L=1100<br>Radsensor L=1150   |
|  | 2.0 16V<br>2.0 16V Turbo<br>2.3 16V<br>2.3 16V Turbo<br>3.0 V6                             |  | 09.93<br>09.93<br>09.93<br>09.93<br>09.94  | 05.98<br>05.98<br>05.98<br>05.98<br>05.98  | 13.0460-3306.2  | 603306   |  | 21089 15,0 +<br><b>ATE</b>   |
|  | 2.0 16V<br>2.0 16V Turbo<br>2.3 16V<br>2.3 16V Turbo<br>3.0 V6                             |  | 09.93<br>09.93<br>09.93<br>09.93<br>09.94  | 05.98<br>05.98<br>05.98<br>05.98<br>05.98  | 24.0109-0130.1  | 409130   |  | 258 9,0 7,5  |
|  | 2.0 16V<br>2.0 16V Turbo<br>2.3 16V<br>2.3 16V Turbo<br>3.0 V6                             |  | 01.96<br>01.96<br>01.96<br>01.96<br>01.96  | 05.98<br>05.98<br>05.98<br>05.98<br>05.98  | 24.0751-1176.1<br>24.0751-1177.1  | 360051<br>360052   | <br> | Radsensor L=1120<br>Radsensor L=1120   |
| <b>SEAT ALHAMBRA I (96-10)</b>   |  |  |  |  |   |  |  |  |
|  | 1.8 T 20V<br>1.9 TDI<br>1.9 TDI<br>2.0 i   | 110<br>66<br>81<br>85  | 7M-W-070000<br>7M-W-070000<br>7M-W-070000<br>7M-W-070000                               | 05.98<br>03.96<br>10.97<br>03.96   | 13.0460-7076.2<br>13.0460-7143.2  | 607076<br>607143   |  | 21848 19,8 +<br>21849 19,8 +/WK<br><b>ATE</b><br><b>ATE</b>                        |
|  | 1.8 T 20V<br>1.9 TDI<br>1.9 TDI<br>1.9 TDI<br>2.0 i  | 110<br>66<br>81<br>85<br>85  | 7M-X-000001<br>7M-X-000001<br>7M-X-000001<br>7M-X-000001<br>7M-X-000001                | 7M-1-530756<br>7M-1-530756<br>7M-1-530756<br>7M-1-530756<br>7M-1-530756          |   | 05.00  |  | 13.0460-7143.2<br>607143<br><b>ATE</b><br>21849 19,8 +/WK                          |
|  | 1.9 TDI<br>1.9 TDI<br>1.9 TDI<br>2.0 i<br>2.0 TDI  | 66<br>85<br>96<br>85<br>103  | 7M-2-500001<br>7M-2-500001<br>7M-2-500001<br>7M-2-500001<br>7M-2-500001                | 08.10<br>08.10<br>11.02<br>08.10<br>11.05  | 13.0460-7154.2  | 607154   |  | 23418 19,4 +/WK<br><b>ATE</b>  |
|  | 1.8 T 20V<br>1.9 TDI<br>1.9 TDI 4motion<br>1.9 TDI 4motion<br>2.8 i V6<br>2.8 i V6 4motion | 110<br>110<br>85<br>96<br>150<br>150   | 7M-2-500001<br>7M-2-500001<br>7M-2-500001<br>7M-2-500001<br>7M-2-500001<br>7M-2-500001 | 08.10<br>05.05<br>02.01<br>06.05<br>06.00<br>02.01                               | 13.0460-7153.2  | 607153   |  | 23269 19,8 +/WK<br><b>ATE</b>  |

|     |  |  |  |  |  |  |  |                                   |                            |                          |
|--|--|--|--|--|---|--|--|---|----------------------------|--------------------------|
| <b>SEAT ALHAMBRA I (96-10)</b>   |  |  |  |  |   |  |  |   |                            |                          |
|    | 1.8 T 20V  | 110  | 7M-1-530756  | 05.98  |   | 24.0125-0114.1   | 425114   |   | 288 25,1 21,0 V L +S +B    |                          |
|  | 1.9 TDI  | 66   | 7M-1-530756  | 03.96  |   | 24.0325-0114.1   | 525114   |   | 288 25,1 21,0 V L +S +B PD |                          |
|  | 1.9 TDI  | 81   |  | 10.97  | 05.00   |  |  |   |                            |                          |
|  | 1.9 TDI  | 85   | 7M-1-530756  | 06.00  |   |  |  |   |                            |                          |
|  | 2.0 i  | 85   | 7M-1-530756  | 03.96  |   |  |  |   |                            |                          |
|  | 1.9 TDI  | 66   | 7M-2-500001  |  | 08.10   |  | 24.0126-0115.1   | 426115  |                            | 300 26,0 22,0 V L +B     |
|  | 1.9 TDI  | 85   | 7M-2-500001  |  | 08.10   |  | 24.0326-0115.1   | 526115  |                            | 300 26,0 22,0 V L +B PD  |
|  | 1.9 TDI  | 96   |  | 11.02  | 08.10   |  |  |   |                            |                          |
|  | 2.0 i  | 85   | 7M-2-500001  |  | 08.10   |  |  |   |                            |                          |
|  | 2.0 TDI  | 103  |  | 11.05  | 08.10   |  |  |   |                            |                          |
|  | 1.8 T 20V  | 110  | 7M-2-500001  |  | 08.10   |  | 24.0126-0119.1   | 426119  |                            | 313 25,9 22,0 V L +B     |
|  | 1.9 TDI  | 110  |  | 05.05  | 08.10   |  | 24.0326-0119.1   | 526119  |                            | 313 25,9 22,0 V L +B PD  |
| 1.9 TDI 4motion  | 85   |  | 02.01  | 08.10  |   |  |  |   |                            |                          |
| 1.9 TDI 4motion  | 96   |  | 06.05  | 08.10  |   |  |  |   |                            |                          |
| 2.8 i V6   | 150  |  | 06.00  | 08.10  |   |  |  |   |                            |                          |
| 2.8 i V6 4motion   | 150  |  | 02.01  | 08.10  |   |  |  |   |                            |                          |
|    | 1.8 T 20V  | 110  |  | 05.98  | 05.00   | 24.0731-1183.3   | 360194   | 2                                | Radsensor L=460            |                          |
|  | 1.9 TDI  | 66   |  | 03.96  | 05.00   | 24.0713-1101.3   | 360143   | 2                                | Radsensor L=464            |                          |
|  | 1.9 TDI  | 81   |  | 10.97  | 05.00   |  |  |   |                            |                          |
|  | 2.0 i  | 85   |  | 03.96  | 05.00   |  |  |   |                            |                          |
|  | 1.8 T 20V  | 110  | 7M-3-513710  | 06.00  |   | 24.0713-1128.3   | 360200   |  + Leitung f. Warnkontakt 1)     | Radsensor L=474            |                          |
|  | 1.9 TDI  | 66   | 7M-3-513710  | 06.00  |   | 24.0713-1127.3   | 360204   |                                  | Radsensor L=474            |                          |
|  | 1.9 TDI  | 85   | 7M-3-513710  | 06.00  |   |  |  |   |                            |                          |
|  | 1.9 TDI  | 96   | 7M-3-513710  | 11.02  |   |  |  |   |                            |                          |
|  | 1.9 TDI 4motion  | 85   | 7M-3-513710  | 02.01  |   |  |  |   |                            |                          |
|  | 2.0 i  | 85   | 7M-3-513710  | 06.00  |   |  |  |   |                            |                          |
|  | 2.8 i V6   | 150  | 7M-3-513710  | 06.00  |   | 24.0713-1128.3   | 360200   | 2  + Leitung f. Warnkontakt 1)   | Radsensor L=474            |                          |
|  | 2.8 i V6 4motion   | 150  | 7M-3-513710  | 02.01  |   |  |  |   |                            |                          |
| 1.8 T 20V  | 110  | 7M-3-513711  |  | 08.10  |   | 24.0711-6114.3   | 360281   | 2  - Leitung f. Warnkontakt 2)   | Radsensor L=479            |                          |
| 1.9 TDI  | 66   | 7M-3-513711  |  | 08.10  |   | 24.0711-6115.3   | 360282   | 2  + Leitung f. Warnkontakt 1)   | Radsensor L=479            |                          |
| 1.9 TDI  | 85   | 7M-3-513711  |  | 08.10  |   |  |  |   |                            |                          |
| 1.9 TDI  | 96   | 7M-3-513711  |  | 08.10  |   |  |  |   |                            |                          |
| 1.9 TDI  | 110  |  | 05.05  | 08.10  |   |  |  |   |                            |                          |
| 1.9 TDI 4motion  | 85   | 7M-3-513711  |  | 08.10  |   |  |  |   |                            |                          |
| 1.9 TDI 4motion  | 96   |  | 06.05  | 08.10  |   |  |  |   |                            |                          |
| 2.0 i  | 85   | 7M-3-513711  |  | 08.10  |   |  |  |   |                            |                          |
| 2.0 TDI  | 103  |  | 11.05  | 08.10  |   |  |  |   |                            |                          |
| 2.8 i V6   | 150  | 7M-3-513711  |  | 08.10  |   |  |  |   |                            |                          |
| 2.8 i V6 4motion   | 150  | 7M-3-513711  |  | 08.10  |   |  |  |   |                            |                          |
|  | 1.8 T 20V  | 110  |  | 05.98  | 05.00   | 13.0460-2819.2   | 602819   |   | 20961 17,6 /S TRW          |                          |
|  | 1.9 TDI  | 66   |  | 03.96  | 05.00   | 13.0460-0072.2   | 610072   |   | Belagsatz-Zubehör TRW      |                          |
|  | 1.9 TDI  | 81   |  | 10.97  | 05.00   |  |  |   |                            |                          |
|  | 2.0 i  | 85   |  | 03.96  | 05.00   |  |  |   |                            |                          |
|  | 1.8 T 20V  | 110  | 7M-1-530756  | 06.00  |   | 13.0460-2859.2   | 602859   |   | 20961 17,2 +/WK/Zub/STRW   |                          |
|  | 1.9 TDI  | 66   |  | 06.00  | 08.10   |  |  |   |                            |                          |
|  | 1.9 TDI  | 85   |  | 06.00  | 08.10   |  |  |   |                            |                          |
|  | 1.9 TDI  | 96   |  | 11.02  | 08.10   |  |  |   |                            |                          |
|  | 2.0 i  | 85   |  | 06.00  | 08.10   |  |  |   |                            |                          |
|  | 2.0 TDI  | 103  |  | 11.05  | 08.10   |  |  |   |                            |                          |
|  | 1.8 T 20V  | 110  | 7M-2-500001  |  | 08.10   |  | 13.0460-2872.2   | 602872  |                            | 23446 16,5 +/WK/Zub/STRW |
|  | 1.9 TDI  | 110  |  | 05.05  | 08.10   |  | 13.0460-0225.2   | 610225  |                            | Belagsatz-Zubehör        |
| 1.9 TDI 4motion  | 85   |  | 02.01  | 08.10  |   |  |  |   |                            |                          |
| 1.9 TDI 4motion  | 96   |  | 06.05  | 08.10  |   |  |  |   |                            |                          |
| 2.8 i V6   | 150  |  | 06.00  | 08.10  |   |  |  |   |                            |                          |
| 2.8 i V6 4motion   | 150  |  | 02.01  | 08.10  |   |  |  |   |                            |                          |
|  | 1.8 T 20V  | 110  | 7M-1-530756  | 05.98  |   | 24.0110-0223.1   | 410223   |   | 268 10,0 8,0 +S +B         |                          |
|  | 1.9 TDI  | 66   |  | 03.96  | 08.10   | 24.0310-0223.1   | 510223   |   | 268 10,0 8,0 +S +B PD      |                          |
|  | 1.9 TDI  | 81   |  | 10.97  | 05.00   |  |  |   |                            |                          |
|  | 1.9 TDI  | 85   |  | 06.00  | 08.10   |  |  |   |                            |                          |
|  | 1.9 TDI  | 96   |  | 11.02  | 08.10   |  |  |   |                            |                          |
|  | 2.0 i  | 85   |  | 03.96  | 08.10   |  |  |   |                            |                          |
|  | 2.0 TDI  | 103  |  | 11.05  | 08.10   |  |  |   |                            |                          |
|  | 1.8 T 20V  | 110  | 7M-2-500001  |  | 08.10   |  | 24.0113-0194.1   | 413194  |                            | 294 13,5 11,5 +B         |
|  | 1.9 TDI  | 110  |  | 05.05  | 08.10   |  |  |   |                            |                          |
|  | 1.9 TDI 4motion  | 85   |  | 02.01  | 08.10   |  |  |   |                            |                          |
|  | 1.9 TDI 4motion  | 96   |  | 06.05  | 08.10   |  |  |   |                            |                          |
|  | 2.8 i V6   | 150  |  | 06.00  | 08.10   |  |  |   |                            |                          |
| 2.8 i V6 4motion   | 150  |  | 02.01  | 08.10  |   |  |  |   |                            |                          |
|  | 1.8 T 20V  | 110  |  | 05.98  | 05.00   | 24.0713-1102.3   | 360144   | 2                              | Radsensor L=1026           |                          |
|  | 1.9 TDI  | 66   |  | 03.96  | 05.00   |  |  |   |                            |                          |
|  | 1.9 TDI  | 81   |  | 10.97  | 05.00   |  |  |   |                            |                          |
|  | 2.0 i  | 85   |  | 03.96  | 05.00   |  |  |   |                            |                          |
|  | 1.8 T 20V  | 110  | 7M-3-513710  | 06.00  |   | 24.0713-1124.3   | 360201   |                                | Radsensor L=1026           |                          |
|  | 1.9 TDI  | 66   | 7M-3-513710  | 06.00  |   | 24.0713-1125.3   | 360202   |  + Leitung f. Warnkontakt 1)   | Radsensor L=1026           |                          |
|  | 1.9 TDI  | 85   | 7M-3-513710  | 06.00  |   |  |  |   |                            |                          |
|  | 1.9 TDI  | 96   | 7M-3-513710  | 11.02  |   |  |  |   |                            |                          |
|  | 1.9 TDI 4motion  | 85   | 7M-3-513710  | 02.01  |   |  |  |   |                            |                          |
|  | 2.0 i  | 85   | 7M-3-513710  | 06.00  |   |  |  |   |                            |                          |
|  | 2.8 i V6   | 150  | 7M-3-513710  | 06.00  |   | 24.0713-1126.3   | 360203   | 2  + Leitung f. Warnkontakt 1) | Radsensor L=1026           |                          |
|  | 2.8 i V6 4motion   | 150  | 7M-3-513710  | 02.01  |   |  |  |   |                            |                          |
| 1.8 T 20V  | 110  | 7M-3-513711  |  | 05.05  |   | 24.0711-6111.3   | 360243   | 1  - Leitung f. Warnkontakt 2) | Radsensor L=1031           |                          |
| 1.9 TDI  | 66   | 7M-3-513711  |  | 05.05  |   | 24.0711-6113.3   | 360228   | 2  + Leitung f. Warnkontakt 1) | Radsensor L=1031           |                          |
| 1.9 TDI  | 85   | 7M-3-513711  |  | 05.05  |   |  |  |   |                            |                          |
| 1.9 TDI  | 96   | 7M-3-513711  |  | 05.05  |   |  |  |   |                            |                          |
| 1.9 TDI 4motion  | 85   | 7M-3-513711  |  | 05.05  |   |  |  |   |                            |                          |

1) + cable f.br.ppad wear indicat. / + cavo p.indic.usura guarn.fr. / + câble l'ind.d'usur.garnit.fr. / + cabl.p.indica.desg.guarn.fr.

2) - cable f.br.ppad wear indicat. / - cavo p.indic.usura guarn.fr. / - câble l'ind.d'usur.garnit.fr. / - cabl.p.indica.desg.guarn.fr.



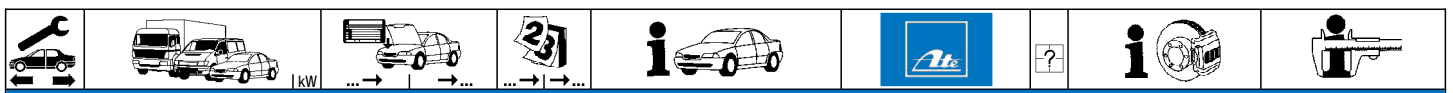

### SEAT ALHAMBRA I (96-10)



|  |                  |     |             |  |       |       |                |        |   |  |                  |
|--|------------------|-----|-------------|--|-------|-------|----------------|--------|---|--|------------------|
|  | 2.0 i            | 85  | 7M-3-513711 |  | 05.05 |       | 24.0711-6111.3 | 360243 | 1 | - Leitung f. Warnkontakt <sup>1)</sup> | Radsensor L=1031 |
|  | 2.8 i V6         | 150 | 7M-3-513711 |  | 05.05 |       | 24.0711-6111.3 | 360228 | 2 | + Leitung f. Warnkontakt <sup>2)</sup> | Radsensor L=1031 |
|  | 2.8 i V6 4motion | 150 | 7M-3-513711 |  | 05.05 |       |                |        |   |  |                  |
|  | 1.8 T 20V        | 110 |             |  | 06.05 | 08.10 | 24.0711-6111.3 | 360243 | 2 | - Leitung f. Warnkontakt <sup>1)</sup> | Radsensor L=1031 |
|  | 1.9 TDI          | 66  |             |  | 06.05 | 08.10 | 24.0711-6111.3 | 360228 | 2 | + Leitung f. Warnkontakt <sup>2)</sup> | Radsensor L=1031 |
|  | 1.9 TDI          | 85  |             |  | 06.05 | 08.10 |                |        |   |  |                  |
|  | 1.9 TDI          | 96  |             |  | 06.05 | 08.10 |                |        |   |  |                  |
|  | 1.9 TDI          | 110 |             |  | 05.05 | 08.10 |                |        |   |  |                  |
|  | 1.9 TDI 4motion  | 85  |             |  | 06.05 | 08.10 |                |        |   |  |                  |
|  | 1.9 TDI 4motion  | 96  |             |  | 06.05 | 08.10 |                |        |   |  |                  |
|  | 2.0 i            | 85  |             |  | 06.05 | 08.10 |                |        |   |  |                  |
|  | 2.0 TDI          | 103 |             |  | 11.05 | 08.10 |                |        |   |  |                  |
|  | 2.8 i V6         | 150 |             |  | 06.05 | 08.10 |                |        |   |  |                  |
|  | 2.8 i V6 4motion | 150 |             |  | 06.05 | 08.10 |                |        |   |  |                  |

### SEAT ALHAMBRA II (10-)

















|  |                 |     |  |  |       |  |         |                |        |  |   |                          |
|--|-----------------|-----|--|--|-------|--|---------|----------------|--------|--|---|--------------------------|
|  | 1.4 TSI         | 110 |  |  | 09.10 |  | PR: 1LJ | 13.0460-7242.2 | 607242 |  | 24332 19,8 +/WK                           | ATE                      |
|  | 1.8 TFSI        | 118 |  |  | 11.12 |  | PR: 1LJ | 13.0470-7242.2 | LD7242 |  | 24332 19,8 +/WK                           | ATE                      |
|  | 2.0 TDI         | 85  |  |  | 04.11 |  | PR: 1LJ |                |        |  |   |                          |
|  | 2.0 TDI         | 100 |  |  | 09.10 |  | PR: 1LJ |                |        |  |   |                          |
|  | 2.0 TDI         | 103 |  |  | 06.10 |  | PR: 1LJ |                |        |  |   |                          |
|  | 2.0 TDI         | 125 |  |  | 09.10 |  | PR: 1LJ |                |        |  |   |                          |
|  | 2.0 TDI         | 130 |  |  | 11.12 |  | PR: 1LJ |                |        |  |   |                          |
|  | 2.0 TDI 4motion | 103 |  |  | 04.11 |  | PR: 1LJ |                |        |  |   |                          |
|  | 2.0 TSI         | 147 |  |  | 09.10 |  | PR: 1LJ |                |        |  |   |                          |
|  | 1.4 TSI         | 110 |  |  | 09.10 |  | PR: 1LW | 13.0460-2764.2 | 602764 |  | 24738 20,0 +/WK/S                         | TRW                      |
|  | 1.8 TFSI        | 118 |  |  | 11.12 |  | PR: 1LW | 13.0470-2764.2 | LD2764 |  | 24738 20,0 +/WK/S                         | TRW                      |
|  | 2.0 TDI         | 85  |  |  | 04.11 |  | PR: 1LW |                |        |  |   |                          |
|  | 2.0 TDI         | 100 |  |  | 09.10 |  | PR: 1LW |                |        |  |   |                          |
|  | 2.0 TDI         | 103 |  |  | 06.10 |  | PR: 1LW |                |        |  |   |                          |
|  | 2.0 TDI         | 110 |  |  | 05.15 |  | PR: 1LW |                |        |  |   |                          |
|  | 2.0 TDI         | 125 |  |  | 09.10 |  | PR: 1LW |                |        |  |   |                          |
|  | 2.0 TDI         | 130 |  |  | 11.12 |  | PR: 1LW |                |        |  |   |                          |
|  | 2.0 TDI         | 135 |  |  | 05.15 |  | PR: 1LW |                |        |  |   |                          |
|  | 2.0 TDI 4Drive  | 110 |  |  | 05.15 |  | PR: 1LW |                |        |  |   |                          |
|  | 2.0 TDI 4Drive  | 135 |  |  | 05.16 |  | PR: 1LW |                |        |  |   |                          |
|  | 2.0 TDI 4motion | 103 |  |  | 04.11 |  | PR: 1LW |                |        |  |   |                          |
|  | 2.0 TSI         | 147 |  |  | 09.10 |  | PR: 1LW |                |        |  |   |                          |
|  | 2.0 TSI         | 162 |  |  | 05.15 |  | PR: 1LW |                |        |  |   |                          |
|  | 1.4 TSI         | 110 |  |  | 09.10 |  | PR: 1LJ | 24.0125-0158.1 | 425158 |  | 312 25,0 22,0 V L +S +B                   |                          |
|  | 1.8 TFSI        | 118 |  |  | 11.12 |  | PR: 1LJ | 24.0325-0158.1 | 525158 |  | 312 25,0 22,0 V L +S +B PD                |                          |
|  | 2.0 TDI         | 85  |  |  | 04.11 |  | PR: 1LJ |                |        |  |   |                          |
|  | 2.0 TDI         | 100 |  |  | 09.10 |  | PR: 1LJ |                |        |  |   |                          |
|  | 2.0 TDI         | 103 |  |  | 06.10 |  | PR: 1LJ |                |        |  |   |                          |
|  | 2.0 TDI         | 125 |  |  | 09.10 |  | PR: 1LJ |                |        |  |   |                          |
|  | 2.0 TDI         | 130 |  |  | 11.12 |  | PR: 1LJ |                |        |  |   |                          |
|  | 2.0 TDI 4motion | 103 |  |  | 04.11 |  | PR: 1LJ |                |        |  |   |                          |
|  | 2.0 TSI         | 147 |  |  | 09.10 |  | PR: 1LJ |                |        |  |   |                          |
|  | 1.4 TSI         | 110 |  |  | 09.10 |  | PR: 1LW | 24.0130-0220.1 | 430220 |  | 314 30,0 27,0 V L +S +B                   |                          |
|  | 1.8 TFSI        | 118 |  |  | 11.12 |  | PR: 1LW |                |        |  |   |                          |
|  | 2.0 TDI         | 85  |  |  | 04.11 |  | PR: 1LW |                |        |  |   |                          |
|  | 2.0 TDI         | 100 |  |  | 09.10 |  | PR: 1LW |                |        |  |   |                          |
|  | 2.0 TDI         | 103 |  |  | 06.10 |  | PR: 1LW |                |        |  |   |                          |
|  | 2.0 TDI         | 110 |  |  | 05.15 |  | PR: 1LW |                |        |  |   |                          |
|  | 2.0 TDI         | 125 |  |  | 09.10 |  | PR: 1LW |                |        |  |   |                          |
|  | 2.0 TDI         | 130 |  |  | 11.12 |  | PR: 1LW |                |        |  |   |                          |
|  | 2.0 TDI         | 135 |  |  | 05.15 |  | PR: 1LW |                |        |  |   |                          |
|  | 2.0 TDI 4Drive  | 110 |  |  | 05.15 |  | PR: 1LW |                |        |  |   |                          |
|  | 2.0 TDI 4Drive  | 135 |  |  | 05.16 |  | PR: 1LW |                |        |  |   |                          |
|  | 2.0 TDI 4motion | 103 |  |  | 04.11 |  | PR: 1LW |                |        |  |   |                          |
|  | 2.0 TSI         | 147 |  |  | 09.10 |  | PR: 1LW |                |        |  |   |                          |
|  | 2.0 TSI         | 162 |  |  | 05.15 |  | PR: 1LW |                |        |  |   |                          |
|  | 1.4 TSI         | 110 |  |  | 09.10 |  |         | 24.0711-5271.3 | 360301 |  | Radsensor                                 |                          |
|  | 1.8 TFSI        | 118 |  |  | 11.12 |  |         | 24.0711-5272.3 | 360302 |  | Radsensor                                 |                          |
|  | 2.0 TDI         | 85  |  |  | 04.11 |  |         |                |        |  |   |                          |
|  | 2.0 TDI         | 100 |  |  | 09.10 |  |         |                |        |  |   |                          |
|  | 2.0 TDI         | 103 |  |  | 06.10 |  |         |                |        |  |   |                          |
|  | 2.0 TDI         | 110 |  |  | 05.15 |  |         |                |        |  |   |                          |
|  | 2.0 TDI         | 125 |  |  | 09.10 |  |         |                |        |  |   |                          |
|  | 2.0 TDI         | 130 |  |  | 11.12 |  |         |                |        |  |   |                          |
|  | 2.0 TDI         | 135 |  |  | 05.15 |  |         |                |        |  |   |                          |
|  | 2.0 TDI 4Drive  | 110 |  |  | 05.15 |  |         |                |        |  |   |                          |
|  | 2.0 TDI 4Drive  | 135 |  |  | 05.16 |  |         |                |        |  |   |                          |
|  | 2.0 TDI 4motion | 103 |  |  | 04.11 |  |         |                |        |  |   |                          |
|  | 2.0 TSI         | 147 |  |  | 09.10 |  |         |                |        |  |   |                          |
|  | 2.0 TSI         | 162 |  |  | 05.15 |  |         |                |        |  |   |                          |
|  | 1.4 TSI         | 110 |  |  | 09.10 |  |         | 13.0460-2880.2 | 602880 |  | elektrische Feststellbremse <sup>3)</sup> | 23914 17,1 /WE/Zub/S TRW |
|  | 1.8 TFSI        | 118 |  |  | 11.12 |  |         | 13.0470-2880.2 | LD2880 |  | elektrische Feststellbremse <sup>3)</sup> | 23914 17,1 /WE/Zub/S TRW |
|  | 2.0 TDI         | 85  |  |  | 04.11 |  |         |                |        |  |   |                          |
|  | 2.0 TDI         | 100 |  |  | 09.10 |  |         |                |        |  |   |                          |
|  | 2.0 TDI         | 103 |  |  | 06.10 |  |         |                |        |  |   |                          |
|  | 2.0 TDI         | 125 |  |  | 09.10 |  |         |                |        |  |   |                          |
|  | 2.0 TDI         | 130 |  |  | 11.12 |  |         |                |        |  |   |                          |
|  | 2.0 TDI 4motion | 103 |  |  | 04.11 |  |         |                |        |  |   |                          |
|  | 2.0 TSI         | 147 |  |  | 09.10 |  |         |                |        |  |   |                          |

<sup>1)</sup> - cable f.br.ppad wear indicat. / - cavo p.indic.usura guarn.fr. / - câbl.l'ind.d'usur.garnit.fr. / - cabl.p.indica.desg.guarn.fr.  
<sup>2)</sup> + cable f.br.ppad wear indicat. / + cavo p.indic.usura guarn.fr. / + câbl.l'ind.d'usur.garnit.fr. / + cabl.p.indica.desg.guarn.fr.  
<sup>3)</sup> electric parking brake / fr.di stazionamento elettrico / frein à main électrique / freno de mano eléctrico







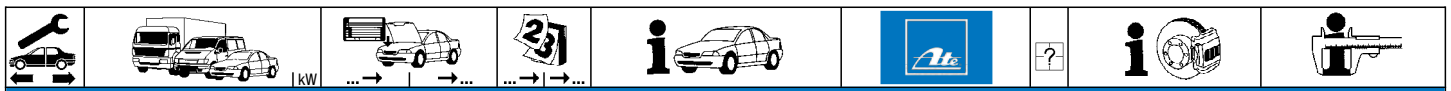

| SEAT ALHAMBRA II (10-)   |  |         |                 |                |         |  |  |  |  |          |           |                                    |            |                |                |         |         |       |       |                |        |         |           |       |       |                |        |         |         |       |       |         |  |         |         |       |       |         |  |         |          |       |       |         |  |                 |         |       |       |         |  |         |         |       |       |         |  |         |         |       |       |                |        |   |                     |         |       |         |  |                |         |       |       |                |        |   |                                     |                |       |         |  |                |         |                 |       |                 |                |                |                                    |            |           |       |       |                 |                |        |         |    |       |                 |  |  |           |    |       |                 |  |  |         |    |       |                 |  |  |         |  |       |                 |  |  |          |     |       |                 |  |  |         |  |       |                 |  |  |         |     |       |                 |  |  |         |     |       |                 |  |  |         |     |       |                 |  |  |         |     |       |                 |  |  |          |     |       |                 |  |  |         |    |       |         |                |        |   |  |           |    |       |         |                |        |         |    |       |         |  |  |           |    |       |         |  |  |         |    |       |         |  |  |         |  |       |         |  |  |          |     |       |         |  |  |         |  |       |         |  |  |         |     |       |         |  |  |         |     |       |         |  |  |         |     |       |         |  |  |         |     |       |         |  |  |          |     |       |         |  |  |         |    |       |         |                |        |   |  |           |    |       |         |                |        |         |    |       |         |  |  |           |    |       |         |  |  |         |    |       |         |  |  |         |  |       |         |  |  |          |     |       |         |  |  |         |  |       |         |  |  |         |     |       |         |  |  |         |     |       |         |  |  |         |     |       |         |  |  |         |     |       |         |  |  |          |     |       |         |  |  |         |    |       |             |                |        |   |  |           |    |       |             |                |        |         |    |       |             |  |  |
|--|--|---------|-----------------|----------------|---------|--|--|--|--|----------|-----------|------------------------------------|------------|----------------|----------------|---------|---------|-------|-------|----------------|--------|---------|-----------|-------|-------|----------------|--------|---------|---------|-------|-------|---------|--|---------|---------|-------|-------|---------|--|---------|----------|-------|-------|---------|--|-----------------|---------|-------|-------|---------|--|---------|---------|-------|-------|---------|--|---------|---------|-------|-------|----------------|--------|---|---------------------|---------|-------|---------|--|----------------|---------|-------|-------|----------------|--------|---|-------------------------------------|----------------|-------|---------|--|----------------|---------|-----------------|-------|-----------------|----------------|----------------|------------------------------------|------------|-----------|-------|-------|-----------------|----------------|--------|---------|----|-------|-----------------|--|--|-----------|----|-------|-----------------|--|--|---------|----|-------|-----------------|--|--|---------|--|-------|-----------------|--|--|----------|-----|-------|-----------------|--|--|---------|--|-------|-----------------|--|--|---------|-----|-------|-----------------|--|--|---------|-----|-------|-----------------|--|--|---------|-----|-------|-----------------|--|--|---------|-----|-------|-----------------|--|--|----------|-----|-------|-----------------|--|--|---------|----|-------|---------|----------------|--------|---|--|-----------|----|-------|---------|----------------|--------|---------|----|-------|---------|--|--|-----------|----|-------|---------|--|--|---------|----|-------|---------|--|--|---------|--|-------|---------|--|--|----------|-----|-------|---------|--|--|---------|--|-------|---------|--|--|---------|-----|-------|---------|--|--|---------|-----|-------|---------|--|--|---------|-----|-------|---------|--|--|---------|-----|-------|---------|--|--|----------|-----|-------|---------|--|--|---------|----|-------|---------|----------------|--------|---|--|-----------|----|-------|---------|----------------|--------|---------|----|-------|---------|--|--|-----------|----|-------|---------|--|--|---------|----|-------|---------|--|--|---------|--|-------|---------|--|--|----------|-----|-------|---------|--|--|---------|--|-------|---------|--|--|---------|-----|-------|---------|--|--|---------|-----|-------|---------|--|--|---------|-----|-------|---------|--|--|---------|-----|-------|---------|--|--|----------|-----|-------|---------|--|--|---------|----|-------|-------------|----------------|--------|---|--|-----------|----|-------|-------------|----------------|--------|---------|----|-------|-------------|--|--|
|  | <table border="1"> <tr> <td>1.4 TSI</td> <td>110</td> <td>09.10</td> <td></td> <td>24.0112-0169.1</td> <td>412169</td> <td rowspan="10">elektrische Feststellbremse <sup>1)</sup></td> <td rowspan="10">282 12,0 10,0 +S +B<br/>282 12,0 10,0 +S +B PD</td> </tr> <tr> <td>1.8 TFSI</td> <td>118</td> <td>11.12</td> <td></td> <td>24.0312-0169.1</td> <td>512169</td> </tr> <tr> <td>2.0 TDI</td> <td>85</td> <td>04.11</td> <td></td> <td></td> <td></td> </tr> <tr> <td>2.0 TDI</td> <td>100</td> <td>09.10</td> <td></td> <td></td> <td></td> </tr> <tr> <td>2.0 TDI</td> <td>103</td> <td>06.10</td> <td></td> <td></td> <td></td> </tr> <tr> <td>2.0 TDI</td> <td>125</td> <td>09.10</td> <td></td> <td></td> <td></td> </tr> <tr> <td>2.0 TDI</td> <td>130</td> <td>11.12</td> <td></td> <td></td> <td></td> </tr> <tr> <td>2.0 TDI 4motion</td> <td>103</td> <td>04.11</td> <td></td> <td></td> <td></td> </tr> <tr> <td>2.0 TSI</td> <td>147</td> <td>09.10</td> <td></td> <td></td> <td></td> </tr> <tr> <td>2.0 TDI</td> <td>110</td> <td>05.15</td> <td></td> <td>24.0112-0210.1</td> <td>412210</td> <td>elektrische Feststellbremse <sup>1)</sup></td> <td>300 12,0 10,0 +S +B</td> </tr> <tr> <td>2.0 TDI</td> <td>135</td> <td>05.15</td> <td></td> <td></td> <td></td> <td></td> <td></td> </tr> <tr> <td>2.0 TDI 4Drive</td> <td>110</td> <td>05.15</td> <td></td> <td></td> <td></td> <td></td> <td></td> </tr> <tr> <td>2.0 TDI 4Drive</td> <td>135</td> <td>05.16</td> <td></td> <td></td> <td></td> <td></td> <td></td> </tr> <tr> <td>2.0 TSI</td> <td>162</td> <td>05.15</td> <td></td> <td></td> <td></td> <td></td> <td></td> </tr> </table>   | 1.4 TSI | 110             | 09.10          |         | 24.0112-0169.1   | 412169   | elektrische Feststellbremse <sup>1)</sup>  | 282 12,0 10,0 +S +B<br>282 12,0 10,0 +S +B PD    | 1.8 TFSI | 118       | 11.12                              |            | 24.0312-0169.1 | 512169         | 2.0 TDI | 85      | 04.11 |       |                |        | 2.0 TDI | 100       | 09.10 |       |                |        | 2.0 TDI | 103     | 06.10 |       |         |  | 2.0 TDI | 125     | 09.10 |       |         |  | 2.0 TDI | 130      | 11.12 |       |         |  | 2.0 TDI 4motion | 103     | 04.11 |       |         |  | 2.0 TSI | 147     | 09.10 |       |         |  | 2.0 TDI | 110     | 05.15 |       | 24.0112-0210.1 | 412210 | elektrische Feststellbremse <sup>1)</sup> | 300 12,0 10,0 +S +B | 2.0 TDI | 135   | 05.15   |  |                |         |       |       | 2.0 TDI 4Drive | 110    | 05.15   |                                     |                |       |         |  | 2.0 TDI 4Drive | 135     | 05.16           |       |                 |                |                |                                    | 2.0 TSI    | 162       | 05.15 |       |                 |                |        |         |    |       |                 |  |  |           |    |       |                 |  |  |         |    |       |                 |  |  |         |  |       |                 |  |  |          |     |       |                 |  |  |         |  |       |                 |  |  |         |     |       |                 |  |  |         |     |       |                 |  |  |         |     |       |                 |  |  |         |     |       |                 |  |  |          |     |       |                 |  |  |         |    |       |         |                |        |   |  |           |    |       |         |                |        |         |    |       |         |  |  |           |    |       |         |  |  |         |    |       |         |  |  |         |  |       |         |  |  |          |     |       |         |  |  |         |  |       |         |  |  |         |     |       |         |  |  |         |     |       |         |  |  |         |     |       |         |  |  |         |     |       |         |  |  |          |     |       |         |  |  |         |    |       |         |                |        |   |  |           |    |       |         |                |        |         |    |       |         |  |  |           |    |       |         |  |  |         |    |       |         |  |  |         |  |       |         |  |  |          |     |       |         |  |  |         |  |       |         |  |  |         |     |       |         |  |  |         |     |       |         |  |  |         |     |       |         |  |  |         |     |       |         |  |  |          |     |       |         |  |  |         |    |       |             |                |        |   |  |           |    |       |             |                |        |         |    |       |             |  |  |
| 1.4 TSI  | 110  | 09.10   |                 | 24.0112-0169.1 | 412169  | elektrische Feststellbremse <sup>1)</sup>  | 282 12,0 10,0 +S +B<br>282 12,0 10,0 +S +B PD    |  |  |          |           |                                    |            |                |                |         |         |       |       |                |        |         |           |       |       |                |        |         |         |       |       |         |  |         |         |       |       |         |  |         |          |       |       |         |  |                 |         |       |       |         |  |         |         |       |       |         |  |         |         |       |       |                |        |   |                     |         |       |         |  |                |         |       |       |                |        |   |                                     |                |       |         |  |                |         |                 |       |                 |                |                |                                    |            |           |       |       |                 |                |        |         |    |       |                 |  |  |           |    |       |                 |  |  |         |    |       |                 |  |  |         |  |       |                 |  |  |          |     |       |                 |  |  |         |  |       |                 |  |  |         |     |       |                 |  |  |         |     |       |                 |  |  |         |     |       |                 |  |  |         |     |       |                 |  |  |          |     |       |                 |  |  |         |    |       |         |                |        |   |  |           |    |       |         |                |        |         |    |       |         |  |  |           |    |       |         |  |  |         |    |       |         |  |  |         |  |       |         |  |  |          |     |       |         |  |  |         |  |       |         |  |  |         |     |       |         |  |  |         |     |       |         |  |  |         |     |       |         |  |  |         |     |       |         |  |  |          |     |       |         |  |  |         |    |       |         |                |        |   |  |           |    |       |         |                |        |         |    |       |         |  |  |           |    |       |         |  |  |         |    |       |         |  |  |         |  |       |         |  |  |          |     |       |         |  |  |         |  |       |         |  |  |         |     |       |         |  |  |         |     |       |         |  |  |         |     |       |         |  |  |         |     |       |         |  |  |          |     |       |         |  |  |         |    |       |             |                |        |   |  |           |    |       |             |                |        |         |    |       |             |  |  |
| 1.8 TFSI   | 118  | 11.12   |                 | 24.0312-0169.1 | 512169  |  |  |  |  |          |           |                                    |            |                |                |         |         |       |       |                |        |         |           |       |       |                |        |         |         |       |       |         |  |         |         |       |       |         |  |         |          |       |       |         |  |                 |         |       |       |         |  |         |         |       |       |         |  |         |         |       |       |                |        |   |                     |         |       |         |  |                |         |       |       |                |        |   |                                     |                |       |         |  |                |         |                 |       |                 |                |                |                                    |            |           |       |       |                 |                |        |         |    |       |                 |  |  |           |    |       |                 |  |  |         |    |       |                 |  |  |         |  |       |                 |  |  |          |     |       |                 |  |  |         |  |       |                 |  |  |         |     |       |                 |  |  |         |     |       |                 |  |  |         |     |       |                 |  |  |         |     |       |                 |  |  |          |     |       |                 |  |  |         |    |       |         |                |        |   |  |           |    |       |         |                |        |         |    |       |         |  |  |           |    |       |         |  |  |         |    |       |         |  |  |         |  |       |         |  |  |          |     |       |         |  |  |         |  |       |         |  |  |         |     |       |         |  |  |         |     |       |         |  |  |         |     |       |         |  |  |         |     |       |         |  |  |          |     |       |         |  |  |         |    |       |         |                |        |   |  |           |    |       |         |                |        |         |    |       |         |  |  |           |    |       |         |  |  |         |    |       |         |  |  |         |  |       |         |  |  |          |     |       |         |  |  |         |  |       |         |  |  |         |     |       |         |  |  |         |     |       |         |  |  |         |     |       |         |  |  |         |     |       |         |  |  |          |     |       |         |  |  |         |    |       |             |                |        |   |  |           |    |       |             |                |        |         |    |       |             |  |  |
| 2.0 TDI  | 85   | 04.11   |                 |                |         |  |  |  |  |          |           |                                    |            |                |                |         |         |       |       |                |        |         |           |       |       |                |        |         |         |       |       |         |  |         |         |       |       |         |  |         |          |       |       |         |  |                 |         |       |       |         |  |         |         |       |       |         |  |         |         |       |       |                |        |   |                     |         |       |         |  |                |         |       |       |                |        |   |                                     |                |       |         |  |                |         |                 |       |                 |                |                |                                    |            |           |       |       |                 |                |        |         |    |       |                 |  |  |           |    |       |                 |  |  |         |    |       |                 |  |  |         |  |       |                 |  |  |          |     |       |                 |  |  |         |  |       |                 |  |  |         |     |       |                 |  |  |         |     |       |                 |  |  |         |     |       |                 |  |  |         |     |       |                 |  |  |          |     |       |                 |  |  |         |    |       |         |                |        |   |  |           |    |       |         |                |        |         |    |       |         |  |  |           |    |       |         |  |  |         |    |       |         |  |  |         |  |       |         |  |  |          |     |       |         |  |  |         |  |       |         |  |  |         |     |       |         |  |  |         |     |       |         |  |  |         |     |       |         |  |  |         |     |       |         |  |  |          |     |       |         |  |  |         |    |       |         |                |        |   |  |           |    |       |         |                |        |         |    |       |         |  |  |           |    |       |         |  |  |         |    |       |         |  |  |         |  |       |         |  |  |          |     |       |         |  |  |         |  |       |         |  |  |         |     |       |         |  |  |         |     |       |         |  |  |         |     |       |         |  |  |         |     |       |         |  |  |          |     |       |         |  |  |         |    |       |             |                |        |   |  |           |    |       |             |                |        |         |    |       |             |  |  |
| 2.0 TDI  | 100  | 09.10   |                 |                |         |  |  |  |  |          |           |                                    |            |                |                |         |         |       |       |                |        |         |           |       |       |                |        |         |         |       |       |         |  |         |         |       |       |         |  |         |          |       |       |         |  |                 |         |       |       |         |  |         |         |       |       |         |  |         |         |       |       |                |        |   |                     |         |       |         |  |                |         |       |       |                |        |   |                                     |                |       |         |  |                |         |                 |       |                 |                |                |                                    |            |           |       |       |                 |                |        |         |    |       |                 |  |  |           |    |       |                 |  |  |         |    |       |                 |  |  |         |  |       |                 |  |  |          |     |       |                 |  |  |         |  |       |                 |  |  |         |     |       |                 |  |  |         |     |       |                 |  |  |         |     |       |                 |  |  |         |     |       |                 |  |  |          |     |       |                 |  |  |         |    |       |         |                |        |   |  |           |    |       |         |                |        |         |    |       |         |  |  |           |    |       |         |  |  |         |    |       |         |  |  |         |  |       |         |  |  |          |     |       |         |  |  |         |  |       |         |  |  |         |     |       |         |  |  |         |     |       |         |  |  |         |     |       |         |  |  |         |     |       |         |  |  |          |     |       |         |  |  |         |    |       |         |                |        |   |  |           |    |       |         |                |        |         |    |       |         |  |  |           |    |       |         |  |  |         |    |       |         |  |  |         |  |       |         |  |  |          |     |       |         |  |  |         |  |       |         |  |  |         |     |       |         |  |  |         |     |       |         |  |  |         |     |       |         |  |  |         |     |       |         |  |  |          |     |       |         |  |  |         |    |       |             |                |        |   |  |           |    |       |             |                |        |         |    |       |             |  |  |
| 2.0 TDI  | 103  | 06.10   |                 |                |         |  |  |  |  |          |           |                                    |            |                |                |         |         |       |       |                |        |         |           |       |       |                |        |         |         |       |       |         |  |         |         |       |       |         |  |         |          |       |       |         |  |                 |         |       |       |         |  |         |         |       |       |         |  |         |         |       |       |                |        |   |                     |         |       |         |  |                |         |       |       |                |        |   |                                     |                |       |         |  |                |         |                 |       |                 |                |                |                                    |            |           |       |       |                 |                |        |         |    |       |                 |  |  |           |    |       |                 |  |  |         |    |       |                 |  |  |         |  |       |                 |  |  |          |     |       |                 |  |  |         |  |       |                 |  |  |         |     |       |                 |  |  |         |     |       |                 |  |  |         |     |       |                 |  |  |         |     |       |                 |  |  |          |     |       |                 |  |  |         |    |       |         |                |        |   |  |           |    |       |         |                |        |         |    |       |         |  |  |           |    |       |         |  |  |         |    |       |         |  |  |         |  |       |         |  |  |          |     |       |         |  |  |         |  |       |         |  |  |         |     |       |         |  |  |         |     |       |         |  |  |         |     |       |         |  |  |         |     |       |         |  |  |          |     |       |         |  |  |         |    |       |         |                |        |   |  |           |    |       |         |                |        |         |    |       |         |  |  |           |    |       |         |  |  |         |    |       |         |  |  |         |  |       |         |  |  |          |     |       |         |  |  |         |  |       |         |  |  |         |     |       |         |  |  |         |     |       |         |  |  |         |     |       |         |  |  |         |     |       |         |  |  |          |     |       |         |  |  |         |    |       |             |                |        |   |  |           |    |       |             |                |        |         |    |       |             |  |  |
| 2.0 TDI  | 125  | 09.10   |                 |                |         |  |  |  |  |          |           |                                    |            |                |                |         |         |       |       |                |        |         |           |       |       |                |        |         |         |       |       |         |  |         |         |       |       |         |  |         |          |       |       |         |  |                 |         |       |       |         |  |         |         |       |       |         |  |         |         |       |       |                |        |   |                     |         |       |         |  |                |         |       |       |                |        |   |                                     |                |       |         |  |                |         |                 |       |                 |                |                |                                    |            |           |       |       |                 |                |        |         |    |       |                 |  |  |           |    |       |                 |  |  |         |    |       |                 |  |  |         |  |       |                 |  |  |          |     |       |                 |  |  |         |  |       |                 |  |  |         |     |       |                 |  |  |         |     |       |                 |  |  |         |     |       |                 |  |  |         |     |       |                 |  |  |          |     |       |                 |  |  |         |    |       |         |                |        |   |  |           |    |       |         |                |        |         |    |       |         |  |  |           |    |       |         |  |  |         |    |       |         |  |  |         |  |       |         |  |  |          |     |       |         |  |  |         |  |       |         |  |  |         |     |       |         |  |  |         |     |       |         |  |  |         |     |       |         |  |  |         |     |       |         |  |  |          |     |       |         |  |  |         |    |       |         |                |        |   |  |           |    |       |         |                |        |         |    |       |         |  |  |           |    |       |         |  |  |         |    |       |         |  |  |         |  |       |         |  |  |          |     |       |         |  |  |         |  |       |         |  |  |         |     |       |         |  |  |         |     |       |         |  |  |         |     |       |         |  |  |         |     |       |         |  |  |          |     |       |         |  |  |         |    |       |             |                |        |   |  |           |    |       |             |                |        |         |    |       |             |  |  |
| 2.0 TDI  | 130  | 11.12   |                 |                |         |  |  |  |  |          |           |                                    |            |                |                |         |         |       |       |                |        |         |           |       |       |                |        |         |         |       |       |         |  |         |         |       |       |         |  |         |          |       |       |         |  |                 |         |       |       |         |  |         |         |       |       |         |  |         |         |       |       |                |        |   |                     |         |       |         |  |                |         |       |       |                |        |   |                                     |                |       |         |  |                |         |                 |       |                 |                |                |                                    |            |           |       |       |                 |                |        |         |    |       |                 |  |  |           |    |       |                 |  |  |         |    |       |                 |  |  |         |  |       |                 |  |  |          |     |       |                 |  |  |         |  |       |                 |  |  |         |     |       |                 |  |  |         |     |       |                 |  |  |         |     |       |                 |  |  |         |     |       |                 |  |  |          |     |       |                 |  |  |         |    |       |         |                |        |   |  |           |    |       |         |                |        |         |    |       |         |  |  |           |    |       |         |  |  |         |    |       |         |  |  |         |  |       |         |  |  |          |     |       |         |  |  |         |  |       |         |  |  |         |     |       |         |  |  |         |     |       |         |  |  |         |     |       |         |  |  |         |     |       |         |  |  |          |     |       |         |  |  |         |    |       |         |                |        |   |  |           |    |       |         |                |        |         |    |       |         |  |  |           |    |       |         |  |  |         |    |       |         |  |  |         |  |       |         |  |  |          |     |       |         |  |  |         |  |       |         |  |  |         |     |       |         |  |  |         |     |       |         |  |  |         |     |       |         |  |  |         |     |       |         |  |  |          |     |       |         |  |  |         |    |       |             |                |        |   |  |           |    |       |             |                |        |         |    |       |             |  |  |
| 2.0 TDI 4motion  | 103  | 04.11   |                 |                |         |  |  |  |  |          |           |                                    |            |                |                |         |         |       |       |                |        |         |           |       |       |                |        |         |         |       |       |         |  |         |         |       |       |         |  |         |          |       |       |         |  |                 |         |       |       |         |  |         |         |       |       |         |  |         |         |       |       |                |        |   |                     |         |       |         |  |                |         |       |       |                |        |   |                                     |                |       |         |  |                |         |                 |       |                 |                |                |                                    |            |           |       |       |                 |                |        |         |    |       |                 |  |  |           |    |       |                 |  |  |         |    |       |                 |  |  |         |  |       |                 |  |  |          |     |       |                 |  |  |         |  |       |                 |  |  |         |     |       |                 |  |  |         |     |       |                 |  |  |         |     |       |                 |  |  |         |     |       |                 |  |  |          |     |       |                 |  |  |         |    |       |         |                |        |   |  |           |    |       |         |                |        |         |    |       |         |  |  |           |    |       |         |  |  |         |    |       |         |  |  |         |  |       |         |  |  |          |     |       |         |  |  |         |  |       |         |  |  |         |     |       |         |  |  |         |     |       |         |  |  |         |     |       |         |  |  |         |     |       |         |  |  |          |     |       |         |  |  |         |    |       |         |                |        |   |  |           |    |       |         |                |        |         |    |       |         |  |  |           |    |       |         |  |  |         |    |       |         |  |  |         |  |       |         |  |  |          |     |       |         |  |  |         |  |       |         |  |  |         |     |       |         |  |  |         |     |       |         |  |  |         |     |       |         |  |  |         |     |       |         |  |  |          |     |       |         |  |  |         |    |       |             |                |        |   |  |           |    |       |             |                |        |         |    |       |             |  |  |
| 2.0 TSI  | 147  | 09.10   |                 |                |         |  |  |  |  |          |           |                                    |            |                |                |         |         |       |       |                |        |         |           |       |       |                |        |         |         |       |       |         |  |         |         |       |       |         |  |         |          |       |       |         |  |                 |         |       |       |         |  |         |         |       |       |         |  |         |         |       |       |                |        |   |                     |         |       |         |  |                |         |       |       |                |        |   |                                     |                |       |         |  |                |         |                 |       |                 |                |                |                                    |            |           |       |       |                 |                |        |         |    |       |                 |  |  |           |    |       |                 |  |  |         |    |       |                 |  |  |         |  |       |                 |  |  |          |     |       |                 |  |  |         |  |       |                 |  |  |         |     |       |                 |  |  |         |     |       |                 |  |  |         |     |       |                 |  |  |         |     |       |                 |  |  |          |     |       |                 |  |  |         |    |       |         |                |        |   |  |           |    |       |         |                |        |         |    |       |         |  |  |           |    |       |         |  |  |         |    |       |         |  |  |         |  |       |         |  |  |          |     |       |         |  |  |         |  |       |         |  |  |         |     |       |         |  |  |         |     |       |         |  |  |         |     |       |         |  |  |         |     |       |         |  |  |          |     |       |         |  |  |         |    |       |         |                |        |   |  |           |    |       |         |                |        |         |    |       |         |  |  |           |    |       |         |  |  |         |    |       |         |  |  |         |  |       |         |  |  |          |     |       |         |  |  |         |  |       |         |  |  |         |     |       |         |  |  |         |     |       |         |  |  |         |     |       |         |  |  |         |     |       |         |  |  |          |     |       |         |  |  |         |    |       |             |                |        |   |  |           |    |       |             |                |        |         |    |       |             |  |  |
| 2.0 TDI  | 110  | 05.15   |                 | 24.0112-0210.1 | 412210  |  |  | elektrische Feststellbremse <sup>1)</sup>  | 300 12,0 10,0 +S +B                              |          |           |                                    |            |                |                |         |         |       |       |                |        |         |           |       |       |                |        |         |         |       |       |         |  |         |         |       |       |         |  |         |          |       |       |         |  |                 |         |       |       |         |  |         |         |       |       |         |  |         |         |       |       |                |        |   |                     |         |       |         |  |                |         |       |       |                |        |   |                                     |                |       |         |  |                |         |                 |       |                 |                |                |                                    |            |           |       |       |                 |                |        |         |    |       |                 |  |  |           |    |       |                 |  |  |         |    |       |                 |  |  |         |  |       |                 |  |  |          |     |       |                 |  |  |         |  |       |                 |  |  |         |     |       |                 |  |  |         |     |       |                 |  |  |         |     |       |                 |  |  |         |     |       |                 |  |  |          |     |       |                 |  |  |         |    |       |         |                |        |   |  |           |    |       |         |                |        |         |    |       |         |  |  |           |    |       |         |  |  |         |    |       |         |  |  |         |  |       |         |  |  |          |     |       |         |  |  |         |  |       |         |  |  |         |     |       |         |  |  |         |     |       |         |  |  |         |     |       |         |  |  |         |     |       |         |  |  |          |     |       |         |  |  |         |    |       |         |                |        |   |  |           |    |       |         |                |        |         |    |       |         |  |  |           |    |       |         |  |  |         |    |       |         |  |  |         |  |       |         |  |  |          |     |       |         |  |  |         |  |       |         |  |  |         |     |       |         |  |  |         |     |       |         |  |  |         |     |       |         |  |  |         |     |       |         |  |  |          |     |       |         |  |  |         |    |       |             |                |        |   |  |           |    |       |             |                |        |         |    |       |             |  |  |
| 2.0 TDI  | 135  | 05.15   |                 |                |         |  |  |  |  |          |           |                                    |            |                |                |         |         |       |       |                |        |         |           |       |       |                |        |         |         |       |       |         |  |         |         |       |       |         |  |         |          |       |       |         |  |                 |         |       |       |         |  |         |         |       |       |         |  |         |         |       |       |                |        |   |                     |         |       |         |  |                |         |       |       |                |        |   |                                     |                |       |         |  |                |         |                 |       |                 |                |                |                                    |            |           |       |       |                 |                |        |         |    |       |                 |  |  |           |    |       |                 |  |  |         |    |       |                 |  |  |         |  |       |                 |  |  |          |     |       |                 |  |  |         |  |       |                 |  |  |         |     |       |                 |  |  |         |     |       |                 |  |  |         |     |       |                 |  |  |         |     |       |                 |  |  |          |     |       |                 |  |  |         |    |       |         |                |        |   |  |           |    |       |         |                |        |         |    |       |         |  |  |           |    |       |         |  |  |         |    |       |         |  |  |         |  |       |         |  |  |          |     |       |         |  |  |         |  |       |         |  |  |         |     |       |         |  |  |         |     |       |         |  |  |         |     |       |         |  |  |         |     |       |         |  |  |          |     |       |         |  |  |         |    |       |         |                |        |   |  |           |    |       |         |                |        |         |    |       |         |  |  |           |    |       |         |  |  |         |    |       |         |  |  |         |  |       |         |  |  |          |     |       |         |  |  |         |  |       |         |  |  |         |     |       |         |  |  |         |     |       |         |  |  |         |     |       |         |  |  |         |     |       |         |  |  |          |     |       |         |  |  |         |    |       |             |                |        |   |  |           |    |       |             |                |        |         |    |       |             |  |  |
| 2.0 TDI 4Drive   | 110  | 05.15   |                 |                |         |  |  |  |  |          |           |                                    |            |                |                |         |         |       |       |                |        |         |           |       |       |                |        |         |         |       |       |         |  |         |         |       |       |         |  |         |          |       |       |         |  |                 |         |       |       |         |  |         |         |       |       |         |  |         |         |       |       |                |        |   |                     |         |       |         |  |                |         |       |       |                |        |   |                                     |                |       |         |  |                |         |                 |       |                 |                |                |                                    |            |           |       |       |                 |                |        |         |    |       |                 |  |  |           |    |       |                 |  |  |         |    |       |                 |  |  |         |  |       |                 |  |  |          |     |       |                 |  |  |         |  |       |                 |  |  |         |     |       |                 |  |  |         |     |       |                 |  |  |         |     |       |                 |  |  |         |     |       |                 |  |  |          |     |       |                 |  |  |         |    |       |         |                |        |   |  |           |    |       |         |                |        |         |    |       |         |  |  |           |    |       |         |  |  |         |    |       |         |  |  |         |  |       |         |  |  |          |     |       |         |  |  |         |  |       |         |  |  |         |     |       |         |  |  |         |     |       |         |  |  |         |     |       |         |  |  |         |     |       |         |  |  |          |     |       |         |  |  |         |    |       |         |                |        |   |  |           |    |       |         |                |        |         |    |       |         |  |  |           |    |       |         |  |  |         |    |       |         |  |  |         |  |       |         |  |  |          |     |       |         |  |  |         |  |       |         |  |  |         |     |       |         |  |  |         |     |       |         |  |  |         |     |       |         |  |  |         |     |       |         |  |  |          |     |       |         |  |  |         |    |       |             |                |        |   |  |           |    |       |             |                |        |         |    |       |             |  |  |
| 2.0 TDI 4Drive   | 135  | 05.16   |                 |                |         |  |  |  |  |          |           |                                    |            |                |                |         |         |       |       |                |        |         |           |       |       |                |        |         |         |       |       |         |  |         |         |       |       |         |  |         |          |       |       |         |  |                 |         |       |       |         |  |         |         |       |       |         |  |         |         |       |       |                |        |   |                     |         |       |         |  |                |         |       |       |                |        |   |                                     |                |       |         |  |                |         |                 |       |                 |                |                |                                    |            |           |       |       |                 |                |        |         |    |       |                 |  |  |           |    |       |                 |  |  |         |    |       |                 |  |  |         |  |       |                 |  |  |          |     |       |                 |  |  |         |  |       |                 |  |  |         |     |       |                 |  |  |         |     |       |                 |  |  |         |     |       |                 |  |  |         |     |       |                 |  |  |          |     |       |                 |  |  |         |    |       |         |                |        |   |  |           |    |       |         |                |        |         |    |       |         |  |  |           |    |       |         |  |  |         |    |       |         |  |  |         |  |       |         |  |  |          |     |       |         |  |  |         |  |       |         |  |  |         |     |       |         |  |  |         |     |       |         |  |  |         |     |       |         |  |  |         |     |       |         |  |  |          |     |       |         |  |  |         |    |       |         |                |        |   |  |           |    |       |         |                |        |         |    |       |         |  |  |           |    |       |         |  |  |         |    |       |         |  |  |         |  |       |         |  |  |          |     |       |         |  |  |         |  |       |         |  |  |         |     |       |         |  |  |         |     |       |         |  |  |         |     |       |         |  |  |         |     |       |         |  |  |          |     |       |         |  |  |         |    |       |             |                |        |   |  |           |    |       |             |                |        |         |    |       |             |  |  |
| 2.0 TSI  | 162  | 05.15   |                 |                |         |  |  |  |  |          |           |                                    |            |                |                |         |         |       |       |                |        |         |           |       |       |                |        |         |         |       |       |         |  |         |         |       |       |         |  |         |          |       |       |         |  |                 |         |       |       |         |  |         |         |       |       |         |  |         |         |       |       |                |        |   |                     |         |       |         |  |                |         |       |       |                |        |   |                                     |                |       |         |  |                |         |                 |       |                 |                |                |                                    |            |           |       |       |                 |                |        |         |    |       |                 |  |  |           |    |       |                 |  |  |         |    |       |                 |  |  |         |  |       |                 |  |  |          |     |       |                 |  |  |         |  |       |                 |  |  |         |     |       |                 |  |  |         |     |       |                 |  |  |         |     |       |                 |  |  |         |     |       |                 |  |  |          |     |       |                 |  |  |         |    |       |         |                |        |   |  |           |    |       |         |                |        |         |    |       |         |  |  |           |    |       |         |  |  |         |    |       |         |  |  |         |  |       |         |  |  |          |     |       |         |  |  |         |  |       |         |  |  |         |     |       |         |  |  |         |     |       |         |  |  |         |     |       |         |  |  |         |     |       |         |  |  |          |     |       |         |  |  |         |    |       |         |                |        |   |  |           |    |       |         |                |        |         |    |       |         |  |  |           |    |       |         |  |  |         |    |       |         |  |  |         |  |       |         |  |  |          |     |       |         |  |  |         |  |       |         |  |  |         |     |       |         |  |  |         |     |       |         |  |  |         |     |       |         |  |  |         |     |       |         |  |  |          |     |       |         |  |  |         |    |       |             |                |        |   |  |           |    |       |             |                |        |         |    |       |             |  |  |
|  | <table border="1"> <tr> <td>1.4 TSI</td> <td>110</td> <td>09.10</td> <td></td> <td>24.0711-6231.3</td> <td>360305</td> <td rowspan="10"> <ul style="list-style-type: none"> <li>PR: 7X0,7X2,7Y0,7Y4</li> <li>PR: 7X0,7X2,7Y0,7Y4</li> <li>PR: 7X0,7X2,7X5,7Y8,7Y9</li> <li>PR: 7X0,7X2,7X5,7Y8,7Y9</li> </ul> </td> <td rowspan="10">Radsensor<br/>Radsensor<br/>Radsensor<br/>Radsensor</td> </tr> <tr> <td>1.8 TFSI</td> <td>118</td> <td>11.12</td> <td></td> <td>24.0711-6232.3</td> <td>360306</td> </tr> <tr> <td>2.0 TDI</td> <td>85</td> <td>04.11</td> <td></td> <td>24.0711-6335.3</td> <td>360365</td> </tr> <tr> <td>2.0 TDI</td> <td>100</td> <td>09.10</td> <td></td> <td>24.0711-6336.3</td> <td>360366</td> </tr> <tr> <td>2.0 TDI</td> <td>103</td> <td>09.10</td> <td></td> <td></td> <td></td> </tr> <tr> <td>2.0 TDI</td> <td>110</td> <td>05.15</td> <td></td> <td></td> <td></td> </tr> <tr> <td>2.0 TDI</td> <td>125</td> <td>09.10</td> <td></td> <td></td> <td></td> </tr> <tr> <td>2.0 TDI</td> <td>130</td> <td>11.12</td> <td></td> <td></td> <td></td> </tr> <tr> <td>2.0 TDI</td> <td>135</td> <td>05.15</td> <td></td> <td></td> <td></td> </tr> <tr> <td>2.0 TSI</td> <td>147</td> <td>09.10</td> <td></td> <td></td> <td></td> </tr> <tr> <td>2.0 TSI</td> <td>162</td> <td>05.15</td> <td></td> <td></td> <td></td> </tr> <tr> <td>2.0 TDI 4Drive</td> <td>110</td> <td>05.15</td> <td></td> <td>24.0711-5271.3</td> <td>360301</td> <td rowspan="3"> <ul style="list-style-type: none"> <li>PR: 7X0,7X2,7Y0,7Y4</li> <li>PR: 7X0,7X2,7Y0,7Y4</li> <li>PR: 7X0,7X2,7X5,7Y8,7Y9</li> </ul> </td> <td rowspan="3">Radsensor<br/>Radsensor<br/>Radsensor</td> </tr> <tr> <td>2.0 TDI 4Drive</td> <td>135</td> <td>05.16</td> <td></td> <td>24.0711-5272.3</td> <td>360302</td> </tr> <tr> <td>2.0 TDI 4motion</td> <td>103</td> <td>04.11</td> <td></td> <td>24.0711-5401.3</td> <td>360330</td> </tr> <tr> <td></td> <td></td> <td></td> <td></td> <td>24.0711-5402.3</td> <td>360331</td> <td></td> <td></td> </tr> </table>  | 1.4 TSI | 110             | 09.10          |         | 24.0711-6231.3   | 360305   | <ul style="list-style-type: none"> <li>PR: 7X0,7X2,7Y0,7Y4</li> <li>PR: 7X0,7X2,7Y0,7Y4</li> <li>PR: 7X0,7X2,7X5,7Y8,7Y9</li> <li>PR: 7X0,7X2,7X5,7Y8,7Y9</li> </ul> | Radsensor<br>Radsensor<br>Radsensor<br>Radsensor | 1.8 TFSI | 118       | 11.12                              |            | 24.0711-6232.3 | 360306         | 2.0 TDI | 85      | 04.11 |       | 24.0711-6335.3 | 360365 | 2.0 TDI | 100       | 09.10 |       | 24.0711-6336.3 | 360366 | 2.0 TDI | 103     | 09.10 |       |         |  | 2.0 TDI | 110     | 05.15 |       |         |  | 2.0 TDI | 125      | 09.10 |       |         |  | 2.0 TDI         | 130     | 11.12 |       |         |  | 2.0 TDI | 135     | 05.15 |       |         |  | 2.0 TSI | 147     | 09.10 |       |                |        | 2.0 TSI                                   | 162                 | 05.15   |       |         |  | 2.0 TDI 4Drive | 110     | 05.15 |       | 24.0711-5271.3 | 360301 | <ul style="list-style-type: none"> <li>PR: 7X0,7X2,7Y0,7Y4</li> <li>PR: 7X0,7X2,7Y0,7Y4</li> <li>PR: 7X0,7X2,7X5,7Y8,7Y9</li> </ul> | Radsensor<br>Radsensor<br>Radsensor | 2.0 TDI 4Drive | 135   | 05.16   |  | 24.0711-5272.3 | 360302  | 2.0 TDI 4motion | 103   | 04.11           |                | 24.0711-5401.3 | 360330                             |            |           |       |       | 24.0711-5402.3  | 360331         |        |         |    |       |                 |  |  |           |    |       |                 |  |  |         |    |       |                 |  |  |         |  |       |                 |  |  |          |     |       |                 |  |  |         |  |       |                 |  |  |         |     |       |                 |  |  |         |     |       |                 |  |  |         |     |       |                 |  |  |         |     |       |                 |  |  |          |     |       |                 |  |  |         |    |       |         |                |        |   |  |           |    |       |         |                |        |         |    |       |         |  |  |           |    |       |         |  |  |         |    |       |         |  |  |         |  |       |         |  |  |          |     |       |         |  |  |         |  |       |         |  |  |         |     |       |         |  |  |         |     |       |         |  |  |         |     |       |         |  |  |         |     |       |         |  |  |          |     |       |         |  |  |         |    |       |         |                |        |   |  |           |    |       |         |                |        |         |    |       |         |  |  |           |    |       |         |  |  |         |    |       |         |  |  |         |  |       |         |  |  |          |     |       |         |  |  |         |  |       |         |  |  |         |     |       |         |  |  |         |     |       |         |  |  |         |     |       |         |  |  |         |     |       |         |  |  |          |     |       |         |  |  |         |    |       |             |                |        |   |  |           |    |       |             |                |        |         |    |       |             |  |  |
| 1.4 TSI  | 110  | 09.10   |                 | 24.0711-6231.3 | 360305  | <ul style="list-style-type: none"> <li>PR: 7X0,7X2,7Y0,7Y4</li> <li>PR: 7X0,7X2,7Y0,7Y4</li> <li>PR: 7X0,7X2,7X5,7Y8,7Y9</li> <li>PR: 7X0,7X2,7X5,7Y8,7Y9</li> </ul> | Radsensor<br>Radsensor<br>Radsensor<br>Radsensor |  |  |          |           |                                    |            |                |                |         |         |       |       |                |        |         |           |       |       |                |        |         |         |       |       |         |  |         |         |       |       |         |  |         |          |       |       |         |  |                 |         |       |       |         |  |         |         |       |       |         |  |         |         |       |       |                |        |   |                     |         |       |         |  |                |         |       |       |                |        |   |                                     |                |       |         |  |                |         |                 |       |                 |                |                |                                    |            |           |       |       |                 |                |        |         |    |       |                 |  |  |           |    |       |                 |  |  |         |    |       |                 |  |  |         |  |       |                 |  |  |          |     |       |                 |  |  |         |  |       |                 |  |  |         |     |       |                 |  |  |         |     |       |                 |  |  |         |     |       |                 |  |  |         |     |       |                 |  |  |          |     |       |                 |  |  |         |    |       |         |                |        |   |  |           |    |       |         |                |        |         |    |       |         |  |  |           |    |       |         |  |  |         |    |       |         |  |  |         |  |       |         |  |  |          |     |       |         |  |  |         |  |       |         |  |  |         |     |       |         |  |  |         |     |       |         |  |  |         |     |       |         |  |  |         |     |       |         |  |  |          |     |       |         |  |  |         |    |       |         |                |        |   |  |           |    |       |         |                |        |         |    |       |         |  |  |           |    |       |         |  |  |         |    |       |         |  |  |         |  |       |         |  |  |          |     |       |         |  |  |         |  |       |         |  |  |         |     |       |         |  |  |         |     |       |         |  |  |         |     |       |         |  |  |         |     |       |         |  |  |          |     |       |         |  |  |         |    |       |             |                |        |   |  |           |    |       |             |                |        |         |    |       |             |  |  |
| 1.8 TFSI   | 118  | 11.12   |                 | 24.0711-6232.3 | 360306  |  |  |  |  |          |           |                                    |            |                |                |         |         |       |       |                |        |         |           |       |       |                |        |         |         |       |       |         |  |         |         |       |       |         |  |         |          |       |       |         |  |                 |         |       |       |         |  |         |         |       |       |         |  |         |         |       |       |                |        |   |                     |         |       |         |  |                |         |       |       |                |        |   |                                     |                |       |         |  |                |         |                 |       |                 |                |                |                                    |            |           |       |       |                 |                |        |         |    |       |                 |  |  |           |    |       |                 |  |  |         |    |       |                 |  |  |         |  |       |                 |  |  |          |     |       |                 |  |  |         |  |       |                 |  |  |         |     |       |                 |  |  |         |     |       |                 |  |  |         |     |       |                 |  |  |         |     |       |                 |  |  |          |     |       |                 |  |  |         |    |       |         |                |        |   |  |           |    |       |         |                |        |         |    |       |         |  |  |           |    |       |         |  |  |         |    |       |         |  |  |         |  |       |         |  |  |          |     |       |         |  |  |         |  |       |         |  |  |         |     |       |         |  |  |         |     |       |         |  |  |         |     |       |         |  |  |         |     |       |         |  |  |          |     |       |         |  |  |         |    |       |         |                |        |   |  |           |    |       |         |                |        |         |    |       |         |  |  |           |    |       |         |  |  |         |    |       |         |  |  |         |  |       |         |  |  |          |     |       |         |  |  |         |  |       |         |  |  |         |     |       |         |  |  |         |     |       |         |  |  |         |     |       |         |  |  |         |     |       |         |  |  |          |     |       |         |  |  |         |    |       |             |                |        |   |  |           |    |       |             |                |        |         |    |       |             |  |  |
| 2.0 TDI  | 85   | 04.11   |                 | 24.0711-6335.3 | 360365  |  |  |  |  |          |           |                                    |            |                |                |         |         |       |       |                |        |         |           |       |       |                |        |         |         |       |       |         |  |         |         |       |       |         |  |         |          |       |       |         |  |                 |         |       |       |         |  |         |         |       |       |         |  |         |         |       |       |                |        |   |                     |         |       |         |  |                |         |       |       |                |        |   |                                     |                |       |         |  |                |         |                 |       |                 |                |                |                                    |            |           |       |       |                 |                |        |         |    |       |                 |  |  |           |    |       |                 |  |  |         |    |       |                 |  |  |         |  |       |                 |  |  |          |     |       |                 |  |  |         |  |       |                 |  |  |         |     |       |                 |  |  |         |     |       |                 |  |  |         |     |       |                 |  |  |         |     |       |                 |  |  |          |     |       |                 |  |  |         |    |       |         |                |        |   |  |           |    |       |         |                |        |         |    |       |         |  |  |           |    |       |         |  |  |         |    |       |         |  |  |         |  |       |         |  |  |          |     |       |         |  |  |         |  |       |         |  |  |         |     |       |         |  |  |         |     |       |         |  |  |         |     |       |         |  |  |         |     |       |         |  |  |          |     |       |         |  |  |         |    |       |         |                |        |   |  |           |    |       |         |                |        |         |    |       |         |  |  |           |    |       |         |  |  |         |    |       |         |  |  |         |  |       |         |  |  |          |     |       |         |  |  |         |  |       |         |  |  |         |     |       |         |  |  |         |     |       |         |  |  |         |     |       |         |  |  |         |     |       |         |  |  |          |     |       |         |  |  |         |    |       |             |                |        |   |  |           |    |       |             |                |        |         |    |       |             |  |  |
| 2.0 TDI  | 100  | 09.10   |                 | 24.0711-6336.3 | 360366  |  |  |  |  |          |           |                                    |            |                |                |         |         |       |       |                |        |         |           |       |       |                |        |         |         |       |       |         |  |         |         |       |       |         |  |         |          |       |       |         |  |                 |         |       |       |         |  |         |         |       |       |         |  |         |         |       |       |                |        |   |                     |         |       |         |  |                |         |       |       |                |        |   |                                     |                |       |         |  |                |         |                 |       |                 |                |                |                                    |            |           |       |       |                 |                |        |         |    |       |                 |  |  |           |    |       |                 |  |  |         |    |       |                 |  |  |         |  |       |                 |  |  |          |     |       |                 |  |  |         |  |       |                 |  |  |         |     |       |                 |  |  |         |     |       |                 |  |  |         |     |       |                 |  |  |         |     |       |                 |  |  |          |     |       |                 |  |  |         |    |       |         |                |        |   |  |           |    |       |         |                |        |         |    |       |         |  |  |           |    |       |         |  |  |         |    |       |         |  |  |         |  |       |         |  |  |          |     |       |         |  |  |         |  |       |         |  |  |         |     |       |         |  |  |         |     |       |         |  |  |         |     |       |         |  |  |         |     |       |         |  |  |          |     |       |         |  |  |         |    |       |         |                |        |   |  |           |    |       |         |                |        |         |    |       |         |  |  |           |    |       |         |  |  |         |    |       |         |  |  |         |  |       |         |  |  |          |     |       |         |  |  |         |  |       |         |  |  |         |     |       |         |  |  |         |     |       |         |  |  |         |     |       |         |  |  |         |     |       |         |  |  |          |     |       |         |  |  |         |    |       |             |                |        |   |  |           |    |       |             |                |        |         |    |       |             |  |  |
| 2.0 TDI  | 103  | 09.10   |                 |                |         |  |  |  |  |          |           |                                    |            |                |                |         |         |       |       |                |        |         |           |       |       |                |        |         |         |       |       |         |  |         |         |       |       |         |  |         |          |       |       |         |  |                 |         |       |       |         |  |         |         |       |       |         |  |         |         |       |       |                |        |   |                     |         |       |         |  |                |         |       |       |                |        |   |                                     |                |       |         |  |                |         |                 |       |                 |                |                |                                    |            |           |       |       |                 |                |        |         |    |       |                 |  |  |           |    |       |                 |  |  |         |    |       |                 |  |  |         |  |       |                 |  |  |          |     |       |                 |  |  |         |  |       |                 |  |  |         |     |       |                 |  |  |         |     |       |                 |  |  |         |     |       |                 |  |  |         |     |       |                 |  |  |          |     |       |                 |  |  |         |    |       |         |                |        |   |  |           |    |       |         |                |        |         |    |       |         |  |  |           |    |       |         |  |  |         |    |       |         |  |  |         |  |       |         |  |  |          |     |       |         |  |  |         |  |       |         |  |  |         |     |       |         |  |  |         |     |       |         |  |  |         |     |       |         |  |  |         |     |       |         |  |  |          |     |       |         |  |  |         |    |       |         |                |        |   |  |           |    |       |         |                |        |         |    |       |         |  |  |           |    |       |         |  |  |         |    |       |         |  |  |         |  |       |         |  |  |          |     |       |         |  |  |         |  |       |         |  |  |         |     |       |         |  |  |         |     |       |         |  |  |         |     |       |         |  |  |         |     |       |         |  |  |          |     |       |         |  |  |         |    |       |             |                |        |   |  |           |    |       |             |                |        |         |    |       |             |  |  |
| 2.0 TDI  | 110  | 05.15   |                 |                |         |  |  |  |  |          |           |                                    |            |                |                |         |         |       |       |                |        |         |           |       |       |                |        |         |         |       |       |         |  |         |         |       |       |         |  |         |          |       |       |         |  |                 |         |       |       |         |  |         |         |       |       |         |  |         |         |       |       |                |        |   |                     |         |       |         |  |                |         |       |       |                |        |   |                                     |                |       |         |  |                |         |                 |       |                 |                |                |                                    |            |           |       |       |                 |                |        |         |    |       |                 |  |  |           |    |       |                 |  |  |         |    |       |                 |  |  |         |  |       |                 |  |  |          |     |       |                 |  |  |         |  |       |                 |  |  |         |     |       |                 |  |  |         |     |       |                 |  |  |         |     |       |                 |  |  |         |     |       |                 |  |  |          |     |       |                 |  |  |         |    |       |         |                |        |   |  |           |    |       |         |                |        |         |    |       |         |  |  |           |    |       |         |  |  |         |    |       |         |  |  |         |  |       |         |  |  |          |     |       |         |  |  |         |  |       |         |  |  |         |     |       |         |  |  |         |     |       |         |  |  |         |     |       |         |  |  |         |     |       |         |  |  |          |     |       |         |  |  |         |    |       |         |                |        |   |  |           |    |       |         |                |        |         |    |       |         |  |  |           |    |       |         |  |  |         |    |       |         |  |  |         |  |       |         |  |  |          |     |       |         |  |  |         |  |       |         |  |  |         |     |       |         |  |  |         |     |       |         |  |  |         |     |       |         |  |  |         |     |       |         |  |  |          |     |       |         |  |  |         |    |       |             |                |        |   |  |           |    |       |             |                |        |         |    |       |             |  |  |
| 2.0 TDI  | 125  | 09.10   |                 |                |         |  |  |  |  |          |           |                                    |            |                |                |         |         |       |       |                |        |         |           |       |       |                |        |         |         |       |       |         |  |         |         |       |       |         |  |         |          |       |       |         |  |                 |         |       |       |         |  |         |         |       |       |         |  |         |         |       |       |                |        |   |                     |         |       |         |  |                |         |       |       |                |        |   |                                     |                |       |         |  |                |         |                 |       |                 |                |                |                                    |            |           |       |       |                 |                |        |         |    |       |                 |  |  |           |    |       |                 |  |  |         |    |       |                 |  |  |         |  |       |                 |  |  |          |     |       |                 |  |  |         |  |       |                 |  |  |         |     |       |                 |  |  |         |     |       |                 |  |  |         |     |       |                 |  |  |         |     |       |                 |  |  |          |     |       |                 |  |  |         |    |       |         |                |        |   |  |           |    |       |         |                |        |         |    |       |         |  |  |           |    |       |         |  |  |         |    |       |         |  |  |         |  |       |         |  |  |          |     |       |         |  |  |         |  |       |         |  |  |         |     |       |         |  |  |         |     |       |         |  |  |         |     |       |         |  |  |         |     |       |         |  |  |          |     |       |         |  |  |         |    |       |         |                |        |   |  |           |    |       |         |                |        |         |    |       |         |  |  |           |    |       |         |  |  |         |    |       |         |  |  |         |  |       |         |  |  |          |     |       |         |  |  |         |  |       |         |  |  |         |     |       |         |  |  |         |     |       |         |  |  |         |     |       |         |  |  |         |     |       |         |  |  |          |     |       |         |  |  |         |    |       |             |                |        |   |  |           |    |       |             |                |        |         |    |       |             |  |  |
| 2.0 TDI  | 130  | 11.12   |                 |                |         |  |  |  |  |          |           |                                    |            |                |                |         |         |       |       |                |        |         |           |       |       |                |        |         |         |       |       |         |  |         |         |       |       |         |  |         |          |       |       |         |  |                 |         |       |       |         |  |         |         |       |       |         |  |         |         |       |       |                |        |   |                     |         |       |         |  |                |         |       |       |                |        |   |                                     |                |       |         |  |                |         |                 |       |                 |                |                |                                    |            |           |       |       |                 |                |        |         |    |       |                 |  |  |           |    |       |                 |  |  |         |    |       |                 |  |  |         |  |       |                 |  |  |          |     |       |                 |  |  |         |  |       |                 |  |  |         |     |       |                 |  |  |         |     |       |                 |  |  |         |     |       |                 |  |  |         |     |       |                 |  |  |          |     |       |                 |  |  |         |    |       |         |                |        |   |  |           |    |       |         |                |        |         |    |       |         |  |  |           |    |       |         |  |  |         |    |       |         |  |  |         |  |       |         |  |  |          |     |       |         |  |  |         |  |       |         |  |  |         |     |       |         |  |  |         |     |       |         |  |  |         |     |       |         |  |  |         |     |       |         |  |  |          |     |       |         |  |  |         |    |       |         |                |        |   |  |           |    |       |         |                |        |         |    |       |         |  |  |           |    |       |         |  |  |         |    |       |         |  |  |         |  |       |         |  |  |          |     |       |         |  |  |         |  |       |         |  |  |         |     |       |         |  |  |         |     |       |         |  |  |         |     |       |         |  |  |         |     |       |         |  |  |          |     |       |         |  |  |         |    |       |             |                |        |   |  |           |    |       |             |                |        |         |    |       |             |  |  |
| 2.0 TDI  | 135  | 05.15   |                 |                |         |  |  |  |  |          |           |                                    |            |                |                |         |         |       |       |                |        |         |           |       |       |                |        |         |         |       |       |         |  |         |         |       |       |         |  |         |          |       |       |         |  |                 |         |       |       |         |  |         |         |       |       |         |  |         |         |       |       |                |        |   |                     |         |       |         |  |                |         |       |       |                |        |   |                                     |                |       |         |  |                |         |                 |       |                 |                |                |                                    |            |           |       |       |                 |                |        |         |    |       |                 |  |  |           |    |       |                 |  |  |         |    |       |                 |  |  |         |  |       |                 |  |  |          |     |       |                 |  |  |         |  |       |                 |  |  |         |     |       |                 |  |  |         |     |       |                 |  |  |         |     |       |                 |  |  |         |     |       |                 |  |  |          |     |       |                 |  |  |         |    |       |         |                |        |   |  |           |    |       |         |                |        |         |    |       |         |  |  |           |    |       |         |  |  |         |    |       |         |  |  |         |  |       |         |  |  |          |     |       |         |  |  |         |  |       |         |  |  |         |     |       |         |  |  |         |     |       |         |  |  |         |     |       |         |  |  |         |     |       |         |  |  |          |     |       |         |  |  |         |    |       |         |                |        |   |  |           |    |       |         |                |        |         |    |       |         |  |  |           |    |       |         |  |  |         |    |       |         |  |  |         |  |       |         |  |  |          |     |       |         |  |  |         |  |       |         |  |  |         |     |       |         |  |  |         |     |       |         |  |  |         |     |       |         |  |  |         |     |       |         |  |  |          |     |       |         |  |  |         |    |       |             |                |        |   |  |           |    |       |             |                |        |         |    |       |             |  |  |
| 2.0 TSI  | 147  | 09.10   |                 |                |         |  |  |  |  |          |           |                                    |            |                |                |         |         |       |       |                |        |         |           |       |       |                |        |         |         |       |       |         |  |         |         |       |       |         |  |         |          |       |       |         |  |                 |         |       |       |         |  |         |         |       |       |         |  |         |         |       |       |                |        |   |                     |         |       |         |  |                |         |       |       |                |        |   |                                     |                |       |         |  |                |         |                 |       |                 |                |                |                                    |            |           |       |       |                 |                |        |         |    |       |                 |  |  |           |    |       |                 |  |  |         |    |       |                 |  |  |         |  |       |                 |  |  |          |     |       |                 |  |  |         |  |       |                 |  |  |         |     |       |                 |  |  |         |     |       |                 |  |  |         |     |       |                 |  |  |         |     |       |                 |  |  |          |     |       |                 |  |  |         |    |       |         |                |        |   |  |           |    |       |         |                |        |         |    |       |         |  |  |           |    |       |         |  |  |         |    |       |         |  |  |         |  |       |         |  |  |          |     |       |         |  |  |         |  |       |         |  |  |         |     |       |         |  |  |         |     |       |         |  |  |         |     |       |         |  |  |         |     |       |         |  |  |          |     |       |         |  |  |         |    |       |         |                |        |   |  |           |    |       |         |                |        |         |    |       |         |  |  |           |    |       |         |  |  |         |    |       |         |  |  |         |  |       |         |  |  |          |     |       |         |  |  |         |  |       |         |  |  |         |     |       |         |  |  |         |     |       |         |  |  |         |     |       |         |  |  |         |     |       |         |  |  |          |     |       |         |  |  |         |    |       |             |                |        |   |  |           |    |       |             |                |        |         |    |       |             |  |  |
| 2.0 TSI  | 162  | 05.15   |                 |                |         |  |  |  |  |          |           |                                    |            |                |                |         |         |       |       |                |        |         |           |       |       |                |        |         |         |       |       |         |  |         |         |       |       |         |  |         |          |       |       |         |  |                 |         |       |       |         |  |         |         |       |       |         |  |         |         |       |       |                |        |   |                     |         |       |         |  |                |         |       |       |                |        |   |                                     |                |       |         |  |                |         |                 |       |                 |                |                |                                    |            |           |       |       |                 |                |        |         |    |       |                 |  |  |           |    |       |                 |  |  |         |    |       |                 |  |  |         |  |       |                 |  |  |          |     |       |                 |  |  |         |  |       |                 |  |  |         |     |       |                 |  |  |         |     |       |                 |  |  |         |     |       |                 |  |  |         |     |       |                 |  |  |          |     |       |                 |  |  |         |    |       |         |                |        |   |  |           |    |       |         |                |        |         |    |       |         |  |  |           |    |       |         |  |  |         |    |       |         |  |  |         |  |       |         |  |  |          |     |       |         |  |  |         |  |       |         |  |  |         |     |       |         |  |  |         |     |       |         |  |  |         |     |       |         |  |  |         |     |       |         |  |  |          |     |       |         |  |  |         |    |       |         |                |        |   |  |           |    |       |         |                |        |         |    |       |         |  |  |           |    |       |         |  |  |         |    |       |         |  |  |         |  |       |         |  |  |          |     |       |         |  |  |         |  |       |         |  |  |         |     |       |         |  |  |         |     |       |         |  |  |         |     |       |         |  |  |         |     |       |         |  |  |          |     |       |         |  |  |         |    |       |             |                |        |   |  |           |    |       |             |                |        |         |    |       |             |  |  |
| 2.0 TDI 4Drive   | 110  | 05.15   |                 | 24.0711-5271.3 | 360301  | <ul style="list-style-type: none"> <li>PR: 7X0,7X2,7Y0,7Y4</li> <li>PR: 7X0,7X2,7Y0,7Y4</li> <li>PR: 7X0,7X2,7X5,7Y8,7Y9</li> </ul>                                  | Radsensor<br>Radsensor<br>Radsensor              |  |  |          |           |                                    |            |                |                |         |         |       |       |                |        |         |           |       |       |                |        |         |         |       |       |         |  |         |         |       |       |         |  |         |          |       |       |         |  |                 |         |       |       |         |  |         |         |       |       |         |  |         |         |       |       |                |        |   |                     |         |       |         |  |                |         |       |       |                |        |   |                                     |                |       |         |  |                |         |                 |       |                 |                |                |                                    |            |           |       |       |                 |                |        |         |    |       |                 |  |  |           |    |       |                 |  |  |         |    |       |                 |  |  |         |  |       |                 |  |  |          |     |       |                 |  |  |         |  |       |                 |  |  |         |     |       |                 |  |  |         |     |       |                 |  |  |         |     |       |                 |  |  |         |     |       |                 |  |  |          |     |       |                 |  |  |         |    |       |         |                |        |   |  |           |    |       |         |                |        |         |    |       |         |  |  |           |    |       |         |  |  |         |    |       |         |  |  |         |  |       |         |  |  |          |     |       |         |  |  |         |  |       |         |  |  |         |     |       |         |  |  |         |     |       |         |  |  |         |     |       |         |  |  |         |     |       |         |  |  |          |     |       |         |  |  |         |    |       |         |                |        |   |  |           |    |       |         |                |        |         |    |       |         |  |  |           |    |       |         |  |  |         |    |       |         |  |  |         |  |       |         |  |  |          |     |       |         |  |  |         |  |       |         |  |  |         |     |       |         |  |  |         |     |       |         |  |  |         |     |       |         |  |  |         |     |       |         |  |  |          |     |       |         |  |  |         |    |       |             |                |        |   |  |           |    |       |             |                |        |         |    |       |             |  |  |
| 2.0 TDI 4Drive   | 135  | 05.16   |                 | 24.0711-5272.3 | 360302  |  |  |  |  |          |           |                                    |            |                |                |         |         |       |       |                |        |         |           |       |       |                |        |         |         |       |       |         |  |         |         |       |       |         |  |         |          |       |       |         |  |                 |         |       |       |         |  |         |         |       |       |         |  |         |         |       |       |                |        |   |                     |         |       |         |  |                |         |       |       |                |        |   |                                     |                |       |         |  |                |         |                 |       |                 |                |                |                                    |            |           |       |       |                 |                |        |         |    |       |                 |  |  |           |    |       |                 |  |  |         |    |       |                 |  |  |         |  |       |                 |  |  |          |     |       |                 |  |  |         |  |       |                 |  |  |         |     |       |                 |  |  |         |     |       |                 |  |  |         |     |       |                 |  |  |         |     |       |                 |  |  |          |     |       |                 |  |  |         |    |       |         |                |        |   |  |           |    |       |         |                |        |         |    |       |         |  |  |           |    |       |         |  |  |         |    |       |         |  |  |         |  |       |         |  |  |          |     |       |         |  |  |         |  |       |         |  |  |         |     |       |         |  |  |         |     |       |         |  |  |         |     |       |         |  |  |         |     |       |         |  |  |          |     |       |         |  |  |         |    |       |         |                |        |   |  |           |    |       |         |                |        |         |    |       |         |  |  |           |    |       |         |  |  |         |    |       |         |  |  |         |  |       |         |  |  |          |     |       |         |  |  |         |  |       |         |  |  |         |     |       |         |  |  |         |     |       |         |  |  |         |     |       |         |  |  |         |     |       |         |  |  |          |     |       |         |  |  |         |    |       |             |                |        |   |  |           |    |       |             |                |        |         |    |       |             |  |  |
| 2.0 TDI 4motion  | 103  | 04.11   |                 | 24.0711-5401.3 | 360330  |  |  |  |  |          |           |                                    |            |                |                |         |         |       |       |                |        |         |           |       |       |                |        |         |         |       |       |         |  |         |         |       |       |         |  |         |          |       |       |         |  |                 |         |       |       |         |  |         |         |       |       |         |  |         |         |       |       |                |        |   |                     |         |       |         |  |                |         |       |       |                |        |   |                                     |                |       |         |  |                |         |                 |       |                 |                |                |                                    |            |           |       |       |                 |                |        |         |    |       |                 |  |  |           |    |       |                 |  |  |         |    |       |                 |  |  |         |  |       |                 |  |  |          |     |       |                 |  |  |         |  |       |                 |  |  |         |     |       |                 |  |  |         |     |       |                 |  |  |         |     |       |                 |  |  |         |     |       |                 |  |  |          |     |       |                 |  |  |         |    |       |         |                |        |   |  |           |    |       |         |                |        |         |    |       |         |  |  |           |    |       |         |  |  |         |    |       |         |  |  |         |  |       |         |  |  |          |     |       |         |  |  |         |  |       |         |  |  |         |     |       |         |  |  |         |     |       |         |  |  |         |     |       |         |  |  |         |     |       |         |  |  |          |     |       |         |  |  |         |    |       |         |                |        |   |  |           |    |       |         |                |        |         |    |       |         |  |  |           |    |       |         |  |  |         |    |       |         |  |  |         |  |       |         |  |  |          |     |       |         |  |  |         |  |       |         |  |  |         |     |       |         |  |  |         |     |       |         |  |  |         |     |       |         |  |  |         |     |       |         |  |  |          |     |       |         |  |  |         |    |       |             |                |        |   |  |           |    |       |             |                |        |         |    |       |             |  |  |
|  |  |         |                 | 24.0711-5402.3 | 360331  |  |  |  |  |          |           |                                    |            |                |                |         |         |       |       |                |        |         |           |       |       |                |        |         |         |       |       |         |  |         |         |       |       |         |  |         |          |       |       |         |  |                 |         |       |       |         |  |         |         |       |       |         |  |         |         |       |       |                |        |   |                     |         |       |         |  |                |         |       |       |                |        |   |                                     |                |       |         |  |                |         |                 |       |                 |                |                |                                    |            |           |       |       |                 |                |        |         |    |       |                 |  |  |           |    |       |                 |  |  |         |    |       |                 |  |  |         |  |       |                 |  |  |          |     |       |                 |  |  |         |  |       |                 |  |  |         |     |       |                 |  |  |         |     |       |                 |  |  |         |     |       |                 |  |  |         |     |       |                 |  |  |          |     |       |                 |  |  |         |    |       |         |                |        |   |  |           |    |       |         |                |        |         |    |       |         |  |  |           |    |       |         |  |  |         |    |       |         |  |  |         |  |       |         |  |  |          |     |       |         |  |  |         |  |       |         |  |  |         |     |       |         |  |  |         |     |       |         |  |  |         |     |       |         |  |  |         |     |       |         |  |  |          |     |       |         |  |  |         |    |       |         |                |        |   |  |           |    |       |         |                |        |         |    |       |         |  |  |           |    |       |         |  |  |         |    |       |         |  |  |         |  |       |         |  |  |          |     |       |         |  |  |         |  |       |         |  |  |         |     |       |         |  |  |         |     |       |         |  |  |         |     |       |         |  |  |         |     |       |         |  |  |          |     |       |         |  |  |         |    |       |             |                |        |   |  |           |    |       |             |                |        |         |    |       |             |  |  |
| SEAT ALTEA (5P1) (04-15)   |  |         |                 |                |         |  |  |  |  |          |           |                                    |            |                |                |         |         |       |       |                |        |         |           |       |       |                |        |         |         |       |       |         |  |         |         |       |       |         |  |         |          |       |       |         |  |                 |         |       |       |         |  |         |         |       |       |         |  |         |         |       |       |                |        |   |                     |         |       |         |  |                |         |       |       |                |        |   |                                     |                |       |         |  |                |         |                 |       |                 |                |                |                                    |            |           |       |       |                 |                |        |         |    |       |                 |  |  |           |    |       |                 |  |  |         |    |       |                 |  |  |         |  |       |                 |  |  |          |     |       |                 |  |  |         |  |       |                 |  |  |         |     |       |                 |  |  |         |     |       |                 |  |  |         |     |       |                 |  |  |         |     |       |                 |  |  |          |     |       |                 |  |  |         |    |       |         |                |        |   |  |           |    |       |         |                |        |         |    |       |         |  |  |           |    |       |         |  |  |         |    |       |         |  |  |         |  |       |         |  |  |          |     |       |         |  |  |         |  |       |         |  |  |         |     |       |         |  |  |         |     |       |         |  |  |         |     |       |         |  |  |         |     |       |         |  |  |          |     |       |         |  |  |         |    |       |         |                |        |   |  |           |    |       |         |                |        |         |    |       |         |  |  |           |    |       |         |  |  |         |    |       |         |  |  |         |  |       |         |  |  |          |     |       |         |  |  |         |  |       |         |  |  |         |     |       |         |  |  |         |     |       |         |  |  |         |     |       |         |  |  |         |     |       |         |  |  |          |     |       |         |  |  |         |    |       |             |                |        |   |  |           |    |       |             |                |        |         |    |       |             |  |  |
|  | <table border="1"> <tr> <td>1.2 TSI</td> <td>77</td> <td>04.10</td> <td>PR: 1ZF</td> <td>13.0460-7117.2</td> <td>607117</td> <td rowspan="15"></td> <td rowspan="15">23131 19,6 +/WK<br/>23131 19,6 +/WK</td> <td rowspan="15">VW<br/>VW</td> </tr> <tr> <td>1.4 i 16V</td> <td>63</td> <td>05.06</td> <td>PR: 1ZF</td> <td>13.0470-7117.2</td> <td>LD7117</td> </tr> <tr> <td>1.4 TSI</td> <td>92</td> <td>11.07</td> <td>PR: 1ZF</td> <td></td> <td></td> </tr> <tr> <td>1.6 i 16V</td> <td>75</td> <td>03.04</td> <td>PR: 1ZF</td> <td></td> <td></td> </tr> <tr> <td>1.6 LPG</td> <td>75</td> <td>09.09</td> <td>PR: 1ZF</td> <td></td> <td></td> </tr> <tr> <td>1.6 TDI</td> <td></td> <td>10.09</td> <td>PR: 1ZF</td> <td></td> <td></td> </tr> <tr> <td>1.8 TFSI</td> <td>118</td> <td>01.07</td> <td>PR: 1ZF</td> <td></td> <td></td> </tr> <tr> <td>1.9 TDI</td> <td></td> <td>03.04</td> <td>PR: 1ZF</td> <td></td> <td></td> </tr> <tr> <td>2.0 FSI</td> <td>110</td> <td>03.04</td> <td>PR: 1ZF</td> <td></td> <td></td> </tr> <tr> <td>2.0 TDI</td> <td>100</td> <td>03.04</td> <td>PR: 1ZF</td> <td></td> <td></td> </tr> <tr> <td>2.0 TDI</td> <td>103</td> <td>03.04</td> <td>PR: 1ZF</td> <td></td> <td></td> </tr> <tr> <td>2.0 TDI</td> <td>125</td> <td>03.06</td> <td>PR: 1ZF</td> <td></td> <td></td> </tr> <tr> <td>2.0 TFSI</td> <td>147</td> <td>03.06</td> <td>PR: 1ZF</td> <td></td> <td></td> </tr> <tr> <td>1.2 TSI</td> <td>77</td> <td>04.10</td> <td>PR: 1ZA,1ZE,1LJ</td> <td>13.0460-7184.2</td> <td>607184</td> <td rowspan="15">23587 20,6 +/WK<br/>23587 20,6 +/WK</td> <td rowspan="15">ATE<br/>ATE</td> </tr> <tr> <td>1.4 i 16V</td> <td>63</td> <td>05.06</td> <td>PR: 1ZA,1ZE,1LJ</td> <td>13.0470-7184.2</td> <td>LD7184</td> </tr> <tr> <td>1.4 TSI</td> <td>92</td> <td>11.07</td> <td>PR: 1ZA,1ZE,1LJ</td> <td></td> <td></td> </tr> <tr> <td>1.6 i 16V</td> <td>75</td> <td>03.04</td> <td>PR: 1ZA,1ZE,1LJ</td> <td></td> <td></td> </tr> <tr> <td>1.6 LPG</td> <td>75</td> <td>09.09</td> <td>PR: 1ZA,1ZE,1LJ</td> <td></td> <td></td> </tr> <tr> <td>1.6 TDI</td> <td></td> <td>10.09</td> <td>PR: 1ZA,1ZE,1LJ</td> <td></td> <td></td> </tr> <tr> <td>1.8 TFSI</td> <td>118</td> <td>01.07</td> <td>PR: 1ZA,1ZE,1LJ</td> <td></td> <td></td> </tr> <tr> <td>1.9 TDI</td> <td></td> <td>03.04</td> <td>PR: 1ZA,1ZE,1LJ</td> <td></td> <td></td> </tr> <tr> <td>2.0 FSI</td> <td>110</td> <td>03.04</td> <td>PR: 1ZA,1ZE,1LJ</td> <td></td> <td></td> </tr> <tr> <td>2.0 TDI</td> <td>100</td> <td>03.04</td> <td>PR: 1ZA,1ZE,1LJ</td> <td></td> <td></td> </tr> <tr> <td>2.0 TDI</td> <td>103</td> <td>03.04</td> <td>PR: 1ZA,1ZE,1LJ</td> <td></td> <td></td> </tr> <tr> <td>2.0 TDI</td> <td>125</td> <td>03.06</td> <td>PR: 1ZA,1ZE,1LJ</td> <td></td> <td></td> </tr> <tr> <td>2.0 TFSI</td> <td>147</td> <td>03.06</td> <td>PR: 1ZA,1ZE,1LJ</td> <td></td> <td></td> </tr> <tr> <td>1.2 TSI</td> <td>77</td> <td>04.10</td> <td>PR: 1ZF</td> <td>24.0122-0210.1</td> <td>422210</td> <td rowspan="15">280 22,0 19,0 V L +S +B<br/>280 22,0 19,0 V L +S +B PD</td> <td rowspan="15"></td> </tr> <tr> <td>1.4 i 16V</td> <td>63</td> <td>05.06</td> <td>PR: 1ZF</td> <td>24.0322-0210.1</td> <td>522210</td> </tr> <tr> <td>1.4 TSI</td> <td>92</td> <td>11.07</td> <td>PR: 1ZF</td> <td></td> <td></td> </tr> <tr> <td>1.6 i 16V</td> <td>75</td> <td>03.04</td> <td>PR: 1ZF</td> <td></td> <td></td> </tr> <tr> <td>1.6 LPG</td> <td>75</td> <td>09.09</td> <td>PR: 1ZF</td> <td></td> <td></td> </tr> <tr> <td>1.6 TDI</td> <td></td> <td>10.09</td> <td>PR: 1ZF</td> <td></td> <td></td> </tr> <tr> <td>1.8 TFSI</td> <td>118</td> <td>01.07</td> <td>PR: 1ZF</td> <td></td> <td></td> </tr> <tr> <td>1.9 TDI</td> <td></td> <td>03.04</td> <td>PR: 1ZF</td> <td></td> <td></td> </tr> <tr> <td>2.0 FSI</td> <td>110</td> <td>03.04</td> <td>PR: 1ZF</td> <td></td> <td></td> </tr> <tr> <td>2.0 TDI</td> <td>100</td> <td>03.04</td> <td>PR: 1ZF</td> <td></td> <td></td> </tr> <tr> <td>2.0 TDI</td> <td>103</td> <td>03.04</td> <td>PR: 1ZF</td> <td></td> <td></td> </tr> <tr> <td>2.0 TDI</td> <td>125</td> <td>03.06</td> <td>PR: 1ZF</td> <td></td> <td></td> </tr> <tr> <td>2.0 TFSI</td> <td>147</td> <td>03.06</td> <td>PR: 1ZF</td> <td></td> <td></td> </tr> <tr> <td>1.2 TSI</td> <td>77</td> <td>04.10</td> <td>PR: 1ZE</td> <td>24.0125-0145.1</td> <td>425145</td> <td rowspan="15">288 25,0 22,0 V L +S +B<br/>288 25,0 22,0 V L +S +B PD</td> <td rowspan="15"></td> </tr> <tr> <td>1.4 i 16V</td> <td>63</td> <td>05.06</td> <td>PR: 1ZE</td> <td>24.0325-0145.1</td> <td>525145</td> </tr> <tr> <td>1.4 TSI</td> <td>92</td> <td>11.07</td> <td>PR: 1ZE</td> <td></td> <td></td> </tr> <tr> <td>1.6 i 16V</td> <td>75</td> <td>03.04</td> <td>PR: 1ZE</td> <td></td> <td></td> </tr> <tr> <td>1.6 LPG</td> <td>75</td> <td>09.09</td> <td>PR: 1ZE</td> <td></td> <td></td> </tr> <tr> <td>1.6 TDI</td> <td></td> <td>10.09</td> <td>PR: 1ZE</td> <td></td> <td></td> </tr> <tr> <td>1.8 TFSI</td> <td>118</td> <td>01.07</td> <td>PR: 1ZE</td> <td></td> <td></td> </tr> <tr> <td>1.9 TDI</td> <td></td> <td>03.04</td> <td>PR: 1ZE</td> <td></td> <td></td> </tr> <tr> <td>2.0 FSI</td> <td>110</td> <td>03.04</td> <td>PR: 1ZE</td> <td></td> <td></td> </tr> <tr> <td>2.0 TDI</td> <td>100</td> <td>03.04</td> <td>PR: 1ZE</td> <td></td> <td></td> </tr> <tr> <td>2.0 TDI</td> <td>103</td> <td>03.04</td> <td>PR: 1ZE</td> <td></td> <td></td> </tr> <tr> <td>2.0 TDI</td> <td>125</td> <td>03.06</td> <td>PR: 1ZE</td> <td></td> <td></td> </tr> <tr> <td>2.0 TFSI</td> <td>147</td> <td>03.06</td> <td>PR: 1ZE</td> <td></td> <td></td> </tr> <tr> <td>1.2 TSI</td> <td>77</td> <td>04.10</td> <td>PR: 1LJ,1ZA</td> <td>24.0125-0158.1</td> <td>425158</td> <td rowspan="3">312 25,0 22,0 V L +S +B<br/>312 25,0 22,0 V L +S +B PD</td> <td rowspan="3"></td> </tr> <tr> <td>1.4 i 16V</td> <td>63</td> <td>05.06</td> <td>PR: 1LJ,1ZA</td> <td>24.0325-0158.1</td> <td>525158</td> </tr> <tr> <td>1.4 TSI</td> <td>92</td> <td>11.07</td> <td>PR: 1LJ,1ZA</td> <td></td> <td></td> </tr> </table> | 1.2 TSI | 77              | 04.10          | PR: 1ZF | 13.0460-7117.2   | 607117   |  | 23131 19,6 +/WK<br>23131 19,6 +/WK               | VW<br>VW | 1.4 i 16V | 63                                 | 05.06      | PR: 1ZF        | 13.0470-7117.2 | LD7117  | 1.4 TSI | 92    | 11.07 | PR: 1ZF        |        |         | 1.6 i 16V | 75    | 03.04 | PR: 1ZF        |        |         | 1.6 LPG | 75    | 09.09 | PR: 1ZF |  |         | 1.6 TDI |       | 10.09 | PR: 1ZF |  |         | 1.8 TFSI | 118   | 01.07 | PR: 1ZF |  |                 | 1.9 TDI |       | 03.04 | PR: 1ZF |  |         | 2.0 FSI | 110   | 03.04 | PR: 1ZF |  |         | 2.0 TDI | 100   | 03.04 | PR: 1ZF        |        |   | 2.0 TDI             | 103     | 03.04 | PR: 1ZF |  |                | 2.0 TDI | 125   | 03.06 | PR: 1ZF        |        |   | 2.0 TFSI                            | 147            | 03.06 | PR: 1ZF |  |                | 1.2 TSI | 77              | 04.10 | PR: 1ZA,1ZE,1LJ | 13.0460-7184.2 | 607184         | 23587 20,6 +/WK<br>23587 20,6 +/WK | ATE<br>ATE | 1.4 i 16V | 63    | 05.06 | PR: 1ZA,1ZE,1LJ | 13.0470-7184.2 | LD7184 | 1.4 TSI | 92 | 11.07 | PR: 1ZA,1ZE,1LJ |  |  | 1.6 i 16V | 75 | 03.04 | PR: 1ZA,1ZE,1LJ |  |  | 1.6 LPG | 75 | 09.09 | PR: 1ZA,1ZE,1LJ |  |  | 1.6 TDI |  | 10.09 | PR: 1ZA,1ZE,1LJ |  |  | 1.8 TFSI | 118 | 01.07 | PR: 1ZA,1ZE,1LJ |  |  | 1.9 TDI |  | 03.04 | PR: 1ZA,1ZE,1LJ |  |  | 2.0 FSI | 110 | 03.04 | PR: 1ZA,1ZE,1LJ |  |  | 2.0 TDI | 100 | 03.04 | PR: 1ZA,1ZE,1LJ |  |  | 2.0 TDI | 103 | 03.04 | PR: 1ZA,1ZE,1LJ |  |  | 2.0 TDI | 125 | 03.06 | PR: 1ZA,1ZE,1LJ |  |  | 2.0 TFSI | 147 | 03.06 | PR: 1ZA,1ZE,1LJ |  |  | 1.2 TSI | 77 | 04.10 | PR: 1ZF | 24.0122-0210.1 | 422210 | 280 22,0 19,0 V L +S +B<br>280 22,0 19,0 V L +S +B PD |  | 1.4 i 16V | 63 | 05.06 | PR: 1ZF | 24.0322-0210.1 | 522210 | 1.4 TSI | 92 | 11.07 | PR: 1ZF |  |  | 1.6 i 16V | 75 | 03.04 | PR: 1ZF |  |  | 1.6 LPG | 75 | 09.09 | PR: 1ZF |  |  | 1.6 TDI |  | 10.09 | PR: 1ZF |  |  | 1.8 TFSI | 118 | 01.07 | PR: 1ZF |  |  | 1.9 TDI |  | 03.04 | PR: 1ZF |  |  | 2.0 FSI | 110 | 03.04 | PR: 1ZF |  |  | 2.0 TDI | 100 | 03.04 | PR: 1ZF |  |  | 2.0 TDI | 103 | 03.04 | PR: 1ZF |  |  | 2.0 TDI | 125 | 03.06 | PR: 1ZF |  |  | 2.0 TFSI | 147 | 03.06 | PR: 1ZF |  |  | 1.2 TSI | 77 | 04.10 | PR: 1ZE | 24.0125-0145.1 | 425145 | 288 25,0 22,0 V L +S +B<br>288 25,0 22,0 V L +S +B PD |  | 1.4 i 16V | 63 | 05.06 | PR: 1ZE | 24.0325-0145.1 | 525145 | 1.4 TSI | 92 | 11.07 | PR: 1ZE |  |  | 1.6 i 16V | 75 | 03.04 | PR: 1ZE |  |  | 1.6 LPG | 75 | 09.09 | PR: 1ZE |  |  | 1.6 TDI |  | 10.09 | PR: 1ZE |  |  | 1.8 TFSI | 118 | 01.07 | PR: 1ZE |  |  | 1.9 TDI |  | 03.04 | PR: 1ZE |  |  | 2.0 FSI | 110 | 03.04 | PR: 1ZE |  |  | 2.0 TDI | 100 | 03.04 | PR: 1ZE |  |  | 2.0 TDI | 103 | 03.04 | PR: 1ZE |  |  | 2.0 TDI | 125 | 03.06 | PR: 1ZE |  |  | 2.0 TFSI | 147 | 03.06 | PR: 1ZE |  |  | 1.2 TSI | 77 | 04.10 | PR: 1LJ,1ZA | 24.0125-0158.1 | 425158 | 312 25,0 22,0 V L +S +B<br>312 25,0 22,0 V L +S +B PD |  | 1.4 i 16V | 63 | 05.06 | PR: 1LJ,1ZA | 24.0325-0158.1 | 525158 | 1.4 TSI | 92 | 11.07 | PR: 1LJ,1ZA |  |  |
| 1.2 TSI  | 77   | 04.10   | PR: 1ZF         | 13.0460-7117.2 | 607117  |  | 23131 19,6 +/WK<br>23131 19,6 +/WK               |  |  |          | VW<br>VW  |                                    |            |                |                |         |         |       |       |                |        |         |           |       |       |                |        |         |         |       |       |         |  |         |         |       |       |         |  |         |          |       |       |         |  |                 |         |       |       |         |  |         |         |       |       |         |  |         |         |       |       |                |        |   |                     |         |       |         |  |                |         |       |       |                |        |   |                                     |                |       |         |  |                |         |                 |       |                 |                |                |                                    |            |           |       |       |                 |                |        |         |    |       |                 |  |  |           |    |       |                 |  |  |         |    |       |                 |  |  |         |  |       |                 |  |  |          |     |       |                 |  |  |         |  |       |                 |  |  |         |     |       |                 |  |  |         |     |       |                 |  |  |         |     |       |                 |  |  |         |     |       |                 |  |  |          |     |       |                 |  |  |         |    |       |         |                |        |   |  |           |    |       |         |                |        |         |    |       |         |  |  |           |    |       |         |  |  |         |    |       |         |  |  |         |  |       |         |  |  |          |     |       |         |  |  |         |  |       |         |  |  |         |     |       |         |  |  |         |     |       |         |  |  |         |     |       |         |  |  |         |     |       |         |  |  |          |     |       |         |  |  |         |    |       |         |                |        |   |  |           |    |       |         |                |        |         |    |       |         |  |  |           |    |       |         |  |  |         |    |       |         |  |  |         |  |       |         |  |  |          |     |       |         |  |  |         |  |       |         |  |  |         |     |       |         |  |  |         |     |       |         |  |  |         |     |       |         |  |  |         |     |       |         |  |  |          |     |       |         |  |  |         |    |       |             |                |        |   |  |           |    |       |             |                |        |         |    |       |             |  |  |
| 1.4 i 16V  | 63   | 05.06   | PR: 1ZF         | 13.0470-7117.2 | LD7117  |  |  |  |  |          |           |                                    |            |                |                |         |         |       |       |                |        |         |           |       |       |                |        |         |         |       |       |         |  |         |         |       |       |         |  |         |          |       |       |         |  |                 |         |       |       |         |  |         |         |       |       |         |  |         |         |       |       |                |        |   |                     |         |       |         |  |                |         |       |       |                |        |   |                                     |                |       |         |  |                |         |                 |       |                 |                |                |                                    |            |           |       |       |                 |                |        |         |    |       |                 |  |  |           |    |       |                 |  |  |         |    |       |                 |  |  |         |  |       |                 |  |  |          |     |       |                 |  |  |         |  |       |                 |  |  |         |     |       |                 |  |  |         |     |       |                 |  |  |         |     |       |                 |  |  |         |     |       |                 |  |  |          |     |       |                 |  |  |         |    |       |         |                |        |   |  |           |    |       |         |                |        |         |    |       |         |  |  |           |    |       |         |  |  |         |    |       |         |  |  |         |  |       |         |  |  |          |     |       |         |  |  |         |  |       |         |  |  |         |     |       |         |  |  |         |     |       |         |  |  |         |     |       |         |  |  |         |     |       |         |  |  |          |     |       |         |  |  |         |    |       |         |                |        |   |  |           |    |       |         |                |        |         |    |       |         |  |  |           |    |       |         |  |  |         |    |       |         |  |  |         |  |       |         |  |  |          |     |       |         |  |  |         |  |       |         |  |  |         |     |       |         |  |  |         |     |       |         |  |  |         |     |       |         |  |  |         |     |       |         |  |  |          |     |       |         |  |  |         |    |       |             |                |        |   |  |           |    |       |             |                |        |         |    |       |             |  |  |
| 1.4 TSI  | 92   | 11.07   | PR: 1ZF         |                |         |  |  |  |  |          |           |                                    |            |                |                |         |         |       |       |                |        |         |           |       |       |                |        |         |         |       |       |         |  |         |         |       |       |         |  |         |          |       |       |         |  |                 |         |       |       |         |  |         |         |       |       |         |  |         |         |       |       |                |        |   |                     |         |       |         |  |                |         |       |       |                |        |   |                                     |                |       |         |  |                |         |                 |       |                 |                |                |                                    |            |           |       |       |                 |                |        |         |    |       |                 |  |  |           |    |       |                 |  |  |         |    |       |                 |  |  |         |  |       |                 |  |  |          |     |       |                 |  |  |         |  |       |                 |  |  |         |     |       |                 |  |  |         |     |       |                 |  |  |         |     |       |                 |  |  |         |     |       |                 |  |  |          |     |       |                 |  |  |         |    |       |         |                |        |   |  |           |    |       |         |                |        |         |    |       |         |  |  |           |    |       |         |  |  |         |    |       |         |  |  |         |  |       |         |  |  |          |     |       |         |  |  |         |  |       |         |  |  |         |     |       |         |  |  |         |     |       |         |  |  |         |     |       |         |  |  |         |     |       |         |  |  |          |     |       |         |  |  |         |    |       |         |                |        |   |  |           |    |       |         |                |        |         |    |       |         |  |  |           |    |       |         |  |  |         |    |       |         |  |  |         |  |       |         |  |  |          |     |       |         |  |  |         |  |       |         |  |  |         |     |       |         |  |  |         |     |       |         |  |  |         |     |       |         |  |  |         |     |       |         |  |  |          |     |       |         |  |  |         |    |       |             |                |        |   |  |           |    |       |             |                |        |         |    |       |             |  |  |
| 1.6 i 16V  | 75   | 03.04   | PR: 1ZF         |                |         |  |  |  |  |          |           |                                    |            |                |                |         |         |       |       |                |        |         |           |       |       |                |        |         |         |       |       |         |  |         |         |       |       |         |  |         |          |       |       |         |  |                 |         |       |       |         |  |         |         |       |       |         |  |         |         |       |       |                |        |   |                     |         |       |         |  |                |         |       |       |                |        |   |                                     |                |       |         |  |                |         |                 |       |                 |                |                |                                    |            |           |       |       |                 |                |        |         |    |       |                 |  |  |           |    |       |                 |  |  |         |    |       |                 |  |  |         |  |       |                 |  |  |          |     |       |                 |  |  |         |  |       |                 |  |  |         |     |       |                 |  |  |         |     |       |                 |  |  |         |     |       |                 |  |  |         |     |       |                 |  |  |          |     |       |                 |  |  |         |    |       |         |                |        |   |  |           |    |       |         |                |        |         |    |       |         |  |  |           |    |       |         |  |  |         |    |       |         |  |  |         |  |       |         |  |  |          |     |       |         |  |  |         |  |       |         |  |  |         |     |       |         |  |  |         |     |       |         |  |  |         |     |       |         |  |  |         |     |       |         |  |  |          |     |       |         |  |  |         |    |       |         |                |        |   |  |           |    |       |         |                |        |         |    |       |         |  |  |           |    |       |         |  |  |         |    |       |         |  |  |         |  |       |         |  |  |          |     |       |         |  |  |         |  |       |         |  |  |         |     |       |         |  |  |         |     |       |         |  |  |         |     |       |         |  |  |         |     |       |         |  |  |          |     |       |         |  |  |         |    |       |             |                |        |   |  |           |    |       |             |                |        |         |    |       |             |  |  |
| 1.6 LPG  | 75   | 09.09   | PR: 1ZF         |                |         |  |  |  |  |          |           |                                    |            |                |                |         |         |       |       |                |        |         |           |       |       |                |        |         |         |       |       |         |  |         |         |       |       |         |  |         |          |       |       |         |  |                 |         |       |       |         |  |         |         |       |       |         |  |         |         |       |       |                |        |   |                     |         |       |         |  |                |         |       |       |                |        |   |                                     |                |       |         |  |                |         |                 |       |                 |                |                |                                    |            |           |       |       |                 |                |        |         |    |       |                 |  |  |           |    |       |                 |  |  |         |    |       |                 |  |  |         |  |       |                 |  |  |          |     |       |                 |  |  |         |  |       |                 |  |  |         |     |       |                 |  |  |         |     |       |                 |  |  |         |     |       |                 |  |  |         |     |       |                 |  |  |          |     |       |                 |  |  |         |    |       |         |                |        |   |  |           |    |       |         |                |        |         |    |       |         |  |  |           |    |       |         |  |  |         |    |       |         |  |  |         |  |       |         |  |  |          |     |       |         |  |  |         |  |       |         |  |  |         |     |       |         |  |  |         |     |       |         |  |  |         |     |       |         |  |  |         |     |       |         |  |  |          |     |       |         |  |  |         |    |       |         |                |        |   |  |           |    |       |         |                |        |         |    |       |         |  |  |           |    |       |         |  |  |         |    |       |         |  |  |         |  |       |         |  |  |          |     |       |         |  |  |         |  |       |         |  |  |         |     |       |         |  |  |         |     |       |         |  |  |         |     |       |         |  |  |         |     |       |         |  |  |          |     |       |         |  |  |         |    |       |             |                |        |   |  |           |    |       |             |                |        |         |    |       |             |  |  |
| 1.6 TDI  |  | 10.09   | PR: 1ZF         |                |         |  |  |  |  |          |           |                                    |            |                |                |         |         |       |       |                |        |         |           |       |       |                |        |         |         |       |       |         |  |         |         |       |       |         |  |         |          |       |       |         |  |                 |         |       |       |         |  |         |         |       |       |         |  |         |         |       |       |                |        |   |                     |         |       |         |  |                |         |       |       |                |        |   |                                     |                |       |         |  |                |         |                 |       |                 |                |                |                                    |            |           |       |       |                 |                |        |         |    |       |                 |  |  |           |    |       |                 |  |  |         |    |       |                 |  |  |         |  |       |                 |  |  |          |     |       |                 |  |  |         |  |       |                 |  |  |         |     |       |                 |  |  |         |     |       |                 |  |  |         |     |       |                 |  |  |         |     |       |                 |  |  |          |     |       |                 |  |  |         |    |       |         |                |        |   |  |           |    |       |         |                |        |         |    |       |         |  |  |           |    |       |         |  |  |         |    |       |         |  |  |         |  |       |         |  |  |          |     |       |         |  |  |         |  |       |         |  |  |         |     |       |         |  |  |         |     |       |         |  |  |         |     |       |         |  |  |         |     |       |         |  |  |          |     |       |         |  |  |         |    |       |         |                |        |   |  |           |    |       |         |                |        |         |    |       |         |  |  |           |    |       |         |  |  |         |    |       |         |  |  |         |  |       |         |  |  |          |     |       |         |  |  |         |  |       |         |  |  |         |     |       |         |  |  |         |     |       |         |  |  |         |     |       |         |  |  |         |     |       |         |  |  |          |     |       |         |  |  |         |    |       |             |                |        |   |  |           |    |       |             |                |        |         |    |       |             |  |  |
| 1.8 TFSI   | 118  | 01.07   | PR: 1ZF         |                |         |  |  |  |  |          |           |                                    |            |                |                |         |         |       |       |                |        |         |           |       |       |                |        |         |         |       |       |         |  |         |         |       |       |         |  |         |          |       |       |         |  |                 |         |       |       |         |  |         |         |       |       |         |  |         |         |       |       |                |        |   |                     |         |       |         |  |                |         |       |       |                |        |   |                                     |                |       |         |  |                |         |                 |       |                 |                |                |                                    |            |           |       |       |                 |                |        |         |    |       |                 |  |  |           |    |       |                 |  |  |         |    |       |                 |  |  |         |  |       |                 |  |  |          |     |       |                 |  |  |         |  |       |                 |  |  |         |     |       |                 |  |  |         |     |       |                 |  |  |         |     |       |                 |  |  |         |     |       |                 |  |  |          |     |       |                 |  |  |         |    |       |         |                |        |   |  |           |    |       |         |                |        |         |    |       |         |  |  |           |    |       |         |  |  |         |    |       |         |  |  |         |  |       |         |  |  |          |     |       |         |  |  |         |  |       |         |  |  |         |     |       |         |  |  |         |     |       |         |  |  |         |     |       |         |  |  |         |     |       |         |  |  |          |     |       |         |  |  |         |    |       |         |                |        |   |  |           |    |       |         |                |        |         |    |       |         |  |  |           |    |       |         |  |  |         |    |       |         |  |  |         |  |       |         |  |  |          |     |       |         |  |  |         |  |       |         |  |  |         |     |       |         |  |  |         |     |       |         |  |  |         |     |       |         |  |  |         |     |       |         |  |  |          |     |       |         |  |  |         |    |       |             |                |        |   |  |           |    |       |             |                |        |         |    |       |             |  |  |
| 1.9 TDI  |  | 03.04   | PR: 1ZF         |                |         |  |  |  |  |          |           |                                    |            |                |                |         |         |       |       |                |        |         |           |       |       |                |        |         |         |       |       |         |  |         |         |       |       |         |  |         |          |       |       |         |  |                 |         |       |       |         |  |         |         |       |       |         |  |         |         |       |       |                |        |   |                     |         |       |         |  |                |         |       |       |                |        |   |                                     |                |       |         |  |                |         |                 |       |                 |                |                |                                    |            |           |       |       |                 |                |        |         |    |       |                 |  |  |           |    |       |                 |  |  |         |    |       |                 |  |  |         |  |       |                 |  |  |          |     |       |                 |  |  |         |  |       |                 |  |  |         |     |       |                 |  |  |         |     |       |                 |  |  |         |     |       |                 |  |  |         |     |       |                 |  |  |          |     |       |                 |  |  |         |    |       |         |                |        |   |  |           |    |       |         |                |        |         |    |       |         |  |  |           |    |       |         |  |  |         |    |       |         |  |  |         |  |       |         |  |  |          |     |       |         |  |  |         |  |       |         |  |  |         |     |       |         |  |  |         |     |       |         |  |  |         |     |       |         |  |  |         |     |       |         |  |  |          |     |       |         |  |  |         |    |       |         |                |        |   |  |           |    |       |         |                |        |         |    |       |         |  |  |           |    |       |         |  |  |         |    |       |         |  |  |         |  |       |         |  |  |          |     |       |         |  |  |         |  |       |         |  |  |         |     |       |         |  |  |         |     |       |         |  |  |         |     |       |         |  |  |         |     |       |         |  |  |          |     |       |         |  |  |         |    |       |             |                |        |   |  |           |    |       |             |                |        |         |    |       |             |  |  |
| 2.0 FSI  | 110  | 03.04   | PR: 1ZF         |                |         |  |  |  |  |          |           |                                    |            |                |                |         |         |       |       |                |        |         |           |       |       |                |        |         |         |       |       |         |  |         |         |       |       |         |  |         |          |       |       |         |  |                 |         |       |       |         |  |         |         |       |       |         |  |         |         |       |       |                |        |   |                     |         |       |         |  |                |         |       |       |                |        |   |                                     |                |       |         |  |                |         |                 |       |                 |                |                |                                    |            |           |       |       |                 |                |        |         |    |       |                 |  |  |           |    |       |                 |  |  |         |    |       |                 |  |  |         |  |       |                 |  |  |          |     |       |                 |  |  |         |  |       |                 |  |  |         |     |       |                 |  |  |         |     |       |                 |  |  |         |     |       |                 |  |  |         |     |       |                 |  |  |          |     |       |                 |  |  |         |    |       |         |                |        |   |  |           |    |       |         |                |        |         |    |       |         |  |  |           |    |       |         |  |  |         |    |       |         |  |  |         |  |       |         |  |  |          |     |       |         |  |  |         |  |       |         |  |  |         |     |       |         |  |  |         |     |       |         |  |  |         |     |       |         |  |  |         |     |       |         |  |  |          |     |       |         |  |  |         |    |       |         |                |        |   |  |           |    |       |         |                |        |         |    |       |         |  |  |           |    |       |         |  |  |         |    |       |         |  |  |         |  |       |         |  |  |          |     |       |         |  |  |         |  |       |         |  |  |         |     |       |         |  |  |         |     |       |         |  |  |         |     |       |         |  |  |         |     |       |         |  |  |          |     |       |         |  |  |         |    |       |             |                |        |   |  |           |    |       |             |                |        |         |    |       |             |  |  |
| 2.0 TDI  | 100  | 03.04   | PR: 1ZF         |                |         |  |  |  |  |          |           |                                    |            |                |                |         |         |       |       |                |        |         |           |       |       |                |        |         |         |       |       |         |  |         |         |       |       |         |  |         |          |       |       |         |  |                 |         |       |       |         |  |         |         |       |       |         |  |         |         |       |       |                |        |   |                     |         |       |         |  |                |         |       |       |                |        |   |                                     |                |       |         |  |                |         |                 |       |                 |                |                |                                    |            |           |       |       |                 |                |        |         |    |       |                 |  |  |           |    |       |                 |  |  |         |    |       |                 |  |  |         |  |       |                 |  |  |          |     |       |                 |  |  |         |  |       |                 |  |  |         |     |       |                 |  |  |         |     |       |                 |  |  |         |     |       |                 |  |  |         |     |       |                 |  |  |          |     |       |                 |  |  |         |    |       |         |                |        |   |  |           |    |       |         |                |        |         |    |       |         |  |  |           |    |       |         |  |  |         |    |       |         |  |  |         |  |       |         |  |  |          |     |       |         |  |  |         |  |       |         |  |  |         |     |       |         |  |  |         |     |       |         |  |  |         |     |       |         |  |  |         |     |       |         |  |  |          |     |       |         |  |  |         |    |       |         |                |        |   |  |           |    |       |         |                |        |         |    |       |         |  |  |           |    |       |         |  |  |         |    |       |         |  |  |         |  |       |         |  |  |          |     |       |         |  |  |         |  |       |         |  |  |         |     |       |         |  |  |         |     |       |         |  |  |         |     |       |         |  |  |         |     |       |         |  |  |          |     |       |         |  |  |         |    |       |             |                |        |   |  |           |    |       |             |                |        |         |    |       |             |  |  |
| 2.0 TDI  | 103  | 03.04   | PR: 1ZF         |                |         |  |  |  |  |          |           |                                    |            |                |                |         |         |       |       |                |        |         |           |       |       |                |        |         |         |       |       |         |  |         |         |       |       |         |  |         |          |       |       |         |  |                 |         |       |       |         |  |         |         |       |       |         |  |         |         |       |       |                |        |   |                     |         |       |         |  |                |         |       |       |                |        |   |                                     |                |       |         |  |                |         |                 |       |                 |                |                |                                    |            |           |       |       |                 |                |        |         |    |       |                 |  |  |           |    |       |                 |  |  |         |    |       |                 |  |  |         |  |       |                 |  |  |          |     |       |                 |  |  |         |  |       |                 |  |  |         |     |       |                 |  |  |         |     |       |                 |  |  |         |     |       |                 |  |  |         |     |       |                 |  |  |          |     |       |                 |  |  |         |    |       |         |                |        |   |  |           |    |       |         |                |        |         |    |       |         |  |  |           |    |       |         |  |  |         |    |       |         |  |  |         |  |       |         |  |  |          |     |       |         |  |  |         |  |       |         |  |  |         |     |       |         |  |  |         |     |       |         |  |  |         |     |       |         |  |  |         |     |       |         |  |  |          |     |       |         |  |  |         |    |       |         |                |        |   |  |           |    |       |         |                |        |         |    |       |         |  |  |           |    |       |         |  |  |         |    |       |         |  |  |         |  |       |         |  |  |          |     |       |         |  |  |         |  |       |         |  |  |         |     |       |         |  |  |         |     |       |         |  |  |         |     |       |         |  |  |         |     |       |         |  |  |          |     |       |         |  |  |         |    |       |             |                |        |   |  |           |    |       |             |                |        |         |    |       |             |  |  |
| 2.0 TDI  | 125  | 03.06   | PR: 1ZF         |                |         |  |  |  |  |          |           |                                    |            |                |                |         |         |       |       |                |        |         |           |       |       |                |        |         |         |       |       |         |  |         |         |       |       |         |  |         |          |       |       |         |  |                 |         |       |       |         |  |         |         |       |       |         |  |         |         |       |       |                |        |   |                     |         |       |         |  |                |         |       |       |                |        |   |                                     |                |       |         |  |                |         |                 |       |                 |                |                |                                    |            |           |       |       |                 |                |        |         |    |       |                 |  |  |           |    |       |                 |  |  |         |    |       |                 |  |  |         |  |       |                 |  |  |          |     |       |                 |  |  |         |  |       |                 |  |  |         |     |       |                 |  |  |         |     |       |                 |  |  |         |     |       |                 |  |  |         |     |       |                 |  |  |          |     |       |                 |  |  |         |    |       |         |                |        |   |  |           |    |       |         |                |        |         |    |       |         |  |  |           |    |       |         |  |  |         |    |       |         |  |  |         |  |       |         |  |  |          |     |       |         |  |  |         |  |       |         |  |  |         |     |       |         |  |  |         |     |       |         |  |  |         |     |       |         |  |  |         |     |       |         |  |  |          |     |       |         |  |  |         |    |       |         |                |        |   |  |           |    |       |         |                |        |         |    |       |         |  |  |           |    |       |         |  |  |         |    |       |         |  |  |         |  |       |         |  |  |          |     |       |         |  |  |         |  |       |         |  |  |         |     |       |         |  |  |         |     |       |         |  |  |         |     |       |         |  |  |         |     |       |         |  |  |          |     |       |         |  |  |         |    |       |             |                |        |   |  |           |    |       |             |                |        |         |    |       |             |  |  |
| 2.0 TFSI   | 147  | 03.06   | PR: 1ZF         |                |         |  |  |  |  |          |           |                                    |            |                |                |         |         |       |       |                |        |         |           |       |       |                |        |         |         |       |       |         |  |         |         |       |       |         |  |         |          |       |       |         |  |                 |         |       |       |         |  |         |         |       |       |         |  |         |         |       |       |                |        |   |                     |         |       |         |  |                |         |       |       |                |        |   |                                     |                |       |         |  |                |         |                 |       |                 |                |                |                                    |            |           |       |       |                 |                |        |         |    |       |                 |  |  |           |    |       |                 |  |  |         |    |       |                 |  |  |         |  |       |                 |  |  |          |     |       |                 |  |  |         |  |       |                 |  |  |         |     |       |                 |  |  |         |     |       |                 |  |  |         |     |       |                 |  |  |         |     |       |                 |  |  |          |     |       |                 |  |  |         |    |       |         |                |        |   |  |           |    |       |         |                |        |         |    |       |         |  |  |           |    |       |         |  |  |         |    |       |         |  |  |         |  |       |         |  |  |          |     |       |         |  |  |         |  |       |         |  |  |         |     |       |         |  |  |         |     |       |         |  |  |         |     |       |         |  |  |         |     |       |         |  |  |          |     |       |         |  |  |         |    |       |         |                |        |   |  |           |    |       |         |                |        |         |    |       |         |  |  |           |    |       |         |  |  |         |    |       |         |  |  |         |  |       |         |  |  |          |     |       |         |  |  |         |  |       |         |  |  |         |     |       |         |  |  |         |     |       |         |  |  |         |     |       |         |  |  |         |     |       |         |  |  |          |     |       |         |  |  |         |    |       |             |                |        |   |  |           |    |       |             |                |        |         |    |       |             |  |  |
| 1.2 TSI  | 77   | 04.10   | PR: 1ZA,1ZE,1LJ | 13.0460-7184.2 | 607184  |  |  |  |  |          |           | 23587 20,6 +/WK<br>23587 20,6 +/WK | ATE<br>ATE |                |                |         |         |       |       |                |        |         |           |       |       |                |        |         |         |       |       |         |  |         |         |       |       |         |  |         |          |       |       |         |  |                 |         |       |       |         |  |         |         |       |       |         |  |         |         |       |       |                |        |   |                     |         |       |         |  |                |         |       |       |                |        |   |                                     |                |       |         |  |                |         |                 |       |                 |                |                |                                    |            |           |       |       |                 |                |        |         |    |       |                 |  |  |           |    |       |                 |  |  |         |    |       |                 |  |  |         |  |       |                 |  |  |          |     |       |                 |  |  |         |  |       |                 |  |  |         |     |       |                 |  |  |         |     |       |                 |  |  |         |     |       |                 |  |  |         |     |       |                 |  |  |          |     |       |                 |  |  |         |    |       |         |                |        |   |  |           |    |       |         |                |        |         |    |       |         |  |  |           |    |       |         |  |  |         |    |       |         |  |  |         |  |       |         |  |  |          |     |       |         |  |  |         |  |       |         |  |  |         |     |       |         |  |  |         |     |       |         |  |  |         |     |       |         |  |  |         |     |       |         |  |  |          |     |       |         |  |  |         |    |       |         |                |        |   |  |           |    |       |         |                |        |         |    |       |         |  |  |           |    |       |         |  |  |         |    |       |         |  |  |         |  |       |         |  |  |          |     |       |         |  |  |         |  |       |         |  |  |         |     |       |         |  |  |         |     |       |         |  |  |         |     |       |         |  |  |         |     |       |         |  |  |          |     |       |         |  |  |         |    |       |             |                |        |   |  |           |    |       |             |                |        |         |    |       |             |  |  |
| 1.4 i 16V  | 63   | 05.06   | PR: 1ZA,1ZE,1LJ | 13.0470-7184.2 | LD7184  |  |  |  |  |          |           |                                    |            |                |                |         |         |       |       |                |        |         |           |       |       |                |        |         |         |       |       |         |  |         |         |       |       |         |  |         |          |       |       |         |  |                 |         |       |       |         |  |         |         |       |       |         |  |         |         |       |       |                |        |   |                     |         |       |         |  |                |         |       |       |                |        |   |                                     |                |       |         |  |                |         |                 |       |                 |                |                |                                    |            |           |       |       |                 |                |        |         |    |       |                 |  |  |           |    |       |                 |  |  |         |    |       |                 |  |  |         |  |       |                 |  |  |          |     |       |                 |  |  |         |  |       |                 |  |  |         |     |       |                 |  |  |         |     |       |                 |  |  |         |     |       |                 |  |  |         |     |       |                 |  |  |          |     |       |                 |  |  |         |    |       |         |                |        |   |  |           |    |       |         |                |        |         |    |       |         |  |  |           |    |       |         |  |  |         |    |       |         |  |  |         |  |       |         |  |  |          |     |       |         |  |  |         |  |       |         |  |  |         |     |       |         |  |  |         |     |       |         |  |  |         |     |       |         |  |  |         |     |       |         |  |  |          |     |       |         |  |  |         |    |       |         |                |        |   |  |           |    |       |         |                |        |         |    |       |         |  |  |           |    |       |         |  |  |         |    |       |         |  |  |         |  |       |         |  |  |          |     |       |         |  |  |         |  |       |         |  |  |         |     |       |         |  |  |         |     |       |         |  |  |         |     |       |         |  |  |         |     |       |         |  |  |          |     |       |         |  |  |         |    |       |             |                |        |   |  |           |    |       |             |                |        |         |    |       |             |  |  |
| 1.4 TSI  | 92   | 11.07   | PR: 1ZA,1ZE,1LJ |                |         |  |  |  |  |          |           |                                    |            |                |                |         |         |       |       |                |        |         |           |       |       |                |        |         |         |       |       |         |  |         |         |       |       |         |  |         |          |       |       |         |  |                 |         |       |       |         |  |         |         |       |       |         |  |         |         |       |       |                |        |   |                     |         |       |         |  |                |         |       |       |                |        |   |                                     |                |       |         |  |                |         |                 |       |                 |                |                |                                    |            |           |       |       |                 |                |        |         |    |       |                 |  |  |           |    |       |                 |  |  |         |    |       |                 |  |  |         |  |       |                 |  |  |          |     |       |                 |  |  |         |  |       |                 |  |  |         |     |       |                 |  |  |         |     |       |                 |  |  |         |     |       |                 |  |  |         |     |       |                 |  |  |          |     |       |                 |  |  |         |    |       |         |                |        |   |  |           |    |       |         |                |        |         |    |       |         |  |  |           |    |       |         |  |  |         |    |       |         |  |  |         |  |       |         |  |  |          |     |       |         |  |  |         |  |       |         |  |  |         |     |       |         |  |  |         |     |       |         |  |  |         |     |       |         |  |  |         |     |       |         |  |  |          |     |       |         |  |  |         |    |       |         |                |        |   |  |           |    |       |         |                |        |         |    |       |         |  |  |           |    |       |         |  |  |         |    |       |         |  |  |         |  |       |         |  |  |          |     |       |         |  |  |         |  |       |         |  |  |         |     |       |         |  |  |         |     |       |         |  |  |         |     |       |         |  |  |         |     |       |         |  |  |          |     |       |         |  |  |         |    |       |             |                |        |   |  |           |    |       |             |                |        |         |    |       |             |  |  |
| 1.6 i 16V  | 75   | 03.04   | PR: 1ZA,1ZE,1LJ |                |         |  |  |  |  |          |           |                                    |            |                |                |         |         |       |       |                |        |         |           |       |       |                |        |         |         |       |       |         |  |         |         |       |       |         |  |         |          |       |       |         |  |                 |         |       |       |         |  |         |         |       |       |         |  |         |         |       |       |                |        |   |                     |         |       |         |  |                |         |       |       |                |        |   |                                     |                |       |         |  |                |         |                 |       |                 |                |                |                                    |            |           |       |       |                 |                |        |         |    |       |                 |  |  |           |    |       |                 |  |  |         |    |       |                 |  |  |         |  |       |                 |  |  |          |     |       |                 |  |  |         |  |       |                 |  |  |         |     |       |                 |  |  |         |     |       |                 |  |  |         |     |       |                 |  |  |         |     |       |                 |  |  |          |     |       |                 |  |  |         |    |       |         |                |        |   |  |           |    |       |         |                |        |         |    |       |         |  |  |           |    |       |         |  |  |         |    |       |         |  |  |         |  |       |         |  |  |          |     |       |         |  |  |         |  |       |         |  |  |         |     |       |         |  |  |         |     |       |         |  |  |         |     |       |         |  |  |         |     |       |         |  |  |          |     |       |         |  |  |         |    |       |         |                |        |   |  |           |    |       |         |                |        |         |    |       |         |  |  |           |    |       |         |  |  |         |    |       |         |  |  |         |  |       |         |  |  |          |     |       |         |  |  |         |  |       |         |  |  |         |     |       |         |  |  |         |     |       |         |  |  |         |     |       |         |  |  |         |     |       |         |  |  |          |     |       |         |  |  |         |    |       |             |                |        |   |  |           |    |       |             |                |        |         |    |       |             |  |  |
| 1.6 LPG  | 75   | 09.09   | PR: 1ZA,1ZE,1LJ |                |         |  |  |  |  |          |           |                                    |            |                |                |         |         |       |       |                |        |         |           |       |       |                |        |         |         |       |       |         |  |         |         |       |       |         |  |         |          |       |       |         |  |                 |         |       |       |         |  |         |         |       |       |         |  |         |         |       |       |                |        |   |                     |         |       |         |  |                |         |       |       |                |        |   |                                     |                |       |         |  |                |         |                 |       |                 |                |                |                                    |            |           |       |       |                 |                |        |         |    |       |                 |  |  |           |    |       |                 |  |  |         |    |       |                 |  |  |         |  |       |                 |  |  |          |     |       |                 |  |  |         |  |       |                 |  |  |         |     |       |                 |  |  |         |     |       |                 |  |  |         |     |       |                 |  |  |         |     |       |                 |  |  |          |     |       |                 |  |  |         |    |       |         |                |        |   |  |           |    |       |         |                |        |         |    |       |         |  |  |           |    |       |         |  |  |         |    |       |         |  |  |         |  |       |         |  |  |          |     |       |         |  |  |         |  |       |         |  |  |         |     |       |         |  |  |         |     |       |         |  |  |         |     |       |         |  |  |         |     |       |         |  |  |          |     |       |         |  |  |         |    |       |         |                |        |   |  |           |    |       |         |                |        |         |    |       |         |  |  |           |    |       |         |  |  |         |    |       |         |  |  |         |  |       |         |  |  |          |     |       |         |  |  |         |  |       |         |  |  |         |     |       |         |  |  |         |     |       |         |  |  |         |     |       |         |  |  |         |     |       |         |  |  |          |     |       |         |  |  |         |    |       |             |                |        |   |  |           |    |       |             |                |        |         |    |       |             |  |  |
| 1.6 TDI  |  | 10.09   | PR: 1ZA,1ZE,1LJ |                |         |  |  |  |  |          |           |                                    |            |                |                |         |         |       |       |                |        |         |           |       |       |                |        |         |         |       |       |         |  |         |         |       |       |         |  |         |          |       |       |         |  |                 |         |       |       |         |  |         |         |       |       |         |  |         |         |       |       |                |        |   |                     |         |       |         |  |                |         |       |       |                |        |   |                                     |                |       |         |  |                |         |                 |       |                 |                |                |                                    |            |           |       |       |                 |                |        |         |    |       |                 |  |  |           |    |       |                 |  |  |         |    |       |                 |  |  |         |  |       |                 |  |  |          |     |       |                 |  |  |         |  |       |                 |  |  |         |     |       |                 |  |  |         |     |       |                 |  |  |         |     |       |                 |  |  |         |     |       |                 |  |  |          |     |       |                 |  |  |         |    |       |         |                |        |   |  |           |    |       |         |                |        |         |    |       |         |  |  |           |    |       |         |  |  |         |    |       |         |  |  |         |  |       |         |  |  |          |     |       |         |  |  |         |  |       |         |  |  |         |     |       |         |  |  |         |     |       |         |  |  |         |     |       |         |  |  |         |     |       |         |  |  |          |     |       |         |  |  |         |    |       |         |                |        |   |  |           |    |       |         |                |        |         |    |       |         |  |  |           |    |       |         |  |  |         |    |       |         |  |  |         |  |       |         |  |  |          |     |       |         |  |  |         |  |       |         |  |  |         |     |       |         |  |  |         |     |       |         |  |  |         |     |       |         |  |  |         |     |       |         |  |  |          |     |       |         |  |  |         |    |       |             |                |        |   |  |           |    |       |             |                |        |         |    |       |             |  |  |
| 1.8 TFSI   | 118  | 01.07   | PR: 1ZA,1ZE,1LJ |                |         |  |  |  |  |          |           |                                    |            |                |                |         |         |       |       |                |        |         |           |       |       |                |        |         |         |       |       |         |  |         |         |       |       |         |  |         |          |       |       |         |  |                 |         |       |       |         |  |         |         |       |       |         |  |         |         |       |       |                |        |   |                     |         |       |         |  |                |         |       |       |                |        |   |                                     |                |       |         |  |                |         |                 |       |                 |                |                |                                    |            |           |       |       |                 |                |        |         |    |       |                 |  |  |           |    |       |                 |  |  |         |    |       |                 |  |  |         |  |       |                 |  |  |          |     |       |                 |  |  |         |  |       |                 |  |  |         |     |       |                 |  |  |         |     |       |                 |  |  |         |     |       |                 |  |  |         |     |       |                 |  |  |          |     |       |                 |  |  |         |    |       |         |                |        |   |  |           |    |       |         |                |        |         |    |       |         |  |  |           |    |       |         |  |  |         |    |       |         |  |  |         |  |       |         |  |  |          |     |       |         |  |  |         |  |       |         |  |  |         |     |       |         |  |  |         |     |       |         |  |  |         |     |       |         |  |  |         |     |       |         |  |  |          |     |       |         |  |  |         |    |       |         |                |        |   |  |           |    |       |         |                |        |         |    |       |         |  |  |           |    |       |         |  |  |         |    |       |         |  |  |         |  |       |         |  |  |          |     |       |         |  |  |         |  |       |         |  |  |         |     |       |         |  |  |         |     |       |         |  |  |         |     |       |         |  |  |         |     |       |         |  |  |          |     |       |         |  |  |         |    |       |             |                |        |   |  |           |    |       |             |                |        |         |    |       |             |  |  |
| 1.9 TDI  |  | 03.04   | PR: 1ZA,1ZE,1LJ |                |         |  |  |  |  |          |           |                                    |            |                |                |         |         |       |       |                |        |         |           |       |       |                |        |         |         |       |       |         |  |         |         |       |       |         |  |         |          |       |       |         |  |                 |         |       |       |         |  |         |         |       |       |         |  |         |         |       |       |                |        |   |                     |         |       |         |  |                |         |       |       |                |        |   |                                     |                |       |         |  |                |         |                 |       |                 |                |                |                                    |            |           |       |       |                 |                |        |         |    |       |                 |  |  |           |    |       |                 |  |  |         |    |       |                 |  |  |         |  |       |                 |  |  |          |     |       |                 |  |  |         |  |       |                 |  |  |         |     |       |                 |  |  |         |     |       |                 |  |  |         |     |       |                 |  |  |         |     |       |                 |  |  |          |     |       |                 |  |  |         |    |       |         |                |        |   |  |           |    |       |         |                |        |         |    |       |         |  |  |           |    |       |         |  |  |         |    |       |         |  |  |         |  |       |         |  |  |          |     |       |         |  |  |         |  |       |         |  |  |         |     |       |         |  |  |         |     |       |         |  |  |         |     |       |         |  |  |         |     |       |         |  |  |          |     |       |         |  |  |         |    |       |         |                |        |   |  |           |    |       |         |                |        |         |    |       |         |  |  |           |    |       |         |  |  |         |    |       |         |  |  |         |  |       |         |  |  |          |     |       |         |  |  |         |  |       |         |  |  |         |     |       |         |  |  |         |     |       |         |  |  |         |     |       |         |  |  |         |     |       |         |  |  |          |     |       |         |  |  |         |    |       |             |                |        |   |  |           |    |       |             |                |        |         |    |       |             |  |  |
| 2.0 FSI  | 110  | 03.04   | PR: 1ZA,1ZE,1LJ |                |         |  |  |  |  |          |           |                                    |            |                |                |         |         |       |       |                |        |         |           |       |       |                |        |         |         |       |       |         |  |         |         |       |       |         |  |         |          |       |       |         |  |                 |         |       |       |         |  |         |         |       |       |         |  |         |         |       |       |                |        |   |                     |         |       |         |  |                |         |       |       |                |        |   |                                     |                |       |         |  |                |         |                 |       |                 |                |                |                                    |            |           |       |       |                 |                |        |         |    |       |                 |  |  |           |    |       |                 |  |  |         |    |       |                 |  |  |         |  |       |                 |  |  |          |     |       |                 |  |  |         |  |       |                 |  |  |         |     |       |                 |  |  |         |     |       |                 |  |  |         |     |       |                 |  |  |         |     |       |                 |  |  |          |     |       |                 |  |  |         |    |       |         |                |        |   |  |           |    |       |         |                |        |         |    |       |         |  |  |           |    |       |         |  |  |         |    |       |         |  |  |         |  |       |         |  |  |          |     |       |         |  |  |         |  |       |         |  |  |         |     |       |         |  |  |         |     |       |         |  |  |         |     |       |         |  |  |         |     |       |         |  |  |          |     |       |         |  |  |         |    |       |         |                |        |   |  |           |    |       |         |                |        |         |    |       |         |  |  |           |    |       |         |  |  |         |    |       |         |  |  |         |  |       |         |  |  |          |     |       |         |  |  |         |  |       |         |  |  |         |     |       |         |  |  |         |     |       |         |  |  |         |     |       |         |  |  |         |     |       |         |  |  |          |     |       |         |  |  |         |    |       |             |                |        |   |  |           |    |       |             |                |        |         |    |       |             |  |  |
| 2.0 TDI  | 100  | 03.04   | PR: 1ZA,1ZE,1LJ |                |         |  |  |  |  |          |           |                                    |            |                |                |         |         |       |       |                |        |         |           |       |       |                |        |         |         |       |       |         |  |         |         |       |       |         |  |         |          |       |       |         |  |                 |         |       |       |         |  |         |         |       |       |         |  |         |         |       |       |                |        |   |                     |         |       |         |  |                |         |       |       |                |        |   |                                     |                |       |         |  |                |         |                 |       |                 |                |                |                                    |            |           |       |       |                 |                |        |         |    |       |                 |  |  |           |    |       |                 |  |  |         |    |       |                 |  |  |         |  |       |                 |  |  |          |     |       |                 |  |  |         |  |       |                 |  |  |         |     |       |                 |  |  |         |     |       |                 |  |  |         |     |       |                 |  |  |         |     |       |                 |  |  |          |     |       |                 |  |  |         |    |       |         |                |        |   |  |           |    |       |         |                |        |         |    |       |         |  |  |           |    |       |         |  |  |         |    |       |         |  |  |         |  |       |         |  |  |          |     |       |         |  |  |         |  |       |         |  |  |         |     |       |         |  |  |         |     |       |         |  |  |         |     |       |         |  |  |         |     |       |         |  |  |          |     |       |         |  |  |         |    |       |         |                |        |   |  |           |    |       |         |                |        |         |    |       |         |  |  |           |    |       |         |  |  |         |    |       |         |  |  |         |  |       |         |  |  |          |     |       |         |  |  |         |  |       |         |  |  |         |     |       |         |  |  |         |     |       |         |  |  |         |     |       |         |  |  |         |     |       |         |  |  |          |     |       |         |  |  |         |    |       |             |                |        |   |  |           |    |       |             |                |        |         |    |       |             |  |  |
| 2.0 TDI  | 103  | 03.04   | PR: 1ZA,1ZE,1LJ |                |         |  |  |  |  |          |           |                                    |            |                |                |         |         |       |       |                |        |         |           |       |       |                |        |         |         |       |       |         |  |         |         |       |       |         |  |         |          |       |       |         |  |                 |         |       |       |         |  |         |         |       |       |         |  |         |         |       |       |                |        |   |                     |         |       |         |  |                |         |       |       |                |        |   |                                     |                |       |         |  |                |         |                 |       |                 |                |                |                                    |            |           |       |       |                 |                |        |         |    |       |                 |  |  |           |    |       |                 |  |  |         |    |       |                 |  |  |         |  |       |                 |  |  |          |     |       |                 |  |  |         |  |       |                 |  |  |         |     |       |                 |  |  |         |     |       |                 |  |  |         |     |       |                 |  |  |         |     |       |                 |  |  |          |     |       |                 |  |  |         |    |       |         |                |        |   |  |           |    |       |         |                |        |         |    |       |         |  |  |           |    |       |         |  |  |         |    |       |         |  |  |         |  |       |         |  |  |          |     |       |         |  |  |         |  |       |         |  |  |         |     |       |         |  |  |         |     |       |         |  |  |         |     |       |         |  |  |         |     |       |         |  |  |          |     |       |         |  |  |         |    |       |         |                |        |   |  |           |    |       |         |                |        |         |    |       |         |  |  |           |    |       |         |  |  |         |    |       |         |  |  |         |  |       |         |  |  |          |     |       |         |  |  |         |  |       |         |  |  |         |     |       |         |  |  |         |     |       |         |  |  |         |     |       |         |  |  |         |     |       |         |  |  |          |     |       |         |  |  |         |    |       |             |                |        |   |  |           |    |       |             |                |        |         |    |       |             |  |  |
| 2.0 TDI  | 125  | 03.06   | PR: 1ZA,1ZE,1LJ |                |         |  |  |  |  |          |           |                                    |            |                |                |         |         |       |       |                |        |         |           |       |       |                |        |         |         |       |       |         |  |         |         |       |       |         |  |         |          |       |       |         |  |                 |         |       |       |         |  |         |         |       |       |         |  |         |         |       |       |                |        |   |                     |         |       |         |  |                |         |       |       |                |        |   |                                     |                |       |         |  |                |         |                 |       |                 |                |                |                                    |            |           |       |       |                 |                |        |         |    |       |                 |  |  |           |    |       |                 |  |  |         |    |       |                 |  |  |         |  |       |                 |  |  |          |     |       |                 |  |  |         |  |       |                 |  |  |         |     |       |                 |  |  |         |     |       |                 |  |  |         |     |       |                 |  |  |         |     |       |                 |  |  |          |     |       |                 |  |  |         |    |       |         |                |        |   |  |           |    |       |         |                |        |         |    |       |         |  |  |           |    |       |         |  |  |         |    |       |         |  |  |         |  |       |         |  |  |          |     |       |         |  |  |         |  |       |         |  |  |         |     |       |         |  |  |         |     |       |         |  |  |         |     |       |         |  |  |         |     |       |         |  |  |          |     |       |         |  |  |         |    |       |         |                |        |   |  |           |    |       |         |                |        |         |    |       |         |  |  |           |    |       |         |  |  |         |    |       |         |  |  |         |  |       |         |  |  |          |     |       |         |  |  |         |  |       |         |  |  |         |     |       |         |  |  |         |     |       |         |  |  |         |     |       |         |  |  |         |     |       |         |  |  |          |     |       |         |  |  |         |    |       |             |                |        |   |  |           |    |       |             |                |        |         |    |       |             |  |  |
| 2.0 TFSI   | 147  | 03.06   | PR: 1ZA,1ZE,1LJ |                |         |  |  |  |  |          |           |                                    |            |                |                |         |         |       |       |                |        |         |           |       |       |                |        |         |         |       |       |         |  |         |         |       |       |         |  |         |          |       |       |         |  |                 |         |       |       |         |  |         |         |       |       |         |  |         |         |       |       |                |        |   |                     |         |       |         |  |                |         |       |       |                |        |   |                                     |                |       |         |  |                |         |                 |       |                 |                |                |                                    |            |           |       |       |                 |                |        |         |    |       |                 |  |  |           |    |       |                 |  |  |         |    |       |                 |  |  |         |  |       |                 |  |  |          |     |       |                 |  |  |         |  |       |                 |  |  |         |     |       |                 |  |  |         |     |       |                 |  |  |         |     |       |                 |  |  |         |     |       |                 |  |  |          |     |       |                 |  |  |         |    |       |         |                |        |   |  |           |    |       |         |                |        |         |    |       |         |  |  |           |    |       |         |  |  |         |    |       |         |  |  |         |  |       |         |  |  |          |     |       |         |  |  |         |  |       |         |  |  |         |     |       |         |  |  |         |     |       |         |  |  |         |     |       |         |  |  |         |     |       |         |  |  |          |     |       |         |  |  |         |    |       |         |                |        |   |  |           |    |       |         |                |        |         |    |       |         |  |  |           |    |       |         |  |  |         |    |       |         |  |  |         |  |       |         |  |  |          |     |       |         |  |  |         |  |       |         |  |  |         |     |       |         |  |  |         |     |       |         |  |  |         |     |       |         |  |  |         |     |       |         |  |  |          |     |       |         |  |  |         |    |       |             |                |        |   |  |           |    |       |             |                |        |         |    |       |             |  |  |
| 1.2 TSI  | 77   | 04.10   | PR: 1ZF         | 24.0122-0210.1 | 422210  | 280 22,0 19,0 V L +S +B<br>280 22,0 19,0 V L +S +B PD  |  |  |  |          |           |                                    |            |                |                |         |         |       |       |                |        |         |           |       |       |                |        |         |         |       |       |         |  |         |         |       |       |         |  |         |          |       |       |         |  |                 |         |       |       |         |  |         |         |       |       |         |  |         |         |       |       |                |        |   |                     |         |       |         |  |                |         |       |       |                |        |   |                                     |                |       |         |  |                |         |                 |       |                 |                |                |                                    |            |           |       |       |                 |                |        |         |    |       |                 |  |  |           |    |       |                 |  |  |         |    |       |                 |  |  |         |  |       |                 |  |  |          |     |       |                 |  |  |         |  |       |                 |  |  |         |     |       |                 |  |  |         |     |       |                 |  |  |         |     |       |                 |  |  |         |     |       |                 |  |  |          |     |       |                 |  |  |         |    |       |         |                |        |   |  |           |    |       |         |                |        |         |    |       |         |  |  |           |    |       |         |  |  |         |    |       |         |  |  |         |  |       |         |  |  |          |     |       |         |  |  |         |  |       |         |  |  |         |     |       |         |  |  |         |     |       |         |  |  |         |     |       |         |  |  |         |     |       |         |  |  |          |     |       |         |  |  |         |    |       |         |                |        |   |  |           |    |       |         |                |        |         |    |       |         |  |  |           |    |       |         |  |  |         |    |       |         |  |  |         |  |       |         |  |  |          |     |       |         |  |  |         |  |       |         |  |  |         |     |       |         |  |  |         |     |       |         |  |  |         |     |       |         |  |  |         |     |       |         |  |  |          |     |       |         |  |  |         |    |       |             |                |        |   |  |           |    |       |             |                |        |         |    |       |             |  |  |
| 1.4 i 16V  | 63   | 05.06   | PR: 1ZF         | 24.0322-0210.1 | 522210  |  |  |  |  |          |           |                                    |            |                |                |         |         |       |       |                |        |         |           |       |       |                |        |         |         |       |       |         |  |         |         |       |       |         |  |         |          |       |       |         |  |                 |         |       |       |         |  |         |         |       |       |         |  |         |         |       |       |                |        |   |                     |         |       |         |  |                |         |       |       |                |        |   |                                     |                |       |         |  |                |         |                 |       |                 |                |                |                                    |            |           |       |       |                 |                |        |         |    |       |                 |  |  |           |    |       |                 |  |  |         |    |       |                 |  |  |         |  |       |                 |  |  |          |     |       |                 |  |  |         |  |       |                 |  |  |         |     |       |                 |  |  |         |     |       |                 |  |  |         |     |       |                 |  |  |         |     |       |                 |  |  |          |     |       |                 |  |  |         |    |       |         |                |        |   |  |           |    |       |         |                |        |         |    |       |         |  |  |           |    |       |         |  |  |         |    |       |         |  |  |         |  |       |         |  |  |          |     |       |         |  |  |         |  |       |         |  |  |         |     |       |         |  |  |         |     |       |         |  |  |         |     |       |         |  |  |         |     |       |         |  |  |          |     |       |         |  |  |         |    |       |         |                |        |   |  |           |    |       |         |                |        |         |    |       |         |  |  |           |    |       |         |  |  |         |    |       |         |  |  |         |  |       |         |  |  |          |     |       |         |  |  |         |  |       |         |  |  |         |     |       |         |  |  |         |     |       |         |  |  |         |     |       |         |  |  |         |     |       |         |  |  |          |     |       |         |  |  |         |    |       |             |                |        |   |  |           |    |       |             |                |        |         |    |       |             |  |  |
| 1.4 TSI  | 92   | 11.07   | PR: 1ZF         |                |         |  |  |  |  |          |           |                                    |            |                |                |         |         |       |       |                |        |         |           |       |       |                |        |         |         |       |       |         |  |         |         |       |       |         |  |         |          |       |       |         |  |                 |         |       |       |         |  |         |         |       |       |         |  |         |         |       |       |                |        |   |                     |         |       |         |  |                |         |       |       |                |        |   |                                     |                |       |         |  |                |         |                 |       |                 |                |                |                                    |            |           |       |       |                 |                |        |         |    |       |                 |  |  |           |    |       |                 |  |  |         |    |       |                 |  |  |         |  |       |                 |  |  |          |     |       |                 |  |  |         |  |       |                 |  |  |         |     |       |                 |  |  |         |     |       |                 |  |  |         |     |       |                 |  |  |         |     |       |                 |  |  |          |     |       |                 |  |  |         |    |       |         |                |        |   |  |           |    |       |         |                |        |         |    |       |         |  |  |           |    |       |         |  |  |         |    |       |         |  |  |         |  |       |         |  |  |          |     |       |         |  |  |         |  |       |         |  |  |         |     |       |         |  |  |         |     |       |         |  |  |         |     |       |         |  |  |         |     |       |         |  |  |          |     |       |         |  |  |         |    |       |         |                |        |   |  |           |    |       |         |                |        |         |    |       |         |  |  |           |    |       |         |  |  |         |    |       |         |  |  |         |  |       |         |  |  |          |     |       |         |  |  |         |  |       |         |  |  |         |     |       |         |  |  |         |     |       |         |  |  |         |     |       |         |  |  |         |     |       |         |  |  |          |     |       |         |  |  |         |    |       |             |                |        |   |  |           |    |       |             |                |        |         |    |       |             |  |  |
| 1.6 i 16V  | 75   | 03.04   | PR: 1ZF         |                |         |  |  |  |  |          |           |                                    |            |                |                |         |         |       |       |                |        |         |           |       |       |                |        |         |         |       |       |         |  |         |         |       |       |         |  |         |          |       |       |         |  |                 |         |       |       |         |  |         |         |       |       |         |  |         |         |       |       |                |        |   |                     |         |       |         |  |                |         |       |       |                |        |   |                                     |                |       |         |  |                |         |                 |       |                 |                |                |                                    |            |           |       |       |                 |                |        |         |    |       |                 |  |  |           |    |       |                 |  |  |         |    |       |                 |  |  |         |  |       |                 |  |  |          |     |       |                 |  |  |         |  |       |                 |  |  |         |     |       |                 |  |  |         |     |       |                 |  |  |         |     |       |                 |  |  |         |     |       |                 |  |  |          |     |       |                 |  |  |         |    |       |         |                |        |   |  |           |    |       |         |                |        |         |    |       |         |  |  |           |    |       |         |  |  |         |    |       |         |  |  |         |  |       |         |  |  |          |     |       |         |  |  |         |  |       |         |  |  |         |     |       |         |  |  |         |     |       |         |  |  |         |     |       |         |  |  |         |     |       |         |  |  |          |     |       |         |  |  |         |    |       |         |                |        |   |  |           |    |       |         |                |        |         |    |       |         |  |  |           |    |       |         |  |  |         |    |       |         |  |  |         |  |       |         |  |  |          |     |       |         |  |  |         |  |       |         |  |  |         |     |       |         |  |  |         |     |       |         |  |  |         |     |       |         |  |  |         |     |       |         |  |  |          |     |       |         |  |  |         |    |       |             |                |        |   |  |           |    |       |             |                |        |         |    |       |             |  |  |
| 1.6 LPG  | 75   | 09.09   | PR: 1ZF         |                |         |  |  |  |  |          |           |                                    |            |                |                |         |         |       |       |                |        |         |           |       |       |                |        |         |         |       |       |         |  |         |         |       |       |         |  |         |          |       |       |         |  |                 |         |       |       |         |  |         |         |       |       |         |  |         |         |       |       |                |        |   |                     |         |       |         |  |                |         |       |       |                |        |   |                                     |                |       |         |  |                |         |                 |       |                 |                |                |                                    |            |           |       |       |                 |                |        |         |    |       |                 |  |  |           |    |       |                 |  |  |         |    |       |                 |  |  |         |  |       |                 |  |  |          |     |       |                 |  |  |         |  |       |                 |  |  |         |     |       |                 |  |  |         |     |       |                 |  |  |         |     |       |                 |  |  |         |     |       |                 |  |  |          |     |       |                 |  |  |         |    |       |         |                |        |   |  |           |    |       |         |                |        |         |    |       |         |  |  |           |    |       |         |  |  |         |    |       |         |  |  |         |  |       |         |  |  |          |     |       |         |  |  |         |  |       |         |  |  |         |     |       |         |  |  |         |     |       |         |  |  |         |     |       |         |  |  |         |     |       |         |  |  |          |     |       |         |  |  |         |    |       |         |                |        |   |  |           |    |       |         |                |        |         |    |       |         |  |  |           |    |       |         |  |  |         |    |       |         |  |  |         |  |       |         |  |  |          |     |       |         |  |  |         |  |       |         |  |  |         |     |       |         |  |  |         |     |       |         |  |  |         |     |       |         |  |  |         |     |       |         |  |  |          |     |       |         |  |  |         |    |       |             |                |        |   |  |           |    |       |             |                |        |         |    |       |             |  |  |
| 1.6 TDI  |  | 10.09   | PR: 1ZF         |                |         |  |  |  |  |          |           |                                    |            |                |                |         |         |       |       |                |        |         |           |       |       |                |        |         |         |       |       |         |  |         |         |       |       |         |  |         |          |       |       |         |  |                 |         |       |       |         |  |         |         |       |       |         |  |         |         |       |       |                |        |   |                     |         |       |         |  |                |         |       |       |                |        |   |                                     |                |       |         |  |                |         |                 |       |                 |                |                |                                    |            |           |       |       |                 |                |        |         |    |       |                 |  |  |           |    |       |                 |  |  |         |    |       |                 |  |  |         |  |       |                 |  |  |          |     |       |                 |  |  |         |  |       |                 |  |  |         |     |       |                 |  |  |         |     |       |                 |  |  |         |     |       |                 |  |  |         |     |       |                 |  |  |          |     |       |                 |  |  |         |    |       |         |                |        |   |  |           |    |       |         |                |        |         |    |       |         |  |  |           |    |       |         |  |  |         |    |       |         |  |  |         |  |       |         |  |  |          |     |       |         |  |  |         |  |       |         |  |  |         |     |       |         |  |  |         |     |       |         |  |  |         |     |       |         |  |  |         |     |       |         |  |  |          |     |       |         |  |  |         |    |       |         |                |        |   |  |           |    |       |         |                |        |         |    |       |         |  |  |           |    |       |         |  |  |         |    |       |         |  |  |         |  |       |         |  |  |          |     |       |         |  |  |         |  |       |         |  |  |         |     |       |         |  |  |         |     |       |         |  |  |         |     |       |         |  |  |         |     |       |         |  |  |          |     |       |         |  |  |         |    |       |             |                |        |   |  |           |    |       |             |                |        |         |    |       |             |  |  |
| 1.8 TFSI   | 118  | 01.07   | PR: 1ZF         |                |         |  |  |  |  |          |           |                                    |            |                |                |         |         |       |       |                |        |         |           |       |       |                |        |         |         |       |       |         |  |         |         |       |       |         |  |         |          |       |       |         |  |                 |         |       |       |         |  |         |         |       |       |         |  |         |         |       |       |                |        |   |                     |         |       |         |  |                |         |       |       |                |        |   |                                     |                |       |         |  |                |         |                 |       |                 |                |                |                                    |            |           |       |       |                 |                |        |         |    |       |                 |  |  |           |    |       |                 |  |  |         |    |       |                 |  |  |         |  |       |                 |  |  |          |     |       |                 |  |  |         |  |       |                 |  |  |         |     |       |                 |  |  |         |     |       |                 |  |  |         |     |       |                 |  |  |         |     |       |                 |  |  |          |     |       |                 |  |  |         |    |       |         |                |        |   |  |           |    |       |         |                |        |         |    |       |         |  |  |           |    |       |         |  |  |         |    |       |         |  |  |         |  |       |         |  |  |          |     |       |         |  |  |         |  |       |         |  |  |         |     |       |         |  |  |         |     |       |         |  |  |         |     |       |         |  |  |         |     |       |         |  |  |          |     |       |         |  |  |         |    |       |         |                |        |   |  |           |    |       |         |                |        |         |    |       |         |  |  |           |    |       |         |  |  |         |    |       |         |  |  |         |  |       |         |  |  |          |     |       |         |  |  |         |  |       |         |  |  |         |     |       |         |  |  |         |     |       |         |  |  |         |     |       |         |  |  |         |     |       |         |  |  |          |     |       |         |  |  |         |    |       |             |                |        |   |  |           |    |       |             |                |        |         |    |       |             |  |  |
| 1.9 TDI  |  | 03.04   | PR: 1ZF         |                |         |  |  |  |  |          |           |                                    |            |                |                |         |         |       |       |                |        |         |           |       |       |                |        |         |         |       |       |         |  |         |         |       |       |         |  |         |          |       |       |         |  |                 |         |       |       |         |  |         |         |       |       |         |  |         |         |       |       |                |        |   |                     |         |       |         |  |                |         |       |       |                |        |   |                                     |                |       |         |  |                |         |                 |       |                 |                |                |                                    |            |           |       |       |                 |                |        |         |    |       |                 |  |  |           |    |       |                 |  |  |         |    |       |                 |  |  |         |  |       |                 |  |  |          |     |       |                 |  |  |         |  |       |                 |  |  |         |     |       |                 |  |  |         |     |       |                 |  |  |         |     |       |                 |  |  |         |     |       |                 |  |  |          |     |       |                 |  |  |         |    |       |         |                |        |   |  |           |    |       |         |                |        |         |    |       |         |  |  |           |    |       |         |  |  |         |    |       |         |  |  |         |  |       |         |  |  |          |     |       |         |  |  |         |  |       |         |  |  |         |     |       |         |  |  |         |     |       |         |  |  |         |     |       |         |  |  |         |     |       |         |  |  |          |     |       |         |  |  |         |    |       |         |                |        |   |  |           |    |       |         |                |        |         |    |       |         |  |  |           |    |       |         |  |  |         |    |       |         |  |  |         |  |       |         |  |  |          |     |       |         |  |  |         |  |       |         |  |  |         |     |       |         |  |  |         |     |       |         |  |  |         |     |       |         |  |  |         |     |       |         |  |  |          |     |       |         |  |  |         |    |       |             |                |        |   |  |           |    |       |             |                |        |         |    |       |             |  |  |
| 2.0 FSI  | 110  | 03.04   | PR: 1ZF         |                |         |  |  |  |  |          |           |                                    |            |                |                |         |         |       |       |                |        |         |           |       |       |                |        |         |         |       |       |         |  |         |         |       |       |         |  |         |          |       |       |         |  |                 |         |       |       |         |  |         |         |       |       |         |  |         |         |       |       |                |        |   |                     |         |       |         |  |                |         |       |       |                |        |   |                                     |                |       |         |  |                |         |                 |       |                 |                |                |                                    |            |           |       |       |                 |                |        |         |    |       |                 |  |  |           |    |       |                 |  |  |         |    |       |                 |  |  |         |  |       |                 |  |  |          |     |       |                 |  |  |         |  |       |                 |  |  |         |     |       |                 |  |  |         |     |       |                 |  |  |         |     |       |                 |  |  |         |     |       |                 |  |  |          |     |       |                 |  |  |         |    |       |         |                |        |   |  |           |    |       |         |                |        |         |    |       |         |  |  |           |    |       |         |  |  |         |    |       |         |  |  |         |  |       |         |  |  |          |     |       |         |  |  |         |  |       |         |  |  |         |     |       |         |  |  |         |     |       |         |  |  |         |     |       |         |  |  |         |     |       |         |  |  |          |     |       |         |  |  |         |    |       |         |                |        |   |  |           |    |       |         |                |        |         |    |       |         |  |  |           |    |       |         |  |  |         |    |       |         |  |  |         |  |       |         |  |  |          |     |       |         |  |  |         |  |       |         |  |  |         |     |       |         |  |  |         |     |       |         |  |  |         |     |       |         |  |  |         |     |       |         |  |  |          |     |       |         |  |  |         |    |       |             |                |        |   |  |           |    |       |             |                |        |         |    |       |             |  |  |
| 2.0 TDI  | 100  | 03.04   | PR: 1ZF         |                |         |  |  |  |  |          |           |                                    |            |                |                |         |         |       |       |                |        |         |           |       |       |                |        |         |         |       |       |         |  |         |         |       |       |         |  |         |          |       |       |         |  |                 |         |       |       |         |  |         |         |       |       |         |  |         |         |       |       |                |        |   |                     |         |       |         |  |                |         |       |       |                |        |   |                                     |                |       |         |  |                |         |                 |       |                 |                |                |                                    |            |           |       |       |                 |                |        |         |    |       |                 |  |  |           |    |       |                 |  |  |         |    |       |                 |  |  |         |  |       |                 |  |  |          |     |       |                 |  |  |         |  |       |                 |  |  |         |     |       |                 |  |  |         |     |       |                 |  |  |         |     |       |                 |  |  |         |     |       |                 |  |  |          |     |       |                 |  |  |         |    |       |         |                |        |   |  |           |    |       |         |                |        |         |    |       |         |  |  |           |    |       |         |  |  |         |    |       |         |  |  |         |  |       |         |  |  |          |     |       |         |  |  |         |  |       |         |  |  |         |     |       |         |  |  |         |     |       |         |  |  |         |     |       |         |  |  |         |     |       |         |  |  |          |     |       |         |  |  |         |    |       |         |                |        |   |  |           |    |       |         |                |        |         |    |       |         |  |  |           |    |       |         |  |  |         |    |       |         |  |  |         |  |       |         |  |  |          |     |       |         |  |  |         |  |       |         |  |  |         |     |       |         |  |  |         |     |       |         |  |  |         |     |       |         |  |  |         |     |       |         |  |  |          |     |       |         |  |  |         |    |       |             |                |        |   |  |           |    |       |             |                |        |         |    |       |             |  |  |
| 2.0 TDI  | 103  | 03.04   | PR: 1ZF         |                |         |  |  |  |  |          |           |                                    |            |                |                |         |         |       |       |                |        |         |           |       |       |                |        |         |         |       |       |         |  |         |         |       |       |         |  |         |          |       |       |         |  |                 |         |       |       |         |  |         |         |       |       |         |  |         |         |       |       |                |        |   |                     |         |       |         |  |                |         |       |       |                |        |   |                                     |                |       |         |  |                |         |                 |       |                 |                |                |                                    |            |           |       |       |                 |                |        |         |    |       |                 |  |  |           |    |       |                 |  |  |         |    |       |                 |  |  |         |  |       |                 |  |  |          |     |       |                 |  |  |         |  |       |                 |  |  |         |     |       |                 |  |  |         |     |       |                 |  |  |         |     |       |                 |  |  |         |     |       |                 |  |  |          |     |       |                 |  |  |         |    |       |         |                |        |   |  |           |    |       |         |                |        |         |    |       |         |  |  |           |    |       |         |  |  |         |    |       |         |  |  |         |  |       |         |  |  |          |     |       |         |  |  |         |  |       |         |  |  |         |     |       |         |  |  |         |     |       |         |  |  |         |     |       |         |  |  |         |     |       |         |  |  |          |     |       |         |  |  |         |    |       |         |                |        |   |  |           |    |       |         |                |        |         |    |       |         |  |  |           |    |       |         |  |  |         |    |       |         |  |  |         |  |       |         |  |  |          |     |       |         |  |  |         |  |       |         |  |  |         |     |       |         |  |  |         |     |       |         |  |  |         |     |       |         |  |  |         |     |       |         |  |  |          |     |       |         |  |  |         |    |       |             |                |        |   |  |           |    |       |             |                |        |         |    |       |             |  |  |
| 2.0 TDI  | 125  | 03.06   | PR: 1ZF         |                |         |  |  |  |  |          |           |                                    |            |                |                |         |         |       |       |                |        |         |           |       |       |                |        |         |         |       |       |         |  |         |         |       |       |         |  |         |          |       |       |         |  |                 |         |       |       |         |  |         |         |       |       |         |  |         |         |       |       |                |        |   |                     |         |       |         |  |                |         |       |       |                |        |   |                                     |                |       |         |  |                |         |                 |       |                 |                |                |                                    |            |           |       |       |                 |                |        |         |    |       |                 |  |  |           |    |       |                 |  |  |         |    |       |                 |  |  |         |  |       |                 |  |  |          |     |       |                 |  |  |         |  |       |                 |  |  |         |     |       |                 |  |  |         |     |       |                 |  |  |         |     |       |                 |  |  |         |     |       |                 |  |  |          |     |       |                 |  |  |         |    |       |         |                |        |   |  |           |    |       |         |                |        |         |    |       |         |  |  |           |    |       |         |  |  |         |    |       |         |  |  |         |  |       |         |  |  |          |     |       |         |  |  |         |  |       |         |  |  |         |     |       |         |  |  |         |     |       |         |  |  |         |     |       |         |  |  |         |     |       |         |  |  |          |     |       |         |  |  |         |    |       |         |                |        |   |  |           |    |       |         |                |        |         |    |       |         |  |  |           |    |       |         |  |  |         |    |       |         |  |  |         |  |       |         |  |  |          |     |       |         |  |  |         |  |       |         |  |  |         |     |       |         |  |  |         |     |       |         |  |  |         |     |       |         |  |  |         |     |       |         |  |  |          |     |       |         |  |  |         |    |       |             |                |        |   |  |           |    |       |             |                |        |         |    |       |             |  |  |
| 2.0 TFSI   | 147  | 03.06   | PR: 1ZF         |                |         |  |  |  |  |          |           |                                    |            |                |                |         |         |       |       |                |        |         |           |       |       |                |        |         |         |       |       |         |  |         |         |       |       |         |  |         |          |       |       |         |  |                 |         |       |       |         |  |         |         |       |       |         |  |         |         |       |       |                |        |   |                     |         |       |         |  |                |         |       |       |                |        |   |                                     |                |       |         |  |                |         |                 |       |                 |                |                |                                    |            |           |       |       |                 |                |        |         |    |       |                 |  |  |           |    |       |                 |  |  |         |    |       |                 |  |  |         |  |       |                 |  |  |          |     |       |                 |  |  |         |  |       |                 |  |  |         |     |       |                 |  |  |         |     |       |                 |  |  |         |     |       |                 |  |  |         |     |       |                 |  |  |          |     |       |                 |  |  |         |    |       |         |                |        |   |  |           |    |       |         |                |        |         |    |       |         |  |  |           |    |       |         |  |  |         |    |       |         |  |  |         |  |       |         |  |  |          |     |       |         |  |  |         |  |       |         |  |  |         |     |       |         |  |  |         |     |       |         |  |  |         |     |       |         |  |  |         |     |       |         |  |  |          |     |       |         |  |  |         |    |       |         |                |        |   |  |           |    |       |         |                |        |         |    |       |         |  |  |           |    |       |         |  |  |         |    |       |         |  |  |         |  |       |         |  |  |          |     |       |         |  |  |         |  |       |         |  |  |         |     |       |         |  |  |         |     |       |         |  |  |         |     |       |         |  |  |         |     |       |         |  |  |          |     |       |         |  |  |         |    |       |             |                |        |   |  |           |    |       |             |                |        |         |    |       |             |  |  |
| 1.2 TSI  | 77   | 04.10   | PR: 1ZE         | 24.0125-0145.1 | 425145  |  |  | 288 25,0 22,0 V L +S +B<br>288 25,0 22,0 V L +S +B PD  |  |          |           |                                    |            |                |                |         |         |       |       |                |        |         |           |       |       |                |        |         |         |       |       |         |  |         |         |       |       |         |  |         |          |       |       |         |  |                 |         |       |       |         |  |         |         |       |       |         |  |         |         |       |       |                |        |   |                     |         |       |         |  |                |         |       |       |                |        |   |                                     |                |       |         |  |                |         |                 |       |                 |                |                |                                    |            |           |       |       |                 |                |        |         |    |       |                 |  |  |           |    |       |                 |  |  |         |    |       |                 |  |  |         |  |       |                 |  |  |          |     |       |                 |  |  |         |  |       |                 |  |  |         |     |       |                 |  |  |         |     |       |                 |  |  |         |     |       |                 |  |  |         |     |       |                 |  |  |          |     |       |                 |  |  |         |    |       |         |                |        |   |  |           |    |       |         |                |        |         |    |       |         |  |  |           |    |       |         |  |  |         |    |       |         |  |  |         |  |       |         |  |  |          |     |       |         |  |  |         |  |       |         |  |  |         |     |       |         |  |  |         |     |       |         |  |  |         |     |       |         |  |  |         |     |       |         |  |  |          |     |       |         |  |  |         |    |       |         |                |        |   |  |           |    |       |         |                |        |         |    |       |         |  |  |           |    |       |         |  |  |         |    |       |         |  |  |         |  |       |         |  |  |          |     |       |         |  |  |         |  |       |         |  |  |         |     |       |         |  |  |         |     |       |         |  |  |         |     |       |         |  |  |         |     |       |         |  |  |          |     |       |         |  |  |         |    |       |             |                |        |   |  |           |    |       |             |                |        |         |    |       |             |  |  |
| 1.4 i 16V  | 63   | 05.06   | PR: 1ZE         | 24.0325-0145.1 | 525145  |  |  |  |  |          |           |                                    |            |                |                |         |         |       |       |                |        |         |           |       |       |                |        |         |         |       |       |         |  |         |         |       |       |         |  |         |          |       |       |         |  |                 |         |       |       |         |  |         |         |       |       |         |  |         |         |       |       |                |        |   |                     |         |       |         |  |                |         |       |       |                |        |   |                                     |                |       |         |  |                |         |                 |       |                 |                |                |                                    |            |           |       |       |                 |                |        |         |    |       |                 |  |  |           |    |       |                 |  |  |         |    |       |                 |  |  |         |  |       |                 |  |  |          |     |       |                 |  |  |         |  |       |                 |  |  |         |     |       |                 |  |  |         |     |       |                 |  |  |         |     |       |                 |  |  |         |     |       |                 |  |  |          |     |       |                 |  |  |         |    |       |         |                |        |   |  |           |    |       |         |                |        |         |    |       |         |  |  |           |    |       |         |  |  |         |    |       |         |  |  |         |  |       |         |  |  |          |     |       |         |  |  |         |  |       |         |  |  |         |     |       |         |  |  |         |     |       |         |  |  |         |     |       |         |  |  |         |     |       |         |  |  |          |     |       |         |  |  |         |    |       |         |                |        |   |  |           |    |       |         |                |        |         |    |       |         |  |  |           |    |       |         |  |  |         |    |       |         |  |  |         |  |       |         |  |  |          |     |       |         |  |  |         |  |       |         |  |  |         |     |       |         |  |  |         |     |       |         |  |  |         |     |       |         |  |  |         |     |       |         |  |  |          |     |       |         |  |  |         |    |       |             |                |        |   |  |           |    |       |             |                |        |         |    |       |             |  |  |
| 1.4 TSI  | 92   | 11.07   | PR: 1ZE         |                |         |  |  |  |  |          |           |                                    |            |                |                |         |         |       |       |                |        |         |           |       |       |                |        |         |         |       |       |         |  |         |         |       |       |         |  |         |          |       |       |         |  |                 |         |       |       |         |  |         |         |       |       |         |  |         |         |       |       |                |        |   |                     |         |       |         |  |                |         |       |       |                |        |   |                                     |                |       |         |  |                |         |                 |       |                 |                |                |                                    |            |           |       |       |                 |                |        |         |    |       |                 |  |  |           |    |       |                 |  |  |         |    |       |                 |  |  |         |  |       |                 |  |  |          |     |       |                 |  |  |         |  |       |                 |  |  |         |     |       |                 |  |  |         |     |       |                 |  |  |         |     |       |                 |  |  |         |     |       |                 |  |  |          |     |       |                 |  |  |         |    |       |         |                |        |   |  |           |    |       |         |                |        |         |    |       |         |  |  |           |    |       |         |  |  |         |    |       |         |  |  |         |  |       |         |  |  |          |     |       |         |  |  |         |  |       |         |  |  |         |     |       |         |  |  |         |     |       |         |  |  |         |     |       |         |  |  |         |     |       |         |  |  |          |     |       |         |  |  |         |    |       |         |                |        |   |  |           |    |       |         |                |        |         |    |       |         |  |  |           |    |       |         |  |  |         |    |       |         |  |  |         |  |       |         |  |  |          |     |       |         |  |  |         |  |       |         |  |  |         |     |       |         |  |  |         |     |       |         |  |  |         |     |       |         |  |  |         |     |       |         |  |  |          |     |       |         |  |  |         |    |       |             |                |        |   |  |           |    |       |             |                |        |         |    |       |             |  |  |
| 1.6 i 16V  | 75   | 03.04   | PR: 1ZE         |                |         |  |  |  |  |          |           |                                    |            |                |                |         |         |       |       |                |        |         |           |       |       |                |        |         |         |       |       |         |  |         |         |       |       |         |  |         |          |       |       |         |  |                 |         |       |       |         |  |         |         |       |       |         |  |         |         |       |       |                |        |   |                     |         |       |         |  |                |         |       |       |                |        |   |                                     |                |       |         |  |                |         |                 |       |                 |                |                |                                    |            |           |       |       |                 |                |        |         |    |       |                 |  |  |           |    |       |                 |  |  |         |    |       |                 |  |  |         |  |       |                 |  |  |          |     |       |                 |  |  |         |  |       |                 |  |  |         |     |       |                 |  |  |         |     |       |                 |  |  |         |     |       |                 |  |  |         |     |       |                 |  |  |          |     |       |                 |  |  |         |    |       |         |                |        |   |  |           |    |       |         |                |        |         |    |       |         |  |  |           |    |       |         |  |  |         |    |       |         |  |  |         |  |       |         |  |  |          |     |       |         |  |  |         |  |       |         |  |  |         |     |       |         |  |  |         |     |       |         |  |  |         |     |       |         |  |  |         |     |       |         |  |  |          |     |       |         |  |  |         |    |       |         |                |        |   |  |           |    |       |         |                |        |         |    |       |         |  |  |           |    |       |         |  |  |         |    |       |         |  |  |         |  |       |         |  |  |          |     |       |         |  |  |         |  |       |         |  |  |         |     |       |         |  |  |         |     |       |         |  |  |         |     |       |         |  |  |         |     |       |         |  |  |          |     |       |         |  |  |         |    |       |             |                |        |   |  |           |    |       |             |                |        |         |    |       |             |  |  |
| 1.6 LPG  | 75   | 09.09   | PR: 1ZE         |                |         |  |  |  |  |          |           |                                    |            |                |                |         |         |       |       |                |        |         |           |       |       |                |        |         |         |       |       |         |  |         |         |       |       |         |  |         |          |       |       |         |  |                 |         |       |       |         |  |         |         |       |       |         |  |         |         |       |       |                |        |   |                     |         |       |         |  |                |         |       |       |                |        |   |                                     |                |       |         |  |                |         |                 |       |                 |                |                |                                    |            |           |       |       |                 |                |        |         |    |       |                 |  |  |           |    |       |                 |  |  |         |    |       |                 |  |  |         |  |       |                 |  |  |          |     |       |                 |  |  |         |  |       |                 |  |  |         |     |       |                 |  |  |         |     |       |                 |  |  |         |     |       |                 |  |  |         |     |       |                 |  |  |          |     |       |                 |  |  |         |    |       |         |                |        |   |  |           |    |       |         |                |        |         |    |       |         |  |  |           |    |       |         |  |  |         |    |       |         |  |  |         |  |       |         |  |  |          |     |       |         |  |  |         |  |       |         |  |  |         |     |       |         |  |  |         |     |       |         |  |  |         |     |       |         |  |  |         |     |       |         |  |  |          |     |       |         |  |  |         |    |       |         |                |        |   |  |           |    |       |         |                |        |         |    |       |         |  |  |           |    |       |         |  |  |         |    |       |         |  |  |         |  |       |         |  |  |          |     |       |         |  |  |         |  |       |         |  |  |         |     |       |         |  |  |         |     |       |         |  |  |         |     |       |         |  |  |         |     |       |         |  |  |          |     |       |         |  |  |         |    |       |             |                |        |   |  |           |    |       |             |                |        |         |    |       |             |  |  |
| 1.6 TDI  |  | 10.09   | PR: 1ZE         |                |         |  |  |  |  |          |           |                                    |            |                |                |         |         |       |       |                |        |         |           |       |       |                |        |         |         |       |       |         |  |         |         |       |       |         |  |         |          |       |       |         |  |                 |         |       |       |         |  |         |         |       |       |         |  |         |         |       |       |                |        |   |                     |         |       |         |  |                |         |       |       |                |        |   |                                     |                |       |         |  |                |         |                 |       |                 |                |                |                                    |            |           |       |       |                 |                |        |         |    |       |                 |  |  |           |    |       |                 |  |  |         |    |       |                 |  |  |         |  |       |                 |  |  |          |     |       |                 |  |  |         |  |       |                 |  |  |         |     |       |                 |  |  |         |     |       |                 |  |  |         |     |       |                 |  |  |         |     |       |                 |  |  |          |     |       |                 |  |  |         |    |       |         |                |        |   |  |           |    |       |         |                |        |         |    |       |         |  |  |           |    |       |         |  |  |         |    |       |         |  |  |         |  |       |         |  |  |          |     |       |         |  |  |         |  |       |         |  |  |         |     |       |         |  |  |         |     |       |         |  |  |         |     |       |         |  |  |         |     |       |         |  |  |          |     |       |         |  |  |         |    |       |         |                |        |   |  |           |    |       |         |                |        |         |    |       |         |  |  |           |    |       |         |  |  |         |    |       |         |  |  |         |  |       |         |  |  |          |     |       |         |  |  |         |  |       |         |  |  |         |     |       |         |  |  |         |     |       |         |  |  |         |     |       |         |  |  |         |     |       |         |  |  |          |     |       |         |  |  |         |    |       |             |                |        |   |  |           |    |       |             |                |        |         |    |       |             |  |  |
| 1.8 TFSI   | 118  | 01.07   | PR: 1ZE         |                |         |  |  |  |  |          |           |                                    |            |                |                |         |         |       |       |                |        |         |           |       |       |                |        |         |         |       |       |         |  |         |         |       |       |         |  |         |          |       |       |         |  |                 |         |       |       |         |  |         |         |       |       |         |  |         |         |       |       |                |        |   |                     |         |       |         |  |                |         |       |       |                |        |   |                                     |                |       |         |  |                |         |                 |       |                 |                |                |                                    |            |           |       |       |                 |                |        |         |    |       |                 |  |  |           |    |       |                 |  |  |         |    |       |                 |  |  |         |  |       |                 |  |  |          |     |       |                 |  |  |         |  |       |                 |  |  |         |     |       |                 |  |  |         |     |       |                 |  |  |         |     |       |                 |  |  |         |     |       |                 |  |  |          |     |       |                 |  |  |         |    |       |         |                |        |   |  |           |    |       |         |                |        |         |    |       |         |  |  |           |    |       |         |  |  |         |    |       |         |  |  |         |  |       |         |  |  |          |     |       |         |  |  |         |  |       |         |  |  |         |     |       |         |  |  |         |     |       |         |  |  |         |     |       |         |  |  |         |     |       |         |  |  |          |     |       |         |  |  |         |    |       |         |                |        |   |  |           |    |       |         |                |        |         |    |       |         |  |  |           |    |       |         |  |  |         |    |       |         |  |  |         |  |       |         |  |  |          |     |       |         |  |  |         |  |       |         |  |  |         |     |       |         |  |  |         |     |       |         |  |  |         |     |       |         |  |  |         |     |       |         |  |  |          |     |       |         |  |  |         |    |       |             |                |        |   |  |           |    |       |             |                |        |         |    |       |             |  |  |
| 1.9 TDI  |  | 03.04   | PR: 1ZE         |                |         |  |  |  |  |          |           |                                    |            |                |                |         |         |       |       |                |        |         |           |       |       |                |        |         |         |       |       |         |  |         |         |       |       |         |  |         |          |       |       |         |  |                 |         |       |       |         |  |         |         |       |       |         |  |         |         |       |       |                |        |   |                     |         |       |         |  |                |         |       |       |                |        |   |                                     |                |       |         |  |                |         |                 |       |                 |                |                |                                    |            |           |       |       |                 |                |        |         |    |       |                 |  |  |           |    |       |                 |  |  |         |    |       |                 |  |  |         |  |       |                 |  |  |          |     |       |                 |  |  |         |  |       |                 |  |  |         |     |       |                 |  |  |         |     |       |                 |  |  |         |     |       |                 |  |  |         |     |       |                 |  |  |          |     |       |                 |  |  |         |    |       |         |                |        |   |  |           |    |       |         |                |        |         |    |       |         |  |  |           |    |       |         |  |  |         |    |       |         |  |  |         |  |       |         |  |  |          |     |       |         |  |  |         |  |       |         |  |  |         |     |       |         |  |  |         |     |       |         |  |  |         |     |       |         |  |  |         |     |       |         |  |  |          |     |       |         |  |  |         |    |       |         |                |        |   |  |           |    |       |         |                |        |         |    |       |         |  |  |           |    |       |         |  |  |         |    |       |         |  |  |         |  |       |         |  |  |          |     |       |         |  |  |         |  |       |         |  |  |         |     |       |         |  |  |         |     |       |         |  |  |         |     |       |         |  |  |         |     |       |         |  |  |          |     |       |         |  |  |         |    |       |             |                |        |   |  |           |    |       |             |                |        |         |    |       |             |  |  |
| 2.0 FSI  | 110  | 03.04   | PR: 1ZE         |                |         |  |  |  |  |          |           |                                    |            |                |                |         |         |       |       |                |        |         |           |       |       |                |        |         |         |       |       |         |  |         |         |       |       |         |  |         |          |       |       |         |  |                 |         |       |       |         |  |         |         |       |       |         |  |         |         |       |       |                |        |   |                     |         |       |         |  |                |         |       |       |                |        |   |                                     |                |       |         |  |                |         |                 |       |                 |                |                |                                    |            |           |       |       |                 |                |        |         |    |       |                 |  |  |           |    |       |                 |  |  |         |    |       |                 |  |  |         |  |       |                 |  |  |          |     |       |                 |  |  |         |  |       |                 |  |  |         |     |       |                 |  |  |         |     |       |                 |  |  |         |     |       |                 |  |  |         |     |       |                 |  |  |          |     |       |                 |  |  |         |    |       |         |                |        |   |  |           |    |       |         |                |        |         |    |       |         |  |  |           |    |       |         |  |  |         |    |       |         |  |  |         |  |       |         |  |  |          |     |       |         |  |  |         |  |       |         |  |  |         |     |       |         |  |  |         |     |       |         |  |  |         |     |       |         |  |  |         |     |       |         |  |  |          |     |       |         |  |  |         |    |       |         |                |        |   |  |           |    |       |         |                |        |         |    |       |         |  |  |           |    |       |         |  |  |         |    |       |         |  |  |         |  |       |         |  |  |          |     |       |         |  |  |         |  |       |         |  |  |         |     |       |         |  |  |         |     |       |         |  |  |         |     |       |         |  |  |         |     |       |         |  |  |          |     |       |         |  |  |         |    |       |             |                |        |   |  |           |    |       |             |                |        |         |    |       |             |  |  |
| 2.0 TDI  | 100  | 03.04   | PR: 1ZE         |                |         |  |  |  |  |          |           |                                    |            |                |                |         |         |       |       |                |        |         |           |       |       |                |        |         |         |       |       |         |  |         |         |       |       |         |  |         |          |       |       |         |  |                 |         |       |       |         |  |         |         |       |       |         |  |         |         |       |       |                |        |   |                     |         |       |         |  |                |         |       |       |                |        |   |                                     |                |       |         |  |                |         |                 |       |                 |                |                |                                    |            |           |       |       |                 |                |        |         |    |       |                 |  |  |           |    |       |                 |  |  |         |    |       |                 |  |  |         |  |       |                 |  |  |          |     |       |                 |  |  |         |  |       |                 |  |  |         |     |       |                 |  |  |         |     |       |                 |  |  |         |     |       |                 |  |  |         |     |       |                 |  |  |          |     |       |                 |  |  |         |    |       |         |                |        |   |  |           |    |       |         |                |        |         |    |       |         |  |  |           |    |       |         |  |  |         |    |       |         |  |  |         |  |       |         |  |  |          |     |       |         |  |  |         |  |       |         |  |  |         |     |       |         |  |  |         |     |       |         |  |  |         |     |       |         |  |  |         |     |       |         |  |  |          |     |       |         |  |  |         |    |       |         |                |        |   |  |           |    |       |         |                |        |         |    |       |         |  |  |           |    |       |         |  |  |         |    |       |         |  |  |         |  |       |         |  |  |          |     |       |         |  |  |         |  |       |         |  |  |         |     |       |         |  |  |         |     |       |         |  |  |         |     |       |         |  |  |         |     |       |         |  |  |          |     |       |         |  |  |         |    |       |             |                |        |   |  |           |    |       |             |                |        |         |    |       |             |  |  |
| 2.0 TDI  | 103  | 03.04   | PR: 1ZE         |                |         |  |  |  |  |          |           |                                    |            |                |                |         |         |       |       |                |        |         |           |       |       |                |        |         |         |       |       |         |  |         |         |       |       |         |  |         |          |       |       |         |  |                 |         |       |       |         |  |         |         |       |       |         |  |         |         |       |       |                |        |   |                     |         |       |         |  |                |         |       |       |                |        |   |                                     |                |       |         |  |                |         |                 |       |                 |                |                |                                    |            |           |       |       |                 |                |        |         |    |       |                 |  |  |           |    |       |                 |  |  |         |    |       |                 |  |  |         |  |       |                 |  |  |          |     |       |                 |  |  |         |  |       |                 |  |  |         |     |       |                 |  |  |         |     |       |                 |  |  |         |     |       |                 |  |  |         |     |       |                 |  |  |          |     |       |                 |  |  |         |    |       |         |                |        |   |  |           |    |       |         |                |        |         |    |       |         |  |  |           |    |       |         |  |  |         |    |       |         |  |  |         |  |       |         |  |  |          |     |       |         |  |  |         |  |       |         |  |  |         |     |       |         |  |  |         |     |       |         |  |  |         |     |       |         |  |  |         |     |       |         |  |  |          |     |       |         |  |  |         |    |       |         |                |        |   |  |           |    |       |         |                |        |         |    |       |         |  |  |           |    |       |         |  |  |         |    |       |         |  |  |         |  |       |         |  |  |          |     |       |         |  |  |         |  |       |         |  |  |         |     |       |         |  |  |         |     |       |         |  |  |         |     |       |         |  |  |         |     |       |         |  |  |          |     |       |         |  |  |         |    |       |             |                |        |   |  |           |    |       |             |                |        |         |    |       |             |  |  |
| 2.0 TDI  | 125  | 03.06   | PR: 1ZE         |                |         |  |  |  |  |          |           |                                    |            |                |                |         |         |       |       |                |        |         |           |       |       |                |        |         |         |       |       |         |  |         |         |       |       |         |  |         |          |       |       |         |  |                 |         |       |       |         |  |         |         |       |       |         |  |         |         |       |       |                |        |   |                     |         |       |         |  |                |         |       |       |                |        |   |                                     |                |       |         |  |                |         |                 |       |                 |                |                |                                    |            |           |       |       |                 |                |        |         |    |       |                 |  |  |           |    |       |                 |  |  |         |    |       |                 |  |  |         |  |       |                 |  |  |          |     |       |                 |  |  |         |  |       |                 |  |  |         |     |       |                 |  |  |         |     |       |                 |  |  |         |     |       |                 |  |  |         |     |       |                 |  |  |          |     |       |                 |  |  |         |    |       |         |                |        |   |  |           |    |       |         |                |        |         |    |       |         |  |  |           |    |       |         |  |  |         |    |       |         |  |  |         |  |       |         |  |  |          |     |       |         |  |  |         |  |       |         |  |  |         |     |       |         |  |  |         |     |       |         |  |  |         |     |       |         |  |  |         |     |       |         |  |  |          |     |       |         |  |  |         |    |       |         |                |        |   |  |           |    |       |         |                |        |         |    |       |         |  |  |           |    |       |         |  |  |         |    |       |         |  |  |         |  |       |         |  |  |          |     |       |         |  |  |         |  |       |         |  |  |         |     |       |         |  |  |         |     |       |         |  |  |         |     |       |         |  |  |         |     |       |         |  |  |          |     |       |         |  |  |         |    |       |             |                |        |   |  |           |    |       |             |                |        |         |    |       |             |  |  |
| 2.0 TFSI   | 147  | 03.06   | PR: 1ZE         |                |         |  |  |  |  |          |           |                                    |            |                |                |         |         |       |       |                |        |         |           |       |       |                |        |         |         |       |       |         |  |         |         |       |       |         |  |         |          |       |       |         |  |                 |         |       |       |         |  |         |         |       |       |         |  |         |         |       |       |                |        |   |                     |         |       |         |  |                |         |       |       |                |        |   |                                     |                |       |         |  |                |         |                 |       |                 |                |                |                                    |            |           |       |       |                 |                |        |         |    |       |                 |  |  |           |    |       |                 |  |  |         |    |       |                 |  |  |         |  |       |                 |  |  |          |     |       |                 |  |  |         |  |       |                 |  |  |         |     |       |                 |  |  |         |     |       |                 |  |  |         |     |       |                 |  |  |         |     |       |                 |  |  |          |     |       |                 |  |  |         |    |       |         |                |        |   |  |           |    |       |         |                |        |         |    |       |         |  |  |           |    |       |         |  |  |         |    |       |         |  |  |         |  |       |         |  |  |          |     |       |         |  |  |         |  |       |         |  |  |         |     |       |         |  |  |         |     |       |         |  |  |         |     |       |         |  |  |         |     |       |         |  |  |          |     |       |         |  |  |         |    |       |         |                |        |   |  |           |    |       |         |                |        |         |    |       |         |  |  |           |    |       |         |  |  |         |    |       |         |  |  |         |  |       |         |  |  |          |     |       |         |  |  |         |  |       |         |  |  |         |     |       |         |  |  |         |     |       |         |  |  |         |     |       |         |  |  |         |     |       |         |  |  |          |     |       |         |  |  |         |    |       |             |                |        |   |  |           |    |       |             |                |        |         |    |       |             |  |  |
| 1.2 TSI  | 77   | 04.10   | PR: 1LJ,1ZA     | 24.0125-0158.1 | 425158  | 312 25,0 22,0 V L +S +B<br>312 25,0 22,0 V L +S +B PD  |  |  |  |          |           |                                    |            |                |                |         |         |       |       |                |        |         |           |       |       |                |        |         |         |       |       |         |  |         |         |       |       |         |  |         |          |       |       |         |  |                 |         |       |       |         |  |         |         |       |       |         |  |         |         |       |       |                |        |   |                     |         |       |         |  |                |         |       |       |                |        |   |                                     |                |       |         |  |                |         |                 |       |                 |                |                |                                    |            |           |       |       |                 |                |        |         |    |       |                 |  |  |           |    |       |                 |  |  |         |    |       |                 |  |  |         |  |       |                 |  |  |          |     |       |                 |  |  |         |  |       |                 |  |  |         |     |       |                 |  |  |         |     |       |                 |  |  |         |     |       |                 |  |  |         |     |       |                 |  |  |          |     |       |                 |  |  |         |    |       |         |                |        |   |  |           |    |       |         |                |        |         |    |       |         |  |  |           |    |       |         |  |  |         |    |       |         |  |  |         |  |       |         |  |  |          |     |       |         |  |  |         |  |       |         |  |  |         |     |       |         |  |  |         |     |       |         |  |  |         |     |       |         |  |  |         |     |       |         |  |  |          |     |       |         |  |  |         |    |       |         |                |        |   |  |           |    |       |         |                |        |         |    |       |         |  |  |           |    |       |         |  |  |         |    |       |         |  |  |         |  |       |         |  |  |          |     |       |         |  |  |         |  |       |         |  |  |         |     |       |         |  |  |         |     |       |         |  |  |         |     |       |         |  |  |         |     |       |         |  |  |          |     |       |         |  |  |         |    |       |             |                |        |   |  |           |    |       |             |                |        |         |    |       |             |  |  |
| 1.4 i 16V  | 63   | 05.06   | PR: 1LJ,1ZA     | 24.0325-0158.1 | 525158  |  |  |  |  |          |           |                                    |            |                |                |         |         |       |       |                |        |         |           |       |       |                |        |         |         |       |       |         |  |         |         |       |       |         |  |         |          |       |       |         |  |                 |         |       |       |         |  |         |         |       |       |         |  |         |         |       |       |                |        |   |                     |         |       |         |  |                |         |       |       |                |        |   |                                     |                |       |         |  |                |         |                 |       |                 |                |                |                                    |            |           |       |       |                 |                |        |         |    |       |                 |  |  |           |    |       |                 |  |  |         |    |       |                 |  |  |         |  |       |                 |  |  |          |     |       |                 |  |  |         |  |       |                 |  |  |         |     |       |                 |  |  |         |     |       |                 |  |  |         |     |       |                 |  |  |         |     |       |                 |  |  |          |     |       |                 |  |  |         |    |       |         |                |        |   |  |           |    |       |         |                |        |         |    |       |         |  |  |           |    |       |         |  |  |         |    |       |         |  |  |         |  |       |         |  |  |          |     |       |         |  |  |         |  |       |         |  |  |         |     |       |         |  |  |         |     |       |         |  |  |         |     |       |         |  |  |         |     |       |         |  |  |          |     |       |         |  |  |         |    |       |         |                |        |   |  |           |    |       |         |                |        |         |    |       |         |  |  |           |    |       |         |  |  |         |    |       |         |  |  |         |  |       |         |  |  |          |     |       |         |  |  |         |  |       |         |  |  |         |     |       |         |  |  |         |     |       |         |  |  |         |     |       |         |  |  |         |     |       |         |  |  |          |     |       |         |  |  |         |    |       |             |                |        |   |  |           |    |       |             |                |        |         |    |       |             |  |  |
| 1.4 TSI  | 92   | 11.07   | PR: 1LJ,1ZA     |                |         |  |  |  |  |          |           |                                    |            |                |                |         |         |       |       |                |        |         |           |       |       |                |        |         |         |       |       |         |  |         |         |       |       |         |  |         |          |       |       |         |  |                 |         |       |       |         |  |         |         |       |       |         |  |         |         |       |       |                |        |   |                     |         |       |         |  |                |         |       |       |                |        |   |                                     |                |       |         |  |                |         |                 |       |                 |                |                |                                    |            |           |       |       |                 |                |        |         |    |       |                 |  |  |           |    |       |                 |  |  |         |    |       |                 |  |  |         |  |       |                 |  |  |          |     |       |                 |  |  |         |  |       |                 |  |  |         |     |       |                 |  |  |         |     |       |                 |  |  |         |     |       |                 |  |  |         |     |       |                 |  |  |          |     |       |                 |  |  |         |    |       |         |                |        |   |  |           |    |       |         |                |        |         |    |       |         |  |  |           |    |       |         |  |  |         |    |       |         |  |  |         |  |       |         |  |  |          |     |       |         |  |  |         |  |       |         |  |  |         |     |       |         |  |  |         |     |       |         |  |  |         |     |       |         |  |  |         |     |       |         |  |  |          |     |       |         |  |  |         |    |       |         |                |        |   |  |           |    |       |         |                |        |         |    |       |         |  |  |           |    |       |         |  |  |         |    |       |         |  |  |         |  |       |         |  |  |          |     |       |         |  |  |         |  |       |         |  |  |         |     |       |         |  |  |         |     |       |         |  |  |         |     |       |         |  |  |         |     |       |         |  |  |          |     |       |         |  |  |         |    |       |             |                |        |   |  |           |    |       |             |                |        |         |    |       |             |  |  |

<sup>1)</sup> electric parking brake / fr.di stazionamento elettrico / frein à main électrique / freno de mano eléctrico

|     |   |  |                          |    |  |  |    |  |
|--|---|--|--|--|---|--|--|--|
| <b>SEAT ALTEA (5P1) (04-15)</b>  |   |  |  |  |   |  |  |  |
|    | 1.6 i 16V<br>1.6 LPG<br>1.6 TDI<br>1.8 TFSI<br>1.9 TDI<br>2.0 FSI<br>2.0 TDI<br>2.0 TDI<br>2.0 TDI<br>2.0 TFSI                                    | 75<br>75<br>118<br>110<br>100<br>103<br>125<br>147                               | 03.04<br>09.09<br>10.09<br>01.07<br>03.04<br>03.04<br>03.04<br>03.04<br>03.06<br>03.06                   | PR: 1LJ,1ZA<br>PR: 1LJ,1ZA<br>PR: 1LJ,1ZA<br>PR: 1LJ,1ZA<br>PR: 1LJ,1ZA<br>PR: 1LJ,1ZA<br>PR: 1LJ,1ZA<br>PR: 1LJ,1ZA<br>PR: 1LJ,1ZA<br>PR: 1LJ,1ZA   | 24.0125-0158.1<br>24.0325-0158.1  | 425158<br>525158   |  | 312 25,0 22,0 VL +S +B<br>312 25,0 22,0 VL +S +B PD                                |
|    | 1.2 TSI<br>1.4 i 16V<br>1.4 TSI<br>1.6 i 16V<br>1.6 LPG<br>1.6 TDI<br>1.8 TFSI<br>1.9 TDI<br>2.0 FSI<br>2.0 TDI<br>2.0 TDI<br>2.0 TDI<br>2.0 TFSI | 77<br>63<br>92<br>75<br>75<br>118<br>110<br>100<br>103<br>125<br>147             | 04.10<br>05.06<br>11.07<br>03.04<br>09.09<br>10.09<br>01.07<br>03.04<br>03.04<br>03.04<br>03.06<br>03.06 |  | 24.0711-5271.3<br>24.0711-5272.3  | 360301<br>360302   | <br> | Radsensor<br>Radsensor   |
|    | 1.2 TSI<br>1.4 i 16V<br>1.4 TSI<br>1.6 i 16V<br>1.6 LPG<br>1.6 TDI<br>1.8 TFSI<br>1.9 TDI<br>2.0 FSI<br>2.0 TDI<br>2.0 TDI<br>2.0 TDI<br>2.0 TFSI | 77<br>63<br>92<br>75<br>75<br>118<br>110<br>100<br>103<br>125<br>147             | 04.10<br>05.06<br>11.07<br>03.04<br>09.09<br>10.09<br>01.07<br>03.04<br>03.04<br>03.04<br>03.06<br>03.06 | PR: 1KD,1KQ,1KZ<br>PR: 1KD,1KQ,1KZ<br>PR: 1KD,1KQ,1KZ<br>PR: 1KD,1KQ,1KZ<br>PR: 1KD,1KQ,1KZ<br>PR: 1KD,1KQ,1KZ<br>PR: 1KD,1KQ,1KZ<br>PR: 1KD,1KQ,1KZ<br>PR: 1KD,1KQ,1KZ<br>PR: 1KD,1KQ,1KZ<br>PR: 1KD,1KQ,1KZ<br>PR: 1KD,1KQ,1KZ | 13.0460-2820.2<br>13.0470-2820.2  | 602820<br>LD2820   |  | 20961 17,6 /S TRW<br>20961 17,6 /S TRW   |
|  | 1.2 TSI<br>1.4 i 16V<br>1.4 TSI<br>1.6 i 16V<br>1.6 LPG<br>1.6 TDI<br>1.8 TFSI<br>1.9 TDI<br>2.0 FSI<br>2.0 TDI<br>2.0 TDI<br>2.0 TDI<br>2.0 TFSI | 77<br>63<br>92<br>75<br>75<br>118<br>110<br>100<br>103<br>125<br>147             | 04.10<br>05.06<br>11.07<br>03.04<br>09.09<br>10.09<br>01.07<br>03.04<br>03.04<br>03.04<br>03.06<br>03.06 | PR: 1KS<br>PR: 1KS<br>PR: 1KS<br>PR: 1KS<br>PR: 1KS<br>PR: 1KS<br>PR: 1KS<br>PR: 1KS<br>PR: 1KS<br>PR: 1KS<br>PR: 1KS  | 13.0460-3858.2<br>13.0470-3858.2  | 603858<br>LD3858   |  | 24563 17,7 /Zub/S BOS<br>24563 17,7 /Zub/S BOS                                     |
|  | 1.2 TSI<br>1.4 i 16V<br>1.4 TSI<br>1.6 i 16V<br>1.6 LPG<br>1.6 TDI<br>1.8 TFSI<br>1.9 TDI<br>2.0 FSI<br>2.0 TDI<br>2.0 TDI<br>2.0 TDI<br>2.0 TFSI | 77<br>63<br>92<br>75<br>75<br>118<br>110<br>100<br>103<br>125<br>147             | 04.10<br>05.06<br>11.07<br>03.04<br>09.09<br>10.09<br>01.07<br>03.04<br>03.04<br>03.04<br>03.06<br>03.06 | PR: 1KF,1KJ<br>PR: 1KF,1KJ<br>PR: 1KF,1KJ<br>PR: 1KF,1KJ<br>PR: 1KF,1KJ<br>PR: 1KF,1KJ<br>PR: 1KF,1KJ<br>PR: 1KF,1KJ<br>PR: 1KF,1KJ<br>PR: 1KF,1KJ<br>PR: 1KF,1KJ  | 13.0460-2880.2<br>13.0470-2880.2  | 602880<br>LD2880   |  | 23914 17,1 /WE/Zub/S TRW<br>23914 17,1 /WE/Zub/S TRW                               |
|  | 1.2 TSI<br>1.4 i 16V<br>1.4 TSI<br>1.6 i 16V<br>1.6 LPG<br>1.6 TDI<br>1.8 TFSI<br>1.9 TDI<br>2.0 FSI<br>2.0 TDI<br>2.0 TDI<br>2.0 TDI<br>2.0 TFSI | 77<br>63<br>92<br>75<br>75<br>118<br>110<br>100<br>103<br>125<br>147             | 04.10<br>05.06<br>11.07<br>03.04<br>09.09<br>10.09<br>01.07<br>03.04<br>03.04<br>03.04<br>03.06<br>03.06 | PR: 1KD,1KQ<br>PR: 1KD,1KQ<br>PR: 1KD,1KQ<br>PR: 1KD,1KQ<br>PR: 1KD,1KQ<br>PR: 1KD,1KQ<br>PR: 1KD,1KQ<br>PR: 1KD,1KQ<br>PR: 1KD,1KQ<br>PR: 1KD,1KQ<br>PR: 1KD,1KQ<br>PR: 1KD,1KQ   | 24.0110-0277.1<br>24.0310-0277.1  | 410277<br>510277   |  | 253 10,0 8,0 +S +B<br>253 10,0 8,0 +S +B PD  |
|  | 1.2 TSI<br>1.4 i 16V<br>1.4 TSI<br>1.6 i 16V<br>1.6 LPG<br>1.6 TDI<br>1.8 TFSI<br>1.9 TDI<br>2.0 FSI<br>2.0 TDI<br>2.0 TDI<br>2.0 TDI             | 77<br>63<br>92<br>75<br>75<br>118<br>110<br>100<br>103<br>125                    | 04.10<br>05.06<br>11.07<br>03.04<br>09.09<br>10.09<br>01.07<br>03.04<br>03.04<br>03.04<br>03.06          | PR: 1KJ,1KZ<br>PR: 1KJ,1KZ<br>PR: 1KJ,1KZ<br>PR: 1KJ,1KZ<br>PR: 1KJ,1KZ<br>PR: 1KJ,1KZ<br>PR: 1KJ,1KZ<br>PR: 1KJ,1KZ<br>PR: 1KJ,1KZ<br>PR: 1KJ,1KZ<br>PR: 1KJ,1KZ  | 24.0112-0169.1<br>24.0312-0169.1  | 412169<br>512169   |  | 282 12,0 10,0 +S +B<br>282 12,0 10,0 +S +B PD                                      |













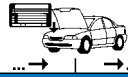



**SEAT ALTEA (5P1) (04-15)**

|  |           |     |  |       |             |                |        |   |   |
|--|-----------|-----|--|-------|-------------|----------------|--------|---|---|
|  | 2.0 TFSI  | 147 |  | 03.06 | PR: 1KJ,1KZ | 24.0112-0169.1 | 412169 |   | 282 12,0 10,0 +S +B<br>282 12,0 10,0 +S +B PD |
|  | 1.2 TSI   | 77  |  | 04.10 | PR: 1KS     | 24.0110-0356.1 | 410356 |   | 272 9,7 8,0 +S +B<br>272 9,7 8,0 +S +B PD     |
|  | 1.4 i 16V | 63  |  | 05.06 | PR: 1KS     | 24.0310-0356.1 | 510356 |   |   |
|  | 1.4 TSI   | 92  |  | 11.07 | PR: 1KS     |                |        |   |   |
|  | 1.6 i 16V | 75  |  | 03.04 | PR: 1KS     |                |        |   |   |
|  | 1.6 LPG   | 75  |  | 09.09 | PR: 1KS     |                |        |   |   |
|  | 1.6 TDI   |     |  | 10.09 | PR: 1KS     |                |        |   |   |
|  | 1.8 TFSI  | 118 |  | 01.07 | PR: 1KS     |                |        |   |   |
|  | 1.9 TDI   |     |  | 03.04 | PR: 1KS     |                |        |   |   |
|  | 2.0 FSI   | 110 |  | 03.04 | PR: 1KS     |                |        |   |   |
|  | 2.0 TDI   | 100 |  | 03.04 | PR: 1KS     |                |        |   |   |
|  | 2.0 TDI   | 103 |  | 03.04 | PR: 1KS     |                |        |   |   |
|  | 2.0 TDI   | 125 |  | 03.06 | PR: 1KS     |                |        |   |   |
|  | 2.0 TFSI  | 147 |  | 03.06 | PR: 1KS     |                |        |   |   |
|  | 1.2 TSI   | 77  |  | 04.10 | PR: 1KF     | 24.0112-0158.1 | 412158 |   | 256 12,0 10,0 +S +B<br>256 12,0 10,0 +B PD    |
|  | 1.4 i 16V | 63  |  | 05.06 | PR: 1KF     | 24.0312-0158.1 | 512158 |   |   |
|  | 1.4 TSI   | 92  |  | 11.07 | PR: 1KF     |                |        |   |   |
|  | 1.6 i 16V | 75  |  | 03.04 | PR: 1KF     |                |        |   |   |
|  | 1.6 LPG   | 75  |  | 09.09 | PR: 1KF     |                |        |   |   |
|  | 1.6 TDI   |     |  | 10.09 | PR: 1KF     |                |        |   |   |
|  | 1.8 TFSI  | 118 |  | 01.07 | PR: 1KF     |                |        |   |   |
|  | 1.9 TDI   |     |  | 03.04 | PR: 1KF     |                |        |   |   |
|  | 2.0 FSI   | 110 |  | 03.04 | PR: 1KF     |                |        |   |   |
|  | 2.0 TDI   | 100 |  | 03.04 | PR: 1KF     |                |        |   |   |
|  | 2.0 TDI   | 103 |  | 03.04 | PR: 1KF     |                |        |   |   |
|  | 2.0 TDI   | 125 |  | 03.06 | PR: 1KF     |                |        |   |   |
|  | 2.0 TFSI  | 147 |  | 03.06 | PR: 1KF     |                |        |   |   |
|  | 1.2 TSI   | 77  |  | 04.10 |             | 24.0711-6231.3 | 360305 |    | Radsensor                                     |
|  | 1.4 i 16V | 63  |  | 05.06 |             | 24.0711-6232.3 | 360306 |    | Radsensor                                     |
|  | 1.4 TSI   | 92  |  | 11.07 |             |                |        |   |   |
|  | 1.6 i 16V | 75  |  | 03.04 |             |                |        |   |   |
|  | 1.6 LPG   | 75  |  | 09.09 |             |                |        |   |   |
|  | 1.6 TDI   |     |  | 10.09 |             |                |        |   |   |
|  | 1.8 TFSI  | 118 |  | 01.07 |             |                |        |   |   |
|  | 1.9 TDI   |     |  | 03.04 |             |                |        |   |   |
|  | 2.0 FSI   | 110 |  | 03.04 |             |                |        |   |   |
|  | 2.0 TDI   | 100 |  | 03.04 |             |                |        |   |   |
|  | 2.0 TDI   | 103 |  | 03.04 |             |                |        |   |   |
|  | 2.0 TDI   | 125 |  | 03.06 |             |                |        |   |   |
|  | 2.0 TFSI  | 147 |  | 03.06 |             |                |        |   |   |
|  | 1.2 TSI   | 77  |  | 04.10 | PR: 1X1     | 24.0711-5271.3 | 360301 |  | Radsensor                                     |
|  | 1.4 i 16V | 63  |  | 05.06 | PR: 1X1     | 24.0711-5272.3 | 360302 |  | Radsensor                                     |
|  | 1.4 TSI   | 92  |  | 11.07 | PR: 1X1     |                |        |   |   |
|  | 1.6 i 16V | 75  |  | 03.04 | PR: 1X1     |                |        |   |   |
|  | 1.6 LPG   | 75  |  | 09.09 | PR: 1X1     |                |        |   |   |
|  | 1.6 TDI   |     |  | 10.09 | PR: 1X1     |                |        |   |   |
|  | 1.8 TFSI  | 118 |  | 01.07 | PR: 1X1     |                |        |   |   |
|  | 1.9 TDI   |     |  | 03.04 | PR: 1X1     |                |        |   |   |
|  | 2.0 FSI   | 110 |  | 03.04 | PR: 1X1     |                |        |   |   |
|  | 2.0 TDI   | 100 |  | 03.04 | PR: 1X1     |                |        |   |   |
|  | 2.0 TDI   | 103 |  | 03.04 | PR: 1X1     |                |        |   |   |
|  | 2.0 TDI   | 125 |  | 03.06 | PR: 1X1     |                |        |   |   |
|  | 2.0 TFSI  | 147 |  | 03.06 | PR: 1X1     |                |        |   |   |

**SEAT ALTEA XL (5P5) (06-15)**

|  |              |     |  |       |                 |                |        |  |                                    |            |
|--|--------------|-----|--|-------|-----------------|----------------|--------|--|------------------------------------|------------|
|  | 1.2 TSI      | 77  |  | 04.10 | PR: 1ZF         | 13.0460-7117.2 | 607117 |  | 23131 19,6 +/WK<br>23131 19,6 +/WK | VW<br>VW   |
|  | 1.4 i 16V    | 63  |  | 05.08 | PR: 1ZF         | 13.0470-7117.2 | LD7117 |  |                                    |            |
|  | 1.4 TSI      | 92  |  | 11.07 | PR: 1ZF         |                |        |  |                                    |            |
|  | 1.6 i 16V    | 75  |  | 10.06 | PR: 1ZF         |                |        |  |                                    |            |
|  | 1.6 LPG      | 75  |  | 09.09 | PR: 1ZF         |                |        |  |                                    |            |
|  | 1.6 TDI      |     |  | 10.09 | PR: 1ZF         |                |        |  |                                    |            |
|  | 1.8 TFSI     | 118 |  | 10.06 | PR: 1ZF         |                |        |  |                                    |            |
|  | 1.9 TDI      |     |  | 10.06 | PR: 1ZF         |                |        |  |                                    |            |
|  | 1.9 TDI 4x4  | 77  |  | 06.09 | PR: 1ZF         |                |        |  |                                    |            |
|  | 2.0 FSI      |     |  | 10.06 | PR: 1ZF         |                |        |  |                                    |            |
|  | 2.0 TDI      |     |  | 10.06 | PR: 1ZF         |                |        |  |                                    |            |
|  | 2.0 TDI      | 125 |  | 10.06 | PR: 1ZF         |                |        |  |                                    |            |
|  | 2.0 TDI 4x4  |     |  | 06.07 | PR: 1ZF         |                |        |  |                                    |            |
|  | 2.0 TFSI 4x4 |     |  | 06.07 | PR: 1ZF         |                |        |  |                                    |            |
|  | 1.2 TSI      | 77  |  | 04.10 | PR: 1ZA,1ZE,1LJ | 13.0460-7184.2 | 607184 |  | 23587 20,6 +/WK<br>23587 20,6 +/WK | ATE<br>ATE |
|  | 1.4 i 16V    | 63  |  | 05.08 | PR: 1ZA,1ZE,1LJ | 13.0470-7184.2 | LD7184 |  |                                    |            |
|  | 1.4 TSI      | 92  |  | 11.07 | PR: 1ZA,1ZE,1LJ |                |        |  |                                    |            |
|  | 1.6 i 16V    | 75  |  | 10.06 | PR: 1ZA,1ZE,1LJ |                |        |  |                                    |            |
|  | 1.6 LPG      | 75  |  | 09.09 | PR: 1ZA,1ZE,1LJ |                |        |  |                                    |            |
|  | 1.6 TDI      |     |  | 10.09 | PR: 1ZA,1ZE,1LJ |                |        |  |                                    |            |
|  | 1.8 TFSI     | 118 |  | 10.06 | PR: 1ZA,1ZE,1LJ |                |        |  |                                    |            |
|  | 1.9 TDI      |     |  | 10.06 | PR: 1ZA,1ZE,1LJ |                |        |  |                                    |            |
|  | 1.9 TDI 4x4  | 77  |  | 06.09 | PR: 1ZA,1ZE,1LJ |                |        |  |                                    |            |
|  | 2.0 FSI      |     |  | 10.06 | PR: 1ZA,1ZE,1LJ |                |        |  |                                    |            |
|  | 2.0 TDI      |     |  | 10.06 | PR: 1ZA,1ZE,1LJ |                |        |  |                                    |            |
|  | 2.0 TDI      | 125 |  | 10.06 | PR: 1ZA,1ZE,1LJ |                |        |  |                                    |            |
|  | 2.0 TDI 4x4  |     |  | 06.07 | PR: 1ZA,1ZE,1LJ |                |        |  |                                    |            |
|  | 2.0 TFSI 4x4 |     |  | 06.07 | PR: 1ZA,1ZE,1LJ |                |        |  |                                    |            |

|     |  |  |  |  |  |  |     |  |
|--|--|--|--|--|---|--|---|--|
| <b>SEAT ALTEA XL (5P5) (06-15)</b>   |  |  |  |  |   |  |   |  |
|    | 1.2 TSI  | 77   | 04.10  | PR: 1ZF  | 24.0122-0210.1  | 422210   |   | 280 22,0 19,0 V L +S +B  |
|  | 1.4 i 16V  | 63   | 05.08  | PR: 1ZF  | 24.0322-0210.1  | 522210   |   | 280 22,0 19,0 V L +S +B PD   |
|  | 1.4 TSI  | 92   | 11.07  | PR: 1ZF  |   |  |   |  |
|  | 1.6 i 16V  | 75   | 10.06  | PR: 1ZF  |   |  |   |  |
|  | 1.6 LPG  | 75   | 09.09  | PR: 1ZF  |   |  |   |  |
|  | 1.6 TDI  |  | 10.09  | PR: 1ZF  |   |  |   |  |
|  | 1.8 TFSI   | 118  | 10.06  | PR: 1ZF  |   |  |   |  |
|  | 1.9 TDI  |  | 10.06  | PR: 1ZF  |   |  |   |  |
|  | 1.9 TDI 4x4  | 77   | 06.09  | PR: 1ZF  |   |  |   |  |
|  | 2.0 FSI  |  | 10.06  | PR: 1ZF  |   |  |   |  |
|  | 2.0 TDI  |  | 10.06  | PR: 1ZF  |   |  |   |  |
|  | 2.0 TDI 4x4  | 125  | 10.06  | PR: 1ZF  |   |  |   |  |
| 2.0 TFSI 4x4   |  | 06.07  | PR: 1ZF  |  |   |  |   |  |
| 2.0 TFSI 4x4   |  | 06.07  | PR: 1ZF  |  |   |  |   |  |
|  | 1.2 TSI  | 77   | 04.10  | PR: 1ZE  | 24.0125-0145.1  | 425145   |   | 288 25,0 22,0 V L +S +B  |
|  | 1.4 i 16V  | 63   | 05.08  | PR: 1ZE  | 24.0325-0145.1  | 525145   |   | 288 25,0 22,0 V L +S +B PD   |
|  | 1.4 TSI  | 92   | 11.07  | PR: 1ZE  |   |  |   |  |
|  | 1.6 i 16V  | 75   | 10.06  | PR: 1ZE  |   |  |   |  |
|  | 1.6 LPG  | 75   | 09.09  | PR: 1ZE  |   |  |   |  |
|  | 1.6 TDI  |  | 10.09  | PR: 1ZE  |   |  |   |  |
|  | 1.8 TFSI   | 118  | 10.06  | PR: 1ZE  |   |  |   |  |
|  | 1.9 TDI  |  | 10.06  | PR: 1ZE  |   |  |   |  |
|  | 1.9 TDI 4x4  | 77   | 06.09  | PR: 1ZE  |   |  |   |  |
|  | 2.0 FSI  |  | 10.06  | PR: 1ZE  |   |  |   |  |
|  | 2.0 TDI  |  | 10.06  | PR: 1ZE  |   |  |   |  |
|  | 2.0 TDI 4x4  | 125  | 10.06  | PR: 1ZE  |   |  |   |  |
| 2.0 TFSI 4x4   |  | 06.07  | PR: 1ZE  |  |   |  |   |  |
| 2.0 TFSI 4x4   |  | 06.07  | PR: 1ZE  |  |   |  |   |  |
|  | 1.2 TSI  | 77   | 04.10  | PR: 1LJ,1ZA  | 24.0125-0158.1  | 425158   |   | 312 25,0 22,0 V L +S +B  |
|  | 1.4 i 16V  | 63   | 05.08  | PR: 1LJ,1ZA  | 24.0325-0158.1  | 525158   |   | 312 25,0 22,0 V L +S +B PD   |
|  | 1.4 TSI  | 92   | 11.07  | PR: 1LJ,1ZA  |   |  |   |  |
|  | 1.6 i 16V  | 75   | 10.06  | PR: 1LJ,1ZA  |   |  |   |  |
|  | 1.6 LPG  | 75   | 09.09  | PR: 1LJ,1ZA  |   |  |   |  |
|  | 1.6 TDI  |  | 10.09  | PR: 1LJ,1ZA  |   |  |   |  |
|  | 1.8 TFSI   | 118  | 10.06  | PR: 1LJ,1ZA  |   |  |   |  |
|  | 1.9 TDI  |  | 10.06  | PR: 1LJ,1ZA  |   |  |   |  |
|  | 1.9 TDI 4x4  | 77   | 06.09  | PR: 1LJ,1ZA  |   |  |   |  |
|  | 2.0 FSI  |  | 10.06  | PR: 1LJ,1ZA  |   |  |   |  |
|  | 2.0 TDI  |  | 10.06  | PR: 1LJ,1ZA  |   |  |   |  |
|  | 2.0 TDI 4x4  | 125  | 10.06  | PR: 1LJ,1ZA  |   |  |   |  |
| 2.0 TFSI 4x4   |  | 06.07  | PR: 1LJ,1ZA  |  |   |  |   |  |
| 2.0 TFSI 4x4   |  | 06.07  | PR: 1LJ,1ZA  |  |   |  |   |  |
|  | 1.2 TSI  | 77   | 04.10  |  | 24.0711-5271.3  | 360301   |  | Radsensor  |
|  | 1.4 i 16V  | 63   | 05.08  |  | 24.0711-5272.3  | 360302   |  | Radsensor  |
|  | 1.4 TSI  | 92   | 11.07  |  |   |  |   |  |
|  | 1.6 i 16V  | 75   | 10.06  |  |   |  |   |  |
|  | 1.6 LPG  | 75   | 09.09  |  |   |  |   |  |
|  | 1.6 TDI  |  | 10.09  |  |   |  |   |  |
|  | 1.8 TFSI   | 118  | 10.06  |  |   |  |   |  |
|  | 1.9 TDI  |  | 10.06  |  |   |  |   |  |
|  | 1.9 TDI 4x4  | 77   | 06.09  |  |   |  |   |  |
|  | 2.0 FSI  |  | 10.06  |  |   |  |   |  |
|  | 2.0 TDI  |  | 10.06  |  |   |  |   |  |
|  | 2.0 TDI 4x4  | 125  | 10.06  |  |   |  |   |  |
| 2.0 TFSI 4x4   |  | 06.07  |  |  |   |  |   |  |
| 2.0 TFSI 4x4   |  | 06.07  |  |  |   |  |   |  |
|  | 1.2 TSI  | 77   | 04.10  | PR: 1KD,1KQ,1KZ  | 13.0460-2820.2  | 602820   |   | 20961 17,6 /S TRW  |
|  | 1.4 i 16V  | 63   | 05.08  | PR: 1KD,1KQ,1KZ  | 13.0470-2820.2  | LD2820   |   | 20961 17,6 /S TRW  |
|  | 1.4 TSI  | 92   | 11.07  | PR: 1KD,1KQ,1KZ  |   |  |   |  |
|  | 1.6 i 16V  | 75   | 10.06  | PR: 1KD,1KQ,1KZ  |   |  |   |  |
|  | 1.6 LPG  | 75   | 09.09  | PR: 1KD,1KQ,1KZ  |   |  |   |  |
|  | 1.6 TDI  |  | 10.09  | PR: 1KD,1KQ,1KZ  |   |  |   |  |
|  | 1.8 TFSI   | 118  | 10.06  | PR: 1KD,1KQ,1KZ  |   |  |   |  |
|  | 1.9 TDI  |  | 10.06  | PR: 1KD,1KQ,1KZ  |   |  |   |  |
|  | 1.9 TDI 4x4  | 77   | 06.09  | PR: 1KD,1KQ,1KZ  |   |  |   |  |
|  | 2.0 FSI  |  | 10.06  | PR: 1KD,1KQ,1KZ  |   |  |   |  |
|  | 2.0 TDI  |  | 10.06  | PR: 1KD,1KQ,1KZ  |   |  |   |  |
|  | 2.0 TDI 4x4  | 125  | 10.06  | PR: 1KD,1KQ,1KZ  |   |  |   |  |
| 2.0 TFSI 4x4   |  | 06.07  | PR: 1KD,1KQ,1KZ  |  |   |  |   |  |
| 2.0 TFSI 4x4   |  | 06.07  | PR: 1KD,1KQ,1KZ  |  |   |  |   |  |
|  | 1.2 TSI  | 77   | 04.10  | PR: 1KS  | 13.0460-3858.2  | 603858   |   | 24563 17,7 /Zub/S BOS  |
|  | 1.4 i 16V  | 63   | 05.08  | PR: 1KS  | 13.0470-3858.2  | LD3858   |   | 24563 17,7 /Zub/S BOS  |
|  | 1.4 TSI  | 92   | 11.07  | PR: 1KS  |   |  |   |  |
|  | 1.6 i 16V  | 75   | 10.06  | PR: 1KS  |   |  |   |  |
|  | 1.6 LPG  | 75   | 09.09  | PR: 1KS  |   |  |   |  |
|  | 1.6 TDI  |  | 10.09  | PR: 1KS  |   |  |   |  |
|  | 1.8 TFSI   | 118  | 10.06  | PR: 1KS  |   |  |   |  |
|  | 1.9 TDI  |  | 10.06  | PR: 1KS  |   |  |   |  |
|  | 1.9 TDI 4x4  | 77   | 06.09  | PR: 1KS  |   |  |   |  |
|  | 2.0 FSI  |  | 10.06  | PR: 1KS  |   |  |   |  |
|  | 2.0 TDI  |  | 10.06  | PR: 1KS  |   |  |   |  |
|  | 2.0 TDI 4x4  | 125  | 10.06  | PR: 1KS  |   |  |   |  |
| 2.0 TFSI 4x4   |  | 06.07  | PR: 1KS  |  |   |  |   |  |
| 2.0 TFSI 4x4   |  | 06.07  | PR: 1KS  |  |   |  |   |  |













**SEAT ALTEA XL (5P5) (06-15)**

|              |             |       |             |                |                |        |  |   |
|--------------|-------------|-------|-------------|----------------|----------------|--------|--|---|
|              | 1.2 TSI     | 77    | 04.10       | PR: 1KD,1KQ    | 24.0110-0277.1 | 410277 |  | 253 10,0 8,0 +S +B<br>253 10,0 8,0 +S +B PD   |
|              | 1.4 i 16V   | 63    | 05.08       | PR: 1KD,1KQ    | 24.0310-0277.1 | 510277 |  |   |
|              | 1.4 TSI     | 92    | 11.07       | PR: 1KD,1KQ    |                |        |  |   |
|              | 1.6 i 16V   | 75    | 10.06       | PR: 1KD,1KQ    |                |        |  |   |
|              | 1.6 LPG     | 75    | 09.09       | PR: 1KD,1KQ    |                |        |  |   |
|              | 1.6 TDI     |       | 10.09       | PR: 1KD,1KQ    |                |        |  |   |
|              | 1.8 TFSI    | 118   | 10.06       | PR: 1KD,1KQ    |                |        |  |   |
|              | 1.9 TDI     |       | 10.06       | PR: 1KD,1KQ    |                |        |  |   |
|              | 1.9 TDI 4x4 | 77    | 06.09       | PR: 1KD,1KQ    |                |        |  |   |
|              | 2.0 FSI     |       | 10.06       | PR: 1KD,1KQ    |                |        |  |   |
| 2.0 TDI      |             | 10.06 | PR: 1KD,1KQ |                |                |        |  |   |
| 2.0 TDI      | 125         | 10.06 | PR: 1KD,1KQ |                |                |        |  |   |
| 2.0 TDI 4x4  |             | 06.07 | PR: 1KD,1KQ |                |                |        |  |   |
| 2.0 TFSI 4x4 |             | 06.07 | PR: 1KD,1KQ |                |                |        |  |   |
|              | 1.2 TSI     | 77    | 04.10       | PR: 1KJ,1KZ    | 24.0112-0169.1 | 412169 |  | 282 12,0 10,0 +S +B<br>282 12,0 10,0 +S +B PD |
|              | 1.4 i 16V   | 63    | 05.08       | PR: 1KJ,1KZ    | 24.0312-0169.1 | 512169 |  |   |
|              | 1.4 TSI     | 92    | 11.07       | PR: 1KJ,1KZ    |                |        |  |   |
|              | 1.6 i 16V   | 75    | 10.06       | PR: 1KJ,1KZ    |                |        |  |   |
|              | 1.6 LPG     | 75    | 09.09       | PR: 1KJ,1KZ    |                |        |  |   |
|              | 1.6 TDI     |       | 10.09       | PR: 1KJ,1KZ    |                |        |  |   |
|              | 1.8 TFSI    | 118   | 10.06       | PR: 1KJ,1KZ    |                |        |  |   |
|              | 1.9 TDI     |       | 10.06       | PR: 1KJ,1KZ    |                |        |  |   |
|              | 1.9 TDI 4x4 | 77    | 06.09       | PR: 1KJ,1KZ    |                |        |  |   |
|              | 2.0 FSI     |       | 10.06       | PR: 1KJ,1KZ    |                |        |  |   |
| 2.0 TDI      |             | 10.06 | PR: 1KJ,1KZ |                |                |        |  |   |
| 2.0 TDI      | 125         | 10.06 | PR: 1KJ,1KZ |                |                |        |  |   |
| 2.0 TDI 4x4  |             | 06.07 | PR: 1KJ,1KZ |                |                |        |  |   |
| 2.0 TFSI 4x4 |             | 06.07 | PR: 1KJ,1KZ |                |                |        |  |   |
|              | 1.2 TSI     | 77    | 04.10       | PR: 1KS        | 24.0110-0356.1 | 410356 |  | 272 9,7 8,0 +S +B<br>272 9,7 8,0 +S +B PD     |
|              | 1.4 i 16V   | 63    | 05.08       | PR: 1KS        | 24.0310-0356.1 | 510356 |  |   |
|              | 1.4 TSI     | 92    | 11.07       | PR: 1KS        |                |        |  |   |
|              | 1.6 i 16V   | 75    | 10.06       | PR: 1KS        |                |        |  |   |
|              | 1.6 LPG     | 75    | 09.09       | PR: 1KS        |                |        |  |   |
|              | 1.6 TDI     |       | 10.09       | PR: 1KS        |                |        |  |   |
|              | 1.8 TFSI    | 118   | 10.06       | PR: 1KS        |                |        |  |   |
|              | 1.9 TDI     |       | 10.06       | PR: 1KS        |                |        |  |   |
|              | 1.9 TDI 4x4 | 77    | 06.09       | PR: 1KS        |                |        |  |   |
|              | 2.0 FSI     |       | 10.06       | PR: 1KS        |                |        |  |   |
| 2.0 TDI      |             | 10.06 | PR: 1KS     |                |                |        |  |   |
| 2.0 TDI      | 125         | 10.06 | PR: 1KS     |                |                |        |  |   |
| 2.0 TDI 4x4  |             | 06.07 | PR: 1KS     |                |                |        |  |   |
| 2.0 TFSI 4x4 |             | 06.07 | PR: 1KS     |                |                |        |  |   |
|              | 1.2 TSI     | 77    | 04.10       |                | 24.0711-6231.3 | 360305 |  | Radsensor<br>Radsensor                        |
|              | 1.4 i 16V   | 63    | 05.08       |                | 24.0711-6232.3 | 360306 |  |   |
|              | 1.4 TSI     | 92    | 11.07       |                |                |        |  |   |
|              | 1.6 i 16V   | 75    | 10.06       |                |                |        |  |   |
|              | 1.6 LPG     | 75    | 09.09       |                |                |        |  |   |
|              | 1.6 TDI     |       | 10.09       |                |                |        |  |   |
|              | 1.8 TFSI    | 118   | 10.06       |                |                |        |  |   |
|              | 1.9 TDI     |       | 10.06       |                |                |        |  |   |
|              | 1.9 TDI 4x4 | 77    | 06.09       |                |                |        |  |   |
|              | 2.0 FSI     |       | 10.06       |                |                |        |  |   |
| 2.0 TDI      |             | 10.06 |             |                |                |        |  |   |
| 2.0 TDI      | 125         | 10.06 |             |                |                |        |  |   |
| 2.0 TDI 4x4  |             | 06.07 |             | 24.0711-5271.3 | 360301         |        |  |   |
| 2.0 TFSI 4x4 |             | 06.07 |             | 24.0711-5272.3 | 360302         |        |  |   |

**SEAT AROSA (6H) (97-05)**

|  |           |    |       |       |                |        |   |  |                   |
|--|-----------|----|-------|-------|----------------|--------|---|--|-------------------|
|  | 1.0 i     | 37 | 05.97 | 04.05 | 13.0460-7100.2 | 607100 |   | 21866 17,2 +<br>21866 17,2 +   | VW<br>ATE         |
|  | 1.4 i     | 44 | 05.97 | 04.05 | 13.0470-7100.2 | LD7100 |   |  |                   |
|  | 1.7 SDI   | 44 | 11.97 | 04.05 |                |        |   |  |                   |
|  | 1.4 i 16V | 74 | 10.99 | 04.05 | 13.0460-2821.2 | 602821 |   | 21945 16,0 /S  | TRW               |
|  | 1.4 TDI   | 55 | 10.99 | 04.05 |                |        |   |  |                   |
|  | 1.0 i     | 37 | 05.97 | 04.05 | 24.0110-0232.1 | 410232 |   | 239 9,9 8,0 +S +B<br>239 18,0 16,0 V L +S +B<br>239 18,0 16,0 V L +S +B PD |                   |
|  | 1.0 i     | 37 | 05.97 | 04.05 | 24.0118-0106.1 | 418106 |   |  |                   |
|  | 1.4 i     | 44 | 05.97 | 04.05 | 24.0318-0106.1 | 518106 |   |  |                   |
|  | 1.7 SDI   | 44 | 11.97 | 04.05 |                |        |   |  |                   |
|  | 1.4 i 16V | 74 | 10.99 | 04.05 | 24.0120-0128.1 | 420128 |   | 256 20,0 18,0 V L +S +B<br>256 20,0 18,0 V L +S +B PD                      |                   |
|  | 1.4 TDI   | 55 | 10.99 | 04.05 | 24.0320-0128.1 | 520128 |   |  |                   |
|  | 1.0 i     | 37 | 05.97 | 04.05 | 24.0711-1361.3 | 360022 |   | Radsensor<br>Radsensor   |                   |
|  | 1.4 i     | 44 | 05.97 | 04.05 | 24.0711-1362.3 | 360023 |   |  |                   |
|  | 1.4 i 16V | 74 | 10.99 | 04.05 |                |        |   |  |                   |
|  | 1.4 TDI   | 55 | 10.99 | 04.05 |                |        |   |  |                   |
|  | 1.7 SDI   | 44 | 11.97 | 04.05 |                |        |   | 20961 17,4 /Zub/S<br>20961 17,4 /Zub/S<br>Belagsatz-Zubehör                | TRW<br>TRW<br>TRW |
|  | 1.4 i 16V | 74 | 10.99 | 04.05 | 13.0460-2894.2 | 602894 |   |  |                   |
|  |           |    |       |       | 13.0470-2894.2 | LD2894 |   |  |                   |
|  |           |    |       |       | 13.0460-0072.2 | 610072 |   |  |                   |
|  | 1.4 i 16V | 74 | 10.99 | 04.05 | 24.0109-0124.1 | 409124 |   |  |                   |
|  | 1.0 i     | 37 | 05.97 | 04.05 | 24.0741-1107.3 | 360042 | 2 | Radsensor  |                   |
|  | 1.4 i     | 44 | 05.97 | 04.05 |                |        |   |  |                   |
|  | 1.4 i 16V | 74 | 10.99 | 04.05 |                |        |   |  |                   |
|  | 1.4 TDI   | 55 | 10.99 | 04.05 |                |        |   |  |                   |
|  | 1.7 SDI   | 44 | 11.97 | 04.05 |                |        |   |  |                   |





| SEAT AROSA (6H) (97-05)  |  | SEAT ATECA (16-)                            |   | SEAT CORDOBA I (93-99)  |   |   |
|--|--|---|---|---|---|---|
|    | 1.0 i<br>1.4 i<br>1.4 TDI<br>1.7 SDI   | 37<br>44<br>55<br>44                        | 6H-X-090000 05.97<br>6H-X-090000 05.97<br>6H-X-090000 10.99<br>6H-X-090000 11.97                      |   | 03.0137-0126.2 650126<br>03.0137-9008.2 669008                          | 180 x 31 HEB<br>Bremsbacken-Zubehör                                   |
|  | 1.0 i<br>1.4 i<br>1.4 TDI<br>1.7 SDI   | 37<br>44<br>55<br>44                        | 6H-X-090001<br>6H-X-090001<br>6H-X-090001<br>6H-X-090001  | 04.05<br>04.05<br>04.05<br>04.05  | 03.0137-0268.2 650268<br>03.0137-9168.2 669168                          | 200 x 40 HEB<br>Bremsbacken-Zubehör                                   |
|    | 1.0 i<br>1.4 i<br>1.4 TDI<br>1.7 SDI   | 37<br>44<br>55<br>44                        | 6H-X-090000 05.97<br>6H-X-090000 05.97<br>6H-X-090000 10.99<br>6H-X-090000 11.97                      |   | 24.0218-0007.1 480003<br>24.0218-0707.2 480211                          | 180/181 x 38,5 - Lager<br>180/181 x 38,5 + Lager                      |
|  | 1.0 i<br>1.4 i<br>1.4 TDI<br>1.7 SDI   | 37<br>44<br>55<br>44                        | 6H-X-090001<br>6H-X-090001<br>6H-X-090001<br>6H-X-090001  | 04.05<br>04.05<br>04.05<br>04.05  | 24.0220-0032.1 480130   | 200/201,5 x 50,1  |
|    | 1.0 i<br>1.4 i<br>1.4 TDI<br>1.7 SDI   | 37<br>44<br>55<br>44                        | 6H-X-090000 05.97<br>6H-X-090000 05.97<br>6H-X-090000 10.99<br>6H-X-090000 11.97                      | - ABS<br>- ABS<br>- ABS<br>- ABS  | 03.0520-0215.3 690215   | 15,87/180x31 TopKit   |
|  | 1.0 i<br>1.4 i<br>1.4 TDI<br>1.7 SDI   | 37<br>44<br>55<br>44                        | 6H-X-090000 05.97<br>6H-X-090000 05.97<br>6H-X-090000 10.99<br>6H-X-090000 11.97                      | + ABS<br>+ ABS<br>+ ABS<br>+ ABS  | 03.0520-3917.3 693917   | 17,46/180x31 TopKit   |
|  | 1.0 i<br>1.4 i<br>1.4 TDI<br>1.7 SDI   | 37<br>44<br>55<br>44                        | 6H-X-090001<br>6H-X-090001<br>6H-X-090001<br>6H-X-090001  | 04.05 - ABS<br>04.05 - ABS<br>04.05 - ABS<br>04.05 - ABS  | 03.0520-0415.3 690415   | 15,87/200x40 TopKit   |
|  | 1.0 i<br>1.4 i<br>1.4 TDI<br>1.7 SDI   | 37<br>44<br>55<br>44                        | 6H-X-090001<br>6H-X-090001<br>6H-X-090001<br>6H-X-090001  | 04.05 + ABS<br>04.05 + ABS<br>04.05 + ABS<br>04.05 + ABS  | 03.0420-1517.3 681517<br>03.0520-1517.3 691517                          | 17,46/200x40 Kit<br>17,46/200x40 TopKit                               |
|    | 1.0 TSI<br>1.4 TSI<br>1.4 TSI 4Drive<br>1.6 TDI<br>2.0 TDI<br>2.0 TDI 4Drive<br>2.0 TDI 4Drive | 85<br>110<br>110<br>85<br>110<br>110<br>140 | 06.16<br>06.16<br>06.16<br>06.16<br>06.16<br>06.16<br>06.16   | PR: 1ZA<br>PR: 1ZA<br>PR: 1ZA<br>PR: 1ZA<br>PR: 1ZA<br>PR: 1ZA<br>PR: 1ZA                                 | 13.0460-2785.2 602785<br>13.0470-2785.2 LD2785<br>24.8190-0065.2 620065 | 25683 20,4 +/WK/S TRW<br>25683 20,4 +/WK/S TRW<br>Warnkontakt L=172mm |
|  | 1.0 TSI<br>1.4 TSI<br>1.4 TSI 4Drive<br>1.6 TDI<br>2.0 TDI<br>2.0 TDI 4Drive<br>2.0 TDI 4Drive | 85<br>110<br>110<br>85<br>110<br>110<br>140 | 06.16<br>06.16<br>06.16<br>06.16<br>06.16<br>06.16<br>06.16   | PR: 1ZA<br>PR: 1ZA<br>PR: 1ZA<br>PR: 1ZA<br>PR: 1ZA<br>PR: 1ZA<br>PR: 1ZA                                 | 24.0125-0158.1 425158   | 312 25,0 22,0 V L +S +B   |
|  | 1.0 TSI<br>1.4 TSI<br>1.4 TSI 4Drive<br>1.6 TDI<br>2.0 TDI<br>2.0 TDI 4Drive<br>2.0 TDI 4Drive | 85<br>110<br>110<br>85<br>110<br>110<br>140 | 06.16<br>06.16<br>06.16<br>06.16<br>06.16<br>06.16<br>06.16   |   | 24.0711-5273.3 360303<br>24.0711-5274.3 360304                          | Radsensor<br>Radsensor  |
|  | 1.0 TSI<br>1.4 TSI<br>1.4 TSI 4Drive<br>1.6 TDI<br>2.0 TDI<br>2.0 TDI 4Drive<br>2.0 TDI 4Drive | 85<br>110<br>110<br>85<br>110<br>110<br>140 | 06.16<br>06.16<br>06.16<br>06.16<br>06.16<br>06.16<br>06.16   | PR: 1KE<br>PR: 1KE<br>PR: 1KE<br>PR: 1KE<br>PR: 1KE<br>PR: 1KE<br>PR: 1KE                                 | 13.0460-7293.2 607293   | elektrische Feststellbremse 1) 25008 16,3 + ATE                       |
|  | 1.0 TSI<br>1.4 TSI<br>1.4 TSI 4Drive<br>1.6 TDI<br>2.0 TDI<br>2.0 TDI 4Drive<br>2.0 TDI 4Drive | 85<br>110<br>110<br>85<br>110<br>110<br>140 | 06.16<br>06.16<br>06.16<br>06.16<br>06.16<br>06.16<br>06.16   | PR: 1KE<br>PR: 1KE<br>PR: 1KE<br>PR: 1KE<br>PR: 1KE<br>PR: 1KE<br>PR: 1KE                                 | 24.0110-0356.1 410356   | elektrische Feststellbremse 1) 272 9,7 8,0 +S +B                      |
|  | 1.0 TSI<br>1.4 TSI<br>1.6 TDI<br>2.0 TDI   | 85<br>110<br>85<br>110                      | 06.16<br>06.16<br>06.16<br>06.16  |   | 24.0711-6337.3 360390   | Radsensor   |
|  | 1.4 TSI 4Drive<br>2.0 TDI 4Drive<br>2.0 TDI 4Drive   | 110<br>110<br>140                           | 06.16<br>06.16<br>06.16   |   | 24.0711-5401.3 360330   | Radsensor   |
| SEAT CORDOBA I (93-99)   |  |   |   |   |   |   |
|  | 1.4 i<br>1.4 i   |   | 6K-TR09920 11.93<br>6K-TR09921  | - ABS<br>- ABS  | 13.0460-7030.2 607030<br>13.0460-7059.2 607059                          | 20889 17,3 /Zub VW<br>20887 17,3 +/Zub VW                             |
|  | 1.4 i<br>1.6 i<br>1.8 i<br>1.9 D<br>1.9 TD   |   | 6K-TR046558 11.93<br>6K-TR046558 11.93<br>6K-TR046558 11.93<br>6K-TR046558 11.93<br>6K-TR046558 11.93 | + ABS<br>+ massive Scheiben 2)<br>+ massive Scheiben 2)<br>+ massive Scheiben 2)<br>+ massive Scheiben 2) | 13.0460-7032.2 607032   | 20887 19,7 +/Zub VW   |

1) electric parking brake / fr.di stazionamento elettrico / frein à main électrique / freno de mano eléctrico

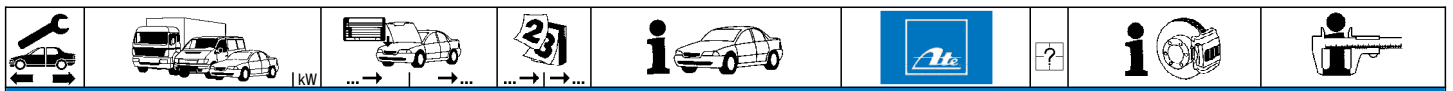
2) + solid discs / + dischi massiccio / + disques massive / + disco macizo



**SEAT CORDOBA I (93-99)**

|  |   |   |  |  |       |  |  |   |     |
|--|---|---|--|--|-------|--|--|---|-----|
|    | 1.4 i<br>1.6 i<br>1.8 i<br>1.9 D<br>1.9 SDI<br>1.9 TD   | 6K-TR046559<br>6K-TR046559<br>66 6K-TR046559<br>6K-TR046559<br>47<br>55 6K-TR046559 |  | 12.96 + ABS<br>12.96 + massive Scheiben <sup>1)</sup><br>12.96 + massive Scheiben <sup>1)</sup><br>12.96 + massive Scheiben <sup>1)</sup><br>12.96 + massive Scheiben <sup>1)</sup><br>12.96 + massive Scheiben <sup>1)</sup>  | 09.95 | 13.0460-7072.2 607072                          |  | 21866 19,7 +  | VW  |
|  | 1.6 i<br>1.8 i<br>1.9 D<br>1.9 SDI<br>1.9 TD  | 66<br>47<br>55  |  | 11.93 12.96 + belüftete Scheiben <sup>2)</sup><br>11.93 12.96 + belüftete Scheiben <sup>2)</sup><br>11.93 12.96 + belüftete Scheiben <sup>2)</sup><br>09.95 12.96 + belüftete Scheiben <sup>2)</sup><br>11.93 12.96 + belüftete Scheiben <sup>2)</sup>   |       | 13.0460-7033.2 607033                          |  | 20887 15,3 +/Zub                                    | VW  |
|  | 1.8 i 16V<br>2.0 i  | 95<br>85  |  | 02.94 12.96<br>11.93 12.96   |       | 13.0460-2821.2 602821                          |  | 21945 16,0 /S                                       | TRW |
|  | 1.4 i<br>1.6 i<br>1.6 i<br>1.8 i<br>1.8 i 16V<br>1.9 D<br>1.9 SDI<br>1.9 TD<br>1.9 TDI<br>1.9 TDI<br>2.0 i              | <br><br>55<br>66<br>95<br><br>47<br>55<br>66<br>81<br>85                            |  | 01.97 05.99 PR: 1LA<br>01.97 05.99 PR: 1LA<br>05.94 05.99 PR: 1LA<br>01.97 05.99 PR: 1LA<br>01.97 05.99 PR: 1LA<br>01.97 05.99 PR: 1LA<br>01.97 05.99 PR: 1LA<br>01.97 05.99 PR: 1LA<br>03.97 05.99 PR: 1LA<br>01.97 05.99 PR: 1LA   |       | 13.0460-7059.2 607059                          |  | 20887 17,3 +/Zub                                    | VW  |
|  | 1.4 i<br>1.6 i<br>1.6 i<br>1.8 i<br>1.8 i 16V<br>1.9 D<br>1.9 SDI<br>1.9 TD<br>1.9 TDI<br>1.9 TDI<br>2.0 i              | <br><br>55<br>66<br>95<br><br>47<br>55<br>66<br>81<br>85                            |  | 01.97 05.99 PR: 1LM<br>01.97 05.99 PR: 1LM<br>05.94 05.99 PR: 1LM<br>01.97 05.99 PR: 1LM<br>01.97 05.99 PR: 1LM<br>01.97 05.99 PR: 1LM<br>01.97 05.99 PR: 1LM<br>01.97 05.99 PR: 1LM<br>01.97 05.99 PR: 1LM<br>03.97 05.99 PR: 1LM<br>01.97 05.99 PR: 1LM  |       | 13.0460-7072.2 607072                          |  | 21866 19,7 +  | VW  |
|  | 1.4 i<br>1.6 i<br>1.6 i<br>1.8 i<br>1.8 i 16V<br>1.9 D<br>1.9 SDI<br>1.9 TD<br>1.9 TDI<br>1.9 TDI<br>2.0 i              | <br><br>55<br>66<br>95<br><br>47<br>55<br>66<br>81<br>85                            |  | 01.97 05.99 PR: 1LG<br>01.97 05.99 PR: 1LG<br>05.94 05.99 PR: 1LG<br>01.97 05.99 PR: 1LG<br>01.97 05.99 PR: 1LG<br>01.97 05.99 PR: 1LG<br>01.97 05.99 PR: 1LG<br>01.97 05.99 PR: 1LG<br>01.97 05.99 PR: 1LG<br>03.97 05.99 PR: 1LG<br>01.97 05.99 PR: 1LG  |       | 13.0460-7101.2 607101                          |  | 21866 15,3 +  | VW  |
|  | 1.4 i<br>1.6 i<br>1.6 i<br>1.8 i<br>1.8 i 16V<br>1.9 D<br>1.9 SDI<br>1.9 TD<br>1.9 TDI<br>1.9 TDI<br>2.0 i              | <br><br>55<br>66<br>95<br><br>47<br>55<br>66<br>81<br>85                            |  | 01.97 05.99 PR: 1LY,1ZK<br>01.97 05.99 PR: 1LY,1ZK<br>05.94 05.99 PR: 1LY,1ZK<br>01.97 05.99 PR: 1LY,1ZK<br>01.97 05.99 PR: 1LY,1ZK<br>01.97 05.99 PR: 1LY,1ZK<br>01.97 05.99 PR: 1LY,1ZK<br>01.97 05.99 PR: 1LY,1ZK<br>01.97 05.99 PR: 1LY,1ZK<br>03.97 05.99 PR: 1LY,1ZK<br>01.97 05.99 PR: 1LY,1ZK  |       | 13.0460-2821.2 602821                          |  | 21945 16,0 /S                                       | TRW |
|  | 1.4 i<br>1.6 i<br>1.6 i<br>1.8 i<br>1.8 i 16V<br>1.9 D<br>1.9 SDI<br>1.9 TD<br>1.9 TDI<br>1.9 TDI<br>2.0 i<br>2.0 i 16V | <br><br>55<br>66<br>95<br><br>47<br>55<br>66<br>81<br>85<br>110                     |  | 01.97 05.99 PR: 1LV,1LW,1LD<br>01.97 05.99 PR: 1LV,1LW,1LD<br>05.94 05.99 PR: 1LV,1LW,1LD<br>01.97 05.99 PR: 1LV,1LW,1LD<br>01.97 05.99 PR: 1LV,1LW,1LD<br>01.97 05.99 PR: 1LV,1LW,1LD<br>01.97 05.99 PR: 1LV,1LW,1LD<br>01.97 05.99 PR: 1LV,1LW,1LD<br>01.97 05.99 PR: 1LV,1LW,1LD<br>03.97 05.99 PR: 1LV,1LW,1LD<br>01.97 05.99 PR: 1LV,1LW,1LD<br>07.96 05.99 |       | 13.0460-2958.2 602958                          |  | 20168 19,3 /S                                       | TRW |
|  | 1.4 i   |   |  | 11.93 12.96 - ABS  |       | 24.0110-0151.1 410151<br>24.0310-0151.1 510151 |  | 239 10,0 8,0 +S +B<br>239 10,0 8,0 +S +B PD         |     |
|  | 1.4 i<br>1.6 i<br>1.8 i<br>1.9 D<br>1.9 SDI<br>1.9 TD   | <br><br>66<br><br>47<br>55  |  | 11.93 12.96 + ABS<br>11.93 12.96 + massive Scheiben <sup>1)</sup><br>11.93 12.96 + massive Scheiben <sup>1)</sup><br>11.93 12.96 + massive Scheiben <sup>1)</sup><br>09.95 12.96 + massive Scheiben <sup>1)</sup><br>11.93 12.96 + massive Scheiben <sup>1)</sup>  |       | 24.0112-0106.1 412106<br>24.0312-0106.1 512106 |  | 239 12,0 10,0 +S +B<br>239 12,0 10,0 +S +B PD       |     |
|  | 1.4 i<br>1.6 i<br>1.8 i<br>1.9 D<br>1.9 SDI<br>1.9 TD   | <br><br>66<br><br>47<br>55  |  | 11.93 12.96 + ABS<br>11.93 12.96 + belüftete Scheiben <sup>2)</sup><br>11.93 12.96 + belüftete Scheiben <sup>2)</sup><br>11.93 12.96 + belüftete Scheiben <sup>2)</sup><br>09.95 12.96 + belüftete Scheiben <sup>2)</sup><br>11.93 12.96 + belüftete Scheiben <sup>2)</sup>  |       | 24.0120-0123.1 420123<br>24.0320-0123.1 520123 |  | 239 20,0 18,0 VL +S +B<br>239 20,0 18,0 VL +S +B PD |     |
|  | 1.8 i 16V<br>2.0 i  | 95<br>85  |  | 02.94 12.96<br>11.93 12.96   |       | 24.0120-0128.1 420128<br>24.0320-0128.1 520128 |  | 256 20,0 18,0 VL +S +B<br>256 20,0 18,0 VL +S +B PD |     |

<sup>1)</sup> + solid discs / + dischi massiccio / + disques massive / + disco macizo  
<sup>2)</sup> + ventilated discs / + dischi ventilati / + disques ventilés / + disco ventilado

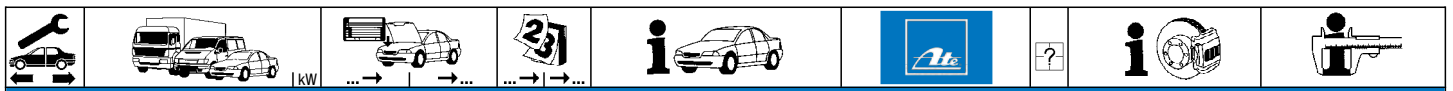







**SEAT CORDOBA I (93-99)**

|           |           |     |             |       |                 |                 |                |        |  |                               |                            |
|-----------|-----------|-----|-------------|-------|-----------------|-----------------|----------------|--------|--|-------------------------------|----------------------------|
|           | 1.4 i     |     |             | 01.97 | 05.99           | PR: 1LA         | 24.0110-0151.1 | 410151 |  |                               | 239 10,0 8,0 +S +B         |
|           | 1.6 i     |     |             | 01.97 | 05.99           | PR: 1LA         | 24.0310-0151.1 | 510151 |  |                               | 239 10,0 8,0 +S +B PD      |
|           | 1.6 i     | 55  |             | 05.94 | 05.99           | PR: 1LA         |                |        |  |                               |                            |
|           | 1.8 i     | 66  |             | 01.97 | 05.99           | PR: 1LA         |                |        |  |                               |                            |
|           | 1.8 i 16V | 95  |             | 01.97 | 05.99           | PR: 1LA         |                |        |  |                               |                            |
|           | 1.9 D     |     |             | 01.97 | 05.99           | PR: 1LA         |                |        |  |                               |                            |
|           | 1.9 SDI   | 47  |             | 01.97 | 05.99           | PR: 1LA         |                |        |  |                               |                            |
|           | 1.9 TD    | 55  |             | 01.97 | 05.99           | PR: 1LA         |                |        |  |                               |                            |
|           | 1.9 TDI   | 66  |             | 01.97 | 05.99           | PR: 1LA         |                |        |  |                               |                            |
|           | 1.9 TDI   | 81  |             | 03.97 | 05.99           | PR: 1LA         |                |        |  |                               |                            |
| 2.0 i     | 85        |     | 01.97       | 05.99 | PR: 1LA         |                 |                |        |  |                               |                            |
|           | 1.4 i     |     |             | 01.97 | 05.99           | PR: 1LM         | 24.0112-0106.1 | 412106 |  |                               | 239 12,0 10,0 +S +B        |
|           | 1.6 i     |     |             | 01.97 | 05.99           | PR: 1LM         | 24.0312-0106.1 | 512106 |  |                               | 239 12,0 10,0 +S +B PD     |
|           | 1.6 i     | 55  |             | 05.94 | 05.99           | PR: 1LM         |                |        |  |                               |                            |
|           | 1.8 i     | 66  |             | 01.97 | 05.99           | PR: 1LM         |                |        |  |                               |                            |
|           | 1.8 i 16V | 95  |             | 01.97 | 05.99           | PR: 1LM         |                |        |  |                               |                            |
|           | 1.9 D     |     |             | 01.97 | 05.99           | PR: 1LM         |                |        |  |                               |                            |
|           | 1.9 SDI   | 47  |             | 01.97 | 05.99           | PR: 1LM         |                |        |  |                               |                            |
|           | 1.9 TD    | 55  |             | 01.97 | 05.99           | PR: 1LM         |                |        |  |                               |                            |
|           | 1.9 TDI   | 66  |             | 01.97 | 05.99           | PR: 1LM         |                |        |  |                               |                            |
|           | 1.9 TDI   | 81  |             | 03.97 | 05.99           | PR: 1LM         |                |        |  |                               |                            |
| 2.0 i     | 85        |     | 01.97       | 05.99 | PR: 1LM         |                 |                |        |  |                               |                            |
|           | 1.4 i     |     |             | 01.97 | 05.99           | PR: 1LG         | 24.0120-0123.1 | 420123 |  |                               | 239 20,0 18,0 V L +S +B    |
|           | 1.6 i     |     |             | 01.97 | 05.99           | PR: 1LG         | 24.0320-0123.1 | 520123 |  |                               | 239 20,0 18,0 V L +S +B PD |
|           | 1.6 i     | 55  |             | 05.94 | 05.99           | PR: 1LG         |                |        |  |                               |                            |
|           | 1.8 i     | 66  |             | 01.97 | 05.99           | PR: 1LG         |                |        |  |                               |                            |
|           | 1.8 i 16V | 95  |             | 01.97 | 05.99           | PR: 1LG         |                |        |  |                               |                            |
|           | 1.9 D     |     |             | 01.97 | 05.99           | PR: 1LG         |                |        |  |                               |                            |
|           | 1.9 SDI   | 47  |             | 01.97 | 05.99           | PR: 1LG         |                |        |  |                               |                            |
|           | 1.9 TD    | 55  |             | 01.97 | 05.99           | PR: 1LG         |                |        |  |                               |                            |
|           | 1.9 TDI   | 66  |             | 01.97 | 05.99           | PR: 1LG         |                |        |  |                               |                            |
|           | 1.9 TDI   | 81  |             | 03.97 | 05.99           | PR: 1LG         |                |        |  |                               |                            |
| 2.0 i     | 85        |     | 01.97       | 05.99 | PR: 1LG         |                 |                |        |  |                               |                            |
|           | 1.4 i     |     |             | 01.97 | 05.99           | PR: 1LY,1ZK     | 24.0120-0128.1 | 420128 |  |                               | 256 20,0 18,0 V L +S +B    |
|           | 1.6 i     |     |             | 01.97 | 05.99           | PR: 1LY,1ZK     | 24.0320-0128.1 | 520128 |  |                               | 256 20,0 18,0 V L +S +B PD |
|           | 1.6 i     | 55  |             | 05.94 | 05.99           | PR: 1LY,1ZK     |                |        |  |                               |                            |
|           | 1.8 i     | 66  |             | 01.97 | 05.99           | PR: 1LY,1ZK     |                |        |  |                               |                            |
|           | 1.8 i 16V | 95  |             | 01.97 | 05.99           | PR: 1LY,1ZK     |                |        |  |                               |                            |
|           | 1.9 D     |     |             | 01.97 | 05.99           | PR: 1LY,1ZK     |                |        |  |                               |                            |
|           | 1.9 SDI   | 47  |             | 01.97 | 05.99           | PR: 1LY,1ZK     |                |        |  |                               |                            |
|           | 1.9 TD    | 55  |             | 01.97 | 05.99           | PR: 1LY,1ZK     |                |        |  |                               |                            |
|           | 1.9 TDI   | 66  |             | 01.97 | 05.99           | PR: 1LY,1ZK     |                |        |  |                               |                            |
|           | 1.9 TDI   | 81  |             | 03.97 | 05.99           | PR: 1LY,1ZK     |                |        |  |                               |                            |
| 2.0 i     | 85        |     | 01.97       | 05.99 | PR: 1LY,1ZK     |                 |                |        |  |                               |                            |
|           | 1.4 i     |     |             | 01.97 | 05.99           | PR: 1LV,1LW,1LD | 24.0122-0101.1 | 422101 |  |                               | 280 22,0 20,0 V L +B       |
|           | 1.6 i     |     |             | 01.97 | 05.99           | PR: 1LV,1LW,1LD |                |        |  |                               |                            |
|           | 1.6 i     | 55  |             | 05.94 | 05.99           | PR: 1LV,1LW,1LD |                |        |  |                               |                            |
|           | 1.8 i     | 66  |             | 01.97 | 05.99           | PR: 1LV,1LW,1LD |                |        |  |                               |                            |
|           | 1.8 i 16V | 95  |             | 01.97 | 05.99           | PR: 1LV,1LW,1LD |                |        |  |                               |                            |
|           | 1.9 D     |     |             | 01.97 | 05.99           | PR: 1LV,1LW,1LD |                |        |  |                               |                            |
|           | 1.9 SDI   | 47  |             | 01.97 | 05.99           | PR: 1LV,1LW,1LD |                |        |  |                               |                            |
|           | 1.9 TD    | 55  |             | 01.97 | 05.99           | PR: 1LV,1LW,1LD |                |        |  |                               |                            |
|           | 1.9 TDI   | 66  |             | 01.97 | 05.99           | PR: 1LV,1LW,1LD |                |        |  |                               |                            |
|           | 1.9 TDI   | 81  |             | 03.97 | 05.99           | PR: 1LV,1LW,1LD |                |        |  |                               |                            |
| 2.0 i     | 85        |     | 01.97       | 05.99 | PR: 1LV,1LW,1LD |                 |                |        |  |                               |                            |
| 2.0 i 16V | 110       |     | 07.96       | 05.99 |                 |                 |                |        |  |                               |                            |
|           | 1.4 i     |     |             | 11.93 | 05.99           |                 | 24.0711-1361.3 | 360022 |  |                               | Radsensor                  |
|           | 1.6 i     |     |             | 11.93 | 05.99           |                 | 24.0711-1362.3 | 360023 |  |                               | Radsensor                  |
|           | 1.6 i     | 55  |             | 05.94 | 05.99           |                 |                |        |  |                               |                            |
|           | 1.8 i     | 66  |             | 11.93 | 05.99           |                 |                |        |  |                               |                            |
|           | 1.8 i 16V | 95  |             | 02.94 | 05.99           |                 |                |        |  |                               |                            |
|           | 1.9 D     |     |             | 11.93 | 05.99           |                 |                |        |  |                               |                            |
|           | 1.9 SDI   | 47  |             | 09.95 | 05.99           |                 |                |        |  |                               |                            |
|           | 1.9 TD    | 55  |             | 11.93 | 05.99           |                 |                |        |  |                               |                            |
|           | 1.9 TDI   | 66  |             | 07.96 | 05.99           |                 |                |        |  |                               |                            |
|           | 1.9 TDI   | 81  |             | 03.97 | 05.99           |                 |                |        |  |                               |                            |
| 2.0 i     | 85        |     | 11.93       | 05.99 |                 |                 |                |        |  |                               |                            |
| 2.0 i 16V | 110       |     | 07.96       | 05.99 |                 |                 |                |        |  |                               |                            |
|           | 1.8 i 16V | 95  | 6K-X-289999 | 02.94 |                 |                 | 13.0460-2937.2 | 602937 |  |                               | 20961 15,2 /Zub/S TRW      |
|           | 1.9 TDI   | 81  | 6K-X-289999 | 03.97 |                 |                 | 13.0460-0419.2 | 610419 |  |                               | Belagsatz-Zubehör TRW      |
|           | 2.0 i     | 85  | 6K-X-289999 | 11.93 |                 |                 |                |        |  |                               |                            |
|           | 2.0 i 16V | 110 | 6K-X-289999 | 07.96 |                 |                 | 13.0460-2984.2 | 602984 |  |                               | 20961 17,2 /Zub/S TRW      |
|           |           |     |             |       |                 |                 | 13.0460-0072.2 | 610072 |  |                               | Belagsatz-Zubehör TRW      |
|           | 1.8 i 16V | 95  | 6K-X-290000 |       | 05.99           | PR: 1KE,1KK,1KQ | 13.0460-2894.2 | 602894 |  |                               | 20961 17,4 /Zub/S TRW      |
|           | 1.9 TDI   | 81  | 6K-X-290000 |       | 05.99           | PR: 1KE,1KK,1KQ | 13.0470-2894.2 | LD2894 |  |                               | 20961 17,4 /Zub/S TRW      |
|           | 2.0 i     | 85  | 6K-X-290000 |       | 05.99           | PR: 1KE,1KK,1KQ |                |        |  |                               |                            |
|           | 2.0 i 16V | 110 | 6K-X-290000 |       | 05.99           | PR: 1KE,1KK,1KQ |                |        |  |                               |                            |
|           |           |     |             |       |                 |                 |                |        |  |                               |                            |
|           | 1.8 i 16V | 95  | 6K-X-289999 | 02.94 |                 |                 | 24.0110-0111.1 | 410111 |  | ohne Sensorring <sup>1)</sup> | 226 10,0 8,0 +B            |
|           | 1.9 TDI   | 81  | 6K-X-289999 | 03.97 |                 |                 | 24.0110-0275.2 | 410275 |  | mit Sensorring <sup>2)</sup>  | 226 10,0 8,0 +B            |
|           | 2.0 i     | 85  | 6K-X-289999 | 11.93 |                 |                 |                |        |  |                               |                            |
|           | 2.0 i 16V | 110 | 6K-X-289999 | 07.96 |                 |                 |                |        |  |                               |                            |
|           |           |     |             |       |                 |                 |                |        |  |                               |                            |
|           | 1.8 i 16V | 95  | 6K-X-290000 |       | 05.99           | PR: 1KE,1KK,1KQ | 24.0109-0124.1 | 409124 |  |                               | 232 9,0 7,0 +B             |
|           | 1.9 TDI   | 81  | 6K-X-290000 |       | 05.99           | PR: 1KE,1KK,1KQ |                |        |  |                               |                            |
|           | 2.0 i     | 85  | 6K-X-290000 |       | 05.99           | PR: 1KE,1KK,1KQ |                |        |  |                               |                            |
|           | 2.0 i 16V | 110 | 6K-X-290000 |       | 05.99           | PR: 1KE,1KK,1KQ |                |        |  |                               |                            |
|           |           |     |             |       |                 |                 |                |        |  |                               |                            |

<sup>1)</sup> without sensor ring / senza sensori / sans secours ABS / sin anillo sensor ABS

<sup>2)</sup> with sensor ring / con sensori / avec secours ABS / con anillo sensor ABS













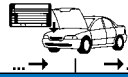















| SEAT CORDOBA I (93-99)   |           |     |             |       |       |             |                |        |                               |                              |
|--|-----------|-----|-------------|-------|-------|-------------|----------------|--------|-------------------------------|------------------------------|
|    | 1.4 i     |     |             | 11.93 | 05.99 |             | 24.0741-1108.3 | 360093 | 2                             | Radsensor L=843              |
|  | 1.6 i     |     |             | 11.93 | 05.99 |             |                |        |                               |                              |
|  | 1.6 i     | 55  |             | 05.94 | 05.99 |             |                |        |                               |                              |
|  | 1.8 i     | 66  |             | 11.93 | 05.99 |             |                |        |                               |                              |
|  | 1.8 i 16V | 95  |             | 02.94 | 05.99 |             |                |        |                               |                              |
|  | 1.9 D     |     |             | 11.93 | 05.99 |             |                |        |                               |                              |
|  | 1.9 SDI   | 47  |             | 09.95 | 05.99 |             |                |        |                               |                              |
|  | 1.9 TD    | 55  |             | 11.93 | 05.99 |             |                |        |                               |                              |
|  | 1.9 TDI   | 66  |             | 07.96 | 05.99 |             |                |        |                               |                              |
|  | 1.9 TDI   | 81  |             | 03.97 | 05.99 |             |                |        |                               |                              |
|  | 2.0 i     | 85  |             | 11.93 | 05.99 |             |                |        |                               |                              |
|  | 2.0 i 16V | 110 |             | 07.96 | 05.99 |             |                |        |                               |                              |
|    | 1.4 i     |     |             | 11.93 | 12.96 | - ABS       | 03.0137-0126.2 | 650126 |                               | 180 x 31 HEB                 |
|  | 1.6 i     |     |             | 11.93 | 12.96 | - ABS       | 03.0137-9008.2 | 669008 |                               | Bremsbacken-Zubehör          |
|  | 1.4 i     |     |             | 11.93 | 12.96 | + ABS       | 03.0137-0268.2 | 650268 |                               | 200 x 40 HEB                 |
|  | 1.6 i     |     |             | 11.93 | 12.96 | + ABS       | 03.0137-9168.2 | 669168 |                               | Bremsbacken-Zubehör          |
|  | 1.8 i     | 66  |             | 11.93 | 12.96 |             |                |        |                               | VW                           |
|  | 1.9 D     |     |             | 11.93 | 12.96 |             |                |        |                               | VW                           |
|  | 1.9 SDI   | 47  |             | 09.95 | 12.96 |             |                |        |                               |                              |
|  | 1.9 TD    | 55  |             | 11.93 | 12.96 |             |                |        |                               |                              |
|  | 1.9 TDI   | 66  |             | 07.96 | 12.96 |             |                |        |                               |                              |
|  | 1.4 i     |     |             | 01.97 | 05.99 | PR: 1KA     | 03.0137-0126.2 | 650126 |                               | 180 x 31 HEB                 |
|  | 1.6 i     |     |             | 01.97 | 05.99 | PR: 1KA     | 03.0137-9008.2 | 669008 |                               | Bremsbacken-Zubehör          |
|  | 1.4 i     |     |             | 01.97 | 05.99 | PR: 1KB,1KM | 03.0137-0268.2 | 650268 |                               | 200 x 40 HEB                 |
|  | 1.6 i     |     |             | 01.97 | 05.99 | PR: 1KB,1KM | 03.0137-9168.2 | 669168 |                               | Bremsbacken-Zubehör          |
|  | 1.6 i     | 55  |             | 05.94 | 05.99 | PR: 1KB,1KM |                |        |                               | VW                           |
|  | 1.8 i     | 66  |             | 01.97 | 05.99 | PR: 1KB,1KM |                |        |                               | VW                           |
|  | 1.9 D     |     |             | 01.97 | 05.99 | PR: 1KB,1KM |                |        |                               |                              |
|  | 1.9 SDI   | 47  |             | 01.97 | 05.99 | PR: 1KB,1KM |                |        |                               |                              |
|  | 1.9 TD    | 55  |             | 01.97 | 05.99 | PR: 1KB,1KM |                |        |                               |                              |
|  | 1.9 TDI   | 66  |             | 01.97 | 05.99 | PR: 1KB,1KM |                |        |                               |                              |
|    | 1.4 i     |     |             | 11.93 | 05.99 | - ABS       | 24.0218-0007.1 | 480003 |                               | 180/181 x 38,5 - Lager       |
|  | 1.6 i     |     |             | 11.93 | 05.99 | - ABS       | 24.0218-0707.2 | 480211 |                               | 180/181 x 38,5 + Lager       |
|  | 1.4 i     |     | 6K-X-290000 | 11.93 |       | + ABS       | 24.0220-0018.1 | 480019 | ohne Sensorring <sup>1)</sup> | 200/201 x 50,0 - Lager       |
|  | 1.6 i     |     | 6K-X-290000 | 11.93 |       | + ABS       | 24.0220-0718.2 | 480209 | ohne Sensorring <sup>1)</sup> | 200/201,5 x 50,0 + Lager     |
|  | 1.6 i     | 55  | 6K-X-290000 | 05.94 |       |             |                |        |                               |                              |
|  | 1.8 i     | 66  | 6K-X-290000 | 11.93 |       |             |                |        |                               |                              |
|  | 1.9 D     |     | 6K-X-290000 | 11.93 |       |             |                |        |                               |                              |
|  | 1.9 SDI   | 47  | 6K-X-290000 | 09.95 |       |             |                |        |                               |                              |
|  | 1.9 TD    | 55  | 6K-X-290000 | 11.93 |       |             |                |        |                               |                              |
|  | 1.9 TDI   | 66  | 6K-X-290000 | 07.96 |       |             |                |        |                               |                              |
|  | 1.4 i     |     | 6K-X-290001 | 05.99 |       | + ABS       | 24.0220-0032.1 | 480130 |                               | 200/201,5 x 50,1             |
|  | 1.6 i     |     | 6K-X-290001 | 05.99 |       | + ABS       |                |        |                               |                              |
|  | 1.6 i     | 55  | 6K-X-290001 | 05.99 |       |             |                |        |                               |                              |
|  | 1.8 i     | 66  | 6K-X-290001 | 05.99 |       |             |                |        |                               |                              |
|  | 1.9 D     |     | 6K-X-290001 | 05.99 |       |             |                |        |                               |                              |
|  | 1.9 SDI   | 47  | 6K-X-290001 | 05.99 |       |             |                |        |                               |                              |
|  | 1.9 TD    | 55  | 6K-X-290001 | 05.99 |       |             |                |        |                               |                              |
|  | 1.9 TDI   | 66  | 6K-X-290001 | 05.99 |       |             |                |        |                               |                              |
|  | 1.4 i     |     |             | 11.93 | 05.99 | - ABS       | 03.0420-0617.3 | 680617 | + Rz GG <sup>2)</sup>         | 17,46/180x31 Kit             |
|  | 1.6 i     |     |             | 11.93 | 05.99 | - ABS       | 03.0520-3917.3 | 693917 | + Rz ALU <sup>3)</sup>        | 17,46/180x31 TopKit          |
|  | 1.4 i     |     |             | 11.93 | 05.99 | + ABS       | 03.0420-1517.3 | 681517 |                               | 17,46/200x40 Kit             |
|  | 1.6 i     |     |             | 11.93 | 05.99 | + ABS       | 03.0520-1517.3 | 691517 |                               | 17,46/200x40 TopKit          |
|  | 1.6 i     | 55  |             | 05.94 | 05.99 |             |                |        |                               |                              |
|  | 1.8 i     | 66  |             | 11.93 | 05.99 |             |                |        |                               |                              |
|  | 1.9 D     |     |             | 11.93 | 05.99 |             |                |        |                               |                              |
|  | 1.9 SDI   | 47  |             | 09.95 | 05.99 |             |                |        |                               |                              |
|  | 1.9 TD    | 55  |             | 11.93 | 05.99 |             |                |        |                               |                              |
|  | 1.9 TDI   | 66  |             | 07.96 | 05.99 |             |                |        |                               |                              |
| SEAT CORDOBA II (6K2) (99-02)  |           |     |             |       |       |             |                |        |                               |                              |
|  | 1.0       | 37  |             | 06.99 | 09.02 |             | 13.0460-7101.2 | 607101 |                               | 21866 15,3 +                 |
|  | 1.4 i     | 44  |             | 06.99 | 09.02 |             |                |        |                               | VW                           |
|  | 1.4 i 16V |     |             | 06.99 | 09.02 |             |                |        |                               |                              |
|  | 1.6 i     | 55  |             | 06.99 | 09.02 |             |                |        |                               |                              |
|  | 1.9 SDI   |     |             | 06.99 | 09.02 |             |                |        |                               |                              |
|  | 1.6 i     | 74  |             | 06.99 | 09.02 |             | 13.0460-2821.2 | 602821 |                               | 21945 16,0 / S               |
|  | 1.9 TDI   | 66  |             | 06.99 | 09.02 |             |                |        |                               | TRW                          |
|  | 1.8 T 20V | 115 |             | 07.00 | 09.02 |             | 13.0460-2958.2 | 602958 |                               | 20168 19,3 / S               |
|  | 1.9 TDI   | 81  |             | 06.99 | 09.02 |             |                |        |                               | TRW                          |
|  | 1.0       | 37  |             | 06.99 | 09.02 |             | 24.0120-0123.1 | 420123 |                               | 239 20,0 18,0 V L + S + B    |
|  | 1.4 i     | 44  |             | 06.99 | 09.02 |             | 24.0320-0123.1 | 520123 |                               | 239 20,0 18,0 V L + S + B PD |
|  | 1.4 i 16V |     |             | 06.99 | 09.02 |             |                |        |                               |                              |
|  | 1.6 i     | 55  |             | 06.99 | 09.02 |             |                |        |                               |                              |
|  | 1.9 SDI   |     |             | 06.99 | 09.02 |             |                |        |                               |                              |
|  | 1.6 i     | 74  |             | 06.99 | 09.02 |             | 24.0120-0128.1 | 420128 |                               | 256 20,0 18,0 V L + S + B    |
|  | 1.9 TDI   | 66  |             | 06.99 | 09.02 |             | 24.0320-0128.1 | 520128 |                               | 256 20,0 18,0 V L + S + B PD |
|  | 1.8 T 20V | 115 |             | 07.00 | 09.02 |             | 24.0122-0101.1 | 422101 |                               | 280 22,0 20,0 V L + B        |
|  | 1.9 TDI   | 81  |             | 06.99 | 09.02 |             |                |        |                               |                              |
|  | 1.0       | 37  |             | 06.99 | 09.02 |             | 24.0711-1361.3 | 360022 |                               | Radsensor                    |
|  | 1.4 i     | 44  |             | 06.99 | 09.02 |             | 24.0711-1362.3 | 360023 |                               | Radsensor                    |
|  | 1.4 i 16V |     |             | 06.99 | 09.02 |             |                |        |                               |                              |
|  | 1.6 i     |     |             | 06.99 | 09.02 |             |                |        |                               |                              |
|  | 1.8 T 20V | 115 |             | 07.00 | 09.02 |             |                |        |                               |                              |
|  | 1.9 SDI   |     |             | 06.99 | 09.02 |             |                |        |                               |                              |

<sup>1)</sup> without sensor ring / senza sensori / sans secours ABS / sin anillo sensor ABS

<sup>2)</sup> + WC cast iron / + CR ghisa / + CR fonte grise / + CR fundición de gris

<sup>3)</sup> + WC aluminium / + CR aluminio / + CR aluminium / + CR aluminio

|     |                       |  |  |  |  |                                    |  |  |  |   |                   |
|--|---|--|--|--|---|--|--|--|--|---|-------------------|
| <b>SEAT CORDOBA II (6K2) (99-02)</b>   |   |  |  |  |   |  |  |  |  |   |                   |
|    | 1.9 TDI<br>1.9 TDI  | 66<br>81   |  | 06.99<br>06.99   | 09.02<br>09.02  |  | 24.0711-1361.3<br>24.0711-1362.3   | 360022<br>360023   | <br>     | Radsensor<br>Radsensor                                      |                   |
|    | 1.8 T 20V<br>1.9 TDI  | 115<br>81  |  | 07.00<br>06.99   | 09.02<br>09.02  |  | 13.0460-2894.2<br>13.0470-2894.2<br>13.0460-0072.2                                 | 602894<br>LD2894<br>610072   |  | 20961 17,4 /Zub/S<br>20961 17,4 /Zub/S<br>Belagsatz-Zubehör | TRW<br>TRW<br>TRW |
|    | 1.8 T 20V<br>1.9 TDI  | 115<br>81  |  | 07.00<br>06.99   | 09.02<br>09.02  |  | 24.0109-0124.1   | 409124   |  | 232 9,0 7,0 +B  |                   |
|    | 1.0<br>1.4 i<br>1.4 i 16V<br>1.6 i<br>1.8 T 20V<br>1.9 SDI<br>1.9 TDI<br>1.9 TDI                      | 37<br>44<br><br><br>115<br><br>66<br>81  |  | 06.99<br>06.99<br>06.99<br>06.99<br>07.00<br>06.99<br>06.99<br>06.99             | 09.02<br>09.02<br>09.02<br>09.02<br>09.02<br>09.02<br>09.02<br>09.02              |  | 24.0741-1108.3   | 360093   | 2   | Radsensor L=843   |                   |
|    | 1.0<br>1.4 i<br>1.4 i 16V<br>1.6 i<br>1.9 SDI<br>1.9 TDI  | 37<br>44<br><br><br>66   |  | 06.99<br>06.99<br>06.99<br>06.99<br>06.99<br>06.99                               | 09.02<br>09.02<br>09.02<br>09.02<br>09.02<br>09.02                                |  | 03.0137-0268.2<br>03.0137-9168.2   | 650268<br>669168   |  | 200 x 40 HEB<br>Bremsbacken-Zubehör                         | VW<br>VW          |
|    | 1.0<br>1.4 i<br>1.4 i 16V<br>1.6 i<br>1.9 SDI<br>1.9 TDI  | 37<br>44<br><br><br>66   |  | 06.99<br>06.99<br>06.99<br>06.99<br>06.99<br>06.99                               | 09.02<br>09.02<br>09.02<br>09.02<br>09.02<br>09.02                                |  | 24.0220-0032.1   | 480130   |  | 200/201,5 x 50,1  |                   |
|    | 1.0<br>1.4 i<br>1.4 i 16V<br>1.6 i<br>1.9 SDI<br>1.9 TDI  | 37<br>44<br><br>55<br>66   |  | 06.99<br>06.99<br>06.99<br>06.99<br>06.99<br>06.99                               | 09.02<br>09.02<br>09.02<br>09.02<br>09.02<br>09.02                                |  | 03.0520-1517.3   | 691517   |  | 17,46/200x40 TopKit   | VW                |
| <b>SEAT CORDOBA III (6L2) (02-09)</b>  |   |  |  |  |   |  |  |  |  |   |                   |
|   | 1.2 i<br>1.4 i 16V<br>1.4 i 16V<br>1.4 TDI<br>1.6 i 16V<br>1.9 SDI<br>1.9 TDI<br>1.9 TDI<br>2.0 i 16V | 47<br><br>74<br><br>47<br>74<br>96<br>85   |  | 10.02<br>10.02<br>10.02<br>02.03<br>10.02<br>10.02<br>10.02<br>10.02             | 06.09<br>06.09<br>06.09<br>06.09<br>06.09<br>06.09<br>06.09<br>06.09              | PR: 1LQ,1ZF<br>PR: 1LQ,1ZF<br>PR: 1LQ,1ZF<br>PR: 1LQ,1ZF<br>PR: 1LQ,1ZF<br>PR: 1LQ,1ZF<br>PR: 1LQ,1ZF<br>PR: 1LQ,1ZF | 13.0460-7111.2<br>13.0470-7111.2   | 607111<br>LD7111   |  | 23130 19,6 +<br>23130 19,6 +                                | VW<br>VW          |
|  | 1.2 i<br>1.4 i 16V<br>1.4 i 16V<br>1.4 TDI<br>1.6 i 16V<br>1.9 SDI<br>1.9 TDI<br>1.9 TDI<br>2.0 i 16V | 47<br><br>74<br><br>47<br>74<br>96<br>85   |  | 10.02<br>10.02<br>10.02<br>02.03<br>10.02<br>10.02<br>10.02<br>10.02             | 06.09<br>06.09<br>06.09<br>06.09<br>06.09<br>06.09<br>06.09<br>06.09              | PR: 1LN,1ZH<br>PR: 1LN,1ZH<br>PR: 1LN,1ZH<br>PR: 1LN,1ZH<br>PR: 1LN,1ZH<br>PR: 1LN,1ZH<br>PR: 1LN,1ZH<br>PR: 1LN,1ZH | 13.0460-2883.2<br>13.0460-2884.2<br>13.0470-2884.2                                 | 602883<br>602884<br>LD2884   |  | 23581 18,8 /S<br>23843 18,8 +/WK/S<br>23843 18,8 +/WK/S     | TRW<br>TRW<br>TRW |
|  | 1.2 i<br>1.4 i 16V<br>1.4 i 16V<br>1.4 TDI<br>1.6 i 16V<br>1.9 SDI<br>1.9 TDI<br>1.9 TDI<br>2.0 i 16V | 47<br><br>74<br><br>47<br>74<br>96<br>85   |  | 10.02<br>10.02<br>10.02<br>02.03<br>10.02<br>10.02<br>10.02<br>10.02             | 06.09<br>06.09<br>06.09<br>06.09<br>06.09<br>06.09<br>06.09<br>06.09              | PR: 1LQ,1ZF<br>PR: 1LQ,1ZF<br>PR: 1LQ,1ZF<br>PR: 1LQ,1ZF<br>PR: 1LQ,1ZF<br>PR: 1LQ,1ZF<br>PR: 1LQ,1ZF<br>PR: 1LQ,1ZF | 24.0122-0151.1<br>24.0322-0151.1   | 422151<br>522151   |  | 256 22,0 19,0 V L +S +B<br>256 22,0 19,0 V L +S +B PD       |                   |
|  | 1.2 i<br>1.4 i 16V<br>1.4 i 16V<br>1.4 TDI<br>1.6 i 16V<br>1.9 SDI<br>1.9 TDI<br>1.9 TDI<br>2.0 i 16V | 47<br><br>74<br><br>47<br>74<br>96<br>85   |  | 10.02<br>10.02<br>10.02<br>02.03<br>10.02<br>10.02<br>10.02<br>10.02             | 06.09<br>06.09<br>06.09<br>06.09<br>06.09<br>06.09<br>06.09<br>06.09              | PR: 1LN,1ZH<br>PR: 1LN,1ZH<br>PR: 1LN,1ZH<br>PR: 1LN,1ZH<br>PR: 1LN,1ZH<br>PR: 1LN,1ZH<br>PR: 1LN,1ZH<br>PR: 1LN,1ZH | 24.0125-0113.1<br>24.0325-0113.1   | 425113<br>525113   |  | 288 25,0 22,0 V L +S +B<br>288 25,0 22,0 V L +S +B PD       |                   |
|  | 1.2 i<br>1.4 i 16V<br>1.4 i 16V<br>1.4 TDI<br>1.6 i 16V<br>1.9 SDI<br>1.9 TDI<br>1.9 TDI<br>2.0 i 16V | 47<br><br>74<br><br>47<br>74<br>96<br>85   |  | 10.02<br>10.02<br>10.02<br>02.03<br>10.02<br>10.02<br>10.02<br>10.02             | 06.09<br>06.09<br>06.09<br>06.09<br>06.09<br>06.09<br>06.09<br>06.09              |  | 24.0711-5273.3<br>24.0711-5274.3   | 360303<br>360304   | <br> | Radsensor<br>Radsensor                                      |                   |



**SEAT CORDOBA III (6L2) (02-09)**

|           |           |    |       |       |       |                |        |  |                      |     |
|-----------|-----------|----|-------|-------|-------|----------------|--------|--|----------------------|-----|
|           | 1.2 i     | 47 |       | 10.02 | 06.09 | 13.0460-2894.2 | 602894 |  | 20961 17,4 /Zub/S    | TRW |
|           | 1.4 i 16V |    |       | 10.02 | 06.09 | 13.0470-2894.2 | LD2894 |  | 20961 17,4 /Zub/S    | TRW |
|           | 1.4 i 16V | 74 |       | 10.02 | 06.09 | 13.0460-2864.2 | 602864 |  | 20961 17,4 /S        | TRW |
|           | 1.4 TDI   |    |       | 10.02 | 06.09 | 13.0460-2877.2 | 602877 |  | 23554 17,2 +/WK/S    | TRW |
|           | 1.6 i 16V |    |       | 02.03 | 06.09 | 13.0470-2877.2 | LD2877 |  | 23554 17,2 +/WK/S    | TRW |
|           | 1.9 SDI   | 47 |       | 10.02 | 06.09 | 13.0460-0072.2 | 610072 |  | Belagsatz-Zubehör    | TRW |
|           | 1.9 TDI   | 74 |       | 10.02 | 06.09 |                |        |  |                      |     |
|           | 1.9 TDI   | 96 |       | 10.02 | 06.09 |                |        |  |                      |     |
| 2.0 i 16V | 85        |    | 10.02 | 06.09 |       |                |        |  |                      |     |
|           | 1.2 i     | 47 |       | 10.02 | 06.09 | 24.0109-0123.1 | 409123 |  | 230 9,0 7,0 +S +B    |     |
|           | 1.4 i 16V |    |       | 10.02 | 06.09 | 24.0309-0123.1 | 509123 |  | 230 9,0 7,0 +S +B PD |     |
|           | 1.4 i 16V | 74 |       | 10.02 | 06.09 |                |        |  |                      |     |
|           | 1.4 TDI   |    |       | 10.02 | 06.09 |                |        |  |                      |     |
|           | 1.6 i 16V |    |       | 02.03 | 06.09 |                |        |  |                      |     |
|           | 1.9 SDI   | 47 |       | 10.02 | 06.09 |                |        |  |                      |     |
|           | 1.9 TDI   | 74 |       | 10.02 | 06.09 |                |        |  |                      |     |
|           | 1.9 TDI   | 96 |       | 10.02 | 06.09 |                |        |  |                      |     |
| 2.0 i 16V | 85        |    | 10.02 | 06.09 |       |                |        |  |                      |     |
|           | 1.2 i     | 47 |       | 10.02 | 06.09 | 24.0711-6233.3 | 360315 |  | Radsensor            |     |
|           | 1.4 i 16V |    |       | 10.02 | 06.09 | 24.0711-6234.3 | 360316 |  | Radsensor            |     |
|           | 1.4 i 16V | 74 |       | 10.02 | 06.09 |                |        |  |                      |     |
|           | 1.4 TDI   |    |       | 10.02 | 06.09 |                |        |  |                      |     |
|           | 1.6 i 16V |    |       | 02.03 | 06.09 |                |        |  |                      |     |
|           | 1.9 SDI   | 47 |       | 10.02 | 06.09 |                |        |  |                      |     |
|           | 1.9 TDI   | 74 |       | 10.02 | 06.09 |                |        |  |                      |     |
|           | 1.9 TDI   | 96 |       | 10.02 | 06.09 |                |        |  |                      |     |
| 2.0 i 16V | 85        |    | 10.02 | 06.09 |       |                |        |  |                      |     |
|           | 1.2 i     | 47 |       | 10.02 | 06.09 | 03.0137-0268.2 | 650268 |  | 200 x 40 HEB         | VW  |
|           | 1.4 i 16V |    |       | 10.02 | 06.09 | 03.0137-9168.2 | 669168 |  | Bremsbacken-Zubehör  | VW  |
|           | 1.4 i 16V | 74 |       | 10.02 | 06.09 |                |        |  |                      |     |
|           | 1.4 TDI   |    |       | 10.02 | 06.09 |                |        |  |                      |     |
|           | 1.6 i 16V |    |       | 02.03 | 06.09 |                |        |  |                      |     |
|           | 1.9 SDI   | 47 |       | 10.02 | 06.09 |                |        |  |                      |     |
|           | 1.9 TDI   | 74 |       | 10.02 | 06.09 |                |        |  |                      |     |
|           | 1.9 TDI   | 96 |       | 10.02 | 06.09 |                |        |  |                      |     |
| 2.0 i 16V | 85        |    | 10.02 | 06.09 |       |                |        |  |                      |     |
|           | 1.2 i     | 47 |       | 10.02 | 06.09 | 24.0220-0037.1 | 480161 |  | 200/201,5 x 50,5     |     |
|           | 1.4 i 16V |    |       | 10.02 | 06.09 |                |        |  |                      |     |
|           | 1.4 i 16V | 74 |       | 10.02 | 06.09 |                |        |  |                      |     |
|           | 1.4 TDI   |    |       | 10.02 | 06.09 |                |        |  |                      |     |
|           | 1.6 i 16V |    |       | 02.03 | 06.09 |                |        |  |                      |     |
|           | 1.9 SDI   | 47 |       | 10.02 | 06.09 |                |        |  |                      |     |
|           | 1.9 TDI   | 74 |       | 10.02 | 06.09 |                |        |  |                      |     |
|           | 1.9 TDI   | 96 |       | 10.02 | 06.09 |                |        |  |                      |     |
| 2.0 i 16V | 85        |    | 10.02 | 06.09 |       |                |        |  |                      |     |

**SEAT EXEO / ST (09-13)**

|  |          |     |  |       |       |             |                |        |  |                         |     |
|--|----------|-----|--|-------|-------|-------------|----------------|--------|--|-------------------------|-----|
|  | 1.6      | 75  |  | 04.09 | 06.13 | PR: 1LA     | 13.0460-7201.2 | 607201 |  | 23763 20,3 +/WK         | ATE |
|  | 1.8 T    | 110 |  | 04.09 | 06.13 | PR: 1LA     | 13.0470-7201.2 | LD7201 |  | 23763 20,3 +/WK         | ATE |
|  | 1.8 TSI  | 88  |  | 09.10 | 06.13 | PR: 1LA     |                |        |  |                         |     |
|  | 1.8 TSI  | 118 |  | 05.10 | 06.13 | PR: 1LA     |                |        |  |                         |     |
|  | 2.0 TDI  | 88  |  | 04.09 | 06.13 | PR: 1LA     |                |        |  |                         |     |
|  | 2.0 TDI  | 105 |  | 04.09 | 06.13 | PR: 1LA     |                |        |  |                         |     |
|  | 2.0 TDI  | 125 |  | 04.09 | 06.13 | PR: 1LA     |                |        |  |                         |     |
|  | 2.0 TFSI |     |  | 04.09 | 06.13 | PR: 1LA     |                |        |  |                         |     |
|  | 1.6      | 75  |  | 04.09 | 06.13 | PR: 1LB,1LT | 13.0460-7110.2 | 607110 |  | 23018 20,3 +/WK         | ATE |
|  | 1.8 T    | 110 |  | 04.09 | 06.13 | PR: 1LB,1LT | 13.0470-7110.2 | LD7110 |  | 23018 20,3 +/WK         | ATE |
|  | 1.8 TSI  | 88  |  | 09.10 | 06.13 | PR: 1LB,1LT |                |        |  |                         |     |
|  | 1.8 TSI  | 118 |  | 05.10 | 06.13 | PR: 1LB,1LT |                |        |  |                         |     |
|  | 2.0 TDI  | 88  |  | 04.09 | 06.13 | PR: 1LB,1LT |                |        |  |                         |     |
|  | 2.0 TDI  | 105 |  | 04.09 | 06.13 | PR: 1LB,1LT |                |        |  |                         |     |
|  | 2.0 TDI  | 125 |  | 04.09 | 06.13 | PR: 1LB,1LT |                |        |  |                         |     |
|  | 2.0 TFSI |     |  | 04.09 | 06.13 | PR: 1LB,1LT |                |        |  |                         |     |
|  | 1.6      | 75  |  | 04.09 | 06.13 | PR: 1LZ     | 13.0460-2837.2 | 602837 |  | 21945 19,6 +/WK/S       | TRW |
|  | 1.8 T    | 110 |  | 04.09 | 06.13 | PR: 1LZ     | 13.0470-2837.2 | LD2837 |  | 21945 19,6 +/WK/S       | TRW |
|  | 1.8 TSI  | 88  |  | 09.10 | 06.13 | PR: 1LZ     |                |        |  |                         |     |
|  | 1.8 TSI  | 118 |  | 05.10 | 06.13 | PR: 1LZ     |                |        |  |                         |     |
|  | 2.0 TDI  | 88  |  | 04.09 | 06.13 | PR: 1LZ     |                |        |  |                         |     |
|  | 2.0 TDI  | 105 |  | 04.09 | 06.13 | PR: 1LZ     |                |        |  |                         |     |
|  | 2.0 TDI  | 125 |  | 04.09 | 06.13 | PR: 1LZ     |                |        |  |                         |     |
|  | 2.0 TFSI |     |  | 04.09 | 06.13 | PR: 1LZ     |                |        |  |                         |     |
|  | 1.6      | 75  |  | 04.09 | 06.13 | PR: 1LA     | 24.0130-0113.1 | 430113 |  | 320 30,0 28,0 V L +S +B |     |
|  | 1.8 T    | 110 |  | 04.09 | 06.13 | PR: 1LA     | 24.0330-0113.1 | 530113 |  | 320 30,0 28,0 V L +B PD |     |
|  | 1.8 TSI  | 88  |  | 09.10 | 06.13 | PR: 1LA     |                |        |  |                         |     |
|  | 1.8 TSI  | 118 |  | 05.10 | 06.13 | PR: 1LA     |                |        |  |                         |     |
|  | 2.0 TDI  | 88  |  | 04.09 | 06.13 | PR: 1LA     |                |        |  |                         |     |
|  | 2.0 TDI  | 105 |  | 04.09 | 06.13 | PR: 1LA     |                |        |  |                         |     |
|  | 2.0 TDI  | 125 |  | 04.09 | 06.13 | PR: 1LA     |                |        |  |                         |     |
|  | 2.0 TFSI |     |  | 04.09 | 06.13 | PR: 1LA     |                |        |  |                         |     |
|  | 1.6      | 75  |  | 04.09 | 06.13 | PR: 1LB     | 24.0125-0105.1 | 425105 |  | 288 25,0 23,0 V L +S +B |     |
|  | 1.8 T    | 110 |  | 04.09 | 06.13 | PR: 1LB     | 24.0325-0105.1 | 525105 |  | 288 25,0 23,0 V L +B PD |     |
|  | 1.8 TSI  | 88  |  | 09.10 | 06.13 | PR: 1LB     |                |        |  |                         |     |
|  | 1.8 TSI  | 118 |  | 05.10 | 06.13 | PR: 1LB     |                |        |  |                         |     |
|  | 2.0 TDI  | 88  |  | 04.09 | 06.13 | PR: 1LB     |                |        |  |                         |     |
|  | 2.0 TDI  | 105 |  | 04.09 | 06.13 | PR: 1LB     |                |        |  |                         |     |
|  | 2.0 TDI  | 125 |  | 04.09 | 06.13 | PR: 1LB     |                |        |  |                         |     |
|  | 2.0 TDI  |     |  | 04.09 | 06.13 | PR: 1LB     |                |        |  |                         |     |



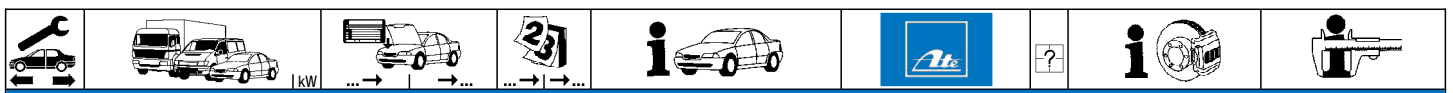

### SEAT EXEO / ST (09-13)

|  |          |     |  |       |       |             |                |        |  |                         |
|--|----------|-----|--|-------|-------|-------------|----------------|--------|--|-------------------------|
|  | 2.0 TFSI |     |  | 04.09 | 06.13 | PR: 1LB     | 24.0125-0105.1 | 425105 |  | 288 25,0 23,0 V L +S +B |
|  |          |     |  |       |       |             | 24.0325-0105.1 | 525105 |  | 288 25,0 23,0 V L +B PD |
|  | 1.6      | 75  |  | 04.09 | 06.13 | PR: 1LT     | 24.0125-0137.1 | 425137 |  | 312 25,0 23,0 V L +S +B |
|  | 1.8 T    | 110 |  | 04.09 | 06.13 | PR: 1LT     | 24.0325-0137.1 | 525137 |  | 312 25,0 23,0 V L +B PD |
|  | 1.8 TSI  | 88  |  | 09.10 | 06.13 | PR: 1LT     |                |        |  |                         |
|  | 1.8 TSI  | 118 |  | 05.10 | 06.13 | PR: 1LT     |                |        |  |                         |
|  | 2.0 TDI  | 88  |  | 04.09 | 06.13 | PR: 1LT     |                |        |  |                         |
|  | 2.0 TDI  | 105 |  | 04.09 | 06.13 | PR: 1LT     |                |        |  |                         |
|  | 2.0 TDI  | 125 |  | 04.09 | 06.13 | PR: 1LT     |                |        |  |                         |
|  | 2.0 TFSI |     |  | 04.09 | 06.13 | PR: 1LT     |                |        |  |                         |
|  | 1.6      | 75  |  | 04.09 | 06.13 | PR: 1LZ     | 24.0122-0152.1 | 422152 |  | 280 22,0 20,0 V L +S +B |
|  | 1.8 T    | 110 |  | 04.09 | 06.13 | PR: 1LZ     | 24.0322-0152.1 | 522152 |  | 280 22,0 20,0 V L +B PD |
|  | 1.8 TSI  | 88  |  | 09.10 | 06.13 | PR: 1LZ     |                |        |  |                         |
|  | 1.8 TSI  | 118 |  | 05.10 | 06.13 | PR: 1LZ     |                |        |  |                         |
|  | 2.0 TDI  | 88  |  | 04.09 | 06.13 | PR: 1LZ     |                |        |  |                         |
|  | 2.0 TDI  | 105 |  | 04.09 | 06.13 | PR: 1LZ     |                |        |  |                         |
|  | 2.0 TDI  | 125 |  | 04.09 | 06.13 | PR: 1LZ     |                |        |  |                         |
|  | 2.0 TFSI |     |  | 04.09 | 06.13 | PR: 1LZ     |                |        |  |                         |
|  | 1.6      | 75  |  | 04.09 | 06.13 | PR: 1KD,1KP | 13.0460-2886.2 | 602886 |  | 20961 16,2 /S           |
|  | 1.8 T    | 110 |  | 04.09 | 06.13 | PR: 1KD,1KP | 13.0470-2886.2 | LD2886 |  | 20961 16,2 /S           |
|  | 1.8 TSI  | 88  |  | 09.10 | 06.13 | PR: 1KD,1KP |                |        |  |                         |
|  | 1.8 TSI  | 118 |  | 05.10 | 06.13 | PR: 1KD,1KP |                |        |  |                         |
|  | 2.0 TDI  | 88  |  | 04.09 | 06.13 | PR: 1KD,1KP |                |        |  |                         |
|  | 2.0 TDI  | 105 |  | 04.09 | 06.13 | PR: 1KD,1KP |                |        |  |                         |
|  | 2.0 TDI  | 125 |  | 04.09 | 06.13 | PR: 1KD,1KP |                |        |  |                         |
|  | 2.0 TFSI |     |  | 04.09 | 06.13 | PR: 1KD,1KP |                |        |  |                         |
|  | 1.6      | 75  |  | 04.09 | 06.13 | PR: 1KW     | 13.0460-2880.2 | 602880 |  | 23914 17,1 /WE/Zub/S    |
|  | 1.8 T    | 110 |  | 04.09 | 06.13 | PR: 1KW     | 13.0470-2880.2 | LD2880 |  | 23914 17,1 /WE/Zub/S    |
|  | 1.8 TSI  | 88  |  | 09.10 | 06.13 | PR: 1KW     |                |        |  |                         |
|  | 1.8 TSI  | 118 |  | 05.10 | 06.13 | PR: 1KW     |                |        |  |                         |
|  | 2.0 TDI  | 88  |  | 04.09 | 06.13 | PR: 1KW     |                |        |  |                         |
|  | 2.0 TDI  | 105 |  | 04.09 | 06.13 | PR: 1KW     |                |        |  |                         |
|  | 2.0 TDI  | 125 |  | 04.09 | 06.13 | PR: 1KW     |                |        |  |                         |
|  | 2.0 TFSI |     |  | 04.09 | 06.13 | PR: 1KW     |                |        |  |                         |
|  | 1.6      | 75  |  | 04.09 | 06.13 | PR: 1KD     | 24.0110-0261.1 | 410261 |  | 245 10,0 8,0 +S +B      |
|  | 1.8 T    | 110 |  | 04.09 | 06.13 | PR: 1KD     | 24.0310-0261.1 | 510261 |  | 245 10,0 8,0 +B PD      |
|  | 1.8 TSI  | 88  |  | 09.10 | 06.13 | PR: 1KD     |                |        |  |                         |
|  | 1.8 TSI  | 118 |  | 05.10 | 06.13 | PR: 1KD     |                |        |  |                         |
|  | 2.0 TDI  | 88  |  | 04.09 | 06.13 | PR: 1KD     |                |        |  |                         |
|  | 2.0 TDI  | 105 |  | 04.09 | 06.13 | PR: 1KD     |                |        |  |                         |
|  | 2.0 TDI  | 125 |  | 04.09 | 06.13 | PR: 1KD     |                |        |  |                         |
|  | 2.0 TFSI |     |  | 04.09 | 06.13 | PR: 1KD     |                |        |  |                         |
|  | 1.6      | 75  |  | 04.09 | 06.13 | PR: 1KP     | 24.0112-0148.1 | 412148 |  | 255 12,0 10,0 +B        |
|  | 1.8 T    | 110 |  | 04.09 | 06.13 | PR: 1KP     | 24.0312-0148.1 | 512148 |  | 255 12,0 10,0 +B PD     |
|  | 1.8 TSI  | 88  |  | 09.10 | 06.13 | PR: 1KP     |                |        |  |                         |
|  | 1.8 TSI  | 118 |  | 05.10 | 06.13 | PR: 1KP     |                |        |  |                         |
|  | 2.0 TDI  | 88  |  | 04.09 | 06.13 | PR: 1KP     |                |        |  |                         |
|  | 2.0 TDI  | 105 |  | 04.09 | 06.13 | PR: 1KP     |                |        |  |                         |
|  | 2.0 TDI  | 125 |  | 04.09 | 06.13 | PR: 1KP     |                |        |  |                         |
|  | 2.0 TFSI |     |  | 04.09 | 06.13 | PR: 1KP     |                |        |  |                         |
|  | 1.6      | 75  |  | 04.09 | 06.13 | PR: 1KW     | 24.0112-0166.1 | 412166 |  | 288 12,0 10,0 +B        |
|  | 1.8 T    | 110 |  | 04.09 | 06.13 | PR: 1KW     | 24.0312-0166.1 | 512166 |  | 288 12,0 10,0 +B PD     |
|  | 1.8 TSI  | 88  |  | 09.10 | 06.13 | PR: 1KW     |                |        |  |                         |
|  | 1.8 TSI  | 118 |  | 05.10 | 06.13 | PR: 1KW     |                |        |  |                         |
|  | 2.0 TDI  | 88  |  | 04.09 | 06.13 | PR: 1KW     |                |        |  |                         |
|  | 2.0 TDI  | 105 |  | 04.09 | 06.13 | PR: 1KW     |                |        |  |                         |
|  | 2.0 TDI  | 125 |  | 04.09 | 06.13 | PR: 1KW     |                |        |  |                         |
|  | 2.0 TFSI |     |  | 04.09 | 06.13 | PR: 1KW     |                |        |  |                         |

### SEAT IBIZA II (93-99)





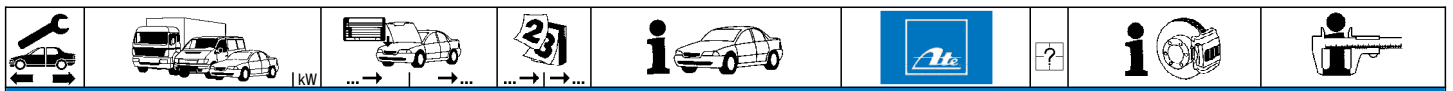







|  |                 |     |             |       |       |         |                |        |  |                  |     |
|--|-----------------|-----|-------------|-------|-------|---------|----------------|--------|--|------------------|-----|
|  | 1.0 i           |     |             | 02.93 | 12.96 | - ABS   | 13.0460-7030.2 | 607030 |  | 20889 17,3 /Zub  | VW  |
|  | 1.3 i           |     |             | 02.93 | 12.96 | - ABS   |                |        |  |                  |     |
|  | 1.4             |     |             | 09.93 | 12.96 | - ABS   |                |        |  |                  |     |
|  | 1.0 i           |     |             | 02.93 | 12.96 | + ABS   | 13.0460-7032.2 | 607032 |  | 20887 19,7 +/Zub | VW  |
|  | 1.3 i           |     |             | 02.93 | 12.96 | + ABS   |                |        |  |                  |     |
|  | 1.4             |     |             | 09.93 | 12.96 | + ABS   |                |        |  |                  |     |
|  | 1.6 i           |     |             | 02.93 | 12.96 |         |                |        |  |                  |     |
|  | 1.8 i           |     |             | 02.93 | 12.96 |         |                |        |  |                  |     |
|  | 1.9 D           |     | 6K-ZR003620 | 02.93 |       |         |                |        |  |                  |     |
|  | 1.9 D           |     | 6K-ZR003611 | 02.93 |       |         |                |        |  |                  |     |
|  | 1.9 TD          |     | 6K-ZR003513 | 02.93 |       |         |                |        |  |                  |     |
|  | 1.8 i           |     | 6K-ZR003621 |       | 12.96 |         | 13.0460-7033.2 | 607033 |  | 20887 15,3 +/Zub | VW  |
|  | 1.9 D           |     | 6K-ZR003612 |       | 12.96 |         | 13.0460-7101.2 | 607101 |  | 21866 15,3 +     | VW  |
|  | 1.9 TD          |     | 6K-ZR003514 |       | 12.96 |         |                |        |  |                  |     |
|  | 1.6 i           |     |             | 02.93 | 12.96 |         | 13.0460-2957.2 | 602957 |  | 20168 16,0 /S    | TRW |
|  | 1.8 i           |     |             | 02.93 | 12.96 |         |                |        |  |                  |     |
|  | 1.8 i 16V       |     |             | 02.94 | 12.96 |         |                |        |  |                  |     |
|  | 2.0 i           |     |             | 02.93 | 12.96 |         |                |        |  |                  |     |
|  | 2.0 i 16V Cupra | 110 |             | 07.96 | 12.96 |         |                |        |  |                  |     |
|  | 1.0 i           |     |             | 01.97 | 07.99 | PR: 1LA | 13.0460-7059.2 | 607059 |  | 20887 17,3 +/Zub | VW  |
|  | 1.3 i           |     |             | 01.97 | 07.99 | PR: 1LA |                |        |  |                  |     |
|  | 1.4             |     |             | 01.97 | 07.99 | PR: 1LA |                |        |  |                  |     |
|  | 1.4 i 16V       |     |             | 01.97 | 07.99 | PR: 1LA |                |        |  |                  |     |
|  | 1.6 i           |     |             | 01.97 | 07.99 | PR: 1LA |                |        |  |                  |     |
|  | 1.8 i           |     |             | 01.97 | 07.99 | PR: 1LA |                |        |  |                  |     |
|  | 1.8 i 16V       |     |             | 01.97 | 07.99 | PR: 1LA |                |        |  |                  |     |
|  | 1.9 D           |     |             | 01.97 | 07.99 | PR: 1LA |                |        |  |                  |     |





**SEAT IBIZA II (93-99)**

|                 |                 |       |       |         |                 |                |        |  |                         |     |
|-----------------|-----------------|-------|-------|---------|-----------------|----------------|--------|--|-------------------------|-----|
|                 | 1.9 SDI         |       | 09.95 | 07.99   | PR: 1LA         | 13.0460-7059.2 | 607059 |  | 20887 17,3 +/Zub        | VW  |
|                 | 1.9 TD          |       | 01.97 | 07.99   | PR: 1LA         |                |        |  |                         |     |
|                 | 1.9 TDI         | 66    | 07.96 | 07.99   | PR: 1LA         |                |        |  |                         |     |
|                 | 1.9 TDI         | 81    | 03.97 | 07.99   | PR: 1LA         |                |        |  |                         |     |
|                 | 2.0 i           |       | 01.97 | 07.99   | PR: 1LA         |                |        |  |                         |     |
|                 | 2.0 i 16V Cupra | 110   | 01.97 | 07.99   | PR: 1LA         |                |        |  |                         |     |
|                 | 1.0 i           |       | 01.97 | 07.99   | PR: 1LG         | 13.0460-7101.2 | 607101 |  | 21866 15,3 +            | VW  |
|                 | 1.3 i           |       | 01.97 | 07.99   | PR: 1LG         |                |        |  |                         |     |
|                 | 1.4             |       | 01.97 | 07.99   | PR: 1LG         |                |        |  |                         |     |
|                 | 1.4 i 16V       | 74    | 01.97 | 07.99   | PR: 1LG         |                |        |  |                         |     |
|                 | 1.6 i           |       | 01.97 | 07.99   | PR: 1LG         |                |        |  |                         |     |
|                 | 1.8 i           |       | 01.97 | 07.99   | PR: 1LG         |                |        |  |                         |     |
|                 | 1.8 i 16V       |       | 01.97 | 07.99   | PR: 1LG         |                |        |  |                         |     |
|                 | 1.9 D           |       | 01.97 | 07.99   | PR: 1LG         |                |        |  |                         |     |
|                 | 1.9 SDI         |       | 09.95 | 07.99   | PR: 1LG         |                |        |  |                         |     |
|                 | 1.9 TD          |       | 01.97 | 07.99   | PR: 1LG         |                |        |  |                         |     |
|                 | 1.9 TDI         | 66    | 07.96 | 07.99   | PR: 1LG         |                |        |  |                         |     |
|                 | 1.9 TDI         | 81    | 03.97 | 07.99   | PR: 1LG         |                |        |  |                         |     |
|                 | 2.0 i           |       | 01.97 | 07.99   | PR: 1LG         |                |        |  |                         |     |
|                 | 2.0 i 16V Cupra | 110   | 01.97 | 07.99   | PR: 1LG         |                |        |  |                         |     |
|                 | 1.0 i           |       | 01.97 | 07.99   | PR: 1LM         | 13.0460-7072.2 | 607072 |  | 21866 19,7 +            | VW  |
|                 | 1.3 i           |       | 01.97 | 07.99   | PR: 1LM         |                |        |  |                         |     |
|                 | 1.4             |       | 01.97 | 07.99   | PR: 1LM         |                |        |  |                         |     |
|                 | 1.4 i 16V       | 74    | 01.97 | 07.99   | PR: 1LM         |                |        |  |                         |     |
|                 | 1.6 i           |       | 01.97 | 07.99   | PR: 1LM         |                |        |  |                         |     |
|                 | 1.8 i           |       | 01.97 | 07.99   | PR: 1LM         |                |        |  |                         |     |
|                 | 1.8 i 16V       |       | 01.97 | 07.99   | PR: 1LM         |                |        |  |                         |     |
|                 | 1.9 D           |       | 01.97 | 07.99   | PR: 1LM         |                |        |  |                         |     |
|                 | 1.9 SDI         |       | 09.95 | 07.99   | PR: 1LM         |                |        |  |                         |     |
|                 | 1.9 TD          |       | 01.97 | 07.99   | PR: 1LM         |                |        |  |                         |     |
|                 | 1.9 TDI         | 66    | 07.96 | 07.99   | PR: 1LM         |                |        |  |                         |     |
|                 | 1.9 TDI         | 81    | 03.97 | 07.99   | PR: 1LM         |                |        |  |                         |     |
|                 | 2.0 i           |       | 01.97 | 07.99   | PR: 1LM         |                |        |  |                         |     |
|                 | 2.0 i 16V Cupra | 110   | 01.97 | 07.99   | PR: 1LM         |                |        |  |                         |     |
|                 | 1.0 i           |       | 01.97 | 07.99   | PR: 1LY,1ZK     | 13.0460-2821.2 | 602821 |  | 21945 16,0 /S           | TRW |
|                 | 1.3 i           |       | 01.97 | 07.99   | PR: 1LY,1ZK     |                |        |  |                         |     |
|                 | 1.4             |       | 01.97 | 07.99   | PR: 1LY,1ZK     |                |        |  |                         |     |
|                 | 1.4 i 16V       | 74    | 01.97 | 07.99   | PR: 1LY,1ZK     |                |        |  |                         |     |
|                 | 1.6 i           |       | 01.97 | 07.99   | PR: 1LY,1ZK     |                |        |  |                         |     |
|                 | 1.8 i           |       | 01.97 | 07.99   | PR: 1LY,1ZK     |                |        |  |                         |     |
|                 | 1.8 i 16V       |       | 01.97 | 07.99   | PR: 1LY,1ZK     |                |        |  |                         |     |
|                 | 1.9 D           |       | 01.97 | 07.99   | PR: 1LY,1ZK     |                |        |  |                         |     |
|                 | 1.9 SDI         |       | 09.95 | 07.99   | PR: 1LY,1ZK     |                |        |  |                         |     |
|                 | 1.9 TD          |       | 01.97 | 07.99   | PR: 1LY,1ZK     |                |        |  |                         |     |
|                 | 1.9 TDI         | 66    | 07.96 | 07.99   | PR: 1LY,1ZK     |                |        |  |                         |     |
|                 | 1.9 TDI         | 81    | 03.97 | 07.99   | PR: 1LY,1ZK     |                |        |  |                         |     |
|                 | 2.0 i           |       | 01.97 | 07.99   | PR: 1LY,1ZK     |                |        |  |                         |     |
|                 | 2.0 i 16V Cupra | 110   | 01.97 | 07.99   | PR: 1LY,1ZK     |                |        |  |                         |     |
|                 | 1.0 i           |       | 01.97 | 07.99   | PR: 1LD,1LV,1LW | 13.0460-2958.2 | 602958 |  | 20168 19,3 /S           | TRW |
|                 | 1.3 i           |       | 01.97 | 07.99   | PR: 1LD,1LV,1LW |                |        |  |                         |     |
|                 | 1.4             |       | 01.97 | 07.99   | PR: 1LD,1LV,1LW |                |        |  |                         |     |
|                 | 1.4 i 16V       | 74    | 01.97 | 07.99   | PR: 1LD,1LV,1LW |                |        |  |                         |     |
|                 | 1.6 i           |       | 01.97 | 07.99   | PR: 1LD,1LV,1LW |                |        |  |                         |     |
|                 | 1.8 i           |       | 01.97 | 07.99   | PR: 1LD,1LV,1LW |                |        |  |                         |     |
|                 | 1.8 i 16V       |       | 01.97 | 07.99   | PR: 1LD,1LV,1LW |                |        |  |                         |     |
|                 | 1.9 D           |       | 01.97 | 07.99   | PR: 1LD,1LV,1LW |                |        |  |                         |     |
|                 | 1.9 SDI         |       | 09.95 | 07.99   | PR: 1LD,1LV,1LW |                |        |  |                         |     |
|                 | 1.9 TD          |       | 01.97 | 07.99   | PR: 1LD,1LV,1LW |                |        |  |                         |     |
|                 | 1.9 TDI         | 66    | 07.96 | 07.99   | PR: 1LD,1LV,1LW |                |        |  |                         |     |
|                 | 1.9 TDI         | 81    | 03.97 | 07.99   | PR: 1LD,1LV,1LW |                |        |  |                         |     |
|                 | 2.0 i           |       | 01.97 | 07.99   | PR: 1LD,1LV,1LW |                |        |  |                         |     |
|                 | 2.0 i 16V Cupra | 110   | 01.97 | 07.99   | PR: 1LD,1LV,1LW |                |        |  |                         |     |
|                 | 1.0 i           |       | 02.93 | 07.99   | PR: 1LA         | 24.0110-0151.1 | 410151 |  | 239 10,0 8,0 +S +B      | VW  |
|                 | 1.3 i           |       | 02.93 | 07.99   | PR: 1LA         |                |        |  |                         |     |
|                 | 1.4             |       | 09.93 | 07.99   | PR: 1LA         |                |        |  |                         |     |
|                 | 1.4 i 16V       | 74    | 09.96 | 07.99   | PR: 1LA         |                |        |  |                         |     |
|                 | 1.6 i           |       | 02.93 | 07.99   | PR: 1LA         |                |        |  |                         |     |
|                 | 1.8 i           |       | 02.93 | 07.99   | PR: 1LA         |                |        |  |                         |     |
|                 | 1.8 i 16V       |       | 02.94 | 07.99   | PR: 1LA         |                |        |  |                         |     |
|                 | 1.9 D           |       | 02.93 | 07.99   | PR: 1LA         |                |        |  |                         |     |
|                 | 1.9 SDI         |       | 09.95 | 07.99   | PR: 1LA         |                |        |  |                         |     |
|                 | 1.9 TD          |       | 02.93 | 07.99   | PR: 1LA         |                |        |  |                         |     |
| 1.9 TDI         | 66              | 07.96 | 07.99 | PR: 1LA |                 |                |        |  |                         |     |
| 1.9 TDI         | 81              | 03.97 | 07.99 | PR: 1LA |                 |                |        |  |                         |     |
| 2.0 i           |                 | 02.93 | 07.99 | PR: 1LA |                 |                |        |  |                         |     |
| 2.0 i 16V Cupra | 110             | 07.96 | 07.99 | PR: 1LA |                 |                |        |  |                         |     |
|                 | 1.0 i           |       | 02.93 | 07.99   | PR: 1LG         | 24.0120-0123.1 | 420123 |  | 239 20,0 18,0 V L +S +B | VW  |
|                 | 1.3 i           |       | 02.93 | 07.99   | PR: 1LG         |                |        |  |                         |     |
|                 | 1.4             |       | 09.93 | 07.99   | PR: 1LG         |                |        |  |                         |     |
|                 | 1.4 i 16V       | 74    | 09.96 | 07.99   | PR: 1LG         |                |        |  |                         |     |
|                 | 1.6 i           |       | 02.93 | 07.99   | PR: 1LG         |                |        |  |                         |     |
|                 | 1.8 i           |       | 02.93 | 07.99   | PR: 1LG         |                |        |  |                         |     |
|                 | 1.8 i 16V       |       | 02.94 | 07.99   | PR: 1LG         |                |        |  |                         |     |
|                 | 1.9 D           |       | 02.93 | 07.99   | PR: 1LG         |                |        |  |                         |     |
|                 | 1.9 SDI         |       | 09.95 | 07.99   | PR: 1LG         |                |        |  |                         |     |
|                 | 1.9 TD          |       | 02.93 | 07.99   | PR: 1LG         |                |        |  |                         |     |
| 1.9 TDI         | 66              | 07.96 | 07.99 | PR: 1LG |                 |                |        |  |                         |     |

|     |  |  |  |  |  |  |  |  |   |  |
|--|--|--|--|--|---|--|--|--|---|--|
| <b>SEAT IBIZA II (93-99)</b>   |  |  |  |  |   |  |  |  |   |  |
|    | 1.9 TDI  | 81   |  | 03.97  | 07.99   | PR: 1LG  | 24.0120-0123.1   | 420123   | 239 20,0 18,0 VL +S +B<br>239 20,0 18,0 VL +S +B PD |  |
|  | 2.0 i  |  |  | 02.93  | 07.99   | PR: 1LG  | 24.0320-0123.1   | 520123   |   |  |
|  | 2.0 i 16V Cupra  | 110  |  | 07.96  | 07.99   | PR: 1LG  |  |  |   |  |
|  | 1.0 i  |  |  | 01.97  | 07.99   | PR: 1LM  | 24.0112-0106.1   | 412106   |   | 239 12,0 10,0 +S +B<br>239 12,0 10,0 +S +B PD  |
|  | 1.3 i  |  |  | 01.97  | 07.99   | PR: 1LM  | 24.0312-0106.1   | 512106   |   |  |
|  | 1.4  |  |  | 01.97  | 07.99   | PR: 1LM  |  |  |   |  |
|  | 1.4 i 16V  | 74   |  | 01.97  | 07.99   | PR: 1LM  |  |  |   |  |
|  | 1.6 i  |  |  | 01.97  | 07.99   | PR: 1LM  |  |  |   |  |
|  | 1.8 i  |  |  | 01.97  | 07.99   | PR: 1LM  |  |  |   |  |
|  | 1.8 i 16V  |  |  | 01.97  | 07.99   | PR: 1LM  |  |  |   |  |
|  | 1.9 D  |  |  | 01.97  | 07.99   | PR: 1LM  |  |  |   |  |
|  | 1.9 SDI  |  |  | 09.95  | 07.99   | PR: 1LM  |  |  |   |  |
| 1.9 TD   |  |  | 01.97  | 07.99  | PR: 1LM   |  |  |  |   |  |
| 1.9 TDI  | 66   |  | 07.96  | 07.99  | PR: 1LM   |  |  |  |   |  |
| 1.9 TDI  | 81   |  | 03.97  | 07.99  | PR: 1LM   |  |  |  |   |  |
| 2.0 i  |  |  | 01.97  | 07.99  | PR: 1LM   |  |  |  |   |  |
| 2.0 i 16V Cupra  | 110  |  | 01.97  | 07.99  | PR: 1LM   |  |  |  |   |  |
| 1.0 i  |  |  | 01.97  | 07.99  | PR: 1LY,1ZK   | 24.0120-0128.1   | 420128   | 256 20,0 18,0 VL +S +B<br>256 20,0 18,0 VL +S +B PD                                |   |  |
| 1.3 i  |  |  | 01.97  | 07.99  | PR: 1LY,1ZK   | 24.0320-0128.1   | 520128   |  |   |  |
| 1.4  |  |  | 01.97  | 07.99  | PR: 1LY,1ZK   |  |  |  |   |  |
| 1.4 i 16V  | 74   |  | 01.97  | 07.99  | PR: 1LY,1ZK   |  |  |  |   |  |
| 1.6 i  |  |  | 01.97  | 07.99  | PR: 1LY,1ZK   |  |  |  |   |  |
| 1.8 i  |  |  | 01.97  | 07.99  | PR: 1LY,1ZK   |  |  |  |   |  |
| 1.8 i 16V  |  |  | 01.97  | 07.99  | PR: 1LY,1ZK   |  |  |  |   |  |
| 1.9 D  |  |  | 01.97  | 07.99  | PR: 1LY,1ZK   |  |  |  |   |  |
| 1.9 SDI  |  |  | 09.95  | 07.99  | PR: 1LY,1ZK   |  |  |  |   |  |
| 1.9 TD   |  |  | 01.97  | 07.99  | PR: 1LY,1ZK   |  |  |  |   |  |
| 1.9 TDI  | 66   |  | 07.96  | 07.99  | PR: 1LY,1ZK   |  |  |  |   |  |
| 1.9 TDI  | 81   |  | 03.97  | 07.99  | PR: 1LY,1ZK   |  |  |  |   |  |
| 2.0 i  |  |  | 01.97  | 07.99  | PR: 1LY,1ZK   |  |  |  |   |  |
| 2.0 i 16V Cupra  | 110  |  | 01.97  | 07.99  | PR: 1LY,1ZK   |  |  |  |   |  |
| 1.0 i  |  |  | 01.97  | 07.99  | PR: 1LD,1LV,1LW   | 24.0122-0101.1   | 422101   | 280 22,0 20,0 VL +B  |   |  |
| 1.3 i  |  |  | 01.97  | 07.99  | PR: 1LD,1LV,1LW   |  |  |  |   |  |
| 1.4  |  |  | 01.97  | 07.99  | PR: 1LD,1LV,1LW   |  |  |  |   |  |
| 1.4 i 16V  | 74   |  | 01.97  | 07.99  | PR: 1LD,1LV,1LW   |  |  |  |   |  |
| 1.6 i  |  |  | 01.97  | 07.99  | PR: 1LD,1LV,1LW   |  |  |  |   |  |
| 1.8 i  |  |  | 01.97  | 07.99  | PR: 1LD,1LV,1LW   |  |  |  |   |  |
| 1.8 i 16V  |  |  | 01.97  | 07.99  | PR: 1LD,1LV,1LW   |  |  |  |   |  |
| 1.9 D  |  |  | 01.97  | 07.99  | PR: 1LD,1LV,1LW   |  |  |  |   |  |
| 1.9 SDI  |  |  | 09.95  | 07.99  | PR: 1LD,1LV,1LW   |  |  |  |   |  |
| 1.9 TD   |  |  | 01.97  | 07.99  | PR: 1LD,1LV,1LW   |  |  |  |   |  |
| 1.9 TDI  | 66   |  | 07.96  | 07.99  | PR: 1LD,1LV,1LW   |  |  |  |   |  |
| 1.9 TDI  | 81   |  | 03.97  | 07.99  | PR: 1LD,1LV,1LW   |  |  |  |   |  |
| 2.0 i  |  |  | 01.97  | 07.99  | PR: 1LD,1LV,1LW   |  |  |  |   |  |
| 2.0 i 16V Cupra  | 110  |  | 01.97  | 07.99  | PR: 1LD,1LV,1LW   |  |  |  |   |  |
|  | 1.0 i  |  |  | 02.93  | 07.99   |  | 24.0711-1361.3   | 360022   | Radsensor<br>Radsensor                              |  |
|  | 1.3 i  |  |  | 02.93  | 07.99   |  | 24.0711-1362.3   | 360023   |   |  |
|  | 1.4  |  |  | 09.93  | 07.99   |  |  |  |   |  |
|  | 1.4 i 16V  | 74   |  | 09.96  | 07.99   |  |  |  |   |  |
|  | 1.6 i  |  |  | 02.93  | 07.99   |  |  |  |   |  |
|  | 1.8 i  |  |  | 02.93  | 07.99   |  |  |  |   |  |
|  | 1.8 i 16V  |  |  | 02.94  | 07.99   |  |  |  |   |  |
|  | 1.9 D  |  |  | 02.93  | 07.99   |  |  |  |   |  |
|  | 1.9 SDI  |  |  | 09.95  | 07.99   |  |  |  |   |  |
|  | 1.9 TD   |  |  | 02.93  | 07.99   |  |  |  |   |  |
|  | 1.9 TDI  | 66   |  | 07.96  | 07.99   |  |  |  |   |  |
|  | 1.9 TDI  | 81   |  | 03.97  | 07.99   |  |  |  |   |  |
| 2.0 i  |  |  | 02.93  | 07.99  |   |  |  |  |   |  |
| 2.0 i 16V Cupra  | 110  |  | 07.96  | 07.99  |   |  |  |  |   |  |
|  | 1.8 i 16V  |  |  | 02.94  | 07.99   |  | 13.0460-2937.2   | 602937   | 20961 15,2 /Zub/S TRW<br>Belagsatz-Zubehör TRW      |  |
|  | 1.9 TDI  | 81   |  | 03.97  | 07.99   |  | 13.0460-0419.2   | 610419   |   |  |
|  | 2.0 i  |  |  | 02.93  | 07.99   |  |  |  |   |  |
|  | 2.0 i 16V Cupra  | 110  |  | 07.96  | 07.99   |  | 13.0460-2984.2   | 602984   |   |  |
|  |  |  |  |  |   |  | 13.0460-0072.2   | 610072   |   |  |
|  | 1.0 i  |  |  | 02.93  | 07.99   | PR: 1KK  | 13.0460-2894.2   | 602894   |   | 20961 17,4 /Zub/S TRW<br>20961 17,4 /Zub/S TRW |
|  | 1.3 i  |  |  | 02.93  | 07.99   | PR: 1KK  | 13.0470-2894.2   | LD2894   |   |  |
|  | 1.4  |  |  | 09.93  | 07.99   | PR: 1KK  |  |  |   |  |
|  | 1.4 i 16V  | 74   |  | 09.96  | 07.99   | PR: 1KK  |  |  |   |  |
|  | 1.6 i  |  |  | 02.93  | 07.99   | PR: 1KK  |  |  |   |  |
|  | 1.8 i  |  |  | 02.93  | 07.99   | PR: 1KK  |  |  |   |  |
|  | 1.8 i 16V  |  |  | 02.94  | 07.99   | PR: 1KK  |  |  |   |  |
| 1.9 D  |  |  | 02.93  | 07.99  | PR: 1KK   |  |  |  |   |  |
| 1.9 SDI  |  |  | 09.95  | 07.99  | PR: 1KK   |  |  |  |   |  |
| 1.9 TD   |  |  | 02.93  | 07.99  | PR: 1KK   |  |  |  |   |  |
| 1.9 TDI  | 66   |  | 07.96  | 07.99  | PR: 1KK   |  |  |  |   |  |
| 1.9 TDI  | 81   |  | 03.97  | 07.99  | PR: 1KK   |  |  |  |   |  |
| 2.0 i  |  |  | 02.93  | 07.99  | PR: 1KK   |  |  |  |   |  |
| 2.0 i 16V Cupra  | 110  |  | 07.96  | 07.99  | PR: 1KK   |  |  |  |   |  |
|  | 1.8 i 16V  |  |  | 02.94  | 07.99   |  | 24.0110-0111.1   | 410111   | 226 10,0 8,0 +B<br>226 10,0 8,0 +B                  |  |
|  | 1.9 TDI  | 81   |  | 03.97  | 07.99   |  | 24.0110-0275.2   | 410275   |   |  |
|  | 2.0 i  |  |  | 02.93  | 07.99   |  |  |  |   |  |
|  | 1.0 i  |  |  | 02.93  | 07.99   | PR: 1KK  | 24.0109-0124.1   | 409124   |   |  |
|  | 1.3 i  |  |  | 02.93  | 07.99   | PR: 1KK  |  |  |   |  |
|  | 1.4  |  |  | 09.93  | 07.99   | PR: 1KK  |  |  |   |  |
|  | 1.4 i 16V  | 74   |  | 09.96  | 07.99   | PR: 1KK  |  |  |   |  |
|  | 1.6 i  |  |  | 02.93  | 07.99   | PR: 1KK  |  |  |   |  |
|  | 1.8 i  |  |  | 02.93  | 07.99   | PR: 1KK  |  |  |   |  |
|  | 1.8 i 16V  |  |  | 02.94  | 07.99   | PR: 1KK  |  |  |   |  |
|  | 1.9 D  |  |  | 02.93  | 07.99   | PR: 1KK  |  |  |   |  |
|  | 1.9 SDI  |  |  | 09.95  | 07.99   | PR: 1KK  |  |  |   |  |
| 1.9 TD   |  |  | 02.93  | 07.99  | PR: 1KK   |  |  |  |   |  |
| 1.9 TDI  | 66   |  | 07.96  | 07.99  | PR: 1KK   |  |  |  |   |  |
| 1.9 TDI  | 81   |  | 03.97  | 07.99  | PR: 1KK   |  |  |  |   |  |
| 2.0 i  |  |  | 02.93  | 07.99  | PR: 1KK   |  |  |  |   |  |
| 2.0 i 16V Cupra  | 110  |  | 07.96  | 07.99  | PR: 1KK   |  |  |  |   |  |

1) without sensor ring / senza sensori / sans secours ABS / sin anillo sensor ABS

2) with sensor ring / con sensori / avec secours ABS / con anillo sensor ABS

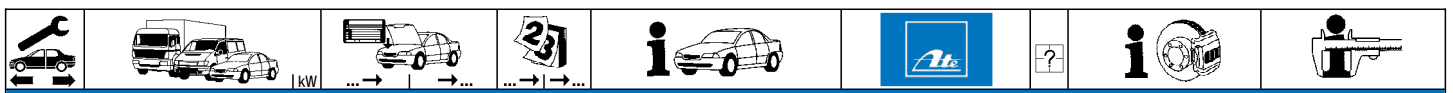

### SEAT IBIZA II (93-99)

|                 |           |       |       |         |         |                |        |   |  |                |        |  |  |
|-----------------|-----------|-------|-------|---------|---------|----------------|--------|---|--|----------------|--------|--|--|
|                 | 1.8 i     |       | 02.93 | 07.99   | PR: 1KK | 24.0109-0124.1 | 409124 |   | 232 9,0 7,0 +B                                   |                |        |  |  |
|                 | 1.8 i 16V |       | 02.94 | 07.99   | PR: 1KK |                |        |   |  |                |        |  |  |
|                 | 1.9 D     |       | 02.93 | 07.99   | PR: 1KK |                |        |   |  |                |        |  |  |
|                 | 1.9 SDI   |       | 09.95 | 07.99   | PR: 1KK |                |        |   |  |                |        |  |  |
|                 | 1.9 TD    |       | 02.93 | 07.99   | PR: 1KK |                |        |   |  |                |        |  |  |
|                 | 1.9 TDI   | 66    | 07.96 | 07.99   | PR: 1KK |                |        |   |  |                |        |  |  |
|                 | 1.9 TDI   | 81    | 03.97 | 07.99   | PR: 1KK |                |        |   |  |                |        |  |  |
|                 | 2.0 i     |       | 02.93 | 07.99   | PR: 1KK |                |        |   |  |                |        |  |  |
| 2.0 i 16V Cupra | 110       | 07.96 | 07.99 | PR: 1KK |         |                |        |   |  |                |        |  |  |
|                 | 1.0 i     |       | 02.93 | 07.99   |         | 24.0741-1108.3 | 360093 | 2   | Radsensor L=843                                  |                |        |  |  |
|                 | 1.3 i     |       | 02.93 | 07.99   |         |                |        |   |  |                |        |  |  |
|                 | 1.4       |       | 09.93 | 07.99   |         |                |        |   |  |                |        |  |  |
|                 | 1.4 i 16V | 74    | 09.96 | 07.99   |         |                |        |   |  |                |        |  |  |
|                 | 1.6 i     |       | 02.93 | 07.99   |         |                |        |   |  |                |        |  |  |
|                 | 1.8 i     |       | 02.93 | 07.99   |         |                |        |   |  |                |        |  |  |
|                 | 1.8 i 16V |       | 02.94 | 07.99   |         |                |        |   |  |                |        |  |  |
|                 | 1.9 D     |       | 02.93 | 07.99   |         |                |        |   |  |                |        |  |  |
|                 | 1.9 SDI   |       | 09.95 | 07.99   |         |                |        |   |  |                |        |  |  |
|                 | 1.9 TD    |       | 02.93 | 07.99   |         |                |        |   |  |                |        |  |  |
|                 | 1.9 TDI   | 66    | 07.96 | 07.99   |         |                |        |   |  |                |        |  |  |
|                 | 1.9 TDI   | 81    | 03.97 | 07.99   |         |                |        |   |  |                |        |  |  |
|                 | 2.0 i     |       | 02.93 | 07.99   |         |                |        |   |  |                |        |  |  |
| 2.0 i 16V Cupra | 110       | 07.96 | 07.99 |         |         |                |        |   |  |                |        |  |  |
|                 | 1.0 i     |       | 02.93 | 07.99   | - ABS   | 03.0137-0126.2 | 650126 |   | 180 x 31 HEB<br>Bremsbacken-Zubehör              |                |        |  |  |
|                 | 1.3 i     |       | 02.93 | 07.99   | - ABS   |                |        |   |  |                |        |  |  |
|                 | 1.4       |       | 09.93 | 07.99   | - ABS   |                |        |   |  |                |        |  |  |
|                 | 1.4 i 16V | 74    | 09.96 | 07.99   | - ABS   |                |        |   |  |                |        |  |  |
|                 | 1.6 i     |       | 02.93 | 07.99   | - ABS   |                |        |   |  |                |        |  |  |
|                 | 1.0 i     |       | 02.93 | 07.99   | + ABS   |                |        |   |  | 03.0137-0268.2 | 650268 |  | 200 x 40 HEB<br>Bremsbacken-Zubehör                |
| 1.3 i           |           | 02.93 | 07.99 | + ABS   |         |                |        |   |  |                |        |  |  |
| 1.4             |           | 09.93 | 07.99 | + ABS   |         |                |        |   |  |                |        |  |  |
| 1.4 i 16V       | 74        | 09.96 | 07.99 | + ABS   |         |                |        |   |  |                |        |  |  |
| 1.6 i           |           | 02.93 | 07.99 | + ABS   |         |                |        |   |  |                |        |  |  |
| 1.8 i           |           | 02.93 | 07.99 |         |         |                |        |   |  |                |        |  |  |
| 1.9 D           |           | 02.93 | 07.99 |         |         |                |        |   |  |                |        |  |  |
| 1.9 SDI         |           | 09.95 | 07.99 |         |         |                |        |   |  |                |        |  |  |
| 1.9 TD          |           | 02.93 | 07.99 |         |         |                |        |   |  |                |        |  |  |
| 1.9 TDI         | 66        | 07.96 | 07.99 |         |         |                |        |   |  |                |        |  |  |
|                 | 1.0 i     |       | 02.93 | 07.99   | - ABS   | 24.0218-0007.1 | 480003 |   | 180/181 x 38,5 - Lager<br>180/181 x 38,5 + Lager |                |        |  |  |
|                 | 1.3 i     |       | 02.93 | 07.99   | - ABS   |                |        |   |  |                |        |  |  |
|                 | 1.4       |       | 09.93 | 07.99   | - ABS   |                |        |   |  |                |        |  |  |
|                 | 1.4 i 16V | 74    | 09.96 | 07.99   | - ABS   |                |        |   |  |                |        |  |  |
|                 | 1.6 i     |       | 02.93 | 07.99   | - ABS   |                |        |   |  |                |        |  |  |
|                 | 1.0 i     |       | 02.93 | 07.99   | + ABS   |                |        |   |  | 24.0220-0018.1 | 480019 | ohne Sensorring <sup>1)</sup><br>ohne Sensorring <sup>1)</sup> | 200/201 x 50,0 - Lager<br>200/201,5 x 50,0 + Lager |
|                 | 1.3 i     |       | 02.93 | 07.99   | + ABS   |                |        |   |  |                |        |  |  |
|                 | 1.4       |       | 09.93 | 07.99   | + ABS   |                |        |   |  |                |        |  |  |
|                 | 1.4 i 16V | 74    | 09.96 | 07.99   | + ABS   |                |        |   |  |                |        |  |  |
|                 | 1.6 i     |       | 02.93 | 07.99   | + ABS   |                |        |   |  |                |        |  |  |
|                 | 1.8 i     |       | 02.93 | 07.99   |         |                |        |   |  |                |        |  |  |
|                 | 1.9 D     |       | 02.93 | 07.99   |         |                |        |   |  |                |        |  |  |
| 1.9 SDI         |           | 09.95 | 07.99 |         |         |                |        |   |  |                |        |  |  |
| 1.9 TD          |           | 02.93 | 07.99 |         |         |                |        |   |  |                |        |  |  |
| 1.9 TDI         | 66        | 07.96 | 07.99 |         |         |                |        |   |  |                |        |  |  |
|                 | 1.0 i     |       | 02.93 | 07.99   | - ABS   | 03.0420-0617.3 | 680617 | + Rz GG <sup>2)</sup><br>+ Rz ALU <sup>3)</sup> | 17,46/180x31 Kit<br>17,46/180x31 TopKit          |                |        |  |  |
|                 | 1.3 i     |       | 02.93 | 07.99   | - ABS   |                |        |   |  |                |        |  |  |
|                 | 1.4       |       | 09.93 | 07.99   | - ABS   |                |        |   |  |                |        |  |  |
|                 | 1.4 i 16V | 74    | 09.96 | 07.99   | - ABS   |                |        |   |  |                |        |  |  |
|                 | 1.6 i     |       | 02.93 | 07.99   | - ABS   |                |        |   |  |                |        |  |  |
|                 | 1.0 i     |       | 02.93 | 07.99   | + ABS   |                |        |   |  | 03.0420-1517.3 | 681517 |  | 17,46/200x40 Kit<br>17,46/200x40 TopKit            |
| 1.3 i           |           | 02.93 | 07.99 | + ABS   |         |                |        |   |  |                |        |  |  |
| 1.4             |           | 09.93 | 07.99 | + ABS   |         |                |        |   |  |                |        |  |  |
| 1.4 i 16V       | 74        | 09.96 | 07.99 | + ABS   |         |                |        |   |  |                |        |  |  |
| 1.6 i           |           | 02.93 | 07.99 | + ABS   |         |                |        |   |  |                |        |  |  |
| 1.8 i           |           | 02.93 | 07.99 |         |         |                |        |   |  |                |        |  |  |
| 1.9 D           |           | 02.93 | 07.99 |         |         |                |        |   |  |                |        |  |  |
| 1.9 SDI         |           | 09.95 | 07.99 |         |         |                |        |   |  |                |        |  |  |
| 1.9 TD          |           | 02.93 | 07.99 |         |         |                |        |   |  |                |        |  |  |
| 1.9 TDI         | 66        | 07.96 | 07.99 |         |         |                |        |   |  |                |        |  |  |





















### SEAT IBIZA III (6K1) (99-02)















|         |           |       |       |             |                |                |        |               |              |    |                |        |  |               |     |
|---------|-----------|-------|-------|-------------|----------------|----------------|--------|---------------|--------------|----|----------------|--------|--|---------------|-----|
|         | 1.0 i     |       | 08.99 | 01.02       | PR: 1LG        | 13.0460-7101.2 | 607101 |               | 21866 15,3 + | VW |                |        |  |               |     |
|         | 1.4 i     | 44    | 08.99 | 01.02       | PR: 1LG        |                |        |               |              |    |                |        |  |               |     |
|         | 1.4 i 16V |       | 08.99 | 01.02       | PR: 1LG        |                |        |               |              |    |                |        |  |               |     |
|         | 1.6 i     |       | 08.99 | 01.02       | PR: 1LG        |                |        |               |              |    |                |        |  |               |     |
|         | 1.9 SDI   | 50    | 08.99 | 01.02       | PR: 1LG        |                |        |               |              |    |                |        |  |               |     |
|         | 1.9 TDI   | 66    | 08.99 | 01.02       | PR: 1LG        |                |        |               |              |    |                |        |  |               |     |
|         | 1.9 TDI   | 81    | 08.99 | 01.02       | PR: 1LG        |                |        |               |              |    |                |        |  |               |     |
|         | 1.0 i     |       | 08.99 | 01.02       | PR: 12K        |                |        |               |              |    | 13.0460-2821.2 | 602821 |  | 21945 16,0 /S | TRW |
|         | 1.4 i     | 44    | 08.99 | 01.02       | PR: 1LM,12K    |                |        |               |              |    |                |        |  |               |     |
|         | 1.4 i 16V |       | 08.99 | 01.02       | PR: 12K        |                |        |               |              |    |                |        |  |               |     |
| 1.6 i   |           | 08.99 | 01.02 | PR: 12K     |                |                |        |               |              |    |                |        |  |               |     |
| 1.9 SDI | 50        | 08.99 | 01.02 | PR: 1LM,12K |                |                |        |               |              |    |                |        |  |               |     |
| 1.9 TDI | 66        | 08.99 | 01.02 | PR: 12K     |                |                |        |               |              |    |                |        |  |               |     |
| 1.9 TDI | 81        | 08.99 | 01.02 | PR: 12K     |                |                |        |               |              |    |                |        |  |               |     |
| 1.0 i   |           | 08.99 | 01.02 | PR: 1LV,1LW | 13.0460-2958.2 | 602958         |        | 20168 19,3 /S | TRW          |    |                |        |  |               |     |
| 1.4 i   | 44        | 08.99 | 01.02 | PR: 1LV,1LW |                |                |        |               |              |    |                |        |  |               |     |

<sup>1)</sup> without sensor ring / senza sensori / sans secours ABS / sin anillo sensor ABS















<sup>2)</sup> + WC cast iron / + CR ghisa / + CR fonte grise / + CR fundición de gris













<sup>3)</sup> + WC aluminium / + CR alluminio / + CR aluminium / + CR aluminio





|     |          |  |  |  |    |  |    |  |
|--|--|--|--|--|---|--|--|--|
| <b>SEAT IBIZA III (6K1) (99-02)</b>  |  |  |  |  |   |  |  |  |
|    | 1.4 i 16V<br>1.6 i<br>1.9 SDI<br>1.9 TDI<br>1.9 TDI                                      | 50<br>66<br>81   | 08.99<br>08.99<br>08.99<br>08.99   | 01.02<br>01.02<br>01.02<br>01.02   | PR: 1LV,1LW<br>PR: 1LV,1LW<br>PR: 1LV,1LW<br>PR: 1LV,1LW  | 13.0460-2958.2<br>602958   |  | 20168 19,3 /S TRW  |
|  | 1.8 T 20V Cupra  | 115  | 07.00  | 01.02  |   | 13.0460-4964.2<br>604964   |  | 21381 15,0 BRE   |
|  | 1.0 i<br>1.4 i<br>1.4 i 16V<br>1.6 i<br>1.9 SDI<br>1.9 TDI<br>1.9 TDI                    | 44<br>50<br>66<br>81   | 08.99<br>08.99<br>08.99<br>08.99<br>08.99<br>08.99                               | 01.02<br>01.02<br>01.02<br>01.02<br>01.02<br>01.02                               | PR: 1LA<br>PR: 1LA<br>PR: 1LA<br>PR: 1LA<br>PR: 1LA<br>PR: 1LA  | 13.0460-7059.2<br>607059   | -ABS   | 20887 17,3 +/Zub VW  |
|    | 1.4 i<br>1.9 SDI   | 44<br>50   | 08.99<br>08.99   | 01.02<br>01.02   | PR: 1LM<br>PR: 1LM  | 24.0112-0106.1<br>412106<br>24.0312-0106.1<br>512106                               |  | 239 12,0 10,0 +S +B<br>239 12,0 10,0 +S +B PD                                      |
|  | 1.0 i<br>1.4 i<br>1.4 i 16V<br>1.6 i<br>1.9 SDI<br>1.9 TDI<br>1.9 TDI                    | 44<br>50<br>66<br>81   | 08.99<br>08.99<br>08.99<br>08.99<br>08.99<br>08.99                               | 01.02<br>01.02<br>01.02<br>01.02<br>01.02<br>01.02                               | PR: 1LG<br>PR: 1LG<br>PR: 1LG<br>PR: 1LG<br>PR: 1LG<br>PR: 1LG  | 24.0120-0123.1<br>420123<br>24.0320-0123.1<br>520123                               |  | 239 20,0 18,0 V L +S +B<br>239 20,0 18,0 V L +S +B PD                              |
|  | 1.0 i<br>1.4 i<br>1.4 i 16V<br>1.6 i<br>1.9 SDI<br>1.9 TDI<br>1.9 TDI                    | 44<br>50<br>66<br>81   | 08.99<br>08.99<br>08.99<br>08.99<br>08.99<br>08.99                               | 01.02<br>01.02<br>01.02<br>01.02<br>01.02<br>01.02                               | PR: 1ZK<br>PR: 1ZK<br>PR: 1ZK<br>PR: 1ZK<br>PR: 1ZK<br>PR: 1ZK  | 24.0120-0128.1<br>420128<br>24.0320-0128.1<br>520128                               |  | 256 20,0 18,0 V L +S +B<br>256 20,0 18,0 V L +S +B PD                              |
|  | 1.0 i<br>1.4 i<br>1.4 i 16V<br>1.6 i<br>1.9 SDI<br>1.9 TDI<br>1.9 TDI                    | 44<br>50<br>66<br>81   | 08.99<br>08.99<br>08.99<br>08.99<br>08.99<br>08.99                               | 01.02<br>01.02<br>01.02<br>01.02<br>01.02<br>01.02                               | PR: 1LV,1LW<br>PR: 1LV,1LW<br>PR: 1LV,1LW<br>PR: 1LV,1LW<br>PR: 1LV,1LW<br>PR: 1LV,1LW  | 24.0122-0101.1<br>422101   |  | 280 22,0 20,0 V L +B   |
|  | 1.0 i<br>1.4 i<br>1.4 i 16V<br>1.6 i<br>1.9 SDI<br>1.9 TDI<br>1.9 TDI                    | 44<br>50<br>66<br>81   | 08.99<br>08.99<br>08.99<br>08.99<br>08.99<br>08.99                               | 01.02<br>01.02<br>01.02<br>01.02<br>01.02<br>01.02                               | PR: 1LA<br>PR: 1LA<br>PR: 1LA<br>PR: 1LA<br>PR: 1LA<br>PR: 1LA  | 24.0110-0151.1<br>410151<br>24.0310-0151.1<br>510151                               | -ABS<br>-ABS   | 239 10,0 8,0 +S +B<br>239 10,0 8,0 +S +B PD  |
|  | 1.0 i<br>1.4 i<br>1.4 i 16V<br>1.6 i<br>1.8 T 20V Cupra<br>1.9 SDI<br>1.9 TDI<br>1.9 TDI | 44<br>115<br>50<br>66<br>81  | 08.99<br>08.99<br>08.99<br>08.99<br>07.00<br>08.99<br>08.99<br>08.99             | 01.02<br>01.02<br>01.02<br>01.02<br>01.02<br>01.02<br>01.02                      |   | 24.0711-1361.3<br>360022<br>24.0711-1362.3<br>360023                               | <br> | Radsensor<br>Radsensor   |
|  | 1.0 i<br>1.4 i<br>1.4 i 16V<br>1.6 i<br>1.8 T 20V Cupra<br>1.9 SDI<br>1.9 TDI<br>1.9 TDI | 44<br>115<br>50<br>66<br>81  | 08.99<br>08.99<br>08.99<br>08.99<br>07.00<br>08.99<br>08.99<br>08.99             | 01.02<br>01.02<br>01.02<br>01.02<br>01.02<br>01.02<br>01.02                      | PR: 1KE,1KK,1KQ<br>PR: 1KE,1KK,1KQ<br>PR: 1KE,1KK,1KQ<br>PR: 1KE,1KK,1KQ<br>PR: 1KE,1KK,1KQ<br>PR: 1KE,1KK,1KQ<br>PR: 1KE,1KK,1KQ | 13.0460-2894.2<br>602894<br>13.0470-2894.2<br>LD2894<br>13.0460-0072.2<br>610072   |  | 20961 17,4 /Zub/S TRW<br>20961 17,4 /Zub/S TRW<br>Belagsatz-Zubehör TRW            |
|  | 1.0 i<br>1.4 i<br>1.4 i 16V<br>1.6 i<br>1.8 T 20V Cupra<br>1.9 SDI<br>1.9 TDI<br>1.9 TDI | 44<br>115<br>50<br>66<br>81  | 08.99<br>08.99<br>08.99<br>08.99<br>07.00<br>08.99<br>08.99<br>08.99             | 01.02<br>01.02<br>01.02<br>01.02<br>01.02<br>01.02<br>01.02                      | PR: 1KE,1KK,1KQ<br>PR: 1KE,1KK,1KQ<br>PR: 1KE,1KK,1KQ<br>PR: 1KE,1KK,1KQ<br>PR: 1KE,1KK,1KQ<br>PR: 1KE,1KK,1KQ<br>PR: 1KE,1KK,1KQ | 24.0109-0124.1<br>409124   |  | 232 9,0 7,0 +B   |
|  | 1.0 i<br>1.4 i<br>1.4 i 16V<br>1.6 i<br>1.8 T 20V Cupra<br>1.9 SDI<br>1.9 TDI<br>1.9 TDI | 44<br>115<br>50<br>66<br>81  | 08.99<br>08.99<br>08.99<br>08.99<br>07.00<br>08.99<br>08.99<br>08.99             | 01.02<br>01.02<br>01.02<br>01.02<br>01.02<br>01.02<br>01.02                      |   | 24.0741-1108.3<br>360093   |   | Radsensor L=843  |
|  | 1.0 i<br>1.4 i<br>1.4 i 16V<br>1.6 i<br>1.9 SDI<br>1.9 TDI                               | 44<br>50<br>66   | 08.99<br>08.99<br>08.99<br>08.99<br>08.99  | 01.02<br>01.02<br>01.02<br>01.02<br>01.02  |   | 03.0137-0268.2<br>650268<br>03.0137-9168.2<br>669168                               |  | 200 x 40 HEB VW<br>Bremsbacken-Zubehör VW  |
|  | 1.0 i<br>1.4 i<br>1.4 i 16V<br>1.6 i   | 44   | 08.99<br>08.99<br>08.99<br>08.99   | 01.02<br>01.02<br>01.02<br>01.02   |   | 24.0220-0032.1<br>480130   |  | 200/201,5 x 50,1   |













|     |   |          |  |    |   |    |  |  |                   |
|--|---|--|--|--|--|--|--|--|-------------------|
| <b>SEAT IBIZA III (6K1) (99-02)</b>  |   |  |  |  |  |  |  |  |                   |
|    | 1.9 SDI<br>1.9 TDI  | 50<br>66   |  | 08.99<br>08.99   | 01.02<br>01.02   |  | 24.0220-0032.1<br>480130   | 200/201,5 x 50,1   |                   |
|    | 1.0 i<br>1.4 i<br>1.4 i 16V<br>1.6 i<br>1.9 SDI<br>1.9 TDI  | 44<br>55<br>55<br>50<br>66   |  | 08.99<br>08.99<br>08.99<br>08.99<br>08.99  | 01.02<br>01.02<br>01.02<br>01.02<br>01.02  |  | 03.0520-1517.3<br>691517   | 17,46/200x40 TopKit VW   |                   |
| <b>SEAT IBIZA IV (6L1) (02-10)</b>   |   |  |  |  |  |  |  |  |                   |
|    | 1.2<br>1.2 i<br>1.2 i 12V<br>1.4 i 16V<br>1.4 i 16V<br>1.4 i 16V<br>1.4 TDI<br>1.4 TDI<br>1.4 TDI<br>1.6 i 16V<br>1.8 T FR<br>1.9 SDI<br>1.9 TDI<br>1.9 TDI<br>1.9 TDI Cupra R<br>2.0 | 44<br>47<br>51<br>55<br>63<br>74<br>51<br>55<br>59<br>110<br>47<br>74<br>96<br>118<br>85 |  | 06.07<br>02.02<br>05.06<br>02.02<br>05.06<br>02.02<br>05.05<br>02.02<br>05.05<br>02.03<br>12.03<br>02.02<br>02.02<br>02.02<br>03.04<br>04.02 | 05.08<br>02.10<br>02.10<br>02.10<br>02.10<br>02.10<br>02.10<br>02.10<br>02.10<br>02.10<br>02.10<br>02.10<br>02.10<br>02.10<br>02.08<br>02.10 | PR: 1LQ,1ZF<br>PR: 1LQ,1ZF<br>PR: 1LQ,1ZF<br>PR: 1LQ,1ZF<br>PR: 1LQ,1ZF<br>PR: 1LQ,1ZF<br>PR: 1LQ,1ZF<br>PR: 1LQ,1ZF<br>PR: 1LQ,1ZF<br>PR: 1LQ,1ZF<br>PR: 1LQ,1ZF<br>PR: 1LQ,1ZF<br>PR: 1LQ,1ZF<br>PR: 1LQ,1ZF<br>PR: 1LQ,1ZF<br>PR: 1LQ,1ZF | 13.0460-7111.2<br>607111<br>13.0470-7111.2<br>LD7111                               | 23130 19,6 +<br>23130 19,6 +   | VW<br>VW          |
|  | 1.2<br>1.2 i<br>1.2 i 12V<br>1.4 i 16V<br>1.4 i 16V<br>1.4 i 16V<br>1.4 TDI<br>1.4 TDI<br>1.4 TDI<br>1.6 i 16V<br>1.8 T FR<br>1.9 SDI<br>1.9 TDI<br>1.9 TDI<br>1.9 TDI Cupra R<br>2.0 | 44<br>47<br>51<br>55<br>63<br>74<br>51<br>55<br>59<br>110<br>47<br>74<br>96<br>118<br>85 |  | 06.07<br>02.02<br>05.06<br>02.02<br>05.06<br>02.02<br>05.05<br>02.02<br>05.05<br>02.03<br>12.03<br>02.02<br>02.02<br>02.02<br>03.04<br>04.02 | 05.08<br>02.10<br>02.10<br>02.10<br>02.10<br>02.10<br>02.10<br>02.10<br>02.10<br>02.10<br>02.10<br>02.10<br>02.10<br>02.10<br>02.08<br>02.10 | PR: 1LN,1ZH<br>PR: 1LN,1ZH<br>PR: 1LN,1ZH<br>PR: 1LN,1ZH<br>PR: 1LN,1ZH<br>PR: 1LN,1ZH<br>PR: 1LN,1ZH<br>PR: 1LN,1ZH<br>PR: 1LN,1ZH<br>PR: 1LN,1ZH<br>PR: 1LN,1ZH<br>PR: 1LN,1ZH<br>PR: 1LN,1ZH<br>PR: 1LN,1ZH<br>PR: 1LN,1ZH<br>PR: 1LN,1ZH | 13.0460-2883.2<br>602883<br>13.0460-2884.2<br>602884<br>13.0470-2884.2<br>LD2884   | 23581 18,8 /S<br>23843 18,8 +/WK/S<br>23843 18,8 +/WK/S                            | TRW<br>TRW<br>TRW |
|  | 1.8 T Cupra R   | 132  |  | 01.04  | 02.10  |  | 13.0460-7081.2<br>607081<br>13.0470-7081.2<br>LD7081                               | 21911 20,3 +<br>21911 20,3 +   | ATE<br>ATE        |
|  | 1.2<br>1.2 i<br>1.2 i 12V<br>1.4 i 16V<br>1.4 i 16V<br>1.4 i 16V<br>1.4 TDI<br>1.4 TDI<br>1.4 TDI<br>1.6 i 16V<br>1.8 T FR<br>1.9 SDI<br>1.9 TDI<br>1.9 TDI<br>1.9 TDI Cupra R<br>2.0 | 44<br>47<br>51<br>55<br>63<br>74<br>51<br>55<br>59<br>110<br>47<br>74<br>96<br>118<br>85 |  | 06.07<br>02.02<br>05.06<br>02.02<br>05.06<br>02.02<br>05.05<br>02.02<br>05.05<br>02.03<br>12.03<br>02.02<br>02.02<br>02.02<br>03.04<br>04.02 | 05.08<br>02.10<br>02.10<br>02.10<br>02.10<br>02.10<br>02.10<br>02.10<br>02.10<br>02.10<br>02.10<br>02.10<br>02.10<br>02.10<br>02.08<br>02.10 | PR: 1LQ,1ZF<br>PR: 1LQ,1ZF<br>PR: 1LQ,1ZF<br>PR: 1LQ,1ZF<br>PR: 1LQ,1ZF<br>PR: 1LQ,1ZF<br>PR: 1LQ,1ZF<br>PR: 1LQ,1ZF<br>PR: 1LQ,1ZF<br>PR: 1LQ,1ZF<br>PR: 1LQ,1ZF<br>PR: 1LQ,1ZF<br>PR: 1LQ,1ZF<br>PR: 1LQ,1ZF<br>PR: 1LQ,1ZF<br>PR: 1LQ,1ZF | 24.0122-0151.1<br>422151<br>24.0322-0151.1<br>522151                               | 256 22,0 19,0 V L +S +B<br>256 22,0 19,0 V L +S +B PD                              |                   |
|  | 1.2<br>1.2 i<br>1.2 i 12V<br>1.4 i 16V<br>1.4 i 16V<br>1.4 i 16V<br>1.4 TDI<br>1.4 TDI<br>1.4 TDI<br>1.6 i 16V<br>1.8 T FR<br>1.9 SDI<br>1.9 TDI<br>1.9 TDI<br>1.9 TDI Cupra R<br>2.0 | 44<br>47<br>51<br>55<br>63<br>74<br>51<br>55<br>59<br>110<br>47<br>74<br>96<br>118<br>85 |  | 06.07<br>02.02<br>05.06<br>02.02<br>05.06<br>02.02<br>05.05<br>02.02<br>05.05<br>02.03<br>12.03<br>02.02<br>02.02<br>02.02<br>03.04<br>04.02 | 05.08<br>02.10<br>02.10<br>02.10<br>02.10<br>02.10<br>02.10<br>02.10<br>02.10<br>02.10<br>02.10<br>02.10<br>02.10<br>02.10<br>02.08<br>02.10 | PR: 1LN,1ZH<br>PR: 1LN,1ZH<br>PR: 1LN,1ZH<br>PR: 1LN,1ZH<br>PR: 1LN,1ZH<br>PR: 1LN,1ZH<br>PR: 1LN,1ZH<br>PR: 1LN,1ZH<br>PR: 1LN,1ZH<br>PR: 1LN,1ZH<br>PR: 1LN,1ZH<br>PR: 1LN,1ZH<br>PR: 1LN,1ZH<br>PR: 1LN,1ZH<br>PR: 1LN,1ZH<br>PR: 1LN,1ZH | 24.0125-0113.1<br>425113<br>24.0325-0113.1<br>525113                               | 288 25,0 22,0 V L +S +B<br>288 25,0 22,0 V L +S +B PD                              |                   |
|  | 1.8 T Cupra R   | 132  |  | 01.04  | 02.10  |  | 24.0125-0123.1<br>425123<br>24.0325-0123.1<br>525123                               | 310 25,0 22,0 V L +S +B<br>310 25,0 22,0 V L +S +B PD                              |                   |
|  | 1.2<br>1.2 i<br>1.2 i 12V<br>1.4 i 16V<br>1.4 i 16V<br>1.4 i 16V<br>1.4 TDI<br>1.4 TDI  | 44<br>47<br>51<br>55<br>63<br>74<br>51<br>55   |  | 06.07<br>02.02<br>05.06<br>02.02<br>05.06<br>02.02<br>05.05<br>02.02   | 05.08<br>02.10<br>02.10<br>02.10<br>02.10<br>02.10<br>02.10<br>02.10   |  | 24.0711-5273.3<br>360303<br>24.0711-5274.3<br>360304                               | Radsensor<br>Radsensor   |                   |



|     |  kW   |  |   |  |   |  |  |    |
|--|---|--|---|--|--|--|--|--|
| <b>SEAT IBIZA IV (6L1) (02-10)</b>   |   |  |   |  |  |  |  |  |
|    | 1.4 TDI 59<br>1.6 i 16V<br>1.8 T Cupra R 132<br>1.8 T FR 110<br>1.9 SDI 47<br>1.9 TDI 74<br>1.9 TDI 96<br>1.9 TDI Cupra R 118<br>2.0 85   |  | 05.05 02.10<br>02.03 02.10<br>01.04 02.10<br>12.03 02.10<br>02.02 02.10<br>02.02 02.10<br>02.02 02.10<br>03.04 02.08<br>04.02 02.10   |  | 24.0711-5273.3 360303<br>24.0711-5274.3 360304   | <input type="checkbox"/><br><input type="checkbox"/>                               |  | Radsensor<br>Radsensor   |
|    | 1.2 44<br>1.2 i 47<br>1.2 i 12V 51<br>1.4 i 16V 55<br>1.4 i 16V 63<br>1.4 i 16V 74<br>1.4 TDI 51<br>1.4 TDI 55<br>1.4 TDI 59<br>1.6 i 16V<br>1.8 T Cupra R 132<br>1.8 T FR 110<br>1.9 SDI 47<br>1.9 TDI 74<br>1.9 TDI 96<br>1.9 TDI Cupra R 118<br>2.0 85 |  | 06.07 05.08<br>02.02 02.10<br>05.06 02.10<br>02.02 02.10<br>05.06 02.10<br>02.02 02.10<br>05.05 02.10<br>02.02 02.10<br>05.05 02.10<br>02.03 02.10<br>01.04 02.10<br>12.03 02.10<br>02.02 02.10<br>02.02 02.10<br>02.02 02.10<br>03.04 02.08<br>04.02 02.10 |  | 13.0460-2894.2 602894<br>13.0470-2894.2 LD2894<br>13.0460-2864.2 602864<br>13.0460-2877.2 602877<br>13.0470-2877.2 LD2877<br>13.0460-0072.2 610072 |  |  | 20961 17,4 /Zub/S TRW<br>20961 17,4 /Zub/S TRW<br>20961 17,4 /S TRW<br>23554 17,2 +/-WK/S TRW<br>23554 17,2 +/-WK/S TRW<br>Belagsatz-Zubehör TRW |
|    | 1.2 44<br>1.2 i 47<br>1.2 i 12V 51<br>1.4 i 16V 55<br>1.4 i 16V 63<br>1.4 i 16V 74<br>1.4 TDI 51<br>1.4 TDI 55<br>1.4 TDI 59<br>1.6 i 16V<br>1.8 T Cupra R 132<br>1.8 T FR 110<br>1.9 SDI 47<br>1.9 TDI 74<br>1.9 TDI 96<br>1.9 TDI Cupra R 118<br>2.0 85 |  | 06.07 05.08<br>02.02 02.10<br>05.06 02.10<br>02.02 02.10<br>05.06 02.10<br>02.02 02.10<br>05.05 02.10<br>02.02 02.10<br>05.05 02.10<br>02.03 02.10<br>01.04 02.10<br>12.03 02.10<br>02.02 02.10<br>02.02 02.10<br>02.02 02.10<br>03.04 02.08<br>04.02 02.10 |  | 24.0109-0123.1 409123<br>24.0309-0123.1 509123   |  |  | 230 9,0 7,0 +S +B<br>230 9,0 7,0 +S +B PD  |
|  | 1.2 44<br>1.2 i 47<br>1.2 i 12V 51<br>1.4 i 16V 55<br>1.4 i 16V 63<br>1.4 i 16V 74<br>1.4 TDI 51<br>1.4 TDI 55<br>1.4 TDI 59<br>1.6 i 16V<br>1.8 T Cupra R 132<br>1.8 T FR 110<br>1.9 SDI 47<br>1.9 TDI 74<br>1.9 TDI 96<br>1.9 TDI Cupra R 118<br>2.0 85 |  | 06.07 05.08<br>02.02 02.10<br>05.06 02.10<br>02.02 02.10<br>05.06 02.10<br>02.02 02.10<br>05.05 02.10<br>02.02 02.10<br>05.05 02.10<br>02.03 02.10<br>01.04 02.10<br>12.03 02.10<br>02.02 02.10<br>02.02 02.10<br>02.02 02.10<br>03.04 02.08<br>04.02 02.10 |  | 24.0711-6233.3 360315<br>24.0711-6234.3 360316   | <input type="checkbox"/><br><input type="checkbox"/>                               |  | Radsensor<br>Radsensor   |
|  | 1.2 44<br>1.2 i 47<br>1.2 i 12V 51<br>1.4 i 16V 55<br>1.4 i 16V 63<br>1.4 i 16V 74<br>1.4 TDI 51<br>1.4 TDI 55<br>1.4 TDI 59<br>1.6 i 16V<br>1.9 SDI 47<br>1.9 TDI 74<br>1.9 TDI 96<br>1.9 TDI Cupra R 118<br>2.0 85                                      |  | 06.07 05.08<br>02.02 02.10<br>05.06 02.10<br>02.02 02.10<br>05.06 02.10<br>02.02 02.10<br>05.05 02.10<br>02.02 02.10<br>05.05 02.10<br>02.03 02.10<br>02.02 02.10<br>02.02 02.10<br>02.02 02.10<br>02.02 02.10<br>03.04 02.08<br>04.02 02.10                |  | 03.0137-0268.2 650268<br>03.0137-9168.2 669168   |  |  | 200 x 40 HEB VW<br>Bremsbacken-Zubehör VW  |
|  | 1.2 44<br>1.2 i 47<br>1.2 i 12V 51<br>1.4 i 16V 55<br>1.4 i 16V 63<br>1.4 i 16V 74<br>1.4 TDI 51<br>1.4 TDI 55<br>1.4 TDI 59<br>1.6 i 16V<br>1.9 SDI 47<br>1.9 TDI 74<br>1.9 TDI 96<br>1.9 TDI Cupra R 118<br>2.0 85                                      |  | 06.07 05.08<br>02.02 02.10<br>05.06 02.10<br>02.02 02.10<br>05.06 02.10<br>02.02 02.10<br>05.05 02.10<br>02.02 02.10<br>05.05 02.10<br>02.03 02.10<br>02.02 02.10<br>02.02 02.10<br>02.02 02.10<br>02.02 02.10<br>02.02 02.10                               |  | 24.0220-0037.1 480161  |  |  | 200/201,5 x 50,5   |

|     |   |    |   |   |  |  |  |  |
|--|---|--|---|---|---|--|--|--|
| <b>SEAT IBIZA IV (6L1) (02-10)</b>   |   |  |   |   |   |  |  |  |
|    | 1.9 TDI<br>1.9 TDI Cupra R<br>2.0   | 96<br>118<br>85  | 02.02<br>03.04<br>04.02   | 02.10<br>02.08<br>02.10   | 24.0220-0037.1  | 480161   |  | 200/201,5 x 50,5   |
|    | 1.2<br>1.2 i<br>1.2 i 12V<br>1.4 i 16V<br>1.4 i 16V<br>1.4 TDI<br>1.4 TDI<br>1.4 TDI<br>1.6 i 16V<br>1.9 SDI<br>1.9 TDI<br>1.9 TDI<br>1.9 TDI Cupra R<br>2.0  | 44<br>47<br>51<br>55<br>63<br>74<br>51<br>55<br>59<br>47<br>74<br>96<br>118<br>85  | 06.07<br>02.02<br>05.06<br>02.02<br>05.06<br>02.02<br>05.05<br>02.02<br>05.05<br>02.02<br>02.02<br>02.02<br>03.04<br>04.02  | 05.08<br>02.10<br>02.10<br>02.10<br>02.10<br>02.10<br>02.10<br>02.10<br>02.10<br>02.10<br>02.10<br>02.10<br>02.08<br>02.10  | 03.0520-8219.3  | 698219   |  | 19,05/200x40 TopKit<br>VW  |
| <b>SEAT IBIZA V / ST / SC (08-)</b>  |   |  |   |   |   |  |  |  |
|    | 1.0<br>1.0 TSI<br>1.0 TSI<br>1.2<br>1.2<br>1.2 TDI<br>1.2 TSI<br>1.2 TSI<br>1.2 TSI<br>1.2 TSI<br>1.4 i 16V<br>1.4 TDI<br>1.4 TDI<br>1.4 TDI<br>1.4 TDI<br>1.4 TSI<br>1.4 TSI FR<br>1.6 i 16V<br>1.6 LPG<br>1.6 TDI<br>1.6 TDI<br>1.8 TSI Cupra<br>1.9 TDI<br>1.9 TDI<br>2.0<br>2.0 TDI | 55<br>70<br>81<br>44<br>51<br>55<br>63<br>66<br>77<br>81<br>63<br>55<br>59<br>66<br>77<br>110<br>103<br>77<br>60<br>66<br>77<br>141<br>66<br>77<br>85<br>105 | 05.15<br>05.15<br>05.15<br>07.09<br>07.08<br>04.10<br>08.12<br>05.15<br>09.10<br>09.15<br>07.08<br>05.15<br>07.08<br>05.15<br>06.09<br>12.13<br>07.08<br>05.11<br>06.09<br>06.09<br>11.15<br>07.08<br>07.08<br>10.08<br>01.10 | PR: 1ZG<br>PR: 1ZG<br>PR: 1ZG<br>PR: 1LQ,1LR,1ZG<br>PR: 1LQ,1LR,1ZG<br>PR: 1LQ,1LR,1ZG<br>PR: 1LQ,1LR,1ZG<br>PR: 1ZG<br>PR: 1LQ,1LR,1ZG<br>PR: 1LQ,1LR,1ZG<br>PR: 1LQ,1LR,1ZG<br>PR: 1ZG<br>PR: 1LQ,1LR,1ZG<br>PR: 1ZG<br>PR: 1LQ,1LR,1ZG<br>PR: 1LQ,1LR,1ZG<br>PR: 1LQ,1LR,1ZG<br>PR: 1LQ,1LR,1ZG<br>PR: 1LQ,1LR,1ZG<br>PR: 1LQ,1LR,1ZG<br>PR: 1ZG<br>PR: 1LQ,1LR,1ZG<br>PR: 1LQ,1LR,1ZG<br>PR: 1LQ,1LR,1ZG<br>PR: 1LQ,1LR,1ZG | 13.0460-7111.2<br>13.0470-7111.2  | 607111<br>LD7111   |  | 23130 19,6 +<br>23130 19,6 +<br>VW<br>VW   |
|  | 1.2<br>1.2<br>1.2 TDI<br>1.2 TSI<br>1.2 TSI<br>1.4 i 16V<br>1.4 TDI<br>1.4 TSI<br>1.4 TSI FR<br>1.6 i 16V<br>1.6 LPG<br>1.6 TDI<br>1.6 TDI<br>1.9 TDI<br>1.9 TDI<br>2.0<br>2.0 TDI  | 44<br>51<br>55<br>63<br>77<br>63<br>59<br>110<br>103<br>77<br>60<br>66<br>77<br>66<br>77<br>85<br>105  | 07.09<br>07.08<br>04.10<br>08.12<br>09.10<br>07.08<br>07.08<br>06.09<br>12.13<br>07.08<br>05.11<br>06.09<br>06.09<br>07.08<br>07.08<br>10.08<br>01.10   |   | 13.0460-7184.2<br>13.0470-7184.2  | 607184<br>LD7184   | + 15" Bremssystem<br>+ 15" Bremssystem   | 23587 20,6 +/WK<br>23587 20,6 +/WK<br>ATE<br>ATE                                   |
|  | 1.0<br>1.0 TSI<br>1.0 TSI<br>1.2 TSI<br>1.2 TSI<br>1.4 TDI<br>1.4 TDI<br>1.4 TDI<br>1.8 TSI Cupra<br>1.4 TSI Cupra  | 55<br>70<br>81<br>66<br>81<br>55<br>66<br>77<br>141<br>132   | 05.15<br>05.15<br>05.15<br>05.15<br>09.15<br>05.15<br>05.15<br>05.15<br>11.15<br>06.09  | PR: 1ZC<br>PR: 1ZC<br>PR: 1ZC<br>PR: 1ZC<br>PR: 1ZC<br>PR: 1ZC<br>PR: 1ZC<br>PR: 1ZC<br>PR: 1ZC<br>PR: 1LV  | 13.0460-7184.2<br>13.0470-7184.2  | 607184<br>LD7184   |  | 23587 20,6 +/WK<br>23587 20,6 +/WK<br>ATE<br>ATE                                   |
|  | 1.0<br>1.0 TSI<br>1.0 TSI<br>1.2<br>1.2<br>1.2 TDI<br>1.2 TSI<br>1.2 TSI<br>1.2 TSI<br>1.2 TSI<br>1.4 i 16V<br>1.4 TDI<br>1.4 TDI<br>1.4 TDI  | 55<br>70<br>81<br>44<br>51<br>55<br>63<br>66<br>77<br>81<br>63<br>55<br>59<br>66   | 05.15<br>05.15<br>05.15<br>07.09<br>07.08<br>04.10<br>08.12<br>05.15<br>09.10<br>09.15<br>07.08<br>05.15<br>07.08<br>05.15  | PR: 1ZG<br>PR: 1ZG<br>PR: 1ZG<br>PR: 1LQ,1LR,1ZG<br>PR: 1LQ,1LR,1ZG<br>PR: 1LQ,1LR,1ZG<br>PR: 1LQ,1LR,1ZG<br>PR: 1ZG<br>PR: 1LQ,1LR,1ZG<br>PR: 1LQ,1LR,1ZG<br>PR: 1LQ,1LR,1ZG<br>PR: 1ZG<br>PR: 1LQ,1LR,1ZG<br>PR: 1ZG  | 24.0122-0151.1<br>24.0322-0151.1  | 422151<br>522151   |  | 24974 16,8 +<br>AP<br>256 22,0 19,0 V L +S +B<br>256 22,0 19,0 V L +S +B PD        |

| SEAT IBIZA V / ST / SC (08-)   |   |   |  |  |                                  |                  |  |  |   |  |  |
|--|---|---|--|--|----------------------------------|------------------|--|--|---|--|--|
|    | 1.4 TDI<br>1.4 TSI<br>1.4 TSI FR<br>1.6 i 16V<br>1.6 LPG<br>1.6 TDI<br>1.6 TDI<br>1.8 TSI Cupra<br>1.9 TDI<br>1.9 TDI<br>2.0<br>2.0 TDI   | 77<br>110<br>103<br>77<br>60<br>66<br>77<br>141<br>66<br>77<br>85<br>105  | 05.15<br>06.09<br>12.13<br>07.08<br>05.11<br>06.09<br>06.09<br>11.15<br>07.08<br>07.08<br>10.08<br>01.10   | PR: 1ZG<br>PR: 1LQ,1LR,1ZG<br>PR: 1LQ,1LR,1ZG<br>PR: 1LQ,1LR,1ZG<br>PR: 1LQ,1LR,1ZG<br>PR: 1LQ,1LR,1ZG<br>PR: 1LQ,1LR,1ZG<br>PR: 1ZG<br>PR: 1LQ,1LR,1ZG<br>PR: 1LQ,1LR,1ZG<br>PR: 1LQ,1LR,1ZG<br>PR: 1LQ,1LR,1ZG   | 24.0122-0151.1<br>24.0322-0151.1 | 422151<br>522151 |  |  | 256 22,0 19,0 VL +S +B<br>256 22,0 19,0 VL +S +B PD |  |  |
|  | 1.2<br>1.2<br>1.2 TDI<br>1.2 TSI<br>1.2 TSI<br>1.4 i 16V<br>1.4 TDI<br>1.4 TSI<br>1.4 TSI FR<br>1.6 i 16V<br>1.6 LPG<br>1.6 TDI<br>1.6 TDI<br>1.9 TDI<br>1.9 TDI<br>2.0<br>2.0 TDI  | 44<br>51<br>55<br>63<br>77<br>63<br>59<br>110<br>103<br>77<br>60<br>66<br>77<br>66<br>77<br>85<br>105   | 07.09<br>07.08<br>04.10<br>08.12<br>09.10<br>07.08<br>07.08<br>06.09<br>12.13<br>07.08<br>05.11<br>06.09<br>06.09<br>07.08<br>07.08<br>10.08<br>01.10  |  | 24.0125-0113.1<br>24.0325-0113.1 | 425113<br>525113 | + 15" Bremssystem<br>+ 15" Bremssystem   |  | 288 25,0 22,0 VL +S +B<br>288 25,0 22,0 VL +S +B PD |  |  |
|  | 1.0<br>1.0 TSI<br>1.0 TSI<br>1.2 TSI<br>1.2 TSI<br>1.4 TDI<br>1.4 TDI<br>1.4 TDI<br>1.8 TSI Cupra   | 55<br>70<br>81<br>66<br>81<br>55<br>66<br>77<br>141   | 05.15<br>05.15<br>05.15<br>05.15<br>09.15<br>05.15<br>05.15<br>05.15<br>11.15  | PR: 1ZC<br>PR: 1ZC<br>PR: 1ZC<br>PR: 1ZC<br>PR: 1ZC<br>PR: 1ZC<br>PR: 1ZC<br>PR: 1ZC   | 24.0125-0113.1<br>24.0325-0113.1 | 425113<br>525113 |  |  | 288 25,0 22,0 VL +S +B<br>288 25,0 22,0 VL +S +B PD |  |  |
|  | 1.0<br>1.0 TSI<br>1.0 TSI<br>1.2<br>1.2<br>1.2 TDI<br>1.2 TSI<br>1.2 TSI<br>1.2 TSI<br>1.2 TSI<br>1.4 i 16V<br>1.4 TDI<br>1.4 TDI<br>1.4 TDI<br>1.4 TSI<br>1.4 TSI Cupra<br>1.4 TSI FR<br>1.6 i 16V<br>1.6 LPG<br>1.6 TDI<br>1.6 TDI<br>1.8 TSI Cupra<br>1.9 TDI<br>1.9 TDI<br>2.0<br>2.0 TDI | 55<br>70<br>81<br>44<br>51<br>55<br>63<br>66<br>77<br>81<br>63<br>55<br>59<br>66<br>77<br>110<br>132<br>103<br>77<br>60<br>66<br>77<br>141<br>66<br>77<br>85<br>105 | 05.15<br>05.15<br>05.15<br>07.09<br>07.08<br>04.10<br>08.12<br>05.15<br>09.10<br>09.15<br>07.08<br>05.15<br>07.08<br>05.15<br>06.09<br>06.09<br>12.13<br>07.08<br>05.11<br>06.09<br>06.09<br>11.15<br>07.08<br>07.08<br>10.08<br>01.10 | PR: 1ZR,1ZS<br>PR: 1ZR,1ZS<br>PR: 1ZR,1ZS<br>PR: 1ZR,1ZS<br>PR: 1ZR,1ZS<br>PR: 1ZR,1ZS<br>PR: 1ZR,1ZS<br>PR: 1ZR,1ZS<br>PR: 1ZR,1ZS<br>PR: 1ZR,1ZS<br>PR: 1ZR,1ZS<br>PR: 1ZR,1ZS<br>PR: 1ZR,1ZS<br>PR: 1ZR,1ZS<br>PR: 1LV<br>PR: 1ZR,1ZS<br>PR: 1ZR,1ZS<br>PR: 1ZR,1ZS<br>PR: 1ZR,1ZS<br>PR: 1ZR,1ZS<br>PR: 1ZR,1ZS<br>PR: 1ZR,1ZS<br>PR: 1ZR,1ZS<br>PR: 1ZR,1ZS<br>PR: 1ZR,1ZS<br>PR: 1ZR,1ZS | 24.0125-0123.1<br>24.0325-0123.1 | 425123<br>525123 |  |  | 310 25,0 22,0 VL +S +B<br>310 25,0 22,0 VL +S +B PD |  |  |
|  | 1.0<br>1.0 TSI<br>1.0 TSI<br>1.2<br>1.2<br>1.2 TDI<br>1.2 TSI<br>1.2 TSI<br>1.2 TSI<br>1.2 TSI<br>1.4 i 16V<br>1.4 TDI<br>1.4 TDI<br>1.4 TDI<br>1.4 TSI<br>1.4 TSI Cupra<br>1.4 TSI FR<br>1.6 i 16V<br>1.6 LPG<br>1.6 TDI<br>1.6 TDI<br>1.6 TDI   | 55<br>70<br>81<br>44<br>51<br>55<br>63<br>66<br>77<br>81<br>63<br>55<br>59<br>66<br>77<br>110<br>132<br>103<br>77<br>60<br>66<br>77                                 | 05.15<br>05.15<br>05.15<br>07.09<br>07.08<br>04.10<br>08.12<br>05.15<br>09.10<br>09.15<br>07.08<br>05.15<br>07.08<br>05.15<br>06.09<br>06.09<br>12.13<br>07.08<br>05.11<br>06.09<br>06.09  |  | 24.0711-5273.3<br>24.0711-5274.3 | 360303<br>360304 | <br> |  | Radsensor<br>Radsensor                              |  |  |

|     |    kW  |  |   |   |  |  |  |  |
|--|--|--|---|---|---|--|--|--|
| SEAT IBIZA V / ST / SC (08-)   |  |  |   |   |   |  |  |  |
|    | 1.8 TSI Cupra 141<br>1.9 TDI 66<br>1.9 TDI 77<br>2.0 85<br>2.0 TDI 105   |  | 11.15<br>07.08<br>07.08<br>10.08<br>01.10   |   | 24.0711-5273.3 360303<br>24.0711-5274.3 360304                                    |  |  | Radsensor<br>Radsensor   |
|    | 1.0 55<br>1.0 TSI 70<br>1.0 TSI 81<br>1.2 44<br>1.2 51<br>1.2 TDI 55<br>1.2 TSI 63<br>1.2 TSI 66<br>1.2 TSI 77<br>1.2 TSI 81<br>1.4 i 16V 63<br>1.4 TDI 55<br>1.4 TDI 59<br>1.4 TDI 66<br>1.4 TDI 77<br>1.4 TSI Cupra 132<br>1.6 i 16V 77<br>1.6 LPG 60<br>1.6 TDI 66<br>1.6 TDI 77<br>1.8 TSI Cupra 141<br>1.9 TDI 66<br>1.9 TDI 77<br>2.0 85<br>2.0 TDI 105                                  |  | 05.15<br>05.15<br>05.15<br>07.09<br>07.08<br>04.10<br>08.12<br>05.15<br>09.10<br>09.15<br>07.08<br>05.15<br>07.08<br>05.15<br>05.15<br>06.09<br>07.08<br>05.11<br>06.09<br>06.09<br>11.15<br>07.08<br>07.08<br>10.08<br>01.10                   | PR: 1KT<br>PR: 1KT<br>PR: 1KT<br>PR: 1KK,1KT<br>PR: 1KK,1KT<br>PR: 1KK,1KT<br>PR: 1KK,1KT<br>PR: 1KT<br>PR: 1KK,1KT<br>PR: 1KK,1KT<br>PR: 1KK,1KT<br>PR: 1KK,1KT<br>PR: 1KK,1KT<br>PR: 1KK,1KT<br>PR: 1KT<br>PR: 1KK,1KT<br>PR: 1KK,1KT<br>PR: 1KK,1KT<br>PR: 1KK,1KT<br>PR: 1KT<br>PR: 1KK,1KT<br>PR: 1KK,1KT<br>PR: 1KK,1KT<br>PR: 1KT<br>PR: 1KT<br>PR: 1KK,1KT<br>PR: 1KK,1KT                             | 13.0460-2894.2 602894<br>13.0470-2894.2 LD2894<br>13.0460-0072.2 610072           |  |  | 20961 17,4 /Zub/S TRW<br>20961 17,4 /Zub/S TRW<br>Belagsatz-Zubehör TRW            |
|  | 1.4 TSI 110<br>1.4 TSI FR 103  |  | 06.09<br>12.13  | PR: 1KD,1KS<br>PR: 1KD,1KS  | 13.0460-2864.2 602864   |  |  | 20961 17,4 /S TRW  |
|  | 1.0 55<br>1.0 TSI 70<br>1.0 TSI 81<br>1.2 TSI 66<br>1.2 TSI 81<br>1.4 TDI 55<br>1.4 TDI 66<br>1.4 TDI 77<br>1.4 TSI Cupra 132<br>1.8 TSI Cupra 141   |  | 05.15<br>05.15<br>05.15<br>05.15<br>09.15<br>05.15<br>05.15<br>05.15<br>06.09<br>11.15  | PR: 1KV<br>PR: 1KV<br>PR: 1KV<br>PR: 1KV<br>PR: 1KV<br>PR: 1KV<br>PR: 1KV<br>PR: 1KP<br>PR: 1KV   | 13.0460-2820.2 602820<br>13.0470-2820.2 LD2820                                    |  |  | 20961 17,6 /S TRW<br>20961 17,6 /S TRW   |
|  | 1.0 55<br>1.0 TSI 70<br>1.0 TSI 81<br>1.2 44<br>1.2 51<br>1.2 TDI 55<br>1.2 TSI 63<br>1.2 TSI 66<br>1.2 TSI 77<br>1.2 TSI 81<br>1.4 i 16V 63<br>1.4 TDI 55<br>1.4 TDI 59<br>1.4 TDI 66<br>1.4 TDI 77<br>1.4 TSI 110<br>1.4 TSI Cupra 132<br>1.4 TSI FR 103<br>1.6 i 16V 77<br>1.6 LPG 60<br>1.6 TDI 66<br>1.6 TDI 77<br>1.8 TSI Cupra 141<br>1.9 TDI 66<br>1.9 TDI 77<br>2.0 85<br>2.0 TDI 105 |  | 05.15<br>05.15<br>05.15<br>07.09<br>07.08<br>04.10<br>08.12<br>05.15<br>09.10<br>09.15<br>07.08<br>05.15<br>07.08<br>05.15<br>05.15<br>06.09<br>06.09<br>12.13<br>07.08<br>05.11<br>06.09<br>06.09<br>11.15<br>07.08<br>07.08<br>07.08<br>01.10 | PR: 1KV,1KT<br>PR: 1KV,1KT<br>PR: 1KV,1KT<br>PR: 1KK,1KT<br>PR: 1KK,1KT<br>PR: 1KK,1KT<br>PR: 1KV,1KT<br>PR: 1KK,1KT<br>PR: 1KK,1KT<br>PR: 1KK,1KT<br>PR: 1KK,1KT<br>PR: 1KK,1KT<br>PR: 1KK,1KT<br>PR: 1KD,1KS<br>PR: 1KP<br>PR: 1KD,1KS<br>PR: 1KK,1KT<br>PR: 1KK,1KT<br>PR: 1KK,1KT<br>PR: 1KK,1KT<br>PR: 1KV,1KT<br>PR: 1KK,1KT<br>PR: 1KK,1KT<br>PR: 1KK,1KT<br>PR: 1KK,1KT<br>PR: 1KK,1KT<br>PR: 1KK,1KT | 24.0109-0123.1 409123<br>24.0309-0123.1 509123                                    |  |  | 230 9,0 7,0 +S +B<br>230 9,0 7,0 +S +B PD  |
|  | 1.0 55<br>1.0 TSI 70<br>1.0 TSI 81<br>1.2 44<br>1.2 51<br>1.2 TDI 55<br>1.2 TSI 63<br>1.2 TSI 66<br>1.2 TSI 77<br>1.2 TSI 81<br>1.4 i 16V 63<br>1.4 TDI 55<br>1.4 TDI 59<br>1.4 TDI 66<br>1.4 TDI 77<br>1.4 TSI 110<br>1.4 TSI Cupra 132<br>1.4 TSI FR 103   |  | 05.15<br>05.15<br>05.15<br>07.09<br>07.08<br>04.10<br>08.12<br>05.15<br>09.10<br>09.15<br>07.08<br>05.15<br>07.08<br>05.15<br>05.15<br>06.09<br>06.09<br>12.13  |   | 24.0711-6233.3 360315<br>24.0711-6234.3 360316                                    |  |  | Radsensor<br>Radsensor   |

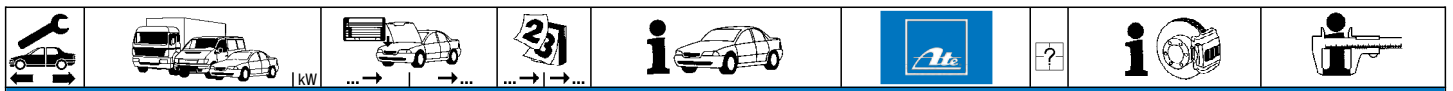

**SEAT IBIZA V / ST / SC (08-)**

|  |   |  |  |   |  |                                  |                                  |                  |  |                                     |                        |  |
|--|---|--|--|---|--|----------------------------------|----------------------------------|------------------|--|-------------------------------------|------------------------|--|
|  | 1.6 i 16V<br>1.6 LPG<br>1.6 TDI<br>1.6 TDI<br>1.8 TSI Cupra<br>1.9 TDI<br>1.9 TDI<br>2.0<br>2.0 TDI   | 77<br>60<br>66<br>77<br>141<br>66<br>77<br>85<br>105   |  | 07.08<br>05.11<br>06.09<br>06.09<br>11.15<br>07.08<br>07.08<br>10.08<br>01.10   |  |                                  | 24.0711-6233.3<br>24.0711-6234.3 | 360315<br>360316 |  |                                     | Radsensor<br>Radsensor |  |
|  | 1.0<br>1.0 TSI<br>1.0 TSI<br>1.2<br>1.2<br>1.2 TDI<br>1.2 TSI<br>1.2 TSI<br>1.2 TSI<br>1.2 TSI<br>1.4 i 16V<br>1.4 TDI<br>1.4 TDI<br>1.4 TDI<br>1.4 TDI<br>1.6 i 16V<br>1.6 LPG<br>1.9 TDI<br>1.9 TDI | 55<br>70<br>81<br>44<br>51<br>55<br>63<br>66<br>77<br>81<br>63<br>55<br>59<br>66<br>77<br>77<br>60<br>66<br>77 |  | 05.15<br>05.15<br>05.15<br>07.09<br>07.08<br>04.10<br>08.12<br>05.15<br>09.10<br>09.15<br>07.08<br>05.15<br>07.08<br>05.15<br>07.08<br>07.08<br>07.08<br>07.08          | PR: 1KM<br>PR: 1KM<br>PR: 1KM<br>PR: 1KM<br>PR: 1KM<br>PR: 1KM<br>PR: 1KM<br>PR: 1KM<br>PR: 1KM<br>PR: 1KM<br>PR: 1KM<br>PR: 1KM<br>PR: 1KM<br>PR: 1KM<br>PR: 1KM<br>PR: 1KM<br>PR: 1KM<br>PR: 1KM | 03.0137-0268.2<br>03.0137-9168.2 | 650268<br>669168                 |                  |  | 200 x 40 HEB<br>Bremsbacken-Zubehör | VW<br>VW               |  |
|  | 1.0<br>1.0 TSI<br>1.0 TSI<br>1.2<br>1.2<br>1.2 TDI<br>1.2 TSI<br>1.2 TSI<br>1.2 TSI<br>1.2 TSI<br>1.4 i 16V<br>1.4 TDI<br>1.4 TDI<br>1.4 TDI<br>1.4 TDI<br>1.6 i 16V<br>1.6 LPG<br>1.9 TDI<br>1.9 TDI | 55<br>70<br>81<br>44<br>51<br>55<br>63<br>66<br>77<br>81<br>63<br>55<br>59<br>66<br>77<br>77<br>60<br>66<br>77 |  | 05.15<br>05.15<br>05.15<br>07.09<br>07.08<br>04.10<br>08.12<br>05.15<br>09.10<br>09.15<br>07.08<br>05.15<br>07.08<br>05.15<br>07.08<br>07.08<br>05.11<br>07.08<br>07.08 | PR: 1KM<br>PR: 1KM<br>PR: 1KM<br>PR: 1KM<br>PR: 1KM<br>PR: 1KM<br>PR: 1KM<br>PR: 1KM<br>PR: 1KM<br>PR: 1KM<br>PR: 1KM<br>PR: 1KM<br>PR: 1KM<br>PR: 1KM<br>PR: 1KM<br>PR: 1KM<br>PR: 1KM<br>PR: 1KM | 24.0220-0037.1                   | 480161                           |                  |  | 200/201,5 x 50,5                    |                        |  |

**SEAT INCA (6K9) (96-03)**

|  |  |                            |   |   |   |  |                                  |                  |   |  |   |     |
|--|--|----------------------------|---|---|---|--|----------------------------------|------------------|---|--|---|-----|
|  | 1.4 i<br>1.4 i 16V<br>1.6 i<br>1.9 D<br>1.9 SDI / TDI            | 44<br>55<br>55<br>47       | 9K-T-011100<br>9K-T-011100<br>9K-T-011100<br>9K-T-011100                | 11.95<br>04.00<br>11.95<br>11.95          | 08.03                                     |  | 13.0460-2958.2                   | 602958           |   |  | 20168 19,3 / S  | TRW |
|  | 1.4 i<br>1.4 i 16V<br>1.6 i<br>1.7 SDI<br>1.9 D<br>1.9 SDI / TDI | 44<br>55<br>55<br>42<br>47 | 9K-T-011101<br>9K-T-011101<br>9K-T-011101<br>9K-T-011101<br>9K-T-011101 | 11.95<br>04.00<br>11.95<br>09.96          | 08.03<br>08.03<br>08.03<br>08.03<br>08.03 |  | 13.0460-2821.2                   | 602821           |   |  | 21945 16,0 / S  | TRW |
|  | 1.4 i<br>1.4 i 16V<br>1.6 i<br>1.9 D<br>1.9 SDI / TDI            | 44<br>55<br>55<br>47       | 9K-T-011100<br>9K-T-011100<br>9K-T-011100<br>9K-T-011100                | 11.95<br>04.00<br>11.95<br>11.95          | 08.03                                     |  | 24.0113-0178.1<br>24.0313-0178.1 | 413178<br>513178 |   |  | 256 12,9 11,0 +S +B<br>256 12,9 11,0 +S +B PD         |     |
|  | 1.4 i<br>1.6 i<br>1.7 SDI<br>1.9 D<br>1.9 SDI / TDI              | 44<br>55<br>42<br>47       | 9K-T-011101<br>9K-T-011101<br>9K-T-011101<br>9K-T-011101                | 11.95<br>04.00<br>09.96                   | 08.03<br>08.03<br>08.03<br>08.03          |  | 24.0120-0128.1<br>24.0320-0128.1 | 420128<br>520128 |   |  | 256 20,0 18,0 V L +S +B<br>256 20,0 18,0 V L +S +B PD |     |
|  | 1.4 i<br>1.4 i 16V<br>1.6 i<br>1.7 SDI<br>1.9 D<br>1.9 SDI / TDI | 44<br>55<br>55<br>42<br>47 |   | 11.95<br>04.00<br>11.95<br>09.96<br>11.95 | 08.03<br>08.03<br>08.03<br>08.03<br>08.03 |  | 24.0711-1361.3<br>24.0711-1362.3 | 360022<br>360023 |   |  | Radsensor<br>Radsensor                                |     |
|  | 1.4 i<br>1.4 i 16V<br>1.6 i<br>1.7 SDI<br>1.9 D<br>1.9 SDI / TDI | 44<br>55<br>55<br>42<br>47 |   | 11.95<br>04.00<br>11.95<br>09.96<br>11.95 | 08.03<br>08.03<br>08.03<br>08.03<br>08.03 |  | 24.0721-1953.3                   | 360155           | 2 |  | Radsensor L=1835                                      |     |
|  | 1.4 i<br>1.4 i 16V<br>1.6 i<br>1.7 SDI                           | 44<br>55<br>55<br>42       | 9K-X-023407<br>9K-X-023407<br>9K-X-023407                               | 11.95<br>04.00<br>11.95<br>09.96          | 08.03                                     |  | 03.0137-0264.2<br>03.0137-9164.2 | 650264<br>669164 |   |  | 230 x 40 HEB<br>Bremsbacken-Zubehör                   | VW  |





### SEAT INCA (6K9) (96-03)













|               |               |             |             |       |       |       |                |        |  |                     |    |
|---------------|---------------|-------------|-------------|-------|-------|-------|----------------|--------|--|---------------------|----|
|               | 1.9 D         | 47          | 9K-X-023407 | 11.95 |       |       | 03.0137-0264.2 | 650264 |  | 230 x 40 HEB        | VW |
|               | 1.9 SDI / TDI |             | 9K-X-023407 | 11.95 |       |       | 03.0137-9164.2 | 669164 |  | Bremsbacken-Zubehör |    |
|               | 1.4 i         | 44          | 9K-X-023408 |       | 08.03 |       | 03.0137-0357.2 | 650357 |  | 230 x 32 HEB        |    |
|               | 1.4 i 16V     | 55          |             | 04.00 | 08.03 |       | 03.0137-9149.2 | 669149 |  | Bremsbacken-Zubehör |    |
|               | 1.6 i         | 55          | 9K-X-023408 |       | 08.03 |       |                |        |  |                     |    |
|               | 1.7 SDI       | 42          | 9K-X-023408 |       | 08.03 |       |                |        |  |                     |    |
| 1.9 D         | 47            | 9K-X-023408 |             | 08.03 |       |       |                |        |  |                     |    |
| 1.9 SDI / TDI |               | 9K-X-023408 |             | 08.03 |       |       |                |        |  |                     |    |
|               | 1.4 i         | 44          | 9K-X-023407 | 11.95 |       | - ABS | 24.0223-0015.1 | 480073 |  | 230/231 x 51        |    |
|               | 1.4 i 16V     | 55          |             | 04.00 | 08.03 |       |                |        |  |                     |    |
|               | 1.6 i         | 55          | 9K-X-023407 | 11.95 |       | - ABS |                |        |  |                     |    |
|               | 1.7 SDI       | 42          | 9K-X-023407 | 09.96 |       | - ABS |                |        |  |                     |    |
|               | 1.9 D         | 47          | 9K-X-023407 | 11.95 |       | - ABS |                |        |  |                     |    |
|               | 1.9 SDI / TDI |             | 9K-X-023407 | 11.95 |       | - ABS |                |        |  |                     |    |
|               | 1.4 i         | 44          | 9K-X-023407 | 11.95 |       | + ABS | 24.0223-0019.1 | 480176 |  | 230/231 x 50,5      |    |
|               | 1.4 i 16V     | 55          |             | 04.00 | 08.03 |       |                |        |  |                     |    |
|               | 1.6 i         | 55          | 9K-X-023407 | 11.95 |       | + ABS |                |        |  |                     |    |
|               | 1.7 SDI       | 42          | 9K-X-023407 | 09.96 |       | + ABS |                |        |  |                     |    |
|               | 1.9 D         | 47          | 9K-X-023407 | 11.95 |       | + ABS |                |        |  |                     |    |
|               | 1.9 SDI / TDI |             | 9K-X-023407 | 11.95 |       | + ABS |                |        |  |                     |    |
|               | 1.4 i         | 44          | 9K-X-023408 |       | 08.03 |       | 24.0223-0020.1 | 480177 |  | 230/231,5 x 39,7    |    |
|               | 1.4 i 16V     | 55          |             | 04.00 | 08.03 |       |                |        |  |                     |    |
|               | 1.6 i         | 55          | 9K-X-023408 |       | 08.03 |       |                |        |  |                     |    |
|               | 1.7 SDI       | 42          | 9K-X-023408 |       | 08.03 |       |                |        |  |                     |    |
|               | 1.9 D         | 47          | 9K-X-023408 |       | 08.03 |       |                |        |  |                     |    |
|               | 1.9 SDI / TDI |             | 9K-X-023408 |       | 08.03 |       |                |        |  |                     |    |
|               | 1.4 i         | 44          | 9K-X-023407 | 11.95 |       |       | 03.0520-6120.3 | 696120 |  | 20,64/230x40 TopKit | VW |
|               | 1.4 i 16V     | 55          |             | 04.00 | 08.03 |       |                |        |  |                     |    |
|               | 1.6 i         | 55          | 9K-X-023407 | 11.95 |       |       |                |        |  |                     |    |
|               | 1.7 SDI       | 42          | 9K-X-023407 | 09.96 |       |       |                |        |  |                     |    |
|               | 1.9 D         | 47          | 9K-X-023407 | 11.95 |       |       |                |        |  |                     |    |
|               | 1.9 SDI / TDI |             | 9K-X-023407 | 11.95 |       |       |                |        |  |                     |    |
|               | 1.4 i         | 44          | 9K-X-023408 |       | 08.03 |       | 03.0520-6920.3 | 696920 |  | 20,64/230x32 TopKit | VW |
|               | 1.4 i 16V     | 55          |             | 04.00 | 08.03 |       |                |        |  |                     |    |
|               | 1.6 i         | 55          | 9K-X-023408 |       | 08.03 |       |                |        |  |                     |    |
|               | 1.7 SDI       | 42          | 9K-X-023408 |       | 08.03 |       |                |        |  |                     |    |
|               | 1.9 D         | 47          | 9K-X-023408 |       | 08.03 |       |                |        |  |                     |    |
|               | 1.9 SDI / TDI |             | 9K-X-023408 |       | 08.03 |       |                |        |  |                     |    |









### SEAT LEON I (1M1) (99-05)













|                  |                |     |       |       |             |                |                |        |                         |                 |     |
|------------------|----------------|-----|-------|-------|-------------|----------------|----------------|--------|-------------------------|-----------------|-----|
|                  | 1.4 i 16V      | 55  |       | 11.99 | 07.05       | PR: 1LQ        | 13.0460-7111.2 | 607111 |                         | 23130 19,6 +    | VW  |
|                  | 1.6 i 16V      |     |       | 11.99 | 07.05       | PR: 1LQ        | 13.0470-7111.2 | LD7111 |                         | 23130 19,6 +    | VW  |
|                  | 1.8 20V        | 92  |       | 11.99 | 07.05       | PR: 1LQ        |                |        |                         |                 |     |
|                  | 1.8 20V T      | 132 |       | 11.99 | 07.05       | PR: 1LQ        |                |        |                         |                 |     |
|                  | 1.8 20V T 4x4  | 132 |       | 11.99 | 07.05       | PR: 1LQ        |                |        |                         |                 |     |
|                  | 1.8 Turbo 4x4  | 154 |       | 05.02 | 07.05       | PR: 1LQ        |                |        |                         |                 |     |
|                  | 1.9 SDI        | 50  |       | 11.99 | 07.05       | PR: 1LQ        |                |        |                         |                 |     |
|                  | 1.9 TDI        |     |       | 11.99 | 07.05       | PR: 1LQ        |                |        |                         |                 |     |
|                  | 1.9 TDI        | 81  |       | 11.99 | 07.05       | PR: 1LQ        |                |        |                         |                 |     |
|                  | 1.9 TDI        | 96  |       | 05.03 | 07.05       | PR: 1LQ        |                |        |                         |                 |     |
|                  | 1.9 TDI        | 110 |       | 02.01 | 07.05       | PR: 1LQ        |                |        |                         |                 |     |
|                  | 1.9 TDI Syncro | 110 |       | 05.02 | 07.05       | PR: 1LQ        |                |        |                         |                 |     |
|                  | 2.3 VR5        | 110 |       | 09.00 | 07.05       | PR: 1LQ        |                |        |                         |                 |     |
|                  | 2.8            | 150 |       | 05.02 | 07.05       | PR: 1LQ        |                |        |                         |                 |     |
|                  | 1.4 i 16V      | 55  |       | 11.99 | 07.05       | PR: 1LS        | 13.0460-7111.2 | 607117 |                         | 23131 19,6 +/WK | VW  |
|                  | 1.6 i 16V      |     |       | 11.99 | 07.05       | PR: 1LS        | 13.0470-7111.2 | LD7117 |                         | 23131 19,6 +/WK | VW  |
| 1.8 20V          | 92             |     | 11.99 | 07.05 | PR: 1LS     |                |                |        |                         |                 |     |
| 1.8 20V T        | 132            |     | 11.99 | 07.05 | PR: 1LS     |                |                |        |                         |                 |     |
| 1.8 20V T 4x4    | 132            |     | 11.99 | 07.05 | PR: 1LS     |                |                |        |                         |                 |     |
| 1.8 Turbo 4x4    | 154            |     | 05.02 | 07.05 | PR: 1LS     |                |                |        |                         |                 |     |
| 1.9 SDI          | 50             |     | 11.99 | 07.05 | PR: 1LS     |                |                |        |                         |                 |     |
| 1.9 TDI          |                |     | 11.99 | 07.05 | PR: 1LS     |                |                |        |                         |                 |     |
| 1.9 TDI          | 81             |     | 11.99 | 07.05 | PR: 1LS     |                |                |        |                         |                 |     |
| 1.9 TDI          | 96             |     | 05.03 | 07.05 | PR: 1LS     |                |                |        |                         |                 |     |
| 1.9 TDI          | 110            |     | 02.01 | 07.05 | PR: 1LS     |                |                |        |                         |                 |     |
| 1.9 TDI Syncro   | 110            |     | 05.02 | 07.05 | PR: 1LS     |                |                |        |                         |                 |     |
| 2.3 VR5          | 110            |     | 09.00 | 07.05 | PR: 1LS     |                |                |        |                         |                 |     |
| 2.8              | 150            |     | 05.02 | 07.05 | PR: 1LS     |                |                |        |                         |                 |     |
| 1.8 T Cupra R    | 154            |     | 05.02 | 07.05 |             | 13.0460-4801.2 | 604801         |        | + 18" Rad <sup>1)</sup> | 21381 15,0 +/WK | BRE |
| 1.8 T Cupra R    | 165            |     | 07.03 | 07.05 |             |                |                |        |                         |                 |     |
| 2.8 V6 Cupra 4x4 | 150            |     | 02.01 | 07.05 |             |                |                |        |                         |                 |     |
| 1.4 i 16V        | 55             |     | 11.99 | 07.05 | PR: 1LE     | 13.0460-7081.2 | 607081         |        | 21911 20,3 +            | ATE             |     |
| 1.6 i 16V        |                |     | 11.99 | 07.05 | PR: 1LE     | 13.0470-7081.2 | LD7081         |        | 21911 20,3 +            | ATE             |     |
| 1.8 20V          | 92             |     | 11.99 | 07.05 | PR: 1LE     |                |                |        |                         |                 |     |
| 1.8 20V T        | 132            |     | 11.99 | 07.05 | PR: 1LE     |                |                |        |                         |                 |     |
| 1.8 20V T 4x4    | 132            |     | 11.99 | 07.05 | PR: 1LE     |                |                |        |                         |                 |     |
| 1.9 SDI          | 50             |     | 11.99 | 07.05 | PR: 1LE     |                |                |        |                         |                 |     |
| 1.9 TDI          |                |     | 11.99 | 07.05 | PR: 1LE     |                |                |        |                         |                 |     |
| 1.9 TDI          | 81             |     | 11.99 | 07.05 | PR: 1LE     |                |                |        |                         |                 |     |
| 1.9 TDI          | 96             |     | 05.03 | 07.05 | PR: 1LE     |                |                |        |                         |                 |     |
| 1.9 TDI          | 110            |     | 02.01 | 07.05 | PR: 1LE     |                |                |        |                         |                 |     |
| 1.9 TDI Syncro   | 110            |     | 05.02 | 07.05 | PR: 1LE     |                |                |        |                         |                 |     |
| 2.3 VR5          | 110            |     | 09.00 | 07.05 | PR: 1LE     |                |                |        |                         |                 |     |
| 2.8              | 150            |     | 05.02 | 07.05 | PR: 1LE     |                |                |        |                         |                 |     |
| 1.4 i 16V        | 55             |     | 11.99 | 07.05 | PR: 1LJ,1ZQ | 13.0460-7122.2 | 607122         |        | 23392 20,3 +/WK         | ATE             |     |
| 1.6 i 16V        |                |     | 11.99 | 07.05 | PR: 1LJ,1ZQ | 13.0470-7122.2 | LD7122         |        | 23392 20,3 +/WK         | ATE             |     |

1) + 18" wheel / + ruota 18" / + roue 18" / + rueda 18"



|     |    kW   |  |   |  |  |     |  |  |
|--|---|--|---|--|---|---|--|--|
| <b>SEAT LEON I (1M1) (99-05)</b>   |   |  |   |  |   |   |  |  |
|    | 1.8 20V 92<br>1.8 20V T 132<br>1.8 20V T 4x4 132<br>1.8 T Cupra R 154<br>1.8 T Cupra R 165<br>1.9 SDI 50<br>1.9 TDI 81<br>1.9 TDI 96<br>1.9 TDI 110<br>1.9 TDI Syncro 110<br>2.3 VR5 110<br>2.8 150<br>2.8 V6 Cupra 4x4 150   |  | 11.99 07.05 PR: 1LJ,1ZQ<br>11.99 07.05 PR: 1LJ,1ZQ<br>11.99 07.05 PR: 1LJ,1ZQ<br>05.02 07.05 PR: 1LT<br>07.03 07.05 PR: 1LT<br>11.99 07.05 PR: 1LJ,1ZQ<br>11.99 07.05 PR: 1LJ,1ZQ<br>11.99 07.05 PR: 1LJ,1ZQ<br>05.03 07.05 PR: 1LJ,1ZQ<br>02.01 07.05 PR: 1LJ,1ZQ<br>05.02 07.05 PR: 1LJ,1ZQ<br>09.00 07.05 PR: 1LJ,1ZQ<br>05.02 07.05 PR: 1LJ,1ZQ<br>02.01 07.05 PR: 1LT                            |  | 13.0460-7122.2 607122<br>13.0470-7122.2 LD7122                                    |   |  | 23392 20,3 +WK ATE<br>23392 20,3 +WK ATE   |
|    | 1.4 i 16V 55<br>1.6 i 16V 92<br>1.8 20V 132<br>1.8 20V T 132<br>1.8 20V T 4x4 132<br>1.8 Turbo 4x4 154<br>1.9 SDI 50<br>1.9 TDI 81<br>1.9 TDI 96<br>1.9 TDI 110<br>1.9 TDI Syncro 110<br>2.3 VR5 110<br>2.8 150   |  | 11.99 07.05 PR: 1LR,1LS<br>11.99 07.05 PR: 1LR,1LS<br>11.99 07.05 PR: 1LR,1LS<br>11.99 07.05 PR: 1LR,1LS<br>05.02 07.05 PR: 1LR,1LS<br>11.99 07.05 PR: 1LR,1LS<br>11.99 07.05 PR: 1LR,1LS<br>11.99 07.05 PR: 1LR,1LS<br>05.03 07.05 PR: 1LR,1LS<br>02.01 07.05 PR: 1LR,1LS<br>05.02 07.05 PR: 1LR,1LS<br>09.00 07.05 PR: 1LR,1LS<br>05.02 07.05 PR: 1LR,1LS   |  | 24.0122-0150.1 422150<br>24.0322-0150.1 522150                                    |   |  | 280 22,0 19,0 V L +S +B<br>280 22,0 19,0 V L +S +B PD                              |
|  | 1.4 i 16V 55<br>1.6 i 16V 92<br>1.8 20V 132<br>1.8 20V T 132<br>1.8 Turbo 4x4 154<br>1.9 SDI 50<br>1.9 TDI 81<br>1.9 TDI 96<br>1.9 TDI 110<br>1.9 TDI Syncro 110<br>2.3 VR5 110<br>2.8 150  |  | 11.99 07.05 PR: 1LQ<br>11.99 07.05 PR: 1LQ<br>11.99 07.05 PR: 1LQ<br>11.99 07.05 PR: 1LQ<br>05.02 07.05 PR: 1LQ<br>11.99 07.05 PR: 1LQ<br>11.99 07.05 PR: 1LQ<br>05.03 07.05 PR: 1LQ<br>02.01 07.05 PR: 1LQ<br>05.02 07.05 PR: 1LQ<br>09.00 07.05 PR: 1LQ<br>05.02 07.05 PR: 1LQ  |  | 24.0122-0151.1 422151<br>24.0322-0151.1 522151                                    |   |  | 256 22,0 19,0 V L +S +B<br>256 22,0 19,0 V L +S +B PD                              |
|  | 1.4 i 16V 55<br>1.6 i 16V 92<br>1.8 20V 132<br>1.8 20V T 132<br>1.8 Turbo 4x4 154<br>1.9 SDI 50<br>1.9 TDI 81<br>1.9 TDI 96<br>1.9 TDI 110<br>1.9 TDI Syncro 110<br>2.3 VR5 110<br>2.8 150  |  | 11.99 07.05 PR: 1LE<br>11.99 07.05 PR: 1LE<br>11.99 07.05 PR: 1LE<br>11.99 07.05 PR: 1LE<br>05.02 07.05 PR: 1LE<br>11.99 07.05 PR: 1LE<br>11.99 07.05 PR: 1LE<br>05.03 07.05 PR: 1LE<br>02.01 07.05 PR: 1LE<br>05.02 07.05 PR: 1LE<br>09.00 07.05 PR: 1LE<br>05.02 07.05 PR: 1LE  |  | 24.0125-0113.1 425113<br>24.0325-0113.1 525113                                    |   |  | 288 25,0 22,0 V L +S +B<br>288 25,0 22,0 V L +S +B PD                              |
|  | 1.4 i 16V 55<br>1.6 i 16V 92<br>1.8 20V 132<br>1.8 20V T 132<br>1.8 Turbo 4x4 154<br>1.8 T Cupra R 154<br>1.8 T Cupra R 165<br>1.8 Turbo 4x4 154<br>1.9 SDI 50<br>1.9 TDI 81<br>1.9 TDI 96<br>1.9 TDI 110<br>1.9 TDI Syncro 110<br>2.3 VR5 110<br>2.8 150<br>2.8 V6 Cupra 4x4 150 |  | 11.99 07.05 PR: 1LJ,1ZQ<br>11.99 07.05 PR: 1LJ,1ZQ<br>11.99 07.05 PR: 1LJ,1ZQ<br>11.99 07.05 PR: 1LJ,1ZQ<br>05.02 07.05 PR: 1LT<br>07.03 07.05 PR: 1LT<br>05.02 07.05 PR: 1LJ,1ZQ<br>11.99 07.05 PR: 1LJ,1ZQ<br>11.99 07.05 PR: 1LJ,1ZQ<br>05.03 07.05 PR: 1LJ,1ZQ<br>02.01 07.05 PR: 1LJ,1ZQ<br>05.02 07.05 PR: 1LJ,1ZQ<br>09.00 07.05 PR: 1LJ,1ZQ<br>05.02 07.05 PR: 1LJ,1ZQ<br>02.01 07.05 PR: 1LT |  | 24.0125-0123.1 425123<br>24.0325-0123.1 525123                                    |   |  | 310 25,0 22,0 V L +S +B<br>310 25,0 22,0 V L +S +B PD                              |
|  | 1.4 i 16V 55<br>1.6 i 16V 92<br>1.8 20V 132<br>1.8 20V T 132<br>1.8 20V T 4x4 132<br>1.8 T Cupra R 154<br>1.8 T Cupra R 165<br>1.8 Turbo 4x4 154<br>1.9 SDI 50<br>1.9 TDI 81<br>1.9 TDI 96<br>1.9 TDI 110<br>1.9 TDI Syncro 110<br>2.3 VR5 110<br>2.8 150<br>2.8 V6 Cupra 4x4 150 |  | 11.99 07.05<br>11.99 07.05<br>11.99 07.05<br>11.99 07.05<br>11.99 07.05<br>05.02 07.05<br>07.03 07.05<br>05.02 07.05<br>11.99 07.05<br>11.99 07.05<br>05.03 07.05<br>02.01 07.05<br>05.02 07.05<br>09.00 07.05<br>05.02 07.05   |  | 24.0711-1361.3 360022<br>24.0711-1362.3 360023                                    |  |  | Radsensor<br>Radsensor   |



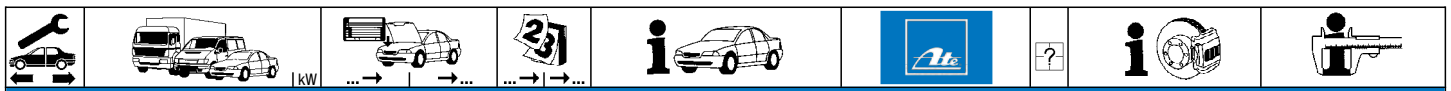

| SEAT LEON I (1M1) (99-05)  |   |   |  |  |  |   |  |                            |  |   |                   |
|--|---|---|--|--|--|---|--|----------------------------|--|---|-------------------|
|    | 2.3 VR5<br>2.8<br>2.8 V6 Cupra 4x4  | 110<br>150<br>150   |  | 09.00<br>05.02<br>02.01  | 07.05<br>07.05<br>07.05  |   | 24.0711-1361.3<br>24.0711-1362.3                   | 360022<br>360023           | <br> | Radsensor<br>Radsensor                                      |                   |
|    | 1.4 i 16V<br>1.6 i 16V<br>1.8 20V<br>1.8 20V T<br>1.8 20V T 4x4<br>1.8 Turbo 4x4<br>1.9 SDI<br>1.9 TDI<br>1.9 TDI<br>1.9 TDI<br>1.9 TDI<br>1.9 TDI Syncro<br>2.3 VR5<br>2.8   | 55<br>55<br>92<br>132<br>132<br>154<br>50<br>81<br>96<br>110<br>110<br>110<br>110<br>150                      |  | 11.99<br>11.99<br>11.99<br>11.99<br>11.99<br>05.02<br>11.99<br>11.99<br>05.03<br>02.01<br>05.02<br>09.00<br>05.02                            | 07.05<br>07.05<br>07.05<br>07.05<br>07.05<br>07.05<br>07.05<br>07.05<br>07.05<br>07.05<br>07.05<br>07.05<br>07.05<br>07.05                   | PR: 1KK,1KP,1KQ<br>PR: 1KK,1KP,1KQ<br>PR: 1KK,1KP,1KQ<br>PR: 1KK,1KP,1KQ<br>PR: 1KK,1KP,1KQ<br>PR: 1KK,1KP,1KQ<br>PR: 1KK,1KP,1KQ<br>PR: 1KK,1KP,1KQ<br>PR: 1KK,1KP,1KQ<br>PR: 1KK,1KP,1KQ<br>PR: 1KK,1KP,1KQ<br>PR: 1KK,1KP,1KQ<br>PR: 1KK,1KP,1KQ | 13.0460-2894.2<br>13.0470-2894.2<br>13.0460-0072.2 | 602894<br>LD2894<br>610072 |  | 20961 17,4 /Zub/S<br>20961 17,4 /Zub/S<br>Belagsatz-Zubehör | TRW<br>TRW<br>TRW |
|  | 1.4 i 16V<br>1.6 i 16V<br>1.8 20V<br>1.8 20V T<br>1.8 20V T 4x4<br>1.8 T Cupra R<br>1.8 T Cupra R<br>1.8 Turbo 4x4<br>1.9 SDI<br>1.9 TDI<br>1.9 TDI<br>1.9 TDI<br>1.9 TDI<br>1.9 TDI Syncro<br>2.3 VR5<br>2.8<br>2.8 V6 Cupra 4x4 | 55<br>55<br>92<br>132<br>132<br>154<br>165<br>154<br>50<br>81<br>96<br>110<br>110<br>110<br>110<br>150<br>150 |  | 11.99<br>11.99<br>11.99<br>11.99<br>11.99<br>05.02<br>07.03<br>05.02<br>11.99<br>11.99<br>05.03<br>02.01<br>05.02<br>09.00<br>05.02<br>02.01 | 07.05<br>07.05<br>07.05<br>07.05<br>07.05<br>07.05<br>07.05<br>07.05<br>07.05<br>07.05<br>07.05<br>07.05<br>07.05<br>07.05<br>07.05<br>07.05 | PR: 1KY,2EE<br>PR: 1KY,2EE<br>PR: 1KY,2EE<br>PR: 1KY,2EE<br>PR: 1KY,2EE<br>PR: 1KY,2EM<br>PR: 1KY,2EM<br>PR: 1KY,2EE<br>PR: 1KY,2EE<br>PR: 1KY,2EE<br>PR: 1KY,2EE<br>PR: 1KY,2EE<br>PR: 1KY,2EE<br>PR: 1KY,2EE<br>PR: 1KY,2EE<br>PR: 1KY,2EM        | 13.0460-2886.2<br>13.0470-2886.2<br>13.0460-0072.2 | 602886<br>LD2886<br>610072 |  | 20961 16,2 /S<br>20961 16,2 /S<br>Belagsatz-Zubehör         | TRW<br>TRW<br>TRW |
|    | 1.4 i 16V<br>1.6 i 16V<br>1.8 20V<br>1.8 20V T<br>1.8 20V T 4x4<br>1.8 T Cupra R<br>1.8 T Cupra R<br>1.8 Turbo 4x4<br>1.9 SDI<br>1.9 TDI<br>1.9 TDI<br>1.9 TDI<br>1.9 TDI<br>1.9 TDI Syncro<br>2.3 VR5<br>2.8<br>2.8 V6 Cupra 4x4 | 55<br>55<br>92<br>132<br>132<br>154<br>165<br>154<br>50<br>81<br>96<br>110<br>110<br>110<br>110<br>150<br>150 |  | 11.99<br>11.99<br>11.99<br>11.99<br>11.99<br>05.02<br>07.03<br>05.02<br>11.99<br>11.99<br>05.03<br>02.01<br>05.02<br>09.00<br>05.02<br>02.01 | 07.05<br>07.05<br>07.05<br>07.05<br>07.05<br>07.05<br>07.05<br>07.05<br>07.05<br>07.05<br>07.05<br>07.05<br>07.05<br>07.05<br>07.05<br>07.05 | PR: 1KY,2EE<br>PR: 1KY,2EE<br>PR: 1KY,2EE<br>PR: 1KY,2EE<br>PR: 1KY,2EE<br>PR: 1KY,2EM<br>PR: 1KY,2EM<br>PR: 1KY,2EE<br>PR: 1KY,2EE<br>PR: 1KY,2EE<br>PR: 1KY,2EE<br>PR: 1KY,2EE<br>PR: 1KY,2EE<br>PR: 1KY,2EE<br>PR: 1KY,2EE<br>PR: 1KY,2EM        | 24.0122-0163.1<br>24.0322-0163.1                   | 422163<br>522163           |  | 256 22,0 20,0 V L +B<br>256 22,0 20,0 V L +B PD             |                   |
|  | 1.4 i 16V<br>1.6 i 16V<br>1.8 20V<br>1.8 20V T<br>1.8 20V T 4x4<br>1.8 Turbo 4x4<br>1.9 SDI<br>1.9 TDI<br>1.9 TDI<br>1.9 TDI<br>1.9 TDI<br>1.9 TDI Syncro<br>2.3 VR5<br>2.8   | 55<br>55<br>92<br>132<br>132<br>154<br>50<br>81<br>96<br>110<br>110<br>110<br>110<br>150                      |  | 11.99<br>11.99<br>11.99<br>11.99<br>11.99<br>05.02<br>11.99<br>11.99<br>05.03<br>02.01<br>05.02<br>09.00<br>05.02                            | 07.05<br>07.05<br>07.05<br>07.05<br>07.05<br>07.05<br>07.05<br>07.05<br>07.05<br>07.05<br>07.05<br>07.05<br>07.05<br>07.05                   | PR: 1KK,1KP,1KQ<br>PR: 1KK,1KP,1KQ<br>PR: 1KK,1KP,1KQ<br>PR: 1KK,1KP,1KQ<br>PR: 1KK,1KP,1KQ<br>PR: 1KK,1KP,1KQ<br>PR: 1KK,1KP,1KQ<br>PR: 1KK,1KP,1KQ<br>PR: 1KK,1KP,1KQ<br>PR: 1KK,1KP,1KQ<br>PR: 1KK,1KP,1KQ<br>PR: 1KK,1KP,1KQ<br>PR: 1KK,1KP,1KQ | 24.0109-0123.1<br>24.0309-0123.1                   | 409123<br>509123           |  | 230 9,0 7,0 +S +B<br>230 9,0 7,0 +S +B PD                   |                   |
|  | 1.4 i 16V<br>1.6 i 16V<br>1.8 20V<br>1.8 20V T<br>1.8 T Cupra R<br>1.8 T Cupra R<br>1.9 SDI<br>1.9 TDI<br>1.9 TDI<br>1.9 TDI<br>1.9 TDI<br>1.9 TDI Syncro<br>2.3 VR5<br>2.8   | 55<br>55<br>92<br>132<br>154<br>165<br>50<br>81<br>96<br>110<br>110<br>110<br>110<br>150                      |  | 11.99<br>11.99<br>11.99<br>11.99<br>05.02<br>07.03<br>11.99<br>11.99<br>05.03<br>02.01<br>09.00<br>05.02                                     | 07.05<br>07.05<br>07.05<br>07.05<br>07.05<br>07.05<br>07.05<br>07.05<br>07.05<br>07.05<br>07.05<br>07.05<br>07.05<br>07.05                   |   | 24.0741-1107.3                                     | 360042                     | 2   | Radsensor   |                   |
|  | 1.8 20V T 4x4<br>1.8 Turbo 4x4<br>1.9 TDI Syncro<br>2.8 V6 Cupra 4x4  | 132<br>154<br>110<br>150  |  | 11.99<br>05.02<br>05.02<br>02.01   | 07.05<br>07.05<br>07.05<br>07.05   |   | 24.0711-1365.3                                     | 360172                     | 2   | Radsensor L=226   |                   |

|     |    |  |   |  |  |  |  |  |
|--|--|--|---|--|---|--|--|--|
| <b>SEAT LEON II (1P1) (05-12)</b>  |  |  |   |  |   |  |  |  |
|    | 1.2 TSI 77<br>1.4 i 16V 63<br>1.4 TSI 92<br>1.6 i 75<br>1.6 LPG / Multifuel 75<br>1.6 TDI 66<br>1.6 TDI Ecomotive 77<br>1.8 TSI 118<br>1.9 TDI 81<br>1.9 TDI 81<br>2.0 Cupra R 195<br>2.0 FSI 110<br>2.0 TDI 125<br>2.0 TFSI 136<br>2.0 TFSI 155<br>2.0 TFSI 177 |  | 02.10 10.12 PR: 1ZF,1ZM<br>06.06 10.12 PR: 1ZF,1ZM<br>11.07 10.12 PR: 1ZF,1ZM<br>08.05 10.12 PR: 1ZF,1ZM<br>12.09 10.12 PR: 1ZF,1ZM<br>11.10 10.12 PR: 1ZF,1ZM<br>02.10 10.12 PR: 1ZF,1ZM<br>06.07 10.12 PR: 1ZF,1ZM<br>08.05 10.12 PR: 1ZF,1ZM<br>08.05 10.12 PR: 1ZF,1ZM<br>11.06 10.12 PR: 1ZF,1ZM<br>08.05 10.12 PR: 1ZF,1ZM<br>08.05 10.12 PR: 1ZF,1ZM<br>02.06 10.12 PR: 1ZF,1ZM<br>08.05 10.12 PR: 1ZF,1ZM<br>09.05 10.12 PR: 1ZF,1ZM<br>11.06 10.12 PR: 1ZF,1ZM |  | 13.0460-7117.2 607117<br>13.0470-7117.2 LD7117                                    |  |  | 23131 19,6 +WK VW<br>23131 19,6 +WK VW   |
|  | 1.2 TSI 77<br>1.4 i 16V 63<br>1.4 TSI 92<br>1.6 i 75<br>1.6 LPG / Multifuel 75<br>1.6 TDI 66<br>1.6 TDI Ecomotive 77<br>1.8 TSI 118<br>1.9 TDI 81<br>1.9 TDI 81<br>2.0 Cupra R 195<br>2.0 FSI 110<br>2.0 TDI 125<br>2.0 TFSI 136<br>2.0 TFSI 155<br>2.0 TFSI 177 |  | 02.10 10.12 PR: 1ZE,1LJ<br>06.06 10.12 PR: 1ZE,1LJ<br>11.07 10.12 PR: 1ZE,1LJ<br>08.05 10.12 PR: 1ZE,1LJ<br>12.09 10.12 PR: 1ZE,1LJ<br>11.10 10.12 PR: 1ZE,1LJ<br>02.10 10.12 PR: 1ZE,1LJ<br>06.07 10.12 PR: 1ZE,1LJ<br>08.05 10.12 PR: 1ZE,1LJ<br>08.05 10.12 PR: 1ZE,1LJ<br>11.06 10.12 PR: 1ZE,1LJ<br>08.05 10.12 PR: 1ZE,1LJ<br>08.05 10.12 PR: 1ZE,1LJ<br>02.06 10.12 PR: 1ZE,1LJ<br>08.05 10.12 PR: 1ZE,1LJ<br>09.05 10.12 PR: 1ZE,1LJ<br>11.06 10.12 PR: 1ZE,1LJ |  | 13.0460-7184.2 607184<br>13.0470-7184.2 LD7184                                    |  |  | 23587 20,6 +WK ATE<br>23587 20,6 +WK ATE   |
|  | 1.2 TSI 77<br>1.4 i 16V 63<br>1.4 TSI 92<br>1.6 i 75<br>1.6 LPG / Multifuel 75<br>1.6 TDI 66<br>1.6 TDI Ecomotive 77<br>1.8 TSI 118<br>1.9 TDI 81<br>1.9 TDI 81<br>2.0 Cupra R 195<br>2.0 FSI 110<br>2.0 TDI 125<br>2.0 TFSI 136<br>2.0 TFSI 155<br>2.0 TFSI 177 |  | 02.10 10.12 PR: 1LU<br>06.06 10.12 PR: 1LU<br>11.07 10.12 PR: 1LU<br>08.05 10.12 PR: 1LU<br>12.09 10.12 PR: 1LU<br>11.10 10.12 PR: 1LU<br>02.10 10.12 PR: 1LU<br>06.07 10.12 PR: 1LU<br>08.05 10.12 PR: 1LU<br>08.05 10.12 PR: 1LU<br>11.06 10.12 PR: 1LU<br>08.05 10.12 PR: 1LU<br>08.05 10.12 PR: 1LU<br>02.06 10.12 PR: 1LU<br>08.05 10.12 PR: 1LU<br>09.05 10.12 PR: 1LU<br>11.06 10.12 PR: 1LU   |  | 13.0460-7200.2 607200<br>13.0470-7200.2 LD7200                                    |  |  | 23801 20,3 +WK ATE<br>23801 20,3 +WK ATE   |
|  | 1.2 TSI 77<br>1.4 i 16V 63<br>1.4 TSI 92<br>1.6 i 75<br>1.6 LPG / Multifuel 75<br>1.6 TDI 66<br>1.6 TDI Ecomotive 77<br>1.8 TSI 118<br>1.9 TDI 81<br>1.9 TDI 81<br>2.0 Cupra R 195<br>2.0 FSI 110<br>2.0 TDI 125<br>2.0 TFSI 136<br>2.0 TFSI 155<br>2.0 TFSI 177 |  | 02.10 10.12 PR: 1LB<br>06.06 10.12 PR: 1LB<br>11.07 10.12 PR: 1LB<br>08.05 10.12 PR: 1LB<br>12.09 10.12 PR: 1LB<br>11.10 10.12 PR: 1LB<br>02.10 10.12 PR: 1LB<br>06.07 10.12 PR: 1LB<br>08.05 10.12 PR: 1LB<br>08.05 10.12 PR: 1LB<br>11.06 10.12 PR: 1LB<br>08.05 10.12 PR: 1LB<br>08.05 10.12 PR: 1LB<br>02.06 10.12 PR: 1LB<br>08.05 10.12 PR: 1LB<br>09.05 10.12 PR: 1LB<br>11.06 10.12 PR: 1LB   |  | 13.0460-7227.2 607227<br>13.0470-7227.2 LD7227                                    |  |  | 23801 20,3 +WK ATE<br>23801 20,4 +WK ATE   |
|  | 1.2 TSI 77<br>1.4 i 16V 63<br>1.4 TSI 92<br>1.6 i 75<br>1.6 LPG / Multifuel 75<br>1.6 TDI 66<br>1.6 TDI Ecomotive 77<br>1.8 TSI 118<br>1.9 TDI 81<br>1.9 TDI 81<br>2.0 Cupra R 195<br>2.0 FSI 110<br>2.0 TDI 125<br>2.0 TFSI 136<br>2.0 TFSI 155<br>2.0 TFSI 177 |  | 02.10 10.12 PR: 1ZF,1ZM<br>06.06 10.12 PR: 1ZF,1ZM<br>11.07 10.12 PR: 1ZF,1ZM<br>08.05 10.12 PR: 1ZF,1ZM<br>12.09 10.12 PR: 1ZF,1ZM<br>11.10 10.12 PR: 1ZF,1ZM<br>02.10 10.12 PR: 1ZF,1ZM<br>06.07 10.12 PR: 1ZF,1ZM<br>08.05 10.12 PR: 1ZF,1ZM<br>08.05 10.12 PR: 1ZF,1ZM<br>11.06 10.12 PR: 1ZF,1ZM<br>08.05 10.12 PR: 1ZF,1ZM<br>08.05 10.12 PR: 1ZF,1ZM<br>02.06 10.12 PR: 1ZF,1ZM<br>08.05 10.12 PR: 1ZF,1ZM<br>09.05 10.12 PR: 1ZF,1ZM<br>11.06 10.12 PR: 1ZF,1ZM |  | 24.0122-0210.1 422210<br>24.0322-0210.1 522210                                    |  |  | 280 22,0 19,0 V L +S +B<br>280 22,0 19,0 V L +S +B PD                              |
|  | 1.2 TSI 77<br>1.4 i 16V 63   |  | 02.10 10.12 PR: 1ZE<br>06.06 10.12 PR: 1ZE  |  | 24.0125-0145.1 425145<br>24.0325-0145.1 525145                                    |  |  | 288 25,0 22,0 V L +S +B<br>288 25,0 22,0 V L +S +B PD                              |



**SEAT LEON II (1P1) (05-12)**

|          |                     |     |       |       |             |             |                |        |        |   |            |
|----------|---------------------|-----|-------|-------|-------------|-------------|----------------|--------|--------|---|------------|
|          | 1.4 TSI             | 92  |       | 11.07 | 10.12       | PR: 1ZE     | 24.0125-0145.1 | 425145 |        | 288 25,0 22,0 VL +S +B<br>288 25,0 22,0 VL +S +B PD |            |
|          | 1.6 i               | 75  |       | 08.05 | 10.12       | PR: 1ZE     | 24.0325-0145.1 | 525145 |        |   |            |
|          | 1.6 LPG / Multifuel | 75  |       | 12.09 | 10.12       | PR: 1ZE     |                |        |        |   |            |
|          | 1.6 TDI             | 66  |       | 11.10 | 10.12       | PR: 1ZE     |                |        |        |   |            |
|          | 1.6 TDI Ecomotive   | 77  |       | 02.10 | 10.12       | PR: 1ZE     |                |        |        |   |            |
|          | 1.8 TSI             | 118 |       | 06.07 | 10.12       | PR: 1ZE     |                |        |        |   |            |
|          | 1.9 TDI             |     |       | 08.05 | 10.12       | PR: 1ZE     |                |        |        |   |            |
|          | 1.9 TDI             | 81  |       | 08.05 | 10.12       | PR: 1ZE     |                |        |        |   |            |
|          | 2.0 Cupra R         | 195 |       | 11.06 | 10.12       | PR: 1ZE     |                |        |        |   |            |
|          | 2.0 FSI             | 110 |       | 08.05 | 10.12       | PR: 1ZE     |                |        |        |   |            |
|          | 2.0 TDI             |     |       | 08.05 | 10.12       | PR: 1ZE     |                |        |        |   |            |
|          | 2.0 TDI             | 125 |       | 02.06 | 10.12       | PR: 1ZE     |                |        |        |   |            |
|          | 2.0 TFSI            | 136 |       | 08.05 | 10.12       | PR: 1ZE     |                |        |        |   |            |
|          | 2.0 TFSI            | 155 |       | 09.05 | 10.12       | PR: 1ZE     |                |        |        |   |            |
| 2.0 TFSI | 177                 |     | 11.06 | 10.12 | PR: 1ZE     |             |                |        |        |   |            |
|          | 1.2 TSI             | 77  |       | 02.10 | 10.12       | PR: 1LJ     | 24.0125-0158.1 | 425158 |        | 312 25,0 22,0 VL +S +B<br>312 25,0 22,0 VL +S +B PD |            |
|          | 1.4 i 16V           | 63  |       | 06.06 | 10.12       | PR: 1LJ     | 24.0325-0158.1 | 525158 |        |   |            |
|          | 1.4 TSI             | 92  |       | 11.07 | 10.12       | PR: 1LJ     |                |        |        |   |            |
|          | 1.6 i               | 75  |       | 08.05 | 10.12       | PR: 1LJ     |                |        |        |   |            |
|          | 1.6 LPG / Multifuel | 75  |       | 12.09 | 10.12       | PR: 1LJ     |                |        |        |   |            |
|          | 1.6 TDI             | 66  |       | 11.10 | 10.12       | PR: 1LJ     |                |        |        |   |            |
|          | 1.6 TDI Ecomotive   | 77  |       | 02.10 | 10.12       | PR: 1LJ     |                |        |        |   |            |
|          | 1.8 TSI             | 118 |       | 06.07 | 10.12       | PR: 1LJ     |                |        |        |   |            |
|          | 1.9 TDI             |     |       | 08.05 | 10.12       | PR: 1LJ     |                |        |        |   |            |
|          | 1.9 TDI             | 81  |       | 08.05 | 10.12       | PR: 1LJ     |                |        |        |   |            |
|          | 2.0 Cupra R         | 195 |       | 11.06 | 10.12       | PR: 1LJ     |                |        |        |   |            |
|          | 2.0 FSI             | 110 |       | 08.05 | 10.12       | PR: 1LJ     |                |        |        |   |            |
|          | 2.0 TDI             |     |       | 08.05 | 10.12       | PR: 1LJ     |                |        |        |   |            |
|          | 2.0 TDI             | 125 |       | 02.06 | 10.12       | PR: 1LJ     |                |        |        |   |            |
| 2.0 TFSI | 136                 |     | 08.05 | 10.12 | PR: 1LJ     |             |                |        |        |   |            |
| 2.0 TFSI | 155                 |     | 09.05 | 10.12 | PR: 1LJ     |             |                |        |        |   |            |
| 2.0 TFSI | 177                 |     | 11.06 | 10.12 | PR: 1LJ     |             |                |        |        |   |            |
|          | 1.2 TSI             | 77  |       | 02.10 | 10.12       | PR: 1LB,1LU | 24.0130-0115.1 | 430115 |        | 345 30,0 27,0 VL +B<br>345 30,0 27,0 VL +B PD       |            |
|          | 1.4 i 16V           | 63  |       | 06.06 | 10.12       | PR: 1LB,1LU | 24.0330-0115.1 | 530115 |        |   |            |
|          | 1.4 TSI             | 92  |       | 11.07 | 10.12       | PR: 1LB,1LU |                |        |        |   |            |
|          | 1.6 i               | 75  |       | 08.05 | 10.12       | PR: 1LB,1LU |                |        |        |   |            |
|          | 1.6 LPG / Multifuel | 75  |       | 12.09 | 10.12       | PR: 1LB,1LU |                |        |        |   |            |
|          | 1.6 TDI             | 66  |       | 11.10 | 10.12       | PR: 1LB,1LU |                |        |        |   |            |
|          | 1.6 TDI Ecomotive   | 77  |       | 02.10 | 10.12       | PR: 1LB,1LU |                |        |        |   |            |
|          | 1.8 TSI             | 118 |       | 06.07 | 10.12       | PR: 1LB,1LU |                |        |        |   |            |
|          | 1.9 TDI             |     |       | 08.05 | 10.12       | PR: 1LB,1LU |                |        |        |   |            |
|          | 1.9 TDI             | 81  |       | 08.05 | 10.12       | PR: 1LB,1LU |                |        |        |   |            |
|          | 2.0 Cupra R         | 195 |       | 11.06 | 10.12       | PR: 1LB,1LU |                |        |        |   |            |
|          | 2.0 FSI             | 110 |       | 08.05 | 10.12       | PR: 1LB,1LU |                |        |        |   |            |
|          | 2.0 TDI             |     |       | 08.05 | 10.12       | PR: 1LB,1LU |                |        |        |   |            |
|          | 2.0 TDI             | 125 |       | 02.06 | 10.12       | PR: 1LB,1LU |                |        |        |   |            |
| 2.0 TFSI | 136                 |     | 08.05 | 10.12 | PR: 1LB,1LU |             |                |        |        |   |            |
| 2.0 TFSI | 155                 |     | 09.05 | 10.12 | PR: 1LB,1LU |             |                |        |        |   |            |
| 2.0 TFSI | 177                 |     | 11.06 | 10.12 | PR: 1LB,1LU |             |                |        |        |   |            |
|          | 1.2 TSI             | 77  |       | 02.10 | 10.12       |             | 24.0711-5271.3 | 360301 | ☐<br>☐ | Radsensor<br>Radsensor                              |            |
|          | 1.4 i 16V           | 63  |       | 06.06 | 10.12       |             | 24.0711-5272.3 | 360302 |        |   |            |
|          | 1.4 TSI             | 92  |       | 11.07 | 10.12       |             |                |        |        |   |            |
|          | 1.6 i               | 75  |       | 08.05 | 10.12       |             |                |        |        |   |            |
|          | 1.6 LPG / Multifuel | 75  |       | 12.09 | 10.12       |             |                |        |        |   |            |
|          | 1.6 TDI             | 66  |       | 11.10 | 10.12       |             |                |        |        |   |            |
|          | 1.6 TDI Ecomotive   | 77  |       | 02.10 | 10.12       |             |                |        |        |   |            |
|          | 1.8 TSI             | 118 |       | 06.07 | 10.12       |             |                |        |        |   |            |
|          | 1.9 TDI             |     |       | 08.05 | 10.12       |             |                |        |        |   |            |
|          | 1.9 TDI             | 81  |       | 08.05 | 10.12       |             |                |        |        |   |            |
|          | 2.0 Cupra R         | 195 |       | 11.06 | 10.12       |             |                |        |        |   |            |
|          | 2.0 FSI             | 110 |       | 08.05 | 10.12       |             |                |        |        |   |            |
|          | 2.0 TDI             |     |       | 08.05 | 10.12       |             |                |        |        |   |            |
|          | 2.0 TDI             | 125 |       | 02.06 | 10.12       |             |                |        |        |   |            |
| 2.0 TFSI | 136                 |     | 08.05 | 10.12 |             |             |                |        |        |   |            |
| 2.0 TFSI | 155                 |     | 09.05 | 10.12 |             |             |                |        |        |   |            |
| 2.0 TFSI | 177                 |     | 11.06 | 10.12 |             |             |                |        |        |   |            |
|          | 1.2 TSI             | 77  |       | 02.10 | 10.12       | PR: 1KD     | 13.0460-2820.2 | 602820 |        | 20961 17,6 /S<br>20961 17,6 /S                      | TRW<br>TRW |
|          | 1.4 i 16V           | 63  |       | 06.06 | 10.12       | PR: 1KD     | 13.0470-2820.2 | LD2820 |        |   |            |
|          | 1.4 TSI             | 92  |       | 11.07 | 10.12       | PR: 1KD     |                |        |        |   |            |
|          | 1.6 i               | 75  |       | 08.05 | 10.12       | PR: 1KD     |                |        |        |   |            |
|          | 1.6 LPG / Multifuel | 75  |       | 12.09 | 10.12       | PR: 1KD     |                |        |        |   |            |
|          | 1.6 TDI             | 66  |       | 11.10 | 10.12       | PR: 1KD     |                |        |        |   |            |
|          | 1.6 TDI Ecomotive   | 77  |       | 02.10 | 10.12       | PR: 1KD     |                |        |        |   |            |
|          | 1.8 TSI             | 118 |       | 06.07 | 10.12       | PR: 1KD     |                |        |        |   |            |
|          | 1.9 TDI             |     |       | 08.05 | 10.12       | PR: 1KD     |                |        |        |   |            |
|          | 1.9 TDI             | 81  |       | 08.05 | 10.12       | PR: 1KD     |                |        |        |   |            |
|          | 2.0 Cupra R         | 195 |       | 11.06 | 10.12       | PR: 1KD     |                |        |        |   |            |
|          | 2.0 FSI             | 110 |       | 08.05 | 10.12       | PR: 1KD     |                |        |        |   |            |
|          | 2.0 TDI             |     |       | 08.05 | 10.12       | PR: 1KD     |                |        |        |   |            |
|          | 2.0 TDI             | 125 |       | 02.06 | 10.12       | PR: 1KD     |                |        |        |   |            |
| 2.0 TFSI | 136                 |     | 08.05 | 10.12 | PR: 1KD     |             |                |        |        |   |            |
| 2.0 TFSI | 155                 |     | 09.05 | 10.12 | PR: 1KD     |             |                |        |        |   |            |
| 2.0 TFSI | 177                 |     | 11.06 | 10.12 | PR: 1KD     |             |                |        |        |   |            |
|          | 1.2 TSI             | 77  |       | 02.10 | 10.12       | PR: 1KY,1KZ | 13.0460-2880.2 | 602880 |        | 23914 17,1 /WE/Zub/S<br>23914 17,1 /WE/Zub/S        | TRW<br>TRW |
|          | 1.4 i 16V           | 63  |       | 06.06 | 10.12       | PR: 1KY,1KZ | 13.0470-2880.2 | LD2880 |        |   |            |
|          | 1.4 TSI             | 92  |       | 11.07 | 10.12       | PR: 1KY,1KZ |                |        |        |   |            |
|          | 1.6 i               | 75  |       | 08.05 | 10.12       | PR: 1KY,1KZ |                |        |        |   |            |

| SEAT LEON II (1P1) (05-12)   |                     |       |       |             |             |                |        |   |                      |                        |                |        |  |                   |     |
|--|---------------------|-------|-------|-------------|-------------|----------------|--------|---|----------------------|------------------------|----------------|--------|--|-------------------|-----|
|     | 1.6 LPG / Multifuel | 75    | 12.09 | 10.12       | PR: 1KY,1KZ | 13.0460-2880.2 | 602880 |   | 23914 17,1 /WE/Zub/S | TRW                    |                |        |  |                   |     |
|  | 1.6 TDI             | 66    | 11.10 | 10.12       | PR: 1KY,1KZ |                |        |   |                      |                        |                |        |  |                   |     |
|  | 1.6 TDI Ecomotive   | 77    | 02.10 | 10.12       | PR: 1KY,1KZ |                |        |   |                      |                        |                |        |  |                   |     |
|  | 1.8 TSI             | 118   | 06.07 | 10.12       | PR: 1KY,1KZ |                |        |   |                      |                        |                |        |  |                   |     |
|  | 1.9 TDI             |       | 08.05 | 10.12       | PR: 1KY,1KZ |                |        |   |                      |                        |                |        |  |                   |     |
|  | 1.9 TDI             | 81    | 08.05 | 10.12       | PR: 1KY,1KZ |                |        |   |                      |                        |                |        |  |                   |     |
|  | 2.0 Cupra R         | 195   | 11.06 | 10.12       | PR: 1KY,1KZ |                |        |   |                      |                        |                |        |  |                   |     |
|  | 2.0 FSI             | 110   | 08.05 | 10.12       | PR: 1KY,1KZ |                |        |   |                      |                        |                |        |  |                   |     |
|  | 2.0 TDI             |       | 08.05 | 10.12       | PR: 1KY,1KZ |                |        |   |                      |                        |                |        |  |                   |     |
|  | 2.0 TDI             | 125   | 02.06 | 10.12       | PR: 1KY,1KZ |                |        |   |                      |                        |                |        |  |                   |     |
|  | 2.0 TFSI            | 136   | 08.05 | 10.12       | PR: 1KY,1KZ |                |        |   |                      |                        |                |        |  |                   |     |
|  | 2.0 TFSI            | 155   | 09.05 | 10.12       | PR: 1KY,1KZ |                |        |   |                      |                        |                |        |  |                   |     |
|  | 2.0 TFSI            | 177   | 11.06 | 10.12       | PR: 1KY,1KZ |                |        |   |                      |                        |                |        |  |                   |     |
|  | 1.2 TSI             | 77    | 02.10 | 10.12       | PR: 1KS,1KT |                |        |   |                      |                        | 13.0460-3858.2 | 603858 |  | 24563 17,7 /Zub/S | BOS |
|  | 1.4 i 16V           | 63    | 06.06 | 10.12       | PR: 1KS,1KT |                |        |   |                      |                        |                |        |  |                   |     |
|  | 1.4 TSI             | 92    | 11.07 | 10.12       | PR: 1KS,1KT |                |        |   |                      |                        |                |        |  |                   |     |
|  | 1.6 i               | 75    | 08.05 | 10.12       | PR: 1KS,1KT |                |        |   |                      |                        |                |        |  |                   |     |
| 1.6 LPG / Multifuel  | 75                  | 12.09 | 10.12 | PR: 1KS,1KT |             |                |        |   |                      |                        |                |        |  |                   |     |
| 1.6 TDI  | 66                  | 11.10 | 10.12 | PR: 1KS,1KT |             |                |        |   |                      |                        |                |        |  |                   |     |
| 1.6 TDI Ecomotive  | 77                  | 02.10 | 10.12 | PR: 1KS,1KT |             |                |        |   |                      |                        |                |        |  |                   |     |
| 1.8 TSI  | 118                 | 06.07 | 10.12 | PR: 1KS,1KT |             |                |        |   |                      |                        |                |        |  |                   |     |
| 1.9 TDI  |                     | 08.05 | 10.12 | PR: 1KS,1KT |             |                |        |   |                      |                        |                |        |  |                   |     |
| 1.9 TDI  | 81                  | 08.05 | 10.12 | PR: 1KS,1KT |             |                |        |   |                      |                        |                |        |  |                   |     |
| 2.0 Cupra R  | 195                 | 11.06 | 10.12 | PR: 1KS,1KT |             |                |        |   |                      |                        |                |        |  |                   |     |
| 2.0 FSI  | 110                 | 08.05 | 10.12 | PR: 1KS,1KT |             |                |        |   |                      |                        |                |        |  |                   |     |
| 2.0 TDI  |                     | 08.05 | 10.12 | PR: 1KS,1KT |             |                |        |   |                      |                        |                |        |  |                   |     |
| 2.0 TDI  | 125                 | 02.06 | 10.12 | PR: 1KS,1KT |             |                |        |   |                      |                        |                |        |  |                   |     |
| 2.0 TFSI   | 136                 | 08.05 | 10.12 | PR: 1KS,1KT |             |                |        |   |                      |                        |                |        |  |                   |     |
| 2.0 TFSI   | 155                 | 09.05 | 10.12 | PR: 1KS,1KT |             |                |        |   |                      |                        |                |        |  |                   |     |
| 2.0 TFSI   | 177                 | 11.06 | 10.12 | PR: 1KS,1KT |             |                |        |   |                      |                        |                |        |  |                   |     |
|    | 1.2 TSI             | 77    | 02.10 | 10.12       | PR: 1KD     | 24.0110-0277.1 | 410277 |   | 253 10,0 8,0 +S +B   | 253 10,0 8,0 +S +B PD  |                |        |  |                   |     |
|  | 1.4 i 16V           | 63    | 06.06 | 10.12       | PR: 1KD     |                |        |   |                      |                        |                |        |  |                   |     |
|  | 1.4 TSI             | 92    | 11.07 | 10.12       | PR: 1KD     |                |        |   |                      |                        |                |        |  |                   |     |
|  | 1.6 i               | 75    | 08.05 | 10.12       | PR: 1KD     |                |        |   |                      |                        |                |        |  |                   |     |
|  | 1.6 LPG / Multifuel | 75    | 12.09 | 10.12       | PR: 1KD     |                |        |   |                      |                        |                |        |  |                   |     |
|  | 1.6 TDI             | 66    | 11.10 | 10.12       | PR: 1KD     |                |        |   |                      |                        |                |        |  |                   |     |
|  | 1.6 TDI Ecomotive   | 77    | 02.10 | 10.12       | PR: 1KD     |                |        |   |                      |                        |                |        |  |                   |     |
|  | 1.8 TSI             | 118   | 06.07 | 10.12       | PR: 1KD     |                |        |   |                      |                        |                |        |  |                   |     |
|  | 1.9 TDI             |       | 08.05 | 10.12       | PR: 1KD     |                |        |   |                      |                        |                |        |  |                   |     |
|  | 1.9 TDI             | 81    | 08.05 | 10.12       | PR: 1KD     |                |        |   |                      |                        |                |        |  |                   |     |
|  | 2.0 Cupra R         | 195   | 11.06 | 10.12       | PR: 1KD     |                |        |   |                      |                        |                |        |  |                   |     |
|  | 2.0 FSI             | 110   | 08.05 | 10.12       | PR: 1KD     |                |        |   |                      |                        |                |        |  |                   |     |
|  | 2.0 TDI             |       | 08.05 | 10.12       | PR: 1KD     |                |        |   |                      |                        |                |        |  |                   |     |
|  | 2.0 TDI             | 125   | 02.06 | 10.12       | PR: 1KD     |                |        |   |                      |                        |                |        |  |                   |     |
|  | 2.0 TFSI            | 136   | 08.05 | 10.12       | PR: 1KD     |                |        |   |                      |                        |                |        |  |                   |     |
|  | 2.0 TFSI            | 155   | 09.05 | 10.12       | PR: 1KD     |                |        |   |                      |                        |                |        |  |                   |     |
|  | 2.0 TFSI            | 177   | 11.06 | 10.12       | PR: 1KD     |                |        |   |                      |                        |                |        |  |                   |     |
|  | 1.2 TSI             | 77    | 02.10 | 10.12       | PR: 1KY,1KZ | 24.0112-0169.1 | 412169 |   | 282 12,0 10,0 +S +B  | 282 12,0 10,0 +S +B PD |                |        |  |                   |     |
|  | 1.4 i 16V           | 63    | 06.06 | 10.12       | PR: 1KY,1KZ |                |        |   |                      |                        |                |        |  |                   |     |
|  | 1.4 TSI             | 92    | 11.07 | 10.12       | PR: 1KY,1KZ |                |        |   |                      |                        |                |        |  |                   |     |
|  | 1.6 i               | 75    | 08.05 | 10.12       | PR: 1KY,1KZ |                |        |   |                      |                        |                |        |  |                   |     |
|  | 1.6 LPG / Multifuel | 75    | 12.09 | 10.12       | PR: 1KY,1KZ |                |        |   |                      |                        |                |        |  |                   |     |
|  | 1.6 TDI             | 66    | 11.10 | 10.12       | PR: 1KY,1KZ |                |        |   |                      |                        |                |        |  |                   |     |
|  | 1.6 TDI Ecomotive   | 77    | 02.10 | 10.12       | PR: 1KY,1KZ |                |        |   |                      |                        |                |        |  |                   |     |
|  | 1.8 TSI             | 118   | 06.07 | 10.12       | PR: 1KY,1KZ |                |        |   |                      |                        |                |        |  |                   |     |
|  | 1.9 TDI             |       | 08.05 | 10.12       | PR: 1KY,1KZ |                |        |   |                      |                        |                |        |  |                   |     |
|  | 1.9 TDI             | 81    | 08.05 | 10.12       | PR: 1KY,1KZ |                |        |   |                      |                        |                |        |  |                   |     |
|  | 2.0 Cupra R         | 195   | 11.06 | 10.12       | PR: 1KY,1KZ |                |        |   |                      |                        |                |        |  |                   |     |
|  | 2.0 FSI             | 110   | 08.05 | 10.12       | PR: 1KY,1KZ |                |        |   |                      |                        |                |        |  |                   |     |
|  | 2.0 TDI             |       | 08.05 | 10.12       | PR: 1KY,1KZ |                |        |   |                      |                        |                |        |  |                   |     |
|  | 2.0 TDI             | 125   | 02.06 | 10.12       | PR: 1KY,1KZ |                |        |   |                      |                        |                |        |  |                   |     |
|  | 2.0 TFSI            | 136   | 08.05 | 10.12       | PR: 1KY,1KZ |                |        |   |                      |                        |                |        |  |                   |     |
|  | 2.0 TFSI            | 155   | 09.05 | 10.12       | PR: 1KY,1KZ |                |        |   |                      |                        |                |        |  |                   |     |
|  | 2.0 TFSI            | 177   | 11.06 | 10.12       | PR: 1KY,1KZ |                |        |   |                      |                        |                |        |  |                   |     |
|  | 1.2 TSI             | 77    | 02.10 | 10.12       | PR: 1KS,1KT | 24.0110-0356.1 | 410356 |   | 272 9,7 8,0 +S +B    | 272 9,7 8,0 +S +B PD   |                |        |  |                   |     |
|  | 1.4 i 16V           | 63    | 06.06 | 10.12       | PR: 1KS,1KT |                |        |   |                      |                        |                |        |  |                   |     |
|  | 1.4 TSI             | 92    | 11.07 | 10.12       | PR: 1KS,1KT |                |        |   |                      |                        |                |        |  |                   |     |
|  | 1.6 i               | 75    | 08.05 | 10.12       | PR: 1KS,1KT |                |        |   |                      |                        |                |        |  |                   |     |
|  | 1.6 LPG / Multifuel | 75    | 12.09 | 10.12       | PR: 1KS,1KT |                |        |   |                      |                        |                |        |  |                   |     |
|  | 1.6 TDI             | 66    | 11.10 | 10.12       | PR: 1KS,1KT |                |        |   |                      |                        |                |        |  |                   |     |
|  | 1.6 TDI Ecomotive   | 77    | 02.10 | 10.12       | PR: 1KS,1KT |                |        |   |                      |                        |                |        |  |                   |     |
|  | 1.8 TSI             | 118   | 06.07 | 10.12       | PR: 1KS,1KT |                |        |   |                      |                        |                |        |  |                   |     |
|  | 1.9 TDI             |       | 08.05 | 10.12       | PR: 1KS,1KT |                |        |   |                      |                        |                |        |  |                   |     |
|  | 1.9 TDI             | 81    | 08.05 | 10.12       | PR: 1KS,1KT |                |        |   |                      |                        |                |        |  |                   |     |
|  | 2.0 Cupra R         | 195   | 11.06 | 10.12       | PR: 1KS,1KT |                |        |   |                      |                        |                |        |  |                   |     |
|  | 2.0 FSI             | 110   | 08.05 | 10.12       | PR: 1KS,1KT |                |        |   |                      |                        |                |        |  |                   |     |
|  | 2.0 TDI             |       | 08.05 | 10.12       | PR: 1KS,1KT |                |        |   |                      |                        |                |        |  |                   |     |
|  | 2.0 TDI             | 125   | 02.06 | 10.12       | PR: 1KS,1KT |                |        |   |                      |                        |                |        |  |                   |     |
|  | 2.0 TFSI            | 136   | 08.05 | 10.12       | PR: 1KS,1KT |                |        |   |                      |                        |                |        |  |                   |     |
|  | 2.0 TFSI            | 155   | 09.05 | 10.12       | PR: 1KS,1KT |                |        |   |                      |                        |                |        |  |                   |     |
|  | 2.0 TFSI            | 177   | 11.06 | 10.12       | PR: 1KS,1KT |                |        |   |                      |                        |                |        |  |                   |     |
|  | 1.2 TSI             | 77    | 02.10 | 10.12       |             | 24.0711-6231.3 | 360305 |  | Radsensor            | Radsensor              |                |        |  |                   |     |
|  | 1.4 i 16V           | 63    | 06.06 | 10.12       |             |                |        |   |                      |                        |                |        |  |                   |     |
|  | 1.4 TSI             | 92    | 11.07 | 10.12       |             |                |        |   |                      |                        |                |        |  |                   |     |
|  | 1.6 i               | 75    | 08.05 | 10.12       |             |                |        |   |                      |                        |                |        |  |                   |     |
|  | 1.6 LPG / Multifuel | 75    | 12.09 | 10.12       |             |                |        |   |                      |                        |                |        |  |                   |     |
|  | 1.6 TDI             | 66    | 11.10 | 10.12       |             |                |        |   |                      |                        |                |        |  |                   |     |

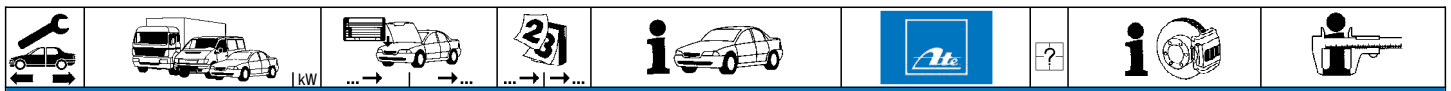

**SEAT LEON II (1P1) (05-12)**

|  |                      |  |       |       |  |                |        |  |           |
|--|----------------------|--|-------|-------|--|----------------|--------|--|-----------|
|  | 1.6 TDI Ecomotive 77 |  | 02.10 | 10.12 |  | 24.0711-6231.3 | 360305 |  | Radsensor |
|  | 1.8 TSI 118          |  | 06.07 | 10.12 |  | 24.0711-6232.3 | 360306 |  | Radsensor |
|  | 1.9 TDI 81           |  | 08.05 | 10.12 |  |                |        |  |           |
|  | 1.9 TDI 81           |  | 08.05 | 10.12 |  |                |        |  |           |
|  | 2.0 Cupra R 195      |  | 11.06 | 10.12 |  |                |        |  |           |
|  | 2.0 FSI 110          |  | 08.05 | 10.12 |  |                |        |  |           |
|  | 2.0 TDI 125          |  | 08.05 | 10.12 |  |                |        |  |           |
|  | 2.0 TDI 125          |  | 02.06 | 10.12 |  |                |        |  |           |
|  | 2.0 TFSI 136         |  | 08.05 | 10.12 |  |                |        |  |           |
|  | 2.0 TFSI 155         |  | 09.05 | 10.12 |  |                |        |  |           |
|  | 2.0 TFSI 177         |  | 11.06 | 10.12 |  |                |        |  |           |

**SEAT LEON III (5F) / SC / ST (12-)**

|  |                    |  |       |  |             |                |        |  |                   |     |
|--|--------------------|--|-------|--|-------------|----------------|--------|--|-------------------|-----|
|  | 1.0 TSI 85         |  | 05.15 |  | PR: 1ZA,1ZE | 13.0460-2785.2 | 602785 |  | 25683 20,4 +/WK/S | TRW |
|  | 1.2 TSI 63         |  | 09.12 |  | PR: 1ZA,1ZE | 13.0470-2785.2 | LD2785 |  | 25683 20,4 +/WK/S | TRW |
|  | 1.2 TSI 77         |  | 09.12 |  | PR: 1ZA,1ZE |                |        |  |                   |     |
|  | 1.2 TSI 81         |  | 04.14 |  | PR: 1ZA,1ZE |                |        |  |                   |     |
|  | 1.4 TGI 81         |  | 10.13 |  | PR: 1ZA,1ZE |                |        |  |                   |     |
|  | 1.4 TSI 90         |  | 09.12 |  | PR: 1ZA,1ZE |                |        |  |                   |     |
|  | 1.4 TSI 92         |  | 05.14 |  | PR: 1ZA,1ZE |                |        |  |                   |     |
|  | 1.4 TSI 103        |  | 09.12 |  | PR: 1ZA,1ZE |                |        |  |                   |     |
|  | 1.4 TSI 110        |  | 05.14 |  | PR: 1ZA,1ZE |                |        |  |                   |     |
|  | 1.6 TDI 66         |  | 09.12 |  | PR: 1ZA,1ZE |                |        |  |                   |     |
|  | 1.6 TDI 77         |  | 09.12 |  | PR: 1ZA,1ZE |                |        |  |                   |     |
|  | 1.6 TDI 81         |  | 09.13 |  | PR: 1ZA,1ZE |                |        |  |                   |     |
|  | 1.6 TDI 4Drive 77  |  | 04.14 |  | PR: 1ZA,1ZE |                |        |  |                   |     |
|  | 1.6 TDI 4Drive 81  |  | 11.14 |  | PR: 1ZA,1ZE |                |        |  |                   |     |
|  | 1.8 TSI 132        |  | 09.12 |  | PR: 1ZA,1ZE |                |        |  |                   |     |
|  | 1.8 TSI 4Drive 132 |  | 11.14 |  | PR: 1ZA,1ZE |                |        |  |                   |     |
|  | 2.0 Cupra 195      |  | 10.13 |  | PR: 1ZA,1ZE |                |        |  |                   |     |
|  | 2.0 Cupra 206      |  | 10.13 |  | PR: 1ZA,1ZE |                |        |  |                   |     |
|  | 2.0 TDI 81         |  | 05.13 |  | PR: 1ZA,1ZE |                |        |  |                   |     |
|  | 2.0 TDI 105        |  | 05.13 |  | PR: 1ZA,1ZE |                |        |  |                   |     |
|  | 2.0 TDI 110        |  | 09.12 |  | PR: 1ZA,1ZE |                |        |  |                   |     |
|  | 2.0 TDI 135        |  | 09.12 |  | PR: 1ZA,1ZE |                |        |  |                   |     |
|  | 2.0 TDI 4Drive 110 |  | 04.14 |  | PR: 1ZA,1ZE |                |        |  |                   |     |
|  | 2.0 TDI 4Drive 135 |  | 11.14 |  | PR: 1ZA,1ZE |                |        |  |                   |     |
|  | 1.0 TSI 85         |  | 05.15 |  | PR: 1ZF     | 13.0460-7303.2 | 607303 |  | 22035 17,5 +/WK   | ATE |
|  | 1.2 TSI 63         |  | 09.12 |  | PR: 1ZF     | 13.0470-7303.2 | LD7303 |  | 22035 17,5 +/WK   | ATE |
|  | 1.2 TSI 77         |  | 09.12 |  | PR: 1ZF     |                |        |  |                   |     |
|  | 1.2 TSI 81         |  | 04.14 |  | PR: 1ZF     |                |        |  |                   |     |
|  | 1.4 TGI 81         |  | 10.13 |  | PR: 1ZF     |                |        |  |                   |     |
|  | 1.4 TSI 90         |  | 09.12 |  | PR: 1ZF     |                |        |  |                   |     |
|  | 1.4 TSI 92         |  | 05.14 |  | PR: 1ZF     |                |        |  |                   |     |
|  | 1.4 TSI 103        |  | 09.12 |  | PR: 1ZF     |                |        |  |                   |     |
|  | 1.4 TSI 110        |  | 05.14 |  | PR: 1ZF     |                |        |  |                   |     |
|  | 1.6 TDI 66         |  | 09.12 |  | PR: 1ZF     |                |        |  |                   |     |
|  | 1.6 TDI 77         |  | 09.12 |  | PR: 1ZF     |                |        |  |                   |     |
|  | 1.6 TDI 81         |  | 09.13 |  | PR: 1ZF     |                |        |  |                   |     |
|  | 1.6 TDI 4Drive 77  |  | 04.14 |  | PR: 1ZF     |                |        |  |                   |     |
|  | 1.6 TDI 4Drive 81  |  | 11.14 |  | PR: 1ZF     |                |        |  |                   |     |
|  | 1.8 TSI 132        |  | 09.12 |  | PR: 1ZF     |                |        |  |                   |     |
|  | 1.8 TSI 4Drive 132 |  | 11.14 |  | PR: 1ZF     |                |        |  |                   |     |
|  | 2.0 Cupra 195      |  | 10.13 |  | PR: 1ZF     |                |        |  |                   |     |
|  | 2.0 Cupra 206      |  | 10.13 |  | PR: 1ZF     |                |        |  |                   |     |
|  | 2.0 TDI 81         |  | 05.13 |  | PR: 1ZF     |                |        |  |                   |     |
|  | 2.0 TDI 105        |  | 05.13 |  | PR: 1ZF     |                |        |  |                   |     |
|  | 2.0 TDI 110        |  | 09.12 |  | PR: 1ZF     |                |        |  |                   |     |
|  | 2.0 TDI 135        |  | 09.12 |  | PR: 1ZF     |                |        |  |                   |     |
|  | 2.0 TDI 4Drive 110 |  | 04.14 |  | PR: 1ZF     |                |        |  |                   |     |
|  | 2.0 TDI 4Drive 135 |  | 11.14 |  | PR: 1ZF     |                |        |  |                   |     |
|  | 1.0 TSI 85         |  | 05.15 |  | PR: 1LJ,1LG | 13.0460-2764.2 | 602764 |  | 24738 20,0 +/WK/S | TRW |
|  | 1.2 TSI 63         |  | 09.12 |  | PR: 1LJ,1LG | 13.0470-2764.2 | LD2764 |  | 24738 20,0 +/WK/S | TRW |
|  | 1.2 TSI 77         |  | 09.12 |  | PR: 1LJ,1LG |                |        |  |                   |     |
|  | 1.2 TSI 81         |  | 04.14 |  | PR: 1LJ,1LG |                |        |  |                   |     |
|  | 1.4 TGI 81         |  | 10.13 |  | PR: 1LJ,1LG |                |        |  |                   |     |
|  | 1.4 TSI 90         |  | 09.12 |  | PR: 1LJ,1LG |                |        |  |                   |     |
|  | 1.4 TSI 92         |  | 05.14 |  | PR: 1LJ,1LG |                |        |  |                   |     |
|  | 1.4 TSI 103        |  | 09.12 |  | PR: 1LJ,1LG |                |        |  |                   |     |
|  | 1.4 TSI 110        |  | 05.14 |  | PR: 1LJ,1LG |                |        |  |                   |     |
|  | 1.6 TDI 66         |  | 09.12 |  | PR: 1LJ,1LG |                |        |  |                   |     |
|  | 1.6 TDI 77         |  | 09.12 |  | PR: 1LJ,1LG |                |        |  |                   |     |
|  | 1.6 TDI 81         |  | 09.13 |  | PR: 1LJ,1LG |                |        |  |                   |     |
|  | 1.6 TDI 4Drive 77  |  | 04.14 |  | PR: 1LJ,1LG |                |        |  |                   |     |
|  | 1.6 TDI 4Drive 81  |  | 11.14 |  | PR: 1LJ,1LG |                |        |  |                   |     |
|  | 1.8 TSI 132        |  | 09.12 |  | PR: 1LJ,1LG |                |        |  |                   |     |
|  | 1.8 TSI 4Drive 132 |  | 11.14 |  | PR: 1LJ,1LG |                |        |  |                   |     |
|  | 2.0 Cupra 195      |  | 10.13 |  | PR: 1LJ,1LG |                |        |  |                   |     |
|  | 2.0 Cupra 206      |  | 10.13 |  | PR: 1LJ,1LG |                |        |  |                   |     |
|  | 2.0 TDI 81         |  | 05.13 |  | PR: 1LJ,1LG |                |        |  |                   |     |
|  | 2.0 TDI 105        |  | 05.13 |  | PR: 1LJ,1LG |                |        |  |                   |     |
|  | 2.0 TDI 110        |  | 09.12 |  | PR: 1LJ,1LG |                |        |  |                   |     |
|  | 2.0 TDI 135        |  | 09.12 |  | PR: 1LJ,1LG |                |        |  |                   |     |
|  | 2.0 TDI 4Drive 110 |  | 04.14 |  | PR: 1LJ,1LG |                |        |  |                   |     |
|  | 2.0 TDI 4Drive 135 |  | 11.14 |  | PR: 1LJ,1LG |                |        |  |                   |     |



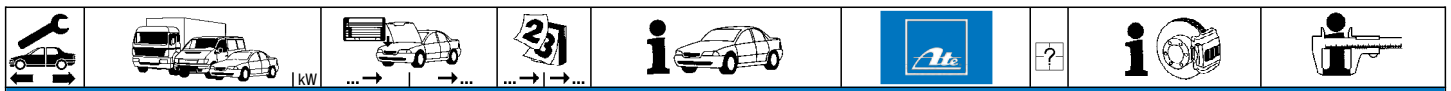

**SEAT LEON III (5F) / SC / ST (12-)**

|  |   |   |   |   |  |                            |   |  |   |                          |
|--|---|---|---|---|--|----------------------------|---|--|---|--------------------------|
|  | 2.0 Cupra<br>2.0 Cupra  | 195<br>206  | 10.13<br>10.13  |   | 13.0460-4833.2<br>13.0470-4833.2<br>24.8190-0302.2 | 604833<br>LD4833<br>620302 | 1 | + Performance Pack<br>+ Performance Pack<br>+ Performance Pack | 24098 17,1 /WE<br>24098 17,1 /WE<br>Warnkontakt L=367,4mm | <b>BRE</b><br><b>BRE</b> |
|  | 1.0 TSI<br>1.2 TSI<br>1.2 TSI<br>1.2 TSI<br>1.4 TGI<br>1.4 TSI<br>1.4 TSI<br>1.4 TSI<br>1.4 TSI<br>1.6 TDI<br>1.6 TDI<br>1.6 TDI<br>1.6 TDI 4Drive<br>1.6 TDI 4Drive<br>1.8 TSI<br>1.8 TSI 4Drive<br>2.0 Cupra<br>2.0 Cupra<br>2.0 TDI<br>2.0 TDI<br>2.0 TDI<br>2.0 TDI<br>2.0 TDI 4Drive<br>2.0 TDI 4Drive | 85<br>63<br>77<br>81<br>81<br>90<br>92<br>103<br>110<br>66<br>77<br>81<br>77<br>81<br>132<br>132<br>195<br>206<br>81<br>105<br>110<br>135<br>110<br>135 | 05.15<br>09.12<br>09.12<br>04.14<br>10.13<br>09.12<br>05.14<br>09.12<br>05.14<br>09.12<br>09.12<br>09.13<br>04.14<br>11.14<br>09.12<br>11.14<br>10.13<br>10.13<br>05.13<br>05.13<br>09.12<br>04.14<br>11.14 | PR: 1ZA<br>PR: 1ZA<br>PR: 1ZA<br>PR: 1ZA<br>PR: 1ZA<br>PR: 1ZA<br>PR: 1ZA<br>PR: 1ZA<br>PR: 1ZA<br>PR: 1ZA<br>PR: 1ZA<br>PR: 1ZA<br>PR: 1ZA<br>PR: 1ZA<br>PR: 1ZA<br>PR: 1ZA<br>PR: 1ZA<br>PR: 1ZA<br>PR: 1ZA<br>PR: 1ZA<br>PR: 1ZA<br>PR: 1ZA<br>PR: 1ZA   | 24.0125-0158.1<br>24.0325-0158.1                   | 425158<br>525158           |   |  | 312 25,0 V L +S +B<br>312 25,0 22,0 V L +S +B PD          |                          |
|  | 1.0 TSI<br>1.2 TSI<br>1.2 TSI<br>1.2 TSI<br>1.4 TGI<br>1.4 TSI<br>1.4 TSI<br>1.4 TSI<br>1.4 TSI<br>1.6 TDI<br>1.6 TDI<br>1.6 TDI<br>1.6 TDI 4Drive<br>1.6 TDI 4Drive<br>1.8 TSI<br>1.8 TSI 4Drive<br>2.0 Cupra<br>2.0 Cupra<br>2.0 TDI<br>2.0 TDI<br>2.0 TDI<br>2.0 TDI<br>2.0 TDI 4Drive<br>2.0 TDI 4Drive | 85<br>63<br>77<br>81<br>81<br>90<br>92<br>103<br>110<br>66<br>77<br>81<br>77<br>81<br>132<br>132<br>195<br>206<br>81<br>105<br>110<br>135<br>110<br>135 | 05.15<br>09.12<br>09.12<br>04.14<br>10.13<br>09.12<br>05.14<br>09.12<br>05.14<br>09.12<br>09.12<br>09.13<br>04.14<br>11.14<br>09.12<br>11.14<br>10.13<br>10.13<br>05.13<br>05.13<br>09.12<br>04.14<br>11.14 | PR: 1ZE<br>PR: 1ZE<br>PR: 1ZE<br>PR: 1ZE<br>PR: 1ZE<br>PR: 1ZE<br>PR: 1ZE<br>PR: 1ZE<br>PR: 1ZE<br>PR: 1ZE<br>PR: 1ZE<br>PR: 1ZE<br>PR: 1ZE<br>PR: 1ZE<br>PR: 1ZE<br>PR: 1ZE<br>PR: 1ZE<br>PR: 1ZE<br>PR: 1ZE<br>PR: 1ZE<br>PR: 1ZE<br>PR: 1ZE<br>PR: 1ZE   | 24.0125-0145.1<br>24.0325-0145.1                   | 425145<br>525145           |   |  | 288 25,0 22,0 V L +S +B<br>288 25,0 22,0 V L +S +B PD     |                          |
|  | 1.0 TSI<br>1.2 TSI<br>1.2 TSI<br>1.2 TSI<br>1.4 TGI<br>1.4 TSI<br>1.4 TSI<br>1.4 TSI<br>1.4 TSI<br>1.6 TDI<br>1.6 TDI<br>1.6 TDI<br>1.6 TDI 4Drive<br>1.6 TDI 4Drive<br>1.8 TSI<br>1.8 TSI 4Drive<br>2.0 Cupra<br>2.0 Cupra<br>2.0 TDI<br>2.0 TDI<br>2.0 TDI<br>2.0 TDI<br>2.0 TDI 4Drive<br>2.0 TDI 4Drive | 85<br>63<br>77<br>81<br>81<br>90<br>92<br>103<br>110<br>66<br>77<br>81<br>77<br>81<br>132<br>132<br>195<br>206<br>81<br>105<br>110<br>135<br>110<br>135 | 05.15<br>09.12<br>09.12<br>04.14<br>10.13<br>09.12<br>05.14<br>09.12<br>05.14<br>09.12<br>09.12<br>09.13<br>04.14<br>11.14<br>09.12<br>11.14<br>10.13<br>10.13<br>05.13<br>05.13<br>09.12<br>04.14<br>11.14 | PR: 1ZF<br>PR: 1ZF<br>PR: 1ZF<br>PR: 1ZF<br>PR: 1ZF<br>PR: 1ZF<br>PR: 1ZF<br>PR: 1ZF<br>PR: 1ZF<br>PR: 1ZF<br>PR: 1ZF<br>PR: 1ZF<br>PR: 1ZF<br>PR: 1ZF<br>PR: 1ZF<br>PR: 1ZF<br>PR: 1ZF<br>PR: 1ZF<br>PR: 1ZF<br>PR: 1ZF<br>PR: 1ZF<br>PR: 1ZF<br>PR: 1ZF   | 24.0124-0258.1                                     | 424258                     |   |  | 276 24,0 21,0 V L +S +B                                   |                          |
|  | 1.0 TSI<br>1.2 TSI<br>1.2 TSI<br>1.2 TSI<br>1.4 TGI<br>1.4 TSI<br>1.4 TSI<br>1.4 TSI<br>1.4 TSI<br>1.6 TDI<br>1.6 TDI<br>1.6 TDI<br>1.6 TDI 4Drive<br>1.6 TDI 4Drive<br>1.8 TSI<br>1.8 TSI 4Drive<br>2.0 Cupra<br>2.0 Cupra<br>2.0 TDI<br>2.0 TDI<br>2.0 TDI<br>2.0 TDI<br>2.0 TDI 4Drive<br>2.0 TDI 4Drive | 85<br>63<br>77<br>81<br>81<br>90<br>92<br>103<br>110<br>66<br>77<br>81<br>77<br>81<br>132<br>132<br>195<br>206<br>81<br>105<br>110<br>135<br>110<br>135 | 05.15<br>09.12<br>09.12<br>04.14<br>10.13<br>09.12<br>05.14<br>09.12<br>05.14<br>09.12<br>09.12<br>09.13<br>04.14<br>11.14<br>09.12<br>11.14<br>10.13<br>10.13<br>05.13<br>05.13<br>09.12<br>04.14<br>11.14 | PR: 1LJ,1LG<br>PR: 1LJ,1LG<br>PR: 1LJ,1LG<br>PR: 1LJ,1LG<br>PR: 1LJ,1LG<br>PR: 1LJ,1LG<br>PR: 1LJ,1LG<br>PR: 1LJ,1LG<br>PR: 1LJ,1LG<br>PR: 1LJ,1LG<br>PR: 1LJ,1LG<br>PR: 1LJ,1LG<br>PR: 1LJ,1LG<br>PR: 1LJ,1LG<br>PR: 1LJ,1LG<br>PR: 1LJ,1LG<br>PR: 1LJ,1LG<br>PR: 1LJ,1LG<br>PR: 1LJ,1LG<br>PR: 1LJ,1LG<br>PR: 1LJ,1LG<br>PR: 1LJ,1LG<br>PR: 1LJ,1LG | 24.0130-0225.1                                     | 430225                     |   |  | 340 30,0 27,0 V L +S +B                                   |                          |



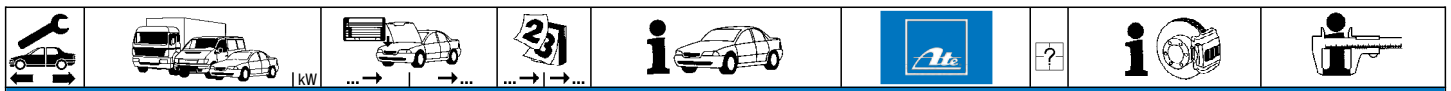

**SEAT LEON III (5F) / SC / ST (12-)**

|  |  |  |  |  |                                  |                  |  |                        |
|--|--|--|--|--|----------------------------------|------------------|--|------------------------|
|  | 1.6 TDI 4Drive 77<br>1.6 TDI 4Drive 81<br>1.8 TSI 132<br>1.8 TSI 4Drive 132<br>2.0 Cupra 195<br>2.0 Cupra 206<br>2.0 TDI 81<br>2.0 TDI 105<br>2.0 TDI 110<br>2.0 TDI 135<br>2.0 TDI 4Drive 110<br>2.0 TDI 4Drive 135   |  | 04.14<br>11.14<br>09.12<br>11.14<br>10.13<br>10.13<br>05.13<br>05.13<br>09.12<br>09.12<br>04.14<br>11.14   | PR: 1LJ,1LG<br>PR: 1LJ,1LG<br>PR: 1LJ,1LG<br>PR: 1LJ,1LG<br>PR: 1LJ,1LG<br>PR: 1LJ,1LG<br>PR: 1LJ,1LG<br>PR: 1LJ,1LG<br>PR: 1LJ,1LG<br>PR: 1LJ,1LG<br>PR: 1LJ,1LG<br>PR: 1LJ,1LG   | 24.0130-0225.1<br>430225         |                  | 340 30,0 27,0 VL +S +B                               |                        |
|  | 1.0 TSI 85<br>1.2 TSI 63<br>1.2 TSI 77<br>1.2 TSI 81<br>1.4 TGI 81<br>1.4 TSI 90<br>1.4 TSI 92<br>1.4 TSI 103<br>1.4 TSI 110<br>1.6 TDI 66<br>1.6 TDI 77<br>1.6 TDI 81<br>1.6 TDI 4Drive 77<br>1.6 TDI 4Drive 81<br>1.8 TSI 132<br>1.8 TSI 4Drive 132<br>2.0 Cupra 195<br>2.0 Cupra 206<br>2.0 TDI 81<br>2.0 TDI 105<br>2.0 TDI 110<br>2.0 TDI 135<br>2.0 TDI 4Drive 110<br>2.0 TDI 4Drive 135 |  | 05.15<br>09.12<br>09.12<br>04.14<br>10.13<br>09.12<br>05.14<br>09.12<br>05.14<br>09.12<br>09.12<br>09.13<br>04.14<br>11.14<br>09.12<br>11.14<br>10.13<br>10.13<br>05.13<br>05.13<br>09.12<br>09.12<br>04.14<br>11.14 |  | 24.0711-5273.3<br>24.0711-5274.3 | 360303<br>360304 | <br>   | Radsensor<br>Radsensor |
|  | 1.0 TSI 85<br>1.2 TSI 63<br>1.2 TSI 77<br>1.2 TSI 81<br>1.4 TGI 81<br>1.4 TSI 90<br>1.4 TSI 92<br>1.4 TSI 103<br>1.4 TSI 110<br>1.6 TDI 66<br>1.6 TDI 77<br>1.6 TDI 81<br>1.6 TDI 4Drive 77<br>1.6 TDI 4Drive 81<br>1.8 TSI 132<br>1.8 TSI 4Drive 132<br>2.0 Cupra 195<br>2.0 Cupra 206<br>2.0 TDI 81<br>2.0 TDI 105<br>2.0 TDI 110<br>2.0 TDI 135<br>2.0 TDI 4Drive 110<br>2.0 TDI 4Drive 135 |  | 05.15<br>09.12<br>09.12<br>04.14<br>10.13<br>09.12<br>05.14<br>09.12<br>05.14<br>09.12<br>09.12<br>09.13<br>04.14<br>11.14<br>09.12<br>11.14<br>10.13<br>10.13<br>05.13<br>05.13<br>09.12<br>09.12<br>04.14<br>11.14 | PR: 1KD<br>PR: 1KD<br>PR: 1KD<br>PR: 1KD<br>PR: 1KD<br>PR: 1KD<br>PR: 1KD<br>PR: 1KD<br>PR: 1KD<br>PR: 1KD<br>PR: 1KD<br>PR: 1KD<br>PR: 1KD<br>PR: 1KD<br>PR: 1KD<br>PR: 1KD<br>PR: 1KD<br>PR: 1KD<br>PR: 1KD<br>PR: 1KD<br>PR: 1KD<br>PR: 1KD<br>PR: 1KD<br>PR: 1KD   | 13.0460-2787.2<br>602787         |                  | 23554 17,3 /S TRW                                    |                        |
|  | 1.0 TSI 85<br>1.2 TSI 63<br>1.2 TSI 77<br>1.2 TSI 81<br>1.4 TGI 81<br>1.4 TSI 90<br>1.4 TSI 92<br>1.4 TSI 103<br>1.4 TSI 110<br>1.6 TDI 66<br>1.6 TDI 77<br>1.6 TDI 81<br>1.6 TDI 4Drive 77<br>1.6 TDI 4Drive 81<br>1.8 TSI 132<br>1.8 TSI 4Drive 132<br>2.0 Cupra 195<br>2.0 Cupra 206<br>2.0 TDI 81<br>2.0 TDI 105<br>2.0 TDI 110<br>2.0 TDI 135<br>2.0 TDI 4Drive 110<br>2.0 TDI 4Drive 135 |  | 05.15<br>09.12<br>09.12<br>04.14<br>10.13<br>09.12<br>05.14<br>09.12<br>05.14<br>09.12<br>09.12<br>09.13<br>04.14<br>11.14<br>09.12<br>11.14<br>10.13<br>10.13<br>05.13<br>05.13<br>09.12<br>09.12<br>04.14<br>11.14 | PR: 1KF,1KW<br>PR: 1KF,1KW<br>PR: 1KF,1KW<br>PR: 1KF,1KW<br>PR: 1KF,1KW<br>PR: 1KF,1KW<br>PR: 1KF,1KW<br>PR: 1KF,1KW<br>PR: 1KF,1KW<br>PR: 1KF,1KW<br>PR: 1KF,1KW<br>PR: 1KF,1KW<br>PR: 1KF,1KW<br>PR: 1KF,1KW<br>PR: 1KF,1KW<br>PR: 1KF,1KW<br>PR: 1KF,1KW<br>PR: 1KF,1KW<br>PR: 1KF,1KW<br>PR: 1KF,1KW<br>PR: 1KF,1KW<br>PR: 1KF,1KW<br>PR: 1KF,1KW<br>PR: 1KF,1KW | 13.0460-2880.2<br>13.0470-2880.2 | 602880<br>LD2880 | 23914 17,1 /WE/Zub/S TRW<br>23914 17,1 /WE/Zub/S TRW |                        |

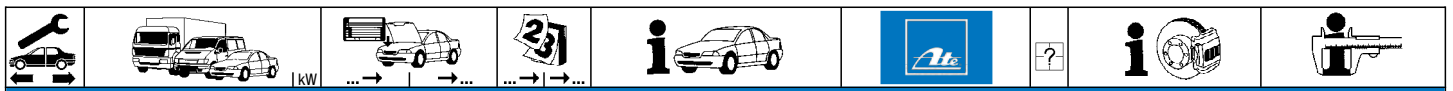

















**SEAT LEON III (5F) / SC / ST (12-)**

|           |                |       |       |             |                |        |  |   |  |                    |
|-----------|----------------|-------|-------|-------------|----------------|--------|--|---|--|--------------------|
|           | 1.0 TSI        | 85    | 05.15 | PR: 1KD     | 24.0110-0277.1 | 410277 |  | 253 10,0 8,0 +S +B<br>253 10,0 8,0 +S +B PD |  |                    |
|           | 1.2 TSI        | 63    | 09.12 | PR: 1KD     | 24.0310-0277.1 | 510277 |  |   |  |                    |
|           | 1.2 TSI        | 77    | 09.12 | PR: 1KD     |                |        |  |   |  |                    |
|           | 1.2 TSI        | 81    | 04.14 | PR: 1KD     |                |        |  |   |  |                    |
|           | 1.4 TGI        | 81    | 10.13 | PR: 1KD     |                |        |  |   |  |                    |
|           | 1.4 TSI        | 90    | 09.12 | PR: 1KD     |                |        |  |   |  |                    |
|           | 1.4 TSI        | 92    | 05.14 | PR: 1KD     |                |        |  |   |  |                    |
|           | 1.4 TSI        | 103   | 09.12 | PR: 1KD     |                |        |  |   |  |                    |
|           | 1.4 TSI        | 110   | 05.14 | PR: 1KD     |                |        |  |   |  |                    |
|           | 1.6 TDI        | 66    | 09.12 | PR: 1KD     |                |        |  |   |  |                    |
|           | 1.6 TDI        | 77    | 09.12 | PR: 1KD     |                |        |  |   |  |                    |
|           | 1.6 TDI        | 81    | 09.13 | PR: 1KD     |                |        |  |   |  |                    |
|           | 1.6 TDI 4Drive | 77    | 04.14 | PR: 1KD     |                |        |  |   |  |                    |
|           | 1.6 TDI 4Drive | 81    | 11.14 | PR: 1KD     |                |        |  |   |  |                    |
|           | 1.8 TSI        | 132   | 09.12 | PR: 1KD     |                |        |  |   |  |                    |
|           | 1.8 TSI 4Drive | 132   | 11.14 | PR: 1KD     |                |        |  |   |  |                    |
|           | 2.0 TDI        | 81    | 05.13 | PR: 1KD     |                |        |  |   |  |                    |
|           | 2.0 TDI        | 105   | 05.13 | PR: 1KD     |                |        |  |   |  |                    |
|           | 2.0 TDI        | 110   | 09.12 | PR: 1KD     |                |        |  |   |  |                    |
|           | 2.0 TDI        | 135   | 09.12 | PR: 1KD     |                |        |  |   |  |                    |
|           | 2.0 TDI 4Drive | 110   | 04.14 | PR: 1KD     |                |        |  |   |  |                    |
|           | 2.0 TDI 4Drive | 135   | 11.14 | PR: 1KD     |                |        |  |   |  |                    |
|           | 2.0 Cupra      | 195   | 10.13 | PR: 1KD     | 24.0110-0277.1 | 410277 |  |   |  | 253 10,0 8,0 +S +B |
|           | 2.0 Cupra      | 206   | 10.13 | PR: 1KD     |                |        |  |   |  |                    |
|           | 1.0 TSI        | 85    | 05.15 | PR: 1KS     | 24.0110-0356.1 | 410356 |  | 272 9,7 8,0 +S +B<br>272 9,7 8,0 +S +B PD   |  |                    |
|           | 1.2 TSI        | 63    | 09.12 | PR: 1KS     | 24.0310-0356.1 | 510356 |  |   |  |                    |
|           | 1.2 TSI        | 77    | 09.12 | PR: 1KS     |                |        |  |   |  |                    |
|           | 1.2 TSI        | 81    | 04.14 | PR: 1KS     |                |        |  |   |  |                    |
|           | 1.4 TGI        | 81    | 10.13 | PR: 1KS     |                |        |  |   |  |                    |
|           | 1.4 TSI        | 90    | 09.12 | PR: 1KS     |                |        |  |   |  |                    |
|           | 1.4 TSI        | 92    | 05.14 | PR: 1KS     |                |        |  |   |  |                    |
|           | 1.4 TSI        | 103   | 09.12 | PR: 1KS     |                |        |  |   |  |                    |
|           | 1.4 TSI        | 110   | 05.14 | PR: 1KS     |                |        |  |   |  |                    |
|           | 1.6 TDI        | 66    | 09.12 | PR: 1KS     |                |        |  |   |  |                    |
|           | 1.6 TDI        | 77    | 09.12 | PR: 1KS     |                |        |  |   |  |                    |
|           | 1.6 TDI        | 81    | 09.13 | PR: 1KS     |                |        |  |   |  |                    |
|           | 1.6 TDI 4Drive | 77    | 04.14 | PR: 1KS     |                |        |  |   |  |                    |
|           | 1.6 TDI 4Drive | 81    | 11.14 | PR: 1KS     |                |        |  |   |  |                    |
|           | 1.8 TSI        | 132   | 09.12 | PR: 1KS     |                |        |  |   |  |                    |
|           | 1.8 TSI 4Drive | 132   | 11.14 | PR: 1KS     |                |        |  |   |  |                    |
|           | 2.0 Cupra      | 195   | 10.13 | PR: 1KS     |                |        |  |   |  |                    |
|           | 2.0 Cupra      | 206   | 10.13 | PR: 1KS     |                |        |  |   |  |                    |
|           | 2.0 TDI        | 81    | 05.13 | PR: 1KS     |                |        |  |   |  |                    |
|           | 2.0 TDI        | 105   | 05.13 | PR: 1KS     |                |        |  |   |  |                    |
|           | 2.0 TDI        | 110   | 09.12 | PR: 1KS     |                |        |  |   |  |                    |
|           | 2.0 TDI        | 135   | 09.12 | PR: 1KS     |                |        |  |   |  |                    |
|           | 2.0 TDI 4Drive | 110   | 04.14 | PR: 1KS     |                |        |  |   |  |                    |
|           | 2.0 TDI 4Drive | 135   | 11.14 | PR: 1KS     |                |        |  |   |  |                    |
|           | 1.0 TSI        | 85    | 05.15 | PR: 1KF,1KW | 24.0122-0219.1 | 422219 |  | 310 22,0 20,0 VL +B                         |  |                    |
|           | 1.2 TSI        | 63    | 09.12 | PR: 1KF,1KW |                |        |  |   |  |                    |
|           | 1.2 TSI        | 77    | 09.12 | PR: 1KF,1KW |                |        |  |   |  |                    |
|           | 1.2 TSI        | 81    | 04.14 | PR: 1KF,1KW |                |        |  |   |  |                    |
|           | 1.4 TGI        | 81    | 10.13 | PR: 1KF,1KW |                |        |  |   |  |                    |
|           | 1.4 TSI        | 90    | 09.12 | PR: 1KF,1KW |                |        |  |   |  |                    |
|           | 1.4 TSI        | 92    | 05.14 | PR: 1KF,1KW |                |        |  |   |  |                    |
|           | 1.4 TSI        | 103   | 09.12 | PR: 1KF,1KW |                |        |  |   |  |                    |
|           | 1.4 TSI        | 110   | 05.14 | PR: 1KF,1KW |                |        |  |   |  |                    |
|           | 1.6 TDI        | 66    | 09.12 | PR: 1KF,1KW |                |        |  |   |  |                    |
|           | 1.6 TDI        | 77    | 09.12 | PR: 1KF,1KW |                |        |  |   |  |                    |
|           | 1.6 TDI        | 81    | 09.13 | PR: 1KF,1KW |                |        |  |   |  |                    |
|           | 1.6 TDI 4Drive | 77    | 04.14 | PR: 1KF,1KW |                |        |  |   |  |                    |
|           | 1.6 TDI 4Drive | 81    | 11.14 | PR: 1KF,1KW |                |        |  |   |  |                    |
|           | 1.8 TSI        | 132   | 09.12 | PR: 1KF,1KW |                |        |  |   |  |                    |
|           | 1.8 TSI 4Drive | 132   | 11.14 | PR: 1KF,1KW |                |        |  |   |  |                    |
|           | 2.0 Cupra      | 195   | 10.13 | PR: 1KF,1KW |                |        |  |   |  |                    |
|           | 2.0 Cupra      | 206   | 10.13 | PR: 1KF,1KW |                |        |  |   |  |                    |
|           | 2.0 TDI        | 81    | 05.13 | PR: 1KF,1KW |                |        |  |   |  |                    |
|           | 2.0 TDI        | 105   | 05.13 | PR: 1KF,1KW |                |        |  |   |  |                    |
|           | 2.0 TDI        | 110   | 09.12 | PR: 1KF,1KW |                |        |  |   |  |                    |
|           | 2.0 TDI        | 135   | 09.12 | PR: 1KF,1KW |                |        |  |   |  |                    |
|           | 2.0 TDI 4Drive | 110   | 04.14 | PR: 1KF,1KW |                |        |  |   |  |                    |
|           | 2.0 TDI 4Drive | 135   | 11.14 | PR: 1KF,1KW |                |        |  |   |  |                    |
|           | 1.0 TSI        | 85    | 05.15 |             | 24.0711-6230.3 | 360310 |  | Radsensor<br>Radsensor                      |  |                    |
|           | 1.2 TSI        | 63    | 09.12 |             | 24.0711-6337.3 | 360390 |  |   |  |                    |
|           | 1.2 TSI        | 77    | 09.12 |             |                |        |  |   |  |                    |
|           | 1.2 TSI        | 81    | 04.14 |             |                |        |  |   |  |                    |
|           | 1.4 TGI        | 81    | 10.13 |             |                |        |  |   |  |                    |
|           | 1.4 TSI        | 90    | 09.12 |             |                |        |  |   |  |                    |
|           | 1.4 TSI        | 92    | 05.14 |             |                |        |  |   |  |                    |
|           | 1.4 TSI        | 103   | 09.12 |             |                |        |  |   |  |                    |
|           | 1.4 TSI        | 110   | 05.14 |             |                |        |  |   |  |                    |
|           | 1.6 TDI        | 66    | 09.12 |             |                |        |  |   |  |                    |
|           | 1.6 TDI        | 77    | 09.12 |             |                |        |  |   |  |                    |
|           | 1.6 TDI        | 81    | 09.13 |             |                |        |  |   |  |                    |
|           | 1.8 TSI        | 132   | 09.12 |             |                |        |  |   |  |                    |
|           | 2.0 Cupra      | 195   | 10.13 |             |                |        |  |   |  |                    |
| 2.0 Cupra | 206            | 10.13 |       |             |                |        |  |   |  |                    |

1) - autom. distance control / - regolatore automatico distanza / - régulation de distance autom. / - regulación automática de distancia  
 2) + autom. distance control / + regolatore automatico distanza / + régulation de distance autom. / + regulación automática de distancia



| SEAT LEON III (5F) / SC / ST (12-)   |                |     |  |       |              |                |        |   |  |                            |
|--|----------------|-----|--|-------|--------------|----------------|--------|---|--|----------------------------|
|    | 2.0 TDI        | 81  |  | 05.13 |              | 24.0711-6230.3 | 360310 | 2 | - autom. Distanzregelung <sup>1)</sup> | Radsensor                  |
|  | 2.0 TDI        | 105 |  | 05.13 |              | 24.0711-6337.3 | 360390 | 2 | + autom. Distanzregelung <sup>2)</sup> | Radsensor                  |
|  | 2.0 TDI        | 110 |  | 09.12 |              |                |        |   |  |                            |
|  | 2.0 TDI        | 135 |  | 09.12 |              |                |        |   |  |                            |
|  | 1.6 TDI 4Drive | 77  |  | 04.14 |              | 24.0711-5271.3 | 360301 |   | - autom. Distanzregelung <sup>1)</sup> | Radsensor                  |
|  | 1.6 TDI 4Drive | 81  |  | 11.14 |              | 24.0711-5272.3 | 360302 |   | - autom. Distanzregelung <sup>1)</sup> | Radsensor                  |
|  | 1.8 TSI 4Drive | 132 |  | 11.14 |              | 24.0711-5401.3 | 360330 |   | + autom. Distanzregelung <sup>2)</sup> | Radsensor                  |
|  | 2.0 TDI 4Drive | 110 |  | 04.14 |              | 24.0711-5402.3 | 360331 |   | + autom. Distanzregelung <sup>2)</sup> | Radsensor                  |
|  | 2.0 TDI 4Drive | 135 |  | 11.14 |              |                |        |   |  |                            |
| SEAT LEON III (5F) ST X-Perience (14-)   |                |     |  |       |              |                |        |   |  |                            |
|    | 1.6 TDI        | 81  |  | 09.14 | PR: 1ZF      | 13.0460-7303.2 | 607303 |   |  | 22035 17,5 +/WK ATE        |
|  | 1.8 TSI        | 132 |  | 09.14 | PR: 1ZF      | 13.0470-7303.2 | LD7303 |   |  | 22035 17,5 +/WK ATE        |
|  | 2.0 TDI        | 110 |  | 09.14 | PR: 1ZF      |                |        |   |  |                            |
|  | 2.0 TDI        | 135 |  | 09.14 | PR: 1ZF      |                |        |   |  |                            |
|  | 1.6 TDI        | 81  |  | 09.14 | PR: 1ZA, 1ZE | 13.0460-2785.2 | 602785 |   |  | 25683 20,4 +/WK/S TRW      |
|  | 1.8 TSI        | 132 |  | 09.14 | PR: 1ZA, 1ZE | 13.0470-2785.2 | LD2785 |   |  | 25683 20,4 +/WK/S TRW      |
|  | 2.0 TDI        | 110 |  | 09.14 | PR: 1ZA, 1ZE |                |        |   |  |                            |
|  | 2.0 TDI        | 135 |  | 09.14 | PR: 1ZA, 1ZE |                |        |   |  |                            |
|    | 1.6 TDI        | 81  |  | 09.14 | PR: 1ZF      | 24.0124-0258.1 | 424258 |   |  | 276 24,0 21,0 V L +S +B    |
|  | 1.8 TSI        | 132 |  | 09.14 | PR: 1ZF      |                |        |   |  |                            |
|  | 2.0 TDI        | 110 |  | 09.14 | PR: 1ZF      |                |        |   |  |                            |
|  | 2.0 TDI        | 135 |  | 09.14 | PR: 1ZF      |                |        |   |  |                            |
|  | 1.6 TDI        | 81  |  | 09.14 | PR: 1ZE      | 24.0125-0145.1 | 425145 |   |  | 288 25,0 22,0 V L +S +B    |
|  | 1.8 TSI        | 132 |  | 09.14 | PR: 1ZE      | 24.0325-0145.1 | 525145 |   |  | 288 25,0 22,0 V L +S +B PD |
|  | 2.0 TDI        | 110 |  | 09.14 | PR: 1ZE      |                |        |   |  |                            |
|  | 2.0 TDI        | 135 |  | 09.14 | PR: 1ZE      |                |        |   |  |                            |
|  | 1.6 TDI        | 81  |  | 09.14 | PR: 1ZA      | 24.0125-0158.1 | 425158 |   |  | 312 25,0 22,0 V L +S +B    |
|  | 1.8 TSI        | 132 |  | 09.14 | PR: 1ZA      | 24.0325-0158.1 | 525158 |   |  | 312 25,0 22,0 V L +S +B PD |
|  | 2.0 TDI        | 110 |  | 09.14 | PR: 1ZA      |                |        |   |  |                            |
|  | 2.0 TDI        | 135 |  | 09.14 | PR: 1ZA      |                |        |   |  |                            |
|    | 1.6 TDI        | 81  |  | 09.14 |              | 24.0711-5273.3 | 360303 |   |  | Radsensor                  |
|  | 1.8 TSI        | 132 |  | 09.14 |              | 24.0711-5274.3 | 360304 |   |  | Radsensor                  |
|  | 2.0 TDI        | 110 |  | 09.14 |              |                |        |   |  |                            |
|  | 2.0 TDI        | 135 |  | 09.14 |              |                |        |   |  |                            |
|    | 1.6 TDI        | 81  |  | 09.14 | PR: 1KD      | 13.0460-2787.2 | 602787 |   |  | 23554 17,3 /S TRW          |
|  | 1.8 TSI        | 132 |  | 09.14 | PR: 1KD      |                |        |   |  |                            |
|  | 2.0 TDI        | 110 |  | 09.14 | PR: 1KD      |                |        |   |  |                            |
|  | 2.0 TDI        | 135 |  | 09.14 | PR: 1KD      |                |        |   |  |                            |
|  | 1.6 TDI        | 81  |  | 09.14 | PR: 1KD      | 24.0110-0277.1 | 410277 |   |  | 253 10,0 8,0 +S +B         |
|  | 1.8 TSI        | 132 |  | 09.14 | PR: 1KD      | 24.0310-0277.1 | 510277 |   |  | 253 10,0 8,0 +S +B PD      |
|  | 2.0 TDI        | 110 |  | 09.14 | PR: 1KD      |                |        |   |  |                            |
|  | 2.0 TDI        | 135 |  | 09.14 | PR: 1KD      |                |        |   |  |                            |
|  | 1.6 TDI        | 81  |  | 09.14 | PR: 1KS      | 24.0110-0356.1 | 410356 |   |  | 272 9,7 8,0 +S +B          |
|  | 1.8 TSI        | 132 |  | 09.14 | PR: 1KS      | 24.0310-0356.1 | 510356 |   |  | 272 9,7 8,0 +S +B PD       |
|  | 2.0 TDI        | 110 |  | 09.14 | PR: 1KS      |                |        |   |  |                            |
|  | 2.0 TDI        | 135 |  | 09.14 | PR: 1KS      |                |        |   |  |                            |
|  | 1.6 TDI        | 81  |  | 09.14 |              | 24.0711-5271.3 | 360301 |   | - Distanzregelung <sup>3)</sup>        | Radsensor                  |
|  | 1.8 TSI        | 132 |  | 09.14 |              | 24.0711-5272.3 | 360302 |   | - Distanzregelung <sup>3)</sup>        | Radsensor                  |
|  | 2.0 TDI        | 110 |  | 09.14 |              | 24.0711-5401.3 | 360330 |   | + Distanzregelung <sup>4)</sup>        | Radsensor                  |
|  | 2.0 TDI        | 135 |  | 09.14 |              | 24.0711-5402.3 | 360331 |   | + Distanzregelung <sup>4)</sup>        | Radsensor                  |
| SEAT MARBELLA (87-98)  |                |     |  |       |              |                |        |   |  |                            |
|  | 0.8            |     |  | 01.87 | 12.92        | 13.0460-3939.2 | 603939 |   |  | 20775 18,0 /WE BDX         |
|  | 0.9            |     |  | 01.87 | 10.98        | 13.0460-0410.2 | 610410 |   |  | Belagsatz-Zubehör BDX      |
|  | 0.8            |     |  | 01.87 | 12.92        | 24.0111-0130.1 | 411130 |   |  | 227 10,8 9,0 +B            |
|  | 0.9            |     |  | 01.87 | 10.98        |                |        |   |  |                            |
|  | 0.8            |     |  | 01.87 | 12.92        | 03.0137-0015.2 | 650015 |   |  | 185 x 31 AUT FI            |
|  | 0.9            |     |  | 01.87 | 10.98        | 03.0137-9021.2 | 669021 |   |  | Bremsbacken-Zubehör FI     |
|  | 0.8            |     |  | 01.87 | 12.92        | 24.0218-5001.1 | 480012 |   |  | 185/186,8 x 37             |
|  | 0.9            |     |  | 01.87 | 10.98        |                |        |   |  |                            |
| SEAT Mii (12-)   |                |     |  |       |              |                |        |   |  |                            |
|  | 1.0            | 44  |  | 05.12 |              | 13.0460-7111.2 | 607111 |   |  | 23130 19,6 + VW            |
|  | 1.0            | 55  |  | 05.12 |              | 13.0470-7111.2 | LD7111 |   |  | 23130 19,6 + VW            |
|  | 1.0 EcoFuel    | 50  |  | 11.12 |              |                |        |   |  |                            |
|  | 1.0            | 44  |  | 05.12 |              | 24.0122-0281.1 | 422281 |   |  | 256 22,0 19,0 V L +S +B    |
|  | 1.0            | 55  |  | 05.12 |              |                |        |   |  |                            |
|  | 1.0 EcoFuel    | 50  |  | 11.12 |              |                |        |   |  |                            |
|  | 1.0            | 44  |  | 05.12 |              | 24.0711-5273.3 | 360303 |   |  | Radsensor                  |
|  | 1.0            | 55  |  | 05.12 |              | 24.0711-5274.3 | 360304 |   |  | Radsensor                  |
|  | 1.0 EcoFuel    | 50  |  | 11.12 |              |                |        |   |  |                            |
|  | 1.0            | 44  |  | 05.12 |              | 24.0711-6233.3 | 360315 |   |  | Radsensor                  |
|  | 1.0            | 55  |  | 05.12 |              | 24.0711-6234.3 | 360316 |   |  | Radsensor                  |
|  | 1.0 EcoFuel    | 50  |  | 11.12 |              |                |        |   |  |                            |
|  | 1.0            | 44  |  | 05.12 |              | 03.0137-0268.2 | 650268 |   |  | 200 x 40 HEB VW            |
|  | 1.0            | 55  |  | 05.12 |              | 03.0137-9168.2 | 669168 |   |  | Bremsbacken-Zubehör VW     |
|  | 1.0 EcoFuel    | 50  |  | 11.12 |              |                |        |   |  |                            |

1) - autom. distance control / - regolatore automatico distanza / - régulation de distance autom. / - regulación automática de distancia  
2) + autom. distance control / + regolatore automatico distanza / + régulation de distance autom. / + regulación automática de distancia  
3) - distance control / - regolazione della distanza / - régulateur de distance / - regulación de distancia  
4) + distance control / + regolazione della distanza / + régulateur de distance / + regulación de distancia

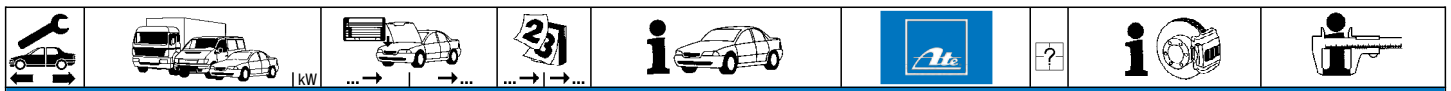













**SEAT Mii (12-)**

|  |             |    |  |       |  |                |        |  |                     |    |
|--|-------------|----|--|-------|--|----------------|--------|--|---------------------|----|
|  | 1.0         | 44 |  | 05.12 |  | 03.0520-4817.3 | 694817 |  | 17,46/200x40 TopKit | VW |
|  | 1.0         | 55 |  | 05.12 |  |                |        |  |                     |    |
|  | 1.0 EcoFuel | 50 |  | 11.12 |  |                |        |  |                     |    |

**SEAT TOLEDO I (1L) (91-98)**

|  |           |     |             |       |       |                |                |        |                            |     |
|--|-----------|-----|-------------|-------|-------|----------------|----------------|--------|----------------------------|-----|
|  | 1.6 i     |     |             | 09.91 | 08.96 | 13.0460-7032.2 | 607032         |        | 20887 19,7 +/Zub           | VW  |
|  | 1.8 i     |     |             | 09.91 | 08.96 |                |                |        |                            |     |
|  | 1.9 D     |     |             | 09.91 | 08.96 |                |                |        |                            |     |
|  | 1.9 TD    | 55  |             | 09.91 | 08.96 |                |                |        |                            |     |
|  | 1.8 i 16V |     | 1L-TR017000 | 09.91 | 03.94 | 13.0460-2821.2 | 602821         |        | 21945 16,0 /S              | TRW |
|  | 1.9 TDI   |     |             |       | 08.96 |                |                |        |                            |     |
|  | 2.0 i     | 85  |             | 09.91 | 08.96 |                |                |        |                            |     |
|  | 1.9 TDI   |     | 1L-TR016999 | 04.95 |       | 13.0460-2958.2 | 602958         |        | 20168 19,3 /S              | TRW |
|  | 2.0 i 16V | 110 |             | 03.94 | 08.96 |                |                |        |                            |     |
|  | 1.6 i     |     |             | 09.96 | 09.98 | 13.0460-7072.2 | 607072         |        | 21866 19,7 +               | VW  |
|  | 1.8 i     |     |             | 09.96 | 09.98 | PR: 1LK,1LM    |                |        |                            |     |
|  | 1.9 D     |     |             | 09.96 | 09.98 | PR: 1LK,1LM    |                |        |                            |     |
|  | 1.9 TD    | 55  |             | 09.96 | 09.98 | PR: 1LK,1LM    |                |        |                            |     |
|  | 1.9 TDI   |     |             | 09.96 | 09.98 | PR: 1LK,1LM    |                |        |                            |     |
|  | 2.0 i     | 85  |             | 09.96 | 09.98 | PR: 1LK,1LM    |                |        |                            |     |
|  | 2.0 i 16V | 110 |             | 09.96 | 09.98 | PR: 1LK,1LM    |                |        |                            |     |
|  | 1.6 i     |     |             | 09.96 | 09.98 | PR: 1LG        | 13.0460-7101.2 | 607101 | 21866 15,3 +               | VW  |
|  | 1.8 i     |     |             | 09.96 | 09.98 | PR: 1LG        |                |        |                            |     |
|  | 1.9 D     |     |             | 09.96 | 09.98 | PR: 1LG        |                |        |                            |     |
|  | 1.9 TD    | 55  |             | 09.96 | 09.98 | PR: 1LG        |                |        |                            |     |
|  | 1.9 TDI   |     |             | 09.96 | 09.98 | PR: 1LG        |                |        |                            |     |
|  | 2.0 i     | 85  |             | 09.96 | 09.98 | PR: 1LG        |                |        |                            |     |
|  | 2.0 i 16V | 110 |             | 09.96 | 09.98 | PR: 1LG        |                |        |                            |     |
|  | 1.6 i     |     |             | 09.96 | 09.98 | PR: 1LD,1LV    | 13.0460-2958.2 | 602958 | 20168 19,3 /S              | TRW |
|  | 1.8 i     |     |             | 09.96 | 09.98 | PR: 1LD,1LV    |                |        |                            |     |
|  | 1.9 D     |     |             | 09.96 | 09.98 | PR: 1LD,1LV    |                |        |                            |     |
|  | 1.9 TD    | 55  |             | 09.96 | 09.98 | PR: 1LD,1LV    |                |        |                            |     |
|  | 1.9 TDI   |     |             | 09.96 | 09.98 | PR: 1LD,1LV    |                |        |                            |     |
|  | 2.0 i     | 85  |             | 09.96 | 09.98 | PR: 1LD,1LV    |                |        |                            |     |
|  | 2.0 i 16V | 110 |             | 09.96 | 09.98 | PR: 1LD,1LV    |                |        |                            |     |
|  | 1.6 i     |     |             | 09.96 | 09.98 | PR: 1LY,1ZK    | 13.0460-2821.2 | 602821 | 21945 16,0 /S              | TRW |
|  | 1.8 i     |     |             | 09.96 | 09.98 | PR: 1LY,1ZK    |                |        |                            |     |
|  | 1.9 D     |     |             | 09.96 | 09.98 | PR: 1LY,1ZK    |                |        |                            |     |
|  | 1.9 TD    | 55  |             | 09.96 | 09.98 | PR: 1LY,1ZK    |                |        |                            |     |
|  | 1.9 TDI   |     |             | 09.96 | 09.98 | PR: 1LY,1ZK    |                |        |                            |     |
|  | 2.0 i     | 85  |             | 09.96 | 09.98 | PR: 1LY,1ZK    |                |        |                            |     |
|  | 2.0 i 16V | 110 |             | 09.96 | 09.98 | PR: 1LY,1ZK    |                |        |                            |     |
|  | 1.6 i     |     |             | 09.91 | 08.96 | 24.0112-0106.1 | 412106         |        | 239 12,0 10,0 +S +B        |     |
|  | 1.8 i     |     |             | 09.91 | 08.96 | 24.0312-0106.1 | 512106         |        | 239 12,0 10,0 +S +B PD     |     |
|  | 1.9 D     |     |             | 09.91 | 08.96 |                |                |        |                            |     |
|  | 1.9 TD    | 55  |             | 09.91 | 08.96 |                |                |        |                            |     |
|  | 1.9 TDI   |     | 1L-TR016999 | 04.95 |       | 24.0113-0178.1 | 413178         |        | 256 12,9 11,0 +S +B        |     |
|  |           |     |             |       |       | 24.0313-0178.1 | 513178         |        | 256 12,9 11,0 +S +B PD     |     |
|  | 1.8 i     |     |             | 09.91 | 08.96 | 24.0120-0128.1 | 420128         |        | 256 20,0 18,0 V L +S +B    |     |
|  | 1.8 i 16V |     | 1L-TR017000 | 09.91 | 03.94 | 24.0320-0128.1 | 520128         |        | 256 20,0 18,0 V L +S +B PD |     |
|  | 1.9 TDI   |     |             |       | 08.96 |                |                |        |                            |     |
|  | 2.0 i     | 85  |             | 09.91 | 08.96 |                |                |        |                            |     |
|  | 2.0 i 16V | 110 |             | 03.94 | 08.96 | 24.0122-0100.1 | 422100         |        | 280 22,0 20,0 V L +B       |     |
|  |           |     |             |       |       | 24.0322-0100.1 | 522100         |        | 280 22,0 20,0 V L +B PD    |     |
|  | 1.6 i     |     |             | 09.96 | 09.98 | PR: 1LK,1LM    | 24.0112-0106.1 | 412106 | 239 12,0 10,0 +S +B        |     |
|  | 1.8 i     |     |             | 09.96 | 09.98 | PR: 1LK,1LM    | 24.0312-0106.1 | 512106 | 239 12,0 10,0 +S +B PD     |     |
|  | 1.9 D     |     |             | 09.96 | 09.98 | PR: 1LK,1LM    |                |        |                            |     |
|  | 1.9 TD    | 55  |             | 09.96 | 09.98 | PR: 1LK,1LM    |                |        |                            |     |
|  | 1.9 TDI   |     |             | 09.96 | 09.98 | PR: 1LK,1LM    |                |        |                            |     |
|  | 2.0 i     | 85  |             | 09.96 | 09.98 | PR: 1LK,1LM    |                |        |                            |     |
|  | 2.0 i 16V | 110 |             | 09.96 | 09.98 | PR: 1LK,1LM    |                |        |                            |     |
|  | 1.6 i     |     |             | 09.96 | 09.98 | PR: 1LG        | 24.0120-0123.1 | 420123 | 239 20,0 18,0 V L +S +B    |     |
|  | 1.8 i     |     |             | 09.96 | 09.98 | PR: 1LG        | 24.0320-0123.1 | 520123 | 239 20,0 18,0 V L +S +B PD |     |
|  | 1.9 D     |     |             | 09.96 | 09.98 | PR: 1LG        |                |        |                            |     |
|  | 1.9 TD    | 55  |             | 09.96 | 09.98 | PR: 1LG        |                |        |                            |     |
|  | 1.9 TDI   |     |             | 09.96 | 09.98 | PR: 1LG        |                |        |                            |     |
|  | 2.0 i     | 85  |             | 09.96 | 09.98 | PR: 1LG        |                |        |                            |     |
|  | 2.0 i 16V | 110 |             | 09.96 | 09.98 | PR: 1LG        |                |        |                            |     |
|  | 1.6 i     |     |             | 09.96 | 09.98 | PR: 1LD        | 24.0122-0100.1 | 422100 | 280 22,0 20,0 V L +B       |     |
|  | 1.8 i     |     |             | 09.96 | 09.98 | PR: 1LD        | 24.0322-0100.1 | 522100 | 280 22,0 20,0 V L +B PD    |     |
|  | 1.9 D     |     |             | 09.96 | 09.98 | PR: 1LD        |                |        |                            |     |
|  | 1.9 TD    | 55  |             | 09.96 | 09.98 | PR: 1LD        |                |        |                            |     |
|  | 1.9 TDI   |     |             | 09.96 | 09.98 | PR: 1LD        |                |        |                            |     |
|  | 2.0 i     | 85  |             | 09.96 | 09.98 | PR: 1LD        |                |        |                            |     |
|  | 2.0 i 16V | 110 |             | 09.96 | 09.98 | PR: 1LD        |                |        |                            |     |
|  | 1.6 i     |     |             | 09.96 | 09.98 | PR: 1LY,1ZK    | 24.0120-0128.1 | 420128 | 256 20,0 18,0 V L +S +B    |     |
|  | 1.8 i     |     |             | 09.96 | 09.98 | PR: 1LY,1ZK    | 24.0320-0128.1 | 520128 | 256 20,0 18,0 V L +S +B PD |     |
|  | 1.9 D     |     |             | 09.96 | 09.98 | PR: 1LY,1ZK    |                |        |                            |     |
|  | 1.9 TD    | 55  |             | 09.96 | 09.98 | PR: 1LY,1ZK    |                |        |                            |     |
|  | 1.9 TDI   |     |             | 09.96 | 09.98 | PR: 1LY,1ZK    |                |        |                            |     |
|  | 2.0 i     | 85  |             | 09.96 | 09.98 | PR: 1LY,1ZK    |                |        |                            |     |
|  | 2.0 i 16V | 110 |             | 09.96 | 09.98 | PR: 1LY,1ZK    |                |        |                            |     |



| SEAT TOLEDO I (1L) (91-98)   |   |                       |   |  |  |  |                                  |                  |   |  |                   |
|--|---|-----------------------|---|--|--|--|----------------------------------|------------------|---|--|-------------------|
|    | 1.6 i<br>1.8 i<br>1.8 i 16V<br>1.9 D<br>1.9 TD<br>1.9 TDI<br>2.0 i<br>2.0 i 16V |                       |   | 09.91<br>09.91<br>09.91<br>09.91<br>09.91<br>04.95<br>09.91<br>03.94 | 09.98<br>09.98<br>09.98<br>09.98<br>09.98<br>09.98<br>09.98<br>09.98 |  | 24.0711-1361.3<br>24.0711-1362.3 | 360022<br>360023 |      | Radsensor<br>Radsensor   |                   |
|    | 1.8 i 16V<br>2.0 i<br>1.9 TDI<br>2.0 i<br>2.0 i 16V                             | 85<br>85<br>110       | 1L-ZD328000   | 09.91<br>09.91<br>04.95<br>08.96<br>08.96<br>03.94                   | 03.94<br>08.96<br>08.96<br>08.96                                     |  | 13.0460-2937.2<br>13.0460-0419.2 | 602937<br>610419 |   | 20961 15,2 /Zub/S<br>Belagsatz-Zubehör<br>20961 17,2 /Zub/S<br>Belagsatz-Zubehör | TRW<br>TRW<br>TRW |
|    | 1.6 i<br>1.8 i<br>1.9 D<br>1.9 TD<br>1.9 TDI<br>2.0 i<br>2.0 i 16V              |                       |   | 09.96<br>09.96<br>09.96<br>09.96<br>09.96<br>09.96<br>09.96          | 09.98<br>09.98<br>09.98<br>09.98<br>09.98<br>09.98<br>09.98          | PR: 1KD,1KK<br>PR: 1KD,1KK<br>PR: 1KD,1KK<br>PR: 1KD,1KK<br>PR: 1KD,1KK<br>PR: 1KD,1KK | 13.0460-2984.2<br>13.0460-0072.2 | 602984<br>610072 |   | 20961 17,2 /Zub/S<br>Belagsatz-Zubehör   | TRW<br>TRW        |
|    | 1.8 i 16V<br>1.9 TDI<br>2.0 i<br>2.0 i 16V                                      | 85<br>110             |   | 09.91<br>11.95<br>09.91<br>03.94                                     | 03.94<br>08.96<br>08.96<br>08.96                                     |  | 24.0110-0111.1<br>24.0110-0275.2 | 410111<br>410275 | ohne Sensorring <sup>1)</sup><br>mit Sensorring <sup>2)</sup>                           | 226 10,0 8,0 +B<br>226 10,0 8,0 +B   |                   |
|  | 1.6 i<br>1.8 i<br>1.9 D<br>1.9 TD<br>1.9 TDI<br>2.0 i<br>2.0 i 16V              |                       |   | 09.96<br>09.96<br>09.96<br>09.96<br>09.96<br>09.96<br>09.96          | 09.98<br>09.98<br>09.98<br>09.98<br>09.98<br>09.98<br>09.98          | PR: 1KK<br>PR: 1KK<br>PR: 1KK<br>PR: 1KK<br>PR: 1KK<br>PR: 1KK                         | 24.0110-0203.1<br>24.0110-0276.2 | 410203<br>410276 | mit Sensorring <sup>2)</sup>  | 226 10,0 8,0 +B<br>226 10,0 8,0 +B   |                   |
|  | 1.6 i<br>1.8 i<br>1.9 D<br>1.9 TD<br>1.9 TDI<br>2.0 i<br>2.0 i 16V              |                       |   | 09.96<br>09.96<br>09.96<br>09.96<br>09.96<br>09.96<br>09.96          | 09.98<br>09.98<br>09.98<br>09.98<br>09.98<br>09.98<br>09.98          | PR: 1KD<br>PR: 1KD<br>PR: 1KD<br>PR: 1KD<br>PR: 1KD<br>PR: 1KD                         | 24.0110-0111.1<br>24.0110-0275.2 | 410111<br>410275 |   | 226 10,0 8,0 +B<br>226 10,0 8,0 +B   |                   |
|  | 1.6 i<br>1.8 i<br>1.8 i 16V<br>1.9 D<br>1.9 TD<br>1.9 TDI<br>2.0 i<br>2.0 i 16V |                       | 1L-ZR054453<br>1L-ZR054453<br>1L-ZR054453<br>1L-ZR054453<br>1L-ZR054453<br>1L-ZR054453<br>1L-ZR054453 | 09.91<br>09.91<br>09.91<br>04.95<br>09.91<br>03.94                   |  |  | 24.0721-1925.1                   | 360039           | 2  | Radsensor L=1220   |                   |
|  | 1.6 i<br>1.8 i<br>1.8 i 16V<br>1.9 D<br>1.9 TD<br>1.9 TDI<br>2.0 i<br>2.0 i 16V |                       | 1L-TR000001<br>1L-TR000001<br>1L-TR000001<br>1L-TR000001<br>1L-TR000001<br>1L-TR000001<br>1L-TR000001 | 09.98<br>09.98<br>03.94<br>09.98<br>09.98<br>09.98<br>09.98          |  |  | 24.0721-1957.3                   | 360293           | 2  | Radsensor L=1198   |                   |
|  | 1.6 i<br>1.6 i<br>1.8 i<br>1.9 D<br>1.9 TD<br>1.9 TDI                           |                       | 1L-ZD310000<br>1L-ZD310001  | 09.91<br>09.91<br>09.91<br>09.91<br>04.95                            | 09.98<br>09.98<br>09.98<br>09.98<br>09.98                            |  | 03.0137-0126.2<br>03.0137-9008.2 | 650126<br>669008 |   | 180 x 31 HEB<br>Bremsbacken-Zubehör  |                   |
|  | 1.6 i<br>1.8 i<br>1.9 D<br>1.9 TD<br>1.9 TDI                                    |                       | 1L-ZD310000<br>1L-ZD310001  | 09.91<br>09.91<br>09.91<br>04.95                                     | 09.98<br>09.98<br>09.98<br>09.98                                     |  | 24.0218-0007.1<br>24.0218-0707.2 | 480003<br>480211 |   | 180/181 x 38,5 - Lager<br>180/181 x 38,5 + Lager                                 |                   |
|  | 1.6 i<br>1.8 i<br>1.9 D<br>1.9 TD<br>1.9 TDI                                    |                       | 1L-ZD310000<br>1L-ZD310001  | 09.91<br>09.91<br>09.91<br>04.95                                     | 09.98<br>09.98<br>09.98<br>09.98                                     |  | 24.0220-0018.1<br>24.0220-0718.2 | 480019<br>480209 | ohne Sensorring <sup>1)</sup><br>ohne Sensorring <sup>1)</sup>                          | 200/201 x 50,0 - Lager<br>200/201,5 x 50,0 + Lager                               |                   |
|  | 1.6 i<br>1.6 i<br>1.8 i<br>1.9 D<br>1.9 TD<br>1.9 TDI                           |                       | 1L-ZD310000<br>1L-ZD310001  | 09.91<br>09.98<br>09.91<br>09.91<br>09.91<br>04.95                   | 09.98<br>09.98<br>09.98<br>09.98<br>09.98                            |  | 03.0420-0617.3<br>03.0520-3917.3 | 680617<br>693917 | + Rz GG <sup>3)</sup><br>+ Rz ALU <sup>4)</sup>   | 17,46/180x31 Kit<br>17,46/180x31 TopKit  | VW<br>VW          |
|  | 1.6 i<br>1.8 i<br>1.9 D<br>1.9 TD<br>1.9 TDI                                    |                       | 1L-ZD310000<br>1L-ZD310001  | 09.91<br>09.91<br>09.91<br>09.91<br>04.95                            | 09.98<br>09.98<br>09.98<br>09.98                                     |  | 03.0420-1517.3<br>03.0520-1517.3 | 681517<br>691517 |   | 17,46/200x40 Kit<br>17,46/200x40 TopKit  | VW<br>VW          |
| SEAT TOLEDO II (1M2) (98-04)   |   |                       |   |  |  |  |                                  |                  |   |  |                   |
|  | 1.4 i 16V<br>1.6 i<br>1.8 4x4<br>1.8 i 20V<br>1.8 i 20VT<br>1.9 SDI<br>1.9 TDI  | 55<br>132<br>50<br>66 |   | 07.99<br>10.98<br>05.01<br>10.98<br>05.01<br>11.99<br>10.98          | 09.04<br>09.04<br>09.04<br>09.04<br>09.04<br>09.04<br>09.04          | PR: 1LQ<br>PR: 1LQ<br>PR: 1LQ<br>PR: 1LQ<br>PR: 1LQ<br>PR: 1LQ<br>PR: 1LQ              | 13.0460-7111.2<br>13.0470-7111.2 | 607111<br>LD7111 |   | 23130 19,6 +<br>23130 19,6 +   | VW<br>VW          |

<sup>1)</sup> without sensor ring / senza sensori / sans secours ABS / sin anillo sensor ABS

<sup>2)</sup> with sensor ring / con sensori / avec secours ABS / con anillo sensor ABS

<sup>3)</sup> + WC cast iron / + CR ghisa / + CR fonte grise / + CR fundición de gris

<sup>4)</sup> + WC aluminium / + CR aluminio / + CR aluminium / + CR aluminio



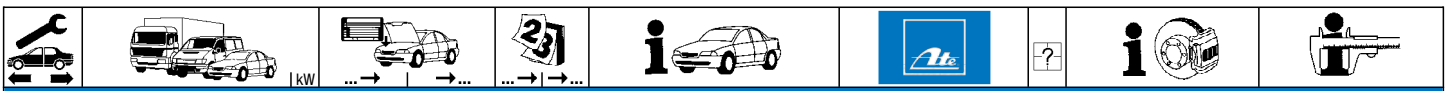





































**SEAT TOLEDO II (1M2) (98-04)**

|          |            |           |           |       |                     |                     |                |        |  |                            |     |
|----------|------------|-----------|-----------|-------|---------------------|---------------------|----------------|--------|--|----------------------------|-----|
|          | 1.9 TDI    | 81        |           | 10.98 | 09.04               | PR: 1LQ             | 13.0460-7111.2 | 607111 |  | 23130 19,6 +               | VW  |
|          | 1.9 TDI    | 96        |           | 05.03 | 09.04               | PR: 1LQ             | 13.0470-7111.2 | LD7111 |  | 23130 19,6 +               | VW  |
|          | 1.9 TDI    | 110       |           | 10.00 | 09.04               | PR: 1LQ             |                |        |  |                            |     |
|          | 2.3 i V5   |           |           | 10.98 | 09.04               | PR: 1LQ             |                |        |  |                            |     |
|          | 2.8        | 150       |           | 10.00 | 09.04               | PR: 1LQ             |                |        |  |                            |     |
|          | 2.8 4x4    | 150       |           | 05.02 | 09.04               | PR: 1LQ             |                |        |  |                            |     |
|          | 1.4 i 16V  | 55        |           | 07.99 | 09.04               | PR: 1LR,1LS         | 13.0460-7117.2 | 607117 |  | 23131 19,6 +/WK            | VW  |
|          | 1.6 i      |           |           | 10.98 | 09.04               | PR: 1LR,1LS         | 13.0470-7117.2 | LD7117 |  | 23131 19,6 +/WK            | VW  |
|          | 1.8 4x4    |           |           | 05.01 | 09.04               | PR: 1LR,1LS         |                |        |  |                            |     |
|          | 1.8 i 20V  |           |           | 10.98 | 09.04               | PR: 1LR,1LS         |                |        |  |                            |     |
|          | 1.8 i 20VT | 132       |           | 05.01 | 09.04               | PR: 1LR,1LS         |                |        |  |                            |     |
|          | 1.9 SDI    | 50        |           | 11.99 | 09.04               | PR: 1LR,1LS         |                |        |  |                            |     |
|          | 1.9 TDI    | 66        |           | 10.98 | 09.04               | PR: 1LR,1LS         |                |        |  |                            |     |
|          | 1.9 TDI    | 81        |           | 10.98 | 09.04               | PR: 1LR,1LS         |                |        |  |                            |     |
|          | 1.9 TDI    | 96        |           | 05.03 | 09.04               | PR: 1LR,1LS         |                |        |  |                            |     |
|          | 1.9 TDI    | 110       |           | 10.00 | 09.04               | PR: 1LR,1LS         |                |        |  |                            |     |
|          | 2.3 i V5   |           |           | 10.98 | 09.04               | PR: 1LR,1LS         |                |        |  |                            |     |
|          | 2.8        | 150       |           | 10.00 | 09.04               | PR: 1LR,1LS         |                |        |  |                            |     |
|          | 2.8 4x4    | 150       |           | 05.02 | 09.04               | PR: 1LR,1LS         |                |        |  |                            |     |
|          | 1.4 i 16V  | 55        | X-800 000 | 07.99 | 09.04               | PR: 1LN,1LE,1ZE,1ZH | 13.0460-7081.2 | 607081 |  | 21911 20,3 +               | ATE |
|          | 1.6 i      |           | X-800 000 | 10.98 | 09.04               | PR: 1LN,1LE,1ZE,1ZH | 13.0470-7081.2 | LD7081 |  | 21911 20,3 +               | ATE |
|          | 1.8 4x4    |           | X-800 000 | 05.01 | 09.04               | PR: 1LN,1LE,1ZE,1ZH |                |        |  |                            |     |
|          | 1.8 i 20V  |           | X-800 000 | 10.98 | 09.04               | PR: 1LN,1LE,1ZE,1ZH |                |        |  |                            |     |
|          | 1.8 i 20VT | 132       | X-800 000 | 05.01 | 09.04               | PR: 1LN,1LE,1ZE,1ZH |                |        |  |                            |     |
| 1.9 SDI  | 50         | X-800 000 | 11.99     | 09.04 | PR: 1LN,1LE,1ZE,1ZH |                     |                |        |  |                            |     |
| 1.9 TDI  | 66         | X-800 000 | 10.98     | 09.04 | PR: 1LN,1LE,1ZE,1ZH |                     |                |        |  |                            |     |
| 1.9 TDI  | 81         | X-800 000 | 10.98     | 09.04 | PR: 1LN,1LE,1ZE,1ZH |                     |                |        |  |                            |     |
| 1.9 TDI  | 96         | X-800 000 | 05.03     | 09.04 | PR: 1LN,1LE,1ZE,1ZH |                     |                |        |  |                            |     |
| 1.9 TDI  | 110        | X-800 000 | 10.00     | 09.04 | PR: 1LN,1LE,1ZE,1ZH |                     |                |        |  |                            |     |
| 2.3 i V5 |            | X-800 000 | 10.98     | 09.04 | PR: 1LN,1LE,1ZE,1ZH |                     |                |        |  |                            |     |
| 2.8      | 150        | X-800 000 | 10.00     | 09.04 | PR: 1LN,1LE,1ZE,1ZH |                     |                |        |  |                            |     |
| 2.8 4x4  | 150        | X-800 000 | 05.02     | 09.04 | PR: 1LN,1LE,1ZE,1ZH |                     |                |        |  |                            |     |
|          | 1.4 i 16V  | 55        | Y-000 001 | 09.04 | 09.04               | PR: 1LN,1LE,1ZE,1ZH | 13.0460-7122.2 | 607122 |  | 23392 20,3 +/WK            | ATE |
|          | 1.6 i      |           | Y-000 001 | 09.04 | 09.04               | PR: 1LN,1LE,1ZE,1ZH | 13.0470-7122.2 | LD7122 |  | 23392 20,3 +/WK            | ATE |
|          | 1.8 4x4    |           | Y-000 001 | 09.04 | 09.04               | PR: 1LN,1LE,1ZE,1ZH |                |        |  |                            |     |
|          | 1.8 i 20V  |           | Y-000 001 | 09.04 | 09.04               | PR: 1LN,1LE,1ZE,1ZH |                |        |  |                            |     |
|          | 1.8 i 20VT | 132       | Y-000 001 | 09.04 | 09.04               | PR: 1LN,1LE,1ZE,1ZH |                |        |  |                            |     |
|          | 1.9 SDI    | 50        | Y-000 001 | 09.04 | 09.04               | PR: 1LN,1LE,1ZE,1ZH |                |        |  |                            |     |
|          | 1.9 TDI    | 66        | Y-000 001 | 09.04 | 09.04               | PR: 1LN,1LE,1ZE,1ZH |                |        |  |                            |     |
|          | 1.9 TDI    | 81        | Y-000 001 | 09.04 | 09.04               | PR: 1LN,1LE,1ZE,1ZH |                |        |  |                            |     |
|          | 1.9 TDI    | 96        | Y-000 001 | 09.04 | 09.04               | PR: 1LN,1LE,1ZE,1ZH |                |        |  |                            |     |
|          | 1.9 TDI    | 110       | Y-000 001 | 09.04 | 09.04               | PR: 1LN,1LE,1ZE,1ZH |                |        |  |                            |     |
|          | 2.3 i V5   |           | Y-000 001 | 09.04 | 09.04               | PR: 1LN,1LE,1ZE,1ZH |                |        |  |                            |     |
|          | 2.8        | 150       | Y-000 001 | 09.04 | 09.04               | PR: 1LN,1LE,1ZE,1ZH |                |        |  |                            |     |
| 2.8 4x4  | 150        | Y-000 001 | 09.04     | 09.04 | PR: 1LN,1LE,1ZE,1ZH |                     |                |        |  |                            |     |
|          | 1.4 i 16V  | 55        |           | 07.99 | 09.04               | PR: 1LJ,1ZQ         | 13.0460-7122.2 | 607122 |  | 23392 20,3 +/WK            | ATE |
|          | 1.6 i      |           |           | 10.98 | 09.04               | PR: 1LJ,1ZQ         | 13.0470-7122.2 | LD7122 |  | 23392 20,3 +/WK            | ATE |
|          | 1.8 4x4    |           |           | 05.01 | 09.04               | PR: 1LJ,1ZQ         |                |        |  |                            |     |
|          | 1.8 i 20V  |           |           | 10.98 | 09.04               | PR: 1LJ,1ZQ         |                |        |  |                            |     |
|          | 1.8 i 20VT | 132       |           | 05.01 | 09.04               | PR: 1LJ,1ZQ         |                |        |  |                            |     |
|          | 1.9 SDI    | 50        |           | 11.99 | 09.04               | PR: 1LJ,1ZQ         |                |        |  |                            |     |
|          | 1.9 TDI    | 66        |           | 04.99 | 09.04               | PR: 1LJ,1ZQ         |                |        |  |                            |     |
|          | 1.9 TDI    | 81        |           | 10.98 | 09.04               | PR: 1LJ,1ZQ         |                |        |  |                            |     |
|          | 1.9 TDI    | 96        |           | 05.03 | 09.04               | PR: 1LJ,1ZQ         |                |        |  |                            |     |
|          | 1.9 TDI    | 110       |           | 10.00 | 09.04               | PR: 1LJ,1ZQ         |                |        |  |                            |     |
|          | 2.3 i V5   |           |           | 10.98 | 09.04               | PR: 1LJ,1ZQ         |                |        |  |                            |     |
|          | 2.8        | 150       |           | 10.00 | 09.04               | PR: 1LJ,1ZQ         |                |        |  |                            |     |
| 2.8 4x4  | 150        |           | 05.02     | 09.04 | PR: 1LJ,1ZQ         |                     |                |        |  |                            |     |
|          | 1.4 i 16V  | 55        |           | 07.99 | 09.04               | PR: 1LQ             | 24.0122-0151.1 | 422151 |  | 256 22,0 19,0 V L +S +B    |     |
|          | 1.6 i      |           |           | 10.98 | 09.04               | PR: 1LQ             | 24.0322-0151.1 | 522151 |  | 256 22,0 19,0 V L +S +B PD |     |
|          | 1.8 4x4    |           |           | 05.01 | 09.04               | PR: 1LQ             |                |        |  |                            |     |
|          | 1.8 i 20V  |           |           | 10.98 | 09.04               | PR: 1LQ             |                |        |  |                            |     |
|          | 1.8 i 20VT | 132       |           | 05.01 | 09.04               | PR: 1LQ             |                |        |  |                            |     |
|          | 1.9 SDI    | 50        |           | 11.99 | 09.04               | PR: 1LQ             |                |        |  |                            |     |
|          | 1.9 TDI    | 66        |           | 10.98 | 09.04               | PR: 1LQ             |                |        |  |                            |     |
|          | 1.9 TDI    | 81        |           | 10.98 | 09.04               | PR: 1LQ             |                |        |  |                            |     |
|          | 1.9 TDI    | 96        |           | 05.03 | 09.04               | PR: 1LQ             |                |        |  |                            |     |
|          | 1.9 TDI    | 110       |           | 10.00 | 09.04               | PR: 1LQ             |                |        |  |                            |     |
|          | 2.3 i V5   |           |           | 10.98 | 09.04               | PR: 1LQ             |                |        |  |                            |     |
|          | 2.8        | 150       |           | 10.00 | 09.04               | PR: 1LQ             |                |        |  |                            |     |
| 2.8 4x4  | 150        |           | 05.02     | 09.04 | PR: 1LQ             |                     |                |        |  |                            |     |
|          | 1.4 i 16V  | 55        |           | 07.99 | 09.04               | PR: 1LR,1LS         | 24.0122-0150.1 | 422150 |  | 280 22,0 19,0 V L +S +B    |     |
|          | 1.6 i      |           |           | 10.98 | 09.04               | PR: 1LR,1LS         |                |        |  |                            |     |
|          | 1.8 4x4    |           |           | 05.01 | 09.04               | PR: 1LR,1LS         |                |        |  |                            |     |
|          | 1.8 i 20V  |           |           | 10.98 | 09.04               | PR: 1LR,1LS         |                |        |  |                            |     |
|          | 1.8 i 20VT | 132       |           | 05.01 | 09.04               | PR: 1LR,1LS         |                |        |  |                            |     |
|          | 1.9 SDI    | 50        |           | 11.99 | 09.04               | PR: 1LR,1LS         |                |        |  |                            |     |
|          | 1.9 TDI    | 66        |           | 10.98 | 09.04               | PR: 1LR,1LS         |                |        |  |                            |     |
|          | 1.9 TDI    | 81        |           | 10.98 | 09.04               | PR: 1LR,1LS         |                |        |  |                            |     |
|          | 1.9 TDI    | 96        |           | 05.03 | 09.04               | PR: 1LR,1LS         |                |        |  |                            |     |
|          | 1.9 TDI    | 110       |           | 10.00 | 09.04               | PR: 1LR,1LS         |                |        |  |                            |     |
|          | 2.3 i V5   |           |           | 10.98 | 09.04               | PR: 1LR,1LS         |                |        |  |                            |     |
|          | 2.8        | 150       |           | 10.00 | 09.04               | PR: 1LR,1LS         |                |        |  |                            |     |
| 2.8 4x4  | 150        |           | 05.02     | 09.04 | PR: 1LR,1LS         |                     |                |        |  |                            |     |
|          | 1.4 i 16V  | 55        |           | 07.99 | 09.04               | PR: 1LJ,1ZQ         | 24.0125-0123.1 | 425123 |  | 310 25,0 22,0 V L +S +B    |     |
|          | 1.6 i      |           |           | 10.98 | 09.04               | PR: 1LJ,1ZQ         |                |        |  |                            |     |









































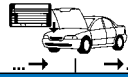





| SEAT TOLEDO II (1M2) (98-04)   |             |       |       |                     |                     |                |        |   |  |  |   |                         |  |
|--|-------------|-------|-------|---------------------|---------------------|----------------|--------|---|--|--|---|-------------------------|--|
|    | 1.8 4x4     |       | 05.01 | 09.04               | PR: 1LJ,1ZQ         | 24.0125-0123.1 | 425123 |   |  |  |   | 310 25,0 22,0 V L +S +B |  |
|  | 1.8 i 20V   |       | 10.98 | 09.04               | PR: 1LJ,1ZQ         |                |        |   |  |  |   |                         |  |
|  | 1.8 i 20V T | 132   | 05.01 | 09.04               | PR: 1LJ,1ZQ         |                |        |   |  |  |   |                         |  |
|  | 1.9 SDI     | 50    | 11.99 | 09.04               | PR: 1LJ,1ZQ         |                |        |   |  |  |   |                         |  |
|  | 1.9 TDI     | 66    | 04.99 | 09.04               | PR: 1LJ,1ZQ         |                |        |   |  |  |   |                         |  |
|  | 1.9 TDI     | 81    | 10.98 | 09.04               | PR: 1LJ,1ZQ         |                |        |   |  |  |   |                         |  |
|  | 1.9 TDI     | 96    | 05.03 | 09.04               | PR: 1LJ,1ZQ         |                |        |   |  |  |   |                         |  |
|  | 1.9 TDI     | 110   | 10.00 | 09.04               | PR: 1LJ,1ZQ         |                |        |   |  |  |   |                         |  |
|  | 2.3 i V5    |       | 10.98 | 09.04               | PR: 1LJ,1ZQ         |                |        |   |  |  |   |                         |  |
|  | 2.8         | 150   | 10.00 | 09.04               | PR: 1LJ,1ZQ         |                |        |   |  |  |   |                         |  |
| 2.8 4x4  | 150         | 05.02 | 09.04 | PR: 1LJ,1ZQ         |                     |                |        |   |  |  |   |                         |  |
|  | 1.4 i 16V   | 55    | 07.99 | 09.04               | PR: 1LN,1LE,1ZE,1ZH | 24.0125-0113.1 | 425113 |   |  |  | 288 25,0 22,0 V L +S +B<br>288 25,0 22,0 V L +S +B PD                   |                         |  |
|  | 1.6 i       |       | 10.98 | 09.04               | PR: 1LN,1LE,1ZE,1ZH |                |        |   |  |  |   |                         |  |
|  | 1.8 4x4     |       | 05.01 | 09.04               | PR: 1LN,1LE,1ZE,1ZH |                |        |   |  |  |   |                         |  |
|  | 1.8 i 20V   |       | 10.98 | 09.04               | PR: 1LN,1LE,1ZE,1ZH |                |        |   |  |  |   |                         |  |
|  | 1.8 i 20V T | 132   | 05.01 | 09.04               | PR: 1LN,1LE,1ZE,1ZH |                |        |   |  |  |   |                         |  |
|  | 1.9 SDI     | 50    | 11.99 | 09.04               | PR: 1LN,1LE,1ZE,1ZH |                |        |   |  |  |   |                         |  |
|  | 1.9 TDI     | 66    | 04.99 | 09.04               | PR: 1LN,1LE,1ZE,1ZH |                |        |   |  |  |   |                         |  |
|  | 1.9 TDI     | 81    | 10.98 | 09.04               | PR: 1LN,1LE,1ZE,1ZH |                |        |   |  |  |   |                         |  |
|  | 1.9 TDI     | 96    | 05.03 | 09.04               | PR: 1LN,1LE,1ZE,1ZH |                |        |   |  |  |   |                         |  |
|  | 1.9 TDI     | 110   | 10.00 | 09.04               | PR: 1LN,1LE,1ZE,1ZH |                |        |   |  |  |   |                         |  |
| 2.3 i V5   |             | 10.98 | 09.04 | PR: 1LN,1LE,1ZE,1ZH |                     |                |        |   |  |  |   |                         |  |
| 2.8  | 150         | 10.00 | 09.04 | PR: 1LN,1LE,1ZE,1ZH |                     |                |        |   |  |  |   |                         |  |
| 2.8 4x4  | 150         | 05.02 | 09.04 | PR: 1LN,1LE,1ZE,1ZH |                     |                |        |   |  |  |   |                         |  |
|    | 1.4 i 16V   | 55    | 07.99 | 09.04               |                     | 24.0711-1361.3 | 360022 |  |  |  | Radsensor   |                         |  |
|  | 1.6 i       |       | 10.98 | 09.04               |                     |                |        |   |  |  |   |                         |  |
|  | 1.8 4x4     |       | 05.01 | 09.04               |                     |                |        |   |  |  |   |                         |  |
|  | 1.8 i 20V   |       | 10.98 | 09.04               |                     |                |        |   |  |  |   |                         |  |
|  | 1.8 i 20V T | 132   | 05.01 | 09.04               |                     |                |        |   |  |  |   |                         |  |
|  | 1.9 SDI     | 50    | 11.99 | 09.04               |                     |                |        |   |  |  |   |                         |  |
|  | 1.9 TDI     | 66    | 10.98 | 09.04               |                     |                |        |   |  |  |   |                         |  |
|  | 1.9 TDI     | 81    | 10.98 | 09.04               |                     |                |        |   |  |  |   |                         |  |
|  | 1.9 TDI     | 96    | 05.03 | 09.04               |                     |                |        |   |  |  |   |                         |  |
|  | 1.9 TDI     | 110   | 10.00 | 09.04               |                     |                |        |   |  |  |   |                         |  |
| 2.3 i V5   |             | 10.98 | 09.04 |                     |                     |                |        |   |  |  |   |                         |  |
| 2.8  | 150         | 05.02 | 09.04 |                     |                     |                |        |   |  |  |   |                         |  |
| 2.8 4x4  | 150         | 09.02 | 09.04 |                     |                     |                |        |   |  |  |   |                         |  |
|   | 1.4 i 16V   | 55    | 07.99 | 09.04               | PR: 1KK,1KP,1KQ     | 13.0460-2894.2 | 602894 |   |  |  | 20961 17,4 /Zub/S TRW<br>20961 17,4 /Zub/S TRW<br>Belagsatz-Zubehör TRW |                         |  |
|  | 1.6 i       |       | 10.98 | 09.04               | PR: 1KK,1KP,1KQ     |                |        |   |  |  |   |                         |  |
|  | 1.8 4x4     |       | 05.01 | 09.04               | PR: 1KK,1KP,1KQ     |                |        |   |  |  |   |                         |  |
|  | 1.8 i 20V   |       | 10.98 | 09.04               | PR: 1KK,1KP,1KQ     |                |        |   |  |  |   |                         |  |
|  | 1.8 i 20V T | 132   | 05.01 | 09.04               | PR: 1KK,1KP,1KQ     |                |        |   |  |  |   |                         |  |
|  | 1.9 SDI     | 50    | 11.99 | 09.04               | PR: 1KK,1KP,1KQ     |                |        |   |  |  |   |                         |  |
|  | 1.9 TDI     | 66    | 10.98 | 09.04               | PR: 1KK,1KP,1KQ     |                |        |   |  |  |   |                         |  |
|  | 1.9 TDI     | 81    | 10.98 | 09.04               | PR: 1KK,1KP,1KQ     |                |        |   |  |  |   |                         |  |
|  | 1.9 TDI     | 96    | 05.03 | 09.04               | PR: 1KK,1KP,1KQ     |                |        |   |  |  |   |                         |  |
|  | 1.9 TDI     | 110   | 10.00 | 09.04               | PR: 1KK,1KP,1KQ     |                |        |   |  |  |   |                         |  |
| 2.3 i V5   |             | 10.98 | 09.04 | PR: 1KK,1KP,1KQ     |                     |                |        |   |  |  |   |                         |  |
| 2.8  | 150         | 10.00 | 09.04 | PR: 1KK,1KP,1KQ     |                     |                |        |   |  |  |   |                         |  |
| 2.8 4x4  | 150         | 05.02 | 09.04 | PR: 1KK,1KP,1KQ     |                     |                |        |   |  |  |   |                         |  |
|  | 1.4 i 16V   | 55    | 07.99 | 09.04               | PR: 1KY,2EE         | 13.0460-2886.2 | 602886 |   |  |  | 20961 16,2 /S TRW<br>20961 16,2 /S TRW<br>Belagsatz-Zubehör TRW         |                         |  |
|  | 1.6 i       |       | 10.98 | 09.04               | PR: 1KY,2EE         |                |        |   |  |  |   |                         |  |
|  | 1.8 4x4     |       | 05.01 | 09.04               | PR: 1KY,2EE         |                |        |   |  |  |   |                         |  |
|  | 1.8 i 20V   |       | 10.98 | 09.04               | PR: 1KY,2EE         |                |        |   |  |  |   |                         |  |
|  | 1.8 i 20V T | 132   | 05.01 | 09.04               | PR: 1KY,2EE         |                |        |   |  |  |   |                         |  |
|  | 1.9 SDI     | 50    | 11.99 | 09.04               | PR: 1KY,2EE         |                |        |   |  |  |   |                         |  |
|  | 1.9 TDI     | 66    | 10.98 | 09.04               | PR: 1KY,2EE         |                |        |   |  |  |   |                         |  |
|  | 1.9 TDI     | 81    | 10.98 | 09.04               | PR: 1KY,2EE         |                |        |   |  |  |   |                         |  |
|  | 1.9 TDI     | 96    | 05.03 | 09.04               | PR: 1KY,2EE         |                |        |   |  |  |   |                         |  |
|  | 1.9 TDI     | 110   | 10.00 | 09.04               | PR: 1KY,2EE         |                |        |   |  |  |   |                         |  |
| 2.3 i V5   |             | 10.98 | 09.04 | PR: 1KY,2EE         |                     |                |        |   |  |  |   |                         |  |
| 2.8  | 150         | 10.00 | 09.04 | PR: 1KY,2EE         |                     |                |        |   |  |  |   |                         |  |
| 2.8 4x4  | 150         | 05.02 | 09.04 | PR: 1KY,2EE         |                     |                |        |   |  |  |   |                         |  |
|  | 1.4 i 16V   | 55    | 07.99 | 09.04               | PR: 1KK,1KP,1KQ     | 24.0109-0123.1 | 409123 |   |  |  | 230 9,0 7,0 +S +B<br>230 9,0 7,0 +S +B PD                               |                         |  |
|  | 1.6 i       |       | 10.98 | 09.04               | PR: 1KK,1KP,1KQ     |                |        |   |  |  |   |                         |  |
|  | 1.8 4x4     |       | 05.01 | 09.04               | PR: 1KK,1KP,1KQ     |                |        |   |  |  |   |                         |  |
|  | 1.8 i 20V   |       | 10.98 | 09.04               | PR: 1KK,1KP,1KQ     |                |        |   |  |  |   |                         |  |
|  | 1.8 i 20V T | 132   | 05.01 | 09.04               | PR: 1KK,1KP,1KQ     |                |        |   |  |  |   |                         |  |
|  | 1.9 SDI     | 50    | 11.99 | 09.04               | PR: 1KK,1KP,1KQ     |                |        |   |  |  |   |                         |  |
|  | 1.9 TDI     | 66    | 10.98 | 09.04               | PR: 1KK,1KP,1KQ     |                |        |   |  |  |   |                         |  |
|  | 1.9 TDI     | 81    | 10.98 | 09.04               | PR: 1KK,1KP,1KQ     |                |        |   |  |  |   |                         |  |
|  | 1.9 TDI     | 96    | 05.03 | 09.04               | PR: 1KK,1KP,1KQ     |                |        |   |  |  |   |                         |  |
|  | 1.9 TDI     | 110   | 10.00 | 09.04               | PR: 1KK,1KP,1KQ     |                |        |   |  |  |   |                         |  |
| 2.3 i V5   |             | 10.98 | 09.04 | PR: 1KK,1KP,1KQ     |                     |                |        |   |  |  |   |                         |  |
| 2.8  | 150         | 10.00 | 09.04 | PR: 1KK,1KP,1KQ     |                     |                |        |   |  |  |   |                         |  |
| 2.8 4x4  | 150         | 05.02 | 09.04 | PR: 1KK,1KP,1KQ     |                     |                |        |   |  |  |   |                         |  |
|  | 1.4 i 16V   | 55    | 07.99 | 09.04               | PR: 1KY,2EE         | 24.0122-0163.1 | 422163 |   |  |  | 256 22,0 20,0 V L +B<br>256 22,0 20,0 V L +B PD                         |                         |  |
|  | 1.6 i       |       | 10.98 | 09.04               | PR: 1KY,2EE         |                |        |   |  |  |   |                         |  |
|  | 1.8 4x4     |       | 05.01 | 09.04               | PR: 1KY,2EE         |                |        |   |  |  |   |                         |  |
|  | 1.8 i 20V   |       | 10.98 | 09.04               | PR: 1KY,2EE         |                |        |   |  |  |   |                         |  |
|  | 1.8 i 20V T | 132   | 05.01 | 09.04               | PR: 1KY,2EE         |                |        |   |  |  |   |                         |  |
|  | 1.9 SDI     | 50    | 11.99 | 09.04               | PR: 1KY,2EE         |                |        |   |  |  |   |                         |  |
|  | 1.9 TDI     | 66    | 10.98 | 09.04               | PR: 1KY,2EE         |                |        |   |  |  |   |                         |  |
|  | 1.9 TDI     | 81    | 10.98 | 09.04               | PR: 1KY,2EE         |                |        |   |  |  |   |                         |  |
|  | 1.9 TDI     | 96    | 05.03 | 09.04               | PR: 1KY,2EE         |                |        |   |  |  |   |                         |  |
|  | 1.9 TDI     | 110   | 10.00 | 09.04               | PR: 1KY,2EE         |                |        |   |  |  |   |                         |  |
| 2.3 i V5   |             | 10.98 | 09.04 | PR: 1KY,2EE         |                     |                |        |   |  |  |   |                         |  |

|     |    |  |                                   |                                   |   |  |  |                               |            |
|--|--|--|---|---|--|--|--|---|------------|
| <b>SEAT TOLEDO II (1M2) (98-04)</b>  |  |  |   |   |  |  |  |   |            |
|    | 2.8<br>2.8 4x4   | 150<br>150   | 10.00<br>05.02  | 09.04<br>09.04  | PR: 1KY,2EE<br>PR: 1KY,2EE   | 24.0122-0163.1<br>24.0322-0163.1   | 422163<br>522163   | 256 22,0 20,0 V L +B<br>256 22,0 20,0 V L +B PD   |            |
|    | 1.4 i 16V<br>1.6 i<br>1.8 4x4<br>1.8 i 20V<br>1.8 i 20VT<br>1.9 SDI<br>1.9 TDI<br>1.9 TDI<br>1.9 TDI<br>2.3 i V5<br>2.8<br>2.8 4x4 | 55<br><br><br>132<br>50<br>66<br>81<br>96<br>110<br><br>150<br>150               | 07.99<br>10.98<br>05.01<br>10.98<br>05.01<br>11.99<br>10.98<br>10.98<br>05.03<br>10.00<br>10.98<br>10.00<br>05.02 | 09.04<br>09.04<br>09.04<br>09.04<br>09.04<br>09.04<br>09.04<br>09.04<br>09.04<br>09.04<br>09.04<br>09.04<br>09.04 |  | 24.0741-1107.3   | 360042   | 2 <br>Radsensor              |            |
| <b>SEAT TOLEDO III (5P2) (05-09)</b>   |  |  |   |   |  |  |  |   |            |
|    | 1.4 16V<br>1.6 i 16V<br>1.8 TFSI<br>1.9 TDI<br>2.0 FSI<br>2.0 TDI<br>2.0 TDI<br>2.0 TFSI   | 63<br>75<br>118<br>77<br>110<br>125<br>147                                       | 05.06<br>10.04<br>01.07<br>10.04<br>10.04<br>10.04<br>01.06<br>11.05  | 03.09<br>03.09<br>03.09<br>03.09<br>03.09<br>03.09<br>03.09<br>03.09  | PR: 1ZF<br>PR: 1ZF<br>PR: 1ZF<br>PR: 1ZF<br>PR: 1ZF<br>PR: 1ZF<br>PR: 1ZF<br>PR: 1ZF   | 13.0460-7117.2<br>13.0470-7117.2   | 607117<br>LD7117   | 23131 19,6 +/WK<br>23131 19,6 +/WK  | VW<br>VW   |
|  | 1.4 16V<br>1.6 i 16V<br>1.8 TFSI<br>1.9 TDI<br>2.0 FSI<br>2.0 TDI<br>2.0 TDI<br>2.0 TFSI   | 63<br>75<br>118<br>77<br>110<br>125<br>147                                       | 05.06<br>10.04<br>01.07<br>10.04<br>10.04<br>10.04<br>01.06<br>11.05  | 03.09<br>03.09<br>03.09<br>03.09<br>03.09<br>03.09<br>03.09<br>03.09  | PR: 1ZE<br>PR: 1ZE<br>PR: 1ZE<br>PR: 1ZE<br>PR: 1ZE<br>PR: 1ZE<br>PR: 1ZE<br>PR: 1ZE   | 13.0460-7184.2<br>13.0470-7184.2   | 607184<br>LD7184   | 23587 20,6 +/WK<br>23587 20,6 +/WK  | ATE<br>ATE |
|    | 1.4 16V<br>1.6 i 16V<br>1.8 TFSI<br>1.9 TDI<br>2.0 FSI<br>2.0 TDI<br>2.0 TDI<br>2.0 TFSI   | 63<br>75<br>118<br>77<br>110<br>125<br>147                                       | 05.06<br>10.04<br>01.07<br>10.04<br>10.04<br>10.04<br>01.06<br>11.05  | 03.09<br>03.09<br>03.09<br>03.09<br>03.09<br>03.09<br>03.09<br>03.09  | PR: 1ZF<br>PR: 1ZF<br>PR: 1ZF<br>PR: 1ZF<br>PR: 1ZF<br>PR: 1ZF<br>PR: 1ZF<br>PR: 1ZF   | 24.0122-0210.1<br>24.0322-0210.1   | 422210<br>522210   | 280 22,0 19,0 V L +S +B<br>280 22,0 19,0 V L +S +B PD   |            |
|  | 1.4 16V<br>1.6 i 16V<br>1.8 TFSI<br>1.9 TDI<br>2.0 FSI<br>2.0 TDI<br>2.0 TDI<br>2.0 TFSI   | 63<br>75<br>118<br>77<br>110<br>125<br>147                                       | 05.06<br>10.04<br>01.07<br>10.04<br>10.04<br>10.04<br>01.06<br>11.05  | 03.09<br>03.09<br>03.09<br>03.09<br>03.09<br>03.09<br>03.09<br>03.09  | PR: 1ZE<br>PR: 1ZE<br>PR: 1ZE<br>PR: 1ZE<br>PR: 1ZE<br>PR: 1ZE<br>PR: 1ZE<br>PR: 1ZE   | 24.0125-0145.1<br>24.0325-0145.1   | 425145<br>525145   | 288 25,0 22,0 V L +S +B<br>288 25,0 22,0 V L +S +B PD   |            |
|  | 1.4 16V<br>1.6 i 16V<br>1.8 TFSI<br>1.9 TDI<br>2.0 FSI<br>2.0 TDI<br>2.0 TDI<br>2.0 TFSI   | 63<br>75<br>118<br>77<br>110<br>125<br>147                                       | 05.06<br>10.04<br>01.07<br>10.04<br>10.04<br>10.04<br>01.06<br>11.05  | 03.09<br>03.09<br>03.09<br>03.09<br>03.09<br>03.09<br>03.09<br>03.09  |  | 24.0711-5271.3<br>24.0711-5272.3   | 360301<br>360302   | <br>Radsensor<br>Radsensor |            |
|  | 1.4 16V<br>1.6 i 16V<br>1.8 TFSI<br>1.9 TDI<br>2.0 FSI<br>2.0 TDI<br>2.0 TDI<br>2.0 TFSI   | 63<br>75<br>118<br>77<br>110<br>125<br>147                                       | 05.06<br>10.04<br>01.07<br>10.04<br>10.04<br>10.04<br>01.06<br>11.05  | 03.09<br>03.09<br>03.09<br>03.09<br>03.09<br>03.09<br>03.09<br>03.09  | PR: 1KD<br>PR: 1KD<br>PR: 1KD<br>PR: 1KD<br>PR: 1KD<br>PR: 1KD<br>PR: 1KD<br>PR: 1KD   | 13.0460-2820.2<br>13.0470-2820.2   | 602820<br>LD2820   | 20961 17,6 /S<br>20961 17,6 /S  | TRW<br>TRW |
|  | 1.4 16V<br>1.6 i 16V<br>1.8 TFSI<br>1.9 TDI<br>2.0 FSI<br>2.0 TDI<br>2.0 TDI<br>2.0 TFSI   | 63<br>75<br>118<br>77<br>110<br>125<br>147                                       | 05.06<br>10.04<br>01.07<br>10.04<br>10.04<br>10.04<br>01.06<br>11.05  | 03.09<br>03.09<br>03.09<br>03.09<br>03.09<br>03.09<br>03.09<br>03.09  | PR: 1KF,1KJ,1KZ<br>PR: 1KF,1KJ,1KZ<br>PR: 1KF,1KJ,1KZ<br>PR: 1KF,1KJ,1KZ<br>PR: 1KF,1KJ,1KZ<br>PR: 1KF,1KJ,1KZ<br>PR: 1KF,1KJ,1KZ<br>PR: 1KF,1KJ,1KZ | 13.0460-2880.2<br>13.0470-2880.2<br>13.0460-0259.2                                 | 602880<br>LD2880<br>610259   | 23914 17,1 /WE/Zub/S<br>23914 17,1 /WE/Zub/S<br>Belagsatz-Zubehör   | TRW<br>TRW |
|  | 1.4 16V<br>1.6 i 16V<br>1.8 TFSI<br>1.9 TDI<br>2.0 FSI<br>2.0 TDI<br>2.0 TDI<br>2.0 TFSI   | 63<br>75<br>118<br>77<br>110<br>125<br>147                                       | 05.06<br>10.04<br>01.07<br>10.04<br>10.04<br>10.04<br>01.06<br>11.05  | 03.09<br>03.09<br>03.09<br>03.09<br>03.09<br>03.09<br>03.09<br>03.09  | PR: 1KD<br>PR: 1KD<br>PR: 1KD<br>PR: 1KD<br>PR: 1KD<br>PR: 1KD<br>PR: 1KD<br>PR: 1KD   | 24.0110-0277.1<br>24.0310-0277.1   | 410277<br>510277   | 253 10,0 8,0 +S +B<br>253 10,0 8,0 +S +B PD   |            |
|  | 1.4 16V<br>1.6 i 16V<br>1.8 TFSI<br>1.9 TDI  | 63<br>75<br>118<br>77  | 05.06<br>10.04<br>01.07<br>10.04  | 03.09<br>03.09<br>03.09<br>03.09  | PR: 1KJ,1KZ<br>PR: 1KJ,1KZ<br>PR: 1KJ,1KZ<br>PR: 1KJ,1KZ   | 24.0112-0169.1<br>24.0312-0169.1   | 412169<br>512169   | 282 12,0 10,0 +S +B<br>282 12,0 10,0 +S +B PD   |            |



|     |  |  |  |  |  |  |  |  |   |   |
|--|--|--|--|--|---|--|--|--|---|---|
| <b>SEAT TOLEDO III (5P2) (05-09)</b>   |  |  |  |  |   |  |  |  |   |   |
|    | 2.0 FSI  | 110  |  | 10.04  | 03.09   | PR: 1KJ,1KZ  | 24.0112-0169.1   | 412169   | 282 12,0 10,0 +S +B<br>282 12,0 10,0 +S +B PD         |   |
|  | 2.0 TDI  |  |  | 10.04  | 03.09   | PR: 1KJ,1KZ  | 24.0312-0169.1   | 512169   |   |   |
|  | 2.0 TDI  | 125  |  | 01.06  | 03.09   | PR: 1KJ,1KZ  |  |  |   |   |
|  | 2.0 TFSI   | 147  |  | 11.05  | 03.09   | PR: 1KJ,1KZ  |  |  |   |   |
|  | 1.4 16V  | 63   |  | 05.06  | 03.09   | PR: 1KF  | 24.0112-0158.1   | 412158   | 256 12,0 10,0 +S +B<br>256 12,0 10,0 +B PD            |   |
|  | 1.6 i 16V  | 75   |  | 10.04  | 03.09   | PR: 1KF  | 24.0312-0158.1   | 512158   |   |   |
|  | 1.8 TFSI   | 118  |  | 01.07  | 03.09   | PR: 1KF  |  |  |   |   |
|  | 1.9 TDI  | 77   |  | 10.04  | 03.09   | PR: 1KF  |  |  |   |   |
|  | 2.0 FSI  | 110  |  | 10.04  | 03.09   | PR: 1KF  |  |  |   |   |
|  | 2.0 TDI  |  |  | 10.04  | 03.09   | PR: 1KF  |  |  |   |   |
| 2.0 TDI  | 125  |  | 01.06  | 03.09  | PR: 1KF   |  |  |  |   |   |
| 2.0 TFSI   | 147  |  | 11.05  | 03.09  | PR: 1KF   |  |  |  |   |   |
|    | 1.4 16V  | 63   |  | 05.06  | 03.09   |  | 24.0711-6231.3   | 360305   | Radsensor<br>Radsensor                                |   |
|  | 1.6 i 16V  | 75   |  | 10.04  | 03.09   |  | 24.0711-6232.3   | 360306   |   |   |
|  | 1.8 TFSI   | 118  |  | 01.07  | 03.09   |  |  |  |   |   |
|  | 1.9 TDI  | 77   |  | 10.04  | 03.09   |  |  |  |   |   |
|  | 2.0 FSI  | 110  |  | 10.04  | 03.09   |  |  |  |   |   |
|  | 2.0 TDI  |  |  | 10.04  | 03.09   |  |  |  |   |   |
|  | 2.0 TDI  | 125  |  | 01.06  | 03.09   |  |  |  |   |   |
|  | 2.0 TFSI   | 147  |  | 11.05  | 03.09   |  |  |  |   |   |
| <b>SEAT TOLEDO IV (KG3) (12-)</b>  |  |  |  |  |   |  |  |  |   |   |
|    | 1.2  | 55   |  | 07.12  |   | PR: 1ZG  | 13.0460-7111.2   | 607111   | 23130 19,6 +<br>23130 19,6 +<br>VW<br>VW              |   |
|  | 1.2 TSI  | 63   |  | 07.12  |   | PR: 1ZG  | 13.0470-7111.2   | LD7111   |   |   |
|  | 1.2 TSI  | 66   |  | 05.15  |   | PR: 1ZG  |  |  |   |   |
|  | 1.2 TSI  | 77   |  | 07.12  |   | PR: 1ZG  |  |  |   |   |
|  | 1.2 TSI  | 81   |  | 05.15  |   | PR: 1ZG  |  |  |   |   |
|  | 1.4 TDI  | 66   |  | 05.15  |   | PR: 1ZG  |  |  |   |   |
|  | 1.4 TSI  | 90   |  | 07.12  |   | PR: 1ZG  |  |  |   |   |
|  | 1.4 TSI  | 92   |  | 05.15  |   | PR: 1ZG  |  |  |   |   |
|  | 1.6  | 77   |  | 07.13  |   | PR: 1ZG  |  |  |   |   |
|  | 1.6 TDI  | 66   |  | 06.13  |   | PR: 1ZG  |  |  |   |   |
|  | 1.6 TDI  | 77   |  | 07.12  |   | PR: 1ZG  |  |  |   |   |
|  | 1.6 TDI  | 85   |  | 05.15  |   | PR: 1ZG  |  |  |   |   |
|  | 1.2  | 55   |  | 07.12  |   | + Bremsscheibendurchm. 288 mm <sup>1)</sup>  | 13.0460-7184.2   | 607184   |   | 23587 20,6 +/WK<br>23587 20,6 +/WK<br>ATE<br>ATE      |
|  | 1.2 TSI  | 63   |  | 07.12  |   | + Bremsscheibendurchm. 288 mm <sup>1)</sup>  | 13.0470-7184.2   | LD7184   |   |   |
|  | 1.2 TSI  | 77   |  | 07.12  |   | + Bremsscheibendurchm. 288 mm <sup>1)</sup>  |  |  |   |   |
|  | 1.4 TSI  | 90   |  | 07.12  |   | + Bremsscheibendurchm. 288 mm <sup>1)</sup>  |  |  |   |   |
|  | 1.6  | 77   |  | 07.13  |   | + Bremsscheibendurchm. 288 mm <sup>1)</sup>  |  |  |   |   |
|  | 1.6 TDI  | 66   |  | 06.13  |   | + Bremsscheibendurchm. 288 mm <sup>1)</sup>  |  |  |   |   |
|  | 1.6 TDI  | 77   |  | 07.12  |   | + Bremsscheibendurchm. 288 mm <sup>1)</sup>  |  |  |   |   |
| 1.2 TSI  | 66   |  | 05.15  |  | PR: 1ZC   | 13.0460-7184.2   | 607184   | 23587 20,6 +/WK<br>23587 20,6 +/WK<br>ATE<br>ATE                                   |   |   |
| 1.2 TSI  | 81   |  | 05.15  |  | PR: 1ZC   | 13.0470-7184.2   | LD7184   |  |   |   |
| 1.4 TDI  | 66   |  | 05.15  |  | PR: 1ZC   |  |  |  |   |   |
| 1.4 TSI  | 92   |  | 05.15  |  | PR: 1ZC   |  |  |  |   |   |
| 1.6 TDI  | 85   |  | 05.15  |  | PR: 1ZC   |  |  |  |   |   |
|  | 1.2  | 55   |  | 07.12  |   | PR: 1ZG  | 24.0122-0151.1   | 422151   | 256 22,0 19,0 V L +S +B<br>256 22,0 19,0 V L +S +B PD |   |
|  | 1.2 TSI  | 63   |  | 07.12  |   | PR: 1ZG  | 24.0322-0151.1   | 522151   |   |   |
|  | 1.2 TSI  | 66   |  | 05.15  |   | PR: 1ZG  |  |  |   |   |
|  | 1.2 TSI  | 77   |  | 07.12  |   | PR: 1ZG  |  |  |   |   |
|  | 1.2 TSI  | 81   |  | 05.15  |   | PR: 1ZG  |  |  |   |   |
|  | 1.4 TDI  | 66   |  | 05.15  |   | PR: 1ZG  |  |  |   |   |
|  | 1.4 TSI  | 90   |  | 07.12  |   | PR: 1ZG  |  |  |   |   |
|  | 1.4 TSI  | 92   |  | 05.15  |   | PR: 1ZG  |  |  |   |   |
|  | 1.6  | 77   |  | 07.13  |   | PR: 1ZG  |  |  |   |   |
|  | 1.6 TDI  | 66   |  | 06.13  |   | PR: 1ZG  |  |  |   |   |
|  | 1.6 TDI  | 77   |  | 07.12  |   | PR: 1ZG  |  |  |   |   |
|  | 1.6 TDI  | 85   |  | 05.15  |   | PR: 1ZG  |  |  |   |   |
|  | 1.2  | 55   |  | 07.12  |   | + Bremsscheibendurchm. 288 mm <sup>1)</sup>  | 24.0125-0113.1   | 425113   |   | 288 25,0 22,0 V L +S +B<br>288 25,0 22,0 V L +S +B PD |
|  | 1.2 TSI  | 63   |  | 07.12  |   | + Bremsscheibendurchm. 288 mm <sup>1)</sup>  | 24.0325-0113.1   | 525113   |   |   |
|  | 1.2 TSI  | 77   |  | 07.12  |   | + Bremsscheibendurchm. 288 mm <sup>1)</sup>  |  |  |   |   |
|  | 1.4 TSI  | 90   |  | 07.12  |   | + Bremsscheibendurchm. 288 mm <sup>1)</sup>  |  |  |   |   |
|  | 1.6  | 77   |  | 07.13  |   | + Bremsscheibendurchm. 288 mm <sup>1)</sup>  |  |  |   |   |
|  | 1.6 TDI  | 66   |  | 06.13  |   | + Bremsscheibendurchm. 288 mm <sup>1)</sup>  |  |  |   |   |
|  | 1.6 TDI  | 77   |  | 07.12  |   | + Bremsscheibendurchm. 288 mm <sup>1)</sup>  |  |  |   |   |
| 1.2 TSI  | 66   |  | 05.15  |  | PR: 1ZC   | 24.0125-0113.1   | 425113   | 288 25,0 22,0 V L +S +B<br>288 25,0 22,0 V L +S +B PD                              |   |   |
| 1.2 TSI  | 81   |  | 05.15  |  | PR: 1ZC   | 24.0325-0113.1   | 525113   |  |   |   |
| 1.4 TDI  | 66   |  | 05.15  |  | PR: 1ZC   |  |  |  |   |   |
| 1.4 TSI  | 92   |  | 05.15  |  | PR: 1ZC   |  |  |  |   |   |
| 1.6 TDI  | 85   |  | 05.15  |  | PR: 1ZC   |  |  |  |   |   |
|  | 1.2  | 55   |  | 07.12  |   |  | 24.0711-5273.3   | 360303   | Radsensor<br>Radsensor                                |   |
|  | 1.2 TSI  | 63   |  | 07.12  |   |  | 24.0711-5274.3   | 360304   |   |   |
|  | 1.2 TSI  | 66   |  | 05.15  |   |  |  |  |   |   |
|  | 1.2 TSI  | 77   |  | 07.12  |   |  |  |  |   |   |
|  | 1.2 TSI  | 81   |  | 05.15  |   |  |  |  |   |   |
|  | 1.4 TDI  | 66   |  | 05.15  |   |  |  |  |   |   |
|  | 1.4 TSI  | 90   |  | 07.12  |   |  |  |  |   |   |
|  | 1.4 TSI  | 92   |  | 05.15  |   |  |  |  |   |   |
|  | 1.6  | 77   |  | 07.13  |   |  |  |  |   |   |
|  | 1.6 TDI  | 66   |  | 06.13  |   |  |  |  |   |   |
|  | 1.6 TDI  | 77   |  | 07.12  |   |  |  |  |   |   |
|  | 1.6 TDI  | 85   |  | 05.15  |   |  |  |  |   |   |













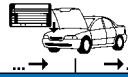

<sup>1)</sup> + brake disc diameter 288mm / + diametro dischi freno 288mm / + diamètre disques frein 288mm / + diámetro disco freno 288mm



















|     |  |  |  |  |  |  |     |  |
|--|--|--|--|--|---|--|---|--|
| <b>SEAT TOLEDO IV (KG3) (12-)</b>  |  |  |  |  |   |  |   |  |
|    | 1.2  | 55   |  | 07.12  |   |  |   |  |
|  | 1.2 TSI  | 63   |  | 07.12  | 13.0460-2820.2  | 602820   |   | 20961 17,6 /S TRW  |
|  | 1.2 TSI  | 66   |  | 05.15  | 13.0470-2820.2  | LD2820   |   | 20961 17,6 /S TRW  |
|  | 1.2 TSI  | 77   |  | 07.12  |   |  |   |  |
|  | 1.2 TSI  | 81   |  | 05.15  |   |  |   |  |
|  | 1.4 TDI  | 66   |  | 05.15  |   |  |   |  |
|  | 1.4 TSI  | 90   |  | 07.12  |   |  |   |  |
|  | 1.4 TSI  | 92   |  | 05.15  |   |  |   |  |
|  | 1.6  | 77   |  | 07.13  |   |  |   |  |
|  | 1.6 TDI  | 66   |  | 06.13  |   |  |   |  |
|  | 1.6 TDI  | 77   |  | 07.12  |   |  |   |  |
|  | 1.6 TDI  | 85   |  | 05.15  |   |  |   |  |
|    | 1.2  | 55   |  | 07.12  |   |  |   |  |
|  | 1.2 TSI  | 63   |  | 07.12  | 24.0109-0123.1  | 409123   |   | 230 9,0 7,0 +S +B  |
|  | 1.2 TSI  | 66   |  | 05.15  | 24.0309-0123.1  | 509123   |   | 230 9,0 7,0 +S +B PD   |
|  | 1.2 TSI  | 77   |  | 07.12  |   |  |   |  |
|  | 1.2 TSI  | 81   |  | 05.15  |   |  |   |  |
|  | 1.4 TDI  | 66   |  | 05.15  |   |  |   |  |
|  | 1.4 TSI  | 90   |  | 07.12  |   |  |   |  |
|  | 1.4 TSI  | 92   |  | 05.15  |   |  |   |  |
|  | 1.6  | 77   |  | 07.13  |   |  |   |  |
|  | 1.6 TDI  | 66   |  | 06.13  |   |  |   |  |
|  | 1.6 TDI  | 77   |  | 07.12  |   |  |   |  |
|  | 1.6 TDI  | 85   |  | 05.15  |   |  |   |  |
|    | 1.2  | 55   |  | 07.12  |   |  |   |  |
|  | 1.2 TSI  | 63   |  | 07.12  | 24.0711-6233.3  | 360315   |    | Radsensor  |
|  | 1.2 TSI  | 66   |  | 05.15  | 24.0711-6234.3  | 360316   |    | Radsensor  |
|  | 1.2 TSI  | 77   |  | 07.12  |   |  |   |  |
|  | 1.2 TSI  | 81   |  | 05.15  |   |  |   |  |
|  | 1.4 TDI  | 66   |  | 05.15  |   |  |   |  |
|  | 1.4 TSI  | 90   |  | 07.12  |   |  |   |  |
|  | 1.4 TSI  | 92   |  | 05.15  |   |  |   |  |
|  | 1.6  | 77   |  | 07.13  |   |  |   |  |
|  | 1.6 TDI  | 66   |  | 06.13  |   |  |   |  |
|  | 1.6 TDI  | 77   |  | 07.12  |   |  |   |  |
|  | 1.6 TDI  | 85   |  | 05.15  |   |  |   |  |
|    | 1.2  | 55   |  | 07.12  |   |  |   |  |
|  | 1.2 TSI  | 63   |  | 07.12  | 03.0137-0521.2  | 650521   |   | 228 x 33 HEB AP  |
|  | 1.2 TSI  | 66   |  | 05.15  | 03.0137-9309.2  | 669309   |   | Bremsbacken-Zubehör AP   |
|  | 1.2 TSI  | 77   |  | 07.12  |   |  |   |  |
|  | 1.2 TSI  | 81   |  | 05.15  |   |  |   |  |
|  | 1.4 TDI  | 66   |  | 05.15  |   |  |   |  |
|  | 1.4 TSI  | 90   |  | 07.12  |   |  |   |  |
|  | 1.4 TSI  | 92   |  | 05.15  |   |  |   |  |
|  | 1.6  | 77   |  | 07.13  |   |  |   |  |
|  | 1.6 TDI  | 66   |  | 06.13  |   |  |   |  |
|  | 1.6 TDI  | 77   |  | 07.12  |   |  |   |  |
|  | 1.6 TDI  | 85   |  | 05.15  |   |  |   |  |
| <b>SKODA CITIGO (12-)</b>  |  |  |  |  |   |  |   |  |
|  | 1.0  | 44   |  | 05.12  |   |  |   |  |
|  | 1.0  | 55   |  | 05.12  | 13.0460-7111.2  | 607111   |   | 23130 19,6 + VW  |
|  | 1.0 CNG  | 50   |  | 11.12  | 13.0470-7111.2  | LD7111   |   | 23130 19,6 + VW  |
|  | 1.0  | 44   |  | 05.12  |   |  |   |  |
|  | 1.0  | 55   |  | 05.12  | 24.0122-0281.1  | 422281   |   | 256 22,0 19,0 V L +S +B  |
|  | 1.0 CNG  | 50   |  | 11.12  |   |  |   |  |
|  | 1.0  | 44   |  | 05.12  |   |  |   |  |
|  | 1.0  | 55   |  | 05.12  | 24.0711-5273.3  | 360303   |  | Radsensor  |
|  | 1.0 CNG  | 50   |  | 11.12  | 24.0711-5274.3  | 360304   |  | Radsensor  |
|  | 1.0  | 44   |  | 05.12  |   |  |   |  |
|  | 1.0  | 55   |  | 05.12  | 24.0711-6233.3  | 360315   |  | Radsensor  |
|  | 1.0 CNG  | 50   |  | 11.12  | 24.0711-6234.3  | 360316   |  | Radsensor  |
|  | 1.0  | 44   |  | 05.12  |   |  |   |  |
|  | 1.0  | 55   |  | 05.12  | 03.0137-0268.2  | 650268   |   | 200 x 40 HEB VW  |
|  | 1.0 CNG  | 50   |  | 11.12  | 03.0137-9168.2  | 669168   |   | Bremsbacken-Zubehör VW   |
|  | 1.0  | 44   |  | 05.12  |   |  |   |  |
|  | 1.0  | 55   |  | 05.12  | 03.0520-4817.3  | 694817   |   | 17,46/200x40 TopKit VW   |
|  | 1.0 CNG  | 50   |  | 11.12  |   |  |   |  |
| <b>SKODA FABIA I (6Y) (99-07)</b>  |  |  |  |  |   |  |   |  |
|  | 1.0 i  | 37   |  | 02.00  | 08.02   | PR: 1LB,1LM  |   |  |
|  | 1.2 i  |  |  | 08.02  | 12.07   | PR: 1LB,1LM  |   |  |
|  | 1.4 i  |  |  | 02.00  | 12.07   | PR: 1LB,1LM  |   |  |
|  | 1.4 i 16V  |  |  | 10.99  | 12.07   | PR: 1LB,1LM  |   |  |
|  | 1.4 TDI  |  |  | 04.03  | 12.07   | PR: 1LB,1LM  |   |  |
|  | 1.9 SDI  | 47   |  | 12.99  | 12.07   | PR: 1LB,1LM  |   |  |
|  | 1.9 TDI  | 74   |  | 02.00  | 12.07   | PR: 1LB,1LM  |   |  |
|  | 1.9 TDI RS   | 96   |  | 09.03  | 12.07   | PR: 1LB,1LM  |   |  |
|  | 2.0 i  | 85   |  | 12.99  | 12.07   | PR: 1LB,1LM  |   |  |
|  | 1.0 i  | 37   |  | 02.00  | 08.02   | PR: 1LQ,1LR  |   |  |
|  | 1.2 i  |  |  | 08.02  | 12.07   | PR: 1LQ,1LR  |   |  |
|  | 1.4 i  |  |  | 02.00  | 12.07   | PR: 1LQ,1LR  |   |  |
|  | 1.4 i 16V  |  |  | 10.99  | 12.07   | PR: 1LQ,1LR  |   |  |
|  | 1.4 TDI  |  |  | 04.03  | 12.07   | PR: 1LQ,1LR  |   |  |
|  | 1.9 SDI  | 47   |  | 12.99  | 12.07   | PR: 1LQ,1LR  |   |  |
|  | 1.9 TDI  | 74   |  | 02.00  | 12.07   | PR: 1LQ,1LR  |   |  |
|  |  |  |  |  |   |  |   |  |





















|     |    |  |  |  |  |  |  |  |                         |
|--|--|--|--|--|---|--|--|--|-------------------------|
| <b>SKODA FABIA I (6Y) (99-07)</b>  |  |  |  |  |   |  |  |  |                         |
|    | 1.9 TDI RS   | 96   | 09.03  | 12.07  | PR: 1LQ,1LR   | 13.0460-7111.2   | 607111   | 23130 19,6 +   | VW                      |
|  | 2.0 i  | 85   | 12.99  | 12.07  | PR: 1LQ,1LR   | 13.0470-7111.2   | LD7111   | 23130 19,6 +   | VW                      |
|  |  |  |  |  |   | 13.0460-7117.2   | 607117   | 23131 19,6 +/WK  | VW                      |
|  |  |  |  |  |   | 13.0470-7117.2   | LD7117   | 23131 19,6 +/WK  | VW                      |
|  | 1.0 i  | 37   | 02.00  | 08.02  | PR: 1LN,1LP   | 13.0460-2883.2   | 602883   | 23581 18,8 /S  | TRW                     |
|  | 1.2 i  |  | 08.02  | 12.07  | PR: 1LN,1LP   | 13.0460-2884.2   | 602884   | 23843 18,8 +/WK/S  | TRW                     |
|  | 1.4 i  |  | 02.00  | 12.07  | PR: 1LN,1LP   | 13.0470-2884.2   | LD2884   | 23843 18,8 +/WK/S  | TRW                     |
|  | 1.4 i 16V  |  | 10.99  | 12.07  | PR: 1LN,1LP   |  |  |  |                         |
|  | 1.4 TDI  |  | 04.03  | 12.07  | PR: 1LN,1LP   |  |  |  |                         |
|  | 1.9 SDI  | 47   | 12.99  | 12.07  | PR: 1LN,1LP   |  |  |  |                         |
| 1.9 TDI  | 74   | 02.00  | 12.07  | PR: 1LN,1LP  |   |  |  |  |                         |
| 1.9 TDI RS   | 96   | 09.03  | 12.07  | PR: 1LN,1LP  |   |  |  |  |                         |
| 2.0 i  | 85   | 12.99  | 12.07  | PR: 1LN,1LP  |   |  |  |  |                         |
|    | 1.0 i  | 37   | 02.00  | 08.02  | PR: 1LB,1LM   | 24.0118-0137.1   | 418137   | 239 18,0 16,0 V L +S +B  |                         |
|  | 1.2 i  |  | 08.02  | 12.07  | PR: 1LB,1LM   | 24.0318-0137.1   | 518137   | 239 18,0 16,0 V L +S +B PD   |                         |
|  | 1.4 i  |  | 02.00  | 12.07  | PR: 1LB,1LM   |  |  |  |                         |
|  | 1.4 i 16V  |  | 10.99  | 12.07  | PR: 1LB,1LM   |  |  |  |                         |
|  | 1.4 TDI  |  | 04.03  | 12.07  | PR: 1LB,1LM   |  |  |  |                         |
|  | 1.9 SDI  | 47   | 12.99  | 12.07  | PR: 1LB,1LM   |  |  |  |                         |
|  | 1.9 TDI  | 74   | 02.00  | 12.07  | PR: 1LB,1LM   |  |  |  |                         |
|  | 1.9 TDI RS   | 96   | 09.03  | 12.07  | PR: 1LB,1LM   |  |  |  |                         |
|  | 2.0 i  | 85   | 12.99  | 12.07  | PR: 1LB,1LM   |  |  |  |                         |
|  |  | 1.0 i  | 37   | 02.00  | 08.02   | PR: 1LQ,1LR  | 24.0122-0151.1   | 422151   | 256 22,0 19,0 V L +S +B |
| 1.2 i  |  |  | 08.02  | 12.07  | PR: 1LQ,1LR   | 24.0322-0151.1   | 522151   | 256 22,0 19,0 V L +S +B PD   |                         |
| 1.4 i  |  |  | 02.00  | 12.07  | PR: 1LQ,1LR   |  |  |  |                         |
| 1.4 i 16V  |  |  | 10.99  | 12.07  | PR: 1LQ,1LR   |  |  |  |                         |
| 1.4 TDI  |  |  | 04.03  | 12.07  | PR: 1LQ,1LR   |  |  |  |                         |
| 1.9 SDI  |  | 47   | 12.99  | 12.07  | PR: 1LQ,1LR   |  |  |  |                         |
| 1.9 TDI  |  | 74   | 02.00  | 12.07  | PR: 1LQ,1LR   |  |  |  |                         |
| 1.9 TDI RS   |  | 96   | 09.03  | 12.07  | PR: 1LQ,1LR   |  |  |  |                         |
| 2.0 i  |  | 85   | 12.99  | 12.07  | PR: 1LQ,1LR   |  |  |  |                         |
|  |  | 1.0 i  | 37   | 02.00  | 08.02   | PR: 1LN,1LP  | 24.0125-0113.1   | 425113   | 288 25,0 22,0 V L +S +B |
|  | 1.2 i  |  | 08.02  | 12.07  | PR: 1LN,1LP   | 24.0325-0113.1   | 525113   | 288 25,0 22,0 V L +S +B PD   |                         |
|  | 1.4 i  |  | 02.00  | 12.07  | PR: 1LN,1LP   |  |  |  |                         |
|  | 1.4 i 16V  |  | 10.99  | 12.07  | PR: 1LN,1LP   |  |  |  |                         |
|  | 1.4 TDI  |  | 04.03  | 12.07  | PR: 1LN,1LP   |  |  |  |                         |
|  | 1.9 SDI  | 47   | 12.99  | 12.07  | PR: 1LN,1LP   |  |  |  |                         |
|  | 1.9 TDI  | 74   | 02.00  | 12.07  | PR: 1LN,1LP   |  |  |  |                         |
|  | 1.9 TDI RS   | 96   | 09.03  | 12.07  | PR: 1LN,1LP   |  |  |  |                         |
|  | 2.0 i  | 85   | 12.99  | 12.07  | PR: 1LN,1LP   |  |  |  |                         |
|  |  | 1.0 i  | 37   | 02.00  | 08.02   |  | 24.0711-5273.3   | 360303   | Radsensor               |
| 1.2 i  |  |  | 08.02  | 12.07  |   | 24.0711-5274.3   | 360304   | Radsensor  |                         |
| 1.4 i  |  |  | 02.00  | 12.07  |   |  |  |  |                         |
| 1.4 i 16V  |  |  | 10.99  | 12.07  |   |  |  |  |                         |
| 1.4 TDI  |  |  | 04.03  | 12.07  |   |  |  |  |                         |
| 1.9 SDI  |  | 47   | 12.99  | 12.07  |   |  |  |  |                         |
| 1.9 TDI  |  | 74   | 02.00  | 12.07  |   |  |  |  |                         |
| 1.9 TDI RS   |  | 96   | 09.03  | 12.07  |   |  |  |  |                         |
| 2.0 i  |  | 85   | 12.99  | 12.07  |   |  |  |  |                         |
|  |  | 1.4 i 16V  |  | 10.99  | 12.07   | PR: 1KK,1KP  | 13.0460-2894.2   | 602894   | 20961 17,4 /Zub/S       |
|  | 1.4 TDI  |  | 04.03  | 12.07  | PR: 1KK,1KP   | 13.0470-2894.2   | LD2894   | 20961 17,4 /Zub/S  | TRW                     |
|  | 1.9 TDI  | 74   | 02.00  | 12.07  | PR: 1KK,1KP   |  |  |  |                         |
|  | 1.9 TDI RS   | 96   | 09.03  | 12.07  | PR: 1KK,1KP   |  |  |  |                         |
|  | 2.0 i  | 85   | 12.99  | 12.07  | PR: 1KK,1KP   |  |  |  |                         |
|  | 1.4 i 16V  |  | 10.99  | 12.07  | PR: 1KK,1KP   | 24.0109-0123.1   | 409123   | 230 9,0 7,0 +S +B  |                         |
|  | 1.4 TDI  |  | 04.03  | 12.07  | PR: 1KK,1KP   | 24.0309-0123.1   | 509123   | 230 9,0 7,0 +S +B PD   |                         |
|  | 1.9 TDI  | 74   | 02.00  | 12.07  | PR: 1KK,1KP   |  |  |  |                         |
|  | 1.9 TDI RS   | 96   | 09.03  | 12.07  | PR: 1KK,1KP   |  |  |  |                         |
|  | 2.0 i  | 85   | 12.99  | 12.07  | PR: 1KK,1KP   |  |  |  |                         |
|  | 1.0 i  | 37   | 02.00  | 08.02  |   | 24.0711-6233.3   | 360315   | Radsensor  |                         |
|  | 1.2 i  |  | 08.02  | 12.07  |   | 24.0711-6234.3   | 360316   | Radsensor  |                         |
|  | 1.4 i  |  | 02.00  | 12.07  |   |  |  |  |                         |
|  | 1.4 i 16V  |  | 10.99  | 12.07  |   |  |  |  |                         |
|  | 1.4 TDI  |  | 04.03  | 12.07  |   |  |  |  |                         |
|  | 1.9 SDI  | 47   | 12.99  | 12.07  |   |  |  |  |                         |
|  | 1.0 i  | 37   | 02.00  | 08.02  |   | 03.0137-0268.2   | 650268   | 200 x 40 HEB   | VW                      |
|  | 1.2 i  |  | 08.02  | 12.07  |   | 03.0137-9168.2   | 669168   | Bremsbacken-Zubehör  | VW                      |
|  | 1.4 i  |  | 02.00  | 12.07  |   |  |  |  |                         |
|  | 1.4 i 16V  |  | 10.99  | 12.07  |   |  |  |  |                         |
|  | 1.4 TDI  |  | 04.03  | 12.07  |   |  |  |  |                         |
| 1.9 SDI  | 47   | 12.99  | 12.07  |  |   |  |  |  |                         |
|  | 1.0 i  | 37   | 02.00  | 08.02  |   | 24.0220-0037.1   | 480161   | 200/201,5 x 50,5   |                         |
|  | 1.2 i  |  | 08.02  | 12.07  |   |  |  |  |                         |
|  | 1.4 i  |  | 02.00  | 12.07  |   |  |  |  |                         |
|  | 1.4 i 16V  |  | 10.99  | 12.07  |   |  |  |  |                         |
|  | 1.4 TDI  |  | 04.03  | 12.07  |   |  |  |  |                         |
| 1.9 SDI  | 47   | 12.99  | 12.07  |  |   |  |  |  |                         |
|  | 1.0 i  | 37   | 02.00  | 08.02  |   | 03.0420-4219.3   | 684219   | 19,05/200x40 Kit   | VW                      |
|  | 1.2 i  |  | 08.02  | 12.07  |   | 03.0520-4219.3   | 694219   | 19,05/200x40 TopKit  | VW                      |
|  | 1.4 i  |  | 02.00  | 12.07  |   |  |  |  |                         |
|  | 1.4 i 16V  |  | 10.99  | 12.07  |   |  |  |  |                         |
|  | 1.4 TDI  |  | 04.03  | 12.07  |   |  |  |  |                         |
| 1.9 SDI  | 47   | 12.99  | 12.07  |  |   |  |  |  |                         |













| SKODA FABIA II (5J) (07-14)  |            |     |    |       |       |                     |                     |                |        |                            |                         |
|--|------------|-----|----|-------|-------|---------------------|---------------------|----------------|--------|----------------------------|-------------------------|
|    | 1.2        | 44  |    | 03.07 | 06.14 | PR: 1LB,1LM         | 13.0460-7100.2      | 607100         |        | 21866 17,2 +               | VW                      |
|  | 1.2        | 51  |    | 03.07 | 06.14 | PR: 1LB,1LM         | 13.0470-7100.2      | LD7100         |        | 21866 17,2 +               | ATE                     |
|  | 1.2 TDI    | 55  |    | 05.10 | 06.14 | PR: 1LB,1LM         | 13.0460-7164.2      | 607164         |        | 21868 17,2 +/WK            | VW                      |
|  | 1.2 TSI    | 63  |    | 03.10 | 06.14 | PR: 1LB,1LM         |                     |                |        |                            |                         |
|  | 1.2 TSI    | 77  |    | 03.10 | 06.14 | PR: 1LB,1LM         |                     |                |        |                            |                         |
|  | 1.4        | 63  |    | 03.07 | 06.14 | PR: 1LB,1LM         |                     |                |        |                            |                         |
|  | 1.4 TDI    | 51  |    | 03.07 | 06.14 | PR: 1LB,1LM         |                     |                |        |                            |                         |
|  | 1.4 TDI    | 59  |    | 03.07 | 06.14 | PR: 1LB,1LM         |                     |                |        |                            |                         |
|  | 1.4 TSI RS | 132 |    | 05.10 | 06.14 | PR: 1LB,1LM         |                     |                |        |                            |                         |
|  | 1.6 i 16V  | 77  |    | 03.07 | 06.14 | PR: 1LB,1LM         |                     |                |        |                            |                         |
|  | 1.6 TDI    | 55  |    | 04.10 | 06.14 | PR: 1LB,1LM         |                     |                |        |                            |                         |
|  | 1.6 TDI    | 66  |    | 03.10 | 06.14 | PR: 1LB,1LM         |                     |                |        |                            |                         |
|  | 1.6 TDI    | 77  |    | 03.10 | 06.14 | PR: 1LB,1LM         |                     |                |        |                            |                         |
|  | 1.9 TDI    | 77  |    | 03.07 | 06.14 | PR: 1LB,1LM         |                     |                |        |                            |                         |
|  |            | 1.2 | 44 |       | 03.07 | 06.14               | PR: 1LQ,1LR,1ZG     | 13.0460-7111.2 | 607111 |                            | 23130 19,6 +            |
| 1.2  |            | 51  |    | 03.07 | 06.14 | PR: 1LQ,1LR,1ZG     | 13.0470-7111.2      | LD7111         |        | 23130 19,6 +               | VW                      |
| 1.2 TDI  |            | 55  |    | 05.10 | 06.14 | PR: 1LQ,1LR,1ZG     | 13.0460-7117.2      | 607117         |        | 23131 19,6 +/WK            | VW                      |
| 1.2 TSI  |            | 63  |    | 03.10 | 06.14 | PR: 1LQ,1LR,1ZG     | 13.0470-7117.2      | LD7117         |        | 23131 19,6 +/WK            | VW                      |
| 1.2 TSI  |            | 77  |    | 03.10 | 06.14 | PR: 1LQ,1LR,1ZG     |                     |                |        |                            |                         |
| 1.4  |            | 63  |    | 03.07 | 06.14 | PR: 1LQ,1LR,1ZG     |                     |                |        |                            |                         |
| 1.4 TDI  |            | 51  |    | 03.07 | 06.14 | PR: 1LQ,1LR,1ZG     |                     |                |        |                            |                         |
| 1.4 TDI  |            | 59  |    | 03.07 | 06.14 | PR: 1LQ,1LR,1ZG     |                     |                |        |                            |                         |
| 1.4 TSI RS   |            | 132 |    | 05.10 | 06.14 | PR: 1LQ,1LR,1ZG     |                     |                |        |                            |                         |
| 1.6 i 16V  |            | 77  |    | 03.07 | 06.14 | PR: 1LQ,1LR,1ZG     |                     |                |        |                            |                         |
| 1.6 TDI  |            | 55  |    | 04.10 | 06.14 | PR: 1LQ,1LR,1ZG     |                     |                |        |                            |                         |
| 1.6 TDI  |            | 66  |    | 03.10 | 06.14 | PR: 1LQ,1LR,1ZG     |                     |                |        |                            |                         |
| 1.6 TDI  |            | 77  |    | 03.10 | 06.14 | PR: 1LQ,1LR,1ZG     |                     |                |        |                            |                         |
| 1.9 TDI  |            | 77  |    | 03.07 | 06.14 | PR: 1LQ,1LR,1ZG     |                     |                |        |                            |                         |
|  |            | 1.2 | 44 |       | 03.07 | 06.14               | PR: 1LN,1ZH         | 13.0460-2883.2 | 602883 |                            | 23581 18,8 /S           |
|  | 1.2        | 51  |    | 03.07 | 06.14 | PR: 1LN,1ZH         | 13.0460-2884.2      | 602884         |        | 23843 18,8 +/WK/S          | TRW                     |
|  | 1.2 TDI    | 55  |    | 05.10 | 06.14 | PR: 1LN,1ZH         | 13.0470-2884.2      | LD2884         |        | 23843 18,8 +/WK/S          | TRW                     |
|  | 1.2 TSI    | 63  |    | 03.10 | 06.14 | PR: 1LN,1ZH         |                     |                |        |                            |                         |
|  | 1.2 TSI    | 77  |    | 03.10 | 06.14 | PR: 1LN,1ZH         |                     |                |        |                            |                         |
|  | 1.4        | 63  |    | 03.07 | 06.14 | PR: 1LN,1ZH         |                     |                |        |                            |                         |
|  | 1.4 TDI    | 51  |    | 03.07 | 06.14 | PR: 1LN,1ZH         |                     |                |        |                            |                         |
|  | 1.4 TDI    | 59  |    | 03.07 | 06.14 | PR: 1LN,1ZH         |                     |                |        |                            |                         |
|  | 1.4 TSI RS | 132 |    | 05.10 | 06.14 | PR: 1LN,1ZH         |                     |                |        |                            |                         |
|  | 1.6 i 16V  | 77  |    | 03.07 | 06.14 | PR: 1LN,1ZH         |                     |                |        |                            |                         |
|  | 1.6 TDI    | 55  |    | 04.10 | 06.14 | PR: 1LN,1ZH         |                     |                |        |                            |                         |
|  | 1.6 TDI    | 66  |    | 03.10 | 06.14 | PR: 1LN,1ZH         |                     |                |        |                            |                         |
|  | 1.6 TDI    | 77  |    | 03.10 | 06.14 | PR: 1LN,1ZH         |                     |                |        |                            |                         |
|  | 1.9 TDI    | 77  |    | 03.07 | 06.14 | PR: 1LN,1ZH         |                     |                |        |                            |                         |
|  |            | 1.2 | 44 |       | 03.07 | 06.14               | PR: 1ZC             | 13.0460-7184.2 | 607184 |                            | 23587 20,6 +/WK         |
| 1.2  |            | 51  |    | 03.07 | 06.14 | PR: 1ZC             | 13.0470-7184.2      | LD7184         |        | 23587 20,6 +/WK            | ATE                     |
| 1.2 TDI  |            | 55  |    | 05.10 | 06.14 | PR: 1ZC             |                     |                |        |                            |                         |
| 1.2 TSI  |            | 63  |    | 03.10 | 06.14 | PR: 1ZC             |                     |                |        |                            |                         |
| 1.2 TSI  |            | 77  |    | 03.10 | 06.14 | PR: 1ZC             |                     |                |        |                            |                         |
| 1.4  |            | 63  |    | 03.07 | 06.14 | PR: 1ZC             |                     |                |        |                            |                         |
| 1.4 TDI  |            | 51  |    | 03.07 | 06.14 | PR: 1ZC             |                     |                |        |                            |                         |
| 1.4 TDI  |            | 59  |    | 03.07 | 06.14 | PR: 1ZC             |                     |                |        |                            |                         |
| 1.4 TSI RS   |            | 132 |    | 05.10 | 06.14 | PR: 1ZC             |                     |                |        |                            |                         |
| 1.6 i 16V  |            | 77  |    | 03.07 | 06.14 | PR: 1ZC             |                     |                |        |                            |                         |
| 1.6 TDI  |            | 55  |    | 04.10 | 06.14 | PR: 1ZC             |                     |                |        |                            |                         |
| 1.6 TDI  |            | 66  |    | 03.10 | 06.14 | PR: 1ZC             |                     |                |        |                            |                         |
| 1.6 TDI  |            | 77  |    | 03.10 | 06.14 | PR: 1ZC             |                     |                |        |                            |                         |
| 1.9 TDI  |            | 77  |    | 03.07 | 06.14 | PR: 1ZC             |                     |                |        |                            |                         |
|  |            | 1.2 | 44 |       | 03.07 | 06.14               | PR: 1LB,1LM         | 24.0118-0137.1 | 418137 |                            | 239 18,0 16,0 V L +S +B |
|  | 1.2        | 51  |    | 03.07 | 06.14 | PR: 1LB,1LM         | 24.0318-0137.1      | 518137         |        | 239 18,0 16,0 V L +S +B PD |                         |
|  | 1.2 TDI    | 55  |    | 05.10 | 06.14 | PR: 1LB,1LM         |                     |                |        |                            |                         |
|  | 1.2 TSI    | 63  |    | 03.10 | 06.14 | PR: 1LB,1LM         |                     |                |        |                            |                         |
|  | 1.2 TSI    | 77  |    | 03.10 | 06.14 | PR: 1LB,1LM         |                     |                |        |                            |                         |
|  | 1.4        | 63  |    | 03.07 | 06.14 | PR: 1LB,1LM         |                     |                |        |                            |                         |
|  | 1.4 TDI    | 51  |    | 03.07 | 06.14 | PR: 1LB,1LM         |                     |                |        |                            |                         |
|  | 1.4 TDI    | 59  |    | 03.07 | 06.14 | PR: 1LB,1LM         |                     |                |        |                            |                         |
|  | 1.4 TSI RS | 132 |    | 05.10 | 06.14 | PR: 1LB,1LM         |                     |                |        |                            |                         |
|  | 1.6 i 16V  | 77  |    | 03.07 | 06.14 | PR: 1LB,1LM         |                     |                |        |                            |                         |
|  | 1.6 TDI    | 55  |    | 04.10 | 06.14 | PR: 1LB,1LM         |                     |                |        |                            |                         |
|  | 1.6 TDI    | 66  |    | 03.10 | 06.14 | PR: 1LB,1LM         |                     |                |        |                            |                         |
|  | 1.6 TDI    | 77  |    | 03.10 | 06.14 | PR: 1LB,1LM         |                     |                |        |                            |                         |
|  | 1.9 TDI    | 77  |    | 03.07 | 06.14 | PR: 1LB,1LM         |                     |                |        |                            |                         |
|  |            | 1.2 | 44 |       | 03.07 | 06.14               | PR: 1LQ,1LR,1ZE,1ZG | 24.0122-0151.1 | 422151 |                            | 256 22,0 19,0 V L +S +B |
| 1.2  |            | 51  |    | 03.07 | 06.14 | PR: 1LQ,1LR,1ZE,1ZG | 24.0322-0151.1      | 522151         |        | 256 22,0 19,0 V L +S +B PD |                         |
| 1.2 TDI  |            | 55  |    | 05.10 | 06.14 | PR: 1LQ,1LR,1ZE,1ZG |                     |                |        |                            |                         |
| 1.2 TSI  |            | 63  |    | 03.10 | 06.14 | PR: 1LQ,1LR,1ZE,1ZG |                     |                |        |                            |                         |
| 1.2 TSI  |            | 77  |    | 03.10 | 06.14 | PR: 1LQ,1LR,1ZE,1ZG |                     |                |        |                            |                         |
| 1.4  |            | 63  |    | 03.07 | 06.14 | PR: 1LQ,1LR,1ZE,1ZG |                     |                |        |                            |                         |
| 1.4 TDI  |            | 51  |    | 03.07 | 06.14 | PR: 1LQ,1LR,1ZE,1ZG |                     |                |        |                            |                         |
| 1.4 TDI  |            | 59  |    | 03.07 | 06.14 | PR: 1LQ,1LR,1ZE,1ZG |                     |                |        |                            |                         |
| 1.4 TSI RS   |            | 132 |    | 05.10 | 06.14 | PR: 1LQ,1LR,1ZE,1ZG |                     |                |        |                            |                         |
| 1.6 i 16V  |            | 77  |    | 03.07 | 06.14 | PR: 1LQ,1LR,1ZE,1ZG |                     |                |        |                            |                         |
| 1.6 TDI  |            | 55  |    | 04.10 | 06.14 | PR: 1LQ,1LR,1ZE,1ZG |                     |                |        |                            |                         |
| 1.6 TDI  |            | 66  |    | 03.10 | 06.14 | PR: 1LQ,1LR,1ZE,1ZG |                     |                |        |                            |                         |
| 1.6 TDI  |            | 77  |    | 03.10 | 06.14 | PR: 1LQ,1LR,1ZE,1ZG |                     |                |        |                            |                         |
| 1.9 TDI  |            | 77  |    | 03.07 | 06.14 | PR: 1LQ,1LR,1ZE,1ZG |                     |                |        |                            |                         |
|  |            | 1.2 | 44 |       | 03.07 | 06.14               | PR: 1LN,1ZC,1ZH     | 24.0125-0113.1 | 425113 |                            | 288 25,0 22,0 V L +S +B |
|  | 1.2        | 51  |    | 03.07 | 06.14 | PR: 1LN,1ZC,1ZH     | 24.0325-0113.1      | 525113         |        | 288 25,0 22,0 V L +S +B PD |                         |
|  | 1.2 TDI    | 55  |    | 05.10 | 06.14 | PR: 1LN,1ZC,1ZH     |                     |                |        |                            |                         |

|     |    |  |    |  |  |  |  |  |
|--|--|--|--|--|---|--|--|--|
| <b>SKODA FABIA II (5J) (07-14)</b>   |  |  |  |  |   |  |  |  |
|    | 1.2 TSI 63<br>1.2 TSI 77<br>1.4 63<br>1.4 TDI 51<br>1.4 TDI 59<br>1.4 TSI RS 132<br>1.6 i 16V 77<br>1.6 TDI 55<br>1.6 TDI 66<br>1.6 TDI 77<br>1.9 TDI 77                                   |  | 03.10 06.14 PR: 1LN,1ZC,1ZH<br>03.10 06.14 PR: 1LN,1ZC,1ZH<br>03.07 06.14 PR: 1LN,1ZC,1ZH<br>03.07 06.14 PR: 1LN,1ZC,1ZH<br>03.07 06.14 PR: 1LN,1ZC,1ZH<br>05.10 06.14 PR: 1LN,1ZC,1ZH<br>03.07 06.14 PR: 1LN,1ZC,1ZH<br>04.10 06.14 PR: 1LN,1ZC,1ZH<br>03.10 06.14 PR: 1LN,1ZC,1ZH<br>03.10 06.14 PR: 1LN,1ZC,1ZH<br>03.07 06.14 PR: 1LN,1ZC,1ZH  | 24.0125-0113.1 425113<br>24.0325-0113.1 525113                                   |   |  |  | 288 25,0 22,0 VL +S +B<br>288 25,0 22,0 VL +S +B PD                                |
|    | 1.2 44<br>1.2 51<br>1.2 TDI 55<br>1.2 TSI 63<br>1.2 TSI 77<br>1.4 63<br>1.4 TDI 51<br>1.4 TDI 59<br>1.4 TSI RS 132<br>1.6 i 16V 77<br>1.6 TDI 55<br>1.6 TDI 66<br>1.6 TDI 77<br>1.9 TDI 77 |  | 03.07 06.14<br>03.07 06.14<br>05.10 06.14<br>03.10 06.14<br>03.10 06.14<br>03.07 06.14<br>03.07 06.14<br>03.07 06.14<br>05.10 06.14<br>03.07 06.14<br>04.10 06.14<br>03.10 06.14<br>03.10 06.14<br>03.07 06.14   | 24.0711-5273.3 360303<br>24.0711-5274.3 360304                                   |   |  |  | Radsensor<br>Radsensor   |
|    | 1.2 44<br>1.2 51<br>1.2 TDI 55<br>1.2 TSI 63<br>1.2 TSI 77<br>1.4 63<br>1.4 TDI 51<br>1.4 TDI 59<br>1.4 TSI RS 132<br>1.6 i 16V 77<br>1.6 TDI 55<br>1.6 TDI 66<br>1.6 TDI 77<br>1.9 TDI 77 |  | 03.07 06.14 PR: 1KK<br>03.07 06.14 PR: 1KK<br>05.10 06.14 PR: 1KK<br>03.10 06.14 PR: 1KK<br>03.10 06.14 PR: 1KK<br>03.07 06.14 PR: 1KK<br>03.07 06.14 PR: 1KK<br>03.07 06.14 PR: 1KK<br>05.10 06.14 PR: 1KK<br>03.07 06.14 PR: 1KK<br>04.10 06.14 PR: 1KK<br>03.10 06.14 PR: 1KK<br>03.10 06.14 PR: 1KK<br>03.07 06.14 PR: 1KK   | 13.0460-2894.2 602894<br>13.0470-2894.2 LD2894                                   |   |  |  | 20961 17,4 /Zub/S TRW<br>20961 17,4 /Zub/S TRW                                     |
|  | 1.2 44<br>1.2 51<br>1.2 TDI 55<br>1.2 TSI 63<br>1.2 TSI 77<br>1.4 63<br>1.4 TDI 51<br>1.4 TDI 59<br>1.4 TSI RS 132<br>1.6 i 16V 77<br>1.6 TDI 55<br>1.6 TDI 66<br>1.6 TDI 77<br>1.9 TDI 77 |  | 03.07 06.14 PR: 1KT,1KV<br>03.07 06.14 PR: 1KT,1KV<br>05.10 06.14 PR: 1KT,1KV<br>03.10 06.14 PR: 1KT,1KV<br>03.10 06.14 PR: 1KT,1KV<br>03.07 06.14 PR: 1KT,1KV<br>03.07 06.14 PR: 1KT,1KV<br>03.07 06.14 PR: 1KT,1KV<br>05.10 06.14 PR: 1KT,1KV<br>03.07 06.14 PR: 1KT,1KV<br>04.10 06.14 PR: 1KT,1KV<br>03.10 06.14 PR: 1KT,1KV<br>03.10 06.14 PR: 1KT,1KV<br>03.07 06.14 PR: 1KT,1KV   | 13.0460-2820.2 602820<br>13.0470-2820.2 LD2820                                   |   |  |  | 20961 17,6 /S TRW<br>20961 17,6 /S TRW   |
|  | 1.2 44<br>1.2 51<br>1.2 TDI 55<br>1.2 TSI 63<br>1.2 TSI 77<br>1.4 63<br>1.4 TDI 51<br>1.4 TDI 59<br>1.4 TSI RS 132<br>1.6 i 16V 77<br>1.6 TDI 55<br>1.6 TDI 66<br>1.6 TDI 77<br>1.9 TDI 77 |  | 03.07 06.14 PR: 1KT,2EJ,1KK,1KV<br>03.07 06.14 PR: 1KT,2EJ,1KK,1KV<br>05.10 06.14 PR: 1KT,1KV,2EJ<br>03.10 06.14 PR: 1KT,1KV,2EJ<br>03.10 06.14 PR: 1KT,1KV,2EJ<br>03.07 06.14 PR: 1KT,2EJ,1KK,1KV<br>03.07 06.14 PR: 1KT,2EJ,1KK,1KV<br>03.07 06.14 PR: 1KT,2EJ,1KK,1KV<br>05.10 06.14 PR: 1KT,1KV,2EJ<br>03.07 06.14 PR: 1KT,1KV,2EJ<br>04.10 06.14 PR: 1KT,1KV,2EJ<br>03.10 06.14 PR: 1KT,1KV,2EJ<br>03.10 06.14 PR: 1KT,1KV,2EJ<br>06.09 06.14 PR: 1KT,2EJ,1KK,1KV | 24.0109-0123.1 409123  |   |  | 230 9,0 7,0 +S +B  |  |
|  | 1.2 44<br>1.2 51<br>1.2 TDI 55<br>1.2 TSI 63<br>1.2 TSI 77<br>1.4 63<br>1.4 TDI 51<br>1.4 TDI 59<br>1.4 TSI RS 132<br>1.6 i 16V 77<br>1.6 TDI 55<br>1.6 TDI 66<br>1.6 TDI 77<br>1.9 TDI 77 |  | 03.07 06.14<br>03.07 06.14<br>05.10 06.14<br>03.10 06.14<br>03.10 06.14<br>03.07 06.14<br>03.07 06.14<br>03.07 06.14<br>05.10 06.14<br>03.07 06.14<br>04.10 06.14<br>03.10 06.14<br>03.10 06.14<br>03.07 06.14   | 24.0711-6233.3 360315<br>24.0711-6234.3 360316                                   |   |  |  | Radsensor<br>Radsensor   |
|  | 1.2 44<br>1.2 51<br>1.2 TDI 55<br>1.2 TSI 63<br>1.2 TSI 77<br>1.4 63   |  | 03.07 06.14<br>03.07 06.14<br>05.10 06.14<br>03.10 06.14<br>03.10 06.14<br>03.07 06.14   | 03.0137-0268.2 650268<br>03.0137-9168.2 669168                                   |   |  | 200 x 40 HEB VW<br>Bremsbacken-Zubehör VW  |  |















|     |   |  |                                   |    |  |  |     |  |            |
|--|---|--|---|--|---|--|---|--|------------|
| <b>SKODA FABIA II (5J) (07-14)</b>   |   |  |   |  |   |  |   |  |            |
|    | 1.4 TDI<br>1.4 TDI<br>1.6 i 16V<br>1.6 TDI<br>1.6 TDI<br>1.6 TDI<br>1.9 TDI   | 51<br>59<br>77<br>55<br>66<br>77<br>77   | 03.07<br>03.07<br>03.07<br>04.10<br>03.10<br>03.10<br>03.07   | 06.14<br>06.14<br>06.14<br>06.14<br>06.14<br>06.14<br>06.14  | 03.0137-0268.2<br>03.0137-9168.2  | 650268<br>669168   |   | 200 x 40 HEB<br>Bremsbacken-Zubehör  | VW<br>VW   |
|    | 1.2<br>1.2<br>1.2 TDI<br>1.2 TSI<br>1.2 TSI<br>1.4<br>1.4 TDI<br>1.4 TDI<br>1.6 i 16V<br>1.6 TDI<br>1.6 TDI<br>1.6 TDI<br>1.9 TDI | 44<br>51<br>55<br>63<br>77<br>63<br>51<br>59<br>77<br>55<br>66<br>77<br>77       | 03.07<br>03.07<br>05.10<br>03.10<br>03.10<br>03.07<br>03.07<br>03.07<br>03.07<br>04.10<br>03.10<br>03.10<br>03.07 | 06.14<br>06.14<br>06.14<br>06.14<br>06.14<br>06.14<br>06.14<br>06.14<br>06.14<br>06.14<br>06.14<br>06.14<br>06.14                    | 24.0220-0037.1  | 480161   |   | 200/201,5 x 50,5   |            |
|    | 1.2<br>1.2<br>1.2 TDI<br>1.2 TSI<br>1.2 TSI<br>1.4<br>1.4 TDI<br>1.4 TDI<br>1.6 i 16V<br>1.6 TDI<br>1.6 TDI<br>1.6 TDI<br>1.9 TDI | 44<br>51<br>55<br>63<br>77<br>63<br>51<br>59<br>77<br>55<br>66<br>77<br>77       | 03.07<br>03.07<br>05.10<br>03.10<br>03.10<br>03.07<br>03.07<br>03.07<br>03.07<br>04.10<br>03.10<br>03.10<br>03.07 | 06.14<br>06.14<br>06.14<br>06.14<br>06.14<br>06.14<br>06.14<br>06.14<br>06.14<br>06.14<br>06.14<br>06.14<br>06.14                    | 03.0520-8219.3  | 698219   |   | 19,05/200x40 TopKit  | VW         |
| <b>SKODA FABIA III (NJ) (14-)</b>  |   |  |   |  |   |  |   |  |            |
|    | 1.0 MPI<br>1.0 MPI<br>1.2 TSI<br>1.2 TSI<br>1.4 TDI<br>1.4 TDI<br>1.4 TDI<br>1.6  | 44<br>55<br>66<br>81<br>55<br>66<br>77<br>81                                     | 08.14<br>08.14<br>08.14<br>08.14<br>05.15<br>08.14<br>08.14<br>01.15  | PR: 1ZC<br>PR: 1ZC<br>PR: 1ZC<br>PR: 1ZC<br>PR: 1ZC<br>PR: 1ZC<br>PR: 1ZC  | 13.0460-7184.2<br>13.0470-7184.2  | 607184<br>LD7184   |   | 23587 20,6 +/WK<br>23587 20,6 +/WK   | ATE<br>ATE |
|  | 1.0 MPI<br>1.0 MPI<br>1.2 TSI<br>1.2 TSI<br>1.4 TDI<br>1.4 TDI<br>1.4 TDI<br>1.6  | 44<br>55<br>66<br>81<br>55<br>66<br>77<br>81                                     | 08.14<br>08.14<br>08.14<br>08.14<br>05.15<br>08.14<br>08.14<br>01.15  | PR: 1ZG<br>PR: 1ZG<br>PR: 1ZG<br>PR: 1ZG<br>PR: 1ZG<br>PR: 1ZG<br>PR: 1ZG  | 13.0460-7111.2<br>13.0470-7111.2  | 607111<br>LD7111   |   | 23130 19,6 +<br>23130 19,6 +   | VW<br>VW   |
|  | 1.0 MPI<br>1.0 MPI<br>1.2 TSI<br>1.2 TSI<br>1.4 TDI<br>1.4 TDI<br>1.4 TDI<br>1.6  | 44<br>55<br>66<br>81<br>55<br>66<br>77<br>81                                     | 08.14<br>08.14<br>08.14<br>08.14<br>05.15<br>08.14<br>08.14<br>01.15  | PR: 1ZC<br>PR: 1ZC<br>PR: 1ZC<br>PR: 1ZC<br>PR: 1ZC<br>PR: 1ZC<br>PR: 1ZC  | 24.0125-0113.1<br>24.0325-0113.1  | 425113<br>525113   |   | 288 25,0 22,0 V L +S +B<br>288 25,0 22,0 V L +S +B PD                              |            |
|  | 1.0 MPI<br>1.0 MPI<br>1.2 TSI<br>1.2 TSI<br>1.4 TDI<br>1.4 TDI<br>1.4 TDI<br>1.6  | 44<br>55<br>66<br>81<br>55<br>66<br>77<br>81                                     | 08.14<br>08.14<br>08.14<br>08.14<br>05.15<br>08.14<br>08.14<br>01.15  | PR: 1ZG<br>PR: 1ZG<br>PR: 1ZG<br>PR: 1ZG<br>PR: 1ZG<br>PR: 1ZG<br>PR: 1ZG  | 24.0122-0151.1<br>24.0322-0151.1  | 422151<br>522151   |   | 256 22,0 19,0 V L +S +B<br>256 22,0 19,0 V L +S +B PD                              |            |
|  | 1.0 MPI<br>1.0 MPI<br>1.2 TSI<br>1.2 TSI<br>1.4 TDI<br>1.4 TDI<br>1.4 TDI<br>1.6  | 44<br>55<br>66<br>81<br>55<br>66<br>77<br>81                                     | 08.14<br>08.14<br>08.14<br>08.14<br>05.15<br>08.14<br>08.14<br>01.15  |  | 24.0711-5273.3<br>24.0711-5274.3  | 360303<br>360304   |  | Radsensor<br>Radsensor   |            |
|  | 1.0 MPI<br>1.0 MPI<br>1.2 TSI<br>1.2 TSI<br>1.4 TDI<br>1.4 TDI<br>1.4 TDI<br>1.6  | 44<br>55<br>66<br>81<br>55<br>66<br>77<br>81                                     | 08.14<br>08.14<br>08.14<br>08.14<br>05.15<br>08.14<br>08.14<br>01.15  | PR: 1KK,1KT,2EJ<br>PR: 1KK,1KT,2EJ<br>PR: 1KK,1KT,2EJ<br>PR: 1KK,1KT,2EJ<br>PR: 1KT<br>PR: 1KK,1KT,2EJ<br>PR: 1KK,1KT,2EJ<br>PR: 1KT | 13.0460-2820.2<br>13.0470-2820.2  | 602820<br>LD2820   |   | 20961 17,6 /S<br>20961 17,6 /S   | TRW<br>TRW |

| SKODA FABIA III (NJ) (14-)   |  |  |  |  |   |                                  |                  |  |  |          |
|--|--|--|--|--|---|----------------------------------|------------------|--|--|----------|
|    | 1.0 MPI<br>1.0 MPI<br>1.2 TSI<br>1.2 TSI<br>1.4 TDI<br>1.4 TDI<br>1.4 TDI<br>1.6 | 44<br>55<br>66<br>81<br>55<br>66<br>77<br>81 |  | 08.14<br>08.14<br>08.14<br>08.14<br>05.15<br>08.14<br>08.14<br>01.15 | PR: 1KK,1KT,2EJ<br>PR: 1KK,1KT,2EJ<br>PR: 1KK,1KT,2EJ<br>PR: 1KT<br>PR: 1KK,1KT,2EJ<br>PR: 1KK,1KT,2EJ<br>PR: 1KT | 24.0109-0123.1                   | 409123           |  | 230 9,0 7,0 +S +B                                  |          |
|    | 1.0 MPI<br>1.0 MPI<br>1.2 TSI<br>1.2 TSI<br>1.4 TDI<br>1.4 TDI<br>1.4 TDI<br>1.6 | 44<br>55<br>66<br>81<br>55<br>66<br>77<br>81 |  | 08.14<br>08.14<br>08.14<br>08.14<br>05.15<br>08.14<br>08.14<br>01.15 |   | 24.0711-6233.3<br>24.0711-6234.3 | 360315<br>360316 | <br> | Radsensor<br>Radsensor                             |          |
|    | 1.0 MPI<br>1.0 MPI<br>1.2 TSI<br>1.2 TSI<br>1.4 TDI<br>1.4 TDI<br>1.4 TDI<br>1.6 | 44<br>55<br>66<br>81<br>55<br>66<br>77<br>81 |  | 08.14<br>08.14<br>08.14<br>08.14<br>05.15<br>08.14<br>08.14<br>01.15 |   | 03.0137-0268.2<br>03.0137-9168.2 | 650268<br>669168 |  | 200 x 40 HEB<br>Bremsbacken-Zubehör                | VW<br>VW |
|    | 1.0 MPI<br>1.0 MPI<br>1.2 TSI<br>1.2 TSI<br>1.4 TDI<br>1.4 TDI<br>1.4 TDI<br>1.6 | 44<br>55<br>66<br>81<br>55<br>66<br>77<br>81 |  | 08.14<br>08.14<br>08.14<br>08.14<br>05.15<br>08.14<br>08.14<br>01.15 |   | 24.0220-0037.1                   | 480161           |  | 200/201,5 x 50,5                                   |          |
|    | 1.0 MPI<br>1.0 MPI<br>1.2 TSI<br>1.2 TSI<br>1.4 TDI<br>1.4 TDI<br>1.4 TDI<br>1.6 | 44<br>55<br>66<br>81<br>55<br>66<br>77<br>81 |  | 08.14<br>08.14<br>08.14<br>08.14<br>05.15<br>08.14<br>08.14<br>01.15 |   | 03.0520-8219.3                   | 698219           |  | 19,05/200x40 TopKit                                | VW       |
| SKODA FELICIA I (791/795) (95-97)  |  |  |  |  |   |                                  |                  |  |  |          |
|  | 1.3 (135)<br>1.3 i (136)<br>1.6 i<br>1.9 D                                       | 50   |  | 10.94 02.98<br>10.94 02.98<br>08.95 02.98<br>10.96 02.98             |   | 13.0460-2964.2                   | 602964           |  | 20861 17,5 /S                                      | TRW      |
|  | 1.3 (135)<br>1.3 i (136)<br>1.6 i<br>1.9 D                                       | 50   |  | 10.94 02.98<br>10.94 02.98<br>08.95 02.98<br>10.96 02.98             |   | 24.0113-0182.1                   | 413182           |  | 236 12,8 11,4 +B                                   |          |
|  | 1.3 (135)<br>1.3 i (136)<br>1.6 i<br>1.9 D                                       | 50   |  | 10.94 02.98<br>10.94 02.98<br>08.95 02.98<br>10.96 02.98             |   | 24.0721-1951.3                   | 360367           | 2   | Radsensor L=1240                                   |          |
|  | 1.3 (135)<br>1.3 i (136)<br>1.6 i<br>1.9 D                                       | 50   |  | 10.94 02.98<br>10.94 02.98<br>08.95 02.98<br>10.96 02.98             |   | 03.0137-0268.2<br>03.0137-9168.2 | 650268<br>669168 |  | 200 x 40 HEB<br>Bremsbacken-Zubehör                | VW<br>VW |
|  | 1.3 (135)<br>1.3 i (136)<br>1.6 i<br>1.9 D                                       | 50   |  | 10.94 02.98<br>10.94 02.98<br>08.95 02.98<br>10.96 02.98             |   | 24.0220-0018.1<br>24.0220-0718.2 | 480019<br>480209 | ohne Sensorring <sup>1)</sup><br>ohne Sensorring <sup>1)</sup>   | 200/201 x 50,0 - Lager<br>200/201,5 x 50,0 + Lager |          |
|  | 1.3 (135) Lim.<br>1.3 i (136) Lim.<br>1.6 i Lim.                                 | 50   |  | 10.94 02.98<br>10.94 02.98<br>08.95 02.98                            |   | 03.0520-5319.3                   | 695319           |  | 19,05/200x40 TopKit                                |          |
|  | 1.3 (135) Kombi<br>1.3 i (136) Kombi<br>1.6 i Kombi<br>1.9 D Kombi               | 50   |  | 10.94 02.98<br>10.94 02.98<br>08.95 02.98<br>10.96 02.98             |   | 03.0520-7022.3                   | 697022           |  | 22,20/200x40 TopKit                                | VW       |
| SKODA FELICIA II (6U) (98-01)  |  |  |  |  |   |                                  |                  |  |  |          |
|  | 1.3 i<br>1.6 i<br>1.9 D  |  |  | 03.98 08.01<br>03.98 08.01<br>03.98 08.01                            |   | 13.0460-2964.2                   | 602964           |  | 20861 17,5 /S                                      | TRW      |
|  | 1.3 i<br>1.6 i<br>1.9 D  |  |  | 03.98 08.01<br>03.98 08.01<br>03.98 08.01                            |   | 24.0113-0182.1                   | 413182           |  | 236 12,8 11,4 +B                                   |          |
|  | 1.3 i<br>1.6 i<br>1.9 D  |  |  | 03.98 08.01<br>03.98 08.01<br>03.98 08.01                            |   | 24.0721-1951.3                   | 360367           | 2   | Radsensor L=1240                                   |          |
|  | 1.3 i<br>1.6 i<br>1.9 D  |  |  | 03.98 08.01<br>03.98 08.01<br>03.98 08.01                            |   | 03.0137-0268.2<br>03.0137-9168.2 | 650268<br>669168 |  | 200 x 40 HEB<br>Bremsbacken-Zubehör                | VW<br>VW |















<sup>1)</sup> without sensor ring / senza sensori / sans secours ABS / sin anillo sensor ABS

| SKODA FELICIA II (6U) (98-01)  |  |                      |  |  |  |   |  |                                      |                  |   |  |
|--|--|----------------------|--|--|--|---|--|--------------------------------------|------------------|---|--|
|    | 1.3 i<br>1.6 i<br>1.9 D  |                      |  | 03.98<br>03.98<br>03.98  | 08.01<br>08.01<br>08.01  |   |  | 24.0220-0018.1<br>24.0220-0718.2     | 480019<br>480209 | ohne Sensorring 1)<br>ohne Sensorring 1)  | 200/201 x 50,0 - Lager<br>200/201,5 x 50,0 + Lager                               |
|    | 1.3 i<br>1.6 i<br>1.9 D  |                      |  | 03.98<br>03.98<br>03.98  | 08.01<br>08.01<br>08.01  | - ABS<br>- ABS<br>- ABS   |  | 03.0520-7022.3                       | 697022           |   | 22,20/200x40 TopKit VW   |
|  | 1.3 i<br>1.6 i<br>1.9 D  |                      |  | 03.98<br>03.98<br>03.98  | 08.01<br>08.01<br>08.01  | + ABS<br>+ ABS<br>+ ABS   |  | 03.0520-5319.3                       | 695319           |   | 19,05/200x40 TopKit  |
| SKODA FELICIA PICK-UP (797) (97-00)  |  |                      |  |  |  |   |  |                                      |                  |   |  |
|    | 1.3<br>1.3<br>1.6<br>1.9 D   | 40<br>50<br>55<br>47 |  | 06.97<br>06.97<br>06.97<br>06.97   | 12.00<br>12.00<br>12.99<br>12.00   |   |  | 13.0460-2964.2                       | 602964           |   | 20861 17,5 /S TRW  |
|    | 1.3<br>1.3<br>1.6<br>1.9 D   | 40<br>50<br>55<br>47 |  | 06.97<br>06.97<br>06.97<br>06.97   | 12.00<br>12.00<br>12.99<br>12.00   |   |  | 24.0113-0182.1                       | 413182           |   | 236 12,8 11,4 +B   |
|    | 1.3<br>1.3<br>1.6<br>1.9 D   | 40<br>50<br>55<br>47 |  | 06.97<br>06.97<br>06.97<br>06.97   | 12.00<br>12.00<br>12.99<br>12.00   |   |  | 24.0741-1107.3                       | 360042           | 2  | Radsensor  |
|    | 1.3<br>1.3<br>1.6<br>1.9 D   | 40<br>50<br>55<br>47 |  | 06.97<br>06.97<br>06.97<br>06.97   | 12.00<br>12.00<br>12.99<br>12.00   |   |  | 03.0137-0268.2<br>03.0137-9168.2     | 650268<br>669168 |   | 200 x 40 HEB<br>Bremsbacken-Zubehör VW   |
|    | 1.3<br>1.3<br>1.6<br>1.9 D   | 40<br>50<br>55<br>47 |  | 06.97<br>06.97<br>06.97<br>06.97   | 12.00<br>12.00<br>12.99<br>12.00   |   |  | 24.0220-0018.1<br>24.0220-0718.2     | 480019<br>480209 | ohne Sensorring 1)<br>ohne Sensorring 1)  | 200/201 x 50,0 - Lager<br>200/201,5 x 50,0 + Lager                               |
|    | 1.3<br>1.3<br>1.6<br>1.9 D   | 40<br>50<br>55<br>47 |  | 06.97<br>06.97<br>06.97<br>06.97   | 12.00<br>12.00<br>12.99<br>12.00   | - ABS<br>- ABS<br>- ABS<br>- ABS  |  | 03.0520-7022.3                       | 697022           |   | 22,20/200x40 TopKit VW   |
|  | 1.3<br>1.3<br>1.6<br>1.9 D   | 40<br>50<br>55<br>47 |  | 06.97<br>06.97<br>06.97<br>06.97   | 12.00<br>12.00<br>12.99<br>12.00   | + ABS<br>+ ABS<br>+ ABS<br>+ ABS  |  | 03.0520-5319.3                       | 695319           |   | 19,05/200x40 TopKit  |
| SKODA OCTAVIA I (1U) (97-10)   |  |                      |  |  |  |   |  |                                      |                  |   |  |
|  | 1.4 i<br>1.6 i<br>1.8 i 20V<br>1.8 i 20V Turbo<br>1.9 SDI<br>1.9 TDI<br>1.9 TDI<br>2.0 i   |                      | 1U-X-415000<br>1U-X-415000<br>1U-X-415000<br>1U-X-415000<br>1U-X-415000<br>1U-X-415000<br>1U-X-415000<br>1U-X-415000   | 04.99<br>10.96<br>10.96<br>03.98<br>05.97<br>10.96<br>08.97<br>04.99   |  | PR: 1LQ,1LR,1LS,1ZM<br>PR: 1LQ,1LR,1LS,1ZM<br>PR: 1LQ,1LR,1LS,1ZM<br>PR: 1LQ,1LR,1LS,1ZM<br>PR: 1LQ,1LR,1LS,1ZM<br>PR: 1LQ,1LR,1LS,1ZM<br>PR: 1LQ,1LR,1LS,1ZM<br>PR: 1LQ,1LR,1LS,1ZM  | 13.0460-7111.2<br>13.0470-7111.2                                     | 607111<br>LD7111                     |                  |   | 23130 19,6 +<br>23130 19,6 +<br>VW<br>VW   |
|  | 1.4 i<br>1.6 i<br>1.8 i 20V<br>1.8 i 20V Turbo<br>1.8 i 20V Turbo 4x4<br>1.9 SDI<br>1.9 TDI<br>1.9 TDI<br>1.9 TDI<br>1.9 TDI<br>1.9 TDI 4x4<br>2.0 i<br>2.0 i 4x4<br>2.0 i 4x4                 |                      | 1U-Y-000001<br>1U-Y-000001<br>1U-Y-000001<br>1U-Y-000001<br>1U-Y-000001<br>1U-Y-000001<br>1U-Y-000001<br>1U-Y-000001<br>1U-Y-000001<br>1U-Y-000001<br>1U-Y-000001<br>1U-Y-000001 |  | 06.10<br>06.10<br>06.10<br>06.10<br>05.01<br>06.10<br>06.10<br>06.10<br>06.10<br>06.10<br>01.03<br>11.99<br>05.01<br>01.00 | PR: 1LQ,1LR,1LS,1ZM<br>PR: 1LQ,1LR,1LS,1ZM<br>PR: 1LQ,1LR,1LS,1ZM<br>PR: 1LQ,1LR,1LS,1ZM<br>PR: 1LQ,1LR,1LS,1ZM<br>PR: 1LQ,1LR,1LS,1ZM<br>PR: 1LQ,1LR,1LS,1ZM<br>PR: 1LQ,1LR,1LS,1ZM<br>PR: 1LQ,1LR,1LS,1ZM<br>PR: 1LQ,1LR,1LS,1ZM<br>PR: 1LQ,1LR,1LS,1ZM<br>PR: 1LQ,1LR,1LS,1ZM<br>PR: 1LQ,1LR,1LS,1ZM<br>PR: 1LQ,1LR,1LS,1ZM  | 13.0460-7117.2<br>13.0470-7117.2                                     | 607117<br>LD7117                     |                  |   | 23131 19,6 +/WK<br>23131 19,6 +/WK<br>VW<br>VW                                   |
|  | 1.4 i<br>1.6 i<br>1.8 i 20V<br>1.8 i 20V Turbo<br>1.8 i 20V Turbo 4x4<br>1.9 SDI<br>1.9 TDI<br>1.9 TDI<br>1.9 TDI<br>1.9 TDI<br>1.9 TDI 4x4<br>2.0 i<br>2.0 i 4x4<br>2.0 i 4x4<br>RS 1.8 T 20V | 92<br>110<br>110     |  | 04.99<br>10.96<br>10.96<br>03.98<br>05.01<br>05.97<br>10.96<br>08.00<br>08.97<br>01.03<br>11.99<br>04.99<br>05.01<br>01.00 | 06.10<br>06.10<br>06.10<br>06.10<br>06.10<br>06.10<br>06.10<br>06.10<br>06.10<br>06.10<br>06.10<br>06.10<br>06.10<br>06.10 | PR: 1LN,1LE,1ZD,1ZE,1ZH<br>PR: 1LN,1LE,1ZD,1ZE,1ZH<br>PR: 1LN,1LE,1ZD,1ZE,1ZH<br>PR: 1LN,1LE,1ZD,1ZE,1ZH<br>PR: 1LN,1LE,1ZD,1ZE,1ZH<br>PR: 1LN,1LE,1ZD,1ZE,1ZH<br>PR: 1LN,1LE,1ZD,1ZE,1ZH<br>PR: 1LN,1LE,1ZD,1ZE,1ZH<br>PR: 1LN,1LE,1ZD,1ZE,1ZH<br>PR: 1LN,1LE,1ZD,1ZE,1ZH<br>PR: 1LN,1LE,1ZD,1ZE,1ZH<br>PR: 1LN,1LE,1ZD,1ZE,1ZH<br>PR: 1LN,1LE,1ZD,1ZE,1ZH<br>PR: 1LN,1LE,1ZD,1ZE,1ZH<br>PR: 1ZN | 13.0460-7081.2<br>13.0470-7081.2<br>13.0460-7122.2<br>13.0470-7122.2 | 607081<br>LD7081<br>607122<br>LD7122 |                  |   | 21911 20,3 +<br>21911 20,3 +<br>23392 20,3 +/WK<br>23392 20,3 +/WK<br>ATE<br>ATE |
|  | 1.4 i<br>1.6 i<br>1.8 i 20V<br>1.8 i 20V Turbo<br>1.8 i 20V Turbo 4x4<br>1.9 SDI<br>1.9 TDI<br>1.9 TDI   | 92<br>110<br>110     |  | 04.99<br>10.96<br>10.96<br>03.98<br>05.01<br>05.97<br>10.96<br>08.00   | 06.10<br>06.10<br>06.10<br>06.10<br>06.10<br>06.10<br>06.10<br>06.10   | PR: 1LQ<br>PR: 1LQ<br>PR: 1LQ<br>PR: 1LQ<br>PR: 1LQ<br>PR: 1LQ<br>PR: 1LQ<br>PR: 1LQ  | 24.0122-0151.1<br>24.0322-0151.1                                     | 422151<br>522151                     |                  |   | 256 22,0 19,0 V L +S +B<br>256 22,0 19,0 V L +S +B PD                            |

1) without sensor ring / senza sensori / sans secours ABS / sin anillo sensor ABS





|     |  |  |  |  |  |  |  |  |   |
|--|--|--|--|--|---|--|--|--|---|
| <b>SKODA OCTAVIA I (1U) (97-10)</b>  |  |  |  |  |   |  |  |  |   |
|    | 1.9 TDI  | 81   | 08.97  | 06.10  | PR: 1LQ   | 24.0122-0151.1   | 422151   | 256 22,0 19,0 VL +S +B<br>256 22,0 19,0 VL +S +B PD                                |   |
|  | 1.9 TDI  | 96   | 01.03  | 06.10  | PR: 1LQ   | 24.0322-0151.1   | 522151   |  |   |
|  | 1.9 TDI 4x4  |  | 11.99  | 06.10  | PR: 1LQ   |  |  |  |   |
|  | 2.0 i  |  | 04.99  | 06.10  | PR: 1LQ   |  |  |  |   |
|  | 2.0 i 4x4  | 85   | 05.01  | 06.10  | PR: 1LQ   |  |  |  |   |
|  | 2.0 i 4x4  | 88   | 01.00  | 06.10  | PR: 1LQ   |  |  |  |   |
|  | 1.4 i  |  | 04.99  | 06.10  | PR: 1LR,1LS,1ZM   | 24.0122-0150.1   | 422150   |  | 280 22,0 19,0 VL +S +B<br>280 22,0 19,0 VL +S +B PD |
|  | 1.6 i  |  | 10.96  | 06.10  | PR: 1LR,1LS,1ZM   | 24.0322-0150.1   | 522150   |  |   |
|  | 1.8 i 20V  | 92   | 10.96  | 06.10  | PR: 1LR,1LS,1ZM   |  |  |  |   |
|  | 1.8 i 20V Turbo  | 110  | 03.98  | 06.10  | PR: 1LR,1LS,1ZM   |  |  |  |   |
| 1.8 i 20V Turbo 4x4  | 110  | 05.01  | 06.10  | PR: 1LR,1LS,1ZM  |   |  |  |  |   |
| 1.9 SDI  |  | 05.97  | 06.10  | PR: 1LR,1LS,1ZM  |   |  |  |  |   |
| 1.9 TDI  | 66   | 10.96  | 06.10  | PR: 1LR,1LS,1ZM  |   |  |  |  |   |
| 1.9 TDI  | 74   | 08.00  | 06.10  | PR: 1LR,1LS,1ZM  |   |  |  |  |   |
| 1.9 TDI  | 81   | 08.97  | 06.10  | PR: 1LR,1LS,1ZM  |   |  |  |  |   |
| 1.9 TDI  | 96   | 01.03  | 06.10  | PR: 1LR,1LS,1ZM  |   |  |  |  |   |
| 1.9 TDI 4x4  |  | 11.99  | 06.10  | PR: 1LR,1LS,1ZM  |   |  |  |  |   |
| 2.0 i  |  | 04.99  | 06.10  | PR: 1LR,1LS,1ZM  |   |  |  |  |   |
| 2.0 i 4x4  | 85   | 05.01  | 06.10  | PR: 1LR,1LS,1ZM  |   |  |  |  |   |
| 2.0 i 4x4  | 88   | 01.00  | 06.10  | PR: 1LR,1LS,1ZM  |   |  |  |  |   |
| 1.4 i  |  | 04.99  | 06.10  | PR: 1LE,1LN,1ZE,1ZH  | 24.0125-0113.1  | 425113   | 288 25,0 22,0 VL +S +B<br>288 25,0 22,0 VL +S +B PD                                |  |   |
| 1.6 i  |  | 10.96  | 06.10  | PR: 1LE,1LN,1ZE,1ZH  | 24.0325-0113.1  | 525113   |  |  |   |
| 1.8 i 20V  | 92   | 10.96  | 06.10  | PR: 1LE,1LN,1ZE,1ZH  |   |  |  |  |   |
| 1.8 i 20V Turbo  | 110  | 03.98  | 06.10  | PR: 1LE,1LN,1ZE,1ZH  |   |  |  |  |   |
| 1.8 i 20V Turbo 4x4  | 110  | 05.01  | 06.10  | PR: 1LE,1LN,1ZE,1ZH  |   |  |  |  |   |
| 1.9 SDI  |  | 05.97  | 06.10  | PR: 1LE,1LN,1ZE,1ZH  |   |  |  |  |   |
| 1.9 TDI  | 66   | 10.96  | 06.10  | PR: 1LE,1LN,1ZE,1ZH  |   |  |  |  |   |
| 1.9 TDI  | 74   | 08.00  | 06.10  | PR: 1LE,1LN,1ZE,1ZH  |   |  |  |  |   |
| 1.9 TDI  | 81   | 08.97  | 06.10  | PR: 1LE,1LN,1ZE,1ZH  |   |  |  |  |   |
| 1.9 TDI  | 96   | 01.03  | 06.10  | PR: 1LE,1LN,1ZE,1ZH  |   |  |  |  |   |
| 1.9 TDI 4x4  |  | 11.99  | 06.10  | PR: 1LE,1LN,1ZE,1ZH  |   |  |  |  |   |
| 2.0 i  |  | 04.99  | 06.10  | PR: 1LE,1LN,1ZE,1ZH  |   |  |  |  |   |
| 2.0 i 4x4  | 85   | 05.01  | 06.10  | PR: 1LE,1LN,1ZE,1ZH  |   |  |  |  |   |
| 2.0 i 4x4  | 88   | 01.00  | 06.10  | PR: 1LE,1LN,1ZE,1ZH  |   |  |  |  |   |
| RS 1.8 T 20V   | 132  | 05.01  | 06.10  | PR: 1ZN  | 24.0125-0123.1  | 425123   | 310 25,0 22,0 VL +S +B<br>310 25,0 22,0 VL +S +B PD                                |  |   |
|  |  |  |  |  | 24.0325-0123.1  | 525123   |  |  |   |
|    | 1.4 i  |  | 04.99  | 06.10  |   | 24.0711-1361.3   | 360022   | Radsensor<br>Radsensor   |   |
|  | 1.6 i  |  | 10.96  | 06.10  |   | 24.0711-1362.3   | 360023   |  |   |
|  | 1.8 i 20V  | 92   | 10.96  | 06.10  |   |  |  |  |   |
|  | 1.8 i 20V Turbo  | 110  | 03.98  | 06.10  |   |  |  |  |   |
|  | 1.8 i 20V Turbo 4x4  | 110  | 05.01  | 06.10  |   |  |  |  |   |
|  | 1.9 SDI  |  | 05.97  | 06.10  |   |  |  |  |   |
|  | 1.9 TDI  | 66   | 10.96  | 06.10  |   |  |  |  |   |
|  | 1.9 TDI  | 74   | 08.00  | 06.10  |   |  |  |  |   |
|  | 1.9 TDI  | 81   | 08.97  | 06.10  |   |  |  |  |   |
|  | 1.9 TDI  | 96   | 01.03  | 06.10  |   |  |  |  |   |
| 1.9 TDI 4x4  |  | 11.99  | 06.10  |  |   |  |  |  |   |
| 2.0 i  |  | 04.99  | 06.10  |  |   |  |  |  |   |
| 2.0 i 4x4  | 85   | 05.01  | 06.10  |  |   |  |  |  |   |
| 2.0 i 4x4  | 88   | 01.00  | 06.10  |  |   |  |  |  |   |
| RS 1.8 T 20V   | 132  | 05.01  | 06.10  |  |   |  |  |  |   |
|  | 1.6 i  |  | 10.96  | 06.10  | PR: 1KK,1KS,1KP   | 13.0460-2894.2   | 602894   | 20961 17,4 /Zub/S TRW<br>20961 17,4 /Zub/S TRW<br>Belagsatz-Zubehör TRW            |   |
|  | 1.8 i 20V  | 92   | 10.96  | 06.10  | PR: 1KK,1KS,1KP   | 13.0470-2894.2   | LD2894   |  |   |
|  | 1.8 i 20V Turbo  | 110  | 03.98  | 06.10  | PR: 1KK,1KS,1KP   | 13.0460-0072.2   | 610072   |  |   |
|  | 1.8 i 20V Turbo 4x4  | 110  | 05.01  | 06.10  | PR: 1KE   |  |  |  |   |
|  | 1.9 SDI  |  | 05.97  | 06.10  | PR: 1KK,1KS,1KP   |  |  |  |   |
|  | 1.9 TDI  | 66   | 08.97  | 06.10  | PR: 1KK,1KS,1KP   |  |  |  |   |
|  | 1.9 TDI  | 74   | 08.00  | 06.10  | PR: 1KK,1KS,1KP   |  |  |  |   |
|  | 1.9 TDI  | 81   | 08.97  | 06.10  | PR: 1KK,1KS,1KP   |  |  |  |   |
|  | 1.9 TDI  | 96   | 01.03  | 06.10  | PR: 1KK,1KS,1KP   |  |  |  |   |
|  | 1.9 TDI 4x4  |  | 11.99  | 06.10  | PR: 1KE   |  |  |  |   |
| 2.0 i  |  | 04.99  | 06.10  | PR: 1KK,1KS,1KP  |   |  |  |  |   |
| 2.0 i 4x4  | 85   | 05.01  | 06.10  | PR: 1KE  |   |  |  |  |   |
| 2.0 i 4x4  | 88   | 01.00  | 06.10  | PR: 1KE  |   |  |  |  |   |
| RS 1.8 T 20V   | 132  | 01.03  | 06.10  | PR: 2ED  | 13.0460-2886.2  | 602886   | 20961 16,2 /S TRW<br>20961 16,2 /S TRW   |  |   |
|  |  |  |  |  | 13.0470-2886.2  | LD2886   |  |  |   |
|  | 1.6 i  |  | 10.96  | 06.10  | PR: 1KK,1KS,1KP   | 24.0109-0123.1   | 409123   | 230 9,0 7,0 +S +B<br>230 9,0 7,0 +S +B PD  |   |
|  | 1.8 i 20V  | 92   | 10.96  | 06.10  | PR: 1KK,1KS,1KP   | 24.0309-0123.1   | 509123   |  |   |
|  | 1.8 i 20V Turbo  | 110  | 03.98  | 06.10  | PR: 1KK,1KS,1KP   |  |  |  |   |
|  | 1.9 SDI  |  | 05.97  | 06.10  | PR: 1KK,1KS,1KP   |  |  |  |   |
|  | 1.9 TDI  | 66   | 10.96  | 06.10  | PR: 1KK,1KS,1KP   |  |  |  |   |
|  | 1.9 TDI  | 74   | 08.00  | 06.10  | PR: 1KK,1KS,1KP   |  |  |  |   |
|  | 1.9 TDI  | 81   | 08.97  | 06.10  | PR: 1KK,1KS,1KP   |  |  |  |   |
|  | 1.9 TDI  | 96   | 01.03  | 06.10  | PR: 1KK,1KS,1KP   |  |  |  |   |
|  | 2.0 i  |  | 04.99  | 06.10  | PR: 1KK,1KS,1KP   |  |  |  |   |
|  | 1.8 i 20V Turbo 4x4  | 110  | 05.01  | 06.10  | PR: 1KE   | 24.0109-0133.1   | 409133   |  | 239 8,9 7,0 +S +B<br>239 8,9 7,0 +S +B PD           |
| 1.9 TDI 4x4  |  | 11.99  | 06.10  | PR: 1KE  | 24.0309-0133.1  | 509133   |  |  |   |
| 2.0 i 4x4  | 85   | 05.01  | 06.10  | PR: 1KE  |   |  |  |  |   |
| 2.0 i 4x4  | 88   | 01.00  | 06.10  | PR: 1KE  |   |  |  |  |   |
| RS 1.8 T 20V   | 132  | 01.03  | 06.10  | PR: 2ED  | 24.0122-0163.1  | 422163   | 256 22,0 20,0 VL +B<br>256 22,0 20,0 VL +B PD                                      |  |   |
|  |  |  |  |  | 24.0322-0163.1  | 522163   |  |  |   |
|  | 1.4 i  |  | 04.99  | 06.10  |   | 24.0741-1107.3   | 360042   | Radsensor  |   |
|  | 1.6 i  |  | 10.96  | 06.10  |   |  |  |  |   |
|  | 1.8 i 20V  | 92   | 10.96  | 06.10  |   |  |  |  |   |
|  | 1.8 i 20V Turbo  | 110  | 03.98  | 06.10  |   |  |  |  |   |
|  | 1.9 SDI  |  | 05.97  | 06.10  |   |  |  |  |   |

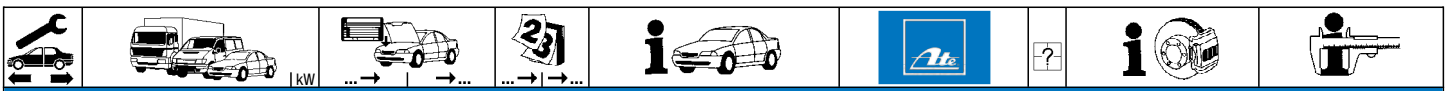

|     |    |  |    |  |  |  |  |  |
|--|--|--|--|--|---|--|--|--|
| <b>SKODA OCTAVIA I (1U) (97-10)</b>  |  |  |  |  |   |  |  |  |
|    | 1.9 TDI 66<br>1.9 TDI 74<br>1.9 TDI 81<br>1.9 TDI 96<br>2.0 i<br>RS 1.8 T 20V 132  |  | 10.96 06.10<br>08.00 06.10<br>08.97 06.10<br>01.03 06.10<br>04.99 06.10<br>05.01 06.10   |  | 24.0741-1107.3 360042   | 2  |  | Radsensor  |
|  | 1.8 i 20V Turbo 4x4 110<br>1.9 TDI 4x4<br>2.0 i 4x4 85<br>2.0 i 4x4 88   |  | 05.01 06.10<br>11.99 06.10<br>05.01 06.10<br>01.00 06.10   |  | 24.0711-1365.3 360172   | 2  |  | Radsensor L=226  |
|    | 1.4 i<br>1.6 i<br>1.9 SDI<br>1.9 TDI 66  |  | 04.99 06.10 PR: 1KN,1KG<br>10.96 06.10 PR: 1KN,1KG<br>05.97 06.10 PR: 1KN,1KG<br>10.96 06.10 PR: 1KN,1KG   |  | 03.0137-0357.2 650357<br>03.0137-9149.2 669149                                    |  |  | 230 x 32 HEB<br>Bremsbacken-Zubehör  |
|    | 1.4 i<br>1.6 i<br>1.9 SDI<br>1.9 TDI 66  |  | 04.99 06.10 PR: 1KN,1KG<br>10.96 06.10 PR: 1KN,1KG<br>05.97 06.10 PR: 1KN,1KG<br>10.96 06.10 PR: 1KN,1KG   |  | 24.0223-0016.1 480111   |  |  | 230/231,5 x 39   |
|    | 1.4 i<br>1.6 i<br>1.9 SDI<br>1.9 TDI 66  |  | 04.99 06.10 PR: 1KG<br>10.96 06.10 PR: 1KG<br>05.97 06.10 PR: 1KG<br>10.96 06.10 PR: 1KG   |  | 03.0520-6920.3 696920   |  |  | 20,64/230x32 TopKit VW   |
|  | 1.4 i<br>1.6 i<br>1.9 SDI<br>1.9 TDI 66  |  | 04.99 06.10 PR: 1KN<br>10.96 06.10 PR: 1KN<br>05.97 06.10 PR: 1KN<br>10.96 06.10 PR: 1KN   |  | 03.0520-5419.3 695419   |  |  | 19,05/230x32 TopKit  |
| <b>SKODA OCTAVIA II (1Z) (04-13)</b>   |  |  |  |  |   |  |  |  |
|    | 1.2 TSI 77<br>1.4 i 16V<br>1.4 TSI 90<br>1.6 75<br>1.6 FSI 85<br>1.6 i 16V 75<br>1.6 TDI 77<br>1.6 TDI 4x4 77<br>1.8 TSI<br>1.8 TSI 4x4<br>1.9 TDI 77<br>1.9 TDI 4x4 77<br>2.0 FSI 110<br>2.0 FSI 4x4 110<br>2.0 TDI 81<br>2.0 TDI 100<br>2.0 TDI 103<br>2.0 TDi 4x4 81<br>2.0 TDi 4x4 103                                 |  | 02.10 01.13 PR: 1ZF,1ZM,1ZC<br>06.04 01.13 PR: 1ZF,1ZM,1ZC<br>11.08 01.13 PR: 1ZF,1ZM,1ZC<br>09.09 01.13 PR: 1ZF,1ZM,1ZC<br>06.04 01.13 PR: 1ZF,1ZM,1ZC<br>06.04 01.13 PR: 1ZF,1ZM,1ZC<br>06.09 01.13 PR: 1ZF,1ZM,1ZC<br>06.09 01.13 PR: 1ZF,1ZM,1ZC<br>06.07 01.13 PR: 1ZF,1ZM,1ZC<br>11.08 01.13 PR: 1ZF,1ZM,1ZC<br>06.04 01.13 PR: 1ZF,1ZM,1ZC<br>11.04 01.13 PR: 1ZF,1ZM,1ZC<br>11.04 01.13 PR: 1ZF,1ZM,1ZC<br>03.10 01.13 PR: 1ZF,1ZM,1ZC<br>06.04 01.13 PR: 1ZF,1ZM,1ZC<br>06.04 01.13 PR: 1ZF,1ZM,1ZC<br>05.11 01.13 PR: 1ZF,1ZM,1ZC<br>07.06 01.13 PR: 1ZF,1ZM,1ZC |  | 13.0460-7117.2 607117<br>13.0470-7117.2 LD7117                                    |  |  | 23131 19,6 +/WK VW<br>23131 19,6 +/WK VW   |
|  | 1.2 TSI 77<br>1.4 i 16V<br>1.4 TSI 90<br>1.6 75<br>1.6 FSI 85<br>1.6 i 16V 75<br>1.6 TDI 77<br>1.6 TDI 4x4 77<br>1.8 TSI<br>1.8 TSI 4x4<br>1.9 TDI 77<br>1.9 TDI 4x4 77<br>2.0 FSI 110<br>2.0 FSI 4x4 110<br>2.0 RS 147<br>2.0 TDI 81<br>2.0 TDI 100<br>2.0 TDI 103<br>2.0 TDi 4x4 81<br>2.0 TDi 4x4 103<br>2.0 TDI RS 125 |  | 02.10 01.13 PR: 1ZE<br>06.04 01.13 PR: 1ZE<br>11.08 01.13 PR: 1ZE<br>09.09 01.13 PR: 1ZE<br>06.04 01.13 PR: 1ZE<br>06.09 01.13 PR: 1ZE<br>06.09 01.13 PR: 1ZE<br>06.07 01.13 PR: 1ZE<br>11.08 01.13 PR: 1ZE<br>06.04 01.13 PR: 1ZE<br>11.04 01.13 PR: 1ZE<br>11.04 01.13 PR: 1ZE<br>10.05 01.13 PR: 1LL,1LP,1ZB<br>03.10 01.13 PR: 1ZE<br>06.04 01.13 PR: 1ZE<br>06.04 01.13 PR: 1ZE<br>05.11 01.13 PR: 1ZE<br>07.06 01.13 PR: 1ZE<br>04.06 01.13 PR: 1LL,1LP,1ZB  |  | 13.0460-7184.2 607184<br>13.0470-7184.2 LD7184                                    |  |  | 23587 20,6 +/WK ATE<br>23587 20,6 +/WK ATE   |
|  | 1.2 TSI 77<br>1.4 i 16V<br>1.4 TSI 90<br>1.6 75<br>1.6 FSI 85<br>1.6 i 16V 75<br>1.6 TDI 77<br>1.6 TDI 4x4 77<br>1.8 TSI<br>1.8 TSI 4x4<br>1.9 TDI 77<br>1.9 TDI 4x4 77<br>2.0 FSI 110<br>2.0 FSI 4x4 110<br>2.0 TDI 81<br>2.0 TDI 100<br>2.0 TDI 103<br>2.0 TDi 4x4 81  |  | 02.10 01.13 PR: 1ZF,1ZM<br>06.04 01.13 PR: 1ZF,1ZM<br>11.08 01.13 PR: 1ZF,1ZM<br>09.09 01.13 PR: 1ZF,1ZM<br>06.04 01.13 PR: 1ZF,1ZM<br>06.04 01.13 PR: 1ZF,1ZM<br>06.09 01.13 PR: 1ZF,1ZM<br>06.09 01.13 PR: 1ZF,1ZM<br>06.07 01.13 PR: 1ZF,1ZM<br>11.08 01.13 PR: 1ZF,1ZM<br>06.04 01.13 PR: 1ZF,1ZM<br>11.04 01.13 PR: 1ZF,1ZM<br>11.04 01.13 PR: 1ZF,1ZM<br>03.10 01.13 PR: 1ZF,1ZM<br>06.04 01.13 PR: 1ZF,1ZM<br>06.04 01.13 PR: 1ZF,1ZM<br>05.11 01.13 PR: 1ZF,1ZM  |  | 24.0122-0210.1 422210<br>24.0322-0210.1 522210                                    |  |  | 280 22,0 19,0 V L +S +B<br>280 22,0 19,0 V L +S +B PD                              |



**SKODA OCTAVIA II (1Z) (04-13)**

|  |             |     |  |       |       |                 |                |        |   |                            |
|--|-------------|-----|--|-------|-------|-----------------|----------------|--------|---|----------------------------|
|    | 2.0 TDI 4x4 | 103 |  | 07.06 | 01.13 | PR: 1ZF,1ZM     | 24.0122-0210.1 | 422210 |   | 280 22,0 19,0 V L +S +B    |
|  |             |     |  |       |       |                 | 24.0322-0210.1 | 522210 |   | 280 22,0 19,0 V L +S +B PD |
|  | 1.2 TSI     | 77  |  | 02.10 | 01.13 | PR: 1ZE         | 24.0125-0145.1 | 425145 |   | 288 25,0 22,0 V L +S +B    |
|  | 1.4 i 16V   |     |  | 06.04 | 01.13 | PR: 1ZE         | 24.0325-0145.1 | 525145 |   | 288 25,0 22,0 V L +S +B PD |
|  | 1.4 TSI     | 90  |  | 11.08 | 01.13 | PR: 1ZE         |                |        |   |                            |
|  | 1.6         | 75  |  | 09.09 | 01.13 | PR: 1ZE         |                |        |   |                            |
|  | 1.6 FSI     | 85  |  | 06.04 | 01.13 | PR: 1ZE         |                |        |   |                            |
|  | 1.6 i 16V   | 75  |  | 06.04 | 01.13 | PR: 1ZE         |                |        |   |                            |
|  | 1.6 TDI     | 77  |  | 06.09 | 01.13 | PR: 1ZE         |                |        |   |                            |
|  | 1.6 TDI 4x4 | 77  |  | 06.09 | 01.13 | PR: 1ZE         |                |        |   |                            |
|  | 1.8 TSI     |     |  | 06.07 | 01.13 | PR: 1ZE         |                |        |   |                            |
|  | 1.8 TSI 4x4 |     |  | 11.08 | 01.13 | PR: 1ZE         |                |        |   |                            |
|  | 1.9 TDI     | 77  |  | 06.04 | 01.13 | PR: 1ZE         |                |        |   |                            |
|  | 1.9 TDI 4x4 | 77  |  | 11.04 | 01.13 | PR: 1ZE         |                |        |   |                            |
|  | 2.0 FSI     | 110 |  | 11.04 | 01.13 | PR: 1ZE         |                |        |   |                            |
|  | 2.0 FSI 4x4 | 110 |  | 11.04 | 01.13 | PR: 1ZE         |                |        |   |                            |
|  | 2.0 TDI     | 81  |  | 03.10 | 01.13 | PR: 1ZE         |                |        |   |                            |
|  | 2.0 TDI     | 100 |  | 06.04 | 01.13 | PR: 1ZE         |                |        |   |                            |
|  | 2.0 TDI     | 103 |  | 06.04 | 01.13 | PR: 1ZE         |                |        |   |                            |
|  | 2.0 TDi 4x4 | 81  |  | 05.11 | 01.13 | PR: 1ZE         |                |        |   |                            |
|  | 2.0 TDi 4x4 | 103 |  | 07.06 | 01.13 | PR: 1ZE         |                |        |   |                            |
|  | 2.0 RS      | 147 |  | 10.05 | 01.13 | PR: 1LL,1LP,1ZB | 24.0125-0158.1 | 425158 |   | 312 25,0 22,0 V L +S +B    |
|  | 2.0 TDI RS  | 125 |  | 04.06 | 01.13 | PR: 1LL,1LP,1ZB | 24.0325-0158.1 | 525158 |   | 312 25,0 22,0 V L +S +B PD |
|    | 1.2 TSI     | 77  |  | 02.10 | 01.13 |                 | 24.0711-5271.3 | 360301 |  | Radsensor                  |
|  | 1.4 i 16V   |     |  | 06.04 | 01.13 |                 | 24.0711-5272.3 | 360302 |  | Radsensor                  |
|  | 1.4 TSI     | 90  |  | 11.08 | 01.13 |                 |                |        |   |                            |
|  | 1.6         | 75  |  | 09.09 | 01.13 |                 |                |        |   |                            |
|  | 1.6 FSI     | 85  |  | 06.04 | 01.13 |                 |                |        |   |                            |
|  | 1.6 i 16V   | 75  |  | 06.04 | 01.13 |                 |                |        |   |                            |
|  | 1.6 TDI     | 77  |  | 06.09 | 01.13 |                 |                |        |   |                            |
|  | 1.6 TDI 4x4 | 77  |  | 06.09 | 01.13 |                 |                |        |   |                            |
|  | 1.8 TSI     |     |  | 06.07 | 01.13 |                 |                |        |   |                            |
|  | 1.8 TSI 4x4 |     |  | 11.08 | 01.13 |                 |                |        |   |                            |
|  | 1.9 TDI     | 77  |  | 06.04 | 01.13 |                 |                |        |   |                            |
|  | 1.9 TDI 4x4 | 77  |  | 11.04 | 01.13 |                 |                |        |   |                            |
|  | 2.0 FSI     | 110 |  | 11.04 | 01.13 |                 |                |        |   |                            |
|  | 2.0 FSI 4x4 | 110 |  | 11.04 | 01.13 |                 |                |        |   |                            |
|  | 2.0 RS      | 147 |  | 10.05 | 01.13 |                 |                |        |   |                            |
|  | 2.0 TDI     | 81  |  | 03.10 | 01.13 |                 |                |        |   |                            |
|  | 2.0 TDI     | 100 |  | 06.04 | 01.13 |                 |                |        |   |                            |
|  | 2.0 TDI     | 103 |  | 06.04 | 01.13 |                 |                |        |   |                            |
|  | 2.0 TDi 4x4 | 81  |  | 05.11 | 01.13 |                 |                |        |   |                            |
|  | 2.0 TDi 4x4 | 103 |  | 07.06 | 01.13 |                 |                |        |   |                            |
|  | 2.0 TDI RS  | 125 |  | 04.06 | 01.13 |                 |                |        |   |                            |
|  | 1.2 TSI     | 77  |  | 02.10 | 01.13 | PR: 1KD         | 13.0460-2820.2 | 602820 |   | 20961 17,6 /S TRW          |
|  | 1.4 i 16V   |     |  | 06.04 | 01.13 | PR: 1KD         | 13.0470-2820.2 | LD2820 |   | 20961 17,6 /S TRW          |
|  | 1.4 TSI     | 90  |  | 11.08 | 01.13 | PR: 1KD         |                |        |   |                            |
|  | 1.6         | 75  |  | 09.09 | 01.13 | PR: 1KD         |                |        |   |                            |
|  | 1.6 FSI     | 85  |  | 06.04 | 01.13 | PR: 1KD         |                |        |   |                            |
|  | 1.6 i 16V   | 75  |  | 06.04 | 01.13 | PR: 1KD         |                |        |   |                            |
|  | 1.6 TDI     | 77  |  | 06.09 | 01.13 | PR: 1KD         |                |        |   |                            |
|  | 1.8 TSI     |     |  | 06.07 | 01.13 | PR: 1KD         |                |        |   |                            |
|  | 1.9 TDI     | 77  |  | 06.04 | 01.13 | PR: 1KD         |                |        |   |                            |
|  | 2.0 FSI     | 110 |  | 11.04 | 01.13 | PR: 1KD         |                |        |   |                            |
|  | 2.0 TDI     | 81  |  | 03.10 | 01.13 | PR: 1KD         |                |        |   |                            |
|  | 2.0 TDI     | 100 |  | 06.04 | 01.13 | PR: 1KD         |                |        |   |                            |
|  | 2.0 TDI     | 103 |  | 06.04 | 01.13 | PR: 1KD         |                |        |   |                            |
|  | 2.0 TDi 4x4 | 81  |  | 05.11 | 01.13 | PR: 1KD         |                |        |   |                            |
|  | 1.2 TSI     | 77  |  | 02.10 | 01.13 | PR: 1KS,1KT     | 13.0460-3858.2 | 603858 |   | 24563 17,7 /Zub/S BOS      |
|  | 1.4 i 16V   |     |  | 06.04 | 01.13 | PR: 1KS,1KT     | 13.0470-3858.2 | LD3858 |   | 24563 17,7 /Zub/S BOS      |
|  | 1.4 TSI     | 90  |  | 11.08 | 01.13 | PR: 1KS,1KT     |                |        |   |                            |
|  | 1.6         | 75  |  | 09.09 | 01.13 | PR: 1KS,1KT     |                |        |   |                            |
|  | 1.6 FSI     | 85  |  | 06.04 | 01.13 | PR: 1KS,1KT     |                |        |   |                            |
|  | 1.6 i 16V   | 75  |  | 06.04 | 01.13 | PR: 1KS,1KT     |                |        |   |                            |
|  | 1.6 TDI     | 77  |  | 06.09 | 01.13 | PR: 1KS,1KT     |                |        |   |                            |
|  | 1.6 TDI 4x4 | 77  |  | 06.09 | 01.13 | PR: 1KS,1KT     |                |        |   |                            |
|  | 1.8 TSI     |     |  | 06.07 | 01.13 | PR: 1KS,1KT     |                |        |   |                            |
|  | 1.8 TSI 4x4 |     |  | 11.08 | 01.13 | PR: 1KS,1KT     |                |        |   |                            |
|  | 1.9 TDI     | 77  |  | 06.04 | 01.13 | PR: 1KS,1KT     |                |        |   |                            |
|  | 1.9 TDI 4x4 | 77  |  | 11.04 | 01.13 | PR: 1KS,1KT     |                |        |   |                            |
|  | 2.0 FSI     | 110 |  | 11.04 | 01.13 | PR: 1KS,1KT     |                |        |   |                            |
|  | 2.0 FSI 4x4 | 110 |  | 11.04 | 01.13 | PR: 1KS,1KT     |                |        |   |                            |
|  | 2.0 RS      | 147 |  | 10.05 | 01.13 | PR: 1KS,1KT     |                |        |   |                            |
|  | 2.0 TDI     | 81  |  | 03.10 | 01.13 | PR: 1KS,1KT     |                |        |   |                            |
|  | 2.0 TDI     | 100 |  | 06.04 | 01.13 | PR: 1KS,1KT     |                |        |   |                            |
|  | 2.0 TDI     | 103 |  | 06.04 | 01.13 | PR: 1KS,1KT     |                |        |   |                            |
|  | 2.0 TDi 4x4 | 81  |  | 05.11 | 01.13 | PR: 1KS,1KT     |                |        |   |                            |
|  | 2.0 TDi 4x4 | 103 |  | 06.06 | 01.13 | PR: 1KS,1KT     |                |        |   |                            |
|  | 2.0 TDI RS  | 125 |  | 04.06 | 01.13 | PR: 1KS,1KT     |                |        |   |                            |
|  | 1.2 TSI     | 77  |  | 02.10 | 01.13 | PR: 1KF         | 13.0460-2880.2 | 602880 |   | 23914 17,1 /WE/Zub/S TRW   |
|  | 1.4 i 16V   |     |  | 06.04 | 01.13 | PR: 1KF         | 13.0470-2880.2 | LD2880 |   | 23914 17,1 /WE/Zub/S TRW   |
|  | 1.4 TSI     | 90  |  | 11.08 | 01.13 | PR: 1KF         |                |        |   |                            |
|  | 1.6         | 75  |  | 09.09 | 01.13 | PR: 1KF         |                |        |   |                            |
|  | 1.6 FSI     | 85  |  | 06.04 | 01.13 | PR: 1KF         |                |        |   |                            |
|  | 1.6 i 16V   | 75  |  | 06.04 | 01.13 | PR: 1KF         |                |        |   |                            |
|  | 1.6 TDI     | 77  |  | 06.09 | 01.13 | PR: 1KF         |                |        |   |                            |



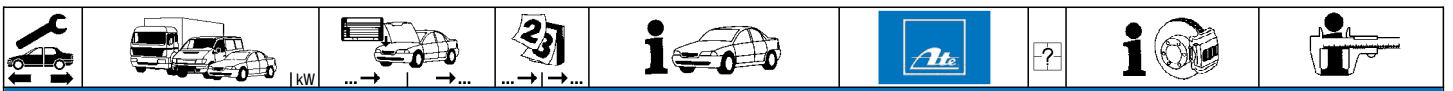

**SKODA OCTAVIA II (1Z) (04-13)**

|  |  |   |   |   |  |                                  |                  |  |   |            |
|--|--|---|---|---|--|----------------------------------|------------------|--|---|------------|
|  | 1.6 TDI 4x4<br>1.8 TSI<br>1.8 TSI 4x4<br>1.9 TDI<br>1.9 TDI 4x4<br>2.0 FSI<br>2.0 FSI 4x4<br>2.0 RS<br>2.0 TDI<br>2.0 TDI<br>2.0 TDI 4x4<br>2.0 TDI 4x4<br>2.0 TDI RS  | 77<br>77<br>77<br>77<br>110<br>110<br>147<br>81<br>100<br>103<br>81<br>103<br>125   | 06.09<br>06.07<br>11.08<br>06.04<br>11.04<br>11.04<br>11.04<br>10.05<br>03.10<br>06.04<br>05.11<br>07.06<br>04.06   | 01.13<br>01.13<br>01.13<br>01.13<br>01.13<br>01.13<br>01.13<br>01.13<br>01.13<br>01.13<br>01.13<br>01.13<br>01.13   | PR: 1KF<br>PR: 1KF<br>PR: 1KF<br>PR: 1KF<br>PR: 1KF<br>PR: 1KF<br>PR: 1KF<br>PR: 1KP<br>PR: 1KF<br>PR: 1KF<br>PR: 1KF<br>PR: 1KF<br>PR: 1KP  | 13.0460-2880.2<br>13.0470-2880.2 | 602880<br>LD2880 |  | 23914 17,1 /WE/Zub/S<br>23914 17,1 /WE/Zub/S  | TRW<br>TRW |
|  | 1.2 TSI<br>1.4 i 16V<br>1.4 TSI<br>1.6<br>1.6 FSI<br>1.6 i 16V<br>1.6 TDI<br>1.8 TSI<br>1.9 TDI<br>2.0 FSI<br>2.0 TDI<br>2.0 TDI<br>2.0 TDI<br>2.0 TDI 4x4   | 77<br>90<br>90<br>75<br>85<br>75<br>77<br>77<br>77<br>110<br>81<br>100<br>103<br>81   | 02.10<br>06.04<br>11.08<br>09.09<br>06.04<br>06.04<br>06.09<br>06.07<br>06.04<br>03.10<br>06.04<br>06.04<br>05.11   | 01.13<br>01.13<br>01.13<br>01.13<br>01.13<br>01.13<br>01.13<br>01.13<br>01.13<br>01.13<br>01.13<br>01.13<br>01.13<br>01.13  | PR: 1KD<br>PR: 1KD<br>PR: 1KD<br>PR: 1KD<br>PR: 1KD<br>PR: 1KD<br>PR: 1KD<br>PR: 1KD<br>PR: 1KD<br>PR: 1KD<br>PR: 1KD<br>PR: 1KD<br>PR: 1KD  | 24.0110-0277.1<br>24.0310-0277.1 | 410277<br>510277 |  | 253 10,0 8,0 +S +B<br>253 10,0 8,0 +S +B PD   |            |
|  | 1.2 TSI<br>1.4 i 16V<br>1.4 TSI<br>1.6<br>1.6 FSI<br>1.6 i 16V<br>1.6 TDI<br>1.6 TDI 4x4<br>1.8 TSI<br>1.8 TSI 4x4<br>1.9 TDI<br>1.9 TDI 4x4<br>2.0 FSI<br>2.0 FSI 4x4<br>2.0 RS<br>2.0 TDI<br>2.0 TDI<br>2.0 TDI 4x4<br>2.0 TDI 4x4<br>2.0 TDI RS | 77<br>90<br>90<br>75<br>85<br>75<br>77<br>77<br>77<br>77<br>77<br>77<br>110<br>110<br>147<br>81<br>100<br>103<br>81<br>103<br>125 | 02.10<br>06.04<br>11.08<br>09.09<br>06.04<br>06.04<br>06.09<br>06.09<br>06.07<br>11.08<br>06.04<br>11.04<br>11.04<br>11.04<br>10.05<br>03.10<br>06.04<br>06.04<br>05.11<br>07.06<br>04.06 | 01.13<br>01.13<br>01.13<br>01.13<br>01.13<br>01.13<br>01.13<br>01.13<br>01.13<br>01.13<br>01.13<br>01.13<br>01.13<br>01.13<br>01.13<br>01.13<br>01.13<br>01.13<br>01.13<br>01.13<br>01.13 | PR: 1KS,1KT<br>PR: 1KS,1KT<br>PR: 1KS,1KT<br>PR: 1KS,1KT<br>PR: 1KS,1KT<br>PR: 1KS,1KT<br>PR: 1KS,1KT<br>PR: 1KS,1KT<br>PR: 1KS,1KT<br>PR: 1KS,1KT<br>PR: 1KS,1KT<br>PR: 1KS,1KT<br>PR: 1KS,1KT<br>PR: 1KS,1KT<br>PR: 1KS,1KT<br>PR: 1KS,1KT<br>PR: 1KS,1KT<br>PR: 1KS,1KT<br>PR: 1KS,1KT<br>PR: 1KS,1KT | 24.0110-0356.1<br>24.0310-0356.1 | 410356<br>510356 |  | 272 9,7 8,0 +S +B<br>272 9,7 8,0 +S +B PD     |            |
|  | 1.2 TSI<br>1.4 i 16V<br>1.4 TSI<br>1.6<br>1.6 FSI<br>1.6 i 16V<br>1.6 TDI<br>1.6 TDI 4x4<br>1.8 TSI<br>1.8 TSI 4x4<br>1.9 TDI<br>1.9 TDI 4x4<br>2.0 FSI<br>2.0 FSI 4x4<br>2.0 TDI<br>2.0 TDI<br>2.0 TDI<br>2.0 TDI 4x4<br>2.0 TDI 4x4              | 77<br>90<br>90<br>75<br>85<br>75<br>77<br>77<br>77<br>77<br>77<br>77<br>110<br>110<br>81<br>100<br>103<br>81<br>103               | 02.10<br>06.04<br>11.08<br>09.09<br>06.04<br>06.04<br>06.09<br>06.09<br>06.07<br>11.08<br>06.04<br>11.04<br>11.04<br>11.04<br>03.10<br>06.04<br>06.04<br>05.11<br>07.06                   | 01.13<br>01.13<br>01.13<br>01.13<br>01.13<br>01.13<br>01.13<br>01.13<br>01.13<br>01.13<br>01.13<br>01.13<br>01.13<br>01.13<br>01.13<br>01.13<br>01.13<br>01.13<br>01.13                   | PR: 1KF<br>PR: 1KF<br>PR: 1KF<br>PR: 1KF<br>PR: 1KF<br>PR: 1KF<br>PR: 1KF<br>PR: 1KF<br>PR: 1KF<br>PR: 1KF<br>PR: 1KF<br>PR: 1KF<br>PR: 1KF<br>PR: 1KF<br>PR: 1KF<br>PR: 1KF<br>PR: 1KF<br>PR: 1KF   | 24.0112-0158.1<br>24.0312-0158.1 | 412158<br>512158 |  | 256 12,0 10,0 +S +B<br>256 12,0 10,0 +B PD    |            |
|  | 2.0 RS<br>2.0 TDI RS   | 147<br>125  | 10.05<br>04.06  | 01.13<br>01.13  | PR: 1KP<br>PR: 1KP   | 24.0112-0169.1<br>24.0312-0169.1 | 412169<br>512169 |  | 282 12,0 10,0 +S +B<br>282 12,0 10,0 +S +B PD |            |
|  | 1.2 TSI<br>1.4 i 16V<br>1.4 TSI<br>1.6<br>1.6 FSI<br>1.6 i 16V<br>1.6 TDI<br>1.8 TSI<br>1.9 TDI<br>2.0 FSI<br>2.0 RS<br>2.0 TDI<br>2.0 TDI<br>2.0 TDI<br>2.0 TDI RS  | 77<br>90<br>90<br>75<br>85<br>75<br>77<br>77<br>77<br>110<br>147<br>81<br>100<br>103<br>125                                       | 02.10<br>06.04<br>11.08<br>09.09<br>06.04<br>06.04<br>06.09<br>06.07<br>06.04<br>11.04<br>10.05<br>03.10<br>06.04<br>06.04<br>04.06   | 01.13<br>01.13<br>01.13<br>01.13<br>01.13<br>01.13<br>01.13<br>01.13<br>01.13<br>01.13<br>01.13<br>01.13<br>01.13<br>01.13<br>01.13   | PR: 1KF<br>PR: 1KF<br>PR: 1KF<br>PR: 1KF<br>PR: 1KF<br>PR: 1KF<br>PR: 1KF<br>PR: 1KF<br>PR: 1KF<br>PR: 1KF<br>PR: 1KF<br>PR: 1KF<br>PR: 1KF<br>PR: 1KF   | 24.0711-6231.3<br>24.0711-6232.3 | 360305<br>360306 |  | Radsensor<br>Radsensor                        |            |





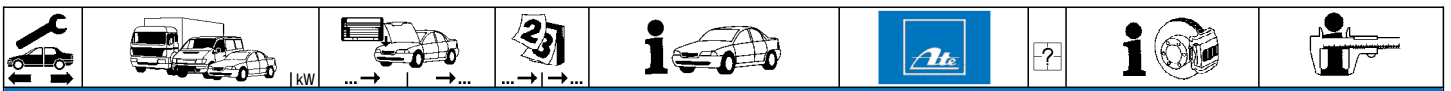

















**SKODA OCTAVIA III (5E) (12-)**

|             |               |       |             |             |                |        |   |   |
|-------------|---------------|-------|-------------|-------------|----------------|--------|---|---|
|             | 1.8 TSI       | 132   | 11.12       | PR: 1ZE     | 24.0125-0145.1 | 425145 |   | 288 25,0 22,0 V L +S +B<br>288 25,0 22,0 V L +S +B PD |
|             | 1.8 TSI 4x4   | 132   | 11.12       | PR: 1ZE     |                | 525145 |   |   |
|             | 2.0 TDI       | 105   | 11.12       | PR: 1ZE     |                |        |   |   |
|             | 2.0 TDI       | 110   | 02.13       | PR: 1ZE     |                |        |   |   |
|             | 2.0 TDI       | 135   | 05.13       | PR: 1ZE     |                |        |   |   |
|             | 2.0 TDI 4x4   | 110   | 11.12       | PR: 1ZE     |                |        |   |   |
|             | 2.0 TDI 4x4   | 135   | 09.14       | PR: 1ZE     |                |        |   |   |
|             | 2.0 TSI RS    | 162   | 05.13       | PR: 1ZE     |                |        |   |   |
|             | 2.0 TSI RS    | 169   | 05.15       | PR: 1ZE     |                |        |   |   |
|             | 1.0 TSI       | 85    | 05.16       | PR: 1ZA,1ZB | 24.0125-0158.1 | 425158 | 312 25,0 22,0 V L +S +B<br>312 25,0 22,0 V L +S +B PD |   |
|             | 1.2 TSI       | 63    | 02.13       | PR: 1ZA,1ZB |                | 525158 |   |   |
|             | 1.2 TSI       | 77    | 02.13       | PR: 1ZA,1ZB |                |        |   |   |
|             | 1.2 TSI       | 81    | 05.15       | PR: 1ZA,1ZB |                |        |   |   |
|             | 1.4 TSI       | 103   | 11.12       | PR: 1ZA,1ZB |                |        |   |   |
|             | 1.4 TSI       | 110   | 05.15       | PR: 1ZA,1ZB |                |        |   |   |
|             | 1.4 TSI G-TEC | 81    | 11.13       | PR: 1ZA,1ZB |                |        |   |   |
|             | 1.6           | 81    | 01.14       | PR: 1ZA,1ZB |                |        |   |   |
|             | 1.6 TDI       | 66    | 02.13       | PR: 1ZA,1ZB |                |        |   |   |
|             | 1.6 TDI       | 77    | 02.13       | PR: 1ZA,1ZB |                |        |   |   |
|             | 1.6 TDI       | 81    | 02.13       | PR: 1ZA,1ZB |                |        |   |   |
|             | 1.6 TDI 4x4   | 77    | 11.12       | PR: 1ZA,1ZB |                |        |   |   |
|             | 1.6 TDI 4x4   | 81    | 05.15       | PR: 1ZA,1ZB |                |        |   |   |
|             | 1.8 TSI       | 132   | 11.12       | PR: 1ZA,1ZB |                |        |   |   |
|             | 1.8 TSI 4x4   | 132   | 11.12       | PR: 1ZA,1ZB |                |        |   |   |
|             | 2.0 TDI       | 105   | 11.12       | PR: 1ZA,1ZB |                |        |   |   |
|             | 2.0 TDI       | 110   | 02.13       | PR: 1ZA,1ZB |                |        |   |   |
|             | 2.0 TDI       | 135   | 05.13       | PR: 1ZA,1ZB |                |        |   |   |
|             | 2.0 TDI 4x4   | 110   | 11.12       | PR: 1ZA,1ZB |                |        |   |   |
|             | 2.0 TDI 4x4   | 135   | 09.14       | PR: 1ZA,1ZB |                |        |   |   |
|             | 2.0 TSI RS    | 162   | 05.13       | PR: 1ZA,1ZB |                |        |   |   |
| 2.0 TSI RS  | 169           | 05.15 | PR: 1ZA,1ZB |             |                |        |   |   |
|             | 1.0 TSI       | 85    | 05.16       | PR: 1LG     | 24.0130-0225.1 | 430225 | 340 30,0 27,0 V L +S +B                               |   |
|             | 1.2 TSI       | 63    | 02.13       | PR: 1LG     |                |        |   |   |
|             | 1.2 TSI       | 77    | 02.13       | PR: 1LG     |                |        |   |   |
|             | 1.2 TSI       | 81    | 05.15       | PR: 1LG     |                |        |   |   |
|             | 1.4 TSI       | 103   | 11.12       | PR: 1LG     |                |        |   |   |
|             | 1.4 TSI       | 110   | 05.15       | PR: 1LG     |                |        |   |   |
|             | 1.4 TSI G-TEC | 81    | 11.13       | PR: 1LG     |                |        |   |   |
|             | 1.6           | 81    | 01.14       | PR: 1LG     |                |        |   |   |
|             | 1.6 TDI       | 66    | 02.13       | PR: 1LG     |                |        |   |   |
|             | 1.6 TDI       | 77    | 02.13       | PR: 1LG     |                |        |   |   |
|             | 1.6 TDI       | 81    | 02.13       | PR: 1LG     |                |        |   |   |
|             | 1.6 TDI 4x4   | 77    | 11.12       | PR: 1LG     |                |        |   |   |
|             | 1.6 TDI 4x4   | 81    | 05.15       | PR: 1LG     |                |        |   |   |
|             | 1.8 TSI       | 132   | 11.12       | PR: 1LG     |                |        |   |   |
|             | 1.8 TSI 4x4   | 132   | 11.12       | PR: 1LG     |                |        |   |   |
|             | 2.0 TDI       | 105   | 11.12       | PR: 1LG     |                |        |   |   |
|             | 2.0 TDI       | 110   | 02.13       | PR: 1LG     |                |        |   |   |
|             | 2.0 TDI       | 135   | 05.13       | PR: 1LG     |                |        |   |   |
|             | 2.0 TDI 4x4   | 110   | 11.12       | PR: 1LG     |                |        |   |   |
|             | 2.0 TDI 4x4   | 135   | 09.14       | PR: 1LG     |                |        |   |   |
|             | 2.0 TSI RS    | 162   | 05.13       | PR: 1LG     |                |        |   |   |
| 2.0 TSI RS  | 169           | 05.15 | PR: 1LG     |             |                |        |   |   |
|             | 1.0 TSI       | 85    | 05.16       | PR: 1ZF     | 24.0124-0258.1 | 424258 | 276 24,0 21,0 V L +S +B                               |   |
|             | 1.2 TSI       | 63    | 02.13       | PR: 1ZF     |                |        |   |   |
|             | 1.2 TSI       | 77    | 02.13       | PR: 1ZF     |                |        |   |   |
|             | 1.2 TSI       | 81    | 05.15       | PR: 1ZF     |                |        |   |   |
|             | 1.4 TSI       | 103   | 11.12       | PR: 1ZF     |                |        |   |   |
|             | 1.4 TSI       | 110   | 05.15       | PR: 1ZF     |                |        |   |   |
|             | 1.4 TSI G-TEC | 81    | 11.13       | PR: 1ZF     |                |        |   |   |
|             | 1.6           | 81    | 01.14       | PR: 1ZF     |                |        |   |   |
|             | 1.6 TDI       | 66    | 02.13       | PR: 1ZF     |                |        |   |   |
|             | 1.6 TDI       | 77    | 02.13       | PR: 1ZF     |                |        |   |   |
|             | 1.6 TDI       | 81    | 02.13       | PR: 1ZF     |                |        |   |   |
|             | 1.6 TDI 4x4   | 77    | 11.12       | PR: 1ZF     |                |        |   |   |
|             | 1.6 TDI 4x4   | 81    | 05.15       | PR: 1ZF     |                |        |   |   |
|             | 1.8 TSI       | 132   | 11.12       | PR: 1ZF     |                |        |   |   |
|             | 1.8 TSI 4x4   | 132   | 11.12       | PR: 1ZF     |                |        |   |   |
|             | 2.0 TDI       | 105   | 11.12       | PR: 1ZF     |                |        |   |   |
|             | 2.0 TDI       | 110   | 02.13       | PR: 1ZF     |                |        |   |   |
|             | 2.0 TDI       | 135   | 05.13       | PR: 1ZF     |                |        |   |   |
|             | 2.0 TDI 4x4   | 110   | 11.12       | PR: 1ZF     |                |        |   |   |
|             | 2.0 TDI 4x4   | 135   | 09.14       | PR: 1ZF     |                |        |   |   |
|             | 2.0 TSI RS    | 162   | 05.13       | PR: 1ZF     |                |        |   |   |
| 2.0 TSI RS  | 169           | 05.15 | PR: 1ZF     |             |                |        |   |   |
|             | 1.0 TSI       | 85    | 05.16       |             | 24.0711-5273.3 | 360303 | Radsensor<br>Radsensor                                |   |
|             | 1.2 TSI       | 63    | 02.13       |             |                | 360304 |   |   |
|             | 1.2 TSI       | 77    | 02.13       |             |                |        |   |   |
|             | 1.2 TSI       | 81    | 05.15       |             |                |        |   |   |
|             | 1.4 TSI       | 103   | 11.12       |             |                |        |   |   |
|             | 1.4 TSI       | 110   | 05.15       |             |                |        |   |   |
|             | 1.4 TSI G-TEC | 81    | 11.13       |             |                |        |   |   |
|             | 1.6           | 81    | 01.14       |             |                |        |   |   |
|             | 1.6 TDI       | 66    | 02.13       |             |                |        |   |   |
|             | 1.6 TDI       | 77    | 02.13       |             |                |        |   |   |
|             | 1.6 TDI       | 81    | 02.13       |             |                |        |   |   |
| 1.6 TDI 4x4 | 77            | 11.12 |             |             |                |        |   |   |



|     |  |  |  |  |  |  |   |  |
|--|--|--|--|--|---|--|---|--|
| <b>SKODA OCTAVIA III (5E) (12-)</b>  |  |  |  |  |   |  |   |  |
|    | 1.6 TDI 4x4  | 81   | 05.15  |  | 24.0711-5273.3  | 360303   |    | Radsensor  |
|  | 1.8 TSI  | 132  | 11.12  |  | 24.0711-5274.3  | 360304   |    | Radsensor  |
|  | 1.8 TSI 4x4  | 132  | 11.12  |  |   |  |   |  |
|  | 2.0 TDI  | 105  | 11.12  |  |   |  |   |  |
|  | 2.0 TDI  | 110  | 02.13  |  |   |  |   |  |
|  | 2.0 TDI  | 135  | 05.13  |  |   |  |   |  |
|  | 2.0 TDI 4x4  | 110  | 11.12  |  |   |  |   |  |
|  | 2.0 TDI 4x4  | 135  | 09.14  |  |   |  |   |  |
|  | 2.0 TSI RS   | 162  | 05.13  |  |   |  |   |  |
|  | 2.0 TSI RS   | 169  | 05.15  |  |   |  |   |  |
|    | 1.0 TSI  | 85   | 05.16  | PR: 1KD  | 13.0460-2787.2  | 602787   |   | 23554 17,3 /S TRW  |
|  | 1.2 TSI  | 63   | 02.13  | PR: 1KD  |   |  |   |  |
|  | 1.2 TSI  | 77   | 02.13  | PR: 1KD  |   |  |   |  |
|  | 1.2 TSI  | 81   | 05.15  | PR: 1KD  |   |  |   |  |
|  | 1.4 TSI  | 103  | 11.12  | PR: 1KD  |   |  |   |  |
|  | 1.4 TSI  | 110  | 05.15  | PR: 1KD  |   |  |   |  |
|  | 1.4 TSI G-TEC  | 81   | 11.13  | PR: 1KD  |   |  |   |  |
|  | 1.6  | 81   | 01.14  | PR: 1KD  |   |  |   |  |
|  | 1.6 TDI  | 66   | 02.13  | PR: 1KD  |   |  |   |  |
|  | 1.6 TDI  | 77   | 02.13  | PR: 1KD  |   |  |   |  |
|  | 1.6 TDI  | 81   | 02.13  | PR: 1KD  |   |  |   |  |
|  | 1.6 TDI 4x4  | 77   | 11.12  | PR: 1KD  |   |  |   |  |
|  | 1.6 TDI 4x4  | 81   | 05.15  | PR: 1KD  |   |  |   |  |
|  | 1.8 TSI  | 132  | 11.12  | PR: 1KD  |   |  |   |  |
|  | 1.8 TSI 4x4  | 132  | 11.12  | PR: 1KD  |   |  |   |  |
|  | 2.0 TDI  | 105  | 11.12  | PR: 1KD  |   |  |   |  |
|  | 2.0 TDI  | 110  | 02.13  | PR: 1KD  |   |  |   |  |
|  | 2.0 TDI  | 135  | 05.13  | PR: 1KD  |   |  |   |  |
|  | 2.0 TDI 4x4  | 110  | 11.12  | PR: 1KD  |   |  |   |  |
|  | 2.0 TDI 4x4  | 135  | 09.14  | PR: 1KD  |   |  |   |  |
|  | 2.0 TSI RS   | 162  | 05.13  | PR: 1KD  |   |  |   |  |
|  | 2.0 TSI RS   | 169  | 05.15  | PR: 1KD  |   |  |   |  |
|    | 1.0 TSI  | 85   | 05.16  | PR: 1KD  | 24.0110-0277.1  | 410277   |   | 253 10,0 8,0 +S +B   |
|  | 1.2 TSI  | 63   | 02.13  | PR: 1KD  | 24.0310-0277.1  | 510277   |   | 253 10,0 8,0 +S +B PD  |
|  | 1.2 TSI  | 77   | 02.13  | PR: 1KD  |   |  |   |  |
|  | 1.2 TSI  | 81   | 05.15  | PR: 1KD  |   |  |   |  |
|  | 1.4 TSI  | 103  | 11.12  | PR: 1KD  |   |  |   |  |
|  | 1.4 TSI  | 110  | 05.15  | PR: 1KD  |   |  |   |  |
|  | 1.4 TSI G-TEC  | 81   | 11.13  | PR: 1KD  |   |  |   |  |
|  | 1.6  | 81   | 01.14  | PR: 1KD  |   |  |   |  |
|  | 1.6 TDI  | 66   | 02.13  | PR: 1KD  |   |  |   |  |
|  | 1.6 TDI  | 77   | 02.13  | PR: 1KD  |   |  |   |  |
|  | 1.6 TDI  | 81   | 02.13  | PR: 1KD  |   |  |   |  |
|  | 1.6 TDI 4x4  | 77   | 11.12  | PR: 1KD  |   |  |   |  |
|  | 1.6 TDI 4x4  | 81   | 05.15  | PR: 1KD  |   |  |   |  |
|  | 1.8 TSI  | 132  | 11.12  | PR: 1KD  |   |  |   |  |
|  | 1.8 TSI 4x4  | 132  | 11.12  | PR: 1KD  |   |  |   |  |
|  | 2.0 TDI  | 105  | 11.12  | PR: 1KD  |   |  |   |  |
|  | 2.0 TDI  | 110  | 02.13  | PR: 1KD  |   |  |   |  |
|  | 2.0 TDI  | 135  | 05.13  | PR: 1KD  |   |  |   |  |
|  | 2.0 TDI 4x4  | 110  | 11.12  | PR: 1KD  |   |  |   |  |
|  | 2.0 TDI 4x4  | 135  | 09.14  | PR: 1KD  |   |  |   |  |
|  | 2.0 TSI RS   | 162  | 05.13  | PR: 1KD  |   |  |   |  |
|  | 2.0 TSI RS   | 169  | 05.15  | PR: 1KD  |   |  |   |  |
|  | 1.0 TSI  | 85   | 05.16  | PR: 1KS,1KT  | 24.0110-0356.1  | 410356   |   | 272 9,7 8,0 +S +B  |
|  | 1.2 TSI  | 63   | 02.13  | PR: 1KS,1KT  | 24.0310-0356.1  | 510356   |   | 272 9,7 8,0 +S +B PD   |
|  | 1.2 TSI  | 77   | 02.13  | PR: 1KS,1KT  |   |  |   |  |
|  | 1.2 TSI  | 81   | 05.15  | PR: 1KS,1KT  |   |  |   |  |
|  | 1.4 TSI  | 103  | 11.12  | PR: 1KS,1KT  |   |  |   |  |
|  | 1.4 TSI  | 110  | 05.15  | PR: 1KS,1KT  |   |  |   |  |
|  | 1.4 TSI G-TEC  | 81   | 11.13  | PR: 1KS,1KT  |   |  |   |  |
|  | 1.6  | 81   | 01.14  | PR: 1KS,1KT  |   |  |   |  |
|  | 1.6 TDI  | 66   | 02.13  | PR: 1KS,1KT  |   |  |   |  |
|  | 1.6 TDI  | 77   | 02.13  | PR: 1KS,1KT  |   |  |   |  |
|  | 1.6 TDI  | 81   | 02.13  | PR: 1KS,1KT  |   |  |   |  |
|  | 1.6 TDI 4x4  | 77   | 11.12  | PR: 1KS,1KT  |   |  |   |  |
|  | 1.6 TDI 4x4  | 81   | 05.15  | PR: 1KS,1KT  |   |  |   |  |
|  | 1.8 TSI  | 132  | 11.12  | PR: 1KS,1KT  |   |  |   |  |
|  | 1.8 TSI 4x4  | 132  | 11.12  | PR: 1KS,1KT  |   |  |   |  |
|  | 2.0 TDI  | 105  | 11.12  | PR: 1KS,1KT  |   |  |   |  |
|  | 2.0 TDI  | 110  | 02.13  | PR: 1KS,1KT  |   |  |   |  |
|  | 2.0 TDI  | 135  | 05.13  | PR: 1KS,1KT  |   |  |   |  |
|  | 2.0 TDI 4x4  | 110  | 11.12  | PR: 1KS,1KT  |   |  |   |  |
|  | 2.0 TDI 4x4  | 135  | 09.14  | PR: 1KS,1KT  |   |  |   |  |
|  | 2.0 TSI RS   | 162  | 05.13  | PR: 1KS,1KT  |   |  |   |  |
|  | 2.0 TSI RS   | 169  | 05.15  | PR: 1KS,1KT  |   |  |   |  |
|  | 1.0 TSI  | 85   | 05.16  |  | 24.0711-6230.3  | 360310   | 2  - Geschwindigkeitsregelanlage <sup>1)</sup> | Radsensor  |
|  | 1.2 TSI  | 63   | 02.13  |  | 24.0711-6337.3  | 360390   | 2  + Geschwindigkeitsregelanlage <sup>2)</sup> | Radsensor  |
|  | 1.2 TSI  | 77   | 02.13  |  |   |  |   |  |
|  | 1.2 TSI  | 81   | 05.15  |  |   |  |   |  |
|  | 1.4 TSI  | 103  | 11.12  |  |   |  |   |  |
|  | 1.4 TSI  | 110  | 05.15  |  |   |  |   |  |
|  | 1.4 TSI G-TEC  | 81   | 11.13  |  |   |  |   |  |
|  | 1.6  | 81   | 01.14  |  |   |  |   |  |
|  | 1.6 TDI  | 66   | 02.13  |  |   |  |   |  |
|  | 1.6 TDI  | 77   | 02.13  |  |   |  |   |  |
|  | 1.6 TDI  | 81   | 02.13  |  |   |  |   |  |

1) - speed control system / - impianto variatore di velocità / - régulateur de vitesse / - sistema de regulación de velocidad  
2) + speed control system / + impianto variatore di velocità / + régulateur de vitesse / + sistema de regulación de velocidad





### SKODA OCTAVIA III (5E) (12-)















|            |               |       |       |  |                |        |  |           |
|------------|---------------|-------|-------|--|----------------|--------|--|-----------|
|            | 1.6 TDI 4x4   | 77    | 11.12 |  | 24.0711-6230.3 | 360310 | 2  - Geschwindigkeitsregelanlage <sup>1)</sup> | Radsensor |
|            | 1.6 TDI 4x4   | 81    | 05.15 |  | 24.0711-6337.3 | 360390 | 2  + Geschwindigkeitsregelanlage <sup>2)</sup> | Radsensor |
|            | 1.8 TSI       | 132   | 11.12 |  |                |        |  |           |
|            | 1.8 TSI 4x4   | 132   | 11.12 |  |                |        |  |           |
|            | 2.0 TDI       | 105   | 11.12 |  |                |        |  |           |
|            | 2.0 TDI       | 110   | 02.13 |  |                |        |  |           |
|            | 2.0 TDI       | 135   | 05.13 |  |                |        |  |           |
|            | 2.0 TDI 4x4   | 110   | 11.12 |  |                |        |  |           |
|            | 2.0 TDI 4x4   | 135   | 09.14 |  |                |        |  |           |
|            | 2.0 TSI RS    | 162   | 05.13 |  |                |        |  |           |
| 2.0 TSI RS | 169           | 05.15 |       |  |                |        |  |           |
|            | 1.0 TSI       | 85    | 05.16 |  | 24.0711-6230.3 | 360310 | 2  - Parkassistent <sup>3)</sup>               | Radsensor |
|            | 1.2 TSI       | 63    | 02.13 |  | 24.0711-6337.3 | 360390 | 2  + Parkassistent <sup>4)</sup>               | Radsensor |
|            | 1.2 TSI       | 77    | 02.13 |  |                |        |  |           |
|            | 1.2 TSI       | 81    | 05.15 |  |                |        |  |           |
|            | 1.4 TSI       | 103   | 11.12 |  |                |        |  |           |
|            | 1.4 TSI       | 110   | 05.15 |  |                |        |  |           |
|            | 1.4 TSI G-TEC | 81    | 11.13 |  |                |        |  |           |
|            | 1.6           | 81    | 01.14 |  |                |        |  |           |
|            | 1.6 TDI       | 66    | 02.13 |  |                |        |  |           |
|            | 1.6 TDI       | 77    | 02.13 |  |                |        |  |           |
|            | 1.6 TDI       | 81    | 02.13 |  |                |        |  |           |
|            | 1.6 TDI 4x4   | 77    | 11.12 |  |                |        |  |           |
|            | 1.6 TDI 4x4   | 81    | 05.15 |  |                |        |  |           |
|            | 1.8 TSI       | 132   | 11.12 |  |                |        |  |           |
|            | 1.8 TSI 4x4   | 132   | 11.12 |  |                |        |  |           |
|            | 2.0 TDI       | 105   | 11.12 |  |                |        |  |           |
|            | 2.0 TDI       | 110   | 02.13 |  |                |        |  |           |
|            | 2.0 TDI       | 135   | 05.13 |  |                |        |  |           |
|            | 2.0 TDI 4x4   | 110   | 11.12 |  |                |        |  |           |
|            | 2.0 TDI 4x4   | 135   | 09.14 |  |                |        |  |           |
| 2.0 TSI RS | 162           | 05.13 |       |  |                |        |  |           |
| 2.0 TSI RS | 169           | 05.15 |       |  |                |        |  |           |

















### SKODA RAPID / RAPID Spaceback (12-)

|         |         |       |         |         |                |        |  |                            |     |
|---------|---------|-------|---------|---------|----------------|--------|--|----------------------------|-----|
|         | 1.2     | 55    | 10.12   | PR: 1ZG | 13.0460-7111.2 | 607111 |  | 23130 19,6 +               | VW  |
|         | 1.2 TSI | 63    | 10.12   | PR: 1ZG | 13.0470-7111.2 | LD7111 |  | 23130 19,6 +               | VW  |
|         | 1.2 TSI | 66    | 05.15   | PR: 1ZG |                |        |  |                            |     |
|         | 1.2 TSI | 77    | 10.12   | PR: 1ZG |                |        |  |                            |     |
|         | 1.2 TSI | 81    | 05.15   | PR: 1ZG |                |        |  |                            |     |
|         | 1.4 TDI | 66    | 05.15   | PR: 1ZG |                |        |  |                            |     |
|         | 1.4 TSI | 90    | 10.12   | PR: 1ZG |                |        |  |                            |     |
|         | 1.4 TSI | 92    | 05.15   | PR: 1ZG |                |        |  |                            |     |
|         | 1.6     | 77    | 07.13   | PR: 1ZG |                |        |  |                            |     |
|         | 1.6 TDI | 66    | 08.13   | PR: 1ZG |                |        |  |                            |     |
| 1.6 TDI | 77      | 10.12 | PR: 1ZG |         |                |        |  |                            |     |
| 1.6 TDI | 85      | 05.15 | PR: 1ZG |         |                |        |  |                            |     |
|         | 1.2     | 55    | 10.12   | PR: 1ZC | 13.0460-7184.2 | 607184 |  | 23587 20,6 +/WK            | ATE |
|         | 1.2 TSI | 63    | 10.12   | PR: 1ZC | 13.0470-7184.2 | LD7184 |  | 23587 20,6 +/WK            | ATE |
|         | 1.2 TSI | 66    | 05.15   | PR: 1ZC |                |        |  |                            |     |
|         | 1.2 TSI | 77    | 10.12   | PR: 1ZC |                |        |  |                            |     |
|         | 1.2 TSI | 81    | 05.15   | PR: 1ZC |                |        |  |                            |     |
|         | 1.4 TDI | 66    | 05.15   | PR: 1ZC |                |        |  |                            |     |
|         | 1.4 TSI | 90    | 10.12   | PR: 1ZC |                |        |  |                            |     |
|         | 1.4 TSI | 92    | 05.15   | PR: 1ZC |                |        |  |                            |     |
|         | 1.6     | 77    | 07.13   | PR: 1ZC |                |        |  |                            |     |
|         | 1.6 TDI | 66    | 08.13   | PR: 1ZC |                |        |  |                            |     |
| 1.6 TDI | 77      | 10.12 | PR: 1ZC |         |                |        |  |                            |     |
| 1.6 TDI | 85      | 05.15 | PR: 1ZC |         |                |        |  |                            |     |
|         | 1.2     | 55    | 10.12   | PR: 1ZG | 24.0122-0151.1 | 422151 |  | 256 22,0 19,0 V L +S +B    |     |
|         | 1.2 TSI | 63    | 10.12   | PR: 1ZG | 24.0322-0151.1 | 522151 |  | 256 22,0 19,0 V L +S +B PD |     |
|         | 1.2 TSI | 66    | 05.15   | PR: 1ZG |                |        |  |                            |     |
|         | 1.2 TSI | 77    | 10.12   | PR: 1ZG |                |        |  |                            |     |
|         | 1.2 TSI | 81    | 05.15   | PR: 1ZG |                |        |  |                            |     |
|         | 1.4 TDI | 66    | 05.15   | PR: 1ZG |                |        |  |                            |     |
|         | 1.4 TSI | 90    | 10.12   | PR: 1ZG |                |        |  |                            |     |
|         | 1.4 TSI | 92    | 05.15   | PR: 1ZG |                |        |  |                            |     |
|         | 1.6     | 77    | 07.13   | PR: 1ZG |                |        |  |                            |     |
|         | 1.6 TDI | 66    | 08.13   | PR: 1ZG |                |        |  |                            |     |
| 1.6 TDI | 77      | 10.12 | PR: 1ZG |         |                |        |  |                            |     |
| 1.6 TDI | 85      | 05.15 | PR: 1ZG |         |                |        |  |                            |     |
|         | 1.2     | 55    | 10.12   | PR: 1ZC | 24.0125-0113.1 | 425113 |  | 288 25,0 22,0 V L +S +B    |     |
|         | 1.2 TSI | 63    | 10.12   | PR: 1ZC | 24.0325-0113.1 | 525113 |  | 288 25,0 22,0 V L +S +B PD |     |
|         | 1.2 TSI | 66    | 05.15   | PR: 1ZC |                |        |  |                            |     |
|         | 1.2 TSI | 77    | 10.12   | PR: 1ZC |                |        |  |                            |     |
|         | 1.2 TSI | 81    | 05.15   | PR: 1ZC |                |        |  |                            |     |
|         | 1.4 TDI | 66    | 05.15   | PR: 1ZC |                |        |  |                            |     |
|         | 1.4 TSI | 90    | 10.12   | PR: 1ZC |                |        |  |                            |     |
|         | 1.4 TSI | 92    | 05.15   | PR: 1ZC |                |        |  |                            |     |
|         | 1.6     | 77    | 07.13   | PR: 1ZC |                |        |  |                            |     |
|         | 1.6 TDI | 66    | 08.13   | PR: 1ZC |                |        |  |                            |     |
| 1.6 TDI | 77      | 10.12 | PR: 1ZC |         |                |        |  |                            |     |
| 1.6 TDI | 85      | 05.15 | PR: 1ZC |         |                |        |  |                            |     |

<sup>1)</sup> - speed control system / - impianto variatore di velocità / - régulateur de vitesse / - sistema de regulación de velocidad  
<sup>2)</sup> + speed control system / + impianto variatore di velocità / + régulateur de vitesse / + sistema de regulación de velocidad  
<sup>3)</sup> - parking assistant / - assistente di parcheggio / - assistance au stationnement / - asistente de aparcamiento  
<sup>4)</sup> + parking assistant / + assistente di parcheggio / + assistance au stationnement / + asistente de aparcamiento



|     |         |  |       |  |                 |  |  |  |        |  |  |  |  |  |  |  |                      |
|--|---------|--|-------|--|-----------------|--|--|--|--------|---|--|--|--|--|--|--|----------------------|
| SKODA RAPID / RAPID Spaceback (12-)  |         |  |       |  |                 |  |  |  |        |   |  |  |  |  |  |  |                      |
|    | 1.2     | 55   | 10.12 |  |                 |  |  | 24.0711-5273.3   | 360303 |   |  |  |  |  |  |  | Radsensor            |
|  | 1.2 TSI | 63   | 10.12 |  |                 |  |  | 24.0711-5274.3   | 360304 |   |  |  |  |  |  |  | Radsensor            |
|  | 1.2 TSI | 66   | 05.15 |  |                 |  |  |  |        |   |  |  |  |  |  |  |                      |
|  | 1.2 TSI | 77   | 10.12 |  |                 |  |  |  |        |   |  |  |  |  |  |  |                      |
|  | 1.2 TSI | 81   | 05.15 |  |                 |  |  |  |        |   |  |  |  |  |  |  |                      |
|  | 1.4 TDI | 66   | 05.15 |  |                 |  |  |  |        |   |  |  |  |  |  |  |                      |
|  | 1.4 TSI | 90   | 10.12 |  |                 |  |  |  |        |   |  |  |  |  |  |  |                      |
|  | 1.4 TSI | 92   | 05.15 |  |                 |  |  |  |        |   |  |  |  |  |  |  |                      |
|  | 1.6     | 77   | 07.13 |  |                 |  |  |  |        |   |  |  |  |  |  |  |                      |
|  | 1.6 TDI | 66   | 08.13 |  |                 |  |  |  |        |   |  |  |  |  |  |  |                      |
|  | 1.6 TDI | 77   | 10.12 |  |                 |  |  |  |        |   |  |  |  |  |  |  |                      |
|  | 1.6 TDI | 85   | 05.15 |  |                 |  |  |  |        |   |  |  |  |  |  |  |                      |
|    | 1.2     | 55   | 10.12 | PR: 1KT  |                 |  |  | 13.0460-2820.2   | 602820 |   |  |  |  |  |  |  | 20961 17,6 /S        |
|  | 1.2 TSI | 63   | 10.12 | PR: 1KT  |                 |  |  | 13.0470-2820.2   | LD2820 |   |  |  |  |  |  |  | 20961 17,6 /S        |
|  | 1.2 TSI | 66   | 05.15 | PR: 1KT  |                 |  |  |  |        |   |  |  |  |  |  |  |                      |
|  | 1.2 TSI | 77   | 10.12 | PR: 1KT  |                 |  |  |  |        |   |  |  |  |  |  |  |                      |
|  | 1.2 TSI | 81   | 05.15 | PR: 1KT  |                 |  |  |  |        |   |  |  |  |  |  |  |                      |
|  | 1.4 TDI | 66   | 05.15 | PR: 1KT  |                 |  |  |  |        |   |  |  |  |  |  |  |                      |
|  | 1.4 TSI | 90   | 10.12 | PR: 1KT  |                 |  |  |  |        |   |  |  |  |  |  |  |                      |
|  | 1.4 TSI | 92   | 05.15 | PR: 1KT  |                 |  |  |  |        |   |  |  |  |  |  |  |                      |
|  | 1.6     | 77   | 07.13 | PR: 1KT  |                 |  |  |  |        |   |  |  |  |  |  |  |                      |
|  | 1.6 TDI | 66   | 08.13 | PR: 1KT  |                 |  |  |  |        |   |  |  |  |  |  |  |                      |
|  | 1.6 TDI | 77   | 10.12 | PR: 1KT  |                 |  |  |  |        |   |  |  |  |  |  |  |                      |
|  | 1.6 TDI | 85   | 05.15 | PR: 1KT  |                 |  |  |  |        |   |  |  |  |  |  |  |                      |
|    | 1.2     | 55   | 10.12 | PR: 1KT  |                 |  |  | 24.0109-0123.1   | 409123 |   |  |  |  |  |  |  | 230 9,0 7,0 +S +B    |
|  | 1.2 TSI | 63   | 10.12 | PR: 1KT  |                 |  |  | 24.0309-0123.1   | 509123 |   |  |  |  |  |  |  | 230 9,0 7,0 +S +B PD |
|  | 1.2 TSI | 66   | 05.15 | PR: 1KT  |                 |  |  |  |        |   |  |  |  |  |  |  |                      |
|  | 1.2 TSI | 77   | 10.12 | PR: 1KT  |                 |  |  |  |        |   |  |  |  |  |  |  |                      |
|  | 1.2 TSI | 81   | 05.15 | PR: 1KT  |                 |  |  |  |        |   |  |  |  |  |  |  |                      |
|  | 1.4 TDI | 66   | 05.15 | PR: 1KT  |                 |  |  |  |        |   |  |  |  |  |  |  |                      |
|  | 1.4 TSI | 90   | 10.12 | PR: 1KT  |                 |  |  |  |        |   |  |  |  |  |  |  |                      |
|  | 1.4 TSI | 92   | 05.15 | PR: 1KT  |                 |  |  |  |        |   |  |  |  |  |  |  |                      |
|  | 1.6     | 77   | 07.13 | PR: 1KT  |                 |  |  |  |        |   |  |  |  |  |  |  |                      |
|  | 1.6 TDI | 66   | 08.13 | PR: 1KT  |                 |  |  |  |        |   |  |  |  |  |  |  |                      |
|  | 1.6 TDI | 77   | 10.12 | PR: 1KT  |                 |  |  |  |        |   |  |  |  |  |  |  |                      |
|  | 1.6 TDI | 85   | 05.15 | PR: 1KT  |                 |  |  |  |        |   |  |  |  |  |  |  |                      |
|    | 1.2     | 55   | 10.12 |  |                 |  |  | 24.0711-6233.3   | 360315 |   |  |  |  |  |  |  | Radsensor            |
|  | 1.2 TSI | 63   | 10.12 |  |                 |  |  | 24.0711-6234.3   | 360316 |   |  |  |  |  |  |  | Radsensor            |
|  | 1.2 TSI | 66   | 05.15 |  |                 |  |  |  |        |   |  |  |  |  |  |  |                      |
|  | 1.2 TSI | 77   | 10.12 |  |                 |  |  |  |        |   |  |  |  |  |  |  |                      |
|  | 1.2 TSI | 81   | 05.15 |  |                 |  |  |  |        |   |  |  |  |  |  |  |                      |
|  | 1.4 TDI | 66   | 05.15 |  |                 |  |  |  |        |   |  |  |  |  |  |  |                      |
|  | 1.4 TSI | 90   | 10.12 |  |                 |  |  |  |        |   |  |  |  |  |  |  |                      |
|  | 1.4 TSI | 92   | 05.15 |  |                 |  |  |  |        |   |  |  |  |  |  |  |                      |
|  | 1.6     | 77   | 07.13 |  |                 |  |  |  |        |   |  |  |  |  |  |  |                      |
|  | 1.6 TDI | 66   | 08.13 |  |                 |  |  |  |        |   |  |  |  |  |  |  |                      |
|  | 1.6 TDI | 77   | 10.12 |  |                 |  |  |  |        |   |  |  |  |  |  |  |                      |
|  | 1.6 TDI | 85   | 05.15 |  |                 |  |  |  |        |   |  |  |  |  |  |  |                      |
|  | 1.2     | 55   | 10.12 | PR: 1KL  |                 |  |  | 03.0137-0521.2   | 650521 |   |  |  |  |  |  |  | 228 x 33 HEB         |
|  | 1.2 TSI | 63   | 10.12 | PR: 1KL  |                 |  |  | 03.0137-9309.2   | 669309 |   |  |  |  |  |  |  | Bremsbacken-Zubehör  |
|  | 1.2 TSI | 66   | 05.15 | PR: 1KL  |                 |  |  |  |        |   |  |  |  |  |  |  |                      |
|  | 1.2 TSI | 77   | 10.12 | PR: 1KL  |                 |  |  |  |        |   |  |  |  |  |  |  |                      |
|  | 1.2 TSI | 81   | 05.15 | PR: 1KL  |                 |  |  |  |        |   |  |  |  |  |  |  |                      |
|  | 1.4 TDI | 66   | 05.15 | PR: 1KL  |                 |  |  |  |        |   |  |  |  |  |  |  |                      |
|  | 1.4 TSI | 90   | 10.12 | PR: 1KL  |                 |  |  |  |        |   |  |  |  |  |  |  |                      |
|  | 1.4 TSI | 92   | 05.15 | PR: 1KL  |                 |  |  |  |        |   |  |  |  |  |  |  |                      |
|  | 1.6     | 77   | 07.13 | PR: 1KL  |                 |  |  |  |        |   |  |  |  |  |  |  |                      |
|  | 1.6 TDI | 66   | 08.13 | PR: 1KL  |                 |  |  |  |        |   |  |  |  |  |  |  |                      |
|  | 1.6 TDI | 77   | 10.12 | PR: 1KL  |                 |  |  |  |        |   |  |  |  |  |  |  |                      |
|  | 1.6 TDI | 85   | 05.15 | PR: 1KL  |                 |  |  |  |        |   |  |  |  |  |  |  |                      |
| SKODA ROOMSTER (5J) (06-15)  |         |  |       |  |                 |  |  |  |        |   |  |  |  |  |  |  |                      |
|  | 1.2     |  | 07.06 | 04.15  | PR: 1LQ,1LR,1ZG |  |  | 13.0460-7111.2   | 607111 |   |  |  |  |  |  |  | 23130 19,6 +         |
|  | 1.2 TDI | 55   | 03.10 | 04.15  | PR: 1LQ,1LR,1ZG |  |  | 13.0470-7111.2   | LD7111 |   |  |  |  |  |  |  | 23130 19,6 +         |
|  | 1.2 TSI | 63   | 03.10 | 04.15  | PR: 1LQ,1LR,1ZG |  |  | 13.0460-7117.2   | 607117 |   |  |  |  |  |  |  | 23131 19,6 +/WK      |
|  | 1.2 TSI | 77   | 03.10 | 04.15  | PR: 1LQ,1LR,1ZG |  |  | 13.0470-7117.2   | LD7117 |   |  |  |  |  |  |  | 23131 19,6 +/WK      |
|  | 1.4     | 63   | 07.06 | 04.15  | PR: 1LQ,1LR,1ZG |  |  |  |        |   |  |  |  |  |  |  |                      |
|  | 1.4 TDI | 51   | 07.06 | 04.15  | PR: 1LQ,1LR,1ZG |  |  |  |        |   |  |  |  |  |  |  |                      |
|  | 1.4 TDI | 59   | 07.06 | 04.15  | PR: 1LQ,1LR,1ZG |  |  |  |        |   |  |  |  |  |  |  |                      |
|  | 1.6     | 77   | 07.06 | 04.15  | PR: 1LQ,1LR,1ZG |  |  |  |        |   |  |  |  |  |  |  |                      |
|  | 1.6 TDI | 66   | 03.10 | 04.15  | PR: 1LQ,1LR,1ZG |  |  |  |        |   |  |  |  |  |  |  |                      |
|  | 1.6 TDI | 77   | 03.10 | 04.15  | PR: 1LQ,1LR,1ZG |  |  |  |        |   |  |  |  |  |  |  |                      |
|  | 1.9 TDI |  | 07.06 | 04.15  | PR: 1LQ,1LR,1ZG |  |  |  |        |   |  |  |  |  |  |  |                      |
|  | 1.2     |  | 07.06 | 04.15  | PR: 1LN         |  |  | 13.0460-2883.2   | 602883 |   |  |  |  |  |  |  | 23581 18,8 /S        |
|  | 1.2 TDI | 55   | 03.10 | 04.15  | PR: 1LN         |  |  | 13.0460-2884.2   | 602884 |   |  |  |  |  |  |  | 23843 18,8 +/WK/S    |
|  | 1.2 TSI | 63   | 03.10 | 04.15  | PR: 1LN         |  |  | 13.0470-2884.2   | LD2884 |   |  |  |  |  |  |  | 23843 18,8 +/WK/S    |
|  | 1.2 TSI | 77   | 03.10 | 04.15  | PR: 1LN         |  |  |  |        |   |  |  |  |  |  |  |                      |
|  | 1.4     | 63   | 07.06 | 04.15  | PR: 1LN         |  |  |  |        |   |  |  |  |  |  |  |                      |
|  | 1.4 TDI | 51   | 07.06 | 04.15  | PR: 1LN         |  |  |  |        |   |  |  |  |  |  |  |                      |
|  | 1.4 TDI | 59   | 07.06 | 04.15  | PR: 1LN         |  |  |  |        |   |  |  |  |  |  |  |                      |
|  | 1.6     | 77   | 07.06 | 04.15  | PR: 1LN         |  |  |  |        |   |  |  |  |  |  |  |                      |
|  | 1.6 TDI | 66   | 03.10 | 04.15  | PR: 1LN         |  |  |  |        |   |  |  |  |  |  |  |                      |
|  | 1.6 TDI | 77   | 03.10 | 04.15  | PR: 1LN         |  |  |  |        |   |  |  |  |  |  |  |                      |
|  | 1.9 TDI |  | 07.06 | 04.15  | PR: 1LN         |  |  |  |        |   |  |  |  |  |  |  |                      |
|  | 1.2     |  | 07.06 | 04.15  | PR: 1ZC         |  |  | 13.0460-7184.2   | 607184 |   |  |  |  |  |  |  | 23587 20,6 +/WK      |
|  | 1.2 TDI | 55   | 03.10 | 04.15  | PR: 1ZC         |  |  | 13.0470-7184.2   | LD7184 |   |  |  |  |  |  |  | 23587 20,6 +/WK      |
|  | 1.2 TSI | 63   | 03.10 | 04.15  | PR: 1ZC         |  |  |  |        |   |  |  |  |  |  |  |                      |

|          |         |    |       |       |             |                 |  |  |  |  |   |  |  |  |  |   |
|--|---------|----|-------|-------|-------------|-----------------|--|--|--|--|---|--|--|--|--|---|
| SKODA ROOMSTER (5J) (06-15)  |         |    |       |       |             |                 |  |  |  |  |   |  |  |  |  |   |
|    | 1.2 TSI | 77 |       | 03.10 | 04.15       | PR: 1ZC         | 13.0460-7184.2 607184<br>13.0470-7184.2 LD7184 |  |  |  | 23587 20,6 +WK ATE<br>23587 20,6 +WK ATE              |  |  |  |  |   |
|  | 1.4     | 63 |       | 07.06 | 04.15       | PR: 1ZC         |  |  |  |  |   |  |  |  |  |   |
|  | 1.4 TDI | 51 |       | 07.06 | 04.15       | PR: 1ZC         |  |  |  |  |   |  |  |  |  |   |
|  | 1.4 TDI | 59 |       | 07.06 | 04.15       | PR: 1ZC         |  |  |  |  |   |  |  |  |  |   |
|  | 1.6     | 77 |       | 07.06 | 04.15       | PR: 1ZC         |  |  |  |  |   |  |  |  |  |   |
|  | 1.6 TDI | 66 |       | 03.10 | 04.15       | PR: 1ZC         |  |  |  |  |   |  |  |  |  |   |
|  | 1.6 TDI | 77 |       | 03.10 | 04.15       | PR: 1ZC         |  |  |  |  |   |  |  |  |  |   |
|  | 1.9 TDI | 77 |       | 07.06 | 04.15       | PR: 1ZC         |  |  |  |  |   |  |  |  |  |   |
|    | 1.2     |    |       | 07.06 | 04.15       | PR: 1LQ,1LR,1ZG | 24.0122-0151.1 422151<br>24.0322-0151.1 522151 |  |  |  | 256 22,0 19,0 V L +S +B<br>256 22,0 19,0 V L +S +B PD |  |  |  |  |   |
|  | 1.2 TDI | 55 |       | 03.10 | 04.15       | PR: 1LQ,1LR,1ZG |  |  |  |  |   |  |  |  |  |   |
|  | 1.2 TSI | 63 |       | 03.10 | 04.15       | PR: 1LQ,1LR,1ZG |  |  |  |  |   |  |  |  |  |   |
|  | 1.2 TSI | 77 |       | 03.10 | 04.15       | PR: 1LQ,1LR,1ZG |  |  |  |  |   |  |  |  |  |   |
|  | 1.4     | 63 |       | 07.06 | 04.15       | PR: 1LQ,1LR,1ZG |  |  |  |  |   |  |  |  |  |   |
|  | 1.4 TDI | 51 |       | 07.06 | 04.15       | PR: 1LQ,1LR,1ZG |  |  |  |  |   |  |  |  |  |   |
|  | 1.4 TDI | 59 |       | 07.06 | 04.15       | PR: 1LQ,1LR,1ZG |  |  |  |  |   |  |  |  |  |   |
|  | 1.6     | 77 |       | 07.06 | 04.15       | PR: 1LQ,1LR,1ZG |  |  |  |  |   |  |  |  |  |   |
|  | 1.6 TDI | 66 |       | 03.10 | 04.15       | PR: 1LQ,1LR,1ZG |  |  |  |  |   |  |  |  |  |   |
|  | 1.6 TDI | 77 |       | 03.10 | 04.15       | PR: 1LQ,1LR,1ZG |  |  |  |  |   |  |  |  |  |   |
|  | 1.9 TDI | 77 |       | 07.06 | 04.15       | PR: 1LQ,1LR,1ZG |  |  |  |  |   |  |  |  |  |   |
|  | 1.2     |    |       | 07.06 | 04.15       | PR: 1LN,1ZC     |  |  |  |  |   | 24.0125-0113.1 425113<br>24.0325-0113.1 525113 |  |  |  | 288 25,0 22,0 V L +S +B<br>288 25,0 22,0 V L +S +B PD |
|  | 1.2 TDI | 55 |       | 03.10 | 04.15       | PR: 1LN,1ZC     |  |  |  |  |   |  |  |  |  |   |
|  | 1.2 TSI | 63 |       | 03.10 | 04.15       | PR: 1LN,1ZC     |  |  |  |  |   |  |  |  |  |   |
|  | 1.2 TSI | 77 |       | 03.10 | 04.15       | PR: 1LN,1ZC     |  |  |  |  |   |  |  |  |  |   |
|  | 1.4     | 63 |       | 07.06 | 04.15       | PR: 1LN,1ZC     |  |  |  |  |   |  |  |  |  |   |
| 1.4 TDI  | 51      |    | 07.06 | 04.15 | PR: 1LN,1ZC |                 |  |  |  |  |   |  |  |  |  |   |
| 1.4 TDI  | 59      |    | 07.06 | 04.15 | PR: 1LN,1ZC |                 |  |  |  |  |   |  |  |  |  |   |
| 1.6  | 77      |    | 07.06 | 04.15 | PR: 1LN,1ZC |                 |  |  |  |  |   |  |  |  |  |   |
| 1.6 TDI  | 66      |    | 03.10 | 04.15 | PR: 1LN,1ZC |                 |  |  |  |  |   |  |  |  |  |   |
| 1.6 TDI  | 77      |    | 03.10 | 04.15 | PR: 1LN,1ZC |                 |  |  |  |  |   |  |  |  |  |   |
| 1.9 TDI  | 77      |    | 07.06 | 04.15 | PR: 1LN,1ZC |                 |  |  |  |  |   |  |  |  |  |   |
|    | 1.2     |    |       | 07.06 | 04.15       |                 | 24.0711-5273.3 360303<br>24.0711-5274.3 360304 |  |  |  | Radsensor<br>Radsensor                                |  |  |  |  |   |
|  | 1.2 TDI | 55 |       | 03.10 | 04.15       |                 |  |  |  |  |   |  |  |  |  |   |
|  | 1.2 TSI | 63 |       | 03.10 | 04.15       |                 |  |  |  |  |   |  |  |  |  |   |
|  | 1.2 TSI | 77 |       | 03.10 | 04.15       |                 |  |  |  |  |   |  |  |  |  |   |
|  | 1.4     | 63 |       | 07.06 | 04.15       |                 |  |  |  |  |   |  |  |  |  |   |
|  | 1.4 TDI | 51 |       | 07.06 | 04.15       |                 |  |  |  |  |   |  |  |  |  |   |
|  | 1.4 TDI | 59 |       | 07.06 | 04.15       |                 |  |  |  |  |   |  |  |  |  |   |
|  | 1.6     | 77 |       | 07.06 | 04.15       |                 |  |  |  |  |   |  |  |  |  |   |
|  | 1.6 TDI | 66 |       | 03.10 | 04.15       |                 |  |  |  |  |   |  |  |  |  |   |
|  | 1.6 TDI | 77 |       | 03.10 | 04.15       |                 |  |  |  |  |   |  |  |  |  |   |
| 1.9 TDI  | 77      |    | 07.06 | 04.15 |             |                 |  |  |  |  |   |  |  |  |  |   |
|    | 1.2     |    |       | 07.06 | 04.15       | PR: 1KK         | 13.0460-2894.2 602894<br>13.0470-2894.2 LD2894 |  |  |  | 20961 17,4 /Zub/S TRW<br>20961 17,4 /Zub/S TRW        |  |  |  |  |   |
|  | 1.2 TDI | 55 |       | 03.10 | 04.15       | PR: 1KK         |  |  |  |  |   |  |  |  |  |   |
|  | 1.2 TSI | 63 |       | 03.10 | 04.15       | PR: 1KK         |  |  |  |  |   |  |  |  |  |   |
|  | 1.2 TSI | 77 |       | 03.10 | 04.15       | PR: 1KK         |  |  |  |  |   |  |  |  |  |   |
|  | 1.4     | 63 |       | 07.06 | 04.15       | PR: 1KK         |  |  |  |  |   |  |  |  |  |   |
|  | 1.4 TDI | 51 |       | 07.06 | 04.15       | PR: 1KK         |  |  |  |  |   |  |  |  |  |   |
|  | 1.4 TDI | 59 |       | 07.06 | 04.15       | PR: 1KK         |  |  |  |  |   |  |  |  |  |   |
|  | 1.6     | 77 |       | 07.06 | 04.15       | PR: 1KK         |  |  |  |  |   |  |  |  |  |   |
|  | 1.6 TDI | 66 |       | 03.10 | 04.15       | PR: 1KK         |  |  |  |  |   |  |  |  |  |   |
|  | 1.6 TDI | 77 |       | 03.10 | 04.15       | PR: 1KK         |  |  |  |  |   |  |  |  |  |   |
| 1.9 TDI  | 77      |    | 07.06 | 04.15 | PR: 1KK     |                 |  |  |  |  |   |  |  |  |  |   |
|    | 1.2     |    |       | 07.06 | 04.15       | PR: 1KT         | 13.0460-2820.2 602820<br>13.0470-2820.2 LD2820 |  |  |  | 20961 17,6 /S TRW<br>20961 17,6 /S TRW                |  |  |  |  |   |
|  | 1.2 TDI | 55 |       | 03.10 | 04.15       | PR: 1KT         |  |  |  |  |   |  |  |  |  |   |
|  | 1.2 TSI | 63 |       | 03.10 | 04.15       | PR: 1KT         |  |  |  |  |   |  |  |  |  |   |
|  | 1.2 TSI | 77 |       | 03.10 | 04.15       | PR: 1KT         |  |  |  |  |   |  |  |  |  |   |
|  | 1.4     | 63 |       | 07.06 | 04.15       | PR: 1KT         |  |  |  |  |   |  |  |  |  |   |
|  | 1.4 TDI | 51 |       | 07.06 | 04.15       | PR: 1KT         |  |  |  |  |   |  |  |  |  |   |
|  | 1.4 TDI | 59 |       | 07.06 | 04.15       | PR: 1KT         |  |  |  |  |   |  |  |  |  |   |
|  | 1.6     | 77 |       | 07.06 | 04.15       | PR: 1KT         |  |  |  |  |   |  |  |  |  |   |
|  | 1.6 TDI | 66 |       | 03.10 | 04.15       | PR: 1KT         |  |  |  |  |   |  |  |  |  |   |
|  | 1.6 TDI | 77 |       | 03.10 | 04.15       | PR: 1KT         |  |  |  |  |   |  |  |  |  |   |
| 1.9 TDI  | 77      |    | 07.06 | 04.15 | PR: 1KT     |                 |  |  |  |  |   |  |  |  |  |   |
|    | 1.2     |    |       | 07.06 | 04.15       | PR: 1KK,1KT     | 24.0109-0123.1 409123<br>24.0309-0123.1 509123 |  |  |  | 230 9,0 7,0 +S +B<br>230 9,0 7,0 +S +B PD             |  |  |  |  |   |
|  | 1.2 TDI | 55 |       | 03.10 | 04.15       | PR: 1KK,1KT     |  |  |  |  |   |  |  |  |  |   |
|  | 1.2 TSI | 63 |       | 03.10 | 04.15       | PR: 1KK,1KT     |  |  |  |  |   |  |  |  |  |   |
|  | 1.2 TSI | 77 |       | 03.10 | 04.15       | PR: 1KK,1KT     |  |  |  |  |   |  |  |  |  |   |
|  | 1.4     | 63 |       | 07.06 | 04.15       | PR: 1KK,1KT     |  |  |  |  |   |  |  |  |  |   |
|  | 1.4 TDI | 51 |       | 07.06 | 04.15       | PR: 1KK,1KT     |  |  |  |  |   |  |  |  |  |   |
|  | 1.4 TDI | 59 |       | 07.06 | 04.15       | PR: 1KK,1KT     |  |  |  |  |   |  |  |  |  |   |
|  | 1.6     | 77 |       | 07.06 | 04.15       | PR: 1KK,1KT     |  |  |  |  |   |  |  |  |  |   |
|  | 1.6 TDI | 66 |       | 03.10 | 04.15       | PR: 1KK,1KT     |  |  |  |  |   |  |  |  |  |   |
|  | 1.6 TDI | 77 |       | 03.10 | 04.15       | PR: 1KK,1KT     |  |  |  |  |   |  |  |  |  |   |
| 1.9 TDI  | 77      |    | 07.06 | 04.15 | PR: 1KK,1KT |                 |  |  |  |  |   |  |  |  |  |   |
|    | 1.2     |    |       | 07.06 | 04.15       | PR: 1KC         | 03.0137-0357.2 650357<br>03.0137-9149.2 669149 |  |  |  | 230 x 32 HEB<br>Bremsbacken-Zubehör                   |  |  |  |  |   |
|  | 1.2 TDI | 55 |       | 03.10 | 04.15       | PR: 1KC         |  |  |  |  |   |  |  |  |  |   |
|  | 1.2 TSI | 63 |       | 03.10 | 04.15       | PR: 1KC         |  |  |  |  |   |  |  |  |  |   |
|  | 1.2 TSI | 77 |       | 03.10 | 04.15       | PR: 1KC         |  |  |  |  |   |  |  |  |  |   |
|  | 1.4     | 63 |       | 07.06 | 04.15       | PR: 1KC         |  |  |  |  |   |  |  |  |  |   |
|  | 1.4 TDI | 51 |       | 07.06 | 04.15       | PR: 1KC         |  |  |  |  |   |  |  |  |  |   |
|  | 1.4 TDI | 59 |       | 07.06 | 04.15       | PR: 1KC         |  |  |  |  |   |  |  |  |  |   |
|  | 1.6     | 77 |       | 07.06 | 04.15       | PR: 1KC         |  |  |  |  |   |  |  |  |  |   |
|  | 1.6 TDI | 66 |       | 03.10 | 04.15       | PR: 1KC         |  |  |  |  |   |  |  |  |  |   |
|  | 1.6 TDI | 77 |       | 03.10 | 04.15       | PR: 1KC         |  |  |  |  |   |  |  |  |  |   |
| 1.9 TDI  | 77      |    | 07.06 | 04.15 | PR: 1KC     |                 |  |  |  |  |   |  |  |  |  |   |



**SKODA ROOMSTER (5J) (06-15)**

|  |   |  |  |   |   |   |                                  |                  |  |                                     |          |
|--|---|--|--|---|---|---|----------------------------------|------------------|--|-------------------------------------|----------|
|  | 1.2<br>1.2 TDI<br>1.2 TSI<br>1.2 TSI<br>1.4<br>1.4 TDI<br>1.4 TDI<br>1.6<br>1.6 TDI<br>1.6 TDI<br>1.9 TDI | 55<br>63<br>77<br>63<br>51<br>59<br>77<br>66<br>77 |  | 03.10<br>03.10<br>03.10<br>03.10<br>03.10<br>03.10<br>03.10<br>03.10<br>03.10<br>03.10<br>03.10 | 04.15<br>04.15<br>04.15<br>04.15<br>04.15<br>04.15<br>04.15<br>04.15<br>04.15<br>04.15<br>04.15 | PR: 1KL<br>PR: 1KL<br>PR: 1KL<br>PR: 1KL<br>PR: 1KL<br>PR: 1KL<br>PR: 1KL<br>PR: 1KL<br>PR: 1KL<br>PR: 1KL<br>PR: 1KL | 03.0137-0521.2<br>03.0137-9309.2 | 650521<br>669309 |  | 228 x 33 HEB<br>Bremsbacken-Zubehör | AP<br>AP |
|  | 1.2<br>1.2 TDI<br>1.2 TSI<br>1.2 TSI<br>1.4<br>1.4 TDI<br>1.4 TDI<br>1.6<br>1.6 TDI<br>1.6 TDI<br>1.9 TDI | 55<br>63<br>77<br>63<br>51<br>59<br>77<br>66<br>77 |  | 05.06<br>03.10<br>03.10<br>03.10<br>07.06<br>07.06<br>07.06<br>03.10<br>03.10<br>03.10<br>07.06 | 04.15<br>04.15<br>04.15<br>04.15<br>04.15<br>04.15<br>04.15<br>04.15<br>04.15<br>04.15<br>04.15 | PR: 1KC<br>PR: 1KC<br>PR: 1KC<br>PR: 1KC<br>PR: 1KC<br>PR: 1KC<br>PR: 1KC<br>PR: 1KC<br>PR: 1KC<br>PR: 1KC<br>PR: 1KC | 24.0223-0016.1                   | 480111           |  | 230/231,5 x 39                      |          |
|  | 1.2<br>1.2 TDI<br>1.2 TSI<br>1.2 TSI<br>1.4<br>1.4 TDI<br>1.4 TDI<br>1.6<br>1.6 TDI<br>1.6 TDI<br>1.9 TDI | 55<br>63<br>77<br>63<br>51<br>59<br>77<br>66<br>77 |  | 07.06<br>03.10<br>03.10<br>03.10<br>07.06<br>07.06<br>07.06<br>03.10<br>03.10<br>03.10<br>07.06 | 04.15<br>04.15<br>04.15<br>04.15<br>04.15<br>04.15<br>04.15<br>04.15<br>04.15<br>04.15<br>04.15 | PR: 1KC<br>PR: 1KC<br>PR: 1KC<br>PR: 1KC<br>PR: 1KC<br>PR: 1KC<br>PR: 1KC<br>PR: 1KC<br>PR: 1KC<br>PR: 1KC<br>PR: 1KC | 03.0520-5419.3                   | 695419           |  | 19,05/230x32 TopKit                 |          |

**SKODA SUPERB I (02-08)**

|  |   |   |  |  |  |  |                                  |                  |   |   |            |
|--|---|---|--|--|--|--|----------------------------------|------------------|---|---|------------|
|  | 1.8 i 20V Turbo<br>1.9 TDI<br>1.9 TDI<br>1.9 TDI<br>1.9 TDI<br>2.0 i<br>2.0 TDI<br>2.5 TDI<br>2.5 TDI<br>2.8 i V6 | 110<br>74<br>77<br>85<br>96<br>85<br>103<br>114<br>120<br>142 |  | 12.01<br>08.02<br>10.05<br>01.07<br>12.01<br>12.01<br>10.05<br>12.01<br>06.03<br>12.01 | 02.08<br>12.07<br>12.07<br>12.07<br>02.08<br>12.07<br>12.07<br>12.07<br>12.07<br>12.07 |  | 13.0460-7110.2<br>13.0470-7110.2 | 607110<br>LD7110 |   | 23018 20,3 +/WK<br>23018 20,3 +/WK                    | ATE<br>ATE |
|  | 1.8 i 20V Turbo<br>1.9 TDI<br>1.9 TDI<br>2.0 i  | 110<br>74<br>96<br>85   | 3U-39046708<br>3U-39046708<br>3U-39046708<br>3U-39046708                               | 12.01<br>08.02<br>12.01<br>12.01   |  |  | 24.0125-0105.1<br>24.0325-0105.1 | 425105<br>525105 |   | 288 25,0 23,0 V L +S +B<br>288 25,0 23,0 V L +B PD    |            |
|  | 1.8 i 20V Turbo<br>1.9 TDI<br>1.9 TDI<br>1.9 TDI<br>2.0 i   | 110<br>74<br>77<br>96<br>85                                   | 3U-39046709<br>3U-39046709<br>3U-69101369<br>3U-69101369<br>3U-39046709<br>3U-69101369 |  |  |  | 24.0125-0171.1<br>24.0325-0171.1 | 425171<br>525171 |   | 288 25,0 23,0 V L +B<br>288 25,0 23,0 V L +B PD       |            |
|  | 1.8 i 20V Turbo<br>1.9 TDI<br>1.9 TDI<br>1.9 TDI<br>1.9 TDI<br>2.0 i  | 110<br>74<br>77<br>85<br>96<br>85                             | 3U-69101370<br>3U-69101370<br>3U-69101370<br>3U-69101370<br>3U-69101370<br>3U-69101370 |  | 02.08<br>12.07<br>12.07<br>01.07<br>12.07<br>02.08                                     |  | 24.0125-0145.1<br>24.0325-0145.1 | 425145<br>525145 |   | 288 25,0 22,0 V L +S +B<br>288 25,0 22,0 V L +S +B PD |            |
|  | 2.0 TDI<br>2.5 TDI<br>2.5 TDI   | 103<br>114<br>120   | 3U-39043704<br>3U-39043704<br>3U-39043704  | 10.05<br>12.01<br>06.03  |  |  | 24.0125-0137.1<br>24.0325-0137.1 | 425137<br>525137 |   | 312 25,0 23,0 V L +S +B<br>312 25,0 23,0 V L +B PD    |            |
|  | 2.8 i V6  | 142   | 3U-39043704  | 12.01  |  |  | 24.0125-0137.1<br>24.0325-0137.1 | 425137<br>525137 |   | 312 25,0 23,0 V L +S +B<br>312 25,0 23,0 V L +B PD    |            |
|  | 2.0 TDI<br>2.5 TDI<br>2.5 TDI   | 103<br>114<br>120   | 3U-39043705<br>3U-39043705<br>3U-39043705  | 3U-69100010<br>3U-69100010<br>3U-69100010  |  |  | 24.0125-0172.1<br>24.0325-0172.1 | 425172<br>525172 |   | 312 25,0 23,0 V L +B<br>312 25,0 23,0 V L +B PD       |            |
|  | 2.8 i V6  | 142   | 3U-39043705  | 3U-69100010  |  |  | 24.0125-0172.1                   | 425172           |   | 312 25,0 23,0 V L +B                                  |            |
|  | 2.0 TDI<br>2.5 TDI<br>2.5 TDI<br>2.8 i V6   | 103<br>114<br>120<br>142                                      | 3U-69100011<br>3U-69100011<br>3U-69100011<br>3U-69100011                               |  | 12.07<br>12.07<br>12.07<br>12.07   |  | 24.0125-0158.1<br>24.0325-0158.1 | 425158<br>525158 |   | 312 25,0 22,0 V L +S +B<br>312 25,0 22,0 V L +S +B PD |            |
|  | 1.8 i 20V Turbo<br>1.9 TDI<br>1.9 TDI<br>1.9 TDI<br>1.9 TDI<br>2.0 i<br>2.0 TDI<br>2.5 TDI<br>2.5 TDI<br>2.8 i V6 | 110<br>74<br>77<br>85<br>96<br>85<br>103<br>114<br>120<br>142 |  | 12.01<br>08.02<br>10.05<br>01.07<br>12.01<br>12.01<br>10.05<br>12.01<br>06.03<br>12.01 | 02.08<br>12.07<br>12.07<br>12.07<br>02.08<br>12.07<br>12.07<br>12.07<br>12.07          |  | 24.0710-5014.3                   | 360369           | 2 | Radsensor   |            |

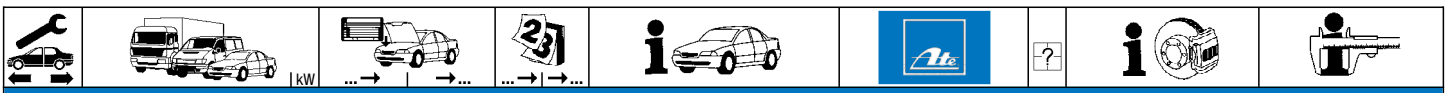

### SKODA SUPERB I (02-08)

|  |                 |     |       |       |  |                |        |  |                    |     |
|--|-----------------|-----|-------|-------|--|----------------|--------|--|--------------------|-----|
|  | 1.8 i 20V Turbo | 110 | 12.01 | 02.08 |  | 13.0460-2820.2 | 602820 |  | 20961 17,6 /S      | TRW |
|  | 1.9 TDI         | 74  | 08.02 | 12.07 |  | 13.0470-2820.2 | LD2820 |  | 20961 17,6 /S      | TRW |
|  | 1.9 TDI         | 77  | 10.05 | 12.07 |  |                |        |  |                    |     |
|  | 1.9 TDI         | 85  | 01.07 | 12.07 |  |                |        |  |                    |     |
|  | 1.9 TDI         | 96  | 12.01 | 12.07 |  |                |        |  |                    |     |
|  | 2.0 i           | 85  | 12.01 | 02.08 |  |                |        |  |                    |     |
|  | 2.0 TDI         | 103 | 10.05 | 12.07 |  |                |        |  |                    |     |
|  | 2.5 TDI         | 114 | 12.01 | 12.07 |  |                |        |  |                    |     |
|  | 2.5 TDI         | 120 | 06.03 | 12.07 |  |                |        |  |                    |     |
|  | 2.8 i V6        | 142 | 12.01 | 12.07 |  |                |        |  |                    |     |
|  | 1.8 i 20V Turbo | 110 | 12.01 | 02.08 |  | 24.0110-0201.1 | 410201 |  | 245 10,0 8,0 +B    |     |
|  | 1.9 TDI         | 74  | 08.02 | 12.07 |  | 24.0310-0201.1 | 510201 |  | 245 10,0 8,0 +B PD |     |
|  | 1.9 TDI         | 77  | 10.05 | 12.07 |  |                |        |  |                    |     |
|  | 1.9 TDI         | 85  | 01.07 | 12.07 |  |                |        |  |                    |     |
|  | 1.9 TDI         | 96  | 12.01 | 12.07 |  |                |        |  |                    |     |
|  | 2.0 i           | 85  | 12.01 | 02.08 |  |                |        |  |                    |     |
|  | 2.0 TDI         | 103 | 10.05 | 12.07 |  |                |        |  |                    |     |
|  | 2.5 TDI         | 114 | 12.01 | 12.07 |  |                |        |  |                    |     |
|  | 2.5 TDI         | 120 | 06.03 | 12.07 |  |                |        |  |                    |     |
|  | 2.8 i V6        | 142 | 12.01 | 12.07 |  |                |        |  |                    |     |

### SKODA SUPERB II (08-15)

|  |                |     |       |       |                 |                |        |  |                            |     |
|--|----------------|-----|-------|-------|-----------------|----------------|--------|--|----------------------------|-----|
|  | 1.4 TSI        | 92  | 08.08 | 02.15 | PR: 1ZE,1LJ,1ZA | 13.0460-7184.2 | 607184 |  | 23587 20,6 +/WK            | ATE |
|  | 1.6 TDI        | 77  | 09.10 | 02.15 | PR: 1ZE,1LJ,1ZA | 13.0470-7184.2 | LD7184 |  | 23587 20,6 +/WK            | ATE |
|  | 1.8 TFSI       |     | 08.08 | 02.15 | PR: 1ZE,1LJ,1ZA |                |        |  |                            |     |
|  | 1.8 TSI 4x4    |     | 10.08 | 02.15 | PR: 1ZE,1LJ,1ZA |                |        |  |                            |     |
|  | 1.9 TDI        | 77  | 08.08 | 02.15 | PR: 1ZE,1LJ,1ZA |                |        |  |                            |     |
|  | 2.0 TDI        | 103 | 08.08 | 02.15 | PR: 1ZE,1LJ,1ZA |                |        |  |                            |     |
|  | 2.0 TDI        | 125 | 08.08 | 02.15 | PR: 1ZE,1LJ,1ZA |                |        |  |                            |     |
|  | 2.0 TDI 4x4    |     | 10.08 | 02.15 | PR: 1ZE,1LJ,1ZA |                |        |  |                            |     |
|  | 2.0 TSI        | 147 | 05.10 | 02.15 | PR: 1ZE,1LJ,1ZA |                |        |  |                            |     |
|  | 3.6 FSI V6 4x4 | 191 | 11.08 | 02.15 | PR: 1ZE,1LJ,1ZA |                |        |  |                            |     |
|  | 1.4 TSI        | 92  | 08.08 | 02.15 | PR: 1LK         | 13.0460-7200.2 | 607200 |  | 23801 20,3 +/WK            | ATE |
|  | 1.6 TDI        | 77  | 09.10 | 02.15 | PR: 1LK         | 13.0470-7200.2 | LD7200 |  | 23801 20,3 +/WK            | ATE |
|  | 1.8 TFSI       |     | 08.08 | 02.15 | PR: 1LK         |                |        |  |                            |     |
|  | 1.8 TSI 4x4    |     | 10.08 | 02.15 | PR: 1LK         |                |        |  |                            |     |
|  | 1.9 TDI        | 77  | 08.08 | 02.15 | PR: 1LK         |                |        |  |                            |     |
|  | 2.0 TDI        | 103 | 08.08 | 02.15 | PR: 1LK         |                |        |  |                            |     |
|  | 2.0 TDI        | 125 | 08.08 | 02.15 | PR: 1LK         |                |        |  |                            |     |
|  | 2.0 TDI 4x4    |     | 10.08 | 02.15 | PR: 1LK         |                |        |  |                            |     |
|  | 2.0 TSI        | 147 | 05.10 | 02.15 | PR: 1LK         |                |        |  |                            |     |
|  | 3.6 FSI V6 4x4 | 191 | 11.08 | 02.15 | PR: 1LK         |                |        |  |                            |     |
|  | 1.4 TSI        | 92  | 08.08 | 02.15 | PR: 1ZE         | 24.0125-0145.1 | 425145 |  | 288 25,0 22,0 V L +S +B    |     |
|  | 1.6 TDI        | 77  | 09.10 | 02.15 | PR: 1ZE         | 24.0325-0145.1 | 525145 |  | 288 25,0 22,0 V L +S +B PD |     |
|  | 1.8 TFSI       |     | 08.08 | 02.15 | PR: 1ZE         |                |        |  |                            |     |
|  | 1.8 TSI 4x4    |     | 10.08 | 02.15 | PR: 1ZE         |                |        |  |                            |     |
|  | 1.9 TDI        | 77  | 08.08 | 02.15 | PR: 1ZE         |                |        |  |                            |     |
|  | 2.0 TDI        | 103 | 08.08 | 02.15 | PR: 1ZE         |                |        |  |                            |     |
|  | 2.0 TDI        | 125 | 08.08 | 02.15 | PR: 1ZE         |                |        |  |                            |     |
|  | 2.0 TDI 4x4    |     | 10.08 | 02.15 | PR: 1ZE         |                |        |  |                            |     |
|  | 2.0 TSI        | 147 | 05.10 | 02.15 | PR: 1ZE         |                |        |  |                            |     |
|  | 3.6 FSI V6 4x4 | 191 | 11.08 | 02.15 | PR: 1ZE         |                |        |  |                            |     |
|  | 1.4 TSI        | 92  | 08.08 | 02.15 | PR: 1LJ,1ZA     | 24.0125-0158.1 | 425158 |  | 312 25,0 22,0 V L +S +B    |     |
|  | 1.6 TDI        | 77  | 09.10 | 02.15 | PR: 1LJ,1ZA     | 24.0325-0158.1 | 525158 |  | 312 25,0 22,0 V L +S +B PD |     |
|  | 1.8 TFSI       |     | 08.08 | 02.15 | PR: 1LJ,1ZA     |                |        |  |                            |     |
|  | 1.8 TSI 4x4    |     | 10.08 | 02.15 | PR: 1LJ,1ZA     |                |        |  |                            |     |
|  | 1.9 TDI        | 77  | 08.08 | 02.15 | PR: 1LJ,1ZA     |                |        |  |                            |     |
|  | 2.0 TDI        | 103 | 08.08 | 02.15 | PR: 1LJ,1ZA     |                |        |  |                            |     |
|  | 2.0 TDI        | 125 | 08.08 | 02.15 | PR: 1LJ,1ZA     |                |        |  |                            |     |
|  | 2.0 TDI 4x4    |     | 10.08 | 02.15 | PR: 1LJ,1ZA     |                |        |  |                            |     |
|  | 2.0 TSI        | 147 | 05.10 | 02.15 | PR: 1LJ,1ZA     |                |        |  |                            |     |
|  | 3.6 FSI V6 4x4 | 191 | 11.08 | 02.15 | PR: 1LJ,1ZA     |                |        |  |                            |     |
|  | 1.4 TSI        | 92  | 08.08 | 02.15 | PR: 1LK         | 24.0130-0115.1 | 430115 |  | 345 30,0 27,0 V L +B       |     |
|  | 1.6 TDI        | 77  | 09.10 | 02.15 | PR: 1LK         | 24.0330-0115.1 | 530115 |  | 345 30,0 27,0 V L +B PD    |     |
|  | 1.8 TFSI       |     | 08.08 | 02.15 | PR: 1LK         |                |        |  |                            |     |
|  | 1.8 TSI 4x4    |     | 10.08 | 02.15 | PR: 1LK         |                |        |  |                            |     |
|  | 1.9 TDI        | 77  | 08.08 | 02.15 | PR: 1LK         |                |        |  |                            |     |
|  | 2.0 TDI        | 103 | 08.08 | 02.15 | PR: 1LK         |                |        |  |                            |     |
|  | 2.0 TDI        | 125 | 08.08 | 02.15 | PR: 1LK         |                |        |  |                            |     |
|  | 2.0 TDI 4x4    |     | 10.08 | 02.15 | PR: 1LK         |                |        |  |                            |     |
|  | 2.0 TSI        | 147 | 05.10 | 02.15 | PR: 1LK         |                |        |  |                            |     |
|  | 3.6 FSI V6 4x4 | 191 | 11.08 | 02.15 | PR: 1LK         |                |        |  |                            |     |
|  | 1.4 TSI        | 92  | 08.08 | 02.15 |                 | 24.0711-5271.3 | 360301 |  | Radsensor                  |     |
|  | 1.6 TDI        | 77  | 09.10 | 02.15 |                 | 24.0711-5272.3 | 360302 |  | Radsensor                  |     |
|  | 1.8 TFSI       |     | 08.08 | 02.15 |                 |                |        |  |                            |     |
|  | 1.8 TSI 4x4    |     | 10.08 | 02.15 |                 |                |        |  |                            |     |
|  | 1.9 TDI        | 77  | 08.08 | 02.15 |                 |                |        |  |                            |     |
|  | 2.0 TDI        | 103 | 08.08 | 02.15 |                 |                |        |  |                            |     |
|  | 2.0 TDI        | 125 | 08.08 | 02.15 |                 |                |        |  |                            |     |
|  | 2.0 TDI 4x4    |     | 10.08 | 02.15 |                 |                |        |  |                            |     |
|  | 2.0 TSI        | 147 | 05.10 | 02.15 |                 |                |        |  |                            |     |
|  | 3.6 FSI V6 4x4 | 191 | 10.08 | 02.15 |                 |                |        |  |                            |     |
|  | 1.4 TSI        | 92  | 08.08 | 02.15 | PR: 1KF,1KJ     | 13.0460-2880.2 | 602880 |  | 23914 17,1 /WE/Zub/S       | TRW |
|  | 1.6 TDI        | 77  | 09.10 | 02.15 | PR: 1KF,1KJ     | 13.0470-2880.2 | LD2880 |  | 23914 17,1 /WE/Zub/S       | TRW |
|  | 1.8 TFSI       |     | 08.08 | 02.15 | PR: 1KF,1KJ     |                |        |  |                            |     |
|  | 1.9 TDI        | 77  | 08.08 | 02.15 | PR: 1KF,1KJ     |                |        |  |                            |     |

























**SKODA SUPERB II (08-15)**















|                |                |       |       |         |                |                |        |                      |                        |     |
|----------------|----------------|-------|-------|---------|----------------|----------------|--------|----------------------|------------------------|-----|
|                | 2.0 TDI        | 103   | 08.08 | 02.15   | PR: 1KF,1KJ    | 13.0460-2880.2 | 602880 |                      | 23914 17,1 /WE/Zub/S   | TRW |
|                | 2.0 TDI        | 125   | 08.08 | 02.15   | PR: 1KF,1KJ    | 13.0470-2880.2 | LD2880 |                      | 23914 17,1 /WE/Zub/S   | TRW |
|                | 2.0 TSI        | 147   | 05.10 | 02.15   | PR: 1KF,1KJ    |                |        |                      |                        |     |
|                | 1.4 TSI        | 92    | 08.08 | 02.15   | PR: 1KS        | 13.0460-3858.2 | 603858 |                      | 24563 17,7 /Zub/S      | BOS |
|                | 1.6 TDI        | 77    | 09.10 | 02.15   | PR: 1KS        | 13.0470-3858.2 | LD3858 |                      | 24563 17,7 /Zub/S      | BOS |
|                | 1.8 TFSI       |       | 08.08 | 02.15   | PR: 1KS        |                |        |                      |                        |     |
|                | 1.8 TSI 4x4    |       | 10.08 | 02.15   | PR: 1KS        |                |        |                      |                        |     |
|                | 1.9 TDI        | 77    | 08.08 | 02.15   | PR: 1KS        |                |        |                      |                        |     |
|                | 2.0 TDI        | 103   | 08.08 | 02.15   | PR: 1KS        |                |        |                      |                        |     |
|                | 2.0 TDI        | 125   | 08.08 | 02.15   | PR: 1KS        |                |        |                      |                        |     |
| 2.0 TDI 4x4    |                | 10.08 | 02.15 | PR: 1KS |                |                |        |                      |                        |     |
| 2.0 TSI        | 147            | 05.10 | 02.15 | PR: 1KS |                |                |        |                      |                        |     |
| 3.6 FSI V6 4x4 | 191            | 10.08 | 02.15 | PR: 1KS |                |                |        |                      |                        |     |
| 1.8 TSI 4x4    |                | 10.08 | 02.15 | PR: 2EA | 13.0460-2880.2 | 602880         |        | 23914 17,1 /WE/Zub/S | TRW                    |     |
| 2.0 TDI 4x4    |                | 10.08 | 02.15 | PR: 2EA | 13.0470-2880.2 | LD2880         |        | 23914 17,1 /WE/Zub/S | TRW                    |     |
| 3.6 FSI V6 4x4 | 191            | 11.08 | 02.15 | PR: 2EA |                |                |        |                      |                        |     |
|                | 1.4 TSI        | 92    | 08.08 | 02.15   | PR: 1KF        | 24.0112-0158.1 | 412158 |                      | 256 12,0 10,0 +S +B    |     |
|                | 1.6 TDI        | 77    | 09.10 | 02.15   | PR: 1KF        | 24.0312-0158.1 | 512158 |                      | 256 12,0 10,0 +B PD    |     |
|                | 1.8 TFSI       |       | 08.08 | 02.15   | PR: 1KF        |                |        |                      |                        |     |
|                | 1.9 TDI        | 77    | 08.08 | 02.15   | PR: 1KF        |                |        |                      |                        |     |
|                | 2.0 TDI        | 103   | 08.08 | 02.15   | PR: 1KF        |                |        |                      |                        |     |
|                | 2.0 TDI        | 125   | 08.08 | 02.15   | PR: 1KF        |                |        |                      |                        |     |
|                | 2.0 TSI        | 147   | 05.10 | 02.15   | PR: 1KF        |                |        |                      |                        |     |
|                | 1.4 TSI        | 92    | 08.08 | 02.15   | PR: 1KJ        | 24.0112-0169.1 | 412169 |                      | 282 12,0 10,0 +S +B    |     |
|                | 1.6 TDI        | 77    | 09.10 | 02.15   | PR: 1KJ        | 24.0312-0169.1 | 512169 |                      | 282 12,0 10,0 +S +B PD |     |
|                | 1.8 TFSI       |       | 08.08 | 02.15   | PR: 1KJ        |                |        |                      |                        |     |
| 1.9 TDI        | 77             | 08.08 | 02.15 | PR: 1KJ |                |                |        |                      |                        |     |
| 2.0 TDI        | 103            | 08.08 | 02.15 | PR: 1KJ |                |                |        |                      |                        |     |
| 2.0 TDI        | 125            | 08.08 | 02.15 | PR: 1KJ |                |                |        |                      |                        |     |
| 2.0 TSI        | 147            | 05.10 | 02.15 | PR: 1KJ |                |                |        |                      |                        |     |
| 1.4 TSI        | 92             | 08.08 | 02.15 | PR: 1KS | 24.0110-0356.1 | 410356         |        | 272 9,7 8,0 +S +B    |                        |     |
| 1.6 TDI        | 77             | 09.10 | 02.15 | PR: 1KS | 24.0310-0356.1 | 510356         |        | 272 9,7 8,0 +S +B PD |                        |     |
| 1.8 TFSI       |                | 08.08 | 02.15 | PR: 1KS |                |                |        |                      |                        |     |
| 1.8 TSI 4x4    |                | 10.08 | 02.15 | PR: 1KS |                |                |        |                      |                        |     |
| 1.9 TDI        | 77             | 08.08 | 02.15 | PR: 1KS |                |                |        |                      |                        |     |
| 2.0 TDI        | 103            | 08.08 | 02.15 | PR: 1KS |                |                |        |                      |                        |     |
| 2.0 TDI        | 125            | 08.08 | 02.15 | PR: 1KS |                |                |        |                      |                        |     |
| 2.0 TDI 4x4    |                | 10.08 | 02.15 | PR: 1KS |                |                |        |                      |                        |     |
| 2.0 TSI        | 147            | 05.10 | 02.15 | PR: 1KS |                |                |        |                      |                        |     |
| 3.6 FSI V6 4x4 | 191            | 11.08 | 02.15 | PR: 1KS |                |                |        |                      |                        |     |
| 1.8 TSI 4x4    |                | 10.08 | 02.15 | PR: 2EA | 24.0122-0219.1 | 422219         |        | 310 22,0 20,0 V L +B |                        |     |
| 2.0 TDI 4x4    |                | 10.08 | 02.15 | PR: 2EA |                |                |        |                      |                        |     |
| 3.6 FSI V6 4x4 | 191            | 11.08 | 02.15 | PR: 2EA |                |                |        |                      |                        |     |
|                | 1.4 TSI        | 92    | 08.08 | 02.15   |                | 24.0711-6231.3 | 360305 |                      | Radsensor              |     |
|                | 1.6 TDI        | 77    | 09.10 | 02.15   |                | 24.0711-6232.3 | 360306 |                      | Radsensor              |     |
|                | 1.8 TFSI       |       | 08.08 | 02.15   |                |                |        |                      |                        |     |
|                | 1.9 TDI        | 77    | 08.08 | 02.15   |                |                |        |                      |                        |     |
|                | 2.0 TDI        | 103   | 08.08 | 02.15   |                |                |        |                      |                        |     |
|                | 2.0 TDI        | 125   | 08.08 | 02.15   |                |                |        |                      |                        |     |
|                | 2.0 TSI        | 147   | 05.10 | 02.15   |                |                |        |                      |                        |     |
|                | 1.8 TSI 4x4    |       | 10.08 | 02.15   |                | 24.0711-5271.3 | 360301 |                      | Radsensor              |     |
|                | 2.0 TDI 4x4    |       | 10.08 | 02.15   |                | 24.0711-5272.3 | 360302 |                      | Radsensor              |     |
|                | 3.6 FSI V6 4x4 | 191   | 11.08 | 02.15   |                |                |        |                      |                        |     |

**SKODA SUPERB II Combi (09-15)**





























|             |             |       |       |                 |                |                |        |                         |                         |     |
|-------------|-------------|-------|-------|-----------------|----------------|----------------|--------|-------------------------|-------------------------|-----|
|             | 1.4 TSI     | 92    | 11.09 | 02.15           | PR: 1LK        | 13.0460-7200.2 | 607200 |                         | 23801 20,3 +/WK         | ATE |
|             | 1.6 TDI     | 77    | 09.10 | 02.15           | PR: 1LK        | 13.0470-7200.2 | LD7200 |                         | 23801 20,3 +/WK         | ATE |
|             | 1.8 TSI     |       | 11.09 | 02.15           | PR: 1LK        |                |        |                         |                         |     |
|             | 1.8 TSI 4x4 |       | 11.09 | 02.15           | PR: 1LK        |                |        |                         |                         |     |
|             | 1.9 TDI     | 77    | 10.09 | 02.15           | PR: 1LK        |                |        |                         |                         |     |
|             | 2.0 TDI     | 103   | 11.09 | 02.15           | PR: 1LK        |                |        |                         |                         |     |
|             | 2.0 TDI     | 125   | 11.09 | 02.15           | PR: 1LK        |                |        |                         |                         |     |
|             | 2.0 TDI 4x4 | 125   | 11.09 | 02.15           | PR: 1LK        |                |        |                         |                         |     |
|             | 2.0 TSI     | 147   | 05.10 | 02.15           | PR: 1LK        |                |        |                         |                         |     |
|             | 3.6 V6 4x4  | 191   | 11.09 | 02.15           | PR: 1LK        |                |        |                         |                         |     |
| 1.4 TSI     | 92          | 11.09 | 02.15 | PR: 1LJ,1ZA,1ZE | 13.0460-7184.2 | 607184         |        | 23587 20,6 +/WK         | ATE                     |     |
| 1.6 TDI     | 77          | 09.10 | 02.15 | PR: 1LJ,1ZA,1ZE | 13.0470-7184.2 | LD7184         |        | 23587 20,6 +/WK         | ATE                     |     |
| 1.8 TSI     |             | 11.09 | 02.15 | PR: 1LJ,1ZA,1ZE |                |                |        |                         |                         |     |
| 1.8 TSI 4x4 |             | 11.09 | 02.15 | PR: 1LJ,1ZA,1ZE |                |                |        |                         |                         |     |
| 1.9 TDI     | 77          | 10.09 | 02.15 | PR: 1LJ,1ZA,1ZE |                |                |        |                         |                         |     |
| 2.0 TDI     | 103         | 11.09 | 02.15 | PR: 1LJ,1ZA,1ZE |                |                |        |                         |                         |     |
| 2.0 TDI     | 125         | 11.09 | 02.15 | PR: 1LJ,1ZA,1ZE |                |                |        |                         |                         |     |
| 2.0 TDI 4x4 | 125         | 11.09 | 02.15 | PR: 1LJ,1ZA,1ZE |                |                |        |                         |                         |     |
| 2.0 TSI     | 147         | 05.10 | 02.15 | PR: 1LJ,1ZA,1ZE |                |                |        |                         |                         |     |
| 3.6 V6 4x4  | 191         | 11.09 | 02.15 | PR: 1LJ,1ZA,1ZE |                |                |        |                         |                         |     |
|             | 1.4 TSI     | 92    | 11.09 | 02.15           | PR: 1LK        | 24.0130-0115.1 | 430115 |                         | 345 30,0 27,0 V L +B    |     |
|             | 1.6 TDI     | 77    | 09.10 | 02.15           | PR: 1LK        | 24.0330-0115.1 | 530115 |                         | 345 30,0 27,0 V L +B PD |     |
|             | 1.8 TSI     |       | 11.09 | 02.15           | PR: 1LK        |                |        |                         |                         |     |
|             | 1.8 TSI 4x4 |       | 11.09 | 02.15           | PR: 1LK        |                |        |                         |                         |     |
|             | 1.9 TDI     | 77    | 10.09 | 02.15           | PR: 1LK        |                |        |                         |                         |     |
|             | 2.0 TDI     | 103   | 11.09 | 02.15           | PR: 1LK        |                |        |                         |                         |     |
|             | 2.0 TDI     | 125   | 11.09 | 02.15           | PR: 1LK        |                |        |                         |                         |     |
|             | 2.0 TDI 4x4 | 125   | 11.09 | 02.15           | PR: 1LK        |                |        |                         |                         |     |
|             | 2.0 TSI     | 147   | 05.10 | 02.15           | PR: 1LK        |                |        |                         |                         |     |
|             | 3.6 V6 4x4  | 191   | 11.09 | 02.15           | PR: 1LK        |                |        |                         |                         |     |
| 1.4 TSI     | 92          | 11.09 | 02.15 | PR: 1ZE         | 24.0125-0145.1 | 425145         |        | 288 25,0 22,0 V L +S +B |                         |     |





























|     |  |  |  |  |  |  |  |  |   |                          |
|--|--|--|--|--|---|--|--|--|---|--------------------------|
| <b>SKODA SUPERB II Combi (09-15)</b>   |  |  |  |  |   |  |  |  |   |                          |
|    | 1.6 TDI  | 77   |  | 09.10  | 02.15   | PR: 1ZE  | 24.0125-0145.1   | 425145   |   | 288 25,0 22,0 V L +S +B  |
|  | 1.8 TSI  |  |  | 11.09  | 02.15   | PR: 1ZE  |  |  |   |                          |
|  | 1.8 TSI 4x4  |  |  | 11.09  | 02.15   | PR: 1ZE  |  |  |   |                          |
|  | 1.9 TDI  | 77   |  | 10.09  | 02.15   | PR: 1ZE  |  |  |   |                          |
|  | 2.0 TDI  | 103  |  | 11.09  | 02.15   | PR: 1ZE  |  |  |   |                          |
|  | 2.0 TDI  | 125  |  | 11.09  | 02.15   | PR: 1ZE  |  |  |   |                          |
|  | 2.0 TDI 4x4  | 125  |  | 11.09  | 02.15   | PR: 1ZE  |  |  |   |                          |
|  | 2.0 TSI  | 147  |  | 05.10  | 02.15   | PR: 1ZE  |  |  |   |                          |
|  | 3.6 V6 4x4   | 191  |  | 11.09  | 02.15   | PR: 1ZE  |  |  |   |                          |
|  | 1.4 TSI  | 92   |  | 11.09  | 02.15   | PR: 1LJ,1ZA  | 24.0125-0158.1   | 425158   |   | 312 25,0 22,0 V L +S +B  |
| 1.6 TDI  | 77   |  | 09.10  | 02.15  | PR: 1LJ,1ZA   | 24.0325-0158.1   | 525158   |  | 312 25,0 22,0 V L +S +B PD  |                          |
| 1.8 TSI  |  |  | 11.09  | 02.15  | PR: 1LJ,1ZA   |  |  |  |   |                          |
| 1.8 TSI 4x4  |  |  | 11.09  | 02.15  | PR: 1LJ,1ZA   |  |  |  |   |                          |
| 1.9 TDI  | 77   |  | 10.09  | 02.15  | PR: 1LJ,1ZA   |  |  |  |   |                          |
| 2.0 TDI  | 103  |  | 11.09  | 02.15  | PR: 1LJ,1ZA   |  |  |  |   |                          |
| 2.0 TDI  | 125  |  | 11.09  | 02.15  | PR: 1LJ,1ZA   |  |  |  |   |                          |
| 2.0 TDI 4x4  | 125  |  | 11.09  | 02.15  | PR: 1LJ,1ZA   |  |  |  |   |                          |
| 2.0 TSI  | 147  |  | 05.10  | 02.15  | PR: 1LJ,1ZA   |  |  |  |   |                          |
| 3.6 V6 4x4   | 191  |  | 11.09  | 02.15  | PR: 1LJ,1ZA   |  |  |  |   |                          |
|    | 1.4 TSI  | 92   |  | 11.09  | 02.15   |  | 24.0711-5271.3   | 360301   |    | Radsensor                |
|  | 1.6 TDI  | 77   |  | 09.10  | 02.15   |  | 24.0711-5272.3   | 360302   |    | Radsensor                |
|  | 1.8 TSI  |  |  | 11.09  | 02.15   |  |  |  |   |                          |
|  | 1.8 TSI 4x4  |  |  | 11.09  | 02.15   |  |  |  |   |                          |
|  | 1.9 TDI  | 77   |  | 10.09  | 02.15   |  |  |  |   |                          |
|  | 2.0 TDI  | 103  |  | 11.09  | 02.15   |  |  |  |   |                          |
|  | 2.0 TDI  | 125  |  | 11.09  | 02.15   |  |  |  |   |                          |
|  | 2.0 TDI 4x4  | 125  |  | 11.09  | 02.15   |  |  |  |   |                          |
|  | 2.0 TSI  | 147  |  | 05.10  | 02.15   |  |  |  |   |                          |
|  | 3.6 V6 4x4   | 191  |  | 11.09  | 02.15   |  |  |  |   |                          |
|    | 1.4 TSI  | 92   |  | 11.09  | 02.15   | PR: 1KF,1KJ  | 13.0460-2880.2   | 602880   |   | 23914 17,1 /WE/Zub/S TRW |
|  | 1.6 TDI  | 77   |  | 09.10  | 02.15   | PR: 1KF,1KJ  | 13.0470-2880.2   | LD2880   |   | 23914 17,1 /WE/Zub/S TRW |
|  | 1.8 TSI  |  |  | 11.09  | 02.15   | PR: 1KF,1KJ  |  |  |   |                          |
|  | 1.9 TDI  | 77   |  | 10.09  | 02.15   | PR: 1KF,1KJ  |  |  |   |                          |
|  | 2.0 TDI  | 103  |  | 11.09  | 02.15   | PR: 1KF,1KJ  |  |  |   |                          |
|  | 2.0 TDI  | 125  |  | 11.09  | 02.15   | PR: 1KF,1KJ  |  |  |   |                          |
|  | 2.0 TDI 4x4  | 125  |  | 11.09  | 02.15   | PR: 1KF,1KJ  |  |  |   |                          |
|  | 2.0 TSI  | 147  |  | 05.10  | 02.15   | PR: 1KF,1KJ  |  |  |   |                          |
|  | 1.4 TSI  | 92   |  | 11.09  | 02.15   | PR: 1KS  | 13.0460-3858.2   | 603858   |   | 24563 17,7 /Zub/S BOS    |
|  | 1.6 TDI  | 77   |  | 09.10  | 02.15   | PR: 1KS  | 13.0470-3858.2   | LD3858   |   | 24563 17,7 /Zub/S BOS    |
| 1.8 TSI  |  |  | 11.09  | 02.15  | PR: 1KS   |  |  |  |   |                          |
| 1.8 TSI 4x4  |  |  | 11.09  | 02.15  | PR: 1KS   |  |  |  |   |                          |
| 1.9 TDI  | 77   |  | 10.09  | 02.15  | PR: 1KS   |  |  |  |   |                          |
| 2.0 TDI  | 103  |  | 11.09  | 02.15  | PR: 1KS   |  |  |  |   |                          |
| 2.0 TDI  | 125  |  | 11.09  | 02.15  | PR: 1KS   |  |  |  |   |                          |
| 2.0 TDI 4x4  | 125  |  | 11.09  | 02.15  | PR: 1KS   |  |  |  |   |                          |
| 2.0 TSI  | 147  |  | 05.10  | 02.15  | PR: 1KS   |  |  |  |   |                          |
| 3.6 V6 4x4   | 191  |  | 11.09  | 02.15  | PR: 1KS   |  |  |  |   |                          |
| 1.8 TSI 4x4  | 125  |  | 11.09  | 02.15  | PR: 2EA   | 13.0460-2880.2   | 602880   |  | 23914 17,1 /WE/Zub/S TRW  |                          |
| 2.0 TDI 4x4  | 125  |  | 11.09  | 02.15  | PR: 2EA   | 13.0470-2880.2   | LD2880   |  | 23914 17,1 /WE/Zub/S TRW  |                          |
| 3.6 V6 4x4   | 191  |  | 11.09  | 02.15  | PR: 2EA   |  |  |  |   |                          |
|  | 1.4 TSI  | 92   |  | 11.09  | 02.15   | PR: 1KF  | 24.0112-0158.1   | 412158   |   | 256 12,0 10,0 +S +B      |
|  | 1.6 TDI  | 77   |  | 09.10  | 02.15   | PR: 1KF  | 24.0312-0158.1   | 512158   |   | 256 12,0 10,0 +B PD      |
|  | 1.8 TSI  |  |  | 11.09  | 02.15   | PR: 1KF  |  |  |   |                          |
|  | 1.9 TDI  | 77   |  | 10.09  | 02.15   | PR: 1KF  |  |  |   |                          |
|  | 2.0 TDI  | 103  |  | 11.09  | 02.15   | PR: 1KF  |  |  |   |                          |
|  | 2.0 TDI  | 125  |  | 11.09  | 02.15   | PR: 1KF  |  |  |   |                          |
|  | 2.0 TSI  | 147  |  | 05.10  | 02.15   | PR: 1KF  |  |  |   |                          |
|  | 1.4 TSI  | 92   |  | 11.09  | 02.15   | PR: 1KJ  | 24.0112-0169.1   | 412169   |   | 282 12,0 10,0 +S +B      |
|  | 1.6 TDI  | 77   |  | 09.10  | 02.15   | PR: 1KJ  | 24.0312-0169.1   | 512169   |   | 282 12,0 10,0 +S +B PD   |
|  | 1.8 TSI  |  |  | 11.09  | 02.15   | PR: 1KJ  |  |  |   |                          |
| 1.9 TDI  | 77   |  | 10.09  | 02.15  | PR: 1KJ   |  |  |  |   |                          |
| 2.0 TDI  | 103  |  | 11.09  | 02.15  | PR: 1KJ   |  |  |  |   |                          |
| 2.0 TDI  | 125  |  | 11.09  | 02.15  | PR: 1KJ   |  |  |  |   |                          |
| 2.0 TSI  | 147  |  | 05.10  | 02.15  | PR: 1KJ   |  |  |  |   |                          |
| 1.4 TSI  | 92   |  | 11.09  | 02.15  | PR: 1KS   | 24.0110-0356.1   | 410356   |  | 272 9,7 8,0 +S +B   |                          |
| 1.6 TDI  | 77   |  | 09.10  | 02.15  | PR: 1KS   | 24.0310-0356.1   | 510356   |  | 272 9,7 8,0 +S +B PD  |                          |
| 1.8 TSI  |  |  | 11.09  | 02.15  | PR: 1KS   |  |  |  |   |                          |
| 1.8 TSI 4x4  |  |  | 11.09  | 02.15  | PR: 1KS   |  |  |  |   |                          |
| 1.9 TDI  | 77   |  | 10.09  | 02.15  | PR: 1KS   |  |  |  |   |                          |
| 2.0 TDI  | 103  |  | 11.09  | 02.15  | PR: 1KS   |  |  |  |   |                          |
| 2.0 TDI  | 125  |  | 11.09  | 02.15  | PR: 1KS   |  |  |  |   |                          |
| 2.0 TDI 4x4  | 125  |  | 11.09  | 02.15  | PR: 1KS   |  |  |  |   |                          |
| 2.0 TSI  | 147  |  | 05.10  | 02.15  | PR: 1KS   |  |  |  |   |                          |
| 3.6 V6 4x4   | 191  |  | 11.09  | 02.15  | PR: 1KS   |  |  |  |   |                          |
| 1.8 TSI 4x4  | 125  |  | 11.09  | 02.15  | PR: 2EA   | 24.0122-0219.1   | 422219   |  | 310 22,0 20,0 V L +B  |                          |
| 2.0 TDI 4x4  | 125  |  | 11.09  | 02.15  | PR: 2EA   |  |  |  |   |                          |
| 3.6 V6 4x4   | 191  |  | 11.09  | 02.15  | PR: 2EA   |  |  |  |   |                          |
|  | 1.4 TSI  | 92   |  | 11.09  | 02.15   |  | 24.0711-6231.3   | 360305   |  | Radsensor                |
|  | 1.6 TDI  | 77   |  | 09.10  | 02.15   |  | 24.0711-6232.3   | 360306   |  | Radsensor                |
|  | 1.8 TSI  |  |  | 11.09  | 02.15   |  |  |  |   |                          |
|  | 1.9 TDI  | 77   |  | 10.09  | 02.15   |  |  |  |   |                          |
|  | 2.0 TDI  | 103  |  | 11.09  | 02.15   |  |  |  |   |                          |
|  | 2.0 TDI  | 125  |  | 11.09  | 02.15   |  |  |  |   |                          |
|  | 2.0 TSI  | 147  |  | 05.10  | 02.15   |  |  |  |   |                          |
|  | 1.8 TSI 4x4  | 125  |  | 11.09  | 02.15   |  | 24.0711-5271.3   | 360301   |  | Radsensor                |
|  | 2.0 TDI 4x4  | 125  |  | 11.09  | 02.15   |  | 24.0711-5272.3   | 360302   |  | Radsensor                |
|  | 3.6 V6 4x4   | 191  |  | 11.09  | 02.15   |  |  |  |   |                          |

|     |    |  |  |  |  |  |  |  |   |                     |   |  |  |
|--|--|--|--|--|---|--|--|--|---|---------------------|---|--|--|
| <b>SKODA SUPERB III (15-)</b>  |  |  |  |  |   |  |  |  |   |                     |   |  |  |
|    | 1.4 TSI  | 92   | 03.15  | PR: 1ZA  | 13.0460-2785.2  | 602785   | 1  | 25683 20,4 +/WK/S<br>25683 20,4 +/WK/S<br>Warnkontakt L=172mm                      | TRW<br>TRW                                |                     |   |  |  |
|  | 1.4 TSI  | 110  | 03.15  | PR: 1ZA  | 13.0470-2785.2  | LD2785   |  |  |   |                     |   |  |  |
|  | 1.4 TSI 4x4  | 110  | 03.15  | PR: 1ZA  | 24.8190-0065.2  | 620065   |  |  |   |                     |   |  |  |
|  | 1.6 TDI  | 88   | 03.15  | PR: 1ZA  |   |  |  |  |   |                     |   |  |  |
|  | 1.8 TSI  | 132  | 03.15  | PR: 1ZA  |   |  |  |  |   |                     |   |  |  |
|  | 2.0 TDI  | 110  | 03.15  | PR: 1ZA  |   |  |  |  |   |                     |   |  |  |
|  | 2.0 TDI  | 140  | 03.15  | PR: 1ZA  |   |  |  |  |   |                     |   |  |  |
|  | 2.0 TDI 4x4  | 110  | 03.15  | PR: 1ZA  |   |  |  |  |   |                     |   |  |  |
|  | 2.0 TDI 4x4  | 140  | 03.15  | PR: 1ZA  |   |  |  |  |   |                     |   |  |  |
|  | 2.0 TSI  | 162  | 03.15  | PR: 1ZA  |   |  |  |  |   |                     |   |  |  |
|  | 2.0 TSI 4x4  | 206  | 03.15  | PR: 1ZA  |   |  |  |  |   |                     |   |  |  |
|  | 1.4 TSI  | 92   | 03.15  | PR: 1LA  | 13.0460-2764.2  | 602764   |  |  |   | 1                   | 24738 20,0 +/WK/S<br>24738 20,0 +/WK/S<br>Warnkontakt L=172mm | TRW<br>TRW   |  |
|  | 1.4 TSI  | 110  | 03.15  | PR: 1LA  | 13.0470-2764.2  | LD2764   |  |  |   |                     |   |  |  |
|  | 1.4 TSI 4x4  | 110  | 03.15  | PR: 1LA  | 24.8190-0065.2  | 620065   |  |  |   |                     |   |  |  |
|  | 1.6 TDI  | 88   | 03.15  | PR: 1LA  |   |  |  |  |   |                     |   |  |  |
|  | 1.8 TSI  | 132  | 03.15  | PR: 1LA  |   |  |  |  |   |                     |   |  |  |
|  | 2.0 TDI  | 110  | 03.15  | PR: 1LA  |   |  |  |  |   |                     |   |  |  |
|  | 2.0 TDI  | 140  | 03.15  | PR: 1LA  |   |  |  |  |   |                     |   |  |  |
| 2.0 TDI 4x4  | 110  | 03.15  | PR: 1LA  |  |   |  |  |  |   |                     |   |  |  |
| 2.0 TDI 4x4  | 140  | 03.15  | PR: 1LA  |  |   |  |  |  |   |                     |   |  |  |
| 2.0 TSI  | 162  | 03.15  | PR: 1LA  |  |   |  |  |  |   |                     |   |  |  |
| 2.0 TSI 4x4  | 206  | 03.15  | PR: 1LA  |  |   |  |  |  |   |                     |   |  |  |
|    | 1.4 TSI  | 92   | 03.15  | PR: 1ZA  | 24.0125-0158.1  | 425158   |  | 312 25,0 22,0 V L +S +B  |   |                     |   |  |  |
|  | 1.4 TSI  | 110  | 03.15  | PR: 1ZA  |   |  |  |  |   |                     |   |  |  |
|  | 1.4 TSI 4x4  | 110  | 03.15  | PR: 1ZA  |   |  |  |  |   |                     |   |  |  |
|  | 1.6 TDI  | 88   | 03.15  | PR: 1ZA  |   |  |  |  |   |                     |   |  |  |
|  | 1.8 TSI  | 132  | 03.15  | PR: 1ZA  |   |  |  |  |   |                     |   |  |  |
|  | 2.0 TDI  | 110  | 03.15  | PR: 1ZA  |   |  |  |  |   |                     |   |  |  |
|  | 2.0 TDI  | 140  | 03.15  | PR: 1ZA  |   |  |  |  |   |                     |   |  |  |
|  | 2.0 TDI 4x4  | 110  | 03.15  | PR: 1ZA  |   |  |  |  |   |                     |   |  |  |
|  | 2.0 TDI 4x4  | 140  | 03.15  | PR: 1ZA  |   |  |  |  |   |                     |   |  |  |
|  | 2.0 TSI  | 162  | 03.15  | PR: 1ZA  |   |  |  |  |   |                     |   |  |  |
|  | 2.0 TSI 4x4  | 206  | 03.15  | PR: 1ZA  |   |  |  |  |   |                     |   |  |  |
|  | 1.4 TSI  | 92   | 03.15  | PR: 1LA  | 24.0130-0225.1  | 430225   |  |  |   |                     | 340 30,0 27,0 V L +S +B                                       |  |  |
|  | 1.4 TSI  | 110  | 03.15  | PR: 1LA  |   |  |  |  |   |                     |   |  |  |
|  | 1.4 TSI 4x4  | 110  | 03.15  | PR: 1LA  |   |  |  |  |   |                     |   |  |  |
|  | 1.6 TDI  | 88   | 03.15  | PR: 1LA  |   |  |  |  |   |                     |   |  |  |
|  | 1.8 TSI  | 132  | 03.15  | PR: 1LA  |   |  |  |  |   |                     |   |  |  |
|  | 2.0 TDI  | 110  | 03.15  | PR: 1LA  |   |  |  |  |   |                     |   |  |  |
|  | 2.0 TDI  | 140  | 03.15  | PR: 1LA  |   |  |  |  |   |                     |   |  |  |
| 2.0 TDI 4x4  | 110  | 03.15  | PR: 1LA  |  |   |  |  |  |   |                     |   |  |  |
| 2.0 TDI 4x4  | 140  | 03.15  | PR: 1LA  |  |   |  |  |  |   |                     |   |  |  |
| 2.0 TSI  | 162  | 03.15  | PR: 1LA  |  |   |  |  |  |   |                     |   |  |  |
| 2.0 TSI 4x4  | 206  | 03.15  | PR: 1LA  |  |   |  |  |  |   |                     |   |  |  |
|  | 1.4 TSI  | 92   | 03.15  |  | 24.0711-5273.3  | 360303   |  | Radsensor<br>Radsensor   |   |                     |   |  |  |
|  | 1.4 TSI  | 110  | 03.15  |  | 24.0711-5274.3  | 360304   |  |  |   |                     |   |  |  |
|  | 1.4 TSI 4x4  | 110  | 03.15  |  |   |  |  |  |   |                     |   |  |  |
|  | 1.6 TDI  | 88   | 03.15  |  |   |  |  |  |   |                     |   |  |  |
|  | 1.8 TSI  | 132  | 03.15  |  |   |  |  |  |   |                     |   |  |  |
|  | 2.0 TDI  | 110  | 03.15  |  |   |  |  |  |   |                     |   |  |  |
|  | 2.0 TDI  | 140  | 03.15  |  |   |  |  |  |   |                     |   |  |  |
|  | 2.0 TDI 4x4  | 110  | 03.15  |  |   |  |  |  |   |                     |   |  |  |
|  | 2.0 TDI 4x4  | 140  | 03.15  |  |   |  |  |  |   |                     |   |  |  |
|  | 2.0 TSI  | 162  | 03.15  |  |   |  |  |  |   |                     |   |  |  |
|  | 2.0 TSI 4x4  | 206  | 03.15  |  |   |  |  |  |   |                     |   |  |  |
|  |  | 1.4 TSI  | 92   | 03.15  | PR: 1KU,1KZ   | 13.0460-7294.2   |  |  |   | 607294              |   | elektrische Feststellbremse <sup>1)</sup><br>elektrische Feststellbremse <sup>1)</sup> | 25009 16,4 +<br>25009 16,4 +<br>ATE<br>ATE |
|  |  | 1.4 TSI  | 110  | 03.15  | PR: 1KU,1KZ   | 13.0470-7294.2   |  |  |   | LD7294              |   |  |  |
|  |  | 1.4 TSI 4x4  | 110  | 03.15  | PR: 1KU,1KZ   |  |  |  |   |                     |   |  |  |
|  |  | 1.6 TDI  | 88   | 03.15  | PR: 1KU,1KZ   |  |  |  |   |                     |   |  |  |
|  |  | 1.8 TSI  | 132  | 03.15  | PR: 1KU,1KZ   |  |  |  |   |                     |   |  |  |
|  |  | 2.0 TDI  | 110  | 03.15  | PR: 1KU,1KZ   |  |  |  |   |                     |   |  |  |
|  |  | 2.0 TDI  | 140  | 03.15  | PR: 1KU,1KZ   |  |  |  |   |                     |   |  |  |
| 2.0 TDI 4x4  |  | 110  | 03.15  | PR: 1KU,1KZ  |   |  |  |  |   |                     |   |  |  |
| 2.0 TDI 4x4  |  | 140  | 03.15  | PR: 1KU,1KZ  |   |  |  |  |   |                     |   |  |  |
| 2.0 TSI  |  | 162  | 03.15  | PR: 1KU,1KZ  |   |  |  |  |   |                     |   |  |  |
| 2.0 TSI 4x4  |  | 206  | 03.15  | PR: 1KU,1KZ  |   |  |  |  |   |                     |   |  |  |
|  |  | 1.4 TSI  | 92   | 03.15  | PR: 1KU   | 24.0112-0210.1   | 412210   |  | elektrische Feststellbremse <sup>1)</sup> | 300 12,0 10,0 +S +B |   |  |  |
|  |  | 1.4 TSI  | 110  | 03.15  | PR: 1KU   |  |  |  |   |                     |   |  |  |
|  |  | 1.4 TSI 4x4  | 110  | 03.15  | PR: 1KU   |  |  |  |   |                     |   |  |  |
|  |  | 1.6 TDI  | 88   | 03.15  | PR: 1KU   |  |  |  |   |                     |   |  |  |
|  |  | 1.8 TSI  | 132  | 03.15  | PR: 1KU   |  |  |  |   |                     |   |  |  |
|  |  | 2.0 TDI  | 110  | 03.15  | PR: 1KU   |  |  |  |   |                     |   |  |  |
|  |  | 2.0 TDI  | 140  | 03.15  | PR: 1KU   |  |  |  |   |                     |   |  |  |
|  | 2.0 TDI 4x4  | 110  | 03.15  | PR: 1KU  |   |  |  |  |   |                     |   |  |  |
|  | 2.0 TDI 4x4  | 140  | 03.15  | PR: 1KU  |   |  |  |  |   |                     |   |  |  |
|  | 2.0 TSI  | 162  | 03.15  | PR: 1KU  |   |  |  |  |   |                     |   |  |  |
|  | 2.0 TSI 4x4  | 206  | 03.15  | PR: 1KU  |   |  |  |  |   |                     |   |  |  |
|  | 1.4 TSI  | 92   | 03.15  | PR: 1KZ  | 24.0122-0219.1  | 422219   |  |  |   |                     | elektrische Feststellbremse <sup>1)</sup>                     | 310 22,0 20,0 V L +B   |  |
|  | 1.4 TSI  | 110  | 03.15  | PR: 1KZ  |   |  |  |  |   |                     |   |  |  |
|  | 1.4 TSI 4x4  | 110  | 03.15  | PR: 1KZ  |   |  |  |  |   |                     |   |  |  |
|  | 1.6 TDI  | 88   | 03.15  | PR: 1KZ  |   |  |  |  |   |                     |   |  |  |
|  | 1.8 TSI  | 132  | 03.15  | PR: 1KZ  |   |  |  |  |   |                     |   |  |  |
|  | 2.0 TDI  | 110  | 03.15  | PR: 1KZ  |   |  |  |  |   |                     |   |  |  |
|  | 2.0 TDI  | 140  | 03.15  | PR: 1KZ  |   |  |  |  |   |                     |   |  |  |
| 2.0 TDI 4x4  | 110  | 03.15  | PR: 1KZ  |  |   |  |  |  |   |                     |   |  |  |
| 2.0 TDI 4x4  | 140  | 03.15  | PR: 1KZ  |  |   |  |  |  |   |                     |   |  |  |
| 2.0 TSI  | 162  | 03.15  | PR: 1KZ  |  |   |  |  |  |   |                     |   |  |  |
| 2.0 TSI 4x4  | 206  | 03.15  | PR: 1KZ  |  |   |  |  |  |   |                     |   |  |  |

<sup>1)</sup> electric parking brake / fr.di stazionamento elettrico / frein à main électrique / freno de mano eléctrico

|     |   |  |                 |                                       |  |  |    |  |
|--|---|--|---|---|---|--|--|--|
| <b>SKODA SUPERB III (15-)</b>  |   |  |   |   |   |  |  |  |
|    | 2.0 TSI<br>2.0 TSI 4x4  | 162<br>206   | 03.15<br>03.15  | PR: 1KZ<br>PR: 1KZ  | 24.0122-0219.1<br>422219  |  | elektrische Feststellbremse <sup>1)</sup>  | 310 22,0 20,0 VL +B  |
|    | 1.4 TSI<br>1.4 TSI<br>1.6 TDI<br>1.8 TSI<br>2.0 TDI<br>2.0 TDI<br>2.0 TSI   | 92<br>110<br>88<br>132<br>110<br>140<br>162                                      | 03.15<br>03.15<br>03.15<br>03.15<br>03.15<br>03.15<br>03.15                                     |   | 24.0711-6230.3<br>24.0711-6337.3  | 360310<br>360390   | 2  - Geschwindigkeitsregelanlage <sup>2)</sup><br>2  + Geschwindigkeitsregelanlage <sup>3)</sup>   | Radsensor<br>Radsensor   |
|  | 1.4 TSI<br>1.4 TSI<br>1.6 TDI<br>1.8 TSI<br>2.0 TDI<br>2.0 TDI<br>2.0 TSI   | 92<br>110<br>88<br>132<br>110<br>140<br>162                                      | 03.15<br>03.15<br>03.15<br>03.15<br>03.15<br>03.15<br>03.15                                     |   | 24.0711-6230.3<br>24.0711-6337.3  | 360310<br>360390   | 2  - Parkassistent <sup>4)</sup><br>2  + Parkassistent <sup>5)</sup>   | Radsensor<br>Radsensor   |
|  | 1.4 TSI 4x4<br>2.0 TDI 4x4<br>2.0 TDI 4x4<br>2.0 TSI 4x4  | 110<br>110<br>140<br>206   | 03.15<br>03.15<br>03.15<br>03.15  |   | 24.0711-5271.3<br>24.0711-5272.3<br>24.0711-5401.3<br>24.0711-5402.3              | 360301<br>360302<br>360330<br>360331   |  - Geschwindigkeitsregelanlage <sup>2)</sup><br> - Geschwindigkeitsregelanlage <sup>2)</sup><br> + Geschwindigkeitsregelanlage <sup>3)</sup><br> + Geschwindigkeitsregelanlage <sup>3)</sup> | Radsensor<br>Radsensor<br>Radsensor<br>Radsensor                                   |
|  | 1.4 TSI 4x4<br>2.0 TDI 4x4<br>2.0 TDI 4x4<br>2.0 TSI 4x4  | 110<br>110<br>140<br>206   | 03.15<br>03.15<br>03.15<br>03.15  |   | 24.0711-5271.3<br>24.0711-5272.3<br>24.0711-5401.3<br>24.0711-5402.3              | 360301<br>360302<br>360330<br>360331   |  - Parkassistent <sup>4)</sup><br> - Parkassistent <sup>4)</sup><br> + Parkassistent <sup>5)</sup><br> + Parkassistent <sup>5)</sup>   | Radsensor<br>Radsensor<br>Radsensor<br>Radsensor                                   |
| <b>SKODA SUPERB III Combi (15-)</b>  |   |  |   |   |   |  |  |  |
|    | 1.4 TSI<br>1.4 TSI<br>1.4 TSI 4x4<br>1.6 TDI<br>1.8 TSI<br>2.0 TDI<br>2.0 TDI<br>2.0 TDI 4x4<br>2.0 TDI 4x4<br>2.0 TSI<br>2.0 TSI 4x4 | 92<br>110<br>110<br>88<br>132<br>110<br>140<br>110<br>140<br>162<br>206          | 03.15<br>03.15<br>03.15<br>03.15<br>03.15<br>03.15<br>03.15<br>03.15<br>03.15<br>03.15<br>03.15 | PR: 1ZA<br>PR: 1ZA<br>PR: 1ZA<br>PR: 1ZA<br>PR: 1ZA<br>PR: 1ZA<br>PR: 1ZA<br>PR: 1ZA<br>PR: 1ZA<br>PR: 1ZA<br>PR: 1ZA | 13.0460-2785.2<br>13.0470-2785.2<br>24.8190-0065.2                                | 602785<br>LD2785<br>620065   |  | 25683 20,4 +/WK/S TRW<br>25683 20,4 +/WK/S TRW<br>Warnkontakt L=172mm              |
|  | 1.4 TSI<br>1.4 TSI<br>1.4 TSI 4x4<br>1.6 TDI<br>1.8 TSI<br>2.0 TDI<br>2.0 TDI<br>2.0 TDI 4x4<br>2.0 TDI 4x4<br>2.0 TSI<br>2.0 TSI 4x4 | 92<br>110<br>110<br>88<br>132<br>110<br>140<br>110<br>140<br>162<br>206          | 03.15<br>03.15<br>03.15<br>03.15<br>03.15<br>03.15<br>03.15<br>03.15<br>03.15<br>03.15<br>03.15 | PR: 1LA<br>PR: 1LA<br>PR: 1LA<br>PR: 1LA<br>PR: 1LA<br>PR: 1LA<br>PR: 1LA<br>PR: 1LA<br>PR: 1LA<br>PR: 1LA<br>PR: 1LA | 13.0460-2764.2<br>13.0470-2764.2<br>24.8190-0065.2                                | 602764<br>LD2764<br>620065   |  | 24738 20,0 +/WK/S TRW<br>24738 20,0 +/WK/S TRW<br>Warnkontakt L=172mm              |
|  | 1.4 TSI<br>1.4 TSI<br>1.4 TSI 4x4<br>1.6 TDI<br>1.8 TSI<br>2.0 TDI<br>2.0 TDI<br>2.0 TDI 4x4<br>2.0 TDI 4x4<br>2.0 TSI<br>2.0 TSI 4x4 | 92<br>110<br>110<br>88<br>132<br>110<br>140<br>110<br>140<br>162<br>206          | 03.15<br>03.15<br>03.15<br>03.15<br>03.15<br>03.15<br>03.15<br>03.15<br>03.15<br>03.15<br>03.15 | PR: 1ZA<br>PR: 1ZA<br>PR: 1ZA<br>PR: 1ZA<br>PR: 1ZA<br>PR: 1ZA<br>PR: 1ZA<br>PR: 1ZA<br>PR: 1ZA<br>PR: 1ZA<br>PR: 1ZA | 24.0125-0158.1<br>24.0325-0158.1  | 425158<br>525158   |  | 312 25,0 22,0 VL +S +B<br>312 25,0 22,0 VL +S +B PD                                |
|  | 1.4 TSI<br>1.4 TSI<br>1.4 TSI 4x4<br>1.6 TDI<br>1.8 TSI<br>2.0 TDI<br>2.0 TDI<br>2.0 TDI 4x4<br>2.0 TDI 4x4<br>2.0 TSI<br>2.0 TSI 4x4 | 92<br>110<br>110<br>88<br>132<br>110<br>140<br>110<br>140<br>162<br>206          | 03.15<br>03.15<br>03.15<br>03.15<br>03.15<br>03.15<br>03.15<br>03.15<br>03.15<br>03.15<br>03.15 | PR: 1LA<br>PR: 1LA<br>PR: 1LA<br>PR: 1LA<br>PR: 1LA<br>PR: 1LA<br>PR: 1LA<br>PR: 1LA<br>PR: 1LA<br>PR: 1LA<br>PR: 1LA | 24.0130-0225.1  | 430225   |  | 340 30,0 27,0 VL +S +B   |
|  | 1.4 TSI<br>1.4 TSI<br>1.4 TSI 4x4<br>1.6 TDI<br>1.8 TSI<br>2.0 TDI<br>2.0 TDI<br>2.0 TDI 4x4<br>2.0 TDI 4x4<br>2.0 TSI<br>2.0 TSI 4x4 | 92<br>110<br>110<br>88<br>132<br>110<br>140<br>110<br>140<br>162<br>206          | 03.15<br>03.15<br>03.15<br>03.15<br>03.15<br>03.15<br>03.15<br>03.15<br>03.15<br>03.15<br>03.15 |   | 24.0711-5273.3<br>24.0711-5274.3  | 360303<br>360304   | <br>   | Radsensor<br>Radsensor   |

<sup>1)</sup> electric parking brake / fr.di stazionamento elettrico / frein à main électrique / freno de mano eléctrico  
<sup>2)</sup> - speed control system / - impianto variatore di velocità / - régulateur de vitesse / - sistema de regulación de velocidad  
<sup>3)</sup> + speed control system / + impianto variatore di velocità / + régulateur de vitesse / + sistema de regulación de velocidad  
<sup>4)</sup> - parking assistant / - assistente di parcheggio / - assistance au stationnement / - asistente de aparcamiento  
<sup>5)</sup> + parking assistant / + assistente di parcheggio / + assistance au stationnement / + asistente de aparcamiento

|     |    |    |    |                  |   |    |      |  |            |
|--|--|--|--|--|--|--|--|--|------------|
| <b>SKODA SUPERB III Combi (15-)</b>  |  |  |  |  |  |  |  |  |            |
|    | 1.4 TSI 92<br>1.4 TSI 110<br>1.4 TSI 4x4 110<br>1.6 TDI 88<br>1.8 TSI 132<br>2.0 TDI 110<br>2.0 TDI 140<br>2.0 TDI 4x4 110<br>2.0 TDI 4x4 140<br>2.0 TSI 162<br>2.0 TSI 4x4 206  | 03.15<br>03.15<br>03.15<br>03.15<br>03.15<br>03.15<br>03.15<br>03.15<br>03.15<br>03.15<br>03.15<br>03.15                                     | PR: 1KU,1KZ<br>PR: 1KU,1KZ<br>PR: 1KU,1KZ<br>PR: 1KU,1KZ<br>PR: 1KU,1KZ<br>PR: 1KU,1KZ<br>PR: 1KU,1KZ<br>PR: 1KU,1KZ<br>PR: 1KU,1KZ<br>PR: 1KU,1KZ<br>PR: 1KU,1KZ  | 13.0460-7294.2 607294<br>13.0470-7294.2 LD7294   |  |  | elektrische Feststellbremse <sup>1)</sup><br>elektrische Feststellbremse <sup>1)</sup> | 25009 16,4 +<br>25009 16,4 +   | ATE<br>ATE |
|    | 1.4 TSI 92<br>1.4 TSI 110<br>1.4 TSI 4x4 110<br>1.6 TDI 88<br>1.8 TSI 132<br>2.0 TDI 110<br>2.0 TDI 140<br>2.0 TDI 4x4 110<br>2.0 TDI 4x4 140<br>2.0 TSI 162<br>2.0 TSI 4x4 206  | 03.15<br>03.15<br>03.15<br>03.15<br>03.15<br>03.15<br>03.15<br>03.15<br>03.15<br>03.15<br>03.15<br>03.15                                     | PR: 1KU,1KZ<br>PR: 1KU,1KZ<br>PR: 1KU,1KZ<br>PR: 1KU,1KZ<br>PR: 1KU,1KZ<br>PR: 1KU,1KZ<br>PR: 1KU,1KZ<br>PR: 1KU,1KZ<br>PR: 1KU,1KZ<br>PR: 1KU,1KZ<br>PR: 1KU,1KZ  | 24.0112-0210.1 412210  |  | elektrische Feststellbremse <sup>1)</sup>  | 300 12,0 10,0 +S +B  |  |            |
|    | 1.4 TSI 92<br>1.4 TSI 110<br>1.6 TDI 88<br>1.8 TSI 132<br>2.0 TDI 110<br>2.0 TDI 140<br>2.0 TSI 162  | 03.15<br>03.15<br>03.15<br>03.15<br>03.15<br>03.15<br>03.15  |  | 24.0711-6230.3 360310<br>24.0711-6337.3 360390   | 2 <br>2    | - Geschwindigkeitsregelanlage <sup>2)</sup><br>+ Geschwindigkeitsregelanlage <sup>3)</sup>   | Radsensor<br>Radsensor   |  |            |
|  | 1.4 TSI 92<br>1.4 TSI 110<br>1.6 TDI 88<br>1.8 TSI 132<br>2.0 TDI 110<br>2.0 TDI 140<br>2.0 TSI 162  | 03.15<br>03.15<br>03.15<br>03.15<br>03.15<br>03.15<br>03.15  |  | 24.0711-6230.3 360310<br>24.0711-6337.3 360390   | 2 <br>2    | - Parkassistent <sup>4)</sup><br>+ Parkassistent <sup>5)</sup>   | Radsensor<br>Radsensor   |  |            |
|  | 1.4 TSI 4x4 110<br>2.0 TDI 4x4 110<br>2.0 TDI 4x4 140<br>2.0 TSI 4x4 206   | 03.15<br>03.15<br>03.15<br>03.15   |  | 24.0711-5271.3 360301<br>24.0711-5272.3 360302<br>24.0711-5401.3 360330<br>24.0711-5402.3 360331 | <br><br><br>      | - Geschwindigkeitsregelanlage <sup>2)</sup><br>- Geschwindigkeitsregelanlage <sup>2)</sup><br>+ Geschwindigkeitsregelanlage <sup>3)</sup><br>+ Geschwindigkeitsregelanlage <sup>3)</sup> | Radsensor<br>Radsensor<br>Radsensor<br>Radsensor                                       |  |            |
|  | 1.4 TSI 4x4 110<br>2.0 TDI 4x4 110<br>2.0 TDI 4x4 140<br>2.0 TSI 4x4 206   | 03.15<br>03.15<br>03.15<br>03.15   |  | 24.0711-5271.3 360301<br>24.0711-5272.3 360302<br>24.0711-5401.3 360330<br>24.0711-5402.3 360331 | <br><br><br> | - Parkassistent <sup>4)</sup><br>- Parkassistent <sup>4)</sup><br>+ Parkassistent <sup>5)</sup><br>+ Parkassistent <sup>5)</sup>   | Radsensor<br>Radsensor<br>Radsensor<br>Radsensor                                       |  |            |
| <b>SKODA YETI (09-)</b>  |  |  |  |  |  |  |  |  |            |
|  | 1.2 TSI 77<br>1.2 TSI 81<br>1.4 TSI 90<br>1.4 TSI 92<br>1.4 TSI 4x4 110<br>1.6 81<br>1.6 TDI 77<br>1.8 TSI 4x4 112<br>1.8 TSI 4x4 118<br>2.0 TDI 81<br>2.0 TDI 103<br>2.0 TDI 110<br>2.0 TDI 4x4 81<br>2.0 TDI 4x4 103<br>2.0 TDI 4x4 110<br>2.0 TDI 4x4 125 | 09.09<br>05.15<br>06.10<br>05.15<br>05.15<br>04.14<br>11.10<br>11.09<br>05.09<br>11.09<br>11.11<br>05.15<br>11.09<br>05.09<br>05.15<br>11.09 | PR: 1ZF<br>PR: 1ZF<br>PR: 1ZF<br>PR: 1ZF<br>PR: 1ZF<br>PR: 1ZF<br>PR: 1ZF<br>PR: 1ZF<br>PR: 1ZF<br>PR: 1ZF<br>PR: 1ZF<br>PR: 1ZF<br>PR: 1ZF<br>PR: 1ZF<br>PR: 1ZF<br>PR: 1ZF   | 13.0460-7117.2 607117<br>13.0470-7117.2 LD7117   |  |  | 23131 19,6 +/WK<br>23131 19,6 +/WK   | VW<br>VW   |            |
|  | 1.2 TSI 77<br>1.2 TSI 81<br>1.4 TSI 90<br>1.4 TSI 92<br>1.4 TSI 4x4 110<br>1.4 TSI 4x4 110<br>1.6 81<br>1.6 TDI 77<br>1.8 TSI 4x4 112<br>1.8 TSI 4x4 118<br>2.0 TDI 81<br>2.0 TDI 103<br>2.0 TDI 110<br>2.0 TDI 4x4 81<br>2.0 TDI 4x4 103<br>2.0 TDI 4x4 125 | 09.09<br>05.15<br>06.10<br>05.15<br>05.15<br>05.15<br>04.14<br>11.10<br>11.09<br>05.09<br>11.11<br>05.15<br>11.09<br>05.09<br>05.15<br>11.09 | PR: 1ZA,1ZE<br>PR: 1ZA,1ZE<br>PR: 1ZA,1ZE<br>PR: 1ZA,1ZE<br>PR: 1ZA,1ZE<br>PR: 1ZA,1ZE<br>PR: 1ZA,1ZE<br>PR: 1ZA,1ZE<br>PR: 1ZA,1ZE<br>PR: 1ZA,1ZE<br>PR: 1ZA,1ZE<br>PR: 1ZA,1ZE<br>PR: 1ZA,1ZE<br>PR: 1ZA,1ZE<br>PR: 1ZA,1ZE<br>PR: 1ZA,1ZE | 13.0460-7184.2 607184<br>13.0470-7184.2 LD7184   |  |  | 23587 20,6 +/WK<br>23587 20,6 +/WK   | ATE<br>ATE   |            |
|  | 1.2 TSI 77<br>1.2 TSI 81<br>1.4 TSI 90<br>1.4 TSI 92<br>1.4 TSI 4x4 110<br>1.6 81<br>1.6 TDI 77<br>1.8 TSI 4x4 112   | 09.09<br>05.15<br>06.10<br>05.15<br>05.15<br>04.14<br>11.10<br>11.09   | PR: 1ZF<br>PR: 1ZF<br>PR: 1ZF<br>PR: 1ZF<br>PR: 1ZF<br>PR: 1ZF<br>PR: 1ZF<br>PR: 1ZF   | 24.0122-0210.1 422210<br>24.0322-0210.1 522210   |  |  | 280 22,0 19,0 V L +S +B<br>280 22,0 19,0 V L +S +B PD                                  |  |            |

<sup>1)</sup> electric parking brake / fr.di stazionamento elettrico / frein à main électrique / freno de mano eléctrico  
<sup>2)</sup> - speed control system / - impianto variatore di velocità / - régulateur de vitesse / - sistema de regulación de velocidad  
<sup>3)</sup> + speed control system / + impianto variatore di velocità / + régulateur de vitesse / + sistema de regulación de velocidad  
<sup>4)</sup> - parking assistant / - assistente di parcheggio / - assistance au stationnement / - asistente de aparcamiento  
<sup>5)</sup> + parking assistant / + assistente di parcheggio / + assistance au stationnement / + asistente de aparcamiento

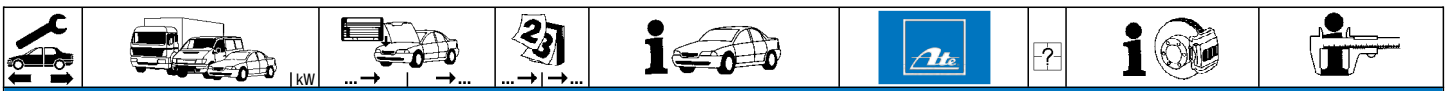

**SKODA YETI (09-)**

|             |             |       |         |                |                |   |        |  |   |
|-------------|-------------|-------|---------|----------------|----------------|---|--------|--|---|
|             | 1.8 TSI 4x4 | 118   | 05.09   | PR: 1ZF        | 24.0122-0210.1 | 422210  |        | 280 22,0 19,0 VL +S +B<br>280 22,0 19,0 VL +S +B PD  |   |
|             | 2.0 TDI     | 81    | 11.09   | PR: 1ZF        | 24.0322-0210.1 | 522210  |        |  |   |
|             | 2.0 TDI     | 103   | 11.11   | PR: 1ZF        |                |   |        |  |   |
|             | 2.0 TDI     | 110   | 05.15   | PR: 1ZF        |                |   |        |  |   |
|             | 2.0 TDI 4x4 | 81    | 11.09   | PR: 1ZF        |                |   |        |  |   |
|             | 2.0 TDI 4x4 | 103   | 05.09   | PR: 1ZF        |                |   |        |  |   |
|             | 2.0 TDI 4x4 | 110   | 05.15   | PR: 1ZF        |                |   |        |  |   |
|             | 2.0 TDI 4x4 | 125   | 11.09   | PR: 1ZF        |                |   |        |  |   |
|             | 1.2 TSI     | 77    | 09.09   | PR: 1ZE        | 24.0125-0145.1 | 425145  |        |  | 288 25,0 22,0 VL +S +B<br>288 25,0 22,0 VL +S +B PD |
| 1.2 TSI     | 81          | 05.15 | PR: 1ZE | 24.0325-0145.1 | 525145         |   |        |  |   |
| 1.4 TSI     | 90          | 06.10 | PR: 1ZE |                |                |   |        |  |   |
| 1.4 TSI     | 92          | 05.15 | PR: 1ZE |                |                |   |        |  |   |
| 1.4 TSI 4x4 | 110         | 05.15 | PR: 1ZE |                |                |   |        |  |   |
| 1.6         | 81          | 04.14 | PR: 1ZE |                |                |   |        |  |   |
| 1.6 TDI     | 77          | 11.10 | PR: 1ZE |                |                |   |        |  |   |
| 1.8 TSI 4x4 | 112         | 11.09 | PR: 1ZE |                |                |   |        |  |   |
| 1.8 TSI 4x4 | 118         | 05.09 | PR: 1ZE |                |                |   |        |  |   |
| 2.0 TDI     | 81          | 11.09 | PR: 1ZE |                |                |   |        |  |   |
| 2.0 TDI     | 103         | 11.11 | PR: 1ZE |                |                |   |        |  |   |
| 2.0 TDI     | 110         | 05.15 | PR: 1ZE |                |                |   |        |  |   |
| 2.0 TDI 4x4 | 81          | 11.09 | PR: 1ZE |                |                |   |        |  |   |
| 2.0 TDI 4x4 | 103         | 05.09 | PR: 1ZE |                |                |   |        |  |   |
| 2.0 TDI 4x4 | 110         | 05.15 | PR: 1ZE |                |                |   |        |  |   |
| 2.0 TDI 4x4 | 125         | 11.09 | PR: 1ZE |                |                |   |        |  |   |
| 1.2 TSI     | 77          | 09.09 | PR: 1ZA | 24.0125-0158.1 | 425158         | 312 25,0 22,0 VL +S +B<br>312 25,0 22,0 VL +S +B PD |        |  |   |
| 1.2 TSI     | 81          | 05.15 | PR: 1ZA | 24.0325-0158.1 | 525158         |   |        |  |   |
| 1.4 TSI     | 90          | 06.10 | PR: 1ZA |                |                |   |        |  |   |
| 1.4 TSI     | 92          | 05.15 | PR: 1ZA |                |                |   |        |  |   |
| 1.4 TSI 4x4 | 110         | 05.15 | PR: 1ZA |                |                |   |        |  |   |
| 1.6         | 81          | 04.14 | PR: 1ZA |                |                |   |        |  |   |
| 1.6 TDI     | 77          | 11.10 | PR: 1ZA |                |                |   |        |  |   |
| 1.8 TSI 4x4 | 112         | 11.09 | PR: 1ZA |                |                |   |        |  |   |
| 1.8 TSI 4x4 | 118         | 05.09 | PR: 1ZA |                |                |   |        |  |   |
| 2.0 TDI     | 81          | 11.09 | PR: 1ZA |                |                |   |        |  |   |
| 2.0 TDI     | 103         | 11.11 | PR: 1ZA |                |                |   |        |  |   |
| 2.0 TDI     | 110         | 05.15 | PR: 1ZA |                |                |   |        |  |   |
| 2.0 TDI 4x4 | 81          | 11.09 | PR: 1ZA |                |                |   |        |  |   |
| 2.0 TDI 4x4 | 103         | 05.09 | PR: 1ZA |                |                |   |        |  |   |
| 2.0 TDI 4x4 | 103         | 05.15 | PR: 1ZA |                |                |   |        |  |   |
| 2.0 TDI 4x4 | 125         | 11.09 | PR: 1ZA |                |                |   |        |  |   |
|             | 1.2 TSI     | 77    | 09.09   |                | 24.0711-5271.3 |   | 360301 |  | Radsensor<br>Radsensor                              |
|             | 1.2 TSI     | 81    | 05.15   |                | 24.0711-5272.3 |   | 360302 |  |   |
|             | 1.4 TSI     | 90    | 06.10   |                |                |   |        |  |   |
|             | 1.4 TSI     | 92    | 05.15   |                |                |   |        |  |   |
|             | 1.4 TSI 4x4 | 110   | 05.15   |                |                |   |        |  |   |
|             | 1.6         | 81    | 04.14   |                |                |   |        |  |   |
|             | 1.6 TDI     | 77    | 11.10   |                |                |   |        |  |   |
|             | 1.8 TSI 4x4 | 112   | 11.09   |                |                |   |        |  |   |
|             | 1.8 TSI 4x4 | 118   | 05.09   |                |                |   |        |  |   |
|             | 2.0 TDI     | 81    | 11.09   |                |                |   |        |  |   |
|             | 2.0 TDI     | 103   | 11.11   |                |                |   |        |  |   |
|             | 2.0 TDI     | 110   | 05.15   |                |                |   |        |  |   |
|             | 2.0 TDI 4x4 | 81    | 11.09   |                |                |   |        |  |   |
|             | 2.0 TDI 4x4 | 103   | 05.09   |                |                |   |        |  |   |
|             | 2.0 TDI 4x4 | 110   | 05.15   |                |                |   |        |  |   |
|             | 1.2 TSI     | 77    | 09.09   | PR: 1KD        | 13.0460-2820.2 | 602820  |        | 20961 17,6 /S TRW<br>20961 17,6 /S TRW               |   |
|             | 1.2 TSI     | 81    | 05.15   | PR: 1KD        | 13.0470-2820.2 | LD2820  |        |  |   |
|             | 1.4 TSI     | 90    | 06.10   | PR: 1KD        |                |   |        |  |   |
|             | 1.4 TSI     | 92    | 05.15   | PR: 1KD        |                |   |        |  |   |
|             | 1.6         | 81    | 04.14   | PR: 1KD        |                |   |        |  |   |
|             | 1.6 TDI     | 77    | 11.10   | PR: 1KD        |                |   |        |  |   |
|             | 2.0 TDI     | 81    | 11.09   | PR: 1KD        |                |   |        |  |   |
|             | 2.0 TDI     | 103   | 11.11   | PR: 1KD        |                |   |        |  |   |
|             | 2.0 TDI     | 110   | 05.15   | PR: 1KD        |                |   |        |  |   |
|             | 1.2 TSI     | 77    | 09.09   | PR: 1KJ        | 13.0460-2880.2 | 602880  |        | 23914 17,1 /WE/Zub/S TRW<br>23914 17,1 /WE/Zub/S TRW |   |
|             | 1.4 TSI     | 90    | 06.10   | PR: 1KJ        | 13.0470-2880.2 | LD2880  |        |  |   |
|             | 1.6 TDI     | 77    | 11.10   | PR: 1KJ        |                |   |        |  |   |
| 1.8 TSI 4x4 | 112         | 11.09 | PR: 1KJ |                |                |   |        |  |   |
| 1.8 TSI 4x4 | 118         | 05.09 | PR: 1KJ |                |                |   |        |  |   |
| 2.0 TDI     | 81          | 11.09 | PR: 1KJ |                |                |   |        |  |   |
| 2.0 TDI 4x4 | 81          | 11.09 | PR: 1KJ |                |                |   |        |  |   |
| 2.0 TDI 4x4 | 103         | 05.09 | PR: 1KJ |                |                |   |        |  |   |
| 2.0 TDI 4x4 | 125         | 11.09 | PR: 1KJ |                |                |   |        |  |   |
| 1.2 TSI     | 77          | 11.09 | PR: 1KS | 13.0460-3858.2 | 603858         | 24563 17,7 /Zub/S BOS<br>24563 17,7 /Zub/S BOS      |        |  |   |
| 1.2 TSI     | 81          | 05.15 | PR: 1KS | 13.0470-3858.2 | LD3858         |   |        |  |   |
| 1.4 TSI     | 90          | 06.10 | PR: 1KS |                |                |   |        |  |   |
| 1.4 TSI     | 92          | 05.15 | PR: 1KS |                |                |   |        |  |   |
| 1.4 TSI 4x4 | 110         | 05.15 | PR: 1KS |                |                |   |        |  |   |
| 1.6         | 81          | 04.14 | PR: 1KS |                |                |   |        |  |   |
| 1.6 TDI     | 77          | 11.10 | PR: 1KS |                |                |   |        |  |   |
| 1.8 TSI 4x4 | 112         | 11.09 | PR: 1KS |                |                |   |        |  |   |
| 1.8 TSI 4x4 | 118         | 11.09 | PR: 1KS |                |                |   |        |  |   |
| 2.0 TDI     | 81          | 11.09 | PR: 1KS |                |                |   |        |  |   |
| 2.0 TDI     | 103         | 11.11 | PR: 1KS |                |                |   |        |  |   |
| 2.0 TDI     | 110         | 05.15 | PR: 1KS |                |                |   |        |  |   |
| 2.0 TDI 4x4 | 81          | 11.09 | PR: 1KS |                |                |   |        |  |   |





### SKODA YETI (09-)

|  |  |  |  |  |  |                                  |                  |  |   |            |
|--|--|--|--|--|--|----------------------------------|------------------|--|---|------------|
|  | 2.0 TDI 4x4<br>2.0 TDI 4x4<br>2.0 TDI 4x4  | 103<br>110<br>125  |  | 11.09<br>05.15<br>11.09  | PR: 1KS<br>PR: 1KS<br>PR: 1KS  | 13.0460-3858.2<br>13.0470-3858.2 | 603858<br>LD3858 |  | 24563 17,7 /Zub/S<br>24563 17,7 /Zub/S        | BOS<br>BOS |
|  | 1.2 TSI<br>1.2 TSI<br>1.4 TSI<br>1.4 TSI<br>1.6<br>1.6 TDI<br>2.0 TDI<br>2.0 TDI<br>2.0 TDI  | 77<br>81<br>90<br>92<br>81<br>77<br>81<br>103<br>110   |  | 09.09<br>05.15<br>06.10<br>05.15<br>04.14<br>11.10<br>11.09<br>11.11<br>05.15  | PR: 1KD<br>PR: 1KD<br>PR: 1KD<br>PR: 1KD<br>PR: 1KD<br>PR: 1KD<br>PR: 1KD<br>PR: 1KD<br>PR: 1KD  | 24.0110-0277.1<br>24.0310-0277.1 | 410277<br>510277 |  | 253 10,0 8,0 +S +B<br>253 10,0 8,0 +S +B PD   |            |
|  | 1.2 TSI<br>1.4 TSI<br>1.6 TDI<br>1.8 TSI 4x4<br>1.8 TSI 4x4<br>2.0 TDI<br>2.0 TDI 4x4<br>2.0 TDI 4x4<br>2.0 TDI 4x4  | 77<br>90<br>77<br>112<br>118<br>81<br>81<br>103<br>125   |  | 09.09<br>06.10<br>11.10<br>11.09<br>05.09<br>11.09<br>11.09<br>05.09<br>11.09  | PR: 1KJ<br>PR: 1KJ<br>PR: 1KJ<br>PR: 1KJ<br>PR: 1KJ<br>PR: 1KJ<br>PR: 1KJ<br>PR: 1KJ<br>PR: 1KJ  | 24.0112-0169.1<br>24.0312-0169.1 | 412169<br>512169 |  | 282 12,0 10,0 +S +B<br>282 12,0 10,0 +S +B PD |            |
|  | 1.2 TSI<br>1.2 TSI<br>1.4 TSI<br>1.4 TSI<br>1.4 TSI 4x4<br>1.6<br>1.6 TDI<br>1.8 TSI 4x4<br>1.8 TSI 4x4<br>2.0 TDI<br>2.0 TDI<br>2.0 TDI<br>2.0 TDI 4x4<br>2.0 TDI 4x4<br>2.0 TDI 4x4<br>2.0 TDI 4x4 | 77<br>81<br>90<br>92<br>110<br>81<br>77<br>112<br>118<br>81<br>103<br>110<br>81<br>103<br>110<br>125 |  | 11.09<br>05.15<br>06.10<br>05.15<br>05.15<br>04.14<br>11.10<br>11.09<br>11.09<br>11.09<br>11.11<br>05.15<br>11.09<br>11.09<br>05.15<br>11.09 | PR: 1KS<br>PR: 1KS<br>PR: 1KS<br>PR: 1KS<br>PR: 1KS<br>PR: 1KS<br>PR: 1KS<br>PR: 1KS<br>PR: 1KS<br>PR: 1KS<br>PR: 1KS<br>PR: 1KS<br>PR: 1KS<br>PR: 1KS<br>PR: 1KS<br>PR: 1KS | 24.0110-0356.1<br>24.0310-0356.1 | 410356<br>510356 |  | 272 9,7 8,0 +S +B<br>272 9,7 8,0 +S +B PD     |            |
|  | 1.2 TSI<br>1.2 TSI<br>1.4 TSI<br>1.4 TSI<br>1.6<br>1.6 TDI<br>2.0 TDI<br>2.0 TDI<br>2.0 TDI  | 77<br>81<br>90<br>92<br>81<br>77<br>81<br>103<br>110   |  | 09.09<br>05.15<br>06.10<br>05.15<br>04.14<br>11.10<br>11.09<br>11.11<br>05.15  | PR: 1X0<br>PR: 1X0<br>PR: 1X0<br>PR: 1X0<br>PR: 1X0<br>PR: 1X0<br>PR: 1X0<br>PR: 1X0<br>PR: 1X0  | 24.0711-6231.3<br>24.0711-6232.3 | 360305<br>360306 | <input type="checkbox"/><br><input type="checkbox"/> | Radsensor<br>Radsensor                        |            |
|  | 1.4 TSI 4x4<br>1.8 TSI 4x4<br>1.8 TSI 4x4<br>2.0 TDI 4x4<br>2.0 TDI 4x4<br>2.0 TDI 4x4<br>2.0 TDI 4x4  | 110<br>112<br>118<br>81<br>103<br>110<br>125   |  | 05.15<br>11.09<br>05.09<br>11.09<br>05.09<br>05.15<br>11.09  | PR: 1X1<br>PR: 1X1<br>PR: 1X1<br>PR: 1X1<br>PR: 1X1<br>PR: 1X1<br>PR: 1X1  | 24.0711-5271.3<br>24.0711-5272.3 | 360301<br>360302 | <input type="checkbox"/><br><input type="checkbox"/> | Radsensor<br>Radsensor                        |            |

### SMART CABRIO (BM450) (00-03)

|  |  |  |  |  |  |                                  |                  |  |  |     |
|--|--|--|--|--|--|----------------------------------|------------------|--|--|-----|
|  | 0.6<br>0.6<br>0.6<br>0.7<br>0.7<br>0.8 CDI | 40<br>45<br>52<br>45<br>55<br>30   |  | 03.00<br>01.01<br>06.02<br>01.03<br>01.03<br>03.01 | 01.04<br>01.04<br>01.04<br>01.04<br>01.04<br>01.04 | 13.0460-3979.2                   | 603979           |  | 21999 15,8 +/-WK                           | BOS |
|  | 0.6<br>0.6<br>0.6<br>0.7<br>0.7<br>0.8 CDI | 40<br>45<br>52<br>45<br>55<br>30   |  | 03.00<br>01.01<br>06.02<br>01.03<br>01.03<br>03.01 | 01.04<br>01.04<br>01.04<br>01.04<br>01.04<br>01.04 | 24.0109-0136.1                   | 409136           |  | 280 9,0 8,0 L +S +B                        |     |
|  | 0.6<br>0.6<br>0.6<br>0.7<br>0.7<br>0.8 CDI | 40<br>45<br>52<br>45<br>55<br>30   | J 000000<br>J 000000<br>J 000000<br>J 000000<br>J 000000<br>J 000000 | 03.00<br>01.01<br>06.02<br>01.03<br>01.03<br>03.01 |  | 03.0137-0393.2<br>03.0137-9308.2 | 650393<br>669308 |  | 203 x 32 HEB<br>Bremsbacken-Zubehör, + AUT | BOS |
|  | 0.6<br>0.6<br>0.6<br>0.7<br>0.7<br>0.8 CDI | 40 J 000001<br>45 J 000001<br>52 J 000001<br>45 J 000001<br>55 J 000001<br>30 J 000001 |  |  | 01.04<br>01.04<br>01.04<br>01.04<br>01.04<br>01.04 | 03.0137-9308.2                   | 669308           |  | Bremsbacken-Zubehör, + AUT                 |     |
|  | 0.6<br>0.6<br>0.6<br>0.7<br>0.7<br>0.8 CDI | 40<br>45<br>52<br>45<br>55<br>30   |  | 03.00<br>01.01<br>06.02<br>01.03<br>01.03<br>03.01 | 01.04<br>01.04<br>01.04<br>01.04<br>01.04<br>01.04 | 24.0220-3027.1                   | 480168           |  | 203/204,5 x 39,6                           |     |



| <b>SMART CABRIO (BM450) (00-03)</b>     |         |    |          |       |       |  |  |                |        |  |  |  |  |  |  |                            |     |
|---|---------|----|----------|-------|-------|--|--|----------------|--------|--|--|--|--|--|--|----------------------------|-----|
|   | 0.6     | 40 | J 000000 | 03.00 |       |  |  | 03.0520-6522.3 | 696522 |  |  |  |  |  |  | 22,20/203x32 TopKit        | BOS |
|   | 0.6     | 45 | J 000000 | 01.01 |       |  |  |                |        |  |  |  |  |  |  |                            |     |
|   | 0.6     | 52 | J 000000 | 06.02 |       |  |  |                |        |  |  |  |  |  |  |                            |     |
|   | 0.7     | 45 | J 000000 | 01.03 |       |  |  |                |        |  |  |  |  |  |  |                            |     |
|   | 0.7     | 55 | J 000000 | 01.03 |       |  |  |                |        |  |  |  |  |  |  |                            |     |
|   | 0.8 CDI | 30 | J 000000 | 03.01 |       |  |  |                |        |  |  |  |  |  |  |                            |     |
| <b>SMART CITY COUPE (BM450) (98-04)</b> |         |    |          |       |       |  |  |                |        |  |  |  |  |  |  |                            |     |
|   | 0.6     | 33 |          | 07.98 | 01.04 |  |  | 13.0460-3979.2 | 603979 |  |  |  |  |  |  | 21999 15,8 +/WK            | BOS |
|   | 0.6     | 40 |          | 07.98 | 01.04 |  |  |                |        |  |  |  |  |  |  |                            |     |
|   | 0.6     | 45 |          | 01.01 | 01.04 |  |  |                |        |  |  |  |  |  |  |                            |     |
|   | 0.6     | 52 |          | 06.02 | 01.04 |  |  |                |        |  |  |  |  |  |  |                            |     |
|   | 0.7     | 37 |          | 01.03 | 01.04 |  |  |                |        |  |  |  |  |  |  |                            |     |
|   | 0.7     | 45 |          | 01.03 | 01.04 |  |  |                |        |  |  |  |  |  |  |                            |     |
|   | 0.7     | 55 |          | 01.03 | 01.04 |  |  |                |        |  |  |  |  |  |  |                            |     |
|   | 0.8 CDI | 30 |          | 11.99 | 01.04 |  |  |                |        |  |  |  |  |  |  |                            |     |
|   | 0.6     | 33 |          | 07.98 | 01.04 |  |  | 24.0109-0136.1 | 409136 |  |  |  |  |  |  | 280 9,0 8,0 L +S +B        |     |
|   | 0.6     | 40 |          | 07.98 | 01.04 |  |  |                |        |  |  |  |  |  |  |                            |     |
|   | 0.6     | 45 |          | 01.01 | 01.04 |  |  |                |        |  |  |  |  |  |  |                            |     |
|   | 0.6     | 52 |          | 06.02 | 01.04 |  |  |                |        |  |  |  |  |  |  |                            |     |
|   | 0.7     | 37 |          | 01.03 | 01.04 |  |  |                |        |  |  |  |  |  |  |                            |     |
|   | 0.7     | 45 |          | 01.03 | 01.04 |  |  |                |        |  |  |  |  |  |  |                            |     |
|   | 0.7     | 55 |          | 01.03 | 01.04 |  |  |                |        |  |  |  |  |  |  |                            |     |
|   | 0.8 CDI | 30 |          | 11.99 | 01.04 |  |  |                |        |  |  |  |  |  |  |                            |     |
|   | 0.6     | 33 |          | 07.98 | 01.04 |  |  | 03.0137-0393.2 | 650393 |  |  |  |  |  |  | 203 x 32 HEB               | BOS |
|   | 0.6     | 40 | J 000000 | 07.98 | 01.04 |  |  | 03.0137-9308.2 | 669308 |  |  |  |  |  |  | Bremsbacken-Zubehör, + AUT |     |
|   | 0.6     | 45 | J 000000 | 01.01 | 01.04 |  |  |                |        |  |  |  |  |  |  |                            |     |
|   | 0.6     | 52 | J 000000 | 06.02 | 01.04 |  |  |                |        |  |  |  |  |  |  |                            |     |
|   | 0.7     | 37 |          | 01.03 | 01.04 |  |  |                |        |  |  |  |  |  |  |                            |     |
|   | 0.7     | 45 |          | 01.03 | 01.04 |  |  |                |        |  |  |  |  |  |  |                            |     |
|   | 0.7     | 55 |          | 01.03 | 01.04 |  |  |                |        |  |  |  |  |  |  |                            |     |
|   | 0.8 CDI | 30 | J 000000 | 11.99 | 01.04 |  |  |                |        |  |  |  |  |  |  |                            |     |
|   | 0.6     | 45 | J 000001 | 01.04 | 01.04 |  |  | 03.0137-9308.2 | 669308 |  |  |  |  |  |  | Bremsbacken-Zubehör, + AUT |     |
|   | 0.6     | 52 | J 000001 | 01.04 | 01.04 |  |  |                |        |  |  |  |  |  |  |                            |     |
|   | 0.8 CDI | 30 | J 000001 | 01.04 | 01.04 |  |  |                |        |  |  |  |  |  |  |                            |     |
|   | 0.6     | 33 |          | 07.98 | 01.04 |  |  | 24.0220-3027.1 | 480168 |  |  |  |  |  |  | 203/204,5 x 39,6           |     |
|   | 0.6     | 40 |          | 07.98 | 01.04 |  |  |                |        |  |  |  |  |  |  |                            |     |
|   | 0.6     | 45 |          | 01.01 | 01.04 |  |  |                |        |  |  |  |  |  |  |                            |     |
|   | 0.6     | 52 |          | 06.02 | 01.04 |  |  |                |        |  |  |  |  |  |  |                            |     |
|   | 0.7     | 37 |          | 01.03 | 01.04 |  |  |                |        |  |  |  |  |  |  |                            |     |
|   | 0.7     | 45 |          | 01.03 | 01.04 |  |  |                |        |  |  |  |  |  |  |                            |     |
|   | 0.7     | 55 |          | 01.03 | 01.04 |  |  |                |        |  |  |  |  |  |  |                            |     |
|   | 0.8 CDI | 30 |          | 11.99 | 01.04 |  |  |                |        |  |  |  |  |  |  |                            |     |
|   | 0.6     | 33 |          | 11.99 | 01.04 |  |  | 03.0520-6522.3 | 696522 |  |  |  |  |  |  | 22,20/203x32 TopKit        | BOS |
|   | 0.6     | 40 | J 000000 | 11.99 | 01.04 |  |  |                |        |  |  |  |  |  |  |                            |     |
|   | 0.6     | 45 | J 000000 | 01.01 | 01.04 |  |  |                |        |  |  |  |  |  |  |                            |     |
|   | 0.6     | 52 | J 000000 | 06.02 | 01.04 |  |  |                |        |  |  |  |  |  |  |                            |     |
|   | 0.7     | 37 |          | 01.03 | 01.04 |  |  |                |        |  |  |  |  |  |  |                            |     |
|   | 0.7     | 45 |          | 01.03 | 01.04 |  |  |                |        |  |  |  |  |  |  |                            |     |
|   | 0.7     | 55 |          | 01.03 | 01.04 |  |  |                |        |  |  |  |  |  |  |                            |     |
|   | 0.8 CDI | 30 | J 000000 | 11.99 | 01.04 |  |  |                |        |  |  |  |  |  |  |                            |     |
| <b>SMART CROSSBLADE (BM450) (02-04)</b> |         |    |          |       |       |  |  |                |        |  |  |  |  |  |  |                            |     |
|   | 0.6     | 52 |          | 06.02 | 01.04 |  |  | 13.0460-3979.2 | 603979 |  |  |  |  |  |  | 21999 15,8 +/WK            | BOS |
|   | 0.6     | 52 |          | 06.02 | 01.04 |  |  | 24.0109-0136.1 | 409136 |  |  |  |  |  |  | 280 9,0 8,0 L +S +B        |     |
|   | 0.6     | 52 | J 000000 | 06.02 | 01.04 |  |  | 03.0137-0393.2 | 650393 |  |  |  |  |  |  | 203 x 32 HEB               | BOS |
|   | 0.6     | 52 | J 000001 | 01.04 | 01.04 |  |  | 03.0137-9308.2 | 669308 |  |  |  |  |  |  | Bremsbacken-Zubehör, + AUT |     |
|   | 0.6     | 52 |          | 06.02 | 01.04 |  |  | 24.0220-3027.1 | 480168 |  |  |  |  |  |  | 203/204,5 x 39,6           |     |
|   | 0.6     | 52 | J 000000 | 06.02 | 01.04 |  |  | 03.0520-6522.3 | 696522 |  |  |  |  |  |  | 22,20/203x32 TopKit        | BOS |
| <b>SMART FORFOUR (BM454) (04-06)</b>    |         |    |          |       |       |  |  |                |        |  |  |  |  |  |  |                            |     |
|   | 1.1     | 70 |          | 03.04 | 12.06 |  |  | 13.0460-2896.2 | 602896 |  |  |  |  |  |  | 21920 16,6 /WK/Zub/S       | TRW |
|   | 1.3     | 70 |          | 03.04 | 12.06 |  |  |                |        |  |  |  |  |  |  |                            |     |
|   | 1.5     | 80 |          | 03.04 | 12.06 |  |  |                |        |  |  |  |  |  |  |                            |     |
|   | 1.5     | 90 |          | 11.04 | 12.06 |  |  |                |        |  |  |  |  |  |  |                            |     |
|   | 1.5 CDI | 50 |          | 08.04 | 12.06 |  |  |                |        |  |  |  |  |  |  |                            |     |
|   | 1.5 CDI | 70 |          | 08.04 | 12.06 |  |  |                |        |  |  |  |  |  |  |                            |     |
|   | 1.1     | 70 |          | 03.04 | 12.06 |  |  | 24.0124-0192.1 | 424192 |  |  |  |  |  |  | 256 24,0 21,5 V +B         |     |
|   | 1.3     | 70 |          | 03.04 | 12.06 |  |  |                |        |  |  |  |  |  |  |                            |     |
|   | 1.5     | 80 |          | 03.04 | 12.06 |  |  |                |        |  |  |  |  |  |  |                            |     |
|   | 1.5     | 90 |          | 11.04 | 12.06 |  |  |                |        |  |  |  |  |  |  |                            |     |
|   | 1.5 CDI | 50 |          | 08.04 | 12.06 |  |  |                |        |  |  |  |  |  |  |                            |     |
|   | 1.5 CDI | 70 |          | 08.04 | 12.06 |  |  |                |        |  |  |  |  |  |  |                            |     |



**SMART FORFOUR (BM454) (04-06)**

|  |  |                                   |  |   |   |                |        |  |                     |     |
|--|--|-----------------------------------|--|---|---|----------------|--------|--|---------------------|-----|
|  | 1.1<br>1.3<br>1.5<br>1.5<br>1.5 BRABUS<br>1.5 CDI<br>1.5 CDI | 70<br>80<br>90<br>130<br>50<br>70 |  | 03.04<br>03.04<br>03.04<br>11.04<br>02.05<br>08.04<br>08.04 | 12.06<br>12.06<br>12.06<br>12.06<br>12.06<br>12.06<br>12.06 | 13.0460-2897.2 | 602897 |  | 21861 15,2 /WK/S    | TRW |
|  | 1.1<br>1.3<br>1.5<br>1.5<br>1.5 BRABUS<br>1.5 CDI<br>1.5 CDI | 70<br>80<br>90<br>130<br>50<br>70 |  | 03.04<br>03.04<br>03.04<br>11.04<br>02.05<br>08.04<br>08.04 | 12.06<br>12.06<br>12.06<br>12.06<br>12.06<br>12.06<br>12.06 | 24.0110-0304.1 | 410304 |  | 250 10,0 8,0 +B     |     |
|  | 1.1<br>1.3<br>1.5<br>1.5 CDI                                 | 70<br>90<br>50                    |  | 03.04<br>03.04<br>11.04<br>08.04                            | 12.06<br>12.06<br>12.06<br>12.06                            | 03.0137-0477.2 | 650477 |  | 203 x 38 HEB        |     |
|  | 1.1<br>1.3<br>1.5<br>1.5 CDI                                 | 70<br>90<br>50                    |  | 03.04<br>03.04<br>11.04<br>08.04                            | 12.06<br>12.06<br>12.06<br>12.06                            | 03.0520-7319.3 | 697319 |  | 19,05/203x38 TopKit |     |

**SMART FORTWO CABRIO (BM450) (04-07)**

















|  |                              |                |  |                         |                         |                                  |                  |  |  |     |
|--|------------------------------|----------------|--|-------------------------|-------------------------|----------------------------------|------------------|--|--|-----|
|  | 0.7<br>0.7 BRABUS<br>0.8 CDI | 45<br>55<br>30 |  | 01.04<br>01.04<br>01.04 | 04.07<br>04.07<br>04.07 | 13.0460-3979.2                   | 603979           |  | 21999 15,8 +/WK                            | BOS |
|  | 0.7<br>0.7 BRABUS<br>0.8 CDI | 45<br>55<br>30 |  | 01.04<br>01.04<br>01.04 | 04.07<br>04.07<br>04.07 | 24.0109-0136.1                   | 409136           |  | 280 9,0 8,0 L +S +B                        |     |
|  | 0.7<br>0.7 BRABUS<br>0.8 CDI | 45<br>55<br>30 |  | 01.04<br>01.04<br>01.04 | 04.07<br>04.07<br>04.07 | 03.0137-0393.2<br>03.0137-9308.2 | 650393<br>669308 |  | 203 x 32 HEB<br>Bremsbacken-Zubehör, + AUT | BOS |
|  | 0.7<br>0.7 BRABUS<br>0.8 CDI | 45<br>55<br>30 |  | 01.04<br>01.04<br>01.04 | 04.07<br>04.07<br>04.07 | 24.0220-3027.1                   | 480168           |  | 203/204,5 x 39,6                           |     |
|  | 0.7<br>0.7 BRABUS<br>0.8 CDI | 45<br>55<br>30 |  | 01.04<br>01.04<br>01.04 | 04.07<br>04.07<br>04.07 | 03.0520-6522.3                   | 696522           |  | 22,20/203x32 TopKit                        | BOS |

























**SMART FORTWO COUPE (BM450) (04-07)**

|  |  |                            |         |   |   |  |                            |  |   |     |
|--|--|----------------------------|---------|---|---|--|----------------------------|--|---|-----|
|  | 0.7<br>0.7<br>0.7<br>0.7 BRABUS<br>0.8 CDI | 37<br>40<br>45<br>55<br>30 |         | 01.04<br>01.04<br>01.04<br>01.04<br>01.04 | 04.07<br>04.07<br>04.07<br>04.07<br>04.07 | 13.0460-3979.2                                     | 603979                     |  | 21999 15,8 +/WK   | BOS |
|  | 0.7<br>0.7<br>0.7 BRABUS<br>0.8 CDI        | 37<br>45<br>55<br>30       |         | 01.04<br>01.04<br>01.04<br>01.04          | 04.07<br>04.07<br>04.07<br>04.07          | 24.0109-0136.1                                     | 409136                     |  | 280 9,0 8,0 L +S +B   |     |
|  | 0.7<br>0.7<br>0.7<br>0.7 BRABUS<br>0.8 CDI | 37<br>40<br>45<br>55<br>30 | J000000 | 01.04<br>01.04<br>01.04<br>01.04<br>01.04 | 04.07<br>04.07<br>04.07<br>04.07<br>04.07 | 24.0110-0331.1<br>03.0137-0393.2<br>03.0137-9308.2 | 410331<br>650393<br>669308 |  | 280 9,6 8,0 L +S +B<br>203 x 32 HEB<br>Bremsbacken-Zubehör, + AUT | BOS |
|  | 0.7<br>0.7<br>0.7<br>0.7 BRABUS<br>0.8 CDI | 37<br>40<br>45<br>55<br>30 |         | 01.04<br>01.04<br>01.04<br>01.04<br>01.04 | 04.07<br>04.07<br>04.07<br>04.07<br>04.07 | 24.0220-3027.1                                     | 480168                     |  | 203/204,5 x 39,6  |     |
|  | 0.7<br>0.7<br>0.7 BRABUS<br>0.8 CDI        | 37<br>45<br>55<br>30       |         | 01.04<br>01.04<br>01.04<br>01.04          | 04.07<br>04.07<br>04.07<br>04.07          | 03.0520-6522.3                                     | 696522                     |  | 22,20/203x32 TopKit   | BOS |

























**SMART FORTWO CABRIO (BM451) (07-)**

|   |   |  |  |  |  |                |        |  |                     |     |
|---|---|--|--|--|--|----------------|--------|--|---------------------|-----|
|   | 0.8 CDI<br>0.8 CDi<br>1.0<br>1.0 BRABUS<br>1.0 BRABUS<br>1.0 MHD Hybrid<br>1.0 Turbo<br>Electric Drive<br>Electric Drive<br>Electric Drive<br>Electric Drive<br>Electric Drive BRABUS | 33<br>40<br>52<br>88<br>71<br>62<br>20<br>30<br>35<br>55<br>60 |  | 04.07<br>08.09<br>04.07<br>07.07<br>04.12<br>10.07<br>04.07<br>12.10<br>11.09<br>12.11<br>04.12<br>01.13 |  | 13.0460-3979.2 | 603979 |  | 21999 15,8 +/WK     | BOS |
|   | 0.8 CDI<br>0.8 CDi<br>1.0<br>1.0 BRABUS<br>1.0 BRABUS<br>1.0 MHD Hybrid   | 33<br>40<br>52<br>88<br>71                                     |  | 04.07<br>08.09<br>04.07<br>07.07<br>04.12<br>10.07   |  | 24.0110-0331.1 | 410331 |  | 280 9,6 8,0 L +S +B |     |
| ↓ | ↓   |  |  |  |  |                |        |  |                     |     |

|     |   |  |  |                                   |  |  |  |  |
|--|---|--|--|---|---|--|--|--|
| <b>SMART FORTWO CABRIO (BM451) (07-)</b>   |   |  |  |   |   |  |  |  |
|    | 1.0 Turbo<br>Electric Drive<br>Electric Drive<br>Electric Drive<br>Electric Drive<br>Electric Drive BRABUS  | 62<br>20<br>30<br>35<br>55<br>60   |  | 04.07<br>12.10<br>11.09<br>12.11<br>04.12<br>01.13  |   | 24.0110-0331.1<br>410331   |  | 280 9,6 8,0 L +S +B  |
|    | 0.8 CDI<br>0.8 CDI<br>1.0<br>1.0 BRABUS<br>1.0 BRABUS<br>1.0 MHD Hybrid<br>1.0 Turbo<br>Electric Drive<br>Electric Drive<br>Electric Drive<br>Electric Drive<br>Electric Drive BRABUS | 33<br>40<br>52<br>88<br>88<br>71<br>62<br>20<br>30<br>35<br>55<br>60             |  | 04.07<br>08.09<br>04.07<br>07.07<br>04.12<br>10.07<br>04.07<br>12.10<br>11.09<br>12.11<br>04.12<br>01.13          |   | 03.0137-0487.2<br>03.0137-9308.2<br>650487<br>669308                               |  | 203 x 32 HEB<br>Bremsbacken-Zubehör, + AUT   |
|    | 0.8 CDI<br>0.8 CDI<br>1.0<br>1.0 BRABUS<br>1.0 BRABUS<br>1.0 MHD Hybrid<br>1.0 Turbo<br>Electric Drive<br>Electric Drive<br>Electric Drive<br>Electric Drive<br>Electric Drive BRABUS | 33<br>40<br>52<br>88<br>88<br>71<br>62<br>20<br>30<br>35<br>55<br>60             |  | 04.07<br>08.09<br>04.07<br>07.07<br>04.12<br>10.07<br>04.07<br>12.10<br>11.09<br>12.11<br>04.12<br>01.13          |   | 24.0220-3027.1<br>480168   |  | 203/204,5 x 39,6   |
|    | 0.8 CDI<br>0.8 CDI<br>1.0<br>1.0 BRABUS<br>1.0 BRABUS<br>1.0 MHD Hybrid<br>1.0 Turbo<br>Electric Drive<br>Electric Drive<br>Electric Drive<br>Electric Drive<br>Electric Drive BRABUS | 33<br>40<br>52<br>88<br>88<br>71<br>62<br>20<br>30<br>35<br>55<br>60             |  | 04.07<br>08.09<br>04.07<br>04.12<br>07.07<br>10.07<br>04.07<br>12.10<br>11.09<br>12.11<br>04.12<br>01.13          |   | 03.0520-9520.3<br>699520   |  | 20,64/203x32 TopKit  |
| <b>SMART FORTWO COUPE (BM451) (07-)</b>  |   |  |  |   |   |  |  |  |
|  | 0.8 CDI<br>0.8 CDI<br>1.0<br>1.0<br>1.0<br>1.0 BRABUS<br>1.0 MHD Hybrid<br>1.0 Turbo<br>Electric Drive<br>Electric Drive<br>Electric Drive<br>Electric Drive<br>Electric Drive BRABUS | 33<br>40<br>45<br>52<br>88<br>72<br>71<br>60<br>20<br>30<br>35<br>55<br>60       |  | 04.07<br>08.09<br>04.07<br>04.07<br>01.10<br>07.07<br>10.07<br>04.07<br>12.10<br>11.09<br>12.11<br>04.12<br>01.13 |   | 13.0460-3979.2<br>603979   |  | 21999 15,8 +/-WK BOS   |
|  | 0.8 CDI<br>0.8 CDI<br>1.0<br>1.0<br>1.0<br>1.0 BRABUS<br>1.0 MHD Hybrid<br>1.0 Turbo<br>Electric Drive<br>Electric Drive<br>Electric Drive<br>Electric Drive<br>Electric Drive BRABUS | 33<br>40<br>45<br>52<br>88<br>72<br>71<br>60<br>20<br>30<br>35<br>55<br>60       |  | 04.07<br>08.09<br>04.07<br>04.07<br>01.10<br>07.07<br>10.07<br>04.07<br>12.10<br>11.09<br>12.11<br>04.12<br>01.13 |   | 24.0110-0331.1<br>410331   |  | 280 9,6 8,0 L +S +B  |
|  | 0.8 CDI<br>0.8 CDI<br>1.0<br>1.0<br>1.0<br>1.0 BRABUS<br>1.0 MHD Hybrid<br>1.0 Turbo<br>Electric Drive<br>Electric Drive<br>Electric Drive<br>Electric Drive<br>Electric Drive BRABUS | 33<br>40<br>45<br>52<br>88<br>72<br>71<br>60<br>20<br>30<br>35<br>55<br>60       |  | 04.07<br>08.09<br>04.07<br>04.07<br>01.10<br>07.07<br>10.07<br>04.07<br>12.10<br>11.09<br>12.11<br>04.12<br>01.13 |   | 03.0137-0487.2<br>03.0137-9308.2<br>650487<br>669308                               |  | 203 x 32 HEB<br>Bremsbacken-Zubehör, + AUT   |

|     |  |  |  |  |  |  |  |  |                            |
|--|--|--|--|--|---|--|--|--|----------------------------|
| <b>SMART FORTWO COUPE (BM451) (07-)</b>  |  |  |  |  |   |  |  |  |                            |
|    | 0.8 CDI  | 33   |  | 04.07  |   | 24.0220-3027.1   | 480168   |  | 203/204,5 x 39,6           |
|  | 0.8 CDi  | 40   |  | 08.09  |   |  |  |  |                            |
|  | 1.0  | 45   |  | 04.07  |   |  |  |  |                            |
|  | 1.0  | 52   |  | 04.07  |   |  |  |  |                            |
|  | 1.0  | 88   |  | 01.10  |   |  |  |  |                            |
|  | 1.0 BRABUS   | 72   |  | 07.07  |   |  |  |  |                            |
|  | 1.0 MHD Hybrid   | 71   |  | 10.07  |   |  |  |  |                            |
|  | 1.0 Turbo  |  |  | 04.07  |   |  |  |  |                            |
|  | Electric Drive   | 20   |  | 12.10  |   |  |  |  |                            |
|  | Electric Drive   | 30   |  | 11.09  |   |  |  |  |                            |
|  | Electric Drive   | 35   |  | 12.11  |   |  |  |  |                            |
|  | Electric Drive   | 55   |  | 04.12  |   |  |  |  |                            |
|  | Electric Drive BRABUS  | 60   |  | 01.13  |   |  |  |  |                            |
|    | 0.8 CDI  | 33   |  | 04.07  |   | 03.0520-9520.3   | 699520   |  | 20,64/203x32 TopKit        |
|  | 0.8 CDi  | 40   |  | 08.09  |   |  |  |  |                            |
|  | 1.0  | 45   |  | 04.07  |   |  |  |  |                            |
|  | 1.0  | 52   |  | 04.07  |   |  |  |  |                            |
|  | 1.0  | 88   |  | 01.10  |   |  |  |  |                            |
|  | 1.0 BRABUS   | 72   |  | 07.07  |   |  |  |  |                            |
|  | 1.0 MHD Hybrid   | 71   |  | 10.07  |   |  |  |  |                            |
|  | 1.0 Turbo  |  |  | 04.07  |   |  |  |  |                            |
|  | Electric Drive   | 20   |  | 12.10  |   |  |  |  |                            |
|  | Electric Drive   | 30   |  | 11.09  |   |  |  |  |                            |
|  | Electric Drive   | 35   |  | 12.11  |   |  |  |  |                            |
|  | Electric Drive   | 55   |  | 04.12  |   |  |  |  |                            |
|  | Electric Drive BRABUS  | 60   |  | 01.13  |   |  |  |  |                            |
| <b>SMART FORTWO (BM453) (14-)</b>  |  |  |  |  |   |  |  |  |                            |
|    | 0.9  | 66   |  | 11.14  |   | 13.0460-7298.2   | 607298   |  | 25702 18,2 + ATE           |
|  | 0.9 Brabus   | 80   |  | 07.16  |   |  |  |  |                            |
|  | 1.0  | 44   |  | 01.15  |   |  |  |  |                            |
|  | 1.0  | 52   |  | 11.14  |   |  |  |  |                            |
|    | 0.9  | 66   |  | 11.14  |   | 24.0112-0171.1   | 412171   | - belüftete Scheiben <sup>1)</sup>   | 259 12,0 10,6 +S +B        |
|  | 0.9 Brabus   | 80   |  | 07.16  |   | 24.0122-0289.1   | 422289   | + belüftete Scheiben <sup>2)</sup>   | 258 22,0 19,8 V L +S +B    |
|  | 1.0  | 44   |  | 01.15  |   |  |  |  |                            |
|  | 1.0  | 52   |  | 11.14  |   |  |  |  |                            |
| <b>SMART FORTWO CABRIO (BM453) (15-)</b>   |  |  |  |  |   |  |  |  |                            |
|   | 0.9  | 66   |  | 09.15  |   | 13.0460-7298.2   | 607298   |  | 25702 18,2 + ATE           |
|  | 0.9 Brabus   | 80   |  | 07.16  |   |  |  |  |                            |
|  | 1.0  | 52   |  | 09.15  |   |  |  |  |                            |
|  | 0.9  | 66   |  | 09.15  |   | 24.0112-0171.1   | 412171   | - belüftete Scheiben <sup>1)</sup>   | 259 12,0 10,6 +S +B        |
|  | 0.9 Brabus   | 80   |  | 07.16  |   | 24.0122-0289.1   | 422289   | + belüftete Scheiben <sup>2)</sup>   | 258 22,0 19,8 V L +S +B    |
|  | 1.0  | 52   |  | 09.15  |   |  |  |  |                            |
| <b>SMART FORFOUR (BM453) (14-)</b>   |  |  |  |  |   |  |  |  |                            |
|  | 0.9  | 66   |  | 11.14  |   | 13.0460-7298.2   | 607298   |  | 25702 18,2 + ATE           |
|  | 0.9 Brabus   | 80   |  | 07.16  |   |  |  |  |                            |
|  | 1.0  | 44   |  | 01.15  |   |  |  |  |                            |
|  | 1.0  | 52   |  | 11.14  |   |  |  |  |                            |
|  | 0.9  | 66   |  | 11.14  |   | 24.0112-0171.1   | 412171   | - belüftete Scheiben <sup>1)</sup>   | 259 12,0 10,6 +S +B        |
|  | 0.9 Brabus   | 80   |  | 07.16  |   | 24.0122-0289.1   | 422289   | + belüftete Scheiben <sup>2)</sup>   | 258 22,0 19,8 V L +S +B    |
|  | 1.0  | 44   |  | 01.15  |   |  |  |  |                            |
|  | 1.0  | 52   |  | 11.14  |   |  |  |  |                            |
| <b>SMART ROADSTER (BM452) (03-05)</b>  |  |  |  |  |   |  |  |  |                            |
|  | 0.7  | 45   |  | 04.03  | 12.05   | 13.0460-3979.2   | 603979   |  | 21999 15,8 +/WK BOS        |
|  | 0.7  | 60   |  | 04.03  | 12.05   |  |  |  |                            |
|  | 0.7 BRABUS   | 74   |  | 03.04  | 12.05   |  |  |  |                            |
|  | 0.7  | 45   |  | 04.03  | 12.05   | 24.0109-0136.1   | 409136   |  | 280 9,0 8,0 L +S +B        |
|  | 0.7  | 60   |  | 04.03  | 12.05   |  |  |  |                            |
|  | 0.7 BRABUS   | 74   |  | 03.04  | 12.05   |  |  |  |                            |
|  | 0.7  | 45   |  | 04.03  | 12.05   | 03.0137-0393.2   | 650393   |  | 203 x 32 HEB BOS           |
|  | 0.7  | 60   |  | 04.03  | 12.05   | 03.0137-9308.2   | 669308   |  | Bremsbacken-Zubehör, + AUT |
|  | 0.7 BRABUS   | 74   |  | 03.04  | 12.05   |  |  |  |                            |
|  | 0.7  | 45   |  | 04.03  | 12.05   | 24.0220-3027.1   | 480168   |  | 203/204,5 x 39,6           |
|  | 0.7  | 60   |  | 04.03  | 12.05   |  |  |  |                            |
|  | 0.7 BRABUS   | 74   |  | 03.04  | 12.05   |  |  |  |                            |
| <b>SMART ROADSTER COUPE (BM452) (03-05)</b>  |  |  |  |  |   |  |  |  |                            |
|  | 0.7  | 45   |  | 04.05  | 12.05   | 13.0460-3979.2   | 603979   |  | 21999 15,8 +/WK BOS        |
|  | 0.7  | 60   |  | 04.03  | 12.05   |  |  |  |                            |
|  | 0.7 BRABUS   | 74   |  | 03.04  | 12.05   |  |  |  |                            |
|  | 0.7  | 45   |  | 04.05  | 12.05   | 24.0109-0136.1   | 409136   |  | 280 9,0 8,0 L +S +B        |
|  | 0.7  | 60   |  | 04.03  | 12.05   |  |  |  |                            |
|  | 0.7 BRABUS   | 74   |  | 03.04  | 12.05   |  |  |  |                            |
|  | 0.7  | 45   |  | 04.05  | 12.05   | 03.0137-0393.2   | 650393   |  | 203 x 32 HEB BOS           |
|  | 0.7  | 60   |  | 04.03  | 12.05   | 03.0137-9308.2   | 669308   |  | Bremsbacken-Zubehör, + AUT |
|  | 0.7 BRABUS   | 74   |  | 03.04  | 12.05   |  |  |  |                            |
|  | 0.7  | 45   |  | 04.05  | 12.05   | 24.0220-3027.1   | 480168   |  | 203/204,5 x 39,6           |
|  | 0.7  | 60   |  | 04.03  | 12.05   |  |  |  |                            |
|  | 0.7 BRABUS   | 74   |  | 03.04  | 12.05   |  |  |  |                            |























<sup>1)</sup> - ventilated discs / - dischi ventilati / - disques ventilés / - disco ventilado  
<sup>2)</sup> + ventilated discs / + dischi ventilati / + disques ventilés / + disco ventilado

|     |                      |  |  |  |  |  |  |  |
|--|--|--|--|--|---|--|--|--|
| <b>SSANG YONG ACTYON SPORTS Pick-up (07-)</b>                                      |  |  |  |  |   |  |  |  |
|    | 2.0 Xdi 4WD  | 104  | 04.07  | - ABS  | 24.0220-3020.2<br>24.0220-3720.2  | 480131<br>480210   | ohne Sensorring <sup>1)</sup><br>ohne Sensorring <sup>1)</sup>                     | 203/204,3 x 44,5 - Lager<br>203/204,3 x 44,5 + Lager                               |
| <b>SSANG YONG KORANDO (96-99)</b>  |  |  |  |  |   |  |  |  |
|    | 2.3 (KJ)<br>2.3 D (KJ)<br>2.9 D (KJ)<br>2.9 TD (KJ)<br>3.2 (KJ)                                      |  | 05.97<br>08.04<br>12.96<br>04.98<br>12.96  | 01.99<br>01.99<br>01.99<br>01.99<br>01.99  | 24.0110-0352.1  | 410352   |  | 299 10,4 8,5 L +B  |
| <b>SSANG YONG REXTON I (02-06)</b>   |  |  |  |  |   |  |  |  |
|    | 2.3 i 16V<br>2.7 Xdi<br>2.7 Xdi<br>2.9 TDiC<br>3.2 i V6  | 110<br>120<br>121<br>88<br>162   | 05.02<br>08.04<br>03.05<br>04.02<br>04.02  | 08.06<br>08.06<br>08.06<br>08.06<br>08.06  | 13.0460-5623.2  | 605623   |  | 23673 15,9 +WK <b>MAN</b>  |
|    | 2.3 i 16V<br>2.7 Xdi<br>2.7 Xdi<br>2.9 TDiC<br>3.2 i V6  | 110<br>120<br>121<br>88<br>162   | 05.02<br>08.04<br>03.05<br>04.02<br>04.02  | 02.06<br>02.06<br>02.06<br>02.06<br>02.06  | 24.0110-0352.1  | 410352   |  | 299 10,4 8,5 L +B  |
| <b>SUBARU BRZ Coupe (Z10) (12-)</b>  |  |  |  |  |   |  |  |  |
|    | 2.0 16V<br>2.0 16V   | 147<br>147   | 06.12<br>06.12   |  | 24.0124-0145.1<br>24.0124-0196.1  | 424145<br>424196   | Low-Type <sup>2)</sup><br>High-Type <sup>3)</sup>                                  | 277 24,0 22,0 V +B<br>294 24,0 22,0 V +B   |
|    | 2.0 16V  | 147  | 06.12  |  | 24.0110-0366.1  | 410366   | Low-Type <sup>2)</sup>   | 286 10,0 8,5 +B  |
| <b>SUBARU FORESTER (97-02)</b>   |  |  |  |  |   |  |  |  |
|    | 2.0<br>2.0<br>2.0 S Turbo  | 90<br>92<br>125  | 08.97<br>07.98<br>07.98  | 09.02<br>09.02<br>04.01  | 13.0460-5851.2  | 605851   |  | 23558 17,2 /WK <b>AKE</b>  |
|    | 2.0<br>2.0<br>2.0 S Turbo  | 90<br>92<br>125  | 08.97<br>07.98<br>07.98  | 09.02<br>09.02<br>04.01  | 24.0124-0145.1  | 424145   |  | 277 24,0 22,0 V +B   |
|   | 2.0 S Turbo  | 125  | 07.98  | 04.01  | 24.0110-0237.1  | 410237   |  | 266 10,0 8,5 +B  |
|  | 2.0<br>2.0   | 90<br>92   | 08.97<br>07.98   | 09.02<br>09.02   | 03.0137-0302.2<br>03.0137-9192.2  | 650302<br>669192   |  | 229 x 37<br>Bremsbacken-Zubehör  |
|  | 2.0<br>2.0   | 90<br>92   | 08.97<br>07.98   | 09.02<br>09.02   | 24.0222-8023.1  | 480094   | - ABS<br>- ABS   | 229/230 x 43,5   |
|  | 2.0 S Turbo  | 125  | 07.98  | 04.01  | 03.0137-3010.2  | 653010   |  | 170 x 32   |
| <b>SUBARU FORESTER (02-08)</b>   |  |  |  |  |   |  |  |  |
|  | 2.0<br>2.0 S Turbo<br>2.0 X<br>2.5 Allrad<br>2.5 AWD<br>2.5 AWD<br>2.5 RX AWD<br>2.5 Turbo<br>2.5 XT | 92<br>130<br>116<br>121<br>112<br>185<br>115<br>155<br>169                       | 09.02<br>09.02<br>09.05<br>07.05<br>06.02<br>05.05<br>11.02<br>12.03<br>09.05    | 05.08<br>05.08<br>05.08<br>05.08<br>05.05<br>09.05<br>08.05<br>05.08<br>05.08    | 13.0460-5787.2  | 605787   |  | 23865 17,6 +WK/Zub <b>TOK</b>  |
|  | 2.0<br>2.0 X<br>2.0 S Turbo<br>2.5 Allrad<br>2.5 AWD<br>2.5 AWD<br>2.5 RX AWD<br>2.5 Turbo<br>2.5 XT | 92<br>116<br>130<br>121<br>112<br>185<br>115<br>155<br>169                       | 09.02<br>09.05<br>09.02<br>07.05<br>06.02<br>05.05<br>11.02<br>12.03<br>09.05    | 05.08<br>05.08<br>05.08<br>05.08<br>05.05<br>09.05<br>08.05<br>05.08<br>05.08    | 24.0124-0145.1<br>24.0124-0196.1  | 424145<br>424196   |  | 277 24,0 22,0 V +B<br>294 24,0 22,0 V +B   |
|  | 2.0 S Turbo<br>2.5 Allrad<br>2.5 AWD<br>2.5 AWD<br>2.5 RX AWD<br>2.5 Turbo<br>2.5 XT                 | 130<br>121<br>112<br>185<br>115<br>155<br>169                                    | 06.03<br>07.05<br>06.02<br>05.05<br>11.02<br>12.03<br>09.05                      | 05.08<br>05.08<br>05.05<br>09.05<br>08.05<br>05.08<br>05.08                      | 13.0460-5628.2  | 605628   |  | 24331 13,8 /WK/Zub   |
|  | 2.0 S Turbo<br>2.5 Allrad<br>2.5 AWD<br>2.5 AWD<br>2.5 RX AWD<br>2.5 Turbo<br>2.5 XT                 | 130<br>121<br>112<br>185<br>115<br>155<br>169                                    | 09.02<br>07.05<br>06.02<br>05.05<br>11.02<br>12.03<br>09.05                      | 05.08<br>05.08<br>05.05<br>09.05<br>08.05<br>05.08<br>05.08                      | 24.0110-0237.1  | 410237   |  | 266 10,0 8,5 +B  |

<sup>1)</sup> without sensor ring / senza sensori / sans secours ABS / sin anillo sensor ABS

<sup>2)</sup> Low Type / Tipo Low / Type Low / Tipo Low

<sup>3)</sup> High Type / Tipo Low / Type High / Tipo Low

|     |    kW   |  |  |                                   |                         |  |  |                           |
|--|---|--|--|---|--|--|--|---|
| <b>SUBARU FORESTER (02-08)</b>   |   |  |  |   |  |  |  |   |
|    | 2.0<br>2.0 X  | 92<br>116  |  | 09.02<br>09.05  | 05.08<br>05.08   | 03.0137-0302.2<br>03.0137-9192.2   | 650302<br>669192   | 229 x 37<br>Bremsbacken-Zubehör   |
|    | 2.0<br>2.0 X  | 92<br>116  |  | 09.02<br>09.05  | 05.08<br>05.08   | 24.0222-8023.1   | 480094   | 229/230 x 43,5  |
|    | 2.0 S Turbo<br>2.5 Allrad<br>2.5 AWD<br>2.5 AWD<br>2.5 RX AWD<br>2.5 Turbo<br>2.5 XT  | 130<br>121<br>112<br>185<br>115<br>155<br>169                                    |  | 09.02<br>07.05<br>06.02<br>05.05<br>11.02<br>12.03<br>09.05   | 05.08<br>05.08<br>05.05<br>09.05<br>08.05<br>05.08<br>05.08  | 03.0137-3010.2   | 653010   | 170 x 32  |
| <b>SUBARU FORESTER (08-13)</b>   |   |  |  |   |  |  |  |   |
|    | 2.0 16V AWD<br>2.0 TD AWD<br>2.5 16V AWD  | 110<br>108<br>126  |  | 01.08<br>09.08<br>01.09   | 03.10<br>03.10<br>02.13  | 13.0460-5787.2   | 605787   | 23865 17,6 +/-WK/Zub <b>TOK</b>   |
|    | 2.0 16V AWD<br>2.0 16V AWD<br>2.0 TD AWD<br>2.5 16V AWD<br>2.5 16V AWD<br>2.5 Turbo AWD   | 110<br>110<br>108<br>126<br>169<br>193   |  | 01.10<br>01.08<br>09.08<br>01.09<br>06.08<br>02.11  | 02.13<br>02.13<br>02.13<br>02.13<br>02.13<br>02.13   | 24.0124-0145.1<br>24.0124-0196.1   | 424145<br>424196   | 277 24,0 22,0 V +B<br>294 24,0 22,0 V +B  |
|    | 2.0 16V AWD<br>2.0 16V AWD<br>2.0 TD AWD<br>2.5 16V AWD<br>2.5 16V AWD<br>2.5 Turbo AWD   | 110<br>110<br>108<br>126<br>169<br>193   |  | 01.10<br>01.08<br>09.08<br>01.09<br>06.08<br>02.11  | 02.13<br>02.13<br>02.13<br>02.13<br>02.13<br>02.13   | 24.0110-0366.1   | 410366   | 286 10,0 8,5 +B   |
|    | 2.0 16V AWD<br>2.0 16V AWD<br>2.0 TD AWD<br>2.5 16V AWD<br>2.5 16V AWD<br>2.5 Turbo AWD   | 110<br>110<br>108<br>126<br>169<br>193   |  | 01.10<br>01.08<br>09.08<br>01.09<br>06.08<br>02.11  | 02.13<br>02.13<br>02.13<br>02.13<br>02.13<br>02.13   | 03.0137-3015.2<br>03.0137-9307.2   | 653015<br>669307   | 190 x 32<br>Bremsbacken-Zubehör   |
| <b>SUBARU FORESTER (13-)</b>   |   |  |  |   |  |  |  |   |
|   | 2.0 XT 4WD  | 177  |  | 03.13   |  | 13.0460-5797.2   | 605797   | 24222 16,9 +/-WK/Zub <b>AKE</b>   |
|  | 2.0 D 4WD<br>2.0 X 4WD<br>2.0 D 4WD<br>2.0 XT 4WD   | 108<br>110<br>108<br>177   |  | 03.13<br>03.13<br>03.13<br>03.13  | - Kollisionswarnsystem (PCS) <sup>1)</sup><br><br>+ Kollisionswarnsystem (PCS) <sup>2)</sup>             | 24.0124-0196.1<br>24.0130-0204.1   | 424196<br>430204   | 294 24,0 22,0 V +B<br>316 30,0 28,0 V +B  |
|  | 2.0 D 4WD<br>2.0 X 4WD  | 108<br>110   |  | 03.13<br>03.13  | Typ D  | 24.0110-0384.1   | 410384   | 274 10,0 8,5 +B   |
|  | 2.0 D 4WD<br>2.0 X 4WD<br>2.0 XT 4WD  | 108<br>110<br>177  |  | 03.13<br>03.13<br>03.13   |  | 03.0137-3045.2   | 653045   | 170 x 35  |
| <b>SUBARU IMPREZA Limousine (93-00)</b>  |   |  |  |   |  |  |  |   |
|  | 1.6 (GC3)<br>1.6 4WD (GC4)<br>1.8 (GC5)<br>1.8 4WD (GC6)<br>2.0 (GC7)<br>2.0 4WD (GC8)<br>2.0 4WD (GC8)<br>2.0 Turbo 4WD (GC8)<br>2.0 Turbo 4WD (GC8)   | <br><br><br><br><br><br>155<br>160   |  | 01.93<br>01.93<br>01.93<br>01.93<br>08.96<br>09.94<br>09.96<br>08.96<br>06.98                                     | 08.96<br>12.00<br>06.96<br>06.96<br>12.00<br>08.96<br>12.00<br>12.00<br>12.00                            | 13.0460-5978.2<br>13.0460-5895.2<br>13.0460-5851.2<br>13.0460-5640.2               | 605978<br>605895<br>605851<br>605640   | 21495 17,0 +/-WK<br><br><br><br><br><br>23780 16,7 /WK/Zub<br>23558 17,2 /WK <b>AKE</b><br>21854 15,0 +/-WK |
|  | 1.6 (GC3)<br>1.6 4WD (GC4)<br>1.8 (GC5)<br>1.8 4WD (GC6)<br>2.0 4WD (GC8)<br>1.6 (GC3)<br>1.6 4WD (GC4)<br>1.8 (GC5)<br>1.8 4WD (GC6)<br>2.0 (GC7)<br>2.0 4WD (GC8)<br>2.0 Turbo 4WD (GC8)<br>2.0 Turbo 4WD (GC8) | <br><br><br><br><br><br><br><br><br><br>155<br>160                               |  | 01.93<br>01.93<br>01.93<br>01.93<br>09.94<br>01.93<br>01.93<br>01.93<br>01.93<br>08.96<br>09.96<br>12.93<br>06.98 | 12.00<br>12.00<br>06.96<br>06.96<br>08.96<br>12.00<br>12.00<br>12.00<br>12.00<br>12.00<br>07.96<br>12.00 | 24.0118-0125.1<br>24.0124-0141.1<br>24.0124-0145.1<br>24.0124-0196.1               | 418125<br>424141<br>424145<br>424196   | - ABS<br><br>+ ABS<br><br>277 24,0 22,0 V +B<br>294 24,0 22,0 V +B  |
|  | 1.6 (GC3)<br>1.6 4WD (GC4)<br>1.8 (GC5)<br>1.8 4WD (GC6)<br>2.0 (GC7)<br>2.0 4WD (GC8)<br>2.0 Turbo 4WD (GC8)   | <br><br><br><br><br>155  |  | 01.93<br>01.93<br>01.93<br>01.93<br>08.96<br>09.94<br>12.93   | 12.00<br>12.00<br>06.96<br>06.96<br>12.00<br>12.00<br>12.00  | 13.0460-5850.2<br>13.0460-0143.2   | 605850<br>610143   | 21703 15,0 +/-WK <b>SUM</b><br>Belagsatz-Zubehör  |

<sup>1)</sup> - collision warning system (PCS) / - sistema anti-collisione (PCS) / - système anticollision (PCS) / - sistema anticollisión (PCS)

<sup>2)</sup> + collision warning system (PCS) / + sistema anti-collisione (PCS) / + système anticollision (PCS) / + sistema anticollisión (PCS)





### SUBARU IMPREZA Limousine (93-00)

|  |  |            |  |  |  |                                  |                  |  |                                 |
|--|--|------------|--|--|--|----------------------------------|------------------|--|---------------------------------|
|  | 1.6 (GC3)<br>1.6 4WD (GC4)<br>1.8 (GC5)<br>1.8 4WD (GC6)<br>2.0 (GC7)<br>2.0 4WD (GC8)<br>2.0 Turbo 4WD (GC8)                        | 155        | 01.93<br>01.93<br>01.93<br>01.93<br>08.96<br>09.94<br>12.93          | 12.00<br>12.00<br>06.96<br>06.96<br>12.00<br>12.00<br>07.98          |  | 24.0110-0237.1                   | 410237           |  | 266 10,0 8,5 +B                 |
|  | 1.6 (GC3)<br>1.6 4WD (GC4)<br>1.8 (GC5)<br>1.8 4WD (GC6)<br>2.0 (GC7)<br>2.0 4WD (GC8)   |            | 01.93<br>01.93<br>01.93<br>01.93<br>08.96<br>09.94                   | 12.00<br>12.00<br>06.96<br>06.96<br>12.00<br>12.00                   |  | 03.0137-0302.2<br>03.0137-9192.2 | 650302<br>669192 |  | 229 x 37<br>Bremsbacken-Zubehör |
|  | 1.6 (GC3)<br>1.6 4WD (GC4)<br>1.8 (GC5)<br>1.8 4WD (GC6)<br>2.0 (GC7)<br>2.0 4WD (GC8)   |            | 01.93<br>01.93<br>01.93<br>01.93<br>08.96<br>09.94                   | 12.00<br>12.00<br>06.96<br>06.96<br>12.00<br>12.00                   | - ABS<br>- ABS<br>- ABS<br>- ABS<br>- ABS<br>- ABS | 24.0222-8023.1                   | 480094           |  | 229/230 x 43,5                  |
|  | 1.6 (GC3)<br>1.6 4WD (GC4)<br>1.8 (GC5)<br>1.8 4WD (GC6)<br>2.0 (GC7)<br>2.0 4WD (GC8)<br>2.0 Turbo 4WD (GC8)<br>2.0 Turbo 4WD (GC8) | 155<br>160 | 01.93<br>01.93<br>01.93<br>01.93<br>08.96<br>09.94<br>12.93<br>06.98 | 12.00<br>12.00<br>06.96<br>06.96<br>12.00<br>12.00<br>12.00<br>12.00 |  | 03.0137-3010.2                   | 653010           |  | 170 x 32                        |

### SUBARU IMPREZA Limousine (00-05)

|  |  |  |  |  |  |  |  |       |   |                   |
|--|--|--|--|--|--|--|--|-------|---|-------------------|
|  | 1.6 TS (GD)<br>1.6 TS (GD)<br>2.0 GX (GD)<br>2.5 RSi (GD)<br>2.0 GX (GD)<br>2.0 WRX Turbo (GD)<br>2.0 WRX Turbo (GD)<br>2.0 WRX STi (GD) | 70<br>70<br>92<br>130<br>92<br>160<br>165<br>195 | 12.00<br>12.00<br>12.00<br>03.01<br>11.02<br>12.00<br>12.02<br>11.02 | 09.05<br>09.05<br>10.02<br>09.05<br>09.05<br>09.05<br>09.05<br>09.05 | - Europa <sup>1)</sup><br>+ Europa <sup>2)</sup> | 13.0460-5895.2<br>13.0460-5851.2<br>13.0460-5787.2<br>13.0460-5640.2<br>13.0460-4973.2 | 605895<br>605851<br>605787<br>605640<br>604973 |       | 23780 16,7 /WK/Zub<br>23558 17,2 /WK<br>23865 17,6 +/WK/Zub<br>21854 15,0 +/WK<br>23325 16,0 +/WK | AKE<br>TOK<br>BRE |
|  | 1.6 TS (GD)<br>2.0 GX (GD)<br>2.5 RSi (GD)<br>2.0 WRX Turbo (GD)<br>2.0 WRX Turbo (GD)   | 70<br>92<br>130<br>160<br>165                    | 12.00<br>12.00<br>03.01<br>12.00<br>12.02                            | 09.05<br>09.05<br>09.05<br>09.05<br>09.05                            | - Europa <sup>1)</sup>                           | 24.0124-0141.1<br>24.0124-0145.1<br>24.0124-0196.1                                     | 424141<br>424145<br>424196                     |       | 260 24,0 22,0 V +B<br>277 24,0 22,0 V +B<br>294 24,0 22,0 V +B                                    |                   |
|  | 2.0 GX (GD)<br>2.5 RSi (GD)<br>2.0 WRX Turbo (GD)<br>2.0 WRX Turbo (GD)  | 92<br>130<br>160<br>165                          | 12.00<br>03.01<br>12.00<br>12.02                                     | 09.05<br>09.05<br>09.05<br>09.05                                     |  | 24.0110-0237.1<br>24.0118-0725.1   | 410237<br>418725                               |       | 266 10,0 8,5 +B<br>290 18,0 16,0 V +B   |                   |
|  | 1.6 TS (GD)  | 70   | 12.00  | 09.05  | - Europa <sup>1)</sup>                           | 03.0137-0302.2<br>03.0137-9192.2   | 650302<br>669192                               |       | 229 x 37<br>Bremsbacken-Zubehör   |                   |
|  | 1.6 TS (GD)  | 70   | 12.00  | 09.05  | - Europa <sup>1)</sup>                           | 24.0222-8023.1   | 480094   | - ABS | 229/230 x 43,5  |                   |
|  | 2.0 GX (GD)<br>2.0 WRX Turbo (GD)<br>2.0 WRX Turbo (GD)<br>2.5 RSi (GD)  | 92<br>160<br>165<br>130                          | 12.00<br>12.00<br>12.02<br>03.01                                     | 09.05<br>09.05<br>09.05<br>09.05                                     |  | 03.0137-3010.2   | 653010   |       | 170 x 32  |                   |

### SUBARU IMPREZA Limousine (05-07)

|  |  |                         |                                  |                                  |  |  |                                      |  |  |                   |
|--|--|-------------------------|----------------------------------|----------------------------------|--|--|--------------------------------------|--|--|-------------------|
|  | 1.5 16V AWD<br>2.0 R AWD<br>2.5 WRX AWD<br>2.0 WRX STi AWD | 77<br>118<br>169<br>206 | 05.06<br>10.05<br>10.05<br>10.05 | 08.07<br>08.07<br>08.07<br>08.07 |  | 13.0460-5793.2<br>13.0460-5787.2<br>13.0460-5640.2<br>13.0460-4973.2 | 605793<br>605787<br>605640<br>604973 |  | 24372 17,3 /WK/Zub<br>23865 17,6 +/WK/Zub<br>21854 15,0 +/WK<br>23325 16,0 +/WK      | AKE<br>TOK<br>BRE |
|  | 1.5 16V AWD<br>2.0 R AWD<br>2.0 WRX STi AWD<br>2.5 WRX AWD | 77<br>118<br>206<br>169 | 05.06<br>10.05<br>10.05<br>10.05 | 08.07<br>08.07<br>08.07<br>08.07 |  | 24.0124-0141.1<br>24.0124-0145.1<br>24.0130-0203.1<br>24.0124-0196.1 | 424141<br>424145<br>430203<br>424196 |  | 260 24,0 22,0 V +B<br>277 24,0 22,0 V +B<br>326 30,0 28,0 V +B<br>294 24,0 22,0 V +B |                   |
|  | 2.0 R AWD<br>2.0 WRX STi AWD                               | 118<br>206              | 10.05<br>10.05                   | 08.07<br>08.07                   |  | 13.0460-5628.2<br>13.0460-4974.2                                     | 605628<br>604974                     |  | 24331 13,8 /WK/Zub<br>21580 14,6 +/WK  | BRE               |
|  | 2.0 R AWD<br>2.5 WRX AWD                                   | 118<br>169              | 10.05<br>10.05                   | 08.07<br>08.07                   |  | 24.0110-0237.1<br>24.0118-0725.1                                     | 410237<br>418725                     |  | 266 10,0 8,5 +B<br>290 18,0 16,0 V +B  |                   |
|  | 1.5 16V AWD  | 77                      | 05.06                            | 08.07                            |  | 03.0137-0302.2<br>03.0137-9192.2                                     | 650302<br>669192                     |  | 229 x 37<br>Bremsbacken-Zubehör  |                   |
|  | 2.0 R AWD  | 118                     | 10.05                            | 08.07                            |  | 03.0137-3010.2   | 653010                               |  | 170 x 32   |                   |

<sup>1)</sup> - Europe / - Europa / - Europe / - Europa  
<sup>2)</sup> + Europe / + Europa / + Europe / + Europa





### SUBARU IMPREZA Kombi (93-00)































|           |                       |       |       |       |                |        |  |  |                          |                |        |  |  |                 |
|-----------|-----------------------|-------|-------|-------|----------------|--------|--|--|--------------------------|----------------|--------|--|--|-----------------|
|           | 1.6 (GF3)             |       | 01.93 | 08.96 | 13.0460-5978.2 | 605978 |  |  | 21495 17,0 +/WK          |                |        |  |  |                 |
|           | 1.6 4WD (GF4)         |       | 01.93 | 08.96 |                |        |  |  |                          |                |        |  |  |                 |
|           | 1.8 (GF5)             |       | 01.93 | 06.96 |                |        |  |  |                          |                |        |  |  |                 |
|           | 1.8 4WD (GF6)         |       | 01.93 | 06.96 | 13.0460-5895.2 | 605895 |  |  | 23780 16,7 /WK/Zub       |                |        |  |  |                 |
|           | 2.0 4WD (GF8)         |       | 08.95 | 08.96 |                |        |  |  |                          |                |        |  |  |                 |
|           | 2.0 Turbo GT 4WD (GF) | 160   | 06.98 | 12.00 |                |        |  |  |                          |                |        |  |  |                 |
|           | 1.6 (GF3)             |       | 01.93 | 12.00 | 13.0460-5851.2 | 605851 |  |  | 23558 17,2 /WK           |                |        |  |  |                 |
|           | 1.6 4WD (GF4)         |       | 01.93 | 12.00 |                |        |  |  |                          |                |        |  |  |                 |
|           | 1.8 (GF5)             |       | 01.93 | 06.96 |                |        |  |  |                          |                |        |  |  |                 |
|           | 1.8 4WD (GF6)         |       | 01.93 | 06.96 | 13.0460-5640.2 | 605640 |  |  | 21854 15,0 +/WK          |                |        |  |  |                 |
|           | 2.0 4WD (GF8)         |       | 08.95 | 08.96 |                |        |  |  |                          |                |        |  |  |                 |
|           | 2.0 Turbo GT 4WD (GF) | 160   | 06.98 | 12.00 |                |        |  |  |                          |                |        |  |  |                 |
|           | 1.6 (GF3)             |       | 01.93 | 12.00 | 24.0118-0125.1 | 418125 |  |  | 242 18,0 16,0 V          |                |        |  |  |                 |
|           | 1.6 4WD (GF4)         |       | 01.93 | 12.00 |                |        |  |  |                          |                |        |  |  |                 |
|           | 1.8 (GF5)             |       | 01.93 | 06.96 |                |        |  |  |                          |                |        |  |  |                 |
|           | 1.8 4WD (GF6)         |       | 01.93 | 06.96 | 24.0124-0141.1 | 424141 |  |  | 260 24,0 22,0 V +B       |                |        |  |  |                 |
|           | 2.0 4WD (GF8)         |       | 08.95 | 08.96 |                |        |  |  |                          |                |        |  |  |                 |
|           | 2.0 Turbo 4WD (GF8)   | 155   | 12.93 | 07.96 |                |        |  |  |                          |                |        |  |  |                 |
|           | 2.0 Turbo GT 4WD (GF) | 160   | 06.98 | 12.00 | 24.0124-0196.1 | 424196 |  |  | 294 24,0 22,0 V +B       |                |        |  |  |                 |
|           | 1.6 (GF3)             |       | 01.93 | 12.00 |                |        |  |  |                          | 13.0460-5850.2 | 605850 |  |  | 21703 15,0 +/WK |
|           | 1.6 4WD (GF4)         |       | 01.93 | 12.00 |                |        |  |  |                          |                |        |  |  |                 |
| 1.8 (GF5) |                       | 01.93 | 06.96 |       |                |        |  |  |                          |                |        |  |  |                 |
|           | 1.8 4WD (GF6)         |       | 01.93 | 06.96 | 13.0460-0143.2 | 610143 |  |  | SUM<br>Belagsatz-Zubehör |                |        |  |  |                 |
|           | 2.0 4WD (GF8)         |       | 08.95 | 12.00 |                |        |  |  |                          |                |        |  |  |                 |
|           | 2.0 Turbo 4WD (GF8)   | 155   | 12.93 | 12.00 |                |        |  |  |                          |                |        |  |  |                 |
|           | 1.6 (GF3)             |       | 01.93 | 12.00 | 24.0110-0237.1 | 410237 |  |  | 266 10,0 8,5 +B          |                |        |  |  |                 |
|           | 1.6 4WD (GF4)         |       | 01.93 | 12.00 |                |        |  |  |                          |                |        |  |  |                 |
|           | 1.8 (GF5)             |       | 01.93 | 06.96 |                |        |  |  |                          |                |        |  |  |                 |
|           | 1.8 4WD (GF6)         |       | 01.93 | 06.96 | 03.0137-0302.2 | 650302 |  |  | 229 x 37                 |                |        |  |  |                 |
|           | 2.0 4WD (GF8)         |       | 08.95 | 12.00 |                |        |  |  |                          |                |        |  |  |                 |
|           | 2.0 Turbo 4WD (GF8)   | 155   | 12.93 | 12.00 |                |        |  |  |                          |                |        |  |  |                 |
|           | 2.0 Turbo GT 4WD (GF) | 160   | 06.98 | 12.00 | 03.0137-9192.2 | 669192 |  |  | Bremsbacken-Zubehör      |                |        |  |  |                 |
|           | 1.6 (GF3)             |       | 01.93 | 12.00 |                |        |  |  |                          | 24.0222-8023.1 | 480094 |  |  | 229/230 x 43,5  |
|           | 1.6 4WD (GF4)         |       | 01.93 | 12.00 |                |        |  |  |                          |                |        |  |  |                 |
| 1.8 (GF5) |                       | 01.93 | 06.96 |       |                |        |  |  |                          |                |        |  |  |                 |
|           | 1.8 4WD (GF6)         |       | 01.93 | 06.96 | 03.0137-3010.2 | 653010 |  |  | 170 x 32                 |                |        |  |  |                 |
|           | 2.0 4WD (GF8)         |       | 08.95 | 12.00 |                |        |  |  |                          |                |        |  |  |                 |
|           | 2.0 Turbo 4WD (GF8)   | 155   | 12.93 | 12.00 |                |        |  |  |                          |                |        |  |  |                 |
|           | 2.0 Turbo GT 4WD (GF) | 160   | 06.98 | 12.00 |                |        |  |  |                          |                |        |  |  |                 |

### SUBARU IMPREZA Kombi (00-05)

|  |                    |     |       |       |                        |                |        |  |                     |
|--|--------------------|-----|-------|-------|------------------------|----------------|--------|--|---------------------|
|  | 1.6 TS (GG)        | 70  | 12.00 | 09.05 | - Europa <sup>1)</sup> | 13.0460-5895.2 | 605895 |  | 23780 16,7 /WK/Zub  |
|  | 1.6 TS (GG)        | 70  | 12.00 | 09.05 | + Europa <sup>2)</sup> |                |        |  |                     |
|  | 2.0 GX (GG)        | 92  | 12.00 | 10.02 |                        |                |        |  |                     |
|  | 2.0 GX (GG)        | 92  | 11.02 | 09.05 |                        | 13.0460-5787.2 | 605787 |  | 23865 17,6 +/WK/Zub |
|  | 2.0 Turbo (GG)     | 160 | 12.00 | 09.05 |                        |                |        |  |                     |
|  | 2.0 WRX Turbo (GG) | 165 | 10.02 | 09.05 |                        |                |        |  |                     |
|  | 1.6 TS (GG)        | 70  | 12.00 | 09.05 |                        | 24.0124-0141.1 | 424141 |  | 260 24,0 22,0 V +B  |
|  | 2.0 GX (GG)        | 92  | 12.00 | 09.05 |                        |                |        |  |                     |
|  | 2.0 Turbo (GG)     | 160 | 12.00 | 09.05 |                        |                |        |  |                     |
|  | 2.0 WRX Turbo (GG) | 165 | 10.02 | 09.05 |                        | 24.0124-0145.1 | 424145 |  | 277 24,0 22,0 V +B  |
|  | 2.0 GX (GG)        | 92  | 11.02 | 09.05 |                        |                |        |  |                     |
|  | 2.0 Turbo (GG)     | 160 | 12.00 | 09.05 |                        |                |        |  |                     |
|  | 2.0 WRX Turbo (GG) | 165 | 10.02 | 09.05 |                        | 13.0460-5628.2 | 605628 |  | 24331 13,8 /WK/Zub  |
|  | 2.0 GX (GG)        | 92  | 12.00 | 09.05 |                        |                |        |  |                     |
|  | 2.0 Turbo (GG)     | 160 | 12.00 | 09.05 |                        |                |        |  |                     |
|  | 2.0 WRX Turbo (GG) | 165 | 10.02 | 09.05 |                        | 24.0118-0725.1 | 418725 |  | 290 18,0 16,0 V +B  |
|  | 1.6 TS (GG)        | 70  | 12.00 | 09.05 | - Europa <sup>1)</sup> |                |        |  |                     |
|  | 2.0 GX (GG)        | 92  | 11.02 | 09.05 |                        |                |        |  |                     |
|  | 1.6 TS (GG)        | 70  | 12.00 | 09.05 | - Europa <sup>1)</sup> | 03.0137-0302.2 | 650302 |  | 229 x 37            |
|  | 2.0 GX (GG)        | 92  | 12.00 | 09.05 |                        |                |        |  |                     |
|  | 2.0 WRX Turbo (GG) | 165 | 10.02 | 09.05 |                        |                |        |  |                     |
|  | 1.6 TS (GG)        | 70  | 12.00 | 09.05 | - Europa <sup>1)</sup> | 24.0222-8023.1 | 480094 |  | 229/230 x 43,5      |
|  | 2.0 GX (GG)        | 92  | 12.00 | 09.05 |                        |                |        |  |                     |
|  | 2.0 WRX Turbo (GG) | 165 | 10.02 | 09.05 |                        |                |        |  |                     |
|  | 1.6 TS (GG)        | 70  | 12.00 | 09.05 | - Europa <sup>1)</sup> | 03.0137-3010.2 | 653010 |  | 170 x 32            |
|  | 2.0 GX (GG)        | 92  | 12.00 | 09.05 |                        |                |        |  |                     |
|  | 2.0 WRX Turbo (GG) | 165 | 10.02 | 09.05 |                        |                |        |  |                     |

<sup>1)</sup> - Europa / - Europa / - Europa / - Europa  
<sup>2)</sup> + Europa / + Europa / + Europa / + Europa

| <b>SUBARU IMPREZA Kombi (05-07)</b> |                  |     |  |       |       |  |  |                |        |  |  |                                 |
|-------------------------------------|------------------|-----|--|-------|-------|--|--|----------------|--------|--|--|---------------------------------|
|                                     | 1.5 16V AWD      | 77  |  | 05.06 | 08.07 |  |  | 13.0460-5793.2 | 605793 |  |  | 24372 17,3 /WK/Zub AKE          |
|                                     | 2.0 R AWD        | 118 |  | 10.05 | 08.07 |  |  | 13.0460-5787.2 | 605787 |  |  | 23865 17,6 +/WK/Zub TOK         |
|                                     | 2.5 WRX AWD      | 169 |  | 10.05 | 08.07 |  |  | 13.0460-5640.2 | 605640 |  |  | 21854 15,0 +/WK                 |
|                                     | 2.0 WRX STI AWD  | 206 |  | 10.05 | 08.07 |  |  | 13.0460-4973.2 | 604973 |  |  | 23325 16,0 +/WK BRE             |
|                                     | 1.5 16V AWD      | 77  |  | 05.06 | 08.07 |  |  | 24.0124-0141.1 | 424141 |  |  | 260 24,0 22,0 V +B              |
|                                     | 2.0 R AWD        | 118 |  | 10.05 | 08.07 |  |  | 24.0124-0145.1 | 424145 |  |  | 277 24,0 22,0 V +B              |
|                                     | 2.0 WRX STI AWD  | 206 |  | 10.05 | 08.07 |  |  | 24.0130-0203.1 | 430203 |  |  | 326 30,0 28,0 V +B              |
|                                     | 2.5 WRX AWD      | 169 |  | 10.05 | 08.07 |  |  | 24.0124-0196.1 | 424196 |  |  | 294 24,0 22,0 V +B              |
|                                     | 2.0 R AWD        | 118 |  | 10.05 | 08.07 |  |  | 13.0460-5628.2 | 605628 |  |  | 24331 13,8 /WK/Zub              |
|                                     | 2.0 WRX STI AWD  | 206 |  | 10.05 | 08.07 |  |  | 13.0460-4974.2 | 604974 |  |  | 21580 14,6 +/WK BRE             |
|                                     | 2.0 R AWD        | 118 |  | 10.05 | 08.07 |  |  | 24.0110-0237.1 | 410237 |  |  | 266 10,0 8,5 +B                 |
|                                     | 2.5 WRX AWD      | 169 |  | 10.05 | 08.07 |  |  | 24.0118-0725.1 | 418725 |  |  | 290 18,0 16,0 V +B              |
|                                     | 1.5 16V AWD      | 77  |  | 05.06 | 08.07 |  |  | 03.0137-0302.2 | 650302 |  |  | 229 x 37<br>Bremsbacken-Zubehör |
|                                     |                  |     |  |       |       |  |  | 03.0137-9192.2 | 669192 |  |  |                                 |
|                                     | 2.0 R AWD        | 118 |  | 10.05 | 08.07 |  |  | 03.0137-3010.2 | 653010 |  |  | 170 x 32                        |
| <b>SUBARU IMPREZA (08-11)</b>       |                  |     |  |       |       |  |  |                |        |  |  |                                 |
|                                     | 1.5 16V          | 79  |  | 02.08 | 12.11 |  |  | 13.0460-5787.2 | 605787 |  |  | 23865 17,6 +/WK/Zub TOK         |
|                                     | 1.5 16V Allrad   | 79  |  | 02.08 | 12.11 |  |  |                |        |  |  |                                 |
|                                     | 2.0 16V Allrad   | 110 |  | 02.08 | 12.11 |  |  |                |        |  |  |                                 |
|                                     | 2.0 16V Allrad   | 118 |  | 02.08 | 12.11 |  |  |                |        |  |  |                                 |
|                                     | 2.0 16V AWD      | 110 |  | 01.11 | 12.11 |  |  |                |        |  |  |                                 |
|                                     | 2.0 D Allrad     | 80  |  | 01.11 | 12.11 |  |  |                |        |  |  |                                 |
|                                     | 2.0 D Allrad     | 110 |  | 01.09 | 12.11 |  |  |                |        |  |  |                                 |
|                                     | 1.5 16V          | 79  |  | 02.08 | 12.11 |  |  | 24.0124-0141.1 | 424141 |  |  | 260 24,0 22,0 V +B              |
|                                     | 1.5 16V Allrad   | 79  |  | 02.08 | 12.11 |  |  |                |        |  |  |                                 |
|                                     | 1.5 16V          | 79  |  | 02.08 | 12.11 |  |  | 24.0124-0145.1 | 424145 |  |  | 277 24,0 22,0 V +B              |
|                                     | 1.5 16V Allrad   | 79  |  | 02.08 | 12.11 |  |  |                |        |  |  |                                 |
|                                     | 2.0 16V Allrad   | 110 |  | 02.08 | 12.11 |  |  |                |        |  |  |                                 |
|                                     | 2.0 16V Allrad   | 118 |  | 02.08 | 12.11 |  |  |                |        |  |  |                                 |
|                                     | 2.0 16V AWD      | 110 |  | 01.11 | 12.11 |  |  |                |        |  |  |                                 |
|                                     | 2.0 D Allrad     | 80  |  | 01.11 | 12.11 |  |  | 24.0124-0196.1 | 424196 |  |  | 294 24,0 22,0 V +B              |
|                                     | 2.0 D Allrad     | 110 |  | 01.09 | 12.11 |  |  |                |        |  |  |                                 |
|                                     | 2.5 16V Allrad   | 169 |  | 02.08 | 12.11 |  |  |                |        |  |  |                                 |
|                                     | 2.5 16V Allrad   | 221 |  | 02.08 | 12.11 |  |  | 24.0130-0203.1 | 430203 |  |  | 326 30,0 28,0 V +B              |
|                                     | 2.5 STi CS400    | 294 |  | 04.10 | 12.11 |  |  |                |        |  |  |                                 |
|                                     | 2.5 WRX S AWD    | 188 |  | 02.09 | 12.10 |  |  |                |        |  |  |                                 |
|                                     | 2.5 WRX STI 330S | 243 |  | 05.09 | 12.10 |  |  |                |        |  |  |                                 |
|                                     | 2.5 WRX STI AWD  | 221 |  | 01.11 | 12.11 |  |  |                |        |  |  |                                 |
|                                     | 2.0 16V Allrad   | 110 |  | 02.08 | 12.11 |  |  | 24.0110-0366.1 | 410366 |  |  | 286 10,0 8,5 +B                 |
|                                     | 2.0 16V Allrad   | 118 |  | 02.08 | 12.11 |  |  |                |        |  |  |                                 |
|                                     | 2.0 16V AWD      | 110 |  | 01.11 | 12.11 |  |  | 03.0137-3015.2 | 653015 |  |  | 190 x 32<br>Bremsbacken-Zubehör |
|                                     | 2.0 D Allrad     | 80  |  | 01.11 | 12.11 |  |  | 03.0137-9307.2 | 669307 |  |  |                                 |
|                                     | 2.0 D Allrad     | 110 |  | 01.09 | 12.11 |  |  |                |        |  |  |                                 |
|                                     | 2.5 16V Allrad   | 169 |  | 02.08 | 12.11 |  |  |                |        |  |  |                                 |
|                                     | 2.5 16V Allrad   | 221 |  | 02.08 | 12.11 |  |  |                |        |  |  |                                 |
|                                     | 2.5 STi CS400    | 294 |  | 04.10 | 12.11 |  |  |                |        |  |  |                                 |
|                                     | 2.5 WRX S AWD    | 188 |  | 02.09 | 12.10 |  |  |                |        |  |  |                                 |
|                                     | 2.5 WRX STI 330S | 243 |  | 05.09 | 12.10 |  |  |                |        |  |  |                                 |
|                                     | 2.5 WRX STI AWD  | 221 |  | 01.11 | 12.11 |  |  |                |        |  |  |                                 |
| <b>SUBARU IMPREZA (GP) (11-)</b>    |                  |     |  |       |       |  |  |                |        |  |  |                                 |
|                                     | 1.6 16V          | 84  |  | 06.12 |       |  |  | 24.0124-0145.1 | 424145 |  |  | 277 24,0 22,0 V +B              |
|                                     | 1.6 16V AWD      | 84  |  | 06.12 |       |  |  |                |        |  |  |                                 |
|                                     | 1.6 16V          | 84  |  | 06.12 |       |  |  | 24.0110-0384.1 | 410384 |  |  | 274 10,0 8,5 +B                 |
|                                     | 1.6 16V AWD      | 84  |  | 06.12 |       |  |  |                |        |  |  |                                 |
|                                     | 1.6 16V          | 84  |  | 06.12 |       |  |  | 03.0137-3045.2 | 653045 |  |  | 170 x 35                        |
|                                     | 1.6 16V AWD      | 84  |  | 06.12 |       |  |  |                |        |  |  |                                 |
| <b>SUBARU JUSTY (95-03)</b>         |                  |     |  |       |       |  |  |                |        |  |  |                                 |
|                                     | 1.3 4x4          | 50  |  | 10.95 | 06.98 |  |  | 13.0460-5985.2 | 605985 |  |  | 21333 15,0 +/WK TOK             |
|                                     | 1.3 4x4          | 50  |  | 07.98 | 09.00 |  |  | 13.0460-5837.2 | 605837 |  |  | 23296 14,5 +/WK BOS             |
|                                     | 1.3 4x4          | 63  |  | 10.00 | 11.03 |  |  |                |        |  |  |                                 |
|                                     | 1.3 4x4          | 50  |  | 10.95 | 09.00 |  |  | 24.0117-0103.1 | 417103 |  |  | 231 17,0 15,0 V +B              |
|                                     | 1.3 4x4          | 63  |  | 10.00 | 11.03 |  |  |                |        |  |  |                                 |

|     |        |  |  |  |   |  |  |  |   |
|--|--|--|--|--|--|--|--|--|---|
| <b>SUBARU JUSTY (95-03)</b>  |  |  |  |  |  |  |  |  |   |
|    | 1.3 4x4  | 50   |  | 10.95  | 06.98  |  | 03.0137-0315.2<br>03.0137-9271.2   | 650315<br>669271   | 200 x 32<br>Bremsbacken-Zubehör                 |
|  | 1.3 4x4<br>1.3 4x4   | 50<br>63   |  | 07.98<br>10.00   | 09.00<br>11.03   |  | 03.0137-0500.2   | 650500   | 200 x 32 HEB <b>BOS</b>                         |
|    | 1.3 4x4<br>1.3 4x4   | 50<br>63   |  | 10.95<br>10.00   | 09.00<br>11.03   |  | 24.0220-0040.1   | 480166   | 200/202 x 40                                    |
| <b>SUBARU JUSTY (G3X) (03-07)</b>  |  |  |  |  |  |  |  |  |   |
|    | 1.3 i 16V 4WD<br>1.5 i 16V 4WD   | 69<br>73   |  | 09.03<br>09.03   | 08.07<br>08.07   |  | 13.0460-3995.2   | 603995   | 23605 15,7 +/WK/Zub/SBOS                        |
|    | 1.3 i 16V 4WD<br>1.5 i 16V 4WD   | 69<br>73   |  | 09.03<br>09.03   | 08.07<br>08.07   |  | 24.0117-0106.1   | 417106   | 253 17,0 15,0 V +B                              |
|    | 1.3 i 16V 4WD<br>1.5 i 16V 4WD   | 69<br>73   |  | 09.03<br>09.03   | 08.07<br>08.07   |  | 03.0137-0465.2<br>03.0137-9300.2   | 650465<br>669300   | 200 x 29 HEB<br>Bremsbacken-Zubehör             |
|    | 1.3 i 16V 4WD<br>1.5 i 16V 4WD   | 69<br>73   |  | 09.03<br>09.03   | 08.07<br>08.07   |  | 03.0520-1415.3   | 691415   | 15,87/200x29 TopKit                             |
| <b>SUBARU JUSTY (07-11)</b>  |  |  |  |  |  |  |  |  |   |
|    | 1.0 i 12V<br>1.3 AWD   | 51<br>67   |  | 09.07<br>03.08   | 05.11 + 14" Rad/ + Schaltgetriebe<br>+  / + 14" Rad/ + Schaltgetriebe       |  | 13.0460-5794.2   | 605794   | 24283 15,5 +/WK/Zub/STRW                        |
|  | 1.0 i 12V<br>1.3 AWD   | 51<br>67   |  | 09.07<br>03.08   | 05.11 + 14" Rad/ + Automatikgetriebe<br>+  / + 14" Rad/ + Automatikgetriebe |  | 13.0460-5887.2   | 605887   | 23507 15,2 +/WK <b>SUM</b>                      |
|  | 1.3 AWD  | 67   |  | 03.08  | 05.11 +   |  | 13.0460-5613.2   | 605613   | 25262 15,0 +/WK/Zub                             |
|    | 1.0 i 12V<br>1.3 AWD   | 51<br>67   |  | 09.07<br>03.08   | 05.11 + 13" Rad <sup>1)</sup><br>+  / + 13" Rad                             |  | 24.0116-0130.1   | 416130   | 234 16,0 15,0 V +B                              |
|  | 1.0 i 12V<br>1.3 AWD   | 51<br>67   |  | 09.07<br>03.08   | 05.11 + 14" Rad/ + Schaltgetriebe<br>+  / + 14" Rad/ + Schaltgetriebe       |  | 24.0122-0263.1   | 422263   | 254 22,0 20,0 V +B                              |
|  | 1.0 i 12V<br>1.3 AWD   | 51<br>67   |  | 09.07<br>03.08   | 05.11 + 14" Rad/ + Automatikgetriebe<br>+  / + 14" Rad/ + Automatikgetriebe |  | 24.0117-0107.1   | 417107   | 246 17,0 16,0 V +B                              |
|    | 1.0 i 12V<br>1.3 AWD   | 51<br>67   |  | 09.07<br>03.08   | 05.11 +   |  | 03.0137-0489.2   | 650489   | 180 x 28  |
| <b>SUBARU LEGACY Limousine (94-99)</b>   |  |  |  |  |  |  |  |  |   |
|  | 2.0 (BD4)<br>2.0 4WD (BD5)<br>2.2 (BD6)<br>2.2 4WD (BD7)                               |  |  | 01.94<br>01.94<br>01.94<br>01.94   | 01.96<br>01.96<br>01.96<br>01.96   |  | 13.0460-5978.2   | 605978   | 21495 17,0 +/WK                                 |
|  | 1.8 (BD2)<br>2.0 (BD4)<br>2.0 4WD (BD5)<br>2.2 (BD6)<br>2.2 4WD (BD7)<br>2.5 4WD (BD9) |  |  | 01.96<br>02.96<br>02.96<br>02.96<br>02.96  | 03.99<br>03.99<br>03.99<br>03.99<br>03.99  |  | 13.0460-5895.2   | 605895   | 23780 16,7 /WK/Zub                              |
|  | 1.8 (BD2)<br>2.0 (BD4)<br>2.0 4WD (BD5)<br>2.2 (BD6)<br>2.2 4WD (BD7)<br>2.5 4WD (BD9) |  |  | 01.96<br>01.94<br>01.94<br>01.94<br>01.94  | 03.99<br>03.99<br>03.99<br>03.99<br>03.99  |  | 24.0124-0141.1   | 424141   | 260 24,0 22,0 V +B                              |
|  | 1.8 (BD2)<br>2.0 (BD4)<br>2.0 4WD (BD5)<br>2.2 (BD6)<br>2.2 4WD (BD7)<br>2.5 4WD (BD9) |  |  | 01.96<br>01.94<br>01.94<br>01.94<br>01.94  | 03.99<br>03.99<br>03.99<br>03.99<br>03.99  |  | 24.0124-0145.1   | 424145   | 277 24,0 22,0 V +B                              |
|  | 1.8 (BD2)<br>2.0 (BD4)<br>2.0 4WD (BD5)<br>2.2 (BD6)<br>2.2 4WD (BD7)<br>2.5 4WD (BD9) |  |  | 01.96<br>01.94<br>01.94<br>01.94<br>01.94  | 03.99<br>03.99<br>03.99<br>03.99<br>03.99  |  | 13.0460-5850.2<br>13.0460-0143.2   | 605850<br>610143   | 21703 15,0 +/WK <b>SUM</b><br>Belagsatz-Zubehör |
|  | 1.8 (BD2)<br>2.0 (BD4)<br>2.0 4WD (BD5)<br>2.2 (BD6)<br>2.2 4WD (BD7)<br>2.5 4WD (BD9) |  |  | 01.96<br>01.94<br>01.94<br>01.94<br>01.94  | 03.99<br>03.99<br>03.99<br>03.99<br>03.99  |  | 24.0110-0237.1   | 410237   | 266 10,0 8,5 +B                                 |
|  | 1.8 (BD2)<br>2.0 (BD4)<br>2.0 4WD (BD5)<br>2.2 (BD6)<br>2.2 4WD (BD7)                  |  |  | 01.96<br>01.94<br>01.94<br>01.94<br>01.94  | 03.99<br>03.99<br>03.99<br>03.99<br>03.99  |  | 03.0137-0302.2<br>03.0137-9192.2   | 650302<br>669192   | 229 x 37<br>Bremsbacken-Zubehör                 |
|  | 1.8 (BD2)<br>2.0 (BD4)<br>2.0 4WD (BD5)<br>2.2 (BD6)<br>2.2 4WD (BD7)                  |  |  | 01.96<br>01.94<br>01.94<br>01.94<br>01.94  | 03.99<br>03.99<br>03.99<br>03.99<br>03.99  |  | 24.0222-8023.1   | 480094   | 229/230 x 43,5                                  |
|  | 1.8 (BD2)<br>2.0 (BD4)<br>2.0 4WD (BD5)<br>2.2 (BD6)<br>2.2 4WD (BD7)<br>2.5 4WD (BD9) |  |  | 01.96<br>01.94<br>01.94<br>01.94<br>01.94  | 03.99<br>03.99<br>03.99<br>03.99<br>03.99  |  | 03.0137-3010.2   | 653010   | 170 x 32  |

1) + 13" wheel / + ruota 13" / + roue 13" / + rueda 13"



**SUBARU LEGACY Kombi (94-98)**

|  |               |  |       |       |                |        |  |                |                      |
|--|---------------|--|-------|-------|----------------|--------|--|----------------|----------------------|
|  | 2.0 (BG4)     |  | 01.94 | 01.96 | 13.0460-5978.2 | 605978 |  | 21495          | 17,0 +/WK            |
|  | 2.0 4WD (BG5) |  | 01.94 | 01.96 |                |        |  |                |                      |
|  | 2.2 4WD (BG7) |  | 01.94 | 01.96 |                |        |  |                |                      |
|  | 2.0 (BG4)     |  | 02.96 | 11.98 | 13.0460-5895.2 | 605895 |  | 23780          | 16,7 /WK/Zub         |
|  | 2.0 4WD (BG5) |  | 02.96 | 11.98 |                |        |  |                |                      |
|  | 2.2 4WD (BG7) |  | 02.96 | 11.98 |                |        |  |                |                      |
|  | 2.5 4WD (BG9) |  | 06.96 | 11.98 | 13.0460-5851.2 | 605851 |  | 23558          | 17,2 /WK <b>AKE</b>  |
|  | 2.0 (BG4)     |  | 01.94 | 11.98 |                |        |  |                |                      |
|  | 2.0 4WD (BG5) |  | 01.94 | 11.98 |                |        |  |                |                      |
|  | 2.2 4WD (BG7) |  | 01.94 | 11.98 | 24.0124-0141.1 | 424141 |  | 260            | 24,0 22,0 V +B       |
|  | 2.5 4WD (BG9) |  | 06.96 | 11.98 |                |        |  |                |                      |
|  | 2.0 (BG4)     |  | 01.94 | 11.98 |                |        |  |                |                      |
|  | 2.0 4WD (BG5) |  | 01.94 | 11.98 | 13.0460-5850.2 | 605850 |  | 21703          | 15,0 +/WK <b>SUM</b> |
|  | 2.2 4WD (BG7) |  | 01.94 | 11.98 |                |        |  |                |                      |
|  | 2.5 4WD (BG9) |  | 06.96 | 11.98 |                |        |  |                |                      |
|  | 2.0 (BG4)     |  | 01.94 | 11.98 | 24.0110-0237.1 | 410237 |  | 266            | 10,0 8,5 +B          |
|  | 2.0 4WD (BG5) |  | 01.94 | 11.98 |                |        |  |                |                      |
|  | 2.2 4WD (BG7) |  | 01.94 | 11.98 |                |        |  |                |                      |
|  | 2.5 4WD (BG9) |  | 06.96 | 11.98 | 03.0137-0302.2 | 650302 |  | 229 x 37       | Bremsbacken-Zubehör  |
|  | 2.0 (BG4)     |  | 01.94 | 11.98 |                |        |  |                |                      |
|  | 2.0 4WD (BG5) |  | 01.94 | 11.98 |                |        |  |                |                      |
|  | 2.2 4WD (BG7) |  | 01.94 | 11.98 | 03.0137-9192.2 | 669192 |  | 229/230 x 43,5 |                      |
|  | 2.0 (BG4)     |  | 01.94 | 11.98 |                |        |  |                |                      |
|  | 2.0 4WD (BG5) |  | 01.94 | 11.98 |                |        |  |                |                      |
|  | 2.5 4WD (BG9) |  | 06.96 | 11.98 | 24.0222-8023.1 | 480094 |  | 170 x 32       |                      |
|  | 2.0 (BG4)     |  | 01.94 | 11.98 |                |        |  |                |                      |
|  | 2.0 4WD (BG5) |  | 01.94 | 11.98 |                |        |  |                |                      |
|  | 2.2 4WD (BG7) |  | 01.94 | 11.98 | 03.0137-3010.2 | 653010 |  |                |                      |
|  | 2.0 (BG4)     |  | 01.94 | 11.98 |                |        |  |                |                      |
|  | 2.0 4WD (BG5) |  | 01.94 | 11.98 |                |        |  |                |                      |
|  | 2.5 4WD (BG9) |  | 06.96 | 11.98 |                |        |  |                |                      |
|  | 2.2 4WD (BG7) |  | 01.94 | 11.98 |                |        |  |                |                      |
|  | 2.0 (BG4)     |  | 01.94 | 11.98 |                |        |  |                |                      |

**SUBARU LEGACY (99-03)**

|  |                     |     |       |       |                |        |  |       |                |
|--|---------------------|-----|-------|-------|----------------|--------|--|-------|----------------|
|  | 2.0 i 16V (BE/BH5A) | 92  | 04.99 | 07.00 | 13.0460-5895.2 | 605895 |  | 23780 | 16,7 /WK/Zub   |
|  | 2.0 i 16V (BE/BH5A) | 92  | 08.00 | 08.03 |                |        |  |       |                |
|  | 2.5 i 16V (BE/BH9A) | 115 | 10.98 | 08.03 |                |        |  |       |                |
|  | 2.0 i 16V (BE/BH5A) | 92  | 04.99 | 07.00 | 24.0124-0141.1 | 424141 |  | 260   | 24,0 22,0 V +B |
|  | 2.0 i 16V (BE/BH5A) | 92  | 08.00 | 08.03 |                |        |  |       |                |
|  | 2.5 i 16V (BE/BH9A) | 115 | 10.98 | 08.03 |                |        |  |       |                |



























**SUBARU LEGACY (03-09)**

|  |                  |     |       |       |                |        |  |       |                          |
|--|------------------|-----|-------|-------|----------------|--------|--|-------|--------------------------|
|  | 2.0 i 16V        | 101 | 09.03 | 10.05 | 13.0460-5787.2 | 605787 |  | 23865 | 17,6 +/WK/Zub <b>TOK</b> |
|  | 2.0 R            | 110 | 09.07 | 04.09 |                |        |  |       |                          |
|  | 2.0 TD           | 110 | 02.08 | 04.09 |                |        |  |       |                          |
|  | 2.5 i 16V        | 121 | 09.03 | 04.09 |                |        |  |       |                          |
|  | 2.5 i 16V        | 127 | 09.07 | 04.09 |                |        |  |       |                          |
|  | 2.0 R AWD        | 121 | 06.05 | 04.09 |                |        |  |       |                          |
|  | 2.0 Turbo HP AWD | 132 | 06.05 | 04.09 |                |        |  |       |                          |
|  | 2.0 Turbo HP AWD | 140 | 06.05 | 04.09 | 13.0460-5797.2 | 605797 |  | 24222 | 16,9 +/WK/Zub <b>AKE</b> |
|  | 2.5 i 16V        | 121 | 09.03 | 04.09 |                |        |  |       |                          |
|  | 3.0 V6           | 180 | 09.03 | 04.09 |                |        |  |       |                          |
|  | 2.0 i 16V        | 101 | 09.03 | 10.05 |                |        |  |       |                          |
|  | 2.0 R            | 110 | 09.07 | 04.09 |                |        |  |       |                          |
|  | 2.5 i 16V        | 121 | 09.03 | 04.09 |                |        |  |       |                          |
|  | 2.5 i 16V        | 127 | 09.07 | 04.09 |                |        |  |       |                          |
|  | 2.0 R AWD        | 121 | 06.05 | 04.09 | 24.0124-0145.1 | 424145 |  | 277   | 24,0 22,0 V +B           |
|  | 2.0 Turbo HP AWD | 132 | 06.05 | 04.09 |                |        |  |       |                          |
|  | 2.0 Turbo HP AWD | 140 | 06.05 | 04.09 |                |        |  |       |                          |
|  | 3.0 V6           | 180 | 09.03 | 06.09 |                |        |  |       |                          |
|  | 2.0 TD           | 110 | 02.08 | 04.09 |                |        |  |       |                          |
|  | 2.0 i 16V        | 101 | 09.03 | 10.05 |                |        |  |       |                          |
|  | 2.0 R            | 110 | 09.07 | 04.09 |                |        |  |       |                          |
|  | 2.5 i 16V        | 121 | 09.03 | 04.09 | 24.0110-0728.1 | 410728 |  | 274   | 10,0 8,5 +B              |
|  | 2.5 i 16V        | 127 | 09.07 | 04.09 |                |        |  |       |                          |
|  | 2.0 R AWD        | 121 | 06.05 | 04.09 |                |        |  |       |                          |
|  | 2.0 Turbo HP AWD | 132 | 06.05 | 04.09 |                |        |  |       |                          |
|  | 2.0 Turbo HP AWD | 140 | 06.05 | 04.09 |                |        |  |       |                          |
|  | 3.0 V6           | 180 | 09.03 | 06.09 |                |        |  |       |                          |
|  | 2.0 R AWD        | 121 | 06.05 | 04.09 |                |        |  |       |                          |
|  | 2.0 Turbo HP AWD | 132 | 06.05 | 04.09 | 24.0118-0725.1 | 418725 |  | 290   | 18,0 16,0 V +B           |
|  | 2.0 Turbo HP AWD | 140 | 06.05 | 04.09 |                |        |  |       |                          |
|  | 3.0 V6           | 180 | 09.03 | 06.09 |                |        |  |       |                          |





























**SUBARU LEGACY (09-)**

|  |               |     |       |  |                |        |  |       |                          |
|--|---------------|-----|-------|--|----------------|--------|--|-------|--------------------------|
|  | 2.0 16V AWD   | 110 | 09.09 |  | 13.0460-5787.2 | 605787 |  | 23865 | 17,6 +/WK/Zub <b>TOK</b> |
|  | 2.0 i LPG AWD | 108 | 09.09 |  |                |        |  |       |                          |
|  | 2.0 TD AWD    | 110 | 09.09 |  |                |        |  |       |                          |
|  | 2.5 16V AWD   | 123 | 09.09 |  | 13.0460-5793.2 | 605793 |  | 24372 | 17,3 /WK/Zub <b>AKE</b>  |
|  | 2.5 16V AWD   | 125 | 09.09 |  |                |        |  |       |                          |
|  | 3.6 R V6 AWD  | 191 | 09.10 |  |                |        |  |       |                          |
|  | 2.0 TD AWD    | 110 | 09.09 |  | 13.0460-5797.2 | 605797 |  | 24222 | 16,9 +/WK/Zub <b>AKE</b> |
|  | 2.0 16V AWD   | 110 | 09.09 |  |                |        |  |       |                          |
|  | 2.0 i AWD     | 110 | 06.12 |  |                |        |  |       |                          |
|  | 2.0 i LPG AWD | 108 | 09.09 |  | 24.0124-0196.1 | 424196 |  | 294   | 24,0 22,0 V +B           |
|  | 2.5 16V AWD   | 123 | 09.09 |  |                |        |  |       |                          |
|  | 2.5 16V AWD   | 125 | 09.09 |  |                |        |  |       |                          |
|  | 2.5 Turbo AWD | 195 | 07.10 |  | 24.0124-0145.1 | 424145 |  | 277   | 24,0 22,0 V +B           |
|  | 3.6 R V6 AWD  | 191 | 09.10 |  |                |        |  |       |                          |
|  | 2.5 Turbo AWD | 195 | 07.10 |  |                |        |  |       |                          |
|  | 3.6 R V6 AWD  | 191 | 09.10 |  | 24.0130-0204.1 | 430204 |  | 316   | 30,0 28,0 V +B           |
|  | 2.5 Turbo AWD | 195 | 07.10 |  |                |        |  |       |                          |
|  | 3.6 R V6 AWD  | 191 | 09.10 |  |                |        |  |       |                          |























|     |                                        |  |  |  |  |  |  |  |
|--|--|--|--|--|---|--|--|--|
| <b>SUBARU LEGACY (09-)</b>   |  |  |  |  |   |  |  |  |
|    | 2.0 16V AWD<br>2.0 i AWD<br>2.0 i LPG AWD<br>2.0 TD AWD<br>2.5 16V AWD<br>2.5 16V AWD<br>3.6 R V6 AWD                  | 110<br>110<br>108<br>110<br>123<br>125<br>191                                    |  | 09.09<br>06.12<br>09.09<br>09.09<br>09.09<br>09.09<br>09.10                      |   | 24.0110-0366.1   | 410366   | 286 10,0 8,5 +B  |
|    | 2.0 16V AWD<br>2.0 i AWD<br>2.0 i LPG AWD<br>2.0 TD AWD<br>2.5 16V AWD<br>2.5 16V AWD<br>2.5 Turbo AWD<br>3.6 R V6 AWD | 110<br>110<br>108<br>110<br>123<br>125<br>195<br>191                             |  | 09.09<br>06.12<br>09.09<br>09.09<br>09.09<br>09.09<br>07.10<br>09.10             |   | 03.0137-3015.2   | 653015   | 190 x 32   |
| <b>SUBARU OUTBACK (00-03)</b>  |  |  |  |  |   |  |  |  |
|    | 2.5<br>3.0 H6  | 115<br>154   |  | 10.00<br>10.00   | 10.03<br>10.03  | 13.0460-5851.2   | 605851   | 23558 17,2 /WK <b>AKE</b>  |
|    | 2.5<br>3.0 H6  | 115<br>154   |  | 10.00<br>10.00   | 10.03<br>10.03  | 24.0124-0196.1   | 424196   | 294 24,0 22,0 V +B   |
| <b>SUBARU OUTBACK (03-09)</b>  |  |  |  |  |   |  |  |  |
|    | 2.0 16V 4x4<br>2.0 TD 4x4<br>2.5 16V 4x4<br>2.5 16V 4x4<br>3.0 V6 4x4  | 101<br>110<br>121<br>127<br>180  |  | 09.03<br>09.08<br>11.03<br>09.08<br>11.03  | 10.05<br>04.09<br>04.09<br>06.09<br>06.09   | 13.0460-5787.2<br>13.0460-5797.2   | 605787<br>605797   | 23865 17,6 +/WK/Zub <b>TOK</b><br>24222 16,9 +/WK/Zub <b>AKE</b>                   |
|    | 2.0 16V 4x4<br>2.0 TD 4x4<br>2.5 16V 4x4<br>2.5 16V 4x4<br>3.0 V6 4x4  | 101<br>110<br>121<br>127<br>180  |  | 09.03<br>09.08<br>11.03<br>09.08<br>11.03  | 10.05<br>04.09<br>04.09<br>06.09<br>06.09   | 24.0124-0145.1   | 424145   | 277 24,0 22,0 V +B   |
|    | 2.0 16V 4x4<br>2.0 TD 4x4<br>2.5 16V 4x4   | 101<br>110<br>127  |  | 09.03<br>09.08<br>09.08  | 10.05<br>04.09<br>06.09   | 24.0110-0728.1   | 410728   | 274 10,0 8,5 +B  |
|   | 2.5 16V 4x4<br>3.0 V6 4x4  | 121<br>180   |  | 11.03<br>11.03   | 04.09<br>06.09  | 24.0110-0728.1<br>24.0118-0725.1   | 410728<br>418725   | 274 10,0 8,5 +B<br>290 18,0 16,0 V +B  |
| <b>SUBARU OUTBACK (09-)</b>  |  |  |  |  |   |  |  |  |
|  | 2.0 TD 4x4<br>2.0 TD 4x4<br>2.5 16V 4x4<br>2.5 16V 4x4<br>3.6 R 4x4<br>3.6 R 4x4                                       | 108<br>110<br>123<br>125<br>188<br>191   |  | 01.13<br>09.09<br>09.09<br>09.09<br>01.12<br>09.09                               |   | 13.0460-5787.2   | 605787   | 23865 17,6 +/WK/Zub <b>TOK</b>   |
|  | 2.5 16V 4x4<br>2.5 16V 4x4<br>3.6 R 4x4<br>3.6 R 4x4   | 125<br>127<br>188<br>191   |  | 09.09<br>01.13<br>01.12<br>09.09   |   | 13.0460-5793.2<br>13.0460-5797.2   | 605793<br>605797   | 24372 17,3 /WK/Zub <b>AKE</b><br>24222 16,9 +/WK/Zub <b>AKE</b>                    |
|  | 2.0 TD 4x4<br>2.0 TD 4x4<br>2.5 16V 4x4<br>2.5 16V 4x4<br>3.6 R 4x4<br>3.6 R 4x4                                       | 108<br>110<br>123<br>125<br>188<br>191   |  | 01.13<br>09.09<br>09.09<br>09.09<br>01.12<br>09.09                               |   | 24.0124-0196.1   | 424196   | 294 24,0 22,0 V +B   |
|  | 2.5 16V 4x4<br>2.5 16V 4x4<br>3.6 R 4x4<br>3.6 R 4x4   | 125<br>127<br>188<br>191   |  | 09.09<br>01.13<br>01.12<br>09.09   |   | 24.0124-0145.1<br>24.0130-0204.1   | 424145<br>430204   | 277 24,0 22,0 V +B<br>316 30,0 28,0 V +B   |
|  | 2.0 TD 4x4<br>2.0 TD 4x4<br>2.5 16V 4x4<br>2.5 16V 4x4<br>3.6 R 4x4<br>3.6 R 4x4                                       | 108<br>110<br>123<br>125<br>188<br>191   |  | 01.13<br>09.09<br>09.09<br>09.09<br>01.12<br>09.09                               |   | 24.0110-0366.1   | 410366   | 286 10,0 8,5 +B  |
|  | 2.0 TD 4x4<br>2.0 TD 4x4<br>2.5 16V 4x4<br>2.5 16V 4x4<br>3.6 R 4x4<br>3.6 R 4x4                                       | 108<br>110<br>123<br>125<br>188<br>191   |  | 01.13<br>09.09<br>09.09<br>09.09<br>01.12<br>09.09                               |   | 03.0137-3015.2   | 653015   | 190 x 32   |
| <b>SUBARU TREZIA (11-)</b>   |  |  |  |  |   |  |  |  |
|  | 1.3 16V<br>1.4 D   | 73<br>66   |  | 03.11<br>03.11   |   | 13.0460-5767.2   | 605767   | 24336 17,5 <b>AKE</b>  |
|  | 1.3 16V<br>1.4 D   | 73<br>66   |  | 03.11<br>03.11   |   | 24.0122-0276.1   | 422276   | 275 22,0 19,0 V +B   |
|  | 1.3 16V<br>1.4 D   | 73<br>66   |  | 03.11<br>03.11   |   | 13.0460-5769.2   | 605769   | 24610 15,0 +/WK  |
|  | 1.3 16V<br>1.4 D   | 73<br>66   |  | 03.11<br>03.11   |   | 24.0109-0163.1   | 409163   | 259 9,0 7,5 +B   |



























|     |  |  |  |  |  |  |  |  |
|--|--|--|--|--|---|--|--|--|
| <b>SUBARU TRIBECA (B9) (05-10)</b>   |  |  |  |  |   |  |  |  |
|    | 3.0 H6<br>3.0 H6<br>3.6 i V6   | 180<br>184<br>190  |  | 10.06<br>01.05<br>12.07  | 11.07<br>09.06<br>10.10   | 13.0460-5797.2   | 605797   | 24222 16,9 +WK/Zub AKE   |
| <b>SUBARU XV (12-)</b>   |  |  |  |  |   |  |  |  |
|    | 1.6 i 16V<br>2.0 D<br>2.0 D<br>2.0 i 16V   | 84<br>80<br>108<br>110   |  | 03.12<br>03.12<br>03.12<br>03.12   |   | 24.0124-0196.1   | 424196   | 294 24,0 22,0 V +B   |
|    | 1.6 i 16V<br>2.0 D<br>2.0 D<br>2.0 i 16V   | 84<br>80<br>108<br>110   |  | 03.12<br>03.12<br>03.12<br>03.12   |   | 24.0110-0384.1   | 410384   | 274 10,0 8,5 +B  |
|    | 1.6 i 16V<br>2.0 D<br>2.0 D<br>2.0 i 16V   | 84<br>80<br>108<br>110   |  | 03.12<br>03.12<br>03.12<br>03.12   |   | 03.0137-3045.2   | 653045   | 170 x 35   |
| <b>SUZUKI ALTO (93-02)</b>   |  |  |  |  |   |  |  |  |
|    | 0.8<br>1.0<br>1.0 16V<br>1.3 16V<br>1.6 16V                                      |  |  | 11.93<br>09.94<br>01.00<br>02.99<br>02.99  | 06.96<br>06.02<br>06.02<br>09.00<br>09.00   | 13.0460-5916.2<br>13.0460-5985.2   | 605916<br>605985   | 20731 15,3 AKE<br>21333 15,0 +WK TOK   |
|    | 0.8<br>1.0<br>1.0 16V<br>1.3 16V<br>1.6 16V                                      |  |  | 11.93<br>09.94<br>01.00<br>10.98<br>10.98  | 06.96<br>06.02<br>06.02<br>09.00<br>09.00   | 24.0110-0136.1<br>24.0117-0103.1<br>24.0120-0163.1                                 | 410136<br>417103<br>420163   | 215 10,0 8,0<br>231 17,0 15,0 V +B<br>235 20,0 18,0 V                              |
|    | 0.8<br>1.0<br>1.0 16V<br>1.3 16V<br>1.6 16V                                      |  |  | 11.93<br>09.94<br>01.00<br>10.98<br>10.98  | 06.96<br>06.02<br>06.02<br>09.00<br>09.00   | 03.0137-0222.2<br>03.0137-9127.2   | 650222<br>669127   | 180 x 31<br>Bremsbacken-Zubehör  |
|    | 1.0<br>1.0 16V<br>1.3 16V<br>1.6 16V   | 39<br>43<br>63<br>71   |  | 09.94<br>01.00<br>10.98<br>10.98   | 06.02<br>06.02<br>09.00<br>09.00  | 03.0137-0470.2<br>03.0137-9127.2   | 650470<br>669127   | 180 x 31<br>Bremsbacken-Zubehör  |
|  | 1.0<br>1.0 16V<br>1.3 16V<br>1.6 16V   | 39<br>43<br>63<br>71   |  | 09.94<br>01.00<br>10.98<br>10.98   | 06.02<br>06.02<br>09.00<br>09.00  | 24.0218-0047.1<br>24.0220-0044.1   | 480194<br>480192   | 180/182 x 40<br>200/202 x 40,2   |
| <b>SUZUKI ALTO (02-08)</b>   |  |  |  |  |   |  |  |  |
|  | 1.1 i 16V (RF410)  | 46   |  | 06.02  | 12.08   | 13.0460-5621.2   | 605621   | 24423 14,6 /Zub  |
|  | 1.1 i 16V (RF410)  | 46   |  | 06.02  | 12.08   | 24.0117-0105.1   | 417105   | 231 17,0 15,0 V +B   |
|  | 1.1 i 16V (RF410)  | 46   |  | 06.02  | 12.08   | 03.0137-0425.2<br>03.0137-9127.2   | 650425<br>669127   | 180 x 26<br>Bremsbacken-Zubehör  |
|  | 1.1 i 16V (RF410)  | 46   |  | 06.02  | 12.08   | 24.0218-0047.1   | 480194   | ohne Sensorring <sup>1)</sup><br>180/182 x 40                                      |
| <b>SUZUKI ALTO (09-)</b>   |  |  |  |  |   |  |  |  |
|  | 1.0 i 12V (AMF310)   | 50   |  | 01.09  |   | 13.0460-5887.2   | 605887   | 23507 15,2 +WK SUM   |
|  | 1.0 i 12V (AMF310)   | 50   |  | 01.09  |   | 24.0120-0225.1   | 420225   | 231 20,0 18,0 V L +B   |
|  | 1.0 i 12V (AMF310)   | 50   |  | 01.09  |   | 03.0137-0503.2   | 650503   | 180 x 26   |
| <b>SUZUKI BALENO (95-02)</b>   |  |  |  |  |   |  |  |  |
|  | 1.3<br>1.3 i 16V<br>1.6 i 16V<br>1.6 i 16V 4x4<br>1.8 i 16V GT<br>1.9 TD         | 52<br>63<br>72<br>72<br>89<br>55   |  | 09.96<br>07.95<br>07.95<br>07.95<br>03.96<br>04.98                               | 01.99<br>01.97<br>01.97<br>01.97<br>01.97<br>01.99                                | 13.0460-5838.2<br>13.0460-0265.2   | 605838<br>610265   | 23400 15,5 +WK AIS<br>Belagsatz-Zubehör  |
|  | 1.3<br>1.3 i 16V<br>1.6 i 16V<br>1.6 i 16V 4x4<br>1.8 i 16V GT<br>1.9 TD         | 52<br>63<br>72<br>72<br>89<br>55   |  | 02.99<br>02.97<br>02.97<br>02.97<br>02.97<br>02.99                               | 05.02<br>05.02<br>05.02<br>05.02<br>05.02<br>05.02                                | 13.0460-5839.2   | 605839   | 23795 15,0 +WK AIS   |
|  | 1.3<br>1.3 i 16V<br>1.6 i 16V<br>1.6 i 16V 4x4<br>1.8 i 16V GT                   | 52<br>63<br>72<br>72<br>89   |  | 09.96<br>07.95<br>07.95<br>07.95<br>03.96  | 05.02<br>05.02<br>05.02<br>05.02<br>05.02   | 24.0120-0163.1<br>24.0120-0197.1   | 420163<br>420197   | 235 20,0 18,0 V<br>246 20,0 18,0 V +B  |

<sup>1)</sup> without sensor ring / senza sensori / sans secours ABS / sin anillo sensor ABS

|     |    |  |        |                 |  |  |  |  |
|--|--|--|--|---|---|--|--|--|
| <b>SUZUKI BALENO (95-02)</b>   |  |  |  |   |   |  |  |  |
|    | 1.9 TD   | 55   | 04.98  | 05.02   | 24.0120-0197.1  | 420197   |  | 246 20,0 18,0 V +B   |
|    | 1.8 i 16V GT<br>1.9 TD   | 89<br>55   | 03.96<br>04.98   | 05.02<br>05.02  | 13.0460-5972.2  | 605972   |  | 21559 11,5   |
|    | 1.3<br>1.3 i 16V<br>1.6 i 16V<br>1.6 i 16V 4x4   | 52<br>63<br>72<br>72   | 09.96<br>07.95<br>07.95<br>07.95   | 05.02<br>05.02<br>05.02<br>05.02  | 03.0137-0315.2<br>03.0137-9271.2  | 650315<br>669271   |  | 200 x 32<br>Bremsbacken-Zubehör  |
|    | 1.3<br>1.3 i 16V<br>1.6 i 16V<br>1.6 i 16V 4x4   | 52<br>63<br>72<br>72   | 09.96<br>07.95<br>07.95<br>07.95   | 05.02<br>05.02<br>05.02<br>05.02  | 24.0220-0044.1  | 480192   |  | 200/202 x 40,2   |
| <b>SUZUKI CARRY (99-04)</b>  |  |  |  |   |   |  |  |  |
|    | 1.3<br>1.3 4x4<br>1.3 i 16V  | 58<br>56<br>58   | 03.99<br>02.99<br>03.00  | 09.04<br>09.04<br>09.04   | 03.0137-0287.2<br>03.0137-9190.2  | 650287<br>669190   |  | 220 x 36<br>Bremsbacken-Zubehör  |
| <b>SUZUKI GRAND VITARA (98-05)</b>   |  |  |  |   |   |  |  |  |
|    | 1.6 i 16V<br>1.6 i 16V 4x4<br>2.0 i 16V 4x4  | 69<br>73<br>94   | 03.98<br>02.00<br>03.98  | 11.04<br>09.02<br>11.04   | 13.0460-5864.2  | 605864   |  | 21907 15,5 +/-WK   |
|  | 2.0 HDI<br>2.0 i 16V<br>2.0 i 16V 4x4<br>2.0 i 16V 4x4<br>2.0 TD<br>2.0 TD 4x4<br>2.5 i V6<br>2.5 i V6<br>2.7 i V6<br>2.7 i V6                   | 80<br>97<br>94<br>103<br>64<br>63<br>106<br>116<br>127<br>135                    | 07.01<br>08.98<br>03.98<br>04.98<br>03.98<br>04.00<br>04.98<br>04.01<br>09.01<br>04.03 | 09.05<br>12.00<br>11.04<br>08.05<br>09.05<br>09.05<br>09.00<br>09.05<br>09.05<br>09.05          | 13.0460-5857.2  | 605857   |  | 23314 15,0 +/-WK <b>SUM</b>  |
|  |  |  |  |   |   |  |  | + Cabrio 1)  |
|  |  |  |  |   |   |  |  | + Kastenwagen 2)   |
|    | 1.6 i 16V<br>1.6 i 16V 4x4<br>2.0 i 16V 4x4  | 69<br>73<br>94   | 03.98<br>02.00<br>03.98  | 11.04<br>09.02<br>11.04   | 24.0117-0109.1  | 417109   |  | 287 17,0 15,0 V  |
|  | 2.0 HDI<br>2.0 i 16V<br>2.0 i 16V 4x4<br>2.0 i 16V 4x4<br>2.0 TD<br>2.0 TD 4x4<br>2.5 i V6<br>2.5 i V6<br>2.7 i V6<br>2.7 i V6                   | 80<br>97<br>94<br>103<br>64<br>63<br>106<br>116<br>127<br>135                    | 07.01<br>08.98<br>03.98<br>04.98<br>03.98<br>04.00<br>04.98<br>04.01<br>09.01<br>04.03 | 09.05<br>12.00<br>11.04<br>08.05<br>09.05<br>09.05<br>09.00<br>09.05<br>09.05<br>09.05          | 24.0122-0200.1  | 422200   |  | 310 22,0 20,0 V  |
|  |  |  |  |   |   |  |  | + Cabrio 1)  |
|  |  |  |  |   |   |  |  | + Kastenwagen 2)   |
|  |  |  |  |   |   |  |  | + Cabrio 1)  |
|  | 1.6 i 16V<br>1.6 i 16V 4x4<br>2.0 HDI<br>2.0 i 16V<br>2.0 i 16V 4x4<br>2.0 i 16V 4x4<br>2.0 TD<br>2.0 TD 4x4<br>2.5 i V6<br>2.5 i V6<br>2.7 i V6 | 69<br>73<br>80<br>97<br>94<br>94<br>103<br>64<br>63<br>106<br>116                | 03.98<br>02.00<br>07.01<br>08.98<br>03.98<br>03.98<br>04.00<br>04.98<br>04.01          | 11.04<br>09.02<br>09.05<br>12.00<br>11.04<br>08.05<br>09.05<br>09.05<br>09.00<br>09.05<br>09.05 | 03.0137-0433.2  | 650433   |  | 220 x 42   |
|  |  |  |  |   |   |  |  | + Kastenwagen 2)   |
|  |  |  |  |   |   |  |  | + Cabrio 1)  |
| <b>SUZUKI GRAND VITARA (05-15)</b>   |  |  |  |   |   |  |  |  |
|  | 1.6 i 16V 4x4<br>1.6 i 16V 4x4<br>1.9 DDiS<br>2.0 VVTi 4x4<br>2.7 VVTi   | 73<br>78<br>95<br>103<br>138   | 09.05<br>04.05<br>10.05<br>10.05<br>10.05  | 08.08   | 13.0460-5609.2  | 605609   |  | 24346 16,4 /WK/Zub   |
|  | 1.6 i 16V 4x4<br>1.6 i 16V 4x4<br>1.9 DDiS<br>2.0 VVTi 4x4<br>2.4 4x4<br>2.4 4x4<br>2.7 VVTi<br>3.2 4x4<br>3.2 4x4                               | 73<br>78<br>95<br>103<br>122<br>124<br>138<br>165<br>171                         | 09.05<br>04.05<br>10.05<br>10.05<br>01.09<br>01.09<br>10.05<br>06.08<br>01.09          | 08.08   | 24.0125-0190.1  | 425190   |  | 295 25,0 23,0 V +B   |
|  | 1.6 i 16V 4x4<br>1.6 i 16V 4x4<br>1.9 DDiS<br>2.0 VVTi 4x4<br>2.7 VVTi   | 73<br>78<br>95<br>103<br>138   | 09.05<br>04.05<br>10.05<br>10.05<br>10.05  | 08.08   | 03.0137-0499.2<br>03.0137-9289.2  | 650499<br>669289   |  | 254 x 41<br>Bremsbacken-Zubehör  |
|  | 2.4 4x4<br>2.4 4x4<br>3.2 4x4<br>3.2 4x4   | 122<br>124<br>165<br>171   | 01.09<br>01.09<br>06.08<br>01.09   |   | 03.0137-0433.2  | 650433   |  | 220 x 42   |
|  |  |  |  |   | 03.0137-3046.2  | 653046   |  | 200 x 37   |





















1) + Convertible / + Cabriolet / + Décapotable / + Cabriolé



























2) + Van / + Furgone / + Fourgonnette / + Furgón

|     |   |  |  |  |  |  |  |  |  |
|--|---|--|--|--|---|--|--|--|--|
| <b>SUZUKI IGNIS I (00-03)</b>  |   |  |  |  |   |  |  |  |  |
|    | 1.3 i 16V<br>1.3 i 16V 4x4  | 61<br>61   |  | 10.00<br>10.00   | 08.03<br>08.03  |  | 13.0460-5887.2<br>605887   | 23507 15,2 +/WK <b>SUM</b>   |  |
|    | 1.3 i 16V<br>1.3 i 16V 4x4  | 61<br>61   |  | 10.00<br>10.00   | 08.03<br>08.03  |  | 24.0117-0108.1<br>417108   | 257 17,0 15,0 V +B   |  |
|    | 1.3 i 16V<br>1.3 i 16V 4x4  | 61<br>61   |  | 10.00<br>10.00   | 08.03<br>08.03  |  | 03.0137-0425.2<br>03.0137-9127.2   | 650425<br>669127   | 180 x 26<br>Bremsbacken-Zubehör                  |
| <b>SUZUKI IGNIS II (03-12)</b>   |   |  |  |  |   |  |  |  |  |
|    | 1.3 DDiS<br>1.3 i 16V<br>1.3 i 16V 4x4<br>1.5 i 16V<br>1.5 i 16V 4x4<br>1.5 Sport   | 51<br>69<br>69<br>73<br>73<br>80   |  | 09.03<br>09.03<br>09.03<br>09.03<br>09.03<br>12.03                               | 12.12<br>12.12<br>12.12<br>12.12<br>12.12<br>12.12                                |  | 13.0460-3995.2<br>603995   | 23605 15,7 +/WK/Zub/SBOS   |  |
|    | 1.3 DDiS<br>1.3 i 16V<br>1.3 i 16V 4x4<br>1.5 i 16V<br>1.5 i 16V 4x4<br>1.5 Sport   | 51<br>69<br>69<br>73<br>73<br>80   |  | 09.03<br>09.03<br>09.03<br>09.03<br>09.03<br>12.03                               | 12.12<br>12.12<br>12.12<br>12.12<br>12.12<br>12.12                                |  | 13.0460-5887.2<br>24.0117-0106.1   | 605887<br>417106   | 23507 15,2 +/WK <b>SUM</b><br>253 17,0 15,0 V +B |
|    | 1.5 Sport   | 80   |  | 12.03  | 12.12   | + Sportfahrwerk <sup>1)</sup>  | 13.0460-5856.2<br>605856   | 24039 14,4 +/WK  |  |
|    | 1.3 DDiS<br>1.3 i 16V<br>1.3 i 16V 4x4<br>1.5 i 16V<br>1.5 i 16V 4x4<br>1.5 Sport   | 51<br>69<br>69<br>73<br>73<br>80   |  | 09.03<br>09.03<br>09.03<br>09.03<br>09.03<br>12.03                               | 12.12<br>12.12<br>12.12<br>12.12<br>12.12<br>12.12                                |  | 03.0137-0465.2<br>03.0137-9300.2   | 650465<br>669300   | 200 x 29 HEB<br>Bremsbacken-Zubehör              |
|    | 1.3 DDiS  | 51   |  | 09.03  | 12.12   | - Sportfahrwerk <sup>2)</sup>  | 03.0520-1415.3<br>691415   | 15,87/200x29 TopKit  |  |
| <b>SUZUKI JIMNY (98-)</b>  |   |  |  |  |   |  |  |  |  |
|   | 1.3 4x4<br>1.3 4x4<br>1.3 i 16V<br>1.3 i 16V<br>1.3 i 16V 4x4<br>1.3 i 16V 4x4<br>1.3 i 16V 4x4<br>1.5 DDiS 4x4<br>1.5 DDiS 4x4 | 63<br>65<br>59<br>60<br>59<br>60<br>63<br>48<br>63                               |  | 09.98<br>09.00<br>09.98<br>02.01<br>09.98<br>02.01<br>08.05<br>12.03<br>08.05    | 08.00<br>08.02  |  | 13.0460-5966.2<br>605966   | 21142 15,0 <b>SUM</b>  |  |
|  | 1.3 4x4<br>1.3 4x4<br>1.3 i 16V<br>1.3 i 16V<br>1.3 i 16V 4x4<br>1.3 i 16V 4x4<br>1.3 i 16V 4x4                                 | 63<br>65<br>59<br>60<br>59<br>60<br>63   | 00203804<br>00203804<br>00203804<br>00203804<br>00203804<br>00203804<br>00203804 | 09.98<br>09.00<br>09.98<br>02.01<br>09.98<br>02.01<br>08.05                      |   |  | 24.0110-0242.1<br>410242   | 290 10,0 8,0 +B  |  |
|  | 1.3 4x4<br>1.3 4x4<br>1.3 i 16V<br>1.3 i 16V<br>1.3 i 16V 4x4<br>1.3 i 16V 4x4<br>1.3 i 16V 4x4                                 | 63<br>65<br>59<br>60<br>59<br>60<br>63   | 00203805<br>00203805<br>00203805<br>00203805<br>00203805<br>00203805<br>00203805 |  | 08.00<br>08.02  |  | 24.0110-0355.1<br>410355   | 290 10,0 8,0 +B  |  |
|  | 1.5 DDiS 4x4<br>1.5 DDiS 4x4  | 48<br>63   | 00201861<br>00201861   | 12.03<br>08.05   |   |  | 24.0117-0104.1<br>417104   | 287 17,0 15,0 V  |  |
|  | 1.3 4x4<br>1.3 4x4<br>1.3 i 16V<br>1.3 i 16V<br>1.3 i 16V 4x4<br>1.3 i 16V 4x4<br>1.3 i 16V 4x4<br>1.5 DDiS 4x4<br>1.5 DDiS 4x4 | 63<br>65<br>59<br>60<br>59<br>60<br>63<br>48<br>63                               |  | 09.98<br>09.00<br>09.98<br>02.01<br>09.98<br>02.01<br>08.05<br>12.03<br>08.05    | 08.00<br>08.02  |  | 03.0137-0287.2<br>03.0137-9128.2   | 650287<br>669128   | 220 x 36<br>Bremsbacken-Zubehör                  |
| <b>SUZUKI KIZASHI (10-15)</b>  |   |  |  |  |   |  |  |  |  |
|  | 2.4 16V<br>2.4 16V<br>2.4 16V<br>2.4 16V<br>2.4 16V 4x4<br>2.4 16V 4x4  | 131<br>134<br>136<br>138<br>131<br>138   |  | 10.10<br>10.10<br>10.10<br>04.12<br>10.10<br>04.12                               |   |  | 24.0126-0172.1<br>426172   | 300 26,0 24,0 V +B   |  |
|  | 2.4 16V<br>2.4 16V<br>2.4 16V<br>2.4 16V<br>2.4 16V 4x4<br>2.4 16V 4x4  | 131<br>134<br>136<br>138<br>131<br>138   |  | 10.10<br>10.10<br>10.10<br>04.12<br>10.10<br>04.12                               |   |  | 24.0112-0195.1<br>412195   | 278 12,0 11,0 +B   |  |

<sup>1)</sup> + sports suspension / + sospensione sportiva / + châssis de sport / + suspensión deportiva

<sup>2)</sup> - sports suspension / - sospensione sportiva / - châssis de sport / - suspensión deportiva

|     |                                  |  |  |                                      |  |  |  |  |
|--|--|--|--|--|---|--|--|--|
| <b>SUZUKI LIANA (01-07)</b>  |  |  |  |  |   |  |  |  |
|    | 1.3 i 16V<br>1.4 DDiS<br>1.6 i 16V<br>1.6 i 16V<br>1.6 i 16V<br>1.6 i 16V 4WD<br>1.6 i 16V 4WD<br>1.6 i 16V 4WD  | 66<br>66<br>76<br>78<br>79<br>76<br>78<br>79                                     |  | 07.01 12.07<br>04.04 12.07<br>07.01 12.07<br>04.02 12.07<br>01.05 12.07<br>07.01 12.07<br>04.02 12.07<br>01.05 12.07 |   | 13.0460-5888.2 605888<br>13.0460-5774.2 605774                                     |  | 23817 16,6 +WK<br>24830 16,1 +WK   |
|    | 1.3 i 16V<br>1.4 DDiS<br>1.6 i 16V<br>1.6 i 16V<br>1.6 i 16V<br>1.6 i 16V 4WD<br>1.6 i 16V 4WD<br>1.6 i 16V 4WD  | 66<br>66<br>76<br>78<br>79<br>76<br>78<br>79                                     |  | 07.01 12.07<br>04.04 12.07<br>07.01 12.07<br>04.02 12.07<br>01.05 12.07<br>07.01 12.07<br>04.02 12.07<br>01.05 12.07 |   | 24.0120-0197.1 420197  |  | 246 20,0 18,0 V +B   |
|    | 1.3 i 16V<br>1.4 DDiS<br>1.6 i 16V<br>1.6 i 16V<br>1.6 i 16V<br>1.6 i 16V 4WD<br>1.6 i 16V 4WD<br>1.6 i 16V 4WD  | 66<br>66<br>76<br>78<br>79<br>76<br>78<br>79                                     |  | 07.01 12.07<br>04.04 12.07<br>07.01 12.07<br>04.02 12.07<br>01.05 12.07<br>07.01 12.07<br>04.02 12.07<br>01.05 12.07 |   | 03.0137-0315.2 650315<br>03.0137-9271.2 669271                                     |  | 200 x 32<br>Bremsbacken-Zubehör  |
|    | 1.3 i 16V<br>1.4 DDiS<br>1.6 i 16V<br>1.6 i 16V<br>1.6 i 16V<br>1.6 i 16V 4WD<br>1.6 i 16V 4WD<br>1.6 i 16V 4WD  | 66<br>66<br>76<br>78<br>79<br>76<br>78<br>79                                     |  | 07.01 12.07<br>04.04 12.07<br>07.01 12.07<br>04.02 12.07<br>01.05 12.07<br>07.01 12.07<br>04.02 12.07<br>01.05 12.07 |   | 24.0220-0044.1 480192  |  | 200/202 x 40,2   |
| <b>SUZUKI SAMURAI (98-04)</b>  |  |  |  |  |   |  |  |  |
|    | 1.3 i 4x4 (SJ413)<br>1.9 D (SJ419)<br>1.9 TD (SJ419)<br>1.9 TD (SJ419)   | 59<br>46<br>46<br>47   |  | 09.00 12.04<br>09.00 12.04<br>11.98 12.04<br>11.98 12.04   |   | 13.0460-5966.2 605966<br>13.0460-5720.2 605720                                     |  | 21142 15,0 SUM<br>20708 14,5/S TRW   |
|   | 1.3 i 4x4 (SJ413)<br>1.3 i 4x4 (SJ413)<br>1.3 i 4x4 (SJ413)<br>1.9 D (SJ419)<br>1.9 TD (SJ419)<br>1.9 TD (SJ419) | 51<br>59<br>59<br>46<br>46<br>47   |  | 11.98 12.04<br>09.00 12.04<br>09.00 12.04<br>09.00 12.04<br>11.98 12.04<br>11.98 12.04                               |   | 24.0110-0192.1 410192<br>24.0110-0242.1 410242                                     |  | 290 10,0 9,0<br>290 10,0 8,0 +B  |
| <b>SUZUKI SPLASH (08-)</b>   |  |  |  |  |   |  |  |  |
|  | 1.0 12V<br>1.0 12V<br>1.2 16V<br>1.2 VVT<br>1.2 VVT<br>1.2 VVT<br>1.3 CDTi                                       | 48<br>50<br>63<br>66<br>67<br>69<br>55   |  | 01.08<br>06.11<br>01.08<br>06.11<br>08.12<br>09.10<br>01.08  |   | 13.0460-5700.2 605700  |  | 23973 17,0 +WK/S TRW   |
|  | 1.0 12V<br>1.0 12V<br>1.2 16V<br>1.2 VVT<br>1.2 VVT<br>1.2 VVT<br>1.3 CDTi                                       | 48<br>50<br>63<br>66<br>67<br>69<br>55   |  | 01.08<br>06.11<br>01.08<br>06.11<br>08.12<br>09.10<br>01.08  |   | 24.0120-0211.1 420211  |  | 252 20,0 18,0 V +S +B  |
|  | 1.0 12V<br>1.0 12V<br>1.2 16V<br>1.2 VVT<br>1.2 VVT<br>1.2 VVT<br>1.3 CDTi                                       | 48<br>50<br>63<br>66<br>67<br>69<br>55   |  | 01.08<br>06.11<br>01.08<br>06.11<br>08.12<br>09.10<br>01.08  |   | 24.0710-5007.3 360339<br>24.0710-5008.3 360340                                     | <input type="checkbox"/><br><input type="checkbox"/>                               | Radsensor L=720<br>Radsensor L=720   |
|  | 1.0 12V<br>1.0 12V<br>1.2 16V<br>1.2 VVT<br>1.2 VVT<br>1.2 VVT<br>1.3 CDTi                                       | 48<br>50<br>63<br>66<br>67<br>69<br>55   |  | 01.08<br>06.11<br>01.08<br>06.11<br>08.12<br>09.10<br>01.08  |   | 24.0710-5009.3 360341<br>24.0710-5010.3 360342                                     | <input type="checkbox"/><br><input type="checkbox"/>                               | Radsensor L=1285<br>Radsensor L=1285   |
|  | 1.0 12V<br>1.0 12V<br>1.2 16V<br>1.2 VVT<br>1.2 VVT<br>1.2 VVT<br>1.3 CDTi                                       | 48<br>50<br>63<br>66<br>67<br>69<br>55   |  | 01.08<br>06.11<br>01.08<br>06.11<br>08.12<br>09.10<br>01.08  |   | 03.0137-0466.2 650466<br>03.0137-9287.2 669287                                     |  | 200 x 32 HEB<br>Bremsbacken-Zubehör BOS<br>BOS                                     |
|  | 1.0 12V<br>1.0 12V<br>1.2 16V<br>1.2 VVT<br>1.2 VVT  | 48<br>50<br>63<br>66<br>67   |  | 01.08<br>06.11<br>01.08<br>06.11<br>08.12  |   | 03.0520-6919.3 696919  |  | 19,05/200x32 TopKit BOS  |

|     |                                     |  |  |                                      |   |  |  |  |
|--|---|--|--|--|--|--|--|--|
| <b>SUZUKI SPLASH (08-)</b>   |   |  |  |  |  |  |  |  |
|    | 1.2 VVT<br>1.3 CDTi   | 69<br>55   |  | 09.10<br>01.08   |  | 03.0520-6919.3   | 696919   | 19,05/200x32 TopKit BOS  |
| <b>SUZUKI SWIFT II (96-04)</b>   |   |  |  |  |  |  |  |  |
|    | 1.0 i (SF310)<br>1.3 i (SF413)<br>1.3 i (SF413)   | 39<br>50<br>63   |  | 11.96 12.04<br>11.96 05.01<br>06.01 12.04  | - ABS  | 13.0460-5763.2   | 605763   | 21730 14,0 +/WK/Zub  |
|    | 1.0 i (SF310)<br>1.3 i 4WD (SF413)  | 39<br>50   |  | 11.96 12.04<br>11.96 05.01   | + ABS  | 13.0460-5985.2   | 605985   | 21333 15,0 +/WK TOK  |
|    | 1.0 i (SF310)<br>1.3 i (SF413)<br>1.3 i (SF413)   | 39<br>50<br>63   |  | 11.96 12.04<br>11.96 05.01<br>06.01 12.04  | - ABS  | 24.0112-0173.1   | 412173   | 232 12,0 9,5 +B  |
|    | 1.0 i (SF310)<br>1.3 i 4WD (SF413)  | 39<br>50   |  | 11.96 12.04<br>11.96 05.01   | + ABS  | 24.0117-0103.1   | 417103   | 231 17,0 15,0 V +B   |
|    | 1.0 i (SF310)<br>1.3 i (SF413)<br>1.3 i (SF413)<br>1.3 i (SF413)<br>1.3 i (SF413)<br>1.3 i (SF413)<br>1.3 i (SF413) | 39<br>50<br>50<br>50<br>63<br>63<br>63   |  | 11.96 12.04<br>11.96 05.01<br>11.96 05.01<br>11.96 05.01<br>06.01 12.04<br>06.01 12.04<br>06.01 12.04                | + 5 türig <sup>1)</sup><br>+ 3 türig <sup>2)</sup><br>+ 2 türig <sup>3)</sup><br>+ 5 türig <sup>1)</sup><br>+ 3 türig <sup>2)</sup><br>+ 2 türig <sup>3)</sup> | 03.0137-0414.2   | 650414   | 180 x 27   |
|    | 1.3 i (SF413)<br>1.3 i (SF413)<br>1.3 i 4WD (SF413)   | 50<br>63<br>50   |  | 11.96 05.01<br>06.01 12.04<br>11.96 05.01  | + 4 türig <sup>4)</sup><br>+ 4 türig <sup>4)</sup>   | 03.0137-0315.2<br>03.0137-9271.2   | 650315<br>669271   | 200 x 32<br>Bremsbacken-Zubehör  |
|    | 1.0 i (SF310)<br>1.3 i (SF413)<br>1.3 i (SF413)<br>1.3 i (SF413)<br>1.3 i (SF413)<br>1.3 i (SF413)<br>1.3 i (SF413) | 39<br>50<br>50<br>50<br>63<br>63<br>63   |  | 11.96 12.04<br>11.96 05.01<br>11.96 05.01<br>11.96 05.01<br>06.01 12.04<br>06.01 12.04<br>06.01 12.04                | + 5 türig <sup>1)</sup><br>+ 3 türig <sup>2)</sup><br>+ 2 türig <sup>3)</sup><br>+ 5 türig <sup>1)</sup><br>+ 3 türig <sup>2)</sup><br>+ 2 türig <sup>3)</sup> | 24.0218-0042.1   | 480164   | 180/182 x 36   |
|    | 1.3 i (SF413)<br>1.3 i (SF413)<br>1.3 i 4WD (SF413)   | 50<br>63<br>50   |  | 11.96 05.01<br>06.01 12.04<br>11.96 05.01  | + 4 türig <sup>4)</sup><br>+ 4 türig <sup>4)</sup>   | 24.0220-0040.1   | 480166   | 200/202 x 40   |
| <b>SUZUKI SWIFT III (05-10)</b>  |   |  |  |  |  |  |  |  |
|   | 1.3 16V<br>1.3 16V 4x4<br>1.3 16V 4x4<br>1.3 DDiS<br>1.3 DDiS<br>1.5 16V 4x4<br>1.5 VVTi<br>1.6 VVTi                | 68<br>66<br>68<br>51<br>55<br>74<br>75<br>92                                     |  | 02.05 09.10<br>01.06 09.10<br>02.05 09.10<br>08.05 09.07<br>08.05 09.10<br>02.05 09.10<br>02.05 09.10<br>05.06 09.10 |  | 13.0460-5700.2   | 605700   | 23973 17,0 +/WK/S TRW  |
|  | 1.3 16V<br>1.3 16V 4x4<br>1.3 16V 4x4<br>1.3 DDiS<br>1.3 DDiS<br>1.5 16V 4x4<br>1.5 VVTi<br>1.6 VVTi                | 68<br>66<br>68<br>51<br>55<br>74<br>75<br>92                                     |  | 02.05 09.10<br>01.06 09.10<br>02.05 09.10<br>08.05 09.07<br>08.05 09.10<br>02.05 09.10<br>02.05 09.10<br>05.06 09.10 |  | 24.0120-0211.1   | 420211   | 252 20,0 18,0 V +S +B  |
|  | 1.6 VVTi  | 92   |  | 05.06 09.10  |  | 13.0460-5929.2   | 605929   | 21719 15,0 +/WK AKE  |
|  | 1.6 VVTi  | 92   |  | 05.06 09.10  |  | 24.0109-0160.1   | 409160   | 278 9,0 8,0 +B   |
|  | 1.3 16V<br>1.3 16V 4x4<br>1.3 16V 4x4<br>1.3 DDiS<br>1.3 DDiS<br>1.5 16V 4x4<br>1.5 VVTi                            | 68<br>66<br>68<br>51<br>55<br>74<br>75   |  | 02.05 09.10<br>01.06 09.10<br>02.05 09.10<br>08.05 09.07<br>08.05 09.10<br>02.05 09.10<br>02.05 09.10                |  | 03.0137-0466.2<br>03.0137-9287.2   | 650466<br>669287   | Produktionsland ☉<br>200 x 32 HEB<br>Bremsbacken-Zubehör BOS                       |
|  | 1.3 16V 4x4<br>1.3 16V 4x4<br>1.5 16V 4x4   | 66<br>68<br>74   |  | 01.06 09.10<br>02.05 09.10<br>02.05 09.10  |  | 03.0137-0315.2   | 650315   | Produktionsland ☉<br>200 x 32  |
|  | 1.3 16V 4x4<br>1.3 16V 4x4<br>1.5 16V 4x4   | 66<br>68<br>74   |  | 01.06 09.10<br>02.05 09.10<br>02.05 09.10  |  | 24.0220-0044.1   | 480192   | Produktionsland ☉<br>200/202 x 40,2  |
|  | 1.3 16V<br>1.3 16V 4x4<br>1.3 16V 4x4<br>1.3 DDiS<br>1.3 DDiS<br>1.5 16V 4x4<br>1.5 VVTi                            | 68<br>66<br>68<br>51<br>55<br>74<br>75   |  | 02.05 09.10<br>01.06 09.10<br>02.05 09.10<br>08.05 09.07<br>08.05 09.10<br>02.05 09.10<br>02.05 09.10                |  | 03.0520-6919.3   | 696919   | 19,05/200x32 TopKit BOS  |

1) + 5 door / + 5 porte / + 5 portes / + 5 puertas  
2) + 3 door / + 3 porte / + 3 portes / + 3 puertas  
3) + 2 door / + 2 porte / + 2 portes / + 2 puertas  
4) + 4 door / + 4 porte / + 4 portes / + 4 puertas



### SUZUKI SWIFT IV (10-)



















|  |          |     |  |       |  |                |        |   |                    |
|--|----------|-----|--|-------|--|----------------|--------|---|--------------------|
|  | 1.2      | 66  |  | 10.10 |  | 24.0122-0280.1 | 422280 |   | 256 22,0 20,0 V +B |
|  | 1.2      | 67  |  | 08.12 |  |                |        |   |                    |
|  | 1.2      | 69  |  | 10.10 |  |                |        |   |                    |
|  | 1.2 4x4  | 66  |  | 10.10 |  |                |        |   |                    |
|  | 1.2 4x4  | 67  |  | 08.12 |  |                |        |   |                    |
|  | 1.2 4x4  | 69  |  | 10.10 |  |                |        |   |                    |
|  | 1.3 DDiS | 55  |  | 10.10 |  |                |        |   |                    |
|  | 1.2      | 66  |  | 10.10 |  | 24.0122-0282.1 | 422282 | + Geschwindigkeitsregelanlage <sup>1)</sup> | 272 22,0 20,0 V +B |
|  | 1.2      | 67  |  | 08.12 |  |                |        |   |                    |
|  | 1.2      | 69  |  | 10.10 |  |                |        |   |                    |
|  | 1.2 4x4  | 66  |  | 10.10 |  |                |        |   |                    |
|  | 1.2 4x4  | 67  |  | 08.12 |  |                |        |   |                    |
|  | 1.2 4x4  | 69  |  | 10.10 |  |                |        |   |                    |
|  | 1.3 DDiS | 55  |  | 10.10 |  |                |        |   |                    |
|  | 1.2      | 66  |  | 10.10 |  | 24.0109-0175.1 | 409175 |   | 259 9,0 8,0 +B     |
|  | 1.2      | 67  |  | 08.12 |  |                |        |   |                    |
|  | 1.2      | 69  |  | 10.10 |  |                |        |   |                    |
|  | 1.2 4x4  | 66  |  | 10.10 |  |                |        |   |                    |
|  | 1.2 4x4  | 67  |  | 08.12 |  |                |        |   |                    |
|  | 1.2 4x4  | 69  |  | 10.10 |  |                |        |   |                    |
|  | 1.3 DDiS | 55  |  | 10.10 |  |                |        |   |                    |
|  | 1.2      | 66  |  | 10.10 |  | 03.0137-0509.2 | 650509 |   | 200 x 26           |
|  | 1.2      | 67  |  | 08.12 |  |                |        |   |                    |
|  | 1.2      | 69  |  | 10.10 |  |                |        |   |                    |
|  | 1.2 4x4  | 66  |  | 10.10 |  |                |        |   |                    |
|  | 1.2 4x4  | 67  |  | 08.12 |  |                |        |   |                    |
|  | 1.2 4x4  | 69  |  | 10.10 |  |                |        |   |                    |
|  | 1.6 16V  | 100 |  | 01.12 |  |                |        |   |                    |























### SUZUKI SX4 (06-15)

|              |               |             |       |       |                   |                |                |        |                           |                      |
|--------------|---------------|-------------|-------|-------|-------------------|----------------|----------------|--------|---------------------------|----------------------|
|              | 1.5 i 16V     | 73          |       | 06.06 | Produktionsland ☺ | 13.0460-2715.2 | 602715         |        | 24391 16,6 +/-WK/Zub/STRW |                      |
|              | 1.5 VVT       | 82          |       | 07.10 |                   |                |                |        |                           |                      |
|              | 1.5 VVT 4x4   | 82          |       | 07.10 |                   |                |                |        |                           |                      |
|              | 1.6 DDiS      | 66          |       | 04.07 |                   |                |                |        |                           |                      |
|              | 1.6 VVT       | 74          |       | 06.06 | Produktionsland ☺ |                |                |        |                           |                      |
|              | 1.6 VVT       | 79          |       | 06.06 | Produktionsland ☺ |                |                |        |                           |                      |
|              | 1.6 VVT       | 88          |       | 10.07 | Produktionsland ☺ |                |                |        |                           |                      |
|              | 1.6 VVT 4x4   | 79          |       | 06.06 | Produktionsland ☺ |                |                |        |                           |                      |
|              | 1.6 VVT 4x4   | 82          |       | 07.09 |                   |                |                |        |                           |                      |
|              | 1.6 VVT 4x4   | 88          |       | 07.09 | Produktionsland ☺ |                |                |        |                           |                      |
|              | 1.9 DDiS      | 88          |       | 06.06 |                   |                |                |        |                           |                      |
|              | 1.9 DDiS 4x4  | 88          |       | 06.06 |                   |                |                |        |                           |                      |
|              | 2.0 DDiS      | 99          |       | 07.09 |                   |                |                |        |                           |                      |
| 2.0 DDiS 4x4 | 99            |             | 07.09 |       |                   |                |                |        |                           |                      |
|              | 1.5 i 16V     | 73          |       | 06.06 | Produktionsland ☺ | 13.0460-5716.2 | 605716         |        | 21561 17,0 +/-WK/Zub      |                      |
|              | 1.6 VVT       | 74          |       | 06.06 | Produktionsland ☺ |                |                |        |                           |                      |
|              | 1.6 VVT       | 79          |       | 06.06 | Produktionsland ☺ |                |                |        |                           |                      |
|              | 1.6 VVT       | 88          |       | 10.07 | Produktionsland ☺ |                |                |        |                           |                      |
|              | 1.6 VVT 4x4   | 79          |       | 06.06 | Produktionsland ☺ |                |                |        |                           |                      |
|              | 1.6 VVT 4x4   | 88          |       | 07.09 | Produktionsland ☺ |                |                |        |                           |                      |
|              | 2.0 i 16V     | 107         |       | 06.06 |                   |                |                |        |                           |                      |
|              | 2.0 i 16V     | 112         |       | 01.10 |                   |                |                |        |                           |                      |
|              | 2.0 i 16V 4x4 | 107         |       | 06.06 |                   |                |                |        |                           |                      |
|              | 2.0 i 16V 4x4 | 112         |       | 01.10 |                   |                |                |        |                           |                      |
|              |               | 1.5 i 16V   | 73    |       | 06.06             |                | 24.0122-0252.1 | 422252 |                           | 280 22,0 20,0 V +B   |
|              |               | 1.5 VVT     | 82    |       | 07.10             |                |                |        |                           |                      |
|              |               | 1.5 VVT 4x4 | 82    |       | 07.10             |                |                |        |                           |                      |
| 1.6 DDiS     |               | 66          |       | 04.07 |                   |                |                |        |                           |                      |
| 1.6 VVT      |               | 74          |       | 06.06 |                   |                |                |        |                           |                      |
| 1.6 VVT      |               | 79          |       | 06.06 |                   |                |                |        |                           |                      |
| 1.6 VVT      |               | 88          |       | 10.07 |                   |                |                |        |                           |                      |
| 1.6 VVT 4x4  |               | 79          |       | 06.06 |                   |                |                |        |                           |                      |
| 1.6 VVT 4x4  |               | 82          |       | 07.09 |                   |                |                |        |                           |                      |
| 1.6 VVT 4x4  |               | 88          |       | 07.09 |                   |                |                |        |                           |                      |
| 1.9 DDiS     |               | 88          |       | 06.06 |                   |                |                |        |                           |                      |
| 1.9 DDiS 4x4 |               | 88          |       | 06.06 |                   |                |                |        |                           |                      |
| 2.0 DDiS     |               | 99          |       | 07.09 |                   |                |                |        |                           |                      |
| 2.0 DDiS 4x4 | 99            |             | 07.09 |       |                   |                |                |        |                           |                      |
|              | 2.0 i 16V     | 107         |       | 06.06 |                   |                |                |        |                           |                      |
|              | 2.0 i 16V     | 112         |       | 01.10 |                   |                |                |        |                           |                      |
|              | 2.0 i 16V 4x4 | 107         |       | 06.06 |                   |                |                |        |                           |                      |
|              | 2.0 i 16V 4x4 | 112         |       | 01.10 |                   |                |                |        |                           |                      |
|              |               | 1.5 i 16V   | 73    |       | 06.06             |                | 13.0460-5929.2 | 605929 | + ABS                     | 21719 15,0 +/-WK AKE |
|              |               | 1.5 VVT     | 82    |       | 07.10             |                |                |        |                           |                      |
|              |               | 1.5 VVT 4x4 | 82    |       | 07.10             |                |                |        |                           |                      |
|              |               | 1.6 DDiS    | 66    |       | 04.07             |                |                |        |                           |                      |
|              |               | 1.6 VVT     | 74    |       | 06.06             |                |                |        |                           |                      |
|              |               | 1.6 VVT     | 79    |       | 06.06             |                |                |        |                           |                      |
|              |               | 1.6 VVT     | 88    |       | 10.07             |                |                |        |                           |                      |
|              |               | 1.6 VVT 4x4 | 79    |       | 06.06             |                |                |        |                           |                      |
|              |               | 1.6 VVT 4x4 | 82    |       | 07.09             |                |                |        |                           |                      |
| 1.6 VVT 4x4  |               | 88          |       | 07.09 |                   |                |                |        |                           |                      |
| 1.9 DDiS     |               | 88          |       | 06.06 |                   |                |                |        |                           |                      |
| 1.9 DDiS 4x4 |               | 88          |       | 06.06 |                   |                |                |        |                           |                      |
| 2.0 DDiS     |               | 99          |       | 07.09 |                   |                |                |        |                           |                      |
| 2.0 DDiS 4x4 | 99            |             | 07.09 |       |                   |                |                |        |                           |                      |

<sup>1)</sup> + speed control system / + impianto variatore di velocità / + régulateur de vitesse / + sistema de regulación de velocidad

































































































































































































































|     |    |                                    |   |   |  |  |  |  |
|--|--|--|---|---|---|--|--|--|
| <b>SUZUKI SX4 (06-15)</b>  |  |  |   |   |   |  |  |  |
|    | 2.0 i 16V<br>2.0 i 16V<br>2.0 i 16V 4x4<br>2.0 i 16V 4x4   | 107<br>112<br>107<br>112   | 06.06<br>01.10<br>06.06<br>01.10  |   | 13.0460-5929.2<br>605929  |  | + ABS  | 21719 15,0 +WK<br>AKE  |
|    | 1.5 i 16V<br>1.5 VVT<br>1.5 VVT 4x4<br>1.6 DDiS<br>1.6 VVT<br>1.6 VVT<br>1.6 VVT<br>1.6 VVT 4x4<br>1.6 VVT 4x4<br>1.6 VVT 4x4<br>1.6 VVT 4x4<br>1.9 DDiS<br>1.9 DDiS 4x4<br>2.0 DDiS<br>2.0 DDiS 4x4<br>2.0 i 16V<br>2.0 i 16V<br>2.0 i 16V 4x4<br>2.0 i 16V 4x4 | 73<br>82<br>82<br>66<br>74<br>79<br>88<br>79<br>82<br>88<br>88<br>88<br>88<br>99<br>99<br>107<br>112<br>107<br>112 | 06.06<br>07.10<br>07.10<br>04.07<br>06.06<br>06.06<br>10.07<br>06.06<br>07.09<br>07.09<br>07.09<br>06.06<br>06.06<br>07.09<br>07.09<br>01.10<br>01.10<br>06.06<br>01.10 |   | 24.0109-0167.1<br>409167  |  | + ABS  | 278 9,0 8,0 +B   |
|    | 1.5 i 16V<br>1.5 VVT<br>1.5 VVT 4x4<br>1.6 DDiS<br>1.6 VVT<br>1.6 VVT<br>1.6 VVT<br>1.6 VVT 4x4<br>1.6 VVT 4x4<br>1.6 VVT 4x4<br>1.6 VVT 4x4<br>1.9 DDiS<br>1.9 DDiS 4x4<br>2.0 DDiS<br>2.0 DDiS 4x4   | 73<br>82<br>82<br>66<br>74<br>79<br>88<br>79<br>82<br>88<br>88<br>88<br>88<br>99<br>99                             | 06.06<br>07.10<br>07.10<br>04.07<br>06.06<br>06.06<br>10.07<br>06.06<br>07.09<br>07.09<br>07.09<br>06.06<br>06.06<br>07.09<br>07.09                                     | Produktionsland (H)<br><br>Produktionsland (H)<br>Produktionsland (H)<br>Produktionsland (H)<br><br>Produktionsland (H) | 03.0137-0490.2<br>650490<br>03.0137-9319.2<br>669319                              |  | - ABS<br>- ABS   | 220 x 35 HEB<br>Bremsbacken-Zubehör<br>BOS<br>BOS                                  |
|    | 1.5 i 16V<br>1.5 VVT<br>1.5 VVT 4x4<br>1.6 DDiS<br>1.6 VVT<br>1.6 VVT<br>1.6 VVT<br>1.6 VVT 4x4<br>1.6 VVT 4x4<br>1.6 VVT 4x4<br>1.6 VVT 4x4<br>1.9 DDiS<br>1.9 DDiS 4x4<br>2.0 DDiS<br>2.0 DDiS 4x4   | 73<br>82<br>82<br>66<br>74<br>79<br>88<br>79<br>82<br>88<br>88<br>88<br>88<br>99<br>99                             | 06.06<br>07.10<br>07.10<br>04.07<br>06.06<br>06.06<br>10.07<br>06.06<br>07.09<br>07.09<br>07.09<br>06.06<br>06.06<br>07.09<br>07.09                                     | Produktionsland (H)<br><br>Produktionsland (H)<br>Produktionsland (H)<br>Produktionsland (H)<br><br>Produktionsland (H) | 03.0520-7719.3<br>697719  |  | - ABS  | 19,05/220x35 TopKit<br>BOS   |
| <b>SUZUKI SX4 (13-)</b>  |  |  |   |   |   |  |  |  |
|  | 1.6 16V<br>1.6 16V 4x4<br>1.6 DDiS<br>1.6 DDiS 4x4   | 88<br>88<br>88<br>88   | 08.13<br>08.13<br>08.13<br>08.13  |   | 24.0122-0290.1<br>422290  |  |  | 280 22,0 20,0 V +B   |
|  | 1.6 16V<br>1.6 16V 4x4<br>1.6 DDiS<br>1.6 DDiS 4x4   | 88<br>88<br>88<br>88   | 08.13<br>08.13<br>08.13<br>08.13  |   | 24.0109-0182.1<br>409182  |  |  | 259 9,0 8,0 +B   |
| <b>SUZUKI VITARA (89-98)</b>   |  |  |   |   |   |  |  |  |
|  | 1.6<br>1.6 Cabrio  |  | 01.89 01.95<br>01.89 01.95  |   | 13.0460-5967.2<br>605967<br>13.0460-2997.2<br>602997<br>13.0460-0449.2<br>610449  |  |  | 21500 15,0 +WK<br>20708 15,8 /S<br>Belagsatz-Zubehör<br>AKE<br>AKE                 |
|  | 1.9 D Allrad<br>1.9 D Cabrio<br>2.0 16V Allrad<br>2.0 i V6<br>2.0 TD Allrad<br>2.0 TD Interc. Allrad   |  | 01.95 03.98<br>01.95 03.98<br>12.96 03.98<br>12.94 03.98<br>12.94 03.98<br>12.95 03.98  |   | 13.0460-5857.2<br>605857  |  |  | 23314 15,0 +WK<br>SUM  |
|  | 1.6<br>1.6 Cabrio  |  | 01.89 01.95<br>01.89 01.95  |   | 24.0110-0242.1<br>410242  |  |  | 290 10,0 8,0 +B  |
|  | 1.6 i 16V  |  | 02.91 12.94   |   | 24.0117-0104.1<br>417104  |  |  | 287 17,0 15,0 V  |
|  | 1.6<br>1.6 Cabrio  | 160000<br>140000   | 01.89<br>01.89  |   | 03.0137-0224.2<br>650224  |  |  | 220 x 36   |
|  | 1.6<br>1.6 Cabrio  | 160001<br>140001   | 01.95<br>01.95  |   | 03.0137-0286.2<br>650286  |  |  | 220 x 36   |
| <b>SUZUKI VITARA (LY) (15-)</b>  |  |  |   |   |   |  |  |  |
|  | 1.6 16V<br>1.6 16V 4x4<br>1.6 DDiS<br>1.6 DDiS 4x4   | 88<br>88<br>88<br>88   | 02.15<br>02.15<br>02.15<br>02.15  |   | 24.0122-0290.1<br>422290  |  |  | 280 22,0 20,0 V +B   |

















































































































|     |  |  |  |  |  |  |  |  |
|--|--|--|--|--|---|--|--|--|
| <b>SUZUKI VITARA (LY) (15-)</b>  |  |  |  |  |   |  |  |  |
|    | 1.6 16V  | 88   |  | 02.15  |   | 24.0109-0182.1   | 409182   | 259 9,0 8,0 +B   |
|  | 1.6 16V 4x4  | 88   |  | 02.15  |   |  |  |  |
|  | 1.6 DDiS   | 88   |  | 02.15  |   |  |  |  |
|  | 1.6 DDiS 4x4   | 88   |  | 02.15  |   |  |  |  |
| <b>SUZUKI WAGON R+ (98-00)</b>   |  |  |  |  |   |  |  |  |
|    | 1.0 i 16V  | 48   |  | 02.98  | 04.00   | 13.0460-5836.2   | 605836   | 23662 15,0 /WK/Zub   |
|  | 1.2 i 16V  | 51   |  | 02.98  | 04.00   | 13.0460-0141.2   | 610141   | Belagsatz-Zubehör  |
|  | 1.2 i 16V 4WD  | 51   |  | 02.98  | 04.00   |  |  |  |
|    | 1.0 i 16V  | 48   |  | 02.98  | 04.00   | 24.0117-0105.1   | 417105   | 231 17,0 15,0 V +B   |
|  | 1.2 i 16V  | 51   |  | 02.98  | 04.00   |  |  |  |
|  | 1.2 i 16V 4WD  | 51   |  | 02.98  | 04.00   |  |  |  |
|    | 1.0 i 16V  | 48   |  | 02.98  | 04.00   | 03.0137-0387.2   | 650387   | 180 x 26   |
|  | 1.2 i 16V  | 51   |  | 02.98  | 04.00   | 03.0137-9264.2   | 669264   | Bremsbacken-Zubehör  |
|  | 1.2 i 16V 4WD  | 51   |  | 02.98  | 04.00   |  |  |  |
|    | 1.0 i 16V  | 48   |  | 02.98  | 04.00   | 24.0218-0046.1   | 480184   | 180/182 x 45,2   |
|  | 1.2 i 16V  | 51   |  | 02.98  | 04.00   |  |  | ohne Sensorring <sup>1)</sup>  |
| <b>SUZUKI WAGON R+ (00-08)</b>   |  |  |  |  |   |  |  |  |
|    | 1.0 i 12V  | 39   |  | 07.03  | 08.05   | 13.0460-5836.2   | 605836   | 23662 15,0 /WK/Zub   |
|  | 1.0 i 16V  | 51   |  | 08.00  | 07.03   | 13.0460-0141.2   | 610141   | Belagsatz-Zubehör  |
|  | 1.0 XT Plus  | 74   |  | 08.00  | 07.01   |  |  |  |
|  | 1.0 i 12V  | 44   |  | 06.04  | 04.08   | 13.0460-3995.2   | 603995   | 23605 15,7 +/WK/Zub/SBOS   |
|  | 1.2 i 16V  | 59   |  | 06.04  | 04.08   |  |  |  |
|  | 1.3 DDiS   | 51   |  | 09.03  | 04.08   |  |  |  |
|  | 1.3 i 16V  | 56   |  | 05.00  | 12.04   |  |  |  |
|  | 1.3 i 16V  | 65   |  | 08.01  | 04.08   |  |  |  |
|  | 1.3 i 16V  | 69   |  | 09.03  | 04.08   |  |  |  |
|  | 1.3 i 16V 4WD  | 56   |  | 10.01  | 12.04   |  |  |  |
|  | 1.3 i 16V 4WD  | 69   |  | 09.03  | 04.08   |  |  |  |
|    | 1.0 i 12V  | 39   |  | 07.03  | 08.05   | 24.0117-0105.1   | 417105   | 231 17,0 15,0 V +B   |
|  | 1.0 i 16V  | 51   |  | 08.00  | 07.03   |  |  |  |
|  | 1.0 XT Plus  | 74   |  | 08.00  | 07.01   |  |  |  |
|  | 1.3 i 16V  | 56   | 210000   | 05.00  |   | 24.0112-0153.1   | 412153   | 247 12,0 10,5 +B   |
|  | 1.3 i 16V 4WD  | 56   | 210000   | 10.01  |   |  |  |  |
|  | 1.0 i 12V  | 44   |  | 06.04  | 04.08   | 24.0117-0106.1   | 417106   | 253 17,0 15,0 V +B   |
|  | 1.2 i 16V  | 59   |  | 06.04  | 04.08   |  |  |  |
|  | 1.3 DDiS   | 51   |  | 09.03  | 04.08   |  |  |  |
|  | 1.3 i 16V  | 56   | 210001   |  | 04.08   |  |  |  |
|  | 1.3 i 16V  | 65   |  | 08.01  | 04.08   |  |  |  |
|  | 1.3 i 16V  | 69   |  | 09.03  | 04.08   |  |  |  |
|  | 1.3 i 16V 4WD  | 56   | 210001   |  | 12.04   |  |  |  |
|  | 1.3 i 16V 4WD  | 69   |  | 09.03  | 04.08   |  |  |  |
|  | 1.0 i 12V  | 39   |  | 07.03  | 08.05   | 03.0137-0387.2   | 650387   | 180 x 26   |
|  | 1.0 i 16V  | 51   |  | 08.00  | 07.03   | 03.0137-9264.2   | 669264   | Bremsbacken-Zubehör  |
|  | 1.0 XT Plus  | 74   |  | 08.00  | 07.01   |  |  |  |
|  | 1.3 i 16V  | 56   |  | 05.00  | 12.04   | 03.0137-0425.2   | 650425   | 180 x 26   |
|  | 1.3 i 16V 4WD  | 56   |  | 10.01  | 12.04   |  |  |  |
|  | 1.0 i 12V  | 44   |  | 06.04  | 04.08   | 03.0137-0465.2   | 650465   | 200 x 29 HEB   |
|  | 1.2 i 16V  | 59   |  | 06.04  | 04.08   | 03.0137-9300.2   | 669300   | Bremsbacken-Zubehör  |
|  | 1.3 DDiS   | 51   |  | 09.03  | 04.08   |  |  |  |
|  | 1.3 i 16V  | 65   |  | 08.01  | 04.08   |  |  |  |
|  | 1.3 i 16V  | 69   |  | 09.03  | 04.08   |  |  |  |
|  | 1.3 i 16V 4WD  | 69   |  | 09.03  | 04.08   |  |  |  |
|  | 1.0 i 12V  | 39   |  | 07.03  | 08.05   | 24.0218-0046.1   | 480184   | 180/182 x 45,2   |
|  | 1.0 i 16V  | 51   |  | 08.00  | 07.03   |  |  |  |
|  | 1.0 XT Plus  | 74   |  | 08.00  | 07.01   |  |  |  |
|  | 1.3 i 16V  | 56   |  | 05.00  | 12.04   | 24.0218-0039.1   | 480160   | 180/182 x 34,5   |
|  | 1.0 i 12V  | 44   |  | 06.04  | 04.08   | 24.0220-0045.1   | 480189   | 200/202 x 38   |
|  | 1.2 i 16V  | 59   |  | 06.04  | 04.08   |  |  |  |
|  | 1.3 DDiS   | 51   |  | 09.03  | 04.08   |  |  |  |
|  | 1.3 i 16V  | 65   |  | 08.01  | 04.08   |  |  |  |
|  | 1.3 i 16V  | 69   |  | 09.03  | 04.08   |  |  |  |
|  | 1.3 i 16V 4WD  | 69   |  | 09.03  | 04.08   |  |  |  |
|  | 1.0 i 12V  | 44   |  | 06.04  | 04.08   | 03.0520-1415.3   | 691415   | 15,87/200x29 TopKit  |
|  | 1.2 i 16V  | 59   |  | 06.04  | 04.08   |  |  |  |
|  | 1.3 DDiS   | 51   |  | 09.03  | 04.08   |  |  |  |
|  | 1.3 i 16V  | 65   |  | 08.01  | 04.08   |  |  |  |
| <b>SUZUKI X-90 (95-97)</b>   |  |  |  |  |   |  |  |  |
|  | 1.6 i 16V  | 71   |  | 09.95  | 10.97   | 13.0460-5967.2   | 605967   | 21500 15,0 +/WK AKE  |
|  | 1.6 i 16V 4x4  | 71   |  | 09.95  | 10.97   |  |  |  |
|  | 1.6 i 16V  | 71   |  | 09.95  | 10.97   | 24.0110-0242.1   | 410242   | 290 10,0 8,0 +B  |
|  | 1.6 i 16V 4x4  | 71   |  | 09.95  | 10.97   |  |  |  |
| <b>TOYOTA 4-RUNNER (96-99)</b>   |  |  |  |  |   |  |  |  |
|  | 2.7 i 16V (N180/185)   | 112  |  | 11.95  | 06.99   | 24.0122-0253.1   | 422253   | 297 22,0 20,0 V  |
|  | 3.4 i V6 (N180/185)  | 136  |  | 11.95  | 06.99   |  |  |  |
|  | 2.7 i 16V (N180/185)   | 112  |  | 11.95  | 06.99   | 24.0122-0185.1   | 422185   | 319 22,0 20,0 V  |
|  | 3.4 i V6 (N180/185)  | 136  |  | 11.95  | 06.99   |  |  |  |

<sup>1)</sup> without sensor ring / senza sensori / sans secours ABS / sin anillo sensor ABS

<sup>2)</sup> - 16" wheel / - ruota 16" / - roue 16" / - rueda 16"

<sup>3)</sup> + 16" wheel / + ruota 16" / + roue 16" / + rueda 16"

|     |    |       |  |    |    |   |  |  |                       |
|--|--|---|--|--|---|---|--|--|-----------------------|
| <b>TOYOTA 4-RUNNER (96-99)</b>   |  |   |  |  |   |   |  |  |                       |
|    | 2.7 i 16V (N180/185)<br>3.4 i V6 (N180/185)  | 112<br>136  |  | 11.95<br>11.95   | 06.99<br>06.99  | 03.0137-0308.2  | 650308   | 295 x 51   |                       |
| <b>TOYOTA ALPHARD II (GGH2_, ANH2_, ATH2_) (08-)</b>                               |  |   |  |  |   |   |  |  |                       |
|    | 3.5  | 202   |  | 04.08  |   | 13.0460-5614.2  | 605614   | 24601 18,0   |                       |
|    | 3.5  | 202   |  | 04.08  |   | 24.0128-0232.1  | 428232   | 296 28,0 25,0 V +B   |                       |
|    | 3.5  | 202   |  | 04.08  |   | 13.0460-5814.2  | 605814   | 23620 16,4 +/WK <b>BOS</b>   |                       |
| <b>TOYOTA AURIS (06-12)</b>  |  |   |  |  |   |   |  |  |                       |
|    | 1.33 Dual-VVTi<br>1.33 Dual-VVTi<br>1.4 D-4D<br>1.4 VVTi<br>1.5<br>1.5 4WD<br>1.6 16V<br>1.6 VVTi<br>1.8 16V<br>1.8 16V<br>1.8 16V 4WD<br>1.8 Hybrid<br>1.8 VVTi<br>1.8 Hybrid | 73<br>74<br>66<br>71<br>81<br>77<br>97<br>91<br>106<br>108<br>100<br>73<br>100<br>73  |  | 01.10<br>05.09<br>03.07<br>03.07<br>09.09<br>09.09<br>05.09<br>03.07<br>02.09<br>02.09<br>02.09<br>09.10<br>10.06<br>09.10 | 09.12<br>09.12<br>09.12<br>09.12<br>09.12<br>09.12<br>09.12<br>09.12<br>09.12<br>09.12<br>09.12<br>09.12<br>09.12<br>09.12<br>09.12 | Produktionsland <br>Produktionsland <br><br>Produktionsland <br>Produktionsland <br>Produktionsland <br>Produktionsland <br>Produktionsland <br>Produktionsland <br>Produktionsland <br>Produktionsland <br>Produktionsland <br>Produktionsland <br>Produktionsland <br>Produktionsland <br>Produktionsland <br>Produktionsland <br>Produktionsland <br>Produktionsland <br>Produktionsland <br>Produktionsland <br>Produktionsland <br>Produktionsland <br>Produktionsland <br>Produktionsland <br>Produktionsland <br>Produktionsland <br>Produktionsland <br>Produktionsland <br>Produktionsland <br>Produktionsland <br>Produktionsland <br>Produktionsland <br>Produktionsland <br>Produktionsland <br>Produktionsland <br>Produktionsland <br>Produktionsland <br>Produktionsland <br>Produktionsland <br>Produktionsland <br>Produktionsland <br>Produktionsland <br>Produktionsland <br>Produktionsland <br>Produktionsland <br>Produktionsland  | 13.0460-5602.2   | 605602   | 24122 19,0 +/WK/Zub   |
|  | 1.33 Dual-VVTi<br>1.33 Dual-VVTi<br>1.4 VVTi<br>1.5<br>1.5 4WD<br>1.6 16V<br>1.6 VVTi<br>1.8 16V<br>1.8 16V<br>1.8 16V 4WD<br>1.8 VVTi<br>2.0 D-4D<br>2.2 D-4D                 | 73<br>74<br>71<br>81<br>77<br>97<br>91<br>106<br>108<br>100<br>100<br>93<br>130       |  | 01.10<br>05.09<br>03.07<br>09.09<br>09.09<br>05.09<br>03.07<br>02.09<br>02.09<br>02.09<br>10.06<br>03.07<br>03.07          | 09.12<br>09.12<br>09.12<br>09.12<br>09.12<br>09.12<br>09.12<br>09.12<br>09.12<br>09.12<br>09.12<br>09.12<br>09.12<br>09.12          | Produktionsland <br>Produktionsland <br>Produktionsland <br>Produktionsland <br>Produktionsland <br>Produktionsland <br>Produktionsland <br>Produktionsland <br>Produktionsland <br>Produktionsland <br>Produktionsland <br>Produktionsland <br>Produktionsland <br>Produktionsland <br>Produktionsland <br>Produktionsland <br>Produktionsland <br>Produktionsland <br>Produktionsland <br>Produktionsland <br>Produktionsland <br>Produktionsland <br>Produktionsland <br>Produktionsland <br>Produktionsland <br>Produktionsland <br>Produktionsland <br>Produktionsland <br>Produktionsland <br>Produktionsland <br>Produktionsland <br>Produktionsland <br>Produktionsland <br>Produktionsland <br>Produktionsland <br>Produktionsland <br>Produktionsland   | 13.0460-5766.2   | 605766   | 24337 17,5            |
|  | 1.33 Dual-VVTi<br>1.33 Dual-VVTi<br>1.4 VVTi<br>1.5<br>1.5 4WD<br>1.6 16V<br>1.6 VVTi<br>1.8 16V<br>1.8 16V<br>1.8 16V 4WD<br>1.8 VVTi<br>2.0 D-4D<br>2.2 D-4D                 | 73<br>74<br>71<br>81<br>77<br>97<br>91<br>106<br>108<br>100<br>100<br>93<br>130       |  | 01.10<br>05.09<br>03.07<br>09.09<br>09.09<br>05.09<br>03.07<br>02.09<br>02.09<br>02.09<br>10.06<br>03.07<br>03.07          | 09.12<br>09.12<br>09.12<br>09.12<br>09.12<br>09.12<br>09.12<br>09.12<br>09.12<br>09.12<br>09.12<br>09.12<br>09.12<br>09.12          | Produktionsland <br>Produktionsland <br>Produktionsland <br>Produktionsland <br>Produktionsland <br>Produktionsland <br>Produktionsland <br>Produktionsland <br>Produktionsland <br>Produktionsland <br>Produktionsland <br>Produktionsland <br>Produktionsland <br>Produktionsland <br>Produktionsland <br>Produktionsland <br>Produktionsland <br>Produktionsland <br>Produktionsland <br>Produktionsland <br>Produktionsland <br>Produktionsland <br>Produktionsland <br>Produktionsland <br>Produktionsland <br>Produktionsland <br>Produktionsland <br>Produktionsland <br>Produktionsland <br>Produktionsland <br>Produktionsland <br>Produktionsland <br>Produktionsland <br>Produktionsland <br>Produktionsland <br>Produktionsland <br>Produktionsland   | 13.0460-5767.2   | 605767   | 24336 17,5 <b>AKE</b> |
|  | 1.33 Dual-VVTi<br>1.33 Dual-VVTi<br>1.4 VVTi<br>1.5<br>1.5 4WD<br>1.6 16V<br>1.6 VVTi<br>1.8 16V<br>1.8 16V<br>1.8 16V 4WD<br>1.8 VVTi<br>1.8 Hybrid<br>1.8 VVTi<br>1.8 Hybrid | 73<br>74<br>71<br>81<br>77<br>97<br>91<br>106<br>108<br>100<br>100<br>73<br>100<br>73 |  | 01.10<br>05.09<br>03.07<br>09.09<br>09.09<br>05.09<br>03.07<br>02.09<br>02.09<br>02.09<br>10.06<br>09.10<br>09.10          | 09.12<br>09.12<br>09.12<br>09.12<br>09.12<br>09.12<br>09.12<br>09.12<br>09.12<br>09.12<br>09.12<br>09.12<br>09.12<br>09.12          | Produktionsland <br>Produktionsland <br>Produktionsland <br>Produktionsland <br>Produktionsland <br>Produktionsland <br>Produktionsland <br>Produktionsland <br>Produktionsland <br>Produktionsland <br>Produktionsland <br>Produktionsland <br>Produktionsland <br>Produktionsland <br>Produktionsland <br>Produktionsland <br>Produktionsland <br>Produktionsland <br>Produktionsland <br>Produktionsland <br>Produktionsland <br>Produktionsland <br>Produktionsland <br>Produktionsland <br>Produktionsland <br>Produktionsland <br>Produktionsland <br>Produktionsland <br>Produktionsland    | 24.0122-0256.1   | 422256   | 275 22,0 19,0 V +B    |
|  | 1.33 Dual-VVTi<br>1.33 Dual-VVTi<br>1.4 D-4D<br>1.4 VVTi<br>1.5<br>1.5 4WD<br>1.6 16V<br>1.6 VVTi<br>1.8 16V<br>1.8 16V<br>1.8 16V 4WD<br>1.8 Hybrid<br>1.8 VVTi<br>1.8 Hybrid | 73<br>74<br>66<br>71<br>81<br>77<br>97<br>91<br>106<br>108<br>100<br>73<br>100<br>73  |  | 01.10<br>05.09<br>03.07<br>03.07<br>09.09<br>09.09<br>05.09<br>03.07<br>02.09<br>02.09<br>02.09<br>09.10<br>10.06<br>09.10 | 09.12<br>09.12<br>09.12<br>09.12<br>09.12<br>09.12<br>09.12<br>09.12<br>09.12<br>09.12<br>09.12<br>09.12<br>09.12<br>09.12          | Produktionsland <br>Produktionsland <br><br>Produktionsland <br>Produktionsland <br>Produktionsland <br>Produktionsland <br>Produktionsland <br>Produktionsland <br>Produktionsland <br>Produktionsland <br>Produktionsland <br>Produktionsland <br>Produktionsland <br>Produktionsland <br>Produktionsland <br>Produktionsland <br>Produktionsland <br>Produktionsland <br>Produktionsland <br>Produktionsland <br>Produktionsland <br>Produktionsland   | 24.0126-0148.1   | 426148   | 273 26,0 23,0 V +B    |
|  | 1.33 Dual-VVTi<br>1.33 Dual-VVTi<br>1.4 VVTi<br>1.5<br>1.5 4WD<br>1.6 16V<br>1.6 VVTi<br>1.8 16V<br>1.8 16V<br>1.8 16V 4WD<br>1.8 Hybrid<br>1.8 VVTi<br>1.8 Hybrid             | 73<br>74<br>71<br>81<br>77<br>97<br>91<br>106<br>108<br>100<br>73<br>100<br>73        |  | 01.10<br>05.09<br>03.07<br>09.09<br>09.09<br>05.09<br>03.07<br>02.09<br>02.09<br>02.09<br>09.10<br>10.06<br>09.10          | 09.12<br>09.12<br>09.12<br>09.12<br>09.12<br>09.12<br>09.12<br>09.12<br>09.12<br>09.12<br>09.12<br>09.12<br>09.12                   | Produktionsland <br>Produktionsland <br><br>Produktionsland <br>Produktionsland <br>Produktionsland <br>Produktionsland <br>Produktionsland <br>Produktionsland <br>Produktionsland <br>Produktionsland <br>Produktionsland <br>Produktionsland <br>Produktionsland <br>Produktionsland <br>Produktionsland <br>Produktionsland <br>Produktionsland <br>Produktionsland <br>Produktionsland <br>Produktionsland <br>Produktionsland <br>Produktionsland   | 24.0128-0159.1   | 428159   | 296 28,0 25,0 V +B    |
|  | 2.0 D-4D<br>2.2 D-4D   | 93<br>130   |  | 03.07<br>03.07   | 09.12<br>09.12  | 24.0126-0156.1  | 426156   | 295 26,0 23,0 V +B   |                       |
|  | 1.33 Dual-VVTi<br>1.33 Dual-VVTi<br>1.4 VVTi<br>1.5<br>1.5 4WD<br>1.6 16V<br>1.6 VVTi<br>1.8 16V<br>1.8 16V<br>1.8 16V 4WD<br>1.8 Hybrid<br>1.8 VVTi<br>1.8 Hybrid             | 73<br>74<br>71<br>81<br>77<br>97<br>91<br>106<br>108<br>100<br>73<br>100<br>73        |  | 01.10<br>05.09<br>03.07<br>09.09<br>09.09<br>05.09<br>03.07<br>02.09<br>02.09<br>02.09<br>09.10<br>10.06<br>09.10          | 09.12<br>09.12<br>09.12<br>09.12<br>09.12<br>09.12<br>09.12<br>09.12<br>09.12<br>09.12<br>09.12<br>09.12<br>09.12                   | Produktionsland <br>Produktionsland <br>Produktionsland <br>Produktionsland <br>Produktionsland <br>Produktionsland <br>Produktionsland <br>Produktionsland <br>Produktionsland <br>Produktionsland <br>Produktionsland <br>Produktionsland <br>Produktionsland    | 13.0460-5769.2   | 605769   | 24610 15,0 +/WK       |
|  | 1.33 Dual-VVTi<br>1.33 Dual-VVTi<br>1.4 D-4D   | 73<br>74<br>66  |  | 01.10<br>05.09<br>03.07  | 09.12<br>09.12<br>09.12   | 13.0460-5604.2  | 605604   | 24664 15,2 +/WK/Zub  |                       |

|          |   |                |       |   |                |   |                |                    |                    |                |                    |          |       |       |   |  |                |        |  |          |              |          |       |   |  |  |  |  |          |    |       |          |   |       |  |  |                |          |    |       |              |   |    |       |  |  |         |     |       |       |   |            |    |       |  |                                     |     |       |       |   |  |            |     |       |             |                                     |                |        |   |                    |  |          |     |          |     |       |                |   |  |                    |  |          |             |       |       |       |   |  |  |  |  |             |     |       |       |   |                |        |  |                    |          |     |       |       |   |  |  |  |  |          |    |       |       |  |  |  |  |  |          |     |       |       |  |  |  |  |  |
|--|---|----------------|-------|---|----------------|---|----------------|--------------------|--------------------|----------------|--------------------|----------|-------|-------|---|--|----------------|--------|--|----------|--------------|----------|-------|---|--|--|--|--|----------|----|-------|----------|---|-------|--|--|----------------|----------|----|-------|--------------|---|----|-------|--|--|---------|-----|-------|-------|---|------------|----|-------|--|-------------------------------------|-----|-------|-------|---|--|------------|-----|-------|-------------|-------------------------------------|----------------|--------|---|--------------------|--|----------|-----|----------|-----|-------|----------------|---|--|--------------------|--|----------|-------------|-------|-------|-------|---|--|--|--|--|-------------|-----|-------|-------|---|----------------|--------|--|--------------------|----------|-----|-------|-------|---|--|--|--|--|----------|----|-------|-------|--|--|--|--|--|----------|-----|-------|-------|--|--|--|--|--|
| <b>TOYOTA AURIS (06-12)</b>  |   |                |       |   |                |   |                |                    |                    |                |                    |          |       |       |   |  |                |        |  |          |              |          |       |   |  |  |  |  |          |    |       |          |   |       |  |  |                |          |    |       |              |   |    |       |  |  |         |     |       |       |   |            |    |       |  |                                     |     |       |       |   |  |            |     |       |             |                                     |                |        |   |                    |  |          |     |          |     |       |                |   |  |                    |  |          |             |       |       |       |   |  |  |  |  |             |     |       |       |   |                |        |  |                    |          |     |       |       |   |  |  |  |  |          |    |       |       |  |  |  |  |  |          |     |       |       |  |  |  |  |  |
|    | <table border="1"> <tr><td>1.4 VVTi</td><td>71</td><td>03.07</td><td>09.12</td><td>Produktionsland </td><td>13.0460-5604.2</td><td>605604</td><td>24664</td><td>15,2 +WK/Zub</td></tr> <tr><td>1.5</td><td>81</td><td>09.09</td><td>09.12</td><td>Produktionsland </td><td></td><td></td><td></td><td></td></tr> <tr><td>1.5 4WD</td><td>77</td><td>09.09</td><td>09.12</td><td>Produktionsland </td><td></td><td></td><td></td><td></td></tr> <tr><td>1.6 16V</td><td>97</td><td>05.09</td><td>09.12</td><td>Produktionsland </td><td></td><td></td><td></td><td></td></tr> <tr><td>1.6 VVTi</td><td>91</td><td>03.07</td><td>09.12</td><td>Produktionsland </td><td></td><td></td><td></td><td></td></tr> <tr><td>1.8 16V</td><td>106</td><td>02.09</td><td>09.12</td><td>Produktionsland </td><td></td><td></td><td></td><td></td></tr> <tr><td>1.8 16V</td><td>108</td><td>02.09</td><td>09.12</td><td>Produktionsland </td><td></td><td></td><td></td><td></td></tr> <tr><td>1.8 16V 4WD</td><td>100</td><td>02.09</td><td>09.12</td><td>Produktionsland </td><td></td><td></td><td></td><td></td></tr> <tr><td>1.8 VVTi</td><td>100</td><td>10.06</td><td>09.12</td><td>Produktionsland </td><td></td><td></td><td></td><td></td></tr> <tr><td>2.0 D-4D</td><td>93</td><td>03.07</td><td>09.12</td><td>Produktionsland </td><td></td><td></td><td></td><td></td></tr> <tr><td>2.2 D-4D</td><td>130</td><td>03.07</td><td>09.12</td><td></td><td></td><td></td><td></td><td></td></tr> </table>  | 1.4 VVTi       | 71    | 03.07   | 09.12          | Produktionsland  | 13.0460-5604.2 | 605604             | 24664              | 15,2 +WK/Zub   | 1.5                | 81       | 09.09 | 09.12 | Produktionsland  |  |                |        |  | 1.5 4WD  | 77           | 09.09    | 09.12 | Produktionsland  |  |  |  |  | 1.6 16V  | 97 | 05.09 | 09.12    | Produktionsland  |       |  |  |                | 1.6 VVTi | 91 | 03.07 | 09.12        | Produktionsland  |    |       |  |  | 1.8 16V | 106 | 02.09 | 09.12 | Produktionsland  |            |    |       |  | 1.8 16V                             | 108 | 02.09 | 09.12 | Produktionsland  |  |            |     |       | 1.8 16V 4WD | 100                                 | 02.09          | 09.12  | Produktionsland  |                    |  |          |     | 1.8 VVTi | 100 | 10.06 | 09.12          | Produktionsland  |  |                    |  |          | 2.0 D-4D    | 93    | 03.07 | 09.12 | Produktionsland  |  |  |  |  | 2.2 D-4D    | 130 | 03.07 | 09.12 |   |                |        |  |                    |          |     |       |       |   |  |  |  |  |          |    |       |       |  |  |  |  |  |          |     |       |       |  |  |  |  |  |
| 1.4 VVTi   | 71  | 03.07          | 09.12 | Produktionsland  | 13.0460-5604.2 | 605604  | 24664          | 15,2 +WK/Zub       |                    |                |                    |          |       |       |   |  |                |        |  |          |              |          |       |   |  |  |  |  |          |    |       |          |   |       |  |  |                |          |    |       |              |   |    |       |  |  |         |     |       |       |   |            |    |       |  |                                     |     |       |       |   |  |            |     |       |             |                                     |                |        |   |                    |  |          |     |          |     |       |                |   |  |                    |  |          |             |       |       |       |   |  |  |  |  |             |     |       |       |   |                |        |  |                    |          |     |       |       |   |  |  |  |  |          |    |       |       |  |  |  |  |  |          |     |       |       |  |  |  |  |  |
| 1.5  | 81  | 09.09          | 09.12 | Produktionsland  |                |   |                |                    |                    |                |                    |          |       |       |   |  |                |        |  |          |              |          |       |   |  |  |  |  |          |    |       |          |   |       |  |  |                |          |    |       |              |   |    |       |  |  |         |     |       |       |   |            |    |       |  |                                     |     |       |       |   |  |            |     |       |             |                                     |                |        |   |                    |  |          |     |          |     |       |                |   |  |                    |  |          |             |       |       |       |   |  |  |  |  |             |     |       |       |   |                |        |  |                    |          |     |       |       |   |  |  |  |  |          |    |       |       |  |  |  |  |  |          |     |       |       |  |  |  |  |  |
| 1.5 4WD  | 77  | 09.09          | 09.12 | Produktionsland  |                |   |                |                    |                    |                |                    |          |       |       |   |  |                |        |  |          |              |          |       |   |  |  |  |  |          |    |       |          |   |       |  |  |                |          |    |       |              |   |    |       |  |  |         |     |       |       |   |            |    |       |  |                                     |     |       |       |   |  |            |     |       |             |                                     |                |        |   |                    |  |          |     |          |     |       |                |   |  |                    |  |          |             |       |       |       |   |  |  |  |  |             |     |       |       |   |                |        |  |                    |          |     |       |       |   |  |  |  |  |          |    |       |       |  |  |  |  |  |          |     |       |       |  |  |  |  |  |
| 1.6 16V  | 97  | 05.09          | 09.12 | Produktionsland  |                |   |                |                    |                    |                |                    |          |       |       |   |  |                |        |  |          |              |          |       |   |  |  |  |  |          |    |       |          |   |       |  |  |                |          |    |       |              |   |    |       |  |  |         |     |       |       |   |            |    |       |  |                                     |     |       |       |   |  |            |     |       |             |                                     |                |        |   |                    |  |          |     |          |     |       |                |   |  |                    |  |          |             |       |       |       |   |  |  |  |  |             |     |       |       |   |                |        |  |                    |          |     |       |       |   |  |  |  |  |          |    |       |       |  |  |  |  |  |          |     |       |       |  |  |  |  |  |
| 1.6 VVTi   | 91  | 03.07          | 09.12 | Produktionsland  |                |   |                |                    |                    |                |                    |          |       |       |   |  |                |        |  |          |              |          |       |   |  |  |  |  |          |    |       |          |   |       |  |  |                |          |    |       |              |   |    |       |  |  |         |     |       |       |   |            |    |       |  |                                     |     |       |       |   |  |            |     |       |             |                                     |                |        |   |                    |  |          |     |          |     |       |                |   |  |                    |  |          |             |       |       |       |   |  |  |  |  |             |     |       |       |   |                |        |  |                    |          |     |       |       |   |  |  |  |  |          |    |       |       |  |  |  |  |  |          |     |       |       |  |  |  |  |  |
| 1.8 16V  | 106   | 02.09          | 09.12 | Produktionsland  |                |   |                |                    |                    |                |                    |          |       |       |   |  |                |        |  |          |              |          |       |   |  |  |  |  |          |    |       |          |   |       |  |  |                |          |    |       |              |   |    |       |  |  |         |     |       |       |   |            |    |       |  |                                     |     |       |       |   |  |            |     |       |             |                                     |                |        |   |                    |  |          |     |          |     |       |                |   |  |                    |  |          |             |       |       |       |   |  |  |  |  |             |     |       |       |   |                |        |  |                    |          |     |       |       |   |  |  |  |  |          |    |       |       |  |  |  |  |  |          |     |       |       |  |  |  |  |  |
| 1.8 16V  | 108   | 02.09          | 09.12 | Produktionsland  |                |   |                |                    |                    |                |                    |          |       |       |   |  |                |        |  |          |              |          |       |   |  |  |  |  |          |    |       |          |   |       |  |  |                |          |    |       |              |   |    |       |  |  |         |     |       |       |   |            |    |       |  |                                     |     |       |       |   |  |            |     |       |             |                                     |                |        |   |                    |  |          |     |          |     |       |                |   |  |                    |  |          |             |       |       |       |   |  |  |  |  |             |     |       |       |   |                |        |  |                    |          |     |       |       |   |  |  |  |  |          |    |       |       |  |  |  |  |  |          |     |       |       |  |  |  |  |  |
| 1.8 16V 4WD  | 100   | 02.09          | 09.12 | Produktionsland  |                |   |                |                    |                    |                |                    |          |       |       |   |  |                |        |  |          |              |          |       |   |  |  |  |  |          |    |       |          |   |       |  |  |                |          |    |       |              |   |    |       |  |  |         |     |       |       |   |            |    |       |  |                                     |     |       |       |   |  |            |     |       |             |                                     |                |        |   |                    |  |          |     |          |     |       |                |   |  |                    |  |          |             |       |       |       |   |  |  |  |  |             |     |       |       |   |                |        |  |                    |          |     |       |       |   |  |  |  |  |          |    |       |       |  |  |  |  |  |          |     |       |       |  |  |  |  |  |
| 1.8 VVTi   | 100   | 10.06          | 09.12 | Produktionsland  |                |   |                |                    |                    |                |                    |          |       |       |   |  |                |        |  |          |              |          |       |   |  |  |  |  |          |    |       |          |   |       |  |  |                |          |    |       |              |   |    |       |  |  |         |     |       |       |   |            |    |       |  |                                     |     |       |       |   |  |            |     |       |             |                                     |                |        |   |                    |  |          |     |          |     |       |                |   |  |                    |  |          |             |       |       |       |   |  |  |  |  |             |     |       |       |   |                |        |  |                    |          |     |       |       |   |  |  |  |  |          |    |       |       |  |  |  |  |  |          |     |       |       |  |  |  |  |  |
| 2.0 D-4D   | 93  | 03.07          | 09.12 | Produktionsland  |                |   |                |                    |                    |                |                    |          |       |       |   |  |                |        |  |          |              |          |       |   |  |  |  |  |          |    |       |          |   |       |  |  |                |          |    |       |              |   |    |       |  |  |         |     |       |       |   |            |    |       |  |                                     |     |       |       |   |  |            |     |       |             |                                     |                |        |   |                    |  |          |     |          |     |       |                |   |  |                    |  |          |             |       |       |       |   |  |  |  |  |             |     |       |       |   |                |        |  |                    |          |     |       |       |   |  |  |  |  |          |    |       |       |  |  |  |  |  |          |     |       |       |  |  |  |  |  |
| 2.2 D-4D   | 130   | 03.07          | 09.12 |   |                |   |                |                    |                    |                |                    |          |       |       |   |  |                |        |  |          |              |          |       |   |  |  |  |  |          |    |       |          |   |       |  |  |                |          |    |       |              |   |    |       |  |  |         |     |       |       |   |            |    |       |  |                                     |     |       |       |   |  |            |     |       |             |                                     |                |        |   |                    |  |          |     |          |     |       |                |   |  |                    |  |          |             |       |       |       |   |  |  |  |  |             |     |       |       |   |                |        |  |                    |          |     |       |       |   |  |  |  |  |          |    |       |       |  |  |  |  |  |          |     |       |       |  |  |  |  |  |
|    | <table border="1"> <tr><td>1.33 Dual-VVTi</td><td>73</td><td>01.10</td><td>09.12</td><td>Produktionsland </td><td>24.0109-0155.1</td><td>409155</td><td></td><td>259 9,0 7,5 +B</td></tr> <tr><td>1.33 Dual-VVTi</td><td>74</td><td>05.09</td><td>09.12</td><td>Produktionsland </td><td></td><td></td><td></td><td></td></tr> <tr><td>1.4 VVTi</td><td>71</td><td>03.07</td><td>09.12</td><td>Produktionsland </td><td></td><td></td><td></td><td></td></tr> <tr><td>1.5</td><td>81</td><td>09.09</td><td>09.12</td><td>Produktionsland </td><td></td><td></td><td></td><td></td></tr> <tr><td>1.5 4WD</td><td>77</td><td>09.09</td><td>09.12</td><td>Produktionsland </td><td></td><td></td><td></td><td></td></tr> <tr><td>1.6 16V</td><td>97</td><td>05.09</td><td>09.12</td><td>Produktionsland </td><td></td><td></td><td></td><td></td></tr> <tr><td>1.6 VVTi</td><td>91</td><td>03.07</td><td>09.12</td><td>Produktionsland </td><td></td><td></td><td></td><td></td></tr> <tr><td>1.8 16V</td><td>106</td><td>02.09</td><td>09.12</td><td>Produktionsland </td><td></td><td></td><td></td><td></td></tr> <tr><td>1.8 16V</td><td>108</td><td>02.09</td><td>09.12</td><td>Produktionsland </td><td></td><td></td><td></td><td></td></tr> <tr><td>1.8 16V 4WD</td><td>100</td><td>02.09</td><td>09.12</td><td>Produktionsland </td><td></td><td></td><td></td><td></td></tr> <tr><td>1.8 Hybrid</td><td>73</td><td>09.10</td><td>09.12</td><td></td><td></td><td></td><td></td><td></td></tr> <tr><td>1.8 VVTi</td><td>100</td><td>10.06</td><td>09.12</td><td>Produktionsland </td><td></td><td></td><td></td><td></td></tr> </table>  | 1.33 Dual-VVTi | 73    | 01.10   | 09.12          | Produktionsland  | 24.0109-0155.1 | 409155             |                    | 259 9,0 7,5 +B | 1.33 Dual-VVTi     | 74       | 05.09 | 09.12 | Produktionsland  |  |                |        |  | 1.4 VVTi | 71           | 03.07    | 09.12 | Produktionsland  |  |  |  |  | 1.5      | 81 | 09.09 | 09.12    | Produktionsland  |       |  |  |                | 1.5 4WD  | 77 | 09.09 | 09.12        | Produktionsland  |    |       |  |  | 1.6 16V | 97  | 05.09 | 09.12 | Produktionsland  |            |    |       |  | 1.6 VVTi                            | 91  | 03.07 | 09.12 | Produktionsland  |  |            |     |       | 1.8 16V     | 106                                 | 02.09          | 09.12  | Produktionsland  |                    |  |          |     | 1.8 16V  | 108 | 02.09 | 09.12          | Produktionsland  |  |                    |  |          | 1.8 16V 4WD | 100   | 02.09 | 09.12 | Produktionsland  |  |  |  |  | 1.8 Hybrid  | 73  | 09.10 | 09.12 |   |                |        |  |                    | 1.8 VVTi | 100 | 10.06 | 09.12 | Produktionsland  |  |  |  |  |          |    |       |       |  |  |  |  |  |          |     |       |       |  |  |  |  |  |
| 1.33 Dual-VVTi   | 73  | 01.10          | 09.12 | Produktionsland  | 24.0109-0155.1 | 409155  |                | 259 9,0 7,5 +B     |                    |                |                    |          |       |       |   |  |                |        |  |          |              |          |       |   |  |  |  |  |          |    |       |          |   |       |  |  |                |          |    |       |              |   |    |       |  |  |         |     |       |       |   |            |    |       |  |                                     |     |       |       |   |  |            |     |       |             |                                     |                |        |   |                    |  |          |     |          |     |       |                |   |  |                    |  |          |             |       |       |       |   |  |  |  |  |             |     |       |       |   |                |        |  |                    |          |     |       |       |   |  |  |  |  |          |    |       |       |  |  |  |  |  |          |     |       |       |  |  |  |  |  |
| 1.33 Dual-VVTi   | 74  | 05.09          | 09.12 | Produktionsland  |                |   |                |                    |                    |                |                    |          |       |       |   |  |                |        |  |          |              |          |       |   |  |  |  |  |          |    |       |          |   |       |  |  |                |          |    |       |              |   |    |       |  |  |         |     |       |       |   |            |    |       |  |                                     |     |       |       |   |  |            |     |       |             |                                     |                |        |   |                    |  |          |     |          |     |       |                |   |  |                    |  |          |             |       |       |       |   |  |  |  |  |             |     |       |       |   |                |        |  |                    |          |     |       |       |   |  |  |  |  |          |    |       |       |  |  |  |  |  |          |     |       |       |  |  |  |  |  |
| 1.4 VVTi   | 71  | 03.07          | 09.12 | Produktionsland  |                |   |                |                    |                    |                |                    |          |       |       |   |  |                |        |  |          |              |          |       |   |  |  |  |  |          |    |       |          |   |       |  |  |                |          |    |       |              |   |    |       |  |  |         |     |       |       |   |            |    |       |  |                                     |     |       |       |   |  |            |     |       |             |                                     |                |        |   |                    |  |          |     |          |     |       |                |   |  |                    |  |          |             |       |       |       |   |  |  |  |  |             |     |       |       |   |                |        |  |                    |          |     |       |       |   |  |  |  |  |          |    |       |       |  |  |  |  |  |          |     |       |       |  |  |  |  |  |
| 1.5  | 81  | 09.09          | 09.12 | Produktionsland  |                |   |                |                    |                    |                |                    |          |       |       |   |  |                |        |  |          |              |          |       |   |  |  |  |  |          |    |       |          |   |       |  |  |                |          |    |       |              |   |    |       |  |  |         |     |       |       |   |            |    |       |  |                                     |     |       |       |   |  |            |     |       |             |                                     |                |        |   |                    |  |          |     |          |     |       |                |   |  |                    |  |          |             |       |       |       |   |  |  |  |  |             |     |       |       |   |                |        |  |                    |          |     |       |       |   |  |  |  |  |          |    |       |       |  |  |  |  |  |          |     |       |       |  |  |  |  |  |
| 1.5 4WD  | 77  | 09.09          | 09.12 | Produktionsland  |                |   |                |                    |                    |                |                    |          |       |       |   |  |                |        |  |          |              |          |       |   |  |  |  |  |          |    |       |          |   |       |  |  |                |          |    |       |              |   |    |       |  |  |         |     |       |       |   |            |    |       |  |                                     |     |       |       |   |  |            |     |       |             |                                     |                |        |   |                    |  |          |     |          |     |       |                |   |  |                    |  |          |             |       |       |       |   |  |  |  |  |             |     |       |       |   |                |        |  |                    |          |     |       |       |   |  |  |  |  |          |    |       |       |  |  |  |  |  |          |     |       |       |  |  |  |  |  |
| 1.6 16V  | 97  | 05.09          | 09.12 | Produktionsland  |                |   |                |                    |                    |                |                    |          |       |       |   |  |                |        |  |          |              |          |       |   |  |  |  |  |          |    |       |          |   |       |  |  |                |          |    |       |              |   |    |       |  |  |         |     |       |       |   |            |    |       |  |                                     |     |       |       |   |  |            |     |       |             |                                     |                |        |   |                    |  |          |     |          |     |       |                |   |  |                    |  |          |             |       |       |       |   |  |  |  |  |             |     |       |       |   |                |        |  |                    |          |     |       |       |   |  |  |  |  |          |    |       |       |  |  |  |  |  |          |     |       |       |  |  |  |  |  |
| 1.6 VVTi   | 91  | 03.07          | 09.12 | Produktionsland  |                |   |                |                    |                    |                |                    |          |       |       |   |  |                |        |  |          |              |          |       |   |  |  |  |  |          |    |       |          |   |       |  |  |                |          |    |       |              |   |    |       |  |  |         |     |       |       |   |            |    |       |  |                                     |     |       |       |   |  |            |     |       |             |                                     |                |        |   |                    |  |          |     |          |     |       |                |   |  |                    |  |          |             |       |       |       |   |  |  |  |  |             |     |       |       |   |                |        |  |                    |          |     |       |       |   |  |  |  |  |          |    |       |       |  |  |  |  |  |          |     |       |       |  |  |  |  |  |
| 1.8 16V  | 106   | 02.09          | 09.12 | Produktionsland  |                |   |                |                    |                    |                |                    |          |       |       |   |  |                |        |  |          |              |          |       |   |  |  |  |  |          |    |       |          |   |       |  |  |                |          |    |       |              |   |    |       |  |  |         |     |       |       |   |            |    |       |  |                                     |     |       |       |   |  |            |     |       |             |                                     |                |        |   |                    |  |          |     |          |     |       |                |   |  |                    |  |          |             |       |       |       |   |  |  |  |  |             |     |       |       |   |                |        |  |                    |          |     |       |       |   |  |  |  |  |          |    |       |       |  |  |  |  |  |          |     |       |       |  |  |  |  |  |
| 1.8 16V  | 108   | 02.09          | 09.12 | Produktionsland  |                |   |                |                    |                    |                |                    |          |       |       |   |  |                |        |  |          |              |          |       |   |  |  |  |  |          |    |       |          |   |       |  |  |                |          |    |       |              |   |    |       |  |  |         |     |       |       |   |            |    |       |  |                                     |     |       |       |   |  |            |     |       |             |                                     |                |        |   |                    |  |          |     |          |     |       |                |   |  |                    |  |          |             |       |       |       |   |  |  |  |  |             |     |       |       |   |                |        |  |                    |          |     |       |       |   |  |  |  |  |          |    |       |       |  |  |  |  |  |          |     |       |       |  |  |  |  |  |
| 1.8 16V 4WD  | 100   | 02.09          | 09.12 | Produktionsland  |                |   |                |                    |                    |                |                    |          |       |       |   |  |                |        |  |          |              |          |       |   |  |  |  |  |          |    |       |          |   |       |  |  |                |          |    |       |              |   |    |       |  |  |         |     |       |       |   |            |    |       |  |                                     |     |       |       |   |  |            |     |       |             |                                     |                |        |   |                    |  |          |     |          |     |       |                |   |  |                    |  |          |             |       |       |       |   |  |  |  |  |             |     |       |       |   |                |        |  |                    |          |     |       |       |   |  |  |  |  |          |    |       |       |  |  |  |  |  |          |     |       |       |  |  |  |  |  |
| 1.8 Hybrid   | 73  | 09.10          | 09.12 |   |                |   |                |                    |                    |                |                    |          |       |       |   |  |                |        |  |          |              |          |       |   |  |  |  |  |          |    |       |          |   |       |  |  |                |          |    |       |              |   |    |       |  |  |         |     |       |       |   |            |    |       |  |                                     |     |       |       |   |  |            |     |       |             |                                     |                |        |   |                    |  |          |     |          |     |       |                |   |  |                    |  |          |             |       |       |       |   |  |  |  |  |             |     |       |       |   |                |        |  |                    |          |     |       |       |   |  |  |  |  |          |    |       |       |  |  |  |  |  |          |     |       |       |  |  |  |  |  |
| 1.8 VVTi   | 100   | 10.06          | 09.12 | Produktionsland  |                |   |                |                    |                    |                |                    |          |       |       |   |  |                |        |  |          |              |          |       |   |  |  |  |  |          |    |       |          |   |       |  |  |                |          |    |       |              |   |    |       |  |  |         |     |       |       |   |            |    |       |  |                                     |     |       |       |   |  |            |     |       |             |                                     |                |        |   |                    |  |          |     |          |     |       |                |   |  |                    |  |          |             |       |       |       |   |  |  |  |  |             |     |       |       |   |                |        |  |                    |          |     |       |       |   |  |  |  |  |          |    |       |       |  |  |  |  |  |          |     |       |       |  |  |  |  |  |
|  | <table border="1"> <tr><td>1.33 Dual-VVTi</td><td>73</td><td>01.10</td><td>09.12</td><td>Produktionsland </td><td>24.0110-0337.1</td><td>410337</td><td></td><td>270 9,9 8,0 +B</td></tr> <tr><td>1.33 Dual-VVTi</td><td>74</td><td>05.09</td><td>09.12</td><td>Produktionsland </td><td></td><td></td><td></td><td></td></tr> <tr><td>1.4 D-4D</td><td>66</td><td>03.07</td><td>09.12</td><td></td><td></td><td></td><td></td><td></td></tr> <tr><td>1.4 VVTi</td><td>71</td><td>03.07</td><td>09.12</td><td>Produktionsland </td><td></td><td></td><td></td><td></td></tr> <tr><td>1.5</td><td>81</td><td>09.09</td><td>09.12</td><td>Produktionsland </td><td></td><td></td><td></td><td></td></tr> <tr><td>1.5 4WD</td><td>77</td><td>09.09</td><td>09.12</td><td>Produktionsland </td><td></td><td></td><td></td><td></td></tr> <tr><td>1.6 16V</td><td>97</td><td>05.09</td><td>09.12</td><td>Produktionsland </td><td></td><td></td><td></td><td></td></tr> <tr><td>1.6 VVTi</td><td>91</td><td>03.07</td><td>09.12</td><td>Produktionsland </td><td></td><td></td><td></td><td></td></tr> <tr><td>1.8 16V</td><td>106</td><td>02.09</td><td>09.12</td><td>Produktionsland </td><td></td><td></td><td></td><td></td></tr> <tr><td>1.8 16V</td><td>108</td><td>02.09</td><td>09.12</td><td>Produktionsland </td><td></td><td></td><td></td><td></td></tr> <tr><td>1.8 16V 4WD</td><td>100</td><td>02.09</td><td>09.12</td><td>Produktionsland </td><td></td><td></td><td></td><td></td></tr> <tr><td>1.8 VVTi</td><td>100</td><td>10.06</td><td>09.12</td><td>Produktionsland </td><td></td><td></td><td></td><td></td></tr> <tr><td>2.0 D-4D</td><td>93</td><td>03.07</td><td>09.12</td><td></td><td></td><td></td><td></td><td></td></tr> <tr><td>2.2 D-4D</td><td>130</td><td>03.07</td><td>09.12</td><td></td><td></td><td></td><td></td><td></td></tr> </table> | 1.33 Dual-VVTi | 73    | 01.10   | 09.12          | Produktionsland  | 24.0110-0337.1 | 410337             |                    | 270 9,9 8,0 +B | 1.33 Dual-VVTi     | 74       | 05.09 | 09.12 | Produktionsland  |  |                |        |  | 1.4 D-4D | 66           | 03.07    | 09.12 |   |  |  |  |  | 1.4 VVTi | 71 | 03.07 | 09.12    | Produktionsland  |       |  |  |                | 1.5      | 81 | 09.09 | 09.12        | Produktionsland  |    |       |  |  | 1.5 4WD | 77  | 09.09 | 09.12 | Produktionsland  |            |    |       |  | 1.6 16V                             | 97  | 05.09 | 09.12 | Produktionsland  |  |            |     |       | 1.6 VVTi    | 91                                  | 03.07          | 09.12  | Produktionsland  |                    |  |          |     | 1.8 16V  | 106 | 02.09 | 09.12          | Produktionsland  |  |                    |  |          | 1.8 16V     | 108   | 02.09 | 09.12 | Produktionsland  |  |  |  |  | 1.8 16V 4WD | 100 | 02.09 | 09.12 | Produktionsland  |                |        |  |                    | 1.8 VVTi | 100 | 10.06 | 09.12 | Produktionsland  |  |  |  |  | 2.0 D-4D | 93 | 03.07 | 09.12 |  |  |  |  |  | 2.2 D-4D | 130 | 03.07 | 09.12 |  |  |  |  |  |
| 1.33 Dual-VVTi   | 73  | 01.10          | 09.12 | Produktionsland  | 24.0110-0337.1 | 410337  |                | 270 9,9 8,0 +B     |                    |                |                    |          |       |       |   |  |                |        |  |          |              |          |       |   |  |  |  |  |          |    |       |          |   |       |  |  |                |          |    |       |              |   |    |       |  |  |         |     |       |       |   |            |    |       |  |                                     |     |       |       |   |  |            |     |       |             |                                     |                |        |   |                    |  |          |     |          |     |       |                |   |  |                    |  |          |             |       |       |       |   |  |  |  |  |             |     |       |       |   |                |        |  |                    |          |     |       |       |   |  |  |  |  |          |    |       |       |  |  |  |  |  |          |     |       |       |  |  |  |  |  |
| 1.33 Dual-VVTi   | 74  | 05.09          | 09.12 | Produktionsland  |                |   |                |                    |                    |                |                    |          |       |       |   |  |                |        |  |          |              |          |       |   |  |  |  |  |          |    |       |          |   |       |  |  |                |          |    |       |              |   |    |       |  |  |         |     |       |       |   |            |    |       |  |                                     |     |       |       |   |  |            |     |       |             |                                     |                |        |   |                    |  |          |     |          |     |       |                |   |  |                    |  |          |             |       |       |       |   |  |  |  |  |             |     |       |       |   |                |        |  |                    |          |     |       |       |   |  |  |  |  |          |    |       |       |  |  |  |  |  |          |     |       |       |  |  |  |  |  |
| 1.4 D-4D   | 66  | 03.07          | 09.12 |   |                |   |                |                    |                    |                |                    |          |       |       |   |  |                |        |  |          |              |          |       |   |  |  |  |  |          |    |       |          |   |       |  |  |                |          |    |       |              |   |    |       |  |  |         |     |       |       |   |            |    |       |  |                                     |     |       |       |   |  |            |     |       |             |                                     |                |        |   |                    |  |          |     |          |     |       |                |   |  |                    |  |          |             |       |       |       |   |  |  |  |  |             |     |       |       |   |                |        |  |                    |          |     |       |       |   |  |  |  |  |          |    |       |       |  |  |  |  |  |          |     |       |       |  |  |  |  |  |
| 1.4 VVTi   | 71  | 03.07          | 09.12 | Produktionsland  |                |   |                |                    |                    |                |                    |          |       |       |   |  |                |        |  |          |              |          |       |   |  |  |  |  |          |    |       |          |   |       |  |  |                |          |    |       |              |   |    |       |  |  |         |     |       |       |   |            |    |       |  |                                     |     |       |       |   |  |            |     |       |             |                                     |                |        |   |                    |  |          |     |          |     |       |                |   |  |                    |  |          |             |       |       |       |   |  |  |  |  |             |     |       |       |   |                |        |  |                    |          |     |       |       |   |  |  |  |  |          |    |       |       |  |  |  |  |  |          |     |       |       |  |  |  |  |  |
| 1.5  | 81  | 09.09          | 09.12 | Produktionsland  |                |   |                |                    |                    |                |                    |          |       |       |   |  |                |        |  |          |              |          |       |   |  |  |  |  |          |    |       |          |   |       |  |  |                |          |    |       |              |   |    |       |  |  |         |     |       |       |   |            |    |       |  |                                     |     |       |       |   |  |            |     |       |             |                                     |                |        |   |                    |  |          |     |          |     |       |                |   |  |                    |  |          |             |       |       |       |   |  |  |  |  |             |     |       |       |   |                |        |  |                    |          |     |       |       |   |  |  |  |  |          |    |       |       |  |  |  |  |  |          |     |       |       |  |  |  |  |  |
| 1.5 4WD  | 77  | 09.09          | 09.12 | Produktionsland  |                |   |                |                    |                    |                |                    |          |       |       |   |  |                |        |  |          |              |          |       |   |  |  |  |  |          |    |       |          |   |       |  |  |                |          |    |       |              |   |    |       |  |  |         |     |       |       |   |            |    |       |  |                                     |     |       |       |   |  |            |     |       |             |                                     |                |        |   |                    |  |          |     |          |     |       |                |   |  |                    |  |          |             |       |       |       |   |  |  |  |  |             |     |       |       |   |                |        |  |                    |          |     |       |       |   |  |  |  |  |          |    |       |       |  |  |  |  |  |          |     |       |       |  |  |  |  |  |
| 1.6 16V  | 97  | 05.09          | 09.12 | Produktionsland  |                |   |                |                    |                    |                |                    |          |       |       |   |  |                |        |  |          |              |          |       |   |  |  |  |  |          |    |       |          |   |       |  |  |                |          |    |       |              |   |    |       |  |  |         |     |       |       |   |            |    |       |  |                                     |     |       |       |   |  |            |     |       |             |                                     |                |        |   |                    |  |          |     |          |     |       |                |   |  |                    |  |          |             |       |       |       |   |  |  |  |  |             |     |       |       |   |                |        |  |                    |          |     |       |       |   |  |  |  |  |          |    |       |       |  |  |  |  |  |          |     |       |       |  |  |  |  |  |
| 1.6 VVTi   | 91  | 03.07          | 09.12 | Produktionsland  |                |   |                |                    |                    |                |                    |          |       |       |   |  |                |        |  |          |              |          |       |   |  |  |  |  |          |    |       |          |   |       |  |  |                |          |    |       |              |   |    |       |  |  |         |     |       |       |   |            |    |       |  |                                     |     |       |       |   |  |            |     |       |             |                                     |                |        |   |                    |  |          |     |          |     |       |                |   |  |                    |  |          |             |       |       |       |   |  |  |  |  |             |     |       |       |   |                |        |  |                    |          |     |       |       |   |  |  |  |  |          |    |       |       |  |  |  |  |  |          |     |       |       |  |  |  |  |  |
| 1.8 16V  | 106   | 02.09          | 09.12 | Produktionsland  |                |   |                |                    |                    |                |                    |          |       |       |   |  |                |        |  |          |              |          |       |   |  |  |  |  |          |    |       |          |   |       |  |  |                |          |    |       |              |   |    |       |  |  |         |     |       |       |   |            |    |       |  |                                     |     |       |       |   |  |            |     |       |             |                                     |                |        |   |                    |  |          |     |          |     |       |                |   |  |                    |  |          |             |       |       |       |   |  |  |  |  |             |     |       |       |   |                |        |  |                    |          |     |       |       |   |  |  |  |  |          |    |       |       |  |  |  |  |  |          |     |       |       |  |  |  |  |  |
| 1.8 16V  | 108   | 02.09          | 09.12 | Produktionsland  |                |   |                |                    |                    |                |                    |          |       |       |   |  |                |        |  |          |              |          |       |   |  |  |  |  |          |    |       |          |   |       |  |  |                |          |    |       |              |   |    |       |  |  |         |     |       |       |   |            |    |       |  |                                     |     |       |       |   |  |            |     |       |             |                                     |                |        |   |                    |  |          |     |          |     |       |                |   |  |                    |  |          |             |       |       |       |   |  |  |  |  |             |     |       |       |   |                |        |  |                    |          |     |       |       |   |  |  |  |  |          |    |       |       |  |  |  |  |  |          |     |       |       |  |  |  |  |  |
| 1.8 16V 4WD  | 100   | 02.09          | 09.12 | Produktionsland  |                |   |                |                    |                    |                |                    |          |       |       |   |  |                |        |  |          |              |          |       |   |  |  |  |  |          |    |       |          |   |       |  |  |                |          |    |       |              |   |    |       |  |  |         |     |       |       |   |            |    |       |  |                                     |     |       |       |   |  |            |     |       |             |                                     |                |        |   |                    |  |          |     |          |     |       |                |   |  |                    |  |          |             |       |       |       |   |  |  |  |  |             |     |       |       |   |                |        |  |                    |          |     |       |       |   |  |  |  |  |          |    |       |       |  |  |  |  |  |          |     |       |       |  |  |  |  |  |
| 1.8 VVTi   | 100   | 10.06          | 09.12 | Produktionsland  |                |   |                |                    |                    |                |                    |          |       |       |   |  |                |        |  |          |              |          |       |   |  |  |  |  |          |    |       |          |   |       |  |  |                |          |    |       |              |   |    |       |  |  |         |     |       |       |   |            |    |       |  |                                     |     |       |       |   |  |            |     |       |             |                                     |                |        |   |                    |  |          |     |          |     |       |                |   |  |                    |  |          |             |       |       |       |   |  |  |  |  |             |     |       |       |   |                |        |  |                    |          |     |       |       |   |  |  |  |  |          |    |       |       |  |  |  |  |  |          |     |       |       |  |  |  |  |  |
| 2.0 D-4D   | 93  | 03.07          | 09.12 |   |                |   |                |                    |                    |                |                    |          |       |       |   |  |                |        |  |          |              |          |       |   |  |  |  |  |          |    |       |          |   |       |  |  |                |          |    |       |              |   |    |       |  |  |         |     |       |       |   |            |    |       |  |                                     |     |       |       |   |  |            |     |       |             |                                     |                |        |   |                    |  |          |     |          |     |       |                |   |  |                    |  |          |             |       |       |       |   |  |  |  |  |             |     |       |       |   |                |        |  |                    |          |     |       |       |   |  |  |  |  |          |    |       |       |  |  |  |  |  |          |     |       |       |  |  |  |  |  |
| 2.2 D-4D   | 130   | 03.07          | 09.12 |   |                |   |                |                    |                    |                |                    |          |       |       |   |  |                |        |  |          |              |          |       |   |  |  |  |  |          |    |       |          |   |       |  |  |                |          |    |       |              |   |    |       |  |  |         |     |       |       |   |            |    |       |  |                                     |     |       |       |   |  |            |     |       |             |                                     |                |        |   |                    |  |          |     |          |     |       |                |   |  |                    |  |          |             |       |       |       |   |  |  |  |  |             |     |       |       |   |                |        |  |                    |          |     |       |       |   |  |  |  |  |          |    |       |       |  |  |  |  |  |          |     |       |       |  |  |  |  |  |
| <b>TOYOTA AURIS (12-)</b>  |   |                |       |   |                |   |                |                    |                    |                |                    |          |       |       |   |  |                |        |  |          |              |          |       |   |  |  |  |  |          |    |       |          |   |       |  |  |                |          |    |       |              |   |    |       |  |  |         |     |       |       |   |            |    |       |  |                                     |     |       |       |   |  |            |     |       |             |                                     |                |        |   |                    |  |          |     |          |     |       |                |   |  |                    |  |          |             |       |       |       |   |  |  |  |  |             |     |       |       |   |                |        |  |                    |          |     |       |       |   |  |  |  |  |          |    |       |       |  |  |  |  |  |          |     |       |       |  |  |  |  |  |
|   | <table border="1"> <tr><td>1.8 Hybrid</td><td>73</td><td>10.12</td><td></td><td>+ Panorama-Sonnendach <sup>1)</sup></td><td>13.0460-5766.2</td><td>605766</td><td></td><td>24337</td><td>17,5</td></tr> <tr><td>1.8 VVTi</td><td>103</td><td>10.12</td><td></td><td></td><td></td><td></td><td></td><td></td><td></td></tr> <tr><td>1.8 VVTi</td><td>106</td><td>10.12</td><td></td><td></td><td></td><td></td><td></td><td></td><td></td></tr> <tr><td>2.0 D-4D</td><td>91</td><td>10.12</td><td></td><td></td><td>13.0460-5603.2</td><td>605603</td><td></td><td>24204</td><td>19,2 +WK/Zub</td></tr> </table>  | 1.8 Hybrid     | 73    | 10.12   |                | + Panorama-Sonnendach <sup>1)</sup>   | 13.0460-5766.2 | 605766             |                    | 24337          | 17,5               | 1.8 VVTi | 103   | 10.12 |   |  |                |        |  |          |              | 1.8 VVTi | 106   | 10.12   |  |  |  |  |          |    |       | 2.0 D-4D | 91  | 10.12 |  |  | 13.0460-5603.2 | 605603   |    | 24204 | 19,2 +WK/Zub |   |    |       |  |  |         |     |       |       |   |            |    |       |  |                                     |     |       |       |   |  |            |     |       |             |                                     |                |        |   |                    |  |          |     |          |     |       |                |   |  |                    |  |          |             |       |       |       |   |  |  |  |  |             |     |       |       |   |                |        |  |                    |          |     |       |       |   |  |  |  |  |          |    |       |       |  |  |  |  |  |          |     |       |       |  |  |  |  |  |
| 1.8 Hybrid   | 73  | 10.12          |       | + Panorama-Sonnendach <sup>1)</sup>   | 13.0460-5766.2 | 605766  |                | 24337              | 17,5               |                |                    |          |       |       |   |  |                |        |  |          |              |          |       |   |  |  |  |  |          |    |       |          |   |       |  |  |                |          |    |       |              |   |    |       |  |  |         |     |       |       |   |            |    |       |  |                                     |     |       |       |   |  |            |     |       |             |                                     |                |        |   |                    |  |          |     |          |     |       |                |   |  |                    |  |          |             |       |       |       |   |  |  |  |  |             |     |       |       |   |                |        |  |                    |          |     |       |       |   |  |  |  |  |          |    |       |       |  |  |  |  |  |          |     |       |       |  |  |  |  |  |
| 1.8 VVTi   | 103   | 10.12          |       |   |                |   |                |                    |                    |                |                    |          |       |       |   |  |                |        |  |          |              |          |       |   |  |  |  |  |          |    |       |          |   |       |  |  |                |          |    |       |              |   |    |       |  |  |         |     |       |       |   |            |    |       |  |                                     |     |       |       |   |  |            |     |       |             |                                     |                |        |   |                    |  |          |     |          |     |       |                |   |  |                    |  |          |             |       |       |       |   |  |  |  |  |             |     |       |       |   |                |        |  |                    |          |     |       |       |   |  |  |  |  |          |    |       |       |  |  |  |  |  |          |     |       |       |  |  |  |  |  |
| 1.8 VVTi   | 106   | 10.12          |       |   |                |   |                |                    |                    |                |                    |          |       |       |   |  |                |        |  |          |              |          |       |   |  |  |  |  |          |    |       |          |   |       |  |  |                |          |    |       |              |   |    |       |  |  |         |     |       |       |   |            |    |       |  |                                     |     |       |       |   |  |            |     |       |             |                                     |                |        |   |                    |  |          |     |          |     |       |                |   |  |                    |  |          |             |       |       |       |   |  |  |  |  |             |     |       |       |   |                |        |  |                    |          |     |       |       |   |  |  |  |  |          |    |       |       |  |  |  |  |  |          |     |       |       |  |  |  |  |  |
| 2.0 D-4D   | 91  | 10.12          |       |   | 13.0460-5603.2 | 605603  |                | 24204              | 19,2 +WK/Zub       |                |                    |          |       |       |   |  |                |        |  |          |              |          |       |   |  |  |  |  |          |    |       |          |   |       |  |  |                |          |    |       |              |   |    |       |  |  |         |     |       |       |   |            |    |       |  |                                     |     |       |       |   |  |            |     |       |             |                                     |                |        |   |                    |  |          |     |          |     |       |                |   |  |                    |  |          |             |       |       |       |   |  |  |  |  |             |     |       |       |   |                |        |  |                    |          |     |       |       |   |  |  |  |  |          |    |       |       |  |  |  |  |  |          |     |       |       |  |  |  |  |  |
|    | <table border="1"> <tr><td>1.2</td><td>85</td><td>03.15</td><td></td><td></td><td>24.0126-0184.1</td><td>426184</td><td></td><td></td><td>277 26,0 23,0 V +B</td></tr> <tr><td>1.3 VVTi</td><td>73</td><td>10.12</td><td></td><td></td><td></td><td></td><td></td><td></td><td></td></tr> <tr><td>1.4 D-4D</td><td>66</td><td>10.12</td><td></td><td></td><td></td><td></td><td></td><td></td><td></td></tr> <tr><td>1.6 D-4D</td><td>82</td><td>04.15</td><td></td><td></td><td></td><td></td><td></td><td></td><td></td></tr> <tr><td>1.6 VVTi</td><td>97</td><td>10.12</td><td></td><td></td><td></td><td></td><td></td><td></td><td></td></tr> <tr><td>1.8 Hybrid</td><td>73</td><td>10.12</td><td></td><td>- Panorama-Sonnendach <sup>2)</sup></td><td></td><td></td><td></td><td></td><td></td></tr> <tr><td>1.8 Hybrid</td><td>73</td><td>10.12</td><td></td><td>+ Panorama-Sonnendach <sup>1)</sup></td><td>24.0128-0159.1</td><td>428159</td><td></td><td>296 28,0 25,0 V +B</td><td></td></tr> <tr><td>1.8 VVTi</td><td>103</td><td>10.12</td><td></td><td></td><td></td><td></td><td></td><td></td><td></td></tr> <tr><td>1.8 VVTi</td><td>106</td><td>10.12</td><td></td><td></td><td></td><td></td><td></td><td></td><td></td></tr> <tr><td>2.0 D-4D</td><td>91</td><td>10.12</td><td></td><td></td><td>24.0126-0156.1</td><td>426156</td><td></td><td>295 26,0 23,0 V +B</td><td></td></tr> </table>  | 1.2            | 85    | 03.15   |                |   | 24.0126-0184.1 | 426184             |                    |                | 277 26,0 23,0 V +B | 1.3 VVTi | 73    | 10.12 |   |  |                |        |  |          |              | 1.4 D-4D | 66    | 10.12   |  |  |  |  |          |    |       | 1.6 D-4D | 82  | 04.15 |  |  |                |          |    |       |              | 1.6 VVTi  | 97 | 10.12 |  |  |         |     |       |       |   | 1.8 Hybrid | 73 | 10.12 |  | - Panorama-Sonnendach <sup>2)</sup> |     |       |       |   |  | 1.8 Hybrid | 73  | 10.12 |             | + Panorama-Sonnendach <sup>1)</sup> | 24.0128-0159.1 | 428159 |   | 296 28,0 25,0 V +B |  | 1.8 VVTi | 103 | 10.12    |     |       |                |   |  |                    |  | 1.8 VVTi | 106         | 10.12 |       |       |   |  |  |  |  | 2.0 D-4D    | 91  | 10.12 |       |   | 24.0126-0156.1 | 426156 |  | 295 26,0 23,0 V +B |          |     |       |       |   |  |  |  |  |          |    |       |       |  |  |  |  |  |          |     |       |       |  |  |  |  |  |
| 1.2  | 85  | 03.15          |       |   | 24.0126-0184.1 | 426184  |                |                    | 277 26,0 23,0 V +B |                |                    |          |       |       |   |  |                |        |  |          |              |          |       |   |  |  |  |  |          |    |       |          |   |       |  |  |                |          |    |       |              |   |    |       |  |  |         |     |       |       |   |            |    |       |  |                                     |     |       |       |   |  |            |     |       |             |                                     |                |        |   |                    |  |          |     |          |     |       |                |   |  |                    |  |          |             |       |       |       |   |  |  |  |  |             |     |       |       |   |                |        |  |                    |          |     |       |       |   |  |  |  |  |          |    |       |       |  |  |  |  |  |          |     |       |       |  |  |  |  |  |
| 1.3 VVTi   | 73  | 10.12          |       |   |                |   |                |                    |                    |                |                    |          |       |       |   |  |                |        |  |          |              |          |       |   |  |  |  |  |          |    |       |          |   |       |  |  |                |          |    |       |              |   |    |       |  |  |         |     |       |       |   |            |    |       |  |                                     |     |       |       |   |  |            |     |       |             |                                     |                |        |   |                    |  |          |     |          |     |       |                |   |  |                    |  |          |             |       |       |       |   |  |  |  |  |             |     |       |       |   |                |        |  |                    |          |     |       |       |   |  |  |  |  |          |    |       |       |  |  |  |  |  |          |     |       |       |  |  |  |  |  |
| 1.4 D-4D   | 66  | 10.12          |       |   |                |   |                |                    |                    |                |                    |          |       |       |   |  |                |        |  |          |              |          |       |   |  |  |  |  |          |    |       |          |   |       |  |  |                |          |    |       |              |   |    |       |  |  |         |     |       |       |   |            |    |       |  |                                     |     |       |       |   |  |            |     |       |             |                                     |                |        |   |                    |  |          |     |          |     |       |                |   |  |                    |  |          |             |       |       |       |   |  |  |  |  |             |     |       |       |   |                |        |  |                    |          |     |       |       |   |  |  |  |  |          |    |       |       |  |  |  |  |  |          |     |       |       |  |  |  |  |  |
| 1.6 D-4D   | 82  | 04.15          |       |   |                |   |                |                    |                    |                |                    |          |       |       |   |  |                |        |  |          |              |          |       |   |  |  |  |  |          |    |       |          |   |       |  |  |                |          |    |       |              |   |    |       |  |  |         |     |       |       |   |            |    |       |  |                                     |     |       |       |   |  |            |     |       |             |                                     |                |        |   |                    |  |          |     |          |     |       |                |   |  |                    |  |          |             |       |       |       |   |  |  |  |  |             |     |       |       |   |                |        |  |                    |          |     |       |       |   |  |  |  |  |          |    |       |       |  |  |  |  |  |          |     |       |       |  |  |  |  |  |
| 1.6 VVTi   | 97  | 10.12          |       |   |                |   |                |                    |                    |                |                    |          |       |       |   |  |                |        |  |          |              |          |       |   |  |  |  |  |          |    |       |          |   |       |  |  |                |          |    |       |              |   |    |       |  |  |         |     |       |       |   |            |    |       |  |                                     |     |       |       |   |  |            |     |       |             |                                     |                |        |   |                    |  |          |     |          |     |       |                |   |  |                    |  |          |             |       |       |       |   |  |  |  |  |             |     |       |       |   |                |        |  |                    |          |     |       |       |   |  |  |  |  |          |    |       |       |  |  |  |  |  |          |     |       |       |  |  |  |  |  |
| 1.8 Hybrid   | 73  | 10.12          |       | - Panorama-Sonnendach <sup>2)</sup>   |                |   |                |                    |                    |                |                    |          |       |       |   |  |                |        |  |          |              |          |       |   |  |  |  |  |          |    |       |          |   |       |  |  |                |          |    |       |              |   |    |       |  |  |         |     |       |       |   |            |    |       |  |                                     |     |       |       |   |  |            |     |       |             |                                     |                |        |   |                    |  |          |     |          |     |       |                |   |  |                    |  |          |             |       |       |       |   |  |  |  |  |             |     |       |       |   |                |        |  |                    |          |     |       |       |   |  |  |  |  |          |    |       |       |  |  |  |  |  |          |     |       |       |  |  |  |  |  |
| 1.8 Hybrid   | 73  | 10.12          |       | + Panorama-Sonnendach <sup>1)</sup>   | 24.0128-0159.1 | 428159  |                | 296 28,0 25,0 V +B |                    |                |                    |          |       |       |   |  |                |        |  |          |              |          |       |   |  |  |  |  |          |    |       |          |   |       |  |  |                |          |    |       |              |   |    |       |  |  |         |     |       |       |   |            |    |       |  |                                     |     |       |       |   |  |            |     |       |             |                                     |                |        |   |                    |  |          |     |          |     |       |                |   |  |                    |  |          |             |       |       |       |   |  |  |  |  |             |     |       |       |   |                |        |  |                    |          |     |       |       |   |  |  |  |  |          |    |       |       |  |  |  |  |  |          |     |       |       |  |  |  |  |  |
| 1.8 VVTi   | 103   | 10.12          |       |   |                |   |                |                    |                    |                |                    |          |       |       |   |  |                |        |  |          |              |          |       |   |  |  |  |  |          |    |       |          |   |       |  |  |                |          |    |       |              |   |    |       |  |  |         |     |       |       |   |            |    |       |  |                                     |     |       |       |   |  |            |     |       |             |                                     |                |        |   |                    |  |          |     |          |     |       |                |   |  |                    |  |          |             |       |       |       |   |  |  |  |  |             |     |       |       |   |                |        |  |                    |          |     |       |       |   |  |  |  |  |          |    |       |       |  |  |  |  |  |          |     |       |       |  |  |  |  |  |
| 1.8 VVTi   | 106   | 10.12          |       |   |                |   |                |                    |                    |                |                    |          |       |       |   |  |                |        |  |          |              |          |       |   |  |  |  |  |          |    |       |          |   |       |  |  |                |          |    |       |              |   |    |       |  |  |         |     |       |       |   |            |    |       |  |                                     |     |       |       |   |  |            |     |       |             |                                     |                |        |   |                    |  |          |     |          |     |       |                |   |  |                    |  |          |             |       |       |       |   |  |  |  |  |             |     |       |       |   |                |        |  |                    |          |     |       |       |   |  |  |  |  |          |    |       |       |  |  |  |  |  |          |     |       |       |  |  |  |  |  |
| 2.0 D-4D   | 91  | 10.12          |       |   | 24.0126-0156.1 | 426156  |                | 295 26,0 23,0 V +B |                    |                |                    |          |       |       |   |  |                |        |  |          |              |          |       |   |  |  |  |  |          |    |       |          |   |       |  |  |                |          |    |       |              |   |    |       |  |  |         |     |       |       |   |            |    |       |  |                                     |     |       |       |   |  |            |     |       |             |                                     |                |        |   |                    |  |          |     |          |     |       |                |   |  |                    |  |          |             |       |       |       |   |  |  |  |  |             |     |       |       |   |                |        |  |                    |          |     |       |       |   |  |  |  |  |          |    |       |       |  |  |  |  |  |          |     |       |       |  |  |  |  |  |
|    | <table border="1"> <tr><td>1.2</td><td>85</td><td>03.15</td><td></td><td></td><td>13.0460-5604.2</td><td>605604</td><td></td><td>24664</td><td>15,2 +WK/Zub</td></tr> <tr><td>1.3 VVTi</td><td>73</td><td>10.12</td><td></td><td></td><td></td><td></td><td></td><td></td><td></td></tr> <tr><td>1.4 D-4D</td><td>66</td><td>10.12</td><td></td><td></td><td></td><td></td><td></td><td></td><td></td></tr> <tr><td>1.6 D-4D</td><td>82</td><td>04.15</td><td></td><td></td><td></td><td></td><td></td><td></td><td></td></tr> <tr><td>1.6 VVTi</td><td>97</td><td>10.12</td><td></td><td></td><td></td><td></td><td></td><td></td><td></td></tr> <tr><td>1.8 Hybrid</td><td>73</td><td>10.12</td><td></td><td></td><td></td><td></td><td></td><td></td><td></td></tr> <tr><td>1.8 VVTi</td><td>103</td><td>10.12</td><td></td><td></td><td></td><td></td><td></td><td></td><td></td></tr> <tr><td>1.8 VVTi</td><td>106</td><td>10.12</td><td></td><td></td><td></td><td></td><td></td><td></td><td></td></tr> <tr><td>2.0 D-4D</td><td>91</td><td>10.12</td><td></td><td></td><td></td><td></td><td></td><td></td><td></td></tr> </table>  | 1.2            | 85    | 03.15   |                |   | 13.0460-5604.2 | 605604             |                    | 24664          | 15,2 +WK/Zub       | 1.3 VVTi | 73    | 10.12 |   |  |                |        |  |          |              | 1.4 D-4D | 66    | 10.12   |  |  |  |  |          |    |       | 1.6 D-4D | 82  | 04.15 |  |  |                |          |    |       |              | 1.6 VVTi  | 97 | 10.12 |  |  |         |     |       |       |   | 1.8 Hybrid | 73 | 10.12 |  |                                     |     |       |       |   |  | 1.8 VVTi   | 103 | 10.12 |             |                                     |                |        |   |                    |  | 1.8 VVTi | 106 | 10.12    |     |       |                |   |  |                    |  | 2.0 D-4D | 91          | 10.12 |       |       |   |  |  |  |  |             |     |       |       |   |                |        |  |                    |          |     |       |       |   |  |  |  |  |          |    |       |       |  |  |  |  |  |          |     |       |       |  |  |  |  |  |
| 1.2  | 85  | 03.15          |       |   | 13.0460-5604.2 | 605604  |                | 24664              | 15,2 +WK/Zub       |                |                    |          |       |       |   |  |                |        |  |          |              |          |       |   |  |  |  |  |          |    |       |          |   |       |  |  |                |          |    |       |              |   |    |       |  |  |         |     |       |       |   |            |    |       |  |                                     |     |       |       |   |  |            |     |       |             |                                     |                |        |   |                    |  |          |     |          |     |       |                |   |  |                    |  |          |             |       |       |       |   |  |  |  |  |             |     |       |       |   |                |        |  |                    |          |     |       |       |   |  |  |  |  |          |    |       |       |  |  |  |  |  |          |     |       |       |  |  |  |  |  |
| 1.3 VVTi   | 73  | 10.12          |       |   |                |   |                |                    |                    |                |                    |          |       |       |   |  |                |        |  |          |              |          |       |   |  |  |  |  |          |    |       |          |   |       |  |  |                |          |    |       |              |   |    |       |  |  |         |     |       |       |   |            |    |       |  |                                     |     |       |       |   |  |            |     |       |             |                                     |                |        |   |                    |  |          |     |          |     |       |                |   |  |                    |  |          |             |       |       |       |   |  |  |  |  |             |     |       |       |   |                |        |  |                    |          |     |       |       |   |  |  |  |  |          |    |       |       |  |  |  |  |  |          |     |       |       |  |  |  |  |  |
| 1.4 D-4D   | 66  | 10.12          |       |   |                |   |                |                    |                    |                |                    |          |       |       |   |  |                |        |  |          |              |          |       |   |  |  |  |  |          |    |       |          |   |       |  |  |                |          |    |       |              |   |    |       |  |  |         |     |       |       |   |            |    |       |  |                                     |     |       |       |   |  |            |     |       |             |                                     |                |        |   |                    |  |          |     |          |     |       |                |   |  |                    |  |          |             |       |       |       |   |  |  |  |  |             |     |       |       |   |                |        |  |                    |          |     |       |       |   |  |  |  |  |          |    |       |       |  |  |  |  |  |          |     |       |       |  |  |  |  |  |
| 1.6 D-4D   | 82  | 04.15          |       |   |                |   |                |                    |                    |                |                    |          |       |       |   |  |                |        |  |          |              |          |       |   |  |  |  |  |          |    |       |          |   |       |  |  |                |          |    |       |              |   |    |       |  |  |         |     |       |       |   |            |    |       |  |                                     |     |       |       |   |  |            |     |       |             |                                     |                |        |   |                    |  |          |     |          |     |       |                |   |  |                    |  |          |             |       |       |       |   |  |  |  |  |             |     |       |       |   |                |        |  |                    |          |     |       |       |   |  |  |  |  |          |    |       |       |  |  |  |  |  |          |     |       |       |  |  |  |  |  |
| 1.6 VVTi   | 97  | 10.12          |       |   |                |   |                |                    |                    |                |                    |          |       |       |   |  |                |        |  |          |              |          |       |   |  |  |  |  |          |    |       |          |   |       |  |  |                |          |    |       |              |   |    |       |  |  |         |     |       |       |   |            |    |       |  |                                     |     |       |       |   |  |            |     |       |             |                                     |                |        |   |                    |  |          |     |          |     |       |                |   |  |                    |  |          |             |       |       |       |   |  |  |  |  |             |     |       |       |   |                |        |  |                    |          |     |       |       |   |  |  |  |  |          |    |       |       |  |  |  |  |  |          |     |       |       |  |  |  |  |  |
| 1.8 Hybrid   | 73  | 10.12          |       |   |                |   |                |                    |                    |                |                    |          |       |       |   |  |                |        |  |          |              |          |       |   |  |  |  |  |          |    |       |          |   |       |  |  |                |          |    |       |              |   |    |       |  |  |         |     |       |       |   |            |    |       |  |                                     |     |       |       |   |  |            |     |       |             |                                     |                |        |   |                    |  |          |     |          |     |       |                |   |  |                    |  |          |             |       |       |       |   |  |  |  |  |             |     |       |       |   |                |        |  |                    |          |     |       |       |   |  |  |  |  |          |    |       |       |  |  |  |  |  |          |     |       |       |  |  |  |  |  |
| 1.8 VVTi   | 103   | 10.12          |       |   |                |   |                |                    |                    |                |                    |          |       |       |   |  |                |        |  |          |              |          |       |   |  |  |  |  |          |    |       |          |   |       |  |  |                |          |    |       |              |   |    |       |  |  |         |     |       |       |   |            |    |       |  |                                     |     |       |       |   |  |            |     |       |             |                                     |                |        |   |                    |  |          |     |          |     |       |                |   |  |                    |  |          |             |       |       |       |   |  |  |  |  |             |     |       |       |   |                |        |  |                    |          |     |       |       |   |  |  |  |  |          |    |       |       |  |  |  |  |  |          |     |       |       |  |  |  |  |  |
| 1.8 VVTi   | 106   | 10.12          |       |   |                |   |                |                    |                    |                |                    |          |       |       |   |  |                |        |  |          |              |          |       |   |  |  |  |  |          |    |       |          |   |       |  |  |                |          |    |       |              |   |    |       |  |  |         |     |       |       |   |            |    |       |  |                                     |     |       |       |   |  |            |     |       |             |                                     |                |        |   |                    |  |          |     |          |     |       |                |   |  |                    |  |          |             |       |       |       |   |  |  |  |  |             |     |       |       |   |                |        |  |                    |          |     |       |       |   |  |  |  |  |          |    |       |       |  |  |  |  |  |          |     |       |       |  |  |  |  |  |
| 2.0 D-4D   | 91  | 10.12          |       |   |                |   |                |                    |                    |                |                    |          |       |       |   |  |                |        |  |          |              |          |       |   |  |  |  |  |          |    |       |          |   |       |  |  |                |          |    |       |              |   |    |       |  |  |         |     |       |       |   |            |    |       |  |                                     |     |       |       |   |  |            |     |       |             |                                     |                |        |   |                    |  |          |     |          |     |       |                |   |  |                    |  |          |             |       |       |       |   |  |  |  |  |             |     |       |       |   |                |        |  |                    |          |     |       |       |   |  |  |  |  |          |    |       |       |  |  |  |  |  |          |     |       |       |  |  |  |  |  |
|    | <table border="1"> <tr><td>1.2</td><td>85</td><td>03.15</td><td></td><td></td><td>24.0110-0337.1</td><td>410337</td><td></td><td></td><td>270 9,9 8,0 +B</td></tr> <tr><td>1.3 VVTi</td><td>73</td><td>10.12</td><td></td><td></td><td></td><td></td><td></td><td></td><td></td></tr> <tr><td>1.4 D-4D</td><td>66</td><td>10.12</td><td></td><td></td><td></td><td></td><td></td><td></td><td></td></tr> <tr><td>1.6 D-4D</td><td>82</td><td>04.15</td><td></td><td></td><td></td><td></td><td></td><td></td><td></td></tr> <tr><td>1.6 VVTi</td><td>97</td><td>10.12</td><td></td><td></td><td></td><td></td><td></td><td></td><td></td></tr> <tr><td>1.8 Hybrid</td><td>73</td><td>10.12</td><td></td><td></td><td></td><td></td><td></td><td></td><td></td></tr> <tr><td>1.8 VVTi</td><td>103</td><td>10.12</td><td></td><td></td><td></td><td></td><td></td><td></td><td></td></tr> <tr><td>1.8 VVTi</td><td>106</td><td>10.12</td><td></td><td></td><td></td><td></td><td></td><td></td><td></td></tr> <tr><td>2.0 D-4D</td><td>91</td><td>10.12</td><td></td><td></td><td></td><td></td><td></td><td></td><td></td></tr> </table>   | 1.2            | 85    | 03.15   |                |   | 24.0110-0337.1 | 410337             |                    |                | 270 9,9 8,0 +B     | 1.3 VVTi | 73    | 10.12 |   |  |                |        |  |          |              | 1.4 D-4D | 66    | 10.12   |  |  |  |  |          |    |       | 1.6 D-4D | 82  | 04.15 |  |  |                |          |    |       |              | 1.6 VVTi  | 97 | 10.12 |  |  |         |     |       |       |   | 1.8 Hybrid | 73 | 10.12 |  |                                     |     |       |       |   |  | 1.8 VVTi   | 103 | 10.12 |             |                                     |                |        |   |                    |  | 1.8 VVTi | 106 | 10.12    |     |       |                |   |  |                    |  | 2.0 D-4D | 91          | 10.12 |       |       |   |  |  |  |  |             |     |       |       |   |                |        |  |                    |          |     |       |       |   |  |  |  |  |          |    |       |       |  |  |  |  |  |          |     |       |       |  |  |  |  |  |
| 1.2  | 85  | 03.15          |       |   | 24.0110-0337.1 | 410337  |                |                    | 270 9,9 8,0 +B     |                |                    |          |       |       |   |  |                |        |  |          |              |          |       |   |  |  |  |  |          |    |       |          |   |       |  |  |                |          |    |       |              |   |    |       |  |  |         |     |       |       |   |            |    |       |  |                                     |     |       |       |   |  |            |     |       |             |                                     |                |        |   |                    |  |          |     |          |     |       |                |   |  |                    |  |          |             |       |       |       |   |  |  |  |  |             |     |       |       |   |                |        |  |                    |          |     |       |       |   |  |  |  |  |          |    |       |       |  |  |  |  |  |          |     |       |       |  |  |  |  |  |
| 1.3 VVTi   | 73  | 10.12          |       |   |                |   |                |                    |                    |                |                    |          |       |       |   |  |                |        |  |          |              |          |       |   |  |  |  |  |          |    |       |          |   |       |  |  |                |          |    |       |              |   |    |       |  |  |         |     |       |       |   |            |    |       |  |                                     |     |       |       |   |  |            |     |       |             |                                     |                |        |   |                    |  |          |     |          |     |       |                |   |  |                    |  |          |             |       |       |       |   |  |  |  |  |             |     |       |       |   |                |        |  |                    |          |     |       |       |   |  |  |  |  |          |    |       |       |  |  |  |  |  |          |     |       |       |  |  |  |  |  |
| 1.4 D-4D   | 66  | 10.12          |       |   |                |   |                |                    |                    |                |                    |          |       |       |   |  |                |        |  |          |              |          |       |   |  |  |  |  |          |    |       |          |   |       |  |  |                |          |    |       |              |   |    |       |  |  |         |     |       |       |   |            |    |       |  |                                     |     |       |       |   |  |            |     |       |             |                                     |                |        |   |                    |  |          |     |          |     |       |                |   |  |                    |  |          |             |       |       |       |   |  |  |  |  |             |     |       |       |   |                |        |  |                    |          |     |       |       |   |  |  |  |  |          |    |       |       |  |  |  |  |  |          |     |       |       |  |  |  |  |  |
| 1.6 D-4D   | 82  | 04.15          |       |   |                |   |                |                    |                    |                |                    |          |       |       |   |  |                |        |  |          |              |          |       |   |  |  |  |  |          |    |       |          |   |       |  |  |                |          |    |       |              |   |    |       |  |  |         |     |       |       |   |            |    |       |  |                                     |     |       |       |   |  |            |     |       |             |                                     |                |        |   |                    |  |          |     |          |     |       |                |   |  |                    |  |          |             |       |       |       |   |  |  |  |  |             |     |       |       |   |                |        |  |                    |          |     |       |       |   |  |  |  |  |          |    |       |       |  |  |  |  |  |          |     |       |       |  |  |  |  |  |
| 1.6 VVTi   | 97  | 10.12          |       |   |                |   |                |                    |                    |                |                    |          |       |       |   |  |                |        |  |          |              |          |       |   |  |  |  |  |          |    |       |          |   |       |  |  |                |          |    |       |              |   |    |       |  |  |         |     |       |       |   |            |    |       |  |                                     |     |       |       |   |  |            |     |       |             |                                     |                |        |   |                    |  |          |     |          |     |       |                |   |  |                    |  |          |             |       |       |       |   |  |  |  |  |             |     |       |       |   |                |        |  |                    |          |     |       |       |   |  |  |  |  |          |    |       |       |  |  |  |  |  |          |     |       |       |  |  |  |  |  |
| 1.8 Hybrid   | 73  | 10.12          |       |   |                |   |                |                    |                    |                |                    |          |       |       |   |  |                |        |  |          |              |          |       |   |  |  |  |  |          |    |       |          |   |       |  |  |                |          |    |       |              |   |    |       |  |  |         |     |       |       |   |            |    |       |  |                                     |     |       |       |   |  |            |     |       |             |                                     |                |        |   |                    |  |          |     |          |     |       |                |   |  |                    |  |          |             |       |       |       |   |  |  |  |  |             |     |       |       |   |                |        |  |                    |          |     |       |       |   |  |  |  |  |          |    |       |       |  |  |  |  |  |          |     |       |       |  |  |  |  |  |
| 1.8 VVTi   | 103   | 10.12          |       |   |                |   |                |                    |                    |                |                    |          |       |       |   |  |                |        |  |          |              |          |       |   |  |  |  |  |          |    |       |          |   |       |  |  |                |          |    |       |              |   |    |       |  |  |         |     |       |       |   |            |    |       |  |                                     |     |       |       |   |  |            |     |       |             |                                     |                |        |   |                    |  |          |     |          |     |       |                |   |  |                    |  |          |             |       |       |       |   |  |  |  |  |             |     |       |       |   |                |        |  |                    |          |     |       |       |   |  |  |  |  |          |    |       |       |  |  |  |  |  |          |     |       |       |  |  |  |  |  |
| 1.8 VVTi   | 106   | 10.12          |       |   |                |   |                |                    |                    |                |                    |          |       |       |   |  |                |        |  |          |              |          |       |   |  |  |  |  |          |    |       |          |   |       |  |  |                |          |    |       |              |   |    |       |  |  |         |     |       |       |   |            |    |       |  |                                     |     |       |       |   |  |            |     |       |             |                                     |                |        |   |                    |  |          |     |          |     |       |                |   |  |                    |  |          |             |       |       |       |   |  |  |  |  |             |     |       |       |   |                |        |  |                    |          |     |       |       |   |  |  |  |  |          |    |       |       |  |  |  |  |  |          |     |       |       |  |  |  |  |  |
| 2.0 D-4D   | 91  | 10.12          |       |   |                |   |                |                    |                    |                |                    |          |       |       |   |  |                |        |  |          |              |          |       |   |  |  |  |  |          |    |       |          |   |       |  |  |                |          |    |       |              |   |    |       |  |  |         |     |       |       |   |            |    |       |  |                                     |     |       |       |   |  |            |     |       |             |                                     |                |        |   |                    |  |          |     |          |     |       |                |   |  |                    |  |          |             |       |       |       |   |  |  |  |  |             |     |       |       |   |                |        |  |                    |          |     |       |       |   |  |  |  |  |          |    |       |       |  |  |  |  |  |          |     |       |       |  |  |  |  |  |
| <b>TOYOTA AURIS Touring Sports (13-)</b>   |   |                |       |   |                |   |                |                    |                    |                |                    |          |       |       |   |  |                |        |  |          |              |          |       |   |  |  |  |  |          |    |       |          |   |       |  |  |                |          |    |       |              |   |    |       |  |  |         |     |       |       |   |            |    |       |  |                                     |     |       |       |   |  |            |     |       |             |                                     |                |        |   |                    |  |          |     |          |     |       |                |   |  |                    |  |          |             |       |       |       |   |  |  |  |  |             |     |       |       |   |                |        |  |                    |          |     |       |       |   |  |  |  |  |          |    |       |       |  |  |  |  |  |          |     |       |       |  |  |  |  |  |
|    | <table border="1"> <tr><td>1.8 Hybrid</td><td>73</td><td>07.13</td><td></td><td>+ Panorama-Sonnendach <sup>1)</sup></td><td>13.0460-5766.2</td><td>605766</td><td></td><td>24337</td><td>17,5</td></tr> <tr><td>2.0 D-4D</td><td>91</td><td>07.13</td><td></td><td></td><td>13.0460-5603.2</td><td>605603</td><td></td><td>24204</td><td>19,2 +WK/Zub</td></tr> </table>  | 1.8 Hybrid     | 73    | 07.13   |                | + Panorama-Sonnendach <sup>1)</sup>   | 13.0460-5766.2 | 605766             |                    | 24337          | 17,5               | 2.0 D-4D | 91    | 07.13 |   |  | 13.0460-5603.2 | 605603 |  | 24204    | 19,2 +WK/Zub |          |       |   |  |  |  |  |          |    |       |          |   |       |  |  |                |          |    |       |              |   |    |       |  |  |         |     |       |       |   |            |    |       |  |                                     |     |       |       |   |  |            |     |       |             |                                     |                |        |   |                    |  |          |     |          |     |       |                |   |  |                    |  |          |             |       |       |       |   |  |  |  |  |             |     |       |       |   |                |        |  |                    |          |     |       |       |   |  |  |  |  |          |    |       |       |  |  |  |  |  |          |     |       |       |  |  |  |  |  |
| 1.8 Hybrid   | 73  | 07.13          |       | + Panorama-Sonnendach <sup>1)</sup>   | 13.0460-5766.2 | 605766  |                | 24337              | 17,5               |                |                    |          |       |       |   |  |                |        |  |          |              |          |       |   |  |  |  |  |          |    |       |          |   |       |  |  |                |          |    |       |              |   |    |       |  |  |         |     |       |       |   |            |    |       |  |                                     |     |       |       |   |  |            |     |       |             |                                     |                |        |   |                    |  |          |     |          |     |       |                |   |  |                    |  |          |             |       |       |       |   |  |  |  |  |             |     |       |       |   |                |        |  |                    |          |     |       |       |   |  |  |  |  |          |    |       |       |  |  |  |  |  |          |     |       |       |  |  |  |  |  |
| 2.0 D-4D   | 91  | 07.13          |       |   | 13.0460-5603.2 | 605603  |                | 24204              | 19,2 +WK/Zub       |                |                    |          |       |       |   |  |                |        |  |          |              |          |       |   |  |  |  |  |          |    |       |          |   |       |  |  |                |          |    |       |              |   |    |       |  |  |         |     |       |       |   |            |    |       |  |                                     |     |       |       |   |  |            |     |       |             |                                     |                |        |   |                    |  |          |     |          |     |       |                |   |  |                    |  |          |             |       |       |       |   |  |  |  |  |             |     |       |       |   |                |        |  |                    |          |     |       |       |   |  |  |  |  |          |    |       |       |  |  |  |  |  |          |     |       |       |  |  |  |  |  |
|    | <table border="1"> <tr><td>1.2</td><td>85</td><td>03.15</td><td></td><td></td><td>24.0126-0184.1</td><td>426184</td><td></td><td></td><td>277 26,0 23,0 V +B</td></tr> <tr><td>1.3 VVTi</td><td>73</td><td>07.13</td><td></td><td></td><td></td><td></td><td></td><td></td><td></td></tr> <tr><td>1.4 D-4D</td><td>66</td><td>07.13</td><td></td><td></td><td></td><td></td><td></td><td></td><td></td></tr> <tr><td>1.6 D-4D</td><td>82</td><td>04.15</td><td></td><td></td><td></td><td></td><td></td><td></td><td></td></tr> <tr><td>1.6 VVTi</td><td>97</td><td>07.13</td><td></td><td></td><td></td><td></td><td></td><td></td><td></td></tr> <tr><td>1.8 Hybrid</td><td>73</td><td>07.13</td><td></td><td>- Panorama-Sonnendach <sup>2)</sup></td><td></td><td></td><td></td><td></td><td></td></tr> <tr><td>1.8 Hybrid</td><td>73</td><td>07.13</td><td></td><td>+ Panorama-Sonnendach <sup>1)</sup></td><td>24.0128-0159.1</td><td>428159</td><td></td><td>296 28,0 25,0 V +B</td><td></td></tr> <tr><td>2.0 D-4D</td><td>91</td><td>07.13</td><td></td><td></td><td>24.0126-0156.1</td><td>426156</td><td></td><td>295 26,0 23,0 V +B</td><td></td></tr> </table>  | 1.2            | 85    | 03.15   |                |   | 24.0126-0184.1 | 426184             |                    |                | 277 26,0 23,0 V +B | 1.3 VVTi | 73    | 07.13 |   |  |                |        |  |          |              | 1.4 D-4D | 66    | 07.13   |  |  |  |  |          |    |       | 1.6 D-4D | 82  | 04.15 |  |  |                |          |    |       |              | 1.6 VVTi  | 97 | 07.13 |  |  |         |     |       |       |   | 1.8 Hybrid | 73 | 07.13 |  | - Panorama-Sonnendach <sup>2)</sup> |     |       |       |   |  | 1.8 Hybrid | 73  | 07.13 |             | + Panorama-Sonnendach <sup>1)</sup> | 24.0128-0159.1 | 428159 |   | 296 28,0 25,0 V +B |  | 2.0 D-4D | 91  | 07.13    |     |       | 24.0126-0156.1 | 426156  |  | 295 26,0 23,0 V +B |  |          |             |       |       |       |   |  |  |  |  |             |     |       |       |   |                |        |  |                    |          |     |       |       |   |  |  |  |  |          |    |       |       |  |  |  |  |  |          |     |       |       |  |  |  |  |  |
| 1.2  | 85  | 03.15          |       |   | 24.0126-0184.1 | 426184  |                |                    | 277 26,0 23,0 V +B |                |                    |          |       |       |   |  |                |        |  |          |              |          |       |   |  |  |  |  |          |    |       |          |   |       |  |  |                |          |    |       |              |   |    |       |  |  |         |     |       |       |   |            |    |       |  |                                     |     |       |       |   |  |            |     |       |             |                                     |                |        |   |                    |  |          |     |          |     |       |                |   |  |                    |  |          |             |       |       |       |   |  |  |  |  |             |     |       |       |   |                |        |  |                    |          |     |       |       |   |  |  |  |  |          |    |       |       |  |  |  |  |  |          |     |       |       |  |  |  |  |  |
| 1.3 VVTi   | 73  | 07.13          |       |   |                |   |                |                    |                    |                |                    |          |       |       |   |  |                |        |  |          |              |          |       |   |  |  |  |  |          |    |       |          |   |       |  |  |                |          |    |       |              |   |    |       |  |  |         |     |       |       |   |            |    |       |  |                                     |     |       |       |   |  |            |     |       |             |                                     |                |        |   |                    |  |          |     |          |     |       |                |   |  |                    |  |          |             |       |       |       |   |  |  |  |  |             |     |       |       |   |                |        |  |                    |          |     |       |       |   |  |  |  |  |          |    |       |       |  |  |  |  |  |          |     |       |       |  |  |  |  |  |
| 1.4 D-4D   | 66  | 07.13          |       |   |                |   |                |                    |                    |                |                    |          |       |       |   |  |                |        |  |          |              |          |       |   |  |  |  |  |          |    |       |          |   |       |  |  |                |          |    |       |              |   |    |       |  |  |         |     |       |       |   |            |    |       |  |                                     |     |       |       |   |  |            |     |       |             |                                     |                |        |   |                    |  |          |     |          |     |       |                |   |  |                    |  |          |             |       |       |       |   |  |  |  |  |             |     |       |       |   |                |        |  |                    |          |     |       |       |   |  |  |  |  |          |    |       |       |  |  |  |  |  |          |     |       |       |  |  |  |  |  |
| 1.6 D-4D   | 82  | 04.15          |       |   |                |   |                |                    |                    |                |                    |          |       |       |   |  |                |        |  |          |              |          |       |   |  |  |  |  |          |    |       |          |   |       |  |  |                |          |    |       |              |   |    |       |  |  |         |     |       |       |   |            |    |       |  |                                     |     |       |       |   |  |            |     |       |             |                                     |                |        |   |                    |  |          |     |          |     |       |                |   |  |                    |  |          |             |       |       |       |   |  |  |  |  |             |     |       |       |   |                |        |  |                    |          |     |       |       |   |  |  |  |  |          |    |       |       |  |  |  |  |  |          |     |       |       |  |  |  |  |  |
| 1.6 VVTi   | 97  | 07.13          |       |   |                |   |                |                    |                    |                |                    |          |       |       |   |  |                |        |  |          |              |          |       |   |  |  |  |  |          |    |       |          |   |       |  |  |                |          |    |       |              |   |    |       |  |  |         |     |       |       |   |            |    |       |  |                                     |     |       |       |   |  |            |     |       |             |                                     |                |        |   |                    |  |          |     |          |     |       |                |   |  |                    |  |          |             |       |       |       |   |  |  |  |  |             |     |       |       |   |                |        |  |                    |          |     |       |       |   |  |  |  |  |          |    |       |       |  |  |  |  |  |          |     |       |       |  |  |  |  |  |
| 1.8 Hybrid   | 73  | 07.13          |       | - Panorama-Sonnendach <sup>2)</sup>   |                |   |                |                    |                    |                |                    |          |       |       |   |  |                |        |  |          |              |          |       |   |  |  |  |  |          |    |       |          |   |       |  |  |                |          |    |       |              |   |    |       |  |  |         |     |       |       |   |            |    |       |  |                                     |     |       |       |   |  |            |     |       |             |                                     |                |        |   |                    |  |          |     |          |     |       |                |   |  |                    |  |          |             |       |       |       |   |  |  |  |  |             |     |       |       |   |                |        |  |                    |          |     |       |       |   |  |  |  |  |          |    |       |       |  |  |  |  |  |          |     |       |       |  |  |  |  |  |
| 1.8 Hybrid   | 73  | 07.13          |       | + Panorama-Sonnendach <sup>1)</sup>   | 24.0128-0159.1 | 428159  |                | 296 28,0 25,0 V +B |                    |                |                    |          |       |       |   |  |                |        |  |          |              |          |       |   |  |  |  |  |          |    |       |          |   |       |  |  |                |          |    |       |              |   |    |       |  |  |         |     |       |       |   |            |    |       |  |                                     |     |       |       |   |  |            |     |       |             |                                     |                |        |   |                    |  |          |     |          |     |       |                |   |  |                    |  |          |             |       |       |       |   |  |  |  |  |             |     |       |       |   |                |        |  |                    |          |     |       |       |   |  |  |  |  |          |    |       |       |  |  |  |  |  |          |     |       |       |  |  |  |  |  |
| 2.0 D-4D   | 91  | 07.13          |       |   | 24.0126-0156.1 | 426156  |                | 295 26,0 23,0 V +B |                    |                |                    |          |       |       |   |  |                |        |  |          |              |          |       |   |  |  |  |  |          |    |       |          |   |       |  |  |                |          |    |       |              |   |    |       |  |  |         |     |       |       |   |            |    |       |  |                                     |     |       |       |   |  |            |     |       |             |                                     |                |        |   |                    |  |          |     |          |     |       |                |   |  |                    |  |          |             |       |       |       |   |  |  |  |  |             |     |       |       |   |                |        |  |                    |          |     |       |       |   |  |  |  |  |          |    |       |       |  |  |  |  |  |          |     |       |       |  |  |  |  |  |

<sup>1)</sup> + panoramic sunroof / + tetto panoramico / + toit panoramique / + techo panorámico

<sup>2)</sup> - panoramic sunroof / - tetto panoramico / - toit panoramique / - techo panorámico



### TOYOTA AURIS Touring Sports (13-)

|  |            |    |  |       |  |                |        |  |       |                |
|--|------------|----|--|-------|--|----------------|--------|--|-------|----------------|
|  | 1.3 VVTi   | 73 |  | 07.13 |  | 13.0460-5604.2 | 605604 |  | 24664 | 15,2 +/WK/Zub  |
|  | 1.4 D-4D   | 66 |  | 07.13 |  |                |        |  |       |                |
|  | 1.2        | 85 |  | 03.15 |  | 13.0460-5604.2 | 605604 |  | 24664 | 15,2 +/WK/Zub  |
|  | 1.6 D-4D   | 82 |  | 04.15 |  |                |        |  |       |                |
|  | 1.6 VVTi   | 97 |  | 07.13 |  |                |        |  |       |                |
|  | 1.8 Hybrid | 73 |  | 07.13 |  |                |        |  |       |                |
|  | 2.0 D-4D   | 91 |  | 07.13 |  |                |        |  |       |                |
|  | 2.0        | 85 |  | 03.15 |  | 24.0110-0337.1 | 410337 |  |       | 270 9,9 8,0 +B |
|  | 1.3 VVTi   | 73 |  | 07.13 |  |                |        |  |       |                |
|  | 1.4 D-4D   | 66 |  | 07.13 |  |                |        |  |       |                |
|  | 1.6 D-4D   | 82 |  | 04.15 |  |                |        |  |       |                |
|  | 1.6 VVTi   | 97 |  | 07.13 |  |                |        |  |       |                |
|  | 1.8 Hybrid | 73 |  | 07.13 |  |                |        |  |       |                |
|  | 2.0 D-4D   | 91 |  | 07.13 |  |                |        |  |       |                |

### TOYOTA AVENSIS (97-03)

|                    |                    |     |       |                              |                              |                |        |     |                |                |     |
|--------------------|--------------------|-----|-------|------------------------------|------------------------------|----------------|--------|-----|----------------|----------------|-----|
|                    | 1.6 16V (AT220)    | 74  |       | 09.97                        | 09.00 + HA-Trommelbremse 1)  | 13.0460-5809.2 | 605809 |     | 21975          | 18,2 +/WK      | ATE |
|                    | 1.6 16V (AT220)    | 81  |       | 09.97                        | 09.00 + HA-Trommelbremse 1)  |                |        |     |                |                |     |
|                    | 1.8 16V (AT221)    | 81  |       | 09.97                        | 09.00 + HA-Trommelbremse 1)  |                |        |     |                |                |     |
|                    | 1.9 TD (CT220)     | 61  |       | 10.97                        | 05.98 + HA-Trommelbremse 1)  |                |        |     |                |                |     |
|                    | 2.0 16V (ST220)    | 94  |       | 09.97                        | 09.00 + HA-Trommelbremse 1)  |                |        |     |                |                |     |
|                    | 2.0 D-4D (CDT220)  | 81  |       | 10.99                        | 02.03 + HA-Trommelbremse 1)  |                |        |     |                |                |     |
|                    | 2.0 TD (CT220)     | 61  |       | 10.97                        | 05.98 + HA-Trommelbremse 1)  |                |        |     |                |                |     |
|                    | 2.0 TD (CT220)     | 66  |       | 09.97                        | 02.03 + HA-Trommelbremse 1)  |                |        |     |                |                |     |
|                    | 1.6 VVT-i (ZZT220) | 81  |       | 10.00                        | 06.01 + HA-Scheibenbremse 2) | 13.0460-5845.2 | 605845 |     | 21961          | 15,5 /WK       | AKE |
|                    | 1.8 VVT-i (ZZT221) | 95  |       | 10.00                        | 06.01 + HA-Scheibenbremse 2) |                |        |     |                |                |     |
| 2.0 16V (ST220)    | 94                 |     | 10.00 | 06.01 + HA-Scheibenbremse 2) |                              |                |        |     |                |                |     |
| 2.0 D-4D (CDT220)  | 81                 |     | 10.99 | 06.01 + HA-Scheibenbremse 2) |                              |                |        |     |                |                |     |
| 2.0 TD (CT220)     | 66                 |     | 09.97 | 06.01 + HA-Scheibenbremse 2) |                              |                |        |     |                |                |     |
| 2.0 VVT-i (AZT220) | 110                |     | 10.00 | 06.01 + HA-Scheibenbremse 2) |                              |                |        |     |                |                |     |
|                    | 1.6 VVT-i (ZZT220) | 81  |       | 07.01                        | 02.03 + HA-Scheibenbremse 2) | 13.0460-5844.2 | 605844 |     | 23996          | 17,5 +/WK      | ATE |
|                    | 1.8 VVT-i (ZZT221) | 95  |       | 07.01                        | 02.03 + HA-Scheibenbremse 2) |                |        |     |                |                |     |
|                    | 1.9 D-4D (CDT220)  | 85  |       | 09.02                        | 02.03 + HA-Scheibenbremse 2) |                |        |     |                |                |     |
|                    | 2.0 16V (ST220)    | 94  |       | 07.01                        | 02.03 + HA-Scheibenbremse 2) |                |        |     |                |                |     |
|                    | 2.0 D-4D (CDT220)  | 81  |       | 07.01                        | 02.03 + HA-Scheibenbremse 2) |                |        |     |                |                |     |
|                    | 2.0 D-4D (CDT220)  | 85  |       | 09.02                        | 02.03 + HA-Scheibenbremse 2) |                |        |     |                |                |     |
|                    | 2.0 TD (CT220)     | 66  |       | 07.01                        | 02.03 + HA-Scheibenbremse 2) |                |        |     |                |                |     |
|                    | 2.0 VVT-i (AZT220) | 110 |       | 07.01                        | 02.03 + HA-Scheibenbremse 2) |                |        |     |                |                |     |
|                    | 1.6 16V (AT220)    | 74  |       | 09.97                        | 09.00 + HA-Trommelbremse 1)  | 24.0125-0140.1 | 425140 |     | 260            | 25,0 23,0 V +B |     |
|                    | 1.6 16V (AT220)    | 81  |       | 09.97                        | 09.00 + HA-Trommelbremse 1)  |                |        |     |                |                |     |
| 1.8 16V (AT221)    | 81                 |     | 09.97 | 09.00 + HA-Trommelbremse 1)  |                              |                |        |     |                |                |     |
| 1.9 TD (CT220)     | 61                 |     | 10.97 | 05.98 + HA-Trommelbremse 1)  |                              |                |        |     |                |                |     |
| 2.0 16V (ST220)    | 94                 |     | 09.97 | 09.00 + HA-Trommelbremse 1)  |                              |                |        |     |                |                |     |
| 2.0 D-4D (CDT220)  | 81                 |     | 10.99 | 02.03 + HA-Trommelbremse 1)  |                              |                |        |     |                |                |     |
| 2.0 TD (CT220)     | 61                 |     | 10.97 | 05.98 + HA-Trommelbremse 1)  |                              |                |        |     |                |                |     |
| 2.0 TD (CT220)     | 66                 |     | 09.97 | 02.03 + HA-Trommelbremse 1)  |                              |                |        |     |                |                |     |
| 1.6 VVT-i (ZZT220) | 81                 |     | 10.00 | 06.01 + HA-Scheibenbremse 2) | 24.0128-0183.1               | 428183         |        | 275 | 28,0 26,0 V +B |                |     |
| 1.8 VVT-i (ZZT221) | 95                 |     | 10.00 | 06.01 + HA-Scheibenbremse 2) |                              |                |        |     |                |                |     |
| 2.0 16V (ST220)    | 94                 |     | 10.00 | 06.01 + HA-Scheibenbremse 2) |                              |                |        |     |                |                |     |
| 2.0 D-4D (CDT220)  | 81                 |     | 10.99 | 06.01 + HA-Scheibenbremse 2) |                              |                |        |     |                |                |     |
| 2.0 TD (CT220)     | 66                 |     | 09.97 | 06.01 + HA-Scheibenbremse 2) |                              |                |        |     |                |                |     |
| 2.0 VVT-i (AZT220) | 110                |     | 10.00 | 06.01 + HA-Scheibenbremse 2) |                              |                |        |     |                |                |     |
| 1.6 VVT-i (ZZT220) | 81                 |     | 07.01 | 02.03 + HA-Scheibenbremse 2) | 24.0125-0156.1               | 425156         |        | 276 | 25,0 23,0 V +B |                |     |
| 1.8 VVT-i (ZZT221) | 95                 |     | 07.01 | 02.03 + HA-Scheibenbremse 2) |                              |                |        |     |                |                |     |
| 1.9 D-4D (CDT220)  | 85                 |     | 09.02 | 02.03 + HA-Scheibenbremse 2) |                              |                |        |     |                |                |     |
| 2.0 16V (ST220)    | 94                 |     | 07.01 | 02.03 + HA-Scheibenbremse 2) |                              |                |        |     |                |                |     |
| 2.0 D-4D (CDT220)  | 81                 |     | 07.01 | 02.03 + HA-Scheibenbremse 2) |                              |                |        |     |                |                |     |
| 2.0 D-4D (CDT220)  | 85                 |     | 09.02 | 02.03 + HA-Scheibenbremse 2) |                              |                |        |     |                |                |     |
| 2.0 TD (CT220)     | 66                 |     | 07.01 | 02.03 + HA-Scheibenbremse 2) |                              |                |        |     |                |                |     |
| 2.0 VVT-i (AZT220) | 110                |     | 07.01 | 02.03 + HA-Scheibenbremse 2) |                              |                |        |     |                |                |     |
|                    | 1.6 VVT-i (ZZT220) | 81  |       | 10.00                        | 06.01                        | 13.0460-5840.2 | 605840 |     | 21833          | 15,0 +/WK      | AKE |
|                    | 1.8 VVT-i (ZZT221) | 95  |       | 10.00                        | 06.01                        |                |        |     |                |                |     |
|                    | 2.0 16V (ST220)    | 94  |       | 10.00                        | 06.01                        |                |        |     |                |                |     |
|                    | 2.0 D-4D (CDT220)  | 81  |       | 10.99                        | 06.01                        |                |        |     |                |                |     |
|                    | 2.0 TD (CT220)     | 66  |       | 09.97                        | 06.01                        |                |        |     |                |                |     |
|                    | 2.0 VVT-i (AZT220) | 110 |       | 10.00                        | 06.01                        |                |        |     |                |                |     |
|                    | 1.6 VVT-i (ZZT220) | 81  |       | 07.01                        | 02.03                        | 13.0460-5869.2 | 605869 |     | 24013          | 14,9 +/WK      | TRW |
|                    | 1.8 VVT-i (ZZT221) | 95  |       | 07.01                        | 02.03                        |                |        |     |                |                |     |
|                    | 1.9 D-4D (CDT220)  | 85  |       | 09.02                        | 02.03                        |                |        |     |                |                |     |
|                    | 2.0 16V (ST220)    | 94  |       | 07.01                        | 02.03                        |                |        |     |                |                |     |
| 2.0 D-4D (CDT220)  | 81                 |     | 07.01 | 02.03                        |                              |                |        |     |                |                |     |
| 2.0 D-4D (CDT220)  | 85                 |     | 09.02 | 02.03                        |                              |                |        |     |                |                |     |
| 2.0 TD (CT220)     | 66                 |     | 07.01 | 02.03                        |                              |                |        |     |                |                |     |
| 2.0 VVT-i (AZT220) | 110                |     | 07.01 | 02.03                        |                              |                |        |     |                |                |     |
|                    | 1.6 VVT-i (ZZT220) | 81  |       | 10.00                        | 06.01                        | 24.0110-0305.1 | 410305 |     | 288            | 10,0 8,5 +B    |     |
|                    | 1.8 VVT-i (ZZT221) | 95  |       | 10.00                        | 06.01                        |                |        |     |                |                |     |
|                    | 2.0 16V (ST220)    | 94  |       | 10.00                        | 06.01                        |                |        |     |                |                |     |
|                    | 2.0 D-4D (CDT220)  | 81  |       | 10.99                        | 06.01                        |                |        |     |                |                |     |
|                    | 2.0 TD (CT220)     | 66  |       | 09.97                        | 06.01                        |                |        |     |                |                |     |
|                    | 2.0 VVT-i (AZT220) | 110 |       | 10.00                        | 06.01                        |                |        |     |                |                |     |
| 1.6 VVT-i (ZZT220) | 81                 |     | 07.01 | 02.03                        | 24.0110-0284.1               | 410284         |        | 271 | 10,0 9,0 +B    |                |     |
| 1.8 VVT-i (ZZT221) | 95                 |     | 07.01 | 02.03                        |                              |                |        |     |                |                |     |
| 1.9 D-4D (CDT220)  | 85                 |     | 09.02 | 02.03                        |                              |                |        |     |                |                |     |
| 2.0 16V (ST220)    | 94                 |     | 07.01 | 02.03                        |                              |                |        |     |                |                |     |
| 2.0 D-4D (CDT220)  | 81                 |     | 07.01 | 02.03                        |                              |                |        |     |                |                |     |
| 2.0 D-4D (CDT220)  | 85                 |     | 09.02 | 02.03                        |                              |                |        |     |                |                |     |

1) + RA drum brake / + P freno a tamburo / + frein à tambour essieu AR / + ET-tambores de freno

2) + RA disc brake / + P disco freno / + frein à disque essieu AR / + ET-disco de freno





**TOYOTA AVENSIS (97-03)**

|  |  |   |  |  |  |                                  |                  |  |                                     |
|--|--|---|--|--|--|----------------------------------|------------------|--|-------------------------------------|
|  | 2.0 TD (CT220)<br>2.0 VVT-i (AZT220)   | 66<br>110                                     |  | 07.01<br>07.01   | 02.03<br>02.03   | 24.0110-0284.1                   | 410284           |  | 271 10,0 9,0 +B                     |
|  | 1.6 16V (AT220)<br>1.6 16V (AT220)<br>1.8 16V (AT221)<br>1.9 TD (CT220)<br>2.0 16V (ST220)<br>2.0 D-4D (CDT220)<br>2.0 TD (CT220)<br>2.0 TD (CT220)                | 74<br>81<br>81<br>61<br>94<br>81<br>61<br>66  |  | 09.97<br>09.97<br>09.97<br>10.97<br>09.97<br>10.99<br>10.97<br>09.97 | 09.00<br>09.00<br>09.00<br>05.98<br>09.00<br>02.03<br>05.98<br>02.03 | 03.0137-0365.2<br>03.0137-9237.2 | 650365<br>669237 |  | 229 x 37 HEB<br>Bremsbacken-Zubehör |
|  | 1.6 16V (AT220)<br>1.6 16V (AT220)<br>1.8 16V (AT221)<br>1.9 TD (CT220)<br>2.0 16V (ST220)<br>2.0 D-4D (CDT220)<br>2.0 TD (CT220)<br>2.0 TD (CT220)                | 74<br>81<br>81<br>61<br>94<br>81<br>61<br>66  |  | 09.97<br>09.97<br>09.97<br>10.97<br>09.97<br>10.99<br>10.97<br>09.97 | 09.00<br>09.00<br>09.00<br>05.98<br>09.00<br>02.03<br>05.98<br>02.03 | 24.0222-8031.1                   | 480152           |  | 229/229,6 x 58                      |
|  | 1.6 16V (AT220)<br>1.6 16V (AT220)<br>1.8 16V (AT221)<br>1.9 TD (CT220)<br>2.0 16V (ST220)<br>2.0 D-4D (CDT220)<br>2.0 TD (CT220)<br>2.0 TD (CT220)                | 74<br>81<br>81<br>61<br>94<br>81<br>61<br>66  |  | 09.97<br>09.97<br>09.97<br>10.97<br>09.97<br>10.99<br>10.97<br>09.97 | 09.00<br>09.00<br>09.00<br>05.98<br>09.00<br>02.03<br>05.98<br>02.03 | 03.0520-8420.3                   | 698420           |  | 20,64/229x37 TopKit TRW             |
|  | 1.6 VVT-i (ZZT220)<br>1.8 VVT-i (ZZT221)<br>1.9 D-4D (CDT220)<br>2.0 16V (ST220)<br>2.0 D-4D (CDT220)<br>2.0 D-4D (CDT220)<br>2.0 TD (CT220)<br>2.0 VVT-i (AZT220) | 81<br>95<br>85<br>94<br>81<br>85<br>66<br>110 |  | 10.00<br>10.00<br>09.02<br>10.00<br>10.99<br>09.02<br>09.97<br>10.00 | 02.03<br>02.03<br>02.03<br>02.03<br>02.03<br>02.03<br>02.03<br>02.03 | 03.0137-0402.2                   | 650402           |  | 170 x 40                            |

**TOYOTA AVENSIS (03-08)**

|  |   |  |  |   |   |                                  |                  |  |                                      |            |
|--|---|--|--|---|---|----------------------------------|------------------|--|--------------------------------------|------------|
|  | 1.6 VVT-i<br>1.8 16V<br>2.0 D-4D<br>2.0 D-4D<br>2.0 VVT-i<br>2.0 VVT-i<br>2.2 D-4D<br>2.2 D-CAT<br>2.2 TD<br>2.4 16V<br>2.4 16V | 81<br>95<br>85<br>93<br>108<br>114<br>110<br>130<br>74<br>120<br>125 |  | 04.03<br>04.03<br>04.03<br>03.06<br>04.03<br>04.03<br>10.05<br>07.05<br>04.05<br>10.03<br>09.03 | 12.07<br>12.07<br>12.07<br>12.07<br>12.07<br>12.07<br>12.07<br>12.07<br>12.07<br>12.07<br>12.07 | 13.0460-5813.2<br>13.0460-0454.2 | 605813<br>610454 |  | 23768 19,3 +/WK<br>Belagsatz-Zubehör | BOS<br>BOS |
|  | 1.6 VVT-i<br>1.8 16V<br>2.0 D-4D<br>2.0 D-4D<br>2.0 VVT-i<br>2.0 VVT-i<br>2.2 D-4D<br>2.2 D-CAT<br>2.2 TD<br>2.4 16V<br>2.4 16V | 81<br>95<br>85<br>93<br>108<br>114<br>110<br>130<br>74<br>120<br>125 |  | 01.08<br>01.08<br>01.08<br>01.08<br>01.08<br>01.08<br>01.08<br>01.08<br>01.08<br>01.08<br>01.08 | 11.08<br>11.08<br>11.08<br>11.08<br>11.08<br>11.08<br>11.08<br>11.08<br>11.08<br>11.08<br>11.08 | 13.0460-5813.2                   | 605813           |  | 23768 19,3 +/WK                      | BOS        |
|  | 1.6 VVT-i<br>1.8 16V<br>2.0 VVT-i<br>2.0 D-4D<br>2.0 D-4D<br>2.0 VVT-i<br>2.4 16V<br>2.4 16V                                    | 81<br>95<br>114<br>85<br>93<br>108<br>120<br>125                     |  | 04.03<br>04.03<br>04.03<br>04.03<br>03.06<br>04.03<br>10.03<br>09.03                            | 11.08<br>11.08<br>11.08<br>11.08<br>11.08<br>11.08<br>11.08<br>11.08                            | 24.0126-0139.1                   | 426139           |  | 277 26,0 24,0 V +B                   |            |
|  | 2.0 D-4D<br>2.0 D-4D<br>2.0 VVT-i<br>2.4 16V<br>2.4 16V   | 85<br>93<br>108<br>120<br>125  |  | 04.03<br>03.06<br>04.03<br>10.03<br>09.03   | 11.08<br>11.08<br>11.08<br>11.08<br>11.08   | 24.0126-0141.1                   | 426141           |  | 295 26,0 24,0 V +B                   |            |
|  | 2.2 D-4D<br>2.2 D-CAT<br>2.2 TD   | 110<br>130<br>74   |  | 10.05<br>07.05<br>04.05   | 11.08<br>11.08<br>11.08   | 24.0126-0138.1                   | 426138           |  | 295 26,0 24,0 V +B                   |            |
|  | 1.6 VVT-i<br>1.8 16V<br>2.0 D-4D<br>2.0 D-4D<br>2.0 VVT-i<br>2.0 VVT-i<br>2.2 D-4D<br>2.2 D-CAT<br>2.2 TD<br>2.4 16V<br>2.4 16V | 81<br>95<br>85<br>93<br>108<br>114<br>110<br>130<br>74<br>120<br>125 |  | 04.03<br>04.03<br>04.03<br>03.06<br>04.03<br>04.03<br>10.05<br>07.05<br>04.05<br>10.03<br>09.03 | 11.08<br>11.08<br>11.08<br>11.08<br>11.08<br>11.08<br>11.08<br>11.08<br>11.08<br>11.08<br>11.08 | 13.0460-5814.2<br>13.0460-0256.2 | 605814<br>610256 |  | 23620 16,4 +/WK<br>Belagsatz-Zubehör | BOS<br>BOS |
|  | 1.6 VVT-i<br>1.8 16V<br>2.0 D-4D<br>2.0 D-4D<br>2.0 VVT-i   | 81<br>95<br>85<br>93<br>108  |  | 04.03<br>04.03<br>04.03<br>03.06<br>04.03   | 11.08<br>11.08<br>11.08<br>11.08<br>11.08   | 24.0110-0311.1                   | 410311           |  | 280 10,0 9,0 +B                      |            |





**TOYOTA AVENSIS (03-08)**

|         |           |     |       |       |       |                |        |  |                 |
|---------|-----------|-----|-------|-------|-------|----------------|--------|--|-----------------|
|         | 2.0 VVT-i | 114 |       | 04.03 | 11.08 | 24.0110-0311.1 | 410311 |  | 280 10,0 9,0 +B |
|         | 2.4 16V   | 120 |       | 10.03 | 11.08 |                |        |  |                 |
|         | 2.4 16V   | 125 |       | 09.03 | 11.08 |                |        |  |                 |
|         | 2.2 D-4D  | 110 |       | 10.05 | 11.08 | 24.0110-0333.1 | 410333 |  | 280 10,0 8,5 +B |
|         | 2.2 D-CAT | 130 |       | 07.05 | 11.08 |                |        |  |                 |
|         | 2.2 TD    | 74  |       | 04.05 | 11.08 |                |        |  |                 |
|         | 1.6 VVT-i | 81  |       | 04.03 | 11.08 | 03.0137-0459.2 | 650459 |  | 172 x 32        |
|         | 1.8 16V   | 95  |       | 04.03 | 11.08 |                |        |  |                 |
|         | 2.0 D-4D  | 85  |       | 04.03 | 11.08 |                |        |  |                 |
|         | 2.0 D-4D  | 93  |       | 03.06 | 11.08 |                |        |  |                 |
|         | 2.0 VVT-i | 108 |       | 04.03 | 11.08 |                |        |  |                 |
|         | 2.0 VVT-i | 114 |       | 04.03 | 11.08 |                |        |  |                 |
|         | 2.2 D-4D  | 110 |       | 10.05 | 11.08 |                |        |  |                 |
|         | 2.2 D-CAT | 130 |       | 07.05 | 11.08 |                |        |  |                 |
|         | 2.2 TD    | 74  |       | 04.05 | 11.08 |                |        |  |                 |
|         | 2.4 16V   | 120 |       | 10.03 | 11.08 |                |        |  |                 |
| 2.4 16V | 125       |     | 09.03 | 11.08 |       |                |        |  |                 |

**TOYOTA AVENSIS (09-)**

|  |           |     |  |       |       |                |        |  |                         |
|--|-----------|-----|--|-------|-------|----------------|--------|--|-------------------------|
|  | 1.6 i 16V | 97  |  | 02.09 |       | 13.0460-5603.2 | 605603 |  | 24204 19,2 +/WK/Zub     |
|  | 1.8 i 16V | 108 |  | 02.09 |       |                |        |  |                         |
|  | 2.0 D-4D  | 91  |  | 11.11 |       |                |        |  |                         |
|  | 2.0 D-4D  | 93  |  | 02.09 |       |                |        |  |                         |
|  | 2.0 i 16V | 112 |  | 02.09 |       |                |        |  |                         |
|  | 2.2 D-4D  | 110 |  | 02.09 | 11.10 | 13.0460-5615.2 | 605615 |  | 24946 19,0 +/WK/Zub BOS |
|  | 2.2 D-4D  | 130 |  | 02.09 | 11.10 |                |        |  |                         |
|  | 1.6 i 16V | 97  |  | 02.09 |       | 24.0126-0156.1 | 426156 |  | 295 26,0 23,0 V +B      |
|  | 1.8 i 16V | 108 |  | 02.09 |       |                |        |  |                         |
|  | 2.0 D-4D  | 91  |  | 11.11 |       |                |        |  |                         |
|  | 2.0 D-4D  | 93  |  | 02.09 |       |                |        |  |                         |
|  | 2.0 i 16V | 112 |  | 02.09 |       |                |        |  |                         |
|  | 2.2 D-4D  | 110 |  | 02.09 |       | 24.0126-0160.1 | 426160 |  | 320 26,0 23,0 V +B      |
|  | 2.2 D-4D  | 130 |  | 02.09 |       |                |        |  |                         |
|  | 1.6 i 16V | 97  |  | 02.09 |       | 13.0460-3853.2 | 603853 |  | 24885 16,8 +/WK/Zub BOS |
|  | 1.8 i 16V | 108 |  | 02.09 |       |                |        |  |                         |
|  | 2.0 D-4D  | 91  |  | 11.11 |       |                |        |  |                         |
|  | 2.0 D-4D  | 93  |  | 02.09 |       |                |        |  |                         |
|  | 2.0 i 16V | 112 |  | 02.09 |       |                |        |  |                         |
|  | 2.2 D-4D  | 110 |  | 02.09 |       |                |        |  |                         |
|  | 1.6 i 16V | 97  |  | 02.09 |       | 24.0111-0169.1 | 411169 |  | 290 11,0 9,0 +B         |
|  | 1.8 i 16V | 108 |  | 02.09 |       |                |        |  |                         |
|  | 2.0 D-4D  | 91  |  | 11.11 |       |                |        |  |                         |
|  | 2.0 D-4D  | 93  |  | 02.09 |       |                |        |  |                         |
|  | 2.0 i 16V | 112 |  | 02.09 |       |                |        |  |                         |
|  | 2.2 D-4D  | 110 |  | 02.09 |       |                |        |  |                         |



























**TOYOTA AVENSIS VERSO (01-09)**

|  |           |     |  |       |       |                |        |  |                                 |
|--|-----------|-----|--|-------|-------|----------------|--------|--|---------------------------------|
|  | 2.0 D-4D  | 85  |  | 08.01 | 08.05 | 13.0460-5846.2 | 605846 |  | 23836 17,0 AKE                  |
|  | 2.0 VVT-i | 110 |  | 08.01 | 11.09 |                |        |  |                                 |
|  | 2.0 D-4D  | 85  |  | 08.01 | 08.05 | 24.0128-0115.1 | 428115 |  | 275 28,0 26,0 V +B              |
|  | 2.0 VVT-i | 110 |  | 08.01 | 11.09 |                |        |  |                                 |
|  | 2.0 D-4D  | 85  |  | 08.01 | 08.05 | 13.0460-5847.2 | 605847 |  | 23646 16,5 +/WK SUM             |
|  | 2.0 VVT-i | 110 |  | 08.01 | 11.09 |                |        |  |                                 |
|  | 2.0 D-4D  | 85  |  | 08.01 | 08.05 | 24.0112-0164.1 | 412164 |  | 291 12,0 10,5 +B                |
|  | 2.0 VVT-i | 110 |  | 08.01 | 11.09 |                |        |  |                                 |
|  | 2.0 D-4D  | 85  |  | 08.01 | 08.05 | 03.0137-0400.2 | 650400 |  | 190 x 45<br>Bremsbacken-Zubehör |
|  | 2.0 VVT-i | 110 |  | 08.01 | 11.09 |                |        |  |                                 |



























**TOYOTA AYGO (05-14)**

|  |               |    |  |       |       |                |        |  |                         |
|--|---------------|----|--|-------|-------|----------------|--------|--|-------------------------|
|  | 1.0 i 12V     | 50 |  | 07.05 | 06.14 | 13.0460-3829.2 | 603829 |  | 23959 17,0 /Zub/S BOS   |
|  | 1.0 i 12V GPL | 50 |  | 07.05 | 06.14 |                |        |  |                         |
|  | 1.4 HDi       | 40 |  | 07.05 | 08.10 |                |        |  |                         |
|  | 1.0 i 12V     | 50 |  | 07.05 | 06.14 | 24.0120-0180.1 | 420180 |  | 247 20,0 18,0 V +S +B   |
|  | 1.0 i 12V GPL | 50 |  | 07.05 | 06.14 |                |        |  |                         |
|  | 1.4 HDi       | 40 |  | 07.05 | 08.10 |                |        |  |                         |
|  | 1.0 i 12V     | 50 |  | 07.05 | 06.14 | 03.0137-0466.2 | 650466 |  | 200 x 32 HEB BOS        |
|  | 1.0 i 12V GPL | 50 |  | 07.05 | 06.14 |                |        |  |                         |
|  | 1.4 HDi       | 40 |  | 07.05 | 08.10 |                |        |  |                         |
|  | 1.0 i 12V     | 50 |  | 07.05 | 06.14 | 24.0220-0046.1 | 480193 |  | 200/201 x 44            |
|  | 1.0 i 12V GPL | 50 |  | 07.05 | 06.14 |                |        |  |                         |
|  | 1.4 HDi       | 40 |  | 07.05 | 08.10 |                |        |  |                         |
|  | 1.0 i 12V     | 50 |  | 07.05 | 06.14 | 03.0520-4117.3 | 694117 |  | 17,46/200x32 TopKit BOS |
|  | 1.0 i 12V GPL | 50 |  | 07.05 | 06.14 |                |        |  |                         |
|  | 1.4 HDi       | 40 |  | 07.05 | 08.10 |                |        |  |                         |



|     |   |  |  |  |  |   |  |  |   |
|--|---|--|--|--|---|---|--|--|---|
| <b>TOYOTA AYGO (14-)</b>   |   |  |  |  |   |   |  |  |   |
|    | 1.0 12V<br>1.2  | 50<br>60   |  | 05.14<br>05.14   |   |   | 13.0460-3829.2   | 603829   | 23959 17,0 /Zub/S <b>BOS</b>                              |
|    | 1.0 12V<br>1.2  | 50<br>60   |  | 05.14<br>05.14   |   |   | 24.0120-0180.1   | 420180   | 247 20,0 18,0 V +S +B                                     |
|    | 1.0 12V<br>1.2  | 50<br>60   |  | 05.14<br>05.14   |   |   | 03.0137-0466.2<br>03.0137-9287.2   | 650466<br>669287   | 200 x 32 HEB <b>BOS</b><br>Bremsbacken-Zubehör <b>BOS</b> |
|    | 1.0 12V<br>1.2  | 50<br>60   |  | 05.14<br>05.14   |   |   | 24.0220-0046.1   | 480193   | 200/201 x 44  |
| <b>TOYOTA CAMRY (96-01)</b>  |   |  |  |  |   |   |  |  |   |
|    | 2.2 16V<br>2.2 16V<br>2.5 16V<br>3.0 V6<br>3.0 V6   | 93<br>96<br>147<br>135<br>140  |  | 11.00<br>08.96<br>08.96<br>08.96<br>08.96  | 11.01<br>11.01<br>11.01<br>11.01<br>11.01   |   | 24.0128-0115.1   | 428115   | 275 28,0 26,0 V +B  |
|    | 2.2 16V<br>2.5 16V<br>3.0 V6<br>3.0 V6  | 96<br>147<br>135<br>140  |  | 08.96<br>08.96<br>08.96<br>08.96   | 07.99<br>07.99<br>07.99<br>07.99  |   | 13.0460-5835.2   | 605835   | 20076 15,5 +/WK <b>AKE</b>                                |
|    | 2.2 16V<br>2.2 16V<br>2.5 16V<br>3.0 V6<br>3.0 V6   | 93<br>96<br>147<br>135<br>140  |  | 11.00<br>08.96<br>08.96<br>08.96<br>08.96  | 11.01<br>11.01<br>11.01<br>11.01<br>11.01   | + 14" Rad <sup>1)</sup><br>+ 14" Rad <sup>1)</sup><br>+ 14" Rad <sup>1)</sup><br>+ 14" Rad <sup>1)</sup><br>+ 14" Rad <sup>1)</sup> | 24.0110-0700.1   | 410700   | 269 10,0 9,0  |
|    | 2.2 16V<br>2.2 16V<br>2.5 16V<br>3.0 V6<br>3.0 V6   | 93<br>96<br>147<br>135<br>140  |  | 11.00<br>08.96<br>08.96<br>08.96<br>08.96  | 11.01<br>11.01<br>11.01<br>11.01<br>11.01   |   | 03.0137-0402.2   | 650402   | 170 x 40  |
| <b>TOYOTA CAMRY (01-05)</b>  |   |  |  |  |   |   |  |  |   |
|    | 2.0 VVT-i (ACV31)<br>2.4 VVT-i (ACV30)<br>3.0 V6 (MCV30)  | 110<br>112<br>137  |  | 12.01<br>12.01<br>12.01  | 12.05<br>12.05<br>12.05   |   | 13.0460-5743.2   | 605743   | 23928 17,3  |
|   | 2.0 VVT-i (ACV31)<br>2.4 VVT-i (ACV30)<br>3.0 V6 (MCV30)  | 110<br>112<br>137  |  | 12.01<br>12.01<br>12.01  | 12.05<br>12.05<br>12.05   |   | 24.0128-0190.1   | 428190   | 296 28,0 26,0 V   |
|  | 2.0 VVT-i (ACV31)<br>2.4 VVT-i (ACV30)<br>3.0 V6 (MCV30)  | 110<br>112<br>137  |  | 12.01<br>12.01<br>12.01  | 12.05<br>12.05<br>12.05   |   | 24.0128-0212.1   | 428212   | 296 28,0 26,0 V   |
|  | 2.0 VVT-i (ACV31)<br>2.4 VVT-i (ACV30)<br>3.0 V6 (MCV30)  | 110<br>112<br>137  |  | 12.01<br>12.01<br>12.01  | 12.05<br>12.05<br>12.05   |   | 13.0460-5738.2   | 605738   | 23702 15,1 /Zub   |
|  | 2.0 VVT-i (ACV31)<br>2.4 VVT-i (ACV30)<br>3.0 V6 (MCV30)  | 110<br>112<br>137  |  | 12.01<br>12.01<br>12.01  | 12.05<br>12.05<br>12.05   |   | 03.0137-0402.2   | 650402   | 170 x 40  |
| <b>TOYOTA CAMRY (06-11)</b>  |   |  |  |  |   |   |  |  |   |
|  | 2.0 VVT-i<br>2.4 VVT-i<br>2.4 VVT-i<br>2.4 VVT-i<br>2.4 VVT-i Hybrid<br>2.4 VVT-i Hybrid<br>3.5 VVT-i<br>3.5 VVT-i<br>3.5 VVT-i | 108<br>116<br>123<br>127<br>105<br>110<br>197<br>204<br>209                      |  | 01.06<br>01.06<br>01.06<br>10.06<br>01.06<br>01.06<br>01.06<br>01.08<br>01.08    | 08.11<br>08.11<br>08.11<br>08.11<br>08.11<br>08.11<br>08.11<br>08.11<br>08.11     |   | 13.0460-5764.2   | 605764   | 24350 17,3 /Zub <b>AKE</b>                                |
|  | 2.0 VVT-i<br>2.4 VVT-i<br>2.4 VVT-i<br>2.4 VVT-i<br>2.4 VVT-i Hybrid<br>2.4 VVT-i Hybrid<br>3.5 VVT-i<br>3.5 VVT-i<br>3.5 VVT-i | 108<br>116<br>123<br>127<br>105<br>110<br>197<br>204<br>209                      |  | 01.06<br>01.06<br>01.06<br>10.06<br>01.06<br>01.06<br>01.06<br>01.08<br>01.08    | 08.11<br>08.11<br>08.11<br>08.11<br>08.11<br>08.11<br>08.11<br>08.11<br>08.11     |   | 24.0128-0159.1   | 428159   | 296 28,0 25,0 V +B  |
|  | 2.0 VVT-i<br>2.4 VVT-i<br>2.4 VVT-i<br>2.4 VVT-i<br>2.4 VVT-i Hybrid<br>2.4 VVT-i Hybrid<br>3.5 VVT-i<br>3.5 VVT-i<br>3.5 VVT-i | 108<br>116<br>123<br>127<br>105<br>110<br>197<br>204<br>209                      |  | 01.06<br>01.06<br>01.06<br>10.06<br>01.06<br>01.06<br>01.06<br>01.08<br>01.08    | 08.11<br>08.11<br>08.11<br>08.11<br>08.11<br>08.11<br>08.11<br>08.11<br>08.11     |   | 13.0460-5765.2   | 605765   | 24338 15,5 <b>AKE</b>                                     |
|  | 2.0 VVT-i<br>2.4 VVT-i<br>2.4 VVT-i<br>2.4 VVT-i<br>2.4 VVT-i Hybrid<br>2.4 VVT-i Hybrid<br>3.5 VVT-i<br>3.5 VVT-i<br>3.5 VVT-i | 108<br>116<br>123<br>127<br>105<br>110<br>197<br>204<br>209                      |  | 01.06<br>01.06<br>01.06<br>10.06<br>01.06<br>01.06<br>01.06<br>01.08<br>01.08    | 08.11<br>08.11<br>08.11<br>08.11<br>08.11<br>08.11<br>08.11<br>08.11<br>08.11     |   | 03.0137-0402.2   | 650402   | 170 x 40  |
|  | ↓<br>↓<br>↓<br>↓<br>↓<br>↓<br>↓<br>↓<br>↓   | ↓<br>↓<br>↓<br>↓<br>↓<br>↓<br>↓<br>↓<br>↓  |  | ↓<br>↓<br>↓<br>↓<br>↓<br>↓<br>↓<br>↓<br>↓  | ↓<br>↓<br>↓<br>↓<br>↓<br>↓<br>↓<br>↓<br>↓   |   | ↓<br>↓<br>↓<br>↓<br>↓<br>↓<br>↓<br>↓<br>↓  | ↓<br>↓<br>↓<br>↓<br>↓<br>↓<br>↓<br>↓<br>↓  | ↓<br>↓<br>↓<br>↓<br>↓<br>↓<br>↓<br>↓<br>↓                 |

1) + 14" wheel / + ruota 14" / + roue 14" / + rueda 14"

|     |    |  |  |  |   |  |  |                      |
|--|--|--|--|--|--|--|--|--|
| <b>TOYOTA CAMRY (06-11)</b>  |  |  |  |  |  |  |  |  |
|    | 3.5 VVT-i<br>3.5 VVT-i<br>3.5 VVT-i  | 197<br>204<br>209  |  | 01.06<br>01.08<br>01.08  | 08.11<br>08.11<br>08.11  | 03.0137-0402.2   | 650402   | 170 x 40   |
| <b>TOYOTA CAMRY (11-)</b>  |  |  |  |  |  |  |  |  |
|    | 2.0 VVT-i<br>2.5 VVT-i<br>2.5 VVT-i<br>2.5 VVT-i Hybrid<br>3.5 VVT-i<br>3.5 VVT-i  | 109<br>133<br>135<br>118<br>183<br>204   |  | 09.11<br>09.11<br>01.12<br>09.11<br>12.12<br>09.11                               |  | 13.0460-5764.2   | 605764   | Produktionsland ☺<br>24350 17,3 /Zub<br>AKE  |
|    | 2.0 VVT-i<br>2.5 VVT-i<br>2.5 VVT-i<br>2.5 VVT-i Hybrid<br>3.5 VVT-i<br>3.5 VVT-i  | 109<br>133<br>135<br>118<br>183<br>204   |  | 09.11<br>09.11<br>01.12<br>09.11<br>12.12<br>09.11                               |  | 24.0128-0159.1   | 428159   | Produktionsland ☺<br>296 28,0 25,0 V +B  |
|    | 2.0 VVT-i<br>2.5 VVT-i<br>2.5 VVT-i<br>2.5 VVT-i Hybrid<br>3.5 VVT-i<br>3.5 VVT-i  | 109<br>133<br>135<br>118<br>183<br>204   |  | 09.11<br>09.11<br>01.12<br>09.11<br>12.12<br>09.11                               |  | 13.0460-5765.2   | 605765   | Produktionsland ☺<br>24338 15,5<br>AKE   |
|    | 2.0 VVT-i<br>2.5 VVT-i<br>2.5 VVT-i<br>2.5 VVT-i Hybrid<br>3.5 VVT-i<br>3.5 VVT-i  | 109<br>133<br>135<br>118<br>183<br>204   |  | 09.11<br>09.11<br>01.12<br>09.11<br>12.12<br>09.11                               |  | 13.0460-5765.2   | 605765   | Produktionsland ☺<br>24338 15,5<br>AKE   |
| <b>TOYOTA CARINA E (92-97)</b>   |  |  |  |  |  |  |  |  |
|    | 1.6 i (AT190)<br>1.8 i (AT191)<br>2.0 D (CT190)<br>2.0 i (ST191)   |  |  | 02.92<br>02.92<br>02.92<br>02.92   | 09.97<br>09.97<br>09.97<br>09.97   | 13.0460-5951.2<br>13.0460-0441.2   | 605951<br>610441   | 21601 17,5 +/WK<br>Belagsatz-Zubehör<br>SUM<br>SUM   |
|    | 1.6 i (AT190)<br>2.0 D (CT190)<br>1.8 i (AT191)<br>2.0 i (ST191)   |  |  | 02.92<br>02.92<br>02.92<br>02.92   | 09.97<br>09.97<br>09.97<br>09.97   | 24.0125-0124.1<br>24.0128-0113.1<br>24.0128-0116.1                                 | 425124<br>428113<br>428116   | 255 24,9 24,0 V +B<br>255 28,0 26,0 V<br>255 28,0 26,0 V   |
|   | 2.0 GTi (ST191)  |  |  | 02.92  | 02.94  | 13.0460-5835.2   | 605835   | 20076 15,5 +/WK<br>AKE   |
|  | 1.6 i (AT190)<br>1.8 i (AT191)<br>2.0 D (CT190)<br>2.0 i (ST191)<br>1.6 i (AT190)<br>1.8 i (AT191)<br>2.0 D (CT190)<br>2.0 i (ST191) |  |  | 02.92<br>02.92<br>02.92<br>02.92<br>01.96<br>01.96<br>01.96<br>01.96             | 12.95 + Hosesi Bremse 1)<br>12.95 + Hosesi Bremse 1)<br>12.95 + Hosesi Bremse 1)<br>12.95 + Hosesi Bremse 1)<br>09.97<br>09.97<br>09.97<br>09.97 | 03.0137-0313.2<br>03.0137-9114.2<br>03.0137-0375.2<br>03.0137-9301.2               | 650313<br>669114<br>650375<br>669301   | 200 x 37<br>Bremsbacken-Zubehör<br>für TRW-System<br>200 x 37 HEB<br>Bremsbacken-Zubehör<br>TRW<br>TRW |
|  | 1.6 i (AT190)<br>1.8 i (AT191)<br>2.0 D (CT190)<br>2.0 i (ST191)   |  |  | 02.92<br>02.92<br>02.92<br>02.92   | 09.97<br>09.97<br>09.97<br>09.97   | 24.0220-0022.1   | 480083   | 200/201 x 55   |
|  | 2.0 GTi (ST191)  |  |  | 03.94  | 09.97  | 03.0137-0402.2   | 650402   | 170 x 40   |
| <b>TOYOTA CELICA (93-99)</b>   |  |  |  |  |  |  |  |  |
|  | 1.8 i (AT200)  |  |  | 11.93  | 11.99  | 13.0460-5951.2<br>13.0460-0441.2   | 605951<br>610441   | 21601 17,5 +/WK<br>Belagsatz-Zubehör<br>SUM<br>SUM   |
|  | 1.8 i (AT200)  |  |  | 11.93  | 11.99  | 24.0125-0124.1   | 425124   | 255 24,9 24,0 V +B   |
|  | 1.8 i (AT200)<br>2.0 i 16V (ST202)   |  |  | 11.93<br>11.93   | 11.99<br>11.99   | 13.0460-5835.2   | 605835   | 20076 15,5 +/WK<br>AKE   |
|  | 1.8 i (AT200)<br>1.8 i (AT200)<br>2.0 i 16V (ST202)  |  |  | 11.93<br>09.95<br>11.93  | 08.95<br>11.99<br>11.99  | 24.0110-0350.1<br>24.0109-0148.1   | 410350<br>409148   | 269 10,0 9,0 +B<br>269 9,0 8,0   |
|  | 1.8 i (AT200)<br>2.0 i 16V (ST202)<br>2.0 Turbo 4x4 (ST205)  |  |  | 11.93<br>11.93<br>02.94  | 11.99<br>11.99<br>11.99  | 03.0137-0402.2   | 650402   | 170 x 40   |
| <b>TOYOTA CELICA (99-05)</b>   |  |  |  |  |  |  |  |  |
|  | 1.8 VVTi (ZZT230)<br>1.8 VVTi TS (ZZT231)<br>1.8 VVTi (ZZT230)<br>1.8 VVTi TS (ZZT231)   | 105<br>141<br>105<br>141   |  | 11.99<br>11.99<br>08.02<br>08.02   | 07.02<br>07.02<br>09.05<br>09.05   | 13.0460-5810.2<br>13.0460-5817.2<br>13.0460-5817.2                                 | 605810<br>605817<br>605817   | 23904 16,5 +/WK<br>AKE<br>23526 17,5 /WE<br>AKE<br>23526 17,5 /WE<br>AKE                               |

1) + Hosesi brake / + freno Hosesi / + freins Hosesi / + freno de Hosesi

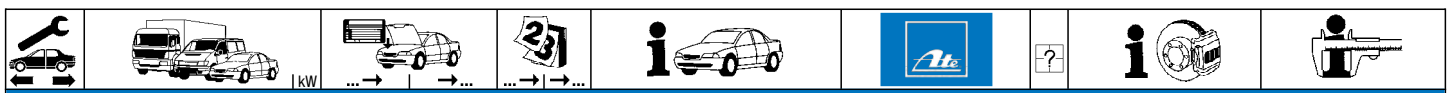

### TOYOTA CELICA (99-05)

|  |                      |     |  |       |       |  |                |        |  |                    |
|--|----------------------|-----|--|-------|-------|--|----------------|--------|--|--------------------|
|  | 1.8 VVTi (ZZT230)    | 105 |  | 11.99 | 07.02 |  | 24.0125-0124.1 | 425124 |  | 255 24,9 24,0 V +B |
|  | 1.8 VVTi (ZZT230)    | 105 |  | 08.02 | 09.05 |  | 24.0125-0700.1 | 425700 |  | 275 25,0 23,0 V    |
|  | 1.8 VVTi TS (ZZT231) | 141 |  | 11.99 | 09.05 |  |                |        |  |                    |
|  | 1.8 VVTi (ZZT230)    | 105 |  | 11.99 | 09.05 |  | 13.0460-5812.2 | 605812 |  | 23521 14,0 +/WK    |
|  | 1.8 VVTi TS (ZZT231) | 141 |  | 11.99 | 09.05 |  | 13.0460-0136.2 | 610136 |  | Belagsatz-Zubehör  |
|  |                      |     |  |       |       |  |                |        |  | <b>SUM</b>         |
|  | 1.8 VVTi (ZZT230)    | 105 |  | 11.99 | 09.05 |  | 24.0109-0711.1 | 409711 |  | 269 9,0 7,5 +B     |
|  | 1.8 VVTi TS (ZZT231) | 141 |  | 11.99 | 09.05 |  |                |        |  |                    |
|  | 1.8 VVTi (ZZT230)    | 105 |  | 11.99 | 09.05 |  | 03.0137-0459.2 | 650459 |  | 172 x 32           |
|  | 1.8 VVTi TS (ZZT231) | 141 |  | 11.99 | 09.05 |  |                |        |  |                    |

### TOYOTA COROLLA (92-97)

|  |                     |  |  |       |       |                                       |                |        |  |                     |
|--|---------------------|--|--|-------|-------|---------------------------------------|----------------|--------|--|---------------------|
|  | 1.3 16V (EE101)     |  |  | 05.92 | 04.97 | + Europa <sup>1)</sup>                | 13.0460-5951.2 | 605951 |  | 21601 17,5 +/WK     |
|  | 1.6 (AE101)         |  |  | 05.92 | 04.97 | + Europa <sup>1)</sup>                | 13.0460-0441.2 | 610441 |  | Belagsatz-Zubehör   |
|  | 1.8 (AE102)         |  |  | 05.92 | 05.95 | + Europa <sup>1)</sup>                |                |        |  |                     |
|  | 1.8 (AE103)         |  |  | 05.95 | 04.97 | + Europa/ + Kombiwagen <sup>2)</sup>  |                |        |  |                     |
|  | 1.8 GTi 4WD         |  |  | 11.92 | 04.95 | + Europa <sup>1)</sup>                |                |        |  |                     |
|  | 2.0 D (CE100)       |  |  | 05.92 | 04.97 | + Europa/ - GUS-Staaten <sup>3)</sup> |                |        |  |                     |
|  | 1.3 (EE100)         |  |  | 05.92 | 05.95 | - Europa <sup>4)</sup>                | 13.0460-5976.2 | 605976 |  | 20870 15,0          |
|  | 1.3 16V (EE101)     |  |  | 05.92 | 04.97 | - Europa <sup>4)</sup>                | 13.0460-0325.2 | 610325 |  | Belagsatz-Zubehör   |
|  | 1.6 (AE101)         |  |  | 05.92 | 04.97 | - Europa <sup>4)</sup>                |                |        |  |                     |
|  | 1.6 GT APEX (AE101) |  |  | 05.92 | 05.95 | - Europa/ + Coupé <sup>5)</sup>       |                |        |  |                     |
|  | 1.8 (AE102)         |  |  | 05.92 | 05.95 | - Europa <sup>4)</sup>                |                |        |  |                     |
|  | 2.0 D (CE100)       |  |  | 05.92 | 04.97 | - Europa/ + GUS-Staaten <sup>6)</sup> |                |        |  |                     |
|  | 1.3 (EE100)         |  |  | 05.92 | 05.95 | + Europa <sup>1)</sup>                | 24.0118-0110.1 | 418110 |  | 238 18,0 17,0 V     |
|  | 1.3 16V (EE101)     |  |  | 05.92 | 04.97 | + Europa <sup>1)</sup>                | 24.0122-0158.1 | 422158 |  | 255 22,0 20,0 V +B  |
|  | 1.6 (AE101)         |  |  | 05.92 | 04.97 | + Europa <sup>1)</sup>                |                |        |  |                     |
|  | 1.8 (AE102)         |  |  | 05.92 | 05.95 | + Europa <sup>1)</sup>                |                |        |  |                     |
|  | 1.8 (AE103)         |  |  | 05.95 | 04.97 | + Europa/ + Kombiwagen <sup>2)</sup>  |                |        |  |                     |
|  | 1.8 GTi 4WD         |  |  | 11.92 | 04.95 | + Europa <sup>1)</sup>                |                |        |  |                     |
|  | 2.0 D (CE100)       |  |  | 05.92 | 04.97 | + Europa/ - GUS-Staaten <sup>3)</sup> |                |        |  |                     |
|  | 1.6 GT APEX (AE101) |  |  | 05.92 | 05.95 | + Coupé <sup>7)</sup>                 | 24.0109-0159.1 | 409159 |  | 266 9,0 8,0 +B      |
|  | 1.8 (AE102)         |  |  | 05.92 | 05.95 | + Europa <sup>1)</sup>                |                |        |  |                     |
|  | 1.3 (EE100)         |  |  | 05.92 | 05.95 | + Europa <sup>1)</sup>                | 03.0137-0221.2 | 650221 |  | 200 x 37/30         |
|  | 1.3 16V (EE101)     |  |  | 05.92 | 04.97 | + Europa <sup>1)</sup>                | 03.0137-9114.2 | 669114 |  | Bremsbacken-Zubehör |
|  | 1.6 (AE101)         |  |  | 05.92 | 04.97 | + Europa <sup>1)</sup>                |                |        |  |                     |
|  | 2.0 D (CE100)       |  |  | 05.92 | 04.97 | + Europa <sup>1)</sup>                |                |        |  |                     |
|  | 1.3 (EE100)         |  |  | 05.92 | 05.95 | - Europa <sup>4)</sup>                | 03.0137-0313.2 | 650313 |  | 200 x 37            |
|  | 1.3 16V (EE101)     |  |  | 05.92 | 04.97 | - Europa <sup>4)</sup>                | 03.0137-9114.2 | 669114 |  | Bremsbacken-Zubehör |
|  | 1.6 (AE101)         |  |  | 05.92 | 04.97 | - Europa <sup>4)</sup>                |                |        |  |                     |
|  | 1.8 (AE102)         |  |  | 05.92 | 05.95 | - Europa <sup>4)</sup>                |                |        |  |                     |
|  | 1.8 (AE103)         |  |  | 05.95 | 04.97 | - Europa/ + Kombiwagen <sup>2)</sup>  |                |        |  |                     |
|  | 2.0 D (CE100)       |  |  | 05.92 | 04.97 | - Europa <sup>4)</sup>                |                |        |  |                     |
|  | 1.3 (EE100)         |  |  | 05.92 | 05.95 | + Europa <sup>1)</sup>                | 24.0220-0023.1 | 480084 |  | 200/201 x 56        |
|  | 1.3 16V (EE101)     |  |  | 05.92 | 04.97 | + Europa <sup>1)</sup>                |                |        |  |                     |
|  | 1.6 (AE101)         |  |  | 05.92 | 04.97 | + Europa <sup>1)</sup>                |                |        |  |                     |
|  | 2.0 D (CE100)       |  |  | 05.92 | 04.97 | + Europa <sup>1)</sup>                |                |        |  |                     |
|  | 1.3 (EE100)         |  |  | 05.92 | 05.95 | - Europa <sup>4)</sup>                | 24.0220-0023.1 | 480084 |  | 200/201 x 56        |
|  | 1.3 16V (EE101)     |  |  | 05.92 | 04.97 | - Europa <sup>4)</sup>                |                |        |  |                     |
|  | 1.6 (AE101)         |  |  | 05.92 | 04.97 | - Europa <sup>4)</sup>                |                |        |  |                     |
|  | 1.8 (AE102)         |  |  | 05.92 | 05.95 | - Europa <sup>4)</sup>                |                |        |  |                     |
|  | 2.0 D (CE100)       |  |  | 05.92 | 04.97 | - Europa <sup>4)</sup>                |                |        |  |                     |

### TOYOTA COROLLA (97-02)

|  |                       |    |  |       |       |   |                |        |  |                    |
|--|-----------------------|----|--|-------|-------|---|----------------|--------|--|--------------------|
|  | 1.4 i (EE111)         | 63 |  | 05.97 | 01.00 | + Schlechtwegeausführung <sup>9)</sup>  | 13.0460-5976.2 | 605976 |  | Produktionsland ☺  |
|  | 1.4 i 16V (ZZE111)    | 71 |  | 02.00 | 12.01 | + Schlechtwegeausführung <sup>9)</sup>  |                |        |  | 20870 15,0         |
|  | 1.6 i (AE111)         | 81 |  | 05.97 | 01.00 | + Schlechtwegeausführung <sup>9)</sup>  |                |        |  |                    |
|  | 1.6 i 16V (ZZE112)    | 81 |  | 02.00 | 12.01 | + Schlechtwegeausführung <sup>9)</sup>  |                |        |  |                    |
|  | 1.4 i (EE111)         | 63 |  | 05.97 | 01.00 | - Schlechtwegeausführung <sup>10)</sup> | 13.0460-5951.2 | 605951 |  | Produktionsland ☺  |
|  | 1.4 i 16V (ZZE111)    | 71 |  | 02.00 | 12.01 | - Schlechtwegeausführung <sup>10)</sup> | 13.0460-0074.2 | 610074 |  | 21601 17,5 +/WK    |
|  | 1.6 i (AE111)         | 81 |  | 05.97 | 01.00 | - Schlechtwegeausführung <sup>10)</sup> |                |        |  | Belagsatz-Zubehör  |
|  | 1.6 i 16V (ZZE112)    | 81 |  | 02.00 | 12.01 | - Schlechtwegeausführung <sup>10)</sup> |                |        |  |                    |
|  | 1.8 i 16V AWD (AE115) | 81 |  | 05.97 | 12.01 | + Kombiwagen <sup>11)</sup>             |                |        |  |                    |
|  | 1.9 D (WZE110)        | 51 |  | 02.00 | 12.01 |   |                |        |  |                    |
|  | 2.0 D (CE110)         | 53 |  | 05.97 | 01.00 |   |                |        |  |                    |
|  | 2.0 D-4D (CDE110)     | 66 |  | 09.00 | 12.01 |   |                |        |  |                    |
|  | 1.4 i (EE111)         | 63 |  | 05.97 | 01.00 | - Schlechtwegeausführung <sup>10)</sup> | 24.0122-0158.1 | 422158 |  | 255 22,0 20,0 V +B |
|  | 1.4 i 16V (ZZE111)    | 71 |  | 02.00 | 12.01 | - Schlechtwegeausführung <sup>10)</sup> |                |        |  |                    |
|  | 1.6 i (AE111)         | 81 |  | 05.97 | 01.00 | - Schlechtwegeausführung <sup>10)</sup> |                |        |  |                    |
|  | 1.6 i 16V (ZZE112)    | 81 |  | 02.00 | 12.01 | - Schlechtwegeausführung <sup>10)</sup> |                |        |  |                    |
|  | 1.8 i 16V AWD (AE115) | 81 |  | 05.97 | 12.01 | + Kombiwagen <sup>11)</sup>             |                |        |  |                    |
|  | 1.9 D (WZE110)        | 51 |  | 02.00 | 12.01 |   |                |        |  |                    |
|  | 2.0 D (CE110)         | 53 |  | 05.97 | 01.00 |   |                |        |  |                    |
|  | 2.0 D-4D (CDE110)     | 66 |  | 09.00 | 12.01 |   |                |        |  |                    |
|  | 1.4 i (EE111)         | 63 |  | 08.98 | 09.99 |   | 13.0460-5835.2 | 605835 |  | 20076 15,5 +/WK    |
|  | 1.4 i 16V (ZZE111)    | 71 |  | 10.99 | 12.01 | Produktionsland ☺                       |                |        |  |                    |
|  | 1.6 i (AE111)         | 81 |  | 08.98 | 09.99 |   |                |        |  |                    |
|  | 1.6 i 16V (ZZE112)    | 81 |  | 10.99 | 12.01 | Produktionsland ☺                       |                |        |  |                    |
|  | 1.9 D (WZE110)        | 51 |  | 10.99 | 12.01 | Produktionsland ☺                       |                |        |  |                    |
|  | 2.0 D (CE110)         | 53 |  | 08.98 | 09.99 |   |                |        |  |                    |
|  | 2.0 D-4D (CDE110)     | 66 |  | 10.99 | 12.01 |   |                |        |  |                    |

<sup>1)</sup> + Europa / + Europa / + Europa / + Europa

<sup>2)</sup> + Europe/ + Estate / + Europa/ + Station Wagon / + Europe/ + Break / + Europa/ + Break

<sup>3)</sup> + Europe/ - GUS States / + Europa/ - Stati del GUS / + Europe/ - Etats de la CEI / + Europa/ - estados del GUS

<sup>4)</sup> - Europa / - Europa / - Europa / - Europa

<sup>5)</sup> - Europe/ + Coupé / - Europa/ + Coupé / - Europe/ + Coupé / - Europa/ + Coupé

<sup>6)</sup> - Europe/ + GUS-Staaten / - Europa/ + Stati del GUS / - Europe/ + Etats de la CEI / - Europa/ + estados del GUS

<sup>7)</sup> + Coupé / + Coupé / + Coupé / + Coupé

<sup>8)</sup> - Europe/ + Estate / - Europa/ + Station Wagon / - Europe/ + Break / - Europa/ + Break

<sup>9)</sup> + rough road construction / + versione per percorsi accidentati / + version pour mauvaise route / + versión 4x4

<sup>10)</sup> - rough road construction / - versione per percorsi accidentati / - version pour mauvaise route / - versión 4x4

<sup>11)</sup> + Estate / + Station Wagon / + Break / + Break

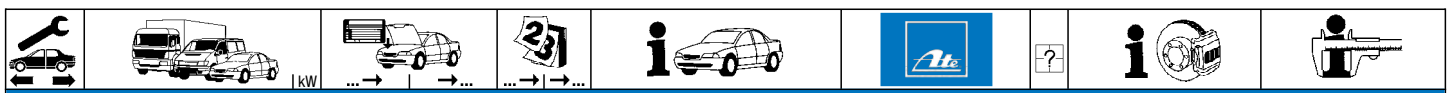

### TOYOTA COROLLA (97-02)

|  |  |  |  |   |   |  |  |                 |                                     |            |
|--|--|--|--|---|---|--|--|-----------------|-------------------------------------|------------|
|  | 1.4 i 16V (ZZE111)<br>1.6 i 16V (ZZE112)<br>1.9 D (WZE110)   | 71<br>81<br>51                         |  | 10.99<br>10.99<br>10.99                                     | 12.01<br>12.01<br>12.01                                     | Produktionsland<br>Produktionsland<br>Produktionsland                    | 13.0460-5869.2<br>605869                             |                 | 24013 14,9 +WK                      | TRW        |
|  | 1.4 i (EE111)<br>1.4 i 16V (ZZE111)<br>1.6 i (AE111)<br>1.6 i 16V (ZZE112)<br>1.9 D (WZE110)<br>2.0 D (CE110)<br>2.0 D-4D (CDE110)     | 63<br>71<br>81<br>81<br>51<br>53<br>66 |  | 08.98<br>02.00<br>08.98<br>02.00<br>02.00<br>08.98<br>09.00 | 01.00<br>12.01<br>01.00<br>12.01<br>12.01<br>01.00<br>12.01 | Produktionsland<br>Produktionsland<br>Produktionsland<br>Produktionsland | 24.0109-0159.1<br>409159                             |                 | 266 9,0 8,0 +B                      |            |
|  | 1.4 i (EE111)<br>1.4 i 16V (ZZE111)<br>1.6 i (AE111)<br>1.6 i 16V (ZZE112)<br>1.8 i 16V AWD (AE115)<br>1.9 D (WZE110)<br>2.0 D (CE110) | 63<br>71<br>81<br>81<br>81<br>51<br>53 |  | 05.97<br>02.00<br>05.97<br>02.00<br>05.97<br>02.00<br>05.97 | 01.00<br>12.01<br>01.00<br>12.01<br>12.01<br>12.01<br>01.00 | + Kombiwagen <sup>1)</sup>   | 03.0137-0313.2<br>650313<br>03.0137-9114.2<br>669114 |                 | 200 x 37<br>Bremsbacken-Zubehör     |            |
|  | 1.4 i (EE111)<br>1.4 i 16V (ZZE111)<br>1.6 i (AE111)<br>1.6 i 16V (ZZE112)<br>1.8 i 16V AWD (AE115)<br>1.9 D (WZE110)<br>2.0 D (CE110) | 63<br>71<br>81<br>81<br>81<br>51<br>53 |  | 05.97<br>02.00<br>05.97<br>02.00<br>05.97<br>02.00<br>05.97 | 01.00<br>12.01<br>01.00<br>12.01<br>12.01<br>12.01<br>01.00 | + Kombiwagen <sup>1)</sup>   | 03.0137-0375.2<br>650375<br>03.0137-9301.2<br>669301 | Produktionsland | 200 x 37 HEB<br>Bremsbacken-Zubehör | TRW<br>TRW |
|  | 1.4 i (EE111)<br>1.4 i 16V (ZZE111)<br>1.6 i (AE111)<br>1.6 i 16V (ZZE112)<br>1.9 D (WZE110)<br>2.0 D (CE110)                          | 63<br>71<br>81<br>81<br>51<br>53       |  | 05.97<br>02.00<br>05.97<br>02.00<br>02.00<br>05.97          | 01.00<br>12.01<br>01.00<br>12.01<br>12.01<br>01.00          |  | 24.0220-0023.1<br>480084                             |                 | 200/201 x 56                        |            |

### TOYOTA COROLLA (02-04)

|  |   |   |  |  |   |  |  |   |   |                   |
|--|---|---|--|--|---|--|--|---|---|-------------------|
|  | 1.4 VVTi (ZZE120)<br>1.6 VVTi (ZZE121)<br>2.0 D-4D (CDE120)   | 71<br>81<br>66                          |  | 01.02<br>01.02<br>01.02                            | 05.04<br>05.04<br>05.04                                     |  | 13.0460-5810.2<br>605810   | Produktionsland                                       | 23904 16,5 +WK  | AKE               |
|  | 1.4 VVTi (ZZE120)<br>1.6 VVTi (ZZE121)<br>1.8 VVTLi TS (ZZE123)<br>2.0 D-4D (CDE120)<br>2.0 D-4D (CDE120)<br>2.0 D-4D (CDE120)                      | 71<br>81<br>141<br>66<br>81<br>85       |  | 02.02<br>08.02<br>01.02<br>08.02<br>01.02<br>05.03 | 05.04<br>05.04<br>05.04<br>05.04<br>05.04<br>05.04          |  | 13.0460-5817.2<br>605817<br>13.0460-5815.2<br>605815<br>13.0460-0138.2<br>610138 | Produktionsland<br>Produktionsland<br>Produktionsland | 23526 17,5 /WE<br>23766 17,8 +WK<br>Belagsatz-Zubehör | AKE<br>TRW<br>TRW |
|  | 1.4 VVTi (ZZE120)<br>1.6 VVTi (ZZE121)<br>2.0 D-4D (CDE120)   | 71<br>81<br>66                          |  | 01.02<br>01.02<br>01.02                            | 05.04<br>05.04<br>05.04                                     |  | 24.0125-0155.1<br>425155   |   | 255 25,0 23,0 V +B                                    |                   |
|  | 1.4 VVTi (ZZE120)<br>1.6 VVTi (ZZE121)<br>2.0 D-4D (CDE120)<br>1.8 VVTLi TS (ZZE123)<br>2.0 D-4D (CDE120)<br>2.0 D-4D (CDE120)<br>2.0 D-4D (CDE120) | 71<br>81<br>66<br>141<br>66<br>81<br>85 |  | 01.02<br>01.02<br>01.02<br>08.02<br>01.02<br>05.03 | 05.04<br>05.04<br>05.04<br>05.04<br>05.04<br>05.04<br>05.04 |  | 24.0125-0168.1<br>425168<br>24.0125-0157.1<br>425157                             | Produktionsland<br>Produktionsland                    | 275 25,0 23,0 V +B<br>275 25,0 23,0 V +B              |                   |
|  | 1.4 VVTi (ZZE120)<br>1.6 VVTi (ZZE121)<br>2.0 D-4D (CDE120)   | 71<br>81<br>66                          |  | 01.02<br>01.02<br>01.02                            | 05.04<br>05.04<br>05.04                                     |  | 13.0460-5812.2<br>605812<br>13.0460-0136.2<br>610136                             | Produktionsland<br>Produktionsland                    | 23521 14,0 +WK<br>Belagsatz-Zubehör                   | SUM<br>SUM        |
|  | 1.4 VVTi (ZZE120)<br>1.6 VVTi (ZZE121)<br>1.8 VVTLi TS (ZZE123)<br>2.0 D-4D (CDE120)<br>2.0 D-4D (CDE120)<br>2.0 D-4D (CDE120)                      | 71<br>81<br>141<br>66<br>81<br>85       |  | 02.02<br>08.02<br>01.02<br>08.02<br>01.02<br>05.03 | 05.04<br>05.04<br>05.04<br>05.04<br>05.04<br>05.04          |  | 13.0460-5819.2<br>605819   | Produktionsland                                       | 23816 16,0 /WK  | TRW               |
|  | 1.4 VVTi (ZZE120)<br>1.6 VVTi (ZZE121)<br>2.0 D-4D (CDE120)   | 71<br>81<br>66                          |  | 01.02<br>01.02<br>01.02                            | 05.04<br>05.04<br>05.04                                     |  | 24.0109-0139.1<br>409139   | Produktionsland                                       | 269 9,0 8,0 +B  |                   |
|  | 1.4 VVTi (ZZE120)<br>1.6 VVTi (ZZE121)<br>1.8 VVTLi TS (ZZE123)<br>2.0 D-4D (CDE120)<br>2.0 D-4D (CDE120)<br>2.0 D-4D (CDE120)                      | 71<br>81<br>141<br>66<br>81<br>85       |  | 02.02<br>08.02<br>01.02<br>08.02<br>01.02<br>05.03 | 05.04<br>05.04<br>05.04<br>05.04<br>05.04<br>05.04          |  | 24.0109-0138.1<br>409138<br>24.0109-0140.1<br>409140                             | Produktionsland<br>Produktionsland                    | 258 9,0 8,0 +B<br>279 9,0 8,0 +B                      |                   |
|  | 1.4 VVTi (ZZE120)<br>1.6 VVTi (ZZE121)<br>2.0 D-4D (CDE120)   | 71<br>81<br>66                          |  | 01.02<br>01.02<br>01.02                            | 05.04<br>05.04<br>05.04                                     |  | 03.0137-0459.2<br>650459   | Produktionsland                                       | 172 x 32  |                   |
|  | 1.4 VVTi (ZZE120)<br>1.6 VVTi (ZZE121)<br>1.8 VVTLi TS (ZZE123)<br>2.0 D-4D (CDE120)<br>2.0 D-4D (CDE120)<br>2.0 D-4D (CDE120)                      | 71<br>81<br>141<br>66<br>81<br>85       |  | 02.02<br>08.02<br>01.02<br>08.02<br>01.02<br>05.03 | 05.04<br>05.04<br>05.04<br>05.04<br>05.04<br>05.04          |  | 03.0137-0464.2<br>650464<br>03.0137-9294.2<br>669294                             | Produktionsland<br>Produktionsland                    | 172 x 22 HEB<br>Bremsbacken-Zubehör                   |                   |

### TOYOTA COROLLA (04-06)

|  |   |                      |  |   |   |  |  |  |                                     |            |
|--|---|----------------------|--|---|---|--|--|--|-------------------------------------|------------|
|  | 1.4 D-4D (NDE120)<br>1.4 VVTi (ZZE120)<br>1.6 VVTi (ZZE121)<br>1.8 VVTi (ZZE123)<br>2.0 D-4D (CDE120) | 66<br>71<br>81<br>85 |  | 06.04<br>06.04<br>06.04<br>06.04<br>06.04 | 10.06<br>10.06<br>10.06<br>10.06<br>10.06 |  | 13.0460-5815.2<br>605815<br>13.0460-0138.2<br>610138 |  | 23766 17,8 +WK<br>Belagsatz-Zubehör | TRW<br>TRW |
|--|---|----------------------|--|---|---|--|--|--|-------------------------------------|------------|

<sup>1)</sup> + Estate / + Station Wagon / + Break / + Break







| TOYOTA COROLLA (04-06) |                   |    |  |       |       |                |        |  |  |                                     |
|------------------------|-------------------|----|--|-------|-------|----------------|--------|--|--|-------------------------------------|
|                        | 1.4 VVTi (ZZE120) | 71 |  | 06.04 | 10.06 | 24.0125-0155.1 | 425155 |  |  | 255 25,0 23,0 V +B                  |
|                        | 1.6 VVTi (ZZE121) | 81 |  | 06.04 | 10.06 |                |        |  |  |                                     |
|                        | 1.4 D-4D (NDE120) | 66 |  | 06.04 | 10.06 | 24.0125-0157.1 | 425157 |  |  | 275 25,0 23,0 V +B                  |
|                        | 1.8 VVTi (ZZE123) |    |  | 06.04 | 10.06 |                |        |  |  |                                     |
|                        | 2.0 D-4D (CDE120) | 85 |  | 06.04 | 10.06 |                |        |  |  |                                     |
|                        |                   |    |  |       |       |                |        |  |  |                                     |
|                        | 1.4 D-4D (NDE120) | 66 |  | 06.04 | 10.06 | 13.0460-5819.2 | 605819 |  |  | 23816 16,0 /WK TRW                  |
|                        | 1.4 VVTi (ZZE120) | 71 |  | 06.04 | 10.06 |                |        |  |  |                                     |
|                        | 1.6 VVTi (ZZE121) | 81 |  | 06.04 | 10.06 |                |        |  |  |                                     |
|                        | 1.8 VVTi (ZZE123) |    |  | 06.04 | 10.06 |                |        |  |  |                                     |
|                        | 2.0 D-4D (CDE120) | 85 |  | 06.04 | 10.06 |                |        |  |  |                                     |
|                        | 1.4 VVTi (ZZE120) | 71 |  | 06.04 | 10.06 | 24.0109-0138.1 | 409138 |  |  | 258 9,0 8,0 +B                      |
|                        | 1.6 VVTi (ZZE121) | 81 |  | 06.04 | 10.06 |                |        |  |  |                                     |
|                        | 1.4 D-4D (NDE120) | 66 |  | 06.04 | 10.06 | 24.0109-0140.1 | 409140 |  |  | 279 9,0 8,0 +B                      |
|                        | 1.8 VVTi (ZZE123) |    |  | 06.04 | 10.06 |                |        |  |  |                                     |
|                        | 2.0 D-4D (CDE120) | 85 |  | 06.04 | 10.06 |                |        |  |  |                                     |
|                        |                   |    |  |       |       |                |        |  |  |                                     |
|                        | 1.4 D-4D (NDE120) | 66 |  | 06.04 | 10.06 | 03.0137-0464.2 | 650464 |  |  | 172 x 22 HEB<br>Bremsbacken-Zubehör |
|                        | 1.4 VVTi (ZZE120) | 71 |  | 06.04 | 10.06 |                |        |  |  |                                     |
|                        | 1.6 VVTi (ZZE121) | 81 |  | 06.04 | 10.06 |                |        |  |  |                                     |
|                        | 1.8 VVTi (ZZE123) |    |  | 06.04 | 10.06 |                |        |  |  |                                     |
|                        | 2.0 D-4D (CDE120) | 85 |  | 06.04 | 10.06 |                |        |  |  |                                     |























| TOYOTA COROLLA (06-13) |                   |    |  |       |       |                |        |  |  |                     |
|------------------------|-------------------|----|--|-------|-------|----------------|--------|--|--|---------------------|
|                        | 1.4 D-4D (NDE150) | 66 |  | 01.09 | 05.13 | 13.0460-5602.2 | 605602 |  |  | 24122 19,0 +/WK/Zub |
|                        | 1.33 16V (NRE150) | 74 |  | 10.08 | 05.13 |                |        |  |  |                     |
|                        | 1.4 VVTi (ZZE150) | 71 |  | 11.06 | 12.08 |                |        |  |  |                     |
|                        | 1.6 VVTi (ZRE151) | 91 |  | 11.06 | 12.08 |                |        |  |  |                     |
|                        | 1.6 VVTi (ZRE151) | 97 |  | 01.09 | 05.13 |                |        |  |  |                     |
|                        | 2.0 D-4D (ADE150) | 93 |  | 01.07 | 05.13 |                |        |  |  |                     |
|                        | 1.4 D-4D (NDE150) | 66 |  | 01.09 | 05.13 | 24.0126-0148.1 | 426148 |  |  | 273 26,0 23,0 V +B  |
|                        | 1.33 16V (NRE150) | 74 |  | 10.08 | 05.13 |                |        |  |  |                     |
|                        | 1.4 VVTi (ZZE150) | 71 |  | 11.06 | 12.08 |                |        |  |  |                     |
|                        | 1.6 VVTi (ZRE151) | 91 |  | 11.06 | 12.08 |                |        |  |  |                     |
|                        | 1.6 VVTi (ZRE151) | 97 |  | 01.09 | 05.13 |                |        |  |  |                     |
|                        | 2.0 D-4D (ADE150) | 93 |  | 01.07 | 05.13 |                |        |  |  |                     |
|                        | 1.33 16V (NRE150) | 74 |  | 10.08 | 05.13 | 13.0460-5769.2 | 605769 |  |  | 24610 15,0 +/WK     |
|                        | 1.4 VVTi (ZZE150) | 71 |  | 11.06 | 12.08 |                |        |  |  |                     |
|                        | 1.6 VVTi (ZRE151) | 91 |  | 11.06 | 12.08 |                |        |  |  |                     |
|                        | 1.6 VVTi (ZRE151) | 97 |  | 01.09 | 05.13 |                |        |  |  |                     |
|                        | 1.4 D-4D (NDE150) | 66 |  | 01.09 | 05.13 |                |        |  |  |                     |
|                        | 2.0 D-4D (ADE150) | 93 |  | 01.07 | 05.13 |                |        |  |  |                     |
|                        | 1.33 16V (NRE150) | 74 |  | 10.08 | 05.13 | 24.0109-0155.1 | 409155 |  |  | 259 9,0 7,5 +B      |
|                        | 1.4 VVTi (ZZE150) | 71 |  | 11.06 | 12.08 |                |        |  |  |                     |
|                        | 1.6 VVTi (ZRE151) | 91 |  | 11.06 | 12.08 |                |        |  |  |                     |
|                        | 1.6 VVTi (ZRE151) | 97 |  | 01.09 | 05.13 |                |        |  |  |                     |
|                        | 1.4 D-4D (NDE150) | 66 |  | 01.09 | 05.13 |                |        |  |  |                     |
|                        | 2.0 D-4D (ADE150) | 93 |  | 01.07 | 05.13 |                |        |  |  |                     |
|                        | 1.33 16V (NRE150) | 74 |  | 10.08 | 05.13 | 24.0110-0337.1 | 410337 |  |  | 270 9,9 8,0 +B      |
|                        | 1.4 VVTi (ZZE150) | 71 |  | 11.06 | 12.08 |                |        |  |  |                     |
|                        | 1.6 VVTi (ZRE151) | 91 |  | 11.06 | 12.08 |                |        |  |  |                     |
|                        | 1.6 VVTi (ZRE151) | 97 |  | 01.09 | 05.13 |                |        |  |  |                     |
|                        | 1.4 D-4D (NDE150) | 66 |  | 01.09 | 05.13 |                |        |  |  |                     |
|                        | 2.0 D-4D (ADE150) | 93 |  | 01.07 | 05.13 |                |        |  |  |                     |































| TOYOTA COROLLA (13-) |           |     |       |       |  |                |        |  |  |                     |
|----------------------|-----------|-----|-------|-------|--|----------------|--------|--|--|---------------------|
|                      | 1.33 VVTi | 73  |       | 06.13 |  | 13.0460-5767.2 | 605767 |  |  | 24336 17,5 AKE      |
|                      | 1.4 D-4D  | 66  |       | 06.13 |  |                |        |  |  |                     |
|                      | 1.6 VVTi  | 90  |       | 06.13 |  |                |        |  |  |                     |
|                      | 1.6 VVTi  | 97  |       | 06.13 |  |                |        |  |  |                     |
|                      | 1.8 VVTi  | 103 |       | 06.13 |  |                |        |  |  |                     |
|                      | 1.33 VVTi | 73  |       | 06.13 |  | 24.0126-0184.1 | 426184 |  |  | 277 26,0 23,0 V +B  |
|                      | 1.4 D-4D  | 66  |       | 06.13 |  |                |        |  |  |                     |
|                      | 1.6 VVTi  | 90  |       | 06.13 |  |                |        |  |  |                     |
|                      | 1.8 VVTi  | 103 |       | 06.13 |  |                |        |  |  |                     |
|                      | 1.33 VVTi | 73  |       | 06.13 |  | 13.0460-5604.2 | 605604 |  |  | 24664 15,2 +/WK/Zub |
|                      | 1.4 D-4D  | 66  |       | 06.13 |  |                |        |  |  |                     |
|                      | 1.6 VVTi  | 90  |       | 06.13 |  |                |        |  |  |                     |
|                      | 1.6 VVTi  | 97  |       | 06.13 |  |                |        |  |  |                     |
|                      | 1.8 VVTi  | 103 |       | 06.13 |  |                |        |  |  |                     |
|                      | 1.6 VVTi  | 90  |       | 06.13 |  |                |        |  |  |                     |
| 1.8 VVTi             | 103       |     | 06.13 |       |  |                |        |  |  |                     |
|                      | 1.33 VVTi | 73  |       | 06.13 |  | 13.0460-5769.2 | 605769 |  |  | 24610 15,0 +/WK     |
|                      | 1.4 D-4D  | 66  |       | 06.13 |  |                |        |  |  |                     |
|                      | 1.6 VVTi  | 90  |       | 06.13 |  |                |        |  |  |                     |
|                      | 1.6 VVTi  | 97  |       | 06.13 |  |                |        |  |  |                     |
|                      | 1.8 VVTi  | 103 |       | 06.13 |  |                |        |  |  |                     |
|                      | 1.6 VVTi  | 90  |       | 06.13 |  |                |        |  |  |                     |
| 1.8 VVTi             | 103       |     | 06.13 |       |  |                |        |  |  |                     |
|                      | 1.33 VVTi | 73  |       | 06.13 |  | 24.0110-0337.1 | 410337 |  |  | 270 9,9 8,0 +B      |
|                      | 1.4 D-4D  | 66  |       | 06.13 |  |                |        |  |  |                     |
|                      | 1.6 VVTi  | 90  |       | 06.13 |  |                |        |  |  |                     |
|                      | 1.6 VVTi  | 97  |       | 06.13 |  |                |        |  |  |                     |
|                      | 1.8 VVTi  | 103 |       | 06.13 |  |                |        |  |  |                     |
|                      | 1.6 VVTi  | 90  |       | 06.13 |  |                |        |  |  |                     |
| 1.8 VVTi             | 103       |     | 06.13 |       |  |                |        |  |  |                     |
|                      | 1.33 VVTi | 73  |       | 06.13 |  | 24.0109-0155.1 | 409155 |  |  | 259 9,0 7,5 +B      |
|                      | 1.4 D-4D  | 66  |       | 06.13 |  |                |        |  |  |                     |
|                      | 1.6 VVTi  | 90  |       | 06.13 |  |                |        |  |  |                     |
|                      | 1.6 VVTi  | 97  |       | 06.13 |  |                |        |  |  |                     |
|                      | 1.8 VVTi  | 103 |       | 06.13 |  |                |        |  |  |                     |
|                      | 1.6 VVTi  | 90  |       | 06.13 |  |                |        |  |  |                     |
| 1.8 VVTi             | 103       |     | 06.13 |       |  |                |        |  |  |                     |

| TOYOTA COROLLA VERSO (02-04) |                   |    |  |       |       |                |        |  |  |                     |
|------------------------------|-------------------|----|--|-------|-------|----------------|--------|--|--|---------------------|
|                              | 1.6 VVTi (ZZE121) | 81 |  | 01.02 | 05.04 | 13.0460-5810.2 | 605810 |  |  | 23904 16,5 +/WK AKE |
|                              | 1.8 VVTi (ZZE122) | 99 |  | 01.02 | 05.04 |                |        |  |  |                     |
|                              | 2.0 D-4D (CDE120) | 66 |  | 01.02 | 05.04 |                |        |  |  |                     |
|                              | 1.6 VVTi (ZZE121) | 81 |  | 01.02 | 05.04 | 24.0125-0155.1 | 425155 |  |  | 255 25,0 23,0 V +B  |
|                              | 1.8 VVTi (ZZE122) | 99 |  | 01.02 | 05.04 |                |        |  |  |                     |
|                              | 2.0 D-4D (CDE120) | 66 |  | 01.02 | 05.04 |                |        |  |  |                     |





























1) - emergency brake assist / - assistenza alla frenata / - assistance de freinage / - asistente de freno  
 2) + emergency brake assist / + assistenza alla frenata / + assistance de freinage / + asistente de freno



|     |    |  |  |                                   |   |  |  |  |            |
|--|--|--|--|---|--|--|--|--|------------|
| <b>TOYOTA COROLLA VERSO (02-04)</b>  |  |  |  |   |  |  |  |  |            |
|    | 1.6 VVTi (ZZE121)<br>1.8 VVTi (ZZE122)<br>2.0 D-4D (CDE120)  | 81<br>99<br>66   |  | 01.02<br>01.02<br>01.02   | 05.04<br>05.04<br>05.04  | 13.0460-5812.2<br>13.0460-0136.2   | 605812<br>610136   | 23521 14,0 +WK<br>Belagsatz-Zubehör  | SUM<br>SUM |
|    | 1.6 VVTi (ZZE121)<br>1.8 VVTi (ZZE122)<br>2.0 D-4D (CDE120)  | 81<br>99<br>66   |  | 01.02<br>01.02<br>01.02   | 05.04<br>05.04<br>05.04  | 24.0109-0139.1   | 409139   | 269 9,0 8,0 +B   |            |
|    | 1.6 VVTi (ZZE121)<br>1.8 VVTi (ZZE122)<br>2.0 D-4D (CDE120)  | 81<br>99<br>66   |  | 01.02<br>01.02<br>01.02   | 05.04<br>05.04<br>05.04  | 03.0137-0459.2   | 650459   | 172 x 32   |            |
| <b>TOYOTA COROLLA VERSO (04-09)</b>  |  |  |  |   |  |  |  |  |            |
|    | 1.6 VVTi (ZNR10)<br>1.8 VVTi (ZNR11)<br>2.0 D-4D (CUR10)<br>2.2 D-4D (AUR10)<br>2.2 D-4D (AUR10)   | 81<br>95<br>85<br>100<br>130   |  | 05.04<br>05.04<br>05.04<br>09.05<br>09.05   | 03.09<br>03.09<br>03.09<br>03.09<br>03.09  | 13.0460-5813.2<br>13.0460-0454.2   | 605813<br>610454   | 23768 19,3 +WK<br>Belagsatz-Zubehör  | BOS<br>BOS |
|    | 1.6 VVTi (ZNR10)<br>1.8 VVTi (ZNR11)<br>2.0 D-4D (CUR10)<br>2.2 D-4D (AUR10)<br>2.2 D-4D (AUR10)   | 81<br>95<br>85<br>100<br>130   |  | 05.04<br>05.04<br>05.04<br>09.05<br>09.05   | 03.09<br>03.09<br>03.09<br>03.09<br>03.09  | 24.0126-0138.1   | 426138   | 295 26,0 24,0 V +B   |            |
|    | 1.6 VVTi (ZNR10)<br>1.8 VVTi (ZNR11)<br>2.0 D-4D (CUR10)<br>2.2 D-4D (AUR10)<br>2.2 D-4D (AUR10)   | 81<br>95<br>85<br>100<br>130   |  | 05.04<br>05.04<br>05.04<br>09.05<br>09.05   | 03.09<br>03.09<br>03.09<br>03.09<br>03.09  | 13.0460-5814.2<br>13.0460-0256.2   | 605814<br>610256   | 23620 16,4 +WK<br>Belagsatz-Zubehör  | BOS<br>BOS |
|    | 1.6 VVTi (ZNR10)<br>1.8 VVTi (ZNR11)<br>2.0 D-4D (CUR10)<br>2.2 D-4D (AUR10)<br>2.2 D-4D (AUR10)   | 81<br>95<br>85<br>100<br>130   |  | 05.04<br>05.04<br>05.04<br>09.05<br>09.05   | 03.09<br>03.09<br>03.09<br>03.09<br>03.09  | 24.0110-0320.1   | 410320   | 290 10,0 8,5 +B  |            |
|    | 1.6 VVTi (ZNR10)<br>1.8 VVTi (ZNR11)<br>2.0 D-4D (CUR10)<br>2.2 D-4D (AUR10)<br>2.2 D-4D (AUR10)   | 81<br>95<br>85<br>100<br>130   |  | 05.04<br>05.04<br>05.04<br>09.05<br>09.05   | 03.09<br>03.09<br>03.09<br>03.09<br>03.09  | 03.0137-3020.2   | 653020   | 180 x 32 HEB   |            |
| <b>TOYOTA FJ CRUISER (06-14)</b>   |  |  |  |   |  |  |  |  |            |
|   | 4.0 V6<br>4.0 V6<br>4.0 V6<br>4.0 VVTi<br>4.0 VVTi 4WD   | 193<br>200<br>203<br>178<br>178  |  | 12.10<br>12.10<br>01.11<br>01.06<br>01.06   | 06.14<br>06.14<br>06.14<br>06.14<br>06.14  | 13.0460-5747.2   | 605747   | 24024 17,0 +WK   |            |
|  | 4.0 V6<br>4.0 V6<br>4.0 V6<br>4.0 VVTi<br>4.0 VVTi 4WD   | 193<br>200<br>203<br>178<br>178  |  | 12.10<br>12.10<br>01.11<br>01.06<br>01.06   | 06.14<br>06.14<br>06.14<br>06.14<br>06.14  | 13.0460-5744.2   | 605744   | 21947 15,4   |            |
|  | 4.0 V6<br>4.0 V6<br>4.0 V6<br>4.0 VVTi<br>4.0 VVTi 4WD   | 193<br>200<br>203<br>178<br>178  |  | 12.10<br>12.10<br>01.11<br>01.06<br>01.06   | 06.14<br>06.14<br>06.14<br>06.14<br>06.14  | 03.0137-3007.2   | 653007   | 209 x 45   |            |
| <b>TOYOTA HIACE (95-06)</b>  |  |  |  |   |  |  |  |  |            |
|  | 2.0 (KLH12)<br>2.4 (RCH12/22)<br>2.4 4WD (RCH18/28)<br>2.4 D (LXH12/18)<br>2.4 TD (LXH12/22)<br>2.4 TD 4WD (LXH18/28)<br>2.5 D-4D (KLH1/2)<br>2.5 D-4D (KLH1/2)<br>2.5 D-4D 4WD (KLH1/2)<br>2.5 D-4D 4WD (KLH1/2)<br>2.7 (RCH13/23)<br>2.7 4WD (RCH19/29)<br>3.0 D (RCH13) | 74<br>85<br>85<br>55<br>66<br>66<br>65<br>75<br>65<br>75<br>105<br>105<br>65     |  | 08.95<br>08.95<br>08.95<br>08.95<br>08.95<br>08.95<br>11.01<br>11.01<br>08.01<br>11.01<br>04.98<br>04.98<br>08.01 | 04.98<br>- ABS<br>04.98<br>- ABS<br>04.98<br>- ABS<br>08.01<br>- ABS<br>08.06<br>- ABS<br>08.06<br>- ABS<br>06.06<br>- ABS<br>06.06<br>- ABS<br>10.03<br>- ABS | 13.0460-5722.2   | 605722   | 21468 15,5   |            |
|  | 2.4 D (LXH12/18)<br>2.4 TD (LXH12/22)<br>2.5 D-4D (KLH1/2)<br>2.5 D-4D (KLH1/2)<br>2.5 D-4D 4WD (KLH1/2)<br>2.5 D-4D 4WD (KLH1/2)<br>2.7 (RCH13/23)<br>3.0 D (RCH13)   | 55<br>66<br>65<br>75<br>65<br>75<br>105<br>65                                    |  | 07.99<br>07.99<br>11.01<br>11.01<br>08.01<br>11.01<br>07.99<br>08.01  | 08.01<br>+ ABS<br>08.01<br>+ ABS<br>08.06<br>+ ABS<br>08.06<br>+ ABS<br>06.06<br>+ ABS<br>10.03<br>+ ABS   | 13.0460-5722.2   | 605722   | 21468 15,5   |            |
|  | 2.0 (KLH12)<br>2.4 (RCH12/22)<br>2.4 D (LXH12/18)<br>2.4 TD (LXH12/22)<br>2.5 D-4D (KLH1/2)<br>2.5 D-4D (KLH1/2)<br>2.7 (RCH13/23)<br>3.0 D (RCH13)  | 74<br>85<br>55<br>66<br>65<br>75<br>105<br>65                                    |  | 08.95<br>08.95<br>08.95<br>08.95<br>11.01<br>11.01<br>04.98<br>08.01  | 04.98<br>04.98<br>08.01<br>08.01<br>08.06<br>08.06<br>06.06<br>10.03   | 24.0128-0189.1   | 428189   | 285 28,0 26,0 V  |            |

|     |    |  |  |                                   |                                  |  |  |  |
|--|--|--|--|---|---|--|--|--|
| <b>TOYOTA HIACE (95-06)</b>  |  |  |  |   |   |  |  |  |
|    | 2.0 (KLH12)<br>2.4 (RCH12/22)<br>2.4 4WD (RCH18/28)<br>2.4 D (LXH12/18)<br>2.4 TD (LXH12/22)<br>2.4 TD 4WD (LXH18/28)<br>2.5 D-4D (KLH1/2)<br>2.5 D-4D (KLH1/2)<br>2.5 D-4D 4WD (KLH1/2)<br>2.5 D-4D 4WD (KLH1/2)<br>2.7 (RCH13/23)<br>2.7 4WD (RCH19/29)<br>3.0 D (RCH13) | 74<br>85<br>85<br>55<br>66<br>66<br>65<br>75<br>65<br>75<br>105<br>105<br>65     |  | 08.95<br>08.95<br>08.95<br>08.95<br>08.95<br>08.95<br>11.01<br>11.01<br>08.01<br>11.01<br>04.98<br>04.98<br>08.01 | 04.98<br>04.98<br>04.98<br>08.01<br>08.01<br>08.01<br>08.06<br>08.06<br>08.04<br>08.06<br>06.06<br>06.06<br>10.03 | 03.0137-0468.2   | 650468   | 270 x 55   |
|    | 2.0 (KLH12)<br>2.4 (RCH12/22)<br>2.4 D (LXH12/18)<br>2.4 TD (LXH12/22)<br>2.7 (RCH13/23)<br>3.0 D (RCH13)  | 74<br>85<br>55<br>66<br>105<br>65  |  | 08.95<br>08.95<br>08.95<br>08.95<br>04.98<br>08.01  | 04.98<br>04.98<br>08.01<br>08.01<br>06.06<br>10.03  | 24.0227-0004.1   | 480303   | 270/272 x 66,5   |
| <b>TOYOTA HIACE (06-)</b>  |  |  |  |   |   |  |  |  |
|    | 2.5 D-4D<br>2.5 D-4D<br>2.5 D-4D 4x4   | 70<br>86<br>86   |  | 09.06<br>09.06<br>09.06   |   | 13.0460-5722.2   | 605722   | 21468 15,5   |
|    | 2.5 D-4D<br>2.5 D-4D   | 70<br>86   |  | 09.06<br>09.06  |   | 24.0128-0189.1   | 428189   | 285 28,0 26,0 V  |
|    | 2.5 D-4D<br>2.5 D-4D<br>2.5 D-4D 4x4   | 70<br>86<br>86   |  | 09.06<br>09.06<br>09.06   |   | 03.0137-0468.2   | 650468   | 270 x 55   |
|    | 2.5 D-4D<br>2.5 D-4D   | 70<br>86   |  | 09.06<br>09.06  |   | 24.0227-0004.1   | 480303   | 270/272 x 66,5   |
| <b>TOYOTA HILUX (88-97)</b>  |  |  |  |   |   |  |  |  |
|    | 1.8 (YN85/90)<br>2.4 D (LN85/90)<br>2.4 D 4WD (LN85/90)  |  |  | 08.88<br>08.88<br>01.94   | 07.97<br>07.97<br>07.97   | 13.0460-5938.2   | 605938   | 21158 15,5 AKE   |
|   | 2.4 D 4WD (LN105/110)<br>2.4 i 4WD (RN106/110)   |  |  | 08.88<br>08.88  | 07.97<br>07.97  | 13.0460-5992.2   | 605992   | 21679 15,0 +/-WK   |
|  | 1.8 (YN85/90)<br>2.4 D (LN85/90)<br>2.4 D 4WD (LN85/90)  |  |  | 08.88<br>08.88<br>01.94   | 07.97<br>07.97<br>07.97   | 24.0125-0118.1   | 425118   | 257 25,0 23,0 V  |
|  | 2.4 D 4WD (LN105/110)<br>2.4 i 4WD (RN106/110)   |  |  | 08.88<br>08.88  | 07.97<br>07.97  | 24.0120-0168.1   | 420168   | 289 20,0 18,0 V  |
|  | 1.8 (YN85/90)<br>2.4 D (LN85/90)   |  |  | 08.88<br>08.88  | 07.97<br>07.97  | 03.0137-0226.2   | 650226   | 254 x 58   |
|  | 2.4 D (LN85/90)<br>2.4 D 4WD (LN105/110)<br>2.4 D 4WD (LN85/90)<br>2.4 i 4WD (RN106/110)   |  |  | 08.88<br>08.88<br>01.94<br>08.88  | 07.97<br>07.97<br>07.97<br>07.97  | 03.0137-0308.2   | 650308   | 295 x 51   |
|  | 2.4 D 4WD (LN85/90)<br>2.4 i 4WD (RN106/110)   |  |  | 01.94<br>08.88  | 07.97<br>07.97  | 24.0229-5004.1   | 480312   | 295/297 x 67   |
| <b>TOYOTA HILUX (97-05)</b>  |  |  |  |   |   |  |  |  |
|  | 2.4 D<br>2.5 D-4D  | 55<br>65   |  | 08.97<br>11.01  | 01.02<br>07.05  | 13.0460-5892.2   | 605892   | 21689 15,5   |
|  | 2.4 i 4WD<br>2.4 TD 4WD<br>2.5 D-4D 4WD  | 103<br>66<br>75  |  | 08.97<br>08.97<br>11.01   | 07.01<br>01.02<br>07.05   | 13.0460-5992.2   | 605992   | 21679 15,0 +/-WK   |
|  | 2.4 D<br>2.5 D-4D  | 55<br>65   |  | 08.97<br>11.01  | 01.02<br>07.05  | 24.0125-0118.1   | 425118   | 257 25,0 23,0 V  |
|  | 2.4 i 4WD<br>2.4 TD 4WD<br>2.5 D-4D 4WD  | 103<br>66<br>75  |  | 08.97<br>08.97<br>11.01   | 07.01<br>01.02<br>07.05   | 24.0120-0168.1   | 420168   | 289 20,0 18,0 V  |
|  | 2.4 i 4WD<br>2.4 TD 4WD<br>2.5 D-4D 4WD  | 103<br>66<br>75  |  | 08.97<br>08.97<br>11.01   | 07.01<br>01.02<br>07.05   | 03.0137-0308.2   | 650308   | 295 x 51   |
|  | 2.4 D<br>2.5 D-4D  | 55<br>65   |  | 08.99<br>11.01  | 01.02<br>07.05  | 24.0225-4018.1   | 480197   | 254/256 x 62   |
|  | 2.4 i 4WD<br>2.4 TD 4WD<br>2.5 D-4D 4WD  | 103<br>66<br>75  |  | 08.97<br>08.97<br>11.01   | 07.01<br>01.02<br>07.05   | 24.0229-5004.1   | 480312   | 295/297 x 67   |
| <b>TOYOTA HILUX (05-)</b>  |  |  |  |   |   |  |  |  |
|  | 2.5 D-4D (KUN15)<br>2.5 D-4D (KUN15)   | 75<br>88   |  | 06.06<br>12.07  |   | 13.0460-5616.2   | 605616   | + kurzer Radstand <sup>1)</sup> 24567 16,0   |
|  | 2.5 D-4D (KUN15)<br>2.5 D-4D (KUN15)   | 75<br>88   |  | 06.06<br>12.07  |   | 24.0128-0249.1   | 428249   | 258 28,0 26,0 V +B   |

<sup>1)</sup> + short wheel base / + passo lungo / + empattement court / + distancia corta entre ejes

|     |              |  |  |  |  |  |  |  |
|--|--|--|--|--|---|--|--|--|
| <b>TOYOTA HILUX (05-)</b>  |  |  |  |  |   |  |  |  |
|    | 2.5 D-4D (KUN15)<br>2.5 D-4D (KUN15)   | 75<br>88   |  | 06.06<br>12.07   |   | 03.0137-0483.2   | 650483   | 254 x 51   |
|  | 2.5 D-4D 4x4 (KUN25)<br>2.5 D-4D 4x4 (KUN25)<br>2.5 D-4D 4x4 (KUN25)<br>3.0 D-4D 4x4 (KUN26) | 75<br>88<br>106<br>126   |  | 08.05<br>12.07<br>12.07<br>12.07   |   | 03.0137-0485.2   | 650485   | 295 x 62   |
|    | 2.5 D-4D 4x4 (KUN25)<br>2.5 D-4D 4x4 (KUN25)<br>2.5 D-4D 4x4 (KUN25)<br>3.0 D-4D 4x4 (KUN26) | 75<br>88<br>106<br>126   |  | 08.05<br>12.07<br>12.07<br>12.07   |   | 24.0229-5003.1   | 480306   | 295/297 x 67   |
| <b>TOYOTA IQ (09-)</b>   |  |  |  |  |   |  |  |  |
|    | 1.0 i 12V<br>1.33<br>1.33<br>1.4 D-4D  | 50<br>69<br>72<br>66   |  | 01.09<br>01.09<br>01.09<br>01.09   |   | 13.0460-5810.2   | 605810   | 23904 16,5 +/WK <b>AKE</b>   |
|    | 1.0 i 12V<br>1.33<br>1.33<br>1.4 D-4D  | 50<br>69<br>72<br>66   |  | 01.09<br>01.09<br>01.09<br>01.09   |   | 24.0120-0219.1   | 420219   | 255 20,0 18,0 V +B   |
|    | 1.0 i 12V<br>1.33<br>1.33<br>1.4 D-4D  | 50<br>69<br>72<br>66   |  | 01.09<br>01.09<br>01.09<br>01.09   | + ABS<br>+ ABS<br>+ ABS<br>+ ABS  | 13.0460-5769.2   | 605769   | 24610 15,0 +/WK  |
|    | 1.0 i 12V<br>1.33<br>1.33<br>1.4 D-4D  | 50<br>69<br>72<br>66   |  | 01.09<br>01.09<br>01.09<br>01.09   | + ABS<br>+ ABS<br>+ ABS<br>+ ABS  | 24.0109-0156.1   | 409156   | 259 9,0 7,5 +B   |
| <b>TOYOTA LAND CRUISER STATION WAGON 80 (90-97)</b>                                |  |  |  |  |   |  |  |  |
|    | 4.0 i (FJ80)<br>4.2 D (HZJ80)<br>4.2 TD (HDJ80)<br>4.5 i 24V (FZJ80)                         |  |  | 01.90 08.92<br>01.90 12.97<br>01.90 12.97<br>08.92 12.97                         |   | 13.0460-5745.2   | 605745   | 21775 15,0 +/WK <b>SUM</b>   |
|    | 4.5 i 24V (FZJ80)  |  |  | 08.92 12.97  |   | 24.0132-0111.1   | 432111   | 311 32,0 30,0 V  |
|   | 4.0 i (FJ80)<br>4.2 D (HZJ80)<br>4.2 TD (HDJ80)<br>4.5 i 24V (FZJ80)                         |  |  | 01.90 08.92<br>01.90 12.97<br>01.90 12.97<br>08.92 12.97                         |   | 13.0460-5744.2   | 605744   | 21947 15,4   |
| <b>TOYOTA LAND CRUISER 90-95 (96-02)</b>   |  |  |  |  |   |  |  |  |
|  | 3.0 D-4D (KD.J90/95)<br>3.0 TD (KZ.J90/95)<br>3.4 i 24V (VZ.J90/95)                          | 120<br>92<br>131   |  | 08.00 08.02<br>04.96 07.00<br>04.96 08.02  |   | 13.0460-5992.2   | 605992   | 21679 15,0 +/WK  |
|  | 3.0 D-4D (KD.J90/95)<br>3.0 TD (KZ.J90/95)<br>3.4 i 24V (VZ.J90/95)                          | 120<br>92<br>131   |  | 08.00 08.02<br>04.96 07.00<br>04.96 08.02  |   | 24.0122-0185.1   | 422185   | 319 22,0 20,0 V  |
|  | 3.0 D-4D (KD.J90/95)<br>3.0 TD (KZ.J90/95)<br>3.4 i 24V (VZ.J90/95)                          | 120<br>92<br>131   |  | 08.00 08.02<br>04.96 07.00<br>04.96 08.02  |   | 13.0460-5744.2   | 605744   | 21947 15,4   |
|  | 3.0 D-4D (KD.J90/95)<br>3.0 TD (KZ.J90/95)<br>3.4 i 24V (VZ.J90/95)                          | 120<br>92<br>131   |  | 08.00 08.02<br>04.96 07.00<br>04.96 08.02  |   | 24.0118-0709.1   | 418709   | 312 18,0 16,0 V +B   |
|  | 3.0 D-4D (KD.J90/95)<br>3.0 TD (KZ.J90/95)<br>3.4 i 24V (VZ.J90/95)                          | 120<br>92<br>131   |  | 08.00 08.02<br>04.96 07.00<br>04.96 08.02  |   | 03.0137-3007.2   | 653007   | 209 x 45   |
| <b>TOYOTA LAND CRUISER 100 (98-08)</b>   |  |  |  |  |   |  |  |  |
|  | 4.2 TDi (HDJ100)<br>4.7 V8 (UZJ100)<br>4.7 V8 (UZJ100)                                       | 150<br>173<br>175  |  | 11.01 07.08<br>11.01 04.02<br>05.02 07.08  |   | 13.0460-5746.2   | 605746   | 23524 17,4 +/WK <b>SUM</b>   |
|  | 4.2 TDi (HDJ100)<br>4.7 V8 (UZJ100)<br>4.7 V8 (UZJ100)                                       | 150<br>173<br>175  |  | 01.98 07.08<br>01.98 04.02<br>05.02 07.08  |   | 24.0132-0148.1   | 432148   | 313 32,0 30,0 V +B   |
|  | 4.2 TDi (HDJ100)<br>4.7 V8 (UZJ100)<br>4.7 V8 (UZJ100)                                       | 150<br>173<br>175  |  | 01.98 07.08<br>01.98 04.02<br>05.02 07.08  |   | 13.0460-5749.2   | 605749   | 23539 17,3   |
|  | 4.2 TDi (HDJ100)<br>4.7 V8 (UZJ100)<br>4.7 V8 (UZJ100)                                       | 150<br>173<br>175  |  | 01.98 07.08<br>01.98 04.02<br>05.02 07.08  |   | 24.0118-0143.1   | 418143   | 329 18,0 16,0 V +B   |
|  | 4.2 TDi (HDJ100)<br>4.7 V8 (UZJ100)<br>4.7 V8 (UZJ100)                                       | 150<br>173<br>175  |  | 01.98 07.08<br>01.98 04.02<br>05.02 07.08  |   | 03.0137-3008.2   | 653008   | 230 x 45   |
| <b>TOYOTA LAND CRUISER 120 (03-)</b>   |  |  |  |  |   |  |  |  |
|  | 3.0 D-4D<br>3.0 D-4D<br>3.0 D-4D<br>4.0 VVTi<br>4.0 VVTi                                     | 120<br>122<br>127<br>183<br>203  |  | 01.03<br>01.05 10.06<br>11.06<br>01.03<br>08.05                                  |   | 13.0460-5747.2   | 605747   | 24024 17,0 +/WK  |



### TOYOTA LAND CRUISER 120 (03-)

|  |          |     |  |       |       |                |        |  |                    |
|--|----------|-----|--|-------|-------|----------------|--------|--|--------------------|
|  | 3.0 D-4D | 120 |  | 01.03 | 10.06 | 24.0128-0194.1 | 428194 |  | 338 28,0 26,0 V +B |
|  | 3.0 D-4D | 122 |  | 01.05 |       |                |        |  |                    |
|  | 3.0 D-4D | 127 |  | 11.06 |       |                |        |  |                    |
|  | 4.0 VVTi | 183 |  | 01.03 |       |                |        |  |                    |
|  | 4.0 VVTi | 203 |  | 08.05 |       |                |        |  |                    |
|  | 3.0 D-4D | 120 |  | 01.03 | 10.06 | 13.0460-5744.2 | 605744 |  | 21947 15,4         |
|  | 3.0 D-4D | 122 |  | 01.05 |       |                |        |  |                    |
|  | 3.0 D-4D | 127 |  | 11.06 |       |                |        |  |                    |
|  | 4.0 VVTi | 183 |  | 01.03 |       |                |        |  |                    |
|  | 4.0 VVTi | 203 |  | 08.05 |       |                |        |  |                    |
|  | 3.0 D-4D | 120 |  | 01.03 | 10.06 | 24.0118-0709.1 | 418709 |  | 312 18,0 16,0 V +B |
|  | 3.0 D-4D | 122 |  | 01.05 |       |                |        |  |                    |
|  | 3.0 D-4D | 127 |  | 11.06 |       |                |        |  |                    |
|  | 4.0 VVTi | 183 |  | 01.03 |       |                |        |  |                    |
|  | 4.0 VVTi | 203 |  | 08.05 |       |                |        |  |                    |
|  | 3.0 D-4D | 120 |  | 01.03 | 10.06 | 03.0137-3007.2 | 653007 |  | 209 x 45           |
|  | 3.0 D-4D | 122 |  | 01.05 |       |                |        |  |                    |
|  | 3.0 D-4D | 127 |  | 11.06 |       |                |        |  |                    |
|  | 4.0 VVTi | 183 |  | 01.03 |       |                |        |  |                    |
|  | 4.0 VVTi | 203 |  | 08.05 |       |                |        |  |                    |

### TOYOTA LAND CRUISER 150 (10-)

|            |                  |     |       |       |                |                |        |                      |                  |
|------------|------------------|-----|-------|-------|----------------|----------------|--------|----------------------|------------------|
|            | 2.7 4WD          | 120 |       | 01.10 |                | 13.0460-5747.2 | 605747 |                      | 24024 17,0 +/-WK |
|            | 2.8 D-4D         | 130 |       | 06.15 |                |                |        |                      |                  |
|            | 3.0 D-4D         | 127 |       | 03.10 |                |                |        |                      |                  |
|            | 3.0 D-4D         | 140 |       | 01.10 |                |                |        |                      |                  |
|            | 3.0 TDi          | 120 |       | 01.10 |                |                |        |                      |                  |
|            | 4.0 V6 Dual VVTi | 205 |       | 01.10 |                |                |        |                      |                  |
|            | 4.0 V6 VVTi      | 183 |       | 01.10 |                |                |        |                      |                  |
|            | 4.0 V6 VVTi      | 202 |       | 01.10 |                |                |        |                      |                  |
|            | 4.0 V6 VVTi      | 203 |       | 01.10 |                |                |        |                      |                  |
|            | 4.0 V6 VVTi      | 207 |       | 01.10 |                |                |        |                      |                  |
| 4.6 V8 4WD | 227              |     | 09.10 |       | 13.0460-5618.2 | 605618         |        | 24386 17,9 +/-WK/Zub |                  |
|            | 2.7 4WD          | 120 |       | 01.10 |                | 13.0460-5744.2 | 605744 |                      | 21947 15,4       |
|            | 2.8 D-4D         | 130 |       | 06.15 |                |                |        |                      |                  |
|            | 3.0 D-4D         | 127 |       | 03.10 |                |                |        |                      |                  |
|            | 3.0 D-4D         | 140 |       | 01.10 |                |                |        |                      |                  |
|            | 3.0 TDi          | 120 |       | 01.10 |                |                |        |                      |                  |
|            | 4.0 V6 Dual VVTi | 205 |       | 01.10 |                |                |        |                      |                  |
|            | 4.0 V6 VVTi      | 183 |       | 01.10 |                |                |        |                      |                  |
|            | 4.0 V6 VVTi      | 202 |       | 01.10 |                |                |        |                      |                  |
|            | 4.0 V6 VVTi      | 203 |       | 01.10 |                |                |        |                      |                  |
|            | 4.0 V6 VVTi      | 207 |       | 01.10 |                |                |        |                      |                  |
|            | 2.7 4WD          | 120 |       | 01.10 |                | 03.0137-3007.2 | 653007 |                      | 209 x 45         |
|            | 2.8 D-4D         | 130 |       | 06.15 |                |                |        |                      |                  |
|            | 3.0 D-4D         | 127 |       | 03.10 |                |                |        |                      |                  |
|            | 3.0 D-4D         | 140 |       | 01.10 |                |                |        |                      |                  |
|            | 3.0 TDi          | 120 |       | 01.10 |                |                |        |                      |                  |
|            | 4.0 V6 Dual VVTi | 205 |       | 01.10 |                |                |        |                      |                  |
|            | 4.0 V6 VVTi      | 183 |       | 01.10 |                |                |        |                      |                  |
|            | 4.0 V6 VVTi      | 202 |       | 01.10 |                |                |        |                      |                  |
|            | 4.0 V6 VVTi      | 203 |       | 01.10 |                |                |        |                      |                  |
|            | 4.0 V6 VVTi      | 207 |       | 01.10 |                |                |        |                      |                  |
| 4.6 V8 4WD | 227              |     | 09.10 |       |                |                |        |                      |                  |

### TOYOTA LAND CRUISER 200 (07-)



































|  |                   |     |  |       |  |                |        |  |                      |
|--|-------------------|-----|--|-------|--|----------------|--------|--|----------------------|
|  | 4.5 D V8 (VDJ200) | 210 |  | 01.08 |  | 13.0460-5618.2 | 605618 |  | 24386 17,9 +/-WK/Zub |
|  | 4.5 D4-D (VDJ200) | 173 |  | 08.07 |  |                |        |  |                      |
|  | 4.5 D4-D (VDJ200) | 195 |  | 01.08 |  |                |        |  |                      |
|  | 4.5 D4-D (VDJ200) | 200 |  | 01.12 |  |                |        |  |                      |
|  | 4.6 V8 (URJ202)   | 227 |  | 09.10 |  |                |        |  |                      |
|  | 4.6 V8 (URJ202)   | 234 |  | 01.12 |  |                |        |  |                      |
|  | 4.7 V8 (UZJ200)   | 202 |  | 08.07 |  |                |        |  |                      |
|  | 4.7 V8 (UZJ200)   | 212 |  | 01.08 |  |                |        |  |                      |
|  | 4.5 D V8 (VDJ200) | 210 |  | 01.08 |  | 13.0460-5619.2 | 605619 |  | 24653 17,3 /Zub      |
|  | 4.5 D4-D (VDJ200) | 173 |  | 08.07 |  |                |        |  |                      |
|  | 4.5 D4-D (VDJ200) | 195 |  | 01.08 |  |                |        |  |                      |
|  | 4.5 D4-D (VDJ200) | 200 |  | 01.12 |  |                |        |  |                      |
|  | 4.6 V8 (URJ202)   | 227 |  | 09.10 |  |                |        |  |                      |
|  | 4.6 V8 (URJ202)   | 234 |  | 01.12 |  |                |        |  |                      |
|  | 4.7 V8 (UZJ200)   | 202 |  | 08.07 |  |                |        |  |                      |
|  | 4.7 V8 (UZJ200)   | 212 |  | 01.08 |  |                |        |  |                      |

































### TOYOTA MR2 (89-00)

|  |                  |     |  |       |       |                |        |  |                 |
|--|------------------|-----|--|-------|-------|----------------|--------|--|-----------------|
|  | 2.0 i 16V        | 125 |  | 12.89 | 11.91 | 24.0125-0129.1 | 425129 |  | 258 25,0 24,0 V |
|  | 2.0 i 16V        | 129 |  | 12.89 | 11.91 |                |        |  |                 |
|  | 2.0 i 16V (SW20) | 115 |  | 12.89 | 11.91 |                |        |  |                 |
|  | 2.0 Turbo        | 177 |  | 12.89 | 11.91 |                |        |  |                 |

### TOYOTA MR2 (00-07)

|  |                  |     |  |       |       |                |        |  |   |
|--|------------------|-----|--|-------|-------|----------------|--------|--|---|
|  | 1.8 VVTi (ZZW30) | 103 |  | 01.00 | 06.07 | 13.0460-5810.2 | 605810 |  | 23904 16,5 +/-WK AKE                        |
|  | 1.8 VVTi (ZZW30) | 103 |  | 01.00 | 06.07 |                |        |  |   |
|  | 1.8 VVTi (ZZW30) | 103 |  | 01.00 | 06.07 | 24.0120-0175.1 | 420175 |  | 255 20,0 18,0 V +B<br>255 20,0 18,0 V +B PD |
|  | 1.8 VVTi (ZZW30) | 103 |  | 01.00 | 06.07 | 24.0320-0175.1 | 520175 |  |   |

























|     |     |  |  |  |  |  |  |  |  |
|--|---|--|--|--|---|--|--|--|--|
| <b>TOYOTA PASEO (95-99)</b>  |   |  |  |  |   |  |  |  |  |
|    | 1.5 i 16V (EL54)  | 66   |  | 08.95  | 12.99   |  | 13.0460-5976.2   | 605976   | 20870 15,0 AKE                           |
|    | 1.5 i 16V (EL54)  | 66   |  | 08.95  | 12.99   |  | 03.0137-0257.2<br>03.0137-9080.2   | 650257<br>669080   | 180 x 28<br>Bremsbacken-Zubehör          |
| <b>TOYOTA PICNIC (96-01)</b>   |   |  |  |  |   |  |  |  |  |
|    | 2.0 i 16V<br>2.0 i 16V<br>2.2 TD  | 90<br>94<br>66   |  | 01.01<br>05.96<br>09.97  | 12.01<br>12.01<br>12.01   |  | 13.0460-5951.2<br>13.0460-0441.2   | 605951<br>610441   | 21601 17,5 +/WK<br>Belagsatz-Zubehör SUM |
|    | 2.0 i 16V<br>2.0 i 16V<br>2.2 TD  | 90<br>94<br>66   |  | 01.01<br>05.96<br>09.97  | 12.01<br>12.01<br>12.01   |  | 24.0128-0114.1   | 428114   | 255 28,0 26,0 V                          |
|    | 2.0 i 16V<br>2.0 i 16V<br>2.2 TD  | 90<br>94<br>66   |  | 01.01<br>05.96<br>09.97  | 12.01<br>12.01<br>12.01   |  | 03.0137-0398.2   | 650398   | 229 x 42                                 |
| <b>TOYOTA PREVIA (90-00)</b>   |   |  |  |  |   |  |  |  |  |
|    | 2.4 i (TCR10)<br>2.4 i (TCR20)<br>2.4 i 4x4 (TCR11)<br>2.4 i 4x4 (TCR21)            | 97<br>110<br>97<br>110   |  | 05.90<br>05.90<br>05.90<br>05.90   | 08.00<br>08.00<br>08.00<br>08.00  | - ABS<br>- ABS<br>- ABS<br>- ABS   | 13.0460-5968.2<br>13.0460-0450.2   | 605968<br>610450   | 21780 15,5 +/WK<br>Belagsatz-Zubehör     |
|    | 2.4 i (TCR10)<br>2.4 i (TCR20)<br>2.4 i 4x4 (TCR11)<br>2.4 i 4x4 (TCR21)            | 97<br>110<br>97<br>110   |  | 05.90<br>05.90<br>05.90<br>05.90   | 08.00<br>08.00<br>08.00<br>08.00  | - ABS<br>- ABS<br>- ABS<br>- ABS   | 24.0125-0116.1<br>24.0122-0183.1   | 425116<br>422183   | 255 25,0 23,0 V<br>279 22,0 20,0 V +B    |
|    | 2.4 i (TCR10)<br>2.4 i (TCR20)<br>2.4 i 4x4 (TCR11)<br>2.4 i 4x4 (TCR21)            | 97<br>110<br>97<br>110   |  | 10.90<br>05.90<br>05.90<br>05.90   | 08.00<br>08.00<br>08.00<br>08.00  | + ABS<br>+ ABS<br>+ ABS<br>+ ABS   | 24.0125-0126.1   | 425126   | 271 25,0 23,0 V                          |
|    | 2.4 i (TCR10)<br>2.4 i (TCR20)<br>2.4 i 4x4 (TCR11)<br>2.4 i 4x4 (TCR21)            | 97<br>110<br>97<br>110   |  | 05.90<br>05.90<br>05.90<br>05.90   | 08.00<br>08.00<br>08.00<br>08.00  | + ABS<br>+ ABS<br>+ ABS<br>+ ABS   | 13.0460-5862.2<br>13.0460-0325.2   | 605862<br>610325   | 21688 15,3<br>Belagsatz-Zubehör AKE      |
|    | 2.4 i (TCR10)<br>2.4 i (TCR20)<br>2.4 i 4x4 (TCR11)<br>2.4 i 4x4 (TCR21)            | 97<br>110<br>97<br>110   |  | 05.90<br>05.90<br>05.90<br>05.90   | 08.00<br>08.00<br>08.00<br>08.00  | + ABS<br>+ ABS<br>+ ABS<br>+ ABS   | 24.0118-0119.1   | 418119   | 291 18,0 17,0 V                          |
|   | 2.4 i (TCR10)<br>2.4 i (TCR20)<br>2.4 i 4x4 (TCR11)<br>2.4 i 4x4 (TCR21)            | 97<br>110<br>97<br>110   |  | 05.90<br>05.90<br>05.90<br>05.90   | 08.00<br>08.00<br>08.00<br>08.00  | + ABS<br>+ ABS<br>+ ABS<br>+ ABS   | 03.0137-9203.2   | 669203   | Bremsbacken-Zubehör                      |
|  | 2.4 i (TCR10)<br>2.4 i (TCR20)<br>2.4 i 4x4 (TCR11)<br>2.4 i 4x4 (TCR21)            | 97<br>110<br>97<br>110   |  | 05.90<br>05.90<br>05.90<br>05.90   | 08.00<br>08.00<br>08.00<br>08.00  | - ABS<br>- ABS<br>- ABS<br>- ABS   | 03.0137-0193.2   | 650193   | 254 x 52                                 |
|  | 2.4 i (TCR10)<br>2.4 i (TCR20)  | 97<br>110  |  | 05.90<br>05.90   | 08.00<br>08.00  | - ABS<br>- ABS   | 24.0225-4010.1   | 480126   | 254/256 x 63                             |
|  | 2.4 i (TCR10)<br>2.4 i (TCR20)<br>2.4 i 4x4 (TCR11)<br>2.4 i 4x4 (TCR21)            | 97<br>110<br>97<br>110   |  | 05.90<br>05.90<br>05.90<br>05.90   | 08.00<br>08.00<br>08.00<br>08.00  | + ABS<br>+ ABS<br>+ ABS<br>+ ABS   | 03.0137-0400.2<br>03.0137-9272.2   | 650400<br>669272   | 190 x 45<br>Bremsbacken-Zubehör          |
| <b>TOYOTA PREVIA (00-05)</b>   |   |  |  |  |   |  |  |  |  |
|  | 2.0 D-4D (CLR30)<br>2.4 VVTi (ACR30)  | 85<br>115  |  | 03.01<br>08.00   | 03.03<br>03.03  |  | 13.0460-5891.2   | 605891   | 23513 17,0 AKE                           |
|  | 2.0 D-4D (CLR30)<br>2.4 VVTi (ACR30)  | 85<br>115  |  | 04.03<br>04.03   | 12.05<br>12.05  |  | 13.0460-5894.2   | 605894   | 23759 17,0                               |
|  | 2.0 D-4D (CLR30)<br>2.4 VVTi (ACR30)  | 85<br>115  |  | 03.01<br>08.00   | 03.03<br>03.03  |  | 24.0128-0115.1   | 428115   | 275 28,0 26,0 V +B                       |
|  | 2.0 D-4D (CLR30)<br>2.4 VVTi (ACR30)  | 85<br>115  |  | 04.03<br>04.03   | 12.05<br>12.05  |  | 24.0128-0190.1   | 428190   | 296 28,0 26,0 V                          |
|  | 2.0 D-4D (CLR30)<br>2.4 VVTi (ACR30)  | 85<br>115  |  | 03.01<br>08.00   | 12.05<br>12.05  |  | 13.0460-5847.2   | 605847   | 23646 16,5 +/WK SUM                      |
|  | 2.0 D-4D (CLR30)<br>2.4 VVTi (ACR30)  | 85<br>115  |  | 03.01<br>08.00   | 12.05<br>12.05  |  | 24.0112-0164.1   | 412164   | 291 12,0 10,5 +B                         |
|  | 2.0 D-4D (CLR30)<br>2.4 VVTi (ACR30)  | 85<br>115  |  | 03.01<br>08.00   | 12.05<br>12.05  |  | 03.0137-0400.2<br>03.0137-9272.2   | 650400<br>669272   | 190 x 45<br>Bremsbacken-Zubehör          |
| <b>TOYOTA PREVIA (05-)</b>   |   |  |  |  |   |  |  |  |  |
|  | 2.4 16V (ACR50)<br>3.5 V6 (GSR50)<br>3.5 V6 (GSR50)<br>3.5 V6 4x4 (GSR50)           | 125<br>200<br>206<br>206   |  | 10.05<br>01.06<br>01.06<br>01.06   |   |  | 13.0460-5614.2   | 605614   | 24601 18,0                               |
|  | 2.4 16V (ACR50)<br>3.5 V6 (GSR50)<br>3.5 V6 (GSR50)<br>3.5 V6 4x4 (GSR50)           | 125<br>200<br>206<br>206   |  | 10.05<br>01.06<br>01.06<br>01.06   |   |  | 24.0128-0232.1   | 428232   | 296 28,0 25,0 V +B                       |
|  | 2.4 16V (ACR50)<br>3.5 V6 (GSR50)<br>3.5 V6 (GSR50)<br>3.5 V6 4x4 (GSR50)           | 125<br>200<br>206<br>206   |  | 10.05<br>01.06<br>01.06<br>01.06   |   |  | 13.0460-5814.2   | 605814   | 23620 16,4 +/WK BOS                      |
|  |  |  |  |  |   |  |  |  |  |





















|     |           |  |  |  |  |  |  |  |
|--|---|--|--|--|---|--|--|--|
| <b>TOYOTA PREVIA (05-)</b>   |   |  |  |  |   |  |  |  |
|    | 2.4 16V (ACR50) 125<br>3.5 V6 (GSR50) 200<br>3.5 V6 (GSR50) 206<br>3.5 V6 4x4 (GSR50) 206 |  | 10.05<br>01.06<br>01.06<br>01.06   |  | 24.0110-0346.1  | 410346   |  | 298 10,0 8,5 +B  |
| <b>TOYOTA PRIUS (00-03)</b>  |   |  |  |  |   |  |  |  |
|    | 1.5 i 16V (NHW11)   | 53   | 05.00 07.03  |  | 13.0460-5810.2  | 605810   |  | 23904 16,5 +/WK AKE  |
|    | 1.5 i 16V (NHW11)   | 53   | 05.00 07.03  |  | 24.0125-0155.1  | 425155   |  | 255 25,0 23,0 V +B   |
|    | 1.5 i 16V (NHW11)   | 53   | 05.00 07.03  |  | 13.0460-5812.2<br>13.0460-0136.2  | 605812<br>610136   |  | 23521 14,0 +/WK SUM<br>Belagsatz-Zubehör SUM                                       |
|    | 1.5 i 16V (NHW11)   | 53   | 05.00 07.03  |  | 24.0109-0139.1  | 409139   |  | 269 9,0 8,0 +B   |
|    | 1.5 i 16V (NHW11)   | 53   | 05.00 07.03  |  | 03.0137-0459.2  | 650459   |  | 172 x 32   |
| <b>TOYOTA PRIUS (03-09)</b>  |   |  |  |  |   |  |  |  |
|    | 1.5 VVTi (NHW20)  | 57   | 08.03 03.09  |  | 13.0460-5810.2  | 605810   |  | 23904 16,5 +/WK AKE  |
|    | 1.5 VVTi (NHW20)  | 57   | 08.03 03.09  |  | 24.0122-0258.1  | 422258   |  | 255 22,0 20,0 V +B   |
|    | 1.5 VVTi (NHW20)  | 57   | 08.03 07.04  |  | 13.0460-5812.2<br>13.0460-0136.2  | 605812<br>610136   |  | 23521 14,0 +/WK SUM<br>Belagsatz-Zubehör SUM                                       |
|    | 1.5 VVTi (NHW20)  | 57   | 08.03 03.09  |  | 24.0109-0711.1  | 409711   |  | 269 9,0 7,5 +B   |
|   | 1.5 VVTi (NHW20)  | 57   | 08.03 03.09  |  | 03.0137-0459.2  | 650459   |  | 172 x 32   |
| <b>TOYOTA PRIUS (09-15)</b>  |   |  |  |  |   |  |  |  |
|  | 1.8 Hybrid (ZVW30)  | 73   | 01.09  |  | 13.0460-5617.2  | 605617   |  | 24451 15,6 /Zub  |
|  | 1.8 Hybrid (ZVW30)  | 73   | 01.09  |  | 24.0125-0196.1  | 425196   |  | 255 25,0 22,0 V +B   |
|  | 1.8 Hybrid (ZVW30)  | 73   | 01.09 05.11  |  | 13.0460-5769.2  | 605769   |  | 24610 15,0 +/WK  |
|  | 1.8 Hybrid (ZVW30)  | 73   | 01.09  |  | 24.0109-0163.1  | 409163   |  | 259 9,0 7,5 +B   |
| <b>TOYOTA PRIUS (15-)</b>  |   |  |  |  |   |  |  |  |
|  | 1.8 Hybrid (ZVW5_)  | 72   | 09.15  |  | 24.0109-0163.1  | 409163   |  | 259 9,0 7,5 +B   |
| <b>TOYOTA PRIUS PLUS (12-)</b>   |   |  |  |  |   |  |  |  |
|  | 1.8 Hybrid (ZVW40)  | 73   | 03.12  |  | 13.0460-5766.2  | 605766   |  | 24337 17,5   |
|  | 1.8 Hybrid (ZVW40)  | 73   | 03.12  |  | 24.0128-0159.1  | 428159   |  | 296 28,0 25,0 V +B   |
|  | 1.8 Hybrid (ZVW40)  | 73   | 03.12  |  | 13.0460-5635.2<br>13.0470-5635.2  | 605635<br>LD5635   |  | 24918 15,0 AKE<br>24918 15,0 AKE   |
| <b>TOYOTA PROACE Kasten/Kombi (13-)</b>  |   |  |  |  |   |  |  |  |
|  | 1.6 D-4D 66<br>2.0 D-4D 94<br>2.0 D-4D 120  |  | 06.13<br>06.13<br>06.13  |  | 24.0128-0214.1  | 428214   | + 15" Rad <sup>1)</sup>  | 280 28,0 26,0 V +S +B  |
|  | 1.6 D-4D 66<br>2.0 D-4D 94<br>2.0 D-4D 120  |  | 06.13<br>06.13<br>06.13  |  | 24.0128-0216.1  | 428216   | + 16" Rad <sup>2)</sup>  | 304 28,0 26,0 V +S +B  |
|  | 1.6 D-4D 66<br>2.0 D-4D 94<br>2.0 D-4D 120  |  | 06.13<br>06.13<br>06.13  |  | 24.0114-0116.1  | 414116   |  | 290 14,0 12,0 +S +B  |
|  | 1.6 D-4D 66<br>2.0 D-4D 94<br>2.0 D-4D 120  |  | 06.13<br>06.13<br>06.13  |  | 03.0137-0334.2  | 650334   |  | 254 x 57 HEB TRW   |

<sup>1)</sup> + 15" wheel / + ruota 15" / + roue 15" / + rueda 15"























<sup>2)</sup> + 16" wheel / + ruota 16" / + roue 16" / + rueda 16"



|     |    |         |  |                                   |  |  |  |  |                                     |            |
|--|--|---|--|---|---|--|--|--|-------------------------------------|------------|
| <b>TOYOTA RAV4 I (94-00)</b>   |  |   |  |   |   |  |  |  |                                     |            |
|    | 2.0 16V (SXA10/11)<br>2.0 16V (SXA10/11)   | 94<br>95  |  | 12.97<br>04.94  | 06.00<br>06.00  |  | 13.0460-5951.2<br>13.0460-0441.2   | 605951<br>610441   | 21601 17,5 +WK<br>Belagsatz-Zubehör | SUM<br>SUM |
|    | 2.0 16V (SXA10/11)<br>2.0 16V (SXA10/11)   | 94<br>95  |  | 12.97<br>04.94  | 06.00<br>06.00  |  | 24.0118-0129.1   | 418129   | 302 18,0 16,0 V +B                  |            |
|    | 2.0 16V (SXA10/11)<br>2.0 16V (SXA10/11)   | 94<br>95  |  | 12.97<br>04.94  | 06.00<br>06.00  |  | 03.0137-0318.2   | 650318   | 229 x 41                            |            |
|    | 2.0 16V (SXA10/11)<br>2.0 16V (SXA10/11)   | 94<br>95  |  | 12.97<br>04.94  | 06.00<br>06.00  |  | 24.0222-8008.1   | 480304   | 229/230,6 x 52,1                    |            |
| <b>TOYOTA RAV4 II (00-05)</b>  |  |   |  |   |   |  |  |  |                                     |            |
|    | 1.8 VVTi<br>2.0 D-4D 4WD<br>2.0 VVTi 4WD<br>2.4 VVTi 4WD<br>2.4 VVTi 4WD   | 92<br>85<br>110<br>112<br>120   |  | 02.01<br>09.01<br>06.00<br>08.03<br>08.03   | 11.05<br>11.05<br>11.05<br>11.05<br>11.05   |  | 13.0460-5848.2   | 605848   | 23585 17,4 +                        | AKE        |
|    | 1.8 VVTi<br>2.0 D-4D 4WD<br>2.0 VVTi 4WD<br>2.4 VVTi 4WD<br>2.4 VVTi 4WD   | 92<br>85<br>110<br>112<br>120   |  | 02.01<br>09.01<br>06.00<br>08.03<br>08.03   | 11.05<br>11.05<br>11.05<br>11.05<br>11.05   |  | 24.0125-0143.1   | 425143   | 275 25,0 23,0 V +B                  |            |
|    | 1.8 VVTi<br>2.0 D-4D 4WD<br>2.0 VVTi 4WD   | 92<br>85<br>110   |  | 02.01<br>09.01<br>06.00   | 11.05 + ABS<br>11.05 + ABS<br>11.05 + ABS   |  | 13.0460-5849.2   | 605849   | 23656 14,0 +WK                      | AKE        |
|    | 1.8 VVTi<br>2.0 D-4D 4WD<br>2.0 VVTi 4WD<br>2.4 VVTi 4WD<br>2.4 VVTi 4WD   | 92<br>85<br>110<br>112<br>120   |  | 02.01<br>09.01<br>06.00<br>08.03<br>08.03   | 11.05 + ABS<br>11.05 + ABS<br>11.05 + ABS<br>11.05 + ABS<br>11.05 + ABS           |  | 24.0109-0152.1   | 409152   | 303 9,0 8,0 +B                      |            |
|    | 1.8 VVTi<br>2.0 D-4D 4WD<br>2.0 VVTi 4WD   | 92<br>85<br>110   |  | 02.01<br>09.01<br>06.00   | 07.02 - ABS<br>07.02 - ABS<br>07.02 - ABS   |  | 03.0137-0318.2   | 650318   | 229 x 41                            |            |
|    | 1.8 VVTi<br>2.0 D-4D 4WD<br>2.0 VVTi 4WD<br>2.4 VVTi 4WD<br>2.4 VVTi 4WD   | 92<br>85<br>110<br>112<br>120   |  | 08.02<br>08.02<br>08.02<br>08.03<br>08.03   | 11.05 - ABS<br>11.05 - ABS<br>11.05 - ABS<br>11.05 - ABS<br>11.05 - ABS           |  | 03.0137-0448.2   | 650448   | 228 x 42                            |            |
|  | 1.8 VVTi<br>2.0 D-4D 4WD<br>2.0 VVTi 4WD<br>2.4 VVTi 4WD<br>2.4 VVTi 4WD   | 92<br>85<br>110<br>112<br>120   |  | 02.01<br>09.01<br>06.00<br>08.03<br>08.03   | 11.05 - ABS<br>11.05 - ABS<br>11.05 - ABS<br>11.05 - ABS<br>11.05 - ABS           |  | 24.0222-8008.1   | 480304   | 229/230,6 x 52,1                    |            |
|  | 1.8 VVTi<br>2.0 D-4D 4WD<br>2.0 VVTi 4WD<br>2.4 VVTi 4WD<br>2.4 VVTi 4WD   | 92<br>85<br>110<br>112<br>120   |  | 02.01<br>09.01<br>06.00<br>08.03<br>08.03   | 11.05 + ABS<br>11.05 + ABS<br>11.05 + ABS<br>11.05 + ABS<br>11.05 + ABS           |  | 03.0137-0400.2<br>03.0137-9272.2   | 650400<br>669272   | 190 x 45<br>Bremsbacken-Zubehör     |            |
| <b>TOYOTA RAV4 III (05-)</b>   |  |   |  |   |   |  |  |  |                                     |            |
|  | 2.0 16V<br>2.0 16V 4WD<br>2.0 VVT-i<br>2.0 VVT-i 4WD<br>2.0 VVT-i 4WD<br>2.2 D-4D<br>2.2 D-4D 4WD<br>2.2 D-4D 4WD<br>2.2 D-CAT 4WD<br>2.4 VVT-i<br>2.4 VVT-i 4WD<br>3.5 VVT-i 4WD<br>3.5 VVT-i 4WD | 116<br>116<br>109<br>109<br>112<br>110<br>100<br>110<br>130<br>125<br>125<br>201<br>206 |  | 12.08<br>12.08<br>03.09<br>03.09<br>03.06<br>12.08<br>03.06<br>12.08<br>03.06<br>11.05<br>11.05<br>11.05<br>08.07 |   |  | 13.0460-5766.2   | 605766   | 24337 17,5                          |            |
|  | 2.0 16V<br>2.0 16V 4WD<br>2.0 VVT-i<br>2.0 VVT-i 4WD<br>2.0 VVT-i 4WD<br>2.2 D-4D<br>2.2 D-4D 4WD<br>2.2 D-4D 4WD<br>2.2 D-CAT 4WD<br>2.4 VVT-i<br>2.4 VVT-i 4WD<br>3.5 VVT-i 4WD<br>3.5 VVT-i 4WD | 116<br>116<br>109<br>109<br>112<br>110<br>100<br>110<br>130<br>125<br>125<br>201<br>206 |  | 12.08<br>12.08<br>03.09<br>03.09<br>03.06<br>12.08<br>03.06<br>12.08<br>03.06<br>11.05<br>11.05<br>11.05<br>08.07 |   |  | 24.0128-0159.1   | 428159   | 296 28,0 25,0 V +B                  |            |
|  | 2.0 16V<br>2.0 16V 4WD<br>2.0 VVT-i<br>2.0 VVT-i 4WD<br>2.0 VVT-i 4WD<br>2.2 D-4D<br>2.2 D-4D 4WD  | 116<br>116<br>109<br>109<br>112<br>110<br>100   |  | 12.08<br>12.08<br>03.09<br>03.09<br>03.06<br>12.08<br>03.06   |   |  | 13.0460-5765.2   | 605765   | 24338 15,5                          | AKE        |
| ↓  | ↓  |   |  |   |   |  |  |  |                                     |            |

|     |    |         |                                   |   |  |  |  |  |
|--|--|---|---|---|---|--|--|--|
| <b>TOYOTA RAV4 III (05-)</b>   |  |   |   |   |   |  |  |  |
|    | 2.2 D-4D 4WD<br>2.2 D-CAT 4WD<br>2.4 VVT-i<br>2.4 VVT-i 4WD<br>3.5 VVT-i 4WD<br>3.5 VVT-i 4WD  | 110<br>130<br>125<br>125<br>201<br>206  | 12.08<br>03.06<br>11.05<br>11.05<br>11.05<br>08.07  |   | 13.0460-5765.2<br>605765  |  |  | 24338 15,5<br><b>AKE</b>   |
|    | 2.0 16V<br>2.0 16V 4WD<br>2.0 VVT-i<br>2.0 VVT-i 4WD<br>2.0 VVT-i 4WD<br>2.2 D-4D<br>2.2 D-4D 4WD<br>2.2 D-4D 4WD<br>2.2 D-CAT 4WD<br>2.4 VVT-i<br>2.4 VVT-i 4WD<br>3.5 VVT-i 4WD<br>3.5 VVT-i 4WD | 116<br>116<br>109<br>109<br>112<br>110<br>100<br>110<br>130<br>125<br>125<br>201<br>206 | 12.08<br>12.08<br>03.09<br>03.09<br>03.06<br>12.08<br>03.06<br>12.08<br>03.06<br>11.05<br>11.05<br>11.05<br>08.07 |   | 24.0112-0714.1<br>412714  |  |  | 281 12,0 10,5 +B   |
|    | 2.0 16V<br>2.0 16V 4WD<br>2.0 VVT-i<br>2.0 VVT-i 4WD<br>2.0 VVT-i 4WD<br>2.2 D-4D<br>2.2 D-4D 4WD<br>2.2 D-4D 4WD<br>2.2 D-CAT 4WD<br>2.4 VVT-i<br>2.4 VVT-i 4WD<br>3.5 VVT-i 4WD<br>3.5 VVT-i 4WD | 116<br>116<br>109<br>109<br>112<br>110<br>100<br>110<br>130<br>125<br>125<br>201<br>206 | 12.08<br>12.08<br>03.09<br>03.09<br>03.06<br>12.08<br>03.06<br>12.08<br>03.06<br>11.05<br>11.05<br>11.05<br>08.07 |   | 03.0137-3012.2<br>653012  |  |  | 172 x 32   |
| <b>TOYOTA RAV4 IV (12-)</b>  |  |   |   |   |   |  |  |  |
|    | 2.0 VVT-i<br>2.0 VVT-i 4WD<br>2.5 Hybrid<br>2.5 Hybrid 4WD<br>2.5 VVT-i 4WD  | 107<br>111<br>114<br>114<br>132   | 12.12<br>12.12<br>10.15<br>10.15<br>12.12   |   | 13.0460-5766.2<br>605766  |  |  | 24337 17,5   |
|  | 2.0 D4-D<br>2.0 D4-D<br>2.0 D4-D 4WD<br>2.2 D4-D 4WD   | 91<br>105<br>91<br>110  | 12.12<br>10.15<br>11.13<br>12.12  |   | 13.0460-5634.2<br>605634  |  |  | 24452 17,5 /Zub<br><b>ADV</b>  |
|  | 2.0 VVT-i<br>2.0 VVT-i 4WD<br>2.5 Hybrid<br>2.5 Hybrid 4WD<br>2.5 VVT-i 4WD  | 107<br>111<br>114<br>114<br>132   | 12.12<br>12.12<br>10.15<br>10.15<br>12.12   | + 16" Rad <sup>1)</sup><br>+ 16" Rad <sup>1)</sup><br>+ 16" Rad <sup>1)</sup><br>+ 16" Rad <sup>1)</sup><br>+ 16" Rad <sup>1)</sup> | 24.0128-0159.1<br>428159  |  |  | 296 28,0 25,0 V +B   |
|  | 2.0 D4-D<br>2.0 D4-D<br>2.0 D4-D 4WD<br>2.0 VVT-i<br>2.0 VVT-i 4WD<br>2.2 D4-D 4WD<br>2.5 Hybrid<br>2.5 Hybrid 4WD<br>2.5 VVT-i 4WD  | 91<br>105<br>91<br>107<br>111<br>110<br>114<br>114<br>132                               | 12.12<br>10.15<br>11.13<br>12.12<br>12.12<br>12.12<br>10.15<br>10.15<br>12.12                                     |   | 13.0460-5765.2<br>605765  |  |  | 24338 15,5<br><b>AKE</b>   |
|  | 2.0 D4-D<br>2.0 D4-D<br>2.0 D4-D 4WD<br>2.0 VVT-i<br>2.0 VVT-i 4WD<br>2.2 D4-D 4WD<br>2.5 Hybrid<br>2.5 Hybrid 4WD<br>2.5 VVT-i 4WD  | 91<br>105<br>91<br>107<br>111<br>110<br>114<br>114<br>132                               | 12.12<br>10.15<br>11.13<br>12.12<br>12.12<br>12.12<br>10.15<br>10.15<br>12.12                                     |   | 24.0112-0714.1<br>412714  |  |  | 281 12,0 10,5 +B   |
|  | 2.0 D4-D<br>2.0 VVT-i 4WD<br>2.2 D4-D 4WD  | 105<br>111<br>110   | 10.15<br>12.12<br>12.12   |   | 03.0137-3012.2<br>653012  |  |  | 172 x 32   |
| <b>TOYOTA STARLET (96-99)</b>  |  |   |   |   |   |  |  |  |
|  | 1.3 i 16V (EP91)<br>1.3 i 16V (EP91)   | 55<br>55  | 01.96<br>05.96  | 04.96<br>07.99  | 13.0460-5969.2<br>605969  |  |  | 21948 13,5 +<br><b>SUM</b>   |
|  |  |   |   |   | 13.0460-5976.2<br>605976  |  |  | 20870 15,0<br><b>AKE</b>   |
|  | 1.3 i 16V (EP91)   | 55  | 05.96   | 07.99   | 24.0118-0124.1<br>418124  |  |  | 238 18,0 17,0 V +B   |
|  | 1.3 i 16V (EP91)   | 55  | 01.96   | 07.99   | 03.0137-0257.2<br>650257<br>03.0137-9080.2<br>669080                              |  |  | 180 x 28<br>Bremsbacken-Zubehör  |

<sup>1)</sup> + 16" wheel / + ruota 16" / + roue 16" / + rueda 16"

























|     |    |  |  |  |    |  |  |  |                                |
|--|--|--|--|--|---|--|--|--|--------------------------------|
| <b>TOYOTA SUPRA (93-98)</b>  |  |  |  |  |   |  |  |  |                                |
|    | 3.0 i 24V (JZA80)<br>3.0 i Turbo (JZA80)   | 168<br>243   |  | 05.93<br>05.93   | 08.98 - Europa 1)<br>08.98 + Europa 2)  |  | 03.0137-0400.2   | 650400   | 190 x 45                       |
| <b>TOYOTA URBAN CRUISER (09-)</b>  |  |  |  |  |   |  |  |  |                                |
|    | 1.33 16V<br>1.33 16V<br>1.4 D-4D<br>1.4 D-4D 4WD   | 73<br>74<br>66<br>66   |  | 04.10<br>04.09<br>04.09<br>04.09   |   |  | 13.0460-5767.2   | 605767   | 24336 17,5 <b>AKE</b>          |
|    | 1.33 16V<br>1.33 16V<br>1.4 D-4D<br>1.4 D-4D 4WD   | 73<br>74<br>66<br>66   |  | 04.10<br>04.09<br>04.09<br>04.09   |   |  | 24.0122-0276.1   | 422276   | 275 22,0 19,0 V +B             |
|    | 1.33 16V<br>1.33 16V<br>1.4 D-4D   | 73<br>74<br>66   |  | 04.10<br>04.09<br>04.09  |   |  | 13.0460-5769.2   | 605769   | 24610 15,0 +/WK                |
|    | 1.33 16V<br>1.33 16V<br>1.4 D-4D<br>1.4 D-4D 4WD   | 73<br>74<br>66<br>66   |  | 04.10<br>04.09<br>04.09<br>04.09   |   |  | 24.0109-0170.1   | 409170   | 259 9,0 7,5 +B                 |
| <b>TOYOTA VERSO (09-)</b>  |  |  |  |  |   |  |  |  |                                |
|    | 1.6 16V<br>1.6 D-4D<br>1.8 16V<br>2.0 D-4D<br>2.0 D-4D   | 97<br>82<br>108<br>91<br>93  |  | 02.09<br>11.13<br>02.09<br>11.12<br>02.09  |   |  | 13.0460-5603.2   | 605603   | 24204 19,2 +/WK/Zub            |
|  | 1.6 D-4D<br>2.0 D-4D   | 82<br>91   |  | 11.13<br>11.12   |   |  | 13.0460-5603.2   | 605603   | 24204 19,2 +/WK/Zub            |
|  | 2.2 D-4D<br>2.2 D-CAT  | 110<br>130   |  | 02.09<br>02.09   | 10.10<br>10.10  |  | 13.0460-5615.2   | 605615   | 24946 19,0 +/WK/Zub <b>BOS</b> |
|    | 1.6 16V<br>1.6 D-4D<br>1.8 16V<br>2.0 D-4D<br>2.0 D-4D   | 97<br>82<br>108<br>91<br>93  |  | 02.09<br>11.13<br>02.09<br>11.12<br>02.09  |   |  | 24.0126-0156.1   | 426156   | 295 26,0 23,0 V +B             |
|  | 2.2 D-4D<br>2.2 D-CAT  | 110<br>130   |  | 02.09<br>02.09   |   |  | 24.0126-0160.1   | 426160   | 320 26,0 23,0 V +B             |
|   | 1.6 16V<br>1.6 D-4D<br>1.8 16V<br>2.0 D-4D<br>2.0 D-4D<br>2.2 D-4D<br>2.2 D-CAT  | 97<br>82<br>108<br>91<br>93<br>110<br>130  |  | 02.09<br>11.13<br>02.09<br>11.12<br>02.09<br>02.09<br>02.09                      |   |  | 13.0460-3854.2   | 603854   | 24926 16,5 +/WK/Zub <b>BOS</b> |
|  | 1.6 16V<br>1.6 D-4D<br>1.8 16V<br>2.0 D-4D<br>2.0 D-4D<br>2.2 D-4D<br>2.2 D-CAT  | 97<br>82<br>108<br>91<br>93<br>110<br>130  |  | 02.09<br>11.13<br>02.09<br>11.12<br>02.09<br>02.09<br>02.09                      |   |  | 24.0111-0168.1   | 411168   | 297 11,0 9,0 +B                |
| <b>TOYOTA VERSO S (10-)</b>  |  |  |  |  |   |  |  |  |                                |
|  | 1.33<br>1.33<br>1.4 D4-D   | 70<br>73<br>66   |  | 11.10<br>11.10<br>11.10  |   |  | 13.0460-5767.2   | 605767   | 24336 17,5 <b>AKE</b>          |
|  | 1.33<br>1.33<br>1.4 D4-D   | 70<br>73<br>66   |  | 11.10<br>11.10<br>11.10  |   |  | 24.0122-0276.1   | 422276   | 275 22,0 19,0 V +B             |
|  | 1.33<br>1.33<br>1.4 D4-D   | 70<br>73<br>66   |  | 11.10<br>11.10<br>11.10  |   |  | 13.0460-5769.2   | 605769   | 24610 15,0 +/WK                |
|  | 1.33<br>1.33<br>1.4 D4-D   | 70<br>73<br>66   |  | 11.10<br>11.10<br>11.10  |   |  | 24.0109-0163.1   | 409163   | 259 9,0 7,5 +B                 |
| <b>TOYOTA YARIS (99-05)</b>  |  |  |  |  |   |  |  |  |                                |
|  | 1.0 i 16V<br>1.3 i 16V<br>1.4 D-4D   | 50<br>63<br>55   |  | 03.99<br>09.99<br>12.01  | 07.99<br>10.04 + HA-Trommelbremse 3)<br>03.03 + HA-Trommelbremse 3)   |  | 13.0460-5811.2   | 605811   | 23348 16,5 +/WK                |
|  | 1.0 i 16V<br>1.0 i 16V<br>1.3 i 16V<br>1.4 D-4D  | 48<br>50<br>64<br>55   |  | 04.03<br>08.99<br>04.02<br>04.03   | 08.05 + HA-Trommelbremse 3)<br>03.03<br>08.05 + HA-Trommelbremse 3)<br>08.05 + HA-Trommelbremse 3)  |  | 13.0460-5800.2   | 605800   | 23340 17,0 +/WK <b>BOS</b>     |
|  | 1.0 i 16V<br>1.0 i 16V<br>1.3 i 16V<br>1.3 i 16V<br>1.4 D-4D<br>1.5 VVTi Sport<br>1.5 VVTi Sport<br>1.5 VVTi Turbo Sport | 48<br>50<br>63<br>64<br>55<br>77<br>78<br>110                                    |  | 04.03<br>08.99<br>09.99<br>04.02<br>12.01<br>01.03<br>04.01<br>04.03             | 08.05 + HA-Scheibenbremse 4)<br>03.03<br>10.04 + HA-Scheibenbremse 4)<br>03.03 + HA-Scheibenbremse 4)<br>08.05 + HA-Scheibenbremse 4)<br>08.05 + HA-Scheibenbremse 4)<br>08.05 + HA-Scheibenbremse 4)<br>03.03 + HA-Scheibenbremse 4)<br>10.04 + HA-Scheibenbremse 4) |  | 13.0460-5810.2   | 605810   | 23904 16,5 +/WK <b>AKE</b>     |

1) - Europe / - Europa / - Europe / - Europa

2) + Europe / + Europa / + Europe / + Europa

3) + RA drum brake / + P freno a tamburo / + frein à tambour essieu AR / + ET-tambores de freno

4) + RA disc brake / + P disco freno / + frein à disque essieu AR / + ET-disco de freno

|     |  |  |  |  |  |  |  |  |                              |
|--|--|--|--|--|---|--|--|--|------------------------------|
| <b>TOYOTA YARIS (99-05)</b>  |  |  |  |  |   |  |  |  |                              |
|    | 1.0 i 16V  | 48   |  | 04.03  | 08.05 + HA-Trommelbremse <sup>1)</sup>  | 24.0118-0131.1   | 418131   |  | 235 17,9 16,0 V +B           |
|  | 1.0 i 16V  | 50   |  | 03.99  | 07.99   |  |  |  |                              |
|  | 1.3 i 16V  | 63   |  | 09.99  | 10.04 + HA-Trommelbremse <sup>1)</sup>  |  |  |  |                              |
|  | 1.3 i 16V  | 64   |  | 04.02  | 08.05 + HA-Trommelbremse <sup>1)</sup>  |  |  |  |                              |
|  | 1.4 D-4D   | 55   |  | 12.01  | 08.05 + HA-Trommelbremse <sup>1)</sup>  |  |  |  |                              |
|    | 1.0 i 16V  | 48   |  | 04.03  | 08.05 + HA-Scheibenbremse <sup>2)</sup>   | 24.0120-0175.1   | 420175   |  | 255 20,0 18,0 V +B           |
|  | 1.0 i 16V  | 50   |  | 08.99  | 03.03   | 24.0320-0175.1   | 520175   |  | <b>255 20,0 18,0 V +B PD</b> |
|  | 1.3 i 16V  | 63   |  | 09.99  | 10.04 + HA-Scheibenbremse <sup>2)</sup>   |  |  |  |                              |
|  | 1.3 i 16V  | 64   |  | 04.02  | 08.05 + HA-Scheibenbremse <sup>2)</sup>   |  |  |  |                              |
|  | 1.4 D-4D   | 55   |  | 12.01  | 08.05 + HA-Scheibenbremse <sup>2)</sup>   |  |  |  |                              |
|  | 1.5 VVTi Sport   | 77   |  | 01.03  | 08.05 + HA-Scheibenbremse <sup>2)</sup>   |  |  |  |                              |
|  | 1.5 VVTi Sport   | 78   |  | 04.01  | 03.03 + HA-Scheibenbremse <sup>2)</sup>   |  |  |  |                              |
| 1.5 VVTi Turbo Sport   | 110  |  | 04.03  | 10.04 + HA-Scheibenbremse <sup>2)</sup>  |   |  |  |  |                              |
|    | 1.0 i 16V  | 48   |  | 04.03  | 08.05 + ABS   | 13.0460-5812.2   | 605812   |  | 23521 14,0 +/WK              |
|  | 1.0 i 16V  | 50   |  | 03.99  | 03.03 + ABS   | 13.0460-0136.2   | 610136   |  | <b>SUM</b>                   |
|  | 1.3 i 16V  | 63   |  | 09.99  | 10.04 + ABS   |  |  |  | <b>SUM</b>                   |
|  | 1.3 i 16V  | 64   |  | 04.02  | 08.05 + ABS   |  |  |  |                              |
|  | 1.4 D-4D   | 55   |  | 12.01  | 08.05 + ABS   |  |  |  |                              |
|  | 1.5 VVTi Sport   | 77   |  | 01.03  | 08.05   |  |  |  |                              |
|  | 1.5 VVTi Sport   | 78   |  | 04.01  | 03.03   |  |  |  |                              |
| 1.5 VVTi Turbo Sport   | 110  |  | 04.03  | 10.04  |   |  |  |  |                              |
|    | 1.0 i 16V  | 48   |  | 04.03  | 08.05 + ABS   | 24.0109-0139.1   | 409139   |  | 269 9,0 8,0 +B               |
|  | 1.0 i 16V  | 50   |  | 03.99  | 03.03 + ABS   |  |  |  |                              |
|  | 1.3 i 16V  | 63   |  | 09.99  | 10.04 + ABS   |  |  |  |                              |
|  | 1.3 i 16V  | 64   |  | 04.02  | 08.05 + ABS   |  |  |  |                              |
|  | 1.4 D-4D   | 55   |  | 12.01  | 08.05 + ABS   |  |  |  |                              |
|    | 1.0 i 16V  | 48   |  | 04.03  | 08.05   | 03.0137-0364.2   | 650364   | Produktionsland ☺  | 200 x 32                     |
|  | 1.0 i 16V  | 50   |  | 03.99  | 03.03   | 03.0137-9236.2   | 669236   |  | Bremsbacken-Zubehör          |
|  | 1.3 i 16V  | 63   |  | 09.99  | 10.04   |  |  |  |                              |
|  | 1.0 i 16V  | 48   |  | 04.03  | 08.05   | 03.0137-0466.2   | 650466   | Produktionsland ☺  | 200 x 32 HEB                 |
|    | 1.0 i 16V  | 50   |  | 03.99  | 03.03   | 03.0137-9287.2   | 669287   |  | <b>BOS</b>                   |
|  | 1.3 i 16V  | 64   |  | 04.02  | 08.05   |  |  |  | <b>BOS</b>                   |
|  | 1.4 D-4D   | 55   |  | 12.01  | 08.05   |  |  |  |                              |
|  | 1.0 i 16V  | 48   |  | 04.03  | 08.05   | 24.0220-0041.1   | 480167   | Produktionsland ☺  | 200/201 x 41,8               |
|   | 1.0 i 16V  | 50   |  | 03.99  | 03.03   |  |  |  |                              |
|  | 1.3 i 16V  | 63   |  | 09.99  | 10.04   |  |  |  |                              |
|  | 1.0 i 16V  | 48   |  | 04.03  | 08.05   | 24.0220-0047.1   | 480199   | Produktionsland ☺  | 200/201 x 41                 |
|  | 1.0 i 16V  | 50   |  | 03.99  | 03.03   |  |  |  |                              |
|  | 1.3 i 16V  | 64   |  | 04.02  | 08.05   |  |  |  |                              |
|  | 1.4 D-4D   | 55   |  | 12.01  | 08.05   |  |  |  |                              |
|  | 1.0 i 16V  | 48   |  | 04.03  | 08.05   | 03.0520-4317.3   | 694317   | Produktionsland ☺  | 17,46/200x32 TopKit          |
|  | 1.0 i 16V  | 50   |  | 03.99  | 03.03   |  |  |  |                              |
|  | 1.3 i 16V  | 63   |  | 09.99  | 10.04   |  |  |  |                              |
|  | 1.0 i 16V  | 48   |  | 04.03  | 08.05   | 03.0520-6519.3   | 696519   | Produktionsland ☺  | 19,05/200x32 TopKit          |
|  | 1.0 i 16V  | 50   |  | 03.99  | 03.03   |  |  |  | <b>BOS</b>                   |
|  | 1.3 i 16V  | 64   |  | 04.02  | 08.05   |  |  |  |                              |
|  | 1.4 D-4D   | 55   |  | 12.01  | 08.05   |  |  |  |                              |
|  | 1.0 i 16V  | 48   |  | 04.03  | 08.05 + ABS   | 03.0137-0459.2   | 650459   |  | 172 x 32                     |
|  | 1.0 i 16V  | 50   |  | 03.99  | 03.03 + ABS   |  |  |  |                              |
|  | 1.3 i 16V  | 63   |  | 09.99  | 10.04 + ABS   |  |  |  |                              |
|  | 1.3 i 16V  | 64   |  | 04.02  | 08.05 + ABS   |  |  |  |                              |
|  | 1.5 VVTi Sport   | 77   |  | 01.03  | 08.05   |  |  |  |                              |
|  | 1.5 VVTi Sport   | 78   |  | 04.01  | 03.03   |  |  |  |                              |
|  | 1.5 VVTi Turbo Sport   | 110  |  | 04.03  | 10.04   |  |  |  |                              |
| <b>TOYOTA YARIS (06-11)</b>  |  |  |  |  |   |  |  |  |                              |
|  | 1.0 GPL  | 51   |  | 01.06  | 08.11 + ABS   | 13.0460-5768.2   | 605768   | Produktionsland ☺  | 24347 17,5                   |
|  | 1.0 VVT-i  | 51   |  | 01.06  | 08.11 + ABS   |  |  |  | <b>AKE</b>                   |
|  | 1.8 VVT-i  | 97   |  | 01.06  | 08.11   |  |  |  |                              |
|  | 1.8 VVT-i  | 98   |  | 01.07  | 08.11   |  |  |  |                              |
|  | 1.0 GPL  | 51   |  | 01.06  | 08.11   | 13.0460-7213.2   | 607213   | Produktionsland ☺  | 24022 17,8 +/WK              |
|  | 1.0 VVT-i  | 51   |  | 01.06  | 08.11   |  |  |  | <b>ATE</b>                   |
|  | 1.3 VVT-i  | 63   |  | 01.06  | 08.11   |  |  |  |                              |
|  | 1.3 VVT-i  | 64   |  | 01.06  | 08.11   |  |  |  |                              |
|  | 1.33 VVT-i   | 73   |  | 07.10  | 08.11   |  |  |  |                              |
|  | 1.33 VVT-i   | 74   |  | 03.09  | 08.11   |  |  |  |                              |
|  | 1.4 D-4D   | 66   |  | 01.06  | 08.11   |  |  |  |                              |
|  | 1.0 GPL  | 51   |  | 01.06  | 08.11 - ABS   | 24.0122-0246.1   | 422246   | Produktionsland ☺  | 255 22,0 19,0 V +B           |
|  | 1.0 VVT-i  | 51   |  | 01.06  | 08.11 - ABS   |  |  |  |                              |
|  | 1.0 GPL  | 51   |  | 01.06  | 08.11 + ABS   | 24.0122-0254.1   | 422254   | Produktionsland ☺  | 275 22,0 19,0 V +B           |
|  | 1.0 VVT-i  | 51   |  | 01.06  | 08.11 + ABS   |  |  |  |                              |
|  | 1.8 VVT-i  | 97   |  | 01.06  | 08.11   |  |  |  |                              |
|  | 1.8 VVT-i  | 98   |  | 01.07  | 08.11   |  |  |  |                              |
|  | 1.0 GPL  | 51   |  | 01.06  | 08.11   | 24.0122-0240.1   | 422240   | Produktionsland ☺  | 258 22,0 20,0 V +B           |
|  | 1.0 VVT-i  | 51   |  | 01.06  | 08.11   |  |  |  |                              |
|  | 1.3 VVT-i  | 63   |  | 01.06  | 08.11   |  |  |  |                              |
|  | 1.3 VVT-i  | 64   |  | 01.06  | 08.11   |  |  |  |                              |
|  | 1.33 VVT-i   | 73   |  | 07.10  | 08.11   |  |  |  |                              |
|  | 1.33 VVT-i   | 74   |  | 03.09  | 08.11   |  |  |  |                              |
| 1.4 D-4D   | 66   |  | 01.06  | 08.11  |   |  |  |  |                              |

<sup>1)</sup> + RA drum brake / + P freno a tamburo / + frein à tambour essieu AR / + ET-tambores de freno

<sup>2)</sup> + RA disc brake / + P disco freno / + frein à disque essieu AR / + ET-disco de freno

























### TOYOTA YARIS (06-11)

|  |  |  |  |   |  |  |                                    |                                     |
|--|--|--|--|---|--|--|------------------------------------|-------------------------------------|
|  | 1.0 GPL<br>1.0 VVT-i<br>1.3 VVT-i<br>1.33 VVT-i<br>1.4 D-4D                            | 51<br>51<br>64<br>73<br>66             |  | 01.06 08.11<br>01.06 08.11<br>01.06 08.11<br>07.10 08.11<br>01.06 08.11                               |  | 24.0710-5002.3 360314<br>24.0710-5001.3 360313 |                                    | Radsensor<br>Radsensor              |
|  | 1.0 GPL<br>1.0 VVT-i<br>1.8 VVT-i<br>1.8 VVT-i   | 51<br>51<br>97<br>98                   |  | 01.06 08.11<br>01.06 08.11<br>01.06 08.11<br>01.07 08.11  |  | 13.0460-5769.2 605769                          | Produktionsland                    | 24610 15,0 +/-WK                    |
|  | 1.0 GPL<br>1.0 VVT-i<br>1.3 VVT-i<br>1.3 VVT-i<br>1.33 VVT-i<br>1.33 VVT-i<br>1.4 D-4D | 51<br>51<br>63<br>64<br>73<br>74<br>66 |  | 01.06 08.11<br>01.06 08.11<br>01.06 08.11<br>01.06 08.11<br>07.10 08.11<br>03.09 08.11<br>01.06 08.11 |  | 13.0460-7214.2 607214                          | Produktionsland                    | 24574 15,0 +/-WK ATE                |
|  | 1.0 GPL<br>1.0 VVT-i<br>1.8 VVT-i<br>1.8 VVT-i   | 51<br>51<br>97<br>98                   |  | 01.06 08.11<br>01.06 08.11<br>01.06 08.11<br>01.07 08.11  |  | 24.0109-0156.1 409156                          | Produktionsland                    | 259 9,0 7,5 +B                      |
|  | 1.0 GPL<br>1.0 VVT-i<br>1.3 VVT-i<br>1.3 VVT-i<br>1.33 VVT-i<br>1.33 VVT-i<br>1.4 D-4D | 51<br>51<br>63<br>64<br>73<br>74<br>66 |  | 01.06 08.11<br>01.06 08.11<br>01.06 08.11<br>01.06 08.11<br>07.10 08.11<br>03.09 08.11<br>01.06 08.11 |  | 24.0109-0142.1 409142                          | Produktionsland                    | 278 9,0 7,0 +B                      |
|  | 1.0 GPL<br>1.0 VVT-i<br>1.3 VVT-i<br>1.4 D-4D  | 51<br>51<br>64<br>66                   |  | 01.06 08.11<br>01.06 08.11<br>01.06 08.11<br>01.06 08.11  |  | 24.0711-6169.3 360283                          | 2                                  | Radsensor                           |
|  | 1.0 GPL<br>1.0 VVT-i<br>1.3 VVT-i<br>1.3 VVT-i<br>1.33 VVT-i<br>1.33 VVT-i<br>1.4 D-4D | 51<br>51<br>63<br>64<br>73<br>74<br>66 |  | 01.06 08.11<br>01.06 08.11<br>01.06 08.11<br>01.06 08.11<br>07.10 08.11<br>03.09 08.11<br>01.06 08.11 |  | 03.0137-0502.2 650502<br>03.0137-9280.2 669280 | Produktionsland<br>Produktionsland | 203 x 38 HEB<br>Bremsbacken-Zubehör |
|  | 1.0 GPL<br>1.0 VVT-i<br>1.3 VVT-i<br>1.3 VVT-i<br>1.33 VVT-i<br>1.33 VVT-i<br>1.4 D-4D | 51<br>51<br>63<br>64<br>73<br>74<br>66 |  | 01.06 08.11<br>01.06 08.11<br>01.06 08.11<br>01.06 08.11<br>07.10 08.11<br>03.09 08.11<br>01.06 08.11 |  | 03.0520-8920.3 698920                          | Produktionsland                    | 20,64/203x38 TopKit AP              |

### TOYOTA YARIS (11-)

|  |  |  |  |   |   |  |       |  |
|--|--|--|--|---|---|--|-------|--|
|  | 1.0 VVTi<br>1.3 VVTi<br>1.3 VVTi<br>1.3 VVTi<br>1.3 VVTi 4WD<br>1.4 D-4D                 | 51<br>63<br>70<br>73<br>70<br>66       |  | 09.11<br>01.11<br>09.11<br>09.11<br>09.11<br>09.11          | Produktionsland<br>Produktionsland<br>Produktionsland<br>Produktionsland<br>Produktionsland<br>Produktionsland                    | 13.0460-7213.2 607213                          |       | 24022 17,8 +/-WK ATE                     |
|  | 1.3 VVTi<br>1.3 VVTi<br>1.3 VVTi<br>1.3 VVTi 4WD<br>1.5 Hybrid<br>1.5 Hybrid             | 63<br>70<br>73<br>70<br>54<br>55       |  | 01.11<br>09.11<br>09.11<br>09.11<br>04.15<br>03.12          | Produktionsland<br>Produktionsland<br>Produktionsland<br>Produktionsland<br>Produktionsland<br>Produktionsland                    | 13.0460-5768.2 605768<br>13.0460-5767.2 605767 |       | 24347 17,5 AKE<br>24336 17,5 AKE         |
|  | 1.0 VVTi<br>1.3 VVTi<br>1.3 VVTi<br>1.3 VVTi<br>1.3 VVTi 4WD<br>1.4 D-4D                 | 51<br>63<br>70<br>73<br>70<br>66       |  | 09.11<br>01.11<br>09.11<br>09.11<br>09.11<br>09.11          | Produktionsland<br>Produktionsland<br>Produktionsland<br>Produktionsland<br>Produktionsland<br>Produktionsland                    | 24.0122-0240.1 422240                          |       | 258 22,0 20,0 V +B                       |
|  | 1.0 VVTi<br>1.3 VVTi<br>1.3 VVTi<br>1.3 VVTi<br>1.3 VVTi 4WD<br>1.5 Hybrid<br>1.5 Hybrid | 51<br>63<br>70<br>73<br>70<br>54<br>55 |  | 09.11<br>01.11<br>09.11<br>09.11<br>09.11<br>04.15<br>03.12 | Produktionsland<br>Produktionsland<br>Produktionsland<br>Produktionsland<br>Produktionsland<br>Produktionsland<br>Produktionsland | 24.0122-0246.1 422246<br>24.0122-0254.1 422254 |       | 255 22,0 19,0 V +B<br>275 22,0 19,0 V +B |
|  | 1.0 VVTi<br>1.3 VVTi<br>1.3 VVTi<br>1.3 VVTi<br>1.3 VVTi 4WD<br>1.4 D-4D                 | 51<br>63<br>70<br>73<br>70<br>66       |  | 09.11<br>01.11<br>09.11<br>09.11<br>09.11<br>09.11          | Produktionsland<br>Produktionsland<br>Produktionsland<br>Produktionsland<br>Produktionsland<br>Produktionsland                    | 24.0710-5013.3 360416<br>24.0710-5012.3 360368 | <br>  | Radsensor L=1165<br>Radsensor L=1165     |
|  | 1.0 VVTi<br>1.3 VVTi<br>1.3 VVTi<br>1.3 VVTi<br>1.3 VVTi 4WD<br>1.4 D-4D<br>1.5 Hybrid   | 51<br>63<br>70<br>73<br>70<br>66<br>54 |  | 09.11<br>01.11<br>09.11<br>09.11<br>09.11<br>09.11<br>04.15 | Produktionsland<br>Produktionsland<br>Produktionsland<br>Produktionsland<br>Produktionsland<br>Produktionsland<br>Produktionsland | 13.0460-7214.2 607214                          | + ESP | 24574 15,0 +/-WK ATE                     |

|     |  |  |  |  |  |  |  |  |                       |     |
|--|--|--|--|--|---|--|--|--|-----------------------|-----|
| <b>TOYOTA YARIS (11-)</b>  |  |  |  |  |   |  |  |  |                       |     |
|    | 1.5 Hybrid   | 55   |  | 03.12  |   | 13.0460-7214.2   | 607214   | + ESP  | 24574 15,0 +WK        | ATE |
|    | 1.0 VVTi   | 51   |  | 09.11  | Produktionsland (F)   | 24.0109-0142.1   | 409142   | + ESP  | 278 9,0 7,0 +B        |     |
|  | 1.3 VVTi   | 63   |  | 01.11  | Produktionsland (F)   |  |  |  |                       |     |
|  | 1.3 VVTi   | 70   |  | 09.11  | Produktionsland (F)   |  |  |  |                       |     |
|  | 1.3 VVTi   | 73   |  | 09.11  | Produktionsland (F)   |  |  |  |                       |     |
|  | 1.3 VVTi 4WD   | 70   |  | 09.11  | Produktionsland (F)   |  |  |  |                       |     |
|  | 1.4 D-4D   | 66   |  | 09.11  |   |  |  |  |                       |     |
|  | 1.5 Hybrid   | 54   |  | 04.15  |   |  |  |  |                       |     |
|  | 1.5 Hybrid   | 55   |  | 03.12  |   |  |  |  |                       |     |
|    | 1.0 VVTi   | 51   |  | 09.11  | Produktionsland (F)   | 03.0137-0502.2   | 650502   | - ESP  | 203 x 38 HEB          |     |
|  | 1.3 VVTi   | 63   |  | 01.11  | Produktionsland (F)   | 03.0137-9280.2   | 669280   | - ESP  | Bremsbacken-Zubehör   |     |
|  | 1.3 VVTi   | 70   |  | 09.11  | Produktionsland (F)   |  |  |  |                       |     |
|  | 1.3 VVTi   | 73   |  | 09.11  | Produktionsland (F)   |  |  |  |                       |     |
|  | 1.3 VVTi 4WD   | 70   |  | 09.11  | Produktionsland (F)   |  |  |  |                       |     |
|  | 1.4 D-4D   | 66   |  | 09.11  |   |  |  |  |                       |     |
|    | 1.0 VVTi   | 51   |  | 09.11  | Produktionsland (F)   | 03.0520-9920.3   | 699920   | - ESP  | 20,64/203x38 TopKit   | AP  |
|  | 1.3 VVTi   | 63   |  | 01.11  | Produktionsland (F)   |  |  |  |                       |     |
|  | 1.3 VVTi   | 70   |  | 09.11  | Produktionsland (F)   |  |  |  |                       |     |
|  | 1.3 VVTi   | 73   |  | 09.11  | Produktionsland (F)   |  |  |  |                       |     |
|  | 1.3 VVTi 4WD   | 70   |  | 09.11  | Produktionsland (F)   |  |  |  |                       |     |
|  | 1.4 D-4D   | 66   |  | 09.11  | Produktionsland (F)   |  |  |  |                       |     |
| <b>TOYOTA YARIS VERSO (99-05)</b>  |  |  |  |  |   |  |  |  |                       |     |
|    | 1.3  | 62   |  | 01.03  | 09.05   | 13.0460-5800.2   | 605800   |  | 23340 17,0 +WK        | BOS |
|  | 1.3  | 63   |  | 11.99  | 03.03   | 13.0460-5810.2   | 605810   |  | 23904 16,5 +WK        | AKE |
|  | 1.4 D-4D   | 55   |  | 12.01  | 09.05   |  |  |  |                       |     |
|  | 1.5  | 77   |  | 05.03  | 09.05   |  |  |  |                       |     |
|  | 1.5  | 78   |  | 03.00  | 03.03   |  |  |  |                       |     |
|  | 1.5 4WD  | 78   |  | 03.00  | 09.05   |  |  |  |                       |     |
|    | 1.3  | 62   |  | 01.03  | 09.05   | 24.0120-0175.1   | 420175   |  | 255 20,0 18,0 V +B    |     |
|  | 1.3  | 63   |  | 11.99  | 03.03   | 24.0320-0175.1   | 520175   |  | 255 20,0 18,0 V +B PD |     |
|  | 1.4 D-4D   | 55   |  | 12.01  | 09.05   |  |  |  |                       |     |
|  | 1.5  | 77   |  | 05.03  | 09.05   |  |  |  |                       |     |
|  | 1.5  | 78   |  | 03.00  | 03.03   |  |  |  |                       |     |
|  | 1.5 4WD  | 78   |  | 03.00  | 09.05   |  |  |  |                       |     |
|   | 1.3  | 62   |  | 01.03  | 09.05   | 13.0460-5812.2   | 605812   | + ABS  | 23521 14,0 +WK        | SUM |
|  | 1.3  | 63   |  | 11.99  | 03.03   | 13.0460-0136.2   | 610136   | + ABS  | Belagsatz-Zubehör     | SUM |
|  | 1.4 D-4D   | 55   |  | 12.01  | 09.05   |  |  | + ABS  |                       |     |
|  | 1.5  | 77   |  | 05.03  | 09.05   |  |  | + ABS  |                       |     |
|  | 1.5  | 78   |  | 03.00  | 03.03   |  |  | + ABS  |                       |     |
|  | 1.5 4WD  | 78   |  | 03.00  | 09.05   |  |  | + ABS  |                       |     |
|  | 1.3  | 62   |  | 01.03  | 09.05   | 24.0109-0139.1   | 409139   | + ABS  | 269 9,0 8,0 +B        |     |
|  | 1.3  | 63   |  | 11.99  | 03.03   |  |  | + ABS  |                       |     |
|  | 1.4 D-4D   | 55   |  | 12.01  | 09.05   |  |  | + ABS  |                       |     |
|  | 1.5  | 77   |  | 05.03  | 09.05   |  |  | + ABS  |                       |     |
|  | 1.5  | 78   |  | 03.00  | 03.03   |  |  | + ABS  |                       |     |
|  | 1.5 4WD  | 78   |  | 03.00  | 09.05   |  |  | + ABS  |                       |     |
|  | 1.3  | 62   |  | 01.03  | 09.05   | 03.0137-0364.2   | 650364   | - ABS  | 200 x 32              |     |
|  | 1.3  | 63   |  | 11.99  | 03.03   | 03.0137-9236.2   | 669236   | - ABS  | Bremsbacken-Zubehör   |     |
|  | 1.4 D-4D   | 55   |  | 12.01  | 09.05   |  |  | - ABS  |                       |     |
|  | 1.5  | 77   |  | 05.03  | 09.05   |  |  | - ABS  |                       |     |
|  | 1.5  | 78   |  | 03.00  | 03.03   |  |  | - ABS  |                       |     |
|  | 1.5 4WD  | 78   |  | 03.00  | 09.05   |  |  | - ABS  |                       |     |
|  | 1.3  | 62   |  | 01.03  | 09.05   | 24.0220-0041.1   | 480167   | - ABS  | 200/201 x 41,8        |     |
|  | 1.3  | 63   |  | 11.99  | 03.03   |  |  | - ABS  |                       |     |
|  | 1.4 D-4D   | 55   |  | 12.01  | 09.05   |  |  | - ABS  |                       |     |
|  | 1.5  | 77   |  | 05.03  | 09.05   |  |  | - ABS  |                       |     |
|  | 1.5  | 78   |  | 03.00  | 03.03   |  |  | - ABS  |                       |     |
|  | 1.5 4WD  | 78   |  | 03.00  | 09.05   |  |  | - ABS  |                       |     |
|  | 1.3  | 62   |  | 01.03  | 09.05   | 03.0520-4317.3   | 694317   | - ABS/ + Automatikgetriebe 1)  | 17,46/200x32 TopKit   |     |
|  | 1.3  | 63   |  | 11.99  | 03.03   |  |  | - ABS/ + Automatikgetriebe 1)  |                       |     |
|  | 1.3  | 62   |  | 01.03  | 09.05   | 03.0520-7119.3   | 697119   | - ABS/ + Schaltgetriebe 2)   | 19,05/200x32 TopKit   |     |
|  | 1.3  | 63   |  | 11.99  | 03.03   |  |  | - ABS/ + Schaltgetriebe 2)   |                       |     |
|  | 1.4 D-4D   | 55   |  | 12.01  | 09.05   |  |  | - ABS  |                       |     |
|  | 1.5  | 77   |  | 05.03  | 09.05   |  |  | - ABS  |                       |     |
|  | 1.5  | 78   |  | 03.00  | 03.03   |  |  | - ABS  |                       |     |
|  | 1.5 4WD  | 78   |  | 03.00  | 09.05   |  |  | - ABS  |                       |     |
|  | 1.3  | 62   |  | 01.03  | 09.05   | 03.0137-0459.2   | 650459   | + ABS  | 172 x 32              |     |
|  | 1.3  | 63   |  | 11.99  | 03.03   |  |  | + ABS  |                       |     |
|  | 1.4 D-4D   | 55   |  | 12.01  | 09.05   |  |  | + ABS  |                       |     |
|  | 1.5  | 77   |  | 05.03  | 09.05   |  |  | + ABS  |                       |     |
|  | 1.5  | 78   |  | 03.00  | 03.03   |  |  | + ABS  |                       |     |
|  | 1.5 4WD  | 78   |  | 03.00  | 09.05   |  |  | + ABS  |                       |     |
| <b>VOLKSWAGEN AMAROK (10-)</b>   |  |  |  |  |   |  |  |  |                       |     |
|  | 2.0 BitDI  | 120  |  | 09.10  |   | 13.0460-3860.2   | 603860   |  | 24484 18,8 /WE/Zub/S  | BOS |
|  | 2.0 BitDI  | 132  |  | 11.11  |   | 13.0470-3860.2   | LD3860   |  | 24484 18,8 /WE/Zub/S  | BOS |
|  | 2.0 BitDI 4motion  | 120  |  | 09.10  |   |  |  |  |                       |     |
|  | 2.0 TDI  | 90   |  | 09.10  |   |  |  |  |                       |     |
|  | 2.0 TDI  | 103  |  | 07.12  |   |  |  |  |                       |     |
|  | 2.0 TDI 4motion  | 90   |  | 09.10  |   |  |  |  |                       |     |
|  | 2.0 TDI 4motion  | 103  |  | 06.12  |   |  |  |  |                       |     |
|  | 2.0 TDI 4motion  | 132  |  | 11.11  |   |  |  |  |                       |     |
|  | 2.0 TSI  | 118  |  | 12.10  |   |  |  |  |                       |     |

1) - ABS/ + autom.transmission / - ABS/ + scatola cambio autom. / - ABS/ + transmission automatique / - ABS/ + cambio automático

2) - ABS/ + manual transmission / - ABS/+ scatola camb.velocità / - ABS/ + transmission mécanique / - ABS/ + cambio de velocidad







**VOLKSWAGEN BORA (98-04)**

|  |   |  |   |   |  |  |  |   |            |
|--|---|--|---|---|--|--|--|---|------------|
|  | 1.9 TDI 110<br>1.9 TDI 4motion 66<br>1.9 TDI 4motion 74<br>1.9 TDI 4motion 85<br>1.9 TDI 4motion 96<br>1.9 TDI 4motion 110<br>2.0 85<br>2.0 4motion 85<br>2.3 V5<br>2.3 V5 4motion<br>2.8 V6 4motion 150  |  | 10.00<br>02.99<br>09.00<br>02.99<br>04.01<br>10.00<br>09.98<br>04.00<br>09.98<br>02.99<br>05.99   | 12.04<br>06.01<br>12.04<br>06.01<br>12.04<br>12.04<br>12.04<br>12.04<br>12.04<br>12.04<br>12.04   | PR: 1LN,1ZD,1ZE,1ZH<br>PR: 1LN,1ZD,1ZE,1ZH<br>PR: 1LN,1ZD,1ZE,1ZH<br>PR: 1LN,1ZD,1ZE,1ZH<br>PR: 1LN,1ZD,1ZE,1ZH<br>PR: 1LN,1ZD,1ZE,1ZH<br>PR: 1LN,1ZD,1ZE,1ZH<br>PR: 1LN,1ZD,1ZE,1ZH<br>PR: 1LN,1ZD,1ZE,1ZH<br>PR: 1LN,1ZD,1ZE,1ZH<br>PR: 1LN,1ZD,1ZE,1ZH  | 13.0460-7122.2 607122<br>13.0470-7122.2 LD7122 |  | 23392 20,3 +WK<br>23392 20,3 +WK                    | ATE<br>ATE |
|  | 1.4 16V<br>1.6<br>1.6 16V<br>1.6 FSI<br>1.8 92<br>1.8 4motion 92<br>1.8 T 110<br>1.8 T 132<br>1.9 SDI<br>1.9 TDI 66<br>1.9 TDI 74<br>1.9 TDI 81<br>1.9 TDI 85<br>1.9 TDI 96<br>1.9 TDI 110<br>1.9 TDI 4motion 66<br>1.9 TDI 4motion 74<br>1.9 TDI 4motion 85<br>1.9 TDI 4motion 96<br>1.9 TDI 4motion 110<br>2.0 85<br>2.0 4motion 85<br>2.3 V5<br>2.3 V5 4motion<br>2.8 V6 4motion 150 |  | 09.98<br>09.98<br>02.00<br>01.02<br>09.98<br>02.99<br>09.00<br>05.02<br>09.98<br>09.98<br>09.00<br>09.98<br>06.01<br>04.01<br>10.00<br>02.99<br>09.00<br>02.99<br>04.01<br>10.00<br>09.98<br>04.00<br>09.98<br>02.99<br>05.99 | 12.04<br>12.04<br>12.04<br>12.04<br>12.04<br>12.04<br>12.04<br>12.04<br>12.04<br>12.04<br>12.04<br>12.04<br>12.04<br>12.04<br>12.04<br>12.04<br>12.04<br>12.04<br>12.04<br>12.04<br>12.04<br>12.04<br>12.04<br>12.04<br>12.04 | PR: 1LR,1LS,1ZR,1ZM<br>PR: 1LR,1LS,1ZR,1ZM<br>PR: 1LR,1LS,1ZR,1ZM<br>PR: 1LR,1LS,1ZR,1ZM<br>PR: 1LR,1LS,1ZR,1ZM<br>PR: 1LR,1LS,1ZR,1ZM<br>PR: 1LR,1LS,1ZR,1ZM<br>PR: 1LR,1LS,1ZR,1ZM<br>PR: 1LR,1LS,1ZR,1ZM<br>PR: 1LR,1LS,1ZR,1ZM<br>PR: 1LR,1LS,1ZR,1ZM<br>PR: 1LR,1LS,1ZR,1ZM<br>PR: 1LR,1LS,1ZR,1ZM<br>PR: 1LR,1LS,1ZR,1ZM<br>PR: 1LR,1LS,1ZR,1ZM<br>PR: 1LR,1LS,1ZR,1ZM<br>PR: 1LR,1LS,1ZR,1ZM<br>PR: 1LR,1LS,1ZR,1ZM<br>PR: 1LR,1LS,1ZR,1ZM<br>PR: 1LR,1LS,1ZR,1ZM<br>PR: 1LR,1LS,1ZR,1ZM<br>PR: 1LR,1LS,1ZR,1ZM<br>PR: 1LR,1LS,1ZR,1ZM<br>PR: 1LR,1LS,1ZR,1ZM | 24.0122-0150.1 422150<br>24.0322-0150.1 522150 |  | 280 22,0 19,0 VL +S +B<br>280 22,0 19,0 VL +S +B PD |            |
|  | 1.4 16V<br>1.6<br>1.6 16V<br>1.6 FSI<br>1.8 92<br>1.8 4motion 92<br>1.8 T 110<br>1.8 T 132<br>1.9 SDI<br>1.9 TDI 66<br>1.9 TDI 74<br>1.9 TDI 81<br>1.9 TDI 85<br>1.9 TDI 96<br>1.9 TDI 110<br>1.9 TDI 4motion 66<br>1.9 TDI 4motion 74<br>1.9 TDI 4motion 85<br>1.9 TDI 4motion 96<br>1.9 TDI 4motion 110<br>2.0 85<br>2.0 4motion 85<br>2.3 V5<br>2.3 V5 4motion<br>2.8 V6 4motion 150 |  | 09.98<br>09.98<br>02.00<br>01.02<br>09.98<br>02.99<br>09.00<br>05.02<br>09.98<br>09.98<br>09.00<br>09.98<br>06.01<br>04.01<br>10.00<br>02.99<br>09.00<br>02.99<br>04.01<br>10.00<br>09.98<br>04.00<br>09.98<br>02.99<br>05.99 | 12.04<br>12.04<br>12.04<br>12.04<br>12.04<br>12.04<br>12.04<br>12.04<br>12.04<br>12.04<br>12.04<br>12.04<br>12.04<br>12.04<br>12.04<br>12.04<br>12.04<br>12.04<br>12.04<br>12.04<br>12.04<br>12.04<br>12.04<br>12.04          | PR: 1LQ<br>PR: 1LQ<br>PR: 1LQ<br>PR: 1LQ<br>PR: 1LQ<br>PR: 1LQ<br>PR: 1LQ<br>PR: 1LQ<br>PR: 1LQ<br>PR: 1LQ<br>PR: 1LQ<br>PR: 1LQ<br>PR: 1LQ<br>PR: 1LQ<br>PR: 1LQ<br>PR: 1LQ<br>PR: 1LQ<br>PR: 1LQ<br>PR: 1LQ<br>PR: 1LQ<br>PR: 1LQ<br>PR: 1LQ<br>PR: 1LQ  | 24.0122-0151.1 422151<br>24.0322-0151.1 522151 |  | 256 22,0 19,0 VL +S +B<br>256 22,0 19,0 VL +S +B PD |            |
|  | 1.4 16V<br>1.6<br>1.6 16V<br>1.6 FSI<br>1.8 92<br>1.8 4motion 92<br>1.8 T 110<br>1.8 T 132<br>1.9 SDI<br>1.9 TDI 66<br>1.9 TDI 74<br>1.9 TDI 81<br>1.9 TDI 85<br>1.9 TDI 96<br>1.9 TDI 110<br>1.9 TDI 4motion 66<br>1.9 TDI 4motion 74<br>1.9 TDI 4motion 85<br>1.9 TDI 4motion 96<br>1.9 TDI 4motion 110<br>2.0 85<br>2.0 4motion 85<br>2.3 V5<br>2.3 V5 4motion<br>2.8 V6 4motion 150 |  | 09.98<br>09.98<br>02.00<br>01.02<br>09.98<br>02.99<br>09.00<br>05.02<br>09.98<br>09.98<br>09.00<br>09.98<br>06.01<br>04.01<br>10.00<br>02.99<br>09.00<br>02.99<br>04.01<br>10.00<br>09.98<br>04.00<br>09.98<br>02.99<br>05.99 | 12.04<br>12.04<br>12.04<br>12.04<br>12.04<br>12.04<br>12.04<br>12.04<br>12.04<br>12.04<br>12.04<br>12.04<br>12.04<br>12.04<br>12.04<br>12.04<br>12.04<br>12.04<br>12.04<br>12.04<br>12.04<br>12.04<br>12.04<br>12.04          | PR: 1LN,1ZD,1ZE,1ZH<br>PR: 1LN,1ZD,1ZE,1ZH<br>PR: 1LN,1ZD,1ZE,1ZH<br>PR: 1LN,1ZD,1ZE,1ZH<br>PR: 1LN,1ZD,1ZE,1ZH<br>PR: 1LN,1ZD,1ZE,1ZH<br>PR: 1LN,1ZD,1ZE,1ZH<br>PR: 1LN,1ZD,1ZE,1ZH<br>PR: 1LN,1ZD,1ZE,1ZH<br>PR: 1LN,1ZD,1ZE,1ZH<br>PR: 1LN,1ZD,1ZE,1ZH<br>PR: 1LN,1ZD,1ZE,1ZH<br>PR: 1LN,1ZD,1ZE,1ZH<br>PR: 1LN,1ZD,1ZE,1ZH<br>PR: 1LN,1ZD,1ZE,1ZH<br>PR: 1LN,1ZD,1ZE,1ZH<br>PR: 1LN,1ZD,1ZE,1ZH<br>PR: 1LN,1ZD,1ZE,1ZH<br>PR: 1LN,1ZD,1ZE,1ZH<br>PR: 1LN,1ZD,1ZE,1ZH<br>PR: 1LN,1ZD,1ZE,1ZH<br>PR: 1LN,1ZD,1ZE,1ZH<br>PR: 1LN,1ZD,1ZE,1ZH<br>PR: 1LN,1ZD,1ZE,1ZH | 24.0125-0113.1 425113<br>24.0325-0113.1 525113 |  | 288 25,0 22,0 VL +S +B<br>288 25,0 22,0 VL +S +B PD |            |

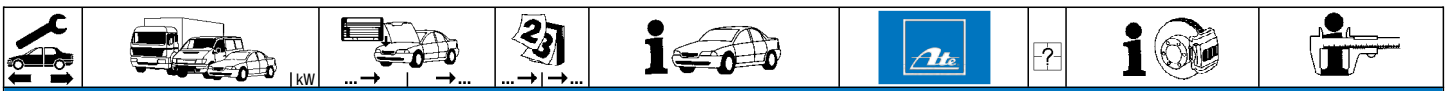

**VOLKSWAGEN BORA (98-04)**

|  |   |   |  |   |  |
|--|---|---|--|---|--|
|  | 1.4 16V<br>1.6<br>1.6 16V<br>1.6 FSI<br>1.8 92<br>1.8 4motion 92<br>1.8 T 110<br>1.8 T 132<br>1.9 SDI<br>1.9 TDI 66<br>1.9 TDI 74<br>1.9 TDI 81<br>1.9 TDI 85<br>1.9 TDI 96<br>1.9 TDI 110<br>1.9 TDI 4motion 66<br>1.9 TDI 4motion 74<br>1.9 TDI 4motion 85<br>1.9 TDI 4motion 96<br>1.9 TDI 4motion 110<br>2.0 85<br>2.0 4motion 85<br>2.3 V5<br>2.3 V5 4motion<br>2.8 V6 4motion 150 | 09.98 12.04 PR: 1LJ,1ZQ<br>09.98 12.04 PR: 1LJ,1ZQ<br>02.00 12.04 PR: 1LJ,1ZQ<br>01.02 12.04 PR: 1LJ,1ZQ<br>09.98 12.04 PR: 1LJ,1ZQ<br>02.99 12.04 PR: 1LJ,1ZQ<br>09.00 12.04 PR: 1LJ,1ZQ<br>05.02 12.04 PR: 1LJ,1ZQ<br>09.98 12.04 PR: 1LJ,1ZQ<br>09.98 06.01 PR: 1LJ,1ZQ<br>09.00 12.04 PR: 1LJ,1ZQ<br>09.98 06.01 PR: 1LJ,1ZQ<br>02.99 06.01 PR: 1LJ,1ZQ<br>04.01 12.04 PR: 1LJ,1ZQ<br>10.00 12.04 PR: 1LJ,1ZQ<br>02.99 06.01 PR: 1LJ,1ZQ<br>09.00 12.04 PR: 1LJ,1ZQ<br>02.99 06.01 PR: 1LJ,1ZQ<br>04.01 12.04 PR: 1LJ,1ZQ<br>10.00 12.04 PR: 1LJ,1ZQ<br>09.98 12.04 PR: 1LJ,1ZQ<br>04.00 12.04 PR: 1LJ,1ZQ<br>09.98 12.04 PR: 1LJ,1ZQ<br>02.99 12.04 PR: 1LJ,1ZQ<br>05.99 12.04 PR: 1LJ,1ZQ   | 24.0125-0123.1 425123<br>24.0325-0123.1 525123 |   | 310 25,0 22,0 VL +S +B<br>310 25,0 22,0 VL +B PD |
|  | 1.4 16V<br>1.6<br>1.6 16V<br>1.6 FSI<br>1.8 92<br>1.8 4motion 92<br>1.8 T 110<br>1.8 T 132<br>1.9 SDI<br>1.9 TDI 66<br>1.9 TDI 74<br>1.9 TDI 81<br>1.9 TDI 85<br>1.9 TDI 96<br>1.9 TDI 110<br>1.9 TDI 4motion 66<br>1.9 TDI 4motion 74<br>1.9 TDI 4motion 85<br>1.9 TDI 4motion 96<br>1.9 TDI 4motion 110<br>2.0 85<br>2.0 4motion 85<br>2.3 V5<br>2.3 V5 4motion<br>2.8 V6 4motion 150 | 09.98 12.04<br>09.98 12.04<br>02.00 12.04<br>01.02 12.04<br>09.98 12.04<br>02.99 12.04<br>09.00 12.04<br>05.02 12.04<br>09.98 12.04<br>09.98 06.01<br>09.00 12.04<br>09.98 06.01<br>02.99 06.01<br>04.01 12.04<br>10.00 12.04<br>02.99 06.01<br>09.00 12.04<br>02.99 06.01<br>04.01 12.04<br>10.00 12.04<br>09.98 12.04<br>04.00 12.04<br>09.98 12.04<br>02.99 12.04<br>05.99 12.04   | 24.0711-1361.3 360022<br>24.0711-1362.3 360023 | <input checked="" type="checkbox"/><br><input type="checkbox"/> | Radsensor<br>Radsensor                           |
|  | 1.4 16V<br>1.6<br>1.6 16V<br>1.6 FSI<br>1.8 92<br>1.8 4motion 92<br>1.8 T 110<br>1.8 T 132<br>1.9 SDI<br>1.9 TDI 66<br>1.9 TDI 74<br>1.9 TDI 81<br>1.9 TDI 85<br>1.9 TDI 96<br>1.9 TDI 110<br>1.9 TDI 4motion 66<br>1.9 TDI 4motion 74<br>1.9 TDI 4motion 85<br>1.9 TDI 4motion 96<br>1.9 TDI 4motion 110<br>2.0 85<br>2.0 4motion 85<br>2.3 V5<br>2.3 V5 4motion<br>2.8 V6 4motion 150 | 09.98 12.04 PR: 1KE,1KP,1KT<br>09.98 12.04 PR: 1KE,1KP,1KT<br>02.00 12.04 PR: 1KE,1KP,1KT<br>01.02 12.04 PR: 1KE,1KP,1KT<br>09.98 12.04 PR: 1KE,1KP,1KT<br>02.99 12.04 PR: 1KE,1KP,1KT<br>09.00 12.04 PR: 1KE,1KP,1KT<br>05.02 12.04 PR: 1KE,1KP,1KT<br>09.98 12.04 PR: 1KE,1KP,1KT<br>09.98 06.01 PR: 1KE,1KP,1KT<br>09.00 12.04 PR: 1KE,1KP,1KT<br>09.98 06.01 PR: 1KE,1KP,1KT<br>02.99 06.01 PR: 1KE,1KP,1KT<br>04.01 12.04 PR: 1KE,1KP,1KT<br>10.00 12.04 PR: 1KE,1KP,1KT<br>02.99 06.01 PR: 1KE,1KP,1KT<br>09.00 12.04 PR: 1KE,1KP,1KT<br>02.99 06.01 PR: 1KE,1KP,1KT<br>04.01 12.04 PR: 1KE,1KP,1KT<br>10.00 12.04 PR: 1KE,1KP,1KT<br>09.98 12.04 PR: 1KE,1KP,1KT<br>04.00 12.04 PR: 1KE,1KP,1KT<br>09.98 12.04 PR: 1KE,1KP,1KT<br>02.99 12.04 PR: 1KE,1KP,1KT<br>05.99 12.04 PR: 1KE,1KP,1KT | 13.0460-2894.2 602894<br>13.0470-2894.2 LD2894 |   | 20961 17,4 /Zub/S TRW<br>20961 17,4 /Zub/S TRW   |
|  | 1.4 16V<br>1.6<br>1.6 16V<br>1.6 FSI<br>1.8 92<br>1.8 4motion 92<br>1.8 T 110<br>1.8 T 132<br>1.9 SDI<br>1.9 TDI 66<br>1.9 TDI 74<br>1.9 TDI 81<br>1.9 TDI 85<br>1.9 TDI 96<br>1.9 TDI 110<br>1.9 TDI 4motion 66<br>1.9 TDI 4motion 74<br>1.9 TDI 4motion 85<br>1.9 TDI 4motion 96<br>1.9 TDI 4motion 110<br>2.0 85<br>2.0 4motion 85<br>2.3 V5<br>2.3 V5 4motion<br>2.8 V6 4motion 150 | 09.98 12.04 PR: 1KY<br>09.98 12.04 PR: 1KY<br>02.00 12.04 PR: 1KY<br>01.02 12.04 PR: 1KY<br>09.98 12.04 PR: 1KY<br>02.99 12.04 PR: 1KY<br>09.00 12.04 PR: 1KY<br>05.02 12.04 PR: 1KY<br>09.98 12.04 PR: 1KY<br>09.98 06.01 PR: 1KY<br>09.00 12.04 PR: 1KY<br>09.98 06.01 PR: 1KY<br>02.99 06.01 PR: 1KY<br>04.01 12.04 PR: 1KY<br>10.00 12.04 PR: 1KY<br>09.98 12.04 PR: 1KY<br>04.00 12.04 PR: 1KY<br>09.98 12.04 PR: 1KY<br>02.99 12.04 PR: 1KY<br>05.99 12.04 PR: 1KY  | 13.0460-2886.2 602886<br>13.0470-2886.2 LD2886 |   | 20961 16,2 /S TRW<br>20961 16,2 /S TRW           |



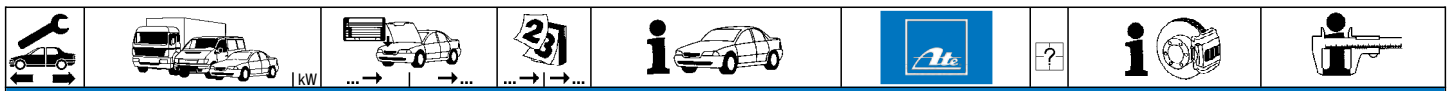

**VOLKSWAGEN BORA (98-04)**

|                 |                 |         |       |             |             |                |                |        |                      |                      |     |
|-----------------|-----------------|---------|-------|-------------|-------------|----------------|----------------|--------|----------------------|----------------------|-----|
|                 | 1.9 TDI         | 85      | 02.99 | 06.01       | PR: 1KY     | 13.0460-2886.2 | 602886         |        | 20961 16,2 /S        | TRW                  |     |
|                 | 1.9 TDI         | 96      | 04.01 | 12.04       | PR: 1KY     | 13.0470-2886.2 | LD2886         |        | 20961 16,2 /S        | TRW                  |     |
|                 | 1.9 TDI         | 110     | 10.00 | 12.04       | PR: 1KY     |                |                |        |                      |                      |     |
|                 | 1.9 TDI 4motion | 66      | 02.99 | 06.01       | PR: 1KY     |                |                |        |                      |                      |     |
|                 | 1.9 TDI 4motion | 74      | 09.00 | 12.04       | PR: 1KY     |                |                |        |                      |                      |     |
|                 | 1.9 TDI 4motion | 85      | 02.99 | 06.01       | PR: 1KY     |                |                |        |                      |                      |     |
|                 | 1.9 TDI 4motion | 96      | 04.01 | 12.04       | PR: 1KY     |                |                |        |                      |                      |     |
|                 | 1.9 TDI 4motion | 110     | 10.00 | 12.04       | PR: 1KY     |                |                |        |                      |                      |     |
|                 | 2.0             | 85      | 09.98 | 12.04       | PR: 1KY     |                |                |        |                      |                      |     |
|                 | 2.0 4motion     | 85      | 04.00 | 12.04       | PR: 1KY     |                |                |        |                      |                      |     |
|                 | 2.3 V5          |         | 09.98 | 12.04       | PR: 1KY     |                |                |        |                      |                      |     |
|                 | 2.3 V5 4motion  |         | 02.99 | 12.04       | PR: 1KY     |                |                |        |                      |                      |     |
|                 | 2.8 V6 4motion  | 150     | 05.99 | 12.04       | PR: 1KY     |                |                |        |                      |                      |     |
|                 |                 | 1.4 16V |       | 09.98       | 12.04       | PR: 1KU,2EE    | 13.0460-2820.2 | 602820 |                      | 20961 17,6 /S        | TRW |
| 1.6             |                 |         | 09.98 | 12.04       | PR: 1KU,2EE | 13.0470-2820.2 | LD2820         |        | 20961 17,6 /S        | TRW                  |     |
| 1.6 16V         |                 |         | 02.00 | 12.04       | PR: 1KU,2EE |                |                |        |                      |                      |     |
| 1.6 FSI         |                 |         | 01.02 | 12.04       | PR: 1KU,2EE |                |                |        |                      |                      |     |
| 1.8             |                 | 92      | 09.98 | 12.04       | PR: 1KU,2EE |                |                |        |                      |                      |     |
| 1.8 4motion     |                 | 92      | 02.99 | 12.04       | PR: 1KU,2EE |                |                |        |                      |                      |     |
| 1.8 T           |                 | 110     | 09.00 | 12.04       | PR: 1KU,2EE |                |                |        |                      |                      |     |
| 1.8 T           |                 | 132     | 05.02 | 12.04       | PR: 1KU,2EE |                |                |        |                      |                      |     |
| 1.9 SDI         |                 |         | 09.98 | 12.04       | PR: 1KU,2EE |                |                |        |                      |                      |     |
| 1.9 TDI         |                 | 66      | 09.98 | 06.01       | PR: 1KU,2EE |                |                |        |                      |                      |     |
| 1.9 TDI         |                 | 74      | 09.00 | 12.04       | PR: 1KU,2EE |                |                |        |                      |                      |     |
| 1.9 TDI         |                 | 81      | 09.98 | 06.01       | PR: 1KU,2EE |                |                |        |                      |                      |     |
| 1.9 TDI         |                 | 85      | 02.99 | 06.01       | PR: 1KU,2EE |                |                |        |                      |                      |     |
| 1.9 TDI         |                 | 96      | 04.01 | 12.04       | PR: 1KU,2EE |                |                |        |                      |                      |     |
| 1.9 TDI         |                 | 110     | 10.00 | 12.04       | PR: 1KU,2EE |                |                |        |                      |                      |     |
| 1.9 TDI 4motion |                 | 66      | 02.99 | 06.01       | PR: 1KU,2EE |                |                |        |                      |                      |     |
| 1.9 TDI 4motion |                 | 74      | 09.00 | 12.04       | PR: 1KU,2EE |                |                |        |                      |                      |     |
| 1.9 TDI 4motion |                 | 85      | 02.99 | 06.01       | PR: 1KU,2EE |                |                |        |                      |                      |     |
| 1.9 TDI 4motion |                 | 96      | 04.01 | 12.04       | PR: 1KU,2EE |                |                |        |                      |                      |     |
| 1.9 TDI 4motion |                 | 110     | 10.00 | 12.04       | PR: 1KU,2EE |                |                |        |                      |                      |     |
| 2.0             |                 | 85      | 09.98 | 12.04       | PR: 1KU,2EE |                |                |        |                      |                      |     |
| 2.0 4motion     |                 | 85      | 04.00 | 12.04       | PR: 1KU,2EE |                |                |        |                      |                      |     |
| 2.3 V5          |                 |         | 09.98 | 12.04       | PR: 1KU,2EE |                |                |        |                      |                      |     |
| 2.3 V5 4motion  |                 |         | 02.99 | 12.04       | PR: 1KU,2EE |                |                |        |                      |                      |     |
| 2.8 V6 4motion  |                 | 150     | 05.99 | 12.04       | PR: 1KU,2EE |                |                |        |                      |                      |     |
|                 |                 | 1.4 16V |       | 09.98       | 12.04       | PR: 1KP,1KT    | 24.0109-0123.1 | 409123 |                      | 230 9,0 7,0 +S +B    |     |
|                 |                 | 1.6     |       | 09.98       | 12.04       | PR: 1KP,1KT    | 24.0309-0123.1 | 509123 |                      | 230 9,0 7,0 +S +B PD |     |
|                 |                 | 1.6 16V |       | 02.00       | 12.04       | PR: 1KP,1KT    |                |        |                      |                      |     |
|                 | 1.6 FSI         |         | 01.02 | 12.04       | PR: 1KP,1KT |                |                |        |                      |                      |     |
|                 | 1.8             | 92      | 09.98 | 12.04       | PR: 1KP,1KT |                |                |        |                      |                      |     |
|                 | 1.8 4motion     | 92      | 02.99 | 12.04       | PR: 1KP,1KT |                |                |        |                      |                      |     |
|                 | 1.8 T           | 110     | 09.00 | 12.04       | PR: 1KP,1KT |                |                |        |                      |                      |     |
|                 | 1.8 T           | 132     | 05.02 | 12.04       | PR: 1KP,1KT |                |                |        |                      |                      |     |
|                 | 1.9 SDI         |         | 09.98 | 12.04       | PR: 1KP,1KT |                |                |        |                      |                      |     |
|                 | 1.9 TDI         | 66      | 09.98 | 06.01       | PR: 1KP,1KT |                |                |        |                      |                      |     |
|                 | 1.9 TDI         | 74      | 09.00 | 12.04       | PR: 1KP,1KT |                |                |        |                      |                      |     |
|                 | 1.9 TDI         | 81      | 09.98 | 06.01       | PR: 1KP,1KT |                |                |        |                      |                      |     |
|                 | 1.9 TDI         | 85      | 02.99 | 06.01       | PR: 1KP,1KT |                |                |        |                      |                      |     |
|                 | 1.9 TDI         | 96      | 04.01 | 12.04       | PR: 1KP,1KT |                |                |        |                      |                      |     |
| 1.9 TDI         | 110             | 10.00   | 12.04 | PR: 1KP,1KT |             |                |                |        |                      |                      |     |
| 1.9 TDI 4motion | 66              | 02.99   | 06.01 | PR: 1KP,1KT |             |                |                |        |                      |                      |     |
| 1.9 TDI 4motion | 74              | 09.00   | 12.04 | PR: 1KP,1KT |             |                |                |        |                      |                      |     |
| 1.9 TDI 4motion | 85              | 02.99   | 06.01 | PR: 1KP,1KT |             |                |                |        |                      |                      |     |
| 1.9 TDI 4motion | 96              | 04.01   | 12.04 | PR: 1KP,1KT |             |                |                |        |                      |                      |     |
| 1.9 TDI 4motion | 110             | 10.00   | 12.04 | PR: 1KP,1KT |             |                |                |        |                      |                      |     |
| 2.0             | 85              | 09.98   | 12.04 | PR: 1KP,1KT |             |                |                |        |                      |                      |     |
| 2.0 4motion     | 85              | 04.00   | 12.04 | PR: 1KP,1KT |             |                |                |        |                      |                      |     |
| 2.3 V5          |                 | 09.98   | 12.04 | PR: 1KP,1KT |             |                |                |        |                      |                      |     |
| 2.3 V5 4motion  |                 | 02.99   | 12.04 | PR: 1KP,1KT |             |                |                |        |                      |                      |     |
| 2.8 V6 4motion  | 150             | 05.99   | 12.04 | PR: 1KP,1KT |             |                |                |        |                      |                      |     |
|                 | 1.4 16V         |         | 09.98 | 12.04       | PR: 1KE     | 24.0109-0133.1 | 409133         |        | 239 8,9 7,0 +S +B    |                      |     |
|                 | 1.6             |         | 09.98 | 12.04       | PR: 1KE     | 24.0309-0133.1 | 509133         |        | 239 8,9 7,0 +S +B PD |                      |     |
|                 | 1.6 16V         |         | 02.00 | 12.04       | PR: 1KE     |                |                |        |                      |                      |     |
|                 | 1.6 FSI         |         | 01.02 | 12.04       | PR: 1KE     |                |                |        |                      |                      |     |
|                 | 1.8             | 92      | 09.98 | 12.04       | PR: 1KE     |                |                |        |                      |                      |     |
|                 | 1.8 4motion     | 92      | 02.99 | 12.04       | PR: 1KE     |                |                |        |                      |                      |     |
|                 | 1.8 T           | 110     | 09.00 | 12.04       | PR: 1KE     |                |                |        |                      |                      |     |
|                 | 1.8 T           | 132     | 05.02 | 12.04       | PR: 1KE     |                |                |        |                      |                      |     |
|                 | 1.9 SDI         |         | 09.98 | 12.04       | PR: 1KE     |                |                |        |                      |                      |     |
|                 | 1.9 TDI         | 66      | 09.98 | 06.01       | PR: 1KE     |                |                |        |                      |                      |     |
|                 | 1.9 TDI         | 74      | 09.00 | 12.04       | PR: 1KE     |                |                |        |                      |                      |     |
|                 | 1.9 TDI         | 81      | 09.98 | 06.01       | PR: 1KE     |                |                |        |                      |                      |     |
|                 | 1.9 TDI         | 85      | 02.99 | 06.01       | PR: 1KE     |                |                |        |                      |                      |     |
|                 | 1.9 TDI         | 96      | 04.01 | 12.04       | PR: 1KE     |                |                |        |                      |                      |     |
| 1.9 TDI         | 110             | 10.00   | 12.04 | PR: 1KE     |             |                |                |        |                      |                      |     |
| 1.9 TDI 4motion | 66              | 02.99   | 06.01 | PR: 1KE     |             |                |                |        |                      |                      |     |
| 1.9 TDI 4motion | 74              | 09.00   | 12.04 | PR: 1KE     |             |                |                |        |                      |                      |     |
| 1.9 TDI 4motion | 85              | 02.99   | 06.01 | PR: 1KE     |             |                |                |        |                      |                      |     |
| 1.9 TDI 4motion | 96              | 04.01   | 12.04 | PR: 1KE     |             |                |                |        |                      |                      |     |
| 1.9 TDI 4motion | 110             | 10.00   | 12.04 | PR: 1KE     |             |                |                |        |                      |                      |     |
| 2.0             | 85              | 09.98   | 12.04 | PR: 1KE     |             |                |                |        |                      |                      |     |
| 2.0 4motion     | 85              | 04.00   | 12.04 | PR: 1KE     |             |                |                |        |                      |                      |     |
| 2.3 V5          |                 | 09.98   | 12.04 | PR: 1KE     |             |                |                |        |                      |                      |     |
| 2.3 V5 4motion  |                 | 02.99   | 12.04 | PR: 1KE     |             |                |                |        |                      |                      |     |

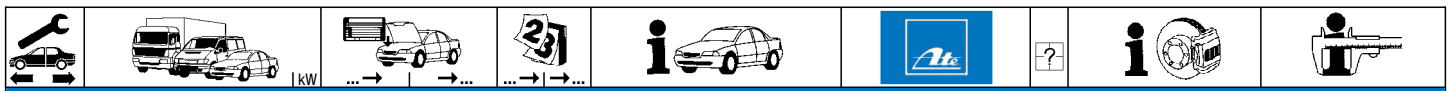















**VOLKSWAGEN BORA (98-04)**

|  |                 |     |  |       |       |                 |                |        |   |                         |
|--|-----------------|-----|--|-------|-------|-----------------|----------------|--------|---|-------------------------|
|  | 2.8 V6 4motion  | 150 |  | 05.99 | 12.04 | PR: 1KE         | 24.0109-0133.1 | 409133 |   | 239 8,9 7,0 +S +B       |
|  | 1.4 16V         |     |  | 09.98 | 12.04 | PR: 1KU,1KY,2EE | 24.0122-0163.1 | 422163 |   | 256 22,0 20,0 V L +B    |
|  | 1.6             |     |  | 09.98 | 12.04 | PR: 1KU,1KY,2EE | 24.0322-0163.1 | 522163 |   | 256 22,0 20,0 V L +B PD |
|  | 1.6 16V         |     |  | 02.00 | 12.04 | PR: 1KU,1KY,2EE |                |        |   |                         |
|  | 1.6 FSI         |     |  | 01.02 | 12.04 | PR: 1KU,1KY,2EE |                |        |   |                         |
|  | 1.8             | 92  |  | 09.98 | 12.04 | PR: 1KU,1KY,2EE |                |        |   |                         |
|  | 1.8 4motion     | 92  |  | 02.99 | 12.04 | PR: 1KU,1KY,2EE |                |        |   |                         |
|  | 1.8 T           | 110 |  | 09.00 | 12.04 | PR: 1KU,1KY,2EE |                |        |   |                         |
|  | 1.8 T           | 132 |  | 05.02 | 12.04 | PR: 1KU,1KY,2EE |                |        |   |                         |
|  | 1.9 SDI         |     |  | 09.98 | 12.04 | PR: 1KU,1KY,2EE |                |        |   |                         |
|  | 1.9 TDI         | 66  |  | 09.98 | 06.01 | PR: 1KU,1KY,2EE |                |        |   |                         |
|  | 1.9 TDI         | 74  |  | 09.00 | 12.04 | PR: 1KU,1KY,2EE |                |        |   |                         |
|  | 1.9 TDI         | 81  |  | 09.98 | 06.01 | PR: 1KU,1KY,2EE |                |        |   |                         |
|  | 1.9 TDI         | 85  |  | 02.99 | 06.01 | PR: 1KU,1KY,2EE |                |        |   |                         |
|  | 1.9 TDI         | 96  |  | 04.01 | 12.04 | PR: 1KU,1KY,2EE |                |        |   |                         |
|  | 1.9 TDI         | 110 |  | 10.00 | 12.04 | PR: 1KU,1KY,2EE |                |        |   |                         |
|  | 1.9 TDI 4motion | 66  |  | 02.99 | 06.01 | PR: 1KU,1KY,2EE |                |        |   |                         |
|  | 1.9 TDI 4motion | 74  |  | 09.00 | 12.04 | PR: 1KU,1KY,2EE |                |        |   |                         |
|  | 1.9 TDI 4motion | 85  |  | 02.99 | 06.01 | PR: 1KU,1KY,2EE |                |        |   |                         |
|  | 1.9 TDI 4motion | 96  |  | 04.01 | 12.04 | PR: 1KU,1KY,2EE |                |        |   |                         |
|  | 1.9 TDI 4motion | 110 |  | 10.00 | 12.04 | PR: 1KU,1KY,2EE |                |        |   |                         |
|  | 2.0             | 85  |  | 09.98 | 12.04 | PR: 1KU,1KY,2EE |                |        |   |                         |
|  | 2.0 4motion     | 85  |  | 04.00 | 12.04 | PR: 1KU,1KY,2EE |                |        |   |                         |
|  | 2.3 V5          |     |  | 09.98 | 12.04 | PR: 1KU,1KY,2EE |                |        |   |                         |
|  | 2.3 V5 4motion  |     |  | 02.99 | 12.04 | PR: 1KU,1KY,2EE |                |        |   |                         |
|  | 2.8 V6 4motion  | 150 |  | 05.99 | 12.04 | PR: 1KU,1KY,2EE |                |        |   |                         |
|  | 1.4 16V         |     |  | 09.98 | 12.04 |                 | 24.0741-1107.3 | 360042 | 2 | Radsensor               |
|  | 1.6             |     |  | 09.98 | 12.04 |                 |                |        |   |                         |
|  | 1.6 16V         |     |  | 02.00 | 12.04 |                 |                |        |   |                         |
|  | 1.6 FSI         |     |  | 01.02 | 12.04 |                 |                |        |   |                         |
|  | 1.8             | 92  |  | 09.98 | 12.04 |                 |                |        |   |                         |
|  | 1.8 T           | 110 |  | 09.00 | 12.04 |                 |                |        |   |                         |
|  | 1.8 T           | 132 |  | 05.02 | 12.04 |                 |                |        |   |                         |
|  | 1.9 SDI         |     |  | 09.98 | 12.04 |                 |                |        |   |                         |
|  | 1.9 TDI         | 66  |  | 09.98 | 06.01 |                 |                |        |   |                         |
|  | 1.9 TDI         | 74  |  | 09.00 | 12.04 |                 |                |        |   |                         |
|  | 1.9 TDI         | 81  |  | 09.98 | 06.01 |                 |                |        |   |                         |
|  | 1.9 TDI         | 85  |  | 02.99 | 06.01 |                 |                |        |   |                         |
|  | 1.9 TDI         | 96  |  | 04.01 | 12.04 |                 |                |        |   |                         |
|  | 1.9 TDI         | 110 |  | 10.00 | 12.04 |                 |                |        |   |                         |
|  | 2.0             | 85  |  | 09.98 | 12.04 |                 |                |        |   |                         |
|  | 2.3 V5          |     |  | 09.98 | 12.04 |                 |                |        |   |                         |
|  | 1.8 4motion     | 92  |  | 02.99 | 12.04 |                 | 24.0711-1365.3 | 360172 | 2 | Radsensor L=226         |
|  | 1.9 TDI 4motion | 66  |  | 02.99 | 06.01 |                 |                |        |   |                         |
|  | 1.9 TDI 4motion | 74  |  | 09.00 | 12.04 |                 |                |        |   |                         |
|  | 1.9 TDI 4motion | 85  |  | 02.99 | 06.01 |                 |                |        |   |                         |
|  | 1.9 TDI 4motion | 96  |  | 04.01 | 12.04 |                 |                |        |   |                         |
|  | 1.9 TDI 4motion | 110 |  | 10.00 | 12.04 |                 |                |        |   |                         |
|  | 2.0 4motion     | 85  |  | 04.00 | 12.04 |                 |                |        |   |                         |
|  | 2.3 V5 4motion  |     |  | 02.99 | 12.04 |                 |                |        |   |                         |
|  | 2.8 V6 4motion  | 150 |  | 05.99 | 12.04 |                 |                |        |   |                         |

**VOLKSWAGEN CADDY II (96-04)**















|  |         |             |             |       |       |  |                |        |   |                            |     |
|--|---------|-------------|-------------|-------|-------|--|----------------|--------|---|----------------------------|-----|
|  | 1.4     |             | 9K-T-514500 | 11.95 |       |  | 13.0460-2958.2 | 602958 |   | 20168 19,3 /S              | TRW |
|  | 1.6     |             | 9K-T-514500 | 11.95 |       |  |                |        |   |                            |     |
|  | 1.9 D   |             | 9K-T-514500 | 11.95 |       |  |                |        |   |                            |     |
|  | 1.9 SDI |             | 9K-T-514500 | 11.95 |       |  |                |        |   |                            |     |
|  | 1.4     | 9K-T-514501 |             |       | 01.04 |  | 13.0460-2821.2 | 602821 |   | 21945 16,0 /S              | TRW |
|  | 1.6     | 9K-T-514501 |             |       | 01.04 |  |                |        |   |                            |     |
|  | 1.7 SDI |             |             | 07.96 | 01.04 |  |                |        |   |                            |     |
|  | 1.9 D   | 9K-T-514501 |             |       | 01.04 |  |                |        |   |                            |     |
|  | 1.9 SDI | 9K-T-514501 |             |       | 01.04 |  |                |        |   |                            |     |
|  | 1.9 TDI |             |             | 09.96 | 01.04 |  |                |        |   |                            |     |
|  | 1.4     |             | 9K-T-514500 | 11.95 |       |  | 24.0113-0178.1 | 413178 |   | 256 12,9 11,0 +S +B        |     |
|  | 1.6     |             | 9K-T-514500 | 11.95 |       |  | 24.0313-0178.1 | 513178 |   | 256 12,9 11,0 +S +B PD     |     |
|  | 1.9 D   |             | 9K-T-514500 | 11.95 |       |  |                |        |   |                            |     |
|  | 1.9 SDI |             | 9K-T-514500 | 11.95 |       |  |                |        |   |                            |     |
|  | 1.4     | 9K-T-514501 |             |       | 01.04 |  | 24.0120-0128.1 | 420128 |   | 256 20,0 18,0 V L +S +B    |     |
|  | 1.6     | 9K-T-514501 |             |       | 01.04 |  | 24.0320-0128.1 | 520128 |   | 256 20,0 18,0 V L +S +B PD |     |
|  | 1.7 SDI |             |             | 07.96 | 01.04 |  |                |        |   |                            |     |
|  | 1.9 D   | 9K-T-514501 |             |       | 01.04 |  |                |        |   |                            |     |
|  | 1.9 SDI | 9K-T-514501 |             |       | 01.04 |  |                |        |   |                            |     |
|  | 1.9 TDI |             |             | 09.96 | 01.04 |  |                |        |   |                            |     |
|  | 1.4     |             |             | 11.95 | 01.04 |  | 24.0711-1361.3 | 360022 |   | Radsensor                  |     |
|  | 1.6     |             |             | 11.95 | 01.04 |  | 24.0711-1362.3 | 360023 |   | Radsensor                  |     |
|  | 1.7 SDI |             |             | 07.96 | 01.04 |  |                |        |   |                            |     |
|  | 1.9 D   |             |             | 11.95 | 01.04 |  |                |        |   |                            |     |
|  | 1.9 SDI |             |             | 11.95 | 01.04 |  |                |        |   |                            |     |
|  | 1.9 TDI |             |             | 09.96 | 01.04 |  |                |        |   |                            |     |
|  | 1.4     |             |             | 11.95 | 01.04 |  | 24.0721-1953.3 | 360155 | 2 | Radsensor L=1835           |     |
|  | 1.6     |             |             | 11.95 | 01.04 |  |                |        |   |                            |     |
|  | 1.7 SDI |             |             | 07.96 | 01.04 |  |                |        |   |                            |     |
|  | 1.9 D   |             |             | 11.95 | 01.04 |  |                |        |   |                            |     |
|  | 1.9 SDI |             |             | 11.95 | 01.04 |  |                |        |   |                            |     |
|  | 1.9 TDI |             |             | 09.96 | 01.04 |  |                |        |   |                            |     |



| VOLKSWAGEN CADDY II (96-04)  |                 |     |             |       |                 |                |        |                               |                          |     |
|--|-----------------|-----|-------------|-------|-----------------|----------------|--------|-------------------------------|--------------------------|-----|
|    | 1.4             |     | 9K-Y-500747 | 11.95 |                 | 03.0137-0264.2 | 650264 |                               | 230 x 40 HEB             | VW  |
|  | 1.6             |     | 9K-Y-500747 | 11.95 |                 | 03.0137-9164.2 | 669164 |                               | Bremsbacken-Zubehör      |     |
|  | 1.7 SDI         |     | 9K-Y-500747 | 07.96 |                 |                |        |                               |                          |     |
|  | 1.9 D           |     | 9K-Y-500747 | 11.95 |                 |                |        |                               |                          |     |
|  | 1.9 SDI         |     | 9K-Y-500747 | 11.95 |                 |                |        |                               |                          |     |
|  | 1.9 TDI         |     | 9K-Y-500747 | 09.96 |                 |                |        |                               |                          |     |
|    | 1.4             |     | 9K-Y-500748 | 01.04 |                 | 03.0137-0357.2 | 650357 |                               | 230 x 32 HEB             |     |
|  | 1.6             |     | 9K-Y-500748 | 01.04 |                 | 03.0137-9149.2 | 669149 |                               | Bremsbacken-Zubehör      |     |
|  | 1.7 SDI         |     | 9K-Y-500748 | 01.04 |                 |                |        |                               |                          |     |
|  | 1.9 D           |     | 9K-Y-500748 | 01.04 |                 |                |        |                               |                          |     |
|  | 1.9 SDI         |     | 9K-Y-500748 | 01.04 |                 |                |        |                               |                          |     |
|  | 1.9 TDI         |     | 9K-Y-500748 | 01.04 |                 |                |        |                               |                          |     |
|    | 1.4             |     | 9K-Y-500747 | 11.95 | - ABS           | 24.0223-0015.1 | 480073 |                               | 230/231 x 51             |     |
|  | 1.6             |     | 9K-Y-500747 | 11.95 | - ABS           |                |        |                               |                          |     |
|  | 1.7 SDI         |     | 9K-Y-500747 | 07.96 | - ABS           |                |        |                               |                          |     |
|  | 1.9 D           |     | 9K-Y-500747 | 11.95 | - ABS           |                |        |                               |                          |     |
|  | 1.9 SDI         |     | 9K-Y-500747 | 11.95 | - ABS           |                |        |                               |                          |     |
|  | 1.9 TDI         |     | 9K-Y-500747 | 09.96 | - ABS           |                |        |                               |                          |     |
|  | 1.4             |     | 9K-Y-500747 | 11.95 | + ABS           | 24.0223-0019.1 | 480176 |                               | 230/231 x 50,5           |     |
|  | 1.6             |     | 9K-Y-500747 | 11.95 | + ABS           |                |        |                               |                          |     |
|  | 1.7 SDI         |     | 9K-Y-500747 | 07.96 | + ABS           |                |        |                               |                          |     |
|  | 1.9 D           |     | 9K-Y-500747 | 11.95 | + ABS           |                |        |                               |                          |     |
|  | 1.9 SDI         |     | 9K-Y-500747 | 11.95 | + ABS           |                |        |                               |                          |     |
|  | 1.9 TDI         |     | 9K-Y-500747 | 09.96 | + ABS           |                |        |                               |                          |     |
|    | 1.4             |     | 9K-Y-500748 | 01.04 |                 | 24.0223-0020.1 | 480177 |                               | 230/231,5 x 39,7         |     |
|  | 1.6             |     | 9K-Y-500748 | 01.04 |                 |                |        |                               |                          |     |
|  | 1.7 SDI         |     | 9K-Y-500748 | 01.04 |                 |                |        |                               |                          |     |
|  | 1.9 D           |     | 9K-Y-500748 | 01.04 |                 |                |        |                               |                          |     |
|  | 1.9 SDI         |     | 9K-Y-500748 | 01.04 |                 |                |        |                               |                          |     |
|  | 1.9 TDI         |     | 9K-Y-500748 | 01.04 |                 |                |        |                               |                          |     |
|   | 1.4             |     | 9K-Y-500747 | 11.95 |                 | 03.0520-6120.3 | 696120 |                               | 20,64/230x40 TopKit      | VW  |
|  | 1.6             |     | 9K-Y-500747 | 11.95 |                 |                |        |                               |                          |     |
|  | 1.7 SDI         |     | 9K-Y-500747 | 07.96 |                 |                |        |                               |                          |     |
|  | 1.9 D           |     | 9K-Y-500747 | 11.95 |                 |                |        |                               |                          |     |
|  | 1.9 SDI         |     | 9K-Y-500747 | 11.95 |                 |                |        |                               |                          |     |
|  | 1.9 TDI         |     | 9K-Y-500747 | 09.96 |                 |                |        |                               |                          |     |
|  | 1.4             |     | 9K-Y-500748 | 01.04 |                 | 03.0520-6920.3 | 696920 |                               | 20,64/230x32 TopKit      | VW  |
|  | 1.6             |     | 9K-Y-500748 | 01.04 |                 |                |        |                               |                          |     |
|  | 1.7 SDI         |     | 9K-Y-500748 | 01.04 |                 |                |        |                               |                          |     |
|  | 1.9 D           |     | 9K-Y-500748 | 01.04 |                 |                |        |                               |                          |     |
|  | 1.9 SDI         |     | 9K-Y-500748 | 01.04 |                 |                |        |                               |                          |     |
|  | 1.9 TDI         |     | 9K-Y-500748 | 01.04 |                 |                |        |                               |                          |     |
| VOLKSWAGEN CADDY Pickup (97-02)  |                 |     |             |       |                 |                |        |                               |                          |     |
|  | 1.6             |     |             | 10.97 | 12.00           | 13.0460-2964.2 | 602964 |                               | 20861 17,5/S             | TRW |
|  | 1.9 D           |     |             | 10.97 | 12.00           |                |        |                               |                          |     |
|  | 1.6             |     |             | 10.97 | 12.00           | 24.0113-0182.1 | 413182 |                               | 236 12,8 11,4 +B         |     |
|  | 1.9 D           |     |             | 10.97 | 12.00           |                |        |                               |                          |     |
|  | 1.6             |     |             | 10.97 | 12.00           | 24.0741-1107.3 | 360042 | 2                             | Radsensor                |     |
|  | 1.9 D           |     |             | 10.97 | 12.00           |                |        |                               |                          |     |
|  | 1.6             |     |             | 10.97 | 12.00           | 03.0137-0268.2 | 650268 |                               | 200 x 40 HEB             | VW  |
|  | 1.9 D           |     |             | 10.97 | 12.00           | 03.0137-9168.2 | 669168 |                               | Bremsbacken-Zubehör      | VW  |
|  | 1.6             |     |             | 10.97 | 12.00           | 24.0220-0018.1 | 480019 | ohne Sensorring <sup>1)</sup> | 200/201 x 50,0 - Lager   |     |
|  | 1.9 D           |     |             | 10.97 | 12.00           | 24.0220-0718.2 | 480209 | ohne Sensorring <sup>1)</sup> | 200/201,5 x 50,0 + Lager |     |
|  | 1.6             |     |             | 10.97 | 12.00           | 03.0520-7022.3 | 697022 |                               | 22,20/200x40 TopKit      | VW  |
|  | 1.9 D           |     |             | 10.97 | 12.00           |                |        |                               |                          |     |
|  | 1.6             |     |             | 10.97 | 12.00           | 03.0520-5319.3 | 695319 |                               | 19,05/200x40 TopKit      |     |
|  | 1.9 D           |     |             | 10.97 | 12.00           |                |        |                               |                          |     |
| VOLKSWAGEN CADDY III (04-15)   |                 |     |             |       |                 |                |        |                               |                          |     |
|  | 1.2 TSI         |     |             | 09.10 | PR: 1ZF,1ZM     | 13.0460-7117.2 | 607117 |                               | 23131 19,6 +/WK          | VW  |
|  | 1.4             | 55  |             | 02.04 | PR: 1ZF,1ZM     | 13.0470-7117.2 | LD7117 |                               | 23131 19,6 +/WK          | VW  |
|  | 1.4 16V         | 59  |             | 05.06 | PR: 1ZF,1ZM     |                |        |                               |                          |     |
|  | 1.6             |     |             | 04.04 | PR: 1ZF,1ZM     |                |        |                               |                          |     |
|  | 1.6 TDI         |     |             | 08.10 | PR: 1ZF,1ZM     |                |        |                               |                          |     |
|  | 1.9 TDI         | 55  |             | 09.05 | PR: 1ZF,1ZM     |                |        |                               |                          |     |
|  | 1.9 TDI         | 77  |             | 02.04 | PR: 1ZF,1ZM     |                |        |                               |                          |     |
|  | 1.9 TDI 4motion | 77  |             | 05.08 | PR: 1ZF,1ZM     |                |        |                               |                          |     |
|  | 2.0 Eco Fuel    | 80  |             | 04.06 | PR: 1ZF,1ZM     |                |        |                               |                          |     |
|  | 2.0 SDI         | 51  |             | 02.04 | PR: 1ZF,1ZM     |                |        |                               |                          |     |
|  | 2.0 TDI         | 81  |             | 10.10 | PR: 1ZF,1ZM     |                |        |                               |                          |     |
|  | 2.0 TDI         | 103 |             | 09.07 | PR: 1ZF,1ZM     |                |        |                               |                          |     |
|  | 2.0 TDI         | 125 |             | 05.12 | PR: 1ZF,1ZM     |                |        |                               |                          |     |
|  | 2.0 TDI 4motion | 81  |             | 10.10 | PR: 1ZF,1ZM     |                |        |                               |                          |     |
|  | 1.2 TSI         |     |             | 09.10 | PR: 1ZE,1LJ,1ZA | 13.0460-7184.2 | 607184 |                               | 23587 20,6 +/WK          | ATE |
|  | 1.4             | 55  |             | 02.04 | PR: 1ZE,1LJ,1ZA | 13.0470-7184.2 | LD7184 |                               | 23587 20,6 +/WK          | ATE |
|  | 1.4 16V         | 59  |             | 05.06 | PR: 1ZE,1LJ,1ZA |                |        |                               |                          |     |
|  | 1.6             |     |             | 04.04 | PR: 1ZE,1LJ,1ZA |                |        |                               |                          |     |
|  | 1.6 TDI         |     |             | 08.10 | PR: 1ZE,1LJ,1ZA |                |        |                               |                          |     |
|  | 1.9 TDI         | 55  |             | 09.05 | PR: 1ZE,1LJ,1ZA |                |        |                               |                          |     |

<sup>1)</sup> without sensor ring / senza sensori / sans secours ABS / sin anillo sensor ABS



|     |    |  |    |    |  |  |    |  |
|--|--|--|--|--|---|--|--|--|
| <b>VOLKSWAGEN CADDY III (04-15)</b>  |  |  |  |  |   |  |  |  |
|    | 1.9 TDI<br>1.9 TDI 4motion<br>2.0 Eco Fuel<br>2.0 SDI<br>2.0 TDI<br>2.0 TDI<br>2.0 TDI<br>2.0 TDI 4motion  | 77<br>77<br>80<br>51<br>81<br>103<br>125<br>81                                   | 02.04<br>05.08<br>04.06<br>02.04<br>10.10<br>09.07<br>05.12<br>10.10   | PR: 1ZE,1LJ,1ZA<br>PR: 1ZE,1LJ,1ZA<br>PR: 1ZE,1LJ,1ZA<br>PR: 1ZE,1LJ,1ZA<br>PR: 1ZE,1LJ,1ZA<br>PR: 1ZE,1LJ,1ZA<br>PR: 1ZE,1LJ,1ZA<br>PR: 1ZE,1LJ,1ZA   | 13.0460-7184.2<br>13.0470-7184.2  | 607184<br>LD7184   |  | 23587 20,6 +/WK<br>23587 20,6 +/WK<br>ATE<br>ATE                                   |
|    | 1.2 TSI<br>1.4<br>1.4 16V<br>1.6<br>1.6 TDI<br>1.9 TDI<br>1.9 TDI<br>1.9 TDI<br>1.9 TDI 4motion<br>2.0 Eco Fuel<br>2.0 SDI<br>2.0 TDI<br>2.0 TDI<br>2.0 TDI<br>2.0 TDI 4motion | 55<br>59<br>55<br>77<br>77<br>80<br>51<br>81<br>103<br>125<br>81                 | 09.10<br>02.04<br>05.06<br>04.04<br>08.10<br>09.05<br>02.04<br>05.08<br>04.06<br>02.04<br>10.10<br>09.07<br>05.12<br>10.10 | PR: 1ZF,1ZM<br>PR: 1ZF,1ZM<br>PR: 1ZF,1ZM<br>PR: 1ZF,1ZM<br>PR: 1ZF,1ZM<br>PR: 1ZF,1ZM<br>PR: 1ZF,1ZM<br>PR: 1ZF,1ZM<br>PR: 1ZF,1ZM<br>PR: 1ZF,1ZM<br>PR: 1ZF,1ZM<br>PR: 1ZF,1ZM<br>PR: 1ZF,1ZM<br>PR: 1ZF,1ZM | 24.0122-0210.1<br>24.0322-0210.1  | 422210<br>522210   |  | 280 22,0 19,0 V L +S +B<br>280 22,0 19,0 V L +S +B PD                              |
|  | 1.2 TSI<br>1.4<br>1.4 16V<br>1.6<br>1.6 TDI<br>1.9 TDI<br>1.9 TDI<br>1.9 TDI 4motion<br>2.0 Eco Fuel<br>2.0 SDI<br>2.0 TDI<br>2.0 TDI<br>2.0 TDI<br>2.0 TDI 4motion            | 55<br>59<br>55<br>77<br>77<br>80<br>51<br>81<br>103<br>125<br>81                 | 09.10<br>02.04<br>05.06<br>04.04<br>08.10<br>09.05<br>02.04<br>05.08<br>04.06<br>02.04<br>10.10<br>09.07<br>05.12<br>10.10 | PR: 1ZE<br>PR: 1ZE<br>PR: 1ZE<br>PR: 1ZE<br>PR: 1ZE<br>PR: 1ZE<br>PR: 1ZE<br>PR: 1ZE<br>PR: 1ZE<br>PR: 1ZE<br>PR: 1ZE<br>PR: 1ZE<br>PR: 1ZE  | 24.0125-0145.1<br>24.0325-0145.1  | 425145<br>525145   |  | 288 25,0 22,0 V L +S +B<br>288 25,0 22,0 V L +S +B PD                              |
|  | 1.2 TSI<br>1.4<br>1.4 16V<br>1.6<br>1.6 TDI<br>1.9 TDI<br>1.9 TDI<br>1.9 TDI 4motion<br>2.0 Eco Fuel<br>2.0 SDI<br>2.0 TDI<br>2.0 TDI<br>2.0 TDI<br>2.0 TDI 4motion            | 55<br>59<br>55<br>77<br>77<br>80<br>51<br>81<br>103<br>125<br>81                 | 09.10<br>02.04<br>05.06<br>04.04<br>08.10<br>09.05<br>02.04<br>05.08<br>04.06<br>02.04<br>10.10<br>09.07<br>05.12<br>10.10 | PR: 1LJ,1ZA<br>PR: 1LJ,1ZA<br>PR: 1LJ,1ZA<br>PR: 1LJ,1ZA<br>PR: 1LJ,1ZA<br>PR: 1LJ,1ZA<br>PR: 1LJ,1ZA<br>PR: 1LJ,1ZA<br>PR: 1LJ,1ZA<br>PR: 1LJ,1ZA<br>PR: 1LJ,1ZA<br>PR: 1LJ,1ZA<br>PR: 1LJ,1ZA                | 24.0125-0158.1<br>24.0325-0158.1  | 425158<br>525158   |  | 312 25,0 22,0 V L +S +B<br>312 25,0 22,0 V L +S +B PD                              |
|  | 1.2 TSI<br>1.4<br>1.4 16V<br>1.6<br>1.6 TDI<br>1.9 TDI<br>1.9 TDI<br>1.9 TDI 4motion<br>2.0 Eco Fuel<br>2.0 SDI<br>2.0 TDI<br>2.0 TDI<br>2.0 TDI<br>2.0 TDI 4motion            | 55<br>59<br>55<br>77<br>77<br>80<br>51<br>81<br>103<br>125<br>81                 | 09.10<br>02.04<br>05.06<br>04.04<br>08.10<br>09.05<br>02.04<br>05.08<br>04.06<br>02.04<br>10.10<br>09.07<br>05.12<br>10.10 |  | 24.0711-5271.3<br>24.0711-5272.3  | 360301<br>360302   | <br> | Radsensor<br>Radsensor   |
|  | 1.4<br>1.4 16V<br>1.6<br>1.9 TDI<br>1.9 TDI<br>2.0 Eco Fuel<br>2.0 SDI<br>2.0 TDI  | 55<br>59<br>55<br>77<br>80<br>51<br>103  | 02.04<br>05.06<br>04.04<br>09.05<br>02.04<br>04.06<br>02.04<br>09.07   | 11.07<br>11.07<br>11.07<br>11.07<br>11.07<br>11.07<br>11.07  | 13.0460-2880.2<br>13.0470-2880.2<br>13.0460-0259.2                                | 602880<br>LD2880<br>610259   |  | 23914 17,1 /WE/Zub/S<br>23914 17,1 /WE/Zub/S<br>Belagsatz-Zubehör<br>TRW<br>TRW    |
|  | 1.2 TSI<br>1.4<br>1.4 16V<br>1.6<br>1.6 TDI<br>1.9 TDI<br>1.9 TDI<br>1.9 TDI 4motion<br>2.0 Eco Fuel<br>2.0 SDI<br>2.0 TDI<br>2.0 TDI<br>2.0 TDI 4motion                       | 55<br>59<br>55<br>77<br>77<br>80<br>51<br>81<br>103<br>125<br>81                 | 09.10<br>12.07<br>12.07<br>12.07<br>08.10<br>12.07<br>12.07<br>05.08<br>12.07<br>12.07<br>10.10<br>12.07<br>05.12<br>10.10 | PR: 1ZF,2E2<br>PR: 1ZF,2E2<br>PR: 1ZF,2E2<br>PR: 1ZF,2E2<br>PR: 1ZF,2E2<br>PR: 1ZF,2E2<br>PR: 1ZF,2E2<br>PR: 1ZF,2E2<br>PR: 1ZF,2E2<br>PR: 1ZF,2E2<br>PR: 1ZF,2E2<br>PR: 1ZF,2E2<br>PR: 1ZF,2E2                | 13.0460-2820.2<br>13.0470-2820.2<br>13.0460-0259.2                                | 602820<br>LD2820<br>610259   |  | 20961 17,6 /S<br>20961 17,6 /S<br>Belagsatz-Zubehör<br>TRW<br>TRW                  |



**VOLKSWAGEN CADDY III (04-15)**

|  |  |  |  |  |  |  |                            |   |            |  |
|--|--|--|--|--|--|--|----------------------------|---|------------|--|
|  | 1.2 TSI<br>1.4<br>1.4 16V<br>1.6<br>1.6 TDI<br>1.9 TDI<br>1.9 TDI<br>1.9 TDI 4motion<br>2.0 Eco Fuel<br>2.0 SDI<br>2.0 TDI<br>2.0 TDI<br>2.0 TDI 4motion | 55<br>59<br>55<br>77<br>77<br>80<br>51<br>81<br>103<br>81  | 2K-B-200 000<br>2K-B-200 000<br>2K-B-200 000<br>2K-B-200 000<br>2K-B-200 000<br>2K-B-200 000<br>2K-B-200 000<br>2K-B-200 000<br>2K-B-200 000<br>2K-B-200 000<br>2K-B-200 000<br>2K-B-200 000                 | 09.10<br>12.07<br>12.07<br>12.07<br>08.10<br>12.07<br>12.07<br>05.08<br>12.07<br>12.07<br>12.07<br>12.07                   | PR: 1ZE,1LJ<br>PR: 1ZE,1LJ<br>PR: 1ZE,1LJ<br>PR: 1ZE,1LJ<br>PR: 1ZE,1LJ<br>PR: 1ZE,1LJ<br>PR: 1ZE,1LJ<br>PR: 1ZE,1LJ<br>PR: 1ZE,1LJ<br>PR: 1ZE,1LJ<br>PR: 1ZE,1LJ<br>PR: 1ZE,1LJ   | 13.0460-2880.2<br>13.0470-2880.2<br>13.0460-0259.2 | 602880<br>LD2880<br>610259 | 23914 17,1 /WE/Zub/S<br>23914 17,1 /WE/Zub/S<br>Belagsatz-Zubehör | TRW<br>TRW |  |
|  | 1.2 TSI<br>1.4<br>1.4 16V<br>1.6<br>1.6 TDI<br>1.9 TDI<br>1.9 TDI<br>1.9 TDI 4motion<br>2.0 Eco Fuel<br>2.0 SDI<br>2.0 TDI<br>2.0 TDI<br>2.0 TDI 4motion | 2K-B-200 001<br>55 2K-B-200 001<br>59 2K-B-200 001<br>2K-B-200 001<br>2K-B-200 001<br>55 2K-B-200 001<br>77 2K-B-200 001<br>77 2K-B-200 001<br>80 2K-B-200 001<br>51 2K-B-200 001<br>81 2K-B-200 001<br>103 2K-B-200 001<br>125<br>81 2K-B-200 001 |  | 05.12  | PR: 1ZA,1ZE,1ZF,2E3<br>PR: 1ZA,1ZE,1ZF,2E3<br>PR: 1ZA,1ZE,1ZF,2E3<br>PR: 1ZA,1ZE,1ZF,2E3<br>PR: 1ZA,1ZE,1ZF,2E3<br>PR: 1ZA,1ZE,1ZF,2E3<br>PR: 1ZA,1ZE,1ZF,2E3<br>PR: 1ZA,1ZE,1ZF,2E3<br>PR: 1ZA,1ZE,1ZF,2E3<br>PR: 1ZA,1ZE,1ZF,2E3<br>PR: 1ZA,1ZE,1ZF,2E3<br>PR: 1ZA,1ZE,1ZF,2E3<br>PR: 1ZA,1ZE,1ZF,2E3<br>PR: 1ZA,1ZE,1ZF,2E3 | 13.0460-3858.2<br>13.0470-3858.2                   | 603858<br>LD3858           | 24563 17,7 /Zub/S<br>24563 17,7 /Zub/S                            | BOS<br>BOS |  |
|  | 1.4<br>1.4 16V<br>1.6<br>1.9 TDI<br>1.9 TDI<br>2.0 Eco Fuel<br>2.0 SDI<br>2.0 TDI  | 55<br>59<br>55<br>77<br>80<br>51<br>103  |  | 02.04<br>05.06<br>04.04<br>09.05<br>02.04<br>04.06<br>02.04<br>09.07   | 11.07<br>11.07<br>11.07<br>11.07<br>11.07<br>11.07<br>11.07  | 24.0112-0158.1<br>24.0312-0158.1                   | 412158<br>512158           | 256 12,0 10,0 +S +B<br>256 12,0 10,0 +B PD                        |            |  |
|  | 1.2 TSI<br>1.4<br>1.4 16V<br>1.6<br>1.6 TDI<br>1.9 TDI<br>1.9 TDI<br>1.9 TDI 4motion<br>2.0 Eco Fuel<br>2.0 SDI<br>2.0 TDI<br>2.0 TDI<br>2.0 TDI 4motion | 55<br>59<br>55<br>77<br>77<br>80<br>51<br>81<br>103<br>125<br>81   |  | 09.10<br>12.07<br>12.07<br>12.07<br>08.10<br>12.07<br>12.07<br>05.08<br>12.07<br>12.07<br>10.10<br>12.07<br>05.12<br>10.10 | PR: 1ZF,2E2<br>PR: 1ZF,2E2<br>PR: 1ZF,2E2<br>PR: 1ZF,2E2<br>PR: 1ZF,2E2<br>PR: 1ZF,2E2<br>PR: 1ZF,2E2<br>PR: 1ZF,2E2<br>PR: 1ZF,2E2<br>PR: 1ZF,2E2<br>PR: 1ZF,2E2<br>PR: 1ZF,2E2<br>PR: 1ZF,2E2  | 24.0110-0277.1<br>24.0310-0277.1                   | 410277<br>510277           | 253 10,0 8,0 +S +B<br>253 10,0 8,0 +S +B PD                       |            |  |
|  | 1.2 TSI<br>1.4<br>1.4 16V<br>1.6<br>1.6 TDI<br>1.9 TDI<br>1.9 TDI<br>1.9 TDI 4motion<br>2.0 Eco Fuel<br>2.0 SDI<br>2.0 TDI<br>2.0 TDI<br>2.0 TDI 4motion | 2K-B-200 000<br>55 2K-B-200 000<br>59 2K-B-200 000<br>2K-B-200 000<br>2K-B-200 000<br>55 2K-B-200 000<br>77 2K-B-200 000<br>77 2K-B-200 000<br>80 2K-B-200 000<br>51 2K-B-200 000<br>81 2K-B-200 000<br>103 2K-B-200 000<br>81 2K-B-200 000        | 2K-B-200 000<br>2K-B-200 000<br>2K-B-200 000<br>2K-B-200 000<br>2K-B-200 000<br>2K-B-200 000<br>2K-B-200 000<br>2K-B-200 000<br>2K-B-200 000<br>2K-B-200 000<br>2K-B-200 000<br>2K-B-200 000<br>2K-B-200 000 | 09.10<br>12.07<br>12.07<br>12.07<br>08.10<br>12.07<br>12.07<br>05.08<br>12.07<br>12.07<br>10.10<br>12.07<br>10.10          | PR: 1ZE,1LJ<br>PR: 1ZE,1LJ<br>PR: 1ZE,1LJ<br>PR: 1ZE,1LJ<br>PR: 1ZE,1LJ<br>PR: 1ZE,1LJ<br>PR: 1ZE,1LJ<br>PR: 1ZE,1LJ<br>PR: 1ZE,1LJ<br>PR: 1ZE,1LJ<br>PR: 1ZE,1LJ<br>PR: 1ZE,1LJ   | 24.0112-0158.1<br>24.0312-0158.1                   | 412158<br>512158           | 256 12,0 10,0 +S +B<br>256 12,0 10,0 +B PD                        |            |  |
|  | 1.2 TSI<br>1.4<br>1.4 16V<br>1.6<br>1.6 TDI<br>1.9 TDI<br>1.9 TDI<br>1.9 TDI 4motion<br>2.0 Eco Fuel<br>2.0 SDI<br>2.0 TDI<br>2.0 TDI<br>2.0 TDI 4motion | 2K-B-200 001<br>55 2K-B-200 001<br>59 2K-B-200 001<br>2K-B-200 001<br>2K-B-200 001<br>55 2K-B-200 001<br>77 2K-B-200 001<br>77 2K-B-200 001<br>80 2K-B-200 001<br>51 2K-B-200 001<br>81 2K-B-200 001<br>103 2K-B-200 001<br>125<br>81 2K-B-200 001 |  | 05.12  | PR: 1ZA,1ZE,1ZF,2E3<br>PR: 1ZA,1ZE,1ZF,2E3<br>PR: 1ZA,1ZE,1ZF,2E3<br>PR: 1ZA,1ZE,1ZF,2E3<br>PR: 1ZA,1ZE,1ZF,2E3<br>PR: 1ZA,1ZE,1ZF,2E3<br>PR: 1ZA,1ZE,1ZF,2E3<br>PR: 1ZA,1ZE,1ZF,2E3<br>PR: 1ZA,1ZE,1ZF,2E3<br>PR: 1ZA,1ZE,1ZF,2E3<br>PR: 1ZA,1ZE,1ZF,2E3<br>PR: 1ZA,1ZE,1ZF,2E3<br>PR: 1ZA,1ZE,1ZF,2E3                        | 24.0110-0356.1<br>24.0310-0356.1                   | 410356<br>510356           | 272 9,7 8,0 +S +B<br>272 9,7 8,0 +S +B PD                         |            |  |
|  | 1.2 TSI<br>1.4<br>1.4 16V<br>1.6<br>1.6 TDI<br>1.9 TDI<br>1.9 TDI<br>2.0 Eco Fuel<br>2.0 SDI<br>2.0 TDI  | 55<br>59<br>55<br>77<br>80<br>51<br>103  |  | 09.10<br>02.04<br>05.06<br>04.04<br>08.10<br>09.05<br>02.04<br>04.06<br>02.04<br>09.07                                     |  | 24.0711-6230.3                                     | 360310                     | 2   | Radsensor  |  |

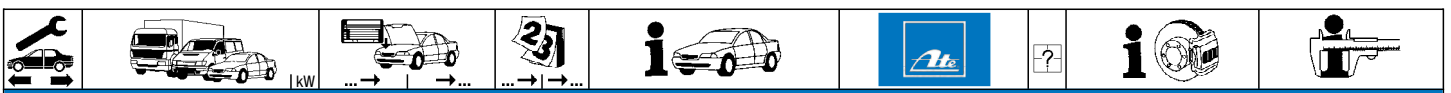

**VOLKSWAGEN CADDY III (04-15)**















|  |                 |     |       |  |                |        |  |           |
|--|-----------------|-----|-------|--|----------------|--------|--|-----------|
|  | 2.0 TDI         | 81  | 10.10 |  | 24.0711-6230.3 | 360310 | 2  - Parkassistent <sup>1)</sup><br>2  + Parkassistent <sup>2)</sup> | Radsensor |
|  | 2.0 TDI         | 125 | 05.12 |  | 24.0711-6337.3 | 360390 |  | Radsensor |
|  | 1.9 TDI 4motion | 77  | 05.08 |  | 24.0711-5271.3 | 360301 |  | Radsensor |
|  | 2.0 TDI 4motion | 81  | 10.10 |  | 24.0711-5272.3 | 360302 |  |           |

**VOLKSWAGEN CADDY IV (15-)**

|  |                 |     |       |         |                |        |  |                            |           |
|--|-----------------|-----|-------|---------|----------------|--------|--|----------------------------|-----------|
|  | 1.0 TSI         | 75  | 11.15 | PR: 1ZE | 24.0125-0145.1 | 425145 |  | 288 25,0 22,0 V L +S +B    |           |
|  | 1.2 TSI         | 62  | 04.15 | PR: 1ZE | 24.0325-0145.1 | 525145 |  | 288 25,0 22,0 V L +S +B PD |           |
|  | 1.4 TGI CNG     | 81  | 04.15 | PR: 1ZE |                |        |  |                            |           |
|  | 1.4 TSI         | 92  | 04.15 | PR: 1ZE |                |        |  |                            |           |
|  | 1.6 TDI         | 55  | 04.15 | PR: 1ZE |                |        |  |                            |           |
|  | 1.6 TDI         | 75  | 04.15 | PR: 1ZE |                |        |  |                            |           |
|  | 2.0 TDI         | 55  | 04.15 | PR: 1ZE |                |        |  |                            |           |
|  | 2.0 TDI         | 75  | 04.15 | PR: 1ZE |                |        |  |                            |           |
|  | 2.0 TDI         | 81  | 09.15 | PR: 1ZE |                |        |  |                            |           |
|  | 2.0 TDI         | 103 | 04.15 | PR: 1ZE |                |        |  |                            |           |
|  | 2.0 TDI         | 110 | 04.15 | PR: 1ZE |                |        |  |                            |           |
|  | 2.0 TDI 4motion | 55  | 04.15 | PR: 1ZE |                |        |  |                            |           |
|  | 2.0 TDI 4motion | 81  | 04.15 | PR: 1ZE |                |        |  |                            |           |
|  | 2.0 TDI 4motion | 90  | 04.15 | PR: 1ZE |                |        |  |                            |           |
|  | 2.0 TDI 4motion | 103 | 04.15 | PR: 1ZE |                |        |  |                            |           |
|  | 2.0 TDI 4motion | 110 | 11.15 | PR: 1ZE |                |        |  |                            |           |
|  | 1.0 TSI         | 75  | 11.15 | PR: 1ZA | 24.0125-0158.1 | 425158 |  | 312 25,0 22,0 V L +S +B    |           |
|  | 1.2 TSI         | 62  | 04.15 | PR: 1ZA | 24.0325-0158.1 | 525158 |  | 312 25,0 22,0 V L +S +B PD |           |
|  | 1.4 TGI CNG     | 81  | 04.15 | PR: 1ZA |                |        |  |                            |           |
|  | 1.4 TSI         | 92  | 04.15 | PR: 1ZA |                |        |  |                            |           |
|  | 1.6 TDI         | 55  | 04.15 | PR: 1ZA |                |        |  |                            |           |
|  | 1.6 TDI         | 75  | 04.15 | PR: 1ZA |                |        |  |                            |           |
|  | 2.0 TDI         | 55  | 04.15 | PR: 1ZA |                |        |  |                            |           |
|  | 2.0 TDI         | 75  | 04.15 | PR: 1ZA |                |        |  |                            |           |
|  | 2.0 TDI         | 81  | 09.15 | PR: 1ZA |                |        |  |                            |           |
|  | 2.0 TDI         | 103 | 04.15 | PR: 1ZA |                |        |  |                            |           |
|  | 2.0 TDI         | 110 | 04.15 | PR: 1ZA |                |        |  |                            |           |
|  | 2.0 TDI 4motion | 55  | 04.15 | PR: 1ZA |                |        |  |                            |           |
|  | 2.0 TDI 4motion | 81  | 04.15 | PR: 1ZA |                |        |  |                            |           |
|  | 2.0 TDI 4motion | 90  | 04.15 | PR: 1ZA |                |        |  |                            |           |
|  | 2.0 TDI 4motion | 103 | 04.15 | PR: 1ZA |                |        |  |                            |           |
|  | 2.0 TDI 4motion | 110 | 11.15 | PR: 1ZA |                |        |  |                            |           |
|  | 1.0 TSI         | 75  | 11.15 |         | 24.0711-5271.3 | 360301 |  | Radsensor                  |           |
|  | 1.2 TSI         | 62  | 04.15 |         | 24.0711-5272.3 | 360302 |  |                            | Radsensor |
|  | 1.4 TGI CNG     | 81  | 04.15 |         |                |        |  |                            |           |
|  | 1.4 TSI         | 92  | 04.15 |         |                |        |  |                            |           |
|  | 1.6 TDI         | 55  | 04.15 |         |                |        |  |                            |           |
|  | 1.6 TDI         | 75  | 04.15 |         |                |        |  |                            |           |
|  | 2.0 TDI         | 55  | 04.15 |         |                |        |  |                            |           |
|  | 2.0 TDI         | 75  | 04.15 |         |                |        |  |                            |           |
|  | 2.0 TDI         | 81  | 09.15 |         |                |        |  |                            |           |
|  | 2.0 TDI         | 103 | 04.15 |         |                |        |  |                            |           |
|  | 2.0 TDI         | 110 | 04.15 |         |                |        |  |                            |           |
|  | 2.0 TDI 4motion | 55  | 04.15 |         |                |        |  |                            |           |
|  | 2.0 TDI 4motion | 81  | 04.15 |         |                |        |  |                            |           |
|  | 2.0 TDI 4motion | 90  | 04.15 |         |                |        |  |                            |           |
|  | 2.0 TDI 4motion | 103 | 04.15 |         |                |        |  |                            |           |
|  | 2.0 TDI 4motion | 110 | 11.15 |         |                |        |  |                            |           |
|  | 1.0 TSI         | 75  | 11.15 |         | 24.0110-0356.1 | 410356 |  | 272 9,7 8,0 +S +B          |           |
|  | 1.2 TSI         | 62  | 04.15 |         | 24.0310-0356.1 | 510356 |  | 272 9,7 8,0 +S +B PD       |           |
|  | 1.4 TGI CNG     | 81  | 04.15 |         |                |        |  |                            |           |
|  | 1.4 TSI         | 92  | 04.15 |         |                |        |  |                            |           |
|  | 1.6 TDI         | 55  | 04.15 |         |                |        |  |                            |           |
|  | 1.6 TDI         | 75  | 04.15 |         |                |        |  |                            |           |
|  | 2.0 TDI         | 55  | 04.15 |         |                |        |  |                            |           |
|  | 2.0 TDI         | 75  | 04.15 |         |                |        |  |                            |           |
|  | 2.0 TDI         | 81  | 09.15 |         |                |        |  |                            |           |
|  | 2.0 TDI         | 103 | 04.15 |         |                |        |  |                            |           |
|  | 2.0 TDI         | 110 | 04.15 |         |                |        |  |                            |           |
|  | 2.0 TDI 4motion | 55  | 04.15 |         |                |        |  |                            |           |
|  | 2.0 TDI 4motion | 81  | 04.15 |         |                |        |  |                            |           |
|  | 2.0 TDI 4motion | 90  | 04.15 |         |                |        |  |                            |           |
|  | 2.0 TDI 4motion | 103 | 04.15 |         |                |        |  |                            |           |
|  | 2.0 TDI 4motion | 110 | 11.15 |         |                |        |  |                            |           |
|  | 1.0 TSI         | 75  | 11.15 |         | 24.0711-6230.3 | 360310 | 2  PR: 1BA,2MH,2MK,7X0,7X1<br>2  PR: 1BH,1BJ,7X0,7X1 | Radsensor                  |           |
|  | 1.2 TSI         | 62  | 04.15 |         | 24.0711-6337.3 | 360390 |  | Radsensor                  |           |
|  | 1.4 TGI CNG     | 81  | 04.15 |         |                |        |  |                            |           |
|  | 1.4 TSI         | 92  | 04.15 |         |                |        |  |                            |           |
|  | 1.6 TDI         | 55  | 04.15 |         |                |        |  |                            |           |
|  | 1.6 TDI         | 75  | 04.15 |         |                |        |  |                            |           |
|  | 2.0 TDI         | 55  | 04.15 |         |                |        |  |                            |           |
|  | 2.0 TDI         | 75  | 04.15 |         |                |        |  |                            |           |
|  | 2.0 TDI         | 81  | 09.15 |         |                |        |  |                            |           |
|  | 2.0 TDI         | 103 | 04.15 |         |                |        |  |                            |           |
|  | 2.0 TDI         | 110 | 04.15 |         |                |        |  |                            |           |
|  | 2.0 TDI 4motion | 55  | 04.15 |         |                |        |  |                            |           |
|  | 2.0 TDI 4motion | 81  | 04.15 |         |                |        |  |                            |           |
|  | 2.0 TDI 4motion | 90  | 04.15 |         |                |        |  |                            |           |
|  | 2.0 TDI 4motion | 103 | 04.15 |         |                |        |  |                            |           |
|  | 2.0 TDI 4motion | 110 | 11.15 |         |                |        |  |                            |           |
|  | 1.0 TSI         | 75  | 11.15 |         | 24.0711-6337.3 | 360390 | 2  PR: 7X5,7X6,7X7,7X9                               | Radsensor                  |           |
|  | 1.2 TSI         | 62  | 04.15 |         |                |        |  |                            |           |

<sup>1)</sup> - parking assistant / - assistente di parcheggio / - assistance au stationnement / - asistente de aparcamiento  
<sup>2)</sup> + parking assistant / + assistente di parcheggio / + assistance au stationnement / + asistente de aparcamiento



|     |    kW |  |  |  |  |  |  |  |                         |
|--|---|--|--|--|---|--|--|--|-------------------------|
| <b>VOLKSWAGEN CADDY IV (15-)</b>   |   |  |  |  |   |  |  |  |                         |
|    | 1.4 TGI CNG 81  |  | 04.15  |  | 24.0711-6337.3  | 360390   | 2  | PR: 7X5,7X6,7X7,7X9  | Radsensor               |
|  | 1.4 TSI 92  |  | 04.15  |  |   |  |  |  |                         |
|  | 1.6 TDI 55  |  | 04.15  |  |   |  |  |  |                         |
|  | 1.6 TDI 75  |  | 04.15  |  |   |  |  |  |                         |
|  | 2.0 TDI 55  |  | 04.15  |  |   |  |  |  |                         |
|  | 2.0 TDI 75  |  | 04.15  |  |   |  |  |  |                         |
|  | 2.0 TDI 81  |  | 09.15  |  |   |  |  |  |                         |
|  | 2.0 TDI 103   |  | 04.15  |  |   |  |  |  |                         |
|  | 2.0 TDI 110   |  | 04.15  |  |   |  |  |  |                         |
|  | 2.0 TDI 4motion 55  |  | 04.15  |  |   |  |  |  |                         |
|  | 2.0 TDI 4motion 81  |  | 04.15  |  |   |  |  |  |                         |
|  | 2.0 TDI 4motion 110   |  | 11.15  |  |   |  |  |  |                         |
|  | 2.0 TDI 4motion 90  |  | 04.15  |  | 24.0711-5401.3  | 360330   |  |  | Radsensor               |
|  | 2.0 TDI 4motion 103   |  | 04.15  |  | 24.0711-5402.3  | 360331   |  |  | Radsensor               |
| <b>VOLKSWAGEN CRAFTER (06-)</b>  |   |  |  |  |   |  |  |  |                         |
|    | 2.0 TDI 103   |  | 11.15  | PR: OWC, OWL   | 13.0460-4826.2  | 604826   |  |  | 29192 20,7 /WE/Zub BRE  |
|  | 2.0 TDI BlueMotion 80   |  | 07.11  | PR: OWC, OWL   | 13.0460-4877.2  | 604877   |  |  | 29192 20,3 /WE/Zub BRE  |
|  | 2.0 TDI BlueMotion 100  |  | 07.11  | PR: OWC, OWL   | 24.8190-0424.2  | 620424   | 2  |  | Warnkontakt L=103,2mm   |
|  | 2.0 TDI BlueMotion 120  |  | 07.11  | PR: OWC, OWL   |   |  |  |  |                         |
|  | 2.5 TDI 65  |  | 04.06  | PR: OWC, OWL   |   |  |  |  |                         |
|  | 2.5 TDI 80  |  | 04.06  | PR: OWC, OWL   |   |  |  |  |                         |
|  | 2.5 TDI 100   |  | 04.06  | PR: OWC, OWL   |   |  |  |  |                         |
|  | 2.5 TDI 120   |  | 04.06  | PR: OWC, OWL   |   |  |  |  |                         |
|  | 2.0 TDI 4motion 120   |  | 11.11  | PR: OWC, OWL   | 13.0460-4826.2  | 604826   |  |  | 29192 20,7 /WE/Zub BRE  |
|  |   |  |  |  | 13.0460-4877.2  | 604877   |  |  | 29192 20,3 /WE/Zub BRE  |
|  |   |  |  |  | 24.8190-0005.2  | 620005   | 2  |  | Warnkontakt L=84mm      |
|  | 2.5 TDI 65  |  | 04.06  | PR: OWF  | 13.0460-4827.2  | 604827   |  |  | 29200 21,0 /WE/Zub BRE  |
|  | 2.5 TDI 80  |  | 04.06  | PR: OWF  | 24.8190-0424.2  | 620424   | 2  |  | Warnkontakt L=103,2mm   |
|  | 2.5 TDI 100   |  | 04.06  | PR: OWF  |   |  |  |  |                         |
|  | 2.5 TDI 120   |  | 04.06  | PR: OWF  |   |  |  |  |                         |
|  | 2.0 TDI 103   |  | 11.15  | PR: OWF  | 13.0460-4827.2  | 604827   |  |  | 29200 21,0 /WE/Zub BRE  |
|  | 2.0 TDI BlueMotion 80   |  | 07.11  | PR: OWF  | 24.8190-0424.2  | 620424   | 2  |  | Warnkontakt L=103,2mm   |
|  | 2.0 TDI BlueMotion 100  |  | 07.11  | PR: OWF  |   |  |  |  |                         |
|  | 2.0 TDI BlueMotion 120  |  | 07.11  | PR: OWF  |   |  |  |  |                         |
|  | 2.5 TDI 65  |  | 07.11  | PR: OWF  |   |  |  |  |                         |
|  | 2.5 TDI 80  |  | 07.11  | PR: OWF  |   |  |  |  |                         |
|  | 2.5 TDI 100   |  | 07.11  | PR: OWF  |   |  |  |  |                         |
|  | 2.5 TDI 120   |  | 07.11  | PR: OWF  |   |  |  |  |                         |
|  | 2.0 TDI 4motion 120   |  | 11.11  | PR: OWF  | 13.0460-4827.2  | 604827   |  |  | 29200 21,0 /WE/Zub BRE  |
|  |   |  |  |  | 24.8190-0005.2  | 620005   | 2  |  | Warnkontakt L=84mm      |
|  | 2.0 TDI 103   |  | 11.15  | PR: OWC, OWF, OWL  |   |  |  |  | 300 28,0 25,0 V L +S +B |
|  | 2.0 TDI 4motion 120   |  | 11.11  | PR: OWC, OWF, OWL  |   |  |  |  |                         |
|  | 2.0 TDI BlueMotion 80   |  | 07.11  | PR: OWC, OWF, OWL  |   |  |  |  |                         |
|  | 2.0 TDI BlueMotion 100  |  | 07.11  | PR: OWC, OWF, OWL  |   |  |  |  |                         |
|  | 2.0 TDI BlueMotion 120  |  | 07.11  | PR: OWC, OWF, OWL  |   |  |  |  |                         |
|  | 2.5 TDI 65  |  | 04.06  | PR: OWC, OWF, OWL  |   |  |  |  |                         |
|  | 2.5 TDI 80  |  | 04.06  | PR: OWC, OWF, OWL  |   |  |  |  |                         |
|  | 2.5 TDI 100   |  | 04.06  | PR: OWC, OWF, OWL  |   |  |  |  |                         |
|  | 2.5 TDI 120   |  | 04.06  | PR: OWC, OWF, OWL  |   |  |  |  |                         |
|  | 2.0 TDI 103   |  | 11.15  |  | 24.0711-5531.3  | 360426   | 2  | Hersteller ATE 1)  | Radsensor L=855         |
|  | 2.0 TDI 4motion 120   |  | 11.11  |  |   |  |  |  |                         |
|  | 2.0 TDI BlueMotion 80   |  | 07.11  |  |   |  |  |  |                         |
|  | 2.0 TDI BlueMotion 100  |  | 07.11  |  |   |  |  |  |                         |
|  | 2.0 TDI BlueMotion 120  |  | 07.11  |  |   |  |  |  |                         |
|  | 2.5 TDI 65  |  | 04.06  |  |   |  |  |  |                         |
|  | 2.5 TDI 80  |  | 04.06  |  |   |  |  |  |                         |
|  | 2.5 TDI 100   |  | 04.06  |  |   |  |  |  |                         |
|  | 2.5 TDI 120   |  | 04.06  |  |   |  |  |  |                         |
|  | 2.0 TDI 103   |  | 11.15  | PR: OWC, OWL   | 13.0460-3832.2  | 603832   |  |  | 29190 20,2 +/-WE/S BOS  |
|  | 2.0 TDI 4motion 120   |  | 11.11  | PR: OWC, OWL   | 24.8190-0418.2  | 620418   | 2  |  | Warnkontakt L=95mm      |
|  | 2.0 TDI BlueMotion 80   |  | 07.11  | PR: OWC, OWL   |   |  |  |  |                         |
|  | 2.0 TDI BlueMotion 100  |  | 07.11  | PR: OWC, OWL   |   |  |  |  |                         |
|  | 2.0 TDI BlueMotion 120  |  | 07.11  | PR: OWC, OWL   |   |  |  |  |                         |
|  | 2.5 TDI 65  |  | 04.06  | PR: OWC, OWL   |   |  |  |  |                         |
|  | 2.5 TDI 80  |  | 04.06  | PR: OWC, OWL   |   |  |  |  |                         |
|  | 2.5 TDI 100   |  | 04.06  | PR: OWC, OWL   |   |  |  |  |                         |
|  | 2.5 TDI 120   |  | 04.06  | PR: OWC, OWL   |   |  |  |  |                         |
|  | 2.0 TDI 103   |  | 11.15  | PR: OWF  | 13.0460-3842.2  | 603842   |  |  | 29217 20,5 /S BOS       |
|  | 2.0 TDI 4motion 120   |  | 11.11  | PR: OWF  | 24.8190-0005.2  | 620005   | 2  |  | Warnkontakt L=84mm      |
|  | 2.0 TDI BlueMotion 80   |  | 07.11  | PR: OWF  |   |  |  |  |                         |
|  | 2.0 TDI BlueMotion 100  |  | 07.11  | PR: OWF  |   |  |  |  |                         |
|  | 2.0 TDI BlueMotion 120  |  | 07.11  | PR: OWF  |   |  |  |  |                         |
|  | 2.5 TDI 65  |  | 04.06  | PR: OWF  |   |  |  |  |                         |
|  | 2.5 TDI 80  |  | 04.06  | PR: OWF  |   |  |  |  |                         |
|  | 2.5 TDI 100   |  | 04.06  | PR: OWF  |   |  |  |  |                         |
|  | 2.5 TDI 120   |  | 04.06  | PR: OWF  |   |  |  |  |                         |
|  | 2.0 TDI 103   |  | 11.15  | PR: OWC, OWL   | 24.0116-0121.1  | 416121   |  |  | 298 16,0 14,0 +S +B     |
|  | 2.0 TDI 4motion 120   |  | 11.11  | PR: OWC, OWL   |   |  |  |  |                         |
|  | 2.0 TDI BlueMotion 80   |  | 07.11  | PR: OWC, OWL   |   |  |  |  |                         |
|  | 2.0 TDI BlueMotion 100  |  | 07.11  | PR: OWC, OWL   |   |  |  |  |                         |
|  | 2.0 TDI BlueMotion 120  |  | 07.11  | PR: OWC, OWL   |   |  |  |  |                         |
|  | 2.5 TDI 65  |  | 04.06  | PR: OWC, OWL   |   |  |  |  |                         |
|  | 2.5 TDI 80  |  | 04.06  | PR: OWC, OWL   |   |  |  |  |                         |
|  | 2.5 TDI 100   |  | 04.06  | PR: OWC, OWL   |   |  |  |  |                         |
|  | 2.5 TDI 120   |  | 04.06  | PR: OWC, OWL   |   |  |  |  |                         |















1) manufacturer restriction ATE / limitazione costruttore ATE / montage d'origine ATE / restricción de fabricante ATE

### VOLKSWAGEN CRAFTER (06-)

|         |                    |       |         |              |                |        |  |                     |                |        |  |               |
|---------|--------------------|-------|---------|--------------|----------------|--------|--|---------------------|----------------|--------|--|---------------|
|         | 2.0 TDI            | 103   | 11.15   | PR: OWF      | 24.0128-0202.1 | 428202 |  | 303 28,0 25,0 VL +B |                |        |  |               |
|         | 2.0 TDI 4motion    | 120   | 11.11   | PR: OWF      |                |        |  |                     |                |        |  |               |
|         | 2.0 TDI BlueMotion | 80    | 07.11   | PR: OWF      |                |        |  |                     |                |        |  |               |
|         | 2.0 TDI BlueMotion | 100   | 07.11   | PR: OWF      |                |        |  |                     |                |        |  |               |
|         | 2.0 TDI BlueMotion | 120   | 07.11   | PR: OWF      |                |        |  |                     |                |        |  |               |
|         | 2.5 TDI            | 65    | 04.06   | PR: OWF      |                |        |  |                     |                |        |  |               |
|         | 2.5 TDI            | 80    | 04.06   | PR: OWF      |                |        |  |                     |                |        |  |               |
|         | 2.5 TDI            | 100   | 04.06   | PR: OWF      |                |        |  |                     |                |        |  |               |
| 2.5 TDI | 120                | 04.06 | PR: OWF |              |                |        |  |                     |                |        |  |               |
|         | 2.0 TDI            | 103   | 11.15   | PR: OWC, OWL | 03.0137-4003.2 | 654003 |  | 180 x 25 /Zub       |                |        |  |               |
|         | 2.0 TDI 4motion    | 120   | 11.11   | PR: OWC, OWL |                |        |  |                     |                |        |  |               |
|         | 2.0 TDI BlueMotion | 80    | 07.11   | PR: OWC, OWL |                |        |  |                     |                |        |  |               |
|         | 2.0 TDI BlueMotion | 100   | 07.11   | PR: OWC, OWL |                |        |  |                     |                |        |  |               |
|         | 2.0 TDI BlueMotion | 120   | 07.11   | PR: OWC, OWL |                |        |  |                     |                |        |  |               |
|         | 2.5 TDI            | 65    | 04.06   | PR: OWC, OWL |                |        |  |                     |                |        |  |               |
|         | 2.5 TDI            | 80    | 04.06   | PR: OWC, OWL |                |        |  |                     |                |        |  |               |
|         | 2.5 TDI            | 100   | 04.06   | PR: OWC, OWL |                |        |  |                     |                |        |  |               |
|         | 2.5 TDI            | 120   | 04.06   | PR: OWC, OWL |                |        |  |                     |                |        |  |               |
|         | 2.0 TDI            | 103   | 11.15   | PR: OWF      |                |        |  |                     | 03.0137-4008.2 | 654008 |  | 172 x 42 /Zub |
|         | 2.0 TDI 4motion    | 120   | 11.11   | PR: OWF      |                |        |  |                     |                |        |  |               |
|         | 2.0 TDI BlueMotion | 80    | 07.11   | PR: OWF      |                |        |  |                     |                |        |  |               |
|         | 2.0 TDI BlueMotion | 100   | 07.11   | PR: OWF      |                |        |  |                     |                |        |  |               |
|         | 2.0 TDI BlueMotion | 120   | 07.11   | PR: OWF      |                |        |  |                     |                |        |  |               |
| 2.5 TDI | 65                 | 04.06 | PR: OWF |              |                |        |  |                     |                |        |  |               |
| 2.5 TDI | 80                 | 04.06 | PR: OWF |              |                |        |  |                     |                |        |  |               |
| 2.5 TDI | 100                | 04.06 | PR: OWF |              |                |        |  |                     |                |        |  |               |
| 2.5 TDI | 120                | 04.06 | PR: OWF |              |                |        |  |                     |                |        |  |               |

### VOLKSWAGEN EOS (06-)

|             |             |       |                 |                     |                |        |                     |                        |     |                |        |  |                        |     |
|-------------|-------------|-------|-----------------|---------------------|----------------|--------|---------------------|------------------------|-----|----------------|--------|--|------------------------|-----|
|             | 1.4 TSI     | 90    | 10.07           | PR: 1LJ,1ZA,1ZD,1ZE | 13.0460-7184.2 | 607184 |                     | 23587 20,6 +/WK        | ATE |                |        |  |                        |     |
|             | 1.4 TSI     | 118   | 05.08           | PR: 1LJ,1ZA,1ZD,1ZE |                |        |                     |                        |     |                |        |  |                        |     |
|             | 1.6 FSI     | 85    | 05.06           | PR: 1LJ,1ZA,1ZD,1ZE |                |        |                     |                        |     |                |        |  |                        |     |
|             | 2.0 FSI     | 110   | 05.06           | PR: 1LJ,1ZA,1ZD,1ZE |                |        |                     |                        |     |                |        |  |                        |     |
|             | 2.0 TDI     | 100   | 11.10           | PR: 1LJ,1ZA,1ZD,1ZE |                |        |                     |                        |     |                |        |  |                        |     |
|             | 2.0 TDI     | 103   | 05.06           | PR: 1LJ,1ZA,1ZD,1ZE |                |        |                     |                        |     |                |        |  |                        |     |
|             | 2.0 TDI 16V | 103   | 05.08           | PR: 1LJ,1ZA,1ZD,1ZE |                |        |                     |                        |     |                |        |  |                        |     |
|             | 2.0 TFSI    | 147   | 05.06           | PR: 1LJ,1ZA,1ZD,1ZE |                |        |                     |                        |     |                |        |  |                        |     |
|             | 2.0 TFSI    | 162   | 11.13           | PR: 1LJ,1ZA,1ZD,1ZE |                |        |                     |                        |     |                |        |  |                        |     |
|             | 2.0 TSI     | 155   | 11.09           | PR: 1LJ,1ZA,1ZD,1ZE |                |        |                     |                        |     |                |        |  |                        |     |
|             | 3.2 V6      | 184   | 05.06           | PR: 1LJ,1ZA,1ZD,1ZE |                |        |                     |                        |     |                |        |  |                        |     |
|             | 3.6 V6      | 191   | 05.09           | PR: 1LJ,1ZA,1ZD,1ZE |                |        |                     |                        |     |                |        |  |                        |     |
|             | 1.4 TSI     | 90    | 10.07           | PR: 1LK             |                |        |                     |                        |     | 13.0460-7200.2 | 607200 |  | 23801 20,3 +/WK        | ATE |
|             | 1.4 TSI     | 118   | 05.08           | PR: 1LK             |                |        |                     |                        |     |                |        |  |                        |     |
| 1.6 FSI     | 85          | 05.06 | PR: 1LK         |                     |                |        |                     |                        |     |                |        |  |                        |     |
| 2.0 FSI     | 110         | 05.06 | PR: 1LK         |                     |                |        |                     |                        |     |                |        |  |                        |     |
| 2.0 TDI     | 100         | 11.10 | PR: 1LK         |                     |                |        |                     |                        |     |                |        |  |                        |     |
| 2.0 TDI     | 103         | 05.06 | PR: 1LK         |                     |                |        |                     |                        |     |                |        |  |                        |     |
| 2.0 TDI 16V | 103         | 05.08 | PR: 1LK         |                     |                |        |                     |                        |     |                |        |  |                        |     |
| 2.0 TFSI    | 147         | 05.06 | PR: 1LK         |                     |                |        |                     |                        |     |                |        |  |                        |     |
| 2.0 TFSI    | 162         | 11.13 | PR: 1LK         |                     |                |        |                     |                        |     |                |        |  |                        |     |
| 2.0 TSI     | 155         | 11.09 | PR: 1LK         |                     |                |        |                     |                        |     |                |        |  |                        |     |
| 3.2 V6      | 184         | 05.06 | PR: 1LK         |                     |                |        |                     |                        |     |                |        |  |                        |     |
| 3.6 V6      | 191         | 05.09 | PR: 1LK         |                     |                |        |                     |                        |     |                |        |  |                        |     |
|             | 1.4 TSI     | 90    | 10.07           | PR: 1ZE             | 24.0125-0145.1 | 425145 |                     | 288 25,0 22,0 VL +S +B | PD  |                |        |  |                        |     |
|             | 1.4 TSI     | 118   | 05.08           | PR: 1ZE             |                |        |                     |                        |     |                |        |  |                        |     |
|             | 1.6 FSI     | 85    | 05.06           | PR: 1ZE             |                |        |                     |                        |     |                |        |  |                        |     |
|             | 2.0 FSI     | 110   | 05.06           | PR: 1ZE             |                |        |                     |                        |     |                |        |  |                        |     |
|             | 2.0 TDI     | 100   | 11.10           | PR: 1ZE             |                |        |                     |                        |     |                |        |  |                        |     |
|             | 2.0 TDI     | 103   | 05.06           | PR: 1ZE             |                |        |                     |                        |     |                |        |  |                        |     |
|             | 2.0 TDI 16V | 103   | 05.08           | PR: 1ZE             |                |        |                     |                        |     |                |        |  |                        |     |
|             | 2.0 TFSI    | 147   | 05.06           | PR: 1ZE             |                |        |                     |                        |     |                |        |  |                        |     |
|             | 2.0 TFSI    | 162   | 11.13           | PR: 1ZE             |                |        |                     |                        |     |                |        |  |                        |     |
|             | 2.0 TSI     | 155   | 11.09           | PR: 1ZE             |                |        |                     |                        |     |                |        |  |                        |     |
|             | 3.2 V6      | 184   | 05.06           | PR: 1ZE             |                |        |                     |                        |     |                |        |  |                        |     |
|             | 3.6 V6      | 191   | 05.09           | PR: 1ZE             |                |        |                     |                        |     |                |        |  |                        |     |
|             | 1.4 TSI     | 90    | 10.07           | PR: 1LJ,1ZA,1ZD     |                |        |                     |                        |     | 24.0125-0158.1 | 425158 |  | 312 25,0 22,0 VL +S +B | PD  |
|             | 1.4 TSI     | 118   | 05.08           | PR: 1LJ,1ZA,1ZD     |                |        |                     |                        |     |                |        |  |                        |     |
| 1.6 FSI     | 85          | 05.06 | PR: 1LJ,1ZA,1ZD |                     |                |        |                     |                        |     |                |        |  |                        |     |
| 2.0 FSI     | 110         | 05.06 | PR: 1LJ,1ZA,1ZD |                     |                |        |                     |                        |     |                |        |  |                        |     |
| 2.0 TDI     | 100         | 11.10 | PR: 1LJ,1ZA,1ZD |                     |                |        |                     |                        |     |                |        |  |                        |     |
| 2.0 TDI     | 103         | 05.06 | PR: 1LJ,1ZA,1ZD |                     |                |        |                     |                        |     |                |        |  |                        |     |
| 2.0 TDI 16V | 103         | 05.08 | PR: 1LJ,1ZA,1ZD |                     |                |        |                     |                        |     |                |        |  |                        |     |
| 2.0 TFSI    | 147         | 05.06 | PR: 1LJ,1ZA,1ZD |                     |                |        |                     |                        |     |                |        |  |                        |     |
| 2.0 TFSI    | 162         | 11.13 | PR: 1LJ,1ZA,1ZD |                     |                |        |                     |                        |     |                |        |  |                        |     |
| 2.0 TSI     | 155         | 11.09 | PR: 1LJ,1ZA,1ZD |                     |                |        |                     |                        |     |                |        |  |                        |     |
| 3.2 V6      | 184         | 05.06 | PR: 1LJ,1ZA,1ZD |                     |                |        |                     |                        |     |                |        |  |                        |     |
| 3.6 V6      | 191         | 05.09 | PR: 1LJ,1ZA,1ZD |                     |                |        |                     |                        |     |                |        |  |                        |     |
| 1.4 TSI     | 90          | 10.07 | PR: 1LK         | 24.0130-0115.1      | 430115         |        | 345 30,0 27,0 VL +B | PD                     |     |                |        |  |                        |     |
| 1.4 TSI     | 118         | 05.08 | PR: 1LK         |                     |                |        |                     |                        |     |                |        |  |                        |     |
| 1.6 FSI     | 85          | 05.06 | PR: 1LK         |                     |                |        |                     |                        |     |                |        |  |                        |     |
| 2.0 FSI     | 110         | 05.06 | PR: 1LK         |                     |                |        |                     |                        |     |                |        |  |                        |     |
| 2.0 TDI     | 100         | 11.10 | PR: 1LK         |                     |                |        |                     |                        |     |                |        |  |                        |     |
| 2.0 TDI     | 103         | 05.06 | PR: 1LK         |                     |                |        |                     |                        |     |                |        |  |                        |     |
| 2.0 TDI 16V | 103         | 05.08 | PR: 1LK         |                     |                |        |                     |                        |     |                |        |  |                        |     |
| 2.0 TFSI    | 147         | 05.06 | PR: 1LK         |                     |                |        |                     |                        |     |                |        |  |                        |     |
| 2.0 TFSI    | 162         | 11.13 | PR: 1LK         |                     |                |        |                     |                        |     |                |        |  |                        |     |
| 2.0 TSI     | 155         | 11.09 | PR: 1LK         |                     |                |        |                     |                        |     |                |        |  |                        |     |

|     |    |  |                          |    |  |  |    |  |            |
|--|--|--|--|--|---|--|--|--|------------|
| <b>VOLKSWAGEN EOS (06-)</b>  |  |  |  |  |   |  |  |  |            |
|    | 3.2 V6<br>3.6 V6   | 184<br>191   | 05.06<br>05.09   | PR: 1LK<br>PR: 1LK   | 24.0130-0115.1<br>24.0330-0115.1  | 430115<br>530115   |  | 345 30,0 27,0 VL +B<br>345 30,0 27,0 VL +B PD                                      |            |
|    | 1.4 TSI<br>1.4 TSI<br>1.6 FSI<br>2.0 FSI<br>2.0 TDI<br>2.0 TDI<br>2.0 TDI 16V<br>2.0 TFSI<br>2.0 TFSI<br>2.0 TSI<br>3.2 V6<br>3.6 V6 | 90<br>118<br>85<br>110<br>100<br>103<br>103<br>147<br>162<br>155<br>184<br>191   | 10.07<br>05.08<br>05.06<br>05.06<br>11.10<br>05.06<br>05.08<br>05.06<br>11.13<br>11.09<br>05.06<br>05.09 |  | 24.0711-5271.3<br>24.0711-5272.3  | 360301<br>360302   | <br> | Radsensor<br>Radsensor   |            |
|    | 1.4 TSI<br>1.4 TSI<br>1.6 FSI<br>2.0 FSI<br>2.0 TDI<br>2.0 TDI<br>2.0 TDI 16V<br>2.0 TFSI<br>2.0 TFSI<br>2.0 TSI<br>3.2 V6<br>3.6 V6 | 90<br>118<br>85<br>110<br>100<br>103<br>103<br>147<br>162<br>155<br>184<br>191   | 10.07<br>05.08<br>05.06<br>05.06<br>11.10<br>05.06<br>05.08<br>05.06<br>11.13<br>11.09<br>05.06<br>05.09 | PR: 1KD<br>PR: 1KD<br>PR: 1KD<br>PR: 1KD<br>PR: 1KD<br>PR: 1KD<br>PR: 1KD<br>PR: 1KD<br>PR: 1KD<br>PR: 1KD<br>PR: 1KD<br>PR: 1KD   | 13.0460-2820.2<br>13.0470-2820.2<br>13.0460-0259.2                                | 602820<br>LD2820<br>610259   |  | 20961 17,6 /S<br>20961 17,6 /S<br>Belagsatz-Zubehör                                | TRW<br>TRW |
|  | 1.4 TSI<br>1.4 TSI<br>1.6 FSI<br>2.0 FSI<br>2.0 TDI<br>2.0 TDI<br>2.0 TDI 16V<br>2.0 TFSI<br>2.0 TFSI<br>2.0 TSI<br>3.2 V6<br>3.6 V6 | 90<br>118<br>85<br>110<br>100<br>103<br>103<br>147<br>162<br>155<br>184<br>191   | 10.07<br>05.08<br>05.06<br>05.06<br>11.10<br>05.06<br>05.08<br>05.06<br>11.13<br>11.09<br>05.06<br>05.09 | PR: 1KS<br>PR: 1KS<br>PR: 1KS<br>PR: 1KS<br>PR: 1KS<br>PR: 1KS<br>PR: 1KS<br>PR: 1KS<br>PR: 1KS<br>PR: 1KS<br>PR: 1KS<br>PR: 1KS   | 13.0460-3858.2<br>13.0470-3858.2  | 603858<br>LD3858   |  | 24563 17,7 /Zub/S<br>24563 17,7 /Zub/S   | BOS<br>BOS |
|  | 1.4 TSI<br>1.4 TSI<br>1.6 FSI<br>2.0 FSI<br>2.0 TDI<br>2.0 TDI<br>2.0 TDI 16V<br>2.0 TFSI<br>2.0 TFSI<br>2.0 TSI<br>3.2 V6<br>3.6 V6 | 90<br>118<br>85<br>110<br>100<br>103<br>103<br>147<br>162<br>155<br>184<br>191   | 10.07<br>05.08<br>05.06<br>05.06<br>11.10<br>05.06<br>05.08<br>05.06<br>11.13<br>11.09<br>05.06<br>05.09 | PR: 1KJ,1KZ<br>PR: 1KJ,1KZ<br>PR: 1KJ,1KZ<br>PR: 1KJ,1KZ<br>PR: 1KJ,1KZ<br>PR: 1KJ,1KZ<br>PR: 1KJ,1KZ<br>PR: 1KJ,1KZ<br>PR: 1KJ,1KZ<br>PR: 1KJ,1KZ<br>PR: 1KJ,1KZ<br>PR: 1KJ,1KZ | 13.0460-2880.2<br>13.0470-2880.2<br>13.0460-0259.2                                | 602880<br>LD2880<br>610259   |  | 23914 17,1 /WE/Zub/S<br>23914 17,1 /WE/Zub/S<br>Belagsatz-Zubehör                  | TRW<br>TRW |
|  | 1.4 TSI<br>1.4 TSI<br>1.6 FSI<br>2.0 FSI<br>2.0 TDI<br>2.0 TDI<br>2.0 TDI 16V<br>2.0 TFSI<br>2.0 TFSI<br>2.0 TSI<br>3.2 V6<br>3.6 V6 | 90<br>118<br>85<br>110<br>100<br>103<br>103<br>147<br>162<br>155<br>184<br>191   | 10.07<br>05.08<br>05.06<br>05.06<br>11.10<br>05.06<br>05.08<br>05.06<br>11.13<br>11.09<br>05.06<br>05.09 | PR: 2EA<br>PR: 2EA<br>PR: 2EA<br>PR: 2EA<br>PR: 2EA<br>PR: 2EA<br>PR: 2EA<br>PR: 2EA<br>PR: 2EA<br>PR: 2EA<br>PR: 2EA<br>PR: 2EA   | 13.0460-2880.2<br>13.0470-2880.2<br>13.0460-0035.2                                | 602880<br>LD2880<br>610035   |  | 23914 17,1 /WE/Zub/S<br>23914 17,1 /WE/Zub/S<br>Belagsatz-Zubehör                  | TRW<br>TRW |
|  | 1.4 TSI<br>1.4 TSI<br>1.6 FSI<br>2.0 FSI<br>2.0 TDI<br>2.0 TDI<br>2.0 TDI 16V<br>2.0 TFSI<br>2.0 TFSI<br>2.0 TSI<br>3.2 V6<br>3.6 V6 | 90<br>118<br>85<br>110<br>100<br>103<br>103<br>147<br>162<br>155<br>184<br>191   | 10.07<br>05.08<br>05.06<br>05.06<br>11.10<br>05.06<br>05.08<br>05.06<br>11.13<br>11.09<br>05.06<br>05.09 | PR: 1KD<br>PR: 1KD<br>PR: 1KD<br>PR: 1KD<br>PR: 1KD<br>PR: 1KD<br>PR: 1KD<br>PR: 1KD<br>PR: 1KD<br>PR: 1KD<br>PR: 1KD<br>PR: 1KD   | 24.0110-0277.1<br>24.0310-0277.1  | 410277<br>510277   |  | 253 10,0 8,0 +S +B<br>253 10,0 8,0 +S +B PD  |            |
|  | 1.4 TSI<br>1.4 TSI<br>1.6 FSI<br>2.0 FSI<br>2.0 TDI<br>2.0 TDI<br>2.0 TDI 16V<br>2.0 TFSI<br>2.0 TFSI<br>2.0 TSI<br>3.2 V6           | 90<br>118<br>85<br>110<br>100<br>103<br>103<br>147<br>162<br>155<br>184          | 10.07<br>05.08<br>05.06<br>05.06<br>11.10<br>05.06<br>05.08<br>05.06<br>11.13<br>11.09<br>05.06          | PR: 1KS<br>PR: 1KS<br>PR: 1KS<br>PR: 1KS<br>PR: 1KS<br>PR: 1KS<br>PR: 1KS<br>PR: 1KS<br>PR: 1KS<br>PR: 1KS<br>PR: 1KS  | 24.0110-0356.1<br>24.0310-0356.1  | 410356<br>510356   |  | 272 9,7 8,0 +S +B<br>272 9,7 8,0 +S +B PD  |            |





**VOLKSWAGEN EOS (06-)**

|  |             |     |  |       |             |                |        |  |                        |
|--|-------------|-----|--|-------|-------------|----------------|--------|--|------------------------|
|  | 3.6 V6      | 191 |  | 05.09 | PR: 1KS     | 24.0110-0356.1 | 410356 |  | 272 9,7 8,0 +S +B      |
|  |             |     |  |       |             | 24.0310-0356.1 | 510356 |  | 272 9,7 8,0 +S +B PD   |
|  | 1.4 TSI     | 90  |  | 10.07 | PR: 1KJ,1KZ | 24.0112-0169.1 | 412169 |  | 282 12,0 10,0 +S +B    |
|  | 1.4 TSI     | 118 |  | 05.08 | PR: 1KJ,1KZ | 24.0312-0169.1 | 512169 |  | 282 12,0 10,0 +S +B PD |
|  | 1.6 FSI     | 85  |  | 05.06 | PR: 1KJ,1KZ |                |        |  |                        |
|  | 2.0 FSI     | 110 |  | 05.06 | PR: 1KJ,1KZ |                |        |  |                        |
|  | 2.0 TDI     | 100 |  | 11.10 | PR: 1KJ,1KZ |                |        |  |                        |
|  | 2.0 TDI     | 103 |  | 05.06 | PR: 1KJ,1KZ |                |        |  |                        |
|  | 2.0 TDI 16V | 103 |  | 05.08 | PR: 1KJ,1KZ |                |        |  |                        |
|  | 2.0 TFSI    | 147 |  | 05.06 | PR: 1KJ,1KZ |                |        |  |                        |
|  | 2.0 TFSI    | 162 |  | 11.13 | PR: 1KJ,1KZ |                |        |  |                        |
|  | 2.0 TSI     | 155 |  | 11.09 | PR: 1KJ,1KZ |                |        |  |                        |
|  | 3.2 V6      | 184 |  | 05.06 | PR: 1KJ,1KZ |                |        |  |                        |
|  | 3.6 V6      | 191 |  | 05.09 | PR: 1KJ,1KZ |                |        |  |                        |
|  | 1.4 TSI     | 90  |  | 10.07 | PR: 2EA     | 24.0122-0219.1 | 422219 |  | 310 22,0 20,0 VL +B    |
|  | 1.4 TSI     | 118 |  | 05.08 | PR: 2EA     |                |        |  |                        |
|  | 1.6 FSI     | 85  |  | 05.06 | PR: 2EA     |                |        |  |                        |
|  | 2.0 FSI     | 110 |  | 05.06 | PR: 2EA     |                |        |  |                        |
|  | 2.0 TDI     | 100 |  | 11.10 | PR: 2EA     |                |        |  |                        |
|  | 2.0 TDI     | 103 |  | 05.06 | PR: 2EA     |                |        |  |                        |
|  | 2.0 TDI 16V | 103 |  | 05.08 | PR: 2EA     |                |        |  |                        |
|  | 2.0 TFSI    | 147 |  | 05.06 | PR: 2EA     |                |        |  |                        |
|  | 2.0 TFSI    | 162 |  | 11.13 | PR: 2EA     |                |        |  |                        |
|  | 2.0 TSI     | 155 |  | 11.09 | PR: 2EA     |                |        |  |                        |
|  | 3.2 V6      | 184 |  | 05.06 | PR: 2EA     |                |        |  |                        |
|  | 3.6 V6      | 191 |  | 05.09 | PR: 2EA     |                |        |  |                        |
|  | 1.4 TSI     | 90  |  | 10.07 | PR: 7X0,7X1 | 24.0711-5271.3 | 360301 |  | Radsensor              |
|  | 1.4 TSI     | 118 |  | 05.08 | PR: 7X0,7X1 | 24.0711-5272.3 | 360302 |  | Radsensor              |
|  | 1.6 FSI     | 85  |  | 05.06 | PR: 7X0,7X1 |                |        |  |                        |
|  | 2.0 FSI     | 110 |  | 05.06 | PR: 7X0,7X1 |                |        |  |                        |
|  | 2.0 TDI     | 100 |  | 11.10 | PR: 7X0,7X1 |                |        |  |                        |
|  | 2.0 TDI     | 103 |  | 05.06 | PR: 7X0,7X1 |                |        |  |                        |
|  | 2.0 TDI 16V | 103 |  | 05.08 | PR: 7X0,7X1 |                |        |  |                        |
|  | 2.0 TFSI    | 147 |  | 05.06 | PR: 7X0,7X1 |                |        |  |                        |
|  | 2.0 TFSI    | 162 |  | 11.13 | PR: 7X0,7X1 |                |        |  |                        |
|  | 2.0 TSI     | 155 |  | 11.09 | PR: 7X0,7X1 |                |        |  |                        |
|  | 3.2 V6      | 184 |  | 05.06 | PR: 7X0,7X1 |                |        |  |                        |
|  | 3.6 V6      | 191 |  | 05.09 | PR: 7X0,7X1 |                |        |  |                        |
|  | 1.4 TSI     | 90  |  | 10.07 | PR: 7X5     | 24.0711-6335.3 | 360365 |  | Radsensor              |
|  | 1.4 TSI     | 118 |  | 05.08 | PR: 7X5     | 24.0711-6336.3 | 360366 |  | Radsensor              |
|  | 1.6 FSI     | 85  |  | 05.06 | PR: 7X5     |                |        |  |                        |
|  | 2.0 FSI     | 110 |  | 05.06 | PR: 7X5     |                |        |  |                        |
|  | 2.0 TDI     | 100 |  | 11.10 | PR: 7X5     |                |        |  |                        |
|  | 2.0 TDI     | 103 |  | 05.06 | PR: 7X5     |                |        |  |                        |
|  | 2.0 TDI 16V | 103 |  | 05.08 | PR: 7X5     |                |        |  |                        |
|  | 2.0 TFSI    | 147 |  | 05.06 | PR: 7X5     |                |        |  |                        |
|  | 2.0 TFSI    | 162 |  | 11.13 | PR: 7X5     |                |        |  |                        |
|  | 2.0 TSI     | 155 |  | 11.09 | PR: 7X5     |                |        |  |                        |
|  | 3.2 V6      | 184 |  | 05.06 | PR: 7X5     |                |        |  |                        |
|  | 3.6 V6      | 191 |  | 05.09 | PR: 7X5     |                |        |  |                        |

**VOLKSWAGEN FOX (05-11)**

|  |         |    |  |       |       |         |                |        |  |                           |     |
|--|---------|----|--|-------|-------|---------|----------------|--------|--|---------------------------|-----|
|  | 1.0     |    |  | 10.03 | 08.11 | PR: 1ZN | 13.0460-7100.2 | 607100 |  | 21866 17,2 +              | VW  |
|  | 1.2     |    |  | 04.05 | 08.11 | PR: 1ZN | 13.0470-7100.2 | LD7100 |  | 21866 17,2 +              | ATE |
|  | 1.4     | 55 |  | 04.05 | 08.11 | PR: 1ZN |                |        |  |                           |     |
|  | 1.4 TDI | 51 |  | 04.05 | 08.11 | PR: 1ZN |                |        |  |                           |     |
|  | 1.6     |    |  | 10.03 | 08.11 | PR: 1ZN |                |        |  |                           |     |
|  | 1.9 D   | 47 |  | 12.07 | 08.11 | PR: 1ZN |                |        |  |                           |     |
|  | 1.0     |    |  | 10.03 | 08.11 | PR: 1ZF | 13.0460-7111.2 | 607111 |  | 23130 19,6 +              | VW  |
|  | 1.2     |    |  | 04.05 | 08.11 | PR: 1ZF | 13.0470-7111.2 | LD7111 |  | 23130 19,6 +              | VW  |
|  | 1.4     | 55 |  | 04.05 | 08.11 | PR: 1ZF |                |        |  |                           |     |
|  | 1.4 TDI | 51 |  | 04.05 | 08.11 | PR: 1ZF |                |        |  |                           |     |
|  | 1.6     |    |  | 10.03 | 08.11 | PR: 1ZF |                |        |  |                           |     |
|  | 1.9 D   | 47 |  | 12.07 | 08.11 | PR: 1ZF |                |        |  |                           |     |
|  | 1.0     |    |  | 10.03 | 08.11 | PR: 1ZN | 24.0118-0137.1 | 418137 |  | 239 18,0 16,0 VL +S +B    |     |
|  | 1.2     |    |  | 04.05 | 08.11 | PR: 1ZN | 24.0318-0137.1 | 518137 |  | 239 18,0 16,0 VL +S +B PD |     |
|  | 1.4     | 55 |  | 04.05 | 08.11 | PR: 1ZN |                |        |  |                           |     |
|  | 1.4 TDI | 51 |  | 04.05 | 08.11 | PR: 1ZN |                |        |  |                           |     |
|  | 1.6     |    |  | 10.03 | 08.11 | PR: 1ZN |                |        |  |                           |     |
|  | 1.9 D   | 47 |  | 12.07 | 08.11 | PR: 1ZN |                |        |  |                           |     |
|  | 1.0     |    |  | 10.03 | 08.11 | PR: 1ZF | 24.0122-0151.1 | 422151 |  | 256 22,0 19,0 VL +S +B    |     |
|  | 1.2     |    |  | 04.05 | 08.11 | PR: 1ZF | 24.0322-0151.1 | 522151 |  | 256 22,0 19,0 VL +S +B PD |     |
|  | 1.4     | 55 |  | 04.05 | 08.11 | PR: 1ZF |                |        |  |                           |     |
|  | 1.4 TDI | 51 |  | 04.05 | 08.11 | PR: 1ZF |                |        |  |                           |     |
|  | 1.6     |    |  | 10.03 | 08.11 | PR: 1ZF |                |        |  |                           |     |
|  | 1.9 D   | 47 |  | 12.07 | 08.11 | PR: 1ZF |                |        |  |                           |     |
|  | 1.0     |    |  | 10.03 | 08.11 |         | 24.0711-5273.3 | 360303 |  | Radsensor                 |     |
|  | 1.2     |    |  | 04.05 | 08.11 |         | 24.0711-5274.3 | 360304 |  | Radsensor                 |     |
|  | 1.4     | 55 |  | 04.05 | 08.11 |         |                |        |  |                           |     |
|  | 1.4 TDI | 51 |  | 04.05 | 08.11 |         |                |        |  |                           |     |
|  | 1.6     |    |  | 10.03 | 08.11 |         |                |        |  |                           |     |
|  | 1.9 D   | 47 |  | 12.07 | 08.11 |         |                |        |  |                           |     |





### VOLKSWAGEN FOX (05-11)

|  |  |  |  |  |  |                                  |                  |  |  |                                     |          |
|--|--|--|--|--|--|----------------------------------|------------------|--|--|-------------------------------------|----------|
|  | 1.0<br>1.2<br>1.4<br>1.4 TDI<br>1.6<br>1.9 D |  |  | 10.03<br>04.05<br>04.05<br>04.05<br>10.03<br>12.07 | 08.11<br>08.11<br>08.11<br>08.11<br>08.11<br>08.11 | 24.0711-6233.3<br>24.0711-6234.3 | 360315<br>360316 |  |  | Radsensor<br>Radsensor              |          |
|  | 1.0<br>1.2<br>1.4<br>1.4 TDI<br>1.6<br>1.9 D |  |  | 10.03<br>04.05<br>04.05<br>04.05<br>10.03<br>12.07 | 08.11<br>08.11<br>08.11<br>08.11<br>08.11<br>08.11 | 03.0137-0268.2<br>03.0137-9168.2 | 650268<br>669168 |  |  | 200 x 40 HEB<br>Bremsbacken-Zubehör | VW<br>VW |
|  | 1.0<br>1.2<br>1.4<br>1.4 TDI<br>1.6<br>1.9 D |  |  | 10.03<br>04.05<br>04.05<br>04.05<br>10.03<br>12.07 | 08.11<br>08.11<br>08.11<br>08.11<br>08.11<br>08.11 | 24.0220-0037.1                   | 480161           |  |  | 200/201,5 x 50,5                    |          |
|  | 1.0<br>1.2<br>1.4<br>1.4 TDI<br>1.6<br>1.9 D |  |  | 10.03<br>04.05<br>04.05<br>04.05<br>10.03<br>12.07 | 08.11<br>08.11<br>08.11<br>08.11<br>08.11<br>08.11 | 03.0520-1517.3                   | 691517           |  |  | 17,46/200x40 TopKit                 | VW       |

### VOLKSWAGEN GOLF III (92-97)

|  |   |   |   |   |  |  |  |  |  |  |                  |   |            |
|--|---|---|---|---|--|--|--|--|--|--|------------------|---|------------|
|  | 1.4<br>1.6<br>1.8 CL/GL<br>1.8 CL/GL<br>1.8 Syncro<br>1.9 D<br>1.9 D Ecomatic<br>1.9 SDI<br>1.9 TD  | 55  | 1H-T-028354<br>1H-T-028354<br>1H-T-028354<br>1H-S-246940<br>1H-S-089450<br>1H-T-028354<br>1H-S-246940<br>1H-T-028354<br>1H-T-028354 | 11.91<br>09.92<br>11.91<br>11.91<br>01.93<br>11.91<br>08.93<br>07.95<br>11.91   |  |  |  |  |  |  | 20887 19,7 +/Zub | VW  |            |
|  | 1.4<br>1.6<br>1.8 CL/GL<br>1.9 D<br>1.9 SDI<br>1.9 TD   | 55  | 1H-T-028355<br>1H-T-028355<br>1H-T-028355<br>1H-T-028355<br>1H-T-028355<br>1H-T-028355  |   | 08.97<br>08.97<br>08.97<br>08.97<br>08.97<br>08.97   | - ABS<br>- ABS<br>- ABS/ + Schaltgetriebe <sup>3)</sup><br>- ABS<br>- ABS<br>- ABS   |  |  |  |  |                  | 21866 19,7 +                                  | VW         |
|  | 2.0<br>2.0 GTI 16V<br>2.8 VR6   | 85<br>110                                     | 1H-S-560000<br>1H-S-560000<br>1H-S-399999   | 11.91<br>08.92<br>01.92   |  |  |  |  |  |  |                  | 20168 19,3 +/WK/S                             | TRW        |
|  | 1.6 CL/GL<br>1.8 CL/GL<br>1.8 Syncro<br>1.9 TDI<br>1.9 TDI<br>1.9 TDI Syncro<br>2.0<br>2.0 GTI 16V  | 74<br>74<br>66<br>81<br>66<br>66<br>85<br>110 | 1H-S-246941<br>1H-S-089451<br>1H-S-560001<br>1H-S-560001  | 07.94<br>07.94<br>10.93<br>02.96<br>03.95<br>04.96<br>04.96<br>04.96  | 08.97<br>08.97<br>08.97<br>04.96<br>04.96<br>04.96<br>04.96  | - ABS<br>- ABS<br>- ABS<br>+ roter Sattel <sup>4)</sup>  |  |  |  |  |                  | 20168 19,3 /S                                 | TRW        |
|  | 1.9 TDI<br>2.0<br>2.0 GTI 16V<br>2.8 VR6<br>2.9 VR6 Syncro  | 81<br>85<br>110                               |   | 05.96<br>05.96<br>05.96<br>10.94  | 08.97<br>08.97<br>08.97<br>08.97   | + roter Sattel <sup>4)</sup>   |  |  |  |  |                  | 21911 20,3 +<br>21911 20,3 +                  | ATE<br>ATE |
|  | 1.4<br>1.6<br>1.6 GT<br>1.8<br>1.8 GT<br>1.8 Syncro<br>1.9 D<br>1.9 D Ecomatic<br>1.9 SDI<br>1.9 TD<br>1.9 TDI<br>1.9 TDI<br>1.9 TDI Syncro<br>2.0 GL<br>2.0 Syncro | 55<br>74<br>66<br>81<br>66<br>79              | 1H-S-246941   | 05.96<br>05.96<br>07.94<br>05.96<br>11.91<br>01.93<br>05.96<br>05.96<br>05.96<br>05.96<br>05.96<br>02.96<br>05.96<br>11.91<br>07.95 | 09.96<br>09.96<br>08.97<br>08.97<br>08.97<br>08.97<br>09.96<br>09.96<br>09.96<br>08.97<br>08.97<br>08.97<br>08.97<br>08.97 | + ABS<br>+ ABS<br>+ ABS<br>+ ABS<br>+ ABS<br>+ ABS<br>+ ABS<br>+ ABS<br>+ ABS<br>+ ABS<br>+ ABS<br>- roter Sattel <sup>5)</sup>          |  |  |  |  | 21945 16,0 /S    | TRW   |            |
|  | 1.4<br>1.6<br>1.9 D<br>1.9 SDI<br>1.9 TD  | 55  |   | 10.96<br>10.96<br>10.96<br>10.96<br>10.96   | 08.97<br>08.97<br>08.97<br>08.97<br>08.97  | + ABS<br>+ ABS<br>+ ABS<br>+ ABS<br>+ ABS  |  |  |  |  |                  | 21866 15,3 +                                  | VW         |
|  | 1.4<br>1.6<br>1.8<br>1.8<br>1.8 Syncro<br>1.9 D<br>1.9 D Ecomatic<br>1.9 SDI<br>1.9 TD  | 55  | 1H-S-246940<br>1H-S-089450<br>1H-S-246940   | 11.91<br>09.92<br>11.91<br>01.93<br>11.91<br>11.91<br>07.95<br>11.91  | 08.97<br>08.97<br>08.97<br>08.97<br>08.97<br>08.97<br>08.97<br>08.97   | - ABS<br>- ABS<br>- ABS/ - GT/+ Automatikgetriebe <sup>6)</sup><br>- ABS/ - GT/+ Schaltgetriebe <sup>7)</sup><br>- ABS<br>- ABS<br>- ABS |  |  |  |  |                  | 239 12,0 10,0 +S +B<br>239 12,0 10,0 +S +B PD |            |

1) + manual transmission / + scatola cambio velocità / + transmission mécanique / + cambio de velocidad  
2) + autom.transmission / + scatola cambio automatico / + transmission automatique / + cambio automático  
3) - ABS/ + manual transmission / - ABS/+ scatola camb.velocità / - ABS/ + transmission mécanique / - ABS/ + cambio de velocidad  
4) + red caliper / + pinza rossa / + étrier rouge / + pinza roja  
5) - red caliper / - pinza rossa / - étrier rouge / - pinza roja  
6) - ABS/ - GT/ + autom.transm. / - ABS/ - GT/+ scatola camb.autom. / - ABS/ - GT/ + transmiss. automatique / - ABS/ - GT/ + cambio automático  
7) - ABS/ - GT/ + manual transm. / - ABS/ - GT/+ scatola camb.velocità / - ABS/ - GT/ + transmiss. mécanique / - ABS/ - GT/ + cambio de velocidad



**VOLKSWAGEN GOLF III (92-97)**

|                |                |             |              |              |                              |  |                       |                                |   |                                   |
|----------------|----------------|-------------|--------------|--------------|------------------------------|--|-----------------------|--------------------------------|---|-----------------------------------|
|                | 1.6 CL/GL      | 74          |              | <b>07.94</b> | <b>08.97</b>                 | - ABS                                    | <b>24.0113-0178.1</b> | 413178                         |   | 256 12,9 11,0 +S +B               |
|                | 1.8            |             | 1H-S-246941  |              | <b>08.97</b>                 | - ABS/ + Automatikgetriebe <sup>1)</sup> | <b>24.0313-0178.1</b> | 513178                         |   | <b>256 12,9 11,0 +S +B PD</b>     |
|                | 1.8 Syncro     |             | 1H-S-089451  |              | <b>08.97</b>                 | - ABS                                    |                       |                                |   |                                   |
|                | 1.9 TDI        | 66          |              | <b>10.93</b> | <b>04.96</b>                 |  |                       |                                |   |                                   |
|                | 1.9 TDI Syncro | 66          |              | <b>03.95</b> | <b>04.96</b>                 |  |                       |                                |   |                                   |
|                | 1.4            |             |              | <b>05.96</b> | <b>09.96</b>                 | + ABS                                    | <b>24.0120-0128.1</b> | 420128                         | für 4-Loch-Felge <sup>2)</sup>              | 256 20,0 18,0 V L +S +B           |
|                | 1.6            | 55          |              | <b>05.96</b> | <b>09.96</b>                 | + ABS                                    | <b>24.0320-0128.1</b> | 520128                         | für 4-Loch-Felge <sup>2)</sup>              | <b>256 20,0 18,0 V L +S +B PD</b> |
|                | 1.6 GT         | 74          |              | <b>07.94</b> | <b>08.97</b>                 |  |                       |                                |   |                                   |
|                | 1.8            |             |              | <b>05.96</b> | <b>08.97</b>                 | + ABS                                    |                       |                                |   |                                   |
|                | 1.8 GT         |             |              | <b>11.91</b> | <b>08.97</b>                 | + ABS                                    |                       |                                |   |                                   |
|                | 1.8 Syncro     |             |              | <b>01.93</b> | <b>08.97</b>                 | + ABS                                    |                       |                                |   |                                   |
|                | 1.9 D          |             |              | <b>05.96</b> | <b>09.96</b>                 | + ABS                                    |                       |                                |   |                                   |
| 1.9 D Ecomatic |                | 1H-S-246941 |              | <b>07.95</b> |                              |  |                       |                                |   |                                   |
| 1.9 SDI        |                |             | <b>05.96</b> | <b>09.96</b> | + ABS                        |  |                       |                                |   |                                   |
| 1.9 TD         | 55             |             | <b>05.96</b> | <b>09.96</b> | + ABS                        |  |                       |                                |   |                                   |
| 1.9 TDI        | 66             |             | <b>05.96</b> | <b>08.97</b> |                              |  |                       |                                |   |                                   |
| 1.9 TDI        | 81             |             | <b>02.96</b> | <b>08.97</b> | - roter Sattel <sup>3)</sup> |  |                       |                                |   |                                   |
| 1.9 TDI Syncro | 66             |             | <b>05.96</b> | <b>08.97</b> |                              |  |                       |                                |   |                                   |
| 2.0 GL         | 79             |             | <b>11.91</b> | <b>08.97</b> |                              |  |                       |                                |   |                                   |
| 2.0 Syncro     |                |             | <b>07.95</b> | <b>08.97</b> |                              |  |                       |                                |   |                                   |
| 1.4            |                |             | <b>10.96</b> | <b>08.97</b> | + ABS                        | <b>24.0120-0123.1</b>                    | 420123                |                                | 239 20,0 18,0 V L +S +B                     |                                   |
| 1.6            | 55             |             | <b>10.96</b> | <b>08.97</b> | + ABS                        | <b>24.0320-0123.1</b>                    | 520123                |                                | <b>239 20,0 18,0 V L +S +B PD</b>           |                                   |
| 1.9 D          |                |             | <b>10.96</b> | <b>08.97</b> | + ABS                        |  |                       |                                |   |                                   |
| 1.9 SDI        |                |             | <b>10.96</b> | <b>08.97</b> | + ABS                        |  |                       |                                |   |                                   |
| 1.9 TD         | 55             |             | <b>10.96</b> | <b>08.97</b> | + ABS                        |  |                       |                                |   |                                   |
| 1.9 TDI        | 81             |             | <b>02.96</b> | <b>04.96</b> | + roter Sattel <sup>4)</sup> | <b>24.0122-0100.1</b>                    | 422100                | für 5-Loch-Felge <sup>5)</sup> | 280 22,0 20,0 V L +B                        |                                   |
| 2.0            | 85             |             | <b>11.91</b> | <b>04.96</b> |                              | <b>24.0322-0100.1</b>                    | 522100                | für 5-Loch-Felge <sup>5)</sup> | <b>280 22,0 20,0 V L +B PD</b>              |                                   |
| 2.0 GTI 16V    | 110            |             | <b>08.92</b> | <b>04.96</b> |                              |  |                       |                                |   |                                   |
| 2.8 VR6        |                | 1H-S-399999 | <b>01.92</b> |              |                              |  |                       |                                |   |                                   |
| 1.9 TDI        | 81             |             | <b>05.96</b> | <b>08.97</b> | + roter Sattel <sup>4)</sup> | <b>24.0125-0108.1</b>                    | 425108                |                                | 288 25,0 23,0 V L +B                        |                                   |
| 2.0            | 85             |             | <b>05.96</b> | <b>08.97</b> |                              |  |                       |                                |   |                                   |
| 2.0 GTI 16V    | 110            |             | <b>05.96</b> | <b>08.97</b> |                              |  |                       |                                |   |                                   |
| 2.8 VR6        |                | 1H-S-400001 | <b>08.97</b> | <b>08.97</b> |                              |  |                       |                                |   |                                   |
| 2.9 VR6 Syncro |                |             | <b>10.94</b> | <b>08.97</b> |                              |  |                       |                                |   |                                   |
|                | 1.4            |             |              | <b>11.91</b> | <b>08.97</b>                 |  | <b>24.0711-1361.3</b> | 360022                         |   | Radsensor                         |
|                | 1.6            |             |              | <b>09.92</b> | <b>08.97</b>                 |  | <b>24.0711-1362.3</b> | 360023                         |   | Radsensor                         |
|                | 1.8            |             |              | <b>11.91</b> | <b>08.97</b>                 |  |                       |                                |   |                                   |
|                | 1.8 Syncro     |             |              | <b>01.93</b> | <b>08.97</b>                 |  |                       |                                |   |                                   |
|                | 1.9 D          |             |              | <b>11.91</b> | <b>08.97</b>                 |  |                       |                                |   |                                   |
|                | 1.9 D Ecomatic |             |              | <b>08.93</b> | <b>07.95</b>                 |  |                       |                                |   |                                   |
|                | 1.9 SDI        |             |              | <b>07.95</b> | <b>08.97</b>                 |  |                       |                                |   |                                   |
|                | 1.9 TD         | 55          |              | <b>11.91</b> | <b>08.97</b>                 |  |                       |                                |   |                                   |
|                | 1.9 TDI        | 66          |              | <b>10.93</b> | <b>08.97</b>                 |  |                       |                                |   |                                   |
|                | 1.9 TDI        | 81          |              | <b>02.96</b> | <b>08.97</b>                 |  |                       |                                |   |                                   |
|                | 1.9 TDI Syncro | 66          |              | <b>03.95</b> | <b>08.97</b>                 |  |                       |                                |   |                                   |
|                | 2.0            | 85          |              | <b>11.91</b> | <b>08.97</b>                 |  |                       |                                |   |                                   |
| 2.0 GL         | 79             |             | <b>11.91</b> | <b>08.97</b> |                              |  |                       |                                |   |                                   |
| 2.0 GTI 16V    | 110            |             | <b>08.92</b> | <b>08.97</b> |                              |  |                       |                                |   |                                   |
| 2.0 Syncro     |                |             | <b>07.95</b> | <b>08.97</b> |                              |  |                       |                                |   |                                   |
| 2.8 VR6        |                |             | <b>01.92</b> | <b>08.97</b> |                              |  |                       |                                |   |                                   |
| 2.9 VR6 Syncro |                |             | <b>10.94</b> | <b>08.97</b> |                              |  |                       |                                |   |                                   |
|                | 1.8 GT         | 85          |              | <b>11.91</b> | <b>08.97</b>                 |  | <b>13.0460-2937.2</b> | 602937                         |   | <b>20961</b> 15,2 /Zub/S          |
|                | 2.0            |             |              | <b>11.91</b> | <b>08.97</b>                 |  | <b>13.0460-0419.2</b> | 610419                         |   | Belagsatz-Zubehör                 |
|                | 2.0 GTI 16V    | 110         | 1H-P-240000  | <b>11.91</b> |                              |  |                       |                                |   | <b>TRW</b>                        |
|                | 2.8 VR6        |             | 1H-P-240000  | <b>01.92</b> |                              |  |                       |                                |   | <b>TRW</b>                        |
|                | 1.6 GT         | 74          |              | <b>07.94</b> | <b>08.97</b>                 |  | <b>13.0460-2984.2</b> | 602984                         |   | <b>20961</b> 17,2 /Zub/S          |
|                | 1.9 TDI        | 81          |              | <b>02.96</b> | <b>08.97</b>                 |  | <b>13.0460-0072.2</b> | 610072                         |   | Belagsatz-Zubehör                 |
|                | 2.0            | 85          | 1H-P-240001  |              | <b>08.97</b>                 |  |                       |                                |   | <b>TRW</b>                        |
|                | 2.0 GTI 16V    | 110         | 1H-P-240001  |              | <b>08.97</b>                 |  |                       |                                |   | <b>TRW</b>                        |
|                | 2.8 VR6        |             | 1H-P-240001  |              | <b>08.97</b>                 |  |                       |                                |   | <b>TRW</b>                        |
| 2.9 VR6 Syncro |                |             | <b>10.94</b> | <b>08.97</b> |                              |  |                       |                                |   |                                   |
|                | 1.6 GT         | 74          |              | <b>07.94</b> | <b>08.97</b>                 |  | <b>24.0110-0111.1</b> | 410111                         | für 4-Loch-Felge/- Sensorring <sup>6)</sup> | 226 10,0 8,0 +B                   |
|                | 1.8 GT         |             |              | <b>11.91</b> | <b>08.97</b>                 |  | <b>24.0110-0275.2</b> | 410275                         | mit Sensorring <sup>7)</sup>                | 226 10,0 8,0 +B                   |
|                | 1.9 TDI        | 81          |              | <b>02.96</b> | <b>08.97</b>                 | - roter Sattel <sup>3)</sup>             |                       |                                |   |                                   |
|                | 2.0 GL         | 79          |              | <b>11.91</b> | <b>08.97</b>                 |  |                       |                                |   |                                   |
|                | 1.9 TDI        | 81          |              | <b>02.96</b> | <b>08.97</b>                 | + roter Sattel <sup>4)</sup>             | <b>24.0110-0203.1</b> | 410203                         | für 5-Loch-Felge <sup>5)</sup>              | 226 10,0 8,0 +B                   |
|                | 2.0            | 85          |              | <b>11.91</b> | <b>08.97</b>                 |  | <b>24.0110-0276.2</b> | 410276                         | mit Sensorring <sup>7)</sup>                | 226 10,0 8,0 +B                   |
|                | 2.0 GTI 16V    | 110         |              | <b>08.92</b> | <b>08.97</b>                 |  |                       |                                |   |                                   |
|                | 2.8 VR6        |             |              | <b>01.92</b> | <b>08.97</b>                 |  |                       |                                |   |                                   |
|                | 1.4            |             | 1H-S-088704  | <b>11.91</b> |                              |  | <b>24.0721-1937.1</b> | 360040                         | 2   | Radsensor L=1062                  |
|                | 1.6            |             | 1H-S-088704  | <b>09.92</b> |                              |  |                       |                                |   |                                   |
|                | 1.8            |             | 1H-S-088704  | <b>11.91</b> |                              |  |                       |                                |   |                                   |
|                | 1.8 Syncro     |             | 1H-S-088704  | <b>01.93</b> |                              |  |                       |                                |   |                                   |
|                | 1.9 D          |             | 1H-S-088704  | <b>11.91</b> |                              |  |                       |                                |   |                                   |
|                | 1.9 D Ecomatic |             |              | <b>08.93</b> | <b>07.95</b>                 |  |                       |                                |   |                                   |
|                | 1.9 SDI        |             | 1H-S-088704  | <b>07.95</b> |                              |  |                       |                                |   |                                   |
|                | 1.9 TD         | 55          | 1H-S-088704  | <b>11.91</b> |                              |  |                       |                                |   |                                   |
|                | 1.9 TDI        | 66          | 1H-S-088704  | <b>10.93</b> |                              |  |                       |                                |   |                                   |
|                | 1.9 TDI        | 81          | 1H-S-088704  | <b>02.96</b> |                              |  |                       |                                |   |                                   |
|                | 2.0            | 85          | 1H-S-088704  | <b>11.91</b> |                              |  |                       |                                |   |                                   |
|                | 2.0 GL         | 79          | 1H-S-088704  | <b>11.91</b> |                              |  |                       |                                |   |                                   |
| 2.0 GTI 16V    | 110            | 1H-S-088704 | <b>08.92</b> |              |                              |  |                       |                                |   |                                   |
| 2.8 VR6        |                | 1H-S-088704 | <b>01.92</b> |              |                              |  |                       |                                |   |                                   |
| 2.9 VR6 Syncro |                | 1H-S-088704 | <b>10.94</b> |              |                              |  |                       |                                |   |                                   |
|                | 1.4            |             | 1H-S-088705  |              | <b>08.97</b>                 |  | <b>24.0721-1191.3</b> | 360091                         | 2   | Radsensor L=1043                  |
|                | 1.6            |             | 1H-S-088705  |              | <b>08.97</b>                 |  |                       |                                |   |                                   |

1) - ABS/ + autom.transmission / - ABS/ + scatola cambio autom. / - ABS/ + transmission automatique / - ABS/ + cambio automático  
2) for 4 bore wheel rim / per cerchione a 4 fori / pour jante à 4 trous / para Llantas de 4 taladros  
3) - red caliper / - pinza rossa / - étrier rouge / - pinza roja  
4) + red caliper / + pinza rossa / + étrier rouge / + pinza roja  
5) for 5 bore wheel rim / per cerchione a 5 fori / pour jante à 5 trous / para Llantas de 5 taladros  
6) for 4-hole rim/sensor ring / per cerch. 4 fori/sensore ruota / pour jante 4 trous/roue codeuse / para llanta cuatro agujeros/anillo sensor  
7) with sensor ring / con sensori / avec secours ABS / con anillo sensor ABS





### VOLKSWAGEN GOLF III (92-97)

|                |                |             |             |             |       |                |                |        |   |  |
|----------------|----------------|-------------|-------------|-------------|-------|----------------|----------------|--------|---|--|
|                | 1.8            |             | 1H-S-088705 |             | 08.97 |                | 24.0721-1191.3 | 360091 | 2 | Radsensor L=1043                                   |
|                | 1.9 D          |             | 1H-S-088705 |             | 08.97 |                |                |        |   |  |
|                | 1.9 SDI        |             | 1H-S-088705 |             | 08.97 |                |                |        |   |  |
|                | 1.9 TD         | 55          | 1H-S-088705 |             | 08.97 |                |                |        |   |  |
|                | 1.9 TDI        | 66          | 1H-S-088705 |             | 08.97 |                |                |        |   |  |
|                | 1.9 TDI        | 81          | 1H-S-088705 |             | 08.97 |                |                |        |   |  |
|                | 1.9 TDI Syncro | 66          |             | 03.95       | 08.97 |                |                |        |   |  |
|                | 2.0            | 85          | 1H-S-088705 |             | 08.97 |                |                |        |   |  |
|                | 2.0 GL         | 79          | 1H-S-088705 |             | 08.97 |                |                |        |   |  |
|                | 2.0 GTI 16V    | 110         | 1H-S-088705 |             | 08.97 |                |                |        |   |  |
| 2.0 Syncro     |                |             | 07.95       | 08.97       |       |                |                |        |   |  |
| 2.8 VR6        |                |             |             | 08.97       |       |                |                |        |   |  |
| 1.8 Syncro     |                |             | 1H-S-088705 |             | 08.97 |                | 24.0751-1139.3 | 360295 | 2 | Radsensor L=1051                                   |
| 2.9 VR6 Syncro |                |             | 1H-S-088705 |             | 08.97 |                |                |        |   |  |
|                | 1.4            |             |             |             | 11.91 | 08.97          | 03.0137-0268.2 | 650268 |   | 200 x 40 HEB<br>Bremsbacken-Zubehör                |
|                | 1.6            | 55          |             |             | 09.92 | 08.97          | 03.0137-9168.2 | 669168 |   |  |
|                | 1.6 CL/GL      |             |             |             | 09.92 | 08.97          |                |        |   |  |
|                | 1.8 CL/GL      |             |             |             | 11.91 | 08.97          |                |        |   |  |
|                | 1.9 D          |             |             |             | 11.91 | 08.97          |                |        |   |  |
|                | 1.9 D Ecomatic |             |             |             | 08.93 | 07.95          |                |        |   |  |
|                | 1.9 SDI        |             |             |             | 07.95 | 08.97          |                |        |   |  |
|                | 1.9 TD         | 55          |             |             | 11.91 | 08.97          |                |        |   |  |
|                | 1.9 TDI        | 66          |             |             | 10.93 | 08.97          |                |        |   |  |
|                | 1.8 Syncro     |             |             |             | 01.93 | 08.97          | 03.0137-0264.2 | 650264 |   |  |
| 1.9 TDI Syncro | 66             |             |             | 03.95       | 08.97 | 03.0137-9044.2 | 669044         |        |   |  |
| 2.0 Syncro     |                |             |             | 07.95       | 08.97 |                |                |        |   |  |
|                | 1.4            |             |             |             | 11.91 | 08.97          | 24.0220-0018.1 | 480019 |   | 200/201 x 50,0 - Lager<br>200/201,5 x 50,0 + Lager |
|                | 1.6 CL/GL      |             |             |             | 09.92 | 08.97          | 24.0220-0718.2 | 480209 |   |  |
|                | 1.8 CL/GL      |             |             |             | 11.91 | 08.97          |                |        |   |  |
|                | 1.9 D          |             |             |             | 11.91 | 08.97          |                |        |   |  |
|                | 1.9 D Ecomatic |             |             |             | 08.93 | 07.95          |                |        |   |  |
|                | 1.9 SDI        |             |             |             | 07.95 | 08.97          |                |        |   |  |
|                | 1.9 TD         | 55          |             |             | 11.91 | 08.97          |                |        |   |  |
|                | 1.9 TDI        | 66          |             |             | 10.93 | 08.97          |                |        |   |  |
|                | 1.8 Syncro     |             |             |             | 01.93 | 08.97          | 24.0223-0017.1 | 480135 |   |  |
|                | 1.9 TDI Syncro | 66          |             |             | 03.95 | 08.97          |                |        |   |  |
| 2.0 Syncro     |                |             |             | 07.95       | 08.97 |                |                |        |   |  |
|                | 1.4            |             |             |             | 11.91 | 08.97          | 03.0520-0415.3 | 690415 |   | 15,87/200x40 TopKit                                |
|                | 1.8 CL/GL      |             | 1H-S-246940 |             | 11.91 | 08.97          |                |        |   |  |
|                | 1.9 D Ecomatic |             | 1H-S-246940 |             | 08.93 | 08.97          |                |        |   |  |
|                | 1.9 TD         | 55          |             |             | 11.91 | 08.97          |                |        |   |  |
|                | 1.6            | 55          |             |             | 09.92 | 08.97          | 03.0420-1517.3 | 681517 |   |  |
|                | 1.6 CL/GL      | 74          |             | 1H-S-246940 | 09.92 | 08.97          | 03.0520-1517.3 | 691517 |   |  |
|                | 1.6 CL/GL      | 74          |             |             | 09.92 | 08.97          |                |        |   |  |
|                | 1.8 CL/GL      |             | 1H-S-246941 |             | 11.91 | 08.97          |                |        |   |  |
|                | 1.8 CL/GL      |             | 1H-S-246941 |             | 08.97 | 08.97          |                |        |   |  |
|                | 1.9 D          |             |             |             | 11.91 | 08.97          |                |        |   |  |
| 1.9 D Ecomatic |                | 1H-S-246941 |             | 07.95       | 08.97 |                |                |        |   |  |
| 1.9 SDI        |                |             |             | 07.95       | 08.97 |                |                |        |   |  |
| 1.9 TDI        | 66             |             |             | 10.93       | 08.97 |                |                |        |   |  |
| 1.6 CL/GL      | 74             |             | 1H-S-246941 |             | 08.97 | 08.97          | 03.0420-4219.3 | 684219 |   |  |
| 1.8 CL/GL      |                |             | 1H-S-246941 |             | 08.97 | 08.97          | 03.0520-4219.3 | 694219 |   |  |















### VOLKSWAGEN GOLF III Variant (93-99)

|                |            |             |             |             |       |       |                |        |  |                  |     |
|----------------|------------|-------------|-------------|-------------|-------|-------|----------------|--------|--|------------------|-----|
|                | 1.4        |             | 1H-TB015953 | 07.93       |       |       | 13.0460-7032.2 | 607032 |  | 20887 19,7 +/Zub | VW  |
|                | 1.8 Syncro |             | 1H-SW369000 | 07.94       |       |       |                |        |  |                  |     |
|                | 1.4        |             |             | 05.96       | 04.99 | - ABS | 13.0460-7072.2 | 607072 |  | 21866 19,7 +     | VW  |
|                | 1.4        |             | 1H-TB015954 |             | 04.96 |       |                |        |  |                  |     |
|                | 1.6        | 74          |             | 07.94       | 04.96 |       | 13.0460-2958.2 | 602958 |  | 20168 19,3 /S    | TRW |
|                | 1.8        |             |             | 05.96       | 04.99 | - ABS |                |        |  |                  |     |
|                | 1.8        |             |             | 07.93       | 04.96 |       |                |        |  |                  |     |
|                | 1.8 Syncro |             | 1H-SW369001 | 1H-TD365209 |       |       |                |        |  |                  |     |
|                | 1.9 D      |             |             | 05.96       | 04.99 | - ABS |                |        |  |                  |     |
|                | 1.9 D      |             |             | 07.93       | 04.96 |       |                |        |  |                  |     |
| 1.9 SDI        |            |             | 05.96       | 04.99       | - ABS |       |                |        |  |                  |     |
| 1.9 SDI        |            |             | 07.95       | 04.96       |       |       |                |        |  |                  |     |
| 1.9 TD         | 55         |             | 05.96       | 04.99       | - ABS |       |                |        |  |                  |     |
| 1.9 TD         | 55         |             | 07.93       | 04.96       |       |       |                |        |  |                  |     |
| 1.9 TDI        | 66         |             | 05.96       | 04.99       | - ABS |       |                |        |  |                  |     |
| 1.9 TDI        | 66         |             | 07.93       | 04.96       |       |       |                |        |  |                  |     |
| 1.4            |            |             |             | 05.96       | 09.96 | + ABS | 13.0460-2821.2 | 602821 |  | 21945 16,0 /S    | TRW |
| 1.6            | 74         |             | 05.96       | 09.96       |       |       |                |        |  |                  |     |
| 1.8            |            |             | 05.96       | 04.99       | + ABS |       |                |        |  |                  |     |
| 1.8 Syncro     |            | 1H-TD365210 |             | 04.99       |       |       |                |        |  |                  |     |
| 1.9 D          |            |             | 05.96       | 09.96       | + ABS |       |                |        |  |                  |     |
| 1.9 SDI        |            |             | 05.96       | 09.96       | + ABS |       |                |        |  |                  |     |
| 1.9 TD         |            |             | 05.96       | 09.96       | + ABS |       |                |        |  |                  |     |
| 1.9 TDI        | 66         |             | 05.96       | 04.99       | + ABS |       |                |        |  |                  |     |
| 1.9 TDI        | 81         |             | 02.96       | 04.99       |       |       |                |        |  |                  |     |
| 1.9 TDI Syncro | 66         |             | 07.95       | 04.99       |       |       |                |        |  |                  |     |
| 2.0            |            |             | 07.93       | 04.99       |       |       |                |        |  |                  |     |
| 2.0 Syncro     |            |             | 07.95       | 04.99       |       |       |                |        |  |                  |     |
| 1.4            |            |             |             | 10.96       | 04.99 | + ABS | 13.0460-7101.2 | 607101 |  | 21866 15,3 +     | VW  |
| 1.9 D          |            |             |             | 10.96       | 04.99 | + ABS |                |        |  |                  |     |
| 1.9 SDI        |            |             |             | 10.96       | 04.99 | + ABS |                |        |  |                  |     |

1) without sensor ring / senza sensori / sans secours ABS / sin anillo sensor ABS

2) + autom.transmission / + scatola cambio automatico / + transmission automatique / + cambio automático

3) + manual transmission / + scatola cambio velocità / + transmission mécanique / + cambio de velocidad

|     |  |  |  |  |  |  |  |  |                            |                  |
|--|--|--|--|--|---|--|--|--|----------------------------|------------------|
| <b>VOLKSWAGEN GOLF III Variant (93-99)</b>   |  |  |  |  |   |  |  |  |                            |                  |
|    | 1.9 TD   |  |  | 10.96  | 04.99   | + ABS  | 13.0460-7101.2   | 607101   | 21866 15,3 +               | VW               |
|  | 2.9 VR6  |  |  | 07.95  | 04.99   |  | 13.0460-7081.2   | 607081   | 21911 20,3 +               | ATE              |
|  |  |  |  |  |   |  | 13.0470-7081.2   | LD7081   | 21911 20,3 +               | ATE              |
|    | 1.4  |  |  | 05.96  | 04.99   | - ABS  | 24.0112-0106.1   | 412106   | 239 12,0 10,0 +S +B        |                  |
|  | 1.4  |  |  | 07.93  | 04.96   |  | 24.0312-0106.1   | 512106   | 239 12,0 10,0 +S +B PD     |                  |
|  | 1.8 Syncro   |  | 1H-SW369000  | 07.94  |   |  |  |  |                            |                  |
|  | 1.6  | 74   |  | 07.94  | 04.96   |  | 24.0113-0178.1   | 413178   | 256 12,9 11,0 +S +B        |                  |
|  | 1.8  |  |  | 05.96  | 04.99   | - ABS  | 24.0313-0178.1   | 513178   | 256 12,9 11,0 +S +B PD     |                  |
|  | 1.8  |  |  | 07.93  | 04.96   |  |  |  |                            |                  |
|  | 1.8 Syncro   |  | 1H-SW369001  | 07.94  |   |  |  |  |                            |                  |
|  | 1.9 D  |  | 1H-TD365209  | 05.96  | 04.99   | - ABS  |  |  |                            |                  |
|  | 1.9 D  |  |  | 07.93  | 04.96   |  |  |  |                            |                  |
|  | 1.9 SDI  |  |  | 05.96  | 04.99   | - ABS  |  |  |                            |                  |
|  | 1.9 SDI  |  |  | 07.95  | 04.96   |  |  |  |                            |                  |
|  | 1.9 TD   | 55   |  | 05.96  | 04.99   | - ABS  |  |  |                            |                  |
|  | 1.9 TD   | 55   |  | 07.93  | 04.96   |  |  |  |                            |                  |
|  | 1.9 TDI  | 66   |  | 05.96  | 04.99   | - ABS  |  |  |                            |                  |
|  | 1.9 TDI  | 66   |  | 07.93  | 04.96   |  |  |  |                            |                  |
|  | 1.4  | 74   |  | 05.96  | 09.96   | + ABS  | 24.0120-0128.1   | 420128   | 256 20,0 18,0 V L +S +B    |                  |
|  | 1.6  |  |  | 05.96  | 04.99   |  | 24.0320-0128.1   | 520128   | 256 20,0 18,0 V L +S +B PD |                  |
|  | 1.8  |  | 1H-TD365210  | 05.96  | 04.99   | + ABS  |  |  |                            |                  |
|  | 1.8 Syncro   |  |  |  | 04.99   |  |  |  |                            |                  |
|  | 1.9 D  |  |  | 05.96  | 09.96   | + ABS  |  |  |                            |                  |
|  | 1.9 SDI  |  |  | 05.96  | 09.96   | + ABS  |  |  |                            |                  |
|  | 1.9 TD   | 55   |  | 05.96  | 09.96   | + ABS  |  |  |                            |                  |
|  | 1.9 TDI  | 66   |  | 05.96  | 04.99   | + ABS  |  |  |                            |                  |
|  | 1.9 TDI  | 81   |  | 02.96  | 04.99   |  |  |  |                            |                  |
|  | 1.9 TDI Syncro   | 66   |  | 07.95  | 04.99   |  |  |  |                            |                  |
|  | 2.0  |  |  | 07.93  | 04.99   |  |  |  |                            |                  |
|  | 2.0 Syncro   |  |  | 07.95  | 04.99   |  |  |  |                            |                  |
|  | 1.4  |  |  | 10.96  | 04.99   | + ABS  | 24.0120-0123.1   | 420123   | 239 20,0 18,0 V L +S +B    |                  |
|  | 1.9 D  |  |  | 10.96  | 04.99   | + ABS  | 24.0320-0123.1   | 520123   | 239 20,0 18,0 V L +S +B PD |                  |
|  | 1.9 SDI  |  |  | 10.96  | 04.99   | + ABS  |  |  |                            |                  |
|  | 1.9 TD   | 55   |  | 10.96  | 04.99   | + ABS  |  |  |                            |                  |
|  | 2.9 VR6  |  |  | 07.95  | 04.99   |  | 24.0125-0108.1   | 425108   | 288 25,0 23,0 V L +B       |                  |
|    | 1.4  | 74   |  | 07.93  | 04.99   |  | 24.0711-1361.3   | 360022   |                            | Radsensor        |
|  | 1.6  |  |  | 07.94  | 04.99   |  | 24.0711-1362.3   | 360023   |                            | Radsensor        |
|  | 1.8  |  |  | 07.93  | 04.99   |  |  |  |                            |                  |
|  | 1.8 Syncro   |  |  | 07.94  | 04.99   |  |  |  |                            |                  |
|  | 1.9 D  |  |  | 07.93  | 04.99   |  |  |  |                            |                  |
|  | 1.9 SDI  |  |  | 07.95  | 04.99   |  |  |  |                            |                  |
|  | 1.9 TD   | 55   |  | 07.93  | 04.99   |  |  |  |                            |                  |
|  | 1.9 TDI  | 66   |  | 07.93  | 04.99   |  |  |  |                            |                  |
|  | 1.9 TDI  | 81   |  | 02.96  | 04.99   |  |  |  |                            |                  |
|  | 1.9 TDI Syncro   | 66   |  | 07.95  | 04.99   |  |  |  |                            |                  |
|  | 2.0  |  |  | 07.93  | 04.99   |  |  |  |                            |                  |
|  | 2.0 Syncro   |  |  | 07.95  | 04.99   |  |  |  |                            |                  |
|  | 2.9 VR6  |  |  | 07.95  | 04.99   |  |  |  |                            |                  |
|  | 2.9 VR6  |  |  | 07.95  | 04.99   |  | 13.0460-2984.2   | 602984   | 20961 17,2 /Zub/S          | TRW              |
|  |  |  |  |  |   |  | 13.0460-0072.2   | 610072   | Belagsatz-Zubehör          | TRW              |
|  | 1.4  | 74   |  | 1H-SW385334  | 07.93   |  | 24.0721-1937.1   | 360040   | 2                          | Radsensor L=1062 |
|  | 1.6  |  |  | 1H-SW385334  | 07.94   |  |  |  |                            |                  |
|  | 1.8  |  |  | 1H-SW385334  | 07.93   |  |  |  |                            |                  |
|  | 1.9 D  |  |  | 1H-SW385334  | 07.93   |  |  |  |                            |                  |
|  | 1.9 TD   | 55   |  | 1H-SW385334  | 07.93   |  |  |  |                            |                  |
|  | 1.9 TDI  | 66   |  | 1H-SW385334  | 07.93   |  |  |  |                            |                  |
|  | 2.0  |  |  | 1H-SW385334  | 07.93   |  |  |  |                            |                  |
|  | 1.4  | 74   | 1H-SW385335  |  | 04.99   |  | 24.0721-1191.3   | 360091   | 2                          | Radsensor L=1043 |
|  | 1.6  |  | 1H-SW385335  |  | 04.99   |  |  |  |                            |                  |
|  | 1.8  |  | 1H-SW385335  |  | 04.99   |  |  |  |                            |                  |
|  | 1.9 D  |  | 1H-SW385335  |  | 04.99   |  |  |  |                            |                  |
|  | 1.9 SDI  |  |  | 07.95  | 04.99   |  |  |  |                            |                  |
|  | 1.9 TD   | 55   | 1H-SW385335  |  | 04.99   |  |  |  |                            |                  |
|  | 1.9 TDI  | 66   | 1H-SW385335  |  | 04.99   |  |  |  |                            |                  |
|  | 1.9 TDI  | 81   |  | 02.96  | 04.99   |  |  |  |                            |                  |
|  | 2.0  |  | 1H-SW385335  |  | 04.99   |  |  |  |                            |                  |
|  | 1.8 Syncro   |  | 1H-SW385335  |  | 04.99   |  | 24.0751-1139.3   | 360295   | 2                          | Radsensor L=1051 |
|  | 1.9 TDI Syncro   | 66   | 1H-SW385335  |  | 04.99   |  |  |  |                            |                  |
|  | 2.0 Syncro   |  | 1H-SW385335  |  | 04.99   |  |  |  |                            |                  |
|  | 2.9 VR6  |  | 1H-SW385335  |  | 04.99   |  |  |  |                            |                  |
|  | 1.4  | 74   |  | 07.93  | 04.99   |  | 03.0137-0268.2   | 650268   | 200 x 40 HEB               | VW               |
|  | 1.6  |  |  | 07.94  | 04.99   |  | 03.0137-9168.2   | 669168   | Bremsbacken-Zubehör        | VW               |
|  | 1.8  |  |  | 07.93  | 04.99   |  |  |  |                            |                  |
|  | 1.9 D  |  |  | 07.93  | 04.99   |  |  |  |                            |                  |
|  | 1.9 SDI  |  |  | 07.95  | 04.99   |  |  |  |                            |                  |
|  | 1.9 TD   | 55   |  | 07.93  | 04.99   |  |  |  |                            |                  |
|  | 1.9 TD   | 66   |  | 07.93  | 04.99   |  |  |  |                            |                  |
|  | 1.9 TDI  | 81   |  | 02.96  | 04.99   |  |  |  |                            |                  |
|  | 2.0  |  |  | 07.93  | 04.99   |  |  |  |                            |                  |
|  | 1.8 Syncro   |  |  | 07.94  | 04.99   |  | 03.0137-0264.2   | 650264   | 230 x 40 HEB               | VW               |
|  | 1.9 TDI Syncro   | 66   |  | 07.95  | 04.99   |  | 03.0137-9044.2   | 669044   | Bremsbacken-Zubehör        | VW               |
|  | 2.0 Syncro   |  |  | 07.95  | 04.99   |  |  |  |                            |                  |



**VOLKSWAGEN GOLF III Variant (93-99)**

|                |            |    |       |       |       |                |        |  |   |
|----------------|------------|----|-------|-------|-------|----------------|--------|--|---|
|                | 1.4        |    |       | 07.93 | 04.99 | 24.0220-0018.1 | 480019 | ohne Sensorring <sup>1)</sup><br>ohne Sensorring <sup>1)</sup> | 200/201 x 50,0 - Lager<br>200/201,5 x 50,0 + Lager  |
|                | 1.6        | 74 |       | 07.94 | 04.99 | 24.0220-0718.2 | 480209 |  |   |
|                | 1.8        |    |       | 07.93 | 04.99 |                |        |  |   |
|                | 1.9 D      |    |       | 07.93 | 04.99 |                |        |  |   |
|                | 1.9 SDI    |    |       | 07.95 | 04.99 |                |        |  |   |
|                | 1.9 TD     | 55 |       | 07.93 | 04.99 |                |        |  |   |
|                | 1.9 TDI    | 66 |       | 07.93 | 04.99 |                |        |  |   |
|                | 1.9 TDI    | 81 |       | 02.96 | 04.99 |                |        |  |   |
|                | 2.0        |    |       | 07.93 | 04.99 |                |        |  |   |
|                | 1.8 Syncro |    |       | 07.94 | 04.99 | 24.0223-0017.1 | 480135 |  |   |
| 1.9 TDI Syncro | 66         |    | 07.95 | 04.99 |       |                |        |  |   |
| 2.0 Syncro     |            |    | 07.95 | 04.99 |       |                |        |  |   |
|                | 1.4        |    |       | 07.93 | 06.95 | 03.0420-1517.3 | 681517 |  | 17,46/200x40 Kit<br>17,46/200x40 TopKit<br>VW<br>VW |
|                | 1.4        |    |       | 07.95 | 04.99 | 03.0420-4219.3 | 684219 |  |   |
|                | 1.6        | 74 |       | 07.94 | 04.99 | 03.0520-1517.3 | 691517 |  |   |
|                | 1.8        |    |       | 07.93 | 04.99 |                |        |  |   |
|                | 1.9 D      |    |       | 07.93 | 04.99 |                |        |  |   |
|                | 1.9 SDI    |    |       | 07.95 | 04.99 |                |        |  |   |
|                | 1.9 TD     | 55 |       | 07.93 | 04.99 |                |        |  |   |
|                | 1.9 TDI    | 66 |       | 07.93 | 04.99 |                |        |  |   |
|                | 1.9 TDI    | 81 |       | 02.96 | 04.99 |                |        |  |   |
|                | 2.0        |    |       | 07.93 | 04.99 |                |        |  |   |





**VOLKSWAGEN GOLF III Cabriolet (94-02)**

|  |         |    |              |              |       |                |        |   |   |
|--|---------|----|--------------|--------------|-------|----------------|--------|---|---|
|  | 1.6     |    | 1E-T-030000  | 10.94        |       | 13.0460-2958.2 | 602958 |   | 20168 19,3 /S<br>TRW                                  |
|  | 1.8     | 55 | 1E-T-030000  | 09.93        |       |                |        |   |   |
|  | 1.8     | 66 | 1E-T-030000  | 09.93        |       |                |        |   |   |
|  | 1.9 TDI | 66 | 1E-T-030000  | 08.95        |       |                |        |   |   |
|  | 2.0     | 85 | 1E-T-030000  | 09.93        |       |                |        |   |   |
|  | 1.6     |    | 1E-V-000001  | 02.02        |       | 13.0460-2821.2 | 602821 |   | 21945 16,0 /S<br>TRW                                  |
|  | 1.8     | 55 | 1E-V-000001  | 02.02        |       |                |        |   |   |
|  | 1.8     | 66 | 1E-V-000001  | 02.02        |       |                |        |   |   |
|  | 1.9 TDI | 66 | 1E-V-000001  | 02.02        |       |                |        |   |   |
|  | 2.0     | 85 | 1E-V-000001  | 02.02        |       |                |        |   |   |
|  | 1.6     |    | 1E-T-030000  | 10.94        |       | 24.0113-0178.1 | 413178 |   | 256 12,9 11,0 +S +B<br>256 12,9 11,0 +S +B PD         |
|  | 1.8     | 55 | 1E-T-030000  | 09.93        |       | 24.0313-0178.1 | 513178 |   |   |
|  | 1.8     | 66 | 1E-T-030000  | 09.93        |       |                |        |   |   |
|  | 1.9 TDI | 66 | 1E-T-030000  | 08.95        |       |                |        |   |   |
|  | 2.0     | 85 | 1E-T-030000  | 09.93        |       |                |        |   |   |
|  | 1.6     |    | 1E-V-000001  | 02.02        |       | 24.0120-0128.1 | 420128 |   | 256 20,0 18,0 V L +S +B<br>256 20,0 18,0 V L +S +B PD |
|  | 1.8     | 55 | 1E-V-000001  | 02.02        |       | 24.0320-0128.1 | 520128 |   |   |
|  | 1.8     | 66 | 1E-V-000001  | 02.02        |       |                |        |   |   |
|  | 1.9 TDI | 66 | 1E-V-000001  | 02.02        |       |                |        |   |   |
|  | 2.0     | 85 | 1E-V-000001  | 02.02        |       |                |        |   |   |
|  | 1.6     |    |              | 10.94        | 02.02 | 24.0711-1361.3 | 360022 |   | Radsensor<br>Radsensor                                |
|  | 1.8     |    |              | 09.93        | 02.02 | 24.0711-1362.3 | 360023 |   |   |
|  | 1.9 TDI | 66 |              | 08.95        | 02.02 |                |        |   |   |
|  | 1.9 TDI | 81 |              | 09.96        | 02.02 |                |        |   |   |
|  | 2.0     | 85 |              | 09.93        | 02.02 |                |        |   |   |
|  | 1.6     |    | 1E-X-014000  | 04.98        |       | 13.0460-2937.2 | 602937 |   | 20961 15,2 /Zub/S<br>Belagsatz-Zubehör<br>TRW<br>TRW  |
|  | 1.8     |    | 1E-X-014000  | 04.98        |       | 13.0460-0419.2 | 610419 |   |   |
|  | 1.9 TDI | 66 | 1E-X-014000  | 04.98        |       |                |        |   |   |
|  | 1.9 TDI | 81 | 1E-X-014000  | 09.96        |       |                |        |   |   |
|  | 2.0     | 85 | 1E-X-014000  | 04.98        |       |                |        |   |   |
|  | 1.6     |    | 1E-X-014001  | 02.02        |       | 13.0460-2984.2 | 602984 |   | 20961 17,2 /Zub/S<br>Belagsatz-Zubehör<br>TRW<br>TRW  |
|  | 1.8     |    | 1E-X-014001  | 02.02        |       | 13.0460-0072.2 | 610072 |   |   |
|  | 1.9 TDI | 66 | 1E-X-014001  | 02.02 + ABS  |       |                |        |   |   |
|  | 1.9 TDI | 81 | 1E-X-014001  | 02.02 + ABS  |       |                |        |   |   |
|  | 2.0     | 85 | 1E-X-014001  | 1E-2-015 000 |       |                |        |   |   |
|  | 2.0     |    | 1E-2-800 001 | 02.02        |       | 13.0460-2894.2 | 602894 |   | 20961 17,4 /Zub/S<br>20961 17,4 /Zub/S<br>TRW<br>TRW  |
|  | 1.9 TDI | 66 | 1E-X-014001  | 02.02 - ABS  |       | 13.0460-2937.2 | 602937 |   |   |
|  | 1.9 TDI | 81 | 1E-X-014001  | 02.02 - ABS  |       |                |        |   |   |
|  |         |    |              |              |       |                |        |   |   |
|  |         |    |              |              |       |                |        |   |   |
|  | 1.6     |    |              | 04.98        | 02.02 | 24.0110-0111.1 | 410111 | ohne Sensorring <sup>1)</sup><br>mit Sensorring <sup>2)</sup> | 226 10,0 8,0 +B<br>226 10,0 8,0 +B                    |
|  | 1.8     |    |              | 04.98        | 02.02 | 24.0110-0275.2 | 410275 |   |   |
|  | 1.9 TDI | 66 |              | 04.98        | 02.02 |                |        |   |   |
|  | 1.9 TDI | 81 |              | 09.96        | 02.02 |                |        |   |   |
|  | 2.0     | 85 |              | 04.98        | 02.02 |                |        |   |   |
|  | 1.6     |    | 1E-S-021846  | 10.94        |       | 24.0721-1937.1 | 360040 | 2   | Radsensor L=1062                                      |
|  | 1.8     |    | 1E-S-021846  | 09.93        |       |                |        |   |   |
|  | 1.9 TDI | 66 | 1E-S-021846  | 08.95        |       |                |        |   |   |
|  | 2.0     | 85 | 1E-S-021846  | 09.93        |       |                |        |   |   |
|  |         |    |              |              |       |                |        |   |   |
|  | 1.6     |    | 1E-S-021847  | 02.02        |       | 24.0721-1191.3 | 360091 | 2   | Radsensor L=1043                                      |
|  | 1.8     |    | 1E-S-021847  | 02.02        |       |                |        |   |   |
|  | 1.9 TDI | 66 | 1E-S-021847  | 02.02        |       |                |        |   |   |
|  | 1.9 TDI | 81 |              | 09.96        | 02.02 |                |        |   |   |
|  | 2.0     | 85 | 1E-S-021847  | 02.02        |       |                |        |   |   |
|  | 1.6     |    |              | 10.94        | 03.98 | 03.0137-0268.2 | 650268 |   | 200 x 40 HEB<br>Bremsbacken-Zubehör<br>VW<br>VW       |
|  | 1.8     |    |              | 09.93        | 03.98 | 03.0137-9168.2 | 669168 |   |   |
|  | 1.9 TDI | 66 |              | 08.95        | 03.98 |                |        |   |   |
|  | 2.0     | 85 |              | 09.93        | 03.98 |                |        |   |   |
|  |         |    |              |              |       |                |        |   |   |

<sup>1)</sup> without sensor ring / senza sensori / sans secours ABS / sin anillo sensor ABS





<sup>2)</sup> with sensor ring / con sensori / avec secours ABS / con anillo sensor ABS

















| VOLKSWAGEN GOLF III Cabriolet (94-02)  |   | KW   |  | 231  |  | i   |  | ATE                              |                  | ? |  | i  |  | i          |  |
|--|---|--|--|--|--|---|--|----------------------------------|------------------|---|--|--|--|------------|--|
|    | 1.6<br>1.8<br>1.9 TDI<br>2.0  |  |  |  |  | 10.94<br>09.93<br>08.95<br>09.93  | 03.98<br>03.98<br>03.98<br>03.98   | 24.0220-0018.1<br>24.0220-0718.2 | 480019<br>480209 |   |  | ohne Sensorring <sup>1)</sup><br>ohne Sensorring <sup>1)</sup> | 200/201 x 50,0 - Lager<br>200/201,5 x 50,0 + Lager |            |  |
|    | 1.6<br>1.8<br>1.9 TDI<br>2.0  |  |  | 1E-SK016363<br>1E-SK016363<br>1E-SK016363<br>1E-SK016363   |  | 10.94<br>09.93<br>08.95<br>09.93  |  | 03.0420-1517.3<br>03.0520-1517.3 | 681517<br>691517 |   |  |  | 17,46/200x40 Kit<br>17,46/200x40 TopKit            | VW<br>VW   |  |
|  | 1.6<br>1.8<br>1.9 TDI<br>2.0  | 1E-SK016364<br>1E-SK016364<br>66 1E-SK016364<br>85 1E-SK016364   |  |  |  |   | 03.98<br>03.98<br>03.98<br>03.98   | 03.0420-4219.3<br>03.0520-4219.3 | 684219<br>694219 |   |  |  | 19,05/200x40 Kit<br>19,05/200x40 TopKit            | VW<br>VW   |  |
| VOLKSWAGEN GOLF IV (98-05)   |   |  |  |  |  |   |  |                                  |                  |   |  |  |  |            |  |
|    | 1.4<br>1.6<br>1.8<br>1.9 SDI<br>1.9 TDI<br>1.9 TDI<br>1.9 TDI<br>1.9 TDI  |  |  | 1J-X-800000<br>1J-X-800000<br>1J-X-800000<br>1J-X-800000<br>1J-X-800000<br>1J-X-800000<br>1J-X-800000<br>1J-X-800000 |  | 10.97<br>10.97<br>10.97<br>10.97<br>09.00<br>10.97<br>05.99   | PR: 1LQ,1LR,1ZF<br>PR: 1LQ,1LR,1ZF<br>PR: 1LQ,1LR,1ZF<br>PR: 1LQ,1LR,1ZF<br>PR: 1LQ,1LR,1ZF<br>PR: 1LQ,1LR,1ZF<br>PR: 1LQ,1LR,1ZF<br>PR: 1LQ,1LR,1ZF   | 13.0460-7111.2<br>13.0470-7111.2 | 607111<br>LD7111 |   |  |  | 23130 19,6 +<br>23130 19,6 +                       | VW<br>VW   |  |
|  | 1.4<br>1.6<br>1.6 FSI<br>1.8<br>1.8 4motion<br>1.9 SDI<br>1.9 TDI<br>1.9 TDI<br>1.9 TDI<br>1.9 TDI<br>1.9 TDI 4motion<br>1.9 TDI 4motion<br>1.9 TDI 4motion<br>2.0<br>2.0 4motion   | 1J-Y-000001<br>1J-Y-000001<br>1J-Y-000001<br>1J-Y-000001<br>50 1J-Y-000001<br>66 1J-Y-000001<br>74 1J-Y-000001<br>81 1J-Y-000001<br>85 1J-Y-000001<br>66<br>74<br>85<br>85 |  |  |  | 10.03<br>10.03<br>10.03<br>10.03<br>10.03<br>06.01<br>06.05<br>10.03<br>06.01<br>07.98<br>09.00<br>06.05<br>11.99<br>06.01<br>08.98<br>04.00  | PR: 1LS,1LQ,1ZF,1ZM<br>PR: 1LS,1LQ,1ZF,1ZM<br>PR: 1LS,1LQ,1ZF,1ZM<br>PR: 1LS,1LQ,1ZF,1ZM<br>PR: 1LS,1LQ,1ZF,1ZM<br>PR: 1LS,1LQ,1ZF,1ZM<br>PR: 1LS,1LQ,1ZF,1ZM<br>PR: 1LS,1LQ,1ZF,1ZM<br>PR: 1LS,1LQ,1ZF,1ZM<br>PR: 1LS,1LQ,1ZF,1ZM<br>PR: 1LS,1LQ,1ZF,1ZM<br>PR: 1LS,1LQ,1ZF,1ZM<br>PR: 1LS,1LQ,1ZF,1ZM<br>PR: 1LS,1LQ,1ZF,1ZM<br>PR: 1LS,1LQ,1ZF,1ZM<br>PR: 1LS,1LQ,1ZF,1ZM             | 13.0460-7117.2<br>13.0470-7117.2 | 607117<br>LD7117 |   |  | 23131 19,6 +/WK<br>23131 19,6 +/WK                             | VW<br>VW   |            |  |
|  | 1.8 T GTI<br>2.3 V5<br>2.3 V5 4motion<br>2.8 V6 4motion   | 132  |  | 1J-X-800000<br>1J-X-800000<br>1J-X-800000  |  | 10.97<br>10.97<br>11.98<br>01.99  | PR: 1LE,1LN,1ZE,1ZH<br>PR: 1LE,1LN,1ZE,1ZH<br>PR: 1LE,1LN,1ZE,1ZH  | 13.0460-7081.2<br>13.0470-7081.2 | 607081<br>LD7081 |   |  |  | 21911 20,3 +<br>21911 20,3 +                       | ATE<br>ATE |  |
|  | 1.8<br>1.8 4motion<br>1.9 TDI<br>1.9 TDI<br>1.9 TDI 4motion<br>1.9 TDI 4motion<br>2.3 V5<br>2.3 V5 4motion<br>2.8 V6 4motion  | 92<br>96<br>110<br>96<br>110   |  |  |  | 10.97<br>07.98<br>04.01<br>09.00<br>04.01<br>09.00<br>10.03<br>10.03<br>10.03   | PR: 1LE,1LJ,1LN,1ZE,1ZH,1ZQ<br>PR: 1LE,1LJ,1LN,1ZE,1ZH,1ZQ<br>PR: 1LE,1LJ,1LN,1ZE,1ZH,1ZQ<br>PR: 1LE,1LJ,1LN,1ZE,1ZH,1ZQ<br>PR: 1LE,1LJ,1LN,1ZE,1ZH,1ZQ<br>PR: 1LE,1LJ,1LN,1ZE,1ZH,1ZQ<br>PR: 1LJ,1ZE,1ZQ<br>PR: 1LJ,1ZE,1ZQ<br>PR: 1LJ,1ZE,1ZQ  | 13.0460-7122.2<br>13.0470-7122.2 | 607122<br>LD7122 |   |  | 23392 20,3 +/WK<br>23392 20,3 +/WK                             | ATE<br>ATE   |            |  |
|  | 3.2 R32 4motion   |  |  |  |  | 06.02   | PR: 1ZT  | 13.0460-7183.2<br>24.8190-0106.2 | 607183<br>620106 | 1 |  |  | 21484 20,5 +/WE<br>Warnkontakt L=270mm             | ATE        |  |
|  | 1.4<br>1.6<br>1.6 FSI<br>1.8<br>1.8 4motion<br>1.9 SDI<br>1.9 TDI<br>1.9 TDI<br>1.9 TDI<br>1.9 TDI<br>1.9 TDI<br>1.9 TDI<br>1.9 TDI 4motion<br>1.9 TDI 4motion<br>1.9 TDI 4motion<br>1.9 TDI 4motion<br>1.9 TDI 4motion<br>2.0<br>2.0 4motion<br>2.3 V5<br>2.3 V5 4motion | 92<br>50<br>66<br>74<br>81<br>85<br>96<br>110<br>66<br>74<br>85<br>96<br>110<br>66<br>74<br>85<br>96<br>110<br>85<br>85  |  |  |  | 10.97<br>10.97<br>01.02<br>10.97<br>07.98<br>10.97<br>09.00<br>10.97<br>05.99<br>04.01<br>09.00<br>09.00<br>07.98<br>09.00<br>11.99<br>04.01<br>09.00<br>08.98<br>04.00<br>10.97<br>11.98 | PR: 1LQ,1ZF<br>PR: 1LQ,1ZF<br>PR: 1LQ,1ZF<br>PR: 1LQ,1ZF<br>PR: 1LQ,1ZF<br>PR: 1LQ,1ZF<br>PR: 1LQ,1ZF<br>PR: 1LQ,1ZF<br>PR: 1LQ,1ZF<br>PR: 1LQ,1ZF<br>PR: 1LQ,1ZF<br>PR: 1LQ,1ZF<br>PR: 1LQ,1ZF<br>PR: 1LQ,1ZF<br>PR: 1LQ,1ZF<br>PR: 1LQ,1ZF<br>PR: 1LQ,1ZF<br>PR: 1LQ,1ZF<br>PR: 1LQ,1ZF<br>PR: 1LQ,1ZF   | 24.0122-0151.1<br>24.0322-0151.1 | 422151<br>522151 |   |  | 256 22,0 19,0 V L +S +B<br>256 22,0 19,0 V L +S +B PD          |  |            |  |
|  | 1.4<br>1.6<br>1.6 FSI<br>1.8<br>1.8 4motion<br>1.9 SDI<br>1.9 TDI<br>1.9 TDI<br>1.9 TDI<br>1.9 TDI<br>1.9 TDI<br>1.9 TDI<br>1.9 TDI 4motion<br>1.9 TDI 4motion<br>1.9 TDI 4motion<br>1.9 TDI 4motion<br>2.0<br>2.0 4motion<br>2.3 V5<br>2.3 V5 4motion                    | 92<br>50<br>66<br>74<br>81<br>85<br>96<br>110<br>66<br>74<br>85<br>96<br>110<br>66<br>74<br>85<br>96<br>110<br>85<br>85  |  |  |  | 10.97<br>10.97<br>01.02<br>10.97<br>07.98<br>10.97<br>09.00<br>10.97<br>05.99<br>04.01<br>09.00<br>09.00<br>07.98<br>09.00<br>11.99<br>04.01<br>09.00<br>08.98<br>04.00<br>10.97<br>11.98 | PR: 1LR,1LS,1ZM<br>PR: 1LR,1LS,1ZM<br>PR: 1LR,1LS,1ZM<br>PR: 1LR,1LS,1ZM<br>PR: 1LR,1LS,1ZM<br>PR: 1LR,1LS,1ZM<br>PR: 1LR,1LS,1ZM<br>PR: 1LR,1LS,1ZM<br>PR: 1LR,1LS,1ZM<br>PR: 1LR,1LS,1ZM<br>PR: 1LR,1LS,1ZM<br>PR: 1LR,1LS,1ZM<br>PR: 1LR,1LS,1ZM<br>PR: 1LR,1LS,1ZM<br>PR: 1LR,1LS,1ZM<br>PR: 1LR,1LS,1ZM<br>PR: 1LR,1LS,1ZM<br>PR: 1LR,1LS,1ZM<br>PR: 1LR,1LS,1ZM<br>PR: 1LR,1LS,1ZM | 24.0122-0150.1<br>24.0322-0150.1 | 422150<br>522150 |   |  | 280 22,0 19,0 V L +S +B<br>280 22,0 19,0 V L +S +B PD          |  |            |  |

<sup>1)</sup> without sensor ring / senza sensori / sans secours ABS / sin anillo sensor ABS



| VOLKSWAGEN GOLF IV (98-05)   |                 |       |       |                     |                     |                |                          |                             |  |                         |                            |
|--|-----------------|-------|-------|---------------------|---------------------|----------------|--------------------------|-----------------------------|--|-------------------------|----------------------------|
|    | 1.9 TDI 4motion | 74    | 09.00 | 06.05               | PR: 1LR,1LS,1ZM     | 24.0122-0150.1 | 422150                   |                             |  |                         | 280 22,0 19,0 V L +S +B    |
|  | 1.9 TDI 4motion | 85    | 11.99 | 06.01               | PR: 1LR,1LS,1ZM     | 24.0322-0150.1 | 522150                   |                             |  |                         | 280 22,0 19,0 V L +S +B PD |
|  | 1.9 TDI 4motion | 96    | 04.01 | 10.03               | PR: 1LR,1LS,1ZM     |                |                          |                             |  |                         |                            |
|  | 1.9 TDI 4motion | 110   | 09.00 | 10.03               | PR: 1LR,1LS,1ZM     |                |                          |                             |  |                         |                            |
|  | 2.0             | 85    | 08.98 | 10.03               | PR: 1LR,1LS,1ZM     |                |                          |                             |  |                         |                            |
|  | 2.0 4motion     | 85    | 04.00 | 10.03               | PR: 1LR,1LS,1ZM     |                |                          |                             |  |                         |                            |
|  | 2.3 V5          |       | 10.97 | 10.03               | PR: 1LR,1LS,1ZM     |                |                          |                             |  |                         |                            |
|  | 2.3 V5 4motion  |       | 11.98 | 10.03               | PR: 1LR,1LS,1ZM     |                |                          |                             |  |                         |                            |
|  | 1.4             |       | 10.97 | 10.03               | PR: 1LE,1LN,1ZE,1ZH | 24.0125-0113.1 | 425113                   |                             |  |                         | 288 25,0 22,0 V L +S +B    |
|  | 1.6             |       | 10.97 | 10.03               | PR: 1LE,1LN,1ZE,1ZH | 24.0325-0113.1 | 525113                   |                             |  |                         | 288 25,0 22,0 V L +S +B PD |
| 1.6 FSI  |                 | 01.02 | 10.03 | PR: 1LE,1LN,1ZE,1ZH |                     |                |                          |                             |  |                         |                            |
| 1.8  |                 | 10.97 | 10.03 | PR: 1LE,1LN,1ZE,1ZH |                     |                |                          |                             |  |                         |                            |
| 1.8 4motion  | 92              | 10.97 | 06.01 | PR: 1LE,1LN,1ZE,1ZH |                     |                |                          |                             |  |                         |                            |
| 1.9 SDI  | 50              | 10.97 | 10.03 | PR: 1LE,1LN,1ZE,1ZH |                     |                |                          |                             |  |                         |                            |
| 1.9 TDI  | 66              | 10.97 | 06.01 | PR: 1LE,1LN,1ZE,1ZH |                     |                |                          |                             |  |                         |                            |
| 1.9 TDI  | 74              | 09.00 | 06.05 | PR: 1LE,1LN,1ZE,1ZH |                     |                |                          |                             |  |                         |                            |
| 1.9 TDI  | 81              | 10.97 | 10.03 | PR: 1LE,1LN,1ZE,1ZH |                     |                |                          |                             |  |                         |                            |
| 1.9 TDI  | 85              | 05.99 | 06.01 | PR: 1LE,1LN,1ZE,1ZH |                     |                |                          |                             |  |                         |                            |
| 1.9 TDI  | 96              | 04.01 | 10.03 | PR: 1LE,1LN,1ZE,1ZH |                     |                |                          |                             |  |                         |                            |
| 1.9 TDI  | 110             | 09.00 | 10.03 | PR: 1LE,1LN,1ZE,1ZH |                     |                |                          |                             |  |                         |                            |
| 1.9 TDI 4motion  | 66              | 07.98 | 06.01 | PR: 1LE,1LN,1ZE,1ZH |                     |                |                          |                             |  |                         |                            |
| 1.9 TDI 4motion  | 74              | 09.00 | 06.05 | PR: 1LE,1LN,1ZE,1ZH |                     |                |                          |                             |  |                         |                            |
| 1.9 TDI 4motion  | 85              | 11.99 | 06.01 | PR: 1LE,1LN,1ZE,1ZH |                     |                |                          |                             |  |                         |                            |
| 1.9 TDI 4motion  | 96              | 04.01 | 10.03 | PR: 1LE,1LN,1ZE,1ZH |                     |                |                          |                             |  |                         |                            |
| 1.9 TDI 4motion  | 110             | 09.00 | 10.03 | PR: 1LE,1LN,1ZE,1ZH |                     |                |                          |                             |  |                         |                            |
| 2.0  | 85              | 08.98 | 10.03 | PR: 1LE,1LN,1ZE,1ZH |                     |                |                          |                             |  |                         |                            |
| 2.0 4motion  | 85              | 04.00 | 10.03 | PR: 1LE,1LN,1ZE,1ZH |                     |                |                          |                             |  |                         |                            |
| 2.3 V5   |                 | 10.97 | 10.03 | PR: 1LE,1LN,1ZE,1ZH |                     |                |                          |                             |  |                         |                            |
| 2.3 V5 4motion   |                 | 11.98 | 10.03 | PR: 1LE,1LN,1ZE,1ZH |                     |                |                          |                             |  |                         |                            |
| 1.8 T GTI  | 132             | 10.97 | 10.03 |                     | 24.0125-0123.1      | 425123         |                          |                             |  | 310 25,0 22,0 V L +S +B |                            |
| 2.3 V5   |                 | 10.97 | 10.03 | PR: 1LJ,1ZQ         | 24.0325-0123.1      | 525123         |                          |                             |  | 310 25,0 22,0 V L +B PD |                            |
| 2.3 V5 4motion   |                 | 11.98 | 10.03 | PR: 1LJ,1ZQ         |                     |                |                          |                             |  |                         |                            |
| 2.8 V6 4motion   |                 | 01.99 | 10.03 | PR: 1LJ,1ZQ         |                     |                |                          |                             |  |                         |                            |
| 3.2 R32 4motion  |                 | 06.02 | 10.03 | PR: 1ZT             | 24.0132-0166.2      | 432166         | <input type="checkbox"/> | zweiteilige Bremsscheibe 1) |  | 334 32,0 30,0 V L +B    |                            |
|  |                 |       |       |                     | 24.0132-0165.2      | 432165         | <input type="checkbox"/> | zweiteilige Bremsscheibe 1) |  | 334 32,0 30,0 V L +B    |                            |
|    | 1.4             |       | 10.97 | 10.03               |                     | 24.0711-1361.3 | 360022                   | <input type="checkbox"/>    |  |                         | Radsensor                  |
|  | 1.6             |       | 10.97 | 10.03               |                     | 24.0711-1362.3 | 360023                   | <input type="checkbox"/>    |  |                         | Radsensor                  |
|  | 1.6 FSI         |       | 01.02 | 10.03               |                     |                |                          |                             |  |                         |                            |
|  | 1.8             |       | 10.97 | 10.03               |                     |                |                          |                             |  |                         |                            |
|  | 1.8 4motion     | 92    | 07.98 | 10.03               |                     |                |                          |                             |  |                         |                            |
|  | 1.8 T GTI       | 132   | 10.97 | 10.03               |                     |                |                          |                             |  |                         |                            |
|  | 1.9 SDI         | 50    | 10.97 | 10.03               |                     |                |                          |                             |  |                         |                            |
|  | 1.9 TDI         | 66    | 10.97 | 06.01               |                     |                |                          |                             |  |                         |                            |
|  | 1.9 TDI         | 74    | 09.00 | 06.05               |                     |                |                          |                             |  |                         |                            |
|  | 1.9 TDI         | 81    | 10.97 | 10.03               |                     |                |                          |                             |  |                         |                            |
|  | 1.9 TDI         | 85    | 05.99 | 06.01               |                     |                |                          |                             |  |                         |                            |
|  | 1.9 TDI         | 96    | 04.01 | 10.03               |                     |                |                          |                             |  |                         |                            |
|  | 1.9 TDI         | 110   | 09.00 | 10.03               |                     |                |                          |                             |  |                         |                            |
|  | 1.9 TDI 4motion | 66    | 07.98 | 06.01               |                     |                |                          |                             |  |                         |                            |
|  | 1.9 TDI 4motion | 74    | 09.00 | 06.05               |                     |                |                          |                             |  |                         |                            |
|  | 1.9 TDI 4motion | 85    | 11.99 | 06.01               |                     |                |                          |                             |  |                         |                            |
|  | 1.9 TDI 4motion | 96    | 04.01 | 10.03               |                     |                |                          |                             |  |                         |                            |
|  | 1.9 TDI 4motion | 110   | 09.00 | 10.03               |                     |                |                          |                             |  |                         |                            |
|  | 2.0             | 85    | 08.98 | 10.03               |                     |                |                          |                             |  |                         |                            |
| 2.0 4motion  | 85              | 04.00 | 10.03 |                     |                     |                |                          |                             |  |                         |                            |
| 2.3 V5   |                 | 10.97 | 10.03 |                     |                     |                |                          |                             |  |                         |                            |
| 2.3 V5 4motion   |                 | 11.98 | 10.03 |                     |                     |                |                          |                             |  |                         |                            |
| 2.8 V6 4motion   |                 | 01.99 | 10.03 |                     |                     |                |                          |                             |  |                         |                            |
| 3.2 R32 4motion  |                 | 06.02 | 10.03 |                     |                     |                |                          |                             |  |                         |                            |
|  | 1.4             |       | 10.97 | 10.03               | PR: 1KK,1KS,1KV     | 13.0460-2894.2 | 602894                   |                             |  |                         | 20961 17,4 /Zub/S TRW      |
|  | 1.6             |       | 10.97 | 10.03               | PR: 1KK,1KS,1KV     | 13.0470-2894.2 | LD2894                   |                             |  |                         | 20961 17,4 /Zub/S TRW      |
|  | 1.6 FSI         |       | 01.02 | 10.03               | PR: 1KK,1KS,1KV     | 13.0460-0072.2 | 610072                   |                             |  |                         | Belagsatz-Zubehör TRW      |
|  | 1.8             |       | 10.97 | 10.03               | PR: 1KK,1KS,1KV     |                |                          |                             |  |                         |                            |
|  | 1.8 4motion     | 92    | 07.98 | 10.03               | PR: 1KE             |                |                          |                             |  |                         |                            |
|  | 1.9 SDI         | 50    | 10.97 | 10.03               | PR: 1KK,1KS,1KV     |                |                          |                             |  |                         |                            |
|  | 1.9 TDI         | 66    | 10.97 | 06.01               | PR: 1KK,1KS,1KV     |                |                          |                             |  |                         |                            |
|  | 1.9 TDI         | 74    | 09.00 | 06.05               | PR: 1KK,1KS,1KV     |                |                          |                             |  |                         |                            |
|  | 1.9 TDI         | 81    | 10.97 | 10.03               | PR: 1KK,1KS,1KV     |                |                          |                             |  |                         |                            |
|  | 1.9 TDI         | 85    | 05.99 | 06.01               | PR: 1KK,1KS,1KV     |                |                          |                             |  |                         |                            |
|  | 1.9 TDI         | 96    | 04.01 | 10.03               | PR: 1KK,1KS,1KV     |                |                          |                             |  |                         |                            |
|  | 1.9 TDI         | 110   | 09.00 | 10.03               | PR: 1KK,1KS,1KV     |                |                          |                             |  |                         |                            |
|  | 1.9 TDI 4motion | 66    | 07.98 | 06.01               | PR: 1KE             |                |                          |                             |  |                         |                            |
|  | 1.9 TDI 4motion | 74    | 09.00 | 06.05               | PR: 1KE             |                |                          |                             |  |                         |                            |
|  | 1.9 TDI 4motion | 85    | 11.99 | 06.01               | PR: 1KE             |                |                          |                             |  |                         |                            |
|  | 1.9 TDI 4motion | 96    | 04.01 | 10.03               | PR: 1KE             |                |                          |                             |  |                         |                            |
|  | 1.9 TDI 4motion | 110   | 09.00 | 10.03               | PR: 1KE             |                |                          |                             |  |                         |                            |
|  | 2.0             | 85    | 08.98 | 10.03               | PR: 1KK,1KS,1KV     |                |                          |                             |  |                         |                            |
|  | 2.0 4motion     | 85    | 04.00 | 10.03               | PR: 1KE             |                |                          |                             |  |                         |                            |
| 2.3 V5   |                 | 10.97 | 10.03 | PR: 1KK,1KS,1KV     |                     |                |                          |                             |  |                         |                            |
| 2.3 V5 4motion   |                 | 11.98 | 10.03 | PR: 1KE             |                     |                |                          |                             |  |                         |                            |
| 2.8 V6 4motion   |                 | 01.99 | 10.03 | PR: 1KE             |                     |                |                          |                             |  |                         |                            |
| 3.2 R32 4motion  |                 | 06.02 | 10.03 | PR: 1KE             |                     |                |                          |                             |  |                         |                            |
|  | 1.4             |       | 10.97 | 10.03               | PR: 1KY             | 13.0460-2886.2 | 602886                   |                             |  |                         | 20961 16,2 /S TRW          |
|  | 1.6             |       | 10.97 | 10.03               | PR: 1KY             | 13.0470-2886.2 | LD2886                   |                             |  |                         | 20961 16,2 /S TRW          |
|  | 1.6 FSI         |       | 01.02 | 10.03               | PR: 1KY             | 13.0460-0072.2 | 610072                   |                             |  |                         | Belagsatz-Zubehör TRW      |
|  | 1.8             |       | 10.97 | 10.03               | PR: 1KY             |                |                          |                             |  |                         |                            |
|  | 1.8 T GTI       | 132   | 10.97 | 10.03               |                     |                |                          |                             |  |                         |                            |

1) two-piece brake disc / disco frenante in due parti / disque d.fr.en deux parties / disco de fr.de dos piezas

|     |                 |  |       |  |                 |  |                |  |        |      |   |  |                      |  |     |  |  |  |
|--|-----------------|--|-------|--|-----------------|--|----------------|--|--------|---|---|--|----------------------|--|-----|--|--|--|
| VOLKSWAGEN GOLF IV (98-05)   |                 |  |       |  |                 |  |                |  |        |   |   |  |                      |  |     |  |  |  |
|    | 1.9 SDI         | 50   |       | 10.97  | 10.03           | PR: 1KY  |                | 13.0460-2886.2   | 602886 |   |   |  |                      | 20961 16,2 /S  | TRW |  |  |  |
|  | 1.9 TDI         | 66   |       | 10.97  | 06.01           | PR: 1KY  |                | 13.0470-2886.2   | LD2886 |   |   |  |                      | 20961 16,2 /S  | TRW |  |  |  |
|  | 1.9 TDI         | 74   |       | 09.00  | 06.05           | PR: 1KY  |                | 13.0460-0072.2   | 610072 |   |   |  |                      | Belagsatz-Zubehör  | TRW |  |  |  |
|  | 1.9 TDI         | 81   |       | 10.97  | 10.03           | PR: 1KY  |                |  |        |   |   |  |                      |  |     |  |  |  |
|  | 1.9 TDI         | 85   |       | 05.99  | 06.01           | PR: 1KY  |                |  |        |   |   |  |                      |  |     |  |  |  |
|  | 1.9 TDI         | 96   |       | 04.01  | 10.03           | PR: 1KY  |                |  |        |   |   |  |                      |  |     |  |  |  |
|  | 1.9 TDI         | 110  |       | 09.00  | 10.03           | PR: 1KY  |                |  |        |   |   |  |                      |  |     |  |  |  |
|  | 2.0             | 85   |       | 08.98  | 10.03           | PR: 1KY  |                |  |        |   |   |  |                      |  |     |  |  |  |
|  | 2.3 V5          |  |       | 10.97  | 10.03           | PR: 1KY  |                |  |        |   |   |  |                      |  |     |  |  |  |
|  | 1.8 4motion     | 92   |       | 07.98  | 10.03           | PR: 1KU,2EE,2EL  |                | 13.0460-2820.2   | 602820 |   |   |  |                      | 20961 17,6 /S  | TRW |  |  |  |
|  | 1.9 TDI 4motion | 66   |       | 07.98  | 06.01           | PR: 1KU,2EE,2EL  |                | 13.0470-2820.2   | LD2820 |   |   |  |                      | 20961 17,6 /S  | TRW |  |  |  |
|  | 1.9 TDI 4motion | 74   |       | 09.00  | 06.05           | PR: 1KU,2EE,2EL  |                | 13.0460-0072.2   | 610072 |   |   |  |                      | Belagsatz-Zubehör  | TRW |  |  |  |
|  | 1.9 TDI 4motion | 85   |       | 11.99  | 06.01           | PR: 1KU,2EE,2EL  |                |  |        |   |   |  |                      |  |     |  |  |  |
|  | 1.9 TDI 4motion | 96   |       | 04.01  | 10.03           | PR: 1KU,2EE,2EL  |                |  |        |   |   |  |                      |  |     |  |  |  |
| 1.9 TDI 4motion  | 110             |  | 09.00 | 10.03  | PR: 1KU,2EE,2EL |  |                |  |        |   |   |  |                      |  |     |  |  |  |
| 2.0 4motion  | 85              |  | 04.00 | 10.03  | PR: 1KU,2EE,2EL |  |                |  |        |   |   |  |                      |  |     |  |  |  |
| 2.3 V5 4motion   |                 |  | 11.98 | 10.03  | PR: 1KU,2EE,2EL |  |                |  |        |   |   |  |                      |  |     |  |  |  |
| 2.8 V6 4motion   |                 |  | 01.99 | 10.03  | PR: 1KU,2EE,2EL |  |                |  |        |   |   |  |                      |  |     |  |  |  |
| 3.2 R32 4motion  |                 |  | 06.02 | 10.03  | PR: 1KU,2EE,2EL |  |                |  |        |   |   |  |                      |  |     |  |  |  |
|    | 1.4             |  |       | 10.97  | 10.03           | PR: 1KK,1KS,1KV  |                | 24.0109-0123.1   | 409123 |   |   |  |                      | 230 9,0 7,0 +S +B  |     |  |  |  |
|  | 1.6             |  |       | 10.97  | 10.03           | PR: 1KK,1KS,1KV  |                | 24.0309-0123.1   | 509123 |   |   |  |                      | 230 9,0 7,0 +S +B PD   |     |  |  |  |
|  | 1.6 FSI         |  |       | 01.02  | 10.03           | PR: 1KK,1KS,1KV  |                |  |        |   |   |  |                      |  |     |  |  |  |
|  | 1.8             |  |       | 10.97  | 10.03           | PR: 1KK,1KS,1KV  |                |  |        |   |   |  |                      |  |     |  |  |  |
|  | 1.9 SDI         | 50   |       | 10.97  | 10.03           | PR: 1KK,1KS,1KV  |                |  |        |   |   |  |                      |  |     |  |  |  |
|  | 1.9 TDI         | 66   |       | 10.97  | 06.01           | PR: 1KK,1KS,1KV  |                |  |        |   |   |  |                      |  |     |  |  |  |
|  | 1.9 TDI         | 74   |       | 09.00  | 06.05           | PR: 1KK,1KS,1KV  |                |  |        |   |   |  |                      |  |     |  |  |  |
|  | 1.9 TDI         | 81   |       | 10.97  | 10.03           | PR: 1KK,1KS,1KV  |                |  |        |   |   |  |                      |  |     |  |  |  |
|  | 1.9 TDI         | 85   |       | 05.99  | 06.01           | PR: 1KK,1KS,1KV  |                |  |        |   |   |  |                      |  |     |  |  |  |
|  | 1.9 TDI         | 96   |       | 04.01  | 10.03           | PR: 1KK,1KS,1KV  |                |  |        |   |   |  |                      |  |     |  |  |  |
|  | 1.9 TDI         | 110  |       | 09.00  | 10.03           | PR: 1KK,1KS,1KV  |                |  |        |   |   |  |                      |  |     |  |  |  |
|  | 2.0             | 85   |       | 08.98  | 10.03           | PR: 1KK,1KS,1KV  |                |  |        |   |   |  |                      |  |     |  |  |  |
|  | 2.3 V5          |  |       | 10.97  | 10.03           | PR: 1KK,1KS,1KV  |                |  |        |   |   |  |                      |  |     |  |  |  |
|  | 1.8 4motion     | 92   |       | 07.98  | 10.03           | PR: 1KE  |                | 24.0109-0133.1   | 409133 |   |   |  |                      | 239 9,0 7,0 +S +B  |     |  |  |  |
| 1.9 TDI 4motion  | 66              |  | 07.98 | 06.01  | PR: 1KE         |  | 24.0309-0133.1 | 509133   |        |   |   |  | 239 9,0 7,0 +S +B PD |  |     |  |  |  |
| 1.9 TDI 4motion  | 74              |  | 09.00 | 06.05  | PR: 1KE         |  |                |  |        |   |   |  |                      |  |     |  |  |  |
| 1.9 TDI 4motion  | 85              |  | 11.99 | 06.01  | PR: 1KE         |  |                |  |        |   |   |  |                      |  |     |  |  |  |
| 1.9 TDI 4motion  | 96              |  | 04.01 | 10.03  | PR: 1KE         |  |                |  |        |   |   |  |                      |  |     |  |  |  |
| 1.9 TDI 4motion  | 110             |  | 09.00 | 10.03  | PR: 1KE         |  |                |  |        |   |   |  |                      |  |     |  |  |  |
| 2.0 4motion  | 85              |  | 04.00 | 10.03  | PR: 1KE         |  |                |  |        |   |   |  |                      |  |     |  |  |  |
| 2.3 V5 4motion   |                 |  | 11.98 | 10.03  | PR: 1KE         |  |                |  |        |   |   |  |                      |  |     |  |  |  |
|  | 1.4             |  |       | 10.97  | 10.03           | PR: 1KY  |                | 24.0122-0163.1   | 422163 |   |   |  |                      | 256 22,0 20,0 V L +B   |     |  |  |  |
|  | 1.6             |  |       | 10.97  | 10.03           | PR: 1KY  |                | 24.0322-0163.1   | 522163 |   |   |  |                      | 256 22,0 20,0 V L +B PD  |     |  |  |  |
|  | 1.6 FSI         |  |       | 01.02  | 10.03           | PR: 1KY  |                |  |        |   |   |  |                      |  |     |  |  |  |
|  | 1.8             |  |       | 10.97  | 10.03           | PR: 1KY  |                |  |        |   |   |  |                      |  |     |  |  |  |
|  | 1.8 T GTI       | 132  |       | 10.97  | 10.03           |  |                |  |        |   |   |  |                      |  |     |  |  |  |
|  | 1.9 SDI         | 50   |       | 10.97  | 10.03           | PR: 1KY  |                |  |        |   |   |  |                      |  |     |  |  |  |
|  | 1.9 TDI         | 66   |       | 10.97  | 06.01           | PR: 1KY  |                |  |        |   |   |  |                      |  |     |  |  |  |
|  | 1.9 TDI         | 74   |       | 09.00  | 06.05           | PR: 1KY  |                |  |        |   |   |  |                      |  |     |  |  |  |
|  | 1.9 TDI         | 81   |       | 10.97  | 10.03           | PR: 1KY  |                |  |        |   |   |  |                      |  |     |  |  |  |
|  | 1.9 TDI         | 85   |       | 05.99  | 06.01           | PR: 1KY  |                |  |        |   |   |  |                      |  |     |  |  |  |
|  | 1.9 TDI         | 96   |       | 04.01  | 10.03           | PR: 1KY  |                |  |        |   |   |  |                      |  |     |  |  |  |
|  | 1.9 TDI         | 110  |       | 09.00  | 10.03           | PR: 1KY  |                |  |        |   |   |  |                      |  |     |  |  |  |
|  | 2.0             | 85   |       | 08.98  | 10.03           | PR: 1KY  |                |  |        |   |   |  |                      |  |     |  |  |  |
|  | 2.3 V5          |  |       | 10.97  | 10.03           | PR: 1KY  |                |  |        |   |   |  |                      |  |     |  |  |  |
| 2.3 V5 4motion   |                 |  | 11.98 | 10.03  | PR: 1KU,2EE,2EL |  |                |  |        |   |   |  |                      |  |     |  |  |  |
| 2.8 V6 4motion   |                 |  | 01.99 | 10.03  | PR: 1KU,2EE,2EL |  |                |  |        |   |   |  |                      |  |     |  |  |  |
| 3.2 R32 4motion  |                 |  | 06.02 | 10.03  | PR: 1KU,2EE,2EL |  |                |  |        |   |   |  |                      |  |     |  |  |  |
|  | 1.4             |  |       | 10.97  | 10.03           |  |                | 24.0741-1107.3   | 360042 | 2   |  |  |                      | Radsensor  |     |  |  |  |
|  | 1.6             |  |       | 10.97  | 10.03           |  |                |  |        |   |   |  |                      |  |     |  |  |  |
|  | 1.6 FSI         |  |       | 01.02  | 10.03           |  |                |  |        |   |   |  |                      |  |     |  |  |  |
|  | 1.8             |  |       | 10.97  | 10.03           |  |                |  |        |   |   |  |                      |  |     |  |  |  |
|  | 1.8 T GTI       | 132  |       | 10.97  | 10.03           |  |                |  |        |   |   |  |                      |  |     |  |  |  |
|  | 1.9 SDI         | 50   |       | 10.97  | 10.03           |  |                |  |        |   |   |  |                      |  |     |  |  |  |
|  | 1.9 TDI         | 66   |       | 10.97  | 06.01           |  |                |  |        |   |   |  |                      |  |     |  |  |  |
|  | 1.9 TDI         | 74   |       | 09.00  | 06.05           |  |                |  |        |   |   |  |                      |  |     |  |  |  |
|  | 1.9 TDI         | 81   |       | 10.97  | 10.03           |  |                |  |        |   |   |  |                      |  |     |  |  |  |
|  | 1.9 TDI         | 85   |       | 05.99  | 06.01           |  |                |  |        |   |   |  |                      |  |     |  |  |  |
|  | 1.9 TDI         | 96   |       | 04.01  | 10.03           |  |                |  |        |   |   |  |                      |  |     |  |  |  |
|  | 1.9 TDI         | 110  |       | 09.00  | 10.03           |  |                |  |        |   |   |  |                      |  |     |  |  |  |
|  | 2.0             | 85   |       | 08.98  | 10.03           |  |                |  |        |   |   |  |                      |  |     |  |  |  |
|  | 2.3 V5          |  |       | 10.97  | 10.03           |  |                |  |        |   |   |  |                      |  |     |  |  |  |
| 1.8 4motion  | 92              |  | 07.98 | 10.03  |                 |  | 24.0711-1365.3 | 360172   | 2      |  |   |  | Radsensor L=226      |  |     |  |  |  |
| 1.9 TDI 4motion  | 66              |  | 07.98 | 06.01  |                 |  |                |  |        |   |   |  |                      |  |     |  |  |  |
| 1.9 TDI 4motion  | 74              |  | 09.00 | 06.05  |                 |  |                |  |        |   |   |  |                      |  |     |  |  |  |
| 1.9 TDI 4motion  | 85              |  | 11.99 | 06.01  |                 |  |                |  |        |   |   |  |                      |  |     |  |  |  |
| 1.9 TDI 4motion  | 96              |  | 04.01 | 10.03  |                 |  |                |  |        |   |   |  |                      |  |     |  |  |  |
| 1.9 TDI 4motion  | 110             |  | 09.00 | 10.03  |                 |  |                |  |        |   |   |  |                      |  |     |  |  |  |
| 2.0 4motion  | 85              |  | 04.00 | 10.03  |                 |  |                |  |        |   |   |  |                      |  |     |  |  |  |
| 2.3 V5 4motion   |                 |  | 11.98 | 10.03  |                 |  |                |  |        |   |   |  |                      |  |     |  |  |  |
| 2.8 V6 4motion   |                 |  | 01.99 | 10.03  |                 |  |                |  |        |   |   |  |                      |  |     |  |  |  |
| 3.2 R32 4motion  |                 |  | 06.02 | 10.03  |                 |  |                |  |        |   |   |  |                      |  |     |  |  |  |

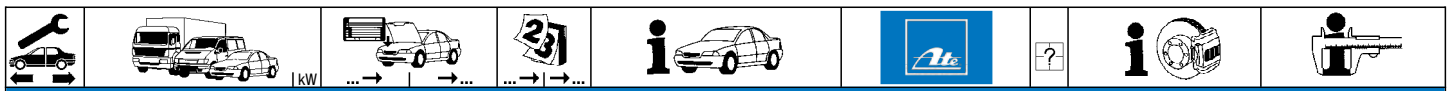

**VOLKSWAGEN GOLF IV Variant (99-06)**

|                |                 |             |             |       |                         |                         |                |        |  |  |                            |     |
|----------------|-----------------|-------------|-------------|-------|-------------------------|-------------------------|----------------|--------|--|--|----------------------------|-----|
|                | 1.4             |             |             | 05.99 | 06.06                   | PR: 1LR,1LS,1ZF,1ZP,1ZM | 13.0460-7117.2 | 607117 |  |  | 23131 19,6 +/WK            | VW  |
|                | 1.6             |             |             | 05.99 | 06.06                   | PR: 1LR,1LS,1ZF,1ZP,1ZM | 13.0470-7117.2 | LD7117 |  |  | 23131 19,6 +/WK            | VW  |
|                | 1.6 FSI         |             |             | 01.02 | 06.06                   | PR: 1LR,1LS,1ZF,1ZP,1ZM |                |        |  |  |                            |     |
|                | 1.8 4motion     | 92          |             | 05.99 | 06.06                   | PR: 1LR,1LS,1ZF,1ZP,1ZM |                |        |  |  |                            |     |
|                | 1.9 SDI         |             |             | 05.99 | 06.06                   | PR: 1LR,1LS,1ZF,1ZP,1ZM |                |        |  |  |                            |     |
|                | 1.9 TDI         | 66          |             | 05.99 | 06.06                   | PR: 1LR,1LS,1ZF,1ZP,1ZM |                |        |  |  |                            |     |
|                | 1.9 TDI         | 74          |             | 09.00 | 06.06                   | PR: 1LR,1LS,1ZF,1ZP,1ZM |                |        |  |  |                            |     |
|                | 1.9 TDI         | 81          |             | 05.99 | 06.06                   | PR: 1LR,1LS,1ZF,1ZP,1ZM |                |        |  |  |                            |     |
|                | 1.9 TDI         | 85          |             | 05.99 | 06.06                   | PR: 1LR,1LS,1ZF,1ZP,1ZM |                |        |  |  |                            |     |
|                | 1.9 TDI         | 96          |             | 04.01 | 06.06                   | PR: 1LR,1LS,1ZF,1ZP,1ZM |                |        |  |  |                            |     |
|                | 1.9 TDI 4motion | 66          |             | 05.99 | 06.06                   | PR: 1LR,1LS,1ZF,1ZP,1ZM |                |        |  |  |                            |     |
|                | 1.9 TDI 4motion | 74          |             | 09.00 | 06.06                   | PR: 1LR,1LS,1ZF,1ZP,1ZM |                |        |  |  |                            |     |
|                | 1.9 TDI 4motion | 85          |             | 11.99 | 06.06                   | PR: 1LR,1LS,1ZF,1ZP,1ZM |                |        |  |  |                            |     |
|                | 2.0             | 85          |             | 05.99 | 06.06                   | PR: 1LR,1LS,1ZF,1ZP,1ZM |                |        |  |  |                            |     |
| 2.0 4motion    |                 |             | 04.00       | 06.06 | PR: 1LR,1LS,1ZF,1ZP,1ZM |                         |                |        |  |  |                            |     |
| 2.3 V5         |                 | 1J-X-800000 |             | 05.99 |                         | PR: 1ZE                 | 13.0460-7081.2 | 607081 |  |  | 21911 20,3 +               | ATE |
| 2.3 V5 4motion |                 | 1J-X-800000 |             | 05.99 |                         | PR: 1ZE                 | 13.0470-7081.2 | LD7081 |  |  | 21911 20,3 +               | ATE |
| 2.8 V6 4motion |                 |             |             | 05.99 | 06.06                   |                         |                |        |  |  |                            |     |
|                | 1.8 T           | 110         |             | 05.00 | 06.06                   | PR: 1ZD,1ZE             | 13.0460-7122.2 | 607122 |  |  | 23392 20,3 +/WK            | ATE |
|                | 1.9 TDI         | 96          |             | 04.01 | 06.06                   | PR: 1ZD,1ZE             | 13.0470-7122.2 | LD7122 |  |  | 23392 20,3 +/WK            | ATE |
|                | 1.9 TDI 4motion | 96          |             | 04.01 | 06.06                   | PR: 1ZD,1ZE             |                |        |  |  |                            |     |
|                | 2.3 V5          |             | 1J-Y-000001 |       | 06.06                   | PR: 1ZD,1ZE             |                |        |  |  |                            |     |
|                | 2.3 V5 4motion  |             | 1J-Y-000001 |       | 06.06                   | PR: 1ZD,1ZE             |                |        |  |  |                            |     |
|                | 2.8 V6 4motion  |             |             |       | 06.06                   | PR: 1ZD,1ZE             |                |        |  |  |                            |     |
|                | 1.4             |             |             | 05.99 | 06.06                   | PR: 1LR,1LS,1ZF,1ZP,1ZM | 24.0122-0150.1 | 422150 |  |  | 280 22,0 19,0 V L +S +B    |     |
|                | 1.6             |             |             | 05.99 | 06.06                   | PR: 1LR,1LS,1ZF,1ZP,1ZM | 24.0322-0150.1 | 522150 |  |  | 280 22,0 19,0 V L +S +B PD |     |
|                | 1.6 FSI         |             |             | 01.02 | 06.06                   | PR: 1LR,1LS,1ZF,1ZP,1ZM |                |        |  |  |                            |     |
|                | 1.8 4motion     | 92          |             | 05.99 | 06.06                   | PR: 1LR,1LS,1ZF,1ZP,1ZM |                |        |  |  |                            |     |
|                | 1.9 SDI         |             |             | 05.99 | 06.06                   | PR: 1LR,1LS,1ZF,1ZP,1ZM |                |        |  |  |                            |     |
|                | 1.9 TDI         | 66          |             | 05.99 | 06.06                   | PR: 1LR,1LS,1ZF,1ZP,1ZM |                |        |  |  |                            |     |
|                | 1.9 TDI         | 74          |             | 09.00 | 06.06                   | PR: 1LR,1LS,1ZF,1ZP,1ZM |                |        |  |  |                            |     |
|                | 1.9 TDI         | 81          |             | 05.99 | 06.06                   | PR: 1LR,1LS,1ZF,1ZP,1ZM |                |        |  |  |                            |     |
|                | 1.9 TDI         | 85          |             | 05.99 | 06.06                   | PR: 1LR,1LS,1ZF,1ZP,1ZM |                |        |  |  |                            |     |
|                | 1.9 TDI         | 96          |             | 04.01 | 06.06                   | PR: 1LR,1LS,1ZF,1ZP,1ZM |                |        |  |  |                            |     |
|                | 1.9 TDI 4motion | 66          |             | 05.99 | 06.06                   | PR: 1LR,1LS,1ZF,1ZP,1ZM |                |        |  |  |                            |     |
|                | 1.9 TDI 4motion | 74          |             | 09.00 | 06.06                   | PR: 1LR,1LS,1ZF,1ZP,1ZM |                |        |  |  |                            |     |
|                | 1.9 TDI 4motion | 85          |             | 11.99 | 06.06                   | PR: 1LR,1LS,1ZF,1ZP,1ZM |                |        |  |  |                            |     |
|                | 2.0             | 85          |             | 05.99 | 06.06                   | PR: 1LR,1LS,1ZF,1ZP,1ZM |                |        |  |  |                            |     |
| 2.0 4motion    |                 |             | 04.00       | 06.06 | PR: 1LR,1LS,1ZF,1ZP,1ZM |                         |                |        |  |  |                            |     |
|                | 1.8 T           | 110         |             | 05.00 | 06.06                   | PR: 1ZD,1ZE             | 24.0125-0113.1 | 425113 |  |  | 288 25,0 22,0 V L +S +B    |     |
|                | 1.9 TDI         | 96          |             | 04.01 | 06.06                   | PR: 1ZD,1ZE             | 24.0325-0113.1 | 525113 |  |  | 288 25,0 22,0 V L +S +B PD |     |
|                | 1.9 TDI 4motion | 96          |             | 04.01 | 06.06                   | PR: 1ZD,1ZE             |                |        |  |  |                            |     |
|                | 2.3 V5          |             |             | 05.99 | 06.06                   | PR: 1ZD,1ZE             |                |        |  |  |                            |     |
|                | 2.3 V5 4motion  |             |             | 05.99 | 06.06                   | PR: 1ZD,1ZE             |                |        |  |  |                            |     |
|                | 2.8 V6 4motion  |             |             |       | 05.99                   | 06.06                   |                |        |  |  |                            |     |
|                | 1.4             |             |             | 05.99 | 06.06                   |                         | 24.0711-1361.3 | 360022 |  |  | Radsensor                  |     |
|                | 1.6             |             |             | 05.99 | 06.06                   |                         | 24.0711-1362.3 | 360023 |  |  | Radsensor                  |     |
|                | 1.6 FSI         |             |             | 01.02 | 06.06                   |                         |                |        |  |  |                            |     |
|                | 1.8 4motion     | 92          |             | 05.99 | 06.06                   |                         |                |        |  |  |                            |     |
|                | 1.8 T           | 110         |             | 05.00 | 06.06                   |                         |                |        |  |  |                            |     |
|                | 1.9 SDI         |             |             | 05.99 | 06.06                   |                         |                |        |  |  |                            |     |
|                | 1.9 TDI         | 66          |             | 05.99 | 06.06                   |                         |                |        |  |  |                            |     |
|                | 1.9 TDI         | 74          |             | 09.00 | 06.06                   |                         |                |        |  |  |                            |     |
|                | 1.9 TDI         | 81          |             | 05.99 | 06.06                   |                         |                |        |  |  |                            |     |
|                | 1.9 TDI         | 85          |             | 05.99 | 06.06                   |                         |                |        |  |  |                            |     |
|                | 1.9 TDI         | 96          |             | 04.01 | 06.06                   |                         |                |        |  |  |                            |     |
|                | 1.9 TDI 4motion | 66          |             | 05.99 | 06.06                   |                         |                |        |  |  |                            |     |
|                | 1.9 TDI 4motion | 74          |             | 09.00 | 06.06                   |                         |                |        |  |  |                            |     |
|                | 1.9 TDI 4motion | 85          |             | 11.99 | 06.06                   |                         |                |        |  |  |                            |     |
| 2.0            | 85              |             | 04.01       | 06.06 |                         |                         |                |        |  |  |                            |     |
| 2.0 4motion    |                 |             | 05.99       | 06.06 |                         |                         |                |        |  |  |                            |     |
| 2.3 V5         |                 |             | 05.99       | 06.06 |                         |                         |                |        |  |  |                            |     |
| 2.3 V5 4motion |                 |             | 05.99       | 06.06 |                         |                         |                |        |  |  |                            |     |
| 2.8 V6 4motion |                 |             | 05.99       | 06.06 |                         |                         |                |        |  |  |                            |     |
|                | 1.4             |             |             | 05.99 | 06.06                   | PR: 1KE,1KP,1KT         | 13.0460-2894.2 | 602894 |  |  | 20961 17,4 /Zub/S          | TRW |
|                | 1.6             |             |             | 05.99 | 06.06                   | PR: 1KE,1KP,1KT         | 13.0470-2894.2 | LD2894 |  |  | 20961 17,4 /Zub/S          | TRW |
|                | 1.6 FSI         |             |             | 01.02 | 06.06                   | PR: 1KE,1KP,1KT         | 13.0460-0072.2 | 610072 |  |  | Belagsatz-Zubehör          | TRW |
|                | 1.8 4motion     | 92          |             | 05.99 | 06.06                   | PR: 1KE                 |                |        |  |  |                            |     |
|                | 1.8 T           | 110         |             | 05.00 | 06.06                   | PR: 1KE,1KP,1KT         |                |        |  |  |                            |     |
|                | 1.9 SDI         |             |             | 05.99 | 06.06                   | PR: 1KE,1KP,1KT         |                |        |  |  |                            |     |
|                | 1.9 TDI         | 66          |             | 05.99 | 06.06                   | PR: 1KE,1KP,1KT         |                |        |  |  |                            |     |
|                | 1.9 TDI         | 74          |             | 09.00 | 06.06                   | PR: 1KE,1KP,1KT         |                |        |  |  |                            |     |
|                | 1.9 TDI         | 81          |             | 05.99 | 06.06                   | PR: 1KE,1KP,1KT         |                |        |  |  |                            |     |
|                | 1.9 TDI         | 85          |             | 05.99 | 06.06                   | PR: 1KE,1KP,1KT         |                |        |  |  |                            |     |
|                | 1.9 TDI         | 96          |             | 04.01 | 06.06                   | PR: 1KE,1KP,1KT         |                |        |  |  |                            |     |
|                | 1.9 TDI 4motion | 66          |             | 05.99 | 06.06                   | PR: 1KE                 |                |        |  |  |                            |     |
|                | 1.9 TDI 4motion | 74          |             | 09.00 | 06.06                   | PR: 1KE                 |                |        |  |  |                            |     |
|                | 1.9 TDI 4motion | 85          |             | 11.99 | 06.06                   | PR: 1KE                 |                |        |  |  |                            |     |
| 2.0            | 85              |             | 04.01       | 06.06 | PR: 1KE                 |                         |                |        |  |  |                            |     |
| 2.0 4motion    |                 |             | 05.99       | 06.06 | PR: 1KE,1KP,1KT         |                         |                |        |  |  |                            |     |
| 2.3 V5         |                 |             | 05.99       | 06.06 | PR: 1KE,1KP,1KT         |                         |                |        |  |  |                            |     |
| 2.3 V5 4motion |                 |             | 05.99       | 06.06 | PR: 1KE                 |                         |                |        |  |  |                            |     |
| 2.8 V6 4motion |                 |             | 05.99       | 06.06 | PR: 1KE                 |                         |                |        |  |  |                            |     |



**VOLKSWAGEN GOLF IV Variant (99-06)**

|  |   |   |  |  |  |                                  |                  |   |   |            |
|--|---|---|--|--|--|----------------------------------|------------------|---|---|------------|
|  | 1.8 4motion<br>1.9 TDI 4motion<br>1.9 TDI 4motion<br>1.9 TDI 4motion<br>2.0 4motion<br>2.3 V5 4motion<br>2.8 V6 4motion | 92<br>66<br>74<br>85<br>96              | 05.99<br>05.99<br>09.00<br>11.99<br>04.01<br>04.00<br>05.99<br>05.99                                     | 06.06<br>06.06<br>06.06<br>06.06<br>06.06<br>06.06<br>06.06<br>06.06                                     | PR: 2EE,2EL<br>PR: 2EE,2EL<br>PR: 2EE,2EL<br>PR: 2EE,2EL<br>PR: 2EE,2EL<br>PR: 2EE,2EL<br>PR: 2EE,2EL<br>PR: 2EE,2EL   | 13.0460-2820.2<br>13.0470-2820.2 | 602820<br>LD2820 |   | 20961 17,6 /S<br>20961 17,6 /S                  | TRW<br>TRW |
|  | 1.4<br>1.6<br>1.6 FSI<br>1.8 T<br>1.9 SDI<br>1.9 TDI<br>1.9 TDI<br>1.9 TDI<br>1.9 TDI<br>1.9 TDI<br>2.0<br>2.3 V5       | 110<br>66<br>74<br>81<br>85<br>96<br>85 | 05.99<br>05.99<br>01.02<br>05.00<br>05.99<br>05.99<br>09.00<br>05.99<br>05.99<br>04.01<br>05.99<br>05.99 | 06.06<br>06.06<br>06.06<br>06.06<br>06.06<br>06.06<br>06.06<br>06.06<br>06.06<br>06.06<br>06.06<br>06.06 | PR: 1KP,1KT<br>PR: 1KP,1KT<br>PR: 1KP,1KT<br>PR: 1KP,1KT<br>PR: 1KP,1KT<br>PR: 1KP,1KT<br>PR: 1KP,1KT<br>PR: 1KP,1KT<br>PR: 1KP,1KT<br>PR: 1KP,1KT<br>PR: 1KP,1KT<br>PR: 1KP,1KT | 24.0109-0123.1<br>24.0309-0123.1 | 409123<br>509123 |   | 230 9,0 7,0 +S +B<br>230 9,0 7,0 +S +B PD       |            |
|  | 1.8 4motion<br>1.9 TDI 4motion<br>1.9 TDI 4motion<br>1.9 TDI 4motion<br>2.0 4motion<br>2.3 V5 4motion<br>2.8 V6 4motion | 92<br>66<br>74<br>85<br>96              | 05.99<br>05.99<br>09.00<br>11.99<br>04.01<br>04.00<br>05.99<br>05.99                                     | 06.06<br>06.06<br>06.06<br>06.06<br>06.06<br>06.06<br>06.06<br>06.06                                     | PR: 1KE<br>PR: 1KE<br>PR: 1KE<br>PR: 1KE<br>PR: 1KE<br>PR: 1KE<br>PR: 1KE<br>PR: 1KE   | 24.0109-0133.1<br>24.0309-0133.1 | 409133<br>509133 |   | 239 8,9 7,0 +S +B<br>239 8,9 7,0 +S +B PD       |            |
|  | 1.8 4motion<br>1.9 TDI 4motion<br>1.9 TDI 4motion<br>1.9 TDI 4motion<br>2.0 4motion<br>2.3 V5 4motion<br>2.8 V6 4motion | 92<br>66<br>74<br>85<br>96              | 05.99<br>05.99<br>09.00<br>11.99<br>04.01<br>04.00<br>05.99<br>05.99                                     | 06.06<br>06.06<br>06.06<br>06.06<br>06.06<br>06.06<br>06.06<br>06.06                                     | PR: 2EE,2EL<br>PR: 2EE,2EL<br>PR: 2EE,2EL<br>PR: 2EE,2EL<br>PR: 2EE,2EL<br>PR: 2EE,2EL<br>PR: 2EE,2EL<br>PR: 2EE,2EL   | 24.0122-0163.1<br>24.0322-0163.1 | 422163<br>522163 |   | 256 22,0 20,0 V L +B<br>256 22,0 20,0 V L +B PD |            |
|  | 1.4<br>1.6<br>1.6 FSI<br>1.8 T<br>1.9 SDI<br>1.9 TDI<br>1.9 TDI<br>1.9 TDI<br>1.9 TDI<br>1.9 TDI<br>2.0<br>2.3 V5       | 110<br>66<br>74<br>81<br>85<br>96<br>85 | 05.99<br>05.99<br>01.02<br>05.00<br>05.99<br>05.99<br>09.00<br>05.99<br>05.99<br>04.01<br>05.99<br>05.99 | 06.06<br>06.06<br>06.06<br>06.06<br>06.06<br>06.06<br>06.06<br>06.06<br>06.06<br>06.06<br>06.06<br>06.06 |  | 24.0741-1107.3                   | 360042           | 2 | Radsensor                                       |            |
|  | 1.8 4motion<br>1.9 TDI 4motion<br>1.9 TDI 4motion<br>1.9 TDI 4motion<br>2.0 4motion<br>2.3 V5 4motion<br>2.8 V6 4motion | 92<br>66<br>74<br>85<br>96              | 05.99<br>05.99<br>09.00<br>11.99<br>04.01<br>04.00<br>05.99<br>05.99                                     | 06.06<br>06.06<br>06.06<br>06.06<br>06.06<br>06.06<br>06.06<br>06.06                                     |  | 24.0711-1365.3                   | 360172           | 2 | Radsensor L=226                                 |            |

**VOLKSWAGEN GOLF V (03-08)**

|  |  |   |   |  |   |                                  |                  |  |                                    |            |
|--|--|---|---|--|---|----------------------------------|------------------|--|------------------------------------|------------|
|  | 1.4 16V<br>1.4 FSI<br>1.4 TSI<br>1.4 TSI<br>1.6 16V<br>1.6 FSI<br>1.9 TDI<br>1.9 TDI<br>1.9 TDI 4motion<br>2.0 FSI<br>2.0 FSI 4motion<br>2.0 GTI<br>2.0 GTI<br>2.0 SDI<br>2.0 TDI<br>2.0 TDI<br>2.0 TDI<br>2.0 TDI<br>2.0 TDI 4motion<br>3.2 R32 | 66<br>90<br>103<br>125<br>75<br>85<br>66<br>77<br>77<br>110<br>110<br>147<br>169<br>55<br>100<br>103<br>125<br>103<br>184 | 10.03<br>10.03<br>05.07<br>05.06<br>11.05<br>01.04<br>10.03<br>05.04<br>10.03<br>08.04<br>10.03<br>09.04<br>09.06<br>01.04<br>10.03<br>10.03<br>11.05<br>08.04<br>11.05 | 09.08<br>09.08<br>09.08<br>09.08<br>09.08<br>09.08<br>09.08<br>09.08<br>09.08<br>09.08<br>09.08<br>09.08<br>09.08<br>09.08<br>09.08<br>09.08<br>09.08<br>09.08<br>09.08<br>09.08 | PR: 1ZF,1ZM,1ZC<br>PR: 1ZF,1ZM,1ZC<br>PR: 1ZF,1ZM,1ZC<br>PR: 1ZF,1ZM,1ZC<br>PR: 1ZF,1ZM,1ZC<br>PR: 1ZF,1ZM,1ZC<br>PR: 1ZF,1ZM,1ZC<br>PR: 1ZF,1ZM,1ZC<br>PR: 1ZF,1ZM,1ZC<br>PR: 1ZF,1ZM,1ZC<br>PR: 1ZF,1ZM,1ZC<br>PR: 1ZF,1ZM,1ZC<br>PR: 1ZF,1ZM,1ZC<br>PR: 1ZF,1ZM,1ZC<br>PR: 1ZF,1ZM,1ZC<br>PR: 1ZF,1ZM,1ZC<br>PR: 1ZF,1ZM,1ZC<br>PR: 1ZF,1ZM,1ZC<br>PR: 1ZF,1ZM,1ZC | 13.0460-7117.2<br>13.0470-7117.2 | 607117<br>LD7117 |  | 23131 19,6 +/WK<br>23131 19,6 +/WK | VW<br>VW   |
|  | 1.4 16V<br>1.4 FSI<br>1.4 TSI<br>1.4 TSI<br>1.6 16V<br>1.6 FSI<br>1.9 TDI<br>1.9 TDI   | 66<br>90<br>103<br>125<br>75<br>85<br>66<br>77  | 10.03<br>10.03<br>05.07<br>05.06<br>11.05<br>01.04<br>10.03<br>10.03  | 09.08<br>09.08<br>09.08<br>09.08<br>09.08<br>09.08<br>09.08<br>09.08   | PR: 1LJ,1LL,1LV,1ZD,1ZP,1ZE<br>PR: 1LJ,1LL,1LV,1ZD,1ZP,1ZE<br>PR: 1LJ,1LL,1LV,1ZD,1ZP,1ZE<br>PR: 1LJ,1LL,1LV,1ZD,1ZP,1ZE<br>PR: 1LJ,1LL,1LV,1ZD,1ZP,1ZE<br>PR: 1LJ,1LL,1LV,1ZD,1ZP,1ZE<br>PR: 1LJ,1LL,1LV,1ZD,1ZP,1ZE<br>PR: 1LJ,1LL,1LV,1ZD,1ZP,1ZE  | 13.0460-7184.2<br>13.0470-7184.2 | 607184<br>LD7184 |  | 23587 20,6 +/WK<br>23587 20,6 +/WK | ATE<br>ATE |



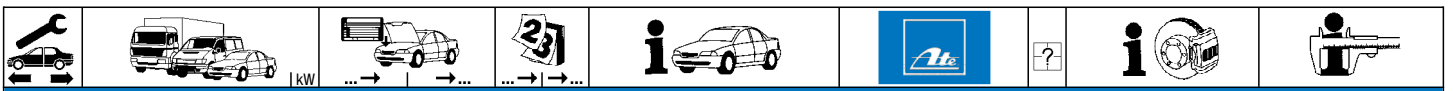

**VOLKSWAGEN GOLF V (03-08)**

|         |                 |       |       |                 |                             |                |        |  |                           |     |
|---------|-----------------|-------|-------|-----------------|-----------------------------|----------------|--------|--|---------------------------|-----|
|         | 1.9 TDI 4motion | 77    | 08.04 | 09.08           | PR: 1LJ,1LL,1LV,1ZD,1ZP,1ZE | 13.0460-7184.2 | 607184 |  | 23587 20,6 +WK            | ATE |
|         | 2.0 FSI         | 110   | 10.03 | 09.08           | PR: 1LJ,1LL,1LV,1ZD,1ZP,1ZE | 13.0470-7184.2 | LD7184 |  | 23587 20,6 +WK            | ATE |
|         | 2.0 FSI 4motion | 110   | 08.04 | 09.08           | PR: 1LJ,1LL,1LV,1ZD,1ZP,1ZE |                |        |  |                           |     |
|         | 2.0 GTI         | 147   | 09.04 | 09.08           | PR: 1LJ,1LL,1LV,1ZD,1ZP,1ZE |                |        |  |                           |     |
|         | 2.0 GTI         | 169   | 09.06 | 09.08           | PR: 1LJ,1LL,1LV,1ZD,1ZP,1ZE |                |        |  |                           |     |
|         | 2.0 SDI         | 55    | 01.04 | 09.08           | PR: 1LJ,1LL,1LV,1ZD,1ZP,1ZE |                |        |  |                           |     |
|         | 2.0 TDI         | 100   | 10.03 | 09.08           | PR: 1LJ,1LL,1LV,1ZD,1ZP,1ZE |                |        |  |                           |     |
|         | 2.0 TDI         | 103   | 10.03 | 09.08           | PR: 1LJ,1LL,1LV,1ZD,1ZP,1ZE |                |        |  |                           |     |
|         | 2.0 TDI         | 125   | 11.05 | 09.08           | PR: 1LJ,1LL,1LV,1ZD,1ZP,1ZE |                |        |  |                           |     |
|         | 2.0 TDI 4motion | 103   | 08.04 | 09.08           | PR: 1LJ,1LL,1LV,1ZD,1ZP,1ZE |                |        |  |                           |     |
|         | 3.2 R32         | 184   | 11.05 | 09.08           | PR: 1LJ,1LL,1LV,1ZD,1ZP,1ZE |                |        |  |                           |     |
|         | 1.4 16V         |       | 10.03 | 09.08           | PR: 1LK,1LM                 | 13.0460-7200.2 | 607200 |  | 23801 20,3 +WK            | ATE |
|         | 1.4 FSI         | 66    | 10.03 | 09.08           | PR: 1LK,1LM                 | 13.0470-7200.2 | LD7200 |  | 23801 20,3 +WK            | ATE |
|         | 1.4 TSI         | 90    | 05.07 | 09.08           | PR: 1LK,1LM                 |                |        |  |                           |     |
|         | 1.4 TSI         | 103   | 05.06 | 09.08           | PR: 1LK,1LM                 |                |        |  |                           |     |
|         | 1.4 TSI         | 125   | 11.05 | 09.08           | PR: 1LK,1LM                 |                |        |  |                           |     |
|         | 1.6 16V         | 75    | 01.04 | 09.08           | PR: 1LK,1LM                 |                |        |  |                           |     |
|         | 1.6 FSI         | 85    | 10.03 | 09.08           | PR: 1LK,1LM                 |                |        |  |                           |     |
|         | 1.9 TDI         | 66    | 05.04 | 09.08           | PR: 1LK,1LM                 |                |        |  |                           |     |
|         | 1.9 TDI         | 77    | 10.03 | 09.08           | PR: 1LK,1LM                 |                |        |  |                           |     |
|         | 1.9 TDI 4motion | 77    | 08.04 | 09.08           | PR: 1LK,1LM                 |                |        |  |                           |     |
|         | 2.0 FSI         | 110   | 10.03 | 09.08           | PR: 1LK,1LM                 |                |        |  |                           |     |
|         | 2.0 FSI 4motion | 110   | 08.04 | 09.08           | PR: 1LK,1LM                 |                |        |  |                           |     |
|         | 2.0 GTI         | 147   | 09.04 | 09.08           | PR: 1LK,1LM                 |                |        |  |                           |     |
|         | 2.0 GTI         | 169   | 09.06 | 09.08           | PR: 1LK,1LM                 |                |        |  |                           |     |
|         | 2.0 SDI         | 55    | 01.04 | 09.08           | PR: 1LK,1LM                 |                |        |  |                           |     |
|         | 2.0 TDI         | 100   | 10.03 | 09.08           | PR: 1LK,1LM                 |                |        |  |                           |     |
|         | 2.0 TDI         | 103   | 10.03 | 09.08           | PR: 1LK,1LM                 |                |        |  |                           |     |
|         | 2.0 TDI         | 125   | 11.05 | 09.08           | PR: 1LK,1LM                 |                |        |  |                           |     |
|         | 2.0 TDI 4motion | 103   | 08.04 | 09.08           | PR: 1LK,1LM                 |                |        |  |                           |     |
| 3.2 R32 | 184             | 11.05 | 09.08 | PR: 1LK,1LM     |                             |                |        |  |                           |     |
|         | 1.4 16V         |       | 10.03 | 09.08           | PR: 1ZF,1ZM,1ZC             | 24.0122-0210.1 | 422210 |  | 280 22,0 19,0 VL +S +B    |     |
|         | 1.4 FSI         | 66    | 10.03 | 09.08           | PR: 1ZF,1ZM,1ZC             | 24.0322-0210.1 | 522210 |  | 280 22,0 19,0 VL +S +B PD |     |
|         | 1.4 TSI         | 90    | 05.07 | 09.08           | PR: 1ZF,1ZM,1ZC             |                |        |  |                           |     |
|         | 1.4 TSI         | 103   | 05.06 | 09.08           | PR: 1ZF,1ZM,1ZC             |                |        |  |                           |     |
|         | 1.4 TSI         | 125   | 11.05 | 09.08           | PR: 1ZF,1ZM,1ZC             |                |        |  |                           |     |
|         | 1.6 16V         | 75    | 01.04 | 09.08           | PR: 1ZF,1ZM,1ZC             |                |        |  |                           |     |
|         | 1.6 FSI         | 85    | 10.03 | 09.08           | PR: 1ZF,1ZM,1ZC             |                |        |  |                           |     |
|         | 1.9 TDI         | 66    | 05.04 | 09.08           | PR: 1ZF,1ZM,1ZC             |                |        |  |                           |     |
|         | 1.9 TDI         | 77    | 10.03 | 09.08           | PR: 1ZF,1ZM,1ZC             |                |        |  |                           |     |
|         | 1.9 TDI 4motion | 77    | 08.04 | 09.08           | PR: 1ZF,1ZM,1ZC             |                |        |  |                           |     |
|         | 2.0 FSI         | 110   | 10.03 | 09.08           | PR: 1ZF,1ZM,1ZC             |                |        |  |                           |     |
|         | 2.0 FSI 4motion | 110   | 08.04 | 09.08           | PR: 1ZF,1ZM,1ZC             |                |        |  |                           |     |
|         | 2.0 GTI         | 147   | 09.04 | 09.08           | PR: 1ZF,1ZM,1ZC             |                |        |  |                           |     |
|         | 2.0 GTI         | 169   | 09.06 | 09.08           | PR: 1ZF,1ZM,1ZC             |                |        |  |                           |     |
|         | 2.0 SDI         | 55    | 01.04 | 09.08           | PR: 1ZF,1ZM,1ZC             |                |        |  |                           |     |
|         | 2.0 TDI         | 100   | 10.03 | 09.08           | PR: 1ZF,1ZM,1ZC             |                |        |  |                           |     |
|         | 2.0 TDI         | 103   | 10.03 | 09.08           | PR: 1ZF,1ZM,1ZC             |                |        |  |                           |     |
|         | 2.0 TDI         | 125   | 11.05 | 09.08           | PR: 1ZF,1ZM,1ZC             |                |        |  |                           |     |
|         | 2.0 TDI 4motion | 103   | 08.04 | 09.08           | PR: 1ZF,1ZM,1ZC             |                |        |  |                           |     |
| 3.2 R32 | 184             | 11.05 | 09.08 | PR: 1ZF,1ZM,1ZC |                             |                |        |  |                           |     |
|         | 1.4 16V         |       | 10.03 | 09.08           | PR: 1ZE,1ZP                 | 24.0125-0145.1 | 425145 |  | 288 25,0 22,0 VL +S +B    |     |
|         | 1.4 FSI         | 66    | 10.03 | 09.08           | PR: 1ZE,1ZP                 | 24.0325-0145.1 | 525145 |  | 288 25,0 22,0 VL +S +B PD |     |
|         | 1.4 TSI         | 90    | 05.07 | 09.08           | PR: 1ZE,1ZP                 |                |        |  |                           |     |
|         | 1.4 TSI         | 103   | 05.06 | 09.08           | PR: 1ZE,1ZP                 |                |        |  |                           |     |
|         | 1.4 TSI         | 125   | 11.05 | 09.08           | PR: 1ZE,1ZP                 |                |        |  |                           |     |
|         | 1.6 16V         | 75    | 01.04 | 09.08           | PR: 1ZE,1ZP                 |                |        |  |                           |     |
|         | 1.6 FSI         | 85    | 10.03 | 09.08           | PR: 1ZE,1ZP                 |                |        |  |                           |     |
|         | 1.9 TDI         | 66    | 05.04 | 09.08           | PR: 1ZE,1ZP                 |                |        |  |                           |     |
|         | 1.9 TDI         | 77    | 10.03 | 09.08           | PR: 1ZE,1ZP                 |                |        |  |                           |     |
|         | 1.9 TDI 4motion | 77    | 08.04 | 09.08           | PR: 1ZE,1ZP                 |                |        |  |                           |     |
|         | 2.0 FSI         | 110   | 10.03 | 09.08           | PR: 1ZE,1ZP                 |                |        |  |                           |     |
|         | 2.0 FSI 4motion | 110   | 08.04 | 09.08           | PR: 1ZE,1ZP                 |                |        |  |                           |     |
|         | 2.0 GTI         | 147   | 09.04 | 09.08           | PR: 1ZE,1ZP                 |                |        |  |                           |     |
|         | 2.0 GTI         | 169   | 09.06 | 09.08           | PR: 1ZE,1ZP                 |                |        |  |                           |     |
|         | 2.0 SDI         | 55    | 01.04 | 09.08           | PR: 1ZE,1ZP                 |                |        |  |                           |     |
|         | 2.0 TDI         | 100   | 10.03 | 09.08           | PR: 1ZE,1ZP                 |                |        |  |                           |     |
|         | 2.0 TDI         | 103   | 10.03 | 09.08           | PR: 1ZE,1ZP                 |                |        |  |                           |     |
|         | 2.0 TDI         | 125   | 11.05 | 09.08           | PR: 1ZE,1ZP                 |                |        |  |                           |     |
|         | 2.0 TDI 4motion | 103   | 08.04 | 09.08           | PR: 1ZE,1ZP                 |                |        |  |                           |     |
| 3.2 R32 | 184             | 11.05 | 09.08 | PR: 1ZE,1ZP     |                             |                |        |  |                           |     |
|         | 1.4 16V         |       | 10.03 | 09.08           | PR: 1LJ,1LL,1LV,1ZD         | 24.0125-0158.1 | 425158 |  | 312 25,0 22,0 VL +S +B    |     |
|         | 1.4 FSI         | 66    | 10.03 | 09.08           | PR: 1LJ,1LL,1LV,1ZD         | 24.0325-0158.1 | 525158 |  | 312 25,0 22,0 VL +S +B PD |     |
|         | 1.4 TSI         | 90    | 05.07 | 09.08           | PR: 1LJ,1LL,1LV,1ZD         |                |        |  |                           |     |
|         | 1.4 TSI         | 103   | 05.06 | 09.08           | PR: 1LJ,1LL,1LV,1ZD         |                |        |  |                           |     |
|         | 1.4 TSI         | 125   | 11.05 | 09.08           | PR: 1LJ,1LL,1LV,1ZD         |                |        |  |                           |     |
|         | 1.6 16V         | 75    | 01.04 | 09.08           | PR: 1LJ,1LL,1LV,1ZD         |                |        |  |                           |     |
|         | 1.6 FSI         | 85    | 10.03 | 09.08           | PR: 1LJ,1LL,1LV,1ZD         |                |        |  |                           |     |
|         | 1.9 TDI         | 66    | 05.04 | 09.08           | PR: 1LJ,1LL,1LV,1ZD         |                |        |  |                           |     |
|         | 1.9 TDI         | 77    | 10.03 | 09.08           | PR: 1LJ,1LL,1LV,1ZD         |                |        |  |                           |     |
|         | 1.9 TDI 4motion | 77    | 08.04 | 09.08           | PR: 1LJ,1LL,1LV,1ZD         |                |        |  |                           |     |
|         | 2.0 FSI         | 110   | 10.03 | 09.08           | PR: 1LJ,1LL,1LV,1ZD         |                |        |  |                           |     |
|         | 2.0 FSI 4motion | 110   | 08.04 | 09.08           | PR: 1LJ,1LL,1LV,1ZD         |                |        |  |                           |     |
|         | 2.0 GTI         | 147   | 09.04 | 09.08           | PR: 1LJ,1LL,1LV,1ZD         |                |        |  |                           |     |
|         | 2.0 GTI         | 169   | 09.06 | 09.08           | PR: 1LJ,1LL,1LV,1ZD         |                |        |  |                           |     |
|         | 2.0 SDI         | 55    | 01.04 | 09.08           | PR: 1LJ,1LL,1LV,1ZD         |                |        |  |                           |     |
|         | 2.0 TDI         | 100   | 10.03 | 09.08           | PR: 1LJ,1LL,1LV,1ZD         |                |        |  |                           |     |















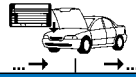

**VOLKSWAGEN GOLF V (03-08)**

















|                 |                 |     |       |       |                         |                         |                |        |  |                            |
|-----------------|-----------------|-----|-------|-------|-------------------------|-------------------------|----------------|--------|--|----------------------------|
|                 | 2.0 TDI         | 103 |       | 10.03 | 09.08                   | PR: 1LJ,1LL,1LV,1ZD     | 24.0125-0158.1 | 425158 |  | 312 25,0 22,0 V L +S +B    |
|                 | 2.0 TDI         | 125 |       | 11.05 | 09.08                   | PR: 1LJ,1LL,1LV,1ZD     | 24.0325-0158.1 | 525158 |  | 312 25,0 22,0 V L +S +B PD |
|                 | 2.0 TDI 4motion | 103 |       | 08.04 | 09.08                   | PR: 1LJ,1LL,1LV,1ZD     |                |        |  |                            |
|                 | 3.2 R32         | 184 |       | 11.05 | 09.08                   | PR: 1LJ,1LL,1LV,1ZD     |                |        |  |                            |
|                 | 1.4 16V         |     |       | 10.03 | 09.08                   | PR: 1LK,1LM             | 24.0130-0115.1 | 430115 |  | 345 30,0 27,0 V L +B       |
|                 | 1.4 FSI         | 66  |       | 10.03 | 09.08                   | PR: 1LK,1LM             | 24.0330-0115.1 | 530115 |  | 345 30,0 27,0 V L +B PD    |
|                 | 1.4 TSI         | 90  |       | 05.07 | 09.08                   | PR: 1LK,1LM             |                |        |  |                            |
|                 | 1.4 TSI         | 103 |       | 05.06 | 09.08                   | PR: 1LK,1LM             |                |        |  |                            |
|                 | 1.4 TSI         | 125 |       | 11.05 | 09.08                   | PR: 1LK,1LM             |                |        |  |                            |
|                 | 1.6 16V         | 75  |       | 01.04 | 09.08                   | PR: 1LK,1LM             |                |        |  |                            |
|                 | 1.6 FSI         | 85  |       | 10.03 | 09.08                   | PR: 1LK,1LM             |                |        |  |                            |
|                 | 1.9 TDI         | 66  |       | 05.04 | 09.08                   | PR: 1LK,1LM             |                |        |  |                            |
|                 | 1.9 TDI         | 77  |       | 10.03 | 09.08                   | PR: 1LK,1LM             |                |        |  |                            |
|                 | 1.9 TDI 4motion | 77  |       | 08.04 | 09.08                   | PR: 1LK,1LM             |                |        |  |                            |
| 2.0 FSI         | 110             |     | 10.03 | 09.08 | PR: 1LK,1LM             |                         |                |        |  |                            |
| 2.0 FSI 4motion | 110             |     | 08.04 | 09.08 | PR: 1LK,1LM             |                         |                |        |  |                            |
| 2.0 GTI         | 147             |     | 09.04 | 09.08 | PR: 1LK,1LM             |                         |                |        |  |                            |
| 2.0 GTI         | 169             |     | 09.06 | 09.08 | PR: 1LK,1LM             |                         |                |        |  |                            |
| 2.0 SDI         | 55              |     | 01.04 | 09.08 | PR: 1LK,1LM             |                         |                |        |  |                            |
| 2.0 TDI         | 100             |     | 10.03 | 09.08 | PR: 1LK,1LM             |                         |                |        |  |                            |
| 2.0 TDI         | 103             |     | 10.03 | 09.08 | PR: 1LK,1LM             |                         |                |        |  |                            |
| 2.0 TDI         | 125             |     | 11.05 | 09.08 | PR: 1LK,1LM             |                         |                |        |  |                            |
| 2.0 TDI 4motion | 103             |     | 08.04 | 09.08 | PR: 1LK,1LM             |                         |                |        |  |                            |
| 3.2 R32         | 184             |     | 11.05 | 09.08 | PR: 1LK,1LM             |                         |                |        |  |                            |
|                 | 1.4 16V         |     |       | 10.03 | 09.08                   |                         | 24.0711-5271.3 | 360301 |  | Radsensor                  |
|                 | 1.4 FSI         | 66  |       | 10.03 | 09.08                   |                         | 24.0711-5272.3 | 360302 |  | Radsensor                  |
|                 | 1.4 TSI         | 90  |       | 05.07 | 09.08                   |                         |                |        |  |                            |
|                 | 1.4 TSI         | 103 |       | 05.06 | 09.08                   |                         |                |        |  |                            |
|                 | 1.4 TSI         | 125 |       | 11.05 | 09.08                   |                         |                |        |  |                            |
|                 | 1.6 16V         | 75  |       | 01.04 | 09.08                   |                         |                |        |  |                            |
|                 | 1.6 FSI         | 85  |       | 10.03 | 09.08                   |                         |                |        |  |                            |
|                 | 1.9 TDI         | 66  |       | 05.04 | 09.08                   |                         |                |        |  |                            |
|                 | 1.9 TDI         | 77  |       | 10.03 | 09.08                   |                         |                |        |  |                            |
|                 | 1.9 TDI 4motion | 77  |       | 08.04 | 09.08                   |                         |                |        |  |                            |
|                 | 2.0 FSI         | 110 |       | 10.03 | 09.08                   |                         |                |        |  |                            |
|                 | 2.0 FSI 4motion | 110 |       | 08.04 | 09.08                   |                         |                |        |  |                            |
|                 | 2.0 GTI         | 147 |       | 09.04 | 09.08                   |                         |                |        |  |                            |
|                 | 2.0 GTI         | 169 |       | 09.06 | 09.08                   |                         |                |        |  |                            |
| 2.0 SDI         | 55              |     | 01.04 | 09.08 |                         |                         |                |        |  |                            |
| 2.0 TDI         | 100             |     | 10.03 | 09.08 |                         |                         |                |        |  |                            |
| 2.0 TDI         | 103             |     | 10.03 | 09.08 |                         |                         |                |        |  |                            |
| 2.0 TDI         | 125             |     | 11.05 | 09.08 |                         |                         |                |        |  |                            |
| 2.0 TDI 4motion | 103             |     | 08.04 | 09.08 |                         |                         |                |        |  |                            |
| 3.2 R32         | 184             |     | 11.05 | 09.08 |                         |                         |                |        |  |                            |
|                 | 1.4 16V         |     |       | 10.03 | 09.08                   | PR: 1KD,1KQ             | 13.0460-2820.2 | 602820 |  | 20961 17,6 /S TRW          |
|                 | 1.4 FSI         | 66  |       | 10.03 | 09.08                   | PR: 1KD,1KQ             | 13.0470-2820.2 | LD2820 |  | 20961 17,6 /S TRW          |
|                 | 1.4 TSI         | 90  |       | 05.07 | 09.08                   | PR: 1KD,1KQ             | 13.0460-0072.2 | 610072 |  | Belagsatz-Zubehör TRW      |
|                 | 1.4 TSI         | 103 |       | 05.06 | 09.08                   | PR: 1KD,1KQ             |                |        |  |                            |
|                 | 1.4 TSI         | 125 |       | 11.05 | 09.08                   | PR: 1KD,1KQ             |                |        |  |                            |
|                 | 1.6 16V         | 75  |       | 01.04 | 09.08                   | PR: 1KD,1KQ             |                |        |  |                            |
|                 | 1.6 FSI         | 85  |       | 10.03 | 09.08                   | PR: 1KD,1KQ             |                |        |  |                            |
|                 | 1.9 TDI         | 66  |       | 05.04 | 09.08                   | PR: 1KD,1KQ             |                |        |  |                            |
|                 | 1.9 TDI         | 77  |       | 10.03 | 09.08                   | PR: 1KD,1KQ             |                |        |  |                            |
|                 | 2.0 FSI         | 110 |       | 10.03 | 09.08                   | PR: 1KD,1KQ             |                |        |  |                            |
|                 | 2.0 GTI         | 147 |       | 09.04 | 09.08                   | PR: 1KD,1KQ             |                |        |  |                            |
|                 | 2.0 GTI         | 169 |       | 09.06 | 09.08                   | PR: 1KD,1KQ             |                |        |  |                            |
|                 | 2.0 SDI         | 55  |       | 01.04 | 09.08                   | PR: 1KD,1KQ             |                |        |  |                            |
|                 | 2.0 TDI         | 100 |       | 10.03 | 09.08                   | PR: 1KD,1KQ             |                |        |  |                            |
| 2.0 TDI         | 103             |     | 10.03 | 09.08 | PR: 1KD,1KQ             |                         |                |        |  |                            |
| 2.0 TDI         | 125             |     | 11.05 | 09.08 | PR: 1KD,1KQ             |                         |                |        |  |                            |
|                 | 1.4 16V         |     |       | 10.03 | 09.08                   | PR: 1KY,1KZ,1KF,1KE,2EL | 13.0460-2880.2 | 602880 |  | 23914 17,1 /WE/Zub/S TRW   |
|                 | 1.4 FSI         | 66  |       | 10.03 | 09.08                   | PR: 1KY,1KZ,1KF,1KE,2EL | 13.0470-2880.2 | LD2880 |  | 23914 17,1 /WE/Zub/S TRW   |
|                 | 1.4 TSI         | 90  |       | 05.07 | 09.08                   | PR: 1KY,1KZ,1KF,1KE,2EL | 13.0460-0259.2 | 610259 |  | Belagsatz-Zubehör TRW      |
|                 | 1.4 TSI         | 103 |       | 05.06 | 09.08                   | PR: 1KY,1KZ,1KF,1KE,2EL |                |        |  |                            |
|                 | 1.4 TSI         | 125 |       | 11.05 | 09.08                   | PR: 1KY,1KZ,1KF,1KE,2EL |                |        |  |                            |
|                 | 1.6 16V         | 75  |       | 01.04 | 09.08                   | PR: 1KY,1KZ,1KF,1KE,2EL |                |        |  |                            |
|                 | 1.6 FSI         | 85  |       | 10.03 | 09.08                   | PR: 1KY,1KZ,1KF,1KE,2EL |                |        |  |                            |
|                 | 1.9 TDI         | 66  |       | 05.04 | 09.08                   | PR: 1KY,1KZ,1KF,1KE,2EL |                |        |  |                            |
|                 | 1.9 TDI         | 77  |       | 10.03 | 09.08                   | PR: 1KY,1KZ,1KF,1KE,2EL |                |        |  |                            |
|                 | 1.9 TDI 4motion | 77  |       | 08.04 | 09.08                   | PR: 1KY,1KZ,1KF,1KE,2EL |                |        |  |                            |
|                 | 2.0 FSI         | 110 |       | 10.03 | 09.08                   | PR: 1KY,1KZ,1KF,1KE,2EL |                |        |  |                            |
|                 | 2.0 FSI 4motion | 110 |       | 08.04 | 09.08                   | PR: 1KY,1KZ,1KF,1KE,2EL |                |        |  |                            |
|                 | 2.0 GTI         | 147 |       | 09.04 | 09.08                   | PR: 1KY,1KZ,1KF,1KE,2EL |                |        |  |                            |
|                 | 2.0 GTI         | 169 |       | 09.06 | 09.08                   | PR: 1KY,1KZ,1KF,1KE,2EL |                |        |  |                            |
| 2.0 SDI         | 55              |     | 01.04 | 09.08 | PR: 1KY,1KZ,1KF,1KE,2EL |                         |                |        |  |                            |
| 2.0 TDI         | 100             |     | 10.03 | 09.08 | PR: 1KY,1KZ,1KF,1KE,2EL |                         |                |        |  |                            |
| 2.0 TDI         | 103             |     | 10.03 | 09.08 | PR: 1KY,1KZ,1KF,1KE,2EL |                         |                |        |  |                            |
| 2.0 TDI 4motion | 103             |     | 08.04 | 09.08 | PR: 1KY,1KZ,1KF,1KE,2EL |                         |                |        |  |                            |
| 3.2 R32         | 184             |     | 11.05 | 09.08 | PR: 1KY,1KZ,1KF,1KE,2EL |                         |                |        |  |                            |
|                 | 1.4 16V         |     |       | 10.03 | 09.08                   | PR: 1KV                 | 13.0460-2880.2 | 602880 |  | 23914 17,1 /WE/Zub/S TRW   |
|                 | 1.4 FSI         | 66  |       | 10.03 | 09.08                   | PR: 1KV                 | 13.0470-2880.2 | LD2880 |  | 23914 17,1 /WE/Zub/S TRW   |
|                 | 1.4 TSI         | 90  |       | 05.07 | 09.08                   | PR: 1KV                 | 13.0460-0259.2 | 610259 |  | Belagsatz-Zubehör TRW      |
|                 | 1.4 TSI         | 103 |       | 05.06 | 09.08                   | PR: 1KV                 |                |        |  |                            |
|                 | 1.4 TSI         | 125 |       | 11.05 | 09.08                   | PR: 1KV                 |                |        |  |                            |
|                 | 1.6 16V         | 75  |       | 01.04 | 09.08                   | PR: 1KV                 |                |        |  |                            |
|                 | 1.6 FSI         | 85  |       | 10.03 | 09.08                   | PR: 1KV                 |                |        |  |                            |
| 1.9 TDI         | 66              |     | 05.04 | 09.08 | PR: 1KV                 |                         |                |        |  |                            |























**VOLKSWAGEN GOLF V (03-08)**

|  |  |  |  |  |   |  |   |
|--|--|--|--|--|---|--|---|
|  | 1.9 TDI<br>1.9 TDI 4motion<br>2.0 FSI<br>2.0 FSI 4motion<br>2.0 GTI<br>2.0 GTI<br>2.0 SDI<br>2.0 TDI<br>2.0 TDI<br>2.0 TDI 4motion<br>3.2 R32  | 77<br>77<br>110<br>110<br>147<br>169<br>55<br>100<br>103<br>103<br>184                                       |  | 10.03 09.08 PR: 1KV<br>08.04 09.08 PR: 1KV<br>10.03 09.08 PR: 1KV<br>08.04 09.08 PR: 1KV<br>09.04 09.08 PR: 1KV<br>09.06 09.08 PR: 1KV<br>01.04 09.08 PR: 1KV<br>10.03 09.08 PR: 1KV<br>10.03 09.08 PR: 1KV<br>08.04 09.08 PR: 1KV<br>11.05 09.08 PR: 1KV  | 13.0460-2880.2 602880<br>13.0470-2880.2 LD2880<br>13.0460-0259.2 610259 |  | 23914 17,1 /WE/Zub/S TRW<br>23914 17,1 /WE/Zub/S TRW<br>Belagsatz-Zubehör |
|  | 1.4 16V<br>1.4 FSI<br>1.4 TSI<br>1.4 TSI<br>1.4 TSI<br>1.6 16V<br>1.6 FSI<br>1.9 TDI<br>1.9 TDI<br>2.0 FSI<br>2.0 GTI<br>2.0 GTI<br>2.0 SDI<br>2.0 TDI<br>2.0 TDI<br>2.0 TDI<br>2.0 TDI  | 66<br>90<br>103<br>125<br>75<br>85<br>66<br>77<br>110<br>147<br>169<br>55<br>100<br>103<br>125               |  | 10.03 09.08 PR: 1KD,1KQ<br>10.03 09.08 PR: 1KD,1KQ<br>05.07 09.08 PR: 1KD,1KQ<br>05.06 09.08 PR: 1KD,1KQ<br>11.05 09.08 PR: 1KD,1KQ<br>01.04 09.08 PR: 1KD,1KQ<br>10.03 09.08 PR: 1KD,1KQ<br>05.04 09.08 PR: 1KD,1KQ<br>10.03 09.08 PR: 1KD,1KQ<br>10.03 09.08 PR: 1KD,1KQ<br>09.04 09.08 PR: 1KD,1KQ<br>09.06 09.08 PR: 1KD,1KQ<br>01.04 09.08 PR: 1KD,1KQ<br>10.03 09.08 PR: 1KD,1KQ<br>10.03 09.08 PR: 1KD,1KQ<br>11.05 09.08 PR: 1KD,1KQ   | 24.0110-0277.1 410277<br>24.0310-0277.1 510277                          |  | 253 10,0 8,0 +S +B<br>253 10,0 8,0 +S +B PD                               |
|  | 1.4 16V<br>1.4 FSI<br>1.4 TSI<br>1.4 TSI<br>1.4 TSI<br>1.6 16V<br>1.6 FSI<br>1.9 TDI<br>1.9 TDI<br>1.9 TDI 4motion<br>2.0 FSI<br>2.0 FSI 4motion<br>2.0 GTI<br>2.0 GTI<br>2.0 SDI<br>2.0 TDI<br>2.0 TDI<br>2.0 TDI<br>2.0 TDI 4motion<br>3.2 R32 | 66<br>90<br>103<br>125<br>75<br>85<br>66<br>77<br>110<br>147<br>169<br>55<br>100<br>103<br>125<br>103<br>184 |  | 10.03 09.08 PR: 1KE,1KF<br>10.03 09.08 PR: 1KE,1KF<br>05.07 09.08 PR: 1KE,1KF<br>05.06 09.08 PR: 1KE,1KF<br>11.05 09.08 PR: 1KE,1KF<br>01.04 09.08 PR: 1KE,1KF<br>10.03 09.08 PR: 1KE,1KF<br>05.04 09.08 PR: 1KE,1KF<br>10.03 09.08 PR: 1KE,1KF<br>08.04 09.08 PR: 1KE,1KF<br>10.03 09.08 PR: 1KE,1KF<br>09.06 09.08 PR: 1KE,1KF<br>01.04 09.08 PR: 1KE,1KF<br>10.03 09.08 PR: 1KE,1KF<br>10.03 09.08 PR: 1KE,1KF<br>11.05 09.08 PR: 1KE,1KF<br>08.04 09.08 PR: 1KE,1KF<br>11.05 09.08 PR: 1KE,1KF           | 24.0112-0158.1 412158<br>24.0312-0158.1 512158                          |  | 256 12,0 10,0 +S +B<br>256 12,0 10,0 +B PD                                |
|  | 1.4 16V<br>1.4 FSI<br>1.4 TSI<br>1.4 TSI<br>1.4 TSI<br>1.6 16V<br>1.6 FSI<br>1.9 TDI<br>1.9 TDI<br>2.0 FSI<br>2.0 GTI<br>2.0 GTI<br>2.0 SDI<br>2.0 TDI<br>2.0 TDI<br>2.0 TDI<br>2.0 TDI  | 66<br>90<br>103<br>125<br>75<br>85<br>66<br>77<br>110<br>147<br>169<br>55<br>100<br>103<br>125               |  | 10.03 09.08 PR: 1KY,1KZ,1KV<br>10.03 09.08 PR: 1KY,1KZ,1KV<br>05.07 09.08 PR: 1KY,1KZ,1KV<br>05.06 09.08 PR: 1KY,1KZ,1KV<br>11.05 09.08 PR: 1KY,1KZ,1KV<br>01.04 09.08 PR: 1KY,1KZ,1KV<br>10.03 09.08 PR: 1KY,1KZ,1KV<br>05.04 09.08 PR: 1KY,1KZ,1KV<br>10.03 09.08 PR: 1KY,1KZ,1KV<br>10.03 09.08 PR: 1KY,1KZ,1KV<br>09.04 09.08 PR: 1KY,1KZ,1KV<br>09.06 09.08 PR: 1KY,1KZ,1KV<br>01.04 09.08 PR: 1KY,1KZ,1KV<br>10.03 09.08 PR: 1KY,1KZ,1KV<br>10.03 09.08 PR: 1KY,1KZ,1KV<br>11.05 09.08 PR: 1KY,1KZ,1KV | 24.0112-0169.1 412169<br>24.0312-0169.1 512169                          |  | 282 12,0 10,0 +S +B<br>282 12,0 10,0 +S +B PD                             |
|  | 1.9 TDI 4motion<br>2.0 FSI 4motion<br>2.0 TDI 4motion<br>3.2 R32   | 77<br>110<br>103<br>184  |  | 08.04 09.08 PR: 2EL<br>08.04 09.08 PR: 2EL<br>08.04 09.08 PR: 2EL<br>11.05 09.08 PR: 2EL   | 24.0122-0219.1 422219   |  | 310 22,0 20,0 V L +B  |
|  | 1.4 16V<br>1.4 FSI<br>1.4 TSI<br>1.4 TSI<br>1.4 TSI<br>1.6 16V<br>1.6 FSI<br>1.9 TDI<br>1.9 TDI<br>2.0 FSI<br>2.0 GTI<br>2.0 GTI<br>2.0 SDI<br>2.0 TDI<br>2.0 TDI<br>2.0 TDI   | 66<br>90<br>103<br>125<br>75<br>85<br>66<br>77<br>110<br>147<br>169<br>55<br>100<br>103<br>125               |  | 10.03 09.08<br>10.03 09.08<br>05.07 09.08<br>05.06 09.08<br>11.05 09.08<br>01.04 09.08<br>10.03 09.08<br>05.04 09.08<br>10.03 09.08<br>10.03 09.08<br>09.04 09.08<br>09.06 09.08<br>01.04 09.08<br>10.03 09.08<br>10.03 09.08<br>11.05 09.08   | 24.0711-6231.3 360305<br>24.0711-6232.3 360306                          | <input type="checkbox"/><br><input type="checkbox"/> | Radsensor<br>Radsensor  |
|  | 1.9 TDI 4motion<br>2.0 FSI 4motion<br>2.0 TDI 4motion<br>3.2 R32   | 77<br>110<br>103<br>184  |  | 08.04 09.08<br>08.04 09.08<br>08.04 09.08<br>11.05 09.08   | 24.0711-5271.3 360301<br>24.0711-5272.3 360302                          | <input type="checkbox"/><br><input type="checkbox"/> | Radsensor<br>Radsensor  |

|     |    |  |  |  |  |  |  |  |   |   |            |            |
|--|--|--|--|--|---|--|--|--|---|---|------------|------------|
| <b>VOLKSWAGEN GOLF V Variant (07-09)</b>   |  |  |  |  |   |  |  |  |   |   |            |            |
|    | 1.4  | 59   | 06.07  | 06.09  | PR: 12M   | 13.0460-7117.2   | 607117   | 23131 19,6 +/WK<br>23131 19,6 +/WK   | VW<br>VW  |   |            |            |
|  | 1.4 TSI  | 90   | 06.07  | 06.09  | PR: 12M   | 13.0470-7117.2   | LD7117   |  |   |   |            |            |
|  | 1.4 TSI  | 103  | 05.07  | 06.09  | PR: 12M   |  |  |  |   |   |            |            |
|  | 1.4 TSI  | 118  | 07.08  | 06.09  | PR: 12M   |  |  |  |   |   |            |            |
|  | 1.4 TSI  | 125  | 05.07  | 06.09  | PR: 12M   |  |  |  |   |   |            |            |
|  | 1.6  | 75   | 05.07  | 06.09  | PR: 12M   |  |  |  |   |   |            |            |
|  | 1.9 TDI  | 77   | 05.07  | 06.09  | PR: 12M   |  |  |  |   |   |            |            |
|  | 1.9 TDI 4motion  | 77   | 12.07  | 06.09  | PR: 12M   |  |  |  |   |   |            |            |
|  | 2.0  | 147  | 06.07  | 06.09  | PR: 12M   |  |  |  |   |   |            |            |
|  | 2.0 TDI  |  | 05.07  | 06.09  | PR: 12M   |  |  |  |   |   |            |            |
|  | 1.4  | 59   | 06.07  | 06.09  | PR: 1LJ,1ZD,1ZE,1ZP   | 13.0460-7184.2   | 607184   |  |   | 23587 20,6 +/WK<br>23587 20,6 +/WK                    | ATE<br>ATE |            |
|  | 1.4 TSI  | 90   | 06.07  | 06.09  | PR: 1LJ,1ZD,1ZE,1ZP   | 13.0470-7184.2   | LD7184   |  |   |   |            |            |
|  | 1.4 TSI  | 103  | 05.07  | 06.09  | PR: 1LJ,1ZD,1ZE,1ZP   |  |  |  |   |   |            |            |
|  | 1.4 TSI  | 118  | 07.08  | 06.09  | PR: 1LJ,1ZD,1ZE,1ZP   |  |  |  |   |   |            |            |
|  | 1.4 TSI  | 125  | 05.07  | 06.09  | PR: 1LJ,1ZD,1ZE,1ZP   |  |  |  |   |   |            |            |
|  | 1.6  | 75   | 05.07  | 06.09  | PR: 1LJ,1ZD,1ZE,1ZP   |  |  |  |   |   |            |            |
|  | 1.9 TDI  | 77   | 05.07  | 06.09  | PR: 1LJ,1ZD,1ZE,1ZP   |  |  |  |   |   |            |            |
|  | 1.9 TDI 4motion  | 77   | 12.07  | 06.09  | PR: 1LJ,1ZD,1ZE,1ZP   |  |  |  |   |   |            |            |
| 2.0  | 147  | 06.07  | 06.09  | PR: 1LJ,1ZD,1ZE,1ZP  |   |  |  |  |   |   |            |            |
| 2.0 TDI  |  | 05.07  | 06.09  | PR: 1LJ,1ZD,1ZE,1ZP  |   |  |  |  |   |   |            |            |
|    | 1.4  | 59   | 06.07  | 06.09  | PR: 12M   | 24.0122-0210.1   | 422210   | 280 22,0 19,0 V L +S +B<br>280 22,0 19,0 V L +S +B PD                              |   |   |            |            |
|  | 1.4 TSI  | 90   | 06.07  | 06.09  | PR: 12M   | 24.0322-0210.1   | 522210   |  |   |   |            |            |
|  | 1.4 TSI  | 103  | 05.07  | 06.09  | PR: 12M   |  |  |  |   |   |            |            |
|  | 1.4 TSI  | 118  | 07.08  | 06.09  | PR: 12M   |  |  |  |   |   |            |            |
|  | 1.4 TSI  | 125  | 05.07  | 06.09  | PR: 12M   |  |  |  |   |   |            |            |
|  | 1.6  | 75   | 05.07  | 06.09  | PR: 12M   |  |  |  |   |   |            |            |
|  | 1.9 TDI  | 77   | 05.07  | 06.09  | PR: 12M   |  |  |  |   |   |            |            |
|  | 1.9 TDI 4motion  | 77   | 12.07  | 06.09  | PR: 12M   |  |  |  |   |   |            |            |
|  | 2.0  | 147  | 06.07  | 06.09  | PR: 12M   |  |  |  |   |   |            |            |
|  | 2.0 TDI  |  | 05.07  | 06.09  | PR: 12M   |  |  |  |   |   |            |            |
|  | 1.4  | 59   | 06.07  | 06.09  | PR: 1ZE,1ZP   | 24.0125-0145.1   | 425145   |  |   | 288 25,0 22,0 V L +S +B<br>288 25,0 22,0 V L +S +B PD |            |            |
|  | 1.4 TSI  | 90   | 06.07  | 06.09  | PR: 1ZE,1ZP   | 24.0325-0145.1   | 525145   |  |   |   |            |            |
|  | 1.4 TSI  | 103  | 05.07  | 06.09  | PR: 1ZE,1ZP   |  |  |  |   |   |            |            |
|  | 1.4 TSI  | 118  | 07.08  | 06.09  | PR: 1ZE,1ZP   |  |  |  |   |   |            |            |
|  | 1.4 TSI  | 125  | 05.07  | 06.09  | PR: 1ZE,1ZP   |  |  |  |   |   |            |            |
|  | 1.6  | 75   | 05.07  | 06.09  | PR: 1ZE,1ZP   |  |  |  |   |   |            |            |
|  | 1.9 TDI  | 77   | 05.07  | 06.09  | PR: 1ZE,1ZP   |  |  |  |   |   |            |            |
|  | 1.9 TDI 4motion  | 77   | 12.07  | 06.09  | PR: 1ZE,1ZP   |  |  |  |   |   |            |            |
| 2.0  | 147  | 06.07  | 06.09  | PR: 1ZE,1ZP  |   |  |  |  |   |   |            |            |
| 2.0 TDI  |  | 05.07  | 06.09  | PR: 1ZE,1ZP  |   |  |  |  |   |   |            |            |
| 1.4  | 59   | 06.07  | 06.09  | PR: 1LJ,1ZD  | 24.0125-0158.1  | 425158   | 312 25,0 22,0 V L +S +B<br>312 25,0 22,0 V L +S +B PD                              |  |   |   |            |            |
| 1.4 TSI  | 90   | 06.07  | 06.09  | PR: 1LJ,1ZD  | 24.0325-0158.1  | 525158   |  |  |   |   |            |            |
| 1.4 TSI  | 103  | 05.07  | 06.09  | PR: 1LJ,1ZD  |   |  |  |  |   |   |            |            |
| 1.4 TSI  | 118  | 07.08  | 06.09  | PR: 1LJ,1ZD  |   |  |  |  |   |   |            |            |
| 1.4 TSI  | 125  | 05.07  | 06.09  | PR: 1LJ,1ZD  |   |  |  |  |   |   |            |            |
| 1.6  | 75   | 05.07  | 06.09  | PR: 1LJ,1ZD  |   |  |  |  |   |   |            |            |
| 1.9 TDI  | 77   | 05.07  | 06.09  | PR: 1LJ,1ZD  |   |  |  |  |   |   |            |            |
| 1.9 TDI 4motion  | 77   | 12.07  | 06.09  | PR: 1LJ,1ZD  |   |  |  |  |   |   |            |            |
| 2.0  | 147  | 06.07  | 06.09  | PR: 1LJ,1ZD  |   |  |  |  |   |   |            |            |
| 2.0 TDI  |  | 05.07  | 06.09  | PR: 1LJ,1ZD  |   |  |  |  |   |   |            |            |
|  | 1.4  | 59   | 06.07  | 06.09  |   | 24.0711-5271.3   |  |  | 360301  | Radsensor<br>Radsensor                                |            |            |
|  | 1.4 TSI  | 90   | 06.07  | 06.09  |   | 24.0711-5272.3   |  |  | 360302  |   |            |            |
|  | 1.4 TSI  | 103  | 05.07  | 06.09  |   |  |  |  |   |   |            |            |
|  | 1.4 TSI  | 118  | 07.08  | 06.09  |   |  |  |  |   |   |            |            |
|  | 1.4 TSI  | 125  | 05.07  | 06.09  |   |  |  |  |   |   |            |            |
|  | 1.6  | 75   | 05.07  | 06.09  |   |  |  |  |   |   |            |            |
|  | 1.9 TDI  | 77   | 05.07  | 06.09  |   |  |  |  |   |   |            |            |
|  | 1.9 TDI 4motion  | 77   | 12.07  | 06.09  |   |  |  |  |   |   |            |            |
|  | 2.0  | 147  | 06.07  | 06.09  |   |  |  |  |   |   |            |            |
|  | 2.0 TDI  |  | 05.07  | 06.09  |   |  |  |  |   |   |            |            |
|  |  | 1.4  | 59   | 06.07  | 06.09   | PR: 1KE,1KF,1KJ  | 13.0460-2880.2   | 602880   | 23914 17,1 /WE/Zub/S<br>23914 17,1 /WE/Zub/S<br>Belagsatz-Zubehör |   |            | TRW<br>TRW |
|  |  | 1.4 TSI  | 90   | 06.07  | 06.09   | PR: 1KE,1KF,1KJ  | 13.0470-2880.2   | LD2880   |   |   |            |            |
|  |  | 1.4 TSI  | 103  | 05.07  | 06.09   | PR: 1KE,1KF,1KJ  | 13.0460-0259.2   | 610259   |   |   |            |            |
|  |  | 1.4 TSI  | 118  | 07.08  | 06.09   | PR: 1KE,1KF,1KJ  |  |  |   |   |            |            |
|  |  | 1.4 TSI  | 125  | 05.07  | 06.09   | PR: 1KE,1KF,1KJ  |  |  |   |   |            |            |
|  |  | 1.6  | 75   | 05.07  | 06.09   | PR: 1KE,1KF,1KJ  |  |  |   |   |            |            |
|  |  | 1.9 TDI  | 77   | 05.07  | 06.09   | PR: 1KE,1KF,1KJ  |  |  |   |   |            |            |
|  |  | 1.9 TDI 4motion  | 77   | 12.07  | 06.09   | PR: 1KE,1KF,1KJ  |  |  |   |   |            |            |
| 2.0  |  | 147  | 06.07  | 06.09  | PR: 1KE,1KF,1KJ   |  |  |  |   |   |            |            |
| 2.0 TDI  |  |  | 05.07  | 06.09  | PR: 1KE,1KF,1KJ   |  |  |  |   |   |            |            |
| 1.4  |  | 59   | 06.07  | 06.09  | PR: 1KV   | 13.0460-2880.2   | 602880   | 23914 17,1 /WE/Zub/S<br>23914 17,1 /WE/Zub/S<br>Belagsatz-Zubehör                  |   | TRW<br>TRW  |            |            |
| 1.4 TSI  |  | 90   | 06.07  | 06.09  | PR: 1KV   | 13.0470-2880.2   | LD2880   |  |   |   |            |            |
| 1.4 TSI  |  | 103  | 05.07  | 06.09  | PR: 1KV   | 13.0460-0259.2   | 610259   |  |   |   |            |            |
| 1.4 TSI  |  | 118  | 07.08  | 06.09  | PR: 1KV   |  |  |  |   |   |            |            |
| 1.4 TSI  |  | 125  | 05.07  | 06.09  | PR: 1KV   |  |  |  |   |   |            |            |
| 1.6  |  | 75   | 05.07  | 06.09  | PR: 1KV   |  |  |  |   |   |            |            |
| 1.9 TDI  |  | 77   | 05.07  | 06.09  | PR: 1KV   |  |  |  |   |   |            |            |
| 1.9 TDI 4motion  |  | 77   | 12.07  | 06.09  | PR: 1KV   |  |  |  |   |   |            |            |
| 2.0  | 147  | 06.07  | 06.09  | PR: 1KV  |   |  |  |  |   |   |            |            |
| 2.0 TDI  |  | 05.07  | 06.09  | PR: 1KV  |   |  |  |  |   |   |            |            |
|  | 1.4  | 59   | 06.07  | 06.09  | PR: 1KE,1KF   | 24.0112-0158.1   | 412158   |  | 256 12,0 10,0 +S +B<br>256 12,0 10,0 +B PD                        |   |            |            |
|  | 1.4 TSI  | 90   | 06.07  | 06.09  | PR: 1KE,1KF   | 24.0312-0158.1   | 512158   |  |   |   |            |            |
|  | 1.4 TSI  | 103  | 05.07  | 06.09  | PR: 1KE,1KF   |  |  |  |   |   |            |            |
|  | 1.4 TSI  | 118  | 07.08  | 06.09  | PR: 1KE,1KF   |  |  |  |   |   |            |            |
|  | 1.4 TSI  | 125  | 05.07  | 06.09  | PR: 1KE,1KF   |  |  |  |   |   |            |            |
|  | 1.6  | 75   | 05.07  | 06.09  | PR: 1KE,1KF   |  |  |  |   |   |            |            |
|  | 1.9 TDI  | 77   | 05.07  | 06.09  | PR: 1KE,1KF   |  |  |  |   |   |            |            |
|  | 1.9 TDI 4motion  | 77   | 12.07  | 06.09  | PR: 1KE,1KF   |  |  |  |   |   |            |            |
|  | 2.0  | 147  | 06.07  | 06.09  | PR: 1KE,1KF   |  |  |  |   |   |            |            |
|  | 2.0 TDI  |  | 05.07  | 06.09  | PR: 1KE,1KF   |  |  |  |   |   |            |            |



















| VOLKSWAGEN GOLF V Variant (07-09)  |  |   |  |   |   |  |  |  |
|--|--|---|--|---|---|--|--|--|
|     |    |         |    |   |    |  |    |  |
|    | 1.9 TDI 4motion 77<br>1.9 TDI 4motion 77<br>2.0 147<br>2.0 TDI<br>1.4 59<br>1.4 TSI 90<br>1.4 TSI 103<br>1.4 TSI 118<br>1.4 TSI 125<br>1.6 75<br>1.9 TDI 77<br>1.9 TDI 4motion 77<br>2.0 147<br>2.0 TDI                                | 77<br>77<br>147<br>59<br>90<br>103<br>118<br>125<br>75<br>77<br>77<br>147               | 05.07<br>12.07<br>06.07<br>05.07<br>06.07<br>06.09<br>05.07<br>06.09<br>05.07<br>06.09<br>12.07<br>06.07<br>05.07                            | 06.09<br>06.09<br>06.09<br>06.09<br>06.09<br>06.09<br>06.09<br>06.09<br>06.09<br>06.09<br>06.09<br>06.09<br>06.09   | PR: 1KE,1KF<br>PR: 1KE,1KF<br>PR: 1KE,1KF<br>PR: 1KE,1KF<br>PR: 1KJ,1KV,1KY<br>PR: 1KJ,1KV,1KY<br>PR: 1KJ,1KV,1KY<br>PR: 1KJ,1KV,1KY<br>PR: 1KJ,1KV,1KY<br>PR: 1KJ,1KV,1KY<br>PR: 1KJ,1KV,1KY<br>PR: 1KJ,1KV,1KY<br>PR: 1KJ,1KV,1KY | 24.0112-0158.1 412158<br>24.0312-0158.1 512158                                     |  | 256 12,0 10,0 +S +B<br>256 12,0 10,0 +B PD   |
|    | 1.4 59<br>1.4 TSI 90<br>1.4 TSI 103<br>1.4 TSI 118<br>1.4 TSI 125<br>1.6 75<br>1.9 TDI 77<br>1.9 TDI 4motion 77<br>2.0 147<br>2.0 TDI  | 59<br>90<br>103<br>118<br>125<br>75<br>77<br>77<br>147                                  | 06.07<br>06.07<br>05.07<br>07.08<br>05.07<br>05.07<br>05.07<br>12.07<br>06.07<br>05.07   | 06.09<br>06.09<br>06.09<br>06.09<br>06.09<br>06.09<br>06.09<br>06.09<br>06.09<br>06.09  | PR: 1KJ,1KV,1KY<br>PR: 1KJ,1KV,1KY<br>PR: 1KJ,1KV,1KY<br>PR: 1KJ,1KV,1KY<br>PR: 1KJ,1KV,1KY<br>PR: 1KJ,1KV,1KY<br>PR: 1KJ,1KV,1KY<br>PR: 1KJ,1KV,1KY<br>PR: 1KJ,1KV,1KY<br>PR: 1KJ,1KV,1KY  | 24.0711-6231.3 360305<br>24.0711-6232.3 360306                                     | <br> | Radsensor<br>Radsensor   |
| VOLKSWAGEN GOLF VI (08-)   |  |   |  |   |   |  |  |  |
|    | 1.2 TSI 59<br>1.4 90<br>1.4 TSI 118<br>1.4 TSI 118<br>1.6 75<br>1.6 BiFuel 75<br>1.6 TDI 66<br>1.6 TDI 77<br>1.8 TSI 118<br>2.0 GTi<br>2.0 R 4motion<br>2.0 TDI 81<br>2.0 TDI 100<br>2.0 TDI 103<br>2.0 TDI 125<br>2.0 TDI 4motion 103 | 59<br>90<br>118<br>118<br>75<br>75<br>66<br>77<br>118<br>81<br>100<br>103<br>125<br>103 | 05.09<br>10.08<br>10.08<br>10.08<br>10.08<br>03.09<br>02.09<br>02.09<br>06.09<br>04.09<br>11.09<br>10.08<br>10.08<br>10.08<br>04.09<br>10.08 | PR: 1ZF<br>PR: 1ZF<br>PR: 1ZF<br>PR: 1ZF<br>PR: 1ZF<br>PR: 1ZF<br>PR: 1ZF<br>PR: 1ZF<br>PR: 1ZF<br>PR: 1ZF<br>PR: 1ZF<br>PR: 1ZF<br>PR: 1ZF<br>PR: 1ZF<br>PR: 1ZF<br>PR: 1ZF  | 13.0460-7117.2 607117<br>13.0470-7117.2 LD7117  |  | 23131 19,6 +/WK VW<br>23131 19,6 +/WK VW   |  |
|  | 1.2 TSI 59<br>1.4 90<br>1.4 TSI 118<br>1.4 TSI 118<br>1.6 75<br>1.6 BiFuel 75<br>1.6 TDI 66<br>1.6 TDI 77<br>1.8 TSI 118<br>2.0 GTi<br>2.0 R 4motion<br>2.0 TDI 81<br>2.0 TDI 100<br>2.0 TDI 103<br>2.0 TDI 125<br>2.0 TDI 4motion 103 | 59<br>90<br>118<br>118<br>75<br>75<br>66<br>77<br>118<br>81<br>100<br>103<br>125<br>103 | 05.09<br>10.08<br>10.08<br>10.08<br>10.08<br>03.09<br>02.09<br>02.09<br>06.09<br>04.09<br>11.09<br>10.08<br>10.08<br>10.08<br>04.09<br>10.08 | PR: 1ZA,1ZB,1ZD,1ZE,1ZP,1LJ,1LL<br>PR: 1ZA,1ZB,1ZD,1ZE,1ZP,1LJ,1LL<br>PR: 1ZA,1ZB,1ZD,1ZE,1ZP,1LJ,1LL<br>PR: 1ZA,1ZB,1ZD,1ZE,1ZP,1LJ,1LL<br>PR: 1ZA,1ZB,1ZD,1ZE,1ZP,1LJ,1LL<br>PR: 1ZA,1ZB,1ZD,1ZE,1ZP,1LJ,1LL<br>PR: 1ZA,1ZB,1ZD,1ZE,1ZP,1LJ,1LL<br>PR: 1ZA,1ZB,1ZD,1ZE,1ZP,1LJ,1LL<br>PR: 1ZA,1ZB,1ZD,1ZE,1ZP,1LJ,1LL<br>PR: 1ZA,1ZB,1ZD,1ZE,1ZP,1LJ,1LL<br>PR: 1ZA,1ZB,1ZD,1ZE,1ZP,1LJ,1LL<br>PR: 1ZA,1ZB,1ZD,1ZE,1ZP,1LJ,1LL<br>PR: 1ZA,1ZB,1ZD,1ZE,1ZP,1LJ,1LL<br>PR: 1ZA,1ZB,1ZD,1ZE,1ZP,1LJ,1LL<br>PR: 1ZA,1ZB,1ZD,1ZE,1ZP,1LJ,1LL | 13.0460-7184.2 607184<br>13.0470-7184.2 LD7184  |  | 23587 20,6 +/WK ATE<br>23587 20,6 +/WK ATE   |  |
|  | 1.2 TSI 59<br>1.4 90<br>1.4 TSI 118<br>1.4 TSI 118<br>1.6 75<br>1.6 BiFuel 75<br>1.6 TDI 66<br>1.6 TDI 77<br>1.8 TSI 118<br>2.0 GTi<br>2.0 R 4motion<br>2.0 TDI 81<br>2.0 TDI 100<br>2.0 TDI 103<br>2.0 TDI 125<br>2.0 TDI 4motion 103 | 59<br>90<br>118<br>118<br>75<br>75<br>66<br>77<br>118<br>81<br>100<br>103<br>125<br>103 | 05.09<br>10.08<br>10.08<br>10.08<br>10.08<br>03.09<br>02.09<br>02.09<br>06.09<br>04.09<br>11.09<br>10.08<br>10.08<br>10.08<br>04.09<br>10.08 | PR: 1LM<br>PR: 1LM<br>PR: 1LM<br>PR: 1LM<br>PR: 1LM<br>PR: 1LM<br>PR: 1LM<br>PR: 1LM<br>PR: 1LM<br>PR: 1LM<br>PR: 1LM<br>PR: 1LM<br>PR: 1LM<br>PR: 1LM<br>PR: 1LM   | 13.0460-7200.2 607200<br>13.0470-7200.2 LD7200  |  | 23801 20,3 +/WK ATE<br>23801 20,3 +/WK ATE   |  |
|  | 1.2 TSI 59<br>1.4 90<br>1.4 TSI 118<br>1.4 TSI 118<br>1.6 75<br>1.6 BiFuel 75<br>1.6 TDI 66<br>1.6 TDI 77<br>1.8 TSI 118<br>2.0 GTi<br>2.0 R 4motion<br>2.0 TDI 81<br>2.0 TDI 100<br>2.0 TDI 103<br>2.0 TDI 125<br>2.0 TDI 4motion 103 | 59<br>90<br>118<br>118<br>75<br>75<br>66<br>77<br>118<br>81<br>100<br>103<br>125<br>103 | 05.09<br>10.08<br>10.08<br>10.08<br>10.08<br>03.09<br>02.09<br>02.09<br>06.09<br>04.09<br>11.09<br>10.08<br>10.08<br>10.08<br>04.09<br>10.08 | PR: 1ZK<br>PR: 1ZK<br>PR: 1ZK<br>PR: 1ZK<br>PR: 1ZK<br>PR: 1ZK<br>PR: 1ZK<br>PR: 1ZK<br>PR: 1ZK<br>PR: 1ZK<br>PR: 1ZK<br>PR: 1ZK<br>PR: 1ZK<br>PR: 1ZK<br>PR: 1ZK   | 13.0460-7227.2 607227<br>13.0470-7227.2 LD7227  |  | 23801 20,3 +/WK ATE<br>23801 20,4 +/WK ATE   |  |





















|     |    kW  |  |    |   |  |  |    |  |            |
|--|--|--|--|---|---|--|--|--|------------|
| VOLKSWAGEN GOLF VI (08-)   |  |  |  |   |   |  |  |  |            |
|    | 2.0 TDI 103<br>2.0 TDI 125<br>2.0 TDI 4motion 103  |  | 10.08<br>04.09<br>10.08  | PR: 1ZK<br>PR: 1ZK<br>PR: 1ZK   | 13.0460-7227.2<br>13.0470-7227.2  | 607227<br>LD7227   |  | 23801 20,3 +WK<br>23801 20,4 +WK   | ATE<br>ATE |
|    | 1.2 TSI 59<br>1.4 90<br>1.4 TSI 118<br>1.4 TSI 118<br>1.6 75<br>1.6 BiFuel 75<br>1.6 TDI 66<br>1.6 TDI 77<br>1.8 TSI 118<br>2.0 GTi<br>2.0 R 4motion<br>2.0 TDI 81<br>2.0 TDI 100<br>2.0 TDI 103<br>2.0 TDI 125<br>2.0 TDI 4motion 103 |  | 05.09<br>10.08<br>10.08<br>10.08<br>10.08<br>03.09<br>02.09<br>02.09<br>06.09<br>04.09<br>11.09<br>10.08<br>10.08<br>10.08<br>04.09<br>10.08 | PR: 1ZF<br>PR: 1ZF<br>PR: 1ZF<br>PR: 1ZF<br>PR: 1ZF<br>PR: 1ZF<br>PR: 1ZF<br>PR: 1ZF<br>PR: 1ZF<br>PR: 1ZF<br>PR: 1ZF<br>PR: 1ZF<br>PR: 1ZF<br>PR: 1ZF<br>PR: 1ZF<br>PR: 1ZF  | 24.0122-0210.1<br>24.0322-0210.1  | 422210<br>522210   |  | 280 22,0 19,0 V L +S +B<br>280 22,0 19,0 V L +S +B PD                              |            |
|  | 1.2 TSI 59<br>1.4 90<br>1.4 TSI 118<br>1.4 TSI 118<br>1.6 75<br>1.6 BiFuel 75<br>1.6 TDI 66<br>1.6 TDI 77<br>1.8 TSI 118<br>2.0 GTi<br>2.0 R 4motion<br>2.0 TDI 81<br>2.0 TDI 100<br>2.0 TDI 103<br>2.0 TDI 125<br>2.0 TDI 4motion 103 |  | 05.09<br>10.08<br>10.08<br>10.08<br>10.08<br>03.09<br>02.09<br>02.09<br>06.09<br>04.09<br>11.09<br>10.08<br>10.08<br>10.08<br>04.09<br>10.08 | PR: 1ZE,1ZP<br>PR: 1ZE,1ZP<br>PR: 1ZE,1ZP<br>PR: 1ZE,1ZP<br>PR: 1ZE,1ZP<br>PR: 1ZE,1ZP<br>PR: 1ZE,1ZP<br>PR: 1ZE,1ZP<br>PR: 1ZE,1ZP<br>PR: 1ZE,1ZP<br>PR: 1ZE,1ZP<br>PR: 1ZE,1ZP<br>PR: 1ZE,1ZP<br>PR: 1ZE,1ZP<br>PR: 1ZE,1ZP<br>PR: 1ZE,1ZP  | 24.0125-0145.1<br>24.0325-0145.1  | 425145<br>525145   |  | 288 25,0 22,0 V L +S +B<br>288 25,0 22,0 V L +S +B PD                              |            |
|  | 1.2 TSI 59<br>1.4 90<br>1.4 TSI 118<br>1.4 TSI 118<br>1.6 75<br>1.6 BiFuel 75<br>1.6 TDI 66<br>1.6 TDI 77<br>1.8 TSI 118<br>2.0 GTi<br>2.0 R 4motion<br>2.0 TDI 81<br>2.0 TDI 100<br>2.0 TDI 103<br>2.0 TDI 125<br>2.0 TDI 4motion 103 |  | 05.09<br>10.08<br>10.08<br>10.08<br>10.08<br>03.09<br>02.09<br>02.09<br>06.09<br>04.09<br>11.09<br>10.08<br>10.08<br>10.08<br>04.09<br>10.08 | PR: 1LJ,1LL,1LV,1ZA,1ZB,1ZD<br>PR: 1LJ,1LL,1LV,1ZA,1ZB,1ZD<br>PR: 1LJ,1LL,1LV,1ZA,1ZB,1ZD<br>PR: 1LJ,1LL,1LV,1ZA,1ZB,1ZD<br>PR: 1LJ,1LL,1LV,1ZA,1ZB,1ZD<br>PR: 1LJ,1LL,1LV,1ZA,1ZB,1ZD<br>PR: 1LJ,1LL,1LV,1ZA,1ZB,1ZD<br>PR: 1LJ,1LL,1LV,1ZA,1ZB,1ZD<br>PR: 1LJ,1LL,1LV,1ZA,1ZB,1ZD<br>PR: 1LJ,1LL,1LV,1ZA,1ZB,1ZD<br>PR: 1LJ,1LL,1LV,1ZA,1ZB,1ZD<br>PR: 1LJ,1LL,1LV,1ZA,1ZB,1ZD<br>PR: 1LJ,1LL,1LV,1ZA,1ZB,1ZD<br>PR: 1LJ,1LL,1LV,1ZA,1ZB,1ZD<br>PR: 1LJ,1LL,1LV,1ZA,1ZB,1ZD | 24.0125-0158.1<br>24.0325-0158.1  | 425158<br>525158   |  | 312 25,0 22,0 V L +S +B<br>312 25,0 22,0 V L +S +B PD                              |            |
|  | 1.2 TSI 59<br>1.4 90<br>1.4 TSI 118<br>1.4 TSI 118<br>1.6 75<br>1.6 BiFuel 75<br>1.6 TDI 66<br>1.6 TDI 77<br>1.8 TSI 118<br>2.0 GTi<br>2.0 R 4motion<br>2.0 TDI 81<br>2.0 TDI 100<br>2.0 TDI 103<br>2.0 TDI 125<br>2.0 TDI 4motion 103 |  | 05.09<br>10.08<br>10.08<br>10.08<br>10.08<br>03.09<br>02.09<br>02.09<br>06.09<br>04.09<br>11.09<br>10.08<br>10.08<br>10.08<br>04.09<br>10.08 | PR: 1LM,1ZK<br>PR: 1LM,1ZK<br>PR: 1LM,1ZK<br>PR: 1LM,1ZK<br>PR: 1LM,1ZK<br>PR: 1LM,1ZK<br>PR: 1LM,1ZK<br>PR: 1LM,1ZK<br>PR: 1LM,1ZK<br>PR: 1LM,1ZK<br>PR: 1LM,1ZK<br>PR: 1LM,1ZK<br>PR: 1LM,1ZK<br>PR: 1LM,1ZK<br>PR: 1LM,1ZK   | 24.0130-0115.1<br>24.0330-0115.1  | 430115<br>530115   |  | 345 30,0 27,0 V L +B<br>345 30,0 27,0 V L +B PD                                    |            |
|  | 1.2 TSI 59<br>1.4 90<br>1.4 TSI 118<br>1.4 TSI 118<br>1.6 75<br>1.6 BiFuel 75<br>1.6 TDI 66<br>1.6 TDI 77<br>1.8 TSI 118<br>2.0 GTi<br>2.0 R 4motion<br>2.0 TDI 81<br>2.0 TDI 100<br>2.0 TDI 103<br>2.0 TDI 125<br>2.0 TDI 4motion 103 |  | 05.09<br>10.08<br>10.08<br>10.08<br>10.08<br>03.09<br>02.09<br>02.09<br>06.09<br>04.09<br>11.09<br>10.08<br>10.08<br>10.08<br>04.09<br>10.08 |   | 24.0711-5271.3<br>24.0711-5272.3  | 360301<br>360302   | <br> | Radsensor<br>Radsensor   |            |

| VOLKSWAGEN GOLF VI (08-)  |               |       |                             |                                 |                |        |  |  |                        |     |
|---|---------------|-------|-----------------------------|---------------------------------|----------------|--------|--|--|------------------------|-----|
|  | 1.2 TSI       |       | 05.09                       | PR: 1KD                         | 13.0460-2820.2 | 602820 |  |  | 20961 17,6 /S          | TRW |
|   | 1.4           | 59    | 10.08                       | PR: 1KD                         | 13.0470-2820.2 | LD2820 |  |  | 20961 17,6 /S          | TRW |
|   | 1.4 TSI       | 90    | 10.08                       | PR: 1KD                         |                |        |  |  |                        |     |
|   | 1.4 TSI       | 118   | 10.08                       | PR: 1KD                         |                |        |  |  |                        |     |
|   | 1.6           | 75    | 10.08                       | PR: 1KD                         |                |        |  |  |                        |     |
|   | 1.6 BiFuel    | 75    | 03.09                       | PR: 1KD                         |                |        |  |  |                        |     |
|   | 1.6 TDI       | 66    | 02.09                       | PR: 1KD                         |                |        |  |  |                        |     |
|   | 1.6 TDI       | 77    | 02.09                       | PR: 1KD                         |                |        |  |  |                        |     |
|   | 1.8 TSI       | 118   | 06.09                       | PR: 1KD                         |                |        |  |  |                        |     |
|   | 2.0 GTi       |       | 04.09                       | PR: 1KD                         |                |        |  |  |                        |     |
|   | 2.0 TDI       | 81    | 10.08                       | PR: 1KD                         |                |        |  |  |                        |     |
|   | 2.0 TDI       | 100   | 10.08                       | PR: 1KD                         |                |        |  |  |                        |     |
|   | 2.0 TDI       | 103   | 10.08                       | PR: 1KD                         |                |        |  |  |                        |     |
| 2.0 TDI   | 125           | 04.09 | PR: 1KD                     |                                 |                |        |  |  |                        |     |
|  | 1.2 TSI       |       | 05.09                       | PR: 1KF,1KY,1KZ,1KE,1KV         | 13.0460-2880.2 | 602880 |  |  | 23914 17,1 /WE/Zub/S   | TRW |
|   | 1.4           | 59    | 10.08                       | PR: 1KF,1KY,1KZ,1KE,1KV         | 13.0470-2880.2 | LD2880 |  |  | 23914 17,1 /WE/Zub/S   | TRW |
|   | 1.4 TSI       | 90    | 10.08                       | PR: 1KF,1KY,1KZ,1KE,1KV         |                |        |  |  |                        |     |
|   | 1.4 TSI       | 118   | 10.08                       | PR: 1KF,1KY,1KZ,1KE,1KV         |                |        |  |  |                        |     |
|   | 1.6           | 75    | 10.08                       | PR: 1KF,1KY,1KZ,1KE,1KV         |                |        |  |  |                        |     |
|   | 1.6 BiFuel    | 75    | 03.09                       | PR: 1KF,1KY,1KZ,1KE,1KV         |                |        |  |  |                        |     |
|   | 1.6 TDI       | 66    | 02.09                       | PR: 1KF,1KY,1KZ,1KE,1KV         |                |        |  |  |                        |     |
|   | 1.6 TDI       | 77    | 02.09                       | PR: 1KF,1KY,1KZ,1KE,1KV         |                |        |  |  |                        |     |
|   | 1.8 TSI       | 118   | 06.09                       | PR: 1KF,1KY,1KZ,1KE,1KV         |                |        |  |  |                        |     |
|   | 2.0 GTi       |       | 04.09                       | PR: 1KF,1KY,1KZ,1KE,1KV         |                |        |  |  |                        |     |
|   | 2.0 R 4motion |       | 11.09                       | PR: 1KF,1KY,1KZ,1KE,1KV,1KW,2EL |                |        |  |  |                        |     |
|   | 2.0 TDI       | 81    | 10.08                       | PR: 1KF,1KY,1KZ,1KE,1KV         |                |        |  |  |                        |     |
|   | 2.0 TDI       | 100   | 10.08                       | PR: 1KF,1KY,1KZ,1KE,1KV         |                |        |  |  |                        |     |
| 2.0 TDI   | 103           | 10.08 | PR: 1KF,1KY,1KZ,1KE,1KV     |                                 |                |        |  |  |                        |     |
| 2.0 TDI   | 125           | 04.09 | PR: 1KF,1KY,1KZ,1KE,1KV     |                                 |                |        |  |  |                        |     |
| 2.0 TDI 4motion   | 103           | 10.08 | PR: 1KF,1KY,1KZ,1KE,1KV,2EL |                                 |                |        |  |  |                        |     |
|  | 1.2 TSI       |       | 05.09                       | PR: 1KS,1KT                     | 13.0460-3858.2 | 603858 |  |  | 24563 17,7 /Zub/S      | BOS |
|   | 1.4           | 59    | 10.08                       | PR: 1KS,1KT                     | 13.0470-3858.2 | LD3858 |  |  | 24563 17,7 /Zub/S      | BOS |
|   | 1.4 TSI       | 90    | 10.08                       | PR: 1KS,1KT                     |                |        |  |  |                        |     |
|   | 1.4 TSI       | 118   | 10.08                       | PR: 1KS,1KT                     |                |        |  |  |                        |     |
|   | 1.6           | 75    | 10.08                       | PR: 1KS,1KT                     |                |        |  |  |                        |     |
|   | 1.6 BiFuel    | 75    | 03.09                       | PR: 1KS,1KT                     |                |        |  |  |                        |     |
|   | 1.6 TDI       | 66    | 02.09                       | PR: 1KS,1KT                     |                |        |  |  |                        |     |
|   | 1.6 TDI       | 77    | 02.09                       | PR: 1KS,1KT                     |                |        |  |  |                        |     |
|   | 1.8 TSI       | 118   | 06.09                       | PR: 1KS,1KT                     |                |        |  |  |                        |     |
|   | 2.0 GTi       |       | 04.09                       | PR: 1KS,1KT                     |                |        |  |  |                        |     |
|   | 2.0 R 4motion |       | 11.09                       | PR: 1KS,1KT                     |                |        |  |  |                        |     |
|   | 2.0 TDI       | 81    | 10.08                       | PR: 1KS,1KT                     |                |        |  |  |                        |     |
|   | 2.0 TDI       | 100   | 10.08                       | PR: 1KS,1KT                     |                |        |  |  |                        |     |
| 2.0 TDI   | 103           | 10.08 | PR: 1KS,1KT                 |                                 |                |        |  |  |                        |     |
| 2.0 TDI   | 125           | 04.09 | PR: 1KS,1KT                 |                                 |                |        |  |  |                        |     |
| 2.0 TDI 4motion   | 103           | 10.08 | PR: 1KS,1KT                 |                                 |                |        |  |  |                        |     |
|  | 1.2 TSI       |       | 05.09                       | PR: 1KD                         | 24.0110-0277.1 | 410277 |  |  | 253 10,0 8,0 +S +B     |     |
|   | 1.4           | 59    | 10.08                       | PR: 1KD                         | 24.0310-0277.1 | 510277 |  |  | 253 10,0 8,0 +S +B PD  |     |
|   | 1.4 TSI       | 90    | 10.08                       | PR: 1KD                         |                |        |  |  |                        |     |
|   | 1.4 TSI       | 118   | 10.08                       | PR: 1KD                         |                |        |  |  |                        |     |
|   | 1.6           | 75    | 10.08                       | PR: 1KD                         |                |        |  |  |                        |     |
|   | 1.6 BiFuel    | 75    | 03.09                       | PR: 1KD                         |                |        |  |  |                        |     |
|   | 1.6 TDI       | 66    | 02.09                       | PR: 1KD                         |                |        |  |  |                        |     |
|   | 1.6 TDI       | 77    | 02.09                       | PR: 1KD                         |                |        |  |  |                        |     |
|   | 1.8 TSI       | 118   | 06.09                       | PR: 1KD                         |                |        |  |  |                        |     |
|   | 2.0 GTi       |       | 04.09                       | PR: 1KD                         |                |        |  |  |                        |     |
|   | 2.0 TDI       | 81    | 10.08                       | PR: 1KD                         |                |        |  |  |                        |     |
|   | 2.0 TDI       | 100   | 10.08                       | PR: 1KD                         |                |        |  |  |                        |     |
|   | 2.0 TDI       | 103   | 10.08                       | PR: 1KD                         |                |        |  |  |                        |     |
| 2.0 TDI   | 125           | 04.09 | PR: 1KD                     |                                 |                |        |  |  |                        |     |
|  | 1.2 TSI       |       | 05.09                       | PR: 1KV,1KY,1KZ                 | 24.0112-0169.1 | 412169 |  |  | 282 12,0 10,0 +S +B    |     |
|   | 1.4           | 59    | 10.08                       | PR: 1KV,1KY,1KZ                 | 24.0312-0169.1 | 512169 |  |  | 282 12,0 10,0 +S +B PD |     |
|   | 1.4 TSI       | 90    | 10.08                       | PR: 1KV,1KY,1KZ                 |                |        |  |  |                        |     |
|   | 1.4 TSI       | 118   | 10.08                       | PR: 1KV,1KY,1KZ                 |                |        |  |  |                        |     |
|   | 1.6           | 75    | 10.08                       | PR: 1KV,1KY,1KZ                 |                |        |  |  |                        |     |
|   | 1.6 BiFuel    | 75    | 03.09                       | PR: 1KV,1KY,1KZ                 |                |        |  |  |                        |     |
|   | 1.6 TDI       | 66    | 02.09                       | PR: 1KV,1KY,1KZ                 |                |        |  |  |                        |     |
|   | 1.6 TDI       | 77    | 02.09                       | PR: 1KV,1KY,1KZ                 |                |        |  |  |                        |     |
|   | 1.8 TSI       | 118   | 06.09                       | PR: 1KV,1KY,1KZ                 |                |        |  |  |                        |     |
|   | 2.0 GTi       |       | 04.09                       | PR: 1KV,1KY,1KZ                 |                |        |  |  |                        |     |
|   | 2.0 TDI       | 81    | 10.08                       | PR: 1KV,1KY,1KZ                 |                |        |  |  |                        |     |
|   | 2.0 TDI       | 100   | 10.08                       | PR: 1KV,1KY,1KZ                 |                |        |  |  |                        |     |
|   | 2.0 TDI       | 103   | 10.08                       | PR: 1KV,1KY,1KZ                 |                |        |  |  |                        |     |
| 2.0 TDI   | 125           | 04.09 | PR: 1KV,1KY,1KZ             |                                 |                |        |  |  |                        |     |
|  | 1.2 TSI       |       | 05.09                       | PR: 1KE,1KF                     | 24.0112-0158.1 | 412158 |  |  | 256 12,0 10,0 +S +B    |     |
|   | 1.4           | 59    | 10.08                       | PR: 1KE,1KF                     | 24.0312-0158.1 | 512158 |  |  | 256 12,0 10,0 +S +B PD |     |
|   | 1.4 TSI       | 90    | 10.08                       | PR: 1KE,1KF                     |                |        |  |  |                        |     |
|   | 1.4 TSI       | 118   | 10.08                       | PR: 1KE,1KF                     |                |        |  |  |                        |     |
|   | 1.6           | 75    | 10.08                       | PR: 1KE,1KF                     |                |        |  |  |                        |     |
|   | 1.6 BiFuel    | 75    | 03.09                       | PR: 1KE,1KF                     |                |        |  |  |                        |     |
|   | 1.6 TDI       | 66    | 02.09                       | PR: 1KE,1KF                     |                |        |  |  |                        |     |
|   | 1.6 TDI       | 77    | 02.09                       | PR: 1KE,1KF                     |                |        |  |  |                        |     |
|   | 1.8 TSI       | 118   | 06.09                       | PR: 1KE,1KF                     |                |        |  |  |                        |     |
|   | 2.0 GTi       |       | 04.09                       | PR: 1KE,1KF                     |                |        |  |  |                        |     |
|   | 2.0 R 4motion |       | 11.09                       | PR: 1KE,1KF                     |                |        |  |  |                        |     |
|   | 2.0 TDI       | 81    | 10.08                       | PR: 1KE,1KF                     |                |        |  |  |                        |     |
|   | 2.0 TDI       | 100   | 10.08                       | PR: 1KE,1KF                     |                |        |  |  |                        |     |
| 2.0 TDI   | 103           | 10.08 | PR: 1KE,1KF                 |                                 |                |        |  |  |                        |     |
| 2.0 TDI   | 125           | 04.09 | PR: 1KE,1KF                 |                                 |                |        |  |  |                        |     |



| VOLKSWAGEN GOLF VI (08-)         |                 |       |                         |                         |                |        |                            |                            |     |
|----------------------------------|-----------------|-------|-------------------------|-------------------------|----------------|--------|----------------------------|----------------------------|-----|
|                                  | 2.0 TDI         | 103   | 10.08                   | PR: 1KE,1KF             | 24.0112-0158.1 | 412158 |                            | 256 12,0 10,0 +S +B        |     |
|                                  | 2.0 TDI         | 125   | 04.09                   | PR: 1KE,1KF             | 24.0312-0158.1 | 512158 |                            | 256 12,0 10,0 +B PD        |     |
|                                  | 2.0 TDI 4motion | 103   | 10.08                   | PR: 1KE,1KF             |                |        |                            |                            |     |
|                                  | 1.2 TSI         |       | 05.09                   | PR: 1KS,1KT             | 24.0110-0356.1 | 410356 |                            | 272 9,7 8,0 +S +B          |     |
|                                  | 1.4             | 59    | 10.08                   | PR: 1KS,1KT             | 24.0310-0356.1 | 510356 |                            | 272 9,7 8,0 +S +B PD       |     |
|                                  | 1.4 TSI         | 90    | 10.08                   | PR: 1KS,1KT             |                |        |                            |                            |     |
|                                  | 1.4 TSI         | 118   | 10.08                   | PR: 1KS,1KT             |                |        |                            |                            |     |
|                                  | 1.6             | 75    | 10.08                   | PR: 1KS,1KT             |                |        |                            |                            |     |
|                                  | 1.6 BiFuel      | 75    | 03.09                   | PR: 1KS,1KT             |                |        |                            |                            |     |
|                                  | 1.6 TDI         | 66    | 02.09                   | PR: 1KS,1KT             |                |        |                            |                            |     |
|                                  | 1.6 TDI         | 77    | 02.09                   | PR: 1KS,1KT             |                |        |                            |                            |     |
|                                  | 1.8 TSI         | 118   | 06.09                   | PR: 1KS,1KT             |                |        |                            |                            |     |
|                                  | 2.0 GTi         |       | 04.09                   | PR: 1KS,1KT             |                |        |                            |                            |     |
|                                  | 2.0 R 4motion   |       | 11.09                   | PR: 1KS,1KT             |                |        |                            |                            |     |
|                                  | 2.0 TDI         | 81    | 10.08                   | PR: 1KS,1KT             |                |        |                            |                            |     |
| 2.0 TDI                          | 100             | 10.08 | PR: 1KS,1KT             |                         |                |        |                            |                            |     |
| 2.0 TDI                          | 103             | 10.08 | PR: 1KS,1KT             |                         |                |        |                            |                            |     |
| 2.0 TDI                          | 125             | 04.09 | PR: 1KS,1KT             |                         |                |        |                            |                            |     |
| 2.0 TDI 4motion                  | 103             | 10.08 | PR: 1KS,1KT             |                         |                |        |                            |                            |     |
| 2.0 R 4motion                    |                 | 11.09 | PR: 1KW,2EL             | 24.0122-0219.1          | 422219         |        | 310 22,0 20,0 V L +B       |                            |     |
| 2.0 TDI 4motion                  | 103             | 10.08 | PR: 1KW,2EL             |                         |                |        |                            |                            |     |
|                                  | 1.2 TSI         |       | 05.09                   |                         | 24.0711-6231.3 | 360305 |                            | Radsensor                  |     |
|                                  | 1.4             | 59    | 10.08                   |                         | 24.0711-6232.3 | 360306 |                            | Radsensor                  |     |
|                                  | 1.4 TSI         | 90    | 10.08                   |                         |                |        |                            |                            |     |
|                                  | 1.4 TSI         | 118   | 10.08                   |                         |                |        |                            |                            |     |
|                                  | 1.6             | 75    | 10.08                   |                         |                |        |                            |                            |     |
|                                  | 1.6 BiFuel      | 75    | 03.09                   |                         |                |        |                            |                            |     |
|                                  | 1.6 TDI         | 66    | 02.09                   |                         |                |        |                            |                            |     |
|                                  | 1.6 TDI         | 77    | 02.09                   |                         |                |        |                            |                            |     |
|                                  | 1.8 TSI         | 118   | 06.09                   |                         |                |        |                            |                            |     |
|                                  | 2.0 GTi         |       | 04.09                   |                         |                |        |                            |                            |     |
|                                  | 2.0 TDI         | 81    | 10.08                   |                         |                |        |                            |                            |     |
|                                  | 2.0 TDI         | 100   | 10.08                   |                         |                |        |                            |                            |     |
|                                  | 2.0 TDI         | 103   | 10.08                   |                         |                |        |                            |                            |     |
|                                  | 2.0 TDI         | 125   | 04.09                   |                         |                |        |                            |                            |     |
|                                  | 2.0 R 4motion   |       | 11.09                   |                         | 24.0711-5271.3 | 360301 |                            | Radsensor                  |     |
| 2.0 TDI 4motion                  | 103             | 10.08 |                         | 24.0711-5272.3          | 360302         |        | Radsensor                  |                            |     |
| VOLKSWAGEN GOLF VI Variant (09-) |                 |       |                         |                         |                |        |                            |                            |     |
|                                  | 1.2 TSI         |       | 08.09                   | PR: 1ZM                 | 13.0460-7117.2 | 607117 |                            | 23131 19,6 +/WK            | VW  |
|                                  | 1.4             | 59    | 07.09                   | PR: 1ZM                 | 13.0470-7117.2 | LD7117 |                            | 23131 19,6 +/WK            | VW  |
|                                  | 1.4 TSI         | 90    | 07.09                   | PR: 1ZM                 |                |        |                            |                            |     |
|                                  | 1.4 TSI         | 118   | 07.09                   | PR: 1ZM                 |                |        |                            |                            |     |
|                                  | 1.6             | 75    | 07.09                   | PR: 1ZM                 |                |        |                            |                            |     |
|                                  | 1.6 MultiFuel   | 75    | 07.09                   | PR: 1ZM                 |                |        |                            |                            |     |
|                                  | 1.6 TDI         |       | 07.09                   | PR: 1ZM                 |                |        |                            |                            |     |
|                                  | 1.6 TDI 4motion | 77    | 07.09                   | PR: 1ZM                 |                |        |                            |                            |     |
|                                  | 2.0             | 147   | 07.09                   | PR: 1ZM                 |                |        |                            |                            |     |
|                                  | 2.0 TDI         |       | 07.09                   | PR: 1ZM                 |                |        |                            |                            |     |
|                                  | 1.2 TSI         |       | 08.09                   | PR: 1ZA,1ZD,1ZE,1ZP,1LJ | 13.0460-7184.2 | 607184 |                            | 23587 20,6 +/WK            | ATE |
|                                  | 1.4             | 59    | 07.09                   | PR: 1ZA,1ZD,1ZE,1ZP,1LJ | 13.0470-7184.2 | LD7184 |                            | 23587 20,6 +/WK            | ATE |
|                                  | 1.4 TSI         | 90    | 07.09                   | PR: 1ZA,1ZD,1ZE,1ZP,1LJ |                |        |                            |                            |     |
|                                  | 1.4 TSI         | 118   | 07.09                   | PR: 1ZA,1ZD,1ZE,1ZP,1LJ |                |        |                            |                            |     |
|                                  | 1.6             | 75    | 07.09                   | PR: 1ZA,1ZD,1ZE,1ZP,1LJ |                |        |                            |                            |     |
| 1.6 MultiFuel                    | 75              | 07.09 | PR: 1ZA,1ZD,1ZE,1ZP,1LJ |                         |                |        |                            |                            |     |
| 1.6 TDI                          |                 | 07.09 | PR: 1ZA,1ZD,1ZE,1ZP,1LJ |                         |                |        |                            |                            |     |
| 1.6 TDI 4motion                  | 77              | 07.09 | PR: 1ZA,1ZD,1ZE,1ZP,1LJ |                         |                |        |                            |                            |     |
| 2.0                              | 147             | 07.09 | PR: 1ZA,1ZD,1ZE,1ZP,1LJ |                         |                |        |                            |                            |     |
| 2.0 TDI                          |                 | 07.09 | PR: 1ZA,1ZD,1ZE,1ZP,1LJ |                         |                |        |                            |                            |     |
|                                  | 1.2 TSI         |       | 08.09                   | PR: 1ZM                 | 24.0122-0210.1 | 422210 |                            | 280 22,0 19,0 V L +S +B    |     |
|                                  | 1.4             | 59    | 07.09                   | PR: 1ZM                 | 24.0322-0210.1 | 522210 |                            | 280 22,0 19,0 V L +S +B PD |     |
|                                  | 1.4 TSI         | 90    | 07.09                   | PR: 1ZM                 |                |        |                            |                            |     |
|                                  | 1.4 TSI         | 118   | 07.09                   | PR: 1ZM                 |                |        |                            |                            |     |
|                                  | 1.6             | 75    | 07.09                   | PR: 1ZM                 |                |        |                            |                            |     |
|                                  | 1.6 MultiFuel   | 75    | 07.09                   | PR: 1ZM                 |                |        |                            |                            |     |
|                                  | 1.6 TDI         |       | 07.09                   | PR: 1ZM                 |                |        |                            |                            |     |
|                                  | 1.6 TDI 4motion | 77    | 07.09                   | PR: 1ZM                 |                |        |                            |                            |     |
|                                  | 2.0             | 147   | 07.09                   | PR: 1ZM                 |                |        |                            |                            |     |
|                                  | 2.0 TDI         |       | 07.09                   | PR: 1ZM                 |                |        |                            |                            |     |
|                                  | 1.2 TSI         |       | 08.09                   | PR: 1LJ,1ZA,1ZD         | 24.0125-0158.1 | 425158 |                            | 312 25,0 22,0 V L +S +B    |     |
|                                  | 1.4             | 59    | 07.09                   | PR: 1LJ,1ZA,1ZD         | 24.0325-0158.1 | 525158 |                            | 312 25,0 22,0 V L +S +B PD |     |
|                                  | 1.4 TSI         | 90    | 07.09                   | PR: 1LJ,1ZA,1ZD         |                |        |                            |                            |     |
|                                  | 1.4 TSI         | 118   | 07.09                   | PR: 1LJ,1ZA,1ZD         |                |        |                            |                            |     |
|                                  | 1.6             | 75    | 07.09                   | PR: 1LJ,1ZA,1ZD         |                |        |                            |                            |     |
| 1.6 MultiFuel                    | 75              | 07.09 | PR: 1LJ,1ZA,1ZD         |                         |                |        |                            |                            |     |
| 1.6 TDI                          |                 | 07.09 | PR: 1LJ,1ZA,1ZD         |                         |                |        |                            |                            |     |
| 1.6 TDI 4motion                  | 77              | 07.09 | PR: 1LJ,1ZA,1ZD         |                         |                |        |                            |                            |     |
| 2.0                              | 147             | 07.09 | PR: 1LJ,1ZA,1ZD         |                         |                |        |                            |                            |     |
| 2.0 TDI                          |                 | 07.09 | PR: 1LJ,1ZA,1ZD         |                         |                |        |                            |                            |     |
| 1.2 TSI                          |                 | 08.09 | PR: 1ZE,1ZP             | 24.0125-0145.1          | 425145         |        | 288 25,0 22,0 V L +S +B    |                            |     |
| 1.4                              | 59              | 07.09 | PR: 1ZE,1ZP             | 24.0325-0145.1          | 525145         |        | 288 25,0 22,0 V L +S +B PD |                            |     |
| 1.4 TSI                          | 90              | 07.09 | PR: 1ZE,1ZP             |                         |                |        |                            |                            |     |
| 1.4 TSI                          | 118             | 07.09 | PR: 1ZE,1ZP             |                         |                |        |                            |                            |     |
| 1.6                              | 75              | 07.09 | PR: 1ZE,1ZP             |                         |                |        |                            |                            |     |
| 1.6 MultiFuel                    | 75              | 07.09 | PR: 1ZE,1ZP             |                         |                |        |                            |                            |     |
| 1.6 TDI                          |                 | 07.09 | PR: 1ZE,1ZP             |                         |                |        |                            |                            |     |

|     |                              |  |  |   |  |  |    |  |
|--|--|--|--|---|---|--|--|--|
| <b>VOLKSWAGEN GOLF VI Variant (09-)</b>  |  |  |  |   |   |  |  |  |
|    | 1.6 TDI 4motion<br>2.0<br>2.0 TDI  | 77<br>147  | 07.09<br>07.09<br>07.09  | PR: 1ZE,1ZP<br>PR: 1ZE,1ZP<br>PR: 1ZE,1ZP   | 24.0125-0145.1<br>24.0325-0145.1  | 425145<br>525145   |  | 288 25,0 22,0 V L +S +B<br>288 25,0 22,0 V L +S +B PD                              |
|    | 1.2 TSI<br>1.4<br>1.4 TSI<br>1.4 TSI<br>1.6<br>1.6 MultiFuel<br>1.6 TDI<br>1.6 TDI 4motion<br>2.0<br>2.0 TDI | 59<br>90<br>118<br>75<br>75<br>77<br>147   | 08.09<br>07.09<br>07.09<br>07.09<br>07.09<br>07.09<br>07.09<br>07.09             |   | 24.0711-5271.3<br>24.0711-5272.3  | 360301<br>360302   | <br>     | Radsensor<br>Radsensor   |
|    | 1.2 TSI<br>1.4<br>1.4 TSI<br>1.4 TSI<br>1.6<br>1.6 MultiFuel<br>1.6 TDI<br>1.6 TDI 4motion<br>2.0<br>2.0 TDI | 59<br>90<br>118<br>75<br>75<br>77<br>147   | 08.09<br>07.09<br>07.09<br>07.09<br>07.09<br>07.09<br>07.09<br>07.09             | PR: 1KS<br>PR: 1KS<br>PR: 1KS<br>PR: 1KS<br>PR: 1KS<br>PR: 1KS<br>PR: 1KS   | 13.0460-3858.2<br>13.0470-3858.2  | 603858<br>LD3858   |  | 24563 17,7 /Zub/S BOS<br>24563 17,7 /Zub/S BOS                                     |
|  | 1.2 TSI<br>1.4<br>1.4 TSI<br>1.4 TSI<br>1.6<br>1.6 MultiFuel<br>1.6 TDI<br>1.6 TDI 4motion<br>2.0<br>2.0 TDI | 59<br>90<br>118<br>75<br>75<br>77<br>147   | 08.09<br>07.09<br>07.09<br>07.09<br>07.09<br>07.09<br>07.09<br>07.09             | PR: 1KE,1KF,1KJ<br>PR: 1KE,1KF,1KJ<br>PR: 1KE,1KF,1KJ<br>PR: 1KE,1KF,1KJ<br>PR: 1KE,1KF,1KJ<br>PR: 1KE,1KF,1KJ<br>PR: 1KE,1KF,1KJ   | 13.0460-2880.2<br>13.0470-2880.2  | 602880<br>LD2880   |  | 23914 17,1 /WE/Zub/S TRW<br>23914 17,1 /WE/Zub/S TRW                               |
|    | 1.2 TSI<br>1.4<br>1.4 TSI<br>1.4 TSI<br>1.6<br>1.6 MultiFuel<br>1.6 TDI<br>1.6 TDI 4motion<br>2.0<br>2.0 TDI | 59<br>90<br>118<br>75<br>75<br>77<br>147   | 08.09<br>07.09<br>07.09<br>07.09<br>07.09<br>07.09<br>07.09<br>07.09             | PR: 1KS<br>PR: 1KS<br>PR: 1KS<br>PR: 1KS<br>PR: 1KS<br>PR: 1KS<br>PR: 1KS   | 24.0110-0356.1<br>24.0310-0356.1  | 410356<br>510356   |  | 272 9,7 8,0 +S +B<br>272 9,7 8,0 +S +B PD  |
|  | 1.2 TSI<br>1.4<br>1.4 TSI<br>1.4 TSI<br>1.6<br>1.6 MultiFuel<br>1.6 TDI<br>1.6 TDI 4motion<br>2.0<br>2.0 TDI | 59<br>90<br>118<br>75<br>75<br>77<br>147   | 08.09<br>07.09<br>07.09<br>07.09<br>07.09<br>07.09<br>07.09<br>07.09             | PR: 1KE,1KF<br>PR: 1KE,1KF<br>PR: 1KE,1KF<br>PR: 1KE,1KF<br>PR: 1KE,1KF<br>PR: 1KE,1KF<br>PR: 1KE,1KF   | 24.0112-0158.1<br>24.0312-0158.1  | 412158<br>512158   |  | 256 12,0 10,0 +S +B<br>256 12,0 10,0 +B PD   |
|  | 1.2 TSI<br>1.4<br>1.4 TSI<br>1.4 TSI<br>1.6<br>1.6 MultiFuel<br>1.6 TDI<br>1.6 TDI 4motion<br>2.0<br>2.0 TDI | 59<br>90<br>118<br>75<br>75<br>77<br>147   | 08.09<br>07.09<br>07.09<br>07.09<br>07.09<br>07.09<br>07.09<br>07.09             | PR: 1KJ<br>PR: 1KJ<br>PR: 1KJ<br>PR: 1KJ<br>PR: 1KJ<br>PR: 1KJ<br>PR: 1KJ   | 24.0112-0169.1<br>24.0312-0169.1  | 412169<br>512169   |  | 282 12,0 10,0 +S +B<br>282 12,0 10,0 +S +B PD                                      |
|  | 1.2 TSI<br>1.4<br>1.4 TSI<br>1.4 TSI<br>1.6<br>1.6 MultiFuel<br>1.6 TDI<br>1.6 TDI 4motion<br>2.0<br>2.0 TDI | 59<br>90<br>118<br>75<br>75<br>77<br>147   | 08.09<br>07.09<br>07.09<br>07.09<br>07.09<br>07.09<br>07.09<br>07.09             |   | 24.0711-6231.3<br>24.0711-6232.3  | 360305<br>360306   | <br> | Radsensor<br>Radsensor   |
| <b>VOLKSWAGEN GOLF VI Cabriolet (11-)</b>  |  |  |  |   |   |  |  |  |
|  | 1.2 TSI<br>1.4 TSI<br>1.4 TSI<br>1.6 TDI<br>2.0 R<br>2.0 TDI<br>2.0 TSI                                      | 77<br>90<br>118<br>77<br>195<br>103<br>155                                       | 06.11<br>06.11<br>06.11<br>06.11<br>01.13<br>06.11<br>06.11                      | PR: 1ZE,1ZD,1ZP,1ZA,1ZB<br>PR: 1ZE,1ZD,1ZP,1ZA,1ZB<br>PR: 1ZE,1ZD,1ZP,1ZA,1ZB<br>PR: 1ZE,1ZD,1ZP,1ZA,1ZB<br>PR: 1ZE,1ZD,1ZP,1ZA,1ZB<br>PR: 1ZE,1ZD,1ZP,1ZA,1ZB<br>PR: 1ZE,1ZD,1ZP,1ZA,1ZB | 13.0460-7184.2<br>13.0470-7184.2  | 607184<br>LD7184   |  | 23587 20,6 +/WK ATE<br>23587 20,6 +/WK ATE   |
|  | 1.2 TSI<br>1.4 TSI<br>1.4 TSI<br>1.6 TDI   | 77<br>90<br>118<br>77  | 06.11<br>06.11<br>06.11<br>06.11   | PR: 1ZK<br>PR: 1ZK<br>PR: 1ZK<br>PR: 1ZK  | 13.0460-7227.2<br>13.0470-7227.2  | 607227<br>LD7227   |  | 23801 20,3 +/WK ATE<br>23801 20,4 +/WK ATE   |
| ↓  | ↓  |  |  |   |   |  |  |  |

|     |  |  |  |   |  |  |    |  |
|--|--|--|--|---|---|--|--|--|
| <b>VOLKSWAGEN GOLF VI Cabriolet (11-)</b>  |  |  |  |   |   |  |  |  |
|    | 2.0 R<br>2.0 TDI<br>2.0 TSI  | 195<br>103<br>155  | 01.13<br>06.11<br>06.11  | PR: 1ZK<br>PR: 1ZK<br>PR: 1ZK   | 13.0460-7227.2<br>13.0470-7227.2  | 607227<br>LD7227   |  | 23801 20,3 +WK<br>23801 20,4 +WK<br>ATE<br>ATE                                     |
|    | 1.2 TSI<br>1.4 TSI<br>1.4 TSI<br>1.6 TDI<br>2.0 R<br>2.0 TDI<br>2.0 TSI          | 77<br>90<br>118<br>77<br>195<br>103<br>155                                       | 06.11<br>06.11<br>06.11<br>06.11<br>01.13<br>06.11<br>06.11                      | PR: 1ZE,1ZP<br>PR: 1ZE,1ZP<br>PR: 1ZE,1ZP<br>PR: 1ZE,1ZP<br>PR: 1ZE,1ZP<br>PR: 1ZE,1ZP<br>PR: 1ZE,1ZP                             | 24.0125-0145.1<br>24.0325-0145.1  | 425145<br>525145   |  | 288 25,0 22,0 V L +S +B<br>288 25,0 22,0 V L +S +B PD                              |
|  | 1.2 TSI<br>1.4 TSI<br>1.4 TSI<br>1.6 TDI<br>2.0 R<br>2.0 TDI<br>2.0 TSI          | 77<br>90<br>118<br>77<br>195<br>103<br>155                                       | 06.11<br>06.11<br>06.11<br>06.11<br>01.13<br>06.11<br>06.11                      | PR: 1ZA,1ZD,1ZB<br>PR: 1ZA,1ZD,1ZB<br>PR: 1ZA,1ZD,1ZB<br>PR: 1ZA,1ZD,1ZB<br>PR: 1ZA,1ZD,1ZB<br>PR: 1ZA,1ZD,1ZB<br>PR: 1ZA,1ZD,1ZB | 24.0125-0158.1<br>24.0325-0158.1  | 425158<br>525158   |  | 312 25,0 22,0 V L +S +B<br>312 25,0 22,0 V L +S +B PD                              |
|  | 1.2 TSI<br>1.4 TSI<br>1.4 TSI<br>1.6 TDI<br>2.0 R<br>2.0 TDI<br>2.0 TSI          | 77<br>90<br>118<br>77<br>195<br>103<br>155                                       | 06.11<br>06.11<br>06.11<br>06.11<br>01.13<br>06.11<br>06.11                      | PR: 1ZK<br>PR: 1ZK<br>PR: 1ZK<br>PR: 1ZK<br>PR: 1ZK<br>PR: 1ZK<br>PR: 1ZK   | 24.0130-0115.1  | 430115   |  | 345 30,0 27,0 V L +B   |
|    | 1.2 TSI<br>1.4 TSI<br>1.4 TSI<br>1.6 TDI<br>2.0 R<br>2.0 TDI<br>2.0 TSI          | 77<br>90<br>118<br>77<br>195<br>103<br>155                                       | 06.11<br>06.11<br>06.11<br>06.11<br>01.13<br>06.11<br>06.11                      |   | 24.0711-5271.3<br>24.0711-5272.3  | 360301<br>360302   | <br>     | Radsensor<br>Radsensor   |
|    | 1.2 TSI<br>1.4 TSI<br>1.4 TSI<br>1.6 TDI<br>2.0 R<br>2.0 TDI<br>2.0 TSI          | 77<br>90<br>118<br>77<br>195<br>103<br>155                                       | 06.11<br>06.11<br>06.11<br>06.11<br>01.13<br>06.11<br>06.11                      | PR: 1KS,1KT<br>PR: 1KS,1KT<br>PR: 1KS,1KT<br>PR: 1KS,1KT<br>PR: 1KS,1KT<br>PR: 1KS,1KT<br>PR: 1KS,1KT                             | 13.0460-3858.2<br>13.0470-3858.2  | 603858<br>LD3858   |  | 24563 17,7 /Zub/S<br>24563 17,7 /Zub/S<br>BOS<br>BOS                               |
|  | 1.2 TSI<br>1.4 TSI<br>1.4 TSI<br>1.6 TDI<br>2.0 R<br>2.0 TDI<br>2.0 TSI          | 77<br>90<br>118<br>77<br>195<br>103<br>155                                       | 06.11<br>06.11<br>06.11<br>06.11<br>01.13<br>06.11<br>06.11                      | PR: 1KD<br>PR: 1KD<br>PR: 1KD<br>PR: 1KD<br>PR: 1KD<br>PR: 1KD<br>PR: 1KD   | 13.0460-2820.2<br>13.0470-2820.2  | 602820<br>LD2820   |  | 20961 17,6 /S<br>20961 17,6 /S<br>TRW<br>TRW                                       |
|  | 1.2 TSI<br>1.4 TSI<br>1.4 TSI<br>1.6 TDI<br>2.0 R<br>2.0 TDI<br>2.0 TSI          | 77<br>90<br>118<br>77<br>195<br>103<br>155                                       | 06.11<br>06.11<br>06.11<br>06.11<br>01.13<br>06.11<br>06.11                      | PR: 1KW<br>PR: 1KW<br>PR: 1KW<br>PR: 1KW<br>PR: 1KW<br>PR: 1KW<br>PR: 1KW   | 13.0460-2880.2<br>13.0470-2880.2  | 602880<br>LD2880   |  | 23914 17,1 /WE/Zub/S<br>23914 17,1 /WE/Zub/S<br>TRW<br>TRW                         |
|  | 1.2 TSI<br>1.4 TSI<br>1.4 TSI<br>1.6 TDI<br>2.0 R<br>2.0 TDI<br>2.0 TSI          | 77<br>90<br>118<br>77<br>195<br>103<br>155                                       | 06.11<br>06.11<br>06.11<br>06.11<br>01.13<br>06.11<br>06.11                      | PR: 1KS,1KT<br>PR: 1KS,1KT<br>PR: 1KS,1KT<br>PR: 1KS,1KT<br>PR: 1KS,1KT<br>PR: 1KS,1KT<br>PR: 1KS,1KT                             | 24.0110-0356.1<br>24.0310-0356.1  | 410356<br>510356   |  | 272 9,7 8,0 +S +B<br>272 9,7 8,0 +S +B PD  |
|  | 1.2 TSI<br>1.4 TSI<br>1.4 TSI<br>1.6 TDI<br>2.0 R<br>2.0 TDI<br>2.0 TSI          | 77<br>90<br>118<br>77<br>195<br>103<br>155                                       | 06.11<br>06.11<br>06.11<br>06.11<br>01.13<br>06.11<br>06.11                      | PR: 1KD<br>PR: 1KD<br>PR: 1KD<br>PR: 1KD<br>PR: 1KD<br>PR: 1KD<br>PR: 1KD   | 24.0110-0277.1<br>24.0310-0277.1  | 410277<br>510277   |  | 253 10,0 8,0 +S +B<br>253 10,0 8,0 +S +B PD  |
|  | 1.2 TSI<br>1.4 TSI<br>1.4 TSI<br>1.6 TDI<br>2.0 R<br>2.0 TDI<br>2.0 TSI          | 77<br>90<br>118<br>77<br>195<br>103<br>155                                       | 06.11<br>06.11<br>06.11<br>06.11<br>01.13<br>06.11<br>06.11                      | PR: 1KW<br>PR: 1KW<br>PR: 1KW<br>PR: 1KW<br>PR: 1KW<br>PR: 1KW<br>PR: 1KW   | 24.0122-0219.1  | 422219   |  | 310 22,0 20,0 V L +B   |
|  | 1.2 TSI<br>1.4 TSI<br>1.4 TSI<br>1.6 TDI<br>2.0 TDI<br>2.0 TSI                   | 77<br>90<br>118<br>77<br>103<br>155  | 06.11<br>06.11<br>06.11<br>06.11<br>06.11<br>06.11                               | 10.11<br>10.11<br>10.11<br>10.11<br>10.11<br>10.11  | 24.0711-6231.3<br>24.0711-6232.3  | 360305<br>360306   | <br> | Radsensor<br>Radsensor   |
|  | 1.2 TSI<br>1.4 TSI<br>1.4 TSI<br>1.6 TDI<br>2.0 R<br>2.0 TDI                     | 77<br>90<br>118<br>77<br>195<br>103  | 11.11<br>11.11<br>11.11<br>11.11<br>01.13<br>11.11                               |   | 24.0711-6335.3<br>24.0711-6336.3  | 360365<br>360366   | <br> | Radsensor<br>Radsensor   |

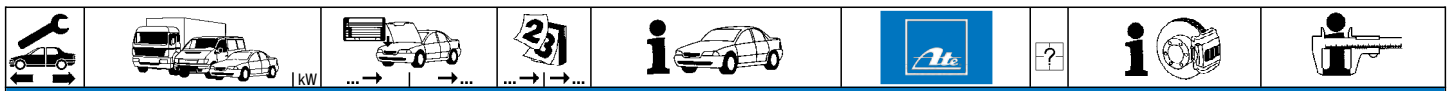

**VOLKSWAGEN GOLF VI Cabriolet (11-)**

|  |         |     |  |       |  |                |        |  |  |           |
|--|---------|-----|--|-------|--|----------------|--------|--|--|-----------|
|  | 2.0 TSI | 155 |  | 11.11 |  | 24.0711-6335.3 | 360365 |  |  | Radsensor |
|  |         |     |  |       |  | 24.0711-6336.3 | 360366 |  |  | Radsensor |

**VOLKSWAGEN GOLF VII (12-)**

|  |                     |     |  |       |                                     |                |        |  |  |                   |     |
|--|---------------------|-----|--|-------|-------------------------------------|----------------|--------|--|--|-------------------|-----|
|  | 1.0 TSI             | 85  |  | 05.15 | PR: 1ZA,1ZB,1ZD,1ZE,1ZP,1LV,1ZC,1ZG | 13.0460-2785.2 | 602785 |  |  | 25683 20,4 +/WK/S | TRW |
|  | 1.2 TSI             | 63  |  | 11.12 | PR: 1ZA,1ZB,1ZD,1ZE,1ZP,1LV,1ZC,1ZG | 13.0470-2785.2 | LD2785 |  |  | 25683 20,4 +/WK/S | TRW |
|  | 1.2 TSI             | 77  |  | 11.12 | PR: 1ZA,1ZB,1ZD,1ZE,1ZP,1LV,1ZC,1ZG |                |        |  |  |                   |     |
|  | 1.2 TSI             | 81  |  | 04.14 | PR: 1ZA,1ZB,1ZD,1ZE,1ZP,1LV,1ZC,1ZG |                |        |  |  |                   |     |
|  | 1.4 GTE Hybrid      | 110 |  | 05.14 | PR: 1ZA,1ZB,1ZD,1ZE,1ZP,1LV,1ZC,1ZG |                |        |  |  |                   |     |
|  | 1.4 TGI             | 81  |  | 08.13 | PR: 1ZA,1ZB,1ZD,1ZE,1ZP,1LV,1ZC,1ZG |                |        |  |  |                   |     |
|  | 1.4 TSI             | 90  |  | 11.12 | PR: 1ZA,1ZB,1ZD,1ZE,1ZP,1LV,1ZC,1ZG |                |        |  |  |                   |     |
|  | 1.4 TSI             | 92  |  | 05.14 | PR: 1ZA,1ZB,1ZD,1ZE,1ZP,1LV,1ZC,1ZG |                |        |  |  |                   |     |
|  | 1.4 TSI             | 103 |  | 11.12 | PR: 1ZA,1ZB,1ZD,1ZE,1ZP,1LV,1ZC,1ZG |                |        |  |  |                   |     |
|  | 1.4 TSI             | 110 |  | 05.14 | PR: 1ZA,1ZB,1ZD,1ZE,1ZP,1LV,1ZC,1ZG |                |        |  |  |                   |     |
|  | 1.4 TSI Multifuel   | 90  |  | 04.13 | PR: 1ZA,1ZB,1ZD,1ZE,1ZP,1LV,1ZC,1ZG |                |        |  |  |                   |     |
|  | 1.4 TSI Multifuel   | 92  |  | 12.13 | PR: 1ZA,1ZB,1ZD,1ZE,1ZP,1LV,1ZC,1ZG |                |        |  |  |                   |     |
|  | 1.6                 | 81  |  | 05.14 | PR: 1ZA,1ZB,1ZD,1ZE,1ZP,1LV,1ZC,1ZG |                |        |  |  |                   |     |
|  | 1.6 TDI             | 66  |  | 04.13 | PR: 1ZA,1ZB,1ZD,1ZE,1ZP,1LV,1ZC,1ZG |                |        |  |  |                   |     |
|  | 1.6 TDI             | 77  |  | 11.12 | PR: 1ZA,1ZB,1ZD,1ZE,1ZP,1LV,1ZC,1ZG |                |        |  |  |                   |     |
|  | 1.6 TDI             | 81  |  | 06.13 | PR: 1ZA,1ZB,1ZD,1ZE,1ZP,1LV,1ZC,1ZG |                |        |  |  |                   |     |
|  | 1.6 TDI 4motion     | 77  |  | 11.12 | PR: 1ZA,1ZB,1ZD,1ZE,1ZP,1LV,1ZC,1ZG |                |        |  |  |                   |     |
|  | 1.6 TDI 4motion     | 81  |  | 01.13 | PR: 1ZA,1ZB,1ZD,1ZE,1ZP,1LV,1ZC,1ZG |                |        |  |  |                   |     |
|  | 2.0 GTD             | 135 |  | 03.13 | PR: 1ZA,1ZB,1ZD,1ZE,1ZP,1LV,1ZC,1ZG |                |        |  |  |                   |     |
|  | 2.0 GTI             | 162 |  | 03.13 | PR: 1ZA,1ZB,1ZD,1ZE,1ZP,1LV,1ZC,1ZG |                |        |  |  |                   |     |
|  | 2.0 GTI             | 195 |  | 02.16 | PR: 1ZA,1ZB,1ZD,1ZE,1ZP,1LV,1ZC,1ZG |                |        |  |  |                   |     |
|  | 2.0 GTI Clubsport S | 228 |  | 05.16 | PR: 1ZA,1ZB,1ZD,1ZE,1ZP,1LV,1ZC,1ZG |                |        |  |  |                   |     |
|  | 2.0 GTI Performance | 169 |  | 03.13 | PR: 1ZA,1ZB,1ZD,1ZE,1ZP,1LV,1ZC,1ZG |                |        |  |  |                   |     |
|  | 2.0 R 4motion       | 221 |  | 09.13 | PR: 1ZA,1ZB,1ZD,1ZE,1ZP,1LV,1ZC,1ZG |                |        |  |  |                   |     |
|  | 2.0 TDI             | 81  |  | 11.12 | PR: 1ZA,1ZB,1ZD,1ZE,1ZP,1LV,1ZC,1ZG |                |        |  |  |                   |     |
|  | 2.0 TDI             | 105 |  | 08.12 | PR: 1ZA,1ZB,1ZD,1ZE,1ZP,1LV,1ZC,1ZG |                |        |  |  |                   |     |
|  | 2.0 TDI             | 110 |  | 11.12 | PR: 1ZA,1ZB,1ZD,1ZE,1ZP,1LV,1ZC,1ZG |                |        |  |  |                   |     |
|  | 2.0 TDI 4motion     | 110 |  | 11.12 | PR: 1ZA,1ZB,1ZD,1ZE,1ZP,1LV,1ZC,1ZG |                |        |  |  |                   |     |
|  | e-Golf              | 85  |  | 08.14 | PR: 1ZA,1ZB,1ZD,1ZE,1ZP,1LV,1ZC,1ZG |                |        |  |  |                   |     |
|  | 1.0 TSI             | 85  |  | 05.15 | PR: 1LJ,1LM                         | 13.0460-2764.2 | 602764 |  |  | 24738 20,0 +/WK/S | TRW |
|  | 1.2 TSI             | 63  |  | 11.12 | PR: 1LJ,1LM                         | 13.0470-2764.2 | LD2764 |  |  | 24738 20,0 +/WK/S | TRW |
|  | 1.2 TSI             | 77  |  | 11.12 | PR: 1LJ,1LM                         |                |        |  |  |                   |     |
|  | 1.2 TSI             | 81  |  | 04.14 | PR: 1LJ,1LM                         |                |        |  |  |                   |     |
|  | 1.4 GTE Hybrid      | 110 |  | 05.14 | PR: 1LJ,1LM                         |                |        |  |  |                   |     |
|  | 1.4 TGI             | 81  |  | 08.13 | PR: 1LJ,1LM                         |                |        |  |  |                   |     |
|  | 1.4 TSI             | 90  |  | 11.12 | PR: 1LJ,1LM                         |                |        |  |  |                   |     |
|  | 1.4 TSI             | 92  |  | 05.14 | PR: 1LJ,1LM                         |                |        |  |  |                   |     |
|  | 1.4 TSI             | 103 |  | 11.12 | PR: 1LJ,1LM                         |                |        |  |  |                   |     |
|  | 1.4 TSI             | 110 |  | 05.14 | PR: 1LJ,1LM                         |                |        |  |  |                   |     |
|  | 1.4 TSI Multifuel   | 90  |  | 04.13 | PR: 1LJ,1LM                         |                |        |  |  |                   |     |
|  | 1.4 TSI Multifuel   | 92  |  | 12.13 | PR: 1LJ,1LM                         |                |        |  |  |                   |     |
|  | 1.6                 | 81  |  | 05.14 | PR: 1LJ,1LM                         |                |        |  |  |                   |     |
|  | 1.6 TDI             | 66  |  | 04.13 | PR: 1LJ,1LM                         |                |        |  |  |                   |     |
|  | 1.6 TDI             | 77  |  | 11.12 | PR: 1LJ,1LM                         |                |        |  |  |                   |     |
|  | 1.6 TDI             | 81  |  | 06.13 | PR: 1LJ,1LM                         |                |        |  |  |                   |     |
|  | 1.6 TDI 4motion     | 77  |  | 11.12 | PR: 1LJ,1LM                         |                |        |  |  |                   |     |
|  | 1.6 TDI 4motion     | 81  |  | 01.13 | PR: 1LJ,1LM                         |                |        |  |  |                   |     |
|  | 2.0 GTD             | 135 |  | 03.13 | PR: 1LJ,1LM                         |                |        |  |  |                   |     |
|  | 2.0 GTI             | 162 |  | 03.13 | PR: 1LJ,1LM                         |                |        |  |  |                   |     |
|  | 2.0 GTI             | 195 |  | 02.16 | PR: 1LJ,1LM                         |                |        |  |  |                   |     |
|  | 2.0 GTI Clubsport S | 228 |  | 05.16 | PR: 1LJ,1LM                         |                |        |  |  |                   |     |
|  | 2.0 GTI Performance | 169 |  | 03.13 | PR: 1LJ,1LM                         |                |        |  |  |                   |     |
|  | 2.0 R 4motion       | 221 |  | 09.13 | PR: 1LJ,1LM                         |                |        |  |  |                   |     |
|  | 2.0 TDI             | 81  |  | 11.12 | PR: 1LJ,1LM                         |                |        |  |  |                   |     |
|  | 2.0 TDI             | 105 |  | 08.12 | PR: 1LJ,1LM                         |                |        |  |  |                   |     |
|  | 2.0 TDI             | 110 |  | 11.12 | PR: 1LJ,1LM                         |                |        |  |  |                   |     |
|  | 2.0 TDI 4motion     | 110 |  | 11.12 | PR: 1LJ,1LM                         |                |        |  |  |                   |     |
|  | 1.0 TSI             | 85  |  | 05.15 | PR: 1ZF                             | 13.0460-7303.2 | 607303 |  |  | 22035 17,5 +/WK   | ATE |
|  | 1.2 TSI             | 63  |  | 11.12 | PR: 1ZF                             | 13.0470-7303.2 | LD7303 |  |  | 22035 17,5 +/WK   | ATE |
|  | 1.2 TSI             | 77  |  | 11.12 | PR: 1ZF                             |                |        |  |  |                   |     |
|  | 1.2 TSI             | 81  |  | 04.14 | PR: 1ZF                             |                |        |  |  |                   |     |
|  | 1.4 GTE Hybrid      | 110 |  | 05.14 | PR: 1ZF                             |                |        |  |  |                   |     |
|  | 1.4 TGI             | 81  |  | 08.13 | PR: 1ZF                             |                |        |  |  |                   |     |
|  | 1.4 TSI             | 90  |  | 11.12 | PR: 1ZF                             |                |        |  |  |                   |     |
|  | 1.4 TSI             | 92  |  | 05.14 | PR: 1ZF                             |                |        |  |  |                   |     |
|  | 1.4 TSI             | 103 |  | 11.12 | PR: 1ZF                             |                |        |  |  |                   |     |
|  | 1.4 TSI             | 110 |  | 05.14 | PR: 1ZF                             |                |        |  |  |                   |     |
|  | 1.4 TSI Multifuel   | 90  |  | 04.13 | PR: 1ZF                             |                |        |  |  |                   |     |
|  | 1.4 TSI Multifuel   | 92  |  | 12.13 | PR: 1ZF                             |                |        |  |  |                   |     |
|  | 1.6                 | 81  |  | 05.14 | PR: 1ZF                             |                |        |  |  |                   |     |
|  | 1.6 TDI             | 66  |  | 04.13 | PR: 1ZF                             |                |        |  |  |                   |     |
|  | 1.6 TDI             | 77  |  | 11.12 | PR: 1ZF                             |                |        |  |  |                   |     |
|  | 1.6 TDI             | 81  |  | 06.13 | PR: 1ZF                             |                |        |  |  |                   |     |
|  | 1.6 TDI 4motion     | 77  |  | 11.12 | PR: 1ZF                             |                |        |  |  |                   |     |
|  | 1.6 TDI 4motion     | 81  |  | 01.13 | PR: 1ZF                             |                |        |  |  |                   |     |
|  | 2.0 GTD             | 135 |  | 03.13 | PR: 1ZF                             |                |        |  |  |                   |     |
|  | 2.0 GTI             | 162 |  | 03.13 | PR: 1ZF                             |                |        |  |  |                   |     |
|  | 2.0 GTI             | 195 |  | 02.16 | PR: 1ZF                             |                |        |  |  |                   |     |
|  | 2.0 GTI Clubsport S | 228 |  | 05.16 | PR: 1ZF                             |                |        |  |  |                   |     |
|  | 2.0 GTI Performance | 169 |  | 03.13 | PR: 1ZF                             |                |        |  |  |                   |     |
|  | 2.0 R 4motion       | 221 |  | 09.13 | PR: 1ZF                             |                |        |  |  |                   |     |
|  | 2.0 TDI             | 81  |  | 11.12 | PR: 1ZF                             |                |        |  |  |                   |     |



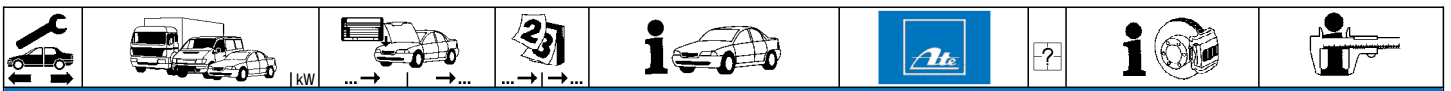

**VOLKSWAGEN GOLF VII (12-)**

|  |                     |     |       |                                     |                |        |  |                            |     |
|--|---------------------|-----|-------|-------------------------------------|----------------|--------|--|----------------------------|-----|
|  | 2.0 TDI             | 105 | 08.12 | PR: 1ZF                             | 13.0460-7303.2 | 607303 |  | 22035 17,5 +WK             | ATE |
|  | 2.0 TDI             | 110 | 11.12 | PR: 1ZF                             | 13.0470-7303.2 | LD7303 |  | 22035 17,5 +WK             | ATE |
|  | 2.0 TDI 4motion     | 110 | 11.12 | PR: 1ZF                             |                |        |  |                            |     |
|  | 1.0 TSI             | 85  | 05.15 | PR: 1ZE,1ZP                         | 24.0125-0145.1 | 425145 |  | 288 25,0 22,0 V L +S +B    |     |
|  | 1.2 TSI             | 63  | 11.12 | PR: 1ZE,1ZP                         | 24.0325-0145.1 | 525145 |  | 288 25,0 22,0 V L +S +B PD |     |
|  | 1.2 TSI             | 77  | 11.12 | PR: 1ZE,1ZP                         |                |        |  |                            |     |
|  | 1.2 TSI             | 81  | 04.14 | PR: 1ZE,1ZP                         |                |        |  |                            |     |
|  | 1.4 GTE Hybrid      | 110 | 05.14 | PR: 1ZE,1ZP                         |                |        |  |                            |     |
|  | 1.4 TGI             | 81  | 08.13 | PR: 1ZE,1ZP                         |                |        |  |                            |     |
|  | 1.4 TSI             | 90  | 11.12 | PR: 1ZE,1ZP                         |                |        |  |                            |     |
|  | 1.4 TSI             | 92  | 05.14 | PR: 1ZE,1ZP                         |                |        |  |                            |     |
|  | 1.4 TSI             | 103 | 11.12 | PR: 1ZE,1ZP                         |                |        |  |                            |     |
|  | 1.4 TSI             | 110 | 05.14 | PR: 1ZE,1ZP                         |                |        |  |                            |     |
|  | 1.4 TSI Multifuel   | 90  | 04.13 | PR: 1ZE,1ZP                         |                |        |  |                            |     |
|  | 1.4 TSI Multifuel   | 92  | 12.13 | PR: 1ZE,1ZP                         |                |        |  |                            |     |
|  | 1.6                 | 81  | 05.14 | PR: 1ZE,1ZP                         |                |        |  |                            |     |
|  | 1.6 TDI             | 66  | 04.13 | PR: 1ZE,1ZP                         |                |        |  |                            |     |
|  | 1.6 TDI             | 77  | 11.12 | PR: 1ZE,1ZP                         |                |        |  |                            |     |
|  | 1.6 TDI             | 81  | 06.13 | PR: 1ZE,1ZP                         |                |        |  |                            |     |
|  | 1.6 TDI 4motion     | 77  | 11.12 | PR: 1ZE,1ZP                         |                |        |  |                            |     |
|  | 1.6 TDI 4motion     | 81  | 01.13 | PR: 1ZE,1ZP                         |                |        |  |                            |     |
|  | 2.0 GTD             | 135 | 03.13 | PR: 1ZE,1ZP                         |                |        |  |                            |     |
|  | 2.0 GTI             | 162 | 03.13 | PR: 1ZE,1ZP                         |                |        |  |                            |     |
|  | 2.0 GTI             | 195 | 02.16 | PR: 1ZE,1ZP                         |                |        |  |                            |     |
|  | 2.0 GTI Clubsport S | 228 | 05.16 | PR: 1ZE,1ZP                         |                |        |  |                            |     |
|  | 2.0 GTI Performance | 169 | 03.13 | PR: 1ZE,1ZP                         |                |        |  |                            |     |
|  | 2.0 R 4motion       | 221 | 09.13 | PR: 1ZE,1ZP                         |                |        |  |                            |     |
|  | 2.0 TDI             | 81  | 11.12 | PR: 1ZE,1ZP                         |                |        |  |                            |     |
|  | 2.0 TDI             | 105 | 08.12 | PR: 1ZE,1ZP                         |                |        |  |                            |     |
|  | 2.0 TDI             | 110 | 11.12 | PR: 1ZE,1ZP                         |                |        |  |                            |     |
|  | 2.0 TDI 4motion     | 110 | 11.12 | PR: 1ZE,1ZP                         |                |        |  |                            |     |
|  | e-Golf              | 85  | 08.14 | PR: 1ZE,1ZP                         |                |        |  |                            |     |
|  | 1.0 TSI             | 85  | 05.15 | PR: 1ZA,1ZB,1ZD,1ZE,1ZP,1LV,1ZC,1ZG | 24.0125-0158.1 | 425158 |  | 312 25,0 22,0 V L +S +B    |     |
|  | 1.2 TSI             | 63  | 11.12 | PR: 1ZA,1ZB,1ZD,1ZE,1ZP,1LV,1ZC,1ZG | 24.0325-0158.1 | 525158 |  | 312 25,0 22,0 V L +S +B PD |     |
|  | 1.2 TSI             | 77  | 11.12 | PR: 1ZA,1ZB,1ZD,1ZE,1ZP,1LV,1ZC,1ZG |                |        |  |                            |     |
|  | 1.2 TSI             | 81  | 04.14 | PR: 1ZA,1ZB,1ZD,1ZE,1ZP,1LV,1ZC,1ZG |                |        |  |                            |     |
|  | 1.4 GTE Hybrid      | 110 | 05.14 | PR: 1ZA,1ZB,1ZD,1ZE,1ZP,1LV,1ZC,1ZG |                |        |  |                            |     |
|  | 1.4 TGI             | 81  | 08.13 | PR: 1ZA,1ZB,1ZD,1ZE,1ZP,1LV,1ZC,1ZG |                |        |  |                            |     |
|  | 1.4 TSI             | 90  | 11.12 | PR: 1ZA,1ZB,1ZD,1ZE,1ZP,1LV,1ZC,1ZG |                |        |  |                            |     |
|  | 1.4 TSI             | 92  | 05.14 | PR: 1ZA,1ZB,1ZD,1ZE,1ZP,1LV,1ZC,1ZG |                |        |  |                            |     |
|  | 1.4 TSI             | 103 | 11.12 | PR: 1ZA,1ZB,1ZD,1ZE,1ZP,1LV,1ZC,1ZG |                |        |  |                            |     |
|  | 1.4 TSI             | 110 | 05.14 | PR: 1ZA,1ZB,1ZD,1ZE,1ZP,1LV,1ZC,1ZG |                |        |  |                            |     |
|  | 1.4 TSI Multifuel   | 90  | 04.13 | PR: 1ZA,1ZB,1ZD,1ZE,1ZP,1LV,1ZC,1ZG |                |        |  |                            |     |
|  | 1.4 TSI Multifuel   | 92  | 12.13 | PR: 1ZA,1ZB,1ZD,1ZE,1ZP,1LV,1ZC,1ZG |                |        |  |                            |     |
|  | 1.6                 | 81  | 05.14 | PR: 1ZA,1ZB,1ZD,1ZE,1ZP,1LV,1ZC,1ZG |                |        |  |                            |     |
|  | 1.6 TDI             | 66  | 04.13 | PR: 1ZA,1ZB,1ZD,1ZE,1ZP,1LV,1ZC,1ZG |                |        |  |                            |     |
|  | 1.6 TDI             | 77  | 11.12 | PR: 1ZA,1ZB,1ZD,1ZE,1ZP,1LV,1ZC,1ZG |                |        |  |                            |     |
|  | 1.6 TDI             | 81  | 06.13 | PR: 1ZA,1ZB,1ZD,1ZE,1ZP,1LV,1ZC,1ZG |                |        |  |                            |     |
|  | 1.6 TDI 4motion     | 77  | 11.12 | PR: 1ZA,1ZB,1ZD,1ZE,1ZP,1LV,1ZC,1ZG |                |        |  |                            |     |
|  | 1.6 TDI 4motion     | 81  | 01.13 | PR: 1ZA,1ZB,1ZD,1ZE,1ZP,1LV,1ZC,1ZG |                |        |  |                            |     |
|  | 2.0 GTD             | 135 | 03.13 | PR: 1ZA,1ZB,1ZD,1ZE,1ZP,1LV,1ZC,1ZG |                |        |  |                            |     |
|  | 2.0 GTI             | 162 | 03.13 | PR: 1ZA,1ZB,1ZD,1ZE,1ZP,1LV,1ZC,1ZG |                |        |  |                            |     |
|  | 2.0 GTI             | 195 | 02.16 | PR: 1ZA,1ZB,1ZD,1ZE,1ZP,1LV,1ZC,1ZG |                |        |  |                            |     |
|  | 2.0 GTI Clubsport S | 228 | 05.16 | PR: 1ZA,1ZB,1ZD,1ZE,1ZP,1LV,1ZC,1ZG |                |        |  |                            |     |
|  | 2.0 GTI Performance | 169 | 03.13 | PR: 1ZA,1ZB,1ZD,1ZE,1ZP,1LV,1ZC,1ZG |                |        |  |                            |     |
|  | 2.0 R 4motion       | 221 | 09.13 | PR: 1ZA,1ZB,1ZD,1ZE,1ZP,1LV,1ZC,1ZG |                |        |  |                            |     |
|  | 2.0 TDI             | 81  | 11.12 | PR: 1ZA,1ZB,1ZD,1ZE,1ZP,1LV,1ZC,1ZG |                |        |  |                            |     |
|  | 2.0 TDI             | 105 | 08.12 | PR: 1ZA,1ZB,1ZD,1ZE,1ZP,1LV,1ZC,1ZG |                |        |  |                            |     |
|  | 2.0 TDI             | 110 | 11.12 | PR: 1ZA,1ZB,1ZD,1ZE,1ZP,1LV,1ZC,1ZG |                |        |  |                            |     |
|  | 2.0 TDI 4motion     | 110 | 11.12 | PR: 1ZA,1ZB,1ZD,1ZE,1ZP,1LV,1ZC,1ZG |                |        |  |                            |     |
|  | 1.0 TSI             | 85  | 05.15 | PR: 1LJ,1LM                         | 24.0130-0225.1 | 430225 |  | 340 30,0 27,0 V L +S +B    |     |
|  | 1.2 TSI             | 63  | 11.12 | PR: 1LJ,1LM                         |                |        |  |                            |     |
|  | 1.2 TSI             | 77  | 11.12 | PR: 1LJ,1LM                         |                |        |  |                            |     |
|  | 1.2 TSI             | 81  | 04.14 | PR: 1LJ,1LM                         |                |        |  |                            |     |
|  | 1.4 GTE Hybrid      | 110 | 05.14 | PR: 1LJ,1LM                         |                |        |  |                            |     |
|  | 1.4 TGI             | 81  | 08.13 | PR: 1LJ,1LM                         |                |        |  |                            |     |
|  | 1.4 TSI             | 90  | 11.12 | PR: 1LJ,1LM                         |                |        |  |                            |     |
|  | 1.4 TSI             | 92  | 05.14 | PR: 1LJ,1LM                         |                |        |  |                            |     |
|  | 1.4 TSI             | 103 | 11.12 | PR: 1LJ,1LM                         |                |        |  |                            |     |
|  | 1.4 TSI             | 110 | 05.14 | PR: 1LJ,1LM                         |                |        |  |                            |     |
|  | 1.4 TSI Multifuel   | 90  | 04.13 | PR: 1LJ,1LM                         |                |        |  |                            |     |
|  | 1.4 TSI Multifuel   | 92  | 12.13 | PR: 1LJ,1LM                         |                |        |  |                            |     |
|  | 1.6                 | 81  | 05.14 | PR: 1LJ,1LM                         |                |        |  |                            |     |
|  | 1.6 TDI             | 66  | 04.13 | PR: 1LJ,1LM                         |                |        |  |                            |     |
|  | 1.6 TDI             | 77  | 11.12 | PR: 1LJ,1LM                         |                |        |  |                            |     |
|  | 1.6 TDI             | 81  | 06.13 | PR: 1LJ,1LM                         |                |        |  |                            |     |
|  | 1.6 TDI 4motion     | 77  | 11.12 | PR: 1LJ,1LM                         |                |        |  |                            |     |
|  | 1.6 TDI 4motion     | 81  | 01.13 | PR: 1LJ,1LM                         |                |        |  |                            |     |
|  | 2.0 GTD             | 135 | 03.13 | PR: 1LJ,1LM                         |                |        |  |                            |     |
|  | 2.0 GTI             | 162 | 03.13 | PR: 1LJ,1LM                         |                |        |  |                            |     |
|  | 2.0 GTI             | 195 | 02.16 | PR: 1LJ,1LM                         |                |        |  |                            |     |
|  | 2.0 GTI Clubsport S | 228 | 05.16 | PR: 1LJ,1LM                         |                |        |  |                            |     |
|  | 2.0 GTI Performance | 169 | 03.13 | PR: 1LJ,1LM                         |                |        |  |                            |     |
|  | 2.0 R 4motion       | 221 | 09.13 | PR: 1LJ,1LM                         |                |        |  |                            |     |
|  | 2.0 TDI             | 81  | 11.12 | PR: 1LJ,1LM                         |                |        |  |                            |     |
|  | 2.0 TDI             | 105 | 08.12 | PR: 1LJ,1LM                         |                |        |  |                            |     |
|  | 2.0 TDI             | 110 | 11.12 | PR: 1LJ,1LM                         |                |        |  |                            |     |





**VOLKSWAGEN GOLF VII (12-)**

|  |                     |     |       |             |                |        |                          |  |
|--|---------------------|-----|-------|-------------|----------------|--------|--------------------------|--|
|  | 2.0 TDI 4motion     | 110 | 11.12 | PR: 1LJ,1LM | 24.0130-0225.1 | 430225 |                          | 340 30,0 27,0 VL +S +B                                     |
|  | 1.0 TSI             | 85  | 05.15 | PR: 1ZF     | 24.0124-0258.1 | 424258 |                          | 276 24,0 21,0 VL +S +B                                     |
|  | 1.2 TSI             | 63  | 11.12 | PR: 1ZF     |                |        |                          |  |
|  | 1.2 TSI             | 77  | 11.12 | PR: 1ZF     |                |        |                          |  |
|  | 1.2 TSI             | 81  | 04.14 | PR: 1ZF     |                |        |                          |  |
|  | 1.4 GTE Hybrid      | 110 | 05.14 | PR: 1ZF     |                |        |                          |  |
|  | 1.4 TGI             | 81  | 08.13 | PR: 1ZF     |                |        |                          |  |
|  | 1.4 TSI             | 90  | 11.12 | PR: 1ZF     |                |        |                          |  |
|  | 1.4 TSI             | 92  | 05.14 | PR: 1ZF     |                |        |                          |  |
|  | 1.4 TSI             | 103 | 11.12 | PR: 1ZF     |                |        |                          |  |
|  | 1.4 TSI             | 110 | 05.14 | PR: 1ZF     |                |        |                          |  |
|  | 1.4 TSI Multifuel   | 90  | 04.13 | PR: 1ZF     |                |        |                          |  |
|  | 1.4 TSI Multifuel   | 92  | 12.13 | PR: 1ZF     |                |        |                          |  |
|  | 1.6                 | 81  | 05.14 | PR: 1ZF     |                |        |                          |  |
|  | 1.6 TDI             | 66  | 04.13 | PR: 1ZF     |                |        |                          |  |
|  | 1.6 TDI             | 77  | 11.12 | PR: 1ZF     |                |        |                          |  |
|  | 1.6 TDI             | 81  | 06.13 | PR: 1ZF     |                |        |                          |  |
|  | 1.6 TDI 4motion     | 77  | 11.12 | PR: 1ZF     |                |        |                          |  |
|  | 1.6 TDI 4motion     | 81  | 01.13 | PR: 1ZF     |                |        |                          |  |
|  | 2.0 GTD             | 135 | 03.13 | PR: 1ZF     |                |        |                          |  |
|  | 2.0 GTI             | 162 | 03.13 | PR: 1ZF     |                |        |                          |  |
|  | 2.0 GTI             | 195 | 02.16 | PR: 1ZF     |                |        |                          |  |
|  | 2.0 GTI Clubsport S | 228 | 05.16 | PR: 1ZF     |                |        |                          |  |
|  | 2.0 GTI Performance | 169 | 03.13 | PR: 1ZF     |                |        |                          |  |
|  | 2.0 R 4motion       | 221 | 09.13 | PR: 1ZF     |                |        |                          |  |
|  | 2.0 TDI             | 81  | 11.12 | PR: 1ZF     |                |        |                          |  |
|  | 2.0 TDI             | 105 | 08.12 | PR: 1ZF     |                |        |                          |  |
|  | 2.0 TDI             | 110 | 11.12 | PR: 1ZF     |                |        |                          |  |
|  | 2.0 TDI 4motion     | 110 | 11.12 | PR: 1ZF     |                |        |                          |  |
|  | 1.0 TSI             | 85  | 05.15 |             | 24.0711-5273.3 | 360303 | <input type="checkbox"/> | Radsensor  |
|  | 1.2 TSI             | 63  | 11.12 |             | 24.0711-5274.3 | 360304 | <input type="checkbox"/> | Radsensor  |
|  | 1.2 TSI             | 77  | 11.12 |             |                |        |                          |  |
|  | 1.2 TSI             | 81  | 04.14 |             |                |        |                          |  |
|  | 1.4 GTE Hybrid      | 110 | 05.14 |             |                |        |                          |  |
|  | 1.4 TGI             | 81  | 08.13 |             |                |        |                          |  |
|  | 1.4 TSI             | 90  | 11.12 |             |                |        |                          |  |
|  | 1.4 TSI             | 92  | 05.14 |             |                |        |                          |  |
|  | 1.4 TSI             | 103 | 11.12 |             |                |        |                          |  |
|  | 1.4 TSI             | 110 | 05.14 |             |                |        |                          |  |
|  | 1.4 TSI Multifuel   | 90  | 04.13 |             |                |        |                          |  |
|  | 1.4 TSI Multifuel   | 92  | 12.13 |             |                |        |                          |  |
|  | 1.6                 | 81  | 05.14 |             |                |        |                          |  |
|  | 1.6 TDI             | 66  | 04.13 |             |                |        |                          |  |
|  | 1.6 TDI             | 77  | 11.12 |             |                |        |                          |  |
|  | 1.6 TDI             | 81  | 06.13 |             |                |        |                          |  |
|  | 1.6 TDI 4motion     | 77  | 11.12 |             |                |        |                          |  |
|  | 1.6 TDI 4motion     | 81  | 01.13 |             |                |        |                          |  |
|  | 2.0 GTD             | 135 | 03.13 |             |                |        |                          |  |
|  | 2.0 GTI             | 162 | 03.13 |             |                |        |                          |  |
|  | 2.0 GTI             | 195 | 02.16 |             |                |        |                          |  |
|  | 2.0 GTI Clubsport S | 228 | 05.16 |             |                |        |                          |  |
|  | 2.0 GTI Performance | 169 | 03.13 |             |                |        |                          |  |
|  | 2.0 R 4motion       | 221 | 09.13 |             |                |        |                          |  |
|  | 2.0 TDI             | 81  | 11.12 |             |                |        |                          |  |
|  | 2.0 TDI             | 105 | 08.12 |             |                |        |                          |  |
|  | 2.0 TDI             | 110 | 11.12 |             |                |        |                          |  |
|  | 2.0 TDI 4motion     | 110 | 11.12 |             |                |        |                          |  |
|  | e-Golf              | 85  | 08.14 |             |                |        |                          |  |
|  | 1.0 TSI             | 85  | 05.15 | PR: 1KE,1KK | 13.0460-7293.2 | 607293 | <input type="checkbox"/> | elektrische Feststellbremse <sup>1)</sup> 25008 16,3 + ATE |
|  | 1.2 TSI             | 63  | 11.12 | PR: 1KE,1KK |                |        |                          |  |
|  | 1.2 TSI             | 77  | 11.12 | PR: 1KE,1KK |                |        |                          |  |
|  | 1.2 TSI             | 81  | 04.14 | PR: 1KE,1KK |                |        |                          |  |
|  | 1.4 GTE Hybrid      | 110 | 05.14 | PR: 1KE,1KK |                |        |                          |  |
|  | 1.4 TGI             | 81  | 08.13 | PR: 1KE,1KK |                |        |                          |  |
|  | 1.4 TSI             | 90  | 11.12 | PR: 1KE,1KK |                |        |                          |  |
|  | 1.4 TSI             | 92  | 05.14 | PR: 1KE,1KK |                |        |                          |  |
|  | 1.4 TSI             | 103 | 11.12 | PR: 1KE,1KK |                |        |                          |  |
|  | 1.4 TSI             | 110 | 05.14 | PR: 1KE,1KK |                |        |                          |  |
|  | 1.4 TSI Multifuel   | 90  | 04.13 | PR: 1KE,1KK |                |        |                          |  |
|  | 1.4 TSI Multifuel   | 92  | 12.13 | PR: 1KE,1KK |                |        |                          |  |
|  | 1.6                 | 81  | 05.14 | PR: 1KE,1KK |                |        |                          |  |
|  | 1.6 TDI             | 66  | 04.13 | PR: 1KE,1KK |                |        |                          |  |
|  | 1.6 TDI             | 77  | 11.12 | PR: 1KE,1KK |                |        |                          |  |
|  | 1.6 TDI             | 81  | 06.13 | PR: 1KE,1KK |                |        |                          |  |
|  | 1.6 TDI 4motion     | 77  | 11.12 | PR: 1KE,1KK |                |        |                          |  |
|  | 1.6 TDI 4motion     | 81  | 01.13 | PR: 1KE,1KK |                |        |                          |  |
|  | 2.0 GTD             | 135 | 03.13 | PR: 1KE,1KK |                |        |                          |  |
|  | 2.0 GTI             | 162 | 03.13 | PR: 1KE,1KK |                |        |                          |  |
|  | 2.0 GTI             | 195 | 02.16 | PR: 1KE,1KK |                |        |                          |  |
|  | 2.0 GTI Clubsport S | 228 | 05.16 | PR: 1KE,1KK |                |        |                          |  |
|  | 2.0 GTI Performance | 169 | 03.13 | PR: 1KE,1KK |                |        |                          |  |
|  | 2.0 R 4motion       | 221 | 09.13 | PR: 1KE,1KK |                |        |                          |  |
|  | 2.0 TDI             | 81  | 11.12 | PR: 1KE,1KK |                |        |                          |  |
|  | 2.0 TDI             | 105 | 08.12 | PR: 1KE,1KK |                |        |                          |  |
|  | 2.0 TDI             | 110 | 11.12 | PR: 1KE,1KK |                |        |                          |  |
|  | 2.0 TDI 4motion     | 110 | 11.12 | PR: 1KE,1KK |                |        |                          |  |

<sup>1)</sup> electric parking brake / fr.di stazionamento elettrico / frein à main électrique / freno de mano eléctrico





**VOLKSWAGEN GOLF VII (12-)**

|                     |                   |       |                 |                 |                |   |   |                      |     |
|---------------------|-------------------|-------|-----------------|-----------------|----------------|---|---|----------------------|-----|
|                     | 1.0 TSI           | 85    | 05.15           | PR: 1KJ,1KV,1KY | 13.0460-7294.2 | 607294                                    | elektrische Feststellbremse <sup>1)</sup> | 25009 16,4 +         | ATE |
|                     | 1.2 TSI           | 63    | 11.12           | PR: 1KJ,1KV,1KY | 13.0470-7294.2 | LD7294                                    | elektrische Feststellbremse <sup>1)</sup> | 25009 16,4 +         | ATE |
|                     | 1.2 TSI           | 77    | 11.12           | PR: 1KJ,1KV,1KY |                |   |   |                      |     |
|                     | 1.2 TSI           | 81    | 04.14           | PR: 1KJ,1KV,1KY |                |   |   |                      |     |
|                     | 1.4 GTE Hybrid    | 110   | 05.14           | PR: 1KJ,1KV,1KY |                |   |   |                      |     |
|                     | 1.4 TGI           | 81    | 08.13           | PR: 1KJ,1KV,1KY |                |   |   |                      |     |
|                     | 1.4 TSI           | 90    | 11.12           | PR: 1KJ,1KV,1KY |                |   |   |                      |     |
|                     | 1.4 TSI           | 92    | 05.14           | PR: 1KJ,1KV,1KY |                |   |   |                      |     |
|                     | 1.4 TSI           | 103   | 11.12           | PR: 1KJ,1KV,1KY |                |   |   |                      |     |
|                     | 1.4 TSI           | 110   | 05.14           | PR: 1KJ,1KV,1KY |                |   |   |                      |     |
|                     | 1.4 TSI Multifuel | 90    | 04.13           | PR: 1KJ,1KV,1KY |                |   |   |                      |     |
|                     | 1.4 TSI Multifuel | 92    | 12.13           | PR: 1KJ,1KV,1KY |                |   |   |                      |     |
|                     | 1.6               | 81    | 05.14           | PR: 1KJ,1KV,1KY |                |   |   |                      |     |
|                     | 1.6 TDI           | 66    | 04.13           | PR: 1KJ,1KV,1KY |                |   |   |                      |     |
|                     | 1.6 TDI           | 77    | 11.12           | PR: 1KJ,1KV,1KY |                |   |   |                      |     |
|                     | 1.6 TDI           | 81    | 06.13           | PR: 1KJ,1KV,1KY |                |   |   |                      |     |
|                     | 1.6 TDI 4motion   | 77    | 11.12           | PR: 1KJ,1KV,1KY |                |   |   |                      |     |
|                     | 1.6 TDI 4motion   | 81    | 01.13           | PR: 1KJ,1KV,1KY |                |   |   |                      |     |
|                     | 2.0 GTD           | 135   | 03.13           | PR: 1KJ,1KV,1KY |                |   |   |                      |     |
|                     | 2.0 GTI           | 162   | 03.13           | PR: 1KJ,1KV,1KY |                |   |   |                      |     |
| 2.0 GTI             | 195               | 02.16 | PR: 1KJ,1KV,1KY |                 |                |   |   |                      |     |
| 2.0 GTI Clubsport S | 228               | 05.16 | PR: 1KJ,1KV,1KY |                 |                |   |   |                      |     |
| 2.0 GTI Performance | 169               | 03.13 | PR: 1KJ,1KV,1KY |                 |                |   |   |                      |     |
| 2.0 R 4motion       | 221               | 09.13 | PR: 1KJ,1KV,1KY |                 |                |   |   |                      |     |
| 2.0 TDI             | 81                | 11.12 | PR: 1KJ,1KV,1KY |                 |                |   |   |                      |     |
| 2.0 TDI             | 105               | 08.12 | PR: 1KJ,1KV,1KY |                 |                |   |   |                      |     |
| 2.0 TDI             | 110               | 11.12 | PR: 1KJ,1KV,1KY |                 |                |   |   |                      |     |
| 2.0 TDI 4motion     | 110               | 11.12 | PR: 1KJ,1KV,1KY |                 |                |   |   |                      |     |
| e-Golf              | 85                | 08.14 | PR: 1KE         | 13.0460-7293.2  | 607293         | elektrische Feststellbremse <sup>1)</sup> | 25008 16,3 +                              | ATE                  |     |
|                     | 1.0 TSI           | 85    | 05.15           | PR: 1KE,1KK     | 24.0110-0356.1 | 410356                                    | elektrische Feststellbremse <sup>1)</sup> | 272 9,7 8,0 +S +B    |     |
|                     | 1.2 TSI           | 63    | 11.12           | PR: 1KE,1KK     | 24.0310-0356.1 | 510356                                    | elektrische Feststellbremse <sup>1)</sup> | 272 9,7 8,0 +S +B PD |     |
|                     | 1.2 TSI           | 77    | 11.12           | PR: 1KE,1KK     |                |   |   |                      |     |
|                     | 1.2 TSI           | 81    | 04.14           | PR: 1KE,1KK     |                |   |   |                      |     |
|                     | 1.4 GTE Hybrid    | 110   | 05.14           | PR: 1KE,1KK     |                |   |   |                      |     |
|                     | 1.4 TGI           | 81    | 08.13           | PR: 1KE,1KK     |                |   |   |                      |     |
|                     | 1.4 TSI           | 90    | 11.12           | PR: 1KE,1KK     |                |   |   |                      |     |
|                     | 1.4 TSI           | 92    | 05.14           | PR: 1KE,1KK     |                |   |   |                      |     |
|                     | 1.4 TSI           | 103   | 11.12           | PR: 1KE,1KK     |                |   |   |                      |     |
|                     | 1.4 TSI           | 110   | 05.14           | PR: 1KE,1KK     |                |   |   |                      |     |
|                     | 1.4 TSI Multifuel | 90    | 04.13           | PR: 1KE,1KK     |                |   |   |                      |     |
|                     | 1.4 TSI Multifuel | 92    | 12.13           | PR: 1KE,1KK     |                |   |   |                      |     |
|                     | 1.6               | 81    | 05.14           | PR: 1KE,1KK     |                |   |   |                      |     |
|                     | 1.6 TDI           | 66    | 04.13           | PR: 1KE,1KK     |                |   |   |                      |     |
|                     | 1.6 TDI           | 77    | 11.12           | PR: 1KE,1KK     |                |   |   |                      |     |
|                     | 1.6 TDI           | 81    | 06.13           | PR: 1KE,1KK     |                |   |   |                      |     |
|                     | 1.6 TDI 4motion   | 77    | 11.12           | PR: 1KE,1KK     |                |   |   |                      |     |
|                     | 1.6 TDI 4motion   | 81    | 01.13           | PR: 1KE,1KK     |                |   |   |                      |     |
|                     | 2.0 GTD           | 135   | 03.13           | PR: 1KE,1KK     |                |   |   |                      |     |
|                     | 2.0 GTI           | 162   | 03.13           | PR: 1KE,1KK     |                |   |   |                      |     |
| 2.0 GTI             | 195               | 02.16 | PR: 1KE,1KK     |                 |                |   |   |                      |     |
| 2.0 GTI Clubsport S | 228               | 05.16 | PR: 1KE,1KK     |                 |                |   |   |                      |     |
| 2.0 GTI Performance | 169               | 03.13 | PR: 1KE,1KK     |                 |                |   |   |                      |     |
| 2.0 R 4motion       | 221               | 09.13 | PR: 1KE,1KK     |                 |                |   |   |                      |     |
| 2.0 TDI             | 81                | 11.12 | PR: 1KE,1KK     |                 |                |   |   |                      |     |
| 2.0 TDI             | 105               | 08.12 | PR: 1KE,1KK     |                 |                |   |   |                      |     |
| 2.0 TDI             | 110               | 11.12 | PR: 1KE,1KK     |                 |                |   |   |                      |     |
| 2.0 TDI 4motion     | 110               | 11.12 | PR: 1KE,1KK     |                 |                |   |   |                      |     |
| e-Golf              | 85                | 08.14 | PR: 1KE,1KK     |                 |                |   |   |                      |     |
|                     | 1.0 TSI           | 85    | 05.15           | PR: 1KV         | 24.0112-0210.1 | 412210                                    | elektrische Feststellbremse <sup>1)</sup> | 300 12,0 10,0 +S +B  |     |
|                     | 1.2 TSI           | 63    | 11.12           | PR: 1KV         |                |   |   |                      |     |
|                     | 1.2 TSI           | 77    | 11.12           | PR: 1KV         |                |   |   |                      |     |
|                     | 1.2 TSI           | 81    | 04.14           | PR: 1KV         |                |   |   |                      |     |
|                     | 1.4 GTE Hybrid    | 110   | 05.14           | PR: 1KV         |                |   |   |                      |     |
|                     | 1.4 TGI           | 81    | 08.13           | PR: 1KV         |                |   |   |                      |     |
|                     | 1.4 TSI           | 90    | 11.12           | PR: 1KV         |                |   |   |                      |     |
|                     | 1.4 TSI           | 92    | 05.14           | PR: 1KV         |                |   |   |                      |     |
|                     | 1.4 TSI           | 103   | 11.12           | PR: 1KV         |                |   |   |                      |     |
|                     | 1.4 TSI           | 110   | 04.14           | PR: 1KV         |                |   |   |                      |     |
|                     | 1.4 TSI Multifuel | 90    | 04.13           | PR: 1KV         |                |   |   |                      |     |
|                     | 1.4 TSI Multifuel | 92    | 12.13           | PR: 1KV         |                |   |   |                      |     |
|                     | 1.6               | 81    | 05.14           | PR: 1KV         |                |   |   |                      |     |
|                     | 1.6 TDI           | 66    | 04.13           | PR: 1KV         |                |   |   |                      |     |
|                     | 1.6 TDI           | 77    | 11.12           | PR: 1KV         |                |   |   |                      |     |
|                     | 1.6 TDI           | 81    | 06.13           | PR: 1KV         |                |   |   |                      |     |
|                     | 1.6 TDI 4motion   | 77    | 11.12           | PR: 1KV         |                |   |   |                      |     |
|                     | 1.6 TDI 4motion   | 81    | 01.13           | PR: 1KV         |                |   |   |                      |     |
|                     | 2.0 GTD           | 135   | 03.13           | PR: 1KV         |                |   |   |                      |     |
|                     | 2.0 GTI           | 162   | 03.13           | PR: 1KV         |                |   |   |                      |     |
| 2.0 GTI             | 195               | 02.16 | PR: 1KV         |                 |                |   |   |                      |     |
| 2.0 GTI Clubsport S | 228               | 05.16 | PR: 1KV         |                 |                |   |   |                      |     |
| 2.0 GTI Performance | 169               | 03.13 | PR: 1KV         |                 |                |   |   |                      |     |
| 2.0 R 4motion       | 221               | 09.13 | PR: 1KV         |                 |                |   |   |                      |     |
| 2.0 TDI             | 81                | 11.12 | PR: 1KV         |                 |                |   |   |                      |     |
| 2.0 TDI             | 105               | 08.12 | PR: 1KV         |                 |                |   |   |                      |     |
| 2.0 TDI             | 110               | 11.12 | PR: 1KV         |                 |                |   |   |                      |     |
| 2.0 TDI 4motion     | 110               | 11.12 | PR: 1KV         |                 |                |   |   |                      |     |
| ↓                   | 1.0 TSI           | 85    | 05.15           | PR: 1KJ,1KY     | 24.0122-0219.1 | 422219                                    | elektrische Feststellbremse <sup>1)</sup> | 310 22,0 20,0 V L +B |     |

<sup>1)</sup> electric parking brake / fr.di stazionamento elettrico / frein à main électrique / freno de mano eléctrico





**VOLKSWAGEN GOLF VII (12-)**

|                     |                     |       |             |             |                |                |  |                                  |           |
|---------------------|---------------------|-------|-------------|-------------|----------------|----------------|--|----------------------------------|-----------|
|                     | 1.2 TSI             | 63    | 11.12       | PR: 1KJ,1KY | 24.0122-0219.1 | 422219         | elektrische Feststellbremse <sup>1)</sup>      | 310 22,0 20,0 V L +B             |           |
|                     | 1.2 TSI             | 77    | 11.12       | PR: 1KJ,1KY |                |                |  |                                  |           |
|                     | 1.2 TSI             | 81    | 04.14       | PR: 1KJ,1KY |                |                |  |                                  |           |
|                     | 1.4 GTE Hybrid      | 110   | 05.14       | PR: 1KJ,1KY |                |                |  |                                  |           |
|                     | 1.4 TGI             | 81    | 08.13       | PR: 1KJ,1KY |                |                |  |                                  |           |
|                     | 1.4 TSI             | 90    | 11.12       | PR: 1KJ,1KY |                |                |  |                                  |           |
|                     | 1.4 TSI             | 92    | 05.14       | PR: 1KJ,1KY |                |                |  |                                  |           |
|                     | 1.4 TSI             | 103   | 11.12       | PR: 1KJ,1KY |                |                |  |                                  |           |
|                     | 1.4 TSI             | 110   | 05.14       | PR: 1KJ,1KY |                |                |  |                                  |           |
|                     | 1.4 TSI Multifuel   | 90    | 04.13       | PR: 1KJ,1KY |                |                |  |                                  |           |
|                     | 1.4 TSI Multifuel   | 92    | 12.13       | PR: 1KJ,1KY |                |                |  |                                  |           |
|                     | 1.6                 | 81    | 05.14       | PR: 1KJ,1KY |                |                |  |                                  |           |
|                     | 1.6 TDI             | 66    | 04.13       | PR: 1KJ,1KY |                |                |  |                                  |           |
|                     | 1.6 TDI             | 77    | 11.12       | PR: 1KJ,1KY |                |                |  |                                  |           |
|                     | 1.6 TDI             | 81    | 06.13       | PR: 1KJ,1KY |                |                |  |                                  |           |
|                     | 1.6 TDI 4motion     | 77    | 11.12       | PR: 1KJ,1KY |                |                |  |                                  |           |
|                     | 1.6 TDI 4motion     | 81    | 01.13       | PR: 1KJ,1KY |                |                |  |                                  |           |
|                     | 2.0 GTD             | 135   | 03.13       | PR: 1KJ,1KY |                |                |  |                                  |           |
|                     | 2.0 GTI             | 162   | 03.13       | PR: 1KJ,1KY |                |                |  |                                  |           |
|                     | 2.0 GTI             | 195   | 02.16       | PR: 1KJ,1KY |                |                |  |                                  |           |
| 2.0 GTI Clubsport S | 228                 | 05.16 | PR: 1KJ,1KY |             |                |                |  |                                  |           |
| 2.0 GTI Performance | 169                 | 03.13 | PR: 1KJ,1KY |             |                |                |  |                                  |           |
| 2.0 R 4motion       | 221                 | 09.13 | PR: 1KJ,1KY |             |                |                |  |                                  |           |
| 2.0 TDI             | 81                  | 11.12 | PR: 1KJ,1KY |             |                |                |  |                                  |           |
| 2.0 TDI             | 105                 | 08.12 | PR: 1KJ,1KY |             |                |                |  |                                  |           |
| 2.0 TDI             | 110                 | 11.12 | PR: 1KJ,1KY |             |                |                |  |                                  |           |
| 2.0 TDI 4motion     | 110                 | 11.12 | PR: 1KJ,1KY |             |                |                |  |                                  |           |
|                     | 1.0 TSI             | 85    | 05.15       |             | 24.0711-6230.3 | 360310         | 2  - Geschwindigkeitsregelanlage <sup>2)</sup> | Radsensor                        |           |
|                     | 1.2 TSI             | 63    | 11.12       |             | 24.0711-6337.3 | 360390         | 2  + Geschwindigkeitsregelanlage <sup>3)</sup> | Radsensor                        |           |
|                     | 1.2 TSI             | 77    | 11.12       |             |                |                |  |                                  |           |
|                     | 1.2 TSI             | 81    | 04.14       |             |                |                |  |                                  |           |
|                     | 1.4 GTE Hybrid      | 110   | 05.14       |             |                |                |  |                                  |           |
|                     | 1.4 TGI             | 81    | 08.13       |             |                |                |  |                                  |           |
|                     | 1.4 TSI             | 90    | 11.12       |             |                |                |  |                                  |           |
|                     | 1.4 TSI             | 92    | 05.14       |             |                |                |  |                                  |           |
|                     | 1.4 TSI             | 103   | 11.12       |             |                |                |  |                                  |           |
|                     | 1.4 TSI             | 110   | 05.14       |             |                |                |  |                                  |           |
|                     | 1.4 TSI Multifuel   | 90    | 04.13       |             |                |                |  |                                  |           |
|                     | 1.4 TSI Multifuel   | 92    | 12.13       |             |                |                |  |                                  |           |
|                     | 1.6                 | 81    | 05.14       |             |                |                |  |                                  |           |
|                     | 1.6 TDI             | 66    | 04.13       |             |                |                |  |                                  |           |
|                     | 1.6 TDI             | 77    | 11.12       |             |                |                |  |                                  |           |
|                     | 1.6 TDI             | 81    | 06.13       |             |                |                |  |                                  |           |
|                     | 2.0 GTD             | 135   | 03.13       |             |                |                |  |                                  |           |
|                     | 2.0 GTI             | 162   | 03.13       |             |                |                |  |                                  |           |
|                     | 2.0 GTI             | 195   | 02.16       |             |                |                |  |                                  |           |
|                     | 2.0 GTI Clubsport S | 228   | 05.16       |             |                |                |  |                                  |           |
|                     | 2.0 GTI Performance | 169   | 03.13       |             |                |                |  |                                  |           |
|                     | 2.0 TDI             | 81    | 11.12       |             |                |                |  |                                  |           |
|                     | 2.0 TDI             | 105   | 08.12       |             |                |                |  |                                  |           |
|                     | 2.0 TDI             | 110   | 11.12       |             |                |                |  |                                  |           |
|                     | e-Golf              | 85    | 08.14       |             |                |                |  |                                  |           |
|                     | 1.0 TSI             | 85    | 05.15       |             |                | 24.0711-6230.3 | 360310   | 2  - Parkassistent <sup>4)</sup> | Radsensor |
|                     | 1.2 TSI             | 63    | 11.12       |             |                | 24.0711-6337.3 | 360390   | 2  + Parkassistent <sup>5)</sup> | Radsensor |
|                     | 1.2 TSI             | 77    | 11.12       |             |                |                |  |                                  |           |
|                     | 1.2 TSI             | 81    | 04.14       |             |                |                |  |                                  |           |
|                     | 1.4 GTE Hybrid      | 110   | 05.14       |             |                |                |  |                                  |           |
|                     | 1.4 TGI             | 81    | 08.13       |             |                |                |  |                                  |           |
|                     | 1.4 TSI             | 90    | 11.12       |             |                |                |  |                                  |           |
|                     | 1.4 TSI             | 92    | 05.14       |             |                |                |  |                                  |           |
|                     | 1.4 TSI             | 103   | 11.12       |             |                |                |  |                                  |           |
| 1.4 TSI             | 110                 | 05.14 |             |             |                |                |  |                                  |           |
| 1.4 TSI Multifuel   | 90                  | 04.13 |             |             |                |                |  |                                  |           |
| 1.4 TSI Multifuel   | 92                  | 12.13 |             |             |                |                |  |                                  |           |
| 1.6                 | 81                  | 05.14 |             |             |                |                |  |                                  |           |
| 1.6 TDI             | 66                  | 04.13 |             |             |                |                |  |                                  |           |
| 1.6 TDI             | 77                  | 11.12 |             |             |                |                |  |                                  |           |
| 1.6 TDI             | 81                  | 06.13 |             |             |                |                |  |                                  |           |
| 2.0 GTD             | 135                 | 03.13 |             |             |                |                |  |                                  |           |
| 2.0 GTI             | 162                 | 03.13 |             |             |                |                |  |                                  |           |
| 2.0 GTI             | 195                 | 02.16 |             |             |                |                |  |                                  |           |
| 2.0 GTI Clubsport S | 228                 | 05.16 |             |             |                |                |  |                                  |           |
| 2.0 GTI Performance | 169                 | 03.13 |             |             |                |                |  |                                  |           |
| 2.0 TDI             | 81                  | 11.12 |             |             |                |                |  |                                  |           |
| 2.0 TDI             | 105                 | 08.12 |             |             |                |                |  |                                  |           |
| 2.0 TDI             | 110                 | 11.12 |             |             |                |                |  |                                  |           |
| e-Golf              | 85                  | 08.14 |             |             |                |                |  |                                  |           |
| 1.6 TDI 4motion     | 77                  | 11.12 |             |             | 24.0711-5271.3 | 360301         | - Geschwindigkeitsregelanlage <sup>2)</sup>    | Radsensor                        |           |
| 1.6 TDI 4motion     | 81                  | 01.13 |             |             | 24.0711-5272.3 | 360302         | - Geschwindigkeitsregelanlage <sup>2)</sup>    | Radsensor                        |           |
| 2.0 R 4motion       | 221                 | 09.13 |             |             | 24.0711-5401.3 | 360330         | + Geschwindigkeitsregelanlage <sup>3)</sup>    | Radsensor                        |           |
| 2.0 TDI 4motion     | 110                 | 11.12 |             |             | 24.0711-5402.3 | 360331         | + Geschwindigkeitsregelanlage <sup>3)</sup>    | Radsensor                        |           |
| 1.6 TDI 4motion     | 77                  | 11.12 |             |             | 24.0711-5271.3 | 360301         | - Parkassistent <sup>4)</sup>                  | Radsensor                        |           |
| 1.6 TDI 4motion     | 81                  | 01.13 |             |             | 24.0711-5272.3 | 360302         | - Parkassistent <sup>4)</sup>                  | Radsensor                        |           |
| 2.0 R 4motion       | 221                 | 09.13 |             |             | 24.0711-5401.3 | 360330         | + Parkassistent <sup>5)</sup>                  | Radsensor                        |           |
| 2.0 TDI 4motion     | 110                 | 11.12 |             |             | 24.0711-5402.3 | 360331         | + Parkassistent <sup>5)</sup>                  | Radsensor                        |           |



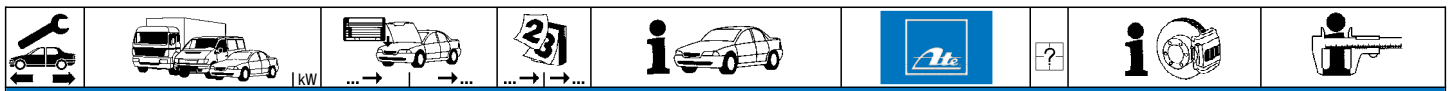

1) electric parking brake / fr.di stazionamento elettrico / frein à main électrique / freno de mano eléctrico  
2) - speed control system / - impianto variatore di velocità / - régulateur de vitesse / - sistema de regulación de velocidad  
3) + speed control system / + impianto variatore di velocità / + régulateur de vitesse / + sistema de regulación de velocidad  
4) - parking assistant / - assistente di parcheggio / - assistance au stationnement / - asistente de aparcamiento  
5) + parking assistant / + assistente di parcheggio / + assistance au stationnement / + asistente de aparcamiento

















**VOLKSWAGEN GOLF VII Variant (13-)**

|                 |                   |       |                             |                             |                |        |  |                            |     |
|-----------------|-------------------|-------|-----------------------------|-----------------------------|----------------|--------|--|----------------------------|-----|
|                 | 1.0 TSI           | 85    | 05.15                       | PR: 1ZA,1ZB,1ZD,1ZE,1ZP,1LV | 13.0460-2785.2 | 602785 |  | 25683 20,4 +/WK/S          | TRW |
|                 | 1.2 TSI           | 63    | 07.13                       | PR: 1ZA,1ZB,1ZD,1ZE,1ZP,1LV | 13.0470-2785.2 | LD2785 |  | 25683 20,4 +/WK/S          | TRW |
|                 | 1.2 TSI           | 77    | 07.13                       | PR: 1ZA,1ZB,1ZD,1ZE,1ZP,1LV |                |        |  |                            |     |
|                 | 1.2 TSI           | 81    | 04.14                       | PR: 1ZA,1ZB,1ZD,1ZE,1ZP,1LV |                |        |  |                            |     |
|                 | 1.4 TSI           | 90    | 07.13                       | PR: 1ZA,1ZB,1ZD,1ZE,1ZP,1LV |                |        |  |                            |     |
|                 | 1.4 TSI           | 92    | 05.14                       | PR: 1ZA,1ZB,1ZD,1ZE,1ZP,1LV |                |        |  |                            |     |
|                 | 1.4 TSI           | 103   | 07.13                       | PR: 1ZA,1ZB,1ZD,1ZE,1ZP,1LV |                |        |  |                            |     |
|                 | 1.4 TSI           | 110   | 05.14                       | PR: 1ZA,1ZB,1ZD,1ZE,1ZP,1LV |                |        |  |                            |     |
|                 | 1.4 TSI CNG       | 81    | 09.13                       | PR: 1ZA,1ZB,1ZD,1ZE,1ZP,1LV |                |        |  |                            |     |
|                 | 1.4 TSI MultiFuel | 90    | 04.13                       | PR: 1ZA,1ZB,1ZD,1ZE,1ZP,1LV |                |        |  |                            |     |
|                 | 1.4 TSI MultiFuel | 92    | 05.14                       | PR: 1ZA,1ZB,1ZD,1ZE,1ZP,1LV |                |        |  |                            |     |
|                 | 1.6               | 81    | 05.14                       | PR: 1ZA,1ZB,1ZD,1ZE,1ZP,1LV |                |        |  |                            |     |
|                 | 1.6 TDI           | 66    | 07.13                       | PR: 1ZA,1ZB,1ZD,1ZE,1ZP,1LV |                |        |  |                            |     |
|                 | 1.6 TDI           | 77    | 07.13                       | PR: 1ZA,1ZB,1ZD,1ZE,1ZP,1LV |                |        |  |                            |     |
|                 | 1.6 TDI           | 81    | 07.13                       | PR: 1ZA,1ZB,1ZD,1ZE,1ZP,1LV |                |        |  |                            |     |
|                 | 1.6 TDI 4motion   |       | 07.13                       | PR: 1ZA,1ZB,1ZD,1ZE,1ZP,1LV |                |        |  |                            |     |
|                 | 2.0 GTD           | 135   | 01.15                       | PR: 1ZA,1ZB,1ZD,1ZE,1ZP,1LV |                |        |  |                            |     |
|                 | 2.0 R 4motion     | 221   | 03.15                       | PR: 1ZA,1ZB,1ZD,1ZE,1ZP,1LV |                |        |  |                            |     |
|                 | 2.0 TDI           | 81    | 07.13                       | PR: 1ZA,1ZB,1ZD,1ZE,1ZP,1LV |                |        |  |                            |     |
|                 | 2.0 TDI           | 110   | 07.13                       | PR: 1ZA,1ZB,1ZD,1ZE,1ZP,1LV |                |        |  |                            |     |
| 2.0 TDI 4motion | 110               | 07.13 | PR: 1ZA,1ZB,1ZD,1ZE,1ZP,1LV |                             |                |        |  |                            |     |
|                 | 1.0 TSI           | 85    | 05.15                       | PR: 1ZF                     | 13.0460-7303.2 | 607303 |  | 22035 17,5 +/WK            | ATE |
|                 | 1.2 TSI           | 63    | 07.13                       | PR: 1ZF                     | 13.0470-7303.2 | LD7303 |  | 22035 17,5 +/WK            | ATE |
|                 | 1.2 TSI           | 77    | 07.13                       | PR: 1ZF                     |                |        |  |                            |     |
|                 | 1.2 TSI           | 81    | 04.14                       | PR: 1ZF                     |                |        |  |                            |     |
|                 | 1.4 TSI           | 90    | 07.13                       | PR: 1ZF                     |                |        |  |                            |     |
|                 | 1.4 TSI           | 92    | 05.14                       | PR: 1ZF                     |                |        |  |                            |     |
|                 | 1.4 TSI           | 103   | 07.13                       | PR: 1ZF                     |                |        |  |                            |     |
|                 | 1.4 TSI           | 110   | 05.14                       | PR: 1ZF                     |                |        |  |                            |     |
|                 | 1.4 TSI CNG       | 81    | 09.13                       | PR: 1ZF                     |                |        |  |                            |     |
|                 | 1.4 TSI MultiFuel | 90    | 04.13                       | PR: 1ZF                     |                |        |  |                            |     |
|                 | 1.4 TSI MultiFuel | 92    | 05.14                       | PR: 1ZF                     |                |        |  |                            |     |
|                 | 1.6               | 81    | 05.14                       | PR: 1ZF                     |                |        |  |                            |     |
|                 | 1.6 TDI           | 66    | 07.13                       | PR: 1ZF                     |                |        |  |                            |     |
|                 | 1.6 TDI           | 77    | 07.13                       | PR: 1ZF                     |                |        |  |                            |     |
|                 | 1.6 TDI           | 81    | 07.13                       | PR: 1ZF                     |                |        |  |                            |     |
|                 | 1.6 TDI 4motion   |       | 07.13                       | PR: 1ZF                     |                |        |  |                            |     |
|                 | 2.0 GTD           | 135   | 01.15                       | PR: 1ZF                     |                |        |  |                            |     |
|                 | 2.0 R 4motion     | 221   | 03.15                       | PR: 1ZF                     |                |        |  |                            |     |
|                 | 2.0 TDI           | 81    | 07.13                       | PR: 1ZF                     |                |        |  |                            |     |
|                 | 2.0 TDI           | 110   | 07.13                       | PR: 1ZF                     |                |        |  |                            |     |
| 2.0 TDI 4motion | 110               | 07.13 | PR: 1ZF                     |                             |                |        |  |                            |     |
|                 | 1.0 TSI           | 85    | 05.15                       | PR: 1LM                     | 13.0460-2764.2 | 602764 |  | 24738 20,0 +/WK/S          | TRW |
|                 | 1.2 TSI           | 63    | 07.13                       | PR: 1LM                     | 13.0470-2764.2 | LD2764 |  | 24738 20,0 +/WK/S          | TRW |
|                 | 1.2 TSI           | 77    | 07.13                       | PR: 1LM                     |                |        |  |                            |     |
|                 | 1.2 TSI           | 81    | 04.14                       | PR: 1LM                     |                |        |  |                            |     |
|                 | 1.4 TSI           | 90    | 07.13                       | PR: 1LM                     |                |        |  |                            |     |
|                 | 1.4 TSI           | 92    | 05.14                       | PR: 1LM                     |                |        |  |                            |     |
|                 | 1.4 TSI           | 103   | 07.13                       | PR: 1LM                     |                |        |  |                            |     |
|                 | 1.4 TSI           | 110   | 05.14                       | PR: 1LM                     |                |        |  |                            |     |
|                 | 1.4 TSI CNG       | 81    | 09.13                       | PR: 1LM                     |                |        |  |                            |     |
|                 | 1.4 TSI MultiFuel | 90    | 04.13                       | PR: 1LM                     |                |        |  |                            |     |
|                 | 1.4 TSI MultiFuel | 92    | 05.14                       | PR: 1LM                     |                |        |  |                            |     |
|                 | 1.6               | 81    | 05.14                       | PR: 1LM                     |                |        |  |                            |     |
|                 | 1.6 TDI           | 66    | 07.13                       | PR: 1LM                     |                |        |  |                            |     |
|                 | 1.6 TDI           | 77    | 07.13                       | PR: 1LM                     |                |        |  |                            |     |
|                 | 1.6 TDI           | 81    | 07.13                       | PR: 1LM                     |                |        |  |                            |     |
|                 | 1.6 TDI 4motion   |       | 07.13                       | PR: 1LM                     |                |        |  |                            |     |
|                 | 2.0 GTD           | 135   | 01.15                       | PR: 1LM                     |                |        |  |                            |     |
|                 | 2.0 R 4motion     | 221   | 03.15                       | PR: 1LM                     |                |        |  |                            |     |
|                 | 2.0 TDI           | 81    | 07.13                       | PR: 1LM                     |                |        |  |                            |     |
|                 | 2.0 TDI           | 110   | 07.13                       | PR: 1LM                     |                |        |  |                            |     |
| 2.0 TDI 4motion | 110               | 07.13 | PR: 1LM                     |                             |                |        |  |                            |     |
|                 | 1.0 TSI           | 85    | 05.15                       | PR: 1ZE,1ZP                 | 24.0125-0145.1 | 425145 |  | 288 25,0 22,0 V L +S +B    |     |
|                 | 1.2 TSI           | 63    | 07.13                       | PR: 1ZE,1ZP                 |                |        |  |                            |     |
|                 | 1.2 TSI           | 77    | 07.13                       | PR: 1ZE,1ZP                 |                |        |  |                            |     |
|                 | 1.2 TSI           | 81    | 04.14                       | PR: 1ZE,1ZP                 |                |        |  |                            |     |
|                 | 1.4 TSI           | 90    | 07.13                       | PR: 1ZE,1ZP                 |                |        |  |                            |     |
|                 | 1.4 TSI           | 92    | 05.14                       | PR: 1ZE,1ZP                 |                |        |  |                            |     |
|                 | 1.4 TSI           | 103   | 07.13                       | PR: 1ZE,1ZP                 |                |        |  |                            |     |
|                 | 1.4 TSI           | 110   | 05.14                       | PR: 1ZE,1ZP                 |                |        |  |                            |     |
|                 | 1.4 TSI CNG       | 81    | 09.13                       | PR: 1ZE,1ZP                 |                |        |  |                            |     |
|                 | 1.4 TSI MultiFuel | 90    | 04.13                       | PR: 1ZE,1ZP                 |                |        |  |                            |     |
|                 | 1.4 TSI MultiFuel | 92    | 05.14                       | PR: 1ZE,1ZP                 |                |        |  |                            |     |
|                 | 1.6               | 81    | 05.14                       | PR: 1ZE,1ZP                 |                |        |  |                            |     |
| 1.6 TDI         | 66                | 07.13 | PR: 1ZE,1ZP                 |                             |                |        |  |                            |     |
| 1.6 TDI         | 77                | 07.13 | PR: 1ZE,1ZP                 |                             |                |        |  |                            |     |
| 1.6 TDI         | 81                | 07.13 | PR: 1ZE,1ZP                 |                             |                |        |  |                            |     |
| 1.6 TDI 4motion |                   | 07.13 | PR: 1ZE,1ZP                 |                             |                |        |  |                            |     |
| 2.0 GTD         | 135               | 01.15 | PR: 1ZE,1ZP                 |                             |                |        |  |                            |     |
| 2.0 R 4motion   | 221               | 03.15 | PR: 1ZE,1ZP                 |                             |                |        |  |                            |     |
| 2.0 TDI         | 81                | 07.13 | PR: 1ZE,1ZP                 |                             |                |        |  |                            |     |
| 2.0 TDI         | 110               | 07.13 | PR: 1ZE,1ZP                 |                             |                |        |  |                            |     |
| 2.0 TDI 4motion | 110               | 07.13 | PR: 1ZE,1ZP                 |                             |                |        |  |                            |     |
| ↓               | 1.0 TSI           | 85    | 05.15                       | PR: 1ZA,1ZB,1ZD,1LV         | 24.0125-0158.1 | 425158 |  | 312 25,0 22,0 V L +S +B    |     |
|                 | 1.2 TSI           | 63    | 07.13                       | PR: 1ZA,1ZB,1ZD,1LV         | 24.0325-0158.1 | 525158 |  | 312 25,0 22,0 V L +S +B PD |     |
|                 | 1.2 TSI           | 77    | 07.13                       | PR: 1ZA,1ZB,1ZD,1LV         |                |        |  |                            |     |













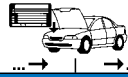













| VOLKSWAGEN GOLF VII Variant (13-)  |                   |       |                     |                     |                |        |   |   |                           |
|--|-------------------|-------|---------------------|---------------------|----------------|--------|---|---|---------------------------|
|    | 1.2 TSI           | 81    | 04.14               | PR: 1ZA,1ZB,1ZD,1LV | 24.0125-0158.1 | 425158 |   |   | 312 25,0 22,0 VL +S +B    |
|  | 1.4 TSI           | 90    | 07.13               | PR: 1ZA,1ZB,1ZD,1LV | 24.0325-0158.1 | 525158 |   |   | 312 25,0 22,0 VL +S +B PD |
|  | 1.4 TSI           | 92    | 05.14               | PR: 1ZA,1ZB,1ZD,1LV |                |        |   |   |                           |
|  | 1.4 TSI           | 103   | 07.13               | PR: 1ZA,1ZB,1ZD,1LV |                |        |   |   |                           |
|  | 1.4 TSI           | 110   | 05.14               | PR: 1ZA,1ZB,1ZD,1LV |                |        |   |   |                           |
|  | 1.4 TSI CNG       | 81    | 09.13               | PR: 1ZA,1ZB,1ZD,1LV |                |        |   |   |                           |
|  | 1.4 TSI MultiFuel | 90    | 04.13               | PR: 1ZA,1ZB,1ZD,1LV |                |        |   |   |                           |
|  | 1.4 TSI MultiFuel | 92    | 05.14               | PR: 1ZA,1ZB,1ZD,1LV |                |        |   |   |                           |
|  | 1.6               | 81    | 05.14               | PR: 1ZA,1ZB,1ZD,1LV |                |        |   |   |                           |
|  | 1.6 TDI           | 66    | 07.13               | PR: 1ZA,1ZB,1ZD,1LV |                |        |   |   |                           |
|  | 1.6 TDI           | 77    | 07.13               | PR: 1ZA,1ZB,1ZD,1LV |                |        |   |   |                           |
|  | 1.6 TDI           | 81    | 07.13               | PR: 1ZA,1ZB,1ZD,1LV |                |        |   |   |                           |
|  | 1.6 TDI 4motion   |       | 07.13               | PR: 1ZA,1ZB,1ZD,1LV |                |        |   |   |                           |
|  | 2.0 GTD           | 135   | 01.15               | PR: 1ZA,1ZB,1ZD,1LV |                |        |   |   |                           |
| 2.0 R 4motion  | 221               | 03.15 | PR: 1ZA,1ZB,1ZD,1LV |                     |                |        |   |   |                           |
| 2.0 TDI  | 81                | 07.13 | PR: 1ZA,1ZB,1ZD,1LV |                     |                |        |   |   |                           |
| 2.0 TDI  | 110               | 07.13 | PR: 1ZA,1ZB,1ZD,1LV |                     |                |        |   |   |                           |
| 2.0 TDI 4motion  | 110               | 07.13 | PR: 1ZA,1ZB,1ZD,1LV |                     |                |        |   |   |                           |
|  | 1.0 TSI           | 85    | 05.15               | PR: 1ZF             | 24.0124-0258.1 | 424258 |   |   | 276 24,0 21,0 VL +S +B    |
|  | 1.2 TSI           | 63    | 07.13               | PR: 1ZF             |                |        |   |   |                           |
|  | 1.2 TSI           | 77    | 07.13               | PR: 1ZF             |                |        |   |   |                           |
|  | 1.2 TSI           | 81    | 04.14               | PR: 1ZF             |                |        |   |   |                           |
|  | 1.4 TSI           | 90    | 07.13               | PR: 1ZF             |                |        |   |   |                           |
|  | 1.4 TSI           | 92    | 05.14               | PR: 1ZF             |                |        |   |   |                           |
|  | 1.4 TSI           | 103   | 07.13               | PR: 1ZF             |                |        |   |   |                           |
|  | 1.4 TSI           | 110   | 05.14               | PR: 1ZF             |                |        |   |   |                           |
|  | 1.4 TSI CNG       | 81    | 09.13               | PR: 1ZF             |                |        |   |   |                           |
|  | 1.4 TSI MultiFuel | 90    | 04.13               | PR: 1ZF             |                |        |   |   |                           |
|  | 1.4 TSI MultiFuel | 92    | 05.14               | PR: 1ZF             |                |        |   |   |                           |
|  | 1.6               | 81    | 05.14               | PR: 1ZF             |                |        |   |   |                           |
|  | 1.6 TDI           | 66    | 07.13               | PR: 1ZF             |                |        |   |   |                           |
|  | 1.6 TDI           | 77    | 07.13               | PR: 1ZF             |                |        |   |   |                           |
| 1.6 TDI  | 81                | 07.13 | PR: 1ZF             |                     |                |        |   |   |                           |
| 1.6 TDI 4motion  |                   | 07.13 | PR: 1ZF             |                     |                |        |   |   |                           |
| 2.0 GTD  | 135               | 01.15 | PR: 1ZF             |                     |                |        |   |   |                           |
| 2.0 R 4motion  | 221               | 03.15 | PR: 1ZF             |                     |                |        |   |   |                           |
| 2.0 TDI  | 81                | 07.13 | PR: 1ZF             |                     |                |        |   |   |                           |
| 2.0 TDI  | 110               | 07.13 | PR: 1ZF             |                     |                |        |   |   |                           |
| 2.0 TDI 4motion  | 110               | 07.13 | PR: 1ZF             |                     |                |        |   |   |                           |
|  | 1.0 TSI           | 85    | 05.15               | PR: 1LM             | 24.0130-0225.1 | 430225 |   |   | 340 30,0 27,0 VL +S +B    |
|  | 1.2 TSI           | 63    | 07.13               | PR: 1LM             |                |        |   |   |                           |
|  | 1.2 TSI           | 77    | 07.13               | PR: 1LM             |                |        |   |   |                           |
|  | 1.2 TSI           | 81    | 04.14               | PR: 1LM             |                |        |   |   |                           |
|  | 1.4 TSI           | 90    | 07.13               | PR: 1LM             |                |        |   |   |                           |
|  | 1.4 TSI           | 92    | 05.14               | PR: 1LM             |                |        |   |   |                           |
|  | 1.4 TSI           | 103   | 07.13               | PR: 1LM             |                |        |   |   |                           |
|  | 1.4 TSI           | 110   | 05.14               | PR: 1LM             |                |        |   |   |                           |
|  | 1.4 TSI CNG       | 81    | 09.13               | PR: 1LM             |                |        |   |   |                           |
|  | 1.4 TSI MultiFuel | 90    | 04.13               | PR: 1LM             |                |        |   |   |                           |
|  | 1.4 TSI MultiFuel | 92    | 05.14               | PR: 1LM             |                |        |   |   |                           |
|  | 1.6               | 81    | 05.14               | PR: 1LM             |                |        |   |   |                           |
|  | 1.6 TDI           | 66    | 07.13               | PR: 1LM             |                |        |   |   |                           |
|  | 1.6 TDI           | 77    | 07.13               | PR: 1LM             |                |        |   |   |                           |
| 1.6 TDI  | 81                | 07.13 | PR: 1LM             |                     |                |        |   |   |                           |
| 1.6 TDI 4motion  |                   | 07.13 | PR: 1LM             |                     |                |        |   |   |                           |
| 2.0 GTD  | 135               | 03.15 | PR: 1LM             |                     |                |        |   |   |                           |
| 2.0 R 4motion  | 221               | 03.15 | PR: 1LM             |                     |                |        |   |   |                           |
| 2.0 TDI  | 81                | 07.13 | PR: 1LM             |                     |                |        |   |   |                           |
| 2.0 TDI  | 110               | 07.13 | PR: 1LM             |                     |                |        |   |   |                           |
| 2.0 TDI 4motion  | 110               | 07.13 | PR: 1LM             |                     |                |        |   |   |                           |
|  | 1.0 TSI           | 85    | 05.15               |                     | 24.0711-5273.3 | 360303 |  |   | Radsensor                 |
|  | 1.2 TSI           | 63    | 07.13               |                     | 24.0711-5274.3 | 360304 |  |   | Radsensor                 |
|  | 1.2 TSI           | 77    | 07.13               |                     |                |        |   |   |                           |
|  | 1.2 TSI           | 81    | 04.14               |                     |                |        |   |   |                           |
|  | 1.4 TSI           | 90    | 07.13               |                     |                |        |   |   |                           |
|  | 1.4 TSI           | 92    | 05.14               |                     |                |        |   |   |                           |
|  | 1.4 TSI           | 103   | 07.13               |                     |                |        |   |   |                           |
|  | 1.4 TSI           | 110   | 05.14               |                     |                |        |   |   |                           |
|  | 1.4 TSI CNG       | 81    | 09.13               |                     |                |        |   |   |                           |
|  | 1.4 TSI MultiFuel | 90    | 04.13               |                     |                |        |   |   |                           |
|  | 1.4 TSI MultiFuel | 92    | 05.14               |                     |                |        |   |   |                           |
|  | 1.6               | 81    | 05.14               |                     |                |        |   |   |                           |
|  | 1.6 TDI           | 66    | 07.13               |                     |                |        |   |   |                           |
|  | 1.6 TDI           | 77    | 07.13               |                     |                |        |   |   |                           |
| 1.6 TDI  | 81                | 07.13 |                     |                     |                |        |   |   |                           |
| 1.6 TDI 4motion  |                   | 07.13 |                     |                     |                |        |   |   |                           |
| 2.0 GTD  | 135               | 01.15 |                     |                     |                |        |   |   |                           |
| 2.0 R 4motion  | 221               | 03.15 |                     |                     |                |        |   |   |                           |
| 2.0 TDI  | 81                | 07.13 |                     |                     |                |        |   |   |                           |
| 2.0 TDI  | 110               | 07.13 |                     |                     |                |        |   |   |                           |
| 2.0 TDI 4motion  | 110               | 07.13 |                     |                     |                |        |   |   |                           |
|  | 1.0 TSI           | 85    | 05.15               | PR: 1KE             | 13.0460-7293.2 | 607293 |   | elektrische Feststellbremse <sup>1)</sup> | 25008 16,3 + ATE          |
|  | 1.2 TSI           | 63    | 07.13               | PR: 1KE             |                |        |   |   |                           |
|  | 1.2 TSI           | 77    | 07.13               | PR: 1KE             |                |        |   |   |                           |
|  | 1.2 TSI           | 81    | 04.14               | PR: 1KE             |                |        |   |   |                           |
|  | 1.4 TSI           | 90    | 07.13               | PR: 1KE             |                |        |   |   |                           |
|  | 1.4 TSI           | 92    | 05.14               | PR: 1KE             |                |        |   |   |                           |

<sup>1)</sup> electric parking brake / fr.di stazionamento elettrico / frein à main électrique / freno de mano eléctrico













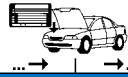







|   |  |  |  |  |  |  |  |  |     |
|--|--|--|--|--|---|--|--|--|-----|
| <b>VOLKSWAGEN GOLF VII Variant (13-)</b>   |  |  |  |  |   |  |  |  |     |
|  | 1.4 TSI  | 103  | 07.13  | PR: 1KE  | 13.0460-7293.2  | 607293   | elektrische Feststellbremse <sup>1)</sup>  | 25008 16,3 +   | ATE |
|  | 1.4 TSI  | 110  | 05.14  | PR: 1KE  |   |  |  |  |     |
|  | 1.4 TSI CNG  | 81   | 09.13  | PR: 1KE  |   |  |  |  |     |
|  | 1.4 TSI MultiFuel  | 90   | 04.13  | PR: 1KE  |   |  |  |  |     |
|  | 1.4 TSI MultiFuel  | 92   | 05.14  | PR: 1KE  |   |  |  |  |     |
|  | 1.6  | 81   | 05.14  | PR: 1KE  |   |  |  |  |     |
|  | 1.6 TDI  | 66   | 07.13  | PR: 1KE  |   |  |  |  |     |
|  | 1.6 TDI  | 77   | 07.13  | PR: 1KE  |   |  |  |  |     |
|  | 1.6 TDI  | 81   | 07.13  | PR: 1KE  |   |  |  |  |     |
|  | 1.6 TDI 4motion  |  | 07.13  | PR: 1KE  |   |  |  |  |     |
|  | 2.0 GTD  | 135  | 01.15  | PR: 1KE  |   |  |  |  |     |
|  | 2.0 R 4motion  | 221  | 03.15  | PR: 1KE  |   |  |  |  |     |
|  | 2.0 TDI  | 81   | 07.13  | PR: 1KE  |   |  |  |  |     |
|  | 2.0 TDI  | 110  | 07.13  | PR: 1KE  |   |  |  |  |     |
| 2.0 TDI 4motion  | 110  | 07.13  | PR: 1KE  |  |   |  |  |  |     |
|  | 1.0 TSI  | 85   | 05.15  | PR: 1KV,1KY  | 13.0460-7294.2  | 607294   | elektrische Feststellbremse <sup>1)</sup>  | 25009 16,4 +   | ATE |
|  | 1.2 TSI  | 63   | 07.13  | PR: 1KV,1KY  |   |  |  |  |     |
|  | 1.2 TSI  | 77   | 07.13  | PR: 1KV,1KY  |   |  |  |  |     |
|  | 1.2 TSI  | 81   | 04.14  | PR: 1KV,1KY  |   |  |  |  |     |
|  | 1.4 TSI  | 90   | 07.13  | PR: 1KV,1KY  |   |  |  |  |     |
|  | 1.4 TSI  | 92   | 05.14  | PR: 1KV,1KY  |   |  |  |  |     |
|  | 1.4 TSI  | 103  | 07.13  | PR: 1KV,1KY  |   |  |  |  |     |
|  | 1.4 TSI  | 110  | 05.14  | PR: 1KV,1KY  |   |  |  |  |     |
|  | 1.4 TSI CNG  | 81   | 09.13  | PR: 1KV,1KY  |   |  |  |  |     |
|  | 1.4 TSI MultiFuel  | 90   | 04.13  | PR: 1KV,1KY  |   |  |  |  |     |
|  | 1.4 TSI MultiFuel  | 92   | 05.14  | PR: 1KV,1KY  |   |  |  |  |     |
|  | 1.6  | 81   | 05.14  | PR: 1KV,1KY  |   |  |  |  |     |
|  | 1.6 TDI  | 66   | 07.13  | PR: 1KV,1KY  |   |  |  |  |     |
|  | 1.6 TDI  | 77   | 07.13  | PR: 1KV,1KY  |   |  |  |  |     |
|  | 1.6 TDI  | 81   | 07.13  | PR: 1KV,1KY  |   |  |  |  |     |
|  | 1.6 TDI 4motion  |  | 07.13  | PR: 1KV,1KY  |   |  |  |  |     |
|  | 2.0 GTD  | 135  | 01.15  | PR: 1KV,1KY  |   |  |  |  |     |
|  | 2.0 R 4motion  | 221  | 03.15  | PR: 1KV,1KY  |   |  |  |  |     |
|  | 2.0 TDI  | 81   | 07.13  | PR: 1KV,1KY  |   |  |  |  |     |
|  | 2.0 TDI  | 110  | 07.13  | PR: 1KV,1KY  |   |  |  |  |     |
| 2.0 TDI 4motion  | 110  | 07.13  | PR: 1KV,1KY  |  |   |  |  |  |     |
|  | 1.0 TSI  | 85   | 05.15  | PR: 1KE  | 24.0110-0356.1  | 410356   | elektrische Feststellbremse <sup>1)</sup>  | 272 9,7 8,0 +S +B  | ATE |
|  | 1.2 TSI  | 63   | 07.13  | PR: 1KE  |   |  |  |  |     |
|  | 1.2 TSI  | 77   | 07.13  | PR: 1KE  |   |  |  |  |     |
|  | 1.2 TSI  | 81   | 04.14  | PR: 1KE  |   |  |  |  |     |
|  | 1.4 TSI  | 90   | 07.13  | PR: 1KE  |   |  |  |  |     |
|  | 1.4 TSI  | 92   | 05.14  | PR: 1KE  |   |  |  |  |     |
|  | 1.4 TSI  | 103  | 07.13  | PR: 1KE  |   |  |  |  |     |
|  | 1.4 TSI  | 110  | 05.14  | PR: 1KE  |   |  |  |  |     |
|  | 1.4 TSI CNG  | 81   | 09.13  | PR: 1KE  |   |  |  |  |     |
|  | 1.4 TSI MultiFuel  | 90   | 04.13  | PR: 1KE  |   |  |  |  |     |
|  | 1.4 TSI MultiFuel  | 92   | 05.14  | PR: 1KE  |   |  |  |  |     |
|  | 1.6  | 81   | 05.14  | PR: 1KE  |   |  |  |  |     |
|  | 1.6 TDI  | 66   | 07.13  | PR: 1KE  |   |  |  |  |     |
|  | 1.6 TDI  | 77   | 07.13  | PR: 1KE  |   |  |  |  |     |
|  | 1.6 TDI  | 81   | 07.13  | PR: 1KE  |   |  |  |  |     |
|  | 1.6 TDI 4motion  |  | 07.13  | PR: 1KE  |   |  |  |  |     |
|  | 2.0 GTD  | 135  | 01.15  | PR: 1KE  |   |  |  |  |     |
|  | 2.0 R 4motion  | 221  | 03.15  | PR: 1KE  |   |  |  |  |     |
|  | 2.0 TDI  | 81   | 07.13  | PR: 1KE  |   |  |  |  |     |
|  | 2.0 TDI  | 110  | 07.13  | PR: 1KE  |   |  |  |  |     |
| 2.0 TDI 4motion  | 110  | 07.13  | PR: 1KE  |  |   |  |  |  |     |
|  | 1.0 TSI  | 85   | 05.15  | PR: 1KV  | 24.0112-0210.1  | 412210   | elektrische Feststellbremse <sup>1)</sup>  | 300 12,0 10,0 +S +B  | ATE |
|  | 1.2 TSI  | 63   | 07.13  | PR: 1KV  |   |  |  |  |     |
|  | 1.2 TSI  | 77   | 07.13  | PR: 1KV  |   |  |  |  |     |
|  | 1.2 TSI  | 81   | 04.14  | PR: 1KV  |   |  |  |  |     |
|  | 1.4 TSI  | 90   | 07.13  | PR: 1KV  |   |  |  |  |     |
|  | 1.4 TSI  | 92   | 05.14  | PR: 1KV  |   |  |  |  |     |
|  | 1.4 TSI  | 103  | 07.13  | PR: 1KV  |   |  |  |  |     |
|  | 1.4 TSI  | 110  | 05.14  | PR: 1KV  |   |  |  |  |     |
|  | 1.4 TSI CNG  | 81   | 09.13  | PR: 1KV  |   |  |  |  |     |
|  | 1.4 TSI MultiFuel  | 90   | 04.13  | PR: 1KV  |   |  |  |  |     |
|  | 1.4 TSI MultiFuel  | 92   | 05.14  | PR: 1KV  |   |  |  |  |     |
|  | 1.6  | 81   | 05.14  | PR: 1KV  |   |  |  |  |     |
|  | 1.6 TDI  | 66   | 07.13  | PR: 1KV  |   |  |  |  |     |
|  | 1.6 TDI  | 77   | 07.13  | PR: 1KV  |   |  |  |  |     |
|  | 1.6 TDI  | 81   | 07.13  | PR: 1KV  |   |  |  |  |     |
|  | 1.6 TDI 4motion  |  | 07.13  | PR: 1KV  |   |  |  |  |     |
|  | 2.0 GTD  | 135  | 01.15  | PR: 1KV  |   |  |  |  |     |
|  | 2.0 R 4motion  | 221  | 03.15  | PR: 1KV  |   |  |  |  |     |
|  | 2.0 TDI  | 81   | 07.13  | PR: 1KV  |   |  |  |  |     |
|  | 2.0 TDI  | 110  | 07.13  | PR: 1KV  |   |  |  |  |     |
| 2.0 TDI 4motion  | 110  | 07.13  | PR: 1KV  |  |   |  |  |  |     |
|  | 1.0 TSI  | 85   | 05.15  | PR: 1KY  | 24.0122-0219.1  | 422219   | elektrische Feststellbremse <sup>1)</sup>  | 310 22,0 20,0 V L +B   | ATE |
|  | 1.2 TSI  | 63   | 07.13  | PR: 1KY  |   |  |  |  |     |
|  | 1.2 TSI  | 77   | 07.13  | PR: 1KY  |   |  |  |  |     |
|  | 1.2 TSI  | 81   | 04.14  | PR: 1KY  |   |  |  |  |     |
|  | 1.4 TSI  | 90   | 07.13  | PR: 1KY  |   |  |  |  |     |
|  | 1.4 TSI  | 92   | 05.14  | PR: 1KY  |   |  |  |  |     |
|  | 1.4 TSI  | 103  | 07.13  | PR: 1KY  |   |  |  |  |     |
|  | 1.4 TSI  | 110  | 05.14  | PR: 1KY  |   |  |  |  |     |
|  | 1.4 TSI CNG  | 81   | 09.13  | PR: 1KY  |   |  |  |  |     |

<sup>1)</sup> electric parking brake / fr.di stazionamento elettrico / frein à main électrique / freno de mano eléctrico





















|     |    |   |   |  |   |  |  |  |
|--|--|---|---|--|--|--|--|--|
| <b>VOLKSWAGEN GOLF VII Variant (13-)</b>   |  |   |   |  |  |  |  |  |
|    | 1.4 TSI MultiFuel 90<br>1.4 TSI MultiFuel 92<br>1.6 81<br>1.6 TDI 66<br>1.6 TDI 77<br>1.6 TDI 81<br>1.6 TDI 4motion 81<br>2.0 GTD 135<br>2.0 R 4motion 221<br>2.0 TDI 81<br>2.0 TDI 110<br>2.0 TDI 4motion 110   | 04.13<br>05.14<br>05.14<br>07.13<br>07.13<br>07.13<br>07.13<br>01.15<br>03.15<br>07.13<br>07.13<br>07.13  | PR: 1KY<br>PR: 1KY<br>PR: 1KY<br>PR: 1KY<br>PR: 1KY<br>PR: 1KY<br>PR: 1KY<br>PR: 1KY<br>PR: 1KY<br>PR: 1KY<br>PR: 1KY   | 24.0122-0219.1<br>422219   |  |  | elektrische Feststellbremse <sup>1)</sup>  | 310 22,0 20,0 V L +B   |
|    | 1.0 TSI 85<br>1.2 TSI 63<br>1.2 TSI 77<br>1.2 TSI 81<br>1.4 TSI 90<br>1.4 TSI 92<br>1.4 TSI 103<br>1.4 TSI 110<br>1.4 TSI CNG 81<br>1.4 TSI MultiFuel 90<br>1.4 TSI MultiFuel 92<br>1.6 81<br>1.6 TDI 66<br>1.6 TDI 77<br>1.6 TDI 81<br>2.0 GTD 135<br>2.0 TDI 81<br>2.0 TDI 110 | 05.15<br>07.13<br>07.13<br>04.14<br>07.13<br>05.14<br>07.13<br>05.14<br>09.13<br>04.13<br>05.14<br>05.14<br>07.13<br>07.13<br>01.15<br>07.13<br>07.13 |   | 24.0711-6230.3 360310<br>24.0711-6337.3 360390                                   | 2  - Geschwindigkeitsregelanlage <sup>2)</sup><br>2  + Geschwindigkeitsregelanlage <sup>3)</sup> |  | Radsensor<br>Radsensor   |  |
|  | 1.0 TSI 85<br>1.2 TSI 63<br>1.2 TSI 77<br>1.2 TSI 81<br>1.4 TSI 90<br>1.4 TSI 92<br>1.4 TSI 103<br>1.4 TSI 110<br>1.4 TSI CNG 81<br>1.4 TSI MultiFuel 90<br>1.4 TSI MultiFuel 92<br>1.6 81<br>1.6 TDI 66<br>1.6 TDI 77<br>1.6 TDI 81<br>2.0 GTD 135<br>2.0 TDI 81<br>2.0 TDI 110 | 05.15<br>07.13<br>07.13<br>04.14<br>07.13<br>05.14<br>07.13<br>05.14<br>09.13<br>04.13<br>05.14<br>05.14<br>07.13<br>07.13<br>01.15<br>07.13<br>07.13 |   | 24.0711-6230.3 360310<br>24.0711-6337.3 360390                                   | 2  - Parkassistent <sup>4)</sup><br>2  + Parkassistent <sup>5)</sup>                             |  | Radsensor<br>Radsensor   |  |
|  | 1.6 TDI 4motion 221<br>2.0 R 4motion 110<br>2.0 TDI 4motion 110  | 07.13<br>03.15<br>07.13   |   | 24.0711-5271.3 360301<br>24.0711-5272.3 360302                                   |  - Geschwindigkeitsregelanlage <sup>2)</sup><br> - Geschwindigkeitsregelanlage <sup>2)</sup> |  | Radsensor<br>Radsensor   |  |
|  | 1.6 TDI 4motion 221<br>2.0 R 4motion 110<br>2.0 TDI 4motion 110  | 07.13<br>03.15<br>07.13   |   | 24.0711-5401.3 360330<br>24.0711-5402.3 360331                                   |  + Geschwindigkeitsregelanlage <sup>3)</sup><br> + Geschwindigkeitsregelanlage <sup>3)</sup> |  | Radsensor<br>Radsensor   |  |
|  | 1.6 TDI 4motion 221<br>2.0 R 4motion 110<br>2.0 TDI 4motion 110  | 07.13<br>03.15<br>07.13   |   | 24.0711-5271.3 360301<br>24.0711-5272.3 360302                                   |  - Parkassistent <sup>4)</sup><br> - Parkassistent <sup>4)</sup>                             |  | Radsensor<br>Radsensor   |  |
|  | 1.6 TDI 4motion 221<br>2.0 R 4motion 110<br>2.0 TDI 4motion 110  | 07.13<br>03.15<br>07.13   |   | 24.0711-5401.3 360330<br>24.0711-5402.3 360331                                   |  + Parkassistent <sup>5)</sup><br> + Parkassistent <sup>5)</sup>                             |  | Radsensor<br>Radsensor   |  |
| <b>VOLKSWAGEN GOLF VII Sportsvan (14-)</b>   |  |   |   |  |  |  |  |  |
|  | 1.0 TSI 85<br>1.2 TSI 63<br>1.2 TSI 81<br>1.4 TSI 92<br>1.4 TSI 110<br>1.4 TSI MultiFuel 92<br>1.6 81<br>1.6 TDI 66<br>1.6 TDI 81<br>2.0 TDI 81<br>2.0 TDI 110   | 05.15<br>03.14<br>03.14<br>03.14<br>05.14<br>04.14<br>05.14<br>02.14<br>05.14<br>05.14<br>05.14   | PR: 1ZA,1ZE,1ZP<br>PR: 1ZA,1ZE,1ZP<br>PR: 1ZA,1ZE,1ZP<br>PR: 1ZA,1ZE,1ZP<br>PR: 1ZA,1ZE,1ZP<br>PR: 1ZA,1ZE,1ZP<br>PR: 1ZA,1ZE,1ZP<br>PR: 1ZA,1ZE,1ZP<br>PR: 1ZA,1ZE,1ZP<br>PR: 1ZA,1ZE,1ZP<br>PR: 1ZA,1ZE,1ZP | 13.0460-2785.2 602785<br>13.0470-2785.2 LD2785                                   |  |  | 25683 20,4 +/WK/S TRW<br>25683 20,4 +/WK/S TRW                                     |  |
|  | 1.0 TSI 85<br>1.2 TSI 63<br>1.2 TSI 81<br>1.4 TSI 92<br>1.4 TSI 110<br>1.4 TSI MultiFuel 92<br>1.6 81<br>1.6 TDI 66<br>1.6 TDI 81<br>2.0 TDI 81<br>2.0 TDI 110   | 05.15<br>03.14<br>03.14<br>03.14<br>05.14<br>04.14<br>05.14<br>02.14<br>05.14<br>05.14<br>05.14   | PR: 1ZF<br>PR: 1ZF<br>PR: 1ZF<br>PR: 1ZF<br>PR: 1ZF<br>PR: 1ZF<br>PR: 1ZF<br>PR: 1ZF<br>PR: 1ZF<br>PR: 1ZF<br>PR: 1ZF   | 13.0460-7303.2 607303<br>13.0470-7303.2 LD7303                                   |  |  | 22035 17,5 +/WK ATE<br>22035 17,5 +/WK ATE   |  |

<sup>1)</sup> electric parking brake / fr.di stazionamento elettrico / frein à main électrique / freno de mano eléctrico  
<sup>2)</sup> - speed control system / - impianto variatore di velocità / - régulateur de vitesse / - sistema de regulación de velocidad  
<sup>3)</sup> + speed control system / + impianto variatore di velocità / + régulateur de vitesse / + sistema de regulación de velocidad  
<sup>4)</sup> - parking assistant / - assistente di parcheggio / - assistance au stationnement / - asistente de aparcamiento  
<sup>5)</sup> + parking assistant / + assistente di parcheggio / + assistance au stationnement / + asistente de aparcamiento













|     |    |  |  |   |  |    |  |  |
|--|--|--|--|---|---|--|--|--|
| <b>VOLKSWAGEN GOLF VII Sportsvan (14-)</b>   |  |  |  |   |   |  |  |  |
|    | 1.0 TSI 85<br>1.2 TSI 63<br>1.2 TSI 81<br>1.4 TSI 92<br>1.4 TSI 110<br>1.4 TSI MultiFuel 92<br>1.6 81<br>1.6 TDI 66<br>1.6 TDI 81<br>2.0 TDI 81<br>2.0 TDI 110 |  | 05.15<br>03.14<br>03.14<br>05.14<br>04.14<br>05.14<br>02.14<br>05.14<br>05.14    | PR: 1ZE,1ZP<br>PR: 1ZE,1ZP<br>PR: 1ZE,1ZP<br>PR: 1ZE,1ZP<br>PR: 1ZE,1ZP<br>PR: 1ZE,1ZP<br>PR: 1ZE,1ZP<br>PR: 1ZE,1ZP<br>PR: 1ZE,1ZP | 24.0125-0145.1 425145<br>24.0325-0145.1 525145                                    |  |  | 288 25,0 22,0 VL +S +B<br>288 25,0 22,0 VL +S +B PD                                |
|  | 1.0 TSI 85<br>1.2 TSI 63<br>1.2 TSI 81<br>1.4 TSI 92<br>1.4 TSI 110<br>1.4 TSI MultiFuel 92<br>1.6 81<br>1.6 TDI 66<br>1.6 TDI 81<br>2.0 TDI 81<br>2.0 TDI 110 |  | 05.15<br>03.14<br>03.14<br>05.14<br>04.14<br>05.14<br>02.14<br>05.14<br>05.14    | PR: 1ZF<br>PR: 1ZF<br>PR: 1ZF<br>PR: 1ZF<br>PR: 1ZF<br>PR: 1ZF<br>PR: 1ZF<br>PR: 1ZF<br>PR: 1ZF                                     | 24.0124-0258.1 424258   |  |  | 276 24,0 21,0 VL +S +B   |
|  | 1.0 TSI 85<br>1.2 TSI 63<br>1.2 TSI 81<br>1.4 TSI 92<br>1.4 TSI 110<br>1.4 TSI MultiFuel 92<br>1.6 81<br>1.6 TDI 66<br>1.6 TDI 81<br>2.0 TDI 81<br>2.0 TDI 110 |  | 05.15<br>03.14<br>03.14<br>05.14<br>04.14<br>05.14<br>02.14<br>05.14<br>05.14    | PR: 1ZA<br>PR: 1ZA<br>PR: 1ZA<br>PR: 1ZA<br>PR: 1ZA<br>PR: 1ZA<br>PR: 1ZA<br>PR: 1ZA<br>PR: 1ZA                                     | 24.0125-0158.1 425158<br>24.0325-0158.1 525158                                    |  |  | 312 25,0 22,0 VL +S +B<br>312 25,0 22,0 VL +S +B PD                                |
|    | 1.0 TSI 85<br>1.2 TSI 63<br>1.2 TSI 81<br>1.4 TSI 92<br>1.4 TSI 110<br>1.4 TSI MultiFuel 92<br>1.6 81<br>1.6 TDI 66<br>1.6 TDI 81<br>2.0 TDI 81<br>2.0 TDI 110 |  | 05.15<br>03.14<br>03.14<br>05.14<br>04.14<br>05.14<br>02.14<br>05.14<br>05.14    |   | 24.0711-5273.3 360303<br>24.0711-5274.3 360304                                    | <br>   |  | Radsensor<br>Radsensor   |
|  | 1.0 TSI 85<br>1.2 TSI 63<br>1.2 TSI 81<br>1.4 TSI 92<br>1.4 TSI 110<br>1.4 TSI MultiFuel 92<br>1.6 81<br>1.6 TDI 66<br>1.6 TDI 81<br>2.0 TDI 81<br>2.0 TDI 110 |  | 05.15<br>03.14<br>03.14<br>05.14<br>04.14<br>05.14<br>02.14<br>05.14<br>05.14    | PR: 1KE<br>PR: 1KE<br>PR: 1KE<br>PR: 1KE<br>PR: 1KE<br>PR: 1KE<br>PR: 1KE<br>PR: 1KE<br>PR: 1KE                                     | 13.0460-7293.2 607293   |  |  | 25008 16,3 + ATE   |
|  | 1.0 TSI 85<br>1.2 TSI 63<br>1.2 TSI 81<br>1.4 TSI 92<br>1.4 TSI 110<br>1.4 TSI MultiFuel 92<br>1.6 81<br>1.6 TDI 66<br>1.6 TDI 81<br>2.0 TDI 81<br>2.0 TDI 110 |  | 05.15<br>03.14<br>03.14<br>05.14<br>04.14<br>05.14<br>02.14<br>05.14<br>05.14    | PR: 1KE<br>PR: 1KE<br>PR: 1KE<br>PR: 1KE<br>PR: 1KE<br>PR: 1KE<br>PR: 1KE<br>PR: 1KE<br>PR: 1KE                                     | 24.0110-0356.1 410356<br>24.0310-0356.1 510356                                    |  |  | 272 9,7 8,0 +S +B<br>272 9,7 8,0 +S +B PD  |
|  | 1.0 TSI 85<br>1.2 TSI 63<br>1.2 TSI 81<br>1.4 TSI 92<br>1.4 TSI 110<br>1.4 TSI MultiFuel 92<br>1.6 81<br>1.6 TDI 66<br>1.6 TDI 81<br>2.0 TDI 81<br>2.0 TDI 110 |  | 05.15<br>03.14<br>03.14<br>05.14<br>04.14<br>05.14<br>02.14<br>05.14<br>05.14    |   | 24.0711-6230.3 360310<br>24.0711-6337.3 360390                                    | 2  - Geschwindigkeitsregelanlage <sup>1)</sup><br>2  + Geschwindigkeitsregelanlage <sup>2)</sup> |  | Radsensor<br>Radsensor   |
|  | 1.0 TSI 85<br>1.2 TSI 63<br>1.2 TSI 81<br>1.4 TSI 92<br>1.4 TSI 110<br>1.4 TSI MultiFuel 92<br>1.6 81<br>1.6 TDI 66<br>1.6 TDI 81<br>2.0 TDI 81<br>2.0 TDI 110 |  | 05.15<br>03.14<br>03.14<br>05.14<br>04.14<br>05.14<br>02.14<br>05.14<br>05.14    |   | 24.0711-6230.3 360310<br>24.0711-6337.3 360390                                    | 2  - Parkassistent <sup>3)</sup><br>2  + Parkassistent <sup>4)</sup>                             |  | Radsensor<br>Radsensor   |













1) - speed control system / - impianto variatore di velocità / - régulateur de vitesse / - sistema de regulación de velocidad  
2) + speed control system / + impianto variatore di velocità / + régulateur de vitesse / + sistema de regulación de velocidad  
3) - parking assistant / - assistente di parcheggio / - assistance au stationnement / - asistente de aparcamiento  
4) + parking assistant / + assistente di parcheggio / + assistance au stationnement / + asistente de aparcamiento



















| VOLKSWAGEN GOLF VII Sportsvan (14-)  |                 |     |  |       |                             |                |        |   |                            |
|--|-----------------|-----|--|-------|-----------------------------|----------------|--------|---|----------------------------|
|     | 2.0 TDI         | 81  |  | 05.14 |                             | 24.0711-6230.3 | 360310 | 2  - Parkassistent <sup>1)</sup>               | Radsensor                  |
|  | 2.0 TDI         | 110 |  | 05.14 |                             | 24.0711-6337.3 | 360390 | 2  + Parkassistent <sup>2)</sup>               | Radsensor                  |
| VOLKSWAGEN GOLF VII ALLTRACK (14-)   |                 |     |  |       |                             |                |        |   |                            |
|    | 1.6 TDI 4motion | 81  |  | 12.14 | PR: 1ZA,1ZB,1ZD,1ZE,1ZP,1LV | 13.0460-2785.2 | 602785 |   | 25683 20,4 +/WK/S TRW      |
|  | 1.8 TSI 4motion | 132 |  | 12.14 | PR: 1ZA,1ZB,1ZD,1ZE,1ZP,1LV | 13.0470-2785.2 | LD2785 |   | 25683 20,4 +/WK/S TRW      |
|  | 2.0 TDI 4motion | 110 |  | 12.14 | PR: 1ZA,1ZB,1ZD,1ZE,1ZP,1LV |                |        |   |                            |
|  | 2.0 TDI 4motion | 135 |  | 12.14 | PR: 1ZA,1ZB,1ZD,1ZE,1ZP,1LV |                |        |   |                            |
|  | 1.6 TDI 4motion | 81  |  | 12.14 | PR: 1ZF                     | 13.0460-7303.2 | 607303 |   | 22035 17,5 +/WK ATE        |
|  | 1.8 TSI 4motion | 132 |  | 12.14 | PR: 1ZF                     | 13.0470-7303.2 | LD7303 |   | 22035 17,5 +/WK ATE        |
|  | 2.0 TDI 4motion | 110 |  | 12.14 | PR: 1ZF                     |                |        |   |                            |
|  | 2.0 TDI 4motion | 135 |  | 12.14 | PR: 1ZF                     |                |        |   |                            |
|  | 1.6 TDI 4motion | 81  |  | 12.14 | PR: 1LM                     | 13.0460-2764.2 | 602764 |   | 24738 20,0 +/WK/S TRW      |
|  | 1.8 TSI 4motion | 132 |  | 12.14 | PR: 1LM                     | 13.0470-2764.2 | LD2764 |   | 24738 20,0 +/WK/S TRW      |
|  | 2.0 TDI 4motion | 110 |  | 12.14 | PR: 1LM                     |                |        |   |                            |
|  | 2.0 TDI 4motion | 135 |  | 12.14 | PR: 1LM                     |                |        |   |                            |
|    | 1.6 TDI 4motion | 81  |  | 12.14 | PR: 1ZE,1ZP                 | 24.0125-0145.1 | 425145 |   | 288 25,0 22,0 V L +S +B    |
|  | 1.8 TSI 4motion | 132 |  | 12.14 | PR: 1ZE,1ZP                 | 24.0325-0145.1 | 525145 |   | 288 25,0 22,0 V L +S +B PD |
|  | 2.0 TDI 4motion | 110 |  | 12.14 | PR: 1ZE,1ZP                 |                |        |   |                            |
|  | 2.0 TDI 4motion | 135 |  | 12.14 | PR: 1ZE,1ZP                 |                |        |   |                            |
|  | 1.6 TDI 4motion | 81  |  | 12.14 | PR: 1ZA,1ZB,1ZD,1LV         | 24.0125-0158.1 | 425158 |   | 312 25,0 22,0 V L +S +B    |
|  | 1.8 TSI 4motion | 132 |  | 12.14 | PR: 1ZA,1ZB,1ZD,1LV         | 24.0325-0158.1 | 525158 |   | 312 25,0 22,0 V L +S +B PD |
|  | 2.0 TDI 4motion | 110 |  | 12.14 | PR: 1ZA,1ZB,1ZD,1LV         |                |        |   |                            |
|  | 2.0 TDI 4motion | 135 |  | 12.14 | PR: 1ZA,1ZB,1ZD,1LV         |                |        |   |                            |
|  | 1.6 TDI 4motion | 81  |  | 12.14 | PR: 1ZF                     | 24.0124-0258.1 | 424258 |   | 276 24,0 21,0 V L +S +B    |
|  | 1.8 TSI 4motion | 132 |  | 12.14 | PR: 1ZF                     |                |        |   |                            |
|  | 2.0 TDI 4motion | 110 |  | 12.14 | PR: 1ZF                     |                |        |   |                            |
|  | 2.0 TDI 4motion | 135 |  | 12.14 | PR: 1ZF                     |                |        |   |                            |
|  | 1.6 TDI 4motion | 81  |  | 12.14 | PR: 1LM                     | 24.0130-0225.1 | 430225 |   | 340 30,0 27,0 V L +S +B    |
|  | 1.8 TSI 4motion | 132 |  | 12.14 | PR: 1LM                     |                |        |   |                            |
|  | 2.0 TDI 4motion | 110 |  | 12.14 | PR: 1LM                     |                |        |   |                            |
|  | 2.0 TDI 4motion | 135 |  | 12.14 | PR: 1LM                     |                |        |   |                            |
|    | 1.6 TDI 4motion | 81  |  | 12.14 |                             | 24.0711-5273.3 | 360303 |    | Radsensor                  |
|  | 1.8 TSI 4motion | 132 |  | 12.14 |                             | 24.0711-5274.3 | 360304 |    | Radsensor                  |
|  | 2.0 TDI 4motion | 110 |  | 12.14 |                             |                |        |   |                            |
|  | 2.0 TDI 4motion | 135 |  | 12.14 |                             |                |        |   |                            |
|   | 1.6 TDI 4motion | 81  |  | 12.14 | PR: 1KE                     | 13.0460-7293.2 | 607293 |   | 25008 16,3 + ATE           |
|  | 1.8 TSI 4motion | 132 |  | 12.14 | PR: 1KE                     |                |        |   |                            |
|  | 2.0 TDI 4motion | 110 |  | 12.14 | PR: 1KE                     |                |        |   |                            |
|  | 2.0 TDI 4motion | 135 |  | 12.14 | PR: 1KE                     |                |        |   |                            |
|  | 1.6 TDI 4motion | 81  |  | 12.14 | PR: 1KV,1KY                 | 13.0460-7294.2 | 607294 |   | 25009 16,4 + ATE           |
|  | 1.8 TSI 4motion | 132 |  | 12.14 | PR: 1KV,1KY                 | 13.0470-7294.2 | LD7294 |   | 25009 16,4 + ATE           |
|  | 2.0 TDI 4motion | 110 |  | 12.14 | PR: 1KV,1KY                 |                |        |   |                            |
|  | 2.0 TDI 4motion | 135 |  | 12.14 | PR: 1KV,1KY                 |                |        |   |                            |
|  | 1.6 TDI 4motion | 81  |  | 12.14 | PR: 1KE                     | 24.0110-0356.1 | 410356 |   | 272 9,7 8,0 +S +B          |
|  | 1.8 TSI 4motion | 132 |  | 12.14 | PR: 1KE                     | 24.0310-0356.1 | 510356 |   | 272 9,7 8,0 +S +B PD       |
|  | 2.0 TDI 4motion | 110 |  | 12.14 | PR: 1KE                     |                |        |   |                            |
|  | 2.0 TDI 4motion | 135 |  | 12.14 | PR: 1KE                     |                |        |   |                            |
|  | 1.6 TDI 4motion | 81  |  | 12.14 | PR: 1KV                     | 24.0112-0210.1 | 412210 |   | 300 12,0 10,0 +S +B        |
|  | 1.8 TSI 4motion | 132 |  | 12.14 | PR: 1KV                     |                |        |   |                            |
|  | 2.0 TDI 4motion | 110 |  | 12.14 | PR: 1KV                     |                |        |   |                            |
|  | 2.0 TDI 4motion | 135 |  | 12.14 | PR: 1KV                     |                |        |   |                            |
|  | 1.6 TDI 4motion | 81  |  | 12.14 | PR: 1KY                     | 24.0122-0219.1 | 422219 |   | 310 22,0 20,0 V L +B       |
|  | 1.8 TSI 4motion | 132 |  | 12.14 | PR: 1KY                     |                |        |   |                            |
|  | 2.0 TDI 4motion | 110 |  | 12.14 | PR: 1KY                     |                |        |   |                            |
|  | 2.0 TDI 4motion | 135 |  | 12.14 | PR: 1KY                     |                |        |   |                            |
|  | 1.6 TDI 4motion | 81  |  | 12.14 |                             | 24.0711-5271.3 | 360301 |  - Geschwindigkeitsregelanlage <sup>3)</sup> | Radsensor                  |
|  | 1.8 TSI 4motion | 132 |  | 12.14 |                             | 24.0711-5272.3 | 360302 |  - Geschwindigkeitsregelanlage <sup>3)</sup> | Radsensor                  |
|  | 2.0 TDI 4motion | 110 |  | 12.14 |                             |                |        |   |                            |
|  | 2.0 TDI 4motion | 135 |  | 12.14 |                             |                |        |   |                            |
|  | 1.6 TDI 4motion | 81  |  | 12.14 |                             | 24.0711-5401.3 | 360330 |  + Geschwindigkeitsregelanlage <sup>4)</sup> | Radsensor                  |
|  | 1.8 TSI 4motion | 132 |  | 12.14 |                             | 24.0711-5402.3 | 360331 |  + Geschwindigkeitsregelanlage <sup>4)</sup> | Radsensor                  |
|  | 2.0 TDI 4motion | 110 |  | 12.14 |                             |                |        |   |                            |
|  | 2.0 TDI 4motion | 135 |  | 12.14 |                             |                |        |   |                            |
|  | 1.6 TDI 4motion | 81  |  | 12.14 |                             | 24.0711-5271.3 | 360301 |  - Parkassistent <sup>1)</sup>               | Radsensor                  |
|  | 1.8 TSI 4motion | 132 |  | 12.14 |                             | 24.0711-5272.3 | 360302 |  - Parkassistent <sup>1)</sup>               | Radsensor                  |
|  | 2.0 TDI 4motion | 110 |  | 12.14 |                             |                |        |   |                            |
|  | 2.0 TDI 4motion | 135 |  | 12.14 |                             |                |        |   |                            |
|  | 1.6 TDI 4motion | 81  |  | 12.14 |                             | 24.0711-5401.3 | 360330 |  + Parkassistent <sup>2)</sup>               | Radsensor                  |
|  | 1.8 TSI 4motion | 132 |  | 12.14 |                             | 24.0711-5402.3 | 360331 |  + Parkassistent <sup>2)</sup>               | Radsensor                  |
|  | 2.0 TDI 4motion | 110 |  | 12.14 |                             |                |        |   |                            |
|  | 2.0 TDI 4motion | 135 |  | 12.14 |                             |                |        |   |                            |
| VOLKSWAGEN GOLF Plus (05-14)   |                 |     |  |       |                             |                |        |   |                            |
|  | 1.2 TSI         |     |  | 08.09 | 01.14 PR: 1ZF,1ZM           | 13.0460-7117.2 | 607117 |   | 23131 19,6 +/WK VW         |
|  | 1.4 16V         |     |  | 01.05 | 01.14 PR: 1ZF,1ZM           | 13.0470-7117.2 | LD7117 |   | 23131 19,6 +/WK VW         |
|  | 1.4 FSI         | 66  |  | 07.05 | 01.14 PR: 1ZF,1ZM           |                |        |   |                            |
|  | 1.4 TSI         | 90  |  | 06.07 | 01.14 PR: 1ZF,1ZM           |                |        |   |                            |
|  | 1.4 TSI         | 103 |  | 05.06 | 01.14 PR: 1ZF,1ZM           |                |        |   |                            |
|  | 1.4 TSI         | 118 |  | 06.08 | 01.14 PR: 1ZF,1ZM           |                |        |   |                            |
|  | 1.4 TSI         | 125 |  | 05.06 | 01.14 PR: 1ZF,1ZM           |                |        |   |                            |
|  | 1.6             | 75  |  | 05.05 | 01.14 PR: 1ZF,1ZM           |                |        |   |                            |
|  | 1.6 BiFuel      | 75  |  | 05.09 | 01.14 PR: 1ZF,1ZM           |                |        |   |                            |
|  | 1.6 FSI         | 85  |  | 01.05 | 01.14 PR: 1ZF,1ZM           |                |        |   |                            |

1) - parking assistant / - assistente di parcheggio / - assistance au stationnement / - assistente de aparcamiento  
2) + parking assistant / + assistente di parcheggio / + assistance au stationnement / + assistente de aparcamiento  
3) - speed control system / - impianto variatore di velocità / - régulateur de vitesse / - sistema de regulación de velocidad  
4) + speed control system / + impianto variatore di velocità / + régulateur de vitesse / + sistema de regulación de velocidad



| VOLKSWAGEN GOLF Plus (05-14)   |  |         |       |                     |                     |                |                |        |   |       |                   |                   |  |
|--|--|---------|-------|---------------------|---------------------|----------------|----------------|--------|---|-------|-------------------|-------------------|--|
|    | 1.6 TDI  |         | 02.09 | 01.14               | PR: 1ZF,1ZM         | 13.0460-7117.2 | 607117         |        |   | 23131 | 19,6 +/WK         | VW                |  |
|  | 1.9 TDI  | 66      | 05.05 | 01.14               | PR: 1ZF,1ZM         | 13.0470-7117.2 | LD7117         |        |   | 23131 | 19,6 +/WK         | VW                |  |
|  | 1.9 TDI  | 77      | 01.05 | 01.14               | PR: 1ZF,1ZM         |                |                |        |   |       |                   |                   |  |
|  | 2.0 FSI  | 110     | 05.05 | 01.14               | PR: 1ZF,1ZM         |                |                |        |   |       |                   |                   |  |
|  | 2.0 TDI  |         | 05.05 | 01.14               | PR: 1ZF,1ZM         |                |                |        |   |       |                   |                   |  |
|  | 2.0 TDI  | 81      | 01.09 | 01.14               | PR: 1ZF,1ZM         |                |                |        |   |       |                   |                   |  |
|  | 2.0 TDI  | 103     | 01.05 | 01.14               | PR: 1ZF,1ZM         |                |                |        |   |       |                   |                   |  |
|  | 1.2 TSI  |         | 08.09 | 01.14               | PR: 1ZA,1ZP,1ZE,1LJ | 13.0460-7184.2 | 607184         |        |   | 23587 | 20,6 +/WK         | ATE               |  |
|  | 1.4 16V  |         | 01.05 | 01.14               | PR: 1ZA,1ZP,1ZE,1LJ | 13.0470-7184.2 | LD7184         |        |   | 23587 | 20,6 +/WK         | ATE               |  |
|  | 1.4 FSI  | 66      | 07.05 | 01.14               | PR: 1ZA,1ZP,1ZE,1LJ |                |                |        |   |       |                   |                   |  |
|  | 1.4 TSI  | 90      | 06.07 | 01.14               | PR: 1ZA,1ZP,1ZE,1LJ |                |                |        |   |       |                   |                   |  |
|  | 1.4 TSI  | 103     | 05.06 | 01.14               | PR: 1ZA,1ZP,1ZE,1LJ |                |                |        |   |       |                   |                   |  |
|  | 1.4 TSI  | 118     | 06.08 | 01.14               | PR: 1ZA,1ZP,1ZE,1LJ |                |                |        |   |       |                   |                   |  |
|  | 1.4 TSI  | 125     | 05.06 | 01.14               | PR: 1ZA,1ZP,1ZE,1LJ |                |                |        |   |       |                   |                   |  |
|  | 1.6  | 75      | 05.05 | 01.14               | PR: 1ZA,1ZP,1ZE,1LJ |                |                |        |   |       |                   |                   |  |
|  | 1.6 BiFuel   | 75      | 05.09 | 01.14               | PR: 1ZA,1ZP,1ZE,1LJ |                |                |        |   |       |                   |                   |  |
|  | 1.6 FSI  | 85      | 01.05 | 01.14               | PR: 1ZA,1ZP,1ZE,1LJ |                |                |        |   |       |                   |                   |  |
|  | 1.6 TDI  |         | 02.09 | 01.14               | PR: 1ZA,1ZP,1ZE,1LJ |                |                |        |   |       |                   |                   |  |
|  | 1.9 TDI  | 66      | 05.05 | 01.14               | PR: 1ZA,1ZP,1ZE,1LJ |                |                |        |   |       |                   |                   |  |
|  | 1.9 TDI  | 77      | 01.05 | 01.14               | PR: 1ZA,1ZP,1ZE,1LJ |                |                |        |   |       |                   |                   |  |
| 2.0 FSI  | 110  | 05.05   | 01.14 | PR: 1ZA,1ZP,1ZE,1LJ |                     |                |                |        |   |       |                   |                   |  |
| 2.0 TDI  |  | 05.05   | 01.14 | PR: 1ZA,1ZP,1ZE,1LJ |                     |                |                |        |   |       |                   |                   |  |
| 2.0 TDI  | 81   | 01.09   | 01.14 | PR: 1ZA,1ZP,1ZE,1LJ |                     |                |                |        |   |       |                   |                   |  |
| 2.0 TDI  | 103  | 01.05   | 01.14 | PR: 1ZA,1ZP,1ZE,1LJ |                     |                |                |        |   |       |                   |                   |  |
|    | 1.2 TSI  |         | 08.09 | 01.14               | PR: 1ZF,1ZM         | 24.0122-0210.1 | 422210         |        |   | 280   | 22,0 V L +S +B    |                   |  |
|  | 1.4 16V  |         | 01.05 | 01.14               | PR: 1ZF,1ZM         | 24.0322-0210.1 | 522210         |        |   | 280   | 22,0 V L +S +B PD |                   |  |
|  | 1.4 FSI  | 66      | 07.05 | 01.14               | PR: 1ZF,1ZM         |                |                |        |   |       |                   |                   |  |
|  | 1.4 TSI  | 90      | 06.07 | 01.14               | PR: 1ZF,1ZM         |                |                |        |   |       |                   |                   |  |
|  | 1.4 TSI  | 103     | 05.06 | 01.14               | PR: 1ZF,1ZM         |                |                |        |   |       |                   |                   |  |
|  | 1.4 TSI  | 118     | 06.08 | 01.14               | PR: 1ZF,1ZM         |                |                |        |   |       |                   |                   |  |
|  | 1.4 TSI  | 125     | 05.06 | 01.14               | PR: 1ZF,1ZM         |                |                |        |   |       |                   |                   |  |
|  | 1.6  | 75      | 05.05 | 01.14               | PR: 1ZF,1ZM         |                |                |        |   |       |                   |                   |  |
|  | 1.6 BiFuel   | 75      | 05.09 | 01.14               | PR: 1ZF,1ZM         |                |                |        |   |       |                   |                   |  |
|  | 1.6 FSI  | 85      | 01.05 | 01.14               | PR: 1ZF,1ZM         |                |                |        |   |       |                   |                   |  |
|  | 1.6 TDI  |         | 02.09 | 01.14               | PR: 1ZF,1ZM         |                |                |        |   |       |                   |                   |  |
|  | 1.9 TDI  | 66      | 05.05 | 01.14               | PR: 1ZF,1ZM         |                |                |        |   |       |                   |                   |  |
|  | 1.9 TDI  | 77      | 01.05 | 01.14               | PR: 1ZF,1ZM         |                |                |        |   |       |                   |                   |  |
|  | 2.0 FSI  | 110     | 05.05 | 01.14               | PR: 1ZF,1ZM         |                |                |        |   |       |                   |                   |  |
|  | 2.0 TDI  |         | 05.05 | 01.14               | PR: 1ZF,1ZM         |                |                |        |   |       |                   |                   |  |
|  | 2.0 TDI  | 81      | 01.09 | 01.14               | PR: 1ZF,1ZM         |                |                |        |   |       |                   |                   |  |
|  | 2.0 TDI  | 103     | 01.05 | 01.14               | PR: 1ZF,1ZM         |                |                |        |   |       |                   |                   |  |
|  |  | 1.2 TSI |       | 08.09               | 01.14               | PR: 1ZE,1ZP    | 24.0125-0145.1 | 425145 |   |       | 288               | 25,0 V L +S +B    |  |
|  |  | 1.4 16V |       | 01.05               | 01.14               | PR: 1ZE,1ZP    | 24.0325-0145.1 | 525145 |   |       | 288               | 25,0 V L +S +B PD |  |
|  |  | 1.4 FSI | 66    | 07.05               | 01.14               | PR: 1ZE,1ZP    |                |        |   |       |                   |                   |  |
| 1.4 TSI  |  | 90      | 06.07 | 01.14               | PR: 1ZE,1ZP         |                |                |        |   |       |                   |                   |  |
| 1.4 TSI  |  | 103     | 05.06 | 01.14               | PR: 1ZE,1ZP         |                |                |        |   |       |                   |                   |  |
| 1.4 TSI  |  | 118     | 06.08 | 01.14               | PR: 1ZE,1ZP         |                |                |        |   |       |                   |                   |  |
| 1.4 TSI  |  | 125     | 05.06 | 01.14               | PR: 1ZE,1ZP         |                |                |        |   |       |                   |                   |  |
| 1.6  |  | 75      | 05.05 | 01.14               | PR: 1ZE,1ZP         |                |                |        |   |       |                   |                   |  |
| 1.6 BiFuel   |  | 75      | 05.09 | 01.14               | PR: 1ZE,1ZP         |                |                |        |   |       |                   |                   |  |
| 1.6 FSI  |  | 85      | 01.05 | 01.14               | PR: 1ZE,1ZP         |                |                |        |   |       |                   |                   |  |
| 1.6 TDI  |  |         | 02.09 | 01.14               | PR: 1ZE,1ZP         |                |                |        |   |       |                   |                   |  |
| 1.9 TDI  |  | 66      | 05.05 | 01.14               | PR: 1ZE,1ZP         |                |                |        |   |       |                   |                   |  |
| 1.9 TDI  |  | 77      | 01.05 | 01.14               | PR: 1ZE,1ZP         |                |                |        |   |       |                   |                   |  |
| 2.0 FSI  |  | 110     | 05.05 | 01.14               | PR: 1ZE,1ZP         |                |                |        |   |       |                   |                   |  |
| 2.0 TDI  |  |         | 05.05 | 01.14               | PR: 1ZE,1ZP         |                |                |        |   |       |                   |                   |  |
| 2.0 TDI  |  | 81      | 01.09 | 01.14               | PR: 1ZE,1ZP         |                |                |        |   |       |                   |                   |  |
| 2.0 TDI  |  | 103     | 01.05 | 01.14               | PR: 1ZE,1ZP         |                |                |        |   |       |                   |                   |  |
|  |  | 1.2 TSI |       | 08.09               | 01.14               | PR: 1LJ,1ZA    | 24.0125-0158.1 | 425158 |   |       | 312               | 25,0 V L +S +B    |  |
|  |  | 1.4 16V |       | 01.05               | 01.14               | PR: 1LJ,1ZA    | 24.0325-0158.1 | 525158 |   |       | 312               | 25,0 V L +S +B PD |  |
|  |  | 1.4 FSI | 66    | 07.05               | 01.14               | PR: 1LJ,1ZA    |                |        |   |       |                   |                   |  |
|  | 1.4 TSI  | 90      | 06.07 | 01.14               | PR: 1LJ,1ZA         |                |                |        |   |       |                   |                   |  |
|  | 1.4 TSI  | 103     | 05.06 | 01.14               | PR: 1LJ,1ZA         |                |                |        |   |       |                   |                   |  |
|  | 1.4 TSI  | 118     | 06.08 | 01.14               | PR: 1LJ,1ZA         |                |                |        |   |       |                   |                   |  |
|  | 1.4 TSI  | 125     | 05.06 | 01.14               | PR: 1LJ,1ZA         |                |                |        |   |       |                   |                   |  |
|  | 1.6  | 75      | 05.05 | 01.14               | PR: 1LJ,1ZA         |                |                |        |   |       |                   |                   |  |
|  | 1.6 BiFuel   | 75      | 05.09 | 01.14               | PR: 1LJ,1ZA         |                |                |        |   |       |                   |                   |  |
|  | 1.6 FSI  | 85      | 01.05 | 01.14               | PR: 1LJ,1ZA         |                |                |        |   |       |                   |                   |  |
|  | 1.6 TDI  |         | 02.09 | 01.14               | PR: 1LJ,1ZA         |                |                |        |   |       |                   |                   |  |
|  | 1.9 TDI  | 66      | 05.05 | 01.14               | PR: 1LJ,1ZA         |                |                |        |   |       |                   |                   |  |
|  | 1.9 TDI  | 77      | 01.05 | 01.14               | PR: 1LJ,1ZA         |                |                |        |   |       |                   |                   |  |
|  | 2.0 FSI  | 110     | 05.05 | 01.14               | PR: 1LJ,1ZA         |                |                |        |   |       |                   |                   |  |
|  | 2.0 TDI  |         | 05.05 | 01.14               | PR: 1LJ,1ZA         |                |                |        |   |       |                   |                   |  |
|  | 2.0 TDI  | 81      | 01.09 | 01.14               | PR: 1LJ,1ZA         |                |                |        |   |       |                   |                   |  |
|  | 2.0 TDI  | 103     | 01.05 | 01.14               | PR: 1LJ,1ZA         |                |                |        |   |       |                   |                   |  |
|  |  | 1.2 TSI |       | 08.09               | 01.14               |                | 24.0711-5271.3 | 360301 |  |       | Radsensor         |                   |  |
|  |  | 1.4 16V |       | 01.05               | 01.14               |                | 24.0711-5272.3 | 360302 |  |       | Radsensor         |                   |  |
|  |  | 1.4 FSI | 66    | 07.05               | 01.14               |                |                |        |   |       |                   |                   |  |
| 1.4 TSI  |  | 90      | 06.07 | 01.14               |                     |                |                |        |   |       |                   |                   |  |
| 1.4 TSI  |  | 103     | 05.06 | 01.14               |                     |                |                |        |   |       |                   |                   |  |
| 1.4 TSI  |  | 118     | 06.08 | 01.14               |                     |                |                |        |   |       |                   |                   |  |
| 1.4 TSI  |  | 125     | 05.06 | 01.14               |                     |                |                |        |   |       |                   |                   |  |
| 1.6  |  | 75      | 05.05 | 01.14               |                     |                |                |        |   |       |                   |                   |  |
| 1.6 BiFuel   |  | 75      | 05.09 | 01.14               |                     |                |                |        |   |       |                   |                   |  |
| 1.6 FSI  |  | 85      | 01.05 | 01.14               |                     |                |                |        |   |       |                   |                   |  |
| 1.6 TDI  |  | 02.09   | 01.14 |                     |                     |                |                |        |   |       |                   |                   |  |
| 1.9 TDI  | 66   | 05.05   | 01.14 |                     |                     |                |                |        |   |       |                   |                   |  |

| VOLKSWAGEN GOLF Plus (05-14)   |   |   |  |  |   |  |  |                                  |                  |  |  |   |                        |
|--|---|---|--|--|---|--|--|----------------------------------|------------------|--|--|---|------------------------|
|    | 1.9 TDI<br>2.0 FSI<br>2.0 TDI<br>2.0 TDI<br>2.0 TDI   | 77<br>110<br>81<br>103  |  | 01.05<br>05.05<br>05.05<br>01.09<br>01.05  | 01.14<br>01.14<br>01.14<br>01.14<br>01.14   |  |  | 24.0711-5271.3<br>24.0711-5272.3 | 360301<br>360302 |  |  |   | Radsensor<br>Radsensor |
|    | 1.2 TSI<br>1.4 16V<br>1.4 FSI<br>1.4 TSI<br>1.4 TSI<br>1.4 TSI<br>1.4 TSI<br>1.6<br>1.6 BiFuel<br>1.6 BiFuel<br>1.6 FSI<br>1.6 TDI<br>1.6 TDI<br>1.9 TDI<br>1.9 TDI<br>2.0 FSI<br>2.0 TDI<br>2.0 TDI<br>2.0 TDI | 66<br>90<br>103<br>118<br>125<br>75<br>75<br>75<br>85<br>66<br>77<br>110<br>81<br>103 |  | 08.09<br>01.05<br>07.05<br>06.07<br>05.06<br>06.08<br>05.06<br>05.05<br>05.09<br>05.09<br>01.05<br>02.09<br>02.09<br>05.05<br>01.05<br>05.05<br>01.09<br>01.05 | 01.14<br>01.14<br>01.14<br>01.14<br>01.14<br>01.14<br>01.14<br>01.14<br>01.14<br>01.14<br>01.14<br>01.14<br>01.14<br>01.14<br>01.14<br>01.14<br>01.14<br>01.14<br>01.14 | PR: 1KD<br>PR: 1KD<br>PR: 1KD<br>PR: 1KD<br>PR: 1KD<br>PR: 1KD<br>PR: 1KD<br>PR: 1KD<br>PR: 1KD<br>PR: 1KD<br>PR: 1KD<br>PR: 1KD<br>PR: 1KD<br>PR: 1KD<br>PR: 1KD<br>PR: 1KD<br>PR: 1KD<br>PR: 1KD   | 13.0460-2820.2<br>13.0470-2820.2<br>13.0460-0259.2 | 602820<br>LD2820<br>610259       |                  |  |  | 20961 17,6 /S<br>20961 17,6 /S<br>Belagsatz-Zubehör               | TRW<br>TRW             |
|  | 1.2 TSI<br>1.4 16V<br>1.4 FSI<br>1.4 TSI<br>1.4 TSI<br>1.4 TSI<br>1.6<br>1.6 BiFuel<br>1.6 FSI<br>1.6 TDI<br>1.9 TDI<br>1.9 TDI<br>2.0 FSI<br>2.0 TDI<br>2.0 TDI<br>2.0 TDI                                     | 66<br>90<br>103<br>118<br>125<br>75<br>75<br>85<br>66<br>77<br>110<br>81<br>103       |  | 08.09<br>01.05<br>07.05<br>06.07<br>05.06<br>06.08<br>05.06<br>05.05<br>05.09<br>01.05<br>02.09<br>05.05<br>01.05<br>05.05<br>01.09<br>01.05                   | 01.14<br>01.14<br>01.14<br>01.14<br>01.14<br>01.14<br>01.14<br>01.14<br>01.14<br>01.14<br>01.14<br>01.14<br>01.14<br>01.14<br>01.14<br>01.14                            | PR: 1KE,1KZ<br>PR: 1KE,1KZ<br>PR: 1KE,1KZ<br>PR: 1KE,1KZ<br>PR: 1KE,1KZ<br>PR: 1KE,1KZ<br>PR: 1KE,1KZ<br>PR: 1KE,1KZ<br>PR: 1KE,1KZ<br>PR: 1KE,1KZ<br>PR: 1KE,1KZ<br>PR: 1KE,1KZ<br>PR: 1KE,1KZ<br>PR: 1KE,1KZ<br>PR: 1KE,1KZ<br>PR: 1KE,1KZ | 13.0460-2880.2<br>13.0470-2880.2<br>13.0460-0259.2 | 602880<br>LD2880<br>610259       |                  |  |  | 23914 17,1 /WE/Zub/S<br>23914 17,1 /WE/Zub/S<br>Belagsatz-Zubehör | TRW<br>TRW             |
|  | 1.2 TSI<br>1.4 16V<br>1.4 FSI<br>1.4 TSI<br>1.4 TSI<br>1.4 TSI<br>1.6<br>1.6 BiFuel<br>1.6 FSI<br>1.6 TDI<br>1.9 TDI<br>1.9 TDI<br>2.0 FSI<br>2.0 TDI<br>2.0 TDI<br>2.0 TDI                                     | 66<br>90<br>103<br>118<br>125<br>75<br>75<br>85<br>66<br>77<br>110<br>81<br>103       |  | 08.09<br>01.05<br>07.05<br>06.07<br>05.06<br>06.08<br>05.06<br>05.05<br>05.09<br>01.05<br>02.09<br>05.05<br>01.05<br>05.05<br>01.09<br>01.05                   | 01.14<br>01.14<br>01.14<br>01.14<br>01.14<br>01.14<br>01.14<br>01.14<br>01.14<br>01.14<br>01.14<br>01.14<br>01.14<br>01.14<br>01.14<br>01.14                            | PR: 1KD<br>PR: 1KD<br>PR: 1KD<br>PR: 1KD<br>PR: 1KD<br>PR: 1KD<br>PR: 1KD<br>PR: 1KD<br>PR: 1KD<br>PR: 1KD<br>PR: 1KD<br>PR: 1KD<br>PR: 1KD<br>PR: 1KD<br>PR: 1KD<br>PR: 1KD   | 24.0110-0277.1<br>24.0310-0277.1                   | 410277<br>510277                 |                  |  |  | 253 10,0 8,0 +S +B<br>253 10,0 8,0 +S +B PD                       |                        |
|  | 1.2 TSI<br>1.4 16V<br>1.4 FSI<br>1.4 TSI<br>1.4 TSI<br>1.4 TSI<br>1.6<br>1.6 BiFuel<br>1.6 FSI<br>1.6 TDI<br>1.9 TDI<br>1.9 TDI<br>2.0 FSI<br>2.0 TDI<br>2.0 TDI<br>2.0 TDI                                     | 66<br>90<br>103<br>118<br>125<br>75<br>75<br>85<br>66<br>77<br>110<br>81<br>103       |  | 08.09<br>01.05<br>07.05<br>06.07<br>05.06<br>06.08<br>05.06<br>05.05<br>05.09<br>01.05<br>02.09<br>05.05<br>01.05<br>05.05<br>01.09<br>01.05                   | 01.14<br>01.14<br>01.14<br>01.14<br>01.14<br>01.14<br>01.14<br>01.14<br>01.14<br>01.14<br>01.14<br>01.14<br>01.14<br>01.14<br>01.14<br>01.14                            | PR: 1KE<br>PR: 1KE<br>PR: 1KE<br>PR: 1KE<br>PR: 1KE<br>PR: 1KE<br>PR: 1KE<br>PR: 1KE<br>PR: 1KE<br>PR: 1KE<br>PR: 1KE<br>PR: 1KE<br>PR: 1KE<br>PR: 1KE<br>PR: 1KE  | 24.0112-0158.1<br>24.0312-0158.1                   | 412158<br>512158                 |                  |  |  | 256 12,0 10,0 +S +B<br>256 12,0 10,0 +B PD                        |                        |
|  | 1.2 TSI<br>1.4 16V<br>1.4 FSI<br>1.4 TSI<br>1.4 TSI<br>1.4 TSI<br>1.6<br>1.6 BiFuel<br>1.6 FSI<br>1.6 TDI<br>1.9 TDI<br>1.9 TDI<br>2.0 FSI<br>2.0 TDI<br>2.0 TDI<br>2.0 TDI                                     | 66<br>90<br>103<br>118<br>125<br>75<br>75<br>85<br>66<br>77<br>110<br>81<br>103       |  | 08.09<br>01.05<br>07.05<br>06.07<br>05.06<br>06.08<br>05.06<br>05.05<br>05.09<br>01.05<br>02.09<br>05.05<br>01.05<br>05.05<br>01.09<br>01.05                   | 01.14<br>01.14<br>01.14<br>01.14<br>01.14<br>01.14<br>01.14<br>01.14<br>01.14<br>01.14<br>01.14<br>01.14<br>01.14<br>01.14<br>01.14<br>01.14                            | PR: 1KZ<br>PR: 1KZ<br>PR: 1KZ<br>PR: 1KZ<br>PR: 1KZ<br>PR: 1KZ<br>PR: 1KZ<br>PR: 1KZ<br>PR: 1KZ<br>PR: 1KZ<br>PR: 1KZ<br>PR: 1KZ<br>PR: 1KZ<br>PR: 1KZ<br>PR: 1KZ  | 24.0112-0169.1<br>24.0312-0169.1                   | 412169<br>512169                 |                  |  |  | 282 12,0 10,0 +S +B<br>282 12,0 10,0 +S +B PD                     |                        |





















| VOLKSWAGEN GOLF Plus (05-14)   |  | VOLKSWAGEN JETTA V (05-10)   |  |  |   |  |  |  |  |
|--|--|--|--|--|---|--|--|--|--|
|     |    |  |    |  |  |  |  |  |  |
| <b>VOLKSWAGEN GOLF Plus (05-14)</b>  |  | <b>VOLKSWAGEN JETTA V (05-10)</b>  |  |  |   |  |  |  |  |
|    | 1.9 TDI 77<br>2.0 FSI 110<br>2.0 TDI 81<br>2.0 TDI 103   |  | 01.05 01.14 PR: 1KZ<br>05.05 01.14 PR: 1KZ<br>05.05 01.14 PR: 1KZ<br>01.09 01.14 PR: 1KZ<br>01.05 01.14 PR: 1KZ  | 24.0112-0169.1 412169<br>24.0312-0169.1 512169                                   |   |  |  | 282 12,0 10,0 +S +B<br>282 12,0 10,0 +S +B PD                                      |  |
|    | 1.2 TSI<br>1.4 16V<br>1.4 FSI 66<br>1.4 TSI 90<br>1.4 TSI 103<br>1.4 TSI 118<br>1.4 TSI 125<br>1.6 75<br>1.6 BiFuel 75<br>1.6 FSI 85<br>1.6 TDI<br>1.9 TDI 66<br>1.9 TDI 77<br>2.0 FSI 110<br>2.0 TDI<br>2.0 TDI 81<br>2.0 TDI 103 |  | 08.09 01.14<br>01.05 01.14<br>07.05 01.14<br>06.07 01.14<br>05.06 01.14<br>06.08 01.14<br>05.06 01.14<br>05.05 01.14<br>05.09 01.14<br>01.05 01.14<br>02.09 01.14<br>05.05 01.14<br>01.05 01.14<br>05.05 01.14<br>05.05 01.14<br>01.09 01.14<br>01.05 01.14  | 24.0711-6231.3 360305<br>24.0711-6232.3 360306                                   |   |  |  | Radsensor<br>Radsensor   |  |
|    | 1.4 TSI 90<br>1.4 TSI 103<br>1.4 TSI 118<br>1.4 TSI 125<br>1.6 FSI 85<br>1.6 i 16V 75<br>1.6 TDI<br>1.9 TDI 77<br>2.0 FSI 110<br>2.0 TDI 100<br>2.0 TDI 103<br>2.0 TDI 125<br>2.0 TFSI<br>2.5 FSI                                  |  | 05.07 10.10 PR: 12M<br>06.06 10.10 PR: 12M<br>07.08 10.10 PR: 12M<br>06.06 10.10 PR: 12M<br>08.05 10.10 PR: 12M<br>08.05 10.10 PR: 12M<br>06.09 10.10 PR: 12M<br>08.05 10.10 PR: 12M<br>08.05 10.10 PR: 12M<br>09.05 10.10 PR: 12M<br>08.05 10.10 PR: 12M<br>06.06 10.10 PR: 12M<br>10.05 10.10 PR: 12M<br>07.08 10.10 PR: 12M   | 13.0460-7117.2 607117<br>13.0470-7117.2 LD7117                                   |   |  | 23131 19,6 +/WK VW<br>23131 19,6 +/WK VW   |  |  |
|  | 1.4 TSI 90<br>1.4 TSI 103<br>1.4 TSI 118<br>1.4 TSI 125<br>1.6 FSI 85<br>1.6 i 16V 75<br>1.6 TDI<br>1.9 TDI 77<br>2.0 FSI 110<br>2.0 TDI 100<br>2.0 TDI 103<br>2.0 TDI 125<br>2.0 TFSI<br>2.5 FSI                                  |  | 05.07 10.10 PR: 1ZE,1ZP,1ZD,1LJ<br>06.06 10.10 PR: 1ZE,1ZP,1ZD,1LJ<br>07.08 10.10 PR: 1ZE,1ZP,1ZD,1LJ<br>06.06 10.10 PR: 1ZE,1ZP,1ZD,1LJ<br>08.05 10.10 PR: 1ZE,1ZP,1ZD,1LJ<br>08.05 10.10 PR: 1ZE,1ZP,1ZD,1LJ<br>06.09 10.10 PR: 1ZE,1ZP,1ZD,1LJ<br>08.05 10.10 PR: 1ZE,1ZP,1ZD,1LJ<br>08.05 10.10 PR: 1ZE,1ZP,1ZD,1LJ<br>09.05 10.10 PR: 1ZE,1ZP,1ZD,1LJ<br>08.05 10.10 PR: 1ZE,1ZP,1ZD,1LJ<br>06.06 10.10 PR: 1ZE,1ZP,1ZD,1LJ<br>10.05 10.10 PR: 1ZE,1ZP,1ZD,1LJ<br>07.08 10.10 PR: 1ZE,1ZP,1ZD,1LJ | 13.0460-7184.2 607184<br>13.0470-7184.2 LD7184                                   |   |  | 23587 20,6 +/WK ATE<br>23587 20,6 +/WK ATE   |  |  |
|  | 1.4 TSI 90<br>1.4 TSI 103<br>1.4 TSI 118<br>1.4 TSI 125<br>1.6 FSI 85<br>1.6 i 16V 75<br>1.6 TDI<br>1.9 TDI 77<br>2.0 FSI 110<br>2.0 TDI 100<br>2.0 TDI 103<br>2.0 TDI 125<br>2.0 TFSI<br>2.5 FSI                                  |  | 05.07 10.10 PR: 12M<br>06.06 10.10 PR: 12M<br>07.08 10.10 PR: 12M<br>06.06 10.10 PR: 12M<br>08.05 10.10 PR: 12M<br>08.05 10.10 PR: 12M<br>06.09 10.10 PR: 12M<br>08.05 10.10 PR: 12M<br>08.05 10.10 PR: 12M<br>09.05 10.10 PR: 12M<br>08.05 10.10 PR: 12M<br>06.06 10.10 PR: 12M<br>10.05 10.10 PR: 12M<br>07.08 10.10 PR: 12M   | 24.0122-0210.1 422210<br>24.0322-0210.1 522210                                   |   |  | 280 22,0 19,0 V L +S +B<br>280 22,0 19,0 V L +S +B PD                              |  |  |
|  | 1.4 TSI 90<br>1.4 TSI 103<br>1.4 TSI 118<br>1.4 TSI 125<br>1.6 FSI 85<br>1.6 i 16V 75<br>1.6 TDI<br>1.9 TDI 77<br>2.0 FSI 110<br>2.0 TDI 100<br>2.0 TDI 103<br>2.0 TDI 125<br>2.0 TFSI<br>2.5 FSI                                  |  | 05.07 10.10 PR: 1ZE,1ZP<br>06.06 10.10 PR: 1ZE,1ZP<br>07.08 10.10 PR: 1ZE,1ZP<br>06.06 10.10 PR: 1ZE,1ZP<br>08.05 10.10 PR: 1ZE,1ZP<br>08.05 10.10 PR: 1ZE,1ZP<br>06.09 10.10 PR: 1ZE,1ZP<br>08.05 10.10 PR: 1ZE,1ZP<br>08.05 10.10 PR: 1ZE,1ZP<br>09.05 10.10 PR: 1ZE,1ZP<br>08.05 10.10 PR: 1ZE,1ZP<br>06.06 10.10 PR: 1ZE,1ZP<br>10.05 10.10 PR: 1ZE,1ZP<br>07.08 10.10 PR: 1ZE,1ZP   | 24.0125-0145.1 425145<br>24.0325-0145.1 525145                                   |   |  | 288 25,0 22,0 V L +S +B<br>288 25,0 22,0 V L +S +B PD                              |  |  |
|  | 1.4 TSI 90<br>1.4 TSI 103<br>1.4 TSI 118<br>1.4 TSI 125<br>1.6 FSI 85<br>1.6 i 16V 75<br>1.6 TDI   |  | 05.07 10.10 PR: 1LJ,1ZD<br>06.06 10.10 PR: 1LJ,1ZD<br>07.08 10.10 PR: 1LJ,1ZD<br>06.06 10.10 PR: 1LJ,1ZD<br>08.05 10.10 PR: 1LJ,1ZD<br>08.05 10.10 PR: 1LJ,1ZD<br>06.09 10.10 PR: 1LJ,1ZD  | 24.0125-0158.1 425158<br>24.0325-0158.1 525158                                   |   |  | 312 25,0 22,0 V L +S +B<br>312 25,0 22,0 V L +S +B PD                              |  |  |

|     |   |  |   |    |  |    |  |  |
|--|---|--|---|--|---|--|--|--|
| <b>VOLKSWAGEN JETTA V (05-10)</b>  |   |  |   |  |   |  |  |  |
|    | 1.9 TDI 77<br>2.0 FSI 110<br>2.0 TDI 100<br>2.0 TDI 103<br>2.0 TDI 125<br>2.0 TFSI<br>2.5 FSI   |  | 08.05<br>08.05<br>09.05<br>08.05<br>06.06<br>10.05<br>07.08   | 10.10 PR: 1LJ,1ZD<br>10.10 PR: 1LJ,1ZD<br>10.10 PR: 1LJ,1ZD<br>10.10 PR: 1LJ,1ZD<br>10.10 PR: 1LJ,1ZD<br>10.10 PR: 1LJ,1ZD<br>10.10 PR: 1LJ,1ZD  | 24.0125-0158.1 425158<br>24.0325-0158.1 525158                                    |  |  | 312 25,0 22,0 VL +S +B<br>312 25,0 22,0 VL +S +B PD                                |
|    | 1.4 TSI 90<br>1.4 TSI 103<br>1.4 TSI 118<br>1.4 TSI 125<br>1.6 FSI 85<br>1.6 i 16V 75<br>1.6 TDI<br>1.9 TDI 77<br>2.0 FSI 110<br>2.0 TDI 100<br>2.0 TDI 103<br>2.0 TDI 125<br>2.0 TFSI<br>2.5 FSI |  | 05.07<br>06.06<br>07.08<br>06.06<br>08.05<br>08.05<br>06.09<br>08.05<br>08.05<br>08.05<br>09.05<br>08.05<br>06.06<br>10.05<br>07.08 | 10.10<br>10.10<br>10.10<br>10.10<br>10.10<br>10.10<br>10.10<br>10.10<br>10.10<br>10.10<br>10.10<br>10.10<br>10.10<br>10.10<br>10.10  | 24.0711-5271.3 360301<br>24.0711-5272.3 360302                                    | <br>     |  | Radsensor<br>Radsensor   |
|    | 1.4 TSI 90<br>1.4 TSI 103<br>1.4 TSI 118<br>1.4 TSI 125<br>1.6 FSI 85<br>1.6 i 16V 75<br>1.6 TDI<br>1.9 TDI 77<br>2.0 FSI 110<br>2.0 TDI 100<br>2.0 TDI 103<br>2.0 TDI 125<br>2.0 TFSI<br>2.5 FSI |  | 05.07<br>06.06<br>07.08<br>06.06<br>08.05<br>08.05<br>06.09<br>08.05<br>08.05<br>09.05<br>08.05<br>06.06<br>10.05<br>07.08          | 10.10 PR: 1KE,1KF,1KJ,1KV<br>10.10 PR: 1KE,1KF,1KJ,1KV<br>10.10 PR: 1KE,1KF,1KJ,1KV<br>10.10 PR: 1KE,1KF,1KJ,1KV<br>10.10 PR: 1KE,1KF,1KJ,1KV<br>10.10 PR: 1KE,1KF,1KJ,1KV<br>10.10 PR: 1KE,1KF,1KJ,1KV<br>10.10 PR: 1KE,1KF,1KJ,1KV<br>10.10 PR: 1KE,1KF,1KJ,1KV<br>10.10 PR: 1KE,1KF,1KJ,1KV<br>10.10 PR: 1KE,1KF,1KJ,1KV<br>10.10 PR: 1KE,1KF,1KJ,1KV<br>10.10 PR: 1KE,1KF,1KJ,1KV<br>10.10 PR: 1KE,1KF,1KJ,1KV | 13.0460-2880.2 602880<br>13.0470-2880.2 LD2880<br>13.0460-0259.2 610259           |  |  | 23914 17,1 /WE/Zub/S TRW<br>23914 17,1 /WE/Zub/S TRW<br>Belagsatz-Zubehör          |
|    | 1.4 TSI 90<br>1.4 TSI 103<br>1.4 TSI 118<br>1.4 TSI 125<br>1.6 FSI 85<br>1.6 i 16V 75<br>1.6 TDI<br>1.9 TDI 77<br>2.0 FSI 110<br>2.0 TDI 100<br>2.0 TDI 103<br>2.0 TDI 125<br>2.0 TFSI<br>2.5 FSI |  | 05.07<br>06.06<br>07.08<br>06.06<br>08.05<br>08.05<br>06.09<br>08.05<br>08.05<br>09.05<br>08.05<br>06.06<br>10.05<br>07.08          | 10.10 PR: 1KE,1KF<br>10.10 PR: 1KE,1KF<br>10.10 PR: 1KE,1KF<br>10.10 PR: 1KE,1KF<br>10.10 PR: 1KE,1KF<br>10.10 PR: 1KE,1KF<br>10.10 PR: 1KE,1KF<br>10.10 PR: 1KE,1KF<br>10.10 PR: 1KE,1KF<br>10.10 PR: 1KE,1KF<br>10.10 PR: 1KE,1KF<br>10.10 PR: 1KE,1KF<br>10.10 PR: 1KE,1KF  | 24.0112-0158.1 412158<br>24.0312-0158.1 512158                                    |  |  | 256 12,0 10,0 +S +B<br>256 12,0 10,0 +B PD   |
|  | 1.4 TSI 90<br>1.4 TSI 103<br>1.4 TSI 118<br>1.4 TSI 125<br>1.6 FSI 85<br>1.6 i 16V 75<br>1.6 TDI<br>1.9 TDI 77<br>2.0 FSI 110<br>2.0 TDI 100<br>2.0 TDI 103<br>2.0 TDI 125<br>2.0 TFSI<br>2.5 FSI |  | 05.07<br>06.06<br>07.08<br>06.06<br>08.05<br>08.05<br>06.09<br>08.05<br>08.05<br>09.05<br>08.05<br>06.06<br>10.05<br>07.08          | 10.10 PR: 1KJ,1KV,1KY<br>10.10 PR: 1KJ,1KV,1KY<br>10.10 PR: 1KJ,1KV,1KY<br>10.10 PR: 1KJ,1KV,1KY<br>10.10 PR: 1KJ,1KV,1KY<br>10.10 PR: 1KJ,1KV,1KY<br>10.10 PR: 1KJ,1KV,1KY<br>10.10 PR: 1KJ,1KV,1KY<br>10.10 PR: 1KJ,1KV,1KY<br>10.10 PR: 1KJ,1KV,1KY<br>10.10 PR: 1KJ,1KV,1KY<br>10.10 PR: 1KJ,1KV,1KY<br>10.10 PR: 1KJ,1KV,1KY  | 24.0112-0169.1 412169<br>24.0312-0169.1 512169                                    |  |  | 282 12,0 10,0 +S +B<br>282 12,0 10,0 +S +B PD                                      |
|  | 1.4 TSI 90<br>1.4 TSI 103<br>1.4 TSI 118<br>1.4 TSI 125<br>1.6 FSI 85<br>1.6 i 16V 75<br>1.6 TDI<br>1.9 TDI 77<br>2.0 FSI 110<br>2.0 TDI 100<br>2.0 TDI 103<br>2.0 TDI 125<br>2.0 TFSI<br>2.5 FSI |  | 05.07<br>06.06<br>07.08<br>06.06<br>08.05<br>08.05<br>06.09<br>08.05<br>08.05<br>09.05<br>08.05<br>06.06<br>10.05<br>07.08          | 10.10<br>10.10<br>10.10<br>10.10<br>10.10<br>10.10<br>10.10<br>10.10<br>10.10<br>10.10<br>10.10<br>10.10<br>10.10<br>10.10   | 24.0711-6231.3 360305<br>24.0711-6232.3 360306                                    | <br> |  | Radsensor<br>Radsensor   |
| <b>VOLKSWAGEN JETTA VI (10-)</b>   |   |  |   |  |   |  |  |  |
|  | 1.2 TSI 77<br>1.4 TSI<br>1.4 TSI 90<br>1.4 TSI 92<br>1.4 TSI 110<br>1.4 TSI Hybrid 110<br>1.6<br>1.6 TDI 77   |  | 04.11<br>04.11<br>04.11<br>08.14<br>08.14<br>04.11<br>12.11<br>04.11  | PR: 12M<br>PR: 12M<br>PR: 12M<br>PR: 12M<br>PR: 12M<br>PR: 12M<br>PR: 12M  | 13.0460-7117.2 607117<br>13.0470-7117.2 LD7117                                    |  |  | 23131 19,6 +/WK VW<br>23131 19,6 +/WK VW   |



| VOLKSWAGEN JETTA VI (10-)  |                |       |                 |                |                |        |  |                            |                            |    |  |
|--|----------------|-------|-----------------|----------------|----------------|--------|--|----------------------------|----------------------------|----|--|
|    | 1.8 TSI        | 125   | 07.14           | PR: 1ZM        | 13.0460-7117.2 | 607117 |  |                            | 23131 19,6 +WK             | VW |  |
|  | 2.0            | 85    | 06.10           | PR: 1ZM        | 13.0470-7117.2 | LD7117 |  |                            | 23131 19,6 +WK             | VW |  |
|  | 2.0 TDI        | 81    | 10.10           | PR: 1ZM        |                |        |  |                            |                            |    |  |
|  | 2.0 TDI        | 103   | 04.11           | PR: 1ZM        |                |        |  |                            |                            |    |  |
|  | 2.0 TDI        | 110   | 08.14           | PR: 1ZM        |                |        |  |                            |                            |    |  |
|  | 2.0 TSI        | 147   | 04.11           | PR: 1ZM        |                |        |  |                            |                            |    |  |
|  | 2.0 TSI        | 155   | 12.12           | PR: 1ZM        |                |        |  |                            |                            |    |  |
|  | 1.2 TSI        | 77    | 04.11           | PR: 1ZQ        | 13.0460-7111.2 | 607111 |  |                            | 23130 19,6 +               | VW |  |
|  | 1.4 TSI        |       | 04.11           | PR: 1ZQ        | 13.0470-7111.2 | LD7111 |  |                            | 23130 19,6 +               | VW |  |
|  | 1.4 TSI        | 90    | 04.11           | PR: 1ZQ        |                |        |  |                            |                            |    |  |
|  | 1.4 TSI        | 92    | 08.14           | PR: 1ZQ        |                |        |  |                            |                            |    |  |
|  | 1.4 TSI        | 110   | 08.14           | PR: 1ZQ        |                |        |  |                            |                            |    |  |
| 1.4 TSI Hybrid   | 110            | 04.11 | PR: 1ZQ         |                |                |        |  |                            |                            |    |  |
| 1.6  |                | 12.11 | PR: 1ZQ         |                |                |        |  |                            |                            |    |  |
| 1.6 TDI  | 77             | 04.11 | PR: 1ZQ         |                |                |        |  |                            |                            |    |  |
| 1.8 TSI  | 125            | 07.14 | PR: 1ZQ         |                |                |        |  |                            |                            |    |  |
| 2.0  | 85             | 06.10 | PR: 1ZQ         |                |                |        |  |                            |                            |    |  |
| 2.0 TDI  | 81             | 10.10 | PR: 1ZQ         |                |                |        |  |                            |                            |    |  |
| 2.0 TDI  | 103            | 04.11 | PR: 1ZQ         |                |                |        |  |                            |                            |    |  |
| 2.0 TDI  | 110            | 08.14 | PR: 1ZQ         |                |                |        |  |                            |                            |    |  |
| 2.0 TSI  | 147            | 04.11 | PR: 1ZQ         |                |                |        |  |                            |                            |    |  |
| 2.0 TSI  | 155            | 12.12 | PR: 1ZQ         |                |                |        |  |                            |                            |    |  |
| 1.2 TSI  | 77             | 04.11 | PR: 1ZA,1ZB,1ZE | 13.0460-7184.2 | 607184         |        |  | 23587 20,6 +WK             | ATE                        |    |  |
| 1.4 TSI  |                | 04.11 | PR: 1ZA,1ZB,1ZE | 13.0470-7184.2 | LD7184         |        |  | 23587 20,6 +WK             | ATE                        |    |  |
| 1.4 TSI  | 90             | 04.11 | PR: 1ZA,1ZB,1ZE |                |                |        |  |                            |                            |    |  |
| 1.4 TSI  | 92             | 08.14 | PR: 1ZA,1ZB,1ZE |                |                |        |  |                            |                            |    |  |
| 1.4 TSI  | 110            | 08.14 | PR: 1ZA,1ZB,1ZE |                |                |        |  |                            |                            |    |  |
| 1.4 TSI Hybrid   | 110            | 04.11 | PR: 1ZA,1ZB,1ZE |                |                |        |  |                            |                            |    |  |
| 1.6  |                | 12.11 | PR: 1ZA,1ZB,1ZE |                |                |        |  |                            |                            |    |  |
| 1.6 TDI  | 77             | 04.11 | PR: 1ZA,1ZB,1ZE |                |                |        |  |                            |                            |    |  |
| 1.8 TSI  | 125            | 07.14 | PR: 1ZA,1ZB,1ZE |                |                |        |  |                            |                            |    |  |
| 2.0  | 85             | 06.10 | PR: 1ZA,1ZB,1ZE |                |                |        |  |                            |                            |    |  |
| 2.0 TDI  | 81             | 10.10 | PR: 1ZA,1ZB,1ZE |                |                |        |  |                            |                            |    |  |
| 2.0 TDI  | 103            | 04.11 | PR: 1ZA,1ZB,1ZE |                |                |        |  |                            |                            |    |  |
| 2.0 TDI  | 110            | 08.14 | PR: 1ZA,1ZB,1ZE |                |                |        |  |                            |                            |    |  |
| 2.0 TSI  | 147            | 04.11 | PR: 1ZA,1ZB,1ZE |                |                |        |  |                            |                            |    |  |
| 2.0 TSI  | 155            | 12.12 | PR: 1ZA,1ZB,1ZE |                |                |        |  |                            |                            |    |  |
| 1.2 TSI  | 77             | 04.11 | PR: 1LV,1ZP     | 13.0460-7285.2 | 607285         |        |  | 23587 20,6 +               | ATE                        |    |  |
| 1.4 TSI  |                | 04.11 | PR: 1LV,1ZP     | 13.0470-7285.2 | LD7285         |        |  | 23587 20,6 +               | ATE                        |    |  |
| 1.4 TSI  | 90             | 04.11 | PR: 1LV,1ZP     |                |                |        |  |                            |                            |    |  |
| 1.4 TSI  | 92             | 08.14 | PR: 1LV,1ZP     |                |                |        |  |                            |                            |    |  |
| 1.4 TSI  | 110            | 08.14 | PR: 1LV,1ZP     |                |                |        |  |                            |                            |    |  |
| 1.4 TSI Hybrid   | 110            | 04.11 | PR: 1LV,1ZP     |                |                |        |  |                            |                            |    |  |
| 1.6  |                | 12.11 | PR: 1LV,1ZP     |                |                |        |  |                            |                            |    |  |
| 1.6 TDI  | 77             | 04.11 | PR: 1LV,1ZP     |                |                |        |  |                            |                            |    |  |
| 1.8 TSI  | 125            | 07.14 | PR: 1LV,1ZP     |                |                |        |  |                            |                            |    |  |
| 2.0  | 85             | 06.10 | PR: 1LV,1ZP     |                |                |        |  |                            |                            |    |  |
| 2.0 TDI  | 81             | 10.10 | PR: 1LV,1ZP     |                |                |        |  |                            |                            |    |  |
| 2.0 TDI  | 103            | 04.11 | PR: 1LV,1ZP     |                |                |        |  |                            |                            |    |  |
| 2.0 TDI  | 110            | 08.14 | PR: 1LV,1ZP     |                |                |        |  |                            |                            |    |  |
| 2.0 TSI  | 147            | 04.11 | PR: 1LV,1ZP     |                |                |        |  |                            |                            |    |  |
| 2.0 TSI  | 155            | 12.12 | PR: 1LV,1ZP     |                |                |        |  |                            |                            |    |  |
|  | 1.2 TSI        | 77    | 04.11           | PR: 1ZM,1ZQ    | 24.0122-0210.1 | 422210 |  |                            | 280 22,0 19,0 V L +S +B    |    |  |
|  | 1.4 TSI        |       | 04.11           | PR: 1ZM,1ZQ    | 24.0322-0210.1 | 522210 |  |                            | 280 22,0 19,0 V L +S +B PD |    |  |
|  | 1.4 TSI        | 90    | 04.11           | PR: 1ZM,1ZQ    |                |        |  |                            |                            |    |  |
|  | 1.4 TSI        | 92    | 08.14           | PR: 1ZM,1ZQ    |                |        |  |                            |                            |    |  |
|  | 1.4 TSI        | 110   | 08.14           | PR: 1ZM,1ZQ    |                |        |  |                            |                            |    |  |
|  | 1.4 TSI Hybrid | 110   | 04.11           | PR: 1ZM,1ZQ    |                |        |  |                            |                            |    |  |
|  | 1.6            |       | 12.11           | PR: 1ZM,1ZQ    |                |        |  |                            |                            |    |  |
|  | 1.6 TDI        | 77    | 04.11           | PR: 1ZM,1ZQ    |                |        |  |                            |                            |    |  |
|  | 1.8 TSI        | 125   | 07.14           | PR: 1ZM,1ZQ    |                |        |  |                            |                            |    |  |
|  | 2.0            | 85    | 06.10           | PR: 1ZM,1ZQ    |                |        |  |                            |                            |    |  |
|  | 2.0 TDI        | 81    | 10.10           | PR: 1ZM,1ZQ    |                |        |  |                            |                            |    |  |
|  | 2.0 TDI        | 103   | 04.11           | PR: 1ZM,1ZQ    |                |        |  |                            |                            |    |  |
| 2.0 TDI  | 110            | 08.14 | PR: 1ZM,1ZQ     |                |                |        |  |                            |                            |    |  |
| 2.0 TSI  | 147            | 04.11 | PR: 1ZM,1ZQ     |                |                |        |  |                            |                            |    |  |
| 2.0 TSI  | 155            | 12.12 | PR: 1ZM,1ZQ     |                |                |        |  |                            |                            |    |  |
| 1.2 TSI  | 77             | 04.11 | PR: 1ZE,1ZP     | 24.0125-0145.1 | 425145         |        |  | 288 25,0 22,0 V L +S +B    |                            |    |  |
| 1.4 TSI  |                | 04.11 | PR: 1ZE,1ZP     | 24.0325-0158.1 | 525158         |        |  | 312 25,0 22,0 V L +S +B PD |                            |    |  |
| 1.4 TSI  | 90             | 04.11 | PR: 1ZE,1ZP     |                |                |        |  |                            |                            |    |  |
| 1.4 TSI  | 92             | 08.14 | PR: 1ZE,1ZP     |                |                |        |  |                            |                            |    |  |
| 1.4 TSI  | 110            | 08.14 | PR: 1ZE,1ZP     |                |                |        |  |                            |                            |    |  |
| 1.4 TSI Hybrid   | 110            | 04.11 | PR: 1ZE,1ZP     |                |                |        |  |                            |                            |    |  |
| 1.6  |                | 12.11 | PR: 1ZE,1ZP     |                |                |        |  |                            |                            |    |  |
| 1.6 TDI  | 77             | 04.11 | PR: 1ZE,1ZP     |                |                |        |  |                            |                            |    |  |
| 1.8 TSI  | 125            | 07.14 | PR: 1ZE,1ZP     |                |                |        |  |                            |                            |    |  |
| 2.0  | 85             | 06.10 | PR: 1ZE,1ZP     |                |                |        |  |                            |                            |    |  |
| 2.0 TDI  | 81             | 10.10 | PR: 1ZE,1ZP     |                |                |        |  |                            |                            |    |  |
| 2.0 TDI  | 103            | 04.11 | PR: 1ZE,1ZP     |                |                |        |  |                            |                            |    |  |
| 2.0 TDI  | 110            | 08.14 | PR: 1ZE,1ZP     |                |                |        |  |                            |                            |    |  |
| 2.0 TSI  | 147            | 04.11 | PR: 1ZE,1ZP     |                |                |        |  |                            |                            |    |  |
| 2.0 TSI  | 155            | 12.12 | PR: 1ZE,1ZP     |                |                |        |  |                            |                            |    |  |
| 1.2 TSI  | 77             | 04.11 | PR: 1ZA,1ZB,1LV | 24.0125-0158.1 | 425158         |        |  | 312 25,0 22,0 V L +S +B    |                            |    |  |
| 1.4 TSI  |                | 04.11 | PR: 1ZA,1ZB,1LV | 24.0325-0145.1 | 525145         |        |  | 288 25,0 22,0 V L +S +B PD |                            |    |  |
| 1.4 TSI  | 90             | 04.11 | PR: 1ZA,1ZB,1LV |                |                |        |  |                            |                            |    |  |
| 1.4 TSI  | 92             | 08.14 | PR: 1ZA,1ZB,1LV |                |                |        |  |                            |                            |    |  |
| 1.4 TSI  | 110            | 08.14 | PR: 1ZA,1ZB,1LV |                |                |        |  |                            |                            |    |  |



|     |    |  |   |    |                 |    |  |  |
|--|--|--|---|--|--|--|--|--|
| <b>VOLKSWAGEN JETTA VI (10-)</b>   |  |  |   |  |  |  |  |  |
|    | 1.4 TSI Hybrid 110<br>1.6 77<br>1.8 TSI 125<br>2.0 85<br>2.0 TDI 103<br>2.0 TDI 110<br>2.0 TSI 147<br>2.0 TSI 155  |  | 04.11<br>12.11<br>04.11<br>07.14<br>06.10<br>10.10<br>04.11<br>08.14<br>04.11<br>12.12  | PR: 1ZA,1ZB,1LV<br>PR: 1ZA,1ZB,1LV<br>PR: 1ZA,1ZB,1LV<br>PR: 1ZA,1ZB,1LV<br>PR: 1ZA,1ZB,1LV<br>PR: 1ZA,1ZB,1LV<br>PR: 1ZA,1ZB,1LV<br>PR: 1ZA,1ZB,1LV<br>PR: 1ZA,1ZB,1LV<br>PR: 1ZA,1ZB,1LV                     | 24.0125-0158.1 425158<br>24.0325-0145.1 525145   |  |  | 312 25,0 22,0 V L +S +B<br>288 25,0 22,0 V L +S +B PD                              |
|    | 1.2 TSI 77<br>1.4 TSI 90<br>1.4 TSI 92<br>1.4 TSI 110<br>1.4 TSI Hybrid 110<br>1.6 77<br>1.6 TDI 77<br>1.8 TSI 125<br>2.0 85<br>2.0 TDI 81<br>2.0 TDI 103<br>2.0 TDI 110<br>2.0 TSI 147<br>2.0 TSI 155 |  | 04.11<br>04.11<br>04.11<br>08.14<br>08.14<br>04.11<br>12.11<br>04.11<br>07.14<br>06.10<br>10.10<br>04.11<br>08.14<br>04.11<br>12.12 |  | 24.0711-5271.3 360301<br>24.0711-5272.3 360302   | <br>   |  | Radsensor<br>Radsensor   |
|    | 1.2 TSI 77<br>1.4 TSI 90<br>1.4 TSI 92<br>1.4 TSI Hybrid 110<br>1.6 77<br>1.6 TDI 77<br>2.0 85<br>2.0 TDI 81<br>2.0 TDI 103<br>2.0 TDI 110<br>2.0 TSI 147<br>2.0 TSI 155                               |  | 04.11<br>04.11<br>04.11<br>04.11<br>12.11<br>04.11<br>06.10<br>10.10<br>04.11<br>04.11<br>04.11<br>12.12                            | PR: 1KS,1KT<br>PR: 1KS,1KT<br>PR: 1KS,1KT<br>PR: 1KS,1KT<br>PR: 1KS,1KT<br>PR: 1KS,1KT<br>PR: 1KS,1KT<br>PR: 1KS,1KT<br>PR: 1KS,1KT<br>PR: 1KS,1KT<br>PR: 1KS,1KT<br>PR: 1KS,1KT                               | 13.0460-3858.2 603858<br>13.0470-3858.2 LD3858   |  |  | 24563 17,7 /Zub/S BOS<br>24563 17,7 /Zub/S BOS                                     |
|  | 1.2 TSI 77<br>1.4 TSI 90<br>1.4 TSI 92<br>1.4 TSI 110<br>1.4 TSI Hybrid 110<br>1.6 77<br>1.6 TDI 77<br>1.8 TSI 125<br>2.0 85<br>2.0 TDI 81<br>2.0 TDI 103<br>2.0 TDI 110<br>2.0 TSI 147<br>2.0 TSI 155 |  | 04.11<br>04.11<br>04.11<br>08.14<br>08.14<br>04.11<br>12.11<br>04.11<br>07.14<br>06.10<br>10.10<br>04.11<br>08.14<br>04.11<br>12.12 | PR: 1KD,1KU<br>PR: 1KD,1KU<br>PR: 1KD,1KU<br>PR: 1KD,1KU<br>PR: 1KD,1KU<br>PR: 1KD,1KU<br>PR: 1KD,1KU<br>PR: 1KD,1KU<br>PR: 1KD,1KU<br>PR: 1KD,1KU<br>PR: 1KD,1KU<br>PR: 1KD,1KU<br>PR: 1KD,1KU<br>PR: 1KD,1KU | 13.0460-2823.2 602823<br>13.0470-2823.2 LD2823   |  |  | 23554 17,2 /S TRW<br>23554 17,2 /S TRW   |
|  | 1.2 TSI 77<br>1.4 TSI 90<br>1.4 TSI 92<br>1.4 TSI 110<br>1.4 TSI Hybrid 110<br>1.6 77<br>1.6 TDI 77<br>1.8 TSI 125<br>2.0 85<br>2.0 TDI 81<br>2.0 TDI 103<br>2.0 TDI 110<br>2.0 TSI 147<br>2.0 TSI 155 |  | 04.11<br>04.11<br>04.11<br>08.14<br>08.14<br>04.11<br>12.11<br>04.11<br>07.14<br>06.10<br>10.10<br>04.11<br>08.14<br>04.11<br>12.12 | PR: 1KD,1KU<br>PR: 1KD,1KU<br>PR: 1KD,1KU<br>PR: 1KD,1KU<br>PR: 1KD,1KU<br>PR: 1KD,1KU<br>PR: 1KD,1KU<br>PR: 1KD,1KU<br>PR: 1KD,1KU<br>PR: 1KD,1KU<br>PR: 1KD,1KU<br>PR: 1KD,1KU<br>PR: 1KD,1KU<br>PR: 1KD,1KU | 24.0110-0277.1 410277<br>24.0310-0277.1 510277   |  |  | 253 10,0 8,0 +S +B<br>253 10,0 8,0 +S +B PD  |
|  | 1.2 TSI 77<br>1.4 TSI 90<br>1.4 TSI 92<br>1.4 TSI Hybrid 110<br>1.6 77<br>1.6 TDI 77<br>2.0 85<br>2.0 TDI 81<br>2.0 TDI 103<br>2.0 TDI 110<br>2.0 TSI 147<br>2.0 TSI 155                               |  | 04.11<br>04.11<br>04.11<br>04.11<br>12.11<br>04.11<br>06.10<br>10.10<br>04.11<br>08.14<br>04.11<br>12.12                            | PR: 1KS,1KT<br>PR: 1KS,1KT<br>PR: 1KS,1KT<br>PR: 1KS,1KT<br>PR: 1KS,1KT<br>PR: 1KS,1KT<br>PR: 1KS,1KT<br>PR: 1KS,1KT<br>PR: 1KS,1KT<br>PR: 1KS,1KT<br>PR: 1KS,1KT<br>PR: 1KS,1KT                               | 24.0110-0356.1 410356<br>24.0310-0356.1 510356   |  |  | 272 9,7 8,0 +S +B<br>272 9,7 8,0 +S +B PD  |
|  | 1.2 TSI 77<br>1.4 TSI 90<br>1.4 TSI 92<br>1.4 TSI 110<br>1.4 TSI Hybrid 110<br>1.6 77<br>1.6 TDI 77<br>1.8 TSI 125<br>2.0 85   |  | 04.11<br>04.11<br>04.11<br>08.14<br>08.14<br>04.11<br>12.11<br>04.11<br>07.14<br>06.10  | PR: 1KS,1KT<br>PR: 1KS,1KT<br>PR: 1KS,1KT<br>PR: 1KS,1KT<br>PR: 1KS,1KT<br>PR: 1KS,1KT<br>PR: 1KS,1KT<br>PR: 1KS,1KT<br>PR: 1KS,1KT<br>PR: 1KS,1KT   | 24.0711-6231.3 360305<br>24.0711-6232.3 360306<br>24.0711-6335.3 360365<br>24.0711-6336.3 360366 | <br><br><br> |  | Radsensor<br>Radsensor<br>Radsensor<br>Radsensor                                   |

1) - lane change assist / - BLIS (Blind Spot Information System) / - assistance pour changement de voie / - asistente de cambio de carril  
2) + lane change assist / + BLIS (Blind Spot Information System) / + assistance pour changement de voie / + asistente de cambio de carril



**VOLKSWAGEN JETTA VI (10-)**

|  |         |     |  |       |  |                |        |   |           |
|--|---------|-----|--|-------|--|----------------|--------|---|-----------|
|  | 2.0 TDI | 81  |  | 10.10 |  | 24.0711-6231.3 | 360305 | <input type="checkbox"/> - Spurwechsellassistent 1) | Radsensor |
|  | 2.0 TDI | 103 |  | 04.11 |  | 24.0711-6232.3 | 360306 | <input type="checkbox"/> - Spurwechsellassistent 1) | Radsensor |
|  | 2.0 TDI | 110 |  | 08.14 |  | 24.0711-6335.3 | 360365 | <input type="checkbox"/> + Spurwechsellassistent 2) | Radsensor |
|  | 2.0 TSI | 147 |  | 04.11 |  | 24.0711-6336.3 | 360366 | <input type="checkbox"/> + Spurwechsellassistent 2) | Radsensor |
|  | 2.0 TSI | 155 |  | 12.12 |  |                |        |   |           |

**VOLKSWAGEN LT/LT 4x4 (96-06)**

|  |       |  |  |       |       |                |        |   |                            |                       |
|--|-------|--|--|-------|-------|----------------|--------|---|----------------------------|-----------------------|
|  | LT 28 |  |  | 05.96 | 07.06 | 13.0460-7196.2 | 607196 |   | 21576 20,7 +/WE            | ATE                   |
|  | LT 35 |  |  | 05.96 | 07.06 | 24.8190-0417.2 | 620417 | 2 | Warnkontakt L=99(167)mm    |                       |
|  | LT 46 |  |  | 05.96 | 07.06 | 13.0460-7909.2 | 607909 |   | 29153 20,0 /WE/Zub/S       | PER                   |
|  |       |  |  |       |       | 13.0460-0281.2 | 610281 |   | Belagsatz-Zubehör          | PER                   |
|  |       |  |  |       |       | 24.8190-0417.2 | 620417 | 2 | Warnkontakt L=99(167)mm    |                       |
|  | LT 28 |  |  | 05.96 | 07.06 | 24.0122-0161.1 | 422161 |   | 276 22,0 19,0 V L +S +B    |                       |
|  | LT 35 |  |  | 05.96 | 07.06 | 24.0322-0161.1 | 522161 |   | 276 22,0 19,0 V L +S +B PD |                       |
|  | LT 46 |  |  | 05.96 | 07.06 |                |        |   |                            |                       |
|  | LT 28 |  |  | 05.96 | 07.06 | 13.0460-7083.2 | 607083 |   | 21621 17,3 +/WE            | ATE                   |
|  | LT 35 |  |  | 05.96 | 07.06 | 24.8190-0407.2 | 620407 | 2 | Warnkontakt L=84(185)mm    |                       |
|  | LT 46 |  |  | 05.96 | 07.06 | 13.0460-7084.2 | 607084 |   | 21592 18,8 +/WE            | ATE                   |
|  |       |  |  |       |       | 24.8190-0407.2 | 620407 | 2 | Warnkontakt L=84(185)mm    |                       |
|  | LT 35 |  |  | 05.96 | 12.03 | 13.0460-3990.2 | 603990 |   | 23021 18,9 /WE             | BOS                   |
|  |       |  |  |       |       | 13.0460-0250.2 | 610250 |   | Belagsatz-Zubehör          | BOS                   |
|  | LT 46 |  |  | 05.96 | 07.06 | 13.0460-7909.2 | 607909 |   | 29153 20,0 /WE/Zub/S       | PER                   |
|  |       |  |  |       |       | 13.0460-0281.2 | 610281 |   | Belagsatz-Zubehör          | PER                   |
|  |       |  |  |       |       | 24.8190-0417.2 | 620417 | 2 | Warnkontakt L=99(167)mm    |                       |
|  | LT 28 |  |  | 05.96 | 07.06 | 24.0112-0142.1 | 412142 |   | für Baumuster LT 28 3)     | 258 12,0 10,0 L +S +B |
|  | LT 35 |  |  | 05.96 | 07.06 | 24.0116-0110.1 | 416110 |   |                            | 272 16,0 14,0 L +S +B |
|  | LT 46 |  |  | 05.96 | 07.06 | 24.0122-0196.1 | 422196 |   | für Baumuster LT 46 4)     | 285 21,9 19,0 V L +B  |
|  | LT 28 |  |  | 05.96 | 07.06 | 03.0137-0397.2 | 650397 |   | 160 x 40                   |                       |
|  | LT 35 |  |  | 05.96 | 07.06 | 03.0137-9255.2 | 669255 |   | Bremsbacken-Zubehör        |                       |
|  |       |  |  |       |       | 03.0137-4001.2 | 654001 |   | 160 x 40 /Zub              |                       |
|  | LT 46 |  |  | 05.96 | 07.06 | 03.0137-4015.2 | 654015 |   | 170 x 40 /Zub              |                       |
|  |       |  |  |       |       | 03.0137-9256.2 | 669256 |   | Bremsbacken-Zubehör        |                       |

**VOLKSWAGEN LUPO (98-05)**

|  |            |    |  |       |       |                     |                |        |                          |                            |     |
|--|------------|----|--|-------|-------|---------------------|----------------|--------|--------------------------|----------------------------|-----|
|  | 1.2 TDI 3L | 45 |  | 06.99 | 08.05 | PR: 1ZB             | 13.0460-7177.2 | 607177 |                          | 23394 13,7 +               | VW  |
|  | 1.0        |    |  | 04.98 | 08.05 | PR: 1LM,1ZN,1LB,1ZC | 13.0460-7100.2 | 607100 |                          | 21866 17,2 +               | VW  |
|  | 1.4        | 44 |  | 09.00 | 08.05 | PR: 1LM,1ZN,1LB,1ZC | 13.0470-7100.2 | LD7100 |                          | 21866 17,2 +               | ATE |
|  | 1.4 16V    | 55 |  | 10.98 | 08.05 | PR: 1LM,1ZN,1LB,1ZC |                |        |                          |                            |     |
|  | 1.4 16V    | 74 |  | 01.99 | 08.05 | PR: 1LM,1ZN,1LB,1ZC |                |        |                          |                            |     |
|  | 1.4 FSI    | 77 |  | 09.00 | 08.05 | PR: 1LM,1ZN,1LB,1ZC |                |        |                          |                            |     |
|  | 1.4 TDI    | 55 |  | 01.99 | 08.05 | PR: 1LM,1ZN,1LB,1ZC |                |        |                          |                            |     |
|  | 1.6 GTI    | 92 |  | 09.00 | 08.05 | PR: 1LM,1ZN,1LB,1ZC |                |        |                          |                            |     |
|  | 1.7 SDI    |    |  | 04.98 | 08.05 | PR: 1LM,1ZN,1LB,1ZC |                |        |                          |                            |     |
|  | 1.0        |    |  | 04.98 | 08.05 | PR: 1ZE,1ZJ,1ZK,1LX | 13.0460-2821.2 | 602821 |                          | 21945 16,0 /S              | TRW |
|  | 1.4        | 44 |  | 09.00 | 08.05 | PR: 1ZE,1ZJ,1ZK,1LX |                |        |                          |                            |     |
|  | 1.4 16V    | 55 |  | 10.98 | 08.05 | PR: 1ZE,1ZJ,1ZK,1LX |                |        |                          |                            |     |
|  | 1.4 16V    | 74 |  | 01.99 | 08.05 | PR: 1ZE,1ZJ,1ZK,1LX |                |        |                          |                            |     |
|  | 1.4 FSI    | 77 |  | 09.00 | 08.05 | PR: 1ZE,1ZJ,1ZK,1LX |                |        |                          |                            |     |
|  | 1.4 TDI    | 55 |  | 01.99 | 08.05 | PR: 1ZE,1ZJ,1ZK,1LX |                |        |                          |                            |     |
|  | 1.6 GTI    | 92 |  | 09.00 | 08.05 | PR: 1ZE,1ZJ,1ZK,1LX |                |        |                          |                            |     |
|  | 1.7 SDI    |    |  | 04.98 | 08.05 | PR: 1ZE,1ZJ,1ZK,1LX |                |        |                          |                            |     |
|  | 1.2 TDI 3L | 45 |  | 06.99 | 08.05 | PR: 1ZB             | 24.0115-0109.1 | 415109 |                          | 239 15,0 13,0 V L +B       |     |
|  | 1.0        |    |  | 04.98 | 08.05 | PR: 1LM,1ZN,1LB,1ZC | 24.0118-0106.1 | 418106 |                          | 239 18,0 16,0 V L +S +B    |     |
|  | 1.4        | 44 |  | 09.00 | 08.05 | PR: 1LM,1ZN,1LB,1ZC | 24.0318-0106.1 | 518106 |                          | 239 18,0 16,0 V L +S +B PD |     |
|  | 1.4 16V    | 55 |  | 10.98 | 08.05 | PR: 1LM,1ZN,1LB,1ZC |                |        |                          |                            |     |
|  | 1.4 16V    | 74 |  | 01.99 | 08.05 | PR: 1LM,1ZN,1LB,1ZC |                |        |                          |                            |     |
|  | 1.4 FSI    | 77 |  | 09.00 | 08.05 | PR: 1LM,1ZN,1LB,1ZC |                |        |                          |                            |     |
|  | 1.4 TDI    | 55 |  | 01.99 | 08.05 | PR: 1LM,1ZN,1LB,1ZC |                |        |                          |                            |     |
|  | 1.6 GTI    | 92 |  | 09.00 | 08.05 | PR: 1LM,1ZN,1LB,1ZC |                |        |                          |                            |     |
|  | 1.7 SDI    |    |  | 04.98 | 08.05 | PR: 1LM,1ZN,1LB,1ZC |                |        |                          |                            |     |
|  | 1.0        |    |  | 04.98 | 08.05 | PR: 1ZE,1ZJ,1ZK     | 24.0120-0128.1 | 420128 |                          | 256 20,0 18,0 V L +S +B    |     |
|  | 1.4        | 44 |  | 09.00 | 08.05 | PR: 1ZE,1ZJ,1ZK     | 24.0320-0128.1 | 520128 |                          | 256 20,0 18,0 V L +S +B PD |     |
|  | 1.4 16V    | 55 |  | 10.98 | 08.05 | PR: 1ZE,1ZJ,1ZK     |                |        |                          |                            |     |
|  | 1.4 16V    | 74 |  | 01.99 | 08.05 | PR: 1ZE,1ZJ,1ZK     |                |        |                          |                            |     |
|  | 1.4 FSI    | 77 |  | 09.00 | 08.05 | PR: 1ZE,1ZJ,1ZK     |                |        |                          |                            |     |
|  | 1.4 TDI    | 55 |  | 01.99 | 08.05 | PR: 1ZE,1ZJ,1ZK     |                |        |                          |                            |     |
|  | 1.6 GTI    | 92 |  | 09.00 | 08.05 | PR: 1ZE,1ZJ,1ZK     |                |        |                          |                            |     |
|  | 1.7 SDI    |    |  | 04.98 | 08.05 | PR: 1ZE,1ZJ,1ZK     |                |        |                          |                            |     |
|  | 1.0        |    |  | 04.98 | 08.05 | PR: 1LX             | 24.0125-0136.1 | 425136 |                          | 256 25,0 23,0 V L          |     |
|  | 1.4        | 44 |  | 09.00 | 08.05 | PR: 1LX             |                |        |                          |                            |     |
|  | 1.4 16V    | 55 |  | 10.98 | 08.05 | PR: 1LX             |                |        |                          |                            |     |
|  | 1.4 16V    | 74 |  | 01.99 | 08.05 | PR: 1LX             |                |        |                          |                            |     |
|  | 1.4 FSI    | 77 |  | 09.00 | 08.05 | PR: 1LX             |                |        |                          |                            |     |
|  | 1.4 TDI    | 55 |  | 01.99 | 08.05 | PR: 1LX             |                |        |                          |                            |     |
|  | 1.6 GTI    | 92 |  | 09.00 | 08.05 | PR: 1LX             |                |        |                          |                            |     |
|  | 1.7 SDI    |    |  | 04.98 | 08.05 | PR: 1LX             |                |        |                          |                            |     |
|  | 1.0        |    |  | 04.98 | 08.05 |                     | 24.0711-1361.3 | 360022 | <input type="checkbox"/> | Radsensor                  |     |
|  | 1.4        | 44 |  | 09.00 | 08.05 |                     | 24.0711-1362.3 | 360023 | <input type="checkbox"/> | Radsensor                  |     |
|  | 1.4 16V    | 55 |  | 10.98 | 08.05 |                     |                |        |                          |                            |     |
|  | 1.4 16V    | 74 |  | 01.99 | 08.05 |                     |                |        |                          |                            |     |
|  | 1.4 FSI    | 77 |  | 09.00 | 08.05 |                     |                |        |                          |                            |     |
|  | 1.4 TDI    | 55 |  | 01.99 | 08.05 |                     |                |        |                          |                            |     |
|  | 1.6 GTI    | 92 |  | 09.00 | 08.05 |                     |                |        |                          |                            |     |
|  | 1.7 SDI    |    |  | 04.98 | 08.05 |                     |                |        |                          |                            |     |

1) - lane change assist / - BLIS (Blind Spot Information System) / - assistance pour changement de voie / - asistente de cambio de carril  
 2) + lane change assist / + BLIS (Blind Spot Information System) / + assistance pour changement de voie / + asistente de cambio de carril  
 3) for design sample LT 28 / per modello tipo LT 28 / pour modèle type LT 28 / para modelo construcc. LT 28  
 4) for design sample LT 46 / per modello tipo LT 46 / pour modèle type LT 46 / para modelo construcc. LT 46



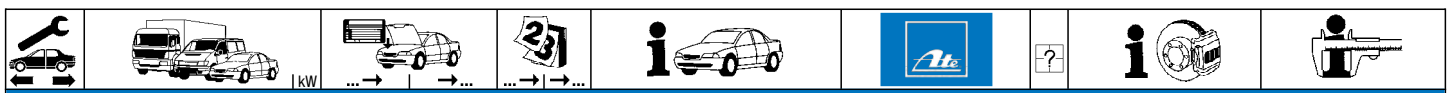

### VOLKSWAGEN LUPO (98-05)

|  |  |                                  |  |  |  |                                  |  |                            |   |   |                   |
|--|--|----------------------------------|--|--|--|----------------------------------|--|----------------------------|---|---|-------------------|
|  | 1.4 16V<br>1.4 FSI<br>1.6 GTI  | 74<br>77<br>92                   |  | 01.99<br>09.00<br>09.00  | 08.05<br>08.05<br>08.05  |                                  | 13.0460-2864.2<br>13.0460-2877.2<br>13.0470-2877.2 | 602864<br>602877<br>LD2877 |   | 20961 17,4 /S<br>23554 17,2 +/WK/S<br>23554 17,2 +/WK/S | TRW<br>TRW<br>TRW |
|  | 1.4 16V<br>1.4 FSI<br>1.6 GTI  | 74<br>77<br>92                   |  | 01.99<br>09.00<br>09.00  | 08.05<br>08.05<br>08.05  |                                  | 24.0109-0124.1                                     | 409124                     |   | 232 9,0 7,0 +B  |                   |
|  | 1.0<br>1.4<br>1.4 16V<br>1.4 16V<br>1.4 FSI<br>1.4 TDI<br>1.6 GTI<br>1.7 SDI | 44<br>55<br>74<br>77<br>55<br>92 |  | 04.98<br>09.00<br>10.98<br>01.99<br>09.00<br>01.99<br>09.00<br>04.98 | 08.05<br>08.05<br>08.05<br>08.05<br>08.05<br>08.05<br>08.05<br>08.05 |                                  | 24.0741-1107.3                                     | 360042                     | 2 | Radsensor   |                   |
|  | 1.2 TDI 3L   | 45                               |  | 06.99  | 08.05  |                                  | 24.0711-6049.3<br>24.0711-6050.3                   | 360126<br>360127           |   | Radsensor<br>Radsensor                                  |                   |
|  | 1.0<br>1.4 16V<br>1.4 TDI<br>1.7 SDI   | 55<br>55                         | 6X-X-003000<br>6X-X-003000<br>6X-X-003000<br>6X-X-003000 | 04.98<br>10.98<br>01.99<br>04.98                                     |  |                                  | 03.0137-0126.2<br>03.0137-9008.2                   | 650126<br>669008           |   | 180 x 31 HEB<br>Bremsbacken-Zubehör                     |                   |
|  | 1.0<br>1.4<br>1.4 16V<br>1.4 TDI<br>1.7 SDI                                  | 44<br>55<br>55<br>55             | 6X-X-003001<br>6X-X-003001<br>6X-X-003001<br>6X-X-003001 | 09.00  | 08.05<br>08.05<br>08.05<br>08.05                                     |                                  | 03.0137-0268.2<br>03.0137-9168.2                   | 650268<br>669168           |   | 200 x 40 HEB<br>Bremsbacken-Zubehör                     | VW<br>VW          |
|  | 1.2 TDI 3L   | 45                               |  | 06.99  | 08.05  |                                  | 03.0137-9008.2                                     | 669008                     |   | Bremsbacken-Zubehör                                     |                   |
|  | 1.0<br>1.4 16V<br>1.4 TDI<br>1.7 SDI   | 55<br>55                         | 6X-X-003000<br>6X-X-003000<br>6X-X-003000<br>6X-X-003000 | 04.98<br>10.98<br>01.99<br>04.98                                     |  |                                  | 24.0218-0036.1                                     | 480147                     |   | 180/181,5 x 41  |                   |
|  | 1.0<br>1.4<br>1.4 16V<br>1.4 TDI<br>1.7 SDI                                  | 44<br>55<br>55<br>55             | 6X-X-003001<br>6X-X-003001<br>6X-X-003001<br>6X-X-003001 | 09.00  | 08.05<br>08.05<br>08.05<br>08.05                                     |                                  | 24.0220-0032.1                                     | 480130                     |   | 200/201,5 x 50,1  |                   |
|  | 1.0<br>1.4 16V<br>1.4 TDI<br>1.7 SDI   | 55<br>55                         | 6X-X-003000<br>6X-X-003000<br>6X-X-003000<br>6X-X-003000 | 04.98<br>10.98<br>01.99<br>04.98                                     |  | - ABS<br>- ABS<br>- ABS<br>- ABS | 03.0520-0215.3                                     | 690215                     |   | 15,87/180x31 TopKit                                     | VW                |
|  | 1.0<br>1.4<br>1.4 16V<br>1.4 TDI<br>1.7 SDI                                  | 44<br>55<br>55<br>55             | 6X-X-003001<br>6X-X-003001<br>6X-X-003001<br>6X-X-003001 | 09.00  | 08.05<br>08.05<br>08.05<br>08.05                                     | - ABS<br>- ABS<br>- ABS<br>- ABS | 03.0520-0415.3                                     | 690415                     |   | 15,87/200x40 TopKit                                     | VW                |
|  | 1.0<br>1.4<br>1.4 16V<br>1.4 TDI<br>1.7 SDI                                  | 44<br>55<br>55<br>55             | 6X-X-003001<br>6X-X-003001<br>6X-X-003001<br>6X-X-003001 | 09.00  | 08.05<br>08.05<br>08.05<br>08.05                                     | + ABS<br>+ ABS<br>+ ABS<br>+ ABS | 03.0520-1517.3<br>03.0420-1517.3                   | 691517<br>681517           |   | 17,46/200x40 TopKit<br>17,46/200x40 Kit                 | VW<br>VW          |

### VOLKSWAGEN NEW BEETLE (98-10)

|  |   |  |                            |   |   |  |                                  |                  |  |   |            |
|--|---|--|----------------------------|---|---|--|----------------------------------|------------------|--|---|------------|
|  | 1.9 TDI<br>2.0  | 66<br>85   | 9C-X-999000<br>9C-X-999000 | 01.98<br>01.98  |   | PR: 1ZM<br>PR: 1ZM   | 13.0460-7111.2<br>13.0470-7111.2 | 607111<br>LD7111 |  | 23130 19,6 +<br>23130 19,6 +                          | VW<br>VW   |
|  | 1.4<br>1.6<br>1.8 T<br>1.8 T<br>1.9 TDI<br>1.9 TDI<br>1.9 TDI<br>2.0                      | 55<br>110<br>132<br>66<br>74<br>77<br>85               | 9C-Y-600001<br>9C-Y-600001 | 08.01<br>11.99<br>10.99<br>11.01<br>10.00<br>07.05<br>05.10                   | 05.10<br>05.10<br>05.10<br>06.05<br>02.01<br>05.10<br>05.10                   | PR: 1ZP,1ZM<br>PR: 1ZP,1ZM<br>PR: 1ZP,1ZM<br>PR: 1ZP,1ZM<br>PR: 1ZP,1ZM<br>PR: 1ZP,1ZM<br>PR: 1ZP,1ZM                | 13.0460-7117.2<br>13.0470-7117.2 | 607117<br>LD7117 |  | 23131 19,6 +/WK<br>23131 19,6 +/WK                    | VW<br>VW   |
|  | 1.9 TDI<br>2.0  | 66<br>85   | 9C-X-699000<br>9C-X-699000 | 01.98<br>01.98  |   | PR: 1ZE,1ZH<br>PR: 1ZE,1ZH   | 13.0460-7081.2<br>13.0470-7081.2 | 607081<br>LD7081 |  | 21911 20,3 +<br>21911 20,3 +                          | ATE<br>ATE |
|  | 1.4<br>1.6<br>1.8 T<br>1.8 T<br>1.9 TDI<br>1.9 TDI<br>1.9 TDI<br>2.0<br>2.3 V5<br>3.2 RSI | 55<br>110<br>132<br>66<br>74<br>77<br>85<br>125<br>165 | 9C-Y-600001<br>9C-Y-600001 | 08.01<br>11.99<br>10.99<br>11.01<br>10.00<br>07.05<br>05.10<br>10.00<br>04.00 | 05.10<br>05.10<br>05.10<br>06.05<br>02.01<br>05.10<br>05.10<br>05.05<br>03.03 | PR: 1ZD,1ZE<br>PR: 1ZD,1ZE<br>PR: 1ZD,1ZE<br>PR: 1ZD,1ZE<br>PR: 1ZD,1ZE<br>PR: 1ZD,1ZE<br>PR: 1ZD,1ZE<br>PR: 1ZD,1ZE | 13.0460-7122.2<br>13.0470-7122.2 | 607122<br>LD7122 |  | 23392 20,3 +/WK<br>23392 20,3 +/WK                    | ATE<br>ATE |
|  | 1.4<br>1.6<br>1.8 T<br>1.8 T<br>1.9 TDI<br>1.9 TDI<br>1.9 TDI<br>2.0                      | 55<br>110<br>132<br>66<br>74<br>77<br>85               |                            | 08.01<br>11.99<br>10.99<br>11.01<br>01.98<br>10.00<br>07.05<br>01.98          | 05.10<br>05.10<br>05.10<br>06.05<br>02.01<br>05.10<br>05.10<br>05.10          | PR: 1ZP,1ZM<br>PR: 1ZP,1ZM<br>PR: 1ZP,1ZM<br>PR: 1ZP,1ZM<br>PR: 1ZP,1ZM<br>PR: 1ZP,1ZM<br>PR: 1ZP,1ZM<br>PR: 1ZP,1ZM | 24.0122-0150.1<br>24.0322-0150.1 | 422150<br>522150 |  | 280 22,0 19,0 V L +S +B<br>280 22,0 19,0 V L +S +B PD |            |
|  | 1.4<br>1.6<br>1.8 T<br>1.8 T  | 55<br>110<br>132                                       |                            | 08.01<br>11.99<br>10.99<br>11.01  | 05.10<br>05.10<br>05.10<br>06.05  | PR: 1ZD,1ZE<br>PR: 1ZD,1ZE<br>PR: 1ZD,1ZE<br>PR: 1ZD,1ZE   | 24.0125-0113.1<br>24.0325-0113.1 | 425113<br>525113 |  | 288 25,0 22,0 V L +S +B<br>288 25,0 22,0 V L +S +B PD |            |

















**VOLKSWAGEN NEW BEETLE (98-10)**

|  |   |  |   |  |   |  |   |
|--|---|--|---|--|---|--|---|
|  | 1.9 TDI 66<br>1.9 TDI 74<br>1.9 TDI 77<br>2.0 85<br>2.3 V5 125<br>3.2 RSI 165                                   |  | 01.98 02.01 PR: 1ZD,1ZE<br>10.00 05.10 PR: 1ZD,1ZE<br>07.05 05.10 PR: 1ZD,1ZE<br>01.98 05.10 PR: 1ZD,1ZE  |  | 24.0125-0113.1 425113<br>24.0325-0113.1 525113                          |  | 288 25,0 22,0 V L +S +B<br>288 25,0 22,0 V L +S +B PD                   |
|  | 1.4 55<br>1.6 110<br>1.8 T 132<br>1.9 TDI 66<br>1.9 TDI 74<br>1.9 TDI 77<br>2.0 85<br>2.3 V5 125<br>3.2 RSI 165 |  | 08.01 05.10<br>11.99 05.10<br>10.99 05.10<br>11.01 06.05<br>01.98 02.01<br>10.00 05.10<br>07.05 05.10<br>01.98 05.10<br>10.00 05.05<br>04.00 03.03  |  | 24.0711-1361.3 360022<br>24.0711-1362.3 360023                          |  | Radsensor<br>Radsensor  |
|  | 1.4 55<br>1.6 110<br>1.8 T 132<br>1.9 TDI 66<br>1.9 TDI 74<br>1.9 TDI 77<br>2.0 85<br>2.3 V5 125                |  | 08.01 05.10 PR: 1KS,1KV<br>11.99 05.10 PR: 1KS,1KV<br>10.99 05.10 PR: 1KS,1KV<br>11.01 06.05 PR: 1KS,1KV<br>01.98 02.01 PR: 1KS,1KV<br>10.00 05.10 PR: 1KS,1KV<br>07.05 05.10 PR: 1KS,1KV<br>01.98 05.10 PR: 1KS,1KV<br>10.00 05.05 PR: 1KS,1KV |  | 13.0460-2894.2 602894<br>13.0470-2894.2 LD2894<br>13.0460-0072.2 610072 |  | 20961 17,4 /Zub/S TRW<br>20961 17,4 /Zub/S TRW<br>Belagsatz-Zubehör TRW |
|  | 1.8 T 132<br>2.3 V5 125   |  | 11.01 06.05 PR: 1KY<br>10.00 05.05 PR: 1KY  |  | 13.0460-2886.2 602886<br>13.0470-2886.2 LD2886<br>13.0460-0072.2 610072 |  | 20961 16,2 /S TRW<br>20961 16,2 /S TRW<br>Belagsatz-Zubehör TRW         |
|  | 3.2 RSI 165   |  | 04.00 03.03   |  | 13.0460-2820.2 602820<br>13.0470-2820.2 LD2820                          |  | 20961 17,6 /S TRW<br>20961 17,6 /S TRW                                  |
|  | 1.4 55<br>1.6 110<br>1.8 T 132<br>1.9 TDI 66<br>1.9 TDI 74<br>1.9 TDI 77<br>2.0 85                              |  | 08.01 05.10 PR: 1KS,1KV<br>11.99 05.10 PR: 1KS,1KV<br>10.99 05.10 PR: 1KS,1KV<br>11.01 06.05 PR: 1KS,1KV<br>01.98 02.01 PR: 1KS,1KV<br>10.00 05.10 PR: 1KS,1KV<br>07.05 05.10 PR: 1KS,1KV<br>01.98 05.10 PR: 1KS,1KV                            |  | 24.0109-0123.1 409123<br>24.0309-0123.1 509123                          |  | 230 9,0 7,0 +S +B<br>230 9,0 7,0 +S +B PD                               |
|  | 1.8 T 132<br>2.3 V5 125<br>3.2 RSI 165  |  | 11.01 06.05 PR: 1KY<br>10.00 05.05 PR: 1KY<br>04.00 03.03   |  | 24.0122-0163.1 422163<br>24.0322-0163.1 522163                          |  | 256 22,0 20,0 V L +B<br>256 22,0 20,0 V L +B PD                         |
|  | 1.4 55<br>1.6 110<br>1.8 T 132<br>1.9 TDI 66<br>1.9 TDI 74<br>1.9 TDI 77<br>2.0 85<br>2.3 V5 125<br>3.2 RSI 165 |  | 08.01 05.10<br>11.99 05.10<br>10.99 05.10<br>11.01 06.05<br>01.98 02.01<br>10.00 05.10<br>07.05 05.10<br>01.98 05.10<br>10.00 05.05<br>04.00 03.03  |  | 24.0741-1107.3 360042   |  | Radsensor   |





















**VOLKSWAGEN NEW BEETLE Cabriolet (03-10)**















|  |   |  |  |  |  |  |   |
|--|---|--|--|--|--|--|---|
|  | 1.4 55<br>1.6 75<br>1.8 T 110<br>1.9 TDI 74<br>1.9 TDI 77<br>2.0 85 |  | 01.03 05.10 PR: 1ZP,1ZM<br>01.03 05.10 PR: 1ZP,1ZM<br>12.03 05.10 PR: 1ZP,1ZM<br>07.03 05.10 PR: 1ZP,1ZM<br>07.05 05.10 PR: 1ZP,1ZM<br>01.03 05.10 PR: 1ZP,1ZM |  | 13.0460-7117.2 607117<br>13.0470-7117.2 LD7117 |  | 23131 19,6 +/WK VW<br>23131 19,6 +/WK VW              |
|  | 1.4 55<br>1.6 75<br>1.8 T 110<br>1.9 TDI 74<br>1.9 TDI 77<br>2.0 85 |  | 01.03 05.10 PR: 1ZD,1ZE<br>01.03 05.10 PR: 1ZD,1ZE<br>12.03 05.10 PR: 1ZD,1ZE<br>07.03 05.10 PR: 1ZD,1ZE<br>07.05 05.10 PR: 1ZD,1ZE<br>01.03 05.10 PR: 1ZD,1ZE |  | 13.0460-7122.2 607122<br>13.0470-7122.2 LD7122 |  | 23392 20,3 +/WK ATE<br>23392 20,3 +/WK ATE            |
|  | 1.4 55<br>1.6 75<br>1.8 T 110<br>1.9 TDI 74<br>1.9 TDI 77<br>2.0 85 |  | 01.03 05.10 PR: 1ZP,1ZM<br>01.03 05.10 PR: 1ZP,1ZM<br>12.03 05.10 PR: 1ZP,1ZM<br>07.03 05.10 PR: 1ZP,1ZM<br>07.05 05.10 PR: 1ZP,1ZM<br>01.03 05.10 PR: 1ZP,1ZM |  | 24.0122-0150.1 422150<br>24.0322-0150.1 522150 |  | 280 22,0 19,0 V L +S +B<br>280 22,0 19,0 V L +S +B PD |
|  | 1.4 55<br>1.6 75<br>1.8 T 110<br>1.9 TDI 74<br>1.9 TDI 77<br>2.0 85 |  | 01.03 05.10 PR: 1ZD,1ZE<br>01.03 05.10 PR: 1ZD,1ZE<br>12.03 05.10 PR: 1ZD,1ZE<br>07.03 05.10 PR: 1ZD,1ZE<br>07.05 05.10 PR: 1ZD,1ZE<br>01.03 05.10 PR: 1ZD,1ZE |  | 24.0125-0113.1 425113<br>24.0325-0113.1 525113 |  | 288 25,0 22,0 V L +S +B<br>288 25,0 22,0 V L +S +B PD |
|  | 1.4 55<br>1.6 75<br>1.8 T 110<br>1.9 TDI 74<br>1.9 TDI 77<br>2.0 85 |  | 01.03 05.10<br>01.03 05.10<br>12.03 05.10<br>07.03 05.10<br>07.05 05.10<br>01.03 05.10   |  | 24.0711-1361.3 360022<br>24.0711-1362.3 360023 |  | Radsensor<br>Radsensor                                |



|     |                                   |  |                 |   |       |  |  |     |                   |  |
|--|---|--|---|---|--|--|--|---|-------------------|--|
| <b>VOLKSWAGEN NEW BEETLE Cabriolet (03-10)</b>                                     |   |  |   |   |  |  |  |   |                   |  |
|    | 1.4<br>1.6<br>1.8 T<br>1.9 TDI<br>1.9 TDI<br>2.0  | 55<br>75<br>110<br>74<br>77<br>85  | 01.03<br>01.03<br>12.03<br>07.03<br>07.05<br>01.03  | 05.10<br>05.10<br>05.10<br>05.10<br>05.10<br>05.10  | PR: 1KS,1KV<br>PR: 1KS,1KV<br>PR: 1KS,1KV<br>PR: 1KS,1KV<br>PR: 1KS,1KV<br>PR: 1KS,1KV | 13.0460-2894.2<br>13.0470-2894.2<br>13.0460-0072.2                                 | 602894<br>LD2894<br>610072   | 20961 17,4 /Zub/S<br>20961 17,4 /Zub/S<br>Belagsatz-Zubehör                           | TRW<br>TRW<br>TRW |  |
|    | 1.4<br>1.6<br>1.8 T<br>1.9 TDI<br>1.9 TDI<br>2.0  | 55<br>75<br>110<br>74<br>77<br>85  | 01.03<br>01.03<br>12.03<br>07.03<br>07.05<br>01.03  | 05.10<br>05.10<br>05.10<br>05.10<br>05.10<br>05.10  | PR: 1KS,1KV<br>PR: 1KS,1KV<br>PR: 1KS,1KV<br>PR: 1KS,1KV<br>PR: 1KS,1KV<br>PR: 1KS,1KV | 24.0109-0123.1<br>24.0309-0123.1   | 409123<br>509123   | 230 9,0 7,0 +S +B<br>230 9,0 7,0 +S +B PD   |                   |  |
|    | 1.4<br>1.6<br>1.8 T<br>1.9 TDI<br>1.9 TDI<br>2.0  | 55<br>75<br>110<br>74<br>77<br>85  | 01.03<br>01.03<br>12.03<br>07.03<br>07.05<br>01.03  | 05.10<br>05.10<br>05.10<br>05.10<br>05.10<br>05.10  |  | 24.0741-1107.3   | 360042   | 2  | Radsensor         |  |
| <b>VOLKSWAGEN BEETLE (11-)</b>   |   |  |   |   |  |  |  |   |                   |  |
|    | 1.2 TSI<br>1.4 TSI<br>1.4 TSI<br>1.6 TDI<br>2.0 TDI<br>2.0 TDI<br>2.0 TSI<br>2.0 TSI<br>2.0 TSI<br>2.0 TSI<br>2.5 | 77<br>110<br>118<br>77<br>103<br>110<br>147<br>155<br>162<br>162<br>125          | 07.11<br>12.14<br>04.11<br>10.11<br>04.11<br>09.14<br>04.11<br>05.13<br>12.14<br>12.14<br>04.11 | PR: 1ZQ<br>PR: 1ZQ<br>PR: 1ZQ<br>PR: 1ZQ<br>PR: 1ZQ<br>PR: 1ZQ<br>PR: 1ZQ<br>PR: 1ZQ<br>PR: 1ZQ<br>PR: 1ZQ<br>PR: 1ZQ   | 13.0460-7111.2<br>13.0470-7111.2   | 607111<br>LD7111   |  | 23130 19,6 +<br>23130 19,6 +  | VW<br>VW          |  |
|  | 1.2 TSI<br>1.4 TSI<br>1.4 TSI<br>1.6 TDI<br>2.0 TDI<br>2.0 TDI<br>2.0 TSI<br>2.0 TSI<br>2.0 TSI<br>2.0 TSI<br>2.5 | 77<br>110<br>118<br>77<br>81<br>103<br>110<br>147<br>155<br>162<br>125           | 10.11<br>12.14<br>10.11<br>10.11<br>12.14<br>10.11<br>09.14<br>10.11<br>05.13<br>12.14<br>04.11 | PR: 1ZA,1ZB,1ZE<br>PR: 1ZA,1ZB,1ZE<br>PR: 1ZA,1ZB,1ZE<br>PR: 1ZA,1ZB,1ZE<br>PR: 1ZA,1ZB,1ZE<br>PR: 1ZA,1ZB,1ZE<br>PR: 1ZA,1ZB,1ZE<br>PR: 1ZA,1ZB,1ZE<br>PR: 1ZA,1ZB,1ZE<br>PR: 1ZA,1ZB,1ZE<br>PR: 1ZA,1ZB,1ZE   | 13.0460-7184.2<br>13.0470-7184.2   | 607184<br>LD7184   |  | 23587 20,6 +/WK<br>23587 20,6 +/WK  | ATE<br>ATE        |  |
|  | 1.2 TSI<br>1.4 TSI<br>1.4 TSI<br>1.6 TDI<br>2.0 TDI<br>2.0 TDI<br>2.0 TSI<br>2.0 TSI<br>2.0 TSI<br>2.0 TSI<br>2.5 | 77<br>110<br>118<br>77<br>81<br>103<br>110<br>147<br>155<br>162<br>125           | 07.11<br>12.14<br>04.11<br>10.11<br>12.14<br>04.11<br>09.14<br>04.11<br>05.13<br>12.14<br>04.11 | PR: 1LV,1ZD,1ZM,1ZP<br>PR: 1LV,1ZD,1ZM,1ZP<br>PR: 1LV,1ZD,1ZM,1ZP<br>PR: 1LV,1ZD,1ZM,1ZP<br>PR: 1LV,1ZD,1ZM,1ZP<br>PR: 1LV,1ZD,1ZM,1ZP<br>PR: 1LV,1ZD,1ZM,1ZP<br>PR: 1LV,1ZD,1ZM,1ZP<br>PR: 1LV,1ZD,1ZM,1ZP<br>PR: 1LV,1ZD,1ZM,1ZP<br>PR: 1LV,1ZD,1ZM,1ZP | 13.0460-7117.2<br>13.0470-7117.2   | 607117<br>LD7117   |  | 23131 19,6 +/WK<br>23131 19,6 +/WK  | VW<br>VW          |  |
|  | 1.2 TSI<br>1.4 TSI<br>1.4 TSI<br>1.6 TDI<br>2.0 TDI<br>2.0 TDI<br>2.0 TSI<br>2.0 TSI<br>2.0 TSI<br>2.0 TSI<br>2.5 | 77<br>110<br>118<br>77<br>81<br>103<br>110<br>147<br>155<br>162<br>125           | 07.11<br>12.14<br>04.11<br>10.11<br>12.14<br>04.11<br>09.14<br>04.11<br>05.13<br>12.14<br>04.11 | PR: 1ZM,1ZQ<br>PR: 1ZM,1ZQ<br>PR: 1ZM,1ZQ<br>PR: 1ZM,1ZQ<br>PR: 1ZM,1ZQ<br>PR: 1ZM,1ZQ<br>PR: 1ZM,1ZQ<br>PR: 1ZM,1ZQ<br>PR: 1ZM,1ZQ<br>PR: 1ZM,1ZQ<br>PR: 1ZM,1ZQ   | 24.0122-0210.1<br>24.0322-0210.1   | 422210<br>522210   |  | 280 22,0 19,0 V L +S +B<br>280 22,0 19,0 V L +S +B PD                                 |                   |  |
|  | 1.2 TSI<br>1.4 TSI<br>1.4 TSI<br>1.6 TDI<br>2.0 TDI<br>2.0 TDI<br>2.0 TSI<br>2.0 TSI<br>2.0 TSI<br>2.0 TSI<br>2.5 | 77<br>110<br>118<br>77<br>81<br>103<br>110<br>147<br>155<br>162<br>125           | 07.11<br>12.14<br>04.11<br>10.11<br>12.14<br>04.11<br>09.14<br>04.11<br>05.13<br>12.14<br>04.11 | PR: 1ZA,1ZB,1ZD,1LV<br>PR: 1ZA,1ZB,1ZD,1LV<br>PR: 1ZA,1ZB,1ZD,1LV<br>PR: 1ZA,1ZB,1ZD,1LV<br>PR: 1ZA,1ZB,1ZD,1LV<br>PR: 1ZA,1ZB,1ZD,1LV<br>PR: 1ZA,1ZB,1ZD,1LV<br>PR: 1ZA,1ZB,1ZD,1LV<br>PR: 1ZA,1ZB,1ZD,1LV<br>PR: 1ZA,1ZB,1ZD,1LV<br>PR: 1ZA,1ZB,1ZD,1LV | 24.0125-0158.1<br>24.0325-0158.1   | 425158<br>525158   |  | 312 25,0 22,0 V L +S +B<br>312 25,0 22,0 V L +S +B PD                                 |                   |  |
|  | 1.2 TSI<br>1.4 TSI<br>1.4 TSI<br>1.6 TDI<br>2.0 TDI<br>2.0 TDI<br>2.0 TSI<br>2.0 TSI<br>2.0 TSI<br>2.0 TSI<br>2.5 | 77<br>110<br>118<br>77<br>81<br>103<br>110<br>147<br>155<br>162<br>125           | 07.11<br>12.14<br>04.11<br>10.11<br>12.14<br>04.11<br>09.14<br>04.11<br>05.13<br>12.14<br>04.11 | PR: 1ZE,1ZP<br>PR: 1ZE,1ZP<br>PR: 1ZE,1ZP<br>PR: 1ZE,1ZP<br>PR: 1ZE,1ZP<br>PR: 1ZE,1ZP<br>PR: 1ZE,1ZP<br>PR: 1ZE,1ZP<br>PR: 1ZE,1ZP<br>PR: 1ZE,1ZP<br>PR: 1ZE,1ZP   | 24.0125-0145.1<br>24.0325-0145.1   | 425145<br>525145   |  | 288 25,0 22,0 V L +S +B<br>288 25,0 22,0 V L +S +B PD                                 |                   |  |



|     |    |  |                          |   |  |  |    |  |            |
|--|--|--|--|---|---|--|--|--|------------|
| <b>VOLKSWAGEN BEETLE (11-)</b>   |  |  |  |   |   |  |  |  |            |
|    | 1.2 TSI<br>1.4 TSI<br>1.4 TSI<br>1.6 TDI<br>2.0 TDI<br>2.0 TDI<br>2.0 TDI<br>2.0 TSI<br>2.0 TSI<br>2.0 TSI<br>2.5            | 77<br>110<br>118<br>77<br>81<br>103<br>110<br>147<br>155<br>162<br>125           | 07.11<br>12.14<br>04.11<br>10.11<br>12.14<br>04.11<br>09.14<br>04.11<br>05.13<br>12.14<br>04.11          |   | 24.0711-5271.3<br>24.0711-5272.3  | 360301<br>360302   | <br>     | Radsensor<br>Radsensor   |            |
|    | 1.2 TSI<br>1.4 TSI<br>1.4 TSI<br>1.6 TDI<br>2.0 TDI<br>2.0 TDI<br>2.0 TDI<br>2.0 TSI<br>2.0 TSI<br>2.0 TSI<br>2.5            | 77<br>110<br>118<br>77<br>81<br>103<br>110<br>147<br>155<br>162<br>125           | 07.11<br>12.14<br>04.11<br>10.11<br>12.14<br>04.11<br>09.14<br>04.11<br>05.13<br>12.14<br>04.11          | PR: 1KD,1KU<br>PR: 1KD,1KU<br>PR: 1KD,1KU<br>PR: 1KD,1KU<br>PR: 1KD,1KU<br>PR: 1KD,1KU<br>PR: 1KD,1KU<br>PR: 1KD,1KU<br>PR: 1KD,1KU<br>PR: 1KD,1KU<br>PR: 1KD,1KU | 13.0460-2823.2<br>13.0470-2823.2  | 602823<br>LD2823   |  | 23554 17,2 /S<br>23554 17,2 /S   | TRW<br>TRW |
|    | 1.2 TSI<br>1.4 TSI<br>1.4 TSI<br>1.6 TDI<br>2.0 TDI<br>2.0 TDI<br>2.0 TDI<br>2.0 TSI<br>2.0 TSI<br>2.0 TSI<br>2.5            | 77<br>110<br>118<br>77<br>81<br>103<br>110<br>147<br>155<br>162<br>125           | 07.11<br>12.14<br>04.11<br>10.11<br>12.14<br>04.11<br>09.14<br>04.11<br>05.13<br>12.14<br>04.11          | PR: 1KS,1KT<br>PR: 1KS,1KT<br>PR: 1KS,1KT<br>PR: 1KS,1KT<br>PR: 1KS,1KT<br>PR: 1KS,1KT<br>PR: 1KS,1KT<br>PR: 1KS,1KT<br>PR: 1KS,1KT<br>PR: 1KS,1KT<br>PR: 1KS,1KT | 13.0460-3858.2<br>13.0470-3858.2  | 603858<br>LD3858   |  | 24563 17,7 /Zub/S<br>24563 17,7 /Zub/S   | BOS<br>BOS |
|    | 1.2 TSI<br>1.4 TSI<br>1.4 TSI<br>1.6 TDI<br>2.0 TDI<br>2.0 TDI<br>2.0 TDI<br>2.0 TSI<br>2.0 TSI<br>2.0 TSI<br>2.5            | 77<br>110<br>118<br>77<br>81<br>103<br>110<br>147<br>155<br>162<br>125           | 07.11<br>12.14<br>04.11<br>10.11<br>12.14<br>04.11<br>09.14<br>04.11<br>05.13<br>12.14<br>04.11          | PR: 1KS,1KT<br>PR: 1KS,1KT<br>PR: 1KS,1KT<br>PR: 1KS,1KT<br>PR: 1KS,1KT<br>PR: 1KS,1KT<br>PR: 1KS,1KT<br>PR: 1KS,1KT<br>PR: 1KS,1KT<br>PR: 1KS,1KT<br>PR: 1KS,1KT | 24.0110-0356.1<br>24.0310-0356.1  | 410356<br>510356   |  | 272 9,7 8,0 +S +B<br>272 9,7 8,0 +S +B PD  |            |
|  | 1.2 TSI<br>1.4 TSI<br>1.4 TSI<br>1.6 TDI<br>2.0 TDI<br>2.0 TDI<br>2.0 TDI<br>2.0 TSI<br>2.0 TSI<br>2.0 TSI<br>2.5            | 77<br>110<br>118<br>77<br>81<br>103<br>110<br>147<br>155<br>162<br>125           | 07.11<br>12.14<br>04.11<br>10.11<br>12.14<br>04.11<br>09.14<br>04.11<br>05.13<br>12.14<br>04.11          | PR: 1KD,1KU<br>PR: 1KD,1KU<br>PR: 1KD,1KU<br>PR: 1KD,1KU<br>PR: 1KD,1KU<br>PR: 1KD,1KU<br>PR: 1KD,1KU<br>PR: 1KD,1KU<br>PR: 1KD,1KU<br>PR: 1KD,1KU<br>PR: 1KD,1KU | 24.0110-0277.1  | 410277   |  | 253 10,0 8,0 +S +B   |            |
|  | 1.2 TSI<br>1.4 TSI<br>1.4 TSI<br>1.6 TDI<br>2.0 TDI<br>2.0 TDI<br>2.0 TDI<br>2.0 TSI<br>2.0 TSI<br>2.0 TSI<br>2.5            | 77<br>110<br>118<br>77<br>81<br>103<br>110<br>147<br>155<br>162<br>125           | 07.11<br>12.14<br>04.11<br>10.11<br>12.14<br>04.11<br>09.14<br>04.11<br>05.13<br>12.14<br>04.11          |   | 24.0711-6231.3<br>24.0711-6232.3  | 360305<br>360306   | <br> | Radsensor<br>Radsensor   |            |
| <b>VOLKSWAGEN BEETLE Cabriolet (12-)</b>   |  |  |  |   |   |  |  |  |            |
|  | 1.2 TSI<br>1.4 TSI<br>1.4 TSI<br>1.6 TDI<br>1.8 TSI<br>2.0 TDI<br>2.0 TDI<br>2.0 TDI<br>2.0 TSI<br>2.0 TSI<br>2.0 TSI<br>2.5 | 77<br>110<br>118<br>77<br>125<br>81<br>103<br>110<br>147<br>155<br>162<br>125    | 11.12<br>12.14<br>11.12<br>11.12<br>12.13<br>12.14<br>11.12<br>09.14<br>11.12<br>05.13<br>12.14<br>12.12 | PR: 1ZQ<br>PR: 1ZQ<br>PR: 1ZQ<br>PR: 1ZQ<br>PR: 1ZQ<br>PR: 1ZQ<br>PR: 1ZQ<br>PR: 1ZQ<br>PR: 1ZQ<br>PR: 1ZQ<br>PR: 1ZQ<br>PR: 1ZQ                                  | 13.0460-7111.2<br>13.0470-7111.2  | 607111<br>LD7111   |  | 23130 19,6 +<br>23130 19,6 +   | VW<br>VW   |
|  | 1.2 TSI<br>1.4 TSI<br>1.4 TSI<br>1.6 TDI<br>1.8 TSI<br>2.0 TDI<br>2.0 TDI  | 77<br>110<br>118<br>77<br>125<br>81<br>103                                       | 11.12<br>12.14<br>11.12<br>11.12<br>12.13<br>12.14<br>11.12  | PR: 1ZM<br>PR: 1ZM<br>PR: 1ZM<br>PR: 1ZM<br>PR: 1ZM<br>PR: 1ZM<br>PR: 1ZM   | 13.0460-7117.2<br>13.0470-7117.2  | 607117<br>LD7117   |  | 23131 19,6 +/WK<br>23131 19,6 +/WK   | VW<br>VW   |

|     |    |  |                          |    |  |  |     |  |
|--|--|--|--|--|---|--|---|--|
| <b>VOLKSWAGEN BEETLE Cabriolet (12-)</b>   |  |  |  |  |   |  |   |  |
|    | 2.0 TDI<br>2.0 TSI<br>2.0 TSI<br>2.0 TSI<br>2.5  | 110<br>147<br>155<br>162<br>125  | 09.14<br>11.12<br>05.13<br>12.14<br>12.12  | PR: 1ZM<br>PR: 1ZM<br>PR: 1ZM<br>PR: 1ZM<br>PR: 1ZM  | 13.0460-7117.2<br>13.0470-7117.2  | 607117<br>LD7117   |   | 23131 19,6 +/WK<br>23131 19,6 +/WK<br>VW<br>VW                                     |
|  | 1.2 TSI<br>1.4 TSI<br>1.4 TSI<br>1.6 TDI<br>1.8 TSI<br>2.0 TDI<br>2.0 TDI<br>2.0 TDI<br>2.0 TSI<br>2.0 TSI<br>2.0 TSI<br>2.5 | 77<br>110<br>118<br>77<br>125<br>81<br>103<br>110<br>147<br>155<br>162<br>125    | 11.12<br>12.14<br>11.12<br>11.12<br>12.13<br>12.14<br>11.12<br>09.14<br>11.12<br>05.13<br>12.14<br>12.12 | PR: 1ZA,1ZB,1ZE<br>PR: 1ZA,1ZB,1ZE<br>PR: 1ZA,1ZB,1ZE<br>PR: 1ZA,1ZB,1ZE<br>PR: 1ZA,1ZB,1ZE<br>PR: 1ZA,1ZB,1ZE<br>PR: 1ZA,1ZB,1ZE<br>PR: 1ZA,1ZB,1ZE<br>PR: 1ZA,1ZB,1ZE<br>PR: 1ZA,1ZB,1ZE<br>PR: 1ZA,1ZB,1ZE<br>PR: 1ZA,1ZB,1ZE | 13.0460-7184.2<br>13.0470-7184.2  | 607184<br>LD7184   |   | 23587 20,6 +/WK<br>23587 20,6 +/WK<br>ATE<br>ATE                                   |
|  | 1.2 TSI<br>1.4 TSI<br>1.4 TSI<br>1.6 TDI<br>1.8 TSI<br>2.0 TDI<br>2.0 TDI<br>2.0 TDI<br>2.0 TSI<br>2.0 TSI<br>2.0 TSI<br>2.5 | 77<br>110<br>118<br>77<br>125<br>81<br>103<br>110<br>147<br>155<br>162<br>125    | 11.12<br>12.14<br>11.12<br>11.12<br>12.13<br>12.14<br>11.12<br>09.14<br>11.12<br>05.13<br>12.14<br>12.12 | PR: 1LV,1ZP<br>PR: 1LV,1ZP<br>PR: 1LV,1ZP<br>PR: 1LV,1ZP<br>PR: 1LV,1ZP<br>PR: 1LV,1ZP<br>PR: 1LV,1ZP<br>PR: 1LV,1ZP<br>PR: 1LV,1ZP<br>PR: 1LV,1ZP<br>PR: 1LV,1ZP<br>PR: 1LV,1ZP   | 13.0460-7285.2<br>13.0470-7285.2  | 607285<br>LD7285   |   | 23587 20,6 +<br>23587 20,6 +<br>ATE<br>ATE   |
|    | 1.2 TSI<br>1.4 TSI<br>1.4 TSI<br>1.6 TDI<br>1.8 TSI<br>2.0 TDI<br>2.0 TDI<br>2.0 TDI<br>2.0 TSI<br>2.0 TSI<br>2.0 TSI<br>2.5 | 77<br>110<br>118<br>77<br>125<br>81<br>103<br>110<br>147<br>155<br>162<br>125    | 11.12<br>12.14<br>11.12<br>11.12<br>12.13<br>12.14<br>11.12<br>09.14<br>11.12<br>05.13<br>12.14<br>12.12 | PR: 1ZM,1ZQ<br>PR: 1ZM,1ZQ<br>PR: 1ZM,1ZQ<br>PR: 1ZM,1ZQ<br>PR: 1ZM,1ZQ<br>PR: 1ZM,1ZQ<br>PR: 1ZM,1ZQ<br>PR: 1ZM,1ZQ<br>PR: 1ZM,1ZQ<br>PR: 1ZM,1ZQ<br>PR: 1ZM,1ZQ<br>PR: 1ZM,1ZQ   | 24.0122-0210.1<br>24.0322-0210.1  | 422210<br>522210   |   | 280 22,0 19,0 V L +S +B<br>280 22,0 19,0 V L +S +B PD                              |
|  | 1.2 TSI<br>1.4 TSI<br>1.4 TSI<br>1.6 TDI<br>1.8 TSI<br>2.0 TDI<br>2.0 TDI<br>2.0 TDI<br>2.0 TSI<br>2.0 TSI<br>2.0 TSI<br>2.5 | 77<br>110<br>118<br>77<br>125<br>81<br>103<br>110<br>147<br>155<br>162<br>125    | 11.12<br>12.14<br>11.12<br>11.12<br>12.13<br>12.14<br>11.12<br>09.14<br>11.12<br>05.13<br>12.14<br>12.12 | PR: 1ZE,1ZP<br>PR: 1ZE,1ZP<br>PR: 1ZE,1ZP<br>PR: 1ZE,1ZP<br>PR: 1ZE,1ZP<br>PR: 1ZE,1ZP<br>PR: 1ZE,1ZP<br>PR: 1ZE,1ZP<br>PR: 1ZE,1ZP<br>PR: 1ZE,1ZP<br>PR: 1ZE,1ZP<br>PR: 1ZE,1ZP   | 24.0125-0145.1<br>24.0325-0145.1  | 425145<br>525145   |   | 288 25,0 22,0 V L +S +B<br>288 25,0 22,0 V L +S +B PD                              |
|  | 1.2 TSI<br>1.4 TSI<br>1.4 TSI<br>1.6 TDI<br>1.8 TSI<br>2.0 TDI<br>2.0 TDI<br>2.0 TDI<br>2.0 TSI<br>2.0 TSI<br>2.0 TSI<br>2.5 | 77<br>110<br>118<br>77<br>125<br>81<br>103<br>110<br>147<br>155<br>162<br>125    | 11.12<br>12.14<br>11.12<br>11.12<br>12.13<br>12.14<br>11.12<br>09.14<br>11.12<br>05.13<br>12.14<br>12.12 | PR: 1ZA,1ZB,1LV<br>PR: 1ZA,1ZB,1LV<br>PR: 1ZA,1ZB,1LV<br>PR: 1ZA,1ZB,1LV<br>PR: 1ZA,1ZB,1LV<br>PR: 1ZA,1ZB,1LV<br>PR: 1ZA,1ZB,1LV<br>PR: 1ZA,1ZB,1LV<br>PR: 1ZA,1ZB,1LV<br>PR: 1ZA,1ZB,1LV<br>PR: 1ZA,1ZB,1LV<br>PR: 1ZA,1ZB,1LV | 24.0125-0158.1<br>24.0325-0158.1  | 425158<br>525158   |   | 312 25,0 22,0 V L +S +B<br>312 25,0 22,0 V L +S +B PD                              |
|  | 1.2 TSI<br>1.4 TSI<br>1.4 TSI<br>1.6 TDI<br>1.8 TSI<br>2.0 TDI<br>2.0 TDI<br>2.0 TDI<br>2.0 TSI<br>2.0 TSI<br>2.0 TSI<br>2.5 | 77<br>110<br>118<br>77<br>125<br>81<br>103<br>110<br>147<br>155<br>162<br>125    | 11.12<br>12.14<br>11.12<br>11.12<br>12.13<br>12.14<br>11.12<br>09.14<br>11.12<br>05.13<br>12.14<br>12.12 |  | 24.0711-5271.3<br>24.0711-5272.3  | 360301<br>360302   |  | Radsensor<br>Radsensor   |
|  | 1.2 TSI<br>1.4 TSI<br>1.4 TSI<br>1.6 TDI<br>1.8 TSI<br>2.0 TDI<br>2.0 TDI<br>2.0 TDI<br>2.0 TSI<br>2.0 TSI                   | 77<br>110<br>118<br>77<br>125<br>81<br>103<br>110<br>147                         | 11.12<br>12.14<br>11.12<br>11.12<br>12.13<br>12.14<br>11.12<br>09.14<br>11.12<br>11.12                   | PR: 1KS,1KT<br>PR: 1KS,1KT<br>PR: 1KS,1KT<br>PR: 1KS,1KT<br>PR: 1KS,1KT<br>PR: 1KS,1KT<br>PR: 1KS,1KT<br>PR: 1KS,1KT<br>PR: 1KS,1KT<br>PR: 1KS,1KT   | 13.0460-3858.2<br>13.0470-3858.2  | 603858<br>LD3858   |   | 24563 17,7 /Zub/S<br>24563 17,7 /Zub/S<br>BOS<br>BOS                               |
| ↓  | ↓  |  |  |  |   |  |   |  |



**VOLKSWAGEN BEETLE Cabriolet (12-)**

|         |         |     |       |             |             |                |        |  |                      |     |
|---------|---------|-----|-------|-------------|-------------|----------------|--------|--|----------------------|-----|
|         | 2.0 TSI | 155 |       | 05.13       | PR: 1KS,1KT | 13.0460-3858.2 | 603858 |  | 24563 17,7 /Zub/S    | BOS |
|         | 2.0 TSI | 162 |       | 12.14       | PR: 1KS,1KT | 13.0470-3858.2 | LD3858 |  | 24563 17,7 /Zub/S    | BOS |
|         | 2.5     | 125 |       | 12.12       | PR: 1KS,1KT |                |        |  |                      |     |
|         | 1.2 TSI | 77  |       | 11.12       | PR: 1KD,1KU | 13.0460-2823.2 | 602823 |  | 23554 17,2 /S        | TRW |
|         | 1.4 TSI | 110 |       | 12.14       | PR: 1KD,1KU | 13.0470-2823.2 | LD2823 |  | 23554 17,2 /S        | TRW |
|         | 1.4 TSI | 118 |       | 11.12       | PR: 1KD,1KU |                |        |  |                      |     |
|         | 1.6 TDI | 77  |       | 11.12       | PR: 1KD,1KU |                |        |  |                      |     |
|         | 1.8 TSI | 125 |       | 12.13       | PR: 1KD,1KU |                |        |  |                      |     |
|         | 2.0 TDI | 81  |       | 12.14       | PR: 1KD,1KU |                |        |  |                      |     |
|         | 2.0 TDI | 103 |       | 11.12       | PR: 1KD,1KU |                |        |  |                      |     |
|         | 2.0 TDI | 110 |       | 09.14       | PR: 1KD,1KU |                |        |  |                      |     |
|         | 2.0 TSI | 147 |       | 11.12       | PR: 1KD,1KU |                |        |  |                      |     |
|         | 2.0 TSI | 155 |       | 05.13       | PR: 1KD,1KU |                |        |  |                      |     |
|         | 2.0 TSI | 162 |       | 12.14       | PR: 1KD,1KU |                |        |  |                      |     |
|         | 2.5     | 125 |       | 12.12       | PR: 1KD,1KU |                |        |  |                      |     |
|         | 1.2 TSI | 77  |       | 11.12       | PR: 1KS,1KT | 24.0110-0356.1 | 410356 |  | 272 9,7 8,0 +S +B    |     |
|         | 1.4 TSI | 110 |       | 12.14       | PR: 1KS,1KT | 24.0310-0356.1 | 510356 |  | 272 9,7 8,0 +S +B PD |     |
|         | 1.4 TSI | 118 |       | 11.12       | PR: 1KS,1KT |                |        |  |                      |     |
|         | 1.6 TDI | 77  |       | 11.12       | PR: 1KS,1KT |                |        |  |                      |     |
|         | 1.8 TSI | 125 |       | 12.13       | PR: 1KS,1KT |                |        |  |                      |     |
|         | 2.0 TDI | 81  |       | 12.14       | PR: 1KS,1KT |                |        |  |                      |     |
|         | 2.0 TDI | 103 |       | 11.12       | PR: 1KS,1KT |                |        |  |                      |     |
|         | 2.0 TDI | 110 |       | 09.14       | PR: 1KS,1KT |                |        |  |                      |     |
|         | 2.0 TSI | 147 |       | 11.12       | PR: 1KS,1KT |                |        |  |                      |     |
|         | 2.0 TSI | 155 |       | 05.13       | PR: 1KS,1KT |                |        |  |                      |     |
|         | 2.0 TSI | 162 |       | 12.14       | PR: 1KS,1KT |                |        |  |                      |     |
|         | 2.5     | 125 |       | 12.12       | PR: 1KS,1KT |                |        |  |                      |     |
|         | 1.2 TSI | 77  |       | 11.12       | PR: 1KD,1KU | 24.0110-0277.1 | 410277 |  | 253 10,0 8,0 +S +B   |     |
|         | 1.4 TSI | 110 |       | 12.14       | PR: 1KD,1KU |                |        |  |                      |     |
|         | 1.4 TSI | 118 |       | 11.12       | PR: 1KD,1KU |                |        |  |                      |     |
| 1.6 TDI | 77      |     | 11.12 | PR: 1KD,1KU |             |                |        |  |                      |     |
| 1.8 TSI | 125     |     | 12.13 | PR: 1KD,1KU |             |                |        |  |                      |     |
| 2.0 TDI | 81      |     | 12.14 | PR: 1KD,1KU |             |                |        |  |                      |     |
| 2.0 TDI | 103     |     | 11.12 | PR: 1KD,1KU |             |                |        |  |                      |     |
| 2.0 TDI | 110     |     | 09.14 | PR: 1KD,1KU |             |                |        |  |                      |     |
| 2.0 TSI | 147     |     | 11.12 | PR: 1KD,1KU |             |                |        |  |                      |     |
| 2.0 TSI | 155     |     | 05.13 | PR: 1KD,1KU |             |                |        |  |                      |     |
| 2.0 TSI | 162     |     | 12.14 | PR: 1KD,1KU |             |                |        |  |                      |     |
| 2.5     | 125     |     | 12.12 | PR: 1KD,1KU |             |                |        |  |                      |     |
|         | 1.2 TSI | 77  |       | 11.12       |             | 24.0711-6231.3 | 360305 |  | Radsensor            |     |
|         | 1.4 TSI | 110 |       | 12.14       |             | 24.0711-6232.3 | 360306 |  | Radsensor            |     |
|         | 1.4 TSI | 118 |       | 11.12       |             |                |        |  |                      |     |
|         | 1.6 TDI | 77  |       | 11.12       |             |                |        |  |                      |     |
|         | 1.8 TSI | 125 |       | 12.13       |             |                |        |  |                      |     |
|         | 2.0 TDI | 81  |       | 12.14       |             |                |        |  |                      |     |
|         | 2.0 TDI | 103 |       | 11.12       |             |                |        |  |                      |     |
|         | 2.0 TDI | 110 |       | 09.14       |             |                |        |  |                      |     |
|         | 2.0 TSI | 147 |       | 11.12       |             |                |        |  |                      |     |
|         | 2.0 TSI | 155 |       | 05.13       |             |                |        |  |                      |     |
|         | 2.0 TSI | 162 |       | 12.14       |             |                |        |  |                      |     |
|         | 2.5     | 125 |       | 12.12       |             |                |        |  |                      |     |

**VOLKSWAGEN PASSAT (97-05)**

|                 |             |             |             |                                       |                                       |                                       |                |        |                 |                   |     |
|-----------------|-------------|-------------|-------------|---------------------------------------|---------------------------------------|---------------------------------------|----------------|--------|-----------------|-------------------|-----|
|                 | 1.6         |             | 3B-X-600000 | 10.96                                 | PR: 1LZ,1ZJ                           | 13.0460-2822.2                        | 602822         |        | 21945 19,6 /S   | TRW               |     |
|                 | 1.8         | 85          | 3B-X-600000 | 01.97                                 | + (GUS) / + GUS-Staaten <sup>1)</sup> |                                       |                |        |                 |                   |     |
|                 | 1.8         | 92          | 3B-X-600000 | 10.96                                 | PR: 1LZ,1ZJ                           |                                       |                |        |                 |                   |     |
|                 | 1.8 4motion |             | 3B-X-600000 | 10.96                                 | PR: 1LZ,1ZJ                           |                                       |                |        |                 |                   |     |
|                 | 1.9 TDI     | 66          | 3B-X-600000 | 10.96                                 | PR: 1LZ,1ZJ                           |                                       |                |        |                 |                   |     |
|                 | 1.6         |             | 3B-Y-000001 |                                       | 09.00                                 | PR: 1LZ,1ZJ                           | 13.0460-2837.2 | 602837 |                 | 21945 19,6 +/WK/S | TRW |
|                 | 1.8         | 85          | 3B-Y-000001 |                                       | 09.00                                 | + (GUS) / + GUS-Staaten <sup>1)</sup> | 13.0470-2837.2 | LD2837 |                 | 21945 19,6 +/WK/S | TRW |
|                 | 1.8         | 92          | 3B-Y-000001 |                                       | 09.00                                 | PR: 1LZ,1ZJ                           |                |        |                 |                   |     |
|                 | 1.8 4motion |             | 3B-Y-000001 |                                       | 09.00                                 | PR: 1LZ,1ZJ                           |                |        |                 |                   |     |
|                 | 1.9 TDI     | 66          | 3B-Y-000001 |                                       | 09.00                                 | PR: 1LZ,1ZJ                           |                |        |                 |                   |     |
|                 | 1.6         |             | 3B-X-600000 | 10.96                                 | PR: 1LB,1ZC                           | 13.0460-7077.2                        | 607077         |        | 21624 20,3 +    | ATE               |     |
|                 | 1.8         | 92          | 3B-X-600000 | 10.96                                 | PR: 1LB,1ZC                           |                                       |                |        |                 |                   |     |
|                 | 1.8 4motion |             | 3B-X-600000 | 10.96                                 | PR: 1LB,1ZC                           |                                       |                |        |                 |                   |     |
|                 | 1.8 T       |             | 3B-X-600000 | 10.96                                 | PR: 1LB,1ZC                           |                                       |                |        |                 |                   |     |
|                 | 1.9 TDI     | 66          | 3B-X-600000 | 10.96                                 | PR: 1LB,1ZC                           |                                       |                |        |                 |                   |     |
| 1.9 TDI         | 81          | 3B-X-600000 | 10.96       | PR: 1LB,1ZC                           |                                       |                                       |                |        |                 |                   |     |
| 1.9 TDI         | 85          | 3B-X-600000 | 08.98       | PR: 1LB,1ZC                           |                                       |                                       |                |        |                 |                   |     |
| 1.9 TDI 4motion |             | 3B-X-600000 | 10.96       | PR: 1LB,1ZC                           |                                       |                                       |                |        |                 |                   |     |
| 2.3             |             | 3B-X-600000 | 10.96       | PR: 1LB,1ZC                           |                                       |                                       |                |        |                 |                   |     |
| 2.3 4motion     |             | 3B-X-600000 | 06.97       | PR: 1LB,1ZC                           |                                       |                                       |                |        |                 |                   |     |
| 2.5 TDI         |             | 3B-X-600000 | 08.98       | PR: 1LB,1ZC                           |                                       |                                       |                |        |                 |                   |     |
| 2.5 TDI 4motion |             | 3B-X-600000 | 08.98       | PR: 1LB,1ZC                           |                                       |                                       |                |        |                 |                   |     |
| 2.8             | 132         | 3B-X-600000 | 01.97       | + (GUS) / + GUS-Staaten <sup>1)</sup> |                                       |                                       |                |        |                 |                   |     |
| 2.8             | 142         | 3B-X-600000 | 08.96       | PR: 1LB,1ZC                           |                                       |                                       |                |        |                 |                   |     |
| 2.8 4motion     |             | 3B-X-600000 | 10.96       | PR: 1LB,1ZC                           |                                       |                                       |                |        |                 |                   |     |
| 1.6             |             | 3B-Y-000001 |             | 06.05                                 | PR: 1LB,1ZC                           | 13.0460-7110.2                        | 607110         |        | 23018 20,3 +/WK | ATE               |     |
| 1.8             | 92          | 3B-Y-000001 |             | 06.05                                 | PR: 1LB,1ZC                           | 13.0470-7110.2                        | LD7110         |        | 23018 20,3 +/WK | ATE               |     |
| 1.8 4motion     |             | 3B-Y-000001 |             | 06.05                                 | PR: 1LB,1ZC                           |                                       |                |        |                 |                   |     |
| 1.8 T           |             | 3B-Y-000001 |             | 06.05                                 | PR: 1LB,1ZC                           |                                       |                |        |                 |                   |     |
| 1.9 TDI         | 66          | 3B-Y-000001 |             | 06.05                                 | PR: 1LB,1ZC                           |                                       |                |        |                 |                   |     |
| 1.9 TDI         | 74          |             |             | 10.00                                 | PR: 1LB,1ZC                           |                                       |                |        |                 |                   |     |
| 1.9 TDI         | 81          | 3B-Y-000001 |             | 06.05                                 | PR: 1LB,1ZC                           |                                       |                |        |                 |                   |     |
| 1.9 TDI         | 85          | 3B-Y-000001 |             | 06.05                                 | PR: 1LB,1ZC                           |                                       |                |        |                 |                   |     |

<sup>1)</sup> + (GUS) / + GUS States / + (Stati del GUS / + (Etats de la CEI / + estados del GUS



**VOLKSWAGEN PASSAT (97-05)**

|  |                 |             |             |       |                                     |                                     |                |        |   |                                      |                         |     |
|--|-----------------|-------------|-------------|-------|-------------------------------------|-------------------------------------|----------------|--------|---|--------------------------------------|-------------------------|-----|
|  | 1.9 TDI         | 96          |             | 10.00 | 06.05                               | PR: 1LB,1ZC                         | 13.0460-7110.2 | 607110 |   |                                      | 23018 20,3 +/WK         | ATE |
|  | 1.9 TDI 4motion | 3B-Y-000001 |             | 06.05 | PR: 1LB,1ZC                         |                                     | 13.0470-7110.2 | LD7110 |   |                                      | 23018 20,3 +/WK         | ATE |
|  | 1.9 TDI 4motion | 96          |             | 10.00 | 06.05                               | PR: 1LB,1ZC                         |                |        |   |                                      |                         |     |
|  | 2.0             | 85          |             | 10.00 | 06.05                               | PR: 1LB,1ZC                         |                |        |   |                                      |                         |     |
|  | 2.0             | 96          |             | 05.02 | 06.05                               | PR: 1LB,1ZC                         |                |        |   |                                      |                         |     |
|  | 2.0 4motion     | 85          |             | 10.00 | 06.05                               | PR: 1LB,1ZC                         |                |        |   |                                      |                         |     |
|  | 2.0 TDI         | 100         |             | 12.03 | 06.05                               | PR: 1LB,1ZC                         |                |        |   |                                      |                         |     |
|  | 2.3             | 3B-Y-000001 |             | 06.05 | PR: 1LB,1ZC                         |                                     |                |        |   |                                      |                         |     |
|  | 2.3 4motion     | 3B-Y-000001 |             | 06.05 | PR: 1LB,1ZC                         |                                     |                |        |   |                                      |                         |     |
|  | 2.5 TDI         | 3B-Y-000001 |             | 06.05 | PR: 1LB,1ZC                         |                                     |                |        |   |                                      |                         |     |
|  | 2.5 TDI 4motion | 3B-Y-000001 |             | 06.05 | PR: 1LB,1ZC                         |                                     |                |        |   |                                      |                         |     |
|  | 2.8             | 132         | 3B-Y-000001 | 06.05 | + (M) / + GUS-Staaten <sup>1)</sup> |                                     |                |        |   |                                      |                         |     |
|  | 2.8             | 142         | 3B-Y-000001 | 06.05 | PR: 1LB,1ZC                         |                                     |                |        |   |                                      |                         |     |
|  | 2.8 4motion     | 3B-Y-000001 |             | 06.05 | PR: 1LB,1ZC                         |                                     |                |        |   |                                      |                         |     |
|  | 1.6             | 3B-Y-000001 |             | 06.05 | PR: 1LE, 1LT                        |                                     | 13.0460-7110.2 | 607110 |   |                                      | 23018 20,3 +/WK         | ATE |
|  | 1.8             | 92          | 3B-Y-000001 | 06.05 | PR: 1LE, 1LT                        |                                     | 13.0470-7110.2 | LD7110 |   |                                      | 23018 20,3 +/WK         | ATE |
|  | 1.8 4motion     | 3B-Y-000001 |             | 06.05 | PR: 1LE, 1LT                        |                                     |                |        |   |                                      |                         |     |
|  | 1.8 T           | 3B-Y-000001 |             | 06.05 | PR: 1LE, 1LT                        |                                     |                |        |   |                                      |                         |     |
|  | 1.9 TDI         | 66          | 3B-Y-000001 | 06.05 | PR: 1LE, 1LT                        |                                     |                |        |   |                                      |                         |     |
|  | 1.9 TDI         | 74          |             | 10.00 | 06.05                               | PR: 1LE, 1LT                        |                |        |   |                                      |                         |     |
|  | 1.9 TDI         | 81          | 3B-Y-000001 | 06.05 | PR: 1LE, 1LT                        |                                     |                |        |   |                                      |                         |     |
|  | 1.9 TDI         | 85          | 3B-Y-000001 | 06.05 | PR: 1LE, 1LT                        |                                     |                |        |   |                                      |                         |     |
|  | 1.9 TDI         | 96          |             | 10.00 | 06.05                               | PR: 1LE, 1LT                        |                |        |   |                                      |                         |     |
|  | 1.9 TDI 4motion | 3B-Y-000001 |             | 06.05 | PR: 1LE, 1LT                        |                                     |                |        |   |                                      |                         |     |
|  | 1.9 TDI 4motion | 96          |             | 10.00 | 06.05                               | PR: 1LE, 1LT                        |                |        |   |                                      |                         |     |
|  | 2.0             | 85          |             | 10.00 | 06.05                               | PR: 1LE, 1LT                        |                |        |   |                                      |                         |     |
|  | 2.0             | 96          |             | 05.02 | 06.05                               | PR: 1LE, 1LT                        |                |        |   |                                      |                         |     |
|  | 2.0 4motion     | 85          |             | 10.00 | 06.05                               | PR: 1LE, 1LT                        |                |        |   |                                      |                         |     |
|  | 2.0 TDI         | 100         |             | 12.03 | 06.05                               | PR: 1LE, 1LT                        |                |        |   |                                      |                         |     |
|  | 2.3             | 3B-Y-000001 |             | 06.05 | PR: 1LE, 1LT                        |                                     |                |        |   |                                      |                         |     |
|  | 2.3 4motion     | 3B-Y-000001 |             | 06.05 | PR: 1LE, 1LT                        |                                     |                |        |   |                                      |                         |     |
|  | 2.5 TDI         | 3B-Y-000001 |             | 06.05 | PR: 1LE, 1LT                        |                                     |                |        |   |                                      |                         |     |
|  | 2.5 TDI 4motion | 3B-Y-000001 |             | 06.05 | PR: 1LE, 1LT                        |                                     |                |        |   |                                      |                         |     |
|  | 2.8             | 132         | 3B-Y-000001 | 06.05 | + (M) / + GUS-Staaten <sup>1)</sup> |                                     |                |        |   |                                      |                         |     |
|  | 2.8             | 142         | 3B-Y-000001 | 06.05 | PR: 1LE, 1LT                        |                                     |                |        |   |                                      |                         |     |
|  | 2.8 4motion     | 3B-Y-000001 |             | 06.05 | PR: 1LE, 1LT                        |                                     |                |        |   |                                      |                         |     |
|  | 4.0 W8 4motion  |             |             | 09.01 | 06.05                               | PR: 1ZF,1ZG                         | 13.0460-7183.2 | 607183 |   | - gepanzerte Fahrzeuge <sup>2)</sup> | 21484 20,5 +/WE         | ATE |
|  |                 |             |             |       |                                     |                                     | 24.8190-0107.2 | 620107 | 1 | - gepanzerte Fahrzeuge <sup>2)</sup> | Warnkontakt L=235mm     | ATE |
|  | 4.0 W8 4motion  |             |             | 09.01 | 06.05                               | PR: 1ZF,1ZG                         | 13.0460-2875.2 | 602875 |   | + gepanzerte Fahrzeuge <sup>3)</sup> | 23280 17,5 +/WK         | TRW |
|  | 1.6             | 85          |             | 10.96 | 09.00                               | PR: 1LZ,1ZJ                         | 24.0122-0152.1 | 422152 |   |                                      | 280 22,0 20,0 V L +S +B |     |
|  | 1.8             | 92          |             | 01.97 | 09.00                               | + (M) / + GUS-Staaten <sup>1)</sup> | 24.0322-0152.1 | 522152 |   |                                      | 280 22,0 20,0 V L +B PD |     |
|  | 1.8 4motion     |             |             | 10.96 | 09.00                               | PR: 1LZ,1ZJ                         |                |        |   |                                      |                         |     |
|  | 1.9 TDI         | 66          |             | 10.96 | 09.00                               | PR: 1LZ,1ZJ                         |                |        |   |                                      |                         |     |
|  | 1.6             |             | 3B-X-124107 | 10.96 | PR: 1LB,1ZC                         |                                     | 24.0125-0115.1 | 425115 |   |                                      | 283 25,0 23,0 V L +B    |     |
|  | 1.8             | 92          | 3B-X-124107 | 10.96 | PR: 1LB,1ZC                         |                                     | 24.0325-0115.1 | 525115 |   |                                      | 283 25,0 23,0 V L +B PD |     |
|  | 1.8 4motion     |             | 3B-X-124107 | 10.96 | PR: 1LB,1ZC                         |                                     |                |        |   |                                      |                         |     |
|  | 1.8 T           |             | 3B-X-124107 | 10.96 | PR: 1LB,1ZC                         |                                     |                |        |   |                                      |                         |     |
|  | 1.9 TDI         | 66          | 3B-X-124107 | 10.96 | PR: 1LB,1ZC                         |                                     |                |        |   |                                      |                         |     |
|  | 1.9 TDI         | 81          | 3B-X-124107 | 10.96 | PR: 1LB,1ZC                         |                                     |                |        |   |                                      |                         |     |
|  | 1.9 TDI         | 85          | 3B-X-124107 | 08.98 | PR: 1LB,1ZC                         |                                     |                |        |   |                                      |                         |     |
|  | 1.9 TDI 4motion |             | 3B-X-124107 | 10.96 | PR: 1LB,1ZC                         |                                     |                |        |   |                                      |                         |     |
|  | 2.3             |             | 3B-X-124107 | 10.96 | PR: 1LB,1ZC                         |                                     |                |        |   |                                      |                         |     |
|  | 2.3 4motion     |             | 3B-X-124107 | 06.97 | PR: 1LB,1ZC                         |                                     |                |        |   |                                      |                         |     |
|  | 2.8             | 132         | 3B-X-124107 | 01.97 | + (M) / + GUS-Staaten <sup>1)</sup> |                                     |                |        |   |                                      |                         |     |
|  | 2.8             | 142         | 3B-X-124107 | 08.96 | PR: 1LB,1ZC                         |                                     |                |        |   |                                      |                         |     |
|  | 2.8 4motion     |             | 3B-X-124107 | 10.96 | PR: 1LB,1ZC                         |                                     |                |        |   |                                      |                         |     |
|  | 1.6             |             | 3B-X-124108 |       | 06.05                               | PR: 1LB,1LE,1ZC                     | 24.0125-0171.1 | 425171 |   |                                      | 288 25,0 23,0 V L +B    |     |
|  | 1.8             | 92          | 3B-X-124108 |       | 06.05                               | PR: 1LB,1LE,1ZC                     | 24.0325-0171.1 | 525171 |   |                                      | 288 25,0 23,0 V L +B PD |     |
|  | 1.8 4motion     |             | 3B-X-124108 |       | 06.05                               | PR: 1LB,1LE,1ZC                     |                |        |   |                                      |                         |     |
|  | 1.8 T           |             | 3B-X-124108 |       | 06.05                               | PR: 1LB,1LE,1ZC                     |                |        |   |                                      |                         |     |
|  | 1.9 TDI         | 66          | 3B-X-124108 |       | 06.05                               | PR: 1LB,1LE,1ZC                     |                |        |   |                                      |                         |     |
|  | 1.9 TDI         | 74          |             | 10.00 | 06.05                               | PR: 1LB,1LE,1ZC                     |                |        |   |                                      |                         |     |
|  | 1.9 TDI         | 81          | 3B-X-124108 |       | 06.05                               | PR: 1LB,1LE,1ZC                     |                |        |   |                                      |                         |     |
|  | 1.9 TDI         | 85          | 3B-X-124108 |       | 06.05                               | PR: 1LB,1LE,1ZC                     |                |        |   |                                      |                         |     |
|  | 1.9 TDI         | 96          |             | 10.00 | 06.05                               | PR: 1LB,1LE,1ZC                     |                |        |   |                                      |                         |     |
|  | 1.9 TDI 4motion |             | 3B-X-124108 |       | 06.05                               | PR: 1LB,1LE,1ZC                     |                |        |   |                                      |                         |     |
|  | 1.9 TDI 4motion | 96          |             | 10.00 | 06.05                               | PR: 1LB,1LE,1ZC                     |                |        |   |                                      |                         |     |
|  | 2.0             | 85          |             | 10.00 | 06.05                               | PR: 1LB,1LE,1ZC                     |                |        |   |                                      |                         |     |
|  | 2.0             | 96          |             | 05.02 | 06.05                               | PR: 1LB,1LE,1ZC                     |                |        |   |                                      |                         |     |
|  | 2.0 4motion     | 85          |             | 10.00 | 06.05                               | PR: 1LB,1LE,1ZC                     |                |        |   |                                      |                         |     |
|  | 2.0 TDI         | 100         |             | 12.03 | 06.05                               | PR: 1LB,1LE,1ZC                     |                |        |   |                                      |                         |     |
|  | 2.3             |             | 3B-X-124108 |       | 09.00                               | PR: 1LB,1LE,1ZC                     |                |        |   |                                      |                         |     |
|  | 2.3 4motion     |             | 3B-X-124108 |       | 09.00                               | PR: 1LB,1LE,1ZC                     |                |        |   |                                      |                         |     |
|  | 2.5 TDI         |             |             | 08.98 | 09.00                               | PR: 1LB,1LE,1ZC                     |                |        |   |                                      |                         |     |
|  | 2.5 TDI 4motion |             |             | 08.98 | 09.00                               | PR: 1LB,1LE,1ZC                     |                |        |   |                                      |                         |     |
|  | 2.8             | 132         | 3B-X-124108 |       | 06.05                               | + (M) / + GUS-Staaten <sup>1)</sup> | 24.0125-0171.1 | 425171 |   |                                      | 288 25,0 23,0 V L +B    |     |
|  | 2.8             | 142         | 3B-X-124108 |       | 09.00                               | PR: 1LB,1LE,1ZC                     |                |        |   |                                      |                         |     |
|  | 2.8 4motion     |             | 3B-X-124108 |       | 09.00                               | PR: 1LB,1LE,1ZC                     |                |        |   |                                      |                         |     |
|  | 2.0 TDI         | 100         |             | 12.03 | 06.05                               | PR: 1LT                             | 24.0125-0172.1 | 425172 |   |                                      | 312 25,0 23,0 V L +B    |     |
|  | 2.5 TDI         |             |             | 10.00 | 06.05                               | PR: 1LT                             | 24.0325-0172.1 | 525172 |   |                                      | 312 25,0 23,0 V L +B PD |     |
|  | 2.5 TDI 4motion |             |             | 10.00 | 06.05                               | PR: 1LT                             |                |        |   |                                      |                         |     |
|  | 2.3             |             |             | 10.00 | 06.05                               | PR: 1LT                             | 24.0125-0172.1 | 425172 |   |                                      | 312 25,0 23,0 V L +B    |     |
|  | 2.3 4motion     |             |             | 10.00 | 06.05                               | PR: 1LT                             |                |        |   |                                      |                         |     |
|  | 2.8             | 142         |             | 10.00 | 06.05                               | PR: 1LT                             |                |        |   |                                      |                         |     |
|  | 2.8 4motion     |             |             | 10.00 | 06.05                               | PR: 1LT                             |                |        |   |                                      |                         |     |

<sup>1)</sup> + (M) / + GUS States / + (M) / + Stati del GUS / + (M) / + Etats de la CEI / + (M) / + estados del GUS

<sup>2)</sup> - armoured vehicles / - veicoli blindati / - véhicule blindé / - vehículo blindado

<sup>3)</sup> + armoured vehicles / + veicoli blindati / + véhicule blindé / + vehículo blindado



**VOLKSWAGEN PASSAT (97-05)**

|  |   |   |  |   |  |      |   |                   |
|--|---|---|--|---|--|------|---|-------------------|
|  | 1.6<br>1.8<br>1.8<br>1.8 T<br>1.9 TDI<br>1.9 TDI<br>1.9 TDI<br>1.9 TDI<br>1.9 TDI<br>2.0<br>2.0<br>2.0 TDI<br>2.3<br>2.5 TDI<br>2.8<br>2.8  | 3B-Y-000001<br>85 3B-Y-000001<br>92 3B-Y-000001<br>3B-Y-000001<br>66 3B-Y-000001<br>74<br>81 3B-Y-000001<br>85 3B-Y-000001<br>96<br>85<br>96<br>100<br>3B-Y-000001<br>3B-Y-000001<br>132 3B-Y-000001<br>142 3B-Y-000001 |  | 06.05<br>09.00 +  / + GUS-Staaten <sup>1)</sup><br>09.00<br>06.05<br>09.00<br>10.00 06.05<br>06.05<br>06.05<br>10.00 06.05<br>10.00 06.05<br>05.02 06.05<br>12.03 06.05<br>06.05<br>06.05<br>06.05 +  / + GUS-Staaten <sup>1)</sup><br>06.05  | 24.0710-5014.3<br>360369   | 2    | Radsensor   |                   |
|  | 1.8 4motion<br>1.9 TDI 4motion<br>2.8 4motion   |   | 10.96 04.97<br>10.96 04.97<br>10.96 04.97  |   | 24.0711-1361.3<br>360022<br>24.0711-1362.3<br>360023                             | <br> | Radsensor<br>Radsensor                              |                   |
|  | 1.8 4motion<br>1.9 TDI 4motion<br>2.3 4motion<br>2.5 TDI 4motion<br>2.8 4motion   | 3B-Y-000001<br>3B-Y-000001<br>3B-Y-000001<br>3B-Y-000001<br>3B-Y-000001   |  | 09.00<br>09.00<br>09.00<br>09.00<br>09.00   | 24.0710-5014.3<br>360369   | 2    | Radsensor   |                   |
|  | 1.9 TDI 4motion<br>1.9 TDI 4motion<br>2.0 4motion<br>2.3 4motion<br>2.5 TDI 4motion<br>2.8 4motion<br>4.0 W8 4motion  | 96<br>85  | 10.00 06.05<br>10.00 06.05<br>10.00 06.05<br>10.00 06.05<br>10.00 06.05<br>10.00 06.05<br>09.01 06.05  |   | 24.0710-5014.3<br>360369   | 2    | Radsensor   |                   |
|  | 1.6<br>1.8<br>1.8<br>1.8 4motion<br>1.8 T<br>1.9 TDI<br>1.9 TDI<br>1.9 TDI<br>1.9 TDI<br>1.9 TDI<br>1.9 TDI 4motion<br>1.9 TDI 4motion<br>2.0<br>2.0<br>2.0 4motion<br>2.0 TDI<br>2.3<br>2.3 4motion<br>2.5 TDI<br>2.5 TDI 4motion<br>2.8<br>2.8<br>2.8 4motion<br>4.0 W8 4motion | 85<br>92<br>66<br>74<br>81<br>85<br>96<br>96<br>85<br>96<br>85<br>100<br>132<br>142   |  | 10.96 06.05 PR: 1KD,1KE,1KF,1KW<br>01.97 09.00 +  / + GUS-Staaten <sup>1)</sup><br>10.96 09.00 PR: 1KD,1KE,1KF,1KW<br>10.96 09.00 PR: 1KD,1KE,1KF,1KW<br>10.96 06.05 PR: 1KD,1KE,1KF,1KW<br>10.96 09.00 PR: 1KD,1KE,1KF,1KW<br>10.96 06.05 PR: 1KD,1KE,1KF,1KW<br>08.98 06.05 PR: 1KD,1KE,1KF,1KW<br>10.00 06.05 PR: 1KD,1KE,1KF,1KW<br>10.96 06.05 PR: 1KD,1KE,1KF,1KW<br>10.00 06.05 PR: 1KD,1KE,1KF,1KW<br>10.00 06.05 PR: 1KD,1KE,1KF,1KW<br>05.02 06.05 PR: 1KD,1KE,1KF,1KW<br>10.00 06.05 PR: 1KD,1KE,1KF,1KW<br>12.03 06.05 PR: 1KD,1KE,1KF,1KW<br>10.96 06.05 PR: 1KD,1KE,1KF,1KW<br>06.97 06.05 PR: 1KD,1KE,1KF,1KW<br>08.98 06.05 PR: 1KD,1KE,1KF,1KW<br>08.98 06.05 PR: 1KD,1KE,1KF,1KW<br>01.97 06.05 +  / + GUS-Staaten <sup>1)</sup><br>08.96 06.05 PR: 1KD,1KE,1KF,1KW<br>10.96 06.05 PR: 1KD,1KE,1KF,1KW<br>09.01 06.05 PR: 1KD,1KE,1KF,1KW | 13.0460-2820.2<br>602820<br>13.0470-2820.2<br>LD2820<br>13.0460-0072.2<br>610072 |      | 20961 17,6 /S<br>20961 17,6 /S<br>Belagsatz-Zubehör | TRW<br>TRW<br>TRW |
|  | 1.6<br>1.8<br>1.8<br>1.8 T<br>1.9 TDI<br>1.9 TDI<br>1.9 TDI<br>1.9 TDI<br>1.9 TDI<br>2.0<br>2.0<br>2.0 4motion<br>2.0 TDI<br>2.3<br>2.3 4motion<br>2.5 TDI<br>2.5 TDI 4motion<br>2.8<br>2.8<br>2.8 4motion<br>4.0 W8 4motion  | 85<br>92<br>66<br>74<br>81<br>85<br>96<br>96<br>85<br>100<br>132<br>142   |  | 10.96 06.05 PR: 1KD,1KE,1KF,1KW<br>01.97 09.00 +  / + GUS-Staaten <sup>1)</sup><br>10.96 09.00 PR: 1KD,1KE,1KF,1KW<br>10.96 06.05 PR: 1KD,1KE,1KF,1KW<br>10.96 09.00 PR: 1KD,1KE,1KF,1KW<br>10.96 06.05 PR: 1KD,1KE,1KF,1KW<br>08.98 06.05 PR: 1KD,1KE,1KF,1KW<br>10.00 06.05 PR: 1KD,1KE,1KF,1KW<br>10.00 06.05 PR: 1KD,1KE,1KF,1KW<br>05.02 06.05 PR: 1KD,1KE,1KF,1KW<br>12.03 06.05 PR: 1KD,1KE,1KF,1KW<br>10.96 06.05 PR: 1KD,1KE,1KF,1KW<br>08.98 06.05 PR: 1KD,1KE,1KF,1KW<br>01.97 06.05 +  / + GUS-Staaten <sup>1)</sup><br>08.96 06.05 PR: 1KD,1KE,1KF,1KW<br>08.96 06.05 PR: 1KD,1KE,1KF,1KW  | 24.0110-0201.1<br>410201<br>24.0310-0201.1<br>510201                             |      | 245 10,0 8,0 +B<br>245 10,0 8,0 +B PD               |                   |
|  | 1.8 4motion<br>1.9 TDI 4motion<br>1.9 TDI 4motion<br>2.0 4motion<br>2.3 4motion<br>2.5 TDI 4motion<br>2.8 4motion<br>4.0 W8 4motion   | 96<br>85  | 10.96 06.05 PR: 1KD,1KF<br>10.96 06.05 PR: 1KD,1KF<br>10.00 06.05 PR: 1KD,1KF<br>10.00 06.05 PR: 1KD,1KF<br>06.97 06.05 PR: 1KD,1KF<br>08.98 06.05 PR: 1KD,1KF<br>10.96 06.05 PR: 1KD,1KF<br>09.01 06.05 PR: 1KD,1KF |   | 24.0110-0224.1<br>410224<br>24.0310-0224.1<br>510224                             |      | 245 10,0 8,0 +B<br>245 10,0 8,0 +B PD               |                   |
|  | 1.8 4motion<br>1.9 TDI 4motion<br>1.9 TDI 4motion<br>2.0 4motion<br>2.3 4motion<br>2.5 TDI 4motion<br>2.8 4motion   | 96<br>85  | 10.96 06.05 PR: 1KE<br>10.96 06.05 PR: 1KE<br>10.00 06.05 PR: 1KE<br>10.00 06.05 PR: 1KE<br>06.97 06.05 PR: 1KE<br>08.98 06.05 PR: 1KE<br>10.96 06.05 PR: 1KE  |   | 24.0122-0221.1<br>422221   |      | 256 22,0 20,0 VL +B                                 |                   |

<sup>1)</sup> + / + GUS States / + / + Stati del GUS / + / + Etats de la CEI / + / + estados del GUS



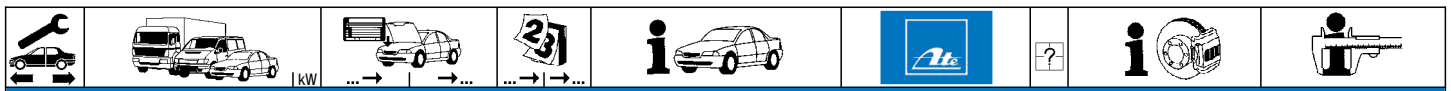

**VOLKSWAGEN PASSAT (97-05)**

|  |                 |    |       |       |         |                |        |  |                      |
|--|-----------------|----|-------|-------|---------|----------------|--------|--|----------------------|
|  | 4.0 W8 4motion  |    | 09.01 | 06.05 | PR: 1KE | 24.0122-0221.1 | 422221 |  | 256 22,0 20,0 V L +B |
|  | 1.8 4motion     |    | 10.96 | 06.05 | PR: 1KW | 24.0122-0222.1 | 422222 |  | 269 22,0 20,0 V L +B |
|  | 1.9 TDI 4motion |    | 10.96 | 06.05 | PR: 1KW |                |        |  |                      |
|  | 1.9 TDI 4motion | 96 | 10.00 | 06.05 | PR: 1KW |                |        |  |                      |
|  | 2.0 4motion     | 85 | 10.00 | 06.05 | PR: 1KW |                |        |  |                      |
|  | 2.3 4motion     |    | 06.97 | 06.05 | PR: 1KW |                |        |  |                      |
|  | 2.5 TDI 4motion |    | 08.98 | 06.05 | PR: 1KW |                |        |  |                      |
|  | 2.8 4motion     |    | 10.96 | 06.05 | PR: 1KW |                |        |  |                      |
|  | 4.0 W8 4motion  |    | 09.01 | 06.05 | PR: 1KW |                |        |  |                      |





**VOLKSWAGEN PASSAT Limousine (05-10)**

|  |                    |     |       |       |                     |                |        |  |                            |     |
|--|--------------------|-----|-------|-------|---------------------|----------------|--------|--|----------------------------|-----|
|  | 1.4 TSI            |     | 10.07 | 07.10 | PR: 1LJ,1LH,1ZG,1ZM | 13.0460-7184.2 | 607184 |  | 23587 20,6 +/WK            | ATE |
|  | 1.6                | 75  | 03.05 | 07.10 | PR: 1LJ,1LH,1ZG,1ZM | 13.0470-7184.2 | LD7184 |  | 23587 20,6 +/WK            | ATE |
|  | 1.6 FSI            | 85  | 03.05 | 07.10 | PR: 1LJ,1LH,1ZG,1ZM |                |        |  |                            |     |
|  | 1.6 TDI            | 77  | 08.09 | 07.10 | PR: 1LJ,1LH,1ZG,1ZM |                |        |  |                            |     |
|  | 1.8 TSI            | 112 | 11.09 | 07.10 | PR: 1LJ,1LH,1ZG,1ZM |                |        |  |                            |     |
|  | 1.8 TSI            | 118 | 10.07 | 07.10 | PR: 1LJ,1LH,1ZG,1ZM |                |        |  |                            |     |
|  | 1.9 TDI            | 77  | 03.05 | 07.10 | PR: 1LJ,1LH,1ZG,1ZM |                |        |  |                            |     |
|  | 2.0 FSI            |     | 03.05 | 07.10 | PR: 1LJ,1LH,1ZG,1ZM |                |        |  |                            |     |
|  | 2.0 FSI            | 147 | 03.05 | 07.10 | PR: 1LJ,1LH,1ZG,1ZM |                |        |  |                            |     |
|  | 2.0 FSI 4motion    | 110 | 03.05 | 07.10 | PR: 1LJ,1LH,1ZG,1ZM |                |        |  |                            |     |
|  | 2.0 TDI            |     | 03.05 | 07.10 | PR: 1LJ,1LH,1ZG,1ZM |                |        |  |                            |     |
|  | 2.0 TDI            |     | 03.05 | 07.10 | PR: 1LJ,1LH,1ZG,1ZM |                |        |  |                            |     |
|  | 2.0 TDI            | 120 | 08.05 | 07.10 | PR: 1LJ,1LH,1ZG,1ZM |                |        |  |                            |     |
|  | 2.0 TDI            | 125 | 08.05 | 07.10 | PR: 1LJ,1LH,1ZG,1ZM |                |        |  |                            |     |
|  | 2.0 TDI 16V        | 103 | 03.05 | 07.10 | PR: 1LJ,1LH,1ZG,1ZM |                |        |  |                            |     |
|  | 2.0 TDI 4motion    | 103 | 03.05 | 07.10 | PR: 1LJ,1LH,1ZG,1ZM |                |        |  |                            |     |
|  | 2.0 TDI 4motion    | 125 | 05.09 | 07.10 | PR: 1LJ,1LH,1ZG,1ZM |                |        |  |                            |     |
|  | 3.2 V6 FSI 4motion | 184 | 09.05 | 07.10 | PR: 1LJ,1LH,1ZG,1ZM |                |        |  |                            |     |
|  | 3.6 R36            | 220 | 04.07 | 07.10 | PR: 1LJ,1LH,1ZG,1ZM |                |        |  |                            |     |
|  | 1.4 TSI            |     | 10.07 | 07.10 | PR: 1LK,1LM         | 13.0460-7200.2 | 607200 |  | 23801 20,3 +/WK            | ATE |
|  | 1.6                | 75  | 03.05 | 07.10 | PR: 1LK,1LM         | 13.0470-7200.2 | LD7200 |  | 23801 20,3 +/WK            | ATE |
|  | 1.6 FSI            | 85  | 03.05 | 07.10 | PR: 1LK,1LM         |                |        |  |                            |     |
|  | 1.6 TDI            | 77  | 08.09 | 07.10 | PR: 1LK,1LM         |                |        |  |                            |     |
|  | 1.8 TSI            | 112 | 11.09 | 07.10 | PR: 1LK,1LM         |                |        |  |                            |     |
|  | 1.8 TSI            | 118 | 10.07 | 07.10 | PR: 1LK,1LM         |                |        |  |                            |     |
|  | 1.9 TDI            | 77  | 03.05 | 07.10 | PR: 1LK,1LM         |                |        |  |                            |     |
|  | 2.0 FSI            |     | 03.05 | 07.10 | PR: 1LK,1LM         |                |        |  |                            |     |
|  | 2.0 FSI            | 147 | 03.05 | 07.10 | PR: 1LK,1LM         |                |        |  |                            |     |
|  | 2.0 FSI 4motion    | 110 | 03.05 | 07.10 | PR: 1LK,1LM         |                |        |  |                            |     |
|  | 2.0 TDI            |     | 03.05 | 07.10 | PR: 1LK,1LM         |                |        |  |                            |     |
|  | 2.0 TDI            |     | 03.05 | 07.10 | PR: 1LK,1LM         |                |        |  |                            |     |
|  | 2.0 TDI            | 120 | 08.05 | 07.10 | PR: 1LK,1LM         |                |        |  |                            |     |
|  | 2.0 TDI            | 125 | 08.05 | 07.10 | PR: 1LK,1LM         |                |        |  |                            |     |
|  | 2.0 TDI 16V        | 103 | 03.05 | 07.10 | PR: 1LK,1LM         |                |        |  |                            |     |
|  | 2.0 TDI 4motion    | 103 | 03.05 | 07.10 | PR: 1LK,1LM         |                |        |  |                            |     |
|  | 2.0 TDI 4motion    | 125 | 05.09 | 07.10 | PR: 1LK,1LM         |                |        |  |                            |     |
|  | 3.2 V6 FSI 4motion | 184 | 09.05 | 07.10 | PR: 1LK,1LM         |                |        |  |                            |     |
|  | 3.6 R36            | 220 | 04.07 | 07.10 | PR: 1LK,1LM         |                |        |  |                            |     |
|  | 1.4 TSI            |     | 10.07 | 07.10 | PR: 1LJ,1LH,1ZG,1ZM | 24.0125-0158.1 | 425158 |  | 312 25,0 22,0 V L +S +B    |     |
|  | 1.6                | 75  | 03.05 | 07.10 | PR: 1LJ,1LH,1ZG,1ZM | 24.0325-0158.1 | 525158 |  | 312 25,0 22,0 V L +S +B PD |     |
|  | 1.6 FSI            | 85  | 03.05 | 07.10 | PR: 1LJ,1LH,1ZG,1ZM |                |        |  |                            |     |
|  | 1.6 TDI            | 77  | 08.09 | 07.10 | PR: 1LJ,1LH,1ZG,1ZM |                |        |  |                            |     |
|  | 1.8 TSI            | 112 | 11.09 | 07.10 | PR: 1LJ,1LH,1ZG,1ZM |                |        |  |                            |     |
|  | 1.8 TSI            | 118 | 10.07 | 07.10 | PR: 1LJ,1LH,1ZG,1ZM |                |        |  |                            |     |
|  | 1.9 TDI            | 77  | 03.05 | 07.10 | PR: 1LJ,1LH,1ZG,1ZM |                |        |  |                            |     |
|  | 2.0 FSI            |     | 03.05 | 07.10 | PR: 1LJ,1LH,1ZG,1ZM |                |        |  |                            |     |
|  | 2.0 FSI            | 147 | 03.05 | 07.10 | PR: 1LJ,1LH,1ZG,1ZM |                |        |  |                            |     |
|  | 2.0 FSI 4motion    | 110 | 03.05 | 07.10 | PR: 1LJ,1LH,1ZG,1ZM |                |        |  |                            |     |
|  | 2.0 TDI            |     | 03.05 | 07.10 | PR: 1LJ,1LH,1ZG,1ZM |                |        |  |                            |     |
|  | 2.0 TDI            |     | 03.05 | 07.10 | PR: 1LJ,1LH,1ZG,1ZM |                |        |  |                            |     |
|  | 2.0 TDI            | 120 | 08.05 | 07.10 | PR: 1LJ,1LH,1ZG,1ZM |                |        |  |                            |     |
|  | 2.0 TDI            | 125 | 08.05 | 07.10 | PR: 1LJ,1LH,1ZG,1ZM |                |        |  |                            |     |
|  | 2.0 TDI 16V        | 103 | 03.05 | 07.10 | PR: 1LJ,1LH,1ZG,1ZM |                |        |  |                            |     |
|  | 2.0 TDI 4motion    | 103 | 03.05 | 07.10 | PR: 1LJ,1LH,1ZG,1ZM |                |        |  |                            |     |
|  | 2.0 TDI 4motion    | 125 | 05.09 | 07.10 | PR: 1LJ,1LH,1ZG,1ZM |                |        |  |                            |     |
|  | 3.2 V6 FSI 4motion | 184 | 09.05 | 07.10 | PR: 1LJ,1LH,1ZG,1ZM |                |        |  |                            |     |
|  | 3.6 R36            | 220 | 04.07 | 07.10 | PR: 1LJ,1LH,1ZG,1ZM |                |        |  |                            |     |
|  | 1.4 TSI            |     | 10.07 | 07.10 | PR: 1LK,1LM         | 24.0130-0115.1 | 430115 |  | 345 30,0 27,0 V L +B       |     |
|  | 1.6                | 75  | 03.05 | 07.10 | PR: 1LK,1LM         | 24.0330-0115.1 | 530115 |  | 345 30,0 27,0 V L +B PD    |     |
|  | 1.6 FSI            | 85  | 03.05 | 07.10 | PR: 1LK,1LM         |                |        |  |                            |     |
|  | 1.6 TDI            | 77  | 08.09 | 07.10 | PR: 1LK,1LM         |                |        |  |                            |     |
|  | 1.8 TSI            | 112 | 11.09 | 07.10 | PR: 1LK,1LM         |                |        |  |                            |     |
|  | 1.8 TSI            | 118 | 10.07 | 07.10 | PR: 1LK,1LM         |                |        |  |                            |     |
|  | 1.9 TDI            | 77  | 03.05 | 07.10 | PR: 1LK,1LM         |                |        |  |                            |     |
|  | 2.0 FSI            |     | 03.05 | 07.10 | PR: 1LK,1LM         |                |        |  |                            |     |
|  | 2.0 FSI            | 147 | 03.05 | 07.10 | PR: 1LK,1LM         |                |        |  |                            |     |
|  | 2.0 FSI 4motion    | 110 | 03.05 | 07.10 | PR: 1LK,1LM         |                |        |  |                            |     |
|  | 2.0 TDI            |     | 03.05 | 07.10 | PR: 1LK,1LM         |                |        |  |                            |     |
|  | 2.0 TDI            |     | 03.05 | 07.10 | PR: 1LK,1LM         |                |        |  |                            |     |
|  | 2.0 TDI            | 120 | 08.05 | 07.10 | PR: 1LK,1LM         |                |        |  |                            |     |
|  | 2.0 TDI            | 125 | 08.05 | 07.10 | PR: 1LK,1LM         |                |        |  |                            |     |
|  | 2.0 TDI 16V        | 103 | 03.05 | 07.10 | PR: 1LK,1LM         |                |        |  |                            |     |
|  | 2.0 TDI 4motion    | 103 | 03.05 | 07.10 | PR: 1LK,1LM         |                |        |  |                            |     |
|  | 2.0 TDI 4motion    | 125 | 05.09 | 07.10 | PR: 1LK,1LM         |                |        |  |                            |     |
|  | 3.2 V6 FSI 4motion | 184 | 09.05 | 07.10 | PR: 1LK,1LM         |                |        |  |                            |     |
|  | 3.6 R36            | 220 | 04.07 | 07.10 | PR: 1LK,1LM         |                |        |  |                            |     |







**VOLKSWAGEN PASSAT Limousine (05-10)**













|  |  |   |  |  |  |   |  |                            |  |   |            |
|--|--|---|--|--|--|---|--|----------------------------|--|---|------------|
|    | 1.4 TSI<br>1.6<br>1.6 FSI<br>1.6 TDI<br>1.8 TSI<br>1.8 TSI<br>1.9 TDI<br>2.0 FSI<br>2.0 FSI<br>2.0 FSI 4motion<br>2.0 TDI<br>2.0 TDI<br>2.0 TDI<br>2.0 TDI<br>2.0 TDI 16V<br>2.0 TDI 4motion<br>2.0 TDI 4motion<br>3.2 V6 FSI 4motion<br>3.6 R36 | 75<br>85<br>85<br>77<br>112<br>118<br>77<br>147<br>110<br>120<br>125<br>103<br>103<br>125<br>184<br>220 |  | 10.07<br>03.05<br>03.05<br>08.09<br>11.09<br>10.07<br>03.05<br>03.05<br>03.05<br>03.05<br>08.05<br>08.05<br>03.05<br>08.05<br>03.05<br>05.09<br>09.05<br>04.07 | 07.10<br>07.10<br>07.10<br>07.10<br>07.10<br>07.10<br>07.10<br>07.10<br>07.10<br>07.10<br>07.10<br>07.10<br>07.10<br>07.10<br>07.10<br>07.10<br>07.10<br>07.10 |   | 24.0711-5271.3<br>24.0711-5272.3                   | 360301<br>360302           |     | Radsensor<br>Radsensor  |            |
|    | 1.4 TSI<br>1.6<br>1.6 FSI<br>1.6 TDI<br>1.8 TSI<br>1.8 TSI<br>1.9 TDI<br>2.0 FSI<br>2.0 FSI<br>2.0 FSI 4motion<br>2.0 TDI<br>2.0 TDI<br>2.0 TDI<br>2.0 TDI<br>2.0 TDI 16V<br>2.0 TDI 4motion<br>2.0 TDI 4motion<br>3.2 V6 FSI 4motion<br>3.6 R36 | 75<br>85<br>85<br>77<br>112<br>118<br>77<br>147<br>110<br>120<br>125<br>103<br>103<br>125<br>184<br>220 |  | 10.07<br>03.05<br>03.05<br>08.09<br>11.09<br>10.07<br>03.05<br>03.05<br>03.05<br>03.05<br>08.05<br>08.05<br>03.05<br>03.05<br>05.09<br>09.05<br>04.07          | 07.10<br>07.10<br>07.10<br>07.10<br>07.10<br>07.10<br>07.10<br>07.10<br>07.10<br>07.10<br>07.10<br>07.10<br>07.10<br>07.10<br>07.10<br>07.10<br>07.10<br>07.10 | PR: 1KU,1KW<br>PR: 1KU,1KW<br>PR: 1KU,1KW<br>PR: 1KU,1KW<br>PR: 1KU,1KW<br>PR: 1KU,1KW<br>PR: 1KU,1KW<br>PR: 1KU,1KW<br>PR: 1KU,1KW<br>PR: 1KU,1KW<br>PR: 1KU,1KW<br>PR: 1KU,1KW<br>PR: 1KU,1KW<br>PR: 1KU,1KW<br>PR: 1KU,1KW<br>PR: 1KU,1KW<br>PR: 1KU,1KW | 13.0460-2880.2<br>13.0470-2880.2<br>13.0460-0259.2 | 602880<br>LD2880<br>610259 | elektrische Feststellbremse <sup>1)</sup><br>elektrische Feststellbremse <sup>1)</sup> | 23914 17,1 /WE/Zub/S<br>23914 17,1 /WE/Zub/S<br>Belagsatz-Zubehör | TRW<br>TRW |
|  | 1.4 TSI<br>1.6<br>1.6 FSI<br>1.6 TDI<br>1.8 TSI<br>1.8 TSI<br>1.9 TDI<br>2.0 FSI<br>2.0 FSI<br>2.0 FSI 4motion<br>2.0 TDI<br>2.0 TDI<br>2.0 TDI<br>2.0 TDI<br>2.0 TDI 16V<br>2.0 TDI 4motion<br>2.0 TDI 4motion<br>3.2 V6 FSI 4motion<br>3.6 R36 | 75<br>85<br>85<br>77<br>112<br>118<br>77<br>147<br>110<br>120<br>125<br>103<br>103<br>125<br>184<br>220 |  | 10.07<br>03.05<br>03.05<br>08.09<br>11.09<br>10.07<br>03.05<br>03.05<br>03.05<br>03.05<br>08.05<br>08.05<br>03.05<br>03.05<br>05.09<br>09.05<br>04.07          | 07.10<br>07.10<br>07.10<br>07.10<br>07.10<br>07.10<br>07.10<br>07.10<br>07.10<br>07.10<br>07.10<br>07.10<br>07.10<br>07.10<br>07.10<br>07.10<br>07.10<br>07.10 | PR: 2EA,2EL<br>PR: 2EA,2EL<br>PR: 2EA,2EL<br>PR: 2EA,2EL<br>PR: 2EA,2EL<br>PR: 2EA,2EL<br>PR: 2EA,2EL<br>PR: 2EA,2EL<br>PR: 2EA,2EL<br>PR: 2EA,2EL<br>PR: 2EA,2EL<br>PR: 2EA,2EL<br>PR: 2EA,2EL<br>PR: 2EA,2EL<br>PR: 2EA,2EL<br>PR: 2EA,2EL<br>PR: 2EA,2EL | 13.0460-2887.2<br>13.0470-2887.2<br>13.0460-0035.2 | 602887<br>LD2887<br>610035 | elektrische Feststellbremse <sup>1)</sup><br>elektrische Feststellbremse <sup>1)</sup> | 23914 17,1 /WE/Zub/S<br>23914 17,1 /WE/Zub/S<br>Belagsatz-Zubehör | TRW<br>TRW |
|  | 1.4 TSI<br>1.6<br>1.6 FSI<br>1.6 TDI<br>1.8 TSI<br>1.8 TSI<br>1.9 TDI<br>2.0 FSI<br>2.0 FSI<br>2.0 FSI 4motion<br>2.0 TDI<br>2.0 TDI<br>2.0 TDI<br>2.0 TDI<br>2.0 TDI 16V<br>2.0 TDI 4motion<br>2.0 TDI 4motion<br>3.2 V6 FSI 4motion<br>3.6 R36 | 75<br>85<br>85<br>77<br>112<br>118<br>77<br>147<br>110<br>120<br>125<br>103<br>103<br>125<br>184<br>220 |  | 10.07<br>03.05<br>03.05<br>08.09<br>11.09<br>10.07<br>03.05<br>03.05<br>03.05<br>03.05<br>08.05<br>08.05<br>03.05<br>03.05<br>05.09<br>09.05<br>04.07          | 07.10<br>07.10<br>07.10<br>07.10<br>07.10<br>07.10<br>07.10<br>07.10<br>07.10<br>07.10<br>07.10<br>07.10<br>07.10<br>07.10<br>07.10<br>07.10<br>07.10<br>07.10 | PR: 1KU,1KW<br>PR: 1KU,1KW<br>PR: 1KU,1KW<br>PR: 1KU,1KW<br>PR: 1KU,1KW<br>PR: 1KU,1KW<br>PR: 1KU,1KW<br>PR: 1KU,1KW<br>PR: 1KU,1KW<br>PR: 1KU,1KW<br>PR: 1KU,1KW<br>PR: 1KU,1KW<br>PR: 1KU,1KW<br>PR: 1KU,1KW<br>PR: 1KU,1KW<br>PR: 1KU,1KW<br>PR: 1KU,1KW | 24.0112-0169.1<br>24.0312-0169.1                   | 412169<br>512169           | elektrische Feststellbremse <sup>1)</sup><br>elektrische Feststellbremse <sup>1)</sup> | 282 12,0 10,0 +S +B<br>282 12,0 10,0 +S +B PD                     |            |
|  | 1.4 TSI<br>1.6<br>1.6 FSI<br>1.6 TDI<br>1.8 TSI<br>1.8 TSI<br>1.9 TDI<br>2.0 FSI<br>2.0 FSI<br>2.0 FSI 4motion<br>2.0 TDI  | 75<br>85<br>85<br>77<br>112<br>118<br>77<br>147<br>110  |  | 10.07<br>03.05<br>03.05<br>08.09<br>11.09<br>10.07<br>03.05<br>03.05<br>03.05  | 07.10<br>07.10<br>07.10<br>07.10<br>07.10<br>07.10<br>07.10<br>07.10<br>07.10  | PR: 2EA,2EL<br>PR: 2EA,2EL<br>PR: 2EA,2EL<br>PR: 2EA,2EL<br>PR: 2EA,2EL<br>PR: 2EA,2EL<br>PR: 2EA,2EL<br>PR: 2EA,2EL<br>PR: 2EA,2EL   | 24.0122-0219.1                                     | 422219                     | elektrische Feststellbremse <sup>1)</sup>  | 310 22,0 20,0 V L +B  |            |

<sup>1)</sup> electric parking brake / fr.di stazionamento elettrico / frein à main électrique / freno de mano eléctrico



| VOLKSWAGEN PASSAT Limousine (05-10)  |   |         |       |                     |                |                     |   |                           |   |                     |         |     |       |       |                     |                |        |   |                     |         |     |       |       |                     |  |  |  |  |             |     |       |       |                     |  |  |  |  |                 |     |       |       |                     |  |  |  |  |                 |     |       |       |                     |  |  |  |  |                    |     |       |       |                     |  |  |  |  |         |     |       |       |                     |  |  |  |  |                 |     |       |       |                     |  |  |  |  |         |     |       |       |                     |  |  |  |  |         |     |       |       |                     |  |  |  |  |             |     |       |       |                     |  |  |  |  |             |     |       |       |                     |  |  |  |  |                 |     |       |       |                     |                |        |   |           |                 |     |       |       |                     |                |        |   |           |                 |     |       |       |                     |  |  |  |  |                    |     |       |       |                     |  |  |  |  |          |     |       |       |                     |  |  |  |  |                    |     |       |       |                     |  |  |  |  |         |     |       |       |                     |  |  |  |  |         |    |       |       |             |                |        |  |                     |     |    |       |       |             |                |        |  |                     |         |    |       |       |             |  |  |  |  |         |    |       |       |             |  |  |  |  |         |     |       |       |             |  |  |  |  |         |     |       |       |             |  |  |  |  |         |    |       |       |             |  |  |  |  |         |     |       |       |             |  |  |  |  |                 |     |       |       |             |  |  |  |  |         |     |       |       |             |  |  |  |  |         |    |       |       |             |  |  |  |  |         |     |       |       |             |  |  |  |  |         |     |       |       |             |  |  |  |  |             |     |       |       |             |  |  |  |  |                 |     |       |       |             |  |  |  |  |                 |     |       |       |             |  |  |  |  |          |     |       |       |             |  |  |  |  |                    |     |       |       |             |  |  |  |  |         |     |       |       |             |  |  |  |  |         |    |       |       |                     |                |        |  |                        |     |    |       |       |                     |                |        |  |                           |         |    |       |       |                     |  |  |  |  |         |    |       |       |                     |  |  |  |  |         |     |       |       |                     |  |  |  |  |         |     |       |       |                     |  |  |  |  |         |    |       |       |                     |  |  |  |  |         |     |       |       |                     |  |  |  |  |                 |     |       |       |                     |  |  |  |  |         |     |       |       |                     |  |  |  |  |         |    |       |       |                     |  |  |  |  |         |     |       |       |                     |  |  |  |  |         |     |       |       |                     |  |  |  |  |             |     |       |       |                     |  |  |  |  |                 |     |       |       |                     |  |  |  |  |                 |     |       |       |                     |  |  |  |  |          |     |       |       |                     |  |  |  |  |
|--|---|---------|-------|---------------------|----------------|---------------------|---|---------------------------|---|---------------------|---------|-----|-------|-------|---------------------|----------------|--------|---|---------------------|---------|-----|-------|-------|---------------------|--|--|--|--|-------------|-----|-------|-------|---------------------|--|--|--|--|-----------------|-----|-------|-------|---------------------|--|--|--|--|-----------------|-----|-------|-------|---------------------|--|--|--|--|--------------------|-----|-------|-------|---------------------|--|--|--|--|---------|-----|-------|-------|---------------------|--|--|--|--|-----------------|-----|-------|-------|---------------------|--|--|--|--|---------|-----|-------|-------|---------------------|--|--|--|--|---------|-----|-------|-------|---------------------|--|--|--|--|-------------|-----|-------|-------|---------------------|--|--|--|--|-------------|-----|-------|-------|---------------------|--|--|--|--|-----------------|-----|-------|-------|---------------------|----------------|--------|---|-----------|-----------------|-----|-------|-------|---------------------|----------------|--------|---|-----------|-----------------|-----|-------|-------|---------------------|--|--|--|--|--------------------|-----|-------|-------|---------------------|--|--|--|--|----------|-----|-------|-------|---------------------|--|--|--|--|--------------------|-----|-------|-------|---------------------|--|--|--|--|---------|-----|-------|-------|---------------------|--|--|--|--|---------|----|-------|-------|-------------|----------------|--------|--|---------------------|-----|----|-------|-------|-------------|----------------|--------|--|---------------------|---------|----|-------|-------|-------------|--|--|--|--|---------|----|-------|-------|-------------|--|--|--|--|---------|-----|-------|-------|-------------|--|--|--|--|---------|-----|-------|-------|-------------|--|--|--|--|---------|----|-------|-------|-------------|--|--|--|--|---------|-----|-------|-------|-------------|--|--|--|--|-----------------|-----|-------|-------|-------------|--|--|--|--|---------|-----|-------|-------|-------------|--|--|--|--|---------|----|-------|-------|-------------|--|--|--|--|---------|-----|-------|-------|-------------|--|--|--|--|---------|-----|-------|-------|-------------|--|--|--|--|-------------|-----|-------|-------|-------------|--|--|--|--|-----------------|-----|-------|-------|-------------|--|--|--|--|-----------------|-----|-------|-------|-------------|--|--|--|--|----------|-----|-------|-------|-------------|--|--|--|--|--------------------|-----|-------|-------|-------------|--|--|--|--|---------|-----|-------|-------|-------------|--|--|--|--|---------|----|-------|-------|---------------------|----------------|--------|--|------------------------|-----|----|-------|-------|---------------------|----------------|--------|--|---------------------------|---------|----|-------|-------|---------------------|--|--|--|--|---------|----|-------|-------|---------------------|--|--|--|--|---------|-----|-------|-------|---------------------|--|--|--|--|---------|-----|-------|-------|---------------------|--|--|--|--|---------|----|-------|-------|---------------------|--|--|--|--|---------|-----|-------|-------|---------------------|--|--|--|--|-----------------|-----|-------|-------|---------------------|--|--|--|--|---------|-----|-------|-------|---------------------|--|--|--|--|---------|----|-------|-------|---------------------|--|--|--|--|---------|-----|-------|-------|---------------------|--|--|--|--|---------|-----|-------|-------|---------------------|--|--|--|--|-------------|-----|-------|-------|---------------------|--|--|--|--|-----------------|-----|-------|-------|---------------------|--|--|--|--|-----------------|-----|-------|-------|---------------------|--|--|--|--|----------|-----|-------|-------|---------------------|--|--|--|--|
|  | <table border="1"> <tr><td>2.0 TDI</td><td>120</td><td>03.05</td><td>07.10</td><td>PR: 2EA,2EL</td><td>24.0122-0219.1</td><td>422219</td><td>elektrische Feststellbremse <sup>1)</sup></td><td>310 22,0 20,0 VL +B</td></tr> <tr><td>2.0 TDI</td><td>125</td><td>08.05</td><td>07.10</td><td>PR: 2EA,2EL</td><td></td><td></td><td></td><td></td></tr> <tr><td>2.0 TDI</td><td>103</td><td>08.05</td><td>07.10</td><td>PR: 2EA,2EL</td><td></td><td></td><td></td><td></td></tr> <tr><td>2.0 TDI 16V</td><td>103</td><td>03.05</td><td>07.10</td><td>PR: 2EA,2EL</td><td></td><td></td><td></td><td></td></tr> <tr><td>2.0 TDI 4motion</td><td>103</td><td>03.05</td><td>07.10</td><td>PR: 2EA,2EL</td><td></td><td></td><td></td><td></td></tr> <tr><td>2.0 TDI 4motion</td><td>125</td><td>05.09</td><td>07.10</td><td>PR: 2EA,2EL</td><td></td><td></td><td></td><td></td></tr> <tr><td>3.2 V6 FSI 4motion</td><td>184</td><td>09.05</td><td>07.10</td><td>PR: 2EA,2EL</td><td></td><td></td><td></td><td></td></tr> <tr><td>3.6 R36</td><td>220</td><td>04.07</td><td>07.10</td><td>PR: 2EA,2EL</td><td></td><td></td><td></td><td></td></tr> </table>  | 2.0 TDI | 120   | 03.05               | 07.10          | PR: 2EA,2EL         | 24.0122-0219.1                            | 422219                    | elektrische Feststellbremse <sup>1)</sup> | 310 22,0 20,0 VL +B | 2.0 TDI | 125 | 08.05 | 07.10 | PR: 2EA,2EL         |                |        |   |                     | 2.0 TDI | 103 | 08.05 | 07.10 | PR: 2EA,2EL         |  |  |  |  | 2.0 TDI 16V | 103 | 03.05 | 07.10 | PR: 2EA,2EL         |  |  |  |  | 2.0 TDI 4motion | 103 | 03.05 | 07.10 | PR: 2EA,2EL         |  |  |  |  | 2.0 TDI 4motion | 125 | 05.09 | 07.10 | PR: 2EA,2EL         |  |  |  |  | 3.2 V6 FSI 4motion | 184 | 09.05 | 07.10 | PR: 2EA,2EL         |  |  |  |  | 3.6 R36 | 220 | 04.07 | 07.10 | PR: 2EA,2EL         |  |  |  |  |                 |     |       |       |                     |  |  |  |  |         |     |       |       |                     |  |  |  |  |         |     |       |       |                     |  |  |  |  |             |     |       |       |                     |  |  |  |  |             |     |       |       |                     |  |  |  |  |                 |     |       |       |                     |                |        |   |           |                 |     |       |       |                     |                |        |   |           |                 |     |       |       |                     |  |  |  |  |                    |     |       |       |                     |  |  |  |  |          |     |       |       |                     |  |  |  |  |                    |     |       |       |                     |  |  |  |  |         |     |       |       |                     |  |  |  |  |         |    |       |       |             |                |        |  |                     |     |    |       |       |             |                |        |  |                     |         |    |       |       |             |  |  |  |  |         |    |       |       |             |  |  |  |  |         |     |       |       |             |  |  |  |  |         |     |       |       |             |  |  |  |  |         |    |       |       |             |  |  |  |  |         |     |       |       |             |  |  |  |  |                 |     |       |       |             |  |  |  |  |         |     |       |       |             |  |  |  |  |         |    |       |       |             |  |  |  |  |         |     |       |       |             |  |  |  |  |         |     |       |       |             |  |  |  |  |             |     |       |       |             |  |  |  |  |                 |     |       |       |             |  |  |  |  |                 |     |       |       |             |  |  |  |  |          |     |       |       |             |  |  |  |  |                    |     |       |       |             |  |  |  |  |         |     |       |       |             |  |  |  |  |         |    |       |       |                     |                |        |  |                        |     |    |       |       |                     |                |        |  |                           |         |    |       |       |                     |  |  |  |  |         |    |       |       |                     |  |  |  |  |         |     |       |       |                     |  |  |  |  |         |     |       |       |                     |  |  |  |  |         |    |       |       |                     |  |  |  |  |         |     |       |       |                     |  |  |  |  |                 |     |       |       |                     |  |  |  |  |         |     |       |       |                     |  |  |  |  |         |    |       |       |                     |  |  |  |  |         |     |       |       |                     |  |  |  |  |         |     |       |       |                     |  |  |  |  |             |     |       |       |                     |  |  |  |  |                 |     |       |       |                     |  |  |  |  |                 |     |       |       |                     |  |  |  |  |          |     |       |       |                     |  |  |  |  |
| 2.0 TDI  | 120   | 03.05   | 07.10 | PR: 2EA,2EL         | 24.0122-0219.1 | 422219              | elektrische Feststellbremse <sup>1)</sup> | 310 22,0 20,0 VL +B       |   |                     |         |     |       |       |                     |                |        |   |                     |         |     |       |       |                     |  |  |  |  |             |     |       |       |                     |  |  |  |  |                 |     |       |       |                     |  |  |  |  |                 |     |       |       |                     |  |  |  |  |                    |     |       |       |                     |  |  |  |  |         |     |       |       |                     |  |  |  |  |                 |     |       |       |                     |  |  |  |  |         |     |       |       |                     |  |  |  |  |         |     |       |       |                     |  |  |  |  |             |     |       |       |                     |  |  |  |  |             |     |       |       |                     |  |  |  |  |                 |     |       |       |                     |                |        |   |           |                 |     |       |       |                     |                |        |   |           |                 |     |       |       |                     |  |  |  |  |                    |     |       |       |                     |  |  |  |  |          |     |       |       |                     |  |  |  |  |                    |     |       |       |                     |  |  |  |  |         |     |       |       |                     |  |  |  |  |         |    |       |       |             |                |        |  |                     |     |    |       |       |             |                |        |  |                     |         |    |       |       |             |  |  |  |  |         |    |       |       |             |  |  |  |  |         |     |       |       |             |  |  |  |  |         |     |       |       |             |  |  |  |  |         |    |       |       |             |  |  |  |  |         |     |       |       |             |  |  |  |  |                 |     |       |       |             |  |  |  |  |         |     |       |       |             |  |  |  |  |         |    |       |       |             |  |  |  |  |         |     |       |       |             |  |  |  |  |         |     |       |       |             |  |  |  |  |             |     |       |       |             |  |  |  |  |                 |     |       |       |             |  |  |  |  |                 |     |       |       |             |  |  |  |  |          |     |       |       |             |  |  |  |  |                    |     |       |       |             |  |  |  |  |         |     |       |       |             |  |  |  |  |         |    |       |       |                     |                |        |  |                        |     |    |       |       |                     |                |        |  |                           |         |    |       |       |                     |  |  |  |  |         |    |       |       |                     |  |  |  |  |         |     |       |       |                     |  |  |  |  |         |     |       |       |                     |  |  |  |  |         |    |       |       |                     |  |  |  |  |         |     |       |       |                     |  |  |  |  |                 |     |       |       |                     |  |  |  |  |         |     |       |       |                     |  |  |  |  |         |    |       |       |                     |  |  |  |  |         |     |       |       |                     |  |  |  |  |         |     |       |       |                     |  |  |  |  |             |     |       |       |                     |  |  |  |  |                 |     |       |       |                     |  |  |  |  |                 |     |       |       |                     |  |  |  |  |          |     |       |       |                     |  |  |  |  |
| 2.0 TDI  | 125   | 08.05   | 07.10 | PR: 2EA,2EL         |                |                     |   |                           |   |                     |         |     |       |       |                     |                |        |   |                     |         |     |       |       |                     |  |  |  |  |             |     |       |       |                     |  |  |  |  |                 |     |       |       |                     |  |  |  |  |                 |     |       |       |                     |  |  |  |  |                    |     |       |       |                     |  |  |  |  |         |     |       |       |                     |  |  |  |  |                 |     |       |       |                     |  |  |  |  |         |     |       |       |                     |  |  |  |  |         |     |       |       |                     |  |  |  |  |             |     |       |       |                     |  |  |  |  |             |     |       |       |                     |  |  |  |  |                 |     |       |       |                     |                |        |   |           |                 |     |       |       |                     |                |        |   |           |                 |     |       |       |                     |  |  |  |  |                    |     |       |       |                     |  |  |  |  |          |     |       |       |                     |  |  |  |  |                    |     |       |       |                     |  |  |  |  |         |     |       |       |                     |  |  |  |  |         |    |       |       |             |                |        |  |                     |     |    |       |       |             |                |        |  |                     |         |    |       |       |             |  |  |  |  |         |    |       |       |             |  |  |  |  |         |     |       |       |             |  |  |  |  |         |     |       |       |             |  |  |  |  |         |    |       |       |             |  |  |  |  |         |     |       |       |             |  |  |  |  |                 |     |       |       |             |  |  |  |  |         |     |       |       |             |  |  |  |  |         |    |       |       |             |  |  |  |  |         |     |       |       |             |  |  |  |  |         |     |       |       |             |  |  |  |  |             |     |       |       |             |  |  |  |  |                 |     |       |       |             |  |  |  |  |                 |     |       |       |             |  |  |  |  |          |     |       |       |             |  |  |  |  |                    |     |       |       |             |  |  |  |  |         |     |       |       |             |  |  |  |  |         |    |       |       |                     |                |        |  |                        |     |    |       |       |                     |                |        |  |                           |         |    |       |       |                     |  |  |  |  |         |    |       |       |                     |  |  |  |  |         |     |       |       |                     |  |  |  |  |         |     |       |       |                     |  |  |  |  |         |    |       |       |                     |  |  |  |  |         |     |       |       |                     |  |  |  |  |                 |     |       |       |                     |  |  |  |  |         |     |       |       |                     |  |  |  |  |         |    |       |       |                     |  |  |  |  |         |     |       |       |                     |  |  |  |  |         |     |       |       |                     |  |  |  |  |             |     |       |       |                     |  |  |  |  |                 |     |       |       |                     |  |  |  |  |                 |     |       |       |                     |  |  |  |  |          |     |       |       |                     |  |  |  |  |
| 2.0 TDI  | 103   | 08.05   | 07.10 | PR: 2EA,2EL         |                |                     |   |                           |   |                     |         |     |       |       |                     |                |        |   |                     |         |     |       |       |                     |  |  |  |  |             |     |       |       |                     |  |  |  |  |                 |     |       |       |                     |  |  |  |  |                 |     |       |       |                     |  |  |  |  |                    |     |       |       |                     |  |  |  |  |         |     |       |       |                     |  |  |  |  |                 |     |       |       |                     |  |  |  |  |         |     |       |       |                     |  |  |  |  |         |     |       |       |                     |  |  |  |  |             |     |       |       |                     |  |  |  |  |             |     |       |       |                     |  |  |  |  |                 |     |       |       |                     |                |        |   |           |                 |     |       |       |                     |                |        |   |           |                 |     |       |       |                     |  |  |  |  |                    |     |       |       |                     |  |  |  |  |          |     |       |       |                     |  |  |  |  |                    |     |       |       |                     |  |  |  |  |         |     |       |       |                     |  |  |  |  |         |    |       |       |             |                |        |  |                     |     |    |       |       |             |                |        |  |                     |         |    |       |       |             |  |  |  |  |         |    |       |       |             |  |  |  |  |         |     |       |       |             |  |  |  |  |         |     |       |       |             |  |  |  |  |         |    |       |       |             |  |  |  |  |         |     |       |       |             |  |  |  |  |                 |     |       |       |             |  |  |  |  |         |     |       |       |             |  |  |  |  |         |    |       |       |             |  |  |  |  |         |     |       |       |             |  |  |  |  |         |     |       |       |             |  |  |  |  |             |     |       |       |             |  |  |  |  |                 |     |       |       |             |  |  |  |  |                 |     |       |       |             |  |  |  |  |          |     |       |       |             |  |  |  |  |                    |     |       |       |             |  |  |  |  |         |     |       |       |             |  |  |  |  |         |    |       |       |                     |                |        |  |                        |     |    |       |       |                     |                |        |  |                           |         |    |       |       |                     |  |  |  |  |         |    |       |       |                     |  |  |  |  |         |     |       |       |                     |  |  |  |  |         |     |       |       |                     |  |  |  |  |         |    |       |       |                     |  |  |  |  |         |     |       |       |                     |  |  |  |  |                 |     |       |       |                     |  |  |  |  |         |     |       |       |                     |  |  |  |  |         |    |       |       |                     |  |  |  |  |         |     |       |       |                     |  |  |  |  |         |     |       |       |                     |  |  |  |  |             |     |       |       |                     |  |  |  |  |                 |     |       |       |                     |  |  |  |  |                 |     |       |       |                     |  |  |  |  |          |     |       |       |                     |  |  |  |  |
| 2.0 TDI 16V  | 103   | 03.05   | 07.10 | PR: 2EA,2EL         |                |                     |   |                           |   |                     |         |     |       |       |                     |                |        |   |                     |         |     |       |       |                     |  |  |  |  |             |     |       |       |                     |  |  |  |  |                 |     |       |       |                     |  |  |  |  |                 |     |       |       |                     |  |  |  |  |                    |     |       |       |                     |  |  |  |  |         |     |       |       |                     |  |  |  |  |                 |     |       |       |                     |  |  |  |  |         |     |       |       |                     |  |  |  |  |         |     |       |       |                     |  |  |  |  |             |     |       |       |                     |  |  |  |  |             |     |       |       |                     |  |  |  |  |                 |     |       |       |                     |                |        |   |           |                 |     |       |       |                     |                |        |   |           |                 |     |       |       |                     |  |  |  |  |                    |     |       |       |                     |  |  |  |  |          |     |       |       |                     |  |  |  |  |                    |     |       |       |                     |  |  |  |  |         |     |       |       |                     |  |  |  |  |         |    |       |       |             |                |        |  |                     |     |    |       |       |             |                |        |  |                     |         |    |       |       |             |  |  |  |  |         |    |       |       |             |  |  |  |  |         |     |       |       |             |  |  |  |  |         |     |       |       |             |  |  |  |  |         |    |       |       |             |  |  |  |  |         |     |       |       |             |  |  |  |  |                 |     |       |       |             |  |  |  |  |         |     |       |       |             |  |  |  |  |         |    |       |       |             |  |  |  |  |         |     |       |       |             |  |  |  |  |         |     |       |       |             |  |  |  |  |             |     |       |       |             |  |  |  |  |                 |     |       |       |             |  |  |  |  |                 |     |       |       |             |  |  |  |  |          |     |       |       |             |  |  |  |  |                    |     |       |       |             |  |  |  |  |         |     |       |       |             |  |  |  |  |         |    |       |       |                     |                |        |  |                        |     |    |       |       |                     |                |        |  |                           |         |    |       |       |                     |  |  |  |  |         |    |       |       |                     |  |  |  |  |         |     |       |       |                     |  |  |  |  |         |     |       |       |                     |  |  |  |  |         |    |       |       |                     |  |  |  |  |         |     |       |       |                     |  |  |  |  |                 |     |       |       |                     |  |  |  |  |         |     |       |       |                     |  |  |  |  |         |    |       |       |                     |  |  |  |  |         |     |       |       |                     |  |  |  |  |         |     |       |       |                     |  |  |  |  |             |     |       |       |                     |  |  |  |  |                 |     |       |       |                     |  |  |  |  |                 |     |       |       |                     |  |  |  |  |          |     |       |       |                     |  |  |  |  |
| 2.0 TDI 4motion  | 103   | 03.05   | 07.10 | PR: 2EA,2EL         |                |                     |   |                           |   |                     |         |     |       |       |                     |                |        |   |                     |         |     |       |       |                     |  |  |  |  |             |     |       |       |                     |  |  |  |  |                 |     |       |       |                     |  |  |  |  |                 |     |       |       |                     |  |  |  |  |                    |     |       |       |                     |  |  |  |  |         |     |       |       |                     |  |  |  |  |                 |     |       |       |                     |  |  |  |  |         |     |       |       |                     |  |  |  |  |         |     |       |       |                     |  |  |  |  |             |     |       |       |                     |  |  |  |  |             |     |       |       |                     |  |  |  |  |                 |     |       |       |                     |                |        |   |           |                 |     |       |       |                     |                |        |   |           |                 |     |       |       |                     |  |  |  |  |                    |     |       |       |                     |  |  |  |  |          |     |       |       |                     |  |  |  |  |                    |     |       |       |                     |  |  |  |  |         |     |       |       |                     |  |  |  |  |         |    |       |       |             |                |        |  |                     |     |    |       |       |             |                |        |  |                     |         |    |       |       |             |  |  |  |  |         |    |       |       |             |  |  |  |  |         |     |       |       |             |  |  |  |  |         |     |       |       |             |  |  |  |  |         |    |       |       |             |  |  |  |  |         |     |       |       |             |  |  |  |  |                 |     |       |       |             |  |  |  |  |         |     |       |       |             |  |  |  |  |         |    |       |       |             |  |  |  |  |         |     |       |       |             |  |  |  |  |         |     |       |       |             |  |  |  |  |             |     |       |       |             |  |  |  |  |                 |     |       |       |             |  |  |  |  |                 |     |       |       |             |  |  |  |  |          |     |       |       |             |  |  |  |  |                    |     |       |       |             |  |  |  |  |         |     |       |       |             |  |  |  |  |         |    |       |       |                     |                |        |  |                        |     |    |       |       |                     |                |        |  |                           |         |    |       |       |                     |  |  |  |  |         |    |       |       |                     |  |  |  |  |         |     |       |       |                     |  |  |  |  |         |     |       |       |                     |  |  |  |  |         |    |       |       |                     |  |  |  |  |         |     |       |       |                     |  |  |  |  |                 |     |       |       |                     |  |  |  |  |         |     |       |       |                     |  |  |  |  |         |    |       |       |                     |  |  |  |  |         |     |       |       |                     |  |  |  |  |         |     |       |       |                     |  |  |  |  |             |     |       |       |                     |  |  |  |  |                 |     |       |       |                     |  |  |  |  |                 |     |       |       |                     |  |  |  |  |          |     |       |       |                     |  |  |  |  |
| 2.0 TDI 4motion  | 125   | 05.09   | 07.10 | PR: 2EA,2EL         |                |                     |   |                           |   |                     |         |     |       |       |                     |                |        |   |                     |         |     |       |       |                     |  |  |  |  |             |     |       |       |                     |  |  |  |  |                 |     |       |       |                     |  |  |  |  |                 |     |       |       |                     |  |  |  |  |                    |     |       |       |                     |  |  |  |  |         |     |       |       |                     |  |  |  |  |                 |     |       |       |                     |  |  |  |  |         |     |       |       |                     |  |  |  |  |         |     |       |       |                     |  |  |  |  |             |     |       |       |                     |  |  |  |  |             |     |       |       |                     |  |  |  |  |                 |     |       |       |                     |                |        |   |           |                 |     |       |       |                     |                |        |   |           |                 |     |       |       |                     |  |  |  |  |                    |     |       |       |                     |  |  |  |  |          |     |       |       |                     |  |  |  |  |                    |     |       |       |                     |  |  |  |  |         |     |       |       |                     |  |  |  |  |         |    |       |       |             |                |        |  |                     |     |    |       |       |             |                |        |  |                     |         |    |       |       |             |  |  |  |  |         |    |       |       |             |  |  |  |  |         |     |       |       |             |  |  |  |  |         |     |       |       |             |  |  |  |  |         |    |       |       |             |  |  |  |  |         |     |       |       |             |  |  |  |  |                 |     |       |       |             |  |  |  |  |         |     |       |       |             |  |  |  |  |         |    |       |       |             |  |  |  |  |         |     |       |       |             |  |  |  |  |         |     |       |       |             |  |  |  |  |             |     |       |       |             |  |  |  |  |                 |     |       |       |             |  |  |  |  |                 |     |       |       |             |  |  |  |  |          |     |       |       |             |  |  |  |  |                    |     |       |       |             |  |  |  |  |         |     |       |       |             |  |  |  |  |         |    |       |       |                     |                |        |  |                        |     |    |       |       |                     |                |        |  |                           |         |    |       |       |                     |  |  |  |  |         |    |       |       |                     |  |  |  |  |         |     |       |       |                     |  |  |  |  |         |     |       |       |                     |  |  |  |  |         |    |       |       |                     |  |  |  |  |         |     |       |       |                     |  |  |  |  |                 |     |       |       |                     |  |  |  |  |         |     |       |       |                     |  |  |  |  |         |    |       |       |                     |  |  |  |  |         |     |       |       |                     |  |  |  |  |         |     |       |       |                     |  |  |  |  |             |     |       |       |                     |  |  |  |  |                 |     |       |       |                     |  |  |  |  |                 |     |       |       |                     |  |  |  |  |          |     |       |       |                     |  |  |  |  |
| 3.2 V6 FSI 4motion   | 184   | 09.05   | 07.10 | PR: 2EA,2EL         |                |                     |   |                           |   |                     |         |     |       |       |                     |                |        |   |                     |         |     |       |       |                     |  |  |  |  |             |     |       |       |                     |  |  |  |  |                 |     |       |       |                     |  |  |  |  |                 |     |       |       |                     |  |  |  |  |                    |     |       |       |                     |  |  |  |  |         |     |       |       |                     |  |  |  |  |                 |     |       |       |                     |  |  |  |  |         |     |       |       |                     |  |  |  |  |         |     |       |       |                     |  |  |  |  |             |     |       |       |                     |  |  |  |  |             |     |       |       |                     |  |  |  |  |                 |     |       |       |                     |                |        |   |           |                 |     |       |       |                     |                |        |   |           |                 |     |       |       |                     |  |  |  |  |                    |     |       |       |                     |  |  |  |  |          |     |       |       |                     |  |  |  |  |                    |     |       |       |                     |  |  |  |  |         |     |       |       |                     |  |  |  |  |         |    |       |       |             |                |        |  |                     |     |    |       |       |             |                |        |  |                     |         |    |       |       |             |  |  |  |  |         |    |       |       |             |  |  |  |  |         |     |       |       |             |  |  |  |  |         |     |       |       |             |  |  |  |  |         |    |       |       |             |  |  |  |  |         |     |       |       |             |  |  |  |  |                 |     |       |       |             |  |  |  |  |         |     |       |       |             |  |  |  |  |         |    |       |       |             |  |  |  |  |         |     |       |       |             |  |  |  |  |         |     |       |       |             |  |  |  |  |             |     |       |       |             |  |  |  |  |                 |     |       |       |             |  |  |  |  |                 |     |       |       |             |  |  |  |  |          |     |       |       |             |  |  |  |  |                    |     |       |       |             |  |  |  |  |         |     |       |       |             |  |  |  |  |         |    |       |       |                     |                |        |  |                        |     |    |       |       |                     |                |        |  |                           |         |    |       |       |                     |  |  |  |  |         |    |       |       |                     |  |  |  |  |         |     |       |       |                     |  |  |  |  |         |     |       |       |                     |  |  |  |  |         |    |       |       |                     |  |  |  |  |         |     |       |       |                     |  |  |  |  |                 |     |       |       |                     |  |  |  |  |         |     |       |       |                     |  |  |  |  |         |    |       |       |                     |  |  |  |  |         |     |       |       |                     |  |  |  |  |         |     |       |       |                     |  |  |  |  |             |     |       |       |                     |  |  |  |  |                 |     |       |       |                     |  |  |  |  |                 |     |       |       |                     |  |  |  |  |          |     |       |       |                     |  |  |  |  |
| 3.6 R36  | 220   | 04.07   | 07.10 | PR: 2EA,2EL         |                |                     |   |                           |   |                     |         |     |       |       |                     |                |        |   |                     |         |     |       |       |                     |  |  |  |  |             |     |       |       |                     |  |  |  |  |                 |     |       |       |                     |  |  |  |  |                 |     |       |       |                     |  |  |  |  |                    |     |       |       |                     |  |  |  |  |         |     |       |       |                     |  |  |  |  |                 |     |       |       |                     |  |  |  |  |         |     |       |       |                     |  |  |  |  |         |     |       |       |                     |  |  |  |  |             |     |       |       |                     |  |  |  |  |             |     |       |       |                     |  |  |  |  |                 |     |       |       |                     |                |        |   |           |                 |     |       |       |                     |                |        |   |           |                 |     |       |       |                     |  |  |  |  |                    |     |       |       |                     |  |  |  |  |          |     |       |       |                     |  |  |  |  |                    |     |       |       |                     |  |  |  |  |         |     |       |       |                     |  |  |  |  |         |    |       |       |             |                |        |  |                     |     |    |       |       |             |                |        |  |                     |         |    |       |       |             |  |  |  |  |         |    |       |       |             |  |  |  |  |         |     |       |       |             |  |  |  |  |         |     |       |       |             |  |  |  |  |         |    |       |       |             |  |  |  |  |         |     |       |       |             |  |  |  |  |                 |     |       |       |             |  |  |  |  |         |     |       |       |             |  |  |  |  |         |    |       |       |             |  |  |  |  |         |     |       |       |             |  |  |  |  |         |     |       |       |             |  |  |  |  |             |     |       |       |             |  |  |  |  |                 |     |       |       |             |  |  |  |  |                 |     |       |       |             |  |  |  |  |          |     |       |       |             |  |  |  |  |                    |     |       |       |             |  |  |  |  |         |     |       |       |             |  |  |  |  |         |    |       |       |                     |                |        |  |                        |     |    |       |       |                     |                |        |  |                           |         |    |       |       |                     |  |  |  |  |         |    |       |       |                     |  |  |  |  |         |     |       |       |                     |  |  |  |  |         |     |       |       |                     |  |  |  |  |         |    |       |       |                     |  |  |  |  |         |     |       |       |                     |  |  |  |  |                 |     |       |       |                     |  |  |  |  |         |     |       |       |                     |  |  |  |  |         |    |       |       |                     |  |  |  |  |         |     |       |       |                     |  |  |  |  |         |     |       |       |                     |  |  |  |  |             |     |       |       |                     |  |  |  |  |                 |     |       |       |                     |  |  |  |  |                 |     |       |       |                     |  |  |  |  |          |     |       |       |                     |  |  |  |  |
|  | <table border="1"> <tr><td>1.4 TSI</td><td>75</td><td>10.07</td><td>07.10</td><td></td><td>24.0711-6231.3</td><td>360305</td><td>☐</td><td>Radsensor</td></tr> <tr><td>1.6</td><td>85</td><td>03.05</td><td>07.10</td><td></td><td>24.0711-6232.3</td><td>360306</td><td>☐</td><td>Radsensor</td></tr> <tr><td>1.6 FSI</td><td>77</td><td>03.05</td><td>07.10</td><td></td><td></td><td></td><td></td><td></td></tr> <tr><td>1.6 TDI</td><td>112</td><td>08.09</td><td>07.10</td><td></td><td></td><td></td><td></td><td></td></tr> <tr><td>1.8 TSI</td><td>118</td><td>11.09</td><td>07.10</td><td></td><td></td><td></td><td></td><td></td></tr> <tr><td>1.8 TSI</td><td>77</td><td>10.07</td><td>07.10</td><td></td><td></td><td></td><td></td><td></td></tr> <tr><td>1.9 TDI</td><td>147</td><td>03.05</td><td>07.10</td><td></td><td></td><td></td><td></td><td></td></tr> <tr><td>2.0 FSI</td><td>120</td><td>03.05</td><td>07.10</td><td></td><td></td><td></td><td></td><td></td></tr> <tr><td>2.0 FSI</td><td>125</td><td>03.05</td><td>07.10</td><td></td><td></td><td></td><td></td><td></td></tr> <tr><td>2.0 TDI</td><td>120</td><td>03.05</td><td>07.10</td><td></td><td></td><td></td><td></td><td></td></tr> <tr><td>2.0 TDI</td><td>125</td><td>08.05</td><td>07.10</td><td></td><td></td><td></td><td></td><td></td></tr> <tr><td>2.0 TDI 16V</td><td>103</td><td>08.05</td><td>07.10</td><td></td><td></td><td></td><td></td><td></td></tr> <tr><td>2.0 TDI 16V</td><td>103</td><td>03.05</td><td>07.10</td><td></td><td></td><td></td><td></td><td></td></tr> <tr><td>2.0 FSI 4motion</td><td>110</td><td>03.05</td><td>07.10</td><td></td><td>24.0711-5271.3</td><td>360301</td><td>☐</td><td>Radsensor</td></tr> <tr><td>2.0 TDI 4motion</td><td>103</td><td>03.05</td><td>07.10</td><td></td><td>24.0711-5272.3</td><td>360302</td><td>☐</td><td>Radsensor</td></tr> <tr><td>2.0 TDI 4motion</td><td>125</td><td>05.09</td><td>07.10</td><td></td><td></td><td></td><td></td><td></td></tr> <tr><td>3.2 V6 FSI 4motion</td><td>184</td><td>09.05</td><td>07.10</td><td></td><td></td><td></td><td></td><td></td></tr> <tr><td>3.6 R36</td><td>220</td><td>04.07</td><td>07.10</td><td></td><td></td><td></td><td></td><td></td></tr> </table>  | 1.4 TSI | 75    | 10.07               | 07.10          |                     | 24.0711-6231.3                            | 360305                    | ☐   | Radsensor           | 1.6     | 85  | 03.05 | 07.10 |                     | 24.0711-6232.3 | 360306 | ☐ | Radsensor           | 1.6 FSI | 77  | 03.05 | 07.10 |                     |  |  |  |  | 1.6 TDI     | 112 | 08.09 | 07.10 |                     |  |  |  |  | 1.8 TSI         | 118 | 11.09 | 07.10 |                     |  |  |  |  | 1.8 TSI         | 77  | 10.07 | 07.10 |                     |  |  |  |  | 1.9 TDI            | 147 | 03.05 | 07.10 |                     |  |  |  |  | 2.0 FSI | 120 | 03.05 | 07.10 |                     |  |  |  |  | 2.0 FSI         | 125 | 03.05 | 07.10 |                     |  |  |  |  | 2.0 TDI | 120 | 03.05 | 07.10 |                     |  |  |  |  | 2.0 TDI | 125 | 08.05 | 07.10 |                     |  |  |  |  | 2.0 TDI 16V | 103 | 08.05 | 07.10 |                     |  |  |  |  | 2.0 TDI 16V | 103 | 03.05 | 07.10 |                     |  |  |  |  | 2.0 FSI 4motion | 110 | 03.05 | 07.10 |                     | 24.0711-5271.3 | 360301 | ☐ | Radsensor | 2.0 TDI 4motion | 103 | 03.05 | 07.10 |                     | 24.0711-5272.3 | 360302 | ☐ | Radsensor | 2.0 TDI 4motion | 125 | 05.09 | 07.10 |                     |  |  |  |  | 3.2 V6 FSI 4motion | 184 | 09.05 | 07.10 |                     |  |  |  |  | 3.6 R36  | 220 | 04.07 | 07.10 |                     |  |  |  |  |                    |     |       |       |                     |  |  |  |  |         |     |       |       |                     |  |  |  |  |         |    |       |       |             |                |        |  |                     |     |    |       |       |             |                |        |  |                     |         |    |       |       |             |  |  |  |  |         |    |       |       |             |  |  |  |  |         |     |       |       |             |  |  |  |  |         |     |       |       |             |  |  |  |  |         |    |       |       |             |  |  |  |  |         |     |       |       |             |  |  |  |  |                 |     |       |       |             |  |  |  |  |         |     |       |       |             |  |  |  |  |         |    |       |       |             |  |  |  |  |         |     |       |       |             |  |  |  |  |         |     |       |       |             |  |  |  |  |             |     |       |       |             |  |  |  |  |                 |     |       |       |             |  |  |  |  |                 |     |       |       |             |  |  |  |  |          |     |       |       |             |  |  |  |  |                    |     |       |       |             |  |  |  |  |         |     |       |       |             |  |  |  |  |         |    |       |       |                     |                |        |  |                        |     |    |       |       |                     |                |        |  |                           |         |    |       |       |                     |  |  |  |  |         |    |       |       |                     |  |  |  |  |         |     |       |       |                     |  |  |  |  |         |     |       |       |                     |  |  |  |  |         |    |       |       |                     |  |  |  |  |         |     |       |       |                     |  |  |  |  |                 |     |       |       |                     |  |  |  |  |         |     |       |       |                     |  |  |  |  |         |    |       |       |                     |  |  |  |  |         |     |       |       |                     |  |  |  |  |         |     |       |       |                     |  |  |  |  |             |     |       |       |                     |  |  |  |  |                 |     |       |       |                     |  |  |  |  |                 |     |       |       |                     |  |  |  |  |          |     |       |       |                     |  |  |  |  |
| 1.4 TSI  | 75  | 10.07   | 07.10 |                     | 24.0711-6231.3 | 360305              | ☐   | Radsensor                 |   |                     |         |     |       |       |                     |                |        |   |                     |         |     |       |       |                     |  |  |  |  |             |     |       |       |                     |  |  |  |  |                 |     |       |       |                     |  |  |  |  |                 |     |       |       |                     |  |  |  |  |                    |     |       |       |                     |  |  |  |  |         |     |       |       |                     |  |  |  |  |                 |     |       |       |                     |  |  |  |  |         |     |       |       |                     |  |  |  |  |         |     |       |       |                     |  |  |  |  |             |     |       |       |                     |  |  |  |  |             |     |       |       |                     |  |  |  |  |                 |     |       |       |                     |                |        |   |           |                 |     |       |       |                     |                |        |   |           |                 |     |       |       |                     |  |  |  |  |                    |     |       |       |                     |  |  |  |  |          |     |       |       |                     |  |  |  |  |                    |     |       |       |                     |  |  |  |  |         |     |       |       |                     |  |  |  |  |         |    |       |       |             |                |        |  |                     |     |    |       |       |             |                |        |  |                     |         |    |       |       |             |  |  |  |  |         |    |       |       |             |  |  |  |  |         |     |       |       |             |  |  |  |  |         |     |       |       |             |  |  |  |  |         |    |       |       |             |  |  |  |  |         |     |       |       |             |  |  |  |  |                 |     |       |       |             |  |  |  |  |         |     |       |       |             |  |  |  |  |         |    |       |       |             |  |  |  |  |         |     |       |       |             |  |  |  |  |         |     |       |       |             |  |  |  |  |             |     |       |       |             |  |  |  |  |                 |     |       |       |             |  |  |  |  |                 |     |       |       |             |  |  |  |  |          |     |       |       |             |  |  |  |  |                    |     |       |       |             |  |  |  |  |         |     |       |       |             |  |  |  |  |         |    |       |       |                     |                |        |  |                        |     |    |       |       |                     |                |        |  |                           |         |    |       |       |                     |  |  |  |  |         |    |       |       |                     |  |  |  |  |         |     |       |       |                     |  |  |  |  |         |     |       |       |                     |  |  |  |  |         |    |       |       |                     |  |  |  |  |         |     |       |       |                     |  |  |  |  |                 |     |       |       |                     |  |  |  |  |         |     |       |       |                     |  |  |  |  |         |    |       |       |                     |  |  |  |  |         |     |       |       |                     |  |  |  |  |         |     |       |       |                     |  |  |  |  |             |     |       |       |                     |  |  |  |  |                 |     |       |       |                     |  |  |  |  |                 |     |       |       |                     |  |  |  |  |          |     |       |       |                     |  |  |  |  |
| 1.6  | 85  | 03.05   | 07.10 |                     | 24.0711-6232.3 | 360306              | ☐   | Radsensor                 |   |                     |         |     |       |       |                     |                |        |   |                     |         |     |       |       |                     |  |  |  |  |             |     |       |       |                     |  |  |  |  |                 |     |       |       |                     |  |  |  |  |                 |     |       |       |                     |  |  |  |  |                    |     |       |       |                     |  |  |  |  |         |     |       |       |                     |  |  |  |  |                 |     |       |       |                     |  |  |  |  |         |     |       |       |                     |  |  |  |  |         |     |       |       |                     |  |  |  |  |             |     |       |       |                     |  |  |  |  |             |     |       |       |                     |  |  |  |  |                 |     |       |       |                     |                |        |   |           |                 |     |       |       |                     |                |        |   |           |                 |     |       |       |                     |  |  |  |  |                    |     |       |       |                     |  |  |  |  |          |     |       |       |                     |  |  |  |  |                    |     |       |       |                     |  |  |  |  |         |     |       |       |                     |  |  |  |  |         |    |       |       |             |                |        |  |                     |     |    |       |       |             |                |        |  |                     |         |    |       |       |             |  |  |  |  |         |    |       |       |             |  |  |  |  |         |     |       |       |             |  |  |  |  |         |     |       |       |             |  |  |  |  |         |    |       |       |             |  |  |  |  |         |     |       |       |             |  |  |  |  |                 |     |       |       |             |  |  |  |  |         |     |       |       |             |  |  |  |  |         |    |       |       |             |  |  |  |  |         |     |       |       |             |  |  |  |  |         |     |       |       |             |  |  |  |  |             |     |       |       |             |  |  |  |  |                 |     |       |       |             |  |  |  |  |                 |     |       |       |             |  |  |  |  |          |     |       |       |             |  |  |  |  |                    |     |       |       |             |  |  |  |  |         |     |       |       |             |  |  |  |  |         |    |       |       |                     |                |        |  |                        |     |    |       |       |                     |                |        |  |                           |         |    |       |       |                     |  |  |  |  |         |    |       |       |                     |  |  |  |  |         |     |       |       |                     |  |  |  |  |         |     |       |       |                     |  |  |  |  |         |    |       |       |                     |  |  |  |  |         |     |       |       |                     |  |  |  |  |                 |     |       |       |                     |  |  |  |  |         |     |       |       |                     |  |  |  |  |         |    |       |       |                     |  |  |  |  |         |     |       |       |                     |  |  |  |  |         |     |       |       |                     |  |  |  |  |             |     |       |       |                     |  |  |  |  |                 |     |       |       |                     |  |  |  |  |                 |     |       |       |                     |  |  |  |  |          |     |       |       |                     |  |  |  |  |
| 1.6 FSI  | 77  | 03.05   | 07.10 |                     |                |                     |   |                           |   |                     |         |     |       |       |                     |                |        |   |                     |         |     |       |       |                     |  |  |  |  |             |     |       |       |                     |  |  |  |  |                 |     |       |       |                     |  |  |  |  |                 |     |       |       |                     |  |  |  |  |                    |     |       |       |                     |  |  |  |  |         |     |       |       |                     |  |  |  |  |                 |     |       |       |                     |  |  |  |  |         |     |       |       |                     |  |  |  |  |         |     |       |       |                     |  |  |  |  |             |     |       |       |                     |  |  |  |  |             |     |       |       |                     |  |  |  |  |                 |     |       |       |                     |                |        |   |           |                 |     |       |       |                     |                |        |   |           |                 |     |       |       |                     |  |  |  |  |                    |     |       |       |                     |  |  |  |  |          |     |       |       |                     |  |  |  |  |                    |     |       |       |                     |  |  |  |  |         |     |       |       |                     |  |  |  |  |         |    |       |       |             |                |        |  |                     |     |    |       |       |             |                |        |  |                     |         |    |       |       |             |  |  |  |  |         |    |       |       |             |  |  |  |  |         |     |       |       |             |  |  |  |  |         |     |       |       |             |  |  |  |  |         |    |       |       |             |  |  |  |  |         |     |       |       |             |  |  |  |  |                 |     |       |       |             |  |  |  |  |         |     |       |       |             |  |  |  |  |         |    |       |       |             |  |  |  |  |         |     |       |       |             |  |  |  |  |         |     |       |       |             |  |  |  |  |             |     |       |       |             |  |  |  |  |                 |     |       |       |             |  |  |  |  |                 |     |       |       |             |  |  |  |  |          |     |       |       |             |  |  |  |  |                    |     |       |       |             |  |  |  |  |         |     |       |       |             |  |  |  |  |         |    |       |       |                     |                |        |  |                        |     |    |       |       |                     |                |        |  |                           |         |    |       |       |                     |  |  |  |  |         |    |       |       |                     |  |  |  |  |         |     |       |       |                     |  |  |  |  |         |     |       |       |                     |  |  |  |  |         |    |       |       |                     |  |  |  |  |         |     |       |       |                     |  |  |  |  |                 |     |       |       |                     |  |  |  |  |         |     |       |       |                     |  |  |  |  |         |    |       |       |                     |  |  |  |  |         |     |       |       |                     |  |  |  |  |         |     |       |       |                     |  |  |  |  |             |     |       |       |                     |  |  |  |  |                 |     |       |       |                     |  |  |  |  |                 |     |       |       |                     |  |  |  |  |          |     |       |       |                     |  |  |  |  |
| 1.6 TDI  | 112   | 08.09   | 07.10 |                     |                |                     |   |                           |   |                     |         |     |       |       |                     |                |        |   |                     |         |     |       |       |                     |  |  |  |  |             |     |       |       |                     |  |  |  |  |                 |     |       |       |                     |  |  |  |  |                 |     |       |       |                     |  |  |  |  |                    |     |       |       |                     |  |  |  |  |         |     |       |       |                     |  |  |  |  |                 |     |       |       |                     |  |  |  |  |         |     |       |       |                     |  |  |  |  |         |     |       |       |                     |  |  |  |  |             |     |       |       |                     |  |  |  |  |             |     |       |       |                     |  |  |  |  |                 |     |       |       |                     |                |        |   |           |                 |     |       |       |                     |                |        |   |           |                 |     |       |       |                     |  |  |  |  |                    |     |       |       |                     |  |  |  |  |          |     |       |       |                     |  |  |  |  |                    |     |       |       |                     |  |  |  |  |         |     |       |       |                     |  |  |  |  |         |    |       |       |             |                |        |  |                     |     |    |       |       |             |                |        |  |                     |         |    |       |       |             |  |  |  |  |         |    |       |       |             |  |  |  |  |         |     |       |       |             |  |  |  |  |         |     |       |       |             |  |  |  |  |         |    |       |       |             |  |  |  |  |         |     |       |       |             |  |  |  |  |                 |     |       |       |             |  |  |  |  |         |     |       |       |             |  |  |  |  |         |    |       |       |             |  |  |  |  |         |     |       |       |             |  |  |  |  |         |     |       |       |             |  |  |  |  |             |     |       |       |             |  |  |  |  |                 |     |       |       |             |  |  |  |  |                 |     |       |       |             |  |  |  |  |          |     |       |       |             |  |  |  |  |                    |     |       |       |             |  |  |  |  |         |     |       |       |             |  |  |  |  |         |    |       |       |                     |                |        |  |                        |     |    |       |       |                     |                |        |  |                           |         |    |       |       |                     |  |  |  |  |         |    |       |       |                     |  |  |  |  |         |     |       |       |                     |  |  |  |  |         |     |       |       |                     |  |  |  |  |         |    |       |       |                     |  |  |  |  |         |     |       |       |                     |  |  |  |  |                 |     |       |       |                     |  |  |  |  |         |     |       |       |                     |  |  |  |  |         |    |       |       |                     |  |  |  |  |         |     |       |       |                     |  |  |  |  |         |     |       |       |                     |  |  |  |  |             |     |       |       |                     |  |  |  |  |                 |     |       |       |                     |  |  |  |  |                 |     |       |       |                     |  |  |  |  |          |     |       |       |                     |  |  |  |  |
| 1.8 TSI  | 118   | 11.09   | 07.10 |                     |                |                     |   |                           |   |                     |         |     |       |       |                     |                |        |   |                     |         |     |       |       |                     |  |  |  |  |             |     |       |       |                     |  |  |  |  |                 |     |       |       |                     |  |  |  |  |                 |     |       |       |                     |  |  |  |  |                    |     |       |       |                     |  |  |  |  |         |     |       |       |                     |  |  |  |  |                 |     |       |       |                     |  |  |  |  |         |     |       |       |                     |  |  |  |  |         |     |       |       |                     |  |  |  |  |             |     |       |       |                     |  |  |  |  |             |     |       |       |                     |  |  |  |  |                 |     |       |       |                     |                |        |   |           |                 |     |       |       |                     |                |        |   |           |                 |     |       |       |                     |  |  |  |  |                    |     |       |       |                     |  |  |  |  |          |     |       |       |                     |  |  |  |  |                    |     |       |       |                     |  |  |  |  |         |     |       |       |                     |  |  |  |  |         |    |       |       |             |                |        |  |                     |     |    |       |       |             |                |        |  |                     |         |    |       |       |             |  |  |  |  |         |    |       |       |             |  |  |  |  |         |     |       |       |             |  |  |  |  |         |     |       |       |             |  |  |  |  |         |    |       |       |             |  |  |  |  |         |     |       |       |             |  |  |  |  |                 |     |       |       |             |  |  |  |  |         |     |       |       |             |  |  |  |  |         |    |       |       |             |  |  |  |  |         |     |       |       |             |  |  |  |  |         |     |       |       |             |  |  |  |  |             |     |       |       |             |  |  |  |  |                 |     |       |       |             |  |  |  |  |                 |     |       |       |             |  |  |  |  |          |     |       |       |             |  |  |  |  |                    |     |       |       |             |  |  |  |  |         |     |       |       |             |  |  |  |  |         |    |       |       |                     |                |        |  |                        |     |    |       |       |                     |                |        |  |                           |         |    |       |       |                     |  |  |  |  |         |    |       |       |                     |  |  |  |  |         |     |       |       |                     |  |  |  |  |         |     |       |       |                     |  |  |  |  |         |    |       |       |                     |  |  |  |  |         |     |       |       |                     |  |  |  |  |                 |     |       |       |                     |  |  |  |  |         |     |       |       |                     |  |  |  |  |         |    |       |       |                     |  |  |  |  |         |     |       |       |                     |  |  |  |  |         |     |       |       |                     |  |  |  |  |             |     |       |       |                     |  |  |  |  |                 |     |       |       |                     |  |  |  |  |                 |     |       |       |                     |  |  |  |  |          |     |       |       |                     |  |  |  |  |
| 1.8 TSI  | 77  | 10.07   | 07.10 |                     |                |                     |   |                           |   |                     |         |     |       |       |                     |                |        |   |                     |         |     |       |       |                     |  |  |  |  |             |     |       |       |                     |  |  |  |  |                 |     |       |       |                     |  |  |  |  |                 |     |       |       |                     |  |  |  |  |                    |     |       |       |                     |  |  |  |  |         |     |       |       |                     |  |  |  |  |                 |     |       |       |                     |  |  |  |  |         |     |       |       |                     |  |  |  |  |         |     |       |       |                     |  |  |  |  |             |     |       |       |                     |  |  |  |  |             |     |       |       |                     |  |  |  |  |                 |     |       |       |                     |                |        |   |           |                 |     |       |       |                     |                |        |   |           |                 |     |       |       |                     |  |  |  |  |                    |     |       |       |                     |  |  |  |  |          |     |       |       |                     |  |  |  |  |                    |     |       |       |                     |  |  |  |  |         |     |       |       |                     |  |  |  |  |         |    |       |       |             |                |        |  |                     |     |    |       |       |             |                |        |  |                     |         |    |       |       |             |  |  |  |  |         |    |       |       |             |  |  |  |  |         |     |       |       |             |  |  |  |  |         |     |       |       |             |  |  |  |  |         |    |       |       |             |  |  |  |  |         |     |       |       |             |  |  |  |  |                 |     |       |       |             |  |  |  |  |         |     |       |       |             |  |  |  |  |         |    |       |       |             |  |  |  |  |         |     |       |       |             |  |  |  |  |         |     |       |       |             |  |  |  |  |             |     |       |       |             |  |  |  |  |                 |     |       |       |             |  |  |  |  |                 |     |       |       |             |  |  |  |  |          |     |       |       |             |  |  |  |  |                    |     |       |       |             |  |  |  |  |         |     |       |       |             |  |  |  |  |         |    |       |       |                     |                |        |  |                        |     |    |       |       |                     |                |        |  |                           |         |    |       |       |                     |  |  |  |  |         |    |       |       |                     |  |  |  |  |         |     |       |       |                     |  |  |  |  |         |     |       |       |                     |  |  |  |  |         |    |       |       |                     |  |  |  |  |         |     |       |       |                     |  |  |  |  |                 |     |       |       |                     |  |  |  |  |         |     |       |       |                     |  |  |  |  |         |    |       |       |                     |  |  |  |  |         |     |       |       |                     |  |  |  |  |         |     |       |       |                     |  |  |  |  |             |     |       |       |                     |  |  |  |  |                 |     |       |       |                     |  |  |  |  |                 |     |       |       |                     |  |  |  |  |          |     |       |       |                     |  |  |  |  |
| 1.9 TDI  | 147   | 03.05   | 07.10 |                     |                |                     |   |                           |   |                     |         |     |       |       |                     |                |        |   |                     |         |     |       |       |                     |  |  |  |  |             |     |       |       |                     |  |  |  |  |                 |     |       |       |                     |  |  |  |  |                 |     |       |       |                     |  |  |  |  |                    |     |       |       |                     |  |  |  |  |         |     |       |       |                     |  |  |  |  |                 |     |       |       |                     |  |  |  |  |         |     |       |       |                     |  |  |  |  |         |     |       |       |                     |  |  |  |  |             |     |       |       |                     |  |  |  |  |             |     |       |       |                     |  |  |  |  |                 |     |       |       |                     |                |        |   |           |                 |     |       |       |                     |                |        |   |           |                 |     |       |       |                     |  |  |  |  |                    |     |       |       |                     |  |  |  |  |          |     |       |       |                     |  |  |  |  |                    |     |       |       |                     |  |  |  |  |         |     |       |       |                     |  |  |  |  |         |    |       |       |             |                |        |  |                     |     |    |       |       |             |                |        |  |                     |         |    |       |       |             |  |  |  |  |         |    |       |       |             |  |  |  |  |         |     |       |       |             |  |  |  |  |         |     |       |       |             |  |  |  |  |         |    |       |       |             |  |  |  |  |         |     |       |       |             |  |  |  |  |                 |     |       |       |             |  |  |  |  |         |     |       |       |             |  |  |  |  |         |    |       |       |             |  |  |  |  |         |     |       |       |             |  |  |  |  |         |     |       |       |             |  |  |  |  |             |     |       |       |             |  |  |  |  |                 |     |       |       |             |  |  |  |  |                 |     |       |       |             |  |  |  |  |          |     |       |       |             |  |  |  |  |                    |     |       |       |             |  |  |  |  |         |     |       |       |             |  |  |  |  |         |    |       |       |                     |                |        |  |                        |     |    |       |       |                     |                |        |  |                           |         |    |       |       |                     |  |  |  |  |         |    |       |       |                     |  |  |  |  |         |     |       |       |                     |  |  |  |  |         |     |       |       |                     |  |  |  |  |         |    |       |       |                     |  |  |  |  |         |     |       |       |                     |  |  |  |  |                 |     |       |       |                     |  |  |  |  |         |     |       |       |                     |  |  |  |  |         |    |       |       |                     |  |  |  |  |         |     |       |       |                     |  |  |  |  |         |     |       |       |                     |  |  |  |  |             |     |       |       |                     |  |  |  |  |                 |     |       |       |                     |  |  |  |  |                 |     |       |       |                     |  |  |  |  |          |     |       |       |                     |  |  |  |  |
| 2.0 FSI  | 120   | 03.05   | 07.10 |                     |                |                     |   |                           |   |                     |         |     |       |       |                     |                |        |   |                     |         |     |       |       |                     |  |  |  |  |             |     |       |       |                     |  |  |  |  |                 |     |       |       |                     |  |  |  |  |                 |     |       |       |                     |  |  |  |  |                    |     |       |       |                     |  |  |  |  |         |     |       |       |                     |  |  |  |  |                 |     |       |       |                     |  |  |  |  |         |     |       |       |                     |  |  |  |  |         |     |       |       |                     |  |  |  |  |             |     |       |       |                     |  |  |  |  |             |     |       |       |                     |  |  |  |  |                 |     |       |       |                     |                |        |   |           |                 |     |       |       |                     |                |        |   |           |                 |     |       |       |                     |  |  |  |  |                    |     |       |       |                     |  |  |  |  |          |     |       |       |                     |  |  |  |  |                    |     |       |       |                     |  |  |  |  |         |     |       |       |                     |  |  |  |  |         |    |       |       |             |                |        |  |                     |     |    |       |       |             |                |        |  |                     |         |    |       |       |             |  |  |  |  |         |    |       |       |             |  |  |  |  |         |     |       |       |             |  |  |  |  |         |     |       |       |             |  |  |  |  |         |    |       |       |             |  |  |  |  |         |     |       |       |             |  |  |  |  |                 |     |       |       |             |  |  |  |  |         |     |       |       |             |  |  |  |  |         |    |       |       |             |  |  |  |  |         |     |       |       |             |  |  |  |  |         |     |       |       |             |  |  |  |  |             |     |       |       |             |  |  |  |  |                 |     |       |       |             |  |  |  |  |                 |     |       |       |             |  |  |  |  |          |     |       |       |             |  |  |  |  |                    |     |       |       |             |  |  |  |  |         |     |       |       |             |  |  |  |  |         |    |       |       |                     |                |        |  |                        |     |    |       |       |                     |                |        |  |                           |         |    |       |       |                     |  |  |  |  |         |    |       |       |                     |  |  |  |  |         |     |       |       |                     |  |  |  |  |         |     |       |       |                     |  |  |  |  |         |    |       |       |                     |  |  |  |  |         |     |       |       |                     |  |  |  |  |                 |     |       |       |                     |  |  |  |  |         |     |       |       |                     |  |  |  |  |         |    |       |       |                     |  |  |  |  |         |     |       |       |                     |  |  |  |  |         |     |       |       |                     |  |  |  |  |             |     |       |       |                     |  |  |  |  |                 |     |       |       |                     |  |  |  |  |                 |     |       |       |                     |  |  |  |  |          |     |       |       |                     |  |  |  |  |
| 2.0 FSI  | 125   | 03.05   | 07.10 |                     |                |                     |   |                           |   |                     |         |     |       |       |                     |                |        |   |                     |         |     |       |       |                     |  |  |  |  |             |     |       |       |                     |  |  |  |  |                 |     |       |       |                     |  |  |  |  |                 |     |       |       |                     |  |  |  |  |                    |     |       |       |                     |  |  |  |  |         |     |       |       |                     |  |  |  |  |                 |     |       |       |                     |  |  |  |  |         |     |       |       |                     |  |  |  |  |         |     |       |       |                     |  |  |  |  |             |     |       |       |                     |  |  |  |  |             |     |       |       |                     |  |  |  |  |                 |     |       |       |                     |                |        |   |           |                 |     |       |       |                     |                |        |   |           |                 |     |       |       |                     |  |  |  |  |                    |     |       |       |                     |  |  |  |  |          |     |       |       |                     |  |  |  |  |                    |     |       |       |                     |  |  |  |  |         |     |       |       |                     |  |  |  |  |         |    |       |       |             |                |        |  |                     |     |    |       |       |             |                |        |  |                     |         |    |       |       |             |  |  |  |  |         |    |       |       |             |  |  |  |  |         |     |       |       |             |  |  |  |  |         |     |       |       |             |  |  |  |  |         |    |       |       |             |  |  |  |  |         |     |       |       |             |  |  |  |  |                 |     |       |       |             |  |  |  |  |         |     |       |       |             |  |  |  |  |         |    |       |       |             |  |  |  |  |         |     |       |       |             |  |  |  |  |         |     |       |       |             |  |  |  |  |             |     |       |       |             |  |  |  |  |                 |     |       |       |             |  |  |  |  |                 |     |       |       |             |  |  |  |  |          |     |       |       |             |  |  |  |  |                    |     |       |       |             |  |  |  |  |         |     |       |       |             |  |  |  |  |         |    |       |       |                     |                |        |  |                        |     |    |       |       |                     |                |        |  |                           |         |    |       |       |                     |  |  |  |  |         |    |       |       |                     |  |  |  |  |         |     |       |       |                     |  |  |  |  |         |     |       |       |                     |  |  |  |  |         |    |       |       |                     |  |  |  |  |         |     |       |       |                     |  |  |  |  |                 |     |       |       |                     |  |  |  |  |         |     |       |       |                     |  |  |  |  |         |    |       |       |                     |  |  |  |  |         |     |       |       |                     |  |  |  |  |         |     |       |       |                     |  |  |  |  |             |     |       |       |                     |  |  |  |  |                 |     |       |       |                     |  |  |  |  |                 |     |       |       |                     |  |  |  |  |          |     |       |       |                     |  |  |  |  |
| 2.0 TDI  | 120   | 03.05   | 07.10 |                     |                |                     |   |                           |   |                     |         |     |       |       |                     |                |        |   |                     |         |     |       |       |                     |  |  |  |  |             |     |       |       |                     |  |  |  |  |                 |     |       |       |                     |  |  |  |  |                 |     |       |       |                     |  |  |  |  |                    |     |       |       |                     |  |  |  |  |         |     |       |       |                     |  |  |  |  |                 |     |       |       |                     |  |  |  |  |         |     |       |       |                     |  |  |  |  |         |     |       |       |                     |  |  |  |  |             |     |       |       |                     |  |  |  |  |             |     |       |       |                     |  |  |  |  |                 |     |       |       |                     |                |        |   |           |                 |     |       |       |                     |                |        |   |           |                 |     |       |       |                     |  |  |  |  |                    |     |       |       |                     |  |  |  |  |          |     |       |       |                     |  |  |  |  |                    |     |       |       |                     |  |  |  |  |         |     |       |       |                     |  |  |  |  |         |    |       |       |             |                |        |  |                     |     |    |       |       |             |                |        |  |                     |         |    |       |       |             |  |  |  |  |         |    |       |       |             |  |  |  |  |         |     |       |       |             |  |  |  |  |         |     |       |       |             |  |  |  |  |         |    |       |       |             |  |  |  |  |         |     |       |       |             |  |  |  |  |                 |     |       |       |             |  |  |  |  |         |     |       |       |             |  |  |  |  |         |    |       |       |             |  |  |  |  |         |     |       |       |             |  |  |  |  |         |     |       |       |             |  |  |  |  |             |     |       |       |             |  |  |  |  |                 |     |       |       |             |  |  |  |  |                 |     |       |       |             |  |  |  |  |          |     |       |       |             |  |  |  |  |                    |     |       |       |             |  |  |  |  |         |     |       |       |             |  |  |  |  |         |    |       |       |                     |                |        |  |                        |     |    |       |       |                     |                |        |  |                           |         |    |       |       |                     |  |  |  |  |         |    |       |       |                     |  |  |  |  |         |     |       |       |                     |  |  |  |  |         |     |       |       |                     |  |  |  |  |         |    |       |       |                     |  |  |  |  |         |     |       |       |                     |  |  |  |  |                 |     |       |       |                     |  |  |  |  |         |     |       |       |                     |  |  |  |  |         |    |       |       |                     |  |  |  |  |         |     |       |       |                     |  |  |  |  |         |     |       |       |                     |  |  |  |  |             |     |       |       |                     |  |  |  |  |                 |     |       |       |                     |  |  |  |  |                 |     |       |       |                     |  |  |  |  |          |     |       |       |                     |  |  |  |  |
| 2.0 TDI  | 125   | 08.05   | 07.10 |                     |                |                     |   |                           |   |                     |         |     |       |       |                     |                |        |   |                     |         |     |       |       |                     |  |  |  |  |             |     |       |       |                     |  |  |  |  |                 |     |       |       |                     |  |  |  |  |                 |     |       |       |                     |  |  |  |  |                    |     |       |       |                     |  |  |  |  |         |     |       |       |                     |  |  |  |  |                 |     |       |       |                     |  |  |  |  |         |     |       |       |                     |  |  |  |  |         |     |       |       |                     |  |  |  |  |             |     |       |       |                     |  |  |  |  |             |     |       |       |                     |  |  |  |  |                 |     |       |       |                     |                |        |   |           |                 |     |       |       |                     |                |        |   |           |                 |     |       |       |                     |  |  |  |  |                    |     |       |       |                     |  |  |  |  |          |     |       |       |                     |  |  |  |  |                    |     |       |       |                     |  |  |  |  |         |     |       |       |                     |  |  |  |  |         |    |       |       |             |                |        |  |                     |     |    |       |       |             |                |        |  |                     |         |    |       |       |             |  |  |  |  |         |    |       |       |             |  |  |  |  |         |     |       |       |             |  |  |  |  |         |     |       |       |             |  |  |  |  |         |    |       |       |             |  |  |  |  |         |     |       |       |             |  |  |  |  |                 |     |       |       |             |  |  |  |  |         |     |       |       |             |  |  |  |  |         |    |       |       |             |  |  |  |  |         |     |       |       |             |  |  |  |  |         |     |       |       |             |  |  |  |  |             |     |       |       |             |  |  |  |  |                 |     |       |       |             |  |  |  |  |                 |     |       |       |             |  |  |  |  |          |     |       |       |             |  |  |  |  |                    |     |       |       |             |  |  |  |  |         |     |       |       |             |  |  |  |  |         |    |       |       |                     |                |        |  |                        |     |    |       |       |                     |                |        |  |                           |         |    |       |       |                     |  |  |  |  |         |    |       |       |                     |  |  |  |  |         |     |       |       |                     |  |  |  |  |         |     |       |       |                     |  |  |  |  |         |    |       |       |                     |  |  |  |  |         |     |       |       |                     |  |  |  |  |                 |     |       |       |                     |  |  |  |  |         |     |       |       |                     |  |  |  |  |         |    |       |       |                     |  |  |  |  |         |     |       |       |                     |  |  |  |  |         |     |       |       |                     |  |  |  |  |             |     |       |       |                     |  |  |  |  |                 |     |       |       |                     |  |  |  |  |                 |     |       |       |                     |  |  |  |  |          |     |       |       |                     |  |  |  |  |
| 2.0 TDI 16V  | 103   | 08.05   | 07.10 |                     |                |                     |   |                           |   |                     |         |     |       |       |                     |                |        |   |                     |         |     |       |       |                     |  |  |  |  |             |     |       |       |                     |  |  |  |  |                 |     |       |       |                     |  |  |  |  |                 |     |       |       |                     |  |  |  |  |                    |     |       |       |                     |  |  |  |  |         |     |       |       |                     |  |  |  |  |                 |     |       |       |                     |  |  |  |  |         |     |       |       |                     |  |  |  |  |         |     |       |       |                     |  |  |  |  |             |     |       |       |                     |  |  |  |  |             |     |       |       |                     |  |  |  |  |                 |     |       |       |                     |                |        |   |           |                 |     |       |       |                     |                |        |   |           |                 |     |       |       |                     |  |  |  |  |                    |     |       |       |                     |  |  |  |  |          |     |       |       |                     |  |  |  |  |                    |     |       |       |                     |  |  |  |  |         |     |       |       |                     |  |  |  |  |         |    |       |       |             |                |        |  |                     |     |    |       |       |             |                |        |  |                     |         |    |       |       |             |  |  |  |  |         |    |       |       |             |  |  |  |  |         |     |       |       |             |  |  |  |  |         |     |       |       |             |  |  |  |  |         |    |       |       |             |  |  |  |  |         |     |       |       |             |  |  |  |  |                 |     |       |       |             |  |  |  |  |         |     |       |       |             |  |  |  |  |         |    |       |       |             |  |  |  |  |         |     |       |       |             |  |  |  |  |         |     |       |       |             |  |  |  |  |             |     |       |       |             |  |  |  |  |                 |     |       |       |             |  |  |  |  |                 |     |       |       |             |  |  |  |  |          |     |       |       |             |  |  |  |  |                    |     |       |       |             |  |  |  |  |         |     |       |       |             |  |  |  |  |         |    |       |       |                     |                |        |  |                        |     |    |       |       |                     |                |        |  |                           |         |    |       |       |                     |  |  |  |  |         |    |       |       |                     |  |  |  |  |         |     |       |       |                     |  |  |  |  |         |     |       |       |                     |  |  |  |  |         |    |       |       |                     |  |  |  |  |         |     |       |       |                     |  |  |  |  |                 |     |       |       |                     |  |  |  |  |         |     |       |       |                     |  |  |  |  |         |    |       |       |                     |  |  |  |  |         |     |       |       |                     |  |  |  |  |         |     |       |       |                     |  |  |  |  |             |     |       |       |                     |  |  |  |  |                 |     |       |       |                     |  |  |  |  |                 |     |       |       |                     |  |  |  |  |          |     |       |       |                     |  |  |  |  |
| 2.0 TDI 16V  | 103   | 03.05   | 07.10 |                     |                |                     |   |                           |   |                     |         |     |       |       |                     |                |        |   |                     |         |     |       |       |                     |  |  |  |  |             |     |       |       |                     |  |  |  |  |                 |     |       |       |                     |  |  |  |  |                 |     |       |       |                     |  |  |  |  |                    |     |       |       |                     |  |  |  |  |         |     |       |       |                     |  |  |  |  |                 |     |       |       |                     |  |  |  |  |         |     |       |       |                     |  |  |  |  |         |     |       |       |                     |  |  |  |  |             |     |       |       |                     |  |  |  |  |             |     |       |       |                     |  |  |  |  |                 |     |       |       |                     |                |        |   |           |                 |     |       |       |                     |                |        |   |           |                 |     |       |       |                     |  |  |  |  |                    |     |       |       |                     |  |  |  |  |          |     |       |       |                     |  |  |  |  |                    |     |       |       |                     |  |  |  |  |         |     |       |       |                     |  |  |  |  |         |    |       |       |             |                |        |  |                     |     |    |       |       |             |                |        |  |                     |         |    |       |       |             |  |  |  |  |         |    |       |       |             |  |  |  |  |         |     |       |       |             |  |  |  |  |         |     |       |       |             |  |  |  |  |         |    |       |       |             |  |  |  |  |         |     |       |       |             |  |  |  |  |                 |     |       |       |             |  |  |  |  |         |     |       |       |             |  |  |  |  |         |    |       |       |             |  |  |  |  |         |     |       |       |             |  |  |  |  |         |     |       |       |             |  |  |  |  |             |     |       |       |             |  |  |  |  |                 |     |       |       |             |  |  |  |  |                 |     |       |       |             |  |  |  |  |          |     |       |       |             |  |  |  |  |                    |     |       |       |             |  |  |  |  |         |     |       |       |             |  |  |  |  |         |    |       |       |                     |                |        |  |                        |     |    |       |       |                     |                |        |  |                           |         |    |       |       |                     |  |  |  |  |         |    |       |       |                     |  |  |  |  |         |     |       |       |                     |  |  |  |  |         |     |       |       |                     |  |  |  |  |         |    |       |       |                     |  |  |  |  |         |     |       |       |                     |  |  |  |  |                 |     |       |       |                     |  |  |  |  |         |     |       |       |                     |  |  |  |  |         |    |       |       |                     |  |  |  |  |         |     |       |       |                     |  |  |  |  |         |     |       |       |                     |  |  |  |  |             |     |       |       |                     |  |  |  |  |                 |     |       |       |                     |  |  |  |  |                 |     |       |       |                     |  |  |  |  |          |     |       |       |                     |  |  |  |  |
| 2.0 FSI 4motion  | 110   | 03.05   | 07.10 |                     | 24.0711-5271.3 | 360301              | ☐   | Radsensor                 |   |                     |         |     |       |       |                     |                |        |   |                     |         |     |       |       |                     |  |  |  |  |             |     |       |       |                     |  |  |  |  |                 |     |       |       |                     |  |  |  |  |                 |     |       |       |                     |  |  |  |  |                    |     |       |       |                     |  |  |  |  |         |     |       |       |                     |  |  |  |  |                 |     |       |       |                     |  |  |  |  |         |     |       |       |                     |  |  |  |  |         |     |       |       |                     |  |  |  |  |             |     |       |       |                     |  |  |  |  |             |     |       |       |                     |  |  |  |  |                 |     |       |       |                     |                |        |   |           |                 |     |       |       |                     |                |        |   |           |                 |     |       |       |                     |  |  |  |  |                    |     |       |       |                     |  |  |  |  |          |     |       |       |                     |  |  |  |  |                    |     |       |       |                     |  |  |  |  |         |     |       |       |                     |  |  |  |  |         |    |       |       |             |                |        |  |                     |     |    |       |       |             |                |        |  |                     |         |    |       |       |             |  |  |  |  |         |    |       |       |             |  |  |  |  |         |     |       |       |             |  |  |  |  |         |     |       |       |             |  |  |  |  |         |    |       |       |             |  |  |  |  |         |     |       |       |             |  |  |  |  |                 |     |       |       |             |  |  |  |  |         |     |       |       |             |  |  |  |  |         |    |       |       |             |  |  |  |  |         |     |       |       |             |  |  |  |  |         |     |       |       |             |  |  |  |  |             |     |       |       |             |  |  |  |  |                 |     |       |       |             |  |  |  |  |                 |     |       |       |             |  |  |  |  |          |     |       |       |             |  |  |  |  |                    |     |       |       |             |  |  |  |  |         |     |       |       |             |  |  |  |  |         |    |       |       |                     |                |        |  |                        |     |    |       |       |                     |                |        |  |                           |         |    |       |       |                     |  |  |  |  |         |    |       |       |                     |  |  |  |  |         |     |       |       |                     |  |  |  |  |         |     |       |       |                     |  |  |  |  |         |    |       |       |                     |  |  |  |  |         |     |       |       |                     |  |  |  |  |                 |     |       |       |                     |  |  |  |  |         |     |       |       |                     |  |  |  |  |         |    |       |       |                     |  |  |  |  |         |     |       |       |                     |  |  |  |  |         |     |       |       |                     |  |  |  |  |             |     |       |       |                     |  |  |  |  |                 |     |       |       |                     |  |  |  |  |                 |     |       |       |                     |  |  |  |  |          |     |       |       |                     |  |  |  |  |
| 2.0 TDI 4motion  | 103   | 03.05   | 07.10 |                     | 24.0711-5272.3 | 360302              | ☐   | Radsensor                 |   |                     |         |     |       |       |                     |                |        |   |                     |         |     |       |       |                     |  |  |  |  |             |     |       |       |                     |  |  |  |  |                 |     |       |       |                     |  |  |  |  |                 |     |       |       |                     |  |  |  |  |                    |     |       |       |                     |  |  |  |  |         |     |       |       |                     |  |  |  |  |                 |     |       |       |                     |  |  |  |  |         |     |       |       |                     |  |  |  |  |         |     |       |       |                     |  |  |  |  |             |     |       |       |                     |  |  |  |  |             |     |       |       |                     |  |  |  |  |                 |     |       |       |                     |                |        |   |           |                 |     |       |       |                     |                |        |   |           |                 |     |       |       |                     |  |  |  |  |                    |     |       |       |                     |  |  |  |  |          |     |       |       |                     |  |  |  |  |                    |     |       |       |                     |  |  |  |  |         |     |       |       |                     |  |  |  |  |         |    |       |       |             |                |        |  |                     |     |    |       |       |             |                |        |  |                     |         |    |       |       |             |  |  |  |  |         |    |       |       |             |  |  |  |  |         |     |       |       |             |  |  |  |  |         |     |       |       |             |  |  |  |  |         |    |       |       |             |  |  |  |  |         |     |       |       |             |  |  |  |  |                 |     |       |       |             |  |  |  |  |         |     |       |       |             |  |  |  |  |         |    |       |       |             |  |  |  |  |         |     |       |       |             |  |  |  |  |         |     |       |       |             |  |  |  |  |             |     |       |       |             |  |  |  |  |                 |     |       |       |             |  |  |  |  |                 |     |       |       |             |  |  |  |  |          |     |       |       |             |  |  |  |  |                    |     |       |       |             |  |  |  |  |         |     |       |       |             |  |  |  |  |         |    |       |       |                     |                |        |  |                        |     |    |       |       |                     |                |        |  |                           |         |    |       |       |                     |  |  |  |  |         |    |       |       |                     |  |  |  |  |         |     |       |       |                     |  |  |  |  |         |     |       |       |                     |  |  |  |  |         |    |       |       |                     |  |  |  |  |         |     |       |       |                     |  |  |  |  |                 |     |       |       |                     |  |  |  |  |         |     |       |       |                     |  |  |  |  |         |    |       |       |                     |  |  |  |  |         |     |       |       |                     |  |  |  |  |         |     |       |       |                     |  |  |  |  |             |     |       |       |                     |  |  |  |  |                 |     |       |       |                     |  |  |  |  |                 |     |       |       |                     |  |  |  |  |          |     |       |       |                     |  |  |  |  |
| 2.0 TDI 4motion  | 125   | 05.09   | 07.10 |                     |                |                     |   |                           |   |                     |         |     |       |       |                     |                |        |   |                     |         |     |       |       |                     |  |  |  |  |             |     |       |       |                     |  |  |  |  |                 |     |       |       |                     |  |  |  |  |                 |     |       |       |                     |  |  |  |  |                    |     |       |       |                     |  |  |  |  |         |     |       |       |                     |  |  |  |  |                 |     |       |       |                     |  |  |  |  |         |     |       |       |                     |  |  |  |  |         |     |       |       |                     |  |  |  |  |             |     |       |       |                     |  |  |  |  |             |     |       |       |                     |  |  |  |  |                 |     |       |       |                     |                |        |   |           |                 |     |       |       |                     |                |        |   |           |                 |     |       |       |                     |  |  |  |  |                    |     |       |       |                     |  |  |  |  |          |     |       |       |                     |  |  |  |  |                    |     |       |       |                     |  |  |  |  |         |     |       |       |                     |  |  |  |  |         |    |       |       |             |                |        |  |                     |     |    |       |       |             |                |        |  |                     |         |    |       |       |             |  |  |  |  |         |    |       |       |             |  |  |  |  |         |     |       |       |             |  |  |  |  |         |     |       |       |             |  |  |  |  |         |    |       |       |             |  |  |  |  |         |     |       |       |             |  |  |  |  |                 |     |       |       |             |  |  |  |  |         |     |       |       |             |  |  |  |  |         |    |       |       |             |  |  |  |  |         |     |       |       |             |  |  |  |  |         |     |       |       |             |  |  |  |  |             |     |       |       |             |  |  |  |  |                 |     |       |       |             |  |  |  |  |                 |     |       |       |             |  |  |  |  |          |     |       |       |             |  |  |  |  |                    |     |       |       |             |  |  |  |  |         |     |       |       |             |  |  |  |  |         |    |       |       |                     |                |        |  |                        |     |    |       |       |                     |                |        |  |                           |         |    |       |       |                     |  |  |  |  |         |    |       |       |                     |  |  |  |  |         |     |       |       |                     |  |  |  |  |         |     |       |       |                     |  |  |  |  |         |    |       |       |                     |  |  |  |  |         |     |       |       |                     |  |  |  |  |                 |     |       |       |                     |  |  |  |  |         |     |       |       |                     |  |  |  |  |         |    |       |       |                     |  |  |  |  |         |     |       |       |                     |  |  |  |  |         |     |       |       |                     |  |  |  |  |             |     |       |       |                     |  |  |  |  |                 |     |       |       |                     |  |  |  |  |                 |     |       |       |                     |  |  |  |  |          |     |       |       |                     |  |  |  |  |
| 3.2 V6 FSI 4motion   | 184   | 09.05   | 07.10 |                     |                |                     |   |                           |   |                     |         |     |       |       |                     |                |        |   |                     |         |     |       |       |                     |  |  |  |  |             |     |       |       |                     |  |  |  |  |                 |     |       |       |                     |  |  |  |  |                 |     |       |       |                     |  |  |  |  |                    |     |       |       |                     |  |  |  |  |         |     |       |       |                     |  |  |  |  |                 |     |       |       |                     |  |  |  |  |         |     |       |       |                     |  |  |  |  |         |     |       |       |                     |  |  |  |  |             |     |       |       |                     |  |  |  |  |             |     |       |       |                     |  |  |  |  |                 |     |       |       |                     |                |        |   |           |                 |     |       |       |                     |                |        |   |           |                 |     |       |       |                     |  |  |  |  |                    |     |       |       |                     |  |  |  |  |          |     |       |       |                     |  |  |  |  |                    |     |       |       |                     |  |  |  |  |         |     |       |       |                     |  |  |  |  |         |    |       |       |             |                |        |  |                     |     |    |       |       |             |                |        |  |                     |         |    |       |       |             |  |  |  |  |         |    |       |       |             |  |  |  |  |         |     |       |       |             |  |  |  |  |         |     |       |       |             |  |  |  |  |         |    |       |       |             |  |  |  |  |         |     |       |       |             |  |  |  |  |                 |     |       |       |             |  |  |  |  |         |     |       |       |             |  |  |  |  |         |    |       |       |             |  |  |  |  |         |     |       |       |             |  |  |  |  |         |     |       |       |             |  |  |  |  |             |     |       |       |             |  |  |  |  |                 |     |       |       |             |  |  |  |  |                 |     |       |       |             |  |  |  |  |          |     |       |       |             |  |  |  |  |                    |     |       |       |             |  |  |  |  |         |     |       |       |             |  |  |  |  |         |    |       |       |                     |                |        |  |                        |     |    |       |       |                     |                |        |  |                           |         |    |       |       |                     |  |  |  |  |         |    |       |       |                     |  |  |  |  |         |     |       |       |                     |  |  |  |  |         |     |       |       |                     |  |  |  |  |         |    |       |       |                     |  |  |  |  |         |     |       |       |                     |  |  |  |  |                 |     |       |       |                     |  |  |  |  |         |     |       |       |                     |  |  |  |  |         |    |       |       |                     |  |  |  |  |         |     |       |       |                     |  |  |  |  |         |     |       |       |                     |  |  |  |  |             |     |       |       |                     |  |  |  |  |                 |     |       |       |                     |  |  |  |  |                 |     |       |       |                     |  |  |  |  |          |     |       |       |                     |  |  |  |  |
| 3.6 R36  | 220   | 04.07   | 07.10 |                     |                |                     |   |                           |   |                     |         |     |       |       |                     |                |        |   |                     |         |     |       |       |                     |  |  |  |  |             |     |       |       |                     |  |  |  |  |                 |     |       |       |                     |  |  |  |  |                 |     |       |       |                     |  |  |  |  |                    |     |       |       |                     |  |  |  |  |         |     |       |       |                     |  |  |  |  |                 |     |       |       |                     |  |  |  |  |         |     |       |       |                     |  |  |  |  |         |     |       |       |                     |  |  |  |  |             |     |       |       |                     |  |  |  |  |             |     |       |       |                     |  |  |  |  |                 |     |       |       |                     |                |        |   |           |                 |     |       |       |                     |                |        |   |           |                 |     |       |       |                     |  |  |  |  |                    |     |       |       |                     |  |  |  |  |          |     |       |       |                     |  |  |  |  |                    |     |       |       |                     |  |  |  |  |         |     |       |       |                     |  |  |  |  |         |    |       |       |             |                |        |  |                     |     |    |       |       |             |                |        |  |                     |         |    |       |       |             |  |  |  |  |         |    |       |       |             |  |  |  |  |         |     |       |       |             |  |  |  |  |         |     |       |       |             |  |  |  |  |         |    |       |       |             |  |  |  |  |         |     |       |       |             |  |  |  |  |                 |     |       |       |             |  |  |  |  |         |     |       |       |             |  |  |  |  |         |    |       |       |             |  |  |  |  |         |     |       |       |             |  |  |  |  |         |     |       |       |             |  |  |  |  |             |     |       |       |             |  |  |  |  |                 |     |       |       |             |  |  |  |  |                 |     |       |       |             |  |  |  |  |          |     |       |       |             |  |  |  |  |                    |     |       |       |             |  |  |  |  |         |     |       |       |             |  |  |  |  |         |    |       |       |                     |                |        |  |                        |     |    |       |       |                     |                |        |  |                           |         |    |       |       |                     |  |  |  |  |         |    |       |       |                     |  |  |  |  |         |     |       |       |                     |  |  |  |  |         |     |       |       |                     |  |  |  |  |         |    |       |       |                     |  |  |  |  |         |     |       |       |                     |  |  |  |  |                 |     |       |       |                     |  |  |  |  |         |     |       |       |                     |  |  |  |  |         |    |       |       |                     |  |  |  |  |         |     |       |       |                     |  |  |  |  |         |     |       |       |                     |  |  |  |  |             |     |       |       |                     |  |  |  |  |                 |     |       |       |                     |  |  |  |  |                 |     |       |       |                     |  |  |  |  |          |     |       |       |                     |  |  |  |  |
| VOLKSWAGEN PASSAT Variant (05-10)  |   |         |       |                     |                |                     |   |                           |   |                     |         |     |       |       |                     |                |        |   |                     |         |     |       |       |                     |  |  |  |  |             |     |       |       |                     |  |  |  |  |                 |     |       |       |                     |  |  |  |  |                 |     |       |       |                     |  |  |  |  |                    |     |       |       |                     |  |  |  |  |         |     |       |       |                     |  |  |  |  |                 |     |       |       |                     |  |  |  |  |         |     |       |       |                     |  |  |  |  |         |     |       |       |                     |  |  |  |  |             |     |       |       |                     |  |  |  |  |             |     |       |       |                     |  |  |  |  |                 |     |       |       |                     |                |        |   |           |                 |     |       |       |                     |                |        |   |           |                 |     |       |       |                     |  |  |  |  |                    |     |       |       |                     |  |  |  |  |          |     |       |       |                     |  |  |  |  |                    |     |       |       |                     |  |  |  |  |         |     |       |       |                     |  |  |  |  |         |    |       |       |             |                |        |  |                     |     |    |       |       |             |                |        |  |                     |         |    |       |       |             |  |  |  |  |         |    |       |       |             |  |  |  |  |         |     |       |       |             |  |  |  |  |         |     |       |       |             |  |  |  |  |         |    |       |       |             |  |  |  |  |         |     |       |       |             |  |  |  |  |                 |     |       |       |             |  |  |  |  |         |     |       |       |             |  |  |  |  |         |    |       |       |             |  |  |  |  |         |     |       |       |             |  |  |  |  |         |     |       |       |             |  |  |  |  |             |     |       |       |             |  |  |  |  |                 |     |       |       |             |  |  |  |  |                 |     |       |       |             |  |  |  |  |          |     |       |       |             |  |  |  |  |                    |     |       |       |             |  |  |  |  |         |     |       |       |             |  |  |  |  |         |    |       |       |                     |                |        |  |                        |     |    |       |       |                     |                |        |  |                           |         |    |       |       |                     |  |  |  |  |         |    |       |       |                     |  |  |  |  |         |     |       |       |                     |  |  |  |  |         |     |       |       |                     |  |  |  |  |         |    |       |       |                     |  |  |  |  |         |     |       |       |                     |  |  |  |  |                 |     |       |       |                     |  |  |  |  |         |     |       |       |                     |  |  |  |  |         |    |       |       |                     |  |  |  |  |         |     |       |       |                     |  |  |  |  |         |     |       |       |                     |  |  |  |  |             |     |       |       |                     |  |  |  |  |                 |     |       |       |                     |  |  |  |  |                 |     |       |       |                     |  |  |  |  |          |     |       |       |                     |  |  |  |  |
|  | <table border="1"> <tr><td>1.4 TSI</td><td>90</td><td>10.07</td><td>07.10</td><td>PR: 1LJ,1LH,1ZG,1ZM</td><td>13.0460-7184.2</td><td>607184</td><td></td><td>23587 20,6 +/WK ATE</td></tr> <tr><td>1.6</td><td>75</td><td>07.05</td><td>07.10</td><td>PR: 1LJ,1LH,1ZG,1ZM</td><td>13.0470-7184.2</td><td>LD7184</td><td></td><td>23587 20,6 +/WK ATE</td></tr> <tr><td>1.6 FSI</td><td>85</td><td>07.05</td><td>07.10</td><td>PR: 1LJ,1LH,1ZG,1ZM</td><td></td><td></td><td></td><td></td></tr> <tr><td>1.6 TDI</td><td>77</td><td>08.09</td><td>07.10</td><td>PR: 1LJ,1LH,1ZG,1ZM</td><td></td><td></td><td></td><td></td></tr> <tr><td>1.8 TSI</td><td>112</td><td>11.09</td><td>07.10</td><td>PR: 1LJ,1LH,1ZG,1ZM</td><td></td><td></td><td></td><td></td></tr> <tr><td>1.8 TSI</td><td>118</td><td>10.07</td><td>07.10</td><td>PR: 1LJ,1LH,1ZG,1ZM</td><td></td><td></td><td></td><td></td></tr> <tr><td>1.9 TDI</td><td>77</td><td>07.05</td><td>07.10</td><td>PR: 1LJ,1LH,1ZG,1ZM</td><td></td><td></td><td></td><td></td></tr> <tr><td>2.0 FSI</td><td>110</td><td>07.05</td><td>07.10</td><td>PR: 1LJ,1LH,1ZG,1ZM</td><td></td><td></td><td></td><td></td></tr> <tr><td>2.0 FSI 4motion</td><td>110</td><td>09.05</td><td>07.10</td><td>PR: 1LJ,1LH,1ZG,1ZM</td><td></td><td></td><td></td><td></td></tr> <tr><td>2.0 TDI</td><td>100</td><td>11.05</td><td>07.10</td><td>PR: 1LJ,1LH,1ZG,1ZM</td><td></td><td></td><td></td><td></td></tr> <tr><td>2.0 TDI</td><td>90</td><td>07.05</td><td>07.10</td><td>PR: 1LJ,1LH,1ZG,1ZM</td><td></td><td></td><td></td><td></td></tr> <tr><td>2.0 TDI</td><td>100</td><td>07.05</td><td>07.10</td><td>PR: 1LJ,1LH,1ZG,1ZM</td><td></td><td></td><td></td><td></td></tr> <tr><td>2.0 TDI</td><td>125</td><td>07.05</td><td>07.10</td><td>PR: 1LJ,1LH,1ZG,1ZM</td><td></td><td></td><td></td><td></td></tr> <tr><td>2.0 TDI 16V</td><td>103</td><td>07.05</td><td>07.10</td><td>PR: 1LJ,1LH,1ZG,1ZM</td><td></td><td></td><td></td><td></td></tr> <tr><td>2.0 TDI 4motion</td><td>103</td><td>08.05</td><td>07.10</td><td>PR: 1LJ,1LH,1ZG,1ZM</td><td></td><td></td><td></td><td></td></tr> <tr><td>2.0 TDI 4motion</td><td>125</td><td>09.05</td><td>07.10</td><td>PR: 1LJ,1LH,1ZG,1ZM</td><td></td><td></td><td></td><td></td></tr> <tr><td>2.0 TDI 4motion</td><td>125</td><td>05.09</td><td>07.10</td><td>PR: 1LJ,1LH,1ZG,1ZM</td><td></td><td></td><td></td><td></td></tr> <tr><td>2.0 TFSI</td><td>147</td><td>07.05</td><td>07.10</td><td>PR: 1LJ,1LH,1ZG,1ZM</td><td></td><td></td><td></td><td></td></tr> <tr><td>3.2 V6 FSI 4motion</td><td>184</td><td>11.05</td><td>07.10</td><td>PR: 1LJ,1LH,1ZG,1ZM</td><td></td><td></td><td></td><td></td></tr> <tr><td>3.6 R36</td><td>220</td><td>04.07</td><td>07.10</td><td>PR: 1LJ,1LH,1ZG,1ZM</td><td></td><td></td><td></td><td></td></tr> <tr><td>1.4 TSI</td><td>90</td><td>10.07</td><td>07.10</td><td>PR: 1LK,1LM</td><td>13.0460-7200.2</td><td>607200</td><td></td><td>23801 20,3 +/WK ATE</td></tr> <tr><td>1.6</td><td>75</td><td>07.05</td><td>07.10</td><td>PR: 1LK,1LM</td><td>13.0470-7200.2</td><td>LD7200</td><td></td><td>23801 20,3 +/WK ATE</td></tr> <tr><td>1.6 FSI</td><td>85</td><td>07.05</td><td>07.10</td><td>PR: 1LK,1LM</td><td></td><td></td><td></td><td></td></tr> <tr><td>1.6 TDI</td><td>77</td><td>08.09</td><td>07.10</td><td>PR: 1LK,1LM</td><td></td><td></td><td></td><td></td></tr> <tr><td>1.8 TSI</td><td>112</td><td>11.09</td><td>07.10</td><td>PR: 1LK,1LM</td><td></td><td></td><td></td><td></td></tr> <tr><td>1.8 TSI</td><td>118</td><td>10.07</td><td>07.10</td><td>PR: 1LK,1LM</td><td></td><td></td><td></td><td></td></tr> <tr><td>1.9 TDI</td><td>77</td><td>07.05</td><td>07.10</td><td>PR: 1LK,1LM</td><td></td><td></td><td></td><td></td></tr> <tr><td>2.0 FSI</td><td>110</td><td>07.05</td><td>07.10</td><td>PR: 1LK,1LM</td><td></td><td></td><td></td><td></td></tr> <tr><td>2.0 FSI 4motion</td><td>110</td><td>09.05</td><td>07.10</td><td>PR: 1LK,1LM</td><td></td><td></td><td></td><td></td></tr> <tr><td>2.0 TDI</td><td>100</td><td>11.05</td><td>07.10</td><td>PR: 1LK,1LM</td><td></td><td></td><td></td><td></td></tr> <tr><td>2.0 TDI</td><td>90</td><td>07.05</td><td>07.10</td><td>PR: 1LK,1LM</td><td></td><td></td><td></td><td></td></tr> <tr><td>2.0 TDI</td><td>100</td><td>07.05</td><td>07.10</td><td>PR: 1LK,1LM</td><td></td><td></td><td></td><td></td></tr> <tr><td>2.0 TDI</td><td>125</td><td>07.05</td><td>07.10</td><td>PR: 1LK,1LM</td><td></td><td></td><td></td><td></td></tr> <tr><td>2.0 TDI 16V</td><td>103</td><td>08.05</td><td>07.10</td><td>PR: 1LK,1LM</td><td></td><td></td><td></td><td></td></tr> <tr><td>2.0 TDI 4motion</td><td>103</td><td>09.05</td><td>07.10</td><td>PR: 1LK,1LM</td><td></td><td></td><td></td><td></td></tr> <tr><td>2.0 TDI 4motion</td><td>125</td><td>05.09</td><td>07.10</td><td>PR: 1LK,1LM</td><td></td><td></td><td></td><td></td></tr> <tr><td>2.0 TFSI</td><td>147</td><td>07.05</td><td>07.10</td><td>PR: 1LK,1LM</td><td></td><td></td><td></td><td></td></tr> <tr><td>3.2 V6 FSI 4motion</td><td>184</td><td>11.05</td><td>07.10</td><td>PR: 1LK,1LM</td><td></td><td></td><td></td><td></td></tr> <tr><td>3.6 R36</td><td>220</td><td>04.07</td><td>07.10</td><td>PR: 1LK,1LM</td><td></td><td></td><td></td><td></td></tr> <tr><td>1.4 TSI</td><td>90</td><td>10.07</td><td>07.10</td><td>PR: 1LJ,1LH,1ZG,1ZM</td><td>24.0125-0158.1</td><td>425158</td><td></td><td>312 25,0 22,0 VL +S +B</td></tr> <tr><td>1.6</td><td>75</td><td>07.05</td><td>07.10</td><td>PR: 1LJ,1LH,1ZG,1ZM</td><td>24.0325-0158.1</td><td>525158</td><td></td><td>312 25,0 22,0 VL +S +B PD</td></tr> <tr><td>1.6 FSI</td><td>85</td><td>07.05</td><td>07.10</td><td>PR: 1LJ,1LH,1ZG,1ZM</td><td></td><td></td><td></td><td></td></tr> <tr><td>1.6 TDI</td><td>77</td><td>08.09</td><td>07.10</td><td>PR: 1LJ,1LH,1ZG,1ZM</td><td></td><td></td><td></td><td></td></tr> <tr><td>1.8 TSI</td><td>112</td><td>11.09</td><td>07.10</td><td>PR: 1LJ,1LH,1ZG,1ZM</td><td></td><td></td><td></td><td></td></tr> <tr><td>1.8 TSI</td><td>118</td><td>10.07</td><td>07.10</td><td>PR: 1LJ,1LH,1ZG,1ZM</td><td></td><td></td><td></td><td></td></tr> <tr><td>1.9 TDI</td><td>77</td><td>07.05</td><td>07.10</td><td>PR: 1LJ,1LH,1ZG,1ZM</td><td></td><td></td><td></td><td></td></tr> <tr><td>2.0 FSI</td><td>110</td><td>07.05</td><td>07.10</td><td>PR: 1LJ,1LH,1ZG,1ZM</td><td></td><td></td><td></td><td></td></tr> <tr><td>2.0 FSI 4motion</td><td>110</td><td>09.05</td><td>07.10</td><td>PR: 1LJ,1LH,1ZG,1ZM</td><td></td><td></td><td></td><td></td></tr> <tr><td>2.0 TDI</td><td>100</td><td>11.05</td><td>07.10</td><td>PR: 1LJ,1LH,1ZG,1ZM</td><td></td><td></td><td></td><td></td></tr> <tr><td>2.0 TDI</td><td>90</td><td>07.05</td><td>07.10</td><td>PR: 1LJ,1LH,1ZG,1ZM</td><td></td><td></td><td></td><td></td></tr> <tr><td>2.0 TDI</td><td>100</td><td>07.05</td><td>07.10</td><td>PR: 1LJ,1LH,1ZG,1ZM</td><td></td><td></td><td></td><td></td></tr> <tr><td>2.0 TDI</td><td>125</td><td>07.05</td><td>07.10</td><td>PR: 1LJ,1LH,1ZG,1ZM</td><td></td><td></td><td></td><td></td></tr> <tr><td>2.0 TDI 16V</td><td>103</td><td>08.05</td><td>07.10</td><td>PR: 1LJ,1LH,1ZG,1ZM</td><td></td><td></td><td></td><td></td></tr> <tr><td>2.0 TDI 4motion</td><td>103</td><td>09.05</td><td>07.10</td><td>PR: 1LJ,1LH,1ZG,1ZM</td><td></td><td></td><td></td><td></td></tr> <tr><td>2.0 TDI 4motion</td><td>125</td><td>05.09</td><td>07.10</td><td>PR: 1LJ,1LH,1ZG,1ZM</td><td></td><td></td><td></td><td></td></tr> <tr><td>2.0 TFSI</td><td>147</td><td>07.05</td><td>07.10</td><td>PR: 1LJ,1LH,1ZG,1ZM</td><td></td><td></td><td></td><td></td></tr> </table> | 1.4 TSI | 90    | 10.07               | 07.10          | PR: 1LJ,1LH,1ZG,1ZM | 13.0460-7184.2                            | 607184                    |   | 23587 20,6 +/WK ATE | 1.6     | 75  | 07.05 | 07.10 | PR: 1LJ,1LH,1ZG,1ZM | 13.0470-7184.2 | LD7184 |   | 23587 20,6 +/WK ATE | 1.6 FSI | 85  | 07.05 | 07.10 | PR: 1LJ,1LH,1ZG,1ZM |  |  |  |  | 1.6 TDI     | 77  | 08.09 | 07.10 | PR: 1LJ,1LH,1ZG,1ZM |  |  |  |  | 1.8 TSI         | 112 | 11.09 | 07.10 | PR: 1LJ,1LH,1ZG,1ZM |  |  |  |  | 1.8 TSI         | 118 | 10.07 | 07.10 | PR: 1LJ,1LH,1ZG,1ZM |  |  |  |  | 1.9 TDI            | 77  | 07.05 | 07.10 | PR: 1LJ,1LH,1ZG,1ZM |  |  |  |  | 2.0 FSI | 110 | 07.05 | 07.10 | PR: 1LJ,1LH,1ZG,1ZM |  |  |  |  | 2.0 FSI 4motion | 110 | 09.05 | 07.10 | PR: 1LJ,1LH,1ZG,1ZM |  |  |  |  | 2.0 TDI | 100 | 11.05 | 07.10 | PR: 1LJ,1LH,1ZG,1ZM |  |  |  |  | 2.0 TDI | 90  | 07.05 | 07.10 | PR: 1LJ,1LH,1ZG,1ZM |  |  |  |  | 2.0 TDI     | 100 | 07.05 | 07.10 | PR: 1LJ,1LH,1ZG,1ZM |  |  |  |  | 2.0 TDI     | 125 | 07.05 | 07.10 | PR: 1LJ,1LH,1ZG,1ZM |  |  |  |  | 2.0 TDI 16V     | 103 | 07.05 | 07.10 | PR: 1LJ,1LH,1ZG,1ZM |                |        |   |           | 2.0 TDI 4motion | 103 | 08.05 | 07.10 | PR: 1LJ,1LH,1ZG,1ZM |                |        |   |           | 2.0 TDI 4motion | 125 | 09.05 | 07.10 | PR: 1LJ,1LH,1ZG,1ZM |  |  |  |  | 2.0 TDI 4motion    | 125 | 05.09 | 07.10 | PR: 1LJ,1LH,1ZG,1ZM |  |  |  |  | 2.0 TFSI | 147 | 07.05 | 07.10 | PR: 1LJ,1LH,1ZG,1ZM |  |  |  |  | 3.2 V6 FSI 4motion | 184 | 11.05 | 07.10 | PR: 1LJ,1LH,1ZG,1ZM |  |  |  |  | 3.6 R36 | 220 | 04.07 | 07.10 | PR: 1LJ,1LH,1ZG,1ZM |  |  |  |  | 1.4 TSI | 90 | 10.07 | 07.10 | PR: 1LK,1LM | 13.0460-7200.2 | 607200 |  | 23801 20,3 +/WK ATE | 1.6 | 75 | 07.05 | 07.10 | PR: 1LK,1LM | 13.0470-7200.2 | LD7200 |  | 23801 20,3 +/WK ATE | 1.6 FSI | 85 | 07.05 | 07.10 | PR: 1LK,1LM |  |  |  |  | 1.6 TDI | 77 | 08.09 | 07.10 | PR: 1LK,1LM |  |  |  |  | 1.8 TSI | 112 | 11.09 | 07.10 | PR: 1LK,1LM |  |  |  |  | 1.8 TSI | 118 | 10.07 | 07.10 | PR: 1LK,1LM |  |  |  |  | 1.9 TDI | 77 | 07.05 | 07.10 | PR: 1LK,1LM |  |  |  |  | 2.0 FSI | 110 | 07.05 | 07.10 | PR: 1LK,1LM |  |  |  |  | 2.0 FSI 4motion | 110 | 09.05 | 07.10 | PR: 1LK,1LM |  |  |  |  | 2.0 TDI | 100 | 11.05 | 07.10 | PR: 1LK,1LM |  |  |  |  | 2.0 TDI | 90 | 07.05 | 07.10 | PR: 1LK,1LM |  |  |  |  | 2.0 TDI | 100 | 07.05 | 07.10 | PR: 1LK,1LM |  |  |  |  | 2.0 TDI | 125 | 07.05 | 07.10 | PR: 1LK,1LM |  |  |  |  | 2.0 TDI 16V | 103 | 08.05 | 07.10 | PR: 1LK,1LM |  |  |  |  | 2.0 TDI 4motion | 103 | 09.05 | 07.10 | PR: 1LK,1LM |  |  |  |  | 2.0 TDI 4motion | 125 | 05.09 | 07.10 | PR: 1LK,1LM |  |  |  |  | 2.0 TFSI | 147 | 07.05 | 07.10 | PR: 1LK,1LM |  |  |  |  | 3.2 V6 FSI 4motion | 184 | 11.05 | 07.10 | PR: 1LK,1LM |  |  |  |  | 3.6 R36 | 220 | 04.07 | 07.10 | PR: 1LK,1LM |  |  |  |  | 1.4 TSI | 90 | 10.07 | 07.10 | PR: 1LJ,1LH,1ZG,1ZM | 24.0125-0158.1 | 425158 |  | 312 25,0 22,0 VL +S +B | 1.6 | 75 | 07.05 | 07.10 | PR: 1LJ,1LH,1ZG,1ZM | 24.0325-0158.1 | 525158 |  | 312 25,0 22,0 VL +S +B PD | 1.6 FSI | 85 | 07.05 | 07.10 | PR: 1LJ,1LH,1ZG,1ZM |  |  |  |  | 1.6 TDI | 77 | 08.09 | 07.10 | PR: 1LJ,1LH,1ZG,1ZM |  |  |  |  | 1.8 TSI | 112 | 11.09 | 07.10 | PR: 1LJ,1LH,1ZG,1ZM |  |  |  |  | 1.8 TSI | 118 | 10.07 | 07.10 | PR: 1LJ,1LH,1ZG,1ZM |  |  |  |  | 1.9 TDI | 77 | 07.05 | 07.10 | PR: 1LJ,1LH,1ZG,1ZM |  |  |  |  | 2.0 FSI | 110 | 07.05 | 07.10 | PR: 1LJ,1LH,1ZG,1ZM |  |  |  |  | 2.0 FSI 4motion | 110 | 09.05 | 07.10 | PR: 1LJ,1LH,1ZG,1ZM |  |  |  |  | 2.0 TDI | 100 | 11.05 | 07.10 | PR: 1LJ,1LH,1ZG,1ZM |  |  |  |  | 2.0 TDI | 90 | 07.05 | 07.10 | PR: 1LJ,1LH,1ZG,1ZM |  |  |  |  | 2.0 TDI | 100 | 07.05 | 07.10 | PR: 1LJ,1LH,1ZG,1ZM |  |  |  |  | 2.0 TDI | 125 | 07.05 | 07.10 | PR: 1LJ,1LH,1ZG,1ZM |  |  |  |  | 2.0 TDI 16V | 103 | 08.05 | 07.10 | PR: 1LJ,1LH,1ZG,1ZM |  |  |  |  | 2.0 TDI 4motion | 103 | 09.05 | 07.10 | PR: 1LJ,1LH,1ZG,1ZM |  |  |  |  | 2.0 TDI 4motion | 125 | 05.09 | 07.10 | PR: 1LJ,1LH,1ZG,1ZM |  |  |  |  | 2.0 TFSI | 147 | 07.05 | 07.10 | PR: 1LJ,1LH,1ZG,1ZM |  |  |  |  |
| 1.4 TSI  | 90  | 10.07   | 07.10 | PR: 1LJ,1LH,1ZG,1ZM | 13.0460-7184.2 | 607184              |   | 23587 20,6 +/WK ATE       |   |                     |         |     |       |       |                     |                |        |   |                     |         |     |       |       |                     |  |  |  |  |             |     |       |       |                     |  |  |  |  |                 |     |       |       |                     |  |  |  |  |                 |     |       |       |                     |  |  |  |  |                    |     |       |       |                     |  |  |  |  |         |     |       |       |                     |  |  |  |  |                 |     |       |       |                     |  |  |  |  |         |     |       |       |                     |  |  |  |  |         |     |       |       |                     |  |  |  |  |             |     |       |       |                     |  |  |  |  |             |     |       |       |                     |  |  |  |  |                 |     |       |       |                     |                |        |   |           |                 |     |       |       |                     |                |        |   |           |                 |     |       |       |                     |  |  |  |  |                    |     |       |       |                     |  |  |  |  |          |     |       |       |                     |  |  |  |  |                    |     |       |       |                     |  |  |  |  |         |     |       |       |                     |  |  |  |  |         |    |       |       |             |                |        |  |                     |     |    |       |       |             |                |        |  |                     |         |    |       |       |             |  |  |  |  |         |    |       |       |             |  |  |  |  |         |     |       |       |             |  |  |  |  |         |     |       |       |             |  |  |  |  |         |    |       |       |             |  |  |  |  |         |     |       |       |             |  |  |  |  |                 |     |       |       |             |  |  |  |  |         |     |       |       |             |  |  |  |  |         |    |       |       |             |  |  |  |  |         |     |       |       |             |  |  |  |  |         |     |       |       |             |  |  |  |  |             |     |       |       |             |  |  |  |  |                 |     |       |       |             |  |  |  |  |                 |     |       |       |             |  |  |  |  |          |     |       |       |             |  |  |  |  |                    |     |       |       |             |  |  |  |  |         |     |       |       |             |  |  |  |  |         |    |       |       |                     |                |        |  |                        |     |    |       |       |                     |                |        |  |                           |         |    |       |       |                     |  |  |  |  |         |    |       |       |                     |  |  |  |  |         |     |       |       |                     |  |  |  |  |         |     |       |       |                     |  |  |  |  |         |    |       |       |                     |  |  |  |  |         |     |       |       |                     |  |  |  |  |                 |     |       |       |                     |  |  |  |  |         |     |       |       |                     |  |  |  |  |         |    |       |       |                     |  |  |  |  |         |     |       |       |                     |  |  |  |  |         |     |       |       |                     |  |  |  |  |             |     |       |       |                     |  |  |  |  |                 |     |       |       |                     |  |  |  |  |                 |     |       |       |                     |  |  |  |  |          |     |       |       |                     |  |  |  |  |
| 1.6  | 75  | 07.05   | 07.10 | PR: 1LJ,1LH,1ZG,1ZM | 13.0470-7184.2 | LD7184              |   | 23587 20,6 +/WK ATE       |   |                     |         |     |       |       |                     |                |        |   |                     |         |     |       |       |                     |  |  |  |  |             |     |       |       |                     |  |  |  |  |                 |     |       |       |                     |  |  |  |  |                 |     |       |       |                     |  |  |  |  |                    |     |       |       |                     |  |  |  |  |         |     |       |       |                     |  |  |  |  |                 |     |       |       |                     |  |  |  |  |         |     |       |       |                     |  |  |  |  |         |     |       |       |                     |  |  |  |  |             |     |       |       |                     |  |  |  |  |             |     |       |       |                     |  |  |  |  |                 |     |       |       |                     |                |        |   |           |                 |     |       |       |                     |                |        |   |           |                 |     |       |       |                     |  |  |  |  |                    |     |       |       |                     |  |  |  |  |          |     |       |       |                     |  |  |  |  |                    |     |       |       |                     |  |  |  |  |         |     |       |       |                     |  |  |  |  |         |    |       |       |             |                |        |  |                     |     |    |       |       |             |                |        |  |                     |         |    |       |       |             |  |  |  |  |         |    |       |       |             |  |  |  |  |         |     |       |       |             |  |  |  |  |         |     |       |       |             |  |  |  |  |         |    |       |       |             |  |  |  |  |         |     |       |       |             |  |  |  |  |                 |     |       |       |             |  |  |  |  |         |     |       |       |             |  |  |  |  |         |    |       |       |             |  |  |  |  |         |     |       |       |             |  |  |  |  |         |     |       |       |             |  |  |  |  |             |     |       |       |             |  |  |  |  |                 |     |       |       |             |  |  |  |  |                 |     |       |       |             |  |  |  |  |          |     |       |       |             |  |  |  |  |                    |     |       |       |             |  |  |  |  |         |     |       |       |             |  |  |  |  |         |    |       |       |                     |                |        |  |                        |     |    |       |       |                     |                |        |  |                           |         |    |       |       |                     |  |  |  |  |         |    |       |       |                     |  |  |  |  |         |     |       |       |                     |  |  |  |  |         |     |       |       |                     |  |  |  |  |         |    |       |       |                     |  |  |  |  |         |     |       |       |                     |  |  |  |  |                 |     |       |       |                     |  |  |  |  |         |     |       |       |                     |  |  |  |  |         |    |       |       |                     |  |  |  |  |         |     |       |       |                     |  |  |  |  |         |     |       |       |                     |  |  |  |  |             |     |       |       |                     |  |  |  |  |                 |     |       |       |                     |  |  |  |  |                 |     |       |       |                     |  |  |  |  |          |     |       |       |                     |  |  |  |  |
| 1.6 FSI  | 85  | 07.05   | 07.10 | PR: 1LJ,1LH,1ZG,1ZM |                |                     |   |                           |   |                     |         |     |       |       |                     |                |        |   |                     |         |     |       |       |                     |  |  |  |  |             |     |       |       |                     |  |  |  |  |                 |     |       |       |                     |  |  |  |  |                 |     |       |       |                     |  |  |  |  |                    |     |       |       |                     |  |  |  |  |         |     |       |       |                     |  |  |  |  |                 |     |       |       |                     |  |  |  |  |         |     |       |       |                     |  |  |  |  |         |     |       |       |                     |  |  |  |  |             |     |       |       |                     |  |  |  |  |             |     |       |       |                     |  |  |  |  |                 |     |       |       |                     |                |        |   |           |                 |     |       |       |                     |                |        |   |           |                 |     |       |       |                     |  |  |  |  |                    |     |       |       |                     |  |  |  |  |          |     |       |       |                     |  |  |  |  |                    |     |       |       |                     |  |  |  |  |         |     |       |       |                     |  |  |  |  |         |    |       |       |             |                |        |  |                     |     |    |       |       |             |                |        |  |                     |         |    |       |       |             |  |  |  |  |         |    |       |       |             |  |  |  |  |         |     |       |       |             |  |  |  |  |         |     |       |       |             |  |  |  |  |         |    |       |       |             |  |  |  |  |         |     |       |       |             |  |  |  |  |                 |     |       |       |             |  |  |  |  |         |     |       |       |             |  |  |  |  |         |    |       |       |             |  |  |  |  |         |     |       |       |             |  |  |  |  |         |     |       |       |             |  |  |  |  |             |     |       |       |             |  |  |  |  |                 |     |       |       |             |  |  |  |  |                 |     |       |       |             |  |  |  |  |          |     |       |       |             |  |  |  |  |                    |     |       |       |             |  |  |  |  |         |     |       |       |             |  |  |  |  |         |    |       |       |                     |                |        |  |                        |     |    |       |       |                     |                |        |  |                           |         |    |       |       |                     |  |  |  |  |         |    |       |       |                     |  |  |  |  |         |     |       |       |                     |  |  |  |  |         |     |       |       |                     |  |  |  |  |         |    |       |       |                     |  |  |  |  |         |     |       |       |                     |  |  |  |  |                 |     |       |       |                     |  |  |  |  |         |     |       |       |                     |  |  |  |  |         |    |       |       |                     |  |  |  |  |         |     |       |       |                     |  |  |  |  |         |     |       |       |                     |  |  |  |  |             |     |       |       |                     |  |  |  |  |                 |     |       |       |                     |  |  |  |  |                 |     |       |       |                     |  |  |  |  |          |     |       |       |                     |  |  |  |  |
| 1.6 TDI  | 77  | 08.09   | 07.10 | PR: 1LJ,1LH,1ZG,1ZM |                |                     |   |                           |   |                     |         |     |       |       |                     |                |        |   |                     |         |     |       |       |                     |  |  |  |  |             |     |       |       |                     |  |  |  |  |                 |     |       |       |                     |  |  |  |  |                 |     |       |       |                     |  |  |  |  |                    |     |       |       |                     |  |  |  |  |         |     |       |       |                     |  |  |  |  |                 |     |       |       |                     |  |  |  |  |         |     |       |       |                     |  |  |  |  |         |     |       |       |                     |  |  |  |  |             |     |       |       |                     |  |  |  |  |             |     |       |       |                     |  |  |  |  |                 |     |       |       |                     |                |        |   |           |                 |     |       |       |                     |                |        |   |           |                 |     |       |       |                     |  |  |  |  |                    |     |       |       |                     |  |  |  |  |          |     |       |       |                     |  |  |  |  |                    |     |       |       |                     |  |  |  |  |         |     |       |       |                     |  |  |  |  |         |    |       |       |             |                |        |  |                     |     |    |       |       |             |                |        |  |                     |         |    |       |       |             |  |  |  |  |         |    |       |       |             |  |  |  |  |         |     |       |       |             |  |  |  |  |         |     |       |       |             |  |  |  |  |         |    |       |       |             |  |  |  |  |         |     |       |       |             |  |  |  |  |                 |     |       |       |             |  |  |  |  |         |     |       |       |             |  |  |  |  |         |    |       |       |             |  |  |  |  |         |     |       |       |             |  |  |  |  |         |     |       |       |             |  |  |  |  |             |     |       |       |             |  |  |  |  |                 |     |       |       |             |  |  |  |  |                 |     |       |       |             |  |  |  |  |          |     |       |       |             |  |  |  |  |                    |     |       |       |             |  |  |  |  |         |     |       |       |             |  |  |  |  |         |    |       |       |                     |                |        |  |                        |     |    |       |       |                     |                |        |  |                           |         |    |       |       |                     |  |  |  |  |         |    |       |       |                     |  |  |  |  |         |     |       |       |                     |  |  |  |  |         |     |       |       |                     |  |  |  |  |         |    |       |       |                     |  |  |  |  |         |     |       |       |                     |  |  |  |  |                 |     |       |       |                     |  |  |  |  |         |     |       |       |                     |  |  |  |  |         |    |       |       |                     |  |  |  |  |         |     |       |       |                     |  |  |  |  |         |     |       |       |                     |  |  |  |  |             |     |       |       |                     |  |  |  |  |                 |     |       |       |                     |  |  |  |  |                 |     |       |       |                     |  |  |  |  |          |     |       |       |                     |  |  |  |  |
| 1.8 TSI  | 112   | 11.09   | 07.10 | PR: 1LJ,1LH,1ZG,1ZM |                |                     |   |                           |   |                     |         |     |       |       |                     |                |        |   |                     |         |     |       |       |                     |  |  |  |  |             |     |       |       |                     |  |  |  |  |                 |     |       |       |                     |  |  |  |  |                 |     |       |       |                     |  |  |  |  |                    |     |       |       |                     |  |  |  |  |         |     |       |       |                     |  |  |  |  |                 |     |       |       |                     |  |  |  |  |         |     |       |       |                     |  |  |  |  |         |     |       |       |                     |  |  |  |  |             |     |       |       |                     |  |  |  |  |             |     |       |       |                     |  |  |  |  |                 |     |       |       |                     |                |        |   |           |                 |     |       |       |                     |                |        |   |           |                 |     |       |       |                     |  |  |  |  |                    |     |       |       |                     |  |  |  |  |          |     |       |       |                     |  |  |  |  |                    |     |       |       |                     |  |  |  |  |         |     |       |       |                     |  |  |  |  |         |    |       |       |             |                |        |  |                     |     |    |       |       |             |                |        |  |                     |         |    |       |       |             |  |  |  |  |         |    |       |       |             |  |  |  |  |         |     |       |       |             |  |  |  |  |         |     |       |       |             |  |  |  |  |         |    |       |       |             |  |  |  |  |         |     |       |       |             |  |  |  |  |                 |     |       |       |             |  |  |  |  |         |     |       |       |             |  |  |  |  |         |    |       |       |             |  |  |  |  |         |     |       |       |             |  |  |  |  |         |     |       |       |             |  |  |  |  |             |     |       |       |             |  |  |  |  |                 |     |       |       |             |  |  |  |  |                 |     |       |       |             |  |  |  |  |          |     |       |       |             |  |  |  |  |                    |     |       |       |             |  |  |  |  |         |     |       |       |             |  |  |  |  |         |    |       |       |                     |                |        |  |                        |     |    |       |       |                     |                |        |  |                           |         |    |       |       |                     |  |  |  |  |         |    |       |       |                     |  |  |  |  |         |     |       |       |                     |  |  |  |  |         |     |       |       |                     |  |  |  |  |         |    |       |       |                     |  |  |  |  |         |     |       |       |                     |  |  |  |  |                 |     |       |       |                     |  |  |  |  |         |     |       |       |                     |  |  |  |  |         |    |       |       |                     |  |  |  |  |         |     |       |       |                     |  |  |  |  |         |     |       |       |                     |  |  |  |  |             |     |       |       |                     |  |  |  |  |                 |     |       |       |                     |  |  |  |  |                 |     |       |       |                     |  |  |  |  |          |     |       |       |                     |  |  |  |  |
| 1.8 TSI  | 118   | 10.07   | 07.10 | PR: 1LJ,1LH,1ZG,1ZM |                |                     |   |                           |   |                     |         |     |       |       |                     |                |        |   |                     |         |     |       |       |                     |  |  |  |  |             |     |       |       |                     |  |  |  |  |                 |     |       |       |                     |  |  |  |  |                 |     |       |       |                     |  |  |  |  |                    |     |       |       |                     |  |  |  |  |         |     |       |       |                     |  |  |  |  |                 |     |       |       |                     |  |  |  |  |         |     |       |       |                     |  |  |  |  |         |     |       |       |                     |  |  |  |  |             |     |       |       |                     |  |  |  |  |             |     |       |       |                     |  |  |  |  |                 |     |       |       |                     |                |        |   |           |                 |     |       |       |                     |                |        |   |           |                 |     |       |       |                     |  |  |  |  |                    |     |       |       |                     |  |  |  |  |          |     |       |       |                     |  |  |  |  |                    |     |       |       |                     |  |  |  |  |         |     |       |       |                     |  |  |  |  |         |    |       |       |             |                |        |  |                     |     |    |       |       |             |                |        |  |                     |         |    |       |       |             |  |  |  |  |         |    |       |       |             |  |  |  |  |         |     |       |       |             |  |  |  |  |         |     |       |       |             |  |  |  |  |         |    |       |       |             |  |  |  |  |         |     |       |       |             |  |  |  |  |                 |     |       |       |             |  |  |  |  |         |     |       |       |             |  |  |  |  |         |    |       |       |             |  |  |  |  |         |     |       |       |             |  |  |  |  |         |     |       |       |             |  |  |  |  |             |     |       |       |             |  |  |  |  |                 |     |       |       |             |  |  |  |  |                 |     |       |       |             |  |  |  |  |          |     |       |       |             |  |  |  |  |                    |     |       |       |             |  |  |  |  |         |     |       |       |             |  |  |  |  |         |    |       |       |                     |                |        |  |                        |     |    |       |       |                     |                |        |  |                           |         |    |       |       |                     |  |  |  |  |         |    |       |       |                     |  |  |  |  |         |     |       |       |                     |  |  |  |  |         |     |       |       |                     |  |  |  |  |         |    |       |       |                     |  |  |  |  |         |     |       |       |                     |  |  |  |  |                 |     |       |       |                     |  |  |  |  |         |     |       |       |                     |  |  |  |  |         |    |       |       |                     |  |  |  |  |         |     |       |       |                     |  |  |  |  |         |     |       |       |                     |  |  |  |  |             |     |       |       |                     |  |  |  |  |                 |     |       |       |                     |  |  |  |  |                 |     |       |       |                     |  |  |  |  |          |     |       |       |                     |  |  |  |  |
| 1.9 TDI  | 77  | 07.05   | 07.10 | PR: 1LJ,1LH,1ZG,1ZM |                |                     |   |                           |   |                     |         |     |       |       |                     |                |        |   |                     |         |     |       |       |                     |  |  |  |  |             |     |       |       |                     |  |  |  |  |                 |     |       |       |                     |  |  |  |  |                 |     |       |       |                     |  |  |  |  |                    |     |       |       |                     |  |  |  |  |         |     |       |       |                     |  |  |  |  |                 |     |       |       |                     |  |  |  |  |         |     |       |       |                     |  |  |  |  |         |     |       |       |                     |  |  |  |  |             |     |       |       |                     |  |  |  |  |             |     |       |       |                     |  |  |  |  |                 |     |       |       |                     |                |        |   |           |                 |     |       |       |                     |                |        |   |           |                 |     |       |       |                     |  |  |  |  |                    |     |       |       |                     |  |  |  |  |          |     |       |       |                     |  |  |  |  |                    |     |       |       |                     |  |  |  |  |         |     |       |       |                     |  |  |  |  |         |    |       |       |             |                |        |  |                     |     |    |       |       |             |                |        |  |                     |         |    |       |       |             |  |  |  |  |         |    |       |       |             |  |  |  |  |         |     |       |       |             |  |  |  |  |         |     |       |       |             |  |  |  |  |         |    |       |       |             |  |  |  |  |         |     |       |       |             |  |  |  |  |                 |     |       |       |             |  |  |  |  |         |     |       |       |             |  |  |  |  |         |    |       |       |             |  |  |  |  |         |     |       |       |             |  |  |  |  |         |     |       |       |             |  |  |  |  |             |     |       |       |             |  |  |  |  |                 |     |       |       |             |  |  |  |  |                 |     |       |       |             |  |  |  |  |          |     |       |       |             |  |  |  |  |                    |     |       |       |             |  |  |  |  |         |     |       |       |             |  |  |  |  |         |    |       |       |                     |                |        |  |                        |     |    |       |       |                     |                |        |  |                           |         |    |       |       |                     |  |  |  |  |         |    |       |       |                     |  |  |  |  |         |     |       |       |                     |  |  |  |  |         |     |       |       |                     |  |  |  |  |         |    |       |       |                     |  |  |  |  |         |     |       |       |                     |  |  |  |  |                 |     |       |       |                     |  |  |  |  |         |     |       |       |                     |  |  |  |  |         |    |       |       |                     |  |  |  |  |         |     |       |       |                     |  |  |  |  |         |     |       |       |                     |  |  |  |  |             |     |       |       |                     |  |  |  |  |                 |     |       |       |                     |  |  |  |  |                 |     |       |       |                     |  |  |  |  |          |     |       |       |                     |  |  |  |  |
| 2.0 FSI  | 110   | 07.05   | 07.10 | PR: 1LJ,1LH,1ZG,1ZM |                |                     |   |                           |   |                     |         |     |       |       |                     |                |        |   |                     |         |     |       |       |                     |  |  |  |  |             |     |       |       |                     |  |  |  |  |                 |     |       |       |                     |  |  |  |  |                 |     |       |       |                     |  |  |  |  |                    |     |       |       |                     |  |  |  |  |         |     |       |       |                     |  |  |  |  |                 |     |       |       |                     |  |  |  |  |         |     |       |       |                     |  |  |  |  |         |     |       |       |                     |  |  |  |  |             |     |       |       |                     |  |  |  |  |             |     |       |       |                     |  |  |  |  |                 |     |       |       |                     |                |        |   |           |                 |     |       |       |                     |                |        |   |           |                 |     |       |       |                     |  |  |  |  |                    |     |       |       |                     |  |  |  |  |          |     |       |       |                     |  |  |  |  |                    |     |       |       |                     |  |  |  |  |         |     |       |       |                     |  |  |  |  |         |    |       |       |             |                |        |  |                     |     |    |       |       |             |                |        |  |                     |         |    |       |       |             |  |  |  |  |         |    |       |       |             |  |  |  |  |         |     |       |       |             |  |  |  |  |         |     |       |       |             |  |  |  |  |         |    |       |       |             |  |  |  |  |         |     |       |       |             |  |  |  |  |                 |     |       |       |             |  |  |  |  |         |     |       |       |             |  |  |  |  |         |    |       |       |             |  |  |  |  |         |     |       |       |             |  |  |  |  |         |     |       |       |             |  |  |  |  |             |     |       |       |             |  |  |  |  |                 |     |       |       |             |  |  |  |  |                 |     |       |       |             |  |  |  |  |          |     |       |       |             |  |  |  |  |                    |     |       |       |             |  |  |  |  |         |     |       |       |             |  |  |  |  |         |    |       |       |                     |                |        |  |                        |     |    |       |       |                     |                |        |  |                           |         |    |       |       |                     |  |  |  |  |         |    |       |       |                     |  |  |  |  |         |     |       |       |                     |  |  |  |  |         |     |       |       |                     |  |  |  |  |         |    |       |       |                     |  |  |  |  |         |     |       |       |                     |  |  |  |  |                 |     |       |       |                     |  |  |  |  |         |     |       |       |                     |  |  |  |  |         |    |       |       |                     |  |  |  |  |         |     |       |       |                     |  |  |  |  |         |     |       |       |                     |  |  |  |  |             |     |       |       |                     |  |  |  |  |                 |     |       |       |                     |  |  |  |  |                 |     |       |       |                     |  |  |  |  |          |     |       |       |                     |  |  |  |  |
| 2.0 FSI 4motion  | 110   | 09.05   | 07.10 | PR: 1LJ,1LH,1ZG,1ZM |                |                     |   |                           |   |                     |         |     |       |       |                     |                |        |   |                     |         |     |       |       |                     |  |  |  |  |             |     |       |       |                     |  |  |  |  |                 |     |       |       |                     |  |  |  |  |                 |     |       |       |                     |  |  |  |  |                    |     |       |       |                     |  |  |  |  |         |     |       |       |                     |  |  |  |  |                 |     |       |       |                     |  |  |  |  |         |     |       |       |                     |  |  |  |  |         |     |       |       |                     |  |  |  |  |             |     |       |       |                     |  |  |  |  |             |     |       |       |                     |  |  |  |  |                 |     |       |       |                     |                |        |   |           |                 |     |       |       |                     |                |        |   |           |                 |     |       |       |                     |  |  |  |  |                    |     |       |       |                     |  |  |  |  |          |     |       |       |                     |  |  |  |  |                    |     |       |       |                     |  |  |  |  |         |     |       |       |                     |  |  |  |  |         |    |       |       |             |                |        |  |                     |     |    |       |       |             |                |        |  |                     |         |    |       |       |             |  |  |  |  |         |    |       |       |             |  |  |  |  |         |     |       |       |             |  |  |  |  |         |     |       |       |             |  |  |  |  |         |    |       |       |             |  |  |  |  |         |     |       |       |             |  |  |  |  |                 |     |       |       |             |  |  |  |  |         |     |       |       |             |  |  |  |  |         |    |       |       |             |  |  |  |  |         |     |       |       |             |  |  |  |  |         |     |       |       |             |  |  |  |  |             |     |       |       |             |  |  |  |  |                 |     |       |       |             |  |  |  |  |                 |     |       |       |             |  |  |  |  |          |     |       |       |             |  |  |  |  |                    |     |       |       |             |  |  |  |  |         |     |       |       |             |  |  |  |  |         |    |       |       |                     |                |        |  |                        |     |    |       |       |                     |                |        |  |                           |         |    |       |       |                     |  |  |  |  |         |    |       |       |                     |  |  |  |  |         |     |       |       |                     |  |  |  |  |         |     |       |       |                     |  |  |  |  |         |    |       |       |                     |  |  |  |  |         |     |       |       |                     |  |  |  |  |                 |     |       |       |                     |  |  |  |  |         |     |       |       |                     |  |  |  |  |         |    |       |       |                     |  |  |  |  |         |     |       |       |                     |  |  |  |  |         |     |       |       |                     |  |  |  |  |             |     |       |       |                     |  |  |  |  |                 |     |       |       |                     |  |  |  |  |                 |     |       |       |                     |  |  |  |  |          |     |       |       |                     |  |  |  |  |
| 2.0 TDI  | 100   | 11.05   | 07.10 | PR: 1LJ,1LH,1ZG,1ZM |                |                     |   |                           |   |                     |         |     |       |       |                     |                |        |   |                     |         |     |       |       |                     |  |  |  |  |             |     |       |       |                     |  |  |  |  |                 |     |       |       |                     |  |  |  |  |                 |     |       |       |                     |  |  |  |  |                    |     |       |       |                     |  |  |  |  |         |     |       |       |                     |  |  |  |  |                 |     |       |       |                     |  |  |  |  |         |     |       |       |                     |  |  |  |  |         |     |       |       |                     |  |  |  |  |             |     |       |       |                     |  |  |  |  |             |     |       |       |                     |  |  |  |  |                 |     |       |       |                     |                |        |   |           |                 |     |       |       |                     |                |        |   |           |                 |     |       |       |                     |  |  |  |  |                    |     |       |       |                     |  |  |  |  |          |     |       |       |                     |  |  |  |  |                    |     |       |       |                     |  |  |  |  |         |     |       |       |                     |  |  |  |  |         |    |       |       |             |                |        |  |                     |     |    |       |       |             |                |        |  |                     |         |    |       |       |             |  |  |  |  |         |    |       |       |             |  |  |  |  |         |     |       |       |             |  |  |  |  |         |     |       |       |             |  |  |  |  |         |    |       |       |             |  |  |  |  |         |     |       |       |             |  |  |  |  |                 |     |       |       |             |  |  |  |  |         |     |       |       |             |  |  |  |  |         |    |       |       |             |  |  |  |  |         |     |       |       |             |  |  |  |  |         |     |       |       |             |  |  |  |  |             |     |       |       |             |  |  |  |  |                 |     |       |       |             |  |  |  |  |                 |     |       |       |             |  |  |  |  |          |     |       |       |             |  |  |  |  |                    |     |       |       |             |  |  |  |  |         |     |       |       |             |  |  |  |  |         |    |       |       |                     |                |        |  |                        |     |    |       |       |                     |                |        |  |                           |         |    |       |       |                     |  |  |  |  |         |    |       |       |                     |  |  |  |  |         |     |       |       |                     |  |  |  |  |         |     |       |       |                     |  |  |  |  |         |    |       |       |                     |  |  |  |  |         |     |       |       |                     |  |  |  |  |                 |     |       |       |                     |  |  |  |  |         |     |       |       |                     |  |  |  |  |         |    |       |       |                     |  |  |  |  |         |     |       |       |                     |  |  |  |  |         |     |       |       |                     |  |  |  |  |             |     |       |       |                     |  |  |  |  |                 |     |       |       |                     |  |  |  |  |                 |     |       |       |                     |  |  |  |  |          |     |       |       |                     |  |  |  |  |
| 2.0 TDI  | 90  | 07.05   | 07.10 | PR: 1LJ,1LH,1ZG,1ZM |                |                     |   |                           |   |                     |         |     |       |       |                     |                |        |   |                     |         |     |       |       |                     |  |  |  |  |             |     |       |       |                     |  |  |  |  |                 |     |       |       |                     |  |  |  |  |                 |     |       |       |                     |  |  |  |  |                    |     |       |       |                     |  |  |  |  |         |     |       |       |                     |  |  |  |  |                 |     |       |       |                     |  |  |  |  |         |     |       |       |                     |  |  |  |  |         |     |       |       |                     |  |  |  |  |             |     |       |       |                     |  |  |  |  |             |     |       |       |                     |  |  |  |  |                 |     |       |       |                     |                |        |   |           |                 |     |       |       |                     |                |        |   |           |                 |     |       |       |                     |  |  |  |  |                    |     |       |       |                     |  |  |  |  |          |     |       |       |                     |  |  |  |  |                    |     |       |       |                     |  |  |  |  |         |     |       |       |                     |  |  |  |  |         |    |       |       |             |                |        |  |                     |     |    |       |       |             |                |        |  |                     |         |    |       |       |             |  |  |  |  |         |    |       |       |             |  |  |  |  |         |     |       |       |             |  |  |  |  |         |     |       |       |             |  |  |  |  |         |    |       |       |             |  |  |  |  |         |     |       |       |             |  |  |  |  |                 |     |       |       |             |  |  |  |  |         |     |       |       |             |  |  |  |  |         |    |       |       |             |  |  |  |  |         |     |       |       |             |  |  |  |  |         |     |       |       |             |  |  |  |  |             |     |       |       |             |  |  |  |  |                 |     |       |       |             |  |  |  |  |                 |     |       |       |             |  |  |  |  |          |     |       |       |             |  |  |  |  |                    |     |       |       |             |  |  |  |  |         |     |       |       |             |  |  |  |  |         |    |       |       |                     |                |        |  |                        |     |    |       |       |                     |                |        |  |                           |         |    |       |       |                     |  |  |  |  |         |    |       |       |                     |  |  |  |  |         |     |       |       |                     |  |  |  |  |         |     |       |       |                     |  |  |  |  |         |    |       |       |                     |  |  |  |  |         |     |       |       |                     |  |  |  |  |                 |     |       |       |                     |  |  |  |  |         |     |       |       |                     |  |  |  |  |         |    |       |       |                     |  |  |  |  |         |     |       |       |                     |  |  |  |  |         |     |       |       |                     |  |  |  |  |             |     |       |       |                     |  |  |  |  |                 |     |       |       |                     |  |  |  |  |                 |     |       |       |                     |  |  |  |  |          |     |       |       |                     |  |  |  |  |
| 2.0 TDI  | 100   | 07.05   | 07.10 | PR: 1LJ,1LH,1ZG,1ZM |                |                     |   |                           |   |                     |         |     |       |       |                     |                |        |   |                     |         |     |       |       |                     |  |  |  |  |             |     |       |       |                     |  |  |  |  |                 |     |       |       |                     |  |  |  |  |                 |     |       |       |                     |  |  |  |  |                    |     |       |       |                     |  |  |  |  |         |     |       |       |                     |  |  |  |  |                 |     |       |       |                     |  |  |  |  |         |     |       |       |                     |  |  |  |  |         |     |       |       |                     |  |  |  |  |             |     |       |       |                     |  |  |  |  |             |     |       |       |                     |  |  |  |  |                 |     |       |       |                     |                |        |   |           |                 |     |       |       |                     |                |        |   |           |                 |     |       |       |                     |  |  |  |  |                    |     |       |       |                     |  |  |  |  |          |     |       |       |                     |  |  |  |  |                    |     |       |       |                     |  |  |  |  |         |     |       |       |                     |  |  |  |  |         |    |       |       |             |                |        |  |                     |     |    |       |       |             |                |        |  |                     |         |    |       |       |             |  |  |  |  |         |    |       |       |             |  |  |  |  |         |     |       |       |             |  |  |  |  |         |     |       |       |             |  |  |  |  |         |    |       |       |             |  |  |  |  |         |     |       |       |             |  |  |  |  |                 |     |       |       |             |  |  |  |  |         |     |       |       |             |  |  |  |  |         |    |       |       |             |  |  |  |  |         |     |       |       |             |  |  |  |  |         |     |       |       |             |  |  |  |  |             |     |       |       |             |  |  |  |  |                 |     |       |       |             |  |  |  |  |                 |     |       |       |             |  |  |  |  |          |     |       |       |             |  |  |  |  |                    |     |       |       |             |  |  |  |  |         |     |       |       |             |  |  |  |  |         |    |       |       |                     |                |        |  |                        |     |    |       |       |                     |                |        |  |                           |         |    |       |       |                     |  |  |  |  |         |    |       |       |                     |  |  |  |  |         |     |       |       |                     |  |  |  |  |         |     |       |       |                     |  |  |  |  |         |    |       |       |                     |  |  |  |  |         |     |       |       |                     |  |  |  |  |                 |     |       |       |                     |  |  |  |  |         |     |       |       |                     |  |  |  |  |         |    |       |       |                     |  |  |  |  |         |     |       |       |                     |  |  |  |  |         |     |       |       |                     |  |  |  |  |             |     |       |       |                     |  |  |  |  |                 |     |       |       |                     |  |  |  |  |                 |     |       |       |                     |  |  |  |  |          |     |       |       |                     |  |  |  |  |
| 2.0 TDI  | 125   | 07.05   | 07.10 | PR: 1LJ,1LH,1ZG,1ZM |                |                     |   |                           |   |                     |         |     |       |       |                     |                |        |   |                     |         |     |       |       |                     |  |  |  |  |             |     |       |       |                     |  |  |  |  |                 |     |       |       |                     |  |  |  |  |                 |     |       |       |                     |  |  |  |  |                    |     |       |       |                     |  |  |  |  |         |     |       |       |                     |  |  |  |  |                 |     |       |       |                     |  |  |  |  |         |     |       |       |                     |  |  |  |  |         |     |       |       |                     |  |  |  |  |             |     |       |       |                     |  |  |  |  |             |     |       |       |                     |  |  |  |  |                 |     |       |       |                     |                |        |   |           |                 |     |       |       |                     |                |        |   |           |                 |     |       |       |                     |  |  |  |  |                    |     |       |       |                     |  |  |  |  |          |     |       |       |                     |  |  |  |  |                    |     |       |       |                     |  |  |  |  |         |     |       |       |                     |  |  |  |  |         |    |       |       |             |                |        |  |                     |     |    |       |       |             |                |        |  |                     |         |    |       |       |             |  |  |  |  |         |    |       |       |             |  |  |  |  |         |     |       |       |             |  |  |  |  |         |     |       |       |             |  |  |  |  |         |    |       |       |             |  |  |  |  |         |     |       |       |             |  |  |  |  |                 |     |       |       |             |  |  |  |  |         |     |       |       |             |  |  |  |  |         |    |       |       |             |  |  |  |  |         |     |       |       |             |  |  |  |  |         |     |       |       |             |  |  |  |  |             |     |       |       |             |  |  |  |  |                 |     |       |       |             |  |  |  |  |                 |     |       |       |             |  |  |  |  |          |     |       |       |             |  |  |  |  |                    |     |       |       |             |  |  |  |  |         |     |       |       |             |  |  |  |  |         |    |       |       |                     |                |        |  |                        |     |    |       |       |                     |                |        |  |                           |         |    |       |       |                     |  |  |  |  |         |    |       |       |                     |  |  |  |  |         |     |       |       |                     |  |  |  |  |         |     |       |       |                     |  |  |  |  |         |    |       |       |                     |  |  |  |  |         |     |       |       |                     |  |  |  |  |                 |     |       |       |                     |  |  |  |  |         |     |       |       |                     |  |  |  |  |         |    |       |       |                     |  |  |  |  |         |     |       |       |                     |  |  |  |  |         |     |       |       |                     |  |  |  |  |             |     |       |       |                     |  |  |  |  |                 |     |       |       |                     |  |  |  |  |                 |     |       |       |                     |  |  |  |  |          |     |       |       |                     |  |  |  |  |
| 2.0 TDI 16V  | 103   | 07.05   | 07.10 | PR: 1LJ,1LH,1ZG,1ZM |                |                     |   |                           |   |                     |         |     |       |       |                     |                |        |   |                     |         |     |       |       |                     |  |  |  |  |             |     |       |       |                     |  |  |  |  |                 |     |       |       |                     |  |  |  |  |                 |     |       |       |                     |  |  |  |  |                    |     |       |       |                     |  |  |  |  |         |     |       |       |                     |  |  |  |  |                 |     |       |       |                     |  |  |  |  |         |     |       |       |                     |  |  |  |  |         |     |       |       |                     |  |  |  |  |             |     |       |       |                     |  |  |  |  |             |     |       |       |                     |  |  |  |  |                 |     |       |       |                     |                |        |   |           |                 |     |       |       |                     |                |        |   |           |                 |     |       |       |                     |  |  |  |  |                    |     |       |       |                     |  |  |  |  |          |     |       |       |                     |  |  |  |  |                    |     |       |       |                     |  |  |  |  |         |     |       |       |                     |  |  |  |  |         |    |       |       |             |                |        |  |                     |     |    |       |       |             |                |        |  |                     |         |    |       |       |             |  |  |  |  |         |    |       |       |             |  |  |  |  |         |     |       |       |             |  |  |  |  |         |     |       |       |             |  |  |  |  |         |    |       |       |             |  |  |  |  |         |     |       |       |             |  |  |  |  |                 |     |       |       |             |  |  |  |  |         |     |       |       |             |  |  |  |  |         |    |       |       |             |  |  |  |  |         |     |       |       |             |  |  |  |  |         |     |       |       |             |  |  |  |  |             |     |       |       |             |  |  |  |  |                 |     |       |       |             |  |  |  |  |                 |     |       |       |             |  |  |  |  |          |     |       |       |             |  |  |  |  |                    |     |       |       |             |  |  |  |  |         |     |       |       |             |  |  |  |  |         |    |       |       |                     |                |        |  |                        |     |    |       |       |                     |                |        |  |                           |         |    |       |       |                     |  |  |  |  |         |    |       |       |                     |  |  |  |  |         |     |       |       |                     |  |  |  |  |         |     |       |       |                     |  |  |  |  |         |    |       |       |                     |  |  |  |  |         |     |       |       |                     |  |  |  |  |                 |     |       |       |                     |  |  |  |  |         |     |       |       |                     |  |  |  |  |         |    |       |       |                     |  |  |  |  |         |     |       |       |                     |  |  |  |  |         |     |       |       |                     |  |  |  |  |             |     |       |       |                     |  |  |  |  |                 |     |       |       |                     |  |  |  |  |                 |     |       |       |                     |  |  |  |  |          |     |       |       |                     |  |  |  |  |
| 2.0 TDI 4motion  | 103   | 08.05   | 07.10 | PR: 1LJ,1LH,1ZG,1ZM |                |                     |   |                           |   |                     |         |     |       |       |                     |                |        |   |                     |         |     |       |       |                     |  |  |  |  |             |     |       |       |                     |  |  |  |  |                 |     |       |       |                     |  |  |  |  |                 |     |       |       |                     |  |  |  |  |                    |     |       |       |                     |  |  |  |  |         |     |       |       |                     |  |  |  |  |                 |     |       |       |                     |  |  |  |  |         |     |       |       |                     |  |  |  |  |         |     |       |       |                     |  |  |  |  |             |     |       |       |                     |  |  |  |  |             |     |       |       |                     |  |  |  |  |                 |     |       |       |                     |                |        |   |           |                 |     |       |       |                     |                |        |   |           |                 |     |       |       |                     |  |  |  |  |                    |     |       |       |                     |  |  |  |  |          |     |       |       |                     |  |  |  |  |                    |     |       |       |                     |  |  |  |  |         |     |       |       |                     |  |  |  |  |         |    |       |       |             |                |        |  |                     |     |    |       |       |             |                |        |  |                     |         |    |       |       |             |  |  |  |  |         |    |       |       |             |  |  |  |  |         |     |       |       |             |  |  |  |  |         |     |       |       |             |  |  |  |  |         |    |       |       |             |  |  |  |  |         |     |       |       |             |  |  |  |  |                 |     |       |       |             |  |  |  |  |         |     |       |       |             |  |  |  |  |         |    |       |       |             |  |  |  |  |         |     |       |       |             |  |  |  |  |         |     |       |       |             |  |  |  |  |             |     |       |       |             |  |  |  |  |                 |     |       |       |             |  |  |  |  |                 |     |       |       |             |  |  |  |  |          |     |       |       |             |  |  |  |  |                    |     |       |       |             |  |  |  |  |         |     |       |       |             |  |  |  |  |         |    |       |       |                     |                |        |  |                        |     |    |       |       |                     |                |        |  |                           |         |    |       |       |                     |  |  |  |  |         |    |       |       |                     |  |  |  |  |         |     |       |       |                     |  |  |  |  |         |     |       |       |                     |  |  |  |  |         |    |       |       |                     |  |  |  |  |         |     |       |       |                     |  |  |  |  |                 |     |       |       |                     |  |  |  |  |         |     |       |       |                     |  |  |  |  |         |    |       |       |                     |  |  |  |  |         |     |       |       |                     |  |  |  |  |         |     |       |       |                     |  |  |  |  |             |     |       |       |                     |  |  |  |  |                 |     |       |       |                     |  |  |  |  |                 |     |       |       |                     |  |  |  |  |          |     |       |       |                     |  |  |  |  |
| 2.0 TDI 4motion  | 125   | 09.05   | 07.10 | PR: 1LJ,1LH,1ZG,1ZM |                |                     |   |                           |   |                     |         |     |       |       |                     |                |        |   |                     |         |     |       |       |                     |  |  |  |  |             |     |       |       |                     |  |  |  |  |                 |     |       |       |                     |  |  |  |  |                 |     |       |       |                     |  |  |  |  |                    |     |       |       |                     |  |  |  |  |         |     |       |       |                     |  |  |  |  |                 |     |       |       |                     |  |  |  |  |         |     |       |       |                     |  |  |  |  |         |     |       |       |                     |  |  |  |  |             |     |       |       |                     |  |  |  |  |             |     |       |       |                     |  |  |  |  |                 |     |       |       |                     |                |        |   |           |                 |     |       |       |                     |                |        |   |           |                 |     |       |       |                     |  |  |  |  |                    |     |       |       |                     |  |  |  |  |          |     |       |       |                     |  |  |  |  |                    |     |       |       |                     |  |  |  |  |         |     |       |       |                     |  |  |  |  |         |    |       |       |             |                |        |  |                     |     |    |       |       |             |                |        |  |                     |         |    |       |       |             |  |  |  |  |         |    |       |       |             |  |  |  |  |         |     |       |       |             |  |  |  |  |         |     |       |       |             |  |  |  |  |         |    |       |       |             |  |  |  |  |         |     |       |       |             |  |  |  |  |                 |     |       |       |             |  |  |  |  |         |     |       |       |             |  |  |  |  |         |    |       |       |             |  |  |  |  |         |     |       |       |             |  |  |  |  |         |     |       |       |             |  |  |  |  |             |     |       |       |             |  |  |  |  |                 |     |       |       |             |  |  |  |  |                 |     |       |       |             |  |  |  |  |          |     |       |       |             |  |  |  |  |                    |     |       |       |             |  |  |  |  |         |     |       |       |             |  |  |  |  |         |    |       |       |                     |                |        |  |                        |     |    |       |       |                     |                |        |  |                           |         |    |       |       |                     |  |  |  |  |         |    |       |       |                     |  |  |  |  |         |     |       |       |                     |  |  |  |  |         |     |       |       |                     |  |  |  |  |         |    |       |       |                     |  |  |  |  |         |     |       |       |                     |  |  |  |  |                 |     |       |       |                     |  |  |  |  |         |     |       |       |                     |  |  |  |  |         |    |       |       |                     |  |  |  |  |         |     |       |       |                     |  |  |  |  |         |     |       |       |                     |  |  |  |  |             |     |       |       |                     |  |  |  |  |                 |     |       |       |                     |  |  |  |  |                 |     |       |       |                     |  |  |  |  |          |     |       |       |                     |  |  |  |  |
| 2.0 TDI 4motion  | 125   | 05.09   | 07.10 | PR: 1LJ,1LH,1ZG,1ZM |                |                     |   |                           |   |                     |         |     |       |       |                     |                |        |   |                     |         |     |       |       |                     |  |  |  |  |             |     |       |       |                     |  |  |  |  |                 |     |       |       |                     |  |  |  |  |                 |     |       |       |                     |  |  |  |  |                    |     |       |       |                     |  |  |  |  |         |     |       |       |                     |  |  |  |  |                 |     |       |       |                     |  |  |  |  |         |     |       |       |                     |  |  |  |  |         |     |       |       |                     |  |  |  |  |             |     |       |       |                     |  |  |  |  |             |     |       |       |                     |  |  |  |  |                 |     |       |       |                     |                |        |   |           |                 |     |       |       |                     |                |        |   |           |                 |     |       |       |                     |  |  |  |  |                    |     |       |       |                     |  |  |  |  |          |     |       |       |                     |  |  |  |  |                    |     |       |       |                     |  |  |  |  |         |     |       |       |                     |  |  |  |  |         |    |       |       |             |                |        |  |                     |     |    |       |       |             |                |        |  |                     |         |    |       |       |             |  |  |  |  |         |    |       |       |             |  |  |  |  |         |     |       |       |             |  |  |  |  |         |     |       |       |             |  |  |  |  |         |    |       |       |             |  |  |  |  |         |     |       |       |             |  |  |  |  |                 |     |       |       |             |  |  |  |  |         |     |       |       |             |  |  |  |  |         |    |       |       |             |  |  |  |  |         |     |       |       |             |  |  |  |  |         |     |       |       |             |  |  |  |  |             |     |       |       |             |  |  |  |  |                 |     |       |       |             |  |  |  |  |                 |     |       |       |             |  |  |  |  |          |     |       |       |             |  |  |  |  |                    |     |       |       |             |  |  |  |  |         |     |       |       |             |  |  |  |  |         |    |       |       |                     |                |        |  |                        |     |    |       |       |                     |                |        |  |                           |         |    |       |       |                     |  |  |  |  |         |    |       |       |                     |  |  |  |  |         |     |       |       |                     |  |  |  |  |         |     |       |       |                     |  |  |  |  |         |    |       |       |                     |  |  |  |  |         |     |       |       |                     |  |  |  |  |                 |     |       |       |                     |  |  |  |  |         |     |       |       |                     |  |  |  |  |         |    |       |       |                     |  |  |  |  |         |     |       |       |                     |  |  |  |  |         |     |       |       |                     |  |  |  |  |             |     |       |       |                     |  |  |  |  |                 |     |       |       |                     |  |  |  |  |                 |     |       |       |                     |  |  |  |  |          |     |       |       |                     |  |  |  |  |
| 2.0 TFSI   | 147   | 07.05   | 07.10 | PR: 1LJ,1LH,1ZG,1ZM |                |                     |   |                           |   |                     |         |     |       |       |                     |                |        |   |                     |         |     |       |       |                     |  |  |  |  |             |     |       |       |                     |  |  |  |  |                 |     |       |       |                     |  |  |  |  |                 |     |       |       |                     |  |  |  |  |                    |     |       |       |                     |  |  |  |  |         |     |       |       |                     |  |  |  |  |                 |     |       |       |                     |  |  |  |  |         |     |       |       |                     |  |  |  |  |         |     |       |       |                     |  |  |  |  |             |     |       |       |                     |  |  |  |  |             |     |       |       |                     |  |  |  |  |                 |     |       |       |                     |                |        |   |           |                 |     |       |       |                     |                |        |   |           |                 |     |       |       |                     |  |  |  |  |                    |     |       |       |                     |  |  |  |  |          |     |       |       |                     |  |  |  |  |                    |     |       |       |                     |  |  |  |  |         |     |       |       |                     |  |  |  |  |         |    |       |       |             |                |        |  |                     |     |    |       |       |             |                |        |  |                     |         |    |       |       |             |  |  |  |  |         |    |       |       |             |  |  |  |  |         |     |       |       |             |  |  |  |  |         |     |       |       |             |  |  |  |  |         |    |       |       |             |  |  |  |  |         |     |       |       |             |  |  |  |  |                 |     |       |       |             |  |  |  |  |         |     |       |       |             |  |  |  |  |         |    |       |       |             |  |  |  |  |         |     |       |       |             |  |  |  |  |         |     |       |       |             |  |  |  |  |             |     |       |       |             |  |  |  |  |                 |     |       |       |             |  |  |  |  |                 |     |       |       |             |  |  |  |  |          |     |       |       |             |  |  |  |  |                    |     |       |       |             |  |  |  |  |         |     |       |       |             |  |  |  |  |         |    |       |       |                     |                |        |  |                        |     |    |       |       |                     |                |        |  |                           |         |    |       |       |                     |  |  |  |  |         |    |       |       |                     |  |  |  |  |         |     |       |       |                     |  |  |  |  |         |     |       |       |                     |  |  |  |  |         |    |       |       |                     |  |  |  |  |         |     |       |       |                     |  |  |  |  |                 |     |       |       |                     |  |  |  |  |         |     |       |       |                     |  |  |  |  |         |    |       |       |                     |  |  |  |  |         |     |       |       |                     |  |  |  |  |         |     |       |       |                     |  |  |  |  |             |     |       |       |                     |  |  |  |  |                 |     |       |       |                     |  |  |  |  |                 |     |       |       |                     |  |  |  |  |          |     |       |       |                     |  |  |  |  |
| 3.2 V6 FSI 4motion   | 184   | 11.05   | 07.10 | PR: 1LJ,1LH,1ZG,1ZM |                |                     |   |                           |   |                     |         |     |       |       |                     |                |        |   |                     |         |     |       |       |                     |  |  |  |  |             |     |       |       |                     |  |  |  |  |                 |     |       |       |                     |  |  |  |  |                 |     |       |       |                     |  |  |  |  |                    |     |       |       |                     |  |  |  |  |         |     |       |       |                     |  |  |  |  |                 |     |       |       |                     |  |  |  |  |         |     |       |       |                     |  |  |  |  |         |     |       |       |                     |  |  |  |  |             |     |       |       |                     |  |  |  |  |             |     |       |       |                     |  |  |  |  |                 |     |       |       |                     |                |        |   |           |                 |     |       |       |                     |                |        |   |           |                 |     |       |       |                     |  |  |  |  |                    |     |       |       |                     |  |  |  |  |          |     |       |       |                     |  |  |  |  |                    |     |       |       |                     |  |  |  |  |         |     |       |       |                     |  |  |  |  |         |    |       |       |             |                |        |  |                     |     |    |       |       |             |                |        |  |                     |         |    |       |       |             |  |  |  |  |         |    |       |       |             |  |  |  |  |         |     |       |       |             |  |  |  |  |         |     |       |       |             |  |  |  |  |         |    |       |       |             |  |  |  |  |         |     |       |       |             |  |  |  |  |                 |     |       |       |             |  |  |  |  |         |     |       |       |             |  |  |  |  |         |    |       |       |             |  |  |  |  |         |     |       |       |             |  |  |  |  |         |     |       |       |             |  |  |  |  |             |     |       |       |             |  |  |  |  |                 |     |       |       |             |  |  |  |  |                 |     |       |       |             |  |  |  |  |          |     |       |       |             |  |  |  |  |                    |     |       |       |             |  |  |  |  |         |     |       |       |             |  |  |  |  |         |    |       |       |                     |                |        |  |                        |     |    |       |       |                     |                |        |  |                           |         |    |       |       |                     |  |  |  |  |         |    |       |       |                     |  |  |  |  |         |     |       |       |                     |  |  |  |  |         |     |       |       |                     |  |  |  |  |         |    |       |       |                     |  |  |  |  |         |     |       |       |                     |  |  |  |  |                 |     |       |       |                     |  |  |  |  |         |     |       |       |                     |  |  |  |  |         |    |       |       |                     |  |  |  |  |         |     |       |       |                     |  |  |  |  |         |     |       |       |                     |  |  |  |  |             |     |       |       |                     |  |  |  |  |                 |     |       |       |                     |  |  |  |  |                 |     |       |       |                     |  |  |  |  |          |     |       |       |                     |  |  |  |  |
| 3.6 R36  | 220   | 04.07   | 07.10 | PR: 1LJ,1LH,1ZG,1ZM |                |                     |   |                           |   |                     |         |     |       |       |                     |                |        |   |                     |         |     |       |       |                     |  |  |  |  |             |     |       |       |                     |  |  |  |  |                 |     |       |       |                     |  |  |  |  |                 |     |       |       |                     |  |  |  |  |                    |     |       |       |                     |  |  |  |  |         |     |       |       |                     |  |  |  |  |                 |     |       |       |                     |  |  |  |  |         |     |       |       |                     |  |  |  |  |         |     |       |       |                     |  |  |  |  |             |     |       |       |                     |  |  |  |  |             |     |       |       |                     |  |  |  |  |                 |     |       |       |                     |                |        |   |           |                 |     |       |       |                     |                |        |   |           |                 |     |       |       |                     |  |  |  |  |                    |     |       |       |                     |  |  |  |  |          |     |       |       |                     |  |  |  |  |                    |     |       |       |                     |  |  |  |  |         |     |       |       |                     |  |  |  |  |         |    |       |       |             |                |        |  |                     |     |    |       |       |             |                |        |  |                     |         |    |       |       |             |  |  |  |  |         |    |       |       |             |  |  |  |  |         |     |       |       |             |  |  |  |  |         |     |       |       |             |  |  |  |  |         |    |       |       |             |  |  |  |  |         |     |       |       |             |  |  |  |  |                 |     |       |       |             |  |  |  |  |         |     |       |       |             |  |  |  |  |         |    |       |       |             |  |  |  |  |         |     |       |       |             |  |  |  |  |         |     |       |       |             |  |  |  |  |             |     |       |       |             |  |  |  |  |                 |     |       |       |             |  |  |  |  |                 |     |       |       |             |  |  |  |  |          |     |       |       |             |  |  |  |  |                    |     |       |       |             |  |  |  |  |         |     |       |       |             |  |  |  |  |         |    |       |       |                     |                |        |  |                        |     |    |       |       |                     |                |        |  |                           |         |    |       |       |                     |  |  |  |  |         |    |       |       |                     |  |  |  |  |         |     |       |       |                     |  |  |  |  |         |     |       |       |                     |  |  |  |  |         |    |       |       |                     |  |  |  |  |         |     |       |       |                     |  |  |  |  |                 |     |       |       |                     |  |  |  |  |         |     |       |       |                     |  |  |  |  |         |    |       |       |                     |  |  |  |  |         |     |       |       |                     |  |  |  |  |         |     |       |       |                     |  |  |  |  |             |     |       |       |                     |  |  |  |  |                 |     |       |       |                     |  |  |  |  |                 |     |       |       |                     |  |  |  |  |          |     |       |       |                     |  |  |  |  |
| 1.4 TSI  | 90  | 10.07   | 07.10 | PR: 1LK,1LM         | 13.0460-7200.2 | 607200              |   | 23801 20,3 +/WK ATE       |   |                     |         |     |       |       |                     |                |        |   |                     |         |     |       |       |                     |  |  |  |  |             |     |       |       |                     |  |  |  |  |                 |     |       |       |                     |  |  |  |  |                 |     |       |       |                     |  |  |  |  |                    |     |       |       |                     |  |  |  |  |         |     |       |       |                     |  |  |  |  |                 |     |       |       |                     |  |  |  |  |         |     |       |       |                     |  |  |  |  |         |     |       |       |                     |  |  |  |  |             |     |       |       |                     |  |  |  |  |             |     |       |       |                     |  |  |  |  |                 |     |       |       |                     |                |        |   |           |                 |     |       |       |                     |                |        |   |           |                 |     |       |       |                     |  |  |  |  |                    |     |       |       |                     |  |  |  |  |          |     |       |       |                     |  |  |  |  |                    |     |       |       |                     |  |  |  |  |         |     |       |       |                     |  |  |  |  |         |    |       |       |             |                |        |  |                     |     |    |       |       |             |                |        |  |                     |         |    |       |       |             |  |  |  |  |         |    |       |       |             |  |  |  |  |         |     |       |       |             |  |  |  |  |         |     |       |       |             |  |  |  |  |         |    |       |       |             |  |  |  |  |         |     |       |       |             |  |  |  |  |                 |     |       |       |             |  |  |  |  |         |     |       |       |             |  |  |  |  |         |    |       |       |             |  |  |  |  |         |     |       |       |             |  |  |  |  |         |     |       |       |             |  |  |  |  |             |     |       |       |             |  |  |  |  |                 |     |       |       |             |  |  |  |  |                 |     |       |       |             |  |  |  |  |          |     |       |       |             |  |  |  |  |                    |     |       |       |             |  |  |  |  |         |     |       |       |             |  |  |  |  |         |    |       |       |                     |                |        |  |                        |     |    |       |       |                     |                |        |  |                           |         |    |       |       |                     |  |  |  |  |         |    |       |       |                     |  |  |  |  |         |     |       |       |                     |  |  |  |  |         |     |       |       |                     |  |  |  |  |         |    |       |       |                     |  |  |  |  |         |     |       |       |                     |  |  |  |  |                 |     |       |       |                     |  |  |  |  |         |     |       |       |                     |  |  |  |  |         |    |       |       |                     |  |  |  |  |         |     |       |       |                     |  |  |  |  |         |     |       |       |                     |  |  |  |  |             |     |       |       |                     |  |  |  |  |                 |     |       |       |                     |  |  |  |  |                 |     |       |       |                     |  |  |  |  |          |     |       |       |                     |  |  |  |  |
| 1.6  | 75  | 07.05   | 07.10 | PR: 1LK,1LM         | 13.0470-7200.2 | LD7200              |   | 23801 20,3 +/WK ATE       |   |                     |         |     |       |       |                     |                |        |   |                     |         |     |       |       |                     |  |  |  |  |             |     |       |       |                     |  |  |  |  |                 |     |       |       |                     |  |  |  |  |                 |     |       |       |                     |  |  |  |  |                    |     |       |       |                     |  |  |  |  |         |     |       |       |                     |  |  |  |  |                 |     |       |       |                     |  |  |  |  |         |     |       |       |                     |  |  |  |  |         |     |       |       |                     |  |  |  |  |             |     |       |       |                     |  |  |  |  |             |     |       |       |                     |  |  |  |  |                 |     |       |       |                     |                |        |   |           |                 |     |       |       |                     |                |        |   |           |                 |     |       |       |                     |  |  |  |  |                    |     |       |       |                     |  |  |  |  |          |     |       |       |                     |  |  |  |  |                    |     |       |       |                     |  |  |  |  |         |     |       |       |                     |  |  |  |  |         |    |       |       |             |                |        |  |                     |     |    |       |       |             |                |        |  |                     |         |    |       |       |             |  |  |  |  |         |    |       |       |             |  |  |  |  |         |     |       |       |             |  |  |  |  |         |     |       |       |             |  |  |  |  |         |    |       |       |             |  |  |  |  |         |     |       |       |             |  |  |  |  |                 |     |       |       |             |  |  |  |  |         |     |       |       |             |  |  |  |  |         |    |       |       |             |  |  |  |  |         |     |       |       |             |  |  |  |  |         |     |       |       |             |  |  |  |  |             |     |       |       |             |  |  |  |  |                 |     |       |       |             |  |  |  |  |                 |     |       |       |             |  |  |  |  |          |     |       |       |             |  |  |  |  |                    |     |       |       |             |  |  |  |  |         |     |       |       |             |  |  |  |  |         |    |       |       |                     |                |        |  |                        |     |    |       |       |                     |                |        |  |                           |         |    |       |       |                     |  |  |  |  |         |    |       |       |                     |  |  |  |  |         |     |       |       |                     |  |  |  |  |         |     |       |       |                     |  |  |  |  |         |    |       |       |                     |  |  |  |  |         |     |       |       |                     |  |  |  |  |                 |     |       |       |                     |  |  |  |  |         |     |       |       |                     |  |  |  |  |         |    |       |       |                     |  |  |  |  |         |     |       |       |                     |  |  |  |  |         |     |       |       |                     |  |  |  |  |             |     |       |       |                     |  |  |  |  |                 |     |       |       |                     |  |  |  |  |                 |     |       |       |                     |  |  |  |  |          |     |       |       |                     |  |  |  |  |
| 1.6 FSI  | 85  | 07.05   | 07.10 | PR: 1LK,1LM         |                |                     |   |                           |   |                     |         |     |       |       |                     |                |        |   |                     |         |     |       |       |                     |  |  |  |  |             |     |       |       |                     |  |  |  |  |                 |     |       |       |                     |  |  |  |  |                 |     |       |       |                     |  |  |  |  |                    |     |       |       |                     |  |  |  |  |         |     |       |       |                     |  |  |  |  |                 |     |       |       |                     |  |  |  |  |         |     |       |       |                     |  |  |  |  |         |     |       |       |                     |  |  |  |  |             |     |       |       |                     |  |  |  |  |             |     |       |       |                     |  |  |  |  |                 |     |       |       |                     |                |        |   |           |                 |     |       |       |                     |                |        |   |           |                 |     |       |       |                     |  |  |  |  |                    |     |       |       |                     |  |  |  |  |          |     |       |       |                     |  |  |  |  |                    |     |       |       |                     |  |  |  |  |         |     |       |       |                     |  |  |  |  |         |    |       |       |             |                |        |  |                     |     |    |       |       |             |                |        |  |                     |         |    |       |       |             |  |  |  |  |         |    |       |       |             |  |  |  |  |         |     |       |       |             |  |  |  |  |         |     |       |       |             |  |  |  |  |         |    |       |       |             |  |  |  |  |         |     |       |       |             |  |  |  |  |                 |     |       |       |             |  |  |  |  |         |     |       |       |             |  |  |  |  |         |    |       |       |             |  |  |  |  |         |     |       |       |             |  |  |  |  |         |     |       |       |             |  |  |  |  |             |     |       |       |             |  |  |  |  |                 |     |       |       |             |  |  |  |  |                 |     |       |       |             |  |  |  |  |          |     |       |       |             |  |  |  |  |                    |     |       |       |             |  |  |  |  |         |     |       |       |             |  |  |  |  |         |    |       |       |                     |                |        |  |                        |     |    |       |       |                     |                |        |  |                           |         |    |       |       |                     |  |  |  |  |         |    |       |       |                     |  |  |  |  |         |     |       |       |                     |  |  |  |  |         |     |       |       |                     |  |  |  |  |         |    |       |       |                     |  |  |  |  |         |     |       |       |                     |  |  |  |  |                 |     |       |       |                     |  |  |  |  |         |     |       |       |                     |  |  |  |  |         |    |       |       |                     |  |  |  |  |         |     |       |       |                     |  |  |  |  |         |     |       |       |                     |  |  |  |  |             |     |       |       |                     |  |  |  |  |                 |     |       |       |                     |  |  |  |  |                 |     |       |       |                     |  |  |  |  |          |     |       |       |                     |  |  |  |  |
| 1.6 TDI  | 77  | 08.09   | 07.10 | PR: 1LK,1LM         |                |                     |   |                           |   |                     |         |     |       |       |                     |                |        |   |                     |         |     |       |       |                     |  |  |  |  |             |     |       |       |                     |  |  |  |  |                 |     |       |       |                     |  |  |  |  |                 |     |       |       |                     |  |  |  |  |                    |     |       |       |                     |  |  |  |  |         |     |       |       |                     |  |  |  |  |                 |     |       |       |                     |  |  |  |  |         |     |       |       |                     |  |  |  |  |         |     |       |       |                     |  |  |  |  |             |     |       |       |                     |  |  |  |  |             |     |       |       |                     |  |  |  |  |                 |     |       |       |                     |                |        |   |           |                 |     |       |       |                     |                |        |   |           |                 |     |       |       |                     |  |  |  |  |                    |     |       |       |                     |  |  |  |  |          |     |       |       |                     |  |  |  |  |                    |     |       |       |                     |  |  |  |  |         |     |       |       |                     |  |  |  |  |         |    |       |       |             |                |        |  |                     |     |    |       |       |             |                |        |  |                     |         |    |       |       |             |  |  |  |  |         |    |       |       |             |  |  |  |  |         |     |       |       |             |  |  |  |  |         |     |       |       |             |  |  |  |  |         |    |       |       |             |  |  |  |  |         |     |       |       |             |  |  |  |  |                 |     |       |       |             |  |  |  |  |         |     |       |       |             |  |  |  |  |         |    |       |       |             |  |  |  |  |         |     |       |       |             |  |  |  |  |         |     |       |       |             |  |  |  |  |             |     |       |       |             |  |  |  |  |                 |     |       |       |             |  |  |  |  |                 |     |       |       |             |  |  |  |  |          |     |       |       |             |  |  |  |  |                    |     |       |       |             |  |  |  |  |         |     |       |       |             |  |  |  |  |         |    |       |       |                     |                |        |  |                        |     |    |       |       |                     |                |        |  |                           |         |    |       |       |                     |  |  |  |  |         |    |       |       |                     |  |  |  |  |         |     |       |       |                     |  |  |  |  |         |     |       |       |                     |  |  |  |  |         |    |       |       |                     |  |  |  |  |         |     |       |       |                     |  |  |  |  |                 |     |       |       |                     |  |  |  |  |         |     |       |       |                     |  |  |  |  |         |    |       |       |                     |  |  |  |  |         |     |       |       |                     |  |  |  |  |         |     |       |       |                     |  |  |  |  |             |     |       |       |                     |  |  |  |  |                 |     |       |       |                     |  |  |  |  |                 |     |       |       |                     |  |  |  |  |          |     |       |       |                     |  |  |  |  |
| 1.8 TSI  | 112   | 11.09   | 07.10 | PR: 1LK,1LM         |                |                     |   |                           |   |                     |         |     |       |       |                     |                |        |   |                     |         |     |       |       |                     |  |  |  |  |             |     |       |       |                     |  |  |  |  |                 |     |       |       |                     |  |  |  |  |                 |     |       |       |                     |  |  |  |  |                    |     |       |       |                     |  |  |  |  |         |     |       |       |                     |  |  |  |  |                 |     |       |       |                     |  |  |  |  |         |     |       |       |                     |  |  |  |  |         |     |       |       |                     |  |  |  |  |             |     |       |       |                     |  |  |  |  |             |     |       |       |                     |  |  |  |  |                 |     |       |       |                     |                |        |   |           |                 |     |       |       |                     |                |        |   |           |                 |     |       |       |                     |  |  |  |  |                    |     |       |       |                     |  |  |  |  |          |     |       |       |                     |  |  |  |  |                    |     |       |       |                     |  |  |  |  |         |     |       |       |                     |  |  |  |  |         |    |       |       |             |                |        |  |                     |     |    |       |       |             |                |        |  |                     |         |    |       |       |             |  |  |  |  |         |    |       |       |             |  |  |  |  |         |     |       |       |             |  |  |  |  |         |     |       |       |             |  |  |  |  |         |    |       |       |             |  |  |  |  |         |     |       |       |             |  |  |  |  |                 |     |       |       |             |  |  |  |  |         |     |       |       |             |  |  |  |  |         |    |       |       |             |  |  |  |  |         |     |       |       |             |  |  |  |  |         |     |       |       |             |  |  |  |  |             |     |       |       |             |  |  |  |  |                 |     |       |       |             |  |  |  |  |                 |     |       |       |             |  |  |  |  |          |     |       |       |             |  |  |  |  |                    |     |       |       |             |  |  |  |  |         |     |       |       |             |  |  |  |  |         |    |       |       |                     |                |        |  |                        |     |    |       |       |                     |                |        |  |                           |         |    |       |       |                     |  |  |  |  |         |    |       |       |                     |  |  |  |  |         |     |       |       |                     |  |  |  |  |         |     |       |       |                     |  |  |  |  |         |    |       |       |                     |  |  |  |  |         |     |       |       |                     |  |  |  |  |                 |     |       |       |                     |  |  |  |  |         |     |       |       |                     |  |  |  |  |         |    |       |       |                     |  |  |  |  |         |     |       |       |                     |  |  |  |  |         |     |       |       |                     |  |  |  |  |             |     |       |       |                     |  |  |  |  |                 |     |       |       |                     |  |  |  |  |                 |     |       |       |                     |  |  |  |  |          |     |       |       |                     |  |  |  |  |
| 1.8 TSI  | 118   | 10.07   | 07.10 | PR: 1LK,1LM         |                |                     |   |                           |   |                     |         |     |       |       |                     |                |        |   |                     |         |     |       |       |                     |  |  |  |  |             |     |       |       |                     |  |  |  |  |                 |     |       |       |                     |  |  |  |  |                 |     |       |       |                     |  |  |  |  |                    |     |       |       |                     |  |  |  |  |         |     |       |       |                     |  |  |  |  |                 |     |       |       |                     |  |  |  |  |         |     |       |       |                     |  |  |  |  |         |     |       |       |                     |  |  |  |  |             |     |       |       |                     |  |  |  |  |             |     |       |       |                     |  |  |  |  |                 |     |       |       |                     |                |        |   |           |                 |     |       |       |                     |                |        |   |           |                 |     |       |       |                     |  |  |  |  |                    |     |       |       |                     |  |  |  |  |          |     |       |       |                     |  |  |  |  |                    |     |       |       |                     |  |  |  |  |         |     |       |       |                     |  |  |  |  |         |    |       |       |             |                |        |  |                     |     |    |       |       |             |                |        |  |                     |         |    |       |       |             |  |  |  |  |         |    |       |       |             |  |  |  |  |         |     |       |       |             |  |  |  |  |         |     |       |       |             |  |  |  |  |         |    |       |       |             |  |  |  |  |         |     |       |       |             |  |  |  |  |                 |     |       |       |             |  |  |  |  |         |     |       |       |             |  |  |  |  |         |    |       |       |             |  |  |  |  |         |     |       |       |             |  |  |  |  |         |     |       |       |             |  |  |  |  |             |     |       |       |             |  |  |  |  |                 |     |       |       |             |  |  |  |  |                 |     |       |       |             |  |  |  |  |          |     |       |       |             |  |  |  |  |                    |     |       |       |             |  |  |  |  |         |     |       |       |             |  |  |  |  |         |    |       |       |                     |                |        |  |                        |     |    |       |       |                     |                |        |  |                           |         |    |       |       |                     |  |  |  |  |         |    |       |       |                     |  |  |  |  |         |     |       |       |                     |  |  |  |  |         |     |       |       |                     |  |  |  |  |         |    |       |       |                     |  |  |  |  |         |     |       |       |                     |  |  |  |  |                 |     |       |       |                     |  |  |  |  |         |     |       |       |                     |  |  |  |  |         |    |       |       |                     |  |  |  |  |         |     |       |       |                     |  |  |  |  |         |     |       |       |                     |  |  |  |  |             |     |       |       |                     |  |  |  |  |                 |     |       |       |                     |  |  |  |  |                 |     |       |       |                     |  |  |  |  |          |     |       |       |                     |  |  |  |  |
| 1.9 TDI  | 77  | 07.05   | 07.10 | PR: 1LK,1LM         |                |                     |   |                           |   |                     |         |     |       |       |                     |                |        |   |                     |         |     |       |       |                     |  |  |  |  |             |     |       |       |                     |  |  |  |  |                 |     |       |       |                     |  |  |  |  |                 |     |       |       |                     |  |  |  |  |                    |     |       |       |                     |  |  |  |  |         |     |       |       |                     |  |  |  |  |                 |     |       |       |                     |  |  |  |  |         |     |       |       |                     |  |  |  |  |         |     |       |       |                     |  |  |  |  |             |     |       |       |                     |  |  |  |  |             |     |       |       |                     |  |  |  |  |                 |     |       |       |                     |                |        |   |           |                 |     |       |       |                     |                |        |   |           |                 |     |       |       |                     |  |  |  |  |                    |     |       |       |                     |  |  |  |  |          |     |       |       |                     |  |  |  |  |                    |     |       |       |                     |  |  |  |  |         |     |       |       |                     |  |  |  |  |         |    |       |       |             |                |        |  |                     |     |    |       |       |             |                |        |  |                     |         |    |       |       |             |  |  |  |  |         |    |       |       |             |  |  |  |  |         |     |       |       |             |  |  |  |  |         |     |       |       |             |  |  |  |  |         |    |       |       |             |  |  |  |  |         |     |       |       |             |  |  |  |  |                 |     |       |       |             |  |  |  |  |         |     |       |       |             |  |  |  |  |         |    |       |       |             |  |  |  |  |         |     |       |       |             |  |  |  |  |         |     |       |       |             |  |  |  |  |             |     |       |       |             |  |  |  |  |                 |     |       |       |             |  |  |  |  |                 |     |       |       |             |  |  |  |  |          |     |       |       |             |  |  |  |  |                    |     |       |       |             |  |  |  |  |         |     |       |       |             |  |  |  |  |         |    |       |       |                     |                |        |  |                        |     |    |       |       |                     |                |        |  |                           |         |    |       |       |                     |  |  |  |  |         |    |       |       |                     |  |  |  |  |         |     |       |       |                     |  |  |  |  |         |     |       |       |                     |  |  |  |  |         |    |       |       |                     |  |  |  |  |         |     |       |       |                     |  |  |  |  |                 |     |       |       |                     |  |  |  |  |         |     |       |       |                     |  |  |  |  |         |    |       |       |                     |  |  |  |  |         |     |       |       |                     |  |  |  |  |         |     |       |       |                     |  |  |  |  |             |     |       |       |                     |  |  |  |  |                 |     |       |       |                     |  |  |  |  |                 |     |       |       |                     |  |  |  |  |          |     |       |       |                     |  |  |  |  |
| 2.0 FSI  | 110   | 07.05   | 07.10 | PR: 1LK,1LM         |                |                     |   |                           |   |                     |         |     |       |       |                     |                |        |   |                     |         |     |       |       |                     |  |  |  |  |             |     |       |       |                     |  |  |  |  |                 |     |       |       |                     |  |  |  |  |                 |     |       |       |                     |  |  |  |  |                    |     |       |       |                     |  |  |  |  |         |     |       |       |                     |  |  |  |  |                 |     |       |       |                     |  |  |  |  |         |     |       |       |                     |  |  |  |  |         |     |       |       |                     |  |  |  |  |             |     |       |       |                     |  |  |  |  |             |     |       |       |                     |  |  |  |  |                 |     |       |       |                     |                |        |   |           |                 |     |       |       |                     |                |        |   |           |                 |     |       |       |                     |  |  |  |  |                    |     |       |       |                     |  |  |  |  |          |     |       |       |                     |  |  |  |  |                    |     |       |       |                     |  |  |  |  |         |     |       |       |                     |  |  |  |  |         |    |       |       |             |                |        |  |                     |     |    |       |       |             |                |        |  |                     |         |    |       |       |             |  |  |  |  |         |    |       |       |             |  |  |  |  |         |     |       |       |             |  |  |  |  |         |     |       |       |             |  |  |  |  |         |    |       |       |             |  |  |  |  |         |     |       |       |             |  |  |  |  |                 |     |       |       |             |  |  |  |  |         |     |       |       |             |  |  |  |  |         |    |       |       |             |  |  |  |  |         |     |       |       |             |  |  |  |  |         |     |       |       |             |  |  |  |  |             |     |       |       |             |  |  |  |  |                 |     |       |       |             |  |  |  |  |                 |     |       |       |             |  |  |  |  |          |     |       |       |             |  |  |  |  |                    |     |       |       |             |  |  |  |  |         |     |       |       |             |  |  |  |  |         |    |       |       |                     |                |        |  |                        |     |    |       |       |                     |                |        |  |                           |         |    |       |       |                     |  |  |  |  |         |    |       |       |                     |  |  |  |  |         |     |       |       |                     |  |  |  |  |         |     |       |       |                     |  |  |  |  |         |    |       |       |                     |  |  |  |  |         |     |       |       |                     |  |  |  |  |                 |     |       |       |                     |  |  |  |  |         |     |       |       |                     |  |  |  |  |         |    |       |       |                     |  |  |  |  |         |     |       |       |                     |  |  |  |  |         |     |       |       |                     |  |  |  |  |             |     |       |       |                     |  |  |  |  |                 |     |       |       |                     |  |  |  |  |                 |     |       |       |                     |  |  |  |  |          |     |       |       |                     |  |  |  |  |
| 2.0 FSI 4motion  | 110   | 09.05   | 07.10 | PR: 1LK,1LM         |                |                     |   |                           |   |                     |         |     |       |       |                     |                |        |   |                     |         |     |       |       |                     |  |  |  |  |             |     |       |       |                     |  |  |  |  |                 |     |       |       |                     |  |  |  |  |                 |     |       |       |                     |  |  |  |  |                    |     |       |       |                     |  |  |  |  |         |     |       |       |                     |  |  |  |  |                 |     |       |       |                     |  |  |  |  |         |     |       |       |                     |  |  |  |  |         |     |       |       |                     |  |  |  |  |             |     |       |       |                     |  |  |  |  |             |     |       |       |                     |  |  |  |  |                 |     |       |       |                     |                |        |   |           |                 |     |       |       |                     |                |        |   |           |                 |     |       |       |                     |  |  |  |  |                    |     |       |       |                     |  |  |  |  |          |     |       |       |                     |  |  |  |  |                    |     |       |       |                     |  |  |  |  |         |     |       |       |                     |  |  |  |  |         |    |       |       |             |                |        |  |                     |     |    |       |       |             |                |        |  |                     |         |    |       |       |             |  |  |  |  |         |    |       |       |             |  |  |  |  |         |     |       |       |             |  |  |  |  |         |     |       |       |             |  |  |  |  |         |    |       |       |             |  |  |  |  |         |     |       |       |             |  |  |  |  |                 |     |       |       |             |  |  |  |  |         |     |       |       |             |  |  |  |  |         |    |       |       |             |  |  |  |  |         |     |       |       |             |  |  |  |  |         |     |       |       |             |  |  |  |  |             |     |       |       |             |  |  |  |  |                 |     |       |       |             |  |  |  |  |                 |     |       |       |             |  |  |  |  |          |     |       |       |             |  |  |  |  |                    |     |       |       |             |  |  |  |  |         |     |       |       |             |  |  |  |  |         |    |       |       |                     |                |        |  |                        |     |    |       |       |                     |                |        |  |                           |         |    |       |       |                     |  |  |  |  |         |    |       |       |                     |  |  |  |  |         |     |       |       |                     |  |  |  |  |         |     |       |       |                     |  |  |  |  |         |    |       |       |                     |  |  |  |  |         |     |       |       |                     |  |  |  |  |                 |     |       |       |                     |  |  |  |  |         |     |       |       |                     |  |  |  |  |         |    |       |       |                     |  |  |  |  |         |     |       |       |                     |  |  |  |  |         |     |       |       |                     |  |  |  |  |             |     |       |       |                     |  |  |  |  |                 |     |       |       |                     |  |  |  |  |                 |     |       |       |                     |  |  |  |  |          |     |       |       |                     |  |  |  |  |
| 2.0 TDI  | 100   | 11.05   | 07.10 | PR: 1LK,1LM         |                |                     |   |                           |   |                     |         |     |       |       |                     |                |        |   |                     |         |     |       |       |                     |  |  |  |  |             |     |       |       |                     |  |  |  |  |                 |     |       |       |                     |  |  |  |  |                 |     |       |       |                     |  |  |  |  |                    |     |       |       |                     |  |  |  |  |         |     |       |       |                     |  |  |  |  |                 |     |       |       |                     |  |  |  |  |         |     |       |       |                     |  |  |  |  |         |     |       |       |                     |  |  |  |  |             |     |       |       |                     |  |  |  |  |             |     |       |       |                     |  |  |  |  |                 |     |       |       |                     |                |        |   |           |                 |     |       |       |                     |                |        |   |           |                 |     |       |       |                     |  |  |  |  |                    |     |       |       |                     |  |  |  |  |          |     |       |       |                     |  |  |  |  |                    |     |       |       |                     |  |  |  |  |         |     |       |       |                     |  |  |  |  |         |    |       |       |             |                |        |  |                     |     |    |       |       |             |                |        |  |                     |         |    |       |       |             |  |  |  |  |         |    |       |       |             |  |  |  |  |         |     |       |       |             |  |  |  |  |         |     |       |       |             |  |  |  |  |         |    |       |       |             |  |  |  |  |         |     |       |       |             |  |  |  |  |                 |     |       |       |             |  |  |  |  |         |     |       |       |             |  |  |  |  |         |    |       |       |             |  |  |  |  |         |     |       |       |             |  |  |  |  |         |     |       |       |             |  |  |  |  |             |     |       |       |             |  |  |  |  |                 |     |       |       |             |  |  |  |  |                 |     |       |       |             |  |  |  |  |          |     |       |       |             |  |  |  |  |                    |     |       |       |             |  |  |  |  |         |     |       |       |             |  |  |  |  |         |    |       |       |                     |                |        |  |                        |     |    |       |       |                     |                |        |  |                           |         |    |       |       |                     |  |  |  |  |         |    |       |       |                     |  |  |  |  |         |     |       |       |                     |  |  |  |  |         |     |       |       |                     |  |  |  |  |         |    |       |       |                     |  |  |  |  |         |     |       |       |                     |  |  |  |  |                 |     |       |       |                     |  |  |  |  |         |     |       |       |                     |  |  |  |  |         |    |       |       |                     |  |  |  |  |         |     |       |       |                     |  |  |  |  |         |     |       |       |                     |  |  |  |  |             |     |       |       |                     |  |  |  |  |                 |     |       |       |                     |  |  |  |  |                 |     |       |       |                     |  |  |  |  |          |     |       |       |                     |  |  |  |  |
| 2.0 TDI  | 90  | 07.05   | 07.10 | PR: 1LK,1LM         |                |                     |   |                           |   |                     |         |     |       |       |                     |                |        |   |                     |         |     |       |       |                     |  |  |  |  |             |     |       |       |                     |  |  |  |  |                 |     |       |       |                     |  |  |  |  |                 |     |       |       |                     |  |  |  |  |                    |     |       |       |                     |  |  |  |  |         |     |       |       |                     |  |  |  |  |                 |     |       |       |                     |  |  |  |  |         |     |       |       |                     |  |  |  |  |         |     |       |       |                     |  |  |  |  |             |     |       |       |                     |  |  |  |  |             |     |       |       |                     |  |  |  |  |                 |     |       |       |                     |                |        |   |           |                 |     |       |       |                     |                |        |   |           |                 |     |       |       |                     |  |  |  |  |                    |     |       |       |                     |  |  |  |  |          |     |       |       |                     |  |  |  |  |                    |     |       |       |                     |  |  |  |  |         |     |       |       |                     |  |  |  |  |         |    |       |       |             |                |        |  |                     |     |    |       |       |             |                |        |  |                     |         |    |       |       |             |  |  |  |  |         |    |       |       |             |  |  |  |  |         |     |       |       |             |  |  |  |  |         |     |       |       |             |  |  |  |  |         |    |       |       |             |  |  |  |  |         |     |       |       |             |  |  |  |  |                 |     |       |       |             |  |  |  |  |         |     |       |       |             |  |  |  |  |         |    |       |       |             |  |  |  |  |         |     |       |       |             |  |  |  |  |         |     |       |       |             |  |  |  |  |             |     |       |       |             |  |  |  |  |                 |     |       |       |             |  |  |  |  |                 |     |       |       |             |  |  |  |  |          |     |       |       |             |  |  |  |  |                    |     |       |       |             |  |  |  |  |         |     |       |       |             |  |  |  |  |         |    |       |       |                     |                |        |  |                        |     |    |       |       |                     |                |        |  |                           |         |    |       |       |                     |  |  |  |  |         |    |       |       |                     |  |  |  |  |         |     |       |       |                     |  |  |  |  |         |     |       |       |                     |  |  |  |  |         |    |       |       |                     |  |  |  |  |         |     |       |       |                     |  |  |  |  |                 |     |       |       |                     |  |  |  |  |         |     |       |       |                     |  |  |  |  |         |    |       |       |                     |  |  |  |  |         |     |       |       |                     |  |  |  |  |         |     |       |       |                     |  |  |  |  |             |     |       |       |                     |  |  |  |  |                 |     |       |       |                     |  |  |  |  |                 |     |       |       |                     |  |  |  |  |          |     |       |       |                     |  |  |  |  |
| 2.0 TDI  | 100   | 07.05   | 07.10 | PR: 1LK,1LM         |                |                     |   |                           |   |                     |         |     |       |       |                     |                |        |   |                     |         |     |       |       |                     |  |  |  |  |             |     |       |       |                     |  |  |  |  |                 |     |       |       |                     |  |  |  |  |                 |     |       |       |                     |  |  |  |  |                    |     |       |       |                     |  |  |  |  |         |     |       |       |                     |  |  |  |  |                 |     |       |       |                     |  |  |  |  |         |     |       |       |                     |  |  |  |  |         |     |       |       |                     |  |  |  |  |             |     |       |       |                     |  |  |  |  |             |     |       |       |                     |  |  |  |  |                 |     |       |       |                     |                |        |   |           |                 |     |       |       |                     |                |        |   |           |                 |     |       |       |                     |  |  |  |  |                    |     |       |       |                     |  |  |  |  |          |     |       |       |                     |  |  |  |  |                    |     |       |       |                     |  |  |  |  |         |     |       |       |                     |  |  |  |  |         |    |       |       |             |                |        |  |                     |     |    |       |       |             |                |        |  |                     |         |    |       |       |             |  |  |  |  |         |    |       |       |             |  |  |  |  |         |     |       |       |             |  |  |  |  |         |     |       |       |             |  |  |  |  |         |    |       |       |             |  |  |  |  |         |     |       |       |             |  |  |  |  |                 |     |       |       |             |  |  |  |  |         |     |       |       |             |  |  |  |  |         |    |       |       |             |  |  |  |  |         |     |       |       |             |  |  |  |  |         |     |       |       |             |  |  |  |  |             |     |       |       |             |  |  |  |  |                 |     |       |       |             |  |  |  |  |                 |     |       |       |             |  |  |  |  |          |     |       |       |             |  |  |  |  |                    |     |       |       |             |  |  |  |  |         |     |       |       |             |  |  |  |  |         |    |       |       |                     |                |        |  |                        |     |    |       |       |                     |                |        |  |                           |         |    |       |       |                     |  |  |  |  |         |    |       |       |                     |  |  |  |  |         |     |       |       |                     |  |  |  |  |         |     |       |       |                     |  |  |  |  |         |    |       |       |                     |  |  |  |  |         |     |       |       |                     |  |  |  |  |                 |     |       |       |                     |  |  |  |  |         |     |       |       |                     |  |  |  |  |         |    |       |       |                     |  |  |  |  |         |     |       |       |                     |  |  |  |  |         |     |       |       |                     |  |  |  |  |             |     |       |       |                     |  |  |  |  |                 |     |       |       |                     |  |  |  |  |                 |     |       |       |                     |  |  |  |  |          |     |       |       |                     |  |  |  |  |
| 2.0 TDI  | 125   | 07.05   | 07.10 | PR: 1LK,1LM         |                |                     |   |                           |   |                     |         |     |       |       |                     |                |        |   |                     |         |     |       |       |                     |  |  |  |  |             |     |       |       |                     |  |  |  |  |                 |     |       |       |                     |  |  |  |  |                 |     |       |       |                     |  |  |  |  |                    |     |       |       |                     |  |  |  |  |         |     |       |       |                     |  |  |  |  |                 |     |       |       |                     |  |  |  |  |         |     |       |       |                     |  |  |  |  |         |     |       |       |                     |  |  |  |  |             |     |       |       |                     |  |  |  |  |             |     |       |       |                     |  |  |  |  |                 |     |       |       |                     |                |        |   |           |                 |     |       |       |                     |                |        |   |           |                 |     |       |       |                     |  |  |  |  |                    |     |       |       |                     |  |  |  |  |          |     |       |       |                     |  |  |  |  |                    |     |       |       |                     |  |  |  |  |         |     |       |       |                     |  |  |  |  |         |    |       |       |             |                |        |  |                     |     |    |       |       |             |                |        |  |                     |         |    |       |       |             |  |  |  |  |         |    |       |       |             |  |  |  |  |         |     |       |       |             |  |  |  |  |         |     |       |       |             |  |  |  |  |         |    |       |       |             |  |  |  |  |         |     |       |       |             |  |  |  |  |                 |     |       |       |             |  |  |  |  |         |     |       |       |             |  |  |  |  |         |    |       |       |             |  |  |  |  |         |     |       |       |             |  |  |  |  |         |     |       |       |             |  |  |  |  |             |     |       |       |             |  |  |  |  |                 |     |       |       |             |  |  |  |  |                 |     |       |       |             |  |  |  |  |          |     |       |       |             |  |  |  |  |                    |     |       |       |             |  |  |  |  |         |     |       |       |             |  |  |  |  |         |    |       |       |                     |                |        |  |                        |     |    |       |       |                     |                |        |  |                           |         |    |       |       |                     |  |  |  |  |         |    |       |       |                     |  |  |  |  |         |     |       |       |                     |  |  |  |  |         |     |       |       |                     |  |  |  |  |         |    |       |       |                     |  |  |  |  |         |     |       |       |                     |  |  |  |  |                 |     |       |       |                     |  |  |  |  |         |     |       |       |                     |  |  |  |  |         |    |       |       |                     |  |  |  |  |         |     |       |       |                     |  |  |  |  |         |     |       |       |                     |  |  |  |  |             |     |       |       |                     |  |  |  |  |                 |     |       |       |                     |  |  |  |  |                 |     |       |       |                     |  |  |  |  |          |     |       |       |                     |  |  |  |  |
| 2.0 TDI 16V  | 103   | 08.05   | 07.10 | PR: 1LK,1LM         |                |                     |   |                           |   |                     |         |     |       |       |                     |                |        |   |                     |         |     |       |       |                     |  |  |  |  |             |     |       |       |                     |  |  |  |  |                 |     |       |       |                     |  |  |  |  |                 |     |       |       |                     |  |  |  |  |                    |     |       |       |                     |  |  |  |  |         |     |       |       |                     |  |  |  |  |                 |     |       |       |                     |  |  |  |  |         |     |       |       |                     |  |  |  |  |         |     |       |       |                     |  |  |  |  |             |     |       |       |                     |  |  |  |  |             |     |       |       |                     |  |  |  |  |                 |     |       |       |                     |                |        |   |           |                 |     |       |       |                     |                |        |   |           |                 |     |       |       |                     |  |  |  |  |                    |     |       |       |                     |  |  |  |  |          |     |       |       |                     |  |  |  |  |                    |     |       |       |                     |  |  |  |  |         |     |       |       |                     |  |  |  |  |         |    |       |       |             |                |        |  |                     |     |    |       |       |             |                |        |  |                     |         |    |       |       |             |  |  |  |  |         |    |       |       |             |  |  |  |  |         |     |       |       |             |  |  |  |  |         |     |       |       |             |  |  |  |  |         |    |       |       |             |  |  |  |  |         |     |       |       |             |  |  |  |  |                 |     |       |       |             |  |  |  |  |         |     |       |       |             |  |  |  |  |         |    |       |       |             |  |  |  |  |         |     |       |       |             |  |  |  |  |         |     |       |       |             |  |  |  |  |             |     |       |       |             |  |  |  |  |                 |     |       |       |             |  |  |  |  |                 |     |       |       |             |  |  |  |  |          |     |       |       |             |  |  |  |  |                    |     |       |       |             |  |  |  |  |         |     |       |       |             |  |  |  |  |         |    |       |       |                     |                |        |  |                        |     |    |       |       |                     |                |        |  |                           |         |    |       |       |                     |  |  |  |  |         |    |       |       |                     |  |  |  |  |         |     |       |       |                     |  |  |  |  |         |     |       |       |                     |  |  |  |  |         |    |       |       |                     |  |  |  |  |         |     |       |       |                     |  |  |  |  |                 |     |       |       |                     |  |  |  |  |         |     |       |       |                     |  |  |  |  |         |    |       |       |                     |  |  |  |  |         |     |       |       |                     |  |  |  |  |         |     |       |       |                     |  |  |  |  |             |     |       |       |                     |  |  |  |  |                 |     |       |       |                     |  |  |  |  |                 |     |       |       |                     |  |  |  |  |          |     |       |       |                     |  |  |  |  |
| 2.0 TDI 4motion  | 103   | 09.05   | 07.10 | PR: 1LK,1LM         |                |                     |   |                           |   |                     |         |     |       |       |                     |                |        |   |                     |         |     |       |       |                     |  |  |  |  |             |     |       |       |                     |  |  |  |  |                 |     |       |       |                     |  |  |  |  |                 |     |       |       |                     |  |  |  |  |                    |     |       |       |                     |  |  |  |  |         |     |       |       |                     |  |  |  |  |                 |     |       |       |                     |  |  |  |  |         |     |       |       |                     |  |  |  |  |         |     |       |       |                     |  |  |  |  |             |     |       |       |                     |  |  |  |  |             |     |       |       |                     |  |  |  |  |                 |     |       |       |                     |                |        |   |           |                 |     |       |       |                     |                |        |   |           |                 |     |       |       |                     |  |  |  |  |                    |     |       |       |                     |  |  |  |  |          |     |       |       |                     |  |  |  |  |                    |     |       |       |                     |  |  |  |  |         |     |       |       |                     |  |  |  |  |         |    |       |       |             |                |        |  |                     |     |    |       |       |             |                |        |  |                     |         |    |       |       |             |  |  |  |  |         |    |       |       |             |  |  |  |  |         |     |       |       |             |  |  |  |  |         |     |       |       |             |  |  |  |  |         |    |       |       |             |  |  |  |  |         |     |       |       |             |  |  |  |  |                 |     |       |       |             |  |  |  |  |         |     |       |       |             |  |  |  |  |         |    |       |       |             |  |  |  |  |         |     |       |       |             |  |  |  |  |         |     |       |       |             |  |  |  |  |             |     |       |       |             |  |  |  |  |                 |     |       |       |             |  |  |  |  |                 |     |       |       |             |  |  |  |  |          |     |       |       |             |  |  |  |  |                    |     |       |       |             |  |  |  |  |         |     |       |       |             |  |  |  |  |         |    |       |       |                     |                |        |  |                        |     |    |       |       |                     |                |        |  |                           |         |    |       |       |                     |  |  |  |  |         |    |       |       |                     |  |  |  |  |         |     |       |       |                     |  |  |  |  |         |     |       |       |                     |  |  |  |  |         |    |       |       |                     |  |  |  |  |         |     |       |       |                     |  |  |  |  |                 |     |       |       |                     |  |  |  |  |         |     |       |       |                     |  |  |  |  |         |    |       |       |                     |  |  |  |  |         |     |       |       |                     |  |  |  |  |         |     |       |       |                     |  |  |  |  |             |     |       |       |                     |  |  |  |  |                 |     |       |       |                     |  |  |  |  |                 |     |       |       |                     |  |  |  |  |          |     |       |       |                     |  |  |  |  |
| 2.0 TDI 4motion  | 125   | 05.09   | 07.10 | PR: 1LK,1LM         |                |                     |   |                           |   |                     |         |     |       |       |                     |                |        |   |                     |         |     |       |       |                     |  |  |  |  |             |     |       |       |                     |  |  |  |  |                 |     |       |       |                     |  |  |  |  |                 |     |       |       |                     |  |  |  |  |                    |     |       |       |                     |  |  |  |  |         |     |       |       |                     |  |  |  |  |                 |     |       |       |                     |  |  |  |  |         |     |       |       |                     |  |  |  |  |         |     |       |       |                     |  |  |  |  |             |     |       |       |                     |  |  |  |  |             |     |       |       |                     |  |  |  |  |                 |     |       |       |                     |                |        |   |           |                 |     |       |       |                     |                |        |   |           |                 |     |       |       |                     |  |  |  |  |                    |     |       |       |                     |  |  |  |  |          |     |       |       |                     |  |  |  |  |                    |     |       |       |                     |  |  |  |  |         |     |       |       |                     |  |  |  |  |         |    |       |       |             |                |        |  |                     |     |    |       |       |             |                |        |  |                     |         |    |       |       |             |  |  |  |  |         |    |       |       |             |  |  |  |  |         |     |       |       |             |  |  |  |  |         |     |       |       |             |  |  |  |  |         |    |       |       |             |  |  |  |  |         |     |       |       |             |  |  |  |  |                 |     |       |       |             |  |  |  |  |         |     |       |       |             |  |  |  |  |         |    |       |       |             |  |  |  |  |         |     |       |       |             |  |  |  |  |         |     |       |       |             |  |  |  |  |             |     |       |       |             |  |  |  |  |                 |     |       |       |             |  |  |  |  |                 |     |       |       |             |  |  |  |  |          |     |       |       |             |  |  |  |  |                    |     |       |       |             |  |  |  |  |         |     |       |       |             |  |  |  |  |         |    |       |       |                     |                |        |  |                        |     |    |       |       |                     |                |        |  |                           |         |    |       |       |                     |  |  |  |  |         |    |       |       |                     |  |  |  |  |         |     |       |       |                     |  |  |  |  |         |     |       |       |                     |  |  |  |  |         |    |       |       |                     |  |  |  |  |         |     |       |       |                     |  |  |  |  |                 |     |       |       |                     |  |  |  |  |         |     |       |       |                     |  |  |  |  |         |    |       |       |                     |  |  |  |  |         |     |       |       |                     |  |  |  |  |         |     |       |       |                     |  |  |  |  |             |     |       |       |                     |  |  |  |  |                 |     |       |       |                     |  |  |  |  |                 |     |       |       |                     |  |  |  |  |          |     |       |       |                     |  |  |  |  |
| 2.0 TFSI   | 147   | 07.05   | 07.10 | PR: 1LK,1LM         |                |                     |   |                           |   |                     |         |     |       |       |                     |                |        |   |                     |         |     |       |       |                     |  |  |  |  |             |     |       |       |                     |  |  |  |  |                 |     |       |       |                     |  |  |  |  |                 |     |       |       |                     |  |  |  |  |                    |     |       |       |                     |  |  |  |  |         |     |       |       |                     |  |  |  |  |                 |     |       |       |                     |  |  |  |  |         |     |       |       |                     |  |  |  |  |         |     |       |       |                     |  |  |  |  |             |     |       |       |                     |  |  |  |  |             |     |       |       |                     |  |  |  |  |                 |     |       |       |                     |                |        |   |           |                 |     |       |       |                     |                |        |   |           |                 |     |       |       |                     |  |  |  |  |                    |     |       |       |                     |  |  |  |  |          |     |       |       |                     |  |  |  |  |                    |     |       |       |                     |  |  |  |  |         |     |       |       |                     |  |  |  |  |         |    |       |       |             |                |        |  |                     |     |    |       |       |             |                |        |  |                     |         |    |       |       |             |  |  |  |  |         |    |       |       |             |  |  |  |  |         |     |       |       |             |  |  |  |  |         |     |       |       |             |  |  |  |  |         |    |       |       |             |  |  |  |  |         |     |       |       |             |  |  |  |  |                 |     |       |       |             |  |  |  |  |         |     |       |       |             |  |  |  |  |         |    |       |       |             |  |  |  |  |         |     |       |       |             |  |  |  |  |         |     |       |       |             |  |  |  |  |             |     |       |       |             |  |  |  |  |                 |     |       |       |             |  |  |  |  |                 |     |       |       |             |  |  |  |  |          |     |       |       |             |  |  |  |  |                    |     |       |       |             |  |  |  |  |         |     |       |       |             |  |  |  |  |         |    |       |       |                     |                |        |  |                        |     |    |       |       |                     |                |        |  |                           |         |    |       |       |                     |  |  |  |  |         |    |       |       |                     |  |  |  |  |         |     |       |       |                     |  |  |  |  |         |     |       |       |                     |  |  |  |  |         |    |       |       |                     |  |  |  |  |         |     |       |       |                     |  |  |  |  |                 |     |       |       |                     |  |  |  |  |         |     |       |       |                     |  |  |  |  |         |    |       |       |                     |  |  |  |  |         |     |       |       |                     |  |  |  |  |         |     |       |       |                     |  |  |  |  |             |     |       |       |                     |  |  |  |  |                 |     |       |       |                     |  |  |  |  |                 |     |       |       |                     |  |  |  |  |          |     |       |       |                     |  |  |  |  |
| 3.2 V6 FSI 4motion   | 184   | 11.05   | 07.10 | PR: 1LK,1LM         |                |                     |   |                           |   |                     |         |     |       |       |                     |                |        |   |                     |         |     |       |       |                     |  |  |  |  |             |     |       |       |                     |  |  |  |  |                 |     |       |       |                     |  |  |  |  |                 |     |       |       |                     |  |  |  |  |                    |     |       |       |                     |  |  |  |  |         |     |       |       |                     |  |  |  |  |                 |     |       |       |                     |  |  |  |  |         |     |       |       |                     |  |  |  |  |         |     |       |       |                     |  |  |  |  |             |     |       |       |                     |  |  |  |  |             |     |       |       |                     |  |  |  |  |                 |     |       |       |                     |                |        |   |           |                 |     |       |       |                     |                |        |   |           |                 |     |       |       |                     |  |  |  |  |                    |     |       |       |                     |  |  |  |  |          |     |       |       |                     |  |  |  |  |                    |     |       |       |                     |  |  |  |  |         |     |       |       |                     |  |  |  |  |         |    |       |       |             |                |        |  |                     |     |    |       |       |             |                |        |  |                     |         |    |       |       |             |  |  |  |  |         |    |       |       |             |  |  |  |  |         |     |       |       |             |  |  |  |  |         |     |       |       |             |  |  |  |  |         |    |       |       |             |  |  |  |  |         |     |       |       |             |  |  |  |  |                 |     |       |       |             |  |  |  |  |         |     |       |       |             |  |  |  |  |         |    |       |       |             |  |  |  |  |         |     |       |       |             |  |  |  |  |         |     |       |       |             |  |  |  |  |             |     |       |       |             |  |  |  |  |                 |     |       |       |             |  |  |  |  |                 |     |       |       |             |  |  |  |  |          |     |       |       |             |  |  |  |  |                    |     |       |       |             |  |  |  |  |         |     |       |       |             |  |  |  |  |         |    |       |       |                     |                |        |  |                        |     |    |       |       |                     |                |        |  |                           |         |    |       |       |                     |  |  |  |  |         |    |       |       |                     |  |  |  |  |         |     |       |       |                     |  |  |  |  |         |     |       |       |                     |  |  |  |  |         |    |       |       |                     |  |  |  |  |         |     |       |       |                     |  |  |  |  |                 |     |       |       |                     |  |  |  |  |         |     |       |       |                     |  |  |  |  |         |    |       |       |                     |  |  |  |  |         |     |       |       |                     |  |  |  |  |         |     |       |       |                     |  |  |  |  |             |     |       |       |                     |  |  |  |  |                 |     |       |       |                     |  |  |  |  |                 |     |       |       |                     |  |  |  |  |          |     |       |       |                     |  |  |  |  |
| 3.6 R36  | 220   | 04.07   | 07.10 | PR: 1LK,1LM         |                |                     |   |                           |   |                     |         |     |       |       |                     |                |        |   |                     |         |     |       |       |                     |  |  |  |  |             |     |       |       |                     |  |  |  |  |                 |     |       |       |                     |  |  |  |  |                 |     |       |       |                     |  |  |  |  |                    |     |       |       |                     |  |  |  |  |         |     |       |       |                     |  |  |  |  |                 |     |       |       |                     |  |  |  |  |         |     |       |       |                     |  |  |  |  |         |     |       |       |                     |  |  |  |  |             |     |       |       |                     |  |  |  |  |             |     |       |       |                     |  |  |  |  |                 |     |       |       |                     |                |        |   |           |                 |     |       |       |                     |                |        |   |           |                 |     |       |       |                     |  |  |  |  |                    |     |       |       |                     |  |  |  |  |          |     |       |       |                     |  |  |  |  |                    |     |       |       |                     |  |  |  |  |         |     |       |       |                     |  |  |  |  |         |    |       |       |             |                |        |  |                     |     |    |       |       |             |                |        |  |                     |         |    |       |       |             |  |  |  |  |         |    |       |       |             |  |  |  |  |         |     |       |       |             |  |  |  |  |         |     |       |       |             |  |  |  |  |         |    |       |       |             |  |  |  |  |         |     |       |       |             |  |  |  |  |                 |     |       |       |             |  |  |  |  |         |     |       |       |             |  |  |  |  |         |    |       |       |             |  |  |  |  |         |     |       |       |             |  |  |  |  |         |     |       |       |             |  |  |  |  |             |     |       |       |             |  |  |  |  |                 |     |       |       |             |  |  |  |  |                 |     |       |       |             |  |  |  |  |          |     |       |       |             |  |  |  |  |                    |     |       |       |             |  |  |  |  |         |     |       |       |             |  |  |  |  |         |    |       |       |                     |                |        |  |                        |     |    |       |       |                     |                |        |  |                           |         |    |       |       |                     |  |  |  |  |         |    |       |       |                     |  |  |  |  |         |     |       |       |                     |  |  |  |  |         |     |       |       |                     |  |  |  |  |         |    |       |       |                     |  |  |  |  |         |     |       |       |                     |  |  |  |  |                 |     |       |       |                     |  |  |  |  |         |     |       |       |                     |  |  |  |  |         |    |       |       |                     |  |  |  |  |         |     |       |       |                     |  |  |  |  |         |     |       |       |                     |  |  |  |  |             |     |       |       |                     |  |  |  |  |                 |     |       |       |                     |  |  |  |  |                 |     |       |       |                     |  |  |  |  |          |     |       |       |                     |  |  |  |  |
| 1.4 TSI  | 90  | 10.07   | 07.10 | PR: 1LJ,1LH,1ZG,1ZM | 24.0125-0158.1 | 425158              |   | 312 25,0 22,0 VL +S +B    |   |                     |         |     |       |       |                     |                |        |   |                     |         |     |       |       |                     |  |  |  |  |             |     |       |       |                     |  |  |  |  |                 |     |       |       |                     |  |  |  |  |                 |     |       |       |                     |  |  |  |  |                    |     |       |       |                     |  |  |  |  |         |     |       |       |                     |  |  |  |  |                 |     |       |       |                     |  |  |  |  |         |     |       |       |                     |  |  |  |  |         |     |       |       |                     |  |  |  |  |             |     |       |       |                     |  |  |  |  |             |     |       |       |                     |  |  |  |  |                 |     |       |       |                     |                |        |   |           |                 |     |       |       |                     |                |        |   |           |                 |     |       |       |                     |  |  |  |  |                    |     |       |       |                     |  |  |  |  |          |     |       |       |                     |  |  |  |  |                    |     |       |       |                     |  |  |  |  |         |     |       |       |                     |  |  |  |  |         |    |       |       |             |                |        |  |                     |     |    |       |       |             |                |        |  |                     |         |    |       |       |             |  |  |  |  |         |    |       |       |             |  |  |  |  |         |     |       |       |             |  |  |  |  |         |     |       |       |             |  |  |  |  |         |    |       |       |             |  |  |  |  |         |     |       |       |             |  |  |  |  |                 |     |       |       |             |  |  |  |  |         |     |       |       |             |  |  |  |  |         |    |       |       |             |  |  |  |  |         |     |       |       |             |  |  |  |  |         |     |       |       |             |  |  |  |  |             |     |       |       |             |  |  |  |  |                 |     |       |       |             |  |  |  |  |                 |     |       |       |             |  |  |  |  |          |     |       |       |             |  |  |  |  |                    |     |       |       |             |  |  |  |  |         |     |       |       |             |  |  |  |  |         |    |       |       |                     |                |        |  |                        |     |    |       |       |                     |                |        |  |                           |         |    |       |       |                     |  |  |  |  |         |    |       |       |                     |  |  |  |  |         |     |       |       |                     |  |  |  |  |         |     |       |       |                     |  |  |  |  |         |    |       |       |                     |  |  |  |  |         |     |       |       |                     |  |  |  |  |                 |     |       |       |                     |  |  |  |  |         |     |       |       |                     |  |  |  |  |         |    |       |       |                     |  |  |  |  |         |     |       |       |                     |  |  |  |  |         |     |       |       |                     |  |  |  |  |             |     |       |       |                     |  |  |  |  |                 |     |       |       |                     |  |  |  |  |                 |     |       |       |                     |  |  |  |  |          |     |       |       |                     |  |  |  |  |
| 1.6  | 75  | 07.05   | 07.10 | PR: 1LJ,1LH,1ZG,1ZM | 24.0325-0158.1 | 525158              |   | 312 25,0 22,0 VL +S +B PD |   |                     |         |     |       |       |                     |                |        |   |                     |         |     |       |       |                     |  |  |  |  |             |     |       |       |                     |  |  |  |  |                 |     |       |       |                     |  |  |  |  |                 |     |       |       |                     |  |  |  |  |                    |     |       |       |                     |  |  |  |  |         |     |       |       |                     |  |  |  |  |                 |     |       |       |                     |  |  |  |  |         |     |       |       |                     |  |  |  |  |         |     |       |       |                     |  |  |  |  |             |     |       |       |                     |  |  |  |  |             |     |       |       |                     |  |  |  |  |                 |     |       |       |                     |                |        |   |           |                 |     |       |       |                     |                |        |   |           |                 |     |       |       |                     |  |  |  |  |                    |     |       |       |                     |  |  |  |  |          |     |       |       |                     |  |  |  |  |                    |     |       |       |                     |  |  |  |  |         |     |       |       |                     |  |  |  |  |         |    |       |       |             |                |        |  |                     |     |    |       |       |             |                |        |  |                     |         |    |       |       |             |  |  |  |  |         |    |       |       |             |  |  |  |  |         |     |       |       |             |  |  |  |  |         |     |       |       |             |  |  |  |  |         |    |       |       |             |  |  |  |  |         |     |       |       |             |  |  |  |  |                 |     |       |       |             |  |  |  |  |         |     |       |       |             |  |  |  |  |         |    |       |       |             |  |  |  |  |         |     |       |       |             |  |  |  |  |         |     |       |       |             |  |  |  |  |             |     |       |       |             |  |  |  |  |                 |     |       |       |             |  |  |  |  |                 |     |       |       |             |  |  |  |  |          |     |       |       |             |  |  |  |  |                    |     |       |       |             |  |  |  |  |         |     |       |       |             |  |  |  |  |         |    |       |       |                     |                |        |  |                        |     |    |       |       |                     |                |        |  |                           |         |    |       |       |                     |  |  |  |  |         |    |       |       |                     |  |  |  |  |         |     |       |       |                     |  |  |  |  |         |     |       |       |                     |  |  |  |  |         |    |       |       |                     |  |  |  |  |         |     |       |       |                     |  |  |  |  |                 |     |       |       |                     |  |  |  |  |         |     |       |       |                     |  |  |  |  |         |    |       |       |                     |  |  |  |  |         |     |       |       |                     |  |  |  |  |         |     |       |       |                     |  |  |  |  |             |     |       |       |                     |  |  |  |  |                 |     |       |       |                     |  |  |  |  |                 |     |       |       |                     |  |  |  |  |          |     |       |       |                     |  |  |  |  |
| 1.6 FSI  | 85  | 07.05   | 07.10 | PR: 1LJ,1LH,1ZG,1ZM |                |                     |   |                           |   |                     |         |     |       |       |                     |                |        |   |                     |         |     |       |       |                     |  |  |  |  |             |     |       |       |                     |  |  |  |  |                 |     |       |       |                     |  |  |  |  |                 |     |       |       |                     |  |  |  |  |                    |     |       |       |                     |  |  |  |  |         |     |       |       |                     |  |  |  |  |                 |     |       |       |                     |  |  |  |  |         |     |       |       |                     |  |  |  |  |         |     |       |       |                     |  |  |  |  |             |     |       |       |                     |  |  |  |  |             |     |       |       |                     |  |  |  |  |                 |     |       |       |                     |                |        |   |           |                 |     |       |       |                     |                |        |   |           |                 |     |       |       |                     |  |  |  |  |                    |     |       |       |                     |  |  |  |  |          |     |       |       |                     |  |  |  |  |                    |     |       |       |                     |  |  |  |  |         |     |       |       |                     |  |  |  |  |         |    |       |       |             |                |        |  |                     |     |    |       |       |             |                |        |  |                     |         |    |       |       |             |  |  |  |  |         |    |       |       |             |  |  |  |  |         |     |       |       |             |  |  |  |  |         |     |       |       |             |  |  |  |  |         |    |       |       |             |  |  |  |  |         |     |       |       |             |  |  |  |  |                 |     |       |       |             |  |  |  |  |         |     |       |       |             |  |  |  |  |         |    |       |       |             |  |  |  |  |         |     |       |       |             |  |  |  |  |         |     |       |       |             |  |  |  |  |             |     |       |       |             |  |  |  |  |                 |     |       |       |             |  |  |  |  |                 |     |       |       |             |  |  |  |  |          |     |       |       |             |  |  |  |  |                    |     |       |       |             |  |  |  |  |         |     |       |       |             |  |  |  |  |         |    |       |       |                     |                |        |  |                        |     |    |       |       |                     |                |        |  |                           |         |    |       |       |                     |  |  |  |  |         |    |       |       |                     |  |  |  |  |         |     |       |       |                     |  |  |  |  |         |     |       |       |                     |  |  |  |  |         |    |       |       |                     |  |  |  |  |         |     |       |       |                     |  |  |  |  |                 |     |       |       |                     |  |  |  |  |         |     |       |       |                     |  |  |  |  |         |    |       |       |                     |  |  |  |  |         |     |       |       |                     |  |  |  |  |         |     |       |       |                     |  |  |  |  |             |     |       |       |                     |  |  |  |  |                 |     |       |       |                     |  |  |  |  |                 |     |       |       |                     |  |  |  |  |          |     |       |       |                     |  |  |  |  |
| 1.6 TDI  | 77  | 08.09   | 07.10 | PR: 1LJ,1LH,1ZG,1ZM |                |                     |   |                           |   |                     |         |     |       |       |                     |                |        |   |                     |         |     |       |       |                     |  |  |  |  |             |     |       |       |                     |  |  |  |  |                 |     |       |       |                     |  |  |  |  |                 |     |       |       |                     |  |  |  |  |                    |     |       |       |                     |  |  |  |  |         |     |       |       |                     |  |  |  |  |                 |     |       |       |                     |  |  |  |  |         |     |       |       |                     |  |  |  |  |         |     |       |       |                     |  |  |  |  |             |     |       |       |                     |  |  |  |  |             |     |       |       |                     |  |  |  |  |                 |     |       |       |                     |                |        |   |           |                 |     |       |       |                     |                |        |   |           |                 |     |       |       |                     |  |  |  |  |                    |     |       |       |                     |  |  |  |  |          |     |       |       |                     |  |  |  |  |                    |     |       |       |                     |  |  |  |  |         |     |       |       |                     |  |  |  |  |         |    |       |       |             |                |        |  |                     |     |    |       |       |             |                |        |  |                     |         |    |       |       |             |  |  |  |  |         |    |       |       |             |  |  |  |  |         |     |       |       |             |  |  |  |  |         |     |       |       |             |  |  |  |  |         |    |       |       |             |  |  |  |  |         |     |       |       |             |  |  |  |  |                 |     |       |       |             |  |  |  |  |         |     |       |       |             |  |  |  |  |         |    |       |       |             |  |  |  |  |         |     |       |       |             |  |  |  |  |         |     |       |       |             |  |  |  |  |             |     |       |       |             |  |  |  |  |                 |     |       |       |             |  |  |  |  |                 |     |       |       |             |  |  |  |  |          |     |       |       |             |  |  |  |  |                    |     |       |       |             |  |  |  |  |         |     |       |       |             |  |  |  |  |         |    |       |       |                     |                |        |  |                        |     |    |       |       |                     |                |        |  |                           |         |    |       |       |                     |  |  |  |  |         |    |       |       |                     |  |  |  |  |         |     |       |       |                     |  |  |  |  |         |     |       |       |                     |  |  |  |  |         |    |       |       |                     |  |  |  |  |         |     |       |       |                     |  |  |  |  |                 |     |       |       |                     |  |  |  |  |         |     |       |       |                     |  |  |  |  |         |    |       |       |                     |  |  |  |  |         |     |       |       |                     |  |  |  |  |         |     |       |       |                     |  |  |  |  |             |     |       |       |                     |  |  |  |  |                 |     |       |       |                     |  |  |  |  |                 |     |       |       |                     |  |  |  |  |          |     |       |       |                     |  |  |  |  |
| 1.8 TSI  | 112   | 11.09   | 07.10 | PR: 1LJ,1LH,1ZG,1ZM |                |                     |   |                           |   |                     |         |     |       |       |                     |                |        |   |                     |         |     |       |       |                     |  |  |  |  |             |     |       |       |                     |  |  |  |  |                 |     |       |       |                     |  |  |  |  |                 |     |       |       |                     |  |  |  |  |                    |     |       |       |                     |  |  |  |  |         |     |       |       |                     |  |  |  |  |                 |     |       |       |                     |  |  |  |  |         |     |       |       |                     |  |  |  |  |         |     |       |       |                     |  |  |  |  |             |     |       |       |                     |  |  |  |  |             |     |       |       |                     |  |  |  |  |                 |     |       |       |                     |                |        |   |           |                 |     |       |       |                     |                |        |   |           |                 |     |       |       |                     |  |  |  |  |                    |     |       |       |                     |  |  |  |  |          |     |       |       |                     |  |  |  |  |                    |     |       |       |                     |  |  |  |  |         |     |       |       |                     |  |  |  |  |         |    |       |       |             |                |        |  |                     |     |    |       |       |             |                |        |  |                     |         |    |       |       |             |  |  |  |  |         |    |       |       |             |  |  |  |  |         |     |       |       |             |  |  |  |  |         |     |       |       |             |  |  |  |  |         |    |       |       |             |  |  |  |  |         |     |       |       |             |  |  |  |  |                 |     |       |       |             |  |  |  |  |         |     |       |       |             |  |  |  |  |         |    |       |       |             |  |  |  |  |         |     |       |       |             |  |  |  |  |         |     |       |       |             |  |  |  |  |             |     |       |       |             |  |  |  |  |                 |     |       |       |             |  |  |  |  |                 |     |       |       |             |  |  |  |  |          |     |       |       |             |  |  |  |  |                    |     |       |       |             |  |  |  |  |         |     |       |       |             |  |  |  |  |         |    |       |       |                     |                |        |  |                        |     |    |       |       |                     |                |        |  |                           |         |    |       |       |                     |  |  |  |  |         |    |       |       |                     |  |  |  |  |         |     |       |       |                     |  |  |  |  |         |     |       |       |                     |  |  |  |  |         |    |       |       |                     |  |  |  |  |         |     |       |       |                     |  |  |  |  |                 |     |       |       |                     |  |  |  |  |         |     |       |       |                     |  |  |  |  |         |    |       |       |                     |  |  |  |  |         |     |       |       |                     |  |  |  |  |         |     |       |       |                     |  |  |  |  |             |     |       |       |                     |  |  |  |  |                 |     |       |       |                     |  |  |  |  |                 |     |       |       |                     |  |  |  |  |          |     |       |       |                     |  |  |  |  |
| 1.8 TSI  | 118   | 10.07   | 07.10 | PR: 1LJ,1LH,1ZG,1ZM |                |                     |   |                           |   |                     |         |     |       |       |                     |                |        |   |                     |         |     |       |       |                     |  |  |  |  |             |     |       |       |                     |  |  |  |  |                 |     |       |       |                     |  |  |  |  |                 |     |       |       |                     |  |  |  |  |                    |     |       |       |                     |  |  |  |  |         |     |       |       |                     |  |  |  |  |                 |     |       |       |                     |  |  |  |  |         |     |       |       |                     |  |  |  |  |         |     |       |       |                     |  |  |  |  |             |     |       |       |                     |  |  |  |  |             |     |       |       |                     |  |  |  |  |                 |     |       |       |                     |                |        |   |           |                 |     |       |       |                     |                |        |   |           |                 |     |       |       |                     |  |  |  |  |                    |     |       |       |                     |  |  |  |  |          |     |       |       |                     |  |  |  |  |                    |     |       |       |                     |  |  |  |  |         |     |       |       |                     |  |  |  |  |         |    |       |       |             |                |        |  |                     |     |    |       |       |             |                |        |  |                     |         |    |       |       |             |  |  |  |  |         |    |       |       |             |  |  |  |  |         |     |       |       |             |  |  |  |  |         |     |       |       |             |  |  |  |  |         |    |       |       |             |  |  |  |  |         |     |       |       |             |  |  |  |  |                 |     |       |       |             |  |  |  |  |         |     |       |       |             |  |  |  |  |         |    |       |       |             |  |  |  |  |         |     |       |       |             |  |  |  |  |         |     |       |       |             |  |  |  |  |             |     |       |       |             |  |  |  |  |                 |     |       |       |             |  |  |  |  |                 |     |       |       |             |  |  |  |  |          |     |       |       |             |  |  |  |  |                    |     |       |       |             |  |  |  |  |         |     |       |       |             |  |  |  |  |         |    |       |       |                     |                |        |  |                        |     |    |       |       |                     |                |        |  |                           |         |    |       |       |                     |  |  |  |  |         |    |       |       |                     |  |  |  |  |         |     |       |       |                     |  |  |  |  |         |     |       |       |                     |  |  |  |  |         |    |       |       |                     |  |  |  |  |         |     |       |       |                     |  |  |  |  |                 |     |       |       |                     |  |  |  |  |         |     |       |       |                     |  |  |  |  |         |    |       |       |                     |  |  |  |  |         |     |       |       |                     |  |  |  |  |         |     |       |       |                     |  |  |  |  |             |     |       |       |                     |  |  |  |  |                 |     |       |       |                     |  |  |  |  |                 |     |       |       |                     |  |  |  |  |          |     |       |       |                     |  |  |  |  |
| 1.9 TDI  | 77  | 07.05   | 07.10 | PR: 1LJ,1LH,1ZG,1ZM |                |                     |   |                           |   |                     |         |     |       |       |                     |                |        |   |                     |         |     |       |       |                     |  |  |  |  |             |     |       |       |                     |  |  |  |  |                 |     |       |       |                     |  |  |  |  |                 |     |       |       |                     |  |  |  |  |                    |     |       |       |                     |  |  |  |  |         |     |       |       |                     |  |  |  |  |                 |     |       |       |                     |  |  |  |  |         |     |       |       |                     |  |  |  |  |         |     |       |       |                     |  |  |  |  |             |     |       |       |                     |  |  |  |  |             |     |       |       |                     |  |  |  |  |                 |     |       |       |                     |                |        |   |           |                 |     |       |       |                     |                |        |   |           |                 |     |       |       |                     |  |  |  |  |                    |     |       |       |                     |  |  |  |  |          |     |       |       |                     |  |  |  |  |                    |     |       |       |                     |  |  |  |  |         |     |       |       |                     |  |  |  |  |         |    |       |       |             |                |        |  |                     |     |    |       |       |             |                |        |  |                     |         |    |       |       |             |  |  |  |  |         |    |       |       |             |  |  |  |  |         |     |       |       |             |  |  |  |  |         |     |       |       |             |  |  |  |  |         |    |       |       |             |  |  |  |  |         |     |       |       |             |  |  |  |  |                 |     |       |       |             |  |  |  |  |         |     |       |       |             |  |  |  |  |         |    |       |       |             |  |  |  |  |         |     |       |       |             |  |  |  |  |         |     |       |       |             |  |  |  |  |             |     |       |       |             |  |  |  |  |                 |     |       |       |             |  |  |  |  |                 |     |       |       |             |  |  |  |  |          |     |       |       |             |  |  |  |  |                    |     |       |       |             |  |  |  |  |         |     |       |       |             |  |  |  |  |         |    |       |       |                     |                |        |  |                        |     |    |       |       |                     |                |        |  |                           |         |    |       |       |                     |  |  |  |  |         |    |       |       |                     |  |  |  |  |         |     |       |       |                     |  |  |  |  |         |     |       |       |                     |  |  |  |  |         |    |       |       |                     |  |  |  |  |         |     |       |       |                     |  |  |  |  |                 |     |       |       |                     |  |  |  |  |         |     |       |       |                     |  |  |  |  |         |    |       |       |                     |  |  |  |  |         |     |       |       |                     |  |  |  |  |         |     |       |       |                     |  |  |  |  |             |     |       |       |                     |  |  |  |  |                 |     |       |       |                     |  |  |  |  |                 |     |       |       |                     |  |  |  |  |          |     |       |       |                     |  |  |  |  |
| 2.0 FSI  | 110   | 07.05   | 07.10 | PR: 1LJ,1LH,1ZG,1ZM |                |                     |   |                           |   |                     |         |     |       |       |                     |                |        |   |                     |         |     |       |       |                     |  |  |  |  |             |     |       |       |                     |  |  |  |  |                 |     |       |       |                     |  |  |  |  |                 |     |       |       |                     |  |  |  |  |                    |     |       |       |                     |  |  |  |  |         |     |       |       |                     |  |  |  |  |                 |     |       |       |                     |  |  |  |  |         |     |       |       |                     |  |  |  |  |         |     |       |       |                     |  |  |  |  |             |     |       |       |                     |  |  |  |  |             |     |       |       |                     |  |  |  |  |                 |     |       |       |                     |                |        |   |           |                 |     |       |       |                     |                |        |   |           |                 |     |       |       |                     |  |  |  |  |                    |     |       |       |                     |  |  |  |  |          |     |       |       |                     |  |  |  |  |                    |     |       |       |                     |  |  |  |  |         |     |       |       |                     |  |  |  |  |         |    |       |       |             |                |        |  |                     |     |    |       |       |             |                |        |  |                     |         |    |       |       |             |  |  |  |  |         |    |       |       |             |  |  |  |  |         |     |       |       |             |  |  |  |  |         |     |       |       |             |  |  |  |  |         |    |       |       |             |  |  |  |  |         |     |       |       |             |  |  |  |  |                 |     |       |       |             |  |  |  |  |         |     |       |       |             |  |  |  |  |         |    |       |       |             |  |  |  |  |         |     |       |       |             |  |  |  |  |         |     |       |       |             |  |  |  |  |             |     |       |       |             |  |  |  |  |                 |     |       |       |             |  |  |  |  |                 |     |       |       |             |  |  |  |  |          |     |       |       |             |  |  |  |  |                    |     |       |       |             |  |  |  |  |         |     |       |       |             |  |  |  |  |         |    |       |       |                     |                |        |  |                        |     |    |       |       |                     |                |        |  |                           |         |    |       |       |                     |  |  |  |  |         |    |       |       |                     |  |  |  |  |         |     |       |       |                     |  |  |  |  |         |     |       |       |                     |  |  |  |  |         |    |       |       |                     |  |  |  |  |         |     |       |       |                     |  |  |  |  |                 |     |       |       |                     |  |  |  |  |         |     |       |       |                     |  |  |  |  |         |    |       |       |                     |  |  |  |  |         |     |       |       |                     |  |  |  |  |         |     |       |       |                     |  |  |  |  |             |     |       |       |                     |  |  |  |  |                 |     |       |       |                     |  |  |  |  |                 |     |       |       |                     |  |  |  |  |          |     |       |       |                     |  |  |  |  |
| 2.0 FSI 4motion  | 110   | 09.05   | 07.10 | PR: 1LJ,1LH,1ZG,1ZM |                |                     |   |                           |   |                     |         |     |       |       |                     |                |        |   |                     |         |     |       |       |                     |  |  |  |  |             |     |       |       |                     |  |  |  |  |                 |     |       |       |                     |  |  |  |  |                 |     |       |       |                     |  |  |  |  |                    |     |       |       |                     |  |  |  |  |         |     |       |       |                     |  |  |  |  |                 |     |       |       |                     |  |  |  |  |         |     |       |       |                     |  |  |  |  |         |     |       |       |                     |  |  |  |  |             |     |       |       |                     |  |  |  |  |             |     |       |       |                     |  |  |  |  |                 |     |       |       |                     |                |        |   |           |                 |     |       |       |                     |                |        |   |           |                 |     |       |       |                     |  |  |  |  |                    |     |       |       |                     |  |  |  |  |          |     |       |       |                     |  |  |  |  |                    |     |       |       |                     |  |  |  |  |         |     |       |       |                     |  |  |  |  |         |    |       |       |             |                |        |  |                     |     |    |       |       |             |                |        |  |                     |         |    |       |       |             |  |  |  |  |         |    |       |       |             |  |  |  |  |         |     |       |       |             |  |  |  |  |         |     |       |       |             |  |  |  |  |         |    |       |       |             |  |  |  |  |         |     |       |       |             |  |  |  |  |                 |     |       |       |             |  |  |  |  |         |     |       |       |             |  |  |  |  |         |    |       |       |             |  |  |  |  |         |     |       |       |             |  |  |  |  |         |     |       |       |             |  |  |  |  |             |     |       |       |             |  |  |  |  |                 |     |       |       |             |  |  |  |  |                 |     |       |       |             |  |  |  |  |          |     |       |       |             |  |  |  |  |                    |     |       |       |             |  |  |  |  |         |     |       |       |             |  |  |  |  |         |    |       |       |                     |                |        |  |                        |     |    |       |       |                     |                |        |  |                           |         |    |       |       |                     |  |  |  |  |         |    |       |       |                     |  |  |  |  |         |     |       |       |                     |  |  |  |  |         |     |       |       |                     |  |  |  |  |         |    |       |       |                     |  |  |  |  |         |     |       |       |                     |  |  |  |  |                 |     |       |       |                     |  |  |  |  |         |     |       |       |                     |  |  |  |  |         |    |       |       |                     |  |  |  |  |         |     |       |       |                     |  |  |  |  |         |     |       |       |                     |  |  |  |  |             |     |       |       |                     |  |  |  |  |                 |     |       |       |                     |  |  |  |  |                 |     |       |       |                     |  |  |  |  |          |     |       |       |                     |  |  |  |  |
| 2.0 TDI  | 100   | 11.05   | 07.10 | PR: 1LJ,1LH,1ZG,1ZM |                |                     |   |                           |   |                     |         |     |       |       |                     |                |        |   |                     |         |     |       |       |                     |  |  |  |  |             |     |       |       |                     |  |  |  |  |                 |     |       |       |                     |  |  |  |  |                 |     |       |       |                     |  |  |  |  |                    |     |       |       |                     |  |  |  |  |         |     |       |       |                     |  |  |  |  |                 |     |       |       |                     |  |  |  |  |         |     |       |       |                     |  |  |  |  |         |     |       |       |                     |  |  |  |  |             |     |       |       |                     |  |  |  |  |             |     |       |       |                     |  |  |  |  |                 |     |       |       |                     |                |        |   |           |                 |     |       |       |                     |                |        |   |           |                 |     |       |       |                     |  |  |  |  |                    |     |       |       |                     |  |  |  |  |          |     |       |       |                     |  |  |  |  |                    |     |       |       |                     |  |  |  |  |         |     |       |       |                     |  |  |  |  |         |    |       |       |             |                |        |  |                     |     |    |       |       |             |                |        |  |                     |         |    |       |       |             |  |  |  |  |         |    |       |       |             |  |  |  |  |         |     |       |       |             |  |  |  |  |         |     |       |       |             |  |  |  |  |         |    |       |       |             |  |  |  |  |         |     |       |       |             |  |  |  |  |                 |     |       |       |             |  |  |  |  |         |     |       |       |             |  |  |  |  |         |    |       |       |             |  |  |  |  |         |     |       |       |             |  |  |  |  |         |     |       |       |             |  |  |  |  |             |     |       |       |             |  |  |  |  |                 |     |       |       |             |  |  |  |  |                 |     |       |       |             |  |  |  |  |          |     |       |       |             |  |  |  |  |                    |     |       |       |             |  |  |  |  |         |     |       |       |             |  |  |  |  |         |    |       |       |                     |                |        |  |                        |     |    |       |       |                     |                |        |  |                           |         |    |       |       |                     |  |  |  |  |         |    |       |       |                     |  |  |  |  |         |     |       |       |                     |  |  |  |  |         |     |       |       |                     |  |  |  |  |         |    |       |       |                     |  |  |  |  |         |     |       |       |                     |  |  |  |  |                 |     |       |       |                     |  |  |  |  |         |     |       |       |                     |  |  |  |  |         |    |       |       |                     |  |  |  |  |         |     |       |       |                     |  |  |  |  |         |     |       |       |                     |  |  |  |  |             |     |       |       |                     |  |  |  |  |                 |     |       |       |                     |  |  |  |  |                 |     |       |       |                     |  |  |  |  |          |     |       |       |                     |  |  |  |  |
| 2.0 TDI  | 90  | 07.05   | 07.10 | PR: 1LJ,1LH,1ZG,1ZM |                |                     |   |                           |   |                     |         |     |       |       |                     |                |        |   |                     |         |     |       |       |                     |  |  |  |  |             |     |       |       |                     |  |  |  |  |                 |     |       |       |                     |  |  |  |  |                 |     |       |       |                     |  |  |  |  |                    |     |       |       |                     |  |  |  |  |         |     |       |       |                     |  |  |  |  |                 |     |       |       |                     |  |  |  |  |         |     |       |       |                     |  |  |  |  |         |     |       |       |                     |  |  |  |  |             |     |       |       |                     |  |  |  |  |             |     |       |       |                     |  |  |  |  |                 |     |       |       |                     |                |        |   |           |                 |     |       |       |                     |                |        |   |           |                 |     |       |       |                     |  |  |  |  |                    |     |       |       |                     |  |  |  |  |          |     |       |       |                     |  |  |  |  |                    |     |       |       |                     |  |  |  |  |         |     |       |       |                     |  |  |  |  |         |    |       |       |             |                |        |  |                     |     |    |       |       |             |                |        |  |                     |         |    |       |       |             |  |  |  |  |         |    |       |       |             |  |  |  |  |         |     |       |       |             |  |  |  |  |         |     |       |       |             |  |  |  |  |         |    |       |       |             |  |  |  |  |         |     |       |       |             |  |  |  |  |                 |     |       |       |             |  |  |  |  |         |     |       |       |             |  |  |  |  |         |    |       |       |             |  |  |  |  |         |     |       |       |             |  |  |  |  |         |     |       |       |             |  |  |  |  |             |     |       |       |             |  |  |  |  |                 |     |       |       |             |  |  |  |  |                 |     |       |       |             |  |  |  |  |          |     |       |       |             |  |  |  |  |                    |     |       |       |             |  |  |  |  |         |     |       |       |             |  |  |  |  |         |    |       |       |                     |                |        |  |                        |     |    |       |       |                     |                |        |  |                           |         |    |       |       |                     |  |  |  |  |         |    |       |       |                     |  |  |  |  |         |     |       |       |                     |  |  |  |  |         |     |       |       |                     |  |  |  |  |         |    |       |       |                     |  |  |  |  |         |     |       |       |                     |  |  |  |  |                 |     |       |       |                     |  |  |  |  |         |     |       |       |                     |  |  |  |  |         |    |       |       |                     |  |  |  |  |         |     |       |       |                     |  |  |  |  |         |     |       |       |                     |  |  |  |  |             |     |       |       |                     |  |  |  |  |                 |     |       |       |                     |  |  |  |  |                 |     |       |       |                     |  |  |  |  |          |     |       |       |                     |  |  |  |  |
| 2.0 TDI  | 100   | 07.05   | 07.10 | PR: 1LJ,1LH,1ZG,1ZM |                |                     |   |                           |   |                     |         |     |       |       |                     |                |        |   |                     |         |     |       |       |                     |  |  |  |  |             |     |       |       |                     |  |  |  |  |                 |     |       |       |                     |  |  |  |  |                 |     |       |       |                     |  |  |  |  |                    |     |       |       |                     |  |  |  |  |         |     |       |       |                     |  |  |  |  |                 |     |       |       |                     |  |  |  |  |         |     |       |       |                     |  |  |  |  |         |     |       |       |                     |  |  |  |  |             |     |       |       |                     |  |  |  |  |             |     |       |       |                     |  |  |  |  |                 |     |       |       |                     |                |        |   |           |                 |     |       |       |                     |                |        |   |           |                 |     |       |       |                     |  |  |  |  |                    |     |       |       |                     |  |  |  |  |          |     |       |       |                     |  |  |  |  |                    |     |       |       |                     |  |  |  |  |         |     |       |       |                     |  |  |  |  |         |    |       |       |             |                |        |  |                     |     |    |       |       |             |                |        |  |                     |         |    |       |       |             |  |  |  |  |         |    |       |       |             |  |  |  |  |         |     |       |       |             |  |  |  |  |         |     |       |       |             |  |  |  |  |         |    |       |       |             |  |  |  |  |         |     |       |       |             |  |  |  |  |                 |     |       |       |             |  |  |  |  |         |     |       |       |             |  |  |  |  |         |    |       |       |             |  |  |  |  |         |     |       |       |             |  |  |  |  |         |     |       |       |             |  |  |  |  |             |     |       |       |             |  |  |  |  |                 |     |       |       |             |  |  |  |  |                 |     |       |       |             |  |  |  |  |          |     |       |       |             |  |  |  |  |                    |     |       |       |             |  |  |  |  |         |     |       |       |             |  |  |  |  |         |    |       |       |                     |                |        |  |                        |     |    |       |       |                     |                |        |  |                           |         |    |       |       |                     |  |  |  |  |         |    |       |       |                     |  |  |  |  |         |     |       |       |                     |  |  |  |  |         |     |       |       |                     |  |  |  |  |         |    |       |       |                     |  |  |  |  |         |     |       |       |                     |  |  |  |  |                 |     |       |       |                     |  |  |  |  |         |     |       |       |                     |  |  |  |  |         |    |       |       |                     |  |  |  |  |         |     |       |       |                     |  |  |  |  |         |     |       |       |                     |  |  |  |  |             |     |       |       |                     |  |  |  |  |                 |     |       |       |                     |  |  |  |  |                 |     |       |       |                     |  |  |  |  |          |     |       |       |                     |  |  |  |  |
| 2.0 TDI  | 125   | 07.05   | 07.10 | PR: 1LJ,1LH,1ZG,1ZM |                |                     |   |                           |   |                     |         |     |       |       |                     |                |        |   |                     |         |     |       |       |                     |  |  |  |  |             |     |       |       |                     |  |  |  |  |                 |     |       |       |                     |  |  |  |  |                 |     |       |       |                     |  |  |  |  |                    |     |       |       |                     |  |  |  |  |         |     |       |       |                     |  |  |  |  |                 |     |       |       |                     |  |  |  |  |         |     |       |       |                     |  |  |  |  |         |     |       |       |                     |  |  |  |  |             |     |       |       |                     |  |  |  |  |             |     |       |       |                     |  |  |  |  |                 |     |       |       |                     |                |        |   |           |                 |     |       |       |                     |                |        |   |           |                 |     |       |       |                     |  |  |  |  |                    |     |       |       |                     |  |  |  |  |          |     |       |       |                     |  |  |  |  |                    |     |       |       |                     |  |  |  |  |         |     |       |       |                     |  |  |  |  |         |    |       |       |             |                |        |  |                     |     |    |       |       |             |                |        |  |                     |         |    |       |       |             |  |  |  |  |         |    |       |       |             |  |  |  |  |         |     |       |       |             |  |  |  |  |         |     |       |       |             |  |  |  |  |         |    |       |       |             |  |  |  |  |         |     |       |       |             |  |  |  |  |                 |     |       |       |             |  |  |  |  |         |     |       |       |             |  |  |  |  |         |    |       |       |             |  |  |  |  |         |     |       |       |             |  |  |  |  |         |     |       |       |             |  |  |  |  |             |     |       |       |             |  |  |  |  |                 |     |       |       |             |  |  |  |  |                 |     |       |       |             |  |  |  |  |          |     |       |       |             |  |  |  |  |                    |     |       |       |             |  |  |  |  |         |     |       |       |             |  |  |  |  |         |    |       |       |                     |                |        |  |                        |     |    |       |       |                     |                |        |  |                           |         |    |       |       |                     |  |  |  |  |         |    |       |       |                     |  |  |  |  |         |     |       |       |                     |  |  |  |  |         |     |       |       |                     |  |  |  |  |         |    |       |       |                     |  |  |  |  |         |     |       |       |                     |  |  |  |  |                 |     |       |       |                     |  |  |  |  |         |     |       |       |                     |  |  |  |  |         |    |       |       |                     |  |  |  |  |         |     |       |       |                     |  |  |  |  |         |     |       |       |                     |  |  |  |  |             |     |       |       |                     |  |  |  |  |                 |     |       |       |                     |  |  |  |  |                 |     |       |       |                     |  |  |  |  |          |     |       |       |                     |  |  |  |  |
| 2.0 TDI 16V  | 103   | 08.05   | 07.10 | PR: 1LJ,1LH,1ZG,1ZM |                |                     |   |                           |   |                     |         |     |       |       |                     |                |        |   |                     |         |     |       |       |                     |  |  |  |  |             |     |       |       |                     |  |  |  |  |                 |     |       |       |                     |  |  |  |  |                 |     |       |       |                     |  |  |  |  |                    |     |       |       |                     |  |  |  |  |         |     |       |       |                     |  |  |  |  |                 |     |       |       |                     |  |  |  |  |         |     |       |       |                     |  |  |  |  |         |     |       |       |                     |  |  |  |  |             |     |       |       |                     |  |  |  |  |             |     |       |       |                     |  |  |  |  |                 |     |       |       |                     |                |        |   |           |                 |     |       |       |                     |                |        |   |           |                 |     |       |       |                     |  |  |  |  |                    |     |       |       |                     |  |  |  |  |          |     |       |       |                     |  |  |  |  |                    |     |       |       |                     |  |  |  |  |         |     |       |       |                     |  |  |  |  |         |    |       |       |             |                |        |  |                     |     |    |       |       |             |                |        |  |                     |         |    |       |       |             |  |  |  |  |         |    |       |       |             |  |  |  |  |         |     |       |       |             |  |  |  |  |         |     |       |       |             |  |  |  |  |         |    |       |       |             |  |  |  |  |         |     |       |       |             |  |  |  |  |                 |     |       |       |             |  |  |  |  |         |     |       |       |             |  |  |  |  |         |    |       |       |             |  |  |  |  |         |     |       |       |             |  |  |  |  |         |     |       |       |             |  |  |  |  |             |     |       |       |             |  |  |  |  |                 |     |       |       |             |  |  |  |  |                 |     |       |       |             |  |  |  |  |          |     |       |       |             |  |  |  |  |                    |     |       |       |             |  |  |  |  |         |     |       |       |             |  |  |  |  |         |    |       |       |                     |                |        |  |                        |     |    |       |       |                     |                |        |  |                           |         |    |       |       |                     |  |  |  |  |         |    |       |       |                     |  |  |  |  |         |     |       |       |                     |  |  |  |  |         |     |       |       |                     |  |  |  |  |         |    |       |       |                     |  |  |  |  |         |     |       |       |                     |  |  |  |  |                 |     |       |       |                     |  |  |  |  |         |     |       |       |                     |  |  |  |  |         |    |       |       |                     |  |  |  |  |         |     |       |       |                     |  |  |  |  |         |     |       |       |                     |  |  |  |  |             |     |       |       |                     |  |  |  |  |                 |     |       |       |                     |  |  |  |  |                 |     |       |       |                     |  |  |  |  |          |     |       |       |                     |  |  |  |  |
| 2.0 TDI 4motion  | 103   | 09.05   | 07.10 | PR: 1LJ,1LH,1ZG,1ZM |                |                     |   |                           |   |                     |         |     |       |       |                     |                |        |   |                     |         |     |       |       |                     |  |  |  |  |             |     |       |       |                     |  |  |  |  |                 |     |       |       |                     |  |  |  |  |                 |     |       |       |                     |  |  |  |  |                    |     |       |       |                     |  |  |  |  |         |     |       |       |                     |  |  |  |  |                 |     |       |       |                     |  |  |  |  |         |     |       |       |                     |  |  |  |  |         |     |       |       |                     |  |  |  |  |             |     |       |       |                     |  |  |  |  |             |     |       |       |                     |  |  |  |  |                 |     |       |       |                     |                |        |   |           |                 |     |       |       |                     |                |        |   |           |                 |     |       |       |                     |  |  |  |  |                    |     |       |       |                     |  |  |  |  |          |     |       |       |                     |  |  |  |  |                    |     |       |       |                     |  |  |  |  |         |     |       |       |                     |  |  |  |  |         |    |       |       |             |                |        |  |                     |     |    |       |       |             |                |        |  |                     |         |    |       |       |             |  |  |  |  |         |    |       |       |             |  |  |  |  |         |     |       |       |             |  |  |  |  |         |     |       |       |             |  |  |  |  |         |    |       |       |             |  |  |  |  |         |     |       |       |             |  |  |  |  |                 |     |       |       |             |  |  |  |  |         |     |       |       |             |  |  |  |  |         |    |       |       |             |  |  |  |  |         |     |       |       |             |  |  |  |  |         |     |       |       |             |  |  |  |  |             |     |       |       |             |  |  |  |  |                 |     |       |       |             |  |  |  |  |                 |     |       |       |             |  |  |  |  |          |     |       |       |             |  |  |  |  |                    |     |       |       |             |  |  |  |  |         |     |       |       |             |  |  |  |  |         |    |       |       |                     |                |        |  |                        |     |    |       |       |                     |                |        |  |                           |         |    |       |       |                     |  |  |  |  |         |    |       |       |                     |  |  |  |  |         |     |       |       |                     |  |  |  |  |         |     |       |       |                     |  |  |  |  |         |    |       |       |                     |  |  |  |  |         |     |       |       |                     |  |  |  |  |                 |     |       |       |                     |  |  |  |  |         |     |       |       |                     |  |  |  |  |         |    |       |       |                     |  |  |  |  |         |     |       |       |                     |  |  |  |  |         |     |       |       |                     |  |  |  |  |             |     |       |       |                     |  |  |  |  |                 |     |       |       |                     |  |  |  |  |                 |     |       |       |                     |  |  |  |  |          |     |       |       |                     |  |  |  |  |
| 2.0 TDI 4motion  | 125   | 05.09   | 07.10 | PR: 1LJ,1LH,1ZG,1ZM |                |                     |   |                           |   |                     |         |     |       |       |                     |                |        |   |                     |         |     |       |       |                     |  |  |  |  |             |     |       |       |                     |  |  |  |  |                 |     |       |       |                     |  |  |  |  |                 |     |       |       |                     |  |  |  |  |                    |     |       |       |                     |  |  |  |  |         |     |       |       |                     |  |  |  |  |                 |     |       |       |                     |  |  |  |  |         |     |       |       |                     |  |  |  |  |         |     |       |       |                     |  |  |  |  |             |     |       |       |                     |  |  |  |  |             |     |       |       |                     |  |  |  |  |                 |     |       |       |                     |                |        |   |           |                 |     |       |       |                     |                |        |   |           |                 |     |       |       |                     |  |  |  |  |                    |     |       |       |                     |  |  |  |  |          |     |       |       |                     |  |  |  |  |                    |     |       |       |                     |  |  |  |  |         |     |       |       |                     |  |  |  |  |         |    |       |       |             |                |        |  |                     |     |    |       |       |             |                |        |  |                     |         |    |       |       |             |  |  |  |  |         |    |       |       |             |  |  |  |  |         |     |       |       |             |  |  |  |  |         |     |       |       |             |  |  |  |  |         |    |       |       |             |  |  |  |  |         |     |       |       |             |  |  |  |  |                 |     |       |       |             |  |  |  |  |         |     |       |       |             |  |  |  |  |         |    |       |       |             |  |  |  |  |         |     |       |       |             |  |  |  |  |         |     |       |       |             |  |  |  |  |             |     |       |       |             |  |  |  |  |                 |     |       |       |             |  |  |  |  |                 |     |       |       |             |  |  |  |  |          |     |       |       |             |  |  |  |  |                    |     |       |       |             |  |  |  |  |         |     |       |       |             |  |  |  |  |         |    |       |       |                     |                |        |  |                        |     |    |       |       |                     |                |        |  |                           |         |    |       |       |                     |  |  |  |  |         |    |       |       |                     |  |  |  |  |         |     |       |       |                     |  |  |  |  |         |     |       |       |                     |  |  |  |  |         |    |       |       |                     |  |  |  |  |         |     |       |       |                     |  |  |  |  |                 |     |       |       |                     |  |  |  |  |         |     |       |       |                     |  |  |  |  |         |    |       |       |                     |  |  |  |  |         |     |       |       |                     |  |  |  |  |         |     |       |       |                     |  |  |  |  |             |     |       |       |                     |  |  |  |  |                 |     |       |       |                     |  |  |  |  |                 |     |       |       |                     |  |  |  |  |          |     |       |       |                     |  |  |  |  |
| 2.0 TFSI   | 147   | 07.05   | 07.10 | PR: 1LJ,1LH,1ZG,1ZM |                |                     |   |                           |   |                     |         |     |       |       |                     |                |        |   |                     |         |     |       |       |                     |  |  |  |  |             |     |       |       |                     |  |  |  |  |                 |     |       |       |                     |  |  |  |  |                 |     |       |       |                     |  |  |  |  |                    |     |       |       |                     |  |  |  |  |         |     |       |       |                     |  |  |  |  |                 |     |       |       |                     |  |  |  |  |         |     |       |       |                     |  |  |  |  |         |     |       |       |                     |  |  |  |  |             |     |       |       |                     |  |  |  |  |             |     |       |       |                     |  |  |  |  |                 |     |       |       |                     |                |        |   |           |                 |     |       |       |                     |                |        |   |           |                 |     |       |       |                     |  |  |  |  |                    |     |       |       |                     |  |  |  |  |          |     |       |       |                     |  |  |  |  |                    |     |       |       |                     |  |  |  |  |         |     |       |       |                     |  |  |  |  |         |    |       |       |             |                |        |  |                     |     |    |       |       |             |                |        |  |                     |         |    |       |       |             |  |  |  |  |         |    |       |       |             |  |  |  |  |         |     |       |       |             |  |  |  |  |         |     |       |       |             |  |  |  |  |         |    |       |       |             |  |  |  |  |         |     |       |       |             |  |  |  |  |                 |     |       |       |             |  |  |  |  |         |     |       |       |             |  |  |  |  |         |    |       |       |             |  |  |  |  |         |     |       |       |             |  |  |  |  |         |     |       |       |             |  |  |  |  |             |     |       |       |             |  |  |  |  |                 |     |       |       |             |  |  |  |  |                 |     |       |       |             |  |  |  |  |          |     |       |       |             |  |  |  |  |                    |     |       |       |             |  |  |  |  |         |     |       |       |             |  |  |  |  |         |    |       |       |                     |                |        |  |                        |     |    |       |       |                     |                |        |  |                           |         |    |       |       |                     |  |  |  |  |         |    |       |       |                     |  |  |  |  |         |     |       |       |                     |  |  |  |  |         |     |       |       |                     |  |  |  |  |         |    |       |       |                     |  |  |  |  |         |     |       |       |                     |  |  |  |  |                 |     |       |       |                     |  |  |  |  |         |     |       |       |                     |  |  |  |  |         |    |       |       |                     |  |  |  |  |         |     |       |       |                     |  |  |  |  |         |     |       |       |                     |  |  |  |  |             |     |       |       |                     |  |  |  |  |                 |     |       |       |                     |  |  |  |  |                 |     |       |       |                     |  |  |  |  |          |     |       |       |                     |  |  |  |  |

<sup>1)</sup> electric parking brake / fr.di stazionamento elettrico / frein à main électrique / freno de mano eléctrico

|     |   |                               |   |   |   |  |  |   |
|--|---|---|---|---|--|--|--|---|
| <b>VOLKSWAGEN PASSAT Variant (05-10)</b>   |   |   |   |   |  |  |  |   |
|    | 3.2 V6 FSI 4motion<br>3.6 R36   | 184<br>220  | 11.05<br>04.07  | 07.10<br>07.10  | PR: 1LJ,1LH,1ZG,1ZM<br>PR: 1LJ,1LH,1ZG,1ZM   | 24.0125-0158.1<br>24.0325-0158.1   | 425158<br>525158   | 312 25,0 22,0 VL +S +B<br>312 25,0 22,0 VL +S +B PD   |
|  | 1.4 TSI<br>1.6<br>1.6 FSI<br>1.6 TDI<br>1.8 TSI<br>1.8 TSI<br>1.9 TDI<br>2.0 FSI<br>2.0 FSI 4motion<br>2.0 TDI<br>2.0 TDI<br>2.0 TDI<br>2.0 TDI<br>2.0 TDI 16V<br>2.0 TDI 4motion<br>2.0 TDI 4motion<br>2.0 TFSI<br>3.2 V6 FSI 4motion<br>3.6 R36 | 90<br>75<br>85<br>77<br>112<br>118<br>77<br>110<br>90<br>100<br>125<br>103<br>103<br>125<br>147<br>184<br>220 | 10.07<br>07.05<br>07.05<br>08.09<br>11.09<br>10.07<br>07.05<br>07.05<br>09.05<br>11.05<br>07.05<br>07.05<br>07.05<br>08.05<br>09.05<br>05.09<br>07.05<br>11.05<br>04.07 | 07.10<br>07.10<br>07.10<br>07.10<br>07.10<br>07.10<br>07.10<br>07.10<br>07.10<br>07.10<br>07.10<br>07.10<br>07.10<br>07.10<br>07.10<br>07.10<br>07.10<br>07.10<br>07.10 | PR: 1LK,1LM<br>PR: 1LK,1LM<br>PR: 1LK,1LM<br>PR: 1LK,1LM<br>PR: 1LK,1LM<br>PR: 1LK,1LM<br>PR: 1LK,1LM<br>PR: 1LK,1LM<br>PR: 1LK,1LM<br>PR: 1LK,1LM<br>PR: 1LK,1LM<br>PR: 1LK,1LM<br>PR: 1LK,1LM<br>PR: 1LK,1LM<br>PR: 1LK,1LM<br>PR: 1LK,1LM<br>PR: 1LK,1LM<br>PR: 1LK,1LM | 24.0130-0115.1<br>24.0330-0115.1   | 430115<br>530115   | 345 30,0 27,0 VL +B<br>345 30,0 27,0 VL +B PD   |
|    | 1.4 TSI<br>1.6<br>1.6 FSI<br>1.6 TDI<br>1.8 TSI<br>1.8 TSI<br>1.9 TDI<br>2.0 FSI<br>2.0 FSI 4motion<br>2.0 TDI<br>2.0 TDI<br>2.0 TDI<br>2.0 TDI<br>2.0 TDI 16V<br>2.0 TDI 4motion<br>2.0 TDI 4motion<br>2.0 TFSI<br>3.2 V6 FSI 4motion<br>3.6 R36 | 90<br>75<br>85<br>77<br>112<br>118<br>77<br>110<br>90<br>100<br>125<br>103<br>103<br>125<br>147<br>184<br>220 | 10.07<br>07.05<br>07.05<br>08.09<br>11.09<br>10.07<br>07.05<br>07.05<br>09.05<br>11.05<br>07.05<br>07.05<br>07.05<br>08.05<br>09.05<br>05.09<br>07.05<br>11.05<br>04.07 | 07.10<br>07.10<br>07.10<br>07.10<br>07.10<br>07.10<br>07.10<br>07.10<br>07.10<br>07.10<br>07.10<br>07.10<br>07.10<br>07.10<br>07.10<br>07.10<br>07.10<br>07.10          |  | 24.0711-5271.3<br>24.0711-5272.3   | 360301<br>360302   | Radensensor<br>Radensensor  |
|  | 1.4 TSI<br>1.6<br>1.6 FSI<br>1.6 TDI<br>1.8 TSI<br>1.8 TSI<br>1.9 TDI<br>2.0 FSI<br>2.0 FSI 4motion<br>2.0 TDI<br>2.0 TDI<br>2.0 TDI<br>2.0 TDI<br>2.0 TDI 16V<br>2.0 TDI 4motion<br>2.0 TDI 4motion<br>2.0 TFSI<br>3.2 V6 FSI 4motion<br>3.6 R36 | 90<br>75<br>85<br>77<br>112<br>118<br>77<br>110<br>90<br>100<br>125<br>103<br>103<br>125<br>147<br>184<br>220 | 10.07<br>07.05<br>07.05<br>08.09<br>11.09<br>10.07<br>07.05<br>07.05<br>09.05<br>11.05<br>07.05<br>07.05<br>07.05<br>08.05<br>09.05<br>05.09<br>07.05<br>11.05<br>04.07 | 07.10<br>07.10<br>07.10<br>07.10<br>07.10<br>07.10<br>07.10<br>07.10<br>07.10<br>07.10<br>07.10<br>07.10<br>07.10<br>07.10<br>07.10<br>07.10<br>07.10<br>07.10          | PR: 1KU,1KW<br>PR: 1KU,1KW<br>PR: 1KU,1KW<br>PR: 1KU,1KW<br>PR: 1KU,1KW<br>PR: 1KU,1KW<br>PR: 1KU,1KW<br>PR: 1KU,1KW<br>PR: 1KU,1KW<br>PR: 1KU,1KW<br>PR: 1KU,1KW<br>PR: 1KU,1KW<br>PR: 1KU,1KW<br>PR: 1KU,1KW<br>PR: 1KU,1KW<br>PR: 1KU,1KW<br>PR: 1KU,1KW<br>PR: 1KU,1KW | 13.0460-2880.2<br>13.0470-2880.2<br>13.0460-0259.2                                 | 602880<br>LD2880<br>610259   | elektrische Feststellbremse <sup>1)</sup><br>elektrische Feststellbremse <sup>1)</sup><br>23914 17,1 /WE/Zub/S TRW<br>Belagsatz-Zubehör |
|  | 1.4 TSI<br>1.6<br>1.6 FSI<br>1.6 TDI<br>1.8 TSI<br>1.8 TSI<br>1.9 TDI<br>2.0 FSI<br>2.0 FSI 4motion<br>2.0 TDI<br>2.0 TDI<br>2.0 TDI<br>2.0 TDI<br>2.0 TDI 16V<br>2.0 TDI 4motion<br>2.0 TDI 4motion<br>2.0 TFSI<br>3.2 V6 FSI 4motion<br>3.6 R36 | 90<br>75<br>85<br>77<br>112<br>118<br>77<br>110<br>90<br>100<br>125<br>103<br>103<br>125<br>147<br>184<br>220 | 10.07<br>07.05<br>07.05<br>08.09<br>11.09<br>10.07<br>07.05<br>07.05<br>09.05<br>11.05<br>07.05<br>07.05<br>07.05<br>08.05<br>09.05<br>05.09<br>07.05<br>11.05<br>04.07 | 07.10<br>07.10<br>07.10<br>07.10<br>07.10<br>07.10<br>07.10<br>07.10<br>07.10<br>07.10<br>07.10<br>07.10<br>07.10<br>07.10<br>07.10<br>07.10<br>07.10<br>07.10          | PR: 2EA,2EL<br>PR: 2EA,2EL<br>PR: 2EA,2EL<br>PR: 2EA,2EL<br>PR: 2EA,2EL<br>PR: 2EA,2EL<br>PR: 2EA,2EL<br>PR: 2EA,2EL<br>PR: 2EA,2EL<br>PR: 2EA,2EL<br>PR: 2EA,2EL<br>PR: 2EA,2EL<br>PR: 2EA,2EL<br>PR: 2EA,2EL<br>PR: 2EA,2EL<br>PR: 2EA,2EL<br>PR: 2EA,2EL<br>PR: 2EA,2EL | 13.0460-2887.2<br>13.0470-2887.2<br>13.0460-0035.2                                 | 602887<br>LD2887<br>610035   | elektrische Feststellbremse <sup>1)</sup><br>elektrische Feststellbremse <sup>1)</sup><br>23914 17,1 /WE/Zub/S TRW<br>Belagsatz-Zubehör |
|  | 1.4 TSI<br>1.6<br>1.6 FSI<br>1.6 TDI<br>1.8 TSI   | 90<br>75<br>85<br>77<br>112   | 10.07<br>07.05<br>07.05<br>08.09<br>11.09   | 07.10<br>07.10<br>07.10<br>07.10<br>07.10   | PR: 1KU,1KW<br>PR: 1KU,1KW<br>PR: 1KU,1KW<br>PR: 1KU,1KW<br>PR: 1KU,1KW  | 24.0112-0169.1<br>24.0312-0169.1   | 412169<br>512169   | elektrische Feststellbremse <sup>1)</sup><br>elektrische Feststellbremse <sup>1)</sup><br>282 12,0 10,0 +S +B<br>282 12,0 10,0 +S +B PD |

<sup>1)</sup> electric parking brake / fr.di stazionamento elettrico / frein à main électrique / freno de mano eléctrico



### VOLKSWAGEN PASSAT Variant (05-10)

|                    |                    |       |       |             |                |                |           |   |   |                        |
|--------------------|--------------------|-------|-------|-------------|----------------|----------------|-----------|---|---|------------------------|
|                    | 1.8 TSI            | 118   | 10.07 | 07.10       | PR: 1KU,1KW    | 24.0112-0169.1 | 412169    | elektrische Feststellbremse <sup>1)</sup> | 282 12,0 10,0 +S +B                       |                        |
|                    | 1.9 TDI            | 77    | 07.05 | 07.10       | PR: 1KU,1KW    | 24.0312-0169.1 | 512169    |   | elektrische Feststellbremse <sup>1)</sup> | 282 12,0 10,0 +S +B PD |
|                    | 2.0 FSI            |       | 07.05 | 07.10       | PR: 1KU,1KW    |                |           |   |   |                        |
|                    | 2.0 FSI 4motion    | 110   | 09.05 | 07.10       | PR: 1KU,1KW    |                |           |   |   |                        |
|                    | 2.0 TDI            |       | 11.05 | 07.10       | PR: 1KU,1KW    |                |           |   |   |                        |
|                    | 2.0 TDI            |       | 07.05 | 07.10       | PR: 1KU,1KW    |                |           |   |   |                        |
|                    | 2.0 TDI            | 90    | 07.05 | 07.10       | PR: 1KU,1KW    |                |           |   |   |                        |
|                    | 2.0 TDI            | 100   | 07.05 | 07.10       | PR: 1KU,1KW    |                |           |   |   |                        |
|                    | 2.0 TDI            | 125   | 07.05 | 07.10       | PR: 1KU,1KW    |                |           |   |   |                        |
|                    | 2.0 TDI 16V        | 103   | 08.05 | 07.10       | PR: 1KU,1KW    |                |           |   |   |                        |
|                    | 2.0 TDI 4motion    | 103   | 09.05 | 07.10       | PR: 1KU,1KW    |                |           |   |   |                        |
|                    | 2.0 TDI 4motion    | 125   | 05.09 | 07.10       | PR: 1KU,1KW    |                |           |   |   |                        |
|                    | 2.0 TFSI           | 147   | 07.05 | 07.10       | PR: 1KU,1KW    |                |           |   |   |                        |
|                    | 3.2 V6 FSI 4motion | 184   | 11.05 | 07.10       | PR: 1KU,1KW    |                |           |   |   |                        |
|                    | 3.6 R36            | 220   | 04.07 | 07.10       | PR: 1KU,1KW    |                |           |   |   |                        |
|                    | 1.4 TSI            | 90    | 10.07 | 07.10       | PR: 2EA,2EL    | 24.0122-0219.1 | 422219    | elektrische Feststellbremse <sup>1)</sup> | 310 22,0 20,0 V L +B                      |                        |
|                    | 1.6                | 75    | 07.05 | 07.10       | PR: 2EA,2EL    |                |           |   |   |                        |
|                    | 1.6 FSI            | 85    | 07.05 | 07.10       | PR: 2EA,2EL    |                |           |   |   |                        |
|                    | 1.6 TDI            | 77    | 08.09 | 07.10       | PR: 2EA,2EL    |                |           |   |   |                        |
|                    | 1.8 TSI            | 112   | 11.09 | 07.10       | PR: 2EA,2EL    |                |           |   |   |                        |
|                    | 1.8 TSI            | 118   | 10.07 | 07.10       | PR: 2EA,2EL    |                |           |   |   |                        |
|                    | 1.9 TDI            | 77    | 07.05 | 07.10       | PR: 2EA,2EL    |                |           |   |   |                        |
|                    | 2.0 FSI            |       | 07.05 | 07.10       | PR: 2EA,2EL    |                |           |   |   |                        |
|                    | 2.0 FSI 4motion    | 110   | 09.05 | 07.10       | PR: 2EA,2EL    |                |           |   |   |                        |
|                    | 2.0 TDI            |       | 11.05 | 07.10       | PR: 2EA,2EL    |                |           |   |   |                        |
|                    | 2.0 TDI            |       | 07.05 | 07.10       | PR: 2EA,2EL    |                |           |   |   |                        |
|                    | 2.0 TDI            | 90    | 07.05 | 07.10       | PR: 2EA,2EL    |                |           |   |   |                        |
|                    | 2.0 TDI            | 100   | 07.05 | 07.10       | PR: 2EA,2EL    |                |           |   |   |                        |
|                    | 2.0 TDI            | 125   | 07.05 | 07.10       | PR: 2EA,2EL    |                |           |   |   |                        |
|                    | 2.0 TDI 16V        | 103   | 08.05 | 07.10       | PR: 2EA,2EL    |                |           |   |   |                        |
| 2.0 TDI 4motion    | 103                | 09.05 | 07.10 | PR: 2EA,2EL |                |                |           |   |   |                        |
| 2.0 TDI 4motion    | 125                | 05.09 | 07.10 | PR: 2EA,2EL |                |                |           |   |   |                        |
| 2.0 TFSI           | 147                | 07.05 | 07.10 | PR: 2EA,2EL |                |                |           |   |   |                        |
| 3.2 V6 FSI 4motion | 184                | 11.05 | 07.10 | PR: 2EA,2EL |                |                |           |   |   |                        |
| 3.6 R36            | 220                | 04.07 | 07.10 | PR: 2EA,2EL |                |                |           |   |   |                        |
|                    | 1.4 TSI            | 90    | 10.07 | 07.10       |                | 24.0711-6231.3 | 360305    |   | Radsensor                                 |                        |
|                    | 1.6                | 75    | 07.05 | 07.10       |                | 24.0711-6232.3 | 360306    |   | Radsensor                                 |                        |
|                    | 1.6 FSI            | 85    | 07.05 | 07.10       |                |                |           |   |   |                        |
|                    | 1.6 TDI            | 77    | 08.09 | 07.10       |                |                |           |   |   |                        |
|                    | 1.8 TSI            | 112   | 11.09 | 07.10       |                |                |           |   |   |                        |
|                    | 1.8 TSI            | 118   | 10.07 | 07.10       |                |                |           |   |   |                        |
|                    | 1.9 TDI            | 77    | 07.05 | 07.10       |                |                |           |   |   |                        |
|                    | 2.0 FSI            |       | 07.05 | 07.10       |                |                |           |   |   |                        |
|                    | 2.0 TDI            |       | 11.05 | 07.10       |                |                |           |   |   |                        |
|                    | 2.0 TDI            |       | 07.05 | 07.10       |                |                |           |   |   |                        |
|                    | 2.0 TDI            | 90    | 07.05 | 07.10       |                |                |           |   |   |                        |
|                    | 2.0 TDI            | 100   | 07.05 | 07.10       |                |                |           |   |   |                        |
|                    | 2.0 TDI            | 125   | 07.05 | 07.10       |                |                |           |   |   |                        |
|                    | 2.0 TDI 16V        | 103   | 08.05 | 07.10       |                |                |           |   |   |                        |
|                    | 2.0 TFSI           | 147   | 07.05 | 07.10       |                |                |           |   |   |                        |
| 2.0 FSI 4motion    | 110                | 09.05 | 07.10 |             | 24.0711-5271.3 | 360301         | Radsensor |   |   |                        |
| 2.0 TDI 4motion    | 103                | 09.05 | 07.10 |             | 24.0711-5272.3 | 360302         | Radsensor |   |   |                        |
| 2.0 TDI 4motion    | 125                | 09.05 | 07.10 |             |                |                |           |   |   |                        |
| 3.2 V6 FSI 4motion | 184                | 11.05 | 07.10 |             |                |                |           |   |   |                        |
| 3.6 R36            | 220                | 04.07 | 07.10 |             |                |                |           |   |   |                        |

### VOLKSWAGEN PASSAT CC (08-11)

|                   |                   |       |       |             |                 |                |                   |     |                            |     |
|-------------------|-------------------|-------|-------|-------------|-----------------|----------------|-------------------|-----|----------------------------|-----|
|                   | 1.4 TSI MultiFuel | 118   | 01.11 | 09.11       | PR: 1LH,1ZM,1ZG | 13.0460-7184.2 | 607184            |     | 23587 20,6 +/WK            | ATE |
|                   | 1.8 TSI           |       | 04.08 | 09.11       | PR: 1LH,1ZM,1ZG | 13.0470-7184.2 | LD7184            |     | 23587 20,6 +/WK            | ATE |
|                   | 2.0 TDI           |       | 04.08 | 09.11       | PR: 1LH,1ZM,1ZG |                |                   |     |                            |     |
|                   | 2.0 TDI           | 125   | 06.08 | 09.11       | PR: 1LH,1ZM,1ZG |                |                   |     |                            |     |
|                   | 2.0 TDI 4motion   | 103   | 08.09 | 09.11       | PR: 1LH,1ZM,1ZG |                |                   |     |                            |     |
|                   | 2.0 TDI 4motion   | 125   | 11.09 | 09.11       | PR: 1LH,1ZM,1ZG |                |                   |     |                            |     |
|                   | 2.0 TSI           |       | 04.08 | 09.11       | PR: 1LH,1ZM,1ZG |                |                   |     |                            |     |
|                   | 3.6 V6 4motion    | 220   | 04.08 | 09.11       | PR: 1LH,1ZM,1ZG |                |                   |     |                            |     |
|                   | 1.4 TSI MultiFuel | 118   | 01.11 | 09.11       | PR: 1LK         | 13.0460-7200.2 | 607200            |     | 23801 20,3 +/WK            | ATE |
|                   | 1.8 TSI           |       | 04.08 | 09.11       | PR: 1LK         | 13.0470-7200.2 | LD7200            |     | 23801 20,3 +/WK            | ATE |
|                   | 2.0 TDI           |       | 04.08 | 09.11       | PR: 1LK         |                |                   |     |                            |     |
|                   | 2.0 TDI           | 125   | 06.08 | 09.11       | PR: 1LK         |                |                   |     |                            |     |
|                   | 2.0 TDI 4motion   | 103   | 08.09 | 09.11       | PR: 1LK         |                |                   |     |                            |     |
|                   | 2.0 TDI 4motion   | 125   | 11.09 | 09.11       | PR: 1LK         |                |                   |     |                            |     |
|                   | 2.0 TSI           |       | 04.08 | 09.11       | PR: 1LK         |                |                   |     |                            |     |
| 3.6 V6 4motion    | 220               | 04.08 | 09.11 | PR: 1LK     |                 |                |                   |     |                            |     |
| 1.4 TSI MultiFuel | 118               | 01.11 | 09.11 | PR: 1LA,1LB | 13.0460-2764.2  | 602764         | 24738 20,0 +/WK/S | TRW |                            |     |
| 1.8 TSI           |                   | 04.08 | 09.11 | PR: 1LA,1LB | 13.0470-2764.2  | LD2764         | 24738 20,0 +/WK/S | TRW |                            |     |
| 2.0 TDI           |                   | 04.08 | 09.11 | PR: 1LA,1LB |                 |                |                   |     |                            |     |
| 2.0 TDI           | 125               | 06.08 | 09.11 | PR: 1LA,1LB |                 |                |                   |     |                            |     |
| 2.0 TDI 4motion   | 103               | 08.09 | 09.11 | PR: 1LA,1LB |                 |                |                   |     |                            |     |
| 2.0 TDI 4motion   | 125               | 11.09 | 09.11 | PR: 1LA,1LB |                 |                |                   |     |                            |     |
| 2.0 TSI           |                   | 04.08 | 09.11 | PR: 1LA,1LB |                 |                |                   |     |                            |     |
| 3.6 V6 4motion    | 220               | 04.08 | 09.11 | PR: 1LA,1LB |                 |                |                   |     |                            |     |
|                   | 1.4 TSI MultiFuel | 118   | 01.11 | 09.11       | PR: 1LH,1ZM,1ZG | 24.0125-0158.1 | 425158            |     | 312 25,0 22,0 V L +S +B    |     |
|                   | 1.8 TSI           |       | 04.08 | 09.11       | PR: 1LH,1ZM,1ZG | 24.0325-0158.1 | 525158            |     | 312 25,0 22,0 V L +S +B PD |     |
|                   | 2.0 TDI           |       | 04.08 | 09.11       | PR: 1LH,1ZM,1ZG |                |                   |     |                            |     |
|                   | 2.0 TDI           | 125   | 06.08 | 09.11       | PR: 1LH,1ZM,1ZG |                |                   |     |                            |     |
|                   | 2.0 TDI 4motion   | 103   | 08.09 | 09.11       | PR: 1LH,1ZM,1ZG |                |                   |     |                            |     |
|                   | 2.0 TDI 4motion   | 125   | 11.09 | 09.11       | PR: 1LH,1ZM,1ZG |                |                   |     |                            |     |

<sup>1)</sup> electric parking brake / fr.di stazionamento elettrico / frein à main électrique / freno de mano eléctrico

| VOLKSWAGEN PASSAT CC (08-11) |                   |                   |       |             |                 |                |                |        |   |   |                            |                          |
|------------------------------|-------------------|-------------------|-------|-------------|-----------------|----------------|----------------|--------|---|---|----------------------------|--------------------------|
|                              | 2.0 TSI           |                   | 04.08 | 09.11       | PR: 1LH,1ZM,1ZG | 24.0125-0158.1 | 425158         |        |   |   | 312 25,0 22,0 V L +S +B    |                          |
|                              | 3.6 V6 4motion    | 220               | 04.08 | 09.11       | PR: 1LH,1ZM,1ZG | 24.0325-0158.1 | 525158         |        |   |   | 312 25,0 22,0 V L +S +B PD |                          |
|                              | 1.4 TSI MultiFuel | 118               | 01.11 | 09.11       | PR: 1LK         | 24.0130-0115.1 | 430115         |        |   |   | 345 30,0 27,0 V L +B       |                          |
|                              | 1.8 TSI           |                   | 04.08 | 09.11       | PR: 1LK         |                |                |        |   |   |                            |                          |
|                              | 2.0 TDI           |                   | 04.08 | 09.11       | PR: 1LK         |                |                |        |   |   |                            |                          |
|                              | 2.0 TDI           | 125               | 06.08 | 09.11       | PR: 1LK         |                |                |        |   |   |                            |                          |
|                              | 2.0 TDI 4motion   | 103               | 08.09 | 09.11       | PR: 1LK         |                |                |        |   |   |                            |                          |
|                              | 2.0 TDI 4motion   | 125               | 11.09 | 09.11       | PR: 1LK         |                |                |        |   |   |                            |                          |
|                              | 2.0 TSI           |                   | 04.08 | 09.11       | PR: 1LK         |                |                |        |   |   |                            |                          |
|                              | 3.6 V6 4motion    | 220               | 04.08 | 09.11       | PR: 1LK         |                |                |        |   |   |                            |                          |
|                              | 1.4 TSI MultiFuel | 118               | 01.11 | 09.11       | PR: 1LA,1LB     | 24.0130-0225.1 | 430225         |        |   |   | 340 30,0 27,0 V L +S +B    |                          |
|                              | 1.8 TSI           |                   | 04.08 | 09.11       | PR: 1LA,1LB     |                |                |        |   |   |                            |                          |
|                              | 2.0 TDI           |                   | 04.08 | 09.11       | PR: 1LA,1LB     |                |                |        |   |   |                            |                          |
|                              | 2.0 TDI           | 125               | 06.08 | 09.11       | PR: 1LA,1LB     |                |                |        |   |   |                            |                          |
|                              | 2.0 TDI 4motion   | 103               | 08.09 | 09.11       | PR: 1LA,1LB     |                |                |        |   |   |                            |                          |
|                              | 2.0 TDI 4motion   | 125               | 11.09 | 09.11       | PR: 1LA,1LB     |                |                |        |   |   |                            |                          |
|                              | 2.0 TSI           |                   | 04.08 | 09.11       | PR: 1LA,1LB     |                |                |        |   |   |                            |                          |
|                              | 3.6 V6 4motion    | 220               | 04.08 | 09.11       | PR: 1LA,1LB     |                |                |        |   |   |                            |                          |
|                              |                   | 1.4 TSI MultiFuel | 118   | 01.11       | 09.11           |                | 24.0711-5271.3 | 360301 |   |   |                            | Radsensor                |
|                              |                   | 1.8 TSI           |       | 04.08       | 09.11           |                | 24.0711-5272.3 | 360302 |   |   |                            | Radsensor                |
| 2.0 TDI                      |                   |                   | 04.08 | 09.11       |                 |                |                |        |   |   |                            |                          |
| 2.0 TDI                      |                   | 125               | 06.08 | 09.11       |                 |                |                |        |   |   |                            |                          |
| 2.0 TDI 4motion              |                   | 103               | 08.09 | 09.11       |                 |                |                |        |   |   |                            |                          |
| 2.0 TDI 4motion              |                   | 125               | 11.09 | 09.11       |                 |                |                |        |   |   |                            |                          |
| 2.0 TSI                      |                   |                   | 04.08 | 09.11       |                 |                |                |        |   |   |                            |                          |
| 3.6 V6 4motion               |                   | 220               | 04.08 | 09.11       |                 |                |                |        |   |   |                            |                          |
|                              |                   | 1.4 TSI MultiFuel | 118   | 01.11       | 09.11           | PR: 1KU,1KW    | 13.0460-2880.2 | 602880 |   | elektrische Feststellbremse <sup>1)</sup> |                            | 23914 17,1 /WE/Zub/S TRW |
|                              |                   | 1.8 TSI           |       | 04.08       | 09.11           | PR: 1KU,1KW    | 13.0470-2880.2 | LD2880 |   | elektrische Feststellbremse <sup>1)</sup> |                            | 23914 17,1 /WE/Zub/S TRW |
|                              | 2.0 TDI           |                   | 04.08 | 09.11       | PR: 1KU,1KW     | 13.0460-0259.2 | 610259         |        |   |   | Belagsatz-Zubehör          |                          |
|                              | 2.0 TDI           | 125               | 06.08 | 09.11       | PR: 1KU,1KW     |                |                |        |   |   |                            |                          |
|                              | 2.0 TDI 4motion   | 103               | 08.09 | 09.11       | PR: 1KU,1KW     |                |                |        |   |   |                            |                          |
|                              | 2.0 TDI 4motion   | 125               | 11.09 | 09.11       | PR: 1KU,1KW     |                |                |        |   |   |                            |                          |
|                              | 2.0 TDI 4motion   | 125               | 11.09 | 09.11       | PR: 1KU,1KW     |                |                |        |   |   |                            |                          |
|                              | 2.0 TSI           |                   | 04.08 | 09.11       | PR: 1KU,1KW     |                |                |        |   |   |                            |                          |
|                              | 3.6 V6 4motion    | 220               | 04.08 | 09.11       | PR: 1KU,1KW     |                |                |        |   |   |                            |                          |
|                              |                   | 1.4 TSI MultiFuel | 118   | 01.11       | 09.11           | PR: 2EA        | 13.0460-2887.2 | 602887 |   | elektrische Feststellbremse <sup>1)</sup> |                            | 23914 17,1 /WE/Zub/S TRW |
| 1.8 TSI                      |                   |                   | 04.08 | 09.11       | PR: 2EA         | 13.0470-2887.2 | LD2887         |        | elektrische Feststellbremse <sup>1)</sup> |   | 23914 17,1 /WE/Zub/S TRW   |                          |
| 2.0 TDI                      |                   |                   | 04.08 | 09.11       | PR: 2EA         |                |                |        |   |   |                            |                          |
| 2.0 TDI                      |                   | 125               | 06.08 | 09.11       | PR: 2EA         |                |                |        |   |   |                            |                          |
| 2.0 TDI 4motion              |                   | 103               | 08.09 | 09.11       | PR: 2EA         |                |                |        |   |   |                            |                          |
| 2.0 TDI 4motion              |                   | 125               | 11.09 | 09.11       | PR: 2EA         |                |                |        |   |   |                            |                          |
| 2.0 TDI 4motion              |                   | 125               | 11.09 | 09.11       | PR: 2EA         |                |                |        |   |   |                            |                          |
| 2.0 TSI                      |                   |                   | 04.08 | 09.11       | PR: 2EA         |                |                |        |   |   |                            |                          |
| 3.6 V6 4motion               |                   | 220               | 04.08 | 09.11       | PR: 2EA         |                |                |        |   |   |                            |                          |
|                              |                   | 1.4 TSI MultiFuel | 118   | 01.11       | 09.11           | PR: 2EA        | 24.0122-0219.1 | 422219 |   | elektrische Feststellbremse <sup>1)</sup> |                            | 310 22,0 20,0 V L +B     |
|                              | 1.8 TSI           |                   | 04.08 | 09.11       | PR: 2EA         |                |                |        |   |   |                            |                          |
|                              | 2.0 TDI           |                   | 04.08 | 09.11       | PR: 2EA         |                |                |        |   |   |                            |                          |
|                              | 2.0 TDI           | 125               | 06.08 | 09.11       | PR: 2EA         |                |                |        |   |   |                            |                          |
|                              | 2.0 TDI 4motion   | 103               | 08.09 | 09.11       | PR: 2EA         |                |                |        |   |   |                            |                          |
|                              | 2.0 TDI 4motion   | 125               | 11.09 | 09.11       | PR: 2EA         |                |                |        |   |   |                            |                          |
|                              | 2.0 TSI           |                   | 04.08 | 09.11       | PR: 2EA         |                |                |        |   |   |                            |                          |
|                              | 3.6 V6 4motion    | 220               | 04.08 | 09.11       | PR: 2EA         |                |                |        |   |   |                            |                          |
|                              |                   | 1.4 TSI MultiFuel | 118   | 01.11       | 09.11           | PR: 1KU,1KW    | 24.0112-0169.1 | 412169 |   | elektrische Feststellbremse <sup>1)</sup> |                            | 282 12,0 10,0 +S +B      |
|                              |                   | 1.8 TSI           |       | 04.08       | 09.11           | PR: 1KU,1KW    | 24.0312-0169.1 | 512169 |   | elektrische Feststellbremse <sup>1)</sup> |                            | 282 12,0 10,0 +S +B PD   |
| 2.0 TDI                      |                   |                   | 04.08 | 09.11       | PR: 1KU,1KW     |                |                |        |   |   |                            |                          |
| 2.0 TDI                      |                   | 125               | 06.08 | 09.11       | PR: 1KU,1KW     |                |                |        |   |   |                            |                          |
| 2.0 TDI 4motion              |                   | 103               | 08.09 | 09.11       | PR: 1KU,1KW     |                |                |        |   |   |                            |                          |
| 2.0 TDI 4motion              |                   | 125               | 11.09 | 09.11       | PR: 1KU,1KW     |                |                |        |   |   |                            |                          |
| 2.0 TSI                      |                   |                   | 04.08 | 09.11       | PR: 1KU,1KW     |                |                |        |   |   |                            |                          |
| 3.6 V6 4motion               |                   | 220               | 04.08 | 09.11       | PR: 1KU,1KW     |                |                |        |   |   |                            |                          |
|                              |                   | 1.8 TSI           |       | 04.08       | 10.10           |                | 24.0711-6231.3 | 360305 |   |   |                            | Radsensor                |
|                              |                   | 2.0 TDI           |       | 04.08       | 10.10           |                | 24.0711-6232.3 | 360306 |   |   |                            | Radsensor                |
|                              | 2.0 TDI           | 125               | 06.08 | 10.10       |                 |                |                |        |   |   |                            |                          |
|                              | 2.0 TSI           |                   | 04.08 | 10.10       |                 |                |                |        |   |   |                            |                          |
|                              | 1.4 TSI MultiFuel | 118               | 01.11 | 09.11       |                 | 24.0711-6335.3 | 360365         |        |   |   | Radsensor                  |                          |
|                              | 1.8 TSI           |                   | 11.10 | 09.11       |                 | 24.0711-6336.3 | 360366         |        |   |   | Radsensor                  |                          |
|                              | 2.0 TDI           |                   | 11.10 | 09.11       |                 |                |                |        |   |   |                            |                          |
|                              | 2.0 TDI           | 125               | 11.10 | 09.11       |                 |                |                |        |   |   |                            |                          |
|                              | 2.0 TDI 4motion   | 103               | 08.09 | 09.11       |                 | 24.0711-5271.3 | 360301         |        |   |   | Radsensor                  |                          |
|                              | 2.0 TDI 4motion   | 125               | 11.09 | 09.11       |                 | 24.0711-5272.3 | 360302         |        |   |   | Radsensor                  |                          |
| 3.6 V6 4motion               | 220               | 04.08             | 09.11 |             |                 |                |                |        |   |   |                            |                          |
| VOLKSWAGEN PASSAT CC (11-)   |                   |                   |       |             |                 |                |                |        |   |   |                            |                          |
|                              | 1.4 TSI           | 110               | 05.15 |             | PR: 1ZM,1ZG     | 13.0460-7184.2 | 607184         |        |   |   | 23587 20,6 +/WK ATE        |                          |
|                              | 1.4 TSI           | 118               | 11.11 |             | PR: 1ZM,1ZG     | 13.0470-7184.2 | LD7184         |        |   |   | 23587 20,6 +/WK ATE        |                          |
|                              | 1.8 TSI           | 118               | 11.11 |             | PR: 1ZM,1ZG     |                |                |        |   |   |                            |                          |
|                              | 2.0 TDI           | 100               | 11.11 |             | PR: 1ZM,1ZG     |                |                |        |   |   |                            |                          |
|                              | 2.0 TDI           | 103               | 11.11 |             | PR: 1ZM,1ZG     |                |                |        |   |   |                            |                          |
|                              | 2.0 TDI           | 110               | 05.15 |             | PR: 1ZM,1ZG     |                |                |        |   |   |                            |                          |
|                              | 2.0 TDI           | 125               | 11.11 |             | PR: 1ZM,1ZG     |                |                |        |   |   |                            |                          |
|                              | 2.0 TDI           | 130               | 12.12 |             | PR: 1ZM,1ZG     |                |                |        |   |   |                            |                          |
|                              | 2.0 TDI           | 135               | 05.15 |             | PR: 1ZM,1ZG     |                |                |        |   |   |                            |                          |
|                              | 2.0 TDI 4motion   | 103               | 11.11 |             | PR: 1ZM,1ZG     |                |                |        |   |   |                            |                          |
| 2.0 TDI 4motion              | 125               | 11.11             |       | PR: 1ZM,1ZG |                 |                |                |        |   |   |                            |                          |
| 2.0 TDI 4motion              | 130               | 12.12             |       | PR: 1ZM,1ZG |                 |                |                |        |   |   |                            |                          |

<sup>1)</sup> electric parking brake / fr.di stazionamento elettrico / frein à main électrique / freno de mano eléctrico















**VOLKSWAGEN PASSAT CC (11-)**

|                |                 |       |             |             |                |        |                          |   |                          |
|----------------|-----------------|-------|-------------|-------------|----------------|--------|--------------------------|---|--------------------------|
|                | 2.0 TSI         | 155   | 11.11       | PR: 1ZM,1ZG | 13.0460-7184.2 | 607184 |                          | 23587 20,6 +/WK                           | ATE                      |
|                | 3.6 V6 4motion  | 220   | 11.11       | PR: 1ZM,1ZG | 13.0470-7184.2 | LD7184 |                          | 23587 20,6 +/WK                           | ATE                      |
|                | 1.4 TSI         | 110   | 05.15       | PR: 1LA,1LB | 13.0460-2764.2 | 602764 |                          | 24738 20,0 +/WK/S                         | TRW                      |
|                | 1.4 TSI         | 118   | 11.11       | PR: 1LA,1LB | 13.0470-2764.2 | LD2764 |                          | 24738 20,0 +/WK/S                         | TRW                      |
|                | 1.8 TSI         | 118   | 11.11       | PR: 1LA,1LB |                |        |                          |   |                          |
|                | 2.0 TDI         | 100   | 11.11       | PR: 1LA,1LB |                |        |                          |   |                          |
|                | 2.0 TDI         | 103   | 11.11       | PR: 1LA,1LB |                |        |                          |   |                          |
|                | 2.0 TDI         | 110   | 05.15       | PR: 1LA,1LB |                |        |                          |   |                          |
|                | 2.0 TDI         | 125   | 11.11       | PR: 1LA,1LB |                |        |                          |   |                          |
|                | 2.0 TDI         | 130   | 12.12       | PR: 1LA,1LB |                |        |                          |   |                          |
|                | 2.0 TDI         | 135   | 05.15       | PR: 1LA,1LB |                |        |                          |   |                          |
|                | 2.0 TDI 4motion | 103   | 11.11       | PR: 1LA,1LB |                |        |                          |   |                          |
|                | 2.0 TDI 4motion | 125   | 11.11       | PR: 1LA,1LB |                |        |                          |   |                          |
|                | 2.0 TDI 4motion | 130   | 12.12       | PR: 1LA,1LB |                |        |                          |   |                          |
| 2.0 TSI        | 155             | 11.11 | PR: 1LA,1LB |             |                |        |                          |   |                          |
| 3.6 V6 4motion | 220             | 11.11 | PR: 1LA,1LB |             |                |        |                          |   |                          |
|                | 1.4 TSI         | 110   | 05.15       | PR: 1ZM,1ZG | 24.0125-0158.1 | 425158 |                          | 312 25,0 22,0 V L +S +B                   |                          |
|                | 1.4 TSI         | 118   | 11.11       | PR: 1ZM,1ZG | 24.0325-0158.1 | 525158 |                          | 312 25,0 22,0 V L +S +B PD                |                          |
|                | 1.8 TSI         | 118   | 11.11       | PR: 1ZM,1ZG |                |        |                          |   |                          |
|                | 2.0 TDI         | 100   | 11.11       | PR: 1ZM,1ZG |                |        |                          |   |                          |
|                | 2.0 TDI         | 103   | 11.11       | PR: 1ZM,1ZG |                |        |                          |   |                          |
|                | 2.0 TDI         | 110   | 11.11       | PR: 1ZM,1ZG |                |        |                          |   |                          |
|                | 2.0 TDI         | 110   | 05.15       | PR: 1ZM,1ZG |                |        |                          |   |                          |
|                | 2.0 TDI         | 125   | 11.11       | PR: 1ZM,1ZG |                |        |                          |   |                          |
|                | 2.0 TDI         | 130   | 12.12       | PR: 1ZM,1ZG |                |        |                          |   |                          |
|                | 2.0 TDI         | 135   | 05.15       | PR: 1ZM,1ZG |                |        |                          |   |                          |
|                | 2.0 TDI 4motion | 103   | 11.11       | PR: 1ZM,1ZG |                |        |                          |   |                          |
|                | 2.0 TDI 4motion | 125   | 11.11       | PR: 1ZM,1ZG |                |        |                          |   |                          |
|                | 2.0 TDI 4motion | 130   | 12.12       | PR: 1ZM,1ZG |                |        |                          |   |                          |
|                | 2.0 TSI         | 155   | 11.11       | PR: 1ZM,1ZG |                |        |                          |   |                          |
| 3.6 V6 4motion | 220             | 11.11 | PR: 1ZM,1ZG |             |                |        |                          |   |                          |
|                | 1.4 TSI         | 110   | 05.15       | PR: 1LA,1LB | 24.0130-0225.1 | 430225 |                          | 340 30,0 27,0 V L +S +B                   |                          |
|                | 1.4 TSI         | 118   | 11.11       | PR: 1LA,1LB |                |        |                          |   |                          |
|                | 1.8 TSI         | 118   | 11.11       | PR: 1LA,1LB |                |        |                          |   |                          |
|                | 2.0 TDI         | 100   | 11.11       | PR: 1LA,1LB |                |        |                          |   |                          |
|                | 2.0 TDI         | 103   | 11.11       | PR: 1LA,1LB |                |        |                          |   |                          |
|                | 2.0 TDI         | 110   | 05.15       | PR: 1LA,1LB |                |        |                          |   |                          |
|                | 2.0 TDI         | 125   | 11.11       | PR: 1LA,1LB |                |        |                          |   |                          |
|                | 2.0 TDI         | 130   | 12.12       | PR: 1LA,1LB |                |        |                          |   |                          |
|                | 2.0 TDI         | 135   | 05.15       | PR: 1LA,1LB |                |        |                          |   |                          |
|                | 2.0 TDI 4motion | 103   | 11.11       | PR: 1LA,1LB |                |        |                          |   |                          |
|                | 2.0 TDI 4motion | 125   | 11.11       | PR: 1LA,1LB |                |        |                          |   |                          |
|                | 2.0 TDI 4motion | 130   | 12.12       | PR: 1LA,1LB |                |        |                          |   |                          |
|                | 2.0 TSI         | 155   | 11.11       | PR: 1LA,1LB |                |        |                          |   |                          |
|                | 3.6 V6 4motion  | 220   | 11.11       | PR: 1LA,1LB |                |        |                          |   |                          |
|                | 1.4 TSI         | 110   | 05.15       |             | 24.0711-5271.3 | 360301 | <input type="checkbox"/> | Radsensor                                 |                          |
|                | 1.4 TSI         | 118   | 11.11       |             | 24.0711-5272.3 | 360302 | <input type="checkbox"/> | Radsensor                                 |                          |
|                | 1.8 TSI         | 118   | 11.11       |             |                |        |                          |   |                          |
|                | 2.0 TDI         | 100   | 11.11       |             |                |        |                          |   |                          |
|                | 2.0 TDI         | 103   | 11.11       |             |                |        |                          |   |                          |
|                | 2.0 TDI         | 110   | 05.15       |             |                |        |                          |   |                          |
|                | 2.0 TDI         | 125   | 11.11       |             |                |        |                          |   |                          |
|                | 2.0 TDI         | 130   | 12.12       |             |                |        |                          |   |                          |
|                | 2.0 TDI         | 135   | 05.15       |             |                |        |                          |   |                          |
|                | 2.0 TDI 4motion | 103   | 11.11       |             |                |        |                          |   |                          |
|                | 2.0 TDI 4motion | 125   | 11.11       |             |                |        |                          |   |                          |
|                | 2.0 TDI 4motion | 130   | 12.12       |             |                |        |                          |   |                          |
|                | 2.0 TSI         | 155   | 11.11       |             |                |        |                          |   |                          |
|                | 3.6 V6 4motion  | 220   | 11.11       |             |                |        |                          |   |                          |
|                | 1.4 TSI         | 110   | 05.15       | PR: 1KW     | 13.0460-2880.2 | 602880 |                          | elektrische Feststellbremse <sup>1)</sup> | 23914 17,1 /WE/Zub/S TRW |
|                | 1.4 TSI         | 118   | 11.11       | PR: 1KW     | 13.0470-2880.2 | LD2880 |                          | elektrische Feststellbremse <sup>1)</sup> | 23914 17,1 /WE/Zub/S TRW |
|                | 1.8 TSI         | 118   | 11.11       | PR: 1KW     |                |        |                          |   |                          |
|                | 2.0 TDI         | 100   | 11.11       | PR: 1KW     |                |        |                          |   |                          |
|                | 2.0 TDI         | 103   | 11.11       | PR: 1KW     |                |        |                          |   |                          |
|                | 2.0 TDI         | 110   | 11.11       | PR: 1KW     |                |        |                          |   |                          |
|                | 2.0 TDI         | 110   | 05.15       | PR: 1KW     |                |        |                          |   |                          |
|                | 2.0 TDI         | 125   | 11.11       | PR: 1KW     |                |        |                          |   |                          |
|                | 2.0 TDI         | 130   | 12.12       | PR: 1KW     |                |        |                          |   |                          |
|                | 2.0 TDI         | 135   | 05.15       | PR: 1KW     |                |        |                          |   |                          |
|                | 2.0 TDI 4motion | 103   | 11.11       | PR: 1KW     |                |        |                          |   |                          |
|                | 2.0 TDI 4motion | 125   | 11.11       | PR: 1KW     |                |        |                          |   |                          |
|                | 2.0 TDI 4motion | 130   | 12.12       | PR: 1KW     |                |        |                          |   |                          |
|                | 2.0 TSI         | 155   | 11.11       | PR: 1KW     |                |        |                          |   |                          |
| 3.6 V6 4motion | 220             | 11.11 | PR: 1KW     |             |                |        |                          |   |                          |
|                | 1.4 TSI         | 110   | 05.15       | PR: 2EA     | 13.0460-2887.2 | 602887 |                          | elektrische Feststellbremse <sup>1)</sup> | 23914 17,1 /WE/Zub/S TRW |
|                | 1.4 TSI         | 118   | 11.11       | PR: 2EA     | 13.0470-2887.2 | LD2887 |                          | elektrische Feststellbremse <sup>1)</sup> | 23914 17,1 /WE/Zub/S TRW |
|                | 1.8 TSI         | 118   | 11.11       | PR: 2EA     |                |        |                          |   |                          |
|                | 2.0 TDI         | 100   | 11.11       | PR: 2EA     |                |        |                          |   |                          |
|                | 2.0 TDI         | 103   | 11.11       | PR: 2EA     |                |        |                          |   |                          |
|                | 2.0 TDI         | 110   | 11.11       | PR: 2EA     |                |        |                          |   |                          |
|                | 2.0 TDI         | 110   | 05.15       | PR: 2EA     |                |        |                          |   |                          |
|                | 2.0 TDI         | 125   | 11.11       | PR: 2EA     |                |        |                          |   |                          |
|                | 2.0 TDI         | 130   | 12.12       | PR: 2EA     |                |        |                          |   |                          |
|                | 2.0 TDI         | 135   | 05.15       | PR: 2EA     |                |        |                          |   |                          |
|                | 2.0 TDI 4motion | 103   | 11.11       | PR: 2EA     |                |        |                          |   |                          |
|                | 2.0 TDI 4motion | 125   | 11.11       | PR: 2EA     |                |        |                          |   |                          |
|                | 2.0 TDI 4motion | 130   | 12.12       | PR: 2EA     |                |        |                          |   |                          |
|                | 2.0 TSI         | 155   | 11.11       | PR: 2EA     |                |        |                          |   |                          |
| 3.6 V6 4motion | 220             | 11.11 | PR: 2EA     |             |                |        |                          |   |                          |





















<sup>1)</sup> electric parking brake / fr.di stazionamento elettrico / frein à main électrique / freno de mano eléctrico

















|     |  |  |  |  |  |  |      |  |                      |     |
|--|--|--|--|--|---|--|--|--|----------------------|-----|
| <b>VOLKSWAGEN PASSAT CC (11-)</b>  |  |  |  |  |   |  |  |  |                      |     |
|    | 1.4 TSI  | 110  | 05.15  | PR: 1KW  | 24.0112-0169.1  | 412169   | elektrische Feststellbremse <sup>1)</sup><br>elektrische Feststellbremse <sup>1)</sup> | 282 12,0 10,0 +S +B  |                      |     |
|  | 1.4 TSI  | 118  | 11.11  | PR: 1KW  | 24.0312-0169.1  | 512169   |  | 282 12,0 10,0 +S +B PD   |                      |     |
|  | 1.8 TSI  | 118  | 11.11  | PR: 1KW  |   |  |  |  |                      |     |
|  | 2.0 TDI  | 100  | 11.11  | PR: 1KW  |   |  |  |  |                      |     |
|  | 2.0 TDI  | 103  | 11.11  | PR: 1KW  |   |  |  |  |                      |     |
|  | 2.0 TDI  | 110  | 05.15  | PR: 1KW  |   |  |  |  |                      |     |
|  | 2.0 TDI  | 125  | 11.11  | PR: 1KW  |   |  |  |  |                      |     |
|  | 2.0 TDI  | 130  | 12.12  | PR: 1KW  |   |  |  |  |                      |     |
|  | 2.0 TDI  | 135  | 05.15  | PR: 1KW  |   |  |  |  |                      |     |
|  | 2.0 TDI 4motion  | 103  | 11.11  | PR: 1KW  |   |  |  |  |                      |     |
|  | 2.0 TDI 4motion  | 125  | 11.11  | PR: 1KW  |   |  |  |  |                      |     |
|  | 2.0 TDI 4motion  | 130  | 12.12  | PR: 1KW  |   |  |  |  |                      |     |
|  | 2.0 TSI  | 155  | 11.11  | PR: 1KW  |   |  |  |  |                      |     |
|  | 3.6 V6 4motion   | 220  | 11.11  | PR: 1KW  |   |  |  |  |                      |     |
|  | 1.4 TSI  | 110  | 05.15  | PR: 2EA  | 24.0122-0219.1  | 422219   |  |  | 310 22,0 20,0 V L +B |     |
|  | 1.4 TSI  | 118  | 11.11  | PR: 2EA  |   |  |  |  |                      |     |
|  | 1.8 TSI  | 118  | 11.11  | PR: 2EA  |   |  |  |  |                      |     |
|  | 2.0 TDI  | 100  | 11.11  | PR: 2EA  |   |  |  |  |                      |     |
|  | 2.0 TDI  | 103  | 11.11  | PR: 2EA  |   |  |  |  |                      |     |
| 2.0 TDI  | 110  | 05.15  | PR: 2EA  |  |   |  |  |  |                      |     |
| 2.0 TDI  | 125  | 11.11  | PR: 2EA  |  |   |  |  |  |                      |     |
| 2.0 TDI  | 130  | 12.12  | PR: 2EA  |  |   |  |  |  |                      |     |
| 2.0 TDI  | 135  | 05.15  | PR: 2EA  |  |   |  |  |  |                      |     |
| 2.0 TDI 4motion  | 103  | 11.11  | PR: 2EA  |  |   |  |  |  |                      |     |
| 2.0 TDI 4motion  | 125  | 11.11  | PR: 2EA  |  |   |  |  |  |                      |     |
| 2.0 TDI 4motion  | 130  | 12.12  | PR: 2EA  |  |   |  |  |  |                      |     |
| 2.0 TSI  | 155  | 11.11  | PR: 2EA  |  |   |  |  |  |                      |     |
| 3.6 V6 4motion   | 220  | 11.11  | PR: 2EA  |  |   |  |  |  |                      |     |
|    | 1.4 TSI  | 110  | 05.15  |  | 24.0711-6335.3  | 360365   | ☐<br>☐   | Radsensor  |                      |     |
|  | 1.4 TSI  | 118  | 11.11  |  | 24.0711-6336.3  | 360366   |  | Radsensor  |                      |     |
|  | 1.8 TSI  | 118  | 11.11  |  |   |  |  |  |                      |     |
|  | 2.0 TDI  | 100  | 11.11  |  |   |  |  |  |                      |     |
|  | 2.0 TDI  | 103  | 11.11  |  |   |  |  |  |                      |     |
|  | 2.0 TDI  | 110  | 05.15  |  |   |  |  |  |                      |     |
|  | 2.0 TDI  | 125  | 11.11  |  |   |  |  |  |                      |     |
|  | 2.0 TDI  | 130  | 12.12  |  |   |  |  |  |                      |     |
|  | 2.0 TDI  | 135  | 05.15  |  |   |  |  |  |                      |     |
|  | 2.0 TSI  | 155  | 11.11  |  |   |  |  |  |                      |     |
| 2.0 TDI 4motion  | 103  | 11.11  |  | 24.0711-5401.3   | 360330  | ☐<br>☐   | Radsensor  |  |                      |     |
| 2.0 TDI 4motion  | 125  | 11.11  |  | 24.0711-5402.3   | 360331  | ☐<br>☐   | Radsensor  |  |                      |     |
| 2.0 TDI 4motion  | 130  | 12.12  |  |  |   |  |  |  |                      |     |
| 3.6 V6 4motion   | 220  | 11.11  |  |  |   |  |  |  |                      |     |
| <b>VOLKSWAGEN PASSAT / PASSAT VARIANT (10-14)</b>                                  |  |  |  |  |   |  |  |  |                      |     |
|  | 1.4 TSI  | 90   | 08.10  | 10.14 PR: 1ZM,1ZG  | 13.0460-7184.2  | 607184   |  | 23587 20,6 +/WK  | ATE                  |     |
|  | 1.4 TSI  | 110  | 08.10  | 10.14 PR: 1ZM,1ZG  | 13.0470-7184.2  | LD7184   |  | 23587 20,6 +/WK  | ATE                  |     |
|  | 1.4 TSI  | 118  | 11.12  | 10.14 PR: 1ZM,1ZG  |   |  |  |  |                      |     |
|  | 1.6 TDI  | 77   | 08.10  | 10.14 PR: 1ZM,1ZG  |   |  |  |  |                      |     |
|  | 1.8 TSI  | 118  | 08.10  | 10.14 PR: 1ZM,1ZG  |   |  |  |  |                      |     |
|  | 2.0 TDI  | 100  | 08.10  | 10.14 PR: 1ZM,1ZG  |   |  |  |  |                      |     |
|  | 2.0 TDI  | 125  | 08.10  | 10.14 PR: 1ZM,1ZG  |   |  |  |  |                      |     |
|  | 2.0 TDI  | 130  | 12.12  | 10.14 PR: 1ZM,1ZG  |   |  |  |  |                      |     |
|  | 2.0 TDI 4motion  | 103  | 08.10  | 10.14 PR: 1ZM,1ZG  |   |  |  |  |                      |     |
|  | 2.0 TDI 4motion  | 125  | 08.10  | 10.14 PR: 1ZM,1ZG  |   |  |  |  |                      |     |
|  | 2.0 TDI 4motion  | 130  | 01.13  | 10.14 PR: 1ZM,1ZG  |   |  |  |  |                      |     |
|  | 2.0 TSI  | 155  | 11.10  | 10.14 PR: 1ZM,1ZG  |   |  |  |  |                      |     |
|  | 3.6 FSI 4motion  | 220  | 01.11  | 10.14 PR: 1ZM,1ZG  |   |  |  |  |                      |     |
|  | 1.4 TSI  | 90   | 08.10  | 10.14 PR: 1LA,1LB  | 13.0460-2764.2  | 602764   |  |  | 24738 20,0 +/WK/S    | TRW |
|  | 1.4 TSI  | 110  | 08.10  | 10.14 PR: 1LA,1LB  | 13.0470-2764.2  | LD2764   |  |  | 24738 20,0 +/WK/S    | TRW |
|  | 1.4 TSI  | 118  | 11.12  | 10.14 PR: 1LA,1LB  |   |  |  |  |                      |     |
|  | 1.6 TDI  | 77   | 08.10  | 10.14 PR: 1LA,1LB  |   |  |  |  |                      |     |
|  | 1.8 TSI  | 118  | 08.10  | 10.14 PR: 1LA,1LB  |   |  |  |  |                      |     |
|  | 2.0 TDI  | 100  | 08.10  | 10.14 PR: 1LA,1LB  |   |  |  |  |                      |     |
| 2.0 TDI  | 125  | 08.10  | 10.14 PR: 1LA,1LB  |  |   |  |  |  |                      |     |
| 2.0 TDI  | 130  | 12.12  | 10.14 PR: 1LA,1LB  |  |   |  |  |  |                      |     |
| 2.0 TDI 4motion  | 103  | 08.10  | 10.14 PR: 1LA,1LB  |  |   |  |  |  |                      |     |
| 2.0 TDI 4motion  | 125  | 08.10  | 10.14 PR: 1LA,1LB  |  |   |  |  |  |                      |     |
| 2.0 TDI 4motion  | 130  | 01.13  | 10.14 PR: 1LA,1LB  |  |   |  |  |  |                      |     |
| 2.0 TSI  | 155  | 11.10  | 10.14 PR: 1LA,1LB  |  |   |  |  |  |                      |     |
| 3.6 FSI 4motion  | 220  | 01.11  | 10.14 PR: 1LA,1LB  |  |   |  |  |  |                      |     |
| 1.4 TSI  | 90   | 08.10  | 10.14 PR: 1ZM,1ZG  | 24.0125-0158.1   | 425158  |  | 312 25,0 22,0 V L +S +B  |  |                      |     |
| 1.4 TSI  | 110  | 08.10  | 10.14 PR: 1ZM,1ZG  | 24.0325-0158.1   | 525158  |  | 312 25,0 22,0 V L +S +B PD   |  |                      |     |
| 1.4 TSI  | 118  | 11.12  | 10.14 PR: 1ZM,1ZG  |  |   |  |  |  |                      |     |
| 1.6 TDI  | 77   | 08.10  | 10.14 PR: 1ZM,1ZG  |  |   |  |  |  |                      |     |
| 1.8 TSI  | 118  | 08.10  | 10.14 PR: 1ZM,1ZG  |  |   |  |  |  |                      |     |
| 2.0 TDI  | 100  | 08.10  | 10.14 PR: 1ZM,1ZG  |  |   |  |  |  |                      |     |
| 2.0 TDI  | 125  | 08.10  | 10.14 PR: 1ZM,1ZG  |  |   |  |  |  |                      |     |
| 2.0 TDI  | 130  | 12.12  | 10.14 PR: 1ZM,1ZG  |  |   |  |  |  |                      |     |
| 2.0 TDI 4motion  | 103  | 08.10  | 10.14 PR: 1ZM,1ZG  |  |   |  |  |  |                      |     |
| 2.0 TDI 4motion  | 125  | 08.10  | 10.14 PR: 1ZM,1ZG  |  |   |  |  |  |                      |     |
| 2.0 TDI 4motion  | 130  | 01.13  | 10.14 PR: 1ZM,1ZG  |  |   |  |  |  |                      |     |
| 2.0 TSI  | 155  | 11.10  | 10.14 PR: 1ZM,1ZG  |  |   |  |  |  |                      |     |
| 3.6 FSI 4motion  | 220  | 01.11  | 10.14 PR: 1ZM,1ZG  |  |   |  |  |  |                      |     |
| 1.4 TSI  | 90   | 08.10  | 10.14 PR: 1LA,1LB  | 24.0130-0225.1   | 430225  |  |  | 340 30,0 27,0 V L +S +B  |                      |     |
| 1.4 TSI  | 110  | 08.10  | 10.14 PR: 1LA,1LB  |  |   |  |  |  |                      |     |
| 1.4 TSI  | 118  | 11.12  | 10.14 PR: 1LA,1LB  |  |   |  |  |  |                      |     |
| 1.6 TDI  | 77   | 08.10  | 10.14 PR: 1LA,1LB  |  |   |  |  |  |                      |     |

<sup>1)</sup> electric parking brake / fr.di stazionamento elettrico / frein à main électrique / freno de mano eléctrico



















|     |    |  |    |    |  |    |      |  |
|--|--|--|--|--|---|--|--|--|
| <b>VOLKSWAGEN PASSAT / PASSAT VARIANT (10-14)</b>                                  |  |  |  |  |   |  |  |  |
|    | 1.8 TSI 118<br>2.0 TDI 125<br>2.0 TDI 130<br>2.0 TDI 4motion 103<br>2.0 TDI 4motion 125<br>2.0 TDI 4motion 130<br>2.0 TSI 155<br>3.6 FSI 4motion 220   |  | 08.10 10.14 PR: 1LA,1LB<br>08.10 10.14 PR: 1LA,1LB<br>08.10 10.14 PR: 1LA,1LB<br>12.12 10.14 PR: 1LA,1LB<br>08.10 10.14 PR: 1LA,1LB<br>08.10 10.14 PR: 1LA,1LB<br>01.13 10.14 PR: 1LA,1LB<br>11.10 10.14 PR: 1LA,1LB<br>01.11 10.14 PR: 1LA,1LB                                  |  | 24.0130-0225.1 430225   |  |  | 340 30,0 27,0 V L +S +B  |
|    | 1.4 TSI 90<br>1.4 TSI 110<br>1.4 TSI 118<br>1.6 TDI 77<br>1.8 TSI 118<br>2.0 TDI 125<br>2.0 TDI 130<br>2.0 TDI 4motion 103<br>2.0 TDI 4motion 125<br>2.0 TDI 4motion 130<br>2.0 TSI 155<br>3.6 FSI 4motion 220 |  | 08.10 10.14 PR: 1KW<br>08.10 10.14 PR: 1KW<br>11.12 10.14 PR: 1KW<br>08.10 10.14 PR: 1KW<br>08.10 10.14 PR: 1KW<br>08.10 10.14 PR: 1KW<br>12.12 10.14 PR: 1KW<br>08.10 10.14 PR: 1KW<br>08.10 10.14 PR: 1KW<br>01.13 10.14 PR: 1KW<br>11.10 10.14 PR: 1KW<br>01.11 10.14 PR: 1KW |  | 24.0711-5271.3 360301<br>24.0711-5272.3 360302                                    | <br>     |  | Radsensor<br>Radsensor   |
|    | 1.4 TSI 90<br>1.4 TSI 110<br>1.4 TSI 118<br>1.6 TDI 77<br>1.8 TSI 118<br>2.0 TDI 125<br>2.0 TDI 130<br>2.0 TDI 4motion 103<br>2.0 TDI 4motion 125<br>2.0 TDI 4motion 130<br>2.0 TSI 155<br>3.6 FSI 4motion 220 |  | 08.10 10.14 PR: 1KW<br>08.10 10.14 PR: 1KW<br>11.12 10.14 PR: 1KW<br>08.10 10.14 PR: 1KW<br>08.10 10.14 PR: 1KW<br>08.10 10.14 PR: 1KW<br>12.12 10.14 PR: 1KW<br>08.10 10.14 PR: 1KW<br>08.10 10.14 PR: 1KW<br>01.13 10.14 PR: 1KW<br>11.10 10.14 PR: 1KW<br>01.11 10.14 PR: 1KW | PR: 1KW<br>PR: 1KW<br>PR: 1KW<br>PR: 1KW<br>PR: 1KW<br>PR: 1KW<br>PR: 1KW<br>PR: 1KW<br>PR: 1KW<br>PR: 1KW<br>PR: 1KW<br>PR: 1KW | 13.0460-2880.2 602880<br>13.0470-2880.2 LD2880                                    |  | elektrische Feststellbremse <sup>1)</sup><br>elektrische Feststellbremse <sup>1)</sup> | 23914 17,1 /WE/Zub/S TRW<br>23914 17,1 /WE/Zub/S TRW                               |
|  | 1.4 TSI 90<br>1.4 TSI 110<br>1.4 TSI 118<br>1.6 TDI 77<br>1.8 TSI 118<br>2.0 TDI 125<br>2.0 TDI 130<br>2.0 TDI 4motion 103<br>2.0 TDI 4motion 125<br>2.0 TDI 4motion 130<br>2.0 TSI 155<br>3.6 FSI 4motion 220 |  | 08.10 10.14 PR: 2EA<br>08.10 10.14 PR: 2EA<br>11.12 10.14 PR: 2EA<br>08.10 10.14 PR: 2EA<br>08.10 10.14 PR: 2EA<br>08.10 10.14 PR: 2EA<br>12.12 10.14 PR: 2EA<br>08.10 10.14 PR: 2EA<br>08.10 10.14 PR: 2EA<br>01.13 10.14 PR: 2EA<br>11.10 10.14 PR: 2EA<br>01.11 10.14 PR: 2EA | PR: 2EA<br>PR: 2EA<br>PR: 2EA<br>PR: 2EA<br>PR: 2EA<br>PR: 2EA<br>PR: 2EA<br>PR: 2EA<br>PR: 2EA<br>PR: 2EA<br>PR: 2EA<br>PR: 2EA | 13.0460-2887.2 602887<br>13.0470-2887.2 LD2887                                    |  | elektrische Feststellbremse <sup>1)</sup><br>elektrische Feststellbremse <sup>1)</sup> | 23914 17,1 /WE/Zub/S TRW<br>23914 17,1 /WE/Zub/S TRW                               |
|  | 1.4 TSI 90<br>1.4 TSI 110<br>1.4 TSI 118<br>1.6 TDI 77<br>1.8 TSI 118<br>2.0 TDI 125<br>2.0 TDI 130<br>2.0 TDI 4motion 103<br>2.0 TDI 4motion 125<br>2.0 TDI 4motion 130<br>2.0 TSI 155<br>3.6 FSI 4motion 220 |  | 08.10 10.14 PR: 1KW<br>08.10 10.14 PR: 1KW<br>11.12 10.14 PR: 1KW<br>08.10 10.14 PR: 1KW<br>08.10 10.14 PR: 1KW<br>08.10 10.14 PR: 1KW<br>12.12 10.14 PR: 1KW<br>08.10 10.14 PR: 1KW<br>08.10 10.14 PR: 1KW<br>01.13 10.14 PR: 1KW<br>11.10 10.14 PR: 1KW<br>01.11 10.14 PR: 1KW | PR: 1KW<br>PR: 1KW<br>PR: 1KW<br>PR: 1KW<br>PR: 1KW<br>PR: 1KW<br>PR: 1KW<br>PR: 1KW<br>PR: 1KW<br>PR: 1KW<br>PR: 1KW<br>PR: 1KW | 24.0112-0169.1 412169<br>24.0312-0169.1 512169                                    |  | elektrische Feststellbremse <sup>1)</sup><br>elektrische Feststellbremse <sup>1)</sup> | 282 12,0 10,0 +S +B<br>282 12,0 10,0 +S +B PD                                      |
|  | 1.4 TSI 90<br>1.4 TSI 110<br>1.4 TSI 118<br>1.6 TDI 77<br>1.8 TSI 118<br>2.0 TDI 125<br>2.0 TDI 130<br>2.0 TDI 4motion 103<br>2.0 TDI 4motion 125<br>2.0 TDI 4motion 130<br>2.0 TSI 155<br>3.6 FSI 4motion 220 |  | 08.10 10.14 PR: 2EA<br>08.10 10.14 PR: 2EA<br>11.12 10.14 PR: 2EA<br>08.10 10.14 PR: 2EA<br>08.10 10.14 PR: 2EA<br>08.10 10.14 PR: 2EA<br>12.12 10.14 PR: 2EA<br>08.10 10.14 PR: 2EA<br>08.10 10.14 PR: 2EA<br>01.13 10.14 PR: 2EA<br>11.10 10.14 PR: 2EA<br>01.11 10.14 PR: 2EA | PR: 2EA<br>PR: 2EA<br>PR: 2EA<br>PR: 2EA<br>PR: 2EA<br>PR: 2EA<br>PR: 2EA<br>PR: 2EA<br>PR: 2EA<br>PR: 2EA<br>PR: 2EA<br>PR: 2EA | 24.0122-0219.1 422219   |  | elektrische Feststellbremse <sup>1)</sup>  | 310 22,0 20,0 V L +B   |
|  | 1.4 TSI 90<br>1.4 TSI 110<br>1.4 TSI 118<br>1.6 TDI 77<br>1.8 TSI 118<br>2.0 TDI 125<br>2.0 TDI 130<br>2.0 TSI 155   |  | 08.10 10.14 PR: 1KW<br>08.10 10.14 PR: 1KW<br>11.12 10.14 PR: 1KW<br>08.10 10.14 PR: 1KW<br>08.10 10.14 PR: 1KW<br>12.12 10.14 PR: 1KW<br>11.10 10.14 PR: 1KW  | PR: 1KW<br>PR: 1KW<br>PR: 1KW<br>PR: 1KW<br>PR: 1KW<br>PR: 1KW<br>PR: 1KW  | 24.0711-6335.3 360365<br>24.0711-6336.3 360366                                    | <br> |  | Radsensor<br>Radsensor   |
|  | 2.0 TDI 4motion 103<br>2.0 TDI 4motion 125<br>2.0 TDI 4motion 130  |  | 08.10 10.14 PR: 1KW<br>08.10 10.14 PR: 1KW<br>01.13 10.14 PR: 1KW  | PR: 1KW<br>PR: 1KW<br>PR: 1KW  | 24.0711-5401.3 360330<br>24.0711-5402.3 360331                                    | <br> |  | Radsensor<br>Radsensor   |

















<sup>1)</sup> electric parking brake / fr.di stazionamento elettrico / frein à main électrique / freno de mano eléctrico

| VOLKSWAGEN PASSAT / PASSAT VARIANT (10-14)   |                 |     |       |       |                             |                                  |                  |   |                            |
|--|-----------------|-----|-------|-------|-----------------------------|----------------------------------|------------------|---|----------------------------|
|    | 3.6 FSI 4motion | 220 | 01.11 | 10.14 |                             | 24.0711-5401.3<br>24.0711-5402.3 | 360330<br>360331 |    | Radsensor<br>Radsensor     |
| VOLKSWAGEN PASSAT ALLTRACK (12-14)   |                 |     |       |       |                             |                                  |                  |   |                            |
|    | 1.8 TSI         | 112 | 01.12 |       | PR: 12M,12G                 | 13.0460-7184.2                   | 607184           |   | 23587 20,6 +/WK ATE        |
|  | 1.8 TSI         | 118 | 01.12 |       | PR: 12M,12G                 | 13.0470-7184.2                   | LD7184           |   | 23587 20,6 +/WK ATE        |
|  | 2.0 TDI         | 103 | 01.12 |       | PR: 12M,12G                 |                                  |                  |   |                            |
|  | 2.0 TDI 4motion | 103 | 01.12 |       | PR: 12M,12G                 |                                  |                  |   |                            |
|  | 2.0 TDI 4motion | 125 | 01.12 |       | PR: 12M,12G                 |                                  |                  |   |                            |
|  | 2.0 TDI 4motion | 130 | 01.13 |       | PR: 12M,12G                 |                                  |                  |   |                            |
|  | 2.0 TSI 4motion | 155 | 01.12 |       | PR: 12M,12G                 |                                  |                  |   |                            |
|  | 1.8 TSI         | 112 | 01.12 |       | PR: 1LA,1LB                 | 13.0460-2764.2                   | 602764           |   | 24738 20,0 +/WK/S TRW      |
|  | 1.8 TSI         | 118 | 01.12 |       | PR: 1LA,1LB                 | 13.0470-2764.2                   | LD2764           |   | 24738 20,0 +/WK/S TRW      |
|  | 2.0 TDI         | 103 | 01.12 |       | PR: 1LA,1LB                 |                                  |                  |   |                            |
|  | 2.0 TDI 4motion | 103 | 01.12 |       | PR: 1LA,1LB                 |                                  |                  |   |                            |
|  | 2.0 TDI 4motion | 125 | 01.12 |       | PR: 1LA,1LB                 |                                  |                  |   |                            |
|  | 2.0 TDI 4motion | 130 | 01.13 |       | PR: 1LA,1LB                 |                                  |                  |   |                            |
|  | 2.0 TSI 4motion | 155 | 01.12 |       | PR: 1LA,1LB                 |                                  |                  |   |                            |
|    | 1.8 TSI         | 112 | 01.12 |       | PR: 12M,12G                 | 24.0125-0158.1                   | 425158           |   | 312 25,0 22,0 V L +S +B    |
|  | 1.8 TSI         | 118 | 01.12 |       | PR: 12M,12G                 | 24.0325-0158.1                   | 525158           |   | 312 25,0 22,0 V L +S +B PD |
|  | 2.0 TDI         | 103 | 01.12 |       | PR: 12M,12G                 |                                  |                  |   |                            |
|  | 2.0 TDI 4motion | 103 | 01.12 |       | PR: 12M,12G                 |                                  |                  |   |                            |
|  | 2.0 TDI 4motion | 125 | 01.12 |       | PR: 12M,12G                 |                                  |                  |   |                            |
|  | 2.0 TDI 4motion | 130 | 01.13 |       | PR: 12M,12G                 |                                  |                  |   |                            |
|  | 2.0 TSI 4motion | 155 | 01.12 |       | PR: 12M,12G                 |                                  |                  |   |                            |
|  | 1.8 TSI         | 112 | 01.12 |       | PR: 1LA,1LB                 | 24.0130-0225.1                   | 430225           |   | 340 30,0 27,0 V L +S +B    |
|  | 1.8 TSI         | 118 | 01.12 |       | PR: 1LA,1LB                 |                                  |                  |   |                            |
|  | 2.0 TDI         | 103 | 01.12 |       | PR: 1LA,1LB                 |                                  |                  |   |                            |
|  | 2.0 TDI 4motion | 103 | 01.12 |       | PR: 1LA,1LB                 |                                  |                  |   |                            |
|  | 2.0 TDI 4motion | 125 | 01.12 |       | PR: 1LA,1LB                 |                                  |                  |   |                            |
|  | 2.0 TDI 4motion | 130 | 01.13 |       | PR: 1LA,1LB                 |                                  |                  |   |                            |
|  | 2.0 TSI 4motion | 155 | 01.12 |       | PR: 1LA,1LB                 |                                  |                  |   |                            |
|    | 1.8 TSI         | 112 | 01.12 |       |                             | 24.0711-5271.3                   | 360301           |    | Radsensor                  |
|  | 1.8 TSI         | 118 | 01.12 |       |                             | 24.0711-5272.3                   | 360302           |    | Radsensor                  |
|  | 2.0 TDI         | 103 | 01.12 |       |                             |                                  |                  |   |                            |
|  | 2.0 TDI 4motion | 103 | 01.12 |       |                             |                                  |                  |   |                            |
|  | 2.0 TDI 4motion | 125 | 01.12 |       |                             |                                  |                  |   |                            |
|  | 2.0 TDI 4motion | 130 | 01.13 |       |                             |                                  |                  |   |                            |
|  | 2.0 TSI 4motion | 155 | 01.12 |       |                             |                                  |                  |   |                            |
|  | 1.8 TSI         | 112 | 01.12 |       | PR: 1KW                     | 13.0460-2880.2                   | 602880           | elektrische Feststellbremse <sup>1)</sup>   | 23914 17,1 /WE/Zub/S TRW   |
|  | 1.8 TSI         | 118 | 01.12 |       | PR: 1KW                     | 13.0470-2880.2                   | LD2880           | elektrische Feststellbremse <sup>1)</sup>   | 23914 17,1 /WE/Zub/S TRW   |
|  | 2.0 TDI         | 103 | 01.12 |       | PR: 1KW                     |                                  |                  |   |                            |
|  | 2.0 TDI 4motion | 103 | 01.12 |       | PR: 1KW                     |                                  |                  |   |                            |
|  | 2.0 TDI 4motion | 125 | 01.12 |       | PR: 1KW                     |                                  |                  |   |                            |
|  | 2.0 TDI 4motion | 130 | 01.13 |       | PR: 1KW                     |                                  |                  |   |                            |
|  | 2.0 TSI 4motion | 155 | 01.12 |       | PR: 1KW                     |                                  |                  |   |                            |
|  | 1.8 TSI         | 112 | 01.12 |       | PR: 2EA                     | 13.0460-2887.2                   | 602887           | elektrische Feststellbremse <sup>1)</sup>   | 23914 17,1 /WE/Zub/S TRW   |
|  | 1.8 TSI         | 118 | 01.12 |       | PR: 2EA                     | 13.0470-2887.2                   | LD2887           | elektrische Feststellbremse <sup>1)</sup>   | 23914 17,1 /WE/Zub/S TRW   |
|  | 2.0 TDI         | 103 | 01.12 |       | PR: 2EA                     |                                  |                  |   |                            |
|  | 2.0 TDI 4motion | 103 | 01.12 |       | PR: 2EA                     |                                  |                  |   |                            |
|  | 2.0 TDI 4motion | 125 | 01.12 |       | PR: 2EA                     |                                  |                  |   |                            |
|  | 2.0 TDI 4motion | 130 | 01.13 |       | PR: 2EA                     |                                  |                  |   |                            |
|  | 2.0 TSI 4motion | 155 | 01.12 |       | PR: 2EA                     |                                  |                  |   |                            |
|  | 1.8 TSI         | 112 | 01.12 |       | PR: 1KW                     | 24.0112-0169.1                   | 412169           | elektrische Feststellbremse <sup>1)</sup>   | 282 12,0 10,0 +S +B        |
|  | 1.8 TSI         | 118 | 01.12 |       | PR: 1KW                     | 24.0312-0169.1                   | 512169           | elektrische Feststellbremse <sup>1)</sup>   | 282 12,0 10,0 +S +B PD     |
|  | 2.0 TDI         | 103 | 01.12 |       | PR: 1KW                     |                                  |                  |   |                            |
|  | 2.0 TDI 4motion | 103 | 01.12 |       | PR: 1KW                     |                                  |                  |   |                            |
|  | 2.0 TDI 4motion | 125 | 01.12 |       | PR: 1KW                     |                                  |                  |   |                            |
|  | 2.0 TDI 4motion | 130 | 01.13 |       | PR: 1KW                     |                                  |                  |   |                            |
|  | 2.0 TSI 4motion | 155 | 01.12 |       | PR: 1KW                     |                                  |                  |   |                            |
|  | 1.8 TSI         | 112 | 01.12 |       | PR: 2EA                     | 24.0122-0219.1                   | 422219           | elektrische Feststellbremse <sup>1)</sup>   | 310 22,0 20,0 V L +B       |
|  | 1.8 TSI         | 118 | 01.12 |       | PR: 2EA                     |                                  |                  |   |                            |
|  | 2.0 TDI         | 103 | 01.12 |       | PR: 2EA                     |                                  |                  |   |                            |
|  | 2.0 TDI 4motion | 103 | 01.12 |       | PR: 2EA                     |                                  |                  |   |                            |
|  | 2.0 TDI 4motion | 125 | 01.12 |       | PR: 2EA                     |                                  |                  |   |                            |
|  | 2.0 TDI 4motion | 130 | 01.13 |       | PR: 2EA                     |                                  |                  |   |                            |
|  | 2.0 TSI 4motion | 155 | 01.12 |       | PR: 2EA                     |                                  |                  |   |                            |
|  | 1.8 TSI         | 112 | 01.12 |       |                             | 24.0711-6335.3                   | 360365           |  | Radsensor                  |
|  | 1.8 TSI         | 118 | 01.12 |       |                             | 24.0711-6336.3                   | 360366           |  | Radsensor                  |
|  | 2.0 TDI         | 103 | 01.12 |       |                             |                                  |                  |   |                            |
|  | 2.0 TDI 4motion | 103 | 01.12 |       |                             | 24.0711-5401.3                   | 360330           |  | Radsensor                  |
|  | 2.0 TDI 4motion | 125 | 01.12 |       |                             | 24.0711-5402.3                   | 360331           |  | Radsensor                  |
|  | 2.0 TDI 4motion | 130 | 01.13 |       |                             |                                  |                  |   |                            |
|  | 2.0 TSI 4motion | 155 | 01.12 |       |                             |                                  |                  |   |                            |
| VOLKSWAGEN PASSAT / PASSAT VARIANT (14-)   |                 |     |       |       |                             |                                  |                  |   |                            |
|  | 1.4 GTE Hybrid  | 115 | 06.15 |       | PR: 1ZA,1ZC,1ZD,1ZG,1ZK,1ZL | 13.0460-2785.2                   | 602785           |   | 25683 20,4 +/WK/S TRW      |
|  | 1.4 TDI         | 77  | 11.14 |       | PR: 1ZA,1ZC,1ZD,1ZG,1ZK,1ZL | 13.0470-2785.2                   | LD2785           |   | 25683 20,4 +/WK/S TRW      |
|  | 1.4 TDI         | 103 | 11.14 |       | PR: 1ZA,1ZC,1ZD,1ZG,1ZK,1ZL | 24.8190-0065.2                   | 620065           | 1   | Warnkontakt L=172mm        |
|  | 1.4 TSI         | 92  | 11.14 |       | PR: 1ZA,1ZC,1ZD,1ZG,1ZK,1ZL |                                  |                  |   |                            |
|  | 1.4 TSI         | 110 | 11.14 |       | PR: 1ZA,1ZC,1ZD,1ZG,1ZK,1ZL |                                  |                  |   |                            |
|  | 1.4 TSI         | 118 | 11.14 |       | PR: 1ZA,1ZC,1ZD,1ZG,1ZK,1ZL |                                  |                  |   |                            |
|  | 1.4 TSI 4motion | 110 | 02.15 |       | PR: 1ZA,1ZC,1ZD,1ZG,1ZK,1ZL |                                  |                  |   |                            |
|  | 1.6 TDI         | 88  | 11.14 |       | PR: 1ZA,1ZC,1ZD,1ZG,1ZK,1ZL |                                  |                  |   |                            |
|  | 1.8 TSI         | 132 | 11.14 |       | PR: 1ZA,1ZC,1ZD,1ZG,1ZK,1ZL |                                  |                  |   |                            |



























<sup>1)</sup> electric parking brake / fr.di stazionamento elettrico / frein à main électrique / freno de mano eléctrico

|     |    |  |  |  |  |  |  |    |                        |
|--|--|--|--|--|---|--|--|--|------------------------|
| <b>VOLKSWAGEN PASSAT / PASSAT VARIANT (14-)</b>                                    |  |  |  |  |   |  |  |  |                        |
|    | 2.0 TDI  | 110  | 11.14  | PR: 1ZA,1ZC,1ZD,1ZG,1ZK,1ZL  | 13.0460-2785.2  | 602785   | 1  | 25683 20,4 +/WK/S<br>25683 20,4 +/WK/S<br>Warnkontakt L=172mm  | TRW<br>TRW             |
|  | 2.0 TDI  | 135  | 07.15  | PR: 1ZA,1ZC,1ZD,1ZG,1ZK,1ZL  | 13.0470-2785.2  | LD2785   |  |  |                        |
|  | 2.0 TDI  | 140  | 11.14  | PR: 1ZA,1ZC,1ZD,1ZG,1ZK,1ZL  | 24.8190-0065.2  | 620065   |  |  |                        |
|  | 2.0 TDI 4motion  | 110  | 02.15  | PR: 1ZA,1ZC,1ZD,1ZG,1ZK,1ZL  |   |  |  |  |                        |
|  | 2.0 TDI 4motion  | 140  | 11.14  | PR: 1ZA,1ZC,1ZD,1ZG,1ZK,1ZL  |   |  |  |  |                        |
|  | 2.0 TDI 4motion  | 176  | 11.14  | PR: 1ZA,1ZC,1ZD,1ZG,1ZK,1ZL  |   |  |  |  |                        |
|  | 2.0 TSI  | 155  | 11.14  | PR: 1ZA,1ZC,1ZD,1ZG,1ZK,1ZL  |   |  |  |  |                        |
|  | 2.0 TSI  | 162  | 05.15  | PR: 1ZA,1ZC,1ZD,1ZG,1ZK,1ZL  |   |  |  |  |                        |
|  | 2.0 TSI 4motion  | 206  | 05.15  | PR: 1ZA,1ZC,1ZD,1ZG,1ZK,1ZL  |   |  |  |  |                        |
|  | 1.4 GTE Hybrid   | 115  | 06.15  | PR: 1LA  | 13.0460-2764.2  | 602764   |  |  |                        |
|  | 1.4 TDI  | 77   | 11.14  | PR: 1LA  | 13.0470-2764.2  | LD2764   |  |  |                        |
|  | 1.4 TDI  | 103  | 11.14  | PR: 1LA  | 24.8190-0065.2  | 620065   |  |  |                        |
|  | 1.4 TSI  | 92   | 11.14  | PR: 1LA  |   |  |  |  |                        |
|  | 1.4 TSI  | 110  | 11.14  | PR: 1LA  |   |  |  |  |                        |
|  | 1.4 TSI  | 118  | 11.14  | PR: 1LA  |   |  |  |  |                        |
|  | 1.4 TSI 4motion  | 110  | 02.15  | PR: 1LA  |   |  |  |  |                        |
|  | 1.6 TDI  | 88   | 11.14  | PR: 1LA  |   |  |  |  |                        |
|  | 1.8 TSI  | 132  | 11.14  | PR: 1LA  |   |  |  |  |                        |
|  | 2.0 TDI  | 110  | 11.14  | PR: 1LA  |   |  |  |  |                        |
| 2.0 TDI  | 135  | 07.15  | PR: 1LA  |  |   |  |  |  |                        |
| 2.0 TDI  | 140  | 11.14  | PR: 1LA  |  |   |  |  |  |                        |
| 2.0 TDI 4motion  | 110  | 02.15  | PR: 1LA  |  |   |  |  |  |                        |
| 2.0 TDI 4motion  | 140  | 11.14  | PR: 1LA  |  |   |  |  |  |                        |
| 2.0 TDI 4motion  | 176  | 11.14  | PR: 1LA  |  |   |  |  |  |                        |
| 2.0 TSI  | 155  | 11.14  | PR: 1LA  |  |   |  |  |  |                        |
| 2.0 TSI  | 162  | 05.15  | PR: 1LA  |  |   |  |  |  |                        |
| 2.0 TSI 4motion  | 206  | 05.15  | PR: 1LA  |  |   |  |  |  |                        |
|    | 1.4 GTE Hybrid   | 115  | 06.15  | PR: 1ZA,1ZC,1ZD,1ZG,1ZK,1ZL  | 24.0125-0158.1  | 425158   |  | 312 25,0 22,0 V L +S +B<br>312 25,0 22,0 V L +S +B PD  |                        |
|  | 1.4 TDI  | 77   | 11.14  | PR: 1ZA,1ZC,1ZD,1ZG,1ZK,1ZL  | 24.0325-0158.1  | 525158   |  |  |                        |
|  | 1.4 TDI  | 103  | 11.14  | PR: 1ZA,1ZC,1ZD,1ZG,1ZK,1ZL  |   |  |  |  |                        |
|  | 1.4 TSI  | 92   | 11.14  | PR: 1ZA,1ZC,1ZD,1ZG,1ZK,1ZL  |   |  |  |  |                        |
|  | 1.4 TSI  | 110  | 11.14  | PR: 1ZA,1ZC,1ZD,1ZG,1ZK,1ZL  |   |  |  |  |                        |
|  | 1.4 TSI  | 118  | 11.14  | PR: 1ZA,1ZC,1ZD,1ZG,1ZK,1ZL  |   |  |  |  |                        |
|  | 1.4 TSI 4motion  | 110  | 02.15  | PR: 1ZA,1ZC,1ZD,1ZG,1ZK,1ZL  |   |  |  |  |                        |
|  | 1.6 TDI  | 88   | 11.14  | PR: 1ZA,1ZC,1ZD,1ZG,1ZK,1ZL  |   |  |  |  |                        |
|  | 1.8 TSI  | 132  | 11.14  | PR: 1ZA,1ZC,1ZD,1ZG,1ZK,1ZL  |   |  |  |  |                        |
|  | 2.0 TDI  | 110  | 11.14  | PR: 1ZA,1ZC,1ZD,1ZG,1ZK,1ZL  |   |  |  |  |                        |
|  | 2.0 TDI  | 135  | 07.15  | PR: 1ZA,1ZC,1ZD,1ZG,1ZK,1ZL  |   |  |  |  |                        |
|  | 2.0 TDI  | 140  | 11.14  | PR: 1ZA,1ZC,1ZD,1ZG,1ZK,1ZL  |   |  |  |  |                        |
|  | 2.0 TDI 4motion  | 110  | 02.15  | PR: 1ZA,1ZC,1ZD,1ZG,1ZK,1ZL  |   |  |  |  |                        |
|  | 2.0 TDI 4motion  | 140  | 11.14  | PR: 1ZA,1ZC,1ZD,1ZG,1ZK,1ZL  |   |  |  |  |                        |
|  | 2.0 TDI 4motion  | 176  | 11.14  | PR: 1ZA,1ZC,1ZD,1ZG,1ZK,1ZL  |   |  |  |  |                        |
|  | 2.0 TSI  | 155  | 11.14  | PR: 1ZA,1ZC,1ZD,1ZG,1ZK,1ZL  |   |  |  |  |                        |
|  | 2.0 TSI  | 162  | 05.15  | PR: 1ZA,1ZC,1ZD,1ZG,1ZK,1ZL  |   |  |  |  |                        |
|  | 2.0 TSI 4motion  | 206  | 05.15  | PR: 1ZA,1ZC,1ZD,1ZG,1ZK,1ZL  |   |  |  |  |                        |
|  |  | 1.4 GTE Hybrid   | 115  | 06.15  |   | 24.0130-0225.1   |  |  |                        |
| 1.4 TDI  |  | 77   | 11.14  | PR: 1LA  |   |  |  |  |                        |
| 1.4 TDI  |  | 103  | 11.14  | PR: 1LA  |   |  |  |  |                        |
| 1.4 TSI  |  | 92   | 11.14  | PR: 1LA  |   |  |  |  |                        |
| 1.4 TSI  |  | 110  | 11.14  | PR: 1LA  |   |  |  |  |                        |
| 1.4 TSI  |  | 118  | 11.14  | PR: 1LA  |   |  |  |  |                        |
| 1.4 TSI 4motion  |  | 110  | 02.15  | PR: 1LA  |   |  |  |  |                        |
| 1.6 TDI  |  | 88   | 11.14  | PR: 1LA  |   |  |  |  |                        |
| 1.8 TSI  |  | 132  | 11.14  | PR: 1LA  |   |  |  |  |                        |
| 2.0 TDI  |  | 110  | 11.14  | PR: 1LA  |   |  |  |  |                        |
| 2.0 TDI  |  | 135  | 07.15  | PR: 1LA  |   |  |  |  |                        |
| 2.0 TDI  |  | 140  | 11.14  | PR: 1LA  |   |  |  |  |                        |
| 2.0 TDI 4motion  |  | 110  | 02.15  | PR: 1LA  |   |  |  |  |                        |
| 2.0 TDI 4motion  |  | 140  | 11.14  | PR: 1LA  |   |  |  |  |                        |
| 2.0 TDI 4motion  |  | 176  | 11.14  | PR: 1LA  |   |  |  |  |                        |
| 2.0 TSI  |  | 155  | 11.14  | PR: 1LA  |   |  |  |  |                        |
| 2.0 TSI  |  | 162  | 05.15  | PR: 1LA  |   |  |  |  |                        |
| 2.0 TSI 4motion  |  | 206  | 05.15  | PR: 1LA  |   |  |  |  |                        |
|  |  | 1.4 GTE Hybrid   | 115  | 06.15  |   | 24.0711-5273.3   | 360303   | <br> | Radsensor<br>Radsensor |
|  | 1.4 TDI  | 77   | 11.14  |  | 24.0711-5274.3  | 360304   |  |  |                        |
|  | 1.4 TDI  | 103  | 11.14  |  |   |  |  |  |                        |
|  | 1.4 TSI  | 92   | 11.14  |  |   |  |  |  |                        |
|  | 1.4 TSI  | 110  | 11.14  |  |   |  |  |  |                        |
|  | 1.4 TSI  | 118  | 11.14  |  |   |  |  |  |                        |
|  | 1.4 TSI 4motion  | 110  | 02.15  |  |   |  |  |  |                        |
|  | 1.6 TDI  | 88   | 11.14  |  |   |  |  |  |                        |
|  | 1.8 TSI  | 132  | 11.14  |  |   |  |  |  |                        |
|  | 2.0 TDI  | 110  | 11.14  |  |   |  |  |  |                        |
|  | 2.0 TDI  | 135  | 07.15  |  |   |  |  |  |                        |
|  | 2.0 TDI  | 140  | 11.14  |  |   |  |  |  |                        |
|  | 2.0 TDI 4motion  | 110  | 02.15  |  |   |  |  |  |                        |
|  | 2.0 TDI 4motion  | 140  | 11.14  |  |   |  |  |  |                        |
|  | 2.0 TDI 4motion  | 176  | 11.14  |  |   |  |  |  |                        |
|  | 2.0 TSI  | 155  | 11.14  |  |   |  |  |  |                        |
|  | 2.0 TSI  | 162  | 05.15  |  |   |  |  |  |                        |
|  | 2.0 TSI 4motion  | 206  | 05.15  |  |   |  |  |  |                        |
|  |  | 1.4 GTE Hybrid   | 115  | 06.15  | PR: 1KU,1KZ,2EA   | 13.0460-7294.2   | 607294   |  |                        |
| 1.4 TDI  |  | 77   | 11.14  | PR: 1KU,1KZ,2EA  | 13.0470-7294.2  | LD7294   |  |  |                        |
| 1.4 TDI  |  | 103  | 11.14  | PR: 1KU,1KZ,2EA  |   |  |  |  |                        |
| 1.4 TSI  |  | 92   | 11.14  | PR: 1KU,1KZ,2EA  |   |  |  |  |                        |
| 1.4 TSI  |  | 110  | 11.14  | PR: 1KU,1KZ,2EA  |   |  |  |  |                        |
| 1.4 TSI  |  | 118  | 11.14  | PR: 1KU,1KZ,2EA  |   |  |  |  |                        |

1) electric parking brake / fr.di stazionamento elettrico / frein à main électrique / freno de mano eléctrico

|     |   |   |    |   |  |  |    |  |                          |
|--|---|---|--|---|---|--|--|--|--------------------------|
| <b>VOLKSWAGEN PASSAT / PASSAT VARIANT (14-)</b>                                    |   |   |  |   |   |  |  |  |                          |
|    | 1.4 TSI 4motion<br>1.6 TDI<br>1.8 TSI<br>2.0 TDI<br>2.0 TDI<br>2.0 TDI<br>2.0 TDI 4motion<br>2.0 TDI 4motion<br>2.0 TDI 4motion<br>2.0 TSI<br>2.0 TSI<br>2.0 TSI 4motion  | 110<br>88<br>132<br>110<br>135<br>140<br>110<br>140<br>176<br>155<br>162<br>206   | 02.15<br>11.14<br>11.14<br>11.14<br>07.15<br>11.14<br>02.15<br>11.14<br>11.14<br>11.14<br>05.15<br>05.15   | PR: 1KU,1KZ,2EA<br>PR: 1KU,1KZ,2EA<br>PR: 1KU,1KZ,2EA<br>PR: 1KU,1KZ,2EA<br>PR: 1KU,1KZ,2EA<br>PR: 1KU,1KZ,2EA<br>PR: 1KU,1KZ,2EA<br>PR: 1KU,1KZ,2EA<br>PR: 1KU,1KZ,2EA<br>PR: 1KU,1KZ,2EA<br>PR: 1KU,1KZ,2EA<br>PR: 1KU,1KZ,2EA                            | 13.0460-7294.2<br>13.0470-7294.2  | 607294<br>LD7294   | elektrische Feststellbremse <sup>1)</sup><br>elektrische Feststellbremse <sup>1)</sup>   | 25009 16,4 +<br>25009 16,4 +<br><b>ATE</b><br><b>ATE</b>                           |                          |
|    | 1.4 GTE Hybrid<br>1.4 TDI<br>1.4 TDI<br>1.4 TSI<br>1.4 TSI<br>1.4 TSI<br>1.4 TSI 4motion<br>1.6 TDI<br>1.8 TSI<br>2.0 TDI<br>2.0 TDI<br>2.0 TDI<br>2.0 TDI 4motion<br>2.0 TDI 4motion<br>2.0 TDI 4motion<br>2.0 TSI<br>2.0 TSI<br>2.0 TSI 4motion | 115<br>77<br>103<br>92<br>110<br>118<br>110<br>88<br>132<br>110<br>135<br>140<br>110<br>140<br>176<br>155<br>162<br>206 | 06.15<br>11.14<br>11.14<br>11.14<br>11.14<br>11.14<br>02.15<br>11.14<br>11.14<br>11.14<br>07.15<br>11.14<br>02.15<br>11.14<br>11.14<br>11.14<br>05.15<br>05.15 | PR: 1KU,2EA<br>PR: 1KU,2EA<br>PR: 1KU,2EA<br>PR: 1KU,2EA<br>PR: 1KU,2EA<br>PR: 1KU,2EA<br>PR: 1KU,2EA<br>PR: 1KU,2EA<br>PR: 1KU,2EA<br>PR: 1KU,2EA<br>PR: 1KU,2EA<br>PR: 1KU,2EA<br>PR: 1KU,2EA<br>PR: 1KU,2EA<br>PR: 1KU,2EA<br>PR: 1KU,2EA<br>PR: 1KU,2EA | 24.0112-0210.1  | 412210   | elektrische Feststellbremse <sup>1)</sup>  | 300 12,0 10,0 +S +B  |                          |
|  | 1.4 GTE Hybrid<br>1.4 TDI<br>1.4 TDI<br>1.4 TSI<br>1.4 TSI<br>1.4 TSI<br>1.4 TSI 4motion<br>1.6 TDI<br>1.8 TSI<br>2.0 TDI<br>2.0 TDI<br>2.0 TDI<br>2.0 TDI 4motion<br>2.0 TDI 4motion<br>2.0 TDI 4motion<br>2.0 TSI<br>2.0 TSI<br>2.0 TSI 4motion | 115<br>77<br>103<br>92<br>110<br>118<br>110<br>88<br>132<br>110<br>135<br>140<br>110<br>140<br>176<br>155<br>162<br>206 | 06.15<br>11.14<br>11.14<br>11.14<br>11.14<br>11.14<br>02.15<br>11.14<br>11.14<br>11.14<br>07.15<br>11.14<br>02.15<br>11.14<br>11.14<br>11.14<br>05.15<br>05.15 | PR: 1KZ<br>PR: 1KZ<br>PR: 1KZ<br>PR: 1KZ<br>PR: 1KZ<br>PR: 1KZ<br>PR: 1KZ<br>PR: 1KZ<br>PR: 1KZ<br>PR: 1KZ<br>PR: 1KZ<br>PR: 1KZ<br>PR: 1KZ<br>PR: 1KZ<br>PR: 1KZ<br>PR: 1KZ<br>PR: 1KZ   | 24.0122-0219.1  | 422219   | elektrische Feststellbremse <sup>1)</sup>  | 310 22,0 20,0 V L +B   |                          |
|  | 1.4 GTE Hybrid<br>1.4 TDI<br>1.4 TDI<br>1.4 TSI<br>1.4 TSI<br>1.4 TSI<br>1.6 TDI<br>1.8 TSI<br>2.0 TDI<br>2.0 TDI<br>2.0 TDI<br>2.0 TDI<br>2.0 TSI<br>2.0 TSI   | 115<br>77<br>103<br>92<br>110<br>118<br>88<br>132<br>110<br>135<br>140<br>140<br>155<br>162                             | 06.15<br>11.14<br>11.14<br>11.14<br>11.14<br>11.14<br>11.14<br>11.14<br>11.14<br>07.15<br>11.14<br>11.14<br>11.14<br>05.15                                     |   | 24.0711-6337.3  | 360390   | 2   | Radsensor  |                          |
|  | 1.4 TSI 4motion<br>2.0 TDI 4motion<br>2.0 TDI 4motion<br>2.0 TDI 4motion<br>2.0 TSI 4motion   | 110<br>110<br>140<br>176<br>206   | 02.15<br>02.15<br>11.14<br>11.14<br>05.15  |   | 24.0711-5401.3<br>24.0711-5402.3  | 360330<br>360331   | <br> | Radsensor<br>Radsensor   |                          |
| <b>VOLKSWAGEN PASSAT ALLTRACK (15-)</b>  |   |   |  |   |   |  |  |  |                          |
|  | 2.0 TDI 4motion<br>2.0 TDI 4motion<br>2.0 TDI 4motion<br>2.0 TDI 4motion<br>2.0 TSI 4motion   | 110<br>135<br>140<br>176<br>162   | 05.15<br>07.15<br>05.15<br>05.15<br>07.15  | PR: 1ZA,1ZC,1ZD,1ZG,1ZK,1ZL<br>PR: 1ZA,1ZC,1ZD,1ZG,1ZK,1ZL<br>PR: 1ZA,1ZC,1ZD,1ZG,1ZK,1ZL<br>PR: 1ZA,1ZC,1ZD,1ZG,1ZK,1ZL<br>PR: 1ZA,1ZC,1ZD,1ZG,1ZK,1ZL   | 13.0460-2785.2<br>13.0470-2785.2<br>24.8190-0065.2                                | 602785<br>LD2785<br>620065   | 1  | 25683 20,4 +/WK/S<br>25683 20,4 +/WK/S<br>Warnkontakt L=172mm                      | <b>TRW</b><br><b>TRW</b> |
|  | 2.0 TDI 4motion<br>2.0 TDI 4motion<br>2.0 TDI 4motion<br>2.0 TDI 4motion<br>2.0 TSI 4motion   | 110<br>135<br>140<br>176<br>162   | 05.15<br>07.15<br>05.15<br>05.15<br>07.15  | PR: 1LA<br>PR: 1LA<br>PR: 1LA<br>PR: 1LA<br>PR: 1LA   | 13.0460-2764.2<br>13.0470-2764.2<br>24.8190-0065.2                                | 602764<br>LD2764<br>620065   | 1  | 24738 20,0 +/WK/S<br>24738 20,0 +/WK/S<br>Warnkontakt L=172mm                      | <b>TRW</b><br><b>TRW</b> |
|  | 2.0 TDI 4motion<br>2.0 TDI 4motion<br>2.0 TDI 4motion<br>2.0 TDI 4motion<br>2.0 TSI 4motion   | 110<br>135<br>140<br>176<br>162   | 05.15<br>07.15<br>05.15<br>05.15<br>07.15  | PR: 1ZA,1ZC,1ZD,1ZG,1ZK,1ZL<br>PR: 1ZA,1ZC,1ZD,1ZG,1ZK,1ZL<br>PR: 1ZA,1ZC,1ZD,1ZG,1ZK,1ZL<br>PR: 1ZA,1ZC,1ZD,1ZG,1ZK,1ZL<br>PR: 1ZA,1ZC,1ZD,1ZG,1ZK,1ZL   | 24.0125-0158.1<br>24.0325-0158.1  | 425158<br>525158   |  | 312 25,0 22,0 V L +S +B<br>312 25,0 22,0 V L +S +B PD                              |                          |
|  | 2.0 TDI 4motion<br>2.0 TDI 4motion<br>2.0 TDI 4motion   | 110<br>135<br>140   | 05.15<br>07.15<br>05.15  | PR: 1LA<br>PR: 1LA<br>PR: 1LA   | 24.0130-0225.1  | 430225   |  | 340 30,0 27,0 V L +S +B  |                          |

<sup>1)</sup> electric parking brake / fr.di stazionamento elettrico / frein à main électrique / freno de mano eléctrico

|     |    kW   |  |  |    |  |  |    |  |
|--|---|--|--|--|---|--|--|--|
| <b>VOLKSWAGEN PASSAT ALLTRACK (15-)</b>  |   |  |  |  |   |  |  |  |
|    | 2.0 TDI 4motion<br>2.0 TSI 4motion  | 176<br>162   | 05.15<br>07.15   | PR: 1LA<br>PR: 1LA   | 24.0130-0225.1  | 430225   |  | 340 30,0 27,0 V L +S +B  |
|    | 2.0 TDI 4motion<br>2.0 TDI 4motion<br>2.0 TDI 4motion<br>2.0 TDI 4motion<br>2.0 TSI 4motion   | 110<br>135<br>140<br>176<br>162  | 05.15<br>07.15<br>05.15<br>05.15<br>07.15  |  | 24.0711-5273.3<br>24.0711-5274.3  | 360303<br>360304   | <br> | Radsensor<br>Radsensor   |
|    | 2.0 TDI 4motion<br>2.0 TDI 4motion<br>2.0 TDI 4motion<br>2.0 TDI 4motion<br>2.0 TSI 4motion   | 110<br>135<br>140<br>176<br>162  | 05.15<br>07.15<br>05.15<br>05.15<br>07.15  | PR: 1KU,1KZ,2EA<br>PR: 1KU,1KZ,2EA<br>PR: 1KU,1KZ,2EA<br>PR: 1KU,1KZ,2EA<br>PR: 1KU,1KZ,2EA  | 13.0460-7294.2<br>13.0470-7294.2  | 607294<br>LD7294   |  | 25009 16,4 +<br>25009 16,4 +<br><b>ATE</b><br><b>ATE</b>                           |
|    | 2.0 TDI 4motion<br>2.0 TDI 4motion<br>2.0 TDI 4motion<br>2.0 TDI 4motion<br>2.0 TSI 4motion   | 110<br>135<br>140<br>176<br>162  | 05.15<br>07.15<br>05.15<br>05.15<br>07.15  | PR: 1KU,2EA<br>PR: 1KU,2EA<br>PR: 1KU,2EA<br>PR: 1KU,2EA<br>PR: 1KU,2EA  | 24.0112-0210.1  | 412210   |  | 300 12,0 10,0 +S +B  |
|    | 2.0 TDI 4motion<br>2.0 TDI 4motion<br>2.0 TDI 4motion<br>2.0 TDI 4motion<br>2.0 TSI 4motion   | 110<br>135<br>140<br>176<br>162  | 05.15<br>07.15<br>05.15<br>05.15<br>07.15  | PR: 1KZ<br>PR: 1KZ<br>PR: 1KZ<br>PR: 1KZ<br>PR: 1KZ  | 24.0122-0219.1  | 422219   |  | 310 22,0 20,0 V L +B   |
|    | 2.0 TDI 4motion<br>2.0 TDI 4motion<br>2.0 TDI 4motion<br>2.0 TDI 4motion<br>2.0 TSI 4motion   | 110<br>135<br>140<br>176<br>162  | 05.15<br>07.15<br>05.15<br>05.15<br>07.15  |  | 24.0711-5401.3<br>24.0711-5402.3  | 360330<br>360331   | <br> | Radsensor<br>Radsensor   |
| <b>VOLKSWAGEN PHAETON (02-)</b>  |   |  |  |  |   |  |  |  |
|    | 3.2 V6<br>3.0 TDI 4motion<br>3.0 V6 TDI 4motion<br>3.2 V6<br>3.2 V6 4motion<br>3.6 V6 4motion<br>4.2 V8 4motion<br>5.0 V10 TDI 4motion<br>6.0 W12 4motion |  | 04.02<br>09.04<br>04.08<br>04.02<br>02.04<br>11.08<br>05.03<br>11.02<br>04.02    | PR: 1LX<br>PR: 12K,1ZL<br>PR: 12K,1ZL<br>PR: 12K,1ZL<br>PR: 12K,1ZL<br>PR: 12K,1ZL<br>PR: 12K,1ZL<br>PR: 12K,1ZL<br>PR: 12K,1ZL                      | 13.0460-2875.2<br>13.0460-7182.2  | 602875<br>607182   |  | 23280 17,5 +/WK<br>23896 20,6 +/WK<br><b>TRW</b><br><b>ATE</b>                     |
|    | 3.0 TDI 4motion<br>3.0 V6 TDI 4motion<br>3.2 V6<br>3.2 V6 4motion<br>3.6 V6 4motion<br>4.2 V8 4motion<br>5.0 V10 TDI 4motion<br>6.0 W12 4motion           |  | 09.04<br>04.08<br>04.02<br>02.04<br>11.08<br>05.03<br>11.02<br>04.02             | PR: 1LC<br>PR: 1LC<br>PR: 1LC<br>PR: 1LC<br>PR: 1LC<br>PR: 1LC<br>PR: 1LC<br>PR: 1LC   | 13.0460-4800.2  | 604800   |  | 23751 17,0 +/WK<br><b>BRE</b>  |
|  | 3.2 V6<br>3.0 TDI 4motion<br>3.0 V6 TDI 4motion<br>3.2 V6<br>3.2 V6 4motion<br>3.6 V6 4motion<br>4.2 V8 4motion<br>5.0 V10 TDI 4motion<br>6.0 W12 4motion |  | 04.02<br>09.04<br>04.08<br>04.02<br>02.04<br>11.08<br>05.03<br>11.02<br>04.02    | PR: 1LX<br>PR: 12K,1ZL<br>PR: 12K,1ZL<br>PR: 12K,1ZL<br>PR: 12K,1ZL<br>PR: 12K,1ZL<br>PR: 12K,1ZL<br>PR: 12K,1ZL<br>PR: 12K,1ZL                      | 24.0130-0183.1<br>24.0134-0100.1  | 430183<br>434100   |  | 323 30,0 28,0 V +B<br>360 34,0 31,0 V L +B   |
|  | 3.0 TDI 4motion<br>3.0 V6 TDI 4motion<br>3.2 V6<br>3.2 V6 4motion<br>3.6 V6 4motion<br>4.2 V8 4motion<br>5.0 V10 TDI 4motion<br>6.0 W12 4motion           |  | 09.04<br>04.08<br>04.02<br>02.04<br>11.08<br>05.03<br>11.02<br>04.02             | PR: 1KD,1KP,1KY<br>PR: 1KD,1KP,1KY<br>PR: 1KD,1KP,1KY<br>PR: 1KD,1KP,1KY<br>PR: 1KD,1KP,1KY<br>PR: 1KD,1KP,1KY<br>PR: 1KD,1KP,1KY<br>PR: 1KD,1KP,1KY | 13.0460-2890.2<br>13.0460-0023.2  | 602890<br>610023   |  | 23326 17,4 /WK/S<br>Belagsatz-Zubehör<br><b>TRW</b>                                |
|  | 3.0 TDI 4motion<br>3.0 V6 TDI 4motion<br>3.2 V6<br>3.2 V6 4motion<br>3.6 V6 4motion<br>4.2 V8 4motion<br>5.0 V10 TDI 4motion<br>6.0 W12 4motion           |  | 09.04<br>04.08<br>04.02<br>02.04<br>11.08<br>05.03<br>11.02<br>04.02             | PR: 1KD<br>PR: 1KD<br>PR: 1KD<br>PR: 1KD<br>PR: 1KD<br>PR: 1KD<br>PR: 1KD<br>PR: 1KD   | 24.0122-0202.1  | 422202   |  | 280 22,0 20,0 V L +B   |
|  | 3.0 TDI 4motion<br>3.0 V6 TDI 4motion<br>3.2 V6<br>3.2 V6 4motion<br>3.6 V6 4motion<br>4.2 V8 4motion<br>5.0 V10 TDI 4motion<br>6.0 W12 4motion           |  | 09.04<br>04.08<br>04.02<br>02.04<br>11.08<br>05.03<br>11.02<br>04.02             | PR: 1KP<br>PR: 1KP<br>PR: 1KP<br>PR: 1KP<br>PR: 1KP<br>PR: 1KP<br>PR: 1KP<br>PR: 1KP   | 24.0122-0212.1  | 422212   |  | 310 22,0 20,0 V L +B   |
|  | 3.0 TDI 4motion<br>3.0 V6 TDI 4motion<br>3.2 V6<br>3.2 V6 4motion<br>3.6 V6 4motion   |  | 09.04<br>04.08<br>04.02<br>02.04<br>11.08  | PR: 1KY<br>PR: 1KY<br>PR: 1KY<br>PR: 1KY<br>PR: 1KY  | 24.0122-0214.1  | 422214   |  | 335 22,0 20,0 V L +B   |



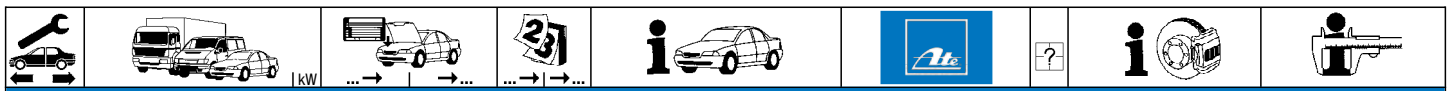

**VOLKSWAGEN PHAETON (02-)**

|  |  |  |                         |                               |                |        |  |                      |
|--|--|--|-------------------------|-------------------------------|----------------|--------|--|----------------------|
|  | 4.2 V8 4motion<br>5.0 V10 TDI 4motion<br>6.0 W12 4motion |  | 05.03<br>11.02<br>04.02 | PR: 1KY<br>PR: 1KY<br>PR: 1KY | 24.0122-0214.1 | 422214 |  | 335 22,0 20,0 V L +B |
|--|--|--|-------------------------|-------------------------------|----------------|--------|--|----------------------|

**VOLKSWAGEN POLO III (95-01)**

|  |  |                            |  |   |                          |                                  |                  |  |   |           |
|--|--|----------------------------|--|---|--------------------------|----------------------------------|------------------|--|---|-----------|
|  | 1.05<br>1.3<br>1.4<br>1.4<br>1.6<br>1.9 D<br>1.9 SDI   |                            | 6N-TY140000<br>6N-TY140000<br>6N-TY140000<br>6N-TY140000<br>6N-TY140000<br>6N-TY140000<br>6N-TY140000  | 10.94<br>10.94<br>07.95<br>07.95<br>10.94<br>10.94<br>10.94   |                          | 13.0460-7059.2                   | 607059           |  | 20887 17,3 +/Zub                                      | VW        |
|  | 1.05<br>1.3<br>1.4<br>1.4<br>1.6<br>1.9 D<br>1.9 SDI   | 40<br>44<br>55             | 6N-TW082000<br>6N-TW082000<br>6N-TW082000<br>6N-TW082000<br>6N-TW082000<br>6N-TW082000<br>6N-TW082000  | 10.94<br>10.94<br>07.95<br>07.95<br>10.94<br>10.94<br>10.94   |                          | 13.0460-7059.2                   | 607059           |  | 20887 17,3 +/Zub                                      | VW        |
|  | 1.0<br>1.05<br>1.3<br>1.4<br>1.4<br>1.4 16V<br>1.6<br>1.7 SDI<br>1.9 D<br>1.9 SDI                                  |                            | 6N-TY140001<br>6N-TY140001<br>6N-TY140001<br>6N-TY140001<br>6N-TY140001<br>6N-TY140001<br>6N-TY140001<br>6N-TY140001<br>6N-TY140001<br>6N-TY140001 | 07.96<br>09.01<br>09.96<br>04.97<br>09.01<br>09.01<br>01.99<br>09.01<br>09.99<br>09.01<br>09.01                   | - ABS                    | 13.0460-7100.2<br>13.0470-7100.2 | 607100<br>LD7100 |  | 21866 17,2 +<br>21866 17,2 +                          | VW<br>ATE |
|  | 1.05<br>1.3<br>1.4<br>1.4<br>1.6<br>1.9 D<br>1.9 SDI   | 40<br>44<br>55             | 6N-TW082001<br>6N-TW082001<br>6N-TW082001<br>6N-TW082001<br>6N-TW082001<br>6N-TW082001<br>6N-TW082001  | 09.96<br>04.97<br>09.01<br>09.01<br>09.99<br>09.01<br>09.01   |                          | 13.0460-7100.2<br>13.0470-7100.2 | 607100<br>LD7100 |  | 21866 17,2 +<br>21866 17,2 +                          | VW<br>ATE |
|  | 1.4 16V<br>1.4 16V<br>1.4 TDI<br>1.6 GTI   | 55<br>74<br>55             |  | 01.99<br>04.96<br>01.99<br>04.98  | + ABS<br>- Motorsport 1) | 13.0460-2821.2                   | 602821           |  | 21945 16,0 /S   | TRW       |
|  | 1.05<br>1.3<br>1.6<br>1.9 D<br>1.9 SDI   | 55                         | 6N-SY087410<br>6N-SY087410<br>6N-SY087410<br>6N-SY087410<br>6N-SY087410  | 10.94<br>10.94<br>10.94<br>10.94<br>10.94   |                          | 24.0110-0232.1                   | 410232           |  | 239 9,9 8,0 +S +B                                     |           |
|  | 1.05<br>1.3<br>1.6<br>1.9 D<br>1.9 SDI   | 55                         | 6N-SW008500<br>6N-SW008500<br>6N-SW008500<br>6N-SW008500<br>6N-SW008500  | 10.94<br>10.94<br>10.94<br>10.94<br>10.94   |                          | 24.0110-0232.1                   | 410232           |  | 239 9,9 8,0 +S +B                                     |           |
|  | 1.0<br>1.05<br>1.3<br>1.4<br>1.4<br>1.4 16V<br>1.6<br>1.7 SDI<br>1.9 D<br>1.9 SDI                                  |                            | 6N-SY087411<br>6N-SY087411<br>6N-SY087411<br>6N-SY087411<br>6N-SY087411<br>6N-SY087411<br>6N-SY087411<br>6N-SY087411<br>6N-SY087411<br>6N-SY087411 | 07.96<br>09.01<br>09.96<br>04.97<br>09.01<br>07.95<br>09.01<br>01.99<br>09.01<br>09.99<br>09.01<br>09.01          | - ABS                    | 24.0118-0106.1<br>24.0318-0106.1 | 418106<br>518106 |  | 239 18,0 16,0 V L +S +B<br>239 18,0 16,0 V L +S +B PD |           |
|  | 1.05<br>1.3<br>1.6<br>1.9 D<br>1.9 SDI   | 55                         | 6N-SW008501<br>6N-SW008501<br>6N-SW008501<br>6N-SW008501<br>6N-SW008501  | 09.96<br>04.97<br>09.99<br>09.01<br>09.01   |                          | 24.0118-0106.1<br>24.0318-0106.1 | 418106<br>518106 |  | 239 18,0 16,0 V L +S +B<br>239 18,0 16,0 V L +S +B PD |           |
|  | 1.4 16V<br>1.4 16V<br>1.4 TDI<br>1.6 GTI   | 55<br>74<br>55             |  | 01.99<br>04.96<br>01.99<br>04.98  | + ABS                    | 24.0120-0128.1<br>24.0320-0128.1 | 420128<br>520128 |  | 256 20,0 18,0 V L +S +B<br>256 20,0 18,0 V L +S +B PD |           |
|  | 1.0<br>1.05<br>1.3<br>1.4<br>1.4<br>1.4 16V<br>1.4 16V<br>1.4 TDI<br>1.6<br>1.6 GTI<br>1.7 SDI<br>1.9 D<br>1.9 SDI |                            |  | 07.96<br>10.94<br>10.94<br>07.95<br>07.95<br>01.99<br>04.96<br>01.99<br>10.94<br>04.98<br>05.97<br>10.94<br>10.94 |                          | 24.0125-0136.1                   | 425136           |  | 256 25,0 23,0 V L                                     |           |
|  | 1.0<br>1.05<br>1.3<br>1.4<br>1.4<br>1.4 16V<br>1.4 16V<br>1.4 TDI<br>1.6<br>1.6 GTI<br>1.7 SDI<br>1.9 D<br>1.9 SDI | 40<br>44<br>55<br>74<br>55 |  | 07.96<br>10.94<br>10.94<br>07.95<br>07.95<br>01.99<br>04.96<br>01.99<br>10.94<br>04.98<br>05.97<br>10.94<br>10.94 |                          | 24.0711-1361.3<br>24.0711-1362.3 | 360022<br>360023 |  | Radsensor<br>Radsensor                                |           |

1) - motorsports / - motorsports / - Motorsport / - motorismo



**VOLKSWAGEN POLO III (95-01)**

|  |  |                |  |   |  |  |  |                                      |  |  |                          |
|--|--|----------------|--|---|--|--|--|--------------------------------------|--|--|--------------------------|
|  | 1.4 16V<br>1.6 GTI   | 74             |  | 04.96<br>04.98  | 09.99<br>09.99   | + ⊕ / - Motorsport <sup>1)</sup>   | 13.0460-2984.2<br>13.0460-0072.2                                     | 602984<br>610072                     |  | 20961 17,2 /Zub/S<br>Belagsatz-Zubehör                                   | TRW<br>TRW               |
|  | 1.4 16V<br>1.4 16V<br>1.4 TDI<br>1.6 GTI   | 55<br>74<br>55 |  | 01.99<br>10.99<br>01.99<br>10.99  | 09.01<br>09.01<br>09.01<br>09.01   | + ABS<br>+ ⊕ / - Motorsport <sup>1)</sup><br>+ ABS   | 13.0460-2894.2<br>13.0470-2894.2<br>13.0460-2886.2<br>13.0470-2886.2 | 602894<br>LD2894<br>602886<br>LD2886 |  | 20961 17,4 /Zub/S<br>20961 17,4 /Zub/S<br>20961 16,2 /S<br>20961 16,2 /S | TRW<br>TRW<br>TRW<br>TRW |
|  | 1.4 16V<br>1.6 GTI   | 74             |  | 04.96<br>04.98  | 09.99<br>09.99   | + ⊕  | 24.0110-0111.1<br>24.0110-0275.2                                     | 410111<br>410275                     | ohne Sensorring <sup>2)</sup><br>mit Sensorring <sup>3)</sup>  | 226 10,0 8,0 +B<br>226 10,0 8,0 +B                                       |                          |
|  | 1.4 16V<br>1.4 16V<br>1.4 TDI<br>1.6 GTI   | 55<br>74<br>55 |  | 01.99<br>10.99<br>01.99<br>10.99  | 09.01<br>09.01<br>09.01<br>09.01   | + ABS<br>+ ⊕<br>+ ABS  | 24.0109-0124.1   | 409124                               |  | 232 9,0 7,0 +B   |                          |
|  | 1.0<br>1.05<br>1.3<br>1.4<br>1.4<br>1.4 16V<br>1.4 16V<br>1.4 TDI<br>1.6<br>1.6 GTI<br>1.7 SDI<br>1.9 D<br>1.9 SDI   |                |  | 07.96<br>10.94<br>10.94<br>07.95<br>07.95<br>01.99<br>04.96<br>01.99<br>10.94<br>04.98<br>05.97<br>10.94<br>10.94   | 09.01<br>09.96<br>09.96<br>04.97<br>09.01<br>09.01<br>09.01<br>09.01<br>09.99<br>09.01<br>09.01<br>09.01<br>09.01  | - ABS<br>- ABS<br>- ABS<br>- ABS<br>- ABS<br>- ABS / - ⊕<br>- ABS<br>- ABS<br>- ABS<br>- ABS<br>- ABS<br>- ABS   | 03.0137-0126.2<br>03.0137-9008.2                                     | 650126<br>669008                     |  | Radsensor L=843  |                          |
|  | 1.0<br>1.0<br>1.05<br>1.05<br>1.3<br>1.3<br>1.4<br>1.4<br>1.4<br>1.4<br>1.4 16V<br>1.4 16V<br>1.4 16V<br>1.4 TDI<br>1.6<br>1.6<br>1.7 SDI<br>1.7 SDI<br>1.9 D<br>1.9 D<br>1.9 SDI<br>1.9 SDI |                | 6N-XY227490<br>6N-XY227490<br>6N-XY227490<br>6N-XY227490<br>6N-XY227490<br>6N-XY227490<br>6N-XY227490<br>6N-XY227490<br>6N-XY227490<br>6N-XY227490<br>6N-XY227490<br>6N-XY227490<br>6N-XY227490<br>6N-XY227490<br>6N-XY227490<br>6N-XY227490<br>6N-XY227490<br>6N-XY227490<br>6N-XY227490<br>6N-XY227490<br>6N-XY227490<br>6N-XY227490 | 07.96<br>10.94<br>10.94<br>07.95<br>07.95<br>01.99<br>04.96<br>09.01<br>09.01<br>09.01<br>09.01<br>09.01<br>09.01<br>09.01<br>09.99<br>05.97<br>09.01<br>10.94<br>10.94<br>09.01          | 09.01<br>09.01<br>09.01<br>09.01<br>09.01<br>09.01<br>09.01<br>09.01<br>09.01<br>09.01<br>09.01<br>09.01<br>09.01<br>09.01<br>09.01<br>09.01<br>09.01<br>09.01<br>09.01<br>09.01<br>09.01<br>09.01 | + ABS<br>+ ABS<br>+ ABS<br>+ ABS<br>+ ABS<br>- ABS<br>+ ABS / - ⊕<br>- ⊕<br>- ABS<br>+ ABS<br>+ ABS<br>+ ABS<br>+ ABS<br>+ ABS<br>+ ABS<br>+ ABS<br>+ ABS<br>+ ABS<br>+ ABS<br>+ ABS<br>+ ABS<br>+ ABS | 03.0137-0268.2<br>03.0137-9168.2                                     | 650268<br>669168                     |  | 200 x 40 HEB<br>Bremsbacken-Zubehör                                      | VW<br>VW                 |
|  | 1.0<br>1.05<br>1.3<br>1.4<br>1.4<br>1.4 16V<br>1.6<br>1.7 SDI<br>1.9 D<br>1.9 SDI  |                |  | 07.96<br>10.94<br>10.94<br>07.95<br>07.95<br>04.96<br>10.94<br>05.97<br>10.94<br>10.94  |  | - ABS<br>- ABS<br>- ABS<br>- ABS<br>- ABS<br>- ABS / - ⊕<br>- ABS<br>- ABS<br>- ABS<br>- ABS   | 24.0218-0007.1<br>24.0218-0707.2                                     | 480003<br>480211                     |  | 180/181 x 38,5 - Lager<br>180/181 x 38,5 + Lager                         |                          |
|  | 1.0<br>1.0<br>1.05<br>1.05<br>1.3<br>1.3<br>1.4<br>1.4<br>1.4<br>1.4<br>1.4 16V<br>1.4 16V<br>1.4 16V<br>1.4 TDI<br>1.6<br>1.6<br>1.7 SDI<br>1.7 SDI<br>1.9 D<br>1.9 D<br>1.9 SDI<br>1.9 SDI |                | 6N-XY227490<br>6N-XY227490<br>6N-XY227490<br>6N-XY227490<br>6N-XY227490<br>6N-XY227490<br>6N-XY227490<br>6N-XY227490<br>6N-XY227490<br>6N-XY227490<br>6N-XY227490<br>6N-XY227490<br>6N-XY227490<br>6N-XY227490<br>6N-XY227490<br>6N-XY227490<br>6N-XY227490<br>6N-XY227490<br>6N-XY227490<br>6N-XY227490<br>6N-XY227490<br>6N-XY227490 | 07.96<br>10.94<br>10.94<br>07.95<br>07.95<br>01.99<br>04.96<br>09.01<br>09.01<br>09.01<br>09.01<br>09.01<br>09.01<br>09.01<br>09.99<br>05.97<br>09.01<br>10.94<br>10.94<br>09.01<br>09.01 |  | + ABS<br>+ ABS<br>+ ABS<br>+ ABS<br>+ ABS<br>+ ABS<br>+ ABS / - ⊕<br>- ⊕<br>- ABS<br>+ ABS<br>+ ABS<br>+ ABS<br>+ ABS<br>+ ABS<br>+ ABS<br>+ ABS<br>+ ABS<br>+ ABS<br>+ ABS<br>+ ABS<br>+ ABS<br>+ ABS | 24.0220-0018.1<br>24.0220-0718.2                                     | 480019<br>480209                     | ohne Sensorring <sup>2)</sup><br>ohne Sensorring <sup>2)</sup> | 200/201 x 50,0 - Lager<br>200/201,5 x 50,0 + Lager                       |                          |

<sup>1)</sup> + ⊕ / - motorsports / + ⊕ / - motorsports / + ⊕ / - Motorsport / + ⊕ / - motorismo

<sup>2)</sup> without sensor ring / senza sensori / sans secours ABS / sin anillo sensor ABS

<sup>3)</sup> with sensor ring / con sensori / avec secours ABS / con anillo sensor ABS

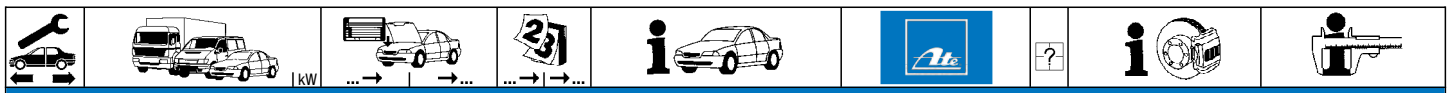

**VOLKSWAGEN POLO III (95-01)**

|         |                |                |             |            |       |                |                |  |  |          |        |   |   |          |
|---------|----------------|----------------|-------------|------------|-------|----------------|----------------|--|--|----------|--------|---|---|----------|
|         | 1.9 D          | 6N-XY227490    | 6N-XY420000 |            |       | 24.0220-0018.1 | 480019         | ohne Sensorring <sup>1)</sup><br>ohne Sensorring <sup>1)</sup> | 200/201 x 50,0 - Lager<br>200/201,5 x 50,0 + Lager |          |        |   |   |          |
|         | 1.9 D          |                | 6N-XY227489 | 10.94      | + ABS | 24.0220-0718.2 | 480209         |  |  |          |        |   |   |          |
|         | 1.9 SDI        | 6N-XY227490    | 6N-XY420000 |            |       |                |                |  |  |          |        |   |   |          |
|         | 1.9 SDI        |                | 6N-XY227489 | 10.94      | + ABS |                |                |  |  |          |        |   |   |          |
|         | 1.0            | 6N-XY420001    |             |            |       | 24.0220-0032.1 | 480130         |  | 200/201,5 x 50,1                                   |          |        |   |   |          |
|         | 1.05           | 6N-XY420001    |             |            |       |                |                |  |  |          |        |   |   |          |
|         | 1.3            | 6N-XY420001    |             |            |       |                |                |  |  |          |        |   |   |          |
|         | 1.4            | 40 6N-XY420001 |             |            |       |                |                |  |  |          |        |   |   |          |
|         | 1.4            | 44 6N-XY420001 |             |            |       |                |                |  |  |          |        |   |   |          |
|         | 1.4 16V        | 55 6N-XY420001 |             |            |       |                |                |  |  |          |        |   |   |          |
|         | 1.4 16V        | 74 6N-XY420001 |             |            |       |                |                |  |  |          |        |   |   |          |
|         | 1.4 TDI        | 55 6N-XY420001 |             |            |       |                |                |  |  |          |        |   |   |          |
|         | 1.7 SDI        | 6N-XY420001    |             |            |       |                |                |  |  |          |        |   |   |          |
|         | 1.9 D          | 6N-XY420001    |             |            |       |                |                |  |  |          |        |   |   |          |
|         | 1.9 SDI        | 6N-XY420001    |             |            |       |                |                |  |  |          |        |   |   |          |
|         | 1.0            |                | 6N-XY227489 | 07.96      | - ABS |                | 03.0420-0617.3 |  |  |          | 680617 | + Rz GG <sup>2)</sup><br>+ Rz ALU <sup>3)</sup> | 17,46/180x31 Kit<br>17,46/180x31 TopKit | VW<br>VW |
|         | 1.05           |                | 6N-XY227489 | 10.94      | - ABS |                | 03.0520-3917.3 |  |  |          | 693917 |   |   |          |
|         | 1.3            |                | 6N-XY227489 | 10.94      | - ABS |                |                |  |  |          |        |   |   |          |
|         | 1.4            | 40             | 6N-XY227489 | 07.95      | - ABS |                |                |  |  |          |        |   |   |          |
| 1.4     | 44             | 6N-XY227489    | 07.95       | - ABS      |       |                |                |  |  |          |        |   |   |          |
| 1.4 16V | 74             | 6N-XY227489    | 04.96       | - ABS/ - ⊕ |       |                |                |  |  |          |        |   |   |          |
| 1.6     | 55             | 6N-XY227489    | 10.94       | - ABS      |       |                |                |  |  |          |        |   |   |          |
| 1.7 SDI |                | 6N-XY227489    | 05.97       | - ABS      |       |                |                |  |  |          |        |   |   |          |
| 1.9 D   |                | 6N-XY227489    | 10.94       | - ABS      |       |                |                |  |  |          |        |   |   |          |
| 1.9 SDI |                | 6N-XY227489    | 10.94       | - ABS      |       |                |                |  |  |          |        |   |   |          |
| 1.0     |                | 6N-XY227490    | 07.96       | + ABS      |       | 03.0420-1517.3 | 681517         |  | 17,46/200x40 Kit<br>17,46/200x40 TopKit            | VW<br>VW |        |   |   |          |
| 1.0     | 6N-XY227490    | 6N-XY227489    | 10.94       | + ABS      |       | 03.0520-1517.3 | 691517         |  |  |          |        |   |   |          |
| 1.05    | 6N-XY227490    | 6N-XY227489    | 10.94       | + ABS      |       |                |                |  |  |          |        |   |   |          |
| 1.3     | 6N-XY227490    | 6N-XY227489    | 10.94       | + ABS      |       |                |                |  |  |          |        |   |   |          |
| 1.3     | 6N-XY227490    | 6N-XY227489    | 07.95       | + ABS      |       |                |                |  |  |          |        |   |   |          |
| 1.4     | 40 6N-XY227490 | 6N-XY227489    | 07.95       | + ABS      |       |                |                |  |  |          |        |   |   |          |
| 1.4     | 40 6N-XY227490 | 6N-XY227489    | 07.95       | + ABS      |       |                |                |  |  |          |        |   |   |          |
| 1.4     | 44 6N-XY227490 | 6N-XY227489    | 07.95       | + ABS      |       |                |                |  |  |          |        |   |   |          |
| 1.4     | 44 6N-XY227490 | 6N-XY227489    | 07.95       | + ABS      |       |                |                |  |  |          |        |   |   |          |
| 1.4 16V | 55             | 6N-XY227489    | 01.99       | + ABS      |       |                |                |  |  |          |        |   |   |          |
| 1.4 16V | 74             | 6N-XY227489    | 04.96       | + ABS/ - ⊕ |       |                |                |  |  |          |        |   |   |          |
| 1.4 16V | 74 6N-XY227490 | 6N-XY227489    | 04.96       | + ABS/ - ⊕ |       |                |                |  |  |          |        |   |   |          |
| 1.4 TDI | 55             | 6N-XY227489    | 01.99       | + ABS      |       |                |                |  |  |          |        |   |   |          |
| 1.6     | 55             | 6N-XY227489    | 10.94       | + ABS      |       |                |                |  |  |          |        |   |   |          |
| 1.6     | 55 6N-XY227490 | 6N-XY227489    | 10.94       | + ABS      |       |                |                |  |  |          |        |   |   |          |
| 1.7 SDI |                | 6N-XY227489    | 05.97       | + ABS      |       |                |                |  |  |          |        |   |   |          |
| 1.7 SDI | 6N-XY227490    | 6N-XY227489    | 05.97       | + ABS      |       |                |                |  |  |          |        |   |   |          |
| 1.9 D   | 6N-XY227490    | 6N-XY227489    | 10.94       | + ABS      |       |                |                |  |  |          |        |   |   |          |
| 1.9 D   | 6N-XY227490    | 6N-XY227489    | 10.94       | + ABS      |       |                |                |  |  |          |        |   |   |          |
| 1.9 SDI | 6N-XY227490    | 6N-XY227489    | 10.94       | + ABS      |       |                |                |  |  |          |        |   |   |          |
| 1.9 SDI | 6N-XY227490    | 6N-XY227489    | 10.94       | + ABS      |       |                |                |  |  |          |        |   |   |          |
| 1.4 16V | 55             |                | 01.99       | 09.01      | - ABS | 03.0420-4219.3 | 684219         |  | 19,05/200x40 Kit<br>19,05/200x40 TopKit            | VW<br>VW |        |   |   |          |
| 1.4 TDI | 55             |                | 01.99       | 09.01      | - ABS | 03.0520-4219.3 | 694219         |  |  |          |        |   |   |          |

**VOLKSWAGEN POLO IV (02-09)**

|         |         |     |       |       |                 |                 |                |                              |          |   |                 |                                    |          |
|---------|---------|-----|-------|-------|-----------------|-----------------|----------------|------------------------------|----------|---|-----------------|------------------------------------|----------|
|         | 1.2     |     |       | 11.01 | 05.09           | PR: 1LM,1ZN     | 13.0460-7164.2 | 607164                       |          | 21868 17,2 +/WK<br>21866 17,2 +<br>21866 17,2 + | VW<br>VW<br>ATE |                                    |          |
|         | 1.2     | 40  |       | 11.01 | 05.09           | PR: 1LM,1ZN     | 13.0460-7100.2 | 607100                       |          |   |                 |                                    |          |
|         | 1.2     | 51  |       | 04.07 | 05.09           | PR: 1LM,1ZN     | 13.0470-7100.2 | LD7100                       |          |   |                 |                                    |          |
|         | 1.4 16V |     |       | 11.01 | 05.09           | PR: 1LM,1ZN     |                |                              |          |   |                 |                                    |          |
|         | 1.4 16V | 63  |       | 05.06 | 05.09           | PR: 1LM,1ZN     |                |                              |          |   |                 |                                    |          |
|         | 1.4 16V | 74  |       | 11.01 | 05.09           | PR: 1LM,1ZN     |                |                              |          |   |                 |                                    |          |
|         | 1.4 FSI |     |       | 11.01 | 05.09           | PR: 1LM,1ZN     |                |                              |          |   |                 |                                    |          |
|         | 1.4 TDI |     |       | 11.01 | 05.09           | PR: 1LM,1ZN     |                |                              |          |   |                 |                                    |          |
|         | 1.6 16V | 77  |       | 05.06 | 05.09           | PR: 1LM,1ZN     |                |                              |          |   |                 |                                    |          |
|         | 1.8 GTI | 110 |       | 09.05 | 05.09           | PR: 1LM,1ZN     |                |                              |          |   |                 |                                    |          |
|         | 1.8 GTI | 132 |       | 06.06 | 05.09           | PR: 1LM,1ZN     |                |                              |          |   |                 |                                    |          |
|         | 1.9 SDI |     |       | 11.01 | 05.09           | PR: 1LM,1ZN     |                |                              |          |   |                 |                                    |          |
|         | 1.9 TDI | 74  |       | 11.01 | 05.09           | PR: 1LM,1ZN     |                |                              |          |   |                 |                                    |          |
|         | 1.9 TDI | 96  |       | 10.03 | 05.09           | PR: 1LM,1ZN     |                |                              |          |   |                 |                                    |          |
|         | 2.0     | 85  |       | 04.02 | 05.09           | PR: 1LM,1ZN     |                |                              |          |   |                 |                                    |          |
|         | 1.2     |     |       | 11.01 | 05.09           | PR: 1LQ,1LR,1ZG | 13.0460-7117.2 | 607117                       |          |   |                 | 23131 19,6 +/WK<br>23131 19,6 +/WK | VW<br>VW |
|         | 1.2     | 40  |       | 11.01 | 05.09           | PR: 1LQ,1LR,1ZG | 13.0470-7117.2 | LD7117                       |          |   |                 |                                    |          |
|         | 1.2     | 51  |       | 04.07 | 05.09           | PR: 1LQ,1LR,1ZG |                |                              |          |   |                 |                                    |          |
|         | 1.4 16V |     |       | 11.01 | 05.09           | PR: 1LQ,1LR,1ZG |                |                              |          |   |                 |                                    |          |
| 1.4 16V | 63      |     | 05.06 | 05.09 | PR: 1LQ,1LR,1ZG |                 |                |                              |          |   |                 |                                    |          |
| 1.4 16V | 74      |     | 11.01 | 05.09 | PR: 1LQ,1LR,1ZG |                 |                |                              |          |   |                 |                                    |          |
| 1.4 FSI |         |     | 11.01 | 05.09 | PR: 1LQ,1LR,1ZG |                 |                |                              |          |   |                 |                                    |          |
| 1.4 TDI |         |     | 11.01 | 05.09 | PR: 1LQ,1LR,1ZG |                 |                |                              |          |   |                 |                                    |          |
| 1.6 16V | 77      |     | 05.06 | 05.09 | PR: 1LQ,1LR,1ZG |                 |                |                              |          |   |                 |                                    |          |
| 1.8 GTI | 110     |     | 09.05 | 05.09 | PR: 1LQ,1LR,1ZG |                 |                |                              |          |   |                 |                                    |          |
| 1.8 GTI | 132     |     | 06.06 | 05.09 | PR: 1LQ,1LR,1ZG |                 |                |                              |          |   |                 |                                    |          |
| 1.9 SDI |         |     | 11.01 | 05.09 | PR: 1LQ,1LR,1ZG |                 |                |                              |          |   |                 |                                    |          |
| 1.9 TDI | 74      |     | 11.01 | 05.09 | PR: 1LQ,1LR,1ZG |                 |                |                              |          |   |                 |                                    |          |
| 1.9 TDI | 96      |     | 10.03 | 05.09 | PR: 1LQ,1LR,1ZG |                 |                |                              |          |   |                 |                                    |          |
| 2.0     | 85      |     | 04.02 | 05.09 | PR: 1LQ,1LR,1ZG |                 |                |                              |          |   |                 |                                    |          |
| 1.2     |         |     | 11.01 | 05.09 | PR: 1ZF         | 13.0460-7111.2  | 607111         | 23130 19,6 +<br>23130 19,6 + | VW<br>VW |   |                 |                                    |          |
| 1.2     | 40      |     | 11.01 | 05.09 | PR: 1ZF         | 13.0470-7111.2  | LD7111         |                              |          |   |                 |                                    |          |
| 1.2     | 51      |     | 04.07 | 05.09 | PR: 1ZF         |                 |                |                              |          |   |                 |                                    |          |
| 1.4 16V |         |     | 11.01 | 05.09 | PR: 1ZF         |                 |                |                              |          |   |                 |                                    |          |
| 1.4 16V | 63      |     | 05.06 | 05.09 | PR: 1ZF         |                 |                |                              |          |   |                 |                                    |          |
| 1.4 16V | 74      |     | 11.01 | 05.09 | PR: 1ZF         |                 |                |                              |          |   |                 |                                    |          |

<sup>1)</sup> without sensor ring / senza sensori / sans secours ABS / sin anillo sensor ABS

<sup>2)</sup> + WC cast iron / + CR ghisa / + CR fonte grise / + CR fundición de gris















<sup>3)</sup> + WC aluminium / + CR alluminio / + CR aluminium / + CR aluminio











**VOLKSWAGEN POLO IV (02-09)**

|         |         |       |       |                     |                 |                |        |                            |                            |     |
|---------|---------|-------|-------|---------------------|-----------------|----------------|--------|----------------------------|----------------------------|-----|
|         | 1.4 FSI |       | 11.01 | 05.09               | PR: 1ZF         | 13.0460-7111.2 | 607111 |                            | 23130 19,6 +               | VW  |
|         | 1.4 TDI |       | 11.01 | 05.09               | PR: 1ZF         | 13.0470-7111.2 | LD7111 |                            | 23130 19,6 +               | VW  |
|         | 1.6 16V | 77    | 05.06 | 05.09               | PR: 1ZF         |                |        |                            |                            |     |
|         | 1.8 GTI | 110   | 09.05 | 05.09               | PR: 1ZF         |                |        |                            |                            |     |
|         | 1.8 GTI | 132   | 06.06 | 05.09               | PR: 1ZF         |                |        |                            |                            |     |
|         | 1.9 SDI |       | 11.01 | 05.09               | PR: 1ZF         |                |        |                            |                            |     |
|         | 1.9 TDI | 74    | 11.01 | 05.09               | PR: 1ZF         |                |        |                            |                            |     |
|         | 1.9 TDI | 96    | 10.03 | 05.09               | PR: 1ZF         |                |        |                            |                            |     |
|         | 2.0     | 85    | 04.02 | 05.09               | PR: 1ZF         |                |        |                            |                            |     |
|         | 1.2     |       | 11.01 | 05.09               | PR: 1LN,1ZD,1ZH | 13.0460-2883.2 | 602883 |                            | 23581 18,8 /S              | TRW |
|         | 1.2     | 40    | 11.01 | 05.09               | PR: 1LN,1ZD,1ZH | 13.0460-2884.2 | 602884 |                            | 23843 18,8 +/WK/S          | TRW |
|         | 1.2     | 51    | 04.07 | 05.09               | PR: 1LN,1ZD,1ZH | 13.0470-2884.2 | LD2884 |                            | 23843 18,8 +/WK/S          | TRW |
|         | 1.4 16V |       | 11.01 | 05.09               | PR: 1LN,1ZD,1ZH |                |        |                            |                            |     |
|         | 1.4 16V | 63    | 05.06 | 05.09               | PR: 1LN,1ZD,1ZH |                |        |                            |                            |     |
|         | 1.4 16V | 74    | 11.01 | 05.09               | PR: 1LN,1ZD,1ZH |                |        |                            |                            |     |
| 1.4 FSI |         | 11.01 | 05.09 | PR: 1LN,1ZD,1ZH     |                 |                |        |                            |                            |     |
| 1.4 TDI |         | 11.01 | 05.09 | PR: 1LN,1ZD,1ZH     |                 |                |        |                            |                            |     |
| 1.6 16V | 77      | 05.06 | 05.09 | PR: 1LN,1ZD,1ZH     |                 |                |        |                            |                            |     |
| 1.8 GTI | 110     | 09.05 | 05.09 | PR: 1LN,1ZD,1ZH     |                 |                |        |                            |                            |     |
| 1.8 GTI | 132     | 06.06 | 05.09 | PR: 1LN,1ZD,1ZH     |                 |                |        |                            |                            |     |
| 1.9 SDI |         | 11.01 | 05.09 | PR: 1LN,1ZD,1ZH     |                 |                |        |                            |                            |     |
| 1.9 TDI | 74      | 11.01 | 05.09 | PR: 1LN,1ZD,1ZH     |                 |                |        |                            |                            |     |
| 1.9 TDI | 96      | 10.03 | 05.09 | PR: 1LN,1ZD,1ZH     |                 |                |        |                            |                            |     |
| 2.0     | 85      | 04.02 | 05.09 | PR: 1LN,1ZD,1ZH     |                 |                |        |                            |                            |     |
| 1.2     |         | 11.01 | 05.09 | PR: 1LJ             | 13.0460-7122.2  | 607122         |        | 23392 20,3 +/WK            | ATE                        |     |
| 1.2     | 40      | 11.01 | 05.09 | PR: 1LJ             | 13.0470-7122.2  | LD7122         |        | 23392 20,3 +/WK            | ATE                        |     |
| 1.2     | 51      | 04.07 | 05.09 | PR: 1LJ             |                 |                |        |                            |                            |     |
| 1.4 16V |         | 11.01 | 05.09 | PR: 1LJ             |                 |                |        |                            |                            |     |
| 1.4 16V | 63      | 05.06 | 05.09 | PR: 1LJ             |                 |                |        |                            |                            |     |
| 1.4 16V | 74      | 11.01 | 05.09 | PR: 1LJ             |                 |                |        |                            |                            |     |
| 1.4 FSI |         | 11.01 | 05.09 | PR: 1LJ             |                 |                |        |                            |                            |     |
| 1.4 TDI |         | 11.01 | 05.09 | PR: 1LJ             |                 |                |        |                            |                            |     |
| 1.6 16V | 77      | 05.06 | 05.09 | PR: 1LJ             |                 |                |        |                            |                            |     |
| 1.8 GTI | 110     | 09.05 | 05.09 | PR: 1LJ             |                 |                |        |                            |                            |     |
| 1.8 GTI | 132     | 06.06 | 05.09 | PR: 1LJ             |                 |                |        |                            |                            |     |
| 1.9 SDI |         | 11.01 | 05.09 | PR: 1LJ             |                 |                |        |                            |                            |     |
| 1.9 TDI | 74      | 11.01 | 05.09 | PR: 1LJ             |                 |                |        |                            |                            |     |
| 1.9 TDI | 96      | 10.03 | 05.09 | PR: 1LJ             |                 |                |        |                            |                            |     |
| 2.0     | 85      | 04.02 | 05.09 | PR: 1LJ             |                 |                |        |                            |                            |     |
|         | 1.2     |       | 11.01 | 05.09               | PR: 1LM,1ZN     | 24.0118-0137.1 | 418137 |                            | 239 18,0 16,0 V L +S +B    |     |
|         | 1.2     | 40    | 11.01 | 05.09               | PR: 1LM,1ZN     | 24.0318-0137.1 | 518137 |                            | 239 18,0 16,0 V L +S +B PD |     |
|         | 1.2     | 51    | 04.07 | 05.09               | PR: 1LM,1ZN     |                |        |                            |                            |     |
|         | 1.4 16V |       | 11.01 | 05.09               | PR: 1LM,1ZN     |                |        |                            |                            |     |
|         | 1.4 16V | 63    | 05.06 | 05.09               | PR: 1LM,1ZN     |                |        |                            |                            |     |
|         | 1.4 16V | 74    | 11.01 | 05.09               | PR: 1LM,1ZN     |                |        |                            |                            |     |
|         | 1.4 FSI |       | 11.01 | 05.09               | PR: 1LM,1ZN     |                |        |                            |                            |     |
|         | 1.4 TDI |       | 11.01 | 05.09               | PR: 1LM,1ZN     |                |        |                            |                            |     |
|         | 1.6 16V | 77    | 05.06 | 05.09               | PR: 1LM,1ZN     |                |        |                            |                            |     |
|         | 1.8 GTI | 110   | 09.05 | 05.09               | PR: 1LM,1ZN     |                |        |                            |                            |     |
|         | 1.8 GTI | 132   | 06.06 | 05.09               | PR: 1LM,1ZN     |                |        |                            |                            |     |
|         | 1.9 SDI |       | 11.01 | 05.09               | PR: 1LM,1ZN     |                |        |                            |                            |     |
|         | 1.9 TDI | 74    | 11.01 | 05.09               | PR: 1LM,1ZN     |                |        |                            |                            |     |
|         | 1.9 TDI | 96    | 10.03 | 05.09               | PR: 1LM,1ZN     |                |        |                            |                            |     |
|         | 2.0     | 85    | 04.02 | 05.09               | PR: 1LM,1ZN     |                |        |                            |                            |     |
| 1.2     |         | 11.01 | 05.09 | PR: 1LQ,1LR,1ZF,1ZG | 24.0122-0151.1  | 422151         |        | 256 22,0 19,0 V L +S +B    |                            |     |
| 1.2     | 40      | 11.01 | 05.09 | PR: 1LQ,1LR,1ZF,1ZG | 24.0322-0151.1  | 522151         |        | 256 22,0 19,0 V L +S +B PD |                            |     |
| 1.2     | 51      | 04.07 | 05.09 | PR: 1LQ,1LR,1ZF,1ZG |                 |                |        |                            |                            |     |
| 1.4 16V |         | 11.01 | 05.09 | PR: 1LQ,1LR,1ZF,1ZG |                 |                |        |                            |                            |     |
| 1.4 16V | 63      | 05.06 | 05.09 | PR: 1LQ,1LR,1ZF,1ZG |                 |                |        |                            |                            |     |
| 1.4 16V | 74      | 11.01 | 05.09 | PR: 1LQ,1LR,1ZF,1ZG |                 |                |        |                            |                            |     |
| 1.4 FSI |         | 11.01 | 05.09 | PR: 1LQ,1LR,1ZF,1ZG |                 |                |        |                            |                            |     |
| 1.4 TDI |         | 11.01 | 05.09 | PR: 1LQ,1LR,1ZF,1ZG |                 |                |        |                            |                            |     |
| 1.6 16V | 77      | 05.06 | 05.09 | PR: 1LQ,1LR,1ZF,1ZG |                 |                |        |                            |                            |     |
| 1.8 GTI | 110     | 09.05 | 05.09 | PR: 1LQ,1LR,1ZF,1ZG |                 |                |        |                            |                            |     |
| 1.8 GTI | 132     | 06.06 | 05.09 | PR: 1LQ,1LR,1ZF,1ZG |                 |                |        |                            |                            |     |
| 1.9 SDI |         | 11.01 | 05.09 | PR: 1LQ,1LR,1ZF,1ZG |                 |                |        |                            |                            |     |
| 1.9 TDI | 74      | 11.01 | 05.09 | PR: 1LQ,1LR,1ZF,1ZG |                 |                |        |                            |                            |     |
| 1.9 TDI | 96      | 10.03 | 05.09 | PR: 1LQ,1LR,1ZF,1ZG |                 |                |        |                            |                            |     |
| 2.0     | 85      | 04.02 | 05.09 | PR: 1LQ,1LR,1ZF,1ZG |                 |                |        |                            |                            |     |
| 1.2     |         | 11.01 | 05.09 | PR: 1LN,1ZD,1ZH     | 24.0125-0113.1  | 425113         |        | 288 25,0 22,0 V L +S +B    |                            |     |
| 1.2     | 40      | 11.01 | 05.09 | PR: 1LN,1ZD,1ZH     | 24.0325-0113.1  | 525113         |        | 288 25,0 22,0 V L +S +B PD |                            |     |
| 1.2     | 51      | 04.07 | 05.09 | PR: 1LN,1ZD,1ZH     |                 |                |        |                            |                            |     |
| 1.4 16V |         | 11.01 | 05.09 | PR: 1LN,1ZD,1ZH     |                 |                |        |                            |                            |     |
| 1.4 16V | 63      | 05.06 | 05.09 | PR: 1LN,1ZD,1ZH     |                 |                |        |                            |                            |     |
| 1.4 16V | 74      | 11.01 | 05.09 | PR: 1LN,1ZD,1ZH     |                 |                |        |                            |                            |     |
| 1.4 FSI |         | 11.01 | 05.09 | PR: 1LN,1ZD,1ZH     |                 |                |        |                            |                            |     |
| 1.4 TDI |         | 11.01 | 05.09 | PR: 1LN,1ZD,1ZH     |                 |                |        |                            |                            |     |
| 1.6 16V | 77      | 05.06 | 05.09 | PR: 1LN,1ZD,1ZH     |                 |                |        |                            |                            |     |
| 1.8 GTI | 110     | 09.05 | 05.09 | PR: 1LN,1ZD,1ZH     |                 |                |        |                            |                            |     |
| 1.8 GTI | 132     | 06.06 | 05.09 | PR: 1LN,1ZD,1ZH     |                 |                |        |                            |                            |     |
| 1.9 SDI |         | 11.01 | 05.09 | PR: 1LN,1ZD,1ZH     |                 |                |        |                            |                            |     |
| 1.9 TDI | 74      | 11.01 | 05.09 | PR: 1LN,1ZD,1ZH     |                 |                |        |                            |                            |     |
| 1.9 TDI | 96      | 10.03 | 05.09 | PR: 1LN,1ZD,1ZH     |                 |                |        |                            |                            |     |
| 2.0     | 85      | 04.02 | 05.09 | PR: 1LN,1ZD,1ZH     |                 |                |        |                            |                            |     |
| 1.2     |         | 11.01 | 05.09 | PR: 1LJ             | 24.0125-0123.1  | 425123         |        | 310 25,0 22,0 V L +S +B    |                            |     |
| 1.2     | 40      | 11.01 | 05.09 | PR: 1LJ             | 24.0325-0123.1  | 525123         |        | 310 25,0 22,0 V L +S +B PD |                            |     |
| 1.2     | 51      | 04.07 | 05.09 | PR: 1LJ             |                 |                |        |                            |                            |     |

|     |   |  |  |    |  |   |   |                                 |
|--|---|--|--|--|---|---|---|---|
| <b>VOLKSWAGEN POLO IV (02-09)</b>  |   |  |  |  |   |   |   |   |
|    | 1.4 16V<br>1.4 16V<br>1.4 16V<br>1.4 FSI<br>1.4 TDI<br>1.6 16V<br>1.8 GTI<br>1.8 GTI<br>1.9 SDI<br>1.9 TDI<br>1.9 TDI<br>2.0                      | 63<br>74<br>77<br>110<br>132<br>74<br>96<br>85                                   |  | 11.01 05.09 PR: 1LJ<br>05.06 05.09 PR: 1LJ<br>11.01 05.09 PR: 1LJ<br>11.01 05.09 PR: 1LJ<br>11.01 05.09 PR: 1LJ<br>09.05 05.09 PR: 1LJ<br>06.06 05.09 PR: 1LJ<br>11.01 05.09 PR: 1LJ<br>11.01 05.09 PR: 1LJ<br>10.03 05.09 PR: 1LJ<br>04.02 05.09 PR: 1LJ  |   | 24.0125-0123.1 425123<br>24.0325-0123.1 525123  |   | 310 25,0 22,0 V L +S +B<br>310 25,0 22,0 V L +B PD  |
|    | 1.2<br>1.2<br>1.2<br>1.4 16V<br>1.4 16V<br>1.4 16V<br>1.4 FSI<br>1.4 TDI<br>1.6 16V<br>1.8 GTI<br>1.8 GTI<br>1.9 SDI<br>1.9 TDI<br>1.9 TDI<br>2.0 | 40<br>51<br>63<br>74<br>77<br>110<br>132<br>74<br>96<br>85                       |  | 11.01 05.09<br>11.01 05.09<br>04.07 05.09<br>11.01 05.09<br>11.01 05.09<br>11.01 05.09<br>05.06 05.09<br>09.05 05.09<br>06.06 05.09<br>11.01 05.09<br>11.01 05.09<br>10.03 05.09<br>04.02 05.09  |   | 24.0711-5273.3 360303<br>24.0711-5274.3 360304  |  | Radsensor<br>Radsensor  |
|    | 1.2<br>1.2<br>1.2<br>1.4 16V<br>1.4 16V<br>1.4 16V<br>1.4 FSI<br>1.4 TDI<br>1.6 16V<br>1.8 GTI<br>1.8 GTI<br>1.9 SDI<br>1.9 TDI<br>1.9 TDI<br>2.0 | 40<br>51<br>63<br>74<br>77<br>110<br>132<br>74<br>96<br>85                       |  | 11.01 05.09 PR: 1KD,1KS,1KV<br>11.01 05.09 PR: 1KD,1KS,1KV<br>04.07 05.09 PR: 1KD,1KS,1KV<br>11.01 05.09 PR: 1KD,1KS,1KV<br>05.06 05.09 PR: 1KD,1KS,1KV<br>11.01 05.09 PR: 1KD,1KS,1KV<br>11.01 05.09 PR: 1KD,1KS,1KV<br>11.01 05.09 PR: 1KD,1KS,1KV<br>09.05 05.09 PR: 1KD,1KS,1KV<br>06.06 05.09 PR: 1KD,1KS,1KV<br>11.01 05.09 PR: 1KD,1KS,1KV<br>11.01 05.09 PR: 1KD,1KS,1KV<br>10.03 05.09 PR: 1KD,1KS,1KV<br>04.02 05.09 PR: 1KD,1KS,1KV   |   | 13.0460-2864.2 602864<br>13.0460-2877.2 602877<br>13.0470-2877.2 LD2877<br>13.0460-0072.2 610072                          |   | 20961 17,4 /S TRW<br>23554 17,2 +/WK/S TRW<br>23554 17,2 +/WK/S TRW<br>Belagsatz-Zubehör TRW                      |
|  | 1.2<br>1.2<br>1.2<br>1.4 16V<br>1.4 16V<br>1.4 16V<br>1.4 FSI<br>1.4 TDI<br>1.6 16V<br>1.8 GTI<br>1.8 GTI<br>1.9 SDI<br>1.9 TDI<br>1.9 TDI<br>2.0 | 40<br>51<br>63<br>74<br>77<br>110<br>132<br>74<br>96<br>85                       |  | 11.01 05.09 PR: 1KK,1KT<br>11.01 05.09 PR: 1KK,1KT<br>04.07 05.09 PR: 1KK,1KT<br>11.01 05.09 PR: 1KK,1KT<br>05.06 05.09 PR: 1KK,1KT<br>11.01 05.09 PR: 1KK,1KT<br>11.01 05.09 PR: 1KK,1KT<br>11.01 05.09 PR: 1KK,1KT<br>09.05 05.09 PR: 1KK,1KT<br>06.06 05.09 PR: 1KK,1KT<br>11.01 05.09 PR: 1KK,1KT<br>11.01 05.09 PR: 1KK,1KT<br>10.03 05.09 PR: 1KK,1KT<br>04.02 05.09 PR: 1KK,1KT   |   | 13.0460-2820.2 602820<br>13.0460-2894.2 602894<br>13.0470-2820.2 LD2820<br>13.0470-2894.2 LD2894<br>13.0460-0072.2 610072 |   | 20961 17,6 /S TRW<br>20961 17,4 /Zub/S TRW<br>20961 17,6 /S TRW<br>20961 17,4 /Zub/S TRW<br>Belagsatz-Zubehör TRW |
|  | 1.2<br>1.2<br>1.2<br>1.4 16V<br>1.4 16V<br>1.4 16V<br>1.4 FSI<br>1.4 TDI<br>1.6 16V<br>1.8 GTI<br>1.8 GTI<br>1.9 SDI<br>1.9 TDI<br>1.9 TDI<br>2.0 | 40<br>51<br>63<br>74<br>77<br>110<br>132<br>74<br>96<br>85                       |  | 11.01 05.09 PR: 1KD,1KS,1KT,1KV<br>11.01 05.09 PR: 1KD,1KS,1KT,1KV<br>04.07 05.09 PR: 1KD,1KS,1KT,1KV<br>05.06 05.09 PR: 1KD,1KS,1KT,1KV<br>11.01 05.09 PR: 1KD,1KS,1KT,1KV<br>11.01 05.09 PR: 1KD,1KS,1KT,1KV<br>11.01 05.09 PR: 1KD,1KS,1KT,1KV<br>05.06 05.09 PR: 1KD,1KS,1KT,1KV<br>09.05 05.09 PR: 1KD,1KS,1KT,1KV<br>06.06 05.09 PR: 1KD,1KS,1KT,1KV<br>11.01 05.09 PR: 1KD,1KS,1KT,1KV<br>11.01 05.09 PR: 1KD,1KS,1KT,1KV<br>10.03 05.09 PR: 1KD,1KS,1KT,1KV<br>04.02 05.09 PR: 1KD,1KS,1KT,1KV |   | 24.0109-0123.1 409123<br>24.0309-0123.1 509123  |   | 230 9,0 7,0 +S +B<br>230 9,0 7,0 +S +B PD   |
|  | 1.2<br>1.2<br>1.2<br>1.4 16V<br>1.4 16V<br>1.4 16V<br>1.4 FSI<br>1.4 TDI<br>1.6 16V<br>1.8 GTI<br>1.8 GTI<br>1.9 SDI<br>1.9 TDI<br>1.9 TDI<br>2.0 | 40<br>51<br>63<br>74<br>77<br>110<br>132<br>74<br>96<br>85                       |  | 11.01 05.09 PR: 1KK<br>11.01 05.09 PR: 1KK<br>04.07 05.09 PR: 1KK<br>11.01 05.09 PR: 1KK<br>05.06 05.09 PR: 1KK<br>11.01 05.09 PR: 1KK<br>11.01 05.09 PR: 1KK<br>11.01 05.09 PR: 1KK<br>09.05 05.09 PR: 1KK<br>06.06 05.09 PR: 1KK<br>11.01 05.09 PR: 1KK<br>11.01 05.09 PR: 1KK<br>10.03 05.09 PR: 1KK<br>04.02 05.09 PR: 1KK   |   | 24.0109-0174.1 409174   |   | 232 9,0 7,0 +S +B   |

| VOLKSWAGEN POLO IV (02-09)   |  |       |       |                 |                |                 |                     |           |                     |        |              |       |                |        |                 |                |         |                  |        |                     |         |         |       |                 |       |         |         |    |         |       |         |       |                 |       |         |       |  |         |         |         |       |                 |       |         |         |    |         |       |         |       |                 |       |         |       |  |         |         |       |       |                 |  |  |         |  |         |       |       |  |                 |    |       |       |  |         |         |       |       |                 |  |  |     |    |         |       |       |  |                 |  |       |       |  |     |    |       |  |                 |  |  |  |  |            |    |       |  |                 |  |  |  |  |         |     |       |  |                 |  |  |  |  |         |    |       |  |                 |  |  |  |  |         |    |       |  |                 |  |  |  |  |         |    |       |  |                 |  |  |  |  |         |     |       |  |                 |  |  |  |  |         |     |       |  |                 |  |  |  |  |     |  |       |  |                 |  |  |  |  |            |    |       |  |                 |  |  |  |  |         |    |       |  |                 |  |  |  |  |         |    |       |  |                 |  |  |  |  |         |    |       |  |                 |  |  |  |  |         |     |       |  |                 |  |  |  |  |           |     |       |  |                 |  |  |  |  |
|--|--|-------|-------|-----------------|----------------|-----------------|---------------------|-----------|---------------------|--------|--------------|-------|----------------|--------|-----------------|----------------|---------|------------------|--------|---------------------|---------|---------|-------|-----------------|-------|---------|---------|----|---------|-------|---------|-------|-----------------|-------|---------|-------|--|---------|---------|---------|-------|-----------------|-------|---------|---------|----|---------|-------|---------|-------|-----------------|-------|---------|-------|--|---------|---------|-------|-------|-----------------|--|--|---------|--|---------|-------|-------|--|-----------------|----|-------|-------|--|---------|---------|-------|-------|-----------------|--|--|-----|----|---------|-------|-------|--|-----------------|--|-------|-------|--|-----|----|-------|--|-----------------|--|--|--|--|------------|----|-------|--|-----------------|--|--|--|--|---------|-----|-------|--|-----------------|--|--|--|--|---------|----|-------|--|-----------------|--|--|--|--|---------|----|-------|--|-----------------|--|--|--|--|---------|----|-------|--|-----------------|--|--|--|--|---------|-----|-------|--|-----------------|--|--|--|--|---------|-----|-------|--|-----------------|--|--|--|--|-----|--|-------|--|-----------------|--|--|--|--|------------|----|-------|--|-----------------|--|--|--|--|---------|----|-------|--|-----------------|--|--|--|--|---------|----|-------|--|-----------------|--|--|--|--|---------|----|-------|--|-----------------|--|--|--|--|---------|-----|-------|--|-----------------|--|--|--|--|-----------|-----|-------|--|-----------------|--|--|--|--|
|    | <table border="1"> <tr><td>1.2</td><td>40</td><td>11.01</td><td>05.09</td><td>24.0711-6233.3</td><td>360315</td><td rowspan="20">Radsensor</td></tr> <tr><td>1.2</td><td>51</td><td>11.01</td><td>05.09</td><td>24.0711-6234.3</td><td>360316</td></tr> <tr><td>1.4 16V</td><td></td><td>04.07</td><td>05.09</td><td></td><td></td></tr> <tr><td>1.4 16V</td><td>63</td><td>11.01</td><td>05.09</td><td></td><td></td></tr> <tr><td>1.4 16V</td><td>74</td><td>05.06</td><td>05.09</td><td></td><td></td></tr> <tr><td>1.4 FSI</td><td></td><td>11.01</td><td>05.09</td><td></td><td></td></tr> <tr><td>1.4 TDI</td><td></td><td>11.01</td><td>05.09</td><td></td><td></td></tr> <tr><td>1.6 16V</td><td>77</td><td>11.01</td><td>05.09</td><td></td><td></td></tr> <tr><td>1.8 GTI</td><td>110</td><td>05.06</td><td>05.09</td><td></td><td></td></tr> <tr><td>1.8 GTI</td><td>132</td><td>09.05</td><td>05.09</td><td></td><td></td></tr> <tr><td>1.9 SDI</td><td></td><td>06.06</td><td>05.09</td><td></td><td></td></tr> <tr><td>1.9 TDI</td><td>74</td><td>11.01</td><td>05.09</td><td></td><td></td></tr> <tr><td>1.9 TDI</td><td>96</td><td>11.01</td><td>05.09</td><td></td><td></td></tr> <tr><td>2.0</td><td>85</td><td>10.03</td><td>05.09</td><td></td><td></td></tr> <tr><td></td><td></td><td>04.02</td><td>05.09</td><td></td><td></td></tr> </table>   | 1.2   | 40    | 11.01           | 05.09          | 24.0711-6233.3  | 360315              | Radsensor | 1.2                 | 51     | 11.01        | 05.09 | 24.0711-6234.3 | 360316 | 1.4 16V         |                | 04.07   | 05.09            |        |                     | 1.4 16V | 63      | 11.01 | 05.09           |       |         | 1.4 16V | 74 | 05.06   | 05.09 |         |       | 1.4 FSI         |       | 11.01   | 05.09 |  |         | 1.4 TDI |         | 11.01 | 05.09           |       |         | 1.6 16V | 77 | 11.01   | 05.09 |         |       | 1.8 GTI         | 110   | 05.06   | 05.09 |  |         | 1.8 GTI | 132   | 09.05 | 05.09           |  |  | 1.9 SDI |  | 06.06   | 05.09 |       |  | 1.9 TDI         | 74 | 11.01 | 05.09 |  |         | 1.9 TDI | 96    | 11.01 | 05.09           |  |  | 2.0 | 85 | 10.03   | 05.09 |       |  |                 |  | 04.02 | 05.09 |  |     |    |       |  |                 |  |  |  |  |            |    |       |  |                 |  |  |  |  |         |     |       |  |                 |  |  |  |  |         |    |       |  |                 |  |  |  |  |         |    |       |  |                 |  |  |  |  |         |    |       |  |                 |  |  |  |  |         |     |       |  |                 |  |  |  |  |         |     |       |  |                 |  |  |  |  |     |  |       |  |                 |  |  |  |  |            |    |       |  |                 |  |  |  |  |         |    |       |  |                 |  |  |  |  |         |    |       |  |                 |  |  |  |  |         |    |       |  |                 |  |  |  |  |         |     |       |  |                 |  |  |  |  |           |     |       |  |                 |  |  |  |  |
| 1.2  | 40   | 11.01 | 05.09 | 24.0711-6233.3  | 360315         | Radsensor       |                     |           |                     |        |              |       |                |        |                 |                |         |                  |        |                     |         |         |       |                 |       |         |         |    |         |       |         |       |                 |       |         |       |  |         |         |         |       |                 |       |         |         |    |         |       |         |       |                 |       |         |       |  |         |         |       |       |                 |  |  |         |  |         |       |       |  |                 |    |       |       |  |         |         |       |       |                 |  |  |     |    |         |       |       |  |                 |  |       |       |  |     |    |       |  |                 |  |  |  |  |            |    |       |  |                 |  |  |  |  |         |     |       |  |                 |  |  |  |  |         |    |       |  |                 |  |  |  |  |         |    |       |  |                 |  |  |  |  |         |    |       |  |                 |  |  |  |  |         |     |       |  |                 |  |  |  |  |         |     |       |  |                 |  |  |  |  |     |  |       |  |                 |  |  |  |  |            |    |       |  |                 |  |  |  |  |         |    |       |  |                 |  |  |  |  |         |    |       |  |                 |  |  |  |  |         |    |       |  |                 |  |  |  |  |         |     |       |  |                 |  |  |  |  |           |     |       |  |                 |  |  |  |  |
| 1.2  | 51   | 11.01 | 05.09 | 24.0711-6234.3  | 360316         |                 |                     |           |                     |        |              |       |                |        |                 |                |         |                  |        |                     |         |         |       |                 |       |         |         |    |         |       |         |       |                 |       |         |       |  |         |         |         |       |                 |       |         |         |    |         |       |         |       |                 |       |         |       |  |         |         |       |       |                 |  |  |         |  |         |       |       |  |                 |    |       |       |  |         |         |       |       |                 |  |  |     |    |         |       |       |  |                 |  |       |       |  |     |    |       |  |                 |  |  |  |  |            |    |       |  |                 |  |  |  |  |         |     |       |  |                 |  |  |  |  |         |    |       |  |                 |  |  |  |  |         |    |       |  |                 |  |  |  |  |         |    |       |  |                 |  |  |  |  |         |     |       |  |                 |  |  |  |  |         |     |       |  |                 |  |  |  |  |     |  |       |  |                 |  |  |  |  |            |    |       |  |                 |  |  |  |  |         |    |       |  |                 |  |  |  |  |         |    |       |  |                 |  |  |  |  |         |    |       |  |                 |  |  |  |  |         |     |       |  |                 |  |  |  |  |           |     |       |  |                 |  |  |  |  |
| 1.4 16V  |  | 04.07 | 05.09 |                 |                |                 |                     |           |                     |        |              |       |                |        |                 |                |         |                  |        |                     |         |         |       |                 |       |         |         |    |         |       |         |       |                 |       |         |       |  |         |         |         |       |                 |       |         |         |    |         |       |         |       |                 |       |         |       |  |         |         |       |       |                 |  |  |         |  |         |       |       |  |                 |    |       |       |  |         |         |       |       |                 |  |  |     |    |         |       |       |  |                 |  |       |       |  |     |    |       |  |                 |  |  |  |  |            |    |       |  |                 |  |  |  |  |         |     |       |  |                 |  |  |  |  |         |    |       |  |                 |  |  |  |  |         |    |       |  |                 |  |  |  |  |         |    |       |  |                 |  |  |  |  |         |     |       |  |                 |  |  |  |  |         |     |       |  |                 |  |  |  |  |     |  |       |  |                 |  |  |  |  |            |    |       |  |                 |  |  |  |  |         |    |       |  |                 |  |  |  |  |         |    |       |  |                 |  |  |  |  |         |    |       |  |                 |  |  |  |  |         |     |       |  |                 |  |  |  |  |           |     |       |  |                 |  |  |  |  |
| 1.4 16V  | 63   | 11.01 | 05.09 |                 |                |                 |                     |           |                     |        |              |       |                |        |                 |                |         |                  |        |                     |         |         |       |                 |       |         |         |    |         |       |         |       |                 |       |         |       |  |         |         |         |       |                 |       |         |         |    |         |       |         |       |                 |       |         |       |  |         |         |       |       |                 |  |  |         |  |         |       |       |  |                 |    |       |       |  |         |         |       |       |                 |  |  |     |    |         |       |       |  |                 |  |       |       |  |     |    |       |  |                 |  |  |  |  |            |    |       |  |                 |  |  |  |  |         |     |       |  |                 |  |  |  |  |         |    |       |  |                 |  |  |  |  |         |    |       |  |                 |  |  |  |  |         |    |       |  |                 |  |  |  |  |         |     |       |  |                 |  |  |  |  |         |     |       |  |                 |  |  |  |  |     |  |       |  |                 |  |  |  |  |            |    |       |  |                 |  |  |  |  |         |    |       |  |                 |  |  |  |  |         |    |       |  |                 |  |  |  |  |         |    |       |  |                 |  |  |  |  |         |     |       |  |                 |  |  |  |  |           |     |       |  |                 |  |  |  |  |
| 1.4 16V  | 74   | 05.06 | 05.09 |                 |                |                 |                     |           |                     |        |              |       |                |        |                 |                |         |                  |        |                     |         |         |       |                 |       |         |         |    |         |       |         |       |                 |       |         |       |  |         |         |         |       |                 |       |         |         |    |         |       |         |       |                 |       |         |       |  |         |         |       |       |                 |  |  |         |  |         |       |       |  |                 |    |       |       |  |         |         |       |       |                 |  |  |     |    |         |       |       |  |                 |  |       |       |  |     |    |       |  |                 |  |  |  |  |            |    |       |  |                 |  |  |  |  |         |     |       |  |                 |  |  |  |  |         |    |       |  |                 |  |  |  |  |         |    |       |  |                 |  |  |  |  |         |    |       |  |                 |  |  |  |  |         |     |       |  |                 |  |  |  |  |         |     |       |  |                 |  |  |  |  |     |  |       |  |                 |  |  |  |  |            |    |       |  |                 |  |  |  |  |         |    |       |  |                 |  |  |  |  |         |    |       |  |                 |  |  |  |  |         |    |       |  |                 |  |  |  |  |         |     |       |  |                 |  |  |  |  |           |     |       |  |                 |  |  |  |  |
| 1.4 FSI  |  | 11.01 | 05.09 |                 |                |                 |                     |           |                     |        |              |       |                |        |                 |                |         |                  |        |                     |         |         |       |                 |       |         |         |    |         |       |         |       |                 |       |         |       |  |         |         |         |       |                 |       |         |         |    |         |       |         |       |                 |       |         |       |  |         |         |       |       |                 |  |  |         |  |         |       |       |  |                 |    |       |       |  |         |         |       |       |                 |  |  |     |    |         |       |       |  |                 |  |       |       |  |     |    |       |  |                 |  |  |  |  |            |    |       |  |                 |  |  |  |  |         |     |       |  |                 |  |  |  |  |         |    |       |  |                 |  |  |  |  |         |    |       |  |                 |  |  |  |  |         |    |       |  |                 |  |  |  |  |         |     |       |  |                 |  |  |  |  |         |     |       |  |                 |  |  |  |  |     |  |       |  |                 |  |  |  |  |            |    |       |  |                 |  |  |  |  |         |    |       |  |                 |  |  |  |  |         |    |       |  |                 |  |  |  |  |         |    |       |  |                 |  |  |  |  |         |     |       |  |                 |  |  |  |  |           |     |       |  |                 |  |  |  |  |
| 1.4 TDI  |  | 11.01 | 05.09 |                 |                |                 |                     |           |                     |        |              |       |                |        |                 |                |         |                  |        |                     |         |         |       |                 |       |         |         |    |         |       |         |       |                 |       |         |       |  |         |         |         |       |                 |       |         |         |    |         |       |         |       |                 |       |         |       |  |         |         |       |       |                 |  |  |         |  |         |       |       |  |                 |    |       |       |  |         |         |       |       |                 |  |  |     |    |         |       |       |  |                 |  |       |       |  |     |    |       |  |                 |  |  |  |  |            |    |       |  |                 |  |  |  |  |         |     |       |  |                 |  |  |  |  |         |    |       |  |                 |  |  |  |  |         |    |       |  |                 |  |  |  |  |         |    |       |  |                 |  |  |  |  |         |     |       |  |                 |  |  |  |  |         |     |       |  |                 |  |  |  |  |     |  |       |  |                 |  |  |  |  |            |    |       |  |                 |  |  |  |  |         |    |       |  |                 |  |  |  |  |         |    |       |  |                 |  |  |  |  |         |    |       |  |                 |  |  |  |  |         |     |       |  |                 |  |  |  |  |           |     |       |  |                 |  |  |  |  |
| 1.6 16V  | 77   | 11.01 | 05.09 |                 |                |                 |                     |           |                     |        |              |       |                |        |                 |                |         |                  |        |                     |         |         |       |                 |       |         |         |    |         |       |         |       |                 |       |         |       |  |         |         |         |       |                 |       |         |         |    |         |       |         |       |                 |       |         |       |  |         |         |       |       |                 |  |  |         |  |         |       |       |  |                 |    |       |       |  |         |         |       |       |                 |  |  |     |    |         |       |       |  |                 |  |       |       |  |     |    |       |  |                 |  |  |  |  |            |    |       |  |                 |  |  |  |  |         |     |       |  |                 |  |  |  |  |         |    |       |  |                 |  |  |  |  |         |    |       |  |                 |  |  |  |  |         |    |       |  |                 |  |  |  |  |         |     |       |  |                 |  |  |  |  |         |     |       |  |                 |  |  |  |  |     |  |       |  |                 |  |  |  |  |            |    |       |  |                 |  |  |  |  |         |    |       |  |                 |  |  |  |  |         |    |       |  |                 |  |  |  |  |         |    |       |  |                 |  |  |  |  |         |     |       |  |                 |  |  |  |  |           |     |       |  |                 |  |  |  |  |
| 1.8 GTI  | 110  | 05.06 | 05.09 |                 |                |                 |                     |           |                     |        |              |       |                |        |                 |                |         |                  |        |                     |         |         |       |                 |       |         |         |    |         |       |         |       |                 |       |         |       |  |         |         |         |       |                 |       |         |         |    |         |       |         |       |                 |       |         |       |  |         |         |       |       |                 |  |  |         |  |         |       |       |  |                 |    |       |       |  |         |         |       |       |                 |  |  |     |    |         |       |       |  |                 |  |       |       |  |     |    |       |  |                 |  |  |  |  |            |    |       |  |                 |  |  |  |  |         |     |       |  |                 |  |  |  |  |         |    |       |  |                 |  |  |  |  |         |    |       |  |                 |  |  |  |  |         |    |       |  |                 |  |  |  |  |         |     |       |  |                 |  |  |  |  |         |     |       |  |                 |  |  |  |  |     |  |       |  |                 |  |  |  |  |            |    |       |  |                 |  |  |  |  |         |    |       |  |                 |  |  |  |  |         |    |       |  |                 |  |  |  |  |         |    |       |  |                 |  |  |  |  |         |     |       |  |                 |  |  |  |  |           |     |       |  |                 |  |  |  |  |
| 1.8 GTI  | 132  | 09.05 | 05.09 |                 |                |                 |                     |           |                     |        |              |       |                |        |                 |                |         |                  |        |                     |         |         |       |                 |       |         |         |    |         |       |         |       |                 |       |         |       |  |         |         |         |       |                 |       |         |         |    |         |       |         |       |                 |       |         |       |  |         |         |       |       |                 |  |  |         |  |         |       |       |  |                 |    |       |       |  |         |         |       |       |                 |  |  |     |    |         |       |       |  |                 |  |       |       |  |     |    |       |  |                 |  |  |  |  |            |    |       |  |                 |  |  |  |  |         |     |       |  |                 |  |  |  |  |         |    |       |  |                 |  |  |  |  |         |    |       |  |                 |  |  |  |  |         |    |       |  |                 |  |  |  |  |         |     |       |  |                 |  |  |  |  |         |     |       |  |                 |  |  |  |  |     |  |       |  |                 |  |  |  |  |            |    |       |  |                 |  |  |  |  |         |    |       |  |                 |  |  |  |  |         |    |       |  |                 |  |  |  |  |         |    |       |  |                 |  |  |  |  |         |     |       |  |                 |  |  |  |  |           |     |       |  |                 |  |  |  |  |
| 1.9 SDI  |  | 06.06 | 05.09 |                 |                |                 |                     |           |                     |        |              |       |                |        |                 |                |         |                  |        |                     |         |         |       |                 |       |         |         |    |         |       |         |       |                 |       |         |       |  |         |         |         |       |                 |       |         |         |    |         |       |         |       |                 |       |         |       |  |         |         |       |       |                 |  |  |         |  |         |       |       |  |                 |    |       |       |  |         |         |       |       |                 |  |  |     |    |         |       |       |  |                 |  |       |       |  |     |    |       |  |                 |  |  |  |  |            |    |       |  |                 |  |  |  |  |         |     |       |  |                 |  |  |  |  |         |    |       |  |                 |  |  |  |  |         |    |       |  |                 |  |  |  |  |         |    |       |  |                 |  |  |  |  |         |     |       |  |                 |  |  |  |  |         |     |       |  |                 |  |  |  |  |     |  |       |  |                 |  |  |  |  |            |    |       |  |                 |  |  |  |  |         |    |       |  |                 |  |  |  |  |         |    |       |  |                 |  |  |  |  |         |    |       |  |                 |  |  |  |  |         |     |       |  |                 |  |  |  |  |           |     |       |  |                 |  |  |  |  |
| 1.9 TDI  | 74   | 11.01 | 05.09 |                 |                |                 |                     |           |                     |        |              |       |                |        |                 |                |         |                  |        |                     |         |         |       |                 |       |         |         |    |         |       |         |       |                 |       |         |       |  |         |         |         |       |                 |       |         |         |    |         |       |         |       |                 |       |         |       |  |         |         |       |       |                 |  |  |         |  |         |       |       |  |                 |    |       |       |  |         |         |       |       |                 |  |  |     |    |         |       |       |  |                 |  |       |       |  |     |    |       |  |                 |  |  |  |  |            |    |       |  |                 |  |  |  |  |         |     |       |  |                 |  |  |  |  |         |    |       |  |                 |  |  |  |  |         |    |       |  |                 |  |  |  |  |         |    |       |  |                 |  |  |  |  |         |     |       |  |                 |  |  |  |  |         |     |       |  |                 |  |  |  |  |     |  |       |  |                 |  |  |  |  |            |    |       |  |                 |  |  |  |  |         |    |       |  |                 |  |  |  |  |         |    |       |  |                 |  |  |  |  |         |    |       |  |                 |  |  |  |  |         |     |       |  |                 |  |  |  |  |           |     |       |  |                 |  |  |  |  |
| 1.9 TDI  | 96   | 11.01 | 05.09 |                 |                |                 |                     |           |                     |        |              |       |                |        |                 |                |         |                  |        |                     |         |         |       |                 |       |         |         |    |         |       |         |       |                 |       |         |       |  |         |         |         |       |                 |       |         |         |    |         |       |         |       |                 |       |         |       |  |         |         |       |       |                 |  |  |         |  |         |       |       |  |                 |    |       |       |  |         |         |       |       |                 |  |  |     |    |         |       |       |  |                 |  |       |       |  |     |    |       |  |                 |  |  |  |  |            |    |       |  |                 |  |  |  |  |         |     |       |  |                 |  |  |  |  |         |    |       |  |                 |  |  |  |  |         |    |       |  |                 |  |  |  |  |         |    |       |  |                 |  |  |  |  |         |     |       |  |                 |  |  |  |  |         |     |       |  |                 |  |  |  |  |     |  |       |  |                 |  |  |  |  |            |    |       |  |                 |  |  |  |  |         |    |       |  |                 |  |  |  |  |         |    |       |  |                 |  |  |  |  |         |    |       |  |                 |  |  |  |  |         |     |       |  |                 |  |  |  |  |           |     |       |  |                 |  |  |  |  |
| 2.0  | 85   | 10.03 | 05.09 |                 |                |                 |                     |           |                     |        |              |       |                |        |                 |                |         |                  |        |                     |         |         |       |                 |       |         |         |    |         |       |         |       |                 |       |         |       |  |         |         |         |       |                 |       |         |         |    |         |       |         |       |                 |       |         |       |  |         |         |       |       |                 |  |  |         |  |         |       |       |  |                 |    |       |       |  |         |         |       |       |                 |  |  |     |    |         |       |       |  |                 |  |       |       |  |     |    |       |  |                 |  |  |  |  |            |    |       |  |                 |  |  |  |  |         |     |       |  |                 |  |  |  |  |         |    |       |  |                 |  |  |  |  |         |    |       |  |                 |  |  |  |  |         |    |       |  |                 |  |  |  |  |         |     |       |  |                 |  |  |  |  |         |     |       |  |                 |  |  |  |  |     |  |       |  |                 |  |  |  |  |            |    |       |  |                 |  |  |  |  |         |    |       |  |                 |  |  |  |  |         |    |       |  |                 |  |  |  |  |         |    |       |  |                 |  |  |  |  |         |     |       |  |                 |  |  |  |  |           |     |       |  |                 |  |  |  |  |
|  |  | 04.02 | 05.09 |                 |                |                 |                     |           |                     |        |              |       |                |        |                 |                |         |                  |        |                     |         |         |       |                 |       |         |         |    |         |       |         |       |                 |       |         |       |  |         |         |         |       |                 |       |         |         |    |         |       |         |       |                 |       |         |       |  |         |         |       |       |                 |  |  |         |  |         |       |       |  |                 |    |       |       |  |         |         |       |       |                 |  |  |     |    |         |       |       |  |                 |  |       |       |  |     |    |       |  |                 |  |  |  |  |            |    |       |  |                 |  |  |  |  |         |     |       |  |                 |  |  |  |  |         |    |       |  |                 |  |  |  |  |         |    |       |  |                 |  |  |  |  |         |    |       |  |                 |  |  |  |  |         |     |       |  |                 |  |  |  |  |         |     |       |  |                 |  |  |  |  |     |  |       |  |                 |  |  |  |  |            |    |       |  |                 |  |  |  |  |         |    |       |  |                 |  |  |  |  |         |    |       |  |                 |  |  |  |  |         |    |       |  |                 |  |  |  |  |         |     |       |  |                 |  |  |  |  |           |     |       |  |                 |  |  |  |  |
|    | <table border="1"> <tr><td>1.2</td><td>40</td><td>11.01</td><td>05.09</td><td>PR: 1KB</td><td>03.0137-0268.2</td><td>650268</td><td>200 x 40 HEB</td><td>VW</td></tr> <tr><td>1.2</td><td>51</td><td>11.01</td><td>05.09</td><td>PR: 1KB</td><td>03.0137-9168.2</td><td>669168</td><td>Bremsbacken-Zubehör</td><td>VW</td></tr> <tr><td>1.4 16V</td><td></td><td>04.07</td><td>05.09</td><td>PR: 1KB</td><td></td><td></td><td></td><td></td></tr> <tr><td>1.4 FSI</td><td></td><td>11.01</td><td>05.09</td><td>PR: 1KB</td><td></td><td></td><td></td><td></td></tr> <tr><td>1.4 TDI</td><td></td><td>11.01</td><td>05.09</td><td>PR: 1KB</td><td></td><td></td><td></td><td></td></tr> <tr><td>1.9 SDI</td><td></td><td>11.01</td><td>05.09</td><td>PR: 1KB</td><td></td><td></td><td></td><td></td></tr> </table>   | 1.2   | 40    | 11.01           | 05.09          |                 | PR: 1KB             |           | 03.0137-0268.2      | 650268 | 200 x 40 HEB | VW    | 1.2            | 51     | 11.01           | 05.09          | PR: 1KB | 03.0137-9168.2   | 669168 | Bremsbacken-Zubehör | VW      | 1.4 16V |       | 04.07           | 05.09 | PR: 1KB |         |    |         |       | 1.4 FSI |       | 11.01           | 05.09 | PR: 1KB |       |  |         |         | 1.4 TDI |       | 11.01           | 05.09 | PR: 1KB |         |    |         |       | 1.9 SDI |       | 11.01           | 05.09 | PR: 1KB |       |  |         |         |       |       |                 |  |  |         |  |         |       |       |  |                 |    |       |       |  |         |         |       |       |                 |  |  |     |    |         |       |       |  |                 |  |       |       |  |     |    |       |  |                 |  |  |  |  |            |    |       |  |                 |  |  |  |  |         |     |       |  |                 |  |  |  |  |         |    |       |  |                 |  |  |  |  |         |    |       |  |                 |  |  |  |  |         |    |       |  |                 |  |  |  |  |         |     |       |  |                 |  |  |  |  |         |     |       |  |                 |  |  |  |  |     |  |       |  |                 |  |  |  |  |            |    |       |  |                 |  |  |  |  |         |    |       |  |                 |  |  |  |  |         |    |       |  |                 |  |  |  |  |         |    |       |  |                 |  |  |  |  |         |     |       |  |                 |  |  |  |  |           |     |       |  |                 |  |  |  |  |
| 1.2  | 40   | 11.01 | 05.09 | PR: 1KB         | 03.0137-0268.2 |                 | 650268              |           | 200 x 40 HEB        | VW     |              |       |                |        |                 |                |         |                  |        |                     |         |         |       |                 |       |         |         |    |         |       |         |       |                 |       |         |       |  |         |         |         |       |                 |       |         |         |    |         |       |         |       |                 |       |         |       |  |         |         |       |       |                 |  |  |         |  |         |       |       |  |                 |    |       |       |  |         |         |       |       |                 |  |  |     |    |         |       |       |  |                 |  |       |       |  |     |    |       |  |                 |  |  |  |  |            |    |       |  |                 |  |  |  |  |         |     |       |  |                 |  |  |  |  |         |    |       |  |                 |  |  |  |  |         |    |       |  |                 |  |  |  |  |         |    |       |  |                 |  |  |  |  |         |     |       |  |                 |  |  |  |  |         |     |       |  |                 |  |  |  |  |     |  |       |  |                 |  |  |  |  |            |    |       |  |                 |  |  |  |  |         |    |       |  |                 |  |  |  |  |         |    |       |  |                 |  |  |  |  |         |    |       |  |                 |  |  |  |  |         |     |       |  |                 |  |  |  |  |           |     |       |  |                 |  |  |  |  |
| 1.2  | 51   | 11.01 | 05.09 | PR: 1KB         | 03.0137-9168.2 |                 | 669168              |           | Bremsbacken-Zubehör | VW     |              |       |                |        |                 |                |         |                  |        |                     |         |         |       |                 |       |         |         |    |         |       |         |       |                 |       |         |       |  |         |         |         |       |                 |       |         |         |    |         |       |         |       |                 |       |         |       |  |         |         |       |       |                 |  |  |         |  |         |       |       |  |                 |    |       |       |  |         |         |       |       |                 |  |  |     |    |         |       |       |  |                 |  |       |       |  |     |    |       |  |                 |  |  |  |  |            |    |       |  |                 |  |  |  |  |         |     |       |  |                 |  |  |  |  |         |    |       |  |                 |  |  |  |  |         |    |       |  |                 |  |  |  |  |         |    |       |  |                 |  |  |  |  |         |     |       |  |                 |  |  |  |  |         |     |       |  |                 |  |  |  |  |     |  |       |  |                 |  |  |  |  |            |    |       |  |                 |  |  |  |  |         |    |       |  |                 |  |  |  |  |         |    |       |  |                 |  |  |  |  |         |    |       |  |                 |  |  |  |  |         |     |       |  |                 |  |  |  |  |           |     |       |  |                 |  |  |  |  |
| 1.4 16V  |  | 04.07 | 05.09 | PR: 1KB         |                |                 |                     |           |                     |        |              |       |                |        |                 |                |         |                  |        |                     |         |         |       |                 |       |         |         |    |         |       |         |       |                 |       |         |       |  |         |         |         |       |                 |       |         |         |    |         |       |         |       |                 |       |         |       |  |         |         |       |       |                 |  |  |         |  |         |       |       |  |                 |    |       |       |  |         |         |       |       |                 |  |  |     |    |         |       |       |  |                 |  |       |       |  |     |    |       |  |                 |  |  |  |  |            |    |       |  |                 |  |  |  |  |         |     |       |  |                 |  |  |  |  |         |    |       |  |                 |  |  |  |  |         |    |       |  |                 |  |  |  |  |         |    |       |  |                 |  |  |  |  |         |     |       |  |                 |  |  |  |  |         |     |       |  |                 |  |  |  |  |     |  |       |  |                 |  |  |  |  |            |    |       |  |                 |  |  |  |  |         |    |       |  |                 |  |  |  |  |         |    |       |  |                 |  |  |  |  |         |    |       |  |                 |  |  |  |  |         |     |       |  |                 |  |  |  |  |           |     |       |  |                 |  |  |  |  |
| 1.4 FSI  |  | 11.01 | 05.09 | PR: 1KB         |                |                 |                     |           |                     |        |              |       |                |        |                 |                |         |                  |        |                     |         |         |       |                 |       |         |         |    |         |       |         |       |                 |       |         |       |  |         |         |         |       |                 |       |         |         |    |         |       |         |       |                 |       |         |       |  |         |         |       |       |                 |  |  |         |  |         |       |       |  |                 |    |       |       |  |         |         |       |       |                 |  |  |     |    |         |       |       |  |                 |  |       |       |  |     |    |       |  |                 |  |  |  |  |            |    |       |  |                 |  |  |  |  |         |     |       |  |                 |  |  |  |  |         |    |       |  |                 |  |  |  |  |         |    |       |  |                 |  |  |  |  |         |    |       |  |                 |  |  |  |  |         |     |       |  |                 |  |  |  |  |         |     |       |  |                 |  |  |  |  |     |  |       |  |                 |  |  |  |  |            |    |       |  |                 |  |  |  |  |         |    |       |  |                 |  |  |  |  |         |    |       |  |                 |  |  |  |  |         |    |       |  |                 |  |  |  |  |         |     |       |  |                 |  |  |  |  |           |     |       |  |                 |  |  |  |  |
| 1.4 TDI  |  | 11.01 | 05.09 | PR: 1KB         |                |                 |                     |           |                     |        |              |       |                |        |                 |                |         |                  |        |                     |         |         |       |                 |       |         |         |    |         |       |         |       |                 |       |         |       |  |         |         |         |       |                 |       |         |         |    |         |       |         |       |                 |       |         |       |  |         |         |       |       |                 |  |  |         |  |         |       |       |  |                 |    |       |       |  |         |         |       |       |                 |  |  |     |    |         |       |       |  |                 |  |       |       |  |     |    |       |  |                 |  |  |  |  |            |    |       |  |                 |  |  |  |  |         |     |       |  |                 |  |  |  |  |         |    |       |  |                 |  |  |  |  |         |    |       |  |                 |  |  |  |  |         |    |       |  |                 |  |  |  |  |         |     |       |  |                 |  |  |  |  |         |     |       |  |                 |  |  |  |  |     |  |       |  |                 |  |  |  |  |            |    |       |  |                 |  |  |  |  |         |    |       |  |                 |  |  |  |  |         |    |       |  |                 |  |  |  |  |         |    |       |  |                 |  |  |  |  |         |     |       |  |                 |  |  |  |  |           |     |       |  |                 |  |  |  |  |
| 1.9 SDI  |  | 11.01 | 05.09 | PR: 1KB         |                |                 |                     |           |                     |        |              |       |                |        |                 |                |         |                  |        |                     |         |         |       |                 |       |         |         |    |         |       |         |       |                 |       |         |       |  |         |         |         |       |                 |       |         |         |    |         |       |         |       |                 |       |         |       |  |         |         |       |       |                 |  |  |         |  |         |       |       |  |                 |    |       |       |  |         |         |       |       |                 |  |  |     |    |         |       |       |  |                 |  |       |       |  |     |    |       |  |                 |  |  |  |  |            |    |       |  |                 |  |  |  |  |         |     |       |  |                 |  |  |  |  |         |    |       |  |                 |  |  |  |  |         |    |       |  |                 |  |  |  |  |         |    |       |  |                 |  |  |  |  |         |     |       |  |                 |  |  |  |  |         |     |       |  |                 |  |  |  |  |     |  |       |  |                 |  |  |  |  |            |    |       |  |                 |  |  |  |  |         |    |       |  |                 |  |  |  |  |         |    |       |  |                 |  |  |  |  |         |    |       |  |                 |  |  |  |  |         |     |       |  |                 |  |  |  |  |           |     |       |  |                 |  |  |  |  |
|    | <table border="1"> <tr><td>1.2</td><td>40</td><td>11.01</td><td>05.09</td><td>PR: 1KB</td><td>24.0220-0037.1</td><td>480161</td><td>200/201,5 x 50,5</td><td></td></tr> <tr><td>1.2</td><td>51</td><td>11.01</td><td>05.09</td><td>PR: 1KB</td><td></td><td></td><td></td><td></td></tr> <tr><td>1.4 16V</td><td></td><td>04.07</td><td>05.09</td><td>PR: 1KB</td><td></td><td></td><td></td><td></td></tr> <tr><td>1.4 FSI</td><td></td><td>11.01</td><td>05.09</td><td>PR: 1KB</td><td></td><td></td><td></td><td></td></tr> <tr><td>1.4 TDI</td><td></td><td>11.01</td><td>05.09</td><td>PR: 1KB</td><td></td><td></td><td></td><td></td></tr> <tr><td>1.9 SDI</td><td></td><td>11.01</td><td>05.09</td><td>PR: 1KB</td><td></td><td></td><td></td><td></td></tr> </table>  | 1.2   | 40    | 11.01           | 05.09          | PR: 1KB         | 24.0220-0037.1      | 480161    | 200/201,5 x 50,5    |        | 1.2          | 51    | 11.01          | 05.09  | PR: 1KB         |                |         |                  |        | 1.4 16V             |         | 04.07   | 05.09 | PR: 1KB         |       |         |         |    | 1.4 FSI |       | 11.01   | 05.09 | PR: 1KB         |       |         |       |  | 1.4 TDI |         | 11.01   | 05.09 | PR: 1KB         |       |         |         |    | 1.9 SDI |       | 11.01   | 05.09 | PR: 1KB         |       |         |       |  |         |         |       |       |                 |  |  |         |  |         |       |       |  |                 |    |       |       |  |         |         |       |       |                 |  |  |     |    |         |       |       |  |                 |  |       |       |  |     |    |       |  |                 |  |  |  |  |            |    |       |  |                 |  |  |  |  |         |     |       |  |                 |  |  |  |  |         |    |       |  |                 |  |  |  |  |         |    |       |  |                 |  |  |  |  |         |    |       |  |                 |  |  |  |  |         |     |       |  |                 |  |  |  |  |         |     |       |  |                 |  |  |  |  |     |  |       |  |                 |  |  |  |  |            |    |       |  |                 |  |  |  |  |         |    |       |  |                 |  |  |  |  |         |    |       |  |                 |  |  |  |  |         |    |       |  |                 |  |  |  |  |         |     |       |  |                 |  |  |  |  |           |     |       |  |                 |  |  |  |  |
| 1.2  | 40   | 11.01 | 05.09 | PR: 1KB         | 24.0220-0037.1 | 480161          | 200/201,5 x 50,5    |           |                     |        |              |       |                |        |                 |                |         |                  |        |                     |         |         |       |                 |       |         |         |    |         |       |         |       |                 |       |         |       |  |         |         |         |       |                 |       |         |         |    |         |       |         |       |                 |       |         |       |  |         |         |       |       |                 |  |  |         |  |         |       |       |  |                 |    |       |       |  |         |         |       |       |                 |  |  |     |    |         |       |       |  |                 |  |       |       |  |     |    |       |  |                 |  |  |  |  |            |    |       |  |                 |  |  |  |  |         |     |       |  |                 |  |  |  |  |         |    |       |  |                 |  |  |  |  |         |    |       |  |                 |  |  |  |  |         |    |       |  |                 |  |  |  |  |         |     |       |  |                 |  |  |  |  |         |     |       |  |                 |  |  |  |  |     |  |       |  |                 |  |  |  |  |            |    |       |  |                 |  |  |  |  |         |    |       |  |                 |  |  |  |  |         |    |       |  |                 |  |  |  |  |         |    |       |  |                 |  |  |  |  |         |     |       |  |                 |  |  |  |  |           |     |       |  |                 |  |  |  |  |
| 1.2  | 51   | 11.01 | 05.09 | PR: 1KB         |                |                 |                     |           |                     |        |              |       |                |        |                 |                |         |                  |        |                     |         |         |       |                 |       |         |         |    |         |       |         |       |                 |       |         |       |  |         |         |         |       |                 |       |         |         |    |         |       |         |       |                 |       |         |       |  |         |         |       |       |                 |  |  |         |  |         |       |       |  |                 |    |       |       |  |         |         |       |       |                 |  |  |     |    |         |       |       |  |                 |  |       |       |  |     |    |       |  |                 |  |  |  |  |            |    |       |  |                 |  |  |  |  |         |     |       |  |                 |  |  |  |  |         |    |       |  |                 |  |  |  |  |         |    |       |  |                 |  |  |  |  |         |    |       |  |                 |  |  |  |  |         |     |       |  |                 |  |  |  |  |         |     |       |  |                 |  |  |  |  |     |  |       |  |                 |  |  |  |  |            |    |       |  |                 |  |  |  |  |         |    |       |  |                 |  |  |  |  |         |    |       |  |                 |  |  |  |  |         |    |       |  |                 |  |  |  |  |         |     |       |  |                 |  |  |  |  |           |     |       |  |                 |  |  |  |  |
| 1.4 16V  |  | 04.07 | 05.09 | PR: 1KB         |                |                 |                     |           |                     |        |              |       |                |        |                 |                |         |                  |        |                     |         |         |       |                 |       |         |         |    |         |       |         |       |                 |       |         |       |  |         |         |         |       |                 |       |         |         |    |         |       |         |       |                 |       |         |       |  |         |         |       |       |                 |  |  |         |  |         |       |       |  |                 |    |       |       |  |         |         |       |       |                 |  |  |     |    |         |       |       |  |                 |  |       |       |  |     |    |       |  |                 |  |  |  |  |            |    |       |  |                 |  |  |  |  |         |     |       |  |                 |  |  |  |  |         |    |       |  |                 |  |  |  |  |         |    |       |  |                 |  |  |  |  |         |    |       |  |                 |  |  |  |  |         |     |       |  |                 |  |  |  |  |         |     |       |  |                 |  |  |  |  |     |  |       |  |                 |  |  |  |  |            |    |       |  |                 |  |  |  |  |         |    |       |  |                 |  |  |  |  |         |    |       |  |                 |  |  |  |  |         |    |       |  |                 |  |  |  |  |         |     |       |  |                 |  |  |  |  |           |     |       |  |                 |  |  |  |  |
| 1.4 FSI  |  | 11.01 | 05.09 | PR: 1KB         |                |                 |                     |           |                     |        |              |       |                |        |                 |                |         |                  |        |                     |         |         |       |                 |       |         |         |    |         |       |         |       |                 |       |         |       |  |         |         |         |       |                 |       |         |         |    |         |       |         |       |                 |       |         |       |  |         |         |       |       |                 |  |  |         |  |         |       |       |  |                 |    |       |       |  |         |         |       |       |                 |  |  |     |    |         |       |       |  |                 |  |       |       |  |     |    |       |  |                 |  |  |  |  |            |    |       |  |                 |  |  |  |  |         |     |       |  |                 |  |  |  |  |         |    |       |  |                 |  |  |  |  |         |    |       |  |                 |  |  |  |  |         |    |       |  |                 |  |  |  |  |         |     |       |  |                 |  |  |  |  |         |     |       |  |                 |  |  |  |  |     |  |       |  |                 |  |  |  |  |            |    |       |  |                 |  |  |  |  |         |    |       |  |                 |  |  |  |  |         |    |       |  |                 |  |  |  |  |         |    |       |  |                 |  |  |  |  |         |     |       |  |                 |  |  |  |  |           |     |       |  |                 |  |  |  |  |
| 1.4 TDI  |  | 11.01 | 05.09 | PR: 1KB         |                |                 |                     |           |                     |        |              |       |                |        |                 |                |         |                  |        |                     |         |         |       |                 |       |         |         |    |         |       |         |       |                 |       |         |       |  |         |         |         |       |                 |       |         |         |    |         |       |         |       |                 |       |         |       |  |         |         |       |       |                 |  |  |         |  |         |       |       |  |                 |    |       |       |  |         |         |       |       |                 |  |  |     |    |         |       |       |  |                 |  |       |       |  |     |    |       |  |                 |  |  |  |  |            |    |       |  |                 |  |  |  |  |         |     |       |  |                 |  |  |  |  |         |    |       |  |                 |  |  |  |  |         |    |       |  |                 |  |  |  |  |         |    |       |  |                 |  |  |  |  |         |     |       |  |                 |  |  |  |  |         |     |       |  |                 |  |  |  |  |     |  |       |  |                 |  |  |  |  |            |    |       |  |                 |  |  |  |  |         |    |       |  |                 |  |  |  |  |         |    |       |  |                 |  |  |  |  |         |    |       |  |                 |  |  |  |  |         |     |       |  |                 |  |  |  |  |           |     |       |  |                 |  |  |  |  |
| 1.9 SDI  |  | 11.01 | 05.09 | PR: 1KB         |                |                 |                     |           |                     |        |              |       |                |        |                 |                |         |                  |        |                     |         |         |       |                 |       |         |         |    |         |       |         |       |                 |       |         |       |  |         |         |         |       |                 |       |         |         |    |         |       |         |       |                 |       |         |       |  |         |         |       |       |                 |  |  |         |  |         |       |       |  |                 |    |       |       |  |         |         |       |       |                 |  |  |     |    |         |       |       |  |                 |  |       |       |  |     |    |       |  |                 |  |  |  |  |            |    |       |  |                 |  |  |  |  |         |     |       |  |                 |  |  |  |  |         |    |       |  |                 |  |  |  |  |         |    |       |  |                 |  |  |  |  |         |    |       |  |                 |  |  |  |  |         |     |       |  |                 |  |  |  |  |         |     |       |  |                 |  |  |  |  |     |  |       |  |                 |  |  |  |  |            |    |       |  |                 |  |  |  |  |         |    |       |  |                 |  |  |  |  |         |    |       |  |                 |  |  |  |  |         |    |       |  |                 |  |  |  |  |         |     |       |  |                 |  |  |  |  |           |     |       |  |                 |  |  |  |  |
|    | <table border="1"> <tr><td>1.2</td><td>40</td><td>11.01</td><td>05.09</td><td>PR: 1KB</td><td>03.0520-1517.3</td><td>691517</td><td>17,46/200x40 TopKit</td><td>VW</td></tr> <tr><td>1.2</td><td>51</td><td>11.01</td><td>05.09</td><td>PR: 1KB</td><td>03.0420-1517.3</td><td>681517</td><td>17,46/200x40 Kit</td><td>VW</td></tr> <tr><td>1.4 16V</td><td></td><td>04.07</td><td>05.09</td><td>PR: 1KB</td><td></td><td></td><td></td><td></td></tr> <tr><td>1.4 FSI</td><td></td><td>11.01</td><td>05.09</td><td>PR: 1KB</td><td></td><td></td><td></td><td></td></tr> <tr><td>1.4 TDI</td><td></td><td>11.01</td><td>05.09</td><td>PR: 1KB</td><td></td><td></td><td></td><td></td></tr> <tr><td>1.9 SDI</td><td></td><td>11.01</td><td>05.09</td><td>PR: 1KB</td><td></td><td></td><td></td><td></td></tr> </table>   | 1.2   | 40    | 11.01           | 05.09          | PR: 1KB         | 03.0520-1517.3      | 691517    | 17,46/200x40 TopKit | VW     | 1.2          | 51    | 11.01          | 05.09  | PR: 1KB         | 03.0420-1517.3 | 681517  | 17,46/200x40 Kit | VW     | 1.4 16V             |         | 04.07   | 05.09 | PR: 1KB         |       |         |         |    | 1.4 FSI |       | 11.01   | 05.09 | PR: 1KB         |       |         |       |  | 1.4 TDI |         | 11.01   | 05.09 | PR: 1KB         |       |         |         |    | 1.9 SDI |       | 11.01   | 05.09 | PR: 1KB         |       |         |       |  |         |         |       |       |                 |  |  |         |  |         |       |       |  |                 |    |       |       |  |         |         |       |       |                 |  |  |     |    |         |       |       |  |                 |  |       |       |  |     |    |       |  |                 |  |  |  |  |            |    |       |  |                 |  |  |  |  |         |     |       |  |                 |  |  |  |  |         |    |       |  |                 |  |  |  |  |         |    |       |  |                 |  |  |  |  |         |    |       |  |                 |  |  |  |  |         |     |       |  |                 |  |  |  |  |         |     |       |  |                 |  |  |  |  |     |  |       |  |                 |  |  |  |  |            |    |       |  |                 |  |  |  |  |         |    |       |  |                 |  |  |  |  |         |    |       |  |                 |  |  |  |  |         |    |       |  |                 |  |  |  |  |         |     |       |  |                 |  |  |  |  |           |     |       |  |                 |  |  |  |  |
| 1.2  | 40   | 11.01 | 05.09 | PR: 1KB         | 03.0520-1517.3 | 691517          | 17,46/200x40 TopKit | VW        |                     |        |              |       |                |        |                 |                |         |                  |        |                     |         |         |       |                 |       |         |         |    |         |       |         |       |                 |       |         |       |  |         |         |         |       |                 |       |         |         |    |         |       |         |       |                 |       |         |       |  |         |         |       |       |                 |  |  |         |  |         |       |       |  |                 |    |       |       |  |         |         |       |       |                 |  |  |     |    |         |       |       |  |                 |  |       |       |  |     |    |       |  |                 |  |  |  |  |            |    |       |  |                 |  |  |  |  |         |     |       |  |                 |  |  |  |  |         |    |       |  |                 |  |  |  |  |         |    |       |  |                 |  |  |  |  |         |    |       |  |                 |  |  |  |  |         |     |       |  |                 |  |  |  |  |         |     |       |  |                 |  |  |  |  |     |  |       |  |                 |  |  |  |  |            |    |       |  |                 |  |  |  |  |         |    |       |  |                 |  |  |  |  |         |    |       |  |                 |  |  |  |  |         |    |       |  |                 |  |  |  |  |         |     |       |  |                 |  |  |  |  |           |     |       |  |                 |  |  |  |  |
| 1.2  | 51   | 11.01 | 05.09 | PR: 1KB         | 03.0420-1517.3 | 681517          | 17,46/200x40 Kit    | VW        |                     |        |              |       |                |        |                 |                |         |                  |        |                     |         |         |       |                 |       |         |         |    |         |       |         |       |                 |       |         |       |  |         |         |         |       |                 |       |         |         |    |         |       |         |       |                 |       |         |       |  |         |         |       |       |                 |  |  |         |  |         |       |       |  |                 |    |       |       |  |         |         |       |       |                 |  |  |     |    |         |       |       |  |                 |  |       |       |  |     |    |       |  |                 |  |  |  |  |            |    |       |  |                 |  |  |  |  |         |     |       |  |                 |  |  |  |  |         |    |       |  |                 |  |  |  |  |         |    |       |  |                 |  |  |  |  |         |    |       |  |                 |  |  |  |  |         |     |       |  |                 |  |  |  |  |         |     |       |  |                 |  |  |  |  |     |  |       |  |                 |  |  |  |  |            |    |       |  |                 |  |  |  |  |         |    |       |  |                 |  |  |  |  |         |    |       |  |                 |  |  |  |  |         |    |       |  |                 |  |  |  |  |         |     |       |  |                 |  |  |  |  |           |     |       |  |                 |  |  |  |  |
| 1.4 16V  |  | 04.07 | 05.09 | PR: 1KB         |                |                 |                     |           |                     |        |              |       |                |        |                 |                |         |                  |        |                     |         |         |       |                 |       |         |         |    |         |       |         |       |                 |       |         |       |  |         |         |         |       |                 |       |         |         |    |         |       |         |       |                 |       |         |       |  |         |         |       |       |                 |  |  |         |  |         |       |       |  |                 |    |       |       |  |         |         |       |       |                 |  |  |     |    |         |       |       |  |                 |  |       |       |  |     |    |       |  |                 |  |  |  |  |            |    |       |  |                 |  |  |  |  |         |     |       |  |                 |  |  |  |  |         |    |       |  |                 |  |  |  |  |         |    |       |  |                 |  |  |  |  |         |    |       |  |                 |  |  |  |  |         |     |       |  |                 |  |  |  |  |         |     |       |  |                 |  |  |  |  |     |  |       |  |                 |  |  |  |  |            |    |       |  |                 |  |  |  |  |         |    |       |  |                 |  |  |  |  |         |    |       |  |                 |  |  |  |  |         |    |       |  |                 |  |  |  |  |         |     |       |  |                 |  |  |  |  |           |     |       |  |                 |  |  |  |  |
| 1.4 FSI  |  | 11.01 | 05.09 | PR: 1KB         |                |                 |                     |           |                     |        |              |       |                |        |                 |                |         |                  |        |                     |         |         |       |                 |       |         |         |    |         |       |         |       |                 |       |         |       |  |         |         |         |       |                 |       |         |         |    |         |       |         |       |                 |       |         |       |  |         |         |       |       |                 |  |  |         |  |         |       |       |  |                 |    |       |       |  |         |         |       |       |                 |  |  |     |    |         |       |       |  |                 |  |       |       |  |     |    |       |  |                 |  |  |  |  |            |    |       |  |                 |  |  |  |  |         |     |       |  |                 |  |  |  |  |         |    |       |  |                 |  |  |  |  |         |    |       |  |                 |  |  |  |  |         |    |       |  |                 |  |  |  |  |         |     |       |  |                 |  |  |  |  |         |     |       |  |                 |  |  |  |  |     |  |       |  |                 |  |  |  |  |            |    |       |  |                 |  |  |  |  |         |    |       |  |                 |  |  |  |  |         |    |       |  |                 |  |  |  |  |         |    |       |  |                 |  |  |  |  |         |     |       |  |                 |  |  |  |  |           |     |       |  |                 |  |  |  |  |
| 1.4 TDI  |  | 11.01 | 05.09 | PR: 1KB         |                |                 |                     |           |                     |        |              |       |                |        |                 |                |         |                  |        |                     |         |         |       |                 |       |         |         |    |         |       |         |       |                 |       |         |       |  |         |         |         |       |                 |       |         |         |    |         |       |         |       |                 |       |         |       |  |         |         |       |       |                 |  |  |         |  |         |       |       |  |                 |    |       |       |  |         |         |       |       |                 |  |  |     |    |         |       |       |  |                 |  |       |       |  |     |    |       |  |                 |  |  |  |  |            |    |       |  |                 |  |  |  |  |         |     |       |  |                 |  |  |  |  |         |    |       |  |                 |  |  |  |  |         |    |       |  |                 |  |  |  |  |         |    |       |  |                 |  |  |  |  |         |     |       |  |                 |  |  |  |  |         |     |       |  |                 |  |  |  |  |     |  |       |  |                 |  |  |  |  |            |    |       |  |                 |  |  |  |  |         |    |       |  |                 |  |  |  |  |         |    |       |  |                 |  |  |  |  |         |    |       |  |                 |  |  |  |  |         |     |       |  |                 |  |  |  |  |           |     |       |  |                 |  |  |  |  |
| 1.9 SDI  |  | 11.01 | 05.09 | PR: 1KB         |                |                 |                     |           |                     |        |              |       |                |        |                 |                |         |                  |        |                     |         |         |       |                 |       |         |         |    |         |       |         |       |                 |       |         |       |  |         |         |         |       |                 |       |         |         |    |         |       |         |       |                 |       |         |       |  |         |         |       |       |                 |  |  |         |  |         |       |       |  |                 |    |       |       |  |         |         |       |       |                 |  |  |     |    |         |       |       |  |                 |  |       |       |  |     |    |       |  |                 |  |  |  |  |            |    |       |  |                 |  |  |  |  |         |     |       |  |                 |  |  |  |  |         |    |       |  |                 |  |  |  |  |         |    |       |  |                 |  |  |  |  |         |    |       |  |                 |  |  |  |  |         |     |       |  |                 |  |  |  |  |         |     |       |  |                 |  |  |  |  |     |  |       |  |                 |  |  |  |  |            |    |       |  |                 |  |  |  |  |         |    |       |  |                 |  |  |  |  |         |    |       |  |                 |  |  |  |  |         |    |       |  |                 |  |  |  |  |         |     |       |  |                 |  |  |  |  |           |     |       |  |                 |  |  |  |  |
| VOLKSWAGEN POLO V (09-)  |  |       |       |                 |                |                 |                     |           |                     |        |              |       |                |        |                 |                |         |                  |        |                     |         |         |       |                 |       |         |         |    |         |       |         |       |                 |       |         |       |  |         |         |         |       |                 |       |         |         |    |         |       |         |       |                 |       |         |       |  |         |         |       |       |                 |  |  |         |  |         |       |       |  |                 |    |       |       |  |         |         |       |       |                 |  |  |     |    |         |       |       |  |                 |  |       |       |  |     |    |       |  |                 |  |  |  |  |            |    |       |  |                 |  |  |  |  |         |     |       |  |                 |  |  |  |  |         |    |       |  |                 |  |  |  |  |         |    |       |  |                 |  |  |  |  |         |    |       |  |                 |  |  |  |  |         |     |       |  |                 |  |  |  |  |         |     |       |  |                 |  |  |  |  |     |  |       |  |                 |  |  |  |  |            |    |       |  |                 |  |  |  |  |         |    |       |  |                 |  |  |  |  |         |    |       |  |                 |  |  |  |  |         |    |       |  |                 |  |  |  |  |         |     |       |  |                 |  |  |  |  |           |     |       |  |                 |  |  |  |  |
|   | <table border="1"> <tr><td>1.0</td><td>44</td><td>01.14</td><td></td><td>PR: 1ZG,1LR,1ZJ</td><td>13.0460-7111.2</td><td>607111</td><td>23130 19,6 +</td><td>VW</td></tr> <tr><td>1.0</td><td>55</td><td>01.14</td><td></td><td>PR: 1ZG,1LR,1ZJ</td><td>13.0470-7111.2</td><td>LD7111</td><td>23130 19,6 +</td><td>VW</td></tr> <tr><td>1.0</td><td>70</td><td>11.14</td><td></td><td>PR: 1ZG,1LR,1ZJ</td><td></td><td></td><td></td><td></td></tr> <tr><td>1.0 TSI</td><td>81</td><td>11.14</td><td></td><td>PR: 1ZG,1LR,1ZJ</td><td></td><td></td><td></td><td></td></tr> <tr><td>1.2</td><td>44</td><td>03.09</td><td></td><td>PR: 1ZG,1LR,1ZJ</td><td></td><td></td><td></td><td></td></tr> <tr><td>1.2</td><td>51</td><td>03.09</td><td></td><td>PR: 1ZG,1LR,1ZJ</td><td></td><td></td><td></td><td></td></tr> <tr><td>1.2 TDI</td><td>55</td><td>10.09</td><td></td><td>PR: 1ZG,1LR,1ZJ</td><td></td><td></td><td></td><td></td></tr> <tr><td>1.2 TSI</td><td>66</td><td>05.11</td><td></td><td>PR: 1ZG,1LR,1ZJ</td><td></td><td></td><td></td><td></td></tr> <tr><td>1.2 TSI</td><td>77</td><td>06.09</td><td></td><td>PR: 1ZG,1LR,1ZJ</td><td></td><td></td><td></td><td></td></tr> <tr><td>1.2 TSI</td><td>81</td><td>01.14</td><td></td><td>PR: 1ZG,1LR,1ZJ</td><td></td><td></td><td></td><td></td></tr> <tr><td>1.4</td><td>63</td><td>03.09</td><td></td><td>PR: 1ZG,1LR,1ZJ</td><td></td><td></td><td></td><td></td></tr> <tr><td>1.4 BiFuel</td><td>60</td><td>03.10</td><td></td><td>PR: 1ZG,1LR,1ZJ</td><td></td><td></td><td></td><td></td></tr> <tr><td>1.4 GTI</td><td>132</td><td>05.10</td><td></td><td>PR: 1ZG,1LR,1ZJ</td><td></td><td></td><td></td><td></td></tr> <tr><td>1.4 TDI</td><td>55</td><td>03.14</td><td></td><td>PR: 1ZG,1LR,1ZJ</td><td></td><td></td><td></td><td></td></tr> <tr><td>1.4 TDI</td><td>66</td><td>02.14</td><td></td><td>PR: 1ZG,1LR,1ZJ</td><td></td><td></td><td></td><td></td></tr> <tr><td>1.4 TDI</td><td>77</td><td>05.14</td><td></td><td>PR: 1ZG,1LR,1ZJ</td><td></td><td></td><td></td><td></td></tr> <tr><td>1.4 TSI</td><td>103</td><td>10.12</td><td></td><td>PR: 1ZG,1LR,1ZJ</td><td></td><td></td><td></td><td></td></tr> <tr><td>1.4 TSI</td><td>110</td><td>05.14</td><td></td><td>PR: 1ZG,1LR,1ZJ</td><td></td><td></td><td></td><td></td></tr> <tr><td>1.6</td><td></td><td>07.14</td><td></td><td>PR: 1ZG,1LR,1ZJ</td><td></td><td></td><td></td><td></td></tr> <tr><td>1.6 BiFuel</td><td>60</td><td>01.11</td><td></td><td>PR: 1ZG,1LR,1ZJ</td><td></td><td></td><td></td><td></td></tr> <tr><td>1.6 TDI</td><td>55</td><td>03.09</td><td></td><td>PR: 1ZG,1LR,1ZJ</td><td></td><td></td><td></td><td></td></tr> <tr><td>1.6 TDI</td><td>66</td><td>06.09</td><td></td><td>PR: 1ZG,1LR,1ZJ</td><td></td><td></td><td></td><td></td></tr> <tr><td>1.6 TDI</td><td>77</td><td>06.09</td><td></td><td>PR: 1ZG,1LR,1ZJ</td><td></td><td></td><td></td><td></td></tr> <tr><td>1.8 GTI</td><td>141</td><td>11.14</td><td></td><td>PR: 1ZG,1LR,1ZJ</td><td></td><td></td><td></td><td></td></tr> <tr><td>2.0 R WRC</td><td>162</td><td>08.13</td><td></td><td>PR: 1ZG,1LR,1ZJ</td><td></td><td></td><td></td><td></td></tr> </table> | 1.0   | 44    | 01.14           |                | PR: 1ZG,1LR,1ZJ | 13.0460-7111.2      | 607111    | 23130 19,6 +        | VW     | 1.0          | 55    | 01.14          |        | PR: 1ZG,1LR,1ZJ | 13.0470-7111.2 | LD7111  | 23130 19,6 +     | VW     | 1.0                 | 70      | 11.14   |       | PR: 1ZG,1LR,1ZJ |       |         |         |    | 1.0 TSI | 81    | 11.14   |       | PR: 1ZG,1LR,1ZJ |       |         |       |  | 1.2     | 44      | 03.09   |       | PR: 1ZG,1LR,1ZJ |       |         |         |    | 1.2     | 51    | 03.09   |       | PR: 1ZG,1LR,1ZJ |       |         |       |  | 1.2 TDI | 55      | 10.09 |       | PR: 1ZG,1LR,1ZJ |  |  |         |  | 1.2 TSI | 66    | 05.11 |  | PR: 1ZG,1LR,1ZJ |    |       |       |  | 1.2 TSI | 77      | 06.09 |       | PR: 1ZG,1LR,1ZJ |  |  |     |    | 1.2 TSI | 81    | 01.14 |  | PR: 1ZG,1LR,1ZJ |  |       |       |  | 1.4 | 63 | 03.09 |  | PR: 1ZG,1LR,1ZJ |  |  |  |  | 1.4 BiFuel | 60 | 03.10 |  | PR: 1ZG,1LR,1ZJ |  |  |  |  | 1.4 GTI | 132 | 05.10 |  | PR: 1ZG,1LR,1ZJ |  |  |  |  | 1.4 TDI | 55 | 03.14 |  | PR: 1ZG,1LR,1ZJ |  |  |  |  | 1.4 TDI | 66 | 02.14 |  | PR: 1ZG,1LR,1ZJ |  |  |  |  | 1.4 TDI | 77 | 05.14 |  | PR: 1ZG,1LR,1ZJ |  |  |  |  | 1.4 TSI | 103 | 10.12 |  | PR: 1ZG,1LR,1ZJ |  |  |  |  | 1.4 TSI | 110 | 05.14 |  | PR: 1ZG,1LR,1ZJ |  |  |  |  | 1.6 |  | 07.14 |  | PR: 1ZG,1LR,1ZJ |  |  |  |  | 1.6 BiFuel | 60 | 01.11 |  | PR: 1ZG,1LR,1ZJ |  |  |  |  | 1.6 TDI | 55 | 03.09 |  | PR: 1ZG,1LR,1ZJ |  |  |  |  | 1.6 TDI | 66 | 06.09 |  | PR: 1ZG,1LR,1ZJ |  |  |  |  | 1.6 TDI | 77 | 06.09 |  | PR: 1ZG,1LR,1ZJ |  |  |  |  | 1.8 GTI | 141 | 11.14 |  | PR: 1ZG,1LR,1ZJ |  |  |  |  | 2.0 R WRC | 162 | 08.13 |  | PR: 1ZG,1LR,1ZJ |  |  |  |  |
| 1.0  | 44   | 01.14 |       | PR: 1ZG,1LR,1ZJ | 13.0460-7111.2 | 607111          | 23130 19,6 +        | VW        |                     |        |              |       |                |        |                 |                |         |                  |        |                     |         |         |       |                 |       |         |         |    |         |       |         |       |                 |       |         |       |  |         |         |         |       |                 |       |         |         |    |         |       |         |       |                 |       |         |       |  |         |         |       |       |                 |  |  |         |  |         |       |       |  |                 |    |       |       |  |         |         |       |       |                 |  |  |     |    |         |       |       |  |                 |  |       |       |  |     |    |       |  |                 |  |  |  |  |            |    |       |  |                 |  |  |  |  |         |     |       |  |                 |  |  |  |  |         |    |       |  |                 |  |  |  |  |         |    |       |  |                 |  |  |  |  |         |    |       |  |                 |  |  |  |  |         |     |       |  |                 |  |  |  |  |         |     |       |  |                 |  |  |  |  |     |  |       |  |                 |  |  |  |  |            |    |       |  |                 |  |  |  |  |         |    |       |  |                 |  |  |  |  |         |    |       |  |                 |  |  |  |  |         |    |       |  |                 |  |  |  |  |         |     |       |  |                 |  |  |  |  |           |     |       |  |                 |  |  |  |  |
| 1.0  | 55   | 01.14 |       | PR: 1ZG,1LR,1ZJ | 13.0470-7111.2 | LD7111          | 23130 19,6 +        | VW        |                     |        |              |       |                |        |                 |                |         |                  |        |                     |         |         |       |                 |       |         |         |    |         |       |         |       |                 |       |         |       |  |         |         |         |       |                 |       |         |         |    |         |       |         |       |                 |       |         |       |  |         |         |       |       |                 |  |  |         |  |         |       |       |  |                 |    |       |       |  |         |         |       |       |                 |  |  |     |    |         |       |       |  |                 |  |       |       |  |     |    |       |  |                 |  |  |  |  |            |    |       |  |                 |  |  |  |  |         |     |       |  |                 |  |  |  |  |         |    |       |  |                 |  |  |  |  |         |    |       |  |                 |  |  |  |  |         |    |       |  |                 |  |  |  |  |         |     |       |  |                 |  |  |  |  |         |     |       |  |                 |  |  |  |  |     |  |       |  |                 |  |  |  |  |            |    |       |  |                 |  |  |  |  |         |    |       |  |                 |  |  |  |  |         |    |       |  |                 |  |  |  |  |         |    |       |  |                 |  |  |  |  |         |     |       |  |                 |  |  |  |  |           |     |       |  |                 |  |  |  |  |
| 1.0  | 70   | 11.14 |       | PR: 1ZG,1LR,1ZJ |                |                 |                     |           |                     |        |              |       |                |        |                 |                |         |                  |        |                     |         |         |       |                 |       |         |         |    |         |       |         |       |                 |       |         |       |  |         |         |         |       |                 |       |         |         |    |         |       |         |       |                 |       |         |       |  |         |         |       |       |                 |  |  |         |  |         |       |       |  |                 |    |       |       |  |         |         |       |       |                 |  |  |     |    |         |       |       |  |                 |  |       |       |  |     |    |       |  |                 |  |  |  |  |            |    |       |  |                 |  |  |  |  |         |     |       |  |                 |  |  |  |  |         |    |       |  |                 |  |  |  |  |         |    |       |  |                 |  |  |  |  |         |    |       |  |                 |  |  |  |  |         |     |       |  |                 |  |  |  |  |         |     |       |  |                 |  |  |  |  |     |  |       |  |                 |  |  |  |  |            |    |       |  |                 |  |  |  |  |         |    |       |  |                 |  |  |  |  |         |    |       |  |                 |  |  |  |  |         |    |       |  |                 |  |  |  |  |         |     |       |  |                 |  |  |  |  |           |     |       |  |                 |  |  |  |  |
| 1.0 TSI  | 81   | 11.14 |       | PR: 1ZG,1LR,1ZJ |                |                 |                     |           |                     |        |              |       |                |        |                 |                |         |                  |        |                     |         |         |       |                 |       |         |         |    |         |       |         |       |                 |       |         |       |  |         |         |         |       |                 |       |         |         |    |         |       |         |       |                 |       |         |       |  |         |         |       |       |                 |  |  |         |  |         |       |       |  |                 |    |       |       |  |         |         |       |       |                 |  |  |     |    |         |       |       |  |                 |  |       |       |  |     |    |       |  |                 |  |  |  |  |            |    |       |  |                 |  |  |  |  |         |     |       |  |                 |  |  |  |  |         |    |       |  |                 |  |  |  |  |         |    |       |  |                 |  |  |  |  |         |    |       |  |                 |  |  |  |  |         |     |       |  |                 |  |  |  |  |         |     |       |  |                 |  |  |  |  |     |  |       |  |                 |  |  |  |  |            |    |       |  |                 |  |  |  |  |         |    |       |  |                 |  |  |  |  |         |    |       |  |                 |  |  |  |  |         |    |       |  |                 |  |  |  |  |         |     |       |  |                 |  |  |  |  |           |     |       |  |                 |  |  |  |  |
| 1.2  | 44   | 03.09 |       | PR: 1ZG,1LR,1ZJ |                |                 |                     |           |                     |        |              |       |                |        |                 |                |         |                  |        |                     |         |         |       |                 |       |         |         |    |         |       |         |       |                 |       |         |       |  |         |         |         |       |                 |       |         |         |    |         |       |         |       |                 |       |         |       |  |         |         |       |       |                 |  |  |         |  |         |       |       |  |                 |    |       |       |  |         |         |       |       |                 |  |  |     |    |         |       |       |  |                 |  |       |       |  |     |    |       |  |                 |  |  |  |  |            |    |       |  |                 |  |  |  |  |         |     |       |  |                 |  |  |  |  |         |    |       |  |                 |  |  |  |  |         |    |       |  |                 |  |  |  |  |         |    |       |  |                 |  |  |  |  |         |     |       |  |                 |  |  |  |  |         |     |       |  |                 |  |  |  |  |     |  |       |  |                 |  |  |  |  |            |    |       |  |                 |  |  |  |  |         |    |       |  |                 |  |  |  |  |         |    |       |  |                 |  |  |  |  |         |    |       |  |                 |  |  |  |  |         |     |       |  |                 |  |  |  |  |           |     |       |  |                 |  |  |  |  |
| 1.2  | 51   | 03.09 |       | PR: 1ZG,1LR,1ZJ |                |                 |                     |           |                     |        |              |       |                |        |                 |                |         |                  |        |                     |         |         |       |                 |       |         |         |    |         |       |         |       |                 |       |         |       |  |         |         |         |       |                 |       |         |         |    |         |       |         |       |                 |       |         |       |  |         |         |       |       |                 |  |  |         |  |         |       |       |  |                 |    |       |       |  |         |         |       |       |                 |  |  |     |    |         |       |       |  |                 |  |       |       |  |     |    |       |  |                 |  |  |  |  |            |    |       |  |                 |  |  |  |  |         |     |       |  |                 |  |  |  |  |         |    |       |  |                 |  |  |  |  |         |    |       |  |                 |  |  |  |  |         |    |       |  |                 |  |  |  |  |         |     |       |  |                 |  |  |  |  |         |     |       |  |                 |  |  |  |  |     |  |       |  |                 |  |  |  |  |            |    |       |  |                 |  |  |  |  |         |    |       |  |                 |  |  |  |  |         |    |       |  |                 |  |  |  |  |         |    |       |  |                 |  |  |  |  |         |     |       |  |                 |  |  |  |  |           |     |       |  |                 |  |  |  |  |
| 1.2 TDI  | 55   | 10.09 |       | PR: 1ZG,1LR,1ZJ |                |                 |                     |           |                     |        |              |       |                |        |                 |                |         |                  |        |                     |         |         |       |                 |       |         |         |    |         |       |         |       |                 |       |         |       |  |         |         |         |       |                 |       |         |         |    |         |       |         |       |                 |       |         |       |  |         |         |       |       |                 |  |  |         |  |         |       |       |  |                 |    |       |       |  |         |         |       |       |                 |  |  |     |    |         |       |       |  |                 |  |       |       |  |     |    |       |  |                 |  |  |  |  |            |    |       |  |                 |  |  |  |  |         |     |       |  |                 |  |  |  |  |         |    |       |  |                 |  |  |  |  |         |    |       |  |                 |  |  |  |  |         |    |       |  |                 |  |  |  |  |         |     |       |  |                 |  |  |  |  |         |     |       |  |                 |  |  |  |  |     |  |       |  |                 |  |  |  |  |            |    |       |  |                 |  |  |  |  |         |    |       |  |                 |  |  |  |  |         |    |       |  |                 |  |  |  |  |         |    |       |  |                 |  |  |  |  |         |     |       |  |                 |  |  |  |  |           |     |       |  |                 |  |  |  |  |
| 1.2 TSI  | 66   | 05.11 |       | PR: 1ZG,1LR,1ZJ |                |                 |                     |           |                     |        |              |       |                |        |                 |                |         |                  |        |                     |         |         |       |                 |       |         |         |    |         |       |         |       |                 |       |         |       |  |         |         |         |       |                 |       |         |         |    |         |       |         |       |                 |       |         |       |  |         |         |       |       |                 |  |  |         |  |         |       |       |  |                 |    |       |       |  |         |         |       |       |                 |  |  |     |    |         |       |       |  |                 |  |       |       |  |     |    |       |  |                 |  |  |  |  |            |    |       |  |                 |  |  |  |  |         |     |       |  |                 |  |  |  |  |         |    |       |  |                 |  |  |  |  |         |    |       |  |                 |  |  |  |  |         |    |       |  |                 |  |  |  |  |         |     |       |  |                 |  |  |  |  |         |     |       |  |                 |  |  |  |  |     |  |       |  |                 |  |  |  |  |            |    |       |  |                 |  |  |  |  |         |    |       |  |                 |  |  |  |  |         |    |       |  |                 |  |  |  |  |         |    |       |  |                 |  |  |  |  |         |     |       |  |                 |  |  |  |  |           |     |       |  |                 |  |  |  |  |
| 1.2 TSI  | 77   | 06.09 |       | PR: 1ZG,1LR,1ZJ |                |                 |                     |           |                     |        |              |       |                |        |                 |                |         |                  |        |                     |         |         |       |                 |       |         |         |    |         |       |         |       |                 |       |         |       |  |         |         |         |       |                 |       |         |         |    |         |       |         |       |                 |       |         |       |  |         |         |       |       |                 |  |  |         |  |         |       |       |  |                 |    |       |       |  |         |         |       |       |                 |  |  |     |    |         |       |       |  |                 |  |       |       |  |     |    |       |  |                 |  |  |  |  |            |    |       |  |                 |  |  |  |  |         |     |       |  |                 |  |  |  |  |         |    |       |  |                 |  |  |  |  |         |    |       |  |                 |  |  |  |  |         |    |       |  |                 |  |  |  |  |         |     |       |  |                 |  |  |  |  |         |     |       |  |                 |  |  |  |  |     |  |       |  |                 |  |  |  |  |            |    |       |  |                 |  |  |  |  |         |    |       |  |                 |  |  |  |  |         |    |       |  |                 |  |  |  |  |         |    |       |  |                 |  |  |  |  |         |     |       |  |                 |  |  |  |  |           |     |       |  |                 |  |  |  |  |
| 1.2 TSI  | 81   | 01.14 |       | PR: 1ZG,1LR,1ZJ |                |                 |                     |           |                     |        |              |       |                |        |                 |                |         |                  |        |                     |         |         |       |                 |       |         |         |    |         |       |         |       |                 |       |         |       |  |         |         |         |       |                 |       |         |         |    |         |       |         |       |                 |       |         |       |  |         |         |       |       |                 |  |  |         |  |         |       |       |  |                 |    |       |       |  |         |         |       |       |                 |  |  |     |    |         |       |       |  |                 |  |       |       |  |     |    |       |  |                 |  |  |  |  |            |    |       |  |                 |  |  |  |  |         |     |       |  |                 |  |  |  |  |         |    |       |  |                 |  |  |  |  |         |    |       |  |                 |  |  |  |  |         |    |       |  |                 |  |  |  |  |         |     |       |  |                 |  |  |  |  |         |     |       |  |                 |  |  |  |  |     |  |       |  |                 |  |  |  |  |            |    |       |  |                 |  |  |  |  |         |    |       |  |                 |  |  |  |  |         |    |       |  |                 |  |  |  |  |         |    |       |  |                 |  |  |  |  |         |     |       |  |                 |  |  |  |  |           |     |       |  |                 |  |  |  |  |
| 1.4  | 63   | 03.09 |       | PR: 1ZG,1LR,1ZJ |                |                 |                     |           |                     |        |              |       |                |        |                 |                |         |                  |        |                     |         |         |       |                 |       |         |         |    |         |       |         |       |                 |       |         |       |  |         |         |         |       |                 |       |         |         |    |         |       |         |       |                 |       |         |       |  |         |         |       |       |                 |  |  |         |  |         |       |       |  |                 |    |       |       |  |         |         |       |       |                 |  |  |     |    |         |       |       |  |                 |  |       |       |  |     |    |       |  |                 |  |  |  |  |            |    |       |  |                 |  |  |  |  |         |     |       |  |                 |  |  |  |  |         |    |       |  |                 |  |  |  |  |         |    |       |  |                 |  |  |  |  |         |    |       |  |                 |  |  |  |  |         |     |       |  |                 |  |  |  |  |         |     |       |  |                 |  |  |  |  |     |  |       |  |                 |  |  |  |  |            |    |       |  |                 |  |  |  |  |         |    |       |  |                 |  |  |  |  |         |    |       |  |                 |  |  |  |  |         |    |       |  |                 |  |  |  |  |         |     |       |  |                 |  |  |  |  |           |     |       |  |                 |  |  |  |  |
| 1.4 BiFuel   | 60   | 03.10 |       | PR: 1ZG,1LR,1ZJ |                |                 |                     |           |                     |        |              |       |                |        |                 |                |         |                  |        |                     |         |         |       |                 |       |         |         |    |         |       |         |       |                 |       |         |       |  |         |         |         |       |                 |       |         |         |    |         |       |         |       |                 |       |         |       |  |         |         |       |       |                 |  |  |         |  |         |       |       |  |                 |    |       |       |  |         |         |       |       |                 |  |  |     |    |         |       |       |  |                 |  |       |       |  |     |    |       |  |                 |  |  |  |  |            |    |       |  |                 |  |  |  |  |         |     |       |  |                 |  |  |  |  |         |    |       |  |                 |  |  |  |  |         |    |       |  |                 |  |  |  |  |         |    |       |  |                 |  |  |  |  |         |     |       |  |                 |  |  |  |  |         |     |       |  |                 |  |  |  |  |     |  |       |  |                 |  |  |  |  |            |    |       |  |                 |  |  |  |  |         |    |       |  |                 |  |  |  |  |         |    |       |  |                 |  |  |  |  |         |    |       |  |                 |  |  |  |  |         |     |       |  |                 |  |  |  |  |           |     |       |  |                 |  |  |  |  |
| 1.4 GTI  | 132  | 05.10 |       | PR: 1ZG,1LR,1ZJ |                |                 |                     |           |                     |        |              |       |                |        |                 |                |         |                  |        |                     |         |         |       |                 |       |         |         |    |         |       |         |       |                 |       |         |       |  |         |         |         |       |                 |       |         |         |    |         |       |         |       |                 |       |         |       |  |         |         |       |       |                 |  |  |         |  |         |       |       |  |                 |    |       |       |  |         |         |       |       |                 |  |  |     |    |         |       |       |  |                 |  |       |       |  |     |    |       |  |                 |  |  |  |  |            |    |       |  |                 |  |  |  |  |         |     |       |  |                 |  |  |  |  |         |    |       |  |                 |  |  |  |  |         |    |       |  |                 |  |  |  |  |         |    |       |  |                 |  |  |  |  |         |     |       |  |                 |  |  |  |  |         |     |       |  |                 |  |  |  |  |     |  |       |  |                 |  |  |  |  |            |    |       |  |                 |  |  |  |  |         |    |       |  |                 |  |  |  |  |         |    |       |  |                 |  |  |  |  |         |    |       |  |                 |  |  |  |  |         |     |       |  |                 |  |  |  |  |           |     |       |  |                 |  |  |  |  |
| 1.4 TDI  | 55   | 03.14 |       | PR: 1ZG,1LR,1ZJ |                |                 |                     |           |                     |        |              |       |                |        |                 |                |         |                  |        |                     |         |         |       |                 |       |         |         |    |         |       |         |       |                 |       |         |       |  |         |         |         |       |                 |       |         |         |    |         |       |         |       |                 |       |         |       |  |         |         |       |       |                 |  |  |         |  |         |       |       |  |                 |    |       |       |  |         |         |       |       |                 |  |  |     |    |         |       |       |  |                 |  |       |       |  |     |    |       |  |                 |  |  |  |  |            |    |       |  |                 |  |  |  |  |         |     |       |  |                 |  |  |  |  |         |    |       |  |                 |  |  |  |  |         |    |       |  |                 |  |  |  |  |         |    |       |  |                 |  |  |  |  |         |     |       |  |                 |  |  |  |  |         |     |       |  |                 |  |  |  |  |     |  |       |  |                 |  |  |  |  |            |    |       |  |                 |  |  |  |  |         |    |       |  |                 |  |  |  |  |         |    |       |  |                 |  |  |  |  |         |    |       |  |                 |  |  |  |  |         |     |       |  |                 |  |  |  |  |           |     |       |  |                 |  |  |  |  |
| 1.4 TDI  | 66   | 02.14 |       | PR: 1ZG,1LR,1ZJ |                |                 |                     |           |                     |        |              |       |                |        |                 |                |         |                  |        |                     |         |         |       |                 |       |         |         |    |         |       |         |       |                 |       |         |       |  |         |         |         |       |                 |       |         |         |    |         |       |         |       |                 |       |         |       |  |         |         |       |       |                 |  |  |         |  |         |       |       |  |                 |    |       |       |  |         |         |       |       |                 |  |  |     |    |         |       |       |  |                 |  |       |       |  |     |    |       |  |                 |  |  |  |  |            |    |       |  |                 |  |  |  |  |         |     |       |  |                 |  |  |  |  |         |    |       |  |                 |  |  |  |  |         |    |       |  |                 |  |  |  |  |         |    |       |  |                 |  |  |  |  |         |     |       |  |                 |  |  |  |  |         |     |       |  |                 |  |  |  |  |     |  |       |  |                 |  |  |  |  |            |    |       |  |                 |  |  |  |  |         |    |       |  |                 |  |  |  |  |         |    |       |  |                 |  |  |  |  |         |    |       |  |                 |  |  |  |  |         |     |       |  |                 |  |  |  |  |           |     |       |  |                 |  |  |  |  |
| 1.4 TDI  | 77   | 05.14 |       | PR: 1ZG,1LR,1ZJ |                |                 |                     |           |                     |        |              |       |                |        |                 |                |         |                  |        |                     |         |         |       |                 |       |         |         |    |         |       |         |       |                 |       |         |       |  |         |         |         |       |                 |       |         |         |    |         |       |         |       |                 |       |         |       |  |         |         |       |       |                 |  |  |         |  |         |       |       |  |                 |    |       |       |  |         |         |       |       |                 |  |  |     |    |         |       |       |  |                 |  |       |       |  |     |    |       |  |                 |  |  |  |  |            |    |       |  |                 |  |  |  |  |         |     |       |  |                 |  |  |  |  |         |    |       |  |                 |  |  |  |  |         |    |       |  |                 |  |  |  |  |         |    |       |  |                 |  |  |  |  |         |     |       |  |                 |  |  |  |  |         |     |       |  |                 |  |  |  |  |     |  |       |  |                 |  |  |  |  |            |    |       |  |                 |  |  |  |  |         |    |       |  |                 |  |  |  |  |         |    |       |  |                 |  |  |  |  |         |    |       |  |                 |  |  |  |  |         |     |       |  |                 |  |  |  |  |           |     |       |  |                 |  |  |  |  |
| 1.4 TSI  | 103  | 10.12 |       | PR: 1ZG,1LR,1ZJ |                |                 |                     |           |                     |        |              |       |                |        |                 |                |         |                  |        |                     |         |         |       |                 |       |         |         |    |         |       |         |       |                 |       |         |       |  |         |         |         |       |                 |       |         |         |    |         |       |         |       |                 |       |         |       |  |         |         |       |       |                 |  |  |         |  |         |       |       |  |                 |    |       |       |  |         |         |       |       |                 |  |  |     |    |         |       |       |  |                 |  |       |       |  |     |    |       |  |                 |  |  |  |  |            |    |       |  |                 |  |  |  |  |         |     |       |  |                 |  |  |  |  |         |    |       |  |                 |  |  |  |  |         |    |       |  |                 |  |  |  |  |         |    |       |  |                 |  |  |  |  |         |     |       |  |                 |  |  |  |  |         |     |       |  |                 |  |  |  |  |     |  |       |  |                 |  |  |  |  |            |    |       |  |                 |  |  |  |  |         |    |       |  |                 |  |  |  |  |         |    |       |  |                 |  |  |  |  |         |    |       |  |                 |  |  |  |  |         |     |       |  |                 |  |  |  |  |           |     |       |  |                 |  |  |  |  |
| 1.4 TSI  | 110  | 05.14 |       | PR: 1ZG,1LR,1ZJ |                |                 |                     |           |                     |        |              |       |                |        |                 |                |         |                  |        |                     |         |         |       |                 |       |         |         |    |         |       |         |       |                 |       |         |       |  |         |         |         |       |                 |       |         |         |    |         |       |         |       |                 |       |         |       |  |         |         |       |       |                 |  |  |         |  |         |       |       |  |                 |    |       |       |  |         |         |       |       |                 |  |  |     |    |         |       |       |  |                 |  |       |       |  |     |    |       |  |                 |  |  |  |  |            |    |       |  |                 |  |  |  |  |         |     |       |  |                 |  |  |  |  |         |    |       |  |                 |  |  |  |  |         |    |       |  |                 |  |  |  |  |         |    |       |  |                 |  |  |  |  |         |     |       |  |                 |  |  |  |  |         |     |       |  |                 |  |  |  |  |     |  |       |  |                 |  |  |  |  |            |    |       |  |                 |  |  |  |  |         |    |       |  |                 |  |  |  |  |         |    |       |  |                 |  |  |  |  |         |    |       |  |                 |  |  |  |  |         |     |       |  |                 |  |  |  |  |           |     |       |  |                 |  |  |  |  |
| 1.6  |  | 07.14 |       | PR: 1ZG,1LR,1ZJ |                |                 |                     |           |                     |        |              |       |                |        |                 |                |         |                  |        |                     |         |         |       |                 |       |         |         |    |         |       |         |       |                 |       |         |       |  |         |         |         |       |                 |       |         |         |    |         |       |         |       |                 |       |         |       |  |         |         |       |       |                 |  |  |         |  |         |       |       |  |                 |    |       |       |  |         |         |       |       |                 |  |  |     |    |         |       |       |  |                 |  |       |       |  |     |    |       |  |                 |  |  |  |  |            |    |       |  |                 |  |  |  |  |         |     |       |  |                 |  |  |  |  |         |    |       |  |                 |  |  |  |  |         |    |       |  |                 |  |  |  |  |         |    |       |  |                 |  |  |  |  |         |     |       |  |                 |  |  |  |  |         |     |       |  |                 |  |  |  |  |     |  |       |  |                 |  |  |  |  |            |    |       |  |                 |  |  |  |  |         |    |       |  |                 |  |  |  |  |         |    |       |  |                 |  |  |  |  |         |    |       |  |                 |  |  |  |  |         |     |       |  |                 |  |  |  |  |           |     |       |  |                 |  |  |  |  |
| 1.6 BiFuel   | 60   | 01.11 |       | PR: 1ZG,1LR,1ZJ |                |                 |                     |           |                     |        |              |       |                |        |                 |                |         |                  |        |                     |         |         |       |                 |       |         |         |    |         |       |         |       |                 |       |         |       |  |         |         |         |       |                 |       |         |         |    |         |       |         |       |                 |       |         |       |  |         |         |       |       |                 |  |  |         |  |         |       |       |  |                 |    |       |       |  |         |         |       |       |                 |  |  |     |    |         |       |       |  |                 |  |       |       |  |     |    |       |  |                 |  |  |  |  |            |    |       |  |                 |  |  |  |  |         |     |       |  |                 |  |  |  |  |         |    |       |  |                 |  |  |  |  |         |    |       |  |                 |  |  |  |  |         |    |       |  |                 |  |  |  |  |         |     |       |  |                 |  |  |  |  |         |     |       |  |                 |  |  |  |  |     |  |       |  |                 |  |  |  |  |            |    |       |  |                 |  |  |  |  |         |    |       |  |                 |  |  |  |  |         |    |       |  |                 |  |  |  |  |         |    |       |  |                 |  |  |  |  |         |     |       |  |                 |  |  |  |  |           |     |       |  |                 |  |  |  |  |
| 1.6 TDI  | 55   | 03.09 |       | PR: 1ZG,1LR,1ZJ |                |                 |                     |           |                     |        |              |       |                |        |                 |                |         |                  |        |                     |         |         |       |                 |       |         |         |    |         |       |         |       |                 |       |         |       |  |         |         |         |       |                 |       |         |         |    |         |       |         |       |                 |       |         |       |  |         |         |       |       |                 |  |  |         |  |         |       |       |  |                 |    |       |       |  |         |         |       |       |                 |  |  |     |    |         |       |       |  |                 |  |       |       |  |     |    |       |  |                 |  |  |  |  |            |    |       |  |                 |  |  |  |  |         |     |       |  |                 |  |  |  |  |         |    |       |  |                 |  |  |  |  |         |    |       |  |                 |  |  |  |  |         |    |       |  |                 |  |  |  |  |         |     |       |  |                 |  |  |  |  |         |     |       |  |                 |  |  |  |  |     |  |       |  |                 |  |  |  |  |            |    |       |  |                 |  |  |  |  |         |    |       |  |                 |  |  |  |  |         |    |       |  |                 |  |  |  |  |         |    |       |  |                 |  |  |  |  |         |     |       |  |                 |  |  |  |  |           |     |       |  |                 |  |  |  |  |
| 1.6 TDI  | 66   | 06.09 |       | PR: 1ZG,1LR,1ZJ |                |                 |                     |           |                     |        |              |       |                |        |                 |                |         |                  |        |                     |         |         |       |                 |       |         |         |    |         |       |         |       |                 |       |         |       |  |         |         |         |       |                 |       |         |         |    |         |       |         |       |                 |       |         |       |  |         |         |       |       |                 |  |  |         |  |         |       |       |  |                 |    |       |       |  |         |         |       |       |                 |  |  |     |    |         |       |       |  |                 |  |       |       |  |     |    |       |  |                 |  |  |  |  |            |    |       |  |                 |  |  |  |  |         |     |       |  |                 |  |  |  |  |         |    |       |  |                 |  |  |  |  |         |    |       |  |                 |  |  |  |  |         |    |       |  |                 |  |  |  |  |         |     |       |  |                 |  |  |  |  |         |     |       |  |                 |  |  |  |  |     |  |       |  |                 |  |  |  |  |            |    |       |  |                 |  |  |  |  |         |    |       |  |                 |  |  |  |  |         |    |       |  |                 |  |  |  |  |         |    |       |  |                 |  |  |  |  |         |     |       |  |                 |  |  |  |  |           |     |       |  |                 |  |  |  |  |
| 1.6 TDI  | 77   | 06.09 |       | PR: 1ZG,1LR,1ZJ |                |                 |                     |           |                     |        |              |       |                |        |                 |                |         |                  |        |                     |         |         |       |                 |       |         |         |    |         |       |         |       |                 |       |         |       |  |         |         |         |       |                 |       |         |         |    |         |       |         |       |                 |       |         |       |  |         |         |       |       |                 |  |  |         |  |         |       |       |  |                 |    |       |       |  |         |         |       |       |                 |  |  |     |    |         |       |       |  |                 |  |       |       |  |     |    |       |  |                 |  |  |  |  |            |    |       |  |                 |  |  |  |  |         |     |       |  |                 |  |  |  |  |         |    |       |  |                 |  |  |  |  |         |    |       |  |                 |  |  |  |  |         |    |       |  |                 |  |  |  |  |         |     |       |  |                 |  |  |  |  |         |     |       |  |                 |  |  |  |  |     |  |       |  |                 |  |  |  |  |            |    |       |  |                 |  |  |  |  |         |    |       |  |                 |  |  |  |  |         |    |       |  |                 |  |  |  |  |         |    |       |  |                 |  |  |  |  |         |     |       |  |                 |  |  |  |  |           |     |       |  |                 |  |  |  |  |
| 1.8 GTI  | 141  | 11.14 |       | PR: 1ZG,1LR,1ZJ |                |                 |                     |           |                     |        |              |       |                |        |                 |                |         |                  |        |                     |         |         |       |                 |       |         |         |    |         |       |         |       |                 |       |         |       |  |         |         |         |       |                 |       |         |         |    |         |       |         |       |                 |       |         |       |  |         |         |       |       |                 |  |  |         |  |         |       |       |  |                 |    |       |       |  |         |         |       |       |                 |  |  |     |    |         |       |       |  |                 |  |       |       |  |     |    |       |  |                 |  |  |  |  |            |    |       |  |                 |  |  |  |  |         |     |       |  |                 |  |  |  |  |         |    |       |  |                 |  |  |  |  |         |    |       |  |                 |  |  |  |  |         |    |       |  |                 |  |  |  |  |         |     |       |  |                 |  |  |  |  |         |     |       |  |                 |  |  |  |  |     |  |       |  |                 |  |  |  |  |            |    |       |  |                 |  |  |  |  |         |    |       |  |                 |  |  |  |  |         |    |       |  |                 |  |  |  |  |         |    |       |  |                 |  |  |  |  |         |     |       |  |                 |  |  |  |  |           |     |       |  |                 |  |  |  |  |
| 2.0 R WRC  | 162  | 08.13 |       | PR: 1ZG,1LR,1ZJ |                |                 |                     |           |                     |        |              |       |                |        |                 |                |         |                  |        |                     |         |         |       |                 |       |         |         |    |         |       |         |       |                 |       |         |       |  |         |         |         |       |                 |       |         |         |    |         |       |         |       |                 |       |         |       |  |         |         |       |       |                 |  |  |         |  |         |       |       |  |                 |    |       |       |  |         |         |       |       |                 |  |  |     |    |         |       |       |  |                 |  |       |       |  |     |    |       |  |                 |  |  |  |  |            |    |       |  |                 |  |  |  |  |         |     |       |  |                 |  |  |  |  |         |    |       |  |                 |  |  |  |  |         |    |       |  |                 |  |  |  |  |         |    |       |  |                 |  |  |  |  |         |     |       |  |                 |  |  |  |  |         |     |       |  |                 |  |  |  |  |     |  |       |  |                 |  |  |  |  |            |    |       |  |                 |  |  |  |  |         |    |       |  |                 |  |  |  |  |         |    |       |  |                 |  |  |  |  |         |    |       |  |                 |  |  |  |  |         |     |       |  |                 |  |  |  |  |           |     |       |  |                 |  |  |  |  |
|  | <table border="1"> <tr><td>1.0</td><td>44</td><td>01.14</td><td></td><td>PR: 1LN,1ZC</td><td>13.0460-7184.2</td><td>607184</td><td>23587 20,6 +/WK</td><td>ATE</td></tr> <tr><td>1.0</td><td>55</td><td>01.14</td><td></td><td>PR: 1LN,1ZC</td><td>13.0470-7184.2</td><td>LD7184</td><td>23587 20,6 +/WK</td><td>ATE</td></tr> <tr><td>1.0</td><td>70</td><td>11.14</td><td></td><td>PR: 1LN,1ZC</td><td></td><td></td><td></td><td></td></tr> <tr><td>1.0 TSI</td><td>81</td><td>11.14</td><td></td><td>PR: 1LN,1ZC</td><td></td><td></td><td></td><td></td></tr> <tr><td>1.2</td><td>44</td><td>03.09</td><td></td><td>PR: 1LN,1ZC,1ZD</td><td></td><td></td><td></td><td></td></tr> <tr><td>1.2</td><td>51</td><td>03.09</td><td></td><td>PR: 1LN,1ZC,1ZD</td><td></td><td></td><td></td><td></td></tr> <tr><td>1.2 TDI</td><td>55</td><td>10.09</td><td></td><td>PR: 1LN,1ZC,1ZD</td><td></td><td></td><td></td><td></td></tr> <tr><td>1.2 TSI</td><td>66</td><td>05.11</td><td></td><td>PR: 1LN,1ZC,1ZD</td><td></td><td></td><td></td><td></td></tr> <tr><td>1.2 TSI</td><td>77</td><td>06.09</td><td></td><td>PR: 1LN,1ZC,1ZD</td><td></td><td></td><td></td><td></td></tr> <tr><td>1.2 TSI</td><td>81</td><td>01.14</td><td></td><td>PR: 1LN,1ZC</td><td></td><td></td><td></td><td></td></tr> <tr><td>1.4</td><td>63</td><td>03.09</td><td></td><td>PR: 1LN,1ZC,1ZD</td><td></td><td></td><td></td><td></td></tr> <tr><td>1.4 BiFuel</td><td>60</td><td>03.10</td><td></td><td>PR: 1LN,1ZC,1ZD</td><td></td><td></td><td></td><td></td></tr> <tr><td>1.4 GTI</td><td>132</td><td>05.10</td><td></td><td>PR: 1LN,1ZC,1ZD</td><td></td><td></td><td></td><td></td></tr> <tr><td>1.4 TDI</td><td>55</td><td>03.14</td><td></td><td>PR: 1LN,1ZC</td><td></td><td></td><td></td><td></td></tr> <tr><td>1.4 TDI</td><td>66</td><td>02.14</td><td></td><td>PR: 1LN,1ZC</td><td></td><td></td><td></td><td></td></tr> <tr><td>1.4 TDI</td><td>77</td><td>05.14</td><td></td><td>PR: 1LN,1ZC</td><td></td><td></td><td></td><td></td></tr> <tr><td>1.4 TSI</td><td>103</td><td>10.12</td><td></td><td>PR: 1LN,1ZC,1ZD</td><td></td><td></td><td></td><td></td></tr> <tr><td>1.4 TSI</td><td>110</td><td>05.14</td><td></td><td>PR: 1LN,1ZC</td><td></td><td></td><td></td><td></td></tr> <tr><td>1.6</td><td></td><td>07.14</td><td></td><td>PR: 1LN,1ZC</td><td></td><td></td><td></td><td></td></tr> <tr><td>1.6 BiFuel</td><td>60</td><td>01.11</td><td></td><td>PR: 1LN,1ZC,1ZD</td><td></td><td></td><td></td><td></td></tr> <tr><td>1.6 TDI</td><td>55</td><td>03.09</td><td></td><td>PR: 1LN,1ZC,1ZD</td><td></td><td></td><td></td><td></td></tr> <tr><td>1.6 TDI</td><td>66</td><td>06.09</td><td></td><td>PR: 1LN,1ZC,1ZD</td><td></td><td></td><td></td><td></td></tr> <tr><td>1.6 TDI</td><td>77</td><td>06.09</td><td></td><td>PR: 1LN,1ZC,1ZD</td><td></td><td></td><td></td><td></td></tr> <tr><td>1.8 GTI</td><td>141</td><td>11.14</td><td></td><td>PR: 1LN,1ZC</td><td></td><td></td><td></td><td></td></tr> </table>  | 1.0   | 44    | 01.14           |                | PR: 1LN,1ZC     | 13.0460-7184.2      | 607184    | 23587 20,6 +/WK     | ATE    | 1.0          | 55    | 01.14          |        | PR: 1LN,1ZC     | 13.0470-7184.2 | LD7184  | 23587 20,6 +/WK  | ATE    | 1.0                 | 70      | 11.14   |       | PR: 1LN,1ZC     |       |         |         |    | 1.0 TSI | 81    | 11.14   |       | PR: 1LN,1ZC     |       |         |       |  | 1.2     | 44      | 03.09   |       | PR: 1LN,1ZC,1ZD |       |         |         |    | 1.2     | 51    | 03.09   |       | PR: 1LN,1ZC,1ZD |       |         |       |  | 1.2 TDI | 55      | 10.09 |       | PR: 1LN,1ZC,1ZD |  |  |         |  | 1.2 TSI | 66    | 05.11 |  | PR: 1LN,1ZC,1ZD |    |       |       |  | 1.2 TSI | 77      | 06.09 |       | PR: 1LN,1ZC,1ZD |  |  |     |    | 1.2 TSI | 81    | 01.14 |  | PR: 1LN,1ZC     |  |       |       |  | 1.4 | 63 | 03.09 |  | PR: 1LN,1ZC,1ZD |  |  |  |  | 1.4 BiFuel | 60 | 03.10 |  | PR: 1LN,1ZC,1ZD |  |  |  |  | 1.4 GTI | 132 | 05.10 |  | PR: 1LN,1ZC,1ZD |  |  |  |  | 1.4 TDI | 55 | 03.14 |  | PR: 1LN,1ZC     |  |  |  |  | 1.4 TDI | 66 | 02.14 |  | PR: 1LN,1ZC     |  |  |  |  | 1.4 TDI | 77 | 05.14 |  | PR: 1LN,1ZC     |  |  |  |  | 1.4 TSI | 103 | 10.12 |  | PR: 1LN,1ZC,1ZD |  |  |  |  | 1.4 TSI | 110 | 05.14 |  | PR: 1LN,1ZC     |  |  |  |  | 1.6 |  | 07.14 |  | PR: 1LN,1ZC     |  |  |  |  | 1.6 BiFuel | 60 | 01.11 |  | PR: 1LN,1ZC,1ZD |  |  |  |  | 1.6 TDI | 55 | 03.09 |  | PR: 1LN,1ZC,1ZD |  |  |  |  | 1.6 TDI | 66 | 06.09 |  | PR: 1LN,1ZC,1ZD |  |  |  |  | 1.6 TDI | 77 | 06.09 |  | PR: 1LN,1ZC,1ZD |  |  |  |  | 1.8 GTI | 141 | 11.14 |  | PR: 1LN,1ZC     |  |  |  |  |           |     |       |  |                 |  |  |  |  |
| 1.0  | 44   | 01.14 |       | PR: 1LN,1ZC     | 13.0460-7184.2 | 607184          | 23587 20,6 +/WK     | ATE       |                     |        |              |       |                |        |                 |                |         |                  |        |                     |         |         |       |                 |       |         |         |    |         |       |         |       |                 |       |         |       |  |         |         |         |       |                 |       |         |         |    |         |       |         |       |                 |       |         |       |  |         |         |       |       |                 |  |  |         |  |         |       |       |  |                 |    |       |       |  |         |         |       |       |                 |  |  |     |    |         |       |       |  |                 |  |       |       |  |     |    |       |  |                 |  |  |  |  |            |    |       |  |                 |  |  |  |  |         |     |       |  |                 |  |  |  |  |         |    |       |  |                 |  |  |  |  |         |    |       |  |                 |  |  |  |  |         |    |       |  |                 |  |  |  |  |         |     |       |  |                 |  |  |  |  |         |     |       |  |                 |  |  |  |  |     |  |       |  |                 |  |  |  |  |            |    |       |  |                 |  |  |  |  |         |    |       |  |                 |  |  |  |  |         |    |       |  |                 |  |  |  |  |         |    |       |  |                 |  |  |  |  |         |     |       |  |                 |  |  |  |  |           |     |       |  |                 |  |  |  |  |
| 1.0  | 55   | 01.14 |       | PR: 1LN,1ZC     | 13.0470-7184.2 | LD7184          | 23587 20,6 +/WK     | ATE       |                     |        |              |       |                |        |                 |                |         |                  |        |                     |         |         |       |                 |       |         |         |    |         |       |         |       |                 |       |         |       |  |         |         |         |       |                 |       |         |         |    |         |       |         |       |                 |       |         |       |  |         |         |       |       |                 |  |  |         |  |         |       |       |  |                 |    |       |       |  |         |         |       |       |                 |  |  |     |    |         |       |       |  |                 |  |       |       |  |     |    |       |  |                 |  |  |  |  |            |    |       |  |                 |  |  |  |  |         |     |       |  |                 |  |  |  |  |         |    |       |  |                 |  |  |  |  |         |    |       |  |                 |  |  |  |  |         |    |       |  |                 |  |  |  |  |         |     |       |  |                 |  |  |  |  |         |     |       |  |                 |  |  |  |  |     |  |       |  |                 |  |  |  |  |            |    |       |  |                 |  |  |  |  |         |    |       |  |                 |  |  |  |  |         |    |       |  |                 |  |  |  |  |         |    |       |  |                 |  |  |  |  |         |     |       |  |                 |  |  |  |  |           |     |       |  |                 |  |  |  |  |
| 1.0  | 70   | 11.14 |       | PR: 1LN,1ZC     |                |                 |                     |           |                     |        |              |       |                |        |                 |                |         |                  |        |                     |         |         |       |                 |       |         |         |    |         |       |         |       |                 |       |         |       |  |         |         |         |       |                 |       |         |         |    |         |       |         |       |                 |       |         |       |  |         |         |       |       |                 |  |  |         |  |         |       |       |  |                 |    |       |       |  |         |         |       |       |                 |  |  |     |    |         |       |       |  |                 |  |       |       |  |     |    |       |  |                 |  |  |  |  |            |    |       |  |                 |  |  |  |  |         |     |       |  |                 |  |  |  |  |         |    |       |  |                 |  |  |  |  |         |    |       |  |                 |  |  |  |  |         |    |       |  |                 |  |  |  |  |         |     |       |  |                 |  |  |  |  |         |     |       |  |                 |  |  |  |  |     |  |       |  |                 |  |  |  |  |            |    |       |  |                 |  |  |  |  |         |    |       |  |                 |  |  |  |  |         |    |       |  |                 |  |  |  |  |         |    |       |  |                 |  |  |  |  |         |     |       |  |                 |  |  |  |  |           |     |       |  |                 |  |  |  |  |
| 1.0 TSI  | 81   | 11.14 |       | PR: 1LN,1ZC     |                |                 |                     |           |                     |        |              |       |                |        |                 |                |         |                  |        |                     |         |         |       |                 |       |         |         |    |         |       |         |       |                 |       |         |       |  |         |         |         |       |                 |       |         |         |    |         |       |         |       |                 |       |         |       |  |         |         |       |       |                 |  |  |         |  |         |       |       |  |                 |    |       |       |  |         |         |       |       |                 |  |  |     |    |         |       |       |  |                 |  |       |       |  |     |    |       |  |                 |  |  |  |  |            |    |       |  |                 |  |  |  |  |         |     |       |  |                 |  |  |  |  |         |    |       |  |                 |  |  |  |  |         |    |       |  |                 |  |  |  |  |         |    |       |  |                 |  |  |  |  |         |     |       |  |                 |  |  |  |  |         |     |       |  |                 |  |  |  |  |     |  |       |  |                 |  |  |  |  |            |    |       |  |                 |  |  |  |  |         |    |       |  |                 |  |  |  |  |         |    |       |  |                 |  |  |  |  |         |    |       |  |                 |  |  |  |  |         |     |       |  |                 |  |  |  |  |           |     |       |  |                 |  |  |  |  |
| 1.2  | 44   | 03.09 |       | PR: 1LN,1ZC,1ZD |                |                 |                     |           |                     |        |              |       |                |        |                 |                |         |                  |        |                     |         |         |       |                 |       |         |         |    |         |       |         |       |                 |       |         |       |  |         |         |         |       |                 |       |         |         |    |         |       |         |       |                 |       |         |       |  |         |         |       |       |                 |  |  |         |  |         |       |       |  |                 |    |       |       |  |         |         |       |       |                 |  |  |     |    |         |       |       |  |                 |  |       |       |  |     |    |       |  |                 |  |  |  |  |            |    |       |  |                 |  |  |  |  |         |     |       |  |                 |  |  |  |  |         |    |       |  |                 |  |  |  |  |         |    |       |  |                 |  |  |  |  |         |    |       |  |                 |  |  |  |  |         |     |       |  |                 |  |  |  |  |         |     |       |  |                 |  |  |  |  |     |  |       |  |                 |  |  |  |  |            |    |       |  |                 |  |  |  |  |         |    |       |  |                 |  |  |  |  |         |    |       |  |                 |  |  |  |  |         |    |       |  |                 |  |  |  |  |         |     |       |  |                 |  |  |  |  |           |     |       |  |                 |  |  |  |  |
| 1.2  | 51   | 03.09 |       | PR: 1LN,1ZC,1ZD |                |                 |                     |           |                     |        |              |       |                |        |                 |                |         |                  |        |                     |         |         |       |                 |       |         |         |    |         |       |         |       |                 |       |         |       |  |         |         |         |       |                 |       |         |         |    |         |       |         |       |                 |       |         |       |  |         |         |       |       |                 |  |  |         |  |         |       |       |  |                 |    |       |       |  |         |         |       |       |                 |  |  |     |    |         |       |       |  |                 |  |       |       |  |     |    |       |  |                 |  |  |  |  |            |    |       |  |                 |  |  |  |  |         |     |       |  |                 |  |  |  |  |         |    |       |  |                 |  |  |  |  |         |    |       |  |                 |  |  |  |  |         |    |       |  |                 |  |  |  |  |         |     |       |  |                 |  |  |  |  |         |     |       |  |                 |  |  |  |  |     |  |       |  |                 |  |  |  |  |            |    |       |  |                 |  |  |  |  |         |    |       |  |                 |  |  |  |  |         |    |       |  |                 |  |  |  |  |         |    |       |  |                 |  |  |  |  |         |     |       |  |                 |  |  |  |  |           |     |       |  |                 |  |  |  |  |
| 1.2 TDI  | 55   | 10.09 |       | PR: 1LN,1ZC,1ZD |                |                 |                     |           |                     |        |              |       |                |        |                 |                |         |                  |        |                     |         |         |       |                 |       |         |         |    |         |       |         |       |                 |       |         |       |  |         |         |         |       |                 |       |         |         |    |         |       |         |       |                 |       |         |       |  |         |         |       |       |                 |  |  |         |  |         |       |       |  |                 |    |       |       |  |         |         |       |       |                 |  |  |     |    |         |       |       |  |                 |  |       |       |  |     |    |       |  |                 |  |  |  |  |            |    |       |  |                 |  |  |  |  |         |     |       |  |                 |  |  |  |  |         |    |       |  |                 |  |  |  |  |         |    |       |  |                 |  |  |  |  |         |    |       |  |                 |  |  |  |  |         |     |       |  |                 |  |  |  |  |         |     |       |  |                 |  |  |  |  |     |  |       |  |                 |  |  |  |  |            |    |       |  |                 |  |  |  |  |         |    |       |  |                 |  |  |  |  |         |    |       |  |                 |  |  |  |  |         |    |       |  |                 |  |  |  |  |         |     |       |  |                 |  |  |  |  |           |     |       |  |                 |  |  |  |  |
| 1.2 TSI  | 66   | 05.11 |       | PR: 1LN,1ZC,1ZD |                |                 |                     |           |                     |        |              |       |                |        |                 |                |         |                  |        |                     |         |         |       |                 |       |         |         |    |         |       |         |       |                 |       |         |       |  |         |         |         |       |                 |       |         |         |    |         |       |         |       |                 |       |         |       |  |         |         |       |       |                 |  |  |         |  |         |       |       |  |                 |    |       |       |  |         |         |       |       |                 |  |  |     |    |         |       |       |  |                 |  |       |       |  |     |    |       |  |                 |  |  |  |  |            |    |       |  |                 |  |  |  |  |         |     |       |  |                 |  |  |  |  |         |    |       |  |                 |  |  |  |  |         |    |       |  |                 |  |  |  |  |         |    |       |  |                 |  |  |  |  |         |     |       |  |                 |  |  |  |  |         |     |       |  |                 |  |  |  |  |     |  |       |  |                 |  |  |  |  |            |    |       |  |                 |  |  |  |  |         |    |       |  |                 |  |  |  |  |         |    |       |  |                 |  |  |  |  |         |    |       |  |                 |  |  |  |  |         |     |       |  |                 |  |  |  |  |           |     |       |  |                 |  |  |  |  |
| 1.2 TSI  | 77   | 06.09 |       | PR: 1LN,1ZC,1ZD |                |                 |                     |           |                     |        |              |       |                |        |                 |                |         |                  |        |                     |         |         |       |                 |       |         |         |    |         |       |         |       |                 |       |         |       |  |         |         |         |       |                 |       |         |         |    |         |       |         |       |                 |       |         |       |  |         |         |       |       |                 |  |  |         |  |         |       |       |  |                 |    |       |       |  |         |         |       |       |                 |  |  |     |    |         |       |       |  |                 |  |       |       |  |     |    |       |  |                 |  |  |  |  |            |    |       |  |                 |  |  |  |  |         |     |       |  |                 |  |  |  |  |         |    |       |  |                 |  |  |  |  |         |    |       |  |                 |  |  |  |  |         |    |       |  |                 |  |  |  |  |         |     |       |  |                 |  |  |  |  |         |     |       |  |                 |  |  |  |  |     |  |       |  |                 |  |  |  |  |            |    |       |  |                 |  |  |  |  |         |    |       |  |                 |  |  |  |  |         |    |       |  |                 |  |  |  |  |         |    |       |  |                 |  |  |  |  |         |     |       |  |                 |  |  |  |  |           |     |       |  |                 |  |  |  |  |
| 1.2 TSI  | 81   | 01.14 |       | PR: 1LN,1ZC     |                |                 |                     |           |                     |        |              |       |                |        |                 |                |         |                  |        |                     |         |         |       |                 |       |         |         |    |         |       |         |       |                 |       |         |       |  |         |         |         |       |                 |       |         |         |    |         |       |         |       |                 |       |         |       |  |         |         |       |       |                 |  |  |         |  |         |       |       |  |                 |    |       |       |  |         |         |       |       |                 |  |  |     |    |         |       |       |  |                 |  |       |       |  |     |    |       |  |                 |  |  |  |  |            |    |       |  |                 |  |  |  |  |         |     |       |  |                 |  |  |  |  |         |    |       |  |                 |  |  |  |  |         |    |       |  |                 |  |  |  |  |         |    |       |  |                 |  |  |  |  |         |     |       |  |                 |  |  |  |  |         |     |       |  |                 |  |  |  |  |     |  |       |  |                 |  |  |  |  |            |    |       |  |                 |  |  |  |  |         |    |       |  |                 |  |  |  |  |         |    |       |  |                 |  |  |  |  |         |    |       |  |                 |  |  |  |  |         |     |       |  |                 |  |  |  |  |           |     |       |  |                 |  |  |  |  |
| 1.4  | 63   | 03.09 |       | PR: 1LN,1ZC,1ZD |                |                 |                     |           |                     |        |              |       |                |        |                 |                |         |                  |        |                     |         |         |       |                 |       |         |         |    |         |       |         |       |                 |       |         |       |  |         |         |         |       |                 |       |         |         |    |         |       |         |       |                 |       |         |       |  |         |         |       |       |                 |  |  |         |  |         |       |       |  |                 |    |       |       |  |         |         |       |       |                 |  |  |     |    |         |       |       |  |                 |  |       |       |  |     |    |       |  |                 |  |  |  |  |            |    |       |  |                 |  |  |  |  |         |     |       |  |                 |  |  |  |  |         |    |       |  |                 |  |  |  |  |         |    |       |  |                 |  |  |  |  |         |    |       |  |                 |  |  |  |  |         |     |       |  |                 |  |  |  |  |         |     |       |  |                 |  |  |  |  |     |  |       |  |                 |  |  |  |  |            |    |       |  |                 |  |  |  |  |         |    |       |  |                 |  |  |  |  |         |    |       |  |                 |  |  |  |  |         |    |       |  |                 |  |  |  |  |         |     |       |  |                 |  |  |  |  |           |     |       |  |                 |  |  |  |  |
| 1.4 BiFuel   | 60   | 03.10 |       | PR: 1LN,1ZC,1ZD |                |                 |                     |           |                     |        |              |       |                |        |                 |                |         |                  |        |                     |         |         |       |                 |       |         |         |    |         |       |         |       |                 |       |         |       |  |         |         |         |       |                 |       |         |         |    |         |       |         |       |                 |       |         |       |  |         |         |       |       |                 |  |  |         |  |         |       |       |  |                 |    |       |       |  |         |         |       |       |                 |  |  |     |    |         |       |       |  |                 |  |       |       |  |     |    |       |  |                 |  |  |  |  |            |    |       |  |                 |  |  |  |  |         |     |       |  |                 |  |  |  |  |         |    |       |  |                 |  |  |  |  |         |    |       |  |                 |  |  |  |  |         |    |       |  |                 |  |  |  |  |         |     |       |  |                 |  |  |  |  |         |     |       |  |                 |  |  |  |  |     |  |       |  |                 |  |  |  |  |            |    |       |  |                 |  |  |  |  |         |    |       |  |                 |  |  |  |  |         |    |       |  |                 |  |  |  |  |         |    |       |  |                 |  |  |  |  |         |     |       |  |                 |  |  |  |  |           |     |       |  |                 |  |  |  |  |
| 1.4 GTI  | 132  | 05.10 |       | PR: 1LN,1ZC,1ZD |                |                 |                     |           |                     |        |              |       |                |        |                 |                |         |                  |        |                     |         |         |       |                 |       |         |         |    |         |       |         |       |                 |       |         |       |  |         |         |         |       |                 |       |         |         |    |         |       |         |       |                 |       |         |       |  |         |         |       |       |                 |  |  |         |  |         |       |       |  |                 |    |       |       |  |         |         |       |       |                 |  |  |     |    |         |       |       |  |                 |  |       |       |  |     |    |       |  |                 |  |  |  |  |            |    |       |  |                 |  |  |  |  |         |     |       |  |                 |  |  |  |  |         |    |       |  |                 |  |  |  |  |         |    |       |  |                 |  |  |  |  |         |    |       |  |                 |  |  |  |  |         |     |       |  |                 |  |  |  |  |         |     |       |  |                 |  |  |  |  |     |  |       |  |                 |  |  |  |  |            |    |       |  |                 |  |  |  |  |         |    |       |  |                 |  |  |  |  |         |    |       |  |                 |  |  |  |  |         |    |       |  |                 |  |  |  |  |         |     |       |  |                 |  |  |  |  |           |     |       |  |                 |  |  |  |  |
| 1.4 TDI  | 55   | 03.14 |       | PR: 1LN,1ZC     |                |                 |                     |           |                     |        |              |       |                |        |                 |                |         |                  |        |                     |         |         |       |                 |       |         |         |    |         |       |         |       |                 |       |         |       |  |         |         |         |       |                 |       |         |         |    |         |       |         |       |                 |       |         |       |  |         |         |       |       |                 |  |  |         |  |         |       |       |  |                 |    |       |       |  |         |         |       |       |                 |  |  |     |    |         |       |       |  |                 |  |       |       |  |     |    |       |  |                 |  |  |  |  |            |    |       |  |                 |  |  |  |  |         |     |       |  |                 |  |  |  |  |         |    |       |  |                 |  |  |  |  |         |    |       |  |                 |  |  |  |  |         |    |       |  |                 |  |  |  |  |         |     |       |  |                 |  |  |  |  |         |     |       |  |                 |  |  |  |  |     |  |       |  |                 |  |  |  |  |            |    |       |  |                 |  |  |  |  |         |    |       |  |                 |  |  |  |  |         |    |       |  |                 |  |  |  |  |         |    |       |  |                 |  |  |  |  |         |     |       |  |                 |  |  |  |  |           |     |       |  |                 |  |  |  |  |
| 1.4 TDI  | 66   | 02.14 |       | PR: 1LN,1ZC     |                |                 |                     |           |                     |        |              |       |                |        |                 |                |         |                  |        |                     |         |         |       |                 |       |         |         |    |         |       |         |       |                 |       |         |       |  |         |         |         |       |                 |       |         |         |    |         |       |         |       |                 |       |         |       |  |         |         |       |       |                 |  |  |         |  |         |       |       |  |                 |    |       |       |  |         |         |       |       |                 |  |  |     |    |         |       |       |  |                 |  |       |       |  |     |    |       |  |                 |  |  |  |  |            |    |       |  |                 |  |  |  |  |         |     |       |  |                 |  |  |  |  |         |    |       |  |                 |  |  |  |  |         |    |       |  |                 |  |  |  |  |         |    |       |  |                 |  |  |  |  |         |     |       |  |                 |  |  |  |  |         |     |       |  |                 |  |  |  |  |     |  |       |  |                 |  |  |  |  |            |    |       |  |                 |  |  |  |  |         |    |       |  |                 |  |  |  |  |         |    |       |  |                 |  |  |  |  |         |    |       |  |                 |  |  |  |  |         |     |       |  |                 |  |  |  |  |           |     |       |  |                 |  |  |  |  |
| 1.4 TDI  | 77   | 05.14 |       | PR: 1LN,1ZC     |                |                 |                     |           |                     |        |              |       |                |        |                 |                |         |                  |        |                     |         |         |       |                 |       |         |         |    |         |       |         |       |                 |       |         |       |  |         |         |         |       |                 |       |         |         |    |         |       |         |       |                 |       |         |       |  |         |         |       |       |                 |  |  |         |  |         |       |       |  |                 |    |       |       |  |         |         |       |       |                 |  |  |     |    |         |       |       |  |                 |  |       |       |  |     |    |       |  |                 |  |  |  |  |            |    |       |  |                 |  |  |  |  |         |     |       |  |                 |  |  |  |  |         |    |       |  |                 |  |  |  |  |         |    |       |  |                 |  |  |  |  |         |    |       |  |                 |  |  |  |  |         |     |       |  |                 |  |  |  |  |         |     |       |  |                 |  |  |  |  |     |  |       |  |                 |  |  |  |  |            |    |       |  |                 |  |  |  |  |         |    |       |  |                 |  |  |  |  |         |    |       |  |                 |  |  |  |  |         |    |       |  |                 |  |  |  |  |         |     |       |  |                 |  |  |  |  |           |     |       |  |                 |  |  |  |  |
| 1.4 TSI  | 103  | 10.12 |       | PR: 1LN,1ZC,1ZD |                |                 |                     |           |                     |        |              |       |                |        |                 |                |         |                  |        |                     |         |         |       |                 |       |         |         |    |         |       |         |       |                 |       |         |       |  |         |         |         |       |                 |       |         |         |    |         |       |         |       |                 |       |         |       |  |         |         |       |       |                 |  |  |         |  |         |       |       |  |                 |    |       |       |  |         |         |       |       |                 |  |  |     |    |         |       |       |  |                 |  |       |       |  |     |    |       |  |                 |  |  |  |  |            |    |       |  |                 |  |  |  |  |         |     |       |  |                 |  |  |  |  |         |    |       |  |                 |  |  |  |  |         |    |       |  |                 |  |  |  |  |         |    |       |  |                 |  |  |  |  |         |     |       |  |                 |  |  |  |  |         |     |       |  |                 |  |  |  |  |     |  |       |  |                 |  |  |  |  |            |    |       |  |                 |  |  |  |  |         |    |       |  |                 |  |  |  |  |         |    |       |  |                 |  |  |  |  |         |    |       |  |                 |  |  |  |  |         |     |       |  |                 |  |  |  |  |           |     |       |  |                 |  |  |  |  |
| 1.4 TSI  | 110  | 05.14 |       | PR: 1LN,1ZC     |                |                 |                     |           |                     |        |              |       |                |        |                 |                |         |                  |        |                     |         |         |       |                 |       |         |         |    |         |       |         |       |                 |       |         |       |  |         |         |         |       |                 |       |         |         |    |         |       |         |       |                 |       |         |       |  |         |         |       |       |                 |  |  |         |  |         |       |       |  |                 |    |       |       |  |         |         |       |       |                 |  |  |     |    |         |       |       |  |                 |  |       |       |  |     |    |       |  |                 |  |  |  |  |            |    |       |  |                 |  |  |  |  |         |     |       |  |                 |  |  |  |  |         |    |       |  |                 |  |  |  |  |         |    |       |  |                 |  |  |  |  |         |    |       |  |                 |  |  |  |  |         |     |       |  |                 |  |  |  |  |         |     |       |  |                 |  |  |  |  |     |  |       |  |                 |  |  |  |  |            |    |       |  |                 |  |  |  |  |         |    |       |  |                 |  |  |  |  |         |    |       |  |                 |  |  |  |  |         |    |       |  |                 |  |  |  |  |         |     |       |  |                 |  |  |  |  |           |     |       |  |                 |  |  |  |  |
| 1.6  |  | 07.14 |       | PR: 1LN,1ZC     |                |                 |                     |           |                     |        |              |       |                |        |                 |                |         |                  |        |                     |         |         |       |                 |       |         |         |    |         |       |         |       |                 |       |         |       |  |         |         |         |       |                 |       |         |         |    |         |       |         |       |                 |       |         |       |  |         |         |       |       |                 |  |  |         |  |         |       |       |  |                 |    |       |       |  |         |         |       |       |                 |  |  |     |    |         |       |       |  |                 |  |       |       |  |     |    |       |  |                 |  |  |  |  |            |    |       |  |                 |  |  |  |  |         |     |       |  |                 |  |  |  |  |         |    |       |  |                 |  |  |  |  |         |    |       |  |                 |  |  |  |  |         |    |       |  |                 |  |  |  |  |         |     |       |  |                 |  |  |  |  |         |     |       |  |                 |  |  |  |  |     |  |       |  |                 |  |  |  |  |            |    |       |  |                 |  |  |  |  |         |    |       |  |                 |  |  |  |  |         |    |       |  |                 |  |  |  |  |         |    |       |  |                 |  |  |  |  |         |     |       |  |                 |  |  |  |  |           |     |       |  |                 |  |  |  |  |
| 1.6 BiFuel   | 60   | 01.11 |       | PR: 1LN,1ZC,1ZD |                |                 |                     |           |                     |        |              |       |                |        |                 |                |         |                  |        |                     |         |         |       |                 |       |         |         |    |         |       |         |       |                 |       |         |       |  |         |         |         |       |                 |       |         |         |    |         |       |         |       |                 |       |         |       |  |         |         |       |       |                 |  |  |         |  |         |       |       |  |                 |    |       |       |  |         |         |       |       |                 |  |  |     |    |         |       |       |  |                 |  |       |       |  |     |    |       |  |                 |  |  |  |  |            |    |       |  |                 |  |  |  |  |         |     |       |  |                 |  |  |  |  |         |    |       |  |                 |  |  |  |  |         |    |       |  |                 |  |  |  |  |         |    |       |  |                 |  |  |  |  |         |     |       |  |                 |  |  |  |  |         |     |       |  |                 |  |  |  |  |     |  |       |  |                 |  |  |  |  |            |    |       |  |                 |  |  |  |  |         |    |       |  |                 |  |  |  |  |         |    |       |  |                 |  |  |  |  |         |    |       |  |                 |  |  |  |  |         |     |       |  |                 |  |  |  |  |           |     |       |  |                 |  |  |  |  |
| 1.6 TDI  | 55   | 03.09 |       | PR: 1LN,1ZC,1ZD |                |                 |                     |           |                     |        |              |       |                |        |                 |                |         |                  |        |                     |         |         |       |                 |       |         |         |    |         |       |         |       |                 |       |         |       |  |         |         |         |       |                 |       |         |         |    |         |       |         |       |                 |       |         |       |  |         |         |       |       |                 |  |  |         |  |         |       |       |  |                 |    |       |       |  |         |         |       |       |                 |  |  |     |    |         |       |       |  |                 |  |       |       |  |     |    |       |  |                 |  |  |  |  |            |    |       |  |                 |  |  |  |  |         |     |       |  |                 |  |  |  |  |         |    |       |  |                 |  |  |  |  |         |    |       |  |                 |  |  |  |  |         |    |       |  |                 |  |  |  |  |         |     |       |  |                 |  |  |  |  |         |     |       |  |                 |  |  |  |  |     |  |       |  |                 |  |  |  |  |            |    |       |  |                 |  |  |  |  |         |    |       |  |                 |  |  |  |  |         |    |       |  |                 |  |  |  |  |         |    |       |  |                 |  |  |  |  |         |     |       |  |                 |  |  |  |  |           |     |       |  |                 |  |  |  |  |
| 1.6 TDI  | 66   | 06.09 |       | PR: 1LN,1ZC,1ZD |                |                 |                     |           |                     |        |              |       |                |        |                 |                |         |                  |        |                     |         |         |       |                 |       |         |         |    |         |       |         |       |                 |       |         |       |  |         |         |         |       |                 |       |         |         |    |         |       |         |       |                 |       |         |       |  |         |         |       |       |                 |  |  |         |  |         |       |       |  |                 |    |       |       |  |         |         |       |       |                 |  |  |     |    |         |       |       |  |                 |  |       |       |  |     |    |       |  |                 |  |  |  |  |            |    |       |  |                 |  |  |  |  |         |     |       |  |                 |  |  |  |  |         |    |       |  |                 |  |  |  |  |         |    |       |  |                 |  |  |  |  |         |    |       |  |                 |  |  |  |  |         |     |       |  |                 |  |  |  |  |         |     |       |  |                 |  |  |  |  |     |  |       |  |                 |  |  |  |  |            |    |       |  |                 |  |  |  |  |         |    |       |  |                 |  |  |  |  |         |    |       |  |                 |  |  |  |  |         |    |       |  |                 |  |  |  |  |         |     |       |  |                 |  |  |  |  |           |     |       |  |                 |  |  |  |  |
| 1.6 TDI  | 77   | 06.09 |       | PR: 1LN,1ZC,1ZD |                |                 |                     |           |                     |        |              |       |                |        |                 |                |         |                  |        |                     |         |         |       |                 |       |         |         |    |         |       |         |       |                 |       |         |       |  |         |         |         |       |                 |       |         |         |    |         |       |         |       |                 |       |         |       |  |         |         |       |       |                 |  |  |         |  |         |       |       |  |                 |    |       |       |  |         |         |       |       |                 |  |  |     |    |         |       |       |  |                 |  |       |       |  |     |    |       |  |                 |  |  |  |  |            |    |       |  |                 |  |  |  |  |         |     |       |  |                 |  |  |  |  |         |    |       |  |                 |  |  |  |  |         |    |       |  |                 |  |  |  |  |         |    |       |  |                 |  |  |  |  |         |     |       |  |                 |  |  |  |  |         |     |       |  |                 |  |  |  |  |     |  |       |  |                 |  |  |  |  |            |    |       |  |                 |  |  |  |  |         |    |       |  |                 |  |  |  |  |         |    |       |  |                 |  |  |  |  |         |    |       |  |                 |  |  |  |  |         |     |       |  |                 |  |  |  |  |           |     |       |  |                 |  |  |  |  |
| 1.8 GTI  | 141  | 11.14 |       | PR: 1LN,1ZC     |                |                 |                     |           |                     |        |              |       |                |        |                 |                |         |                  |        |                     |         |         |       |                 |       |         |         |    |         |       |         |       |                 |       |         |       |  |         |         |         |       |                 |       |         |         |    |         |       |         |       |                 |       |         |       |  |         |         |       |       |                 |  |  |         |  |         |       |       |  |                 |    |       |       |  |         |         |       |       |                 |  |  |     |    |         |       |       |  |                 |  |       |       |  |     |    |       |  |                 |  |  |  |  |            |    |       |  |                 |  |  |  |  |         |     |       |  |                 |  |  |  |  |         |    |       |  |                 |  |  |  |  |         |    |       |  |                 |  |  |  |  |         |    |       |  |                 |  |  |  |  |         |     |       |  |                 |  |  |  |  |         |     |       |  |                 |  |  |  |  |     |  |       |  |                 |  |  |  |  |            |    |       |  |                 |  |  |  |  |         |    |       |  |                 |  |  |  |  |         |    |       |  |                 |  |  |  |  |         |    |       |  |                 |  |  |  |  |         |     |       |  |                 |  |  |  |  |           |     |       |  |                 |  |  |  |  |



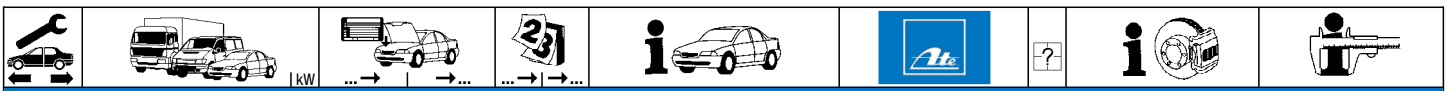

**VOLKSWAGEN POLO V (09-)**

|  |                   |     |              |                 |  |                  |  |  |                          |
|--|-------------------|-----|--------------|-----------------|--|------------------|--|--|--------------------------|
|  |                   |     |              |                 |  |                  |  |  |                          |
|  | <b>2.0 R WRC</b>  | 162 | <b>08.13</b> | PR: 1LN,1ZC,1ZD | <b>13.0460-7184.2</b><br><b>13.0470-7184.2</b> | 607184<br>LD7184 |  | <b>23587 20,6 +WK</b><br><b>23587 20,6 +WK</b> | <b>ATE</b><br><b>ATE</b> |
|  | <b>1.0</b>        | 44  | <b>01.14</b> | PR: 1LR,1ZG,1ZJ | <b>24.0122-0151.1</b>                          | 422151           |  | <b>256 22,0 19,0 V L +S +B</b>                 |                          |
|  | <b>1.0</b>        | 55  | <b>01.14</b> | PR: 1LR,1ZG,1ZJ | <b>24.0322-0151.1</b>                          | 522151           |  | <b>256 22,0 19,0 V L +S +B PD</b>              |                          |
|  | <b>1.0</b>        | 70  | <b>11.14</b> | PR: 1LR,1ZG,1ZJ |  |                  |  |  |                          |
|  | <b>1.0 TSI</b>    | 81  | <b>11.14</b> | PR: 1LR,1ZG,1ZJ |  |                  |  |  |                          |
|  | <b>1.2</b>        | 44  | <b>03.09</b> | PR: 1LR,1ZG,1ZJ |  |                  |  |  |                          |
|  | <b>1.2</b>        | 51  | <b>03.09</b> | PR: 1LR,1ZG,1ZJ |  |                  |  |  |                          |
|  | <b>1.2 TDI</b>    | 55  | <b>10.09</b> | PR: 1LR,1ZG,1ZJ |  |                  |  |  |                          |
|  | <b>1.2 TSI</b>    | 66  | <b>05.11</b> | PR: 1LR,1ZG,1ZJ |  |                  |  |  |                          |
|  | <b>1.2 TSI</b>    | 77  | <b>06.09</b> | PR: 1LR,1ZG,1ZJ |  |                  |  |  |                          |
|  | <b>1.2 TSI</b>    | 81  | <b>01.14</b> | PR: 1LR,1ZG,1ZJ |  |                  |  |  |                          |
|  | <b>1.4</b>        | 63  | <b>03.09</b> | PR: 1LR,1ZG,1ZJ |  |                  |  |  |                          |
|  | <b>1.4 BiFuel</b> | 60  | <b>03.10</b> | PR: 1LR,1ZG,1ZJ |  |                  |  |  |                          |
|  | <b>1.4 GTI</b>    | 132 | <b>05.10</b> | PR: 1LR,1ZG,1ZJ |  |                  |  |  |                          |
|  | <b>1.4 TDI</b>    | 55  | <b>03.14</b> | PR: 1LR,1ZG,1ZJ |  |                  |  |  |                          |
|  | <b>1.4 TDI</b>    | 66  | <b>02.14</b> | PR: 1LR,1ZG,1ZJ |  |                  |  |  |                          |
|  | <b>1.4 TDI</b>    | 77  | <b>05.14</b> | PR: 1LR,1ZG,1ZJ |  |                  |  |  |                          |
|  | <b>1.4 TSI</b>    | 103 | <b>10.12</b> | PR: 1LR,1ZG,1ZJ |  |                  |  |  |                          |
|  | <b>1.4 TSI</b>    | 110 | <b>05.14</b> | PR: 1LR,1ZG,1ZJ |  |                  |  |  |                          |
|  | <b>1.6</b>        |     | <b>07.14</b> | PR: 1LR,1ZG,1ZJ |  |                  |  |  |                          |
|  | <b>1.6 BiFuel</b> | 60  | <b>01.11</b> | PR: 1LR,1ZG,1ZJ |  |                  |  |  |                          |
|  | <b>1.6 TDI</b>    | 55  | <b>03.09</b> | PR: 1LR,1ZG,1ZJ |  |                  |  |  |                          |
|  | <b>1.6 TDI</b>    | 66  | <b>06.09</b> | PR: 1LR,1ZG,1ZJ |  |                  |  |  |                          |
|  | <b>1.6 TDI</b>    | 77  | <b>06.09</b> | PR: 1LR,1ZG,1ZJ |  |                  |  |  |                          |
|  | <b>1.8 GTI</b>    | 141 | <b>11.14</b> | PR: 1LR,1ZG,1ZJ |  |                  |  |  |                          |
|  | <b>2.0 R WRC</b>  | 162 | <b>11.14</b> | PR: 1LR,1ZG,1ZJ |  |                  |  |  |                          |
|  | <b>1.0</b>        | 44  | <b>01.14</b> | PR: 1LN,1ZC     | <b>24.0125-0113.1</b>                          | 425113           |  | <b>288 25,0 22,0 V L +S +B</b>                 |                          |
|  | <b>1.0</b>        | 55  | <b>01.14</b> | PR: 1LN,1ZC     | <b>24.0325-0113.1</b>                          | 525113           |  | <b>288 25,0 22,0 V L +S +B PD</b>              |                          |
|  | <b>1.0</b>        | 70  | <b>11.14</b> | PR: 1LN,1ZC     |  |                  |  |  |                          |
|  | <b>1.0 TSI</b>    | 81  | <b>11.14</b> | PR: 1LN,1ZC     |  |                  |  |  |                          |
|  | <b>1.2</b>        | 44  | <b>03.09</b> | PR: 1LN,1ZC,1ZD |  |                  |  |  |                          |
|  | <b>1.2</b>        | 51  | <b>03.09</b> | PR: 1LN,1ZC,1ZD |  |                  |  |  |                          |
|  | <b>1.2 TDI</b>    | 55  | <b>10.09</b> | PR: 1LN,1ZC,1ZD |  |                  |  |  |                          |
|  | <b>1.2 TSI</b>    | 66  | <b>05.11</b> | PR: 1LN,1ZC,1ZD |  |                  |  |  |                          |
|  | <b>1.2 TSI</b>    | 77  | <b>06.09</b> | PR: 1LN,1ZC,1ZD |  |                  |  |  |                          |
|  | <b>1.2 TSI</b>    | 81  | <b>01.14</b> | PR: 1LN,1ZC     |  |                  |  |  |                          |
|  | <b>1.4</b>        | 63  | <b>03.09</b> | PR: 1LN,1ZC,1ZD |  |                  |  |  |                          |
|  | <b>1.4 BiFuel</b> | 60  | <b>03.10</b> | PR: 1LN,1ZC,1ZD |  |                  |  |  |                          |
|  | <b>1.4 GTI</b>    | 132 | <b>05.10</b> | PR: 1LN,1ZC,1ZD |  |                  |  |  |                          |
|  | <b>1.4 TDI</b>    | 55  | <b>03.14</b> | PR: 1LN,1ZC     |  |                  |  |  |                          |
|  | <b>1.4 TDI</b>    | 66  | <b>02.14</b> | PR: 1LN,1ZC     |  |                  |  |  |                          |
|  | <b>1.4 TDI</b>    | 77  | <b>05.14</b> | PR: 1LN,1ZC     |  |                  |  |  |                          |
|  | <b>1.4 TSI</b>    | 103 | <b>10.12</b> | PR: 1LN,1ZC,1ZD |  |                  |  |  |                          |
|  | <b>1.4 TSI</b>    | 110 | <b>05.14</b> | PR: 1LN,1ZC     |  |                  |  |  |                          |
|  | <b>1.6</b>        |     | <b>07.14</b> | PR: 1LN,1ZC     |  |                  |  |  |                          |
|  | <b>1.6 BiFuel</b> | 60  | <b>01.11</b> | PR: 1LN,1ZC,1ZD |  |                  |  |  |                          |
|  | <b>1.6 TDI</b>    | 55  | <b>03.09</b> | PR: 1LN,1ZC,1ZD |  |                  |  |  |                          |
|  | <b>1.6 TDI</b>    | 66  | <b>06.09</b> | PR: 1LN,1ZC,1ZD |  |                  |  |  |                          |
|  | <b>1.6 TDI</b>    | 77  | <b>06.09</b> | PR: 1LN,1ZC,1ZD |  |                  |  |  |                          |
|  | <b>1.8 GTI</b>    | 141 | <b>11.14</b> | PR: 1LN,1ZC     |  |                  |  |  |                          |
|  | <b>2.0 R WRC</b>  | 162 | <b>08.13</b> | PR: 1LN,1ZC,1ZD |  |                  |  |  |                          |
|  | <b>1.2</b>        | 44  | <b>03.09</b> | PR: 1ZP,1ZR     | <b>24.0125-0123.1</b>                          | 425123           |  | <b>310 25,0 22,0 V L +S +B</b>                 |                          |
|  | <b>1.2</b>        | 51  | <b>03.09</b> | PR: 1ZP,1ZR     | <b>24.0325-0123.1</b>                          | 525123           |  | <b>310 25,0 22,0 V L +B PD</b>                 |                          |
|  | <b>1.2 TDI</b>    | 55  | <b>10.09</b> | PR: 1ZP,1ZR     |  |                  |  |  |                          |
|  | <b>1.2 TSI</b>    | 66  | <b>05.11</b> | PR: 1ZP,1ZR     |  |                  |  |  |                          |
|  | <b>1.2 TSI</b>    | 77  | <b>06.09</b> | PR: 1ZP,1ZR     |  |                  |  |  |                          |
|  | <b>1.2 TSI</b>    | 81  | <b>01.14</b> | PR: 1ZP,1ZR     |  |                  |  |  |                          |
|  | <b>1.4</b>        | 63  | <b>03.09</b> | PR: 1ZP,1ZR     |  |                  |  |  |                          |
|  | <b>1.4 BiFuel</b> | 60  | <b>03.10</b> | PR: 1ZP,1ZR     |  |                  |  |  |                          |
|  | <b>1.4 GTI</b>    | 132 | <b>05.10</b> | PR: 1ZP,1ZR     |  |                  |  |  |                          |
|  | <b>1.4 TSI</b>    | 103 | <b>10.12</b> | PR: 1ZP,1ZR     |  |                  |  |  |                          |
|  | <b>1.6</b>        |     | <b>07.14</b> | PR: 1ZP,1ZR     |  |                  |  |  |                          |
|  | <b>1.6 BiFuel</b> | 60  | <b>01.11</b> | PR: 1ZP,1ZR     |  |                  |  |  |                          |
|  | <b>1.6 TDI</b>    | 55  | <b>03.09</b> | PR: 1ZP,1ZR     |  |                  |  |  |                          |
|  | <b>1.6 TDI</b>    | 66  | <b>06.09</b> | PR: 1ZP,1ZR     |  |                  |  |  |                          |
|  | <b>1.6 TDI</b>    | 77  | <b>06.09</b> | PR: 1ZP,1ZR     |  |                  |  |  |                          |
|  | <b>1.8 GTI</b>    | 141 | <b>11.14</b> | PR: 1ZP,1ZR     |  |                  |  |  |                          |
|  | <b>2.0 R WRC</b>  | 162 | <b>08.13</b> | PR: 1ZP,1ZR     |  |                  |  |  |                          |
|  | <b>1.0</b>        | 44  | <b>01.14</b> |                 | <b>24.0711-5273.3</b>                          | 360303           |  | <b>Radsensor</b>                               |                          |
|  | <b>1.0</b>        | 55  | <b>01.14</b> |                 | <b>24.0711-5274.3</b>                          | 360304           |  | <b>Radsensor</b>                               |                          |
|  | <b>1.0</b>        | 70  | <b>11.14</b> |                 |  |                  |  |  |                          |
|  | <b>1.0 TSI</b>    | 81  | <b>11.14</b> |                 |  |                  |  |  |                          |
|  | <b>1.2</b>        | 44  | <b>03.09</b> |                 |  |                  |  |  |                          |
|  | <b>1.2</b>        | 51  | <b>03.09</b> |                 |  |                  |  |  |                          |
|  | <b>1.2 TDI</b>    | 55  | <b>10.09</b> |                 |  |                  |  |  |                          |
|  | <b>1.2 TSI</b>    | 66  | <b>05.11</b> |                 |  |                  |  |  |                          |
|  | <b>1.2 TSI</b>    | 77  | <b>06.09</b> |                 |  |                  |  |  |                          |
|  | <b>1.2 TSI</b>    | 81  | <b>01.14</b> |                 |  |                  |  |  |                          |
|  | <b>1.4</b>        | 63  | <b>03.09</b> |                 |  |                  |  |  |                          |
|  | <b>1.4 BiFuel</b> | 60  | <b>03.10</b> |                 |  |                  |  |  |                          |
|  | <b>1.4 GTI</b>    | 132 | <b>05.10</b> |                 |  |                  |  |  |                          |
|  | <b>1.4 TDI</b>    | 55  | <b>03.14</b> |                 |  |                  |  |  |                          |
|  | <b>1.4 TDI</b>    | 66  | <b>02.14</b> |                 |  |                  |  |  |                          |
|  | <b>1.4 TDI</b>    | 77  | <b>05.14</b> |                 |  |                  |  |  |                          |
|  | <b>1.4 TSI</b>    | 103 | <b>10.12</b> |                 |  |                  |  |  |                          |
|  | <b>1.4 TSI</b>    | 110 | <b>05.14</b> |                 |  |                  |  |  |                          |













**VOLKSWAGEN POLO V (09-)**

|  |  |   |   |  |                                  |                  |  |  |
|--|--|---|---|--|----------------------------------|------------------|--|--|
|  | 1.6<br>1.6 BiFuel<br>1.6 TDI<br>1.6 TDI<br>1.6 TDI<br>1.8 GTI<br>2.0 R WRC   | 60<br>55<br>66<br>77<br>141<br>162  | 07.14<br>01.11<br>03.09<br>06.09<br>06.09<br>11.14<br>08.13   |  | 24.0711-5273.3<br>24.0711-5274.3 | 360303<br>360304 |  | Radsensor<br>Radsensor                               |
|  | 1.0<br>1.0<br>1.0<br>1.0 TSI<br>1.2<br>1.2<br>1.2 TDI<br>1.2 TSI<br>1.2 TSI<br>1.2 TSI<br>1.4<br>1.4 BiFuel<br>1.4 GTI<br>1.4 TDI<br>1.4 TDI<br>1.4 TDI<br>1.4 TSI<br>1.4 TSI<br>1.6<br>1.6 BiFuel<br>1.6 TDI<br>1.6 TDI<br>1.6 TDI<br>1.6 GTI<br>1.8 GTI<br>2.0 R WRC | 44<br>55<br>70<br>81<br>44<br>51<br>55<br>66<br>77<br>81<br>63<br>60<br>132<br>55<br>66<br>77<br>103<br>110<br>60<br>60<br>55<br>66<br>77<br>141<br>162 | 01.14<br>01.14<br>11.14<br>11.14<br>03.09<br>03.09<br>10.09<br>05.11<br>06.09<br>01.14<br>03.09<br>03.10<br>05.10<br>03.14<br>02.14<br>05.14<br>10.12<br>05.14<br>07.14<br>01.11<br>03.09<br>06.09<br>06.09<br>11.14<br>08.13 | PR: 1KK,1KT,2EJ<br>PR: 1KK,1KT,2EJ<br>PR: 1KK,1KT,2EJ<br>PR: 1KK,1KT,2EJ<br>PR: 1KK,1KT,1KV<br>PR: 1KK,1KT,1KV<br>PR: 1KK,1KT,1KV<br>PR: 1KK,1KT,1KV<br>PR: 1KK,1KT,1KV<br>PR: 1KK,1KT,2EJ<br>PR: 1KK,1KT,1KV<br>PR: 1KK,1KT,1KV<br>PR: 1KK,1KT,1KV<br>PR: 1KK,1KT,2EJ<br>PR: 1KK,1KT,2EJ<br>PR: 1KK,1KT,2EJ<br>PR: 1KK,1KT,1KV<br>PR: 1KK,1KT,2EJ<br>PR: 1KK,1KT,1KV<br>PR: 1KK,1KT,1KV<br>PR: 1KK,1KT,1KV<br>PR: 1KK,1KT,1KV<br>PR: 1KK,1KT,2EJ<br>PR: 1KK,1KT,1KV   | 13.0460-2820.2<br>13.0470-2820.2 | 602820<br>LD2820 |  | 20961 17,6 /S<br>20961 17,6 /S<br>TRW<br>TRW         |
|  | 1.0<br>1.0<br>1.0<br>1.0 TSI<br>1.2<br>1.2<br>1.2 TDI<br>1.2 TSI<br>1.2 TSI<br>1.2 TSI<br>1.4<br>1.4 BiFuel<br>1.4 GTI<br>1.4 TDI<br>1.4 TDI<br>1.4 TDI<br>1.4 TSI<br>1.4 TSI<br>1.6<br>1.6 BiFuel<br>1.6 TDI<br>1.6 TDI<br>1.6 TDI<br>1.6 GTI<br>2.0 R WRC            | 44<br>55<br>70<br>81<br>44<br>51<br>55<br>66<br>77<br>81<br>63<br>60<br>132<br>55<br>66<br>77<br>103<br>110<br>60<br>60<br>55<br>66<br>77<br>141<br>162 | 01.14<br>01.14<br>11.14<br>11.14<br>03.09<br>03.09<br>10.09<br>05.11<br>06.09<br>01.14<br>03.09<br>03.10<br>05.10<br>03.14<br>02.14<br>05.14<br>10.12<br>05.14<br>07.14<br>01.11<br>03.09<br>06.09<br>06.09<br>11.14<br>08.13 | PR: 2EJ<br>PR: 2EJ<br>PR: 2EJ<br>PR: 2EJ<br>PR: 2EJ<br>PR: 2EJ<br>PR: 2EJ<br>PR: 2EJ<br>PR: 2EJ<br>PR: 2EJ<br>PR: 2EJ<br>PR: 2EJ<br>PR: 2EJ<br>PR: 2EJ<br>PR: 2EJ<br>PR: 2EJ<br>PR: 2EJ<br>PR: 2EJ<br>PR: 2EJ<br>PR: 2EJ<br>PR: 2EJ<br>PR: 2EJ<br>PR: 2EJ<br>PR: 2EJ<br>PR: 2EJ  | 13.0460-2894.2<br>13.0470-2894.2 | 602894<br>LD2894 |  | 20961 17,4 /Zub/S<br>20961 17,4 /Zub/S<br>TRW<br>TRW |
|  | 1.0<br>1.0<br>1.0<br>1.0 TSI<br>1.2<br>1.2<br>1.2 TDI<br>1.2 TSI<br>1.2 TSI<br>1.2 TSI<br>1.4<br>1.4 BiFuel<br>1.4 GTI<br>1.4 TDI<br>1.4 TDI<br>1.4 TDI<br>1.4 TSI<br>1.4 TSI<br>1.6<br>1.6 BiFuel<br>1.6 TDI<br>1.6 TDI<br>1.6 TDI<br>1.6 GTI<br>2.0 R WRC            | 44<br>55<br>70<br>81<br>44<br>51<br>55<br>66<br>77<br>81<br>63<br>60<br>132<br>55<br>66<br>77<br>103<br>110<br>60<br>60<br>55<br>66<br>77<br>141<br>162 | 01.14<br>01.14<br>11.14<br>11.14<br>03.09<br>03.09<br>10.09<br>05.11<br>06.09<br>01.14<br>03.09<br>03.10<br>03.14<br>02.14<br>05.14<br>10.12<br>05.14<br>07.14<br>01.11<br>03.09<br>06.09<br>06.09<br>11.14<br>08.13          | PR: 1KK,1KT,2EJ<br>PR: 1KK,1KT,2EJ<br>PR: 1KK,1KT,2EJ<br>PR: 1KK,1KT,2EJ<br>PR: 1KK,1KT,1KV,2EJ<br>PR: 1KK,1KT,1KV,2EJ<br>PR: 1KK,1KT,1KV,2EJ<br>PR: 1KK,1KT,1KV,2EJ<br>PR: 1KK,1KT,1KV,2EJ<br>PR: 1KK,1KT,1KV,2EJ<br>PR: 1KK,1KT,2EJ<br>PR: 1KK,1KT,1KV,2EJ<br>PR: 1KK,1KT,2EJ<br>PR: 1KK,1KT,2EJ<br>PR: 1KK,1KT,2EJ<br>PR: 1KK,1KT,2EJ<br>PR: 1KK,1KT,2EJ<br>PR: 1KK,1KT,2EJ<br>PR: 1KK,1KT,1KV,2EJ<br>PR: 1KK,1KT,1KV,2EJ<br>PR: 1KK,1KT,1KV,2EJ<br>PR: 1KK,1KT,1KV,2EJ<br>PR: 1KK,1KT,1KV,2EJ<br>PR: 1KK,1KT,2EJ | 24.0109-0123.1<br>24.0309-0123.1 | 409123<br>509123 |  | 230 9,0 7,0 +S +B<br>230 9,0 7,0 +S +B PD            |
|  | 1.0<br>1.0<br>1.0<br>1.0 TSI<br>1.2<br>1.2<br>1.2 TDI<br>1.2 TSI<br>1.2 TSI<br>1.2 TSI<br>1.4<br>1.4 BiFuel<br>1.4 GTI<br>1.4 TDI<br>1.4 TDI<br>1.4 TDI<br>1.4 TSI<br>1.4 TSI<br>1.6<br>1.6 BiFuel<br>1.6 TDI<br>1.6 TDI<br>1.6 TDI<br>1.6 GTI<br>2.0 R WRC            | 44<br>55<br>70<br>81<br>44<br>51<br>55<br>66<br>77<br>81<br>63<br>60<br>132<br>55<br>66<br>77<br>103<br>110<br>60<br>60<br>55<br>66<br>77<br>141<br>162 | 01.14<br>01.14<br>11.14<br>11.14<br>03.09<br>03.09<br>10.09<br>05.11<br>06.09<br>01.14<br>03.09<br>03.10<br>03.14<br>02.14<br>05.14<br>10.12<br>05.14<br>07.14<br>01.11<br>03.09<br>06.09<br>06.09<br>11.14<br>08.13          | PR: 1KK,1KT,1KV,2EJ  | 24.0109-0123.1                   | 409123           |  | 230 9,0 7,0 +S +B                                    |
|  | 1.0<br>1.0<br>1.0<br>1.0 TSI<br>1.2  | 44<br>55<br>70<br>81<br>44  | 01.14<br>01.14<br>11.14<br>11.14<br>03.09   |  | 24.0711-6233.3<br>24.0711-6234.3 | 360315<br>360316 |  | Radsensor<br>Radsensor                               |

**VOLKSWAGEN POLO V (09-)**

|  |  |  |  |   |  |  |   |
|--|--|--|--|---|--|--|---|
|    | 1.2 51<br>1.2 TDI 55<br>1.2 TSI 66<br>1.2 TSI 77<br>1.2 TSI 81<br>1.4 63<br>1.4 BiFuel 60<br>1.4 GTI 132<br>1.4 TDI 55<br>1.4 TDI 66<br>1.4 TDI 77<br>1.4 TSI 103<br>1.4 TSI 110<br>1.6 60<br>1.6 BiFuel 55<br>1.6 TDI 66<br>1.6 TDI 77<br>1.8 GTI 141<br>2.0 R WRC 162                      |  | 03.09<br>10.09<br>05.11<br>06.09<br>01.14<br>03.09<br>03.10<br>05.10<br>03.14<br>02.14<br>05.14<br>10.12<br>05.14<br>07.14<br>01.11<br>03.09<br>06.09<br>06.09<br>11.14<br>08.13   |   | 24.0711-6233.3 360315<br>24.0711-6234.3 360316 | <br> | Radsensor<br>Radsensor                    |
|    | 1.2 44<br>1.2 51<br>1.2 TDI 55<br>1.2 TSI 66<br>1.2 TSI 77<br>1.4 63<br>1.4 BiFuel 60<br>1.4 TSI 103<br>1.6 BiFuel 60<br>1.6 TDI 55<br>1.6 TDI 66<br>1.6 TDI 77  |  | 03.09 PR: 1KB,1KM<br>03.09 PR: 1KB,1KM<br>10.09 PR: 1KB,1KM<br>05.11 PR: 1KB,1KM<br>06.09 PR: 1KB,1KM<br>03.09 PR: 1KB,1KM<br>03.10 PR: 1KB,1KM<br>10.12 PR: 1KB,1KM<br>01.11 PR: 1KB,1KM<br>03.09 PR: 1KB,1KM<br>06.09 PR: 1KB,1KM<br>06.09 PR: 1KB,1KM   | PR: 1KB,1KM<br>PR: 1KB,1KM<br>PR: 1KB,1KM<br>PR: 1KB,1KM<br>PR: 1KB,1KM<br>PR: 1KB,1KM<br>PR: 1KB,1KM<br>PR: 1KB,1KM<br>PR: 1KB,1KM<br>PR: 1KB,1KM<br>PR: 1KB,1KM   | 03.0137-0268.2 650268<br>03.0137-9168.2 669168 |  | 200 x 40 HEB VW<br>Bremsbacken-Zubehör VW |
|  | 1.0 44<br>1.0 55<br>1.0 70<br>1.0 TSI 81<br>1.2 TSI 81<br>1.4 TDI 55<br>1.4 TDI 66<br>1.4 TDI 77<br>1.4 TSI 110<br>1.6 44  |  | 01.14 PR: 1KM<br>01.14 PR: 1KM<br>11.14 PR: 1KM<br>11.14 PR: 1KM<br>01.14 PR: 1KM<br>03.14 PR: 1KM<br>02.14 PR: 1KM<br>05.14 PR: 1KM<br>05.14 PR: 1KM<br>07.14 PR: 1KM   | PR: 1KM<br>PR: 1KM<br>PR: 1KM<br>PR: 1KM<br>PR: 1KM<br>PR: 1KM<br>PR: 1KM<br>PR: 1KM<br>PR: 1KM<br>PR: 1KM  | 03.0137-0268.2 650268<br>03.0137-9168.2 669168 |  | 200 x 40 HEB VW<br>Bremsbacken-Zubehör VW |
|  | 1.0 44<br>1.0 55<br>1.0 70<br>1.0 TSI 81<br>1.2 44<br>1.2 51<br>1.2 TDI 55<br>1.2 TSI 66<br>1.2 TSI 77<br>1.2 TSI 81<br>1.4 63<br>1.4 BiFuel 60<br>1.4 TDI 55<br>1.4 TDI 66<br>1.4 TDI 77<br>1.4 TSI 103<br>1.4 TSI 110<br>1.6 44<br>1.6 BiFuel 60<br>1.6 TDI 55<br>1.6 TDI 66<br>1.6 TDI 77 |  | 01.14 PR: 1KM<br>01.14 PR: 1KM<br>11.14 PR: 1KM<br>11.14 PR: 1KM<br>03.09 PR: 1KB,1KM<br>03.09 PR: 1KB,1KM<br>10.09 PR: 1KB,1KM<br>05.11 PR: 1KB,1KM<br>06.09 PR: 1KB,1KM<br>01.14 PR: 1KM<br>03.09 PR: 1KB,1KM<br>03.10 PR: 1KB,1KM<br>03.14 PR: 1KM<br>02.14 PR: 1KM<br>05.14 PR: 1KM<br>10.12 PR: 1KB,1KM<br>05.14 PR: 1KM<br>07.14 PR: 1KM<br>01.11 PR: 1KB,1KM<br>03.09 PR: 1KB,1KM<br>06.09 PR: 1KB,1KM<br>06.09 PR: 1KB,1KM | PR: 1KM<br>PR: 1KM<br>PR: 1KM<br>PR: 1KM<br>PR: 1KB,1KM<br>PR: 1KB,1KM<br>PR: 1KB,1KM<br>PR: 1KB,1KM<br>PR: 1KB,1KM<br>PR: 1KB,1KM<br>PR: 1KB,1KM<br>PR: 1KB,1KM<br>PR: 1KB,1KM<br>PR: 1KB,1KM<br>PR: 1KB,1KM<br>PR: 1KB,1KM<br>PR: 1KB,1KM<br>PR: 1KB,1KM<br>PR: 1KB,1KM<br>PR: 1KB,1KM<br>PR: 1KB,1KM | 24.0220-0037.1 480161                          |  | 200/201,5 x 50,5                          |
|  | 1.2 44<br>1.2 51<br>1.2 TDI 55<br>1.2 TSI 66<br>1.2 TSI 77<br>1.2 TSI 81<br>1.4 63<br>1.4 BiFuel 60<br>1.4 TSI 103<br>1.6 44<br>1.6 BiFuel 60<br>1.6 TDI 55<br>1.6 TDI 66<br>1.6 TDI 77  |  | 03.09 PR: 1KB<br>03.09 PR: 1KB<br>10.09 PR: 1KB<br>05.11 PR: 1KB<br>06.09 PR: 1KB<br>01.14 PR: 1KB<br>03.09 PR: 1KB<br>03.10 PR: 1KB<br>10.12 PR: 1KB<br>07.14 PR: 1KB<br>01.11 PR: 1KB<br>03.09 PR: 1KB<br>06.09 PR: 1KB<br>06.09 PR: 1KB   | PR: 1KB<br>PR: 1KB<br>PR: 1KB<br>PR: 1KB<br>PR: 1KB<br>PR: 1KB<br>PR: 1KB<br>PR: 1KB<br>PR: 1KB<br>PR: 1KB<br>PR: 1KB<br>PR: 1KB<br>PR: 1KB<br>PR: 1KB  | 03.0520-4817.3 694817                          |  | 17,46/200x40 TopKit VW                    |
|  | 1.0 44<br>1.0 55<br>1.0 70<br>1.0 TSI 81<br>1.2 44<br>1.2 51<br>1.2 TDI 55<br>1.2 TSI 66<br>1.2 TSI 77   |  | 01.14 PR: 1KM<br>01.14 PR: 1KM<br>11.14 PR: 1KM<br>11.14 PR: 1KM<br>03.09 PR: 1KM<br>03.09 PR: 1KM<br>10.09 PR: 1KM<br>05.11 PR: 1KM<br>06.09 PR: 1KM  | PR: 1KM<br>PR: 1KM<br>PR: 1KM<br>PR: 1KM<br>PR: 1KM<br>PR: 1KM<br>PR: 1KM<br>PR: 1KM<br>PR: 1KM   | 03.0520-8219.3 698219                          |  | 19,05/200x40 TopKit VW                    |





**VOLKSWAGEN POLO V (09-)**

|  |            |     |  |       |         |                |        |  |  |                     |    |
|--|------------|-----|--|-------|---------|----------------|--------|--|--|---------------------|----|
|  | 1.2 TSI    | 81  |  | 01.14 | PR: 1KM | 03.0520-8219.3 | 698219 |  |  | 19,05/200x40 TopKit | VW |
|  | 1.4        | 63  |  | 03.09 | PR: 1KM |                |        |  |  |                     |    |
|  | 1.4 BiFuel | 60  |  | 03.10 | PR: 1KM |                |        |  |  |                     |    |
|  | 1.4 TDI    | 55  |  | 03.14 | PR: 1KM |                |        |  |  |                     |    |
|  | 1.4 TDI    | 66  |  | 02.14 | PR: 1KM |                |        |  |  |                     |    |
|  | 1.4 TDI    | 77  |  | 05.14 | PR: 1KM |                |        |  |  |                     |    |
|  | 1.4 TSI    | 103 |  | 10.12 | PR: 1KM |                |        |  |  |                     |    |
|  | 1.4 TSI    | 110 |  | 05.14 | PR: 1KM |                |        |  |  |                     |    |
|  | 1.6        |     |  | 07.14 | PR: 1KM |                |        |  |  |                     |    |
|  | 1.6 BiFuel | 60  |  | 01.11 | PR: 1KM |                |        |  |  |                     |    |
|  | 1.6 TDI    | 55  |  | 03.09 | PR: 1KM |                |        |  |  |                     |    |
|  | 1.6 TDI    | 66  |  | 06.09 | PR: 1KM |                |        |  |  |                     |    |
|  | 1.6 TDI    | 77  |  | 06.09 | PR: 1KM |                |        |  |  |                     |    |

**VOLKSWAGEN POLO Classic (96-01)**

|  |         |    |             |                |             |                |        |   |                               |                            |     |
|--|---------|----|-------------|----------------|-------------|----------------|--------|---|-------------------------------|----------------------------|-----|
|  | 1.4     |    | 6K-V-022628 | 12.95          | - ABS       | 13.0460-7059.2 | 607059 |   |                               | 20887 17,3 +/Zub           | VW  |
|  | 1.4     |    | 6K-V-022628 | 12.95          | + ABS       | 13.0460-7072.2 | 607072 |   |                               | 21866 19,7 +               | VW  |
|  | 1.6     | 55 | 6K-V-022628 | 05.96          |             |                |        |   |                               |                            |     |
|  | 1.7 SDI |    | 6K-V-022628 | 07.97          |             |                |        |   |                               |                            |     |
|  | 1.9 SDI |    | 6K-V-022628 | 12.95          |             |                |        |   |                               |                            |     |
|  | 1.4     |    | 6K-V-022629 |                | 09.01       | 13.0460-7101.2 | 607101 |   |                               | 21866 15,3 +               | VW  |
|  | 1.6     | 55 | 6K-V-022629 |                | 09.01       |                |        |   |                               |                            |     |
|  | 1.7 SDI |    | 6K-V-022629 |                | 09.01       |                |        |   |                               |                            |     |
|  | 1.9 SDI |    | 6K-V-022629 |                | 09.01       |                |        |   |                               |                            |     |
|  | 1.6     | 55 |             | 05.96          | 09.01       | 13.0460-2821.2 | 602821 |   |                               | 21945 16,0 /S              | TRW |
|  | 1.6     | 74 |             | 05.96          | 09.01       |                |        |   |                               |                            |     |
|  | 1.8     |    |             | 03.98          | 09.01 + MEX |                |        |   |                               |                            |     |
|  | 1.9 TDI | 66 |             | 09.96          | 09.01       |                |        |   |                               |                            |     |
|  | 1.9 TDI | 81 |             | 06.98          | 09.01       |                |        |   |                               |                            |     |
|  | 2.0     | 85 |             | 03.99          | 09.01 + MEX |                |        |   |                               |                            |     |
|  | 1.4     |    | 6K-V-022628 | 12.95          | - ABS       | 24.0110-0151.1 | 410151 |   |                               | 239 10,0 8,0 +S +B         |     |
|  | 1.4     |    | 6K-V-022628 | 12.95          | + ABS       | 24.0310-0151.1 | 510151 |   |                               | 239 10,0 8,0 +S +B PD      |     |
|  | 1.6     | 55 | 6K-V-022628 | 05.96          |             | 24.0112-0106.1 | 412106 |   |                               | 239 12,0 10,0 +S +B        |     |
|  | 1.7 SDI |    | 6K-V-022628 | 07.97          |             | 24.0312-0106.1 | 512106 |   |                               | 239 12,0 10,0 +S +B PD     |     |
|  | 1.9 SDI |    | 6K-V-022628 | 12.95          |             |                |        |   |                               |                            |     |
|  | 1.4     |    | 6K-V-022629 |                | 09.01       | 24.0120-0123.1 | 420123 |   |                               | 239 20,0 18,0 V L +S +B    |     |
|  | 1.6     | 55 | 6K-V-022629 |                | 09.01       | 24.0320-0123.1 | 520123 |   |                               | 239 20,0 18,0 V L +S +B PD |     |
|  | 1.7 SDI |    | 6K-V-022629 |                | 09.01       |                |        |   |                               |                            |     |
|  | 1.9 SDI |    | 6K-V-022629 |                | 09.01       |                |        |   |                               |                            |     |
|  | 1.6     | 55 |             | 05.96          | 09.01       | 24.0120-0128.1 | 420128 |   |                               | 256 20,0 18,0 V L +S +B    |     |
|  | 1.6     | 74 |             | 05.96          | 09.01       | 24.0320-0128.1 | 520128 |   |                               | 256 20,0 18,0 V L +S +B PD |     |
|  | 1.8     |    |             | 03.98          | 09.01 + MEX |                |        |   |                               |                            |     |
|  | 1.9 TDI | 66 |             | 09.96          | 09.01       |                |        |   |                               |                            |     |
|  | 1.9 TDI | 81 |             | 06.98          | 09.01       |                |        |   |                               |                            |     |
|  | 2.0     | 85 |             | 03.99          | 09.01 + MEX |                |        |   |                               |                            |     |
|  | 1.4     |    |             | 12.95          | 09.01       | 24.0711-1361.3 | 360022 |   |                               | Radsensor                  |     |
|  | 1.6     | 55 |             | 11.95          | 09.01       | 24.0711-1362.3 | 360023 |   |                               | Radsensor                  |     |
|  | 1.6     | 74 |             | 05.96          | 09.01       |                |        |   |                               |                            |     |
|  | 1.7 SDI |    |             | 11.97          | 09.01       |                |        |   |                               |                            |     |
|  | 1.8     |    |             | 03.98          | 09.01 + MEX |                |        |   |                               |                            |     |
|  | 1.9 SDI |    |             | 12.95          | 09.01       |                |        |   |                               |                            |     |
|  | 1.9 TDI | 66 |             | 01.97          | 09.01       |                |        |   |                               |                            |     |
|  | 1.9 TDI | 81 |             | 06.98          | 09.01       |                |        |   |                               |                            |     |
|  | 2.0     | 85 |             | 03.99          | 09.01 + MEX |                |        |   |                               |                            |     |
|  | 1.9 TDI | 81 |             | 06.98          | 09.99       | 13.0460-2937.2 | 602937 |   |                               | 20961 15,2 /Zub/S          | TRW |
|  | 1.9 TDI | 81 |             | 06.98          | 09.99       | 13.0460-2984.2 | 602984 |   |                               | 20961 17,2 /Zub/S          | TRW |
|  |         |    |             |                |             | 13.0460-0072.2 | 610072 |   |                               | Belagsatz-Zubehör          | TRW |
|  | 1.9 TDI | 81 |             | 10.99          | 09.01       | 13.0460-2894.2 | 602894 |   |                               | 20961 17,4 /Zub/S          | TRW |
|  |         |    |             |                |             | 13.0470-2894.2 | LD2894 |   |                               | 20961 17,4 /Zub/S          | TRW |
|  |         |    |             |                |             | 13.0460-2886.2 | 602886 |   |                               | 20961 16,2 /S              | TRW |
|  |         |    |             |                |             | 13.0470-2886.2 | LD2886 |   |                               | 20961 16,2 /S              | TRW |
|  |         |    |             |                |             | 13.0460-0072.2 | 610072 |   |                               | Belagsatz-Zubehör          | TRW |
|  | 1.9 TDI | 81 |             | 06.98          | 09.99       | 24.0110-0111.1 | 410111 |   | ohne Sensorring <sup>1)</sup> | 226 10,0 8,0 +B            |     |
|  | 1.9 TDI | 81 |             | 24.0110-0275.2 | 410275      | 24.0110-0275.2 | 410275 |   | mit Sensorring <sup>2)</sup>  | 226 10,0 8,0 +B            |     |
|  | 1.9 TDI | 81 |             | 10.99          | 09.01       | 24.0109-0124.1 | 409124 |   |                               | 232 9,0 7,0 +B             |     |
|  | 1.4     |    |             | 12.95          | 09.01       | 24.0711-6049.3 | 360126 | 2 |                               | Radsensor                  |     |
|  | 1.6     | 55 |             | 11.95          | 09.01       |                |        |   |                               |                            |     |
|  | 1.6     | 74 |             | 05.96          | 09.01       |                |        |   |                               |                            |     |
|  | 1.7 SDI |    |             | 11.97          | 09.01       |                |        |   |                               |                            |     |
|  | 1.8     |    |             | 03.98          | 09.01 + MEX |                |        |   |                               |                            |     |
|  | 1.9 SDI |    |             | 12.95          | 09.01       |                |        |   |                               |                            |     |
|  | 1.9 TDI | 66 |             | 01.97          | 09.01       |                |        |   |                               |                            |     |
|  | 1.9 TDI | 81 |             | 06.98          | 09.01       |                |        |   |                               |                            |     |
|  | 2.0     | 85 |             | 03.99          | 09.01 + MEX |                |        |   |                               |                            |     |
|  | 1.4     |    |             | 12.95          | 09.99       | 03.0137-0126.2 | 650126 |   |                               | 180 x 31 HEB               |     |
|  | 1.6     | 55 |             | 11.95          | 09.99       | 03.0137-9008.2 | 669008 |   |                               | Bremsbacken-Zubehör        |     |
|  | 1.4     |    |             | 10.99          | 09.01       | 03.0137-0268.2 | 650268 |   |                               | 200 x 40 HEB               | VW  |
|  | 1.4     |    |             | 12.95          | 09.99       | 03.0137-9168.2 | 669168 |   |                               | Bremsbacken-Zubehör        | VW  |
|  | 1.6     | 55 |             | 10.99          | 09.01       |                |        |   |                               |                            |     |
|  | 1.6     | 55 |             | 11.95          | 09.99       |                |        |   |                               |                            |     |
|  | 1.6     | 74 |             | 12.95          | 09.01       |                |        |   |                               |                            |     |
|  | 1.7 SDI |    |             | 07.97          | 09.01       |                |        |   |                               |                            |     |
|  | 1.8     |    |             | 03.98          | 09.01 + MEX |                |        |   |                               |                            |     |
|  | 1.9 SDI |    |             | 12.95          | 09.01       |                |        |   |                               |                            |     |

<sup>1)</sup> without sensor ring / senza sensori / sans secours ABS / sin anillo sensor ABS  
<sup>2)</sup> with sensor ring / con sensori / avec secours ABS / con anillo sensor ABS

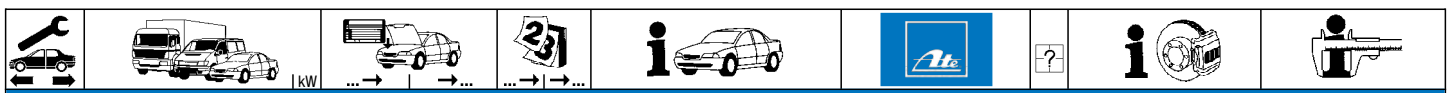

**VOLKSWAGEN POLO Classic (96-01)**













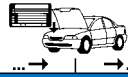

|  |  |                            |  |  |   |  |                                  |                  |  |  |          |
|--|--|----------------------------|--|--|---|--|----------------------------------|------------------|--|--|----------|
|  | 1.9 TDI<br>2.0   | 66<br>85                   |  | 09.96<br>03.99   | 09.01<br>09.01 + MEX  |  | 03.0137-0268.2<br>03.0137-9168.2 | 650268<br>669168 |  | 200 x 40 HEB<br>Bremsbacken-Zubehör                | VW<br>VW |
|  | 1.4<br>1.6   | 55                         |  | 12.95<br>11.95   | 09.99 - ABS<br>09.99 - ABS  |  | 24.0218-0007.1<br>24.0218-0707.2 | 480003<br>480211 |  | 180/181 x 38,5 - Lager<br>180/181 x 38,5 + Lager   |          |
|  | 1.4<br>1.6<br>1.6<br>1.7 SDI<br>1.8<br>1.9 SDI<br>1.9 TDI<br>2.0               | 55<br>55<br>74<br>66<br>85 |  | 12.95<br>11.95<br>12.95<br>07.97<br>03.98<br>12.95<br>09.96<br>03.99                   | 09.99 + ABS<br>09.99 + ABS<br>09.99<br>09.99<br>09.99 + MEX<br>09.99<br>09.99<br>09.99 + MEX          |  | 24.0220-0018.1<br>24.0220-0718.2 | 480019<br>480209 | ohne Sensorring <sup>1)</sup><br>ohne Sensorring <sup>1)</sup> | 200/201 x 50,0 - Lager<br>200/201,5 x 50,0 + Lager |          |
|  | 1.4<br>1.6<br>1.6<br>1.7 SDI<br>1.8<br>1.9 SDI<br>1.9 TDI<br>2.0               | 55<br>74<br>66<br>85       |  | 10.99<br>10.99<br>10.99<br>10.99<br>10.99<br>10.99<br>10.99<br>10.99                   | 09.01<br>09.01<br>09.01<br>09.01 + MEX<br>09.01<br>09.01<br>09.01 + MEX                               |  | 24.0220-0032.1                   | 480130           |  | 200/201,5 x 50,1                                   |          |
|  | 1.4<br>1.6   | 55                         |  | 12.95<br>11.95   | 09.99 - ABS<br>09.99 - ABS  |  | 03.0420-0617.3<br>03.0520-3917.3 | 680617<br>693917 | + Rz GG <sup>2)</sup><br>+ Rz ALU <sup>3)</sup>                | 17,46/180x31 Kit<br>17,46/180x31 TopKit            | VW<br>VW |
|  | 1.4<br>1.4<br>1.6<br>1.6<br>1.6<br>1.7 SDI<br>1.8<br>1.9 SDI<br>1.9 TDI<br>2.0 | 55<br>55<br>74<br>66<br>85 |  | 10.99<br>12.95<br>10.99<br>11.95<br>12.95<br>07.97<br>03.98<br>12.95<br>09.96<br>03.99 | 09.01<br>09.99 + ABS<br>09.01<br>09.99 + ABS<br>09.01<br>09.01 + MEX<br>09.01<br>09.01<br>09.01 + MEX |  | 03.0420-4219.3<br>03.0520-4219.3 | 684219<br>694219 |  | 19,05/200x40 Kit<br>19,05/200x40 TopKit            | VW<br>VW |

**VOLKSWAGEN POLO Variant (97-01)**

|  |   |                |             |   |   |  |  |  |   |   |                          |
|--|---|----------------|-------------|---|---|--|--|--|---|---|--------------------------|
|  | 1.4<br>1.4<br>1.6<br>1.7 SDI<br>1.9 SDI                       | 55             | 6K-V-022628 | 03.97   | - ABS<br>+ ABS  |  | 13.0460-7059.2<br>13.0460-7072.2   | 607059<br>607072                               |   | 20887 17,3 +/Zub<br>21866 19,7 +  | VW<br>VW                 |
|  | 1.4<br>1.6<br>1.7 SDI<br>1.9 SDI                              | 55             | 6K-V-022629 | 09.01<br>09.01<br>09.01<br>09.01                            |   |  | 13.0460-7101.2   | 607101   |   | 21866 15,3 +  | VW                       |
|  | 1.6<br>1.8<br>1.9 TDI<br>1.9 TDI                              | 74<br>66<br>81 |             | 05.97<br>05.97<br>01.97<br>06.98                            | 09.01<br>09.01<br>09.01<br>09.01  |  | 13.0460-2821.2   | 602821   |   | 21945 16,0 /S   | TRW                      |
|  | 1.4<br>1.4<br>1.6<br>1.7 SDI<br>1.9 SDI                       | 55             | 6K-V-022628 | 03.97   | - ABS<br>+ ABS  |  | 24.0110-0151.1<br>24.0310-0151.1   | 410151<br>510151                               |   | 239 10,0 8,0 +S +B<br>239 10,0 8,0 +S +B PD   |                          |
|  | 1.4<br>1.6<br>1.7 SDI<br>1.9 SDI                              | 55             | 6K-V-022628 | 03.97   | + ABS   |  | 24.0112-0106.1<br>24.0312-0106.1   | 412106<br>512106                               |   | 239 12,0 10,0 +S +B<br>239 12,0 10,0 +S +B PD   |                          |
|  | 1.4<br>1.6<br>1.7 SDI<br>1.9 SDI                              | 55             | 6K-V-022629 | 09.01<br>09.01<br>09.01<br>09.01                            |   |  | 24.0120-0123.1<br>24.0320-0123.1   | 420123<br>520123                               |   | 239 20,0 18,0 V L +S +B<br>239 20,0 18,0 V L +S +B PD   |                          |
|  | 1.6<br>1.8<br>1.9 TDI<br>1.9 TDI                              | 74<br>66<br>81 |             | 05.97<br>05.97<br>01.97<br>06.98                            | 09.01<br>09.01<br>09.01<br>09.01  |  | 24.0120-0128.1<br>24.0320-0128.1   | 420128<br>520128                               |   | 256 20,0 18,0 V L +S +B<br>256 20,0 18,0 V L +S +B PD   |                          |
|  | 1.4<br>1.6<br>1.7 SDI<br>1.8<br>1.9 SDI<br>1.9 TDI<br>1.9 TDI | 66<br>81       |             | 03.97<br>05.97<br>08.97<br>05.97<br>03.97<br>01.97<br>06.98 | 09.01 + ABS<br>09.01 + ABS<br>09.01 + ABS<br>09.01 + ABS<br>09.01 + ABS<br>09.01 + ABS<br>09.01 + ABS |  | 24.0711-1361.3<br>24.0711-1362.3   | 360022<br>360023                               |   | Radsensor<br>Radsensor  |                          |
|  | 1.9 TDI   | 81             |             | 06.98   | 09.01   |  | 13.0460-2894.2<br>13.0470-2894.2<br>13.0460-2886.2<br>13.0470-2886.2<br>13.0460-0072.2 | 602894<br>LD2894<br>602886<br>LD2886<br>610072 |   | 20961 17,4 /Zub/S<br>20961 17,4 /Zub/S<br>20961 16,2 /S<br>20961 16,2 /S<br>Belagsatz-Zubehör | TRW<br>TRW<br>TRW<br>TRW |
|  | 1.9 TDI   | 81             |             | 06.98   | 09.01   |  | 24.0109-0124.1   | 409124   |   | 232 9,0 7,0 +B  |                          |
|  | 1.4<br>1.6<br>1.7 SDI<br>1.8<br>1.9 SDI<br>1.9 TDI<br>1.9 TDI | 66<br>81       |             | 03.97<br>05.97<br>08.97<br>05.97<br>03.97<br>01.97<br>06.98 | 09.01<br>09.01<br>09.01<br>09.01<br>09.01<br>09.01<br>09.01   |  | 24.0741-1108.3   | 360093   | 2 | Radsensor L=843   |                          |















<sup>1)</sup> without sensor ring / senza sensori / sans secours ABS / sin anillo sensor ABS  
<sup>2)</sup> + WC cast iron / + CR ghisa / + CR fonte grise / + CR fundición de gris  
<sup>3)</sup> + WC aluminium / + CR alluminio / + CR aluminium / + CR aluminio



|     |   |       |                                   |   |  |  |  |  |  |
|--|---|---|---|---|---|--|--|--|--|
| <b>VOLKSWAGEN POLO Variant (97-01)</b>   |   |   |   |   |   |  |  |  |  |
|    | 1.4<br>1.6<br>1.7 SDI<br>1.8<br>1.9 SDI<br>1.9 TDI  | 66  | 03.97<br>05.97<br>08.97<br>05.97<br>03.97<br>01.97  | 09.01<br>09.01<br>09.01<br>09.01<br>09.01<br>09.01  |   | 03.0137-0268.2<br>03.0137-9168.2   | 650268<br>669168   | 200 x 40 HEB<br>Bremsbacken-Zubehör  | VW<br>VW   |
|    | 1.4<br>1.6<br>1.7 SDI<br>1.8<br>1.9 SDI<br>1.9 TDI  | 66  | 03.97<br>05.97<br>08.97<br>05.97<br>03.97<br>01.97  | 09.99<br>09.99<br>09.99<br>09.99<br>09.99<br>09.99  |   | 24.0220-0018.1<br>24.0220-0718.2   | 480019<br>480209   | ohne Sensorring <sup>1)</sup><br>ohne Sensorring <sup>1)</sup>                     | 200/201 x 50,0 - Lager<br>200/201,5 x 50,0 + Lager |
|  | 1.4<br>1.6<br>1.7 SDI<br>1.8<br>1.9 SDI<br>1.9 TDI  | 66  | 10.99<br>10.99<br>10.99<br>10.99<br>10.99<br>10.99  | 09.01<br>09.01<br>09.01<br>09.01<br>09.01<br>09.01  |   | 24.0220-0032.1   | 480130   |  | 200/201,5 x 50,1                                   |
|    | 1.4<br>1.6<br>1.7 SDI<br>1.8<br>1.9 SDI<br>1.9 TDI  | 66  | 03.97<br>05.97<br>08.97<br>05.97<br>03.97<br>01.97  | 09.01<br>09.01<br>09.01<br>09.01<br>09.01<br>09.01  |   | 03.0420-4219.3<br>03.0520-4219.3   | 684219<br>694219   | 19,05/200x40 Kit<br>19,05/200x40 TopKit  | VW<br>VW   |
| <b>VOLKSWAGEN SCIROCCO (08-)</b>   |   |   |   |   |   |  |  |  |  |
|    | 1.4 TSI<br>1.4 TSI<br>1.4 TSI<br>2.0 R<br>2.0 R<br>2.0 TDI<br>2.0 TDI<br>2.0 TDI<br>2.0 TDI<br>2.0 TSI<br>2.0 TSI<br>2.0 TSI<br>2.0 TSI | 90<br>92<br>118<br>195<br>206<br>103<br>110<br>125<br>130<br>132<br>147<br>155<br>162 | 09.08<br>11.13<br>08.08<br>11.09<br>08.14<br>10.08<br>11.13<br>05.09<br>01.13<br>11.13<br>08.08<br>11.09<br>11.13 | PR: 1LJ,1ZA,1ZB,1ZD,1ZE,1ZP<br>PR: 1LJ,1ZA,1ZB,1ZD,1ZE,1ZP<br>PR: 1LJ,1ZA,1ZB,1ZD,1ZE,1ZP<br>PR: 1LJ,1ZA,1ZB,1ZD,1ZE,1ZP<br>PR: 1LJ,1ZA,1ZB,1ZD,1ZE,1ZP<br>PR: 1LJ,1ZA,1ZB,1ZD,1ZE,1ZP<br>PR: 1LJ,1ZA,1ZB,1ZD,1ZE,1ZP<br>PR: 1LJ,1ZA,1ZB,1ZD,1ZE,1ZP<br>PR: 1LJ,1ZA,1ZB,1ZD,1ZE,1ZP<br>PR: 1LJ,1ZA,1ZB,1ZD,1ZE,1ZP<br>PR: 1LJ,1ZA,1ZB,1ZD,1ZE,1ZP<br>PR: 1LJ,1ZA,1ZB,1ZD,1ZE,1ZP<br>PR: 1LJ,1ZA,1ZB,1ZD,1ZE,1ZP |   | 13.0460-7184.2<br>13.0470-7184.2   | 607184<br>LD7184   | 23587 20,6 +WK<br>23587 20,6 +WK   | ATE<br>ATE   |
|  | 1.4 TSI<br>1.4 TSI<br>1.4 TSI<br>2.0 R<br>2.0 R<br>2.0 TDI<br>2.0 TDI<br>2.0 TDI<br>2.0 TDI<br>2.0 TSI<br>2.0 TSI<br>2.0 TSI<br>2.0 TSI | 90<br>92<br>118<br>195<br>206<br>103<br>110<br>125<br>130<br>132<br>147<br>155<br>162 | 09.08<br>11.13<br>08.08<br>11.09<br>08.14<br>10.08<br>11.13<br>05.09<br>01.13<br>11.13<br>08.08<br>11.09<br>11.13 | PR: 1ZK<br>PR: 1ZK<br>PR: 1ZK<br>PR: 1ZK<br>PR: 1ZK<br>PR: 1ZK<br>PR: 1ZK<br>PR: 1ZK<br>PR: 1ZK<br>PR: 1ZK<br>PR: 1ZK<br>PR: 1ZK<br>PR: 1ZK   |   | 13.0460-7227.2<br>13.0470-7227.2   | 607227<br>LD7227   | 23801 20,3 +WK<br>23801 20,4 +WK   | ATE<br>ATE   |
|  | 1.4 TSI<br>1.4 TSI<br>1.4 TSI<br>2.0 R<br>2.0 R<br>2.0 TDI<br>2.0 TDI<br>2.0 TDI<br>2.0 TDI<br>2.0 TSI<br>2.0 TSI<br>2.0 TSI<br>2.0 TSI | 90<br>92<br>118<br>195<br>206<br>103<br>110<br>125<br>130<br>132<br>147<br>155<br>162 | 09.08<br>11.13<br>08.08<br>11.09<br>08.14<br>10.08<br>11.13<br>05.09<br>01.13<br>11.13<br>08.08<br>11.09<br>11.13 | PR: 1ZE,1ZP<br>PR: 1ZE,1ZP<br>PR: 1ZE,1ZP<br>PR: 1ZE,1ZP<br>PR: 1ZE,1ZP<br>PR: 1ZE,1ZP<br>PR: 1ZE,1ZP<br>PR: 1ZE,1ZP<br>PR: 1ZE,1ZP<br>PR: 1ZE,1ZP<br>PR: 1ZE,1ZP<br>PR: 1ZE,1ZP<br>PR: 1ZE,1ZP   |   | 24.0125-0145.1<br>24.0325-0145.1   | 425145<br>525145   | 288 25,0 22,0 V L +S +B<br>288 25,0 22,0 V L +S +B PD                              |  |
|  | 1.4 TSI<br>1.4 TSI<br>1.4 TSI<br>2.0 R<br>2.0 R<br>2.0 TDI<br>2.0 TDI<br>2.0 TDI<br>2.0 TDI<br>2.0 TSI<br>2.0 TSI<br>2.0 TSI<br>2.0 TSI | 90<br>92<br>118<br>195<br>206<br>103<br>110<br>125<br>130<br>132<br>147<br>155<br>162 | 09.08<br>11.13<br>08.08<br>11.09<br>08.14<br>10.08<br>11.13<br>05.09<br>01.13<br>11.13<br>08.08<br>11.09<br>11.13 | PR: 1LJ,1ZA,1ZB,1ZD<br>PR: 1LJ,1ZA,1ZB,1ZD<br>PR: 1LJ,1ZA,1ZB,1ZD<br>PR: 1LJ,1ZA,1ZB,1ZD<br>PR: 1LJ,1ZA,1ZB,1ZD<br>PR: 1LJ,1ZA,1ZB,1ZD<br>PR: 1LJ,1ZA,1ZB,1ZD<br>PR: 1LJ,1ZA,1ZB,1ZD<br>PR: 1LJ,1ZA,1ZB,1ZD<br>PR: 1LJ,1ZA,1ZB,1ZD<br>PR: 1LJ,1ZA,1ZB,1ZD<br>PR: 1LJ,1ZA,1ZB,1ZD<br>PR: 1LJ,1ZA,1ZB,1ZD   |   | 24.0125-0158.1<br>24.0325-0158.1   | 425158<br>525158   | 312 25,0 22,0 V L +S +B<br>312 25,0 22,0 V L +S +B PD                              |  |
|  | 1.4 TSI<br>1.4 TSI<br>1.4 TSI<br>2.0 R<br>2.0 R<br>2.0 TDI<br>2.0 TDI<br>2.0 TDI  | 90<br>92<br>118<br>195<br>206<br>103<br>110<br>125                                    | 09.08<br>11.13<br>08.08<br>11.09<br>08.14<br>10.08<br>11.13<br>05.09  | PR: 1ZK<br>PR: 1ZK<br>PR: 1ZK<br>PR: 1ZK<br>PR: 1ZK<br>PR: 1ZK<br>PR: 1ZK<br>PR: 1ZK  |   | 24.0130-0115.1<br>24.0330-0115.1   | 430115<br>530115   | 345 30,0 27,0 V L +B<br>345 30,0 27,0 V L +B PD                                    |  |

<sup>1)</sup> without sensor ring / senza sensori / sans secours ABS / sin anillo sensor ABS































|     |   |       |                                   |    |  |  |  |  |            |
|--|---|---|---|--|---|--|--|--|------------|
| <b>VOLKSWAGEN SCIROCCO (08-)</b>   |   |   |   |  |   |  |  |  |            |
|    | 2.0 TDI<br>2.0 TSI<br>2.0 TSI<br>2.0 TSI<br>2.0 TSI   | 130<br>132<br>147<br>155<br>162   | 01.13<br>11.13<br>08.08<br>11.09<br>11.13   | PR: 12K<br>PR: 12K<br>PR: 12K<br>PR: 12K<br>PR: 12K  | 24.0130-0115.1<br>24.0330-0115.1  | 430115<br>530115   |  | 345 30,0 27,0 VL +B<br>345 30,0 27,0 VL +B PD                                      |            |
|    | 1.4 TSI<br>1.4 TSI<br>1.4 TSI<br>2.0 R<br>2.0 R<br>2.0 TDI<br>2.0 TDI<br>2.0 TDI<br>2.0 TDI<br>2.0 TSI<br>2.0 TSI<br>2.0 TSI<br>2.0 TSI | 90<br>92<br>118<br>195<br>206<br>103<br>110<br>125<br>130<br>132<br>147<br>155<br>162 | 09.08<br>11.13<br>08.08<br>11.09<br>08.14<br>10.08<br>11.13<br>05.09<br>01.13<br>11.13<br>08.08<br>11.09<br>11.13 |  | 24.0711-5271.3<br>24.0711-5272.3  | 360301<br>360302   | <input type="checkbox"/><br><input type="checkbox"/>                               | Radsensor<br>Radsensor   |            |
|    | 1.4 TSI<br>1.4 TSI<br>1.4 TSI<br>2.0 R<br>2.0 R<br>2.0 TDI<br>2.0 TDI<br>2.0 TDI<br>2.0 TDI<br>2.0 TSI<br>2.0 TSI<br>2.0 TSI<br>2.0 TSI | 90<br>92<br>118<br>195<br>206<br>103<br>110<br>125<br>130<br>132<br>147<br>155<br>162 | 09.08<br>11.13<br>08.08<br>11.09<br>08.14<br>10.08<br>11.13<br>05.09<br>01.13<br>11.13<br>08.08<br>11.09<br>11.13 | PR: 1KD<br>PR: 1KD<br>PR: 1KD<br>PR: 1KD<br>PR: 1KD<br>PR: 1KD<br>PR: 1KD<br>PR: 1KD<br>PR: 1KD<br>PR: 1KD<br>PR: 1KD<br>PR: 1KD   | 13.0460-2820.2<br>13.0470-2820.2<br>13.0460-0259.2                                | 602820<br>LD2820<br>610259   |  | 20961 17,6 /S<br>20961 17,6 /S<br>Belagsatz-Zubehör                                | TRW<br>TRW |
|  | 1.4 TSI<br>1.4 TSI<br>1.4 TSI<br>2.0 R<br>2.0 R<br>2.0 TDI<br>2.0 TDI<br>2.0 TDI<br>2.0 TDI<br>2.0 TSI<br>2.0 TSI<br>2.0 TSI<br>2.0 TSI | 90<br>92<br>118<br>195<br>206<br>103<br>110<br>125<br>130<br>132<br>147<br>155<br>162 | 09.08<br>11.13<br>08.08<br>11.09<br>08.14<br>10.08<br>11.13<br>05.09<br>01.13<br>11.13<br>08.08<br>11.09<br>11.13 | PR: 1KE,1KW<br>PR: 1KE,1KW<br>PR: 1KE,1KW<br>PR: 1KE,1KW<br>PR: 1KE,1KW<br>PR: 1KE,1KW<br>PR: 1KE,1KW<br>PR: 1KE,1KW<br>PR: 1KE,1KW<br>PR: 1KE,1KW<br>PR: 1KE,1KW<br>PR: 1KE,1KW | 13.0460-2880.2<br>13.0470-2880.2<br>13.0460-0259.2                                | 602880<br>LD2880<br>610259   |  | 23914 17,1 /WE/Zub/S<br>23914 17,1 /WE/Zub/S<br>Belagsatz-Zubehör                  | TRW<br>TRW |
|  | 1.4 TSI<br>1.4 TSI<br>1.4 TSI<br>2.0 R<br>2.0 R<br>2.0 TDI<br>2.0 TDI<br>2.0 TDI<br>2.0 TDI<br>2.0 TSI<br>2.0 TSI<br>2.0 TSI<br>2.0 TSI | 90<br>92<br>118<br>195<br>206<br>103<br>110<br>125<br>130<br>132<br>147<br>155<br>162 | 09.08<br>11.13<br>08.08<br>11.09<br>08.14<br>10.08<br>11.13<br>05.09<br>01.13<br>11.13<br>08.08<br>11.09<br>11.13 | PR: 1KS<br>PR: 1KS<br>PR: 1KS<br>PR: 1KS<br>PR: 1KS<br>PR: 1KS<br>PR: 1KS<br>PR: 1KS<br>PR: 1KS<br>PR: 1KS<br>PR: 1KS<br>PR: 1KS   | 13.0460-3858.2<br>13.0470-3858.2  | 603858<br>LD3858   |  | 24563 17,7 /Zub/S<br>24563 17,7 /Zub/S   | BOS<br>BOS |
|  | 1.4 TSI<br>1.4 TSI<br>1.4 TSI<br>2.0 R<br>2.0 R<br>2.0 TDI<br>2.0 TDI<br>2.0 TDI<br>2.0 TDI<br>2.0 TSI<br>2.0 TSI<br>2.0 TSI<br>2.0 TSI | 90<br>92<br>118<br>195<br>206<br>103<br>110<br>125<br>130<br>132<br>147<br>155<br>162 | 09.08<br>11.13<br>08.08<br>11.09<br>08.14<br>10.08<br>11.13<br>05.09<br>01.13<br>11.13<br>08.08<br>11.09<br>11.13 | PR: 1KT<br>PR: 1KT<br>PR: 1KT<br>PR: 1KT<br>PR: 1KT<br>PR: 1KT<br>PR: 1KT<br>PR: 1KT<br>PR: 1KT<br>PR: 1KT<br>PR: 1KT<br>PR: 1KT   | 13.0460-3858.2<br>13.0470-3858.2  | 603858<br>LD3858   |  | 24563 17,7 /Zub/S<br>24563 17,7 /Zub/S   | BOS<br>BOS |
|  | 1.4 TSI<br>1.4 TSI<br>1.4 TSI<br>2.0 R<br>2.0 R<br>2.0 TDI<br>2.0 TDI<br>2.0 TDI<br>2.0 TDI<br>2.0 TSI<br>2.0 TSI<br>2.0 TSI<br>2.0 TSI | 90<br>92<br>118<br>195<br>206<br>103<br>110<br>125<br>130<br>132<br>147<br>155<br>162 | 09.08<br>11.13<br>08.08<br>11.09<br>08.14<br>10.08<br>11.13<br>05.09<br>01.13<br>11.13<br>08.08<br>11.09<br>11.13 | PR: 1KD<br>PR: 1KD<br>PR: 1KD<br>PR: 1KD<br>PR: 1KD<br>PR: 1KD<br>PR: 1KD<br>PR: 1KD<br>PR: 1KD<br>PR: 1KD<br>PR: 1KD<br>PR: 1KD   | 24.0110-0277.1<br>24.0310-0277.1  | 410277<br>510277   |  | 253 10,0 8,0 +S +B<br>253 10,0 8,0 +S +B PD  |            |
|  | 1.4 TSI<br>1.4 TSI<br>1.4 TSI   | 90<br>92<br>118   | 09.08<br>11.13<br>08.08   | PR: 1KE<br>PR: 1KE<br>PR: 1KE  | 24.0112-0158.1<br>24.0312-0158.1  | 412158<br>512158   |  | 256 12,0 10,0 +S +B<br>256 12,0 10,0 +S +B PD                                      |            |

### VOLKSWAGEN SCIROCCO (08-)

|  |         |     |  |       |             |                |        |  |                      |
|--|---------|-----|--|-------|-------------|----------------|--------|--|----------------------|
|  | 2.0 R   | 195 |  | 11.09 | PR: 1KE     | 24.0112-0158.1 | 412158 |  | 256 12,0 10,0 +S +B  |
|  | 2.0 R   | 206 |  | 08.14 | PR: 1KE     | 24.0312-0158.1 | 512158 |  | 256 12,0 10,0 +B PD  |
|  | 2.0 TDI | 103 |  | 10.08 | PR: 1KE     |                |        |  |                      |
|  | 2.0 TDI | 110 |  | 11.13 | PR: 1KE     |                |        |  |                      |
|  | 2.0 TDI | 125 |  | 05.09 | PR: 1KE     |                |        |  |                      |
|  | 2.0 TDI | 130 |  | 01.13 | PR: 1KE     |                |        |  |                      |
|  | 2.0 TSI | 132 |  | 11.13 | PR: 1KE     |                |        |  |                      |
|  | 2.0 TSI | 147 |  | 08.08 | PR: 1KE     |                |        |  |                      |
|  | 2.0 TSI | 155 |  | 11.13 | PR: 1KE     |                |        |  |                      |
|  | 2.0 TSI | 155 |  | 11.09 | PR: 1KE     |                |        |  |                      |
|  | 1.4 TSI | 90  |  | 09.08 | PR: 1KS,1KT | 24.0110-0356.1 | 410356 |  | 272 9,7 8,0 +S +B    |
|  | 1.4 TSI | 92  |  | 11.13 | PR: 1KS,1KT | 24.0310-0356.1 | 510356 |  | 272 9,7 8,0 +S +B PD |
|  | 1.4 TSI | 118 |  | 08.08 | PR: 1KS,1KT |                |        |  |                      |
|  | 2.0 R   | 195 |  | 11.09 | PR: 1KS,1KT |                |        |  |                      |
|  | 2.0 R   | 206 |  | 08.14 | PR: 1KS,1KT |                |        |  |                      |
|  | 2.0 TDI | 103 |  | 10.08 | PR: 1KS,1KT |                |        |  |                      |
|  | 2.0 TDI | 110 |  | 11.13 | PR: 1KS,1KT |                |        |  |                      |
|  | 2.0 TDI | 125 |  | 05.09 | PR: 1KS,1KT |                |        |  |                      |
|  | 2.0 TDI | 130 |  | 01.13 | PR: 1KS,1KT |                |        |  |                      |
|  | 2.0 TSI | 132 |  | 11.13 | PR: 1KS,1KT |                |        |  |                      |
|  | 2.0 TSI | 147 |  | 08.08 | PR: 1KS,1KT |                |        |  |                      |
|  | 2.0 TSI | 155 |  | 11.09 | PR: 1KS,1KT |                |        |  |                      |
|  | 2.0 TSI | 162 |  | 11.13 | PR: 1KS,1KT |                |        |  |                      |
|  | 1.4 TSI | 90  |  | 09.08 | PR: 1KW     | 24.0122-0219.1 | 422219 |  | 310 22,0 20,0 V L +B |
|  | 1.4 TSI | 92  |  | 11.13 | PR: 1KW     |                |        |  |                      |
|  | 1.4 TSI | 118 |  | 08.08 | PR: 1KW     |                |        |  |                      |
|  | 2.0 R   | 195 |  | 11.09 | PR: 1KW     |                |        |  |                      |
|  | 2.0 R   | 206 |  | 08.14 | PR: 1KW     |                |        |  |                      |
|  | 2.0 TDI | 103 |  | 10.08 | PR: 1KW     |                |        |  |                      |
|  | 2.0 TDI | 110 |  | 11.13 | PR: 1KW     |                |        |  |                      |
|  | 2.0 TDI | 125 |  | 05.09 | PR: 1KW     |                |        |  |                      |
|  | 2.0 TDI | 130 |  | 01.13 | PR: 1KW     |                |        |  |                      |
|  | 2.0 TSI | 132 |  | 11.13 | PR: 1KW     |                |        |  |                      |
|  | 2.0 TSI | 147 |  | 08.08 | PR: 1KW     |                |        |  |                      |
|  | 2.0 TSI | 155 |  | 11.09 | PR: 1KW     |                |        |  |                      |
|  | 2.0 TSI | 162 |  | 11.13 | PR: 1KW     |                |        |  |                      |
|  | 1.4 TSI | 90  |  | 09.08 |             | 24.0711-6231.3 | 360305 |  | Radsensor            |
|  | 1.4 TSI | 92  |  | 11.13 |             | 24.0711-6232.3 | 360306 |  | Radsensor            |
|  | 1.4 TSI | 118 |  | 08.08 |             |                |        |  |                      |
|  | 2.0 R   | 195 |  | 11.09 |             |                |        |  |                      |



















### VOLKSWAGEN SHARAN I (95-10)

|     |                    |             |             |             |       |                |                |        |                            |                 |     |
|-----|--------------------|-------------|-------------|-------------|-------|----------------|----------------|--------|----------------------------|-----------------|-----|
|     | 1.8 T              | 110         | 7M-W-070000 | 09.97       |       | 13.0460-7076.2 | 607076         |        | 21848 19,8 +               | ATE             |     |
|     | 1.9 TDI            | 66          | 7M-W-070000 | 09.95       |       | 13.0460-7143.2 | 607143         |        | 21849 19,8 +/WK            | ATE             |     |
|     | 1.9 TDI            | 81          | 7M-W-070000 | 09.96       |       |                |                |        |                            |                 |     |
|     | 2.0                |             | 7M-W-070000 | 09.95       |       |                |                |        |                            |                 |     |
|     | 2.8 VR6            | 128         | 7M-W-070000 | 09.95       |       |                |                |        |                            |                 |     |
|     | 2.8 VR6 Syncro     | 128         | 7M-W-070000 | 11.96       |       |                |                |        |                            |                 |     |
|     | 1.8 T              | 110         | 7M-X-000001 | 7M-1-070000 |       |                | 13.0460-7143.2 | 607143 |                            | 21849 19,8 +/WK | ATE |
|     | 1.9 TDI            | 66          | 7M-X-000001 | 7M-1-070000 |       |                |                |        |                            |                 |     |
|     | 1.9 TDI            | 81          | 7M-X-000001 | 7M-1-070000 |       |                |                |        |                            |                 |     |
|     | 1.9 TDI            | 85          | 7M-X-000001 | 7M-1-070000 | 05.00 |                |                |        |                            |                 |     |
|     | 2.0                |             | 7M-X-000001 | 7M-1-070000 |       |                |                |        |                            |                 |     |
|     | 2.0 TDI            |             | 7M-X-000001 | 7M-1-070000 | 11.05 |                |                |        |                            |                 |     |
|     | 2.8 VR6            | 128         | 7M-X-000001 | 7M-Y-050000 |       |                |                |        |                            |                 |     |
|     | 2.8 VR6 Syncro     | 128         | 7M-X-000001 | 7M-Y-050000 |       |                |                |        |                            |                 |     |
|     | 1.9 TDI            | 66          | 7M-2-000001 |             | 06.10 |                | 13.0460-7154.2 | 607154 |                            | 23418 19,4 +/WK | ATE |
|     | 1.9 TDI            | 85          | 7M-2-000001 |             | 06.10 |                |                |        |                            |                 |     |
|     | 1.9 TDI            | 96          |             |             | 11.02 |                |                |        |                            |                 |     |
|     | 2.0                |             | 7M-2-000001 |             | 06.10 |                |                |        |                            |                 |     |
|     | 2.0 TDI            |             | 7M-2-000001 |             | 06.10 |                |                |        |                            |                 |     |
|     | 1.8 T              | 110         | 7M-2-000001 |             | 06.10 |                | 13.0460-7153.2 | 607153 |                            | 23269 19,8 +/WK | ATE |
|     | 1.9 TDI            | 110         |             | 06.05       |       |                |                |        |                            |                 |     |
|     | 1.9 TDI 4motion    | 85          |             | 05.00       |       |                |                |        |                            |                 |     |
|     | 2.8 V6 24V         | 150         |             | 04.00       |       |                |                |        |                            |                 |     |
|     | 2.8 V6 24V 4motion | 150         |             | 04.00       |       |                |                |        |                            |                 |     |
|     | 2.8 VR6            | 128         | 7M-1-000001 |             | 06.10 |                |                |        |                            |                 |     |
|     | 2.8 VR6 Syncro     | 128         | 7M-1-000001 |             | 06.10 |                |                |        |                            |                 |     |
|     | 1.8 T              | 110         | 7M-1-070000 | 09.97       |       | 24.0125-0114.1 | 425114         |        | 288 25,1 21,0 V L +S +B    |                 |     |
|     | 1.9 TDI            | 66          | 7M-1-070000 | 09.95       |       | 24.0325-0114.1 | 525114         |        | 288 25,1 21,0 V L +S +B PD |                 |     |
|     | 1.9 TDI            | 81          |             | 09.96       | 04.00 |                |                |        |                            |                 |     |
|     | 1.9 TDI            | 85          | 7M-1-070000 | 05.00       |       |                |                |        |                            |                 |     |
| 2.0 |                    | 7M-1-070000 | 09.95       |             |       |                |                |        |                            |                 |     |
|     | 2.8 VR6            | 128         |             | 09.95       | 04.00 |                |                |        |                            |                 |     |
|     | 2.8 VR6 Syncro     | 128         |             | 11.96       | 04.00 |                |                |        |                            |                 |     |
|     | 1.9 TDI            | 66          | 7M-2-000001 |             | 06.10 | 24.0126-0115.1 | 426115         |        | 300 26,0 22,0 V L +B       |                 |     |
|     | 1.9 TDI            | 85          | 7M-2-000001 |             | 06.10 | 24.0326-0115.1 | 526115         |        | 300 26,0 22,0 V L +B PD    |                 |     |

|     |  |  |  |  |  |  |                                   |                                   |                          |
|--|--|--|--|--|---|--|---|---|--------------------------|
| <b>VOLKSWAGEN SHARAN I (95-10)</b>   |  |  |  |  |   |  |   |   |                          |
|    | 1.9 TDI  | 96   |  | 11.02  | 06.10   | 24.0126-0115.1   | 426115  |   | 300 26,0 22,0 V L +B     |
|  | 2.0  |  | 7M-2-000001  |  | 06.10   | 24.0326-0115.1   | 526115  |   | 300 26,0 22,0 V L +B PD  |
|  | 2.0 TDI  |  |  | 11.05  | 06.10   |  |   |   |                          |
|  | 1.8 T  | 110  | 7M-2-000001  |  | 06.10   | 24.0126-0119.1   | 426119  |   | 313 25,9 22,0 V L +B     |
|  | 1.9 TDI  | 110  |  | 06.05  | 06.10   | 24.0326-0119.1   | 526119  |   | 313 25,9 22,0 V L +B PD  |
|  | 1.9 TDI 4motion  | 85   |  | 05.00  | 06.10   |  |   |   |                          |
| 2.8 V6 24V   | 150  |  | 04.00  | 06.10  |   |  |   |   |                          |
| 2.8 V6 24V 4motion   | 150  |  | 04.00  | 06.10  |   |  |   |   |                          |
|    | 1.8 T  | 110  |  | 09.97  | 04.00   | 24.0731-1183.3   | 360194  | 2                                | Radsensor L=460          |
|  | 1.9 TDI  | 66   |  | 09.95  | 04.00   | 24.0713-1101.3   | 360143  | 2                                | Radsensor L=464          |
|  | 1.9 TDI  | 81   |  | 09.96  | 04.00   |  |   |   |                          |
|  | 2.0  |  |  | 09.95  | 04.00   |  |   |   |                          |
|  | 2.8 VR6  | 128  |  | 09.95  | 04.00   |  |   |   |                          |
|  | 2.8 VR6 Syncro   | 128  |  | 11.96  | 04.00   |  |   |   |                          |
|  | 1.8 T  | 110  |  | 05.00  | 04.02   | 24.0713-1128.3   | 360200  |  + Leitung f. Warnkontakt 1)     | Radsensor L=474          |
|  | 1.9 TDI  | 66   |  | 05.00  | 04.02   | 24.0713-1127.3   | 360204  |                                  | Radsensor L=474          |
|  | 1.9 TDI  | 85   |  | 05.00  | 04.02   |  |   |   |                          |
|  | 1.9 TDI 4motion  | 85   |  | 05.00  | 04.02   |  |   |   |                          |
|  | 2.0  |  |  | 05.00  | 04.02   |  |   |   |                          |
|  | 1.8 T  | 110  | 7M-3-030000  | 05.02  |   | 24.0713-1128.3   | 360200  | 2  + Leitung f. Warnkontakt 1)   | Radsensor L=474          |
| 1.9 TDI  | 66   | 7M-3-030000  | 05.02  |  | 24.0713-1127.3  | 360204   | 2  - Leitung f. Warnkontakt 2)   | Radsensor L=474   |                          |
| 1.9 TDI  | 85   | 7M-3-030000  | 05.02  |  |   |  |   |   |                          |
| 1.9 TDI 4motion  | 85   | 7M-3-030000  | 05.02  |  |   |  |   |   |                          |
| 2.0  |  | 7M-3-030000  | 05.02  |  |   |  |   |   |                          |
| 2.8 V6 24V   | 150  | 7M-3-030000  | 04.00  |  | 24.0713-1128.3  | 360200   | 2  + Leitung f. Warnkontakt 1)   | Radsensor L=474   |                          |
| 2.8 V6 24V 4motion   | 150  | 7M-3-030000  | 04.00  |  |   |  |   |   |                          |
| 1.8 T  | 110  | 7M-3-030001  |  | 06.10  | 24.0711-6114.3  | 360281   | 2  - Leitung f. Warnkontakt 2)   | Radsensor L=479   |                          |
| 1.9 TDI  | 66   | 7M-3-030001  |  | 06.10  | 24.0711-6115.3  | 360282   | 2  + Leitung f. Warnkontakt 1)   | Radsensor L=479   |                          |
| 1.9 TDI  | 85   | 7M-3-030001  |  | 06.10  |   |  |   |   |                          |
| 1.9 TDI  | 96   |  | 11.02  | 06.10  |   |  |   |   |                          |
| 1.9 TDI  | 110  |  | 06.05  | 06.10  |   |  |   |   |                          |
| 1.9 TDI 4motion  | 85   | 7M-3-030001  |  | 06.10  |   |  |   |   |                          |
| 2.0  |  | 7M-3-030001  |  | 06.10  |   |  |   |   |                          |
| 2.0 TDI  |  |  | 11.05  | 06.10  |   |  |   |   |                          |
| 2.8 V6 24V   | 150  | 7M-3-030001  |  | 06.10  |   |  |   |   |                          |
| 2.8 V6 24V 4motion   | 150  | 7M-3-030001  |  | 06.10  |   |  |   |   |                          |
|   | 1.8 T  | 110  |  | 09.97  | 04.00   | 13.0460-2819.2   | 602819  |   | 20961 17,6 /S TRW        |
|  | 1.9 TDI  | 66   |  | 09.95  | 04.00   | 13.0460-0072.2   | 610072  |   | Belagsatz-Zubehör TRW    |
|  | 1.9 TDI  | 81   |  | 09.96  | 04.00   |  |   |   |                          |
|  | 2.0  |  |  | 09.95  | 04.00   |  |   |   |                          |
|  | 2.8 VR6  | 128  |  | 09.95  | 04.00   |  |   |   |                          |
|  | 2.8 VR6 Syncro   | 128  |  | 11.96  | 04.00   |  |   |   |                          |
|  | 1.8 T  | 110  | 7M-1-070000  | 05.00  |   | 13.0460-2859.2   | 602859  |   | 20961 17,2 +/WK/Zub/STRW |
|  | 1.9 TDI  | 66   |  | 05.00  | 06.10   |  |   |   |                          |
|  | 1.9 TDI  | 85   |  | 05.00  | 06.10   |  |   |   |                          |
|  | 1.9 TDI  | 96   |  | 11.02  | 06.10   |  |   |   |                          |
|  | 2.0  |  |  | 05.00  | 06.10   |  |   |   |                          |
|  | 2.0 TDI  |  |  | 11.05  | 06.10   |  |   |   |                          |
| 1.8 T  | 110  | 7M-2-000001  |  | 06.10  | 13.0460-2872.2  | 602872   |   | 23446 16,5 +/WK/Zub/STRW  |                          |
| 1.9 TDI  | 110  |  | 06.05  | 06.10  | 13.0460-0225.2  | 610225   |   | Belagsatz-Zubehör   |                          |
| 1.9 TDI 4motion  | 85   |  | 05.00  | 06.10  |   |  |   |   |                          |
| 2.8 V6 24V   | 150  |  | 04.00  | 06.10  |   |  |   |   |                          |
| 2.8 V6 24V 4motion   | 150  |  | 04.00  | 06.10  |   |  |   |   |                          |
|  | 1.8 T  | 110  | 7M-1-070000  | 09.97  |   | 24.0110-0223.1   | 410223  |   | 268 10,0 8,0 +S +B       |
|  | 1.9 TDI  | 66   |  | 09.95  | 06.10   | 24.0310-0223.1   | 510223  |   | 268 10,0 8,0 +S +B PD    |
|  | 1.9 TDI  | 81   |  | 09.96  | 04.00   |  |   |   |                          |
|  | 1.9 TDI  | 85   |  | 05.00  | 06.10   |  |   |   |                          |
|  | 1.9 TDI  | 96   |  | 11.02  | 06.10   |  |   |   |                          |
|  | 2.0  |  |  | 09.95  | 06.10   |  |   |   |                          |
|  | 2.0 TDI  |  |  | 11.05  | 06.10   |  |   |   |                          |
|  | 2.8 VR6  | 128  |  | 09.95  | 04.00   |  |   |   |                          |
|  | 2.8 VR6 Syncro   | 128  |  | 11.96  | 04.00   |  |   |   |                          |
|  | 1.8 T  | 110  | 7M-2-000001  |  | 06.10   | 24.0113-0194.1   | 413194  |   | 294 13,5 11,5 +B         |
|  | 1.9 TDI  | 110  |  | 06.05  | 06.10   |  |   |   |                          |
|  | 1.9 TDI 4motion  | 85   |  | 05.00  | 06.10   |  |   |   |                          |
| 2.8 V6 24V   | 150  |  | 04.00  | 06.10  |   |  |   |   |                          |
| 2.8 V6 24V 4motion   | 150  |  | 04.00  | 06.10  |   |  |   |   |                          |
|  | 1.8 T  | 110  |  | 09.97  | 04.00   | 24.0713-1102.3   | 360144  | 2                              | Radsensor L=1026         |
|  | 1.9 TDI  | 66   |  | 09.95  | 04.00   |  |   |   |                          |
|  | 1.9 TDI  | 81   |  | 09.96  | 04.00   |  |   |   |                          |
|  | 2.0  |  |  | 09.95  | 04.00   |  |   |   |                          |
|  | 2.8 VR6  | 128  |  | 09.95  | 04.00   |  |   |   |                          |
|  | 2.8 VR6 Syncro   | 128  |  | 11.96  | 04.00   |  |   |   |                          |
|  | 1.8 T  | 110  | 7M-2-000001  | 05.00  |   | 24.0713-1124.3   | 360201  |  + Leitung f. Warnkontakt 1)   | Radsensor L=1026         |
|  | 1.9 TDI  | 66   | 7M-3-030000  | 05.00  |   | 24.0713-1125.3   | 360202  |                                | Radsensor L=1026         |
|  | 1.9 TDI  | 85   | 7M-3-030000  | 05.00  |   |  |   |   |                          |
|  | 1.9 TDI  | 96   | 7M-3-030000  | 11.02  |   |  |   |   |                          |
|  | 2.0  |  | 7M-3-030000  | 05.00  |   |  |   |   |                          |
|  | 1.8 T  | 110  | 7M-2-000001  | 7M-3-030000  |   | 24.0713-1126.3   | 360203  | 2  + Leitung f. Warnkontakt 1) | Radsensor L=1026         |
| 1.9 TDI 4motion  | 85   | 7M-3-030000  | 05.00  |  |   |  |   |   |                          |
| 2.8 V6 24V   | 150  | 7M-3-030000  | 04.00  |  |   |  |   |   |                          |
| 2.8 V6 24V 4motion   | 150  | 7M-3-030000  | 04.00  |  |   |  |   |   |                          |
| 1.8 T  | 110  | 7M-3-030001  |  | 06.10  | 24.0711-6111.3  | 360243   | 2  - Leitung f. Warnkontakt 2) | Radsensor L=1031  |                          |
| 1.9 TDI  | 66   | 7M-3-030001  |  | 06.10  | 24.0711-6113.3  | 360228   | 2  + Leitung f. Warnkontakt 1) | Radsensor L=1031  |                          |
| 1.9 TDI  | 85   | 7M-3-030001  |  | 06.10  |   |  |   |   |                          |

1) + cable f.br.ppad wear indicat. / + cavo p.indic.usura guarn.fr. / + câble.l'ind.d'usur.garnit.fr. / + cabl.p.indica.desg.guarn.fr.

2) - cable f.br.ppad wear indicat. / - cavo p.indic.usura guarn.fr. / - câble.l'ind.d'usur.garnit.fr. / - cabl.p.indica.desg.guarn.fr.

|     |    |                             |    |                       |  |  |    |  |            |
|--|--|---|--|---|---|--|--|--|------------|
| <b>VOLKSWAGEN SHARAN I (95-10)</b>   |  |   |  |   |   |  |  |  |            |
|    | 1.9 TDI<br>1.9 TDI<br>1.9 TDI 4motion<br>2.0<br>2.0 TDI<br>2.8 V6 24V<br>2.8 V6 24V 4motion  | 96<br>110<br>85 7M-3-030001<br>7M-3-030001<br>150 7M-3-030001<br>150 7M-3-030001                            | 11.02<br>06.10<br>06.10<br>06.10<br>11.05<br>06.10<br>06.10<br>06.10   |   | 24.0711-6111.3<br>24.0711-6113.3  | 360243<br>360228   | 2  - Leitung f. Warnkontakt 1)<br>2  + Leitung f. Warnkontakt 2) | Radsensor L=1031<br>Radsensor L=1031   |            |
| <b>VOLKSWAGEN SHARAN II (10-)</b>  |  |   |  |   |   |  |  |  |            |
|    | 1.4 TSI<br>1.4 TSI<br>1.8 TSI<br>2.0 TDI<br>2.0 TDI<br>2.0 TDI<br>2.0 TDI<br>2.0 TDI<br>2.0 TDI<br>2.0 TDI<br>2.0 TDI 4motion<br>2.0 TDI 4motion<br>2.0 TDI 4motion<br>2.0 TDI 4motion<br>2.0 TSI<br>2.0 TSI | 110<br>110<br>118<br>85<br>100<br>103<br>110<br>125<br>130<br>135<br>100<br>103<br>110<br>135<br>147<br>162 | 07.10<br>04.15<br>05.12<br>04.15<br>07.10<br>04.15<br>04.15<br>07.10<br>01.13<br>04.15<br>05.11<br>04.15<br>04.15<br>05.16<br>10.10<br>04.15 | PR: 1LW<br>PR: 1LW<br>PR: 1LW<br>PR: 1LW<br>PR: 1LW<br>PR: 1LW<br>PR: 1LW<br>PR: 1LW                  | 13.0460-2764.2<br>13.0470-2764.2  | 602764<br>LD2764   |  | 24738 20,0 +/WK/S<br>24738 20,0 +/WK/S   | TRW<br>TRW |
|  | 1.4 TSI<br>1.8 TSI<br>2.0 TDI<br>2.0 TDI<br>2.0 TDI<br>2.0 TDI 4motion<br>2.0 TSI  | 110<br>118<br>100<br>125<br>130<br>100<br>147   | 07.10<br>05.12<br>07.10<br>07.10<br>01.13<br>05.11<br>10.10  | PR: 1LJ<br>PR: 1LJ<br>PR: 1LJ<br>PR: 1LJ<br>PR: 1LJ<br>PR: 1LJ  | 13.0460-7242.2<br>13.0470-7242.2  | 607242<br>LD7242   |  | 24332 19,8 +/WK<br>24332 19,8 +/WK   | ATE<br>ATE |
|  | 1.4 TSI<br>1.8 TSI<br>2.0 TDI<br>2.0 TDI<br>2.0 TDI<br>2.0 TDI 4motion<br>2.0 TSI  | 110<br>118<br>100<br>125<br>130<br>100<br>147   | 07.12<br>07.12<br>07.12<br>07.12<br>01.13<br>07.12<br>07.12  | PR: 1LX<br>PR: 1LX<br>PR: 1LX<br>PR: 1LX<br>PR: 1LX<br>PR: 1LX  | 13.0460-2764.2<br>13.0470-2764.2  | 602764<br>LD2764   |  | 24738 20,0 +/WK/S<br>24738 20,0 +/WK/S   | TRW<br>TRW |
|   | 1.4 TSI<br>1.8 TSI<br>2.0 TDI<br>2.0 TDI<br>2.0 TDI<br>2.0 TDI 4motion<br>2.0 TSI  | 110<br>118<br>100<br>125<br>130<br>100<br>147   | 07.10<br>05.12<br>07.10<br>07.10<br>01.13<br>05.11<br>10.10  | PR: 1LJ<br>PR: 1LJ<br>PR: 1LJ<br>PR: 1LJ<br>PR: 1LJ<br>PR: 1LJ  | 24.0125-0158.1<br>24.0325-0158.1  | 425158<br>525158   |  | 312 25,0 22,0 V L +S +B<br>312 25,0 22,0 V L +S +B PD                              |            |
|  | 1.4 TSI<br>1.4 TSI<br>1.8 TSI<br>2.0 TDI<br>2.0 TDI<br>2.0 TDI<br>2.0 TDI<br>2.0 TDI<br>2.0 TDI<br>2.0 TDI<br>2.0 TDI 4motion<br>2.0 TDI 4motion<br>2.0 TDI 4motion<br>2.0 TDI 4motion<br>2.0 TSI<br>2.0 TSI | 110<br>110<br>118<br>85<br>100<br>103<br>110<br>125<br>130<br>135<br>100<br>103<br>110<br>135<br>147<br>162 | 07.10<br>04.15<br>05.12<br>04.15<br>07.10<br>04.15<br>04.15<br>07.10<br>01.13<br>04.15<br>05.11<br>04.15<br>04.15<br>05.16<br>10.10<br>04.15 | PR: 1LW,1LX<br>PR: 1LW,1LX<br>PR: 1LW,1LX<br>PR: 1LW,1LX<br>PR: 1LW,1LX<br>PR: 1LW,1LX<br>PR: 1LW,1LX | 24.0130-0220.1  | 430220   |  | 314 30,0 27,0 V L +S +B  |            |
|  | 1.4 TSI<br>1.4 TSI<br>1.8 TSI<br>2.0 TDI<br>2.0 TDI<br>2.0 TDI<br>2.0 TDI<br>2.0 TDI<br>2.0 TDI<br>2.0 TDI<br>2.0 TDI 4motion<br>2.0 TDI 4motion<br>2.0 TDI 4motion<br>2.0 TDI 4motion<br>2.0 TSI<br>2.0 TSI | 110<br>110<br>118<br>85<br>100<br>103<br>110<br>125<br>130<br>135<br>100<br>103<br>110<br>135<br>147<br>162 | 07.10<br>04.15<br>05.12<br>04.15<br>07.10<br>04.15<br>04.15<br>07.10<br>01.13<br>04.15<br>05.11<br>04.15<br>04.15<br>05.16<br>10.10<br>04.15 |   | 24.0711-5271.3<br>24.0711-5272.3  | 360301<br>360302   | <br>   | Radsensor<br>Radsensor   |            |
|  | 1.4 TSI<br>1.8 TSI<br>2.0 TDI<br>2.0 TDI<br>2.0 TDI<br>2.0 TDI 4motion<br>2.0 TSI  | 110<br>118<br>100<br>125<br>130<br>100<br>147   | 07.10<br>05.12<br>07.10<br>01.13<br>05.11<br>10.10   |   | 13.0460-2880.2<br>13.0470-2880.2  | 602880<br>LD2880   | elektrische Feststellbremse 3)<br>elektrische Feststellbremse 3)   | 23914 17,1 /WE/Zub/S<br>23914 17,1 /WE/Zub/S                                       | TRW<br>TRW |

1) - cable f.br.ppad wear indicat. / - cavo p.indic.usura guarn.fr. / - câbl.l'ind.d'usur.garnit.fr. / - cabl.p.indica.desq.guarn.fr.  
2) + cable f.br.ppad wear indicat. / + cavo p.indic.usura guarn.fr. / + câbl.l'ind.d'usur.garnit.fr. / + cabl.p.indica.desq.guarn.fr.  
3) electric parking brake / fr.di stazionamento elettrico / frein à main électrique / freno de mano eléctrico



### VOLKSWAGEN SHARAN II (10-)

|                 |                 |         |       |                         |                     |                     |                          |                          |   |                        |           |
|-----------------|-----------------|---------|-------|-------------------------|---------------------|---------------------|--------------------------|--------------------------|---|------------------------|-----------|
|                 | 1.4 TSI         | 110     |       | 07.10                   |                     | 24.0112-0169.1      | 412169                   |                          | elektrische Feststellbremse <sup>1)</sup> | 282 12,0 10,0 +S +B    |           |
|                 | 1.8 TSI         | 118     |       | 05.12                   |                     | 24.0312-0169.1      | 512169                   |                          | elektrische Feststellbremse <sup>1)</sup> | 282 12,0 10,0 +S +B PD |           |
|                 | 2.0 TDI         | 100     |       | 07.10                   |                     |                     |                          |                          |   |                        |           |
|                 | 2.0 TDI         | 125     |       | 07.10                   |                     |                     |                          |                          |   |                        |           |
|                 | 2.0 TDI         | 130     |       | 01.13                   |                     |                     |                          |                          |   |                        |           |
|                 | 2.0 TDI 4motion | 100     |       | 05.11                   |                     |                     |                          |                          |   |                        |           |
|                 | 2.0 TSI         | 147     |       | 10.10                   |                     |                     |                          |                          |   |                        |           |
|                 | 1.4 TSI         | 110     |       | 04.15                   |                     | 24.0112-0210.1      | 412210                   |                          | elektrische Feststellbremse <sup>1)</sup> | 300 12,0 10,0 +S +B    |           |
|                 | 2.0 TDI         | 85      |       | 04.15                   |                     |                     |                          |                          |   |                        |           |
|                 | 2.0 TDI         | 103     |       | 04.15                   |                     |                     |                          |                          |   |                        |           |
|                 | 2.0 TDI         | 110     |       | 04.15                   |                     |                     |                          |                          |   |                        |           |
|                 | 2.0 TDI         | 135     |       | 04.15                   |                     |                     |                          |                          |   |                        |           |
|                 | 2.0 TDI 4motion | 103     |       | 04.15                   |                     |                     |                          |                          |   |                        |           |
|                 | 2.0 TDI 4motion | 110     |       | 04.15                   |                     |                     |                          |                          |   |                        |           |
|                 | 2.0 TDI 4motion | 135     |       | 05.16                   |                     |                     |                          |                          |   |                        |           |
|                 | 2.0 TSI         | 162     |       | 04.15                   |                     |                     |                          |                          |   |                        |           |
|                 |                 | 1.4 TSI | 110   |                         | 07.10               | PR: 7X0,7X2,7X8,7X9 | 24.0711-6231.3           | 360305                   | <input type="checkbox"/>                  |                        | Radsensor |
|                 |                 | 1.8 TSI | 118   |                         | 05.12               | PR: 7X0,7X2,7X8,7X9 | 24.0711-6232.3           | 360306                   | <input type="checkbox"/>                  |                        | Radsensor |
| 2.0 TDI         |                 | 100     |       | 07.10                   | PR: 7X0,7X2,7X8,7X9 |                     |                          |                          |   |                        |           |
| 2.0 TDI         |                 | 125     |       | 07.10                   | PR: 7X0,7X2,7X8,7X9 |                     |                          |                          |   |                        |           |
| 2.0 TDI         |                 | 130     |       | 01.13                   | PR: 7X0,7X2,7X8,7X9 |                     |                          |                          |   |                        |           |
| 2.0 TDI 4motion |                 | 100     |       | 05.11                   | PR: 7X0,7X2,7X8,7X9 |                     |                          |                          |   |                        |           |
| 2.0 TSI         |                 | 147     |       | 10.10                   | PR: 7X0,7X2,7X8,7X9 |                     |                          |                          |   |                        |           |
| 1.4 TSI         |                 | 110     |       | 07.10                   | PR: 7X5,7X6         | 24.0711-6335.3      | 360365                   | <input type="checkbox"/> |   | Radsensor              |           |
| 1.8 TSI         |                 | 118     |       | 05.12                   | PR: 7X5,7X6         | 24.0711-6336.3      | 360366                   | <input type="checkbox"/> |   | Radsensor              |           |
| 2.0 TDI         |                 | 100     |       | 07.10                   | PR: 7X5,7X6         |                     |                          |                          |   |                        |           |
| 2.0 TDI         |                 | 125     |       | 07.10                   | PR: 7X5,7X6         |                     |                          |                          |   |                        |           |
| 2.0 TDI         |                 | 130     |       | 01.13                   | PR: 7X5,7X6         |                     |                          |                          |   |                        |           |
| 2.0 TDI 4motion |                 | 100     |       | 05.11                   | PR: 7X5,7X6         |                     |                          |                          |   |                        |           |
| 2.0 TSI         |                 | 147     |       | 10.10                   | PR: 7X5,7X6         |                     |                          |                          |   |                        |           |
| 1.4 TSI         |                 | 110     |       | 04.15                   | PR: 7X0,7X2,7Y0,7Y4 | 24.0711-6231.3      | 360305                   | <input type="checkbox"/> |   | Radsensor              |           |
| 2.0 TDI         |                 | 85      |       | 04.15                   | PR: 7X0,7X2,7Y0,7Y4 | 24.0711-6232.3      | 360306                   | <input type="checkbox"/> |   | Radsensor              |           |
| 2.0 TDI         | 103             |         | 04.15 | PR: 7X0,7X2,7Y0,7Y4     |                     |                     |                          |                          |   |                        |           |
| 2.0 TDI         | 110             |         | 04.15 | PR: 7X0,7X2,7Y0,7Y4     |                     |                     |                          |                          |   |                        |           |
| 2.0 TDI         | 135             |         | 04.15 | PR: 7X0,7X2,7Y0,7Y4     |                     |                     |                          |                          |   |                        |           |
| 2.0 TDI 4motion | 103             |         | 04.15 | PR: 7X0,7X2,7Y0,7Y4     |                     |                     |                          |                          |   |                        |           |
| 2.0 TDI 4motion | 110             |         | 04.15 | PR: 7X0,7X2,7Y0,7Y4     |                     |                     |                          |                          |   |                        |           |
| 2.0 TDI 4motion | 135             |         | 05.16 | PR: 7X0,7X2,7Y0,7Y4     |                     |                     |                          |                          |   |                        |           |
| 2.0 TSI         | 162             |         | 04.15 | PR: 7X0,7X2,7Y0,7Y4     |                     |                     |                          |                          |   |                        |           |
| 1.4 TSI         | 110             |         | 04.15 | PR: 7X0,7X2,7X5,7Y8,7Y9 | 24.0711-6335.3      | 360365              | <input type="checkbox"/> |                          | Radsensor                                 |                        |           |
| 2.0 TDI         | 85              |         | 04.15 | PR: 7X0,7X2,7X5,7Y8,7Y9 | 24.0711-6336.3      | 360366              | <input type="checkbox"/> |                          | Radsensor                                 |                        |           |
| 2.0 TDI         | 103             |         | 04.15 | PR: 7X0,7X2,7X5,7Y8,7Y9 |                     |                     |                          |                          |   |                        |           |
| 2.0 TDI         | 110             |         | 04.15 | PR: 7X0,7X2,7X5,7Y8,7Y9 |                     |                     |                          |                          |   |                        |           |
| 2.0 TDI         | 135             |         | 04.15 | PR: 7X0,7X2,7X5,7Y8,7Y9 |                     |                     |                          |                          |   |                        |           |
| 2.0 TDI 4motion | 103             |         | 04.15 | PR: 7X0,7X2,7X5,7Y8,7Y9 |                     |                     |                          |                          |   |                        |           |
| 2.0 TDI 4motion | 110             |         | 04.15 | PR: 7X0,7X2,7X5,7Y8,7Y9 |                     |                     |                          |                          |   |                        |           |
| 2.0 TDI 4motion | 135             |         | 05.16 | PR: 7X0,7X2,7X5,7Y8,7Y9 |                     |                     |                          |                          |   |                        |           |
| 2.0 TSI         | 162             |         | 04.15 | PR: 7X0,7X2,7X5,7Y8,7Y9 |                     |                     |                          |                          |   |                        |           |

### VOLKSWAGEN TARO (89-97)

|  |           |  |             |       |       |                |        |  |                                     |                 |     |
|--|-----------|--|-------------|-------|-------|----------------|--------|--|-------------------------------------|-----------------|-----|
|  | 1.8       |  |             | 04.89 | 09.94 | 13.0460-5938.2 | 605938 |  |                                     | 21158 15,5      | AKE |
|  | 2.2       |  |             | 06.89 | 07.94 |                |        |  |                                     |                 |     |
|  | 2.4 D     |  |             | 04.89 | 03.97 |                |        |  |                                     |                 |     |
|  | 1.8       |  |             | 04.89 | 09.94 | 24.0125-0118.1 | 425118 |  |                                     | 257 25,0 23,0 V |     |
|  | 2.2       |  |             | 06.89 | 07.94 |                |        |  |                                     |                 |     |
|  | 2.4 D     |  |             | 04.89 | 03.97 |                |        |  |                                     |                 |     |
|  | 2.4 D 4x4 |  |             | 07.94 | 03.97 | 24.0120-0168.1 | 420168 |  | + Einzelradaufhängung <sup>2)</sup> | 289 20,0 18,0 V |     |
|  | 2.4i 4x4  |  |             | 06.89 | 03.97 |                |        |  |                                     |                 |     |
|  | 1.8       |  | 7A-RH010000 | 04.89 |       | 03.0137-0226.2 | 650226 |  |                                     | 254 x 58        |     |
|  | 2.2       |  | 7A-RH010000 | 06.89 |       |                |        |  |                                     |                 |     |
|  | 2.4 D     |  | 7A-RH010000 | 04.89 |       |                |        |  |                                     |                 |     |

### VOLKSWAGEN TIGUAN (07-)

|  |                  |     |  |       |  |                |        |  |  |                            |     |
|--|------------------|-----|--|-------|--|----------------|--------|--|--|----------------------------|-----|
|  | 1.4 TSI          |     |  | 11.07 |  | 13.0460-7242.2 | 607242 |  |  | 24332 19,8 +/WK            | ATE |
|  | 1.4 TSI          | 90  |  | 08.10 |  | 13.0470-7242.2 | LD7242 |  |  | 24332 19,8 +/WK            | ATE |
|  | 1.4 TSI          | 92  |  | 05.15 |  |                |        |  |  |                            |     |
|  | 1.4 TSI 4motion  |     |  | 09.07 |  |                |        |  |  |                            |     |
|  | 2.0 TDI          | 81  |  | 04.10 |  |                |        |  |  |                            |     |
|  | 2.0 TDI          | 103 |  | 03.08 |  |                |        |  |  |                            |     |
|  | 2.0 TDI          | 110 |  | 05.15 |  |                |        |  |  |                            |     |
|  | 2.0 TDI 4motion  |     |  | 01.08 |  |                |        |  |  |                            |     |
|  | 2.0 TDI 4motion  | 103 |  | 11.07 |  |                |        |  |  |                            |     |
|  | 2.0 TDI 4motion  | 110 |  | 05.15 |  |                |        |  |  |                            |     |
|  | 2.0 TDI 4motion  | 135 |  | 05.15 |  |                |        |  |  |                            |     |
|  | 2.0 TFSI 4motion |     |  | 02.08 |  |                |        |  |  |                            |     |
|  | 2.0 TSI 4motion  |     |  | 11.07 |  |                |        |  |  |                            |     |
|  | 1.4 TSI          |     |  | 11.07 |  | 24.0125-0158.1 | 425158 |  |  | 312 25,0 22,0 V L +S +B    |     |
|  | 1.4 TSI          | 90  |  | 08.10 |  | 24.0325-0158.1 | 525158 |  |  | 312 25,0 22,0 V L +S +B PD |     |
|  | 1.4 TSI          | 92  |  | 05.15 |  |                |        |  |  |                            |     |
|  | 1.4 TSI 4motion  |     |  | 09.07 |  |                |        |  |  |                            |     |
|  | 2.0 TDI          | 81  |  | 04.10 |  |                |        |  |  |                            |     |
|  | 2.0 TDI          | 103 |  | 03.08 |  |                |        |  |  |                            |     |
|  | 2.0 TDI          | 110 |  | 05.15 |  |                |        |  |  |                            |     |
|  | 2.0 TDI 4motion  |     |  | 01.08 |  |                |        |  |  |                            |     |
|  | 2.0 TDI 4motion  | 103 |  | 11.07 |  |                |        |  |  |                            |     |
|  | 2.0 TDI 4motion  | 110 |  | 05.15 |  |                |        |  |  |                            |     |

<sup>1)</sup> electric parking brake / fr.di stazionamento elettrico / frein à main électrique / freno de mano eléctrico

<sup>2)</sup> + independent suspension / + sospens. ruote indipendenti / + suspension indépendante / + suspensión independiente























**VOLKSWAGEN TIGUAN (07-)**

|  |  |   |   |   |  |                            |  |  |   |
|--|--|---|---|---|--|----------------------------|--|--|---|
|  | 2.0 TDI 4motion<br>2.0 TFSI 4motion<br>2.0 TSI 4motion   | 135   | 05.15<br>02.08<br>11.07   |   | 24.0125-0158.1<br>24.0325-0158.1                   | 425158<br>525158           |  |  | 312 25,0 22,0 V L +S +B<br>312 25,0 22,0 V L +S +B PD                     |
|  | 1.4 TSI<br>1.4 TSI<br>1.4 TSI<br>1.4 TSI 4motion<br>2.0 TDI<br>2.0 TDI<br>2.0 TDI<br>2.0 TDI 4motion<br>2.0 TDI 4motion<br>2.0 TDI 4motion<br>2.0 TDI 4motion<br>2.0 TFSI 4motion<br>2.0 TSI 4motion | 90<br>92<br>81<br>103<br>110<br>103<br>110<br>103<br>110<br>135 | 11.07<br>08.10<br>05.15<br>09.07<br>04.10<br>03.08<br>05.15<br>01.08<br>11.07<br>05.15<br>05.15<br>02.08<br>11.07 |   | 24.0711-5271.3<br>24.0711-5272.3                   | 360301<br>360302           |  |  | Radsensor<br>Radsensor  |
|  | 1.4 TSI<br>1.4 TSI<br>1.4 TSI<br>1.4 TSI 4motion<br>2.0 TDI<br>2.0 TDI<br>2.0 TDI<br>2.0 TDI 4motion<br>2.0 TDI 4motion<br>2.0 TDI 4motion<br>2.0 TDI 4motion<br>2.0 TFSI 4motion<br>2.0 TSI 4motion | 90<br>92<br>81<br>103<br>110<br>103<br>110<br>103<br>110<br>135 | 11.07<br>08.10<br>05.15<br>09.07<br>04.10<br>03.08<br>05.15<br>01.08<br>11.07<br>05.15<br>05.15<br>02.08<br>11.07 |   | 13.0460-2880.2<br>13.0470-2880.2<br>13.0460-0259.2 | 602880<br>LD2880<br>610259 |  |  | 23914 17,1 /WE/Zub/S TRW<br>23914 17,1 /WE/Zub/S TRW<br>Belagsatz-Zubehör |
|  | 1.4 TSI<br>1.4 TSI<br>1.4 TSI<br>1.4 TSI 4motion<br>2.0 TDI<br>2.0 TDI<br>2.0 TDI<br>2.0 TDI 4motion<br>2.0 TDI 4motion<br>2.0 TDI 4motion<br>2.0 TDI 4motion<br>2.0 TFSI 4motion<br>2.0 TSI 4motion | 90<br>92<br>81<br>103<br>110<br>103<br>110<br>103<br>110<br>135 | 11.07<br>08.10<br>05.15<br>09.07<br>04.10<br>03.08<br>05.15<br>01.08<br>11.07<br>05.15<br>05.15<br>02.08<br>11.07 |   | 24.0112-0169.1<br>24.0312-0169.1                   | 412169<br>512169           |  |  | 282 12,0 10,0 +S +B<br>282 12,0 10,0 +S +B PD                             |
|  | 1.4 TSI<br>1.4 TSI<br>1.4 TSI<br>2.0 TDI<br>2.0 TDI<br>2.0 TDI   | 90<br>92<br>81<br>103<br>110                                    | 11.07<br>08.10<br>05.15<br>04.10<br>03.08<br>05.15  |   | 24.0711-6231.3<br>24.0711-6232.3                   | 360305<br>360306           |  |  | Radsensor<br>Radsensor  |
|  | 1.4 TSI 4motion<br>2.0 TDI 4motion<br>2.0 TDI 4motion<br>2.0 TDI 4motion<br>2.0 TDI 4motion<br>2.0 TFSI 4motion<br>2.0 TSI 4motion   | 103<br>110<br>135   | 09.07<br>01.08<br>11.07<br>05.15<br>02.08<br>11.07  |   | 24.0711-5271.3<br>24.0711-5272.3                   | 360301<br>360302           |  |  | Radsensor<br>Radsensor  |
|  | 1.4 TSI<br>1.4 TSI<br>1.4 TSI<br>2.0 TDI<br>2.0 TDI<br>2.0 TDI   | 90<br>92<br>81<br>103<br>110                                    | 11.07<br>08.10<br>05.15<br>04.10<br>03.08<br>05.15  | PR: 7X5,7X6<br>PR: 7X5,7X6<br>PR: 7X5,7X6<br>PR: 7X5,7X6<br>PR: 7X5,7X6 | 24.0711-6335.3<br>24.0711-6336.3                   | 360365<br>360366           |  |  | Radsensor<br>Radsensor  |
|  | 1.4 TSI 4motion<br>2.0 TDI 4motion<br>2.0 TDI 4motion<br>2.0 TDI 4motion<br>2.0 TFSI 4motion<br>2.0 TSI 4motion  | 103<br>110<br>135   | 09.07<br>01.08<br>11.07<br>05.15<br>05.15<br>02.08<br>11.07   | PR: 7X5,7X6<br>PR: 7X5,7X6<br>PR: 7X5,7X6<br>PR: 7X5,7X6<br>PR: 7X5,7X6 | 24.0711-5401.3<br>24.0711-5402.3                   | 360330<br>360331           |  |  | Radsensor<br>Radsensor  |

**VOLKSWAGEN TIGUAN (16-)**

|  |   |   |   |  |  |                            |   |  |   |
|--|---|---|---|--|--|----------------------------|---|--|---|
|  | 1.4 TSI<br>1.4 TSI<br>1.4 TSI 4motion<br>2.0 TDI<br>2.0 TDI<br>2.0 TDI 4motion<br>2.0 TDI 4motion<br>2.0 TDI 4motion<br>2.0 TSI 4motion | 92<br>110<br>110<br>85<br>110<br>110<br>140<br>176<br>132 | 01.16<br>05.16<br>05.16<br>05.16<br>02.16<br>02.16<br>04.16<br>05.16<br>02.16 | PR: 1ZA,1ZD<br>PR: 1ZA,1ZD<br>PR: 1ZA,1ZD<br>PR: 1ZA,1ZD<br>PR: 1ZA,1ZD<br>PR: 1ZA,1ZD<br>PR: 1ZA,1ZD<br>PR: 1ZA,1ZD | 13.0460-2785.2<br>13.0470-2785.2<br>24.8190-0065.2 | 602785<br>LD2785<br>620065 | 1 |  | 25683 20,4 +/WK/S TRW<br>25683 20,4 +/WK/S TRW<br>Warnkontakt L=172mm |
|  | 1.4 TSI<br>1.4 TSI<br>1.4 TSI 4motion<br>2.0 TDI<br>2.0 TDI<br>2.0 TDI 4motion<br>2.0 TDI 4motion                                       | 92<br>110<br>110<br>85<br>110<br>110<br>140               | 01.16<br>05.16<br>05.16<br>05.16<br>02.16<br>02.16<br>04.16                   | PR: 1LA,1LW<br>PR: 1LA,1LW<br>PR: 1LA,1LW<br>PR: 1LA,1LW<br>PR: 1LA,1LW<br>PR: 1LA,1LW                               | 13.0460-2764.2<br>13.0470-2764.2<br>24.8190-0065.2 | 602764<br>LD2764<br>620065 | 1 |  | 24738 20,0 +/WK/S TRW<br>24738 20,0 +/WK/S TRW<br>Warnkontakt L=172mm |





































|     |   |  |  |   |  |  |       |      |                              |            |
|--|---|--|--|---|---|--|---|--|------------------------------|------------|
| <b>VOLKSWAGEN TIGUAN (16-)</b>   |   |  |  |   |   |  |   |  |                              |            |
|    | 2.0 TDI 4motion<br>2.0 TSI 4motion  | 176<br>132   | 05.16<br>02.16   | PR: 1LA,1LW<br>PR: 1LA,1LW  | 13.0460-2764.2<br>13.0470-2764.2<br>24.8190-0065.2                                | 602764<br>LD2764<br>620065   | 1   | 24738 20,0 +/WK/S<br>24738 20,0 +/WK/S<br>Warnkontakt L=172mm                          | TRW<br>TRW                   |            |
|    | 1.4 TSI<br>1.4 TSI<br>1.4 TSI 4motion<br>2.0 TDI<br>2.0 TDI<br>2.0 TDI 4motion<br>2.0 TDI 4motion<br>2.0 TDI 4motion<br>2.0 TSI 4motion | 92<br>110<br>110<br>85<br>110<br>110<br>140<br>176<br>132                        | 01.16<br>05.16<br>05.16<br>05.16<br>02.16<br>02.16<br>04.16<br>05.16<br>02.16    | PR: 1ZA,1ZD<br>PR: 1ZA,1ZD<br>PR: 1ZA,1ZD<br>PR: 1ZA,1ZD<br>PR: 1ZA,1ZD<br>PR: 1ZA,1ZD<br>PR: 1ZA,1ZD<br>PR: 1ZA,1ZD<br>PR: 1ZA,1ZD | 24.0125-0158.1<br>24.0325-0158.1  | 425158<br>525158   |   | 312 25,0 22,0 V L +S +B<br>312 25,0 22,0 V L +S +B PD                                  |                              |            |
|  | 1.4 TSI<br>1.4 TSI<br>1.4 TSI 4motion<br>2.0 TDI<br>2.0 TDI<br>2.0 TDI 4motion<br>2.0 TDI 4motion<br>2.0 TDI 4motion<br>2.0 TSI 4motion | 92<br>110<br>110<br>85<br>110<br>110<br>140<br>176<br>132                        | 01.16<br>05.16<br>05.16<br>05.16<br>02.16<br>02.16<br>04.16<br>05.16<br>02.16    | PR: 1LW<br>PR: 1LW<br>PR: 1LW<br>PR: 1LW<br>PR: 1LW<br>PR: 1LW<br>PR: 1LW<br>PR: 1LW<br>PR: 1LW                                     | 24.0130-0220.1  | 430220   |   | 314 30,0 27,0 V L +S +B  |                              |            |
|  | 1.4 TSI<br>1.4 TSI<br>1.4 TSI 4motion<br>2.0 TDI<br>2.0 TDI<br>2.0 TDI 4motion<br>2.0 TDI 4motion<br>2.0 TDI 4motion<br>2.0 TSI 4motion | 92<br>110<br>110<br>85<br>110<br>110<br>140<br>176<br>132                        | 01.16<br>05.16<br>05.16<br>05.16<br>02.16<br>02.16<br>04.16<br>05.16<br>02.16    | PR: 1LA<br>PR: 1LA<br>PR: 1LA<br>PR: 1LA<br>PR: 1LA<br>PR: 1LA<br>PR: 1LA<br>PR: 1LA<br>PR: 1LA                                     | 24.0130-0225.1  | 430225   |   | 340 30,0 27,0 V L +S +B  |                              |            |
|    | 1.4 TSI<br>1.4 TSI<br>1.4 TSI 4motion<br>2.0 TDI<br>2.0 TDI<br>2.0 TDI 4motion<br>2.0 TDI 4motion<br>2.0 TDI 4motion<br>2.0 TSI 4motion | 92<br>110<br>110<br>85<br>110<br>110<br>140<br>176<br>132                        | 01.16<br>05.16<br>05.16<br>05.16<br>02.16<br>02.16<br>04.16<br>05.16<br>02.16    |   | 24.0711-5273.3<br>24.0711-5274.3  | 360303<br>360304   |      | Radsensor<br>Radsensor   |                              |            |
|  | 1.4 TSI<br>1.4 TSI<br>1.4 TSI 4motion<br>2.0 TDI<br>2.0 TDI<br>2.0 TDI 4motion<br>2.0 TDI 4motion<br>2.0 TDI 4motion<br>2.0 TSI 4motion | 92<br>110<br>110<br>85<br>110<br>110<br>140<br>176<br>132                        | 01.16<br>05.16<br>05.16<br>05.16<br>02.16<br>02.16<br>04.16<br>05.16<br>02.16    | PR: 1KU,1KZ<br>PR: 1KU,1KZ<br>PR: 1KU,1KZ<br>PR: 1KU,1KZ<br>PR: 1KU,1KZ<br>PR: 1KU,1KZ<br>PR: 1KU,1KZ<br>PR: 1KU,1KZ<br>PR: 1KU,1KZ | 13.0460-7294.2<br>13.0470-7294.2  | 607294<br>LD7294   |   | elektrische Feststellbremse <sup>1)</sup><br>elektrische Feststellbremse <sup>1)</sup> | 25009 16,4 +<br>25009 16,4 + | ATE<br>ATE |
|  | 1.4 TSI<br>1.4 TSI<br>1.4 TSI 4motion<br>2.0 TDI<br>2.0 TDI<br>2.0 TDI 4motion<br>2.0 TDI 4motion<br>2.0 TDI 4motion<br>2.0 TSI 4motion | 92<br>110<br>110<br>85<br>110<br>110<br>140<br>176<br>132                        | 01.16<br>05.16<br>05.16<br>05.16<br>02.16<br>02.16<br>04.16<br>05.16<br>02.16    | PR: 1KU<br>PR: 1KU<br>PR: 1KU<br>PR: 1KU<br>PR: 1KU<br>PR: 1KU<br>PR: 1KU<br>PR: 1KU<br>PR: 1KU                                     | 24.0112-0210.1  | 412210   |   | elektrische Feststellbremse <sup>1)</sup>  | 300 12,0 10,0 +S +B          |            |
|  | 1.4 TSI<br>1.4 TSI<br>1.4 TSI 4motion<br>2.0 TDI<br>2.0 TDI<br>2.0 TDI 4motion<br>2.0 TDI 4motion<br>2.0 TDI 4motion<br>2.0 TSI 4motion | 92<br>110<br>110<br>85<br>110<br>110<br>140<br>176<br>132                        | 01.16<br>05.16<br>05.16<br>05.16<br>02.16<br>02.16<br>04.16<br>05.16<br>02.16    | PR: 1KZ<br>PR: 1KZ<br>PR: 1KZ<br>PR: 1KZ<br>PR: 1KZ<br>PR: 1KZ<br>PR: 1KZ<br>PR: 1KZ<br>PR: 1KZ                                     | 24.0122-0219.1  | 422219   |   | elektrische Feststellbremse <sup>1)</sup>  | 310 22,0 20,0 V L +B         |            |
|  | 1.4 TSI<br>1.4 TSI<br>2.0 TDI<br>2.0 TDI  | 92<br>110<br>85<br>110   | 01.16<br>05.16<br>05.16<br>02.16   |   | 24.0711-6337.3  | 360390   | 2  | Radsensor  |                              |            |
|  | 1.4 TSI 4motion<br>2.0 TDI 4motion<br>2.0 TDI 4motion<br>2.0 TDI 4motion<br>2.0 TSI 4motion   | 110<br>110<br>140<br>176<br>132  | 05.16<br>02.16<br>04.16<br>05.16<br>02.16  |   | 24.0711-5401.3<br>24.0711-5402.3  | 360330<br>360331   |    | Radsensor<br>Radsensor   |                              |            |
| <b>VOLKSWAGEN TOUAREG I (03-10)</b>  |   |  |  |   |   |  |   |  |                              |            |
|  | 2.5 R5 TDI<br>3.0 V6 TDI<br>3.0 V6 TDI<br>3.2 V6<br>3.6 V6 FSI  | 176<br>206   | 01.03<br>11.04<br>10.07<br>11.02<br>01.06  | 03.10 PR: 1LB<br>03.10 PR: 1LB<br>03.10 PR: 1LB<br>12.05 PR: 1LB<br>03.10 PR: 1LB   | 13.0460-7191.2<br>13.0470-7191.2<br>13.0460-7245.2                                | 607191<br>LD7191<br>607245   |   | 23835 19,6 +/WK<br>23835 19,6 +/WK<br>23747 19,6 +/WK                                  | ATE<br>ATE<br>ATE            |            |
|  | 4.2 V8<br>4.2 V8 FSI<br>5.0 TDI R50<br>5.0 V10 TDI  | 228<br>257<br>258<br>230   | 12.02<br>12.06<br>01.08<br>11.02   | 11.06 PR: 1LB<br>03.10 PR: 1LB<br>03.10 PR: 1LB<br>03.10 PR: 1LB  | 13.0460-7191.2<br>13.0460-7245.2  | 607191<br>607245   |   | 23835 19,6 +/WK<br>23747 19,6 +/WK   | ATE<br>ATE                   |            |

<sup>1)</sup> electric parking brake / fr.di stazionamento elettrico / frein à main électrique / freno de mano eléctrico

**VOLKSWAGEN TOUAREG I (03-10)**



















|  |             |     |  |       |       |             |                |        |   |  |                         |     |
|--|-------------|-----|--|-------|-------|-------------|----------------|--------|---|--|-------------------------|-----|
|  | 6.0 W12     | 331 |  | 08.04 | 11.06 | PR: 1LB     | 13.0460-7191.2 | 607191 |   |  | 23835 19,6 +/WK         | ATE |
|  |             |     |  |       |       |             | 13.0460-7245.2 | 607245 |   |  | 23747 19,6 +/WK         | ATE |
|  | 2.5 R5 TDI  |     |  | 01.06 | 03.10 | PR: 1LE     | 13.0460-4833.2 | 604833 |   |  | 24098 17,1 /WE          | BRE |
|  | 3.0 V6 TDI  |     |  | 01.06 | 03.10 | PR: 1LE     | 13.0470-4833.2 | LD4833 |   |  | 24098 17,1 /WE          | BRE |
|  | 3.0 V6 TDI  | 176 |  | 10.07 | 03.10 | PR: 1LE     | 24.8190-0929.2 | 620929 | 2 |  | Warnkontakt L=417,4mm   |     |
|  | 3.2 V6      |     |  | 11.02 | 12.05 | PR: 1LE     |                |        |   |  |                         |     |
|  | 3.6 V6 FSI  | 206 |  | 01.06 | 03.10 | PR: 1LE     |                |        |   |  |                         |     |
|  | 4.2 V8      | 228 |  | 01.06 | 11.06 | PR: 1LE     | 13.0460-4833.2 | 604833 |   |  | 24098 17,1 /WE          | BRE |
|  | 4.2 V8 FSI  | 257 |  | 12.06 | 03.10 | PR: 1LE     | 24.8190-0929.2 | 620929 | 2 |  | Warnkontakt L=417,4mm   |     |
|  | 5.0 TDI R50 | 258 |  | 01.08 | 03.10 | PR: 1LE     |                |        |   |  |                         |     |
|  | 5.0 V10 TDI | 230 |  | 01.06 | 03.10 | PR: 1LE     |                |        |   |  |                         |     |
|  | 6.0 W12     | 331 |  | 01.06 | 11.06 | PR: 1LE     |                |        |   |  |                         |     |
|  | 2.5 R5 TDI  |     |  | 01.03 | 03.10 | PR: 1LC     | 13.0460-4992.2 | 604992 |   |  | 23692 16,6 /WE          | BRE |
|  | 3.0 V6 TDI  |     |  | 11.04 | 03.10 | PR: 1LC     | 13.0470-4992.2 | LD4992 |   |  | 23692 16,6 /WE          | BRE |
|  | 3.2 V6      |     |  | 11.02 | 12.05 | PR: 1LC     | 13.0460-0279.2 | 610279 |   |  | Belagsatz-Zubehör       |     |
|  | 3.6 V6 FSI  | 206 |  | 01.06 | 03.10 | PR: 1LC     | 24.8190-0929.2 | 620929 | 2 |  | Warnkontakt L=417,4mm   |     |
|  | 4.2 V8      | 228 |  | 12.02 | 11.06 | PR: 1LC     | 13.0460-4992.2 | 604992 |   |  | 23692 16,6 /WE          | BRE |
|  | 4.2 V8 FSI  | 257 |  | 12.06 | 03.10 | PR: 1LC     | 13.0460-0279.2 | 610279 |   |  | Belagsatz-Zubehör       |     |
|  | 5.0 TDI R50 | 230 |  | 11.02 | 03.10 | PR: 1LC     | 24.8190-0929.2 | 620929 | 2 |  | Warnkontakt L=417,4mm   |     |
|  | 6.0 W12     | 331 |  | 08.04 | 11.06 | PR: 1LC     |                |        |   |  |                         |     |
|  | 2.5 R5 TDI  |     |  | 01.03 | 03.10 | PR: 1LF     | 13.0460-4993.2 | 604993 |   |  | 23693 16,6 /WE          | BRE |
|  | 3.0 V6 TDI  |     |  | 11.04 | 03.10 | PR: 1LF     | 13.0470-4993.2 | LD4993 |   |  | 23693 16,6 /WE          | BRE |
|  | 3.0 V6 TDI  | 176 |  | 10.07 | 03.10 | PR: 1LF     | 13.0460-0279.2 | 610279 |   |  | Belagsatz-Zubehör       |     |
|  | 3.2 V6      |     |  | 11.02 | 12.05 | PR: 1LF     | 24.8190-0929.2 | 620929 | 2 |  | Warnkontakt L=417,4mm   |     |
|  | 3.6 V6 FSI  | 206 |  | 01.06 | 03.10 | PR: 1LF     |                |        |   |  |                         |     |
|  | 4.2 V8      | 228 |  | 12.02 | 11.06 | PR: 1LF     | 13.0460-4993.2 | 604993 |   |  | 23693 16,6 /WE          | BRE |
|  | 4.2 V8 FSI  | 257 |  | 12.06 | 03.10 | PR: 1LF     | 13.0460-0279.2 | 610279 |   |  | Belagsatz-Zubehör       |     |
|  | 5.0 TDI R50 | 258 |  | 01.08 | 03.10 | PR: 1LF     | 24.8190-0929.2 | 620929 | 2 |  | Warnkontakt L=417,4mm   |     |
|  | 5.0 V10 TDI | 230 |  | 11.02 | 03.10 | PR: 1LF     |                |        |   |  |                         |     |
|  | 6.0 W12     | 331 |  | 08.04 | 11.06 | PR: 1LF     |                |        |   |  |                         |     |
|  | 2.5 R5 TDI  |     |  | 01.03 | 03.10 | PR: 1LT,1LU | 13.0460-4852.2 | 604852 |   |  | 24553 15,8 /WE          | BRE |
|  | 3.0 V6 TDI  |     |  | 11.04 | 03.10 | PR: 1LT,1LU | 24.8190-0936.2 | 620936 | 2 |  | Warnkontakt L=367,4mm   |     |
|  | 3.0 V6 TDI  | 176 |  | 10.07 | 03.10 | PR: 1LT,1LU |                |        |   |  |                         |     |
|  | 3.6 V6 FSI  | 206 |  | 01.06 | 03.10 | PR: 1LT,1LU |                |        |   |  |                         |     |
|  | 4.2 V8 FSI  | 257 |  | 12.06 | 03.10 | PR: 1LT,1LU |                |        |   |  |                         |     |
|  | 5.0 TDI R50 | 258 |  | 01.08 | 03.10 | PR: 1LT,1LU |                |        |   |  |                         |     |
|  | 5.0 V10 TDI | 230 |  | 11.02 | 03.10 | PR: 1LT,1LU |                |        |   |  |                         |     |
|  | 6.0 W12     | 331 |  | 08.04 | 11.06 | PR: 1LT,1LU |                |        |   |  |                         |     |
|  | 2.5 R5 TDI  |     |  | 01.03 | 03.10 | PR: 1LB     | 24.0130-0114.1 | 430114 |   |  | 308 29,5 25,5 V L +B    |     |
|  | 3.0 V6 TDI  |     |  | 11.04 | 03.10 | PR: 1LB     |                |        |   |  |                         |     |
|  | 3.0 V6 TDI  | 176 |  | 10.07 | 03.10 | PR: 1LB     |                |        |   |  |                         |     |
|  | 3.2 V6      |     |  | 11.02 | 12.05 | PR: 1LB     |                |        |   |  |                         |     |
|  | 3.6 V6 FSI  | 206 |  | 01.06 | 03.10 | PR: 1LB     |                |        |   |  |                         |     |
|  | 4.2 V8      | 228 |  | 12.02 | 11.06 | PR: 1LB     |                |        |   |  |                         |     |
|  | 4.2 V8 FSI  | 257 |  | 12.06 | 03.10 | PR: 1LB     |                |        |   |  |                         |     |
|  | 5.0 TDI R50 | 258 |  | 01.08 | 03.10 | PR: 1LB     |                |        |   |  |                         |     |
|  | 5.0 V10 TDI | 230 |  | 11.02 | 03.10 | PR: 1LB     |                |        |   |  |                         |     |
|  | 6.0 W12     | 331 |  | 08.04 | 11.06 | PR: 1LB     |                |        |   |  |                         |     |
|  | 2.5 R5 TDI  |     |  | 01.03 | 03.10 | PR: 1LC,1LE | 24.0132-0117.1 | 432117 |   |  | 330 32,0 30,0 V L +S +B |     |
|  | 3.0 V6 TDI  |     |  | 11.04 | 03.10 | PR: 1LC,1LE | 24.0132-0118.1 | 432118 |   |  | 330 32,0 30,0 V L +S +B |     |
|  | 3.0 V6 TDI  | 176 |  | 10.07 | 03.10 | PR: 1LC,1LE |                |        |   |  |                         |     |
|  | 3.2 V6      |     |  | 11.02 | 12.05 | PR: 1LC,1LE |                |        |   |  |                         |     |
|  | 3.6 V6 FSI  | 206 |  | 01.06 | 03.10 | PR: 1LC,1LE |                |        |   |  |                         |     |
|  | 4.2 V8      | 228 |  | 12.02 | 11.06 | PR: 1LC,1LE |                |        |   |  |                         |     |
|  | 4.2 V8 FSI  | 257 |  | 12.06 | 03.10 | PR: 1LC,1LE |                |        |   |  |                         |     |
|  | 5.0 TDI R50 | 258 |  | 01.08 | 03.10 | PR: 1LC,1LE |                |        |   |  |                         |     |
|  | 5.0 V10 TDI | 230 |  | 11.02 | 03.10 | PR: 1LC,1LE |                |        |   |  |                         |     |
|  | 6.0 W12     | 331 |  | 08.04 | 11.06 | PR: 1LC,1LE |                |        |   |  |                         |     |
|  | 2.5 R5 TDI  |     |  | 01.03 | 03.10 | PR: 1LF     | 24.0134-0123.1 | 434123 |   |  | 350 34,0 32,0 V L +B    |     |
|  | 3.0 V6 TDI  |     |  | 11.04 | 03.10 | PR: 1LF     | 24.0134-0124.1 | 434124 |   |  | 350 34,0 32,0 V L +B    |     |
|  | 3.0 V6 TDI  | 176 |  | 10.07 | 03.10 | PR: 1LF     |                |        |   |  |                         |     |
|  | 3.2 V6      |     |  | 11.02 | 12.05 | PR: 1LF     |                |        |   |  |                         |     |
|  | 3.6 V6 FSI  | 206 |  | 01.06 | 03.10 | PR: 1LF     |                |        |   |  |                         |     |
|  | 4.2 V8      | 228 |  | 12.02 | 11.06 | PR: 1LF     |                |        |   |  |                         |     |
|  | 4.2 V8 FSI  | 257 |  | 12.06 | 03.10 | PR: 1LF     |                |        |   |  |                         |     |
|  | 5.0 TDI R50 | 258 |  | 01.08 | 03.10 | PR: 1LF     |                |        |   |  |                         |     |
|  | 5.0 V10 TDI | 230 |  | 11.02 | 03.10 | PR: 1LF     |                |        |   |  |                         |     |
|  | 6.0 W12     | 331 |  | 08.04 | 11.06 | PR: 1LF     |                |        |   |  |                         |     |
|  | 2.5 R5 TDI  |     |  | 01.03 | 03.10 | PR: 1LT,1LU | 24.0136-0111.1 | 436111 |   |  | 368 36,0 34,0 V L +B    |     |
|  | 3.0 V6 TDI  |     |  | 11.04 | 03.10 | PR: 1LT,1LU |                |        |   |  |                         |     |
|  | 3.0 V6 TDI  | 176 |  | 10.07 | 03.10 | PR: 1LT,1LU |                |        |   |  |                         |     |
|  | 3.6 V6 FSI  | 206 |  | 01.06 | 03.10 | PR: 1LT,1LU |                |        |   |  |                         |     |
|  | 4.2 V8 FSI  | 257 |  | 12.06 | 03.10 | PR: 1LT,1LU |                |        |   |  |                         |     |
|  | 5.0 TDI R50 | 258 |  | 01.08 | 03.10 | PR: 1LT,1LU |                |        |   |  |                         |     |
|  | 5.0 V10 TDI | 230 |  | 11.02 | 03.10 | PR: 1LT,1LU |                |        |   |  |                         |     |
|  | 6.0 W12     | 331 |  | 08.04 | 11.06 | PR: 1LT,1LU |                |        |   |  |                         |     |
|  | 2.5 R5 TDI  |     |  | 01.03 | 03.10 |             | 24.0711-5401.3 | 360330 |   |  | Radsensor               |     |
|  | 3.0 V6 TDI  |     |  | 11.04 | 03.10 |             | 24.0711-5402.3 | 360331 |   |  | Radsensor               |     |
|  | 3.0 V6 TDI  | 176 |  | 10.07 | 03.10 |             |                |        |   |  |                         |     |
|  | 3.2 V6      |     |  | 11.02 | 12.05 |             |                |        |   |  |                         |     |
|  | 3.6 V6 FSI  | 206 |  | 01.06 | 03.10 |             |                |        |   |  |                         |     |
|  | 4.2 V8      | 228 |  | 12.02 | 11.06 |             |                |        |   |  |                         |     |
|  | 4.2 V8 FSI  | 257 |  | 12.06 | 03.10 |             |                |        |   |  |                         |     |
|  | 5.0 TDI R50 | 258 |  | 01.08 | 03.10 |             |                |        |   |  |                         |     |
|  | 5.0 V10 TDI | 230 |  | 11.02 | 03.10 |             |                |        |   |  |                         |     |
|  | 6.0 W12     | 331 |  | 08.04 | 11.06 |             |                |        |   |  |                         |     |

|     |   |  |        |    |  |  |    |            |
|--|---|--|--|--|---|--|--|--|
| <b>VOLKSWAGEN TOUAREG I (03-10)</b>  |   |  |  |  |   |  |  |  |
|    | 2.5 R5 TDI<br>3.0 V6 TDI<br>3.0 V6 TDI<br>3.2 V6<br>3.6 V6 FSI<br>4.2 V8<br>4.2 V8 FSI<br>5.0 TDI R50<br>5.0 V10 TDI<br>6.0 W12 | 176<br>206<br>228<br>257<br>258<br>230<br>331                                    | 01.03<br>11.04<br>10.07<br>11.02<br>01.06<br>12.02<br>12.06<br>01.08<br>11.02<br>08.04 | 03.10 PR: 1KE<br>03.10 PR: 1KE<br>03.10 PR: 1KE<br>12.05 PR: 1KE<br>03.10 PR: 1KE<br>11.06 PR: 1KE<br>03.10 PR: 1KE<br>03.10 PR: 1KE<br>03.10 PR: 1KE<br>11.06 PR: 1KE   | 13.0460-7190.2<br>13.0470-7190.2<br>13.0460-7247.2                                | 607190<br>LD7190<br>607247   |  | 24367 19,1 +/WK<br>24367 19,1 +/WK<br>24367 19,2 +/WK<br>ATE<br>ATE<br>ATE                   |
|  | 2.5 R5 TDI<br>3.0 V6 TDI<br>3.0 V6 TDI<br>3.2 V6<br>3.6 V6 FSI<br>4.2 V8<br>4.2 V8 FSI<br>5.0 TDI R50<br>5.0 V10 TDI<br>6.0 W12 | 176<br>206<br>228<br>257<br>258<br>230<br>331                                    | 01.06<br>01.06<br>10.07<br>11.02<br>01.06<br>01.06<br>12.06<br>01.08<br>01.06<br>01.06 | 03.10 PR: 1KQ<br>03.10 PR: 1KQ<br>03.10 PR: 1KQ<br>12.05 PR: 1KQ<br>03.10 PR: 1KQ<br>11.06 PR: 1KQ<br>03.10 PR: 1KQ<br>03.10 PR: 1KQ<br>03.10 PR: 1KQ<br>11.06 PR: 1KQ   | 13.0460-4834.2<br>13.0470-4834.2<br>24.8190-0930.2                                | 604834<br>LD4834<br>620930   | 2  | 24097 17,1 /WE<br>24097 17,1 /WE<br>Warnkontakt L=252,4mm<br>BRE<br>BRE                      |
|  | 2.5 R5 TDI<br>3.0 V6 TDI<br>3.0 V6 TDI<br>3.2 V6<br>3.6 V6 FSI<br>4.2 V8<br>4.2 V8 FSI<br>5.0 TDI R50<br>5.0 V10 TDI<br>6.0 W12 | 176<br>206<br>228<br>257<br>258<br>230<br>331                                    | 01.03<br>11.04<br>10.07<br>11.02<br>01.06<br>12.02<br>12.06<br>01.08<br>11.02<br>08.04 | 03.10 PR: 1KF<br>03.10 PR: 1KF<br>03.10 PR: 1KF<br>12.05 PR: 1KF<br>03.10 PR: 1KF<br>11.06 PR: 1KF<br>03.10 PR: 1KF<br>03.10 PR: 1KF<br>03.10 PR: 1KF<br>11.06 PR: 1KF   | 13.0460-4976.2<br>13.0470-4976.2<br>13.0460-0280.2<br>24.8190-0930.2              | 604976<br>LD4976<br>610280<br>620930   | 2  | 23694 16,7 /WE<br>23694 16,7 /WE<br>Belagsatz-Zubehör<br>Warnkontakt L=252,4mm<br>BRE<br>BRE |
|  | 2.5 R5 TDI<br>3.0 V6 TDI<br>3.0 V6 TDI<br>3.2 V6<br>3.6 V6 FSI<br>4.2 V8<br>4.2 V8 FSI<br>5.0 TDI R50<br>5.0 V10 TDI            | 176<br>206<br>257<br>258<br>230  | 01.03<br>11.04<br>10.07<br>01.06<br>12.06<br>01.08<br>11.02                            | 03.10 PR: 1KD,2ED<br>03.10 PR: 1KD,2ED<br>03.10 PR: 1KD,2ED<br>03.10 PR: 1KD,2ED<br>03.10 PR: 1KD,2ED<br>03.10 PR: 1KD,2ED<br>03.10 PR: 1KD,2ED  | 13.0460-4850.2<br>13.0470-4850.2<br>24.8190-0930.2                                | 604850<br>LD4850<br>620930   | 2  | 24296 15,5 /WE<br>24296 15,5 /WE<br>Warnkontakt L=252,4mm<br>BRE<br>BRE                      |
|    | 2.5 R5 TDI<br>3.0 V6 TDI<br>3.0 V6 TDI<br>3.2 V6<br>3.6 V6 FSI<br>4.2 V8<br>4.2 V8 FSI<br>5.0 TDI R50<br>5.0 V10 TDI<br>6.0 W12 | 176<br>206<br>228<br>257<br>258<br>230<br>331                                    | 01.03<br>11.04<br>10.07<br>11.02<br>01.06<br>12.02<br>12.06<br>01.08<br>11.02<br>08.04 | 03.10 PR: 1KE<br>03.10 PR: 1KE<br>03.10 PR: 1KE<br>12.05 PR: 1KE<br>03.10 PR: 1KE<br>11.06 PR: 1KE<br>03.10 PR: 1KE<br>03.10 PR: 1KE<br>03.10 PR: 1KE<br>11.06 PR: 1KE   | 24.0122-0215.1  | 422215   |  | 314 22,0 18,0 V L +S +B  |
|  | 2.5 R5 TDI<br>3.0 V6 TDI<br>3.0 V6 TDI<br>3.2 V6<br>3.6 V6 FSI<br>4.2 V8<br>4.2 V8 FSI<br>5.0 TDI R50<br>5.0 V10 TDI<br>6.0 W12 | 176<br>206<br>228<br>257<br>258<br>230<br>331                                    | 01.03<br>11.04<br>10.07<br>11.02<br>01.06<br>12.02<br>12.06<br>01.08<br>11.02<br>08.04 | 03.10 PR: 1KF,1KQ<br>03.10 PR: 1KF,1KQ<br>03.10 PR: 1KF,1KQ<br>12.05 PR: 1KF,1KQ<br>03.10 PR: 1KF,1KQ<br>11.06 PR: 1KF,1KQ<br>03.10 PR: 1KF,1KQ<br>03.10 PR: 1KF,1KQ<br>03.10 PR: 1KF,1KQ<br>11.06 PR: 1KF,1KQ   | 24.0128-0149.1  | 428149   |  | 330 28,0 26,0 V L +S +B  |
|  | 2.5 R5 TDI<br>3.0 V6 TDI<br>3.0 V6 TDI<br>3.2 V6<br>3.6 V6 FSI<br>4.2 V8<br>4.2 V8 FSI<br>5.0 TDI R50<br>5.0 V10 TDI            | 176<br>206<br>257<br>258<br>230  | 01.03<br>11.04<br>10.07<br>01.06<br>12.06<br>01.08<br>11.02                            | 03.10 PR: 1KD,2ED<br>03.10 PR: 1KD,2ED<br>03.10 PR: 1KD,2ED<br>03.10 PR: 1KD,2ED<br>03.10 PR: 1KD,2ED<br>03.10 PR: 1KD,2ED<br>03.10 PR: 1KD,2ED  | 24.0128-0169.1  | 428169   |  | 358 28,0 26,0 V L +B   |
|  | 2.5 R5 TDI<br>3.0 V6 TDI<br>3.0 V6 TDI<br>3.2 V6<br>3.6 V6 FSI<br>4.2 V8<br>4.2 V8 FSI<br>5.0 TDI R50<br>5.0 V10 TDI<br>6.0 W12 | 176<br>206<br>228<br>257<br>258<br>230<br>331                                    | 01.03<br>11.04<br>10.07<br>11.02<br>01.06<br>12.02<br>12.06<br>01.08<br>11.02<br>08.04 | 03.10<br>03.10<br>03.10<br>12.05<br>03.10<br>11.06<br>03.10<br>03.10<br>03.10<br>11.06   | 24.0711-5401.3<br>24.0711-5402.3  | 360330<br>360331   | <br> | Radsensor<br>Radsensor   |
|  | 2.5 R5 TDI<br>3.0 V6 TDI<br>3.0 V6 TDI<br>3.2 V6<br>3.6 V6 FSI<br>4.2 V8<br>4.2 V8 FSI<br>5.0 TDI R50<br>5.0 V10 TDI<br>6.0 W12 | 176<br>206<br>228<br>257<br>258<br>230<br>331                                    | 01.03<br>11.04<br>10.07<br>11.02<br>01.06<br>12.02<br>12.06<br>01.08<br>11.02<br>08.04 | 03.10 PR: 1KF,1KQ,2ED<br>03.10 PR: 1KF,1KQ,2ED<br>03.10 PR: 1KF,1KQ,2ED<br>12.05 PR: 1KF,1KQ,2ED<br>03.10 PR: 1KF,1KQ,2ED<br>11.06 PR: 1KF,1KQ,2ED<br>03.10 PR: 1KF,1KQ,2ED<br>03.10 PR: 1KF,1KQ,2ED<br>03.10 PR: 1KF,1KQ,2ED<br>11.06 PR: 1KF,1KQ,2ED | 03.0137-0451.2<br>03.0137-9288.2<br>03.0137-9700.2<br>03.0137-9702.2              | 650451<br>669288<br>669700<br>669702   |  | 210 x 30<br>Bremsbacken-Zubehör<br>Bremsbacken-Zubehör<br>Spreizschloß Satz                  |













|     |   |  |        |   |                           |  |    |    |
|--|---|--|--|---|--|--|--|--|
| <b>VOLKSWAGEN TOUAREG I (03-10)</b>  |   |  |  |   |  |  |  |  |
|    | 2.5 R5 TDI<br>3.0 V6 TDI<br>3.0 V6 TDI<br>3.2 V6<br>3.6 V6 FSI<br>4.2 V8<br>4.2 V8 FSI<br>5.0 TDI R50<br>5.0 V10 TDI<br>6.0 W12   | 176<br>206<br>228<br>257<br>258<br>230<br>331                                    | 01.03<br>11.04<br>10.07<br>11.02<br>01.06<br>12.02<br>12.06<br>01.08<br>11.02<br>08.04 | 03.10<br>03.10<br>03.10<br>12.05<br>03.10<br>11.06<br>03.10<br>03.10<br>03.10<br>11.06  | PR: 1KE<br>PR: 1KE<br>PR: 1KE<br>PR: 1KE<br>PR: 1KE<br>PR: 1KE<br>PR: 1KE<br>PR: 1KE<br>PR: 1KE<br>PR: 1KE | 03.0137-0419.2<br>03.0137-9288.2<br>03.0137-9700.2<br>03.0137-9702.2               | 650419<br>669288<br>669700<br>669702   | 185 x 30<br>Bremsbacken-Zubehör<br>Bremsbacken-Zubehör<br>Spreizschloß Satz  |
| <b>VOLKSWAGEN TOUAREG II (10-)</b>   |   |  |  |   |  |  |  |  |
|    | 3.0 V6 TDI<br>3.0 V6 TDI<br>3.0 V6 TDI<br>3.0 V6 TDI<br>3.0 V6 TDI<br>3.6 V6 FSI  | 150<br>165<br>176<br>180<br>193<br>206   | 04.10<br>06.10<br>04.10<br>05.11<br>09.14<br>04.10                                     | PR: 1LC,1LE<br>PR: 1LC,1LE<br>PR: 1LC,1LE<br>PR: 1LC,1LE<br>PR: 1LC,1LE<br>PR: 1LC,1LE  | 13.0460-4833.2<br>13.0470-4833.2<br>24.8190-0013.2   | 604833<br>LD4833<br>620013   | 2  | 24098 17,1 /WE<br>24098 17,1 /WE<br>Warnkontakt L=323mm  |
|  | 3.0 V6 TSI Hybrid<br>4.2 V8 FSI<br>4.2 V8 TDI   | 245<br>265<br>250  | 04.10<br>01.11<br>04.10  | PR: 1LC,1LE<br>PR: 1LC,1LE<br>PR: 1LC,1LE   | 13.0460-4833.2<br>24.8190-0013.2   | 604833<br>620013   | 2  | 24098 17,1 /WE<br>Warnkontakt L=323mm  |
|  | 3.0 V6 TDI<br>3.0 V6 TDI<br>3.0 V6 TDI<br>3.0 V6 TDI<br>3.0 V6 TDI<br>3.0 V6 TSI Hybrid<br>3.6 V6 FSI<br>4.2 V8 FSI<br>4.2 V8 TDI | 150<br>165<br>176<br>180<br>193<br>245<br>206<br>265<br>250                      | 04.10<br>06.10<br>04.10<br>05.11<br>09.14<br>04.10<br>04.10<br>01.11<br>04.10          | PR: 1LG,1LW<br>PR: 1LG,1LW<br>PR: 1LG,1LW<br>PR: 1LG,1LW<br>PR: 1LG,1LW<br>PR: 1LG,1LW<br>PR: 1LG,1LW<br>PR: 1LG,1LW<br>PR: 1LG,1LW                                 | 13.0460-4852.2<br>24.8190-0014.2   | 604852<br>620014   | 2  | 24553 15,8 /WE<br>Warnkontakt L=296mm  |
|  | 3.0 V6 TDI<br>3.0 V6 TDI<br>3.0 V6 TDI<br>3.0 V6 TDI<br>3.0 V6 TDI<br>3.0 V6 TSI Hybrid<br>3.6 V6 FSI<br>4.2 V8 FSI<br>4.2 V8 TDI | 150<br>165<br>176<br>180<br>193<br>245<br>206<br>265<br>250                      | 04.10<br>06.10<br>04.10<br>05.11<br>09.14<br>04.10<br>04.10<br>01.11<br>04.10          | PR: 1LJ<br>PR: 1LJ<br>PR: 1LJ<br>PR: 1LJ<br>PR: 1LJ<br>PR: 1LJ<br>PR: 1LJ<br>PR: 1LJ<br>PR: 1LJ   | 13.0460-4852.2<br>24.8190-0014.2   | 604852<br>620014   | 2  | 24553 15,8 /WE<br>Warnkontakt L=296mm  |
|   | 3.0 V6 TDI<br>3.0 V6 TDI<br>3.0 V6 TDI<br>3.0 V6 TDI<br>3.0 V6 TDI<br>3.0 V6 TSI Hybrid<br>3.6 V6 FSI<br>4.2 V8 FSI<br>4.2 V8 TDI | 150<br>165<br>176<br>180<br>193<br>245<br>206<br>265<br>250                      | 04.10<br>06.10<br>04.10<br>05.11<br>09.14<br>04.10<br>04.10<br>01.11<br>04.10          | PR: 1LG,1LJ,1LW<br>PR: 1LG,1LJ,1LW<br>PR: 1LG,1LJ,1LW<br>PR: 1LJ,1LW<br>PR: 1LG,1LJ,1LW<br>PR: 1LG,1LJ,1LW<br>PR: 1LG,1LJ,1LW<br>PR: 1LG,1LJ,1LW<br>PR: 1LG,1LJ,1LW | 24.0136-0123.1<br>24.0136-0124.1   | 436123<br>436124   | <br>  | 360 36,0 34,0 V L +S +B<br>360 36,0 34,0 V L +S +B   |
|  | 3.0 V6 TDI<br>3.0 V6 TDI<br>3.0 V6 TDI<br>3.0 V6 TDI<br>3.0 V6 TDI<br>3.0 V6 TSI Hybrid<br>3.6 V6 FSI<br>4.2 V8 FSI<br>4.2 V8 TDI | 150<br>165<br>176<br>180<br>193<br>245<br>206<br>265<br>250                      | 04.10<br>06.10<br>04.10<br>05.11<br>09.14<br>04.10<br>04.10<br>01.11<br>04.10          | PR: 1LC,1LE<br>PR: 1LC,1LE<br>PR: 1LC,1LE<br>PR: 1LC,1LE<br>PR: 1LC,1LE<br>PR: 1LC,1LE<br>PR: 1LC,1LE<br>PR: 1LC,1LE<br>PR: 1LC,1LE                                 | 24.0132-0117.1<br>24.0132-0118.1   | 432117<br>432118   | <br> | 330 32,0 30,0 V L +S +B<br>330 32,0 30,0 V L +S +B   |
|  | 3.0 V6 TDI<br>3.0 V6 TDI<br>3.0 V6 TDI<br>3.0 V6 TDI<br>3.0 V6 TDI<br>3.0 V6 TSI Hybrid<br>3.6 V6 FSI<br>4.2 V8 FSI<br>4.2 V8 TDI | 150<br>165<br>176<br>180<br>193<br>245<br>206<br>265<br>250                      | 04.10<br>06.10<br>04.10<br>05.11<br>09.14<br>04.10<br>04.10<br>01.11<br>04.10          |   | 24.0711-5403.3   | 360361   | 2   | Radsensor  |
|  | 3.0 V6 TDI<br>3.0 V6 TDI<br>3.0 V6 TDI<br>3.0 V6 TDI<br>3.0 V6 TDI<br>3.0 V6 TSI Hybrid<br>3.6 V6 FSI<br>4.2 V8 FSI<br>4.2 V8 TDI | 150<br>165<br>176<br>180<br>193<br>245<br>206<br>265<br>250                      | 04.10<br>06.10<br>04.11<br>05.11<br>09.14<br>04.10<br>04.10<br>01.11<br>04.10          | PR: 1KJ,2EG<br>PR: 1KJ,2EG<br>PR: 1KJ,2EG<br>PR: 2EG<br>PR: 1KJ,2EG<br>PR: 1KJ,2EG<br>PR: 1KJ,2EG<br>PR: 1KJ,2EG<br>PR: 1KJ,2EG                                     | 13.0460-4872.2<br>13.0470-4872.2<br>24.8190-0015.2   | 604872<br>LD4872<br>620015   | 2  | elektrische Feststellbremse /+ USA <sup>1)</sup><br>elektrische Feststellbremse <sup>2)</sup><br>24721 16,9 /WE<br>24721 16,9 /WE<br>Warnkontakt L=138mm |
|  | 3.0 V6 TDI<br>3.0 V6 TDI<br>3.0 V6 TDI<br>3.0 V6 TDI<br>3.0 V6 TDI<br>3.0 V6 TSI Hybrid<br>3.6 V6 FSI<br>4.2 V8 FSI<br>4.2 V8 TDI | 150<br>165<br>176<br>180<br>193<br>245<br>206<br>265<br>250                      | 04.10<br>06.10<br>04.10<br>05.11<br>09.14<br>04.10<br>04.10<br>01.11<br>04.10          | PR: 1KQ<br>PR: 1KQ<br>PR: 1KQ<br>PR: 1KQ<br>PR: 1KQ<br>PR: 1KQ<br>PR: 1KQ<br>PR: 1KQ<br>PR: 1KQ   | 13.0460-4872.2<br>13.0470-4872.2<br>24.8190-0015.2   | 604872<br>LD4872<br>620015   | 2  | elektrische Feststellbremse <sup>2)</sup><br>elektrische Feststellbremse <sup>2)</sup><br>24721 16,9 /WE<br>24721 16,9 /WE<br>Warnkontakt L=138mm        |

<sup>1)</sup> electric parking brake /+ USA / fr.di stazionamento elettrico /+ USA / frein à main électrique /+ USA / freno de mano eléctrico /+ USA

















<sup>2)</sup> electric parking brake / fr.di stazionamento elettrico / frein à main électrique / freno de mano eléctrico

|     |   |   |    |  |  |    |  |  |
|--|---|---|--|--|---|--|--|--|
| <b>VOLKSWAGEN TOUAREG II (10-)</b>   |   |   |  |  |   |  |  |  |
|    | 3.0 V6 TDI 150<br>3.0 V6 TDI 165<br>3.0 V6 TDI 176<br>3.0 V6 TDI 180<br>3.0 V6 TDI 193<br>3.0 V6 TSI Hybrid 245<br>3.6 V6 FSI 206<br>4.2 V8 FSI 265<br>4.2 V8 TDI 250   | 04.10<br>06.10<br>04.10<br>05.11<br>09.14<br>04.10<br>04.10<br>01.11<br>04.10   | PR: 1KJ,1KQ,2EG<br>PR: 1KJ,1KQ,2EG<br>PR: 1KJ,1KQ,2EG<br>PR: 1KQ,2EG<br>PR: 1KJ,1KQ,2EG<br>PR: 1KJ,1KQ,2EG<br>PR: 1KJ,1KQ,2EG<br>PR: 1KJ,1KQ,2EG   | 24.0128-0149.1   | 428149  |  | elektrische Feststellbremse <sup>1)</sup>  | 330 28,0 26,0 VL +S +B   |
|    | 3.0 V6 TDI 150<br>3.0 V6 TDI 165<br>3.0 V6 TDI 176<br>3.0 V6 TDI 180<br>3.0 V6 TDI 193<br>3.0 V6 TSI Hybrid 245<br>3.6 V6 FSI 206<br>4.2 V8 FSI 265<br>4.2 V8 TDI 250   | 04.10<br>06.10<br>04.10<br>05.11<br>09.14<br>04.10<br>04.10<br>01.11<br>04.10   |  | 24.0711-5403.3   | 360361  | 2   |  | Radsensor  |
|    | 3.0 V6 TDI 150<br>3.0 V6 TDI 165<br>3.0 V6 TDI 176<br>3.0 V6 TDI 180<br>3.0 V6 TDI 193<br>3.0 V6 TSI Hybrid 245<br>3.6 V6 FSI 206<br>4.2 V8 FSI 265<br>4.2 V8 TDI 250   | 04.10<br>06.10<br>04.10<br>05.11<br>09.14<br>04.10<br>04.10<br>01.11<br>04.10   |  | 03.0137-3019.2   | 653019  |  |  | 210 x 30   |
| <b>VOLKSWAGEN TOURAN I (03-15)</b>   |   |   |  |  |   |  |  |  |
|    | 1.2 TSI 77<br>1.4 TSI 103<br>1.4 TSI 125<br>1.4 TSI EcoFuel 110<br>1.6 75<br>1.6 FSI 85<br>1.6 TDI 66<br>1.9 TDI 74<br>1.9 TDI 77<br>2.0 Eco Fuel 80<br>2.0 FSI 85<br>2.0 FSI 110<br>2.0 TDI 81<br>2.0 TDI 125<br>2.0 TDI 130 | 05.10<br>09.06<br>11.06<br>05.09<br>07.03<br>02.03<br>05.10<br>11.04<br>02.03<br>08.03<br>02.06<br>10.04<br>10.03<br>08.03<br>02.03<br>02.06<br>01.13 | PR: 1ZA,1ZD,1ZE,1ZP,1LJ<br>PR: 1ZA,1ZD,1ZE,1ZP,1LJ<br>PR: 1ZA,1ZD,1ZE,1ZP,1LJ<br>PR: 1ZA,1ZD,1ZE,1ZP,1LJ<br>PR: 1ZA,1ZD,1ZE,1ZP,1LJ<br>PR: 1ZA,1ZD,1ZE,1ZP,1LJ<br>PR: 1ZA,1ZD,1ZE,1ZP,1LJ<br>PR: 1ZA,1ZD,1ZE,1ZP,1LJ<br>PR: 1ZA,1ZD,1ZE,1ZP,1LJ<br>PR: 1ZA,1ZD,1ZE,1ZP,1LJ<br>PR: 1ZA,1ZD,1ZE,1ZP,1LJ<br>PR: 1ZA,1ZD,1ZE,1ZP,1LJ<br>PR: 1ZA,1ZD,1ZE,1ZP,1LJ<br>PR: 1ZA,1ZD,1ZE,1ZP,1LJ<br>PR: 1ZA,1ZD,1ZE,1ZP,1LJ<br>PR: 1ZA,1ZD,1ZE,1ZP,1LJ | 13.0460-7184.2<br>13.0470-7184.2   | 607184<br>LD7184  |  |  | 23587 20,6 +WK ATE<br>23587 20,6 +WK ATE   |
|  | 1.2 TSI 77<br>1.4 TSI 103<br>1.4 TSI 125<br>1.4 TSI EcoFuel 110<br>1.6 75<br>1.6 FSI 85<br>1.6 TDI 66<br>1.9 TDI 74<br>1.9 TDI 77<br>2.0 Eco Fuel 80<br>2.0 FSI 85<br>2.0 FSI 110<br>2.0 TDI 81<br>2.0 TDI 125<br>2.0 TDI 130 | 05.10<br>09.06<br>11.06<br>05.09<br>07.03<br>02.03<br>05.10<br>11.04<br>02.03<br>08.03<br>02.06<br>10.04<br>10.03<br>08.03<br>02.03<br>02.06<br>01.13 | PR: 1ZE,1ZP<br>PR: 1ZE,1ZP<br>PR: 1ZE,1ZP<br>PR: 1ZE,1ZP<br>PR: 1ZE,1ZP<br>PR: 1ZE,1ZP<br>PR: 1ZE,1ZP<br>PR: 1ZE,1ZP<br>PR: 1ZE,1ZP<br>PR: 1ZE,1ZP<br>PR: 1ZE,1ZP<br>PR: 1ZE,1ZP<br>PR: 1ZE,1ZP<br>PR: 1ZE,1ZP<br>PR: 1ZE,1ZP<br>PR: 1ZE,1ZP   | 24.0125-0145.1<br>24.0325-0145.1   | 425145<br>525145  |  |  | 288 25,0 22,0 VL +S +B<br>288 25,0 22,0 VL +S +B PD                                |
|  | 1.2 TSI 77<br>1.4 TSI 103<br>1.4 TSI 125<br>1.4 TSI EcoFuel 110<br>1.6 75<br>1.6 FSI 85<br>1.6 TDI 66<br>1.9 TDI 74<br>1.9 TDI 77<br>2.0 Eco Fuel 80<br>2.0 FSI 85<br>2.0 FSI 110<br>2.0 TDI 81<br>2.0 TDI 125<br>2.0 TDI 130 | 05.10<br>09.06<br>11.06<br>05.09<br>07.03<br>02.03<br>05.10<br>11.04<br>02.03<br>08.03<br>02.06<br>10.04<br>10.03<br>08.03<br>02.03<br>02.06<br>01.13 | PR: 1LJ,1ZA,1ZD<br>PR: 1LJ,1ZA,1ZD<br>PR: 1LJ,1ZA,1ZD<br>PR: 1LJ,1ZA,1ZD<br>PR: 1LJ,1ZA,1ZD<br>PR: 1LJ,1ZA,1ZD<br>PR: 1LJ,1ZA,1ZD<br>PR: 1LJ,1ZA,1ZD<br>PR: 1LJ,1ZA,1ZD<br>PR: 1LJ,1ZA,1ZD<br>PR: 1LJ,1ZA,1ZD<br>PR: 1LJ,1ZA,1ZD<br>PR: 1LJ,1ZA,1ZD<br>PR: 1LJ,1ZA,1ZD<br>PR: 1LJ,1ZA,1ZD<br>PR: 1LJ,1ZA,1ZD   | 24.0125-0158.1<br>24.0325-0158.1   | 425158<br>525158  |  |  | 312 25,0 22,0 VL +S +B<br>312 25,0 22,0 VL +S +B PD                                |
|  | 1.2 TSI 77<br>1.4 TSI 103<br>1.4 TSI 125<br>1.4 TSI EcoFuel 110<br>1.6 75<br>1.6 FSI 85<br>1.6 TDI 81   | 05.10<br>09.06<br>11.06<br>05.09<br>07.03<br>02.03<br>05.10   |  | 24.0711-5271.3<br>24.0711-5272.3   | 360301<br>360302  | <br> |  | Radsensor<br>Radsensor   |

<sup>1)</sup> electric parking brake / fr.di stazionamento elettrico / frein à main électrique / freno de mano eléctrico

|     |    kW   |  |    |   |  |  |  |  |
|--|---|--|--|---|---|--|--|--|
| <b>VOLKSWAGEN TOURAN I (03-15)</b>   |   |  |  |   |   |  |  |  |
|    | 1.9 TDI 66<br>1.9 TDI 74<br>1.9 TDI 77<br>2.0 Eco Fuel 80<br>2.0 FSI 85<br>2.0 FSI 110<br>2.0 TDI 81<br>2.0 TDI 125<br>2.0 TDI 130  |  | 11.04<br>02.03<br>08.03<br>02.06<br>10.04<br>10.03<br>08.03<br>02.03<br>02.06<br>01.13   |   | 24.0711-5271.3 360301<br>24.0711-5272.3 360302                                    |  |  | Radsensor<br>Radsensor   |
|    | 1.2 TSI 77<br>1.4 TSI 103<br>1.4 TSI 125<br>1.4 TSI EcoFuel 110<br>1.6 75<br>1.6 FSI 85<br>1.6 TDI 66<br>1.9 TDI 74<br>1.9 TDI 77<br>2.0 Eco Fuel 80<br>2.0 FSI 85<br>2.0 FSI 110<br>2.0 TDI 81<br>2.0 TDI 125                |  | 05.10<br>09.06<br>11.06<br>05.09<br>07.03<br>02.03<br>05.10<br>11.04<br>02.03<br>08.03<br>02.06<br>10.04<br>10.03<br>08.03<br>02.03<br>02.06 | PR: 1KE,1KF,1KJ<br>PR: 1KE,1KF,1KJ<br>PR: 1KE,1KF,1KJ<br>PR: 1KE,1KF,1KJ<br>PR: 1KE,1KF,1KJ<br>PR: 1KE,1KF,1KJ<br>PR: 1KE,1KF,1KJ<br>PR: 1KE,1KF,1KJ<br>PR: 1KE,1KF,1KJ<br>PR: 1KE,1KF,1KJ<br>PR: 1KE,1KF,1KJ<br>PR: 1KE,1KF,1KJ<br>PR: 1KE,1KF,1KJ<br>PR: 1KE,1KF,1KJ<br>PR: 1KE,1KF,1KJ | 13.0460-2880.2 602880<br>13.0470-2880.2 LD2880<br>13.0460-0259.2 610259           |  | 23914 17,1 /WE/Zub/S TRW<br>23914 17,1 /WE/Zub/S TRW<br>Belagsatz-Zubehör          |  |
|  | 1.2 TSI 77<br>1.4 TSI 103<br>1.4 TSI 125<br>1.4 TSI EcoFuel 110<br>1.6 75<br>1.6 FSI 85<br>1.6 TDI 66<br>1.9 TDI 74<br>1.9 TDI 77<br>2.0 Eco Fuel 80<br>2.0 FSI 85<br>2.0 FSI 110<br>2.0 TDI 81<br>2.0 TDI 125<br>2.0 TDI 130 |  | 05.10<br>09.06<br>11.06<br>05.09<br>07.03<br>02.03<br>05.10<br>11.04<br>02.03<br>08.03<br>02.06<br>10.04<br>10.03<br>08.03<br>02.03<br>01.13 | PR: 1KS<br>PR: 1KS<br>PR: 1KS<br>PR: 1KS<br>PR: 1KS<br>PR: 1KS<br>PR: 1KS<br>PR: 1KS<br>PR: 1KS<br>PR: 1KS<br>PR: 1KS<br>PR: 1KS<br>PR: 1KS<br>PR: 1KS  | 13.0460-3858.2 603858<br>13.0470-3858.2 LD3858                                    |  | 24563 17,7 /Zub/S BOS<br>24563 17,7 /Zub/S BOS                                     |  |
|  | 1.2 TSI 77<br>1.4 TSI 103<br>1.4 TSI 125<br>1.4 TSI EcoFuel 110<br>1.6 75<br>1.6 FSI 85<br>1.6 TDI 66<br>1.9 TDI 74<br>1.9 TDI 77<br>2.0 Eco Fuel 80<br>2.0 FSI 85<br>2.0 FSI 110<br>2.0 TDI 81<br>2.0 TDI 125                |  | 05.10<br>09.06<br>11.06<br>05.09<br>07.03<br>02.03<br>05.10<br>11.04<br>02.03<br>08.03<br>02.06<br>10.04<br>10.03<br>08.03<br>02.03<br>02.06 | PR: 1KE,1KF<br>PR: 1KE,1KF<br>PR: 1KE,1KF<br>PR: 1KE,1KF<br>PR: 1KE,1KF<br>PR: 1KE,1KF<br>PR: 1KE,1KF<br>PR: 1KE,1KF<br>PR: 1KE,1KF<br>PR: 1KE,1KF<br>PR: 1KE,1KF<br>PR: 1KE,1KF<br>PR: 1KE,1KF<br>PR: 1KE,1KF  | 24.0112-0158.1 412158<br>24.0312-0158.1 512158                                    |  | 256 12,0 10,0 +S +B<br>256 12,0 10,0 +B PD   |  |
|  | 1.2 TSI 77<br>1.4 TSI 103<br>1.4 TSI 125<br>1.4 TSI EcoFuel 110<br>1.6 75<br>1.6 FSI 85<br>1.6 TDI 66<br>1.9 TDI 74<br>1.9 TDI 77<br>2.0 Eco Fuel 80<br>2.0 FSI 85<br>2.0 FSI 110<br>2.0 TDI 81<br>2.0 TDI 125                |  | 05.10<br>09.06<br>11.06<br>05.09<br>07.03<br>02.03<br>05.10<br>11.04<br>02.03<br>08.03<br>02.06<br>10.04<br>10.03<br>08.03<br>02.03<br>02.06 | PR: 1KJ<br>PR: 1KJ<br>PR: 1KJ<br>PR: 1KJ<br>PR: 1KJ<br>PR: 1KJ<br>PR: 1KJ<br>PR: 1KJ<br>PR: 1KJ<br>PR: 1KJ<br>PR: 1KJ<br>PR: 1KJ<br>PR: 1KJ<br>PR: 1KJ  | 24.0112-0169.1 412169<br>24.0312-0169.1 512169                                    |  | 282 12,0 10,0 +S +B<br>282 12,0 10,0 +B PD   |  |
|  | 1.2 TSI 77<br>1.4 TSI 103<br>1.4 TSI 125<br>1.4 TSI EcoFuel 110<br>1.6 75<br>1.6 FSI 85<br>1.6 TDI 66<br>1.9 TDI 74<br>1.9 TDI 77<br>2.0 Eco Fuel 80<br>2.0 FSI 85<br>2.0 FSI 110<br>2.0 TDI 81<br>2.0 TDI 125                |  | 05.10<br>09.06<br>11.06<br>05.09<br>07.03<br>02.03<br>05.10<br>11.04<br>02.03<br>08.03<br>02.06<br>10.04<br>10.03<br>08.03<br>02.03<br>02.06 | PR: 1KS<br>PR: 1KS<br>PR: 1KS<br>PR: 1KS<br>PR: 1KS<br>PR: 1KS<br>PR: 1KS<br>PR: 1KS<br>PR: 1KS<br>PR: 1KS<br>PR: 1KS<br>PR: 1KS<br>PR: 1KS<br>PR: 1KS  | 24.0110-0356.1 410356<br>24.0310-0356.1 510356                                    |  | 272 9,7 8,0 +S +B<br>272 9,7 8,0 +S +B PD  |  |



|     |    |              |   |   |  |  |  |   |
|--|--|--|---|---|---|--|--|---|
| <b>VOLKSWAGEN TOURAN I (03-15)</b>   |  |  |   |   |   |  |  |   |
|    | 2.0 FSI<br>2.0 TDI<br>2.0 TDI<br>2.0 TDI<br>2.0 TDI  | 110<br>81<br>125<br>130  | 10.03<br>08.03<br>02.03<br>02.06<br>01.13   | PR: 1KS<br>PR: 1KS<br>PR: 1KS<br>PR: 1KS  | 24.0110-0356.1<br>24.0310-0356.1  | 410356<br>510356   |  | 272 9,7 8,0 +S +B<br>272 9,7 8,0 +S +B PD   |
|    | 1.2 TSI<br>1.4 TSI<br>1.4 TSI<br>1.4 TSI EcoFuel<br>1.6<br>1.6 FSI<br>1.6 TDI<br>1.9 TDI<br>1.9 TDI<br>1.9 TDI<br>2.0 Eco Fuel<br>2.0 FSI<br>2.0 FSI<br>2.0 TDI<br>2.0 TDI<br>2.0 TDI<br>2.0 TDI | 77<br>103<br>125<br>110<br>75<br>85<br>66<br>74<br>77<br>80<br>85<br>110<br>81<br>125<br>130 | 05.10<br>09.06<br>11.06<br>05.09<br>07.03<br>02.03<br>05.10<br>11.04<br>02.03<br>08.03<br>02.06<br>10.04<br>10.03<br>08.03<br>02.03<br>02.06<br>01.13 | - Parkassistent <sup>1)</sup><br>- Parkassistent <sup>1)</sup><br>- Parkassistent <sup>1)</sup><br>- Parkassistent <sup>1)</sup><br>- Parkassistent <sup>1)</sup><br>- Parkassistent <sup>1)</sup><br>- Parkassistent <sup>1)</sup><br>- Parkassistent <sup>1)</sup><br>- Parkassistent <sup>1)</sup><br>- Parkassistent <sup>1)</sup><br>- Parkassistent <sup>1)</sup><br>- Parkassistent <sup>1)</sup><br>- Parkassistent <sup>1)</sup><br>- Parkassistent <sup>1)</sup><br>- Parkassistent <sup>1)</sup><br>- Parkassistent <sup>1)</sup><br>- Parkassistent <sup>1)</sup> | 24.0711-6231.3<br>24.0711-6232.3  | 360305<br>360306   | <input type="checkbox"/><br><input type="checkbox"/>                               | Radsensor<br>Radsensor  |
|  | 1.2 TSI<br>1.4 TSI<br>1.4 TSI<br>1.4 TSI EcoFuel<br>1.6<br>1.6 FSI<br>1.6 TDI<br>1.9 TDI<br>1.9 TDI<br>1.9 TDI<br>2.0 Eco Fuel<br>2.0 FSI<br>2.0 FSI<br>2.0 TDI<br>2.0 TDI<br>2.0 TDI<br>2.0 TDI | 77<br>103<br>125<br>110<br>75<br>85<br>66<br>74<br>77<br>80<br>85<br>110<br>81<br>125<br>130 | 05.10<br>09.06<br>11.06<br>05.09<br>07.03<br>02.03<br>05.10<br>11.04<br>02.03<br>08.03<br>02.06<br>10.04<br>10.03<br>08.03<br>02.03<br>02.06<br>01.13 | + Parkassistent <sup>2)</sup><br>+ Parkassistent <sup>2)</sup><br>+ Parkassistent <sup>2)</sup><br>+ Parkassistent <sup>2)</sup><br>+ Parkassistent <sup>2)</sup><br>+ Parkassistent <sup>2)</sup><br>+ Parkassistent <sup>2)</sup><br>+ Parkassistent <sup>2)</sup><br>+ Parkassistent <sup>2)</sup><br>+ Parkassistent <sup>2)</sup><br>+ Parkassistent <sup>2)</sup><br>+ Parkassistent <sup>2)</sup><br>+ Parkassistent <sup>2)</sup><br>+ Parkassistent <sup>2)</sup><br>+ Parkassistent <sup>2)</sup><br>+ Parkassistent <sup>2)</sup><br>+ Parkassistent <sup>2)</sup> | 24.0711-6335.3<br>24.0711-6336.3  | 360365<br>360366   | <input type="checkbox"/><br><input type="checkbox"/>                               | Radsensor<br>Radsensor  |
| <b>VOLKSWAGEN TOURAN II (15-)</b>  |  |  |   |   |   |  |  |   |
|  | 1.2 TSI<br>1.4 TSI<br>1.6 TDI<br>1.6 TDI<br>1.8 TSI<br>2.0 TDI<br>2.0 TDI<br>2.0 TDI   | 81<br>110<br>81<br>85<br>132<br>81<br>110<br>140   | 09.15<br>09.15<br>09.15<br>05.16<br>11.15<br>11.15<br>09.15<br>11.15  | PR: 1ZA,1ZD<br>PR: 1ZA,1ZD<br>PR: 1ZA,1ZD<br>PR: 1ZA,1ZD<br>PR: 1ZA,1ZD<br>PR: 1ZA,1ZD<br>PR: 1ZA,1ZD<br>PR: 1ZA,1ZD  | 13.0460-2785.2<br>13.0470-2785.2<br>24.8190-0065.2                                | 602785<br>LD2785<br>620065   | 1 <input type="checkbox"/>   | 25683 20,4 +/WK/S TRW<br>25683 20,4 +/WK/S TRW<br>Warnkontakt L=172mm   |
|  | 1.2 TSI<br>1.4 TSI<br>1.6 TDI<br>1.6 TDI<br>1.8 TSI<br>2.0 TDI<br>2.0 TDI<br>2.0 TDI   | 81<br>110<br>81<br>85<br>132<br>81<br>110<br>140   | 09.15<br>09.15<br>09.15<br>05.16<br>11.15<br>11.15<br>09.15<br>11.15  | PR: 1ZA,1ZD<br>PR: 1ZA,1ZD<br>PR: 1ZA,1ZD<br>PR: 1ZA,1ZD<br>PR: 1ZA,1ZD<br>PR: 1ZA,1ZD<br>PR: 1ZA,1ZD<br>PR: 1ZA,1ZD  | 24.0125-0158.1<br>24.0325-0158.1  | 425158<br>525158   |  | 312 25,0 22,0 V L +S +B<br>312 25,0 22,0 V L +S +B PD   |
|  | 1.2 TSI<br>1.4 TSI<br>1.6 TDI<br>1.6 TDI<br>1.8 TSI<br>2.0 TDI<br>2.0 TDI<br>2.0 TDI   | 81<br>110<br>81<br>85<br>132<br>81<br>110<br>140   | 09.15<br>09.15<br>09.15<br>05.16<br>11.15<br>11.15<br>09.15<br>11.15  |   | 24.0711-5273.3<br>24.0711-5274.3  | 360303<br>360304   | <input type="checkbox"/><br><input type="checkbox"/>                               | Radsensor<br>Radsensor  |
|  | 1.2 TSI<br>1.4 TSI<br>1.6 TDI<br>1.6 TDI<br>1.8 TSI<br>2.0 TDI<br>2.0 TDI<br>2.0 TDI   | 81<br>110<br>81<br>85<br>132<br>81<br>110<br>140   | 09.15<br>09.15<br>09.15<br>05.16<br>11.15<br>11.15<br>09.15<br>11.15  | PR: 1KE<br>PR: 1KE<br>PR: 1KE<br>PR: 1KE<br>PR: 1KE<br>PR: 1KE<br>PR: 1KE   | 13.0460-7293.2  | 607293   |  | elektrische Feststellbremse <sup>3)</sup><br>25008 16,3 + ATE   |
|  | 1.2 TSI<br>1.4 TSI<br>1.6 TDI<br>1.6 TDI<br>1.8 TSI<br>2.0 TDI<br>2.0 TDI<br>2.0 TDI   | 81<br>110<br>81<br>85<br>132<br>81<br>110<br>140   | 09.15<br>09.15<br>09.15<br>05.16<br>11.15<br>11.15<br>09.15<br>11.15  | PR: 1KU<br>PR: 1KU<br>PR: 1KU<br>PR: 1KU<br>PR: 1KU<br>PR: 1KU<br>PR: 1KU   | 13.0460-7294.2<br>13.0470-7294.2  | 607294<br>LD7294   |  | elektrische Feststellbremse <sup>3)</sup><br>elektrische Feststellbremse <sup>3)</sup><br>25009 16,4 + ATE<br>25009 16,4 + ATE      |
|  | 1.2 TSI<br>1.4 TSI<br>1.6 TDI<br>1.6 TDI<br>1.8 TSI  | 81<br>110<br>81<br>85<br>132   | 09.15<br>09.15<br>09.15<br>05.16<br>11.15   | PR: 1KE<br>PR: 1KE<br>PR: 1KE<br>PR: 1KE<br>PR: 1KE   | 24.0110-0356.1<br>24.0310-0356.1  | 410356<br>510356   |  | elektrische Feststellbremse <sup>3)</sup><br>elektrische Feststellbremse <sup>3)</sup><br>272 9,7 8,0 +S +B<br>272 9,7 8,0 +S +B PD |

<sup>1)</sup> - parking assistant / - assistente di parcheggio / - assistance au stationnement / - asistente de aparcamiento  
<sup>2)</sup> + parking assistant / + assistente di parcheggio / + assistance au stationnement / + asistente de aparcamiento  
<sup>3)</sup> electric parking brake / fr.di stazionamento elettrico / frein à main électrique / freno de mano eléctrico



### VOLKSWAGEN TOURAN II (15-)

|  |         |     |  |              |         |                       |        |   |                             |           |
|--|---------|-----|--|--------------|---------|-----------------------|--------|---|-----------------------------|-----------|
|  | 2.0 TDI | 81  |  | <b>11.15</b> | PR: 1KE | <b>24.0110-0356.1</b> | 410356 | elektrische Feststellbremse <sup>1)</sup> | 272 9,7 8,0 +S +B           |           |
|  | 2.0 TDI | 110 |  | <b>09.15</b> | PR: 1KE | <b>24.0310-0356.1</b> | 510356 | elektrische Feststellbremse <sup>1)</sup> | <b>272 9,7 8,0 +S +B PD</b> |           |
|  | 2.0 TDI | 140 |  | <b>11.15</b> | PR: 1KE |                       |        |   |                             |           |
|  | 1.2 TSI | 81  |  | <b>09.15</b> | PR: 1KU | <b>24.0112-0210.1</b> | 412210 | elektrische Feststellbremse <sup>1)</sup> | 300 12,0 10,0 +S +B         |           |
|  | 1.4 TSI | 110 |  | <b>09.15</b> | PR: 1KU |                       |        |   |                             |           |
|  | 1.6 TDI | 81  |  | <b>09.15</b> | PR: 1KU |                       |        |   |                             |           |
|  | 1.6 TDI | 85  |  | <b>05.16</b> | PR: 1KU |                       |        |   |                             |           |
|  | 1.8 TSI | 132 |  | <b>11.15</b> | PR: 1KU |                       |        |   |                             |           |
|  | 2.0 TDI | 81  |  | <b>11.15</b> | PR: 1KU |                       |        |   |                             |           |
|  | 2.0 TDI | 110 |  | <b>09.15</b> | PR: 1KU |                       |        |   |                             |           |
|  | 2.0 TDI | 140 |  | <b>11.15</b> | PR: 1KU |                       |        |   |                             |           |
|  | 1.2 TSI | 81  |  | <b>09.15</b> |         | <b>24.0711-6337.3</b> | 360390 |   | 2                           | Radsensor |
|  | 1.4 TSI | 110 |  | <b>09.15</b> |         |                       |        |   |                             |           |
|  | 1.6 TDI | 81  |  | <b>09.15</b> |         |                       |        |   |                             |           |
|  | 1.6 TDI | 85  |  | <b>05.16</b> |         |                       |        |   |                             |           |
|  | 1.8 TSI | 132 |  | <b>11.15</b> |         |                       |        |   |                             |           |

### VOLKSWAGEN TRANSPORTER (T4) (90-03)

|                |             |             |              |              |              |                       |                       |        |  |                                    |              |
|----------------|-------------|-------------|--------------|--------------|--------------|-----------------------|-----------------------|--------|--|------------------------------------|--------------|
|                | 1.8         |             |              | <b>12.90</b> | <b>07.92</b> | PR: 1LA               | <b>13.0460-2972.2</b> | 602972 |  | 20124 18,9/S                       | TRW          |
|                | 1.9 D       |             |              | <b>07.90</b> | <b>04.96</b> | PR: 1LA               |                       |        |  |                                    |              |
|                | 1.9 TD      |             |              | <b>10.92</b> | <b>04.96</b> | PR: 1LA               |                       |        |  |                                    |              |
|                | 2.0         |             |              | <b>07.90</b> | <b>04.96</b> | PR: 1LA               |                       |        |  |                                    |              |
|                | 2.4 D       |             |              | <b>07.90</b> | <b>04.96</b> | PR: 1LA               |                       |        |  |                                    |              |
|                | 2.5         |             |              | <b>10.90</b> | <b>04.96</b> | PR: 1LA               |                       |        |  |                                    |              |
|                | 2.5 TDI     |             |              | <b>09.95</b> | <b>04.96</b> | PR: 1LA               |                       |        |  |                                    |              |
|                | 1.9 D       | 70-P-160001 | 70-X-250000  |              |              |                       | <b>13.0460-2982.2</b> | 602982 |  |                                    | 21479 19,2/S |
| 1.9 TD         | 70-P-160001 | 70-X-250000 |              |              |              |                       |                       |        |  |                                    |              |
| 2.0            | 70-P-160001 | 70-X-250000 |              |              |              |                       |                       |        |  |                                    |              |
| 2.4 D          | 70-P-160001 | 70-X-250000 |              |              |              |                       |                       |        |  |                                    |              |
| 2.4 D Syncro   |             | 70-X-250000 | <b>11.92</b> |              | PR: 1LP      |                       |                       |        |  |                                    |              |
| 2.5            | 70-P-160001 | 70-X-250000 |              |              | PR: 1LP      |                       |                       |        |  |                                    |              |
| 2.5 Syncro     |             | 70-X-250000 | <b>11.92</b> |              | PR: 1LP      |                       |                       |        |  |                                    |              |
| 2.5 TDI        |             | 70-X-250000 | <b>09.95</b> |              | PR: 1LP      |                       |                       |        |  |                                    |              |
| 2.5 TDI Syncro |             | 70-X-250000 | <b>09.95</b> |              | PR: 1LP      |                       |                       |        |  |                                    |              |
| 2.8            |             | 70-X-250000 | <b>11.95</b> |              | PR: 1LP      |                       |                       |        |  |                                    |              |
| 1.9 D          | 70-Y-000001 |             |              | <b>09.03</b> | PR: 1LP      | <b>13.0460-2838.2</b> | 602838                |        |  | 21479 19,2 +/-WK/S                 | TRW          |
| 1.9 TD         | 70-Y-000001 |             |              | <b>09.03</b> | PR: 1LP      |                       |                       |        |  |                                    |              |
| 2.0            | 70-Y-000001 |             |              | <b>09.03</b> | PR: 1LP      |                       |                       |        |  |                                    |              |
| 2.4 D          | 70-Y-000001 |             |              | <b>09.03</b> | PR: 1LP      |                       |                       |        |  |                                    |              |
| 2.4 D Syncro   | 70-Y-000001 |             |              | <b>09.03</b> | PR: 1LP      |                       |                       |        |  |                                    |              |
| 2.5            | 70-Y-000001 |             |              | <b>09.03</b> | PR: 1LP      |                       |                       |        |  |                                    |              |
| 2.5 Syncro     | 70-Y-000001 |             |              | <b>09.03</b> | PR: 1LP      |                       |                       |        |  |                                    |              |
| 2.5 TDI        | 70-Y-000001 |             |              | <b>09.03</b> | PR: 1LP      |                       |                       |        |  |                                    |              |
| 2.5 TDI Syncro | 70-Y-000001 |             |              | <b>09.03</b> | PR: 1LP      |                       |                       |        |  |                                    |              |
| 2.8            | 70-Y-000001 |             |              | <b>09.03</b> | PR: 1LP      |                       |                       |        |  |                                    |              |
| 1.9 D          |             | 70-X-250000 | <b>07.90</b> |              | PR: 1LE      | <b>13.0460-2973.2</b> | 602973                |        |  | 21635 18,0 + Belagsatz-Zubehör     | TRW          |
| 1.9 TD         |             | 70-X-250000 | <b>10.92</b> |              | PR: 1LE      | <b>13.0460-0286.2</b> | 610286                |        |  |                                    |              |
| 2.0            |             | 70-X-250000 | <b>07.90</b> |              | PR: 1LE      |                       |                       |        |  |                                    |              |
| 2.4 D          |             | 70-X-250000 | <b>07.90</b> |              | PR: 1LE      |                       |                       |        |  |                                    |              |
| 2.4 D Syncro   |             | 70-X-250000 | <b>11.92</b> |              | PR: 1LE      |                       |                       |        |  |                                    |              |
| 2.5            |             | 70-X-250000 | <b>10.90</b> |              | PR: 1LE      |                       |                       |        |  |                                    |              |
| 2.5 Syncro     |             | 70-X-250000 | <b>11.92</b> |              | PR: 1LE      |                       |                       |        |  |                                    |              |
| 2.5 TDI        |             | 70-X-250000 | <b>09.95</b> |              | PR: 1LE      |                       |                       |        |  |                                    |              |
| 2.5 TDI Syncro |             | 70-X-250000 | <b>09.95</b> |              | PR: 1LE      |                       |                       |        |  |                                    |              |
| 2.8            |             | 70-X-250000 | <b>11.95</b> |              | PR: 1LE      |                       |                       |        |  |                                    |              |
| 1.9 D          | 70-Y-000001 |             |              | <b>09.03</b> | PR: 1LE      | <b>13.0460-2839.2</b> | 602839                |        |  | 23176 18,7 +/-WK Belagsatz-Zubehör | TRW          |
| 1.9 TD         | 70-Y-000001 |             |              | <b>09.03</b> | PR: 1LE      | <b>13.0460-0286.2</b> | 610286                |        |  |                                    |              |
| 2.0            | 70-Y-000001 |             |              | <b>09.03</b> | PR: 1LE      |                       |                       |        |  |                                    |              |
| 2.4 D          | 70-Y-000001 |             |              | <b>09.03</b> | PR: 1LE      |                       |                       |        |  |                                    |              |
| 2.4 D Syncro   | 70-Y-000001 |             |              | <b>09.03</b> | PR: 1LE      |                       |                       |        |  |                                    |              |
| 2.5            | 70-Y-000001 |             |              | <b>09.03</b> | PR: 1LE      |                       |                       |        |  |                                    |              |
| 2.5 Syncro     | 70-Y-000001 |             |              | <b>09.03</b> | PR: 1LE      |                       |                       |        |  |                                    |              |
| 2.5 TDI        | 70-Y-000001 |             |              | <b>09.03</b> | PR: 1LE      |                       |                       |        |  |                                    |              |
| 2.5 TDI Syncro | 70-Y-000001 |             |              | <b>09.03</b> | PR: 1LE      |                       |                       |        |  |                                    |              |
| 2.8            | 70-Y-000001 |             |              | <b>09.03</b> | PR: 1LE      |                       |                       |        |  |                                    |              |
| 1.9 D          |             | 70-X-250000 | <b>05.96</b> |              | PR: 1LU      | <b>13.0460-7102.2</b> | 607102                |        |  | 21883 19,8 +                       | ATE          |
| 1.9 TD         |             | 70-X-250000 | <b>05.96</b> |              | PR: 1LU      |                       |                       |        |  |                                    |              |
| 2.0            |             | 70-X-250000 | <b>05.96</b> |              | PR: 1LU      |                       |                       |        |  |                                    |              |
| 2.4 D          |             | 70-X-250000 | <b>05.96</b> |              | PR: 1LU      |                       |                       |        |  |                                    |              |
| 2.4 D Syncro   |             | 70-X-250000 | <b>07.95</b> |              | PR: 1LU      |                       |                       |        |  |                                    |              |
| 2.5            |             | 70-X-250000 | <b>05.96</b> |              | PR: 1LU      |                       |                       |        |  |                                    |              |
| 2.5 Syncro     |             | 70-X-250000 | <b>07.95</b> |              | PR: 1LU      |                       |                       |        |  |                                    |              |
| 2.5 TDI        |             | 70-X-250000 | <b>05.96</b> |              | PR: 1LU      |                       |                       |        |  |                                    |              |
| 2.5 TDI Syncro |             | 70-X-250000 | <b>09.95</b> |              | PR: 1LU      |                       |                       |        |  |                                    |              |
| 2.8            |             | 70-X-250000 | <b>11.95</b> |              | PR: 1LU      |                       |                       |        |  |                                    |              |
| 1.9 D          | 70-Y-000001 |             |              | <b>09.03</b> | PR: 1LU      | <b>13.0460-7124.2</b> | 607124                |        |  | 21885 20,4 +/-WK                   | ATE          |
| 1.9 TD         | 70-Y-000001 |             |              | <b>09.03</b> | PR: 1LU      |                       |                       |        |  |                                    |              |
| 2.0            | 70-Y-000001 |             |              | <b>09.03</b> | PR: 1LU      |                       |                       |        |  |                                    |              |
| 2.4 D          | 70-Y-000001 |             |              | <b>09.03</b> | PR: 1LU      |                       |                       |        |  |                                    |              |
| 2.4 D Syncro   | 70-Y-000001 |             |              | <b>09.03</b> | PR: 1LU      |                       |                       |        |  |                                    |              |
| 2.5            | 70-Y-000001 |             |              | <b>09.03</b> | PR: 1LU      |                       |                       |        |  |                                    |              |
| 2.5 Syncro     | 70-Y-000001 |             |              | <b>09.03</b> | PR: 1LU      |                       |                       |        |  |                                    |              |
| 2.5 TDI        | 70-Y-000001 |             |              | <b>09.03</b> | PR: 1LU      |                       |                       |        |  |                                    |              |

<sup>1)</sup> electric parking brake / fr.di stazionamento elettrico / frein à main électrique / freno de mano eléctrico

| VOLKSWAGEN TRANSPORTER (T4) (90-03)                    |  |  |   |  |  |  |   |   |                         |
|--|--|--|---|--|--|--|---|---|-------------------------|
|  | 2.5 TDI Syncro<br>2.8  | 70-Y-000001<br>70-Y-000001   |   | 09.03<br>09.03   | PR: 1LU<br>PR: 1LU   | 13.0460-7124.2<br>607124   |   | 21885 20,4 +/WK                                 | ATE                     |
|  | 1.9 D<br>1.9 TD<br>2.0<br>2.4 D<br>2.5<br>2.5 TDI<br>2.8   |  | 70-1-000954<br>70-1-000954<br>70-1-000954<br>70-1-000954<br>70-1-000954<br>70-1-000954<br>70-1-000954 | 05.97<br>05.97<br>05.97<br>05.97<br>05.97<br>05.97<br>05.97                            | PR: 1LB<br>PR: 1LB<br>PR: 1LB<br>PR: 1LB<br>PR: 1LB<br>PR: 1LB<br>PR: 1LB                                  | 13.0460-7123.2<br>607123   |   | 23034 18,8 +/WK                                 | ATE                     |
|  | 1.9 D<br>1.9 TD<br>2.0<br>2.4 D<br>2.4 D Syncro<br>2.5<br>2.5 Syncro<br>2.5 TDI<br>2.5 TDI Syncro<br>2.8 | 70-1-000955<br>70-1-000955<br>70-1-000955<br>70-1-000955<br>70-1-000955<br>70-1-000955<br>70-1-000955<br>70-1-000955<br>70-1-000955<br>70-1-000955 |   | 09.03<br>09.03<br>09.03<br>09.03<br>07.95<br>07.95<br>09.03<br>09.03<br>09.03<br>09.03 | PR: 1LB<br>PR: 1LB<br>PR: 1LB<br>PR: 1LB<br>PR: 1LB<br>PR: 1LB<br>PR: 1LB<br>PR: 1LB<br>PR: 1LB<br>PR: 1LB | 13.0460-7153.2<br>607153   |   | 23269 19,8 +/WK                                 | ATE                     |
|  | 1.8<br>1.9 D<br>1.9 TD<br>2.0<br>2.4 D<br>2.5<br>2.5 TDI   |  |   | 12.90<br>07.90<br>10.92<br>07.90<br>07.90<br>10.90<br>09.95                            | 07.92<br>04.96<br>04.96<br>04.96<br>04.96<br>04.96<br>04.96  | PR: 1LA<br>PR: 1LA<br>PR: 1LA<br>PR: 1LA<br>PR: 1LA<br>PR: 1LA<br>PR: 1LA  | 24.0116-0108.1<br>416108                      |   | 260 16,0 13,0           |
|  | 1.9 D<br>1.9 TD<br>2.0<br>2.4 D<br>2.4 D Syncro<br>2.5<br>2.5 Syncro<br>2.5 TDI<br>2.5 TDI Syncro        | 70-P-160001<br>70-P-160001<br>70-P-160001<br>70-P-160001<br>70-P-160001<br>70-P-160001   |   |  | 04.96<br>04.96<br>04.96<br>04.96<br>11.92<br>11.92<br>09.95<br>09.95                                       | PR: 1LP<br>PR: 1LP<br>PR: 1LP<br>PR: 1LP<br>PR: 1LP<br>PR: 1LP<br>PR: 1LP<br>PR: 1LP   | 24.0118-0105.1<br>418105                      |   | 282 18,0 15,0 +B        |
|  | 1.9 D<br>1.9 TD<br>2.0<br>2.4 D<br>2.4 D Syncro<br>2.5<br>2.5 Syncro<br>2.5 TDI<br>2.5 TDI Syncro<br>2.8 |  |   | 05.96<br>05.96<br>05.96<br>05.96<br>05.96<br>05.96<br>05.96<br>05.96<br>05.96<br>11.95 | 09.03<br>09.03<br>09.03<br>09.03<br>09.03<br>09.03<br>09.03<br>09.03<br>09.03<br>09.03                     | PR: 1LP<br>PR: 1LP<br>PR: 1LP<br>PR: 1LP<br>PR: 1LP<br>PR: 1LP<br>PR: 1LP<br>PR: 1LP<br>PR: 1LP<br>PR: 1LP   | 24.0118-0111.1<br>418111                      |   | 282 18,0 15,0 L +S +B   |
|  | 1.9 D<br>1.9 TD<br>2.0<br>2.4 D<br>2.4 D Syncro<br>2.5<br>2.5 Syncro<br>2.5 TDI                          |  |   | 07.90<br>10.92<br>07.90<br>07.90<br>11.92<br>10.90<br>11.92<br>09.95                   | 04.96<br>04.96<br>04.96<br>04.96<br>06.95<br>04.96<br>06.95<br>04.96                                       | PR: 1LE,1LU<br>PR: 1LE,1LU<br>PR: 1LE,1LU<br>PR: 1LE,1LU<br>PR: 1LE,1LU<br>PR: 1LE,1LU<br>PR: 1LE,1LU<br>PR: 1LE,1LU                               | 24.0124-0118.1<br>424118                      |   | 280 24,0 20,0 V L +B    |
|  | 1.9 D<br>1.9 TD<br>2.0<br>2.4 D<br>2.4 D Syncro<br>2.5<br>2.5 Syncro<br>2.5 TDI<br>2.5 TDI Syncro<br>2.8 |  |   | 05.96<br>05.96<br>05.96<br>05.96<br>07.95<br>05.96<br>07.95<br>05.96<br>09.95<br>11.95 | 09.03<br>09.03<br>09.03<br>09.03<br>09.03<br>09.03<br>09.03<br>09.03<br>09.03<br>09.03                     | PR: 1LE,1LU<br>PR: 1LE,1LU<br>PR: 1LE,1LU<br>PR: 1LE,1LU<br>PR: 1LE,1LU<br>PR: 1LE,1LU<br>PR: 1LE,1LU<br>PR: 1LE,1LU<br>PR: 1LE,1LU<br>PR: 1LE,1LU | 24.0124-0128.1<br>424128                      |   | 280 24,0 20,0 V L +S +B |
|  | 1.9 D<br>1.9 TD<br>2.0<br>2.4 D<br>2.5<br>2.5 TDI<br>2.8   |  | 70-1-000954<br>70-1-000954<br>70-1-000954<br>70-1-000954<br>70-1-000954<br>70-1-000954                | 05.97<br>05.97<br>05.97<br>05.97<br>05.97<br>05.97                                     | PR: 1LB<br>PR: 1LB<br>PR: 1LB<br>PR: 1LB<br>PR: 1LB<br>PR: 1LB   | 24.0126-0115.1<br>426115<br>24.0326-0115.1<br>526115   |   | 300 26,0 22,0 V L +B<br>300 26,0 22,0 V L +B PD |                         |
|  | 1.9 D<br>1.9 TD<br>2.0<br>2.4 D<br>2.4 D Syncro<br>2.5<br>2.5 Syncro<br>2.5 TDI<br>2.5 TDI Syncro<br>2.8 | 70-1-000955<br>70-1-000955<br>70-1-000955<br>70-1-000955<br>70-1-000955<br>70-1-000955<br>70-1-000955<br>70-1-000955<br>70-1-000955                |   | 09.03<br>09.03<br>09.03<br>09.03<br>07.95<br>07.95<br>09.03<br>09.03<br>09.03<br>09.03 | PR: 1LB<br>PR: 1LB<br>PR: 1LB<br>PR: 1LB<br>PR: 1LB<br>PR: 1LB<br>PR: 1LB<br>PR: 1LB<br>PR: 1LB<br>PR: 1LB | 24.0126-0119.1<br>426119<br>24.0326-0119.1<br>526119   |   | 313 25,9 22,0 V L +B<br>313 25,9 22,0 V L +B PD |                         |
| 1.9 D<br>1.9 TD<br>2.0<br>2.4 D<br>2.4 D Syncro<br>2.5 | 70-T-200000<br>70-T-200000<br>70-T-200000<br>70-T-200000<br>70-T-200000                                  |  | 09.03<br>09.03<br>09.03<br>09.03<br>09.03   | PR: 2E2<br>PR: 2E2<br>PR: 2E2<br>PR: 2E2<br>PR: 2E2                                    | 13.0460-2874.2<br>602874<br>13.0460-0225.2<br>610225   |  | 23224 16,5 +/WK/Zub/STRW<br>Belagsatz-Zubehör |   |                         |



**VOLKSWAGEN TRANSPORTER (T4) (90-03)**

|                |                |             |             |       |         |                |                |   |   |
|----------------|----------------|-------------|-------------|-------|---------|----------------|----------------|---|---|
|                | 2.5 Syncro     | 70-T-200000 |             | 09.03 | PR: 2E2 | 13.0460-2874.2 | 602874         | 23224 16,5 +/WK/STRW<br>Belagsatz-Zubehör |   |
|                | 2.5 TDI        | 70-T-200000 |             | 09.03 | PR: 2E2 | 13.0460-0225.2 | 610225         |   |   |
|                | 2.5 TDI Syncro | 70-T-200000 |             | 09.03 | PR: 2E2 |                |                |   |   |
|                | 2.8            | 70-T-200000 |             | 09.03 | PR: 2E2 |                |                |   |   |
|                | 1.9 D          |             |             | 05.97 | 09.03   | PR: 2E3        | 13.0460-2872.2 | 602872                                    | 23446 16,5 +/WK/Zub/STRW<br>Belagsatz-Zubehör |
|                | 1.9 TD         |             |             | 05.97 | 09.03   | PR: 2E3        | 13.0460-0225.2 | 610225                                    |   |
|                | 2.0            |             |             | 05.97 | 09.03   | PR: 2E3        |                |   |   |
|                | 2.4 D          |             |             | 05.97 | 09.03   | PR: 2E3        |                |   |   |
|                | 2.4 D Syncro   |             |             | 05.97 | 09.03   | PR: 2E3        |                |   |   |
|                | 2.5            |             |             | 05.97 | 09.03   | PR: 2E3        |                |   |   |
| 2.5 Syncro     |                |             | 05.97       | 09.03 | PR: 2E3 |                |                |   |   |
| 2.5 TDI        |                |             | 05.97       | 09.03 | PR: 2E3 |                |                |   |   |
| 2.5 TDI Syncro |                |             | 05.97       | 09.03 | PR: 2E3 |                |                |   |   |
| 2.8            |                |             | 05.97       | 09.03 | PR: 2E3 |                |                |   |   |
|                | 1.9 D          | 70-T-200000 |             | 09.03 | PR: 2E2 | 24.0112-0138.1 | 412138         | 280 12,0 10,0 +S +B                       |   |
|                | 1.9 TD         | 70-T-200000 |             | 09.03 | PR: 2E2 |                |                |   |   |
|                | 2.0            | 70-T-200000 |             | 09.03 | PR: 2E2 |                |                |   |   |
|                | 2.4 D          | 70-T-200000 |             | 09.03 | PR: 2E2 |                |                |   |   |
|                | 2.4 D Syncro   |             | 05.96       | 09.03 | PR: 2E2 |                |                |   |   |
|                | 2.5            | 70-T-200000 |             | 09.03 | PR: 2E2 |                |                |   |   |
|                | 2.5 Syncro     |             | 05.96       | 09.03 | PR: 2E2 |                |                |   |   |
|                | 2.5 TDI        | 70-T-200000 |             | 09.03 | PR: 2E2 |                |                |   |   |
|                | 2.5 TDI Syncro |             | 05.96       | 09.03 | PR: 2E2 |                |                |   |   |
|                | 2.8            | 70-T-200000 |             | 09.03 | PR: 2E2 |                |                |   |   |
|                | 1.9 D          |             |             | 05.97 | 09.03   | PR: 2E3        | 24.0113-0194.1 | 413194                                    | 294 13,5 11,5 +B                              |
|                | 1.9 TD         |             |             | 05.97 | 09.03   | PR: 2E3        |                |   |   |
|                | 2.0            |             |             | 05.97 | 09.03   | PR: 2E3        |                |   |   |
|                | 2.4 D          |             |             | 05.97 | 09.03   | PR: 2E3        |                |   |   |
|                | 2.4 D Syncro   |             |             | 05.97 | 09.03   | PR: 2E3        |                |   |   |
|                | 2.5            |             |             | 05.97 | 09.03   | PR: 2E3        |                |   |   |
|                | 2.5 Syncro     |             |             | 05.97 | 09.03   | PR: 2E3        |                |   |   |
|                | 2.5 TDI        |             |             | 05.97 | 09.03   | PR: 2E3        |                |   |   |
|                | 2.5 TDI Syncro |             |             | 05.97 | 09.03   | PR: 2E3        |                |   |   |
|                | 2.8            |             |             | 05.97 | 09.03   | PR: 2E3        |                |   |   |
|                | 1.8            |             |             | 12.90 | 07.92   |                | 03.0137-0256.2 | 650256                                    | 268 x 56 HEB<br>Bremsbacken-Zubehör           |
|                | 1.9 D          |             | 70-T-199999 | 07.90 |         |                | 03.0137-9156.2 | 669156                                    |   |
|                | 1.9 TD         |             | 70-T-199999 | 10.92 |         |                |                |   |   |
|                | 2.0            |             | 70-T-199999 | 07.90 |         |                |                |   |   |
|                | 2.4 D          |             | 70-T-199999 | 07.90 |         |                |                |   |   |
|                | 2.4 D Syncro   |             | 70-T-199999 | 11.92 |         |                |                |   |   |
|                | 2.5            |             | 70-T-199999 | 10.90 |         |                |                |   |   |
|                | 2.5 Syncro     |             | 70-T-199999 | 11.92 |         |                |                |   |   |
|                | 2.5 TDI        |             | 70-T-199999 | 09.95 |         |                |                |   |   |
|                | 2.5 TDI Syncro |             | 70-T-199999 | 09.95 |         |                |                |   |   |
|                | 1.8            |             |             | 12.90 | 07.92   |                | 24.0226-8001.1 | 480051                                    | 268/269,5 x 68,4                              |
|                | 1.9 D          |             | 70-T-199999 | 07.90 |         |                |                |   |   |
|                | 1.9 TD         |             | 70-T-199999 | 10.92 |         |                |                |   |   |
|                | 2.0            |             | 70-T-199999 | 07.90 |         |                |                |   |   |
|                | 2.4 D          |             | 70-T-199999 | 07.90 |         |                |                |   |   |
|                | 2.4 D Syncro   |             | 70-T-199999 | 11.92 |         |                |                |   |   |
|                | 2.5            |             | 70-T-199999 | 10.90 |         |                |                |   |   |
|                | 2.5 Syncro     |             | 70-T-199999 | 11.92 |         |                |                |   |   |
|                | 2.5 TDI        |             | 70-T-199999 | 09.95 |         |                |                |   |   |
|                | 2.5 TDI Syncro |             | 70-T-199999 | 09.95 |         |                |                |   |   |
|                | 1.8            |             |             | 12.90 | 07.92   |                | 03.0420-3420.3 | 683420                                    | 20,64/268x56 Kit <b>BDX</b>                   |
|                | 1.9 D          |             | 70-T-199999 | 07.90 |         |                |                |   |   |
|                | 1.9 TD         |             | 70-T-199999 | 10.92 |         |                |                |   |   |
|                | 2.0            |             | 70-T-199999 | 07.90 |         |                |                |   |   |
|                | 2.4 D          |             | 70-T-199999 | 07.90 |         |                |                |   |   |
|                | 2.4 D Syncro   |             | 70-T-199999 | 11.92 |         |                |                |   |   |
|                | 2.5            |             | 70-T-199999 | 10.90 |         |                |                |   |   |
|                | 2.5 Syncro     |             | 70-T-199999 | 11.92 |         |                |                |   |   |
|                | 2.5 TDI        |             | 70-T-199999 | 09.95 |         |                |                |   |   |
|                | 2.5 TDI Syncro |             | 70-T-199999 | 09.95 |         |                |                |   |   |

**VOLKSWAGEN TRANSPORTER (T5) BUS / MULTIVAN / KASTEN (03-)**



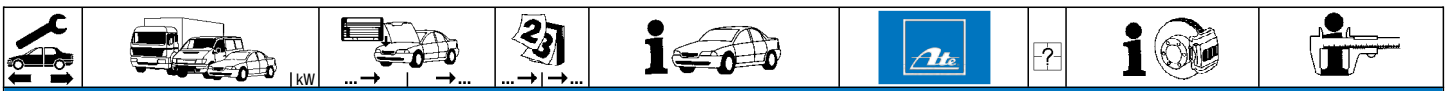

|        |                   |     |       |         |         |                |        |                            |
|--------|-------------------|-----|-------|---------|---------|----------------|--------|----------------------------|
|        | 1.9 TDI           | 62  |       | 01.06   | PR: 2E3 | 13.0460-7236.2 | 607236 | 23746 19,7 +/WK <b>ATE</b> |
|        | 1.9 TDI           | 63  |       | 04.03   | PR: 2E3 |                |        |                            |
|        | 1.9 TDI           | 75  |       | 06.06   | PR: 2E3 |                |        |                            |
|        | 1.9 TDI           | 77  |       | 04.03   | PR: 2E3 |                |        |                            |
|        | 2.0               |     |       | 06.03   | PR: 2E3 |                |        |                            |
|        | 2.0 BiTDI         | 132 |       | 09.09   | PR: 2E3 |                |        |                            |
|        | 2.0 BiTDI 4motion | 132 |       | 09.09   | PR: 2E3 |                |        |                            |
|        | 2.0 TDI           | 62  |       | 09.09   | PR: 2E3 |                |        |                            |
|        | 2.0 TDI           | 75  |       | 09.09   | PR: 2E3 |                |        |                            |
|        | 2.0 TDI           | 84  |       | 05.11   | PR: 2E3 |                |        |                            |
|        | 2.0 TDI           | 100 |       | 05.10   | PR: 2E3 |                |        |                            |
|        | 2.0 TDI           | 103 |       | 09.09   | PR: 2E3 |                |        |                            |
|        | 2.0 TDI 4motion   | 100 |       | 05.10   | PR: 2E3 |                |        |                            |
|        | 2.0 TDI 4motion   | 103 |       | 09.09   | PR: 2E3 |                |        |                            |
|        | 2.0 TSI           |     |       | 05.11   | PR: 2E3 |                |        |                            |
|        | 2.0 TSI 4motion   | 150 |       | 07.11   | PR: 2E3 |                |        |                            |
|        | 2.5 TDI           |     |       | 02.03   | PR: 2E3 |                |        |                            |
|        | 2.5 TDI           | 96  |       | 02.03   | PR: 2E3 |                |        |                            |
|        | 2.5 TDI 4motion   | 96  |       | 07.04   | PR: 2E3 |                |        |                            |
|        | 2.5 TDI 4motion   | 128 |       | 07.04   | PR: 2E3 |                |        |                            |
| 3.2 V6 |                   |     | 02.03 | PR: 2E3 |         |                |        |                            |



**VOLKSWAGEN TRANSPORTER (T5) BUS / MULTIVAN / KASTEN (03-)**

|  |                       |     |                          |         |                       |        |  |                        |            |
|--|-----------------------|-----|--------------------------|---------|-----------------------|--------|--|------------------------|------------|
|  | <b>3.2 V6 4motion</b> |     | <b>07.04</b>             | PR: 2E3 | <b>13.0460-7236.2</b> | 607236 |  | <b>23746</b> 19,7 +/WK | <b>ATE</b> |
|  | 1.9 TDI               | 62  | 7H-A-050000 <b>01.06</b> | PR: 2E4 | <b>13.0460-7240.2</b> | 607240 |  | <b>23746</b> 18,1 +/WK | <b>ATE</b> |
|  | 1.9 TDI               | 63  | 7H-A-050000 <b>04.03</b> | PR: 2E4 |                       |        |  |                        |            |
|  | 1.9 TDI               | 75  | 7H-A-050000 <b>06.06</b> | PR: 2E4 |                       |        |  |                        |            |
|  | 1.9 TDI               | 77  | 7H-A-050000 <b>04.03</b> | PR: 2E4 |                       |        |  |                        |            |
|  | 2.0                   |     | 7H-A-050000 <b>06.03</b> | PR: 2E4 |                       |        |  |                        |            |
|  | 2.0 BiTDI             | 132 | 7H-A-050000 <b>09.09</b> | PR: 2E4 |                       |        |  |                        |            |
|  | 2.0 BiTDI 4motion     | 132 | 7H-A-050000 <b>09.09</b> | PR: 2E4 |                       |        |  |                        |            |
|  | 2.0 TDI               | 62  | 7H-A-050000 <b>09.09</b> | PR: 2E4 |                       |        |  |                        |            |
|  | 2.0 TDI               | 75  | 7H-A-050000 <b>09.09</b> | PR: 2E4 |                       |        |  |                        |            |
|  | 2.0 TDI               | 103 | 7H-A-050000 <b>09.09</b> | PR: 2E4 |                       |        |  |                        |            |
|  | 2.0 TDI 4motion       | 103 | 7H-A-050000 <b>09.09</b> | PR: 2E4 |                       |        |  |                        |            |
|  | 2.5 TDI               |     | 7H-A-050000 <b>02.03</b> | PR: 2E4 |                       |        |  |                        |            |
|  | 2.5 TDI               | 96  | 7H-A-050000 <b>02.03</b> | PR: 2E4 |                       |        |  |                        |            |
|  | 2.5 TDI 4motion       | 96  | 7H-A-050000 <b>07.04</b> | PR: 2E4 |                       |        |  |                        |            |
|  | 2.5 TDI 4motion       | 128 | 7H-A-050000 <b>07.04</b> | PR: 2E4 |                       |        |  |                        |            |
|  | 3.2 V6                |     | 7H-A-050000 <b>02.03</b> | PR: 2E4 |                       |        |  |                        |            |
|  | 3.2 V6 4motion        |     | 7H-A-050000 <b>07.04</b> | PR: 2E4 |                       |        |  |                        |            |
|  | 1.9 TDI               | 62  | 7H-A-200001              | PR: 2E4 | <b>13.0460-7286.2</b> | 607286 |  | <b>24623</b> 18,2 +/WK | <b>ATE</b> |
|  | 1.9 TDI               | 63  | 7H-A-200001              | PR: 2E4 |                       |        |  |                        |            |
|  | 1.9 TDI               | 75  | 7H-A-200001              | PR: 2E4 |                       |        |  |                        |            |
|  | 1.9 TDI               | 77  | 7H-A-200001              | PR: 2E4 |                       |        |  |                        |            |
|  | 2.0                   |     | 7H-A-200001              | PR: 2E4 |                       |        |  |                        |            |
|  | 2.0 BiTDI             | 132 | 7H-A-200001              | PR: 2E4 |                       |        |  |                        |            |
|  | 2.0 BiTDI 4motion     | 132 | 7H-A-200001              | PR: 2E4 |                       |        |  |                        |            |
|  | 2.0 TDI               | 62  | 7H-A-200001              | PR: 2E4 |                       |        |  |                        |            |
|  | 2.0 TDI               | 75  | 7H-A-200001              | PR: 2E4 |                       |        |  |                        |            |
|  | 2.0 TDI               | 84  |                          | PR: 2E4 |                       |        |  |                        |            |
|  | 2.0 TDI               | 100 | 7H-A-200001              | PR: 2E4 |                       |        |  |                        |            |
|  | 2.0 TDI               | 103 | 7H-A-200001              | PR: 2E4 |                       |        |  |                        |            |
|  | 2.0 TDI 4motion       | 100 | 7H-A-200001              | PR: 2E4 |                       |        |  |                        |            |
|  | 2.0 TDI 4motion       | 103 | 7H-A-200001              | PR: 2E4 |                       |        |  |                        |            |
|  | 2.0 TSI               |     |                          | PR: 2E4 |                       |        |  |                        |            |
|  | 2.0 TSI 4motion       | 150 |                          | PR: 2E4 |                       |        |  |                        |            |
|  | 2.5 TDI               |     | 7H-A-200001              | PR: 2E4 |                       |        |  |                        |            |
|  | 2.5 TDI               | 96  | 7H-A-200001              | PR: 2E4 |                       |        |  |                        |            |
|  | 2.5 TDI 4motion       | 96  | 7H-A-200001              | PR: 2E4 |                       |        |  |                        |            |
|  | 2.5 TDI 4motion       | 128 | 7H-A-200001              | PR: 2E4 |                       |        |  |                        |            |
|  | 3.2 V6                |     | 7H-A-200001              | PR: 2E4 |                       |        |  |                        |            |
|  | 3.2 V6 4motion        |     | 7H-A-200001              | PR: 2E4 |                       |        |  |                        |            |
|  | 1.9 TDI               | 62  | <b>01.06</b>             | PR: 2E3 | <b>24.0130-0114.1</b> | 430114 |  | 308 29,5 25,5 VL +B    |            |
|  | 1.9 TDI               | 63  | <b>04.03</b>             | PR: 2E3 |                       |        |  |                        |            |
|  | 1.9 TDI               | 75  | <b>06.06</b>             | PR: 2E3 |                       |        |  |                        |            |
|  | 1.9 TDI               | 77  | <b>04.03</b>             | PR: 2E3 |                       |        |  |                        |            |
|  | 2.0                   |     | <b>06.03</b>             | PR: 2E3 |                       |        |  |                        |            |
|  | 2.0 BiTDI             | 132 | <b>09.09</b>             | PR: 2E3 |                       |        |  |                        |            |
|  | 2.0 BiTDI 4motion     | 132 | <b>09.09</b>             | PR: 2E3 |                       |        |  |                        |            |
|  | 2.0 TDI               | 62  | <b>09.09</b>             | PR: 2E3 |                       |        |  |                        |            |
|  | 2.0 TDI               | 75  | <b>09.09</b>             | PR: 2E3 |                       |        |  |                        |            |
|  | 2.0 TDI               | 84  | <b>05.11</b>             | PR: 2E3 |                       |        |  |                        |            |
|  | 2.0 TDI               | 100 | <b>05.10</b>             | PR: 2E3 |                       |        |  |                        |            |
|  | 2.0 TDI               | 103 | <b>09.09</b>             | PR: 2E3 |                       |        |  |                        |            |
|  | 2.0 TDI 4motion       | 100 | <b>05.10</b>             | PR: 2E3 |                       |        |  |                        |            |
|  | 2.0 TDI 4motion       | 103 | <b>09.09</b>             | PR: 2E3 |                       |        |  |                        |            |
|  | 2.0 TSI               |     | <b>05.11</b>             | PR: 2E3 |                       |        |  |                        |            |
|  | 2.0 TSI 4motion       | 150 | <b>07.11</b>             | PR: 2E3 |                       |        |  |                        |            |
|  | 2.5 TDI               |     | <b>02.03</b>             | PR: 2E3 |                       |        |  |                        |            |
|  | 2.5 TDI               | 96  | <b>02.03</b>             | PR: 2E3 |                       |        |  |                        |            |
|  | 2.5 TDI 4motion       | 96  | <b>07.04</b>             | PR: 2E3 |                       |        |  |                        |            |
|  | 2.5 TDI 4motion       | 128 | <b>07.04</b>             | PR: 2E3 |                       |        |  |                        |            |
|  | 3.2 V6                |     | <b>02.03</b>             | PR: 2E3 |                       |        |  |                        |            |
|  | 3.2 V6 4motion        |     | <b>07.04</b>             | PR: 2E3 |                       |        |  |                        |            |
|  | 1.9 TDI               | 62  | 7H-A-050000 <b>01.06</b> | PR: 2E4 | <b>24.0132-0116.1</b> | 432116 |  | 333 32,5 28,5 VL +S +B |            |
|  | 1.9 TDI               | 63  | 7H-A-050000 <b>04.03</b> | PR: 2E4 |                       |        |  |                        |            |
|  | 1.9 TDI               | 75  | 7H-A-050000 <b>06.06</b> | PR: 2E4 |                       |        |  |                        |            |
|  | 1.9 TDI               | 77  | 7H-A-050000 <b>04.03</b> | PR: 2E4 |                       |        |  |                        |            |
|  | 2.0                   |     | 7H-A-050000 <b>06.03</b> | PR: 2E4 |                       |        |  |                        |            |
|  | 2.0 BiTDI             | 132 | 7H-A-050000 <b>09.09</b> | PR: 2E4 |                       |        |  |                        |            |
|  | 2.0 BiTDI 4motion     | 132 | 7H-A-050000 <b>09.09</b> | PR: 2E4 |                       |        |  |                        |            |
|  | 2.0 TDI               | 62  | 7H-A-050000 <b>09.09</b> | PR: 2E4 |                       |        |  |                        |            |
|  | 2.0 TDI               | 75  | 7H-A-050000 <b>09.09</b> | PR: 2E4 |                       |        |  |                        |            |
|  | 2.0 TDI               | 103 | 7H-A-050000 <b>09.09</b> | PR: 2E4 |                       |        |  |                        |            |
|  | 2.0 TDI 4motion       | 103 | 7H-A-050000 <b>09.09</b> | PR: 2E4 |                       |        |  |                        |            |
|  | 2.5 TDI               |     | 7H-A-050000 <b>02.03</b> | PR: 2E4 |                       |        |  |                        |            |
|  | 2.5 TDI               | 96  | 7H-A-050000 <b>02.03</b> | PR: 2E4 |                       |        |  |                        |            |
|  | 2.5 TDI 4motion       | 96  | 7H-A-050000 <b>07.04</b> | PR: 2E4 |                       |        |  |                        |            |
|  | 2.5 TDI 4motion       | 128 | 7H-A-050000 <b>07.04</b> | PR: 2E4 |                       |        |  |                        |            |
|  | 3.2 V6                |     | 7H-A-050000 <b>02.03</b> | PR: 2E4 |                       |        |  |                        |            |
|  | 3.2 V6 4motion        |     | 7H-A-050000 <b>07.04</b> | PR: 2E4 |                       |        |  |                        |            |
|  | 1.9 TDI               | 62  | 7H-A-200001              | PR: 2E4 | <b>24.0133-0100.1</b> | 433100 |  | 340 32,6 29,5 VL +S +B |            |
|  | 1.9 TDI               | 63  | 7H-A-200001              | PR: 2E4 |                       |        |  |                        |            |
|  | 1.9 TDI               | 75  | 7H-A-200001              | PR: 2E4 |                       |        |  |                        |            |
|  | 1.9 TDI               | 77  | 7H-A-200001              | PR: 2E4 |                       |        |  |                        |            |
|  | 2.0                   |     | 7H-A-200001              | PR: 2E4 |                       |        |  |                        |            |
|  | 2.0 BiTDI             | 132 | 7H-A-200001              | PR: 2E4 |                       |        |  |                        |            |
|  | 2.0 BiTDI 4motion     | 132 | 7H-A-200001              | PR: 2E4 |                       |        |  |                        |            |
|  | 2.0 TDI               | 62  | 7H-A-200001              | PR: 2E4 |                       |        |  |                        |            |







| VOLKSWAGEN TRANSPORTER (T5) BUS / MULTIVAN / KASTEN (03-)                          |   | KW  |  | 2.7  |   | i                                |                  | Ate |  | ? |   | i   |  | Key |  |
|--|---|---|--|--|---|----------------------------------|------------------|-----|--|---|---|---|--|-----|--|
|    | 2.0 TDI<br>2.0 TDI<br>2.0 TDI<br>2.0 TDI<br>2.0 TDI 4motion<br>2.0 TDI 4motion<br>2.0 TSI<br>2.0 TSI 4motion<br>2.5 TDI<br>2.5 TDI<br>2.5 TDI 4motion<br>2.5 TDI 4motion<br>3.2 V6<br>3.2 V6 4motion  | 75<br>84<br>100<br>103<br>100<br>103<br>150<br>150<br>96<br>96<br>128<br>128<br>128                               | 7H-A-200001<br>7H-A-200001<br>7H-A-200001<br>7H-A-200001<br>7H-A-200001<br>7H-A-200001<br>7H-A-200001<br>7H-A-200001<br>7H-A-200001<br>7H-A-200001<br>7H-A-200001<br>7H-A-200001<br>7H-A-200001  | 05.11<br>05.11<br>07.11  | PR: 2E4<br>PR: 2E4<br>PR: 2E4<br>PR: 2E4<br>PR: 2E4<br>PR: 2E4<br>PR: 2E4<br>PR: 2E4<br>PR: 2E4<br>PR: 2E4<br>PR: 2E4<br>PR: 2E4<br>PR: 2E4   | 24.0133-0100.1                   | 433100           |     |  |   |   | 340 32,6 29,5 VL +S +B                        |  |     |  |
|    | 1.9 TDI<br>1.9 TDI<br>1.9 TDI<br>1.9 TDI<br>2.0<br>2.0 BiTDI<br>2.0 BiTDI 4motion<br>2.0 TDI<br>2.0 TDI<br>2.0 TDI<br>2.0 TDI<br>2.0 TDI 4motion<br>2.0 TDI 4motion<br>2.0 TSI<br>2.0 TSI 4motion<br>2.5 TDI<br>2.5 TDI<br>2.5 TDI 4motion<br>2.5 TDI 4motion<br>3.2 V6<br>3.2 V6 4motion | 62<br>63<br>75<br>77<br>132<br>132<br>62<br>75<br>84<br>100<br>103<br>100<br>103<br>150<br>150<br>96<br>96<br>128 | 7H-5-120000<br>7H-5-120000<br>7H-5-120000<br>7H-5-120000<br>7H-5-120000<br>7H-5-120000<br>7H-5-120000<br>7H-5-120000<br>7H-5-120000<br>7H-5-120000<br>7H-5-120000<br>7H-5-120000<br>7H-5-120000<br>7H-5-120000<br>7H-5-120000<br>7H-5-120000<br>7H-5-120000<br>7H-5-120000<br>7H-5-120000<br>7H-5-120000<br>7H-5-120000<br>7H-5-120000 | 01.06<br>04.03<br>06.06<br>04.03<br>06.03<br>09.09<br>09.09<br>09.09<br>09.09<br>05.11<br>05.10<br>09.09<br>05.10<br>09.09<br>05.11<br>07.11<br>02.03<br>02.03<br>07.04<br>07.04<br>02.03<br>07.04 | PR: OWL,OWN,OWM,OWP,OWQ<br>PR: OWL,OWN,OWM,OWP,OWQ<br>PR: OWL,OWN,OWM,OWP,OWQ<br>PR: OWL,OWN,OWM,OWP,OWQ<br>PR: OWL,OWN,OWM,OWP,OWQ<br>PR: OWL,OWN,OWM,OWP,OWQ<br>PR: OWL,OWN,OWM,OWP,OWQ<br>PR: OWL,OWN,OWM,OWP,OWQ<br>PR: OWL,OWN,OWM,OWP,OWQ<br>PR: OWL,OWN,OWM,OWP,OWQ<br>PR: OWL,OWN,OWM,OWP,OWQ<br>PR: OWL,OWN,OWM,OWP,OWQ<br>PR: OWL,OWN,OWM,OWP,OWQ<br>PR: OWL,OWN,OWM,OWP,OWQ<br>PR: OWL,OWN,OWM,OWP,OWQ<br>PR: OWL,OWN,OWM,OWP,OWQ<br>PR: OWL,OWN,OWM,OWP,OWQ<br>PR: OWL,OWN,OWM,OWP,OWQ<br>PR: OWL,OWN,OWM,OWP,OWQ<br>PR: OWL,OWN,OWM,OWP,OWQ<br>PR: OWL,OWN,OWM,OWP,OWQ<br>PR: OWL,OWN,OWM,OWP,OWQ<br>PR: OWL,OWN,OWM,OWP,OWQ | 24.0711-5271.3<br>24.0711-5272.3 | 360301<br>360302 |     |  |   | Radsensor<br>Radsensor                        |   |  |     |  |
|    | 1.9 TDI<br>1.9 TDI<br>2.0<br>2.5 TDI<br>2.5 TDI<br>2.5 TDI 4motion<br>2.5 TDI 4motion<br>3.2 V6<br>3.2 V6 4motion   | 63<br>77<br>96<br>96<br>128   | 7H-5-120000<br>7H-5-120000<br>7H-5-120000<br>7H-5-120000<br>7H-5-120000<br>7H-5-120000<br>7H-5-120000<br>7H-5-120000<br>7H-5-120000<br>7H-5-120000   | 04.03<br>04.03<br>06.03<br>02.03<br>02.03<br>07.04<br>07.04<br>02.03<br>07.04  | PR: OWL,OWN,OWM,OWP,OWQ<br>PR: OWL,OWN,OWM,OWP,OWQ<br>PR: OWL,OWN,OWM,OWP,OWQ<br>PR: OWL,OWN,OWM,OWP,OWQ<br>PR: OWL,OWN,OWM,OWP,OWQ<br>PR: OWL,OWN,OWM,OWP,OWQ<br>PR: OWL,OWN,OWM,OWP,OWQ<br>PR: OWL,OWN,OWM,OWP,OWQ<br>PR: OWL,OWN,OWM,OWP,OWQ<br>PR: OWL,OWN,OWM,OWP,OWQ  | 13.0460-2882.2<br>13.0460-0023.2 | 602882<br>610023 |     |  |   | 23326 17,4 /WK/Zub/S<br>Belagsatz-Zubehör TRW |   |  |     |  |
|  | 1.9 TDI<br>1.9 TDI<br>1.9 TDI<br>1.9 TDI<br>2.0<br>2.0 BiTDI<br>2.0 BiTDI 4motion<br>2.0 TDI<br>2.0 TDI<br>2.0 TDI<br>2.0 TDI<br>2.0 TDI 4motion<br>2.0 TDI 4motion<br>2.5 TDI<br>2.5 TDI<br>2.5 TDI 4motion<br>2.5 TDI 4motion<br>3.2 V6<br>3.2 V6 4motion                               | 62<br>63<br>75<br>77<br>132<br>132<br>62<br>75<br>103<br>103<br>103<br>103<br>96<br>96<br>128                     | 7H-6-000001<br>7H-6-000001<br>7H-6-000001<br>7H-6-000001<br>7H-6-000001<br>7H-6-000001<br>7H-6-000001<br>7H-6-000001<br>7H-6-000001<br>7H-6-000001<br>7H-6-000001<br>7H-6-000001<br>7H-6-000001<br>7H-6-000001<br>7H-6-000001<br>7H-6-000001<br>7H-6-000001<br>7H-6-000001<br>7H-6-000001<br>7H-6-000001<br>7H-6-000001                | 04.03<br>04.03<br>06.03<br>02.03<br>02.03<br>07.04<br>07.04<br>02.03<br>07.04<br>07.04<br>02.03<br>07.04   | PR: 2E3,2E4<br>PR: 2E3,2E4<br>PR: 2E3,2E4<br>PR: 2E3,2E4<br>PR: 2E3,2E4<br>PR: 2E3,2E4<br>PR: 2E3,2E4<br>PR: 2E3,2E4<br>PR: 2E3,2E4<br>PR: 2E3,2E4<br>PR: 2E3,2E4<br>PR: 2E3,2E4<br>PR: 2E3,2E4<br>PR: 2E3,2E4<br>PR: 2E3,2E4<br>PR: 2E3,2E4<br>PR: 2E3,2E4<br>PR: 2E3,2E4<br>PR: 2E3,2E4<br>PR: 2E3,2E4<br>PR: 2E3,2E4<br>PR: 2E3,2E4  | 13.0460-2882.2<br>13.0460-0023.2 | 602882<br>610023 |     |  |   | 23326 17,4 /WK/Zub/S<br>Belagsatz-Zubehör TRW |   |  |     |  |
|  | 1.9 TDI<br>1.9 TDI<br>1.9 TDI<br>1.9 TDI<br>2.0<br>2.5 TDI<br>2.5 TDI<br>2.5 TDI 4motion<br>2.5 TDI 4motion<br>3.2 V6<br>3.2 V6 4motion   | 62<br>63<br>75<br>77<br>96<br>96<br>128   | 7H-8-027999<br>7H-8-027999<br>7H-8-027999<br>7H-8-027999<br>7H-8-027999<br>7H-8-027999<br>7H-8-027999<br>7H-8-027999<br>7H-8-027999<br>7H-8-027999<br>7H-8-027999  | 01.06<br>04.03<br>06.06<br>04.03<br>06.03<br>02.03<br>02.03<br>07.04<br>07.04<br>02.03<br>07.04  | PR: OWR<br>PR: OWR<br>PR: OWR<br>PR: OWR<br>PR: OWR<br>PR: OWR<br>PR: OWR<br>PR: OWR<br>PR: OWR<br>PR: OWR<br>PR: OWR   | 13.0460-7218.2                   | 607218           |     |  |   | 24367 19,1 +/-WK<br>ATE                       |   |  |     |  |
|  | 1.9 TDI<br>1.9 TDI<br>1.9 TDI<br>1.9 TDI<br>2.0<br>2.5 TDI<br>2.5 TDI<br>2.5 TDI 4motion<br>2.5 TDI 4motion<br>3.2 V6<br>3.2 V6 4motion   | 62<br>63<br>75<br>77<br>96<br>96<br>128   | 7H-8-028000<br>7H-8-028000<br>7H-8-028000<br>7H-8-028000<br>7H-8-028000<br>7H-8-028000<br>7H-8-028000<br>7H-8-028000<br>7H-8-028000<br>7H-8-028000<br>7H-8-028000  | 04.03<br>04.03<br>06.06<br>04.03<br>06.03<br>02.03<br>02.03<br>07.04<br>07.04<br>02.03<br>07.04  | PR: OWR<br>PR: OWR<br>PR: OWR<br>PR: OWR<br>PR: OWR<br>PR: OWR<br>PR: OWR<br>PR: OWR<br>PR: OWR<br>PR: OWR<br>PR: OWR   | 13.0460-2882.2<br>13.0460-0023.2 | 602882<br>610023 |     |  |   | 23326 17,4 /WK/Zub/S<br>Belagsatz-Zubehör TRW |   |  |     |  |
|  | 1.9 TDI<br>1.9 TDI<br>1.9 TDI   | 62<br>63<br>75  | 7H-A-200001<br>7H-A-200001<br>7H-A-200001  |  |   | 13.0460-2882.2<br>13.0460-0023.2 | 602882<br>610023 |     |  |   |   | 23326 17,4 /WK/Zub/S<br>Belagsatz-Zubehör TRW |  |     |  |



















**VOLKSWAGEN TRANSPORTER (T5) BUS / MULTIVAN / KASTEN (03-)**

|  |  |  |   |  |  |                                      |  |   |
|--|--|--|---|--|--|--------------------------------------|--|---|
|  | 3.2 V6<br>3.2 V6 4motion   | 7H-A-200001<br>7H-A-200001   |   |  | 24.0122-0211.1   | 422211                               |  | 294 21,9 19,5 VL +S +B  |
|  | 1.9 TDI<br>1.9 TDI<br>1.9 TDI<br>1.9 TDI<br>2.0<br>2.0 BiTDI<br>2.0 BiTDI 4motion<br>2.0 TDI<br>2.0 TDI<br>2.0 TDI<br>2.0 TDI<br>2.0 TDI<br>2.0 TDI 4motion<br>2.0 TDI 4motion<br>2.0 TSI<br>2.0 TSI 4motion<br>2.5 TDI<br>2.5 TDI<br>2.5 TDI 4motion<br>2.5 TDI 4motion<br>3.2 V6<br>3.2 V6 4motion | 62<br>63<br>75<br>77<br><br>132<br>132<br>62<br>75<br>84<br>100<br>103<br>100<br>103<br>150<br><br>96<br>96<br>128 | 01.06<br>04.03<br>06.06<br>04.03<br>06.03<br>09.09<br>09.09<br>09.09<br>05.11<br>05.10<br>09.09<br>05.10<br>09.09<br>05.11<br>07.11<br>02.03<br>02.03<br>07.04<br>07.04<br>02.03<br>07.04 |  | 24.0711-5271.3<br>24.0711-5272.3                                     | 360301<br>360302                     | <br> | Radsensor<br>Radsensor  |
|  | 1.9 TDI<br>1.9 TDI<br>1.9 TDI<br>1.9 TDI<br>2.0<br>2.0 BiTDI<br>2.0 BiTDI 4motion<br>2.0 TDI<br>2.0 TDI<br>2.0 TDI<br>2.0 TDI<br>2.0 TDI<br>2.0 TDI 4motion<br>2.0 TDI 4motion<br>2.5 TDI<br>2.5 TDI<br>2.5 TDI 4motion<br>2.5 TDI 4motion<br>3.2 V6<br>3.2 V6 4motion                               | 62<br>63<br>75<br>77<br><br>132<br>132<br>62<br>75<br>100<br>103<br>100<br>103<br>100<br>103<br>96<br>96<br>128    | 01.06<br>04.03<br>06.06<br>04.03<br>06.03<br>09.09<br>09.09<br>09.09<br>05.10<br>09.09<br>05.10<br>09.09<br>09.09<br>05.10<br>02.03<br>02.03<br>07.04<br>07.04<br>02.03<br>07.04          | PR: OWR,0E0,0E9<br>PR: OWR,0E0,0E9<br>PR: OWR,0E0,0E9<br>PR: OWR,0E0,0E9<br>PR: OWR,0E0,0E9<br>PR: OWR,0E0,0E9<br>PR: OWR,0E0,0E9<br>PR: OWR,0E0,0E9<br>PR: OWR,0E0,0E9<br>PR: OWR,0E0,0E9<br>PR: OWR,0E0,0E9<br>PR: OWR,0E0,0E9<br>PR: OWR,0E0,0E9<br>PR: OWR,0E0,0E9<br>PR: OWR,0E0,0E9<br>PR: OWR,0E0,0E9<br>PR: OWR,0E0,0E9<br>PR: OWR,0E0,0E9<br>PR: OWR,0E0,0E9<br>PR: OWR,0E0,0E9 | 03.0137-0419.2<br>03.0137-9288.2<br>03.0137-9700.2<br>03.0137-9702.2 | 650419<br>669288<br>669700<br>669702 |  | 185 x 30<br>Bremsbacken-Zubehör<br>Bremsbacken-Zubehör<br>Spreizschloß Satz |

**VOLKSWAGEN TRANSPORTER (T5) PRITSCHEN / FAHRGESTELL (03-)**

|  |   |   |   |   |                |        |  |                    |
|--|---|---|---|---|----------------|--------|--|--------------------|
|  | 1.9 TDI<br>1.9 TDI<br>1.9 TDI<br>1.9 TDI<br>2.0<br>2.0 BiTDI<br>2.0 BiTDI 4motion<br>2.0 TDI<br>2.0 TDI<br>2.0 TDI<br>2.0 TDI<br>2.0 TDI<br>2.0 TDI 4motion<br>2.0 TDI 4motion<br>2.0 TSI<br>2.5 TDI<br>2.5 TDI<br>2.5 TDI 4motion<br>2.5 TDI 4motion<br>3.2 V6<br>3.2 V6 | 62<br>63<br>75<br>77<br>85<br>132<br>132<br>62<br>75<br>84<br>100<br>103<br>100<br>103<br>110<br>96<br>128<br>96<br>128<br>170<br>173 | 01.06<br>04.03<br>06.06<br>04.03<br>06.03<br>09.09<br>09.09<br>09.09<br>05.11<br>05.10<br>09.09<br>05.10<br>09.09<br>09.09<br>07.12<br>02.03<br>02.03<br>07.04<br>07.04<br>02.04<br>08.03   | PR: 2E3<br>PR: 2E3<br>PR: 2E3<br>PR: 2E3<br>PR: 2E3<br>PR: 2E3<br>PR: 2E3<br>PR: 2E3<br>PR: 2E3<br>PR: 2E3<br>PR: 2E3<br>PR: 2E3<br>PR: 2E3<br>PR: 2E3<br>PR: 2E3<br>PR: 2E3<br>PR: 2E3<br>PR: 2E3<br>PR: 2E3<br>PR: 2E3<br>PR: 2E3 | 13.0460-7236.2 | 607236 |  | 23746 19,7 +WK ATE |
|  | 1.9 TDI<br>1.9 TDI<br>1.9 TDI<br>1.9 TDI<br>2.0<br>2.0 BiTDI<br>2.0 BiTDI 4motion<br>2.0 TDI<br>2.0 TDI<br>2.0 TDI<br>2.0 TDI<br>2.0 TDI<br>2.0 TDI 4motion<br>2.0 TDI 4motion<br>2.5 TDI<br>2.5 TDI<br>2.5 TDI 4motion<br>2.5 TDI 4motion<br>3.2 V6<br>3.2 V6            | 62<br>63<br>75<br>77<br>85<br>132<br>132<br>62<br>75<br>103<br>103<br>110<br>96<br>128<br>96<br>128<br>170<br>173                     | 7J-A-010000 01.06<br>7J-A-010000 04.03<br>7J-A-010000 06.06<br>7J-A-010000 04.03<br>7J-A-010000 06.03<br>7J-A-010000 09.09<br>7J-A-010000 09.09<br>7J-A-010000 09.09<br>7J-A-010000 09.09<br>7J-A-010000 05.10<br>7J-A-010000 09.09<br>7J-A-010000 09.09<br>7J-A-010000 09.09<br>7J-A-010000 09.09<br>7J-A-010000 07.12<br>7J-A-010000 02.03<br>7J-A-010000 02.03<br>7J-A-010000 07.04<br>7J-A-010000 07.04<br>7J-A-010000 02.04<br>7J-A-010000 08.03 | PR: 2E4<br>PR: 2E4<br>PR: 2E4<br>PR: 2E4<br>PR: 2E4<br>PR: 2E4<br>PR: 2E4<br>PR: 2E4<br>PR: 2E4<br>PR: 2E4<br>PR: 2E4<br>PR: 2E4<br>PR: 2E4<br>PR: 2E4<br>PR: 2E4<br>PR: 2E4<br>PR: 2E4<br>PR: 2E4<br>PR: 2E4<br>PR: 2E4<br>PR: 2E4 | 13.0460-7240.2 | 607240 |  | 23746 18,1 +WK ATE |
|  | 1.9 TDI<br>1.9 TDI<br>1.9 TDI   | 62 7J-A-200001<br>63 7J-A-200001<br>75 7J-A-200001  |   | PR: 2E4<br>PR: 2E4<br>PR: 2E4   | 13.0460-7286.2 | 607286 |  | 24623 18,2 +WK ATE |

|     |   |   |   |   |  |  |  |   |  |                            |                        |
|--|---|---|---|---|---|--|--|---|--|----------------------------|------------------------|
| VOLKSWAGEN TRANSPORTER (T5) PRITSCH / FAHRGESTELL (03-)                            |   |   |   |   |   |  |  |   |  |                            |                        |
|    | 1.9 TDI<br>2.0<br>2.0 BitDI<br>2.0 BitDI 4motion<br>2.0 TDI<br>2.0 TDI<br>2.0 TDI<br>2.0 TDI<br>2.0 TDI 4motion<br>2.0 TDI 4motion<br>2.0 TSI<br>2.5 TDI<br>2.5 TDI<br>2.5 TDI 4motion<br>2.5 TDI 4motion<br>3.2 V6<br>3.2 V6   | 77 7J-A-200001<br>85 7J-A-200001<br>132 7J-A-200001<br>132 7J-A-200001<br>62 7J-A-200001<br>75 7J-A-200001<br>84<br>100<br>103 7J-A-200001<br>100<br>103 7J-A-200001<br>110<br>96 7J-A-200001<br>128 7J-A-200001<br>96 7J-A-200001<br>128 7J-A-200001<br>170 7J-A-200001<br>173 7J-A-200001   |   |   |   |  |  | PR: 2E4<br>PR: 2E4<br>PR: 2E4<br>PR: 2E4<br>PR: 2E4<br>PR: 2E4<br>PR: 2E4<br>PR: 2E4<br>PR: 2E4<br>PR: 2E4<br>PR: 2E4<br>PR: 2E4<br>PR: 2E4<br>PR: 2E4<br>PR: 2E4<br>PR: 2E4  | 13.0460-7286.2 607286  | 24623 18,2 +WK ATE         |                        |
|    | 1.9 TDI<br>1.9 TDI<br>1.9 TDI<br>1.9 TDI<br>2.0<br>2.0 BitDI<br>2.0 BitDI 4motion<br>2.0 TDI<br>2.0 TDI<br>2.0 TDI<br>2.0 TDI<br>2.0 TDI<br>2.0 TDI 4motion<br>2.0 TDI 4motion<br>2.0 TSI<br>2.5 TDI<br>2.5 TDI<br>2.5 TDI 4motion<br>2.5 TDI 4motion<br>3.2 V6<br>3.2 V6 | 62<br>63<br>75<br>77<br>85<br>132<br>132<br>62<br>75<br>84<br>100<br>103<br>100<br>103<br>110<br>96<br>128<br>96<br>128<br>170<br>173   |   | 01.06<br>04.03<br>06.06<br>04.03<br>06.03<br>09.09<br>09.09<br>09.09<br>09.09<br>05.11<br>05.10<br>09.09<br>05.10<br>09.09<br>07.12<br>02.03<br>02.03<br>07.04<br>07.04<br>02.04<br>08.03 |   |  |  | PR: 2E3<br>PR: 2E3<br>PR: 2E3<br>PR: 2E3<br>PR: 2E3<br>PR: 2E3<br>PR: 2E3<br>PR: 2E3<br>PR: 2E3<br>PR: 2E3<br>PR: 2E3<br>PR: 2E3<br>PR: 2E3<br>PR: 2E3<br>PR: 2E3<br>PR: 2E3<br>PR: 2E3<br>PR: 2E3<br>PR: 2E3<br>PR: 2E3<br>PR: 2E3 | 24.0130-0114.1 430114  | 308 29,5 25,5 VL +B        |                        |
|  | 1.9 TDI<br>1.9 TDI<br>1.9 TDI<br>1.9 TDI<br>2.0<br>2.0 BitDI<br>2.0 BitDI 4motion<br>2.0 TDI<br>2.0 TDI<br>2.0 TDI<br>2.0 TDI<br>2.0 TDI 4motion<br>2.0 TDI 4motion<br>2.0 TSI<br>2.5 TDI<br>2.5 TDI<br>2.5 TDI 4motion<br>2.5 TDI 4motion<br>3.2 V6<br>3.2 V6            | 62<br>63<br>75<br>77<br>85<br>132<br>132<br>62<br>75<br>103<br>103<br>96<br>128<br>96<br>128<br>170<br>173  | 7J-A-010000<br>7J-A-010000<br>7J-A-010000<br>7J-A-010000<br>7J-A-010000<br>7J-A-010000<br>7J-A-010000<br>7J-A-010000<br>7J-A-010000<br>7J-A-010000<br>7J-A-010000<br>7J-A-010000<br>7J-A-010000<br>7J-A-010000<br>7J-A-010000<br>7J-A-010000<br>7J-A-010000<br>7J-A-010000<br>7J-A-010000<br>7J-A-010000<br>7J-A-010000 | 01.06<br>04.03<br>06.06<br>04.03<br>06.03<br>09.09<br>09.09<br>09.09<br>09.09<br>05.11<br>05.10<br>09.09<br>05.10<br>09.09<br>07.12<br>02.03<br>02.03<br>07.04<br>07.04<br>02.04<br>08.03 |   |  |  | PR: 2E4<br>PR: 2E4<br>PR: 2E4<br>PR: 2E4<br>PR: 2E4<br>PR: 2E4<br>PR: 2E4<br>PR: 2E4<br>PR: 2E4<br>PR: 2E4<br>PR: 2E4<br>PR: 2E4<br>PR: 2E4<br>PR: 2E4<br>PR: 2E4<br>PR: 2E4<br>PR: 2E4<br>PR: 2E4<br>PR: 2E4<br>PR: 2E4            | 24.0132-0116.1 432116  | 333 32,5 28,5 VL +S +B     |                        |
|  | 1.9 TDI<br>1.9 TDI<br>1.9 TDI<br>1.9 TDI<br>2.0<br>2.0 BitDI<br>2.0 BitDI 4motion<br>2.0 TDI<br>2.0 TDI<br>2.0 TDI<br>2.0 TDI<br>2.0 TDI 4motion<br>2.0 TDI 4motion<br>2.0 TSI<br>2.5 TDI<br>2.5 TDI<br>2.5 TDI 4motion<br>2.5 TDI 4motion<br>3.2 V6<br>3.2 V6            | 62 7J-A-200001<br>63 7J-A-200001<br>75 7J-A-200001<br>77 7J-A-200001<br>85 7J-A-200001<br>132 7J-A-200001<br>132 7J-A-200001<br>62 7J-A-200001<br>75 7J-A-200001<br>84<br>100<br>103 7J-A-200001<br>100<br>103 7J-A-200001<br>110<br>96 7J-A-200001<br>128 7J-A-200001<br>96 7J-A-200001<br>128 7J-A-200001<br>170 7J-A-200001<br>173 7J-A-200001 |   |   |   |  |  |   | PR: 2E4<br>PR: 2E4<br>PR: 2E4<br>PR: 2E4<br>PR: 2E4<br>PR: 2E4<br>PR: 2E4<br>PR: 2E4<br>PR: 2E4<br>PR: 2E4<br>PR: 2E4<br>PR: 2E4<br>PR: 2E4<br>PR: 2E4<br>PR: 2E4<br>PR: 2E4<br>PR: 2E4<br>PR: 2E4<br>PR: 2E4<br>PR: 2E4 | 24.0133-0100.1 433100      | 340 32,6 29,5 VL +S +B |
|  | 1.9 TDI<br>1.9 TDI<br>1.9 TDI<br>1.9 TDI<br>2.0<br>2.0 BitDI<br>2.0 BitDI 4motion<br>2.0 TDI<br>2.0 TDI<br>2.0 TDI  | 62<br>63<br>75<br>77<br>85<br>132<br>132<br>62<br>75<br>84  |   | 01.06<br>04.03<br>06.06<br>04.03<br>06.03<br>09.09<br>09.09<br>09.09<br>09.09<br>05.11  |   |  |  |   | 24.0711-5271.3 360301<br>24.0711-5272.3 360302   | Radensensor<br>Radensensor |                        |

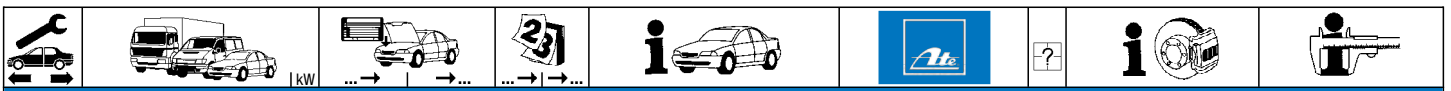

**VOLKSWAGEN TRANSPORTER (T5) PRITSCH / FAHRGESTELL (03-)**

|  |   |  |  |  |  |  |   |                        |
|--|---|--|--|--|--|--|---|------------------------|
|  | 2.0 TDI 100<br>2.0 TDI 103<br>2.0 TDI 4motion 100<br>2.0 TDI 4motion 103<br>2.0 TSI 110<br>2.5 TDI 96<br>2.5 TDI 128<br>2.5 TDI 4motion 96<br>2.5 TDI 4motion 128<br>3.2 V6 170<br>3.2 V6 173   |  | 05.10<br>09.09<br>05.10<br>09.09<br>07.12<br>02.03<br>02.03<br>07.04<br>07.04<br>02.04<br>08.03  |  |  | 24.0711-5271.3 360301<br>24.0711-5272.3 360302 |   | Radsensor<br>Radsensor |
|  | 1.9 TDI 62<br>1.9 TDI 63<br>1.9 TDI 75<br>1.9 TDI 77<br>2.0 85<br>2.0 BiTDI 132<br>2.0 BiTDI 4motion 132<br>2.0 TDI 62<br>2.0 TDI 75<br>2.0 TDI 103<br>2.0 TDI 4motion 103<br>2.5 TDI 96<br>2.5 TDI 128<br>2.5 TDI 4motion 96<br>2.5 TDI 4motion 128<br>3.2 V6 170<br>3.2 V6 173  | 7J-A-010000<br>7J-A-010000<br>7J-A-010000<br>7J-A-010000<br>7J-A-010000<br>7J-A-010000<br>7J-A-010000<br>7J-A-010000<br>7J-A-010000<br>7J-A-010000<br>7J-A-010000<br>7J-A-010000<br>7J-A-010000<br>7J-A-010000<br>7J-A-010000<br>7J-A-010000<br>7J-A-010000  | 01.06<br>04.03<br>06.06<br>04.03<br>06.03<br>09.09<br>09.09<br>09.09<br>09.09<br>09.09<br>02.03<br>02.03<br>07.04<br>07.04<br>02.04<br>08.03 | PR: 2E3,2E4<br>PR: 2E3,2E4<br>PR: 2E3,2E4<br>PR: 2E3,2E4<br>PR: 2E3,2E4<br>PR: 2E3,2E4<br>PR: 2E3,2E4<br>PR: 2E3,2E4<br>PR: 2E3,2E4<br>PR: 2E3,2E4<br>PR: 2E3,2E4<br>PR: 2E3,2E4<br>PR: 2E3,2E4<br>PR: 2E3,2E4<br>PR: 2E3,2E4<br>PR: 2E3,2E4 | 13.0460-2882.2 602882<br>13.0460-0023.2 610023 |  | 23326 17,4 /WK/Zub/S TRW<br>Belagsatz-Zubehör |                        |
|  | 1.9 TDI 62<br>1.9 TDI 63<br>1.9 TDI 75<br>1.9 TDI 77<br>2.0 85<br>2.5 TDI 96<br>2.5 TDI 128<br>2.5 TDI 4motion 96<br>2.5 TDI 4motion 128<br>3.2 V6 170<br>3.2 V6 173  | 7J-8-000788<br>7J-8-000788<br>7J-8-000788<br>7J-8-000788<br>7J-8-000788<br>7J-8-000788<br>7J-8-000788<br>7J-8-000788<br>7J-8-000788<br>7J-8-000788<br>7J-8-000788  | 01.06<br>04.03<br>06.06<br>04.03<br>06.03<br>02.03<br>02.03<br>07.04<br>07.04<br>02.04<br>08.03  | PR: 0WR,0E0,0E9<br>PR: 0WR,0E0,0E9<br>PR: 0WR,0E0,0E9<br>PR: 0WR,0E0,0E9<br>PR: 0WR,0E0,0E9<br>PR: 0WR,0E0,0E9<br>PR: 0WR,0E0,0E9<br>PR: 0WR,0E0,0E9<br>PR: 0WR,0E0,0E9<br>PR: 0WR,0E0,0E9<br>PR: 0WR,0E0,0E9                                | 13.0460-7218.2 607218                          |  | 24367 19,1 +/-WK ATE                          |                        |
|  | 1.9 TDI 62<br>1.9 TDI 63<br>1.9 TDI 75<br>1.9 TDI 77<br>2.0 85<br>2.5 TDI 96<br>2.5 TDI 128<br>2.5 TDI 4motion 96<br>2.5 TDI 4motion 128<br>3.2 V6 170<br>3.2 V6 173  | 7J-8-000789<br>7J-8-030000<br>7J-8-000789<br>7J-8-030000<br>7J-8-000789<br>7J-8-030000<br>7J-8-000789<br>7J-8-030000<br>7J-8-000789<br>7J-8-030000<br>7J-8-000789<br>7J-8-030000   |  | PR: 0WR,0E0,0E9<br>PR: 0WR,0E0,0E9<br>PR: 0WR,0E0,0E9<br>PR: 0WR,0E0,0E9<br>PR: 0WR,0E0,0E9<br>PR: 0WR,0E0,0E9<br>PR: 0WR,0E0,0E9<br>PR: 0WR,0E0,0E9<br>PR: 0WR,0E0,0E9<br>PR: 0WR,0E0,0E9<br>PR: 0WR,0E0,0E9                                | 13.0460-2882.2 602882<br>13.0460-0023.2 610023 |  | 23326 17,4 /WK/Zub/S TRW<br>Belagsatz-Zubehör |                        |
|  | 1.9 TDI 62<br>1.9 TDI 63<br>1.9 TDI 75<br>1.9 TDI 77<br>2.0 85<br>2.0 BiTDI 132<br>2.0 BiTDI 4motion 132<br>2.0 TDI 62<br>2.0 TDI 75<br>2.0 TDI 84<br>2.0 TDI 100<br>2.0 TDI 103<br>2.0 TDI 4motion 100<br>2.0 TDI 4motion 103<br>2.0 TSI 110<br>2.5 TDI 96<br>2.5 TDI 128<br>2.5 TDI 4motion 96<br>2.5 TDI 4motion 128<br>3.2 V6 170<br>3.2 V6 173 | 7J-A-200001<br>7J-A-200001<br>7J-A-200001<br>7J-A-200001<br>7J-A-200001<br>7J-A-200001<br>7J-A-200001<br>7J-A-200001<br>7J-A-200001<br>7J-A-200001<br>7J-A-200001<br>7J-A-200001<br>7J-A-200001<br>7J-A-200001<br>7J-A-200001<br>7J-A-200001<br>7J-A-200001<br>7J-A-200001<br>7J-A-200001<br>7J-A-200001 | 05.11<br>05.10<br>05.10<br>07.12   |  | 13.0460-2882.2 602882<br>13.0460-0023.2 610023 |  | 23326 17,4 /WK/Zub/S TRW<br>Belagsatz-Zubehör |                        |
|  | 1.9 TDI 62<br>1.9 TDI 63<br>1.9 TDI 75<br>1.9 TDI 77<br>2.0 85<br>2.0 BiTDI 132<br>2.0 BiTDI 4motion 132<br>2.0 TDI 62<br>2.0 TDI 75<br>2.0 TDI 103<br>2.0 TDI 4motion 103<br>2.5 TDI 96<br>2.5 TDI 128<br>2.5 TDI 4motion 96<br>2.5 TDI 4motion 128<br>3.2 V6 170<br>3.2 V6 173  | 7J-A-010000<br>7J-A-010000<br>7J-A-010000<br>7J-A-010000<br>7J-A-010000<br>7J-A-010000<br>7J-A-010000<br>7J-A-010000<br>7J-A-010000<br>7J-A-010000<br>7J-A-010000<br>7J-A-010000<br>7J-A-010000<br>7J-A-010000<br>7J-A-010000<br>7J-A-010000<br>7J-A-010000  | 01.06<br>04.03<br>06.06<br>04.03<br>06.03<br>09.09<br>09.09<br>09.09<br>09.09<br>09.09<br>02.03<br>02.03<br>07.04<br>07.04<br>02.04          | PR: 2E3,2E4<br>PR: 2E3,2E4<br>PR: 2E3,2E4<br>PR: 2E3,2E4<br>PR: 2E3,2E4<br>PR: 2E3,2E4<br>PR: 2E3,2E4<br>PR: 2E3,2E4<br>PR: 2E3,2E4<br>PR: 2E3,2E4<br>PR: 2E3,2E4<br>PR: 2E3,2E4<br>PR: 2E3,2E4<br>PR: 2E3,2E4<br>PR: 2E3,2E4<br>PR: 2E3,2E4 | 24.0122-0211.1 422211                          |  | 294 21,9 19,5 VL +S +B                        |                        |

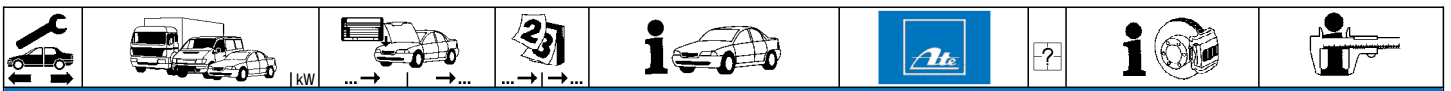

**VOLKSWAGEN TRANSPORTER (T5) PRITSCH / FAHRGESTELL (03-)**

|  |                   |     |             |              |                 |                       |        |  |                        |
|--|-------------------|-----|-------------|--------------|-----------------|-----------------------|--------|--|------------------------|
|  |                   |     |             |              |                 |                       |        |  |                        |
|  | 3.2 V6            | 173 | 7J-A-010000 | <b>08.03</b> | PR: 2E3,2E4     | <b>24.0122-0211.1</b> | 422211 |  | 294 21,9 19,5 VL +S +B |
|  | 1.9 TDI           | 62  | 7J-8-000788 | <b>01.06</b> | PR: OWR,0E0,0E9 | <b>24.0122-0215.1</b> | 422215 |  | 314 22,0 18,0 VL +S +B |
|  | 1.9 TDI           | 63  | 7J-8-000788 | <b>04.03</b> | PR: OWR,0E0,0E9 |                       |        |  |                        |
|  | 1.9 TDI           | 75  | 7J-8-000788 | <b>06.06</b> | PR: OWR,0E0,0E9 |                       |        |  |                        |
|  | 1.9 TDI           | 77  | 7J-8-000788 | <b>04.03</b> | PR: OWR,0E0,0E9 |                       |        |  |                        |
|  | 2.0               | 85  | 7J-8-000788 | <b>06.03</b> | PR: OWR,0E0,0E9 |                       |        |  |                        |
|  | 2.5 TDI           | 96  | 7J-8-000788 | <b>02.03</b> | PR: OWR,0E0,0E9 |                       |        |  |                        |
|  | 2.5 TDI           | 128 | 7J-8-000788 | <b>02.03</b> | PR: OWR,0E0,0E9 |                       |        |  |                        |
|  | 2.5 TDI 4motion   | 96  | 7J-8-000788 | <b>07.04</b> | PR: OWR,0E0,0E9 |                       |        |  |                        |
|  | 2.5 TDI 4motion   | 128 | 7J-8-000788 | <b>07.04</b> | PR: OWR,0E0,0E9 |                       |        |  |                        |
|  | 3.2 V6            | 170 | 7J-8-000788 | <b>02.04</b> | PR: OWR,0E0,0E9 |                       |        |  |                        |
|  | 3.2 V6            | 173 | 7J-8-000788 | <b>08.03</b> | PR: OWR,0E0,0E9 |                       |        |  |                        |
|  | 1.9 TDI           | 62  | 7J-8-000789 | 7J-8-030000  | PR: OWR,0E0,0E9 | <b>24.0122-0211.1</b> | 422211 |  | 294 21,9 19,5 VL +S +B |
|  | 1.9 TDI           | 63  | 7J-8-000789 | 7J-8-030000  | PR: OWR,0E0,0E9 |                       |        |  |                        |
|  | 1.9 TDI           | 75  | 7J-8-000789 | 7J-8-030000  | PR: OWR,0E0,0E9 |                       |        |  |                        |
|  | 1.9 TDI           | 77  | 7J-8-000789 | 7J-8-030000  | PR: OWR,0E0,0E9 |                       |        |  |                        |
|  | 2.0               | 85  | 7J-8-000789 | 7J-8-030000  | PR: OWR,0E0,0E9 |                       |        |  |                        |
|  | 2.5 TDI           | 96  | 7J-8-000789 | 7J-8-030000  | PR: OWR,0E0,0E9 |                       |        |  |                        |
|  | 2.5 TDI           | 128 | 7J-8-000789 | 7J-8-030000  | PR: OWR,0E0,0E9 |                       |        |  |                        |
|  | 2.5 TDI 4motion   | 96  | 7J-8-000789 | 7J-8-030000  | PR: OWR,0E0,0E9 |                       |        |  |                        |
|  | 2.5 TDI 4motion   | 128 | 7J-8-000789 | 7J-8-030000  | PR: OWR,0E0,0E9 |                       |        |  |                        |
|  | 3.2 V6            | 170 | 7J-8-000789 | 7J-8-030000  | PR: OWR,0E0,0E9 |                       |        |  |                        |
|  | 3.2 V6            | 173 | 7J-8-000789 | 7J-8-030000  | PR: OWR,0E0,0E9 |                       |        |  |                        |
|  | 1.9 TDI           | 62  | 7J-A-200001 |              |                 | <b>24.0122-0211.1</b> | 422211 |  | 294 21,9 19,5 VL +S +B |
|  | 1.9 TDI           | 63  | 7J-A-200001 |              |                 |                       |        |  |                        |
|  | 1.9 TDI           | 75  | 7J-A-200001 |              |                 |                       |        |  |                        |
|  | 1.9 TDI           | 77  | 7J-A-200001 |              |                 |                       |        |  |                        |
|  | 2.0               | 85  | 7J-A-200001 |              |                 |                       |        |  |                        |
|  | 2.0 BiTDI         | 132 | 7J-A-200001 |              |                 |                       |        |  |                        |
|  | 2.0 BiTDI 4motion | 132 | 7J-A-200001 |              |                 |                       |        |  |                        |
|  | 2.0 TDI           | 62  | 7J-A-200001 |              |                 |                       |        |  |                        |
|  | 2.0 TDI           | 75  | 7J-A-200001 |              |                 |                       |        |  |                        |
|  | 2.0 TDI           | 84  |             | <b>05.11</b> |                 |                       |        |  |                        |
|  | 2.0 TDI           | 100 |             | <b>05.10</b> |                 |                       |        |  |                        |
|  | 2.0 TDI           | 103 | 7J-A-200001 |              |                 |                       |        |  |                        |
|  | 2.0 TDI 4motion   | 100 |             | <b>05.10</b> |                 |                       |        |  |                        |
|  | 2.0 TDI 4motion   | 103 | 7J-A-200001 |              |                 |                       |        |  |                        |
|  | 2.0 TSI           | 110 |             | <b>07.12</b> |                 |                       |        |  |                        |
|  | 2.5 TDI           | 96  | 7J-A-200001 |              |                 |                       |        |  |                        |
|  | 2.5 TDI           | 128 | 7J-A-200001 |              |                 |                       |        |  |                        |
|  | 2.5 TDI 4motion   | 96  | 7J-A-200001 |              |                 |                       |        |  |                        |
|  | 2.5 TDI 4motion   | 128 | 7J-A-200001 |              |                 |                       |        |  |                        |
|  | 3.2 V6            | 170 | 7J-A-200001 |              |                 |                       |        |  |                        |
|  | 3.2 V6            | 173 | 7J-A-200001 |              |                 |                       |        |  |                        |
|  | 1.9 TDI           | 62  |             | <b>01.06</b> |                 | <b>24.0711-5271.3</b> | 360301 |  | Radsensor              |
|  | 1.9 TDI           | 63  |             | <b>04.03</b> |                 | <b>24.0711-5272.3</b> | 360302 |  | Radsensor              |
|  | 1.9 TDI           | 75  |             | <b>06.06</b> |                 |                       |        |  |                        |
|  | 1.9 TDI           | 77  |             | <b>04.03</b> |                 |                       |        |  |                        |
|  | 2.0               | 85  |             | <b>06.03</b> |                 |                       |        |  |                        |
|  | 2.0 BiTDI         | 132 |             | <b>09.09</b> |                 |                       |        |  |                        |
|  | 2.0 BiTDI 4motion | 132 |             | <b>09.09</b> |                 |                       |        |  |                        |
|  | 2.0 TDI           | 62  |             | <b>09.09</b> |                 |                       |        |  |                        |
|  | 2.0 TDI           | 75  |             | <b>09.09</b> |                 |                       |        |  |                        |
|  | 2.0 TDI           | 84  |             | <b>05.11</b> |                 |                       |        |  |                        |
|  | 2.0 TDI           | 100 |             | <b>05.10</b> |                 |                       |        |  |                        |
|  | 2.0 TDI           | 103 |             | <b>09.09</b> |                 |                       |        |  |                        |
|  | 2.0 TDI 4motion   | 100 |             | <b>05.10</b> |                 |                       |        |  |                        |
|  | 2.0 TDI 4motion   | 103 |             | <b>09.09</b> |                 |                       |        |  |                        |
|  | 2.0 TSI           | 110 |             | <b>07.12</b> |                 |                       |        |  |                        |
|  | 2.5 TDI           | 96  |             | <b>02.03</b> |                 |                       |        |  |                        |
|  | 2.5 TDI           | 128 |             | <b>02.03</b> |                 |                       |        |  |                        |
|  | 2.5 TDI 4motion   | 96  |             | <b>07.04</b> |                 |                       |        |  |                        |
|  | 2.5 TDI 4motion   | 128 |             | <b>07.04</b> |                 |                       |        |  |                        |
|  | 3.2 V6            | 170 |             | <b>02.04</b> |                 |                       |        |  |                        |
|  | 3.2 V6            | 173 |             | <b>08.03</b> |                 |                       |        |  |                        |
|  | 1.9 TDI           | 62  |             | <b>01.06</b> | PR: OWR,0E0,0E9 | <b>03.0137-0419.2</b> | 650419 |  | 185 x 30               |
|  | 1.9 TDI           | 63  |             | <b>04.03</b> | PR: OWR,0E0,0E9 | <b>03.0137-9288.2</b> | 669288 |  | Bremsbacken-Zubehör    |
|  | 1.9 TDI           | 75  |             | <b>06.06</b> | PR: OWR,0E0,0E9 | <b>03.0137-9700.2</b> | 669700 |  | Bremsbacken-Zubehör    |
|  | 1.9 TDI           | 77  |             | <b>04.03</b> | PR: OWR,0E0,0E9 | <b>03.0137-9702.2</b> | 669702 |  | Spreizschloß Satz      |
|  | 2.0               | 85  |             | <b>06.03</b> | PR: OWR,0E0,0E9 |                       |        |  |                        |
|  | 2.0 BiTDI         | 132 |             | <b>09.09</b> | PR: OWR,0E0,0E9 |                       |        |  |                        |
|  | 2.0 BiTDI 4motion | 132 |             | <b>09.09</b> | PR: OWR,0E0,0E9 |                       |        |  |                        |
|  | 2.0 TDI           | 62  |             | <b>09.09</b> | PR: OWR,0E0,0E9 |                       |        |  |                        |
|  | 2.0 TDI           | 75  |             | <b>09.09</b> | PR: OWR,0E0,0E9 |                       |        |  |                        |
|  | 2.0 TDI           | 100 |             | <b>05.10</b> | PR: OWR,0E0,0E9 |                       |        |  |                        |
|  | 2.0 TDI           | 103 |             | <b>09.09</b> | PR: OWR,0E0,0E9 |                       |        |  |                        |
|  | 2.0 TDI 4motion   | 100 |             | <b>05.10</b> | PR: OWR,0E0,0E9 |                       |        |  |                        |
|  | 2.0 TDI 4motion   | 103 |             | <b>09.09</b> | PR: OWR,0E0,0E9 |                       |        |  |                        |
|  | 2.5 TDI           | 96  |             | <b>02.03</b> | PR: OWR,0E0,0E9 |                       |        |  |                        |
|  | 2.5 TDI           | 128 |             | <b>02.03</b> | PR: OWR,0E0,0E9 |                       |        |  |                        |
|  | 2.5 TDI 4motion   | 96  |             | <b>07.04</b> | PR: OWR,0E0,0E9 |                       |        |  |                        |
|  | 2.5 TDI 4motion   | 128 |             | <b>07.04</b> | PR: OWR,0E0,0E9 |                       |        |  |                        |
|  | 3.2 V6            | 170 |             | <b>02.04</b> | PR: OWR,0E0,0E9 |                       |        |  |                        |
|  | 3.2 V6            | 173 |             | <b>08.03</b> | PR: OWR,0E0,0E9 |                       |        |  |                        |























**VOLKSWAGEN TRANSPORTER (T6) (15-)**

|  |                 |     |       |                |        |                         |                         |     |
|--|-----------------|-----|-------|----------------|--------|-------------------------|-------------------------|-----|
|  | 2.0 TDI         | 62  | 04.15 | 13.0460-7236.2 | 607236 | + 16" Rad <sup>1)</sup> | 23746 19,7 +/WK         | ATE |
|  | 2.0 TDI         | 75  | 04.15 |                |        |                         |                         |     |
|  | 2.0 TDI         | 103 | 04.15 |                |        |                         |                         |     |
|  | 2.0 TDI         | 110 | 04.15 |                |        |                         |                         |     |
|  | 2.0 TDI         | 132 | 04.15 |                |        |                         |                         |     |
|  | 2.0 TDI         | 150 | 06.15 |                |        |                         |                         |     |
|  | 2.0 TDI 4motion | 103 | 06.15 |                |        |                         |                         |     |
|  | 2.0 TDI 4motion | 110 | 08.15 |                |        |                         |                         |     |
|  | 2.0 TDI 4motion | 132 | 06.15 |                |        |                         |                         |     |
|  | 2.0 TDI 4motion | 150 | 06.15 |                |        |                         |                         |     |
|  | 2.0 TSI         | 110 | 04.15 |                |        |                         |                         |     |
|  | 2.0 TSI         | 150 | 04.15 |                |        |                         |                         |     |
|  | 2.0 TSI 4motion | 150 | 06.15 |                |        |                         |                         |     |
|  | 2.0 TDI         | 62  | 04.15 | 13.0460-7286.2 | 607286 | + 17" Rad <sup>2)</sup> | 24623 18,2 +/WK         | ATE |
|  | 2.0 TDI         | 75  | 04.15 |                |        |                         |                         |     |
|  | 2.0 TDI         | 103 | 04.15 |                |        |                         |                         |     |
|  | 2.0 TDI         | 110 | 04.15 |                |        |                         |                         |     |
|  | 2.0 TDI         | 132 | 04.15 |                |        |                         |                         |     |
|  | 2.0 TDI         | 150 | 06.15 |                |        |                         |                         |     |
|  | 2.0 TDI 4motion | 103 | 06.15 |                |        |                         |                         |     |
|  | 2.0 TDI 4motion | 110 | 08.15 |                |        |                         |                         |     |
|  | 2.0 TDI 4motion | 132 | 06.15 |                |        |                         |                         |     |
|  | 2.0 TDI 4motion | 150 | 06.15 |                |        |                         |                         |     |
|  | 2.0 TSI         | 110 | 04.15 |                |        |                         |                         |     |
|  | 2.0 TSI         | 150 | 04.15 |                |        |                         |                         |     |
|  | 2.0 TSI 4motion | 150 | 06.15 |                |        |                         |                         |     |
|  | 2.0 TDI         | 62  | 04.15 | 24.0130-0114.1 | 430114 | + 16" Rad <sup>1)</sup> | 308 29,5 25,5 V L +B    |     |
|  | 2.0 TDI         | 75  | 04.15 |                |        |                         |                         |     |
|  | 2.0 TDI         | 103 | 04.15 |                |        |                         |                         |     |
|  | 2.0 TDI         | 110 | 04.15 |                |        |                         |                         |     |
|  | 2.0 TDI         | 132 | 04.15 |                |        |                         |                         |     |
|  | 2.0 TDI         | 150 | 06.15 |                |        |                         |                         |     |
|  | 2.0 TDI 4motion | 103 | 06.15 |                |        |                         |                         |     |
|  | 2.0 TDI 4motion | 110 | 08.15 |                |        |                         |                         |     |
|  | 2.0 TDI 4motion | 132 | 06.15 |                |        |                         |                         |     |
|  | 2.0 TDI 4motion | 150 | 06.15 |                |        |                         |                         |     |
|  | 2.0 TSI         | 110 | 04.15 |                |        |                         |                         |     |
|  | 2.0 TSI         | 150 | 04.15 |                |        |                         |                         |     |
|  | 2.0 TSI 4motion | 150 | 06.15 |                |        |                         |                         |     |
|  | 2.0 TDI         | 62  | 04.15 | 24.0133-0100.1 | 433100 | + 17" Rad <sup>2)</sup> | 340 32,6 29,5 V L +S +B |     |
|  | 2.0 TDI         | 75  | 04.15 |                |        |                         |                         |     |
|  | 2.0 TDI         | 103 | 04.15 |                |        |                         |                         |     |
|  | 2.0 TDI         | 110 | 04.15 |                |        |                         |                         |     |
|  | 2.0 TDI         | 132 | 04.15 |                |        |                         |                         |     |
|  | 2.0 TDI         | 150 | 06.15 |                |        |                         |                         |     |
|  | 2.0 TDI 4motion | 103 | 06.15 |                |        |                         |                         |     |
|  | 2.0 TDI 4motion | 110 | 08.15 |                |        |                         |                         |     |
|  | 2.0 TDI 4motion | 132 | 06.15 |                |        |                         |                         |     |
|  | 2.0 TDI 4motion | 150 | 06.15 |                |        |                         |                         |     |
|  | 2.0 TSI         | 110 | 04.15 |                |        |                         |                         |     |
|  | 2.0 TSI         | 150 | 04.15 |                |        |                         |                         |     |
|  | 2.0 TSI 4motion | 150 | 06.15 |                |        |                         |                         |     |
|  | 2.0 TDI         | 62  | 04.15 | 24.0711-5271.3 | 360301 |                         | Radsensor               |     |
|  | 2.0 TDI         | 75  | 04.15 |                |        |                         |                         |     |
|  | 2.0 TDI         | 103 | 04.15 |                |        |                         |                         |     |
|  | 2.0 TDI         | 110 | 04.15 |                |        |                         |                         |     |
|  | 2.0 TDI         | 132 | 04.15 |                |        |                         |                         |     |
|  | 2.0 TDI         | 150 | 06.15 |                |        |                         |                         |     |
|  | 2.0 TDI 4motion | 103 | 06.15 |                |        |                         |                         |     |
|  | 2.0 TDI 4motion | 110 | 08.15 |                |        |                         |                         |     |
|  | 2.0 TDI 4motion | 132 | 06.15 |                |        |                         |                         |     |
|  | 2.0 TDI 4motion | 150 | 06.15 |                |        |                         |                         |     |
|  | 2.0 TSI         | 110 | 04.15 |                |        |                         |                         |     |
|  | 2.0 TSI         | 150 | 04.15 |                |        |                         |                         |     |
|  | 2.0 TSI 4motion | 150 | 06.15 |                |        |                         |                         |     |
|  | 2.0 TDI         | 62  | 04.15 | 13.0460-2882.2 | 602882 |                         | 23326 17,4 /WK/Zub/S    | TRW |
|  | 2.0 TDI         | 75  | 04.15 |                |        |                         |                         |     |
|  | 2.0 TDI         | 103 | 04.15 |                |        |                         |                         |     |
|  | 2.0 TDI         | 110 | 04.15 |                |        |                         |                         |     |
|  | 2.0 TDI         | 132 | 04.15 |                |        |                         |                         |     |
|  | 2.0 TDI         | 150 | 06.15 |                |        |                         |                         |     |
|  | 2.0 TDI 4motion | 103 | 06.15 |                |        |                         |                         |     |
|  | 2.0 TDI 4motion | 110 | 08.15 |                |        |                         |                         |     |
|  | 2.0 TDI 4motion | 132 | 06.15 |                |        |                         |                         |     |
|  | 2.0 TDI 4motion | 150 | 06.15 |                |        |                         |                         |     |
|  | 2.0 TSI         | 110 | 04.15 |                |        |                         |                         |     |
|  | 2.0 TSI         | 150 | 04.15 |                |        |                         |                         |     |
|  | 2.0 TSI 4motion | 150 | 06.15 |                |        |                         |                         |     |
|  | 2.0 TDI         | 62  | 04.15 | 24.0122-0211.1 | 422211 |                         | 294 21,9 19,5 V L +S +B |     |
|  | 2.0 TDI         | 75  | 04.15 |                |        |                         |                         |     |
|  | 2.0 TDI         | 103 | 04.15 |                |        |                         |                         |     |
|  | 2.0 TDI         | 110 | 04.15 |                |        |                         |                         |     |
|  | 2.0 TDI         | 132 | 04.15 |                |        |                         |                         |     |
|  | 2.0 TDI         | 150 | 06.15 |                |        |                         |                         |     |
|  | 2.0 TDI 4motion | 103 | 06.15 |                |        |                         |                         |     |
|  | 2.0 TDI 4motion | 110 | 08.15 |                |        |                         |                         |     |
|  | 2.0 TDI 4motion | 132 | 06.15 |                |        |                         |                         |     |















<sup>1)</sup> + 16" wheel / + ruota 16" / + roue 16" / + rueda 16"

<sup>2)</sup> + 17" wheel / + ruota 17" / + roue 17" / + rueda 17"



| VOLKSWAGEN TRANSPORTER (T6) (15-)  |  |  |  |  |   |  |  |   |                           |
|--|--|--|--|--|---|--|--|---|---------------------------|
|     |  |  |  |  |  |  |  |     |                           |
|    | 2.0 TDI 4motion  | 150  |  | 06.15  |   | 24.0122-0211.1   | 422211   |   | 294 21,9 19,5 VL +S +B    |
|  | 2.0 TSI  | 110  |  | 04.15  |   |  |  |   |                           |
|  | 2.0 TSI  | 150  |  | 04.15  |   |  |  |   |                           |
|  | 2.0 TSI 4motion  | 150  |  | 06.15  |   |  |  |   |                           |
|    | 2.0 TDI  | 62   |  | 04.15  |   | 24.0711-5271.3   | 360301   |    | Radsensor                 |
|  | 2.0 TDI  | 75   |  | 04.15  |   | 24.0711-5272.3   | 360302   |    | Radsensor                 |
|  | 2.0 TDI  | 103  |  | 04.15  |   |  |  |   |                           |
|  | 2.0 TDI  | 110  |  | 04.15  |   |  |  |   |                           |
|  | 2.0 TDI  | 132  |  | 04.15  |   |  |  |   |                           |
|  | 2.0 TDI  | 150  |  | 06.15  |   |  |  |   |                           |
|  | 2.0 TDI 4motion  | 103  |  | 06.15  |   |  |  |   |                           |
|  | 2.0 TDI 4motion  | 110  |  | 08.15  |   |  |  |   |                           |
|  | 2.0 TDI 4motion  | 132  |  | 06.15  |   |  |  |   |                           |
|  | 2.0 TDI 4motion  | 150  |  | 06.15  |   |  |  |   |                           |
|  | 2.0 TSI  | 110  |  | 04.15  |   |  |  |   |                           |
|  | 2.0 TSI  | 150  |  | 04.15  |   |  |  |   |                           |
|  | 2.0 TSI 4motion  | 150  |  | 06.15  |   |  |  |   |                           |
| VOLKSWAGEN VENTO (92-98)   |  |  |  |  |   |  |  |   |                           |
|    | 1.4  |  | 1H-T-015953  | 11.91  |   | 13.0460-7032.2   | 607032   |   | 20887 19,7 +/Zub VW       |
|  | 1.6  | 55   | 1H-T-015953  | 09.92  | + Schaltgetriebe <sup>1)</sup>  |  |  |   |                           |
|  | 1.6  | 55   | 1H-S-430000  | 09.92  | + Automatikgetriebe <sup>2)</sup>   |  |  |   |                           |
|  | 1.8  | 55   | 1H-T-015953  | 01.92  | + Schaltgetriebe <sup>1)</sup>  |  |  |   |                           |
|  | 1.8 CL/GL  | 66   | 1H-S-430000  | 01.92  |   |  |  |   |                           |
|  | 1.9 D  |  | 1H-T-015953  | 11.91  |   |  |  |   |                           |
|  | 1.9 TD   | 55   | 1H-S-430000  | 01.92  |   |  |  |   |                           |
|  | 1.4  |  | 1H-T-015954  | 09.98  | - ABS   | 13.0460-7072.2   | 607072   |   | 21866 19,7 + VW           |
|  | 1.6  | 55   | 1H-T-015954  | 09.98  | + Schaltgetriebe <sup>1)</sup>  |  |  |   |                           |
|  | 1.8  | 55   | 1H-T-015954  | 09.98  | + Schaltgetriebe <sup>1)</sup>  |  |  |   |                           |
|  | 1.9 D  |  | 1H-T-015954  | 09.98  | - ABS   |  |  |   |                           |
|  | 1.9 SDI  |  |  | 04.97  | 09.98 - ABS   |  |  |   |                           |
|  | 1.6  | 55   | 1H-S-430001  | 09.98  | + Automatikgetriebe <sup>2)</sup>   | 13.0460-2958.2   | 602958   |   | 20168 19,3 /S TRW         |
|  | 1.6 CL/GL  | 74   |  | 07.94  | 09.98   |  |  |   |                           |
|  | 1.8  | 55   |  | 01.92  | 09.98 + Automatikgetriebe <sup>2)</sup>   |  |  |   |                           |
|  | 1.8 CL/GL  | 66   | 1H-S-430001  | 09.98  |   |  |  |   |                           |
|  | 1.9 TD   | 55   | 1H-S-430001  | 09.98  |   |  |  |   |                           |
|  | 1.9 TDI  | 66   |  | 07.93  | 09.98 - ABS   |  |  |   |                           |
|  | 1.4  |  |  | 05.96  | 09.96 + ABS   | 13.0460-2821.2   | 602821   |   | 21945 16,0 /S TRW         |
|  | 1.6 GT   | 74   |  | 07.94  | 09.98   |  |  |   |                           |
|  | 1.8 GT   | 66   |  | 01.92  | 09.98   |  |  |   |                           |
|  | 1.9 D  |  |  | 05.96  | 09.96 + ABS   |  |  |   |                           |
|  | 1.9 TDI  | 66   |  | 07.93  | 09.98   |  |  |   |                           |
|  | 1.9 TDI  | 81   |  | 02.96  | 09.98 + ABS   |  |  |   |                           |
|  | 2.0 CL/GL  |  |  | 11.91  | 09.98   |  |  |   |                           |
|  | 1.4  |  |  | 10.96  | 09.98 + ABS   | 13.0460-7101.2   | 607101   |   | 21866 15,3 + VW           |
|  | 1.9 D  |  |  | 10.96  | 09.98 + ABS   |  |  |   |                           |
|  | 1.9 SDI  |  |  | 04.97  | 09.98 + ABS   |  |  |   |                           |
|  | 2.0 GT   |  | 1H-S-560000  | 11.91  |   | 13.0460-2806.2   | 602806   |   | 20168 19,3 +/WK/S TRW     |
|  | 2.8 VR6  |  | 1H-S-560000  | 01.92  |   |  |  |   |                           |
|  | 2.0 GT   |  | 1H-S-560001  | 04.96  |   | 13.0460-2958.2   | 602958   |   | 20168 19,3 /S TRW         |
|  | 2.0 GT   |  |  | 05.96  | 09.98   | 13.0460-7081.2   | 607081   |   | 21911 20,3 + ATE          |
|  | 2.8 VR6  |  | 1H-S-560001  | 09.98  |   | 13.0470-7081.2   | LD7081   |   | 21911 20,3 + ATE          |
|  | 1.4  |  |  | 11.91  | 09.98 - ABS   | 24.0112-0106.1   | 412106   |   | 239 12,0 10,0 +S +B       |
|  | 1.6  | 55   | 1H-S-430000  | 09.92  | + Automatikgetriebe <sup>2)</sup>   | 24.0312-0106.1   | 512106   |   | 239 12,0 10,0 +S +B PD    |
|  | 1.6  | 55   |  | 09.92  | 09.98 + Schaltgetriebe <sup>1)</sup>  |  |  |   |                           |
|  | 1.8  | 55   |  | 01.92  | 09.98 + Schaltgetriebe <sup>1)</sup>  |  |  |   |                           |
|  | 1.8 CL/GL  | 66   | 1H-S-430000  | 01.92  |   |  |  |   |                           |
|  | 1.9 D  |  |  | 11.91  | 09.98 - ABS   |  |  |   |                           |
|  | 1.9 SDI  |  |  | 04.97  | 09.98 - ABS   |  |  |   |                           |
|  | 1.9 TD   | 55   | 1H-S-430000  | 11.91  |   |  |  |   |                           |
|  | 1.6  | 55   | 1H-S-430001  | 09.98  | + Automatikgetriebe <sup>2)</sup>   | 24.0113-0178.1   | 413178   |   | 256 12,9 11,0 +S +B       |
|  | 1.6 CL/GL  | 74   |  | 07.94  | 09.98   | 24.0313-0178.1   | 513178   |   | 256 12,9 11,0 +S +B PD    |
|  | 1.8  | 55   |  | 01.92  | 09.98 + Automatikgetriebe <sup>2)</sup>   |  |  |   |                           |
|  | 1.8 CL/GL  | 66   | 1H-S-430001  | 09.98  |   |  |  |   |                           |
|  | 1.9 TD   | 55   | 1H-S-430001  | 09.98  |   |  |  |   |                           |
|  | 1.9 TDI  | 66   |  | 07.93  | 09.98 - ABS   |  |  |   |                           |
|  | 1.4  |  |  | 05.96  | 09.96 + ABS   | 24.0120-0128.1   | 420128   |   | 256 20,0 18,0 VL +S +B    |
|  | 1.6 GT   | 74   |  | 07.94  | 09.98   | 24.0320-0128.1   | 520128   |   | 256 20,0 18,0 VL +S +B PD |
|  | 1.8 GT   | 66   |  | 01.92  | 09.98   |  |  |   |                           |
|  | 1.9 D  |  |  | 05.96  | 09.96 + ABS   |  |  |   |                           |
|  | 1.9 TDI  | 66   |  | 07.93  | 09.98 + ABS   |  |  |   |                           |
|  | 1.9 TDI  | 81   |  | 02.96  | 09.98   |  |  |   |                           |
|  | 2.0 CL/GL  |  |  | 11.91  | 09.98   |  |  |   |                           |
|  | 1.4  |  |  | 10.96  | 09.98 + ABS   | 24.0120-0123.1   | 420123   |   | 239 20,0 18,0 VL +S +B    |
|  | 1.9 D  |  |  | 10.96  | 09.98 + ABS   | 24.0320-0123.1   | 520123   |   | 239 20,0 18,0 VL +S +B PD |
|  | 1.9 SDI  |  |  | 04.97  | 09.98 + ABS   |  |  |   |                           |
|  | 2.0 GT   |  |  | 11.91  | 04.96   | 24.0122-0100.1   | 422100   |   | 280 22,0 20,0 VL +B       |
|  | 2.8 VR6  |  | 1H-S-560000  | 01.92  |   | 24.0322-0100.1   | 522100   |   | 280 22,0 20,0 VL +B PD    |
|  | 2.0 GT   |  |  | 05.96  | 09.98   | 24.0125-0108.1   | 425108   |   | 288 25,0 23,0 VL +B       |
|  | 2.8 VR6  |  | 1H-S-560001  | 09.98  |   |  |  |   |                           |
|  | 1.4  |  |  | 11.91  | 09.98   | 24.0711-1361.3   | 360022   |  | Radsensor                 |
|  | 1.6  |  |  | 09.92  | 09.98   | 24.0711-1362.3   | 360023   |  | Radsensor                 |
|  | 1.8  |  |  | 01.92  | 09.98   |  |  |   |                           |
|  | 1.9 D  |  |  | 11.91  | 09.98   |  |  |   |                           |
|  | 1.9 SDI  |  |  | 04.97  | 09.98   |  |  |   |                           |

<sup>1)</sup> + manual transmission / + scatola cambio velocità / + transmission mécanique / + cambio de velocidad  
<sup>2)</sup> + autom.transmission / + scatola cambio automatico / + transmission automatique / + cambio automático





















| VOLKSWAGEN VENTO (92-98)   |  |                                  |  |  |   |  |                                  |                  |  |  |            |
|--|--|----------------------------------|--|--|---|--|----------------------------------|------------------|--|--|------------|
|    | 1.9 TD<br>1.9 TDI<br>2.0<br>2.8 VR6  | 55                               |  | 11.91<br>07.93<br>11.91<br>01.92                                     | 09.98<br>09.98<br>09.98<br>09.98  |  | 24.0711-1361.3<br>24.0711-1362.3 | 360022<br>360023 |     | Radsensor<br>Radsensor                             |            |
|    | 1.6 GT<br>1.8 GT<br>1.9 GT TDI<br>2.0<br>2.0 GT<br>2.8 VR6                     | 74<br>66                         |  | 07.94<br>01.92<br>07.93<br>11.91<br>11.91<br>01.92                   | 09.98<br>09.98<br>09.98<br>09.98<br>09.98<br>09.98                            |  | 13.0460-2937.2<br>13.0460-0419.2 | 602937<br>610419 |  | 20961 15,2 /Zub/S<br>Belagsatz-Zubehör             | TRW<br>TRW |
|    | 1.6 GT<br>1.8 GT<br>1.9 GT TDI<br>1.9 TDI<br>2.0 CL/GL<br>2.0 GT<br>2.8 VR6    | 74<br>66<br>81                   |  | 07.94<br>01.92<br>07.93<br>02.96<br>11.91<br>01.92                   | 09.98<br>09.98<br>09.98<br>09.98<br>09.98<br>09.98                            |  | 24.0110-0111.1<br>24.0110-0275.2 | 410111<br>410275 | für 4-Loch-Felge/- Sensorring <sup>1)</sup><br>mit Sensorring <sup>2)</sup>            | 226 10,0 8,0 +B<br>226 10,0 8,0 +B                 |            |
|    | 1.4<br>1.6<br>1.8<br>1.9 D<br>1.9 TD<br>1.9 TDI<br>2.0<br>2.8 VR6              | 55                               |  | 11.91<br>09.92<br>01.92<br>11.91<br>11.91<br>07.93<br>11.91<br>01.92 | 09.98<br>09.98<br>09.98<br>09.98<br>09.98<br>09.98<br>09.98<br>09.98          |  | 24.0721-1937.1                   | 360040           | 2   | Radsensor L=1062                                   |            |
|   | 1.4<br>1.6<br>1.8<br>1.9 D<br>1.9 SDI<br>1.9 TD<br>1.9 TDI<br>2.0<br>2.8 VR6   | 55                               |  | 04.97  | 09.98<br>09.98<br>09.98<br>09.98<br>09.98<br>09.98<br>09.98<br>09.98<br>09.98 |  | 24.0721-1191.3                   | 360091           | 2  | Radsensor L=1043                                   |            |
|  | 1.4<br>1.6<br>1.8<br>1.9 D<br>1.9 SDI<br>1.9 TD<br>1.9 TDI                     | 55                               |  | 11.91<br>09.92<br>01.92<br>11.91<br>04.97<br>11.91<br>07.93          | 09.98<br>09.98<br>09.98<br>09.98<br>09.98<br>09.98<br>09.98                   |  | 24.0220-0018.1<br>24.0220-0718.2 | 480019<br>480209 | ohne Sensorring <sup>4)</sup><br>ohne Sensorring <sup>4)</sup>                         | 200/201 x 50,0 - Lager<br>200/201,5 x 50,0 + Lager |            |
|  | 1.4<br>1.6<br>1.6<br>1.8<br>1.8 CL/GL<br>1.9 D<br>1.9 SDI<br>1.9 TD<br>1.9 TDI | 55<br>55<br>55<br>66             |  | 11.91<br>09.92<br>01.92<br>11.91<br>04.97<br>11.91<br>07.93          | 09.98<br>09.98<br>09.98<br>09.98<br>09.98<br>09.98<br>09.98                   |  | 03.0420-1517.3<br>03.0520-1517.3 | 681517<br>691517 |  | 17,46/200x40 Kit<br>17,46/200x40 TopKit            | VW<br>VW   |
|  | 1.6<br>1.6 CL/GL<br>1.8<br>1.8 CL/GL<br>1.9 TD<br>1.9 TDI                      | 55<br>74<br>55<br>66<br>55<br>66 |  | 07.94<br>01.92<br>01.92<br>09.98<br>09.98<br>07.93                   | 09.98<br>09.98<br>09.98<br>09.98<br>09.98<br>09.98                            |  | 03.0420-4219.3<br>03.0520-4219.3 | 684219<br>694219 |  | 19,05/200x40 Kit<br>19,05/200x40 TopKit            | VW<br>VW   |
| VOLKSWAGEN UP / LOAD UP (11-)  |  |                                  |  |  |   |  |                                  |                  |  |  |            |
|  | 1.0<br>1.0<br>1.0<br>1.0 EcoFuel<br>e-up                                       | 44<br>55<br>66<br>50<br>60       |  | 12.11<br>12.11<br>05.16<br>11.12<br>09.13                            | PR: 1LA,1ZQ<br>PR: 1LA,1ZQ<br>PR: 1LA,1ZQ<br>PR: 1LA,1ZQ<br>PR: 1ZQ           |  | 13.0460-7111.2<br>13.0470-7111.2 | 607111<br>LD7111 |  | 23130 19,6 +<br>23130 19,6 +                       | VW<br>VW   |
|  | 1.0<br>1.0<br>1.0<br>1.0 EcoFuel<br>e-up                                       | 44<br>55<br>66<br>50<br>60       |  | 12.11<br>12.11<br>05.16<br>11.12<br>09.13                            | PR: 1LA,1ZQ<br>PR: 1LA,1ZQ<br>PR: 1LA,1ZQ<br>PR: 1LA,1ZQ<br>PR: 1LA,1ZQ       |  | 24.0122-0281.1                   | 422281           |  | 256 22,0 19,0 V L +S +B                            |            |
|  | 1.0<br>1.0<br>1.0<br>1.0 EcoFuel<br>e-up                                       | 44<br>55<br>66<br>50<br>60       |  | 12.11<br>12.11<br>05.16<br>11.12<br>09.13                            |   |  | 24.0711-5273.3<br>24.0711-5274.3 | 360303<br>360304 |   | Radsensor<br>Radsensor                             |            |

<sup>1)</sup> for 4-hole rim/-sensor ring / per cerch.4 fori/-sensore ruota / pour jante 4 trous/-roue codeuse / para llanta cuatro agujeros/-anillo sensor

<sup>2)</sup> with sensor ring / con sensori / avec secours ABS / con anillo sensor ABS

<sup>3)</sup> for 5 bore wheel rim / per cerchione a 5 fori / pour jante à 5 trous / para Llantas de 5 taladros

<sup>4)</sup> without sensor ring / senza sensori / sans secours ABS / sin anillo sensor ABS

|     |  |  |  |  |  |  |   |  |
|--|--|--|--|--|---|--|---|--|
| <b>VOLKSWAGEN UP / LOAD UP (11-)</b>   |  |  |  |  |   |  |   |  |
|    | 1.0<br>1.0<br>1.0<br>1.0 EcoFuel<br>e-up   | 44<br>55<br>66<br>50<br>60   | 12.11<br>12.11<br>05.16<br>11.12<br>09.13  |  | 24.0711-6233.3<br>24.0711-6234.3  | 360315<br>360316   |  | Radsensor<br>Radsensor   |
|    | 1.0<br>1.0<br>1.0<br>1.0<br>1.0 EcoFuel<br>e-up                                  | 44<br>55<br>44<br>55<br>66<br>50<br>60   | 12.11<br>12.11<br>06.12<br>06.12<br>05.16<br>11.12<br>09.13                      | 05.12<br>05.12   | 03.0137-0268.2<br>03.0137-9168.2  | 650268<br>669168   |   | 200 x 40 HEB<br>Bremsbacken-Zubehör<br>200 x 40 HEB<br>Bremsbacken-Zubehör         |
|    | 1.0<br>1.0<br>1.0<br>1.0 EcoFuel   | 44<br>55<br>66<br>50   | 12.11<br>12.11<br>05.16<br>11.12   |  | 03.0520-4817.3  | 694817   |   | 17,46/200x40 TopKit  |
|  | e-up   | 60   | 09.13  |  | 03.0520-8219.3  | 698219   |   | 19,05/200x40 TopKit  |
| <b>VOLVO 940 II Limousine (95-98)</b>  |  |  |  |  |   |  |   |  |
|    | 2.0 T<br>2.3<br>2.3<br>2.3 T<br>2.3 ti<br>2.4 TD Intercooler                     | 114<br>85<br>96<br>121<br>99<br>90   | 04.96<br>08.94<br>08.94<br>08.94<br>01.95<br>08.94                               | 10.98<br>07.95<br>10.98<br>10.98<br>10.98<br>10.98                               | 13.0460-3914.2<br>13.0460-2985.2<br>13.0460-0429.2                                | 603914<br>602985<br>610429   |   | 21233 16,7<br>20164 18,2<br>Belagsatz-Zubehör                                      |
|    | 2.0 T<br>2.3<br>2.3<br>2.3 T<br>2.3 ti<br>2.4 TD Intercooler                     | 114<br>85<br>96<br>121<br>99<br>90   | 04.96<br>08.94<br>08.94<br>08.94<br>01.95<br>08.94                               | 10.98<br>07.95<br>10.98<br>10.98<br>10.98<br>10.98                               | 24.0126-0105.1  | 426105   |   | 280 26,0 23,0 V +B   |
|    | 2.0 T<br>2.3<br>2.3<br>2.3 T<br>2.3 ti<br>2.4 TD Intercooler                     | 114<br>85<br>96<br>121<br>99<br>90   | 04.96<br>08.94<br>08.94<br>08.94<br>01.95<br>08.94                               | 10.98<br>07.95<br>10.98<br>10.98<br>10.98<br>10.98                               | 13.0460-3401.2<br>13.0460-0088.2  | 603401<br>610088   |   | 20755 14,4<br>Belagsatz-Zubehör  |
|  | 2.0 T<br>2.3<br>2.3<br>2.3 T<br>2.3 ti<br>2.4 TD Intercooler                     | 114<br>85<br>96<br>121<br>99<br>90   | 04.96<br>08.94<br>08.94<br>08.94<br>01.95<br>08.94                               | 10.98<br>07.95<br>10.98<br>10.98<br>10.98<br>10.98                               | 13.0460-2935.2  | 602935   |   | 21385 13,8 /S  |
|  | 2.0 T<br>2.3<br>2.3<br>2.3 T<br>2.3 ti<br>2.4 TD Intercooler                     | 114<br>85<br>96<br>121<br>99<br>90   | 04.96<br>08.94<br>08.94<br>08.94<br>01.95<br>08.94                               | 10.98<br>07.95<br>10.98<br>10.98<br>10.98<br>10.98                               | 24.0110-0189.1  | 410189   |   | 281 9,6 8,4 +B   |
|  | 2.0 T<br>2.3<br>2.3<br>2.3 T<br>2.3 ti<br>2.4 TD Intercooler                     | 114<br>85<br>96<br>121<br>99<br>90   | 04.96<br>08.94<br>08.94<br>08.94<br>01.95<br>08.94                               | 10.98<br>07.95<br>10.98<br>10.98<br>10.98<br>10.98                               | 24.0110-0206.1  | 410206   |   | 265 10,0 8,0   |
|  | 2.0 T<br>2.3<br>2.3<br>2.3 T<br>2.3 ti<br>2.4 TD Intercooler                     | 114<br>85<br>96<br>121<br>99<br>90   | 04.96<br>08.94<br>08.94<br>08.94<br>01.95<br>08.94                               | 10.98<br>07.95<br>10.98<br>10.98<br>10.98<br>10.98                               | 03.0137-0169.2<br>03.0137-9065.2  | 650169<br>669065   |   | 160 x 25<br>Bremsbacken-Zubehör  |
|  | 2.0 T<br>2.3<br>2.3<br>2.3 T<br>2.3 ti<br>2.4 TD Intercooler                     | 114<br>85<br>96<br>121<br>99<br>90   | 04.96<br>08.94<br>08.94<br>08.94<br>01.95<br>08.94                               | 10.98<br>07.95<br>10.98<br>10.98<br>10.98<br>10.98                               | 03.0137-0299.2<br>03.0137-9199.2  | 650299<br>669199   |   | 160 x 25<br>Bremsbacken-Zubehör  |
| <b>VOLVO 940 II Kombi (95-98)</b>  |  |  |  |  |   |  |   |  |
|  | 2.0 T<br>2.3<br>2.3<br>2.3 T<br>2.3 T<br>2.3 ti<br>2.4 TD Intercooler            | 114<br>85<br>96<br>121<br>126<br>99<br>90  | 04.96<br>08.94<br>08.94<br>08.94<br>08.95<br>01.95<br>08.94                      | 10.98<br>07.95<br>10.98<br>10.98<br>10.98<br>10.98<br>10.98                      | 13.0460-3914.2<br>13.0460-2985.2<br>13.0460-0429.2                                | 603914<br>602985<br>610429   |   | 21233 16,7<br>20164 18,2<br>Belagsatz-Zubehör                                      |
|  | 2.0 T<br>2.3<br>2.3<br>2.3 T<br>2.3 T<br>2.3 ti<br>2.4 TD Intercooler            | 114<br>85<br>96<br>121<br>126<br>99<br>90  | 04.96<br>08.94<br>08.94<br>08.94<br>08.95<br>01.95<br>08.94                      | 10.98<br>07.95<br>10.98<br>10.98<br>10.98<br>10.98<br>10.98                      | 24.0126-0105.1  | 426105   |   | 280 26,0 23,0 V +B   |

1) - multi link axle / - assale Multi-link / - essieu multi-link / - eje Multi-Link  
2) + multi link axle / + assale Multi-link / + essieu multi-link / + eje Multi-Link



















**VOLVO 940 II Kombi (95-98)**

|  |                    |     |  |       |       |                                  |                |        |  |                     |     |
|--|--------------------|-----|--|-------|-------|----------------------------------|----------------|--------|--|---------------------|-----|
|  | 2.0 T              | 114 |  | 04.96 | 10.98 | - Multi-Link-Achse <sup>1)</sup> | 13.0460-3401.2 | 603401 |  | 20755 14,4          | ATE |
|  | 2.3                | 85  |  | 08.94 | 07.95 | - Multi-Link-Achse <sup>1)</sup> | 13.0460-0088.2 | 610088 |  | Belagsatz-Zubehör   | ATE |
|  | 2.3                | 96  |  | 08.94 | 10.98 | - Multi-Link-Achse <sup>1)</sup> |                |        |  |                     |     |
|  | 2.3 T              | 121 |  | 08.94 | 10.98 | - Multi-Link-Achse <sup>1)</sup> |                |        |  |                     |     |
|  | 2.3 T              | 126 |  | 08.95 | 10.98 | - Multi-Link-Achse <sup>1)</sup> |                |        |  |                     |     |
|  | 2.3 ti             | 99  |  | 01.95 | 10.98 | - Multi-Link-Achse <sup>1)</sup> |                |        |  |                     |     |
|  | 2.4 TD Intercooler | 90  |  | 08.94 | 10.98 | - Multi-Link-Achse <sup>1)</sup> |                |        |  |                     |     |
|  | 2.0 T              | 114 |  | 04.96 | 10.98 | + Multi-Link-Achse <sup>2)</sup> | 13.0460-2935.2 | 602935 |  | 21385 13,8 / S      | TRW |
|  | 2.3                | 85  |  | 08.94 | 07.95 | + Multi-Link-Achse <sup>2)</sup> |                |        |  |                     |     |
|  | 2.3                | 96  |  | 08.94 | 10.98 | + Multi-Link-Achse <sup>2)</sup> |                |        |  |                     |     |
|  | 2.3 T              | 121 |  | 08.94 | 10.98 | + Multi-Link-Achse <sup>2)</sup> |                |        |  |                     |     |
|  | 2.3 T              | 126 |  | 08.95 | 10.98 | + Multi-Link-Achse <sup>2)</sup> |                |        |  |                     |     |
|  | 2.3 ti             | 99  |  | 01.95 | 10.98 | + Multi-Link-Achse <sup>2)</sup> |                |        |  |                     |     |
|  | 2.4 TD Intercooler | 90  |  | 08.94 | 10.98 | + Multi-Link-Achse <sup>2)</sup> |                |        |  |                     |     |
|  | 2.0 T              | 114 |  | 04.96 | 10.98 | - Multi-Link-Achse <sup>1)</sup> | 24.0110-0189.1 | 410189 |  | 281 9,6 8,4 +B      |     |
|  | 2.3                | 85  |  | 08.94 | 07.95 | - Multi-Link-Achse <sup>1)</sup> |                |        |  |                     |     |
|  | 2.3                | 96  |  | 08.94 | 10.98 | - Multi-Link-Achse <sup>1)</sup> |                |        |  |                     |     |
|  | 2.3 T              | 121 |  | 08.94 | 10.98 | - Multi-Link-Achse <sup>1)</sup> |                |        |  |                     |     |
|  | 2.3 T              | 126 |  | 08.95 | 10.98 | - Multi-Link-Achse <sup>1)</sup> |                |        |  |                     |     |
|  | 2.3 ti             | 99  |  | 01.95 | 10.98 | - Multi-Link-Achse <sup>1)</sup> |                |        |  |                     |     |
|  | 2.4 TD Intercooler | 90  |  | 08.94 | 10.98 | - Multi-Link-Achse <sup>1)</sup> |                |        |  |                     |     |
|  | 2.0 T              | 114 |  | 04.96 | 10.98 | + Multi-Link-Achse <sup>2)</sup> | 24.0110-0206.1 | 410206 |  | 265 10,0 8,0        |     |
|  | 2.3                | 85  |  | 08.94 | 07.95 | + Multi-Link-Achse <sup>2)</sup> |                |        |  |                     |     |
|  | 2.3                | 96  |  | 08.94 | 10.98 | + Multi-Link-Achse <sup>2)</sup> |                |        |  |                     |     |
|  | 2.3 T              | 121 |  | 08.94 | 10.98 | + Multi-Link-Achse <sup>2)</sup> |                |        |  |                     |     |
|  | 2.3 T              | 126 |  | 08.95 | 10.98 | + Multi-Link-Achse <sup>2)</sup> |                |        |  |                     |     |
|  | 2.3 ti             | 99  |  | 01.95 | 10.98 | + Multi-Link-Achse <sup>2)</sup> |                |        |  |                     |     |
|  | 2.4 TD Intercooler | 90  |  | 08.94 | 10.98 | + Multi-Link-Achse <sup>2)</sup> |                |        |  |                     |     |
|  | 2.0 T              | 114 |  | 04.96 | 10.98 | - Multi-Link-Achse <sup>1)</sup> | 03.0137-0169.2 | 650169 |  | 160 x 25            |     |
|  | 2.3                | 85  |  | 08.94 | 07.95 | - Multi-Link-Achse <sup>1)</sup> | 03.0137-9065.2 | 669065 |  | Bremsbacken-Zubehör |     |
|  | 2.3                | 96  |  | 08.94 | 10.98 | - Multi-Link-Achse <sup>1)</sup> |                |        |  |                     |     |
|  | 2.3 T              | 121 |  | 08.94 | 10.98 | - Multi-Link-Achse <sup>1)</sup> |                |        |  |                     |     |
|  | 2.3 T              | 126 |  | 08.95 | 10.98 | - Multi-Link-Achse <sup>1)</sup> |                |        |  |                     |     |
|  | 2.3 ti             | 99  |  | 01.95 | 10.98 | - Multi-Link-Achse <sup>1)</sup> |                |        |  |                     |     |
|  | 2.4 TD Intercooler | 90  |  | 08.94 | 10.98 | - Multi-Link-Achse <sup>1)</sup> |                |        |  |                     |     |
|  | 2.0 T              | 114 |  | 04.96 | 10.98 | + Multi-Link-Achse <sup>2)</sup> | 03.0137-0299.2 | 650299 |  | 160 x 25            |     |
|  | 2.3                | 85  |  | 08.94 | 07.95 | + Multi-Link-Achse <sup>2)</sup> | 03.0137-9199.2 | 669199 |  | Bremsbacken-Zubehör |     |
|  | 2.3                | 96  |  | 08.94 | 10.98 | + Multi-Link-Achse <sup>2)</sup> |                |        |  |                     |     |
|  | 2.3 T              | 121 |  | 08.94 | 10.98 | + Multi-Link-Achse <sup>2)</sup> |                |        |  |                     |     |
|  | 2.3 T              | 126 |  | 08.95 | 10.98 | + Multi-Link-Achse <sup>2)</sup> |                |        |  |                     |     |
|  | 2.3 ti             | 99  |  | 01.95 | 10.98 | + Multi-Link-Achse <sup>2)</sup> |                |        |  |                     |     |
|  | 2.4 TD Intercooler | 90  |  | 08.94 | 10.98 | + Multi-Link-Achse <sup>2)</sup> |                |        |  |                     |     |

**VOLVO C30 Coupe (06-12)**

|          |                  |        |        |       |       |  |                |        |                             |                         |     |
|----------|------------------|--------|--------|-------|-------|--|----------------|--------|-----------------------------|-------------------------|-----|
|          | 1.6              | 74     |        | 09.06 | 12.12 |  | 13.0460-7193.2 | 607193 | + 15"/16" Rad <sup>3)</sup> | 23723 18,1 +            | ATE |
|          | 1.6 D            | 80     |        | 09.06 | 12.12 |  | 13.0470-7193.2 | LD7193 | + 15"/16" Rad <sup>3)</sup> | 23723 18,1 +            | ATE |
|          | 1.6 D Efficiency | 77     |        | 09.08 | 12.12 |  |                |        |                             |                         |     |
|          | 1.6 D2           | 84     |        | 10.10 | 12.12 |  |                |        |                             |                         |     |
|          | 1.8              | 92     |        | 09.06 | 12.12 |  |                |        |                             |                         |     |
|          | 1.8 FlexiFuel    | 92     |        | 04.07 | 12.12 |  |                |        |                             |                         |     |
|          | 2.0              | 107    |        | 09.06 | 12.12 |  |                |        |                             |                         |     |
|          | 2.0 D            | 100    |        | 09.06 | 12.12 |  |                |        |                             |                         |     |
|          | 2.0 D3           | 110    |        | 10.10 | 12.12 |  |                |        |                             |                         |     |
|          | 2.0 D4           | 130    |        | 10.10 | 12.12 |  |                |        |                             |                         |     |
|          | 2.4 D5           | 120    |        | 10.06 | 12.12 |  |                |        |                             |                         |     |
|          | 2.4 D5           | 132    |        | 09.06 | 12.12 |  |                |        |                             |                         |     |
|          | 2.4 i            | 125    |        | 09.06 | 12.12 |  |                |        |                             |                         |     |
|          | 2.5 T5           | 162    |        | 09.06 | 12.12 |  |                |        |                             |                         |     |
|          | 2.5 T5           | 169    |        | 03.07 | 12.12 |  |                |        |                             |                         |     |
| Electric | 82               |        | 12.10  | 12.12 |       |  |                |        |                             |                         |     |
|          | 1.6              | 74     |        | 09.06 | 12.12 |  | 24.0125-0117.1 | 425117 | + 15" Rad <sup>4)</sup>     | 278 25,0 23,0 V L +B    |     |
|          | 1.6 D            | 80     |        | 09.06 | 12.12 |  | 24.0325-0117.1 | 525117 | + 15" Rad <sup>4)</sup>     | 278 25,0 23,0 V L +B PD |     |
|          | 1.6 D Efficiency | 77     |        | 09.08 | 12.12 |  | 24.0125-0162.1 | 425162 | + 16" Rad <sup>5)</sup>     | 300 25,0 23,0 V L +B    |     |
|          | 1.6 D2           | 84     |        | 10.10 | 12.12 |  | 24.0325-0162.1 | 525162 | + 16" Rad <sup>5)</sup>     | 300 25,0 23,0 V L +B PD |     |
|          | 1.8              | 92     |        | 09.06 | 12.12 |  |                |        |                             |                         |     |
|          | 1.8 FlexiFuel    | 92     |        | 04.07 | 12.12 |  |                |        |                             |                         |     |
|          | 2.0              | 107    |        | 09.06 | 12.12 |  |                |        |                             |                         |     |
|          | 2.0 D            | 100    |        | 09.06 | 12.12 |  |                |        |                             |                         |     |
|          | 2.0 D3           | 110    |        | 10.10 | 12.12 |  |                |        |                             |                         |     |
|          | 2.0 D4           | 130    |        | 10.10 | 12.12 |  |                |        |                             |                         |     |
|          | 2.4 D5           | 120    |        | 10.06 | 12.12 |  |                |        |                             |                         |     |
|          | 2.4 D5           | 132    |        | 09.06 | 12.12 |  |                |        |                             |                         |     |
|          | 2.4 i            | 125    |        | 09.06 | 12.12 |  |                |        |                             |                         |     |
|          | 2.5 T5           | 162    |        | 09.06 | 12.12 |  |                |        |                             |                         |     |
|          | 2.5 T5           | 169    |        | 03.07 | 12.12 |  |                |        |                             |                         |     |
| Electric | 82               |        | 12.10  | 12.12 |       |  |                |        |                             |                         |     |
|          | 1.6              | 74     |        | 09.06 | 12.12 |  | 24.0711-5123.3 | 360065 | 2                           | Radsensor               |     |
|          | 1.6 D            | 80     |        | 09.06 | 12.12 |  |                |        |                             |                         |     |
|          | 1.6 D Efficiency | 77     |        | 09.08 | 12.12 |  |                |        |                             |                         |     |
|          | 1.6 D2           | 84     | 192315 | 10.10 | 12.12 |  |                |        |                             |                         |     |
|          | 1.8              | 92     |        | 09.06 | 12.12 |  |                |        |                             |                         |     |
|          | 1.8 FlexiFuel    | 92     |        | 04.07 | 12.12 |  |                |        |                             |                         |     |
|          | 2.0              | 107    |        | 09.06 | 12.12 |  |                |        |                             |                         |     |
| 2.0 D    | 100              |        | 09.06  | 12.12 |       |  |                |        |                             |                         |     |
| 2.0 D3   | 110              | 192315 | 10.10  | 12.12 |       |  |                |        |                             |                         |     |
| 2.0 D4   | 130              | 192315 | 10.10  | 12.12 |       |  |                |        |                             |                         |     |

1) - multi link axle / - assale Multi-link / - essieu multi-link / - eje Multi-Link  
 2) + multi link axle / + assale Multi-link / + essieu multi-link / + eje Multi-Link  
 3) + 15"/16" wheel / + ruota 15"/16" / + roue 15"/16" / + rueda 15"/16"  
 4) + 15" wheel / + ruota 15" / + roue 15" / + rueda 15"  
 5) + 16" wheel / + ruota 16" / + roue 16" / + rueda 16"



















|     |  |  |  |  |  |  |  |  |  |                      |     |
|--|--|--|--|--|---|--|--|--|--|----------------------|-----|
| <b>VOLVO C30 Coupe (06-12)</b>   |  |  |  |  |   |  |  |  |  |                      |     |
|    | 2.4 D5   | 120  |  | 10.06  | 12.12   | 24.0711-5123.3   | 360065   | 2  |  | Radsensor            |     |
|  | 2.4 D5   | 132  |  | 09.06  | 12.12   |  |  |  |  |                      |     |
|  | 2.4 i  | 125  |  | 09.06  | 12.12   |  |  |  |  |                      |     |
|  | 2.5 T5   | 162  |  | 09.06  | 12.12   |  |  |  |  |                      |     |
|  | 2.5 T5   | 169  |  | 03.07  | 12.12   |  |  |  |  |                      |     |
|  | Electric   | 82   | 192315   | 12.10  |   |  |  |  |  |                      |     |
|    | 1.6 D2   | 84   | 192316   |  | 12.12   | 24.0711-5198.3   | 360239   | 2  |  | Radsensor            |     |
|  | 2.0 D3   | 110  | 192316   |  | 12.12   |  |  |  |  |                      |     |
|  | 2.0 D4   | 130  | 192316   |  | 12.12   |  |  |  |  |                      |     |
|  | Electric   | 82   | 192316   |  | 12.12   |  |  |  |  |                      |     |
|  |  |  |  |  |   |  |  |  |  |                      |     |
|    | 1.6  | 74   |  | 09.06  | 12.12   | 13.0460-7195.2   | 607195   |  | ersetzt Belag mit Federn <sup>1)</sup> | 23482 16,6 +         | ATE |
|  | 1.6 D  | 80   |  | 09.06  | 12.12   | 13.0470-7195.2   | LD7195   |  | ersetzt Belag mit Federn <sup>1)</sup> | 23482 16,6 +         | ATE |
|  | 1.6 D Efficiency   | 77   |  | 09.08  | 12.12   |  |  |  |  |                      |     |
|  | 1.6 D2   | 84   |  | 10.10  | 12.12   |  |  |  |  |                      |     |
|  | 1.8  | 92   |  | 09.06  | 12.12   |  |  |  |  |                      |     |
|  | 1.8 FlexiFuel  | 92   |  | 04.07  | 12.12   |  |  |  |  |                      |     |
|  | 2.0  | 107  |  | 09.06  | 12.12   |  |  |  |  |                      |     |
|  | 2.0 D  | 100  |  | 09.06  | 12.12   |  |  |  |  |                      |     |
|  | 2.0 D3   | 110  |  | 10.10  | 12.12   |  |  |  |  |                      |     |
|  | 2.0 D4   | 130  |  | 10.10  | 12.12   |  |  |  |  |                      |     |
|  | 2.4 D5   | 120  |  | 10.06  | 12.12   |  |  |  |  |                      |     |
|  | 2.4 D5   | 132  |  | 09.06  | 12.12   |  |  |  |  |                      |     |
|  | 2.4 i  | 125  |  | 09.06  | 12.12   |  |  |  |  |                      |     |
|  | 2.5 T5   | 162  |  | 09.06  | 12.12   |  |  |  |  |                      |     |
|  | 2.5 T5   | 169  |  | 03.07  | 12.12   |  |  |  |  |                      |     |
|    | 1.6  | 74   |  | 09.06  | 12.12   | 24.0111-0158.1   | 411158   |  |  | 280 11,0 9,0 +S +B   |     |
|  | 1.6 D  | 80   |  | 09.06  | 12.12   | 24.0311-0158.1   | 511158   |  |  | 280 11,0 9,0 +B PD   |     |
|  | 1.6 D Efficiency   | 77   |  | 09.08  | 12.12   |  |  |  |  |                      |     |
|  | 1.6 D2   | 84   |  | 10.10  | 12.12   |  |  |  |  |                      |     |
|  | 1.8  | 92   |  | 09.06  | 12.12   |  |  |  |  |                      |     |
|  | 1.8 FlexiFuel  | 92   |  | 04.07  | 12.12   |  |  |  |  |                      |     |
|  | 2.0  | 107  |  | 09.06  | 12.12   |  |  |  |  |                      |     |
|  | 2.0 D  | 100  |  | 09.06  | 12.12   |  |  |  |  |                      |     |
|  | 2.0 D3   | 110  |  | 10.10  | 12.12   |  |  |  |  |                      |     |
|  | 2.0 D4   | 130  |  | 10.10  | 12.12   |  |  |  |  |                      |     |
|  | 2.4 D5   | 120  |  | 10.06  | 12.12   |  |  |  |  |                      |     |
|  | 2.4 D5   | 132  |  | 09.06  | 12.12   |  |  |  |  |                      |     |
|  | 2.4 i  | 125  |  | 09.06  | 12.12   |  |  |  |  |                      |     |
|  | 2.5 T5   | 162  |  | 09.06  | 12.12   |  |  |  |  |                      |     |
|  | 2.5 T5   | 169  |  | 03.07  | 12.12   |  |  |  |  |                      |     |
|  | 1.6  | 74   |  | 09.06  | 12.12   | 24.0711-6220.3   | 360256   | 2  |  | Radsensor            |     |
|  | 1.6 D  | 80   |  | 09.06  | 12.12   |  |  |  |  |                      |     |
|  | 1.6 D Efficiency   | 77   |  | 09.08  | 12.12   |  |  |  |  |                      |     |
|  | 1.6 D2   | 84   |  | 10.10  | 12.12   |  |  |  |  |                      |     |
|  | 1.8  | 92   |  | 09.06  | 12.12   |  |  |  |  |                      |     |
|  | 1.8 FlexiFuel  | 92   |  | 04.07  | 12.12   |  |  |  |  |                      |     |
|  | 2.0  | 107  |  | 09.06  | 12.12   |  |  |  |  |                      |     |
|  | 2.0 D  | 100  |  | 09.06  | 12.12   |  |  |  |  |                      |     |
|  | 2.0 D3   | 110  |  | 10.10  | 12.12   |  |  |  |  |                      |     |
|  | 2.0 D4   | 130  |  | 10.10  | 12.12   |  |  |  |  |                      |     |
|  | 2.4 D5   | 120  |  | 10.06  | 12.12   |  |  |  |  |                      |     |
|  | 2.4 D5   | 132  |  | 09.06  | 12.12   |  |  |  |  |                      |     |
|  | 2.4 i  | 125  |  | 09.06  | 12.12   |  |  |  |  |                      |     |
|  | 2.5 T5   | 162  |  | 09.06  | 12.12   |  |  |  |  |                      |     |
|  | 2.5 T5   | 169  |  | 03.07  | 12.12   |  |  |  |  |                      |     |
| Electric   | 82   |  | 12.10  | 12.12  |   |  |  |  |  |                      |     |
| <b>VOLVO C70 Coupe (97-02)</b>   |  |  |  |  |   |  |  |  |  |                      |     |
|  | 2.0  | 132  |  | 03.97  | 12.98   | 13.0460-7193.2   | 607193   |  | + 15"/16" Rad <sup>2)</sup>            | 23723 18,1 +         | ATE |
|  | 2.0 T  | 166  |  | 03.97  | 12.98   | 13.0470-7193.2   | LD7193   |  | + 15"/16" Rad <sup>2)</sup>            | 23723 18,1 +         | ATE |
|  | 2.5 T  | 142  |  | 03.97  | 12.98   |  |  |  |  |                      |     |
|  | 2.3 T5   | 176  |  | 03.97  | 12.98   | 13.0460-7193.2   | 607193   |  | + 15"/16" Rad <sup>2)</sup>            | 23723 18,1 +         | ATE |
|  | 2.0  | 132  |  | 01.99  | 09.02   | 13.0460-7053.2   | 607053   |  | + 15"/16" Rad <sup>2)</sup>            | 21273 19,5 +/WE      | ATE |
|  | 2.0 T  | 120  |  | 03.00  | 09.02   | 13.0470-7053.2   | LD7053   |  | + 15"/16" Rad <sup>2)</sup>            | 21273 19,5 +/WE      | ATE |
|  | 2.0 T  | 166  |  | 01.99  | 09.02   |  |  |  |  |                      |     |
|  | 2.5  | 121  |  | 09.99  | 09.02   |  |  |  |  |                      |     |
| 2.5  | 125  |  | 11.99  | 09.02  |   |  |  |  |  |                      |     |
| 2.5 T  | 142  |  | 01.99  | 09.02  |   |  |  |  |  |                      |     |
| 2.3 T5   | 176  |  | 01.99  | 09.02  | 13.0460-7053.2  | 607053   |  | + 15"/16" Rad <sup>2)</sup>  | 21273 19,5 +/WE                        | ATE                  |     |
|  | 2.0  | 132  |  | 03.97  | 09.02   | 24.0126-0102.1   | 426102   |  | + 15" Rad <sup>3)</sup>                | 280 26,0 23,0 V +B   |     |
|  | 2.0 T  | 120  |  | 03.00  | 09.02   |  |  |  |  |                      |     |
|  | 2.0 T  | 166  |  | 03.97  | 09.02   |  |  |  |  |                      |     |
|  | 2.3 T5   | 176  |  | 03.97  | 09.02   |  |  |  |  |                      |     |
|  | 2.5  | 121  |  | 03.99  | 09.02   |  |  |  |  |                      |     |
|  | 2.5  | 125  |  | 11.99  | 09.02   |  |  |  |  |                      |     |
|  | 2.5 T  | 142  |  | 03.97  | 09.02   |  |  |  |  |                      |     |
|  | 2.0  | 132  |  | 03.97  | 09.02   | 24.0126-0107.1   | 426107   |  | + 16" Rad <sup>4)</sup>                | 302 26,0 23,0 V L +B |     |
| 2.0 T  | 120  |  | 03.00  | 09.02  | 24.0326-0107.1  | 526107   |  | + 16" Rad <sup>4)</sup>  | 302 26,0 23,0 V L +B PD                |                      |     |
| 2.0 T  | 166  |  | 03.97  | 09.02  |   |  |  |  |  |                      |     |
| 2.3 T5   | 176  |  | 03.97  | 09.02  |   |  |  |  |  |                      |     |
| 2.5  | 121  |  | 03.99  | 09.02  |   |  |  |  |  |                      |     |
| 2.5  | 125  |  | 11.99  | 09.02  |   |  |  |  |  |                      |     |
| 2.5 T  | 142  |  | 03.97  | 09.02  |   |  |  |  |  |                      |     |

<sup>1)</sup> replaces pad with springs / sostituisce la guarnizione con molle / remplace la garniture avec ressorts / sustituye guarnición con resortes

<sup>2)</sup> + 15"/16" wheel / + ruota 15"/16" / + roue 15"/16" / + rueda 15"/16"

<sup>3)</sup> + 15" wheel / + ruota 15" / + roue 15" / + rueda 15"

















<sup>4)</sup> + 16" wheel / + ruota 16" / + roue 16" / + rueda 16"





















|     |  |  |  |  |  |  |  |  |                       |
|--|--|--|--|--|---|--|--|--|-----------------------|
| <b>VOLVO C70 Coupe (97-02)</b>   |  |  |  |  |   |  |  |  |                       |
|    | 2.0  | 132  |  | 03.97  | 12.98   | 24.0711-1146.1   | 360060   | 2  | Radsensor             |
|  | 2.0 T  | 166  |  | 03.97  | 12.98   |  |  |  |                       |
|  | 2.3 T5   | 176  |  | 03.97  | 12.98   |  |  |  |                       |
|  | 2.5 T  | 142  |  | 03.97  | 12.98   |  |  |  |                       |
|  | 2.0  | 132  |  | 01.99  | 09.02   | 24.0711-6011.3   | 360120   | 2  | Radsensor L=1000      |
| 2.0 T  | 120  |  | 03.00  | 09.02  |   |  |  |  |                       |
| 2.0 T  | 166  |  | 01.99  | 09.02  |   |  |  |  |                       |
| 2.3 T5   | 176  |  | 01.99  | 09.02  |   |  |  |  |                       |
| 2.5  | 121  |  | 03.99  | 09.02  |   |  |  |  |                       |
| 2.5  | 125  |  | 11.99  | 09.02  |   |  |  |  |                       |
| 2.5 T  | 142  |  | 01.99  | 09.02  |   |  |  |  |                       |
|    | 2.0  | 132  |  | 03.97  | 09.02   | 13.0460-4044.2   | 604044   |  | 20755 15,1 ATE        |
|  | 2.0 T  | 120  |  | 03.00  | 09.02   | 13.0470-4044.2   | LD4044   |  | 20755 15,1 ATE        |
|  | 2.0 T  | 166  |  | 03.97  | 09.02   |  |  |  |                       |
|  | 2.3 T5   | 176  |  | 03.97  | 09.02   |  |  |  |                       |
|  | 2.5  | 121  |  | 03.99  | 09.02   |  |  |  |                       |
| 2.5  | 125  |  | 11.99  | 09.02  |   |  |  |  |                       |
| 2.5 T  | 142  |  | 03.97  | 09.02  |   |  |  |  |                       |
|    | 2.0  | 132  |  | 03.97  | 09.02   | 24.0110-0214.1   | 410214   |  | 295 9,6 8,4 +B        |
|  | 2.0 T  | 120  |  | 03.00  | 09.02   |  |  |  |                       |
|  | 2.0 T  | 166  |  | 03.97  | 09.02   |  |  |  |                       |
|  | 2.3 T5   | 176  |  | 03.97  | 09.02   |  |  |  |                       |
|  | 2.5  | 121  |  | 03.99  | 09.02   |  |  |  |                       |
| 2.5  | 125  |  | 11.99  | 09.02  |   |  |  |  |                       |
| 2.5 T  | 142  |  | 03.97  | 09.02  |   |  |  |  |                       |
|    | 2.0  | 132  |  | 03.97  | 12.98   | 24.0741-1105.1   | 360195   | 1  | Radsensor L=1220/1840 |
|  | 2.0 T  | 166  |  | 03.97  | 12.98   |  |  |  |                       |
|  | 2.3 T5   | 176  |  | 03.97  | 12.98   |  |  |  |                       |
|  | 2.5 T  | 142  |  | 03.97  | 12.98   |  |  |  |                       |
|  | 2.0  | 132  |  | 01.99  | 09.02   | 24.0711-5025.3   | 360234   | 1  | Radsensor L=1215/1855 |
| 2.0 T  | 120  |  | 03.00  | 09.02  |   |  |  |  |                       |
| 2.0 T  | 166  |  | 01.99  | 09.02  |   |  |  |  |                       |
| 2.3 T5   | 176  |  | 01.99  | 09.02  |   |  |  |  |                       |
| 2.5  | 121  |  | 03.99  | 09.02  |   |  |  |  |                       |
| 2.5  | 125  |  | 11.99  | 09.02  |   |  |  |  |                       |
| 2.5 T  | 142  |  | 01.99  | 09.02  |   |  |  |  |                       |
|   | 2.0  | 132  |  | 03.97  | 09.02   | 03.0137-0260.2   | 650260   |  | 178 x 25              |
|  | 2.0 T  | 120  |  | 03.00  | 09.02   | 03.0137-9176.2   | 669176   |  | Bremsbacken-Zubehör   |
|  | 2.0 T  | 166  |  | 03.97  | 09.02   |  |  |  |                       |
|  | 2.3 T5   | 176  |  | 03.97  | 09.02   |  |  |  |                       |
|  | 2.5  | 121  |  | 03.99  | 09.02   |  |  |  |                       |
| 2.5  | 125  |  | 11.99  | 09.02  |   |  |  |  |                       |
| 2.5 T  | 142  |  | 03.97  | 09.02  |   |  |  |  |                       |
| <b>VOLVO C70 I Cabrio (98-06)</b>  |  |  |  |  |   |  |  |  |                       |
|  | 2.0  | 132  |  | 03.98  | 02.06   | 13.0460-7053.2   | 607053   |  | 21273 19,5 +/WE ATE   |
|  | 2.0 T  | 120  |  | 03.00  | 02.06   | 13.0470-7053.2   | LD7053   |  | 21273 19,5 +/WE ATE   |
|  | 2.4 T  | 147  |  | 07.02  | 02.06   |  |  |  |                       |
|  | 2.5  | 125  |  | 06.98  | 02.06   |  |  |  |                       |
|  | 2.5 T  | 142  |  | 03.98  | 02.06   |  |  |  |                       |
| 2.0 T  | 166  |  | 03.98  | 02.06  | 13.0460-7053.2  | 607053   |  | 21273 19,5 +/WE ATE  |                       |
| 2.3 T5   | 176  |  | 03.98  | 02.06  |   |  |  |  |                       |
| 2.3 T5   | 180  |  | 07.02  | 02.06  |   |  |  |  |                       |
|  | 2.0  | 132  |  | 03.98  | 02.06   | 24.0126-0102.1   | 426102   |  | + 15" Rad 1)          |
|  | 2.0 T  | 120  |  | 03.00  | 02.06   |  |  |  |                       |
|  | 2.0 T  | 166  |  | 03.98  | 02.06   |  |  |  |                       |
|  | 2.3 T5   | 176  |  | 03.98  | 02.06   |  |  |  |                       |
|  | 2.3 T5   | 180  |  | 07.02  | 02.06   |  |  |  |                       |
| 2.4 T  | 147  |  | 07.02  | 02.06  |   |  |  |  |                       |
| 2.5  | 125  |  | 06.98  | 02.06  |   |  |  |  |                       |
| 2.5 T  | 142  |  | 03.98  | 02.06  |   |  |  |  |                       |
|  | 2.0  | 132  |  | 03.98  | 02.06   | 24.0126-0107.1   | 426107   |  | + 16" Rad 2)          |
|  | 2.0 T  | 120  |  | 03.00  | 02.06   | 24.0326-0107.1   | 526107   |  | + 16" Rad 2)          |
|  | 2.0 T  | 166  |  | 03.98  | 02.06   |  |  |  |                       |
|  | 2.3 T5   | 176  |  | 03.98  | 02.06   |  |  |  |                       |
|  | 2.3 T5   | 180  |  | 07.02  | 02.06   |  |  |  |                       |
| 2.4 T  | 147  |  | 07.02  | 02.06  |   |  |  |  |                       |
| 2.5  | 125  |  | 06.98  | 02.06  |   |  |  |  |                       |
| 2.5 T  | 142  |  | 03.98  | 02.06  |   |  |  |  |                       |
|  | 2.0  | 132  |  | 03.98  | 12.98   | 24.0711-1146.1   | 360060   | 2  | Radsensor             |
|  | 2.0 T  | 166  |  | 03.98  | 12.98   |  |  |  |                       |
|  | 2.3 T5   | 176  |  | 03.98  | 12.98   |  |  |  |                       |
|  | 2.5  | 125  |  | 06.98  | 12.98   |  |  |  |                       |
|  | 2.5 T  | 142  |  | 03.98  | 12.98   |  |  |  |                       |
| 2.0  | 132  |  | 01.99  | 02.06  | 24.0711-6011.3  | 360120   | 2  | Radsensor L=1000   |                       |
| 2.0 T  | 120  |  | 03.00  | 02.06  |   |  |  |  |                       |
| 2.0 T  | 166  |  | 01.99  | 02.06  |   |  |  |  |                       |
| 2.3 T5   | 176  |  | 01.99  | 02.06  |   |  |  |  |                       |
| 2.3 T5   | 180  |  | 07.02  | 02.06  |   |  |  |  |                       |
| 2.4 T  | 147  |  | 07.02  | 02.06  |   |  |  |  |                       |
| 2.5  | 125  |  | 01.99  | 02.06  |   |  |  |  |                       |
| 2.5 T  | 142  |  | 01.99  | 02.06  |   |  |  |  |                       |

1) + 15" wheel / + ruota 15" / + roue 15" / + rueda 15"

















2) + 16" wheel / + ruota 16" / + roue 16" / + rueda 16"









|   |  |  |  |                                      |  |  |  |   |                                 |                       |
|--|--|--|--|--|---|--|--|---|---------------------------------|-----------------------|
| <b>VOLVO C70 I Cabrio (98-06)</b>  |  |  |  |  |   |  |  |   |                                 |                       |
|  | 2.0<br>2.0 T<br>2.0 T<br>2.3 T5<br>2.3 T5<br>2.4 T<br>2.5<br>2.5 T               | 132<br>120<br>166<br>176<br>180<br>147<br>125<br>142                             |  | 03.98 02.06<br>03.00 02.06<br>03.98 02.06<br>03.98 02.06<br>07.02 02.06<br>07.02 02.06<br>06.98 02.06<br>03.98 02.06 |   | 13.0460-4044.2<br>13.0470-4044.2   | 604044<br>LD4044   |   | 20755 15,1<br>20755 15,1        | ATE<br>ATE            |
|  | 2.0<br>2.0 T<br>2.0 T<br>2.3 T5<br>2.3 T5<br>2.4 T<br>2.5<br>2.5 T               | 132<br>120<br>166<br>176<br>180<br>147<br>125<br>142                             |  | 03.98 02.06<br>03.00 02.06<br>03.98 02.06<br>03.98 02.06<br>07.02 02.06<br>07.02 02.06<br>06.98 02.06<br>03.98 02.06 |   | 24.0110-0214.1   | 410214   |   | 295 9,6 8,4 +B                  |                       |
|  | 2.0<br>2.0 T<br>2.3 T5<br>2.5<br>2.5 T   | 132<br>166<br>176<br>125<br>142  |  | 03.98 12.98<br>03.98 12.98<br>03.98 12.98<br>06.98 12.98<br>03.98 12.98  |   | 24.0741-1105.1   | 360195   | 1  |                                 | Radsensor L=1220/1840 |
|  | 2.0<br>2.0 T<br>2.0 T<br>2.3 T5<br>2.3 T5<br>2.4 T<br>2.5<br>2.5 T               | 132<br>120<br>166<br>176<br>180<br>147<br>125<br>142                             |  | 01.99 02.06<br>03.00 02.06<br>01.99 02.06<br>01.99 02.06<br>07.02 02.06<br>07.02 02.06<br>01.99 02.06<br>01.99 02.06 |   | 24.0711-5025.3   | 360234   | 1  |                                 | Radsensor L=1215/1855 |
|  | 2.0<br>2.0 T<br>2.0 T<br>2.3 T5<br>2.3 T5<br>2.4 T<br>2.5<br>2.5 T               | 132<br>120<br>166<br>176<br>180<br>147<br>125<br>142                             |  | 03.98 02.06<br>03.00 02.06<br>03.98 02.06<br>03.98 02.06<br>07.02 02.06<br>07.02 02.06<br>06.98 02.06<br>03.98 02.06 |   | 03.0137-0260.2<br>03.0137-9176.2   | 650260<br>669176   |   | 178 x 25<br>Bremsbacken-Zubehör |                       |

|  |  |   |                  |   |  |  |                                      |   |  |  |            |
|--|--|---|------------------|---|--|--|--------------------------------------|---|--|--|------------|
| <b>VOLVO C70 II Cabrio (06-13)</b>   |  |   |                  |   |  |  |                                      |   |  |  |            |
|   | 2.0 D<br>2.0 D3<br>2.0 D4<br>2.4<br>2.4 D<br>2.4 D5<br>2.4 i<br>2.5 T5<br>2.5 T5 | 100<br>110<br>130<br>103<br>120<br>132<br>125<br>162<br>169 |                  | 06.08 07.13 - (USA) <br>10.10 07.13<br>10.10 07.13<br>03.06 07.13 - (USA) <br>03.07 07.13<br>03.06 07.13 - (USA) <br>03.06 07.13 - (USA) <br>03.06 07.13 - (USA) <br>03.07 07.13 - (USA)   |  | 13.0460-7193.2<br>13.0470-7193.2                                     | 607193<br>LD7193                     |   | - 17" Rad <sup>1)</sup><br>- 17" Rad <sup>1)</sup>   | 23723 18,1 +<br>23723 18,1 +   | ATE<br>ATE |
|  | 2.0 D<br>2.0 D3<br>2.0 D4<br>2.4<br>2.4 D<br>2.4 D5<br>2.4 i<br>2.5 T5<br>2.5 T5 | 100<br>110<br>130<br>103<br>120<br>132<br>125<br>162<br>169 |                  | 06.08 07.13 - (USA) <br>10.10 07.13<br>10.10 07.13<br>03.06 07.13 - (USA) <br>03.07 07.13<br>03.06 07.13 - (USA) <br>03.06 07.13 - (USA) <br>03.06 07.13 - (USA) <br>03.07 07.13 - (USA)  |  | 13.0460-7204.2<br>13.0470-7204.2                                     | 607204<br>LD7204                     |   | + 17" Rad <sup>2)</sup><br>+ 17" Rad <sup>2)</sup>   | 23912 18,8 +<br>23912 18,8 +   | ATE<br>ATE |
|  | 2.0 D<br>2.0 D3<br>2.0 D4<br>2.4<br>2.4 D<br>2.4 D5<br>2.4 i<br>2.5 T5<br>2.5 T5 | 100<br>110<br>130<br>103<br>120<br>132<br>125<br>162<br>169 |                  | 06.08 07.13<br>10.10 07.13<br>10.10 07.13<br>03.06 07.13<br>03.07 07.13<br>03.06 07.13<br>03.06 07.13<br>03.06 07.13<br>03.07 07.13   |  | 24.0125-0117.1<br>24.0325-0117.1<br>24.0125-0162.1<br>24.0325-0162.1 | 425117<br>525117<br>425162<br>525162 |   | + 15" Rad <sup>3)</sup><br>+ 15" Rad <sup>3)</sup><br>+ 16" Rad <sup>4)</sup><br>+ 16" Rad <sup>4)</sup> | 278 25,0 23,0 V L +B<br>278 25,0 23,0 V L +B PD<br>300 25,0 23,0 V L +B<br>300 25,0 23,0 V L +B PD |            |
|  | 2.0 D<br>2.0 D3<br>2.0 D4<br>2.4<br>2.4 D<br>2.4 D5<br>2.4 i<br>2.5 T5<br>2.5 T5 | 100<br>110<br>130<br>103<br>120<br>132<br>125<br>162<br>169 |                  | 06.08 07.13<br>10.10 07.13<br>10.10 07.13<br>03.06 07.13<br>03.07 07.13<br>03.06 07.13<br>03.06 07.13<br>03.06 07.13<br>03.07 07.13   |  | 24.0125-0197.1<br>24.0325-0197.1                                     | 425197<br>525197                     |   | + 17" Rad <sup>2)</sup><br>+ 17" Rad <sup>2)</sup>   | 320 25,0 23,0 V L +B<br>320 25,0 23,0 V L +B PD  |            |
|  | 2.0 D<br>2.0 D3<br>2.0 D4<br>2.4<br>2.4 D5<br>2.4 i<br>2.5 T5<br>2.5 T5          | 100<br>110<br>130<br>103<br>132<br>125<br>162<br>169        | 107408<br>107408 | 06.08 07.13<br>10.10<br>10.10<br>03.06 07.13<br>03.06 07.13<br>03.06 07.13<br>03.06 07.13<br>03.07 07.13  |  | 24.0711-5123.3   | 360065                               | 2  |  | Radsensor  |            |
|  | 2.0 D3<br>2.0 D4<br>2.4 D  | 110 107409<br>130 107409<br>120                             |                  | 07.13<br>07.13<br>03.07 07.13   |  | 24.0711-5198.3   | 360239                               | 2  |  | Radsensor  |            |











1) - 17" wheel / - ruota 17" / - roue 17" / - rueda 17"  
2) + 17" wheel / + ruota 17" / + roue 17" / + rueda 17"  
3) + 15" wheel / + ruota 15" / + roue 15" / + rueda 15"  
4) + 16" wheel / + ruota 16" / + roue 16" / + rueda 16"

|     |  |  |  |  |  |  |  |     |  |            |                |        |   |           |
|--|--|--|--|--|---|--|--|---|--|------------|----------------|--------|---|-----------|
| <b>VOLVO C70 II Cabrio (06-13)</b>   |  |  |  |  |   |  |  |   |  |            |                |        |   |           |
|    | 2.0 D  | 100  |  | 06.08  | 07.13   | 13.0460-7195.2   | 607195   | ersetzt Belag mit Federn <sup>1)</sup>  | 23482 16,6 +<br>23482 16,6 +             | ATE<br>ATE |                |        |   |           |
|  | 2.0 D3   | 110  |  | 10.10  | 07.13   |  |  |   |  |            | 13.0470-7195.2 | LD7195 |   |           |
|  | 2.0 D4   | 130  |  | 10.10  | 07.13   |  |  |   |  |            |                |        |   |           |
|  | 2.4  | 103  |  | 03.06  | 07.13   |  |  |   |  |            |                |        |   |           |
|  | 2.4 D  | 120  |  | 03.07  | 07.13   |  |  |   |  |            |                |        |   |           |
|  | 2.4 D5   | 132  |  | 03.06  | 07.13   |  |  |   |  |            |                |        |   |           |
|  | 2.4 i  | 125  |  | 03.06  | 07.13   |  |  |   |  |            |                |        |   |           |
|  | 2.5 T5   | 162  |  | 03.06  | 07.13   |  |  |   |  |            |                |        |   |           |
|  | 2.5 T5   | 169  |  | 03.07  | 07.13   |  |  |   |  |            |                |        |   |           |
|    | 2.0 D  | 100  |  | 06.08  | 07.13   | 24.0111-0158.1   | 411158   | ersetzt Belag mit Federn <sup>1)</sup>  | 280 11,0 9,0 +S +B<br>280 11,0 9,0 +B PD |            |                |        |   |           |
|  | 2.0 D3   | 110  |  | 10.10  | 07.13   |  |  |   |  |            | 24.0311-0158.1 | 511158 |   |           |
|  | 2.0 D4   | 130  |  | 10.10  | 07.13   |  |  |   |  |            |                |        |   |           |
|  | 2.4  | 103  |  | 03.06  | 07.13   |  |  |   |  |            |                |        |   |           |
|  | 2.4 D  | 120  |  | 03.07  | 07.13   |  |  |   |  |            |                |        |   |           |
|  | 2.4 D5   | 132  |  | 03.06  | 07.13   |  |  |   |  |            |                |        |   |           |
|  | 2.4 i  | 125  |  | 03.06  | 07.13   |  |  |   |  |            |                |        |   |           |
|  | 2.5 T5   | 162  |  | 03.06  | 07.13   |  |  |   |  |            |                |        |   |           |
|  | 2.5 T5   | 169  |  | 03.07  | 07.13   |  |  |   |  |            |                |        |   |           |
|    | 2.0 D  | 100  |  | 06.08  | 07.13   | 24.0711-6220.3   | 360256   | 2  | Radsensor                                |            |                |        |   |           |
|  | 2.4  | 103  |  | 03.06  | 07.13   |  |  |   |  |            |                |        |   |           |
|  | 2.4 D  | 120  |  | 03.07  | 07.13   |  |  |   |  |            |                |        |   |           |
|  | 2.4 D5   | 132  |  | 03.06  | 07.13   |  |  |   |  |            |                |        |   |           |
|  | 2.4 i  | 125  |  | 03.06  | 07.13   |  |  |   |  |            |                |        |   |           |
|  | 2.5 T5   | 162  |  | 03.06  | 07.13   |  |  |   |  |            |                |        |   |           |
|  | 2.5 T5   | 169  |  | 03.07  | 07.13   |  |  |   |  |            |                |        |   |           |
|  | 2.0 D3   | 110  |  | 10.10  | 07.13   |  |  |   |  |            | 24.0711-6221.3 | 360258 | 2  | Radsensor |
|  | 2.0 D4   | 130  |  | 10.10  | 07.13   |  |  |   |  |            |                |        |   |           |
|  | 2.0 D4   | 130  |  | 10.10  | 07.13   |  |  |   |  |            |                |        |   |           |
| <b>VOLVO S40 I (95-03)</b>   |  |  |  |  |   |  |  |   |  |            |                |        |   |           |
|    | 1.6  | 77   |  | 09.95  | 08.97   | 13.0460-2830.2   | 602830   |   | 21920 14,6 /WK/Zub/S                     | TRW        |                |        |   |           |
|  | 1.8 (1731)   | 85   |  | 07.95  | 08.97   |  |  |   |  |            |                |        |   |           |
|  | 1.9 T4   | 147  |  | 05.97  | 08.97   |  |  |   |  |            |                |        |   |           |
|  | 1.9 TD   | 66   |  | 07.95  | 08.97   |  |  |   |  |            |                |        |   |           |
|  | 2.0  | 100  |  | 07.95  | 08.97   |  |  |   |  |            |                |        |   |           |
|  | 2.0  | 103  |  | 07.95  | 08.97   |  |  |   |  |            |                |        |   |           |
|  | 1.6  | 77   |  | 09.97  | 08.99   |  |  |   |  |            | 13.0460-2853.2 | 602853 |   |           |
|  | 1.6  | 80   |  | 03.99  | 12.03   |  |  |   |  |            |                |        |   |           |
|  | 1.8 (1731)   | 85   |  | 09.97  | 08.99   |  |  |   |  |            |                |        |   |           |
|  | 1.8 (1783)   | 90   |  | 03.99  | 12.03   |  |  |   |  |            |                |        |   |           |
|  | 1.8 i (1834)   | 90   |  | 06.01  | 12.03   |  |  |   |  |            |                |        |   |           |
|  | 1.8 i (1834)   | 92   |  | 03.98  | 12.03   |  |  |   |  |            |                |        |   |           |
|  | 1.9 DI   | 70   |  | 03.99  | 07.00   |  |  |   |  |            |                |        |   |           |
|  | 1.9 DI   | 75   |  | 07.00  | 12.03   |  |  |   |  |            |                |        |   |           |
|  | 1.9 DI   | 85   |  | 07.00  | 12.03   |  |  |   |  |            |                |        |   |           |
|  | 1.9 T4   | 147  |  | 09.97  | 07.00   |  |  |   |  |            |                |        |   |           |
|  | 1.9 TD   | 66   |  | 09.97  | 08.99   |  |  |   |  |            |                |        |   |           |
|  | 2.0  | 100  |  | 09.97  | 12.03   |  |  |   |  |            |                |        |   |           |
|  | 2.0  | 103  |  | 09.97  | 08.99   |  |  |   |  |            |                |        |   |           |
| 2.0 T  | 118  |  | 10.97  | 07.00  |   |  |  |   |  |            |                |        |   |           |
| 2.0 T  | 120  |  | 06.01  | 12.03  |   |  |  |   |  |            |                |        |   |           |
| 2.0 T  | 121  |  | 07.00  | 06.01  |   |  |  |   |  |            |                |        |   |           |
| 2.0 T4   | 147  |  | 07.00  | 12.03  |   |  |  |   |  |            |                |        |   |           |
|  | 1.6  | 77   |  | 09.95  | 08.97   | 24.0124-0136.1   | 424136   |   | 256 24,0 21,5 V +B                       |            |                |        |   |           |
|  | 1.8 (1731)   | 85   |  | 07.95  | 08.97   |  |  |   |  |            |                |        |   |           |
|  | 1.9 T4   | 147  |  | 05.97  | 08.97   |  |  |   |  |            |                |        |   |           |
|  | 1.9 TD   | 66   |  | 07.95  | 08.97   |  |  |   |  |            |                |        |   |           |
|  | 2.0  | 100  |  | 07.95  | 08.97   |  |  |   |  |            |                |        |   |           |
|  | 2.0  | 103  |  | 07.95  | 08.97   |  |  |   |  |            |                |        |   |           |
|  | 1.6  | 77   |  | 09.97  | 08.99   |  |  |   |  |            | 24.0124-0159.1 | 424159 |   |           |
|  | 1.6  | 80   |  | 03.99  | 12.03   |  |  |   |  |            |                |        | 24.0324-0159.1  | 524159    |
|  | 1.8 (1731)   | 85   |  | 09.97  | 08.99   |  |  |   |  |            |                |        |   |           |
|  | 1.8 (1783)   | 90   |  | 03.99  | 12.03   |  |  |   |  |            |                |        |   |           |
|  | 1.8 i (1834)   | 90   |  | 06.01  | 12.03   |  |  |   |  |            |                |        |   |           |
|  | 1.8 i (1834)   | 92   |  | 03.98  | 12.03   |  |  |   |  |            |                |        |   |           |
|  | 1.9 DI   | 70   |  | 03.99  | 07.00   |  |  |   |  |            |                |        |   |           |
|  | 1.9 DI   | 75   |  | 07.00  | 12.03   |  |  |   |  |            |                |        |   |           |
|  | 1.9 DI   | 85   |  | 07.00  | 12.03   |  |  |   |  |            |                |        |   |           |
|  | 1.9 T4   | 147  |  | 09.97  | 07.00   |  |  |   |  |            |                |        |   |           |
|  | 1.9 TD   | 66   |  | 09.97  | 08.99   |  |  |   |  |            |                |        |   |           |
|  | 2.0  | 100  |  | 09.97  | 12.03   |  |  |   |  |            |                |        |   |           |
|  | 2.0  | 103  |  | 09.97  | 08.99   |  |  |   |  |            |                |        |   |           |
| 2.0 T  | 118  |  | 10.97  | 07.00  |   |  |  |   |  |            |                |        |   |           |
| 2.0 T  | 120  |  | 06.01  | 12.03  |   |  |  |   |  |            |                |        |   |           |
| 2.0 T  | 121  |  | 07.00  | 06.01  |   |  |  |   |  |            |                |        |   |           |
| 2.0 T4   | 147  |  | 07.00  | 12.03  |   |  |  |   |  |            |                |        |   |           |
|  | 1.6  | 77   |  | 09.95  | 08.99   | 13.0460-2831.2   | 602831   |   | 21861 15,2 /WK/S                         | TRW        |                |        |   |           |
|  | 1.6  | 80   |  | 03.99  | 12.03   |  |  |   |  |            |                |        |   |           |
|  | 1.8 (1731)   | 85   |  | 07.95  | 08.99   |  |  |   |  |            |                |        |   |           |
|  | 1.8 (1783)   | 90   |  | 03.99  | 12.03   |  |  |   |  |            |                |        |   |           |
|  | 1.8 i (1834)   | 90   |  | 06.01  | 12.03   |  |  |   |  |            |                |        |   |           |
|  | 1.8 i (1834)   | 92   |  | 03.98  | 12.03   |  |  |   |  |            |                |        |   |           |
|  | 1.9 DI   | 70   |  | 03.99  | 07.00   |  |  |   |  |            |                |        |   |           |
|  | 1.9 DI   | 75   |  | 07.00  | 12.03   |  |  |   |  |            |                |        |   |           |
|  | 1.9 DI   | 85   |  | 07.00  | 12.03   |  |  |   |  |            |                |        |   |           |
|  | 1.9 T4   | 147  |  | 05.97  | 07.00   |  |  |   |  |            |                |        |   |           |
|  | 1.9 TD   | 66   |  | 07.95  | 08.99   |  |  |   |  |            |                |        |   |           |

<sup>1)</sup> replaces pad with springs / sostituisce la guarnizione con molle / remplace la garniture avec ressorts / sustituye guarnición con resortes

| VOLVO S40 I (95-03)  |  | VOLVO S40 II (04-12)       |   |  |  |   |                          |
|--|--|----------------------------|---|--|--|---|--------------------------|
|    | 2.0 100<br>2.0 103<br>2.0 T 118<br>2.0 T 120<br>2.0 T 121<br>2.0 T4 147  |                            | 07.95 12.03<br>07.95 08.99<br>10.97 07.00<br>06.01 12.03<br>07.00 06.01<br>07.00 12.03  | 13.0460-2831.2 602831  |  | 21861 15,2 /WK/S TRW  |                          |
|    | 1.6 77<br>1.6 80<br>1.8 (1731) 85<br>1.8 (1783) 90<br>1.8 i (1834) 90<br>1.8 i (1834) 92<br>1.9 DI 70<br>1.9 DI 75<br>1.9 DI 85<br>1.9 T4 147<br>1.9 TD 66<br>2.0 100<br>2.0 103<br>2.0 T 118<br>2.0 T 120<br>2.0 T 121<br>2.0 T4 147  |                            | 09.95 08.99<br>03.99 12.03<br>07.95 08.99<br>03.99 12.03<br>06.01 12.03<br>03.98 12.03<br>03.99 07.00<br>07.00 12.03<br>07.00 12.03<br>05.97 07.00<br>07.95 08.99<br>07.95 12.03<br>07.95 08.99<br>10.97 07.00<br>06.01 12.03<br>07.00 06.01<br>07.00 12.03   | 24.0110-0229.1 410229  |  | 260 10,0 8,4 +B   |                          |
|    | 1.6 D 80<br>1.6 D 81<br>1.6 D2 84<br>1.6 i 74<br>1.8 92<br>1.8 FlexiFuel 92<br>2.0 D 100<br>2.0 D3 110<br>2.0 D4 96<br>2.0 D4 130<br>2.0 FlexiFuel 107<br>2.0 i 107<br>2.4 103<br>2.4 125<br>2.4 4X4 125<br>2.4 D5 132<br>2.5 T5 162<br>2.5 T5 169<br>2.5 T5 AWD 162<br>2.5 T5 AWD 169 |                            | 04.07 05.12 - (USA) ⤴<br>01.05 05.12 - (USA) ⤴<br>10.10 05.12 - (USA) ⤴<br>10.10 05.12 - (USA) ⤴<br>04.04 05.12 - (USA) ⤴<br>04.07 05.12 - (USA) ⤴<br>01.04 05.12 - (USA) ⤴<br>10.10 05.12 - (USA) ⤴<br>10.10 05.12 - (USA) ⤴<br>10.06 05.12 - (USA) ⤴<br>10.06 05.12 - (USA) ⤴<br>01.04 05.12 - (USA) ⤴<br>01.04 05.12 - (USA) ⤴<br>08.06 05.12 - (USA) ⤴<br>03.06 05.12 - (USA) ⤴<br>01.04 05.12 - (USA) ⤴<br>03.07 05.12 - (USA) ⤴<br>04.04 05.12 - (USA) ⤴<br>03.07 05.12 - (USA) ⤴ | 13.0460-7193.2 607193<br>13.0470-7193.2 LD7193<br>13.0460-7204.2 607204<br>13.0470-7204.2 LD7204   | - 17" Rad <sup>1)</sup><br>- 17" Rad <sup>1)</sup><br>+ 17" Rad <sup>2)</sup><br>+ 17" Rad <sup>2)</sup>   | 23723 18,1 +<br>23723 18,1 +<br>23912 18,8 +<br>23912 18,8 +  | ATE<br>ATE<br>ATE<br>ATE |
|  | 1.6 D 80<br>1.6 D 81<br>1.6 i 74<br>1.8 92<br>1.8 FlexiFuel 92<br>2.0 D 100<br>2.0 D4 96<br>2.0 FlexiFuel 107<br>2.0 i 107<br>2.4 103<br>2.4 125<br>2.4 4X4 125<br>2.4 D5 132<br>2.5 T5 162<br>2.5 T5 169<br>2.5 T5 AWD 162<br>2.5 T5 AWD 169  |                            | 04.07 05.12<br>01.05 05.12<br>01.05 05.12<br>04.04 05.12<br>04.07 05.12<br>01.04 05.12<br>07.05 05.12<br>10.06 05.12<br>10.06 05.12<br>01.04 05.12<br>01.04 05.12<br>08.06 05.12<br>03.06 05.12<br>01.04 05.12<br>03.07 05.12<br>04.04 05.12<br>03.07 05.12   | 24.0125-0117.1 425117<br>24.0325-0117.1 525117<br>24.0125-0162.1 425162<br>24.0325-0162.1 525162<br>24.0125-0197.1 425197<br>24.0325-0197.1 525197 | + 15" Rad <sup>3)</sup><br>+ 15" Rad <sup>3)</sup><br>+ 16" Rad <sup>4)</sup><br>+ 16" Rad <sup>4)</sup><br>+ 17" Rad <sup>2)</sup><br>+ 17" Rad <sup>2)</sup> | 278 25,0 23,0 V L +B<br>278 25,0 23,0 V L +B PD<br>300 25,0 23,0 V L +B<br>300 25,0 23,0 V L +B PD<br>320 25,0 23,0 V L +B<br>320 25,0 23,0 V L +B PD |                          |
|  | 1.6 D2 84<br>2.0 D3 110<br>2.0 D4 130  |                            | 10.10 05.12<br>10.10 05.12<br>10.10 05.12   | 24.0125-0117.1 425117<br>24.0325-0117.1 525117<br>24.0125-0162.1 425162<br>24.0325-0162.1 525162   | + 15" Rad <sup>3)</sup><br>+ 15" Rad <sup>3)</sup><br>+ 16" Rad <sup>4)</sup><br>+ 16" Rad <sup>4)</sup>   | 278 25,0 23,0 V L +B<br>278 25,0 23,0 V L +B PD<br>300 25,0 23,0 V L +B<br>300 25,0 23,0 V L +B PD  |                          |
|  | 1.6 D2 84<br>2.0 D3 110<br>2.0 D4 130  |                            | 10.10 05.12<br>10.10 05.12<br>10.10 05.12   | 24.0125-0197.1 425197<br>24.0325-0197.1 525197   | + 17" Rad <sup>2)</sup><br>+ 17" Rad <sup>2)</sup>   | 320 25,0 23,0 V L +B<br>320 25,0 23,0 V L +B PD   |                          |
|  | 1.6 D 80<br>1.6 D 81<br>1.6 D2 84<br>1.6 i 74<br>1.8 92<br>1.8 FlexiFuel 92<br>2.0 D 100<br>2.0 D3 110<br>2.0 D4 96<br>2.0 D4 130<br>2.0 FlexiFuel 107<br>2.0 i 107<br>2.4 103<br>2.4 125<br>2.4 4X4 125<br>2.4 D5 132<br>2.5 T5 162<br>2.5 T5 169                                     | 501142<br>501142<br>501142 | 04.07 05.12<br>01.05 05.12<br>10.10<br>01.05 05.12<br>04.04 05.12<br>04.07 05.12<br>01.04 05.12<br>10.10<br>07.05 05.12<br>10.10<br>10.06 05.12<br>10.06 05.12<br>01.04 05.12<br>01.04 05.12<br>08.06 05.12<br>03.06 05.12<br>01.04 05.12<br>03.07 05.12  | 24.0711-5123.3 360065  | 2   | Radsensor   |                          |



















1) - 17" wheel / - ruota 17" / - roue 17" / - rueda 17"  
2) + 17" wheel / + ruota 17" / + roue 17" / + rueda 17"  
3) + 15" wheel / + ruota 15" / + roue 15" / + rueda 15"  
4) + 16" wheel / + ruota 16" / + roue 16" / + rueda 16"

| VOLVO S40 II (04-12)   |   |   |  |  |  |  |  |  |                                      |        |  |  |  |                          |
|--|---|---|--|--|--|--|--|--|--------------------------------------|--------|--|--|--|--------------------------|
|    | 2.5 T5 AWD<br>2.5 T5 AWD  | 162<br>169  |  | 04.04<br>03.07   | 05.12<br>05.12   |  |  | 24.0711-5123.3   | 360065                               | 2      |   |  | Radsensor  |                          |
|  | 1.6 D2<br>2.0 D3<br>2.0 D4  | 84 501143<br>110 501143<br>130 501143   |  |  | 05.12<br>05.12<br>05.12  |  |  | 24.0711-5198.3   | 360239                               | 2      |   |  | Radsensor  |                          |
|    | 1.6 D<br>1.6 D<br>1.6 D2<br>1.6 i<br>1.8<br>1.8 FlexiFuel<br>2.0 D<br>2.0 D3<br>2.0 D4<br>2.0 D4<br>2.0 FlexiFuel<br>2.0 i<br>2.4<br>2.4<br>2.4 4X4<br>2.4 D5<br>2.5 T5<br>2.5 T5<br>2.5 T5 AWD<br>2.5 T5 AWD | 80<br>81<br>84<br>74<br>92<br>92<br>100<br>110<br>96<br>130<br>107<br>107<br>103<br>125<br>125<br>132<br>162<br>169<br>162<br>169 |  | 04.07<br>01.05<br>10.10<br>01.05<br>04.04<br>04.07<br>01.04<br>10.10<br>07.05<br>10.10<br>10.06<br>10.06<br>01.04<br>01.04<br>08.06<br>03.06<br>01.04<br>03.07<br>04.04<br>03.07 | 05.12<br>05.12<br>05.12<br>05.12<br>05.12<br>05.12<br>05.12<br>05.12<br>05.12<br>05.12<br>05.12<br>05.12<br>05.12<br>05.12<br>05.12<br>05.12<br>05.12<br>05.12<br>05.12<br>05.12<br>05.12<br>05.12 |  |  | 13.0460-7195.2<br>13.0470-7195.2                                     | 607195<br>LD7195                     |        |  | ersetzt Belag mit Federn <sup>1)</sup><br>ersetzt Belag mit Federn <sup>1)</sup>                         | 23482 16,6 +<br>23482 16,6 +                                 | ATE<br>ATE               |
|    | 1.6 D<br>1.6 D<br>1.6 D2<br>1.6 i<br>1.8<br>1.8 FlexiFuel<br>2.0 D<br>2.0 D3<br>2.0 D4<br>2.0 D4<br>2.0 FlexiFuel<br>2.0 i<br>2.4<br>2.4<br>2.4 4X4<br>2.4 D5<br>2.5 T5<br>2.5 T5<br>2.5 T5 AWD<br>2.5 T5 AWD | 80<br>81<br>84<br>74<br>92<br>92<br>100<br>110<br>96<br>130<br>107<br>107<br>103<br>125<br>125<br>132<br>162<br>169<br>162<br>169 |  | 04.07<br>01.05<br>10.10<br>01.05<br>04.04<br>04.07<br>01.04<br>10.10<br>07.05<br>10.10<br>10.06<br>10.06<br>01.04<br>01.04<br>08.06<br>03.06<br>01.04<br>03.07<br>04.04<br>03.07 | 05.12<br>05.12<br>05.12<br>05.12<br>05.12<br>05.12<br>05.12<br>05.12<br>05.12<br>05.12<br>05.12<br>05.12<br>05.12<br>05.12<br>05.12<br>05.12<br>05.12<br>05.12<br>05.12<br>05.12<br>05.12<br>05.12 |  |  | 24.0111-0158.1<br>24.0311-0158.1                                     | 411158<br>511158                     |        |  |  | 280 11,0 9,0 +S +B<br>280 11,0 9,0 +B PD                     |                          |
|  | 1.6 D<br>1.6 D<br>1.6 i<br>1.8<br>1.8 FlexiFuel<br>2.0 D<br>2.0 D4<br>2.0 FlexiFuel<br>2.0 i<br>2.4<br>2.4<br>2.4 D5<br>2.5 T5<br>2.5 T5<br>2.5 T5 AWD<br>2.5 T5 AWD  | 80<br>81<br>74<br>92<br>92<br>100<br>96<br>107<br>107<br>103<br>125<br>132<br>162<br>169<br>162<br>169                            |  | 04.07<br>01.05<br>01.05<br>04.04<br>04.07<br>01.04<br>07.05<br>10.06<br>10.06<br>01.04<br>01.04<br>03.06<br>01.04<br>03.07<br>04.04<br>03.07                                     | 05.12<br>05.12<br>05.12<br>05.12<br>05.12<br>05.12<br>05.12<br>05.12<br>05.12<br>05.12<br>05.12<br>05.12<br>05.12<br>05.12<br>05.12<br>05.12<br>05.12  |  |  | 24.0711-6220.3   | 360256                               | 2      |   |  | Radsensor  |                          |
|  | 2.4 4X4<br>2.5 T5 AWD<br>2.5 T5 AWD   | 125<br>162<br>169   |  | 08.06<br>04.04<br>03.07  | 05.12<br>05.12<br>05.12  |  |  | 24.0711-6143.3<br>24.0711-6144.3                                     | 360136<br>360137                     | 2<br>2 | <br> |  | Radsensor<br>Radsensor                                       |                          |
|  | 1.6 D2<br>2.0 D3<br>2.0 D4  | 84<br>110<br>130  |  | 10.10<br>10.10<br>10.10  | 05.12<br>05.12<br>05.12  |  |  | 24.0711-6221.3   | 360258                               | 2      |   |  | Radsensor  |                          |
| VOLVO S60 I (00-09)  |   |   |  |  |  |  |  |  |                                      |        |  |  |  |                          |
|  | 2.0 T<br>2.3 T5<br>2.3 T5<br>2.4<br>2.4<br>2.4 Bi-Fuel<br>2.4 D<br>2.4 D<br>2.4 D5<br>2.4 D5<br>2.4 T<br>2.4 T AWD<br>2.4 T5<br>2.5 T<br>2.5 T AWD<br>2.5 AWD<br>R 2.5 T<br>R 2.5 T AWD                       | 132<br>184<br>195<br>103<br>125<br>103<br>93<br>96<br>120<br>136<br>147<br>147<br>191<br>154<br>154<br>224<br>220<br>221          |  | 09.01<br>08.00<br>07.00<br>11.00<br>11.00<br>06.02<br>09.05<br>12.01<br>07.01<br>09.05<br>11.00<br>11.01<br>04.04<br>02.04<br>04.04<br>09.03<br>04.04<br>03.03                   | 01.09<br>04.04<br>09.02<br>01.09<br>01.09<br>01.09<br>01.09<br>01.09<br>01.09<br>01.09<br>01.09<br>01.09<br>01.09<br>01.09<br>01.09<br>04.10<br>05.07<br>01.09                                     |  |  | 13.0460-7145.2<br>13.0470-7145.2<br>13.0460-7187.2<br>13.0470-7187.2 | 607145<br>LD7145<br>607187<br>LD7187 |        |  | - 17" Rad <sup>2)</sup><br>- 17" Rad <sup>2)</sup><br>+ 17" Rad <sup>3)</sup><br>+ 17" Rad <sup>3)</sup> | 23073 18,8 +<br>23073 18,8 +<br>23950 19,5 +<br>23950 19,5 + | ATE<br>ATE<br>ATE<br>ATE |
|  | 2.5 AWD<br>R 2.5 T<br>R 2.5 T AWD   | 224<br>220<br>221   |  | 09.03<br>04.04<br>03.03  | 04.10<br>05.07<br>01.09  |  |  | 13.0460-4804.2   | 604804                               |        |  |  | 23092 15,6   | BRE                      |

<sup>1)</sup> replaces pad with springs / sostituisce la guarnizione con molle / remplace la garniture avec ressorts / sustituye guarnición con resortes

<sup>2)</sup> - 17" wheel / - ruota 17" / - roue 17" / - rueda 17"

<sup>3)</sup> + 17" wheel / + ruota 17" / + roue 17" / + rueda 17"

|     |  |  |  |  |  |  |  |     |                              |
|--|--|--|--|--|---|--|--|---|------------------------------|
| <b>VOLVO S60 I (00-09)</b>   |  |  |  |  |   |  |  |   |                              |
|    | 2.0 T  | 132  |  | 09.01  | 01.09   | 24.0126-0122.1   | 426122   | + 15" Rad <sup>1)</sup>   | 286 26,0 23,0 V +B           |
|  | 2.3 T5   | 184  |  | 08.00  | 04.04   | 24.0128-0123.1   | 428123   | + 16" Rad <sup>2)</sup>   | 305 27,9 25,0 V +B           |
|  | 2.3 T5   | 195  |  | 07.00  | 09.02   | 24.0328-0123.1   | 528123   | + 16" Rad <sup>2)</sup>   | <b>305 27,9 25,0 V +B PD</b> |
|  | 2.4  | 103  |  | 11.00  | 01.09   | 24.0128-0144.1   | 428144   | + 17" Rad <sup>3)</sup>   | 316 28,0 25,0 V L +B         |
|  | 2.4  | 125  |  | 11.00  | 01.09   | 24.0128-0184.1   | 428184   | + 17" Rad <sup>3)</sup>   | 320 28,0 25,0 V L +B         |
|  | 2.4 Bi-Fuel  | 103  |  | 06.02  | 01.09   |  |  |   |                              |
|  | 2.4 D  | 93   |  | 09.05  | 01.09   |  |  |   |                              |
|  | 2.4 D  | 96   |  | 12.01  | 01.09   |  |  |   |                              |
|  | 2.4 D5   | 120  |  | 07.01  | 01.09   |  |  |   |                              |
|  | 2.4 D5   | 136  |  | 09.05  | 01.09   |  |  |   |                              |
|  | 2.4 T  | 147  |  | 11.00  | 01.09   |  |  |   |                              |
|  | 2.4 T AWD  | 147  |  | 11.01  | 01.09   |  |  |   |                              |
|  | 2.4 T5   | 191  |  | 04.04  | 01.09   |  |  |   |                              |
|  | 2.5 T  | 154  |  | 02.04  | 01.09   |  |  |   |                              |
|  | 2.5 T AWD  | 154  |  | 04.04  | 01.09   |  |  |   |                              |
|    | 2.0 T  | 132  |  | 09.01  | 01.09   | 24.0711-6214.3   | 360230   |    | Radsensor L=965              |
|  | 2.3 T5   | 184  |  | 08.00  | 04.04   | 24.0711-6211.3   | 360233   |    | Radsensor L=1085             |
|  | 2.3 T5   | 195  |  | 07.00  | 09.02   |  |  |   |                              |
|  | 2.4  | 103  |  | 11.00  | 01.09   |  |  |   |                              |
|  | 2.4  | 125  |  | 11.00  | 01.09   |  |  |   |                              |
|  | 2.4 Bi-Fuel  | 103  |  | 06.02  | 01.09   |  |  |   |                              |
|  | 2.4 D  | 93   |  | 09.05  | 01.09   |  |  |   |                              |
|  | 2.4 D  | 96   |  | 12.01  | 01.09   |  |  |   |                              |
|  | 2.4 D5   | 120  |  | 07.01  | 01.09   |  |  |   |                              |
|  | 2.4 D5   | 136  |  | 09.05  | 01.09   |  |  |   |                              |
|  | 2.4 T  | 147  |  | 11.00  | 01.09   |  |  |   |                              |
|  | 2.4 T AWD  | 147  |  | 11.01  | 01.09   |  |  |   |                              |
|  | 2.4 T5   | 191  |  | 04.04  | 01.09   |  |  |   |                              |
|  | 2.5 AWD  | 224  |  | 09.03  | 04.10   |  |  |   |                              |
|  | 2.5 T  | 154  |  | 02.04  | 01.09   |  |  |   |                              |
|  | 2.5 T AWD  | 154  |  | 04.04  | 01.09   |  |  |   |                              |
|  | R 2.5 T  | 220  |  | 04.04  | 05.07   |  |  |   |                              |
|  | R 2.5 T AWD  | 221  |  | 03.03  | 01.09   |  |  |   |                              |
|    | 2.0 T  | 132  |  | 09.01  | 01.09   | 13.0460-7135.2   | 607135   |   | 23076 17,5 + ATE             |
|  | 2.3 T5   | 184  |  | 08.00  | 04.04   | 13.0470-7135.2   | LD7135   |   | 23076 17,5 + ATE             |
|  | 2.3 T5   | 195  |  | 07.00  | 09.02   |  |  |   |                              |
|  | 2.4  | 103  |  | 11.00  | 01.09   |  |  |   |                              |
|  | 2.4  | 125  |  | 11.00  | 01.09   |  |  |   |                              |
|  | 2.4 Bi-Fuel  | 103  |  | 06.02  | 01.09   |  |  |   |                              |
|  | 2.4 D  | 93   |  | 09.05  | 01.09   |  |  |   |                              |
|  | 2.4 D  | 96   |  | 12.01  | 01.09   |  |  |   |                              |
|  | 2.4 D5   | 120  |  | 07.01  | 01.09   |  |  |   |                              |
|  | 2.4 D5   | 136  |  | 09.05  | 01.09   |  |  |   |                              |
|  | 2.4 T  | 147  |  | 11.00  | 01.09   |  |  |   |                              |
|  | 2.4 T AWD  | 147  |  | 11.01  | 01.09   |  |  |   |                              |
|  | 2.4 T5   | 191  |  | 04.04  | 01.09   |  |  |   |                              |
|  | 2.5 T  | 154  |  | 02.04  | 01.09   |  |  |   |                              |
|  | 2.5 T AWD  | 154  |  | 04.04  | 01.09   |  |  |   |                              |
|  | 2.5 AWD  | 224  |  | 09.03  | 04.10   | 13.0460-4964.2   | 604964   |   | 21381 15,0 BRE               |
|  | R 2.5 T  | 220  |  | 04.04  | 05.07   |  |  |   |                              |
|  | R 2.5 T AWD  | 221  |  | 03.03  | 01.09   |  |  |   |                              |
|  | 2.0 T  | 132  |  | 09.01  | 01.09   | 24.0112-0151.1   | 412151   |   | 288 11,9 10,0 +B             |
|  | 2.3 T5   | 184  |  | 08.00  | 04.04   | 24.0312-0151.1   | 512151   |   | <b>288 11,9 10,0 +B PD</b>   |
|  | 2.3 T5   | 195  |  | 07.00  | 09.02   |  |  |   |                              |
|  | 2.4  | 103  |  | 11.00  | 01.09   |  |  |   |                              |
|  | 2.4  | 125  |  | 11.00  | 01.09   |  |  |   |                              |
|  | 2.4 Bi-Fuel  | 103  |  | 06.02  | 01.09   |  |  |   |                              |
|  | 2.4 D  | 93   |  | 09.05  | 01.09   |  |  |   |                              |
|  | 2.4 D  | 96   |  | 12.01  | 01.09   |  |  |   |                              |
|  | 2.4 D5   | 120  |  | 07.01  | 01.09   |  |  |   |                              |
|  | 2.4 D5   | 136  |  | 09.05  | 01.09   |  |  |   |                              |
|  | 2.4 T  | 147  |  | 11.00  | 01.09   |  |  |   |                              |
|  | 2.4 T AWD  | 147  |  | 11.01  | 01.09   |  |  |   |                              |
|  | 2.4 T5   | 191  |  | 04.04  | 01.09   |  |  |   |                              |
|  | 2.5 T  | 154  |  | 02.04  | 01.09   |  |  |   |                              |
|  | 2.5 T AWD  | 154  |  | 04.04  | 01.09   |  |  |   |                              |
|  | 2.0 T  | 132  |  | 09.01  | 01.09   | 24.0711-6212.3   | 360249   |  | Radsensor L=1255             |
|  | 2.3 T5   | 184  |  | 08.00  | 04.04   | 24.0711-6213.3   | 360250   |  | Radsensor L=1255             |
|  | 2.3 T5   | 195  |  | 07.00  | 09.02   |  |  |   |                              |
|  | 2.4  | 103  |  | 11.00  | 01.09   |  |  |   |                              |
|  | 2.4  | 125  |  | 11.00  | 01.09   |  |  |   |                              |
|  | 2.4 Bi-Fuel  | 103  |  | 06.02  | 01.09   |  |  |   |                              |
|  | 2.4 D  | 93   |  | 09.05  | 01.09   |  |  |   |                              |
|  | 2.4 D  | 96   |  | 12.01  | 01.09   |  |  |   |                              |
|  | 2.4 D5   | 120  |  | 07.01  | 01.09   |  |  |   |                              |
|  | 2.4 D5   | 136  |  | 09.05  | 01.09   |  |  |   |                              |
|  | 2.4 T  | 147  |  | 11.00  | 01.09   |  |  |   |                              |
|  | 2.4 T AWD  | 147  |  | 11.01  | 01.09   |  |  |   |                              |
|  | 2.4 T5   | 191  |  | 04.04  | 01.09   |  |  |   |                              |
|  | 2.5 AWD  | 224  |  | 09.03  | 04.10   |  |  |   |                              |
|  | 2.5 T  | 154  |  | 02.04  | 01.09   |  |  |   |                              |
|  | 2.5 T AWD  | 154  |  | 04.04  | 01.09   |  |  |   |                              |
|  | R 2.5 T  | 220  |  | 04.04  | 05.07   |  |  |   |                              |
|  | R 2.5 T AWD  | 221  |  | 03.03  | 01.09   |  |  |   |                              |

<sup>1)</sup> + 15" wheel / + ruota 15" / + roue 15" / + rueda 15"

<sup>2)</sup> + 16" wheel / + ruota 16" / + roue 16" / + rueda 16"

<sup>3)</sup> + 17" wheel / + ruota 17" / + roue 17" / + rueda 17"

|                            |             |     |  |       |       |  |  |                |        |  |  |                     |
|----------------------------|-------------|-----|--|-------|-------|--|--|----------------|--------|--|--|---------------------|
|                            |             |     |  |       |       |  |  |                |        |  |  |                     |
| <b>VOLVO S60 I (00-09)</b> |             |     |  |       |       |  |  |                |        |  |  |                     |
|                            | 2.0 T       | 132 |  | 09.01 | 01.09 |  |  | 03.0137-0450.2 | 650450 |  |  | 178 x 25            |
|                            | 2.3 T5      | 184 |  | 08.00 | 04.04 |  |  | 03.0137-9283.2 | 669283 |  |  | Bremsbacken-Zubehör |
|                            | 2.3 T5      | 195 |  | 07.00 | 09.02 |  |  |                |        |  |  |                     |
|                            | 2.4         | 103 |  | 11.00 | 01.09 |  |  |                |        |  |  |                     |
|                            | 2.4         | 125 |  | 11.00 | 01.09 |  |  |                |        |  |  |                     |
|                            | 2.4 Bi-Fuel | 103 |  | 06.02 | 01.09 |  |  |                |        |  |  |                     |
|                            | 2.4 D       | 93  |  | 09.05 | 01.09 |  |  |                |        |  |  |                     |
|                            | 2.4 D       | 96  |  | 12.01 | 01.09 |  |  |                |        |  |  |                     |
|                            | 2.4 D5      | 120 |  | 07.01 | 01.09 |  |  |                |        |  |  |                     |
|                            | 2.4 D5      | 136 |  | 09.05 | 01.09 |  |  |                |        |  |  |                     |
|                            | 2.4 T       | 147 |  | 11.00 | 01.09 |  |  |                |        |  |  |                     |
|                            | 2.4 T AWD   | 147 |  | 11.01 | 01.09 |  |  |                |        |  |  |                     |
|                            | 2.4 T5      | 191 |  | 04.04 | 01.09 |  |  |                |        |  |  |                     |
|                            | 2.5 AWD     | 224 |  | 09.03 | 04.10 |  |  |                |        |  |  |                     |
|                            | 2.5 T       | 154 |  | 02.04 | 01.09 |  |  |                |        |  |  |                     |
|                            | 2.5 T AWD   | 154 |  | 04.04 | 01.09 |  |  |                |        |  |  |                     |
|                            | R 2.5 T     | 220 |  | 04.04 | 05.07 |  |  |                |        |  |  |                     |
|                            | R 2.5 T AWD | 221 |  | 03.03 | 01.09 |  |  |                |        |  |  |                     |

|                           |             |     |  |       |  |  |                |        |  |  |              |     |
|---------------------------|-------------|-----|--|-------|--|--|----------------|--------|--|--|--------------|-----|
| <b>VOLVO S60 II (10-)</b> |             |     |  |       |  |  |                |        |  |  |              |     |
|                           | 1.5 T2      | 90  |  | 10.15 |  | + Bremsscheibendurchm. 300 mm <sup>1)</sup>        | 13.0460-7228.2 | 607228 |  |  | 24123 20,3 + | ATE |
|                           | 1.6 D DRIVE | 84  |  | 01.11 |  | + Bremsscheibendurchm. 300 mm <sup>1)</sup>        | 13.0470-7228.2 | LD7228 |  |  | 24123 20,3 + | ATE |
|                           | 2.0 D5      | 165 |  | 03.15 |  | + Bremsscheibendurchm. 300 mm <sup>1)</sup>        |                |        |  |  |              |     |
|                           | 2.0 T       | 132 |  | 12.13 |  | + Bremsscheibendurchm. 300 mm <sup>1)</sup>        |                |        |  |  |              |     |
|                           | 2.0 T       | 149 |  | 04.10 |  | + Bremsscheibendurchm. 300 mm <sup>1)</sup>        |                |        |  |  |              |     |
|                           | 2.0 T4      | 140 |  | 05.15 |  | + Bremsscheibendurchm. 300 mm <sup>1)</sup>        |                |        |  |  |              |     |
|                           | 2.5 T5 AWD  | 186 |  | 09.12 |  | + Bremsscheibendurchm. 300 mm <sup>1)</sup>        |                |        |  |  |              |     |
|                           | D2          | 84  |  | 04.13 |  | + Bremsscheibendurchm. 300 mm <sup>1)</sup>        |                |        |  |  |              |     |
|                           | D2          | 88  |  | 03.15 |  | + Bremsscheibendurchm. 300 mm <sup>1)</sup>        |                |        |  |  |              |     |
|                           | D3          | 100 |  | 05.12 |  | + Bremsscheibendurchm. 300 mm <sup>1)</sup>        |                |        |  |  |              |     |
|                           | D3          | 110 |  | 03.15 |  | + Bremsscheibendurchm. 300 mm <sup>1)</sup>        |                |        |  |  |              |     |
|                           | D3          | 120 |  | 04.10 |  | + Bremsscheibendurchm. 300 mm <sup>1)</sup>        |                |        |  |  |              |     |
|                           | D4          | 120 |  | 05.12 |  | + Bremsscheibendurchm. 300 mm <sup>1)</sup>        |                |        |  |  |              |     |
|                           | D4          | 133 |  | 09.13 |  | + Bremsscheibendurchm. 300 mm <sup>1)</sup>        |                |        |  |  |              |     |
|                           | D4          | 140 |  | 03.15 |  | + Bremsscheibendurchm. 300 mm <sup>1)</sup>        |                |        |  |  |              |     |
|                           | D4 AWD      | 140 |  | 03.15 |  | + Bremsscheibendurchm. 300 mm <sup>1)</sup>        |                |        |  |  |              |     |
|                           | D5          | 151 |  | 04.10 |  | + Bremsscheibendurchm. 300 mm <sup>1)</sup>        |                |        |  |  |              |     |
|                           | D5          | 158 |  | 06.11 |  | + Bremsscheibendurchm. 300 mm <sup>1)</sup>        |                |        |  |  |              |     |
|                           | D5          | 169 |  | 04.14 |  | + Bremsscheibendurchm. 300 mm <sup>1)</sup>        |                |        |  |  |              |     |
|                           | D5 AWD      | 151 |  | 04.10 |  | + Bremsscheibendurchm. 300 mm <sup>1)</sup>        |                |        |  |  |              |     |
|                           | D5 AWD      | 158 |  | 06.11 |  | + Bremsscheibendurchm. 300 mm <sup>1)</sup>        |                |        |  |  |              |     |
|                           | D5 AWD      | 169 |  | 04.14 |  | + Bremsscheibendurchm. 300 mm <sup>1)</sup>        |                |        |  |  |              |     |
|                           | T3          | 110 |  | 04.10 |  | + Bremsscheibendurchm. 300 mm <sup>1)</sup>        |                |        |  |  |              |     |
|                           | T3          | 112 |  | 03.15 |  | + Bremsscheibendurchm. 300 mm <sup>1)</sup>        |                |        |  |  |              |     |
|                           | T4          | 132 |  | 04.10 |  | + Bremsscheibendurchm. 300 mm <sup>1)</sup>        |                |        |  |  |              |     |
|                           | T4F         | 132 |  | 04.11 |  | + Bremsscheibendurchm. 300 mm <sup>1)</sup>        |                |        |  |  |              |     |
|                           | T5          | 176 |  | 04.10 |  | + Bremsscheibendurchm. 300 mm <sup>1)</sup>        |                |        |  |  |              |     |
|                           | T5          | 180 |  | 09.13 |  | + Bremsscheibendurchm. 300 mm <sup>1)</sup>        |                |        |  |  |              |     |
|                           | T6          | 225 |  | 09.13 |  | + Bremsscheibendurchm. 300 mm <sup>1)</sup>        | 13.0460-7228.2 | 607228 |  |  | 24123 20,3 + | ATE |
|                           | T6 AWD      | 224 |  | 04.10 |  | + Bremsscheibendurchm. 300 mm <sup>1)</sup>        |                |        |  |  |              |     |
|                           | T6 AWD      | 225 |  | 09.15 |  | + Bremsscheibendurchm. 300 mm <sup>1)</sup>        |                |        |  |  |              |     |
|                           | T6 AWD      | 242 |  | 04.14 |  | + Bremsscheibendurchm. 300 mm <sup>1)</sup>        |                |        |  |  |              |     |
|                           | 1.5 T2      | 90  |  | 10.15 |  | + Bremsscheibendurchm. 316mm / 336mm <sup>2)</sup> | 13.0460-7243.2 | 607243 |  |  | 24142 20,6 + | ATE |
|                           | 1.6 D DRIVE | 84  |  | 01.11 |  | + Bremsscheibendurchm. 316mm / 336mm <sup>2)</sup> | 13.0470-7243.2 | LD7243 |  |  | 24142 20,6 + | ATE |
|                           | 2.0 D5      | 165 |  | 03.15 |  | + Bremsscheibendurchm. 316mm / 336mm <sup>2)</sup> |                |        |  |  |              |     |
|                           | 2.0 T       | 132 |  | 12.13 |  | + Bremsscheibendurchm. 316mm / 336mm <sup>2)</sup> |                |        |  |  |              |     |
|                           | 2.0 T       | 149 |  | 04.10 |  | + Bremsscheibendurchm. 316mm / 336mm <sup>2)</sup> |                |        |  |  |              |     |
|                           | 2.0 T4      | 140 |  | 05.15 |  | + Bremsscheibendurchm. 316mm / 336mm <sup>2)</sup> |                |        |  |  |              |     |
|                           | 2.5 T5 AWD  | 186 |  | 09.12 |  | + Bremsscheibendurchm. 316mm / 336mm <sup>2)</sup> |                |        |  |  |              |     |
|                           | D2          | 84  |  | 04.13 |  | + Bremsscheibendurchm. 316mm / 336mm <sup>2)</sup> |                |        |  |  |              |     |
|                           | D2          | 88  |  | 03.15 |  | + Bremsscheibendurchm. 316mm / 336mm <sup>2)</sup> |                |        |  |  |              |     |
|                           | D3          | 100 |  | 05.12 |  | + Bremsscheibendurchm. 316mm / 336mm <sup>2)</sup> |                |        |  |  |              |     |
|                           | D3          | 110 |  | 03.15 |  | + Bremsscheibendurchm. 316mm / 336mm <sup>2)</sup> |                |        |  |  |              |     |
|                           | D3          | 120 |  | 04.10 |  | + Bremsscheibendurchm. 316mm / 336mm <sup>2)</sup> |                |        |  |  |              |     |
|                           | D4          | 120 |  | 05.12 |  | + Bremsscheibendurchm. 316mm / 336mm <sup>2)</sup> |                |        |  |  |              |     |
|                           | D4          | 133 |  | 09.13 |  | + Bremsscheibendurchm. 316mm / 336mm <sup>2)</sup> |                |        |  |  |              |     |
|                           | D4          | 140 |  | 03.15 |  | + Bremsscheibendurchm. 316mm / 336mm <sup>2)</sup> |                |        |  |  |              |     |
|                           | D4 AWD      | 140 |  | 03.15 |  | + Bremsscheibendurchm. 316mm / 336mm <sup>2)</sup> |                |        |  |  |              |     |
|                           | D5          | 151 |  | 04.10 |  | + Bremsscheibendurchm. 316mm / 336mm <sup>2)</sup> |                |        |  |  |              |     |
|                           | D5          | 158 |  | 06.11 |  | + Bremsscheibendurchm. 316mm / 336mm <sup>2)</sup> |                |        |  |  |              |     |
|                           | D5          | 169 |  | 04.14 |  | + Bremsscheibendurchm. 316mm / 336mm <sup>2)</sup> |                |        |  |  |              |     |
|                           | D5 AWD      | 151 |  | 04.10 |  | + Bremsscheibendurchm. 316mm / 336mm <sup>2)</sup> |                |        |  |  |              |     |
|                           | D5 AWD      | 158 |  | 06.11 |  | + Bremsscheibendurchm. 316mm / 336mm <sup>2)</sup> |                |        |  |  |              |     |
|                           | D5 AWD      | 169 |  | 04.14 |  | + Bremsscheibendurchm. 316mm / 336mm <sup>2)</sup> |                |        |  |  |              |     |
|                           | T3          | 110 |  | 04.10 |  | + Bremsscheibendurchm. 316mm / 336mm <sup>2)</sup> |                |        |  |  |              |     |
|                           | T3          | 112 |  | 03.15 |  | + Bremsscheibendurchm. 316mm / 336mm <sup>2)</sup> |                |        |  |  |              |     |
|                           | T4          | 132 |  | 04.10 |  | + Bremsscheibendurchm. 316mm / 336mm <sup>2)</sup> |                |        |  |  |              |     |
|                           | T4F         | 132 |  | 04.11 |  | + Bremsscheibendurchm. 316mm / 336mm <sup>2)</sup> |                |        |  |  |              |     |
|                           | T5          | 176 |  | 04.10 |  | + Bremsscheibendurchm. 316mm / 336mm <sup>2)</sup> |                |        |  |  |              |     |
|                           | T5          | 180 |  | 09.13 |  | + Bremsscheibendurchm. 316mm / 336mm <sup>2)</sup> |                |        |  |  |              |     |
|                           | T6 AWD      | 224 |  | 04.10 |  | + Bremsscheibendurchm. 316mm / 336mm <sup>2)</sup> |                |        |  |  |              |     |
|                           | T6          | 225 |  | 09.13 |  | + Bremsscheibendurchm. 316mm / 336mm <sup>2)</sup> | 13.0460-7243.2 | 607243 |  |  | 24142 20,6 + | ATE |
|                           | T6 AWD      | 225 |  | 09.15 |  | + Bremsscheibendurchm. 316mm / 336mm <sup>2)</sup> |                |        |  |  |              |     |
|                           | T6 AWD      | 242 |  | 04.14 |  | + Bremsscheibendurchm. 316mm / 336mm <sup>2)</sup> |                |        |  |  |              |     |

<sup>1)</sup> + brake disc diameter 300mm / + diametro dischi freno 300mm / + diamètre disques frein 300mm / + diámetro disco freno 300mm

<sup>2)</sup> + brake disc diameter 316mm / 336mm / + diametro dischi freno 316mm / 336mm / + diamètre disques frein 316mm / 336mm / + diámetro disco freno 316mm / 336mm



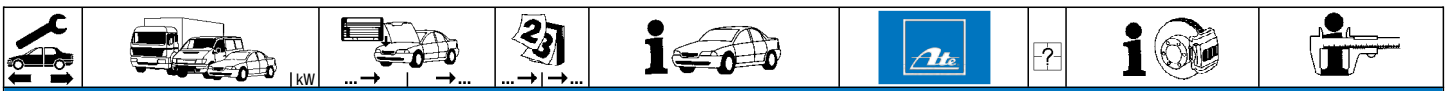

**VOLVO S60 II (10-)**

|             |             |       |   |   |                |        |                         |   |  |
|-------------|-------------|-------|---|---|----------------|--------|-------------------------|---|--|
|             | 1.5 T2      | 90    | 10.15                                       | + Bremsscheibendurchm. 300 mm <sup>1)</sup> | 24.0128-0154.1 | 428154 |                         | 300 28,0 26,0 V L +S +B<br>300 28,0 26,0 V L +S +B PD |  |
|             | 1.6 D DRIVE | 84    | 01.11                                       | + Bremsscheibendurchm. 300 mm <sup>1)</sup> | 24.0328-0154.1 | 528154 |                         |   |  |
|             | 2.0 D5      | 165   | 03.15                                       | + Bremsscheibendurchm. 300 mm <sup>1)</sup> |                |        |                         |   |  |
|             | 2.0 T       | 132   | 12.13                                       | + Bremsscheibendurchm. 300 mm <sup>1)</sup> |                |        |                         |   |  |
|             | 2.0 T       | 149   | 04.10                                       | + Bremsscheibendurchm. 300 mm <sup>1)</sup> |                |        |                         |   |  |
|             | 2.0 T4      | 140   | 05.15                                       | + Bremsscheibendurchm. 300 mm <sup>1)</sup> |                |        |                         |   |  |
|             | 2.5 T5 AWD  | 186   | 09.12                                       | + Bremsscheibendurchm. 300 mm <sup>1)</sup> |                |        |                         |   |  |
|             | D2          | 84    | 04.13                                       | + Bremsscheibendurchm. 300 mm <sup>1)</sup> |                |        |                         |   |  |
|             | D2          | 88    | 03.15                                       | + Bremsscheibendurchm. 300 mm <sup>1)</sup> |                |        |                         |   |  |
|             | D3          | 100   | 05.12                                       | + Bremsscheibendurchm. 300 mm <sup>1)</sup> |                |        |                         |   |  |
|             | D3          | 110   | 03.15                                       | + Bremsscheibendurchm. 300 mm <sup>1)</sup> |                |        |                         |   |  |
|             | D3          | 120   | 04.10                                       | + Bremsscheibendurchm. 300 mm <sup>1)</sup> |                |        |                         |   |  |
|             | D4          | 120   | 05.12                                       | + Bremsscheibendurchm. 300 mm <sup>1)</sup> |                |        |                         |   |  |
|             | D4          | 133   | 09.13                                       | + Bremsscheibendurchm. 300 mm <sup>1)</sup> |                |        |                         |   |  |
|             | D4          | 140   | 03.15                                       | + Bremsscheibendurchm. 300 mm <sup>1)</sup> |                |        |                         |   |  |
|             | D4 AWD      | 140   | 03.15                                       | + Bremsscheibendurchm. 300 mm <sup>1)</sup> |                |        |                         |   |  |
|             | D5          | 151   | 04.10                                       | + Bremsscheibendurchm. 300 mm <sup>1)</sup> |                |        |                         |   |  |
|             | D5          | 158   | 06.11                                       | + Bremsscheibendurchm. 300 mm <sup>1)</sup> |                |        |                         |   |  |
|             | D5          | 169   | 04.14                                       | + Bremsscheibendurchm. 300 mm <sup>1)</sup> |                |        |                         |   |  |
|             | D5 AWD      | 151   | 04.10                                       | + Bremsscheibendurchm. 300 mm <sup>1)</sup> |                |        |                         |   |  |
|             | D5 AWD      | 158   | 06.11                                       | + Bremsscheibendurchm. 300 mm <sup>1)</sup> |                |        |                         |   |  |
|             | D5 AWD      | 169   | 04.14                                       | + Bremsscheibendurchm. 300 mm <sup>1)</sup> |                |        |                         |   |  |
|             | T3          | 110   | 04.10                                       | + Bremsscheibendurchm. 300 mm <sup>1)</sup> |                |        |                         |   |  |
|             | T3          | 112   | 03.15                                       | + Bremsscheibendurchm. 300 mm <sup>1)</sup> |                |        |                         |   |  |
|             | T4          | 132   | 04.10                                       | + Bremsscheibendurchm. 300 mm <sup>1)</sup> |                |        |                         |   |  |
|             | T4F         | 132   | 04.11                                       | + Bremsscheibendurchm. 300 mm <sup>1)</sup> |                |        |                         |   |  |
|             | T5          | 176   | 04.10                                       | + Bremsscheibendurchm. 300 mm <sup>1)</sup> |                |        |                         |   |  |
|             | T5          | 180   | 09.13                                       | + Bremsscheibendurchm. 300 mm <sup>1)</sup> |                |        |                         |   |  |
|             | T6          | 225   | 09.13                                       | + Bremsscheibendurchm. 300 mm <sup>1)</sup> |                |        |                         |   |  |
|             | T6 AWD      | 224   | 04.10                                       | + Bremsscheibendurchm. 300 mm <sup>1)</sup> |                |        |                         |   |  |
|             | T6 AWD      | 225   | 09.15                                       | + Bremsscheibendurchm. 300 mm <sup>1)</sup> |                |        |                         |   |  |
|             | T6 AWD      | 242   | 04.14                                       | + Bremsscheibendurchm. 300 mm <sup>1)</sup> |                |        |                         |   |  |
|             | 1.5 T2      | 90    | 10.15                                       | + Bremsscheibendurchm. 316mm <sup>2)</sup>  | 24.0128-0162.1 | 428162 |                         |   |  |
| 1.6 D DRIVE | 84          | 01.11 | + Bremsscheibendurchm. 316mm <sup>2)</sup>  | 24.0328-0162.1                              | 528162         |        |                         |   |  |
| 2.0 D5      | 165         | 03.15 | + Bremsscheibendurchm. 316mm <sup>2)</sup>  |   |                |        |                         |   |  |
| 2.0 T       | 149         | 04.10 | + Bremsscheibendurchm. 316mm <sup>2)</sup>  |   |                |        |                         |   |  |
| 2.0 T4      | 140         | 05.15 | + Bremsscheibendurchm. 316mm <sup>2)</sup>  |   |                |        |                         |   |  |
| 2.5 T5 AWD  | 186         | 09.12 | + Bremsscheibendurchm. 316mm <sup>2)</sup>  |   |                |        |                         |   |  |
| D2          | 84          | 04.13 | + Bremsscheibendurchm. 316mm <sup>2)</sup>  |   |                |        |                         |   |  |
| D2          | 88          | 03.15 | + Bremsscheibendurchm. 316mm <sup>2)</sup>  |   |                |        |                         |   |  |
| D3          | 100         | 05.12 | + Bremsscheibendurchm. 316mm <sup>2)</sup>  |   |                |        |                         |   |  |
| D3          | 110         | 03.15 | + Bremsscheibendurchm. 316mm <sup>2)</sup>  |   |                |        |                         |   |  |
| D3          | 120         | 04.10 | + Bremsscheibendurchm. 316mm <sup>2)</sup>  |   |                |        |                         |   |  |
| D4          | 120         | 05.12 | + Bremsscheibendurchm. 316mm <sup>2)</sup>  |   |                |        |                         |   |  |
| D4          | 133         | 09.13 | + Bremsscheibendurchm. 316mm <sup>2)</sup>  |   |                |        |                         |   |  |
| D4          | 140         | 03.15 | + Bremsscheibendurchm. 316mm <sup>2)</sup>  |   |                |        |                         |   |  |
| D4 AWD      | 140         | 03.15 | + Bremsscheibendurchm. 316mm <sup>2)</sup>  |   |                |        |                         |   |  |
| D5          | 151         | 04.10 | + Bremsscheibendurchm. 316mm <sup>2)</sup>  |   |                |        |                         |   |  |
| D5          | 158         | 06.11 | + Bremsscheibendurchm. 316mm <sup>2)</sup>  |   |                |        |                         |   |  |
| D5          | 169         | 04.14 | + Bremsscheibendurchm. 316mm <sup>2)</sup>  |   |                |        |                         |   |  |
| D5 AWD      | 151         | 04.10 | + Bremsscheibendurchm. 316mm <sup>2)</sup>  |   |                |        |                         |   |  |
| D5 AWD      | 158         | 06.11 | + Bremsscheibendurchm. 316mm <sup>2)</sup>  |   |                |        |                         |   |  |
| D5 AWD      | 169         | 04.14 | + Bremsscheibendurchm. 316mm <sup>2)</sup>  |   |                |        |                         |   |  |
| T3          | 110         | 04.10 | + Bremsscheibendurchm. 316mm <sup>2)</sup>  |   |                |        |                         |   |  |
| T3          | 112         | 03.15 | + Bremsscheibendurchm. 316mm <sup>2)</sup>  |   |                |        |                         |   |  |
| T4          | 132         | 04.10 | + Bremsscheibendurchm. 316mm <sup>2)</sup>  |   |                |        |                         |   |  |
| T4F         | 132         | 04.11 | + Bremsscheibendurchm. 316mm <sup>2)</sup>  |   |                |        |                         |   |  |
| T5          | 176         | 04.10 | + Bremsscheibendurchm. 316mm <sup>2)</sup>  |   |                |        |                         |   |  |
| T5          | 180         | 09.13 | + Bremsscheibendurchm. 316mm <sup>2)</sup>  |   |                |        |                         |   |  |
| T6          | 225         | 09.13 | + Bremsscheibendurchm. 316mm <sup>2)</sup>  |   |                |        |                         |   |  |
| T6 AWD      | 224         | 04.10 | + Bremsscheibendurchm. 316mm <sup>2)</sup>  |   |                |        |                         |   |  |
| T6 AWD      | 225         | 09.15 | + Bremsscheibendurchm. 316mm <sup>2)</sup>  |   |                |        |                         |   |  |
| T6 AWD      | 242         | 04.14 | + Bremsscheibendurchm. 316mm <sup>2)</sup>  |   |                |        |                         |   |  |
| 1.5 T2      | 90          | 10.15 | + Bremsscheibendurchm. 336 mm <sup>3)</sup> | 24.0128-0210.1                              | 428210         |        | 336 28,0 26,0 V L +S +B |   |  |
| 1.6 D DRIVE | 84          | 01.11 | + Bremsscheibendurchm. 336 mm <sup>3)</sup> |   |                |        |                         |   |  |
| 2.0 D5      | 165         | 03.15 | + Bremsscheibendurchm. 336 mm <sup>3)</sup> |   |                |        |                         |   |  |
| 2.0 T       | 149         | 04.10 | + Bremsscheibendurchm. 336 mm <sup>3)</sup> |   |                |        |                         |   |  |
| 2.0 T4      | 140         | 05.15 | + Bremsscheibendurchm. 336 mm <sup>3)</sup> |   |                |        |                         |   |  |
| 2.5 T5 AWD  | 186         | 09.12 | + Bremsscheibendurchm. 336 mm <sup>3)</sup> |   |                |        |                         |   |  |
| D2          | 84          | 04.13 | + Bremsscheibendurchm. 336 mm <sup>3)</sup> |   |                |        |                         |   |  |
| D2          | 88          | 03.15 | + Bremsscheibendurchm. 336 mm <sup>3)</sup> |   |                |        |                         |   |  |
| D3          | 100         | 05.12 | + Bremsscheibendurchm. 336 mm <sup>3)</sup> |   |                |        |                         |   |  |
| D3          | 110         | 03.15 | + Bremsscheibendurchm. 336 mm <sup>3)</sup> |   |                |        |                         |   |  |
| D3          | 120         | 04.10 | + Bremsscheibendurchm. 336 mm <sup>3)</sup> |   |                |        |                         |   |  |
| D4          | 120         | 05.12 | + Bremsscheibendurchm. 336 mm <sup>3)</sup> |   |                |        |                         |   |  |
| D4          | 133         | 09.13 | + Bremsscheibendurchm. 336 mm <sup>3)</sup> |   |                |        |                         |   |  |
| D4          | 140         | 03.15 | + Bremsscheibendurchm. 336 mm <sup>3)</sup> |   |                |        |                         |   |  |
| D4 AWD      | 140         | 03.15 | + Bremsscheibendurchm. 336 mm <sup>3)</sup> |   |                |        |                         |   |  |
| D5          | 151         | 04.10 | + Bremsscheibendurchm. 336 mm <sup>3)</sup> |   |                |        |                         |   |  |
| D5          | 158         | 06.11 | + Bremsscheibendurchm. 336 mm <sup>3)</sup> |   |                |        |                         |   |  |
| D5          | 169         | 04.14 | + Bremsscheibendurchm. 336 mm <sup>3)</sup> |   |                |        |                         |   |  |
| D5 AWD      | 151         | 04.10 | + Bremsscheibendurchm. 336 mm <sup>3)</sup> |   |                |        |                         |   |  |
| D5 AWD      | 158         | 06.11 | + Bremsscheibendurchm. 336 mm <sup>3)</sup> |   |                |        |                         |   |  |
| D5 AWD      | 169         | 04.14 | + Bremsscheibendurchm. 336 mm <sup>3)</sup> |   |                |        |                         |   |  |
| T3          | 110         | 04.10 | + Bremsscheibendurchm. 336 mm <sup>3)</sup> |   |                |        |                         |   |  |
| T3          | 112         | 03.15 | + Bremsscheibendurchm. 336 mm <sup>3)</sup> |   |                |        |                         |   |  |
| T4          | 132         | 04.10 | + Bremsscheibendurchm. 336 mm <sup>3)</sup> |   |                |        |                         |   |  |

<sup>1)</sup> + brake disc diameter 300mm / + diametro dischi freno 300mm / + diamètre disques frein 300mm / + diámetro disco freno 300mm

<sup>2)</sup> + brake disc diameter 316mm / + diametro dischi freno 316mm / + diamètre disques frein 316mm / + diámetro disco freno 316mm

<sup>3)</sup> + brake disc diameter 336mm / + diametro dischi freno 336mm / + diamètre disques frein 336mm / + diámetro disco freno 336mm





**VOLVO S60 II (10-)**

|  |             |     |  |       |   |                |        |  |                                    |                        |
|--|-------------|-----|--|-------|---|----------------|--------|--|------------------------------------|------------------------|
|  | T4F         | 132 |  | 04.11 | + Bremsscheibendurchm. 336 mm <sup>1)</sup> | 24.0128-0210.1 | 428210 |  |                                    | 336 28,0 26,0 VL +S +B |
|  | T5          | 176 |  | 04.10 | + Bremsscheibendurchm. 336 mm <sup>1)</sup> |                |        |  |                                    |                        |
|  | T5          | 180 |  | 09.13 | + Bremsscheibendurchm. 336 mm <sup>1)</sup> |                |        |  |                                    |                        |
|  | T6          | 225 |  | 09.13 | + Bremsscheibendurchm. 336 mm <sup>1)</sup> |                |        |  |                                    |                        |
|  | T6 AWD      | 224 |  | 04.10 | + Bremsscheibendurchm. 336 mm <sup>1)</sup> |                |        |  |                                    |                        |
|  | T6 AWD      | 225 |  | 09.15 | + Bremsscheibendurchm. 336 mm <sup>1)</sup> |                |        |  |                                    |                        |
|  | T6 AWD      | 242 |  | 04.14 | + Bremsscheibendurchm. 336 mm <sup>1)</sup> |                |        |  |                                    |                        |
|  | 1.5 T2      | 90  |  | 10.15 |   | 24.0711-5198.3 | 360239 |  |                                    | Radsensor              |
|  | 1.6 D DRIVe | 84  |  | 01.11 |   | 24.0711-5241.3 | 360319 |  |                                    | Radsensor              |
|  | 2.0 D5      | 165 |  | 03.15 |   |                |        |  |                                    |                        |
|  | 2.0 T       | 149 |  | 04.10 |   |                |        |  |                                    |                        |
|  | 2.0 T4      | 140 |  | 05.15 |   |                |        |  |                                    |                        |
|  | 2.5 T5 AWD  | 186 |  | 09.12 |   |                |        |  |                                    |                        |
|  | D2          | 84  |  | 04.13 |   |                |        |  |                                    |                        |
|  | D2          | 88  |  | 03.15 |   |                |        |  |                                    |                        |
|  | D3          | 100 |  | 05.12 |   |                |        |  |                                    |                        |
|  | D3          | 110 |  | 03.15 |   |                |        |  |                                    |                        |
|  | D3          | 120 |  | 04.10 |   |                |        |  |                                    |                        |
|  | D4          | 120 |  | 05.12 |   |                |        |  |                                    |                        |
|  | D4          | 133 |  | 09.13 |   |                |        |  |                                    |                        |
|  | D4          | 140 |  | 03.15 |   |                |        |  |                                    |                        |
|  | D4 AWD      | 140 |  | 03.15 |   |                |        |  |                                    |                        |
|  | D5          | 151 |  | 04.10 |   |                |        |  |                                    |                        |
|  | D5          | 158 |  | 06.11 |   |                |        |  |                                    |                        |
|  | D5          | 169 |  | 04.14 |   |                |        |  |                                    |                        |
|  | D5 AWD      | 151 |  | 04.10 |   |                |        |  |                                    |                        |
|  | D5 AWD      | 158 |  | 06.11 |   |                |        |  |                                    |                        |
|  | D5 AWD      | 169 |  | 04.14 |   |                |        |  |                                    |                        |
|  | T3          | 110 |  | 04.10 |   |                |        |  |                                    |                        |
|  | T3          | 112 |  | 03.15 |   |                |        |  |                                    |                        |
|  | T4          | 132 |  | 04.10 |   |                |        |  |                                    |                        |
|  | T4F         | 132 |  | 04.11 |   |                |        |  |                                    |                        |
|  | T5          | 176 |  | 04.10 |   |                |        |  |                                    |                        |
|  | T5          | 180 |  | 09.13 |   |                |        |  |                                    |                        |
|  | T6          | 225 |  | 09.13 |   |                |        |  |                                    |                        |
|  | T6 AWD      | 224 |  | 04.10 |   |                |        |  |                                    |                        |
|  | T6 AWD      | 225 |  | 09.15 |   |                |        |  |                                    |                        |
|  | T6 AWD      | 242 |  | 04.14 |   |                |        |  |                                    |                        |
|  | 3.0 T6 AWD  | 258 |  | 05.14 |   | 24.0711-5198.3 | 360239 |  |                                    | Radsensor              |
|  | 1.5 T2      | 90  |  | 10.15 |   | 13.0460-2722.2 | 602722 |  | - belüftete Scheiben <sup>2)</sup> | 24496 17,3 /Zub/S TRW  |
|  | 1.6 D DRIVe | 84  |  | 01.11 |   | 13.0470-2722.2 | LD2722 |  | - belüftete Scheiben <sup>2)</sup> | 24496 17,3 /Zub/S TRW  |
|  | 2.0 D5      | 165 |  | 03.15 |   |                |        |  |                                    |                        |
|  | 2.0 T       | 149 |  | 04.10 |   |                |        |  |                                    |                        |
|  | 2.0 T4      | 140 |  | 05.15 |   |                |        |  |                                    |                        |
|  | 2.5 T5 AWD  | 186 |  | 09.12 |   |                |        |  |                                    |                        |
|  | D2          | 84  |  | 04.13 |   |                |        |  |                                    |                        |
|  | D2          | 88  |  | 03.15 |   |                |        |  |                                    |                        |
|  | D3          | 100 |  | 05.12 |   |                |        |  |                                    |                        |
|  | D3          | 110 |  | 03.15 |   |                |        |  |                                    |                        |
|  | D3          | 120 |  | 04.10 |   |                |        |  |                                    |                        |
|  | D4          | 120 |  | 05.12 |   |                |        |  |                                    |                        |
|  | D4          | 133 |  | 09.13 |   |                |        |  |                                    |                        |
|  | D4          | 140 |  | 03.15 |   |                |        |  |                                    |                        |
|  | D4 AWD      | 140 |  | 03.15 |   |                |        |  |                                    |                        |
|  | D5          | 151 |  | 04.10 |   |                |        |  |                                    |                        |
|  | D5          | 158 |  | 06.11 |   |                |        |  |                                    |                        |
|  | D5          | 169 |  | 04.14 |   |                |        |  |                                    |                        |
|  | D5 AWD      | 151 |  | 04.10 |   |                |        |  |                                    |                        |
|  | D5 AWD      | 158 |  | 06.11 |   |                |        |  |                                    |                        |
|  | D5 AWD      | 169 |  | 04.14 |   |                |        |  |                                    |                        |
|  | T3          | 110 |  | 04.10 |   |                |        |  |                                    |                        |
|  | T3          | 112 |  | 03.15 |   |                |        |  |                                    |                        |
|  | T4          | 132 |  | 04.10 |   |                |        |  |                                    |                        |
|  | T4F         | 132 |  | 04.11 |   |                |        |  |                                    |                        |
|  | T5          | 176 |  | 04.10 |   |                |        |  |                                    |                        |
|  | T5          | 180 |  | 09.13 |   |                |        |  |                                    |                        |
|  | T6          | 225 |  | 09.13 |   |                |        |  |                                    |                        |
|  | T6 AWD      | 224 |  | 04.10 |   |                |        |  |                                    |                        |
|  | T6 AWD      | 225 |  | 09.15 |   |                |        |  |                                    |                        |
|  | T6 AWD      | 242 |  | 04.14 |   |                |        |  |                                    |                        |
|  | 1.5 T2      | 90  |  | 10.15 |   | 13.0460-2736.2 | 602736 |  | + belüftete Scheiben <sup>3)</sup> | 24496 17,3 /Zub/S TRW  |
|  | 1.6 D DRIVe | 84  |  | 01.11 |   | 13.0470-2736.2 | LD2736 |  | + belüftete Scheiben <sup>3)</sup> | 24496 17,3 /Zub/S TRW  |
|  | 2.0 D5      | 165 |  | 03.15 |   |                |        |  |                                    |                        |
|  | 2.0 T       | 149 |  | 04.10 |   |                |        |  |                                    |                        |
|  | 2.0 T4      | 140 |  | 05.15 |   |                |        |  |                                    |                        |
|  | 2.5 T5 AWD  | 186 |  | 09.12 |   |                |        |  |                                    |                        |
|  | D2          | 84  |  | 04.13 |   |                |        |  |                                    |                        |
|  | D2          | 88  |  | 03.15 |   |                |        |  |                                    |                        |
|  | D3          | 100 |  | 05.12 |   |                |        |  |                                    |                        |
|  | D3          | 110 |  | 03.15 |   |                |        |  |                                    |                        |
|  | D3          | 120 |  | 04.10 |   |                |        |  |                                    |                        |
|  | D4          | 120 |  | 05.12 |   |                |        |  |                                    |                        |
|  | D4          | 133 |  | 09.13 |   |                |        |  |                                    |                        |
|  | D4          | 140 |  | 03.15 |   |                |        |  |                                    |                        |
|  | D4 AWD      | 140 |  | 03.15 |   |                |        |  |                                    |                        |
|  | D5          | 151 |  | 04.10 |   |                |        |  |                                    |                        |
|  | D5          | 158 |  | 06.11 |   |                |        |  |                                    |                        |

<sup>1)</sup> + brake disc diameter 336mm / + diametro dischi freno 336mm / + diamètre disques frein 336mm / + diámetro disco freno 336mm

<sup>2)</sup> - ventilated discs / - dischi ventilati / - disques ventilés / - disco ventilado

<sup>3)</sup> + ventilated discs / + dischi ventilati / + disques ventilés / + disco ventilado



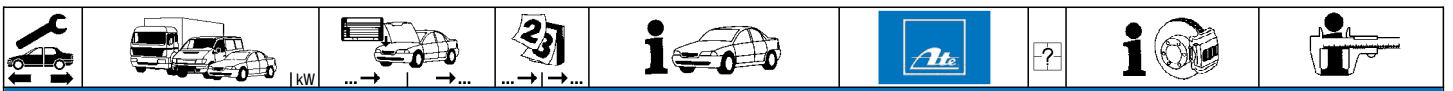

**VOLVO S60 II (10-)**

|  |   |   |    |     |     |     |   |   |                  |  |  |                    |  |
|--|---|---|----|-----|-----|-----|---|---|------------------|--|--|--------------------|--|
|  | D5<br>D5 AWD<br>D5 AWD<br>D5 AWD<br>T3<br>T3<br>T4<br>T4F<br>T5<br>T5<br>T6<br>T6 AWD<br>T6 AWD<br>T6 AWD   | 169<br>151<br>158<br>169<br>110<br>112<br>132<br>132<br>176<br>180<br>225<br>224<br>225<br>242  | kW | ... | ... | ... | 04.14<br>04.10<br>06.11<br>04.14<br>04.10<br>03.15<br>04.10<br>04.11<br>04.10<br>09.13<br>09.13<br>04.10<br>09.15<br>04.14  | 13.0460-2736.2<br>13.0470-2736.2  | 602736<br>LD2736 | + belüftete Scheiben <sup>1)</sup><br>+ belüftete Scheiben <sup>1)</sup> | 24496 17,3 /Zub/S<br>24496 17,3 /Zub/S | TRW<br>TRW         |  |
|  | 1.5 T2<br>1.6 D DRIVe<br>2.0 D5<br>2.0 T<br>2.0 T4<br>2.5 T5 AWD<br>D2<br>D2<br>D3<br>D3<br>D3<br>D4<br>D4<br>D4<br>D4 AWD<br>D5<br>D5<br>D5<br>D5 AWD<br>D5 AWD<br>D5 AWD<br>T3<br>T3<br>T4<br>T4F<br>T5<br>T5<br>T6<br>T6 AWD<br>T6 AWD<br>T6 AWD | 90<br>84<br>165<br>149<br>140<br>186<br>84<br>88<br>100<br>110<br>120<br>120<br>133<br>140<br>140<br>151<br>158<br>169<br>151<br>158<br>169<br>110<br>112<br>132<br>132<br>176<br>180<br>225<br>224<br>225<br>242 |    |     |     |     |   | 10.15<br>01.11<br>03.15<br>04.10<br>05.15<br>09.12<br>04.13<br>03.15<br>05.12<br>03.15<br>04.10<br>05.12<br>09.13<br>03.15<br>03.15<br>04.10<br>06.11<br>04.14<br>04.10<br>06.11<br>04.14<br>04.10<br>03.15<br>04.10<br>04.11<br>04.10<br>09.13<br>09.13<br>04.10<br>09.15<br>04.14 | 24.0111-0147.1   | 411147   | - belüftete Scheiben <sup>2)</sup>     | 302 11,0 9,0 +S +B |  |
|  | 1.5 T2<br>1.6 D DRIVe<br>2.0 D5<br>2.0 T<br>2.0 T4<br>2.5 T5 AWD<br>D2<br>D2<br>D3<br>D3<br>D3<br>D4<br>D4<br>D4<br>D4 AWD<br>D5<br>D5<br>D5<br>D5 AWD<br>D5 AWD<br>D5 AWD<br>T3<br>T3<br>T4<br>T4F<br>T5<br>T5<br>T6<br>T6 AWD<br>T6 AWD<br>T6 AWD | 90<br>84<br>165<br>149<br>140<br>186<br>84<br>88<br>100<br>110<br>120<br>120<br>133<br>140<br>140<br>151<br>158<br>169<br>151<br>158<br>169<br>110<br>112<br>132<br>132<br>176<br>180<br>225<br>224<br>225<br>242 |    |     |     |     | 10.15<br>01.11<br>03.15<br>04.10<br>05.15<br>09.12<br>04.13<br>03.15<br>05.12<br>03.15<br>04.10<br>05.12<br>09.13<br>03.15<br>03.15<br>04.10<br>06.11<br>04.10<br>06.11<br>04.10<br>03.15<br>04.10<br>04.11<br>04.10<br>09.13<br>09.13<br>04.10<br>09.15<br>04.14 | 24.0122-0259.1  | 422259           | + belüftete Scheiben <sup>1)</sup>                                       | 302 22,0 20,0 V L +S +B                |                    |  |
|  | 1.5 T2<br>1.6 D DRIVe<br>2.0 D5<br>2.0 T<br>2.0 T4<br>D2<br>D2<br>D3<br>D3<br>D3<br>D4<br>D4<br>D4<br>D4 AWD<br>D5<br>D5<br>D5<br>D5 AWD<br>D5 AWD<br>D5 AWD<br>T3<br>T3<br>T4<br>T4F<br>T5<br>T5<br>T6<br>T6 AWD<br>T6 AWD<br>T6 AWD               | 90<br>84<br>165<br>149<br>140<br>84<br>88<br>100<br>110<br>120<br>120<br>133<br>140<br>140<br>151<br>158<br>169<br>151<br>158<br>169<br>110<br>112<br>132<br>132<br>176<br>180<br>225<br>224<br>225<br>242        |    |     |     |     |   | 10.15<br>01.11<br>03.15<br>04.10<br>05.15<br>04.13<br>03.15<br>05.12<br>03.15<br>04.10<br>05.12<br>09.13<br>03.15<br>04.10<br>06.11<br>04.10<br>06.11<br>04.10<br>03.15<br>04.10<br>04.11<br>04.10<br>09.13<br>09.13<br>04.10<br>09.15<br>04.14                                     | 24.0711-6221.3   | 360258   | 2                                      | Radsensor          |  |



<sup>1)</sup> + ventilated discs / + dischi ventilati / + disques ventilés / + disco ventilado  
<sup>2)</sup> - ventilated discs / - dischi ventilati / - disques ventilés / - disco ventilado



**VOLVO S60 II (10-)**















|  |            |     |  |       |  |                |        |   |  |           |
|--|------------|-----|--|-------|--|----------------|--------|---|--|-----------|
|  | D5         | 151 |  | 04.10 |  | 24.0711-6221.3 | 360258 | 2 |  | Radsensor |
|  | D5         | 158 |  | 06.11 |  |                |        |   |  |           |
|  | D5         | 169 |  | 04.14 |  |                |        |   |  |           |
|  | T3         | 110 |  | 04.10 |  |                |        |   |  |           |
|  | T3         | 112 |  | 03.15 |  |                |        |   |  |           |
|  | T4         | 132 |  | 04.10 |  |                |        |   |  |           |
|  | T4F        | 132 |  | 04.11 |  |                |        |   |  |           |
|  | T5         | 176 |  | 04.10 |  |                |        |   |  |           |
|  | T5         | 180 |  | 09.13 |  |                |        |   |  |           |
|  | T6         | 225 |  | 09.13 |  |                |        |   |  |           |
|  | 2.5 T5 AWD | 186 |  | 09.12 |  | 24.0711-6369.3 | 360395 | 2 |  | Radsensor |
|  | 3.0 T6 AWD | 258 |  | 05.14 |  |                |        |   |  |           |
|  | D4 AWD     | 140 |  | 03.15 |  |                |        |   |  |           |
|  | D5 AWD     | 151 |  | 04.10 |  |                |        |   |  |           |
|  | D5 AWD     | 158 |  | 06.11 |  |                |        |   |  |           |
|  | D5 AWD     | 169 |  | 04.14 |  |                |        |   |  |           |
|  | T6 AWD     | 224 |  | 04.10 |  |                |        |   |  |           |
|  | T6 AWD     | 225 |  | 09.15 |  |                |        |   |  |           |
|  | T6 AWD     | 242 |  | 04.14 |  |                |        |   |  |           |

**VOLVO S70 (97-00)**

|  |              |     |  |       |       |                |        |  |                         |                         |     |
|--|--------------|-----|--|-------|-------|----------------|--------|--|-------------------------|-------------------------|-----|
|    | 2.0          | 93  |  | 01.97 | 11.00 | 13.0460-7053.2 | 607053 |  |                         | 21273 19,5 +/WE         | ATE |
|  | 2.0          | 105 |  | 01.97 | 11.00 | 13.0470-7053.2 | LD7053 |  |                         | 21273 19,5 +/WE         | ATE |
|  | 2.0 20V      | 120 |  | 01.97 | 11.00 |                |        |  |                         |                         |     |
|  | 2.0 20V      | 132 |  | 01.97 | 11.00 |                |        |  |                         |                         |     |
|  | 2.0 T        | 155 |  | 01.97 | 11.00 |                |        |  |                         |                         |     |
|  | 2.0 T        | 166 |  | 01.97 | 11.00 |                |        |  |                         |                         |     |
|  | 2.3          | 195 |  | 04.99 | 09.00 |                |        |  |                         |                         |     |
|  | 2.4          | 103 |  | 08.99 | 11.00 |                |        |  |                         |                         |     |
|  | 2.4          | 125 |  | 01.97 | 11.00 |                |        |  |                         |                         |     |
|  | 2.4 AWD      |     |  | 10.98 | 05.99 |                |        |  |                         |                         |     |
|  | 2.4 AWD      | 103 |  | 04.99 | 09.00 |                |        |  |                         |                         |     |
|  | 2.4 AWD      | 106 |  | 11.96 | 05.99 |                |        |  |                         |                         |     |
|  | 2.4 AWD      | 142 |  | 11.96 | 09.00 |                |        |  |                         |                         |     |
|  | 2.4 Blu-Fuel | 103 |  | 07.97 | 09.00 |                |        |  |                         |                         |     |
|  | 2.4 T        | 142 |  | 01.97 | 11.00 |                |        |  |                         |                         |     |
|  | 2.5          | 106 |  | 01.97 | 11.00 |                |        |  |                         |                         |     |
|  | 2.5          | 121 |  | 06.98 | 11.00 |                |        |  |                         |                         |     |
|  | 2.5 Bifuel   | 103 |  | 07.99 | 11.00 |                |        |  |                         |                         |     |
|  | 2.5 Bifuel   | 106 |  | 10.98 | 11.00 |                |        |  |                         |                         |     |
|  | 2.5 TDI      | 103 |  | 01.97 | 11.00 |                |        |  |                         |                         |     |
|  | 2.5 TDI AWD  | 103 |  | 10.99 | 09.00 |                |        |  |                         |                         |     |
|  | 2.3 T        | 184 |  | 01.97 | 11.00 | 13.0460-7053.2 | 607053 |  |                         | 21273 19,5 +/WE         | ATE |
|  | 2.3 T5       | 176 |  | 01.97 | 11.00 |                |        |  |                         |                         |     |
|  | 2.0          | 93  |  | 01.97 | 11.00 | 24.0126-0102.1 | 426102 |  | + 15" Rad <sup>1)</sup> | 280 26,0 23,0 V +B      |     |
|  | 2.0          | 105 |  | 01.97 | 11.00 |                |        |  |                         |                         |     |
|  | 2.0 20V      | 120 |  | 01.97 | 11.00 |                |        |  |                         |                         |     |
|  | 2.0 20V      | 132 |  | 01.97 | 11.00 |                |        |  |                         |                         |     |
|  | 2.0 T        | 155 |  | 01.97 | 11.00 |                |        |  |                         |                         |     |
|  | 2.0 T        | 166 |  | 01.97 | 11.00 |                |        |  |                         |                         |     |
|  | 2.3          | 195 |  | 04.99 | 09.00 |                |        |  |                         |                         |     |
|  | 2.3 T        | 184 |  | 01.97 | 11.00 |                |        |  |                         |                         |     |
|  | 2.3 T5       | 176 |  | 01.97 | 11.00 |                |        |  |                         |                         |     |
|  | 2.4          | 103 |  | 08.99 | 11.00 |                |        |  |                         |                         |     |
|  | 2.4          | 125 |  | 01.97 | 11.00 |                |        |  |                         |                         |     |
|  | 2.4 AWD      |     |  | 10.98 | 05.99 |                |        |  |                         |                         |     |
|  | 2.4 AWD      | 103 |  | 04.99 | 09.00 |                |        |  |                         |                         |     |
|  | 2.4 AWD      | 106 |  | 11.96 | 05.99 |                |        |  |                         |                         |     |
|  | 2.4 AWD      | 142 |  | 11.96 | 09.00 |                |        |  |                         |                         |     |
|  | 2.4 Blu-Fuel | 103 |  | 07.97 | 09.00 |                |        |  |                         |                         |     |
|  | 2.4 T        | 142 |  | 01.97 | 11.00 |                |        |  |                         |                         |     |
|  | 2.5          | 106 |  | 01.97 | 11.00 |                |        |  |                         |                         |     |
|  | 2.5          | 121 |  | 06.98 | 11.00 |                |        |  |                         |                         |     |
|  | 2.5 Bifuel   | 103 |  | 07.99 | 11.00 |                |        |  |                         |                         |     |
|  | 2.5 Bifuel   | 106 |  | 10.98 | 11.00 |                |        |  |                         |                         |     |
|  | 2.5 TDI      | 103 |  | 01.97 | 11.00 |                |        |  |                         |                         |     |
|  | 2.5 TDI AWD  | 103 |  | 10.99 | 09.00 |                |        |  |                         |                         |     |
|  | 2.0          | 93  |  | 01.97 | 11.00 | 24.0126-0107.1 | 426107 |  | + 16" Rad <sup>2)</sup> | 302 26,0 23,0 V L +B    |     |
|  | 2.0          | 105 |  | 01.97 | 11.00 | 24.0326-0107.1 | 526107 |  | + 16" Rad <sup>2)</sup> | 302 26,0 23,0 V L +B PD |     |
|  | 2.0 20V      | 120 |  | 01.97 | 11.00 |                |        |  |                         |                         |     |
|  | 2.0 20V      | 132 |  | 01.97 | 11.00 |                |        |  |                         |                         |     |
|  | 2.0 T        | 155 |  | 01.97 | 11.00 |                |        |  |                         |                         |     |
|  | 2.0 T        | 166 |  | 01.97 | 11.00 |                |        |  |                         |                         |     |
|  | 2.3          | 195 |  | 04.99 | 09.00 |                |        |  |                         |                         |     |
|  | 2.3 T        | 184 |  | 01.97 | 11.00 |                |        |  |                         |                         |     |
|  | 2.3 T5       | 176 |  | 01.97 | 11.00 |                |        |  |                         |                         |     |
|  | 2.4          | 103 |  | 08.99 | 11.00 |                |        |  |                         |                         |     |
|  | 2.4          | 125 |  | 01.97 | 11.00 |                |        |  |                         |                         |     |
|  | 2.4 AWD      |     |  | 10.98 | 05.99 |                |        |  |                         |                         |     |
|  | 2.4 AWD      | 103 |  | 04.99 | 09.00 |                |        |  |                         |                         |     |
|  | 2.4 AWD      | 106 |  | 11.96 | 05.99 |                |        |  |                         |                         |     |
|  | 2.4 AWD      | 142 |  | 11.96 | 09.00 |                |        |  |                         |                         |     |
|  | 2.4 Blu-Fuel | 103 |  | 07.97 | 09.00 |                |        |  |                         |                         |     |
|  | 2.4 T        | 142 |  | 01.97 | 11.00 |                |        |  |                         |                         |     |
|  | 2.5          | 106 |  | 01.97 | 11.00 |                |        |  |                         |                         |     |
|  | 2.5          | 121 |  | 06.98 | 11.00 |                |        |  |                         |                         |     |
|  | 2.5 Bifuel   | 103 |  | 07.99 | 11.00 |                |        |  |                         |                         |     |







1) + 15" wheel / + ruota 15" / + roue 15" / + rueda 15"

2) + 16" wheel / + ruota 16" / + roue 16" / + rueda 16"

|     |   |  |   |  |  |     |  |  |
|--|---|--|---|--|---|---|--|--|
| <b>VOLVO S70 (97-00)</b>   |   |  |   |  |   |   |  |  |
|    | 2.5 Bifuel 106<br>2.5 TDI 103<br>2.5 TDi AWD 103  |  | 10.98 11.00<br>01.97 11.00<br>10.99 09.00   |  | 24.0126-0107.1 426107<br>24.0326-0107.1 526107                                    |   | + 16" Rad <sup>1)</sup><br>+ 16" Rad <sup>1)</sup>                                 | 302 26,0 23,0 V L +B<br>302 26,0 23,0 V L +B PD                                    |
|    | 2.0 93<br>2.0 105<br>2.0 20V 120<br>2.0 20V 132<br>2.0 T 155<br>2.0 T 166<br>2.3 T 184<br>2.3 T5 176<br>2.4 125<br>2.4 AWD 106<br>2.4 AWD 142<br>2.4 Blu-Fuel 103<br>2.4 T 142<br>2.5 106<br>2.5 121<br>2.5 Bifuel 106<br>2.5 TDI 103   |  | 01.97 12.98<br>01.97 12.98<br>01.97 12.98<br>01.97 12.98<br>01.97 12.98<br>01.97 12.98<br>01.97 12.98<br>01.97 12.98<br>10.98 12.98<br>11.96 12.98<br>11.96 12.98<br>07.97 12.98<br>01.97 12.98<br>01.97 12.98<br>06.98 12.98<br>10.98 12.98<br>01.97 12.98   |  | 24.0711-1146.1 360060   | 2  |  | Radsensor  |
|  | 2.0 93<br>2.0 105<br>2.0 20V 120<br>2.0 20V 132<br>2.0 T 155<br>2.0 T 166<br>2.3 195<br>2.3 T 184<br>2.3 T5 176<br>2.4 103<br>2.4 125<br>2.4 AWD 103<br>2.4 AWD 106<br>2.4 AWD 142<br>2.4 Blu-Fuel 103<br>2.4 T 142<br>2.5 106<br>2.5 121<br>2.5 Bifuel 103<br>2.5 Bifuel 106<br>2.5 TDI 103<br>2.5 TDi AWD 103 |  | 01.99 11.00<br>01.99 11.00<br>01.99 11.00<br>01.99 11.00<br>01.99 11.00<br>01.99 11.00<br>04.99 09.00<br>01.99 11.00<br>01.99 11.00<br>08.99 11.00<br>01.99 11.00<br>01.99 05.99<br>04.99 09.00<br>01.99 05.99<br>01.99 09.00<br>01.99 09.00<br>01.99 11.00<br>01.99 11.00<br>07.99 11.00<br>01.99 11.00<br>01.99 11.00<br>10.99 09.00                |  | 24.0711-6011.3 360120   | 2  |  | Radsensor L=1000   |
|  | 2.0 93<br>2.0 105<br>2.0 20V 120<br>2.0 20V 132<br>2.0 T 155<br>2.0 T 166<br>2.3 195<br>2.3 T 184<br>2.3 T5 176<br>2.4 103<br>2.4 125<br>2.4 AWD 103<br>2.4 AWD 106<br>2.4 AWD 142<br>2.4 Blu-Fuel 103<br>2.4 T 142<br>2.5 106<br>2.5 121<br>2.5 Bifuel 103<br>2.5 Bifuel 106<br>2.5 TDI 103<br>2.5 TDi AWD 103 |  | 01.97 11.00<br>01.97 11.00<br>01.97 11.00<br>01.97 11.00<br>01.97 11.00<br>01.97 11.00<br>04.99 09.00<br>01.97 11.00<br>01.97 11.00<br>08.99 11.00<br>01.97 11.00<br>10.98 05.99<br>04.99 09.00<br>11.96 05.99<br>11.96 09.00<br>07.97 09.00<br>01.97 11.00<br>01.97 11.00<br>06.98 11.00<br>07.99 11.00<br>10.98 11.00<br>01.97 11.00<br>10.99 09.00 |  | 13.0460-4044.2 604044<br>13.0470-4044.2 LD4044                                    |   |  | 20755 15,1 ATE<br>20755 15,1 ATE   |
|  | 2.0 93<br>2.0 105<br>2.0 20V 120<br>2.0 20V 132<br>2.0 T 155<br>2.0 T 166<br>2.3 195<br>2.3 T 184<br>2.3 T5 176<br>2.4 103<br>2.4 125<br>2.4 AWD 103<br>2.4 AWD 106<br>2.4 AWD 142<br>2.4 Blu-Fuel 103<br>2.4 T 142<br>2.5 106<br>2.5 121<br>2.5 Bifuel 103<br>2.5 Bifuel 106<br>2.5 TDI 103<br>2.5 TDi AWD 103 |  | 01.97 11.00<br>01.97 11.00<br>01.97 11.00<br>01.97 11.00<br>01.97 11.00<br>01.97 11.00<br>04.99 09.00<br>01.97 11.00<br>01.97 11.00<br>08.99 11.00<br>01.97 11.00<br>10.98 05.99<br>04.99 09.00<br>11.96 05.99<br>11.96 09.00<br>07.97 09.00<br>01.97 11.00<br>01.97 11.00<br>06.98 11.00<br>07.99 11.00<br>10.98 11.00<br>01.97 11.00<br>07.99 11.00 |  | 24.0110-0214.1 410214   |   |  | 295 9,6 8,4 +B   |

<sup>1)</sup> + 16" wheel / + ruota 16" / + roue 16" / + rueda 16"



| VOLVO S70 (97-00)  |              |     |  |       |       |                |        |   |   |              |  |                       |     |
|--|--------------|-----|--|-------|-------|----------------|--------|---|---|--------------|--|-----------------------|-----|
|    | 2.5 Bifuel   | 106 |  | 10.98 | 11.00 | 24.0110-0214.1 | 410214 |   |   |              |  | 295 9,6 8,4 +B        |     |
|  | 2.5 TDI      | 103 |  | 01.97 | 11.00 |                |        |   |   |              |  |                       |     |
|  | 2.5 TDi AWD  | 103 |  | 10.99 | 09.00 |                |        |   |   |              |  |                       |     |
|    | 2.0          | 93  |  | 01.97 | 12.98 | 24.0741-1105.1 | 360195 | 1 |  |              |  | Radsensor L=1220/1840 |     |
|  | 2.0          | 105 |  | 01.97 | 12.98 |                |        |   |   |              |  |                       |     |
|  | 2.0 20V      | 120 |  | 01.97 | 12.98 |                |        |   |   |              |  |                       |     |
|  | 2.0 20V      | 132 |  | 01.97 | 12.98 |                |        |   |   |              |  |                       |     |
|  | 2.0 T        | 155 |  | 01.97 | 12.98 |                |        |   |   |              |  |                       |     |
|  | 2.0 T        | 166 |  | 01.97 | 12.98 |                |        |   |   |              |  |                       |     |
|  | 2.3 T        | 184 |  | 01.97 | 12.98 |                |        |   |   |              |  |                       |     |
|  | 2.3 T5       | 176 |  | 01.97 | 12.98 |                |        |   |   |              |  |                       |     |
|  | 2.4          | 125 |  | 01.97 | 12.98 |                |        |   |   |              |  |                       |     |
|  | 2.4 AWD      |     |  | 10.98 | 12.98 |                |        |   |   |              |  |                       |     |
|  | 2.4 AWD      | 106 |  | 11.96 | 12.98 |                |        |   |   |              |  |                       |     |
|  | 2.4 AWD      | 142 |  | 11.96 | 12.98 |                |        |   |   |              |  |                       |     |
|  | 2.4 Blu-Fuel | 103 |  | 07.97 | 12.98 |                |        |   |   |              |  |                       |     |
|  | 2.4 T        | 142 |  | 01.97 | 12.98 |                |        |   |   |              |  |                       |     |
|  | 2.5          | 106 |  | 01.97 | 12.98 |                |        |   |   |              |  |                       |     |
|  | 2.5          | 121 |  | 06.98 | 12.98 |                |        |   |   |              |  |                       |     |
|  | 2.5 Bifuel   | 106 |  | 10.98 | 12.98 |                |        |   |   |              |  |                       |     |
|  | 2.5 TDI      | 103 |  | 01.97 | 12.98 |                |        |   |   |              |  |                       |     |
|  | 2.0          | 93  |  | 01.99 | 11.00 | 24.0711-5025.3 | 360234 | 1 |  |              |  | Radsensor L=1215/1855 |     |
|  | 2.0          | 105 |  | 01.99 | 11.00 |                |        |   |   |              |  |                       |     |
|  | 2.0 20V      | 120 |  | 01.99 | 11.00 |                |        |   |   |              |  |                       |     |
|  | 2.0 20V      | 132 |  | 01.99 | 11.00 |                |        |   |   |              |  |                       |     |
|  | 2.0 T        | 155 |  | 01.99 | 11.00 |                |        |   |   |              |  |                       |     |
|  | 2.0 T        | 166 |  | 01.99 | 11.00 |                |        |   |   |              |  |                       |     |
|  | 2.3          | 195 |  | 04.99 | 09.00 |                |        |   |   |              |  |                       |     |
|  | 2.3 T        | 184 |  | 01.99 | 11.00 |                |        |   |   |              |  |                       |     |
|  | 2.3 T5       | 176 |  | 01.99 | 11.00 |                |        |   |   |              |  |                       |     |
|  | 2.4          | 103 |  | 08.99 | 11.00 |                |        |   |   |              |  |                       |     |
|  | 2.4          | 125 |  | 01.99 | 11.00 |                |        |   |   |              |  |                       |     |
|  | 2.4 AWD      |     |  | 01.99 | 05.99 |                |        |   |   |              |  |                       |     |
|  | 2.4 AWD      | 103 |  | 04.99 | 09.00 |                |        |   |   |              |  |                       |     |
|  | 2.4 AWD      | 106 |  | 01.99 | 05.99 |                |        |   |   |              |  |                       |     |
|  | 2.4 AWD      | 142 |  | 01.99 | 09.00 |                |        |   |   |              |  |                       |     |
|  | 2.4 Blu-Fuel | 103 |  | 01.99 | 09.00 |                |        |   |   |              |  |                       |     |
|  | 2.4 T        | 142 |  | 01.99 | 11.00 |                |        |   |   |              |  |                       |     |
|  | 2.5          | 106 |  | 01.99 | 11.00 |                |        |   |   |              |  |                       |     |
|  | 2.5          | 121 |  | 01.99 | 11.00 |                |        |   |   |              |  |                       |     |
|  | 2.5 Bifuel   | 103 |  | 07.99 | 11.00 |                |        |   |   |              |  |                       |     |
|  | 2.5 Bifuel   | 106 |  | 01.99 | 11.00 |                |        |   |   |              |  |                       |     |
|  | 2.5 TDI      | 103 |  | 01.99 | 11.00 |                |        |   |   |              |  |                       |     |
|  | 2.5 TDi AWD  | 103 |  | 10.99 | 09.00 |                |        |   |   |              |  |                       |     |
|  | 2.0          | 93  |  | 01.97 | 11.00 | 03.0137-0260.2 | 650260 |   |   |              |  | 178 x 25              |     |
|  | 2.0          | 105 |  | 01.97 | 11.00 | 03.0137-9176.2 | 669176 |   |   |              |  | Bremsbacken-Zubehör   |     |
|  | 2.0 20V      | 120 |  | 01.97 | 11.00 |                |        |   |   |              |  |                       |     |
|  | 2.0 20V      | 132 |  | 01.97 | 11.00 |                |        |   |   |              |  |                       |     |
|  | 2.0 T        | 155 |  | 01.97 | 11.00 |                |        |   |   |              |  |                       |     |
|  | 2.0 T        | 166 |  | 01.97 | 11.00 |                |        |   |   |              |  |                       |     |
|  | 2.3          | 195 |  | 04.99 | 09.00 |                |        |   |   |              |  |                       |     |
|  | 2.3 T        | 184 |  | 01.97 | 11.00 |                |        |   |   |              |  |                       |     |
|  | 2.3 T5       | 176 |  | 01.97 | 11.00 |                |        |   |   |              |  |                       |     |
|  | 2.4          | 103 |  | 08.99 | 11.00 |                |        |   |   |              |  |                       |     |
|  | 2.4          | 125 |  | 01.97 | 11.00 |                |        |   |   |              |  |                       |     |
|  | 2.4 AWD      |     |  | 10.98 | 05.99 |                |        |   |   |              |  |                       |     |
|  | 2.4 AWD      | 103 |  | 04.99 | 09.00 |                |        |   |   |              |  |                       |     |
|  | 2.4 AWD      | 106 |  | 11.96 | 05.99 |                |        |   |   |              |  |                       |     |
|  | 2.4 AWD      | 142 |  | 11.96 | 09.00 |                |        |   |   |              |  |                       |     |
|  | 2.4 Blu-Fuel | 103 |  | 07.97 | 09.00 |                |        |   |   |              |  |                       |     |
|  | 2.4 T        | 142 |  | 01.97 | 11.00 |                |        |   |   |              |  |                       |     |
|  | 2.5          | 106 |  | 01.97 | 11.00 |                |        |   |   |              |  |                       |     |
|  | 2.5          | 121 |  | 06.98 | 11.00 |                |        |   |   |              |  |                       |     |
|  | 2.5 Bifuel   | 103 |  | 07.99 | 11.00 |                |        |   |   |              |  |                       |     |
|  | 2.5 Bifuel   | 106 |  | 10.98 | 11.00 |                |        |   |   |              |  |                       |     |
|  | 2.5 TDI      | 103 |  | 01.97 | 11.00 |                |        |   |   |              |  |                       |     |
|  | 2.5 TDi AWD  | 103 |  | 10.99 | 09.00 |                |        |   |   |              |  |                       |     |
| VOLVO S80 I (98-06)  |              |     |  |       |       |                |        |   |   |              |  |                       |     |
|  | 2.0          | 120 |  | 06.98 | 02.06 | 13.0460-7145.2 | 607145 |   |   | - 17" Rad 1) |  | 23073 18,8 +          | ATE |
|  | 2.0 T        | 132 |  | 12.99 | 02.06 | 13.0470-7145.2 | LD7145 |   |   | - 17" Rad 1) |  | 23073 18,8 +          | ATE |
|  | 2.0 T        | 166 |  | 06.98 | 02.06 | 13.0460-7187.2 | 607187 |   |   | + 17" Rad 2) |  | 23950 19,5 +          | ATE |
|  | 2.4          | 103 |  | 01.99 | 02.06 | 13.0470-7187.2 | LD7187 |   |   | + 17" Rad 2) |  | 23950 19,5 +          | ATE |
|  | 2.4          | 125 |  | 01.99 | 02.06 |                |        |   |   |              |  |                       |     |
|  | 2.4 Bi-Fuel  | 103 |  | 09.01 | 02.06 |                |        |   |   |              |  |                       |     |
|  | 2.4 D        | 96  |  | 10.01 | 02.06 |                |        |   |   |              |  |                       |     |
|  | 2.4 D5       | 120 |  | 08.01 | 02.06 |                |        |   |   |              |  |                       |     |
|  | 2.4 T        | 147 |  | 06.00 | 02.06 |                |        |   |   |              |  |                       |     |
|  | 2.5 T        | 154 |  | 07.03 | 02.06 |                |        |   |   |              |  |                       |     |
|  | 2.5 TDI      | 103 |  | 01.99 | 02.06 |                |        |   |   |              |  |                       |     |
|  | 2.9          | 147 |  | 03.99 | 02.06 |                |        |   |   |              |  |                       |     |
|  | 2.9          | 150 |  | 05.98 | 02.06 |                |        |   |   |              |  |                       |     |
|  | 3.0          | 144 |  | 06.01 | 02.06 |                |        |   |   |              |  |                       |     |
|  | 2.8 T6       | 200 |  | 05.98 | 02.06 | 13.0460-7145.2 | 607145 |   |   | - 17" Rad 1) |  | 23073 18,8 +          | ATE |
|  | 3.0 T6       | 200 |  | 06.01 | 02.06 | 13.0460-7187.2 | 607187 |   |   | + 17" Rad 2) |  | 23950 19,5 +          | ATE |
|  |              |     |  |       |       | 13.0470-7187.2 | LD7187 |   |   | + 17" Rad 2) |  | 23950 19,5 +          | ATE |

1) - 17" wheel / - ruota 17" / - roue 17" / - rueda 17"  
2) + 17" wheel / + ruota 17" / + roue 17" / + rueda 17"





**VOLVO S80 I (98-06)**

|  |   |   |  |  |  |  |                                      |  |  |
|--|---|---|--|--|--|--|--------------------------------------|--|--|
|  | 2.0<br>2.0 T<br>2.0 T<br>2.4<br>2.4<br>2.4 Bi-Fuel<br>2.4 D<br>2.4 D5<br>2.4 T<br>2.5 T<br>2.5 TDI<br>2.8 T6<br>2.9<br>2.9<br>3.0<br>3.0 T6 | 120<br>132<br>166<br>103<br>125<br>103<br>96<br>120<br>147<br>154<br>103<br>200<br>147<br>150<br>144<br>200 |  | 06.98<br>12.99<br>06.98<br>01.99<br>01.99<br>09.01<br>10.01<br>08.01<br>06.00<br>07.03<br>01.99<br>05.98<br>03.99<br>05.98<br>06.01<br>06.01 | 02.06<br>02.06<br>02.06<br>02.06<br>02.06<br>02.06<br>02.06<br>02.06<br>02.06<br>02.06<br>02.06<br>02.06<br>02.06<br>02.06<br>02.06<br>02.06 | 24.0126-0122.1<br>24.0128-0123.1<br>24.0328-0123.1<br>24.0128-0184.1 | 426122<br>428123<br>528123<br>428184 | + 15" Rad <sup>1)</sup><br>+ 16" Rad <sup>2)</sup><br>+ 16" Rad <sup>2)</sup><br>+ 17" Rad <sup>3)</sup> | 286 26,0 23,0 V +B<br>305 27,9 25,0 V +B<br><b>305 27,9 25,0 V +B PD</b><br>320 28,0 25,0 V L +B |
|  | 2.0<br>2.0 T<br>2.4<br>2.4<br>2.5 TDI<br>2.8 T6<br>2.9<br>2.9   | 120<br>166<br>103<br>125<br>103<br>200<br>147<br>150  | 116810<br>116810<br>116810<br>116810<br>116810<br>116810<br>116810<br>116810   | 06.98<br>06.98<br>01.99<br>01.99<br>01.99<br>05.98<br>03.99<br>05.98   |  | 24.0711-6211.3   | 360233                               | 2  | Radsensor L=1085   |
|  | 2.0<br>2.0 T<br>2.0 T<br>2.4<br>2.4<br>2.4 Bi-Fuel<br>2.4 D<br>2.4 D5<br>2.4 T<br>2.5 T<br>2.5 TDI<br>2.8 T6<br>2.9<br>2.9<br>3.0<br>3.0 T6 | 120<br>132<br>166<br>103<br>125<br>103<br>96<br>120<br>147<br>154<br>103<br>200<br>147<br>150<br>144<br>200 | 116811<br>116811<br>116811<br>116811<br>116811<br>116811<br>116811<br>116811<br>116811<br>116811<br>116811<br>116811<br>116811<br>116811<br>116811 | 12.99<br>02.06<br>02.06<br>02.06<br>02.06<br>09.01<br>10.01<br>08.01<br>06.00<br>07.03<br>02.06<br>02.06<br>02.06<br>02.06<br>06.01<br>06.01 | 02.06<br>02.06<br>02.06<br>02.06<br>02.06<br>02.06<br>02.06<br>02.06<br>02.06<br>02.06<br>02.06<br>02.06<br>02.06<br>02.06<br>02.06<br>02.06 | 24.0711-6214.3<br>24.0711-6211.3                                     | 360230<br>360233                     | <br>   | Radsensor L=965<br>Radsensor L=1085  |
|  | 2.0<br>2.0 T<br>2.0 T<br>2.4<br>2.4<br>2.4 Bi-Fuel<br>2.4 D<br>2.4 D5<br>2.4 T<br>2.5 T<br>2.5 TDI<br>2.8 T6<br>2.9<br>2.9<br>3.0<br>3.0 T6 | 120<br>132<br>166<br>103<br>125<br>103<br>96<br>120<br>147<br>154<br>103<br>200<br>147<br>150<br>144<br>200 |  | 06.98<br>12.99<br>06.98<br>01.99<br>01.99<br>09.01<br>10.01<br>08.01<br>06.00<br>07.03<br>01.99<br>05.98<br>03.99<br>05.98<br>06.01<br>06.01 | 02.06<br>02.06<br>02.06<br>02.06<br>02.06<br>02.06<br>02.06<br>02.06<br>02.06<br>02.06<br>02.06<br>02.06<br>02.06<br>02.06<br>02.06<br>02.06 | 13.0460-7135.2<br>13.0470-7135.2                                     | 607135<br>LD7135                     |  | 23076 17,5 +<br>23076 17,5 +<br><b>ATE</b><br><b>ATE</b>   |
|  | 2.0<br>2.0 T<br>2.0 T<br>2.4<br>2.4<br>2.4 Bi-Fuel<br>2.4 D<br>2.4 D5<br>2.4 T<br>2.5 T<br>2.5 TDI<br>2.8 T6<br>2.9<br>2.9<br>3.0<br>3.0 T6 | 120<br>132<br>166<br>103<br>125<br>103<br>96<br>120<br>147<br>154<br>103<br>200<br>147<br>150<br>144<br>200 |  | 06.98<br>12.99<br>06.98<br>01.99<br>01.99<br>09.01<br>10.01<br>08.01<br>06.00<br>07.03<br>01.99<br>05.98<br>03.99<br>05.98<br>06.01<br>06.01 | 02.06<br>02.06<br>02.06<br>02.06<br>02.06<br>02.06<br>02.06<br>02.06<br>02.06<br>02.06<br>02.06<br>02.06<br>02.06<br>02.06<br>02.06<br>02.06 | 24.0112-0151.1<br>24.0312-0151.1                                     | 412151<br>512151                     |  | 288 11,9 10,0 +B<br><b>288 11,9 10,0 +B PD</b>   |
|  | 2.0<br>2.0 T<br>2.4<br>2.4<br>2.5 TDI<br>2.8 T6<br>2.9<br>2.9   | 120<br>166<br>103<br>125<br>103<br>200<br>147<br>150  | 116810<br>116810<br>116810<br>116810<br>116810<br>116810<br>116810<br>116810   | 06.98<br>06.98<br>01.99<br>01.99<br>01.99<br>05.98<br>03.99<br>05.98   |  | 24.0711-6019.3   | 360257                               | 2  | Radsensor L=1260   |
|  | 2.0<br>2.0 T<br>2.0 T<br>2.4<br>2.4<br>2.4 Bi-Fuel<br>2.4 D   | 120<br>132<br>166<br>103<br>125<br>103<br>96  | 116811<br>116811<br>116811<br>116811<br>116811<br>116811   | 02.06<br>12.99<br>02.06<br>02.06<br>02.06<br>02.06<br>09.01<br>10.01   | 02.06<br>02.06<br>02.06<br>02.06<br>02.06<br>02.06<br>02.06<br>02.06   | 24.0711-6212.3<br>24.0711-6213.3                                     | 360249<br>360250                     | <br>   | Radsensor L=1255<br>Radsensor L=1255   |

<sup>1)</sup> + 15" wheel / + ruota 15" / + roue 15" / + rueda 15"

<sup>2)</sup> + 16" wheel / + ruota 16" / + roue 16" / + rueda 16"

<sup>3)</sup> + 17" wheel / + ruota 17" / + roue 17" / + rueda 17"



### VOLVO S80 I (98-06)

|             |         |            |       |       |                |                |                                      |
|-------------|---------|------------|-------|-------|----------------|----------------|--------------------------------------|
|             | 2.4 D5  | 120        | 08.01 | 02.06 | 24.0711-6212.3 | 360249         | Radsensor L=1255<br>Radsensor L=1255 |
|             | 2.4 T   | 147        | 06.00 | 02.06 | 24.0711-6213.3 | 360250         |                                      |
|             | 2.5 T   | 154        | 07.03 | 02.06 |                |                |                                      |
|             | 2.5 TDI | 103 116811 |       | 02.06 |                |                |                                      |
|             | 2.8 T6  | 200 116811 |       | 02.06 |                |                |                                      |
|             | 2.9     | 147 116811 |       | 02.06 |                |                |                                      |
|             | 2.9     | 150 116811 |       | 02.06 |                |                |                                      |
|             | 3.0     | 144        | 06.01 | 02.06 |                |                |                                      |
|             | 3.0 T6  | 200        | 06.01 | 02.06 |                |                |                                      |
|             |         | 2.0        | 120   | 06.98 | 02.06          | 03.0137-0450.2 |                                      |
| 2.0 T       |         | 132        | 12.99 | 02.06 | 03.0137-9283.2 | 669283         |                                      |
| 2.0 T       |         | 166        | 06.98 | 02.06 |                |                |                                      |
| 2.4         |         | 103        | 01.99 | 02.06 |                |                |                                      |
| 2.4         |         | 125        | 01.99 | 02.06 |                |                |                                      |
| 2.4 Bi-Fuel |         | 103        | 09.01 | 02.06 |                |                |                                      |
| 2.4 D       |         | 96         | 10.01 | 02.06 |                |                |                                      |
| 2.4 D5      |         | 120        | 08.01 | 02.06 |                |                |                                      |
| 2.4 T       |         | 147        | 06.00 | 02.06 |                |                |                                      |
| 2.5 T       |         | 154        | 07.03 | 02.06 |                |                |                                      |
| 2.5 TDI     |         | 103        | 01.99 | 02.06 |                |                |                                      |
| 2.8 T6      |         | 200        | 05.98 | 02.06 |                |                |                                      |
| 2.9         |         | 147        | 03.99 | 02.06 |                |                |                                      |
| 2.9         |         | 150        | 05.98 | 02.06 |                |                |                                      |
| 3.0         |         | 144        | 06.01 | 02.06 |                |                |                                      |
| 3.0 T6      |         | 200        | 06.01 | 02.06 |                |                |                                      |

### VOLVO S80 II (06-)

|                 |               |       |       |  |                |        |                             |                              |            |
|-----------------|---------------|-------|-------|--|----------------|--------|-----------------------------|------------------------------|------------|
|                 | 1.6 D DRiVe   |       | 01.10 |  | 13.0460-7228.2 | 607228 | + 16" Rad <sup>1)</sup>     | 24123 20,3 +<br>24123 20,3 + | ATE<br>ATE |
|                 | 2.0           | 107   | 09.07 |  | 13.0470-7228.2 | LD7228 | + 16" Rad <sup>1)</sup>     |                              |            |
|                 | 2.0 D         | 100   | 09.07 |  |                |        |                             |                              |            |
|                 | 2.0 Drive-E   | 180   | 12.14 |  |                |        |                             |                              |            |
|                 | 2.0 FlexiFuel | 107   | 09.07 |  |                |        |                             |                              |            |
|                 | 2.0 T         | 149   | 01.10 |  |                |        |                             |                              |            |
|                 | 2.0 TDi       | 100   | 02.08 |  |                |        |                             |                              |            |
|                 | 2.4 D         | 120   | 03.06 |  |                |        |                             |                              |            |
|                 | 2.4 D         | 129   | 04.09 |  |                |        |                             |                              |            |
|                 | 2.4 D5        | 136   | 03.06 |  |                |        |                             |                              |            |
|                 | 2.4 D5        | 151   | 11.08 |  |                |        |                             |                              |            |
|                 | 2.4 D5        | 158   | 06.11 |  |                |        |                             |                              |            |
|                 | 2.4 D5 AWD    | 136   | 01.07 |  |                |        |                             |                              |            |
|                 | 2.4 D5 AWD    | 151   | 01.10 |  |                |        |                             |                              |            |
|                 | 2.4 D5 AWD    | 158   | 06.11 |  |                |        |                             |                              |            |
|                 | 2.5 T         | 147   | 03.06 |  |                |        |                             |                              |            |
|                 | 2.5 T         | 170   | 01.10 |  |                |        |                             |                              |            |
|                 | 2.5 T         | 183   | 09.12 |  |                |        |                             |                              |            |
|                 | 2.5 T         | 187   | 01.12 |  |                |        |                             |                              |            |
|                 | 2.5 T AWD     | 147   | 10.06 |  |                |        |                             |                              |            |
| 2.5 T FlexFuel  | 147           | 04.08 |       |  |                |        |                             |                              |            |
| 2.5 T FlexiFuel | 170           | 01.10 |       |  |                |        |                             |                              |            |
| 3.0 T6 AWD      | 210           | 01.07 |       |  |                |        |                             |                              |            |
| 3.2             |               | 03.06 |       |  |                |        |                             |                              |            |
| 3.2 AWD         |               | 01.07 |       |  |                |        |                             |                              |            |
| D2              | 84            | 04.13 |       |  |                |        |                             |                              |            |
| D3              | 100           | 05.12 |       |  |                |        |                             |                              |            |
| D3              | 120           | 01.10 |       |  |                |        |                             |                              |            |
| D4              | 133           | 09.13 |       |  |                |        |                             |                              |            |
| T4              | 132           | 10.10 |       |  |                |        |                             |                              |            |
| T4F             | 132           | 05.11 |       |  |                |        |                             |                              |            |
| T5              | 177           | 10.10 |       |  |                |        |                             |                              |            |
| T5              | 180           | 09.13 |       |  |                |        |                             |                              |            |
| 4.4 V8 AWD      | 232           | 03.06 |       |  | 13.0460-7228.2 | 607228 | + 16" Rad <sup>1)</sup>     | 24123 20,3 +                 | ATE        |
| T6 AWD          | 224           | 10.10 |       |  |                |        |                             |                              |            |
|                 | 1.6 D DRiVe   |       | 01.10 |  | 13.0460-7243.2 | 607243 | + 17"/18" Rad <sup>2)</sup> | 24142 20,6 +<br>24142 20,6 + | ATE<br>ATE |
|                 | 2.0           | 107   | 09.07 |  | 13.0470-7243.2 | LD7243 | + 17"/18" Rad <sup>2)</sup> |                              |            |
|                 | 2.0 D         | 100   | 09.07 |  |                |        |                             |                              |            |
|                 | 2.0 Drive-E   | 180   | 12.14 |  |                |        |                             |                              |            |
|                 | 2.0 FlexiFuel | 107   | 09.07 |  |                |        |                             |                              |            |
|                 | 2.0 T         | 149   | 01.10 |  |                |        |                             |                              |            |
|                 | 2.0 TDi       | 100   | 02.08 |  |                |        |                             |                              |            |
|                 | 2.4 D         | 120   | 03.06 |  |                |        |                             |                              |            |
|                 | 2.4 D         | 129   | 04.09 |  |                |        |                             |                              |            |
|                 | 2.4 D5        | 136   | 03.06 |  |                |        |                             |                              |            |
|                 | 2.4 D5        | 151   | 11.08 |  |                |        |                             |                              |            |
|                 | 2.4 D5        | 158   | 06.11 |  |                |        |                             |                              |            |
|                 | 2.4 D5 AWD    | 136   | 01.07 |  |                |        |                             |                              |            |
|                 | 2.4 D5 AWD    | 151   | 01.10 |  |                |        |                             |                              |            |
|                 | 2.4 D5 AWD    | 158   | 06.11 |  |                |        |                             |                              |            |
|                 | 2.5 T         | 147   | 03.06 |  |                |        |                             |                              |            |
|                 | 2.5 T         | 170   | 01.10 |  |                |        |                             |                              |            |
|                 | 2.5 T         | 183   | 09.12 |  |                |        |                             |                              |            |
|                 | 2.5 T         | 187   | 01.12 |  |                |        |                             |                              |            |
|                 | 2.5 T AWD     | 147   | 10.06 |  |                |        |                             |                              |            |
| 2.5 T FlexFuel  | 147           | 04.08 |       |  |                |        |                             |                              |            |
| 2.5 T FlexiFuel | 170           | 01.10 |       |  |                |        |                             |                              |            |
| 3.0 T6 AWD      | 210           | 01.07 |       |  |                |        |                             |                              |            |
| 3.2             |               | 03.06 |       |  |                |        |                             |                              |            |
| 3.2 AWD         |               | 01.07 |       |  |                |        |                             |                              |            |

<sup>1)</sup> + 16" wheel / + ruota 16" / + roue 16" / + rueda 16"  
<sup>2)</sup> + 17"/18" wheel / + ruota 17"/18" / + roue 17"/18" / + rueda 17"/18"

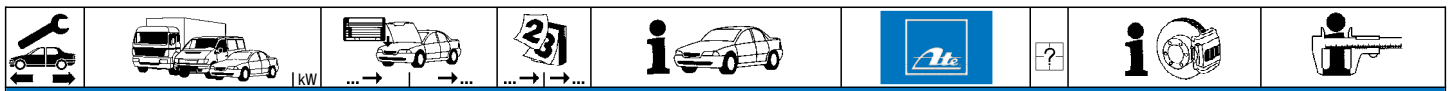

**VOLVO S80 II (06-)**

|  |  |   |   |                                  |  |  |   |  |
|--|--|---|---|----------------------------------|--|--|---|--|
|  | D2 84<br>D3 100<br>D3 120<br>D4 133<br>T4 132<br>T4F 132<br>T5 177<br>T5 180   | 04.13<br>05.12<br>01.10<br>09.13<br>10.10<br>05.11<br>10.10<br>09.13  | 13.0460-7243.2<br>13.0470-7243.2  | 607243<br>LD7243                 | + 17"/18" Rad <sup>1)</sup><br>+ 17"/18" Rad <sup>1)</sup> | 24142 20,6 +<br>24142 20,6 +                       | ATE<br>ATE  |  |
|  | 4.4 V8 AWD 232<br>T6 AWD 224   | 03.06<br>10.10  | 13.0460-7243.2  | 607243                           | + 17"/18" Rad <sup>1)</sup>                                | 24142 20,6 +                                       | ATE   |  |
|  | 1.6 D DRIVE<br>2.0<br>2.0 D<br>2.0 Drive-E<br>2.0 FlexiFuel<br>2.0 T<br>2.0 TDi<br>2.4 D<br>2.4 D<br>2.4 D5<br>2.4 D5<br>2.4 D5<br>2.4 D5 AWD<br>2.4 D5 AWD<br>2.4 D5 AWD<br>2.5 T<br>2.5 T<br>2.5 T<br>2.5 T<br>2.5 T AWD<br>2.5 T FlexFuel<br>2.5 T FlexiFuel<br>3.0 T6 AWD<br>3.2<br>3.2 AWD<br>4.4 V8 AWD<br>D2<br>D3<br>D3<br>D4<br>T4<br>T4F<br>T5<br>T5<br>T6 AWD | 107<br>100<br>180<br>107<br>149<br>100<br>120<br>129<br>136<br>151<br>158<br>136<br>151<br>158<br>147<br>170<br>183<br>187<br>147<br>147<br>170<br>210<br>232<br>84<br>100<br>120<br>133<br>132<br>132<br>177<br>180<br>224 | 01.10<br>09.07<br>09.07<br>12.14<br>09.07<br>01.10<br>02.08<br>03.06<br>04.09<br>03.06<br>11.08<br>06.11<br>01.07<br>01.10<br>06.11<br>03.06<br>01.10<br>01.12<br>10.06<br>04.08<br>01.10<br>01.07<br>03.06<br>01.07<br>03.06<br>05.12<br>01.10<br>09.13<br>10.10<br>05.11<br>10.10<br>09.13<br>10.10 | 24.0128-0154.1<br>24.0328-0154.1 | 428154<br>528154   | + 16" Rad <sup>2)</sup><br>+ 16" Rad <sup>2)</sup> | 300 28,0 26,0 V L +S +B<br>300 28,0 26,0 V L +S +B PD |  |
|  | 1.6 D DRIVE<br>2.0<br>2.0 D<br>2.0 Drive-E<br>2.0 FlexiFuel<br>2.0 T<br>2.0 TDi<br>2.4 D<br>2.4 D<br>2.4 D5<br>2.4 D5<br>2.4 D5<br>2.4 D5 AWD<br>2.4 D5 AWD<br>2.4 D5 AWD<br>2.5 T<br>2.5 T<br>2.5 T<br>2.5 T<br>2.5 T AWD<br>2.5 T FlexFuel<br>2.5 T FlexiFuel<br>3.0 T6 AWD<br>3.2<br>3.2 AWD<br>4.4 V8 AWD<br>D2<br>D3<br>D3<br>D4<br>T4<br>T4F<br>T5<br>T5<br>T6 AWD | 107<br>100<br>180<br>107<br>149<br>100<br>120<br>129<br>136<br>151<br>158<br>136<br>151<br>158<br>147<br>170<br>183<br>187<br>147<br>147<br>170<br>210<br>232<br>84<br>100<br>120<br>133<br>132<br>132<br>177<br>180<br>224 | 01.10<br>09.07<br>09.07<br>12.14<br>09.07<br>01.10<br>02.08<br>03.06<br>04.09<br>03.06<br>11.08<br>06.11<br>01.07<br>01.10<br>06.11<br>03.06<br>01.10<br>01.12<br>10.06<br>04.08<br>01.10<br>01.07<br>03.06<br>01.07<br>03.06<br>05.12<br>01.10<br>09.13<br>10.10<br>05.11<br>10.10<br>09.13<br>10.10 | 24.0128-0162.1<br>24.0328-0162.1 | 428162<br>528162   | + 17" Rad <sup>3)</sup><br>+ 17" Rad <sup>3)</sup> | 316 28,0 26,0 V L +S +B<br>316 28,0 26,0 V L +S +B PD |  |
|  | 1.6 D DRIVE<br>2.0<br>2.0 D<br>2.0 Drive-E<br>2.0 FlexiFuel<br>2.0 T<br>2.0 TDi<br>2.4 D<br>2.4 D<br>2.4 D5<br>2.4 D5<br>2.4 D5<br>2.4 D5 AWD<br>2.4 D5 AWD<br>2.4 D5 AWD<br>2.5 T<br>2.5 T<br>2.5 T<br>2.5 T<br>2.5 T AWD<br>2.5 T FlexFuel<br>2.5 T FlexiFuel<br>3.0 T6 AWD<br>3.2<br>3.2 AWD<br>4.4 V8 AWD<br>D2<br>D3<br>D3<br>D4<br>T4<br>T4F<br>T5<br>T5<br>T6 AWD | 107<br>100<br>180<br>107<br>149<br>100<br>120<br>129<br>136<br>151<br>158<br>136<br>151<br>158<br>147<br>170<br>183<br>187<br>147<br>147<br>170<br>210<br>232<br>84<br>100<br>120<br>133<br>132<br>132<br>177<br>180<br>224 | 01.10<br>09.07<br>09.07<br>12.14<br>09.07<br>01.10<br>02.08<br>03.06<br>04.09<br>03.06<br>11.08<br>06.11<br>01.07<br>01.10<br>06.11<br>03.06<br>01.10<br>01.12<br>10.06<br>04.08<br>01.10<br>01.07<br>03.06<br>01.07<br>03.06<br>05.12<br>01.10<br>09.13<br>10.10<br>05.11<br>10.10<br>09.13<br>10.10 | 24.0128-0210.1                   | 428210   | + 18" Rad <sup>4)</sup>                            | 336 28,0 26,0 V L +S +B                               |  |

<sup>1)</sup> + 17"/18" wheel / + ruota 17"/18" / + roue 17"/18" / + rueda 17"/18"

<sup>2)</sup> + 16" wheel / + ruota 16" / + roue 16" / + rueda 16"

<sup>3)</sup> + 17" wheel / + ruota 17" / + roue 17" / + rueda 17"

<sup>4)</sup> + 18" wheel / + ruota 18" / + roue 18" / + rueda 18"





**VOLVO S80 II (06-)**

|  |   |   |  |  |                        |
|--|---|---|--|--|------------------------|
|  | 2.4 D 120<br>2.4 D 129<br>2.4 D5 136<br>2.4 D5 151<br>2.4 D5 158<br>2.4 D5 AWD 136<br>2.4 D5 AWD 151<br>2.4 D5 AWD 158<br>2.5 T 147<br>2.5 T 170<br>2.5 T 183<br>2.5 T 187<br>2.5 T AWD 147<br>2.5 T FlexFuel 147<br>2.5 T FlexiFuel 170<br>3.0 T6 AWD 210<br>3.2<br>3.2 AWD<br>4.4 V8 AWD 232<br>D2 84<br>D3 100<br>D3 120<br>D4 133<br>T5 177<br>T5 180<br>T6 AWD 224 | 03.06<br>04.09<br>03.06<br>11.08<br>06.11<br>01.07<br>01.10<br>06.11<br>03.06<br>01.10<br>09.12<br>01.12<br>10.06<br>04.08<br>01.10<br>03.06<br>01.07<br>03.06<br>04.13<br>05.12<br>01.10<br>09.13<br>10.10<br>09.13<br>10.10 | 24.0128-0210.1<br>428210                             | + 18" Rad <sup>1)</sup>  | 336 28,0 26,0 VL +S +B |
|  | 1.6 D DRIVE 107<br>2.0 D 100<br>2.0 FlexiFuel 107<br>2.0 T 149<br>2.0 TDi 100<br>2.4 D 120<br>2.4 D 129<br>2.4 D5 136<br>2.4 D5 151<br>2.4 D5 AWD 136<br>2.4 D5 AWD 151<br>2.5 T 147<br>2.5 T AWD 147<br>2.5 T FlexFuel 147<br>3.0 T6 AWD 210<br>3.2<br>3.2 AWD<br>4.4 V8 AWD 232<br>D3 120   | 01.10<br>09.07<br>09.07<br>09.07<br>01.10<br>02.08<br>03.06<br>04.09<br>03.06<br>11.08<br>01.07<br>01.10<br>03.06<br>10.06<br>04.08<br>01.07<br>03.06<br>01.07<br>03.06<br>01.10  | 24.0711-5198.3<br>360239                             | 2  | Radsensor              |
|  | 2.0 Drive-E 180<br>2.4 D5 158<br>2.4 D5 AWD 158<br>2.5 T 170<br>2.5 T 183<br>2.5 T 187<br>2.5 T FlexiFuel 170<br>D2 84<br>D3 100<br>T4 132<br>T4F 132<br>T5 177<br>T5 180<br>T6 AWD 224   | 12.14<br>06.11<br>06.11<br>01.10<br>09.12<br>01.12<br>01.10<br>04.13<br>05.12<br>10.10<br>05.11<br>10.10<br>09.13<br>10.10  | 24.0711-5198.3<br>360239                             | 2  - Kollisionswarnsystem <sup>2)</sup>                                      | Radsensor              |
|  | 2.0 Drive-E 180<br>2.4 D5 158<br>2.4 D5 AWD 158<br>2.5 T 170<br>2.5 T 183<br>2.5 T 187<br>2.5 T FlexiFuel 170<br>D2 84<br>D3 100<br>D4 133<br>T4 132<br>T4F 132<br>T5 177<br>T5 180<br>T6 AWD 224   | 12.14<br>06.11<br>06.11<br>01.10<br>09.12<br>01.12<br>01.10<br>04.13<br>05.12<br>09.13<br>10.10<br>05.11<br>10.10<br>09.13<br>10.10   | 24.0711-5198.3<br>24.0711-5241.3<br>360239<br>360319 | + Kollisionswarnsystem <sup>3)</sup><br>+ Kollisionswarnsystem <sup>3)</sup> | Radsensor<br>Radsensor |
|  | 1.6 D DRIVE 107<br>2.0 D 100<br>2.0 Drive-E 180<br>2.0 FlexiFuel 107<br>2.0 T 149<br>2.0 TDi 100<br>2.4 D 120<br>2.4 D 129<br>2.4 D5 136<br>2.4 D5 151<br>2.4 D5 158  | 01.10<br>09.07<br>09.07<br>12.14<br>09.07<br>01.10<br>02.08<br>03.06<br>04.09<br>03.06<br>11.08<br>06.11  | 13.0460-2737.2<br>602737                             | - elektrische Feststellbremse <sup>4)</sup>                                  | 24537 15,8 /Zub/S TRW  |

<sup>1)</sup> + 18" wheel / + ruota 18" / + roue 18" / + rueda 18"  
<sup>2)</sup> - collision warning system / - sistema anti-collozione / - système anticollision / - sistema anticollisión  
<sup>3)</sup> + collision warning system / + sistema anti-collozione / + système anticollision / + sistema anticollisión  
<sup>4)</sup> - electric parking brake / - freno a mano elettrico / - frein à main électrique / - freno de mano eléctrico



**VOLVO S80 II (06-)**

|                 |                 |     |       |                                    |                                  |                |   |   |                   |     |
|-----------------|-----------------|-----|-------|------------------------------------|----------------------------------|----------------|---|---|-------------------|-----|
|                 | 2.4 D5 AWD      | 136 |       | 01.07                              |                                  | 13.0460-2737.2 | 602737                                      | - elektrische Feststellbremse <sup>1)</sup> | 24537 15,8 /Zub/S | TRW |
|                 | 2.4 D5 AWD      | 151 |       | 01.10                              |                                  |                |   |   |                   |     |
|                 | 2.4 D5 AWD      | 158 |       | 06.11                              |                                  |                |   |   |                   |     |
|                 | 2.5 T           | 147 |       | 03.06                              |                                  |                |   |   |                   |     |
|                 | 2.5 T           | 170 |       | 01.10                              |                                  |                |   |   |                   |     |
|                 | 2.5 T           | 183 |       | 09.12                              |                                  |                |   |   |                   |     |
|                 | 2.5 T           | 187 |       | 01.12                              |                                  |                |   |   |                   |     |
|                 | 2.5 T AWD       | 147 |       | 10.06                              |                                  |                |   |   |                   |     |
|                 | 2.5 T FlexFuel  | 147 |       | 04.08                              |                                  |                |   |   |                   |     |
|                 | 2.5 T FlexiFuel | 170 |       | 01.10                              |                                  |                |   |   |                   |     |
|                 | 3.0 T6 AWD      | 210 |       | 01.07                              |                                  |                |   |   |                   |     |
|                 | 3.2             |     |       | 03.06                              |                                  |                |   |   |                   |     |
|                 | 3.2 AWD         |     |       | 01.07                              |                                  |                |   |   |                   |     |
|                 | 4.4 V8 AWD      | 232 |       | 03.06                              |                                  |                |   |   |                   |     |
|                 | D2              | 84  |       | 04.13                              |                                  |                |   |   |                   |     |
|                 | D3              | 100 |       | 05.12                              |                                  |                |   |   |                   |     |
|                 | D3              | 120 |       | 01.10                              |                                  |                |   |   |                   |     |
|                 | D4              | 133 |       | 09.13                              |                                  |                |   |   |                   |     |
|                 | T4              | 132 |       | 10.10                              |                                  |                |   |   |                   |     |
|                 | T4F             | 132 |       | 05.11                              |                                  |                |   |   |                   |     |
|                 | T5              | 177 |       | 10.10                              |                                  |                |   |   |                   |     |
|                 | T5              | 180 |       | 09.13                              |                                  |                |   |   |                   |     |
|                 | T6 AWD          | 224 |       | 10.10                              |                                  |                |   |   |                   |     |
|                 | 1.6 D DRIVE     |     |       | 01.10                              | + massive Scheiben <sup>2)</sup> | 13.0460-2722.2 | 602722                                      | + elektrische Feststellbremse <sup>3)</sup> | 24496 17,3 /Zub/S | TRW |
|                 | 2.0             | 107 |       | 09.07                              | + massive Scheiben <sup>2)</sup> | 13.0470-2722.2 | LD2722                                      | + elektrische Feststellbremse <sup>3)</sup> | 24496 17,3 /Zub/S | TRW |
|                 | 2.0 D           | 100 |       | 09.07                              | + massive Scheiben <sup>2)</sup> |                |   |   |                   |     |
|                 | 2.0 Drive-E     | 180 |       | 12.14                              | + massive Scheiben <sup>2)</sup> |                |   |   |                   |     |
|                 | 2.0 FlexiFuel   | 107 |       | 09.07                              | + massive Scheiben <sup>2)</sup> |                |   |   |                   |     |
| 2.0 T           | 149             |     | 01.10 | + massive Scheiben <sup>2)</sup>   |                                  |                |   |   |                   |     |
| 2.0 TDi         | 100             |     | 02.08 | + massive Scheiben <sup>2)</sup>   |                                  |                |   |   |                   |     |
| 2.4 D           | 120             |     | 03.06 | + massive Scheiben <sup>2)</sup>   |                                  |                |   |   |                   |     |
| 2.4 D           | 129             |     | 04.09 | + massive Scheiben <sup>2)</sup>   |                                  |                |   |   |                   |     |
| 2.4 D5          | 136             |     | 03.06 | + massive Scheiben <sup>2)</sup>   |                                  |                |   |   |                   |     |
| 2.4 D5          | 151             |     | 11.08 | + massive Scheiben <sup>2)</sup>   |                                  |                |   |   |                   |     |
| 2.4 D5          | 158             |     | 06.11 | + massive Scheiben <sup>2)</sup>   |                                  |                |   |   |                   |     |
| 2.4 D5 AWD      | 136             |     | 01.07 | + massive Scheiben <sup>2)</sup>   |                                  |                |   |   |                   |     |
| 2.4 D5 AWD      | 151             |     | 01.10 | + massive Scheiben <sup>2)</sup>   |                                  |                |   |   |                   |     |
| 2.4 D5 AWD      | 158             |     | 06.11 | + massive Scheiben <sup>2)</sup>   |                                  |                |   |   |                   |     |
| 2.5 T           | 147             |     | 03.06 | + massive Scheiben <sup>2)</sup>   |                                  |                |   |   |                   |     |
| 2.5 T           | 170             |     | 01.10 | + massive Scheiben <sup>2)</sup>   |                                  |                |   |   |                   |     |
| 2.5 T           | 183             |     | 09.12 | + massive Scheiben <sup>2)</sup>   |                                  |                |   |   |                   |     |
| 2.5 T           | 187             |     | 01.12 | + massive Scheiben <sup>2)</sup>   |                                  |                |   |   |                   |     |
| 2.5 T AWD       | 147             |     | 10.06 | + massive Scheiben <sup>2)</sup>   |                                  |                |   |   |                   |     |
| 2.5 T FlexFuel  | 147             |     | 04.08 | + massive Scheiben <sup>2)</sup>   |                                  |                |   |   |                   |     |
| 2.5 T FlexiFuel | 170             |     | 01.10 | + massive Scheiben <sup>2)</sup>   |                                  |                |   |   |                   |     |
| 3.0 T6 AWD      | 210             |     | 01.07 | + massive Scheiben <sup>2)</sup>   |                                  |                |   |   |                   |     |
| 3.2             |                 |     | 03.06 | + massive Scheiben <sup>2)</sup>   |                                  |                |   |   |                   |     |
| 3.2 AWD         |                 |     | 01.07 | + massive Scheiben <sup>2)</sup>   |                                  |                |   |   |                   |     |
| 4.4 V8 AWD      | 232             |     | 03.06 | + massive Scheiben <sup>2)</sup>   |                                  |                |   |   |                   |     |
| D2              | 84              |     | 04.13 | + massive Scheiben <sup>2)</sup>   |                                  |                |   |   |                   |     |
| D3              | 100             |     | 05.12 | + massive Scheiben <sup>2)</sup>   |                                  |                |   |   |                   |     |
| D3              | 120             |     | 01.10 | + massive Scheiben <sup>2)</sup>   |                                  |                |   |   |                   |     |
| D4              | 133             |     | 09.13 | + massive Scheiben <sup>2)</sup>   |                                  |                |   |   |                   |     |
| T4              | 132             |     | 10.10 | + massive Scheiben <sup>2)</sup>   |                                  |                |   |   |                   |     |
| T4F             | 132             |     | 05.11 | + massive Scheiben <sup>2)</sup>   |                                  |                |   |   |                   |     |
| T5              | 177             |     | 10.10 | + massive Scheiben <sup>2)</sup>   |                                  |                |   |   |                   |     |
| T5              | 180             |     | 09.13 | + massive Scheiben <sup>2)</sup>   |                                  |                |   |   |                   |     |
| T6 AWD          | 224             |     | 10.10 | + massive Scheiben <sup>2)</sup>   |                                  |                |   |   |                   |     |
| 1.6 D DRIVE     |                 |     | 01.10 | + belüftete Scheiben <sup>4)</sup> | 13.0460-2736.2                   | 602736         | + elektrische Feststellbremse <sup>3)</sup> | 24496 17,3 /Zub/S                           | TRW               |     |
| 2.0             | 107             |     | 09.07 | + belüftete Scheiben <sup>4)</sup> | 13.0470-2736.2                   | LD2736         | + elektrische Feststellbremse <sup>3)</sup> | 24496 17,3 /Zub/S                           | TRW               |     |
| 2.0 D           | 100             |     | 09.07 | + belüftete Scheiben <sup>4)</sup> |                                  |                |   |   |                   |     |
| 2.0 Drive-E     | 180             |     | 12.14 | + belüftete Scheiben <sup>4)</sup> |                                  |                |   |   |                   |     |
| 2.0 FlexiFuel   | 107             |     | 09.07 | + belüftete Scheiben <sup>4)</sup> |                                  |                |   |   |                   |     |
| 2.0 T           | 149             |     | 01.10 | + belüftete Scheiben <sup>4)</sup> |                                  |                |   |   |                   |     |
| 2.0 TDi         | 100             |     | 02.08 | + belüftete Scheiben <sup>4)</sup> |                                  |                |   |   |                   |     |
| 2.4 D           | 120             |     | 03.06 | + belüftete Scheiben <sup>4)</sup> |                                  |                |   |   |                   |     |
| 2.4 D           | 129             |     | 04.09 | + belüftete Scheiben <sup>4)</sup> |                                  |                |   |   |                   |     |
| 2.4 D5          | 136             |     | 03.06 | + belüftete Scheiben <sup>4)</sup> |                                  |                |   |   |                   |     |
| 2.4 D5          | 151             |     | 11.08 | + belüftete Scheiben <sup>4)</sup> |                                  |                |   |   |                   |     |
| 2.4 D5          | 158             |     | 06.11 | + belüftete Scheiben <sup>4)</sup> |                                  |                |   |   |                   |     |
| 2.4 D5 AWD      | 136             |     | 01.07 | + belüftete Scheiben <sup>4)</sup> |                                  |                |   |   |                   |     |
| 2.4 D5 AWD      | 151             |     | 01.10 | + belüftete Scheiben <sup>4)</sup> |                                  |                |   |   |                   |     |
| 2.4 D5 AWD      | 158             |     | 06.11 | + belüftete Scheiben <sup>4)</sup> |                                  |                |   |   |                   |     |
| 2.5 T           | 147             |     | 03.06 | + belüftete Scheiben <sup>4)</sup> |                                  |                |   |   |                   |     |
| 2.5 T           | 170             |     | 01.10 | + belüftete Scheiben <sup>4)</sup> |                                  |                |   |   |                   |     |
| 2.5 T           | 183             |     | 09.12 | + belüftete Scheiben <sup>4)</sup> |                                  |                |   |   |                   |     |
| 2.5 T           | 187             |     | 01.12 | + belüftete Scheiben <sup>4)</sup> |                                  |                |   |   |                   |     |
| 2.5 T AWD       | 147             |     | 10.06 | + belüftete Scheiben <sup>4)</sup> |                                  |                |   |   |                   |     |
| 2.5 T FlexFuel  | 147             |     | 04.08 | + belüftete Scheiben <sup>4)</sup> |                                  |                |   |   |                   |     |
| 2.5 T FlexiFuel | 170             |     | 01.10 | + belüftete Scheiben <sup>4)</sup> |                                  |                |   |   |                   |     |
| 3.0 T6 AWD      | 210             |     | 01.07 | + belüftete Scheiben <sup>4)</sup> |                                  |                |   |   |                   |     |
| 3.2             |                 |     | 03.06 | + belüftete Scheiben <sup>4)</sup> |                                  |                |   |   |                   |     |
| 3.2 AWD         |                 |     | 01.07 | + belüftete Scheiben <sup>4)</sup> |                                  |                |   |   |                   |     |
| 4.4 V8 AWD      | 232             |     | 03.06 | + belüftete Scheiben <sup>4)</sup> |                                  |                |   |   |                   |     |
| D2              | 84              |     | 04.13 | + belüftete Scheiben <sup>4)</sup> |                                  |                |   |   |                   |     |
| D3              | 100             |     | 05.12 | + belüftete Scheiben <sup>4)</sup> |                                  |                |   |   |                   |     |
| D3              | 120             |     | 01.10 | + belüftete Scheiben <sup>4)</sup> |                                  |                |   |   |                   |     |

<sup>1)</sup> - electric parking brake / - freno a mano elettrico / - frein à main électrique / - freno de mano eléctrico

<sup>2)</sup> + solid discs / + dischi massiccio / + disques massive / + disco macizo















<sup>3)</sup> + electric parking brake / + freno a mano elettrico / + frein à main électrique / + freno de mano eléctrico

<sup>4)</sup> + ventilated discs / + dischi ventilati / + disques ventilés / + disco ventilado

















|     |                 |  |  |  |                                    |  |        |  |   |  |   |  |  |  |  |  |  |
|--|-----------------|--|--|--|------------------------------------|--|--------|--|---|---|---|--|--|--|--|--|--|
| <b>VOLVO S80 II (06-)</b>  |                 |  |  |  |                                    |  |        |  |   |   |   |  |  |  |  |  |  |
|    | 2.4 D5          | 158  |  | 06.11  | + belüftete Scheiben <sup>1)</sup> | 24.0122-0259.1   | 422259 |  |   |   | + elektrische Feststellbremse <sup>2)</sup> | 302 22,0 20,0 VL +S +B   |  |  |  |  |  |
|  | 2.4 D5 AWD      | 136  |  | 01.07  | + belüftete Scheiben <sup>1)</sup> |  |        |  |   |   |   |  |  |  |  |  |  |
|  | 2.4 D5 AWD      | 151  |  | 01.10  | + belüftete Scheiben <sup>1)</sup> |  |        |  |   |   |   |  |  |  |  |  |  |
|  | 2.4 D5 AWD      | 158  |  | 06.11  | + belüftete Scheiben <sup>1)</sup> |  |        |  |   |   |   |  |  |  |  |  |  |
|  | 2.5 T           | 147  |  | 03.06  | + belüftete Scheiben <sup>1)</sup> |  |        |  |   |   |   |  |  |  |  |  |  |
|  | 2.5 T           | 170  |  | 01.10  | + belüftete Scheiben <sup>1)</sup> |  |        |  |   |   |   |  |  |  |  |  |  |
|  | 2.5 T           | 183  |  | 09.12  | + belüftete Scheiben <sup>1)</sup> |  |        |  |   |   |   |  |  |  |  |  |  |
|  | 2.5 T           | 187  |  | 01.12  | + belüftete Scheiben <sup>1)</sup> |  |        |  |   |   |   |  |  |  |  |  |  |
|  | 2.5 T AWD       | 147  |  | 10.06  | + belüftete Scheiben <sup>1)</sup> |  |        |  |   |   |   |  |  |  |  |  |  |
|  | 2.5 T FlexFuel  | 147  |  | 04.08  | + belüftete Scheiben <sup>1)</sup> |  |        |  |   |   |   |  |  |  |  |  |  |
|  | 2.5 T FlexiFuel | 170  |  | 01.10  | + belüftete Scheiben <sup>1)</sup> |  |        |  |   |   |   |  |  |  |  |  |  |
|  | 3.0 T6 AWD      | 210  |  | 01.07  | + belüftete Scheiben <sup>1)</sup> |  |        |  |   |   |   |  |  |  |  |  |  |
|  | 3.2             |  |  | 03.06  | + belüftete Scheiben <sup>1)</sup> |  |        |  |   |   |   |  |  |  |  |  |  |
|  | 3.2 AWD         |  |  | 01.07  | + belüftete Scheiben <sup>1)</sup> |  |        |  |   |   |   |  |  |  |  |  |  |
|  | 4.4 V8 AWD      | 232  |  | 03.06  | + belüftete Scheiben <sup>1)</sup> |  |        |  |   |   |   |  |  |  |  |  |  |
|  | D2              | 84   |  | 04.13  | + belüftete Scheiben <sup>1)</sup> |  |        |  |   |   |   |  |  |  |  |  |  |
|  | D3              | 100  |  | 05.12  | + belüftete Scheiben <sup>1)</sup> |  |        |  |   |   |   |  |  |  |  |  |  |
|  | D3              | 120  |  | 01.10  | + belüftete Scheiben <sup>1)</sup> |  |        |  |   |   |   |  |  |  |  |  |  |
|  | D4              | 133  |  | 09.13  | + belüftete Scheiben <sup>1)</sup> |  |        |  |   |   |   |  |  |  |  |  |  |
|  | T4              | 132  |  | 10.10  | + belüftete Scheiben <sup>1)</sup> |  |        |  |   |   |   |  |  |  |  |  |  |
|  | T4F             | 132  |  | 05.11  | + belüftete Scheiben <sup>1)</sup> |  |        |  |   |   |   |  |  |  |  |  |  |
|  | T5              | 177  |  | 10.10  | + belüftete Scheiben <sup>1)</sup> |  |        |  |   |   |   |  |  |  |  |  |  |
|  | T5              | 180  |  | 09.13  | + belüftete Scheiben <sup>1)</sup> |  |        |  |   |   |   |  |  |  |  |  |  |
|  | T6 AWD          | 224  |  | 10.10  | + belüftete Scheiben <sup>1)</sup> |  |        |  |   |   |   |  |  |  |  |  |  |
|    | 1.6 D DRIVE     |  |  | 01.10  |                                    | 24.0711-6221.3   | 360258 | 2  |    |   | Radsensor                                   |  |  |  |  |  |  |
|  | 2.0             | 107  |  | 09.07  |                                    |  |        |  |   |   |   |  |  |  |  |  |  |
|  | 2.0 D           | 100  |  | 09.07  |                                    |  |        |  |   |   |   |  |  |  |  |  |  |
|  | 2.0 Drive-E     | 180  |  | 12.14  |                                    |  |        |  |   |   |   |  |  |  |  |  |  |
|  | 2.0 FlexiFuel   | 107  |  | 09.07  |                                    |  |        |  |   |   |   |  |  |  |  |  |  |
|  | 2.0 T           | 149  |  | 01.10  |                                    |  |        |  |   |   |   |  |  |  |  |  |  |
|  | 2.0 TDi         | 100  |  | 02.08  |                                    |  |        |  |   |   |   |  |  |  |  |  |  |
|  | 2.4 D           | 120  |  | 03.06  |                                    |  |        |  |   |   |   |  |  |  |  |  |  |
|  | 2.4 D           | 129  |  | 04.09  |                                    |  |        |  |   |   |   |  |  |  |  |  |  |
|  | 2.4 D5          | 136  |  | 03.06  |                                    |  |        |  |   |   |   |  |  |  |  |  |  |
|  | 2.4 D5          | 151  |  | 11.08  |                                    |  |        |  |   |   |   |  |  |  |  |  |  |
|  | 2.4 D5          | 158  |  | 06.11  |                                    |  |        |  |   |   |   |  |  |  |  |  |  |
|  | 2.5 T           | 147  |  | 03.06  |                                    |  |        |  |   |   |   |  |  |  |  |  |  |
|  | 2.5 T           | 170  |  | 01.10  |                                    |  |        |  |   |   |   |  |  |  |  |  |  |
|  | 2.5 T           | 183  |  | 09.12  |                                    |  |        |  |   |   |   |  |  |  |  |  |  |
|  | 2.5 T           | 187  |  | 01.12  |                                    |  |        |  |   |   |   |  |  |  |  |  |  |
|  | 2.5 T FlexFuel  | 147  |  | 04.08  |                                    |  |        |  |   |   |   |  |  |  |  |  |  |
|  | 2.5 T FlexiFuel | 170  |  | 01.10  |                                    |  |        |  |   |   |   |  |  |  |  |  |  |
|  | 3.2             |  |  | 03.06  |                                    |  |        |  |   |   |   |  |  |  |  |  |  |
|  | D2              | 84   |  | 04.13  |                                    |  |        |  |   |   |   |  |  |  |  |  |  |
|  | D3              | 100  |  | 05.12  |                                    |  |        |  |   |   |   |  |  |  |  |  |  |
|  | D3              | 120  |  | 01.10  |                                    |  |        |  |   |   |   |  |  |  |  |  |  |
|  | D4              | 133  |  | 09.13  |                                    |  |        |  |   |   |   |  |  |  |  |  |  |
|  | T4              | 132  |  | 10.10  |                                    |  |        |  |   |   |   |  |  |  |  |  |  |
|  | T4F             | 132  |  | 05.11  |                                    |  |        |  |   |   |   |  |  |  |  |  |  |
|  | T5              | 177  |  | 10.10  |                                    |  |        |  |   |   |   |  |  |  |  |  |  |
|  | T5              | 180  |  | 09.13  |                                    |  |        |  |   |   |   |  |  |  |  |  |  |
|  | 2.4 D5 AWD      | 136  |  | 01.07  |                                    | 24.0711-6369.3   | 360395 | 2  |  |   | Radsensor                                   |  |  |  |  |  |  |
|  | 2.4 D5 AWD      | 151  |  | 01.10  |                                    |  |        |  |   |   |   |  |  |  |  |  |  |
|  | 2.4 D5 AWD      | 158  |  | 06.11  |                                    |  |        |  |   |   |   |  |  |  |  |  |  |
|  | 2.5 T AWD       | 147  |  | 10.06  |                                    |  |        |  |   |   |   |  |  |  |  |  |  |
|  | 3.0 T6 AWD      | 210  |  | 01.07  |                                    |  |        |  |   |   |   |  |  |  |  |  |  |
|  | 3.2 AWD         |  |  | 01.07  |                                    |  |        |  |   |   |   |  |  |  |  |  |  |
|  | 4.4 V8 AWD      | 232  |  | 03.06  |                                    |  |        |  |   |   |   |  |  |  |  |  |  |
|  | T6 AWD          | 224  |  | 10.10  |                                    |  |        |  |   |   |   |  |  |  |  |  |  |
|  | 1.6 D DRIVE     |  |  | 01.10  |                                    | 03.0137-0450.2   | 650450 |  |   |   | 178 x 25                                    |  |  |  |  |  |  |
|  | 2.0             | 107  |  | 09.07  |                                    | 03.0137-9283.2   | 669283 |  |   |   | Bremsbacken-Zubehör                         |  |  |  |  |  |  |
|  | 2.0 D           | 100  |  | 09.07  |                                    |  |        |  |   |   |   |  |  |  |  |  |  |
|  | 2.0 FlexiFuel   | 107  |  | 09.07  |                                    |  |        |  |   |   |   |  |  |  |  |  |  |
|  | 2.0 T           | 149  |  | 01.10  |                                    |  |        |  |   |   |   |  |  |  |  |  |  |
|  | 2.0 TDi         | 100  |  | 02.08  |                                    |  |        |  |   |   |   |  |  |  |  |  |  |
|  | 2.4 D           | 120  |  | 03.06  |                                    |  |        |  |   |   |   |  |  |  |  |  |  |
|  | 2.4 D           | 129  |  | 04.09  |                                    |  |        |  |   |   |   |  |  |  |  |  |  |
|  | 2.4 D5          | 136  |  | 03.06  |                                    |  |        |  |   |   |   |  |  |  |  |  |  |
|  | 2.4 D5          | 151  |  | 11.08  |                                    |  |        |  |   |   |   |  |  |  |  |  |  |
|  | 2.4 D5          | 158  |  | 06.11  |                                    |  |        |  |   |   |   |  |  |  |  |  |  |
|  | 2.4 D5 AWD      | 136  |  | 01.07  |                                    |  |        |  |   |   |   |  |  |  |  |  |  |
|  | 2.4 D5 AWD      | 151  |  | 01.10  |                                    |  |        |  |   |   |   |  |  |  |  |  |  |
|  | 2.4 D5 AWD      | 158  |  | 06.11  |                                    |  |        |  |   |   |   |  |  |  |  |  |  |
|  | 2.5 T           | 147  |  | 03.06  |                                    |  |        |  |   |   |   |  |  |  |  |  |  |
|  | 2.5 T           | 170  |  | 01.10  |                                    |  |        |  |   |   |   |  |  |  |  |  |  |
|  | 2.5 T           | 183  |  | 09.12  |                                    |  |        |  |   |   |   |  |  |  |  |  |  |
|  | 2.5 T           | 187  |  | 01.12  |                                    |  |        |  |   |   |   |  |  |  |  |  |  |
|  | 2.5 T AWD       | 147  |  | 10.06  |                                    |  |        |  |   |   |   |  |  |  |  |  |  |
|  | 2.5 T FlexFuel  | 147  |  | 04.08  |                                    |  |        |  |   |   |   |  |  |  |  |  |  |
|  | 2.5 T FlexiFuel | 170  |  | 01.10  |                                    |  |        |  |   |   |   |  |  |  |  |  |  |
|  | 3.0 T6 AWD      | 210  |  | 01.07  |                                    |  |        |  |   |   |   |  |  |  |  |  |  |
|  | 3.2             |  |  | 03.06  |                                    |  |        |  |   |   |   |  |  |  |  |  |  |
|  | 3.2 AWD         |  |  | 01.07  |                                    |  |        |  |   |   |   |  |  |  |  |  |  |
|  | 4.4 V8 AWD      | 232  |  | 03.06  |                                    |  |        |  |   |   |   |  |  |  |  |  |  |
|  | D2              | 84   |  | 04.13  |                                    |  |        |  |   |   |   |  |  |  |  |  |  |
|  | D3              | 120  |  | 01.10  |                                    |  |        |  |   |   |   |  |  |  |  |  |  |
|  | T5              | 177  |  | 10.10  |                                    |  |        |  |   |   |   |  |  |  |  |  |  |

<sup>1)</sup> + ventilated discs / + dischi ventilati / + disques ventilés / + disco ventilado

<sup>2)</sup> + electric parking brake / + freno a mano elettrico / + frein à main électrique / + freno de mano eléctrico

| VOLVO S80 II (06-)   |  |
|--|--|
|    | T6 AWD 224 10.10 03.0137-0450.2 650450 03.0137-9283.2 669283 178 x 25 Bremsbacken-Zubehör  |
| VOLVO S90 I (97-98)  |  |
|    | 2.5 125 11.96 10.98 13.0460-2985.2 602985 20164 18,2 TRW<br>2.5 132 11.96 10.97<br>2.9 132 01.97 05.98<br>2.9 150 01.97 05.98  |
|    | 2.5 125 11.96 10.98 24.0126-0102.1 426102 280 26,0 23,0 V +B<br>2.5 132 11.96 10.98<br>2.9 132 01.97 05.98<br>2.9 150 01.97 05.98  |
|    | 2.5 125 11.96 10.98 13.0460-2935.2 602935 21385 13,8 /S TRW<br>2.5 132 11.96 10.97<br>2.9 132 01.97 05.98<br>2.9 150 01.97 05.98   |
|    | 2.5 125 11.96 10.98 24.0112-0150.1 412150 277 11,9 10,0 +B<br>2.5 132 11.96 10.97<br>2.9 132 01.97 05.98<br>2.9 150 01.97 05.98  |
|    | 2.5 125 11.96 10.98 03.0137-0299.2 650299 160 x 25<br>2.5 132 11.96 10.97 03.0137-9199.2 669199 Bremsbacken-Zubehör<br>2.9 132 01.97 05.98<br>2.9 150 01.97 05.98  |
| VOLVO V40 (95-04)  |  |
|    | 1.6 77 12.95 08.97 13.0460-2830.2 602830 21920 14,6 /WK/Zub/S TRW<br>1.8 (1731) 85 07.95 08.97<br>1.9 T4 147 05.97 08.97<br>1.9 TD 66 07.95 08.97<br>2.0 100 07.95 08.97<br>2.0 103 07.95 08.97  |
|    | 1.6 77 09.97 08.99 13.0460-2853.2 602853 21983 17,2 /WK/Zub/S TRW<br>1.6 80 03.99 07.04<br>1.8 (1731) 85 09.97 08.99<br>1.8 (1783) 90 03.99 07.04<br>1.8 i (1834) 90 06.01 07.04<br>1.8 i (1834) 92 03.98 07.04<br>1.9 DI 70 03.99 07.00<br>1.9 DI 75 07.00 07.04<br>1.9 DI 85 07.00 07.04<br>1.9 T4 147 09.97 07.00<br>1.9 TD 66 09.97 08.99<br>2.0 100 09.97 07.04<br>2.0 103 09.97 08.99<br>2.0 T 118 10.97 07.00<br>2.0 T 120 06.01 07.04<br>2.0 T 121 07.00 06.01<br>2.0 T4 147 07.00 04.04                 |
|    | 1.6 77 12.95 08.97 24.0124-0136.1 424136 256 24,0 21,5 V +B<br>1.8 (1731) 85 07.95 08.97<br>1.9 T4 147 05.97 08.97<br>1.9 TD 66 07.95 08.97<br>2.0 100 07.95 08.97<br>2.0 103 07.95 08.97  |
|  | 1.6 77 09.97 08.99 24.0124-0159.1 424159 281 23,9 21,5 V +B<br>1.6 80 03.99 07.04 24.0324-0159.1 524159<br>1.8 (1731) 85 09.97 08.99<br>1.8 (1783) 90 03.99 07.04<br>1.8 i (1834) 90 06.01 07.04<br>1.8 i (1834) 92 03.98 07.04<br>1.9 DI 70 03.99 07.00<br>1.9 DI 75 07.00 07.04<br>1.9 DI 85 07.00 07.04<br>1.9 T4 147 09.97 07.00<br>1.9 TD 66 09.97 08.99<br>2.0 100 09.97 07.04<br>2.0 103 09.97 08.99<br>2.0 T 118 10.97 07.00<br>2.0 T 120 06.01 07.04<br>2.0 T 121 07.00 06.01<br>2.0 T4 147 07.00 04.04 |
|  | 1.6 77 12.95 08.99 13.0460-2831.2 602831 21861 15,2 /WK/S TRW<br>1.6 80 03.99 07.04<br>1.8 (1731) 85 07.95 08.99<br>1.8 (1783) 90 03.99 07.04<br>1.8 i (1834) 90 06.01 07.04<br>1.8 i (1834) 92 03.98 07.04<br>1.9 DI 70 03.99 07.00<br>1.9 DI 75 07.00 07.04<br>1.9 DI 85 07.00 07.04<br>1.9 T4 147 05.97 07.00<br>1.9 TD 66 07.95 08.99<br>2.0 100 07.95 07.04<br>2.0 103 07.95 08.99  |
| ↓  | ↓  |



| VOLVO V40 (95-04) |              |     |  |       |       |  |                |        |  |                      |
|-------------------|--------------|-----|--|-------|-------|--|----------------|--------|--|----------------------|
|                   | 2.0 T        | 118 |  | 10.97 | 07.00 |  | 13.0460-2831.2 | 602831 |  | 21861 15,2 /WK/S TRW |
|                   | 2.0 T        | 120 |  | 06.01 | 07.04 |  |                |        |  |                      |
|                   | 2.0 T        | 121 |  | 07.00 | 06.01 |  |                |        |  |                      |
|                   | 2.0 T4       | 147 |  | 07.00 | 04.04 |  |                |        |  |                      |
|                   | 1.6          | 77  |  | 12.95 | 08.99 |  | 24.0110-0229.1 | 410229 |  | 260 10,0 8,4 +B      |
|                   | 1.6          | 80  |  | 03.99 | 07.04 |  |                |        |  |                      |
|                   | 1.8 (1731)   | 85  |  | 07.95 | 08.99 |  |                |        |  |                      |
|                   | 1.8 (1783)   | 90  |  | 03.99 | 07.04 |  |                |        |  |                      |
|                   | 1.8 i (1834) | 90  |  | 06.01 | 07.04 |  |                |        |  |                      |
|                   | 1.8 i (1834) | 92  |  | 03.98 | 07.04 |  |                |        |  |                      |
|                   | 1.9 DI       | 70  |  | 03.99 | 07.00 |  |                |        |  |                      |
|                   | 1.9 DI       | 75  |  | 07.00 | 07.04 |  |                |        |  |                      |
|                   | 1.9 DI       | 85  |  | 07.00 | 07.04 |  |                |        |  |                      |
|                   | 1.9 T4       | 147 |  | 05.97 | 07.00 |  |                |        |  |                      |
|                   | 1.9 TD       | 66  |  | 07.95 | 08.99 |  |                |        |  |                      |
|                   | 2.0          | 100 |  | 07.95 | 07.04 |  |                |        |  |                      |
|                   | 2.0          | 103 |  | 07.95 | 08.99 |  |                |        |  |                      |
|                   | 2.0 T        | 118 |  | 10.97 | 07.00 |  |                |        |  |                      |
|                   | 2.0 T        | 120 |  | 06.01 | 07.04 |  |                |        |  |                      |
|                   | 2.0 T        | 121 |  | 07.00 | 06.01 |  |                |        |  |                      |
|                   | 2.0 T4       | 147 |  | 07.00 | 04.04 |  |                |        |  |                      |

| VOLVO V40 (12-) |         |     |  |       |  |  |                |        |                             |                         |
|-----------------|---------|-----|--|-------|--|--|----------------|--------|-----------------------------|-------------------------|
|                 | D2      | 84  |  | 09.12 |  |  | 13.0460-7193.2 | 607193 | + 15"/16" Rad <sup>1)</sup> | 23723 18,1 + ATE        |
|                 | D2      | 88  |  | 02.15 |  |  | 13.0470-7193.2 | LD7193 | + 15"/16" Rad <sup>1)</sup> | 23723 18,1 + ATE        |
|                 | D3      | 110 |  | 09.12 |  |  |                |        |                             |                         |
|                 | D4      | 130 |  | 09.12 |  |  |                |        |                             |                         |
|                 | D4      | 140 |  | 05.14 |  |  |                |        |                             |                         |
|                 | T2      | 90  |  | 02.15 |  |  |                |        |                             |                         |
|                 | T2 GTDi | 88  |  | 03.13 |  |  |                |        |                             |                         |
|                 | T3      | 112 |  | 02.15 |  |  |                |        |                             |                         |
|                 | T3 GTDi | 110 |  | 09.12 |  |  |                |        |                             |                         |
|                 | T4      | 132 |  | 04.13 |  |  |                |        |                             |                         |
|                 | T4      | 140 |  | 08.15 |  |  |                |        |                             |                         |
|                 | T4      | 147 |  | 04.14 |  |  |                |        |                             |                         |
|                 | T4 GTDi | 132 |  | 09.12 |  |  |                |        |                             |                         |
|                 | T5      | 157 |  | 03.13 |  |  |                |        |                             |                         |
|                 | T5      | 180 |  | 05.14 |  |  |                |        |                             |                         |
|                 | T5 AWD  | 157 |  | 03.13 |  |  |                |        |                             |                         |
|                 | T5 AWD  | 180 |  | 05.14 |  |  |                |        |                             |                         |
|                 | D2      | 84  |  | 09.12 |  |  | 13.0460-7204.2 | 607204 | + 17" Rad <sup>2)</sup>     | 23912 18,8 + ATE        |
|                 | D2      | 88  |  | 02.15 |  |  | 13.0470-7204.2 | LD7204 | + 17" Rad <sup>2)</sup>     | 23912 18,8 + ATE        |
|                 | D3      | 110 |  | 09.12 |  |  |                |        |                             |                         |
|                 | D4      | 130 |  | 09.12 |  |  |                |        |                             |                         |
|                 | D4      | 140 |  | 05.14 |  |  |                |        |                             |                         |
|                 | T2      | 90  |  | 02.15 |  |  |                |        |                             |                         |
|                 | T2 GTDi | 88  |  | 03.13 |  |  |                |        |                             |                         |
|                 | T3      | 112 |  | 02.15 |  |  |                |        |                             |                         |
|                 | T3 GTDi | 110 |  | 09.12 |  |  |                |        |                             |                         |
|                 | T4      | 132 |  | 04.13 |  |  |                |        |                             |                         |
|                 | T4      | 140 |  | 08.15 |  |  |                |        |                             |                         |
|                 | T4      | 147 |  | 04.14 |  |  |                |        |                             |                         |
|                 | T4 AWD  | 132 |  | 04.13 |  |  |                |        |                             |                         |
|                 | T4 AWD  | 140 |  | 05.14 |  |  |                |        |                             |                         |
|                 | T4 GTDi | 132 |  | 09.12 |  |  |                |        |                             |                         |
|                 | T5      | 157 |  | 03.13 |  |  |                |        |                             |                         |
|                 | T5      | 180 |  | 05.14 |  |  |                |        |                             |                         |
|                 | T5      | 187 |  | 09.12 |  |  |                |        |                             |                         |
|                 | T5 AWD  | 157 |  | 03.13 |  |  |                |        |                             |                         |
|                 | T5 AWD  | 180 |  | 05.14 |  |  |                |        |                             |                         |
|                 | T5 AWD  | 187 |  | 01.13 |  |  |                |        |                             |                         |
|                 | D2      | 84  |  | 09.12 |  |  | 24.0125-0162.1 | 425162 | + 16" Rad <sup>3)</sup>     | 300 25,0 23,0 V L +B    |
|                 | D2      | 88  |  | 02.15 |  |  |                |        |                             |                         |
|                 | D3      | 110 |  | 09.12 |  |  |                |        |                             |                         |
|                 | D4      | 130 |  | 09.12 |  |  |                |        |                             |                         |
|                 | D4      | 140 |  | 05.14 |  |  |                |        |                             |                         |
|                 | T2      | 90  |  | 02.15 |  |  |                |        |                             |                         |
|                 | T3      | 112 |  | 02.15 |  |  |                |        |                             |                         |
|                 | T3 GTDi | 110 |  | 09.12 |  |  |                |        |                             |                         |
|                 | T4      | 132 |  | 04.13 |  |  |                |        |                             |                         |
|                 | T4      | 140 |  | 08.15 |  |  |                |        |                             |                         |
|                 | T4      | 147 |  | 04.14 |  |  |                |        |                             |                         |
|                 | T4 GTDi | 132 |  | 09.12 |  |  |                |        |                             |                         |
|                 | T5      | 157 |  | 03.13 |  |  |                |        |                             |                         |
|                 | T5      | 180 |  | 05.14 |  |  |                |        |                             |                         |
|                 | T5 AWD  | 157 |  | 03.13 |  |  |                |        |                             |                         |
|                 | T5 AWD  | 180 |  | 05.14 |  |  |                |        |                             |                         |
|                 | T5 AWD  | 187 |  | 01.13 |  |  |                |        |                             |                         |
|                 | D2      | 84  |  | 09.12 |  |  | 24.0125-0197.1 | 425197 | + 17" Rad <sup>2)</sup>     | 320 25,0 23,0 V L +B    |
|                 | D2      | 88  |  | 02.15 |  |  | 24.0325-0197.1 | 525197 | + 17" Rad <sup>2)</sup>     | 320 25,0 23,0 V L +B PD |
|                 | D3      | 110 |  | 09.12 |  |  |                |        |                             |                         |
|                 | D4      | 130 |  | 09.12 |  |  |                |        |                             |                         |
|                 | D4      | 140 |  | 05.14 |  |  |                |        |                             |                         |
|                 | T2      | 90  |  | 02.15 |  |  |                |        |                             |                         |
|                 | T2 GTDi | 88  |  | 03.13 |  |  |                |        |                             |                         |
|                 | T3      | 112 |  | 02.15 |  |  |                |        |                             |                         |
|                 | T3 GTDi | 110 |  | 09.12 |  |  |                |        |                             |                         |
|                 | T4      | 132 |  | 04.13 |  |  |                |        |                             |                         |

<sup>1)</sup> + 15"/16" wheel / + ruota 15"/16" / + roue 15"/16" / + rueda 15"/16"

<sup>2)</sup> + 17" wheel / + ruota 17" / + roue 17" / + rueda 17"

<sup>3)</sup> + 16" wheel / + ruota 16" / + roue 16" / + rueda 16"





**VOLVO V40 (12-)**

|  |   |  |  |                                  |                  |  |  |
|--|---|--|--|----------------------------------|------------------|--|--|
|  | T4<br>T4<br>T4 AWD<br>T4 AWD<br>T4 GTDi<br>T5<br>T5<br>T5<br>T5 AWD<br>T5 AWD<br>T5 AWD   | 140<br>147<br>132<br>140<br>132<br>157<br>180<br>187<br>157<br>180<br>187  | 08.15<br>04.14<br>04.13<br>05.14<br>09.12<br>03.13<br>05.14<br>09.12<br>03.13<br>05.14<br>01.13  | 24.0125-0197.1<br>24.0325-0197.1 | 425197<br>525197 | + 17" Rad <sup>1)</sup><br>+ 17" Rad <sup>1)</sup>                   | 320 25,0 23,0 VL +B<br>320 25,0 23,0 VL +B PD            |
|  | D2<br>D2<br>D3<br>D4<br>D4<br>T2<br>T2 GTDi<br>T3<br>T3 GTDi<br>T4<br>T4<br>T4<br>T4 AWD<br>T4 AWD<br>T4 GTDi<br>T5<br>T5<br>T5<br>T5 AWD<br>T5 AWD<br>T5 AWD | 84<br>88<br>110<br>130<br>140<br>90<br>88<br>112<br>110<br>132<br>140<br>147<br>132<br>140<br>140<br>132<br>157<br>180<br>187<br>157<br>180<br>187 | 09.12<br>02.15<br>09.12<br>09.12<br>05.14<br>02.15<br>03.13<br>02.15<br>09.12<br>04.13<br>08.15<br>04.14<br>04.13<br>05.14<br>09.12<br>03.13<br>09.12<br>03.13<br>05.14<br>01.13 | 24.0711-5198.3                   | 360239           | 2  | Radsensor  |
|  | D2<br>D3<br>D4<br>D4<br>T2<br>T2 GTDi<br>T3<br>T3 GTDi<br>T4<br>T4<br>T4<br>T4 AWD<br>T4 AWD<br>T4 GTDi<br>T5<br>T5<br>T5<br>T5 AWD<br>T5 AWD<br>T5 AWD       | 88<br>110<br>130<br>140<br>90<br>88<br>112<br>110<br>132<br>140<br>147<br>132<br>140<br>140<br>132<br>157<br>180<br>187<br>157<br>180<br>187       | 02.15<br>09.12<br>09.12<br>05.14<br>02.15<br>03.13<br>02.15<br>09.12<br>04.13<br>08.15<br>04.14<br>04.13<br>05.14<br>09.12<br>03.13<br>09.12<br>03.13<br>05.14<br>01.13          | 13.0460-7195.2<br>13.0470-7195.2 | 607195<br>LD7195 |  | 23482 16,6 +<br>23482 16,6 +<br><b>ATE</b><br><b>ATE</b> |
|  | D2  | 84   | 09.12  | 13.0460-7195.2<br>13.0470-7195.2 | 607195<br>LD7195 | - ALU Bremsscheibe <sup>2)</sup><br>- ALU Bremsscheibe <sup>2)</sup> | 23482 16,6 +<br>23482 16,6 +<br><b>ATE</b><br><b>ATE</b> |
|  | D2<br>D3<br>D4<br>D4<br>T2<br>T2 GTDi<br>T3<br>T3 GTDi<br>T4<br>T4<br>T4<br>T4 AWD<br>T4 AWD<br>T4 GTDi<br>T5<br>T5<br>T5<br>T5 AWD<br>T5 AWD<br>T5 AWD       | 88<br>110<br>130<br>140<br>90<br>88<br>112<br>110<br>132<br>140<br>147<br>132<br>140<br>140<br>132<br>157<br>180<br>187<br>157<br>180<br>187       | 02.15<br>09.12<br>09.12<br>05.14<br>02.15<br>03.13<br>02.15<br>09.12<br>04.13<br>08.15<br>04.14<br>04.13<br>05.14<br>09.12<br>03.13<br>09.12<br>03.13<br>05.14<br>01.13          | 24.0111-0158.1                   | 411158           |  | 280 11,0 9,0 +S +B                                       |
|  | D2  | 84   | 09.12  | 24.0111-0158.1                   | 411158           | - ALU Bremsscheibe <sup>2)</sup>                                     | 280 11,0 9,0 +S +B                                       |
|  | D2<br>D2<br>D3<br>D4<br>D4<br>T2<br>T2 GTDi<br>T3<br>T3 GTDi<br>T4<br>T4<br>T4<br>T4 AWD<br>T4 AWD<br>T4 GTDi   | 84<br>88<br>110<br>130<br>140<br>90<br>88<br>112<br>110<br>132<br>140<br>140<br>132<br>140<br>140<br>132   | 09.12<br>02.15<br>09.12<br>09.12<br>05.14<br>02.15<br>03.13<br>02.15<br>09.12<br>04.13<br>08.15<br>04.14<br>04.13<br>05.14<br>09.12  | 24.0711-6351.3                   | 360358           | 2  | Radsensor  |
|  | T4<br>↓   | 147<br>↓   | 04.14<br>↓   |                                  |                  |  |  |

<sup>1)</sup> + 17" wheel / + ruota 17" / + roue 17" / + rueda 17"  
<sup>2)</sup> - ALU brake disc / - freno de ALU / - disque de frein ALU / - freno de ALU

| <b>VOLVO V40 (12-)</b>   |  |  |                                      |  |   |                |  |  |  |   |                          |
|--------------------------|--|--|--------------------------------------|--|---|----------------|--|--|--|---|--------------------------|
|                          | T4 AWD<br>T4 AWD<br>T4 GTDi<br>T5<br>T5<br>T5<br>T5 AWD<br>T5 AWD<br>T5 AWD  | 132<br>140<br>132<br>157<br>180<br>187<br>157<br>180<br>187  |                                      | 04.13<br>05.14<br>09.12<br>03.13<br>05.14<br>09.12<br>03.13<br>05.14<br>01.13  |   | 24.0711-6351.3 | 360358   | 2  | Radsensor  |   |                          |
| <b>VOLVO V50 (04-12)</b> |  |  |                                      |  |   |                |  |  |  |   |                          |
|                          | 1.6 D<br>1.6 D<br>1.6 D2<br>1.6 i<br>1.8<br>1.8 FlexiFuel<br>2.0 D<br>2.0 D3<br>2.0 D4<br>2.0 FlexiFuel<br>2.0 i<br>2.4<br>2.4<br>2.4 AWD<br>2.4 D5<br>2.4 Tdi<br>2.5 T5<br>2.5 T5<br>2.5 T5 AWD<br>2.5 T5 AWD | 80<br>81<br>84<br>74<br>92<br>92<br>100<br>110<br>130<br>107<br>107<br>103<br>125<br>125<br>132<br>120<br>162<br>169<br>162<br>169 |                                      | 04.07<br>01.05<br>01.10<br>01.05<br>04.04<br>04.04<br>10.10<br>10.10<br>01.10<br>10.06<br>04.04<br>04.04<br>08.06<br>03.06<br>05.07<br>04.04<br>03.07<br>04.04<br>03.07          | 05.12<br>05.12<br>05.12<br>05.12<br>05.12<br>05.12<br>05.12<br>05.12<br>05.12<br>05.12<br>05.12<br>05.12<br>05.12<br>05.12<br>05.12<br>05.12<br>05.12<br>05.12<br>05.12<br>05.12<br>05.12 |                | 13.0460-7193.2<br>13.0470-7193.2<br>13.0460-7204.2<br>13.0470-7204.2                                     | 607193<br>LD7193<br>607204<br>LD7204                     | - 17" Rad <sup>1)</sup><br>- 17" Rad <sup>1)</sup><br>+ 17" Rad <sup>2)</sup><br>+ 17" Rad <sup>2)</sup>   | 23723 18,1 +<br>23723 18,1 +<br>23912 18,8 +<br>23912 18,8 +  | ATE<br>ATE<br>ATE<br>ATE |
|                          | 1.6 D<br>1.6 D<br>1.6 i<br>1.8<br>1.8 FlexiFuel<br>2.0 D<br>2.0 FlexiFuel<br>2.0 i<br>2.4<br>2.4<br>2.4 AWD<br>2.4 D5<br>2.4 Tdi<br>2.5 T5<br>2.5 T5<br>2.5 T5 AWD<br>2.5 T5 AWD                               | 80<br>81<br>74<br>92<br>92<br>100<br>107<br>107<br>103<br>125<br>125<br>132<br>120<br>162<br>169<br>162<br>169                     |                                      | 04.07<br>01.05<br>01.05<br>04.04<br>04.07<br>04.04<br>01.10<br>10.06<br>04.04<br>04.04<br>08.06<br>03.06<br>05.07<br>04.04<br>03.07<br>04.04<br>03.07                            | 05.12<br>05.12<br>05.12<br>05.12<br>05.12<br>05.12<br>05.12<br>05.12<br>05.12<br>05.12<br>05.12<br>05.12<br>05.12<br>05.12<br>05.12<br>05.12<br>05.12<br>05.12                            |                | 24.0125-0117.1<br>24.0325-0117.1<br>24.0125-0162.1<br>24.0325-0162.1<br>24.0125-0197.1<br>24.0325-0197.1 | 425117<br>525117<br>425162<br>525162<br>425197<br>525197 | + 15" Rad <sup>3)</sup><br>+ 15" Rad <sup>3)</sup><br>+ 16" Rad <sup>4)</sup><br>+ 16" Rad <sup>4)</sup><br>+ 17" Rad <sup>2)</sup><br>+ 17" Rad <sup>2)</sup> | 278 25,0 23,0 V L +B<br>278 25,0 23,0 V L +B PD<br>300 25,0 23,0 V L +B<br>300 25,0 23,0 V L +B PD<br>320 25,0 23,0 V L +B<br>320 25,0 23,0 V L +B PD |                          |
|                          | 1.6 D2<br>2.0 D3<br>2.0 D4   | 84<br>110<br>130   |                                      | 01.10<br>10.10<br>10.10  | 05.12<br>05.12<br>05.12   |                | 24.0125-0117.1<br>24.0325-0117.1<br>24.0125-0162.1<br>24.0325-0162.1                                     | 425117<br>525117<br>425162<br>525162                     | + 15" Rad <sup>3)</sup><br>+ 15" Rad <sup>3)</sup><br>+ 16" Rad <sup>4)</sup><br>+ 16" Rad <sup>4)</sup>   | 278 25,0 23,0 V L +B<br>278 25,0 23,0 V L +B PD<br>300 25,0 23,0 V L +B<br>300 25,0 23,0 V L +B PD  |                          |
|                          | 1.6 D2<br>2.0 D3<br>2.0 D4   | 84<br>110<br>130   |                                      | 01.10<br>01.10<br>10.10  | 05.12<br>05.12<br>05.12   |                | 24.0125-0197.1<br>24.0325-0197.1   | 425197<br>525197   | + 17" Rad <sup>2)</sup><br>+ 17" Rad <sup>2)</sup>   | 320 25,0 23,0 V L +B<br>320 25,0 23,0 V L +B PD   |                          |
|                          | 1.6 D<br>1.6 D<br>1.6 D2<br>1.6 i<br>1.8<br>1.8 FlexiFuel<br>2.0 D<br>2.0 D3<br>2.0 D4<br>2.0 FlexiFuel<br>2.0 i<br>2.4<br>2.4<br>2.4 AWD<br>2.4 D5<br>2.4 Tdi<br>2.5 T5<br>2.5 T5<br>2.5 T5 AWD<br>2.5 T5 AWD | 80<br>81<br>84<br>74<br>92<br>92<br>100<br>110<br>130<br>107<br>107<br>103<br>125<br>125<br>132<br>120<br>162<br>169<br>162<br>169 | 550147                               | 04.07<br>01.05<br>01.10<br>01.05<br>04.04<br>04.07<br>04.04<br>10.10<br>10.10<br>01.10<br>10.06<br>04.04<br>04.04<br>08.06<br>03.06<br>05.07<br>04.04<br>03.07<br>04.04<br>03.07 | 05.12<br>05.12<br>05.12<br>05.12<br>05.12<br>05.12<br>05.12<br>05.12<br>05.12<br>05.12<br>05.12<br>05.12<br>05.12<br>05.12<br>05.12<br>05.12<br>05.12<br>05.12<br>05.12<br>05.12<br>05.12 |                | 24.0711-5123.3   | 360065   | 2  | Radsensor   |                          |
|                          | 1.6 D2<br>2.0 D3<br>2.0 D4<br>2.0 FlexiFuel  | 84<br>110<br>130<br>107  | 550148<br>550148<br>550148<br>550148 |  | 05.12<br>05.12<br>05.12<br>05.12  |                | 24.0711-5198.3   | 360239   | 2  | Radsensor   |                          |
|                          | 1.6 D<br>1.6 D<br>1.6 D2<br>1.6 i<br>1.8<br>1.8 FlexiFuel<br>2.0 D<br>2.0 D3   | 80<br>81<br>84<br>74<br>92<br>92<br>100<br>110   |                                      | 04.07<br>01.05<br>01.10<br>01.05<br>04.04<br>04.07<br>04.04<br>10.10   | 05.12<br>05.12<br>05.12<br>05.12<br>05.12<br>05.12<br>05.12<br>05.12  |                | 13.0460-7195.2<br>13.0470-7195.2   | 607195<br>LD7195   | ersetzt Belag mit Federn <sup>5)</sup><br>ersetzt Belag mit Federn <sup>5)</sup>   | 23482 16,6 +<br>23482 16,6 +  | ATE<br>ATE               |

1) - 17" wheel / - ruota 17" / - roue 17" / - rueda 17"  
2) + 17" wheel / + ruota 17" / + roue 17" / + rueda 17"  
3) + 15" wheel / + ruota 15" / + roue 15" / + rueda 15"  
4) + 16" wheel / + ruota 16" / + roue 16" / + rueda 16"  
5) replaces pad with springs / sostituisce la guarnizione con molle / remplace la garniture avec ressorts / sustituye guarnición con resortes

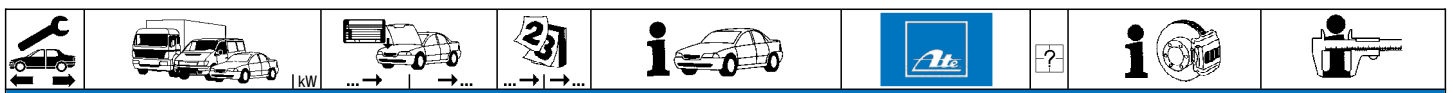

| VOLVO V50 (04-12) |               |     |       |       |       |                |        |                |  |  |            |                |        |   |  |           |  |
|-------------------|---------------|-----|-------|-------|-------|----------------|--------|----------------|--|--|------------|----------------|--------|---|--|-----------|--|
|                   | 2.0 D4        | 130 |       | 10.10 | 05.12 | 13.0460-7195.2 | 607195 | LD7195         | ersetzt Belag mit Federn <sup>1)</sup><br>ersetzt Belag mit Federn <sup>1)</sup> | 23482 16,6 +<br>23482 16,6 +             | ATE<br>ATE |                |        |   |  |           |  |
|                   | 2.0 FlexiFuel | 107 |       | 01.10 | 05.12 |                |        |                |  |  |            |                |        |   |  |           |  |
|                   | 2.0 i         | 107 |       | 10.06 | 05.12 |                |        |                |  |  |            |                |        |   |  |           |  |
|                   | 2.4           | 103 |       | 04.04 | 05.12 |                |        |                |  |  |            |                |        |   |  |           |  |
|                   | 2.4           | 125 |       | 04.04 | 05.12 |                |        |                |  |  |            |                |        |   |  |           |  |
|                   | 2.4 AWD       | 125 |       | 08.06 | 05.12 |                |        |                |  |  |            |                |        |   |  |           |  |
|                   | 2.4 D5        | 132 |       | 03.06 | 05.12 |                |        |                |  |  |            |                |        |   |  |           |  |
|                   | 2.4 Tdi       | 120 |       | 05.07 | 05.12 |                |        |                |  |  |            |                |        |   |  |           |  |
|                   | 2.5 T5        | 162 |       | 04.04 | 05.12 |                |        |                |  |  |            |                |        |   |  |           |  |
|                   | 2.5 T5        | 169 |       | 03.07 | 05.12 |                |        |                |  |  |            |                |        |   |  |           |  |
| 2.5 T5 AWD        | 162           |     | 04.04 | 05.12 |       |                |        |                |  |  |            |                |        |   |  |           |  |
| 2.5 T5 AWD        | 169           |     | 03.07 | 05.12 |       |                |        |                |  |  |            |                |        |   |  |           |  |
|                   | 1.6 D         | 80  |       | 04.07 | 05.12 | 24.0111-0158.1 | 411158 | 24.0311-0158.1 | 511158   | 280 11,0 9,0 +S +B<br>280 11,0 9,0 +B PD |            |                |        |   |  |           |  |
|                   | 1.6 D         | 81  |       | 01.05 | 05.12 |                |        |                |  |  |            |                |        |   |  |           |  |
|                   | 1.6 D2        | 84  |       | 01.10 | 05.12 |                |        |                |  |  |            |                |        |   |  |           |  |
|                   | 1.6 i         | 74  |       | 01.05 | 05.12 |                |        |                |  |  |            |                |        |   |  |           |  |
|                   | 1.8           | 92  |       | 04.04 | 05.12 |                |        |                |  |  |            |                |        |   |  |           |  |
|                   | 1.8 FlexiFuel | 92  |       | 04.07 | 05.12 |                |        |                |  |  |            |                |        |   |  |           |  |
|                   | 2.0 D         | 100 |       | 04.04 | 05.12 |                |        |                |  |  |            |                |        |   |  |           |  |
|                   | 2.0 D3        | 110 |       | 10.10 | 05.12 |                |        |                |  |  |            |                |        |   |  |           |  |
|                   | 2.0 D4        | 130 |       | 10.10 | 05.12 |                |        |                |  |  |            |                |        |   |  |           |  |
|                   | 2.0 FlexiFuel | 107 |       | 01.10 | 05.12 |                |        |                |  |  |            |                |        |   |  |           |  |
|                   | 2.0 i         | 107 |       | 10.06 | 05.12 |                |        |                |  |  |            |                |        |   |  |           |  |
|                   | 2.4           | 103 |       | 04.04 | 05.12 |                |        |                |  |  |            |                |        |   |  |           |  |
|                   | 2.4           | 125 |       | 04.04 | 05.12 |                |        |                |  |  |            |                |        |   |  |           |  |
|                   | 2.4 AWD       | 125 |       | 08.06 | 05.12 |                |        |                |  |  |            |                |        |   |  |           |  |
|                   | 2.4 D5        | 132 |       | 03.06 | 05.12 |                |        |                |  |  |            |                |        |   |  |           |  |
|                   | 2.4 Tdi       | 120 |       | 05.07 | 05.12 |                |        |                |  |  |            |                |        |   |  |           |  |
|                   | 2.5 T5        | 162 |       | 04.04 | 05.12 |                |        |                |  |  |            |                |        |   |  |           |  |
|                   | 2.5 T5        | 169 |       | 03.07 | 05.12 |                |        |                |  |  |            |                |        |   |  |           |  |
| 2.5 T5 AWD        | 162           |     | 04.04 | 05.12 |       |                |        |                |  |  |            |                |        |   |  |           |  |
| 2.5 T5 AWD        | 169           |     | 03.07 | 05.12 |       |                |        |                |  |  |            |                |        |   |  |           |  |
|                   | 1.6 D         | 80  |       | 04.07 | 05.12 | 24.0711-6220.3 | 360256 | 2              |  | Radsensor                                |            |                |        |   |  |           |  |
|                   | 1.6 D         | 81  |       | 01.05 | 05.12 |                |        |                |  |  |            |                |        |   |  |           |  |
|                   | 1.6 i         | 74  |       | 01.05 | 05.12 |                |        |                |  |  |            |                |        |   |  |           |  |
|                   | 1.8           | 92  |       | 04.04 | 05.12 |                |        |                |  |  |            |                |        |   |  |           |  |
|                   | 1.8 FlexiFuel | 92  |       | 04.07 | 05.12 |                |        |                |  |  |            |                |        |   |  |           |  |
|                   | 2.0 D         | 100 |       | 04.04 | 05.12 |                |        |                |  |  |            |                |        |   |  |           |  |
|                   | 2.4           | 103 |       | 04.04 | 05.12 |                |        |                |  |  |            |                |        |   |  |           |  |
|                   | 2.4           | 125 |       | 04.04 | 05.12 |                |        |                |  |  |            |                |        |   |  |           |  |
|                   | 2.4 D5        | 132 |       | 03.06 | 05.12 |                |        |                |  |  |            |                |        |   |  |           |  |
|                   | 2.4 Tdi       | 120 |       | 05.07 | 05.12 |                |        |                |  |  |            |                |        |   |  |           |  |
|                   | 2.5 T5        | 162 |       | 04.04 | 05.12 |                |        |                |  |  |            |                |        |   |  |           |  |
|                   | 2.5 T5        | 169 |       | 03.07 | 05.12 |                |        |                |  |  |            |                |        |   |  |           |  |
|                   | 2.5 T5 AWD    | 162 |       | 04.04 | 05.12 |                |        |                |  |  |            |                |        |   |  |           |  |
|                   | 2.5 T5 AWD    | 169 |       | 03.07 | 05.12 |                |        |                |  |  |            |                |        |   |  |           |  |
|                   | 1.6 D2        | 84  |       | 01.10 | 05.12 |                |        |                |  |  |            | 24.0711-6221.3 | 360258 | 2 |  | Radsensor |  |
|                   | 2.0 D3        | 110 |       | 10.10 | 05.12 |                |        |                |  |  |            |                |        |   |  |           |  |
|                   | 2.0 D4        | 130 |       | 10.10 | 05.12 |                |        |                |  |  |            |                |        |   |  |           |  |
|                   | 2.0 FlexiFuel | 107 |       | 01.10 | 05.12 |                |        |                |  |  |            |                |        |   |  |           |  |
| 2.0 i             | 107           |     | 10.06 | 05.12 |       |                |        |                |  |  |            |                |        |   |  |           |  |

### VOLVO V60 (10-)

|         |                       |     |       |   |   |                |        |        |              |                              |            |
|---------|-----------------------|-----|-------|---|---|----------------|--------|--------|--------------|------------------------------|------------|
|         | 1.5 T2                | 90  |       | 01.16                                       | + Bremsscheibendurchm. 300 mm <sup>2)</sup> | 13.0460-7228.2 | 607228 | LD7228 |              | 24123 20,3 +<br>24123 20,3 + | ATE<br>ATE |
|         | 1.6 DRiVe             | 84  |       | 06.11                                       | + Bremsscheibendurchm. 300 mm <sup>2)</sup> |                |        |        |              |                              |            |
|         | 2.0 D2                | 88  |       | 03.15                                       | + Bremsscheibendurchm. 300 mm <sup>2)</sup> |                |        |        |              |                              |            |
|         | 2.0 T                 | 149 |       | 11.10                                       | + Bremsscheibendurchm. 300 mm <sup>2)</sup> |                |        |        |              |                              |            |
|         | 2.0 T4                | 140 |       | 05.15                                       | + Bremsscheibendurchm. 300 mm <sup>2)</sup> |                |        |        |              |                              |            |
|         | 2.4 D5                | 158 |       | 06.11                                       | + Bremsscheibendurchm. 300 mm <sup>2)</sup> |                |        |        |              |                              |            |
|         | 2.4 D5 AWD            | 158 |       | 06.11                                       | + Bremsscheibendurchm. 300 mm <sup>2)</sup> |                |        |        |              |                              |            |
|         | 2.4 D5 Hybrid AWD     | 120 |       | 03.15                                       | + Bremsscheibendurchm. 300 mm <sup>2)</sup> |                |        |        |              |                              |            |
|         | 2.4 D6 Plug-in-Hybrid | 158 |       | 11.12                                       | + Bremsscheibendurchm. 300 mm <sup>2)</sup> |                |        |        |              |                              |            |
|         | D 3                   | 100 |       | 10.12                                       | + Bremsscheibendurchm. 300 mm <sup>2)</sup> |                |        |        |              |                              |            |
|         | D 3                   | 120 |       | 11.10                                       | + Bremsscheibendurchm. 300 mm <sup>2)</sup> |                |        |        |              |                              |            |
|         | D 5                   | 151 |       | 11.10                                       | + Bremsscheibendurchm. 300 mm <sup>2)</sup> |                |        |        |              |                              |            |
|         | D 5 AWD               | 151 |       | 11.10                                       | + Bremsscheibendurchm. 300 mm <sup>2)</sup> |                |        |        |              |                              |            |
|         | D3                    | 110 |       | 03.15                                       | + Bremsscheibendurchm. 300 mm <sup>2)</sup> |                |        |        |              |                              |            |
|         | D4                    | 133 |       | 10.13                                       | + Bremsscheibendurchm. 300 mm <sup>2)</sup> |                |        |        |              |                              |            |
|         | D4                    | 140 |       | 03.15                                       | + Bremsscheibendurchm. 300 mm <sup>2)</sup> |                |        |        |              |                              |            |
|         | D4 AWD                | 120 |       | 12.12                                       | + Bremsscheibendurchm. 300 mm <sup>2)</sup> |                |        |        |              |                              |            |
|         | D4 AWD                | 133 |       | 10.13                                       | + Bremsscheibendurchm. 300 mm <sup>2)</sup> |                |        |        |              |                              |            |
|         | D4 AWD                | 140 |       | 03.15                                       | + Bremsscheibendurchm. 300 mm <sup>2)</sup> |                |        |        |              |                              |            |
|         | D5                    | 165 |       | 03.15                                       | + Bremsscheibendurchm. 300 mm <sup>2)</sup> |                |        |        |              |                              |            |
|         | D5                    | 169 |       | 04.14                                       | + Bremsscheibendurchm. 300 mm <sup>2)</sup> |                |        |        |              |                              |            |
|         | D5 AWD                | 169 |       | 04.14                                       | + Bremsscheibendurchm. 300 mm <sup>2)</sup> |                |        |        |              |                              |            |
|         | D6 Hybrid AWD         | 162 |       | 03.15                                       | + Bremsscheibendurchm. 300 mm <sup>2)</sup> |                |        |        |              |                              |            |
|         | T3                    | 110 |       | 11.10                                       | + Bremsscheibendurchm. 300 mm <sup>2)</sup> |                |        |        |              |                              |            |
|         | T3                    | 112 |       | 03.15                                       | + Bremsscheibendurchm. 300 mm <sup>2)</sup> |                |        |        |              |                              |            |
|         | T4                    | 132 |       | 11.10                                       | + Bremsscheibendurchm. 300 mm <sup>2)</sup> |                |        |        |              |                              |            |
|         | T4F                   | 132 |       | 04.11                                       | + Bremsscheibendurchm. 300 mm <sup>2)</sup> |                |        |        |              |                              |            |
|         | T5                    | 157 |       | 04.14                                       | + Bremsscheibendurchm. 300 mm <sup>2)</sup> |                |        |        |              |                              |            |
| T5      | 177                   |     | 11.10 | + Bremsscheibendurchm. 300 mm <sup>2)</sup> |   |                |        |        |              |                              |            |
| T5      | 180                   |     | 10.13 | + Bremsscheibendurchm. 300 mm <sup>2)</sup> |   |                |        |        |              |                              |            |
| T 6 AWD | 224                   |     | 11.10 | + Bremsscheibendurchm. 300 mm <sup>2)</sup> | 13.0460-7228.2                              | 607228         |        |        | 24123 20,3 + | ATE                          |            |
| T6      | 225                   |     | 10.13 | + Bremsscheibendurchm. 300 mm <sup>2)</sup> |   |                |        |        |              |                              |            |
| T6 AWD  | 225                   |     | 10.13 | + Bremsscheibendurchm. 300 mm <sup>2)</sup> |   |                |        |        |              |                              |            |
| T6 AWD  | 242                   |     | 04.14 | + Bremsscheibendurchm. 300 mm <sup>2)</sup> |   |                |        |        |              |                              |            |

<sup>1)</sup> replaces pad with springs / sostituisce la guarnizione con molle / remplace la garniture avec ressorts / sustituye guarnición con resortes

<sup>2)</sup> + brake disc diameter 300mm / + diametro dischi freno 300mm / + diamètre disques frein 300mm / + diámetro disco freno 300mm





## VOLVO V60 (10-)

|         |                       |       |  |  |                |        |              |   |            |
|---------|-----------------------|-------|--|--|----------------|--------|--------------|---|------------|
|         | 1.5 T2                | 90    | 01.16  | + Bremsscheibendurchm. 316mm / 336mm <sup>1)</sup> | 13.0460-7243.2 | 607243 |              | 24142 20,6 +<br>24142 20,6 +                          | ATE<br>ATE |
|         | 1.6 DRIVe             | 84    | 06.11  | + Bremsscheibendurchm. 316mm / 336mm <sup>1)</sup> | 13.0470-7243.2 | LD7243 |              |   |            |
|         | 2.0 D2                | 88    | 03.15  | + Bremsscheibendurchm. 316mm / 336mm <sup>1)</sup> |                |        |              |   |            |
|         | 2.0 T                 | 149   | 11.10  | + Bremsscheibendurchm. 316mm / 336mm <sup>1)</sup> |                |        |              |   |            |
|         | 2.0 T4                | 140   | 05.15  | + Bremsscheibendurchm. 316mm / 336mm <sup>1)</sup> |                |        |              |   |            |
|         | 2.4 D5                | 158   | 06.11  | + Bremsscheibendurchm. 316mm / 336mm <sup>1)</sup> |                |        |              |   |            |
|         | 2.4 D5 AWD            | 158   | 06.11  | + Bremsscheibendurchm. 316mm / 336mm <sup>1)</sup> |                |        |              |   |            |
|         | 2.4 D5 Hybrid AWD     | 120   | 03.15  | + Bremsscheibendurchm. 316mm / 336mm <sup>1)</sup> |                |        |              |   |            |
|         | 2.4 D6 Plug-in-Hybrid | 158   | 11.12  | + Bremsscheibendurchm. 316mm / 336mm <sup>1)</sup> |                |        |              |   |            |
|         | D 3                   | 100   | 11.12  | + Bremsscheibendurchm. 316mm / 336mm <sup>1)</sup> |                |        |              |   |            |
|         | D 3                   | 120   | 11.10  | + Bremsscheibendurchm. 316mm / 336mm <sup>1)</sup> |                |        |              |   |            |
|         | D 5                   | 151   | 11.10  | + Bremsscheibendurchm. 316mm / 336mm <sup>1)</sup> |                |        |              |   |            |
|         | D 5 AWD               | 151   | 11.10  | + Bremsscheibendurchm. 316mm / 336mm <sup>1)</sup> |                |        |              |   |            |
|         | D3                    | 110   | 03.15  | + Bremsscheibendurchm. 316mm / 336mm <sup>1)</sup> |                |        |              |   |            |
|         | D4                    | 133   | 10.13  | + Bremsscheibendurchm. 316mm / 336mm <sup>1)</sup> |                |        |              |   |            |
|         | D4                    | 140   | 03.15  | + Bremsscheibendurchm. 316mm / 336mm <sup>1)</sup> |                |        |              |   |            |
|         | D4 AWD                | 120   | 12.12  | + Bremsscheibendurchm. 316mm / 336mm <sup>1)</sup> |                |        |              |   |            |
|         | D4 AWD                | 133   | 10.13  | + Bremsscheibendurchm. 316mm / 336mm <sup>1)</sup> |                |        |              |   |            |
|         | D4 AWD                | 140   | 03.15  | + Bremsscheibendurchm. 316mm / 336mm <sup>1)</sup> |                |        |              |   |            |
|         | D5                    | 165   | 03.15  | + Bremsscheibendurchm. 316mm / 336mm <sup>1)</sup> |                |        |              |   |            |
|         | D5                    | 169   | 04.14  | + Bremsscheibendurchm. 316mm / 336mm <sup>1)</sup> |                |        |              |   |            |
|         | D5 AWD                | 169   | 04.14  | + Bremsscheibendurchm. 316mm / 336mm <sup>1)</sup> |                |        |              |   |            |
|         | D6 Hybrid AWD         | 162   | 03.15  | + Bremsscheibendurchm. 316mm / 336mm <sup>1)</sup> |                |        |              |   |            |
|         | T3                    | 110   | 11.10  | + Bremsscheibendurchm. 316mm / 336mm <sup>1)</sup> |                |        |              |   |            |
| T3      | 112                   | 03.15 | + Bremsscheibendurchm. 316mm / 336mm <sup>1)</sup> |  |                |        |              |   |            |
| T4      | 132                   | 11.10 | + Bremsscheibendurchm. 316mm / 336mm <sup>1)</sup> |  |                |        |              |   |            |
| T4F     | 132                   | 04.11 | + Bremsscheibendurchm. 316mm / 336mm <sup>1)</sup> |  |                |        |              |   |            |
| T5      | 157                   | 04.14 | + Bremsscheibendurchm. 316mm / 336mm <sup>1)</sup> |  |                |        |              |   |            |
| T5      | 177                   | 11.10 | + Bremsscheibendurchm. 316mm / 336mm <sup>1)</sup> |  |                |        |              |   |            |
| T5      | 180                   | 10.13 | + Bremsscheibendurchm. 316mm / 336mm <sup>1)</sup> |  |                |        |              |   |            |
| T 6 AWD | 224                   | 11.10 | + Bremsscheibendurchm. 316mm / 336mm <sup>1)</sup> | 13.0460-7243.2                                     | 607243         |        | 24142 20,6 + | ATE   |            |
| T6      | 225                   | 10.13 | + Bremsscheibendurchm. 316mm / 336mm <sup>1)</sup> |  |                |        |              |   |            |
| T6 AWD  | 225                   | 10.13 | + Bremsscheibendurchm. 316mm / 336mm <sup>1)</sup> |  |                |        |              |   |            |
| T6 AWD  | 242                   | 04.14 | + Bremsscheibendurchm. 316mm / 336mm <sup>1)</sup> |  |                |        |              |   |            |
|         | 1.5 T2                | 90    | 01.16  | + Bremsscheibendurchm. 300 mm <sup>2)</sup>        | 24.0128-0154.1 | 428154 |              | 300 28,0 26,0 V L +S +B<br>300 28,0 26,0 V L +S +B PD |            |
|         | 1.6 DRIVe             | 84    | 06.11  | + Bremsscheibendurchm. 300 mm <sup>2)</sup>        | 24.0328-0154.1 | 528154 |              |   |            |
|         | 2.0 D2                | 88    | 03.15  | + Bremsscheibendurchm. 300 mm <sup>2)</sup>        |                |        |              |   |            |
|         | 2.0 T                 | 149   | 11.10  | + Bremsscheibendurchm. 300 mm <sup>2)</sup>        |                |        |              |   |            |
|         | 2.0 T4                | 140   | 05.15  | + Bremsscheibendurchm. 300 mm <sup>2)</sup>        |                |        |              |   |            |
|         | 2.4 D5                | 158   | 06.11  | + Bremsscheibendurchm. 300 mm <sup>2)</sup>        |                |        |              |   |            |
|         | 2.4 D5 AWD            | 158   | 06.11  | + Bremsscheibendurchm. 300 mm <sup>2)</sup>        |                |        |              |   |            |
|         | 2.4 D5 Hybrid AWD     | 120   | 03.15  | + Bremsscheibendurchm. 300 mm <sup>2)</sup>        |                |        |              |   |            |
|         | 2.4 D6 Plug-in-Hybrid | 158   | 11.12  | + Bremsscheibendurchm. 300 mm <sup>2)</sup>        |                |        |              |   |            |
|         | D 3                   | 100   | 10.12  | + Bremsscheibendurchm. 300 mm <sup>2)</sup>        |                |        |              |   |            |
|         | D 3                   | 120   | 11.10  | + Bremsscheibendurchm. 300 mm <sup>2)</sup>        |                |        |              |   |            |
|         | D 5                   | 151   | 11.10  | + Bremsscheibendurchm. 300 mm <sup>2)</sup>        |                |        |              |   |            |
|         | D 5 AWD               | 151   | 11.10  | + Bremsscheibendurchm. 300 mm <sup>2)</sup>        |                |        |              |   |            |
|         | D3                    | 110   | 03.15  | + Bremsscheibendurchm. 300 mm <sup>2)</sup>        |                |        |              |   |            |
|         | D4                    | 133   | 10.13  | + Bremsscheibendurchm. 300 mm <sup>2)</sup>        |                |        |              |   |            |
|         | D4                    | 140   | 03.15  | + Bremsscheibendurchm. 300 mm <sup>2)</sup>        |                |        |              |   |            |
|         | D4 AWD                | 120   | 12.12  | + Bremsscheibendurchm. 300 mm <sup>2)</sup>        |                |        |              |   |            |
|         | D4 AWD                | 133   | 10.13  | + Bremsscheibendurchm. 300 mm <sup>2)</sup>        |                |        |              |   |            |
|         | D4 AWD                | 140   | 03.15  | + Bremsscheibendurchm. 300 mm <sup>2)</sup>        |                |        |              |   |            |
|         | D5                    | 165   | 03.15  | + Bremsscheibendurchm. 300 mm <sup>2)</sup>        |                |        |              |   |            |
|         | D5                    | 169   | 04.14  | + Bremsscheibendurchm. 300 mm <sup>2)</sup>        |                |        |              |   |            |
|         | D5 AWD                | 169   | 04.14  | + Bremsscheibendurchm. 300 mm <sup>2)</sup>        |                |        |              |   |            |
|         | D6 Hybrid AWD         | 162   | 03.15  | + Bremsscheibendurchm. 300 mm <sup>2)</sup>        |                |        |              |   |            |
|         | T 6 AWD               | 224   | 11.10  | + Bremsscheibendurchm. 300 mm <sup>2)</sup>        |                |        |              |   |            |
| T3      | 110                   | 11.10 | + Bremsscheibendurchm. 300 mm <sup>2)</sup>        |  |                |        |              |   |            |
| T3      | 112                   | 03.15 | + Bremsscheibendurchm. 300 mm <sup>2)</sup>        |  |                |        |              |   |            |
| T4      | 132                   | 11.10 | + Bremsscheibendurchm. 300 mm <sup>2)</sup>        |  |                |        |              |   |            |
| T4F     | 132                   | 04.11 | + Bremsscheibendurchm. 300 mm <sup>2)</sup>        |  |                |        |              |   |            |
| T5      | 157                   | 04.14 | + Bremsscheibendurchm. 300 mm <sup>2)</sup>        |  |                |        |              |   |            |
| T5      | 177                   | 11.10 | + Bremsscheibendurchm. 300 mm <sup>2)</sup>        |  |                |        |              |   |            |
| T5      | 180                   | 10.13 | + Bremsscheibendurchm. 300 mm <sup>2)</sup>        |  |                |        |              |   |            |
| T6      | 225                   | 10.13 | + Bremsscheibendurchm. 300 mm <sup>2)</sup>        |  |                |        |              |   |            |
| T6 AWD  | 225                   | 10.13 | + Bremsscheibendurchm. 300 mm <sup>2)</sup>        |  |                |        |              |   |            |
| T6 AWD  | 242                   | 04.14 | + Bremsscheibendurchm. 300 mm <sup>2)</sup>        |  |                |        |              |   |            |
|         | 1.5 T2                | 90    | 01.16  | + Bremsscheibendurchm. 316mm <sup>3)</sup>         | 24.0128-0162.1 | 428162 |              | 316 28,0 26,0 V L +S +B<br>316 28,0 26,0 V L +S +B PD |            |
|         | 1.6 DRIVe             | 84    | 06.11  | + Bremsscheibendurchm. 316mm <sup>3)</sup>         | 24.0328-0162.1 | 528162 |              |   |            |
|         | 2.0 D2                | 88    | 03.15  | + Bremsscheibendurchm. 316mm <sup>3)</sup>         |                |        |              |   |            |
|         | 2.0 T                 | 149   | 11.10  | + Bremsscheibendurchm. 316mm <sup>3)</sup>         |                |        |              |   |            |
|         | 2.0 T4                | 140   | 05.15  | + Bremsscheibendurchm. 316mm <sup>3)</sup>         |                |        |              |   |            |
|         | 2.4 D5                | 158   | 06.11  | + Bremsscheibendurchm. 316mm <sup>3)</sup>         |                |        |              |   |            |
|         | 2.4 D5 AWD            | 158   | 06.11  | + Bremsscheibendurchm. 316mm <sup>3)</sup>         |                |        |              |   |            |
|         | 2.4 D5 Hybrid AWD     | 120   | 03.15  | + Bremsscheibendurchm. 316mm <sup>3)</sup>         |                |        |              |   |            |
|         | 2.4 D6 Plug-in-Hybrid | 158   | 11.12  | + Bremsscheibendurchm. 316mm <sup>3)</sup>         |                |        |              |   |            |
|         | D 3                   | 100   | 10.12  | + Bremsscheibendurchm. 316mm <sup>3)</sup>         |                |        |              |   |            |
|         | D 3                   | 120   | 11.10  | + Bremsscheibendurchm. 316mm <sup>3)</sup>         |                |        |              |   |            |
|         | D 5                   | 151   | 11.10  | + Bremsscheibendurchm. 316mm <sup>3)</sup>         |                |        |              |   |            |
|         | D 5 AWD               | 151   | 11.10  | + Bremsscheibendurchm. 316mm <sup>3)</sup>         |                |        |              |   |            |
|         | D3                    | 110   | 03.15  | + Bremsscheibendurchm. 316mm <sup>3)</sup>         |                |        |              |   |            |
|         | D4                    | 133   | 10.13  | + Bremsscheibendurchm. 316mm <sup>3)</sup>         |                |        |              |   |            |
|         | D4                    | 140   | 03.15  | + Bremsscheibendurchm. 316mm <sup>3)</sup>         |                |        |              |   |            |
|         | D4 AWD                | 120   | 12.12  | + Bremsscheibendurchm. 316mm <sup>3)</sup>         |                |        |              |   |            |
|         | D4 AWD                | 133   | 10.13  | + Bremsscheibendurchm. 316mm <sup>3)</sup>         |                |        |              |   |            |
|         | D4 AWD                | 140   | 03.15  | + Bremsscheibendurchm. 316mm <sup>3)</sup>         |                |        |              |   |            |

<sup>1)</sup> + brake disc diameter 316mm / 336mm / + diametro dischi freno 316mm / 336mm / + diamètre disques frein 316mm / 336mm / + diámetro disco freno 316mm / 336mm

<sup>2)</sup> + brake disc diameter 300mm / + diametro dischi freno 300mm / + diamètre disques frein 300mm / + diámetro disco freno 300mm

<sup>3)</sup> + brake disc diameter 316mm / + diametro dischi freno 316mm / + diamètre disques frein 316mm / + diámetro disco freno 316mm



**VOLVO V60 (10-)**

|        |                       |       |   |   |                |        |  |   |
|--------|-----------------------|-------|---|---|----------------|--------|--|---|
|        | D5                    | 165   | 03.15                                       | + Bremsscheibendurchm. 316mm <sup>1)</sup>  | 24.0128-0162.1 | 428162 |  | 316 28,0 26,0 VL +S +B<br>316 28,0 26,0 VL +S +B PD |
|        | D5                    | 169   | 04.14                                       | + Bremsscheibendurchm. 316mm <sup>1)</sup>  | 24.0328-0162.1 | 528162 |  |   |
|        | D5 AWD                | 169   | 04.14                                       | + Bremsscheibendurchm. 316mm <sup>1)</sup>  |                |        |  |   |
|        | D6 Hybrid AWD         | 162   | 03.15                                       | + Bremsscheibendurchm. 316mm <sup>1)</sup>  |                |        |  |   |
|        | T 6 AWD               | 224   | 11.10                                       | + Bremsscheibendurchm. 316mm <sup>1)</sup>  |                |        |  |   |
|        | T3                    | 110   | 11.10                                       | + Bremsscheibendurchm. 316mm <sup>1)</sup>  |                |        |  |   |
|        | T3                    | 112   | 03.15                                       | + Bremsscheibendurchm. 316mm <sup>1)</sup>  |                |        |  |   |
|        | T4                    | 132   | 11.10                                       | + Bremsscheibendurchm. 316mm <sup>1)</sup>  |                |        |  |   |
|        | T4F                   | 132   | 04.11                                       | + Bremsscheibendurchm. 316mm <sup>1)</sup>  |                |        |  |   |
|        | T5                    | 157   | 04.14                                       | + Bremsscheibendurchm. 316mm <sup>1)</sup>  |                |        |  |   |
|        | T5                    | 177   | 11.10                                       | + Bremsscheibendurchm. 316mm <sup>1)</sup>  |                |        |  |   |
| T5     | 180                   | 10.13 | + Bremsscheibendurchm. 316mm <sup>1)</sup>  |   |                |        |  |   |
| T6     | 225                   | 10.13 | + Bremsscheibendurchm. 316mm <sup>1)</sup>  |   |                |        |  |   |
| T6 AWD | 225                   | 10.13 | + Bremsscheibendurchm. 316mm <sup>1)</sup>  |   |                |        |  |   |
| T6 AWD | 242                   | 04.14 | + Bremsscheibendurchm. 316mm <sup>1)</sup>  |   |                |        |  |   |
|        | 1.5 T2                | 90    | 01.16                                       | + Bremsscheibendurchm. 336 mm <sup>2)</sup> | 24.0128-0210.1 | 428210 |  | 336 28,0 26,0 VL +S +B                              |
|        | 1.6 DRiVe             | 84    | 06.11                                       | + Bremsscheibendurchm. 336 mm <sup>2)</sup> |                |        |  |   |
|        | 2.0 D2                | 88    | 03.15                                       | + Bremsscheibendurchm. 336 mm <sup>2)</sup> |                |        |  |   |
|        | 2.0 T                 | 149   | 11.10                                       | + Bremsscheibendurchm. 336 mm <sup>2)</sup> |                |        |  |   |
|        | 2.0 T4                | 140   | 05.15                                       | + Bremsscheibendurchm. 336 mm <sup>2)</sup> |                |        |  |   |
|        | 2.4 D5                | 158   | 06.11                                       | + Bremsscheibendurchm. 336 mm <sup>2)</sup> |                |        |  |   |
|        | 2.4 D5 AWD            | 158   | 06.11                                       | + Bremsscheibendurchm. 336 mm <sup>2)</sup> |                |        |  |   |
|        | 2.4 D5 Hybrid AWD     | 120   | 03.15                                       | + Bremsscheibendurchm. 336 mm <sup>2)</sup> |                |        |  |   |
|        | 2.4 D6 Plug-in-Hybrid | 158   | 11.12                                       | + Bremsscheibendurchm. 336 mm <sup>2)</sup> |                |        |  |   |
|        | D 3                   | 100   | 10.12                                       | + Bremsscheibendurchm. 336 mm <sup>2)</sup> |                |        |  |   |
|        | D 3                   | 120   | 11.10                                       | + Bremsscheibendurchm. 336 mm <sup>2)</sup> |                |        |  |   |
|        | D 5                   | 151   | 11.10                                       | + Bremsscheibendurchm. 336 mm <sup>2)</sup> |                |        |  |   |
|        | D 5 AWD               | 151   | 11.10                                       | + Bremsscheibendurchm. 336 mm <sup>2)</sup> |                |        |  |   |
|        | D3                    | 110   | 03.15                                       | + Bremsscheibendurchm. 336 mm <sup>2)</sup> |                |        |  |   |
|        | D4                    | 133   | 10.13                                       | + Bremsscheibendurchm. 336 mm <sup>2)</sup> |                |        |  |   |
|        | D4                    | 140   | 03.15                                       | + Bremsscheibendurchm. 336 mm <sup>2)</sup> |                |        |  |   |
|        | D4 AWD                | 120   | 12.12                                       | + Bremsscheibendurchm. 336 mm <sup>2)</sup> |                |        |  |   |
|        | D4 AWD                | 133   | 10.13                                       | + Bremsscheibendurchm. 336 mm <sup>2)</sup> |                |        |  |   |
|        | D4 AWD                | 140   | 03.15                                       | + Bremsscheibendurchm. 336 mm <sup>2)</sup> |                |        |  |   |
|        | D5                    | 165   | 03.15                                       | + Bremsscheibendurchm. 336 mm <sup>2)</sup> |                |        |  |   |
|        | D5                    | 169   | 04.14                                       | + Bremsscheibendurchm. 336 mm <sup>2)</sup> |                |        |  |   |
|        | D5 AWD                | 169   | 04.14                                       | + Bremsscheibendurchm. 336 mm <sup>2)</sup> |                |        |  |   |
|        | D6 Hybrid AWD         | 162   | 03.15                                       | + Bremsscheibendurchm. 336 mm <sup>2)</sup> |                |        |  |   |
|        | T 6 AWD               | 224   | 11.10                                       | + Bremsscheibendurchm. 336 mm <sup>2)</sup> |                |        |  |   |
|        | T3                    | 110   | 11.10                                       | + Bremsscheibendurchm. 336 mm <sup>2)</sup> |                |        |  |   |
|        | T3                    | 112   | 03.15                                       | + Bremsscheibendurchm. 336 mm <sup>2)</sup> |                |        |  |   |
|        | T4                    | 132   | 11.10                                       | + Bremsscheibendurchm. 336 mm <sup>2)</sup> |                |        |  |   |
|        | T4F                   | 132   | 04.11                                       | + Bremsscheibendurchm. 336 mm <sup>2)</sup> |                |        |  |   |
|        | T5                    | 157   | 04.14                                       | + Bremsscheibendurchm. 336 mm <sup>2)</sup> |                |        |  |   |
|        | T5                    | 177   | 11.10                                       | + Bremsscheibendurchm. 336 mm <sup>2)</sup> |                |        |  |   |
|        | T5                    | 180   | 10.13                                       | + Bremsscheibendurchm. 336 mm <sup>2)</sup> |                |        |  |   |
|        | T6                    | 225   | 10.13                                       | + Bremsscheibendurchm. 336 mm <sup>2)</sup> |                |        |  |   |
|        | T6 AWD                | 225   | 10.13                                       | + Bremsscheibendurchm. 336 mm <sup>2)</sup> |                |        |  |   |
| T6 AWD | 242                   | 04.14 | + Bremsscheibendurchm. 336 mm <sup>2)</sup> |   |                |        |  |   |
|        | 1.5 T2                | 90    | 01.16                                       |   | 24.0711-5198.3 | 360239 |  | Radsensor<br>Radsensor                              |
|        | 1.6 DRiVe             | 84    | 06.11                                       |   | 24.0711-5241.3 | 360319 |  |   |
|        | 2.0 D2                | 88    | 03.15                                       |   |                |        |  |   |
|        | 2.0 T                 | 149   | 11.10                                       |   |                |        |  |   |
|        | 2.0 T4                | 140   | 05.15                                       |   |                |        |  |   |
|        | 2.4 D5                | 158   | 06.11                                       |   |                |        |  |   |
|        | 2.4 D5 AWD            | 158   | 06.11                                       |   |                |        |  |   |
|        | 2.4 D5 Hybrid AWD     | 120   | 03.15                                       |   |                |        |  |   |
|        | 2.4 D6 Plug-in-Hybrid | 158   | 11.12                                       |   |                |        |  |   |
|        | 3.0 T6 AWD            | 258   | 05.14                                       |   |                |        |  |   |
|        | D 3                   | 100   | 10.12                                       |   |                |        |  |   |
|        | D 3                   | 120   | 11.10                                       |   |                |        |  |   |
|        | D 5                   | 151   | 11.10                                       |   |                |        |  |   |
|        | D 5 AWD               | 151   | 11.10                                       |   |                |        |  |   |
|        | D3                    | 110   | 03.15                                       |   |                |        |  |   |
|        | D4                    | 133   | 10.13                                       |   |                |        |  |   |
|        | D4                    | 140   | 03.15                                       |   |                |        |  |   |
|        | D4 AWD                | 120   | 12.12                                       |   |                |        |  |   |
|        | D4 AWD                | 133   | 10.13                                       |   |                |        |  |   |
|        | D4 AWD                | 140   | 03.15                                       |   |                |        |  |   |
|        | D5                    | 165   | 03.15                                       |   |                |        |  |   |
|        | D5                    | 169   | 04.14                                       |   |                |        |  |   |
|        | D5 AWD                | 169   | 04.14                                       |   |                |        |  |   |
|        | D6 Hybrid AWD         | 162   | 03.15                                       |   |                |        |  |   |
|        | T 6 AWD               | 224   | 11.10                                       |   |                |        |  |   |
|        | T 6 AWD               | 224   | 11.10                                       |   |                |        |  |   |
|        | T3                    | 110   | 11.10                                       |   |                |        |  |   |
|        | T3                    | 112   | 03.15                                       |   |                |        |  |   |
|        | T4                    | 132   | 11.10                                       |   |                |        |  |   |
|        | T4F                   | 132   | 04.11                                       |   |                |        |  |   |
|        | T5                    | 157   | 04.14                                       |   |                |        |  |   |
|        | T5                    | 177   | 11.10                                       |   |                |        |  |   |
|        | T5                    | 180   | 10.13                                       |   |                |        |  |   |
| T6     | 225                   | 10.13 |   |   |                |        |  |   |
| T6 AWD | 225                   | 10.13 |   |   |                |        |  |   |

<sup>1)</sup> + brake disc diameter 316mm / + diametro dischi freno 316mm / + diamètre disques frein 316mm / + diámetro disco freno 316mm

<sup>2)</sup> + brake disc diameter 336mm / + diametro dischi freno 336mm / + diamètre disques frein 336mm / + diámetro disco freno 336mm

**VOLVO V60 (10-)**

|        |                       |       |                                    |                                    |                |        |   |                    |     |
|--------|-----------------------|-------|------------------------------------|------------------------------------|----------------|--------|---|--------------------|-----|
|        | 1.5 T2                | 90    | 01.16                              | + massive Scheiben <sup>1)</sup>   | 13.0460-2722.2 | 602722 | -   | 24496 17,3 /Zub/S  | TRW |
|        | 1.6 DRIVe             | 84    | 06.11                              | + massive Scheiben <sup>1)</sup>   | 13.0470-2722.2 | LD2722 | -   | 24496 17,3 /Zub/S  | TRW |
|        | 2.0 D2                | 88    | 03.15                              | + massive Scheiben <sup>1)</sup>   |                |        |   |                    |     |
|        | 2.0 T                 | 149   | 11.10                              | + massive Scheiben <sup>1)</sup>   |                |        |   |                    |     |
|        | 2.0 T4                | 140   | 05.15                              | + massive Scheiben <sup>1)</sup>   |                |        |   |                    |     |
|        | 2.4 D5                | 158   | 06.11                              | + massive Scheiben <sup>1)</sup>   |                |        |   |                    |     |
|        | 2.4 D5 AWD            | 158   | 06.11                              | + massive Scheiben <sup>1)</sup>   |                |        |   |                    |     |
|        | 2.4 D5 Hybrid AWD     | 120   | 03.15                              | + massive Scheiben <sup>1)</sup>   |                |        |   |                    |     |
|        | 2.4 D6 Plug-in-Hybrid | 158   | 11.12                              | + massive Scheiben <sup>1)</sup>   |                |        |   |                    |     |
|        | 3.0 T6 AWD            | 258   | 05.14                              | + massive Scheiben <sup>1)</sup>   |                |        |   |                    |     |
|        | D 3                   | 100   | 10.12                              | + massive Scheiben <sup>1)</sup>   |                |        |   |                    |     |
|        | D 3                   | 120   | 11.10                              | + massive Scheiben <sup>1)</sup>   |                |        |   |                    |     |
|        | D 5                   | 151   | 11.10                              | + massive Scheiben <sup>1)</sup>   |                |        |   |                    |     |
|        | D 5 AWD               | 151   | 11.10                              | + massive Scheiben <sup>1)</sup>   |                |        |   |                    |     |
|        | D3                    | 110   | 03.15                              | + massive Scheiben <sup>1)</sup>   |                |        |   |                    |     |
|        | D4                    | 133   | 10.13                              | + massive Scheiben <sup>1)</sup>   |                |        |   |                    |     |
|        | D4                    | 140   | 03.15                              | + massive Scheiben <sup>1)</sup>   |                |        |   |                    |     |
|        | D4 AWD                | 120   | 12.12                              | + massive Scheiben <sup>1)</sup>   |                |        |   |                    |     |
|        | D4 AWD                | 133   | 10.13                              | + massive Scheiben <sup>1)</sup>   |                |        |   |                    |     |
|        | D4 AWD                | 140   | 03.15                              | + massive Scheiben <sup>1)</sup>   |                |        |   |                    |     |
|        | D5                    | 165   | 03.15                              | + massive Scheiben <sup>1)</sup>   |                |        |   |                    |     |
|        | D5                    | 169   | 04.14                              | + massive Scheiben <sup>1)</sup>   |                |        |   |                    |     |
|        | D5 AWD                | 169   | 04.14                              | + massive Scheiben <sup>1)</sup>   |                |        |   |                    |     |
|        | D6 Hybrid AWD         | 162   | 03.15                              | + massive Scheiben <sup>1)</sup>   |                |        |   |                    |     |
|        | T 6 AWD               | 224   | 11.10                              | + massive Scheiben <sup>1)</sup>   |                |        |   |                    |     |
|        | T3                    | 110   | 11.10                              | + massive Scheiben <sup>1)</sup>   |                |        |   |                    |     |
|        | T3                    | 112   | 03.15                              | + massive Scheiben <sup>1)</sup>   |                |        |   |                    |     |
|        | T4                    | 132   | 11.10                              | + massive Scheiben <sup>1)</sup>   |                |        |   |                    |     |
|        | T4F                   | 132   | 04.11                              | + massive Scheiben <sup>1)</sup>   |                |        |   |                    |     |
|        | T5                    | 157   | 04.14                              | + massive Scheiben <sup>1)</sup>   |                |        |   |                    |     |
| T5     | 177                   | 11.10 | + massive Scheiben <sup>1)</sup>   |                                    |                |        |   |                    |     |
| T5     | 180                   | 10.13 | + massive Scheiben <sup>1)</sup>   |                                    |                |        |   |                    |     |
| T6     | 225                   | 10.13 | + massive Scheiben <sup>1)</sup>   |                                    |                |        |   |                    |     |
| T6 AWD | 225                   | 10.13 | + massive Scheiben <sup>1)</sup>   |                                    |                |        |   |                    |     |
| T6 AWD | 242                   | 04.14 | + massive Scheiben <sup>1)</sup>   |                                    |                |        |   |                    |     |
|        | 1.5 T2                | 90    | 01.16                              | + belüftete Scheiben <sup>2)</sup> | 13.0460-2736.2 | 602736 | elektrische Feststellbremse <sup>3)</sup> | 24496 17,3 /Zub/S  | TRW |
|        | 1.6 DRIVe             | 84    | 06.11                              | + belüftete Scheiben <sup>2)</sup> | 13.0470-2736.2 | LD2736 | elektrische Feststellbremse <sup>3)</sup> | 24496 17,3 /Zub/S  | TRW |
|        | 2.0 D2                | 88    | 03.15                              | + belüftete Scheiben <sup>2)</sup> |                |        |   |                    |     |
|        | 2.0 T                 | 149   | 11.10                              | + belüftete Scheiben <sup>2)</sup> |                |        |   |                    |     |
|        | 2.0 T4                | 140   | 05.15                              | + belüftete Scheiben <sup>2)</sup> |                |        |   |                    |     |
|        | 2.4 D5                | 158   | 06.11                              | + belüftete Scheiben <sup>2)</sup> |                |        |   |                    |     |
|        | 2.4 D5 AWD            | 158   | 06.11                              | + belüftete Scheiben <sup>2)</sup> |                |        |   |                    |     |
|        | 2.4 D5 Hybrid AWD     | 120   | 03.15                              | + belüftete Scheiben <sup>2)</sup> |                |        |   |                    |     |
|        | 2.4 D6 Plug-in-Hybrid | 158   | 11.12                              | + belüftete Scheiben <sup>2)</sup> |                |        |   |                    |     |
|        | 3.0 T6 AWD            | 258   | 05.14                              | + belüftete Scheiben <sup>2)</sup> |                |        |   |                    |     |
|        | D 3                   | 100   | 10.12                              | + belüftete Scheiben <sup>2)</sup> |                |        |   |                    |     |
|        | D 3                   | 120   | 11.10                              | + belüftete Scheiben <sup>2)</sup> |                |        |   |                    |     |
|        | D 5                   | 151   | 11.10                              | + belüftete Scheiben <sup>2)</sup> |                |        |   |                    |     |
|        | D 5 AWD               | 151   | 11.10                              | + belüftete Scheiben <sup>2)</sup> |                |        |   |                    |     |
|        | D3                    | 110   | 03.15                              | + belüftete Scheiben <sup>2)</sup> |                |        |   |                    |     |
|        | D4                    | 133   | 10.13                              | + belüftete Scheiben <sup>2)</sup> |                |        |   |                    |     |
|        | D4                    | 140   | 03.15                              | + belüftete Scheiben <sup>2)</sup> |                |        |   |                    |     |
|        | D4 AWD                | 120   | 12.12                              | + belüftete Scheiben <sup>2)</sup> |                |        |   |                    |     |
|        | D4 AWD                | 133   | 10.13                              | + belüftete Scheiben <sup>2)</sup> |                |        |   |                    |     |
|        | D4 AWD                | 140   | 03.15                              | + belüftete Scheiben <sup>2)</sup> |                |        |   |                    |     |
|        | D5                    | 165   | 03.15                              | + belüftete Scheiben <sup>2)</sup> |                |        |   |                    |     |
|        | D5                    | 169   | 04.14                              | + belüftete Scheiben <sup>2)</sup> |                |        |   |                    |     |
|        | D5 AWD                | 169   | 04.14                              | + belüftete Scheiben <sup>2)</sup> |                |        |   |                    |     |
|        | D6 Hybrid AWD         | 162   | 03.15                              | + belüftete Scheiben <sup>2)</sup> |                |        |   |                    |     |
|        | T 6 AWD               | 224   | 11.10                              | + belüftete Scheiben <sup>2)</sup> |                |        |   |                    |     |
|        | T3                    | 110   | 11.10                              | + belüftete Scheiben <sup>2)</sup> |                |        |   |                    |     |
|        | T3                    | 112   | 03.15                              | + belüftete Scheiben <sup>2)</sup> |                |        |   |                    |     |
|        | T4                    | 132   | 11.10                              | + belüftete Scheiben <sup>2)</sup> |                |        |   |                    |     |
|        | T4F                   | 132   | 04.11                              | + belüftete Scheiben <sup>2)</sup> |                |        |   |                    |     |
|        | T5                    | 157   | 04.14                              | + belüftete Scheiben <sup>2)</sup> |                |        |   |                    |     |
| T5     | 177                   | 11.10 | + belüftete Scheiben <sup>2)</sup> |                                    |                |        |   |                    |     |
| T5     | 180                   | 10.13 | + belüftete Scheiben <sup>2)</sup> |                                    |                |        |   |                    |     |
| T6     | 225                   | 10.13 | + belüftete Scheiben <sup>2)</sup> |                                    |                |        |   |                    |     |
| T6 AWD | 225                   | 10.13 | + belüftete Scheiben <sup>2)</sup> |                                    |                |        |   |                    |     |
| T6 AWD | 242                   | 04.14 | + belüftete Scheiben <sup>2)</sup> |                                    |                |        |   |                    |     |
|        | 1.6 DRIVe             | 84    | 06.11                              | + massive Scheiben <sup>1)</sup>   | 24.0111-0147.1 | 411147 |   | 302 11,0 9,0 +S +B |     |
|        | 2.0 D2                | 88    | 03.15                              | + massive Scheiben <sup>1)</sup>   |                |        |   |                    |     |
|        | 2.0 T                 | 149   | 11.10                              | + massive Scheiben <sup>1)</sup>   |                |        |   |                    |     |
|        | 2.0 T4                | 140   | 05.15                              | + massive Scheiben <sup>1)</sup>   |                |        |   |                    |     |
|        | 2.4 D5                | 158   | 06.11                              | + massive Scheiben <sup>1)</sup>   |                |        |   |                    |     |
|        | 2.4 D5 AWD            | 158   | 06.11                              | + massive Scheiben <sup>1)</sup>   |                |        |   |                    |     |
|        | 2.4 D5 Hybrid AWD     | 120   | 03.15                              | + massive Scheiben <sup>1)</sup>   |                |        |   |                    |     |
|        | 2.4 D6 Plug-in-Hybrid | 158   | 11.12                              | + massive Scheiben <sup>1)</sup>   |                |        |   |                    |     |
|        | 3.0 T6 AWD            | 258   | 05.14                              | + massive Scheiben <sup>1)</sup>   |                |        |   |                    |     |
|        | D 3                   | 100   | 10.12                              | + massive Scheiben <sup>1)</sup>   |                |        |   |                    |     |
|        | D 3                   | 120   | 11.10                              | + massive Scheiben <sup>1)</sup>   |                |        |   |                    |     |
|        | D 5                   | 151   | 11.10                              | + massive Scheiben <sup>1)</sup>   |                |        |   |                    |     |
|        | D 5 AWD               | 151   | 11.10                              | + massive Scheiben <sup>1)</sup>   |                |        |   |                    |     |
|        | D3                    | 110   | 03.15                              | + massive Scheiben <sup>1)</sup>   |                |        |   |                    |     |
| D4     | 133                   | 10.13 | + massive Scheiben <sup>1)</sup>   |                                    |                |        |   |                    |     |
| D4     | 140                   | 03.15 | + massive Scheiben <sup>1)</sup>   |                                    |                |        |   |                    |     |
| D4 AWD | 120                   | 12.12 | + massive Scheiben <sup>1)</sup>   |                                    |                |        |   |                    |     |

<sup>1)</sup> + solid discs / + dischi massiccio / + disques massive / + disco macizo

<sup>2)</sup> + ventilated discs / + dischi ventilati / + disques ventilés / + disco ventilado



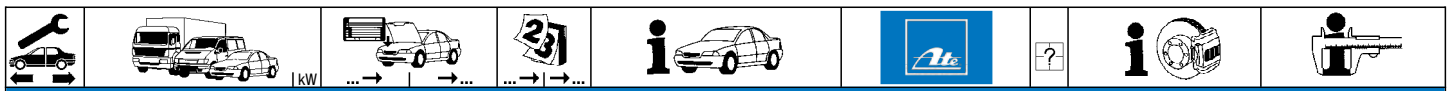









<sup>3)</sup> electric parking brake / fr.di stazionamento elettrico / frein à main électrique / freno de mano eléctrico



# VOLVO V60 (10-)







|                       |                   |                       |       |                                    |                |                |        |                    |                                    |                |        |  |                         |
|-----------------------|-------------------|-----------------------|-------|------------------------------------|----------------|----------------|--------|--------------------|------------------------------------|----------------|--------|--|-------------------------|
|                       | D4 AWD            | 133                   | 10.13 | + massive Scheiben <sup>1)</sup>   | 24.0111-0147.1 | 411147         |        | 302 11,0 9,0 +S +B |                                    |                |        |  |                         |
|                       | D4 AWD            | 140                   | 03.15 | + massive Scheiben <sup>1)</sup>   |                |                |        |                    |                                    |                |        |  |                         |
|                       | D5                | 165                   | 03.15 | + massive Scheiben <sup>1)</sup>   |                |                |        |                    |                                    |                |        |  |                         |
|                       | D5                | 169                   | 04.14 | + massive Scheiben <sup>1)</sup>   |                |                |        |                    |                                    |                |        |  |                         |
|                       | D5 AWD            | 169                   | 04.14 | + massive Scheiben <sup>1)</sup>   |                |                |        |                    |                                    |                |        |  |                         |
|                       | D6 Hybrid AWD     | 162                   | 03.15 | + massive Scheiben <sup>1)</sup>   |                |                |        |                    |                                    |                |        |  |                         |
|                       | T 6 AWD           | 224                   | 11.10 | + massive Scheiben <sup>1)</sup>   |                |                |        |                    |                                    |                |        |  |                         |
|                       | T3                | 110                   | 11.10 | + massive Scheiben <sup>1)</sup>   |                |                |        |                    |                                    |                |        |  |                         |
|                       | T3                | 112                   | 03.15 | + massive Scheiben <sup>1)</sup>   |                |                |        |                    |                                    |                |        |  |                         |
|                       | T4                | 132                   | 11.10 | + massive Scheiben <sup>1)</sup>   |                |                |        |                    |                                    |                |        |  |                         |
|                       | T4F               | 132                   | 04.11 | + massive Scheiben <sup>1)</sup>   |                |                |        |                    |                                    |                |        |  |                         |
|                       | T5                | 157                   | 04.14 | + massive Scheiben <sup>1)</sup>   |                |                |        |                    |                                    |                |        |  |                         |
|                       | T5                | 177                   | 11.10 | + massive Scheiben <sup>1)</sup>   |                |                |        |                    |                                    |                |        |  |                         |
|                       | T5                | 180                   | 10.13 | + massive Scheiben <sup>1)</sup>   |                |                |        |                    |                                    |                |        |  |                         |
|                       | T6                | 225                   | 10.13 | + massive Scheiben <sup>1)</sup>   |                |                |        |                    |                                    |                |        |  |                         |
|                       | T6 AWD            | 225                   | 10.13 | + massive Scheiben <sup>1)</sup>   |                |                |        |                    |                                    |                |        |  |                         |
|                       | T6 AWD            | 242                   | 04.14 | + massive Scheiben <sup>1)</sup>   |                |                |        |                    |                                    |                |        |  |                         |
|                       |                   | 1.5 T2                | 90    | 01.16                              |                |                |        |                    | + belüftete Scheiben <sup>2)</sup> | 24.0122-0259.1 | 422259 |  | 302 22,0 20,0 V L +S +B |
|                       |                   | 1.6 DRIVe             | 84    | 06.11                              |                |                |        |                    | + belüftete Scheiben <sup>2)</sup> |                |        |  |                         |
|                       |                   | 2.0 D2                | 88    | 03.15                              |                |                |        |                    | + belüftete Scheiben <sup>2)</sup> |                |        |  |                         |
| 2.0 T                 |                   | 149                   | 11.10 | + belüftete Scheiben <sup>2)</sup> |                |                |        |                    |                                    |                |        |  |                         |
| 2.0 T4                |                   | 140                   | 05.15 | + belüftete Scheiben <sup>2)</sup> |                |                |        |                    |                                    |                |        |  |                         |
| 2.4 D5                |                   | 158                   | 06.11 | + belüftete Scheiben <sup>2)</sup> |                |                |        |                    |                                    |                |        |  |                         |
| 2.4 D5 AWD            |                   | 158                   | 06.11 | + belüftete Scheiben <sup>2)</sup> |                |                |        |                    |                                    |                |        |  |                         |
| 2.4 D5 Hybrid AWD     |                   | 120                   | 03.15 | + belüftete Scheiben <sup>2)</sup> |                |                |        |                    |                                    |                |        |  |                         |
| 2.4 D6 Plug-in-Hybrid |                   | 158                   | 11.12 | + belüftete Scheiben <sup>2)</sup> |                |                |        |                    |                                    |                |        |  |                         |
| 3.0 T6 AWD            |                   | 258                   | 05.14 | + belüftete Scheiben <sup>2)</sup> |                |                |        |                    |                                    |                |        |  |                         |
| D 3                   |                   | 100                   | 10.12 | + belüftete Scheiben <sup>2)</sup> |                |                |        |                    |                                    |                |        |  |                         |
| D 3                   |                   | 120                   | 11.10 | + belüftete Scheiben <sup>2)</sup> |                |                |        |                    |                                    |                |        |  |                         |
| D 5                   |                   | 151                   | 11.10 | + belüftete Scheiben <sup>2)</sup> |                |                |        |                    |                                    |                |        |  |                         |
| D 5 AWD               |                   | 151                   | 11.10 | + belüftete Scheiben <sup>2)</sup> |                |                |        |                    |                                    |                |        |  |                         |
| D3                    |                   | 110                   | 03.15 | + belüftete Scheiben <sup>2)</sup> |                |                |        |                    |                                    |                |        |  |                         |
| D4                    |                   | 133                   | 10.13 | + belüftete Scheiben <sup>2)</sup> |                |                |        |                    |                                    |                |        |  |                         |
| D4                    |                   | 140                   | 03.15 | + belüftete Scheiben <sup>2)</sup> |                |                |        |                    |                                    |                |        |  |                         |
| D4 AWD                |                   | 120                   | 12.12 | + belüftete Scheiben <sup>2)</sup> |                |                |        |                    |                                    |                |        |  |                         |
| D4 AWD                |                   | 133                   | 10.13 | + belüftete Scheiben <sup>2)</sup> |                |                |        |                    |                                    |                |        |  |                         |
| D4 AWD                |                   | 140                   | 03.15 | + belüftete Scheiben <sup>2)</sup> |                |                |        |                    |                                    |                |        |  |                         |
| D5                    |                   | 165                   | 03.15 | + belüftete Scheiben <sup>2)</sup> |                |                |        |                    |                                    |                |        |  |                         |
| D5                    |                   | 169                   | 04.14 | + belüftete Scheiben <sup>2)</sup> |                |                |        |                    |                                    |                |        |  |                         |
| D5 AWD                |                   | 169                   | 04.14 | + belüftete Scheiben <sup>2)</sup> |                |                |        |                    |                                    |                |        |  |                         |
| D6 Hybrid AWD         |                   | 162                   | 03.15 | + belüftete Scheiben <sup>2)</sup> |                |                |        |                    |                                    |                |        |  |                         |
| T 6 AWD               |                   | 224                   | 11.10 | + belüftete Scheiben <sup>2)</sup> |                |                |        |                    |                                    |                |        |  |                         |
| T3                    |                   | 110                   | 11.10 | + belüftete Scheiben <sup>2)</sup> |                |                |        |                    |                                    |                |        |  |                         |
| T3                    |                   | 112                   | 03.15 | + belüftete Scheiben <sup>2)</sup> |                |                |        |                    |                                    |                |        |  |                         |
| T4                    |                   | 132                   | 11.10 | + belüftete Scheiben <sup>2)</sup> |                |                |        |                    |                                    |                |        |  |                         |
| T4F                   |                   | 132                   | 04.11 | + belüftete Scheiben <sup>2)</sup> |                |                |        |                    |                                    |                |        |  |                         |
| T5                    |                   | 157                   | 04.14 | + belüftete Scheiben <sup>2)</sup> |                |                |        |                    |                                    |                |        |  |                         |
| T5                    |                   | 177                   | 11.10 | + belüftete Scheiben <sup>2)</sup> |                |                |        |                    |                                    |                |        |  |                         |
| T5                    |                   | 180                   | 10.13 | + belüftete Scheiben <sup>2)</sup> |                |                |        |                    |                                    |                |        |  |                         |
| T6                    |                   | 225                   | 10.13 | + belüftete Scheiben <sup>2)</sup> |                |                |        |                    |                                    |                |        |  |                         |
| T6 AWD                |                   | 225                   | 10.13 | + belüftete Scheiben <sup>2)</sup> |                |                |        |                    |                                    |                |        |  |                         |
| T6 AWD                |                   | 242                   | 04.14 | + belüftete Scheiben <sup>2)</sup> |                |                |        |                    |                                    |                |        |  |                         |
|                       |                   | 1.6 DRIVe             | 84    | 06.11                              |                | 24.0711-6369.3 | 360395 | 2                  | Radsensor                          |                |        |  |                         |
|                       |                   | 2.0 T                 | 149   | 11.10                              |                |                |        |                    |                                    |                |        |  |                         |
|                       |                   | 2.0 T4                | 140   | 05.15                              |                |                |        |                    |                                    |                |        |  |                         |
|                       |                   | 2.4 D5                | 158   | 06.11                              |                |                |        |                    |                                    |                |        |  |                         |
|                       |                   | 2.4 D6 Plug-in-Hybrid | 158   | 11.12                              |                |                |        |                    |                                    |                |        |  |                         |
|                       |                   | D 3                   | 100   | 10.12                              |                |                |        |                    |                                    |                |        |  |                         |
|                       |                   | D 3                   | 120   | 11.10                              |                |                |        |                    |                                    |                |        |  |                         |
|                       |                   | D 5                   | 151   | 11.10                              |                |                |        |                    |                                    |                |        |  |                         |
|                       |                   | D3                    | 110   | 03.15                              |                |                |        |                    |                                    |                |        |  |                         |
|                       |                   | D4                    | 133   | 10.13                              |                |                |        |                    |                                    |                |        |  |                         |
|                       |                   | D4                    | 140   | 03.15                              |                |                |        |                    |                                    |                |        |  |                         |
|                       |                   | D5                    | 169   | 04.14                              |                |                |        |                    |                                    |                |        |  |                         |
|                       | T3                | 110                   | 11.10 |                                    |                |                |        |                    |                                    |                |        |  |                         |
|                       | T3                | 112                   | 03.15 |                                    |                |                |        |                    |                                    |                |        |  |                         |
| T4                    | 132               | 11.10                 |       |                                    |                |                |        |                    |                                    |                |        |  |                         |
| T4F                   | 132               | 04.11                 |       |                                    |                |                |        |                    |                                    |                |        |  |                         |
| T5                    | 177               | 11.10                 |       |                                    |                |                |        |                    |                                    |                |        |  |                         |
| T5                    | 180               | 10.13                 |       |                                    |                |                |        |                    |                                    |                |        |  |                         |
| T6                    | 225               | 10.13                 |       |                                    |                |                |        |                    |                                    |                |        |  |                         |
|                       | 1.5 T2            | 90                    | 01.16 |                                    | 24.0711-6221.3 | 360258         | 2      | Radsensor          |                                    |                |        |  |                         |
|                       | 2.0 D2            | 88                    | 03.15 |                                    |                |                |        |                    |                                    |                |        |  |                         |
|                       | 2.4 D5 Hybrid AWD | 120                   | 03.15 |                                    |                |                |        |                    |                                    |                |        |  |                         |
|                       | D5                | 165                   | 03.15 |                                    |                |                |        |                    |                                    |                |        |  |                         |
|                       | T5                | 157                   | 04.14 |                                    |                |                |        |                    |                                    |                |        |  |                         |
|                       | 2.4 D5 AWD        | 158                   | 06.11 |                                    | 24.0711-6369.3 | 360395         | 2      | Radsensor          |                                    |                |        |  |                         |
|                       | 3.0 T6 AWD        | 258                   | 05.14 |                                    |                |                |        |                    |                                    |                |        |  |                         |
|                       | D 5 AWD           | 151                   | 11.10 |                                    |                |                |        |                    |                                    |                |        |  |                         |
|                       | D4 AWD            | 120                   | 12.12 |                                    |                |                |        |                    |                                    |                |        |  |                         |
|                       | D4 AWD            | 133                   | 10.13 |                                    |                |                |        |                    |                                    |                |        |  |                         |
|                       | D4 AWD            | 140                   | 03.15 |                                    |                |                |        |                    |                                    |                |        |  |                         |
|                       | D5 AWD            | 169                   | 04.14 |                                    |                |                |        |                    |                                    |                |        |  |                         |
|                       | D6 Hybrid AWD     | 162                   | 03.15 |                                    |                |                |        |                    |                                    |                |        |  |                         |
|                       | T 6 AWD           | 224                   | 11.10 |                                    |                |                |        |                    |                                    |                |        |  |                         |
|                       | T6 AWD            | 225                   | 10.13 |                                    |                |                |        |                    |                                    |                |        |  |                         |
| T6 AWD                | 242               | 04.14                 |       |                                    |                |                |        |                    |                                    |                |        |  |                         |

<sup>1)</sup> + solid discs / + dischi massiccio / + disques massive / + disco macizo  
<sup>2)</sup> + ventilated discs / + dischi ventilati / + disques ventilés / + disco ventilado

|     |  |  |  |  |  |  |  |  |                    |     |
|--|--|--|--|--|---|--|--|--|--------------------|-----|
| <b>VOLVO V70 I (97-00)</b>   |  |  |  |  |   |  |  |  |                    |     |
|    | 2.0  | 93   |  | 01.97  | 03.00   | 13.0460-7053.2   | 607053   |  | 21273 19,5 +WE     | ATE |
|  | 2.0  | 105  |  | 01.97  | 03.00   | 13.0470-7053.2   | LD7053   |  | 21273 19,5 +WE     | ATE |
|  | 2.0 20V  | 120  |  | 01.97  | 03.00   |  |  |  |                    |     |
|  | 2.0 20V  | 132  |  | 01.97  | 03.00   |  |  |  |                    |     |
|  | 2.0 T  | 155  |  | 01.97  | 03.00   |  |  |  |                    |     |
|  | 2.3 AWD  |  |  | 04.97  | 09.98   |  |  |  |                    |     |
|  | 2.3 T5 AWD   | 176  |  | 01.97  | 03.00   |  |  |  |                    |     |
|  | 2.4  | 103  |  | 08.99  | 03.00   |  |  |  |                    |     |
|  | 2.4  | 125  |  | 01.97  | 03.00   |  |  |  |                    |     |
|  | 2.4 AWD  | 121  |  | 10.98  | 05.99   |  |  |  |                    |     |
|  | 2.4 Bi-Fuel  | 103  |  | 08.99  | 03.00   |  |  |  |                    |     |
|  | 2.4 T  | 142  |  | 01.97  | 03.00   |  |  |  |                    |     |
|  | 2.5  | 106  |  | 01.97  | 03.00   |  |  |  |                    |     |
|  | 2.5  | 121  |  | 06.98  | 03.00   |  |  |  |                    |     |
|  | 2.5 Bi-Fuel  | 106  |  | 10.98  | 08.99   |  |  |  |                    |     |
|  | 2.5 T AWD  | 142  |  | 01.97  | 03.00   |  |  |  |                    |     |
|  | 2.5 TDI  | 103  |  | 01.97  | 03.00   |  |  |  |                    |     |
|  | 2.0 T  | 166  |  | 01.97  | 03.00   | 13.0460-7053.2   | 607053   |  | 21273 19,5 +WE     | ATE |
|  | 2.0 T AWD  | 166  |  | 01.97  | 03.00   |  |  |  |                    |     |
|  | 2.3 T  | 184  |  | 01.97  | 03.00   |  |  |  |                    |     |
| 2.3 T AWD  | 184  |  | 04.97  | 03.00  |   |  |  |  |                    |     |
| 2.3 T5   | 176  |  | 01.97  | 03.00  |   |  |  |  |                    |     |
| 2.3 T5 AWD   | 176  |  | 01.97  | 03.00  |   |  |  |  |                    |     |
| 2.4  | 103  |  | 08.99  | 03.00  |   |  |  |  |                    |     |
| 2.4  | 125  |  | 01.97  | 03.00  |   |  |  |  |                    |     |
| 2.4 AWD  | 121  |  | 10.98  | 05.99  |   |  |  |  |                    |     |
| 2.4 Bi-Fuel  | 103  |  | 08.99  | 03.00  |   |  |  |  |                    |     |
| 2.4 T  | 142  |  | 01.97  | 03.00  |   |  |  |  |                    |     |
| 2.5  | 106  |  | 01.97  | 03.00  |   |  |  |  |                    |     |
| 2.5  | 121  |  | 06.98  | 03.00  |   |  |  |  |                    |     |
| 2.5 AWD  | 195  |  | 03.99  | 03.00  |   |  |  |  |                    |     |
| 2.5 Bi-Fuel  | 106  |  | 10.98  | 08.99  |   |  |  |  |                    |     |
| 2.5 T AWD  | 142  |  | 01.97  | 03.00  |   |  |  |  |                    |     |
| 2.5 TDI  | 103  |  | 01.97  | 03.00  |   |  |  |  |                    |     |
|    | 2.0  | 93   |  | 01.97  | 03.00   | 24.0126-0102.1   | 426102   | + 15" Rad 1)   | 280 26,0 23,0 V +B |     |
|  | 2.0  | 105  |  | 01.97  | 03.00   |  |  |  |                    |     |
|  | 2.0 20V  | 120  |  | 01.97  | 03.00   |  |  |  |                    |     |
|  | 2.0 20V  | 132  |  | 01.97  | 03.00   |  |  |  |                    |     |
|  | 2.0 T  | 155  |  | 01.97  | 03.00   |  |  |  |                    |     |
|  | 2.0 T  | 166  |  | 01.97  | 03.00   |  |  |  |                    |     |
|  | 2.0 T AWD  | 166  |  | 01.97  | 03.00   |  |  |  |                    |     |
|  | 2.3 AWD  |  |  | 04.97  | 09.98   |  |  |  |                    |     |
|  | 2.3 T  | 184  |  | 01.97  | 03.00   |  |  |  |                    |     |
|  | 2.3 T AWD  | 184  |  | 04.97  | 03.00   |  |  |  |                    |     |
|  | 2.3 T5   | 176  |  | 01.97  | 03.00   |  |  |  |                    |     |
|  | 2.3 T5 AWD   | 176  |  | 01.97  | 03.00   |  |  |  |                    |     |
|  | 2.4  | 103  |  | 08.99  | 03.00   |  |  |  |                    |     |
|  | 2.4  | 125  |  | 01.97  | 03.00   |  |  |  |                    |     |
|  | 2.4 AWD  | 121  |  | 10.98  | 05.99   |  |  |  |                    |     |
|  | 2.4 Bi-Fuel  | 103  |  | 08.99  | 03.00   |  |  |  |                    |     |
|  | 2.4 T  | 142  |  | 01.97  | 03.00   |  |  |  |                    |     |
|  | 2.5  | 106  |  | 01.97  | 03.00   |  |  |  |                    |     |
|  | 2.5  | 121  |  | 06.98  | 03.00   |  |  |  |                    |     |
|  | 2.5 AWD  | 195  |  | 03.99  | 03.00   |  |  |  |                    |     |
| 2.5 Bi-Fuel  | 106  |  | 10.98  | 08.99  |   |  |  |  |                    |     |
| 2.5 T AWD  | 142  |  | 01.97  | 03.00  |   |  |  |  |                    |     |
| 2.5 TDI  | 103  |  | 01.97  | 03.00  |   |  |  |  |                    |     |
| 2.0  | 93   |  | 01.97  | 03.00  | 24.0126-0107.1  | 426107   | + 16" Rad 2)   | 302 26,0 23,0 V L +B   |                    |     |
| 2.0  | 105  |  | 01.97  | 03.00  | 24.0326-0107.1  | 526107   | + 16" Rad 2)   | 302 26,0 23,0 V L +B PD  |                    |     |
| 2.0 20V  | 120  |  | 01.97  | 03.00  |   |  |  |  |                    |     |
| 2.0 20V  | 132  |  | 01.97  | 03.00  |   |  |  |  |                    |     |
| 2.0 T  | 155  |  | 01.97  | 03.00  |   |  |  |  |                    |     |
| 2.0 T  | 166  |  | 01.97  | 03.00  |   |  |  |  |                    |     |
| 2.0 T AWD  | 166  |  | 01.97  | 03.00  |   |  |  |  |                    |     |
| 2.3 AWD  |  |  | 04.97  | 09.98  |   |  |  |  |                    |     |
| 2.3 T  | 184  |  | 01.97  | 03.00  |   |  |  |  |                    |     |
| 2.3 T AWD  | 184  |  | 04.97  | 03.00  |   |  |  |  |                    |     |
| 2.3 T5   | 176  |  | 01.97  | 03.00  |   |  |  |  |                    |     |
| 2.3 T5 AWD   | 176  |  | 01.97  | 03.00  |   |  |  |  |                    |     |
| 2.4  | 103  |  | 08.99  | 03.00  |   |  |  |  |                    |     |
| 2.4  | 125  |  | 01.97  | 03.00  |   |  |  |  |                    |     |
| 2.4 AWD  | 121  |  | 10.98  | 05.99  |   |  |  |  |                    |     |
| 2.4 Bi-Fuel  | 103  |  | 08.99  | 03.00  |   |  |  |  |                    |     |
| 2.4 T  | 142  |  | 01.97  | 03.00  |   |  |  |  |                    |     |
| 2.5  | 106  |  | 01.97  | 03.00  |   |  |  |  |                    |     |
| 2.5  | 121  |  | 06.98  | 03.00  |   |  |  |  |                    |     |
| 2.5 AWD  | 195  |  | 03.99  | 03.00  |   |  |  |  |                    |     |
| 2.5 Bi-Fuel  | 106  |  | 10.98  | 08.99  |   |  |  |  |                    |     |
| 2.5 T AWD  | 142  |  | 01.97  | 03.00  |   |  |  |  |                    |     |
| 2.5 TDI  | 103  |  | 01.97  | 03.00  |   |  |  |  |                    |     |
|  | 2.0  | 93   |  | 01.97  | 12.98   | 24.0711-1146.1   | 360060   | 2  | Radsensor          |     |
|  | 2.0  | 105  |  | 01.97  | 12.98   |  |  |  |                    |     |
|  | 2.0 20V  | 120  |  | 01.97  | 12.98   |  |  |  |                    |     |
|  | 2.0 20V  | 132  |  | 01.97  | 12.98   |  |  |  |                    |     |
|  | 2.0 T  | 155  |  | 01.97  | 12.98   |  |  |  |                    |     |
|  | 2.0 T  | 166  |  | 01.97  | 12.98   |  |  |  |                    |     |
|  | 2.0 T AWD  | 166  |  | 01.97  | 12.98   |  |  |  |                    |     |
|  | 2.3 AWD  |  |  | 04.97  | 12.98   |  |  |  |                    |     |
|  | 2.3 T  | 184  |  | 01.97  | 12.98   |  |  |  |                    |     |
|  | 2.3 T AWD  | 184  |  | 04.97  | 12.98   |  |  |  |                    |     |
|  | 2.3 T5   | 176  |  | 01.97  | 12.98   |  |  |  |                    |     |
|  | 2.3 T5 AWD   | 176  |  | 01.97  | 12.98   |  |  |  |                    |     |
|  | 2.4  | 125  |  | 01.97  | 12.98   |  |  |  |                    |     |
|  | 2.4 AWD  | 121  |  | 10.98  | 12.98   |  |  |  |                    |     |
|  | 2.4 T  | 142  |  | 01.97  | 12.98   |  |  |  |                    |     |
|  | 2.5  | 106  |  | 01.97  | 12.98   |  |  |  |                    |     |
|  | 2.5  | 121  |  | 06.98  | 12.98   |  |  |  |                    |     |
|  | 2.5 Bi-Fuel  | 106  |  | 10.98  | 12.98   |  |  |  |                    |     |

1) + 15" wheel / + ruota 15" / + roue 15" / + rueda 15"

2) + 16" wheel / + ruota 16" / + roue 16" / + rueda 16"

| VOLVO V70 I (97-00)  |  |            |     |       |       |                |                |        |  |                  |                   |
|--|--|------------|-----|-------|-------|----------------|----------------|--------|--|------------------|-------------------|
|    | 2.5 T AWD  | 142        |     | 01.97 | 12.98 | 24.0711-1146.1 | 360060         | 2      |  | Radsensor        |                   |
|  | 2.5 TDI  | 103        |     | 01.97 | 12.98 |                |                |        |  |                  |                   |
|    | 2.0  | 93         |     | 01.99 | 03.00 | 24.0711-6011.3 | 360120         | 2      |  | Radsensor L=1000 |                   |
|  | 2.0  | 105        |     | 01.99 | 03.00 |                |                |        |  |                  |                   |
|  | 2.0 20V  | 120        |     | 01.99 | 03.00 |                |                |        |  |                  |                   |
|  | 2.0 20V  | 132        |     | 01.99 | 03.00 |                |                |        |  |                  |                   |
|  | 2.0 T  | 155        |     | 01.99 | 03.00 |                |                |        |  |                  |                   |
|  | 2.0 T  | 166        |     | 01.99 | 03.00 |                |                |        |  |                  |                   |
|  | 2.3 AWD  |            |     | 01.99 | 05.99 |                |                |        |  |                  |                   |
|  | 2.3 T  | 184        |     | 01.99 | 03.00 |                |                |        |  |                  |                   |
|  | 2.3 T5   | 176        |     | 01.99 | 03.00 |                |                |        |  |                  |                   |
|  | 2.4  | 103        |     | 08.99 | 03.00 |                |                |        |  |                  |                   |
|  | 2.4  | 125        |     | 01.99 | 03.00 |                |                |        |  |                  |                   |
|  | 2.4 AWD  | 121        |     | 01.99 | 05.99 |                |                |        |  |                  |                   |
|  | 2.4 Bi-Fuel  | 103        |     | 08.99 | 03.00 |                |                |        |  |                  |                   |
|  | 2.4 T  | 142        |     | 01.99 | 03.00 |                |                |        |  |                  |                   |
|  | 2.5  | 106        |     | 01.99 | 03.00 |                |                |        |  |                  |                   |
|  | 2.5  | 121        |     | 01.99 | 03.00 |                |                |        |  |                  |                   |
|  | 2.5 AWD  | 195        |     | 03.99 | 03.00 |                |                |        |  |                  |                   |
|  | 2.5 Bi-Fuel  | 106        |     | 01.99 | 08.99 |                |                |        |  |                  |                   |
|  | 2.5 T AWD  | 142        |     | 01.99 | 03.00 |                |                |        |  |                  |                   |
|  | 2.5 TDI  | 103        |     | 01.99 | 03.00 |                |                |        |  |                  |                   |
|  |  | 2.0        | 93  |       | 01.97 | 12.99          | 13.0460-4044.2 | 604044 |  |                  | 20755 15,1 ATE    |
|  |  | 2.0        | 105 |       | 01.97 | 12.99          | 13.0470-4044.2 | LD4044 |  |                  | 20755 15,1 ATE    |
|  |  | 2.0 20V    | 120 |       | 01.97 | 12.99          |                |        |  |                  |                   |
|  |  | 2.0 20V    | 132 |       | 01.97 | 12.99          |                |        |  |                  |                   |
|  |  | 2.0 T      | 155 |       | 01.97 | 12.99          |                |        |  |                  |                   |
| 2.0 T  |  | 166        |     | 01.97 | 12.99 |                |                |        |  |                  |                   |
| 2.3 AWD  |  |            |     | 04.97 | 09.98 |                |                |        |  |                  |                   |
| 2.3 T  |  | 184        |     | 01.97 | 12.99 |                |                |        |  |                  |                   |
| 2.3 T5   |  | 176        |     | 01.97 | 12.99 |                |                |        |  |                  |                   |
| 2.4  |  | 103        |     | 08.99 | 12.99 |                |                |        |  |                  |                   |
| 2.4  |  | 125        |     | 01.97 | 12.99 |                |                |        |  |                  |                   |
| 2.4 AWD  |  | 121        |     | 10.98 | 05.99 |                |                |        |  |                  |                   |
| 2.4 Bi-Fuel  |  | 103        |     | 08.99 | 12.99 |                |                |        |  |                  |                   |
| 2.4 T  |  | 142        |     | 01.97 | 12.99 |                |                |        |  |                  |                   |
| 2.5  |  | 106        |     | 01.97 | 12.99 |                |                |        |  |                  |                   |
| 2.5  |  | 121        |     | 06.98 | 12.99 |                |                |        |  |                  |                   |
| 2.5 Bi-Fuel  |  | 106        |     | 10.98 | 08.99 |                |                |        |  |                  |                   |
| 2.5 TDI  |  | 103        |     | 01.97 | 12.99 |                |                |        |  |                  |                   |
|  |  | 2.0 T AWD  | 166 |       | 01.97 | 12.99          | 13.0460-2935.2 | 602935 |  |                  | 21385 13,8 /S TRW |
|  |  | 2.3 T AWD  | 184 |       | 04.97 | 12.99          |                |        |  |                  |                   |
|  |  | 2.3 T5 AWD | 176 |       | 01.97 | 12.99          |                |        |  |                  |                   |
|  |  | 2.5 AWD    | 195 |       | 03.99 | 12.99          |                |        |  |                  |                   |
|  |  | 2.5 T AWD  | 142 |       | 01.97 | 12.99          |                |        |  |                  |                   |
|  |  | 2.0        | 93  |       | 01.00 | 03.00          | 13.0460-7135.2 | 607135 |  |                  | 23076 17,5 + ATE  |
|  |  | 2.0        | 105 |       | 01.00 | 03.00          | 13.0470-7135.2 | LD7135 |  |                  | 23076 17,5 + ATE  |
|  | 2.0 20V  | 120        |     | 01.00 | 03.00 |                |                |        |  |                  |                   |
|  | 2.0 20V  | 132        |     | 01.00 | 03.00 |                |                |        |  |                  |                   |
|  | 2.0 T  | 155        |     | 01.00 | 03.00 |                |                |        |  |                  |                   |
|  | 2.0 T  | 166        |     | 01.00 | 03.00 |                |                |        |  |                  |                   |
|  | 2.0 T AWD  | 166        |     | 01.00 | 03.00 |                |                |        |  |                  |                   |
|  | 2.3 T  | 184        |     | 01.00 | 03.00 |                |                |        |  |                  |                   |
|  | 2.3 T AWD  | 184        |     | 01.00 | 03.00 |                |                |        |  |                  |                   |
|  | 2.3 T5   | 176        |     | 01.00 | 03.00 |                |                |        |  |                  |                   |
|  | 2.3 T5 AWD   | 176        |     | 01.00 | 03.00 |                |                |        |  |                  |                   |
|  | 2.4  | 103        |     | 01.00 | 03.00 |                |                |        |  |                  |                   |
|  | 2.4  | 125        |     | 01.00 | 03.00 |                |                |        |  |                  |                   |
|  | 2.4 Bi-Fuel  | 103        |     | 01.00 | 03.00 |                |                |        |  |                  |                   |
|  | 2.4 T  | 142        |     | 01.00 | 03.00 |                |                |        |  |                  |                   |
|  | 2.5  | 106        |     | 01.00 | 03.00 |                |                |        |  |                  |                   |
|  | 2.5  | 121        |     | 01.00 | 03.00 |                |                |        |  |                  |                   |
|  | 2.5 AWD  | 195        |     | 01.00 | 03.00 |                |                |        |  |                  |                   |
|  | 2.5 T AWD  | 142        |     | 01.00 | 03.00 |                |                |        |  |                  |                   |
|  | 2.5 TDI  | 103        |     | 01.00 | 03.00 |                |                |        |  |                  |                   |
|  | 2.0  | 93         |     | 01.97 | 03.00 | 24.0110-0214.1 | 410214         |        |  | 295 9,6 8,4 +B   |                   |
|  | 2.0  | 105        |     | 01.97 | 03.00 |                |                |        |  |                  |                   |
|  | 2.0 20V  | 120        |     | 01.97 | 03.00 |                |                |        |  |                  |                   |
|  | 2.0 20V  | 132        |     | 01.97 | 03.00 |                |                |        |  |                  |                   |
|  | 2.0 T  | 155        |     | 01.97 | 03.00 |                |                |        |  |                  |                   |
|  | 2.0 T  | 166        |     | 01.97 | 03.00 |                |                |        |  |                  |                   |
|  | 2.0 T AWD  | 166        |     | 01.97 | 03.00 |                |                |        |  |                  |                   |
|  | 2.3 AWD  |            |     | 04.97 | 09.98 |                |                |        |  |                  |                   |
|  | 2.3 T  | 184        |     | 01.97 | 03.00 |                |                |        |  |                  |                   |
|  | 2.3 T AWD  | 184        |     | 04.97 | 03.00 |                |                |        |  |                  |                   |
|  | 2.3 T5   | 176        |     | 01.97 | 03.00 |                |                |        |  |                  |                   |
|  | 2.3 T5 AWD   | 176        |     | 01.97 | 03.00 |                |                |        |  |                  |                   |
|  | 2.4  | 103        |     | 08.99 | 03.00 |                |                |        |  |                  |                   |
|  | 2.4  | 125        |     | 01.97 | 03.00 |                |                |        |  |                  |                   |
|  | 2.4 AWD  | 121        |     | 10.98 | 05.99 |                |                |        |  |                  |                   |
|  | 2.4 Bi-Fuel  | 103        |     | 08.99 | 03.00 |                |                |        |  |                  |                   |
|  | 2.4 T  | 142        |     | 01.97 | 03.00 |                |                |        |  |                  |                   |
|  | 2.5  | 106        |     | 01.97 | 03.00 |                |                |        |  |                  |                   |
|  | 2.5  | 121        |     | 06.98 | 03.00 |                |                |        |  |                  |                   |
|  | 2.5 AWD  | 195        |     | 03.99 | 03.00 |                |                |        |  |                  |                   |
|  | 2.5 Bi-Fuel  | 106        |     | 10.98 | 08.99 |                |                |        |  |                  |                   |
|  | 2.5 T AWD  | 142        |     | 01.97 | 03.00 |                |                |        |  |                  |                   |





**VOLVO V70 I (97-00)**

|  |             |     |        |       |       |                |        |   |                       |
|--|-------------|-----|--------|-------|-------|----------------|--------|---|-----------------------|
|  | 2.5 TDI     | 103 |        | 01.97 | 03.00 | 24.0110-0214.1 | 410214 |   | 295 9,6 8,4 +B        |
|  | 2.0 T AWD   | 166 | 587043 | 01.97 |       | 24.0110-0292.1 | 410292 |   | 283 10,0 8,0          |
|  | 2.3 T AWD   | 184 | 587043 | 04.97 |       |                |        |   |                       |
|  | 2.3 T5 AWD  | 176 | 587043 | 01.97 |       |                |        |   |                       |
|  | 2.5 T AWD   | 142 | 587043 | 01.97 |       |                |        |   |                       |
|  | 2.0 T AWD   | 166 | 587044 |       | 03.00 | 24.0112-0165.1 | 412165 |   | 288 12,0 10,0 +B      |
|  | 2.3 T AWD   | 184 | 587044 |       | 03.00 |                |        |   |                       |
|  | 2.3 T5 AWD  | 176 | 587044 |       | 03.00 |                |        |   |                       |
|  | 2.5 AWD     | 195 |        | 03.99 | 03.00 |                |        |   |                       |
|  | 2.5 T AWD   | 142 | 587044 |       | 03.00 |                |        |   |                       |
|  | 2.0         | 93  |        | 01.97 | 12.98 | 24.0741-1105.1 | 360195 | 1 | Radsensor L=1220/1840 |
|  | 2.0         | 105 |        | 01.97 | 12.98 |                |        |   |                       |
|  | 2.0 20V     | 120 |        | 01.97 | 12.98 |                |        |   |                       |
|  | 2.0 20V     | 132 |        | 01.97 | 12.98 |                |        |   |                       |
|  | 2.0 T       | 155 |        | 01.97 | 12.98 |                |        |   |                       |
|  | 2.0 T       | 166 |        | 01.97 | 12.98 |                |        |   |                       |
|  | 2.0 T AWD   | 166 |        | 01.97 | 12.98 |                |        |   |                       |
|  | 2.3 AWD     |     |        | 04.97 | 09.98 |                |        |   |                       |
|  | 2.3 T       | 184 |        | 01.97 | 12.98 |                |        |   |                       |
|  | 2.3 T AWD   | 184 |        | 04.97 | 12.98 |                |        |   |                       |
|  | 2.3 T5      | 176 |        | 01.97 | 12.98 |                |        |   |                       |
|  | 2.3 T5 AWD  | 176 |        | 01.97 | 12.98 |                |        |   |                       |
|  | 2.4         | 125 |        | 01.97 | 12.98 |                |        |   |                       |
|  | 2.4 AWD     | 121 |        | 10.98 | 12.98 |                |        |   |                       |
|  | 2.4 T       | 142 |        | 01.97 | 12.98 |                |        |   |                       |
|  | 2.5         | 106 |        | 01.97 | 12.98 |                |        |   |                       |
|  | 2.5         | 121 |        | 06.98 | 12.98 |                |        |   |                       |
|  | 2.5 Bi-Fuel | 106 |        | 10.98 | 12.98 |                |        |   |                       |
|  | 2.5 T AWD   | 142 |        | 01.97 | 12.98 |                |        |   |                       |
|  | 2.5 TDI     | 103 |        | 01.97 | 12.98 |                |        |   |                       |
|  | 2.0         | 93  |        | 01.99 | 03.00 | 24.0711-5025.3 | 360234 | 1 | Radsensor L=1215/1855 |
|  | 2.0         | 105 |        | 01.99 | 03.00 |                |        |   |                       |
|  | 2.0 20V     | 120 |        | 01.99 | 03.00 |                |        |   |                       |
|  | 2.0 20V     | 132 |        | 01.99 | 03.00 |                |        |   |                       |
|  | 2.0 T       | 155 |        | 01.99 | 03.00 |                |        |   |                       |
|  | 2.0 T       | 166 |        | 01.99 | 03.00 |                |        |   |                       |
|  | 2.3 T       | 184 |        | 01.99 | 03.00 |                |        |   |                       |
|  | 2.3 T5      | 176 |        | 01.99 | 03.00 |                |        |   |                       |
|  | 2.4         | 103 |        | 08.99 | 03.00 |                |        |   |                       |
|  | 2.4         | 125 |        | 01.99 | 03.00 |                |        |   |                       |
|  | 2.4 AWD     | 121 |        | 01.99 | 05.99 |                |        |   |                       |
|  | 2.4 Bi-Fuel | 103 |        | 08.99 | 03.00 |                |        |   |                       |
|  | 2.4 T       | 142 |        | 01.99 | 03.00 |                |        |   |                       |
|  | 2.5         | 106 |        | 01.99 | 03.00 |                |        |   |                       |
|  | 2.5         | 121 |        | 01.99 | 03.00 |                |        |   |                       |
|  | 2.5 Bi-Fuel | 106 |        | 01.99 | 08.99 |                |        |   |                       |
|  | 2.5 TDI     | 103 |        | 01.99 | 03.00 |                |        |   |                       |
|  | 2.0 T AWD   | 166 |        | 01.99 | 03.00 | 24.0711-6012.3 | 360276 | 2 | Radsensor L=1720/1345 |
|  | 2.3 T AWD   | 184 |        | 01.99 | 03.00 |                |        |   |                       |
|  | 2.3 T5 AWD  | 176 |        | 01.99 | 03.00 |                |        |   |                       |
|  | 2.5 AWD     | 195 |        | 03.99 | 03.00 |                |        |   |                       |
|  | 2.5 T AWD   | 142 |        | 01.99 | 03.00 |                |        |   |                       |
|  | 2.0         | 93  |        | 01.97 | 03.00 | 03.0137-0260.2 | 650260 |   | 178 x 25              |
|  | 2.0         | 105 |        | 01.97 | 03.00 | 03.0137-9176.2 | 669176 |   | Bremsbacken-Zubehör   |
|  | 2.0 20V     | 120 |        | 01.97 | 03.00 |                |        |   |                       |
|  | 2.0 20V     | 132 |        | 01.97 | 03.00 |                |        |   |                       |
|  | 2.0 T       | 155 |        | 01.97 | 03.00 |                |        |   |                       |
|  | 2.0 T       | 166 |        | 01.97 | 03.00 |                |        |   |                       |
|  | 2.3 AWD     |     |        | 04.97 | 09.98 |                |        |   |                       |
|  | 2.3 T       | 184 |        | 01.97 | 03.00 |                |        |   |                       |
|  | 2.3 T5      | 176 |        | 01.97 | 03.00 |                |        |   |                       |
|  | 2.4         | 103 |        | 08.99 | 03.00 |                |        |   |                       |
|  | 2.4         | 125 |        | 01.97 | 03.00 |                |        |   |                       |
|  | 2.4 AWD     | 121 |        | 10.98 | 05.99 |                |        |   |                       |
|  | 2.4 Bi-Fuel | 103 |        | 08.99 | 03.00 |                |        |   |                       |
|  | 2.4 T       | 142 |        | 01.97 | 03.00 |                |        |   |                       |
|  | 2.5         | 106 |        | 01.97 | 03.00 |                |        |   |                       |
|  | 2.5         | 121 |        | 06.98 | 03.00 |                |        |   |                       |
|  | 2.5 Bi-Fuel | 106 |        | 10.98 | 08.99 |                |        |   |                       |
|  | 2.5 TDI     | 103 |        | 01.97 | 03.00 |                |        |   |                       |
|  | 2.0 T AWD   | 166 |        | 01.97 | 03.00 | 03.0137-0449.2 | 650449 |   | 178 x 25              |
|  | 2.3 T AWD   | 184 |        | 04.97 | 03.00 |                |        |   |                       |
|  | 2.3 T5 AWD  | 176 |        | 01.97 | 03.00 |                |        |   |                       |
|  | 2.5 AWD     | 195 |        | 03.99 | 03.00 |                |        |   |                       |
|  | 2.5 T AWD   | 142 |        | 01.97 | 03.00 |                |        |   |                       |

**VOLVO V70 II (00-07)**

|  |             |     |  |       |       |                |        |                         |              |     |
|--|-------------|-----|--|-------|-------|----------------|--------|-------------------------|--------------|-----|
|  | 2.0 T       | 132 |  | 07.01 | 07.07 | 13.0460-7145.2 | 607145 | - 17" Rad <sup>1)</sup> | 23073 18,8 + | ATE |
|  | 2.3         | 195 |  | 10.00 | 09.04 | 13.0470-7145.2 | LD7145 | - 17" Rad <sup>1)</sup> | 23073 18,8 + | ATE |
|  | 2.4         |     |  | 03.00 | 07.07 |                |        |                         |              |     |
|  | 2.4         | 103 |  | 03.00 | 07.07 |                |        |                         |              |     |
|  | 2.4 4X4     | 121 |  | 03.00 | 09.03 |                |        |                         |              |     |
|  | 2.4 Bi-Fuel | 103 |  | 09.01 | 07.07 |                |        |                         |              |     |
|  | 2.4 D       | 93  |  | 05.05 | 07.07 |                |        |                         |              |     |
|  | 2.4 D       | 96  |  | 12.01 | 07.07 |                |        |                         |              |     |
|  | 2.4 D5      | 120 |  | 08.01 | 07.07 |                |        |                         |              |     |

<sup>1)</sup> - 17" wheel / - ruota 17" / - roue 17" / - rueda 17"



















**VOLVO V70 II (00-07)**

|             |             |     |       |       |                |                |        |                  |                              |     |
|-------------|-------------|-----|-------|-------|----------------|----------------|--------|------------------|------------------------------|-----|
|             | 2.4 D5      | 136 |       | 12.05 | 07.07          | 13.0460-7145.2 | 607145 | - 17" Rad 1)     | 23073 18,8 +                 | ATE |
|             | 2.4 D5 AWD  | 120 |       | 03.03 | 07.07          | 13.0470-7145.2 | LD7145 | - 17" Rad 1)     | 23073 18,8 +                 | ATE |
|             | 2.4 D5 AWD  | 136 |       | 12.05 | 07.07          |                |        |                  |                              |     |
|             | 2.4 T       | 147 |       | 03.00 | 07.07          |                |        |                  |                              |     |
|             | 2.4 T AWD   | 147 |       | 09.01 | 07.07          |                |        |                  |                              |     |
|             | 2.5 T       | 154 |       | 04.04 | 07.07          |                |        |                  |                              |     |
|             | 2.5 T AWD   | 154 |       | 09.02 | 07.07          |                |        |                  |                              |     |
|             | 2.5 TDI     | 103 |       | 03.00 | 07.07          |                |        |                  |                              |     |
|             | 2.3 T5      | 184 |       | 03.00 | 07.07          | 13.0460-7145.2 | 607145 | - 17" Rad 1)     | 23073 18,8 +                 | ATE |
|             | 2.4 T5      | 191 |       | 04.04 | 07.07          |                |        |                  |                              |     |
|             | 2.0 T       | 132 |       | 07.01 | 07.07          | 13.0460-7187.2 | 607187 | + 17" Rad 2)     | 23950 19,5 +                 | ATE |
|             | 2.3         | 195 |       | 10.00 | 09.04          | 13.0470-7187.2 | LD7187 | + 17" Rad 2)     | 23950 19,5 +                 | ATE |
|             | 2.3 T5      | 184 |       | 03.00 | 07.07          |                |        |                  |                              |     |
|             | 2.4         |     |       | 03.00 | 07.07          |                |        |                  |                              |     |
| 2.4         | 103         |     | 03.00 | 07.07 |                |                |        |                  |                              |     |
| 2.4 4X4     | 121         |     | 03.00 | 09.03 |                |                |        |                  |                              |     |
| 2.4 Bi-Fuel | 103         |     | 09.01 | 07.07 |                |                |        |                  |                              |     |
| 2.4 D       | 93          |     | 05.05 | 07.07 |                |                |        |                  |                              |     |
| 2.4 D       | 96          |     | 12.01 | 07.07 |                |                |        |                  |                              |     |
| 2.4 D5      | 120         |     | 08.01 | 07.07 |                |                |        |                  |                              |     |
| 2.4 D5      | 136         |     | 12.05 | 07.07 |                |                |        |                  |                              |     |
| 2.4 D5 AWD  | 120         |     | 03.03 | 07.07 |                |                |        |                  |                              |     |
| 2.4 D5 AWD  | 136         |     | 12.05 | 07.07 |                |                |        |                  |                              |     |
| 2.4 T       | 147         |     | 03.00 | 07.07 |                |                |        |                  |                              |     |
| 2.4 T AWD   | 147         |     | 09.01 | 07.07 |                |                |        |                  |                              |     |
| 2.4 T5      | 191         |     | 04.04 | 07.07 |                |                |        |                  |                              |     |
| 2.5 T       | 154         |     | 04.04 | 07.07 |                |                |        |                  |                              |     |
| 2.5 T AWD   | 154         |     | 09.02 | 07.07 |                |                |        |                  |                              |     |
| 2.5 TDI     | 103         |     | 03.00 | 07.07 |                |                |        |                  |                              |     |
| 2.5 R Sport | 221         |     | 12.02 | 08.07 | 13.0460-4804.2 | 604804         |        | 23092 15,6       | BRE                          |     |
| R 2.5 T AWD | 221         |     | 03.03 | 07.07 |                |                |        |                  |                              |     |
|             | 2.0 T       | 132 |       | 07.01 | 07.07          | 24.0126-0122.1 | 426122 | + 15" Rad 3)     | 286 26,0 23,0 V +B           |     |
|             | 2.3         | 195 |       | 10.00 | 09.04          | 24.0128-0123.1 | 428123 | + 16" Rad 4)     | 305 27,9 25,0 V +B           |     |
|             | 2.3 T5      | 184 |       | 03.00 | 07.07          | 24.0328-0123.1 | 528123 | + 16" Rad 4)     | <b>305 27,9 25,0 V +B PD</b> |     |
|             | 2.4         |     |       | 03.00 | 07.07          | 24.0128-0184.1 | 428184 | + 17" Rad 2)     | 320 28,0 25,0 V L +B         |     |
|             | 2.4         | 103 |       | 03.00 | 07.07          |                |        |                  |                              |     |
|             | 2.4 4X4     | 121 |       | 03.00 | 09.03          |                |        |                  |                              |     |
|             | 2.4 Bi-Fuel | 103 |       | 09.01 | 07.07          |                |        |                  |                              |     |
|             | 2.4 D       | 93  |       | 05.05 | 07.07          |                |        |                  |                              |     |
|             | 2.4 D       | 96  |       | 12.01 | 07.07          |                |        |                  |                              |     |
|             | 2.4 D5      | 120 |       | 08.01 | 07.07          |                |        |                  |                              |     |
|             | 2.4 D5      | 136 |       | 12.05 | 07.07          |                |        |                  |                              |     |
|             | 2.4 D5 AWD  | 120 |       | 03.03 | 07.07          |                |        |                  |                              |     |
|             | 2.4 D5 AWD  | 136 |       | 12.05 | 07.07          |                |        |                  |                              |     |
|             | 2.4 T       | 147 |       | 03.00 | 07.07          |                |        |                  |                              |     |
| 2.4 T AWD   | 147         |     | 09.01 | 07.07 |                |                |        |                  |                              |     |
| 2.4 T5      | 191         |     | 04.04 | 07.07 |                |                |        |                  |                              |     |
| 2.5 T       | 154         |     | 04.04 | 07.07 |                |                |        |                  |                              |     |
| 2.5 T AWD   | 154         |     | 09.02 | 07.07 |                |                |        |                  |                              |     |
| 2.5 TDI     | 103         |     | 03.00 | 07.07 |                |                |        |                  |                              |     |
| 2.0 T       | 132         |     | 07.01 | 07.07 | 24.0711-6214.3 | 360230         |        | Radsensor L=965  |                              |     |
| 2.3         | 195         |     | 10.00 | 09.04 | 24.0711-6211.3 | 360233         |        | Radsensor L=1085 |                              |     |
| 2.3 T5      | 184         |     | 03.00 | 07.07 |                |                |        |                  |                              |     |
| 2.4         |             |     | 03.00 | 07.07 |                |                |        |                  |                              |     |
| 2.4         | 103         |     | 03.00 | 07.07 |                |                |        |                  |                              |     |
| 2.4 4X4     | 121         |     | 03.00 | 09.03 |                |                |        |                  |                              |     |
| 2.4 Bi-Fuel | 103         |     | 09.01 | 07.07 |                |                |        |                  |                              |     |
| 2.4 D       | 93          |     | 05.05 | 07.07 |                |                |        |                  |                              |     |
| 2.4 D       | 96          |     | 12.01 | 07.07 |                |                |        |                  |                              |     |
| 2.4 D5      | 120         |     | 08.01 | 07.07 |                |                |        |                  |                              |     |
| 2.4 D5      | 136         |     | 12.05 | 07.07 |                |                |        |                  |                              |     |
| 2.4 D5 AWD  | 120         |     | 03.03 | 07.07 |                |                |        |                  |                              |     |
| 2.4 D5 AWD  | 136         |     | 12.05 | 07.07 |                |                |        |                  |                              |     |
| 2.4 T       | 147         |     | 03.00 | 07.07 |                |                |        |                  |                              |     |
| 2.4 T AWD   | 147         |     | 09.01 | 07.07 |                |                |        |                  |                              |     |
| 2.4 T5      | 191         |     | 04.04 | 07.07 |                |                |        |                  |                              |     |
| 2.5 R Sport | 221         |     | 12.02 | 08.07 |                |                |        |                  |                              |     |
| 2.5 T       | 154         |     | 04.04 | 07.07 |                |                |        |                  |                              |     |
| 2.5 T AWD   | 154         |     | 09.02 | 07.07 |                |                |        |                  |                              |     |
| 2.5 TDI     | 103         |     | 03.00 | 07.07 |                |                |        |                  |                              |     |
| R 2.5 T AWD | 221         |     | 03.03 | 07.07 |                |                |        |                  |                              |     |
|             | 2.0 T       | 132 |       | 07.01 | 07.07          | 13.0460-7135.2 | 607135 |                  | 23076 17,5 +                 | ATE |
|             | 2.3         | 195 |       | 10.00 | 09.04          | 13.0470-7135.2 | LD7135 |                  | 23076 17,5 +                 | ATE |
|             | 2.3 T5      | 184 |       | 03.00 | 07.07          |                |        |                  |                              |     |
|             | 2.4         |     |       | 03.00 | 07.07          |                |        |                  |                              |     |
|             | 2.4         | 103 |       | 03.00 | 07.07          |                |        |                  |                              |     |
|             | 2.4 4X4     | 121 |       | 03.00 | 09.03          |                |        |                  |                              |     |
|             | 2.4 Bi-Fuel | 103 |       | 09.01 | 07.07          |                |        |                  |                              |     |
|             | 2.4 D       | 93  |       | 05.05 | 07.07          |                |        |                  |                              |     |
|             | 2.4 D       | 96  |       | 12.01 | 07.07          |                |        |                  |                              |     |
|             | 2.4 D5      | 120 |       | 08.01 | 07.07          |                |        |                  |                              |     |
|             | 2.4 D5      | 136 |       | 12.05 | 07.07          |                |        |                  |                              |     |
|             | 2.4 D5 AWD  | 120 |       | 03.03 | 07.07          |                |        |                  |                              |     |
|             | 2.4 D5 AWD  | 136 |       | 12.05 | 07.07          |                |        |                  |                              |     |
|             | 2.4 T       | 147 |       | 03.00 | 07.07          |                |        |                  |                              |     |
| 2.4 T AWD   | 147         |     | 09.01 | 07.07 |                |                |        |                  |                              |     |
| 2.4 T5      | 191         |     | 04.04 | 07.07 |                |                |        |                  |                              |     |

1) - 17" wheel / - ruota 17" / - roue 17" / - rueda 17"  
 2) + 17" wheel / + ruota 17" / + roue 17" / + rueda 17"  
 3) + 15" wheel / + ruota 15" / + roue 15" / + rueda 15"  
 4) + 16" wheel / + ruota 16" / + roue 16" / + rueda 16"

|     |   |    |  |    |   |  |  |  |                              |            |
|--|---|--|--|--|--|--|--|--|------------------------------|------------|
| <b>VOLVO V70 II (00-07)</b>  |   |  |  |  |  |  |  |  |                              |            |
|    | 2.5 T<br>2.5 T AWD<br>2.5 TDI<br>2.5 R Sport<br>R 2.5 T AWD   | 154<br>154<br>103<br>221<br>221  |  | 04.04 07.07<br>09.02 07.07<br>03.00 07.07<br>12.02 08.07<br>03.03 07.07  |  | 13.0460-7135.2<br>13.0470-7135.2   | 607135<br>LD7135   | 23076 17,5 +<br>23076 17,5 +<br><br>21381 15,0                                     | ATE<br>ATE<br><br>BRE        |            |
|    | 2.0 T<br>2.3<br>2.3 T5<br>2.4<br>2.4<br>2.4 4X4<br>2.4 Bi-Fuel<br>2.4 D<br>2.4 D<br>2.4 D5<br>2.4 D5<br>2.4 D5 AWD<br>2.4 D5 AWD<br>2.4 T<br>2.4 T AWD<br>2.4 T5<br>2.5 T<br>2.5 T AWD<br>2.5 TDI                               | 132<br>195<br>184<br>103<br>121<br>103<br>93<br>96<br>120<br>136<br>120<br>136<br>147<br>147<br>191<br>154<br>154<br>103               |  | 07.01 07.07<br>10.00 09.04<br>03.00 07.07<br>03.00 07.07<br>03.00 07.07<br>03.00 09.03<br>09.01 07.07<br>05.05 07.07<br>12.01 07.07<br>08.01 07.07<br>12.05 07.07<br>03.03 07.07<br>12.05 07.07<br>03.00 07.07<br>09.01 07.07<br>04.04 07.07<br>04.04 07.07<br>09.02 07.07<br>03.00 07.07                |  | 24.0112-0151.1<br>24.0312-0151.1   | 412151<br>512151   | 288 11,9 10,0 +B<br>288 11,9 10,0 +B PD  |                              |            |
|    | 2.0 T<br>2.3<br>2.3 T5<br>2.4<br>2.4<br>2.4 4X4<br>2.4 Bi-Fuel<br>2.4 D<br>2.4 D<br>2.4 D5<br>2.4 D5<br>2.4 D5 AWD<br>2.4 D5 AWD<br>2.4 T<br>2.4 T AWD<br>2.4 T5<br>2.5 R Sport<br>2.5 T<br>2.5 T AWD<br>2.5 TDI<br>R 2.5 T AWD | 132<br>195<br>184<br>103<br>121<br>103<br>93<br>96<br>120<br>136<br>120<br>136<br>147<br>147<br>191<br>221<br>154<br>154<br>103<br>221 |  | 07.01 07.07<br>10.00 09.04<br>03.00 07.07<br>03.00 07.07<br>03.00 09.03<br>09.01 07.07<br>05.05 07.07<br>12.01 07.07<br>08.01 07.07<br>12.05 07.07<br>03.03 07.07<br>12.05 07.07<br>03.00 07.07<br>09.01 07.07<br>04.04 07.07<br>12.02 08.07<br>04.04 07.07<br>09.02 07.07<br>03.00 07.07<br>03.03 07.07 |  | 24.0711-6212.3<br>24.0711-6213.3   | 360249<br>360250   | Radsensor L=1255<br>Radsensor L=1255   |                              |            |
|  | 2.0 T<br>2.3<br>2.3 T5<br>2.4<br>2.4<br>2.4 4X4<br>2.4 Bi-Fuel<br>2.4 D<br>2.4 D<br>2.4 D5<br>2.4 D5<br>2.4 D5 AWD<br>2.4 D5 AWD<br>2.4 T<br>2.4 T AWD<br>2.4 T5<br>2.5 R Sport<br>2.5 T<br>2.5 T AWD<br>2.5 TDI<br>R 2.5 T AWD | 132<br>195<br>184<br>103<br>121<br>103<br>93<br>96<br>120<br>136<br>120<br>136<br>147<br>147<br>191<br>221<br>154<br>154<br>103<br>221 |  | 07.01 07.07<br>10.00 09.04<br>03.00 07.07<br>03.00 07.07<br>03.00 09.03<br>09.01 07.07<br>05.05 07.07<br>12.01 07.07<br>08.01 07.07<br>12.05 07.07<br>03.03 07.07<br>12.05 07.07<br>03.00 07.07<br>09.01 07.07<br>04.04 07.07<br>12.02 08.07<br>04.04 07.07<br>09.02 07.07<br>03.00 07.07<br>03.03 07.07 |  | 03.0137-0450.2<br>03.0137-9283.2   | 650450<br>669283   | 178 x 25<br>Bremsbacken-Zubehör  |                              |            |
| <b>VOLVO V70 III (07-)</b>   |   |  |  |  |  |  |  |  |                              |            |
|  | 1.6 DRiVe<br>1.6 T4F<br>2.0<br>2.0 BiFuel<br>2.0 D<br>2.0 D3<br>2.0 D3<br>2.0 D4<br>2.0 FlexiFuel<br>2.0 GDI<br>2.0 T<br>2.4 D<br>2.4 D<br>2.4 D4 AWD<br>2.4 D5<br>2.4 D5<br>2.4 D5<br>2.4 D5 AWD<br>2.4 D5 AWD                 | 132<br>107<br>100<br>157<br>100<br>100<br>120<br>120<br>107<br>157<br>149<br>120<br>129<br>120<br>136<br>151<br>158<br>136<br>151      |  | 01.10<br>01.11<br>10.07<br>03.13<br>10.07<br>05.12<br>03.10<br>01.13<br>09.07<br>03.13<br>01.10<br>08.07<br>10.09<br>01.13<br>08.07<br>12.09<br>06.11<br>10.07<br>12.09  | + Bremsscheibendurchm. 300 mm <sup>1)</sup><br>+ Bremsscheibendurchm. 300 mm <sup>1)</sup><br>+ Bremsscheibendurchm. 300 mm <sup>1)</sup><br>+ Bremsscheibendurchm. 300 mm <sup>1)</sup><br>+ Bremsscheibendurchm. 300 mm <sup>1)</sup><br>+ Bremsscheibendurchm. 300 mm <sup>1)</sup><br>+ Bremsscheibendurchm. 300 mm <sup>1)</sup><br>+ Bremsscheibendurchm. 300 mm <sup>1)</sup><br>+ Bremsscheibendurchm. 300 mm <sup>1)</sup><br>+ Bremsscheibendurchm. 300 mm <sup>1)</sup><br>+ Bremsscheibendurchm. 300 mm <sup>1)</sup><br>+ Bremsscheibendurchm. 300 mm <sup>1)</sup><br>+ Bremsscheibendurchm. 300 mm <sup>1)</sup><br>+ Bremsscheibendurchm. 300 mm <sup>1)</sup><br>+ Bremsscheibendurchm. 300 mm <sup>1)</sup><br>+ Bremsscheibendurchm. 300 mm <sup>1)</sup><br>+ Bremsscheibendurchm. 300 mm <sup>1)</sup><br>+ Bremsscheibendurchm. 300 mm <sup>1)</sup><br>+ Bremsscheibendurchm. 300 mm <sup>1)</sup><br>+ Bremsscheibendurchm. 300 mm <sup>1)</sup> |  | 13.0460-7228.2<br>13.0470-7228.2   | 607228<br>LD7228   | 24123 20,3 +<br>24123 20,3 + | ATE<br>ATE |

<sup>1)</sup> + brake disc diameter 300mm / + diametro dischi freno 300mm / + diamètre disques frein 300mm / + diámetro disco freno 300mm





**VOLVO V70 III (07-)**

|    |                 |       |  |  |                |        |  |                            |     |
|----|-----------------|-------|--|--|----------------|--------|--|----------------------------|-----|
|    | 2.4 D5 AWD      | 158   | 06.11  | + Bremsscheibendurchm. 300 mm <sup>1)</sup>        | 13.0460-7228.2 | 607228 |  | 24123 20,3 +               | ATE |
|    | 2.5 T           | 147   | 08.07  | + Bremsscheibendurchm. 300 mm <sup>1)</sup>        | 13.0470-7228.2 | LD7228 |  | 24123 20,3 +               | ATE |
|    | 2.5 T           | 170   | 10.09  | + Bremsscheibendurchm. 300 mm <sup>1)</sup>        |                |        |  |                            |     |
|    | 2.5 T FlexiFuel | 147   | 04.08  | + Bremsscheibendurchm. 300 mm <sup>1)</sup>        |                |        |  |                            |     |
|    | 2.5 T FlexiFuel | 170   | 10.09  | + Bremsscheibendurchm. 300 mm <sup>1)</sup>        |                |        |  |                            |     |
|    | 3.0 T6 AWD      | 210   | 08.07  | + Bremsscheibendurchm. 300 mm <sup>1)</sup>        |                |        |  |                            |     |
|    | 3.0 T6 AWD      | 224   | 04.11  | + Bremsscheibendurchm. 300 mm <sup>1)</sup>        |                |        |  |                            |     |
|    | 3.2             | 175   | 08.07  | + Bremsscheibendurchm. 300 mm <sup>1)</sup>        |                |        |  |                            |     |
|    | 3.2 AWD         | 175   | 08.07  | + Bremsscheibendurchm. 300 mm <sup>1)</sup>        |                |        |  |                            |     |
|    | D2              | 88    | 03.15  | + Bremsscheibendurchm. 300 mm <sup>1)</sup>        |                |        |  |                            |     |
|    | D3              | 110   | 03.15  | + Bremsscheibendurchm. 300 mm <sup>1)</sup>        |                |        |  |                            |     |
|    | D4              | 133   | 10.13  | + Bremsscheibendurchm. 300 mm <sup>1)</sup>        |                |        |  |                            |     |
|    | D4 AWD          | 133   | 10.13  | + Bremsscheibendurchm. 300 mm <sup>1)</sup>        |                |        |  |                            |     |
|    | T4              | 132   | 10.10  | + Bremsscheibendurchm. 300 mm <sup>1)</sup>        |                |        |  |                            |     |
|    | T4              | 140   | 03.15  | + Bremsscheibendurchm. 300 mm <sup>1)</sup>        |                |        |  |                            |     |
| T5 | 177             | 01.10 | + Bremsscheibendurchm. 300 mm <sup>1)</sup>        |  |                |        |  |                            |     |
| T5 | 180             | 10.13 | + Bremsscheibendurchm. 300 mm <sup>1)</sup>        |  |                |        |  |                            |     |
|    | 1.6 DRiVe       |       | 01.10  | + Bremsscheibendurchm. 316mm / 336mm <sup>2)</sup> | 13.0460-7243.2 | 607243 |  | 24142 20,6 +               | ATE |
|    | 1.6 T4F         | 132   | 01.11  | + Bremsscheibendurchm. 316mm / 336mm <sup>2)</sup> | 13.0470-7243.2 | LD7243 |  | 24142 20,6 +               | ATE |
|    | 2.0             | 107   | 10.07  | + Bremsscheibendurchm. 316mm / 336mm <sup>2)</sup> |                |        |  |                            |     |
|    | 2.0 BiFuel      | 157   | 03.13  | + Bremsscheibendurchm. 316mm / 336mm <sup>2)</sup> |                |        |  |                            |     |
|    | 2.0 D           | 100   | 10.07  | + Bremsscheibendurchm. 316mm / 336mm <sup>2)</sup> |                |        |  |                            |     |
|    | 2.0 D3          | 100   | 05.12  | + Bremsscheibendurchm. 316mm / 336mm <sup>2)</sup> |                |        |  |                            |     |
|    | 2.0 D3          | 120   | 03.10  | + Bremsscheibendurchm. 316mm / 336mm <sup>2)</sup> |                |        |  |                            |     |
|    | 2.0 D4          | 120   | 01.13  | + Bremsscheibendurchm. 316mm / 336mm <sup>2)</sup> |                |        |  |                            |     |
|    | 2.0 FlexiFuel   | 107   | 09.07  | + Bremsscheibendurchm. 316mm / 336mm <sup>2)</sup> |                |        |  |                            |     |
|    | 2.0 GDI         | 157   | 03.13  | + Bremsscheibendurchm. 316mm / 336mm <sup>2)</sup> |                |        |  |                            |     |
|    | 2.0 T           | 149   | 01.10  | + Bremsscheibendurchm. 316mm / 336mm <sup>2)</sup> |                |        |  |                            |     |
|    | 2.4 D           | 120   | 08.07  | + Bremsscheibendurchm. 316mm / 336mm <sup>2)</sup> |                |        |  |                            |     |
|    | 2.4 D           | 129   | 10.09  | + Bremsscheibendurchm. 316mm / 336mm <sup>2)</sup> |                |        |  |                            |     |
|    | 2.4 D4 AWD      | 120   | 01.13  | + Bremsscheibendurchm. 316mm / 336mm <sup>2)</sup> |                |        |  |                            |     |
|    | 2.4 D5          | 136   | 08.07  | + Bremsscheibendurchm. 316mm / 336mm <sup>2)</sup> |                |        |  |                            |     |
|    | 2.4 D5          | 151   | 12.09  | + Bremsscheibendurchm. 316mm / 336mm <sup>2)</sup> |                |        |  |                            |     |
|    | 2.4 D5          | 158   | 06.11  | + Bremsscheibendurchm. 316mm / 336mm <sup>2)</sup> |                |        |  |                            |     |
|    | 2.4 D5 AWD      | 136   | 10.07  | + Bremsscheibendurchm. 316mm / 336mm <sup>2)</sup> |                |        |  |                            |     |
|    | 2.4 D5 AWD      | 151   | 12.09  | + Bremsscheibendurchm. 316mm / 336mm <sup>2)</sup> |                |        |  |                            |     |
|    | 2.4 D5 AWD      | 158   | 06.11  | + Bremsscheibendurchm. 316mm / 336mm <sup>2)</sup> |                |        |  |                            |     |
|    | 2.5 T           | 147   | 08.07  | + Bremsscheibendurchm. 316mm / 336mm <sup>2)</sup> |                |        |  |                            |     |
|    | 2.5 T           | 170   | 10.09  | + Bremsscheibendurchm. 316mm / 336mm <sup>2)</sup> |                |        |  |                            |     |
|    | 2.5 T FlexiFuel | 147   | 04.08  | + Bremsscheibendurchm. 316mm / 336mm <sup>2)</sup> |                |        |  |                            |     |
|    | 2.5 T FlexiFuel | 170   | 10.09  | + Bremsscheibendurchm. 316mm / 336mm <sup>2)</sup> |                |        |  |                            |     |
|    | 3.0 T6 AWD      | 210   | 08.07  | + Bremsscheibendurchm. 316mm / 336mm <sup>2)</sup> |                |        |  |                            |     |
|    | 3.0 T6 AWD      | 224   | 04.11  | + Bremsscheibendurchm. 316mm / 336mm <sup>2)</sup> |                |        |  |                            |     |
|    | 3.2             | 175   | 08.07  | + Bremsscheibendurchm. 316mm / 336mm <sup>2)</sup> |                |        |  |                            |     |
|    | 3.2 AWD         | 175   | 08.07  | + Bremsscheibendurchm. 316mm / 336mm <sup>2)</sup> |                |        |  |                            |     |
|    | D2              | 88    | 03.15  | + Bremsscheibendurchm. 316mm / 336mm <sup>2)</sup> |                |        |  |                            |     |
|    | D3              | 110   | 03.15  | + Bremsscheibendurchm. 316mm / 336mm <sup>2)</sup> |                |        |  |                            |     |
|    | D4              | 133   | 10.13  | + Bremsscheibendurchm. 316mm / 336mm <sup>2)</sup> |                |        |  |                            |     |
|    | D4 AWD          | 133   | 10.13  | + Bremsscheibendurchm. 316mm / 336mm <sup>2)</sup> |                |        |  |                            |     |
| T4 | 132             | 10.10 | + Bremsscheibendurchm. 316mm / 336mm <sup>2)</sup> |  |                |        |  |                            |     |
| T4 | 140             | 03.15 | + Bremsscheibendurchm. 316mm / 336mm <sup>2)</sup> |  |                |        |  |                            |     |
| T5 | 177             | 01.10 | + Bremsscheibendurchm. 316mm / 336mm <sup>2)</sup> |  |                |        |  |                            |     |
| T5 | 180             | 10.13 | + Bremsscheibendurchm. 316mm / 336mm <sup>2)</sup> |  |                |        |  |                            |     |
|    | 3.0 T6 AWD      | 210   | 08.07  | + Bremsscheibendurchm. 336 mm <sup>3)</sup>        | 13.0460-7243.2 | 607243 |  | 24142 20,6 +               | ATE |
|    | 3.2             | 175   | 08.07  | + Bremsscheibendurchm. 336 mm <sup>3)</sup>        |                |        |  |                            |     |
|    | 3.2 AWD         | 175   | 08.07  | + Bremsscheibendurchm. 336 mm <sup>3)</sup>        |                |        |  |                            |     |
|    | 1.6 DRiVe       |       | 01.10  | + Bremsscheibendurchm. 300 mm <sup>1)</sup>        | 24.0128-0154.1 | 428154 |  | 300 28,0 26,0 V L +S +B    |     |
|    | 1.6 T4F         | 132   | 01.11  | + Bremsscheibendurchm. 300 mm <sup>1)</sup>        | 24.0328-0154.1 | 528154 |  | 300 28,0 26,0 V L +S +B PD |     |
|    | 2.0             | 107   | 10.07  | + Bremsscheibendurchm. 300 mm <sup>1)</sup>        |                |        |  |                            |     |
|    | 2.0 BiFuel      | 157   | 03.13  | + Bremsscheibendurchm. 300 mm <sup>1)</sup>        |                |        |  |                            |     |
|    | 2.0 D           | 100   | 10.07  | + Bremsscheibendurchm. 300 mm <sup>1)</sup>        |                |        |  |                            |     |
|    | 2.0 D3          | 100   | 05.12  | + Bremsscheibendurchm. 300 mm <sup>1)</sup>        |                |        |  |                            |     |
|    | 2.0 D3          | 120   | 03.10  | + Bremsscheibendurchm. 300 mm <sup>1)</sup>        |                |        |  |                            |     |
|    | 2.0 D4          | 120   | 01.13  | + Bremsscheibendurchm. 300 mm <sup>1)</sup>        |                |        |  |                            |     |
|    | 2.0 FlexiFuel   | 107   | 09.07  | + Bremsscheibendurchm. 300 mm <sup>1)</sup>        |                |        |  |                            |     |
|    | 2.0 GDI         | 157   | 03.13  | + Bremsscheibendurchm. 300 mm <sup>1)</sup>        |                |        |  |                            |     |
|    | 2.0 T           | 149   | 01.10  | + Bremsscheibendurchm. 300 mm <sup>1)</sup>        |                |        |  |                            |     |
|    | 2.4 D           | 120   | 08.07  | + Bremsscheibendurchm. 300 mm <sup>1)</sup>        |                |        |  |                            |     |
|    | 2.4 D           | 129   | 10.09  | + Bremsscheibendurchm. 300 mm <sup>1)</sup>        |                |        |  |                            |     |
|    | 2.4 D4 AWD      | 120   | 01.13  | + Bremsscheibendurchm. 300 mm <sup>1)</sup>        |                |        |  |                            |     |
|    | 2.4 D5          | 136   | 08.07  | + Bremsscheibendurchm. 300 mm <sup>1)</sup>        |                |        |  |                            |     |
|    | 2.4 D5          | 151   | 12.09  | + Bremsscheibendurchm. 300 mm <sup>1)</sup>        |                |        |  |                            |     |
|    | 2.4 D5          | 158   | 06.11  | + Bremsscheibendurchm. 300 mm <sup>1)</sup>        |                |        |  |                            |     |
|    | 2.4 D5 AWD      | 136   | 10.07  | + Bremsscheibendurchm. 300 mm <sup>1)</sup>        |                |        |  |                            |     |
|    | 2.4 D5 AWD      | 151   | 12.09  | + Bremsscheibendurchm. 300 mm <sup>1)</sup>        |                |        |  |                            |     |
|    | 2.4 D5 AWD      | 158   | 06.11  | + Bremsscheibendurchm. 300 mm <sup>1)</sup>        |                |        |  |                            |     |
|    | 2.5 T           | 147   | 08.07  | + Bremsscheibendurchm. 300 mm <sup>1)</sup>        |                |        |  |                            |     |
|    | 2.5 T           | 170   | 10.09  | + Bremsscheibendurchm. 300 mm <sup>1)</sup>        |                |        |  |                            |     |
|    | 2.5 T FlexiFuel | 147   | 04.08  | + Bremsscheibendurchm. 300 mm <sup>1)</sup>        |                |        |  |                            |     |
|    | 2.5 T FlexiFuel | 170   | 10.09  | + Bremsscheibendurchm. 300 mm <sup>1)</sup>        |                |        |  |                            |     |
|    | 3.0 T6 AWD      | 210   | 08.07  | + Bremsscheibendurchm. 300 mm <sup>1)</sup>        |                |        |  |                            |     |
|    | 3.0 T6 AWD      | 224   | 04.11  | + Bremsscheibendurchm. 300 mm <sup>1)</sup>        |                |        |  |                            |     |
|    | 3.2             | 175   | 08.07  | + Bremsscheibendurchm. 300 mm <sup>1)</sup>        |                |        |  |                            |     |
|    | 3.2 AWD         | 175   | 08.07  | + Bremsscheibendurchm. 300 mm <sup>1)</sup>        |                |        |  |                            |     |
| D2 | 88              | 03.15 | + Bremsscheibendurchm. 300 mm <sup>1)</sup>        |  |                |        |  |                            |     |
| D3 | 110             | 03.15 | + Bremsscheibendurchm. 300 mm <sup>1)</sup>        |  |                |        |  |                            |     |
| D4 | 133             | 10.13 | + Bremsscheibendurchm. 300 mm <sup>1)</sup>        |  |                |        |  |                            |     |

<sup>1)</sup> + brake disc diameter 300mm / + diametro dischi freno 300mm / + diamètre disques frein 300mm / + diámetro disco freno 300mm

<sup>2)</sup> + brake disc diameter 316mm / 336mm / + diametro dischi freno 316mm / 336mm / + diamètre disques frein 316mm / 336mm / + diámetro disco freno 316mm / 336mm

<sup>3)</sup> + brake disc diameter 336mm / + diametro dischi freno 336mm / + diamètre disques frein 336mm / + diámetro disco freno 336mm



**VOLVO V70 III (07-)**



|    |                 |     |       |   |   |                |        |   |                           |
|----|-----------------|-----|-------|---|---|----------------|--------|---|---------------------------|
|    | D4 AWD          | 133 |       | 10.13                                       | + Bremsscheibendurchm. 300 mm <sup>1)</sup> | 24.0128-0154.1 | 428154 |   | 300 28,0 26,0 VL +S +B    |
|    | T4              | 132 |       | 10.10                                       | + Bremsscheibendurchm. 300 mm <sup>1)</sup> | 24.0328-0154.1 | 528154 |   | 300 28,0 26,0 VL +S +B PD |
|    | T4              | 140 |       | 03.15                                       | + Bremsscheibendurchm. 300 mm <sup>1)</sup> |                |        |   |                           |
|    | T5              | 177 |       | 01.10                                       | + Bremsscheibendurchm. 300 mm <sup>1)</sup> |                |        |   |                           |
|    | T5              | 180 |       | 10.13                                       | + Bremsscheibendurchm. 300 mm <sup>1)</sup> |                |        |   |                           |
|    | 1.6 DRIVE       |     |       | 01.10                                       | + Bremsscheibendurchm. 316mm <sup>2)</sup>  | 24.0128-0162.1 | 428162 |   | 316 28,0 26,0 VL +S +B    |
|    | 1.6 T4F         | 132 |       | 01.11                                       | + Bremsscheibendurchm. 316mm <sup>2)</sup>  | 24.0328-0162.1 | 528162 |   | 316 28,0 26,0 VL +S +B PD |
|    | 2.0             | 107 |       | 10.07                                       | + Bremsscheibendurchm. 316mm <sup>2)</sup>  |                |        |   |                           |
|    | 2.0 BiFuel      | 157 |       | 03.13                                       | + Bremsscheibendurchm. 316mm <sup>2)</sup>  |                |        |   |                           |
|    | 2.0 D           | 100 |       | 10.07                                       | + Bremsscheibendurchm. 316mm <sup>2)</sup>  |                |        |   |                           |
|    | 2.0 D3          | 100 |       | 05.12                                       | + Bremsscheibendurchm. 316mm <sup>2)</sup>  |                |        |   |                           |
|    | 2.0 D3          | 120 |       | 03.10                                       | + Bremsscheibendurchm. 316mm <sup>2)</sup>  |                |        |   |                           |
|    | 2.0 D4          | 120 |       | 01.13                                       | + Bremsscheibendurchm. 316mm <sup>2)</sup>  |                |        |   |                           |
|    | 2.0 FlexiFuel   | 107 |       | 09.07                                       | + Bremsscheibendurchm. 316mm <sup>2)</sup>  |                |        |   |                           |
|    | 2.0 GDI         | 157 |       | 03.13                                       | + Bremsscheibendurchm. 316mm <sup>2)</sup>  |                |        |   |                           |
|    | 2.0 T           | 149 |       | 01.10                                       | + Bremsscheibendurchm. 316mm <sup>2)</sup>  |                |        |   |                           |
|    | 2.4 D           | 120 |       | 08.07                                       | + Bremsscheibendurchm. 316mm <sup>2)</sup>  |                |        |   |                           |
|    | 2.4 D           | 129 |       | 10.09                                       | + Bremsscheibendurchm. 316mm <sup>2)</sup>  |                |        |   |                           |
|    | 2.4 D4 AWD      | 120 |       | 01.13                                       | + Bremsscheibendurchm. 316mm <sup>2)</sup>  |                |        |   |                           |
|    | 2.4 D5          | 136 |       | 08.07                                       | + Bremsscheibendurchm. 316mm <sup>2)</sup>  |                |        |   |                           |
|    | 2.4 D5          | 151 |       | 12.09                                       | + Bremsscheibendurchm. 316mm <sup>2)</sup>  |                |        |   |                           |
|    | 2.4 D5          | 158 |       | 06.11                                       | + Bremsscheibendurchm. 316mm <sup>2)</sup>  |                |        |   |                           |
|    | 2.4 D5 AWD      | 136 |       | 10.07                                       | + Bremsscheibendurchm. 316mm <sup>2)</sup>  |                |        |   |                           |
|    | 2.4 D5 AWD      | 151 |       | 12.09                                       | + Bremsscheibendurchm. 316mm <sup>2)</sup>  |                |        |   |                           |
|    | 2.4 D5 AWD      | 158 |       | 06.11                                       | + Bremsscheibendurchm. 316mm <sup>2)</sup>  |                |        |   |                           |
|    | 2.5 T           | 147 |       | 08.07                                       | + Bremsscheibendurchm. 316mm <sup>2)</sup>  |                |        |   |                           |
|    | 2.5 T           | 170 |       | 10.09                                       | + Bremsscheibendurchm. 316mm <sup>2)</sup>  |                |        |   |                           |
|    | 2.5 T FlexiFuel | 147 |       | 04.08                                       | + Bremsscheibendurchm. 316mm <sup>2)</sup>  |                |        |   |                           |
|    | 2.5 T FlexiFuel | 170 |       | 10.09                                       | + Bremsscheibendurchm. 316mm <sup>2)</sup>  |                |        |   |                           |
|    | 3.0 T6 AWD      | 210 |       | 08.07                                       | + Bremsscheibendurchm. 316mm <sup>2)</sup>  |                |        |   |                           |
|    | 3.0 T6 AWD      | 224 |       | 04.11                                       | + Bremsscheibendurchm. 316mm <sup>2)</sup>  |                |        |   |                           |
|    | 3.2             | 175 |       | 08.07                                       | + Bremsscheibendurchm. 316mm <sup>2)</sup>  |                |        |   |                           |
|    | 3.2 AWD         | 175 |       | 08.07                                       | + Bremsscheibendurchm. 316mm <sup>2)</sup>  |                |        |   |                           |
|    | D2              | 88  |       | 03.15                                       | + Bremsscheibendurchm. 316mm <sup>2)</sup>  |                |        |   |                           |
|    | D3              | 110 |       | 03.15                                       | + Bremsscheibendurchm. 316mm <sup>2)</sup>  |                |        |   |                           |
|    | D4              | 133 |       | 10.13                                       | + Bremsscheibendurchm. 316mm <sup>2)</sup>  |                |        |   |                           |
|    | D4 AWD          | 133 |       | 10.13                                       | + Bremsscheibendurchm. 316mm <sup>2)</sup>  |                |        |   |                           |
|    | T4              | 132 |       | 10.10                                       | + Bremsscheibendurchm. 316mm <sup>2)</sup>  |                |        |   |                           |
|    | T4              | 140 |       | 03.15                                       | + Bremsscheibendurchm. 316mm <sup>2)</sup>  |                |        |   |                           |
|    | T5              | 177 |       | 01.10                                       | + Bremsscheibendurchm. 316mm <sup>2)</sup>  |                |        |   |                           |
| T5 | 180             |     | 10.13 | + Bremsscheibendurchm. 316mm <sup>2)</sup>  |   |                |        |   |                           |
|    | 1.6 DRIVE       |     |       | 01.10                                       | + Bremsscheibendurchm. 336 mm <sup>3)</sup> | 24.0128-0210.1 | 428210 |   | 336 28,0 26,0 VL +S +B    |
|    | 1.6 T4F         | 132 |       | 01.11                                       | + Bremsscheibendurchm. 336 mm <sup>3)</sup> |                |        |   |                           |
|    | 2.0             | 107 |       | 10.07                                       | + Bremsscheibendurchm. 336 mm <sup>3)</sup> |                |        |   |                           |
|    | 2.0 BiFuel      | 157 |       | 03.13                                       | + Bremsscheibendurchm. 336 mm <sup>3)</sup> |                |        |   |                           |
|    | 2.0 D           | 100 |       | 10.07                                       | + Bremsscheibendurchm. 336 mm <sup>3)</sup> |                |        |   |                           |
|    | 2.0 D3          | 100 |       | 05.12                                       | + Bremsscheibendurchm. 336 mm <sup>3)</sup> |                |        |   |                           |
|    | 2.0 D3          | 120 |       | 03.10                                       | + Bremsscheibendurchm. 336 mm <sup>3)</sup> |                |        |   |                           |
|    | 2.0 D4          | 120 |       | 01.13                                       | + Bremsscheibendurchm. 336 mm <sup>3)</sup> |                |        |   |                           |
|    | 2.0 FlexiFuel   | 107 |       | 09.07                                       | + Bremsscheibendurchm. 336 mm <sup>3)</sup> |                |        |   |                           |
|    | 2.0 GDI         | 157 |       | 03.13                                       | + Bremsscheibendurchm. 336 mm <sup>3)</sup> |                |        |   |                           |
|    | 2.0 T           | 149 |       | 01.10                                       | + Bremsscheibendurchm. 336 mm <sup>3)</sup> |                |        |   |                           |
|    | 2.4 D           | 120 |       | 08.07                                       | + Bremsscheibendurchm. 336 mm <sup>3)</sup> |                |        |   |                           |
|    | 2.4 D           | 129 |       | 10.09                                       | + Bremsscheibendurchm. 336 mm <sup>3)</sup> |                |        |   |                           |
|    | 2.4 D4 AWD      | 120 |       | 01.13                                       | + Bremsscheibendurchm. 336 mm <sup>3)</sup> |                |        |   |                           |
|    | 2.4 D5          | 136 |       | 08.07                                       | + Bremsscheibendurchm. 336 mm <sup>3)</sup> |                |        |   |                           |
|    | 2.4 D5          | 151 |       | 12.09                                       | + Bremsscheibendurchm. 336 mm <sup>3)</sup> |                |        |   |                           |
|    | 2.4 D5          | 158 |       | 06.11                                       | + Bremsscheibendurchm. 336 mm <sup>3)</sup> |                |        |   |                           |
|    | 2.4 D5 AWD      | 136 |       | 10.07                                       | + Bremsscheibendurchm. 336 mm <sup>3)</sup> |                |        |   |                           |
|    | 2.4 D5 AWD      | 151 |       | 12.09                                       | + Bremsscheibendurchm. 336 mm <sup>3)</sup> |                |        |   |                           |
|    | 2.4 D5 AWD      | 158 |       | 06.11                                       | + Bremsscheibendurchm. 336 mm <sup>3)</sup> |                |        |   |                           |
|    | 2.5 T           | 147 |       | 08.07                                       | + Bremsscheibendurchm. 336 mm <sup>3)</sup> |                |        |   |                           |
|    | 2.5 T           | 170 |       | 10.09                                       | + Bremsscheibendurchm. 336 mm <sup>3)</sup> |                |        |   |                           |
|    | 2.5 T FlexiFuel | 147 |       | 04.08                                       | + Bremsscheibendurchm. 336 mm <sup>3)</sup> |                |        |   |                           |
|    | 2.5 T FlexiFuel | 170 |       | 10.09                                       | + Bremsscheibendurchm. 336 mm <sup>3)</sup> |                |        |   |                           |
|    | 3.0 T6 AWD      | 210 |       | 08.07                                       | + Bremsscheibendurchm. 336 mm <sup>3)</sup> |                |        |   |                           |
|    | 3.0 T6 AWD      | 224 |       | 04.11                                       | + Bremsscheibendurchm. 336 mm <sup>3)</sup> |                |        |   |                           |
|    | 3.2             | 175 |       | 08.07                                       | + Bremsscheibendurchm. 336 mm <sup>3)</sup> |                |        |   |                           |
|    | 3.2 AWD         | 175 |       | 08.07                                       | + Bremsscheibendurchm. 336 mm <sup>3)</sup> |                |        |   |                           |
|    | D2              | 88  |       | 03.15                                       | + Bremsscheibendurchm. 336 mm <sup>3)</sup> |                |        |   |                           |
|    | D3              | 110 |       | 03.15                                       | + Bremsscheibendurchm. 336 mm <sup>3)</sup> |                |        |   |                           |
|    | D4              | 133 |       | 10.13                                       | + Bremsscheibendurchm. 336 mm <sup>3)</sup> |                |        |   |                           |
|    | D4 AWD          | 133 |       | 10.13                                       | + Bremsscheibendurchm. 336 mm <sup>3)</sup> |                |        |   |                           |
|    | T4              | 132 |       | 10.10                                       | + Bremsscheibendurchm. 336 mm <sup>3)</sup> |                |        |   |                           |
|    | T4              | 140 |       | 03.15                                       | + Bremsscheibendurchm. 336 mm <sup>3)</sup> |                |        |   |                           |
|    | T5              | 177 |       | 01.10                                       | + Bremsscheibendurchm. 336 mm <sup>3)</sup> |                |        |   |                           |
| T5 | 180             |     | 10.13 | + Bremsscheibendurchm. 336 mm <sup>3)</sup> |   |                |        |   |                           |
|    | 1.6 DRIVE       |     |       | 01.10                                       |   | 24.0711-5198.3 | 360239 | 2 | Radsensor                 |
|    | 1.6 T4F         | 132 |       | 01.11                                       |   |                |        |   |                           |
|    | 2.0             | 107 |       | 10.07                                       |   |                |        |   |                           |
|    | 2.0 D           | 100 |       | 10.07                                       |   |                |        |   |                           |
|    | 2.0 FlexiFuel   | 107 |       | 09.07                                       |   |                |        |   |                           |
|    | 2.0 T           | 149 |       | 01.10                                       |   |                |        |   |                           |
|    | 2.4 D           | 120 |       | 08.07                                       |   |                |        |   |                           |
|    | 2.4 D           | 129 |       | 10.09                                       |   |                |        |   |                           |
|    | 2.4 D5          | 136 |       | 08.07                                       |   |                |        |   |                           |
|    | 2.4 D5          | 151 |       | 12.09                                       |   |                |        |   |                           |

<sup>1)</sup> + brake disc diameter 300mm / + diametro dischi freno 300mm / + diamètre disques frein 300mm / + diámetro disco freno 300mm

<sup>2)</sup> + brake disc diameter 316mm / + diametro dischi freno 316mm / + diamètre disques frein 316mm / + diámetro disco freno 316mm

<sup>3)</sup> + brake disc diameter 336mm / + diametro dischi freno 336mm / + diamètre disques frein 336mm / + diámetro disco freno 336mm



| VOLVO V70 III (07-)  |                 |            |       |                |                |        |                                  |                           |           |  |  |  |
|--|-----------------|------------|-------|----------------|----------------|--------|----------------------------------|---------------------------|-----------|--|--|--|
|    | 2.4 D5 AWD      | 136        | 10.07 | 24.0711-5198.3 | 360239         | 2      |                                  | Radsensor                 |           |  |  |  |
|  | 2.4 D5 AWD      | 151        | 12.09 |                |                |        |                                  |                           |           |  |  |  |
|  | 2.5 T           | 147        | 08.07 |                |                |        |                                  |                           |           |  |  |  |
|  | 2.5 T           | 170        | 10.09 |                |                |        |                                  |                           |           |  |  |  |
|  | 2.5 T FlexiFuel | 147        | 04.08 |                |                |        |                                  |                           |           |  |  |  |
|  | 2.5 T FlexiFuel | 170        | 10.09 |                |                |        |                                  |                           |           |  |  |  |
|  | 3.0 T6 AWD      | 210        | 08.07 |                |                |        |                                  |                           |           |  |  |  |
|  | 3.2             | 175        | 08.07 |                |                |        |                                  |                           |           |  |  |  |
|  | 3.2 AWD         | 175        | 08.07 |                |                |        |                                  |                           |           |  |  |  |
|  | T4              | 132        | 10.10 |                |                |        |                                  |                           |           |  |  |  |
|  | T5              | 177        | 01.10 |                |                |        |                                  |                           |           |  |  |  |
|  |                 | 2.0 D3     | 100   | 05.12          | 24.0711-5198.3 | 360239 | 2                                | - Kollisionswarnsystem 1) | Radsensor |  |  |  |
| 2.0 D3   |                 | 120        | 03.10 |                |                |        |                                  |                           |           |  |  |  |
| 2.0 D4   |                 | 120        | 01.13 |                |                |        |                                  |                           |           |  |  |  |
| 2.4 D4 AWD   |                 | 120        | 01.13 |                |                |        |                                  |                           |           |  |  |  |
| 2.4 D5   |                 | 158        | 06.11 |                |                |        |                                  |                           |           |  |  |  |
| 2.4 D5 AWD   |                 | 158        | 06.11 |                |                |        |                                  |                           |           |  |  |  |
| 3.0 T6 AWD   |                 | 224        | 04.11 |                |                |        |                                  |                           |           |  |  |  |
| D4   |                 | 133        | 10.13 |                |                |        |                                  |                           |           |  |  |  |
| D4 AWD   |                 | 133        | 10.13 |                |                |        |                                  |                           |           |  |  |  |
| T5   |                 | 180        | 10.13 |                |                |        |                                  |                           |           |  |  |  |
|  |                 | 2.0 BiFuel | 157   | 03.13          | 24.0711-5198.3 | 360239 |                                  | + Kollisionswarnsystem 2) | Radsensor |  |  |  |
|  |                 | 2.0 D3     | 100   | 05.12          | 24.0711-5241.3 | 360319 |                                  | + Kollisionswarnsystem 2) | Radsensor |  |  |  |
|  | 2.0 D3          | 120        | 03.10 |                |                |        |                                  |                           |           |  |  |  |
|  | 2.0 D4          | 120        | 01.13 |                |                |        |                                  |                           |           |  |  |  |
|  | 2.0 GDI         | 157        | 03.13 |                |                |        |                                  |                           |           |  |  |  |
|  | 2.4 D4 AWD      | 120        | 01.13 |                |                |        |                                  |                           |           |  |  |  |
|  | 2.4 D5          | 158        | 06.11 |                |                |        |                                  |                           |           |  |  |  |
|  | 2.4 D5 AWD      | 158        | 06.11 |                |                |        |                                  |                           |           |  |  |  |
|  | 3.0 T6 AWD      | 224        | 04.11 |                |                |        |                                  |                           |           |  |  |  |
|  | D2              | 88         | 03.15 |                |                |        |                                  |                           |           |  |  |  |
|  | D3              | 110        | 03.15 |                |                |        |                                  |                           |           |  |  |  |
|  | D4              | 133        | 10.13 |                |                |        |                                  |                           |           |  |  |  |
|    | 1.6 DRIVE       |            | 01.10 | 13.0460-2737.2 | 602737         |        | + mechanische Feststellbremse 3) | 24537 15,8 /Zub/S         | TRW       |  |  |  |
|  | 1.6 T4F         | 132        | 01.11 |                |                |        |                                  |                           |           |  |  |  |
|  | 2.0             | 107        | 10.07 |                |                |        |                                  |                           |           |  |  |  |
|  | 2.0 BiFuel      | 157        | 03.13 |                |                |        |                                  |                           |           |  |  |  |
|  | 2.0 D           | 100        | 10.07 |                |                |        |                                  |                           |           |  |  |  |
|  | 2.0 D3          | 100        | 05.12 |                |                |        |                                  |                           |           |  |  |  |
|  | 2.0 D3          | 120        | 03.10 |                |                |        |                                  |                           |           |  |  |  |
|  | 2.0 D4          | 120        | 01.13 |                |                |        |                                  |                           |           |  |  |  |
|  | 2.0 FlexiFuel   | 107        | 09.07 |                |                |        |                                  |                           |           |  |  |  |
|  | 2.0 GDI         | 157        | 03.13 |                |                |        |                                  |                           |           |  |  |  |
|  | 2.0 T           | 149        | 01.10 |                |                |        |                                  |                           |           |  |  |  |
|  | 2.4 D           | 120        | 08.07 |                |                |        |                                  |                           |           |  |  |  |
| 2.4 D  | 129             | 10.09      |       |                |                |        |                                  |                           |           |  |  |  |
| 2.4 D4 AWD   | 120             | 01.13      |       |                |                |        |                                  |                           |           |  |  |  |
| 2.4 D5   | 136             | 08.07      |       |                |                |        |                                  |                           |           |  |  |  |
| 2.4 D5   | 151             | 12.09      |       |                |                |        |                                  |                           |           |  |  |  |
| 2.4 D5   | 158             | 06.11      |       |                |                |        |                                  |                           |           |  |  |  |
| 2.4 D5 AWD   | 136             | 10.07      |       |                |                |        |                                  |                           |           |  |  |  |
| 2.4 D5 AWD   | 151             | 12.09      |       |                |                |        |                                  |                           |           |  |  |  |
| 2.4 D5 AWD   | 158             | 06.11      |       |                |                |        |                                  |                           |           |  |  |  |
| 2.5 T  | 147             | 08.07      |       |                |                |        |                                  |                           |           |  |  |  |
| 2.5 T  | 170             | 10.09      |       |                |                |        |                                  |                           |           |  |  |  |
| 2.5 T FlexiFuel  | 147             | 04.08      |       |                |                |        |                                  |                           |           |  |  |  |
| 2.5 T FlexiFuel  | 170             | 10.09      |       |                |                |        |                                  |                           |           |  |  |  |
| 3.0 T6 AWD   | 210             | 08.07      |       |                |                |        |                                  |                           |           |  |  |  |
| 3.0 T6 AWD   | 224             | 04.11      |       |                |                |        |                                  |                           |           |  |  |  |
| 3.2  | 175             | 08.07      |       |                |                |        |                                  |                           |           |  |  |  |
| 3.2 AWD  | 175             | 08.07      |       |                |                |        |                                  |                           |           |  |  |  |
| D2   | 88              | 03.15      |       |                |                |        |                                  |                           |           |  |  |  |
| D3   | 110             | 03.15      |       |                |                |        |                                  |                           |           |  |  |  |
| D4   | 133             | 10.13      |       |                |                |        |                                  |                           |           |  |  |  |
| D4 AWD   | 133             | 10.13      |       |                |                |        |                                  |                           |           |  |  |  |
| T4   | 132             | 10.10      |       |                |                |        |                                  |                           |           |  |  |  |
| T4   | 140             | 03.15      |       |                |                |        |                                  |                           |           |  |  |  |
| T5   | 177             | 01.10      |       |                |                |        |                                  |                           |           |  |  |  |
| T5   | 180             | 10.13      |       |                |                |        |                                  |                           |           |  |  |  |
|  | 1.6 DRIVE       |            | 01.10 | 13.0460-2722.2 | 602722         |        | + elektrische Feststellbremse 5) | 24496 17,3 /Zub/S         | TRW       |  |  |  |
|  | 1.6 T4F         | 132        | 01.11 | 13.0470-2722.2 | LD2722         |        | + elektrische Feststellbremse 5) | 24496 17,3 /Zub/S         | TRW       |  |  |  |
|  | 2.0             | 107        | 10.07 |                |                |        |                                  |                           |           |  |  |  |
|  | 2.0 BiFuel      | 157        | 03.13 |                |                |        |                                  |                           |           |  |  |  |
|  | 2.0 D           | 100        | 10.07 |                |                |        |                                  |                           |           |  |  |  |
|  | 2.0 D3          | 100        | 05.12 |                |                |        |                                  |                           |           |  |  |  |
|  | 2.0 D3          | 120        | 03.10 |                |                |        |                                  |                           |           |  |  |  |
|  | 2.0 D4          | 120        | 01.13 |                |                |        |                                  |                           |           |  |  |  |
|  | 2.0 FlexiFuel   | 107        | 09.07 |                |                |        |                                  |                           |           |  |  |  |
|  | 2.0 GDI         | 157        | 03.13 |                |                |        |                                  |                           |           |  |  |  |
|  | 2.0 T           | 149        | 01.10 |                |                |        |                                  |                           |           |  |  |  |
|  | 2.4 D           | 120        | 08.07 |                |                |        |                                  |                           |           |  |  |  |
| 2.4 D  | 129             | 10.09      |       |                |                |        |                                  |                           |           |  |  |  |
| 2.4 D4 AWD   | 120             | 01.13      |       |                |                |        |                                  |                           |           |  |  |  |
| 2.4 D5   | 136             | 08.07      |       |                |                |        |                                  |                           |           |  |  |  |

1) - collision warning system / - sistema anti-collosione / - système anticollision / - sistema anticollision

2) + collision warning system / + sistema anti-collosione / + système anticollision / + sistema anticollision

3) + mechanical parking brake / + fr. stazionamento meccanico / + frein à main mécanique / + freno de mano mecánica

4) - ventilated discs / - dischi ventilati / - disques ventilés / - disco ventilado

5) + electric parking brake / + freno a mano elettrico / + frein à main électrique / + freno de mano eléctrico





**VOLVO V70 III (07-)**

|                 |                 |              |                                    |                                    |                       |        |   |                          |            |
|-----------------|-----------------|--------------|------------------------------------|------------------------------------|-----------------------|--------|---|--------------------------|------------|
|                 | 2.4 D5          | 151          | <b>12.09</b>                       | - belüftete Scheiben <sup>1)</sup> | <b>13.0460-2722.2</b> | 602722 | + elektrische Feststellbremse <sup>2)</sup> | <b>24496</b> 17,3 /Zub/S | <b>TRW</b> |
|                 | 2.4 D5          | 158          | <b>06.11</b>                       | - belüftete Scheiben <sup>1)</sup> | <b>13.0470-2722.2</b> | LD2722 | + elektrische Feststellbremse <sup>2)</sup> | <b>24496</b> 17,3 /Zub/S | <b>TRW</b> |
|                 | 2.4 D5 AWD      | 136          | <b>10.07</b>                       | - belüftete Scheiben <sup>1)</sup> |                       |        |   |                          |            |
|                 | 2.4 D5 AWD      | 151          | <b>12.09</b>                       | - belüftete Scheiben <sup>1)</sup> |                       |        |   |                          |            |
|                 | 2.4 D5 AWD      | 158          | <b>06.11</b>                       | - belüftete Scheiben <sup>1)</sup> |                       |        |   |                          |            |
|                 | 2.5 T           | 147          | <b>08.07</b>                       | - belüftete Scheiben <sup>1)</sup> |                       |        |   |                          |            |
|                 | 2.5 T           | 170          | <b>10.09</b>                       | - belüftete Scheiben <sup>1)</sup> |                       |        |   |                          |            |
|                 | 2.5 T FlexiFuel | 147          | <b>04.08</b>                       | - belüftete Scheiben <sup>1)</sup> |                       |        |   |                          |            |
|                 | 2.5 T FlexiFuel | 170          | <b>10.09</b>                       | - belüftete Scheiben <sup>1)</sup> |                       |        |   |                          |            |
|                 | 3.0 T6 AWD      | 210          | <b>08.07</b>                       | - belüftete Scheiben <sup>1)</sup> |                       |        |   |                          |            |
|                 | 3.0 T6 AWD      | 224          | <b>04.11</b>                       | - belüftete Scheiben <sup>1)</sup> |                       |        |   |                          |            |
|                 | 3.2             | 175          | <b>08.07</b>                       | - belüftete Scheiben <sup>1)</sup> |                       |        |   |                          |            |
|                 | 3.2 AWD         | 175          | <b>08.07</b>                       | - belüftete Scheiben <sup>1)</sup> |                       |        |   |                          |            |
|                 | D2              | 88           | <b>03.15</b>                       | - belüftete Scheiben <sup>1)</sup> |                       |        |   |                          |            |
|                 | D3              | 110          | <b>03.15</b>                       | - belüftete Scheiben <sup>1)</sup> |                       |        |   |                          |            |
|                 | D4              | 133          | <b>10.13</b>                       | - belüftete Scheiben <sup>1)</sup> |                       |        |   |                          |            |
|                 | D4 AWD          | 133          | <b>10.13</b>                       | - belüftete Scheiben <sup>1)</sup> |                       |        |   |                          |            |
|                 | T4              | 132          | <b>10.10</b>                       | - belüftete Scheiben <sup>1)</sup> |                       |        |   |                          |            |
|                 | T4              | 140          | <b>03.15</b>                       | - belüftete Scheiben <sup>1)</sup> |                       |        |   |                          |            |
|                 | T5              | 177          | <b>01.10</b>                       | - belüftete Scheiben <sup>1)</sup> |                       |        |   |                          |            |
| T5              | 180             | <b>10.13</b> | - belüftete Scheiben <sup>1)</sup> |                                    |                       |        |   |                          |            |
|                 | 1.6 DRIVE       |              | <b>01.10</b>                       | + belüftete Scheiben <sup>3)</sup> | <b>13.0460-2736.2</b> | 602736 | + elektrische Feststellbremse <sup>2)</sup> | <b>24496</b> 17,3 /Zub/S | <b>TRW</b> |
|                 | 1.6 T4F         | 132          | <b>01.11</b>                       | + belüftete Scheiben <sup>3)</sup> | <b>13.0470-2736.2</b> | LD2736 | + elektrische Feststellbremse <sup>2)</sup> | <b>24496</b> 17,3 /Zub/S | <b>TRW</b> |
|                 | 2.0             | 107          | <b>10.07</b>                       | + belüftete Scheiben <sup>3)</sup> |                       |        |   |                          |            |
|                 | 2.0 BiFuel      | 157          | <b>03.13</b>                       | + belüftete Scheiben <sup>3)</sup> |                       |        |   |                          |            |
|                 | 2.0 D           | 100          | <b>10.07</b>                       | + belüftete Scheiben <sup>3)</sup> |                       |        |   |                          |            |
|                 | 2.0 D3          | 100          | <b>05.12</b>                       | + belüftete Scheiben <sup>3)</sup> |                       |        |   |                          |            |
|                 | 2.0 D3          | 120          | <b>03.10</b>                       | + belüftete Scheiben <sup>3)</sup> |                       |        |   |                          |            |
|                 | 2.0 D4          | 120          | <b>01.13</b>                       | + belüftete Scheiben <sup>3)</sup> |                       |        |   |                          |            |
|                 | 2.0 FlexiFuel   | 107          | <b>09.07</b>                       | + belüftete Scheiben <sup>3)</sup> |                       |        |   |                          |            |
|                 | 2.0 GDI         | 157          | <b>03.13</b>                       | + belüftete Scheiben <sup>3)</sup> |                       |        |   |                          |            |
|                 | 2.0 T           | 149          | <b>01.10</b>                       | + belüftete Scheiben <sup>3)</sup> |                       |        |   |                          |            |
|                 | 2.4 D           | 120          | <b>08.07</b>                       | + belüftete Scheiben <sup>3)</sup> |                       |        |   |                          |            |
|                 | 2.4 D           | 129          | <b>10.09</b>                       | + belüftete Scheiben <sup>3)</sup> |                       |        |   |                          |            |
|                 | 2.4 D4 AWD      | 120          | <b>01.13</b>                       | + belüftete Scheiben <sup>3)</sup> |                       |        |   |                          |            |
|                 | 2.4 D5          | 136          | <b>08.07</b>                       | + belüftete Scheiben <sup>3)</sup> |                       |        |   |                          |            |
|                 | 2.4 D5          | 151          | <b>12.09</b>                       | + belüftete Scheiben <sup>3)</sup> |                       |        |   |                          |            |
|                 | 2.4 D5          | 158          | <b>06.11</b>                       | + belüftete Scheiben <sup>3)</sup> |                       |        |   |                          |            |
|                 | 2.4 D5 AWD      | 136          | <b>10.07</b>                       | + belüftete Scheiben <sup>3)</sup> |                       |        |   |                          |            |
|                 | 2.4 D5 AWD      | 151          | <b>12.09</b>                       | + belüftete Scheiben <sup>3)</sup> |                       |        |   |                          |            |
|                 | 2.4 D5 AWD      | 158          | <b>06.11</b>                       | + belüftete Scheiben <sup>3)</sup> |                       |        |   |                          |            |
|                 | 2.5 T           | 147          | <b>08.07</b>                       | + belüftete Scheiben <sup>3)</sup> |                       |        |   |                          |            |
|                 | 2.5 T           | 170          | <b>10.09</b>                       | + belüftete Scheiben <sup>3)</sup> |                       |        |   |                          |            |
|                 | 2.5 T FlexiFuel | 147          | <b>04.08</b>                       | + belüftete Scheiben <sup>3)</sup> |                       |        |   |                          |            |
|                 | 2.5 T FlexiFuel | 170          | <b>10.09</b>                       | + belüftete Scheiben <sup>3)</sup> |                       |        |   |                          |            |
|                 | 3.0 T6 AWD      | 210          | <b>08.07</b>                       | + belüftete Scheiben <sup>3)</sup> |                       |        |   |                          |            |
|                 | 3.0 T6 AWD      | 224          | <b>04.11</b>                       | + belüftete Scheiben <sup>3)</sup> |                       |        |   |                          |            |
|                 | 3.2             | 175          | <b>08.07</b>                       | + belüftete Scheiben <sup>3)</sup> |                       |        |   |                          |            |
|                 | 3.2 AWD         | 175          | <b>08.07</b>                       | + belüftete Scheiben <sup>3)</sup> |                       |        |   |                          |            |
|                 | D2              | 88           | <b>03.15</b>                       | + belüftete Scheiben <sup>3)</sup> |                       |        |   |                          |            |
|                 | D3              | 110          | <b>03.15</b>                       | + belüftete Scheiben <sup>3)</sup> |                       |        |   |                          |            |
| D4              | 133             | <b>10.13</b> | + belüftete Scheiben <sup>3)</sup> |                                    |                       |        |   |                          |            |
| D4 AWD          | 133             | <b>10.13</b> | + belüftete Scheiben <sup>3)</sup> |                                    |                       |        |   |                          |            |
| T4              | 132             | <b>10.10</b> | + belüftete Scheiben <sup>3)</sup> |                                    |                       |        |   |                          |            |
| T4              | 140             | <b>03.15</b> | + belüftete Scheiben <sup>3)</sup> |                                    |                       |        |   |                          |            |
| T5              | 177             | <b>01.10</b> | + belüftete Scheiben <sup>3)</sup> |                                    |                       |        |   |                          |            |
| T5              | 180             | <b>10.13</b> | + belüftete Scheiben <sup>3)</sup> |                                    |                       |        |   |                          |            |
|                 | 1.6 DRIVE       |              | <b>01.10</b>                       |                                    | <b>24.0112-0180.1</b> | 412180 | + mechanische Feststellbremse <sup>4)</sup> | 302 12,0 10,0 +S +B      |            |
|                 | 1.6 T4F         | 132          | <b>01.11</b>                       |                                    |                       |        |   |                          |            |
|                 | 2.0             | 107          | <b>10.07</b>                       |                                    |                       |        |   |                          |            |
|                 | 2.0 BiFuel      | 157          | <b>03.13</b>                       |                                    |                       |        |   |                          |            |
|                 | 2.0 D           | 100          | <b>10.07</b>                       |                                    |                       |        |   |                          |            |
|                 | 2.0 D3          | 100          | <b>05.12</b>                       |                                    |                       |        |   |                          |            |
|                 | 2.0 D3          | 120          | <b>03.10</b>                       |                                    |                       |        |   |                          |            |
|                 | 2.0 D4          | 120          | <b>01.13</b>                       |                                    |                       |        |   |                          |            |
|                 | 2.0 FlexiFuel   | 107          | <b>09.07</b>                       |                                    |                       |        |   |                          |            |
|                 | 2.0 GDI         | 157          | <b>03.13</b>                       |                                    |                       |        |   |                          |            |
|                 | 2.0 T           | 149          | <b>01.10</b>                       |                                    |                       |        |   |                          |            |
|                 | 2.4 D           | 120          | <b>08.07</b>                       |                                    |                       |        |   |                          |            |
|                 | 2.4 D           | 129          | <b>10.09</b>                       |                                    |                       |        |   |                          |            |
|                 | 2.4 D4 AWD      | 120          | <b>01.13</b>                       |                                    |                       |        |   |                          |            |
|                 | 2.4 D5          | 136          | <b>08.07</b>                       |                                    |                       |        |   |                          |            |
|                 | 2.4 D5          | 151          | <b>12.09</b>                       |                                    |                       |        |   |                          |            |
|                 | 2.4 D5          | 158          | <b>06.11</b>                       |                                    |                       |        |   |                          |            |
|                 | 2.4 D5 AWD      | 136          | <b>10.07</b>                       |                                    |                       |        |   |                          |            |
|                 | 2.4 D5 AWD      | 151          | <b>12.09</b>                       |                                    |                       |        |   |                          |            |
|                 | 2.4 D5 AWD      | 158          | <b>06.11</b>                       |                                    |                       |        |   |                          |            |
| 2.5 T           | 147             | <b>08.07</b> |                                    |                                    |                       |        |   |                          |            |
| 2.5 T           | 170             | <b>10.09</b> |                                    |                                    |                       |        |   |                          |            |
| 2.5 T FlexiFuel | 147             | <b>04.08</b> |                                    |                                    |                       |        |   |                          |            |
| 2.5 T FlexiFuel | 170             | <b>10.09</b> |                                    |                                    |                       |        |   |                          |            |
| 3.0 T6 AWD      | 210             | <b>08.07</b> |                                    |                                    |                       |        |   |                          |            |
| 3.0 T6 AWD      | 224             | <b>04.11</b> |                                    |                                    |                       |        |   |                          |            |
| 3.2             | 175             | <b>08.07</b> |                                    |                                    |                       |        |   |                          |            |
| 3.2 AWD         | 175             | <b>08.07</b> |                                    |                                    |                       |        |   |                          |            |
| D2              | 88              | <b>03.15</b> |                                    |                                    |                       |        |   |                          |            |
| D3              | 110             | <b>03.15</b> |                                    |                                    |                       |        |   |                          |            |

<sup>1)</sup> - ventilated discs / - dischi ventilati / - disques ventilés / - disco ventilado

<sup>2)</sup> + electric parking brake / + freno a mano elettrico / + frein à main électrique / + freno de mano eléctrico

<sup>3)</sup> + ventilated discs / + dischi ventilati / + disques ventilés / + disco ventilado

<sup>4)</sup> + mechanical parking brake / + fr. stazionamento meccanico / + frein à main mécanique / + freno de mano mecánica



| <b>VOLVO V70 III (07-)</b> |                 |       |                                    |                                    |                |   |   |                         |
|----------------------------|-----------------|-------|------------------------------------|------------------------------------|----------------|---|---|-------------------------|
|                            | D4              | 133   | 10.13                              |                                    | 24.0112-0180.1 | 412180                                      | + mechanische Feststellbremse <sup>1)</sup> | 302 12,0 10,0 +S +B     |
|                            | D4 AWD          | 133   | 10.13                              |                                    |                |   |   |                         |
|                            | T4              | 132   | 10.10                              |                                    |                |   |   |                         |
|                            | T4              | 140   | 03.15                              |                                    |                |   |   |                         |
|                            | T5              | 177   | 01.10                              |                                    |                |   |   |                         |
|                            | T5              | 180   | 10.13                              |                                    |                |   |   |                         |
|                            | 1.6 DRIVE       |       | 01.10                              | + belüftete Scheiben <sup>2)</sup> | 24.0122-0259.1 | 422259                                      | + elektrische Feststellbremse <sup>3)</sup> | 302 22,0 20,0 V L +S +B |
|                            | 1.6 T4F         | 132   | 01.11                              | + belüftete Scheiben <sup>2)</sup> |                |   |   |                         |
|                            | 2.0             | 107   | 10.07                              | + belüftete Scheiben <sup>2)</sup> |                |   |   |                         |
|                            | 2.0 BiFuel      | 157   | 03.13                              | + belüftete Scheiben <sup>2)</sup> |                |   |   |                         |
|                            | 2.0 D           | 100   | 10.07                              | + belüftete Scheiben <sup>2)</sup> |                |   |   |                         |
|                            | 2.0 D3          | 100   | 05.12                              | + belüftete Scheiben <sup>2)</sup> |                |   |   |                         |
|                            | 2.0 D3          | 120   | 03.10                              | + belüftete Scheiben <sup>2)</sup> |                |   |   |                         |
|                            | 2.0 D4          | 120   | 01.13                              | + belüftete Scheiben <sup>2)</sup> |                |   |   |                         |
|                            | 2.0 FlexiFuel   | 107   | 09.07                              | + belüftete Scheiben <sup>2)</sup> |                |   |   |                         |
|                            | 2.0 GDI         | 157   | 03.13                              | + belüftete Scheiben <sup>2)</sup> |                |   |   |                         |
|                            | 2.0 T           | 149   | 01.10                              | + belüftete Scheiben <sup>2)</sup> |                |   |   |                         |
|                            | 2.4 D           | 120   | 08.07                              | + belüftete Scheiben <sup>2)</sup> |                |   |   |                         |
|                            | 2.4 D           | 129   | 10.09                              | + belüftete Scheiben <sup>2)</sup> |                |   |   |                         |
|                            | 2.4 D4 AWD      | 120   | 01.13                              | + belüftete Scheiben <sup>2)</sup> |                |   |   |                         |
|                            | 2.4 D5          | 136   | 08.07                              | + belüftete Scheiben <sup>2)</sup> |                |   |   |                         |
|                            | 2.4 D5          | 151   | 12.09                              | + belüftete Scheiben <sup>2)</sup> |                |   |   |                         |
|                            | 2.4 D5          | 158   | 06.11                              | + belüftete Scheiben <sup>2)</sup> |                |   |   |                         |
|                            | 2.4 D5 AWD      | 136   | 10.07                              | + belüftete Scheiben <sup>2)</sup> |                |   |   |                         |
|                            | 2.4 D5 AWD      | 151   | 12.09                              | + belüftete Scheiben <sup>2)</sup> |                |   |   |                         |
|                            | 2.4 D5 AWD      | 158   | 06.11                              | + belüftete Scheiben <sup>2)</sup> |                |   |   |                         |
|                            | 2.5 T           | 147   | 08.07                              | + belüftete Scheiben <sup>2)</sup> |                |   |   |                         |
|                            | 2.5 T           | 170   | 10.09                              | + belüftete Scheiben <sup>2)</sup> |                |   |   |                         |
|                            | 2.5 T FlexiFuel | 147   | 04.08                              | + belüftete Scheiben <sup>2)</sup> |                |   |   |                         |
|                            | 2.5 T FlexiFuel | 170   | 10.09                              | + belüftete Scheiben <sup>2)</sup> |                |   |   |                         |
|                            | 3.0 T6 AWD      | 210   | 08.07                              | + belüftete Scheiben <sup>2)</sup> |                |   |   |                         |
|                            | 3.0 T6 AWD      | 224   | 04.11                              | + belüftete Scheiben <sup>2)</sup> |                |   |   |                         |
|                            | 3.2             | 175   | 08.07                              | + belüftete Scheiben <sup>2)</sup> |                |   |   |                         |
|                            | 3.2 AWD         | 175   | 08.07                              | + belüftete Scheiben <sup>2)</sup> |                |   |   |                         |
|                            | D2              | 88    | 03.15                              | + belüftete Scheiben <sup>2)</sup> |                |   |   |                         |
|                            | D3              | 110   | 03.15                              | + belüftete Scheiben <sup>2)</sup> |                |   |   |                         |
|                            | D4              | 133   | 10.13                              | + belüftete Scheiben <sup>2)</sup> |                |   |   |                         |
| D4 AWD                     | 133             | 10.13 | + belüftete Scheiben <sup>2)</sup> |                                    |                |   |   |                         |
| T4                         | 132             | 10.10 | + belüftete Scheiben <sup>2)</sup> |                                    |                |   |   |                         |
| T4                         | 140             | 03.15 | + belüftete Scheiben <sup>2)</sup> |                                    |                |   |   |                         |
| T5                         | 177             | 01.10 | + belüftete Scheiben <sup>2)</sup> |                                    |                |   |   |                         |
| T5                         | 180             | 10.13 | + belüftete Scheiben <sup>2)</sup> |                                    |                |   |   |                         |
| 1.6 DRIVE                  |                 | 01.10 | + massive Scheiben <sup>4)</sup>   | 24.0111-0147.1                     | 411147         | + elektrische Feststellbremse <sup>3)</sup> | 302 11,0 9,0 +S +B                          |                         |
| 1.6 T4F                    | 132             | 01.11 | + massive Scheiben <sup>4)</sup>   |                                    |                |   |   |                         |
| 2.0                        | 107             | 10.07 | + massive Scheiben <sup>4)</sup>   |                                    |                |   |   |                         |
| 2.0 BiFuel                 | 157             | 03.13 | + massive Scheiben <sup>4)</sup>   |                                    |                |   |   |                         |
| 2.0 D                      | 100             | 10.07 | + massive Scheiben <sup>4)</sup>   |                                    |                |   |   |                         |
| 2.0 D3                     | 100             | 05.12 | + massive Scheiben <sup>4)</sup>   |                                    |                |   |   |                         |
| 2.0 D3                     | 120             | 03.10 | + massive Scheiben <sup>4)</sup>   |                                    |                |   |   |                         |
| 2.0 D4                     | 120             | 01.13 | + massive Scheiben <sup>4)</sup>   |                                    |                |   |   |                         |
| 2.0 FlexiFuel              | 107             | 09.07 | + massive Scheiben <sup>4)</sup>   |                                    |                |   |   |                         |
| 2.0 GDI                    | 157             | 03.13 | + massive Scheiben <sup>4)</sup>   |                                    |                |   |   |                         |
| 2.0 T                      | 149             | 01.10 | + massive Scheiben <sup>4)</sup>   |                                    |                |   |   |                         |
| 2.4 D                      | 120             | 08.07 | + massive Scheiben <sup>4)</sup>   |                                    |                |   |   |                         |
| 2.4 D                      | 129             | 10.09 | + massive Scheiben <sup>4)</sup>   |                                    |                |   |   |                         |
| 2.4 D4 AWD                 | 120             | 01.13 | + massive Scheiben <sup>4)</sup>   |                                    |                |   |   |                         |
| 2.4 D5                     | 136             | 08.07 | + massive Scheiben <sup>4)</sup>   |                                    |                |   |   |                         |
| 2.4 D5                     | 151             | 12.09 | + massive Scheiben <sup>4)</sup>   |                                    |                |   |   |                         |
| 2.4 D5                     | 158             | 06.11 | + massive Scheiben <sup>4)</sup>   |                                    |                |   |   |                         |
| 2.4 D5 AWD                 | 136             | 10.07 | + massive Scheiben <sup>4)</sup>   |                                    |                |   |   |                         |
| 2.4 D5 AWD                 | 151             | 12.09 | + massive Scheiben <sup>4)</sup>   |                                    |                |   |   |                         |
| 2.4 D5 AWD                 | 158             | 06.11 | + massive Scheiben <sup>4)</sup>   |                                    |                |   |   |                         |
| 2.5 T                      | 147             | 08.07 | + massive Scheiben <sup>4)</sup>   |                                    |                |   |   |                         |
| 2.5 T                      | 170             | 10.09 | + massive Scheiben <sup>4)</sup>   |                                    |                |   |   |                         |
| 2.5 T FlexiFuel            | 147             | 04.08 | + massive Scheiben <sup>4)</sup>   |                                    |                |   |   |                         |
| 2.5 T FlexiFuel            | 170             | 10.09 | + massive Scheiben <sup>4)</sup>   |                                    |                |   |   |                         |
| 3.0 T6 AWD                 | 210             | 08.07 | + massive Scheiben <sup>4)</sup>   |                                    |                |   |   |                         |
| 3.0 T6 AWD                 | 224             | 04.11 | + massive Scheiben <sup>4)</sup>   |                                    |                |   |   |                         |
| 3.2                        | 175             | 08.07 | + massive Scheiben <sup>4)</sup>   |                                    |                |   |   |                         |
| 3.2 AWD                    | 175             | 08.07 | + massive Scheiben <sup>4)</sup>   |                                    |                |   |   |                         |
| D2                         | 88              | 03.15 | + massive Scheiben <sup>4)</sup>   |                                    |                |   |   |                         |
| D3                         | 110             | 03.15 | + massive Scheiben <sup>4)</sup>   |                                    |                |   |   |                         |
| D4                         | 133             | 10.13 | + massive Scheiben <sup>4)</sup>   |                                    |                |   |   |                         |
| D4 AWD                     | 133             | 10.13 | + massive Scheiben <sup>4)</sup>   |                                    |                |   |   |                         |
| T4                         | 132             | 10.10 | + massive Scheiben <sup>4)</sup>   |                                    |                |   |   |                         |
| T4                         | 140             | 03.15 | + massive Scheiben <sup>4)</sup>   |                                    |                |   |   |                         |
| T5                         | 177             | 01.10 | + massive Scheiben <sup>4)</sup>   |                                    |                |   |   |                         |
| T5                         | 180             | 10.13 | + massive Scheiben <sup>4)</sup>   |                                    |                |   |   |                         |
|                            | 1.6 DRIVE       |       | 01.10                              |                                    | 24.0711-6221.3 | 360258                                      | 2   | Radsensor               |
|                            | 1.6 T4F         | 132   | 01.11                              |                                    |                |   |   |                         |
|                            | 2.0             | 107   | 10.07                              |                                    |                |   |   |                         |
|                            | 2.0 BiFuel      | 157   | 03.13                              |                                    |                |   |   |                         |
|                            | 2.0 D           | 100   | 10.07                              |                                    |                |   |   |                         |
|                            | 2.0 D3          | 100   | 05.12                              |                                    |                |   |   |                         |
|                            | 2.0 D3          | 120   | 03.10                              |                                    |                |   |   |                         |
|                            | 2.0 D4          | 120   | 01.13                              |                                    |                |   |   |                         |
| 2.0 FlexiFuel              | 107             | 09.07 |                                    |                                    |                |   |   |                         |

<sup>1)</sup> + mechanical parking brake / + fr. stazionamento meccanico / + frein à main mécanique / + freno de mano mecánica

<sup>2)</sup> + ventilated discs / + dischi ventilati / + disques ventilés / + disco ventilado

<sup>3)</sup> + electric parking brake / + freno a mano elettrico / + frein à main électrique / + freno de mano eléctrico

<sup>4)</sup> + solid discs / + dischi massiccio / + disques massive / + disco macizo



| VOLVO V70 III (07-) |                 |     |       |       |  |                |        |   |  |           |
|---------------------|-----------------|-----|-------|-------|--|----------------|--------|---|--|-----------|
|                     | 2.0 GDI         | 157 |       | 03.13 |  | 24.0711-6221.3 | 360258 | 2 |  | Radsensor |
|                     | 2.0 T           | 149 |       | 01.10 |  |                |        |   |  |           |
|                     | 2.4 D           | 120 |       | 08.07 |  |                |        |   |  |           |
|                     | 2.4 D           | 129 |       | 10.09 |  |                |        |   |  |           |
|                     | 2.4 D5          | 136 |       | 08.07 |  |                |        |   |  |           |
|                     | 2.4 D5          | 151 |       | 12.09 |  |                |        |   |  |           |
|                     | 2.4 D5          | 158 |       | 06.11 |  |                |        |   |  |           |
|                     | 2.5 T           | 147 |       | 08.07 |  |                |        |   |  |           |
|                     | 2.5 T           | 170 |       | 10.09 |  |                |        |   |  |           |
|                     | 2.5 T FlexiFuel | 147 |       | 04.08 |  |                |        |   |  |           |
|                     | 2.5 T FlexiFuel | 170 |       | 10.09 |  |                |        |   |  |           |
|                     | 3.2             | 175 |       | 08.07 |  |                |        |   |  |           |
|                     | D2              | 88  |       | 03.15 |  |                |        |   |  |           |
|                     | D3              | 110 |       | 03.15 |  |                |        |   |  |           |
|                     | D4              | 133 |       | 10.13 |  |                |        |   |  |           |
|                     | T4              | 132 |       | 10.10 |  |                |        |   |  |           |
|                     | T4              | 140 |       | 03.15 |  |                |        |   |  |           |
|                     | T5              | 177 |       | 01.10 |  |                |        |   |  |           |
|                     | T5              | 180 |       | 10.13 |  |                |        |   |  |           |
|                     | 2.4 D4 AWD      | 120 |       | 01.13 |  | 24.0711-6369.3 | 360395 | 2 |  | Radsensor |
| 2.4 D5 AWD          | 136             |     | 10.07 |       |  |                |        |   |  |           |
| 2.4 D5 AWD          | 151             |     | 12.09 |       |  |                |        |   |  |           |
| 2.4 D5 AWD          | 158             |     | 06.11 |       |  |                |        |   |  |           |
| 3.0 T6 AWD          | 210             |     | 08.07 |       |  |                |        |   |  |           |
| 3.0 T6 AWD          | 224             |     | 04.11 |       |  |                |        |   |  |           |
| 3.2 AWD             | 175             |     | 08.07 |       |  |                |        |   |  |           |
| D4 AWD              | 133             |     | 10.13 |       |  |                |        |   |  |           |

| VOLVO V90 I (97-98) |     |     |  |       |       |                |        |  |  |                     |
|---------------------|-----|-----|--|-------|-------|----------------|--------|--|--|---------------------|
|                     | 2.5 | 125 |  | 11.96 | 10.98 | 13.0460-2985.2 | 602985 |  |  | 20164 18,2 TRW      |
|                     | 2.5 | 132 |  | 11.96 | 10.97 |                |        |  |  |                     |
|                     | 2.9 | 132 |  | 01.97 | 12.98 |                |        |  |  |                     |
|                     | 2.9 | 150 |  | 01.97 | 12.98 |                |        |  |  |                     |
|                     | 2.5 | 125 |  | 11.96 | 10.98 | 24.0126-0102.1 | 426102 |  |  | 280 26,0 23,0 V +B  |
|                     | 2.5 | 132 |  | 11.96 | 10.97 |                |        |  |  |                     |
|                     | 2.9 | 132 |  | 01.97 | 12.98 |                |        |  |  |                     |
|                     | 2.9 | 150 |  | 01.97 | 12.98 |                |        |  |  |                     |
|                     | 2.5 | 125 |  | 11.96 | 10.98 | 13.0460-2935.2 | 602935 |  |  | 21385 13,8 /S TRW   |
|                     | 2.5 | 132 |  | 11.96 | 10.97 |                |        |  |  |                     |
|                     | 2.9 | 132 |  | 01.97 | 12.98 |                |        |  |  |                     |
|                     | 2.9 | 150 |  | 01.97 | 12.98 |                |        |  |  |                     |
|                     | 2.5 | 125 |  | 11.96 | 10.98 | 24.0112-0150.1 | 412150 |  |  | 277 11,9 10,0 +B    |
|                     | 2.5 | 132 |  | 11.96 | 10.97 |                |        |  |  |                     |
|                     | 2.9 | 132 |  | 01.97 | 12.98 |                |        |  |  |                     |
|                     | 2.9 | 150 |  | 01.97 | 12.98 |                |        |  |  |                     |
|                     | 2.5 | 125 |  | 11.96 | 10.98 | 03.0137-0299.2 | 650299 |  |  | 160 x 25            |
|                     | 2.5 | 132 |  | 11.96 | 10.97 | 03.0137-9199.2 | 669199 |  |  | Bremsbacken-Zubehör |
|                     | 2.9 | 132 |  | 01.97 | 12.98 |                |        |  |  |                     |
|                     | 2.9 | 150 |  | 01.97 | 12.98 |                |        |  |  |                     |

| VOLVO XC60 (08-) |              |        |        |       |  |                |        |  |  |                      |
|------------------|--------------|--------|--------|-------|--|----------------|--------|--|--|----------------------|
|                  | 2.0 D3       | 100    |        | 04.12 |  | 13.0460-7272.2 | 607272 |  |  | 24399 20,4 +/WE ATE  |
|                  | 2.0 D3 DRIVe | 120    |        | 03.10 |  |                |        |  |  |                      |
|                  | 2.0 T        | 149    |        | 03.10 |  |                |        |  |  |                      |
|                  | 2.4 D        | 120    |        | 07.09 |  |                |        |  |  |                      |
|                  | 2.4 D        | 129    |        | 04.09 |  |                |        |  |  |                      |
|                  | 2.4 D AWD    | 120    |        | 09.08 |  |                |        |  |  |                      |
|                  | 2.4 D AWD    | 129    |        | 06.09 |  |                |        |  |  |                      |
|                  | 2.4 D5       | 158    |        | 06.11 |  |                |        |  |  |                      |
|                  | 2.4 D5 AWD   | 136    |        | 09.08 |  |                |        |  |  |                      |
|                  | 2.4 D5 AWD   | 151    |        | 04.09 |  |                |        |  |  |                      |
|                  | 2.4 D5 AWD   | 158    |        | 06.11 |  |                |        |  |  |                      |
|                  | 3.0 T6 AWD   | 210    |        | 09.08 |  |                |        |  |  |                      |
|                  | 3.0 T6 AWD   | 224    |        | 03.10 |  |                |        |  |  |                      |
|                  | 3.2 AWD      | 175    |        | 04.09 |  |                |        |  |  |                      |
|                  | 3.2 AWD      | 179    |        | 03.10 |  |                |        |  |  |                      |
|                  | D4           | 133    |        | 10.13 |  |                |        |  |  |                      |
|                  | D4 AWD       | 133    |        | 10.13 |  |                |        |  |  |                      |
|                  | D5 AWD       | 169    | 775000 | 04.14 |  |                |        |  |  |                      |
|                  | T5           | 177    |        | 09.10 |  |                |        |  |  |                      |
|                  | T5           | 180    |        | 10.13 |  |                |        |  |  |                      |
| T5 AWD           | 180          |        | 10.13  |       |  |                |        |  |  |                      |
| T5 AWD           | 187          |        | 04.14  |       |  |                |        |  |  |                      |
| T6               | 225          |        | 10.13  |       |  |                |        |  |  |                      |
| T6 AWD           | 225          |        | 10.13  |       |  |                |        |  |  |                      |
| T6 AWD           | 242          | 775000 | 04.14  |       |  |                |        |  |  |                      |
|                  | 2.0 D3       | 100    |        | 04.12 |  | 24.0130-0212.1 | 430212 |  |  | 328 30,0 28,0 V L +B |
|                  | 2.0 D3 DRIVe | 120    |        | 03.10 |  |                |        |  |  |                      |
|                  | 2.0 T        | 149    |        | 03.10 |  |                |        |  |  |                      |
|                  | 2.4 D        | 120    |        | 07.09 |  |                |        |  |  |                      |
|                  | 2.4 D        | 129    |        | 04.09 |  |                |        |  |  |                      |
|                  | 2.4 D AWD    | 120    |        | 09.08 |  |                |        |  |  |                      |
|                  | 2.4 D AWD    | 129    |        | 06.09 |  |                |        |  |  |                      |
|                  | 2.4 D5       | 158    |        | 06.11 |  |                |        |  |  |                      |
|                  | 2.4 D5 AWD   | 136    |        | 09.08 |  |                |        |  |  |                      |
| 2.4 D5 AWD       | 151          |        | 04.09  |       |  |                |        |  |  |                      |
| 2.4 D5 AWD       | 158          |        | 06.11  |       |  |                |        |  |  |                      |



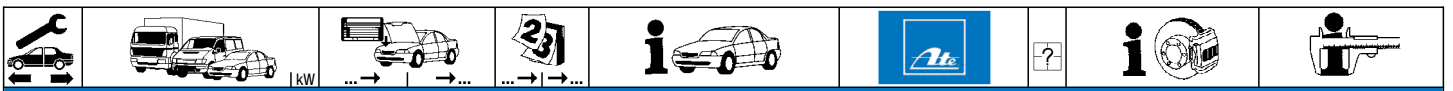

**VOLVO XC60 (08-)**

|  |   |   |  |  |  |                                  |                  |  |  |            |
|--|---|---|--|--|--|----------------------------------|------------------|--|--|------------|
|  | 3.0 T6 AWD<br>3.0 T6 AWD<br>3.2 AWD<br>3.2 AWD<br>D4<br>D4 AWD<br>D5 AWD<br>T5<br>T5<br>T5 AWD<br>T5 AWD<br>T6<br>T6 AWD<br>T6 AWD  | 210<br>224<br>175<br>179<br>133<br>133<br>169<br>177<br>180<br>180<br>187<br>225<br>225<br>242  |  | 09.08<br>03.10<br>04.09<br>03.10<br>10.13<br>10.13<br>04.14<br>09.10<br>10.13<br>10.13<br>04.14<br>10.13<br>10.13<br>04.14   |  | 24.0130-0212.1<br>430212         |                  |  | 328 30,0 28,0 V L +B                   |            |
|  | 2.0 D3<br>2.0 D3 DRIVe<br>2.0 T<br>2.4 D<br>2.4 D<br>2.4 D AWD<br>2.4 D AWD<br>2.4 D5<br>2.4 D5 AWD<br>2.4 D5 AWD<br>2.4 D5 AWD<br>3.0 T6 AWD<br>3.0 T6 AWD<br>3.2 AWD<br>3.2 AWD<br>D3<br>D4<br>D4<br>D4 AWD<br>D4 AWD<br>D5 AWD<br>D5 AWD<br>T5<br>T5<br>T5 AWD<br>T5 AWD<br>T6<br>T6 AWD<br>T6 AWD | 100<br>120<br>149<br>120<br>129<br>120<br>129<br>158<br>136<br>151<br>158<br>210<br>224<br>175<br>179<br>110<br>133<br>140<br>133<br>140<br>162<br>169<br>177<br>180<br>180<br>187<br>225<br>225<br>242 |  | 04.12<br>03.10<br>03.10<br>07.09<br>04.09<br>09.08<br>06.09<br>06.11<br>09.08<br>04.09<br>06.11<br>09.08<br>03.10<br>04.09<br>03.10<br>03.15<br>10.13<br>03.15<br>10.13<br>03.15<br>04.14<br>09.10<br>10.13<br>10.13<br>04.14<br>10.13<br>10.13<br>04.14 |  | 24.0711-5198.3<br>24.0711-5241.3 | 360239<br>360319 | <input type="checkbox"/><br><input type="checkbox"/> | Radsensor<br>Radsensor                 |            |
|  | 2.0 D3<br>2.0 D3 DRIVe<br>2.0 T<br>2.4 D<br>2.4 D<br>2.4 D AWD<br>2.4 D AWD<br>2.4 D5<br>2.4 D5 AWD<br>2.4 D5 AWD<br>2.4 D5 AWD<br>3.0 T6 AWD<br>3.0 T6 AWD<br>3.2 AWD<br>3.2 AWD<br>D3<br>D4<br>D4<br>D4 AWD<br>D4 AWD<br>D5 AWD<br>D5 AWD<br>T5<br>T5<br>T5 AWD<br>T5 AWD<br>T6<br>T6 AWD           | 100<br>120<br>149<br>120<br>129<br>120<br>129<br>158<br>136<br>151<br>158<br>210<br>224<br>175<br>179<br>110<br>133<br>140<br>133<br>140<br>162<br>169<br>177<br>180<br>180<br>187<br>225<br>242        |  | 04.12<br>03.10<br>03.10<br>07.09<br>04.09<br>09.08<br>06.09<br>06.11<br>09.08<br>04.09<br>06.11<br>09.08<br>03.10<br>04.09<br>03.10<br>03.15<br>10.13<br>03.15<br>10.13<br>03.15<br>04.14<br>09.10<br>10.13<br>10.13<br>04.14<br>04.14                   | 789937<br>789937<br>789937<br>789937<br>789937<br>789937<br>789937<br>789937 | 13.0460-2736.2<br>13.0470-2736.2 | 602736<br>LD2736 |  | 24496 17,3 /Zub/S<br>24496 17,3 /Zub/S | TRW<br>TRW |
|  | D3<br>D4<br>D4 AWD<br>D5 AWD<br>D5 AWD<br>T6<br>T6 AWD<br>T6 AWD  | 110 789938<br>140 789938<br>140 789938<br>162 789938<br>169 789938<br>225<br>225<br>242 789938  |  | 10.13<br>10.13   |  | 13.0460-2736.2<br>13.0470-2736.2 | 602736<br>LD2736 |  | 24496 17,3 /Zub/S<br>24496 17,3 /Zub/S | TRW<br>TRW |
|  | 2.0 D3<br>2.0 D3 DRIVe<br>2.0 T<br>2.4 D<br>2.4 D<br>2.4 D AWD<br>2.4 D AWD<br>2.4 D5<br>2.4 D5 AWD   | 100<br>120<br>149<br>120<br>129<br>120<br>129<br>158<br>136   |  | 04.12<br>03.10<br>03.10<br>07.09<br>04.09<br>09.08<br>06.09<br>06.11<br>09.08  |  | 24.0122-0261.1<br>422261         |                  |  | 302 22,0 20,0 V L +B                   |            |



### VOLVO XC60 (08-)

|  |   |  |  |  |  |                |        |   |  |                      |
|--|---|--|--|--|--|----------------|--------|---|--|----------------------|
|  | 2.4 D5 AWD<br>2.4 D5 AWD<br>3.0 T6 AWD<br>3.0 T6 AWD<br>3.2 AWD<br>3.2 AWD<br>D3<br>D4<br>D4<br>D4 AWD<br>D4 AWD<br>D5 AWD<br>D5 AWD<br>T5<br>T5<br>T5 AWD<br>T5 AWD<br>T6<br>T6 AWD<br>T6 AWD                      | 151<br>158<br>210<br>224<br>175<br>179<br>110<br>133<br>140<br>133<br>140<br>162<br>169<br>177<br>180<br>180<br>187<br>225<br>225<br>242 |  | 04.09<br>06.11<br>09.08<br>03.10<br>04.09<br>03.10<br>03.15<br>10.13<br>03.15<br>10.13<br>03.15<br>03.15<br>04.14<br>09.10<br>10.13<br>10.13<br>04.14<br>10.13<br>04.14          |  | 24.0122-0261.1 | 422261 |   |  | 302 22,0 20,0 V L +B |
|  | 2.0 D3<br>2.0 D3 DRIVe<br>2.0 T<br>2.4 D<br>2.4 D<br>2.4 D AWD<br>2.4 D AWD<br>2.4 D5<br>2.4 D5 AWD<br>2.4 D5 AWD<br>2.4 D5 AWD<br>3.0 T6 AWD<br>3.0 T6 AWD<br>3.2 AWD<br>3.2 AWD<br>D4<br>D4 AWD<br>T5<br>T5<br>T6 | 100<br>120<br>149<br>120<br>129<br>120<br>129<br>158<br>136<br>151<br>158<br>210<br>224<br>175<br>179<br>133<br>133<br>177<br>180<br>225 |  | 04.12<br>03.10<br>03.10<br>07.09<br>04.09<br>09.08<br>06.09<br>06.11<br>09.08<br>04.09<br>06.11<br>09.08<br>03.10<br>04.09<br>03.10<br>10.13<br>10.13<br>09.10<br>10.13<br>10.13 |  | 24.0711-6369.3 | 360395 | 2 |  | Radsensor            |
|  | D4 AWD<br>D5 AWD<br>D5 AWD<br>T5 AWD<br>T5 AWD<br>T6 AWD<br>T6 AWD  | 140<br>162<br>169<br>180<br>187<br>225<br>242  |  | 03.15<br>03.15<br>04.14<br>10.13<br>04.14<br>10.13<br>04.14  |  | 24.0711-6369.3 | 360395 | 2 |  | Radsensor            |
|  | D3<br>D4<br>T6  | 110<br>140<br>225  |  | 03.15<br>03.15<br>10.13  |  | 24.0711-6221.3 | 360258 | 2 |  | Radsensor            |

### VOLVO XC70 I CROSS COUNTRY (00-07)

|  |  |                                 |  |   |  |  |                                      |  |  |   |            |
|--|--|---------------------------------|--|---|--|--|--------------------------------------|--|--|---|------------|
|  | 2.4 AWD<br>2.4 D5 AWD<br>2.4 T XC AWD<br>2.5 D5 XC AWD<br>2.5 T XC AWD | 121<br>136<br>120<br>120<br>154 |  | 03.00 09.03<br>12.05 07.07<br>11.97 09.02<br>09.02 07.07<br>09.02 07.07 |  | 13.0460-7145.2<br>13.0470-7145.2                                     | 607145<br>LD7145                     |  |  | 23073 18,8 +<br>23073 18,8 +  | ATE<br>ATE |
|  | 2.4 AWD<br>2.4 D5 AWD<br>2.4 T XC AWD<br>2.5 D5 XC AWD<br>2.5 T XC AWD | 121<br>136<br>120<br>120<br>154 |  | 03.00 09.03<br>12.05 07.07<br>11.97 09.02<br>09.02 07.07<br>09.02 07.07 |  | 24.0126-0122.1<br>24.0128-0123.1<br>24.0328-0123.1<br>24.0128-0184.1 | 426122<br>428123<br>528123<br>428184 |  | + 15" Rad <sup>1)</sup><br>+ 16" Rad <sup>2)</sup><br>+ 16" Rad <sup>2)</sup><br>+ 17" Rad <sup>3)</sup> | 286 26,0 23,0 V +B<br>305 27,9 25,0 V +B<br>305 27,9 25,0 V +B PD<br>320 28,0 25,0 V L +B |            |
|  | 2.4 AWD<br>2.4 D5 AWD<br>2.4 T XC AWD<br>2.5 D5 XC AWD<br>2.5 T XC AWD | 121<br>136<br>120<br>120<br>154 |  | 03.00 09.03<br>12.05 07.07<br>11.97 09.02<br>09.02 07.07<br>09.02 07.07 |  | 24.0711-6214.3<br>24.0711-6211.3                                     | 360230<br>360233                     |  |  | Radsensor L=965<br>Radsensor L=1085   |            |
|  | 2.4 AWD<br>2.4 D5 AWD<br>2.4 T XC AWD<br>2.5 D5 XC AWD<br>2.5 T XC AWD | 121<br>136<br>120<br>120<br>154 |  | 03.00 09.03<br>12.05 07.07<br>11.97 09.02<br>09.02 07.07<br>09.02 07.07 |  | 13.0460-7135.2<br>13.0470-7135.2                                     | 607135<br>LD7135                     |  |  | 23076 17,5 +<br>23076 17,5 +  | ATE<br>ATE |
|  | 2.4 AWD<br>2.4 D5 AWD<br>2.4 T XC AWD<br>2.5 D5 XC AWD<br>2.5 T XC AWD | 121<br>136<br>120<br>120<br>154 |  | 03.00 09.03<br>12.05 07.07<br>11.97 09.02<br>09.02 07.07<br>09.02 07.07 |  | 24.0112-0151.1<br>24.0312-0151.1                                     | 412151<br>512151                     |  |  | 288 11,9 10,0 +B<br>288 11,9 10,0 +B PD   |            |
|  | 2.4 AWD<br>2.4 D5 AWD<br>2.4 T XC AWD<br>2.5 D5 XC AWD<br>2.5 T XC AWD | 121<br>136<br>120<br>120<br>154 |  | 03.00 09.03<br>12.05 07.07<br>11.97 09.02<br>09.02 07.07<br>09.02 07.07 |  | 24.0711-6212.3<br>24.0711-6213.3                                     | 360249<br>360250                     |  |  | Radsensor L=1255<br>Radsensor L=1255  |            |

<sup>1)</sup> + 15" wheel / + ruota 15" / + roue 15" / + rueda 15"

<sup>2)</sup> + 16" wheel / + ruota 16" / + roue 16" / + rueda 16"

<sup>3)</sup> + 17" wheel / + ruota 17" / + roue 17" / + rueda 17"



**VOLVO XC70 I CROSS COUNTRY (00-07)**

|  |               |     |  |       |       |                |        |  |          |                |        |                     |
|--|---------------|-----|--|-------|-------|----------------|--------|--|----------|----------------|--------|---------------------|
|  | 2.4 AWD       | 121 |  | 03.00 | 09.03 | 03.0137-0450.2 | 650450 |  | 178 x 25 |                |        |                     |
|  | 2.4 D5 AWD    | 136 |  | 12.05 | 07.07 |                |        |  |          | 03.0137-9283.2 | 669283 | Bremsbacken-Zubehör |
|  | 2.4 T XC AWD  |     |  | 11.97 | 09.02 |                |        |  |          |                |        |                     |
|  | 2.5 D5 XC AWD | 120 |  | 09.02 | 07.07 |                |        |  |          |                |        |                     |
|  | 2.5 T XC AWD  | 154 |  | 09.02 | 07.07 |                |        |  |          |                |        |                     |

**VOLVO XC70 II CROSS COUNTRY (07-)**

|            |            |            |     |       |       |                |                |                         |                         |                         |                |                |                         |                         |                            |  |                |        |                             |                         |     |
|------------|------------|------------|-----|-------|-------|----------------|----------------|-------------------------|-------------------------|-------------------------|----------------|----------------|-------------------------|-------------------------|----------------------------|--|----------------|--------|-----------------------------|-------------------------|-----|
|            | 2.0 D3     | 120        |     | 08.11 |       | 13.0460-7228.2 | 607228         | + 16" Rad <sup>1)</sup> | 24123 20,3 +            | ATE                     |                |                |                         |                         |                            |  |                |        |                             |                         |     |
|            | 2.0 D3 AWD | 120        |     | 08.11 |       |                |                |                         |                         |                         | 13.0470-7228.2 | LD7228         | + 16" Rad <sup>1)</sup> | 24123 20,3 +            | ATE                        |  |                |        |                             |                         |     |
|            | 2.4 D      | 129        |     | 01.10 |       |                |                |                         |                         |                         |                |                |                         |                         |                            |  |                |        |                             |                         |     |
|            | 2.4 D AWD  | 120        |     | 08.07 |       |                |                |                         |                         |                         |                |                |                         |                         |                            |  |                |        |                             |                         |     |
|            | 2.4 D5 AWD | 136        |     | 08.07 |       |                |                |                         |                         |                         |                |                |                         |                         |                            |  |                |        |                             |                         |     |
|            | 2.4 D5 AWD | 151        |     | 12.09 |       |                |                |                         |                         |                         |                |                |                         |                         |                            |  |                |        |                             |                         |     |
|            | 2.4 D5 AWD | 158        |     | 06.11 |       |                |                |                         |                         |                         |                |                |                         |                         |                            |  |                |        |                             |                         |     |
|            | 3.0 T6 AWD | 210        |     | 01.08 |       |                |                |                         |                         |                         |                |                |                         |                         |                            |  |                |        |                             |                         |     |
|            | 3.0 T6 AWD | 224        |     | 01.10 |       |                |                |                         |                         |                         |                |                |                         |                         |                            |  |                |        |                             |                         |     |
|            | 3.2        | 179        |     | 08.07 |       |                |                |                         |                         |                         |                |                |                         |                         |                            |  |                |        |                             |                         |     |
|            | 3.2 AWD    | 175        |     | 08.07 |       |                |                |                         |                         |                         |                |                |                         |                         |                            |  |                |        |                             |                         |     |
|            | 3.2 AWD    | 179        |     | 08.07 |       |                |                |                         |                         |                         |                |                |                         |                         |                            |  |                |        |                             |                         |     |
|            | D4         | 133        |     | 10.13 |       |                |                |                         |                         |                         |                |                |                         |                         |                            |  |                |        |                             |                         |     |
|            | D4 AWD     | 133        |     | 10.13 |       |                |                |                         |                         |                         |                |                |                         |                         |                            |  |                |        |                             |                         |     |
|            | D5 AWD     | 162        |     | 03.15 |       |                |                |                         |                         |                         |                |                |                         |                         |                            |  |                |        |                             |                         |     |
|            | T5         | 180        |     | 10.13 |       |                |                |                         |                         |                         |                |                |                         |                         |                            |  |                |        |                             |                         |     |
|            | T5 AWD     | 187        |     | 08.15 |       |                |                |                         |                         |                         |                |                |                         |                         |                            |  |                |        |                             |                         |     |
|            |            | 2.0 D3     | 120 |       | 08.11 |                |                |                         |                         |                         |                |                |                         |                         |                            |  | 13.0460-7243.2 | 607243 | + 17"/18" Rad <sup>2)</sup> | 24142 20,6 +            | ATE |
|            |            | 2.0 D3 AWD | 120 |       | 08.11 |                |                |                         |                         |                         |                |                |                         |                         |                            |  |                |        |                             |                         |     |
| 2.4 D      |            | 129        |     | 01.10 |       |                |                |                         |                         |                         |                |                |                         |                         |                            |  |                |        |                             |                         |     |
| 2.4 D AWD  |            | 120        |     | 08.07 |       |                |                |                         |                         |                         |                |                |                         |                         |                            |  |                |        |                             |                         |     |
| 2.4 D5 AWD |            | 136        |     | 08.07 |       |                |                |                         |                         |                         |                |                |                         |                         |                            |  |                |        |                             |                         |     |
| 2.4 D5 AWD |            | 151        |     | 12.09 |       |                |                |                         |                         |                         |                |                |                         |                         |                            |  |                |        |                             |                         |     |
| 2.4 D5 AWD |            | 158        |     | 06.11 |       |                |                |                         |                         |                         |                |                |                         |                         |                            |  |                |        |                             |                         |     |
| 3.0 T6 AWD |            | 210        |     | 01.08 |       |                |                |                         |                         |                         |                |                |                         |                         |                            |  |                |        |                             |                         |     |
| 3.0 T6 AWD |            | 224        |     | 01.10 |       |                |                |                         |                         |                         |                |                |                         |                         |                            |  |                |        |                             |                         |     |
| 3.2        |            | 179        |     | 08.07 |       |                |                |                         |                         |                         |                |                |                         |                         |                            |  |                |        |                             |                         |     |
| 3.2 AWD    |            | 175        |     | 08.07 |       |                |                |                         |                         |                         |                |                |                         |                         |                            |  |                |        |                             |                         |     |
| 3.2 AWD    |            | 179        |     | 08.07 |       |                |                |                         |                         |                         |                |                |                         |                         |                            |  |                |        |                             |                         |     |
| D4         |            | 133        |     | 10.13 |       |                |                |                         |                         |                         |                |                |                         |                         |                            |  |                |        |                             |                         |     |
| D4 AWD     |            | 133        |     | 10.13 |       |                |                |                         |                         |                         |                |                |                         |                         |                            |  |                |        |                             |                         |     |
| D5 AWD     |            | 162        |     | 03.15 |       |                |                |                         |                         |                         |                |                |                         |                         |                            |  |                |        |                             |                         |     |
| T5         |            | 180        |     | 10.13 |       |                |                |                         |                         |                         |                |                |                         |                         |                            |  |                |        |                             |                         |     |
| T5 AWD     |            | 187        |     | 08.15 |       |                |                |                         |                         |                         |                |                |                         |                         |                            |  |                |        |                             |                         |     |
|            |            | 2.0 D3     | 120 |       | 08.11 |                | 24.0128-0154.1 | 428154                  | + 16" Rad <sup>1)</sup> | 300 28,0 26,0 V L +S +B |                |                |                         |                         |                            |  |                |        |                             |                         |     |
|            |            | 2.0 D3 AWD | 120 |       | 08.11 |                |                |                         |                         |                         |                | 24.0328-0154.1 | 528154                  | + 16" Rad <sup>1)</sup> | 300 28,0 26,0 V L +S +B PD |  |                |        |                             |                         |     |
|            | 2.4 D      | 129        |     | 01.10 |       |                |                |                         |                         |                         |                |                |                         |                         |                            |  |                |        |                             |                         |     |
|            | 2.4 D AWD  | 120        |     | 08.07 |       |                |                |                         |                         |                         |                |                |                         |                         |                            |  |                |        |                             |                         |     |
|            | 2.4 D5 AWD | 136        |     | 08.07 |       |                |                |                         |                         |                         |                |                |                         |                         |                            |  |                |        |                             |                         |     |
|            | 2.4 D5 AWD | 151        |     | 12.09 |       |                |                |                         |                         |                         |                |                |                         |                         |                            |  |                |        |                             |                         |     |
|            | 2.4 D5 AWD | 158        |     | 06.11 |       |                |                |                         |                         |                         |                |                |                         |                         |                            |  |                |        |                             |                         |     |
|            | 3.0 T6 AWD | 210        |     | 01.08 |       |                |                |                         |                         |                         |                |                |                         |                         |                            |  |                |        |                             |                         |     |
|            | 3.0 T6 AWD | 224        |     | 01.10 |       |                |                |                         |                         |                         |                |                |                         |                         |                            |  |                |        |                             |                         |     |
|            | 3.2        | 179        |     | 08.07 |       |                |                |                         |                         |                         |                |                |                         |                         |                            |  |                |        |                             |                         |     |
|            | 3.2 AWD    | 175        |     | 08.07 |       |                |                |                         |                         |                         |                |                |                         |                         |                            |  |                |        |                             |                         |     |
|            | 3.2 AWD    | 179        |     | 08.07 |       |                |                |                         |                         |                         |                |                |                         |                         |                            |  |                |        |                             |                         |     |
|            | D4         | 133        |     | 10.13 |       |                |                |                         |                         |                         |                |                |                         |                         |                            |  |                |        |                             |                         |     |
|            | D4 AWD     | 133        |     | 10.13 |       |                |                |                         |                         |                         |                |                |                         |                         |                            |  |                |        |                             |                         |     |
|            | D5 AWD     | 162        |     | 03.15 |       |                |                |                         |                         |                         |                |                |                         |                         |                            |  |                |        |                             |                         |     |
|            | T5         | 180        |     | 10.13 |       |                |                |                         |                         |                         |                |                |                         |                         |                            |  |                |        |                             |                         |     |
|            | T5 AWD     | 187        |     | 08.15 |       |                |                |                         |                         |                         |                |                |                         |                         |                            |  |                |        |                             |                         |     |
|            |            | 2.0 D3     | 120 |       | 08.11 |                |                |                         |                         |                         |                |                |                         |                         |                            |  | 24.0128-0162.1 | 428162 | + 17" Rad <sup>3)</sup>     | 316 28,0 26,0 V L +S +B |     |
|            |            | 2.0 D3 AWD | 120 |       | 08.11 |                |                |                         |                         |                         |                |                |                         |                         |                            |  |                |        |                             |                         |     |
| 2.4 D      |            | 129        |     | 01.10 |       |                |                |                         |                         |                         |                |                |                         |                         |                            |  |                |        |                             |                         |     |
| 2.4 D AWD  |            | 120        |     | 08.07 |       |                |                |                         |                         |                         |                |                |                         |                         |                            |  |                |        |                             |                         |     |
| 2.4 D5 AWD |            | 136        |     | 08.07 |       |                |                |                         |                         |                         |                |                |                         |                         |                            |  |                |        |                             |                         |     |
| 2.4 D5 AWD |            | 151        |     | 12.09 |       |                |                |                         |                         |                         |                |                |                         |                         |                            |  |                |        |                             |                         |     |
| 2.4 D5 AWD |            | 158        |     | 06.11 |       |                |                |                         |                         |                         |                |                |                         |                         |                            |  |                |        |                             |                         |     |
| 3.0 T6 AWD |            | 210        |     | 01.08 |       |                |                |                         |                         |                         |                |                |                         |                         |                            |  |                |        |                             |                         |     |
| 3.0 T6 AWD |            | 224        |     | 01.10 |       |                |                |                         |                         |                         |                |                |                         |                         |                            |  |                |        |                             |                         |     |
| 3.2        |            | 179        |     | 08.07 |       |                |                |                         |                         |                         |                |                |                         |                         |                            |  |                |        |                             |                         |     |
| 3.2 AWD    |            | 175        |     | 08.07 |       |                |                |                         |                         |                         |                |                |                         |                         |                            |  |                |        |                             |                         |     |
| 3.2 AWD    |            | 179        |     | 08.07 |       |                |                |                         |                         |                         |                |                |                         |                         |                            |  |                |        |                             |                         |     |
| D4         |            | 133        |     | 10.13 |       |                |                |                         |                         |                         |                |                |                         |                         |                            |  |                |        |                             |                         |     |
| D4 AWD     |            | 133        |     | 10.13 |       |                |                |                         |                         |                         |                |                |                         |                         |                            |  |                |        |                             |                         |     |
| D5 AWD     |            | 162        |     | 03.15 |       |                |                |                         |                         |                         |                |                |                         |                         |                            |  |                |        |                             |                         |     |
| T5         |            | 180        |     | 10.13 |       |                |                |                         |                         |                         |                |                |                         |                         |                            |  |                |        |                             |                         |     |
| T5 AWD     |            | 187        |     | 08.15 |       |                |                |                         |                         |                         |                |                |                         |                         |                            |  |                |        |                             |                         |     |
|            |            | 2.0 D3     | 120 |       | 08.11 |                | 24.0128-0210.1 | 428210                  | + 18" Rad <sup>4)</sup> | 336 28,0 26,0 V L +S +B |                |                |                         |                         |                            |  |                |        |                             |                         |     |
|            |            | 2.0 D3 AWD | 120 |       | 08.11 |                |                |                         |                         |                         |                |                |                         |                         |                            |  |                |        |                             |                         |     |
|            | 2.4 D      | 129        |     | 01.10 |       |                |                |                         |                         |                         |                |                |                         |                         |                            |  |                |        |                             |                         |     |
|            | 2.4 D AWD  | 120        |     | 08.07 |       |                |                |                         |                         |                         |                |                |                         |                         |                            |  |                |        |                             |                         |     |
|            | 2.4 D5 AWD | 136        |     | 08.07 |       |                |                |                         |                         |                         |                |                |                         |                         |                            |  |                |        |                             |                         |     |
|            | 2.4 D5 AWD | 151        |     | 12.09 |       |                |                |                         |                         |                         |                |                |                         |                         |                            |  |                |        |                             |                         |     |
|            | 2.4 D5 AWD | 158        |     | 06.11 |       |                |                |                         |                         |                         |                |                |                         |                         |                            |  |                |        |                             |                         |     |
|            | 3.0 T6 AWD | 210        |     | 01.08 |       |                |                |                         |                         |                         |                |                |                         |                         |                            |  |                |        |                             |                         |     |
|            | 3.0 T6 AWD | 224        |     | 01.10 |       |                |                |                         |                         |                         |                |                |                         |                         |                            |  |                |        |                             |                         |     |
|            | 3.2        | 179        |     | 08.07 |       |                |                |                         |                         |                         |                |                |                         |                         |                            |  |                |        |                             |                         |     |
|            | 3.2 AWD    | 175        |     | 08.07 |       |                |                |                         |                         |                         |                |                |                         |                         |                            |  |                |        |                             |                         |     |
|            | 3.2 AWD    | 179        |     | 08.07 |       |                |                |                         |                         |                         |                |                |                         |                         |                            |  |                |        |                             |                         |     |

1) + 16" wheel / + ruota 16" / + roue 16" / + rueda 16"  
 2) + 17"/18" wheel / + ruota 17"/18" / + roue 17"/18" / + rueda 17"/18"  
 3) + 17" wheel / + ruota 17" / + roue 17" / + rueda 17"  
 4) + 18" wheel / + ruota 18" / + roue 18" / + rueda 18"





**VOLVO XC70 II CROSS COUNTRY (07-)**

|  |   |   |   |  |                                  |                  |  |  |
|--|---|---|---|--|----------------------------------|------------------|--|--|
|  | D4<br>D4 AWD<br>D5 AWD<br>T5<br>T5 AWD  | 133<br>133<br>162<br>180<br>187   | 10.13<br>10.13<br>03.15<br>10.13<br>08.15   |  | 24.0128-0210.1                   | 428210           | + 18" Rad <sup>1)</sup>  | 336 28,0 26,0 V L +S +B                        |
|  | 2.0 D3<br>2.0 D3 AWD<br>2.4 D<br>2.4 D AWD<br>2.4 D5 AWD<br>2.4 D5 AWD<br>2.4 D5 AWD<br>3.0 T6 AWD<br>3.0 T6 AWD<br>3.2<br>3.2 AWD<br>3.2 AWD<br>D4<br>D4 AWD<br>D5 AWD<br>T5<br>T5 AWD           | 120<br>120<br>129<br>120<br>136<br>151<br>158<br>210<br>224<br>179<br>175<br>179<br>133<br>133<br>162<br>180<br>187 | 08.11<br>08.11<br>01.10<br>08.07<br>08.07<br>12.09<br>06.11<br>01.08<br>01.10<br>08.07<br>08.07<br>08.07<br>10.13<br>10.13<br>03.15<br>10.13<br>08.15 |  | 24.0711-5198.3                   | 360239           | 2  - Kollisionswarnsystem <sup>2)</sup>  | Radsensor                                      |
|  | 2.0 D3<br>2.0 D3 AWD<br>2.4 D<br>2.4 D AWD<br>2.4 D5 AWD<br>2.4 D5 AWD<br>2.4 D5 AWD<br>3.0 T6 AWD<br>3.0 T6 AWD<br>3.2<br>3.2 AWD<br>3.2 AWD<br>D4<br>D4 AWD<br>D5 AWD<br>T5<br>T5 AWD           | 120<br>120<br>129<br>120<br>136<br>151<br>158<br>210<br>224<br>179<br>175<br>179<br>133<br>133<br>162<br>180<br>187 | 08.11<br>08.11<br>01.10<br>08.07<br>08.07<br>12.09<br>06.11<br>01.08<br>01.10<br>08.07<br>08.07<br>08.07<br>10.13<br>10.13<br>03.15<br>10.13<br>08.15 |  | 24.0711-5198.3<br>24.0711-5241.3 | 360239<br>360319 | + Kollisionswarnsystem <sup>3)</sup><br>+ Kollisionswarnsystem <sup>3)</sup>               | Radsensor<br>Radsensor                         |
|  | 2.0 D3<br>2.0 D3 AWD<br>2.4 D<br>2.4 D AWD<br>2.4 D5 AWD<br>2.4 D5 AWD<br>2.4 D5 AWD<br>3.0 T6 AWD<br>3.0 T6 AWD<br>3.2<br>3.2 AWD<br>3.2 AWD<br>D4<br>D4 AWD<br>D5 AWD<br>T5<br>T5 AWD<br>T5 AWD | 120<br>120<br>129<br>120<br>136<br>151<br>158<br>210<br>224<br>179<br>175<br>179<br>133<br>133<br>162<br>180<br>187 | 08.11<br>08.11<br>01.10<br>08.07<br>08.07<br>12.09<br>06.11<br>01.08<br>01.10<br>08.07<br>08.07<br>08.07<br>10.13<br>10.13<br>03.15<br>10.13<br>08.15 |  | 13.0460-2737.2                   | 602737           | + mechanische Feststellbremse <sup>4)</sup>  | 24537 15,8 /Zub/S TRW                          |
|  | 2.0 D3<br>2.0 D3 AWD<br>2.4 D<br>2.4 D AWD<br>2.4 D5 AWD<br>2.4 D5 AWD<br>2.4 D5 AWD<br>3.0 T6 AWD<br>3.0 T6 AWD<br>3.2<br>3.2 AWD<br>3.2 AWD<br>D4<br>D4 AWD<br>D5 AWD<br>T5<br>T5 AWD           | 120<br>120<br>129<br>120<br>136<br>151<br>158<br>210<br>224<br>179<br>175<br>179<br>133<br>133<br>162<br>180<br>187 | 08.11<br>08.11<br>01.10<br>08.07<br>08.07<br>12.09<br>06.11<br>01.08<br>01.10<br>08.07<br>08.07<br>08.07<br>10.13<br>10.13<br>03.15<br>10.13<br>08.15 | + belüftete Scheiben <sup>5)</sup><br>+ belüftete Scheiben <sup>5)</sup><br>+ belüftete Scheiben <sup>5)</sup><br>+ belüftete Scheiben <sup>5)</sup><br>+ belüftete Scheiben <sup>5)</sup><br>+ belüftete Scheiben <sup>5)</sup><br>+ belüftete Scheiben <sup>5)</sup><br>+ belüftete Scheiben <sup>5)</sup><br>+ belüftete Scheiben <sup>5)</sup><br>+ belüftete Scheiben <sup>5)</sup><br>+ belüftete Scheiben <sup>5)</sup><br>+ belüftete Scheiben <sup>5)</sup><br>+ belüftete Scheiben <sup>5)</sup><br>+ belüftete Scheiben <sup>5)</sup><br>+ belüftete Scheiben <sup>5)</sup><br>+ belüftete Scheiben <sup>5)</sup> | 13.0460-2736.2<br>13.0470-2736.2 | 602736<br>LD2736 | + elektrische Feststellbremse <sup>6)</sup><br>+ elektrische Feststellbremse <sup>6)</sup> | 24496 17,3 /Zub/S TRW<br>24496 17,3 /Zub/S TRW |
|  | 2.0 D3<br>2.0 D3 AWD<br>2.4 D<br>2.4 D AWD<br>2.4 D5 AWD<br>2.4 D5 AWD<br>2.4 D5 AWD<br>3.0 T6 AWD<br>3.0 T6 AWD<br>3.2<br>3.2 AWD<br>3.2 AWD<br>D4<br>D4 AWD<br>D5 AWD<br>T5<br>T5 AWD           | 120<br>120<br>129<br>120<br>136<br>151<br>158<br>210<br>224<br>179<br>175<br>179<br>133<br>133<br>162<br>180<br>187 | 08.11<br>08.11<br>01.10<br>08.07<br>08.07<br>12.09<br>06.11<br>01.08<br>01.10<br>08.07<br>08.07<br>08.07<br>10.13<br>10.13<br>03.15<br>10.13<br>08.15 | + massive Scheiben <sup>7)</sup><br>+ massive Scheiben <sup>7)</sup><br>+ massive Scheiben <sup>7)</sup><br>+ massive Scheiben <sup>7)</sup><br>+ massive Scheiben <sup>7)</sup><br>+ massive Scheiben <sup>7)</sup><br>+ massive Scheiben <sup>7)</sup><br>+ massive Scheiben <sup>7)</sup><br>+ massive Scheiben <sup>7)</sup><br>+ massive Scheiben <sup>7)</sup><br>+ massive Scheiben <sup>7)</sup><br>+ massive Scheiben <sup>7)</sup><br>+ massive Scheiben <sup>7)</sup><br>+ massive Scheiben <sup>7)</sup><br>+ massive Scheiben <sup>7)</sup><br>+ massive Scheiben <sup>7)</sup>                                 | 13.0460-2722.2<br>13.0470-2722.2 | 602722<br>LD2722 | + elektrische Feststellbremse <sup>6)</sup><br>+ elektrische Feststellbremse <sup>6)</sup> | 24496 17,3 /Zub/S TRW<br>24496 17,3 /Zub/S TRW |

<sup>1)</sup> + 18" wheel / + ruota 18" / + roue 18" / + rueda 18"

<sup>2)</sup> - collision warning system / - sistema anti-collozione / - système anticollision / - sistema anticollisión

<sup>3)</sup> + collision warning system / + sistema anti-collozione / + système anticollision / + sistema anticollisión

<sup>4)</sup> + mechanical parking brake / + fr. stazionamento meccanico / + frein à main mécanique / + freno de mano mecánica

<sup>5)</sup> + ventilated discs / + dischi ventilati / + disques ventilés / + disco ventilado

<sup>6)</sup> + electric parking brake / + freno a mano elettrico / + frein à main électrique / + freno de mano eléctrico

<sup>7)</sup> + solid discs / + dischi massiccio / + disques massive / + disco macizo





















### VOLVO XC70 II CROSS COUNTRY (07-)

|  |   |   |   |  |                                  |                  |  |  |            |
|--|---|---|---|--|----------------------------------|------------------|--|--|------------|
|  | D4 AWD<br>D5 AWD<br>T5<br>T5 AWD  | 133<br>162<br>180<br>187  | 10.13<br>03.15<br>10.13<br>08.15  | + massive Scheiben <sup>1)</sup><br>+ massive Scheiben <sup>1)</sup><br>+ massive Scheiben <sup>1)</sup><br>+ massive Scheiben <sup>1)</sup>   | 13.0460-2722.2<br>13.0470-2722.2 | 602722<br>LD2722 | + elektrische Feststellbremse <sup>2)</sup><br>+ elektrische Feststellbremse <sup>2)</sup> | 24496 17,3 /Zub/S<br>24496 17,3 /Zub/S | TRW<br>TRW |
|  | 2.0 D3<br>2.0 D3 AWD<br>2.4 D<br>2.4 D AWD<br>2.4 D5 AWD<br>2.4 D5 AWD<br>2.4 D5 AWD<br>3.0 T6 AWD<br>3.0 T6 AWD<br>3.2<br>3.2 AWD<br>3.2 AWD<br>D4<br>D4 AWD<br>D5 AWD<br>T5<br>T5 AWD | 120<br>120<br>129<br>120<br>136<br>151<br>158<br>210<br>224<br>179<br>175<br>179<br>133<br>133<br>162<br>180<br>187 | 08.11<br>08.11<br>01.10<br>08.07<br>08.07<br>12.09<br>06.11<br>01.08<br>01.10<br>08.07<br>08.07<br>08.07<br>10.13<br>10.13<br>03.15<br>10.13<br>08.15 |  | 24.0112-0180.1                   | 412180           | - elektrische Feststellbremse <sup>3)</sup>  | 302 12,0 10,0 +S +B                    |            |
|  | 2.0 D3<br>2.0 D3 AWD<br>2.4 D<br>2.4 D AWD<br>2.4 D5 AWD<br>2.4 D5 AWD<br>2.4 D5 AWD<br>3.0 T6 AWD<br>3.0 T6 AWD<br>3.2<br>3.2 AWD<br>3.2 AWD<br>D4<br>D4 AWD<br>D5 AWD<br>T5<br>T5 AWD | 120<br>120<br>129<br>120<br>136<br>151<br>158<br>210<br>224<br>179<br>175<br>179<br>133<br>133<br>162<br>180<br>187 | 08.11<br>08.11<br>01.10<br>08.07<br>08.07<br>12.09<br>06.11<br>01.08<br>01.10<br>08.07<br>08.07<br>08.07<br>10.13<br>10.13<br>03.15<br>10.13<br>08.15 | + belüftete Scheiben <sup>4)</sup><br>+ belüftete Scheiben <sup>4)</sup><br>+ belüftete Scheiben <sup>4)</sup><br>+ belüftete Scheiben <sup>4)</sup><br>+ belüftete Scheiben <sup>4)</sup><br>+ belüftete Scheiben <sup>4)</sup><br>+ belüftete Scheiben <sup>4)</sup><br>+ belüftete Scheiben <sup>4)</sup><br>+ belüftete Scheiben <sup>4)</sup><br>+ belüftete Scheiben <sup>4)</sup><br>+ belüftete Scheiben <sup>4)</sup><br>+ belüftete Scheiben <sup>4)</sup><br>+ belüftete Scheiben <sup>4)</sup><br>+ belüftete Scheiben <sup>4)</sup><br>+ belüftete Scheiben <sup>4)</sup><br>+ belüftete Scheiben <sup>4)</sup><br>+ belüftete Scheiben <sup>4)</sup> | 24.0122-0259.1                   | 422259           | + elektrische Feststellbremse <sup>2)</sup>  | 302 22,0 20,0 V L +S +B                |            |
|  | 2.0 D3<br>2.0 D3 AWD<br>2.4 D<br>2.4 D AWD<br>2.4 D5 AWD<br>2.4 D5 AWD<br>2.4 D5 AWD<br>3.0 T6 AWD<br>3.0 T6 AWD<br>3.2<br>3.2 AWD<br>3.2 AWD<br>D4<br>D4 AWD<br>D5 AWD<br>T5<br>T5 AWD | 120<br>120<br>129<br>120<br>136<br>151<br>158<br>210<br>224<br>179<br>175<br>179<br>133<br>133<br>162<br>180<br>187 | 08.11<br>08.11<br>01.10<br>08.07<br>08.07<br>12.09<br>06.11<br>01.08<br>01.10<br>08.07<br>08.07<br>08.07<br>10.13<br>10.13<br>03.15<br>10.13<br>08.15 | + massive Scheiben <sup>1)</sup><br>+ massive Scheiben <sup>1)</sup><br>+ massive Scheiben <sup>1)</sup><br>+ massive Scheiben <sup>1)</sup><br>+ massive Scheiben <sup>1)</sup><br>+ massive Scheiben <sup>1)</sup><br>+ massive Scheiben <sup>1)</sup><br>+ massive Scheiben <sup>1)</sup><br>+ massive Scheiben <sup>1)</sup><br>+ massive Scheiben <sup>1)</sup><br>+ massive Scheiben <sup>1)</sup><br>+ massive Scheiben <sup>1)</sup><br>+ massive Scheiben <sup>1)</sup><br>+ massive Scheiben <sup>1)</sup><br>+ massive Scheiben <sup>1)</sup><br>+ massive Scheiben <sup>1)</sup><br>+ massive Scheiben <sup>1)</sup>                                   | 24.0111-0147.1                   | 411147           | + elektrische Feststellbremse <sup>2)</sup>  | 302 11,0 9,0 +S +B                     |            |
|  | 2.0 D3<br>2.4 D<br>3.2<br>D4<br>T5  | 120<br>129<br>179<br>133<br>180   | 08.11<br>01.10<br>08.07<br>10.13<br>10.13   |  | 24.0711-6221.3                   | 360258           | 2  |  | Radsensor  |
|  | 2.0 D3 AWD<br>2.4 D AWD<br>2.4 D5 AWD<br>2.4 D5 AWD<br>2.4 D5 AWD<br>3.0 T6 AWD<br>3.0 T6 AWD<br>3.2 AWD<br>3.2 AWD<br>D4 AWD   | 120<br>120<br>136<br>151<br>158<br>210<br>224<br>175<br>179<br>133  | 08.11<br>08.07<br>08.07<br>12.09<br>06.11<br>01.08<br>01.10<br>08.07<br>08.07<br>10.13  |  | 24.0711-6369.3                   | 360395           | 2  |  | Radsensor  |
|  | D5 AWD<br>T5 AWD  | 162<br>187  | 03.15<br>08.15  |  | 24.0711-6369.3                   | 360395           | 2  |  | Radsensor  |

### VOLVO XC90 (02-14)

|  |  |  |  |  |  |  |   |   |                                 |
|--|--|--|--|--|--|--|---|---|---------------------------------|
|  | 2.4 D3<br>2.4 D5<br>2.4 D5<br>2.4 D5 AWD<br>2.4 D5 AWD<br>2.5 T<br>2.5 T AWD<br>3.0 T6<br>3.2<br>3.2 | 120<br>120<br>136<br>120<br>147<br>154<br>154<br>200<br>175<br>179 | 04.10<br>04.09<br>05.06<br>10.02<br>01.11<br>10.02<br>10.12<br>10.02<br>05.06<br>04.10 | 12.14<br>12.14<br>12.14<br>12.14<br>12.14<br>12.14<br>12.14<br>12.14<br>12.14<br>12.14 | 13.0460-7187.2<br>13.0470-7187.2<br>13.0460-7272.2<br>13.0460-7188.2<br>13.0470-7188.2 | 607187<br>LD7187<br>607272<br>607188<br>LD7188 | + 16" Rad <sup>5)</sup><br>+ 16" Rad <sup>5)</sup><br>+ 17" Rad <sup>6)</sup><br>+ 17,5" Rad <sup>7)</sup><br>+ 17,5" Rad <sup>7)</sup> | 23950 19,5 +<br>23950 19,5 +<br>24399 20,4 +/WE<br>24141 19,1 +<br>24141 19,1 + | ATE<br>ATE<br>ATE<br>ATE<br>ATE |
|--|--|--|--|--|--|--|---|---|---------------------------------|

<sup>1)</sup> + solid discs / + dischi massiccio / + disques massive / + disco macizo  
<sup>2)</sup> + electric parking brake / + freno a mano elettrico / + frein à main électrique / + freno de mano eléctrico  
<sup>3)</sup> - electric parking brake / - freno a mano elettrico / - frein à main électrique / - freno de mano eléctrico  
<sup>4)</sup> + ventilated discs / + dischi ventilati / + disques ventilés / + disco ventilado  
<sup>5)</sup> + 16" wheel / + ruota 16" / + roue 16" / + rueda 16"  
<sup>6)</sup> + 17" wheel / + ruota 17" / + roue 17" / + rueda 17"  
<sup>7)</sup> + 17,5" wheel / + ruota 17,5" / + roue 17,5" / + rueda 17,5"

|     |                                |  |  |                 |                |  |  |  |                   |
|--|--|--|--|---|---|--|--|--|-------------------|
| <b>VOLVO XC90 (02-14)</b>  |  |  |  |   |   |  |  |  |                   |
|    | 4.0 V8   | 232  |  | 01.05   | 12.14   | 13.0460-7187.2 607187<br>13.0460-7272.2 607272<br>13.0460-7188.2 607188            | + 16" Rad <sup>1)</sup><br>+ 17" Rad <sup>2)</sup><br>+ 17,5" Rad <sup>3)</sup>    | 23950 19,5 +<br>24399 20,4 +/-WE<br>24141 19,1 +                                   | ATE<br>ATE<br>ATE |
|    | 2.4 D3<br>2.4 D5<br>2.4 D5<br>2.4 D5 AWD<br>2.4 D5 AWD<br>2.5 T<br>2.5 T AWD<br>3.0 T6<br>3.2<br>3.2<br>4.0 V8 | 120<br>120<br>136<br>120<br>147<br>154<br>154<br>200<br>175<br>179<br>232        |  | 04.10<br>04.09<br>05.06<br>10.02<br>01.11<br>10.02<br>10.12<br>10.02<br>05.06<br>04.10<br>01.05 | 12.14<br>12.14<br>12.14<br>12.14<br>12.14<br>12.14<br>12.14<br>12.14<br>12.14<br>12.14<br>12.14 | 24.0128-0144.1 428144<br>24.0130-0116.1 430116                                     | + 16" Rad <sup>1)</sup><br>+ 17,5" Rad <sup>3)</sup>                               | 316 28,0 25,0 V L +B<br>336 30,0 27,0 V L +B                                       |                   |
|    | 2.4 D3<br>2.4 D5<br>2.4 D5<br>2.4 D5 AWD<br>2.4 D5 AWD<br>2.5 T<br>2.5 T AWD<br>3.0 T6<br>3.2<br>3.2<br>4.0 V8 | 120<br>120<br>136<br>120<br>147<br>154<br>154<br>200<br>175<br>179<br>232        |  | 04.10<br>04.09<br>05.06<br>10.02<br>01.11<br>10.02<br>10.12<br>10.02<br>05.06<br>04.10<br>01.05 | 12.14<br>12.14<br>12.14<br>12.14<br>12.14<br>12.14<br>12.14<br>12.14<br>12.14<br>12.14<br>12.14 | 24.0711-6366.3 360392<br>24.0711-6367.3 360393                                     | <input type="checkbox"/><br><input type="checkbox"/>                               | Radsensor L=975<br>Radsensor L=1095  |                   |
|    | 2.4 D3<br>2.4 D5<br>2.4 D5<br>2.4 D5 AWD<br>2.4 D5 AWD<br>2.5 T<br>2.5 T AWD<br>3.0 T6<br>3.2<br>3.2<br>4.0 V8 | 120<br>120<br>136<br>120<br>147<br>154<br>154<br>200<br>175<br>179<br>232        |  | 04.10<br>04.09<br>05.06<br>10.02<br>01.11<br>10.02<br>10.12<br>10.02<br>05.06<br>04.10<br>01.05 | 12.14<br>12.14<br>12.14<br>12.14<br>12.14<br>12.14<br>12.14<br>12.14<br>12.14<br>12.14<br>12.14 | 13.0460-7189.2 607189  |  | 24011 18,7 +   | ATE               |
|   | 2.4 D3<br>2.4 D5<br>2.4 D5<br>2.4 D5 AWD<br>2.4 D5 AWD<br>2.5 T<br>2.5 T AWD<br>3.0 T6<br>3.2<br>3.2<br>4.0 V8 | 120<br>120<br>136<br>120<br>147<br>154<br>154<br>200<br>175<br>179<br>232        |  | 04.10<br>04.09<br>05.06<br>10.02<br>01.11<br>10.02<br>10.12<br>10.02<br>05.06<br>04.10<br>01.05 | 12.14<br>12.14<br>12.14<br>12.14<br>12.14<br>12.14<br>12.14<br>12.14<br>12.14<br>12.14<br>12.14 | 24.0120-0122.1 420122  |  | 308 20,0 18,0 V +B   |                   |
|  | 2.4 D3<br>2.4 D5<br>2.4 D5<br>2.4 D5 AWD<br>2.4 D5 AWD<br>2.5 T<br>2.5 T AWD<br>3.0 T6<br>3.2<br>3.2<br>4.0 V8 | 120<br>120<br>136<br>120<br>147<br>154<br>154<br>200<br>175<br>179<br>232        |  | 04.10<br>04.09<br>05.06<br>10.02<br>01.11<br>10.02<br>10.12<br>10.02<br>05.06<br>04.10<br>01.05 | 12.14<br>12.14<br>12.14<br>12.14<br>12.14<br>12.14<br>12.14<br>12.14<br>12.14<br>12.14<br>12.14 | 24.0711-6215.3 360251<br>24.0711-6216.3 360252                                     | <input type="checkbox"/><br><input type="checkbox"/>                               | Radsensor L=1200<br>Radsensor L=1440   |                   |
|  | 2.4 D3<br>2.4 D5<br>2.4 D5<br>2.4 D5 AWD<br>2.4 D5 AWD<br>2.5 T<br>2.5 T AWD<br>3.0 T6<br>3.2<br>3.2<br>4.0 V8 | 120<br>120<br>136<br>120<br>147<br>154<br>154<br>200<br>175<br>179<br>232        |  | 04.10<br>04.09<br>05.06<br>10.02<br>01.11<br>10.02<br>10.12<br>10.02<br>05.06<br>04.10<br>01.05 | 12.14<br>12.14<br>12.14<br>12.14<br>12.14<br>12.14<br>12.14<br>12.14<br>12.14<br>12.14<br>12.14 | 03.0137-3034.2 653034  |  | 178 x 25   |                   |

1) + 16" wheel / + ruota 16" / + roue 16" / + rueda 16"  
2) + 17" wheel / + ruota 17" / + roue 17" / + rueda 17"  
3) + 17,5" wheel / + ruota 17,5" / + roue 17,5" / + rueda 17,5"





- D** Abbildungen Scheibenbremsbeläge
- EN** Illustrations disc brake pads
- FR** Illustrations Plaquettes de frein à disque
- IT** Illustrazioni Pastiglie Freno
- ES** Ilustraciones de pastillas
- NL** Afbeeldingen schijfremblokjes
- DA** Tegning bremseklodser
- SV** Avbildningar skivbromsbelägg
- HU** Ábrák - betétek tárcsafékhez
- PT** Figuras Calços do travão de disco
- RU** Рисунки дисковых тормозных колодок
- CZ** Zobrazení obložení kotoučových brzd
- PL** Rysunki okładzin hamulców tarczowych
- EL** Εικόνες τακακίων δισκόφρενων
- TR** Fren disk kaplaması resimleri
- ZH** 制动摩擦片图片
- JA** 図版 ブレーキパッド組み込みキット
- AR** صور مزلاقات المكبح القرصي

# K24-F

# Abbildungen Scheibenbremsbeläge

Illustrations disc brake pads - Illustrazioni pastiglie freno -

Illustrations plaquettes de frein - Ilustraciones pastillas de freno

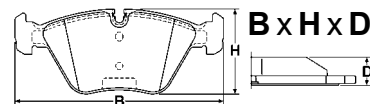

Maßstab - scale - scala - échelle - escala 1:2

**13.0460-2600.2 602600**



NISSAN, RENAULT



TRW

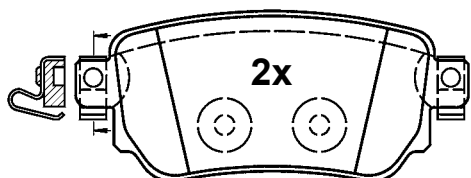

25965 15,0

103,6 x 44,6 x 15,0

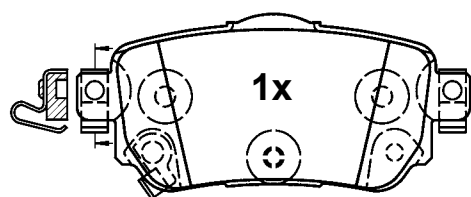

25966 15,0

103,6 x 46,4 x 15,0

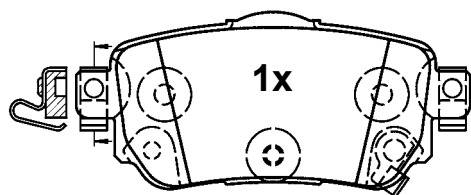

25967 15,0

103,6 x 46,4 x 15,0

**13.0460-2700.2 602700**



AUDI



TRW

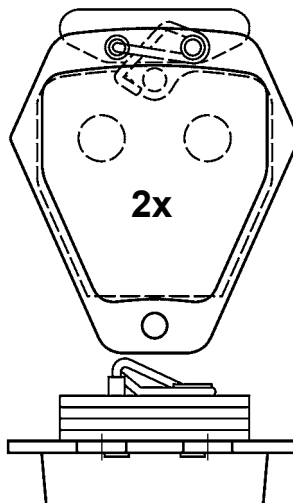

21454 17,0

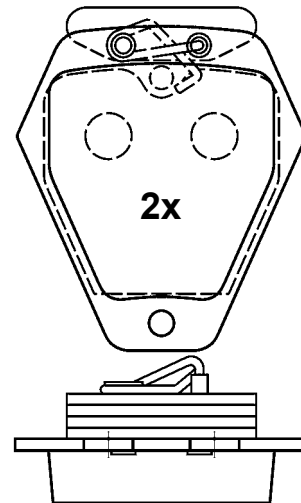

21454 17,0

76,1 x 85,6 x 17,0

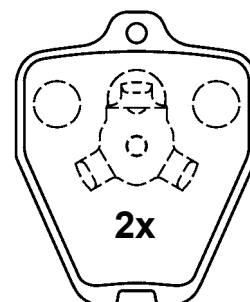

21452 18,5

63,3 x 77,4 x 18,5

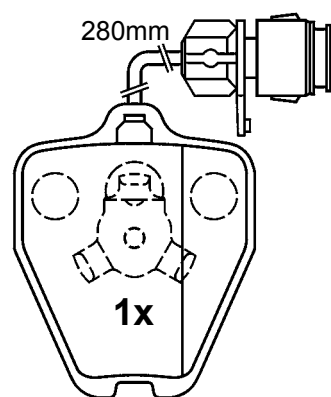

23825 18,5

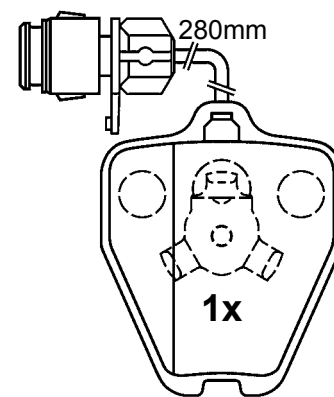

23825 18,5

63,3 x 77,4 x 18,5

4x



# Abbildungen Scheibenbremsbeläge

Illustrations disc brake pads - Illustrazioni pastiglie freno -

Illustrations plaquettes de frein - Ilustraciones pastillas de freno

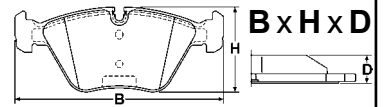

Maßstab - scale - scala - échelle - escala 1:2

**13.0460-2701.2 602701**



AUDI



TRW

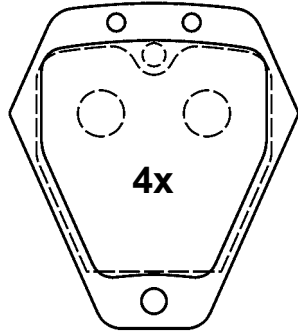

4x

76,1 x 85,6 x 17,0

21454 17,0

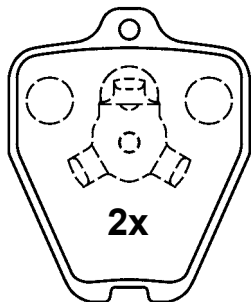

2x

63,3 x 77,4 x 18,5

21452 18,5

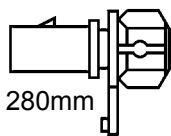

280mm

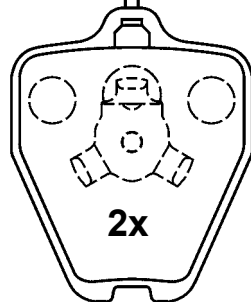

2x

63,3 x 77,4 x 18,5

23829 18,5

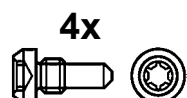

4x

**13.0460-2704.2 602704**



LANCIA



TRW

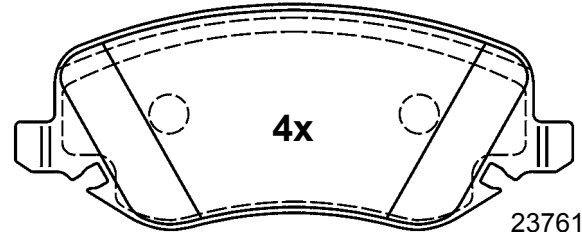

4x

23761 18,8

146,5 x 59,2 x 18,8

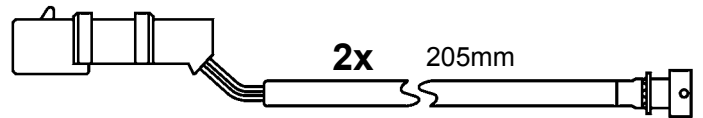

2x

205mm



2x

M8x22

**13.0460-2705.2 602705**



AUDI



TRW

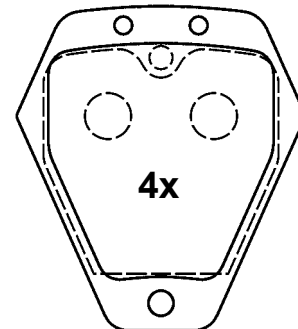

4x

21454 17,0

76,1 x 85,6 x 17,0

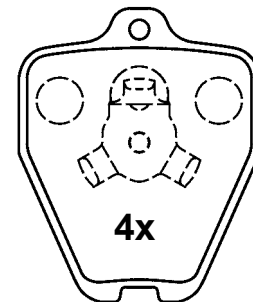

4x

21452 18,5

63,3 x 77,4 x 18,5

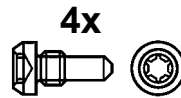

4x



# Abbildungen Scheibenbremsbeläge

Illustrations disc brake pads - Illustrazioni pastiglie freno -

Illustrations plaquettes de frein - Ilustraciones pastillas de freno

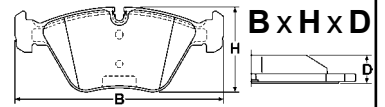

Maßstab - scale - scala - échelle - escala 1:2

## 13.0460-2706.2 602706

CITROEN

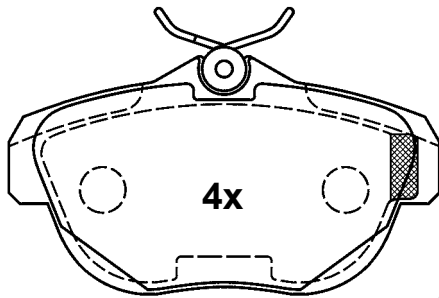

24462 16,7

113,8 x 62,7 x 16,7



## 13.0460-2708.2 602708

MERCEDES BENZ

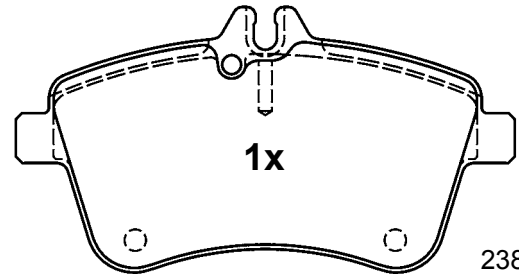

23881 20,0

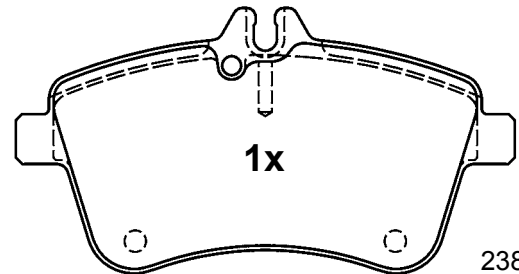

23881 20,0

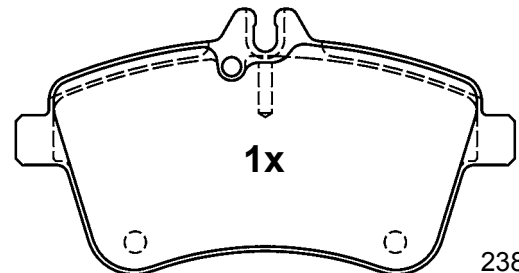

23881 20,0

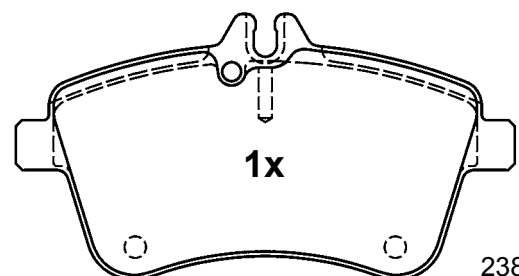

23881 20,0

131,3 x 69,8 x 20,0

## 13.0460-2707.2 602707

ALFA ROMEO, LANCIA

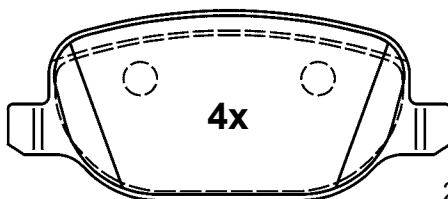

23760 17,7

116,8 x 49,8 x 17,7

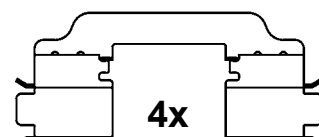

# Abbildungen Scheibenbremsbeläge

Illustrations disc brake pads - Illustrazioni pastiglie freno -

Illustrations plaquettes de frein - Ilustraciones pastillas de freno

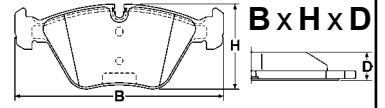

Maßstab - scale - scala - échelle - escala 1:2

**13.0460-2709.2 602709**



DACIA, MERCEDES BENZ,  
NISSAN, RENAULT



TRW

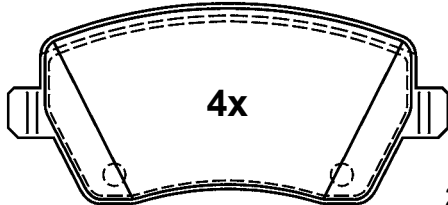

23973 17,4

116,4 x 52,4 x 17,4

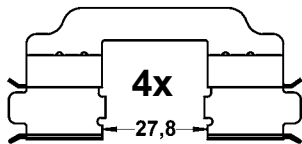

**13.0460-2711.2 602711**



MERCEDES BENZ



TRW

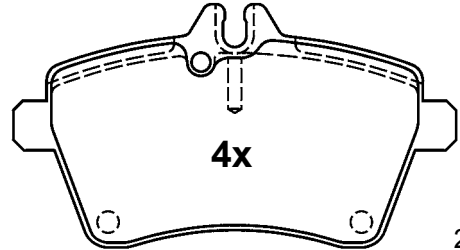

24077 19,1

116,4 x 63,8 x 19,1

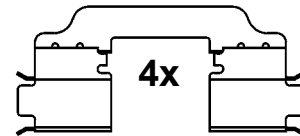

**13.0460-2710.2 602710**



BMW, MINI



TRW

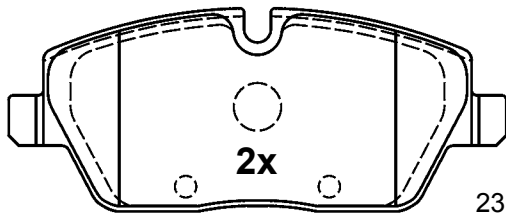

23915 17,6

131,3 x 53,2 x 17,6

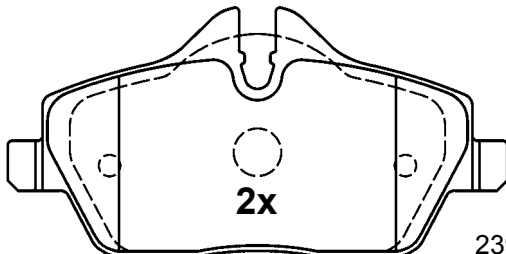

23916 17,6

131,3 x 65,3 x 17,6

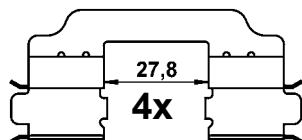

**13.0460-2712.2 602712**



MERCEDES BENZ



TRW

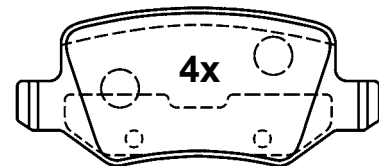

23138 14,6

95,7 x 41,3 x 14,6

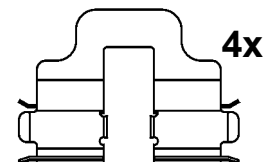

# Abbildungen Scheibenbremsbeläge

Illustrations disc brake pads - Illustrazioni pastiglie freno -

Illustrations plaquettes de frein - Ilustraciones pastillas de freno



Maßstab - scale - scala - échelle - escala 1:2

## 13.0460-2713.2 602713

BMW, MINI

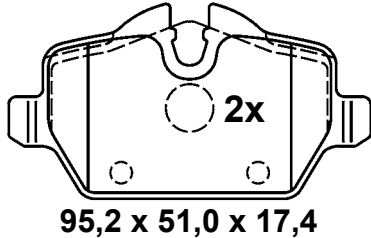

23623 17,4

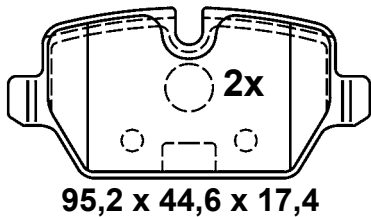

23624 17,4

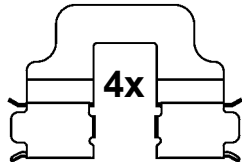

## 13.0460-2715.2 602715

FIAT, SUZUKI

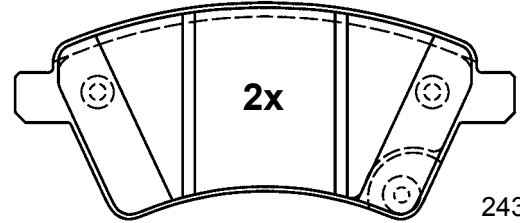

24391 16,6

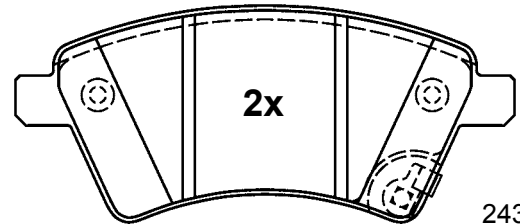

24392 16,6

131,3 x 57,0 x 16,6

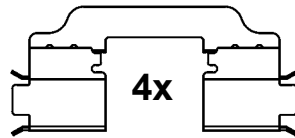

## 13.0460-2714.2 602714

MINI

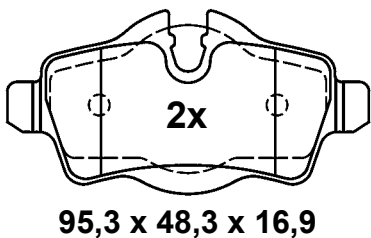

24289 16,9

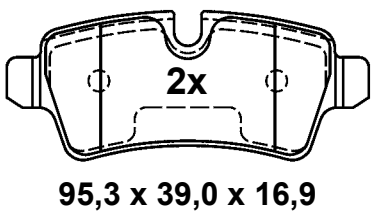

24290 16,9

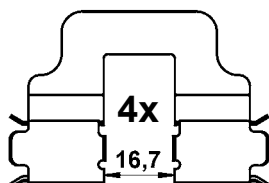

## 13.0460-2716.2 602716

BMW

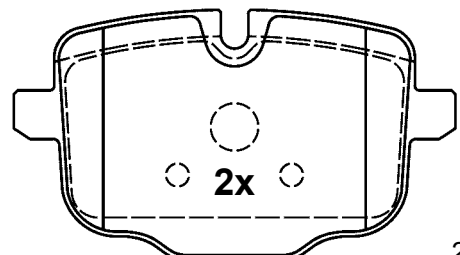

24703 17,8

166,0 x 65,5 x 17,8

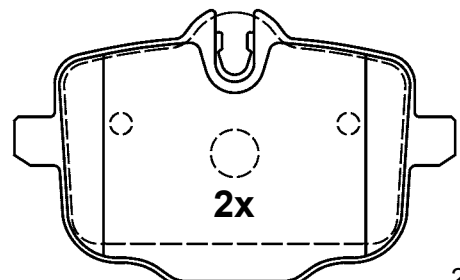

24704 17,8

166,0 x 72,4 x 17,8

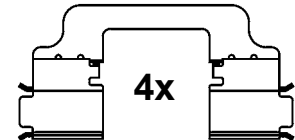

# Abbildungen Scheibenbremsbeläge

Illustrations disc brake pads - Illustrazioni pastiglie freno -

Illustrations plaquettes de frein - Ilustraciones pastillas de freno

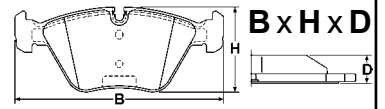

Maßstab - scale - scala - échelle - escala 1:2

## 13.0460-2717.2 602717



AUDI



TRW

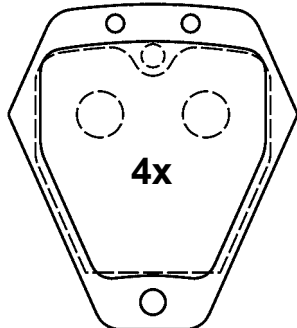

4x

76,1 x 85,6 x 17,0

21454 17,0

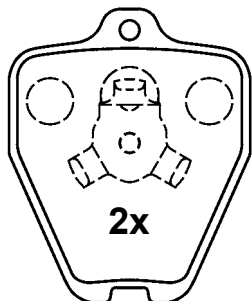

2x

63,3 x 77,4 x 18,5

21452 18,5

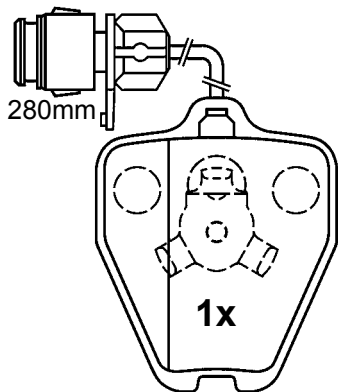

280mm

1x

63,3 x 77,4 x 18,5

23825 18,5

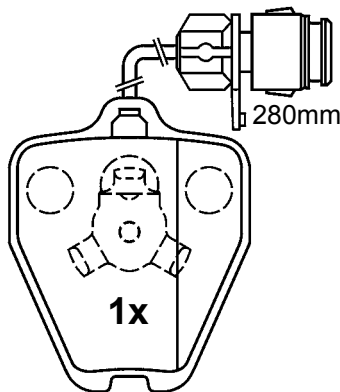

280mm

1x

63,3 x 77,4 x 18,5

23825 18,5

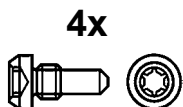

4x

## 13.0460-2718.2 602718



LAND ROVER



TRW

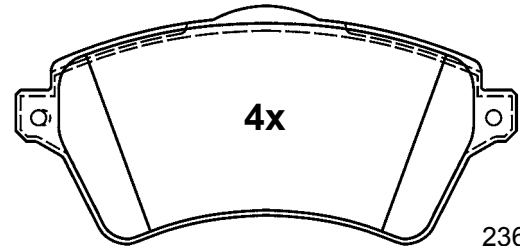

4x

23615 18,3

131,4 x 62,1 x 18,3



4x

M8x22

## 13.0460-2719.2 602719



LAND ROVER



TRW

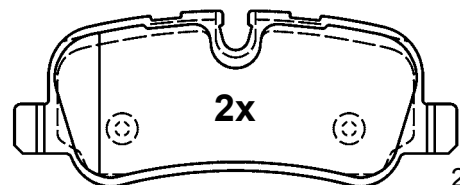

2x

24192 17,4

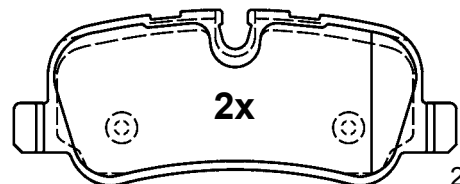

2x

24192 17,4

116,6 x 46,4 x 17,4



4x

M8x21

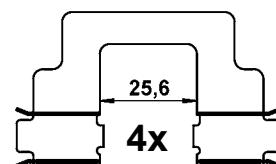

25,6

4x

# Abbildungen Scheibenbremsbeläge

Illustrations disc brake pads - Illustrazioni pastiglie freno -

Illustrations plaquettes de frein - Ilustraciones pastillas de freno

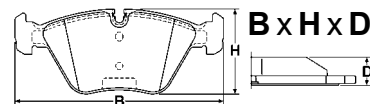

Maßstab - scale - scala - échelle - escala 1:2

**13.0460-2720.2 602720**

LAND ROVER

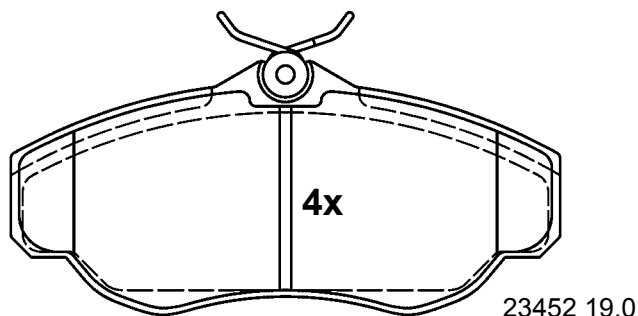

23452 19,0

144,8 x 66,3 x 19,0



M8x22

**13.0460-2722.2 602722**

FORD, LAND ROVER, VOLVO

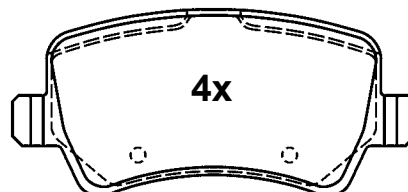

24496 17,3

106,0 x 48,7 x 17,3

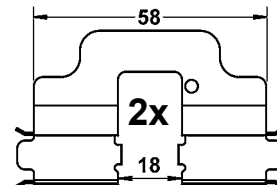
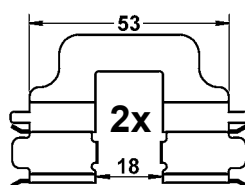

M8x21

**13.0460-2721.2 602721**

LAND ROVER

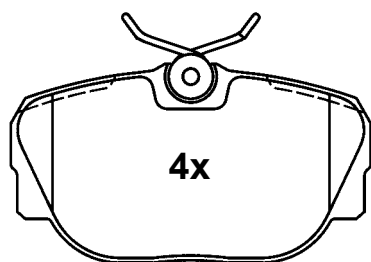

23458 15,6

94,7 x 51,9 x 15,6

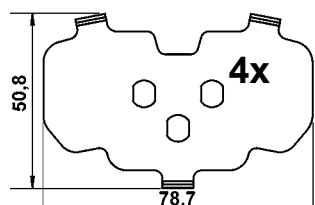

M8x22

**13.0460-2723.2 602723**

FORD

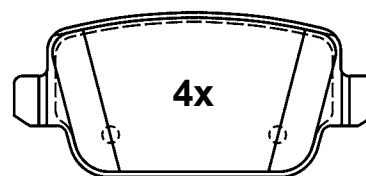

24537 16,1

95,1 x 43,2 x 16,1

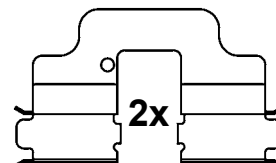
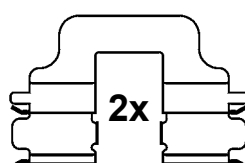

M8x21

# Abbildungen Scheibenbremsbeläge

Illustrations disc brake pads - Illustrazioni pastiglie freno -

Illustrations plaquettes de frein - Ilustraciones pastillas de freno

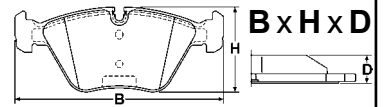

Maßstab - scale - scala - échelle - escala 1:2

## 13.0460-2724.2 602724

LANCIA

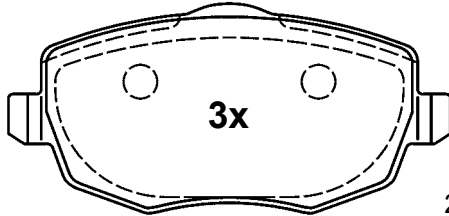

23073 16,7

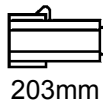

203mm

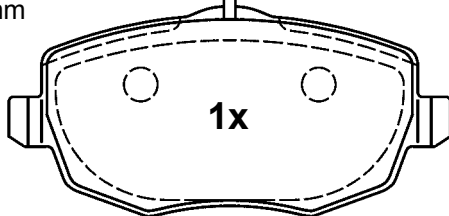

24515 16,7



M8x22

116,8 x 55,2 x 16,7

## 13.0460-2726.2 602726

MERCEDES BENZ

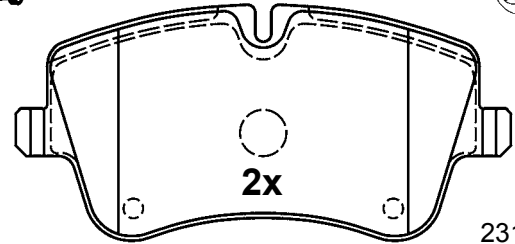

23145 19,8

131,1 x 69,8 x 19,8

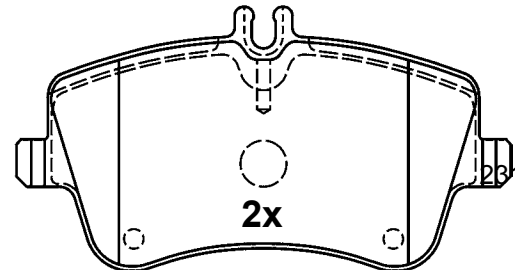

23144 19,8

131,1 x 62,1 x 19,8

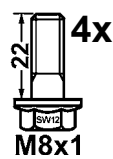

M8x1

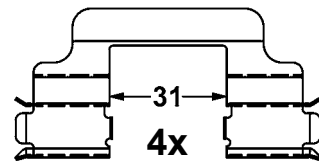

## 13.0460-2725.2 602725

MINI

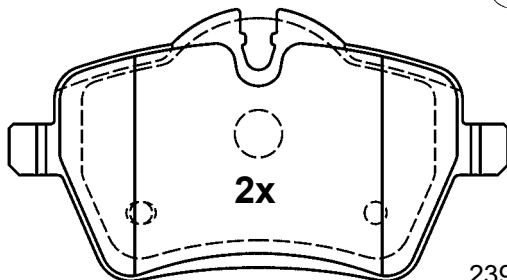

23984 17,8

131,6 x 71,3 x 17,8

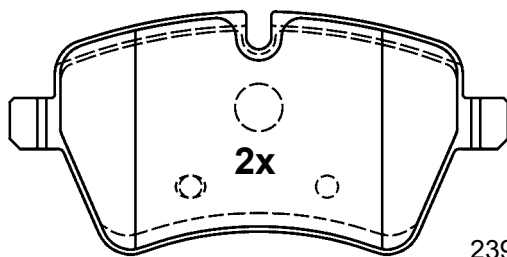

23985 17,8

131,6 x 63,9 x 17,8



M8x21

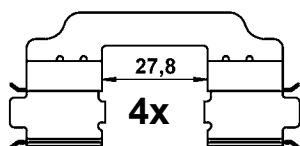

## 13.0460-2727.2 602727

MERCEDES BENZ

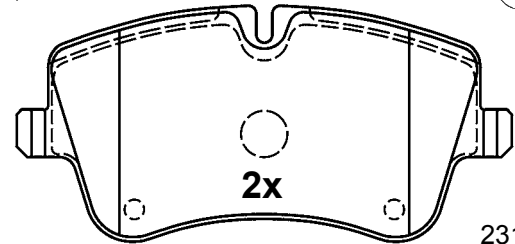

23145 19,8

131,1 x 69,8 x 19,8

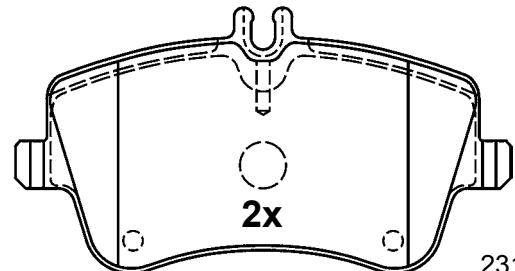

23144 19,8

131,1 x 62,1 x 19,8

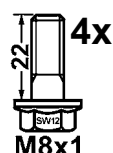

M8x1

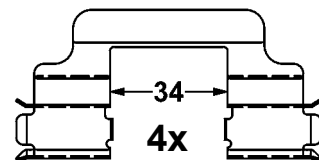



# Abbildungen Scheibenbremsbeläge

Illustrations disc brake pads - Illustrazioni pastiglie freno -

Illustrations plaquettes de frein - Ilustraciones pastillas de freno

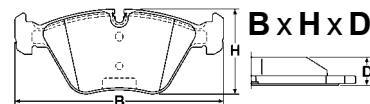

Maßstab - scale - scala - échelle - escala 1:2

**13.0460-2728.2 602728**

LAND ROVER

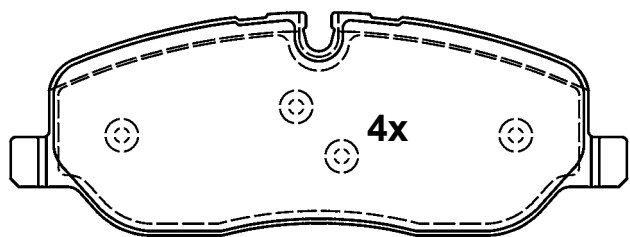

24191 18,1

162,7 x 58,7 x 18,1

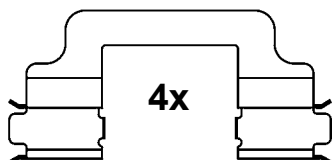

**13.0460-2730.2 602730**

JAGUAR

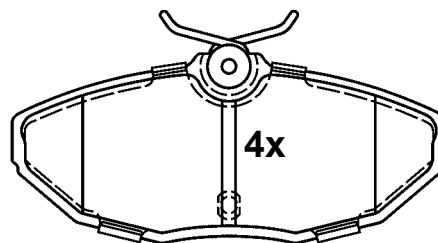

23424 17,6

114,3 x 49,5 x 17,6

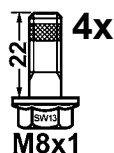

**13.0460-2729.2 602729**

JAGUAR

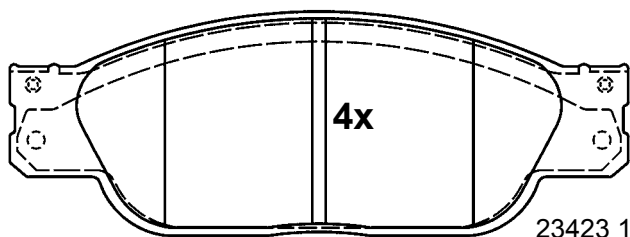

23423 17,8

163,3 x 58,1 x 17,8

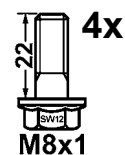
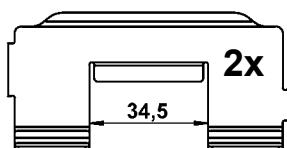
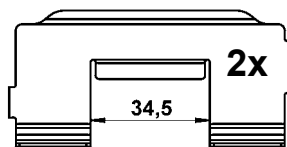

**13.0460-2731.2 602731**

LAND ROVER

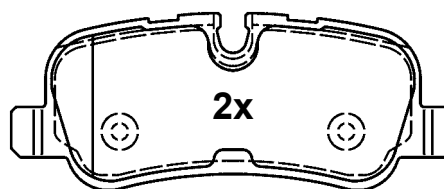

24192 17,1

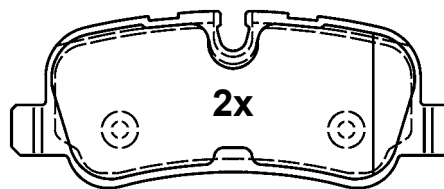

24192 17,1

116,6 x 46,4 x 17,1

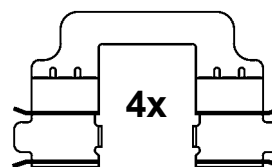

# Abbildungen Scheibenbremsbeläge

Illustrations disc brake pads - Illustrazioni pastiglie freno -

Illustrations plaquettes de frein - Ilustraciones pastillas de freno

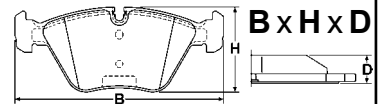

Maßstab - scale - scala - échelle - escala 1:2

## 13.0460-2732.2 602732



MERCEDES BENZ



TRW

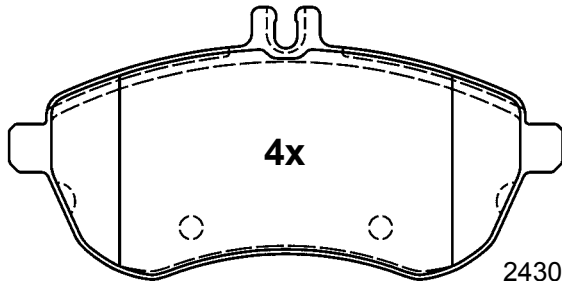

4x

24306 20,3

146,0 x 71,5 x 20,3



4x

M8x22

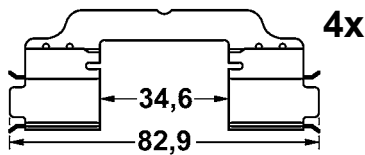

4x

34,6

82,9

## 13.0460-2734.2 602734



MERCEDES BENZ



TRW

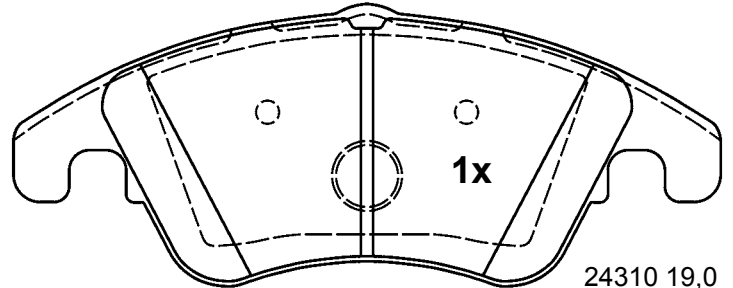

1x

24310 19,0

188,0 x 73,7 x 19,0

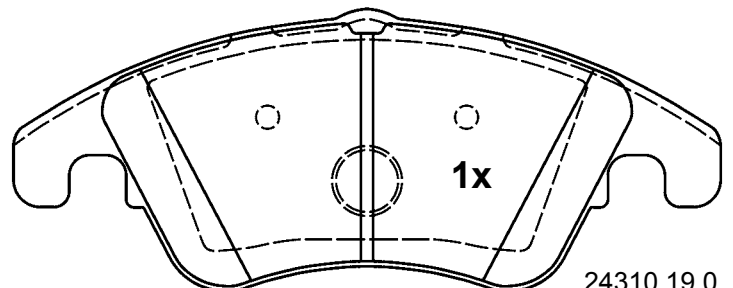

1x

24310 19,0

188,0 x 73,7 x 19,0

## 13.0460-2733.2 602733



MERCEDES BENZ



TRW

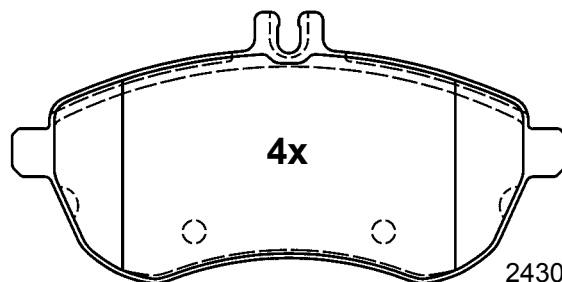

4x

24306 20,3

146,0 x 71,5 x 20,3



4x

M8x22

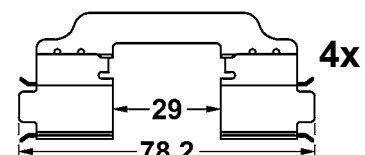

4x

29

78,2

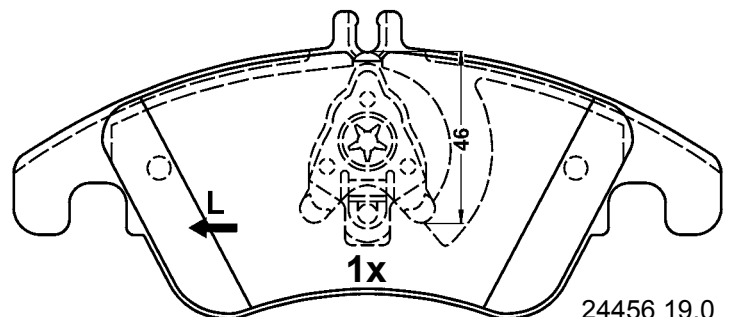

1x

24456 19,0

188,0 x 80,8 x 19,0

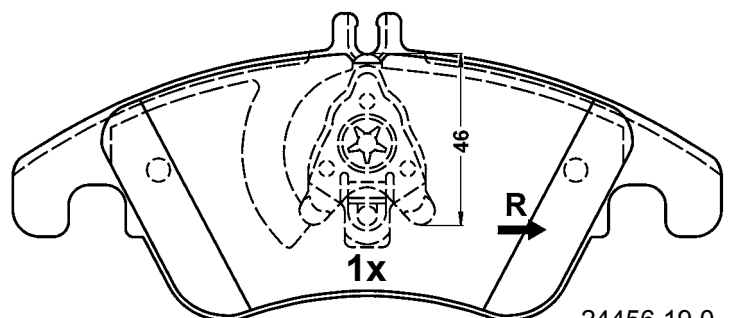

1x

24456 19,0

188,0 x 80,8 x 19,0

4x

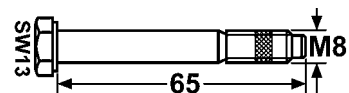

SW13

M8

65

# Abbildungen Scheibenbremsbeläge

Illustrations disc brake pads - Illustrazioni pastiglie freno -

Illustrations plaquettes de frein - Ilustraciones pastillas de freno

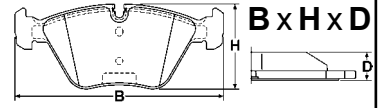

Maßstab - scale - scala - échelle - escala 1:2

## 13.0460-2735.2 602735

RENAULT

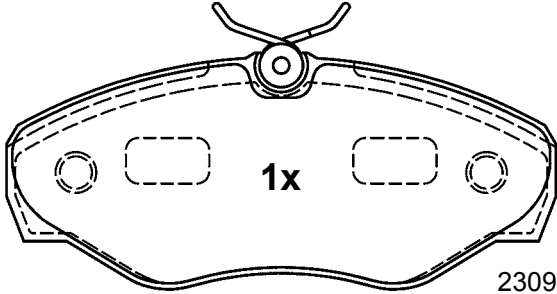

23099 18,4

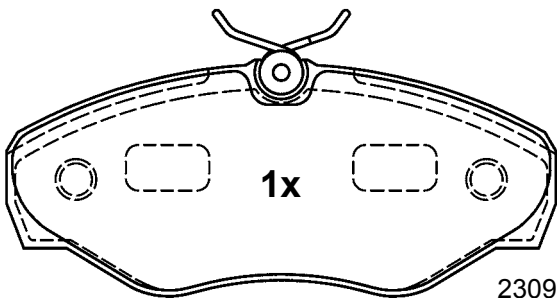

23099 18,4

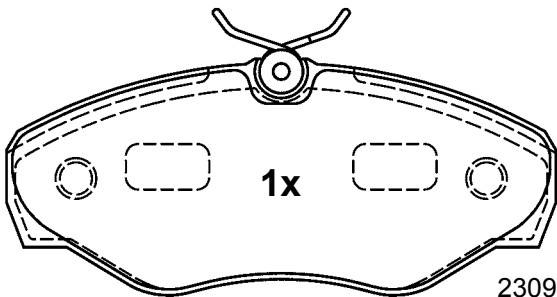

23099 18,4

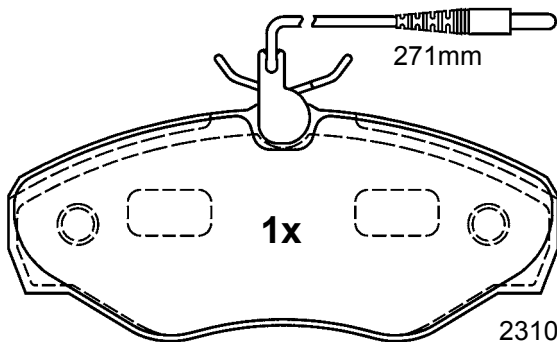

23100 18,4

144,8 x 62,4 x 18,4

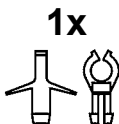
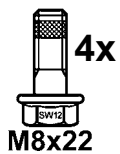

## 13.0460-2736.2 602736

VOLVO

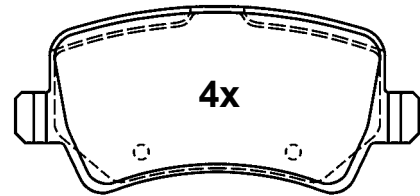

24496 17,3

106,1 x 48,7 x 17,3

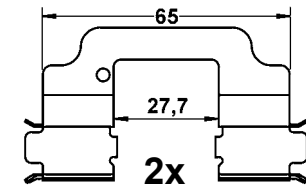
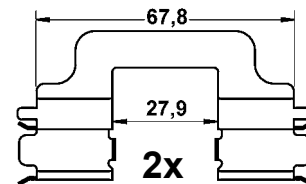

## 13.0460-2737.2 602737

LAND ROVER, VOLVO

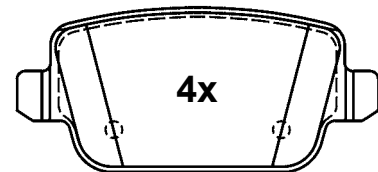

24537 15,8

95,1 x 43,2 x 15,8

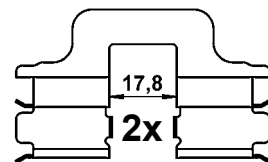
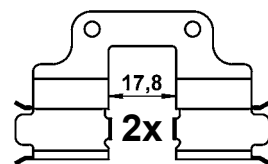

# Abbildungen Scheibenbremsbeläge

Illustrations disc brake pads - Illustrazioni pastiglie freno -

Illustrations plaquettes de frein - Ilustraciones pastillas de freno

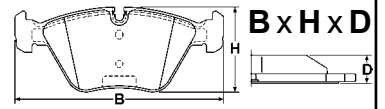

Maßstab - scale - scala - échelle - escala 1:2

**13.0460-2738.2 602738**

CITROEN, FIAT, PEUGEOT

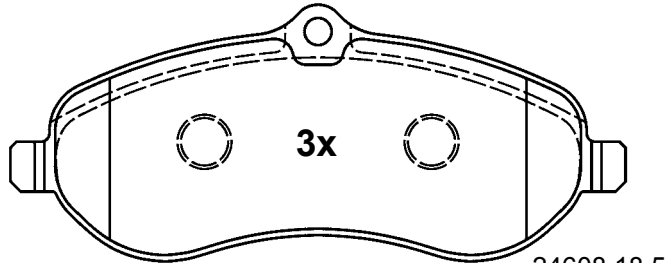

24608 18,5

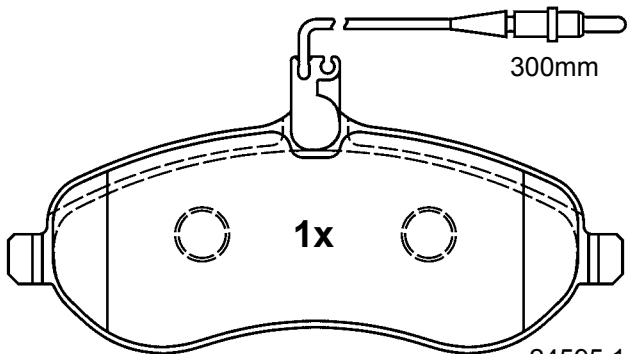

300mm

24595 18,5

162,0 x 67,3 x 18,5

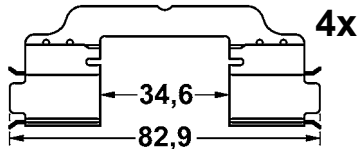

**13.0460-2740.2 602740**

CITROEN, PEUGEOT, RENAULT

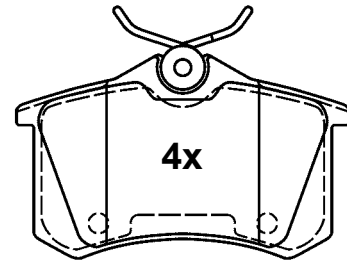

23554 17,2

87,2 x 53,0 x 17,2

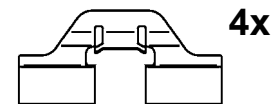
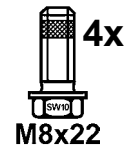

**13.0460-2739.2 602739**

CITROEN, FIAT, PEUGEOT

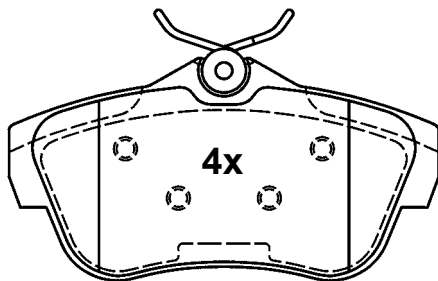

24578 16,5

113,3 x 58,5 x 16,5



**13.0460-2741.2 602741**

RENAULT

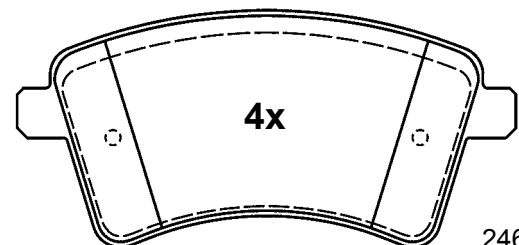

24693 18,5

131,0 x 62,3 x 18,5

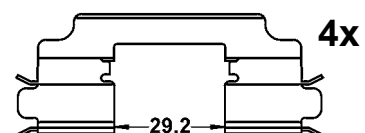

# Abbildungen Scheibenbremsbeläge

Illustrations disc brake pads - Illustrazioni pastiglie freno -

Illustrations plaquettes de frein - Ilustraciones pastillas de freno



Maßstab - scale - scala - échelle - escala 1:2

**13.0460-2742.2 602742**

MERCEDES BENZ, RENAULT

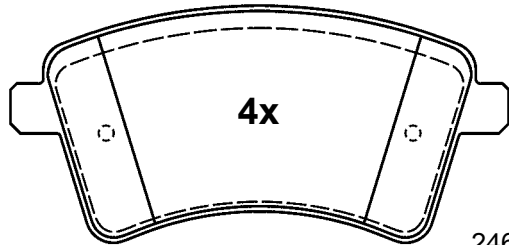

24693 17,5

131,0 x 62,3 x 17,5

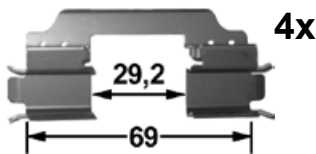

**13.0460-2744.2 602744**

MERCEDES BENZ, RENAULT

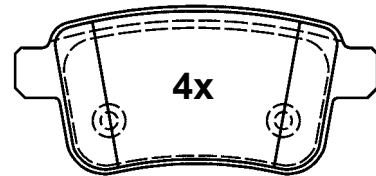

24692 15,9

95,4 x 43,8 x 15,9

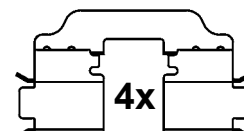

**13.0460-2743.2 602743**

RENAULT

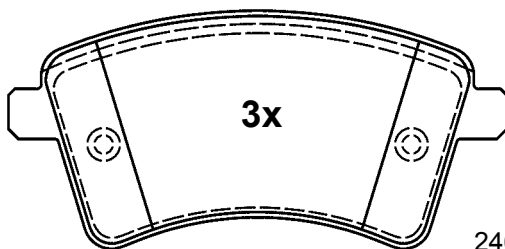

24693 17,5

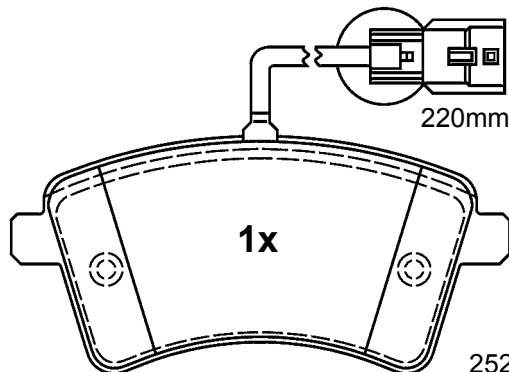

25291 17,5

131,0 x 62,3 x 17,5



**13.0460-2745.2 602745**

CITROEN, PEUGEOT

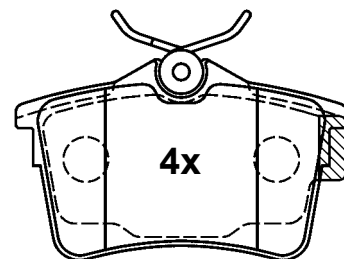

24765 16,5

87,2 x 52,8 x 16,5

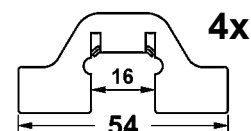

# Abbildungen Scheibenbremsbeläge

Illustrations disc brake pads - Illustrazioni pastiglie freno -

Illustrations plaquettes de frein - Ilustraciones pastillas de freno

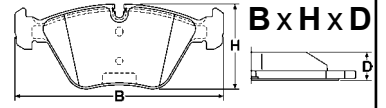

Maßstab - scale - scala - échelle - escala 1:2

**13.0460-2746.2 602746**



AUDI



TRW

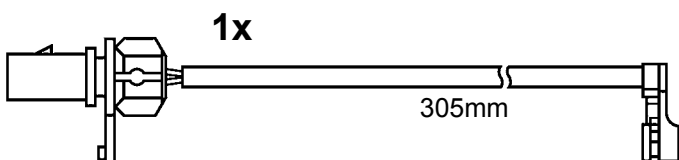
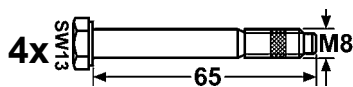
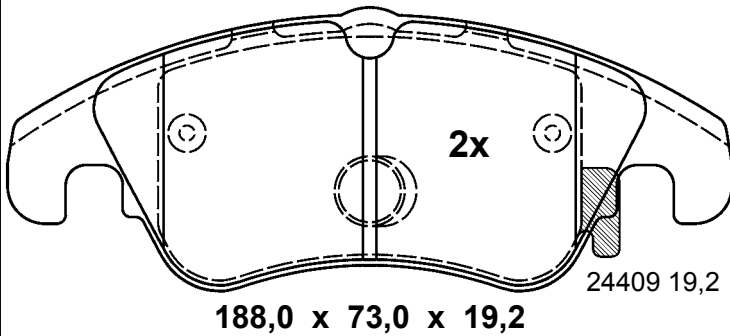
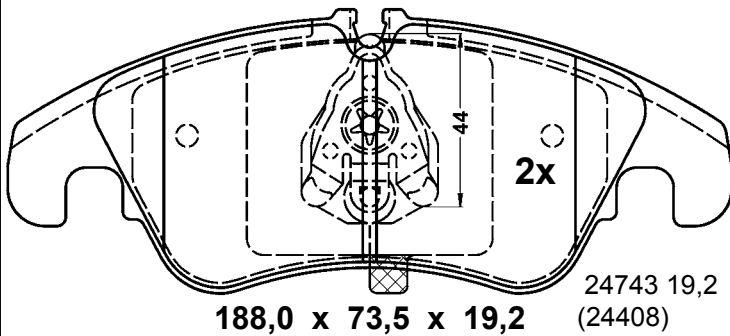

**13.0460-2747.2 602747**



AUDI



TRW

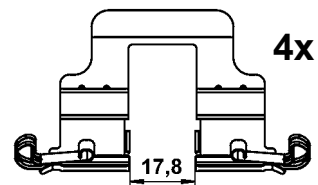
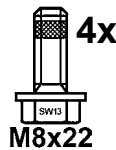
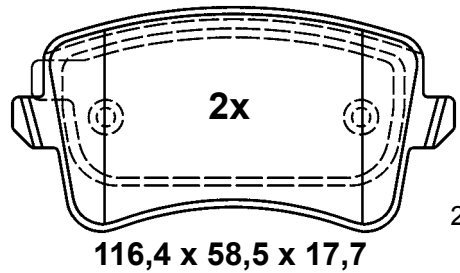
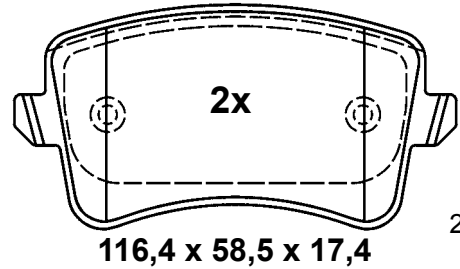

**13.0460-2748.2 602748**



AUDI



TRW

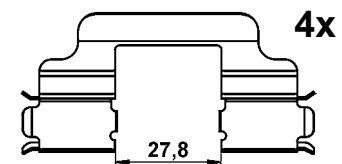
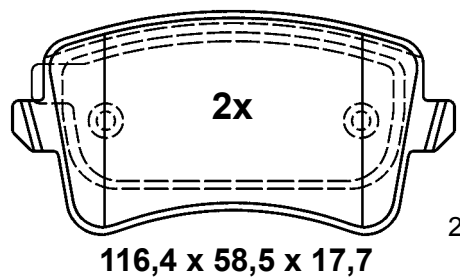
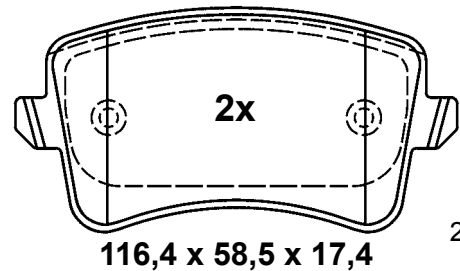



# Abbildungen Scheibenbremsbeläge

Illustrations disc brake pads - Illustrazioni pastiglie freno -

Illustrations plaquettes de frein - Ilustraciones pastillas de freno

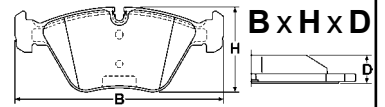

Maßstab - scale - scala - échelle - escala 1:2

**13.0460-2750.2 602750**



IVECO



TRW

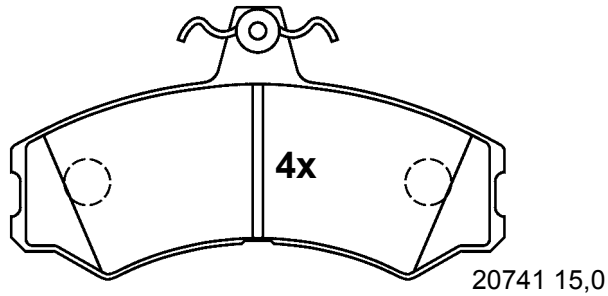

129,9 x 71,0 x 15,0

**13.0460-2752.2 602752**



CITROEN, FIAT, LANCIA,  
PEUGEOT



TRW

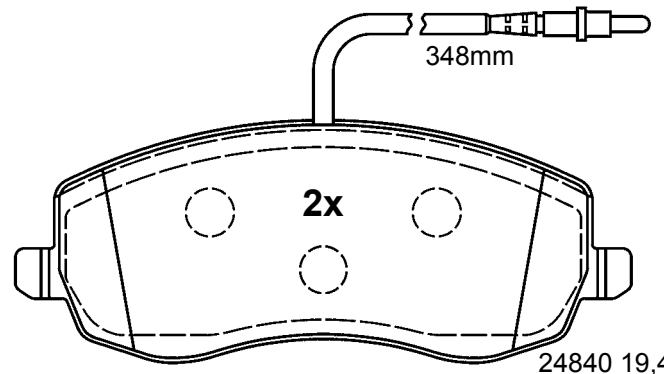
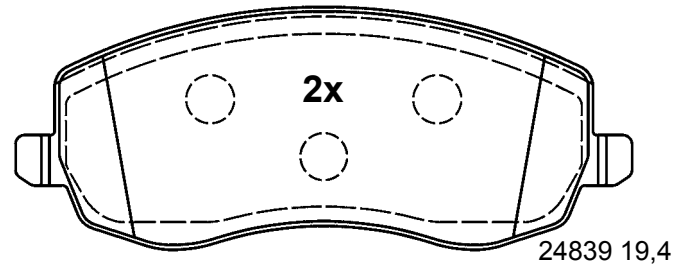

162,5 x 63,8 x 19,4

**13.0460-2751.2 602751**



IVECO



TRW

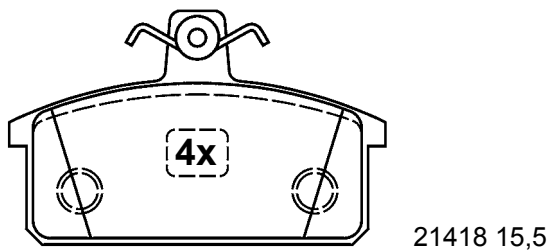

99,9 x 61,0 x 15,5

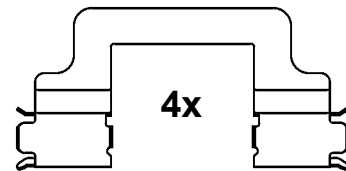

**13.0460-2753.2 602753**



RENAULT



TRW

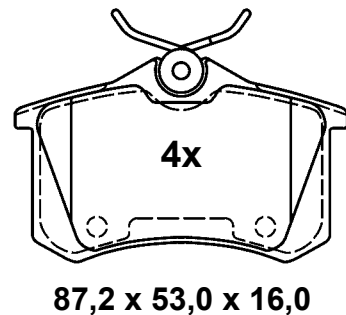

87,2 x 53,0 x 16,0

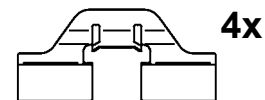

# Abbildungen Scheibenbremsbeläge

Illustrations disc brake pads - Illustrazioni pastiglie freno -

Illustrations plaquettes de frein - Ilustraciones pastillas de freno

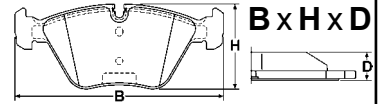

Maßstab - scale - scala - échelle - escala 1:2

## 13.0460-2754.2 602754

OPEL, SAAB, VAUXHALL

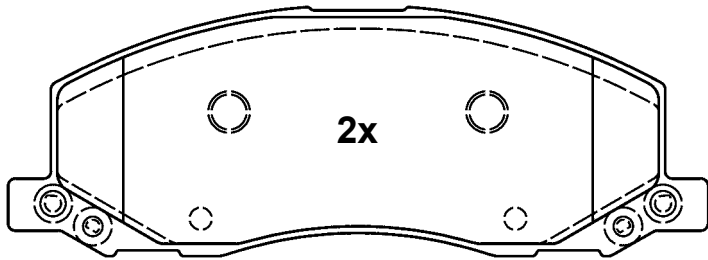

24418 17,0

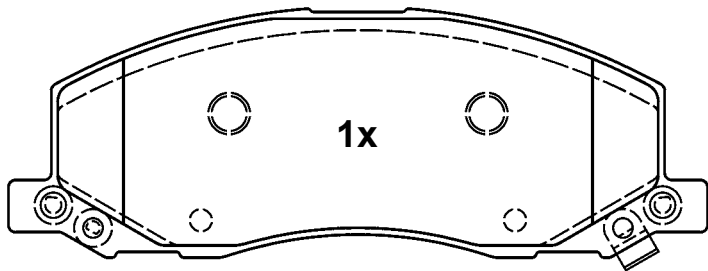

24419 17,0

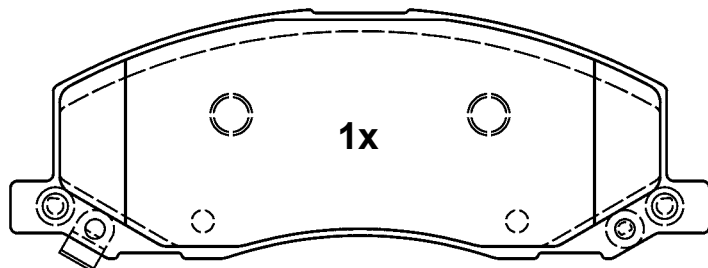

24410 17,0

184,5 x 65,4 x 17,0

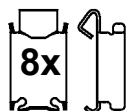

## 13.0460-2755.2 602755

OPEL, VAUXHALL

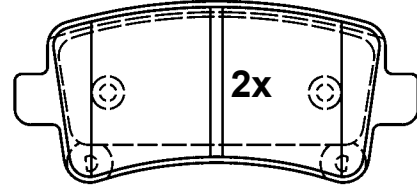

24421 17,2

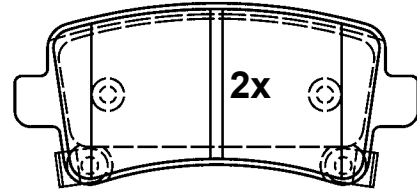

24422 17,2

106,3 x 47,1 x 17,2

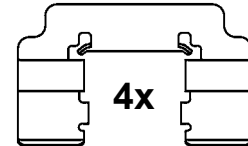

## 13.0460-2756.2 602756

RENAULT

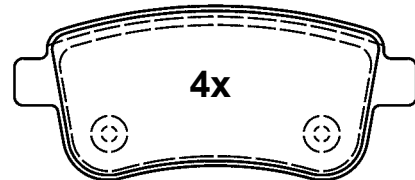

24820 16,1

106,3 x 45,3 x 16,1

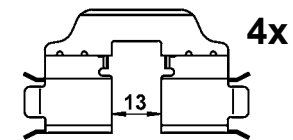
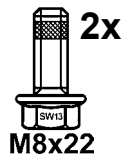

## 13.0460-2757.2 602757

RENAULT

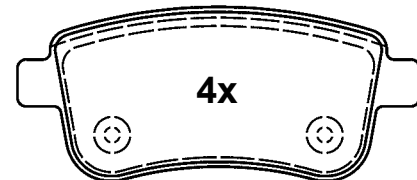

24820 16,1

106,3 x 45,3 x 16,1

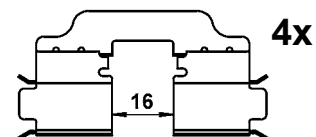
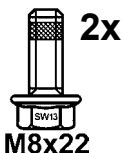

# Abbildungen Scheibenbremsbeläge

Illustrations disc brake pads - Illustrazioni pastiglie freno -

Illustrations plaquettes de frein - Ilustraciones pastillas de freno

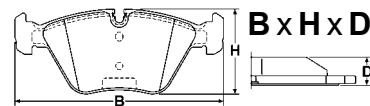

Maßstab - scale - scala - échelle - escala 1:2

## 13.0460-2758.2 602758



OPEL, VAUXHALL



TRW

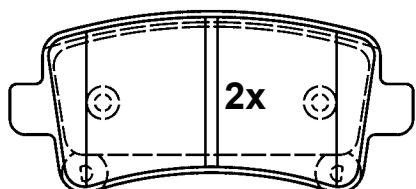

24421 17,2

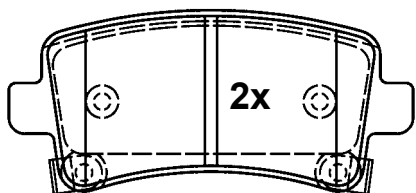

24422 17,2

106,3 x 47,1 x 17,2

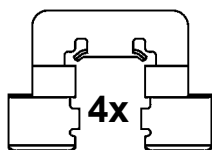

4x

## 13.0460-2760.2 602760



BMW



TRW

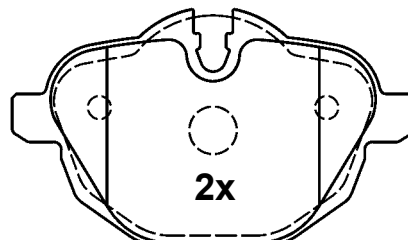

24561 17,7

106,0 x 63,2 x 17,7

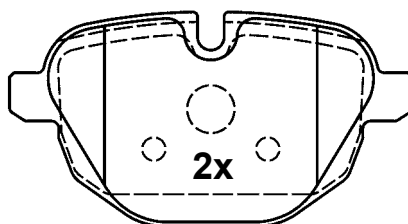

24562 17,7

106,0 x 56,2 x 17,7



4x

M8x21

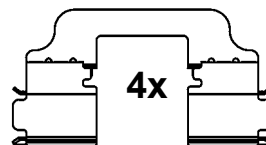

4x

## 13.0460-2759.2 602759



BMW



TRW

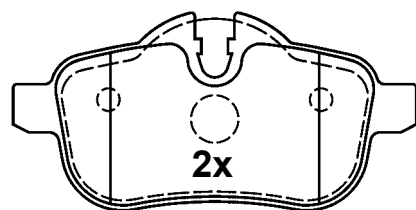

24559 17,8

106,0 x 52,3 x 17,8

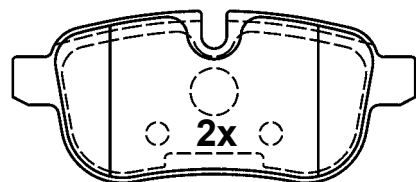

24560 17,8

106,0 x 45,1 x 17,8



4x

M8x21

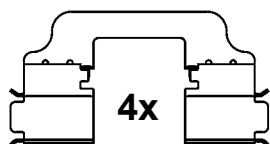

4x

## 13.0460-2761.2 602761



CITROEN, PEUGEOT



TRW

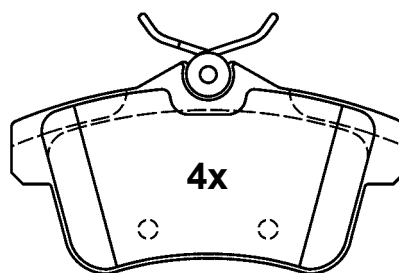

24922 17,5

103,8 x 55,6 x 17,5

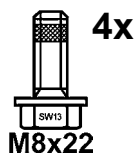

4x

M8x22

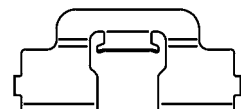

4x

# Abbildungen Scheibenbremsbeläge

Illustrations disc brake pads - Illustrazioni pastiglie freno -

Illustrations plaquettes de frein - Ilustraciones pastillas de freno



Maßstab - scale - scala - échelle - escala 1:2

**13.0460-2762.2 602762**



LAND ROVER



TRW

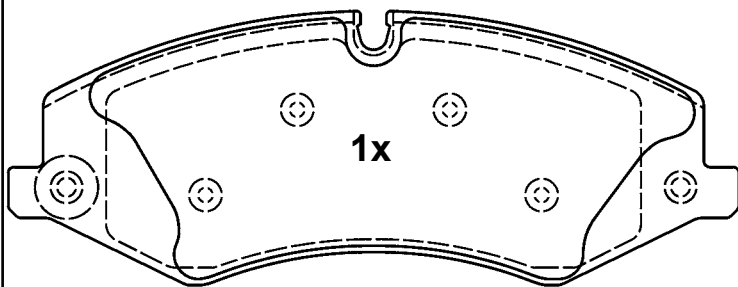
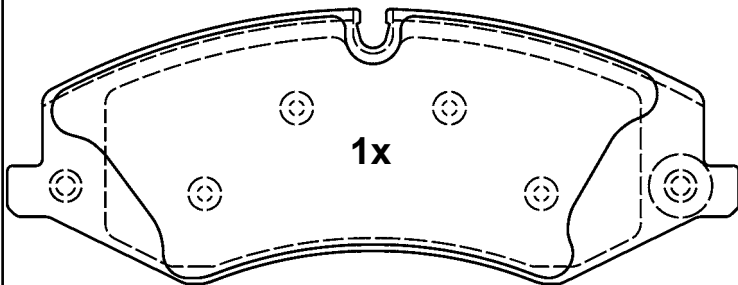
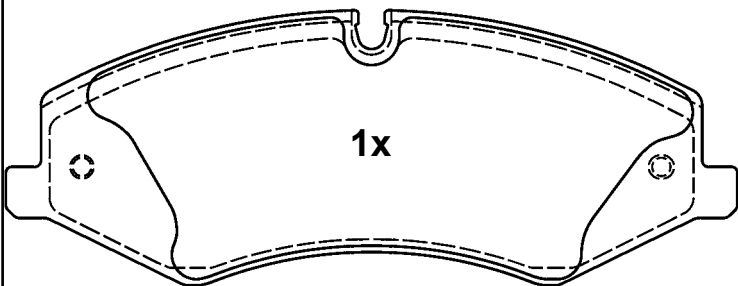
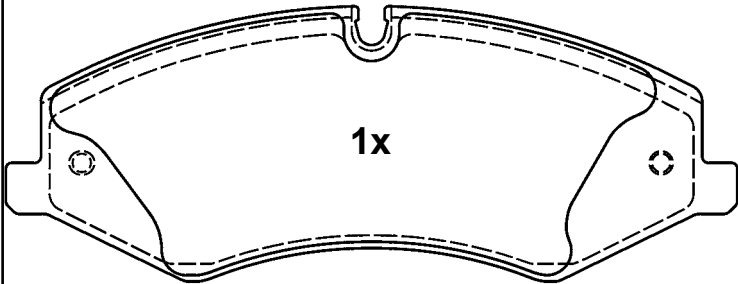

**192,7 x 72,2 x 18,5**

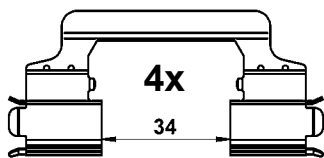

**13.0460-2763.2 602763**



ALFA ROMEO



TRW

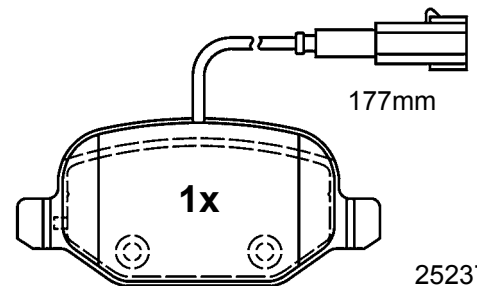
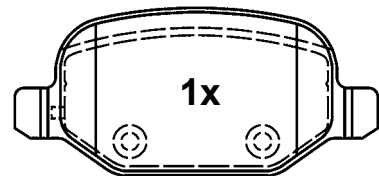
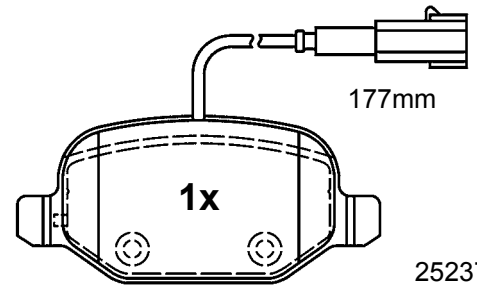
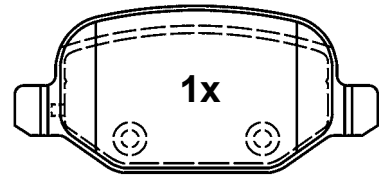

**95,5 x 43,9 x 17,2**

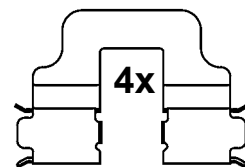
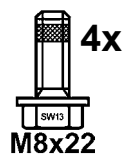

# Abbildungen Scheibenbremsbeläge

Illustrations disc brake pads - Illustrazioni pastiglie freno -

Illustrations plaquettes de frein - Ilustraciones pastillas de freno



Maßstab - scale - scala - échelle - escala 1:2

## 13.0460-2764.2 602764



AUDI, SEAT, SKODA,  
VOLKSWAGEN



TRW

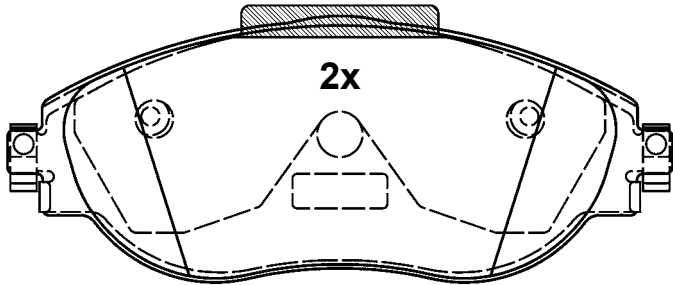

24738 20,0

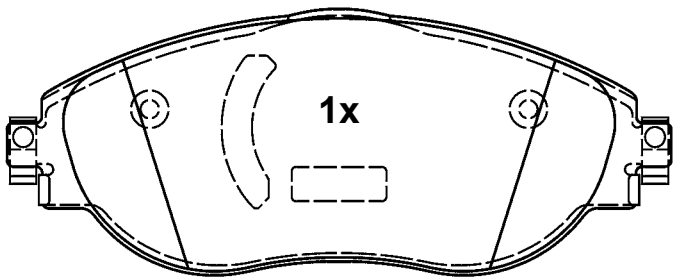

24738 20,0

## 13.0460-2765.2 602765



AUDI



TRW

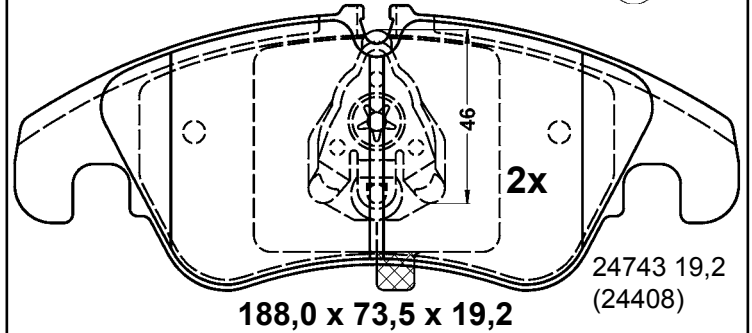

24743 19,2  
(24408)

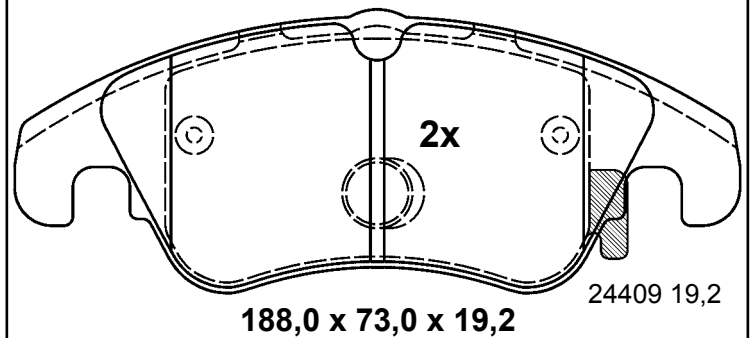

24409 19,2

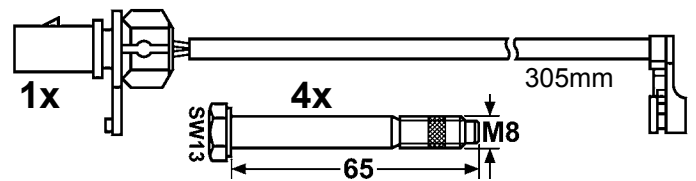

1x

4x

M8

65

305mm

## 13.0460-2766.2 602766



CHRYSLER, FIAT



BOS

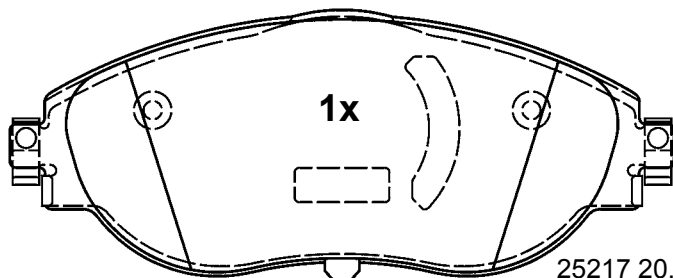

25217 20,0

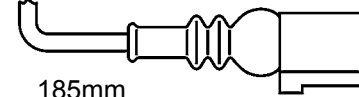

185mm

175,0 x 70,0 x 20,0

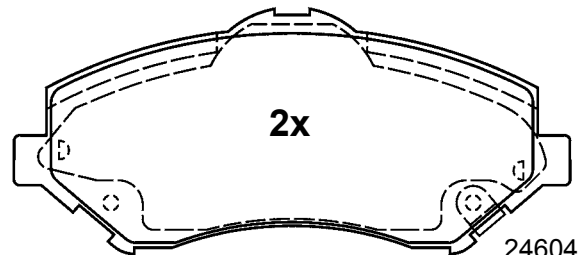

24604 18,7

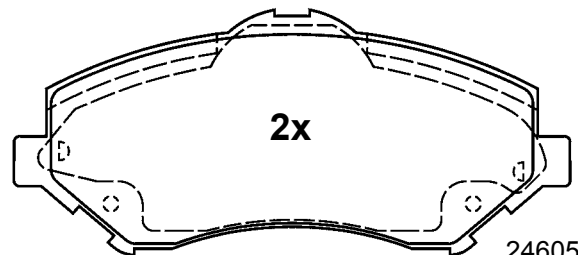

24605 18,7

146,6 x 64,3 x 18,7

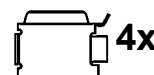

4x



4x

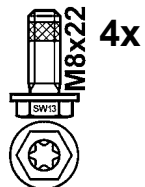

4x

# Abbildungen Scheibenbremsbeläge

Illustrations disc brake pads - Illustrazioni pastiglie freno -

Illustrations plaquettes de frein - Ilustraciones pastillas de freno

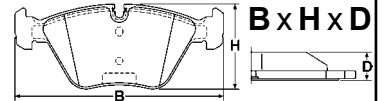

Maßstab - scale - scala - échelle - escala 1:2

## 13.0460-2767.2 602767

ALFA ROMEO

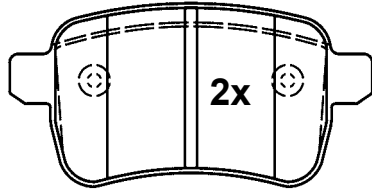

25156 17,4

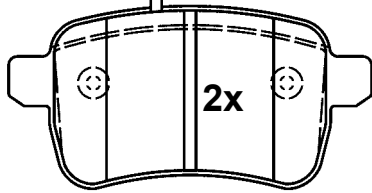
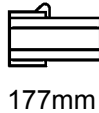

25157 17,4

95,6 x 48,1 x 17,4

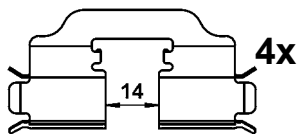
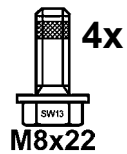

## 13.0460-2768.2 602768

ALFA ROMEO

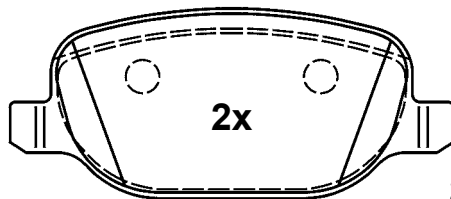

23811 17,7

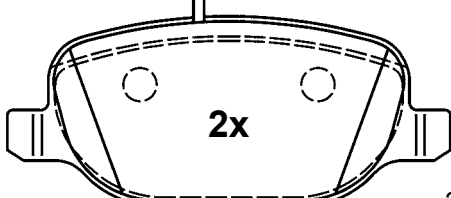
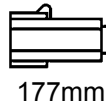

24788 17,7

116,8 x 49,8 x 17,7

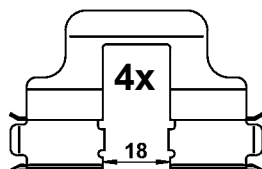
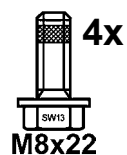

## 13.0460-2769.2 602769

AUDI

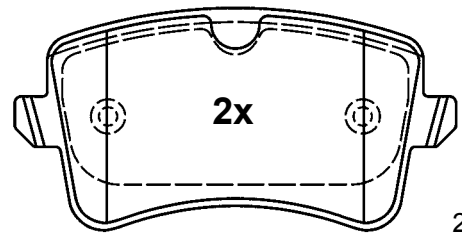

24606 17,4

116,4 x 58,5 x 17,4

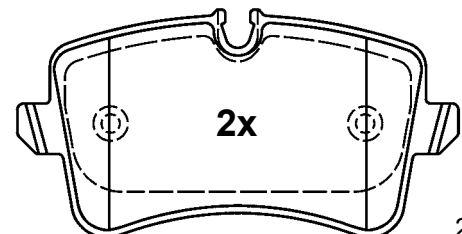

25214 17,4

116,4 x 59,8 x 17,4

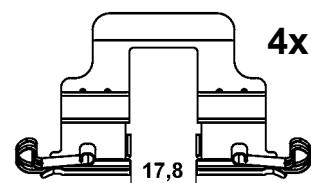
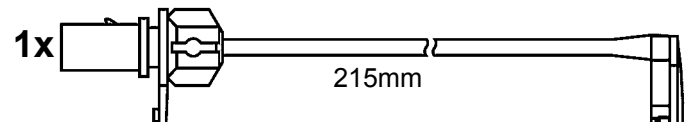



# Abbildungen Scheibenbremsbeläge

Illustrations disc brake pads - Illustrazioni pastiglie freno -

Illustrations plaquettes de frein - Ilustraciones pastillas de freno

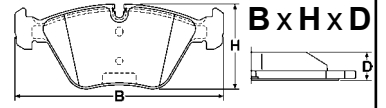

Maßstab - scale - scala - échelle - escala 1:2

**13.0460-2770.2 602770**



AUDI, PORSCHE



TRW

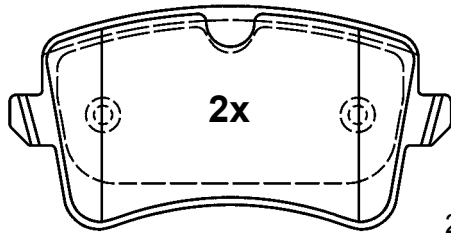

24606 17,4

116,4 x 58,5 x 17,4

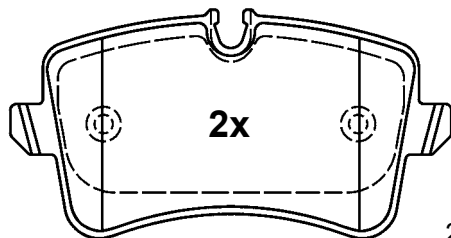

25214 17,4

116,4 x 59,8 x 17,4

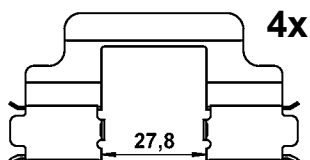
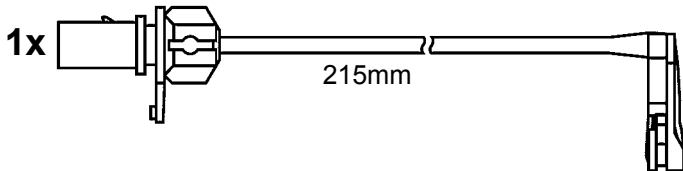

**13.0460-2771.2 602771**



CHRYSLER, FIAT



TRW

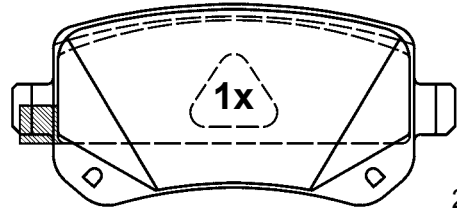

24822 15,7

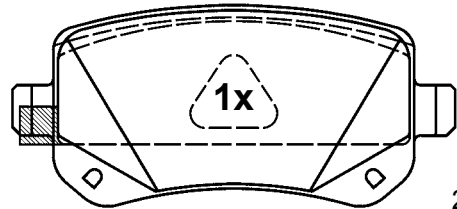

24822 15,7

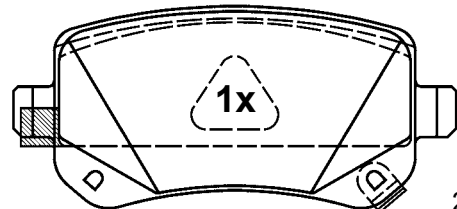

24823 15,7

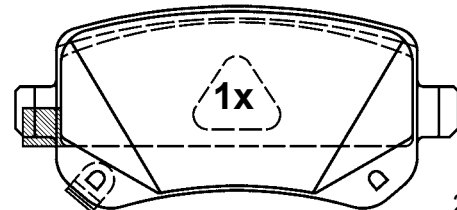

24824 15,7

116,6 x 52,5 x 15,7

4x



4x

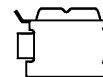

# Abbildungen Scheibenbremsbeläge

Illustrations disc brake pads - Illustrazioni pastiglie freno -

Illustrations plaquettes de frein - Ilustraciones pastillas de freno

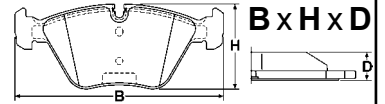

Maßstab - scale - scala - échelle - escala 1:2

**13.0460-2772.2 602772**



KIA



TRW

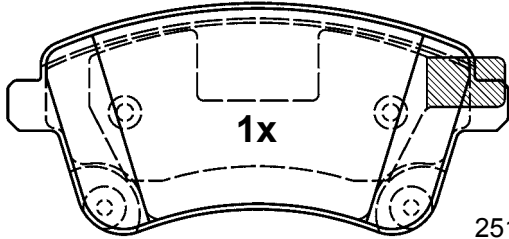

1x

25184 19,4

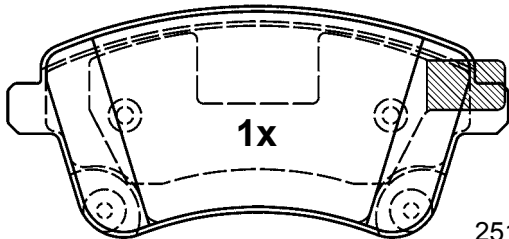

1x

25184 19,4

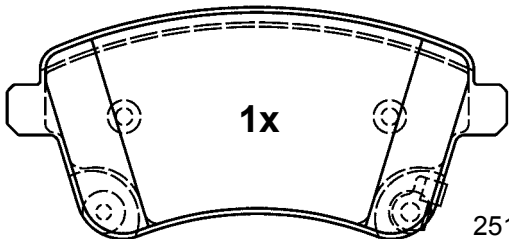

1x

25185 19,4

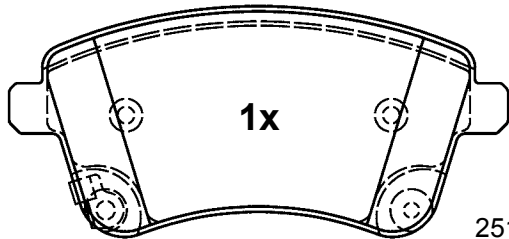

1x

25186 19,4

131,6 x 60,6 x 19,4



4x

M8x21

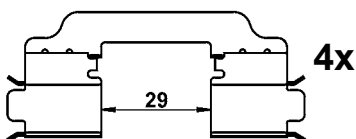

4x

29

**13.0460-2773.2 602773**



AUDI



TRW

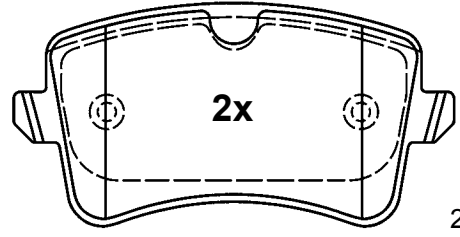

2x

24606 17,4

116,4 x 58,5 x 17,4

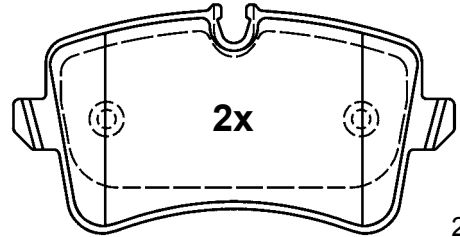

2x

25214 17,4

116,4 x 59,8 x 17,4

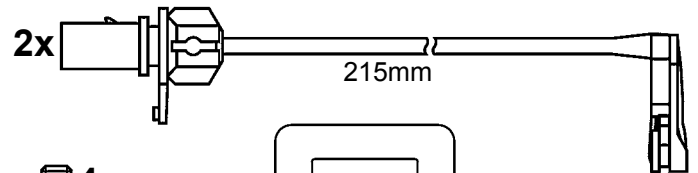

2x

215mm



4x

M8x21

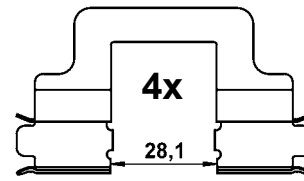

4x

28,1

**13.0460-2774.2 602774**



NISSAN



TRW

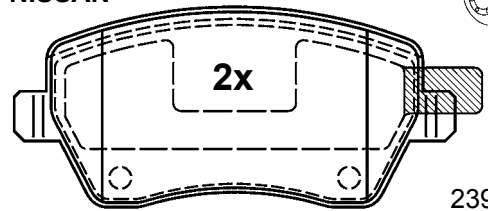

2x

23973 17,4

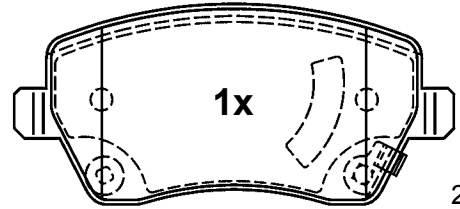

1x

24403 17,4

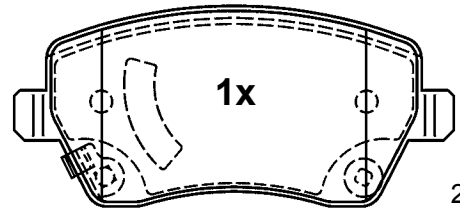

1x

24403 17,4

116,3 x 52,4 x 17,4

# Abbildungen Scheibenbremsbeläge

Illustrations disc brake pads - Illustrazioni pastiglie freno -

Illustrations plaquettes de frein - Ilustraciones pastillas de freno

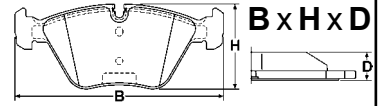

Maßstab - scale - scala - échelle - escala 1:2

## 13.0460-2775.2 602775



CITROEN



TRW

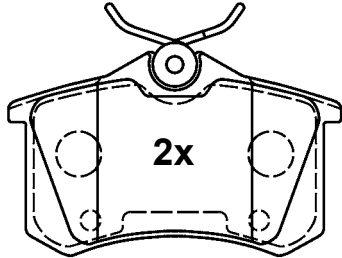

2x

23554 17,2

87,2 x 53,0 x 17,2

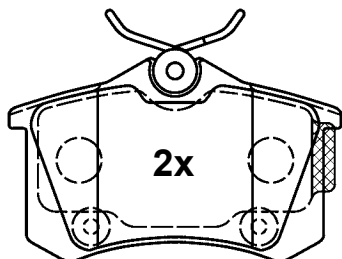

2x

23554 16,3

87,2 x 53,0 x 16,3

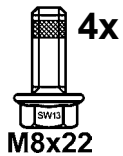

M8x22

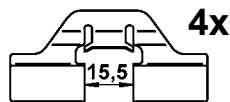

4x

15,5

## 13.0460-2778.2 602778



MERCEDES BENZ



TRW

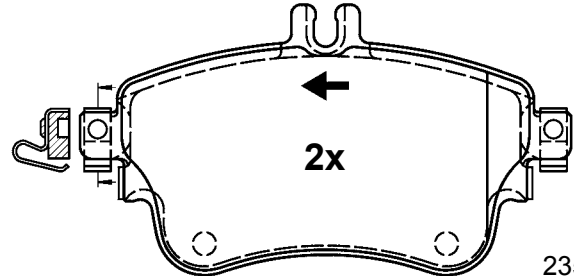

2x

23526 19,3

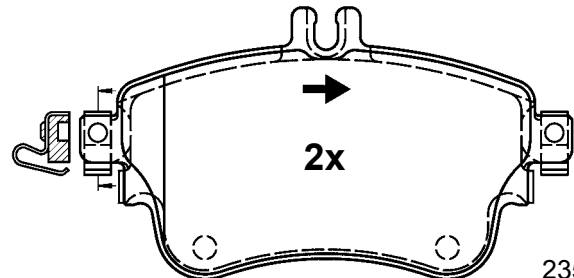

2x

23526 19,3

129,0 x 71,3 x 19,3



M8x22

## 13.0460-2776.2 602776



MERCEDES BENZ



TRW

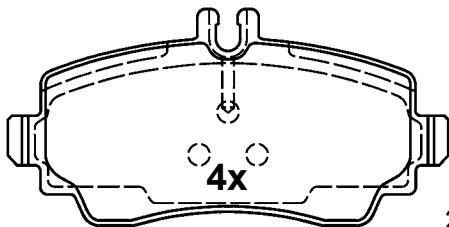

4x

23070 17,0

116,5 x 57,1 x 17,0

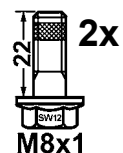

M8x1

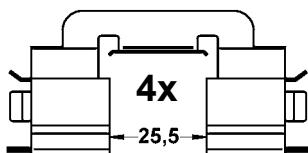

4x

25,5

## 13.0460-2779.2 602779



MERCEDES BENZ



TRW

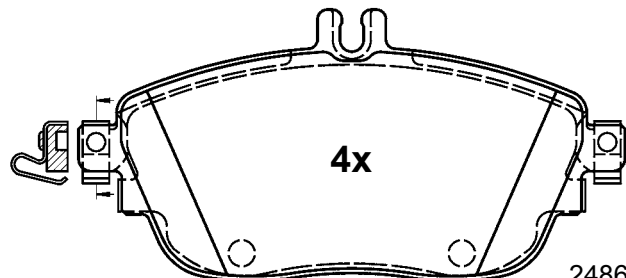

4x

24869 19,3

144,0 x 71,6 x 19,3



M8x22

# Abbildungen Scheibenbremsbeläge

Illustrations disc brake pads - Illustrazioni pastiglie freno -

Illustrations plaquettes de frein - Ilustraciones pastillas de freno

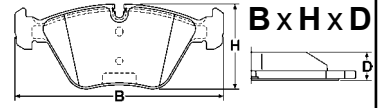

Maßstab - scale - scala - échelle - escala 1:2

## 13.0460-2780.2 602780



MERCEDES BENZ



TRW

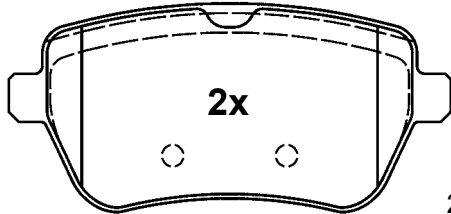

2x

25072 18,8

116,2 x 54,7 x 18,8

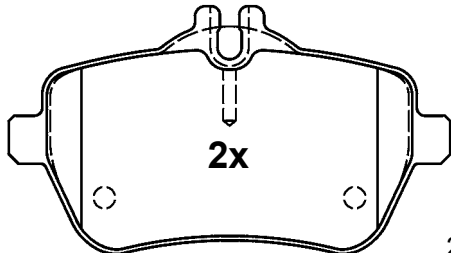

2x

25071 18,8

116,2 x 65,0 x 18,8

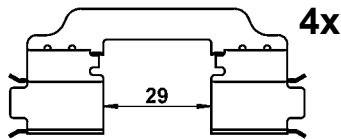
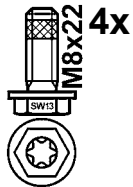

4x

29

## 13.0460-2782.2 602782



MERCEDES BENZ



TRW

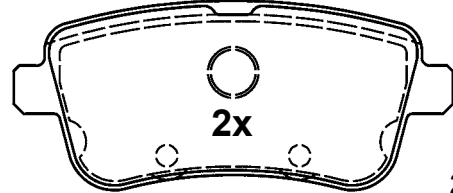

2x

25215 18,6

116,3 x 49,8 x 18,6

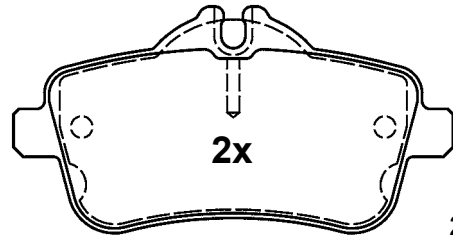

2x

25216 18,6

116,3 x 59,8 x 18,6

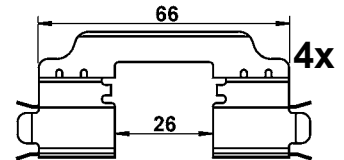

4x

## 13.0460-2783.2 602783



FIAT



TRW

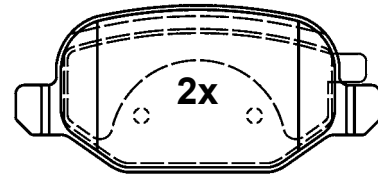

2x

25410 14,4

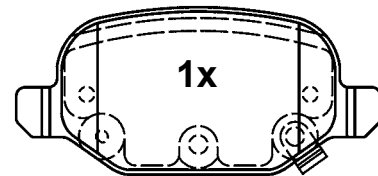

1x

25411 14,4

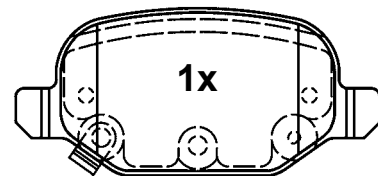

1x

25412 14,4

## 13.0460-2781.2 602781



MERCEDES BENZ



TRW

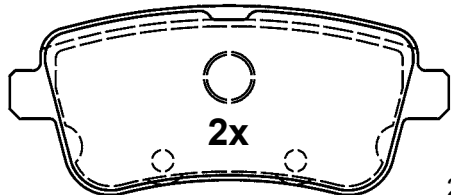

2x

25215 18,6

116,3 x 49,8 x 18,6

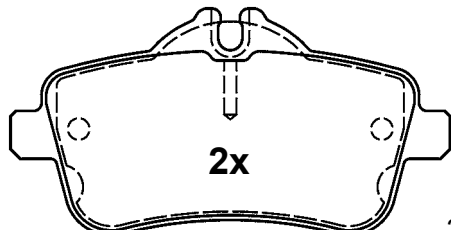

2x

25216 18,6

116,3 x 59,8 x 18,6

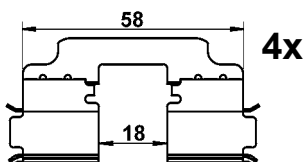
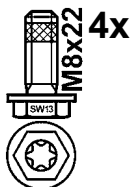

4x

58

18

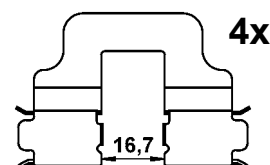
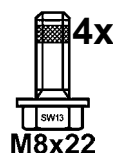

4x

16,7

# Abbildungen Scheibenbremsbeläge

Illustrations disc brake pads - Illustrazioni pastiglie freno -

Illustrations plaquettes de frein - Ilustraciones pastillas de freno



Maßstab - scale - scala - échelle - escala 1:2

## 13.0460-2784.2 602784



FORD



TRW

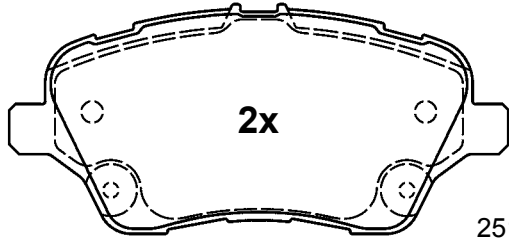

25134 17,2

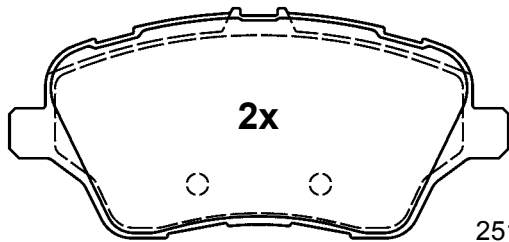

25135 17,2

131,5 x 60,0 x 17,2

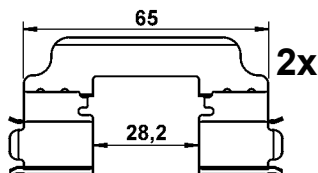
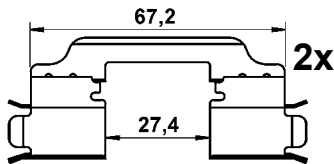

M8x21

## 13.0460-2785.2 602785



AUDI, SEAT, SKODA,  
VOLKSWAGEN



TRW

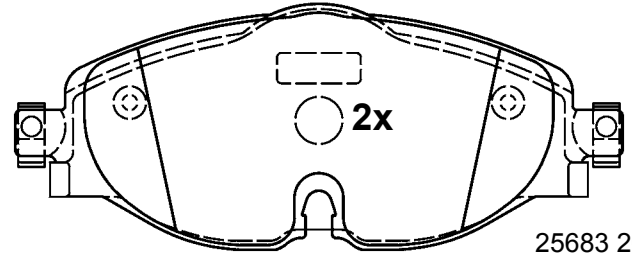

25683 20,4

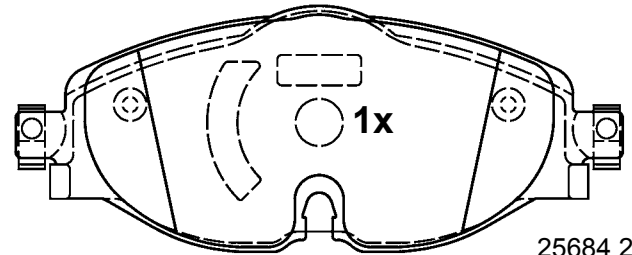

25684 20,4

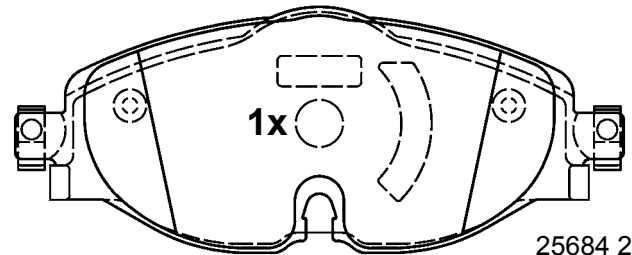

25684 20,4

160,0 x 64,5 x 20,4

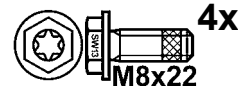
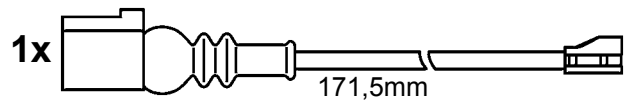

## 13.0460-2786.2 602786



MERCEDES BENZ



TRW

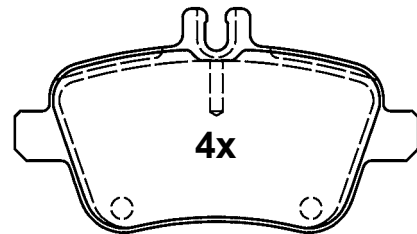

24848 18,3

106,4 x 58,9 x 18,3

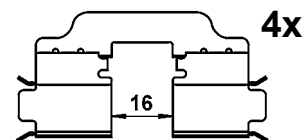
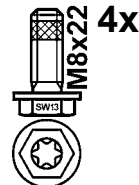

# Abbildungen Scheibenbremsbeläge

Illustrations disc brake pads - Illustrazioni pastiglie freno -

Illustrations plaquettes de frein - Ilustraciones pastillas de freno

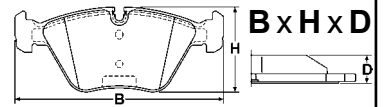

Maßstab - scale - scala - échelle - escala 1:2

## 13.0460-2787.2 602787

SEAT, SKODA

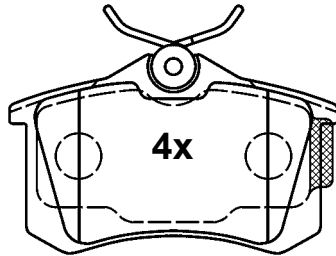

23554 17,3

57,5 x 52,9 x 17,3

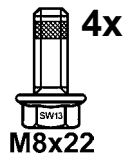

## 13.0460-2789.2 602789

FIAT

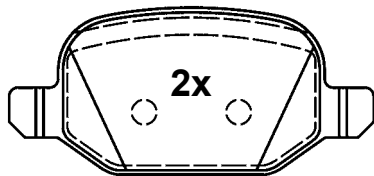

25652 17,1

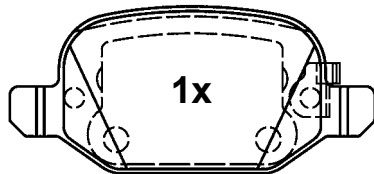

25653 17,1

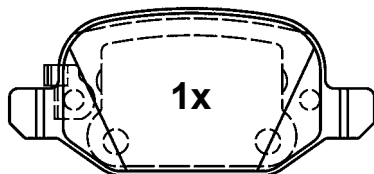

25654 17,1

95,8 x 43,8 x 17,1

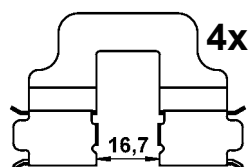
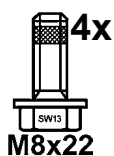

## 13.0460-2792.2 602792

MERCEDES BENZ

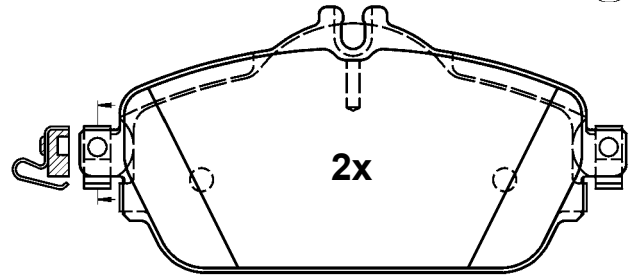

19,6

144,0 x 70,0 x 19,6

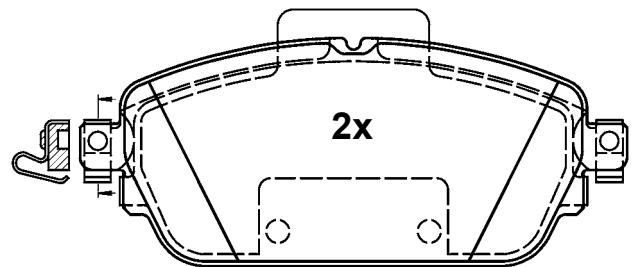

19,6

144,0 x 60,0 x 19,6

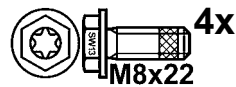

## 13.0460-2793.2 602793

FIAT, OPEL, VAUXHALL

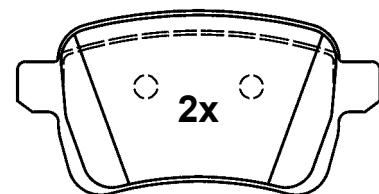

25973 17,2

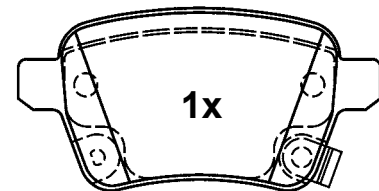

25974 17,2

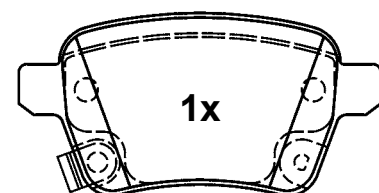

25975 17,2

95,5 x 47,7 x 17,2

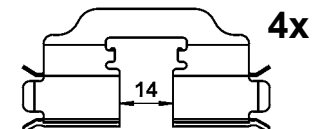
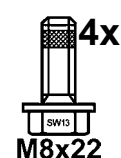



# Abbildungen Scheibenbremsbeläge

Illustrations disc brake pads - Illustrazioni pastiglie freno -

Illustrations plaquettes de frein - Ilustraciones pastillas de freno



Maßstab - scale - scala - échelle - escala 1:2

## 13.0460-2800.2 602800

HONDA

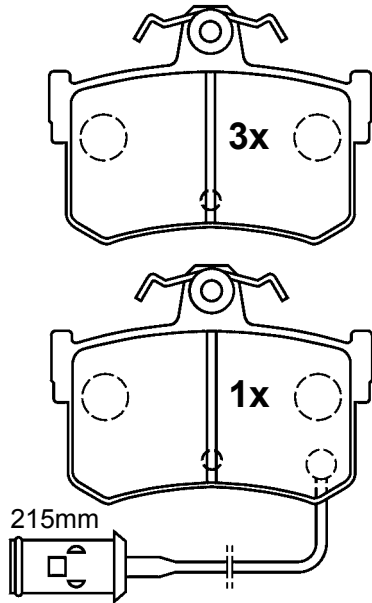

20087 14,6

20091 14,6

85,1 x 62,2 x 14,6

## 13.0460-2804.2 602804

MG, ROVER

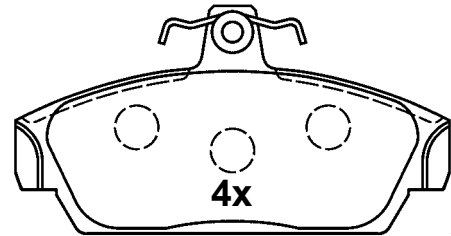

21518 17,0

115,2 x 60,4 x 17,0

## 13.0460-2803.2 602803

HONDA, MG, ROVER

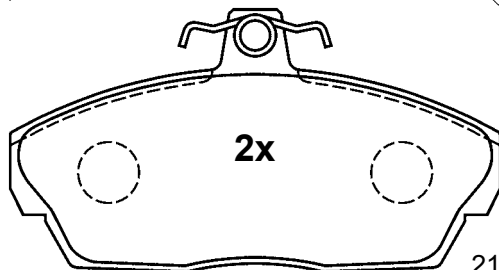

21515 17,5

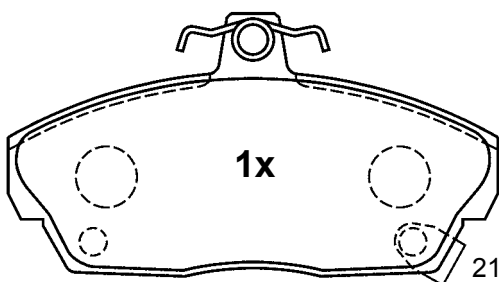

21516 17,5

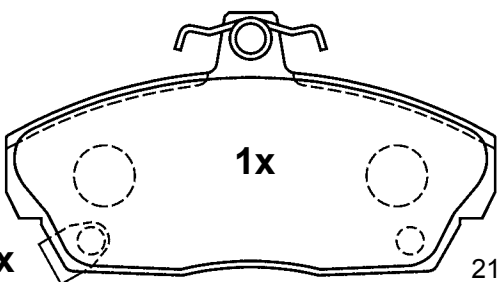

21517 17,5

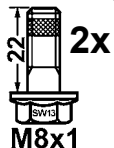

129,1 x 68,8 x 17,5

## 13.0460-2805.2 602805

ROVER

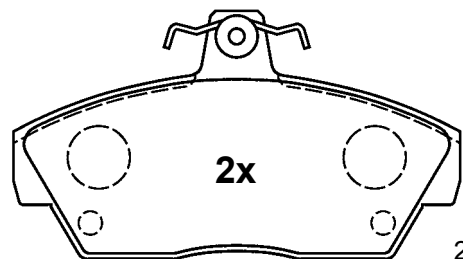

21520 17,5

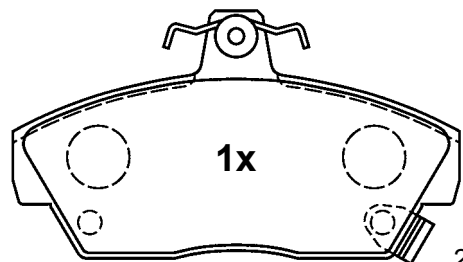

21521 17,5

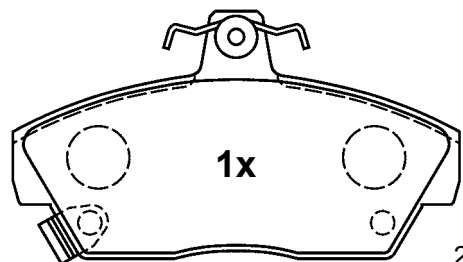

21522 17,5

117,5 x 65,6 x 17,5

# Abbildungen Scheibenbremsbeläge

Illustrations disc brake pads - Illustrazioni pastiglie freno -

Illustrations plaquettes de frein - Ilustraciones pastillas de freno

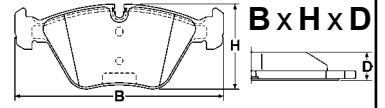

Maßstab - scale - scala - échelle - escala 1:2

## 13.0460-2806.2 602806



VOLKSWAGEN



TRW

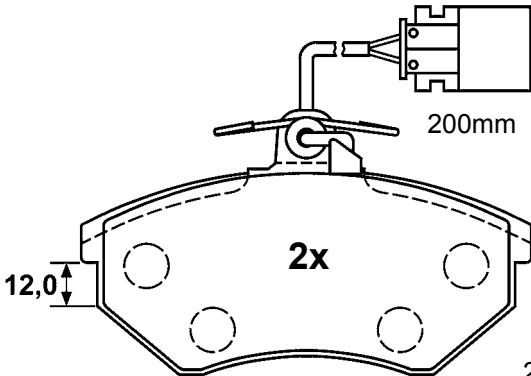
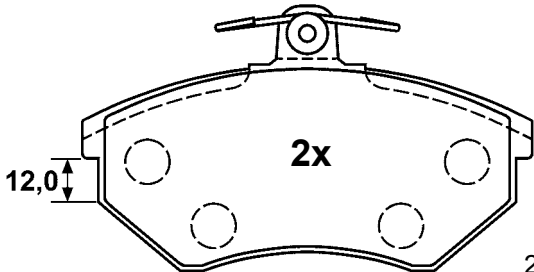

119,0 x 69,5 x 19,3

## 13.0460-2810.2 602810



RENAULT



TRW

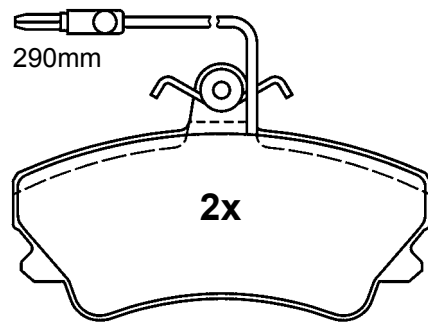
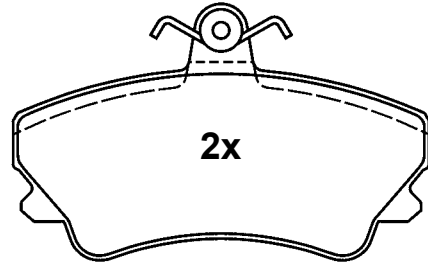

110,0 x 67,5 18,0

## 13.0460-2809.2 602809



ALFA ROMEO



TRW

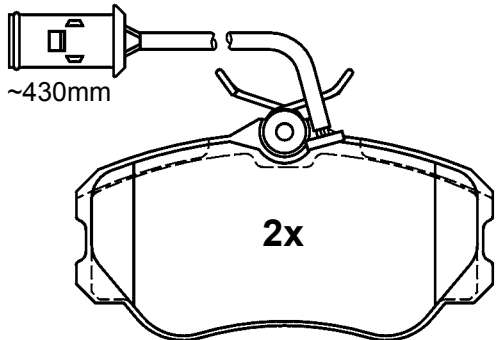
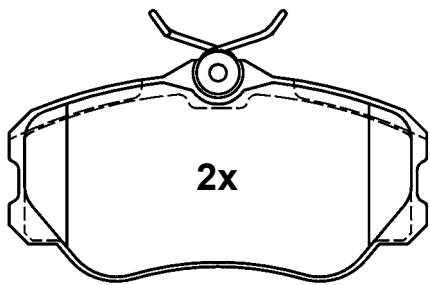

110,0 x 58,5 x 19,4

## 13.0460-2811.2 602811



SAAB



TRW

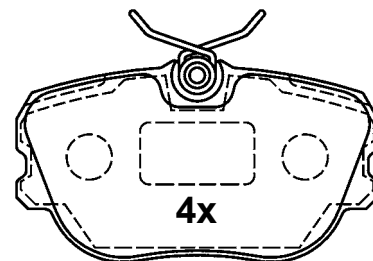

94,8 x 52,6 x 17,0

# Abbildungen Scheibenbremsbeläge

Illustrations disc brake pads - Illustrazioni pastiglie freno -

Illustrations plaquettes de frein - Ilustraciones pastillas de freno

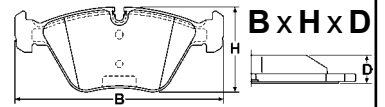

Maßstab - scale - scala - échelle - escala 1:2

**13.0460-2812.2 602812**

VOLVO

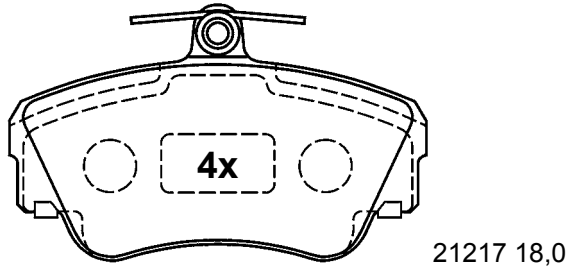

21217 18,0

109,9 x 67,5 x 18,0



**13.0460-2816.2 602816**

PEUGEOT

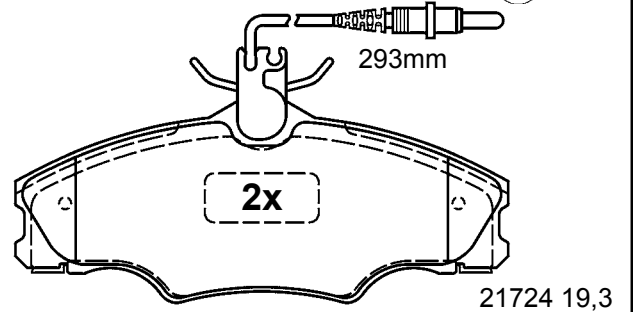

21724 19,3

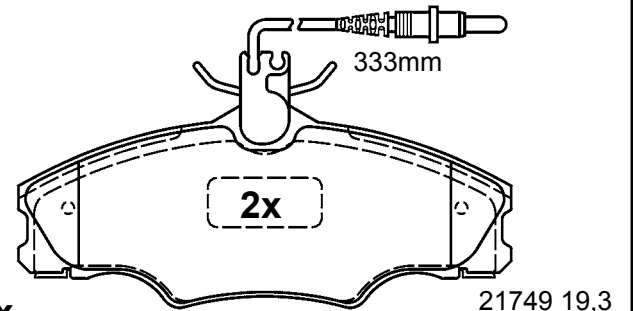

21749 19,3



130,0 x 52,8 x 19,3

**13.0460-2817.2 602817**

CITROEN, PEUGEOT

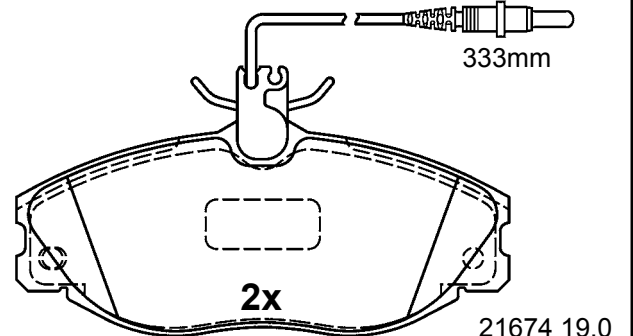

21674 19,0

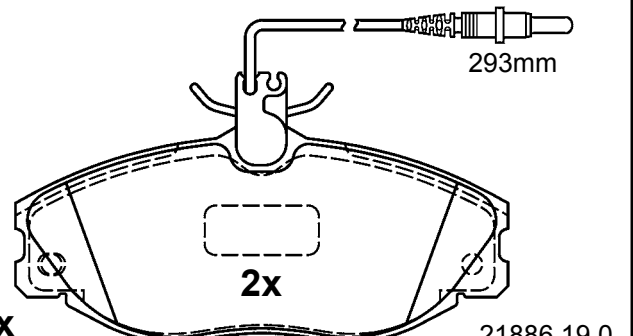

21886 19,0



129,9 x 56,4 x 19,0

**13.0460-2815.2 602815**

OPEL, VAUXHALL

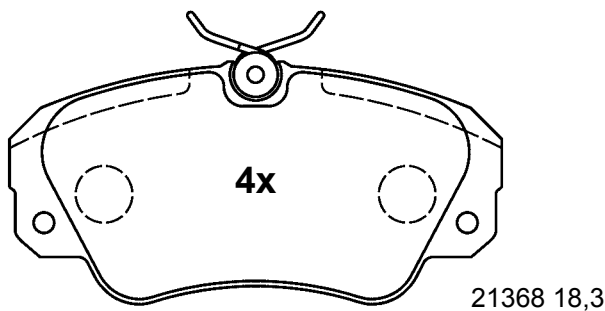

21368 18,3

129,9 x 63,8 x 18,3



# Abbildungen Scheibenbremsbeläge

Illustrations disc brake pads - Illustrazioni pastiglie freno -

Illustrations plaquettes de frein - Ilustraciones pastillas de freno

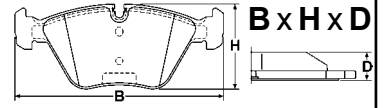

Maßstab - scale - scala - échelle - escala 1:2

**13.0460-2819.2 602819**



CITROEN, FIAT, FORD, LANCIA  
PEUGEOT, SEAT, VOLKSWAGEN



TRW

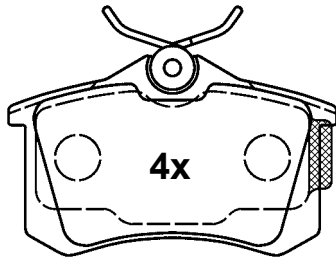

20961 17,6

87,6 x 52,9 x 17,6



M8x21

**13.0460-2821.2 602821**



EAT, VOLKSWAGEN



TRW

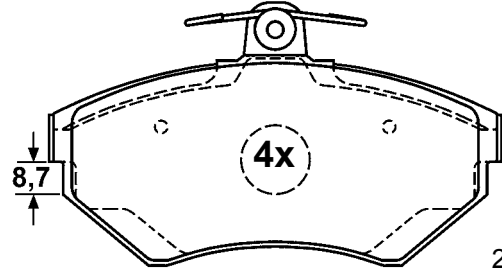

21945 16,0

119,1 x 69,5 x 16,0



M8x21

**13.0460-2820.2 602820**



AUDI, SEAT, SKODA  
VOLKSWAGEN



TRW

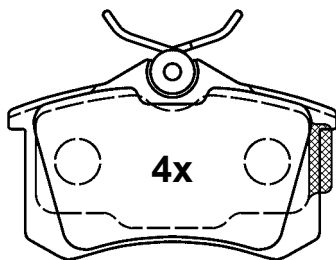

20961 17,6

87,6 x 52,9 x 17,6



M8x22

**13.0460-2822.2 602822**



SEAT, VOLKSWAGEN



TRW

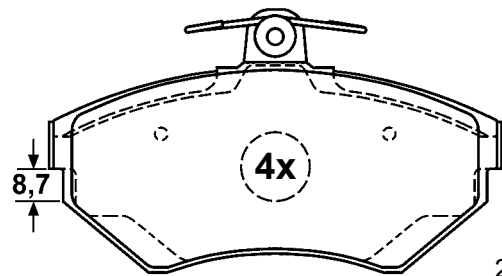

21945 19,6

119,1 x 69,5 x 19,6



M8x21

# Abbildungen Scheibenbremsbeläge

Illustrations disc brake pads - Illustrazioni pastiglie freno -

Illustrations plaquettes de frein - Ilustraciones pastillas de freno

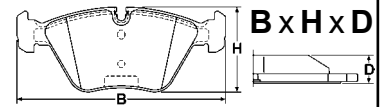

Maßstab - scale - scala - échelle - escala 1:2

**13.0460-2823.2 602823**



CITROEN, PEUGEOT,  
VOLKSWAGEN



TRW

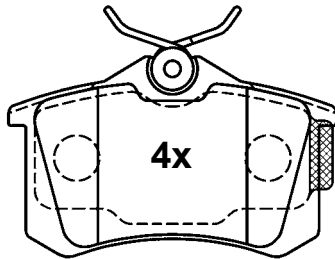

23554 17,2

86,8 x 52,9 x 17,2

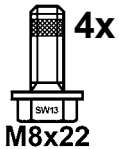

M8x22

**13.0460-2825.2 602825**



CITROEN



TRW

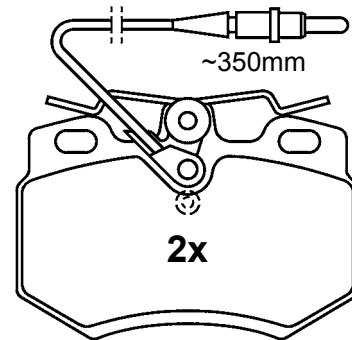

21616 17,7

**13.0460-2824.2 602824**



RENAULT



TRW

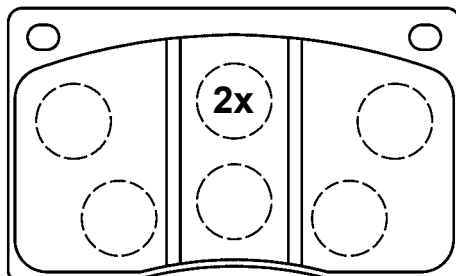

20380 15,6

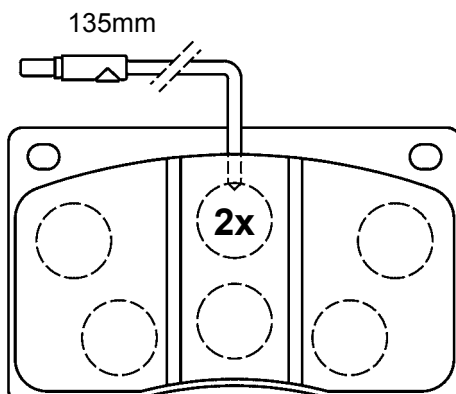

21110 15,6

119,7 x 71,0 x 15,6

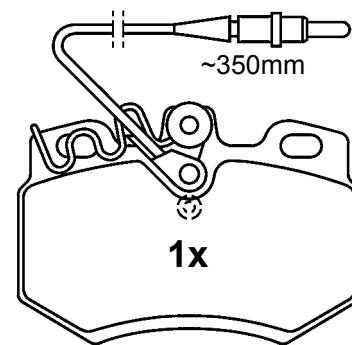

21614 17,7

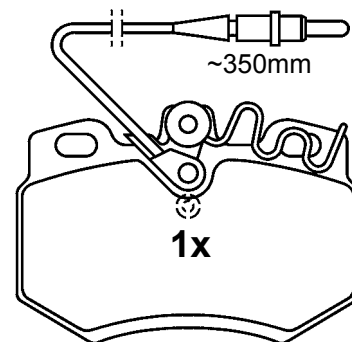

21615 17,7

89,9 x 62,9 x 17,7

# Abbildungen Scheibenbremsbeläge

Illustrations disc brake pads - Illustrazioni pastiglie freno -

Illustrations plaquettes de frein - Ilustraciones pastillas de freno

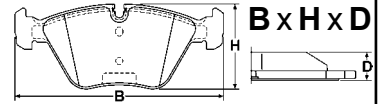

Maßstab - scale - scala - échelle - escala 1:2

## 13.0460-2826.2 602826



ALFA ROMEO, FIAT, LANCIA



TRW

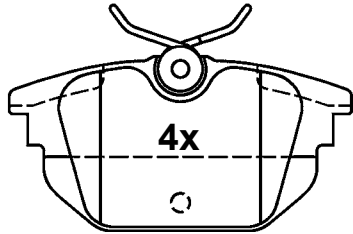

23177 14,2

87,0 x 44,6 x 14,2



## 13.0460-2827.2 602827



ALFA ROMEO, LANCIA



TRW

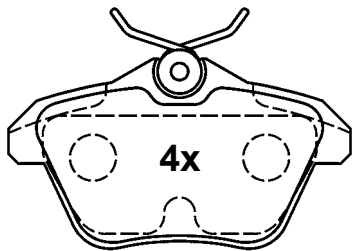

21606 16,7

89,8 x 49,9 x 16,7



## 13.0460-2829.2 602829



CITROEN, PEUGEOT



TRW

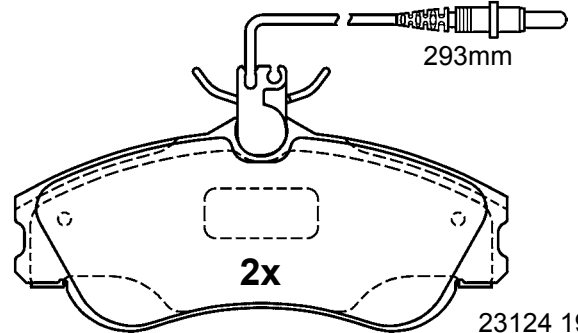

23124 19,0

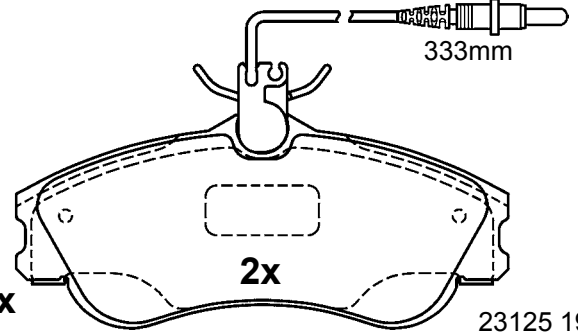

23125 19,0



## 13.0460-2830.2 602830



MITSUBISHI, VOLVO



TRW

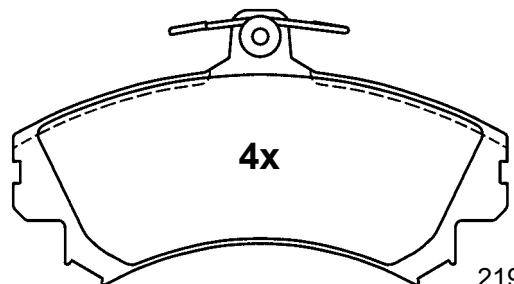

21920 14,6

129,9 x 72,7 x 14,6

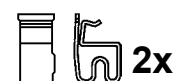
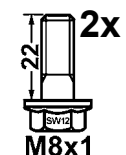
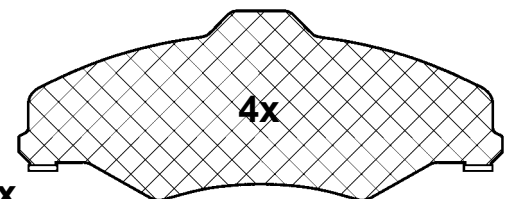

## 13.0460-2828.2 602828



MERCEDES BENZ



TRW

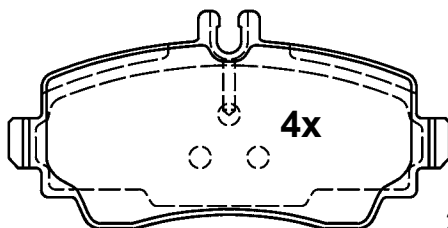

23070 19,5

116,5 x 57,1 x 19,5

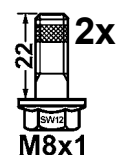



# Abbildungen Scheibenbremsbeläge

Illustrations disc brake pads - Illustrazioni pastiglie freno -

Illustrations plaquettes de frein - Ilustraciones pastillas de freno

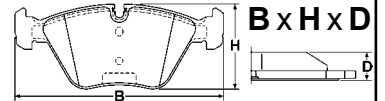

Maßstab - scale - scala - échelle - escala 1:2

## 13.0460-2831.2 602831



MITSUBISHI, VOLVO

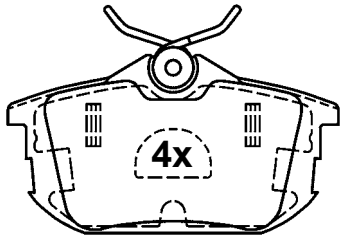

87,0 x 47,0 x 15,2

21861 15,2

## 13.0460-2834.2 602834



DACIA, RENAULT

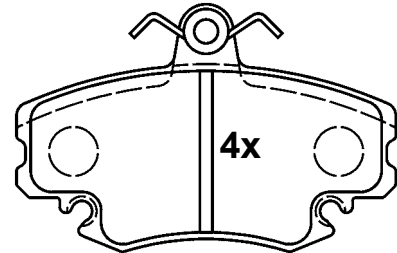

99,9 x 64,9 x 18,0

21463 18,0

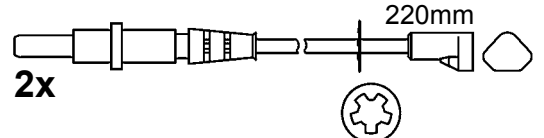

## 13.0460-2832.2 602832



RENAULT

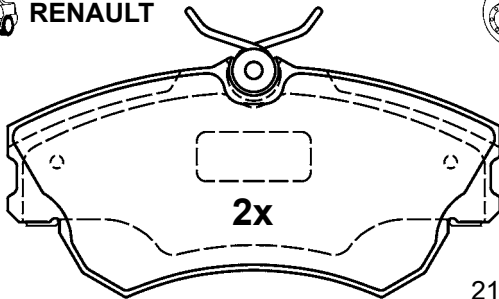

21888 18,1

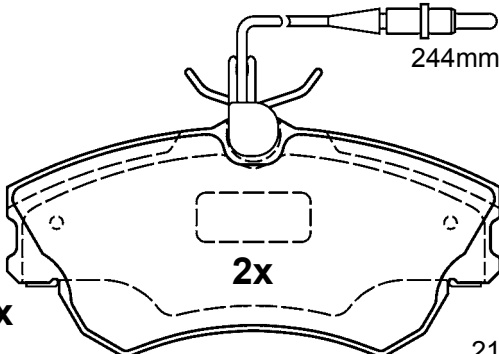

129,8 x 63,0 x 18,1

21889 18,1



## 13.0460-2835.2 602835



FORD

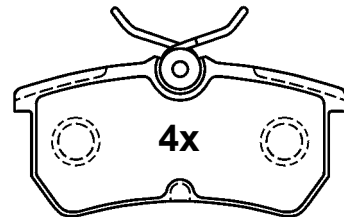

87,5 x 42,4 x 14,8

23353 14,8



## 13.0460-2833.2 602833



MERCEDES BENZ

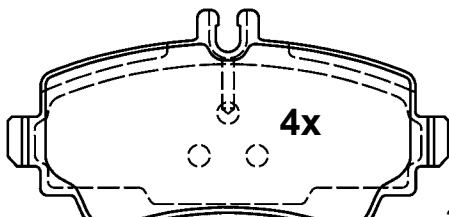

116,5 x 57,1 x 17,0

23070 17,0

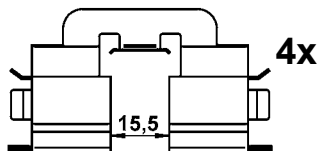
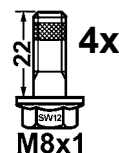

## 13.0460-2836.2 602836



RENAULT

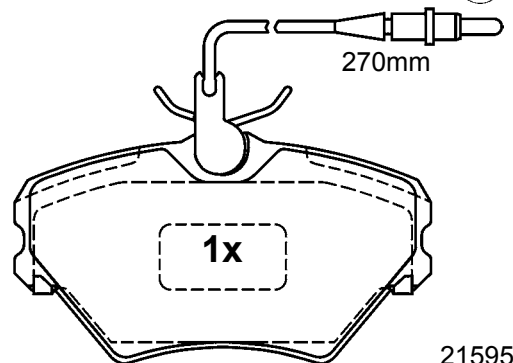

21595 18,3

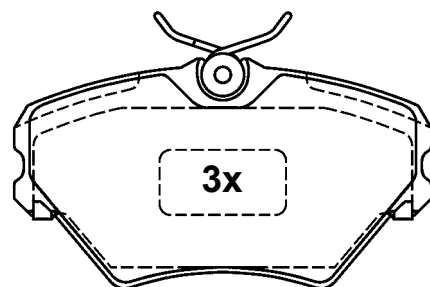

109,9 x 60,7 x 18,3

21596 18,3



# Abbildungen Scheibenbremsbeläge

Illustrations disc brake pads - Illustrazioni pastiglie freno -

Illustrations plaquettes de frein - Ilustraciones pastillas de freno

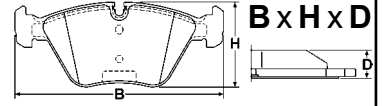

Maßstab - scale - scala - échelle - escala 1:2

## 13.0460-2837.2 602837



AUDI, SEAT, VOLKSWAGEN



TRW

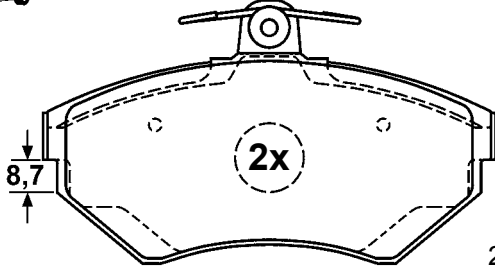

21945 19,6

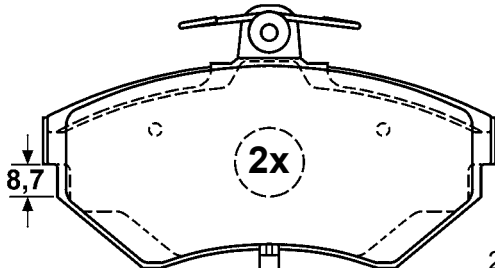

23393 19,6



M8x21

119,1 x 69,5 x 19,6

## 13.0460-2839.2 602839



VOLKSWAGEN



TRW

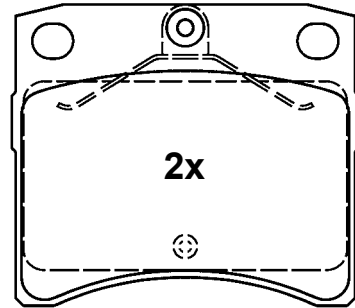

20651 18,3

91,5 x 80,0 x 18,3

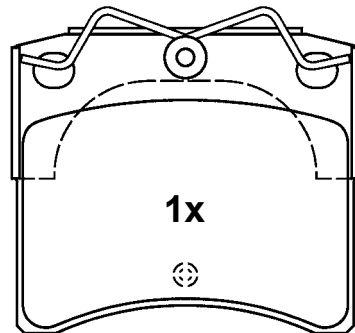

21635 18,7

91,7 x 80,0 x 18,7

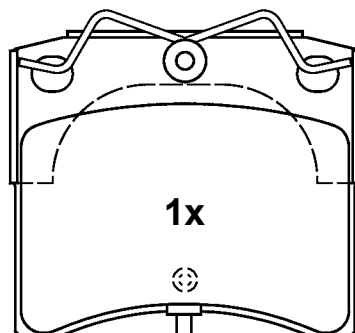

23176 18,7

91,7 x 80,0 x 18,7

## 13.0460-2838.2 602838



VOLKSWAGEN



TRW

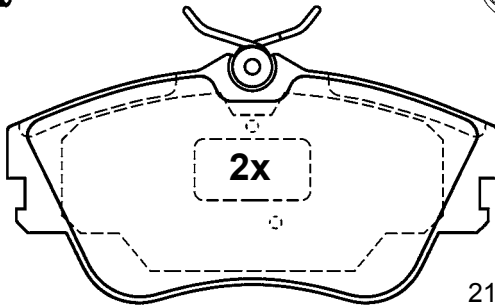

21479 19,2

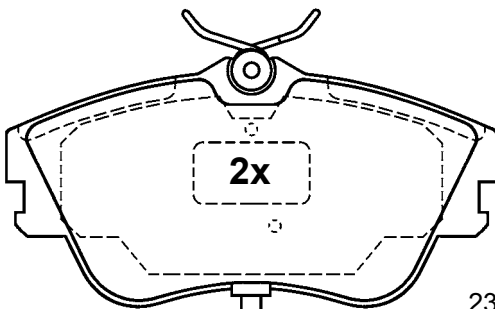

23445 19,2

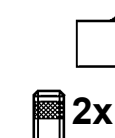

M8x21

129,9 x 65,2 x 19,2

# Abbildungen Scheibenbremsbeläge

Illustrations disc brake pads - Illustrazioni pastiglie freno -

Illustrations plaquettes de frein - Ilustraciones pastillas de freno



Maßstab - scale - scala - échelle - escala 1:2

## 13.0460-2840.2 602840



NISSAN, OPEL, RENAULT  
VAUXHALL

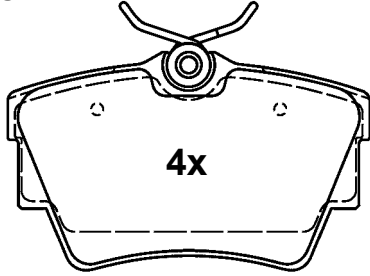

4x

23980 16,5



94,4 x 57,2 x 16,5

## 13.0460-2844.2 602844



PEUGEOT

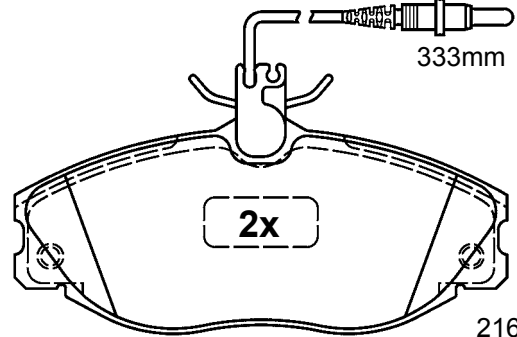

333mm

2x

21674 19,4

## 13.0460-2842.2 602842



PEUGEOT



4x

20961 15,2



86,8 x 52,9 x 15,2

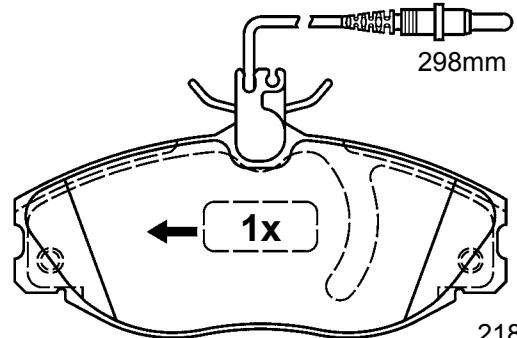

298mm

1x

21886 19,4

## 13.0460-2843.2 602843



IVECO

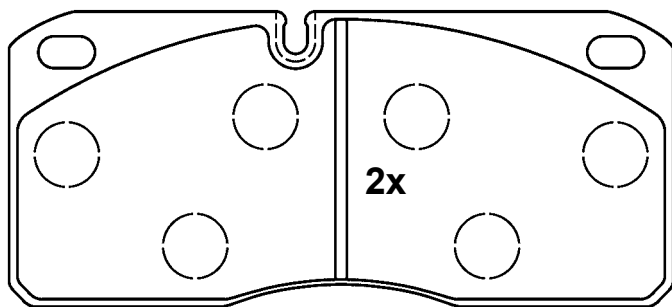

2x

29067 22,3

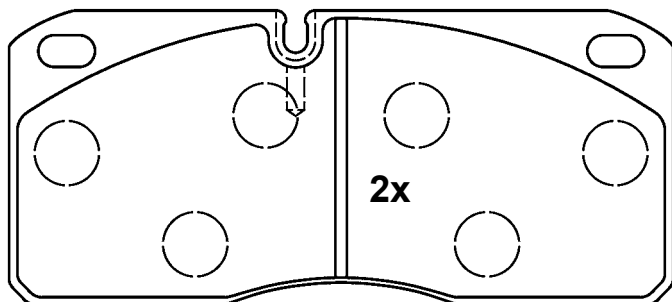

2x

29067 22,3

176,0 x 77,8 x 22,3

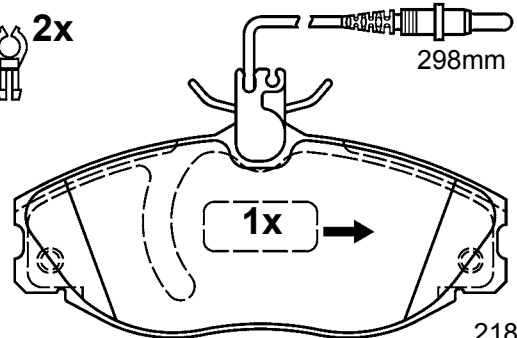

298mm

1x

21886 19,4



129,8 x 56,4 x 19,4

## 13.0460-2845.2 602845



RENAULT

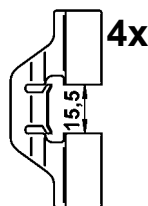

4x

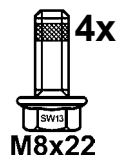

4x

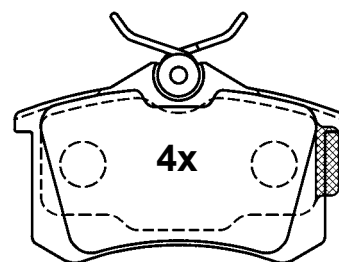

4x

23554 16,4

86,8 x 52,9 x 16,4

# Abbildungen Scheibenbremsbeläge

Illustrations disc brake pads - Illustrazioni pastiglie freno -

Illustrations plaquettes de frein - Ilustraciones pastillas de freno

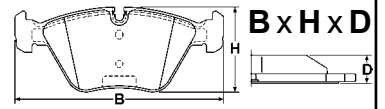

Maßstab - scale - scala - échelle - escala 1:2

**13.0460-2846.2 602846**



VOLVO



TRW

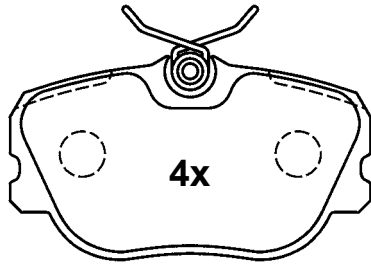

4x

21010 15,8

95,0 x 52,3 x 15,8



M8x21

**13.0460-2850.2 602850**



CITROEN, FIAT, PEUGEOT



TRW

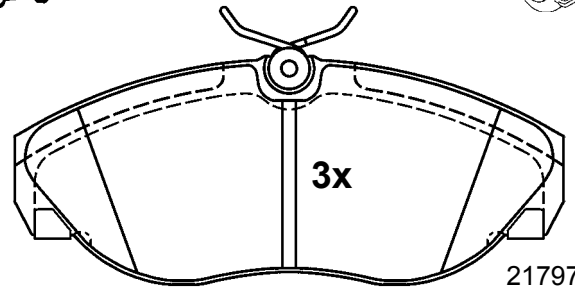

3x

21797 19,7

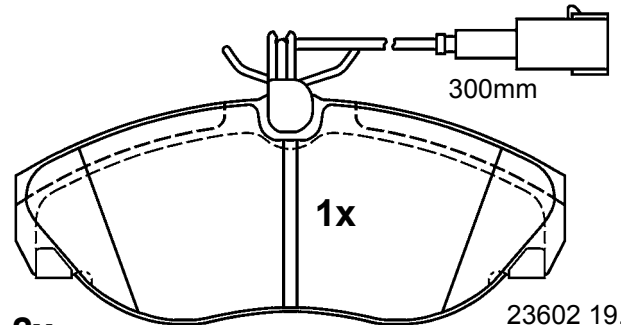

1x

300mm

23602 19,7



M8x21

144,8 x 60,8 x 19,7

**13.0460-2847.2 602847**



AUDI



ATE

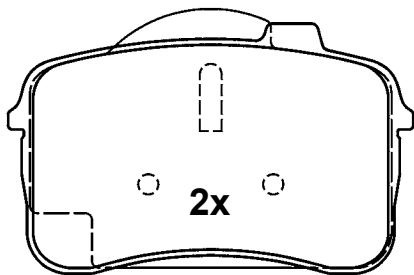

2x

21219 17,8

107,2 x 66,2 x 17,8

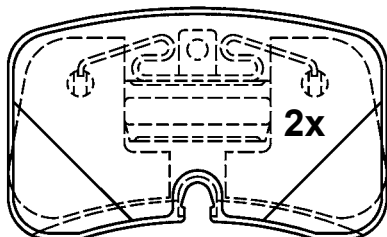

2x

21306 16,8

100,0 x 61,1 x 16,8

**13.0460-2852.2 602852**



CITROEN, FIAT, PEUGEOT



TRW

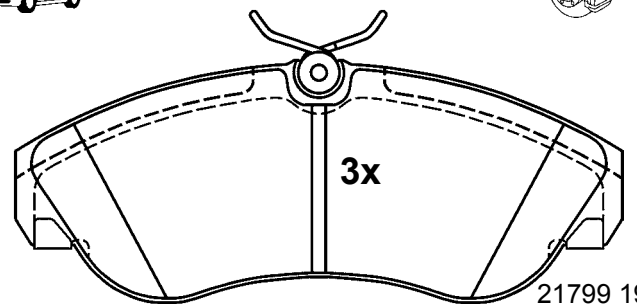

3x

21799 19,7

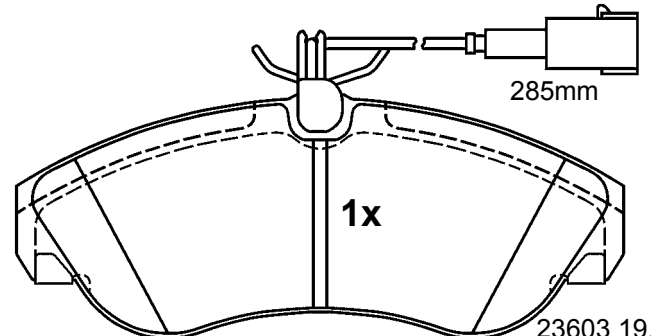

1x

285mm

23603 19,7



M8x21

159,8 x 64,1 x 19,7

# Abbildungen Scheibenbremsbeläge

Illustrations disc brake pads - Illustrazioni pastiglie freno -

Illustrations plaquettes de frein - Ilustraciones pastillas de freno

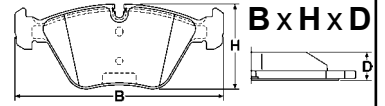

Maßstab - scale - scala - échelle - escala 1:2

**13.0460-2853.2 602853**



MITSUBISHI, SMART, VOLVO



TRW

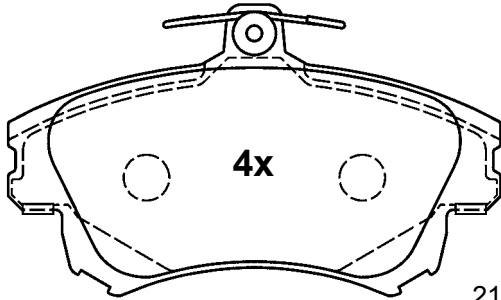

21983 17,2

129,9 x 76,7 x 17,2

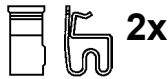
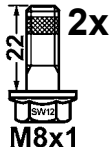

**13.0460-2857.2 602857**



OPEL, VAUXHALL



TRW

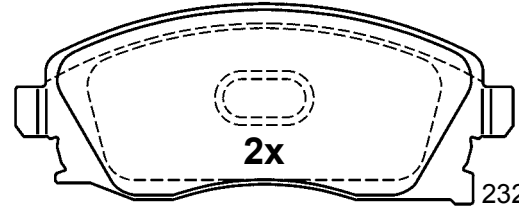

23225 17,0

131,5 x 52,3 x 17,0

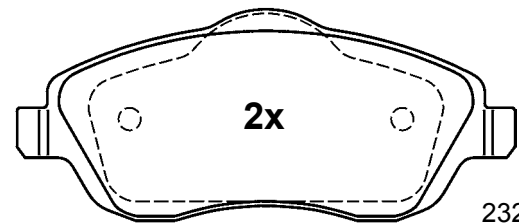

23226 17,0

131,5 x 55,4 x 17,0

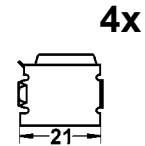
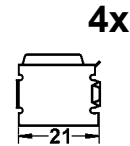
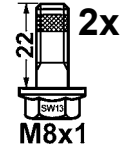
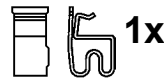

**13.0460-2855.2 602855**



MERCEDES BENZ



TRW

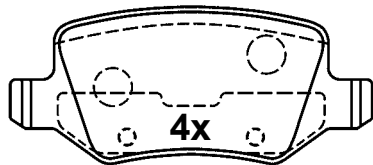

23138 14,6

95,7 x 41,3 x 14,6

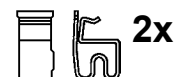
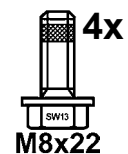
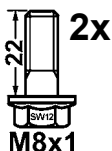

**13.0460-2858.2 602858**



OPEL, VAUXHALL



TRW

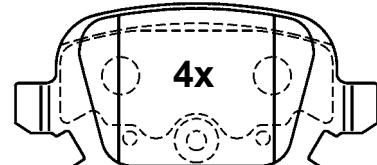

23284 14,0

95,6 x 43,8 x 14,0



# Abbildungen Scheibenbremsbeläge

Illustrations disc brake pads - Illustrazioni pastiglie freno -

Illustrations plaquettes de frein - Ilustraciones pastillas de freno

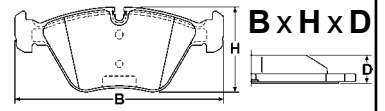

Maßstab - scale - scala - échelle - escala 1:2

## 13.0460-2859.2 602859



FORD, SEAT, VOLKSWAGEN



TRW

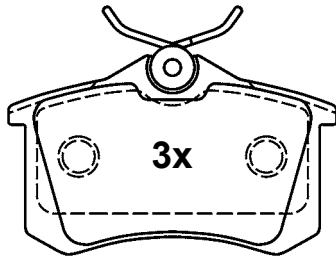

3x

20961 17,2

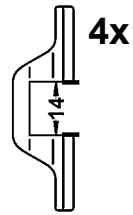

4x

205mm

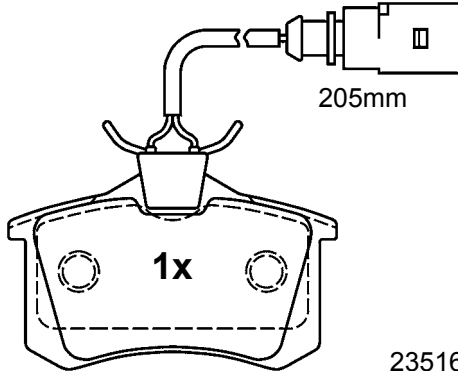

1x

23516 17,2



4x

M8x21

87,6 x 52,9 x 17,2

## 13.0460-2863.2 602863



CITROEN, FIAT, LANCIA  
PEUGEOT



TRW

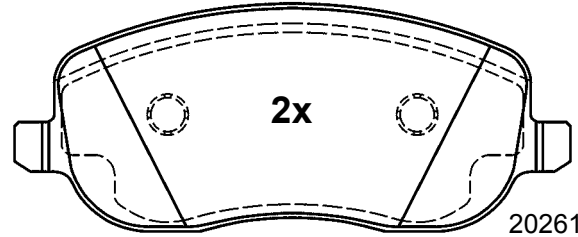

2x

20261 19,0

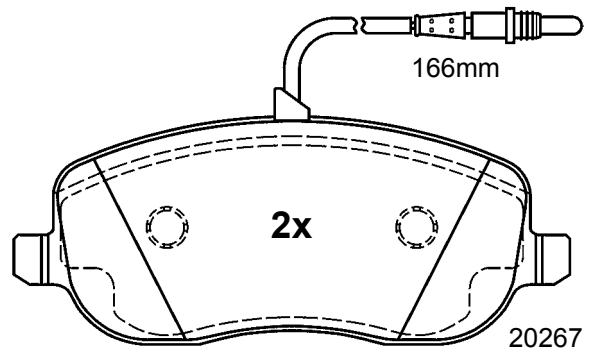

166mm

2x

20267 19,0

146,6 x 60,0 19,0

## 13.0460-2860.2 602860



AUDI



TRW

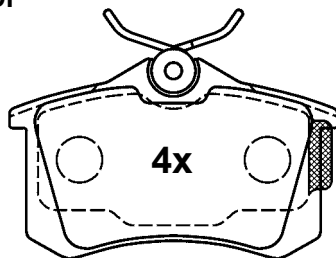

4x

23554 16,3

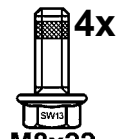

4x

M8x22

86,8 x 52,9 x 16,3

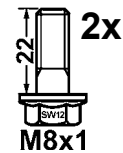

2x

M8x1

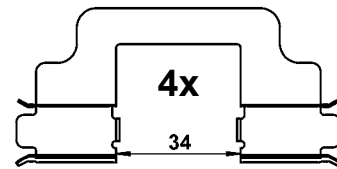

4x

34

## 13.0460-2864.2 602864



AUDI, SEAT, VOLKSWAGEN



TRW

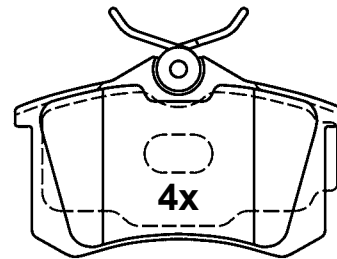

4x

20961 17,4

87,2 x 52,9 x 17,4

## 13.0460-2862.2 602862



CITROEN, PEUGEOT



TRW

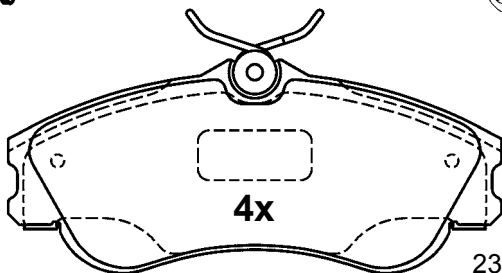

4x

23346 19,0



2x

M8x21

129,9 x 56,2 x 19,0



2x

M8x21



# Abbildungen Scheibenbremsbeläge

Illustrations disc brake pads - Illustrazioni pastiglie freno -

Illustrations plaquettes de frein - Ilustraciones pastillas de freno

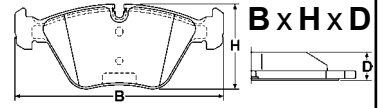

Maßstab - scale - scala - échelle - escala 1:2

## 13.0460-2867.2 602867



ALFA ROMEO, FIAT, LANCIA



TRW

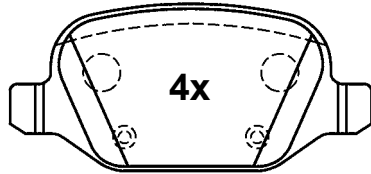

23517 16,6

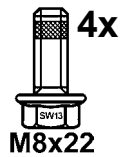

95,6 x 43,9 x 16,6

## 13.0460-2869.2 602869



PEUGEOT



TRW

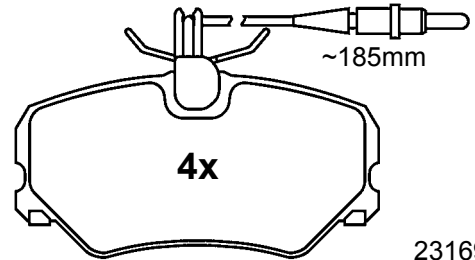

23169 19,4

## 13.0460-2868.2 602868



KIA, OPEL, VAUXHALL



TRW

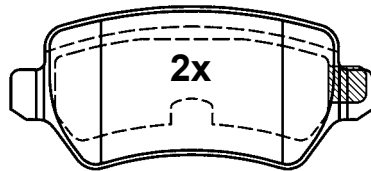

23417 15,3

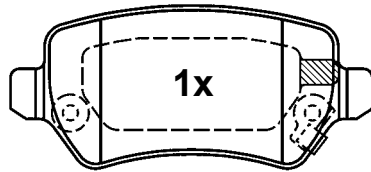

23654 15,3

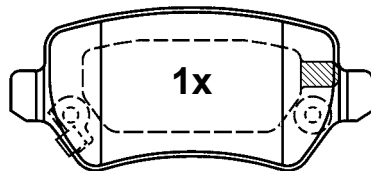

23655 15,3

95,3 x 42,8 x 15,3

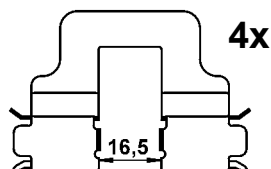
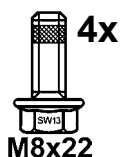

94,8 x 48,9 x 19,4

## 13.0460-2870.2 602870



NISSAN, OPEL, RENAULT  
VAUXHALL



TRW

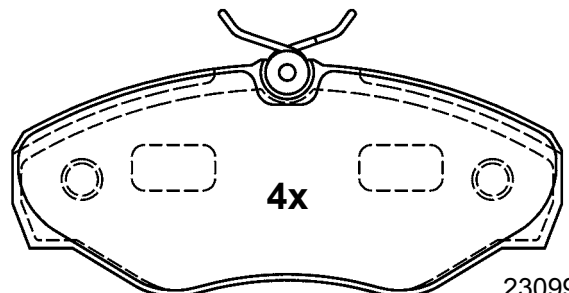

23099 18,4

145,0 x 62,4 x 18,4

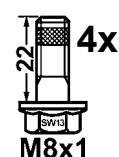

# Abbildungen Scheibenbremsbeläge

Illustrations disc brake pads - Illustrazioni pastiglie freno -

Illustrations plaquettes de frein - Ilustraciones pastillas de freno

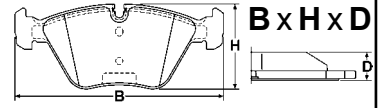

Maßstab - scale - scala - échelle - escala 1:2

**13.0460-2871.2 602871**



CITROËN



TRW

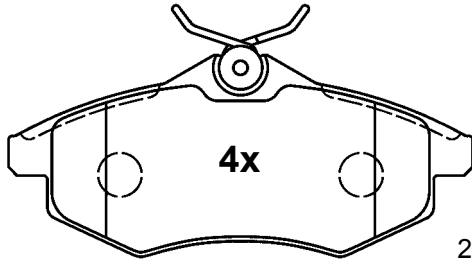

23407 19,0



122,6 x 53,2 x 19,0

**13.0460-2874.2 602874**



VOLKSWAGEN



TRW

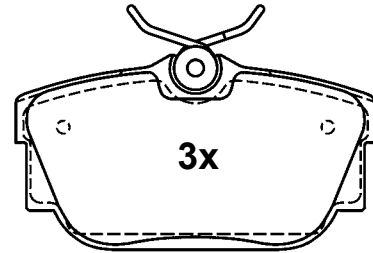

23224 16,5

**13.0460-2872.2 602872**



FORD, SEAT, VOLKSWAGEN



TRW

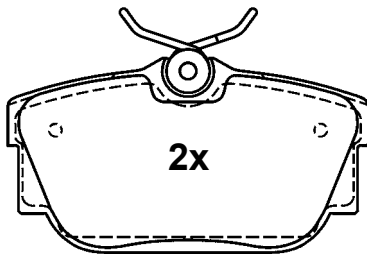

23224 16,5

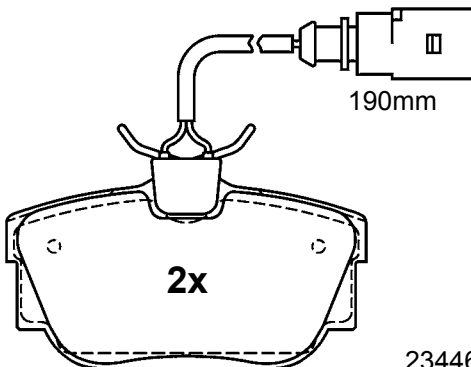

190mm

94,7 x 50,9 x 16,5



M8x21

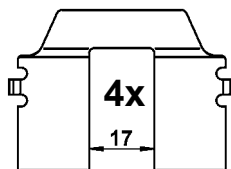

4x

17

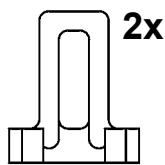

2x



M8x21

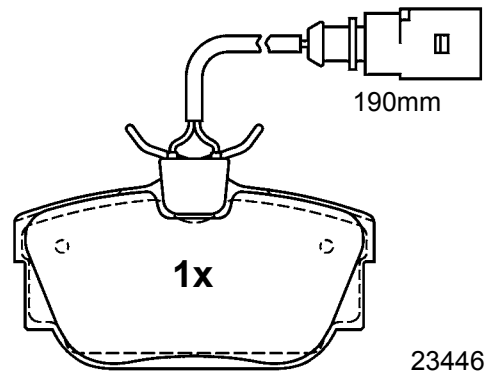

190mm

23446 16,5

94,7 x 50,9 x 16,5

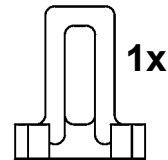

1x

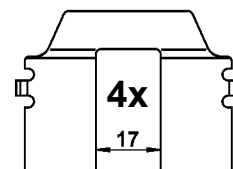

4x

17

# Abbildungen Scheibenbremsbeläge

Illustrations disc brake pads - Illustrazioni pastiglie freno -

Illustrations plaquettes de frein - Ilustraciones pastillas de freno

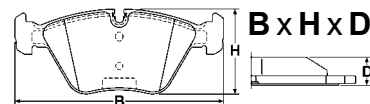

Maßstab - scale - scala - échelle - escala 1:2

## 13.0460-2875.2 602875



AUDI, VOLKSWAGEN



TRW

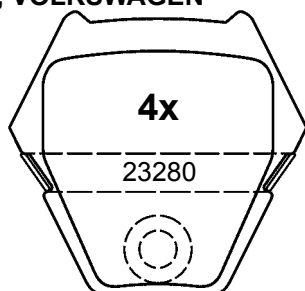

77,1 x 74,7 x 17,5

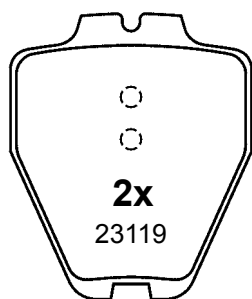
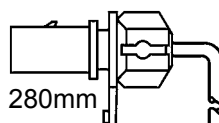

63,2 x 75,3 x 17,5

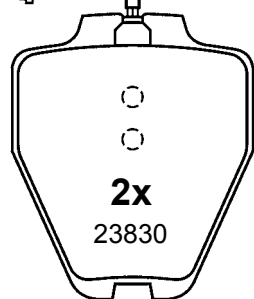

63,2 x 75,3 x 17,5

## 13.0460-2877.2 602877



SEAT, VOLKSWAGEN



TRW

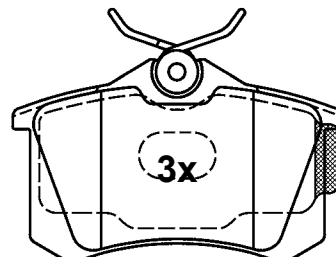

23554 17,2

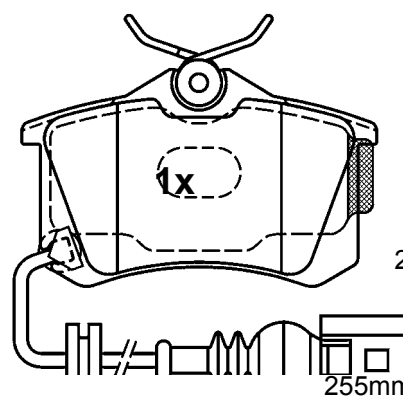

23823 17,2

87,2 x 52,9 x 17,2

## 13.0460-2876.2 602876



AUDI



TRW

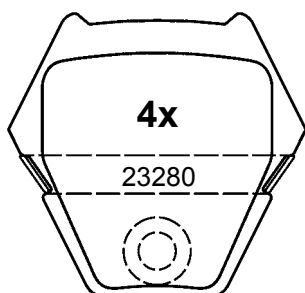

77,1 x 74,7 x 17,5

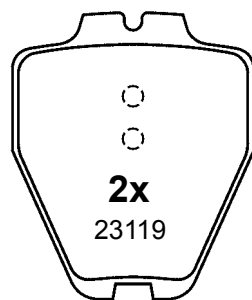
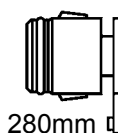

63,2 x 75,3 x 17,5

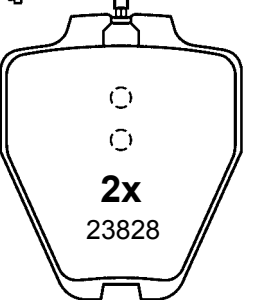

63,2 x 75,3 x 17,5

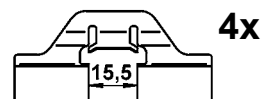
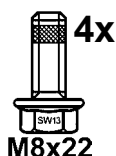

## 13.0460-2878.2 602878



LANCIA



TRW

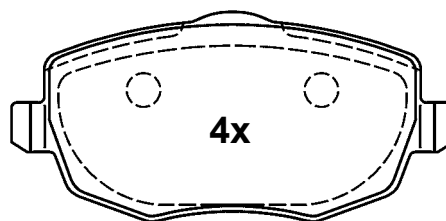

24073 16,7

116,8 x 55,2 x 16,7

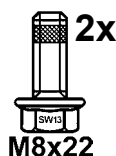

# Abbildungen Scheibenbremsbeläge

Illustrations disc brake pads - Illustrazioni pastiglie freno -

Illustrations plaquettes de frein - Ilustraciones pastillas de freno

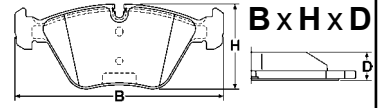

Maßstab - scale - scala - échelle - escala 1:2

**13.0460-2879.2 602879**

FIAT, LANCIA

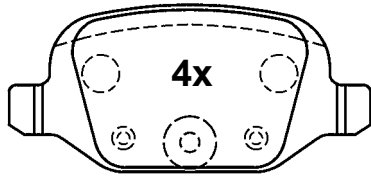

23601 13,7

95,6 x 43,9 x 13,7

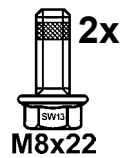

**13.0460-2881.2 602881**

CITROEN

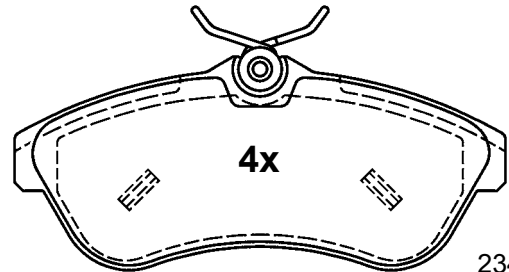

23409 19,3

128,8 x 56,1 x 19,3



**13.0460-2880.2 602880**

AUDI, SEAT, SKODA,  
VOLKSWAGEN

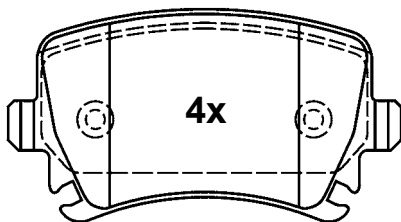

23914 17,1

105,3 x 55,9 x 17,1

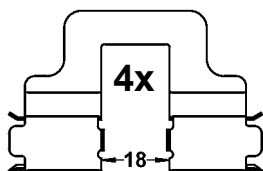
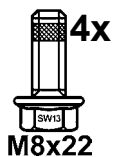

**13.0460-2882.2 602882**

VOLKSWAGEN

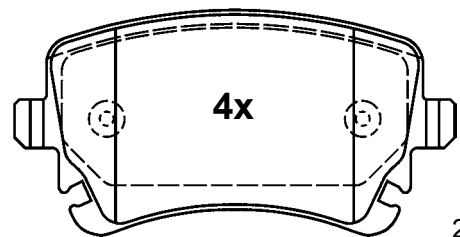

23326 17,4

116,1 x 59 x 17,4

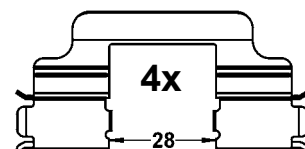
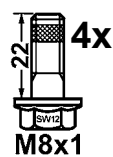
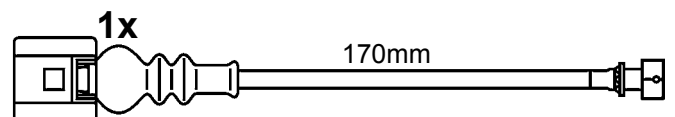

# Abbildungen Scheibenbremsbeläge

Illustrations disc brake pads - Illustrazioni pastiglie freno -

Illustrations plaquettes de frein - Ilustraciones pastillas de freno

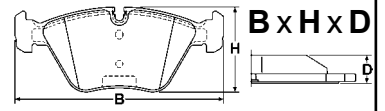

Maßstab - scale - scala - échelle - escala 1:2

## 13.0460-2883.2 602883

SEAT, SKODA, VOLKSWAGEN

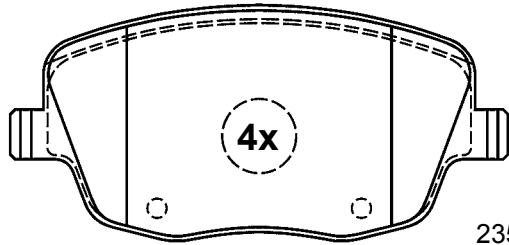

23581 18,8



131,4 x 62,0 x 18,8

## 13.0460-2885.2 602885

MERCEDES BENZ

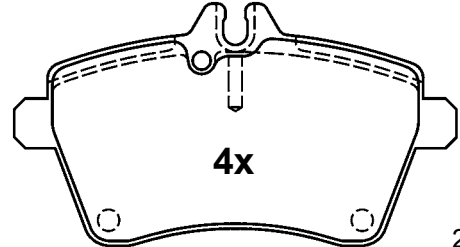

24077 19,1

116,4 x 63,8 x 19,1

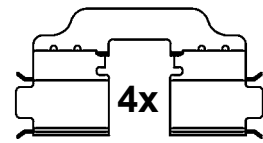

## 13.0460-2884.2 602884

SEAT, SKODA, VOLKSWAGEN

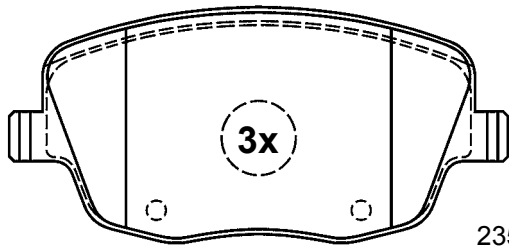

23581 18,8

## 13.0460-2886.2 602886

AUDI, SEAT, VOLKSWAGEN

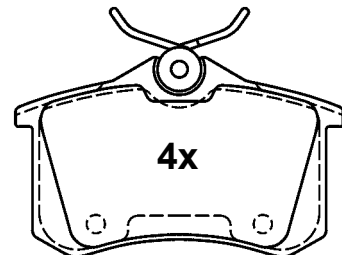

20961 16,2

87,5 x 52,9 x 16,2



## 13.0460-2887.2 602887

AUDI, VOLKSWAGEN

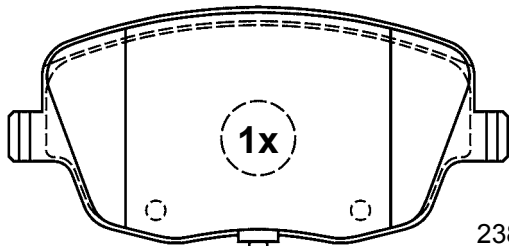

23843 18,8

160mm

131,4 x 62,0 x 18,8

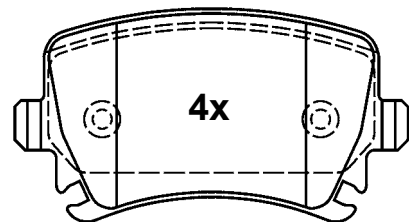
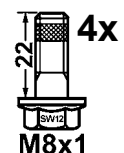

23914 17,1

105,3 x 55,9 x 17,1

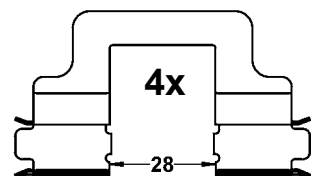

# Abbildungen Scheibenbremsbeläge

Illustrations disc brake pads - Illustrazioni pastiglie freno -

Illustrations plaquettes de frein - Ilustraciones pastillas de freno

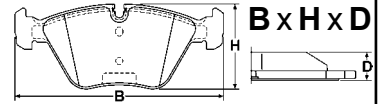

Maßstab - scale - scala - échelle - escala 1:2

**13.0460-2888.2 602888**

AUDI, BENTLEY

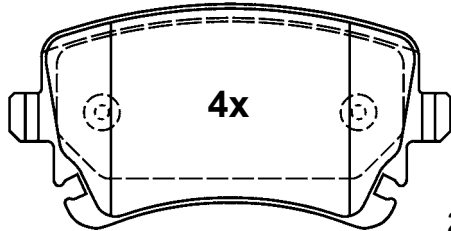

23326 17,4

116,1 x 59,0 x 17,4



**13.0460-2889.2 602889**

AUDI

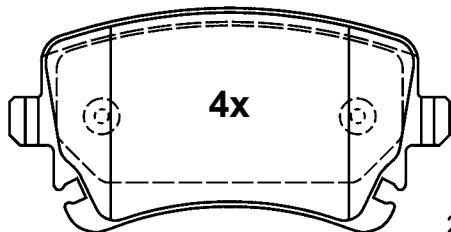

23326 17,4

116,1 x 59,0 x 17,4

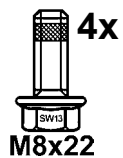

**13.0460-2890.2 602890**

VOLKSWAGEN

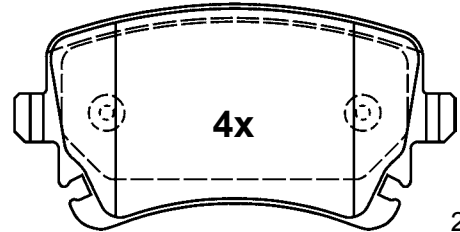

23326 17,4

116,1 x 59,0 x 17,4

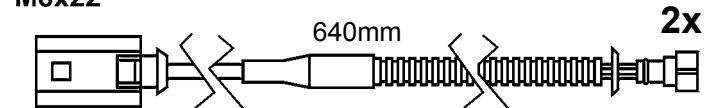

**13.0460-2891.2 602891**

PEUGEOT

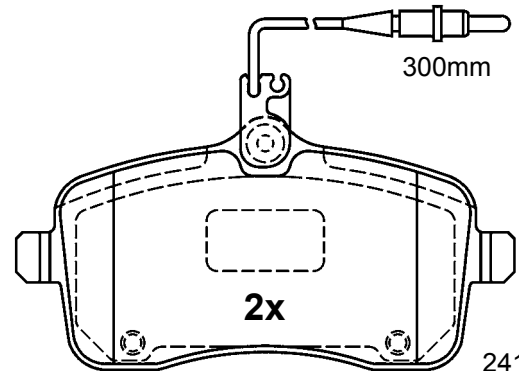

24134 19,6

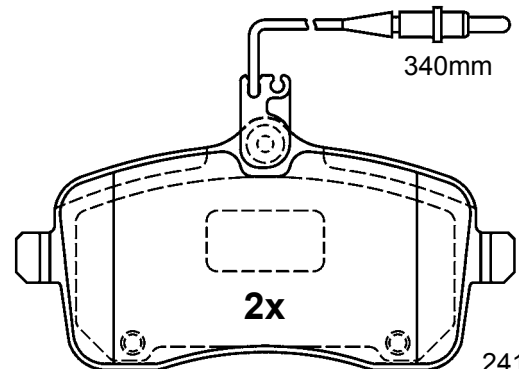

24175 19,6

131,4 x 67,5 x 19,6





# Abbildungen Scheibenbremsbeläge

Illustrations disc brake pads - Illustrazioni pastiglie freno -

Illustrations plaquettes de frein - Ilustraciones pastillas de freno

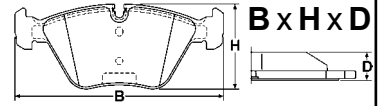

Maßstab - scale - scala - échelle - escala 1:2

## 13.0460-2892.2 602892



CITROEN, PEUGEOT



TRW

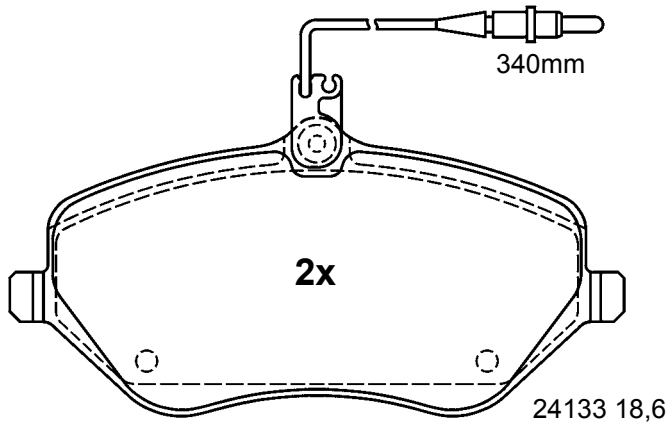
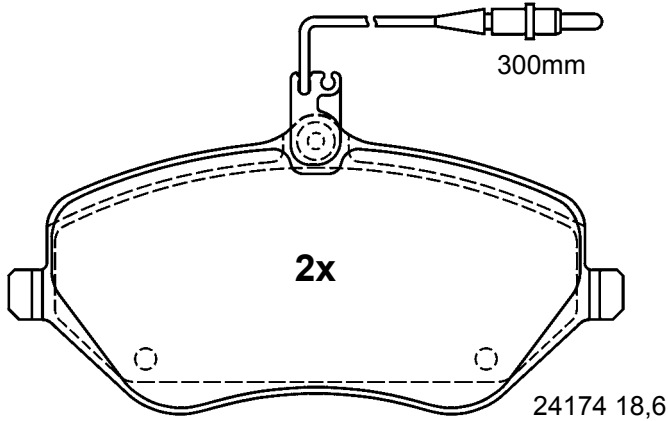

162,3 x 79,0 18,6

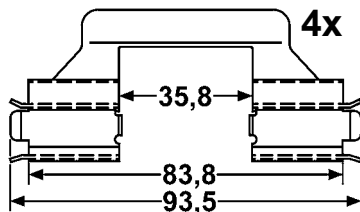

## 13.0460-2893.2 602893



CITROEN, PEUGEOT



TRW

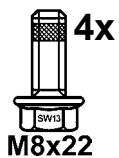
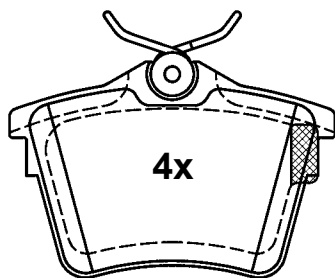

86,1 x 56,9 x 17,7

## 13.0460-2894.2 602894



AUDI, SEAT, SKODA  
VOLKSWAGEN



TRW

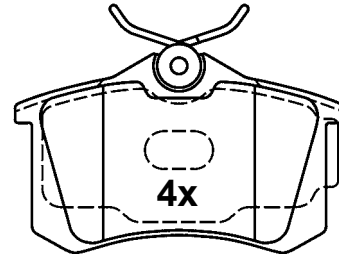

87,5 x 52,9 x 17,4

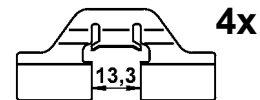
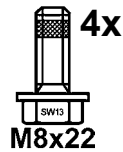

## 13.0460-2895.2 602895



RENAULT



TRW

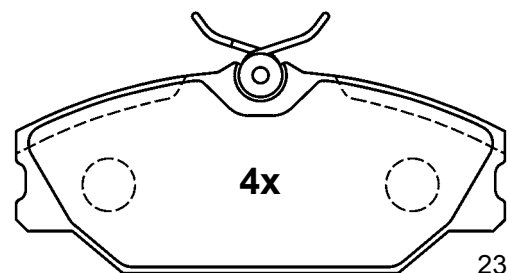

128,6 x 55,5 x 18,0

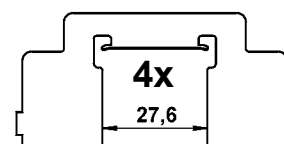

# Abbildungen Scheibenbremsbeläge

Illustrations disc brake pads - Illustrazioni pastiglie freno -

Illustrations plaquettes de frein - Ilustraciones pastillas de freno

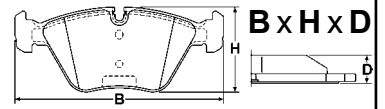

Maßstab - scale - scala - échelle - escala 1:2

## 13.0460-2896.2 602896

MITSUBISHI, SMART

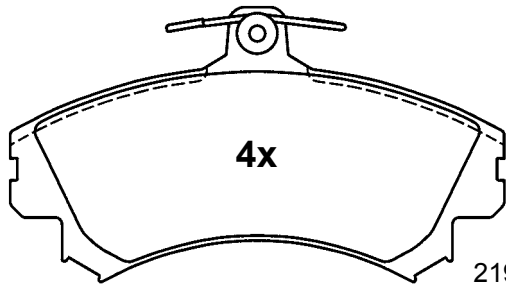

4x

21920 16,6

129,9 x 72,7 x 16,6

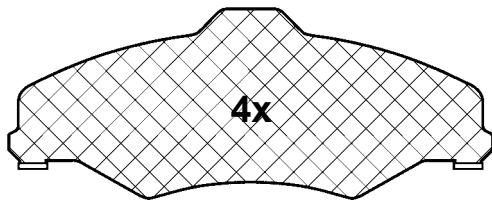

4x

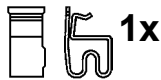
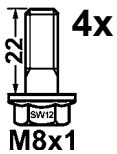

1x

## 13.0460-2897.2 602897

MITSUBISHI, SMART

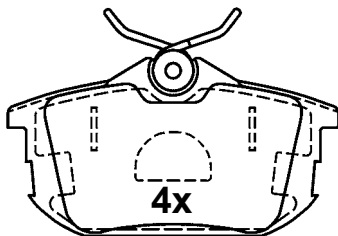

4x

21861 15,2

87,0 x 47,0 x 15,2

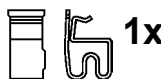

1x

## 13.0460-2898.2 602898

JAGUAR

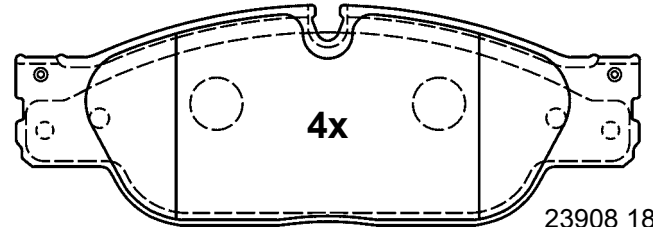

4x

23908 18,0

164,3 x 58,1 x 18,0

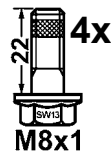

8x

## 13.0460-2899.2 602899

CHRYSLER, JEEP

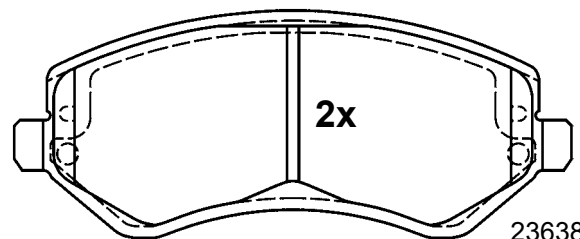

2x

23638 18,3

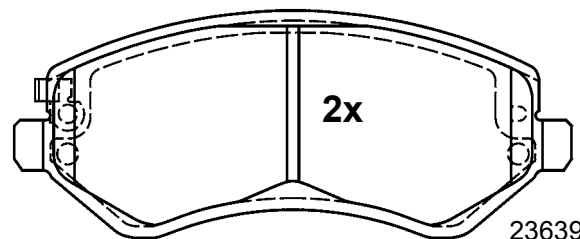

2x

23639 18,3

146,4 x 59,4 x 18,3

# Abbildungen Scheibenbremsbeläge

Illustrations disc brake pads - Illustrazioni pastiglie freno -

Illustrations plaquettes de frein - Ilustraciones pastillas de freno

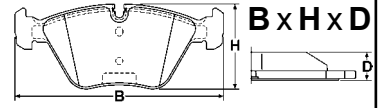

Maßstab - scale - scala - échelle - escala 1:2

**13.0460-2901.2 602901**



ALFA ROMEO, CITROEN,  
FIAT, PEUGEOT



TRW

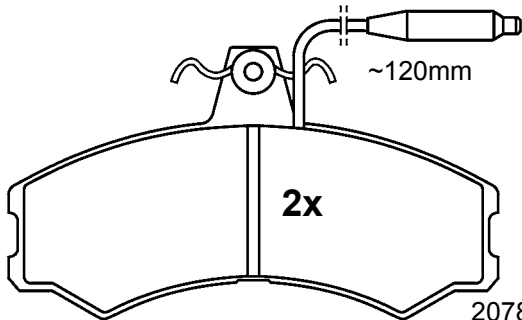
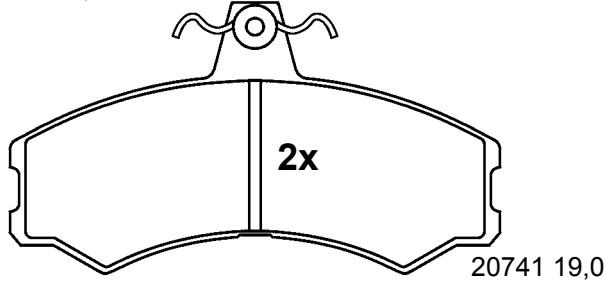

130,0 x 71,4 x 19,0

**13.0460-2903.2 602903**



VOLKSWAGEN



TRW

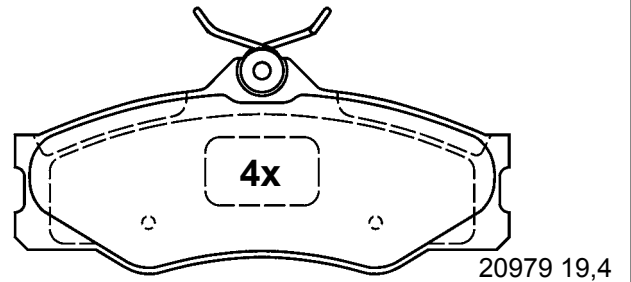

130,0 x 56,7 x 19,4



**13.0460-2902.2 602902**



CITROEN, FIAT, PEUGEOT



TRW

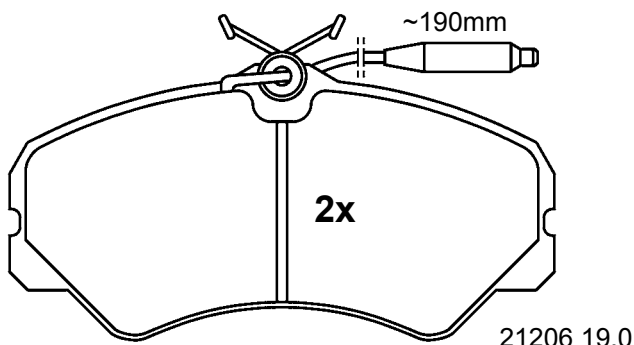
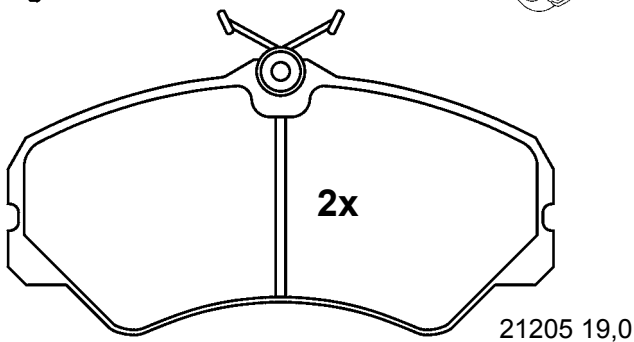

145,0 x 71,6 x 19,0

**13.0460-2905.2 602905**



VOLKSWAGEN



TRW

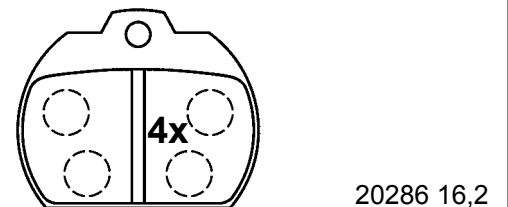

63,3 x 52,1 x 16,2

# Abbildungen Scheibenbremsbeläge

Illustrations disc brake pads - Illustrazioni pastiglie freno -

Illustrations plaquettes de frein - Ilustraciones pastillas de freno

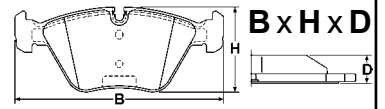

Maßstab - scale - scala - échelle - escala 1:2

## 13.0460-2912.2 602912



FORD



TRW

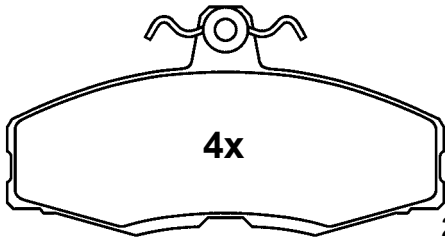

4x

20861 17,7

115,0 x 60,3 x 17,7



M8x21

## 13.0460-2925.2 602925



AUDI



TRW

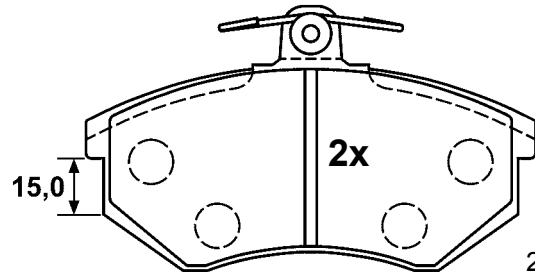

2x

15,0

20669 19,0

## 13.0460-2921.2 602921



BMW



TRW

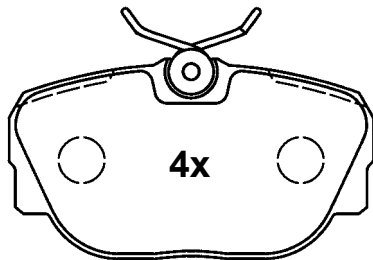

4x

21173 17,0

94,8 x 51,9 x 17,0



M8x21

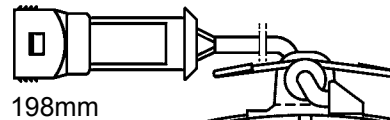

198mm

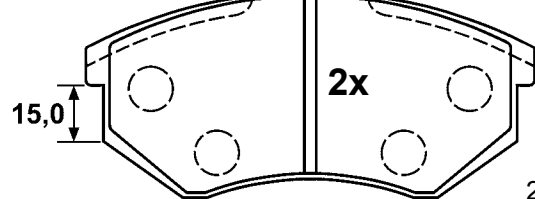

2x

15,0

20901 19,0

119,0 x 69,5 x 19,0



M8x21

## 13.0460-2923.2 602923



MERCEDES BENZ



TRW

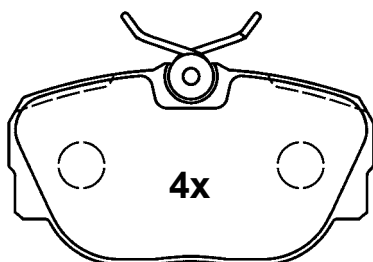

4x

21055 17,0

94,7 x 51,9 x 17,0



M8x21

## 13.0460-2926.2 602926



AUDI



TRW

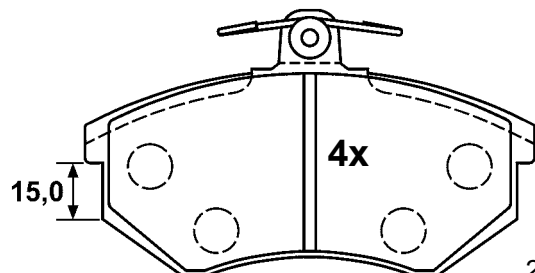

4x

15,0

20669 15,7

119,0 x 69,5 x 15,7



M8x21

# Abbildungen Scheibenbremsbeläge

Illustrations disc brake pads - Illustrazioni pastiglie freno -

Illustrations plaquettes de frein - Ilustraciones pastillas de freno

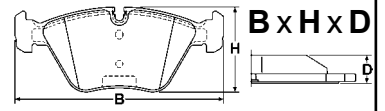

Maßstab - scale - scala - échelle - escala 1:2

**13.0460-2927.2 602927**



MERCEDES BENZ



TRW

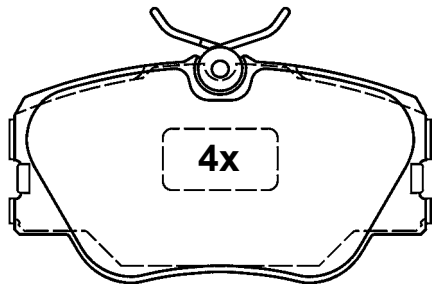

20941 19,3  
(21028)

110,0 x 59,6 x 19,3



M8x21

**13.0460-2933.2 602933**



FORD



TRW

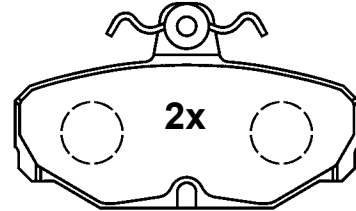

20981 13,8

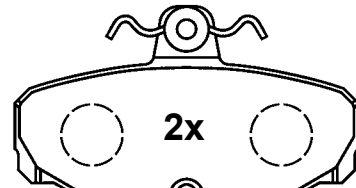

21079 13,8

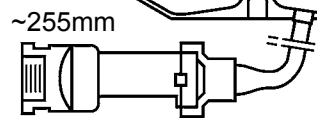

90,0 x 53,8 x 13,8



M8x21

**13.0460-2928.2 602928**



FORD



TRW

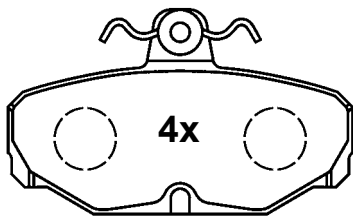

20981 13,8

90,0 x 53,8 x 13,8



M8x21

**13.0460-2934.2 602934**



AUDI



TRW

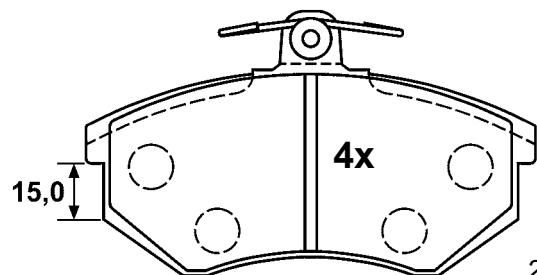

20669 19,0

119,0 x 69,5 x 19,0



M8x21

# Abbildungen Scheibenbremsbeläge

Illustrations disc brake pads - Illustrazioni pastiglie freno -

Illustrations plaquettes de frein - Ilustraciones pastillas de freno

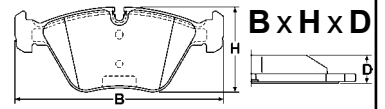

Maßstab - scale - scala - échelle - escala 1:2

**13.0460-2935.2 602935**



VOLVO



TRW

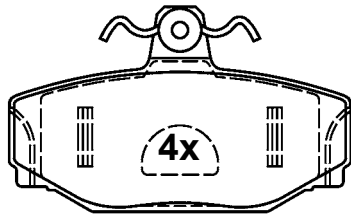

21385 13,8

89,9 x 53,5 x 13,8



M8x21

**13.0460-2937.2 602937**



PEUGEOT, SEAT, VOLKSWAGEN



TRW

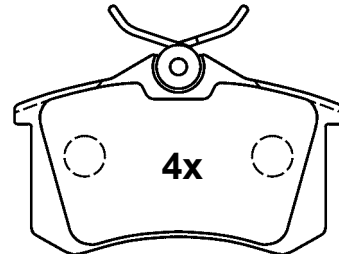

20961 15,2

87,6 x 52,9 x 15,2



M8x21

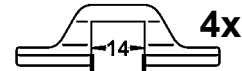

4x

**13.0460-2936.2 602936**



AUD



TRW

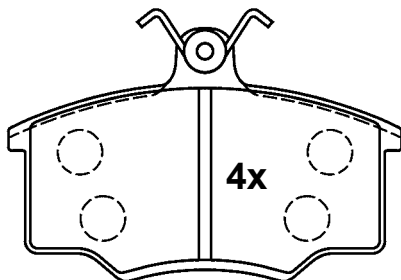

20574 15,3

103,8 x 66,6 x 15,3



M8x21

**13.0460-2941.2 602941**



AUTOBIANCHI, FIAT, LANCIA



TRW

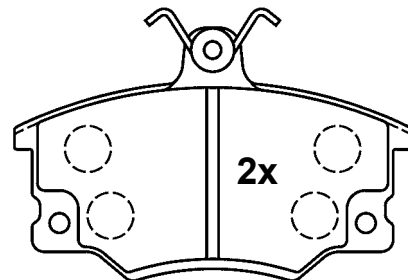

20838 17,0

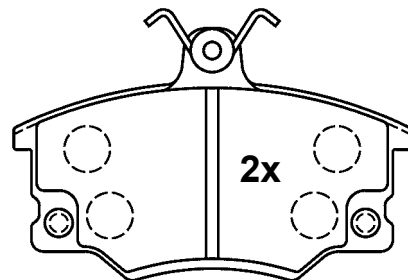

20839 17,0

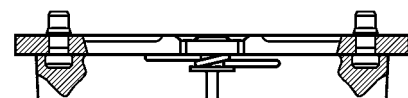

M8x21

104,6 x 66,6 x 17,0



# Abbildungen Scheibenbremsbeläge

Illustrations disc brake pads - Illustrazioni pastiglie freno -

Illustrations plaquettes de frein - Ilustraciones pastillas de freno

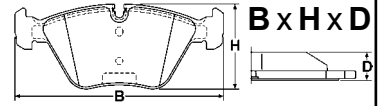

Maßstab - scale - scala - échelle - escala 1:2

## 13.0460-2943.2 602943



VOLVO

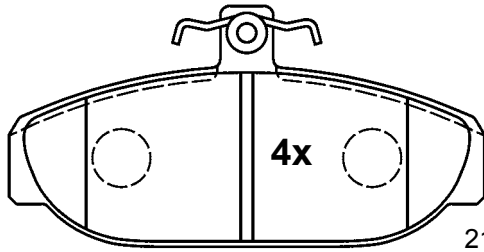

21266 17,0

124,8 x 64,8 x 17,0



## 13.0460-2948.2 602948



FIAT, LANCIA

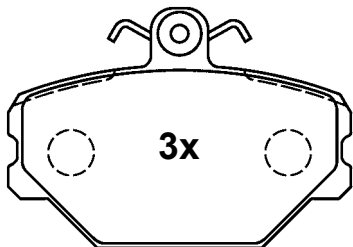

21100 16,7

90,0 x 63,0 x 16,7



## 13.0460-2949.2 602949



ALFA ROMEO, FIAT, LANCIA

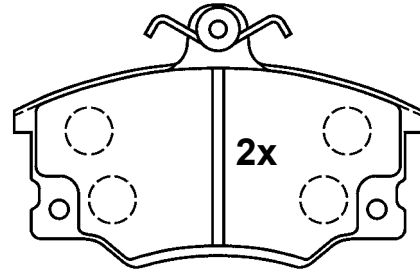

20838 17,0

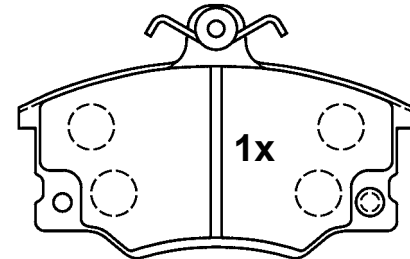

20833 17,0

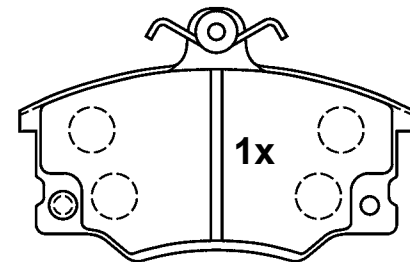
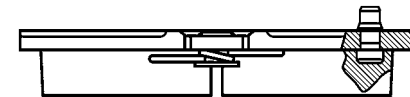

20834 17,0



104,0 x 67,0 x 17,0

## 13.0460-2951.2 602951



ALFA ROMEO, FIAT, LANCIA

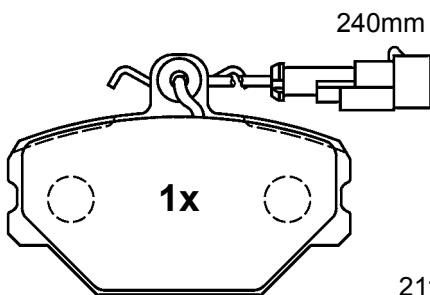

21105 16,7

90,0 x 63,0 x 16,7

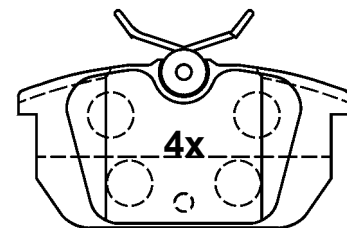

21103 14,2

87,0 x 44,6 x 14,2



# Abbildungen Scheibenbremsbeläge

Illustrations disc brake pads - Illustrazioni pastiglie freno -

Illustrations plaquettes de frein - Ilustraciones pastillas de freno

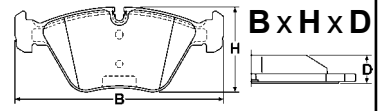

Maßstab - scale - scala - échelle - escala 1:2

## 13.0460-2952.2 602952

FIAT, LANCIA

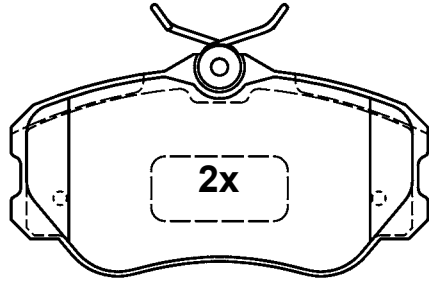

21182 19,4

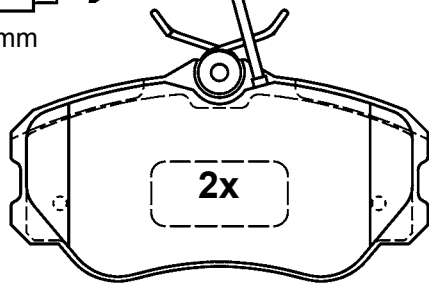
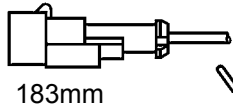

21185 19,4

109,8 x 58,5 x 19,4



## 13.0460-2953.2 602953

VOLVO

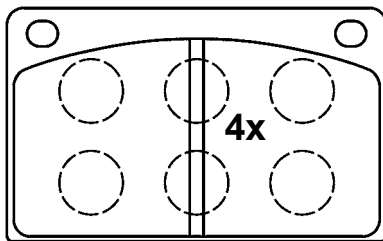

20200 16,0

98,3 x 60,3 x 16,0

## 13.0460-2954.2 602954

VOLVO

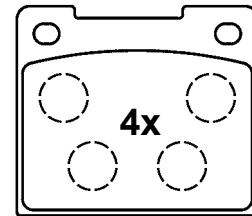

20088 14,3

63,4 x 55,1 x 14,3

## 13.0460-2955.2 602955

PEUGEOT

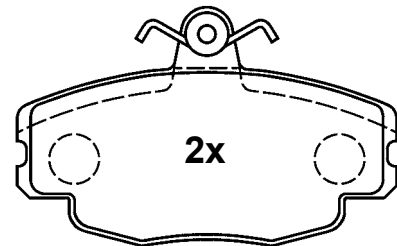

20772 18,0

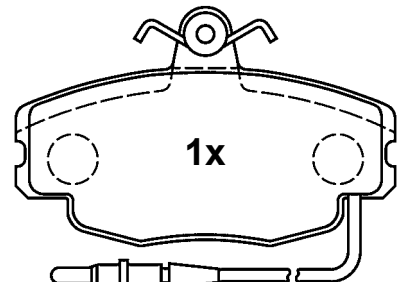

20937 18,0

195mm

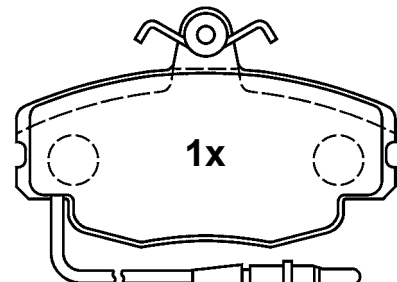

20938 18,0

195mm

100,0 x 63,5 x 18,0



# Abbildungen Scheibenbremsbeläge

Illustrations disc brake pads - Illustrazioni pastiglie freno -

Illustrations plaquettes de frein - Ilustraciones pastillas de freno

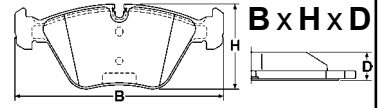

Maßstab - scale - scala - échelle - escala 1:2

## 13.0460-2956.2 602956

PEUGEOT

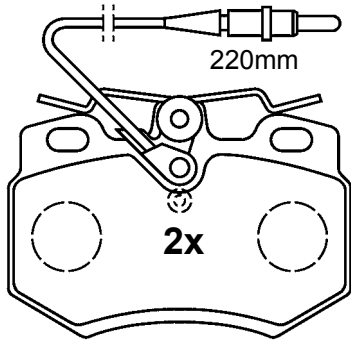

20989 17,7

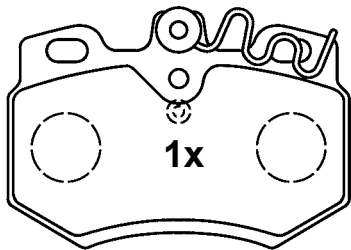

21022 17,7

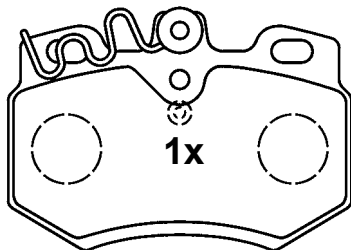

21023 17,7

90,0 x 62,9 x 17,7

## 13.0460-2958.2 602958

SEAT, VOLKSWAGEN

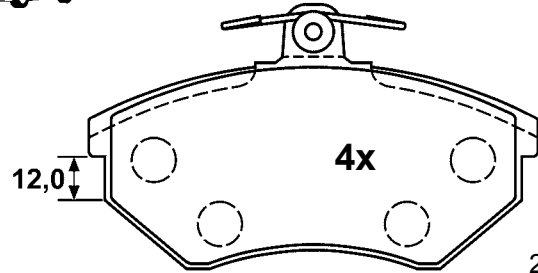

20168 19,3



119,0 x 69,5 x 19,3

## 13.0460-2959.2 602959

CHRYSLER

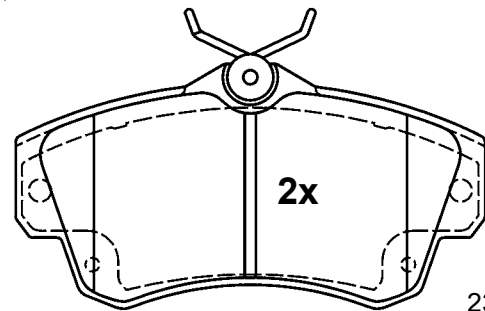

23532 21,0

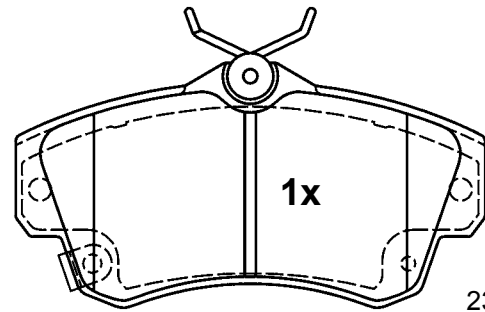

23533 21,0

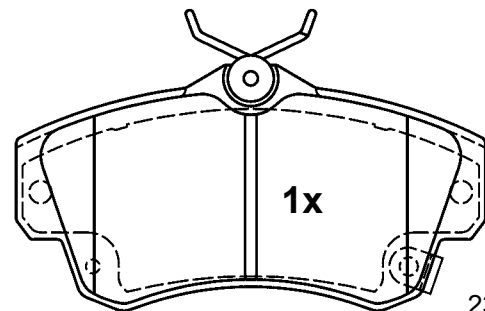

23534 21,0

## 13.0460-2957.2 602957

SEAT, VOLKSWAGEN

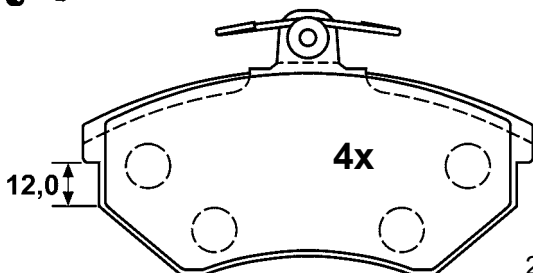

20168 16,0



119,0 x 69,5 x 16,0



123,9 x 64,6 x 21,0



# Abbildungen Scheibenbremsbeläge

Illustrations disc brake pads - Illustrazioni pastiglie freno -

Illustrations plaquettes de frein - Ilustraciones pastillas de freno

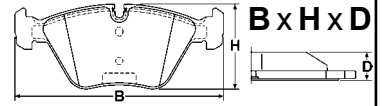

Maßstab - scale - scala - échelle - escala 1:2

## 13.0460-2962.2 602962



ALFA ROMEO, FIAT, LANCIA



TRW

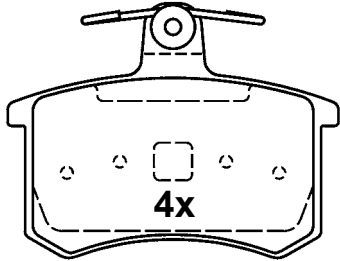

20668 16,6

87,0 x 66,8 x 16,6

## 13.0460-2965.2 602965



LADA



TRW

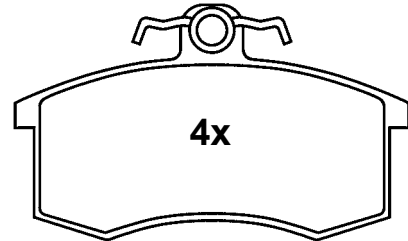

21170 17,3

## 13.0460-2963.2 602963



AUDI



TRW

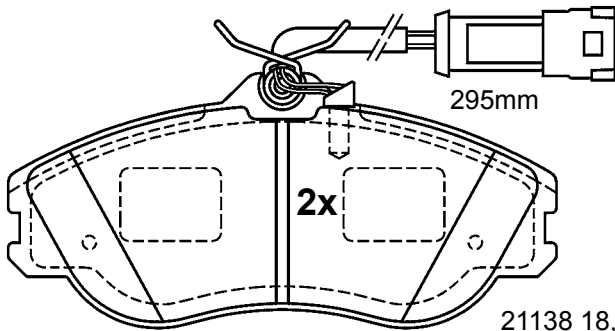

295mm

21138 18,8

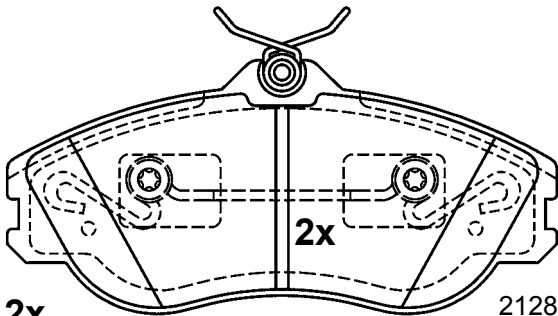

21288 18,8



144,9 x 67,0 x 18,8

## 13.0460-2966.2 602966



LADA



TRW

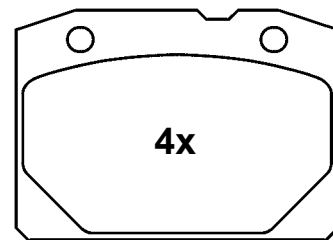

20166 16,0

83,9 x 60,5 x 16,0

## 13.0460-2967.2 602967



RENAULT



TRW

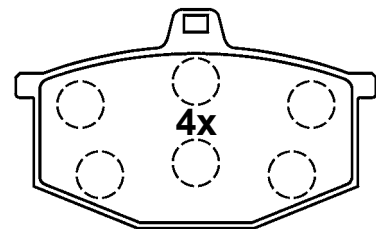

20480 15,5

## 13.0460-2964.2 602964



SKODA, VOLKSWAGEN



TRW

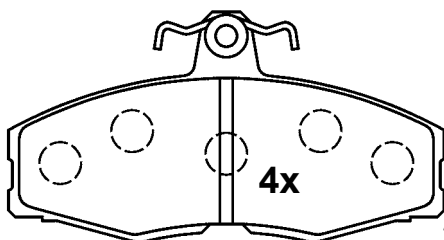

20861 17,5

114,8 x 60,6 x 17,5



93,4 x 56,3 x 15,5

# Abbildungen Scheibenbremsbeläge

Illustrations disc brake pads - Illustrazioni pastiglie freno -

Illustrations plaquettes de frein - Ilustraciones pastillas de freno



Maßstab - scale - scala - échelle - escala 1:2

**13.0460-2968.2 602968**



ALFA ROMEO



TRW

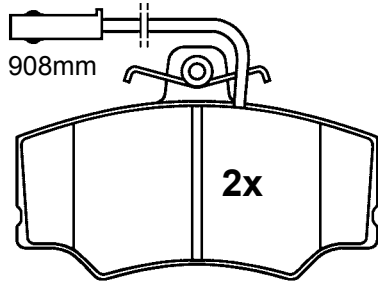

20332 17,0

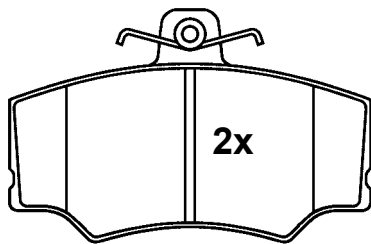

21271 17,0

95,0 x 61,8 x 17,0

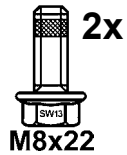

**13.0460-2971.2 602971**



PEUGEOT



TRW

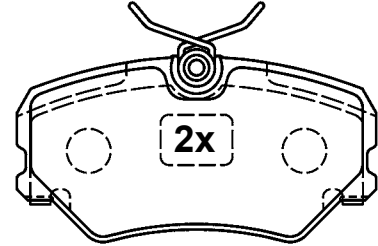

21209 18,5

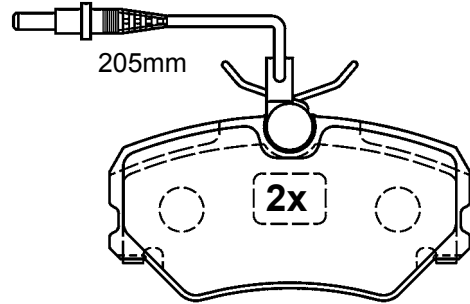

21210 18,5

94,9 x 48,9 x 18,5



**13.0460-2969.2 602969**



ALFA ROMEO



TRW

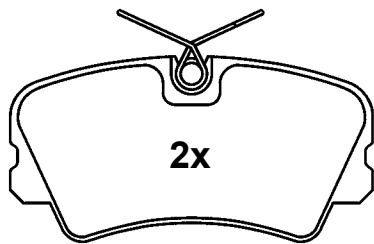

21165 16,8

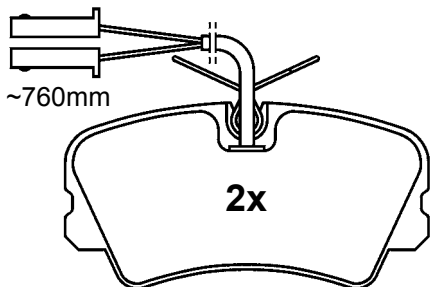

21166 16,8

94,9 x 48,5 x 16,8

**13.0460-2972.2 602972**



VOLKSWAGEN



TRW

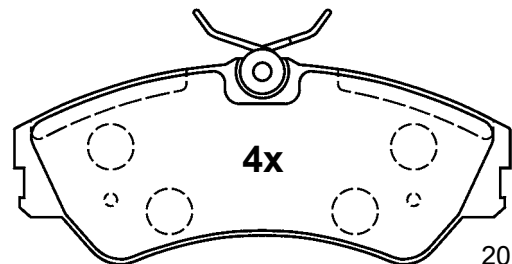

20124 18,9

129,8 x 54,5 x 18,9



# Abbildungen Scheibenbremsbeläge

Illustrations disc brake pads - Illustrazioni pastiglie freno -

Illustrations plaquettes de frein - Ilustraciones pastillas de freno

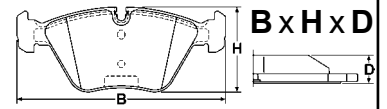

Maßstab - scale - scala - échelle - escala 1:2

## 13.0460-2973.2 602973

VOLKSWAGEN

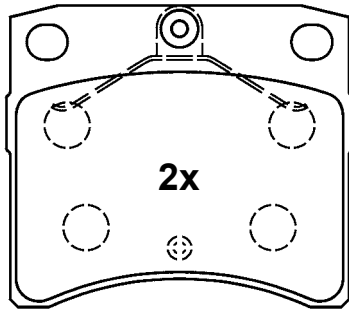

91,5 x 80,0 x 18,0

20651 18,0

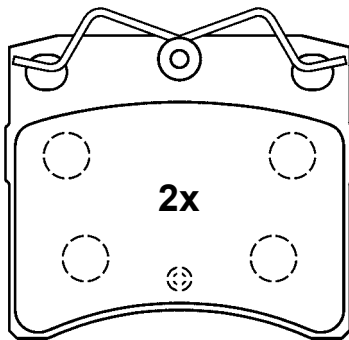

91,5 x 80,0 x 18,0

21635 18,0

## 13.0460-2975.2 602975

MERCEDES BENZ

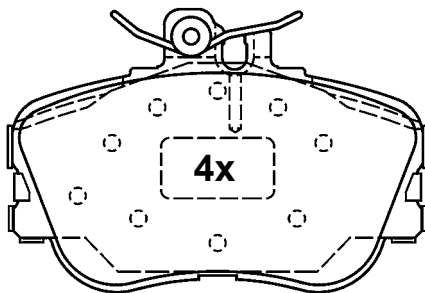

110,0 x 74,5 x 20,3

21439 20,3



M8x21

## 13.0460-2976.2 602976

CITROEN, FIAT, PEUGEOT

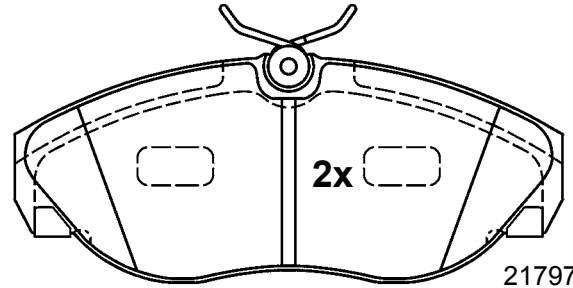

21797 19,7

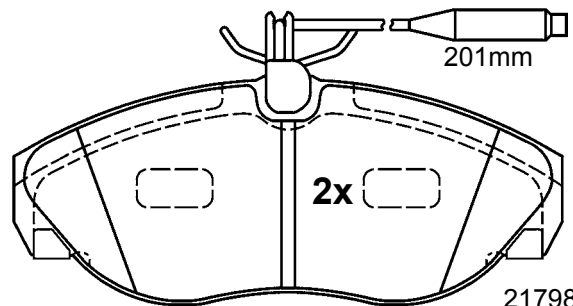

21798 19,7



M8x21

144,8 x 60,8 x 19,7

## 13.0460-2977.2 602977

CITROEN, FIAT, PEUGEOT

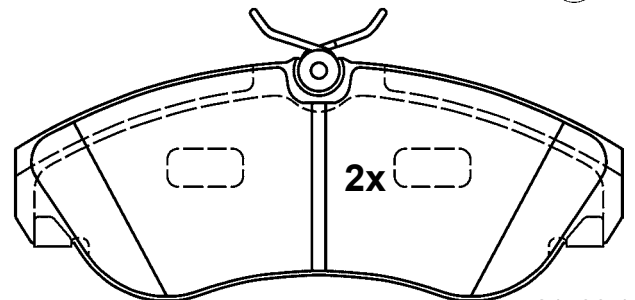

21799 19,7

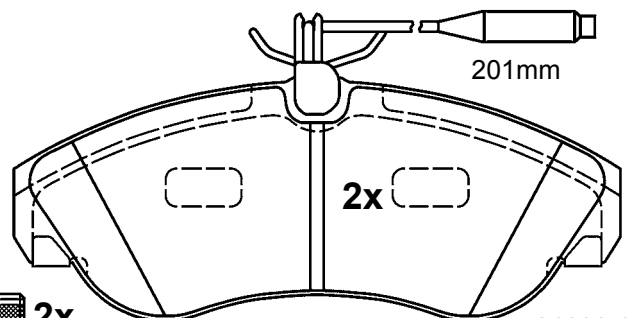

21800 19,7



M8x21

159,8 x 64,1 x 19,7



# Abbildungen Scheibenbremsbeläge

Illustrations disc brake pads - Illustrazioni pastiglie freno -

Illustrations plaquettes de frein - Ilustraciones pastillas de freno



Maßstab - scale - scala - échelle - escala 1:2

## 13.0460-2978.2 602978



CITROEN, FIAT, LANCIA,  
PEUGEOT



TRW

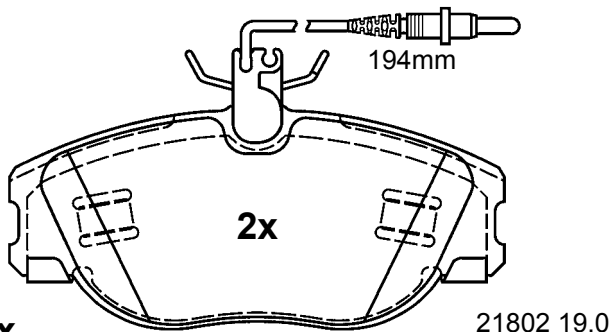
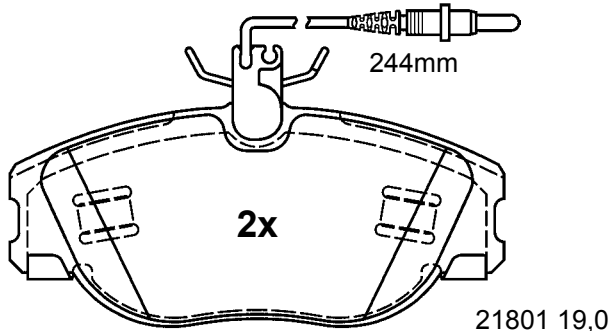

129,8 x 58,7 x 19,0

## 13.0460-2980.2 602980



ALFA ROMEO, LANCIA



TRW

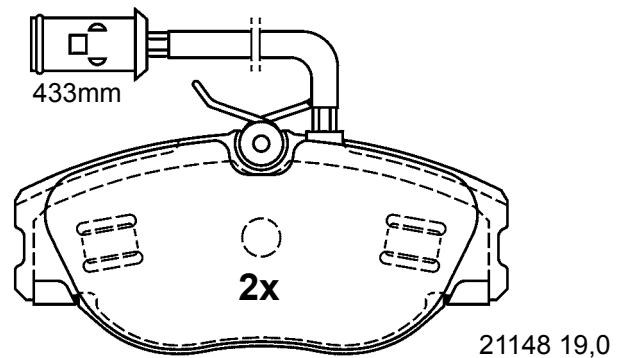
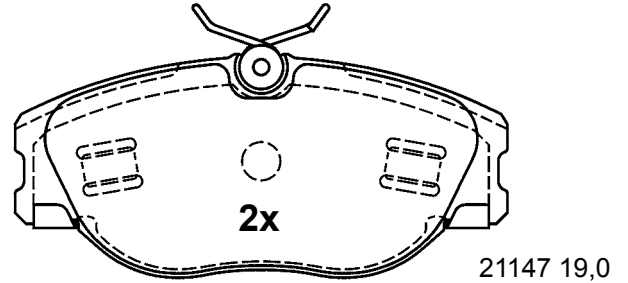

130,0 x 58,7 x 19,0

## 13.0460-2979.2 602979



ALFA ROMEO, FIAT, LANCIA



TRW

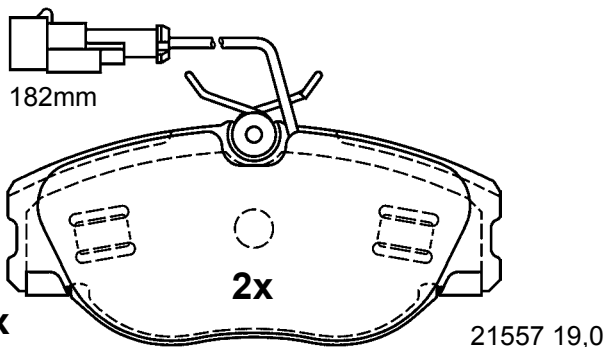
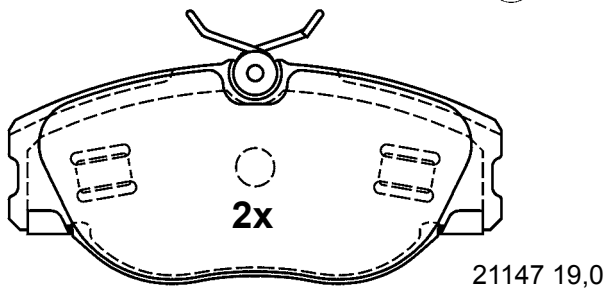

130,0 x 58,7 x 19,0

## 13.0460-2981.2 602981



CITROEN



TRW

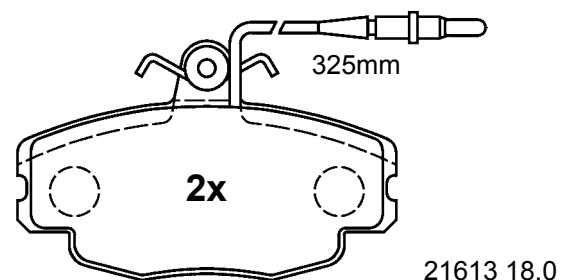
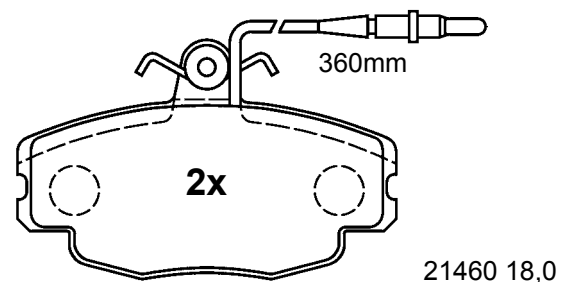

100,0 x 63,5 x 18,0

# Abbildungen Scheibenbremsbeläge

Illustrations disc brake pads - Illustrazioni pastiglie freno -

Illustrations plaquettes de frein - Ilustraciones pastillas de freno

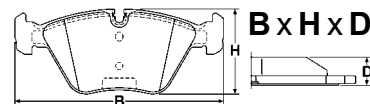

Maßstab - scale - scala - échelle - escala 1:2

**13.0460-2982.2 602982**



VOLKSWAGEN



M8x21

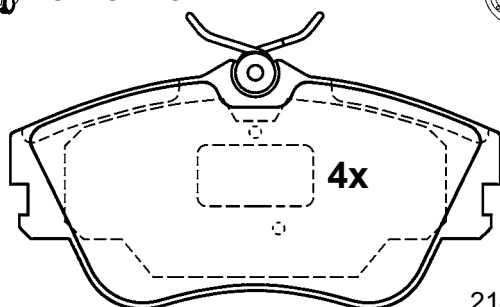

4x

21479 19,2

129,9 x 65,2 x 19,2

**13.0460-2985.2 602985**



VOLVO

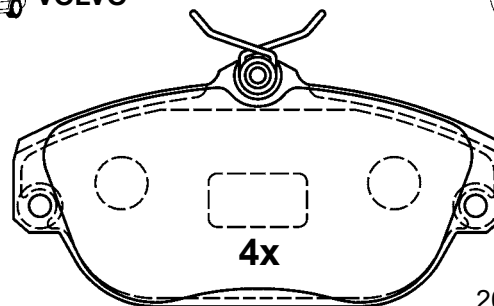

4x

20164 18,2

128,9 x 64,7 x 18,2

**13.0460-2983.2 602983**



RENAULT

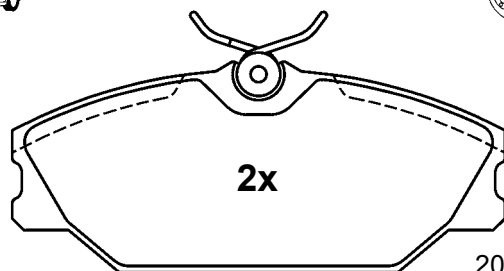

2x

20919 18,0

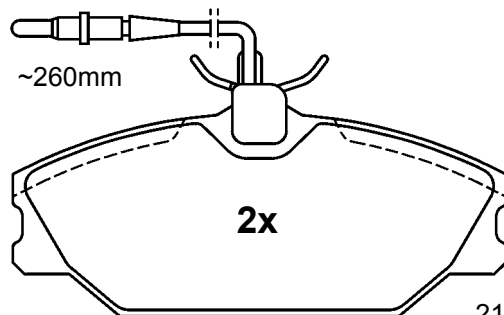

~260mm

2x

21388 18,0

129,9 x 55,5 x 18,0



M8x21

**13.0460-2987.2 602987**



ALFA ROMEO, LANCIA

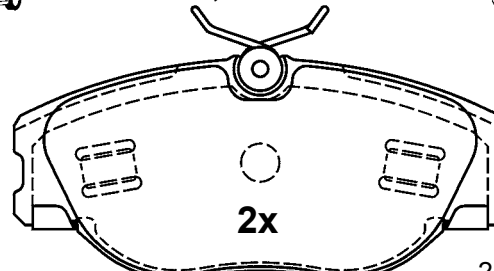

2x

21147 19,0

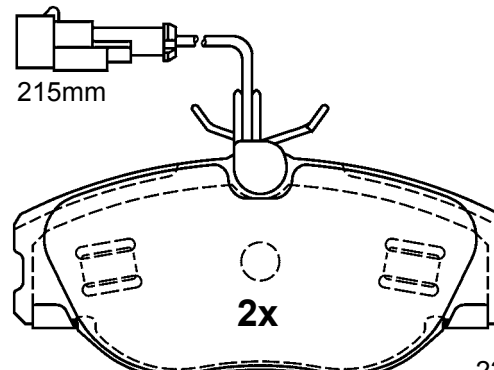

215mm

2x

23168 19,0

130,0 x 58,7 x 19,0



M8x21

**13.0460-2984.2 602984**



SEAT, VOLKSWAGEN

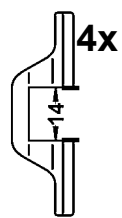

M8x21

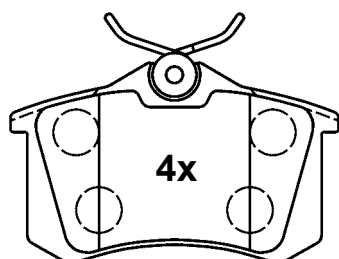

4x

20961 17,2

87,6 x 52,9 x 17,2

**13.0460-2997.2 602997**



SEAT, SUZUKI



M8x21

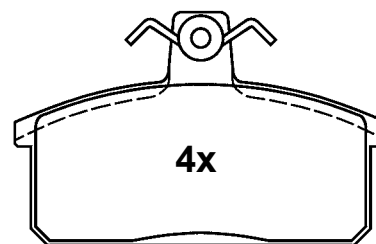

4x

20708 15,8

98,9 x 61,6 x 15,8

# Abbildungen Scheibenbremsbeläge

Illustrations disc brake pads - Illustrazioni pastiglie freno -

Illustrations plaquettes de frein - Ilustraciones pastillas de freno

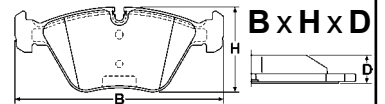

Maßstab - scale - scala - échelle - escala 1:2

## 13.0460-3010.2 603010

 DAF, NSU, OPEL, TALBOT,  
VAUXHALL, VOLKSWAGEN, VOLVO  ATE

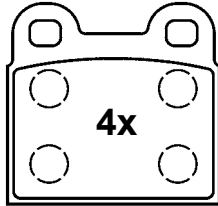

20009 15,0

55,7 x 53,0 x 15,0

## 13.0460-3013.2 603013

 ALFA ROMEO  ATE

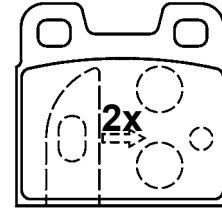

20641 15,0

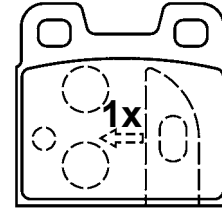

20642 15,0

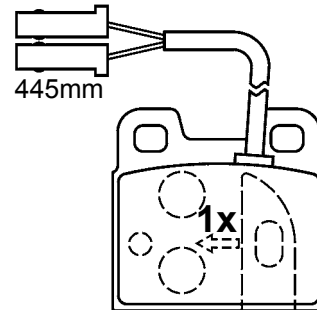

20912 15,0

55,7 x 53,0 x 15,0

## 13.0460-3011.2 603011

 ALFA ROMEO  ATE

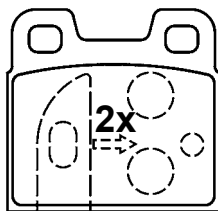

20641 15,0

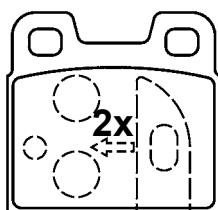

20642 15,0

55,8 x 53,0 x 15,0

## 13.0460-3014.2 603014

 ALFA ROMEO  ATE

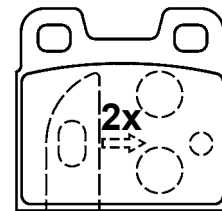

20641 15,0

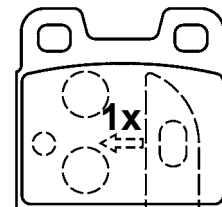

20642 15,0

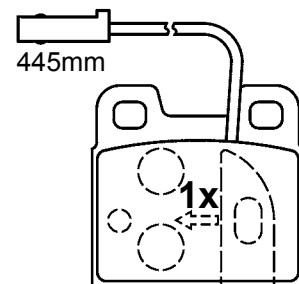

20387 15,0

55,7 x 53,0 x 15,0

# Abbildungen Scheibenbremsbeläge

Illustrations disc brake pads - Illustrazioni pastiglie freno -

Illustrations plaquettes de frein - Ilustraciones pastillas de freno

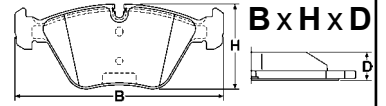

Maßstab - scale - scala - échelle - escala 1:2

**13.0460-3024.2 603024**



BMW



ATE

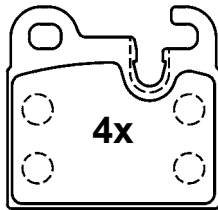

20436 15,0

55,8 x 53,1 x 15,0

**13.0460-3401.2 603401**



VOLVO



ATE

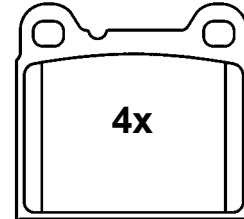

20755 14,4

61,5 x 56,4 x 14,4

**13.0460-3306.2 603306**



SAAB, VOLVO



ATE

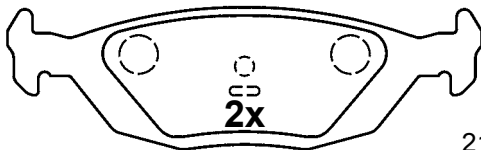

21090 15,0

125,0 x 37,4 x 15,0

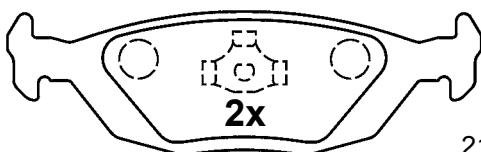

21089 15,0

**13.0460-3403.2 603403**



VOLVO



ATE

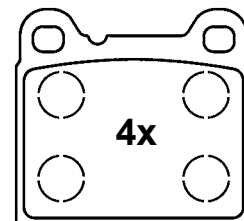

20755 14,4

61,5 x 56,4 x 14,4

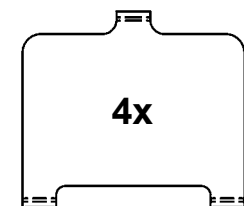

58,4 x 50,9

# Abbildungen Scheibenbremsbeläge

Illustrations disc brake pads - Illustrazioni pastiglie freno -

Illustrations plaquettes de frein - Ilustraciones pastillas de freno

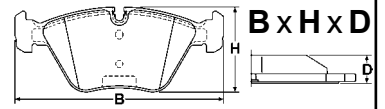

Maßstab - scale - scala - échelle - escala 1:2

**13.0460-3504.2 603504**



MERCEDES BENZ



ATE

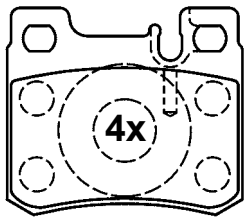

21301 15,5

61,9 x 53,9 x 15,5

**13.0460-3605.2 603605**



BMW, MG, ROVER, SAAB



ATE

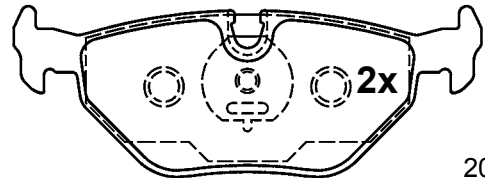

20180 17,3

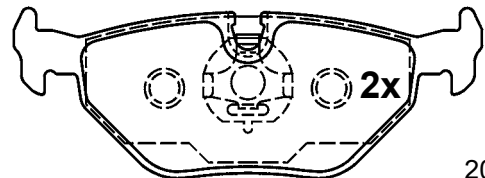

20181 17,3

123,0 x 44,9 x 17,3

**13.0460-3602.2 603602**



AUDI



TRW

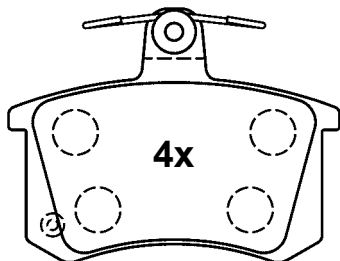

21144 15,8

87,6 x 66,8 x 15,8



M8x21

**13.0460-3612.2 603612**



PORSCHE



ATE

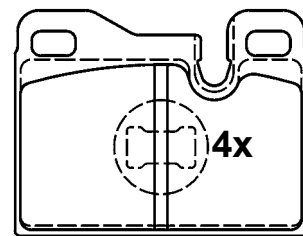

20482 18,5

76,8 x 58,9 x 18,5



# Abbildungen Scheibenbremsbeläge

Illustrations disc brake pads - Illustrazioni pastiglie freno -

Illustrations plaquettes de frein - Ilustraciones pastillas de freno

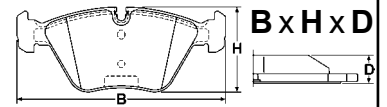

Maßstab - scale - scala - échelle - escala 1:2

**13.0460-3800.2 603800**



NISSAN, OPEL, RENAULT,  
VAUXHALL



BOS

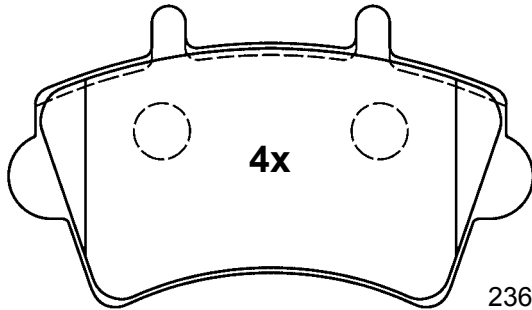

23613 17,7

138,7 x 79,6 x 17,7

**13.0460-3805.2 603805**



MERCEDES BENZ



ATE

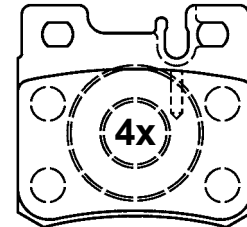

21197 15,0

61,8 x 58,6 x 15,0

**13.0460-3803.2 603803**



BMW



ATE

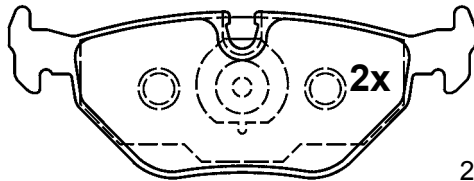

20995 17,3

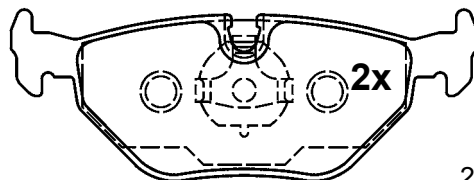

20996 17,3

123,0 x 44,9 x 17,3

**13.0460-3806.2 603806**



NISSAN, OPEL, RENAULT,  
VAUXHALL



BOS

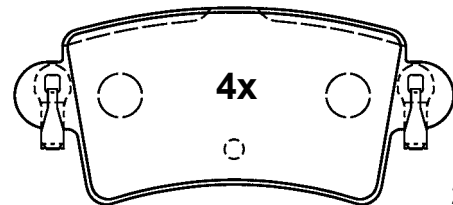

23669 16,8

115,9 x 51,4 x 16,8

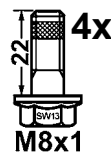

**13.0460-3804.2 603804**



MERCEDES BENZ



ATE

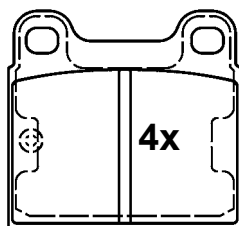

21035 15,0

61,8 x 56,5 x 15,0

**13.0460-3807.2 603807**



FIAT



BDX

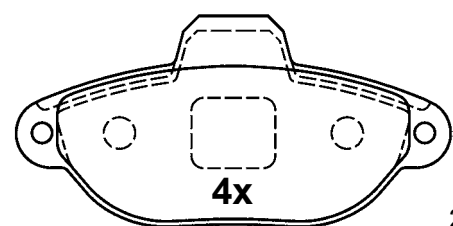

21436 17,0

114,8 x 55,5 x 17,0



2x

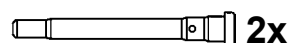

2x



# Abbildungen Scheibenbremsbeläge

Illustrations disc brake pads - Illustrazioni pastiglie freno -

Illustrations plaquettes de frein - Ilustraciones pastillas de freno

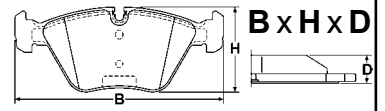

Maßstab - scale - scala - échelle - escala 1:2

**13.0460-3809.2 603809**



FIAT



BOS

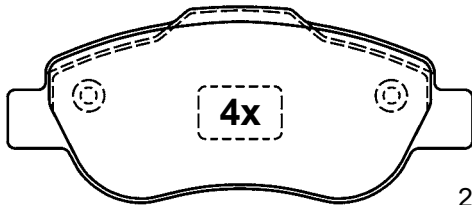

24072 17,9

122,8 x 51,7 x 17,9

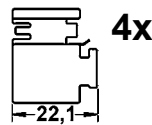
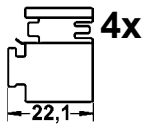
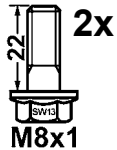

**13.0460-3811.2 603811**



CITROEN, FIAT, LANCIA,  
PEUGEOT



BOS

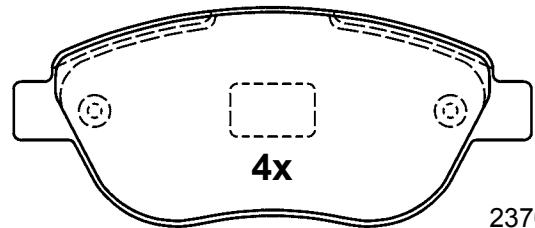

23708 19,2

136,8 x 57,4 x 19,2

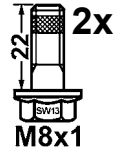

**13.0460-3810.2 603810**



FIAT, LANCIA



BOS

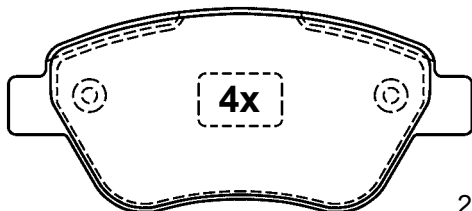

23705 18,1

122,8 x 53,3 x 18,1

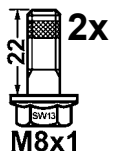

**13.0460-3813.2 603813**



CITROEN, PEUGEOT



BOS

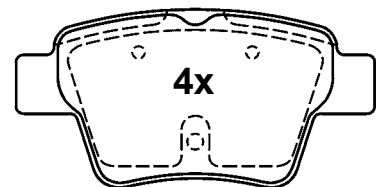

24150 17,6

94,8 x 46,9 x 17,6

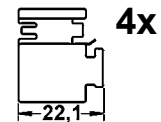
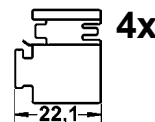
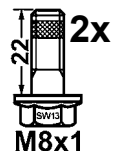

# Abbildungen Scheibenbremsbeläge

Illustrations disc brake pads - Illustrazioni pastiglie freno -

Illustrations plaquettes de frein - Ilustraciones pastillas de freno

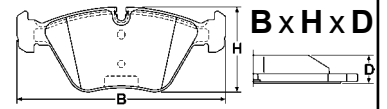

Maßstab - scale - scala - échelle - escala 1:2

**13.0460-3814.2 603814**

RENAULT

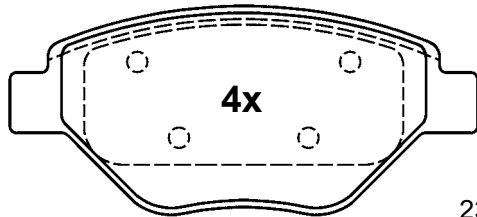

23934 18,2

122,8 x 54,3 x 18,2

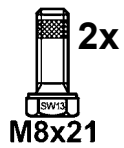

**13.0460-3818.2 603818**

CITROEN, FIAT, LANCIA, PEUGEOT

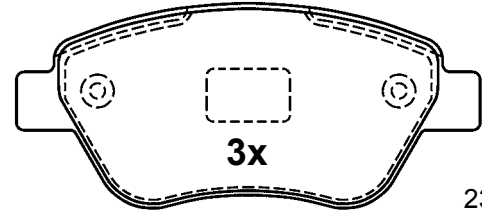

23707 18,1

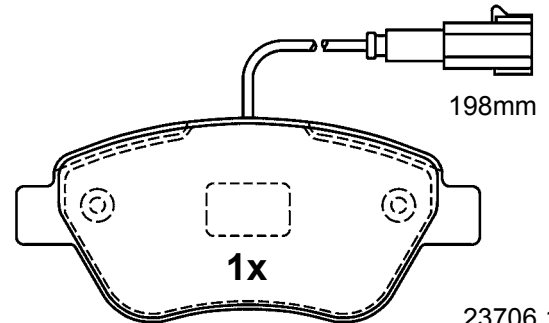

198mm

23706 18,1

122,8 x 53,3 x 18,1

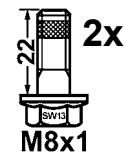

**13.0460-3815.2 603815**

RENAULT

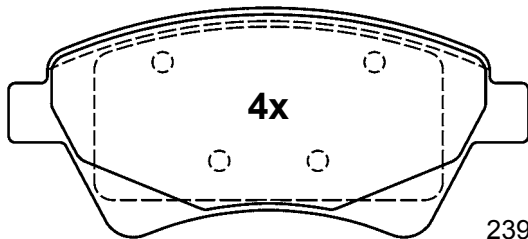

23930 18,2

136,8 x 59,5 x 18,2

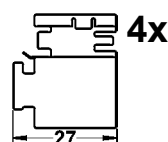
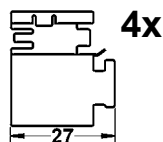
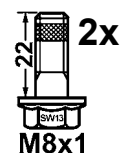

**13.0460-3819.2 603819**

MERCEDES BENZ

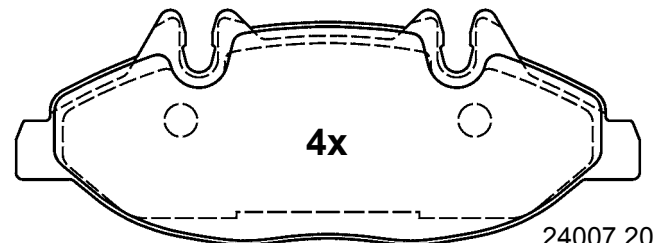

24007 20,8

164,8 x 61,8 x 20,8

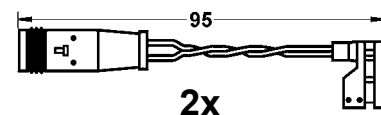

# Abbildungen Scheibenbremsbeläge

Illustrations disc brake pads - Illustrazioni pastiglie freno -

Illustrations plaquettes de frein - Ilustraciones pastillas de freno

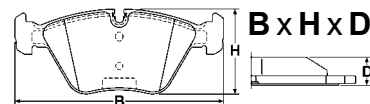

Maßstab - scale - scala - échelle - escala 1:2

## 13.0460-3821.2 603821



MERCEDES BENZ



BOS

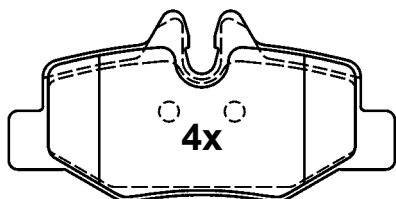

24008 18,3

101,8 x 50,2 x 18,3

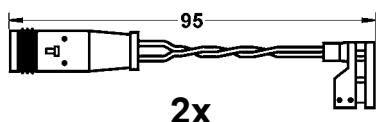

2x

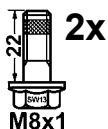

## 13.0460-3822.2 603822



RENAULT



BDX

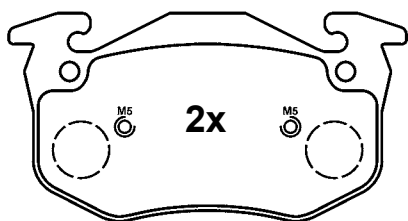

21597 11,0

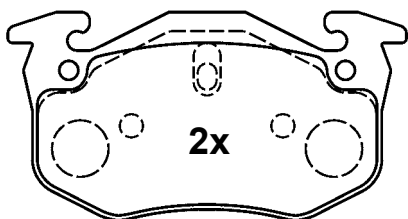

21600 11,0

105,0 x 54,9 x 11,0

4x



## 13.0460-3823.2 603823



CITROEN, PEUGEOT



BDX

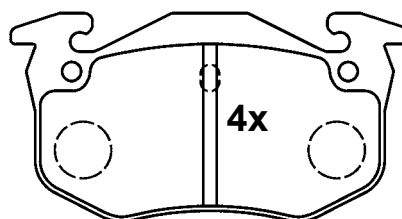

20974 11,0

105,0 x 54,9 x 11,0

## 13.0460-3824.2 603824



FIAT



TRW

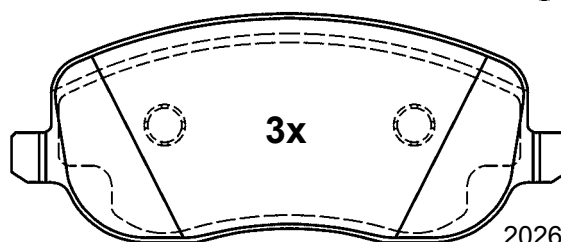

20261 19,0

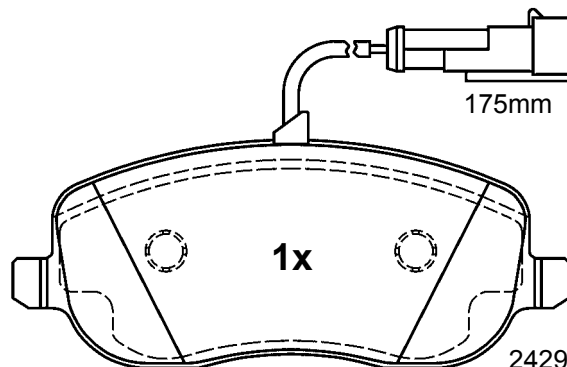

24294 19,0

146,6 x 60,0 x 19,0



## 13.0460-3825.2 603825



FIAT



TRW

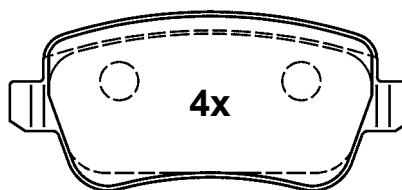

24348 17,1

105,5 x 46,4 x 17,1



# Abbildungen Scheibenbremsbeläge

Illustrations disc brake pads - Illustrazioni pastiglie freno -

Illustrations plaquettes de frein - Ilustraciones pastillas de freno



Maßstab - scale - scala - échelle - escala 1:2

## 13.0460-3826.2 603826

ALFA ROMEO, FIAT

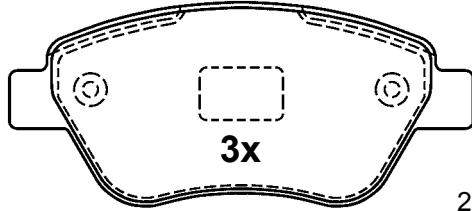

3x

23707 18,0

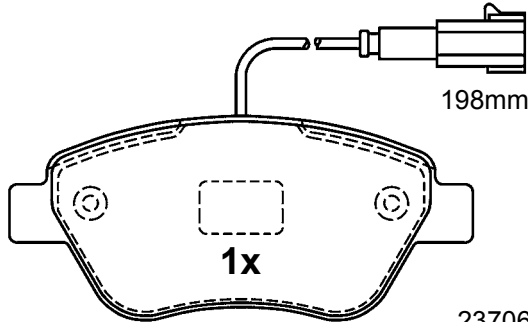

198mm

1x

23706 18,0

122,8 x 53,3 x 18,0

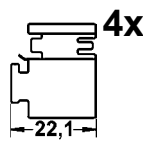
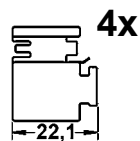
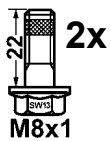

## 13.0460-3828.2 603828

FIAT

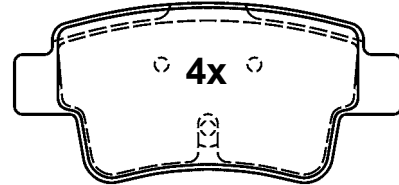

4x

24349 17,5

101,8 x 47,1 x 17,5

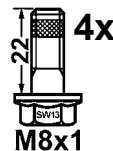

## 13.0460-3827.2 603827

FIAT, LANCIA, OPEL, VAUXHALL

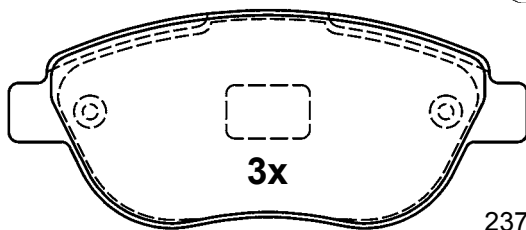

3x

23710 19,6

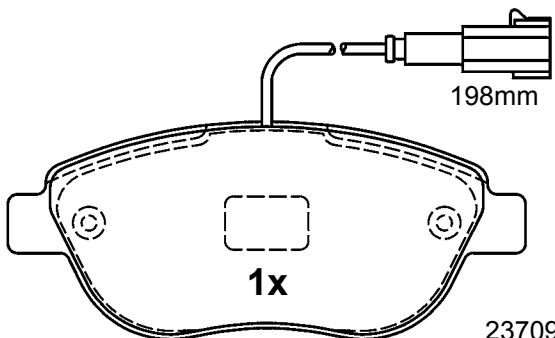

198mm

1x

23709 19,6

136,8 x 57,4 x 19,6

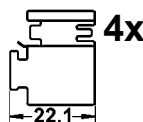
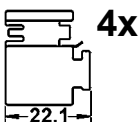
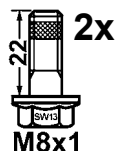

## 13.0460-3829.2 603829

CITROEN, PEUGEOT, TOYOTA

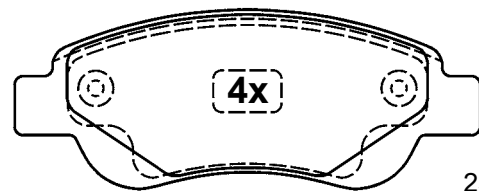

4x

23959 17,0

122,6 x 46,9 x 17,0

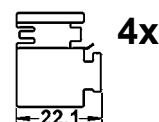
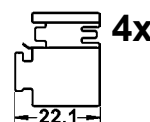
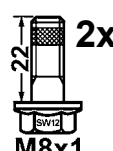

# Abbildungen Scheibenbremsbeläge

Illustrations disc brake pads - Illustrazioni pastiglie freno -

Illustrations plaquettes de frein - Ilustraciones pastillas de freno

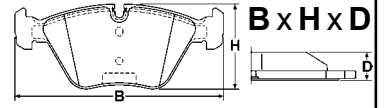

Maßstab - scale - scala - échelle - escala 1:2

**13.0460-3831.2 603831**

FORD, JAGUAR

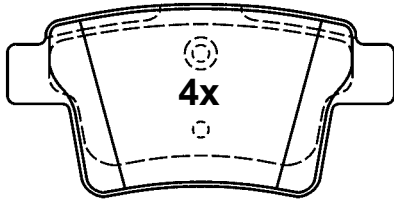

24260 17,3

101,8 x 50,5 x 17,3

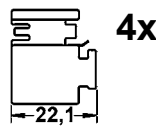
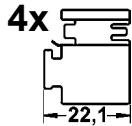
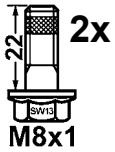

**13.0460-3833.2 603833**

FORD

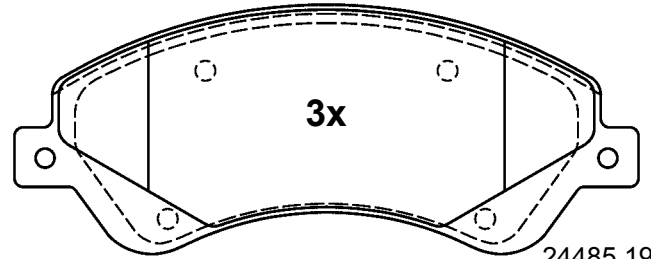

24485 19,0

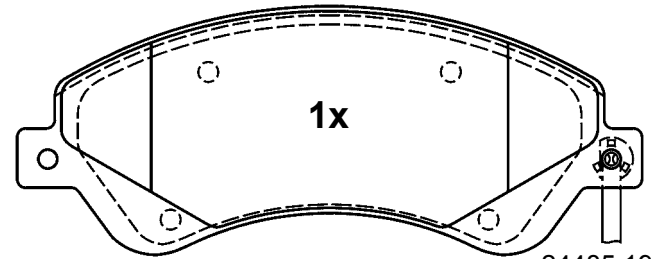

24485 19,0

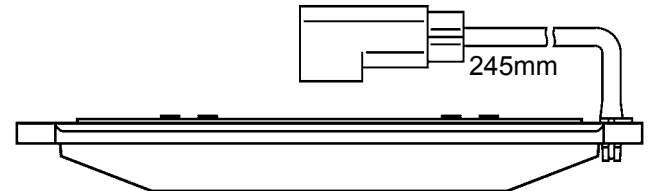

164,8 x 65,5 x 19,0

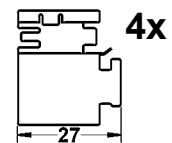
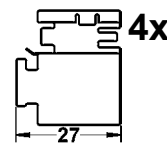

**13.0460-3832.2 603832**

VOLKSWAGEN

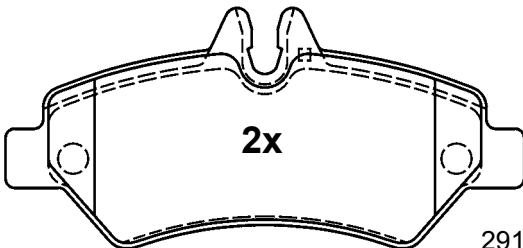

29190 20,2

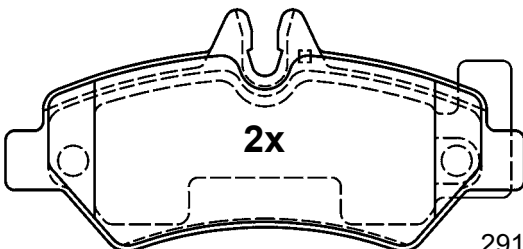

29190 20,2

136,8 x 63,0 x 20,2

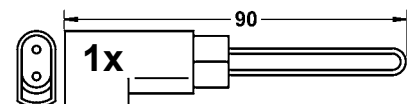
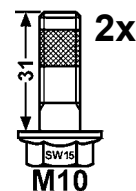
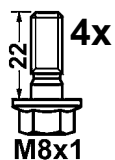

# Abbildungen Scheibenbremsbeläge

Illustrations disc brake pads - Illustrazioni pastiglie freno -

Illustrations plaquettes de frein - Ilustraciones pastillas de freno

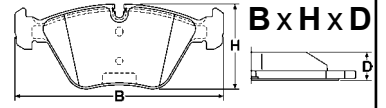

Maßstab - scale - scala - échelle - escala 1:2

**13.0460-3834.2 603834**



FORD



BOS

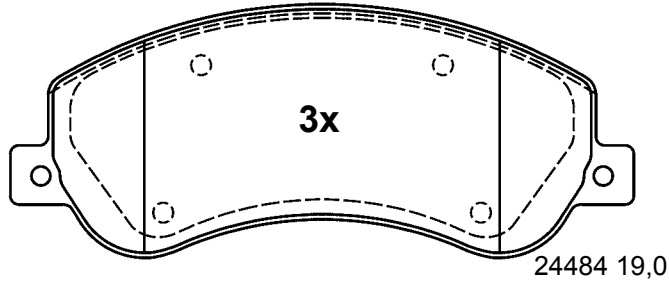

24484 19,0

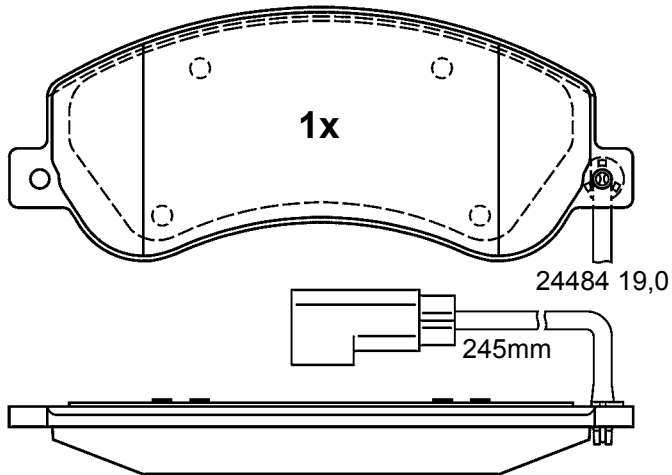

24484 19,0

**164,8 x 66,8 x 19,0**

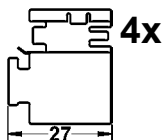

4x

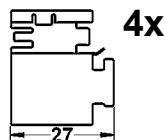

4x

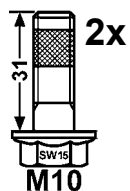

2x

M10

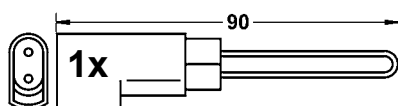

1x

90

**13.0460-3835.2 603835**



FORD



BOS

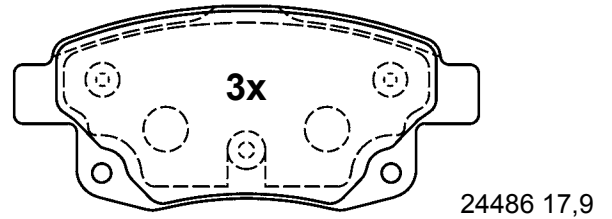

24486 17,9

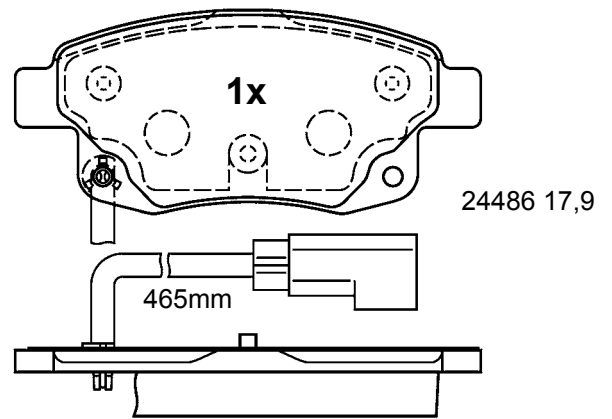

24486 17,9

**122,8 x 53,6 x 17,9**

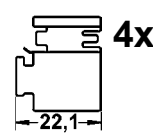

4x

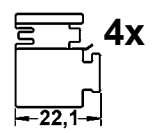

4x

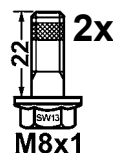

2x

M8x1

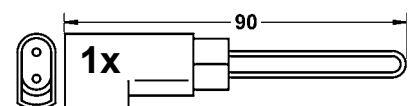

1x

90



# Abbildungen Scheibenbremsbeläge

Illustrations disc brake pads - Illustrazioni pastiglie freno -

Illustrations plaquettes de frein - Ilustraciones pastillas de freno

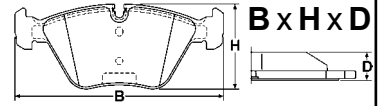

Maßstab - scale - scala - échelle - escala 1:2

## 13.0460-3836.2 603836



CITROEN



BOS

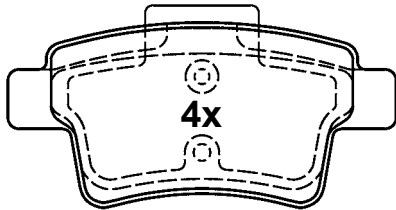

4x

24540 16,3

101,8 x 48,3 x 16,3

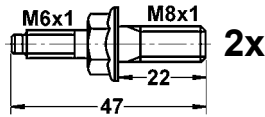

2x

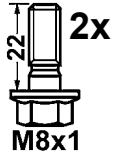

M8x1

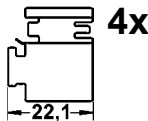

4x

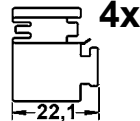

4x

## 13.0460-3838.2 603838



FIAT, FORD



BOS

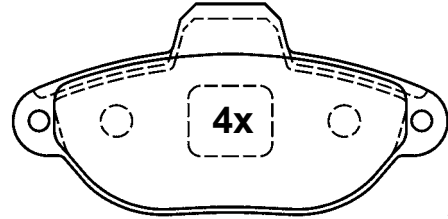

4x

21436 17,0

114,8 x 55,5 x 17,0

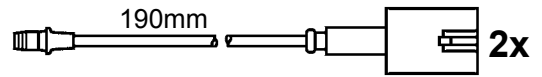

2x



2x

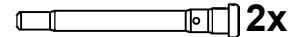

2x

## 13.0460-3837.2 603837



MERCEDES BENZ



BOS

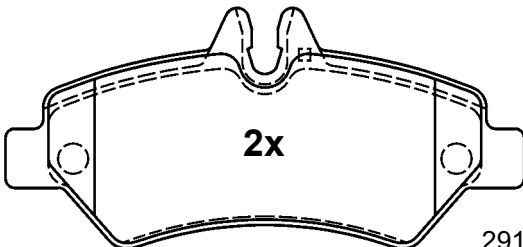

2x

29190 20,2

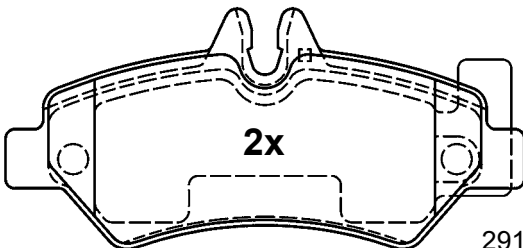

2x

29190 20,2

136,8 x 63,0 x 20,2

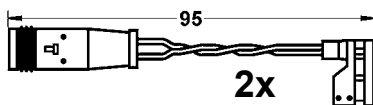

2x

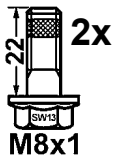

M8x1

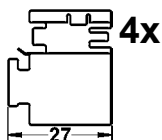

4x

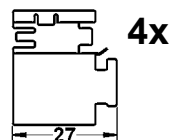

4x

## 13.0460-3839.2 603839



OPEL, VAUXHALL



BOS

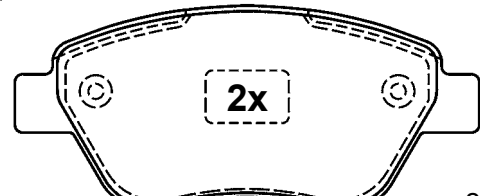

2x

23982 18,1

122,8 x 53,3 x 18,1

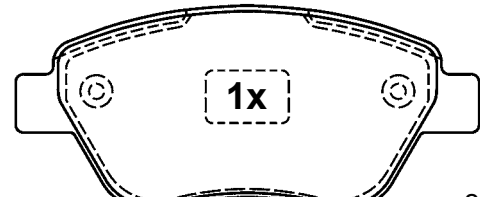

1x

23707 17,9

122,8 x 53,3 x 17,9

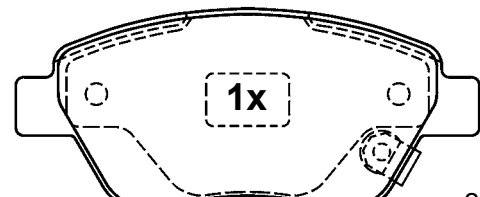

1x

24288 17,9

122,8 x 53,3 x 17,9

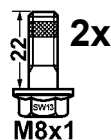

2x

M8x1

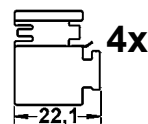

4x

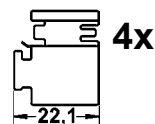

4x

# Abbildungen Scheibenbremsbeläge

Illustrations disc brake pads - Illustrazioni pastiglie freno -

Illustrations plaquettes de frein - Ilustraciones pastillas de freno

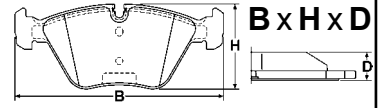

Maßstab - scale - scala - échelle - escala 1:2

## 13.0460-3840.2 603840

FIAT, OPEL, VAUXHALL

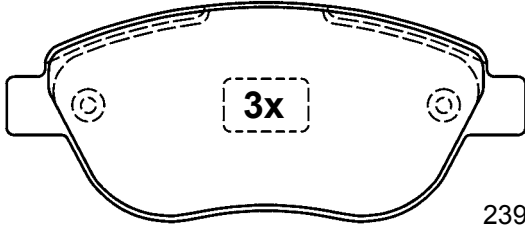

23981 19,6

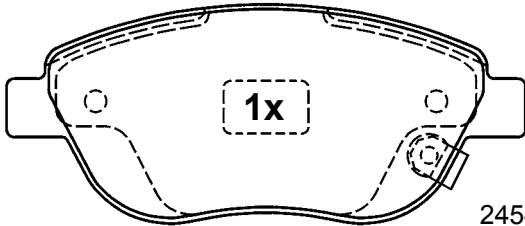

24549 19,6

136,9 x 57,4 x 19,6

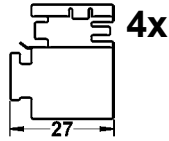
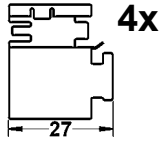
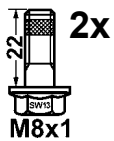

## 13.0460-3841.2 603841

OPEL, VAUXHALL

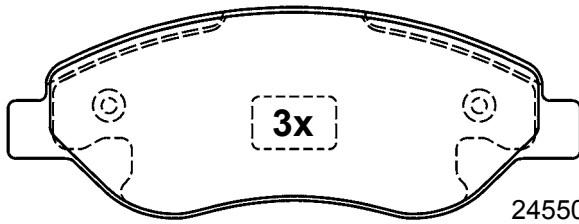

24550 19,5

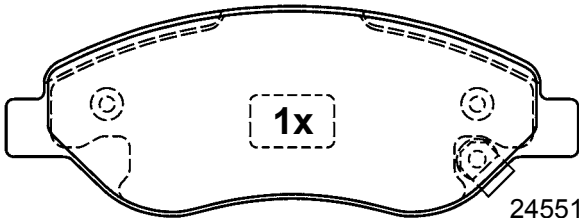

24551 19,5

150,9 x 54,9 x 19,5

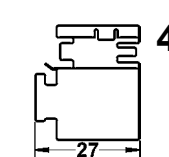
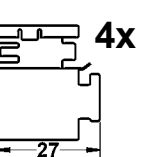
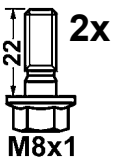

## 13.0460-3842.2 603842

MERCEDES BENZ, VOLKSWAGEN

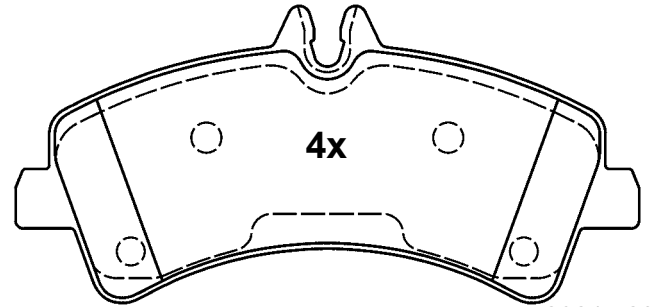

29217 20,5

164,8 x 78,2 x 20,5

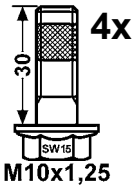

## 13.0460-3846.2 603846

FIAT, FORD

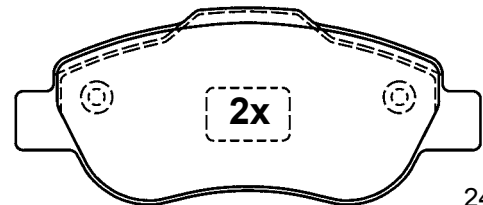

24072 17,9

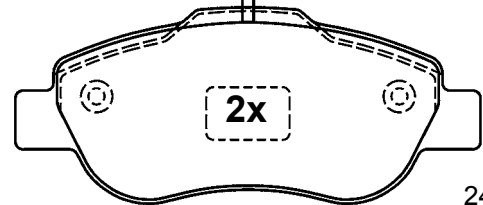
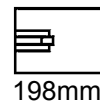

24764 17,9

122,8 x 51,7 x 17,9

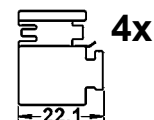
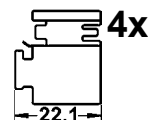
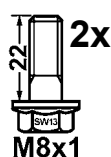

# Abbildungen Scheibenbremsbeläge

Illustrations disc brake pads - Illustrazioni pastiglie freno -

Illustrations plaquettes de frein - Ilustraciones pastillas de freno

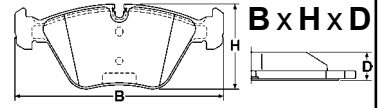

Maßstab - scale - scala - échelle - escala 1:2

## 13.0460-3847.2 603847



PEUGEOT



BOS

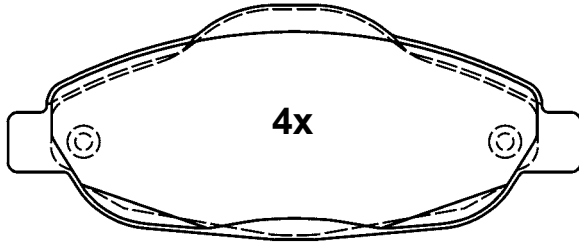

151,0 x 62,0 x 17,8

24660 17,8

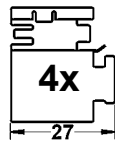
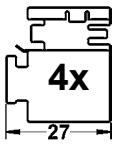
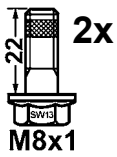

## 13.0460-3850.2 603850



FIAT



BOS

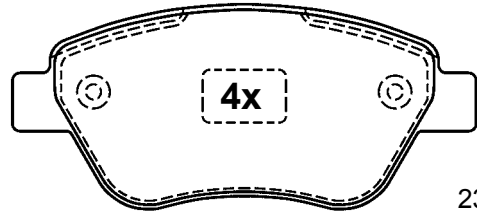

122,9 x 53,3 x 18,0

23707 18,0

## 13.0460-3848.2 603848



OPEL, VAUXHALL



BOS

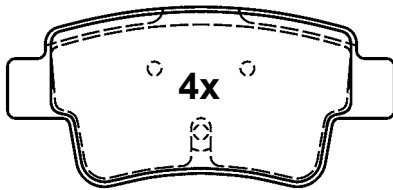

101,8 x 47,1 x 17,6

24349 17,6

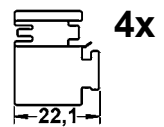
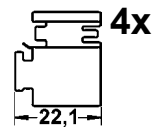
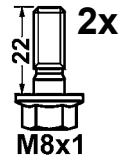

## 13.0460-3851.2 603851



PEUGEOT



BOS

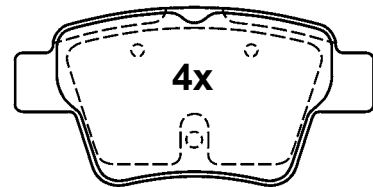

94,8 x 46,9 x 17,6

24150 17,6

## 13.0460-3849.2 603849



FIAT



BOS

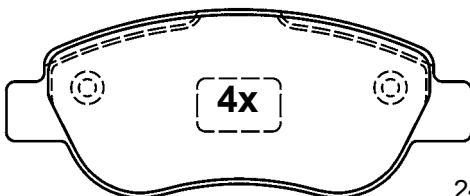

122,8 x 49,3 x 17,9

24393 17,9

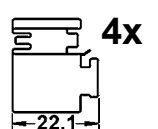
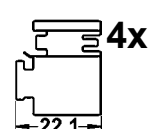
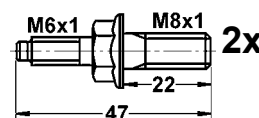
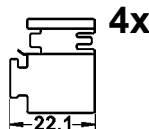
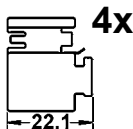
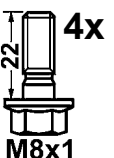

# Abbildungen Scheibenbremsbeläge

Illustrations disc brake pads - Illustrazioni pastiglie freno -

Illustrations plaquettes de frein - Ilustraciones pastillas de freno

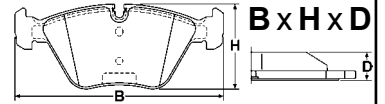

Maßstab - scale - scala - échelle - escala 1:2

## 13.0460-3852.2 603852



MERCEDES BENZ



BOS

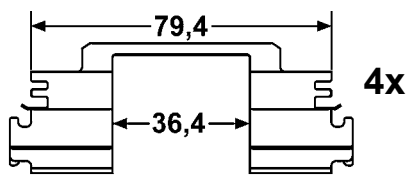
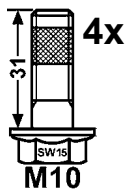
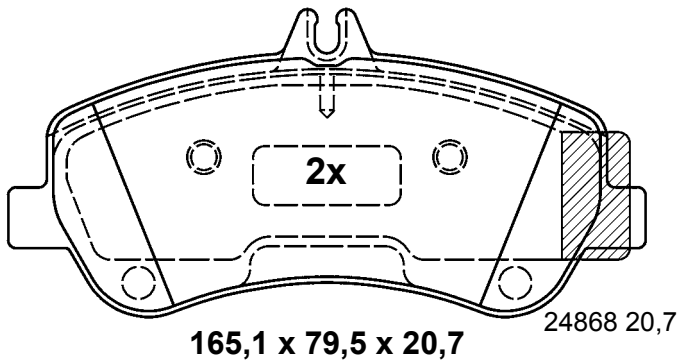
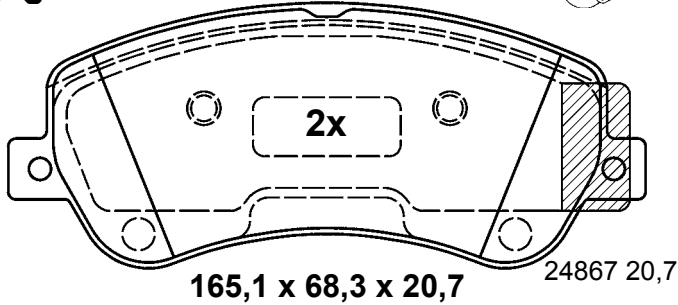

## 13.0460-3854.2 603854



TOYOTA



BOS

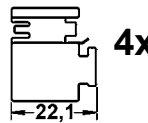
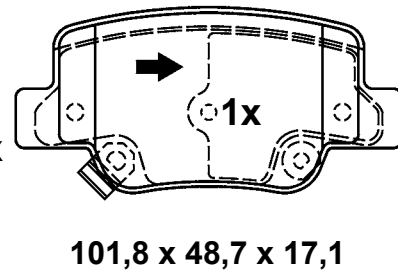
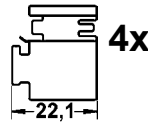
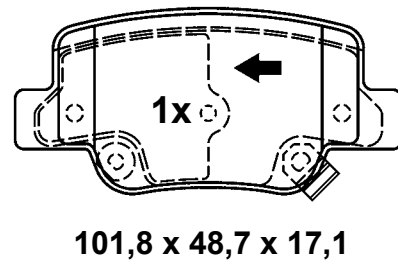
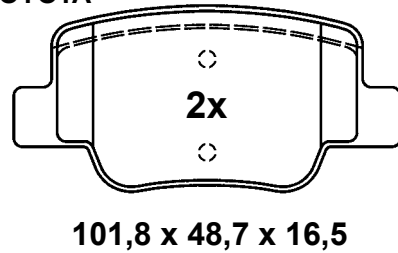

## 13.0460-3853.2 603853



TOYOTA



BOS

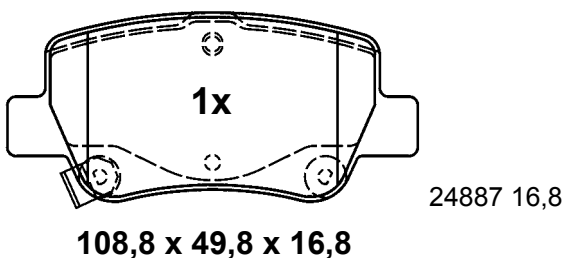
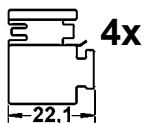
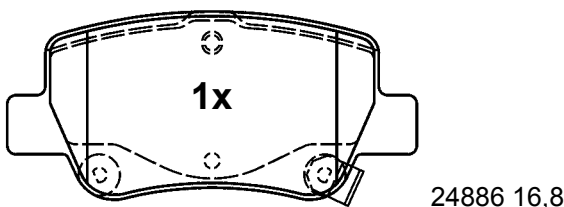
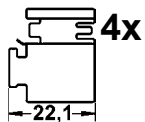
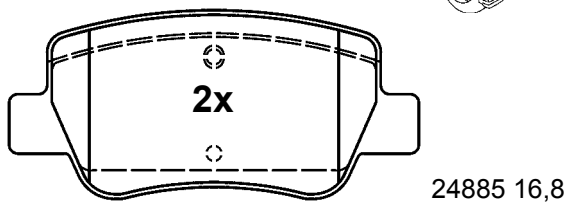

## 13.0460-3855.2 603855



CITROEN



BOS

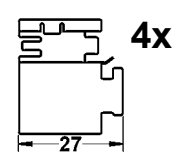
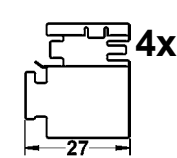
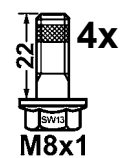
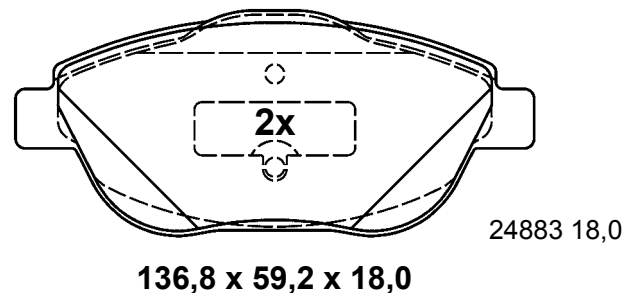
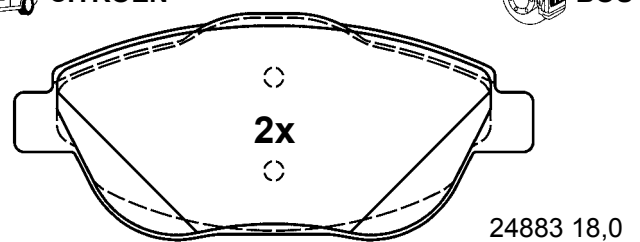

# Abbildungen Scheibenbremsbeläge

Illustrations disc brake pads - Illustrazioni pastiglie freno -

Illustrations plaquettes de frein - Ilustraciones pastillas de freno

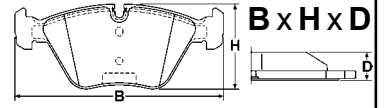

Maßstab - scale - scala - échelle - escala 1:2

## 13.0460-3856.2 603856

NISSAN

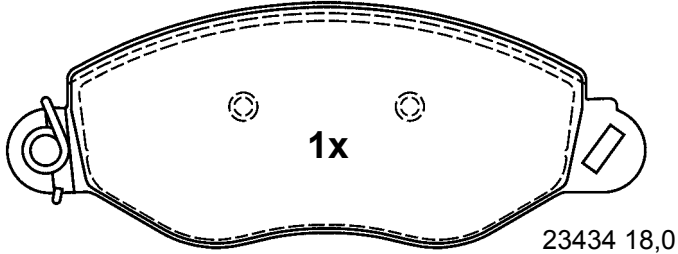

23434 18,0

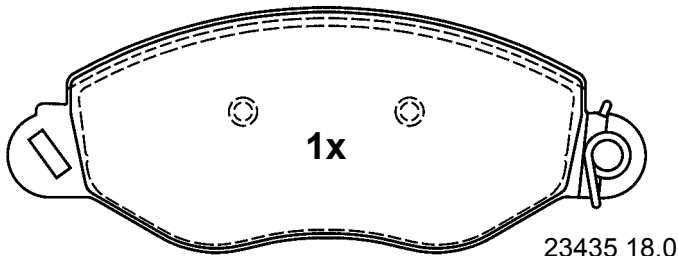

23435 18,0

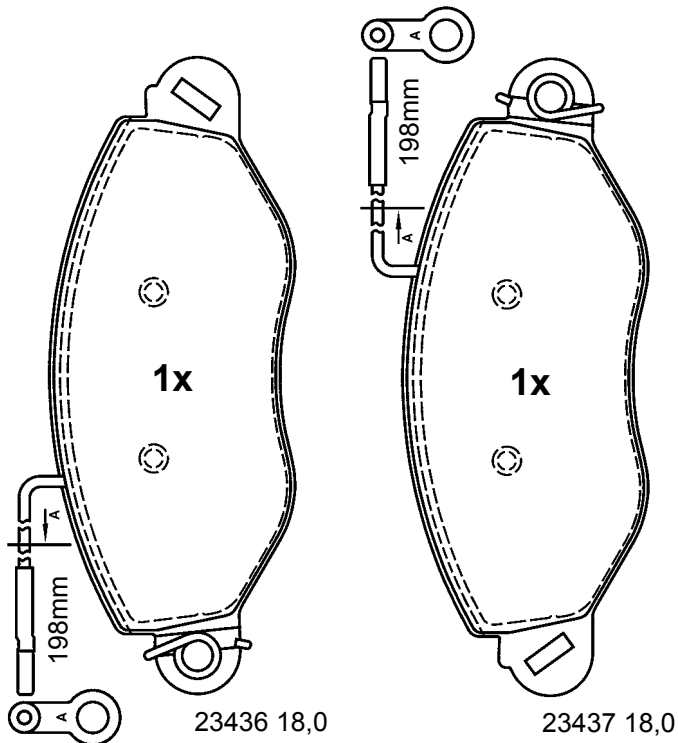

23436 18,0

23437 18,0

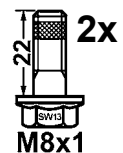

168,3 x 63,9 x 18,0

## 13.0460-3857.2 603857

BMW

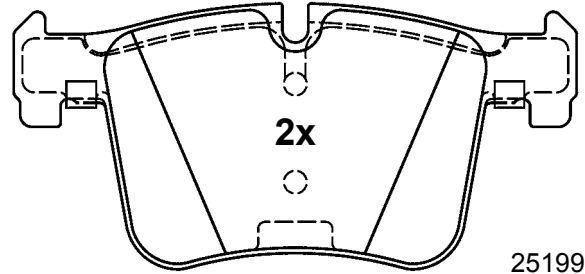

25199 19,6

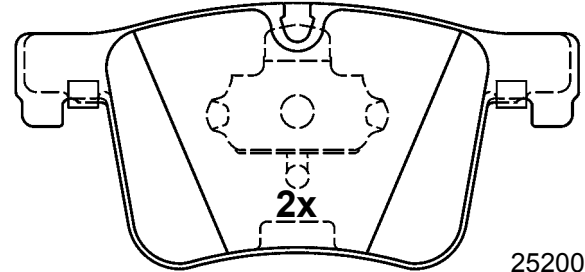

25200 19,6

148,2 x 69,8 x 19,6

## 13.0460-3858.2 603858

AUDI, SEAT,  
SKODA, VOLKSWAGEN

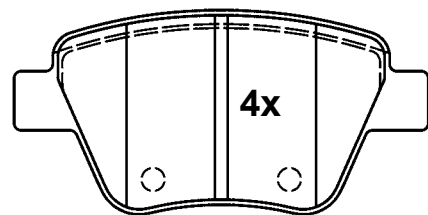

24563 17,7

109,3 x 53,4 x 17,7

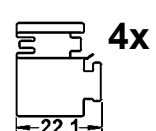
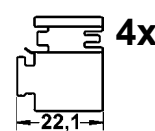
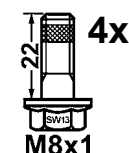

# Abbildungen Scheibenbremsbeläge

Illustrations disc brake pads - Illustrazioni pastiglie freno -

Illustrations plaquettes de frein - Ilustraciones pastillas de freno

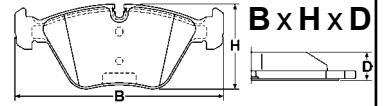

Maßstab - scale - scala - échelle - escala 1:2

## 13.0460-3859.2 603859



BMW



BOS

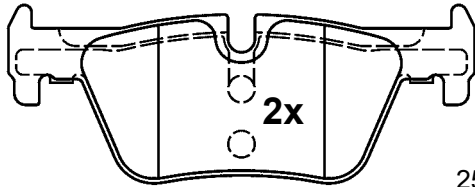

25307 17,5

123,0 x 46,7 x 17,5

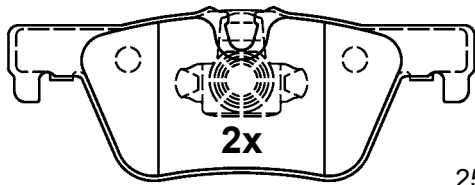

25308 17,5

123,0 x 45,3 x 17,5

## 13.0460-3861.2 603861



ALFA ROMEO, FIAT, LANCIA



BOS

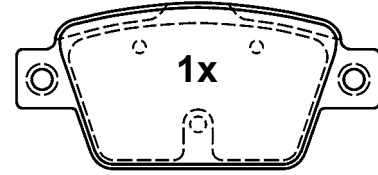

23714 17,6

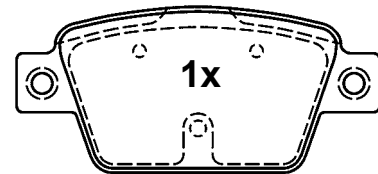

23714 17,6

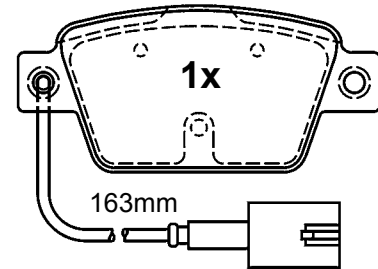

25527 17,6

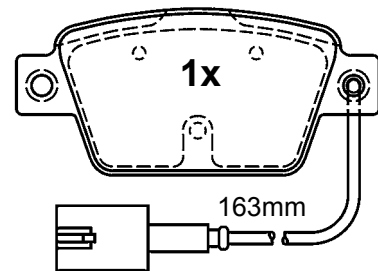

25526 17,6

94,8 x 42,9 x 17,6

## 13.0460-3860.2 603860



VOLKSWAGEN



BOS

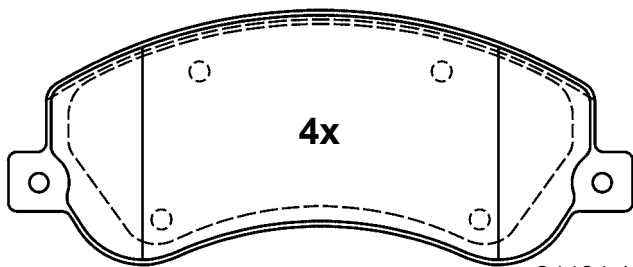

24484 18,8

164,8 x 66,8 x 18,8

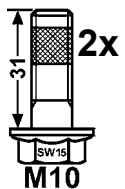

2x

M10

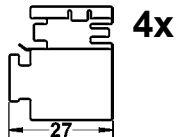

4x

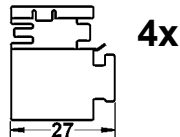

4x

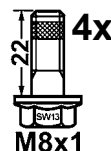

4x

M8x1

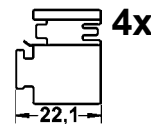

4x

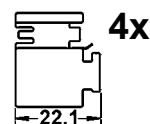

4x



# Abbildungen Scheibenbremsbeläge

Illustrations disc brake pads - Illustrazioni pastiglie freno -

Illustrations plaquettes de frein - Ilustraciones pastillas de freno

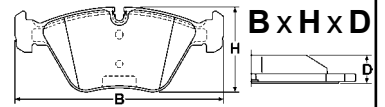

Maßstab - scale - scala - échelle - escala 1:2

**13.0460-3862.2 603862**



FIAT



BOS

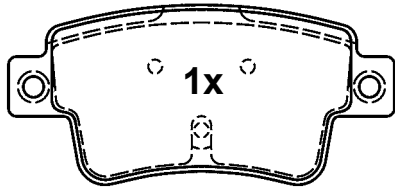

25451 17,6  
(24349)

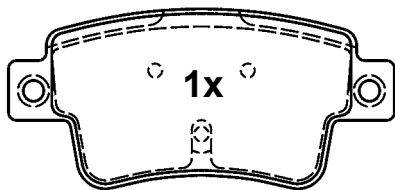

25451 17,6  
(24349)

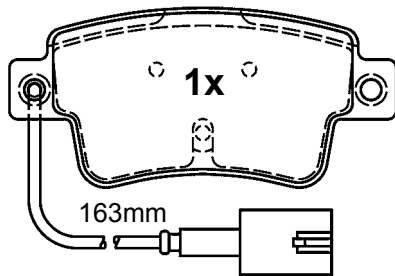

25357 17,6

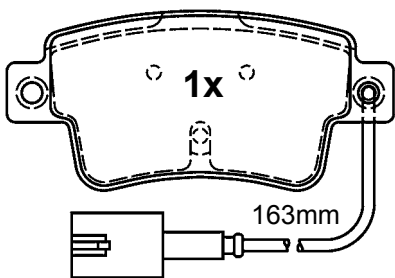

25357 17,6

**101,8 x 47,1 x 17,6**

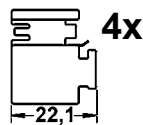
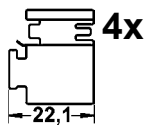
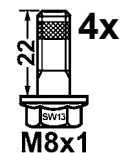

**13.0460-3863.2 603863**



ALFA ROMEO, CITROEN,  
FIAT, PEUGEOT



BOS

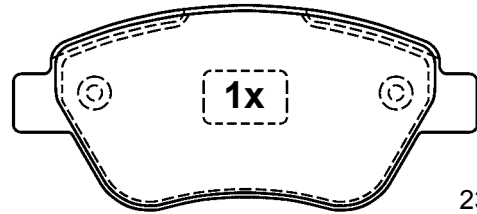

23707 18,0

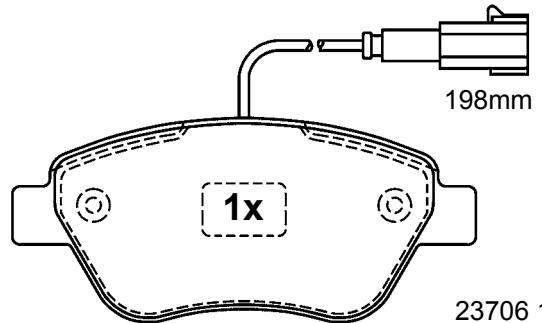

23706 18,0

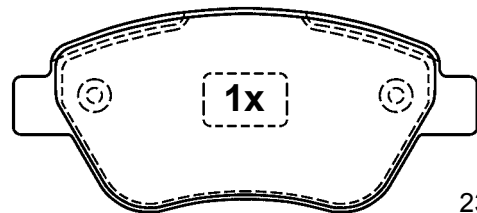

23707 18,0

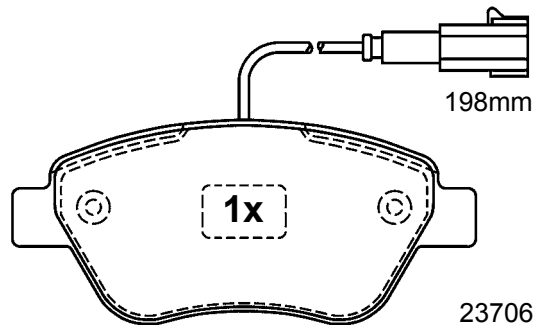

23706 18,0

**122,8 x 53,3 x 18,0**

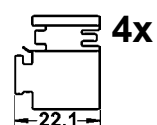
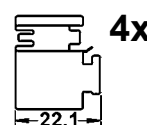
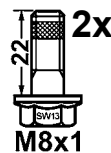

# Abbildungen Scheibenbremsbeläge

Illustrations disc brake pads - Illustrazioni pastiglie freno -

Illustrations plaquettes de frein - Ilustraciones pastillas de freno

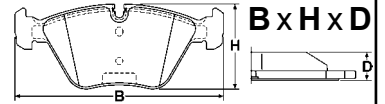

Maßstab - scale - scala - échelle - escala 1:2

## 13.0460-3864.2 603864



FIAT



BOS

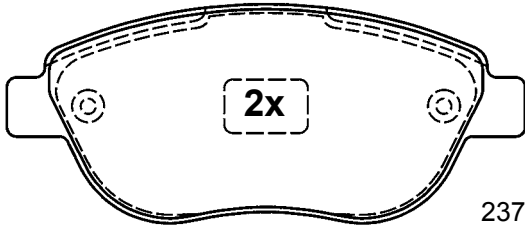

23710 19,6

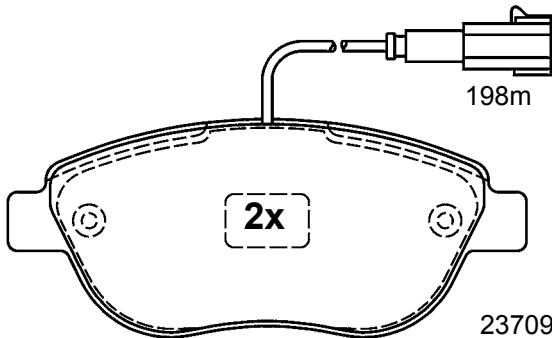

23709 19,6

136,8 x 57,4 x 19,6

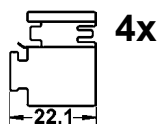
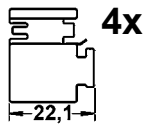
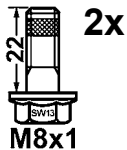

## 13.0460-3865.2 603865



BMW



BOS

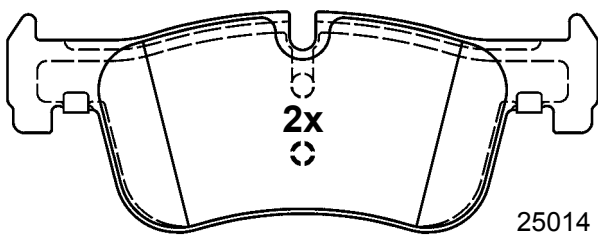

25014 18,2

155,7 x 57,8 x 18,2

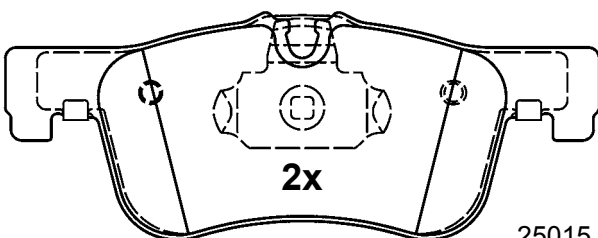

25015 18,2

156,7 x 59,7 x 18,2

## 13.0460-3866.2 603866



BMW



BOS

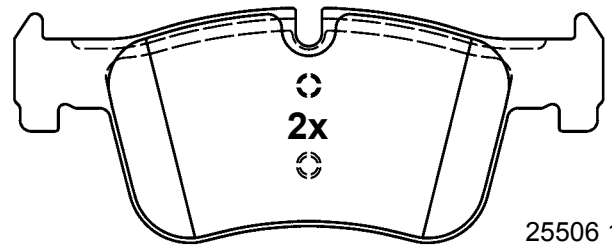

25506 18,2

155,7 x 61,6 x 18,2

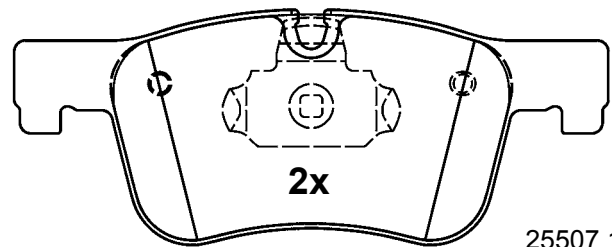

25507 18,2

156,7 x 61,6 x 18,2

## 13.0460-3867.2 603867



CITROEN, PEUGEOT



BOS

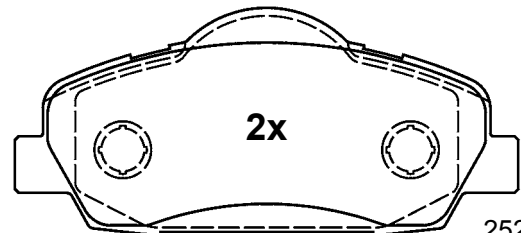

25250 18,9

132,8 x 60,0 x 18,9

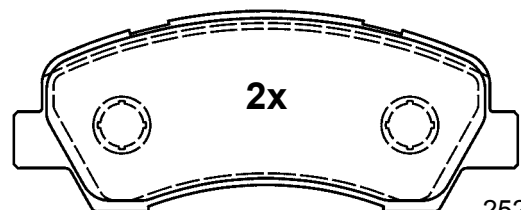

25250 18,9

132,8 x 52,5 x 18,9

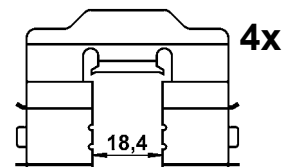
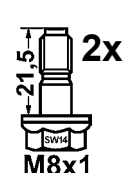

# Abbildungen Scheibenbremsbeläge

Illustrations disc brake pads - Illustrazioni pastiglie freno -

Illustrations plaquettes de frein - Ilustraciones pastillas de freno



Maßstab - scale - scala - échelle - escala 1:2

## 13.0460-3870.2 603870



PEUGEOT



BOS

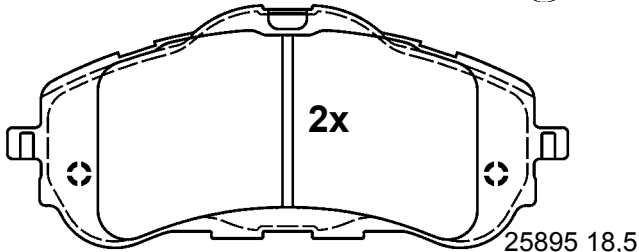

147,8 x 63,5 x 18,5

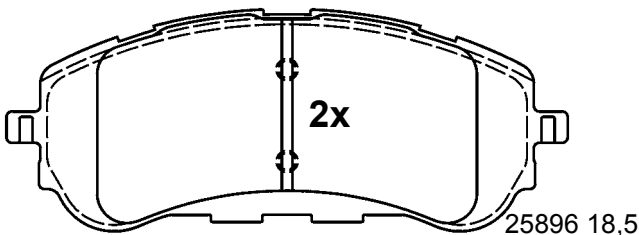

147,8 x 58,3 x 18,5

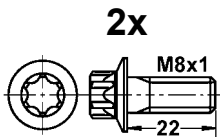

2x

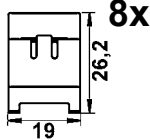

8x

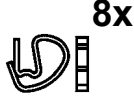

8x

## 13.0460-3872.2 603872



CITROEN, PEUGEOT



BOS

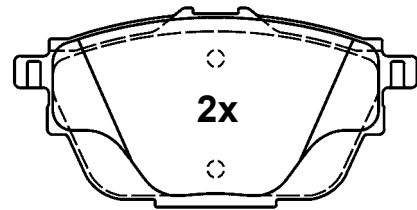

105,8 x 51,9 x 17,7

25827 17,7

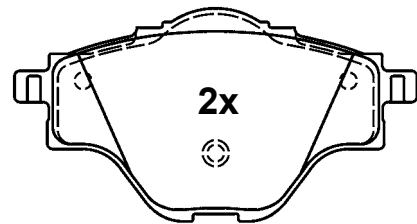

105,8 x 55,4 x 17,7

25828 17,7

## 13.0460-3871.2 603871



CITROEN, PEUGEOT



BOS

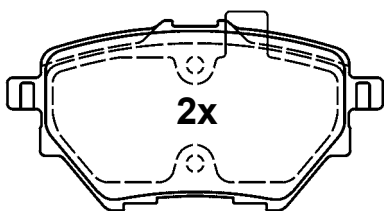

98,8 x 49,9 x 17,8

25839 17,8



98,8 x 53,5 x 17,8

25840 17,8

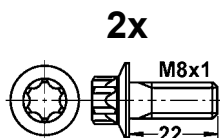

2x

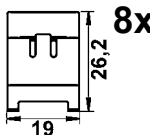

8x

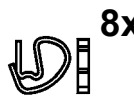

8x

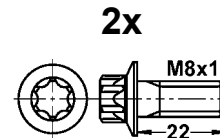

2x

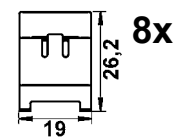

8x



8x

# Abbildungen Scheibenbremsbeläge

Illustrations disc brake pads - Illustrazioni pastiglie freno -

Illustrations plaquettes de frein - Ilustraciones pastillas de freno

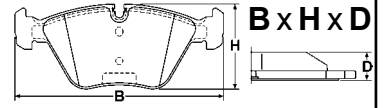

Maßstab - scale - scala - échelle - escala 1:2

## 13.0460-3902.2 603902



PEUGEOT



BDX

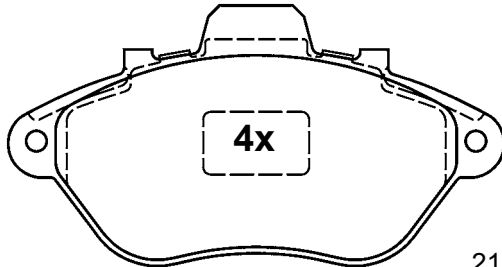

21299 17,0  
(21300)  
(20035)  
(20036)

130,8 x 68,7 x 17,0

125mm 2x

345mm 2x

## 13.0460-3905.2 603905



ALFA ROMEO



BDX

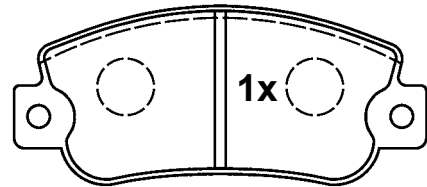

21131 14,7

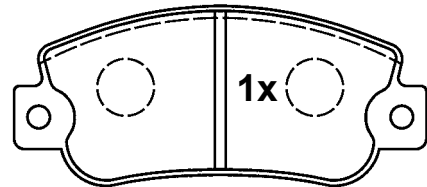

21131 14,7

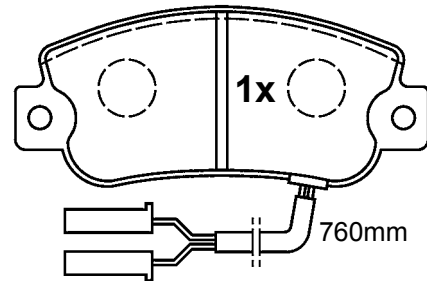

21132 14,7

760mm

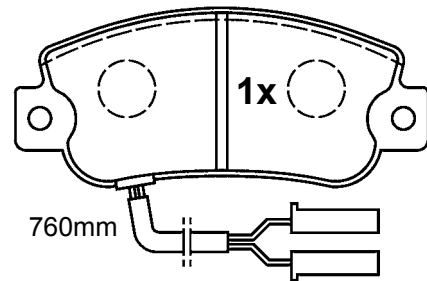

21133 14,7

760mm

## 13.0460-3904.2 603904



FIAT



BDX

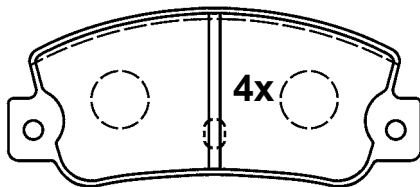

21107 12,0

108,9 x 47,1 x 12,0

108,9 x 47,4 x 14,7

# Abbildungen Scheibenbremsbeläge

Illustrations disc brake pads - Illustrazioni pastiglie freno -

Illustrations plaquettes de frein - Ilustraciones pastillas de freno



Maßstab - scale - scala - échelle - escala 1:2

## 13.0460-3911.2 603911



PEUGEOT, RENAULT



BDX

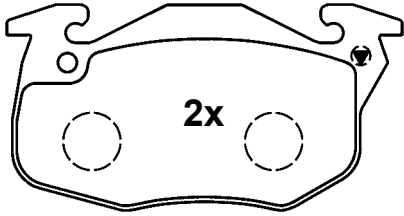

20905 18,0  
(20986)

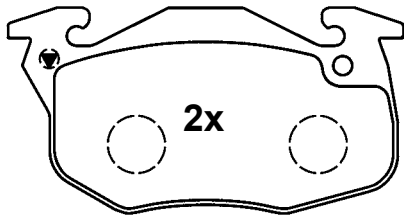

20906 18,0  
(20987)

105,0 x 54,0 x 18,0

183mm 2x

## 13.0460-3915.2 603915



CITROEN



BDX

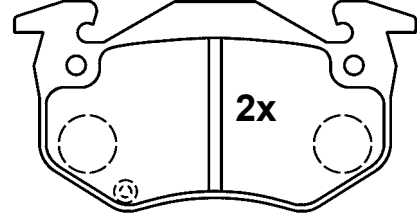

20859 18,0  
(20860)

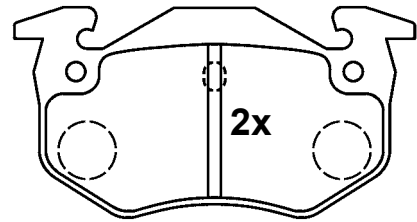

20635 18,0  
(20636)

105,0 x 54,9 x 18,0

113mm 2x

236mm 2x

## 13.0460-3914.2 603914



VOLVO



BDX

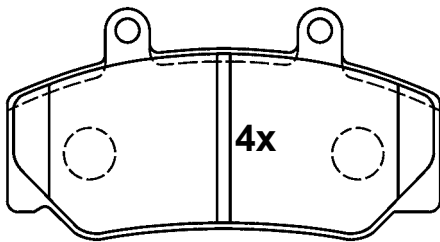

21233 16,7

113,8 x 62,2 x 16,7

## 13.0460-3916.2 603916



CITROEN



BDX

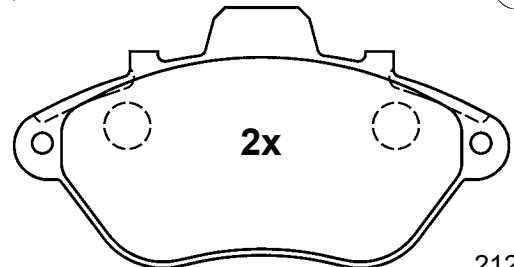

21299 15,9  
(21300)

130,8 x 68,7 x 15,9

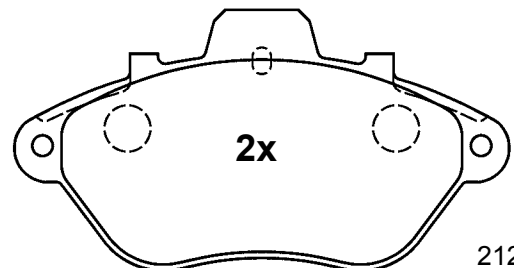

21296 16,5  
(21297)

130,8 x 68,7 x 16,5

125mm 2x

345mm 2x



# Abbildungen Scheibenbremsbeläge

Illustrations disc brake pads - Illustrazioni pastiglie freno -

Illustrations plaquettes de frein - Ilustraciones pastillas de freno

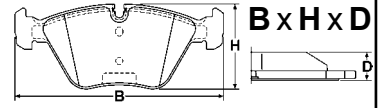

Maßstab - scale - scala - échelle - escala 1:2

**13.0460-3926.2 603926**

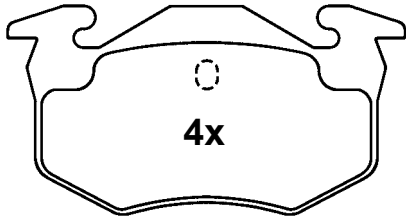

20974 10,8

105,0 x 54,8 x 10,8

**13.0460-3933.2 603933**

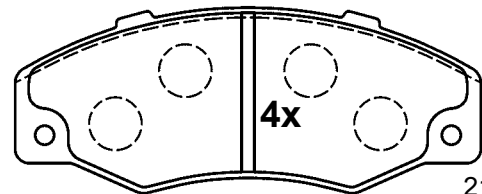

21016 17,0  
(21086)  
(21087)

123,1 x 48,8 x 17,0

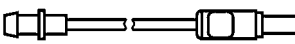
380mm  2x

**13.0460-3928.2 603928**

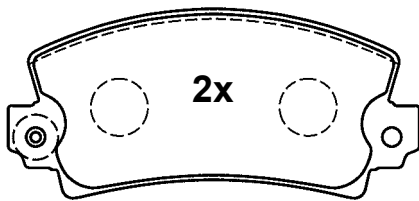

20140 14,0

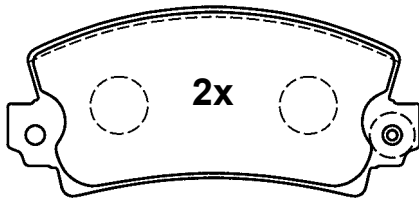

20141 14,0

108,8 x 49,3 x 14,0

**13.0460-3936.2 603936**

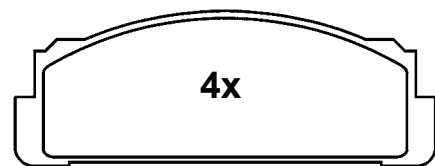

20073 17,3

108,9 x 39,0 x 17,3









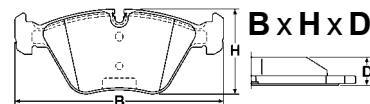

# Abbildungen Scheibenbremsbeläge

Illustrations disc brake pads - Illustrazioni pastiglie freno -

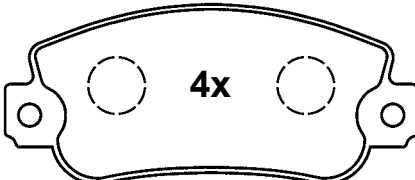
Illustrations plaquettes de frein - Ilustraciones pastillas de freno

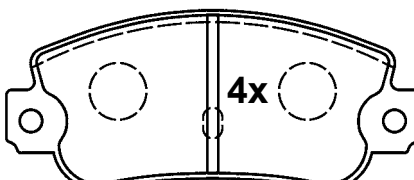

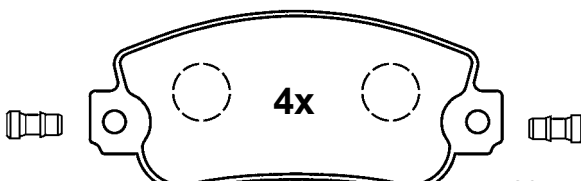
Maßstab - scale - scala - échelle - escala 1:2

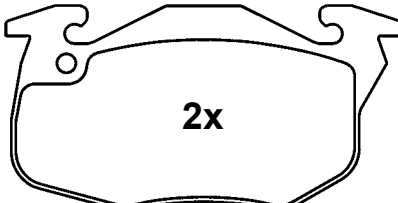
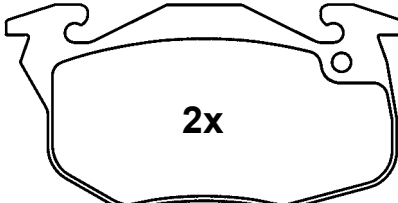
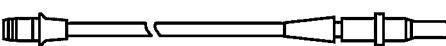
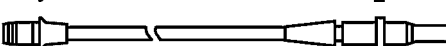
| 13.0460-3939.2 603939   | 13.0460-3942.2 603942  |
|---|--|
| <p> FIAT, SEAT</p> <p> BDX</p>  <p>20775 18,0</p> <p>108,9 x 47,4 x 18,0</p>  | <p> FIAT, LANCIA</p> <p> BDX</p>  <p>20841 12,0</p> <p>109,0 x 47,4 x 12,0</p>   |
| 13.0460-3940.2 603940   | 13.0460-3943.2 603943  |
| <p> AUTOBIANCHI, FIAT,<br/>LANCIA, SEAT</p> <p> BDX</p>  <p>20775 18,0<br/>(20776/20777)</p> <p>109,0 x 47,4 x 18,0</p> | <p> PEUGEOT</p> <p> BDX</p>  <p>20905 18,0</p>  <p>20906 18,0</p> <p>105,0 x 54,3 x 18,0</p> <p>190mm  2x</p> <p>305mm  2x</p> |



# Abbildungen Scheibenbremsbeläge

Illustrations disc brake pads - Illustrazioni pastiglie freno -

Illustrations plaquettes de frein - Ilustraciones pastillas de freno

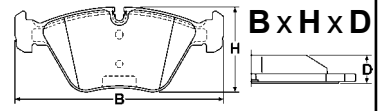

Maßstab - scale - scala - échelle - escala 1:2

## 13.0460-3944.2 603944

FORD

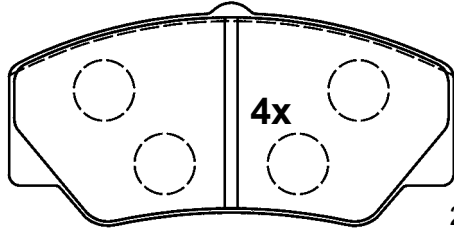

21141 18,0

116,9 x 58,6 x 18,0

## 13.0460-3947.2 603947

CITROEN

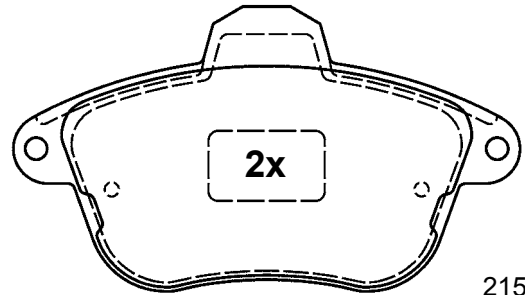

21509 17,0  
(21513)

## 13.0460-3945.2 603945

MERCEDES BENZ

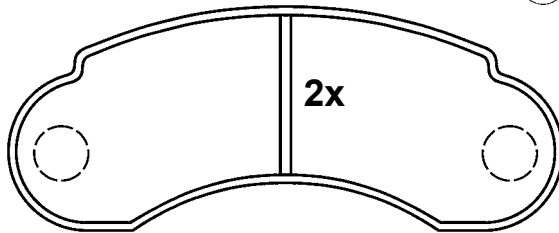

20932 14,0

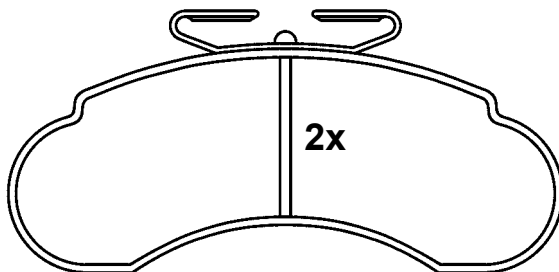

20934 14,0

145,5 x 59,0 x 14,0

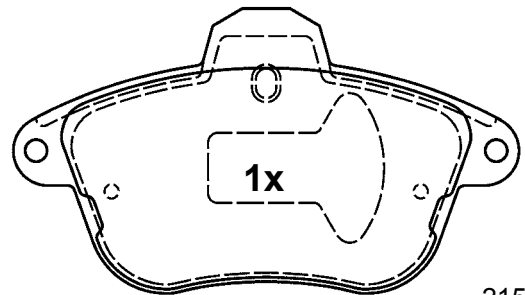

21505 17,0

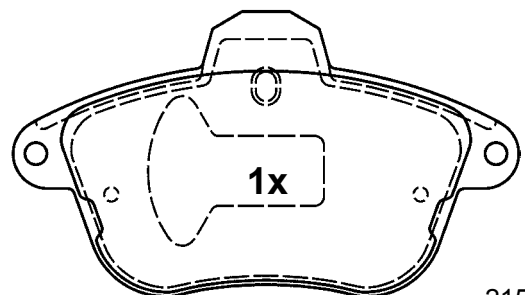

21510 17,0

## 13.0460-3946.2 603946

OPEL, RENAULT, VAUXHALL

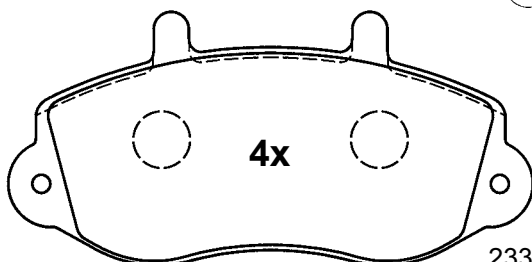

23302 18,0

138,8 x 66,5 x 18,0

130,8 x 73,1 x 17,0

125mm 2x

345mm 2x

# Abbildungen Scheibenbremsbeläge

Illustrations disc brake pads - Illustrazioni pastiglie freno -

Illustrations plaquettes de frein - Ilustraciones pastillas de freno

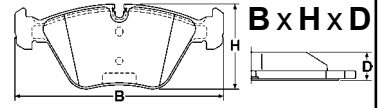

Maßstab - scale - scala - échelle - escala 1:2

## 13.0460-3948.2 603948

PEUGEOT

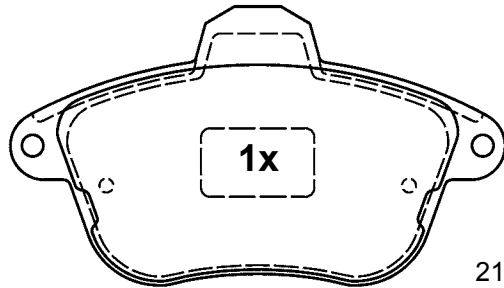

21509 17,0

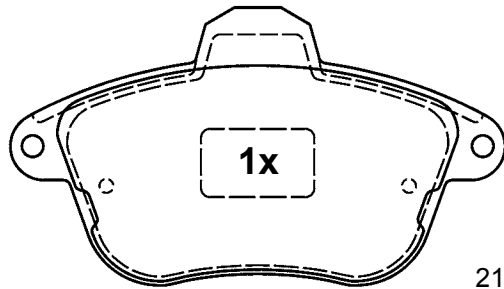

21509 17,0

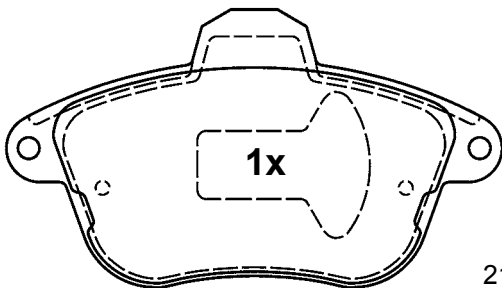

21508 17,0

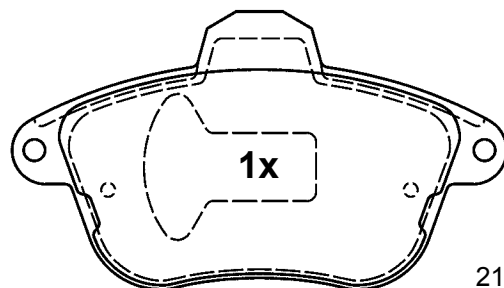

21512 17,0

130,8 x 73,1 x 17,0

125mm 2x

345mm 2x

## 13.0460-3949.2 603949

FIAT

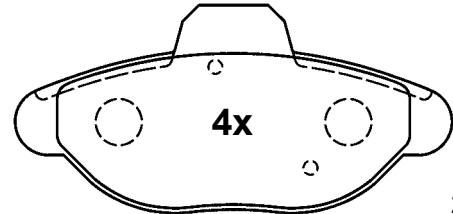

21365 17,0

114,8 x 54,8 x 17,0

## 13.0460-3950.2 603950

FIAT, LANCIA

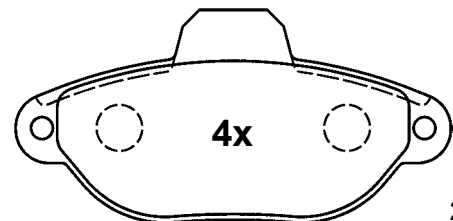

21436 17,0

115,0 x 55,2 x 17,0

## 13.0460-3951.2 603951

FIAT, LANCIA

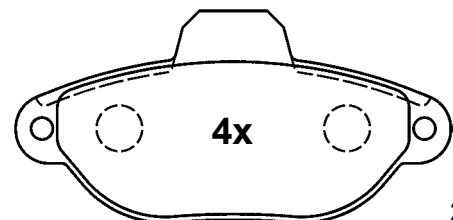

21436 16,2

114,8 x 55,2 x 16,2

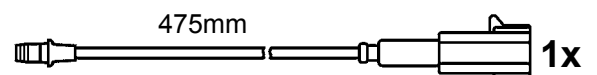

# Abbildungen Scheibenbremsbeläge

Illustrations disc brake pads - Illustrazioni pastiglie freno -

Illustrations plaquettes de frein - Ilustraciones pastillas de freno



Maßstab - scale - scala - échelle - escala 1:2

## 13.0460-3952.2 603952



CITROEN, PEUGEOT



BDX

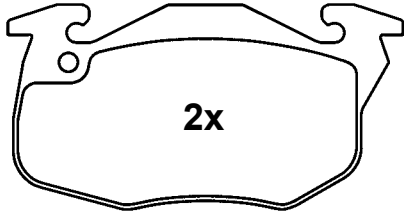

20905 18,0

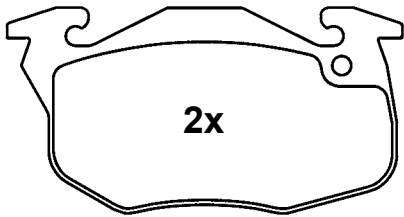

20906 18,0

105,0 x 54,3 x 18,0

280mm 2x

365mm 2x

## 13.0460-3955.2 603955



RENAULT



BDX

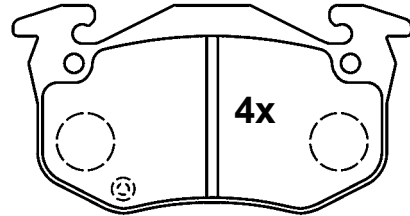

20634 15,0  
(21096)  
(21097)

105,0 x 54,9 x 15,0

183mm 2x

## 13.0460-3953.2 603953



RENAULT



BDX

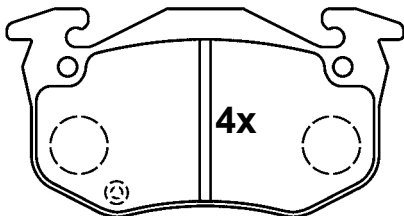

20634 15,0

105,0 x 54,9 x 15,0

## 13.0460-3956.2 603956



CITROEN



BDX

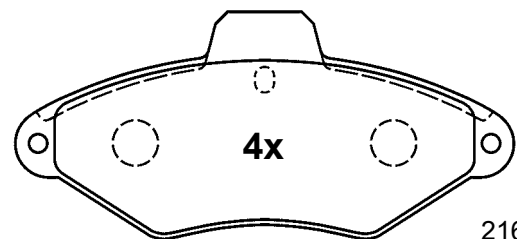

21631 17,0

130,8 x 60,0 x 17,0

152mm 2x

364mm 2x

## 13.0460-3954.2 603954



CITROEN, PEUGEOT, RENAULT



BDX

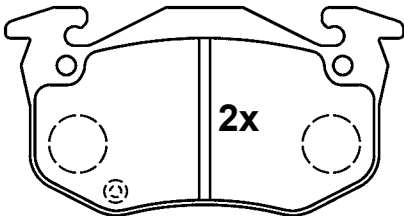

20973 11,0

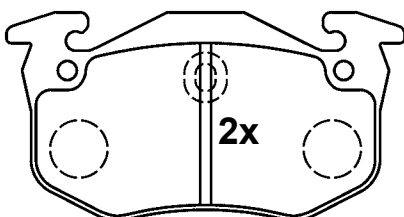

20974 11,0

105,0 x 54,9 x 11,0

# Abbildungen Scheibenbremsbeläge

Illustrations disc brake pads - Illustrazioni pastiglie freno -

Illustrations plaquettes de frein - Ilustraciones pastillas de freno



Maßstab - scale - scala - échelle - escala 1:2

## 13.0460-3957.2 603957



CITROEN, FIAT, PEUGEOT



BDX

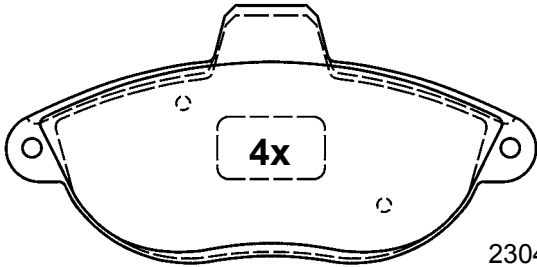

4x

23042 19,0

139,8 x 68,8 x 19,0

270mm 2x

2x

2x

2x

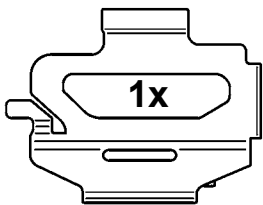

1x

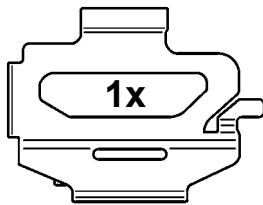

1x

## 13.0460-3959.2 603959



FORD



BDX

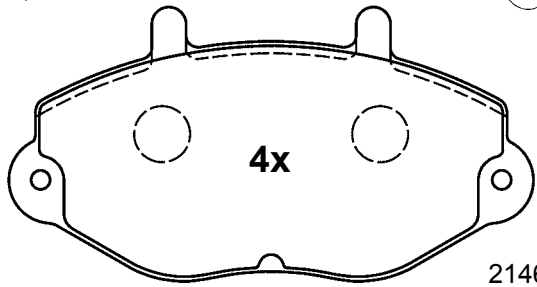

4x

21469 18,0

138,7 x 72,1 x 18,0

## 13.0460-3960.2 603960



FORD



BDX

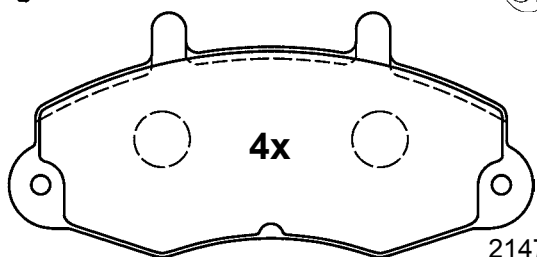

4x

21470 18,0

138,7 x 64,1 x 18,0

## 13.0460-3961.2 603961



RENAULT, TALBOT



BDX

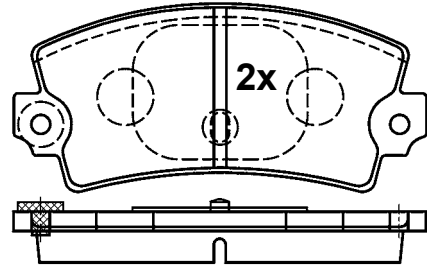

2x

20336 14,0

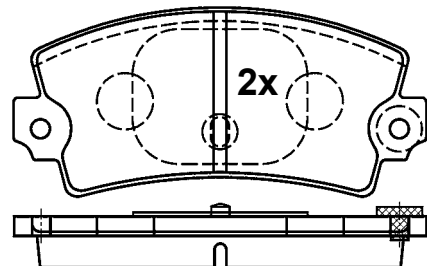

2x

20337 14,0

108,9 x 49,8 x 14,0

2x

## 13.0460-3962.2 603962

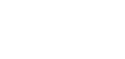

CITROEN, PEUGEOT



BDX

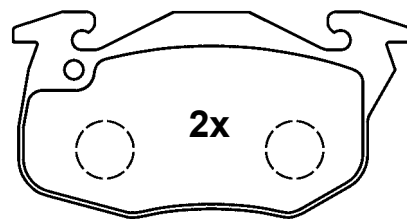

2x

20905 18,0

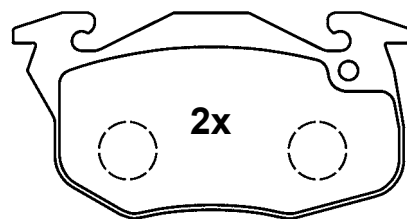

2x

20906 18,0

105,0 x 54,0 x 18,0

# Abbildungen Scheibenbremsbeläge

Illustrations disc brake pads - Illustrazioni pastiglie freno -

Illustrations plaquettes de frein - Ilustraciones pastillas de freno

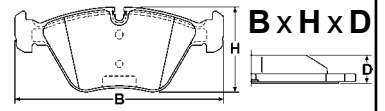

Maßstab - scale - scala - échelle - escala 1:2

## 13.0460-3963.2 603963

FORD

BDX

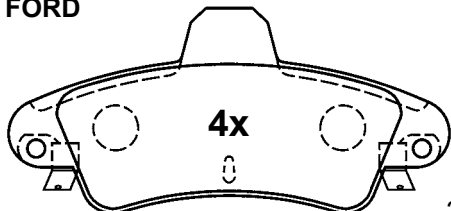

21586 15,0

115,7 x 53,6 x 15,0

## 13.0460-3966.2 603966

CITROEN, PEUGEOT

BOS

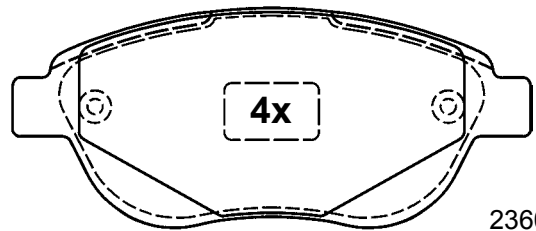

23600 19,4

136,8 x 57,5 x 19,4

## 13.0460-3964.2 603964

FORD

BDX

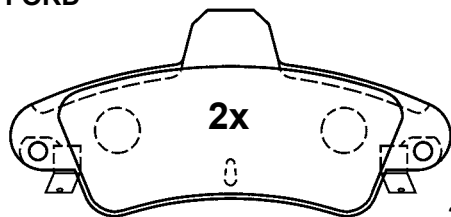

23410 15,0

(21586)

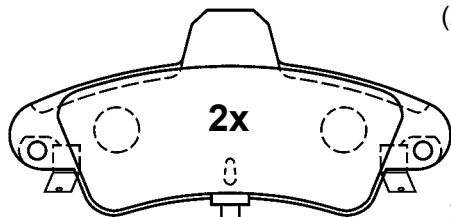

23411 15,0

115,7 x 53,6 x 15,0

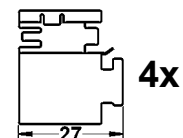
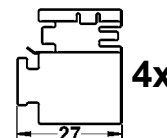
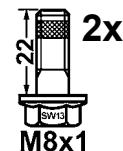
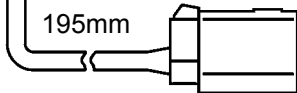

## 13.0460-3968.2 603968

RENAULT

BDX

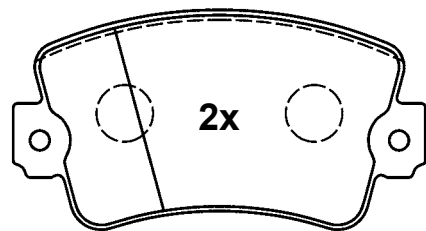

20488 18,5  
(20570)

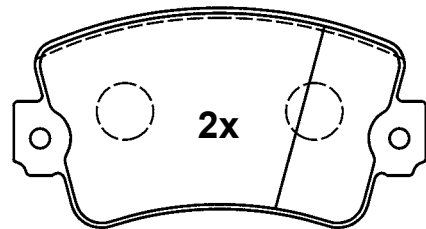

20489 18,5  
(20571)

108,9 x 57,5 x 18,5

## 13.0460-3965.2 603965

FORD

BDX

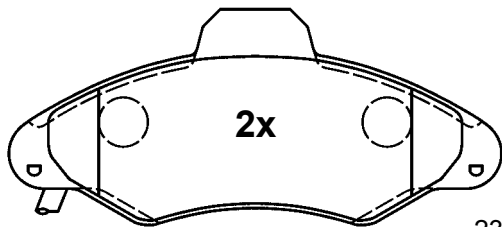

23300 18,0

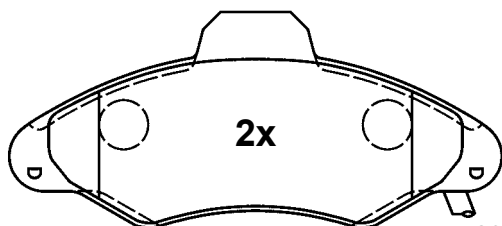

23301 18,0

130,8 x 57,3 x 18,0





# Abbildungen Scheibenbremsbeläge

Illustrations disc brake pads - Illustrazioni pastiglie freno -

Illustrations plaquettes de frein - Ilustraciones pastillas de freno

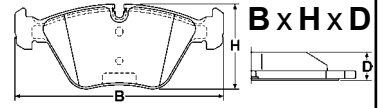

Maßstab - scale - scala - échelle - escala 1:2

**13.0460-3969.2 603969**

OPEL, RENAULT, VAUXHALL

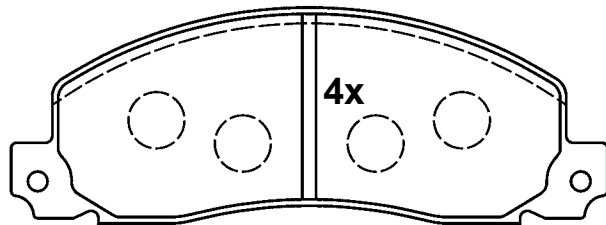

20926 18,5  
(20927 / 20928 / 20929)

**155,8 x 56,6 x 18,5**

325mm **2x**

**13.0460-3973.2 603973**

CITROEN

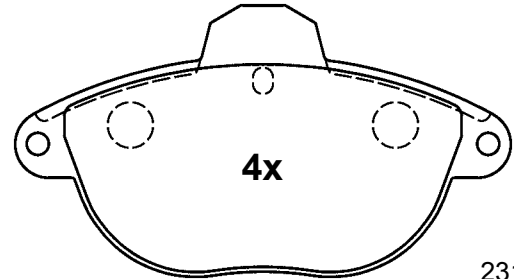

23146 17,0

**130,8 x 71,4 x 17,0**

168mm **2x**

364mm **2x**

**13.0460-3972.2 603972**

CITROEN

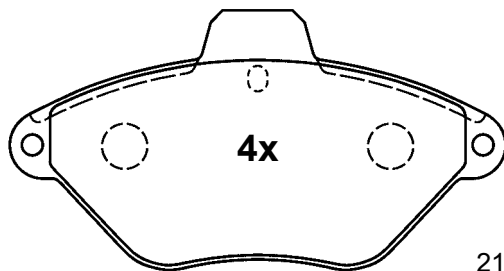

21632 16,0

**130,9 x 69,0 x 16,0**

152mm **2x**

364mm **2x**

**13.0460-3975.2 603975**

PEUGEOT

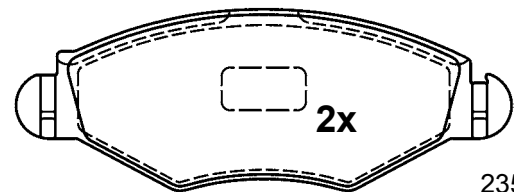

23597 18,0

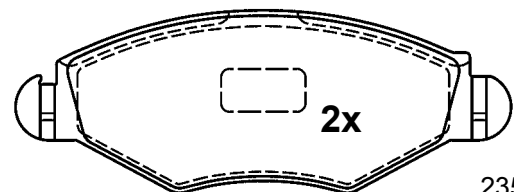

23598 18,0

**131,0 x 47,3 x 18,0**

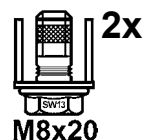

# Abbildungen Scheibenbremsbeläge

Illustrations disc brake pads - Illustrazioni pastiglie freno -

Illustrations plaquettes de frein - Ilustraciones pastillas de freno

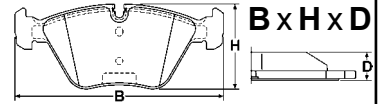

Maßstab - scale - scala - échelle - escala 1:2

## 13.0460-3976.2 603976



OPEL, VAUXHALL



BOS

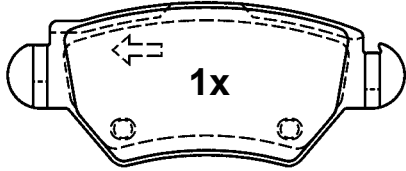

23258 16,5

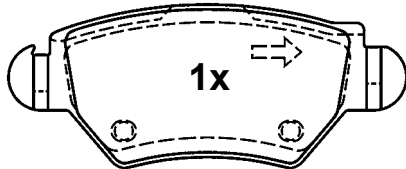

23259 16,5

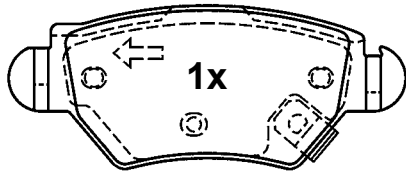

23262 16,5

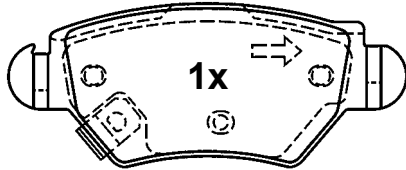

23263 16,5

104,6 x 42,7 x 16,5

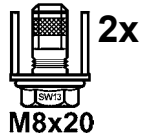

## 13.0460-3978.2 603978



CITROEN, PEUGEOT



BOS

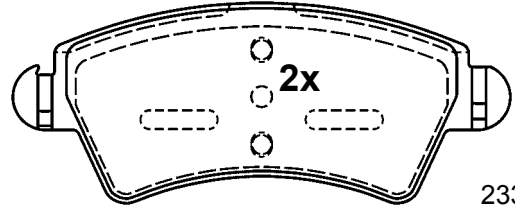

23332 18,0

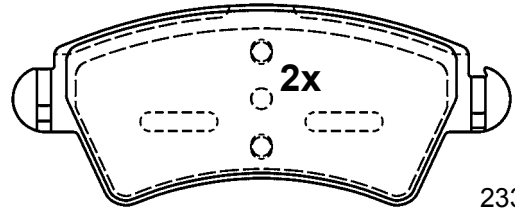

23333 18,0

130,8 x 52,4 x 18,0

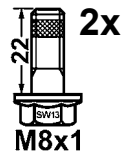

## 13.0460-3979.2 603979



SMART



BOS

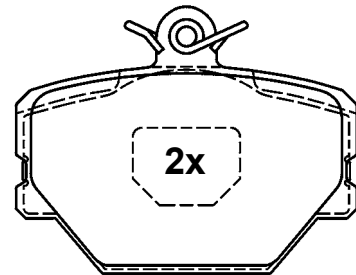

21999 15,8

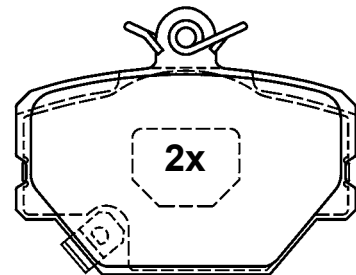

23001 15,8

90,0 x 70,1 x 15,8

## 13.0460-3977.2 603977



CITROEN, NISSAN, RENAULT



BOS

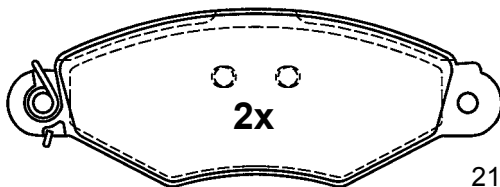

21980 18,0

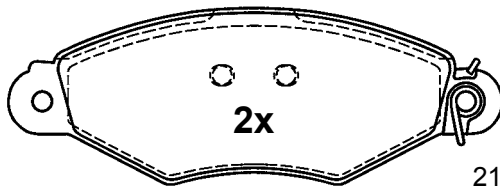

21981 18,0

130,7 x 47,2 x 18,0



# Abbildungen Scheibenbremsbeläge

Illustrations disc brake pads - Illustrazioni pastiglie freno -

Illustrations plaquettes de frein - Ilustraciones pastillas de freno

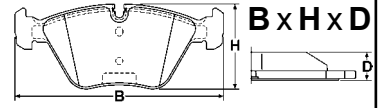

Maßstab - scale - scala - échelle - escala 1:2

**13.0460-3980.2 603980**



MERCEDES BENZ



BOS

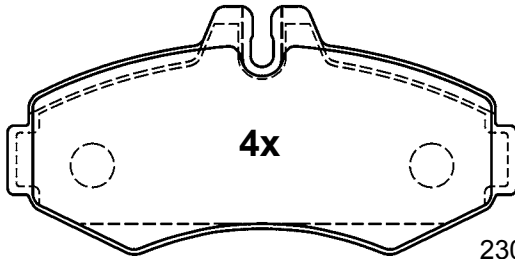

23022 20,9

134,4 x 64,5 x 20,9

**13.0460-3983.2 603983**



FIAT, LANCIA



BOS

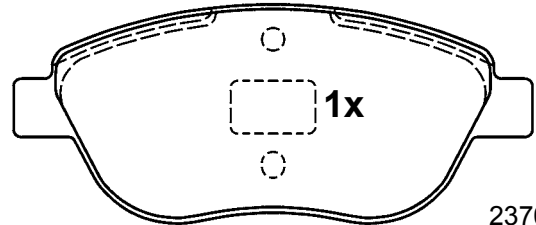

23708 19,4

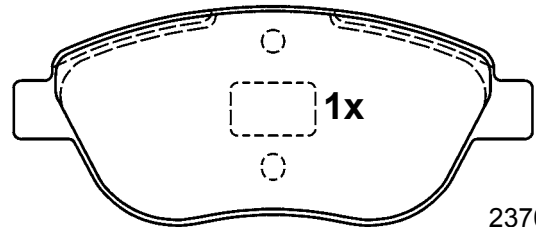

23708 19,4

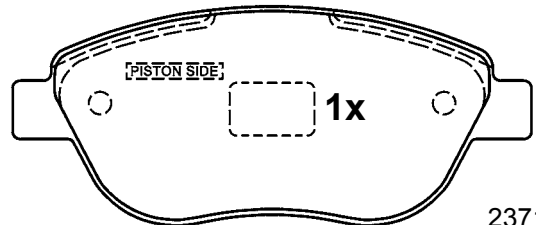

23710 19,4

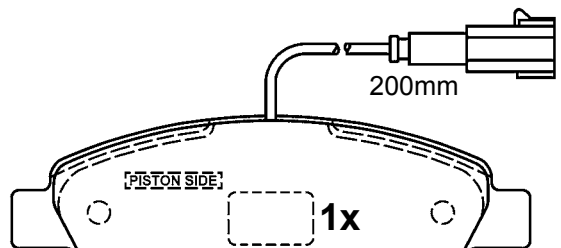

23709 19,4

136,8 x 57,4 x 19,4

**13.0460-3982.2 603982**



FIAT



BOS

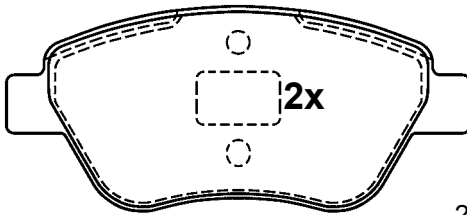

23705 18,1

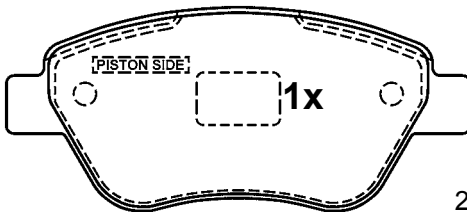

23707 18,1

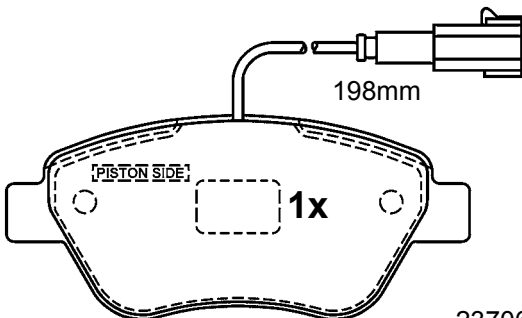

23706 18,1

122,8 x 53,3 x 18,1

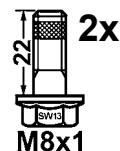
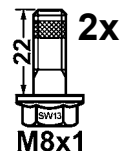

# Abbildungen Scheibenbremsbeläge

Illustrations disc brake pads - Illustrazioni pastiglie freno -

Illustrations plaquettes de frein - Ilustraciones pastillas de freno



Maßstab - scale - scala - échelle - escala 1:2

## 13.0460-3984.2 603984



ALFA ROMEO, FIAT, LANCIA



BOS

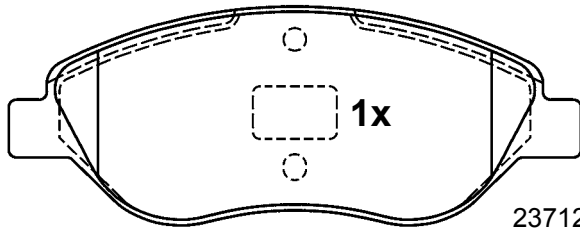

23712 19,4

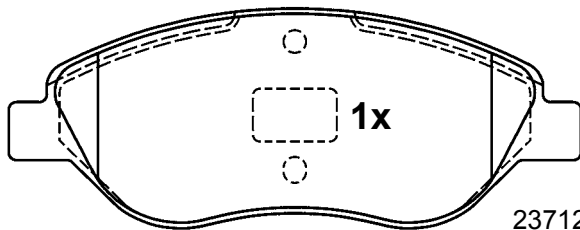

23712 19,4

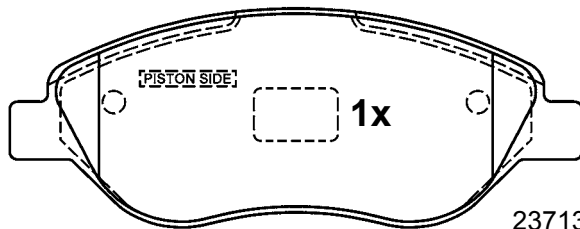

23713 19,4

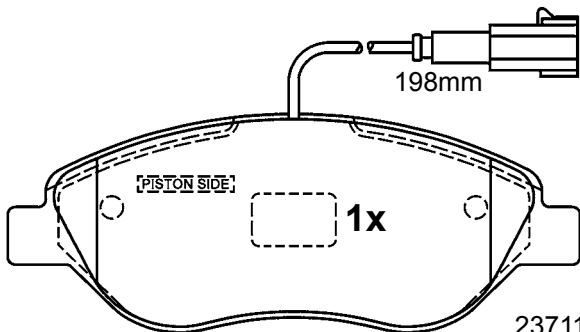

23711 19,4

150,8 x 57,4 x 19,4

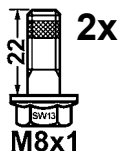

M8x1

## 13.0460-3985.2 603985



MERCEDES BENZ



BOS

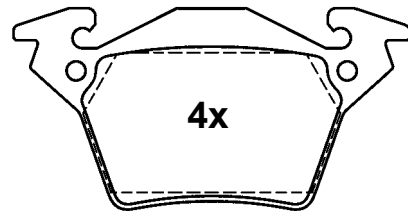

23020 17,9

105,0 x 52,9 x 17,9

## 13.0460-3986.2 603986



CITROEN



BOS

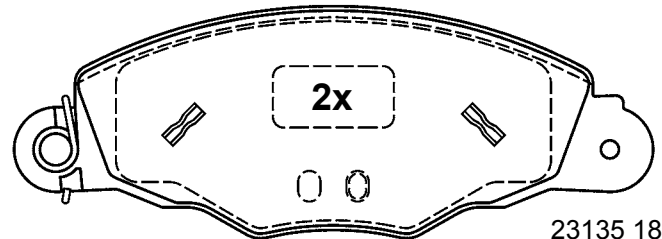

23135 18,0

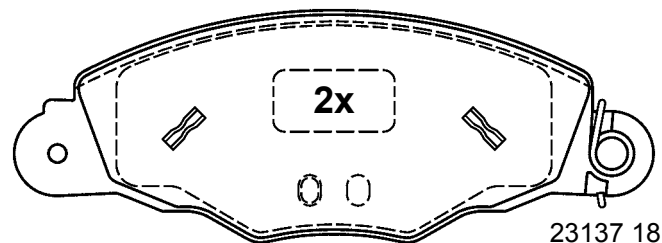

23137 18,0

168,9 x 61,1 x 18,0

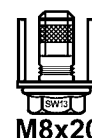

M8x20

410mm 2x

180mm 2x

# Abbildungen Scheibenbremsbeläge

Illustrations disc brake pads - Illustrazioni pastiglie freno -

Illustrations plaquettes de frein - Ilustraciones pastillas de freno

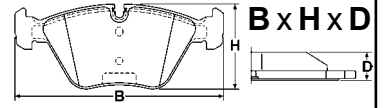

Maßstab - scale - scala - échelle - escala 1:2

**13.0460-3987.2 603987**

 FORD, JAGUAR

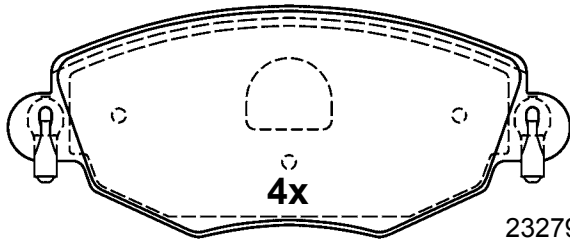

23279 18,4

148,8 x 60,5 x 18,4

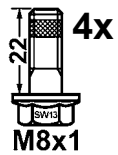

**13.0460-3990.2 603990**

 MERCEDES BENZ,  
VOLKSWAGEN

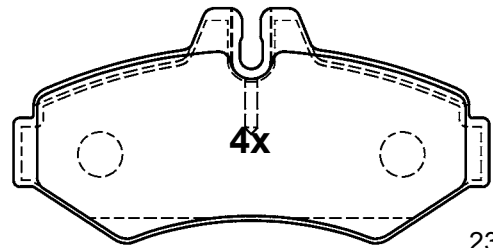

23021 18,9

125,8 x 61,9 x 18,9

**13.0460-3988.2 603988**

 FORD, JAGUAR, RENAULT

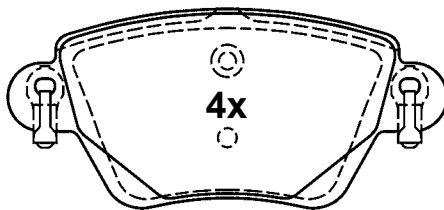

23557 17,2

115,7 x 52 x 17,2

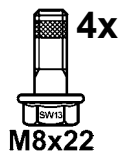

**13.0460-3991.2 603991**

 ALFA ROMEO, FIAT, LANCIA

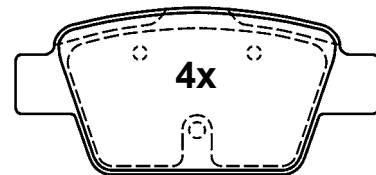

23714 16,6

94,8 x 42,9 x 16,6

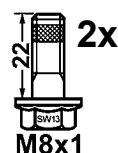

# Abbildungen Scheibenbremsbeläge

Illustrations disc brake pads - Illustrazioni pastiglie freno -

Illustrations plaquettes de frein - Ilustraciones pastillas de freno

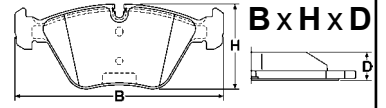

Maßstab - scale - scala - échelle - escala 1:2

**13.0460-3992.2 603992**

**13.0460-3993.2 603993**

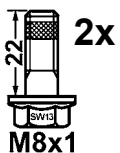
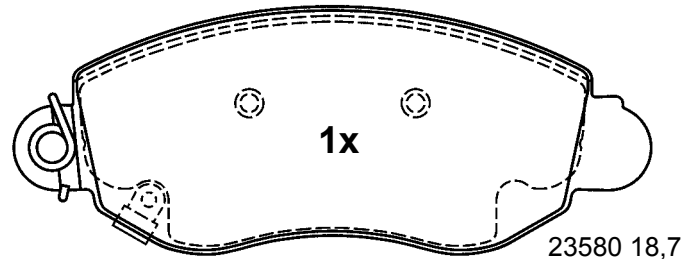
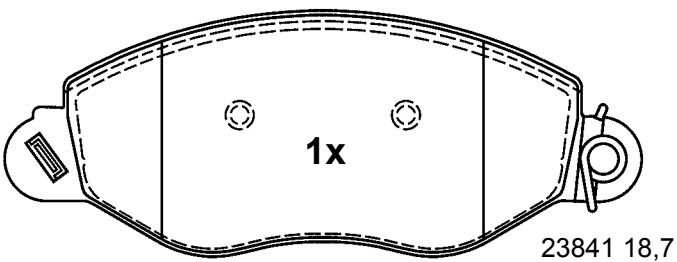
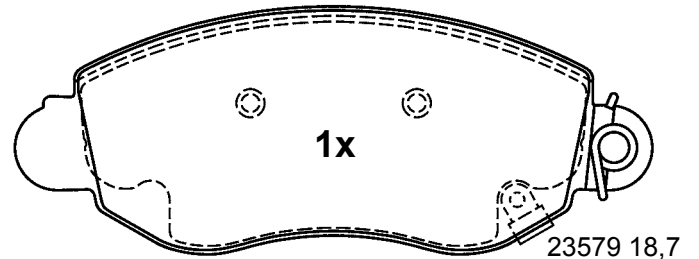
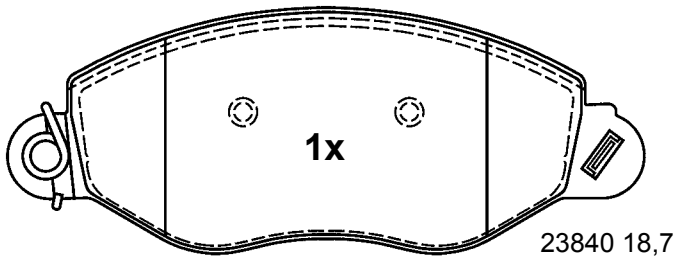
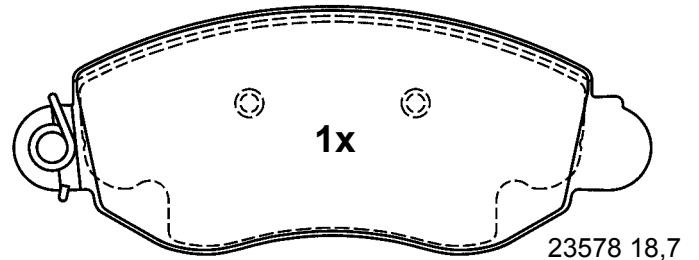
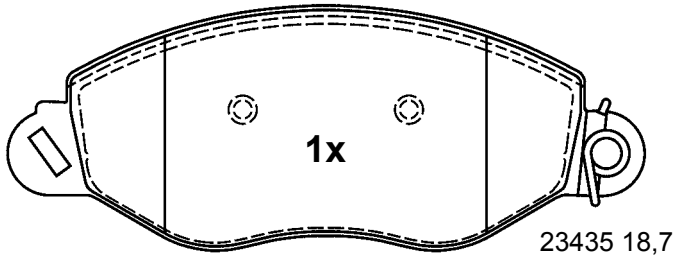
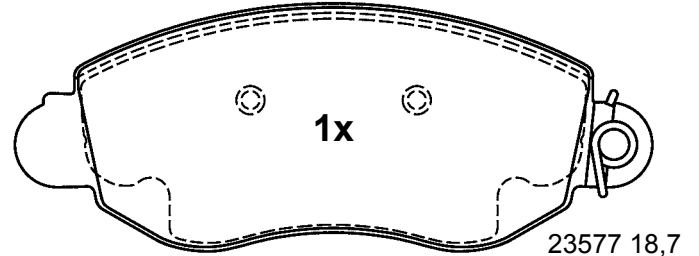
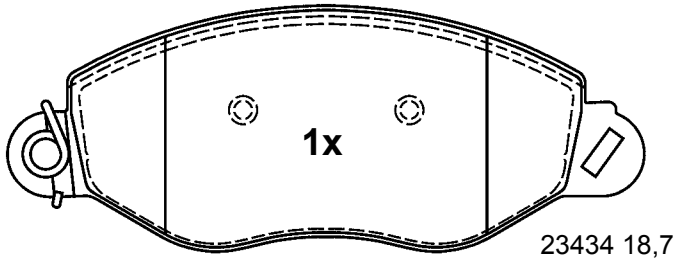

168,3 x 63,9 x 18,7

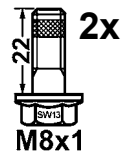

168,5 x 65,1 x 18,7



# Abbildungen Scheibenbremsbeläge

Illustrations disc brake pads - Illustrazioni pastiglie freno -

Illustrations plaquettes de frein - Ilustraciones pastillas de freno

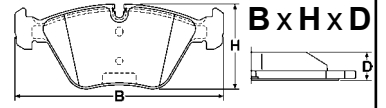

Maßstab - scale - scala - échelle - escala 1:2

## 13.0460-3994.2 603994



CITROEN, PEUGEOT



BOS

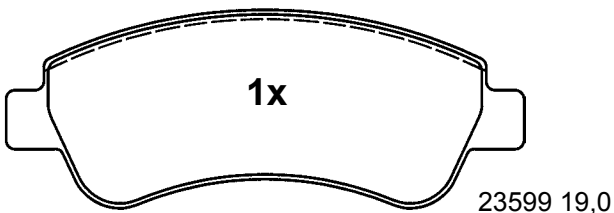
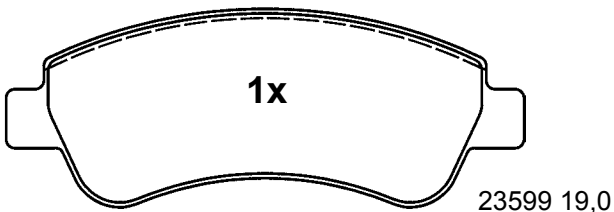
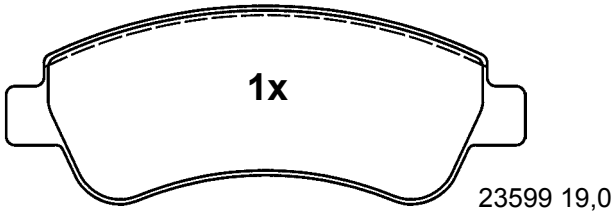
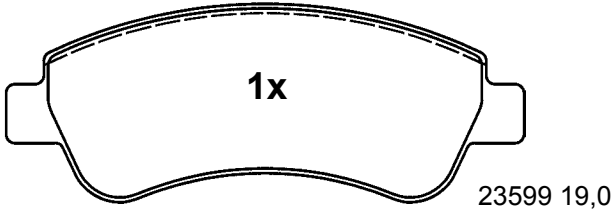

136,8 x 52,0 x 19,0

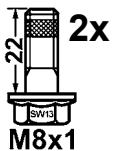
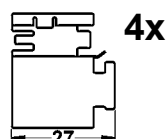
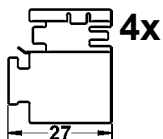

## 13.0460-3995.2 603995



OPEL, SUBARU, SUZUKI,  
VAUXHALL



BOS

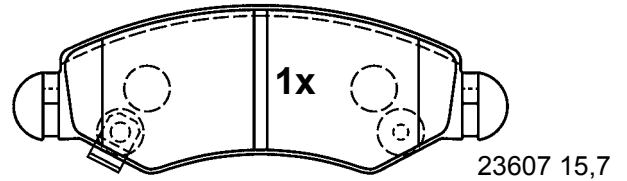
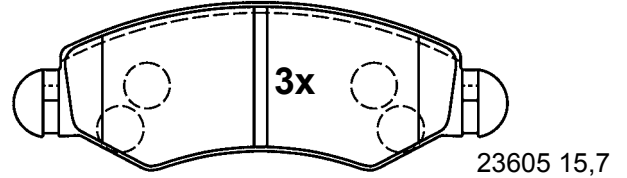

130,7 x 43,9 x 15,7

2x

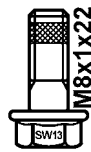

## 13.0460-3996.2 603996



CITROEN



BOS

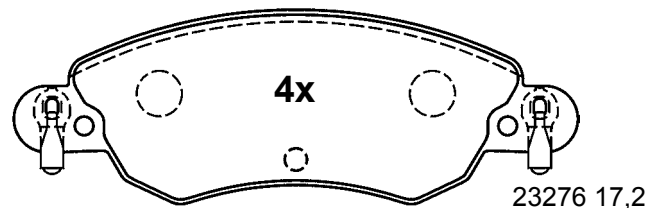

148,8 x 50,9 x 17,2

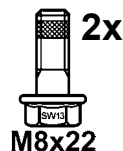
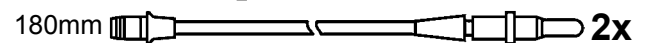

# Abbildungen Scheibenbremsbeläge

Illustrations disc brake pads - Illustrazioni pastiglie freno -

Illustrations plaquettes de frein - Ilustraciones pastillas de freno

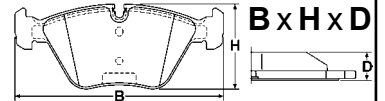

Maßstab - scale - scala - échelle - escala 1:2

**13.0460-3997.2 603997**

CITROEN

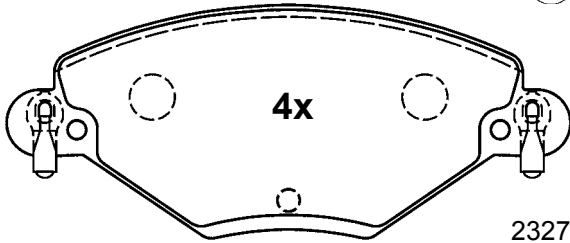

23277 17,7

148,7 x 61,2 x 17,7



**13.0460-3998.2 603998**

CITROEN

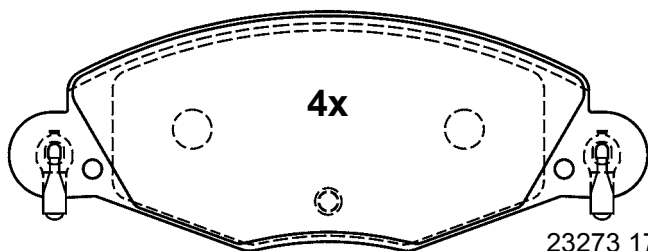

23273 17,8

168,7 x 62,8 x 17,8



**13.0460-3999.2 603999**

MERCEDES BENZ

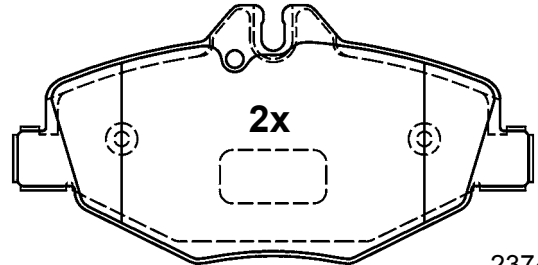

23743 20,1

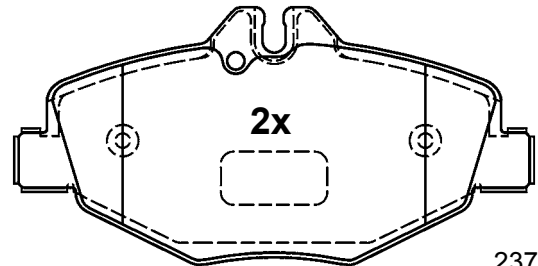
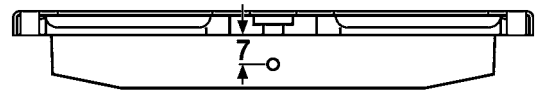

23744 20,1

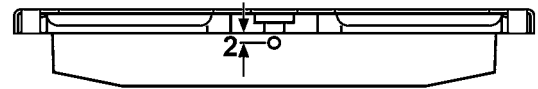

137,0 x 67,8 x 20,1

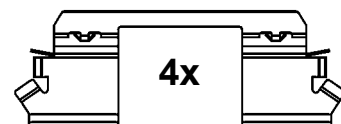
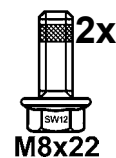
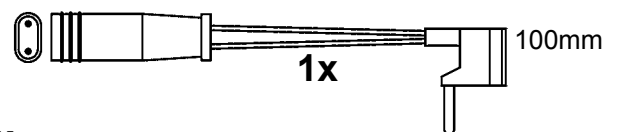
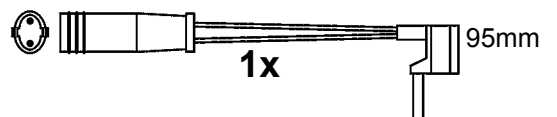
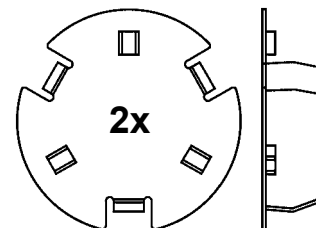

# Abbildungen Scheibenbremsbeläge

Illustrations disc brake pads - Illustrazioni pastiglie freno -

Illustrations plaquettes de frein - Ilustraciones pastillas de freno

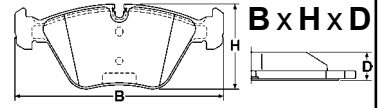

Maßstab - scale - scala - échelle - escala 1:2

**13.0460-4014.2 604014**



PEUGEOT



ATE

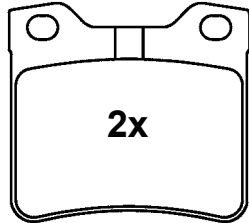

21278 16,4

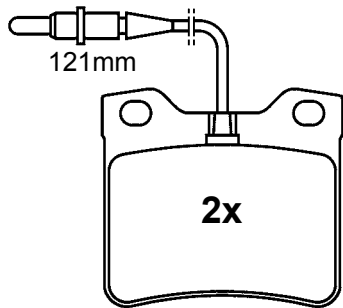

21279 16,4

63,7 x 57,8 x 16,4

**13.0460-4028.2 604028**



AUDI, VOLKSWAGEN



ATE

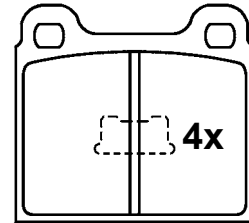

20228 15,3

61,8 x 56,8 x 15,3

**13.0460-4019.2 604019**



ALFA ROMEO



ATE

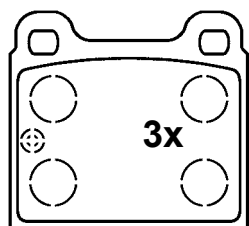

20034 15,0

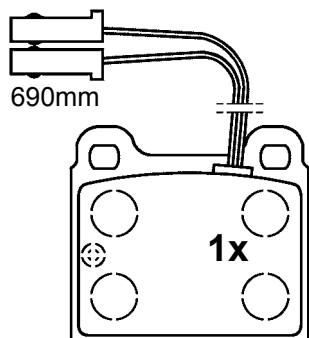

20911 15,0

61,8 x 56,5 x 15,0

**13.0460-4029.2 604029**



AUDI, VOLKSWAGEN



ATE

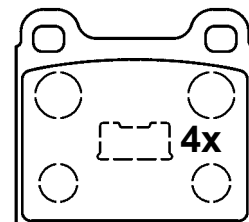

20228 18,5

61,7 x 56,8 x 18,5

# Abbildungen Scheibenbremsbeläge

Illustrations disc brake pads - Illustrazioni pastiglie freno -

Illustrations plaquettes de frein - Ilustraciones pastillas de freno

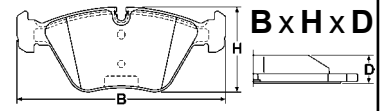

Maßstab - scale - scala - échelle - escala 1:2

## 13.0460-4030.2 604030



MERCEDES BENZ



ATE

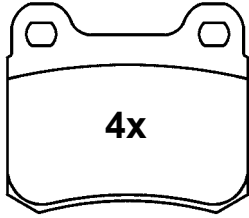

20687 13,5

61,8 x 54,3 x 13,5

## 13.0460-4036.2 604036



MERCEDES BENZ



ATE

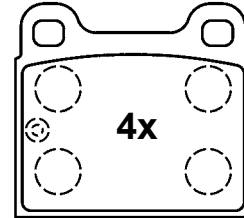

21035 15,0

61,7 x 56,5 x 15,0

## 13.0460-4033.2 604033



AUDI, BMW, PORSCHE,  
TALBOT, VOLKSWAGEN



ATE

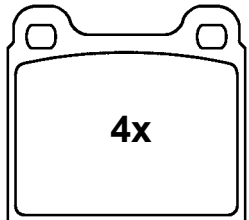

20034 15,0

61,8 x 56,5 x 15,0

## 13.0460-4037.2 604037



MERCEDES BENZ



ATE

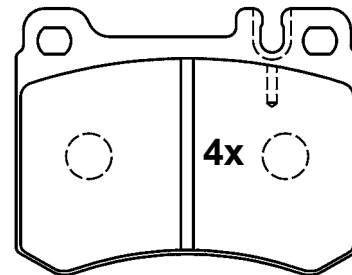

21024 17,5

89,7 x 70,2 x 17,5

## 13.0460-4034.2 604034



MERCEDES BENZ



ATE

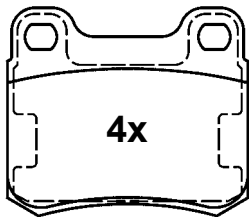

20687 15,5

61,8 x 54,3 x 15,5

## 13.0460-4040.2 604040



OPEL, SAAB, VAUXHALL



ATE

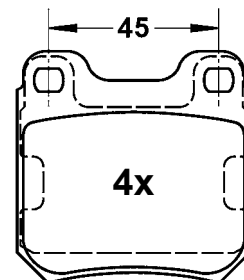

21050 15,8

61,6 x 61,2 x 15,8

## 13.0460-4035.2 604035



ALFA ROMEO, FORD, OPEL,  
SAAB, TALBOT, VAUXHALL



ATE

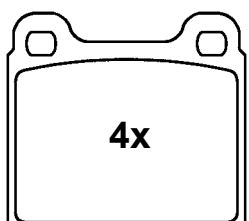

20173 15,0

61,8 x 56,5 x 15,0







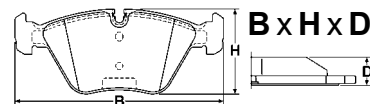

# Abbildungen Scheibenbremsbeläge

Illustrations disc brake pads - Illustrazioni pastiglie freno -

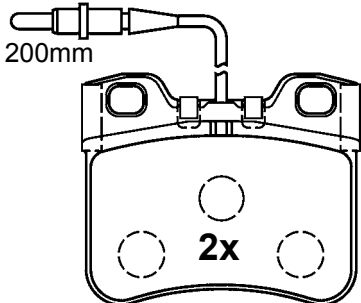
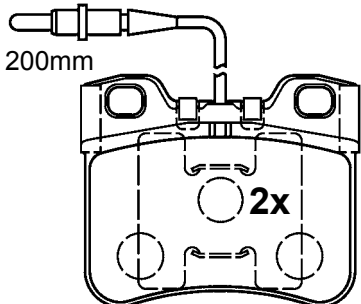
Illustrations plaquettes de frein - Ilustraciones pastillas de freno

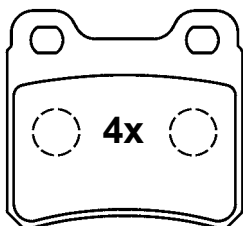

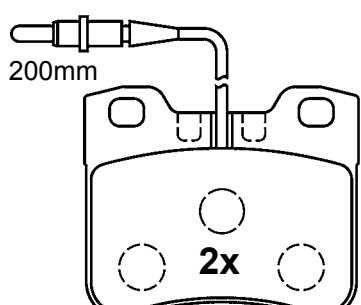
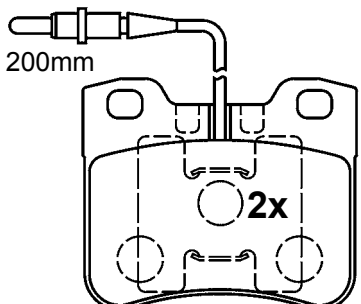
Maßstab - scale - scala - échelle - escala 1:2

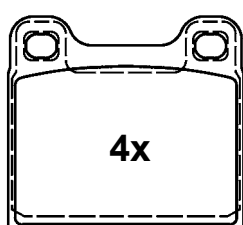
| 13.0460-4041.2 604041   | 13.0460-4043.2 604043  |
|---|--|
| <p> <b>CITROEN</b>  <b>ATE</b></p>  <p>21289 16,8</p>  <p>21179 16,8</p> <p><b>72,9 x 60,6 x 16,8</b></p>                 | <p> <b>OPEL, SAAB, VAUXHALL</b>  <b>ATE</b></p>  <p>21140 15,0</p> <p><b>61,7 x 57,5 x 15,0</b></p> |
| 13.0460-4042.2 604042   | 13.0460-4044.2 604044  |
| <p> <b>CITROEN, PEUGEOT</b>  <b>ATE</b></p>  <p>21267 16,8</p>  <p>21191 16,8</p> <p><b>71,9 x 60,6 x 16,8</b></p> | <p> <b>VOLVO</b>  <b>ATE</b></p>  <p>20755 15,1</p> <p><b>61,8 x 56,5 x 15,1</b></p>          |

# Abbildungen Scheibenbremsbeläge

Illustrations disc brake pads - Illustrazioni pastiglie freno -

Illustrations plaquettes de frein - Ilustraciones pastillas de freno

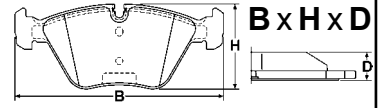

Maßstab - scale - scala - échelle - escala 1:2

**13.0460-4047.2 604047**



CHRYSLER, MERCEDES BENZ



ATE

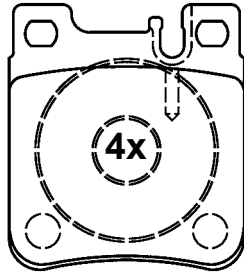

21305 15,7

61,7 x 69,5 x 15,7

**13.0460-4058.2 604058**



FORD



ATE

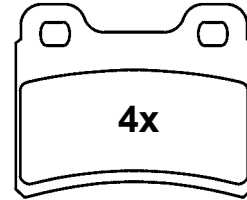

21832 14,9

61,7 x 51,1 x 14,9

**13.0460-4048.2 604048**



PORSCHE



ATE

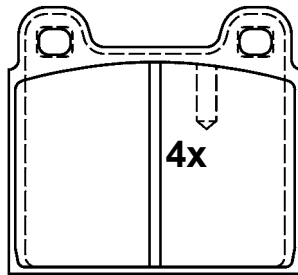

20011 15,0

76,7 x 70,0 x 15,0

**13.0460-4059.2 604059**



PEUGEOT



ATE

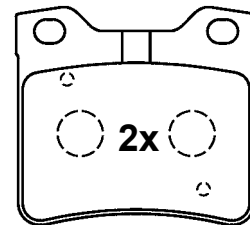

21278 16,4

**13.0460-4056.2 604056**



PORSCHE



BRE

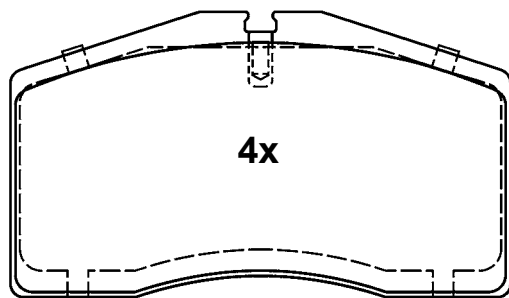

21402 17,5

131,7 x 75,0 x 17,5

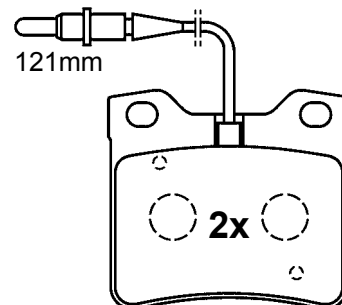

21279 16,4

63,7 x 57,8 x 16,4



# Abbildungen Scheibenbremsbeläge

Illustrations disc brake pads - Illustrazioni pastiglie freno -

Illustrations plaquettes de frein - Ilustraciones pastillas de freno

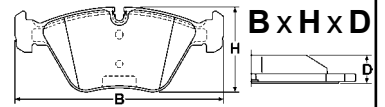

Maßstab - scale - scala - échelle - escala 1:2

## 13.0460-4060.2 604060



MERCEDES BENZ



ATE

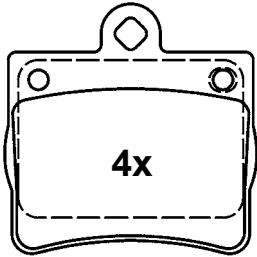

21900 15,0

63,7 x 63,2 x 15,0

## 13.0460-4065.2 604065



MERCEDES BENZ



ATE

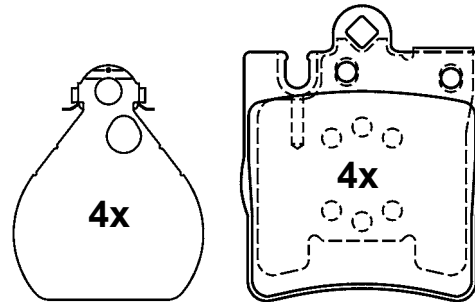

21899 15,3

63,7 x 78,0 x 15,3

## 13.0460-4066.2 604066



CITROEN, PEUGEOT



ATE

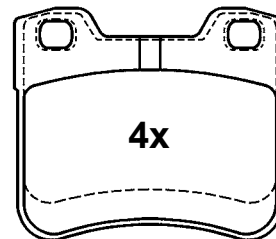

21857 17,7

71,9 x 60,6 x 17,7

## 13.0460-4064.2 604064



CHRYSLER, MERCEDES BENZ



ATE

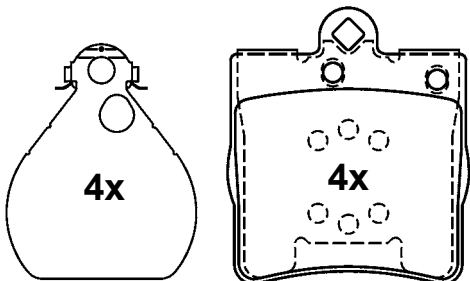

21919 15,3

63,8 x 72,8 x 15,3

## 13.0460-4069.2 604069



MERCEDES BENZ



ATE

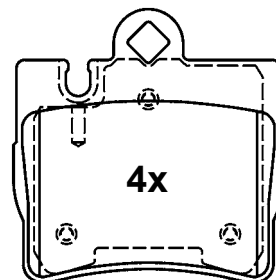

23078 15,9

70,9 x 72,1 x 15,9

# Abbildungen Scheibenbremsbeläge

Illustrations disc brake pads - Illustrazioni pastiglie freno -

Illustrations plaquettes de frein - Ilustraciones pastillas de freno

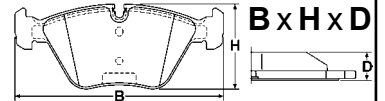

Maßstab - scale - scala - échelle - escala 1:2

## 13.0460-4070.2 604070



PORSCHE



ATE

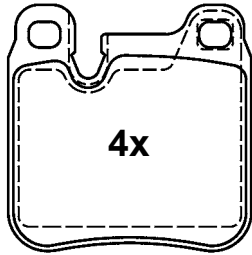

4x

21163 14,5

63,7 x 64,6 x 14,5

## 13.0460-4800.2 604800



VOLKSWAGEN



BRE

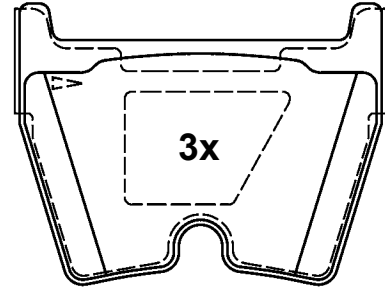

3x

23751 17,0

## 13.0460-4201.2 604201



MERCEDES BENZ



ATE

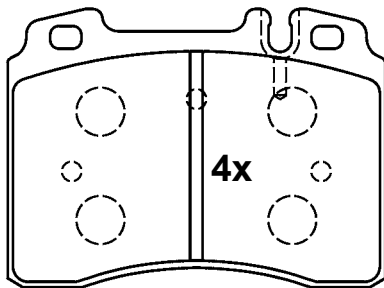

4x

21153 17,5

99,8 x 73,6 x 17,5

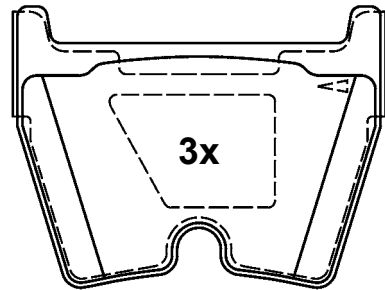

3x

23751 17,0

## 13.0460-4202.2 604202



MERCEDES BENZ



ATE

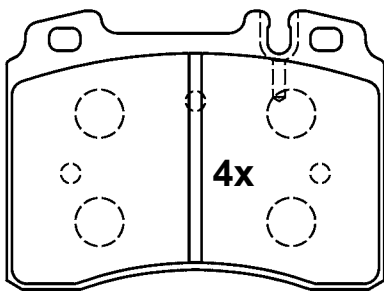

4x

21153 16,0

99,8 x 73,6 x 16,0

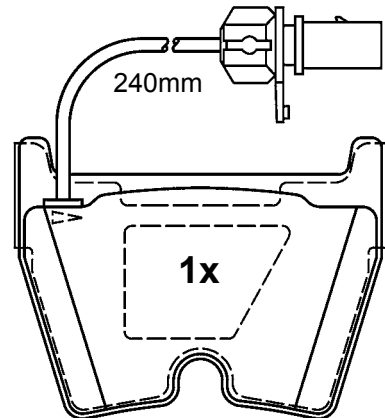

240mm

1x

23764 17,0

## 13.0460-4401.2 604401



MERCEDES BENZ



ATE

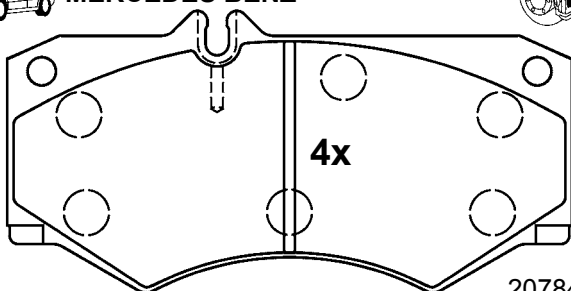

4x

20784 18,0

149,0 x 75,0 x 18,0

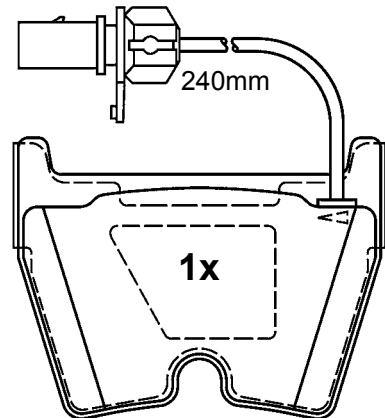

240mm

1x

23765 17,0

97,3 x 73,9 x 17,0

# Abbildungen Scheibenbremsbeläge

Illustrations disc brake pads - Illustrazioni pastiglie freno -

Illustrations plaquettes de frein - Ilustraciones pastillas de freno

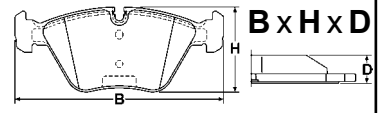

Maßstab - scale - scala - échelle - escala 1:2

## 13.0460-4801.2 604801



SEAT



BRE

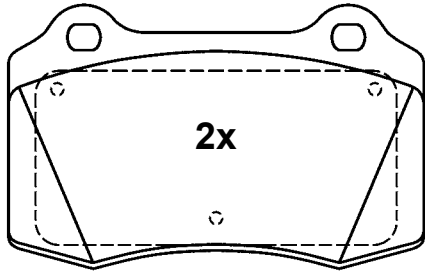

2x

21381 15,0

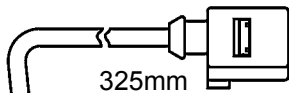

325mm

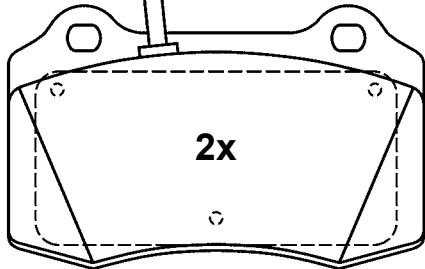

2x

24143 15,0

109,8 x 69,2 x 15,0

## 13.0460-4803.2 604803



ALFA ROMEO



BRE

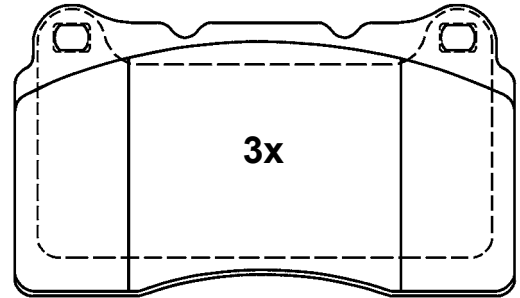

3x

23092 15,6

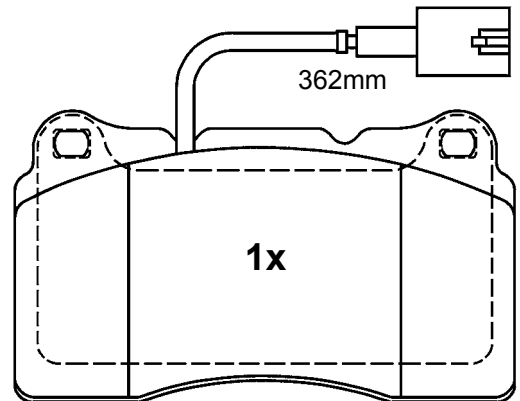

362mm

1x

23111 15,6

131,8 x 77,2 x 15,6

## 13.0460-4802.2 604802



AUDI



BRE

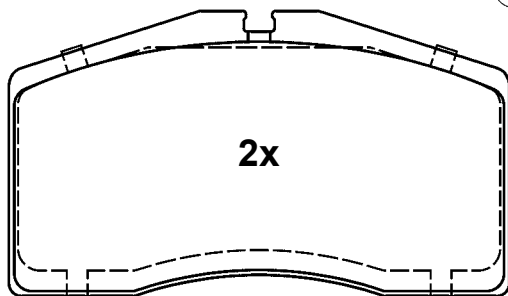

2x

23773 17,5

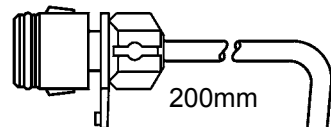

200mm

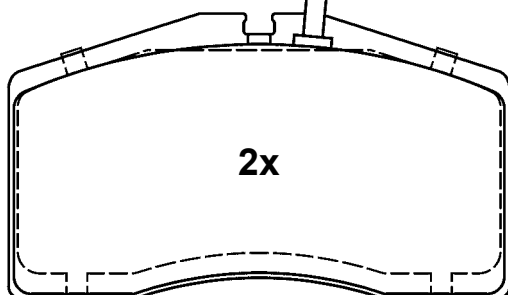

2x

23774 17,5

131,7 x 75,0 x 17,5

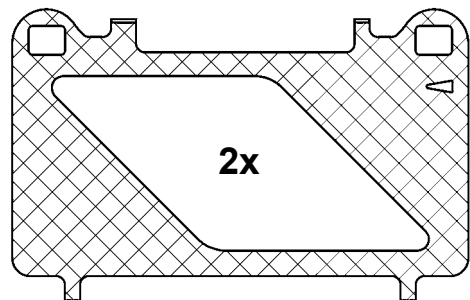

2x

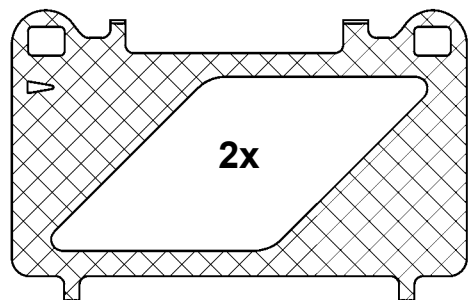

2x

# Abbildungen Scheibenbremsbeläge

Illustrations disc brake pads - Illustrazioni pastiglie freno -

Illustrations plaquettes de frein - Ilustraciones pastillas de freno

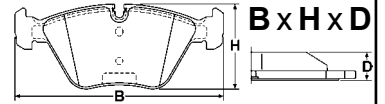

Maßstab - scale - scala - échelle - escala 1:2

## 13.0460-4804.2 604804

VOLVO

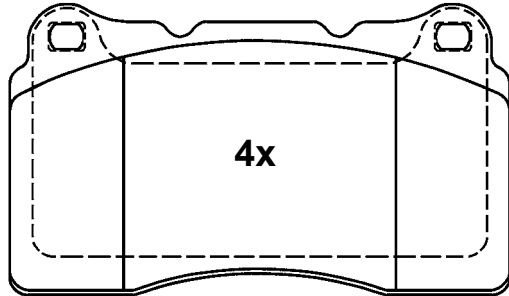

23092 15,6

131,8 x 77,2 x 15,6

## 13.0460-4807.2 604807

CITROEN, FIAT, PEUGEOT

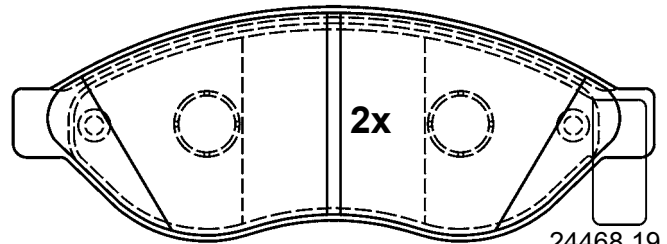

24468 19,1

## 13.0460-4805.2 604805

RENAULT

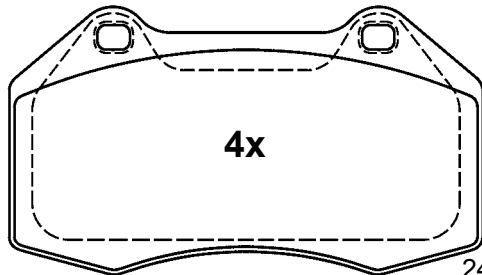

24162 15,2

124,6 x 70,4 x 15,2

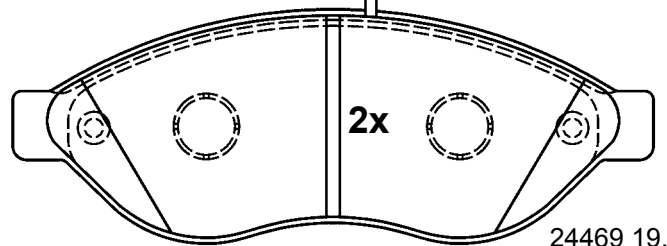
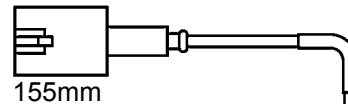

24469 19,1

169,2 x 61,5 x 19,1

## 13.0460-4806.2 604806

MERCEDES BENZ

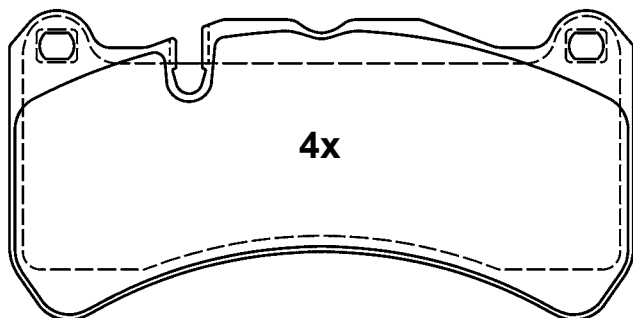

23955 16,2

164,6 x 81,5 x 16,2

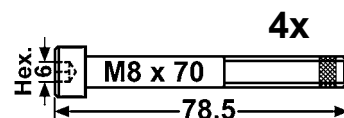
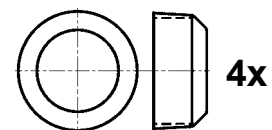
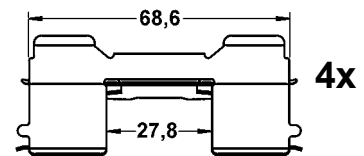

# Abbildungen Scheibenbremsbeläge

Illustrations disc brake pads - Illustrazioni pastiglie freno -

Illustrations plaquettes de frein - Ilustraciones pastillas de freno

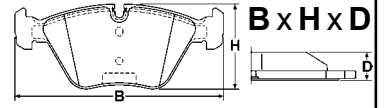

Maßstab - scale - scala - échelle - escala 1:2

**13.0460-4809.2 604809**



CITROEN, FIAT, PEUGEOT



BRE

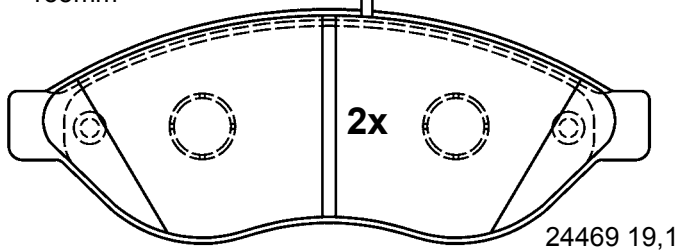
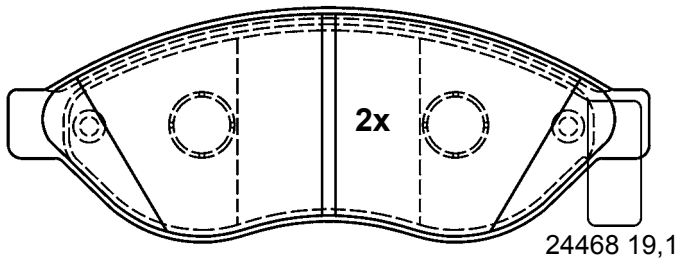

**169,3 x 61,5 x 19,1**

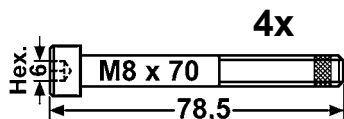
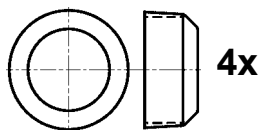
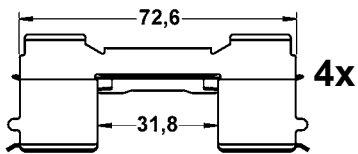

**13.0460-4810.2 604810**



CITROEN, FIAT, PEUGEOT



BRE

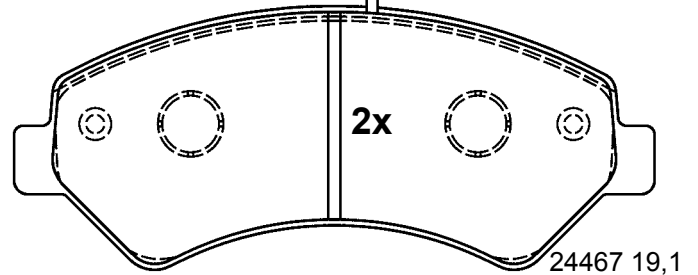
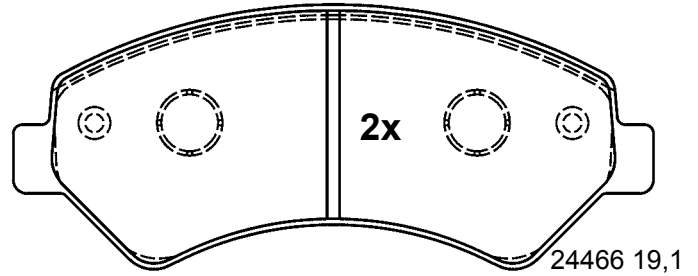

**169,3 x 69,1 x 19,1**

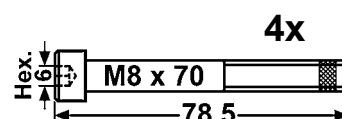
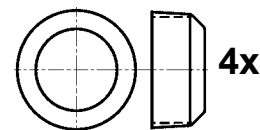
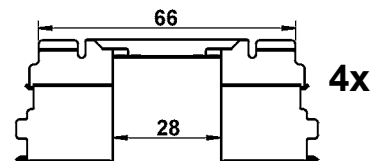

# Abbildungen Scheibenbremsbeläge

Illustrations disc brake pads - Illustrazioni pastiglie freno -

Illustrations plaquettes de frein - Ilustraciones pastillas de freno

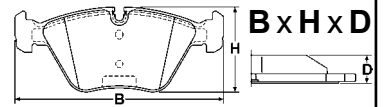

Maßstab - scale - scala - échelle - escala 1:2

## 13.0460-4811.2 604811



CITROEN, FIAT, PEUGEOT



BRE

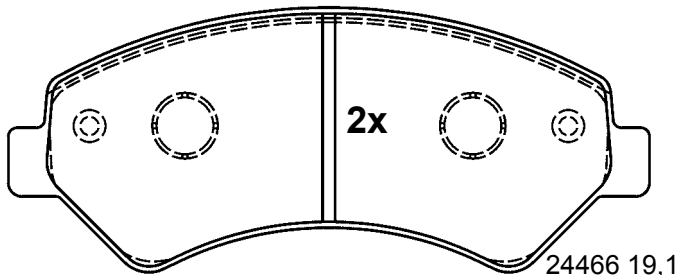

24466 19,1

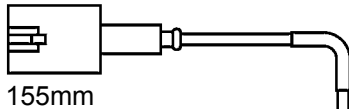

155mm

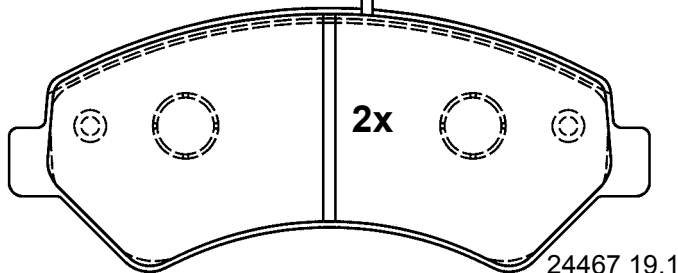

24467 19,1

169,3 x 69,1 x 19,1

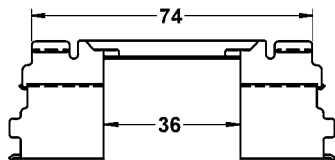

4x

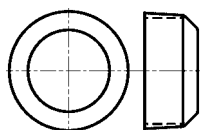

4x

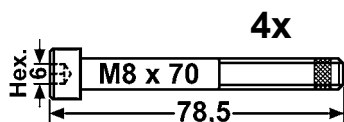

4x

Hex. M8 x 70 78,5

## 13.0460-4812.2 604812



CITROEN, FIAT, PEUGEOT



BRE

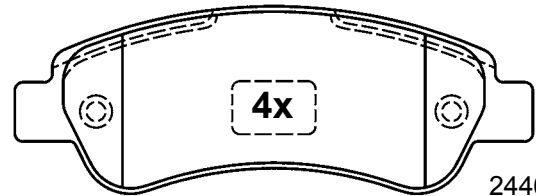

24465 19,2

136,8 x 48,9 x 19,2

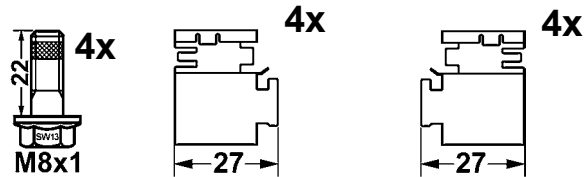

4x M8x1

4x 27

4x 27

## 13.0460-4814.2 604814



PORSCHE



BRE

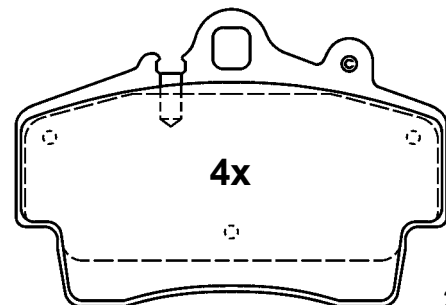

21937 15,5

114,0 x 78,0 x 15,5

## 13.0460-4815.2 604815



PORSCHE



BRE

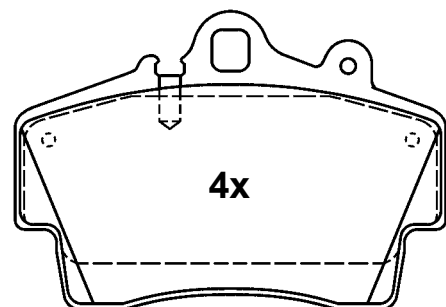

21937 15,5

114,0 x 78,0 x 15,5



# Abbildungen Scheibenbremsbeläge

Illustrations disc brake pads - Illustrazioni pastiglie freno -  
Illustrations plaquettes de frein - Ilustraciones pastillas de freno

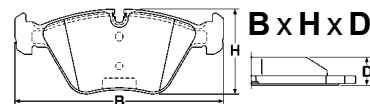

Maßstab - scale - scala - échelle - escala 1:2

**13.0460-4816.2 604816**

PORSCHE

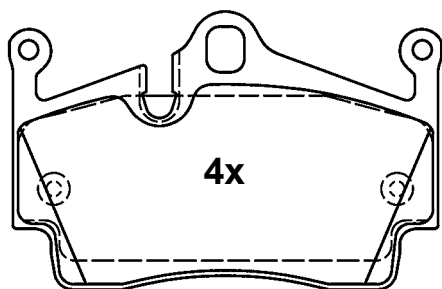

24541 15,5

112,0 x 73,0 x 15,5

**13.0460-4818.2 604818**

NISSAN

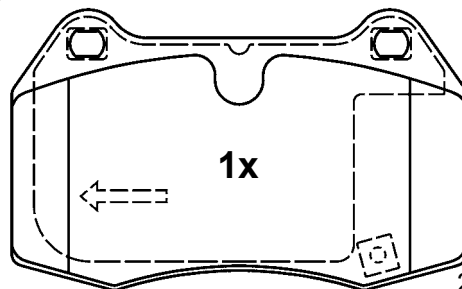

23142 15,1

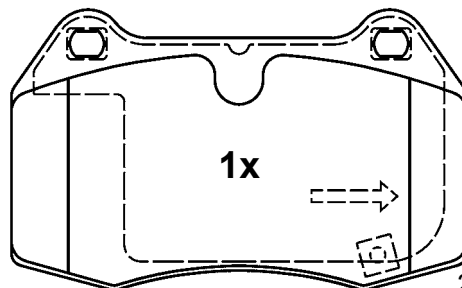

23142 15,1

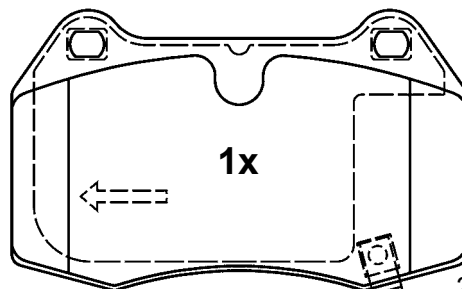

23143 15,1

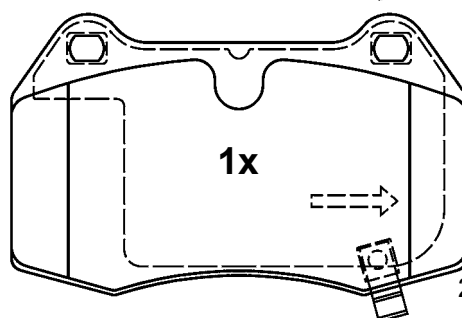

23143 15,1



120,0 x 73,5 x 15,1

**13.0460-4817.2 604817**

MERCEDES BENZ

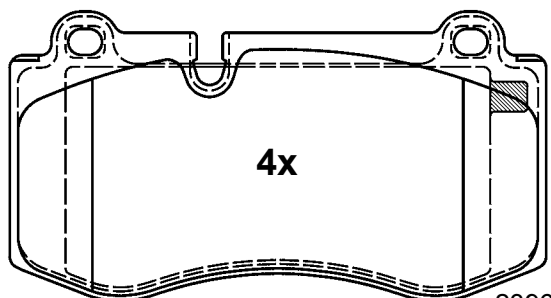

23960 18,3

141,6 x 75,8 x 18,3

**13.0460-4819.2 604819**

MERCEDES BENZ

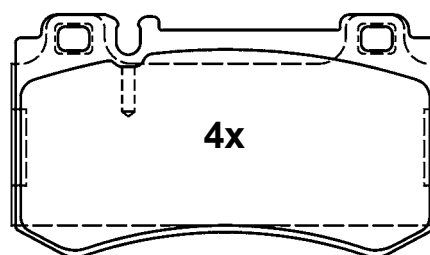

23478 14,6

112,0 x 64,0 x 14,6



# Abbildungen Scheibenbremsbeläge

Illustrations disc brake pads - Illustrazioni pastiglie freno -

Illustrations plaquettes de frein - Ilustraciones pastillas de freno

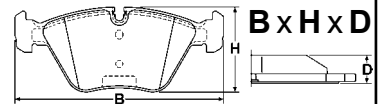

Maßstab - scale - scala - échelle - escala 1:2

**13.0460-4823.2 604823**



IVECO



BRE

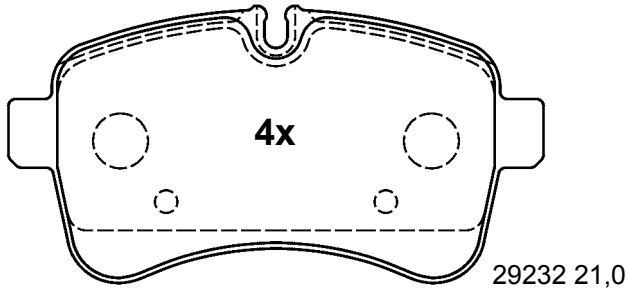

29232 21,0

141,1 x 72,6 x 21,0

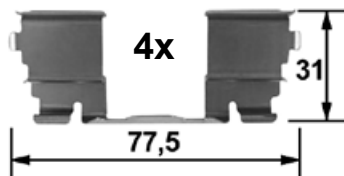

4x

31

77,5

4x

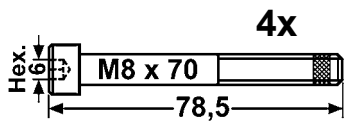

4x

M8 x 70

78,5

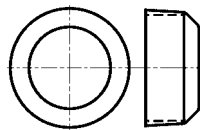

**13.0460-4827.2 604827**



MERCEDES BENZ, VOLKSWAGEN



BRE

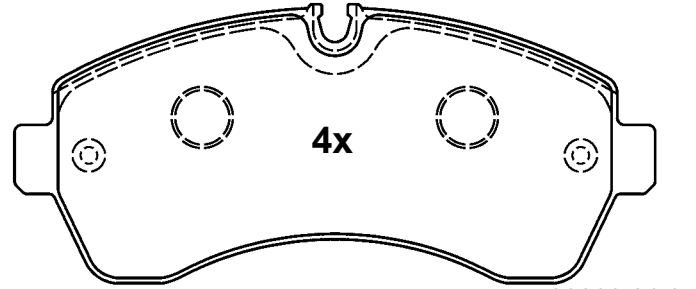

29200 21,0

169,1 x 73,4 x 21,0

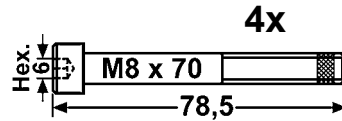

4x

M8 x 70

78,5

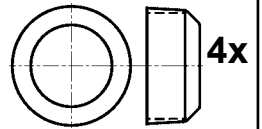

4x

**13.0460-4826.2 604826**



MERCEDES BENZ, VOLKSWAGEN



BRE

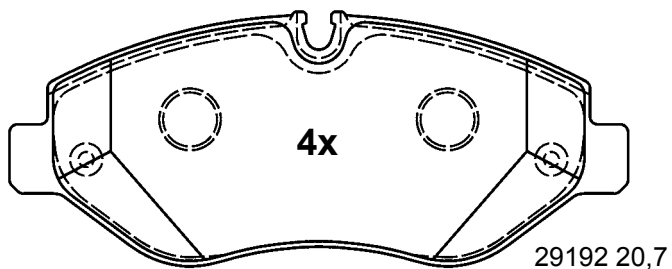

29192 20,7

163,1 x 67,1 x 20,7

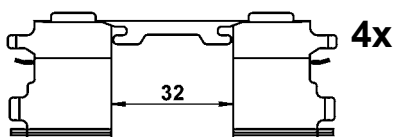

4x

32

4x

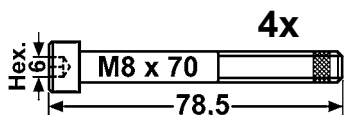

4x

M8 x 70

78,5

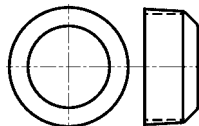

**13.0460-4828.2 604828**



IVECO



BRE

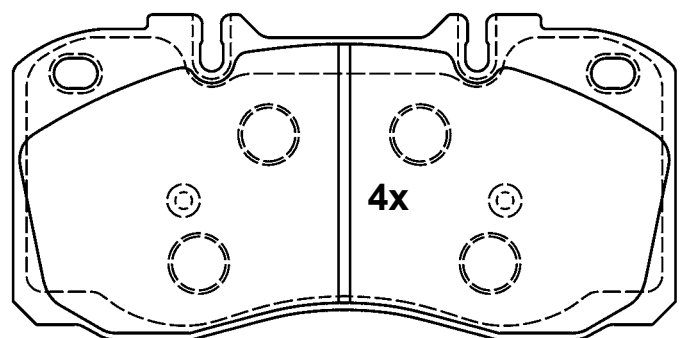

29122 22,1

174,7 x 85,5 x 22,1

# Abbildungen Scheibenbremsbeläge

Illustrations disc brake pads - Illustrazioni pastiglie freno -

Illustrations plaquettes de frein - Ilustraciones pastillas de freno

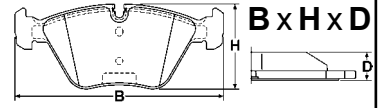

Maßstab - scale - scala - échelle - escala 1:2

**13.0460-4829.2 604829**



IVECO

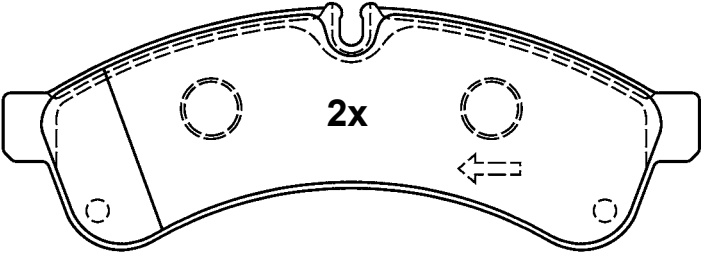

29231 22,7

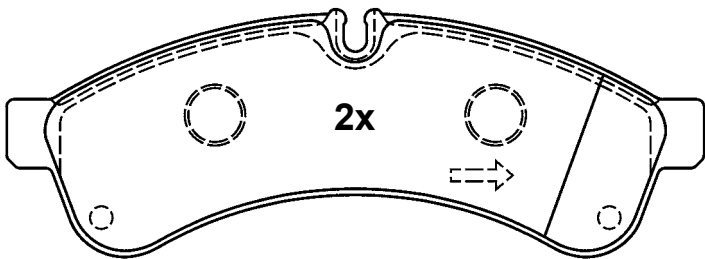

29231 22,7

184,2 x 64,7 x 22,7

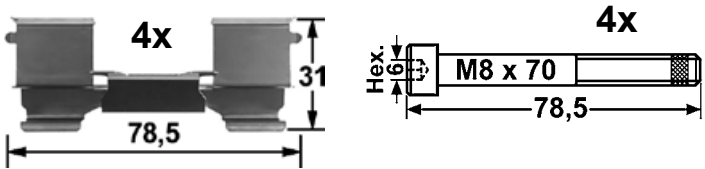

**13.0460-4830.2 604830**



IVECO

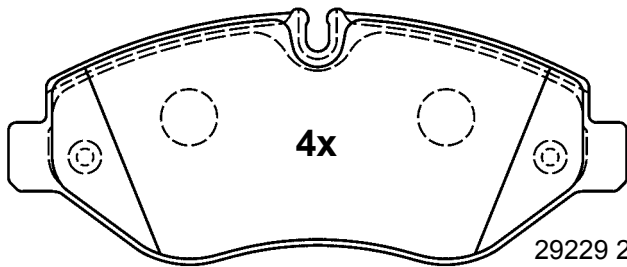

29229 20,7

163,1 x 67,1 x 20,7

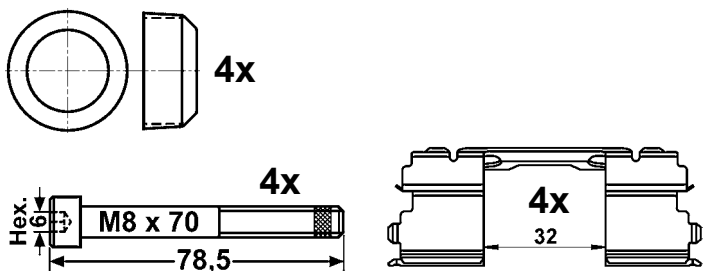

**13.0460-4832.2 604832**



FORD

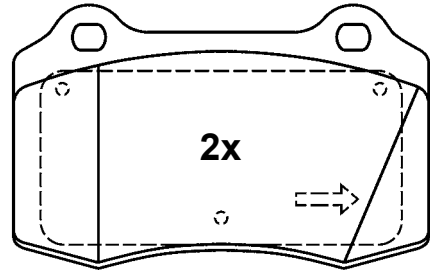

21381 18,0

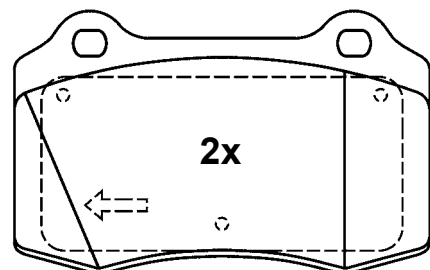

21381 18,0

109,8 x 69,2 x 18,0

**13.0460-4833.2 604833**



AUDI, SEAT, VOLKSWAGEN

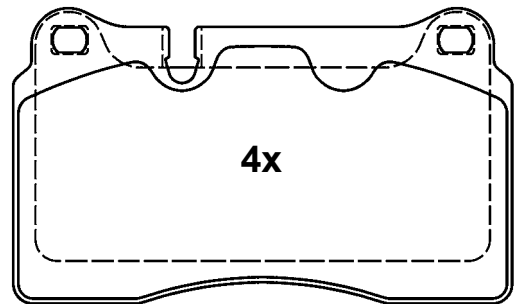

24098 17,1

131,6 x 77,3 x 17,1



# Abbildungen Scheibenbremsbeläge

Illustrations disc brake pads - Illustrazioni pastiglie freno -

Illustrations plaquettes de frein - Ilustraciones pastillas de freno

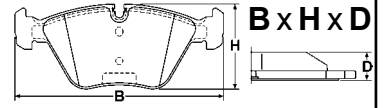

Maßstab - scale - scala - échelle - escala 1:2

**13.0460-4834.2 604834**

 VOLKSWAGEN

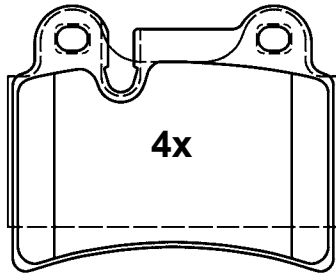

24097 17,1

86,8 x 70,1 x 17,1

**13.0460-4839.2 604839**

 MERCEDES BENZ

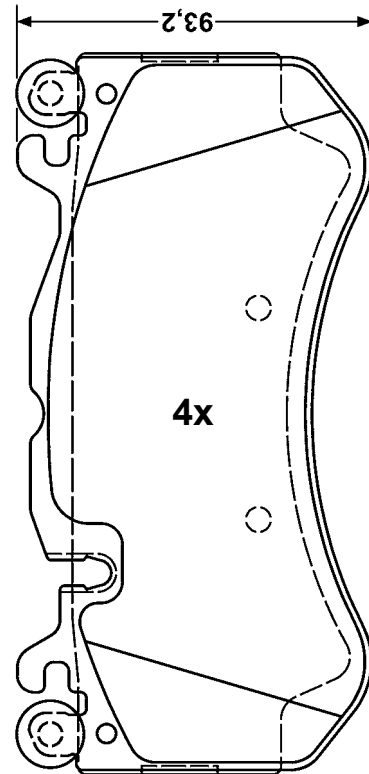

24455 16,8

189,8 x 93,2 x 16,8

**13.0460-4837.2 604837**

 LAND ROVER

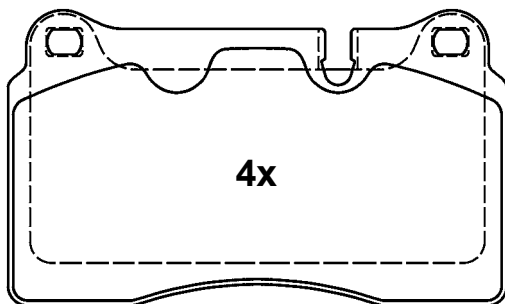

20217 17,1

131,6 x 77,3 x 17,1

**13.0460-4840.2 604840**

 PORSCHE

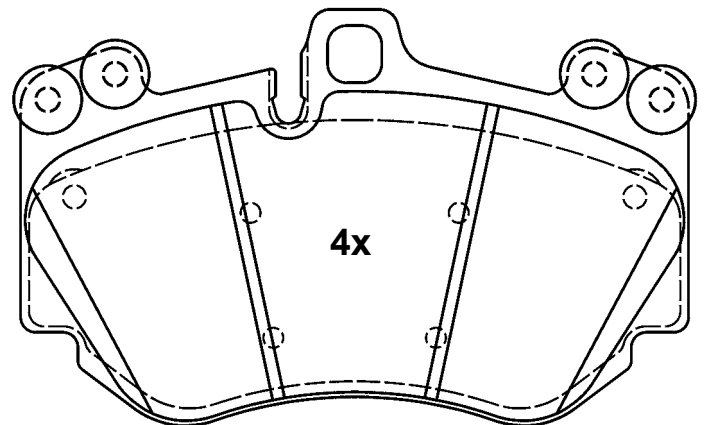

23961 16,8

176,0 x 109,6 x 16,8

# Abbildungen Scheibenbremsbeläge

Illustrations disc brake pads - Illustrazioni pastiglie freno -

Illustrations plaquettes de frein - Ilustraciones pastillas de freno

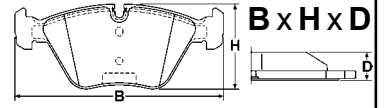

Maßstab - scale - scala - échelle - escala 1:2

**13.0460-4841.2 604841**



JAGUAR



BRE

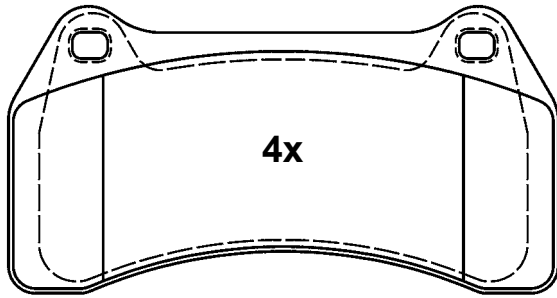

23489 16,3

144,7 x 75,3 x 16,3

**13.0460-4843.2 604843**



PORSCHÉ



BRE

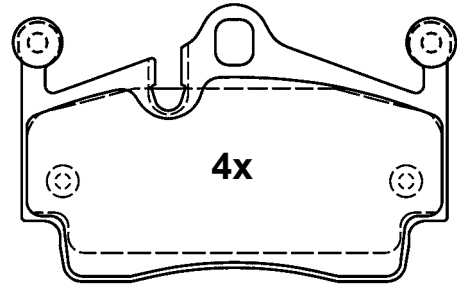

15,5

112,0 x 73,0 x 15,5

**13.0460-4842.2 604842**



PORSCHÉ



BRE

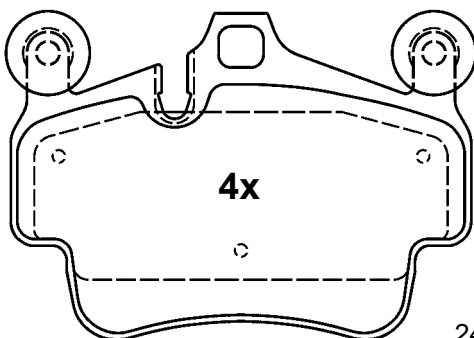

24049 17,0

121,0 x 86,0 x 17,0

**13.0460-4844.2 604844**



IVECO



BRE

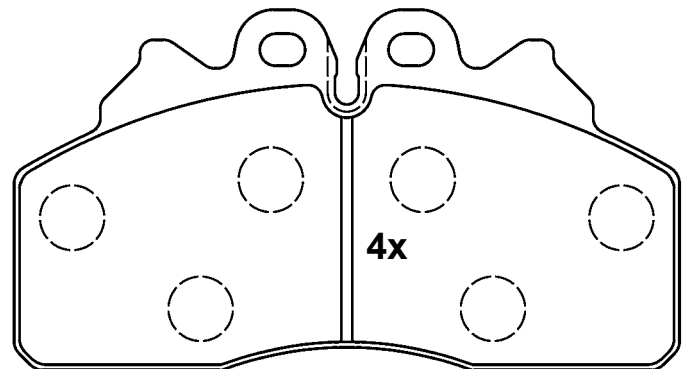

29256 27,0

175,4 x 94,9 x 27,0



# Abbildungen Scheibenbremsbeläge

Illustrations disc brake pads - Illustrazioni pastiglie freno -

Illustrations plaquettes de frein - Ilustraciones pastillas de freno

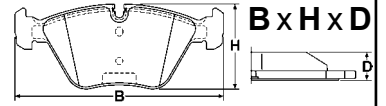

Maßstab - scale - scala - échelle - escala 1:2

**13.0460-4847.2 604847**

IVECO, RENAULT

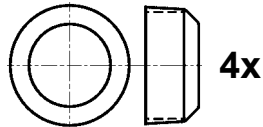
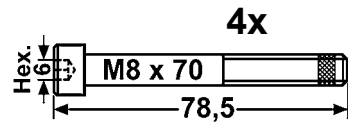
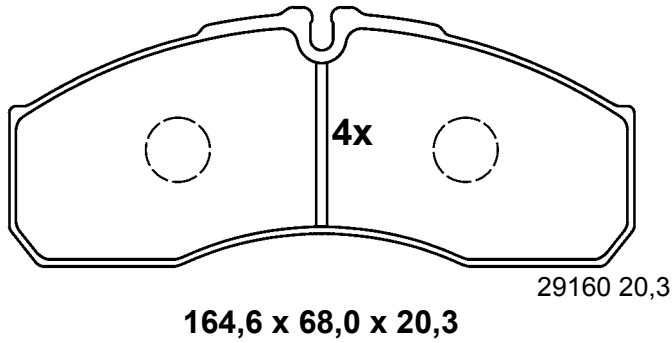

**13.0460-4849.2 604849**

BMW

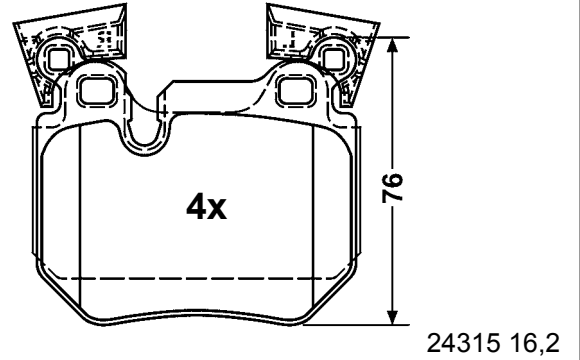

**13.0460-4848.2 604848**

BMW

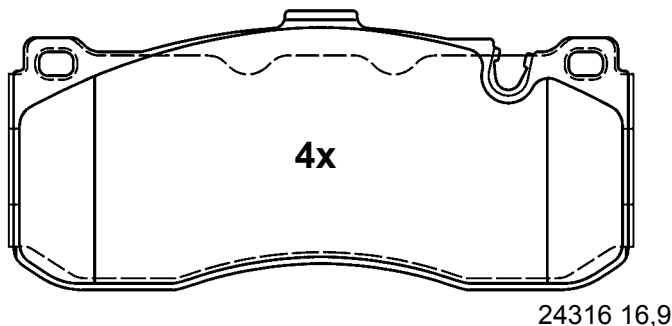

164,7 x 73,5 x 16,9

**13.0460-4850.2 604850**

AUDI, PORSCHE, VOLKSWAGEN

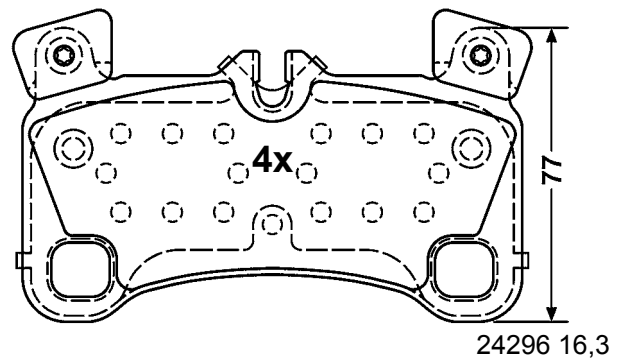

132,1 x 77,0 x 16,3



# Abbildungen Scheibenbremsbeläge

Illustrations disc brake pads - Illustrazioni pastiglie freno -

Illustrations plaquettes de frein - Ilustraciones pastillas de freno



Maßstab - scale - scala - échelle - escala 1:2

**13.0460-4851.2 604851**

ALFA ROMEO

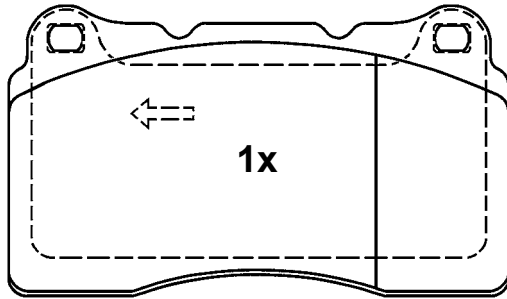

23092 16,0

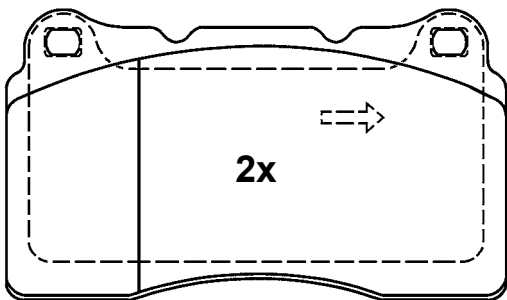

23092 16,0

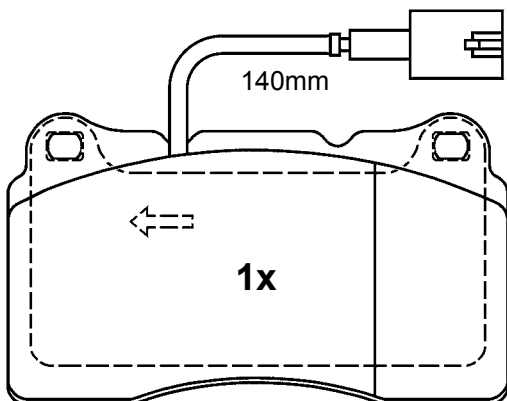

23111 16,0

**131,8 x 77,2 x 16,0**

**13.0460-4852.2 604852**

PORSCHE, VOLKSWAGEN

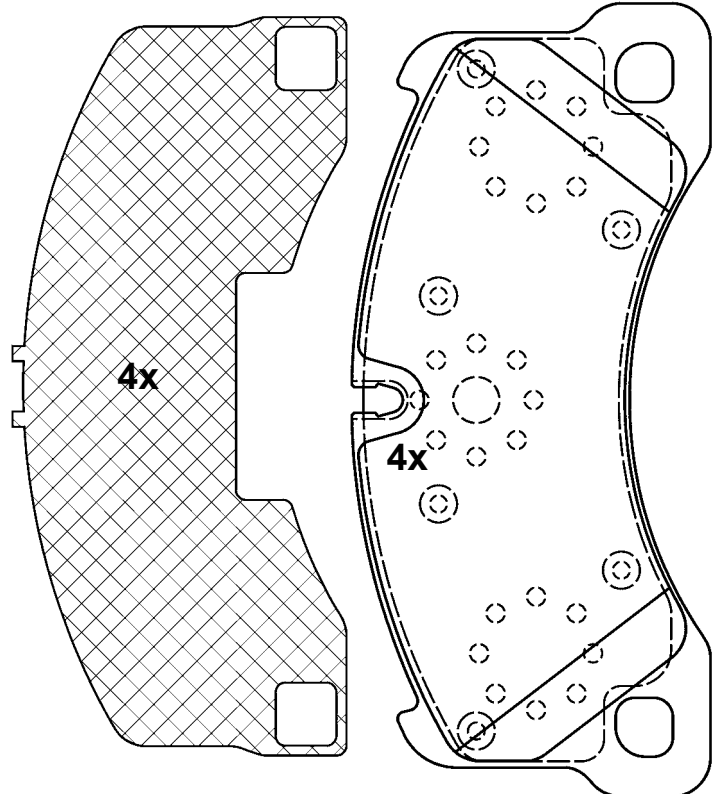

**209,5 x 94,2 x 15,8**

24553 15,8

**13.0460-4853.2 604853**

ALFA ROMEO, FIAT

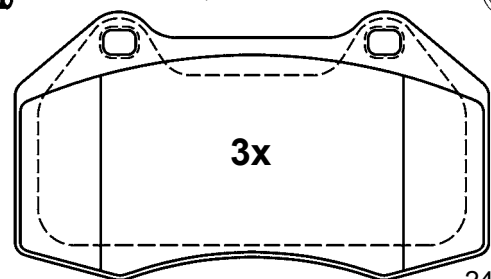

24162 15,2

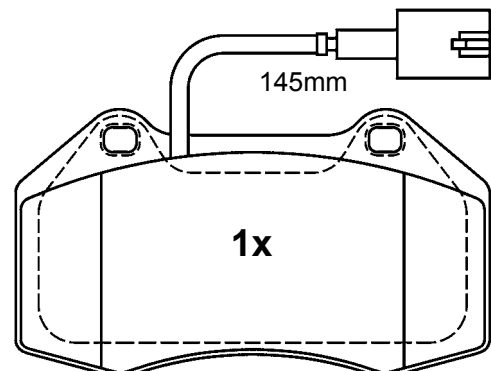

24687 15,2

**124,6 x 70,4 x 15,2**



# Abbildungen Scheibenbremsbeläge

Illustrations disc brake pads - Illustrazioni pastiglie freno -

Illustrations plaquettes de frein - Ilustraciones pastillas de freno

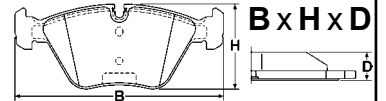

Maßstab - scale - scala - échelle - escala 1:2

**13.0460-4854.2 604854**

**13.0460-4855.2 604855**



ALFA ROMEO



BRE

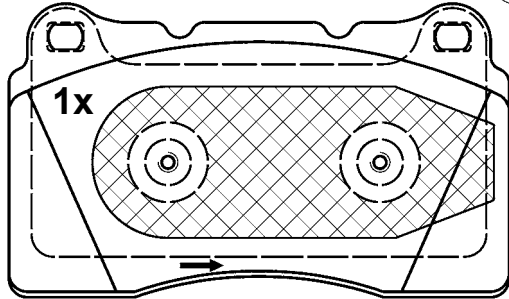

23092 16,3

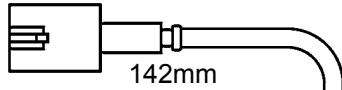

142mm

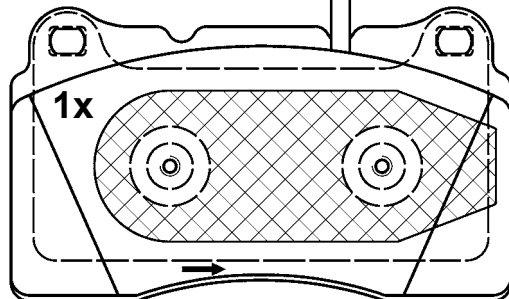

23756 16,3

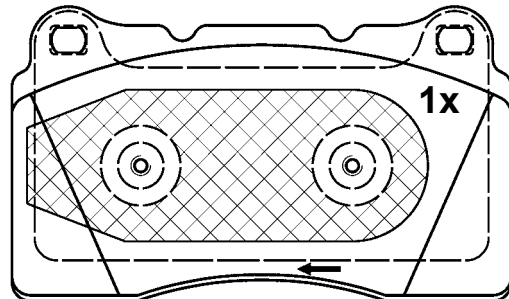

23092 16,3

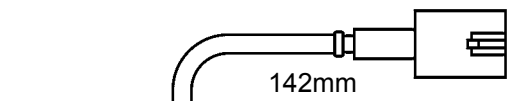

142mm

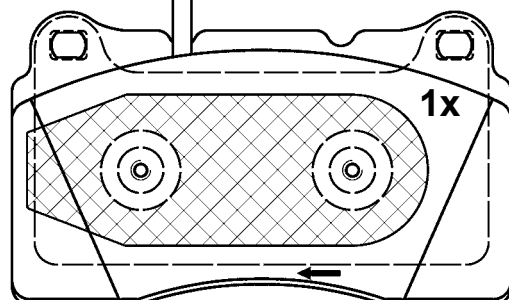

23756 16,3

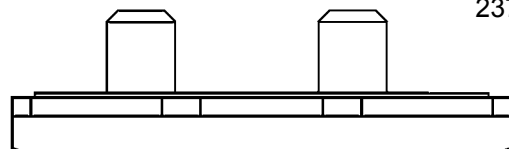

**131,8 x 77,2 x 16,3**



OPEL, VAUXHALL



BRE

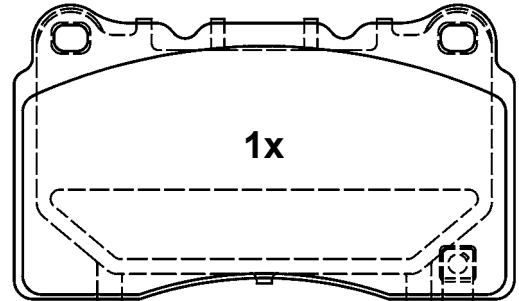

23325 16,4

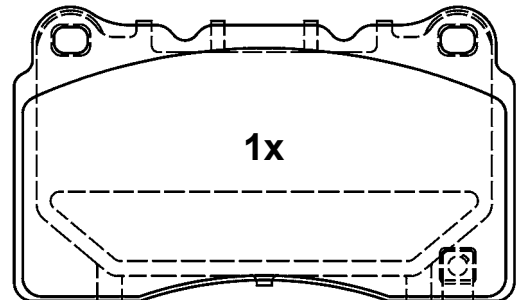

23325 16,4

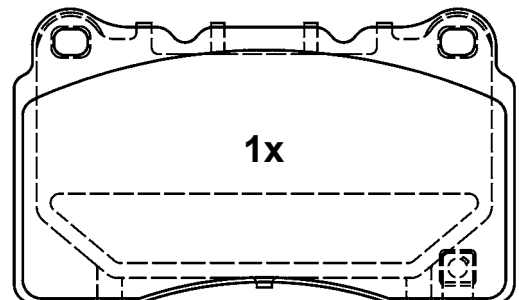

23325 16,4

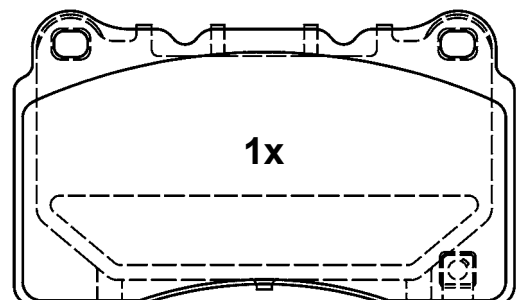

23325 16,4

**131,6 x 77,2 x 16,4**

# Abbildungen Scheibenbremsbeläge

Illustrations disc brake pads - Illustrazioni pastiglie freno -

Illustrations plaquettes de frein - Ilustraciones pastillas de freno



Maßstab - scale - scala - échelle - escala 1:2

**13.0460-4856.2 604856**

OPEL, RENAULT, VAUXHALL

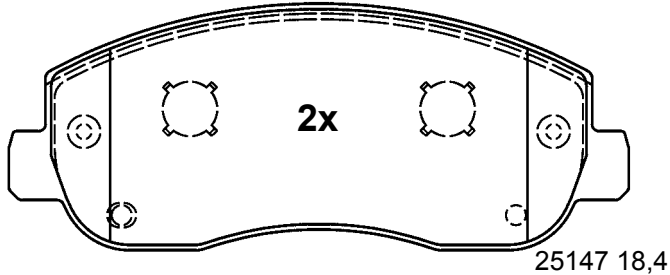

25147 18,4

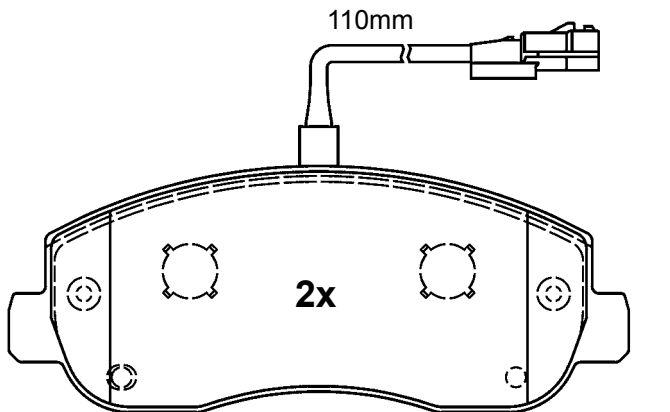

25148 18,4

163,5 x 64,6 x 18,4

**13.0460-4858.2 604858**

OPEL, RENAULT, VAUXHALL

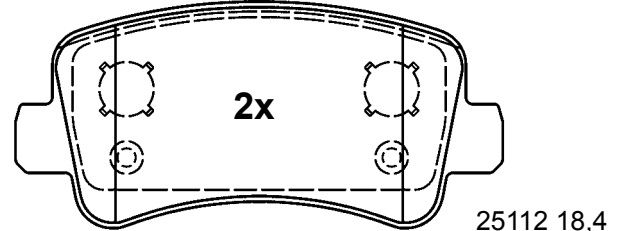

25112 18,4

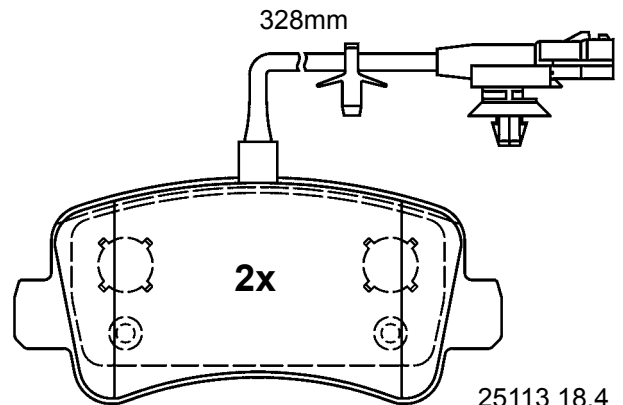

25113 18,4

128,5 x 59,5 x 18,4

**13.0460-4857.2 604857**

OPEL, RENAULT, VAUXHALL

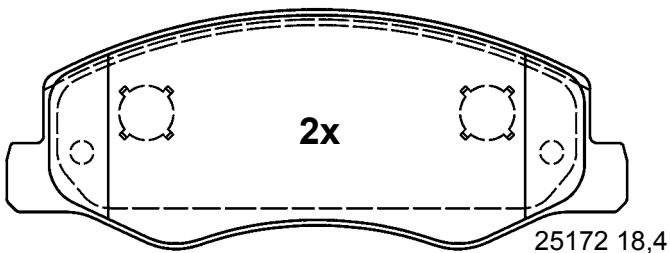

25172 18,4

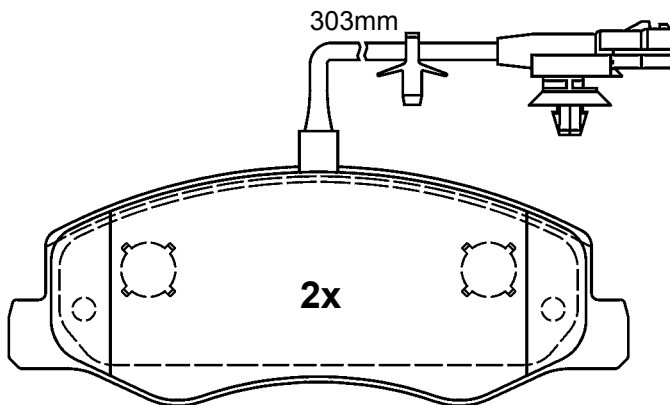

25173 18,4

163,5 x 62,9 x 18,4

**13.0460-4859.2 604859**

OPEL, RENAULT, VAUXHALL

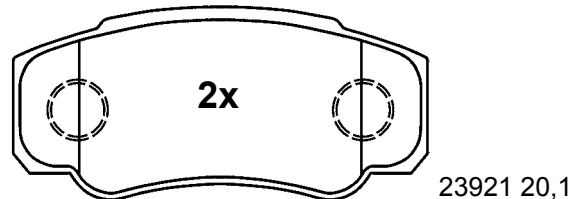

23921 20,1

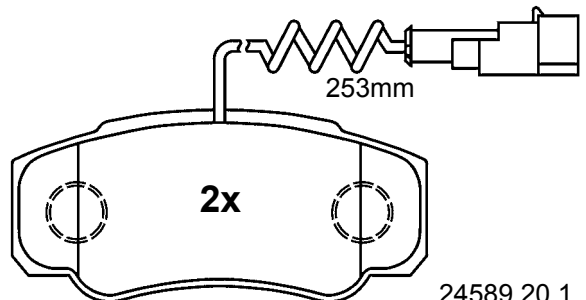

24589 20,1

109,6 x 50,0 x 20,1

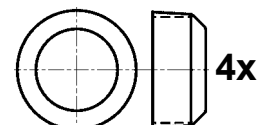
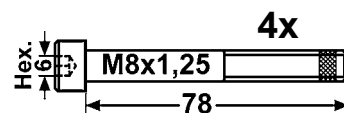

# Abbildungen Scheibenbremsbeläge

Illustrations disc brake pads - Illustrazioni pastiglie freno -

Illustrations plaquettes de frein - Ilustraciones pastillas de freno

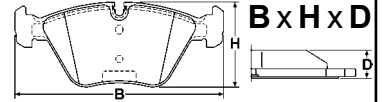

Maßstab - scale - scala - échelle - escala 1:2

## 13.0460-4860.2 604860

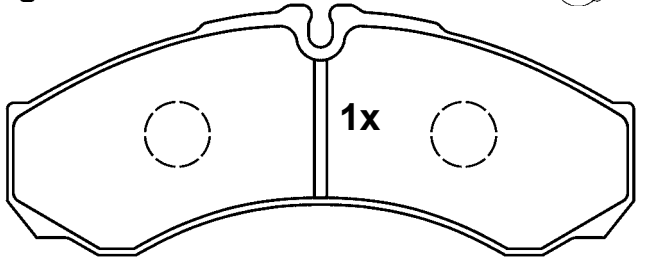

29121 20,3

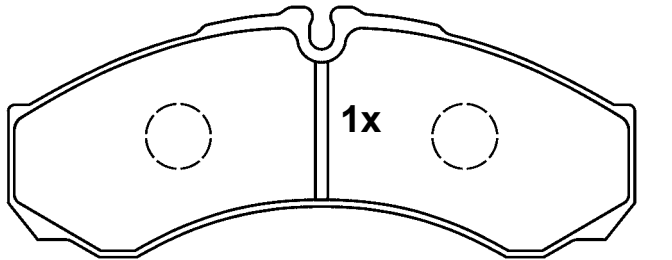

29121 20,3

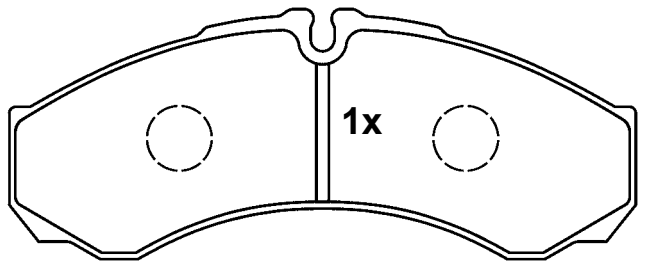

29121 20,3

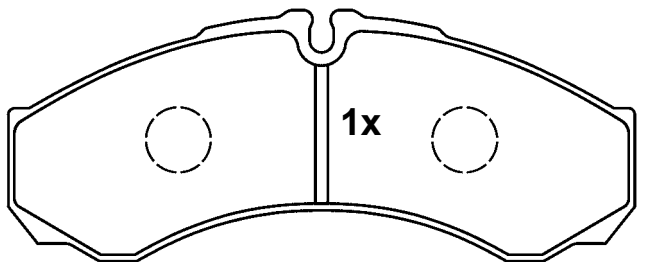

29121 20,3

164,6 x 66,5 x 20,3

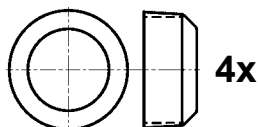
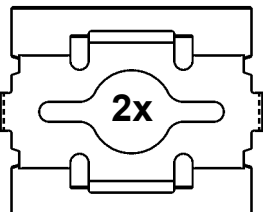
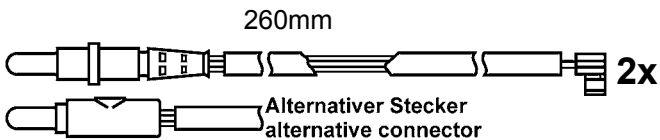

## 13.0460-4861.2 604861

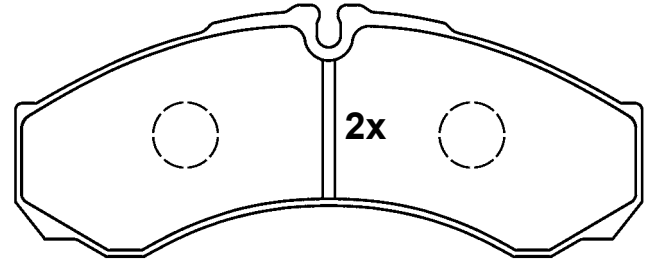

29121 20,3

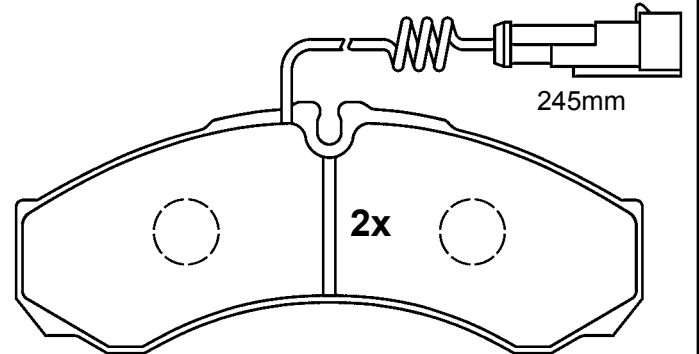

29260 20,3

164,6 x 66,5 x 20,3

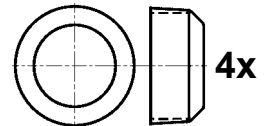
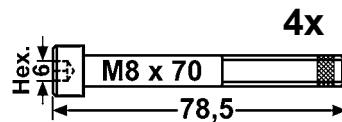

## 13.0460-4862.2 604862

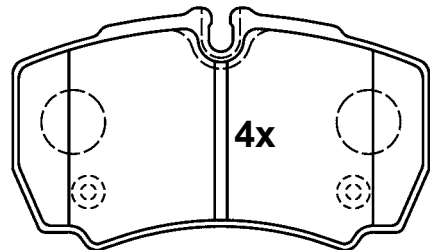

29123 20,3

109,6 x 63,7 x 20,3

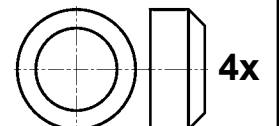
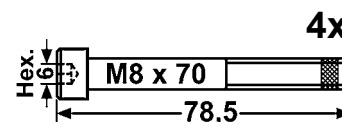
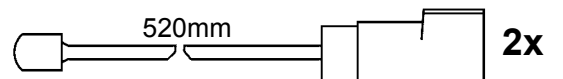

# Abbildungen Scheibenbremsbeläge

Illustrations disc brake pads - Illustrazioni pastiglie freno -

Illustrations plaquettes de frein - Ilustraciones pastillas de freno

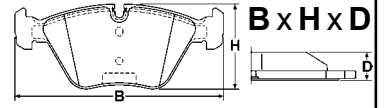

Maßstab - scale - scala - échelle - escala 1:2

**13.0460-4863.2 604863**



MERCEDES BENZ



BRE

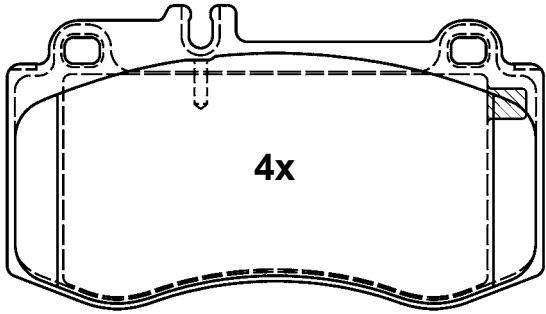

24976 17,5

141,5 x 79,8 x 17,5

**13.0460-4865.2 604865**



NISSAN



BRE

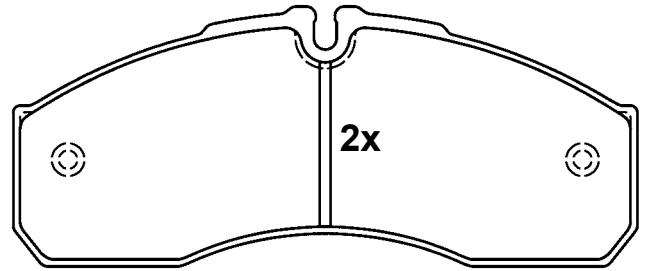

29160 20,3

**13.0460-4864.2 604864**



AUDI



BRE

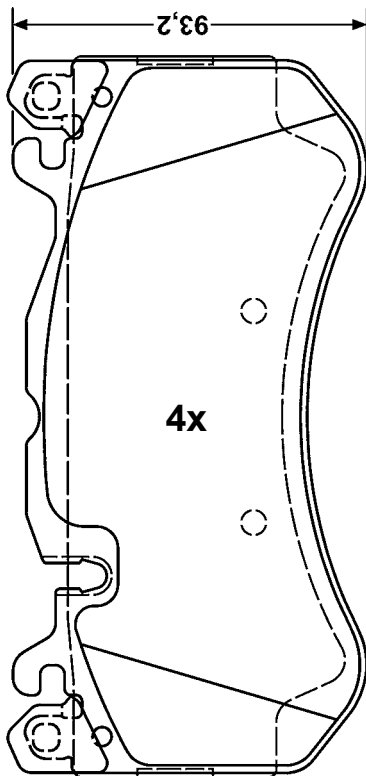

24455 16,8

189,8 x 93,2 x 16,8

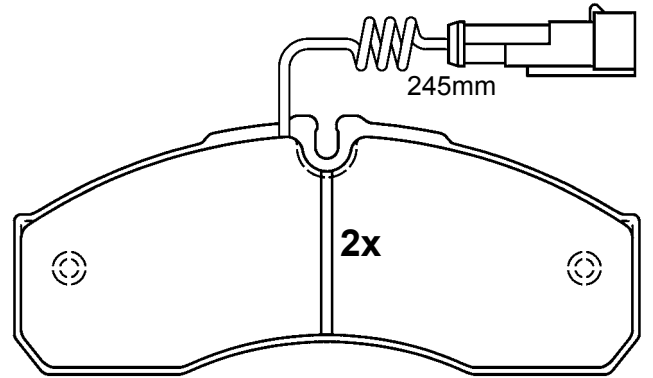

29327 20,3

164,6 x 68,0 x 20,3

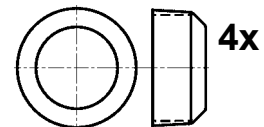

4x

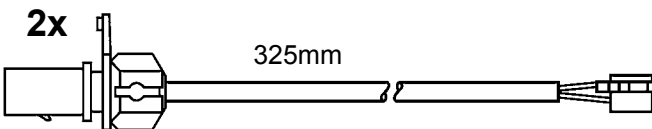

2x

325mm

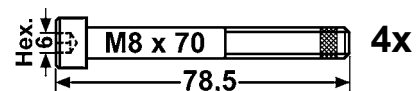

Hex.

M8 x 70

78,5

4x



# Abbildungen Scheibenbremsbeläge

Illustrations disc brake pads - Illustrazioni pastiglie freno -

Illustrations plaquettes de frein - Ilustraciones pastillas de freno

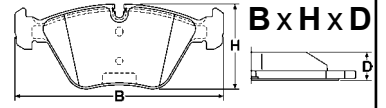

Maßstab - scale - scala - échelle - escala 1:2

**13.0460-4866.2 604866**



NISSAN, RENAULT



BRE

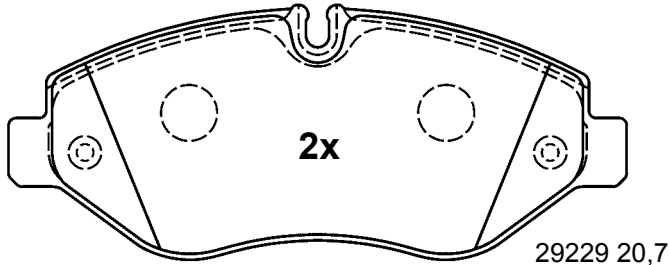

29229 20,7

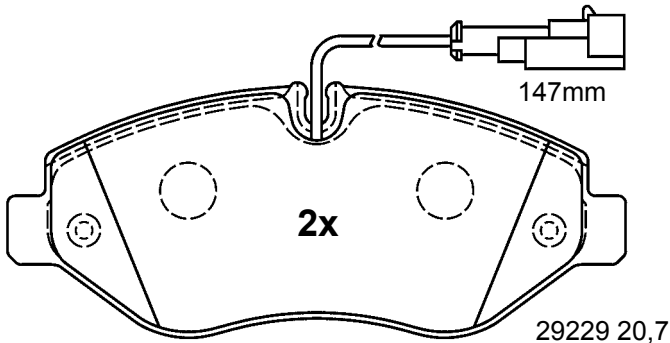

29229 20,7

**163,1 x 67,1 x 20,7**

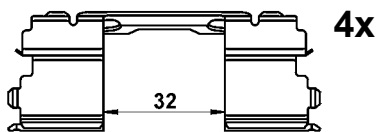

4x

32

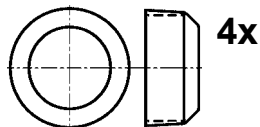

4x

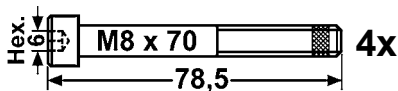

4x

78,5

**13.0460-4867.2 604867**



ALFA ROMEO



BRE

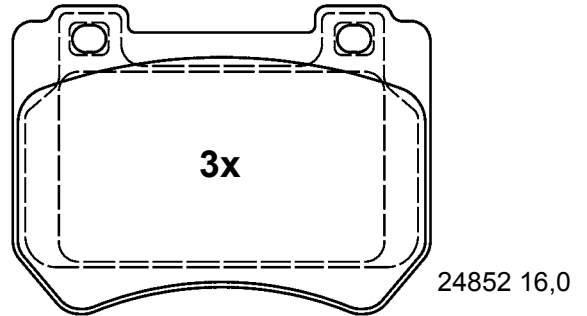

24852 16,0

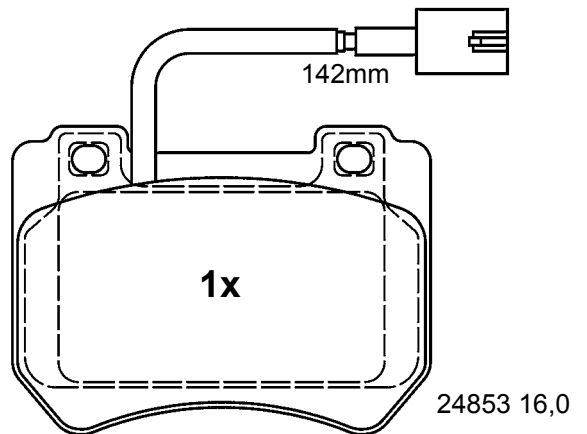

24853 16,0

**109,8 x 80,8 x 16,0**



# Abbildungen Scheibenbremsbeläge

Illustrations disc brake pads - Illustrazioni pastiglie freno -

Illustrations plaquettes de frein - Ilustraciones pastillas de freno



Maßstab - scale - scala - échelle - escala 1:2

**13.0460-4869.2 604869**



MERCEDES BENZ



BRE

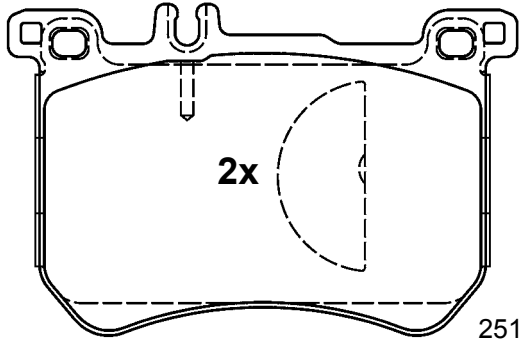

2x

25183 17,9

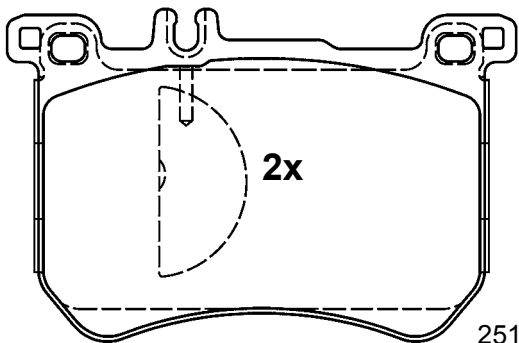

2x

25183 17,9

134,4 x 86,0 x 17,9

**13.0460-4870.2 604870**



MERCEDES BENZ



BRE

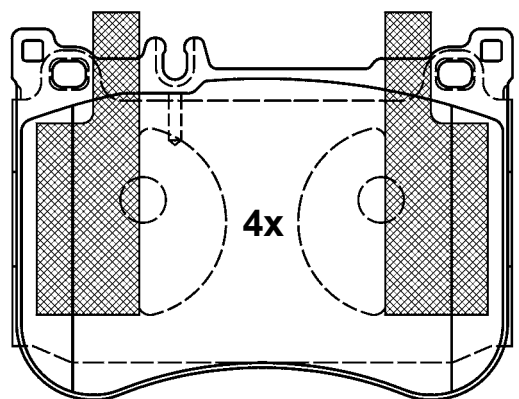

4x

25179 17,8

132,0 x 97,5 x 17,8

**13.0460-4872.2 604872**



VOLKSWAGEN



BRE

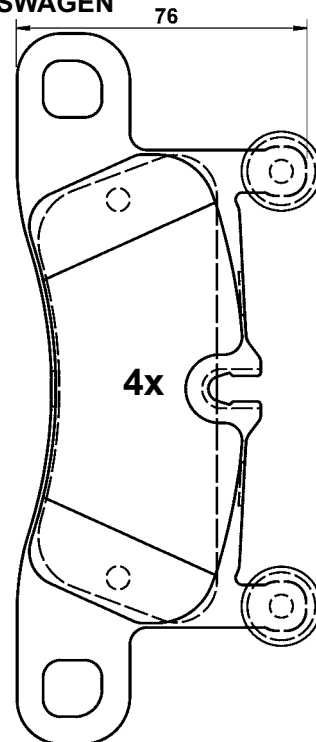

76

4x

24721 16,9

187,5 x 76,0 x 16,9

**13.0460-4873.2 604873**



AUDI



BRE

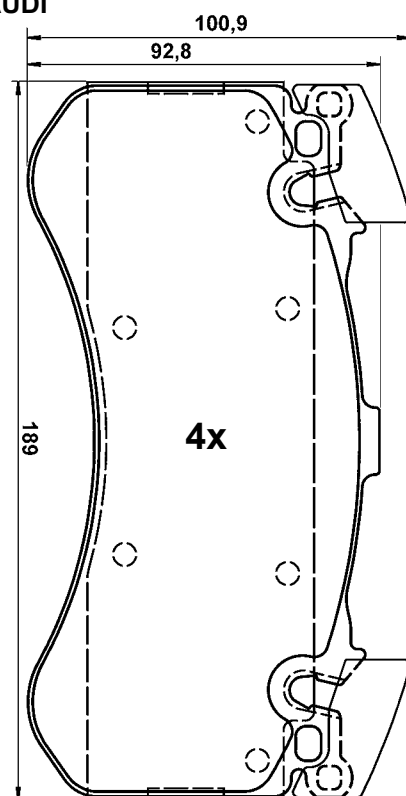

100,9

92,8

4x

189

24847 17,0

189,0 x 92,8 x 17,0

# Abbildungen Scheibenbremsbeläge

Illustrations disc brake pads - Illustrazioni pastiglie freno -

Illustrations plaquettes de frein - Ilustraciones pastillas de freno

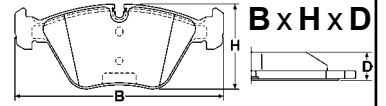

Maßstab - scale - scala - échelle - escala 1:2

**13.0460-4874.2 604874**

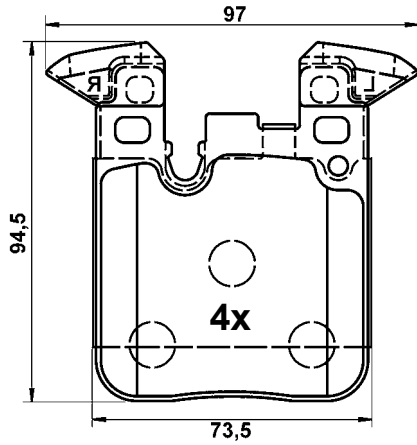

25029 16,7

**73,5 x 94,5 x 16,7**

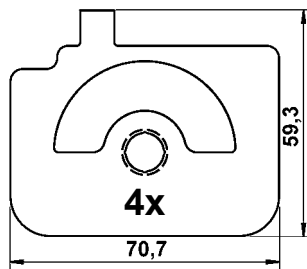

**13.0460-4877.2 604877**



MERCEDES BENZ, VOLKSWAGEN

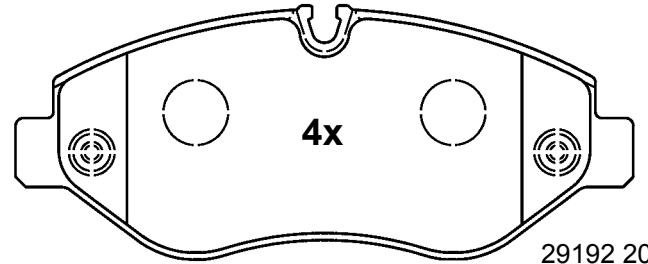

29192 20,3

**163,2 x 66,8 x 20,3**

**13.0460-4875.2 604875**

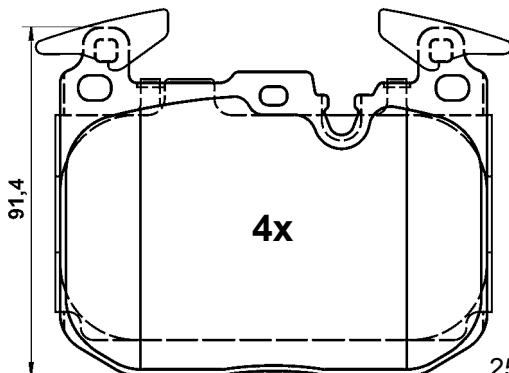

25028 18,0

**114,5 x 91,4 x 18,0**

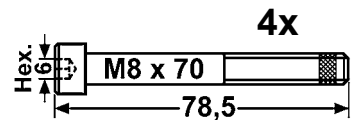
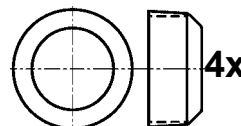
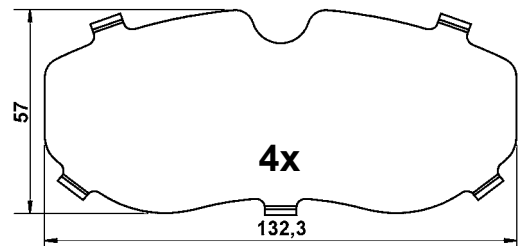

# Abbildungen Scheibenbremsbeläge

Illustrations disc brake pads - Illustrazioni pastiglie freno -

Illustrations plaquettes de frein - Ilustraciones pastillas de freno

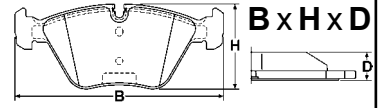

Maßstab - scale - scala - échelle - escala 1:2

**13.0460-4879.2 604879**



AUDI, PORSCHE



BRE

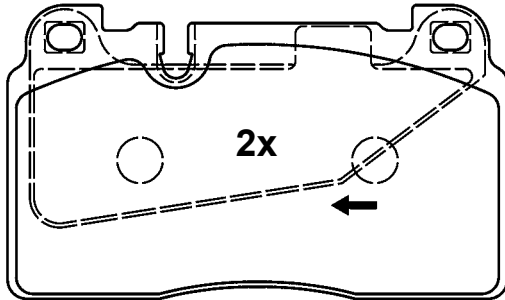

25643 16,8

131,8 x 77,2 x 16,8

**13.0460-4882.2 604882**



MERCEDES BENZ



BRE

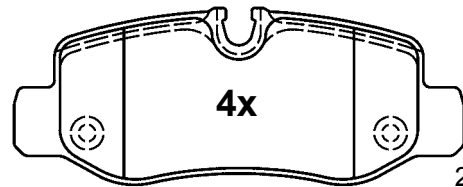

22102 18,2

118,5 x 46,4 x 18,2

**13.0460-4884.2 604884**



MERCEDES BENZ



BRE

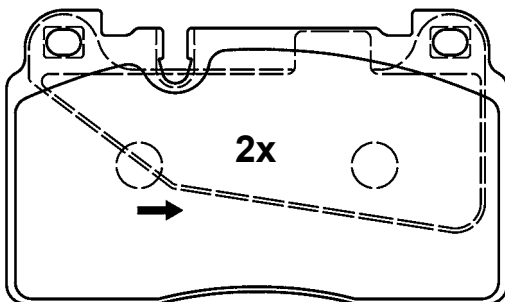

25643 16,8

184,1 x 75,0 x 20,7

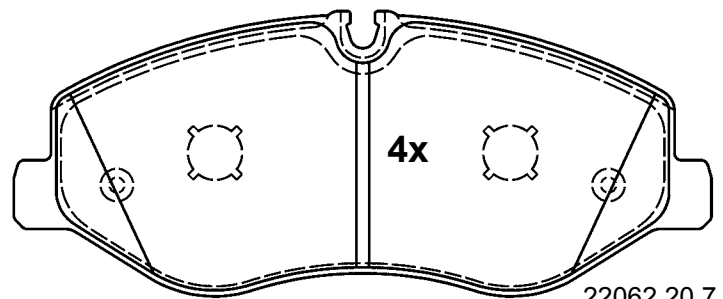

22062 20,7

# Abbildungen Scheibenbremsbeläge

Illustrations disc brake pads - Illustrazioni pastiglie freno -

Illustrations plaquettes de frein - Ilustraciones pastillas de freno

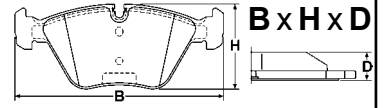

Maßstab - scale - scala - échelle - escala 1:2

**13.0460-4900.2 604900**

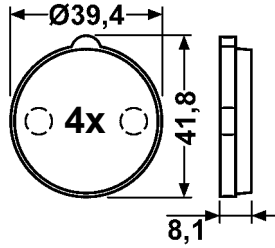

20371 8,1

Ø39,4 x 41,8 x 8,1

**13.0460-4910.2 604910**



20285 7,0

Ø 30,5 x 7,0

**13.0460-4906.2 604906**

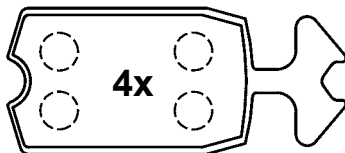

20207 12,0

89,6 x 38,1 x 12,0

**13.0460-4911.2 604911**

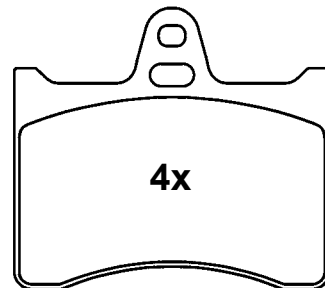

20389 15,4

82,9 x 75,0 x 15,4

# Abbildungen Scheibenbremsbeläge

Illustrations disc brake pads - Illustrazioni pastiglie freno -

Illustrations plaquettes de frein - Ilustraciones pastillas de freno

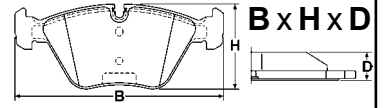

Maßstab - scale - scala - échelle - escala 1:2

**13.0460-4913.2 604913**

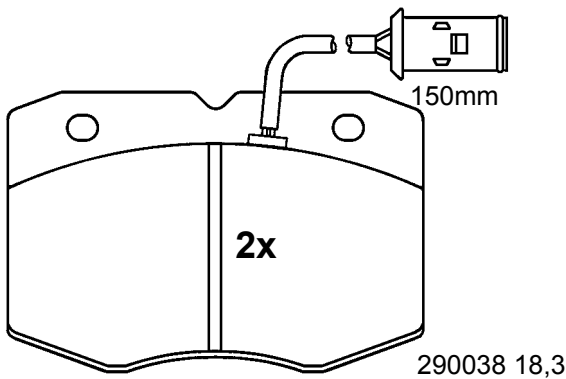
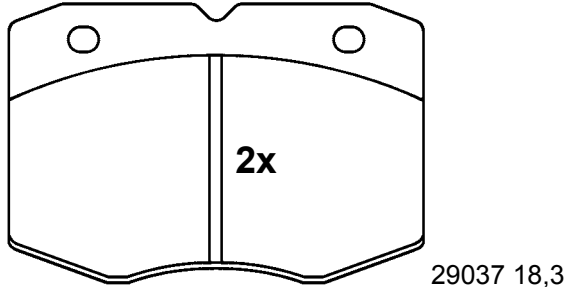

109,5 x 73,0 x 18,3

**13.0460-4918.2 604918**

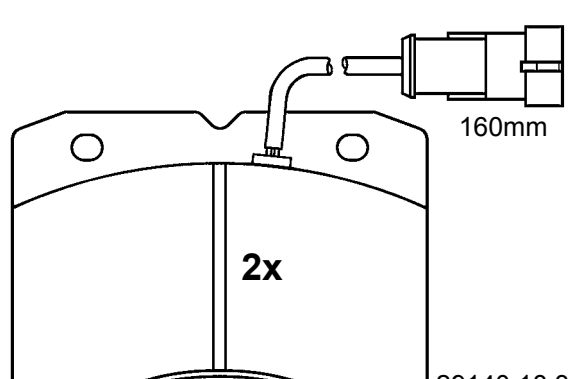
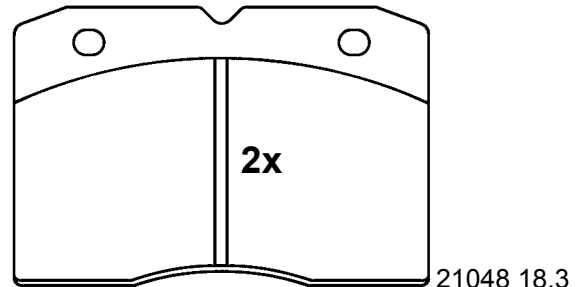

109,5 x 73,0 x 18,3

**13.0460-4914.2 604914**

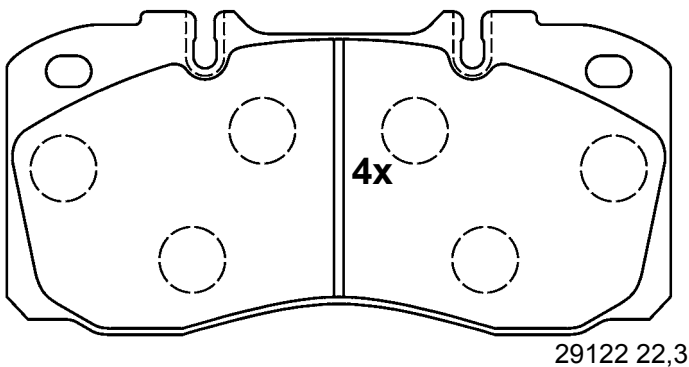

174,7 x 85,5 x 22,3

**13.0460-4919.2 604919**

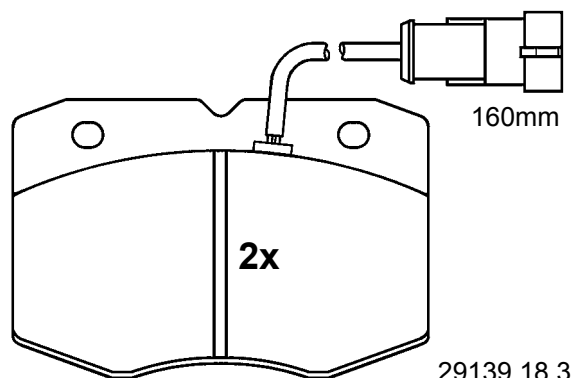
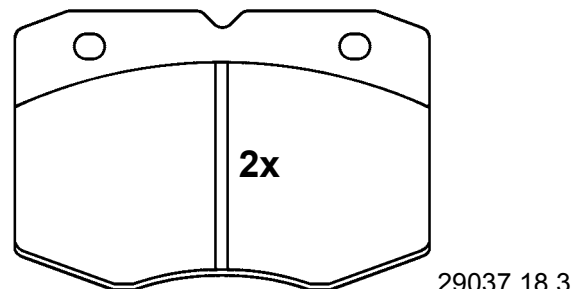

109,5 x 73,0 x 18,3

# Abbildungen Scheibenbremsbeläge

Illustrations disc brake pads - Illustrazioni pastiglie freno -

Illustrations plaquettes de frein - Ilustraciones pastillas de freno

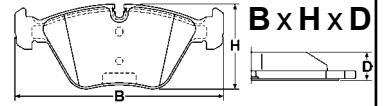

Maßstab - scale - scala - échelle - escala 1:2

**13.0460-4921.2 604921**



CITROËN



CIT

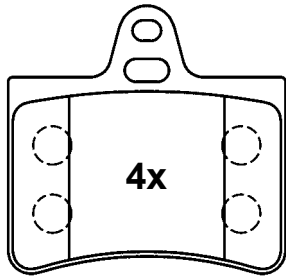

23305 15,2

72,9 x 70,6 x 15,2

**13.0460-4956.2 604956**



CITROËN



CIT

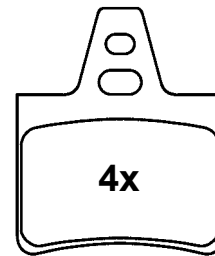

20162 15,4

54,0 x 64,7 x 15,4

**13.0460-4955.2 604955**



ALFA ROMEO, IVECO



BRE

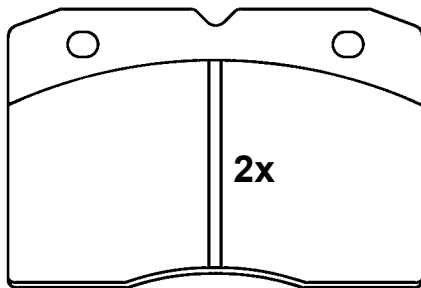

21048 18,3

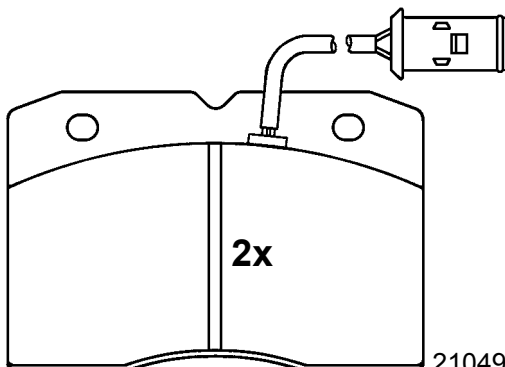

21049 18,3

109,5 x 73,0 x 18,3

**13.0460-4957.2 604957**



RENAULT



BRE

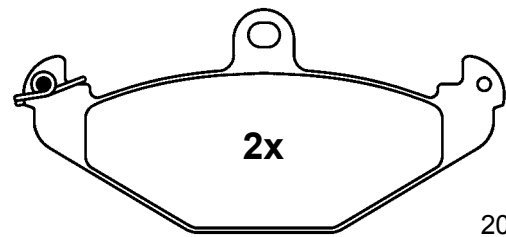

20410 15,0

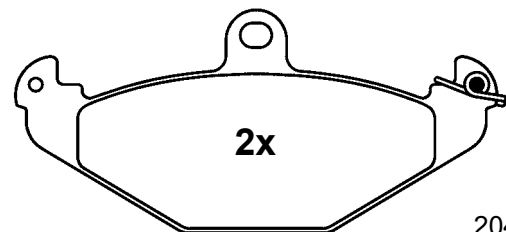

20423 15,0

126,0 x 58,0 x 15,0



# Abbildungen Scheibenbremsbeläge

Illustrations disc brake pads - Illustrazioni pastiglie freno -

Illustrations plaquettes de frein - Ilustraciones pastillas de freno

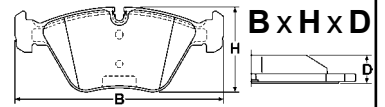

Maßstab - scale - scala - échelle - escala 1:2

**13.0460-4958.2 604958**

 LANCIA

 BRE

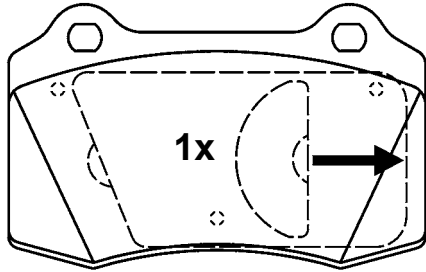

21381 17,3

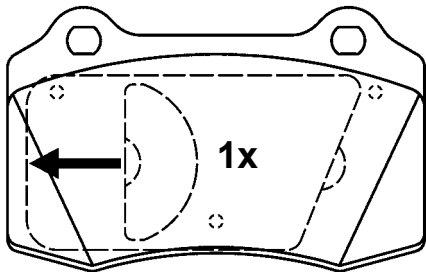

21381 17,3

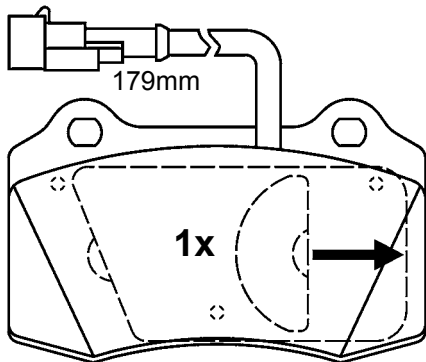

21382 17,3

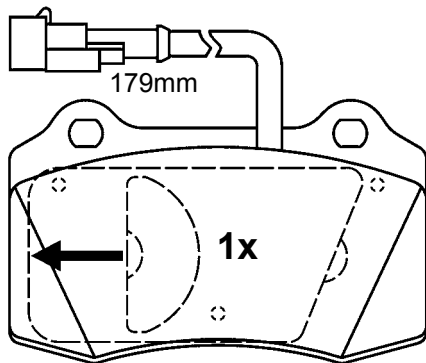

21382 17,3

**109,8 x 69,2 x 17,3**

**13.0460-4964.2 604964**

 DE TOMASO, JAGUAR, SEAT,  
VOLVO

 BRE

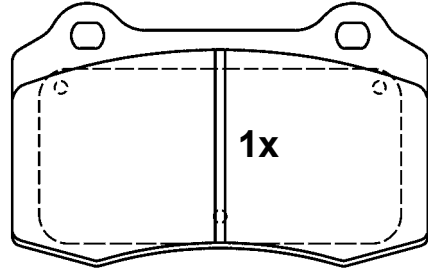

21381 15,0

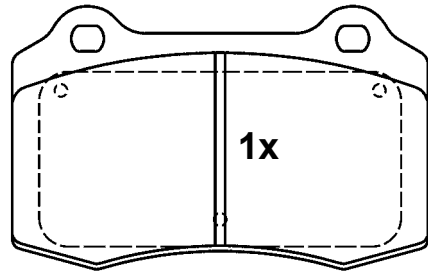

21381 15,0

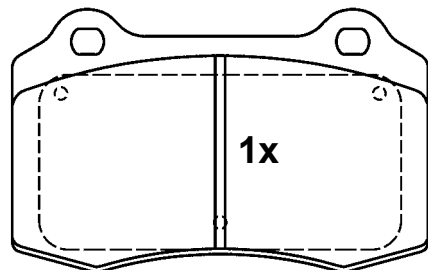

21381 15,0

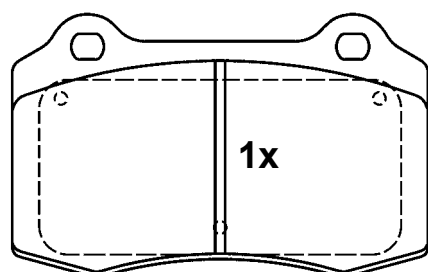

21381 15,0

**109,8 x 69,3 x 15,0**



# Abbildungen Scheibenbremsbeläge

Illustrations disc brake pads - Illustrazioni pastiglie freno -

Illustrations plaquettes de frein - Ilustraciones pastillas de freno

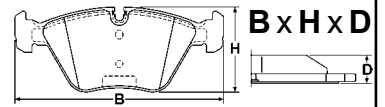

Maßstab - scale - scala - échelle - escala 1:2

**13.0460-4965.2 604965**



BMW



BRE

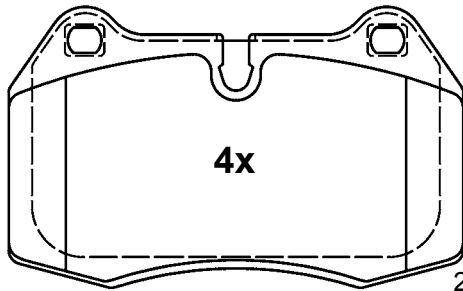

21471 18,0

119,8 x 73,6 x 18,0

**13.0460-4968.2 604968**



ALFA ROMEO, FIAT



BRE

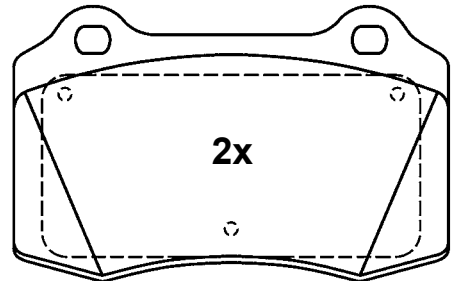

21381 18,0

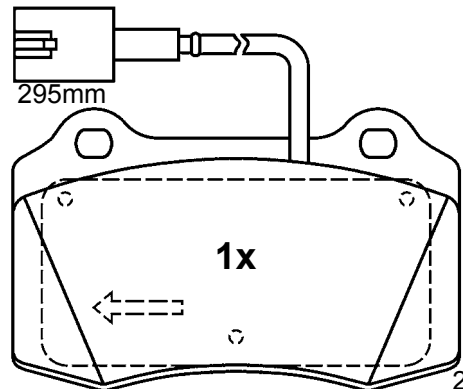

23206 18,0

**13.0460-4966.2 604966**



IVECO, RENAULT



BRE

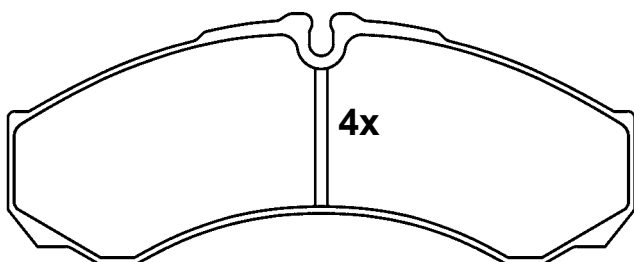

29121 20,3

164,6 x 66,5 x 20,3

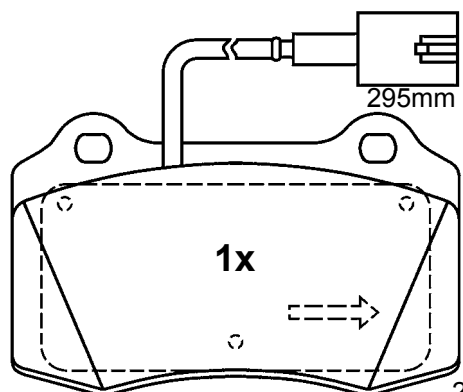

23207 18,0

109,8 x 69,2 x 18,0

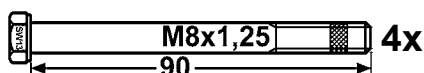

# Abbildungen Scheibenbremsbeläge

Illustrations disc brake pads - Illustrazioni pastiglie freno -

Illustrations plaquettes de frein - Ilustraciones pastillas de freno

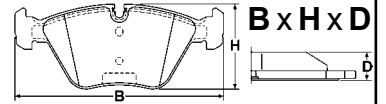

Maßstab - scale - scala - échelle - escala 1:2

**13.0460-4969.2 604969**

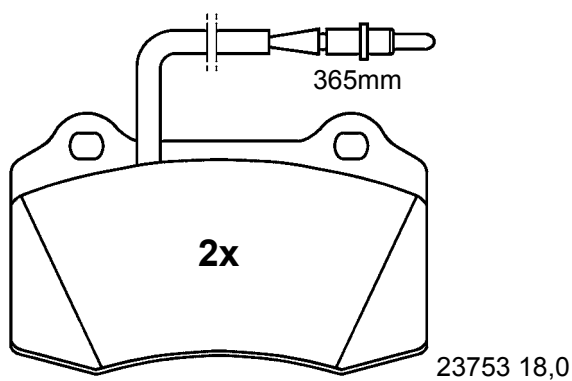
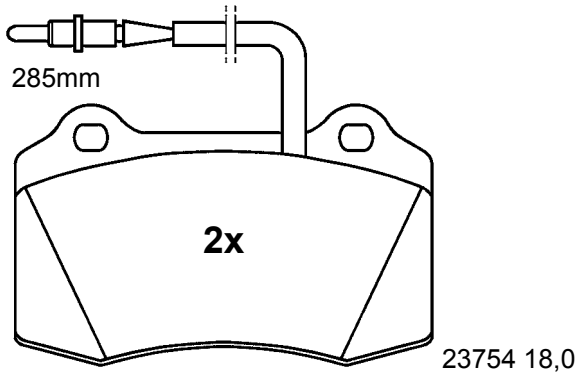

**109,8 x 69,2 x 18,0**

**13.0460-4971.2 604971**

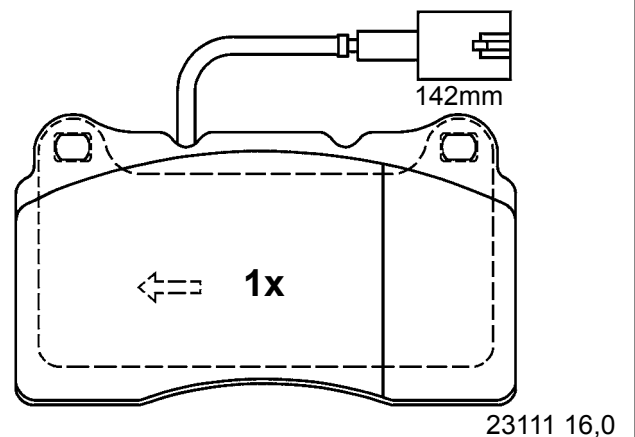
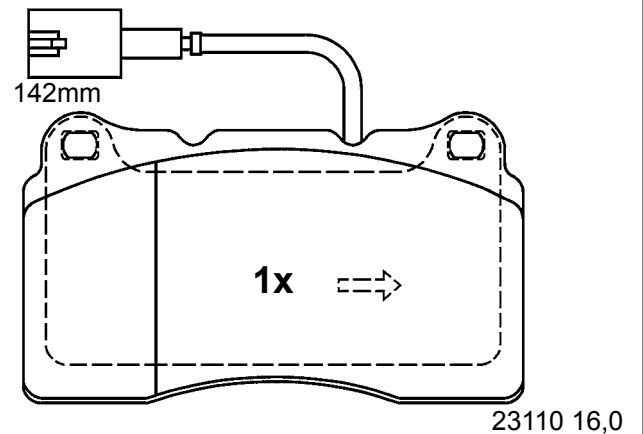
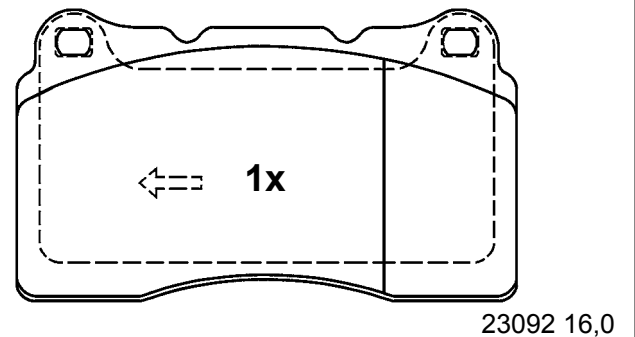
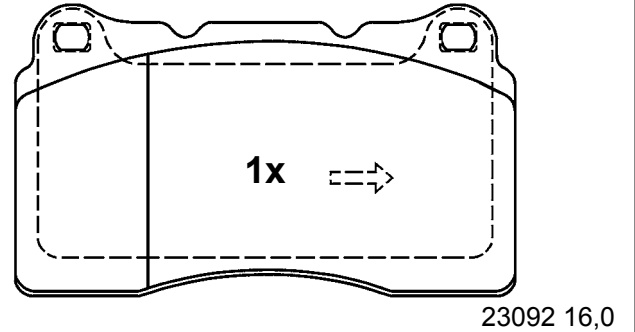

**131,8 x 77,2 x 16,0**



# Abbildungen Scheibenbremsbeläge

Illustrations disc brake pads - Illustrazioni pastiglie freno -

Illustrations plaquettes de frein - Ilustraciones pastillas de freno

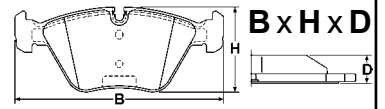

Maßstab - scale - scala - échelle - escala 1:2

**13.0460-4972.2 604972**



PEUGEOT



BRE

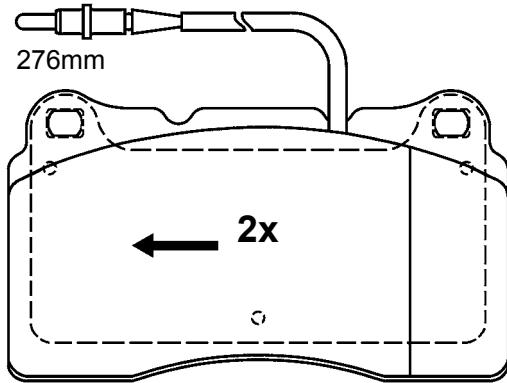

23575 16,0

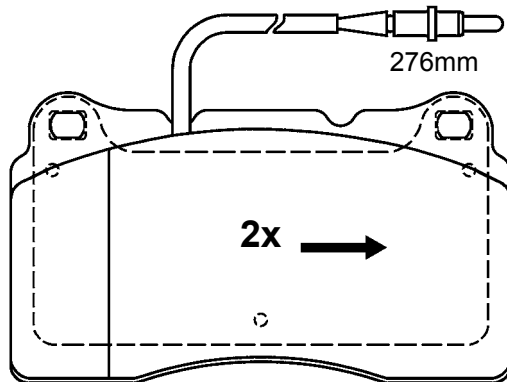

23576 16,0

**131,8 x 77,2 x 16,0**

**1x**  
 (UK) Brake pad paste  
 To avoid disk brake squeaking  
 (D) Bremsklotzpaste  
 Gegen Quietschen von Scheibenbremsen  
 (I) Grasso per freni  
 Contro il fischi in frenatura  
 (F) Pâte pour plaquette de freins  
 Contre le grincement de freins

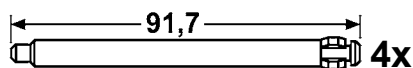

**13.0460-4973.2 604973**



MITSUBISHI, SUBARU



BRE

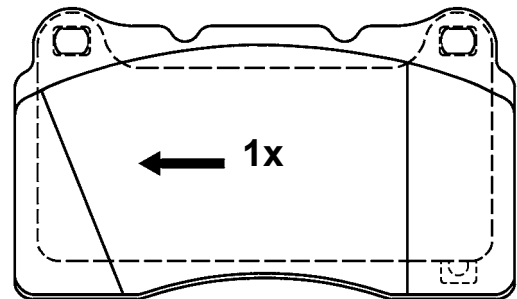

23092 16,0

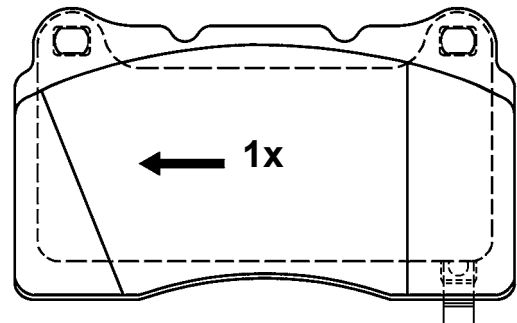

23325 16,0

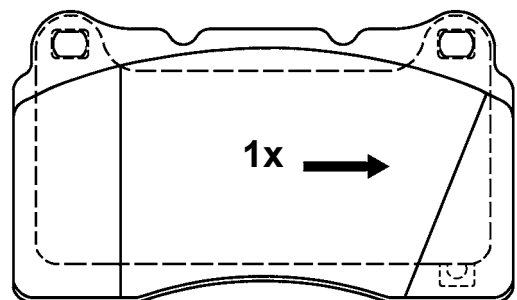

23092 16,0

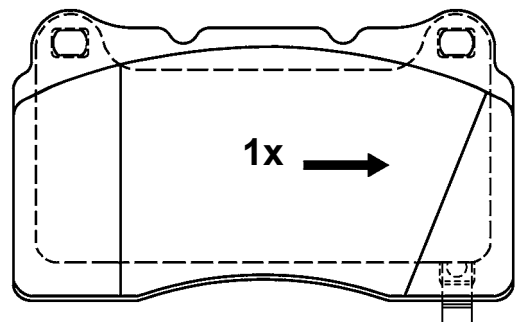

23325 16,0

**131,8 x 77,2 x 16,0**

# Abbildungen Scheibenbremsbeläge

Illustrations disc brake pads - Illustrazioni pastiglie freno -

Illustrations plaquettes de frein - Ilustraciones pastillas de freno

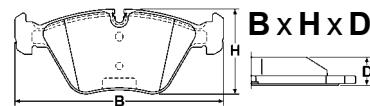

Maßstab - scale - scala - échelle - escala 1:2

**13.0460-4974.2 604974**



MITSUBISHI, NISSAN, SUBARU



BRE

**13.0460-4976.2 604976**



AUDI, PORSCHE, VOLKSWAGEN



BRE

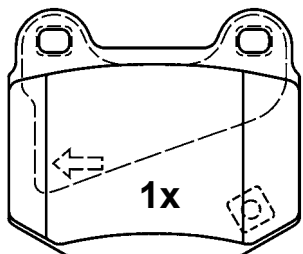

21580 14,6

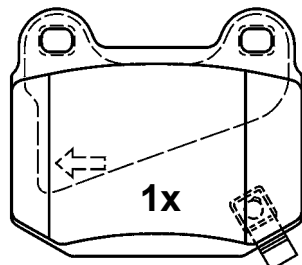

23323 14,6

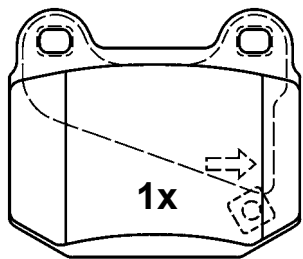

21580 14,6

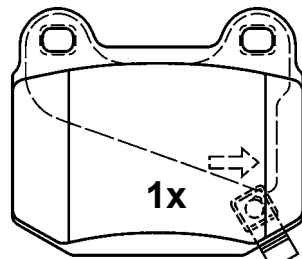

23323 14,6

76,9 x 65,5 x 14,6

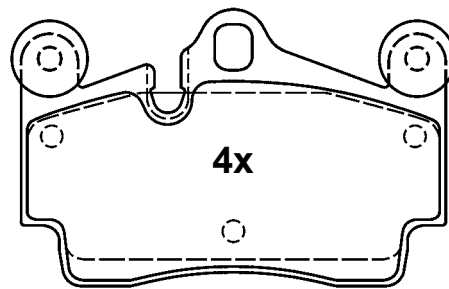

23694 16,7

112,0 x 73,0 x 16,7

**13.0460-4975.2 604975**



MERCEDES BENZ



BRE

**13.0460-4977.2 604977**



MERCEDES BENZ



BRE

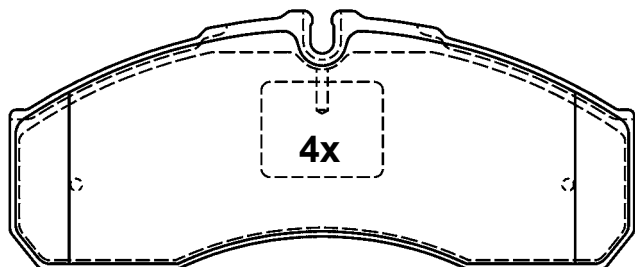

29160 20,8

164,8 x 68,0 x 20,8

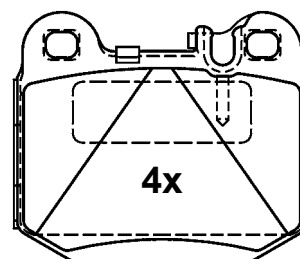

23157 15,8

76,5 x 65,5 x 15,8

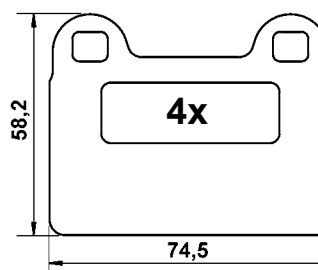

# Abbildungen Scheibenbremsbeläge

Illustrations disc brake pads - Illustrazioni pastiglie freno -

Illustrations plaquettes de frein - Ilustraciones pastillas de freno

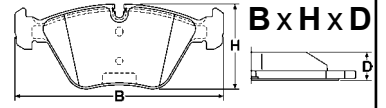

Maßstab - scale - scala - échelle - escala 1:2

**13.0460-4978.2 604978**



CITROEN, FIAT, PEUGEOT



BRE

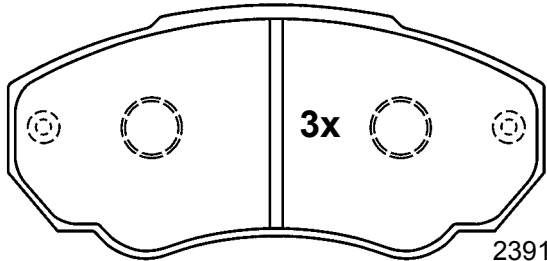

23917 19,3

155mm

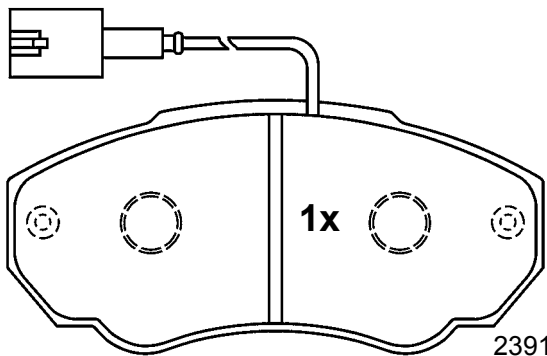

23918 19,3

**140,6 x 66,0 x 19,3**

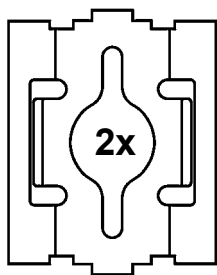

2x

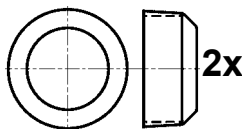

2x

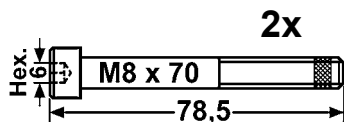

2x

**13.0460-4979.2 604979**



CITROEN, FIAT, PEUGEOT



BRE

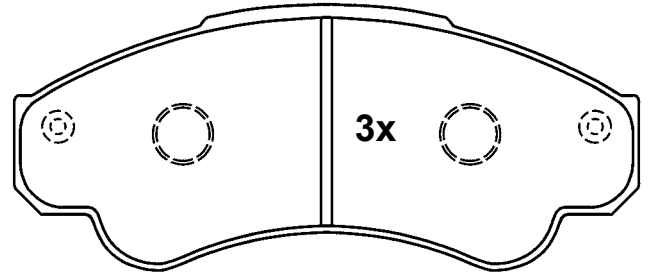

23919 19,3



155mm

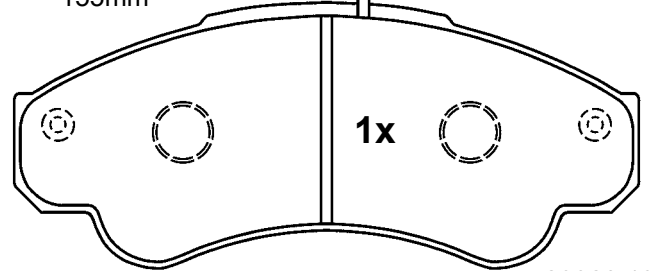

23920 19,3

**164,6 x 69,3 x 19,3**

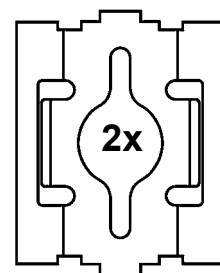

2x

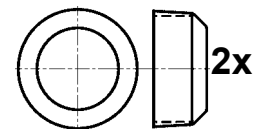

2x

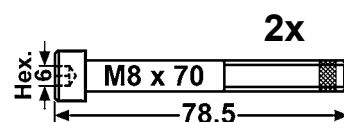

2x



# Abbildungen Scheibenbremsbeläge

Illustrations disc brake pads - Illustrazioni pastiglie freno -

Illustrations plaquettes de frein - Ilustraciones pastillas de freno

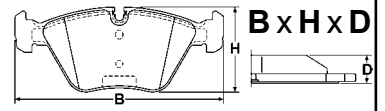

Maßstab - scale - scala - échelle - escala 1:2

## 13.0460-4980.2 604980



CITROEN, FIAT, PEUGEOT



BRE

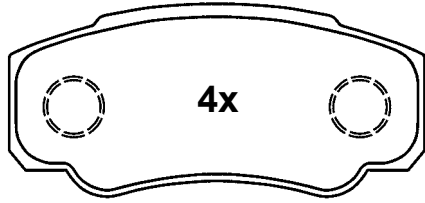

23921 20,3

109,6 x 50,0 x 20,3

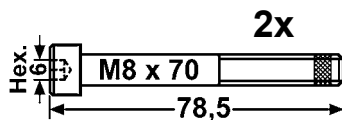
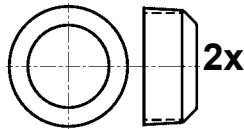
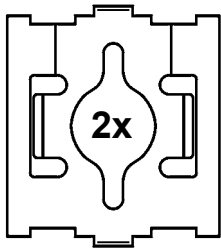

## 13.0460-4985.2 604985



ALFA ROMEO



BRE

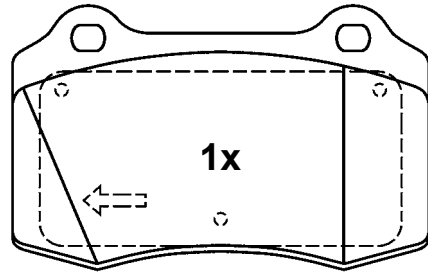

21381 18,0

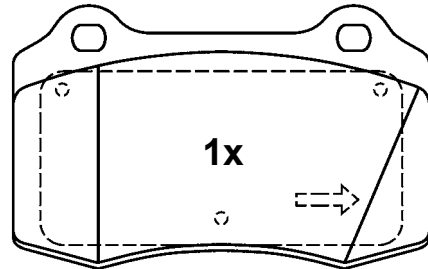

21381 18,0

## 13.0460-4984.2 604984



MERCEDES BENZ



BRE

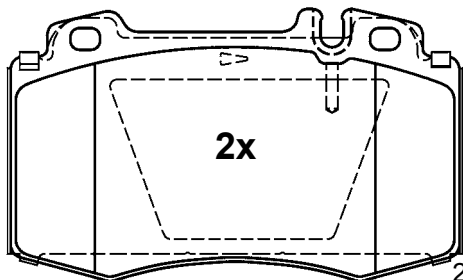

23271 17,4

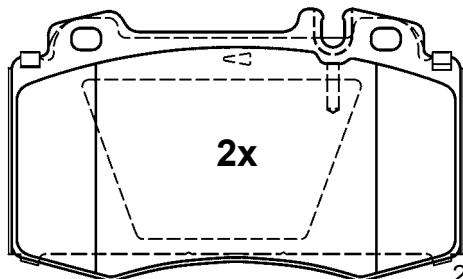
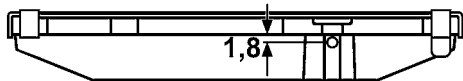

23271 17,4

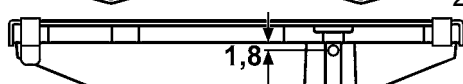

119,5 x 71,7 x 17,4

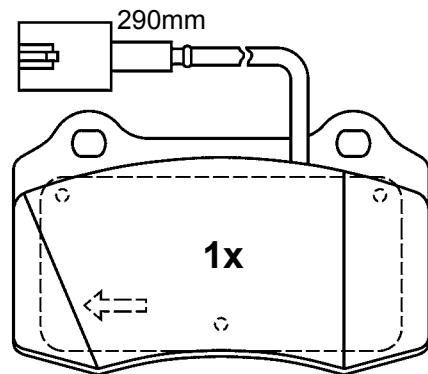

23206 18,0

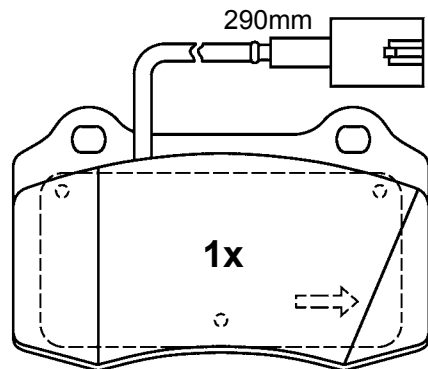

23207 18,0

109,8 x 69,2 x 18,0



# Abbildungen Scheibenbremsbeläge

Illustrations disc brake pads - Illustrazioni pastiglie freno -

Illustrations plaquettes de frein - Ilustraciones pastillas de freno

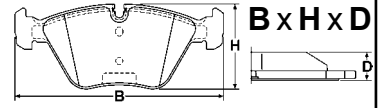

Maßstab - scale - scala - échelle - escala 1:2

**13.0460-4986.2 604986**

RENAULT

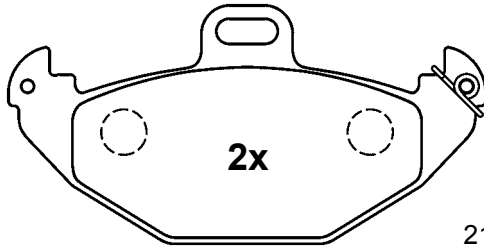

21965 15,0

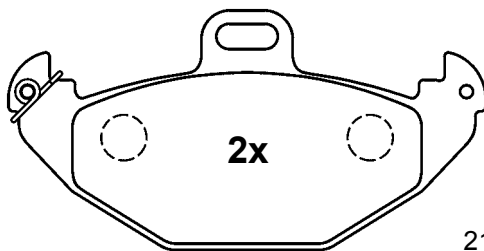

21966 15,0

126,1 x 63,0 x 15,0

**13.0460-4988.2 604988**

PORSCHE

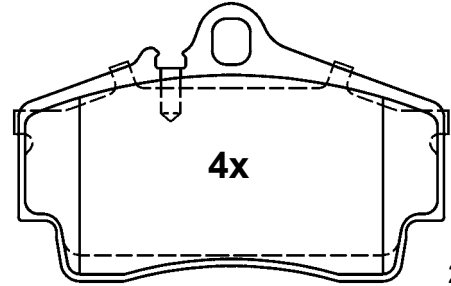

21792 15,2

112,2 x 73,0 x 15,2

**13.0460-4987.2 604987**

PORSCHE

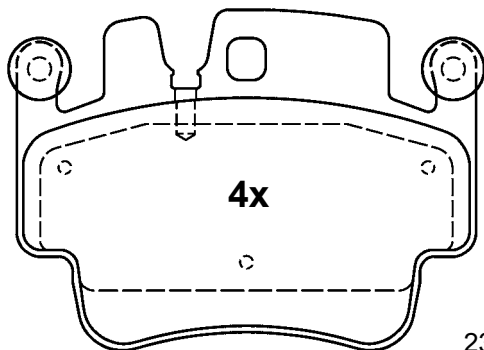

23329 17,0

121,3 x 90,3 x 17,0

**13.0460-4989.2 604989**

IVECO

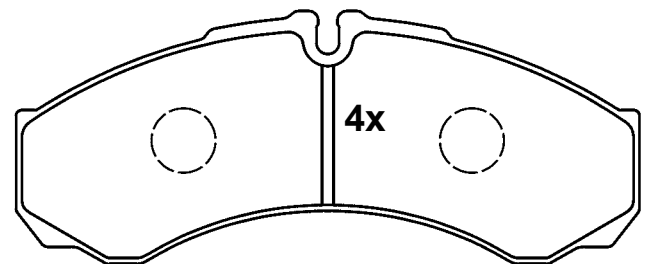

29212 17,3

4x

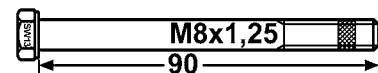

164,8 x 66,5 x 17,3

# Abbildungen Scheibenbremsbeläge

Illustrations disc brake pads - Illustrazioni pastiglie freno -

Illustrations plaquettes de frein - Ilustraciones pastillas de freno

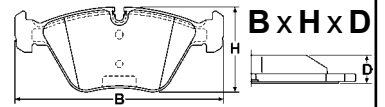

Maßstab - scale - scala - échelle - escala 1:2

**13.0460-4990.2 604990**



MERCEDES BENZ



BRE

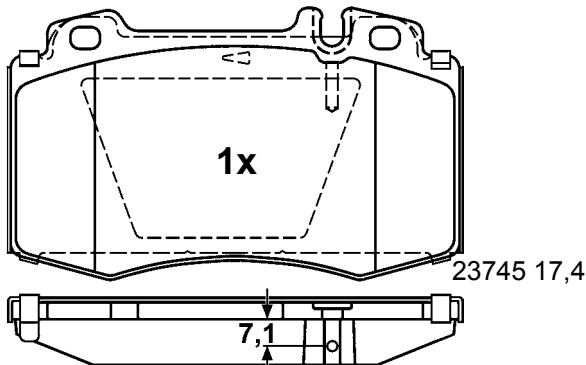
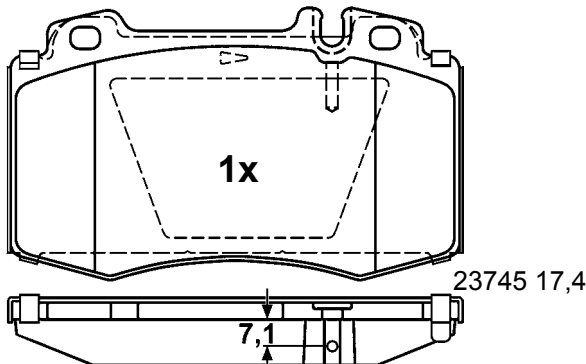
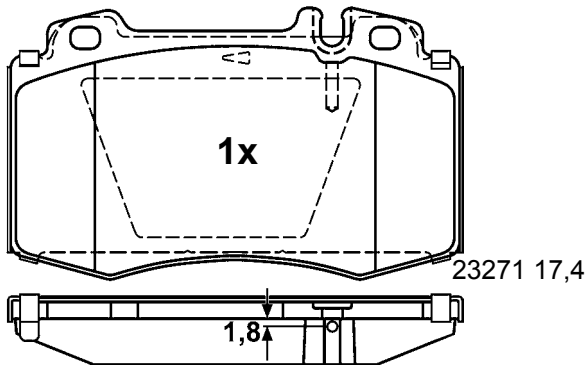
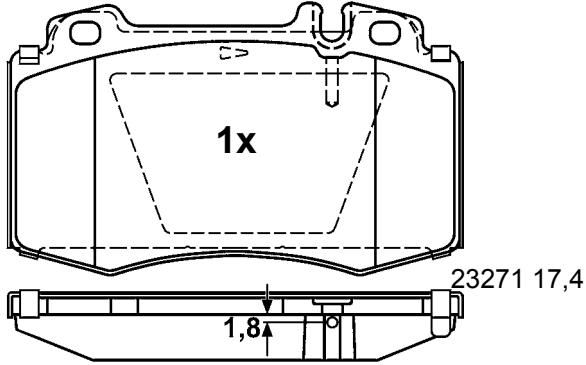

**119,5 x 71,7 x 17,4**

**13.0460-4991.2 604991**



ALFA ROMEO



BRE

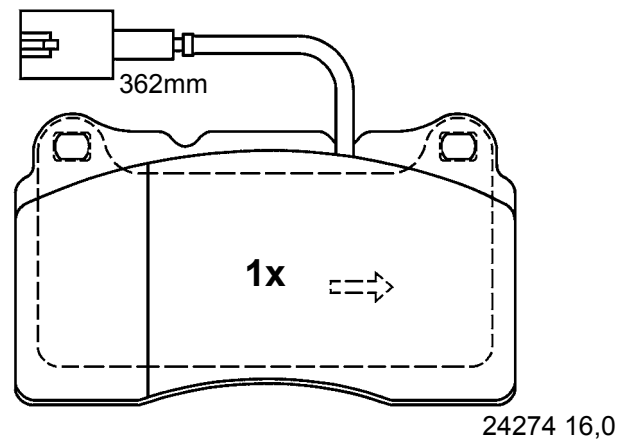
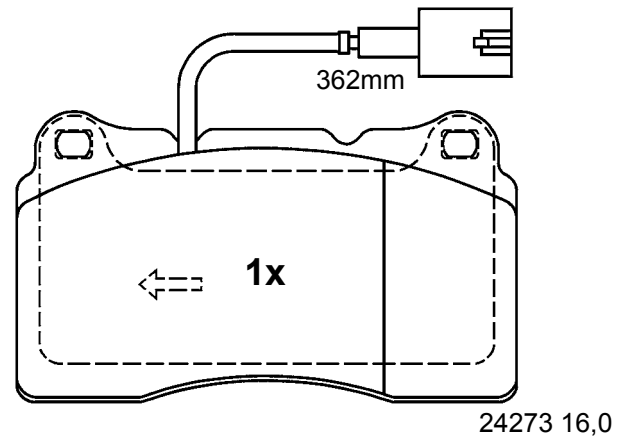
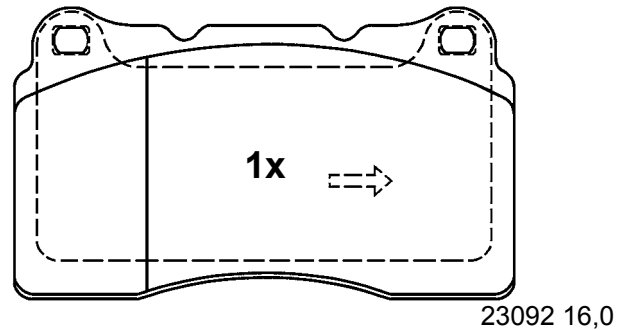
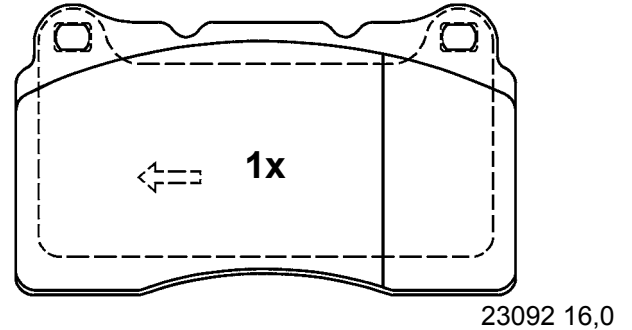

**131,8 x 77,2 x 16,0**



# Abbildungen Scheibenbremsbeläge

Illustrations disc brake pads - Illustrazioni pastiglie freno -

Illustrations plaquettes de frein - Ilustraciones pastillas de freno

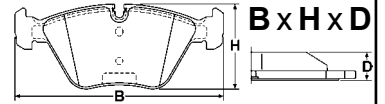

Maßstab - scale - scala - échelle - escala 1:2

## 13.0460-4992.2 604992



PORSCHE, VOLKSWAGEN



BRE

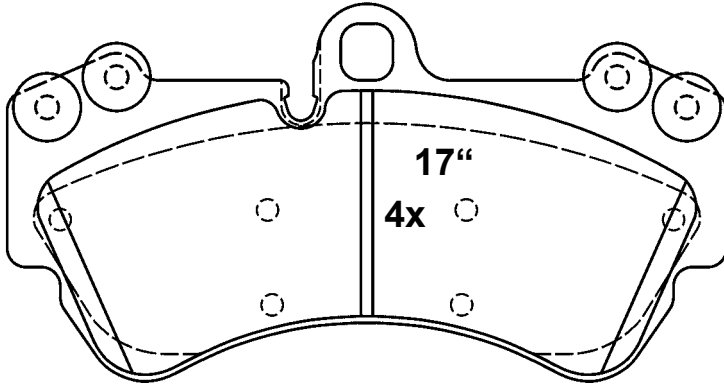

23692 16,6

190 x 99,4 x 16,6

## 13.0460-4995.2 604995



CITROEN, FIAT, LANCIA, PEUGEOT



BRE

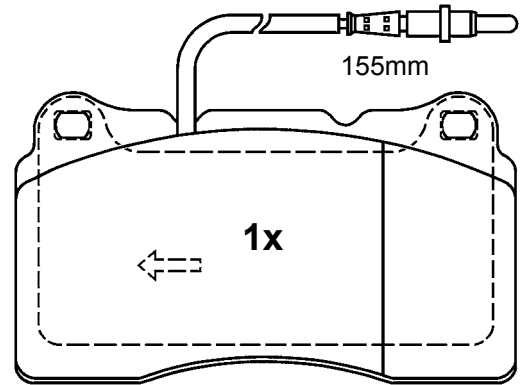

23576 15,6

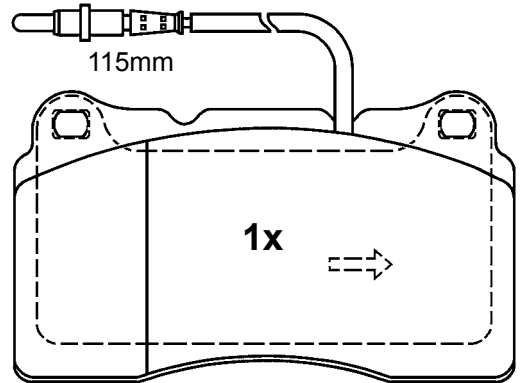

23575 15,6

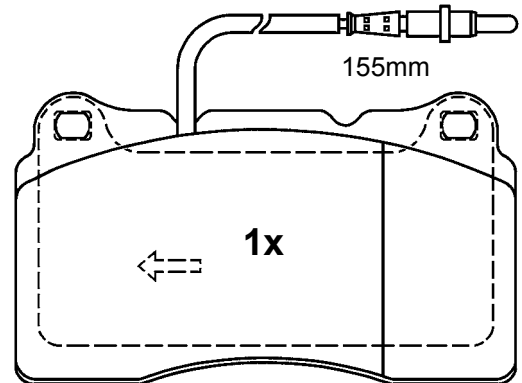

23576 15,6

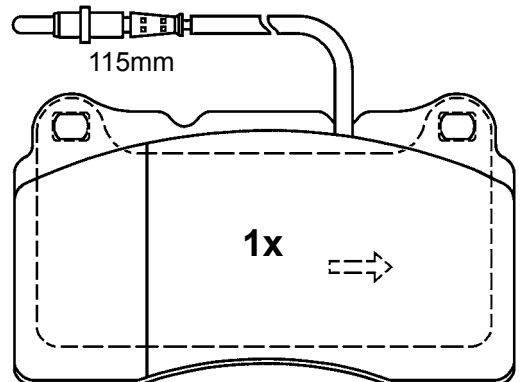

23575 15,6

## 13.0460-4993.2 604993



AUDI, PORSCHE, VOLKSWAGEN



BRE

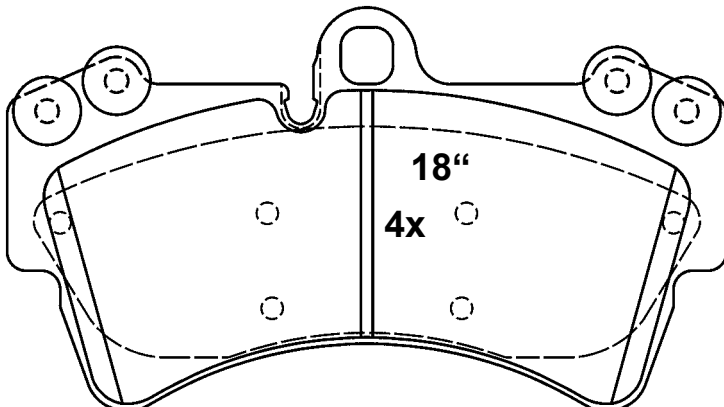

23693 16,6

190,0 x 106,4 x 16,6

## 13.0460-4994.2 604994



MERCEDES BENZ



BRE

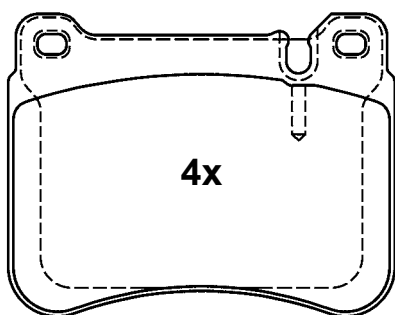

23945 16,5

101,7 x 79,3 x 16,5

# Abbildungen Scheibenbremsbeläge

Illustrations disc brake pads - Illustrazioni pastiglie freno -

Illustrations plaquettes de frein - Ilustraciones pastillas de freno

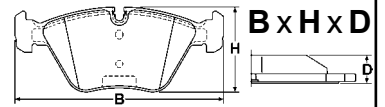

Maßstab - scale - scala - échelle - escala 1:2

**13.0460-4996.2 604996**

IVECO

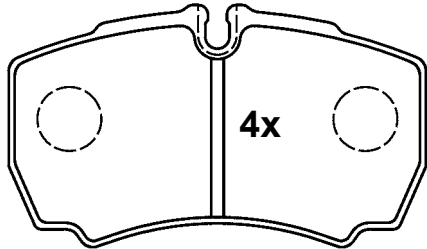

29123 20,3

109,8 x 63,8 x 20,3

**13.0460-4999.2 604999**

PORSCHE

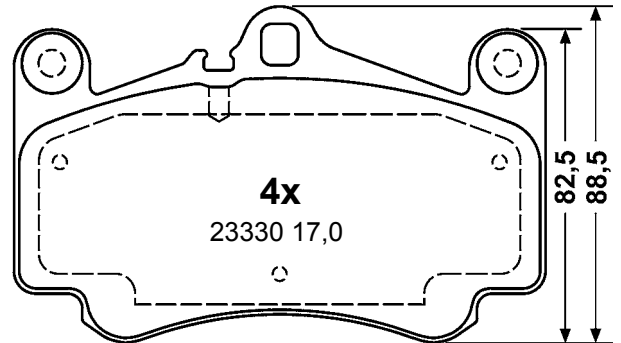

23330 17,0

140,0 x 88,5 x 17,0

**13.0460-4997.2 604997**

MERCEDES BENZ

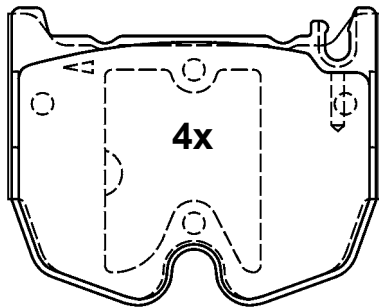

23944 17,5  
(23943)

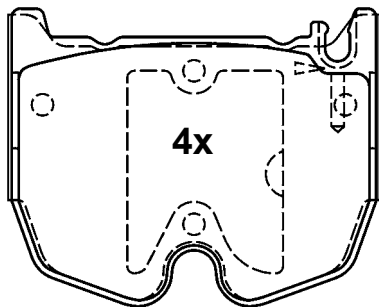

23944 17,5  
(23943)

97,8 x 78,5 x 17,5

**13.0460-5029.2 605029**

BMW

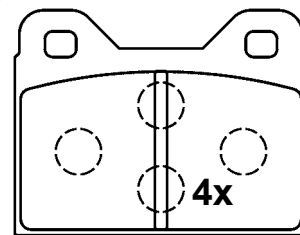

20126 15,0

76,8 x 58,8 x 15,0

**13.0460-5030.2 605030**

OPEL, VAUXHALL

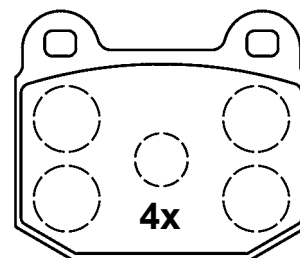

20323 16,5

76,8 x 65,5 x 16,5

**13.0460-4998.2 604998**

MERCEDES BENZ

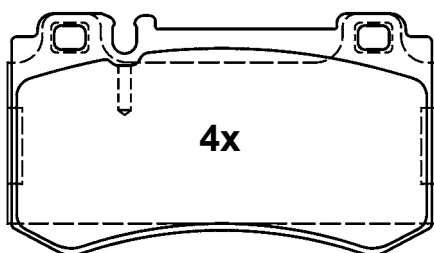

23478 16,5

112,0 x 63,8 x 16,5

**13.0460-5032.2 605032**

BMW, STEYR

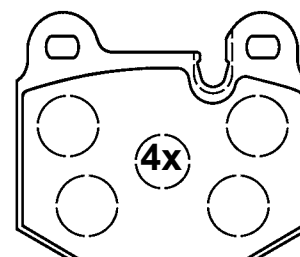

20588 16,5

76,5 x 65,5 x 16,5

# Abbildungen Scheibenbremsbeläge

Illustrations disc brake pads - Illustrazioni pastiglie freno -

Illustrations plaquettes de frein - Ilustraciones pastillas de freno

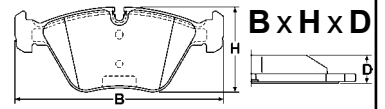

Maßstab - scale - scala - échelle - escala 1:2

**13.0460-5403.2 605403**



AUDI



ATE

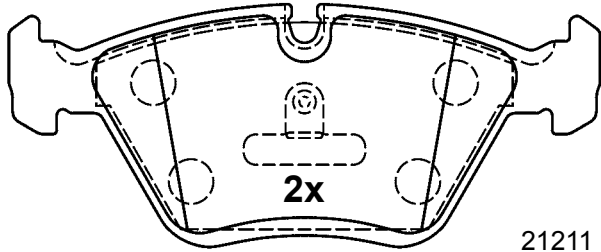

21211 18,7

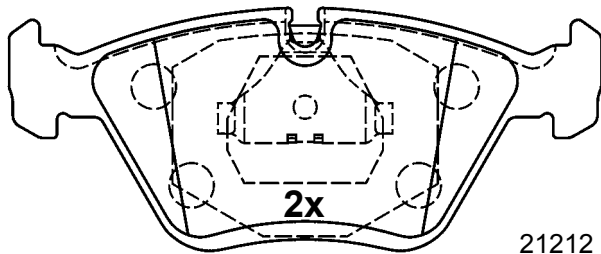

21212 18,7

156,4 x 64,0 x 18,7

**13.0460-5409.2 605409**



FIAT, INNOCENTI



ATE

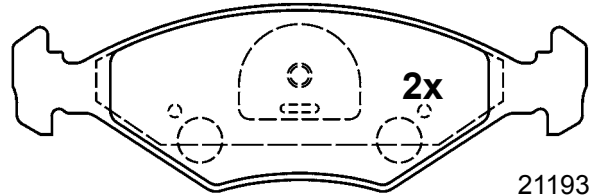

21193 18,0

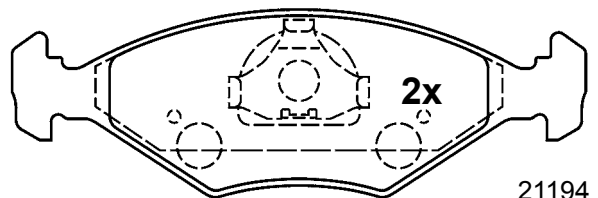

21194 18,0

151,3 x 49,2 x 18,0

**13.0460-5405.2 605405**



BMW



ATE

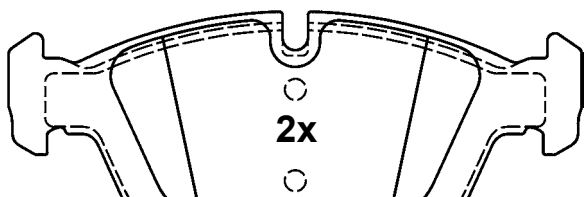

21643 17,8

151,3 x 57,3 x 17,8

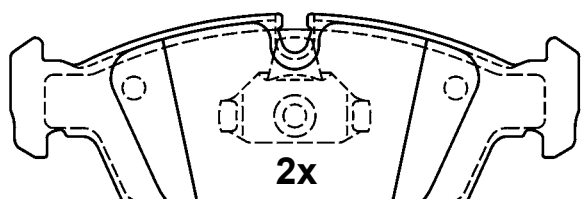

21644 17,8

150,1 x 57,3 x 17,8

**13.0460-5410.2 605410**



FIAT



ATE

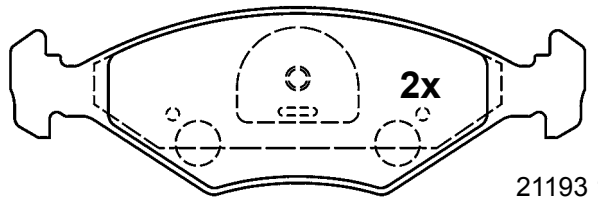

21193 18,0

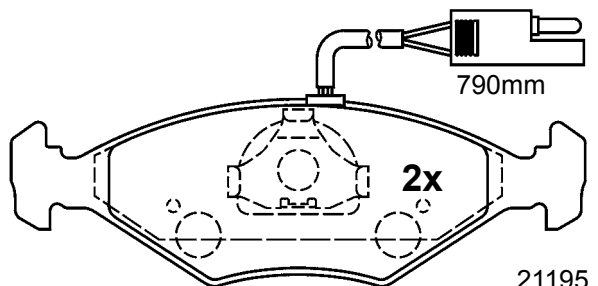

21195 18,0

151,3 x 49,2 x 18,0



# Abbildungen Scheibenbremsbeläge

Illustrations disc brake pads - Illustrazioni pastiglie freno -

Illustrations plaquettes de frein - Ilustraciones pastillas de freno

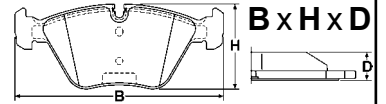

Maßstab - scale - scala - échelle - escala 1:2

## 13.0460-5600.2 605600

HYUNDAI, KIA

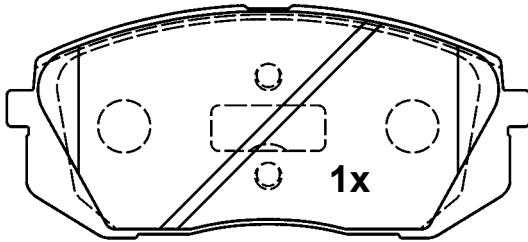

24501 16,7

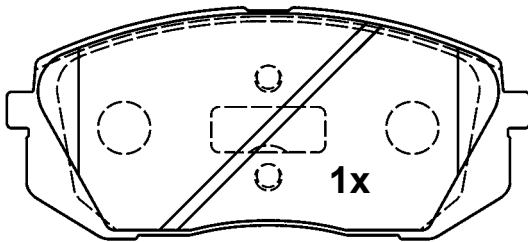

24501 16,7

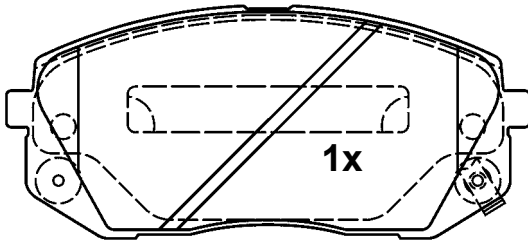

24502 16,7

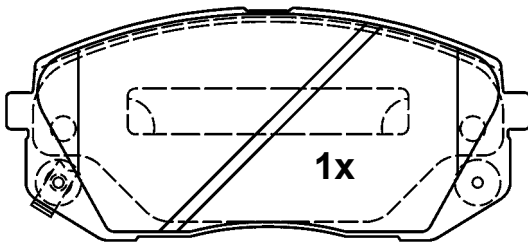

24503 16,7

137,8 x 60,9 x 16,7

## 13.0460-5601.2 605601

KIA

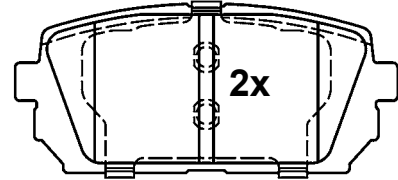

24491 16,0

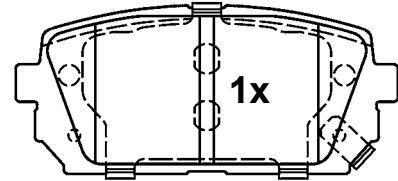

24492 16,0

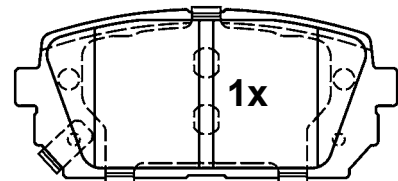

24493 16,0

100,7 x 44,0 x 16,0

## 13.0460-5602.2 605602

TOYOTA

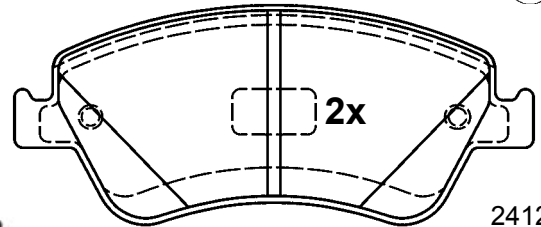

24122 19,0

4x



136,7 x 57,9 x 19,0

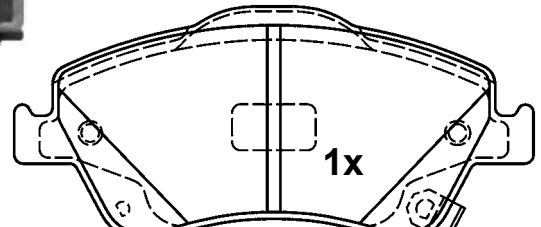

24590 19,0

4x



136,7 x 61,4 x 19,0

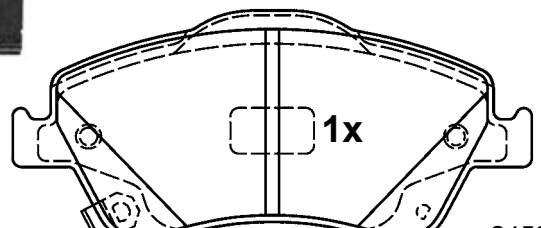

24591 19,0

136,7 x 61,4 x 19,0

# Abbildungen Scheibenbremsbeläge

Illustrations disc brake pads - Illustrazioni pastiglie freno -

Illustrations plaquettes de frein - Ilustraciones pastillas de freno

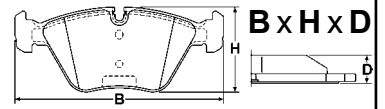

Maßstab - scale - scala - échelle - escala 1:2

## 13.0460-5603.2 605603

TOYOTA

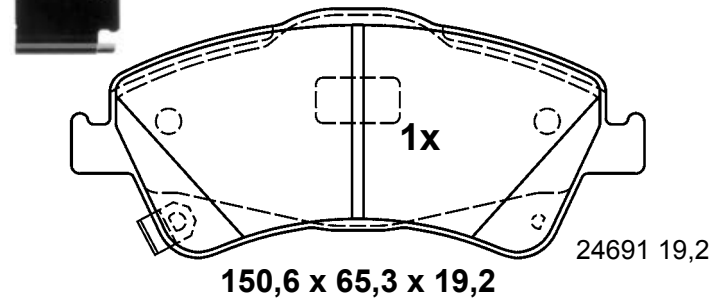
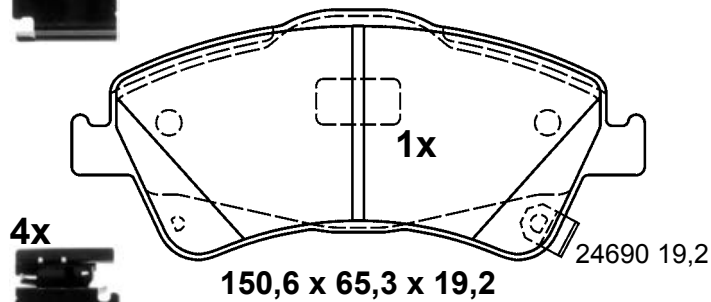
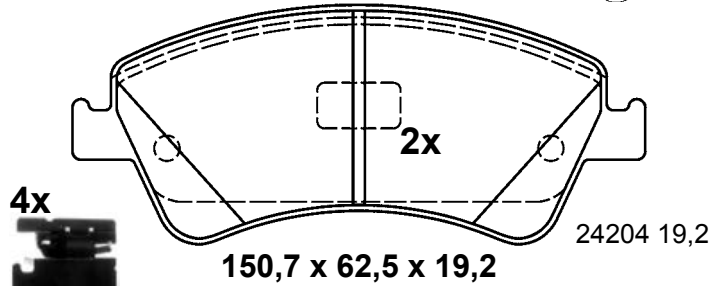

## 13.0460-5604.2 605604

TOYOTA

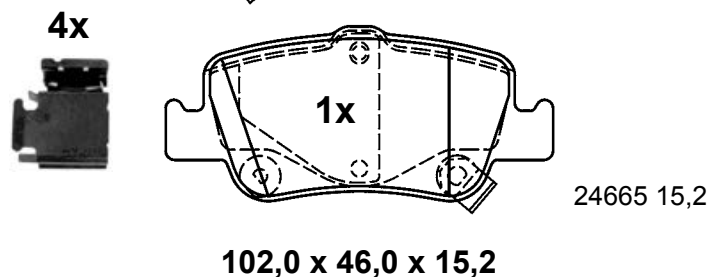
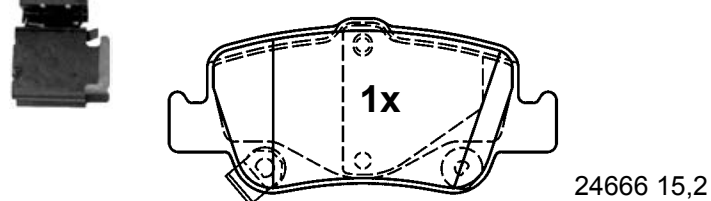
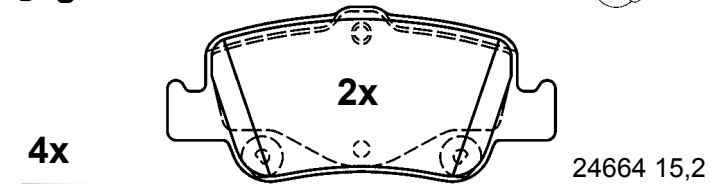

## 13.0460-5605.2 605605

MAZDA

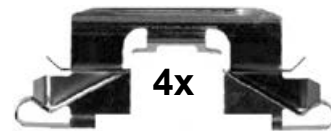
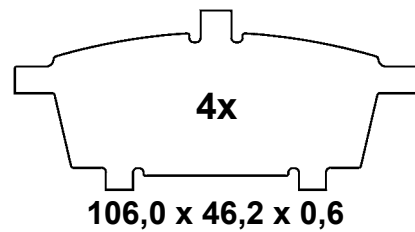
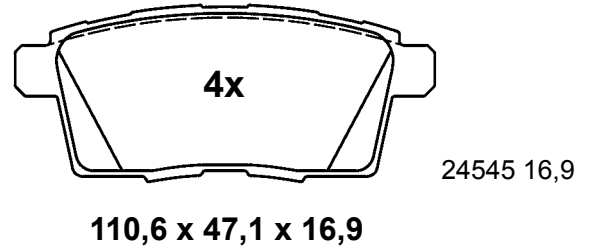

## 13.0460-5606.2 605606

MAZDA

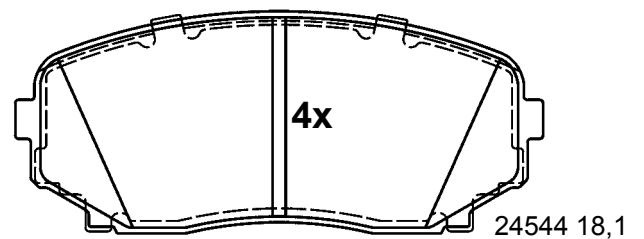

# Abbildungen Scheibenbremsbeläge

Illustrations disc brake pads - Illustrazioni pastiglie freno -

Illustrations plaquettes de frein - Ilustraciones pastillas de freno

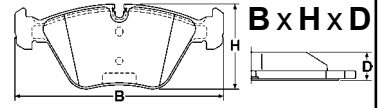

Maßstab - scale - scala - échelle - escala 1:2

## 13.0460-5607.2 605607



LEXUS

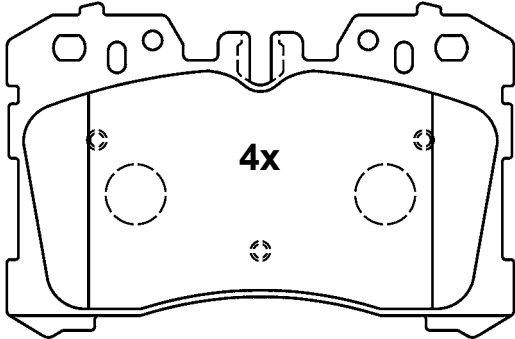

24245 18,5

133,7 x 87,9 x 18,5

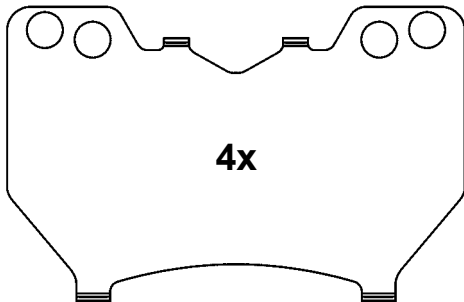

D = 0,6

## 13.0460-5609.2 605609



SUZUKI

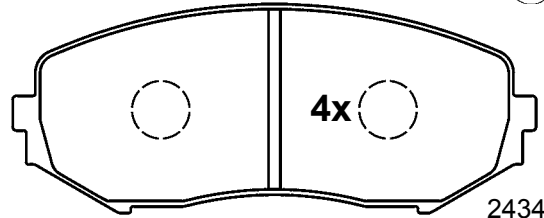

24346 16,4

138,0 x 54,7 x 16,4

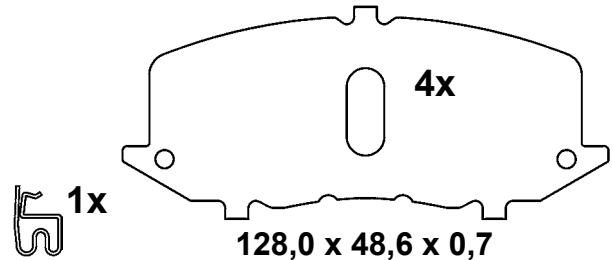

1x

128,0 x 48,6 x 0,7

## 13.0460-5610.2 605610



MAZDA

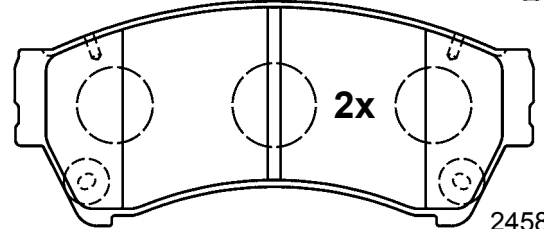

24582 17,4

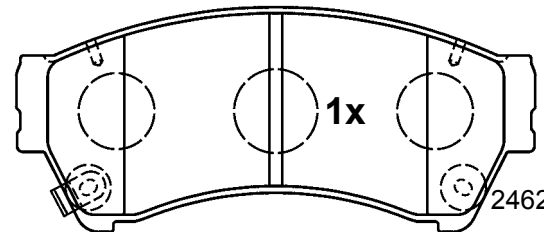

24629 17,4

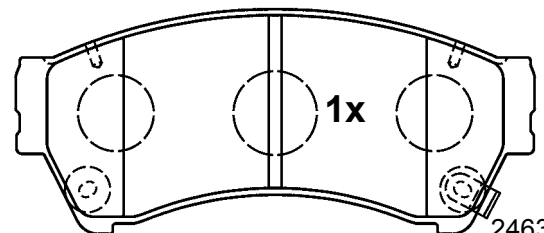

24630 17,4

136,6 x 58,8 x 17,4

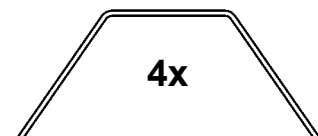

4x

## 13.0460-5608.2 605608



LEXUS

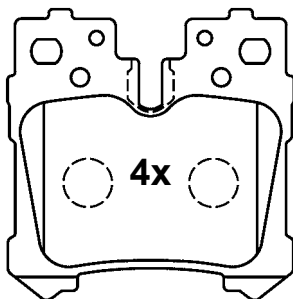

24244 18,5

75,0 x 76,7 x 18,5

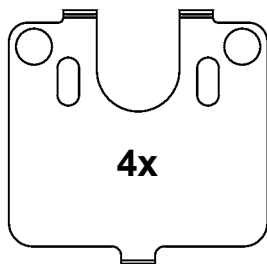

68,0 x 59,0 x 0,6

# Abbildungen Scheibenbremsbeläge

Illustrations disc brake pads - Illustrazioni pastiglie freno -

Illustrations plaquettes de frein - Ilustraciones pastillas de freno

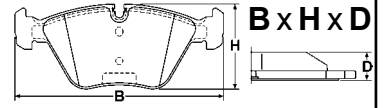

Maßstab - scale - scala - échelle - escala 1:2

**13.0460-5611.2 605611**



OPEL, SAAB, VAUXHALL



MAN

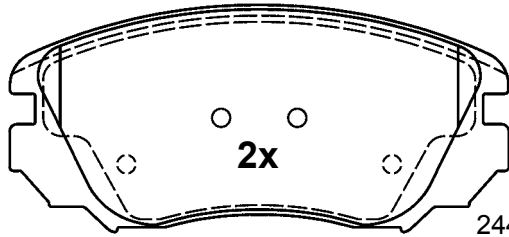

24415 19,1

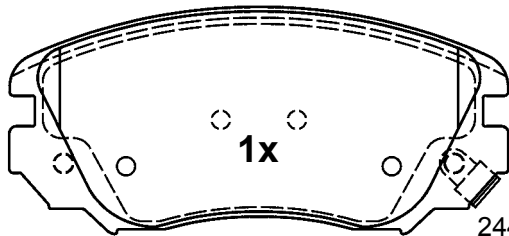

24416 19,1

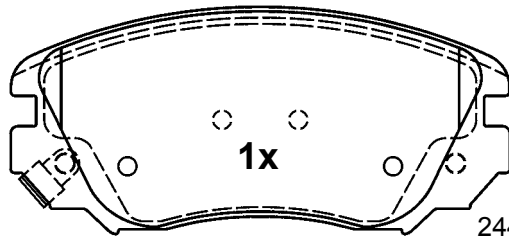

24417 19,1

**131,4 x 59,7 x 19,1**

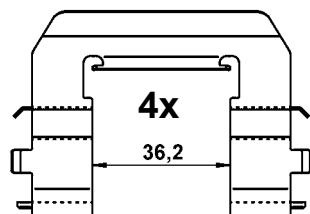
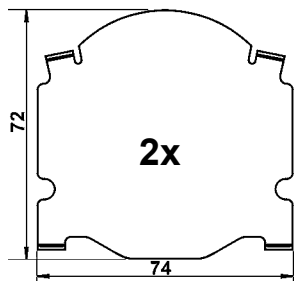

**13.0460-5612.2 605612**



OPEL, SAAB, VAUXHALL



MAN

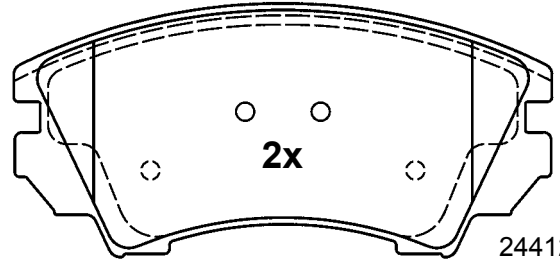

24412 19,0

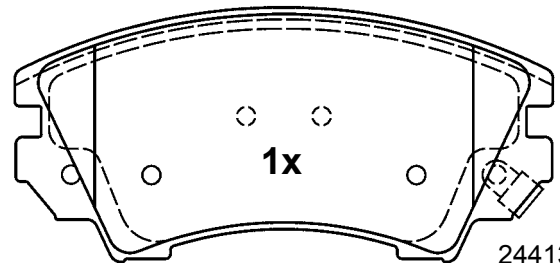

24413 19,0

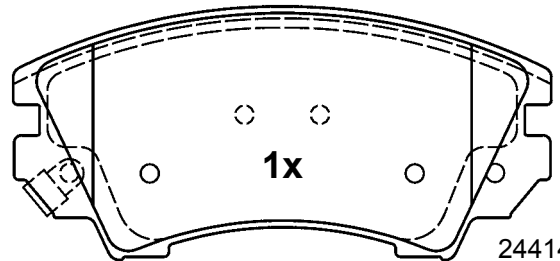

24414 19,0

**141,9 x 66,7 x 19,0**

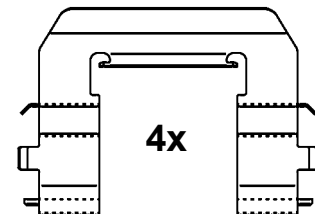
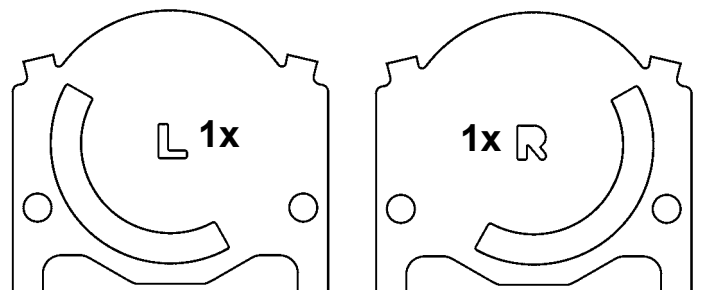

# Abbildungen Scheibenbremsbeläge

Illustrations disc brake pads - Illustrazioni pastiglie freno -

Illustrations plaquettes de frein - Ilustraciones pastillas de freno

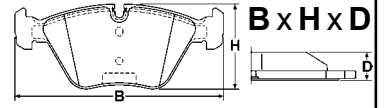

Maßstab - scale - scala - échelle - escala 1:2

**13.0460-5613.2 605613**



DAIHATSU, SUBARU

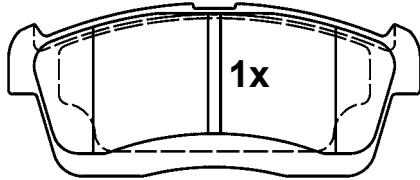

25262 15,0

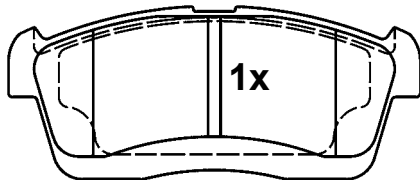

25262 15,0

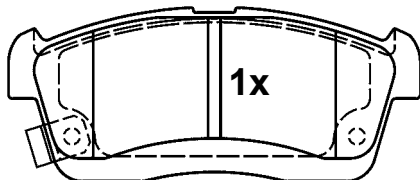

25274 15,0

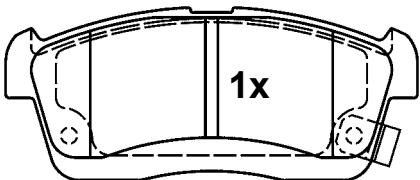

25273 15,0

**108,4 x 45,6 x 15,0**

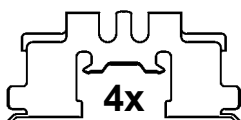

**13.0460-5614.2 605614**



TOYOTA

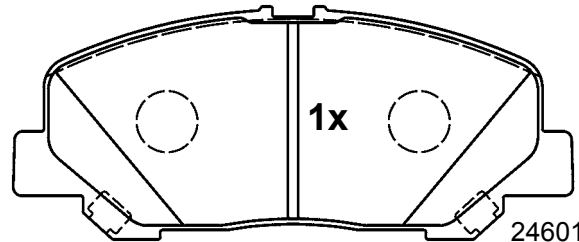

24601 18,0

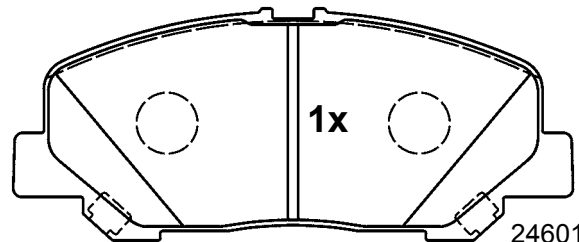

24601 18,0

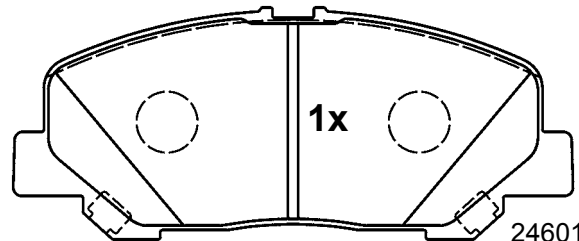

24601 18,0

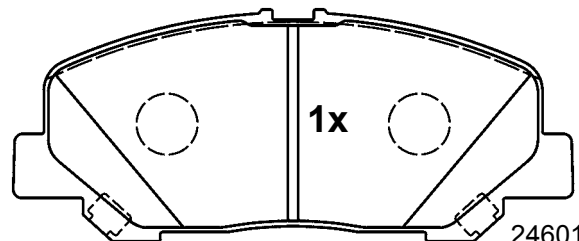

24601 18,0

**147,6 x 60,8 x 18,0**

# Abbildungen Scheibenbremsbeläge

Illustrations disc brake pads - Illustrazioni pastiglie freno -  
Illustrations plaquettes de frein - Ilustraciones pastillas de freno

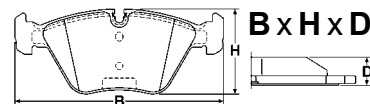

Maßstab - scale - scala - échelle - escala 1:2

## 13.0460-5615.2 605615



TOYOTA



BOS

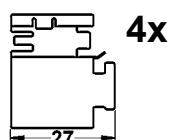
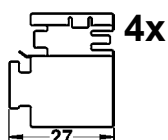
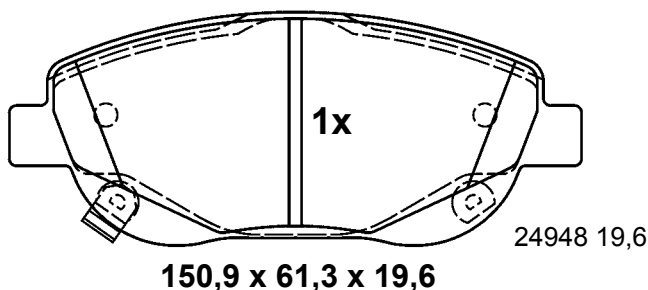
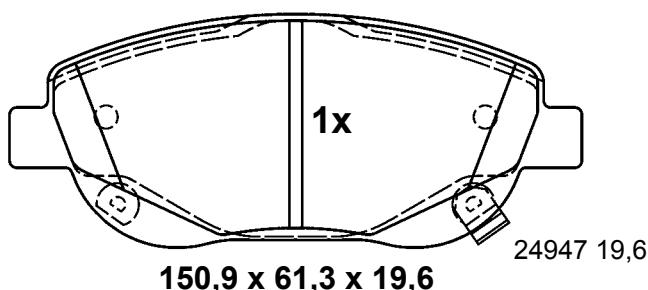
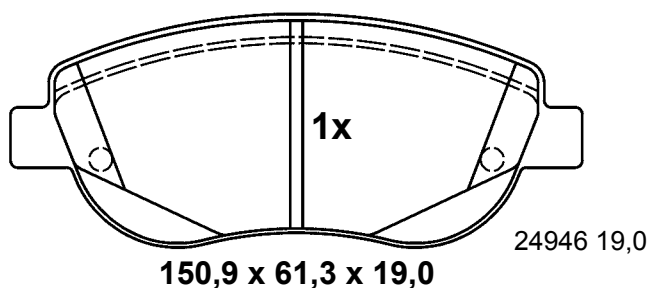
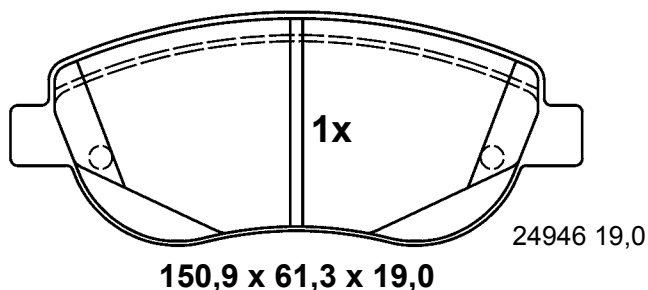

## 13.0460-5616.2 605616



TOYOTA

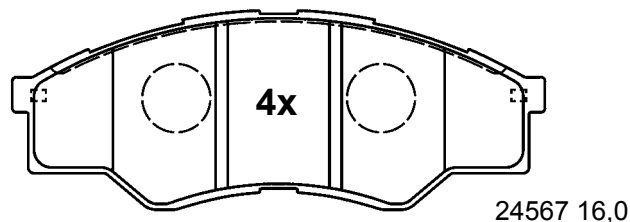

140,1 x 52,0 x 16,0

## 13.0460-5617.2 605617



LEXUS, TOYOTA

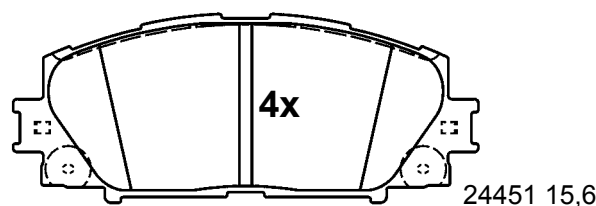

122,7 x 49,6 x 15,6

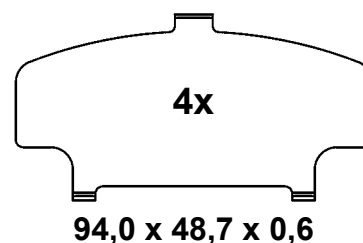



# Abbildungen Scheibenbremsbeläge

Illustrations disc brake pads - Illustrazioni pastiglie freno -

Illustrations plaquettes de frein - Ilustraciones pastillas de freno

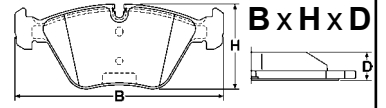

Maßstab - scale - scala - échelle - escala 1:2

**13.0460-5618.2 605618**

 TOYOTA

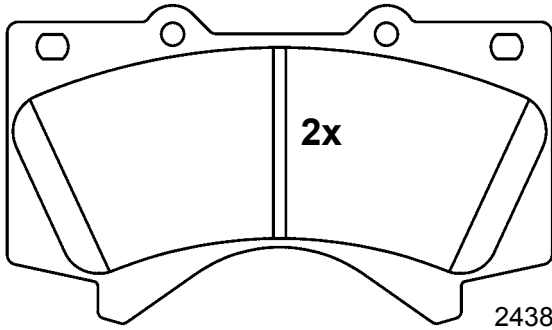

24386 17,9

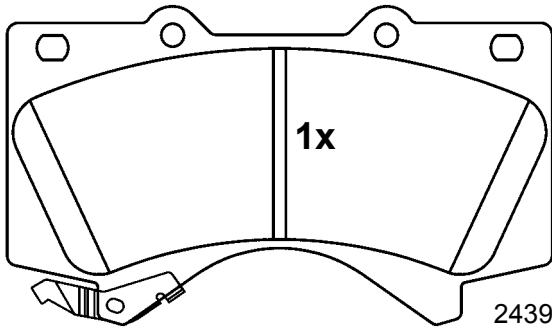

24394 17,9

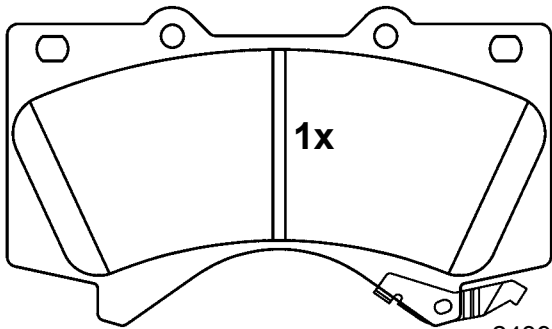

24395 17,9

**143,7 x 83,3 x 17,9**

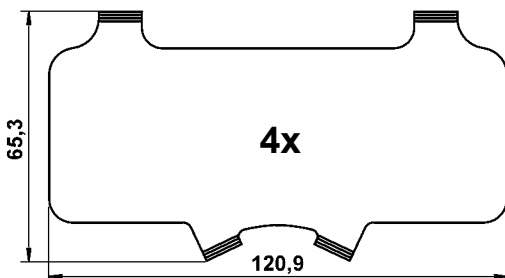

**13.0460-5619.2 605619**

 LEXUS, TOYOTA

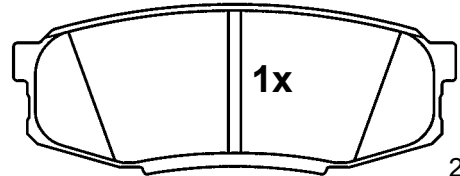

24635 17,3

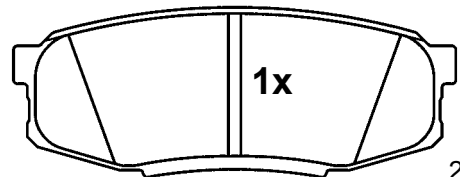

24635 17,3

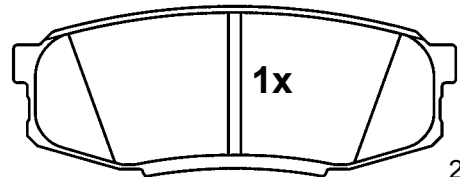

24635 17,3

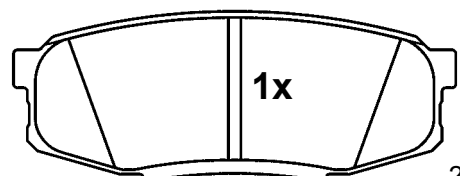

24635 17,3

**116,3 x 44,6 x 17,3**

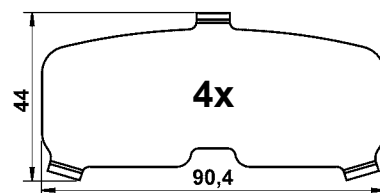

# Abbildungen Scheibenbremsbeläge

Illustrations disc brake pads - Illustrazioni pastiglie freno -

Illustrations plaquettes de frein - Ilustraciones pastillas de freno

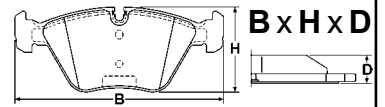

Maßstab - scale - scala - échelle - escala 1:2

## 13.0460-5620.2 605620



HONDA



AKE

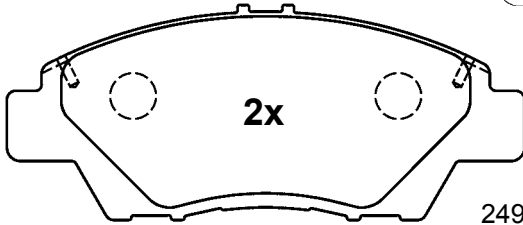

2x

24979 15,9

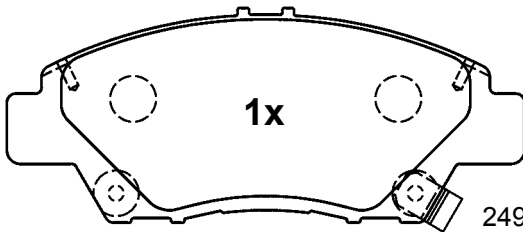

1x

24980 15,9

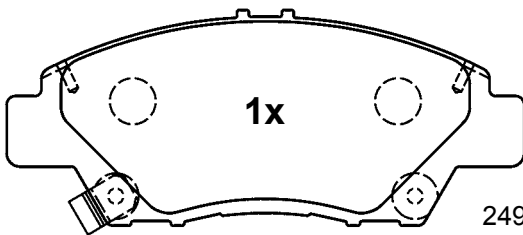

1x

24981 15,9

136,4 x 56,4 x 15,9

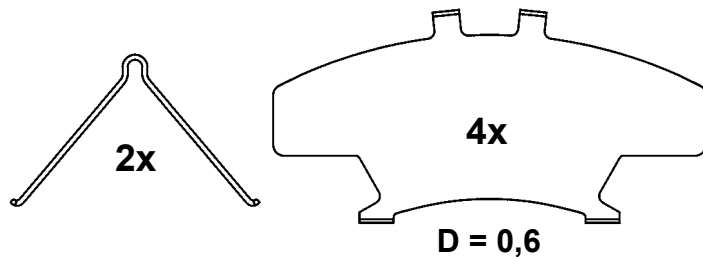

2x

4x

D = 0,6

## 13.0460-5622.2 605622



HYUNDAI



MAN

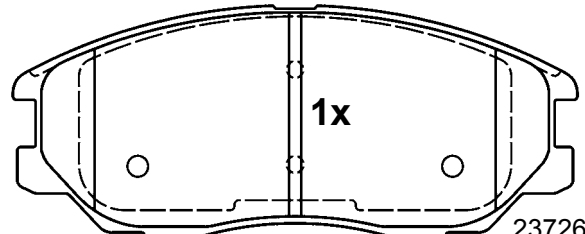

1x

23726 16,5

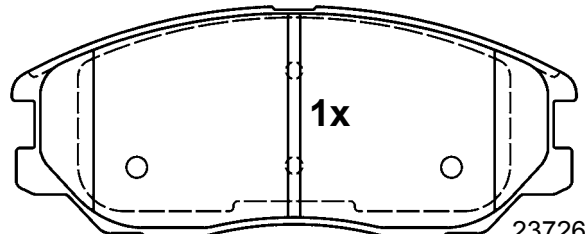

1x

23726 16,5

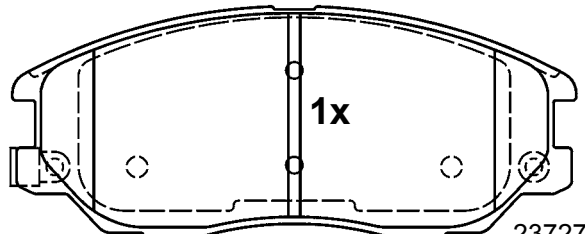

1x

23727 16,5

## 13.0460-5621.2 605621



CITROEN, MITSUBISHI,  
PEUGEOT, SUZUKI

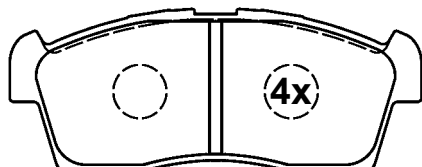

4x

24423 14,6

108,5 x 42,2 x 14,6

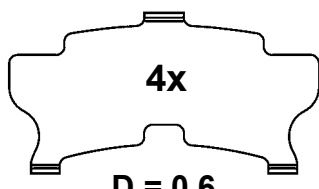

4x

D = 0,6

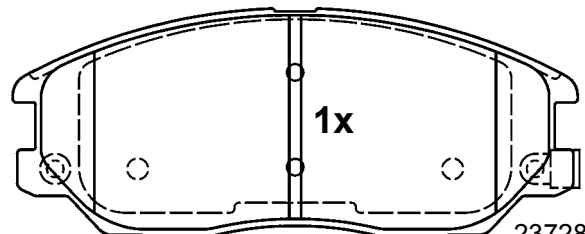

1x

23728 16,5

148,8 x 60,8 x 16,5

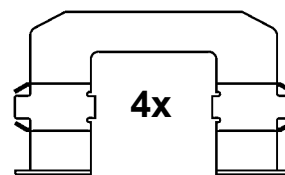

4x

# Abbildungen Scheibenbremsbeläge

Illustrations disc brake pads - Illustrazioni pastiglie freno -

Illustrations plaquettes de frein - Ilustraciones pastillas de freno

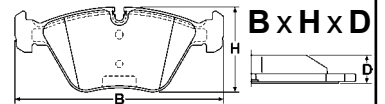

Maßstab - scale - scala - échelle - escala 1:2

**13.0460-5623.2 605623**



SSANG YONG



MAN

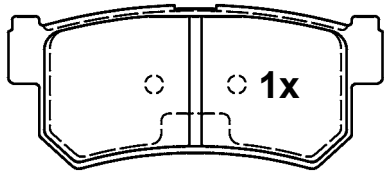

23673 15,9

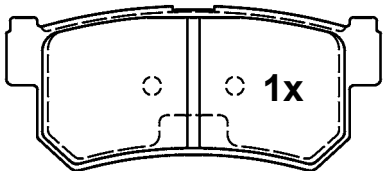

23673 15,9

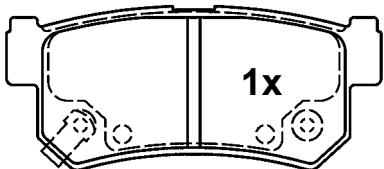

23674 15,9

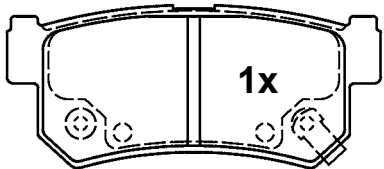

23675 15,9

**98,5 x 42,8 x 15,9**

**13.0460-5625.2 605625**



MAZDA



AKE

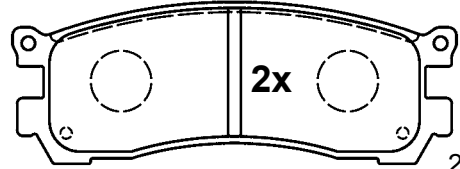

21319 14,9

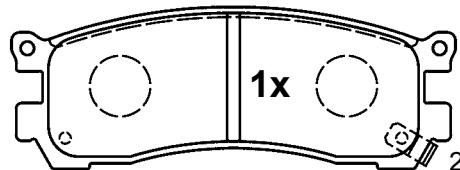

21320 14,9

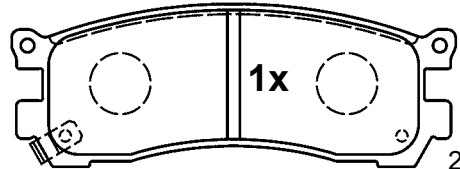

21321 14,9

**117,1 x 42,5 x 14,9**

**13.0460-5626.2 605626**



NISSAN



AKE

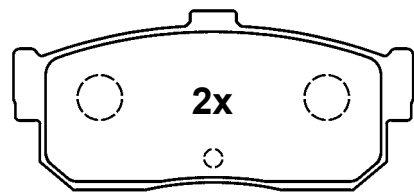

21713 16,0

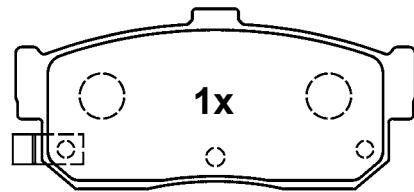

21714 16,0

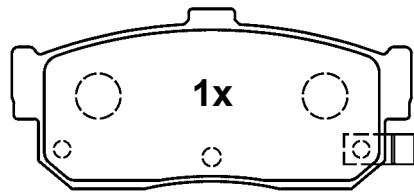

21715 16,0



**M8x21**

**105,3 x 47,0 x 16,0**



# Abbildungen Scheibenbremsbeläge

Illustrations disc brake pads - Illustrazioni pastiglie freno -

Illustrations plaquettes de frein - Ilustraciones pastillas de freno



Maßstab - scale - scala - échelle - escala 1:2

## 13.0460-5627.2 605627

MAZDA

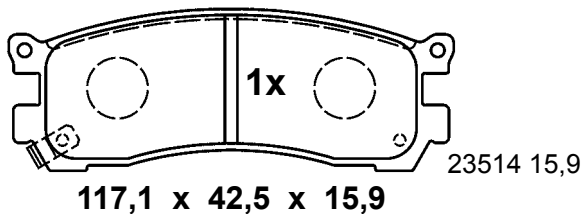
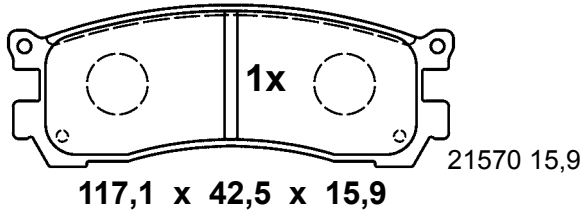
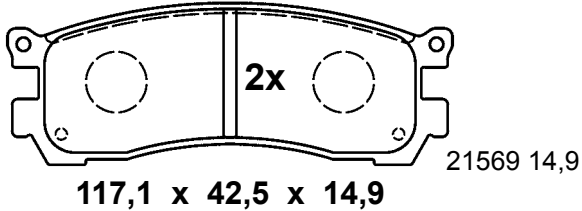

## 13.0460-5629.2 605629

JEEP

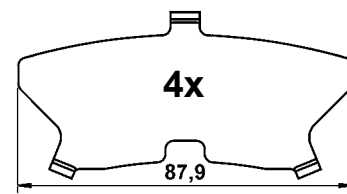
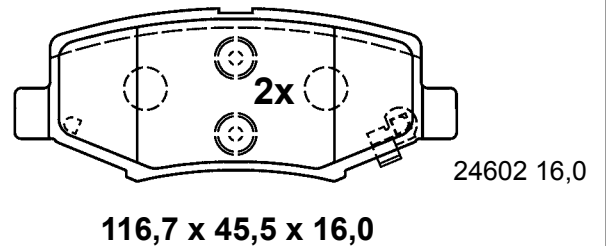
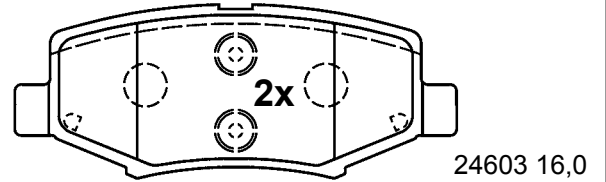

## 13.0460-5628.2 605628

SUBARU

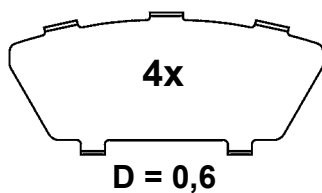
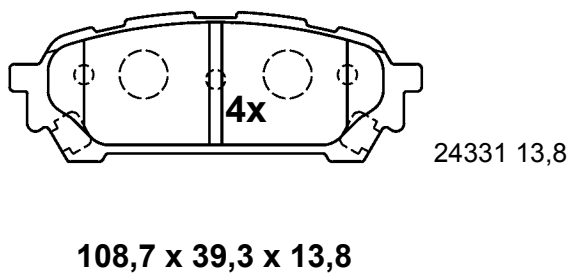

## 13.0460-5631.2 605631

MITSUBISHI

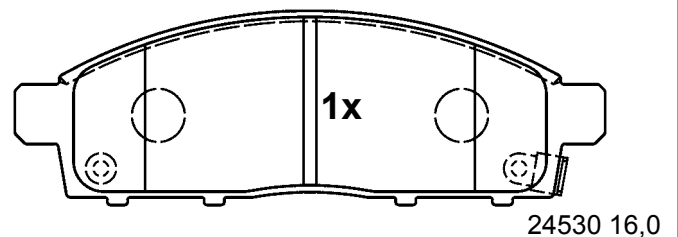
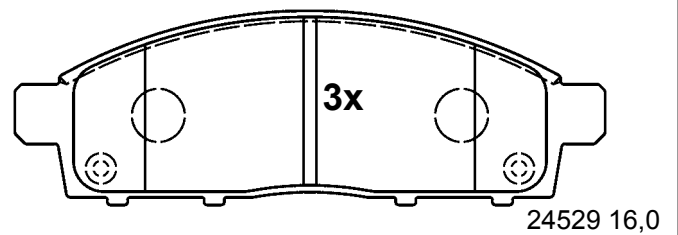

155,4 x 50,9 x 16,0

# Abbildungen Scheibenbremsbeläge

Illustrations disc brake pads - Illustrazioni pastiglie freno -

Illustrations plaquettes de frein - Ilustraciones pastillas de freno

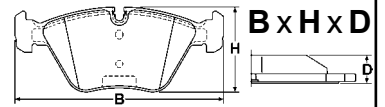

Maßstab - scale - scala - échelle - escala 1:2

**13.0460-5632.2 605632**

NISSAN

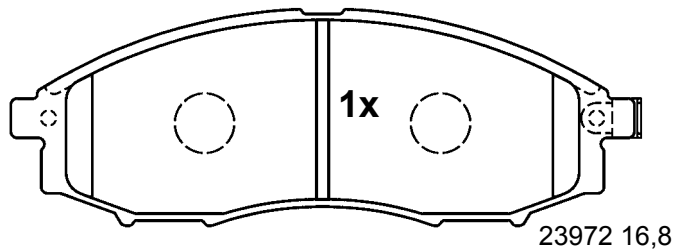
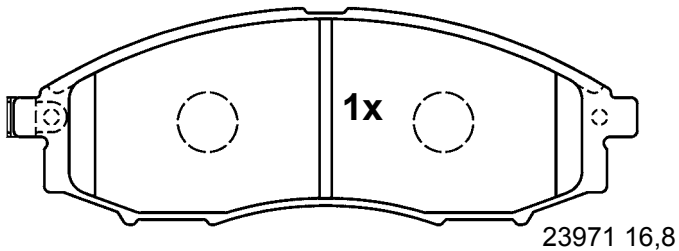
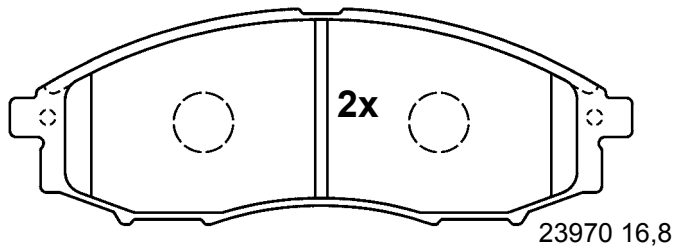

**164,2 x 56,7 x 16,8**

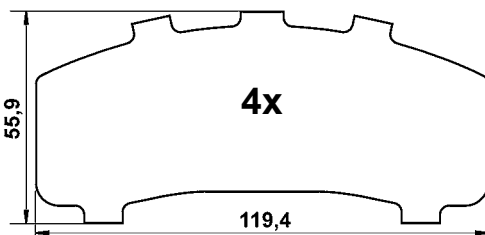

**13.0460-5633.2 605633**

HYUNDAI, KIA

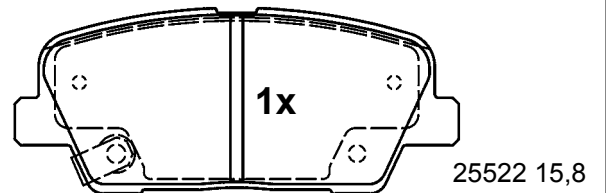
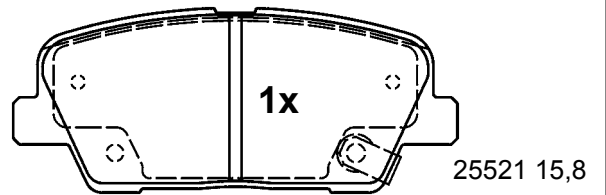
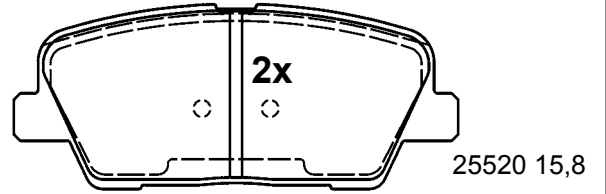

**117,0 x 48,4 x 15,8**

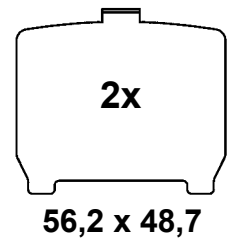
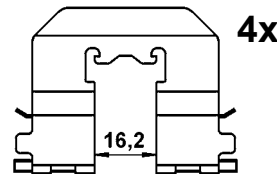

**13.0460-5634.2 605634**

LEXUS, TOYOTA

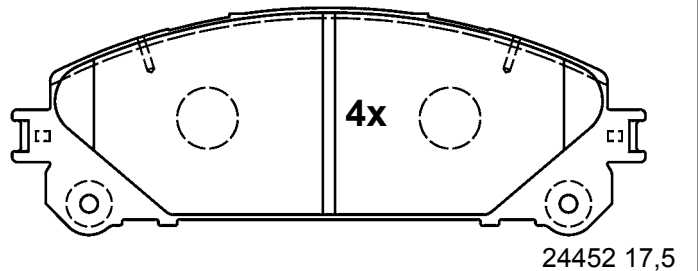

**167,0 x 59,4 x 17,5**



# Abbildungen Scheibenbremsbeläge

Illustrations disc brake pads - Illustrazioni pastiglie freno -

Illustrations plaquettes de frein - Ilustraciones pastillas de freno

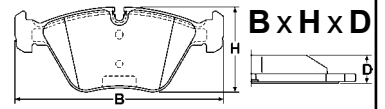

Maßstab - scale - scala - échelle - escala 1:2

**13.0460-5635.2 605635**



LEXUS, TOYOTA



AKE

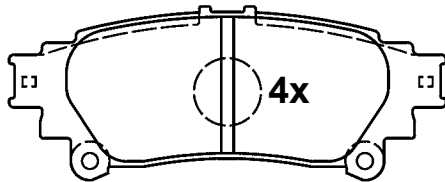

24918 15,0

**115,2 x 45,7 x 15,0**

**13.0460-5637.2 605637**



HYUNDAI



MAN

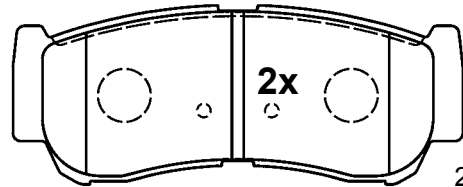

24488 14,9

**13.0460-5636.2 605636**



HYUNDAI



MAN

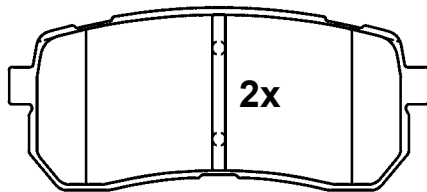

24600 14,9

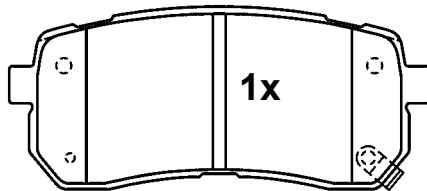

24600 14,9

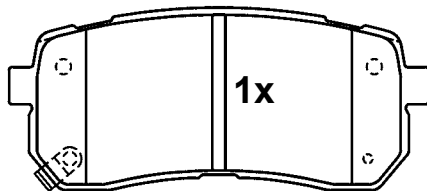

24600 14,9

**110,6 x 47,7 x 14,9**

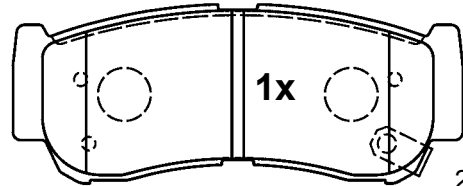

24489 14,9

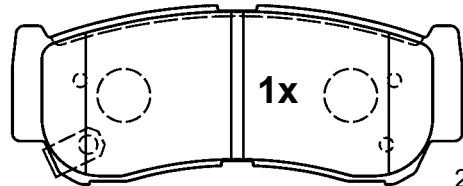

24490 14,9

**118,6 x 47,0 x 14,9**

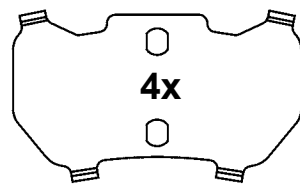
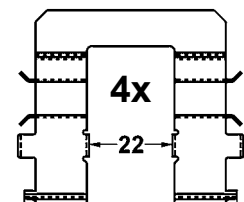
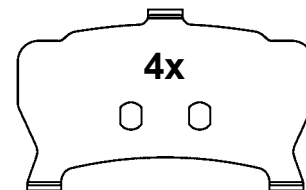

**76,2 x 45,1 x 0,6**

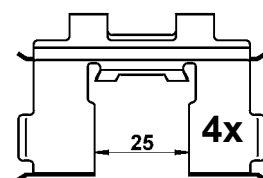



# Abbildungen Scheibenbremsbeläge

Illustrations disc brake pads - Illustrazioni pastiglie freno -

Illustrations plaquettes de frein - Ilustraciones pastillas de freno

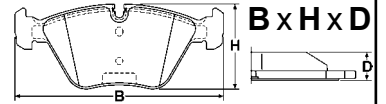

Maßstab - scale - scala - échelle - escala 1:2

**13.0460-5638.2 605638**

HYUNDAI

AKE

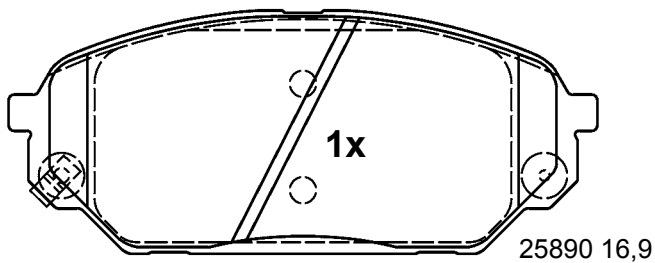
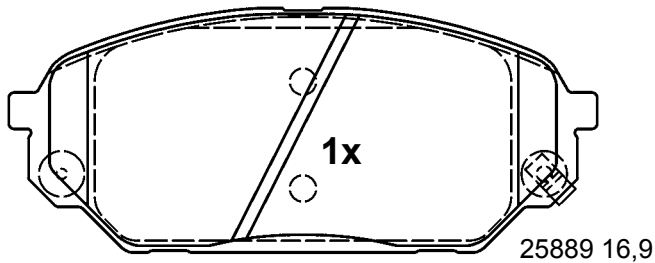
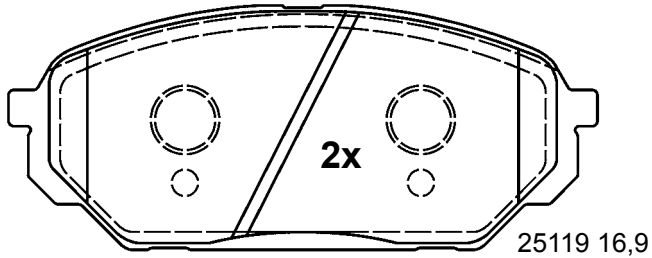

**155,0 x 64,5 x 16,9**

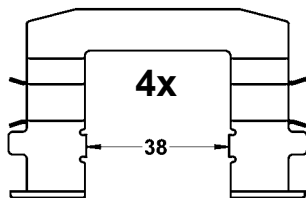
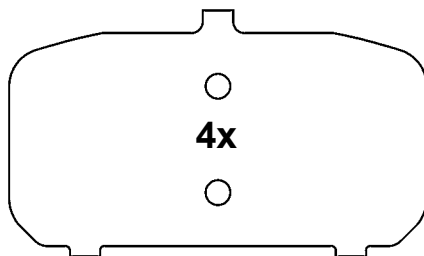

**13.0460-5639.2 605639**

HYUNDAI

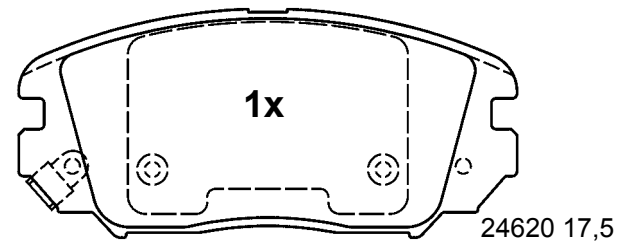
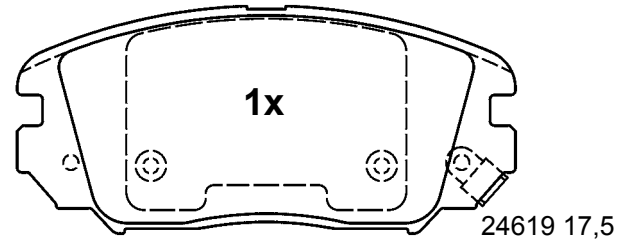
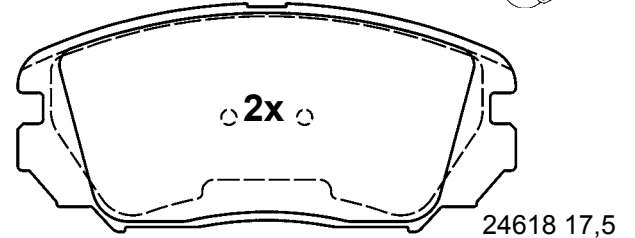

**131,3 x 59,9 x 17,5**

**13.0460-5640.2 605640**

SUBARU

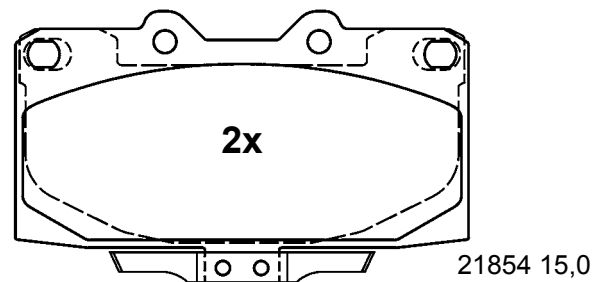
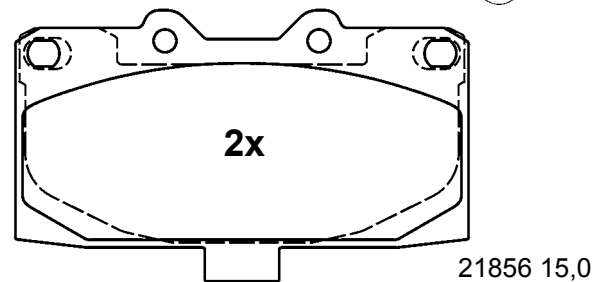

**119,3 x 71,2 x 15,0**

# Abbildungen Scheibenbremsbeläge

Illustrations disc brake pads - Illustrazioni pastiglie freno -

Illustrations plaquettes de frein - Ilustraciones pastillas de freno

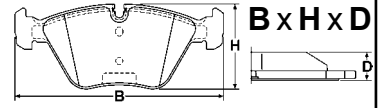

Maßstab - scale - scala - échelle - escala 1:2

**13.0460-5641.2 605641**

 HYUNDAI

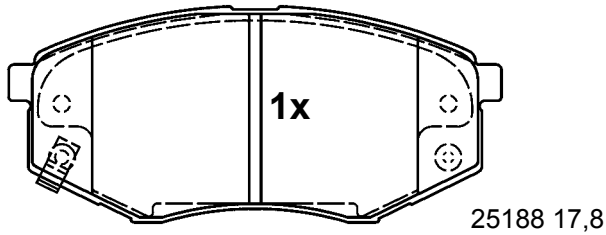
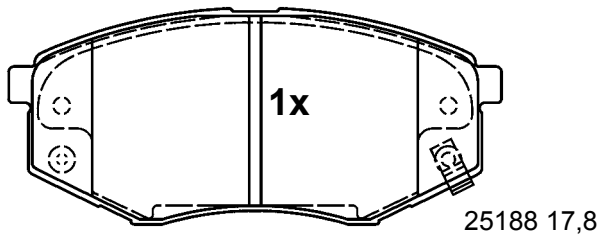
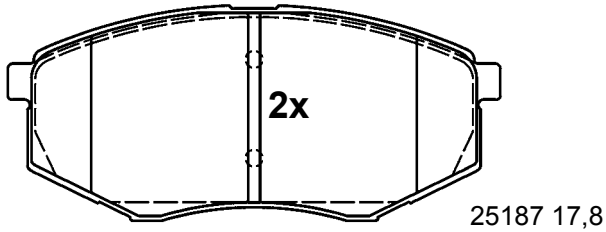

**131,3 x 59,9 x 17,8**

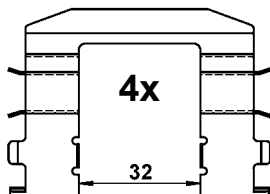
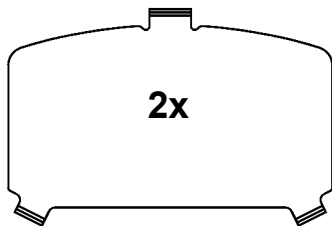

**13.0460-5642.2 605642**

 CHEVROLET

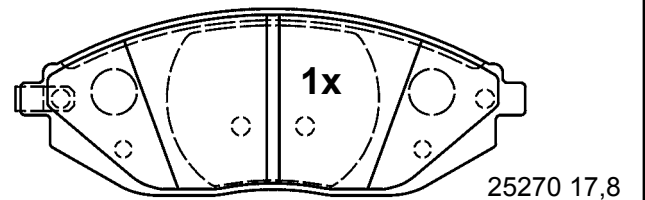
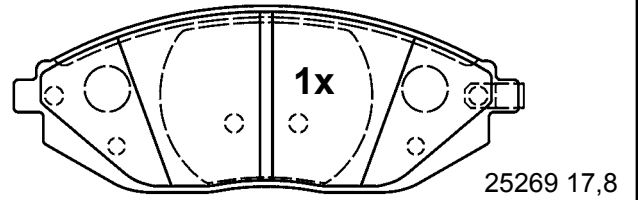
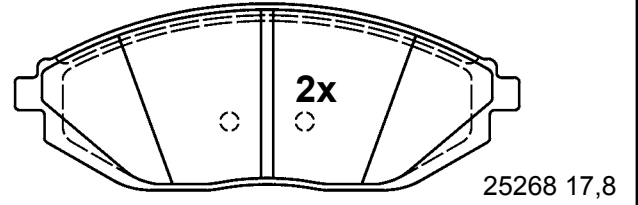

**133,2 x 49,0 x 17,8**

# Abbildungen Scheibenbremsbeläge

Illustrations disc brake pads - Illustrazioni pastiglie freno -

Illustrations plaquettes de frein - Ilustraciones pastillas de freno

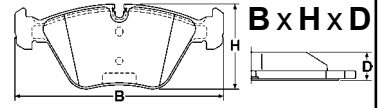

Maßstab - scale - scala - échelle - escala 1:2

**13.0460-5645.2 605645**

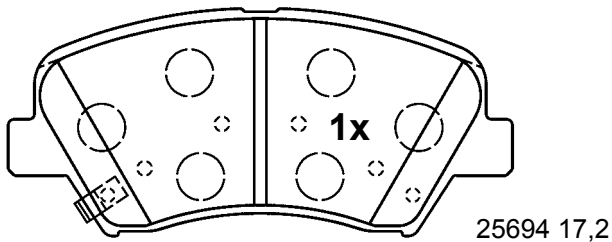
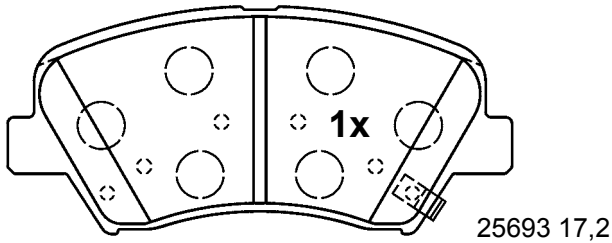
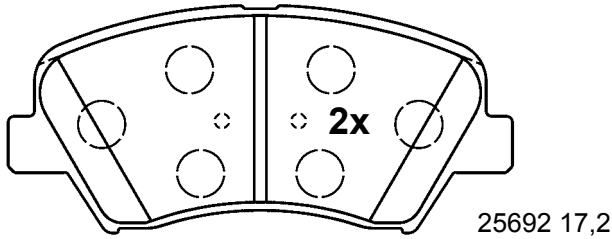

**132,9 x 60,0 x 17,2**

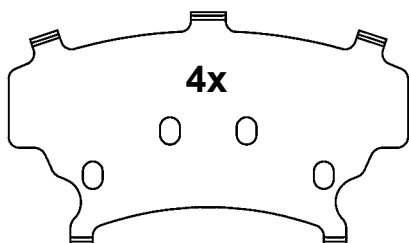

**105,4 x 61,3 x 0,6**

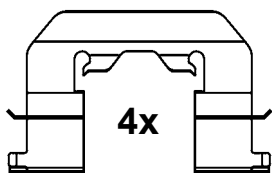

**13.0460-5646.2 605646**

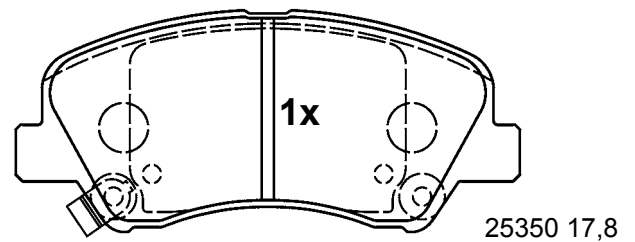
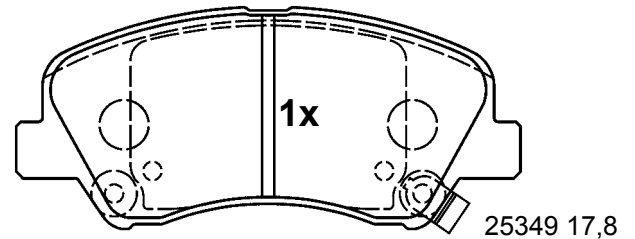
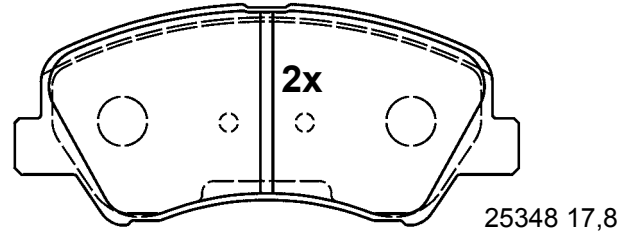

**132,7 x 57,9 x 17,8**

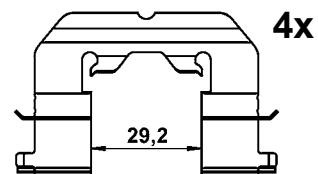
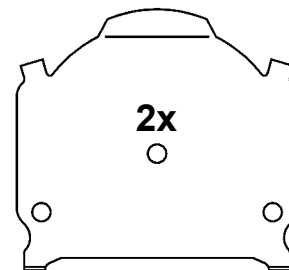

# Abbildungen Scheibenbremsbeläge

Illustrations disc brake pads - Illustrazioni pastiglie freno -

Illustrations plaquettes de frein - Ilustraciones pastillas de freno

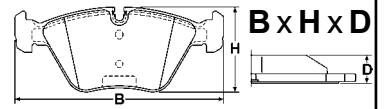

Maßstab - scale - scala - échelle - escala 1:2

**13.0460-5648.2 605648**

**13.0460-5649.2 605649**



HONDA



NIS



KIA



MAN

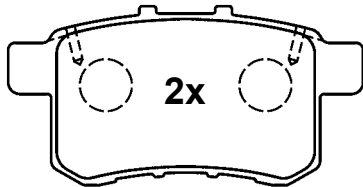

24435 14,8

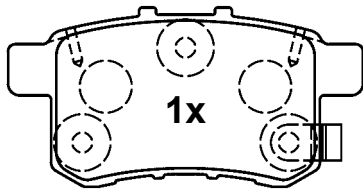

24661 14,8

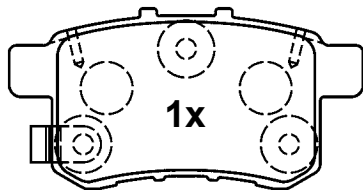

24662 14,8

**93,5 x 47,1 x 14,8**

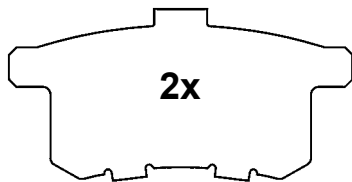

**2x**

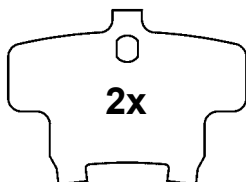

**2x**

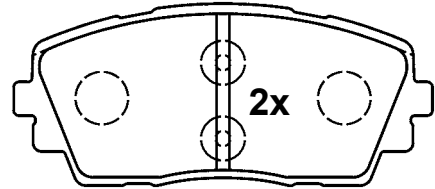

25365 16,0

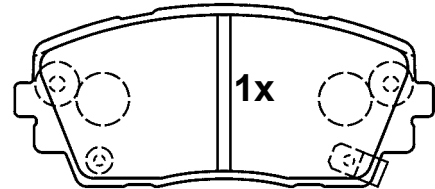

25366 16,0

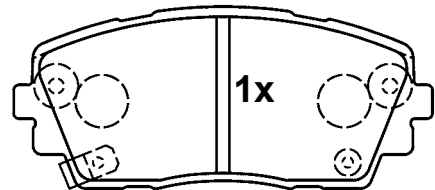

25367 16,0

**110,2 x 47,6 x 16,0**

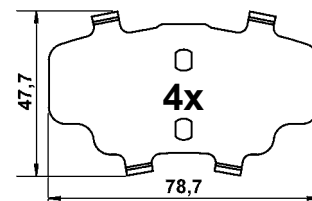

**4x**

47,7

78,7

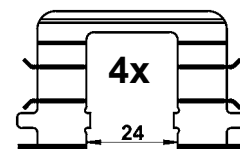

**4x**

24

# Abbildungen Scheibenbremsbeläge

Illustrations disc brake pads - Illustrazioni pastiglie freno -

Illustrations plaquettes de frein - Ilustraciones pastillas de freno

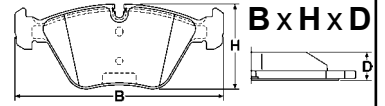

Maßstab - scale - scala - échelle - escala 1:2

**13.0460-5700.2 605700**



OPEL, SUZUKI, VAUXHALL



TRW

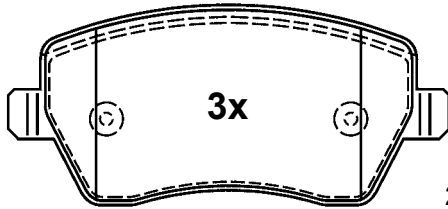

23973 17,0

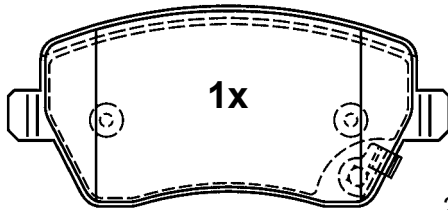

24403 17,0

116,3 x 52,4 x 17,0



M8x21

**13.0460-5703.2 605703**



SAAB



ATE

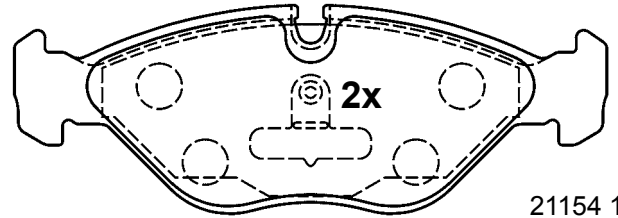

21154 19,5

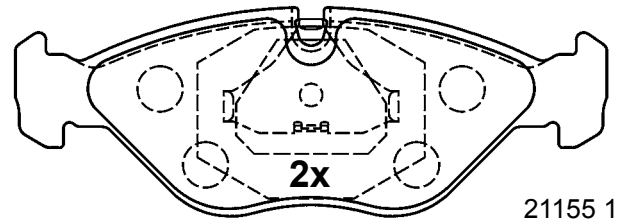

21155 19,5

156,4 x 54,6 x 19,5

**13.0460-5701.2 605701**



VOLKSWAGEN



ATE

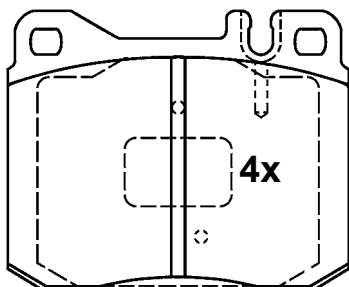

20392 18,5

89,7 x 73,8 x 18,5

**13.0460-5709.2 605709**



DAIHATSU, MITSUBISHI



AKE

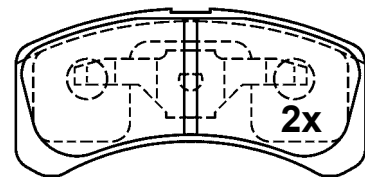

24229 14,8

91,9 x 44,3 x 14,8

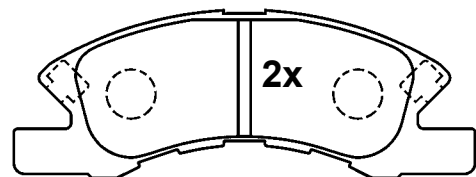

24230 15,3

121,9 x 44,3 x 15,3

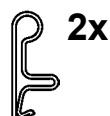

2x



2x



2x

# Abbildungen Scheibenbremsbeläge

Illustrations disc brake pads - Illustrazioni pastiglie freno -

Illustrations plaquettes de frein - Ilustraciones pastillas de freno

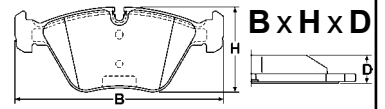

Maßstab - scale - scala - échelle - escala 1:2

**13.0460-5710.2 605710**

DAIHATSU

AKE

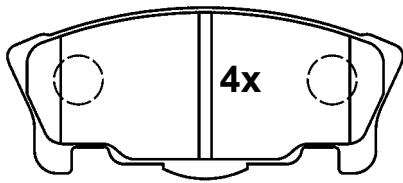

23783 14,0

104,6 x 45,1 x 14,0

**13.0460-5712.2 605712**

KIA

ATE

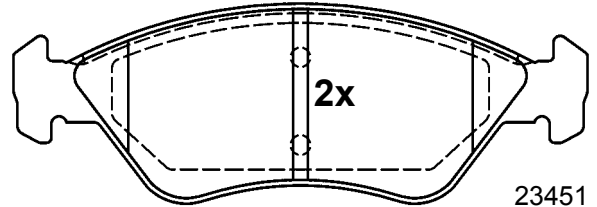

23451 17,5

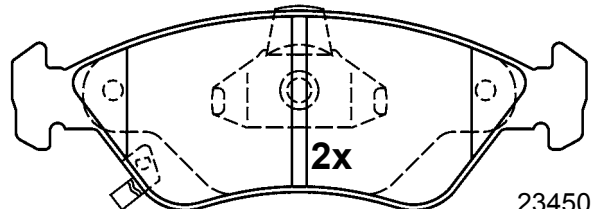

23450 17,5

151,4 x 52,4 x 17,5

**13.0460-5711.2 605711**

HONDA

AKE

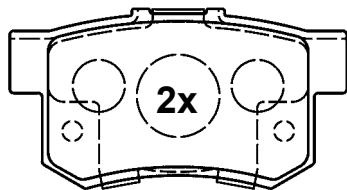

23736 15,7

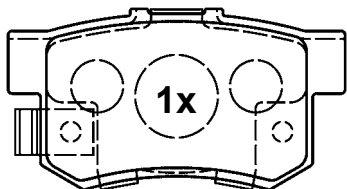

23652 15,7

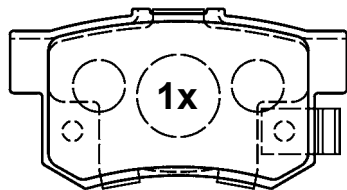

23653 15,7

88,8 x 47,5 x 15,7

**13.0460-5713.2 605713**

DAIHATSU

SUM

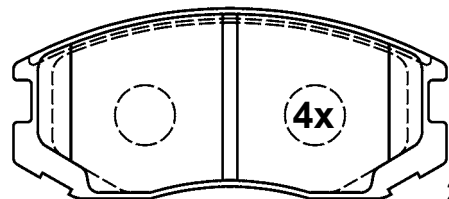

21650 15,5

114,1 x 50,0 x 15,5

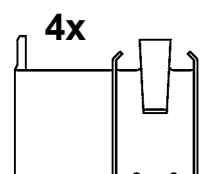
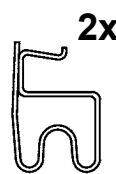
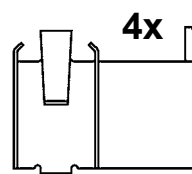



# Abbildungen Scheibenbremsbeläge

Illustrations disc brake pads - Illustrazioni pastiglie freno -

Illustrations plaquettes de frein - Ilustraciones pastillas de freno

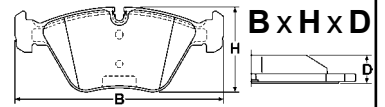

Maßstab - scale - scala - échelle - escala 1:2

## 13.0460-5714.2 605714



HONDA



ATE

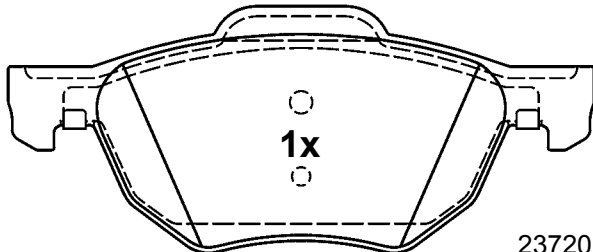

1x

154,9 x 64,6 x 17,5

23720 17,5

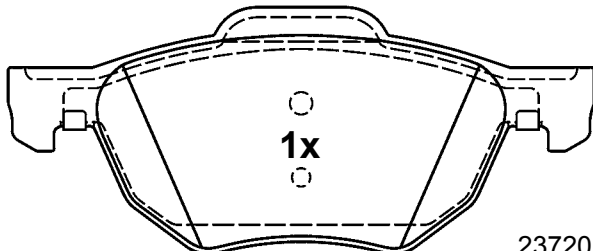

1x

154,9 x 64,6 x 17,5

23720 17,5

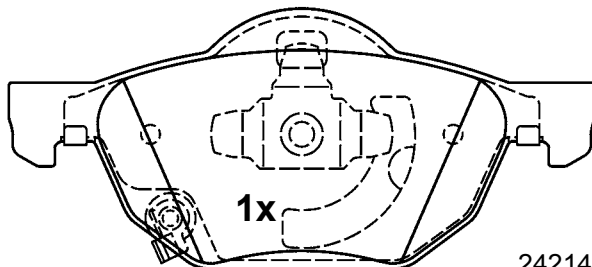

1x

154,9 x 68,3 x 17,5

24214 17,5

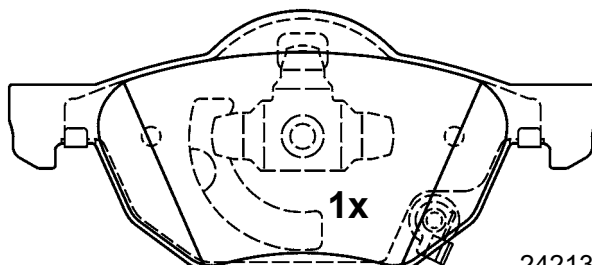

1x

154,9 x 68,3 x 17,5

24213 17,5

## 13.0460-5716.2 605716



NISSAN, RENAULT, SUZUKI

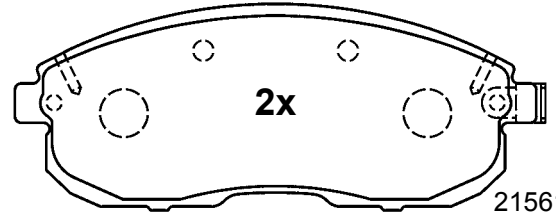

2x

21561 17,0

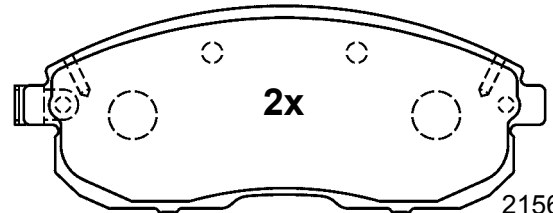

2x

21562 17,0

137,3 x 54,4 x 17,0

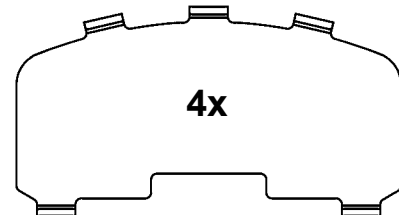

4x

D = 0,6

## 13.0460-5717.2 605717



NISSAN

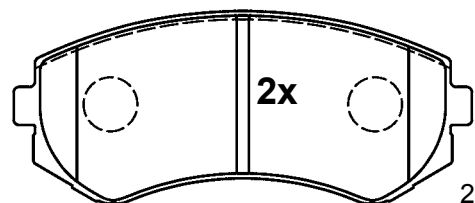

2x

23502 16,0

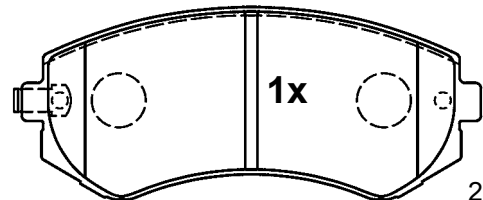

1x

23503 16,0

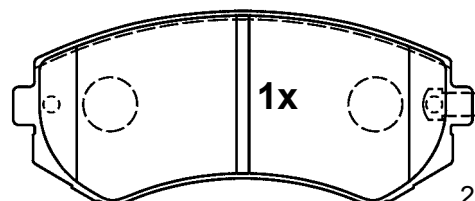

1x

23504 16,0

121,0 x 50,5 x 16,0

# Abbildungen Scheibenbremsbeläge

Illustrations disc brake pads - Illustrazioni pastiglie freno -

Illustrations plaquettes de frein - Ilustraciones pastillas de freno

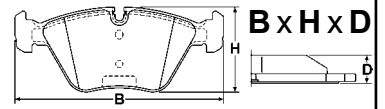

Maßstab - scale - scala - échelle - escala 1:2

**13.0460-5718.2 605718**

HYUNDAI

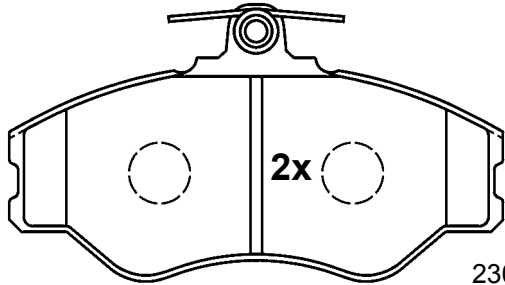

23081 18,0

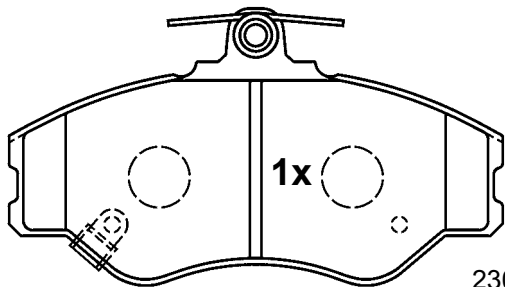

23082 18,0

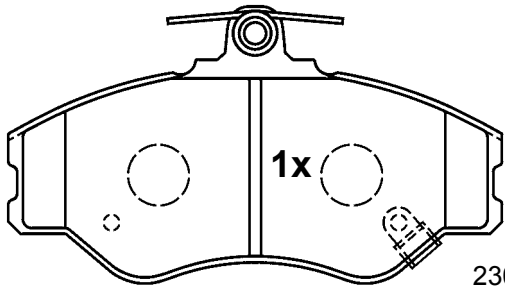

23083 18,0

129,9 x 72,8 x 18,0

**13.0460-5720.2 605720**

SUZUKI

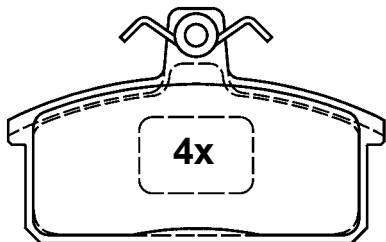

20708 14,5

98,9 x 61,5 x 14,5



M8x21

**13.0460-5722.2 605722**

TOYOTA

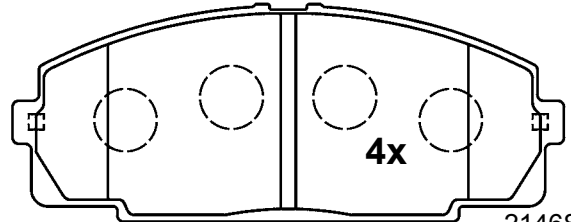

21468 15,5

145,4 x 57,0 x 15,5

**13.0460-5725.2 605725**

KIA

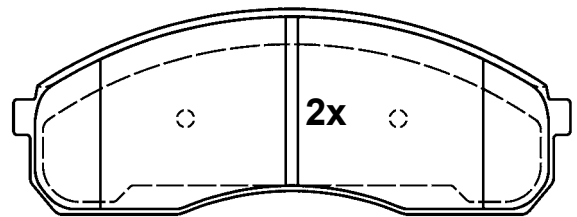

23649 17,2

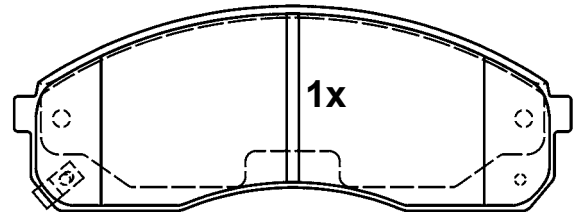

23650 17,2

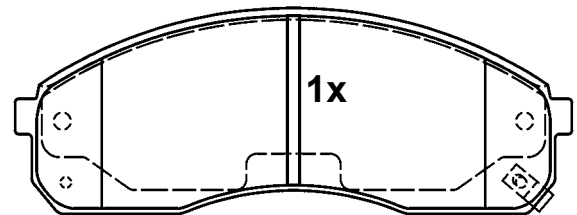

23651 17,2

154,1 x 56,5 x 17,2

# Abbildungen Scheibenbremsbeläge

Illustrations disc brake pads - Illustrazioni pastiglie freno -

Illustrations plaquettes de frein - Ilustraciones pastillas de freno



Maßstab - scale - scala - échelle - escala 1:2

**13.0460-5727.2 605727**

NISSAN

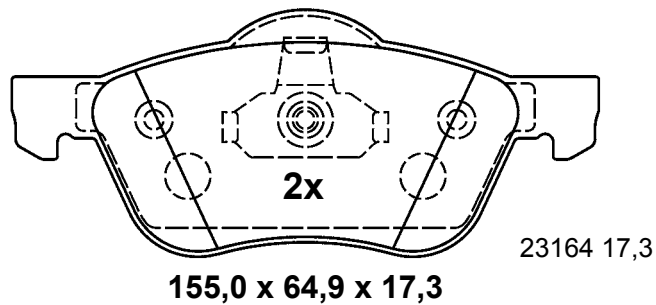
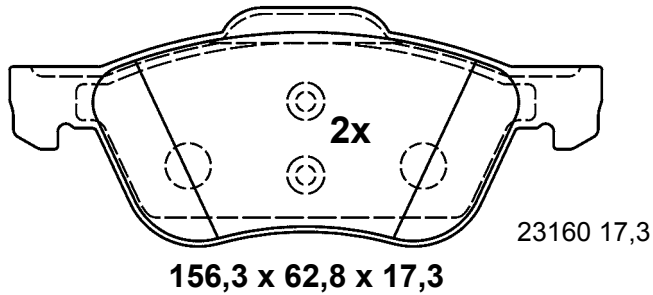

**13.0460-5732.2 605732**

MAZDA

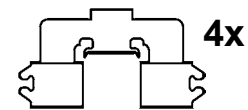
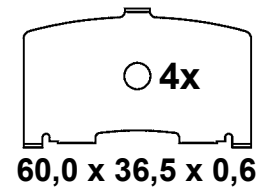
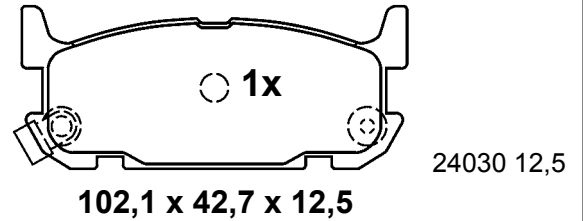
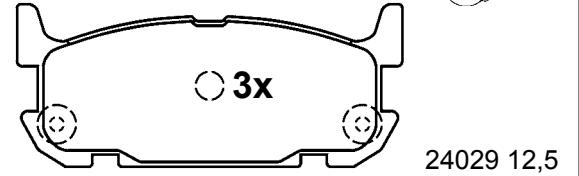

**13.0460-5731.2 605731**

HONDA

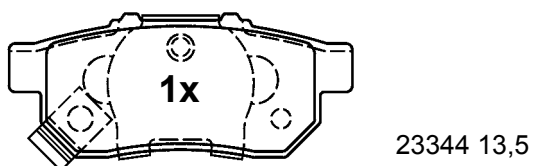
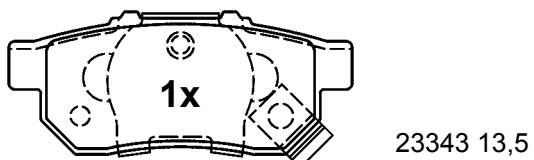
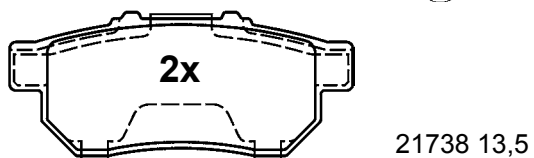

88,8 x 37,6 x 13,5

**13.0460-5734.2 605734**

LEXUS

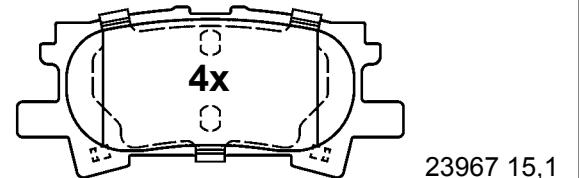

101,8 x 44,0 x 15,1



# Abbildungen Scheibenbremsbeläge

Illustrations disc brake pads - Illustrazioni pastiglie freno -

Illustrations plaquettes de frein - Ilustraciones pastillas de freno

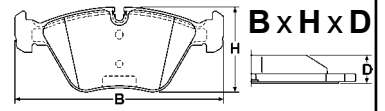

Maßstab - scale - scala - échelle - escala 1:2

## 13.0460-5735.2 605735

 CHRYSLER, JEEP, MITSUBISHI

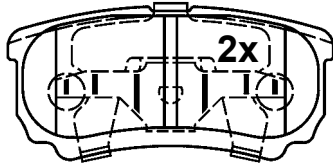

85,5 x 40,1 x 16,0

24014 16,0

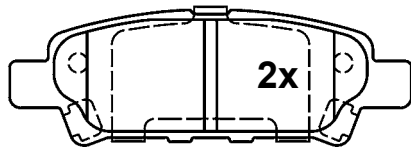

105,9 x 35,7 x 16,0

24015 16,0



## 13.0460-5738.2 605738

 LEXUS, TOYOTA

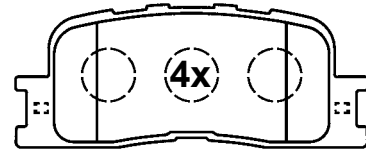

92,6 x 37,7 x 15,1

23702 15,1

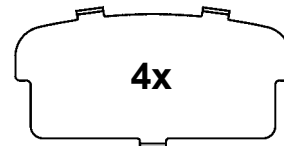

D = 0,6

## 13.0460-5736.2 605736

 MAZDA

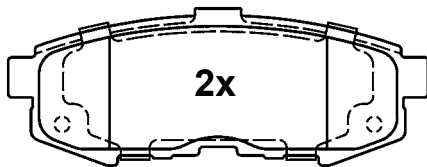

24215 15,7

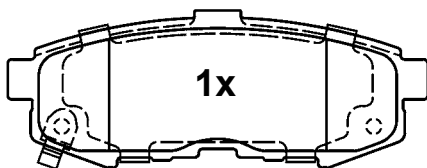

24216 15,7

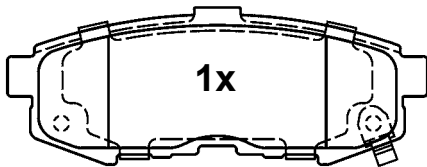

24217 15,7

110,4 x 41,1 x 15,7

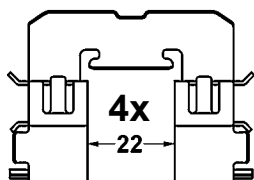

## 13.0460-5739.2 605739

 CHEVROLET, DAEWOO

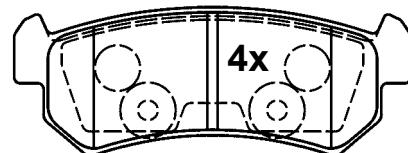

24071 14,9

104,3 x 38,9 x 14,6

# Abbildungen Scheibenbremsbeläge

Illustrations disc brake pads - Illustrazioni pastiglie freno -

Illustrations plaquettes de frein - Ilustraciones pastillas de freno



Maßstab - scale - scala - échelle - escala 1:2

## 13.0460-5742.2 605742

HYUNDAI, KIA

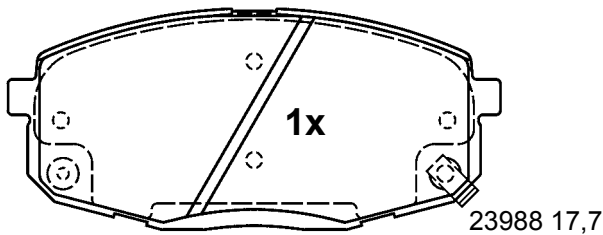
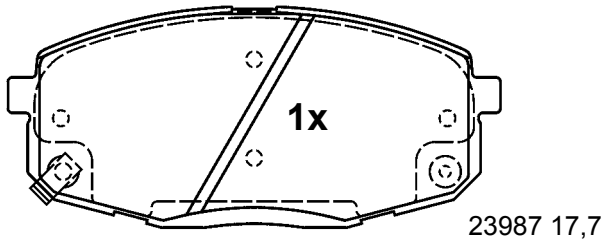
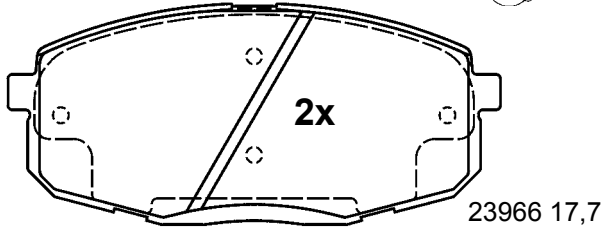

130,0 x 57,9 x 17,7

## 13.0460-5745.2 605745

TOYOTA



SUM

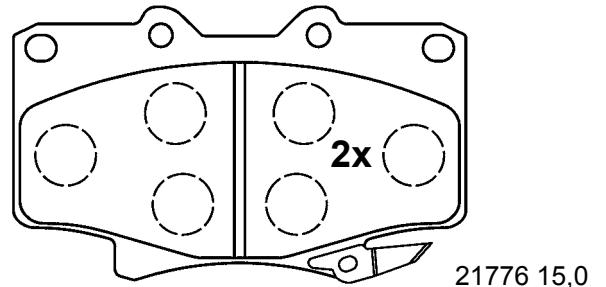
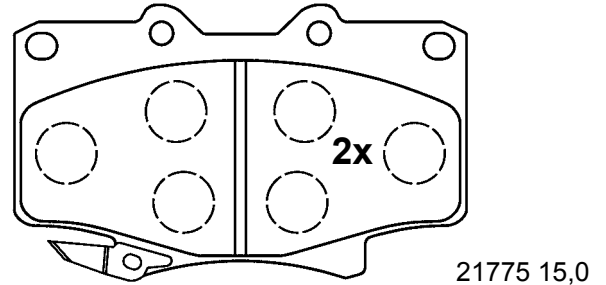

119,1 x 71,9 x 15,0

## 13.0460-5743.2 605743

TOYOTA

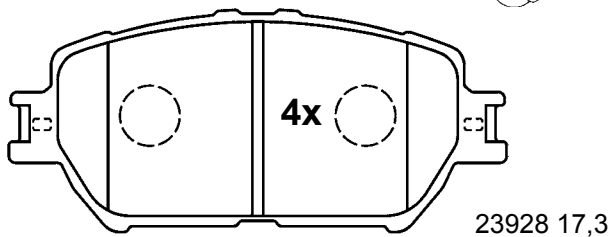

131,4 x 58,5 x 17,3

## 13.0460-5746.2 605746

LEXUS, TOYOTA



SUM

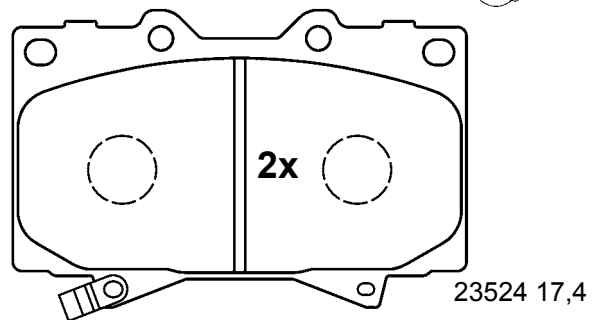

## 13.0460-5744.2 605744

LEXUS, MITSUBISHI, TOYOTA

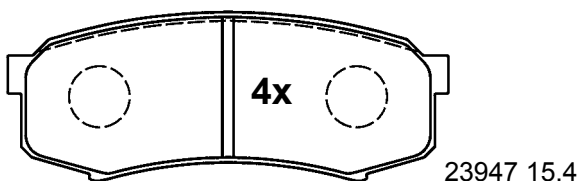

116,2 x 44,0 x 15,4

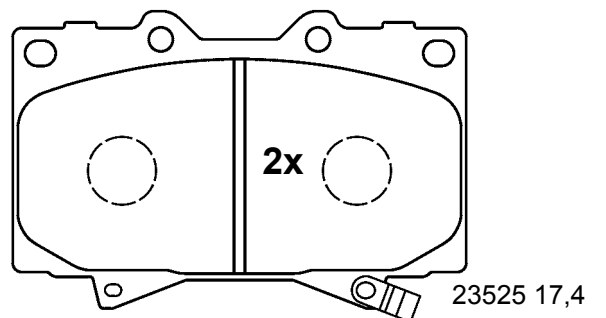

119,3 x 78,0 x 17,4

# Abbildungen Scheibenbremsbeläge

Illustrations disc brake pads - Illustrazioni pastiglie freno -

Illustrations plaquettes de frein - Ilustraciones pastillas de freno

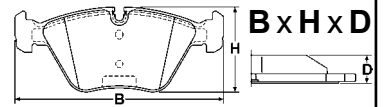

Maßstab - scale - scala - échelle - escala 1:2

**13.0460-5747.2 605747**

 LEXUS, MITSUBISHI, TOYOTA

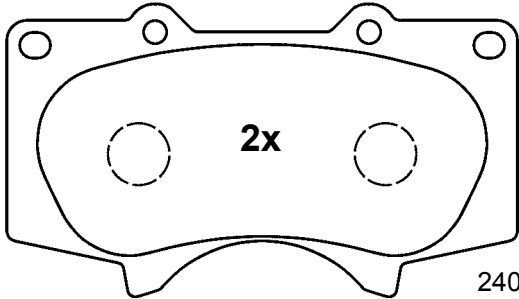

24024 17,0

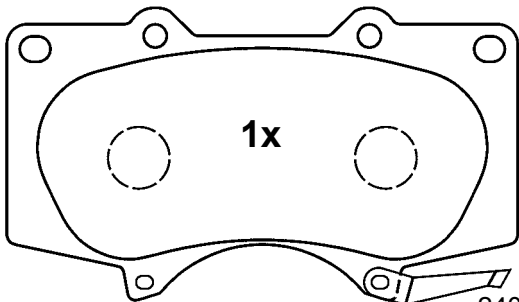

24026 17,0

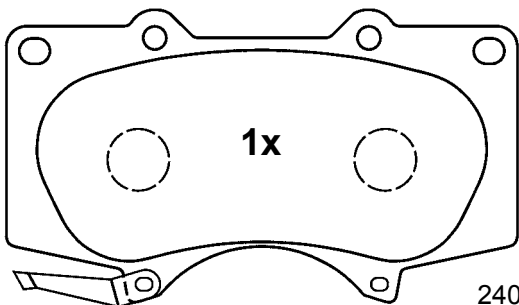

24025 17,0

134,2 x 76,9 x 17,0

**13.0460-5748.2 605748**

 LEXUS

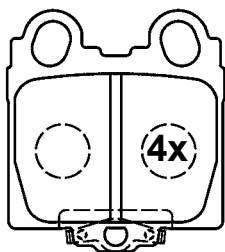

23429 15,5

57,2 x 63,8 x 15,5

**13.0460-5749.2 605749**

 LEXUS, TOYOTA

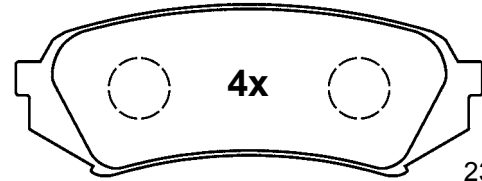

23539 17,3

123,0 x 45,1 x 17,3

**13.0460-5750.2 605750**

 LEXUS

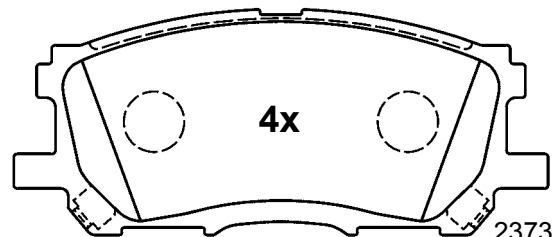

23734 16,8

140,8 x 59,5 x 16,8



# Abbildungen Scheibenbremsbeläge

Illustrations disc brake pads - Illustrazioni pastiglie freno -

Illustrations plaquettes de frein - Ilustraciones pastillas de freno

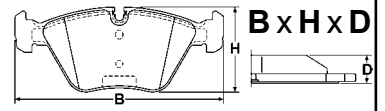

Maßstab - scale - scala - échelle - escala 1:2

## 13.0460-5751.2 605751

NISSAN

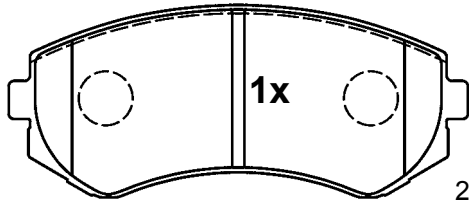

23502 16,0

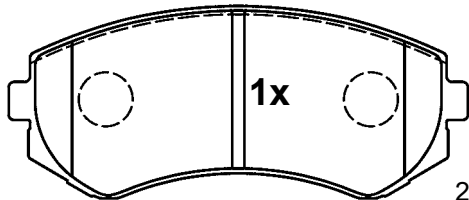

23502 16,0

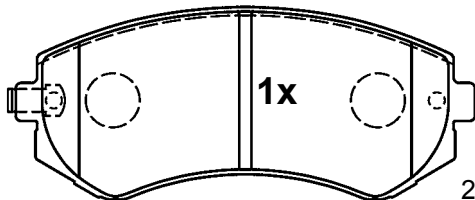

23503 16,0

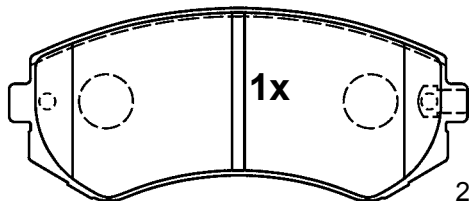

23504 16,0

121,0 x 50,5 x 16,0

## 13.0460-5752.2 605752

NISSAN

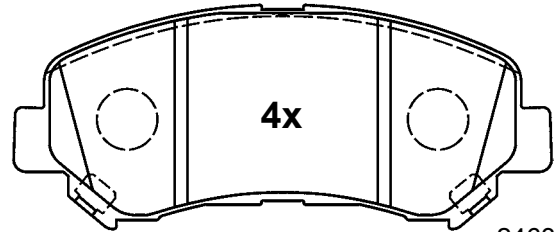

24632 17,0

142,0 x 59,0 x 17,0

## 13.0460-5753.2 605753

HONDA

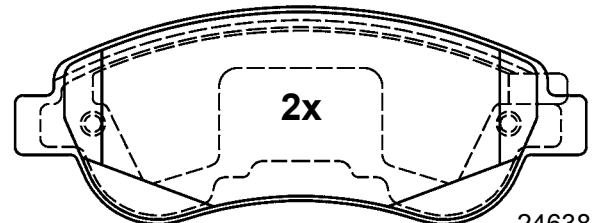

24638 20,0

151,1 x 57,0 x 20,0

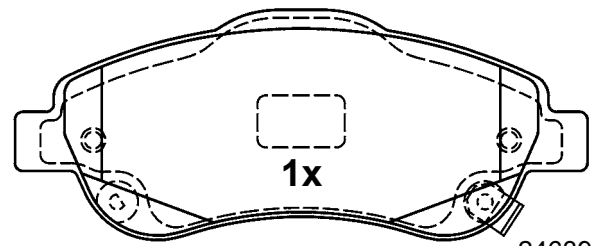

24639 19,3

151,1 x 60,5 x 19,3

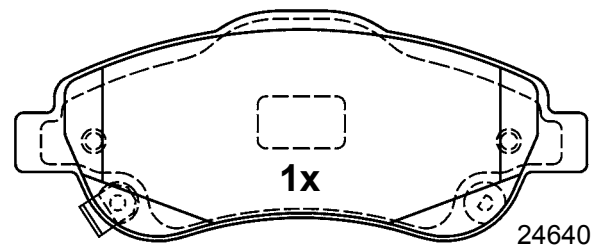

24640 19,3

151,1 x 60,5 x 19,3

2x



4x



4x



# Abbildungen Scheibenbremsbeläge

Illustrations disc brake pads - Illustrazioni pastiglie freno -

Illustrations plaquettes de frein - Ilustraciones pastillas de freno

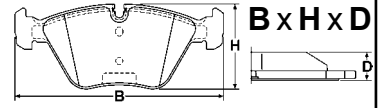

Maßstab - scale - scala - échelle - escala 1:2

**13.0460-5754.2 605754**

**13.0460-5755.2 605755**



HONDA



HONDA



SUM

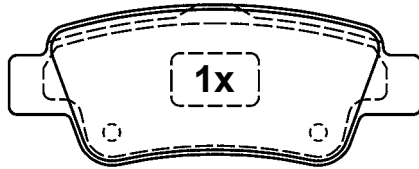

24635 16,6

108,8 x 42,2 x 16,6

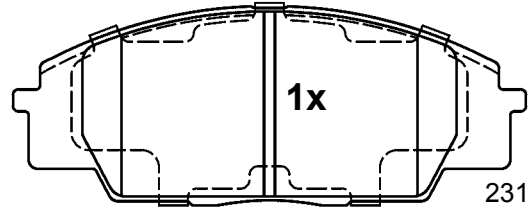

23178 16,6

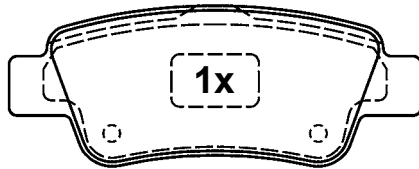

24635 16,6

108,8 x 42,2 x 16,6

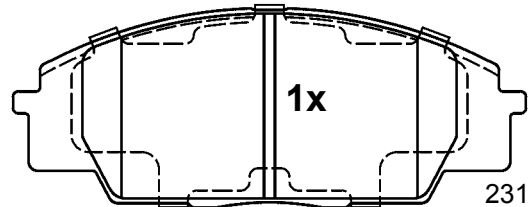

23178 16,6

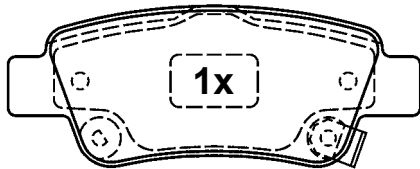

24636 16,9

108,8 x 42,2 x 16,9

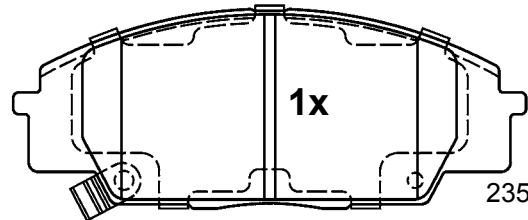

23530 16,6

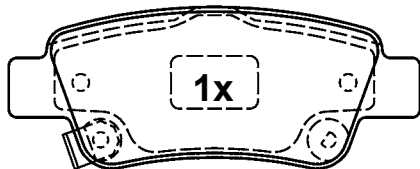

24637 16,9

108,8 x 42,2 x 16,9

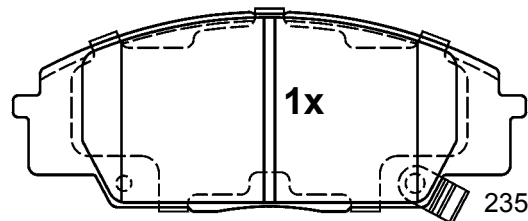

23531 16,6

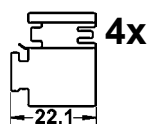
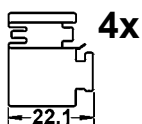
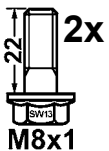

135,3 x 52,4 x 16,6

# Abbildungen Scheibenbremsbeläge

Illustrations disc brake pads - Illustrazioni pastiglie freno -

Illustrations plaquettes de frein - Ilustraciones pastillas de freno

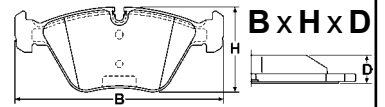

Maßstab - scale - scala - échelle - escala 1:2

**13.0460-5756.2 605756**

HONDA

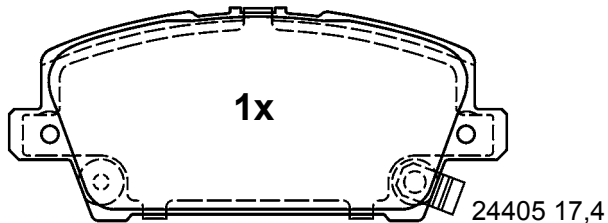
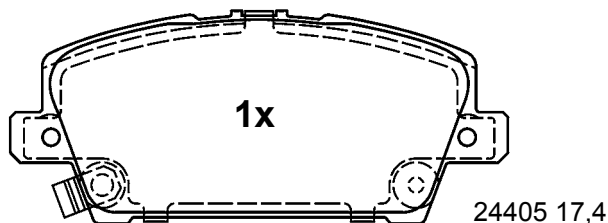
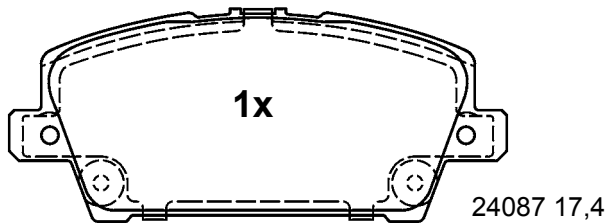
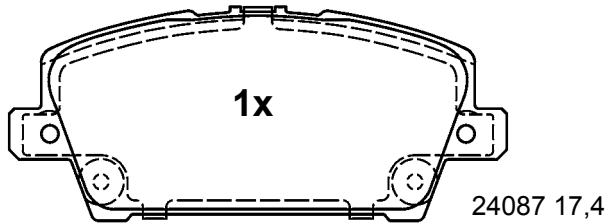

131,5 x 55,7 x 17,4



**13.0460-5757.2 605757**

HONDA

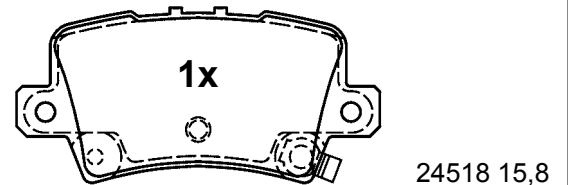
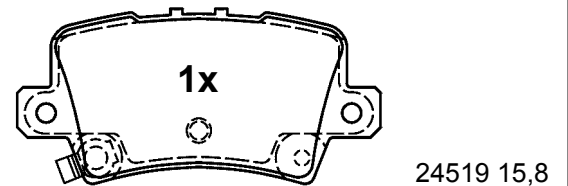
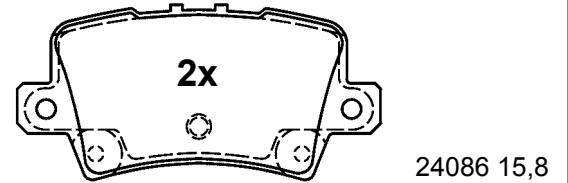

95,7 x 46,2 x 15,8



**13.0460-5760.2 605760**

CHRYSLER, CITROEN, JEEP,  
LANCIA, MITSUBISHI, PEUGEOT



AKE

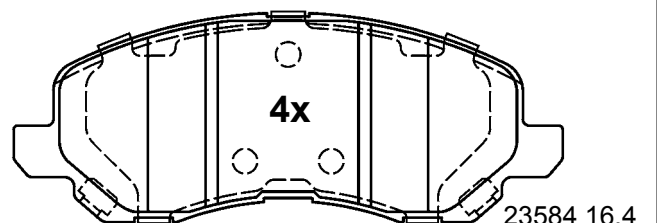

144,8 x 54,9 x 16,4



# Abbildungen Scheibenbremsbeläge

Illustrations disc brake pads - Illustrazioni pastiglie freno -

Illustrations plaquettes de frein - Ilustraciones pastillas de freno

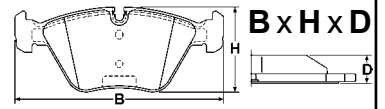

Maßstab - scale - scala - échelle - escala 1:2

**13.0460-5761.2 605761**

MAZDA

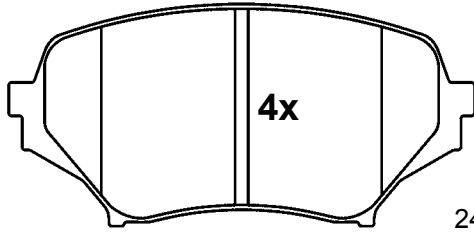

24297 14,4

122,9 x 58,3 x 14,4

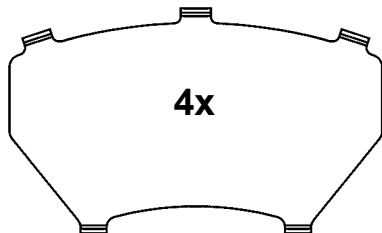

98,0 x 59,2 x 0,6

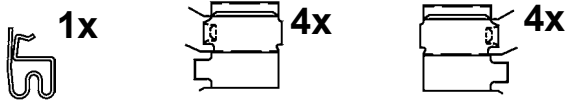

**13.0460-5763.2 605763**

SUZUKI

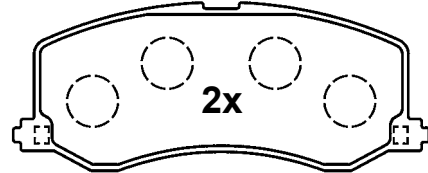

21730 14,0

109,2 x 43,8 x 14,0

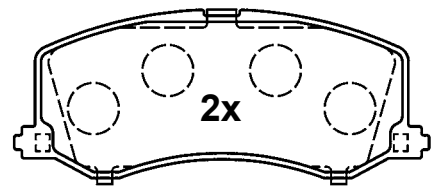

21730 14,9

109,2 x 43,8 x 14,9



**13.0460-5762.2 605762**

MAZDA

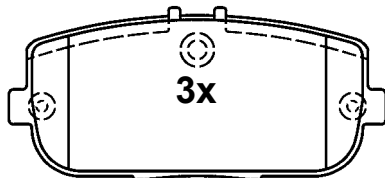

24298 14,0

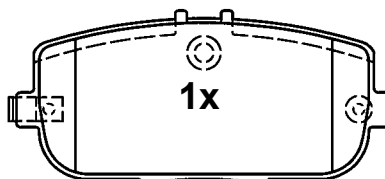

24299 14,0

99,2 x 45,0 x 14,0

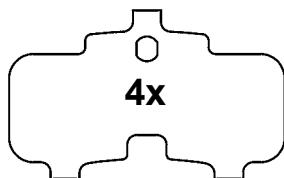

72,6 x 44,3 x 0,6

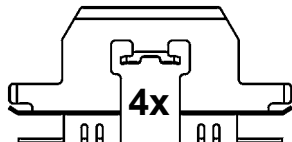

**13.0460-5764.2 605764**

LEXUS, TOYOTA



AKE

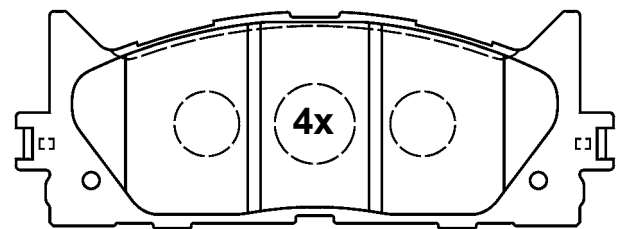

24350 17,3

157,6 x 57,0 x 17,3



4x

# Abbildungen Scheibenbremsbeläge

Illustrations disc brake pads - Illustrazioni pastiglie freno -

Illustrations plaquettes de frein - Ilustraciones pastillas de freno



Maßstab - scale - scala - échelle - escala 1:2

**13.0460-5765.2 605765**

LEXUS, TOYOTA

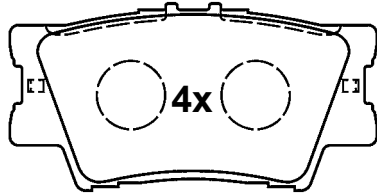

24338 15,5

96,6 x 49,2 x 15,5

**13.0460-5768.2 605768**

TOYOTA

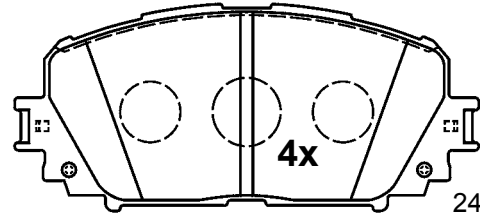

24347 17,5

122,7 x 54,0 x 17,5

**13.0460-5766.2 605766**

TOYOTA

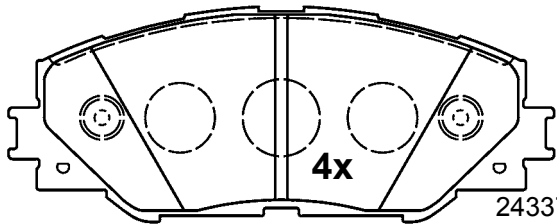

24337 17,5

146,4 x 56,8 x 17,5

**13.0460-5769.2 605769**

LEXUS, SUBARU, TOYOTA

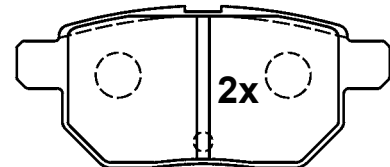

24612 15,0

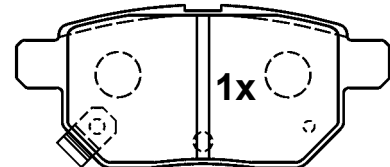

24610 15,0

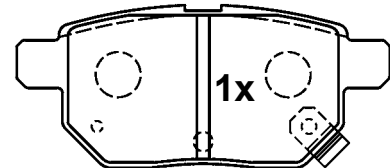

24611 15,0

98,5 x 42,4 x 15,0

**13.0460-5767.2 605767**

LEXUS, SUBARU, TOYOTA

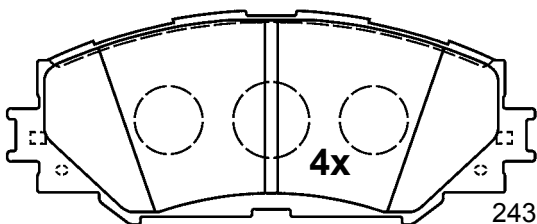

24336 17,5

139,0 x 56,1 x 17,5

**13.0460-5770.2 605770**

LEXUS

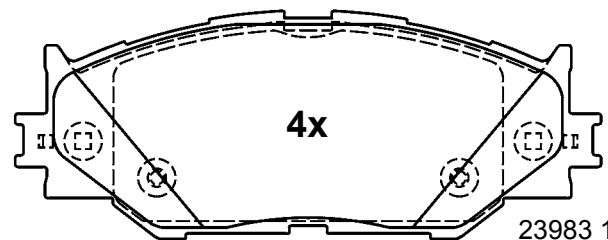

23983 17,0

154,6 x 59,5 x 17,0

# Abbildungen Scheibenbremsbeläge

Illustrations disc brake pads - Illustrazioni pastiglie freno -

Illustrations plaquettes de frein - Ilustraciones pastillas de freno

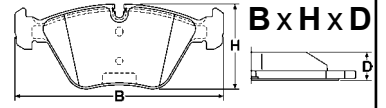

Maßstab - scale - scala - échelle - escala 1:2

**13.0460-5771.2 605771**

**13.0460-5772.2 605772**



KIA



MAN



KIA



SUM

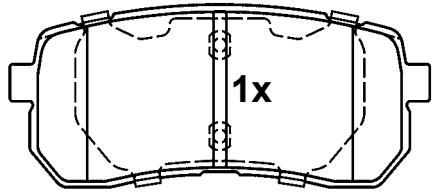

24600 14,9

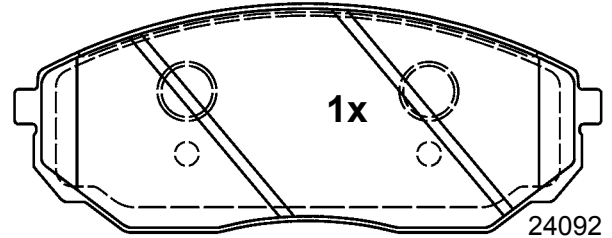

24092 17,1

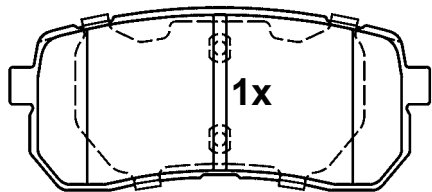

24600 14,9

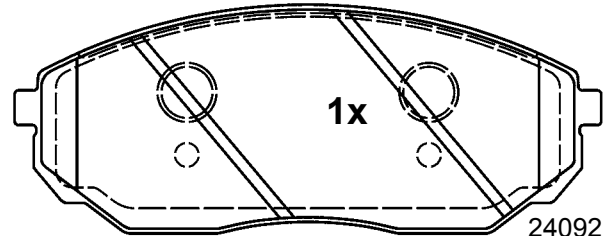

24092 17,1

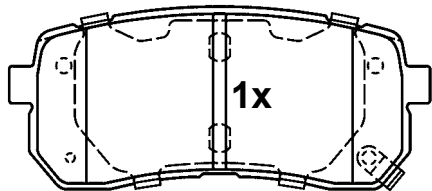

24599 14,9

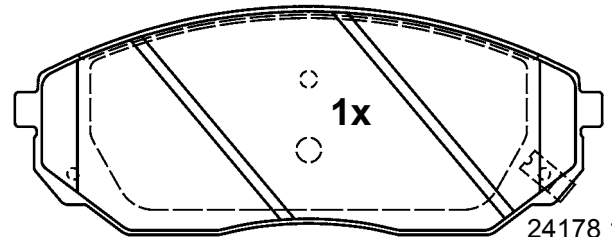

24178 17,1

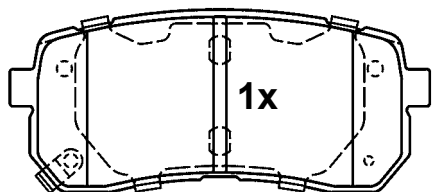

24686 14,9

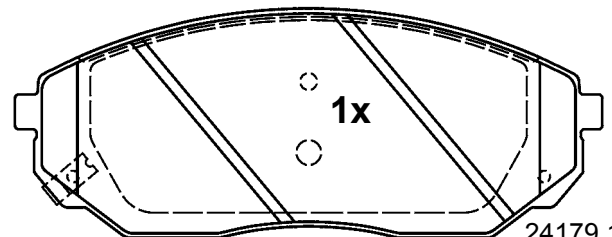

24179 17,1

**110,6 x 47,7 x 14,9**

**154,8 x 60,0 x 17,1**

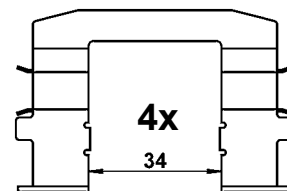
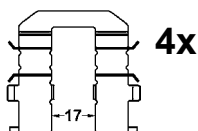



# Abbildungen Scheibenbremsbeläge

Illustrations disc brake pads - Illustrazioni pastiglie freno -

Illustrations plaquettes de frein - Ilustraciones pastillas de freno

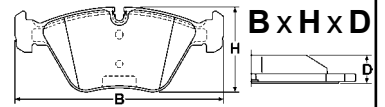

Maßstab - scale - scala - échelle - escala 1:2

## 13.0460-5773.2 605773

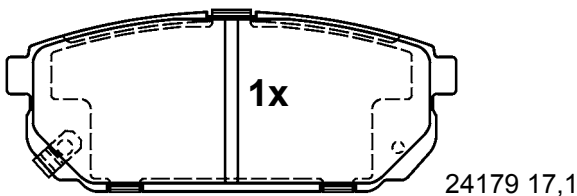
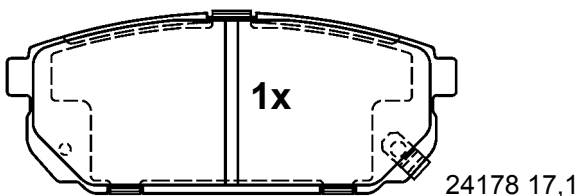
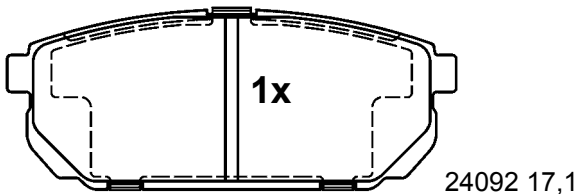
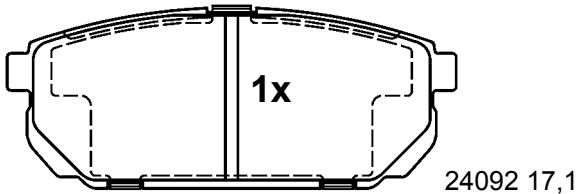

154,8 x 60,1 x 17,1

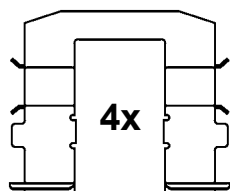

## 13.0460-5774.2 605774

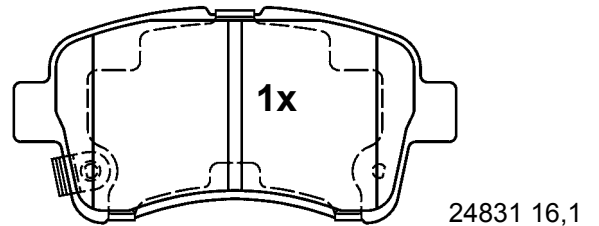
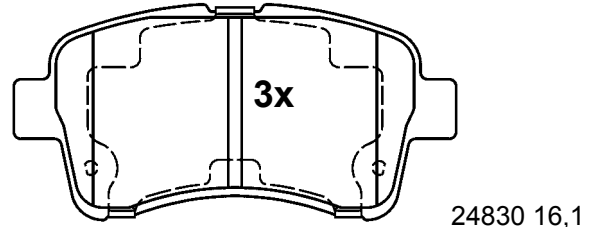

116,6 x 56,0 x 16,1

## 13.0460-5775.2 605775

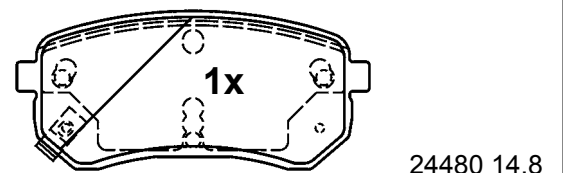
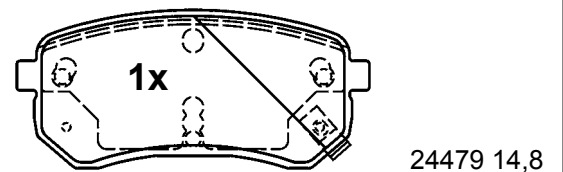
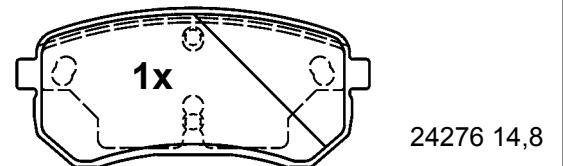
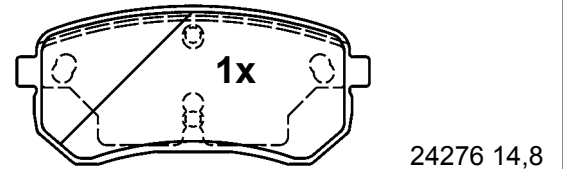

92,4 x 41,0 x 14,8

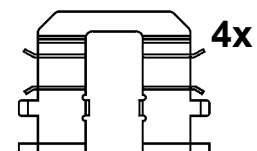

# Abbildungen Scheibenbremsbeläge

Illustrations disc brake pads - Illustrazioni pastiglie freno -

Illustrations plaquettes de frein - Ilustraciones pastillas de freno

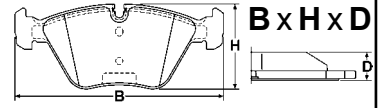

Maßstab - scale - scala - échelle - escala 1:2

**13.0460-5776.2 605776**



HYUNDAI, KIA



AKE

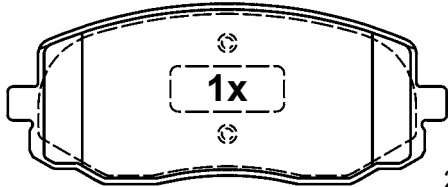

24275 16,5

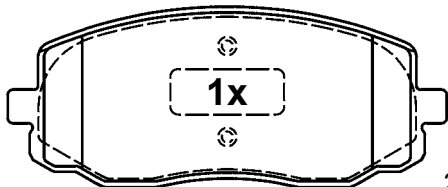

24275 16,5

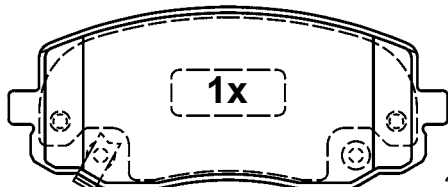

24410 16,5

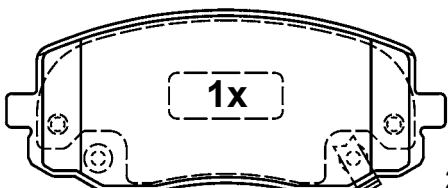

24411 16,5

**115,9 x 47,3 x 16,5**

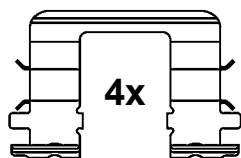

**4x**

**13.0460-5777.2 605777**



HYUNDAI, KIA

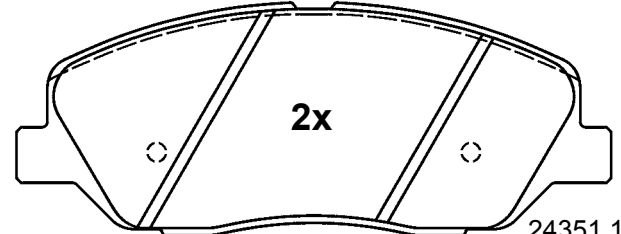

24351 16,3

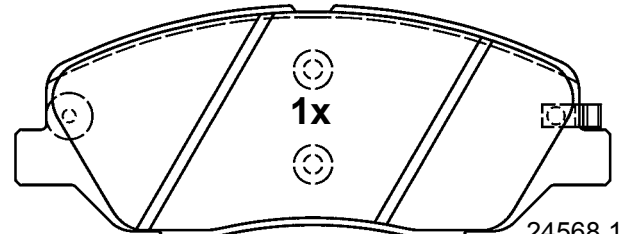

24568 16,3

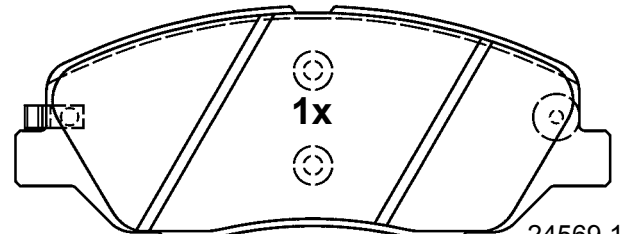

24569 16,3

**156,7 x 60,9 x 16,3**

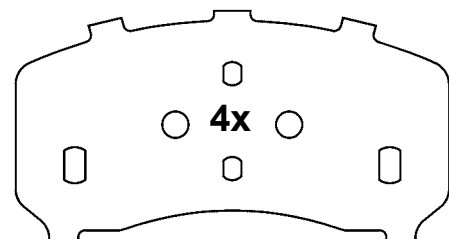

**114,3 x 60,5 x 0,6**

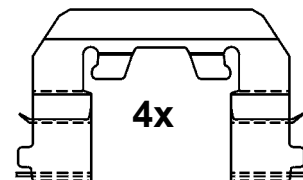

**4x**

# Abbildungen Scheibenbremsbeläge

Illustrations disc brake pads - Illustrazioni pastiglie freno -

Illustrations plaquettes de frein - Ilustraciones pastillas de freno

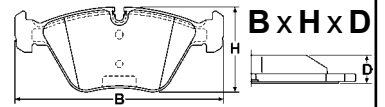

Maßstab - scale - scala - échelle - escala 1:2

## 13.0460-5778.2 605778



NISSAN, RENAULT



SUM

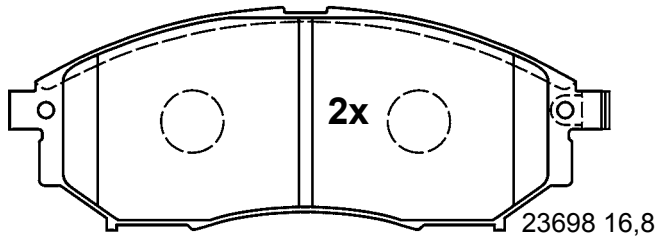
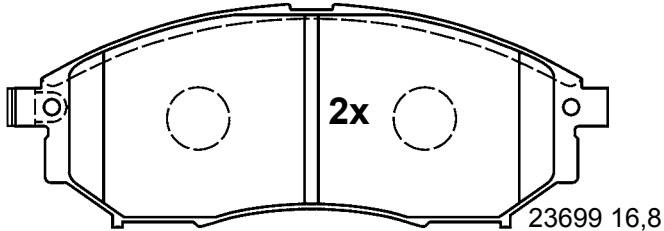

157,0 x 58,5 x 16,8

## 13.0460-5780.2 605780



HYUNDAI, KIA

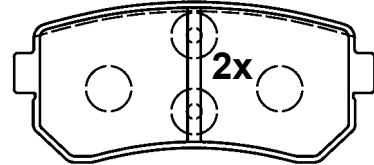

24320 15,3

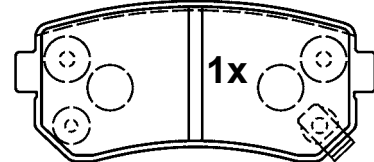

24321 15,3

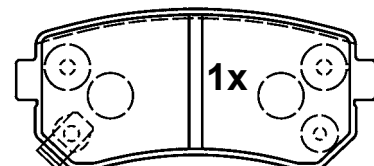

24322 15,3

93,1 x 41,0 x 15,3

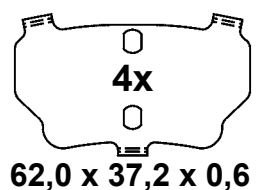
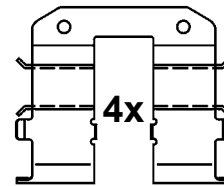

62,0 x 37,2 x 0,6

## 13.0460-5779.2 605779



HYUNDAI, KIA

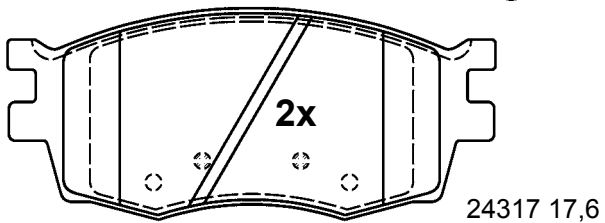

24317 17,6

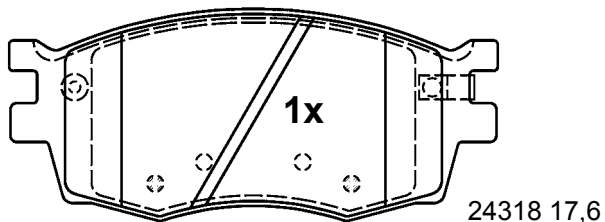

24318 17,6

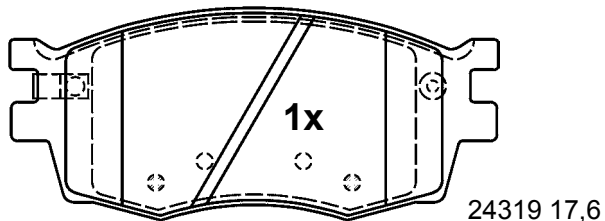

24319 17,6

129,6 x 55,9 x 17,6



## 13.0460-5782.2 605782



HYUNDAI

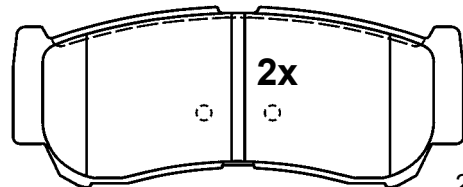

24488 14,9

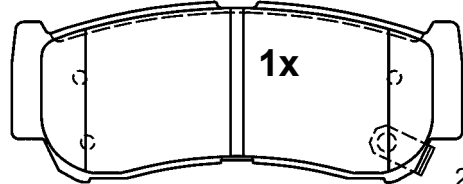

24489 14,9

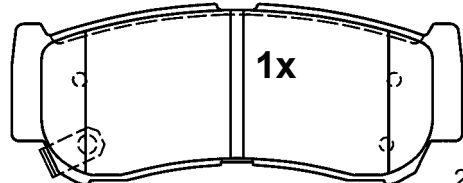

24490 14,9

118,6 x 47,0 x 14,9

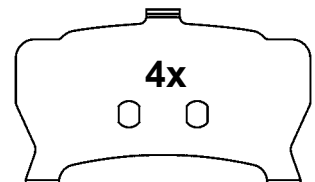
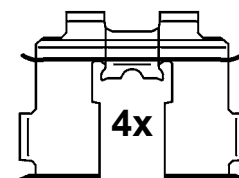

77,7 x 46,9 x 0,6

# Abbildungen Scheibenbremsbeläge

Illustrations disc brake pads - Illustrazioni pastiglie freno -

Illustrations plaquettes de frein - Ilustraciones pastillas de freno

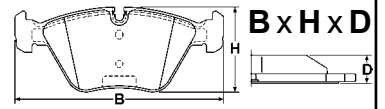

Maßstab - scale - scala - échelle - escala 1:2

**13.0460-5783.2 605783**

NISSAN

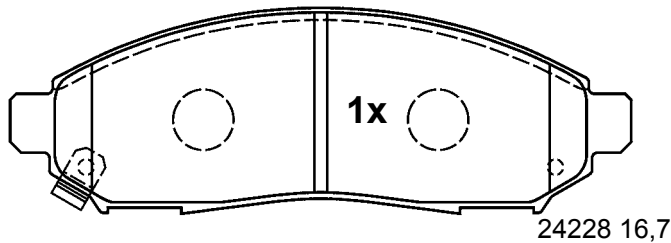
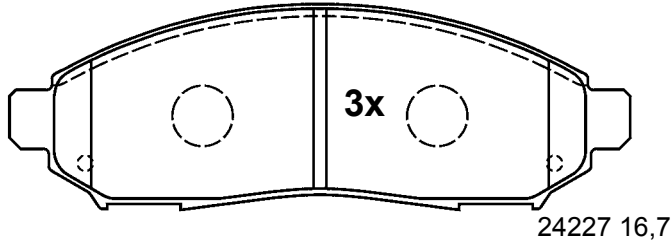

163,7 x 54,2 x 16,7

**13.0460-5785.2 605785**

CHEVROLET, OPEL, VAUXHALL

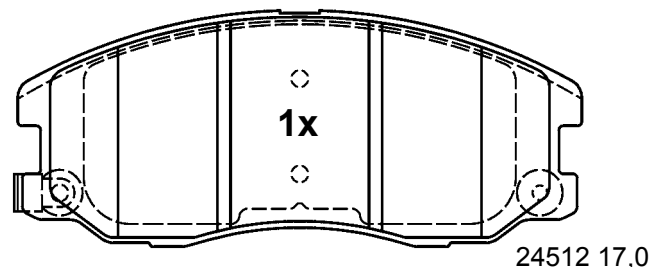
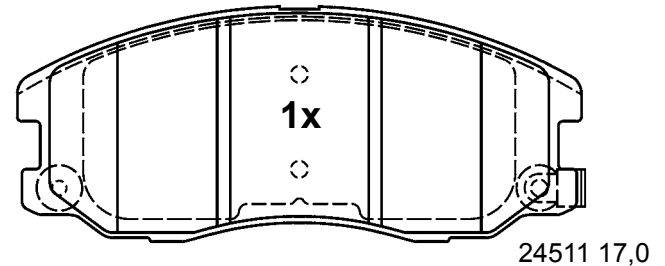
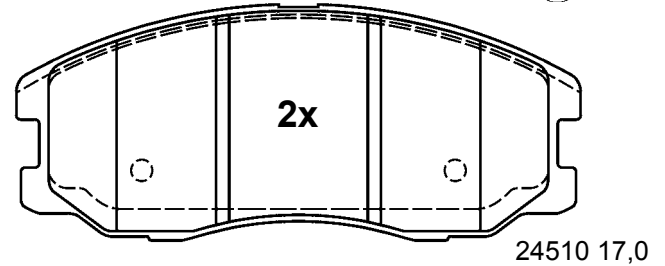

148,9 x 61,9 x 17,0

**13.0460-5784.2 605784**

NISSAN

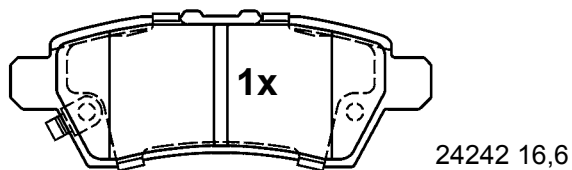
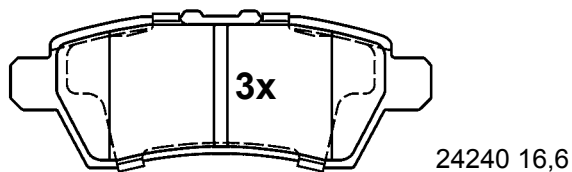

110,6 x 40,8 x 16,6

**13.0460-5786.2 605786**

HYUNDAI, KIA

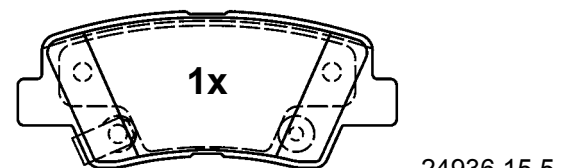
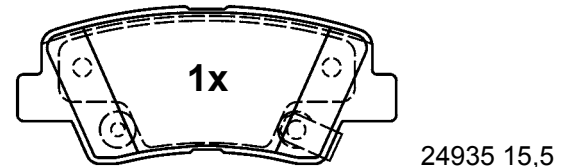
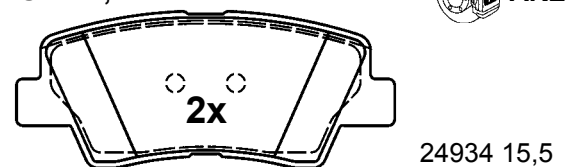

99,8 x 41,1 x 16,6

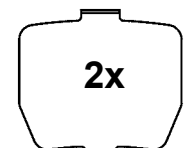
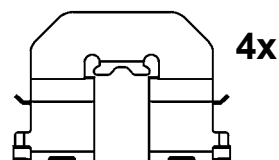

# Abbildungen Scheibenbremsbeläge

Illustrations disc brake pads - Illustrazioni pastiglie freno -

Illustrations plaquettes de frein - Ilustraciones pastillas de freno

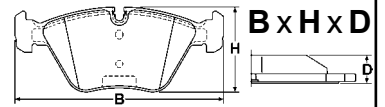

Maßstab - scale - scala - échelle - escala 1:2

## 13.0460-5787.2 605787

SUBARU

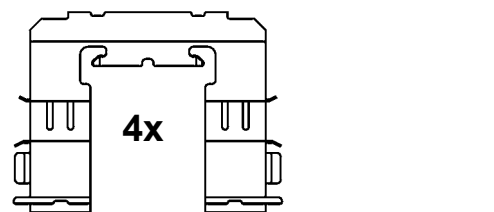
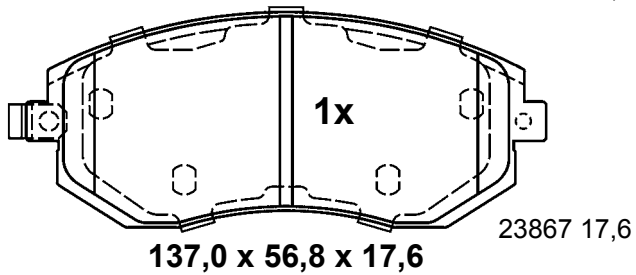
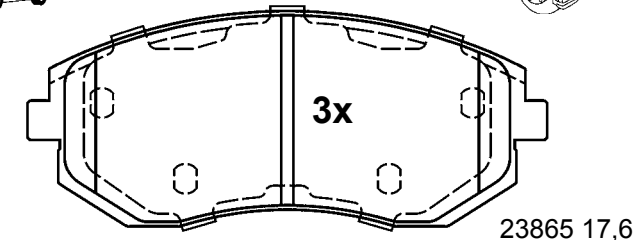

## 13.0460-5789.2 605789

LEXUS

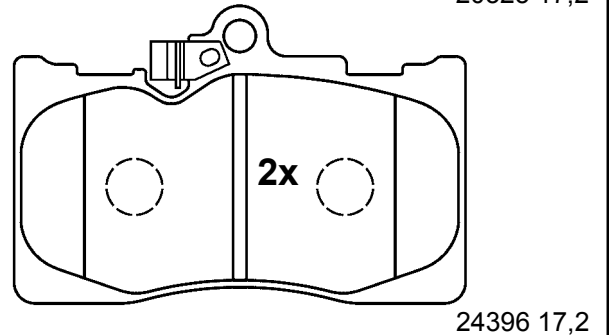
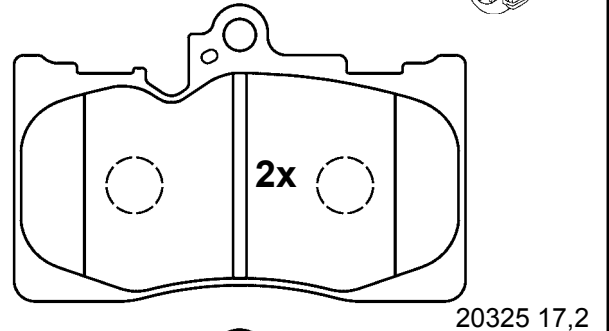

118,5 x 77,7 x 17,2

## 13.0460-5788.2 605788

CHEVROLET, OPEL, VAUXHALL

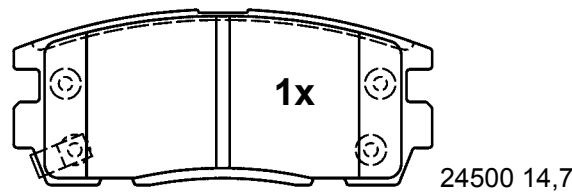
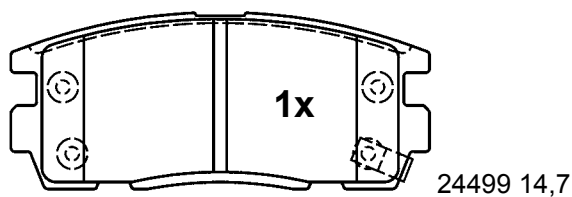
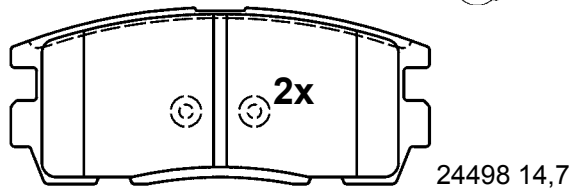

110,4 x 46,0 x 14,7

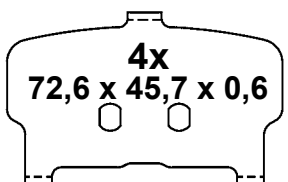

## 13.0460-5790.2 605790

LEXUS

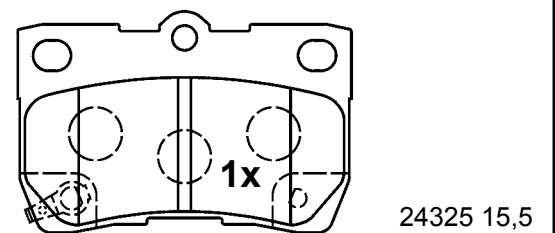
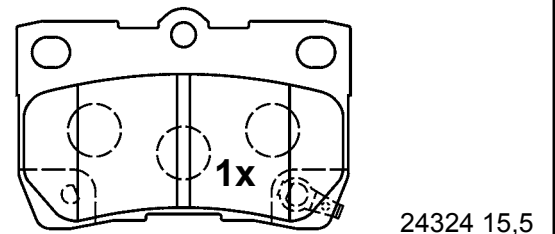
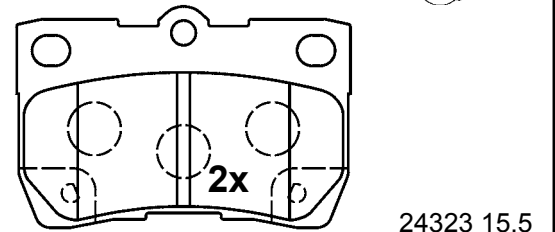

88,0 x 58,2 x 15,5



# Abbildungen Scheibenbremsbeläge

Illustrations disc brake pads - Illustrazioni pastiglie freno -

Illustrations plaquettes de frein - Ilustraciones pastillas de freno

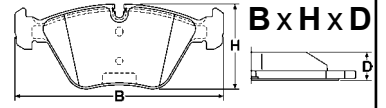

Maßstab - scale - scala - échelle - escala 1:2

**13.0460-5791.2 605791**



KIA



TOK

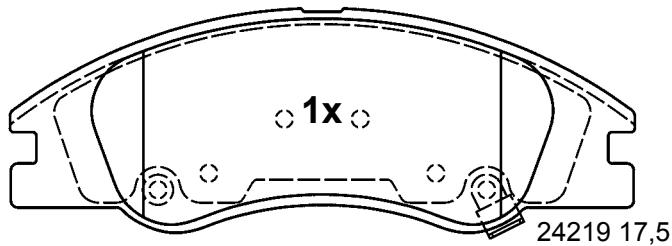
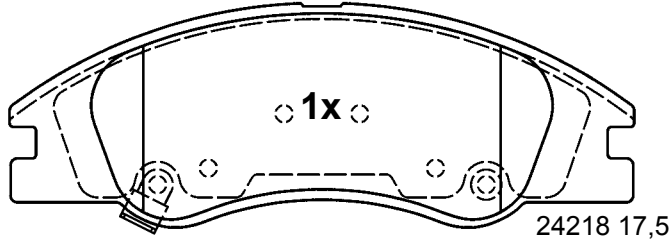
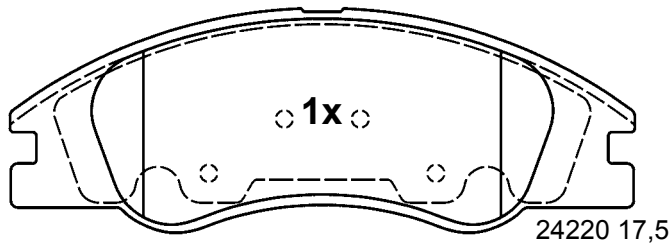
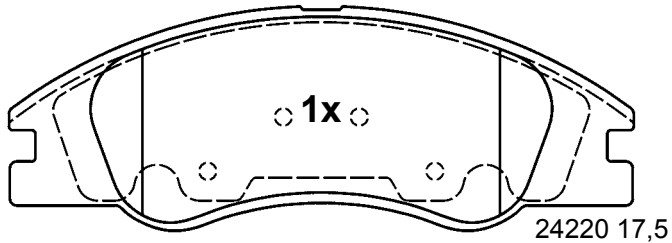

164,9 x 59,0 x 17,5

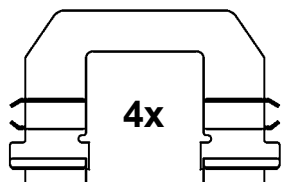

**13.0460-5792.2 605792**



HYUNDAI

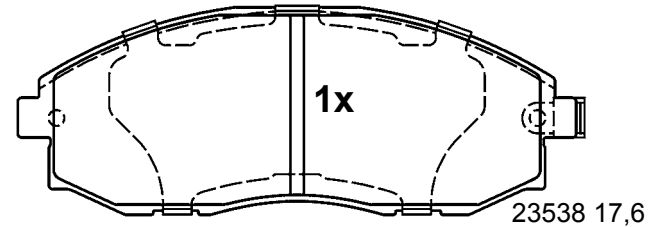
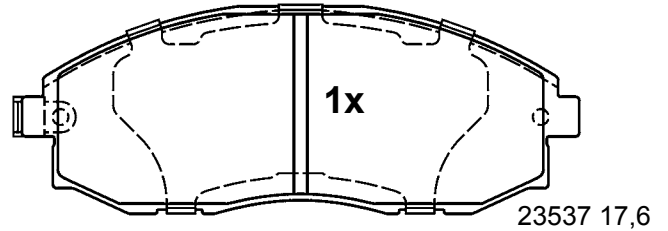
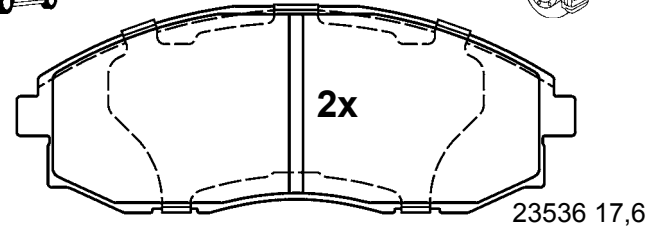

147,1 x 53,6 x 17,6

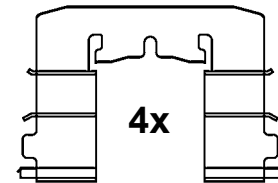

**13.0460-5793.2 605793**



SUZUKI



AKE

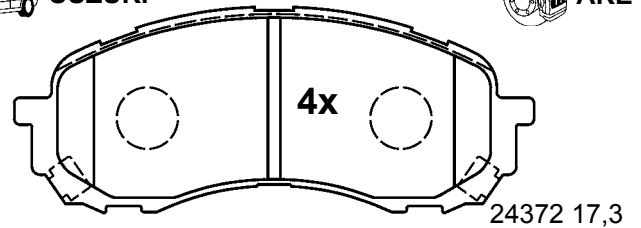

137,1 x 54,1 x 17,3



106,7 x 52,1 x 0,6

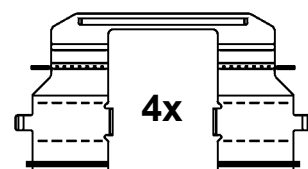



# Abbildungen Scheibenbremsbeläge

Illustrations disc brake pads - Illustrazioni pastiglie freno -

Illustrations plaquettes de frein - Ilustraciones pastillas de freno

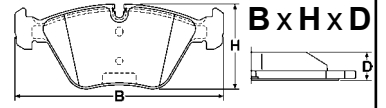

Maßstab - scale - scala - échelle - escala 1:2

**13.0460-5794.2 605794**



DAIHATSU, FORD, MAZDA,  
SUBARU



TRW

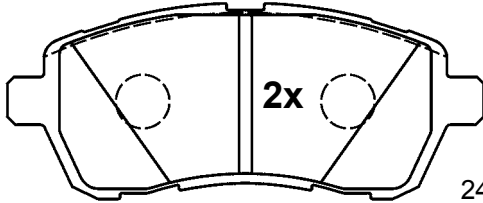

24283 15,5

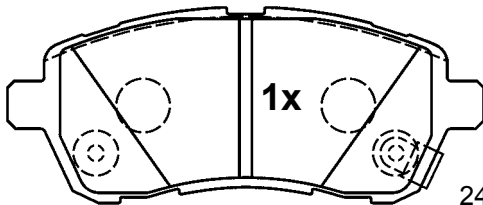

24284 15,5

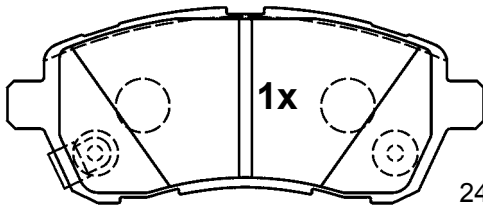

24285 15,5

125,4 x 51,4 x 15,5

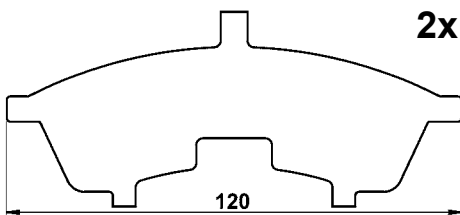

2x

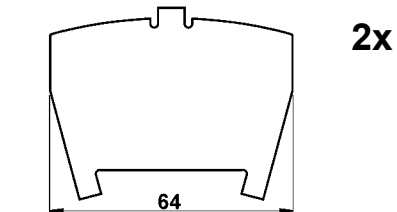

2x

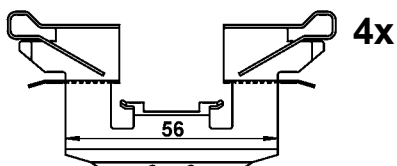

4x

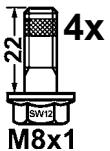

22  
M8x1

**13.0460-5795.2 605795**



MAZDA

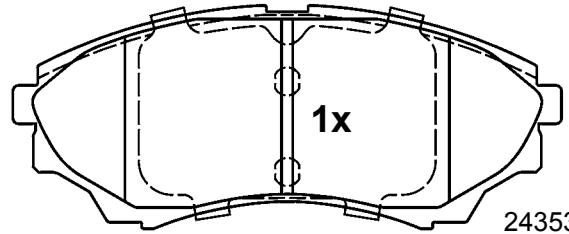

24353 16,0

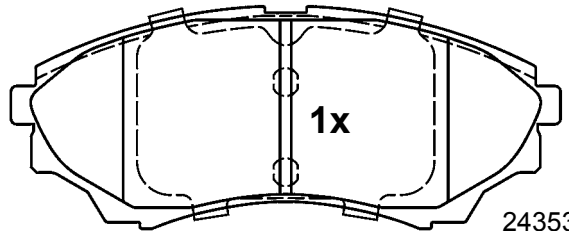

24353 16,0

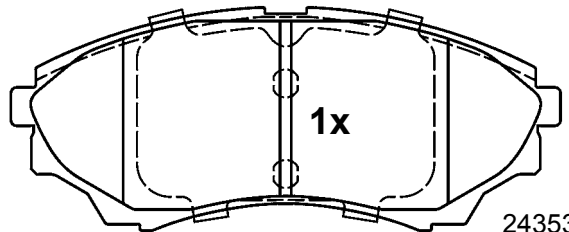

24353 16,0

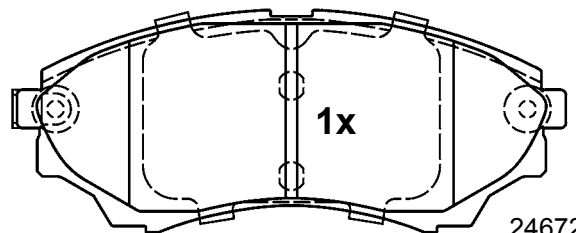

24672 16,0

145,0 x 58,5 x 16,0

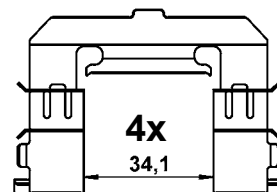

4x

34,1

# Abbildungen Scheibenbremsbeläge

Illustrations disc brake pads - Illustrazioni pastiglie freno -

Illustrations plaquettes de frein - Ilustraciones pastillas de freno

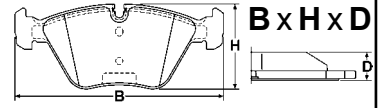

Maßstab - scale - scala - échelle - escala 1:2

**13.0460-5797.2 605797**

 SUBARU

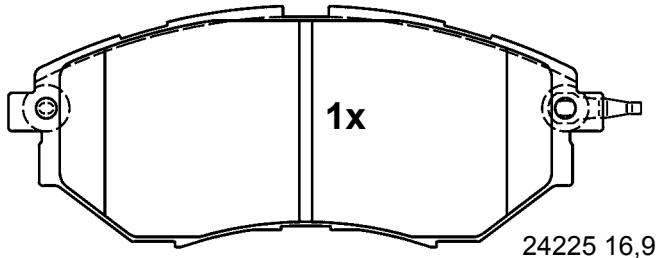
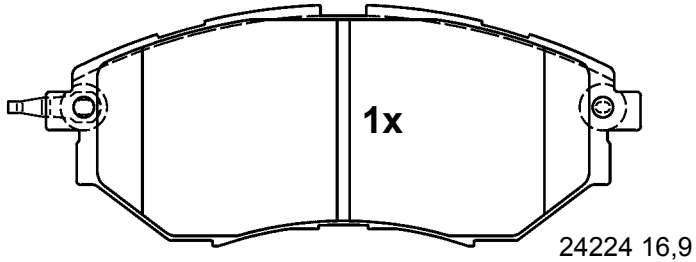
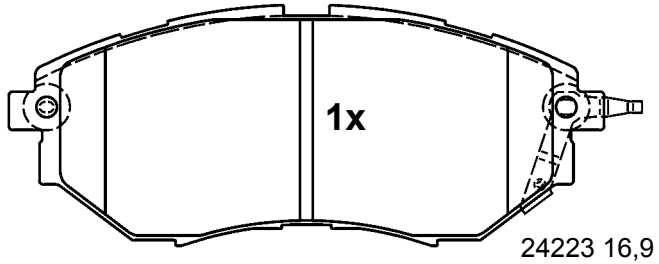
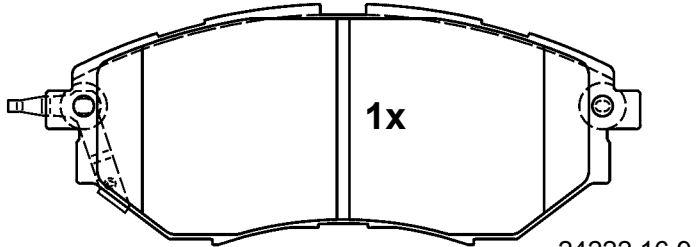

156,9 x 63,4 x 16,9

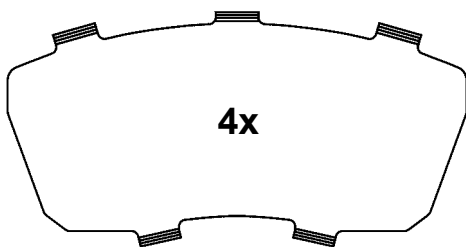

D = 0,6

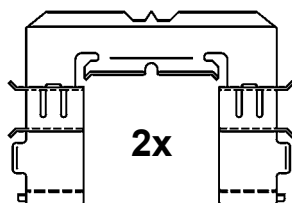
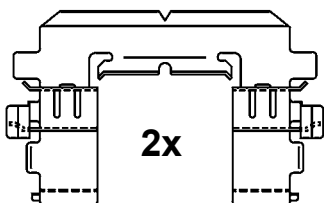

**13.0460-5799.2 605799**

 HYUNDAI, KIA

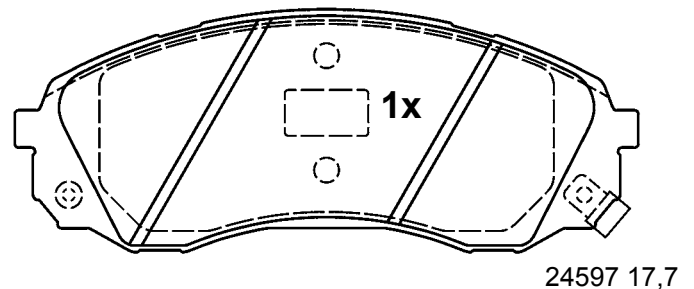
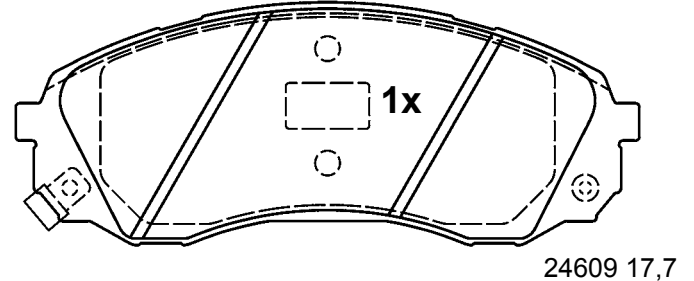
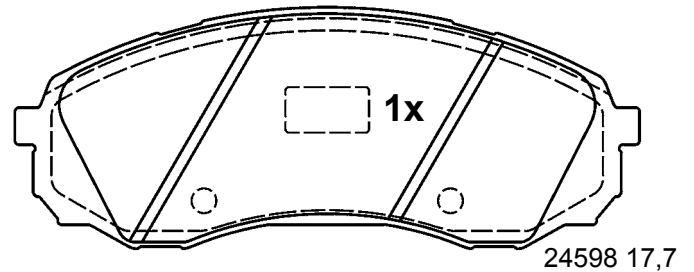
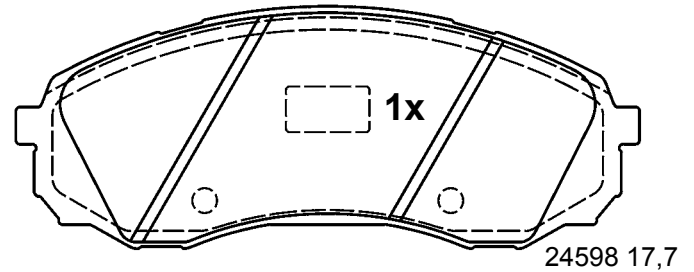

164,4 x 63,3 x 17,7

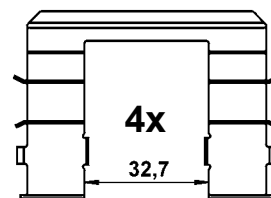

# Abbildungen Scheibenbremsbeläge

Illustrations disc brake pads - Illustrazioni pastiglie freno -

Illustrations plaquettes de frein - Ilustraciones pastillas de freno



Maßstab - scale - scala - échelle - escala 1:2

## 13.0460-5800.2 605800



TOYOTA



BOS

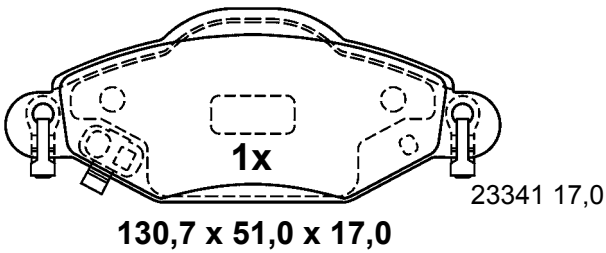
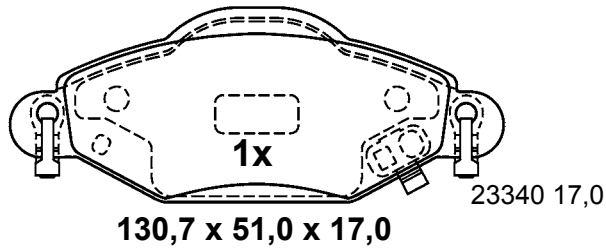
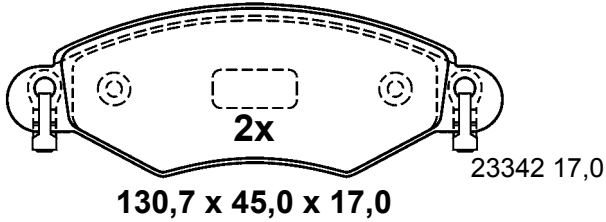

## 13.0460-5802.2 605802



MAZDA

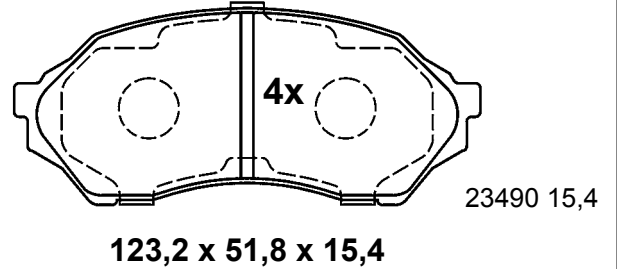

## 13.0460-5803.2 605803



HYUNDAI

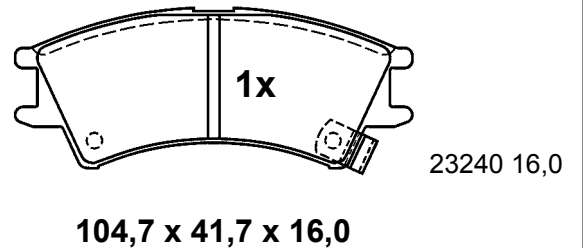
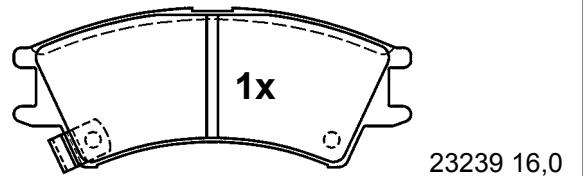
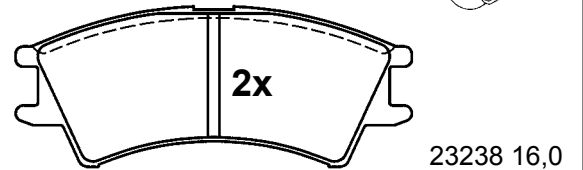

## 13.0460-5801.2 605801



NISSAN



TRW

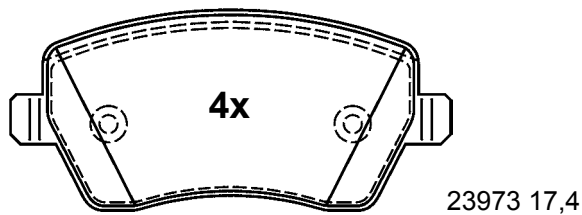

116,3 x 52,4 x 17,4

## 13.0460-5804.2 605804



MAZDA



AKE

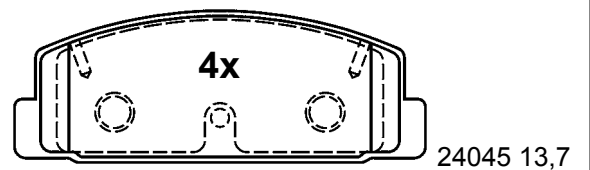

107,7 x 39,4 x 13,7

# Abbildungen Scheibenbremsbeläge

Illustrations disc brake pads - Illustrazioni pastiglie freno -

Illustrations plaquettes de frein - Ilustraciones pastillas de freno

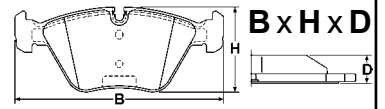

Maßstab - scale - scala - échelle - escala 1:2

## 13.0460-5806.2 605806

FORD, KIA, MAZDA

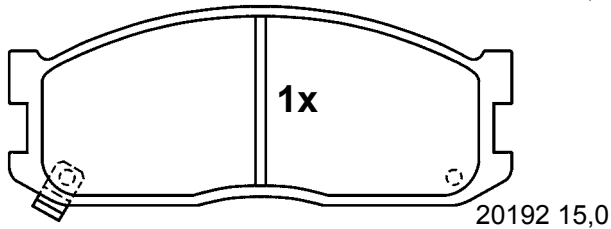
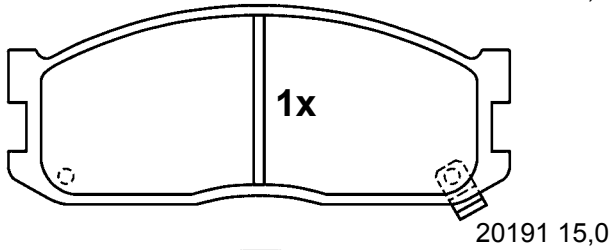
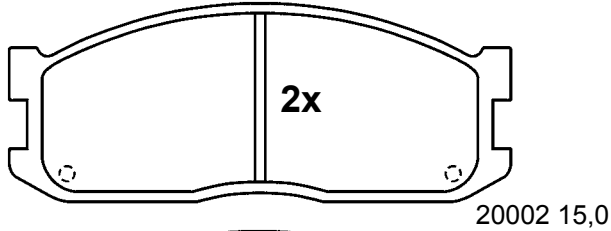

133,1 x 52,1 x 15,0

## 13.0460-5808.2 605808

NISSAN

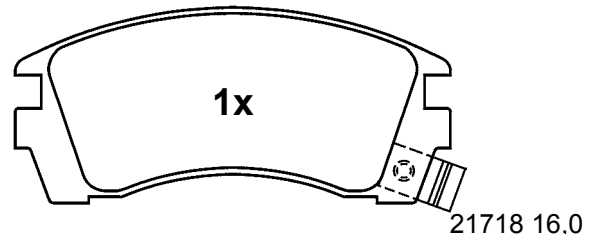
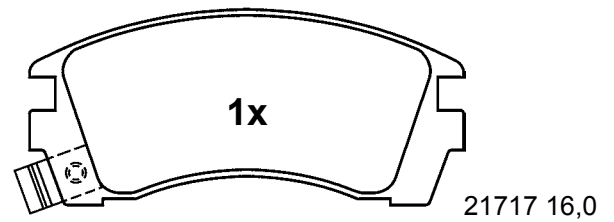
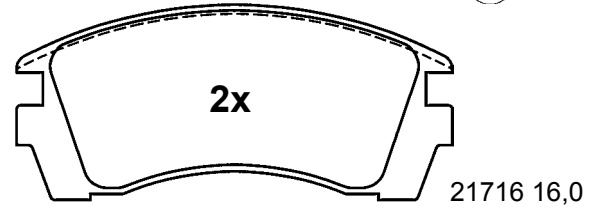

114,9 x 51,5 x 16,0

## 13.0460-5807.2 605807

NISSAN



TRW

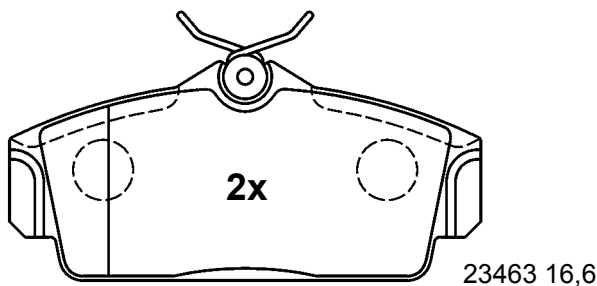
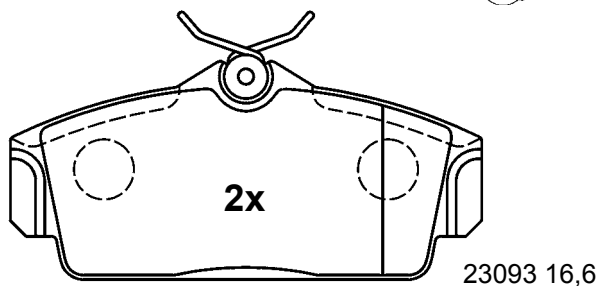

124,0 x 57,2 x 16,6

## 13.0460-5809.2 605809

TOYOTA



ATE

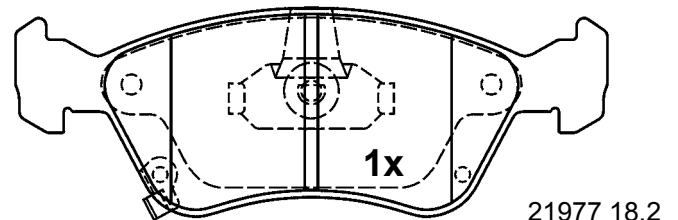
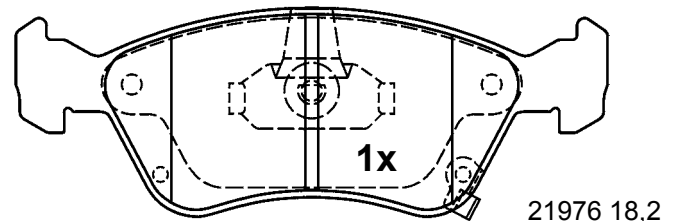
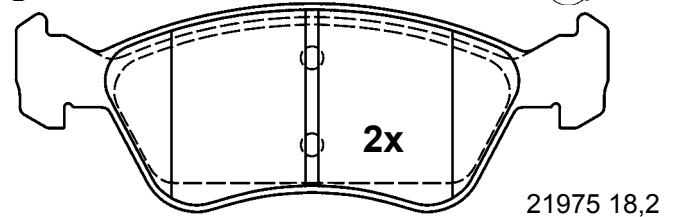

156,3 x 54,8 x 18,2

# Abbildungen Scheibenbremsbeläge

Illustrations disc brake pads - Illustrazioni pastiglie freno -

Illustrations plaquettes de frein - Ilustraciones pastillas de freno

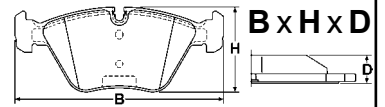

Maßstab - scale - scala - échelle - escala 1:2

## 13.0460-5810.2 605810

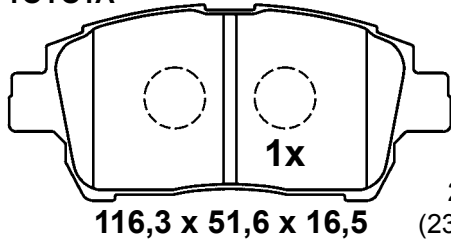

116,3 x 51,6 x 16,5

23904 16,5  
(23510/24778)

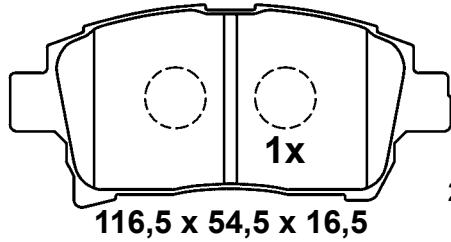

116,5 x 54,5 x 16,5

23905 16,5  
(24779)

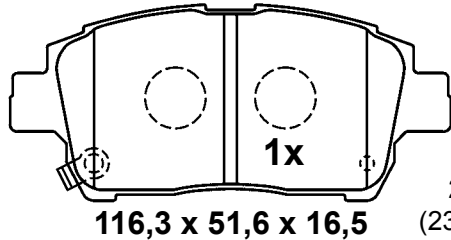

116,3 x 51,6 x 16,5

23906 16,5  
(23511/24780)

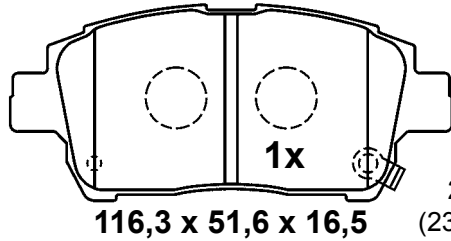

116,3 x 51,6 x 16,5

23907 16,5  
(23512/24781)



## 13.0460-5812.2 605812

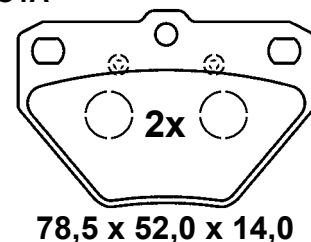

78,5 x 52,0 x 14,0

23521 14,0

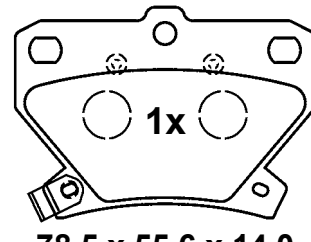

78,5 x 55,6 x 14,0

23522 14,0

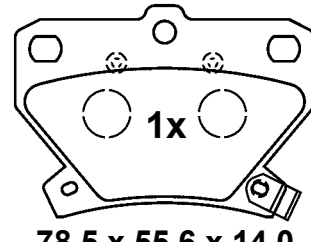

78,5 x 55,6 x 14,0

23523 14,0



## 13.0460-5811.2 605811

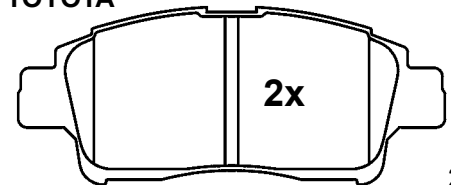

23348 16,5

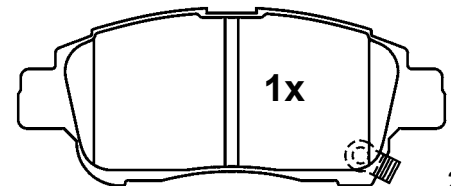

23349 16,5

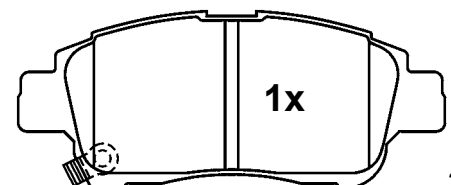

23350 16,5

112,4 x 46,7 x 16,5



## 13.0460-5813.2 605813

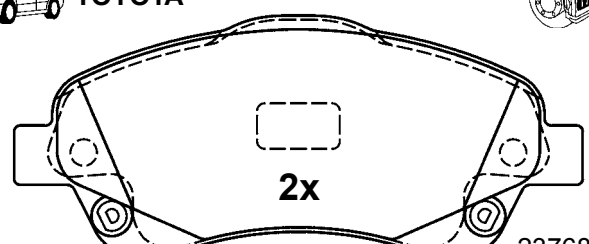

23768 19,3

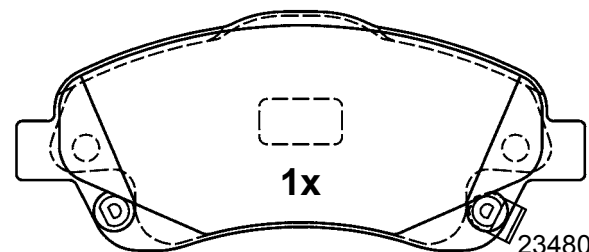

23480 19,3

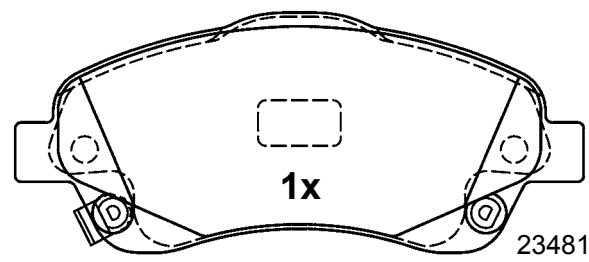

23481 19,3

150,8 x 63,0 x 19,3



# Abbildungen Scheibenbremsbeläge

Illustrations disc brake pads - Illustrazioni pastiglie freno -

Illustrations plaquettes de frein - Ilustraciones pastillas de freno

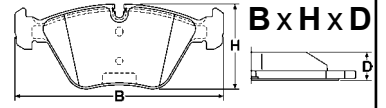

Maßstab - scale - scala - échelle - escala 1:2

## 13.0460-5814.2 605814

TOYOTA

BOS

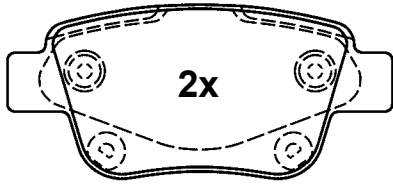

23620 16,4

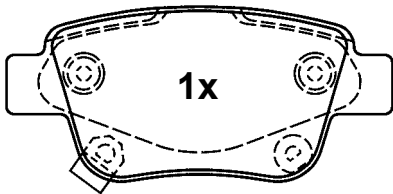

23621 16,4

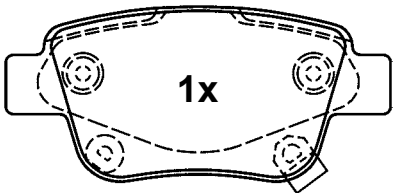

23622 16,4

101,8 x 45,9 x 16,4

## 13.0460-5816.2 605816

DAIHATSU

BOS

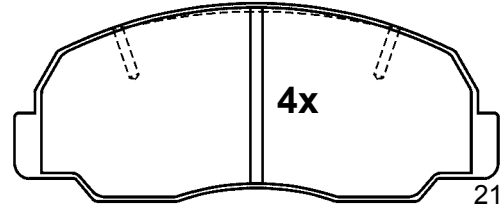

21243 14,0

127,8 x 52,3 x 14,0

## 13.0460-5817.2 605817

TOYOTA

AKE

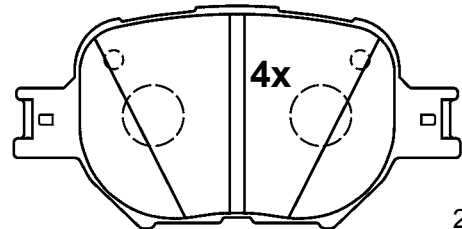

23526 17,5

117,9 x 58,6 x 17,5

## 13.0460-5815.2 605815

TOYOTA

TRW

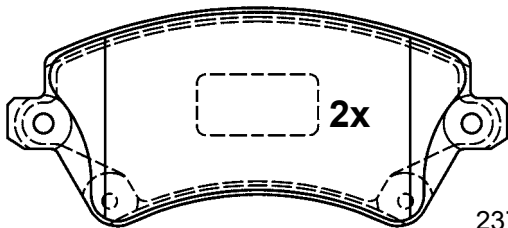

23766 17,8

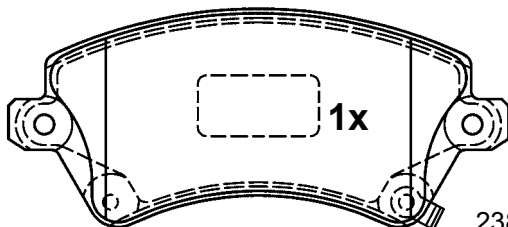

23818 17,8

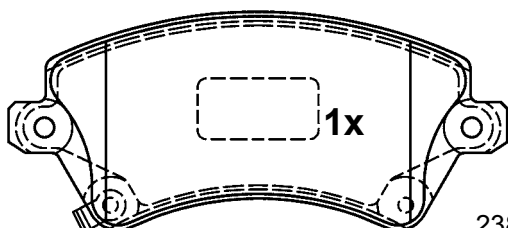

23819 17,8

131,5 x 57,3 x 17,8

## 13.0460-5818.2 605818

HONDA

AKE

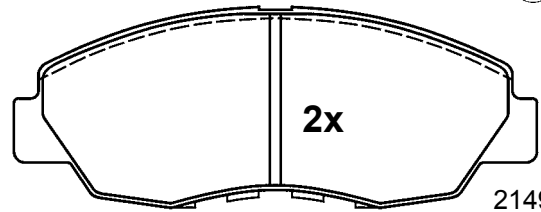

21497 18,0

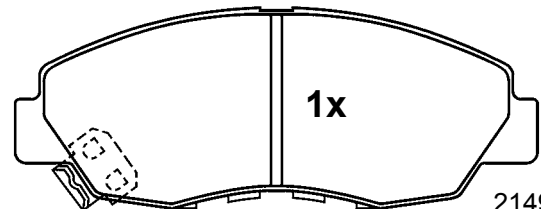

21498 18,0

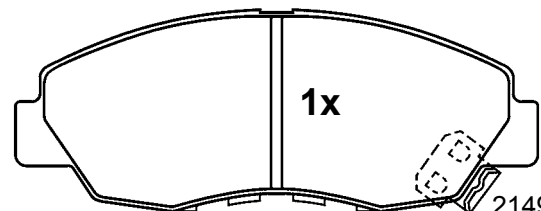

21499 18,0

137,8 x 52,7 x 18,0



# Abbildungen Scheibenbremsbeläge

Illustrations disc brake pads - Illustrazioni pastiglie freno -

Illustrations plaquettes de frein - Ilustraciones pastillas de freno

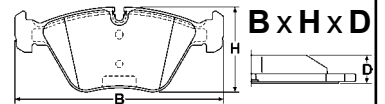

Maßstab - scale - scala - échelle - escala 1:2

## 13.0460-5819.2 605819

TOYOTA

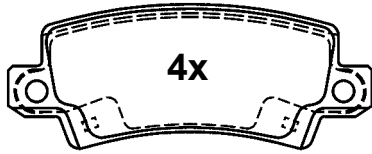

23816 16,0

95,6 x 37,9 x 16,0



## 13.0460-5821.2 605821

MAZDA

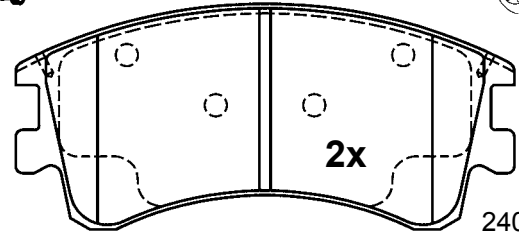

24046 18,6

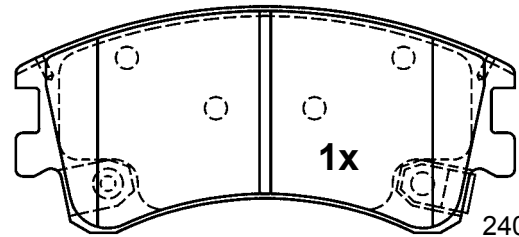

24047 18,6

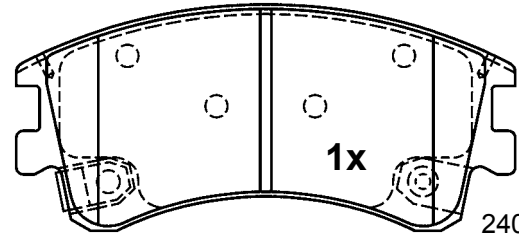

24048 18,6

131,8 x 59,5 x 18,0

## 13.0460-5820.2 605820

HONDA

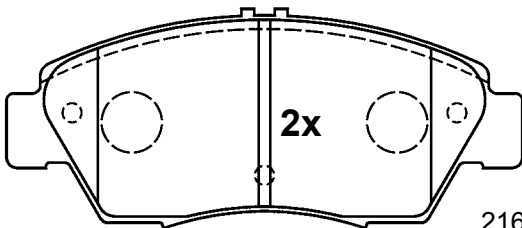

21694 16,3

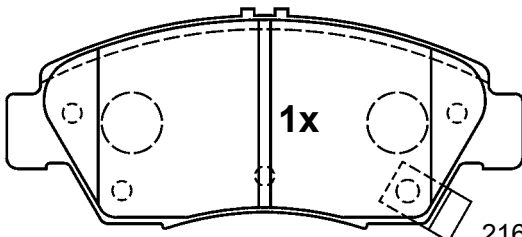

21696 16,3

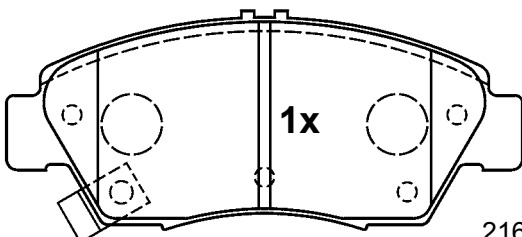

21695 16,3

136,7 x 57,4 x 16,3

## 13.0460-5822.2 605822

MAZDA

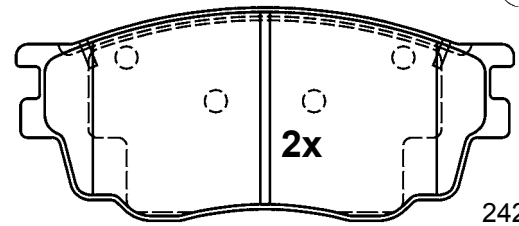

24246 16,8

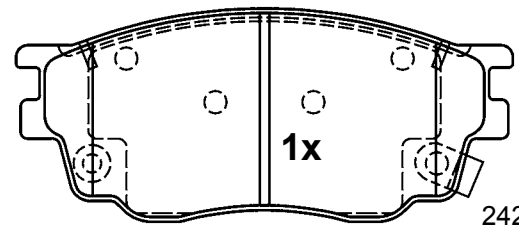

24249 16,8

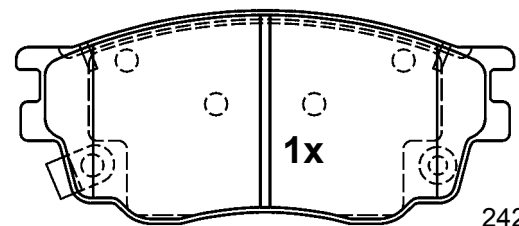

24248 16,8

131,3 x 56,1 x 16,8



# Abbildungen Scheibenbremsbeläge

Illustrations disc brake pads - Illustrazioni pastiglie freno -

Illustrations plaquettes de frein - Ilustraciones pastillas de freno

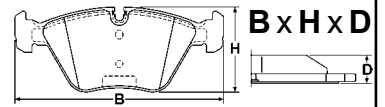

Maßstab - scale - scala - échelle - escala 1:2

## 13.0460-5824.2 605824



DAIHATSU, MAZDA



AKE

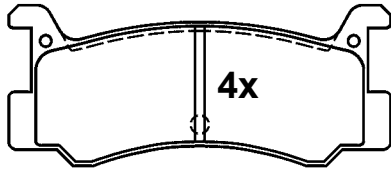

20008 13,0

101,7 x 42,2 x 13,0

## 13.0460-5826.2 605826



MITSUBISHI, PROTON



AKE

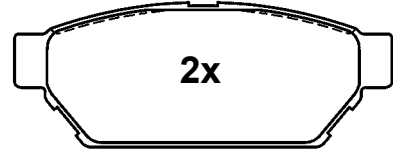

21872 14,5

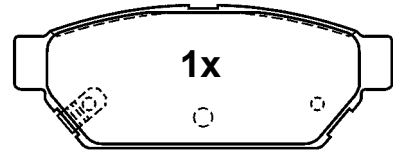

21873 14,5

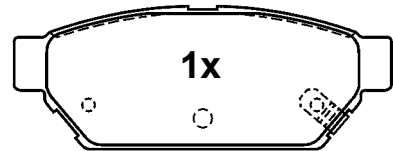

21874 14,5

99,0 x 37,8 x 14,5

## 13.0460-5825.2 605825



HONDA, MG, NISSAN



TRW

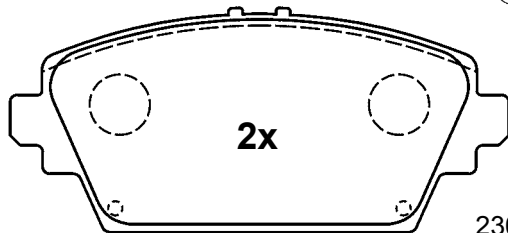

23094 16,5

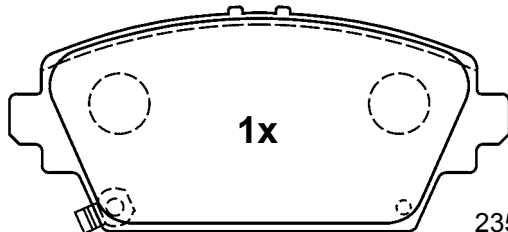

23563 16,5

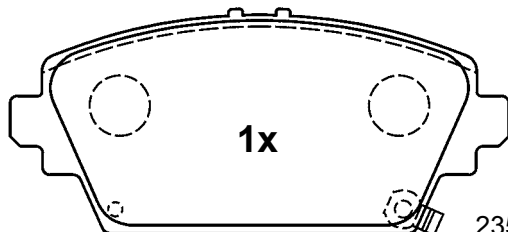

23564 16,5

131,8 x 58,5 x 16,5

## 13.0460-5827.2 605827



HONDA



TRW

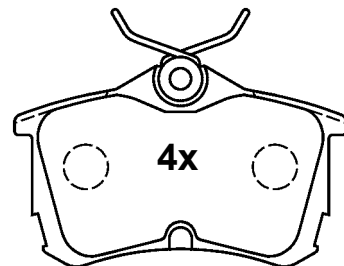

23527 14,5

87,1 x 53,0 x 14,5

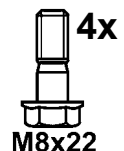
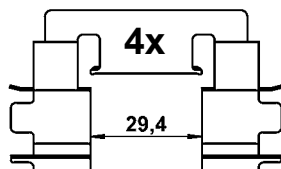
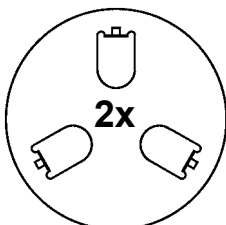
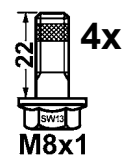

# Abbildungen Scheibenbremsbeläge

Illustrations disc brake pads - Illustrazioni pastiglie freno -

Illustrations plaquettes de frein - Ilustraciones pastillas de freno

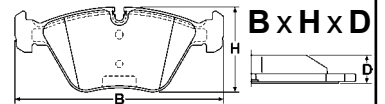

Maßstab - scale - scala - échelle - escala 1:2

## 13.0460-5829.2 605829

HYUNDAI

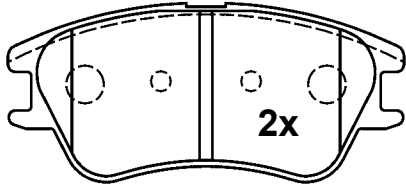

24277 16,0

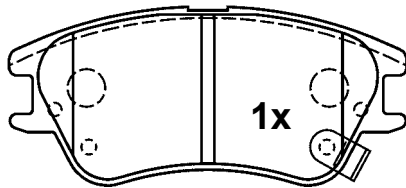

24397 16,0

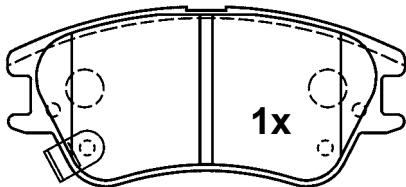

24398 16,0

104,7 x 47,3 x 16,0

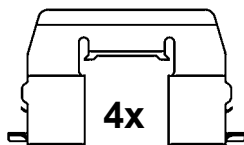

4x

## 13.0460-5831.2 605831

MAZDA



SUM

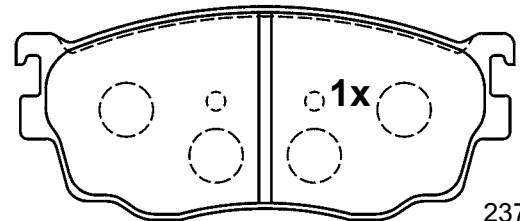

23777 16,0

131,5 x 56,2 x 16,0

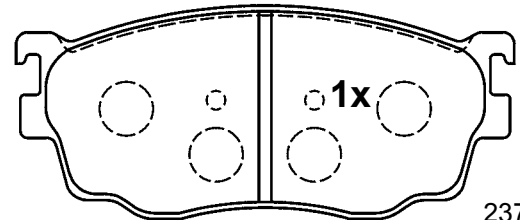

23777 16,0

131,5 x 56,2 x 16,0

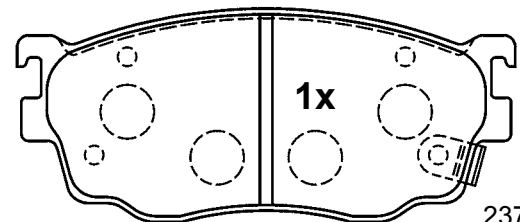

23778 17,0

131,5 x 56,2 x 17,0

## 13.0460-5830.2 605830

LAND ROVER



TRW

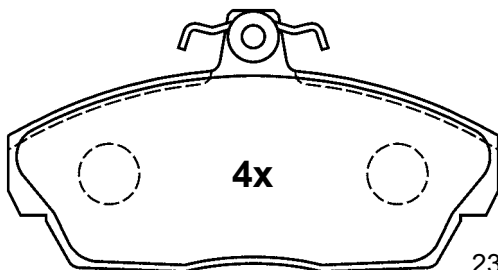

23158 17,5

129,1 x 68,7 x 17,5



4x

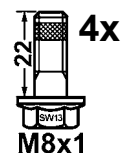

22

SW13

M8x1

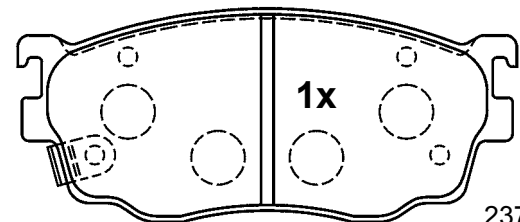

23779 17,0

131,5 x 56,2 x 17,0

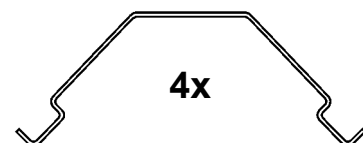

4x

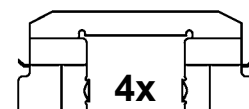

4x

# Abbildungen Scheibenbremsbeläge

Illustrations disc brake pads - Illustrazioni pastiglie freno -

Illustrations plaquettes de frein - Ilustraciones pastillas de freno

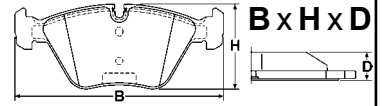

Maßstab - scale - scala - échelle - escala 1:2

## 13.0460-5832.2 605832

HYUNDAI

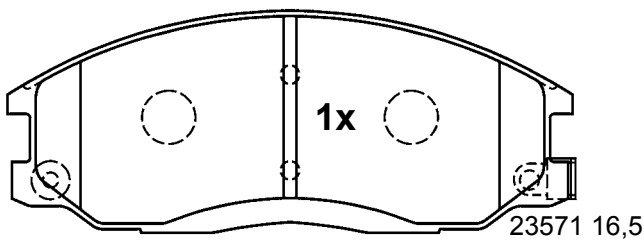
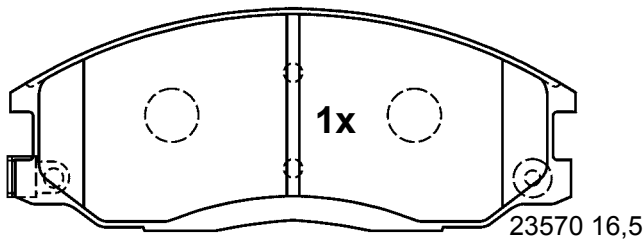
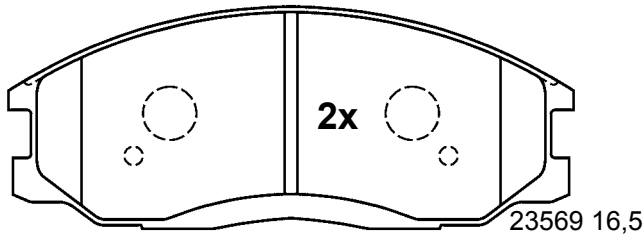

149,0 x 58,1 x 16,5

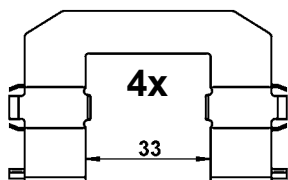

## 13.0460-5833.2 605833

HYUNDAI, KIA

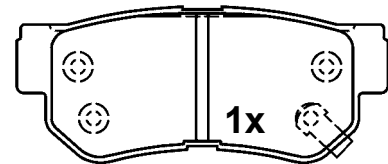
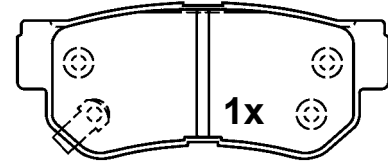
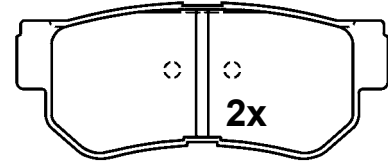

98,6 x 40,9 x 14,4

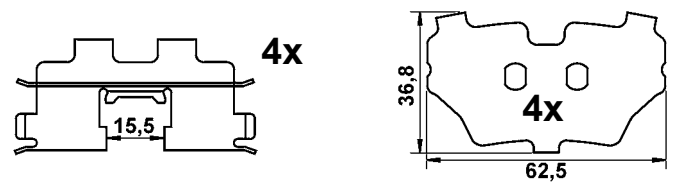

## 13.0460-5834.2 605834

MAZDA

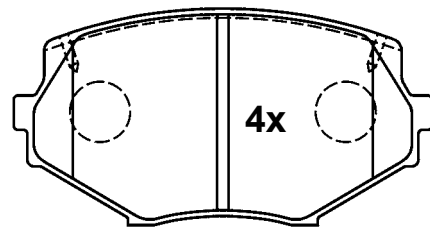

110,1 x 57,2 x 13,0

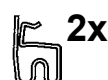
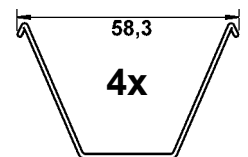
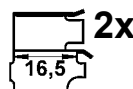
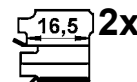

# Abbildungen Scheibenbremsbeläge

Illustrations disc brake pads - Illustrazioni pastiglie freno -

Illustrations plaquettes de frein - Ilustraciones pastillas de freno

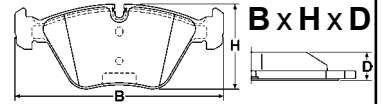

Maßstab - scale - scala - échelle - escala 1:2

**13.0460-5835.2 605835**

TOYOTA

AKE

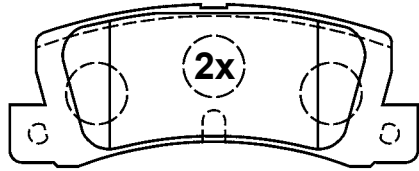

15,5

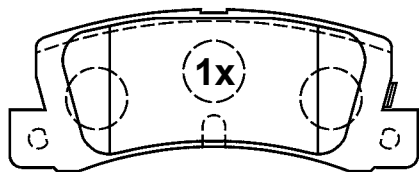

20076 15,5

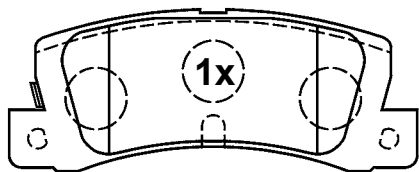

20077 15,5

107,7 x 42,6 x 15,5

**13.0460-5837.2 605837**

SUBARU, SUZUKI

BOS

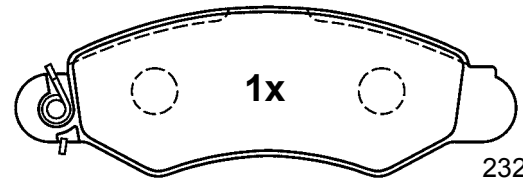

23296 14,5

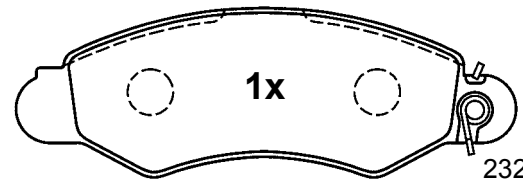

23297 14,5

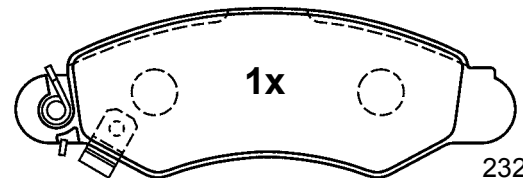

23298 14,5

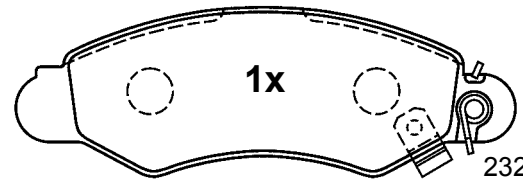

23299 14,5

131,0 x 44,5 x 14,5

**13.0460-5836.2 605836**

SUZUKI

AKE

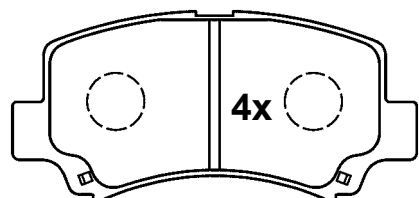

23662 15,0

106,1 x 50,1 x 15,0

2x

**13.0460-5838.2 605838**

SUZUKI

AIS

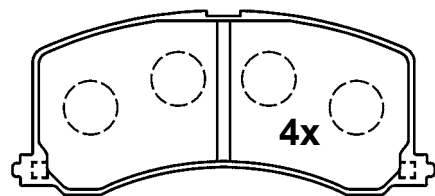

23400 15,5

111,5 x 48,7 x 15,5

4x

# Abbildungen Scheibenbremsbeläge

Illustrations disc brake pads - Illustrazioni pastiglie freno -

Illustrations plaquettes de frein - Ilustraciones pastillas de freno

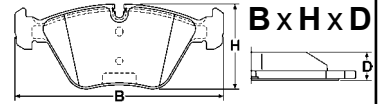

Maßstab - scale - scala - échelle - escala 1:2

**13.0460-5839.2 605839**

SUZUKI

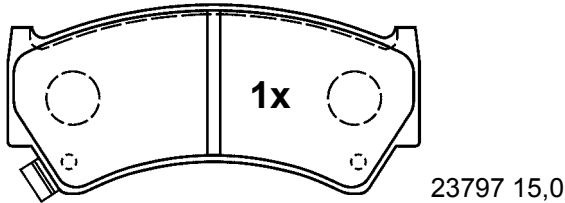
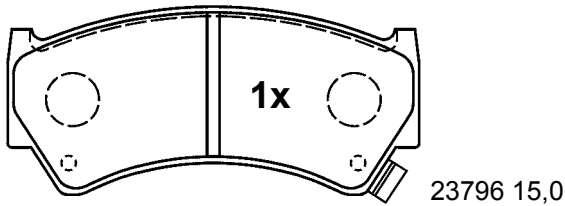
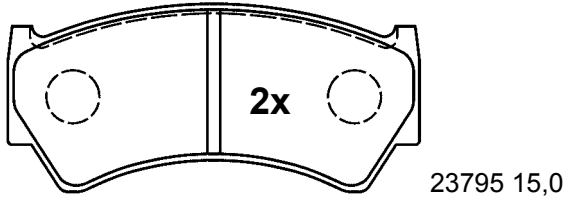

108,6 x 47,9 x 15,0

**13.0460-5841.2 605841**

NISSAN

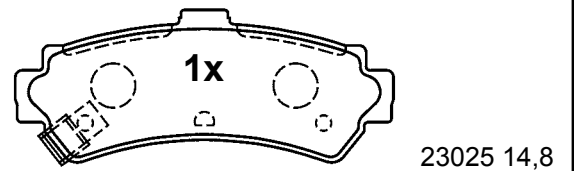
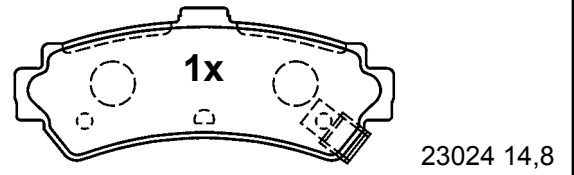
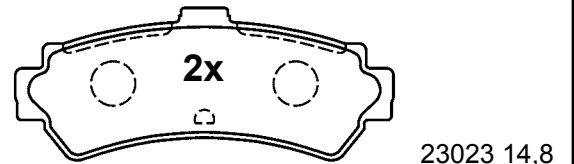

99,4 x 40,1 x 14,8

**13.0460-5840.2 605840**

LEXUS, TOYOTA

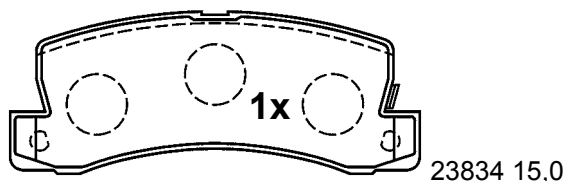
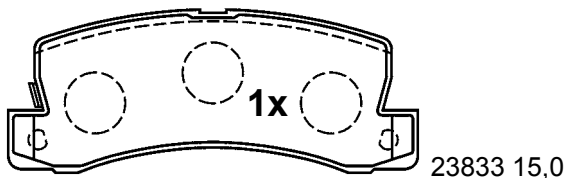
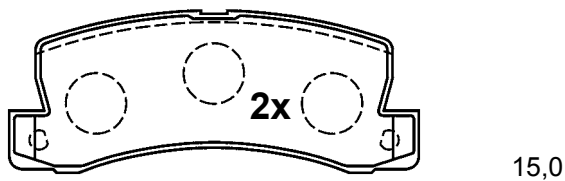

107,7 x 42,6 x 15,0

**13.0460-5842.2 605842**

NISSAN

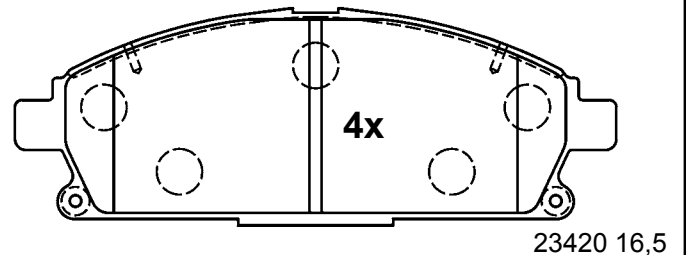

158,8 x 56,3 x 16,5



# Abbildungen Scheibenbremsbeläge

Illustrations disc brake pads - Illustrazioni pastiglie freno -

Illustrations plaquettes de frein - Ilustraciones pastillas de freno



Maßstab - scale - scala - échelle - escala 1:2

## 13.0460-5843.2 605843



NISSAN, RENAULT

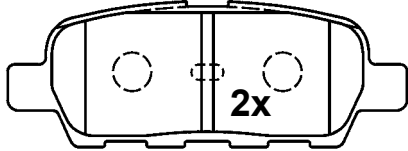

23871 14,3

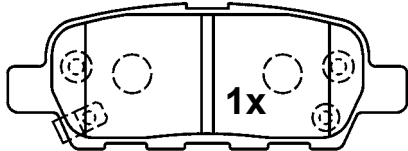

23872 14,3

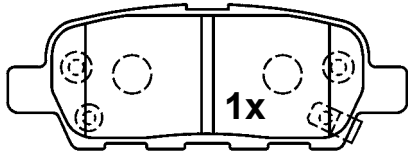

14,3

105,5 x 38,1 x 14,3

## 13.0460-5845.2 605845



TOYOTA

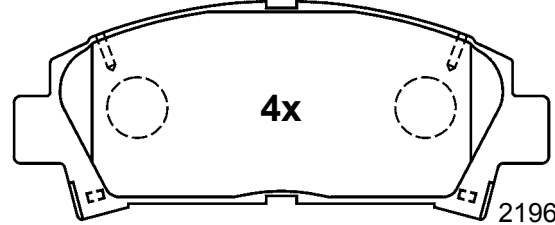

21961 15,5



2x

140,9 x 56,0 x 15,5

## 13.0460-5846.2 605846



TOYOTA

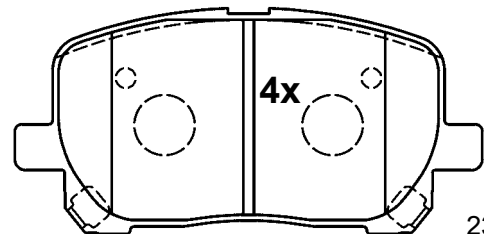

23836 17,0

123,1 x 59,6 x 17,0

## 13.0460-5844.2 605844



TOYOTA

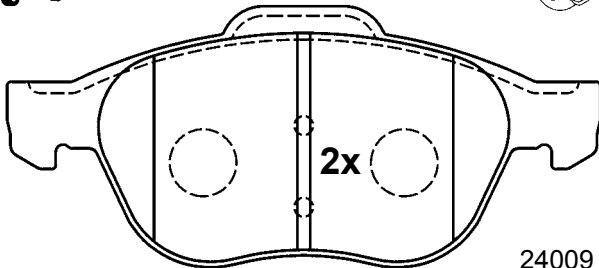

24009 17,5

156,3 x 68,6 x 17,5

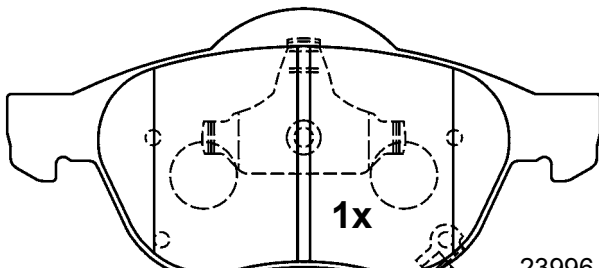

23996 17,5

155,1 x 71,1 x 17,5

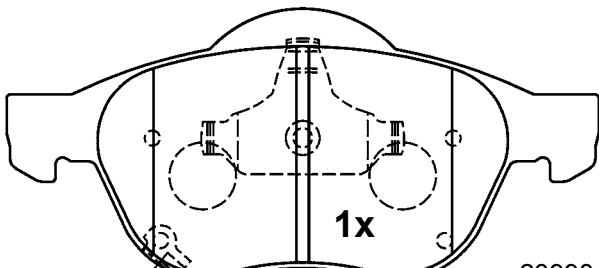

23998 17,5

155,1 x 71,1 x 17,5

## 13.0460-5847.2 605847



TOYOTA

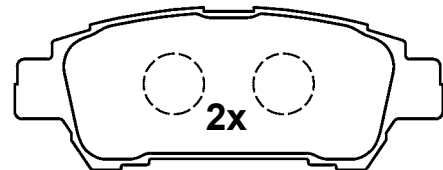

23646 16,5

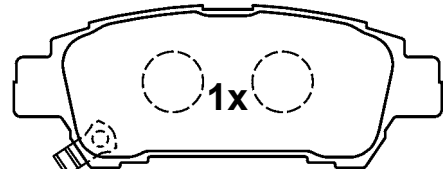

23647 16,5

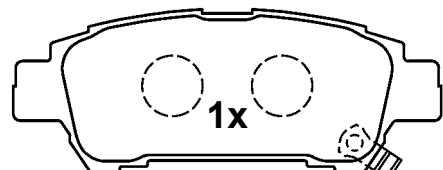

23648 16,5

112,8 x 43,0 x 16,5

# Abbildungen Scheibenbremsbeläge

Illustrations disc brake pads - Illustrazioni pastiglie freno -

Illustrations plaquettes de frein - Ilustraciones pastillas de freno

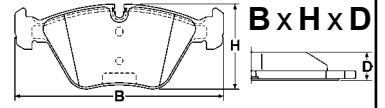

Maßstab - scale - scala - échelle - escala 1:2

## 13.0460-5848.2 605848



TOYOTA



AKE

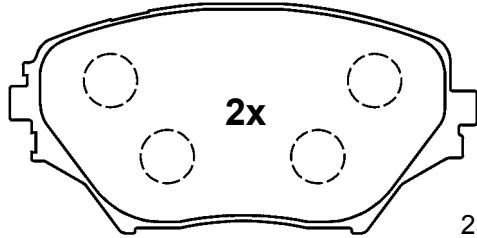

23585 17,4

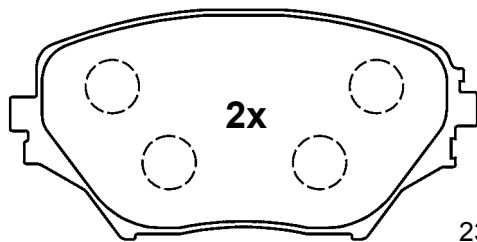

23586 17,4

123,0 x 60,4 x 17,4

## 13.0460-5850.2 605850



SUBARU



SUM

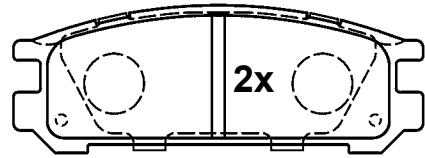

21703 15,0

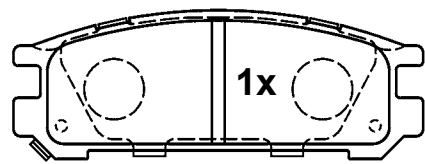

21704 15,0

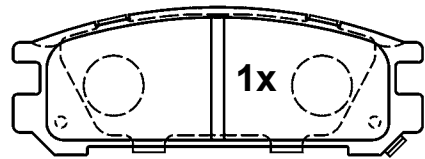

21705 15,0

107,8 x 38,7 x 15,0

## 13.0460-5849.2 605849



TOYOTA



AKE

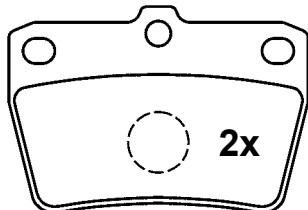

23656 14,0

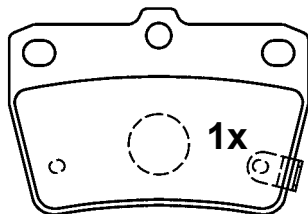

23658 14,0

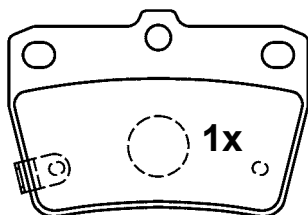

23657 14,0

78,5 x 54,1 x 14,0

## 13.0460-5851.2 605851



SUBARU



AKE

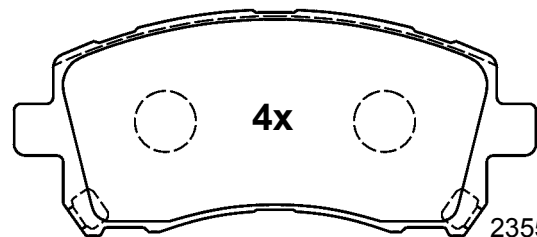

23558 17,2

137,7 x 59,6 x 17,2

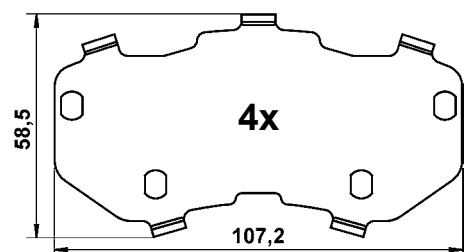

2x

107,2

58,5

# Abbildungen Scheibenbremsbeläge

Illustrations disc brake pads - Illustrazioni pastiglie freno -

Illustrations plaquettes de frein - Ilustraciones pastillas de freno



Maßstab - scale - scala - échelle - escala 1:2

## 13.0460-5852.2 605852

DAIHATSU

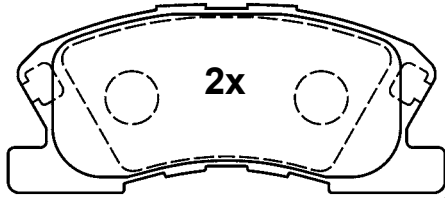

115,4 x 49,6 x 15,0

23497 15,0

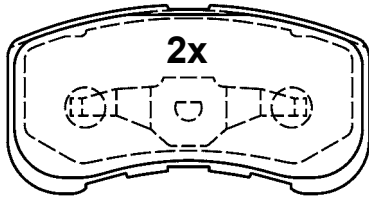

95,0 x 49,6 x 14,8

23498 14,8



## 13.0460-5855.2 605855

CHRYSLER, CITROEN, JEEP  
LANCIA, MITSUBISHI, PEUGEOT

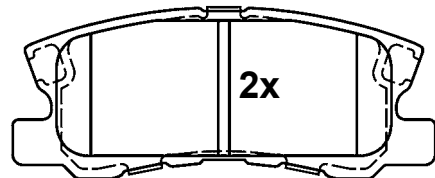

111,3 x 44,8 x 16,0

23582 16,0

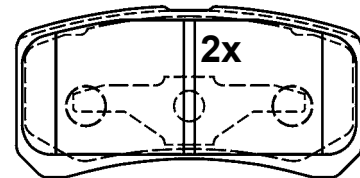

91,0 x 44,9 x 16,0

23583 16,0

## 13.0460-5853.2 605853

MITSUBISHI



SUM

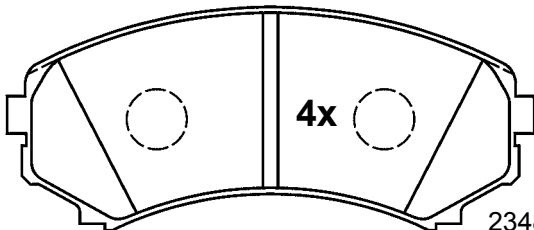

139,0 x 58,6 x 15,4

23488 15,4



## 13.0460-5856.2 605856

MAZDA, SUZUKI

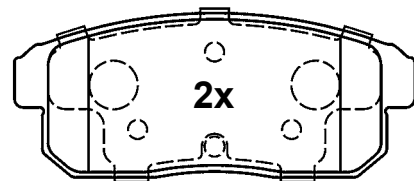

24039 14,4

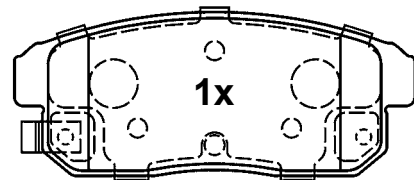

24040 14,4

## 13.0460-5854.2 605854

MITSUBISHI



SUM

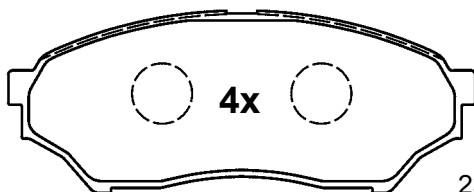

123,0 x 47,9 x 15,5

23487 15,5

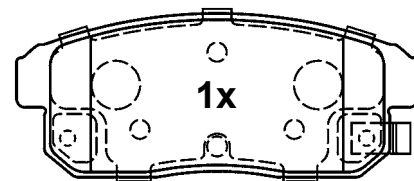

24041 14,4

105,6 x 43,1 x 14,4

# Abbildungen Scheibenbremsbeläge

Illustrations disc brake pads - Illustrazioni pastiglie freno -

Illustrations plaquettes de frein - Ilustraciones pastillas de freno

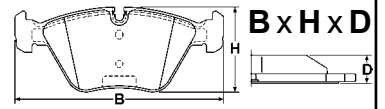

Maßstab - scale - scala - échelle - escala 1:2

**13.0460-5857.2 605857**

SUZUKI

SUM

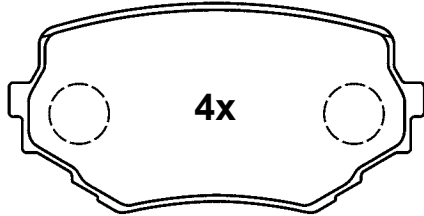

23313 15,0

**110,1 x 55,0 x 15,0**

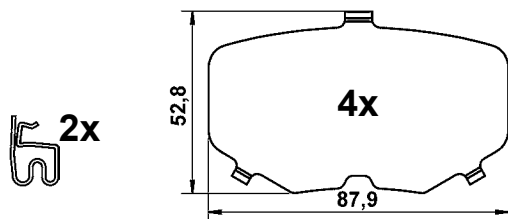

**13.0460-5859.2 605859**

CHEVROLET, DAEWOO

AKE

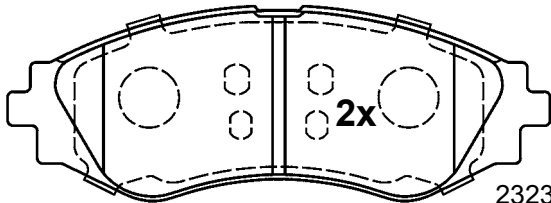

23234 16,9

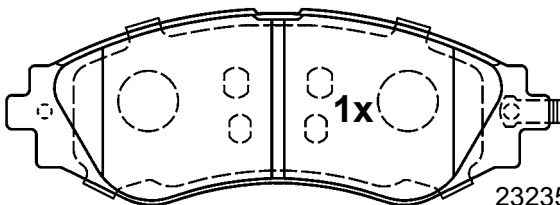

23235 16,9

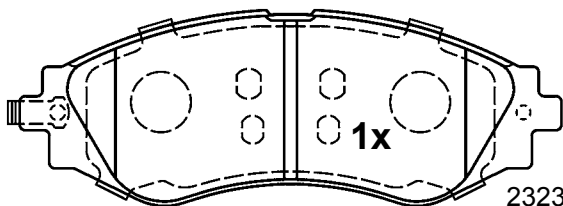

23236 16,9

**143,0 x 51,2 x 16,9**

**13.0460-5860.2 605860**

HONDA

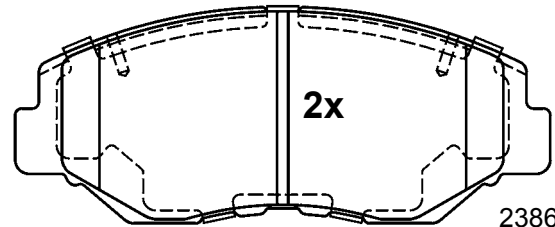

23868 17,1

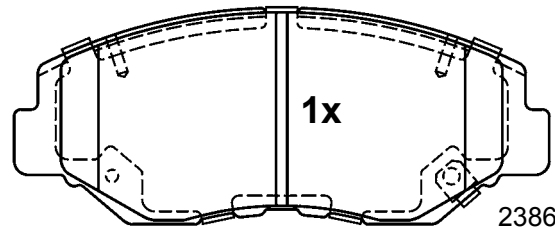

23869 17,1

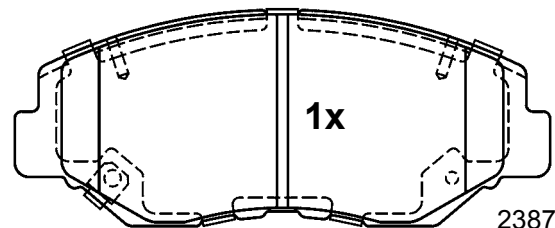

23870 17,1

**141,7 x 56,7 x 17,1**

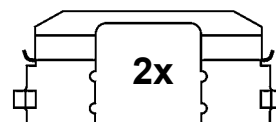
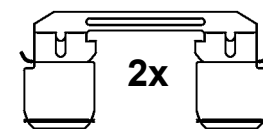
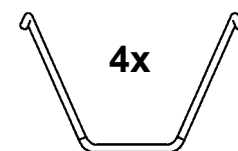

# Abbildungen Scheibenbremsbeläge

Illustrations disc brake pads - Illustrazioni pastiglie freno -

Illustrations plaquettes de frein - Ilustraciones pastillas de freno



Maßstab - scale - scala - échelle - escala 1:2

## 13.0460-5861.2 605861

 HONDA

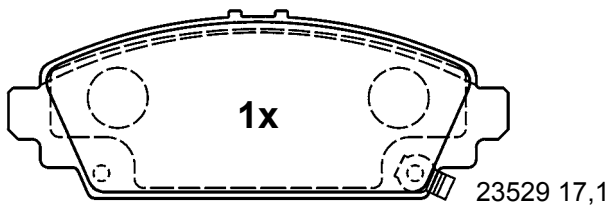
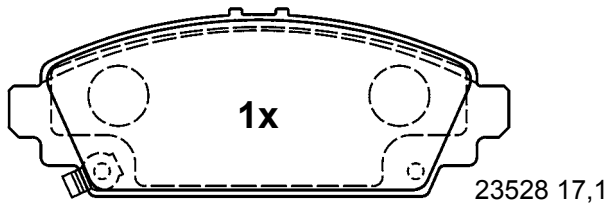
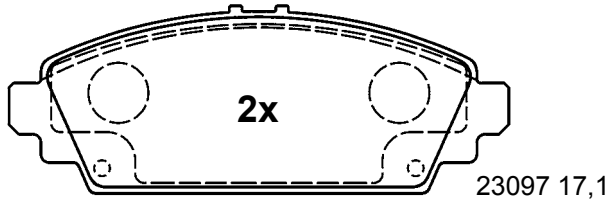

131,7 x 49,2 x 17,1

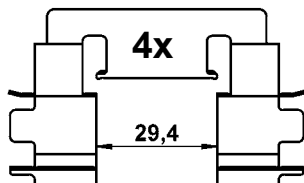
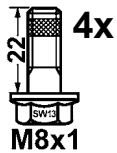

## 13.0460-5862.2 605862

 TOYOTA

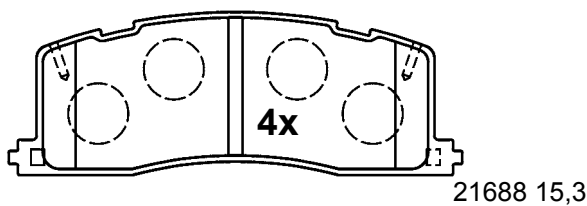

119,7 x 42,8 x 15,3

## 13.0460-5863.2 605863

 CHEVROLET, DAEWOO

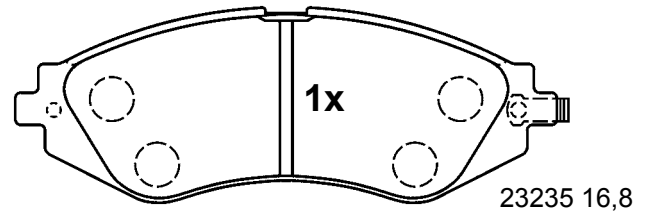
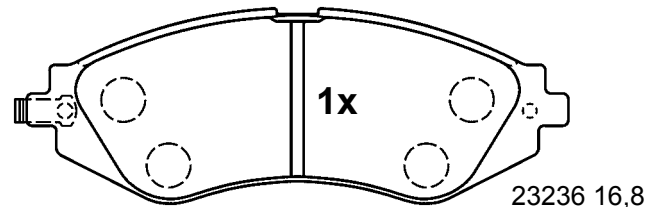
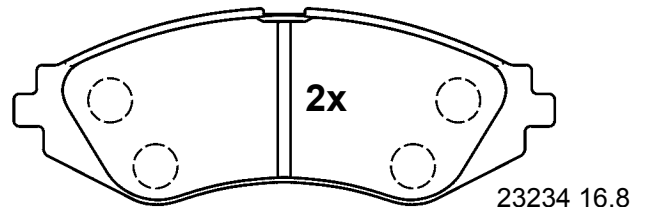

143,0 x 51,4 x 16,8

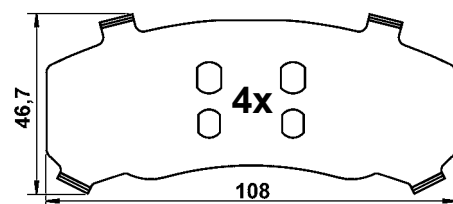

# Abbildungen Scheibenbremsbeläge

Illustrations disc brake pads - Illustrazioni pastiglie freno -

Illustrations plaquettes de frein - Ilustraciones pastillas de freno

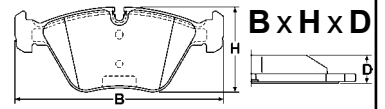

Maßstab - scale - scala - échelle - escala 1:2

**13.0460-5864.2 605864**

SUZUKI

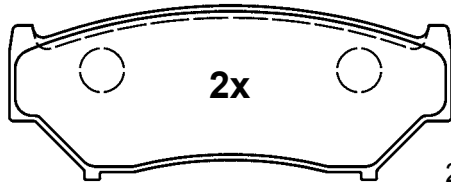

21907 15,5

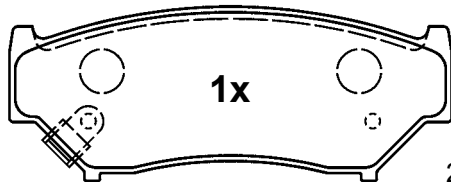

21908 15,5

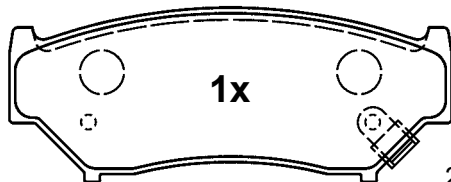

21909 15,5

**116,6 x 45,6 x 15,5**

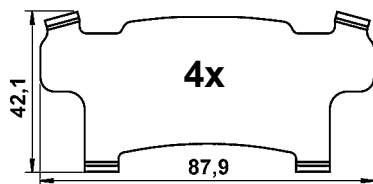

**13.0460-5865.2 605865**

MAZDA



AKE

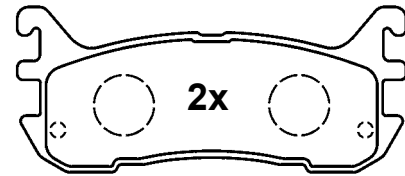

23387 12,6

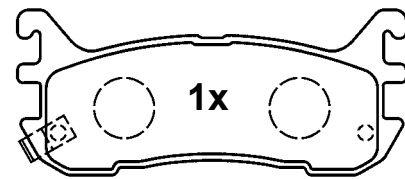

23388 12,6

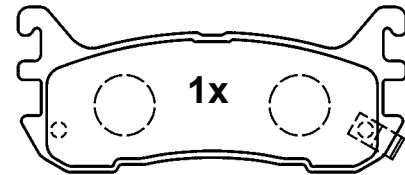

23389 12,6

**102,2 x 43,0 x 12,6**

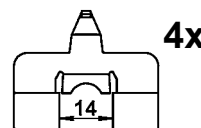
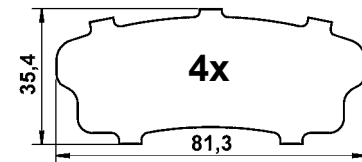

4x



4x

**13.0460-5866.2 605866**

MAZDA



AKE

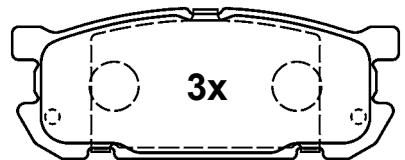

23876 12,4

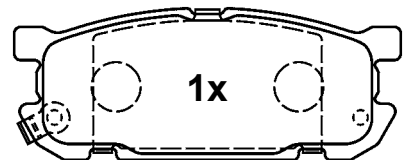

23878 12,4

**102,2 x 39,8 x 12,4**



# Abbildungen Scheibenbremsbeläge

Illustrations disc brake pads - Illustrazioni pastiglie freno -

Illustrations plaquettes de frein - Ilustraciones pastillas de freno



Maßstab - scale - scala - échelle - escala 1:2

**13.0460-5867.2 605867**

MAZDA

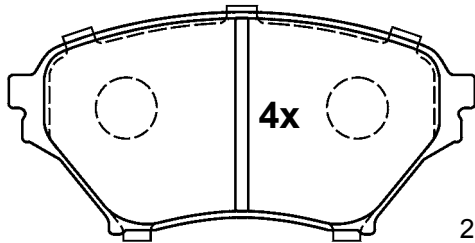

23863 14,3

123,1 x 58,5 x 14,3

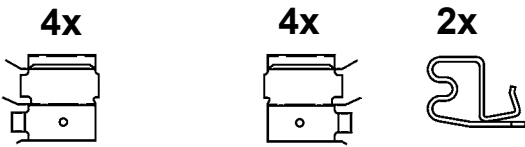

**13.0460-5869.2 605869**

TOYOTA

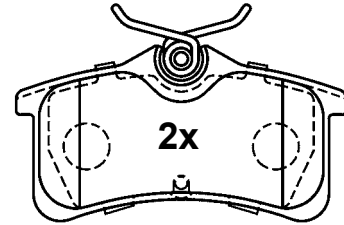

24013 14,9

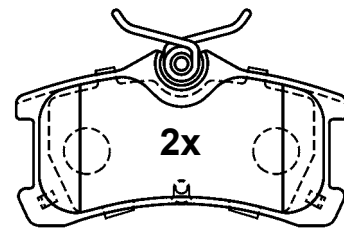

24020 14,9

87,0 x 46,0 x 14,9



**13.0460-5868.2 605868**

KIA

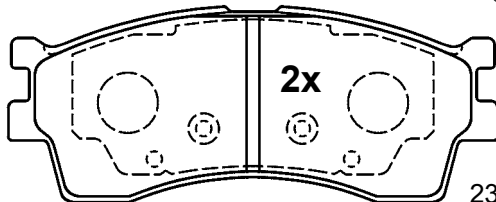

23873 15,8

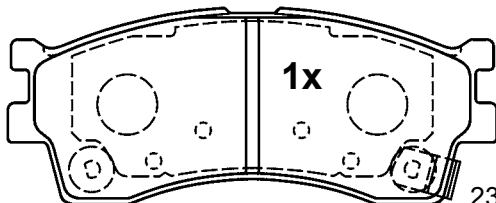

23874 15,8

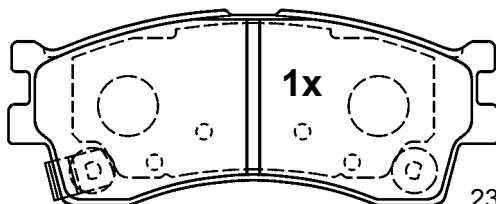

23875 15,8

129,0 x 51,3 x 15,8

**13.0460-5871.2 605871**

KIA

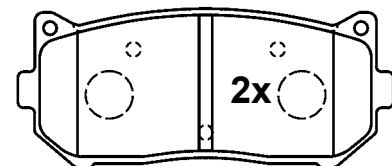

23455 13,7

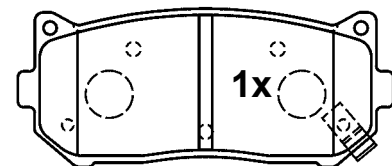

23456 13,7

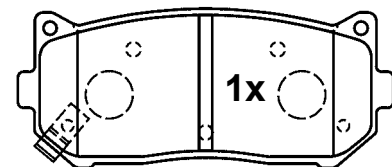

23457 13,7

98,8 x 41,8 x 13,7



# Abbildungen Scheibenbremsbeläge

Illustrations disc brake pads - Illustrazioni pastiglie freno -

Illustrations plaquettes de frein - Ilustraciones pastillas de freno

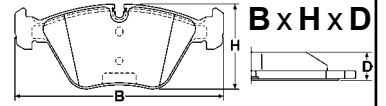

Maßstab - scale - scala - échelle - escala 1:2

**13.0460-5872.2 605872**

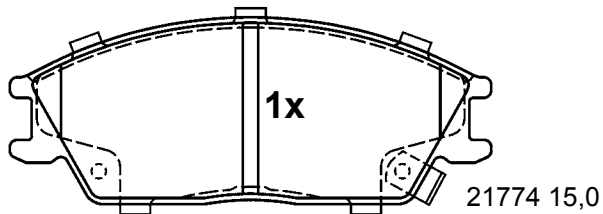
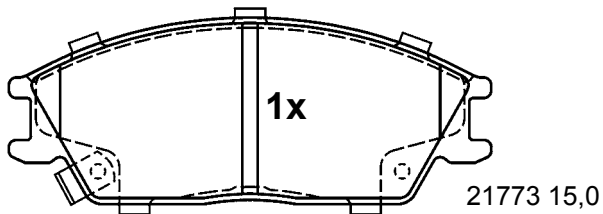
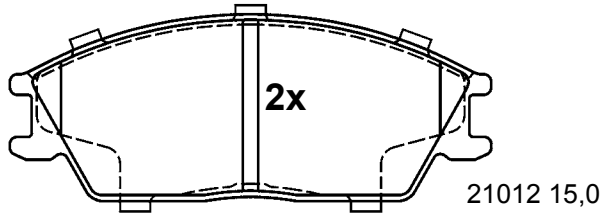

**127,5 x 49,0 x 15,0**

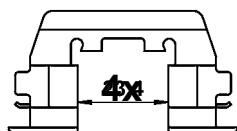

**13.0460-5873.2 605873**

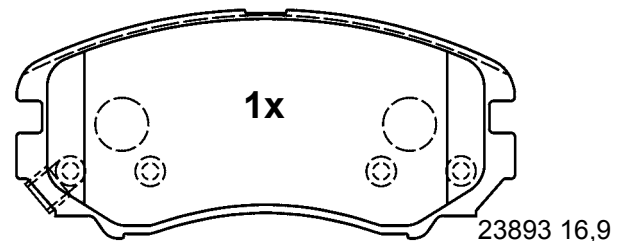
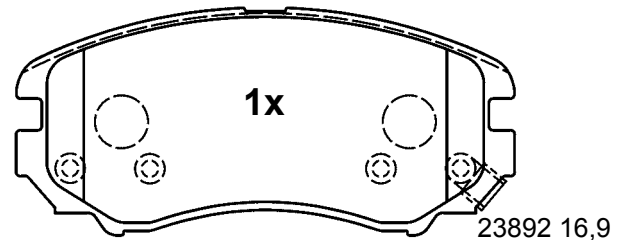
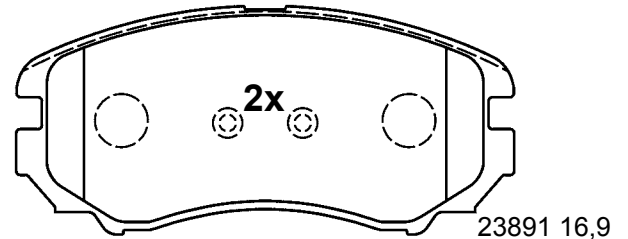

**131,5 x 60,3 x 16,9**

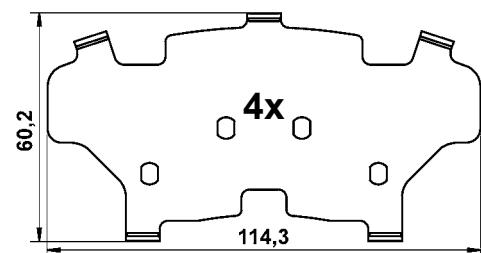

# Abbildungen Scheibenbremsbeläge

Illustrations disc brake pads - Illustrazioni pastiglie freno -

Illustrations plaquettes de frein - Ilustraciones pastillas de freno

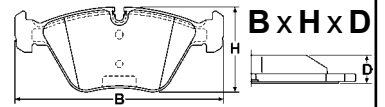

Maßstab - scale - scala - échelle - escala 1:2

## 13.0460-5874.2 605874



HYUNDAI, KIA



SUM

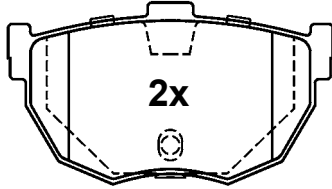

21553 14,0

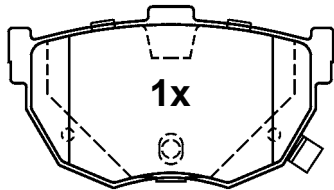

21554 14,0

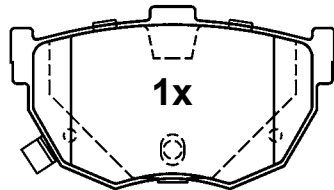

21555 14,0

85,3 x 46,6 x 14,0

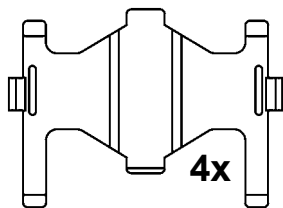

4x

## 13.0460-5876.2 605876



HYUNDAI



MAN

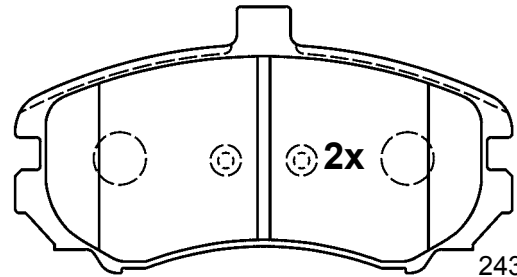

24369 17,2

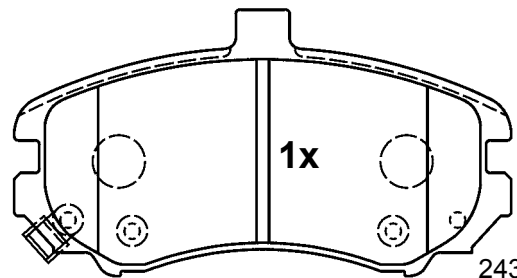

24374 17,2

## 13.0460-5875.2 605875



HYUNDAI



MAN

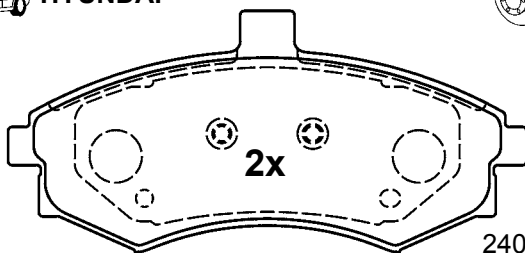

24033 17,7

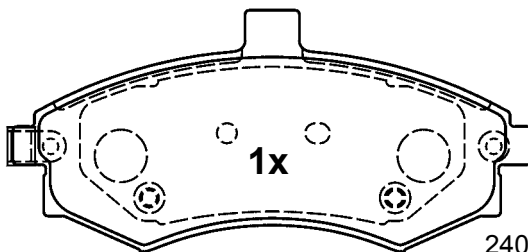

24031 17,7

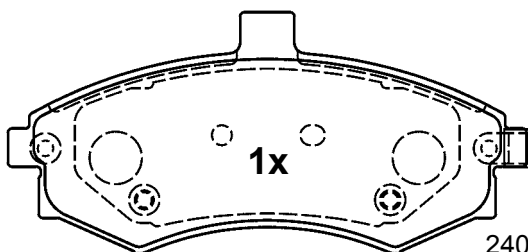

24032 17,7

137,3 x 63,5 x 17,7

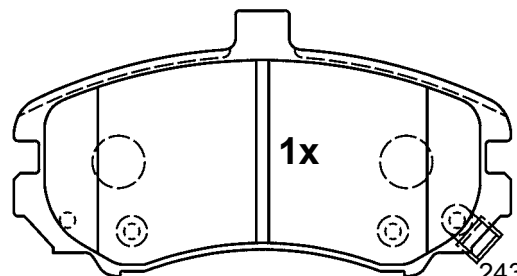

24373 17,2

131,2 x 70,1 x 17,2

# Abbildungen Scheibenbremsbeläge

Illustrations disc brake pads - Illustrazioni pastiglie freno -

Illustrations plaquettes de frein - Ilustraciones pastillas de freno

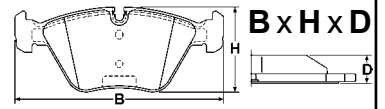

Maßstab - scale - scala - échelle - escala 1:2

**13.0460-5877.2 605877**

MAZDA

SUM

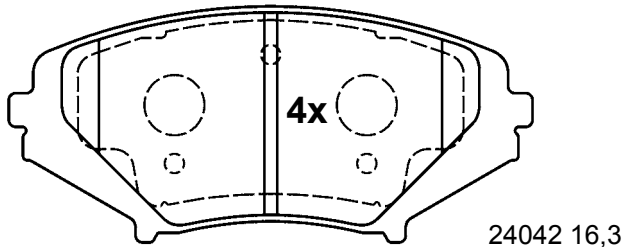

137,9 x 62,1 x 16,3

**13.0460-5879.2 605879**

NISSAN

AKE

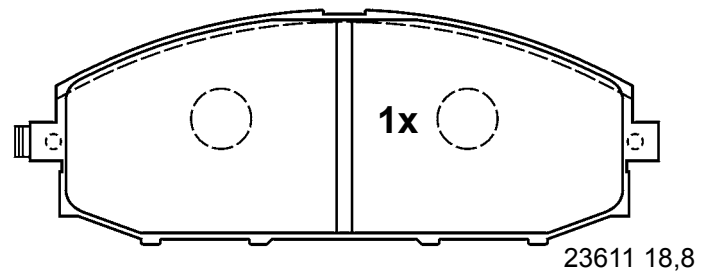
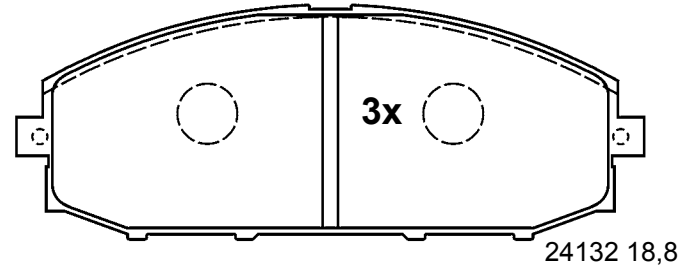

165,8 x 61,4 x 18,8

**13.0460-5878.2 605878**

HONDA

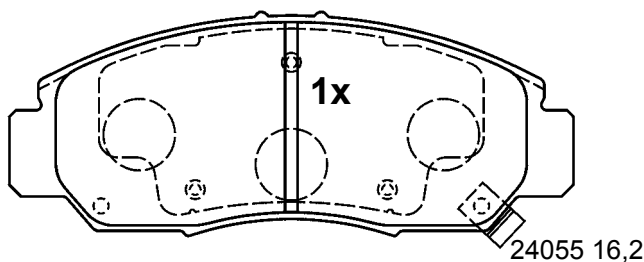
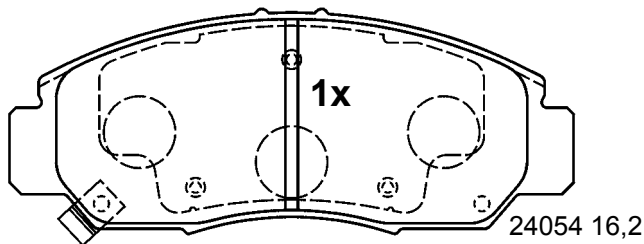
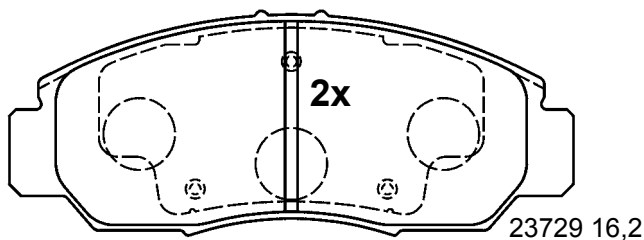

148,7 x 59,0 x 16,2

**13.0460-5880.2 605880**

NISSAN

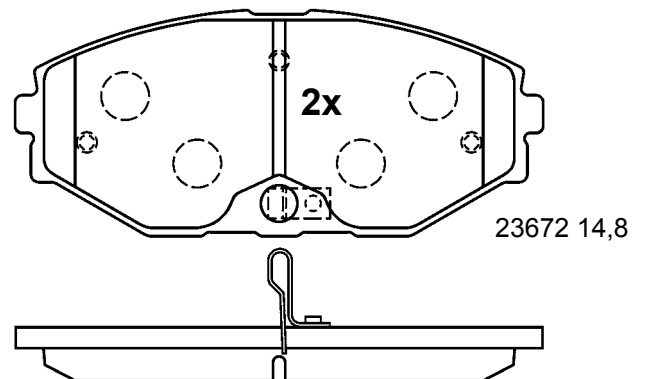
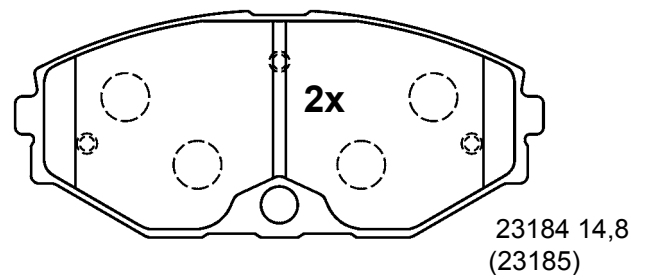

139,1 x 59,5 x 14,8

# Abbildungen Scheibenbremsbeläge

Illustrations disc brake pads - Illustrazioni pastiglie freno -

Illustrations plaquettes de frein - Ilustraciones pastillas de freno

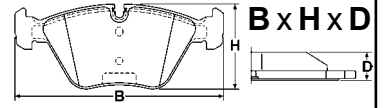

Maßstab - scale - scala - échelle - escala 1:2

## 13.0460-5881.2 605881

NISSAN

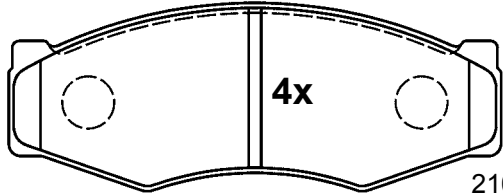

21099 17,0

130,0 x 49,5 x 17,0

## 13.0460-5885.2 605885

HYUNDAI, MITSUBISHI

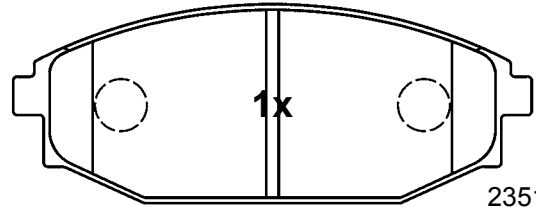

23518 17,0

## 13.0460-5882.2 605882

LEXUS

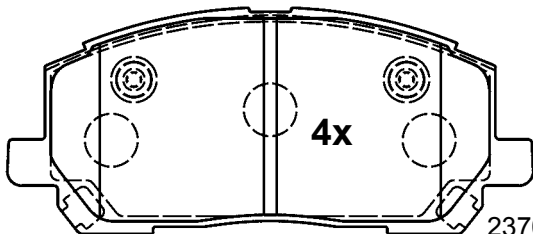

23703 17,9

138,7 x 59,6 x 17,9



2x

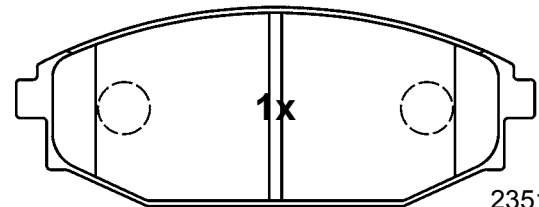

23518 17,0

## 13.0460-5884.2 605884

MAZDA



SUM

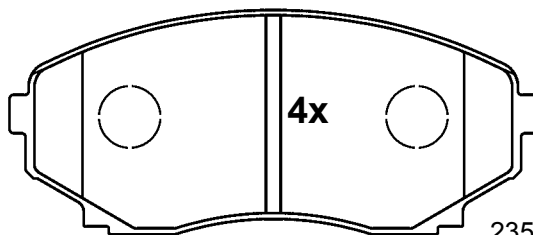

23515 15,8

139,2 x 60,2 x 15,8

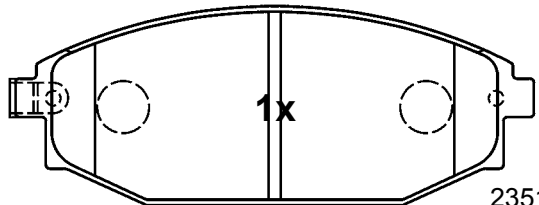

23519 17,0

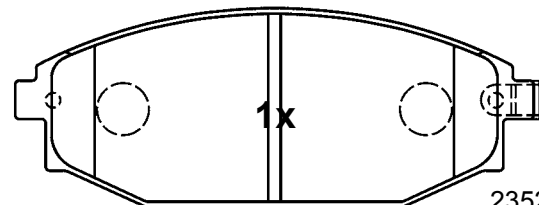

23520 17,0

137,1 x 52,4 x 17,0

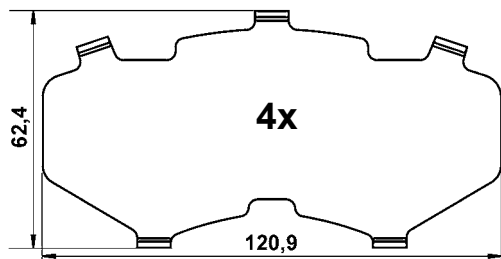

4x

62,4

120,9

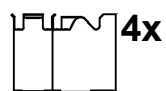

4x



2x



4x

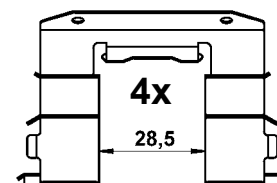

4x

28,5

# Abbildungen Scheibenbremsbeläge

Illustrations disc brake pads - Illustrazioni pastiglie freno -

Illustrations plaquettes de frein - Ilustraciones pastillas de freno

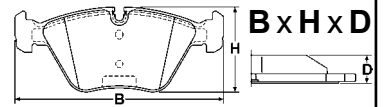

Maßstab - scale - scala - échelle - escala 1:2

## 13.0460-5886.2 605886

HYUNDAI

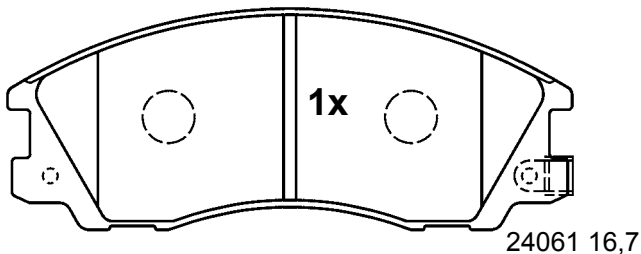
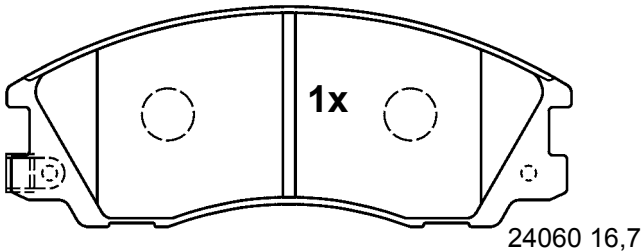
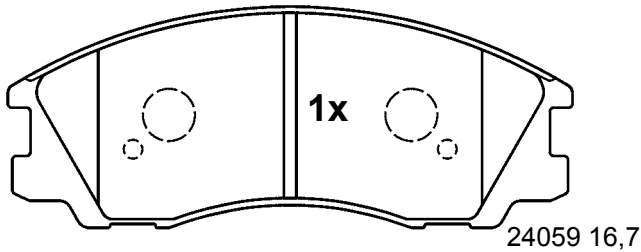
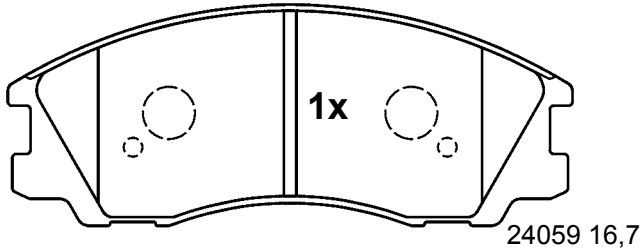

148,8 x 58,0 x 16,7

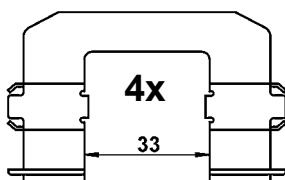

## 13.0460-5887.2 605887

DAIHATSU, NISSAN, SUBARU, SUZUKI

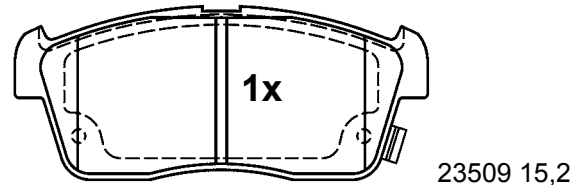
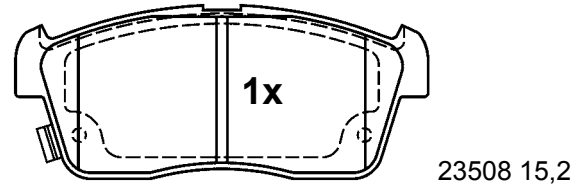
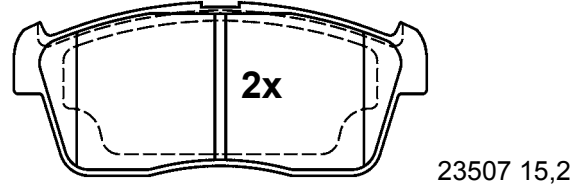

108,4 x 45,6 x 15,2

## 13.0460-5888.2 605888

SUZUKI

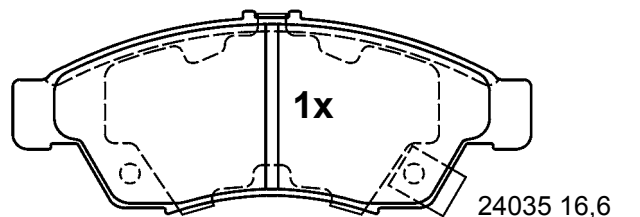
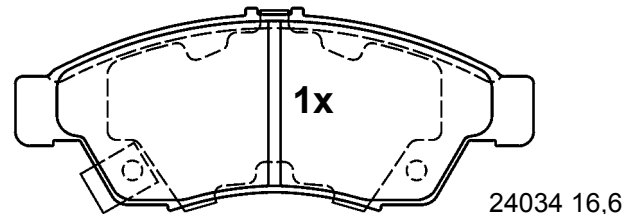
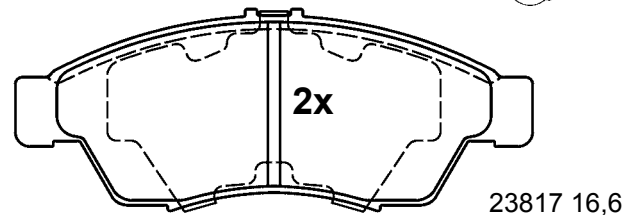

136,5 x 53,3 x 16,6



# Abbildungen Scheibenbremsbeläge

Illustrations disc brake pads - Illustrazioni pastiglie freno -

Illustrations plaquettes de frein - Ilustraciones pastillas de freno

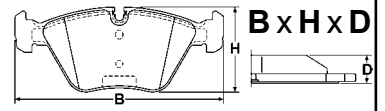

Maßstab - scale - scala - échelle - escala 1:2

**13.0460-5889.2 605889**

MITSUBISHI

SUM

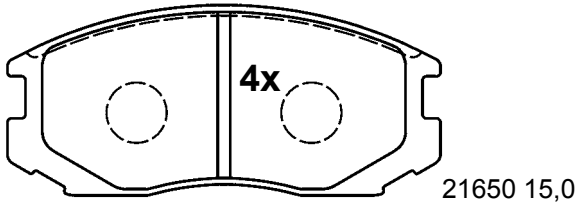

114,1 x 50,0 x 15,0

2x

**13.0460-5891.2 605891**

TOYOTA

AKE

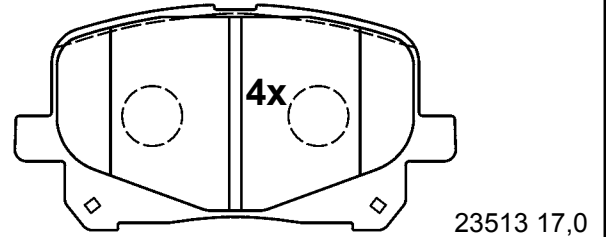

116,6 x 59,4 x 17,0

**13.0460-5890.2 605890**

MITSUBISHI

AKE

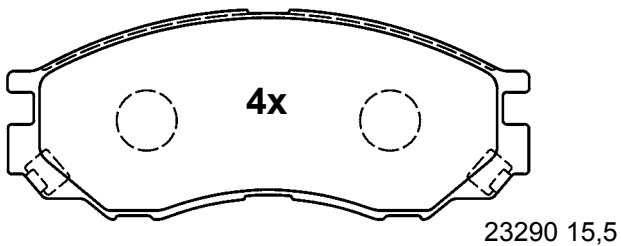

137,6 x 55,1 x 15,5

2x

**13.0460-5892.2 605892**

TOYOTA

AKE

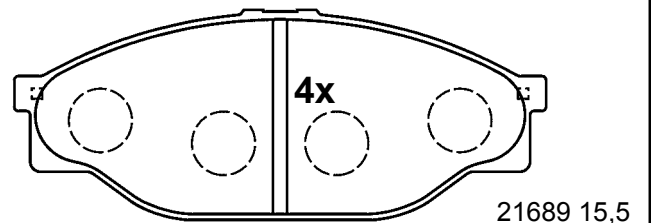

140,1 x 54,9 x 15,5

# Abbildungen Scheibenbremsbeläge

Illustrations disc brake pads - Illustrazioni pastiglie freno -

Illustrations plaquettes de frein - Ilustraciones pastillas de freno

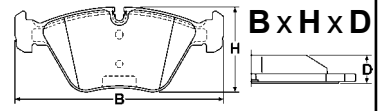

Maßstab - scale - scala - échelle - escala 1:2

**13.0460-5894.2 605894**

 TOYOTA

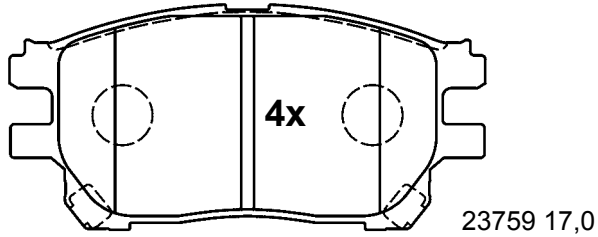

125,6 x 59,5 x 17,0

**13.0460-5896.2 605896**

 KIA

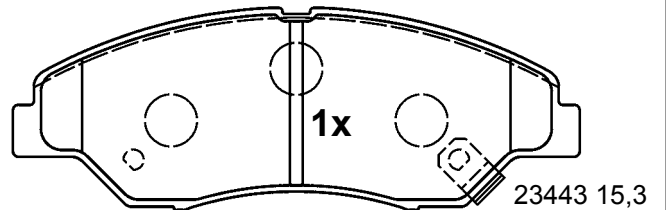
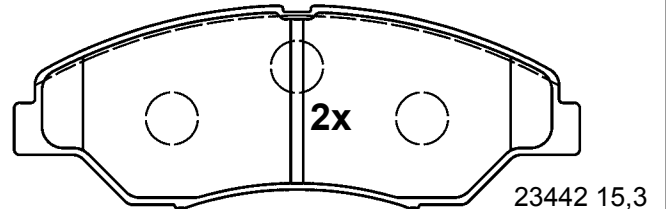

**13.0460-5895.2 605895**

 SUBARU

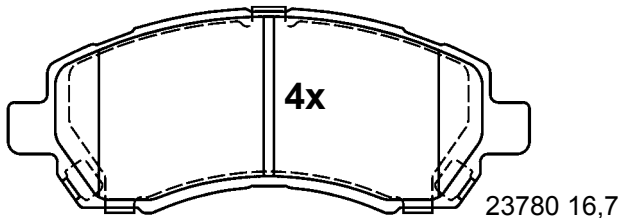

137,8 x 53,8 x 16,7

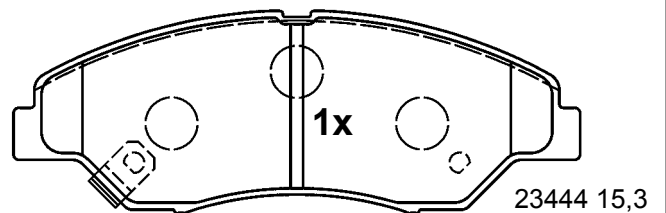

149,0 x 52,9 x 15,3

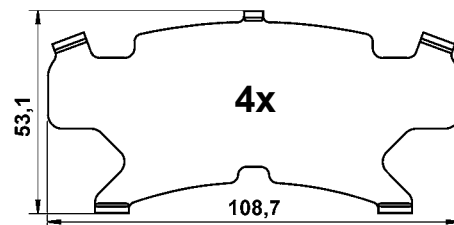
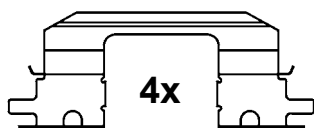

# Abbildungen Scheibenbremsbeläge

Illustrations disc brake pads - Illustrazioni pastiglie freno -

Illustrations plaquettes de frein - Ilustraciones pastillas de freno

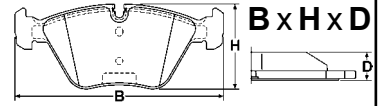

Maßstab - scale - scala - échelle - escala 1:2

**13.0460-5897.2 605897**



KIA

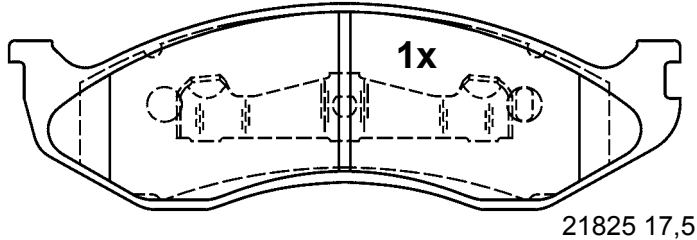

21825 17,5

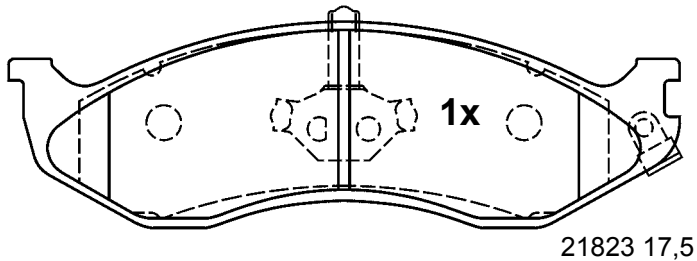

21823 17,5

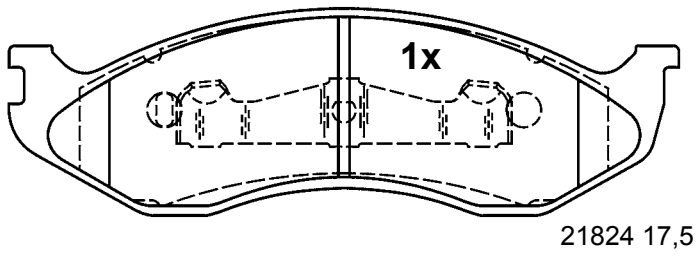

21824 17,5

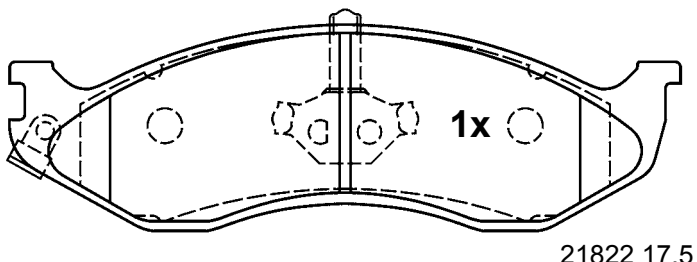

21822 17,5

**177,0 x 54,3 x 17,5**

**13.0460-5898.2 605898**



DAIHATSU

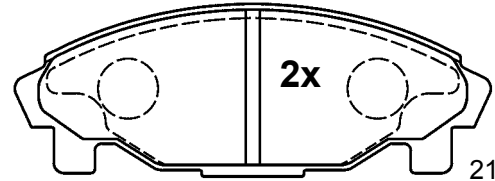

21952 15,0

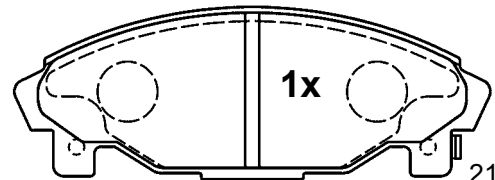

21953 15,0

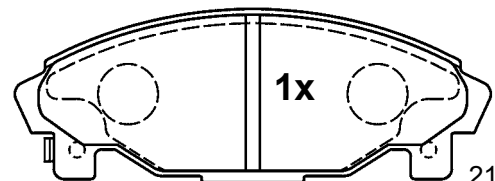

21954 15,0

**125,5 x 45,2 x 15,0**

**13.0460-5899.2 605899**



CHEVROLET, DAEWOO



AKE

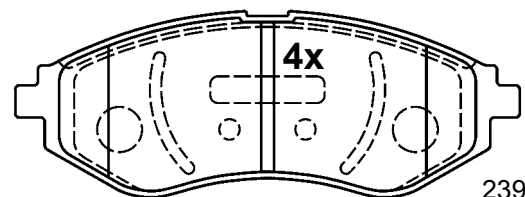

23974 17,6

**133,1 x 48,9 x 17,6**



# Abbildungen Scheibenbremsbeläge

Illustrations disc brake pads - Illustrazioni pastiglie freno -

Illustrations plaquettes de frein - Ilustraciones pastillas de freno



Maßstab - scale - scala - échelle - escala 1:2

**13.0460-5916.2 605916**

HONDA, SUZUKI

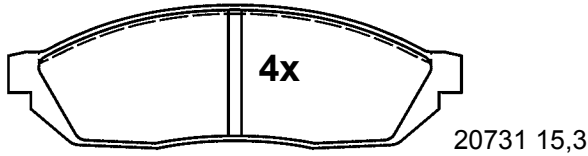

119,4 x 38,2 x 15,3

**13.0460-5919.2 605919**

HONDA

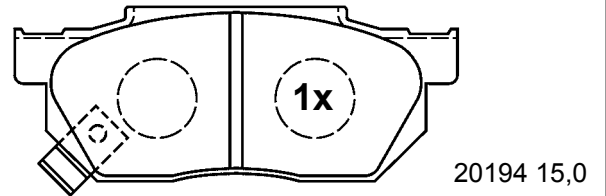
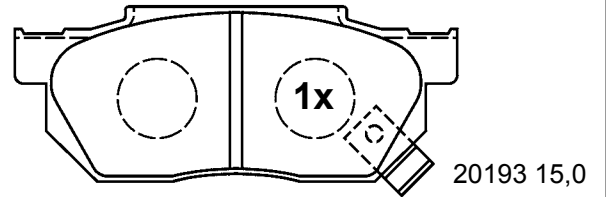
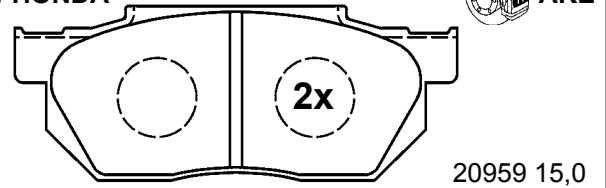

115,8 x 45,0 x 15,0

**13.0460-5918.2 605918**

HONDA

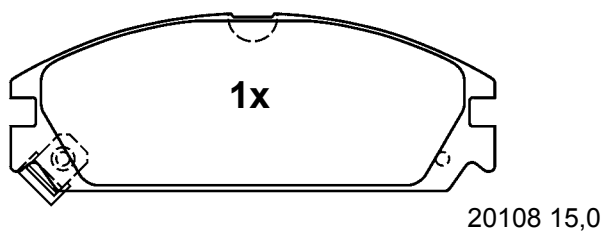
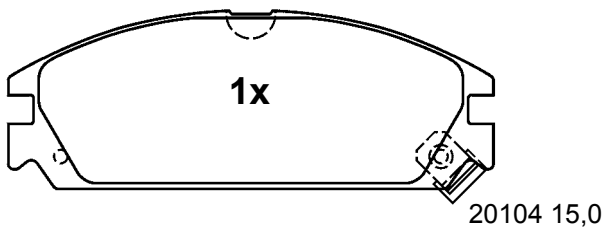
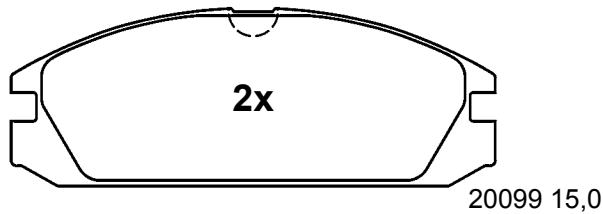

127,7 x 48,7 x 15,0

**13.0460-5920.2 605920**

HONDA

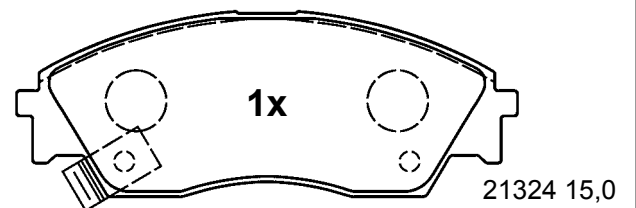
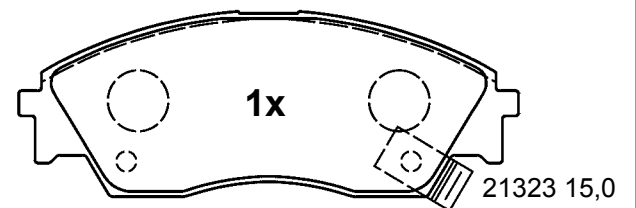
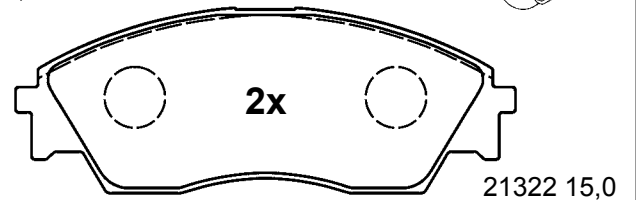

132,2 x 50,0 x 15,0

# Abbildungen Scheibenbremsbeläge

Illustrations disc brake pads - Illustrazioni pastiglie freno -

Illustrations plaquettes de frein - Ilustraciones pastillas de freno

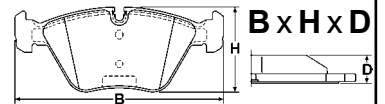

Maßstab - scale - scala - échelle - escala 1:2

**13.0460-5923.2 605923**



KIA



AKE

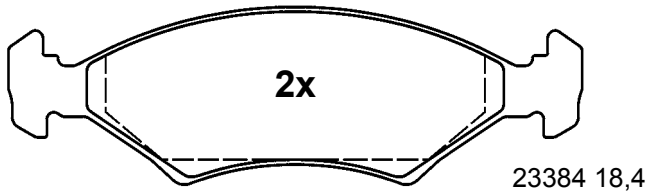

23384 18,4

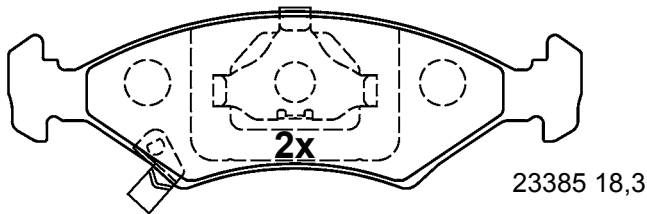

23385 18,3

151,3 x 46,4 x 18,3

**13.0460-5926.2 605926**



ISUZU, OPEL, VAUXHALLI



AKE

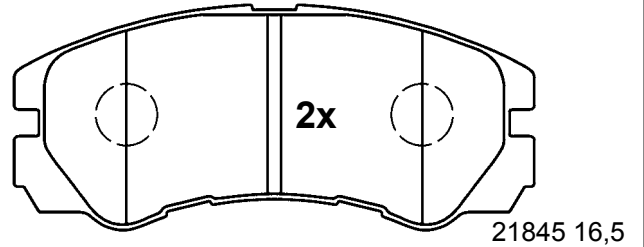

21845 16,5

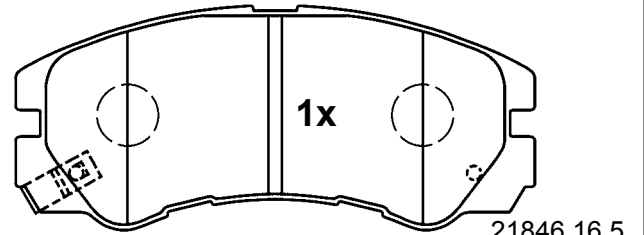

21846 16,5

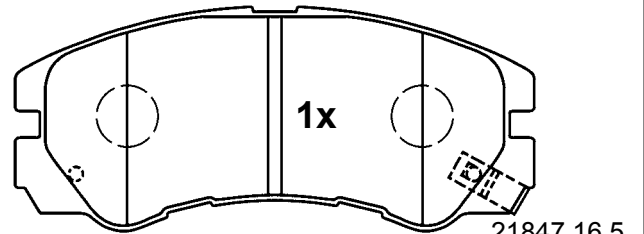

21847 16,5

137,7 x 58,6 x 16,5

**13.0460-5924.2 605924**



KIA



ATE

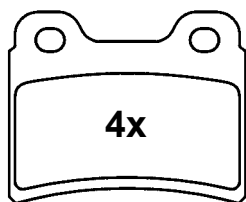

21832 14,9

61,7 x 51,1 x 14,9

**13.0460-5927.2 605927**



ISUZU, OPEL, VAUXHALL



AKE

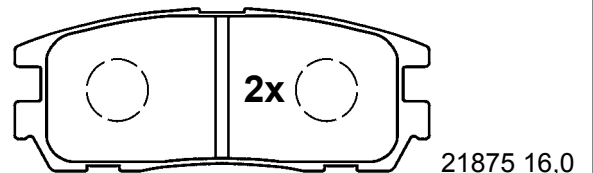

21875 16,0

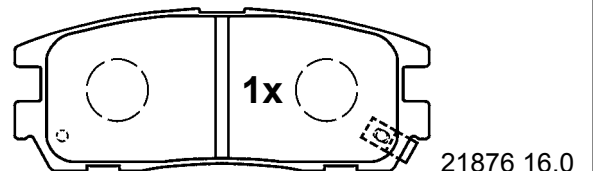

21876 16,0

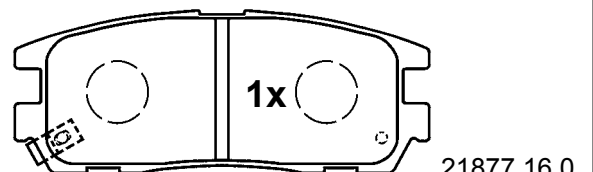

21877 16,0

109,6 x 42,8 x 16,0

# Abbildungen Scheibenbremsbeläge

Illustrations disc brake pads - Illustrazioni pastiglie freno -

Illustrations plaquettes de frein - Ilustraciones pastillas de freno

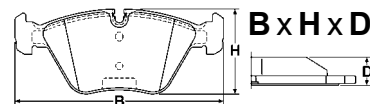

Maßstab - scale - scala - échelle - escala 1:2

## 13.0460-5929.2 605929



HONDA, MG, ROVER, SUZUKI



AKE

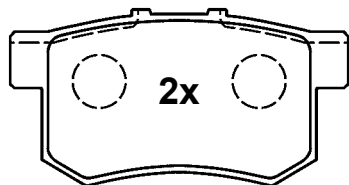

21719 15,0

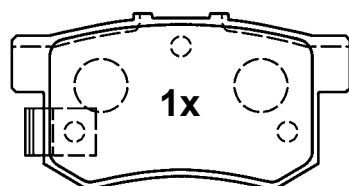

21720 15,0

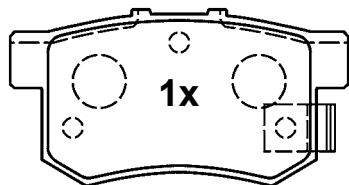

21721 15,0

88,9 x 47,1 x 15,0

## 13.0460-5933.2 605933



HYUNDAI, KIA, NISSAN



AKE

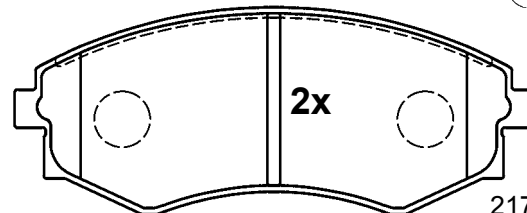

21725 16,8

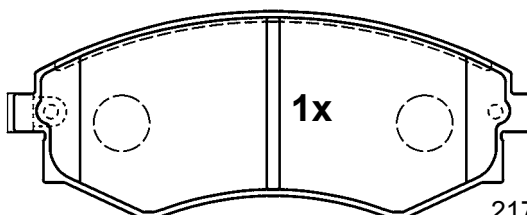

21726 16,8

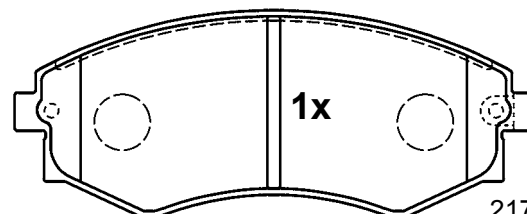

21727 16,8

137,0 x 54,5 x 16,8

## 13.0460-5932.2 605932



FORD, MAZDA



AKE

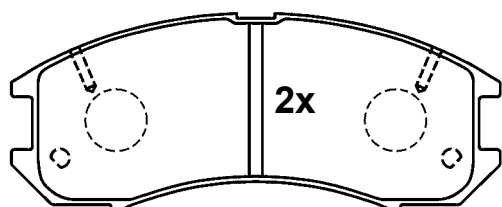

21378 15,0

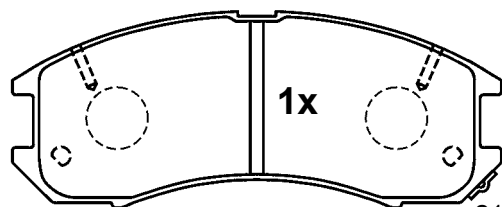

21379 16,0

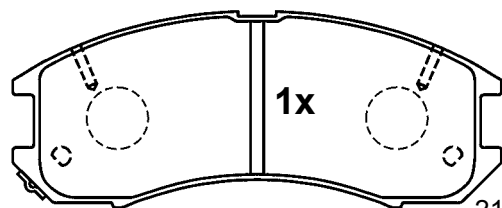

21380 16,0

130,0 x 52,5 x 16,0

## 13.0460-5934.2 605934



MAZDA



AKE

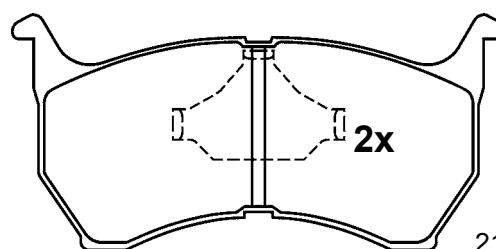

21041 15,0

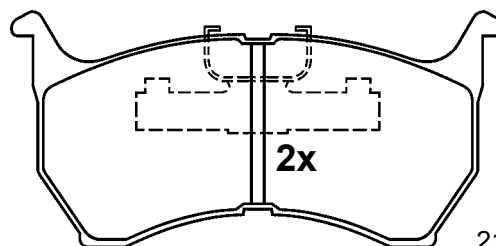

21168 15,0

130,0 x 61,2 x 15,0



# Abbildungen Scheibenbremsbeläge

Illustrations disc brake pads - Illustrazioni pastiglie freno -

Illustrations plaquettes de frein - Ilustraciones pastillas de freno



Maßstab - scale - scala - échelle - escala 1:2

**13.0460-5935.2 605935**

TOYOTA

SUM

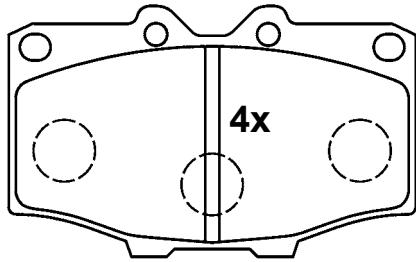

20852 15,5

107,1 x 65,7 x 15,5

**13.0460-5938.2 605938**

TOYOTA, VOLKSWAGEN

AKE

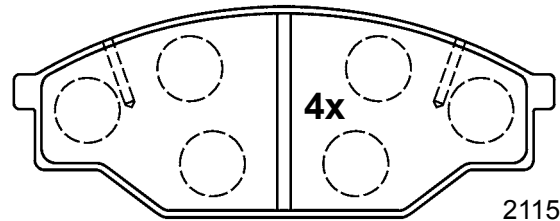

21158 15,5

**13.0460-5936.2 605936**

HONDA, HYUNDAI

AKE

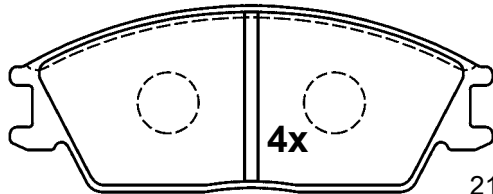

21012 15,0

127,5 x 49,0 x 15,0

142,7 x 55,5 x 15,5

**13.0460-5937.2 605937**

NISSAN

AKE

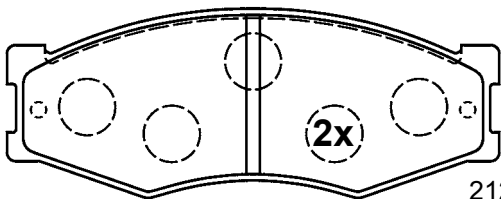

21229 17,0

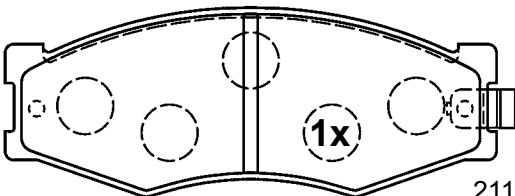

21119 17,0

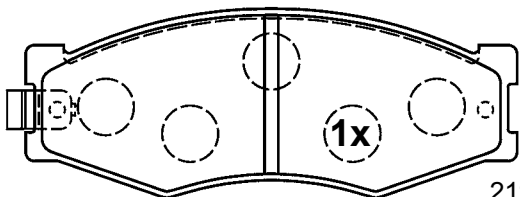

21130 17,0

130,2 x 49,7 x 17,0

**13.0460-5940.2 605940**

MITSUBISHI

SUM

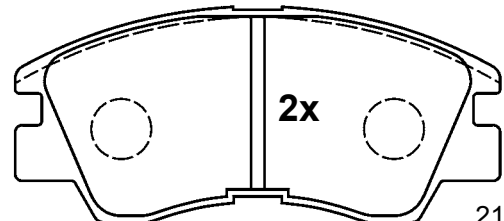

21375 16,0

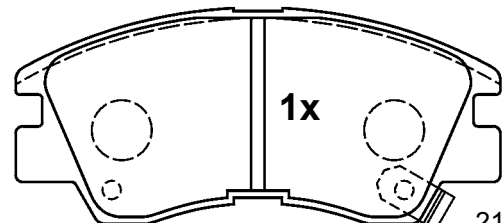

21373 16,0

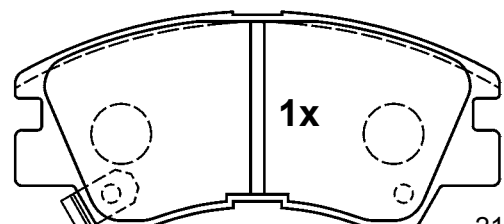

21374 16,0

127,9 x 57,1 x 16,0



# Abbildungen Scheibenbremsbeläge

Illustrations disc brake pads - Illustrazioni pastiglie freno -

Illustrations plaquettes de frein - Ilustraciones pastillas de freno

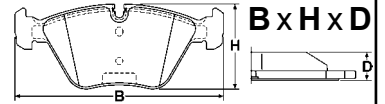

Maßstab - scale - scala - échelle - escala 1:2

## 13.0460-5941.2 605941

NISSAN

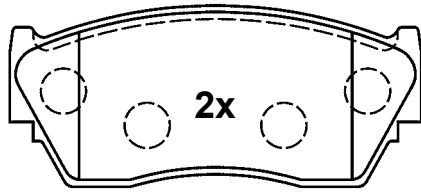

21657 16,4

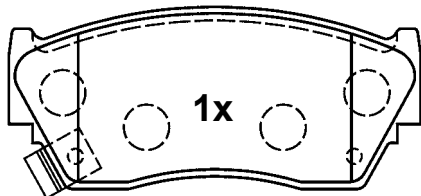

21658 16,4

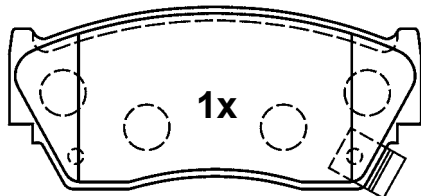

21659 16,4

108,3 x 47,9 x 16,4

## 13.0460-5943.2 605943

HONDA

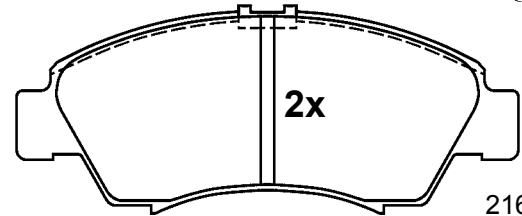

21697 15,0

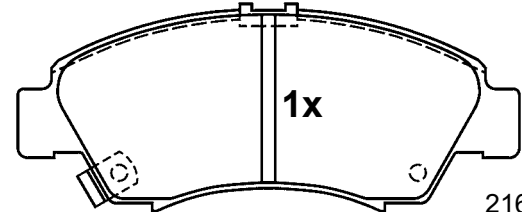

21698 15,0

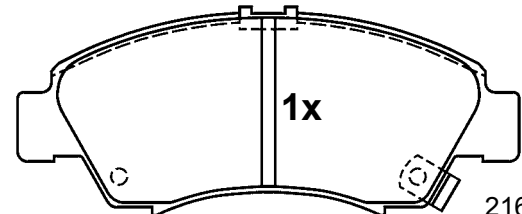

21699 15,0

131,3 x 54,6 x 15,0

## 13.0460-5942.2 605942

ISUZU, OPEL, VAUXHALL

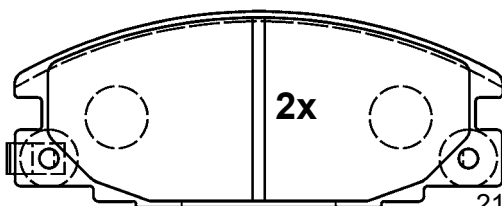

21543 16,5

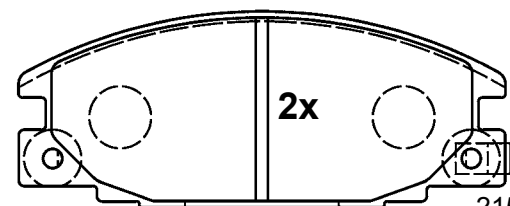

21544 16,5

127,1 x 50,9 x 16,5

## 13.0460-5944.2 605944

KIA, MAZDA

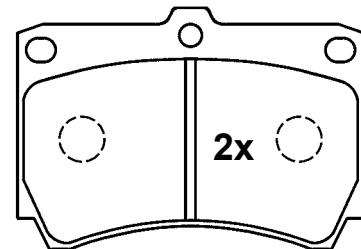

21654 15,0

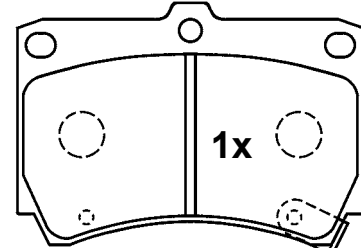

21655 15,0

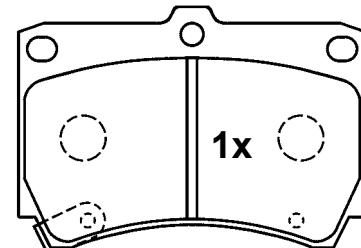

21656 15,0

91,6 x 64,2 x 15,0

# Abbildungen Scheibenbremsbeläge

Illustrations disc brake pads - Illustrazioni pastiglie freno -

Illustrations plaquettes de frein - Ilustraciones pastillas de freno



Maßstab - scale - scala - échelle - escala 1:2

**13.0460-5949.2 605949**

NISSAN

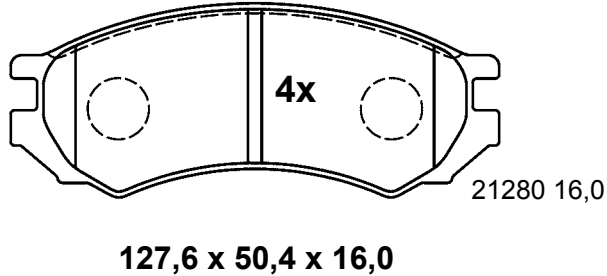

**13.0460-5952.2 605952**

MITSUBISHI, PROTON

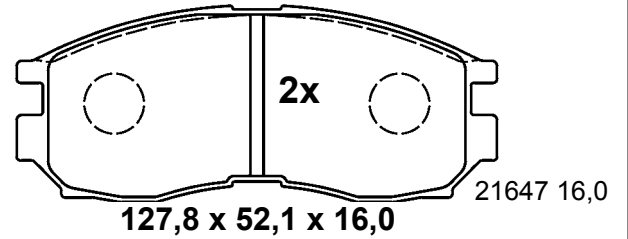

**13.0460-5950.2 605950**

NISSAN

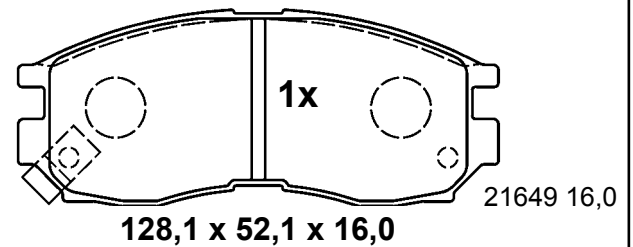
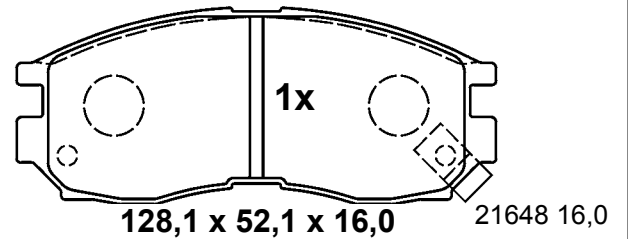
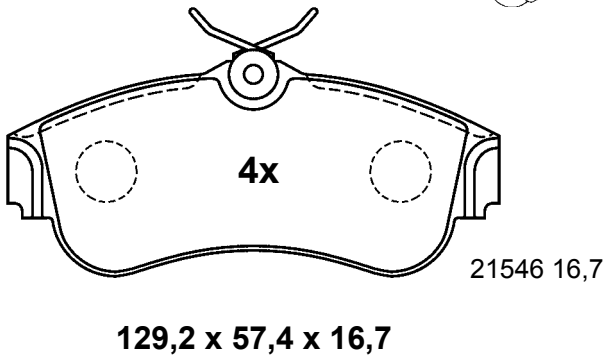

**13.0460-5951.2 605951**

TOYOTA

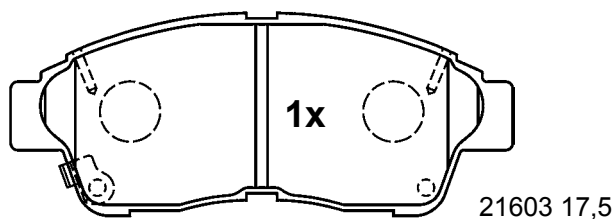
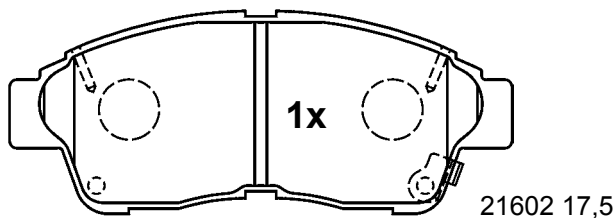
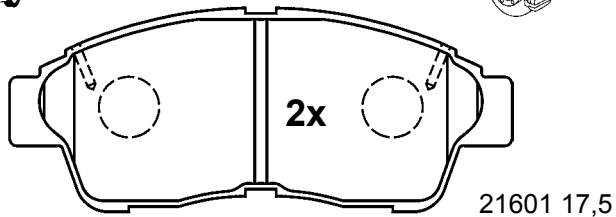

132,9 x 53,0 x 17,5

**13.0460-5953.2 605953**

MITSUBISHI, PROTON

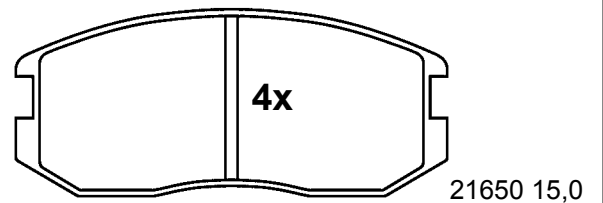

114,1 x 50,0 x 15,0



# Abbildungen Scheibenbremsbeläge

Illustrations disc brake pads - Illustrazioni pastiglie freno -

Illustrations plaquettes de frein - Ilustraciones pastillas de freno

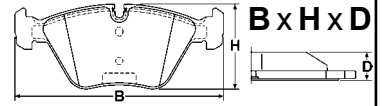

Maßstab - scale - scala - échelle - escala 1:2

**13.0460-5954.2 605954**



FORD, MAZDA



SUM

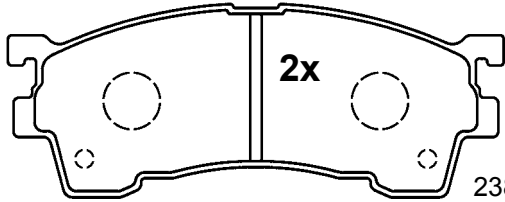

23845 15,8

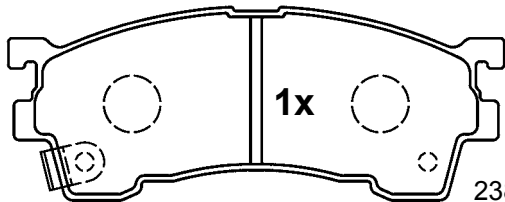

23846 15,8

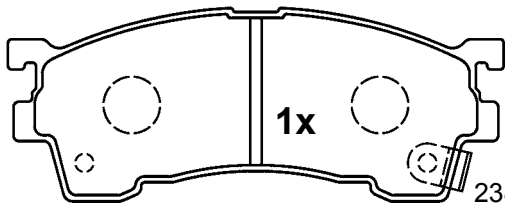

23847 15,8

**132,1 x 51,6 x 15,8**

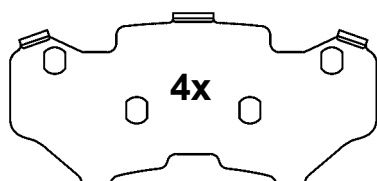

**96,5 x 47,3 x 0,6**

**13.0460-5955.2 605955**



HONDA, ROVER



AKE

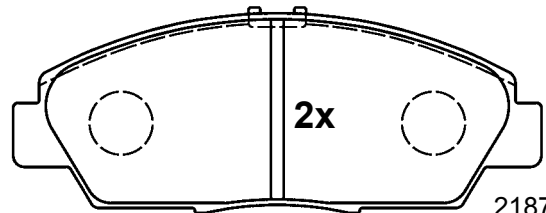

21879 18,6

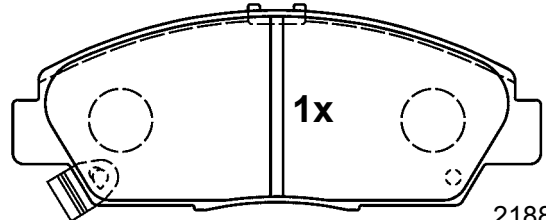

21880 18,6

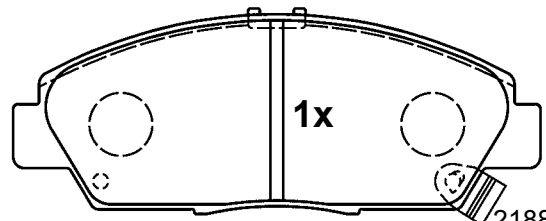

21881 18,6

**137,8 x 53,8 x 18,6**

# Abbildungen Scheibenbremsbeläge

Illustrations disc brake pads - Illustrazioni pastiglie freno -

Illustrations plaquettes de frein - Ilustraciones pastillas de freno



Maßstab - scale - scala - échelle - escala 1:2

## 13.0460-5956.2 605956

NISSAN

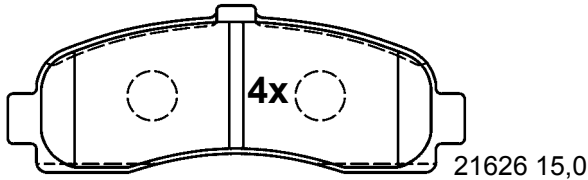

120,8 x 45,0 x 15,0

## 13.0460-5958.2 605958

CITROEN, MITSUBISHI, PEUGEOT

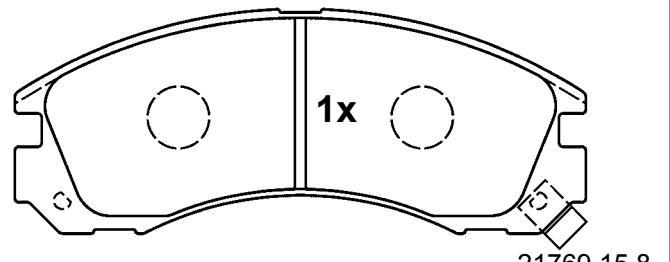
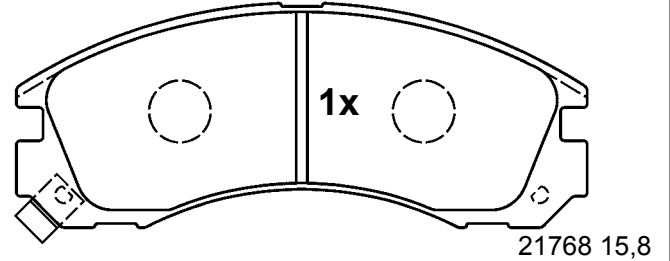
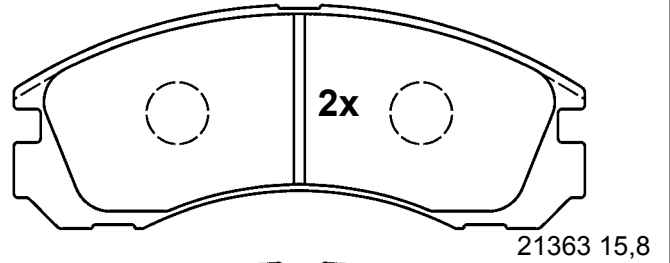

149,9 x 58,8 x 15,8

## 13.0460-5957.2 605957

NISSAN

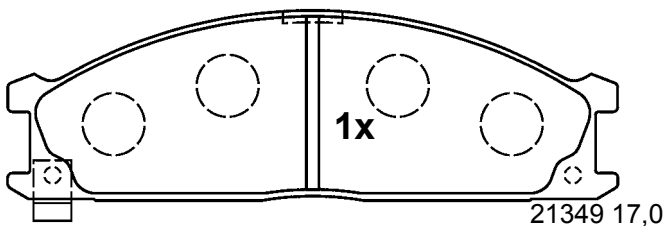
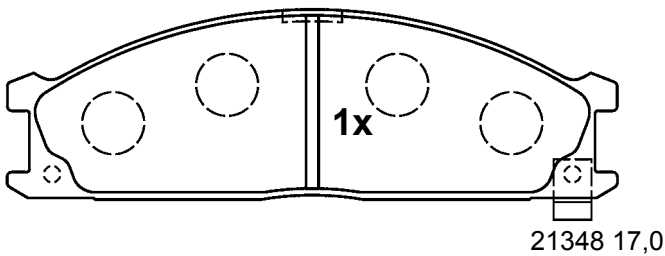
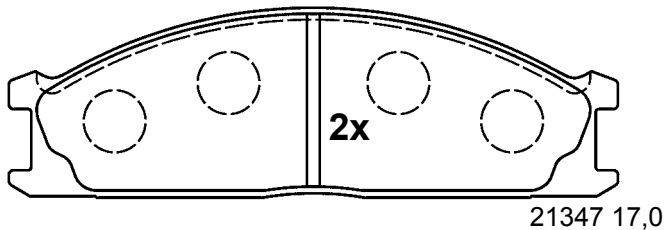

160,6 x 49,3 x 17,0

## 13.0460-5959.2 605959

FORD, NISSAN

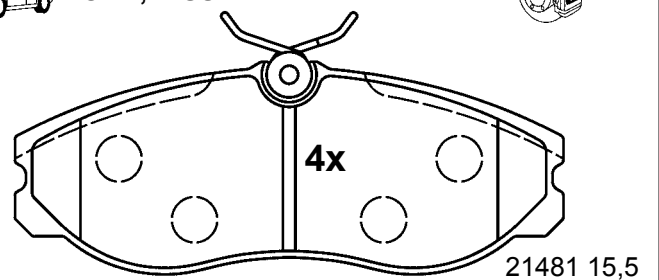

144,9 x 55,6 x 15,5

## 13.0460-5960.2 605960

NISSAN

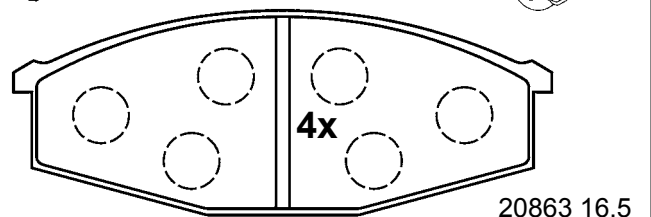

142,1 x 53,5 x 16,5



# Abbildungen Scheibenbremsbeläge

Illustrations disc brake pads - Illustrazioni pastiglie freno -

Illustrations plaquettes de frein - Ilustraciones pastillas de freno

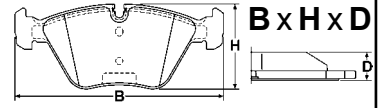

Maßstab - scale - scala - échelle - escala 1:2

**13.0460-5961.2 605961**

SUZUKI

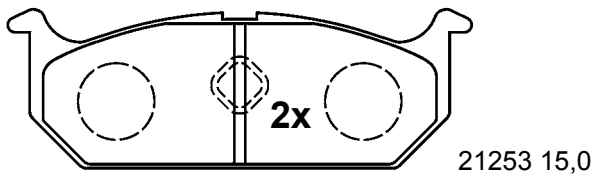
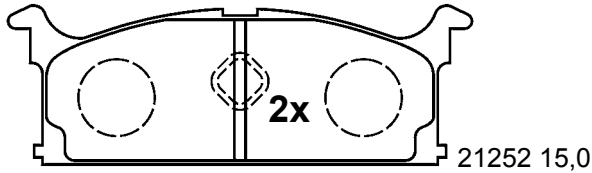

123,1 x 41,7 x 15,0

**13.0460-5966.2 605966**

SUZUKI

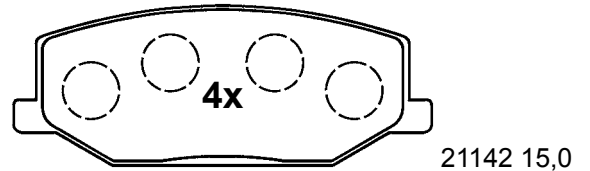

110,4 x 41,6 x 15,0

**13.0460-5962.2 605962**

NISSAN

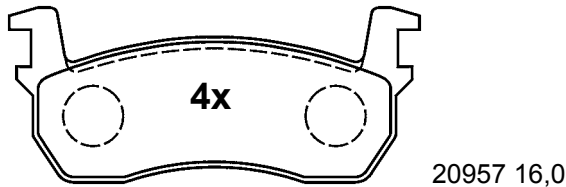

108,1 x 45,3 x 16,0

**13.0460-5967.2 605967**

SUZUKI

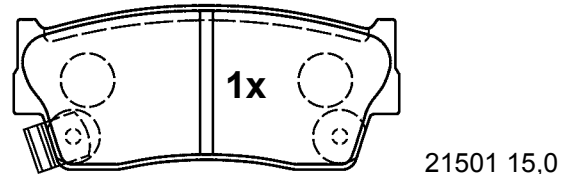
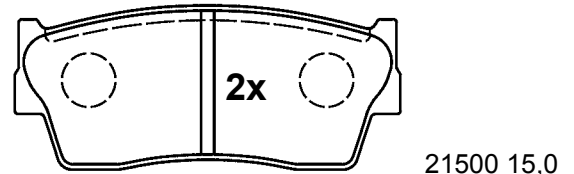

**13.0460-5963.2 605963**

NISSAN, SUBARU

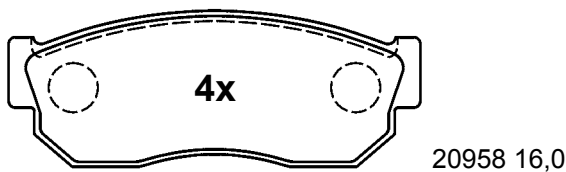

108,7 x 40,5 x 16,0

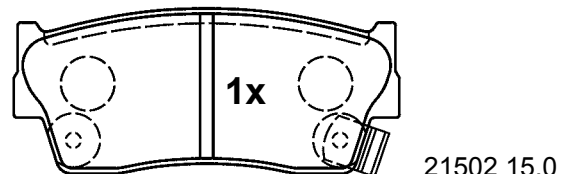

103,4 x 43,7 x 15,0



# Abbildungen Scheibenbremsbeläge

Illustrations disc brake pads - Illustrazioni pastiglie freno -

Illustrations plaquettes de frein - Ilustraciones pastillas de freno

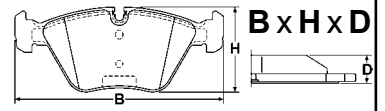

Maßstab - scale - scala - échelle - escala 1:2

**13.0460-5968.2 605968**

TOYOTA

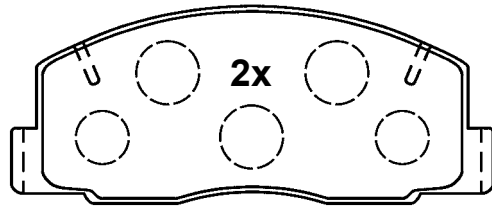

128,3 x 52,1 x 15,5

21369 15,5

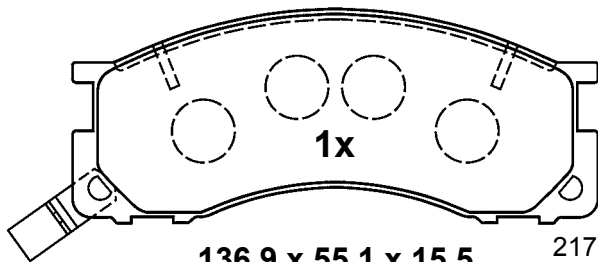

136,9 x 55,1 x 15,5

21780 15,5

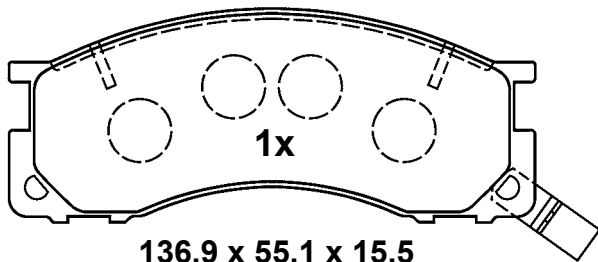

136,9 x 55,1 x 15,5

21781 15,5

**13.0460-5969.2 605969**

TOYOTA



SUM

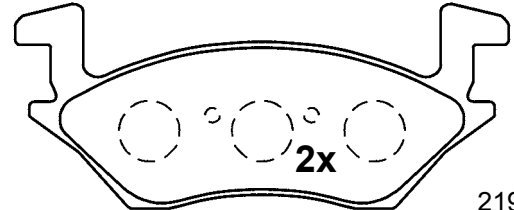

131,9 x 54,3 x 13,5

21948 13,5

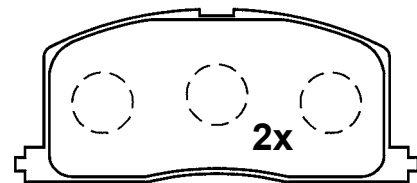

106,1 x 45,7 x 13,5

21949 13,5

**13.0460-5970.2 605970**

KIA, MAZDA



SUM

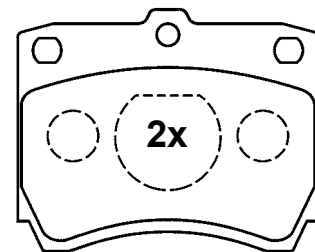

21357 13,5

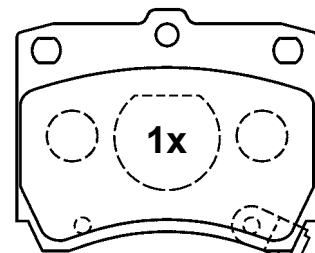

21355 13,5

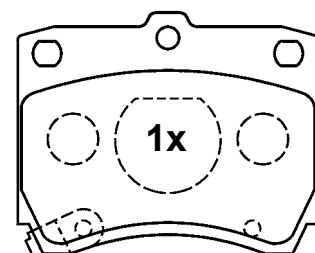

21356 13,5

78,7 x 63,4 x 13,5

# Abbildungen Scheibenbremsbeläge

Illustrations disc brake pads - Illustrazioni pastiglie freno -

Illustrations plaquettes de frein - Ilustraciones pastillas de freno

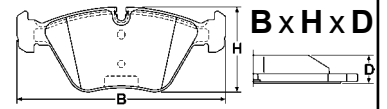

Maßstab - scale - scala - échelle - escala 1:2

**13.0460-5972.2 605972**



DAIHATSU, MAZDA, SUZUKI

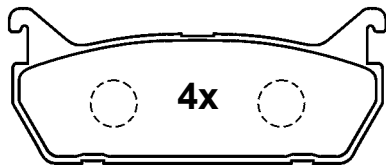

21559 11,5

102,3 x 39,3 x 11,5

**13.0460-5974.2 605974**



MAZDA



SUM

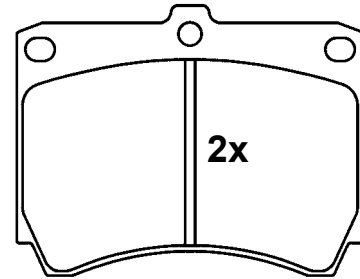

21539 15,0

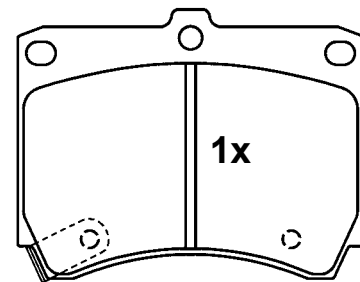

21540 15,0

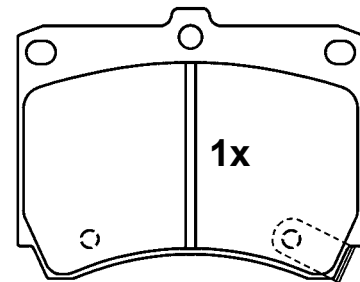

21541 15,0

91,6 x 70,5 x 15,0

**13.0460-5973.2 605973**



FORD, MAZDA

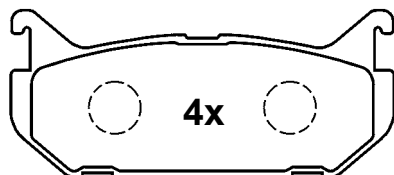

21766 13,5

99,9 x 43,6 x 13,5

**13.0460-5976.2 605976**



TOYOTA



AKE

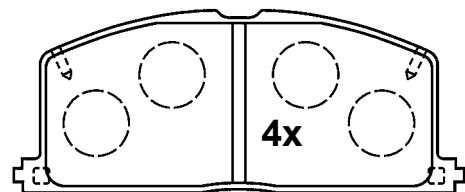

20870 15,0

119,8 x 47,6 x 15,0

# Abbildungen Scheibenbremsbeläge

Illustrations disc brake pads - Illustrazioni pastiglie freno -

Illustrations plaquettes de frein - Ilustraciones pastillas de freno

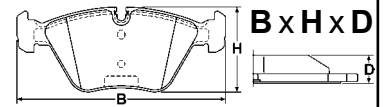

Maßstab - scale - scala - échelle - escala 1:2

## 13.0460-5978.2 605978

SUBARU

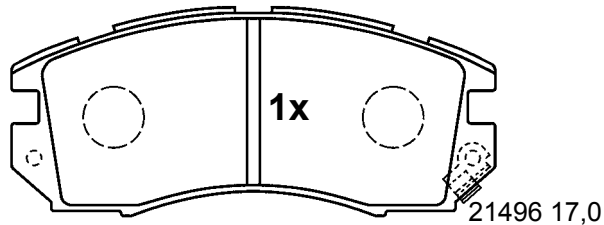
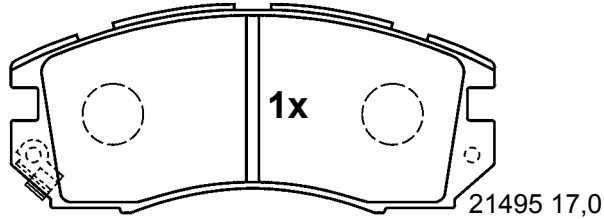
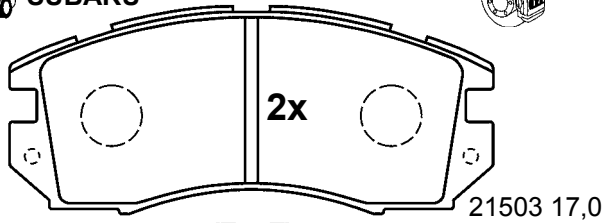

127,7 x 54,4 x 17,0

## 13.0460-5981.2 605981

MITSUBISHI

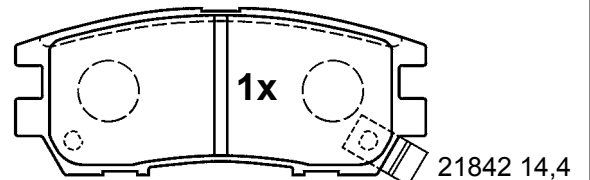
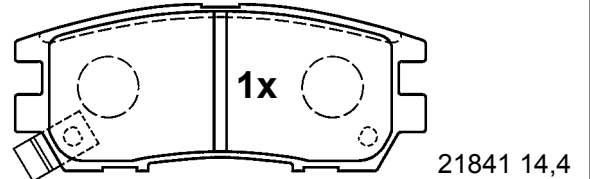
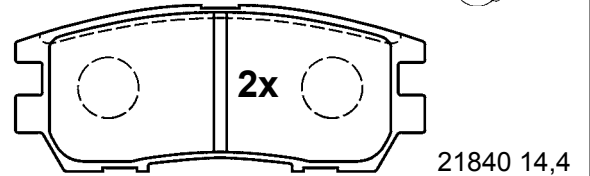

107,8 x 43,8 x 14,4

## 13.0460-5979.2 605979

MAZDA

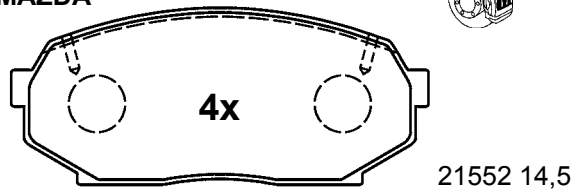

110,1 x 46,1 x 14,5

## 13.0460-5982.2 605982

HONDA

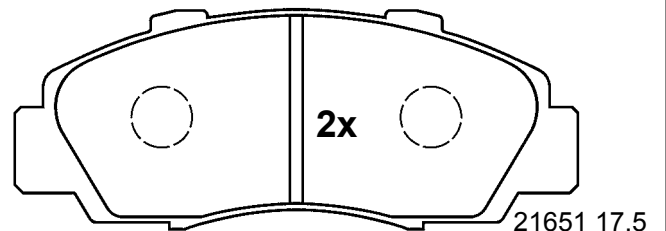

## 13.0460-5980.2 605980

CHRYSLER, MITSUBISHI

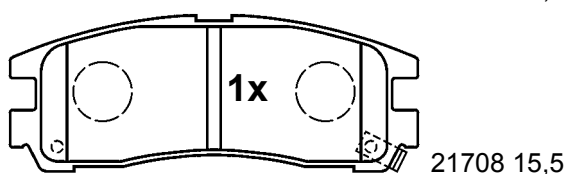
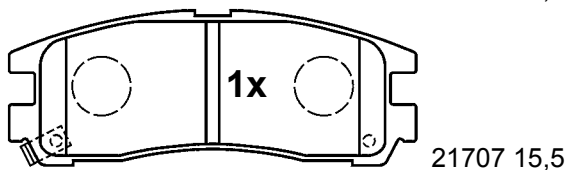
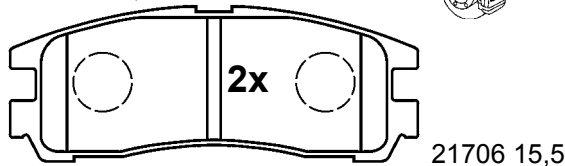

107,7 x 41,3 x 15,5

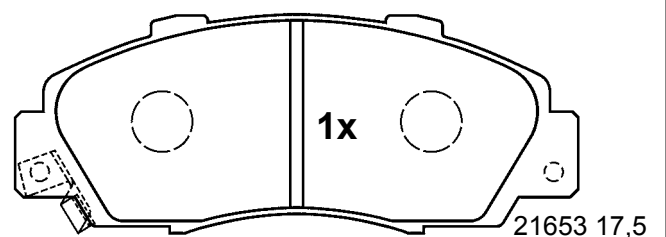
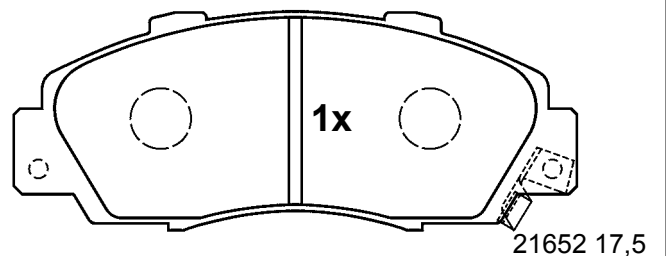

148,7 x 57,8 x 17,5

# Abbildungen Scheibenbremsbeläge

Illustrations disc brake pads - Illustrazioni pastiglie freno -

Illustrations plaquettes de frein - Ilustraciones pastillas de freno

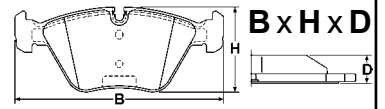

Maßstab - scale - scala - échelle - escala 1:2

**13.0460-5983.2 605983**

NISSAN

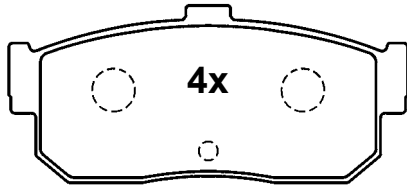

21713 16,5

105,3 x 47,0 x 16,5

**13.0460-5987.2 605987**

MITSUBISHI

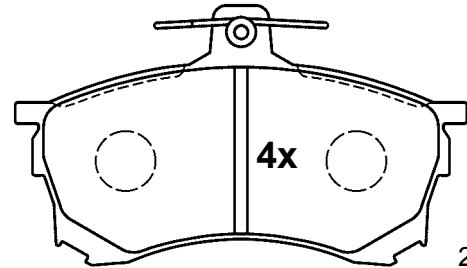

23080 15,0

119,3 x 68,6 x 15,0

**13.0460-5985.2 605985**

SUBARU, SUZUKI

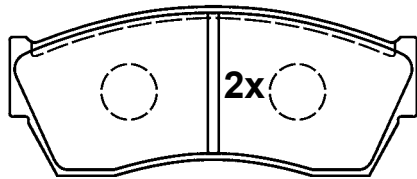

21333 15,0

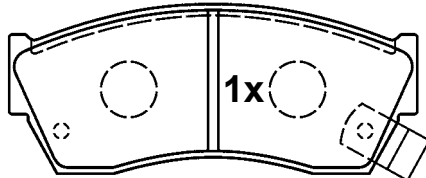

21334 15,0

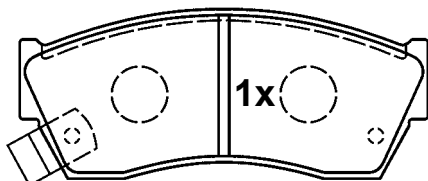

21335 15,0

107,5 x 44,6 x 15,0

**13.0460-5988.2 605988**

NISSAN

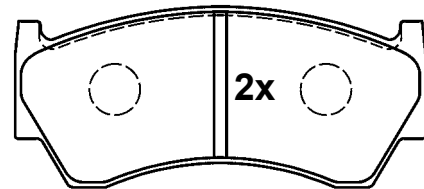

23004 15,9

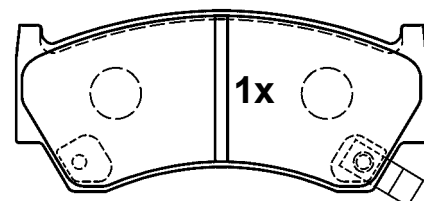

23005 15,9

**13.0460-5986.2 605986**

NISSAN

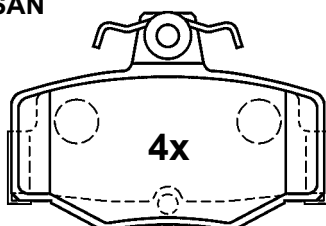

21545 14,9

82,2 x 57,0 x 14,9

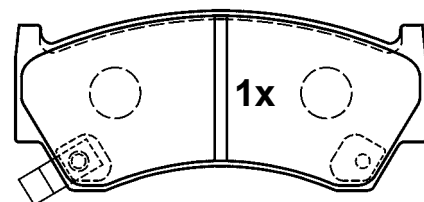

23006 15,9

108,6 x 47,9 x 15,9

# Abbildungen Scheibenbremsbeläge

Illustrations disc brake pads - Illustrazioni pastiglie freno -

Illustrations plaquettes de frein - Ilustraciones pastillas de freno

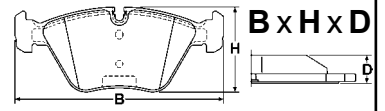

Maßstab - scale - scala - échelle - escala 1:2

**13.0460-5989.2 605989**



NISSAN



AKE

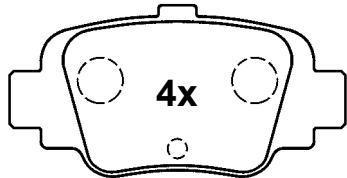

23454 14,9

88,7 x 45,4 x 14,9

**13.0460-5992.2 605992**



TOYOTA

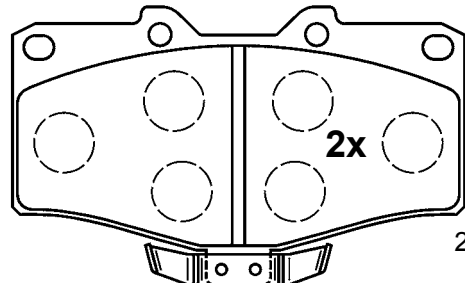

21681 15,0

119,3 x 73,5 x 15,0

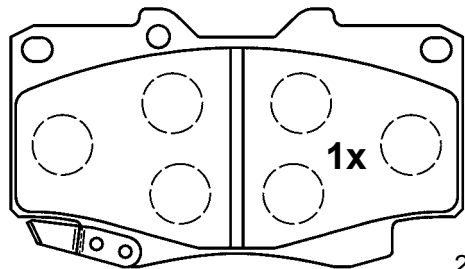

21679 15,0

119,3 x 68,1 x 15,0

**13.0460-5991.2 605991**



SUBARU



AKE

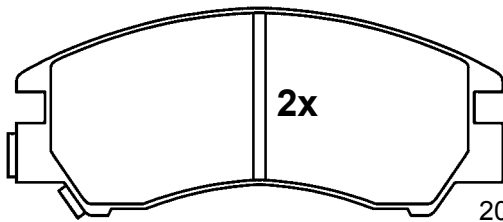

20112 18,0

127,2 x 55,0 x 18,0

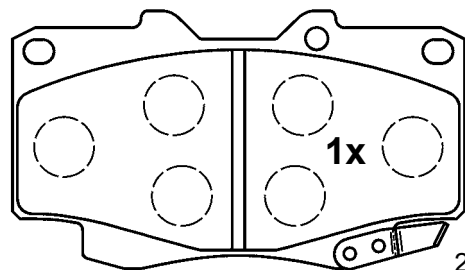

21680 15,0

119,3 x 68,1 x 15,0

**13.0460-5993.2 605993**



DAEWOO



TRW

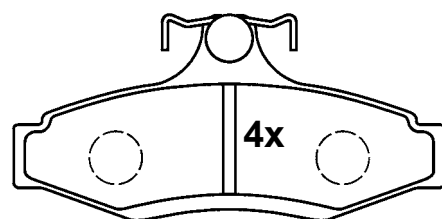

23237 14,5

114,0 x 55,1 x 14,5

# Abbildungen Scheibenbremsbeläge

Illustrations disc brake pads - Illustrazioni pastiglie freno -

Illustrations plaquettes de frein - Ilustraciones pastillas de freno

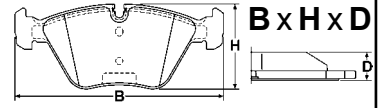

Maßstab - scale - scala - échelle - escala 1:2

## 13.0460-5994.2 605994

 DAEWOO

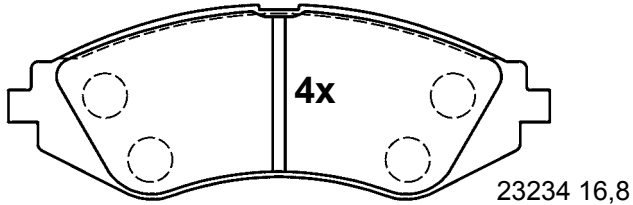

23234 16,8

143,0 x 51,4 x 16,8

## 13.0460-5998.2 605998

 HONDA, MG, ROVER

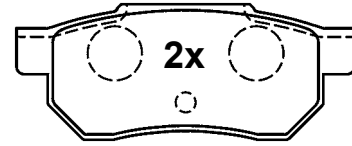

21312 12,8

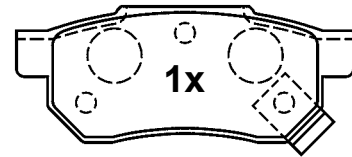

21313 12,8

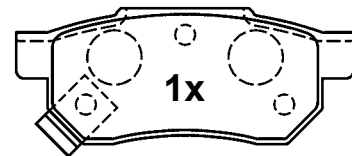

21314 12,8

89,0 x 35,2 x 12,8

## 13.0460-5995.2 605995

 FORD, MAZDA

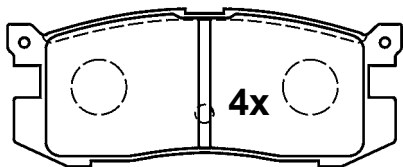

21558 13,0

104,2 x 41,6 x 13,0

## 13.0460-5999.2 605999

 ROVER

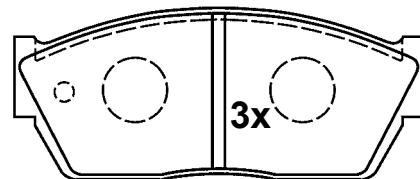

20895 15,0

## 13.0460-5996.2 605996

 CHEVROLET, DAEWOO

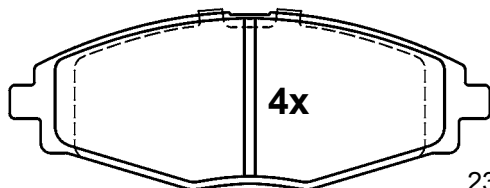

23241 16,1

127,1 x 48,2 x 16,1

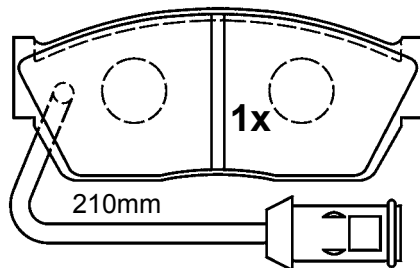

21127 15,0

107,3 x 44,9 x 15,0



# Abbildungen Scheibenbremsbeläge

Illustrations disc brake pads - Illustrazioni pastiglie freno -

Illustrations plaquettes de frein - Ilustraciones pastillas de freno

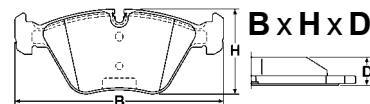

Maßstab - scale - scala - échelle - escala 1:2

**13.0460-6015.2 606015**



MERCEDES BENZ



ATE

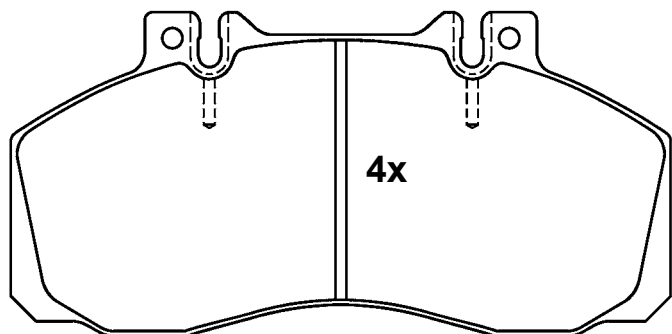

29835 22,0

174,6 x 85,5 x 22,0

**13.0460-6031.2 606031**



MERCEDES BENZ



ATE

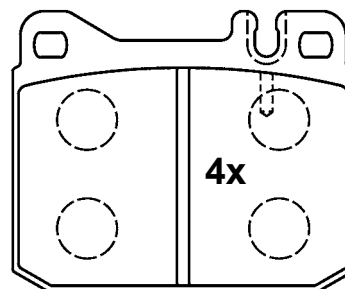

29581 15,0

**13.0460-6027.2 606027**



ALFA ROMEO, FORD,  
MERCEDES BENZ, VOLKSWAGEN



ATE

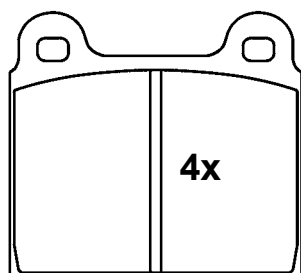

20011 15,0

76,8 x 70,0 x 15,0

89,7 x 73,9 x 15,0

**13.0460-6033.2 606033**



BMW



ATE

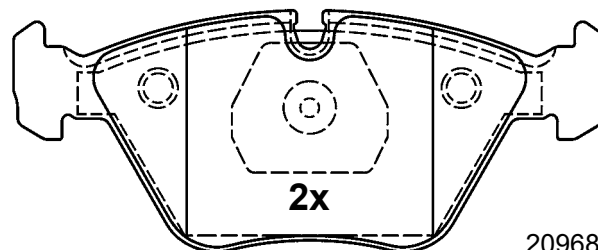

20968 20,3

**13.0460-6028.2 606028**



VOLKSWAGEN



ATE

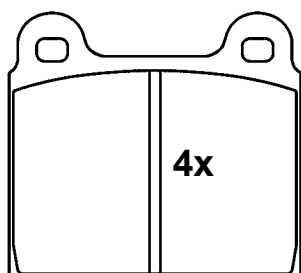

20011 18,5

76,8 x 70,0 x 18,5

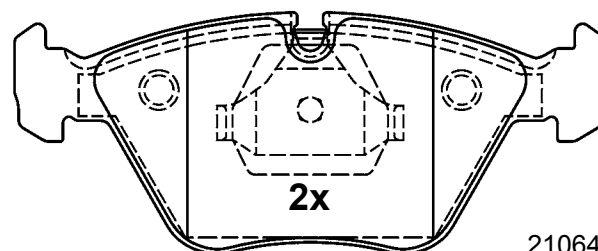

21064 20,3

156,3 x 63,5 x 20,3

# Abbildungen Scheibenbremsbeläge

Illustrations disc brake pads - Illustrazioni pastiglie freno -

Illustrations plaquettes de frein - Ilustraciones pastillas de freno

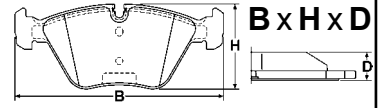

Maßstab - scale - scala - échelle - escala 1:2

**13.0460-6036.2 606036**



MERCEDES BENZ



ATE

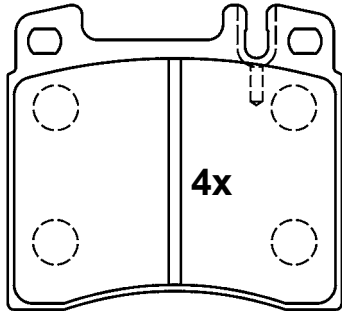

4x

21304 18,5

89,5 x 81,2 x 18,5

**13.0460-6911.2 606911**



FORD



AP

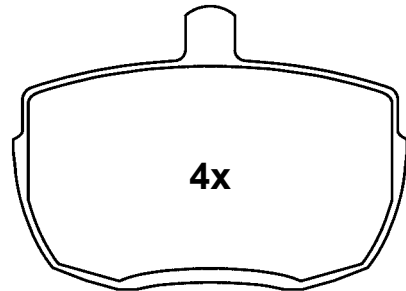

4x

20359 18,0

104,9 x 74,7 x 18,0

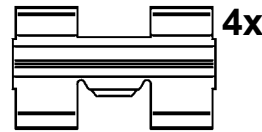

4x

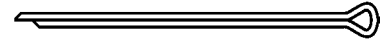

4x

**13.0460-6910.2 606910**



FORD, ROVER



AP

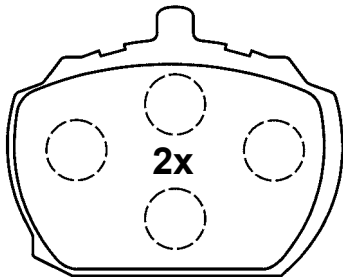

2x

20364 15,0

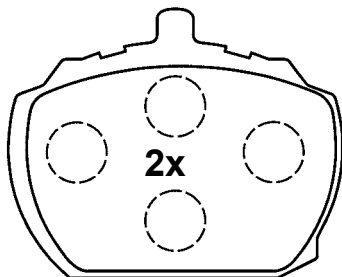

2x

20365 15,0

89,1 x 71,1 x 15,0

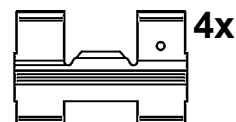

4x

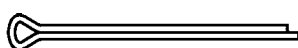

4x

**13.0460-6914.2 606914**



AUSTIN, INNOCENTI, ROVER



AP

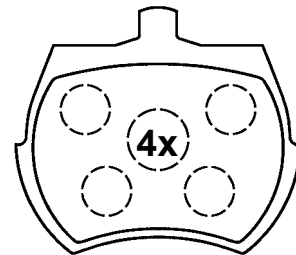

4x

20038 14,0

74,2 x 64,1 x 14,0

# Abbildungen Scheibenbremsbeläge

Illustrations disc brake pads - Illustrazioni pastiglie freno -

Illustrations plaquettes de frein - Ilustraciones pastillas de freno

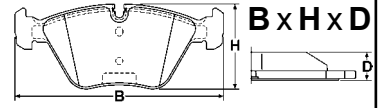

Maßstab - scale - scala - échelle - escala 1:2

**13.0460-6916.2 606916**



LAND ROVER

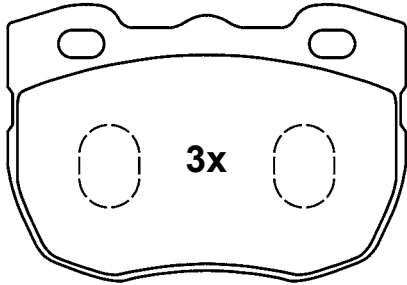

21459 18,5

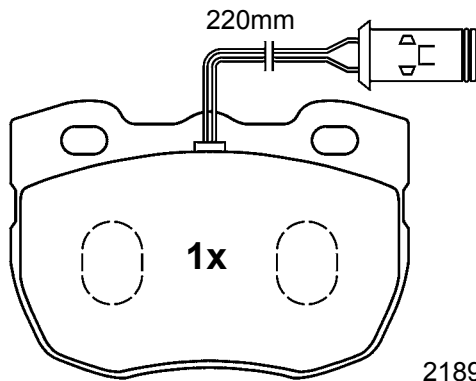

21897 18,5

104,8 x 72,4 x 18,5

**13.0460-6921.2 606921**



SEAT

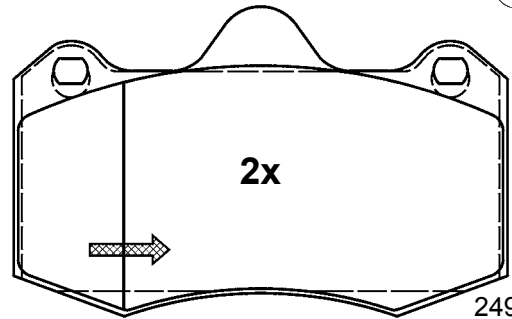

24974 16,8

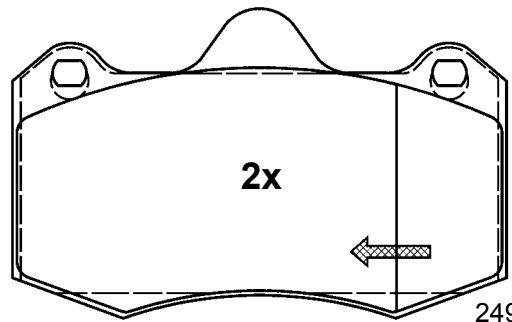

24974 16,8

130,0 x 81,6 x 16,8

**13.0460-6917.2 606917**



LAND ROVER

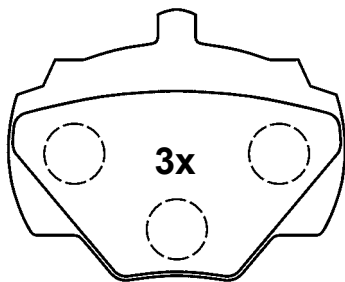

21237 15,5  
(21238)

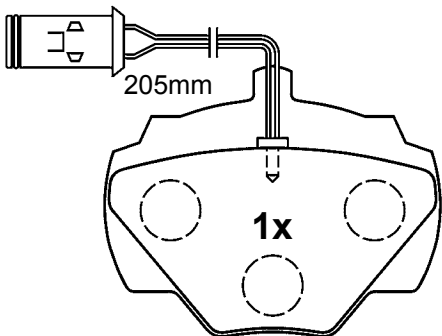

21514 15,5

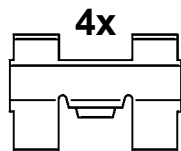

88,6 x 72,1 x 15,5



**13.0460-6922.2 606922**



LAND ROVER

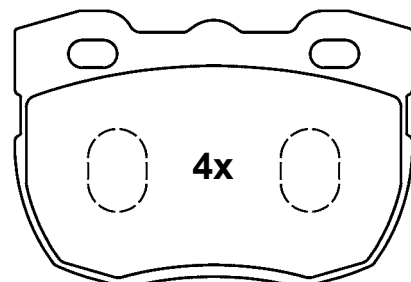

21459 17,5

104,8 x 72,4 x 17,5

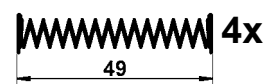
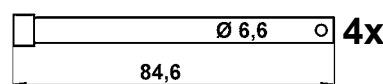
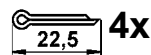
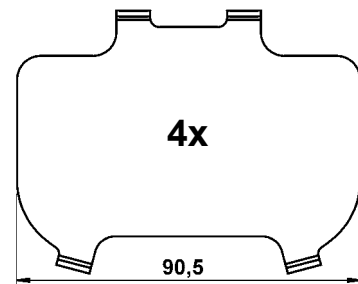

# Abbildungen Scheibenbremsbeläge

Illustrations disc brake pads - Illustrazioni pastiglie freno -

Illustrations plaquettes de frein - Ilustraciones pastillas de freno

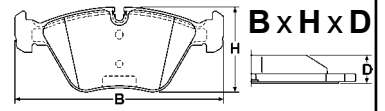

Maßstab - scale - scala - échelle - escala 1:2

## 13.0460-6923.2 606923



LAND ROVER



AP

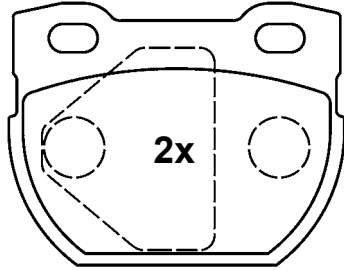

23471 14,5

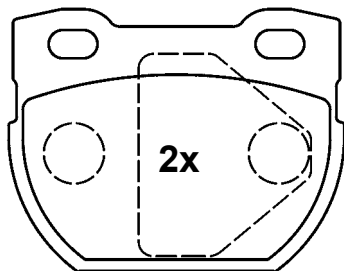

23471 14,5

88,4 x 68,9 x 14,5

## 13.0460-6925.2 606925



LAND ROVER



AP

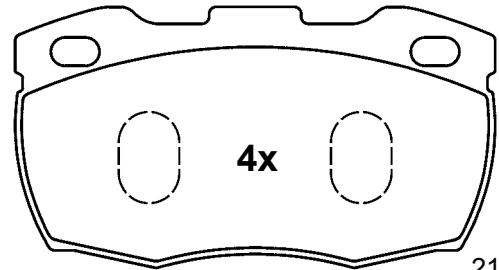

21519 17,8

126,5 x 68,6 x 17,8



4x

## 13.0460-6926.2 606926



LAND ROVER



AP

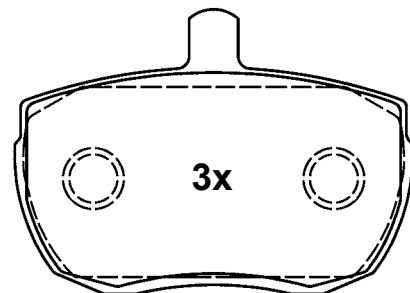

20359 19,2

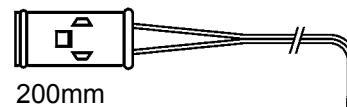

200mm

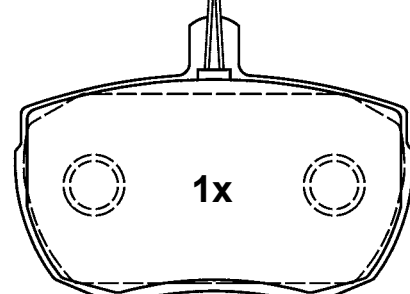

21160 19,2

104,9 x 74,7 x 19,2

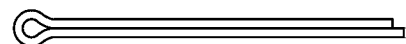

4x

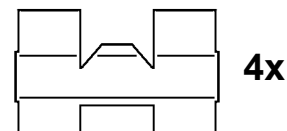

4x

## 13.0460-6924.2 606924



LAND ROVER



AP

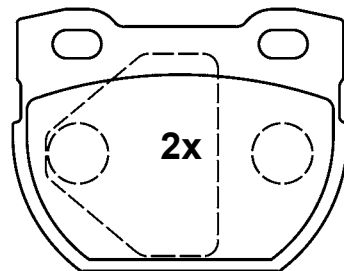

23471 17,5

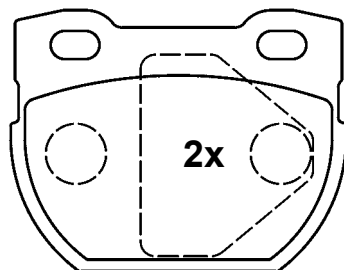

23471 17,5

88,4 x 68,9 x 17,5



4x



4x

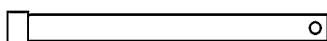

4x

# Abbildungen Scheibenbremsbeläge

Illustrations disc brake pads - Illustrazioni pastiglie freno -

Illustrations plaquettes de frein - Ilustraciones pastillas de freno

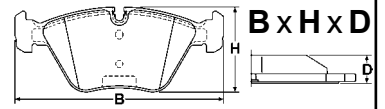

Maßstab - scale - scala - échelle - escala 1:2

**13.0460-7005.2 607005**



FORD



ATE

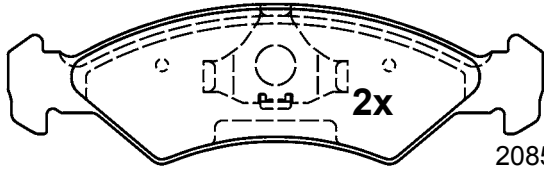

20857 17,5

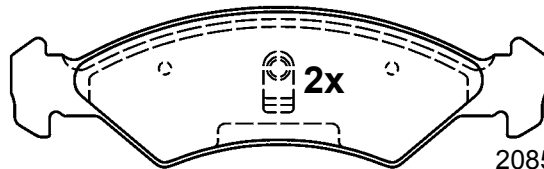

20858 17,5

141,3 x 42,0 x 17,5

**13.0460-7030.2 607030**



SEAT, VOLKSWAGEN



VW

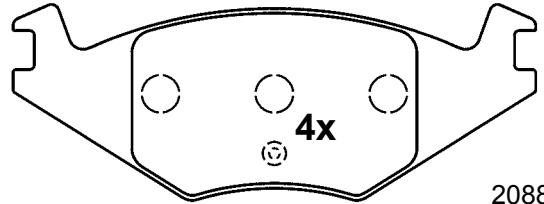

20889 17,3

137,8 x 51,5 x 17,3

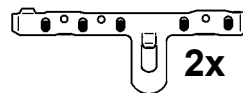

2x

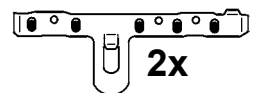

2x

**13.0460-7027.2 607027**



FORD



ATE

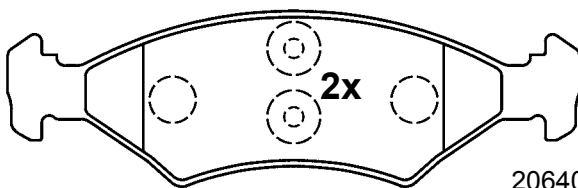

20640 17,5

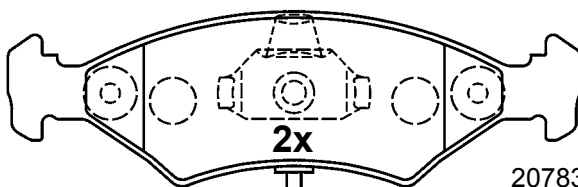

20783 17,5

255mm

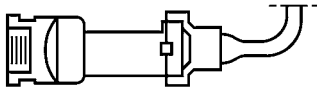

151,3 x 46,4 x 17,5

**13.0460-7032.2 607032**



SEAT, VOLKSWAGEN



VW

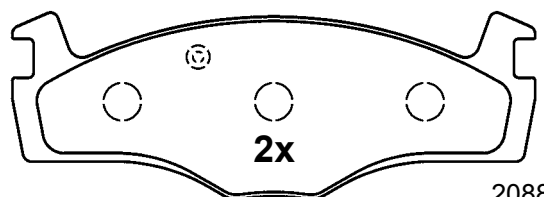

20887 19,7

137,8 x 48,9 x 19,7

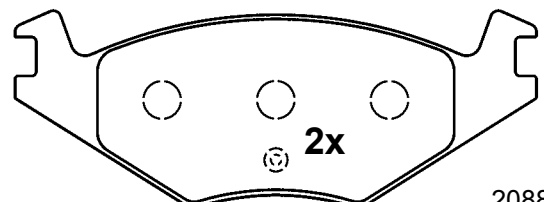

20888 19,7

137,8 x 51,5 x 19,7

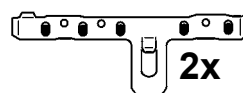

2x

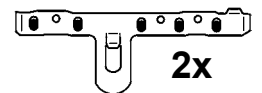

2x



# Abbildungen Scheibenbremsbeläge

Illustrations disc brake pads - Illustrazioni pastiglie freno -

Illustrations plaquettes de frein - Ilustraciones pastillas de freno

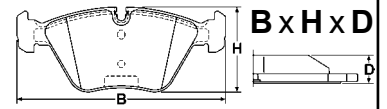

Maßstab - scale - scala - échelle - escala 1:2

**13.0460-7033.2 607033**



SEAT, VOLKSWAGEN



VW

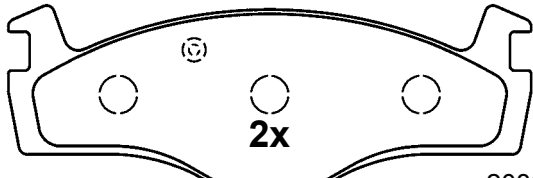

2x

20887 15,3

137,8 x 48,9 x 15,3

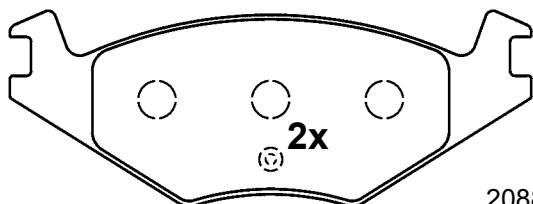

2x

20888 15,3

137,8 x 51,5 x 15,3

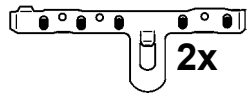

2x

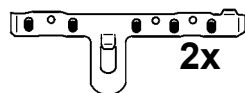

2x

**13.0460-7040.2 607040**



FORD



ATE

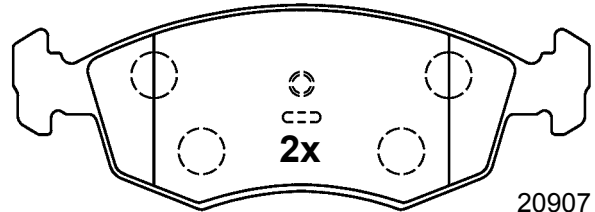

2x

20907 18,0

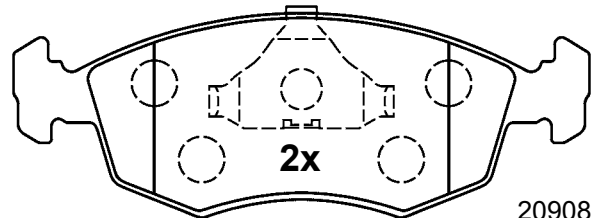

2x

20908 18,0

151,3 x 52,5 x 18,0

**13.0460-7036.2 607036**



BMW



ATE

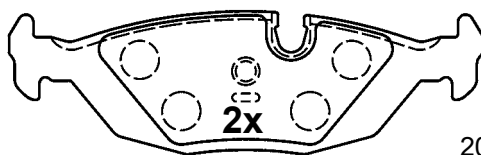

2x

20675 16,5

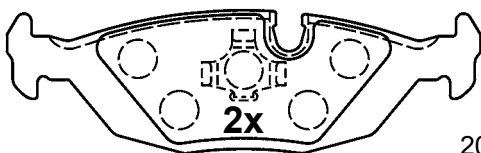

2x

20756 16,5

125,0 x 37,6 x 16,5

**13.0460-7041.2 607041**



FORD



ATE

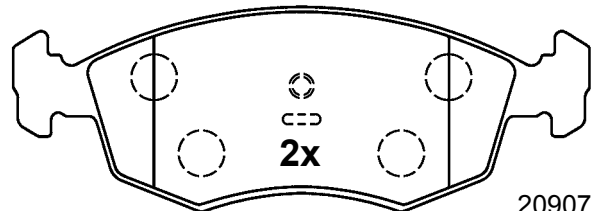

2x

20907 18,0

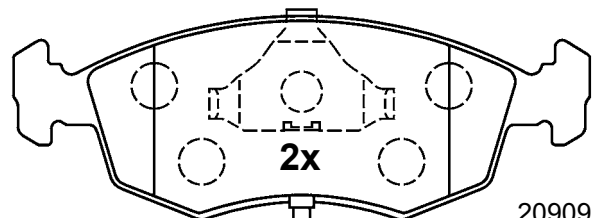

2x

20909 18,0

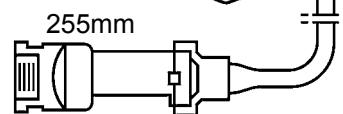

255mm

151,3 x 52,5 x 18,0



# Abbildungen Scheibenbremsbeläge

Illustrations disc brake pads - Illustrazioni pastiglie freno -

Illustrations plaquettes de frein - Ilustraciones pastillas de freno

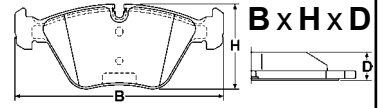

Maßstab - scale - scala - échelle - escala 1:2

**13.0460-7042.2 607042**



FORD, HYUNDAI



TRW

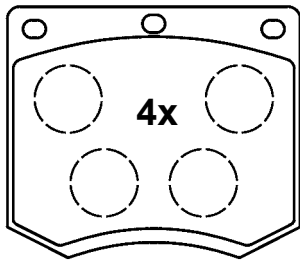

20491 15,0

78,1 x 65,1 x 15,0

**13.0460-7047.2 607047**



BMW



ATE

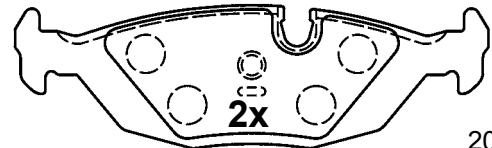

20675 16,5

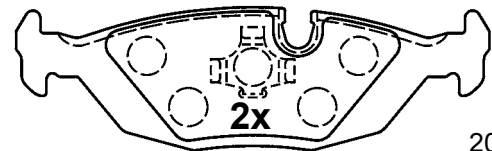

20756 16,5

125,0 x 37,6 x 16,5

**13.0460-7046.2 607046**



BMW



ATE

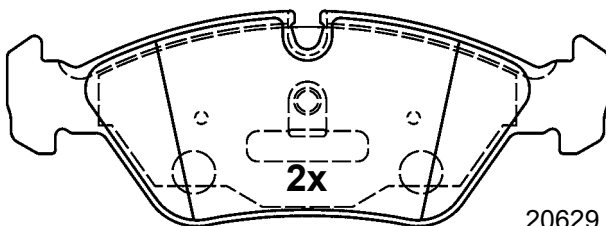

20629 20,3

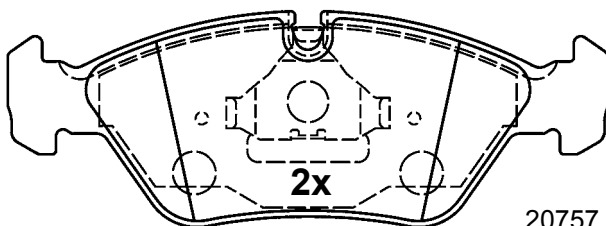

20757 20,3

158,3 x 56,7 x 20,3

**13.0460-7048.2 607048**



OPEL, VAUXHALL



DEL

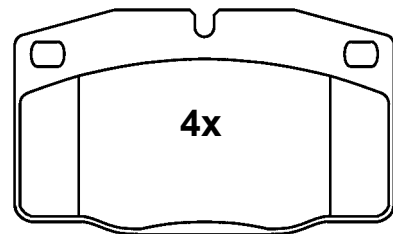

20939 15,8

100,0 x 59,0 x 15,8

# Abbildungen Scheibenbremsbeläge

Illustrations disc brake pads - Illustrazioni pastiglie freno -

Illustrations plaquettes de frein - Ilustraciones pastillas de freno

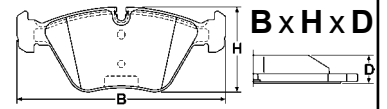

Maßstab - scale - scala - échelle - escala 1:2

**13.0460-7050.2 607050**



AUDI



ATE

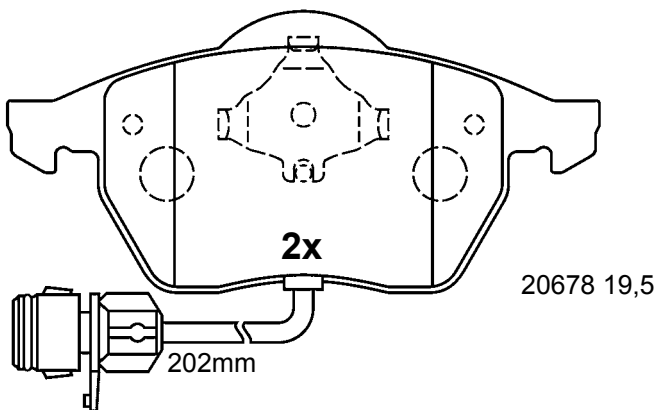
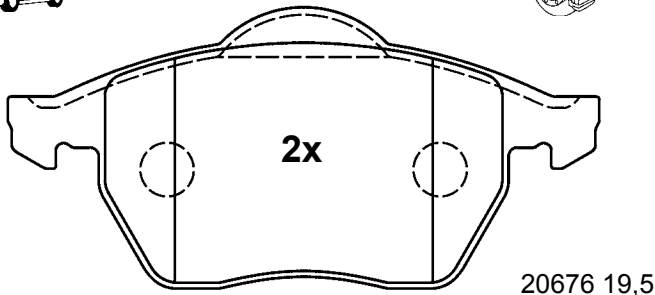

156,3 x 74,0 x 19,5

**13.0460-7052.2 607052**



CHEVROLET, DAEWOO, OPEL,  
VAUXHALL



ATE

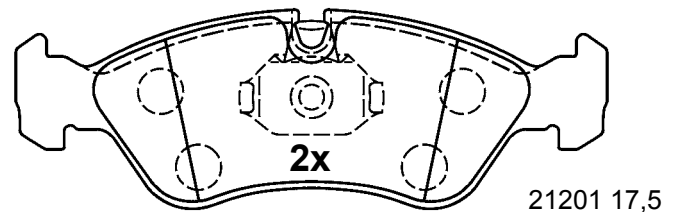
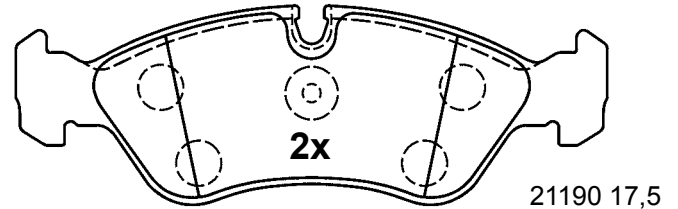

156,3 x 52,3 x 17,5

**13.0460-7051.2 607051**



CHEVROLET, DAEWOO, OPEL,  
VAUXHALL



ATE

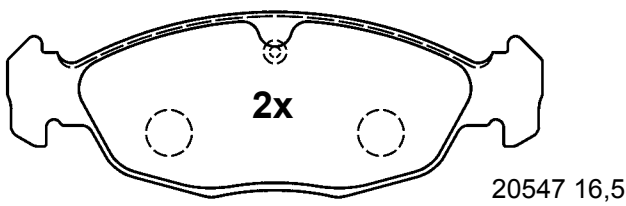

141,2 x 48,4 x 16,5

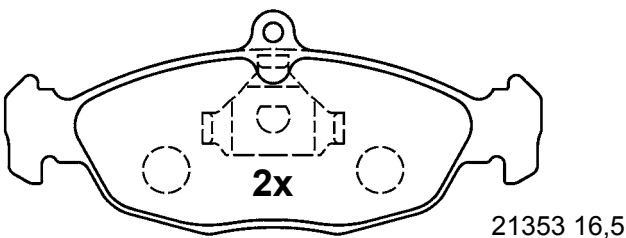

140,0 x 58,3 x 16,5

**13.0460-7053.2 607053**



VOLVO



ATE

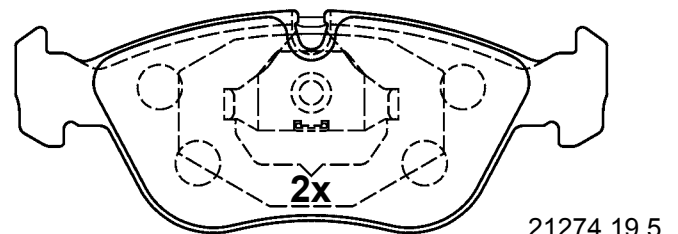
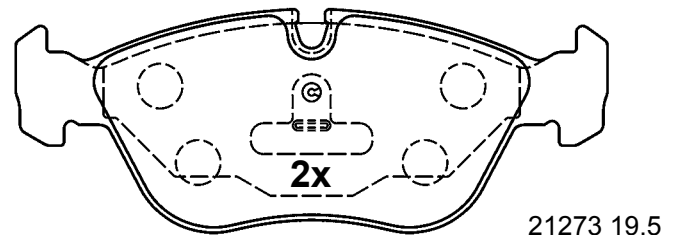

156,3 x 58,5 x 19,5

# Abbildungen Scheibenbremsbeläge

Illustrations disc brake pads - Illustrazioni pastiglie freno -

Illustrations plaquettes de frein - Ilustraciones pastillas de freno

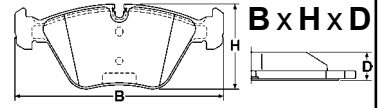

Maßstab - scale - scala - échelle - escala 1:2

## 13.0460-7055.2 607055



ALFA ROMEO



ATE

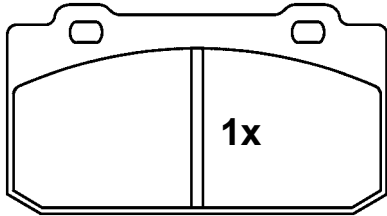

20944 14,8

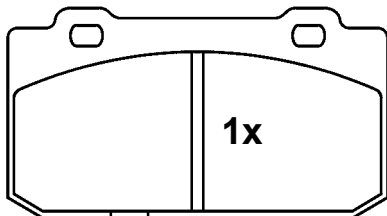

21063 14,8

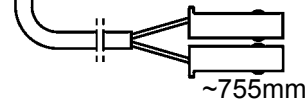

~755mm

## 13.0460-7056.2 607056



FORD



ATE

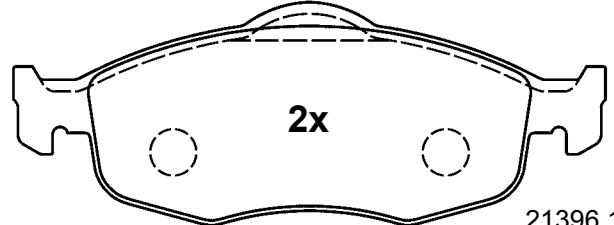

21396 17,5

156,3 x 58,5 x 17,5

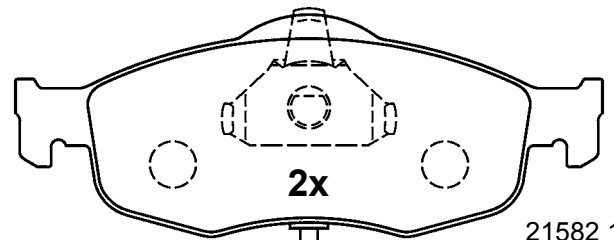

21582 17,5

~205mm

155,1 x 58,5 x 17,5

## 13.0460-7057.2 607057



FORD



ATE

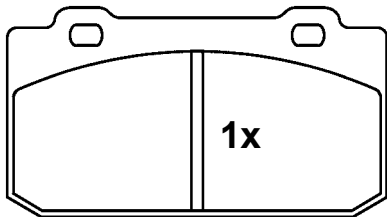

20944 14,8

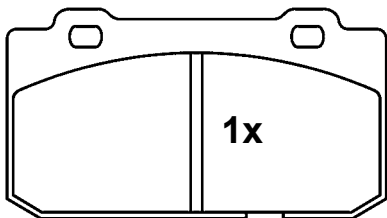

21098 14,8

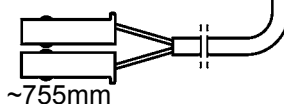

~755mm

100,0 x 54,8 x 14,8

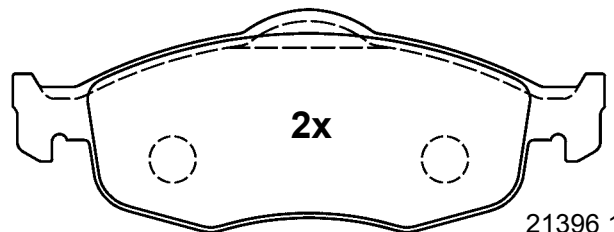

21396 17,5

156,3 x 58,5 x 17,5

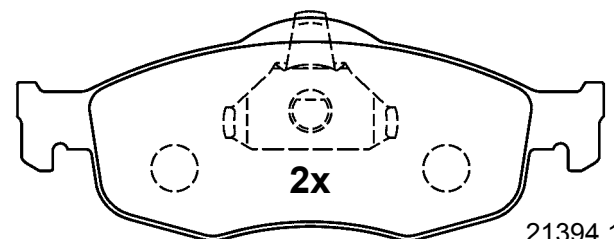

21394 17,5

155,1 x 58,5 x 17,5

# Abbildungen Scheibenbremsbeläge

Illustrations disc brake pads - Illustrazioni pastiglie freno -

Illustrations plaquettes de frein - Ilustraciones pastillas de freno

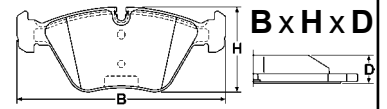

Maßstab - scale - scala - échelle - escala 1:2

## 13.0460-7058.2 607058

PEUGEOT

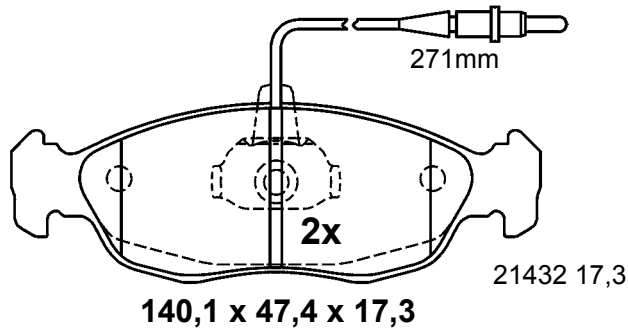
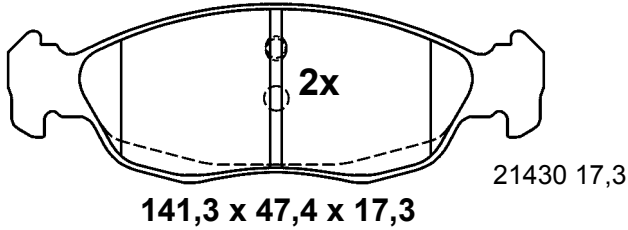

## 13.0460-7060.2 607060

FORD

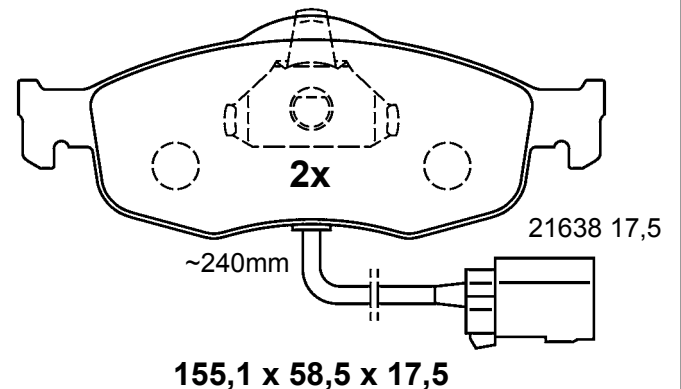
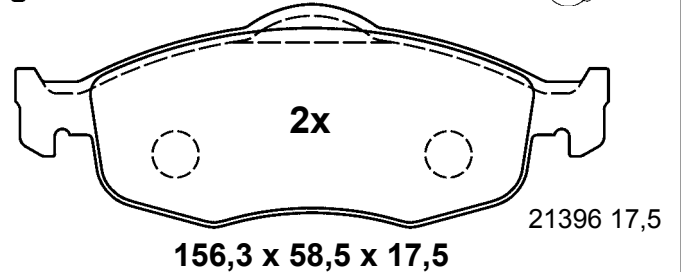

## 13.0460-7059.2 607059

SEAT, VOLKSWAGEN

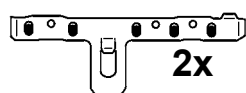
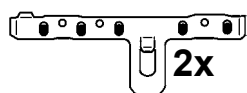
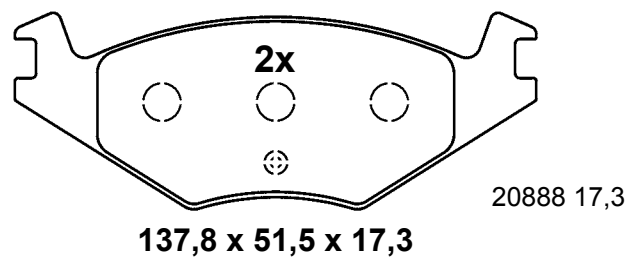
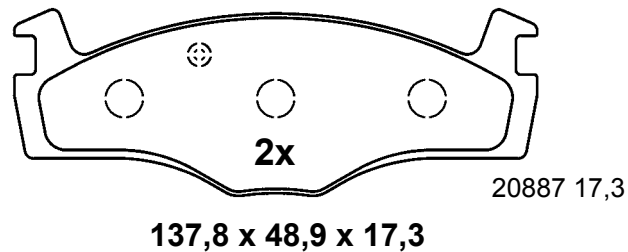

## 13.0460-7061.2 607061

CITROEN, FIAT,  
LANCIA, PEUGEOT

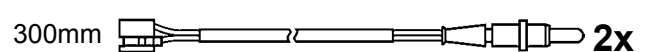
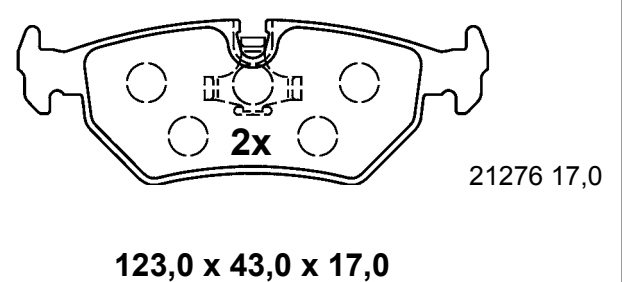
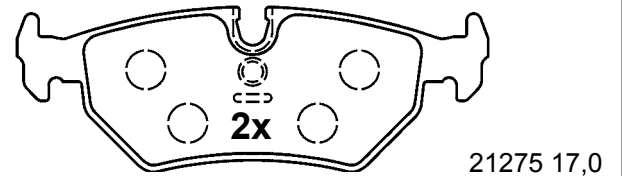

# Abbildungen Scheibenbremsbeläge

Illustrations disc brake pads - Illustrazioni pastiglie freno -

Illustrations plaquettes de frein - Ilustraciones pastillas de freno

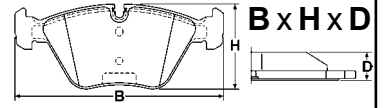

Maßstab - scale - scala - échelle - escala 1:2

## 13.0460-7063.2 607063



FIAT



ATE

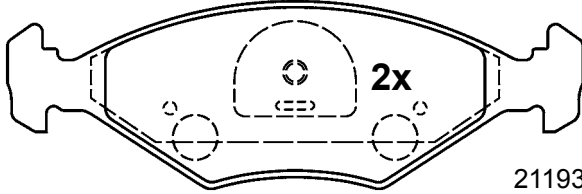

2x

21193 18,0

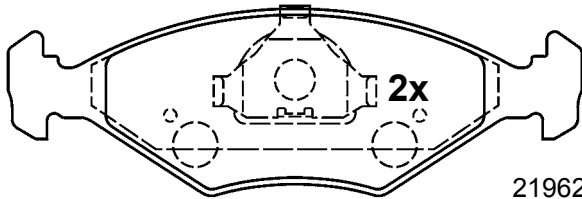

2x

21962 18,0

151,3 x 49,2 x 18,0

## 13.0460-7065.2 607065



FIAT, LANCIA



ATE

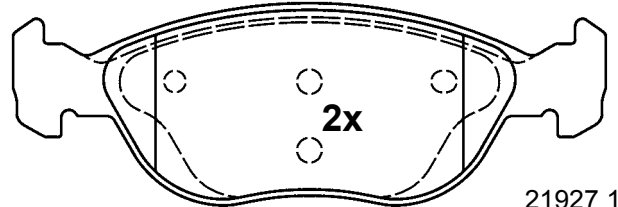

2x

21927 17,9

## 13.0460-7064.2 607064



FIAT, LANCIA



ATE

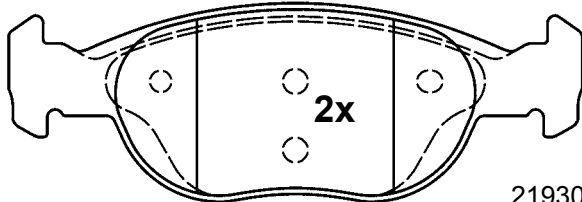

2x

21930 17,9

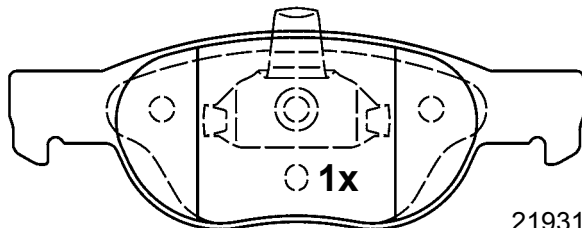

1x

21931 17,9

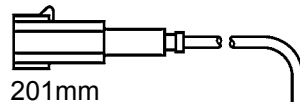

201mm

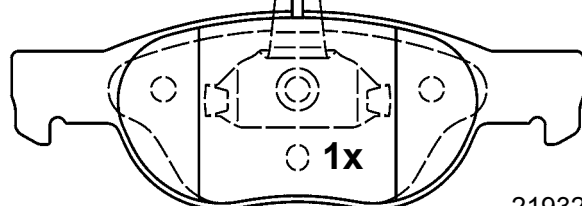

1x

21932 17,9

151,3 x 52,0 x 17,9

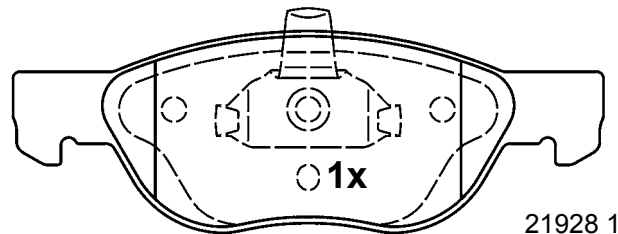

1x

21928 17,9

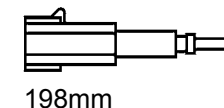

198mm

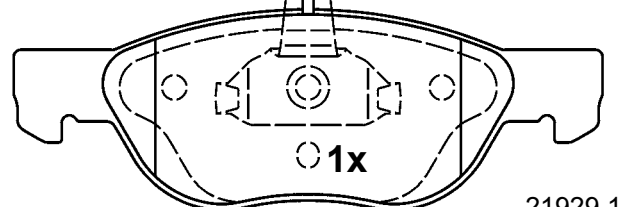

1x

21929 17,9

156,3 x 52,7 x 17,9

# Abbildungen Scheibenbremsbeläge

Illustrations disc brake pads - Illustrazioni pastiglie freno -

Illustrations plaquettes de frein - Ilustraciones pastillas de freno

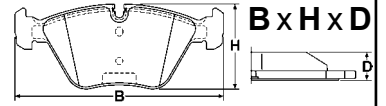

Maßstab - scale - scala - échelle - escala 1:2

**13.0460-7067.2 607067**



ALFA ROMEO



ATE

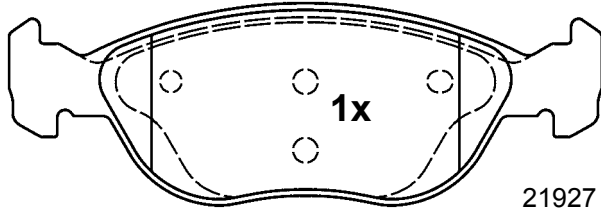

21927 17,9

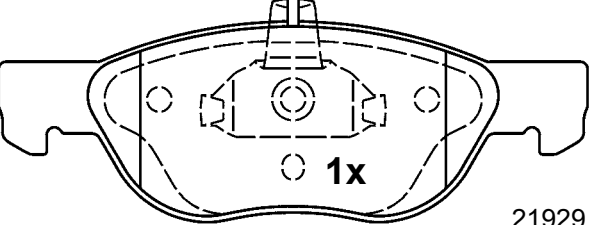
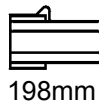

21929 17,9

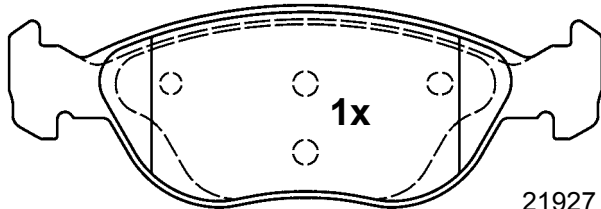

21927 17,9

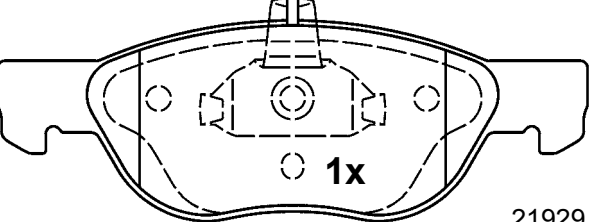
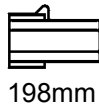

21929 17,9

**156,3 x 52,7 x 17,9**

**13.0460-7068.2 607068**



ALFA ROMEO



ATE

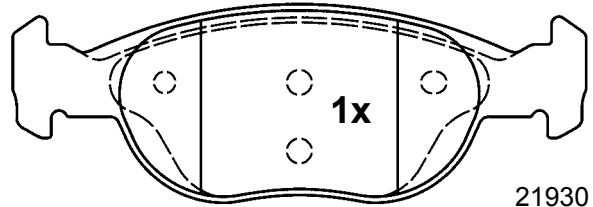

21930 17,9

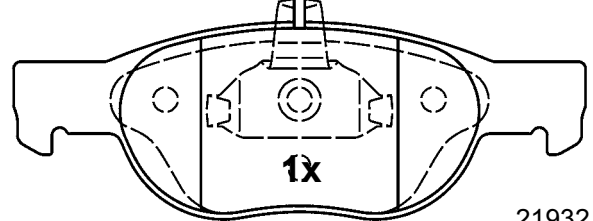
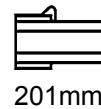

21932 17,9

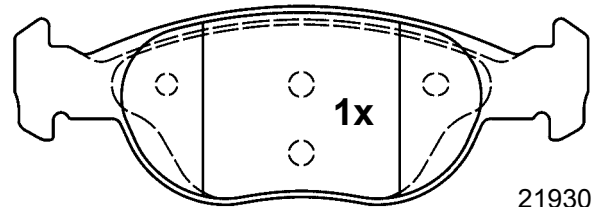

21930 17,9

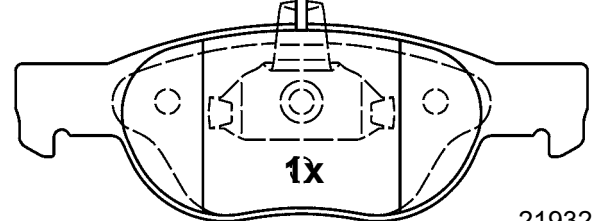
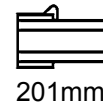

21932 17,9

**151,3 x 52,0 x 17,9**



# Abbildungen Scheibenbremsbeläge

Illustrations disc brake pads - Illustrazioni pastiglie freno -

Illustrations plaquettes de frein - Ilustraciones pastillas de freno

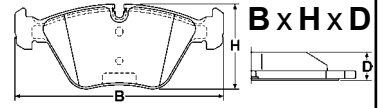

Maßstab - scale - scala - échelle - escala 1:2

## 13.0460-7069.2 607069



ALFA ROMEO, FIAT, LANCIA



ATE

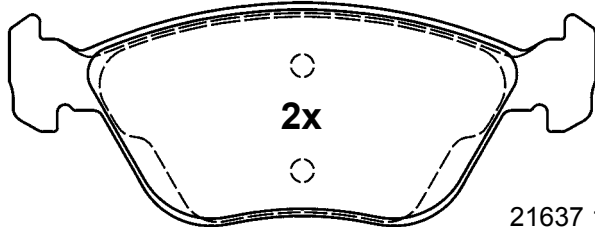

2x

21637 19,3

156,3 x 59,1 x 19,3

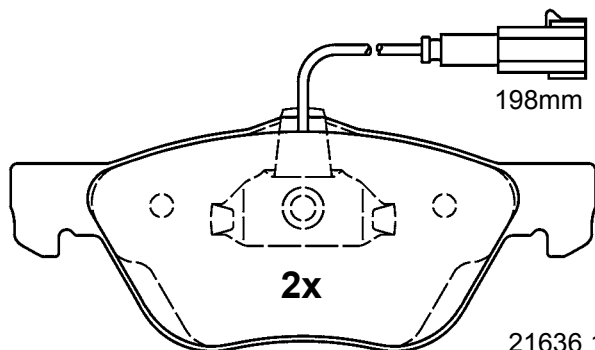

198mm

2x

21636 19,3

155,1 x 61,8 x 19,3

## 13.0460-7072.2 607072



SEAT, VOLKSWAGEN



ATE

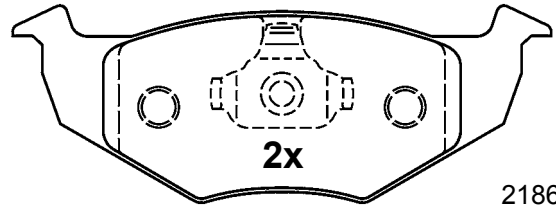

2x

21866 19,7

141,8 x 51,2 x 19,7

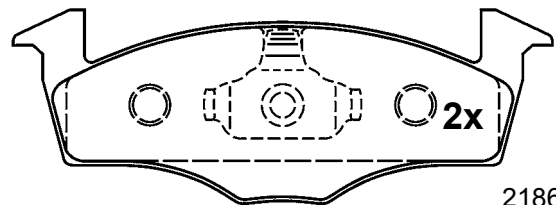

2x

21868 19,7

141,8 x 50,6 x 19,7

## 13.0460-7071.2 607071



FORD, MAZDA



ATE

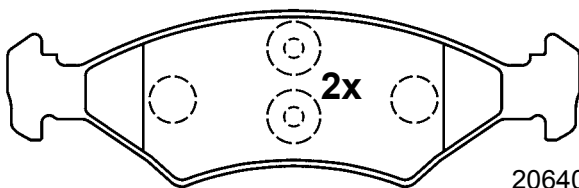

2x

20640 17,5

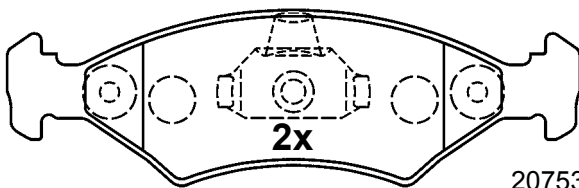

2x

20753 17,5

151,3 x 46,4 x 17,5

## 13.0460-7073.2 607073



FORD, MAZDA



ATE

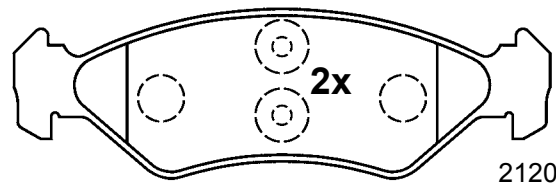

2x

21202 16,9

141,3 x 44,4 x 16,9

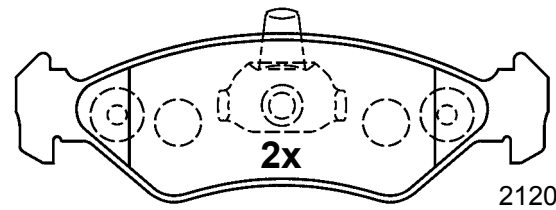

2x

21203 16,9

140,1 x 44,4 x 16,9

# Abbildungen Scheibenbremsbeläge

Illustrations disc brake pads - Illustrazioni pastiglie freno -

Illustrations plaquettes de frein - Ilustraciones pastillas de freno

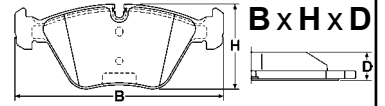

Maßstab - scale - scala - échelle - escala 1:2

## 13.0460-7076.2 607076



FORD, SEAT, VOLKSWAGEN



ATE

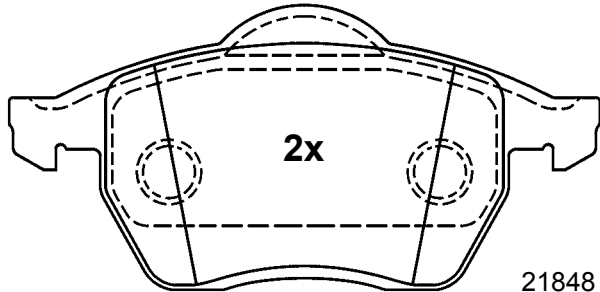

156,3 x 74,0 x 19,8

21848 19,8

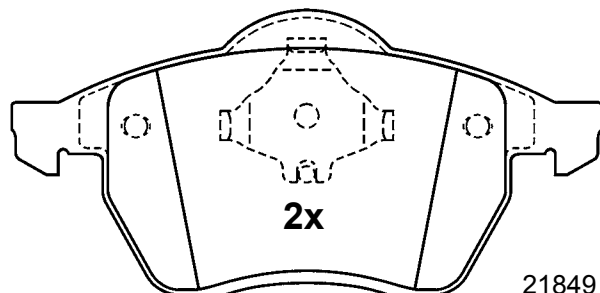

156,3 x 74,0 x 20,3

21849 20,3

## 13.0460-7078.2 607078



BMW



ATE

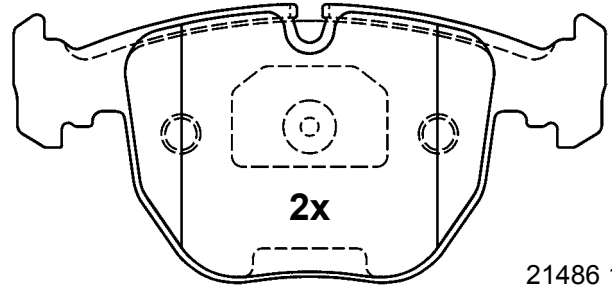

21486 19,3

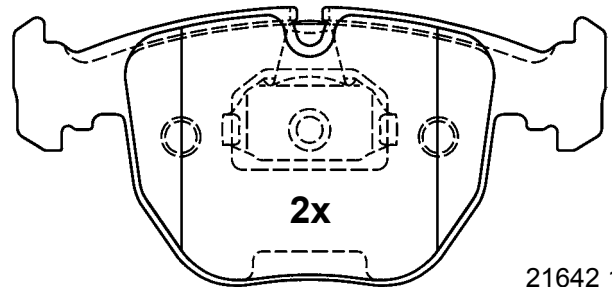

21642 19,3

156,3 x 73,2 x 19,3

## 13.0460-7077.2 607077



AUDI, VOLKSWAGEN



ATE

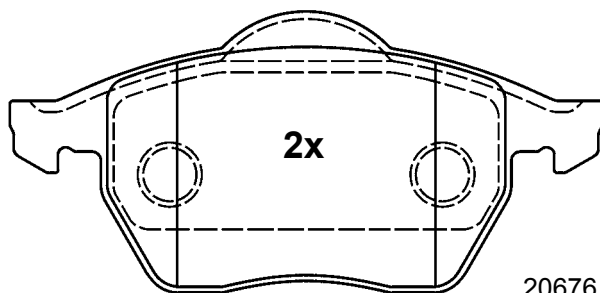

156,3 x 74,0 x 19,8

20676 19,8

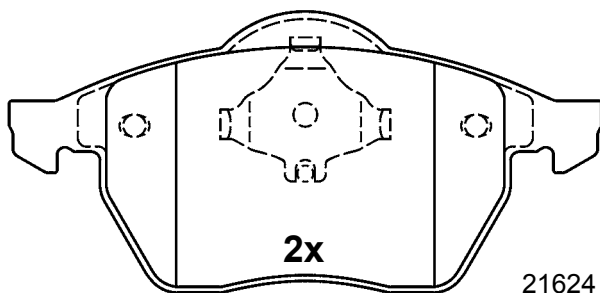

156,3 x 74,0 x 20,3

21624 20,3

21646 20,3

## 13.0460-7079.2 607079



BMW, LAND ROVER



ATE

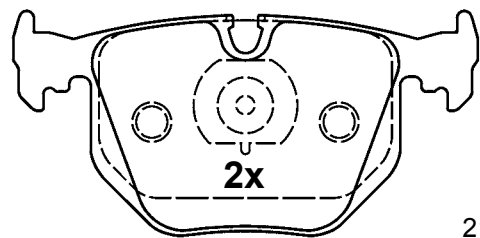

21282 17,3

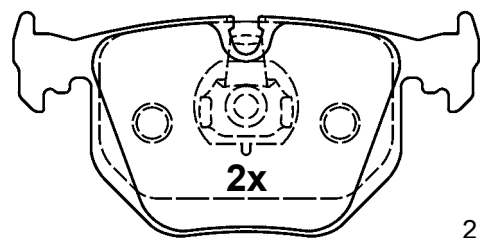

21487 17,3

123,0 x 59,2 x 17,3

# Abbildungen Scheibenbremsbeläge

Illustrations disc brake pads - Illustrazioni pastiglie freno -

Illustrations plaquettes de frein - Ilustraciones pastillas de freno

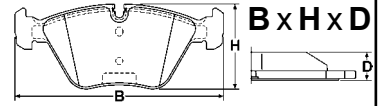

Maßstab - scale - scala - échelle - escala 1:2

## 13.0460-7080.2 607080

OPEL, SAAB, VAUXHALL

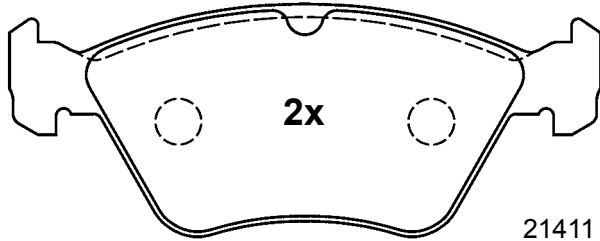

156,3 x 60,7 x 17,5

21411 17,5

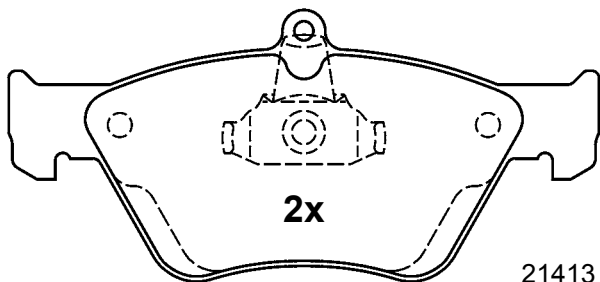

155,1 x 70,6 x 18,3

21413 18,3

## 13.0460-7083.2 607083

MERCEDES BENZ,  
VOLKSWAGEN

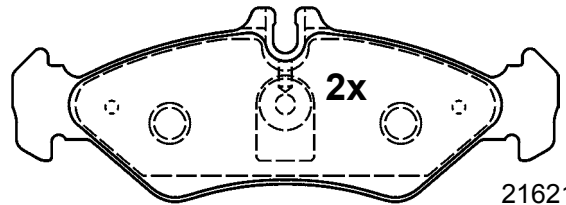

21621 17,3

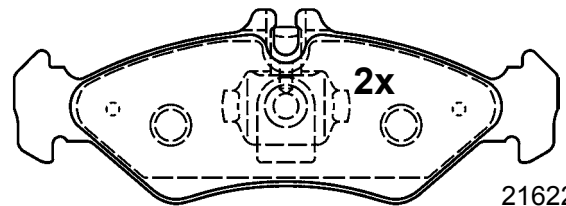

21622 17,3

141,3 x 49,9 x 17,3

## 13.0460-7081.2 607081

AUDI, SEAT, SKODA,  
VOLKSWAGEN

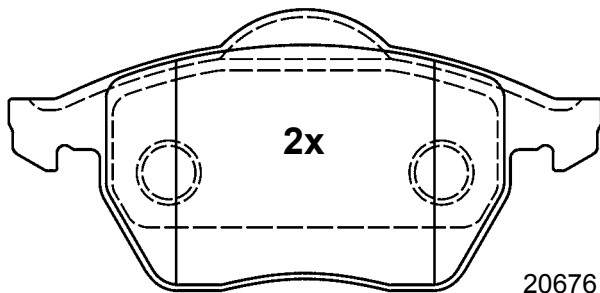

156,3 x 74,0 x 19,8

20676 19,8

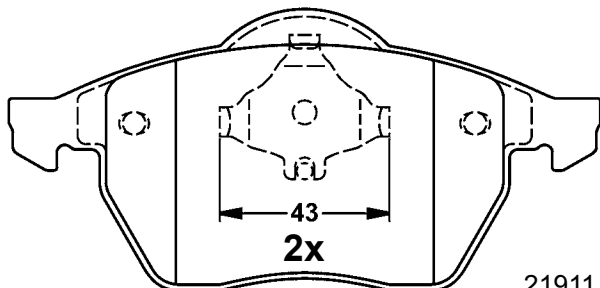

156,3 x 74,0 x 20,3

21911 20,3

## 13.0460-7084.2 607084

MERCEDES BENZ,  
VOLKSWAGEN

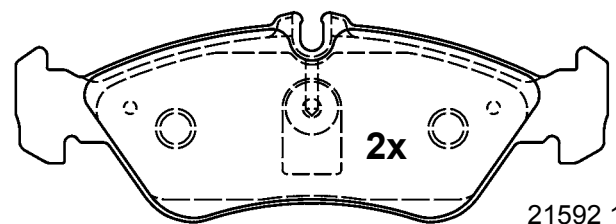

21592 18,8

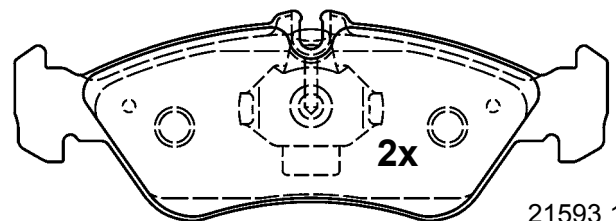

21593 18,8

156,3 x 54,8 x 18,8



# Abbildungen Scheibenbremsbeläge

Illustrations disc brake pads - Illustrazioni pastiglie freno -

Illustrations plaquettes de frein - Ilustraciones pastillas de freno

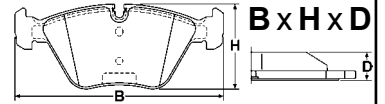

Maßstab - scale - scala - échelle - escala 1:2

## 13.0460-7085.2 607085



MERCEDES BENZ



ATE

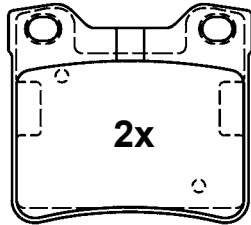

21278 16,9

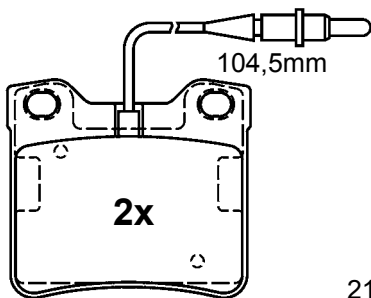

21904 16,9

63,7 x 57,4 x 16,9

## 13.0460-7087.2 607087



CHRYSLER, MERCEDES BENZ



ATE

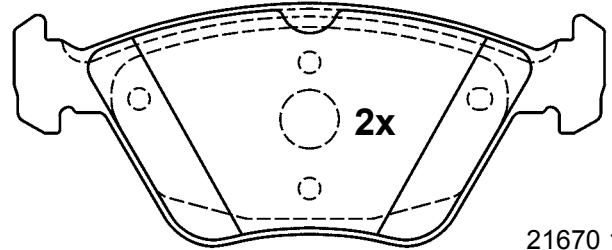

21670 19,4

156,3 x 63,5 x 19,4

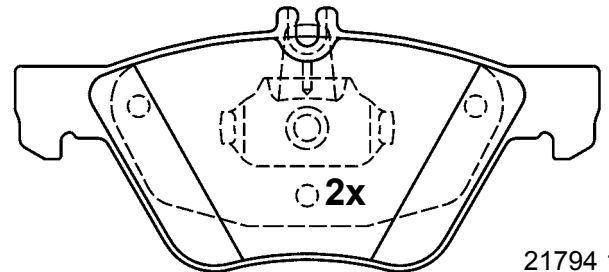

21794 19,4

155,1 x 69,3 x 19,4

## 13.0460-7086.2 607086



MERCEDES BENZ



ATE

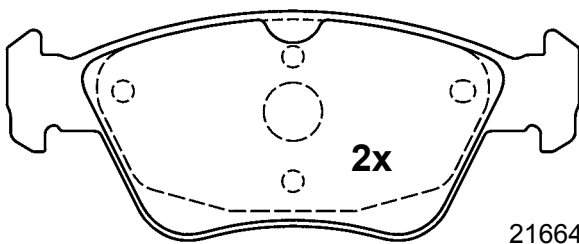

21664 19,8

151,3 x 59,8 x 19,8

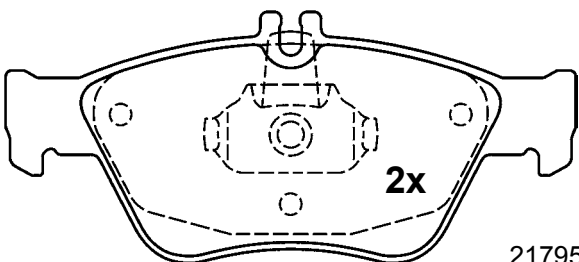

21795 19,8

150,1 x 66,2 x 19,8

## 13.0460-7088.2 607088



CITROEN, PEUGEOT



ATE

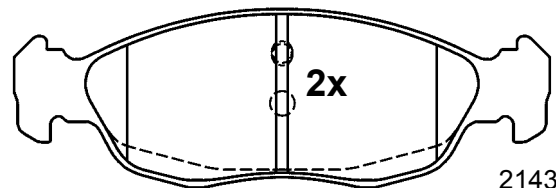

21430 17,3

141,3 x 47,4 x 17,3

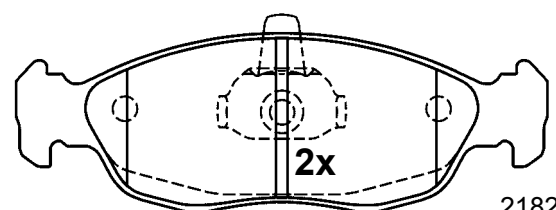

21827 17,3

140,1 x 47,4 x 17,3

# Abbildungen Scheibenbremsbeläge

Illustrations disc brake pads - Illustrazioni pastiglie freno -

Illustrations plaquettes de frein - Ilustraciones pastillas de freno

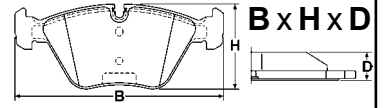

Maßstab - scale - scala - échelle - escala 1:2

**13.0460-7089.2 607089**



BMW



ATE

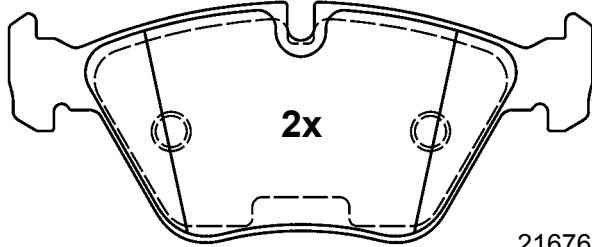

2x

21676 20,3

154,6 x 63,5 x 20,3

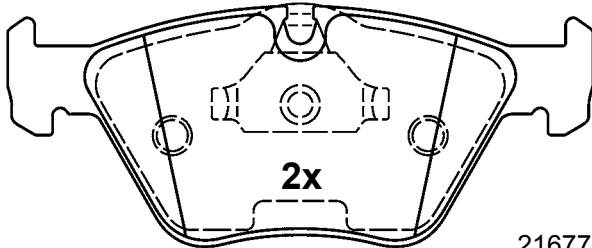

2x

21677 20,3

155,1 x 63,5 x 20,3

**13.0460-7091.2 607091**



OPEL, SAAB, VAUXHALL



ATE

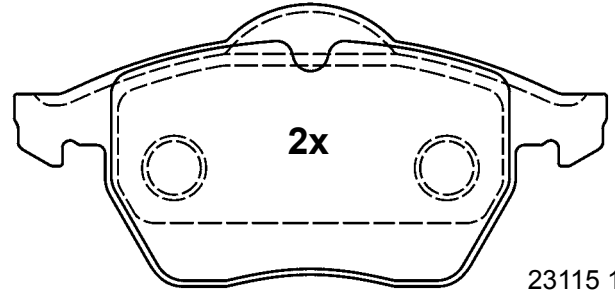

2x

23115 19,8

156,3 x 74,0 x 19,8

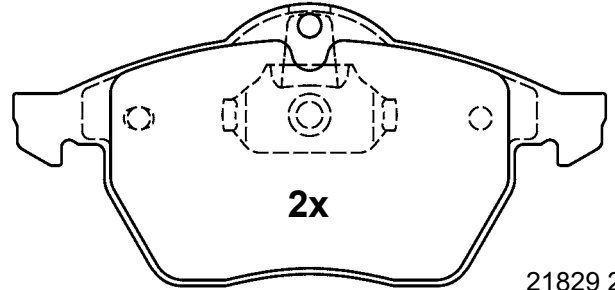

2x

21829 20,3

155,1 x 74,0 x 20,3

**13.0460-7090.2 607090**



BMW



ATE

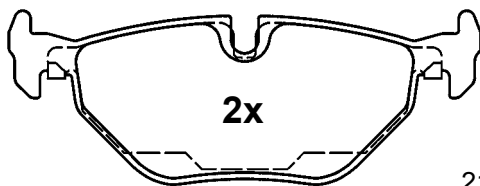

2x

21891 17,3

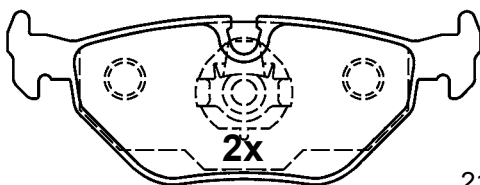

2x

21691 17,3

123,0 x 44,9 x 17,3

**13.0460-7100.2 607100**



SEAT, SKODA, VOLKSWAGEN



VW

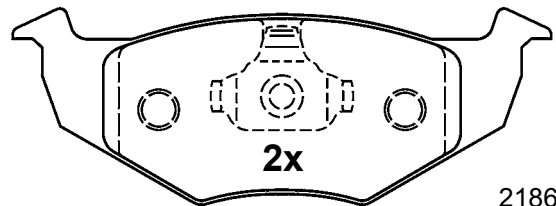

2x

21866 17,2

141,8 x 51,2 x 17,2

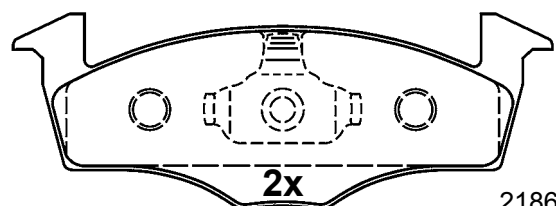

2x

21868 17,2

141,8 x 50,6 x 17,2



# Abbildungen Scheibenbremsbeläge

Illustrations disc brake pads - Illustrazioni pastiglie freno -

Illustrations plaquettes de frein - Ilustraciones pastillas de freno

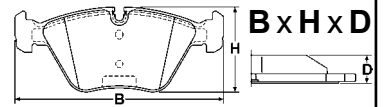

Maßstab - scale - scala - échelle - escala 1:2

## 13.0460-7101.2 607101

 SEAT, VOLKSWAGEN

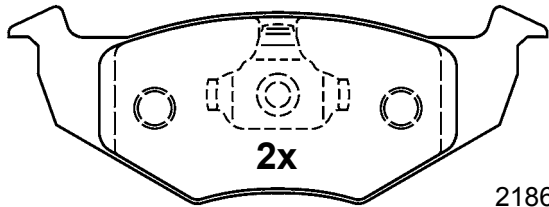

21866 15,3

141,8 x 51,2 x 15,3

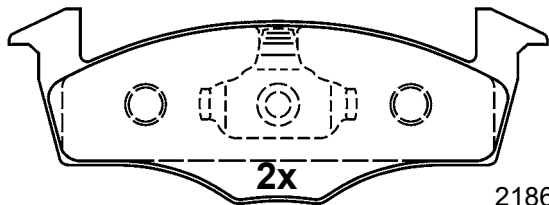

21868 15,3

141,8 x 50,6 x 15,3

## 13.0460-7105.2 607105

 ALFA ROMEO, LANCIA

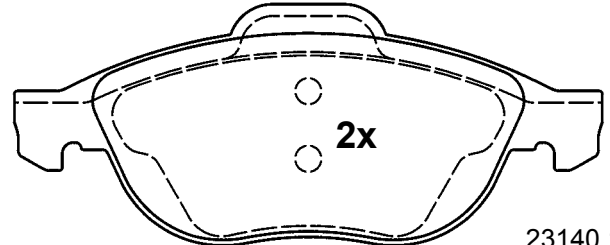

23140 19,4

156,3 x 63,8 x 19,4

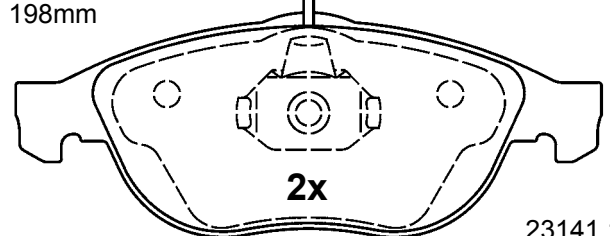
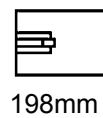

23141 19,4

155,1 x 59,3 x 19,4

## 13.0460-7102.2 607102

 VOLKSWAGEN

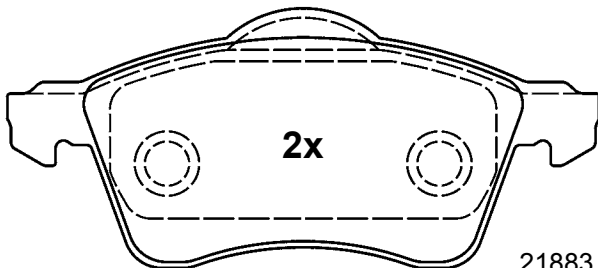

21883 19,8

156,3 x 68,5 x 19,8

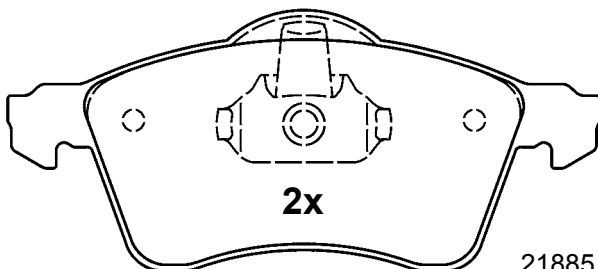

21885 20,4

156,3 x 68,5 x 20,4

## 13.0460-7107.2 607107

 PEUGEOT

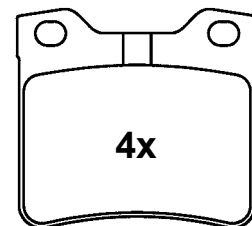

21278 16,4

63,7 x 57,8 x 16,4



# Abbildungen Scheibenbremsbeläge

Illustrations disc brake pads - Illustrazioni pastiglie freno -

Illustrations plaquettes de frein - Ilustraciones pastillas de freno



Maßstab - scale - scala - échelle - escala 1:2

**13.0460-7108.2 607108**

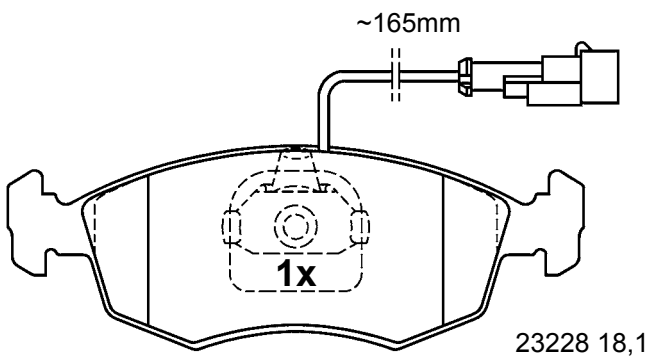
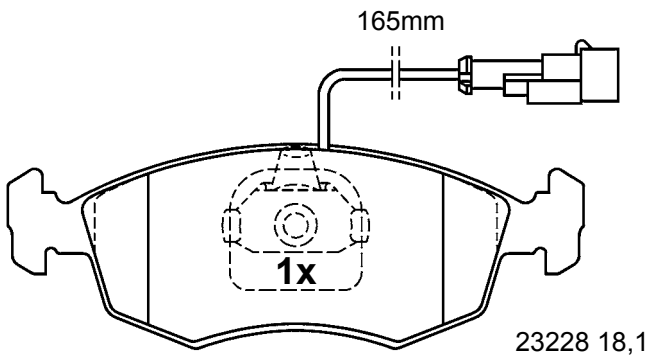
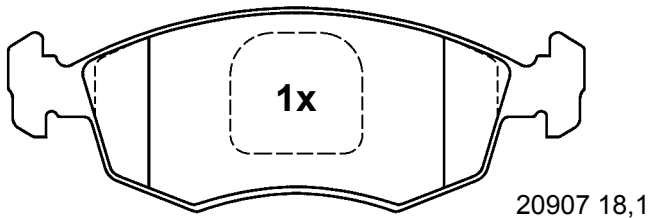
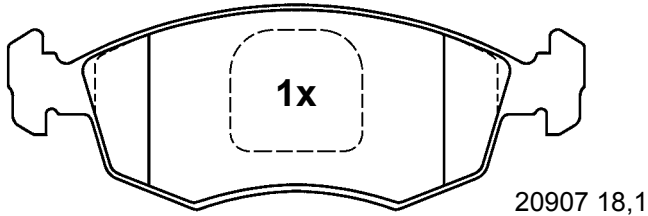

**151,3 x 52,5 x 18,1**

**13.0460-7110.2 607110**



AUDI, SEAT, SKODA,  
VOLKSWAGEN

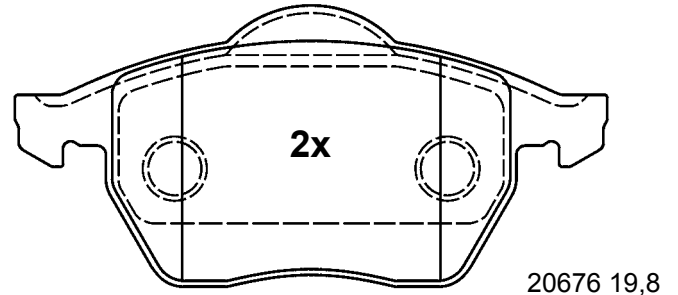

**156,3 x 74,0 x 19,8**

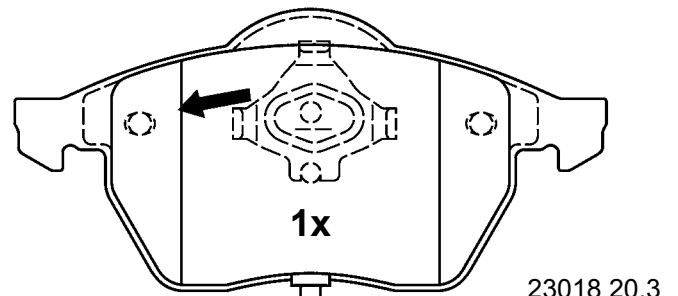

**156,3 x 74,0 x 20,3**

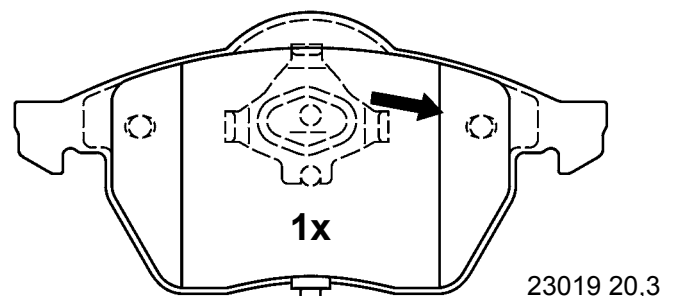

**156,3 x 74,0 x 20,3**



# Abbildungen Scheibenbremsbeläge

Illustrations disc brake pads - Illustrazioni pastiglie freno -

Illustrations plaquettes de frein - Ilustraciones pastillas de freno

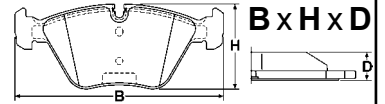

Maßstab - scale - scala - échelle - escala 1:2

## 13.0460-7111.2 607111



AUDI, SEAT, SKODA,  
VOLKSWAGEN



VW

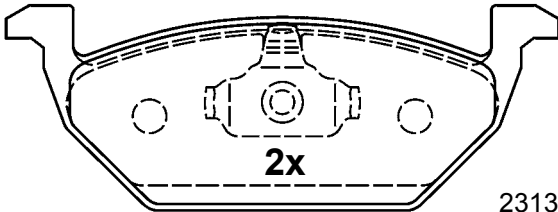

2x

23130 19,6

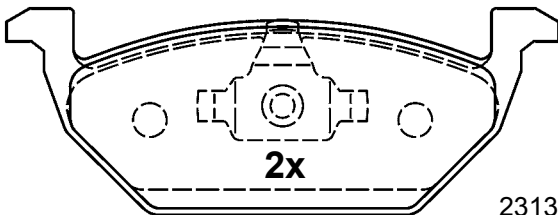

2x

23131 19,6

146,0 x 54,7 x 19,6

## 13.0460-7113.2 607113



FIAT



ATE

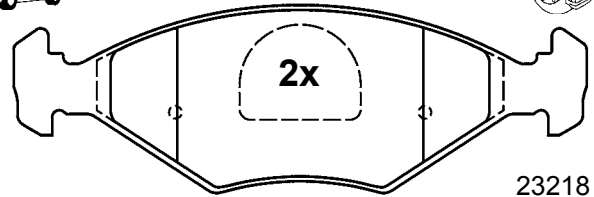

2x

23218 18,0

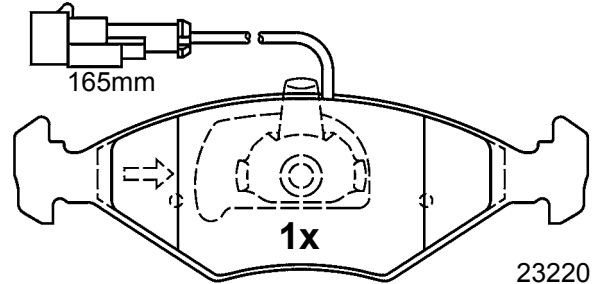

165mm

1x

23220 18,0

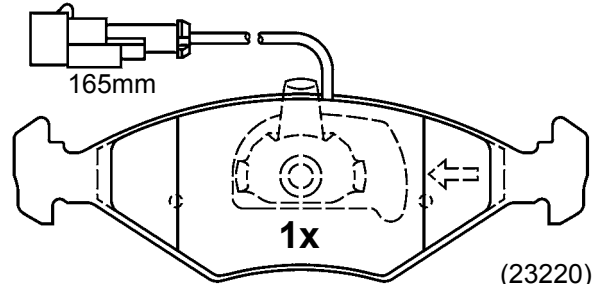

165mm

1x

(23220) 18,0

151,3 x 49,2 x 18,0

## 13.0460-7112.2 607112



ALFA ROMEO



ATE

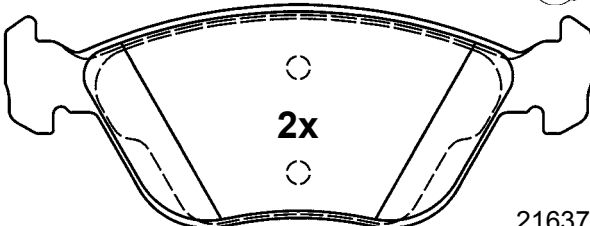

2x

21637 19,3

156,3 x 59,1 x 19,3

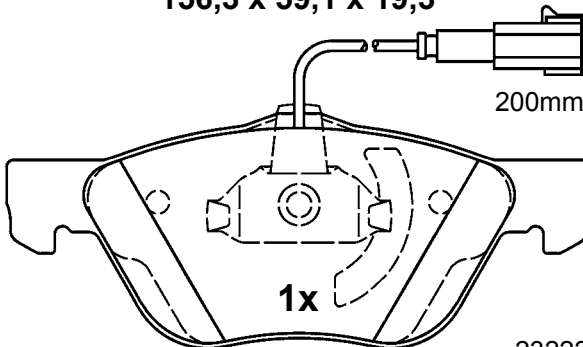

200mm

1x

23222 19,3

155,1 x 61,8 x 19,3

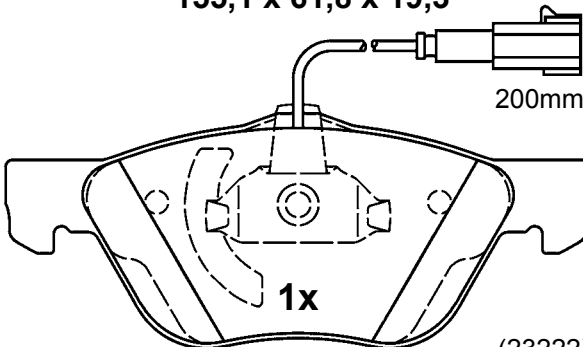

200mm

1x

(23222) 19,3

155,1 x 61,8 x 19,3

## 13.0460-7114.2 607114



FIAT, LANCIA



ATE

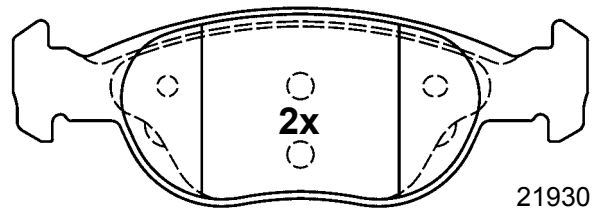

2x

21930 17,9

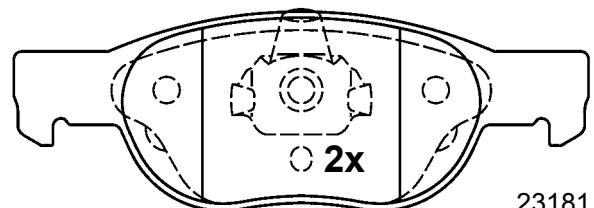

2x

23181 17,9

151,3 x 52,0 x 17,9

# Abbildungen Scheibenbremsbeläge

Illustrations disc brake pads - Illustrazioni pastiglie freno -

Illustrations plaquettes de frein - Ilustraciones pastillas de freno

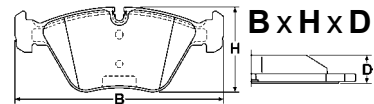

Maßstab - scale - scala - échelle - escala 1:2

## 13.0460-7115.2 607115



OPEL, VAUXHALL



ATE

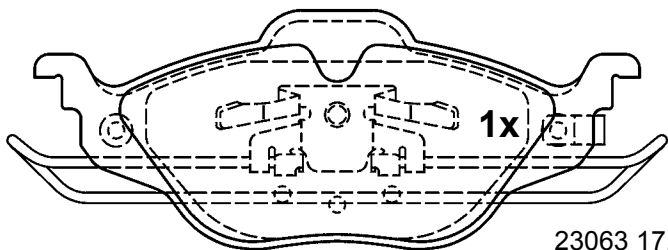

23063 17,5

160,0 x 63,0 x 17,5

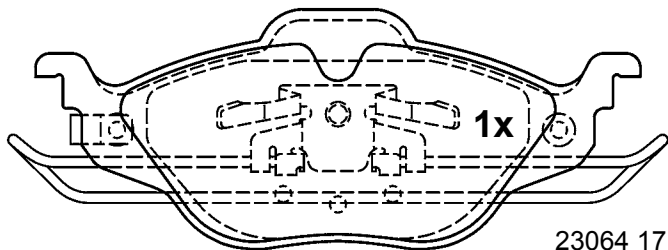

23064 17,5

160,0 x 63,0 x 17,5

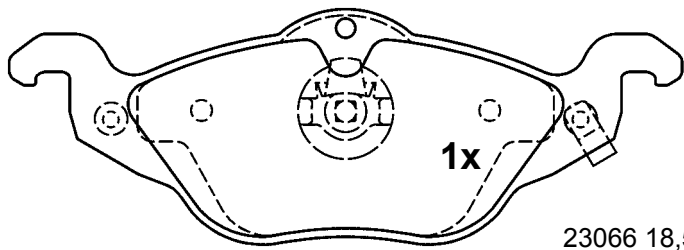

23066 18,5

177,6 x 62,0 x 18,5

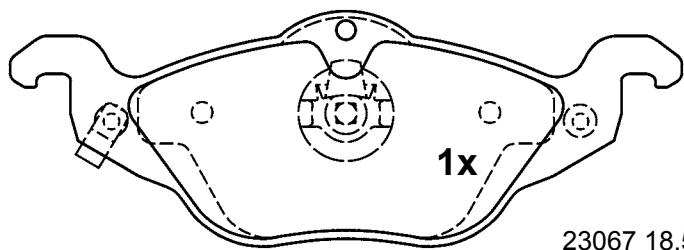

23067 18,5

177,6 x 62,0 x 18,5

## 13.0460-7116.2 607116



OPEL, VAUXHALL



ATE

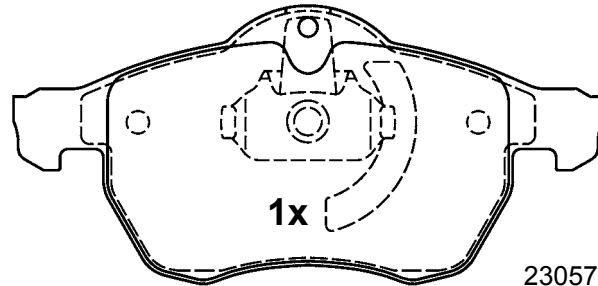

23057 20,2

155,1 x 71,4 x 20,2

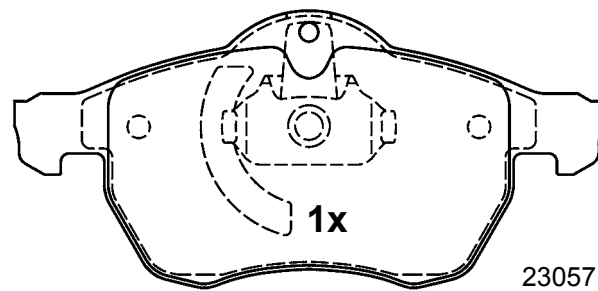

23057 20,2

155,1 x 71,4 x 20,2

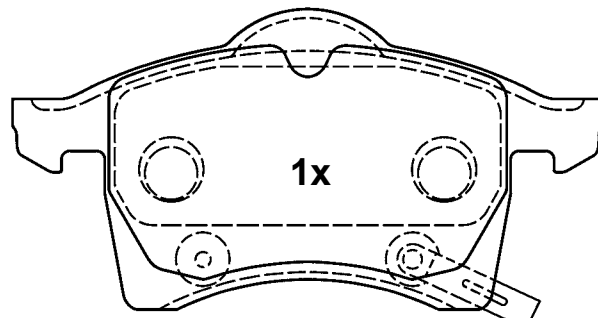

23058 19,6

156,3 x 78,5 x 19,6

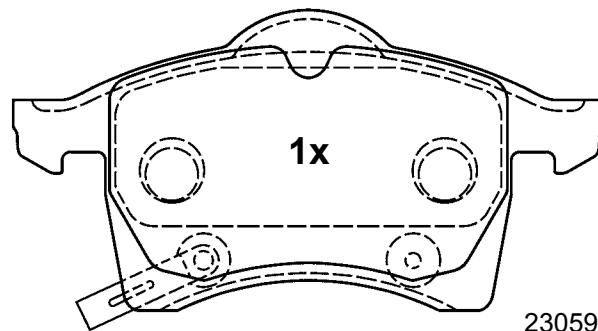

23059 19,6

156,3 x 78,5 x 19,6

# Abbildungen Scheibenbremsbeläge

Illustrations disc brake pads - Illustrazioni pastiglie freno -

Illustrations plaquettes de frein - Ilustraciones pastillas de freno

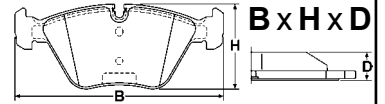

Maßstab - scale - scala - échelle - escala 1:2

## 13.0460-7117.2 607117



AUDI, SEAT, SKODA,  
VOLKSWAGEN



VW

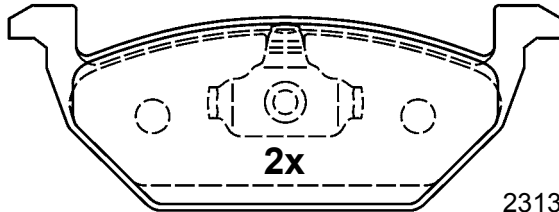

2x

23130 19,6

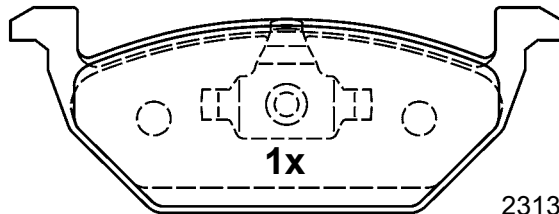

1x

23131 19,6

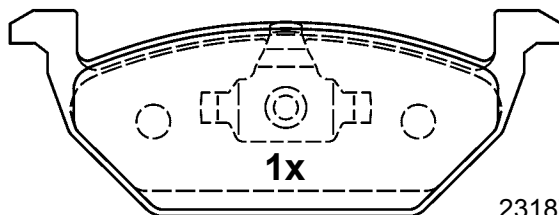

1x

23187 19,6

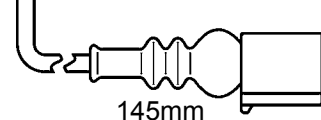

145mm

146,0 x 54,7 x 19,6

## 13.0460-7122.2 607122



AUDI, SEAT, SKODA,  
VOLKSWAGEN



ATE

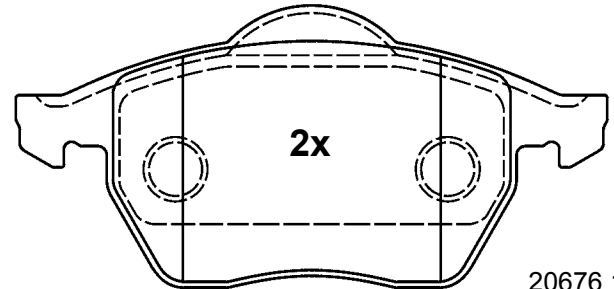

2x

20676 19,8

156,3 x 74,0 x 19,8

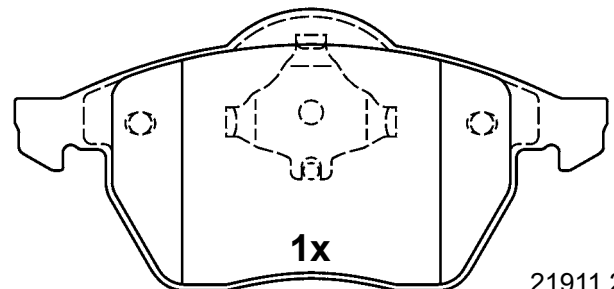

1x

21911 20,3

156,3 x 74,0 x 20,3

## 13.0460-7121.2 607121



FORD



ATE

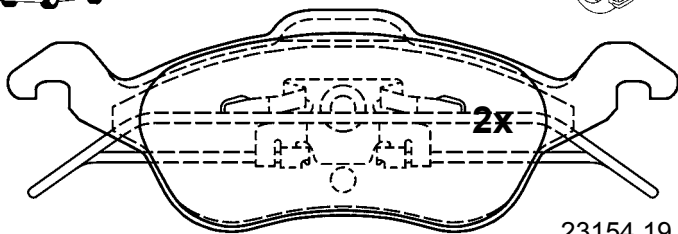

2x

23154 19,4

177,8 x 58,2 x 19,4

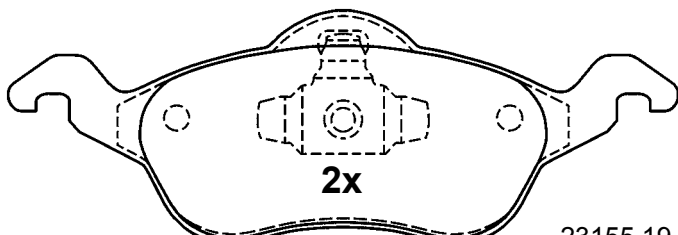

2x

23155 19,4

177,8 x 60,8 x 19,4

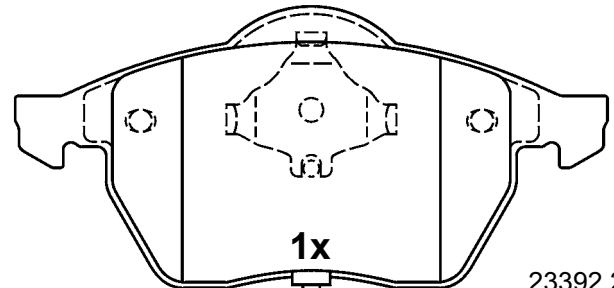

1x

23392 20,3

145mm

156,3 x 74,0 x 20,3

# Abbildungen Scheibenbremsbeläge

Illustrations disc brake pads - Illustrazioni pastiglie freno -

Illustrations plaquettes de frein - Ilustraciones pastillas de freno

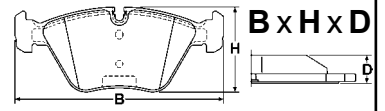

Maßstab - scale - scala - échelle - escala 1:2

**13.0460-7123.2 607123**

 VOLKSWAGEN

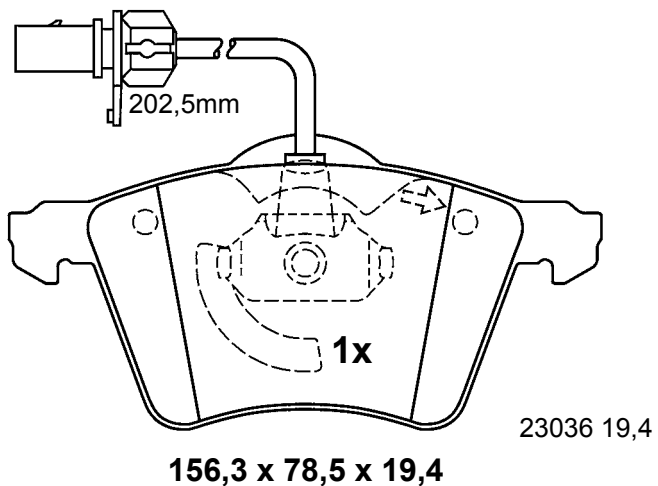
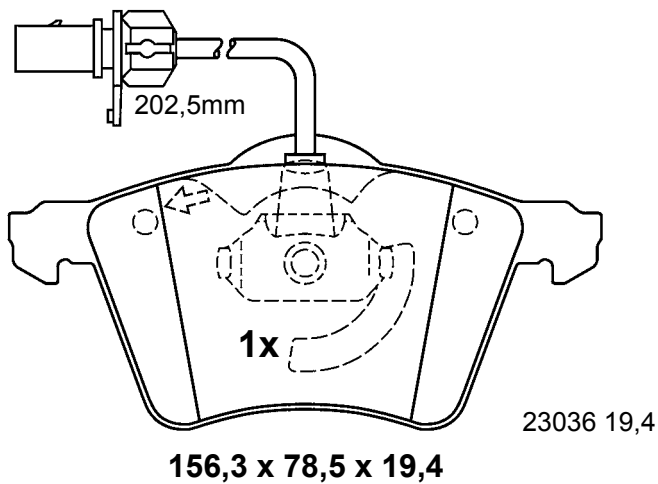
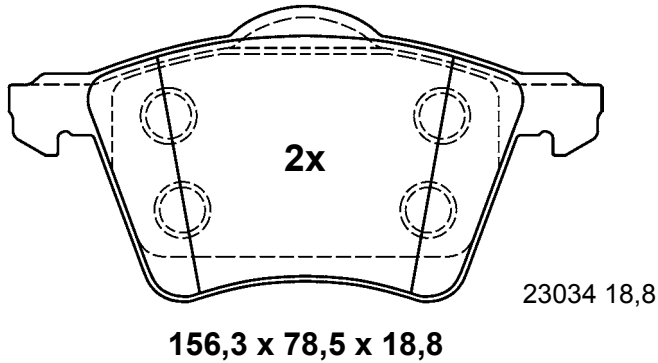

**13.0460-7124.2 607124**

 VOLKSWAGEN

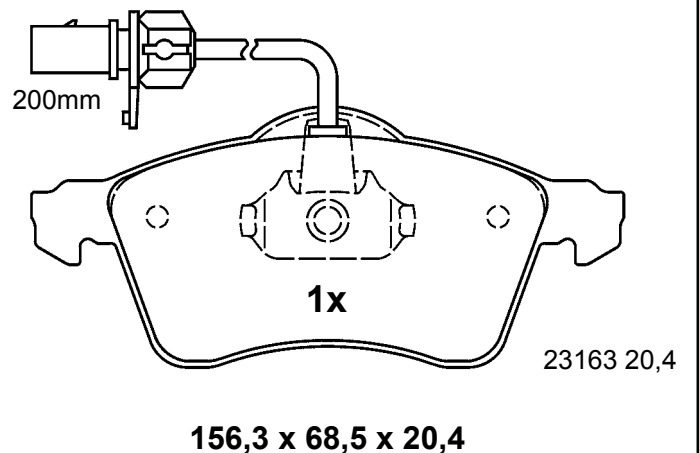
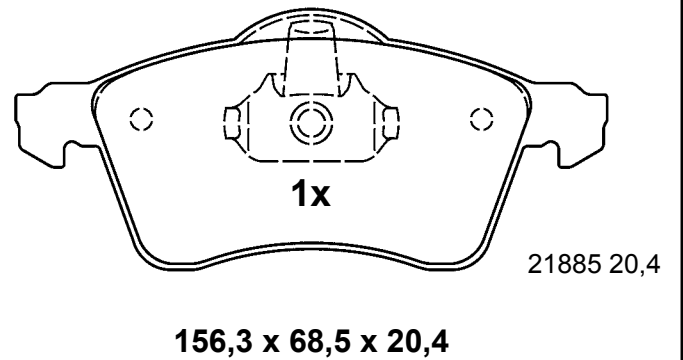
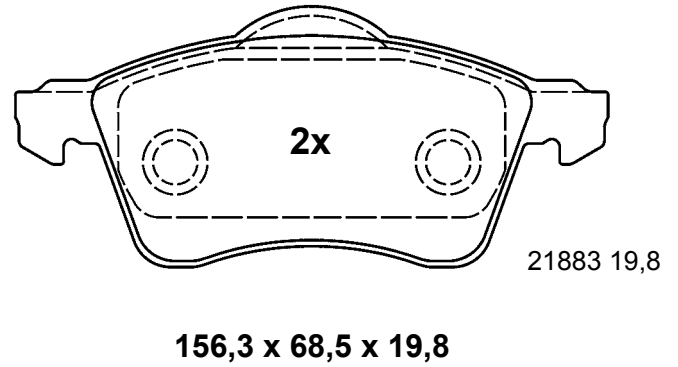

# Abbildungen Scheibenbremsbeläge

Illustrations disc brake pads - Illustrazioni pastiglie freno -

Illustrations plaquettes de frein - Ilustraciones pastillas de freno

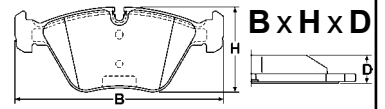

Maßstab - scale - scala - échelle - escala 1:2

## 13.0460-7125.2 607125



FIAT



ATE

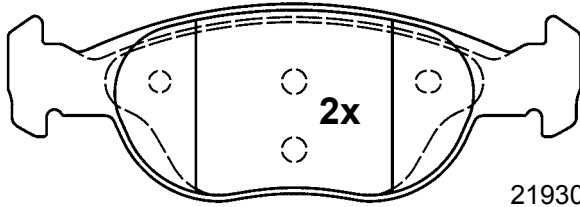

21930 17,9

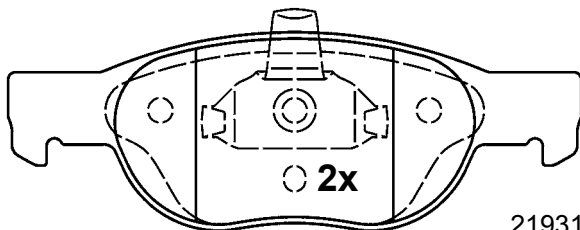

21931 17,9

151,3 x 52,0 x 17,9

## 13.0460-7128.2 607128



FIAT



ATE

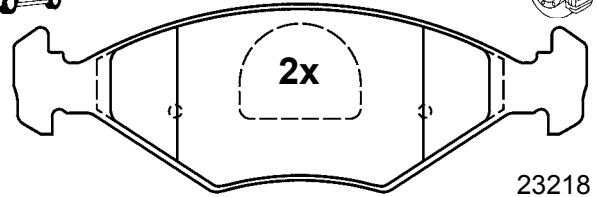

23218 18,0

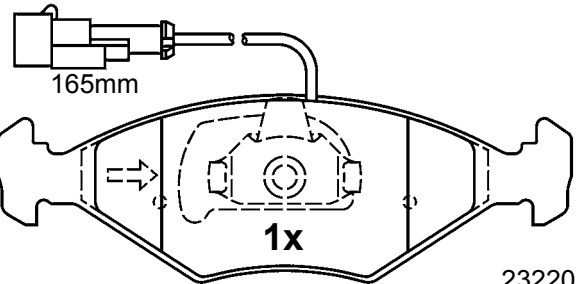

23220 18,0

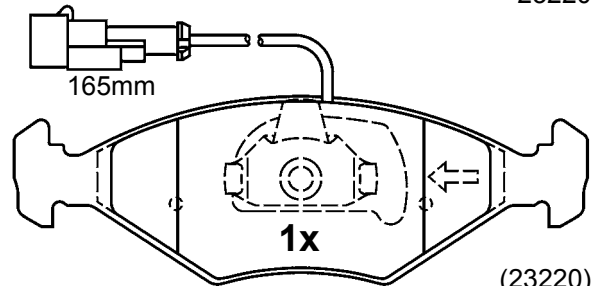

(23220) 18,0

151,3 x 49,2 x 18,0

## 13.0460-7126.2 607126



FIAT



ATE

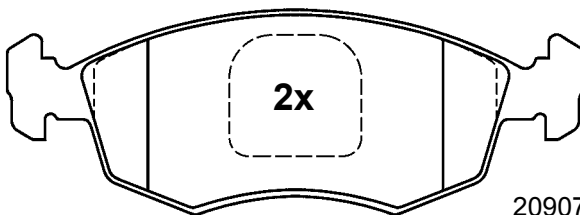

20907 18,1

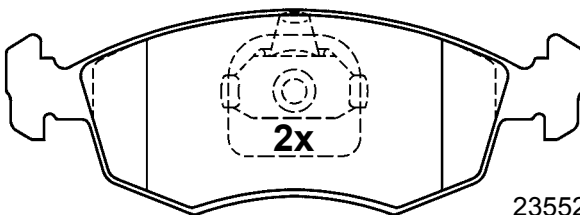

23552 18,1

151,3 x 52,5 x 18,1

## 13.0460-7129.2 607129



LANCIA



ATE

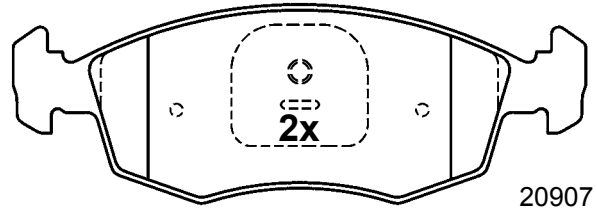

20907 18,1

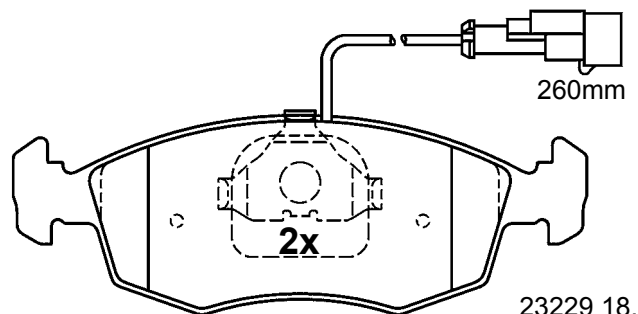

23229 18,1

151,3 x 52,5 x 18,1



# Abbildungen Scheibenbremsbeläge

Illustrations disc brake pads - Illustrazioni pastiglie freno -

Illustrations plaquettes de frein - Ilustraciones pastillas de freno

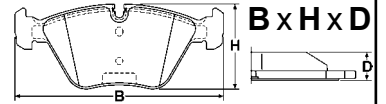

Maßstab - scale - scala - échelle - escala 1:2

## 13.0460-7131.2 607131



LANCIA



ATE

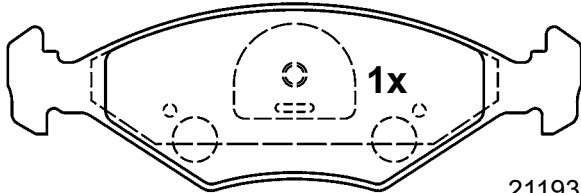

21193 18,0

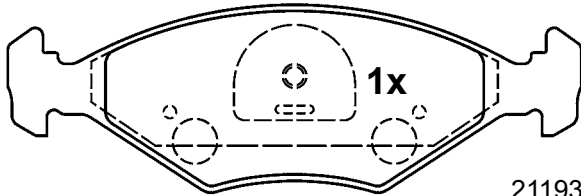

21193 18,0

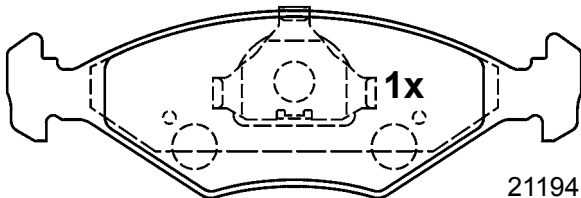

21194 18,0

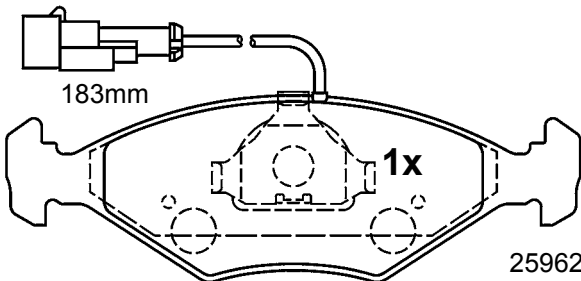

25962 18,0

151,3 x 49,2 x 18,0

## 13.0460-7132.2 607132



FIAT



ATE

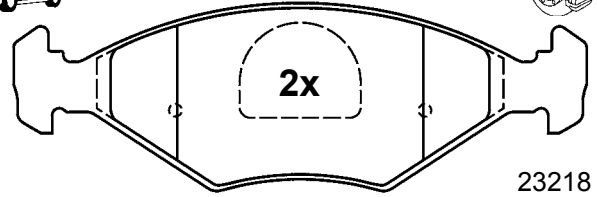

23218 18,0

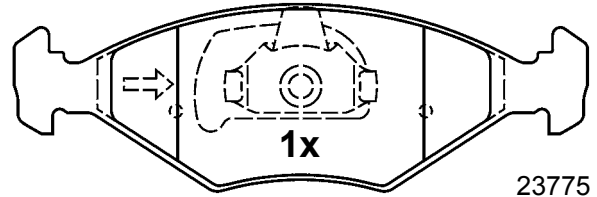

23775 18,0

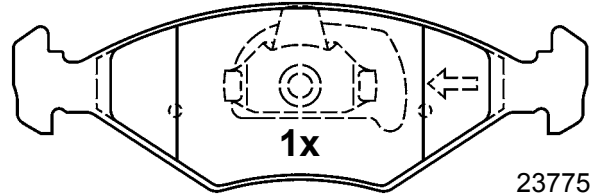

23775 18,0

151,3 x 49,2 x 18,0

## 13.0460-7133.2 607133



FIAT



ATE

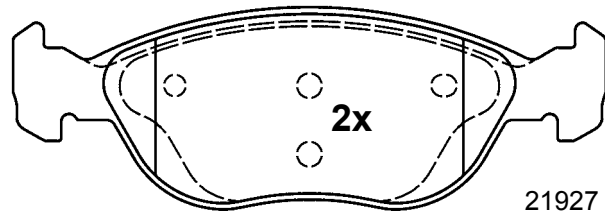

21927 17,9

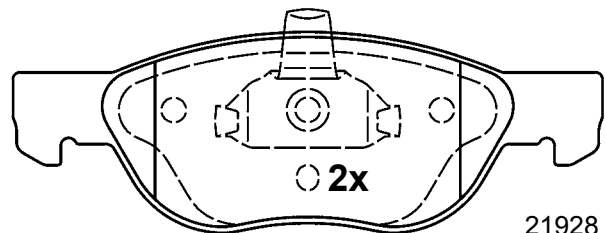

21928 17,9

156,3 x 52,7 x 17,9

# Abbildungen Scheibenbremsbeläge

Illustrations disc brake pads - Illustrazioni pastiglie freno -

Illustrations plaquettes de frein - Ilustraciones pastillas de freno

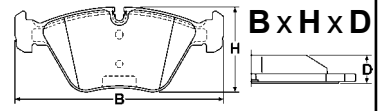

Maßstab - scale - scala - échelle - escala 1:2

**13.0460-7134.2 607134**

PEUGEOT

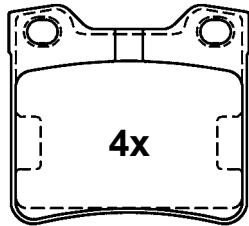

21278 16,4

63,7 x 57,8 x 16,4

**13.0460-7137.2 607137**

NISSAN, RENAULT

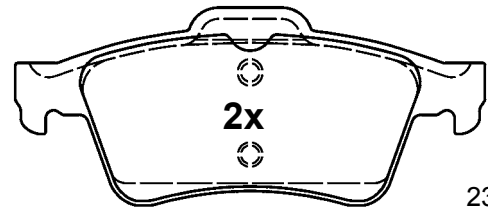

23482 15,8

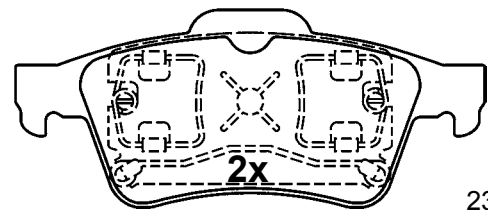

23483 15,8

123,0 x 51,9 x 15,8

**13.0460-7135.2 607135**

VOLVO

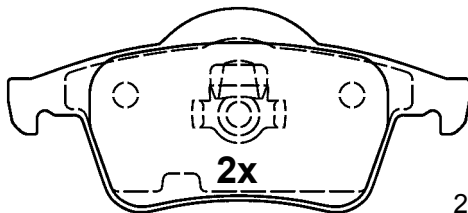

23076 17,5

122,4 x 53,7 x 17,5

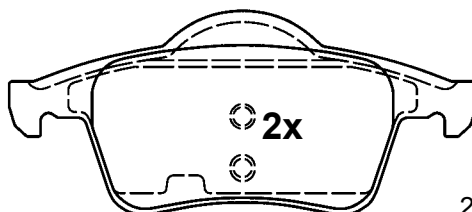

23077 17,5

123,6 x 53,7 x 17,5

**13.0460-7138.2 607138**

DAIMLER, JAGUAR

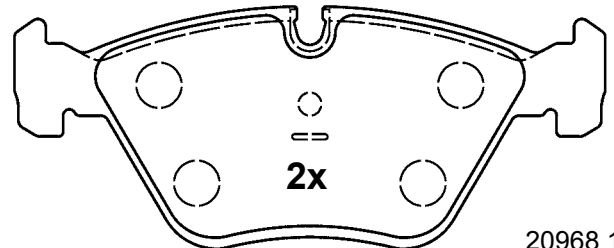

20968 17,5

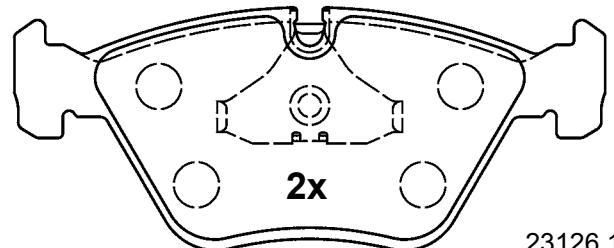

23126 17,5

156,4 x 64,0 x 17,5

# Abbildungen Scheibenbremsbeläge

Illustrations disc brake pads - Illustrazioni pastiglie freno -

Illustrations plaquettes de frein - Ilustraciones pastillas de freno



Maßstab - scale - scala - échelle - escala 1:2

## 13.0460-7139.2 607139

ALFA ROMEO, LANCIA

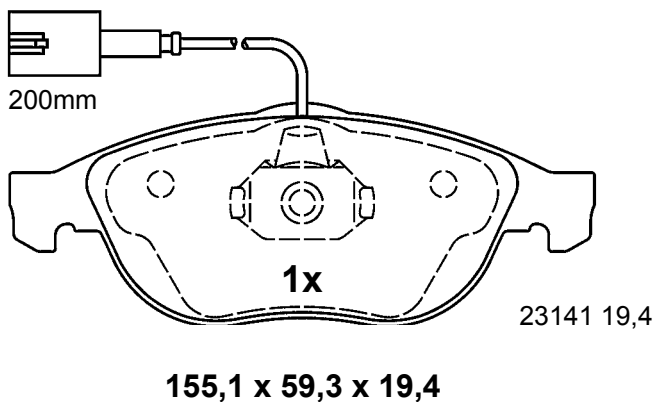
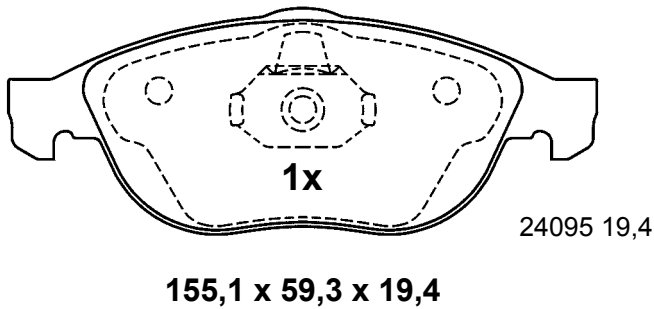
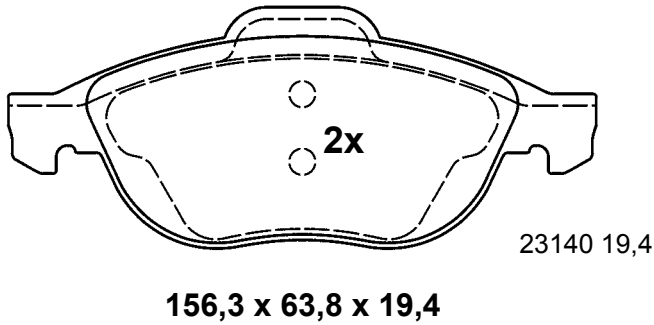

## 13.0460-7140.2 607140

ALFA ROMEO, FIAT, LANCIA

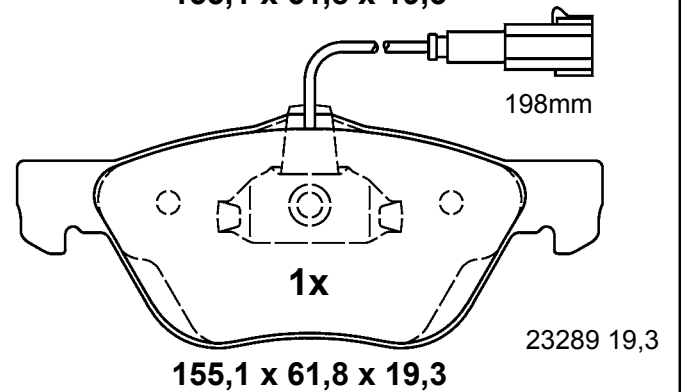
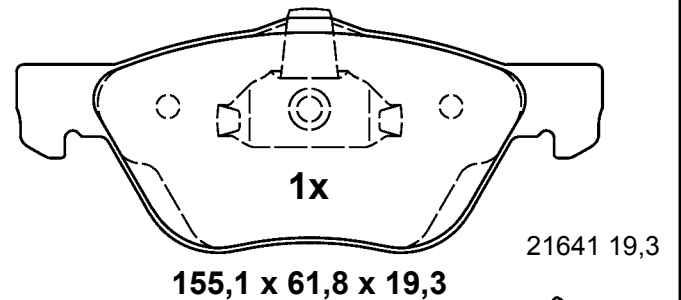
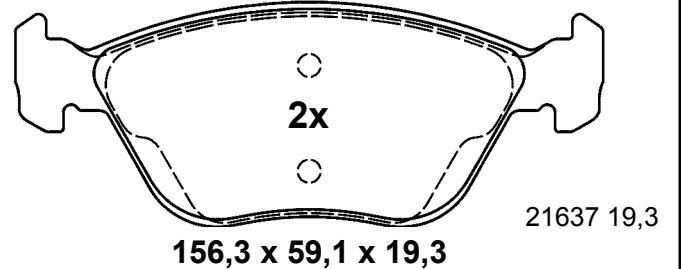

## 13.0460-7141.2 607141

FIAT

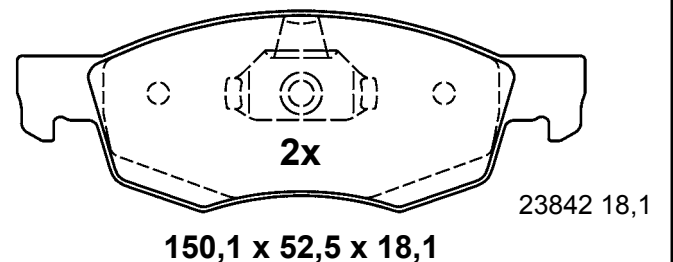
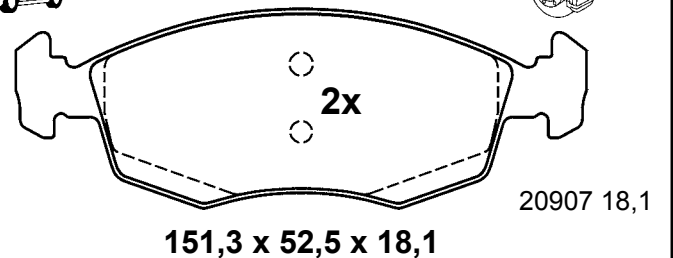

# Abbildungen Scheibenbremsbeläge

Illustrations disc brake pads - Illustrazioni pastiglie freno -

Illustrations plaquettes de frein - Ilustraciones pastillas de freno

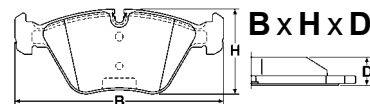

Maßstab - scale - scala - échelle - escala 1:2

## 13.0460-7142.2 607142



FORD, MAZDA



ATE

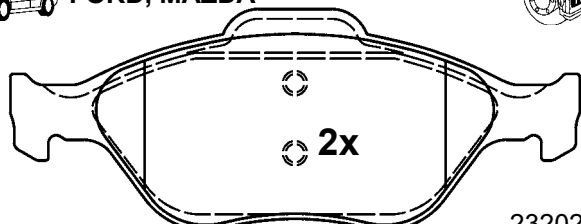

151,3 x 58,2 x 17,8

23202 17,8

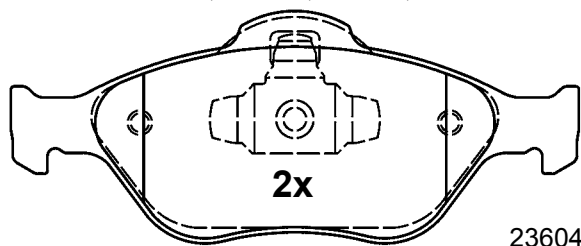

150,1 x 61,0 x 17,8

23604 17,8

## 13.0460-7144.2 607144



MG, ROVER



ATE

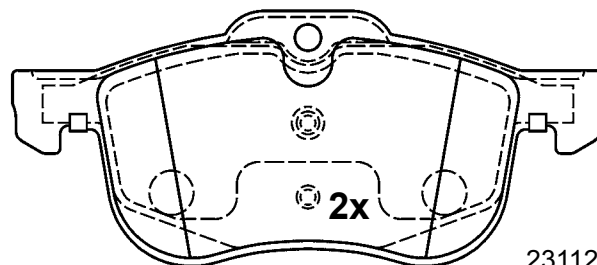

156,4 x 67,2 x 19,1

23112 19,1

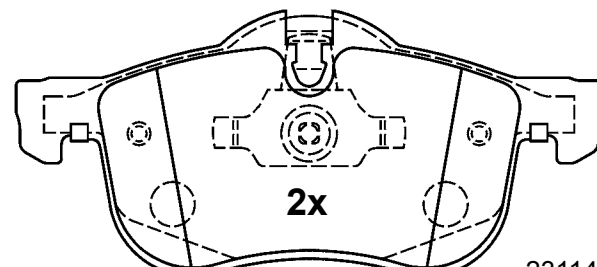

155,1 x 70,1 x 19,1

23114 19,1

## 13.0460-7143.2 607143



FORD, SEAT, VOLKSWAGEN



ATE

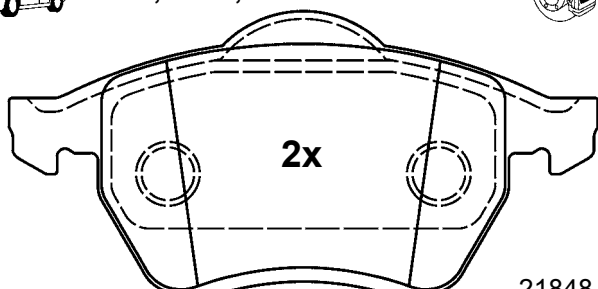

156,3 x 74,0 x 19,8

21848 19,8

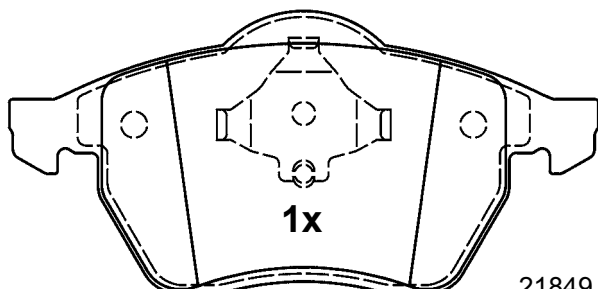

156,3 x 74,0 x 20,3

21849 20,3

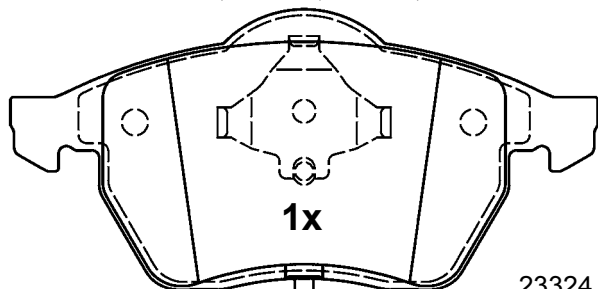

156,3 x 74,0 x 20,3

23324 20,3

200mm

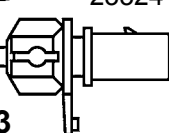

## 13.0460-7145.2 607145



VOLVO



ATE

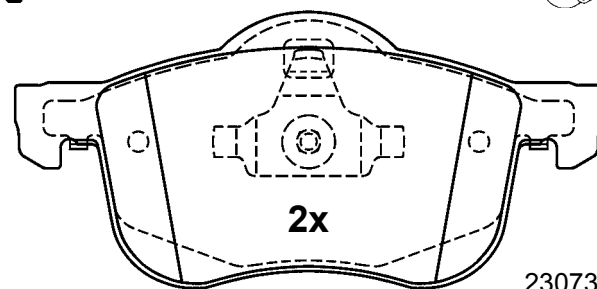

155,1 x 72,5 x 18,8

23073 18,8

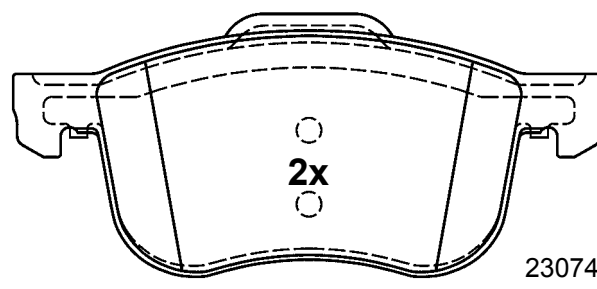

156,3 x 69,1 x 18,8

23074 18,8







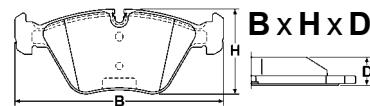

# Abbildungen Scheibenbremsbeläge

Illustrations disc brake pads - Illustrazioni pastiglie freno -

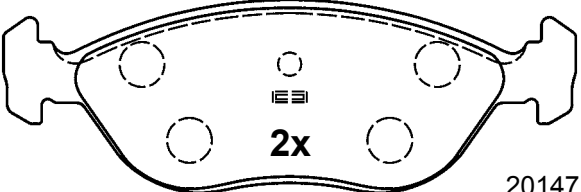
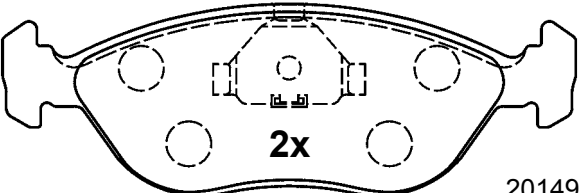
Illustrations plaquettes de frein - Ilustraciones pastillas de freno

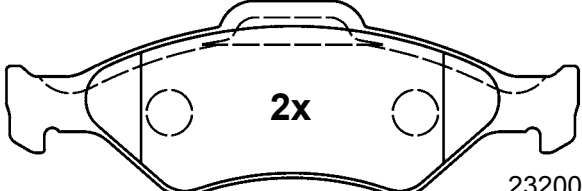
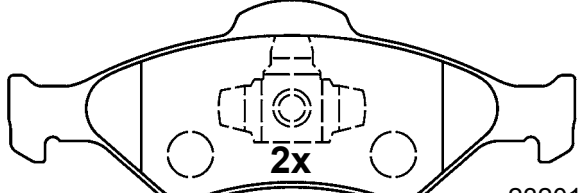

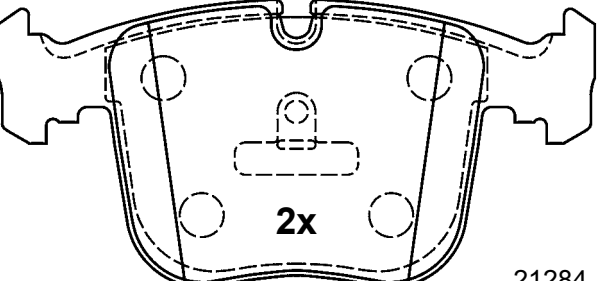
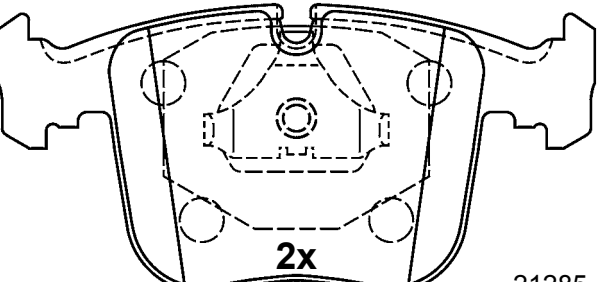
Maßstab - scale - scala - échelle - escala 1:2

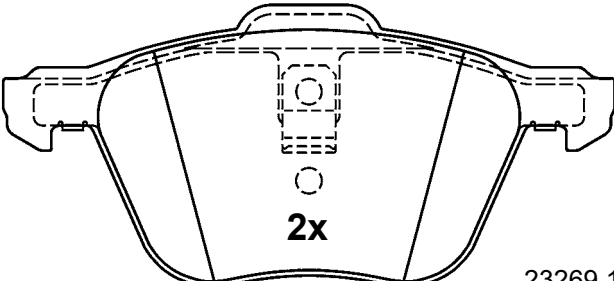
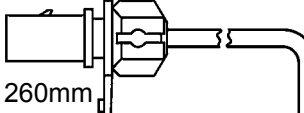
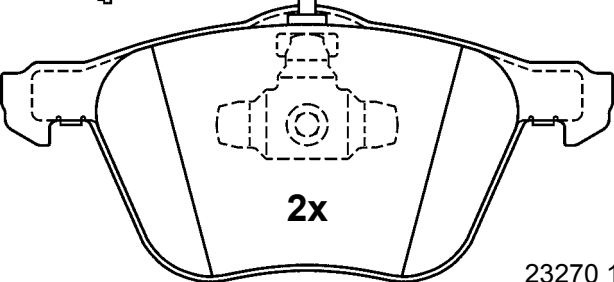
| 13.0460-7146.2 607146  | 13.0460-7148.2 607148   |
|--|---|
| <p> VOLVO  ATE</p>  <p>20147 17,0</p>  <p>20149 17,0</p> <p>151,3 x 50,6 x 17,0</p>       | <p> FORD, MAZDA  ATE</p>  <p>23200 18,0</p> <p>151,3 x 51,3 x 18,0</p>  <p>23201 18,0</p> <p>150,1 x 54,1 x 18,0</p>  |
| 13.0460-7147.2 607147  | 13.0460-7153.2 607153   |
| <p> BMW  ATE</p>  <p>21284 19,1</p>  <p>21285 19,1</p> <p>156,4 x 75,0 x 19,1</p> | <p> FORD, SEAT, VOLKSWAGEN  ATE</p>  <p>23269 19,8</p> <p>161,3 x 74,4 x 19,8</p>  <p>260mm</p>  <p>23270 19,8</p> <p>161,3 x 72,9 x 19,8</p> |



# Abbildungen Scheibenbremsbeläge

Illustrations disc brake pads - Illustrazioni pastiglie freno -

Illustrations plaquettes de frein - Ilustraciones pastillas de freno

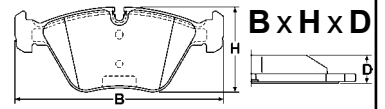

Maßstab - scale - scala - échelle - escala 1:2

## 13.0460-7154.2 607154

FORD, SEAT, VOLKSWAGEN

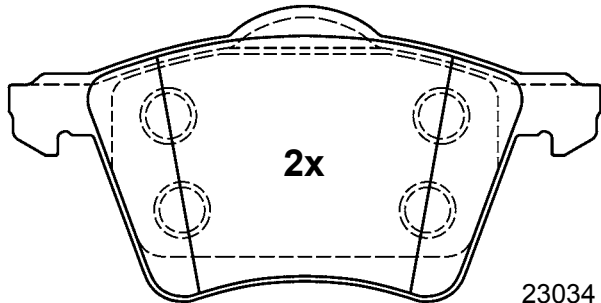

2x

23034 18,8

156,3 x 78,5 x 18,8

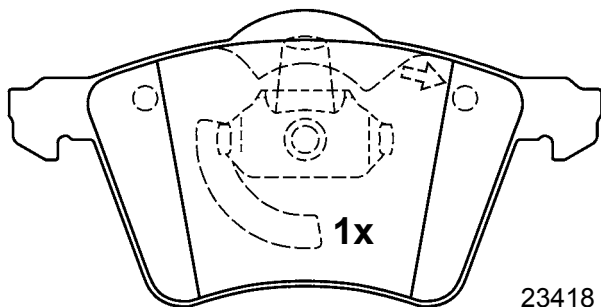

1x

23418 19,4

156,3 x 78,5 x 19,4

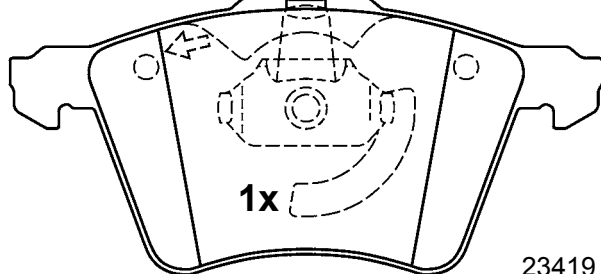
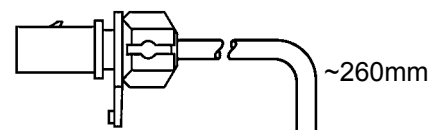

1x

23419 19,4

156,3 x 78,5 x 19,4

## 13.0460-7155.2 607155

BMW, MG

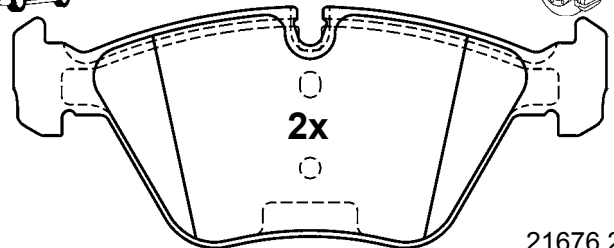

2x

21676 20,3

156,3 x 63,5 x 20,3

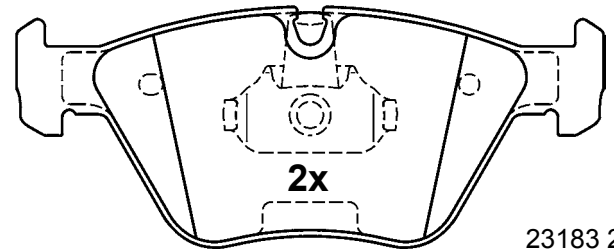

2x

23183 20,3

155,1 x 63,5 x 20,3

## 13.0460-7156.2 607156

FORD

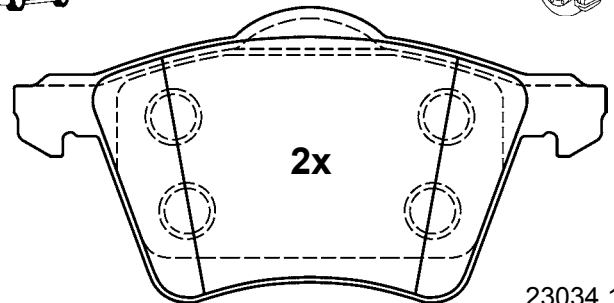

2x

23034 19,4

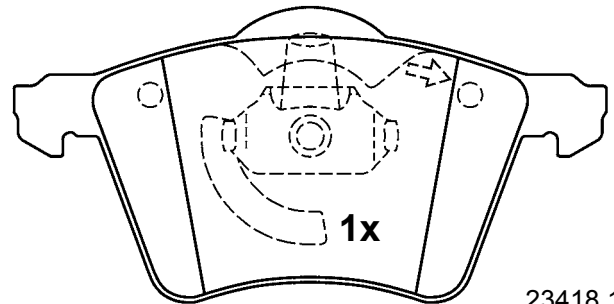

1x

23418 19,4

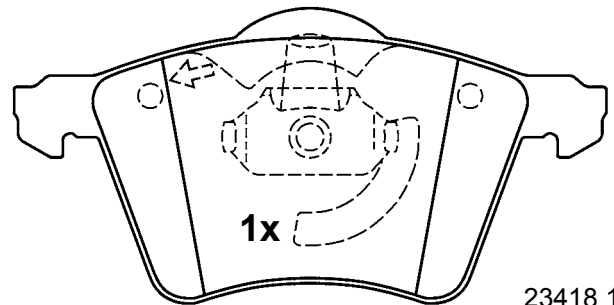

1x

23418 19,4

156,3 x 78,5 x 19,5



# Abbildungen Scheibenbremsbeläge

Illustrations disc brake pads - Illustrazioni pastiglie freno -

Illustrations plaquettes de frein - Ilustraciones pastillas de freno

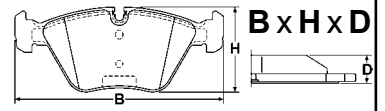

Maßstab - scale - scala - échelle - escala 1:2

## 13.0460-7157.2 607157



RENAULT



ATE

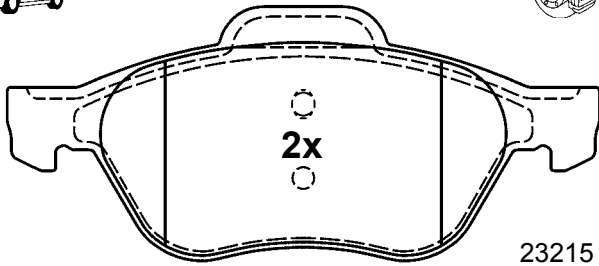

156,3 x 66,8 x 18,3

23215 18,3

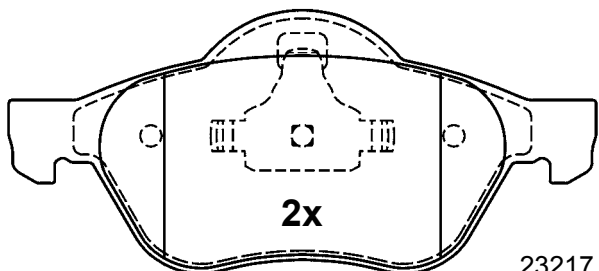

155,1 x 68,9 x 18,3

23217 18,3

## 13.0460-7159.2 607159



RENAULT



ATE

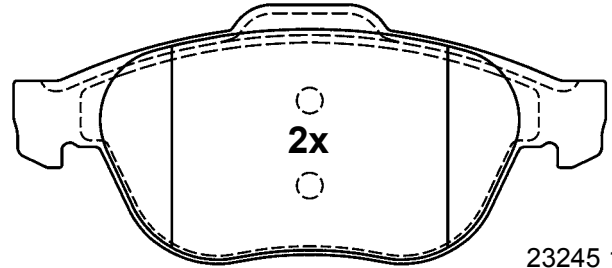

156,3 x 68,3 x 18,3

23245 18,3

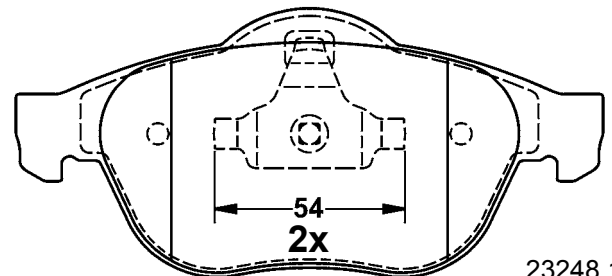

155,1 x 70,8 x 18,3

23248 18,3

## 13.0460-7158.2 607158



RENAULT



ATE

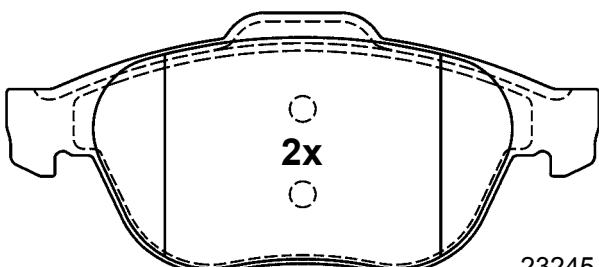

156,3 x 68,3 x 18,3

23245 18,3

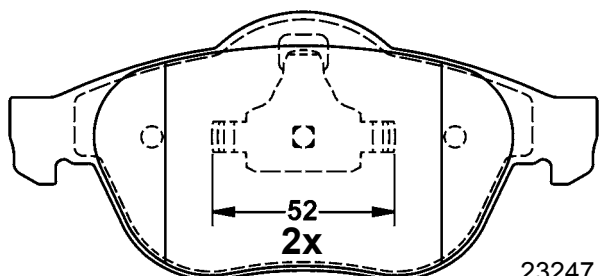

155,1 x 70,8 x 18,3

23247 18,3

## 13.0460-7160.2 607160



FORD



ATE

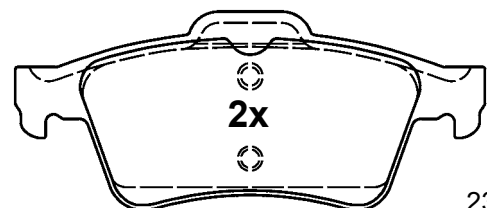

23482 16,7

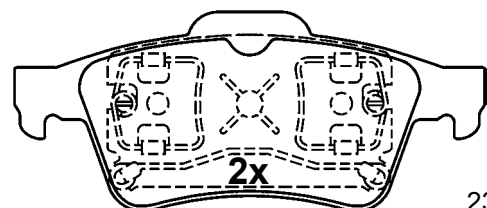

23483 16,7

123,0 x 51,9 x 16,7

# Abbildungen Scheibenbremsbeläge

Illustrations disc brake pads - Illustrazioni pastiglie freno -

Illustrations plaquettes de frein - Ilustraciones pastillas de freno

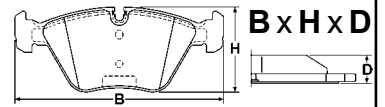

Maßstab - scale - scala - échelle - escala 1:2

## 13.0460-7161.2 607161



MINI



ATE

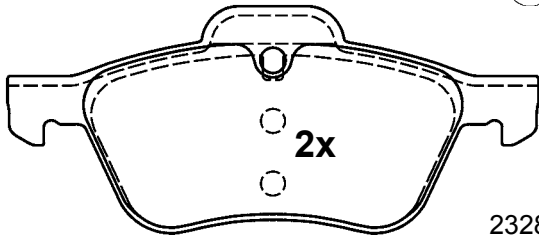

2x

23281 18,3

140,1 x 59,8 x 18,3

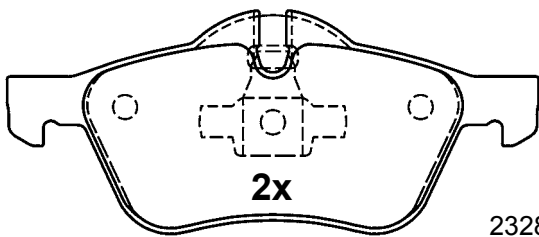

2x

23282 18,3

140,1 x 58,7 x 18,3

## 13.0460-7163.2 607163



FORD



ATE

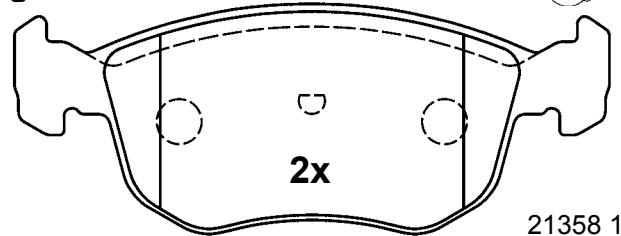

2x

21358 19,8

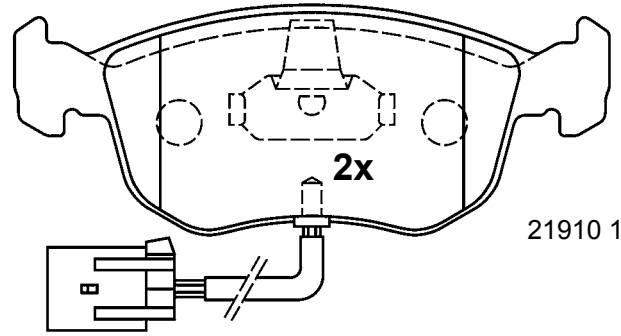

2x

21910 19,8

210mm

156,4 x 60,0 x 19,8

## 13.0460-7162.2 607162



MINI



ATE

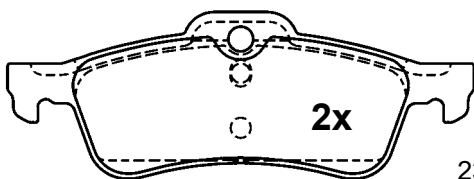

2x

23716 15,8

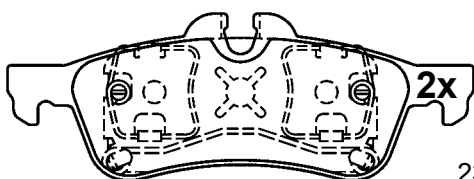

2x

23717 15,8

123,0 x 43,8 x 15,8

## 13.0460-7164.2 607164



SKODA, VOLKSWAGEN



VW

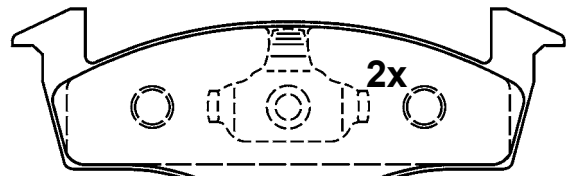

2x

21868 17,2

141,8 x 50,6 x 17,2

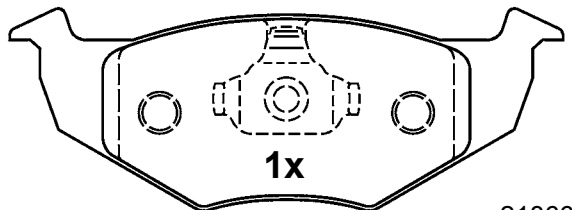

1x

21866 17,2

141,8 x 51,2 x 17,2

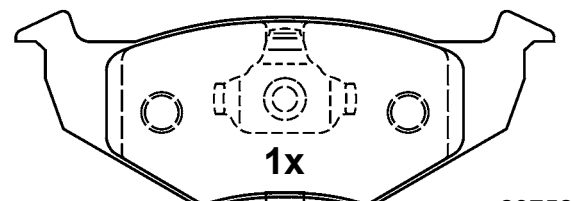

1x

23752 17,2

150mm

141,8 x 51,2 x 17,2

# Abbildungen Scheibenbremsbeläge

Illustrations disc brake pads - Illustrazioni pastiglie freno -

Illustrations plaquettes de frein - Ilustraciones pastillas de freno

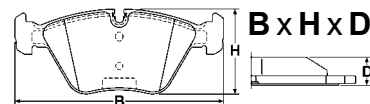

Maßstab - scale - scala - échelle - escala 1:2

## 13.0460-7165.2 607165

FORD

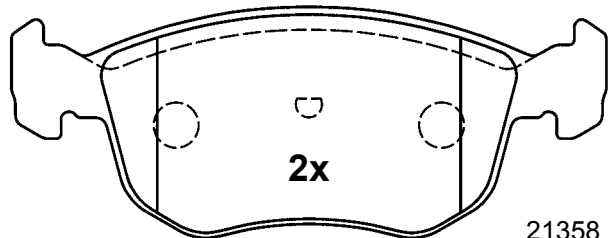

21358 19,8

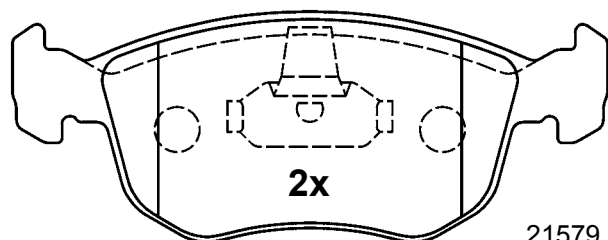

21579 19,8

156,4 x 60,0 x 19,8

## 13.0460-7167.2 607167

BMW

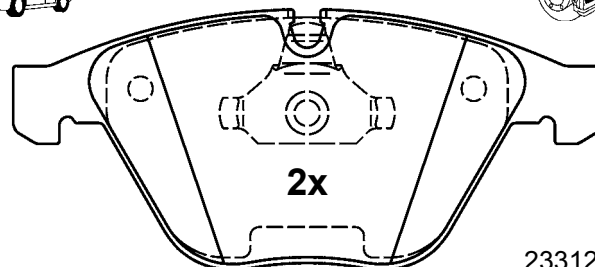

23312 20,3

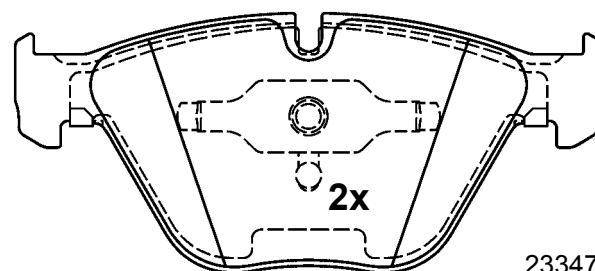

23347 20,3

155,1 x 68,3 x 20,3

## 13.0460-7166.2 607166

AUDI

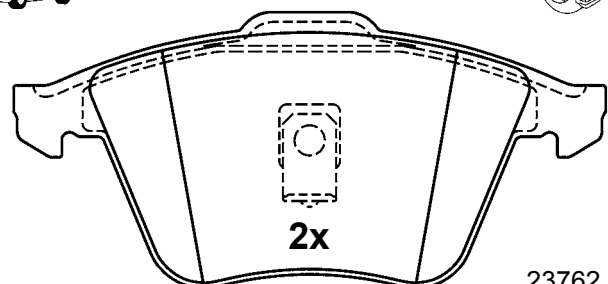

23762 20,4

156,3 x 72,9 x 20,4

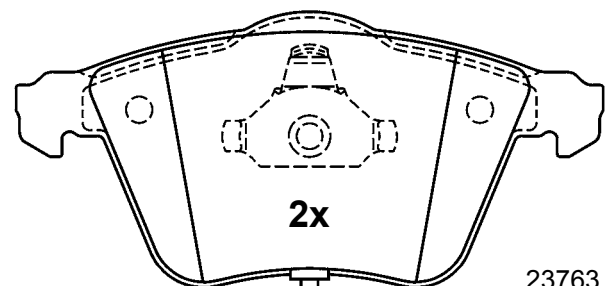

23763 20,4

200mm

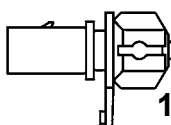

155,1 x 72,9 x 20,4

## 13.0460-7168.2 607168

BMW

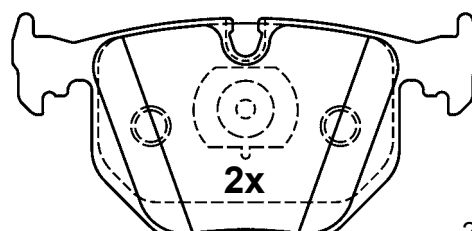

21282 17,3

123,0 x 59,2 x 17,3

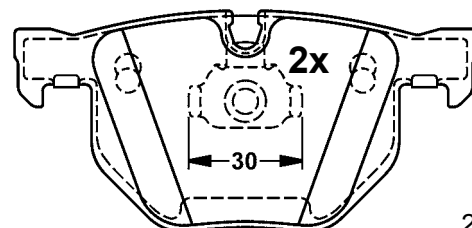

23447 17,3

121,8 x 57,8 x 17,3

# Abbildungen Scheibenbremsbeläge

Illustrations disc brake pads - Illustrazioni pastiglie freno -

Illustrations plaquettes de frein - Ilustraciones pastillas de freno

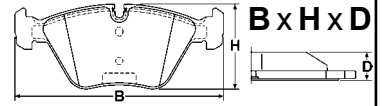

Maßstab - scale - scala - échelle - escala 1:2

**13.0460-7169.2 607169**

BMW

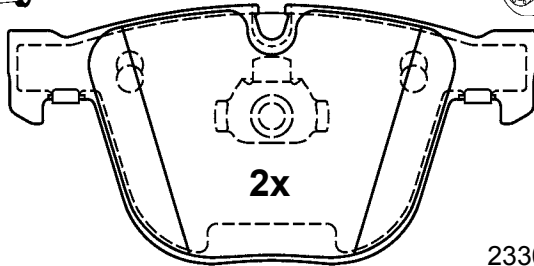

23309 17,3

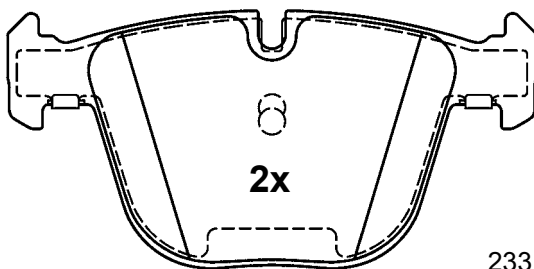

23310 17,3

**139,5 x 67,8 x 17,3**

**13.0460-7171.2 607171**

MERCEDES BENZ

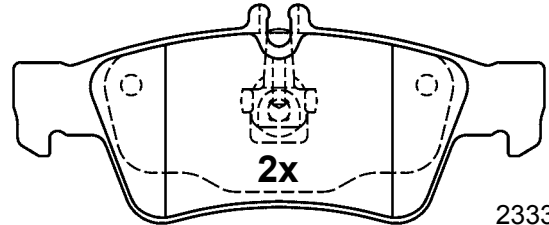

23334 16,7

**140,1 x 57,5 x 16,7**

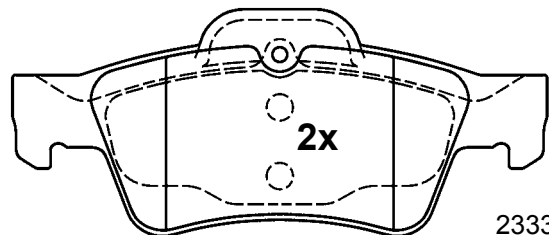

23335 16,7

**141,3 x 59,4 x 16,7**

**13.0460-7170.2 607170**

BMW

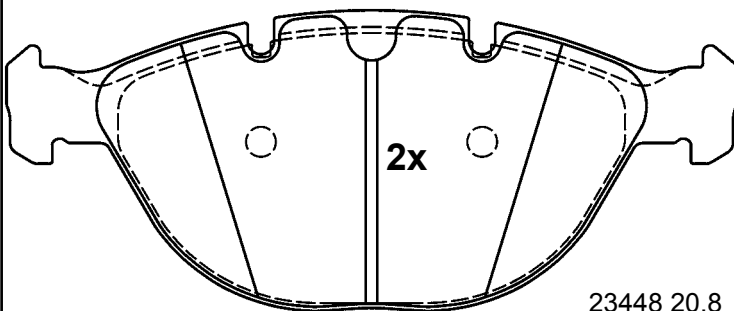

23448 20,8

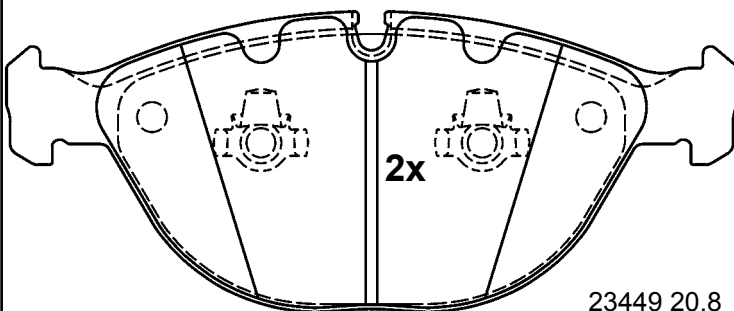

23449 20,8

**193,0 x 79,0 x 20,8**

**13.0460-7172.2 607172**

FIAT, OPEL, SAAB, VAUXHALL

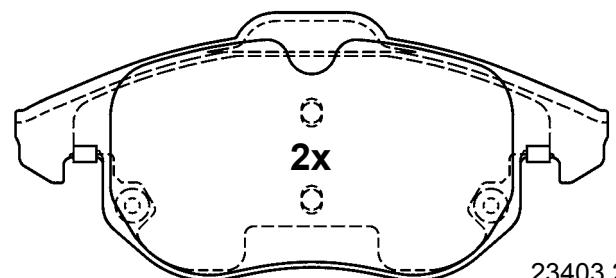

23403 20,1

**156,3 x 70,7 x 20,1**

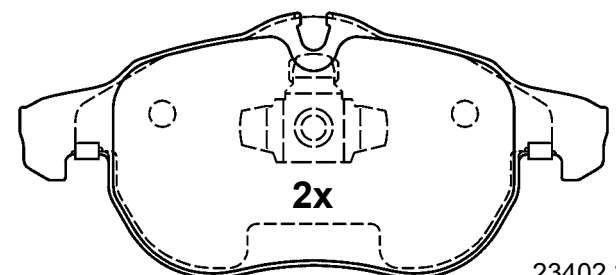

23402 20,1

**155,1 x 69,6 x 20,1**

# Abbildungen Scheibenbremsbeläge

Illustrations disc brake pads - Illustrazioni pastiglie freno -

Illustrations plaquettes de frein - Ilustraciones pastillas de freno

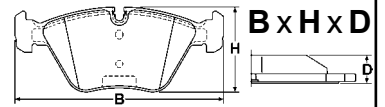

Maßstab - scale - scala - échelle - escala 1:2

## 13.0460-7173.2 607173

OPEL, SAAB, VAUXHALL

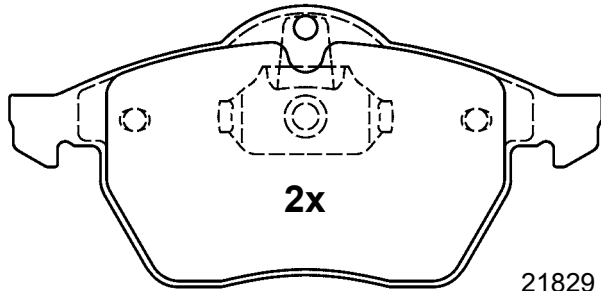

21829 20,3

155,1 x 74,0 x 20,3

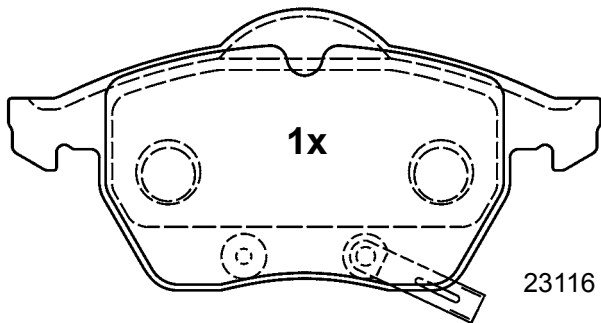

23116 19,6

156,3 x 74,0 x 19,6

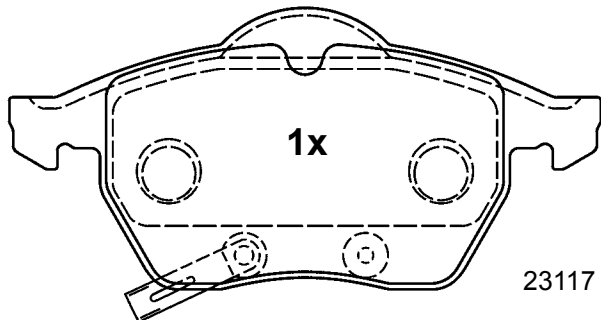

23117 19,6

156,3 x 74,0 x 19,6

## 13.0460-7174.2 607174

BMW

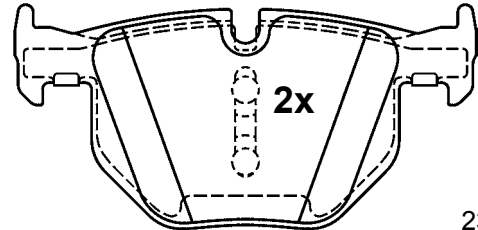

23732 17,3

121,8 x 59,2 x 17,3

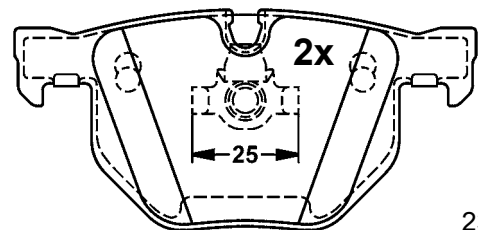

23737 17,3

121,8 x 57,8 x 17,3

## 13.0460-7176.2 607176

BMW

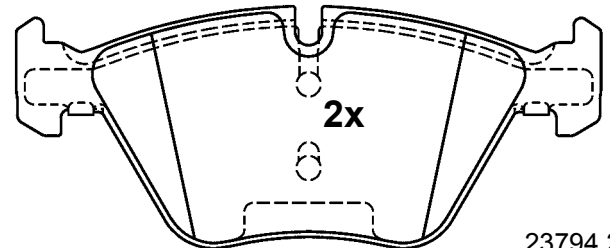

23794 20,3

154,6 x 63,5 x 20,3

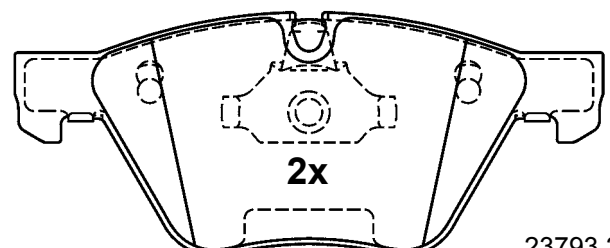

23793 20,3

155,1 x 63,5 x 20,3



# Abbildungen Scheibenbremsbeläge

Illustrations disc brake pads - Illustrazioni pastiglie freno -

Illustrations plaquettes de frein - Ilustraciones pastillas de freno

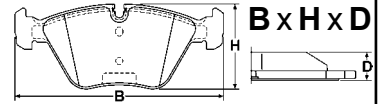

Maßstab - scale - scala - échelle - escala 1:2

## 13.0460-7177.2 607177

VOLKSWAGEN

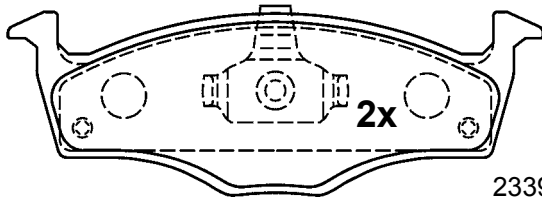

23394 13,7

141,6 x 48,0 x 13,7

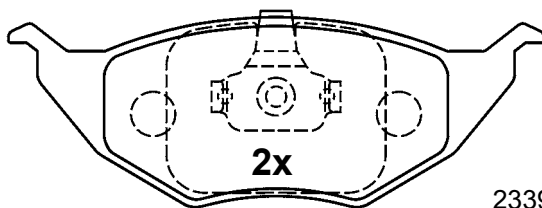

23395 13,7

141,6 x 49,9 x 13,7

## 13.0460-7179.2 607179

OPEL, VAUXHALL

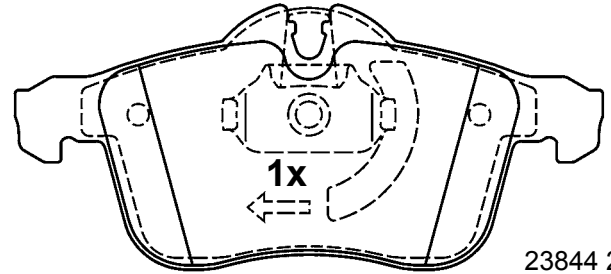

23844 20,5

155,1 x 70,0 x 20,5

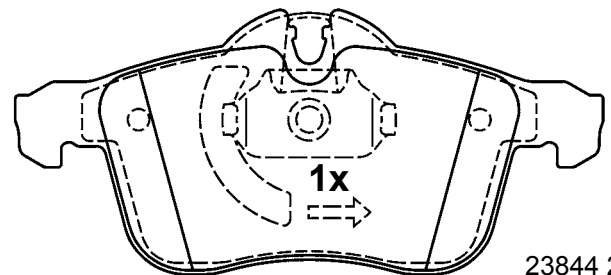

23844 20,5

155,1 x 70,0 x 20,5

## 13.0460-7178.2 607178

AUDI

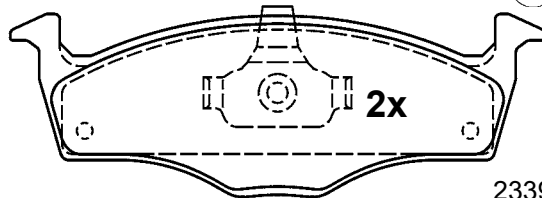

23394 13,7

141,6 x 48,0 x 13,7

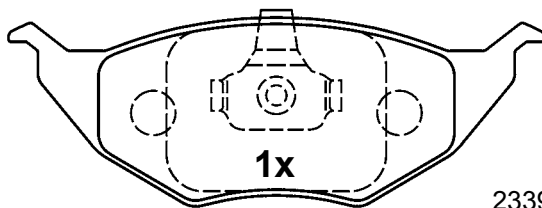

23395 13,7

141,6 x 49,9 x 13,7

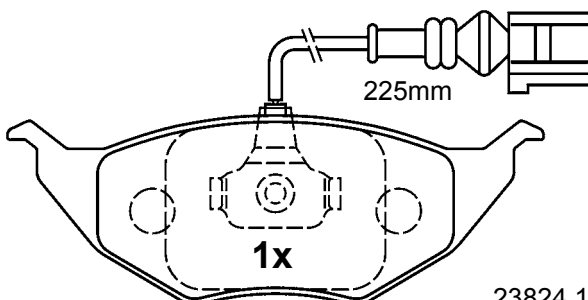

23824 13,7

141,6 x 49,9 x 13,7

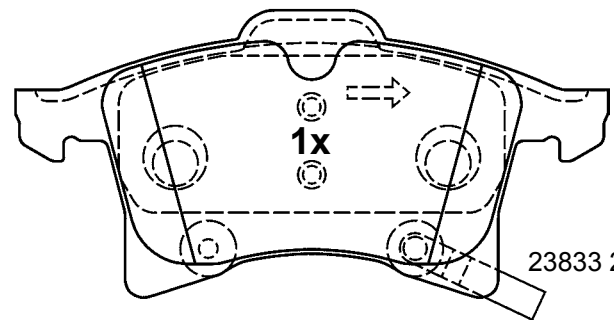

23833 20,2

156,3 x 76,0 x 20,2

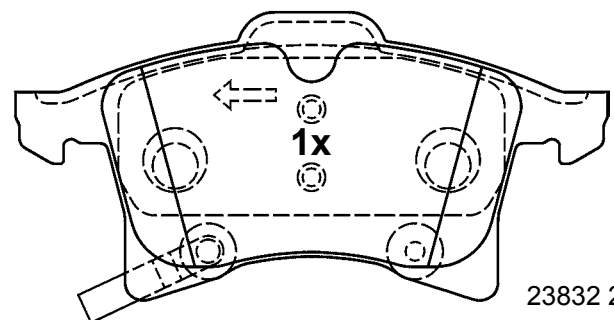

23832 20,2

156,3 x 76,0 x 20,2



# Abbildungen Scheibenbremsbeläge

Illustrations disc brake pads - Illustrazioni pastiglie freno -

Illustrations plaquettes de frein - Ilustraciones pastillas de freno

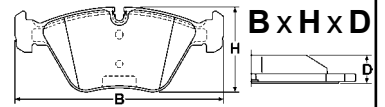

Maßstab - scale - scala - échelle - escala 1:2

## 13.0460-7180.2 607180

ALFA ROMEO

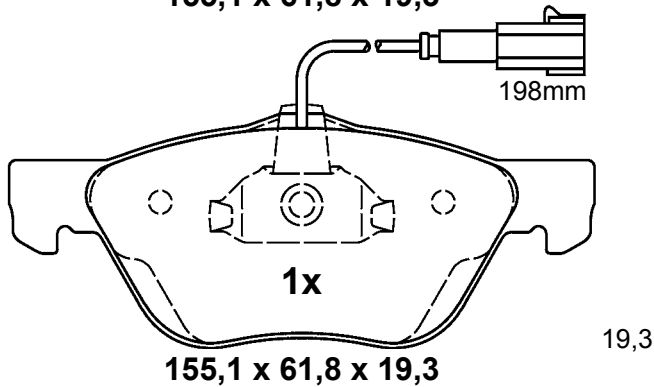
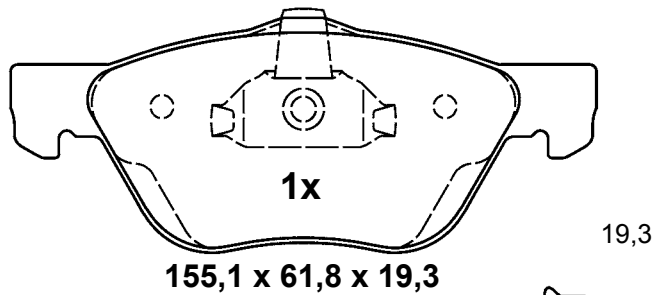
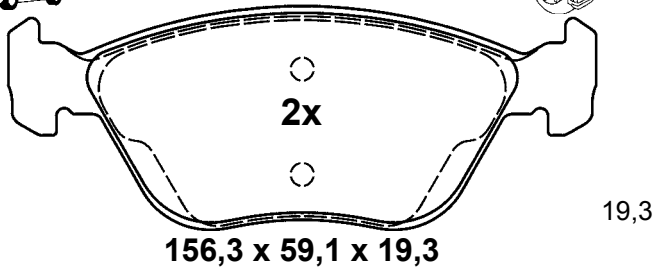

## 13.0460-7182.2 607182

AUDI, VOLKSWAGEN

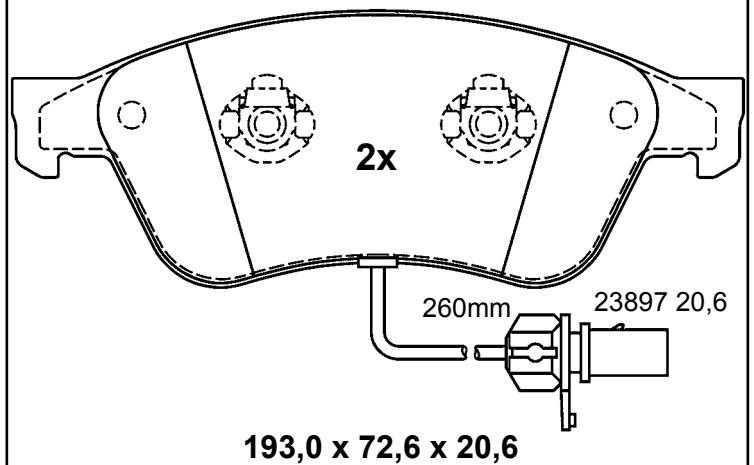
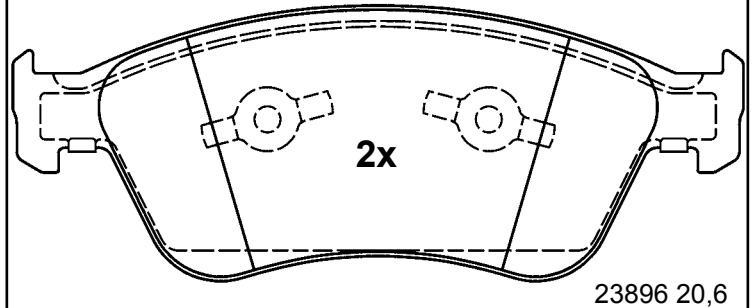

## 13.0460-7183.2 607183

AUDI, BENTLEY, BMW, CHRYSLER, MERCEDES BENZ, ROLLS ROYCE VOLKSWAGEN

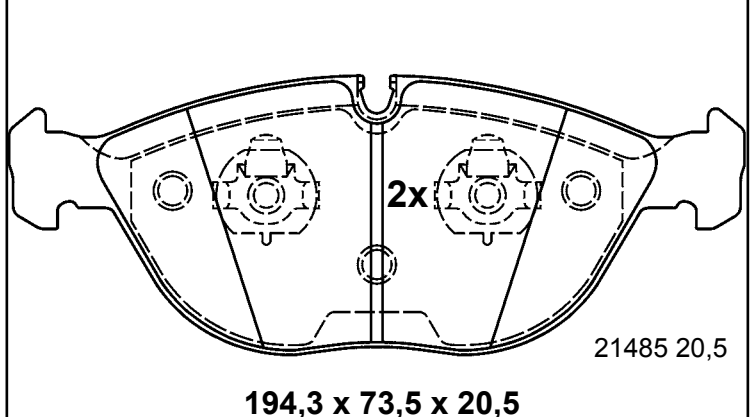
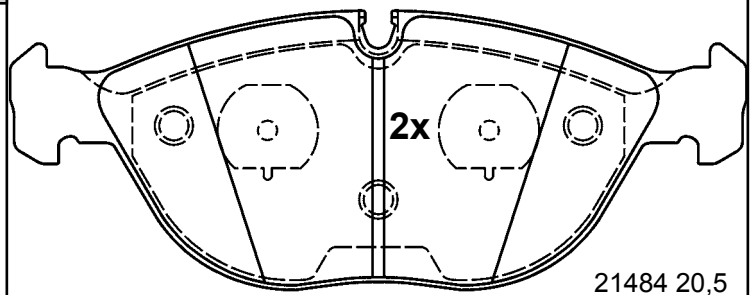

## 13.0460-7181.2 607181

ALFA ROMEO

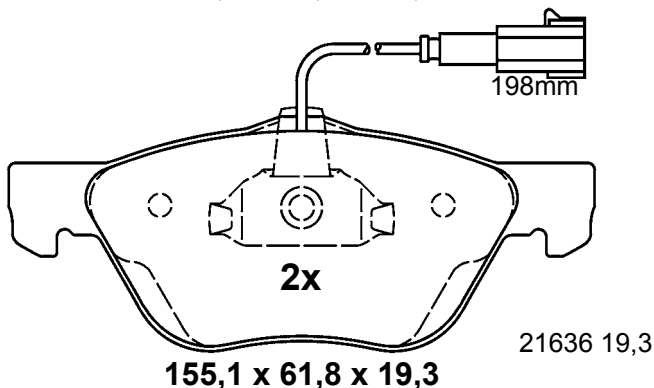
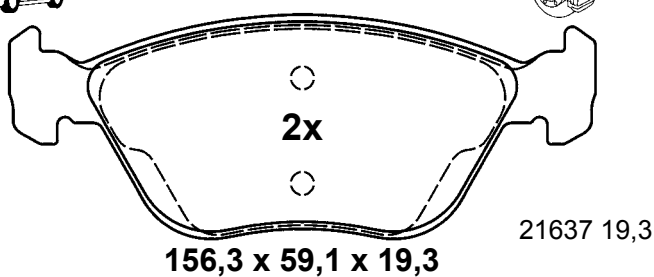

# Abbildungen Scheibenbremsbeläge

Illustrations disc brake pads - Illustrazioni pastiglie freno -

Illustrations plaquettes de frein - Ilustraciones pastillas de freno

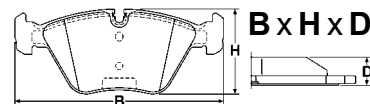

Maßstab - scale - scala - échelle - escala 1:2

## 13.0460-7184.2 607184



AUDI, SEAT, SKODA  
VOLKSWAGEN



ATE

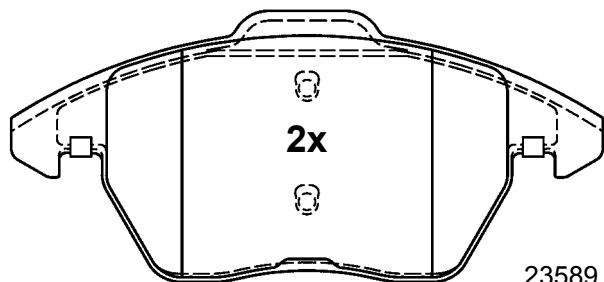

23589 20,6

156,3 x 71,3 x 20,6

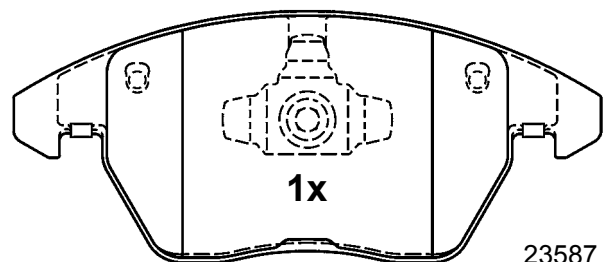

23587 20,6

155,1 x 66,0 x 20,6

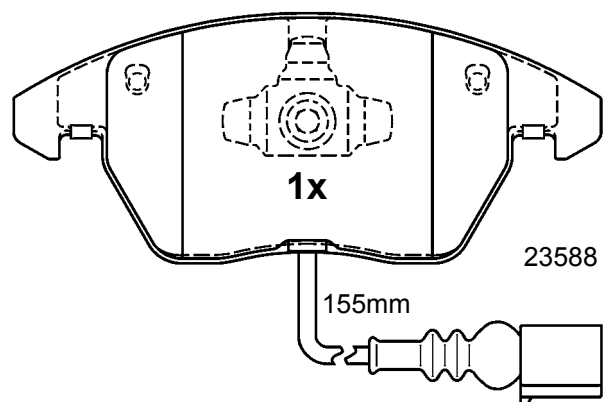

23588 20,6

155,1 x 66,0 x 20,6

## 13.0460-7185.2 607185



BMW



ATE

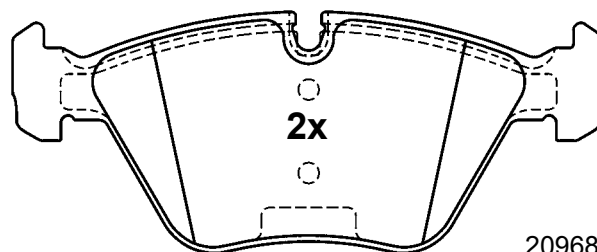

20968 20,3

156,3 x 63,5 x 20,3

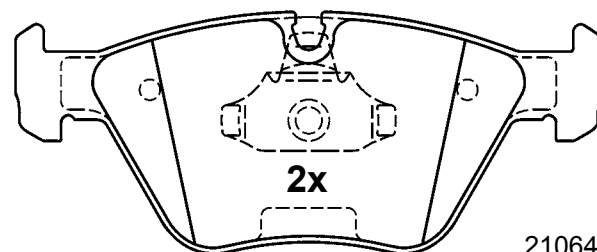

21064 20,3

155,1 x 63,5 x 20,3

## 13.0460-7186.2 607186



FORD



ATE

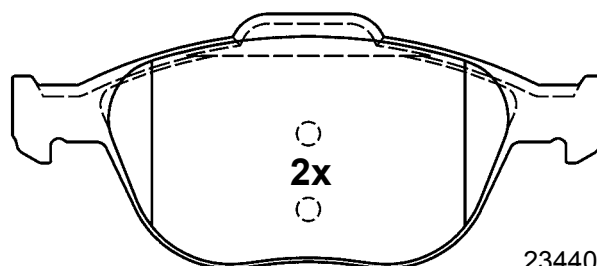

23440 17,6

156,3 x 67,3 x 17,6

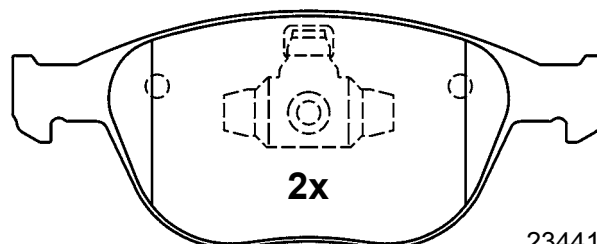

23441 18,1

156,3 x 62,5 x 18,1

# Abbildungen Scheibenbremsbeläge

Illustrations disc brake pads - Illustrazioni pastiglie freno -

Illustrations plaquettes de frein - Ilustraciones pastillas de freno

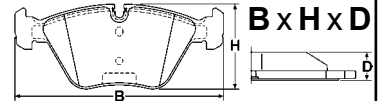

Maßstab - scale - scala - échelle - escala 1:2

## 13.0460-7187.2 607187



VOLVO



ATE

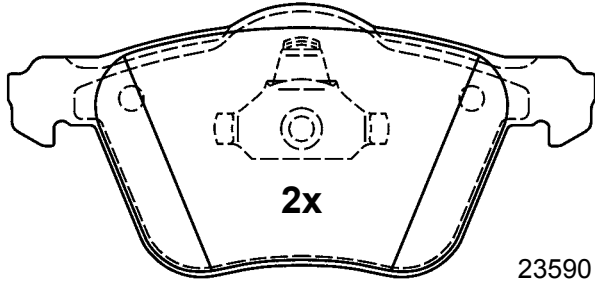

2x

23590 19,5

155,1 x 72,0 x 19,5

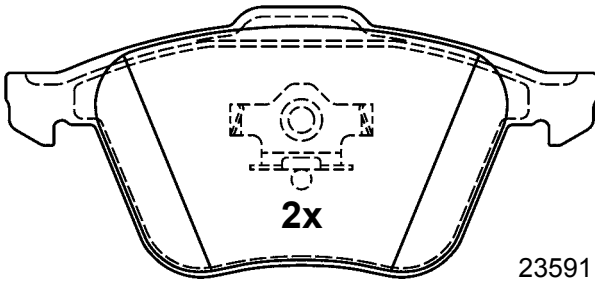

2x

23591 18,0

156,3 x 71,0 x 18,0

## 13.0460-7189.2 607189



VOLVO



ATE

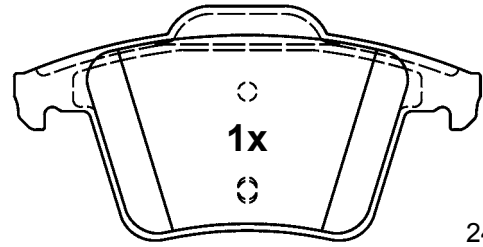

1x

24011 18,7

123,0 x 61,7 x 18,7

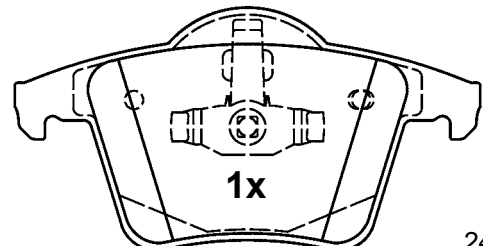

1x

24012 18,7

123,0 x 63,7 x 18,7

## 13.0460-7188.2 607188



VOLVO



ATE

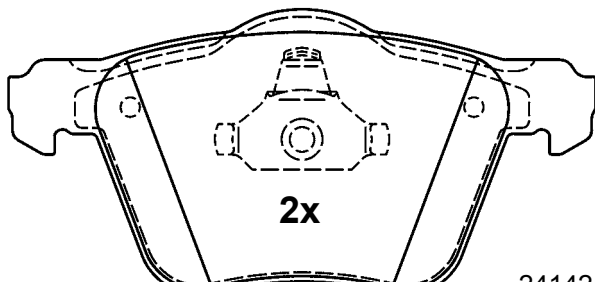

2x

24142 20,6

155,1 x 75,1 x 20,6

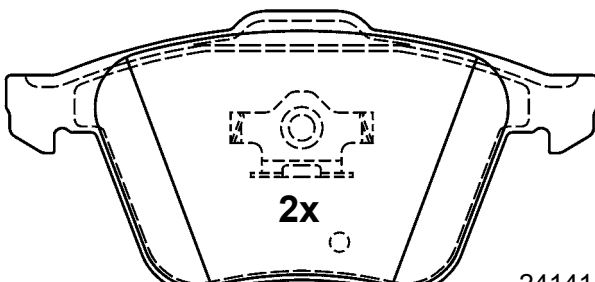

2x

24141 19,1

156,3 x 74,1 x 19,1

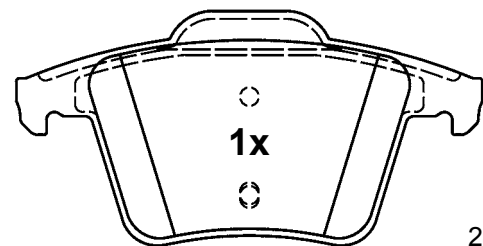

1x

24011 18,7

123,0 x 61,7 x 18,7

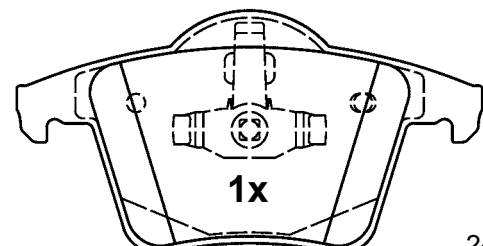

1x

24012 18,7

123,0 x 63,7 x 18,7

# Abbildungen Scheibenbremsbeläge

Illustrations disc brake pads - Illustrazioni pastiglie freno -

Illustrations plaquettes de frein - Ilustraciones pastillas de freno



Maßstab - scale - scala - échelle - escala 1:2

**13.0460-7190.2 607190**



VOLKSWAGEN



ATE

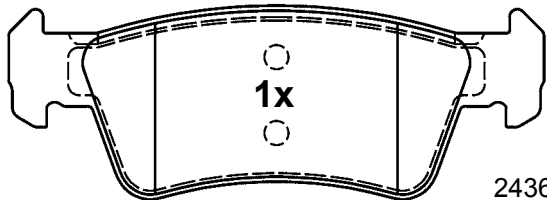

1x

24367 19,1

141,3 x 50,9 x 19,1

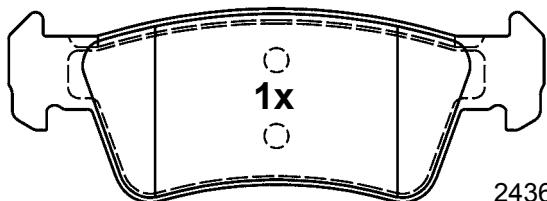

1x

24367 19,1

141,3 x 50,9 x 19,1

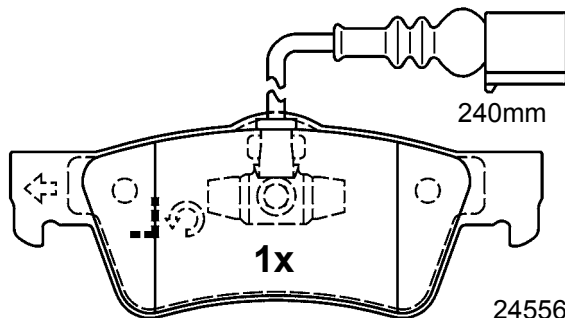

240mm

1x

24556 19,1

140,7 x 53,9 x 19,1

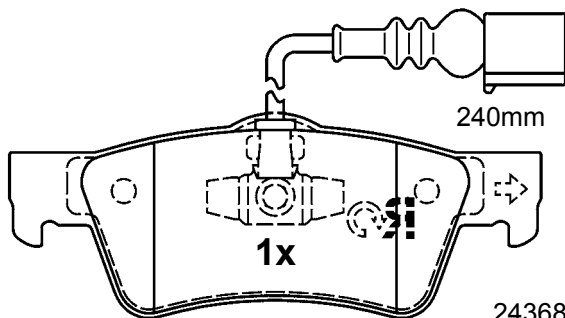

240mm

1x

24368 19,1

140,7 x 53,9 x 19,1

**13.0460-7191.2 607191**



VOLKSWAGEN



ATE

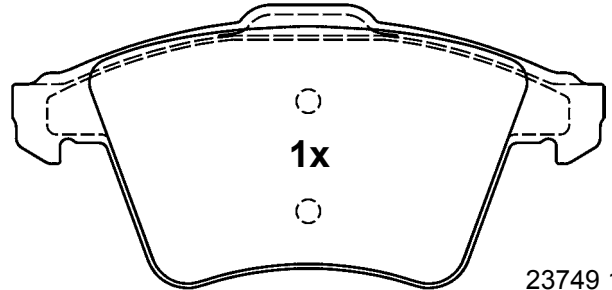

1x

23749 19,1

156,2 x 74,8 x 19,1

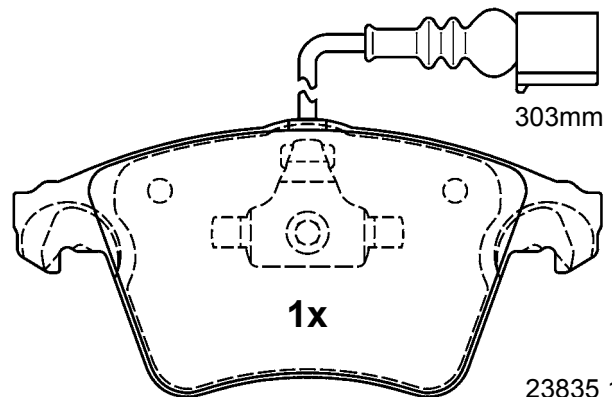

303mm

1x

23835 19,6

155,0 x 73,3 x 19,6

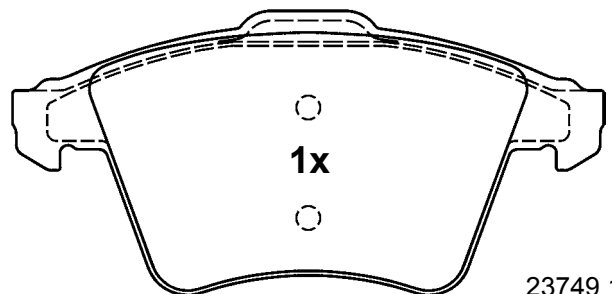

1x

23749 19,1

156,2 x 74,8 x 19,1

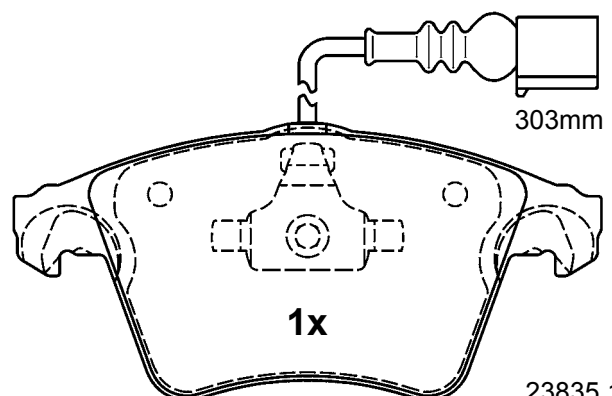

303mm

1x

23835 19,6

155,0 x 73,3 x 19,6

# Abbildungen Scheibenbremsbeläge

Illustrations disc brake pads - Illustrazioni pastiglie freno -

Illustrations plaquettes de frein - Ilustraciones pastillas de freno

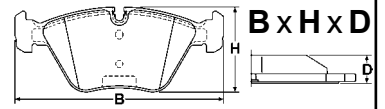

Maßstab - scale - scala - échelle - escala 1:2

## 13.0460-7193.2 607193

FORD, MAZDA, VOLVO

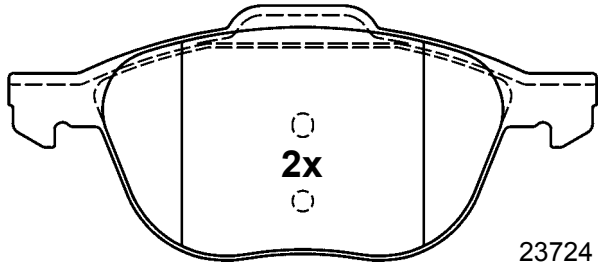

23724 18,1

156,3 x 67,0 x 18,1

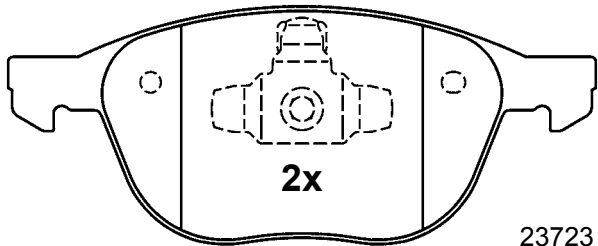

23723 18,1

155,1 x 62,4 x 18,1

## 13.0460-7195.2 607195

FORD, MAZDA, OPEL, SAAB, VAUXHALL, VOLVO

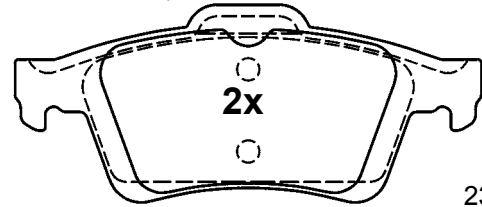

23482 16,6

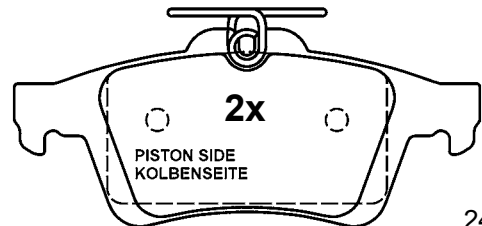

24137 16,6

123,0 x 52,0 x 16,6

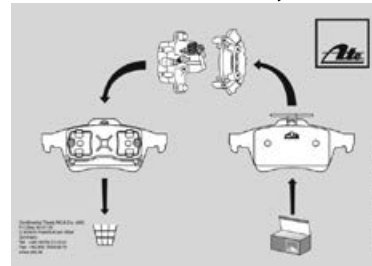

## 13.0460-7194.2 607194

FORD, OPEL, SAAB, VAUXHALL

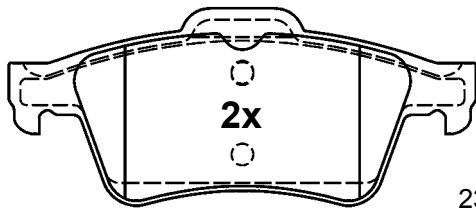

23482 16,6

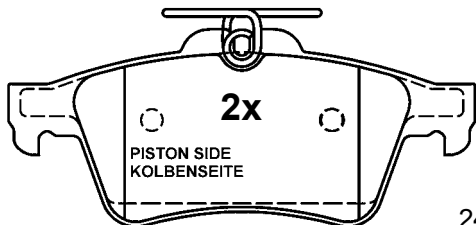

24137 16,6

123,0 x 52,0 x 16,6

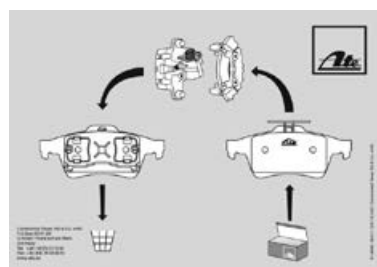

## 13.0460-7196.2 607196

MERCEDES BENZ, VOLKSWAGEN

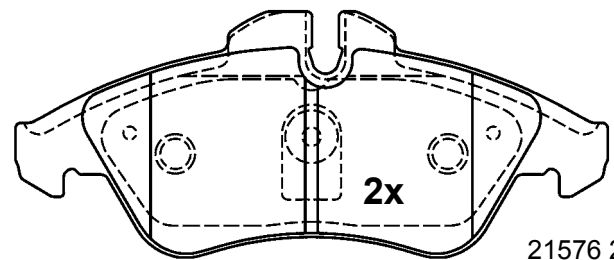

21576 20,7

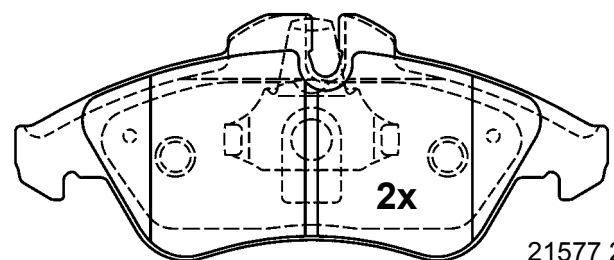

21577 20,7

156,3 x 64,8 x 20,7



# Abbildungen Scheibenbremsbeläge

Illustrations disc brake pads - Illustrazioni pastiglie freno -

Illustrations plaquettes de frein - Ilustraciones pastillas de freno

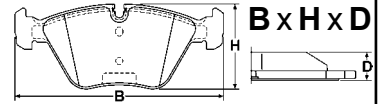

Maßstab - scale - scala - échelle - escala 1:2

**13.0460-7199.2 607199**



OPEL, SAAB, VAUXHALL



ATE

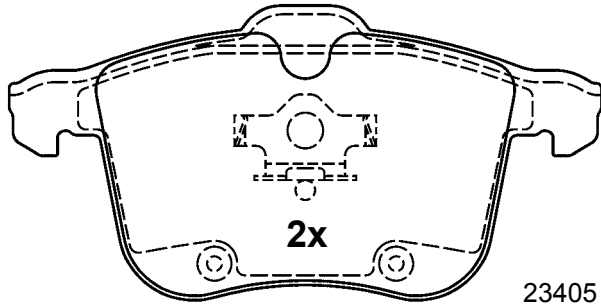

2x

23405 20,1

156,4 x 77,6 x 20,1

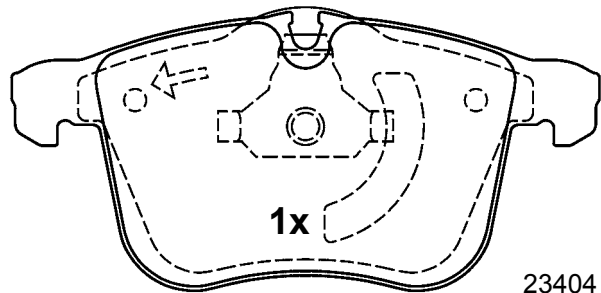

1x

23404 20,6

155,1 x 74,5 x 20,6

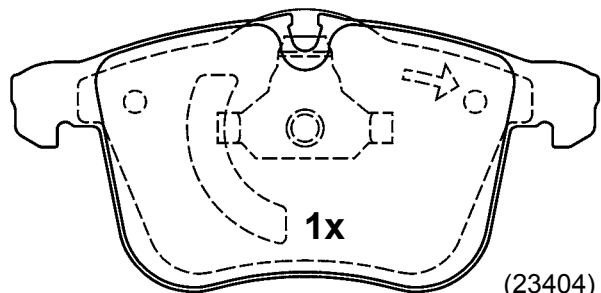

1x

(23404) 20,6

155,1 x 74,5 x 20,6

**13.0460-7200.2 607200**



AUDI, SKODA, VOLKSWAGEN



ATE

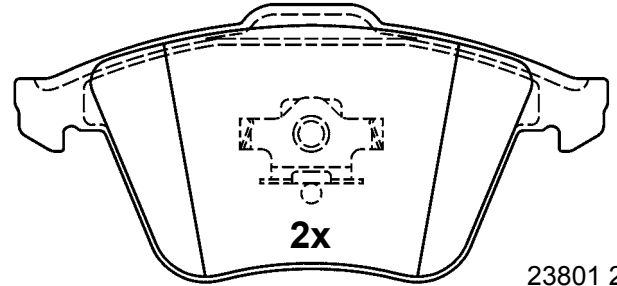

2x

23801 20,3

156,3 x 72,9 x 20,3

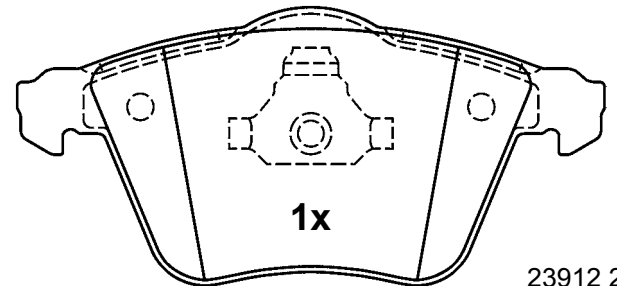

1x

23912 20,3

155,1 x 72,9 x 20,3

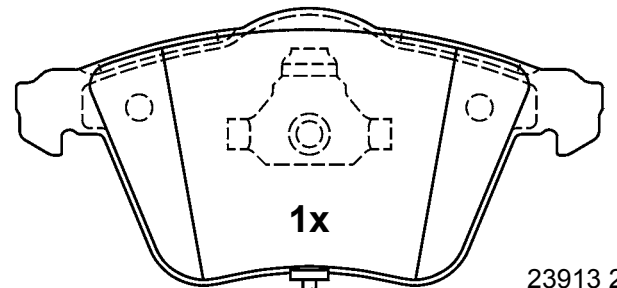

1x

23913 20,3

177,5mm

155,1 x 72,9 x 20,3



# Abbildungen Scheibenbremsbeläge

Illustrations disc brake pads - Illustrazioni pastiglie freno -

Illustrations plaquettes de frein - Ilustraciones pastillas de freno



Maßstab - scale - scala - échelle - escala 1:2

## 13.0460-7201.2 607201

AUDI, SEAT

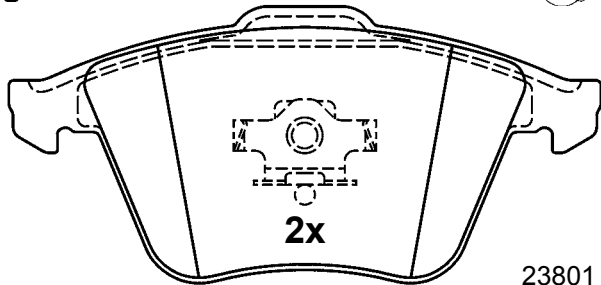

2x

156,3 x 72,9 x 20,3

23801 20,3

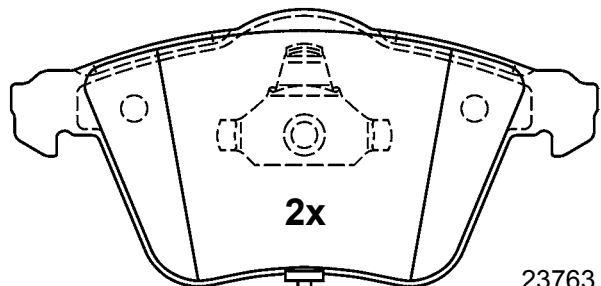

2x

23763 20,3

242,5mm

155,1 x 72,9 x 20,3

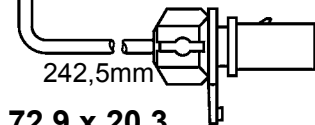

## 13.0460-7203.2 607203

MERCEDES BENZ

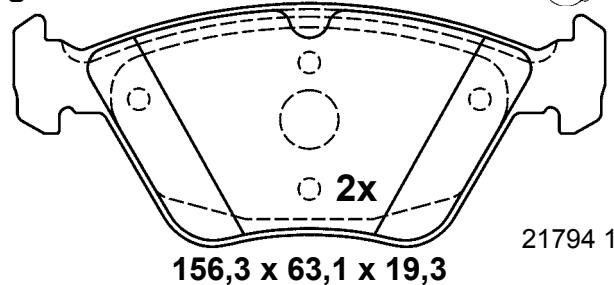

2x

156,3 x 63,1 x 19,3

21794 19,3

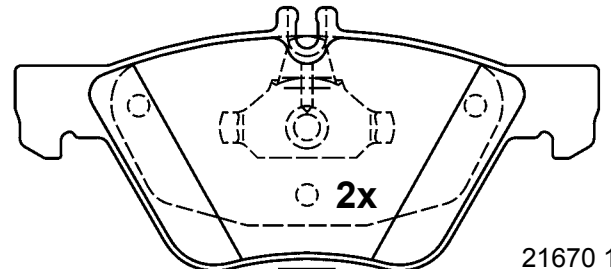

2x

21670 19,3

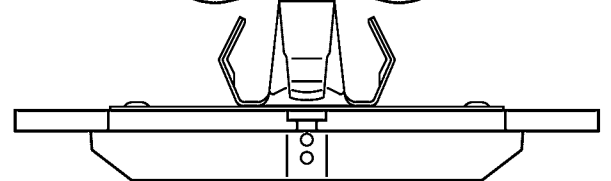

155,1 x 69,3 x 19,3

## 13.0460-7202.2 607202

CITROEN, PEUGEOT

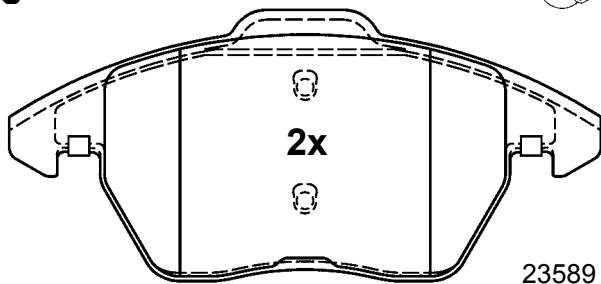

2x

156,3 x 71,3 x 19,1

23589 19,1

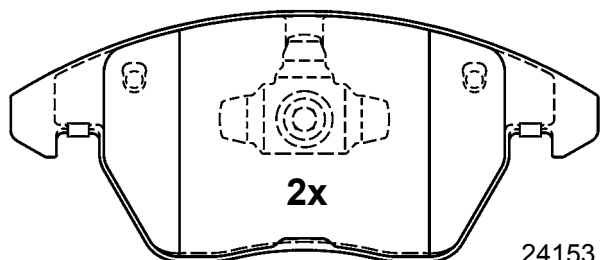

2x

155,1 x 66,0 x 19,1

24153 19,1

## 13.0460-7204.2 607204

FORD, MAZDA, SAAB, VOLVO

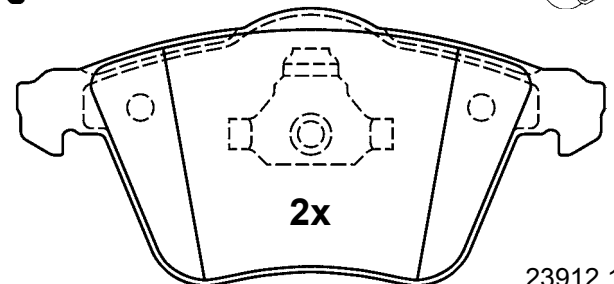

2x

155,1 x 72,9 x 18,8

23912 18,8

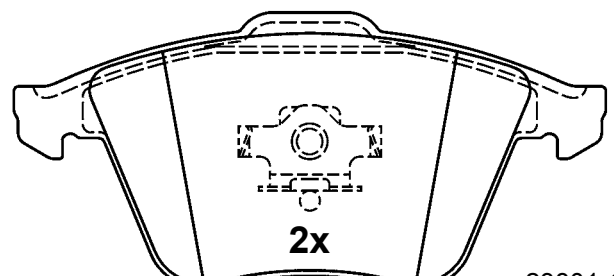

2x

156,3 x 72,9 x 18,8

23801 18,8



# Abbildungen Scheibenbremsbeläge

Illustrations disc brake pads - Illustrazioni pastiglie freno -

Illustrations plaquettes de frein - Ilustraciones pastillas de freno

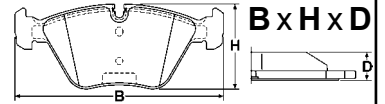

Maßstab - scale - scala - échelle - escala 1:2

## 13.0460-7205.2 607205

FORD, MAZDA

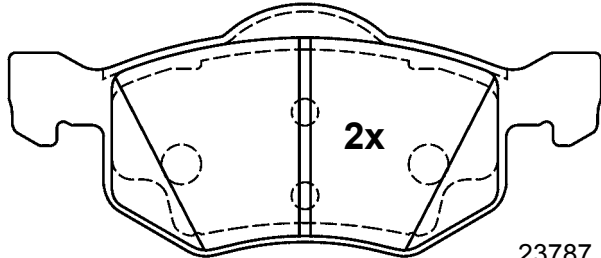

23787 19,0

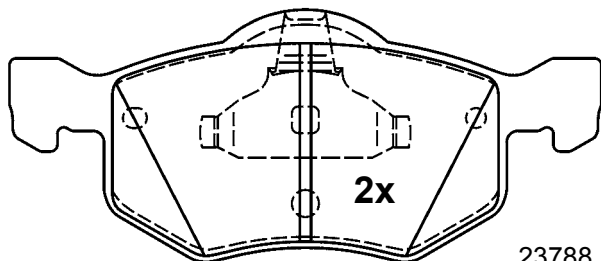

23788 19,0

156,2 x 66,5 x 19,0

## 13.0460-7207.2 607207

CHRYSLER

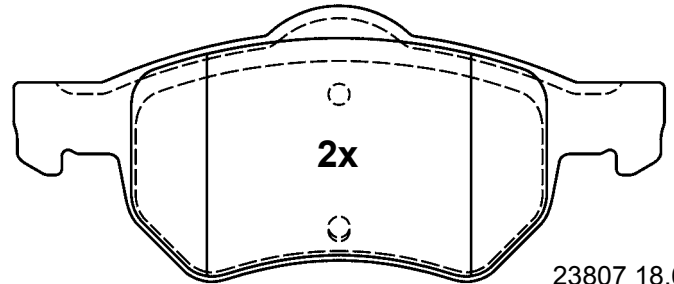

23807 18,6

172,2 x 72,5 x 18,6

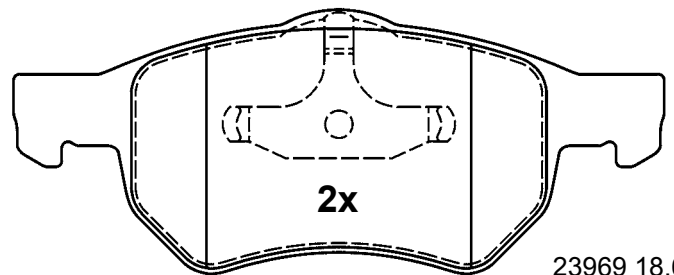

23969 18,6

172,2 x 69,2 x 18,6

## 13.0460-7206.2 607206

JEEP

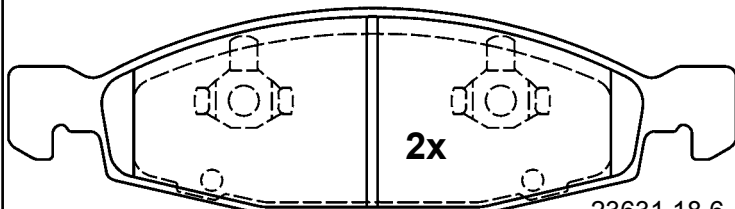

23631 18,6

192,2 x 54,4 x 18,6

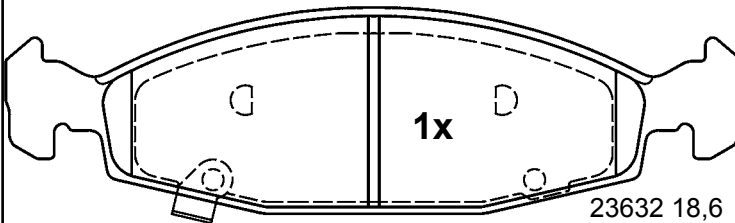

23632 18,6

194,3 x 54,4 x 18,6

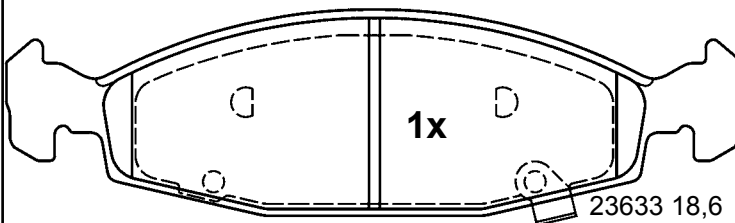

23633 18,6

194,3 x 54,4 x 18,6

## 13.0460-7209.2 607209

JAGUAR

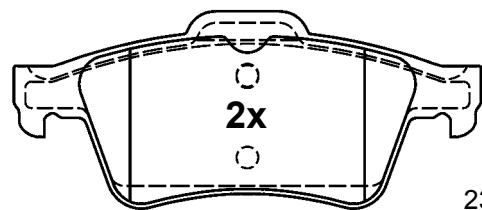

23482 16,6

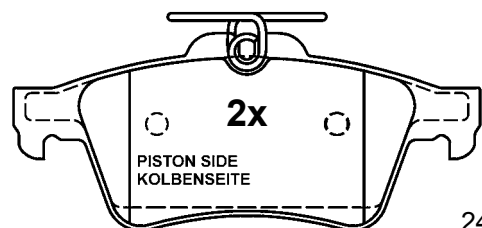

24137 16,6

123,0 x 52,0 x 16,6

# Abbildungen Scheibenbremsbeläge

Illustrations disc brake pads - Illustrazioni pastiglie freno -

Illustrations plaquettes de frein - Ilustraciones pastillas de freno



Maßstab - scale - scala - échelle - escala 1:2

**13.0460-7210.2 607210**

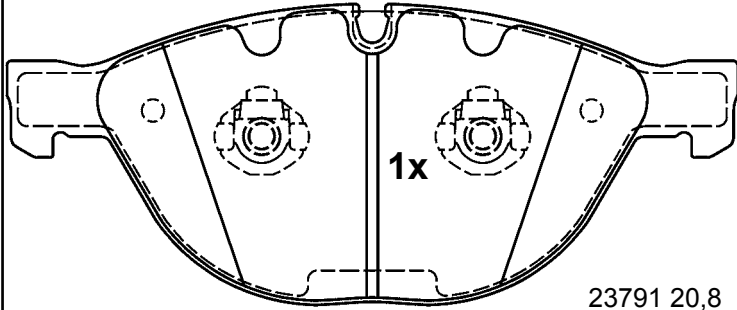

23791 20,8

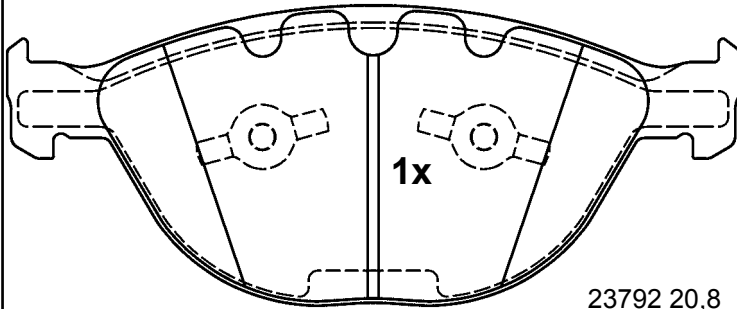

23792 20,8

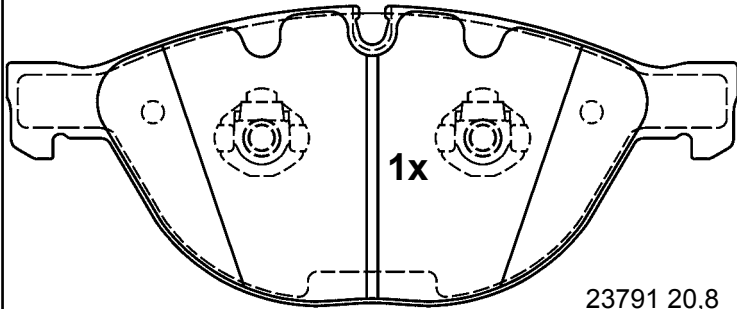

23791 20,8

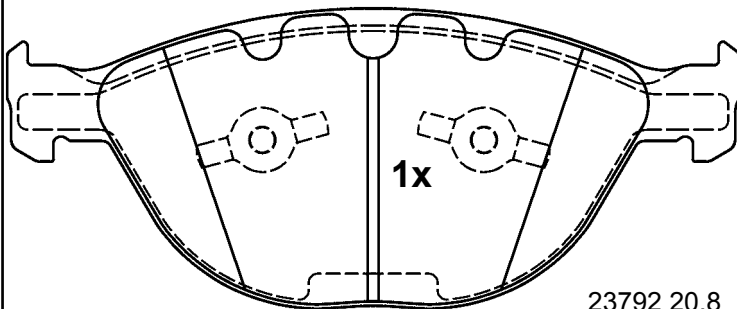

23792 20,8

**193,0 x 79,0 x 20,8**

**13.0460-7211.2 607211**

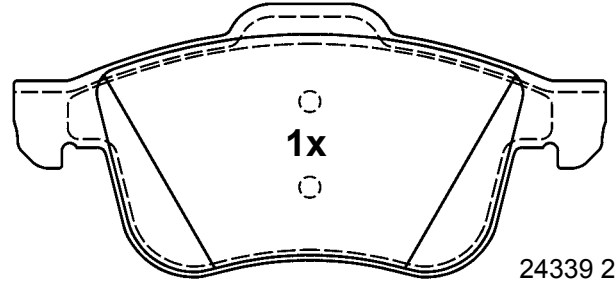

24339 20,5

**156,3 x 71,5 x 20,5**

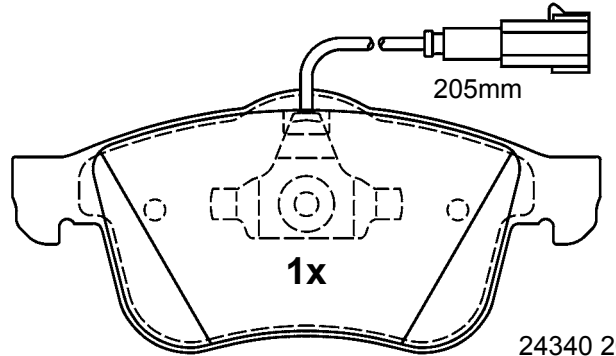

24340 20,3

**155,1 x 69,0 x 20,3**

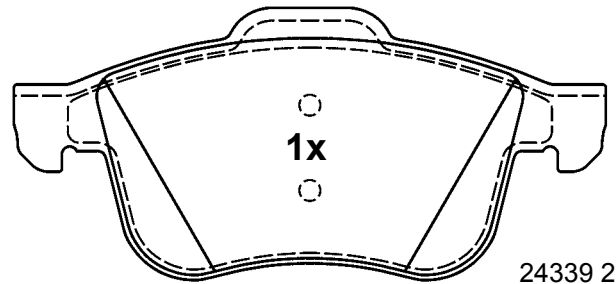

24339 20,5

**156,3 x 71,5 x 20,5**

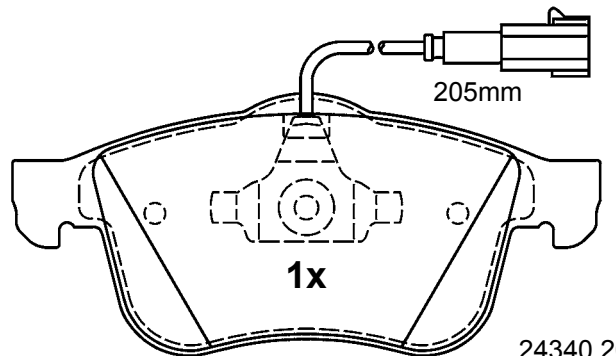

24340 20,3

**155,1 x 69,0 x 20,3**



# Abbildungen Scheibenbremsbeläge

Illustrations disc brake pads - Illustrazioni pastiglie freno -

Illustrations plaquettes de frein - Ilustraciones pastillas de freno

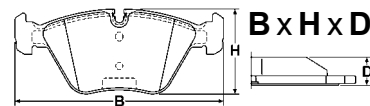

Maßstab - scale - scala - échelle - escala 1:2

## 13.0460-7212.2 607212

FIAT, OPEL, SAAB, VAUXHALL

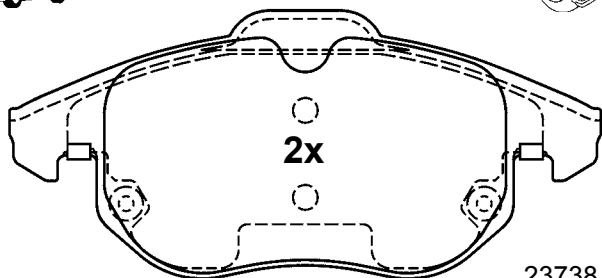

156,3 x 70,7 x 20,1

23738 20,1

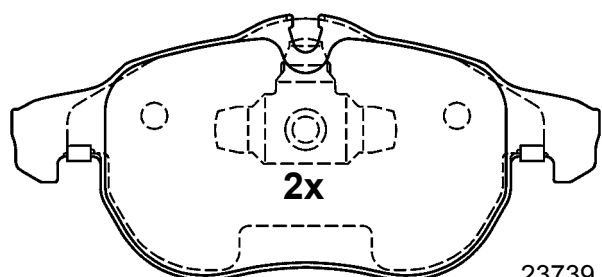

155,1 x 69,6 x 20,1

23739 20,1

## 13.0460-7214.2 607214

DAIHATSU, TOYOTA

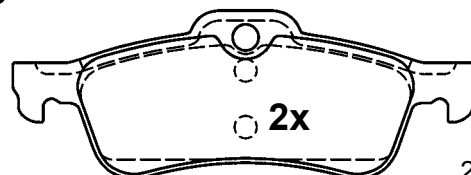

123,0 x 43,8 x 15,0

24574 15,0

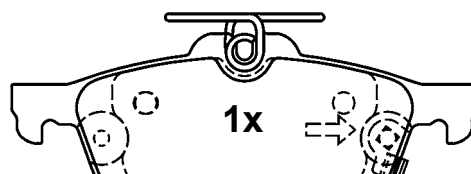

123,0 x 43,8 x 14,8

24575 14,8

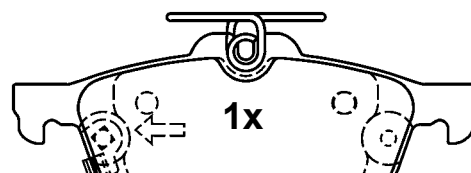

123,0 x 43,8 x 14,8

24576 14,8

## 13.0460-7213.2 607213

DAIHATSU, TOYOTA

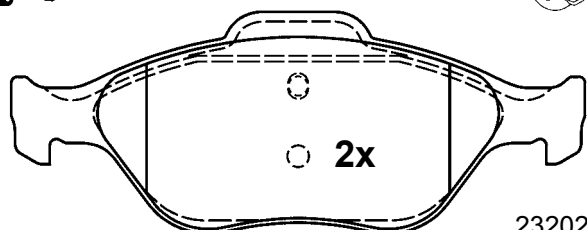

151,3 x 58,2 x 17,8

23202 17,8

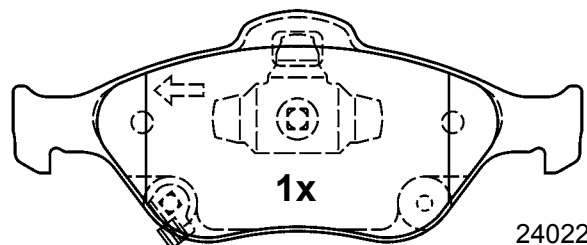

150,1 x 61,0 x 17,8

24022 17,8

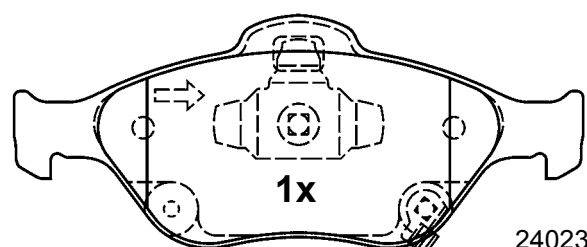

150,1 x 61,0 x 17,8

24023 17,8

## 13.0460-7215.2 607215

BMW

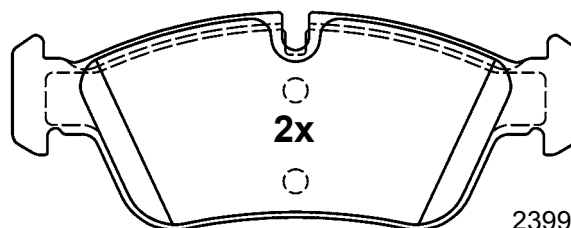

149,3 x 57,3 x 17,8

23999 17,8

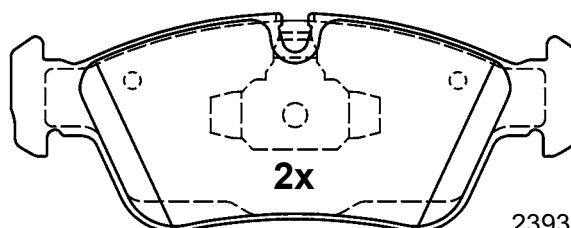

150,1 x 57,3 x 17,8

23935 17,8

# Abbildungen Scheibenbremsbeläge

Illustrations disc brake pads - Illustrazioni pastiglie freno -

Illustrations plaquettes de frein - Ilustraciones pastillas de freno

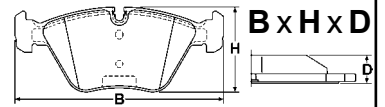

Maßstab - scale - scala - échelle - escala 1:2

## 13.0460-7216.2 607216

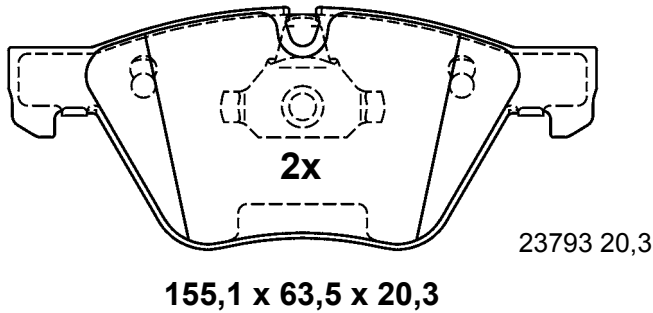
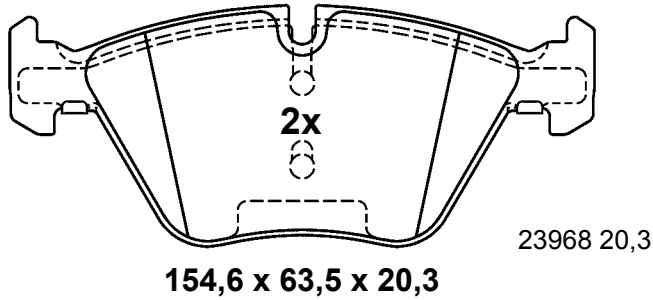

## 13.0460-7218.2 607218

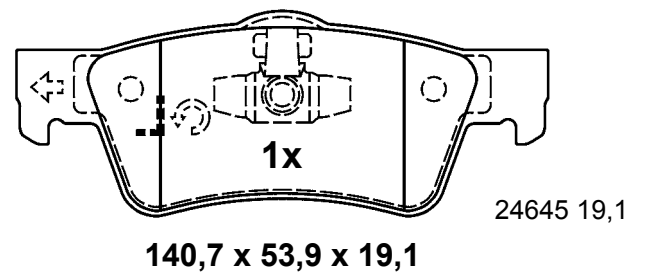
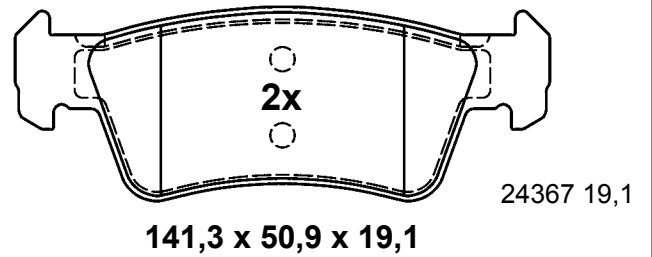

## 13.0460-7217.2 607217

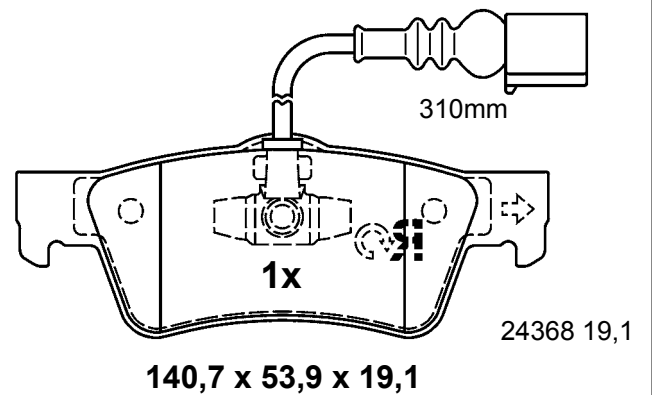
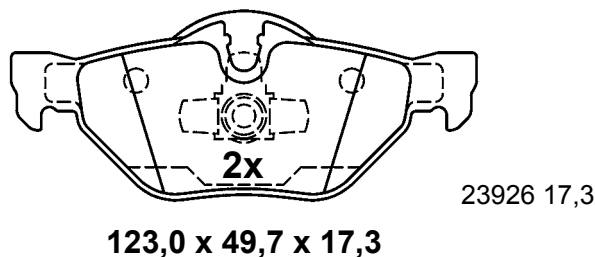
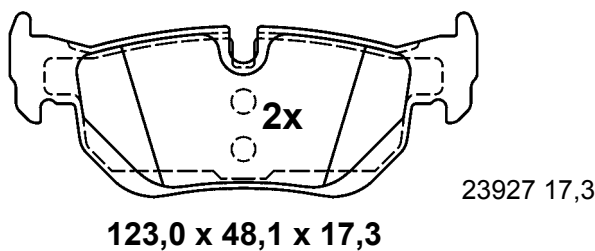

# Abbildungen Scheibenbremsbeläge

Illustrations disc brake pads - Illustrazioni pastiglie freno -

Illustrations plaquettes de frein - Ilustraciones pastillas de freno

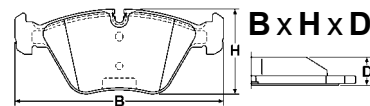

Maßstab - scale - scala - échelle - escala 1:2

**13.0460-7219.2 607219**



MERCEDES BENZ



ATE

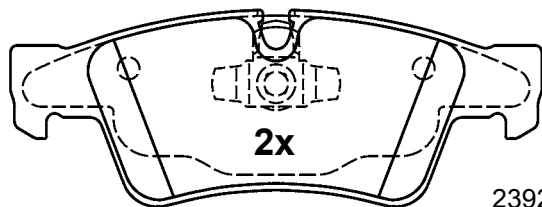

2x

23923 17,6

140,1 x 51,6 x 17,6

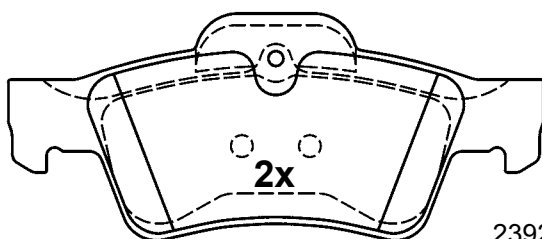

2x

23924 17,6

141,3 x 59,6 x 17,6

**13.0460-7221.2 607221**



RENAULT



ATE

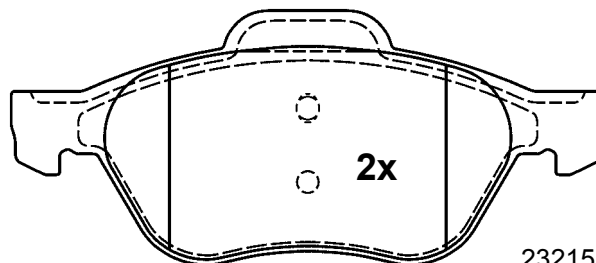

2x

23215 18,3

156,3 x 66,8 x 18,3

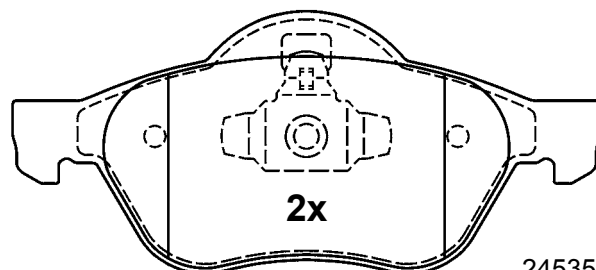

2x

24535 18,3

155,1 x 68,9 x 18,3

**13.0460-7220.2 607220**



MERCEDES BENZ



ATE

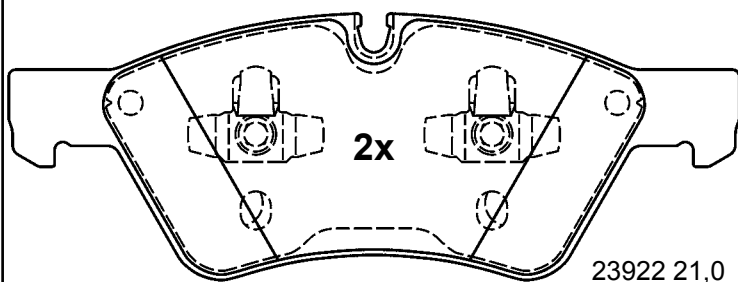

2x

23922 21,0

192,9 x 69,9 x 21,0

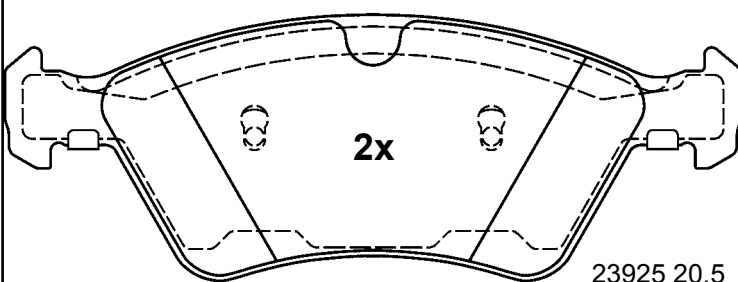

2x

23925 20,5

194,3 x 70,0 x 20,5

**13.0460-7222.2 607222**



RENAULT



ATE

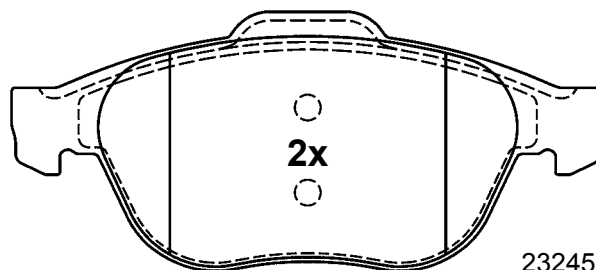

2x

23245 18,3

156,3 x 68,3 x 18,3

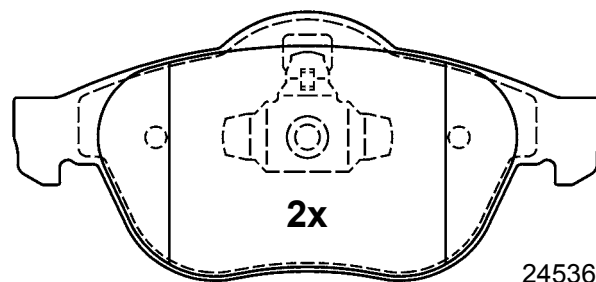

2x

24536 18,3

155,1 x 70,8 x 18,3



# Abbildungen Scheibenbremsbeläge

Illustrations disc brake pads - Illustrazioni pastiglie freno -

Illustrations plaquettes de frein - Ilustraciones pastillas de freno

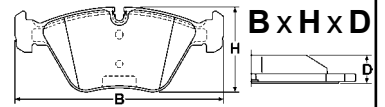

Maßstab - scale - scala - échelle - escala 1:2

## 13.0460-7223.2 607223

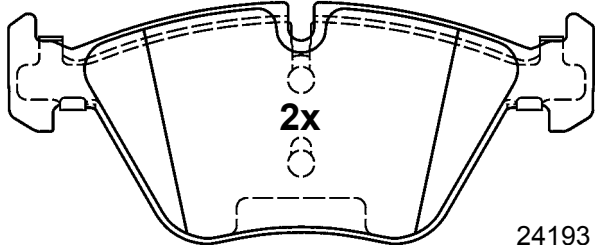

24193 20,3

154,6 x 63,5 x 20,3

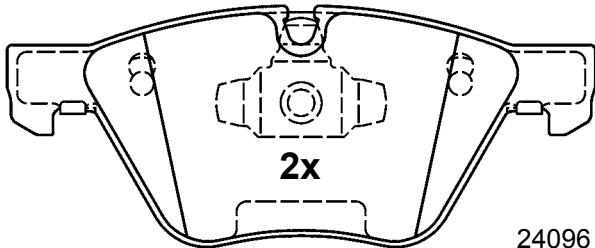

24096 20,3

155,1 x 63,5 x 20,3

## 13.0460-7225.2 607225

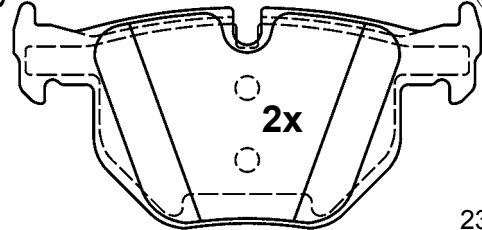

23551 17,3

123,0 x 59,2 x 17,3

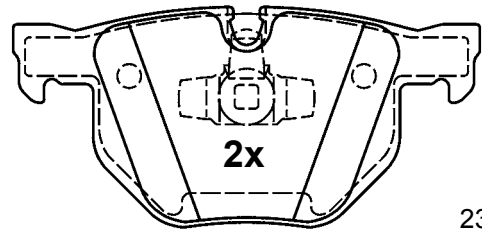

23550 17,3

123,0 x 58,0 x 17,3

## 13.0460-7226.2 607226

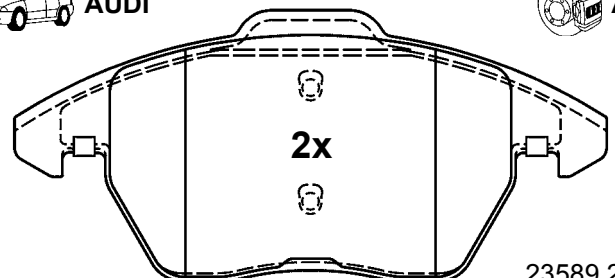

23589 20,4

155,1 x 71,3 x 20,4

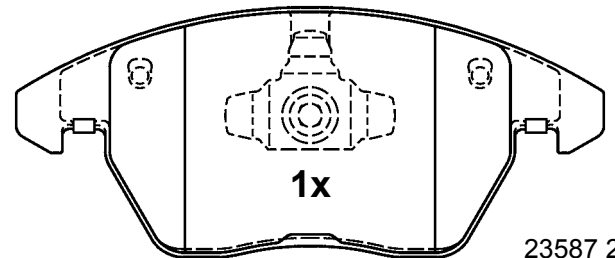

23587 20,8

155,1 x 66,0 x 20,8

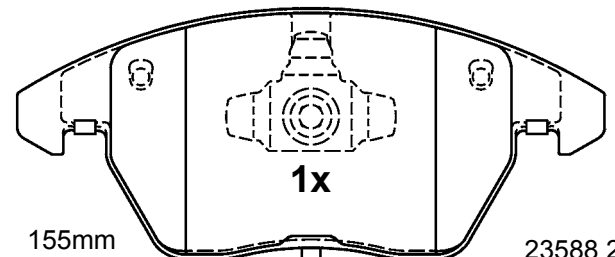

23588 20,8

155mm

155,1 x 66,0 x 20,8

## 13.0460-7224.2 607224

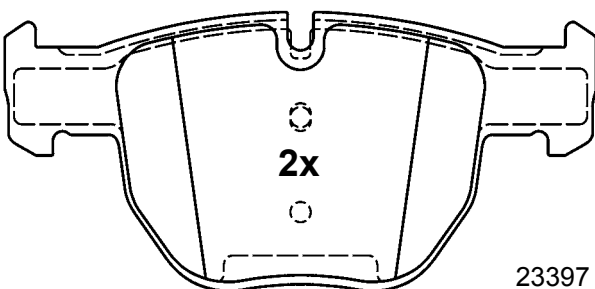

23397 19,4

156,3 x 73,2 x 19,4

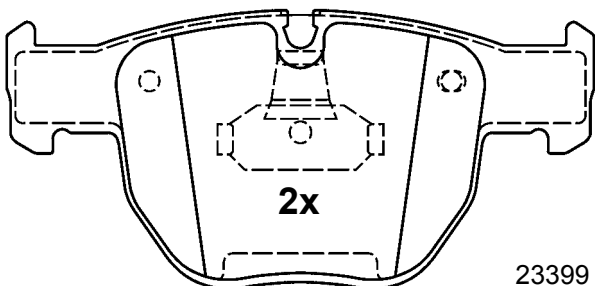

23399 19,4

155,0 x 73,2 x 19,4



# Abbildungen Scheibenbremsbeläge

Illustrations disc brake pads - Illustrazioni pastiglie freno -

Illustrations plaquettes de frein - Ilustraciones pastillas de freno

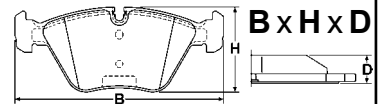

Maßstab - scale - scala - échelle - escala 1:2

## 13.0460-7227.2 607227

AUDI, SEAT, VOLKSWAGEN

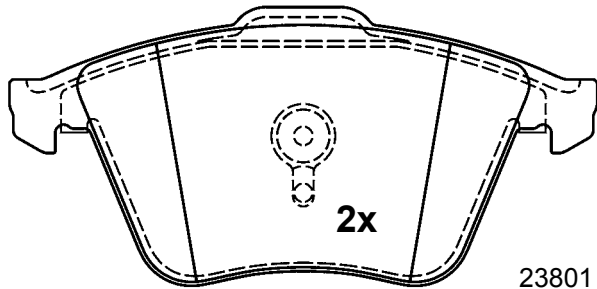

2x

23801 20,3

156,3 x 72,9 x 20,3

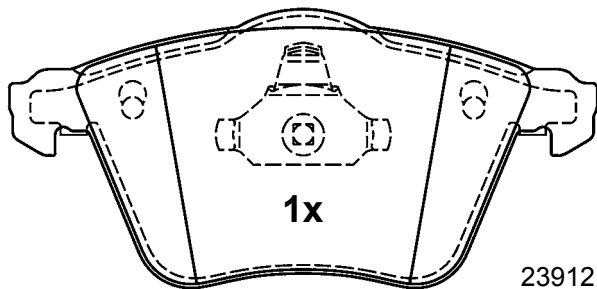

1x

23912 20,3

155,1 x 72,9 x 20,3

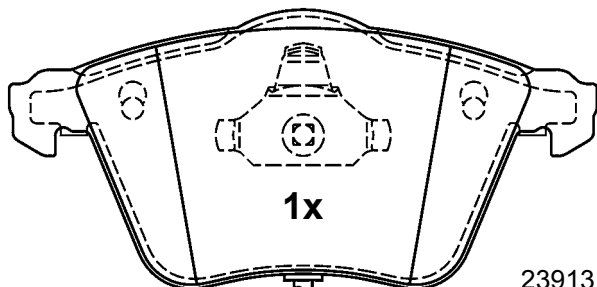

1x

23913 20,3

155,1 x 72,9 x 20,3

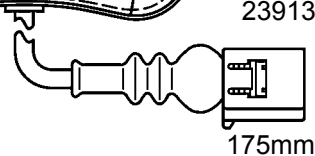

175mm

## 13.0460-7228.2 607228

FORD, LAND ROVER, VOLVO

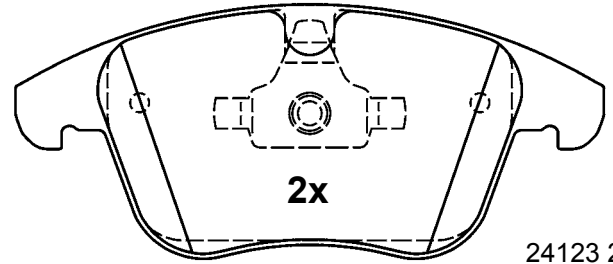

2x

24123 20,3

155,1 x 66,6 x 20,3

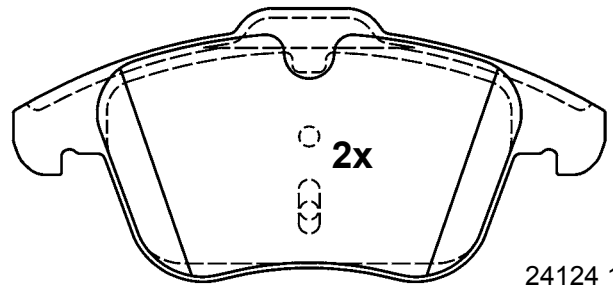

2x

24124 19,3

156,3 x 72,0 x 19,3

## 13.0460-7229.2 607229

CITROEN, PEUGEOT

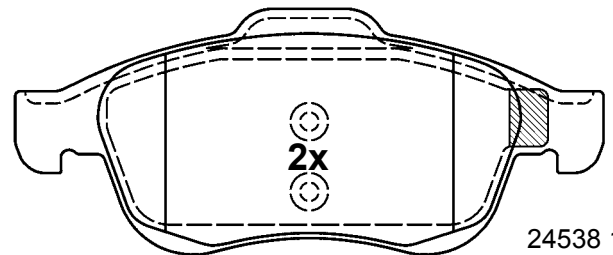

2x

24538 18,5

155,1 x 64,7 x 18,5

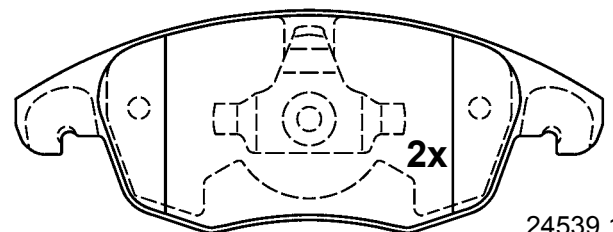

2x

24539 18,5

155,1 x 58,3 x 18,5

# Abbildungen Scheibenbremsbeläge

Illustrations disc brake pads - Illustrazioni pastiglie freno -

Illustrations plaquettes de frein - Ilustraciones pastillas de freno



Maßstab - scale - scala - échelle - escala 1:2

## 13.0460-7230.2 607230

CITROEN, PEUGEOT

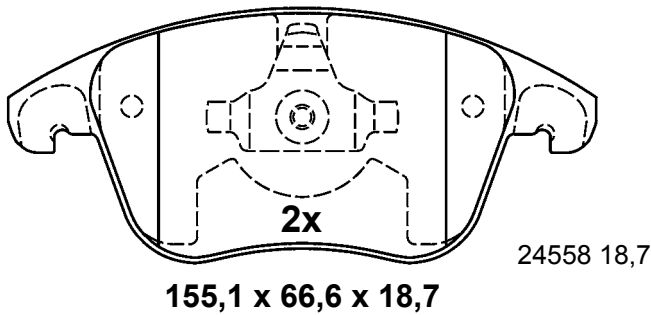
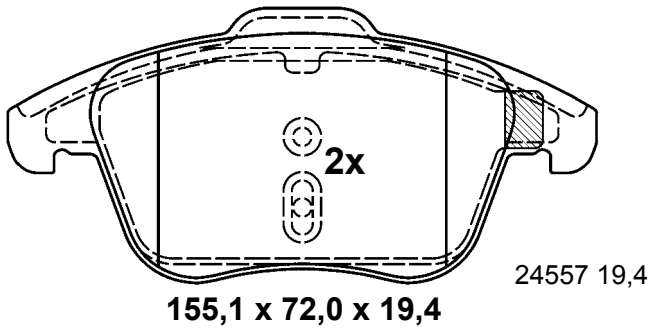

## 13.0460-7232.2 607232

BMW

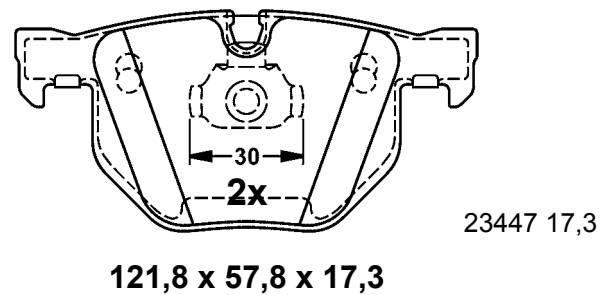
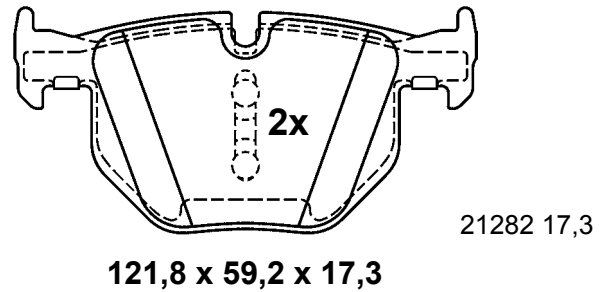

## 13.0460-7231.2 607231

BMW

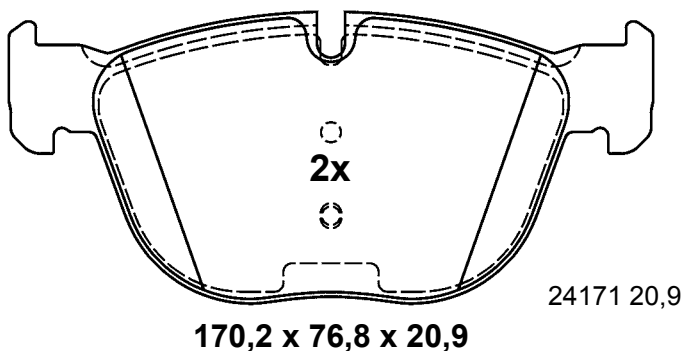
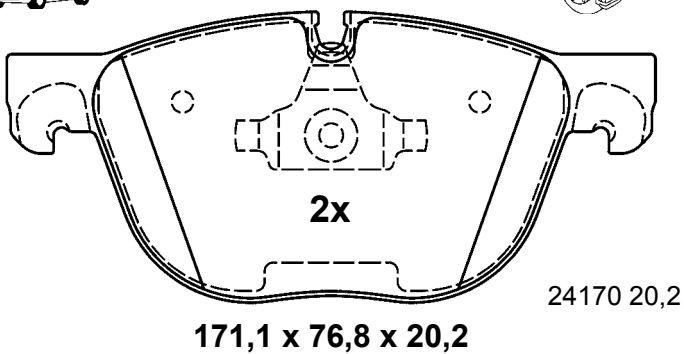

## 13.0460-7234.2 607234

FORD, MAZDA

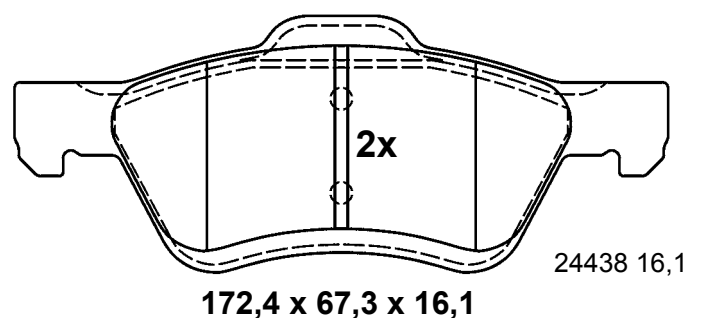
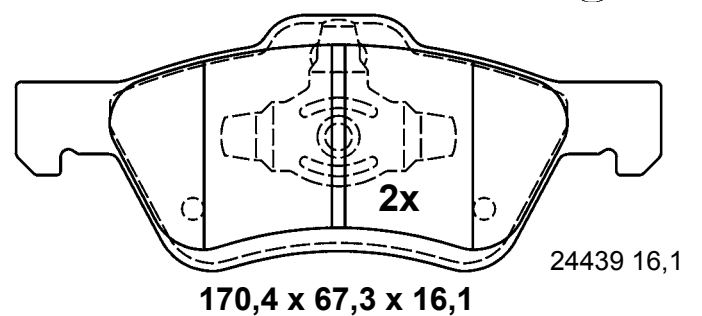

# Abbildungen Scheibenbremsbeläge

Illustrations disc brake pads - Illustrazioni pastiglie freno -

Illustrations plaquettes de frein - Ilustraciones pastillas de freno

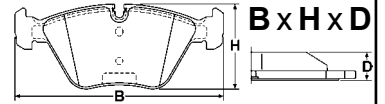

Maßstab - scale - scala - échelle - escala 1:2

## 13.0460-7235.2 607235



FORD, MAZDA



ATE

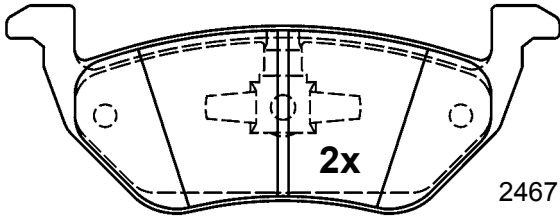

2x

24671 18,0

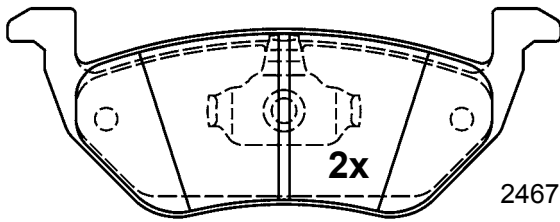

2x

24670 18,0

146,0 x 54,0 x 18,0

## 13.0460-7236.2 607236



VOLKSWAGEN



ATE

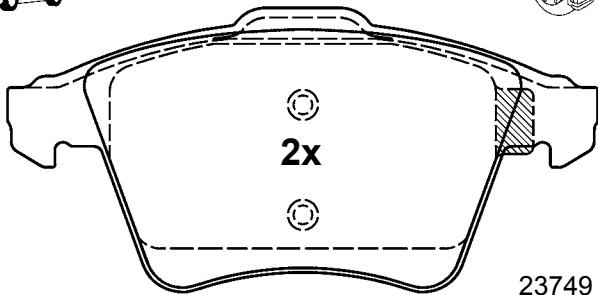

2x

23749 18,7

156,2 x 74,8 x 18,7

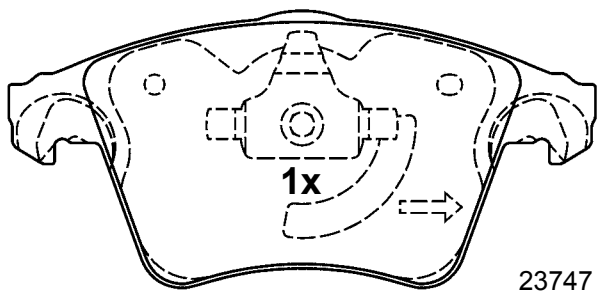

1x

23747 19,7

155,0 x 73,3 x 19,7

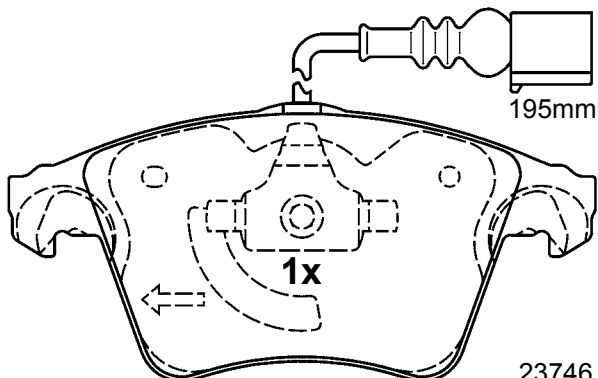

1x

23746 19,7

155,01 x 73,3 x 19,7

## 13.0460-7237.2 607237



BMW



ATE

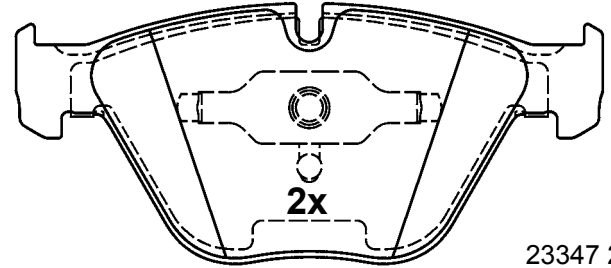

2x

23347 20,3

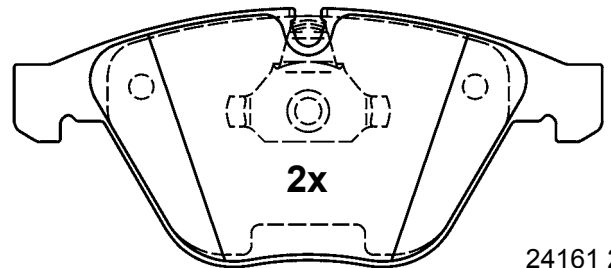

2x

24161 20,3

155,1 x 68,3 x 20,3

## 13.0460-7238.2 607238



BMW



ATE

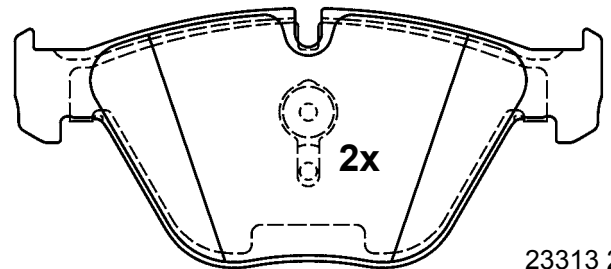

2x

23313 20,3

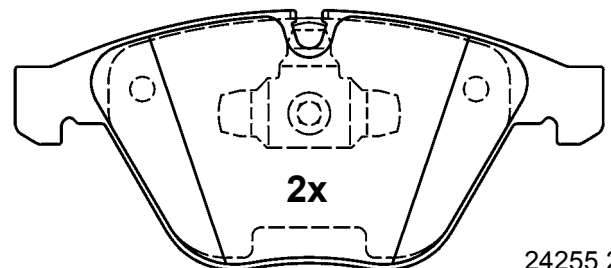

2x

24255 20,3

155,1 x 68,3 x 20,3

# Abbildungen Scheibenbremsbeläge

Illustrations disc brake pads - Illustrazioni pastiglie freno -

Illustrations plaquettes de frein - Ilustraciones pastillas de freno

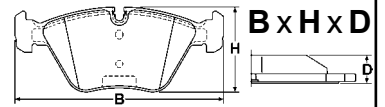

Maßstab - scale - scala - échelle - escala 1:2

## 13.0460-7239.2 607239



BMW



ATE

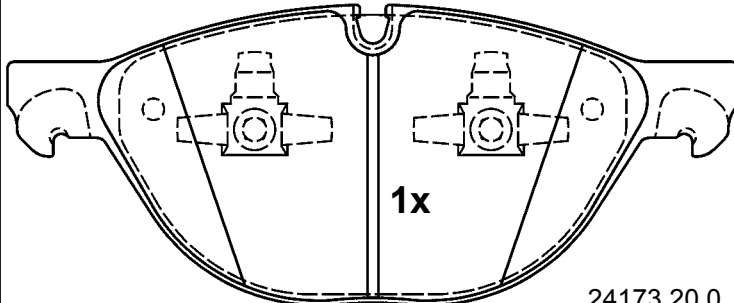

1x

24173 20,0

193,0 x 79,0 x 20,0

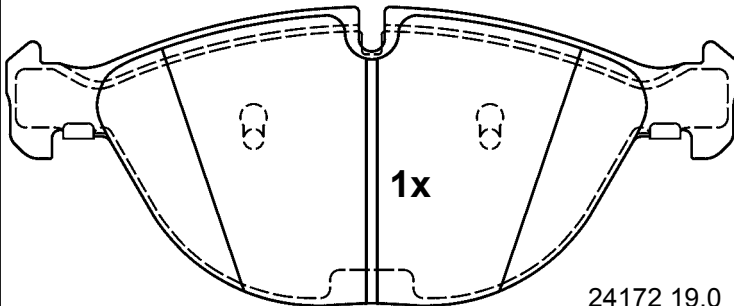

1x

24172 19,0

193,0 x 79,0 x 19,0

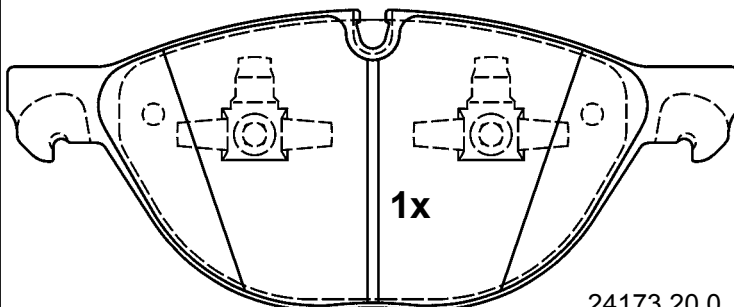

1x

24173 20,0

193,0 x 79,0 x 20,0

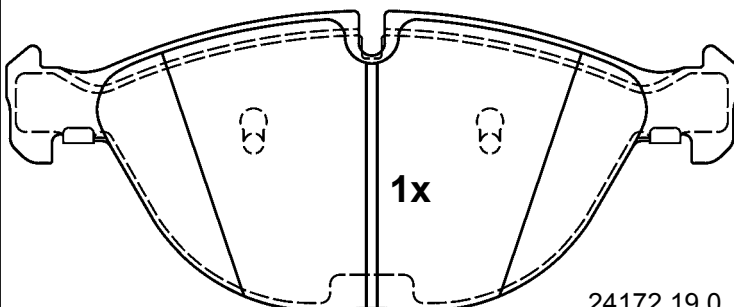

1x

24172 19,0

193,0 x 79,0 x 19,0

## 13.0460-7240.2 607240



VOLKSWAGEN



ATE

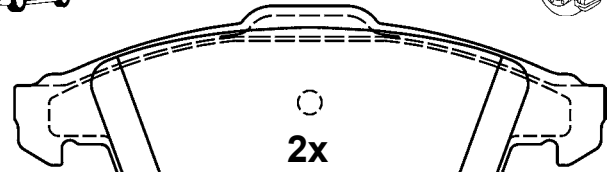

2x

23749 17,6

156,2 x 74,8 x 17,6

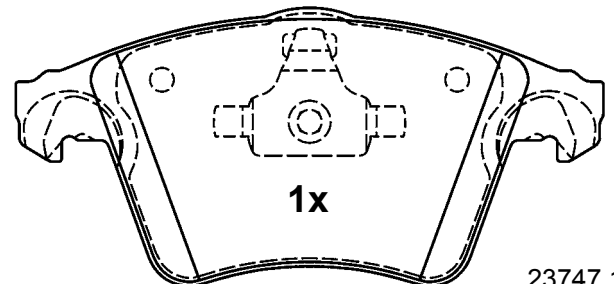

1x

23747 18,1

155,0 x 73,3 x 18,1

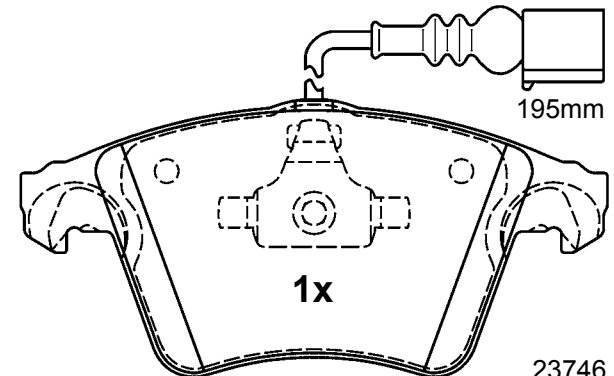

1x

23746 18,1

155,0 x 73,3 x 18,1

## 13.0460-7241.2 607241



JAGUAR



ATE

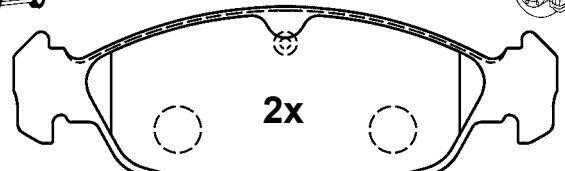

2x

20547 16,5

141,2 x 48,4 x 16,5

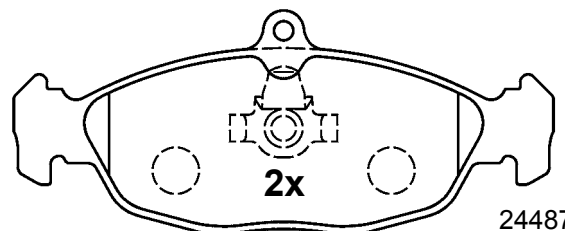

2x

24487 16,5

140,0 x 58,3 x 16,5

# Abbildungen Scheibenbremsbeläge

Illustrations disc brake pads - Illustrazioni pastiglie freno -

Illustrations plaquettes de frein - Ilustraciones pastillas de freno

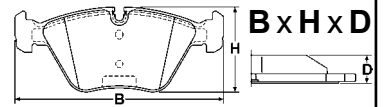

Maßstab - scale - scala - échelle - escala 1:2

## 13.0460-7242.2 607242



AUDI, SEAT, VOLKSWAGEN



ATE

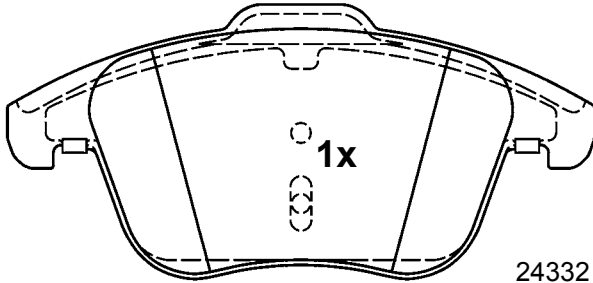

1x

24332 19,8

155,1 x 72,0 x 19,8

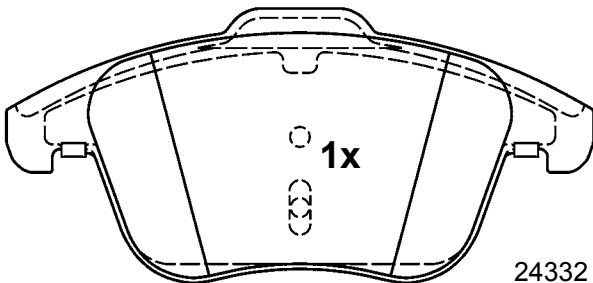

1x

24332 19,8

155,1 x 72,0 x 19,8

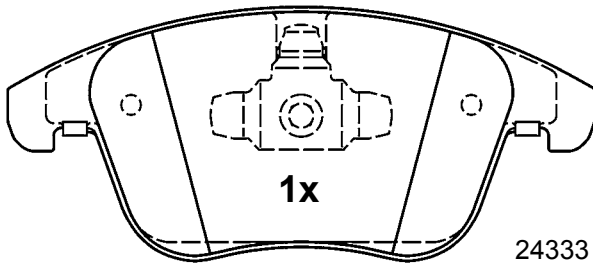

1x

24333 21,3

155,1 x 67,0 x 21,3

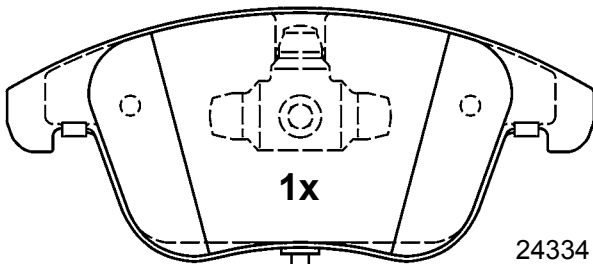

1x

24334 21,3

155mm

155,1 x 67,0 x 21,3

## 13.0460-7243.2 607243



FORD, VOLVO



ATE

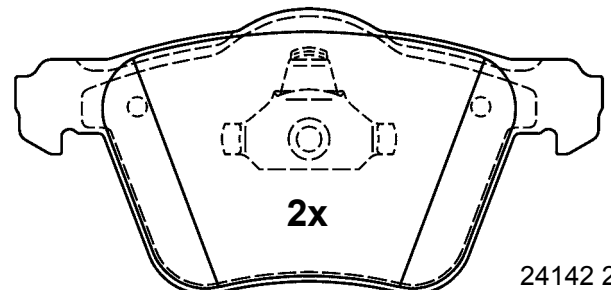

2x

24142 20,6

155,1 x 75,3 x 20,6

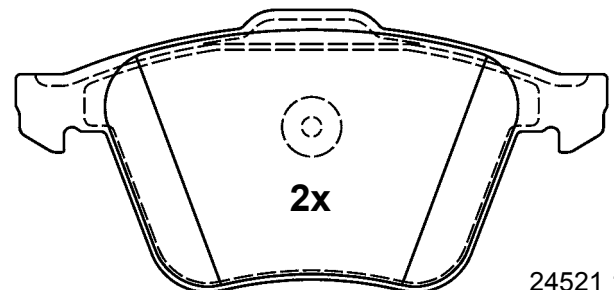

2x

24521 19,1

156,4 x 74,3 x 19,1

## 13.0460-7244.2 607244



MERCEDES BENZ



ATE

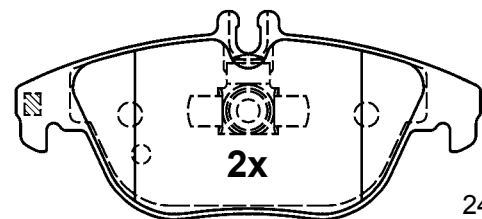

2x

24253 17,8

122,5 x 54,4 x 17,8

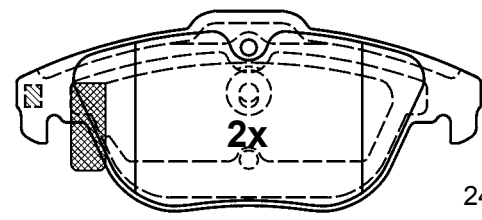

2x

24254 18,0

122,5 x 52,3 x 18,0



# Abbildungen Scheibenbremsbeläge

Illustrations disc brake pads - Illustrazioni pastiglie freno -

Illustrations plaquettes de frein - Ilustraciones pastillas de freno

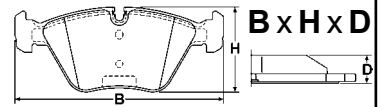

Maßstab - scale - scala - échelle - escala 1:2

## 13.0460-7245.2 607245



VOLKSWAGEN



ATE

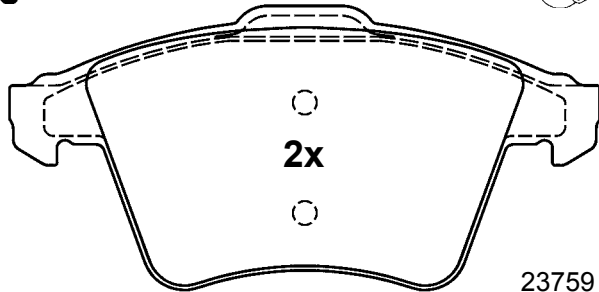

2x

23759 19,1

156,2 x 74,8 x 19,1

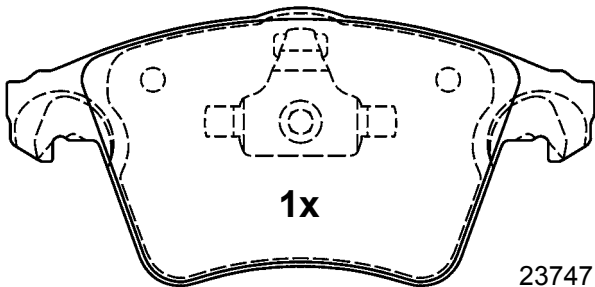

1x

23747 19,6

155,0 x 73,3 x 19,6

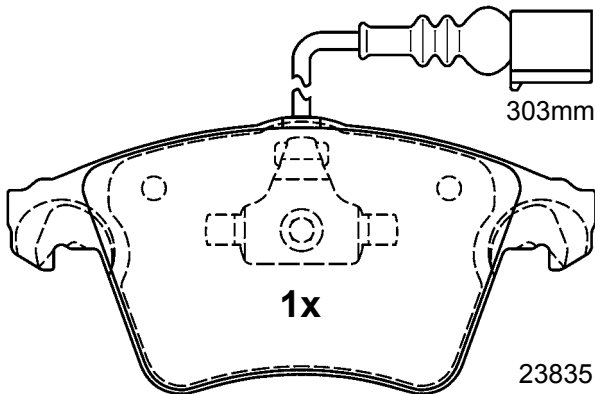

303mm

1x

23835 19,6

155,0 x 73,3 x 19,6

## 13.0460-7246.2 607246



JAGUAR



ATE

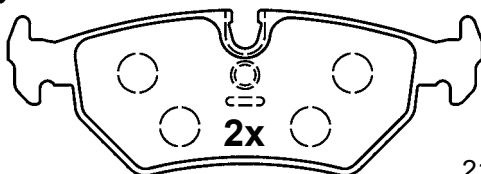

2x

21275 17,0

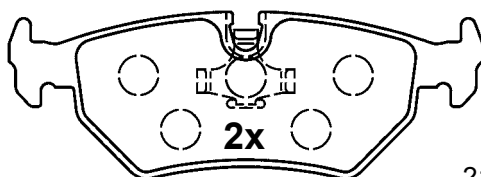

2x

21276 17,0

123,0 x 43,0 x 17,0

## 13.0460-7247.2 607247



VOLKSWAGEN



ATE

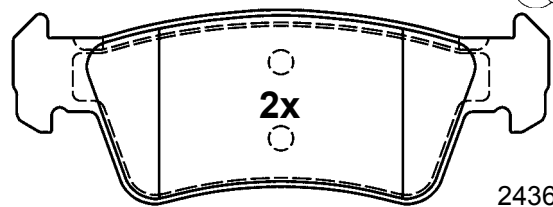

2x

24367 19,2

141,3 x 50,9 x 19,2

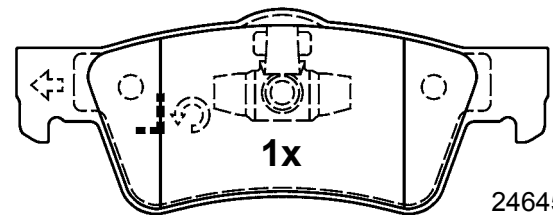

1x

24645 19,2

140,7 x 53,9 x 19,2

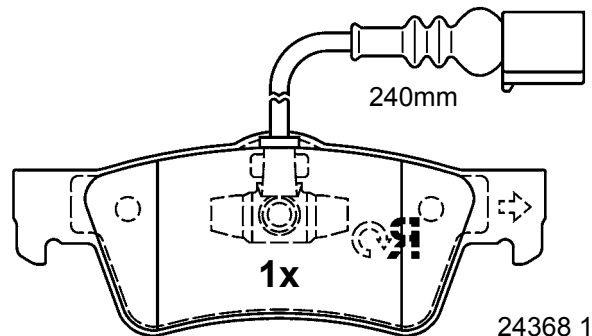

240mm

1x

24368 19,2

140,7 x 53,9 x 19,2

## 13.0460-7248.2 607248



RENAULT



ATE

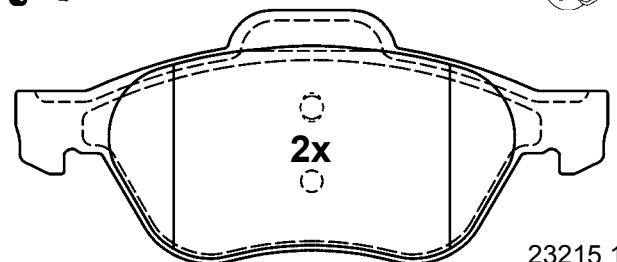

2x

23215 17,5

156,3 x 67,0 x 17,5

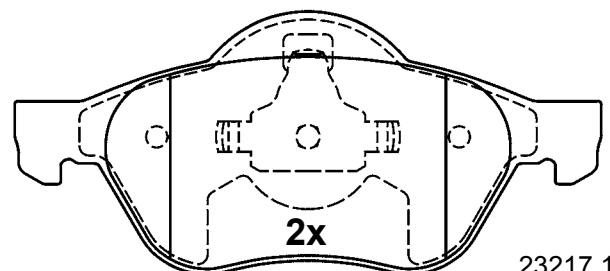

2x

23217 17,5

155,2 x 69,0 x 17,5

# Abbildungen Scheibenbremsbeläge

Illustrations disc brake pads - Illustrazioni pastiglie freno -

Illustrations plaquettes de frein - Ilustraciones pastillas de freno

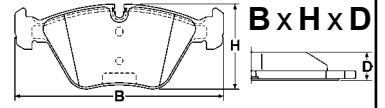

Maßstab - scale - scala - échelle - escala 1:2

**13.0460-7249.2 607249**

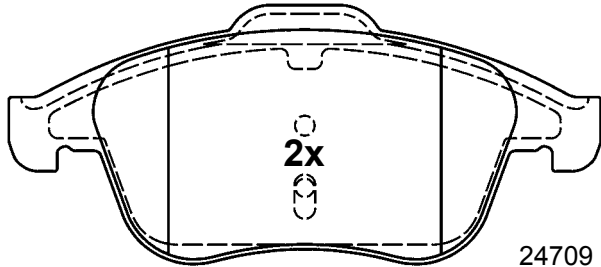

156,3 x 68,3 x 18,6

24709 18,6

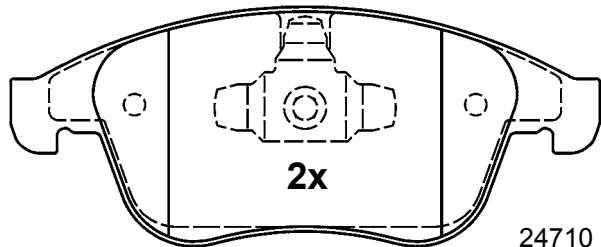

155,1 x 63,0 x 18,6

24710 18,6

**13.0460-7251.2 607251**

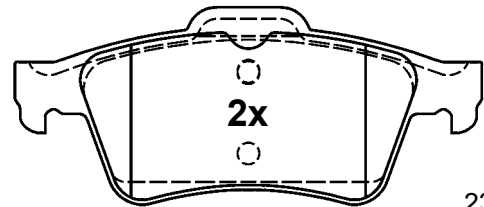

23482 15,8

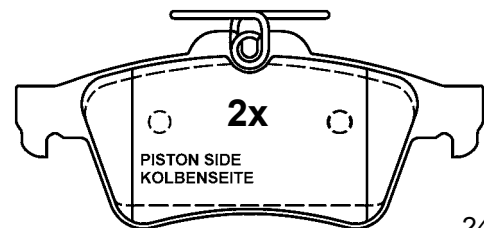

24137 15,8

123,0 x 52,0 x 15,8

**13.0460-7250.2 607250**

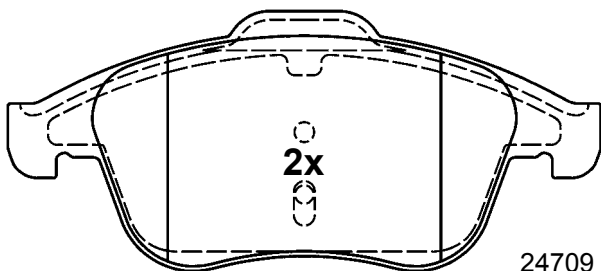

156,3 x 68,3 x 17,5

24709 17,5

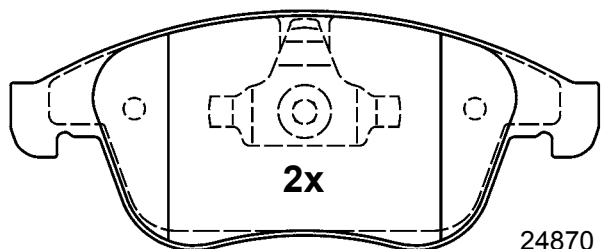

155,2 x 63,0 x 17,5

24870 17,5

**13.0460-7252.2 607252**

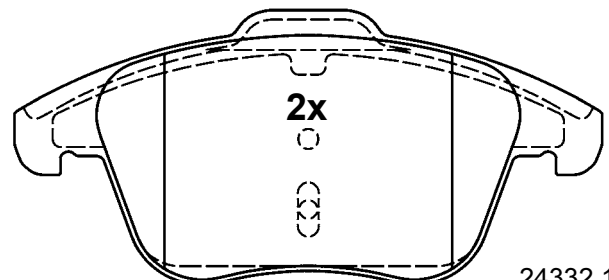

24332 18,3

155,1 x 72,0 x 18,3

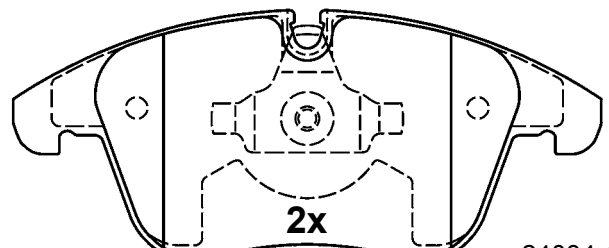

24084 19,3

155,2 x 66,5 x 19,3

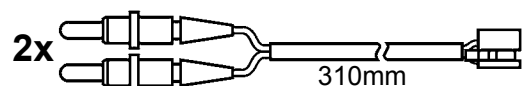

# Abbildungen Scheibenbremsbeläge

Illustrations disc brake pads - Illustrazioni pastiglie freno -

Illustrations plaquettes de frein - Ilustraciones pastillas de freno

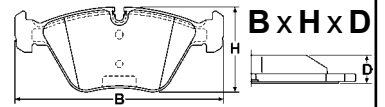

Maßstab - scale - scala - échelle - escala 1:2

## 13.0460-7253.2 607253



CITROËN



ATE

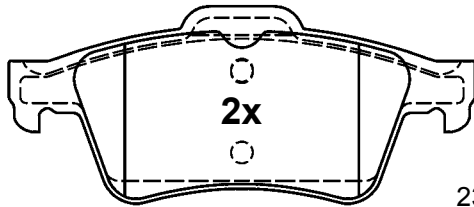

23482 15,8

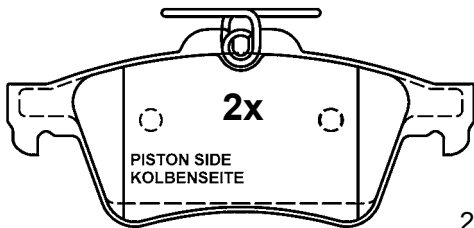

24137 15,8

123,0 x 52,0 x 5,8

2x

PISTON SIDE  
KOLBENSEITE

## 13.0460-7256.2 607256



AUDI



ATE

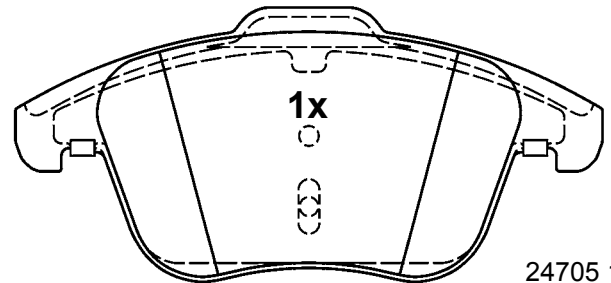

24705 19,8

155,1 x 72,0 x 19,8

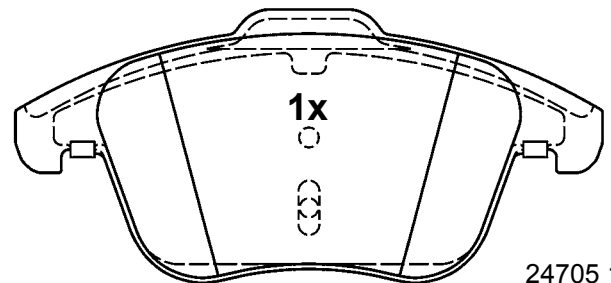

24705 19,8

155,1 x 72,0 x 19,8

1x

## 13.0460-7255.2 607255



JAGUAR



ATE

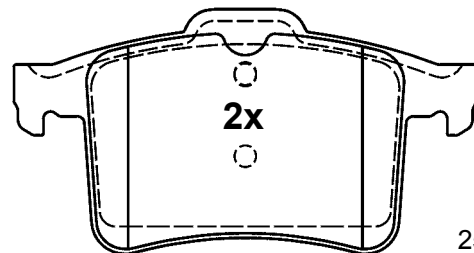

25114 15,8

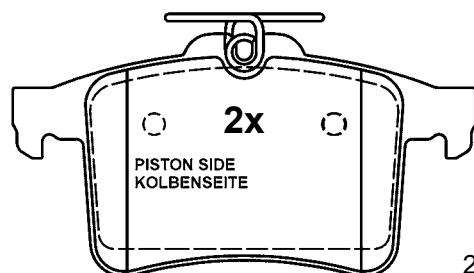

25115 15,8

122,0 x 64,1 x 15,8

2x

2x

PISTON SIDE  
KOLBENSEITE

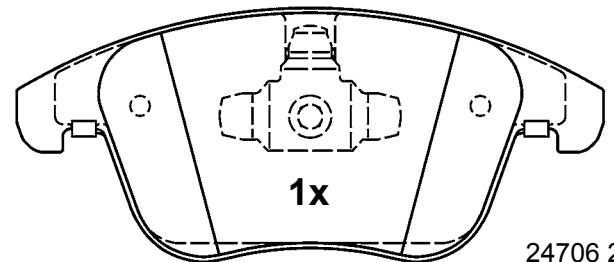

24706 21,3

155,1 x 67,0 x 21,3

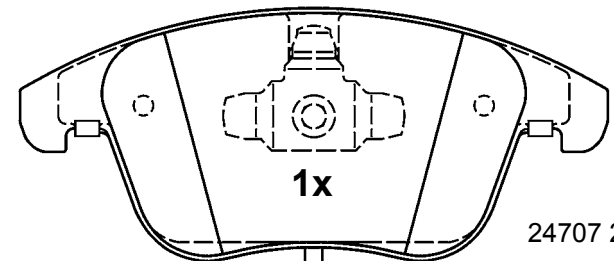

24707 21,3

155,1 x 67,0 x 21,3

281mm

1x

1x

# Abbildungen Scheibenbremsbeläge

Illustrations disc brake pads - Illustrazioni pastiglie freno -

Illustrations plaquettes de frein - Ilustraciones pastillas de freno

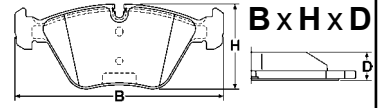

Maßstab - scale - scala - échelle - escala 1:2

## 13.0460-7257.2 607257



MERCEDES BENZ



ATE

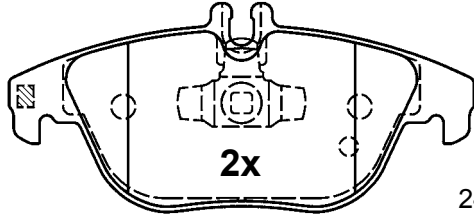

2x

24253 18,0

122,5 x 54,4 x 18,0

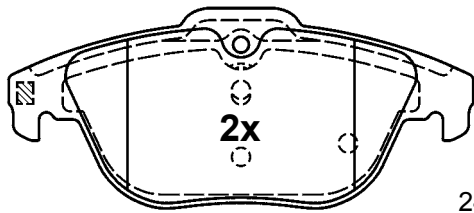

2x

24254 18,0

122,5 x 52,3 x 18,0

## 13.0460-7260.2 607260



BMW



ATE

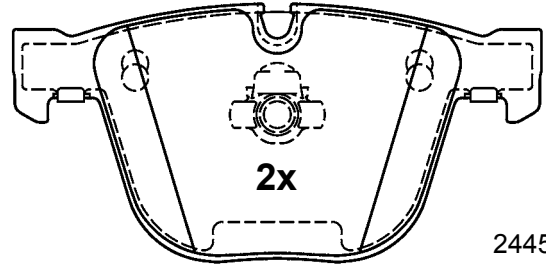

2x

24458 17,3

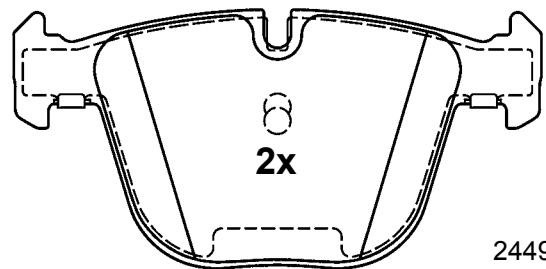

2x

24495 17,3

139,5 x 67,8 x 17,3

## 13.0460-7259.2 607259



MERCEDES BENZ



ATE

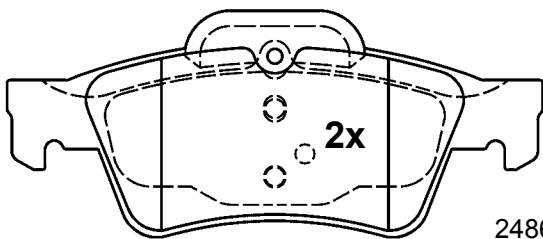

2x

24862 16,7

141,1 x 59,6 x 16,7

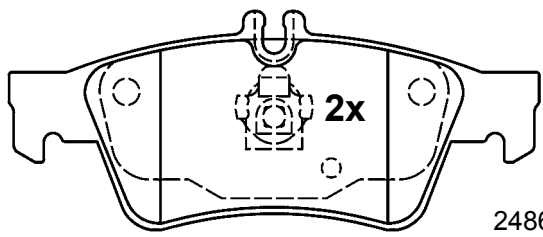

2x

24863 16,7

139,8 x 57,5 x 16,7



BMW



ATE

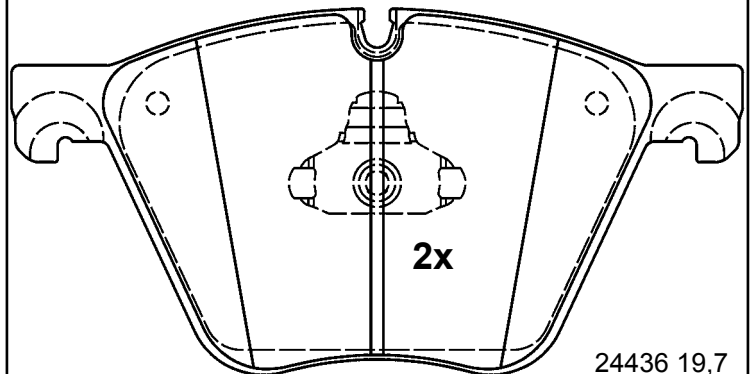

2x

24436 19,7

192,8 x 96,5 x 19,7

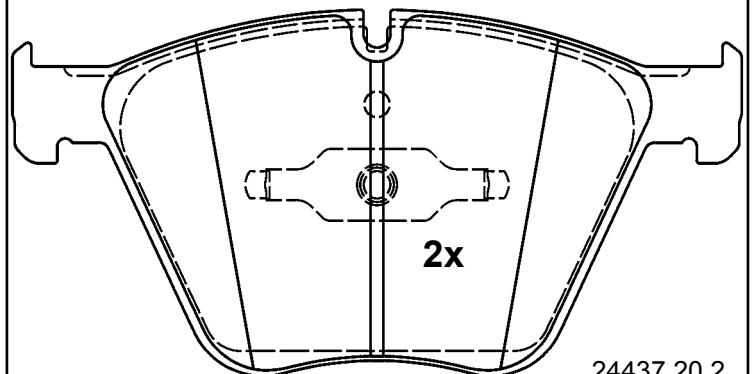

2x

24437 20,2

192,2 x 96,5 x 20,2

# Abbildungen Scheibenbremsbeläge

Illustrations disc brake pads - Illustrazioni pastiglie freno -

Illustrations plaquettes de frein - Ilustraciones pastillas de freno

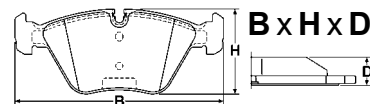

Maßstab - scale - scala - échelle - escala 1:2

**13.0460-7262.2 607262**



CHEVROLET, OPEL, VAUXHALL



ATE

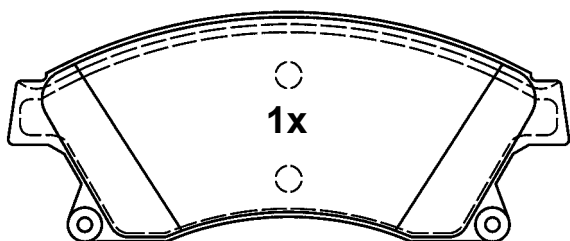

25031 19,1

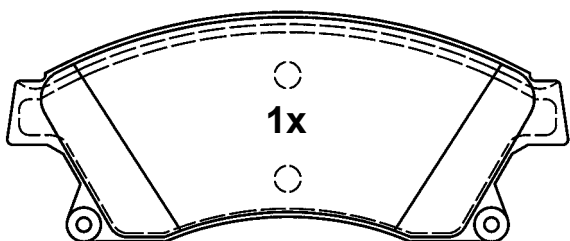

25031 19,1

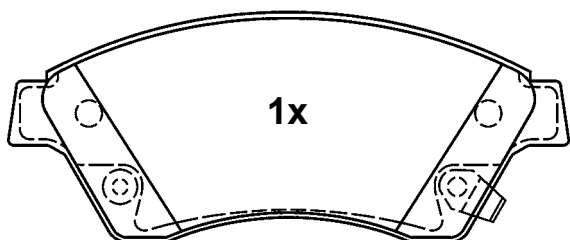

25032 19,1

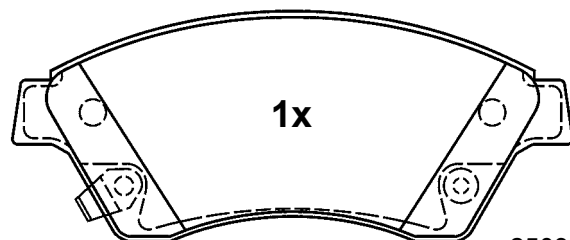

25033 19,1

**148,2 x 60,1 x 19,1**

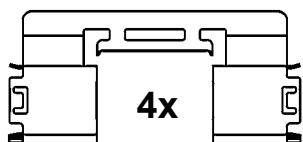

**13.0460-7263.2 607263**



CHEVROLET, OPEL, VAUXHALL



ATE

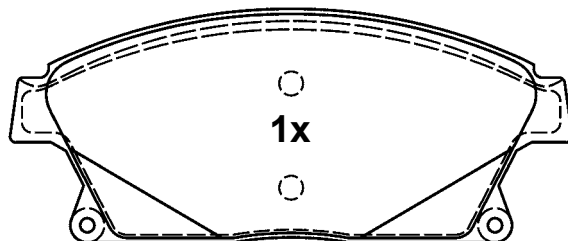

25034 19,1

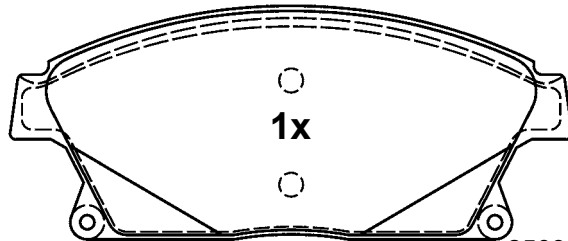

25034 19,1

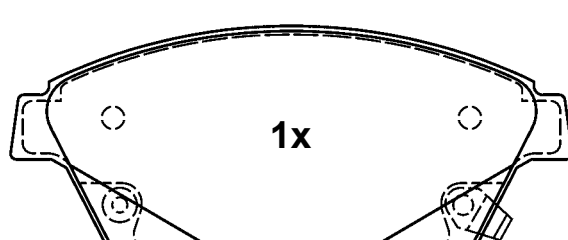

25035 19,1

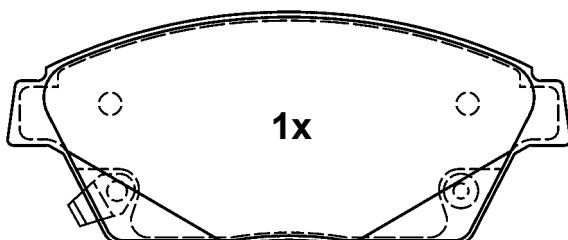

25036 19,1

**148,2 x 61,1 x 19,1**

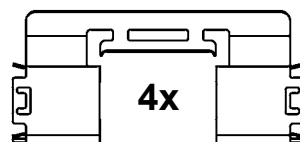

# Abbildungen Scheibenbremsbeläge

Illustrations disc brake pads - Illustrazioni pastiglie freno -

Illustrations plaquettes de frein - Ilustraciones pastillas de freno

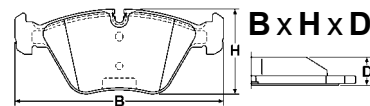

Maßstab - scale - scala - échelle - escala 1:2

## 13.0460-7264.2 607264



CHEVROLET, OPEL, VAUXHALL



ATE

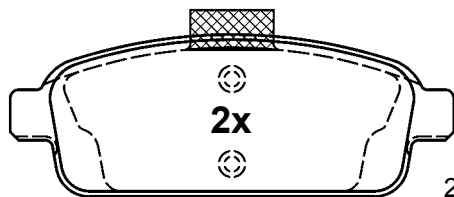

2x

25096 17,0

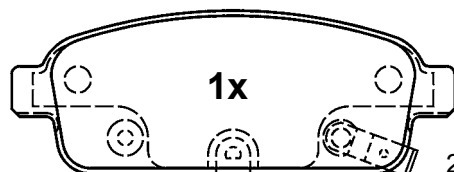

1x

25097 17,0

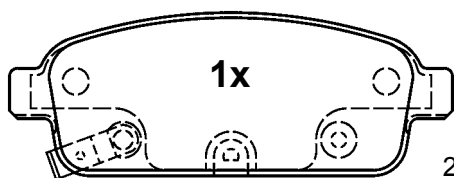

1x

25098 17,0

116,5 x 42,7 x 17,0

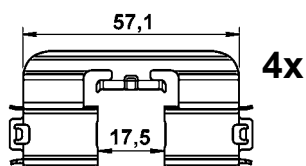

4x

## 13.0460-7266.2 607266



DACIA, RENAULT



ATE

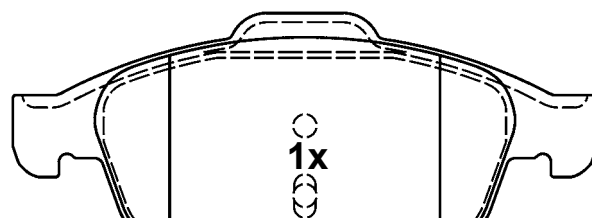

1x

24538 17,9

155,1 x 64,7 x 17,9

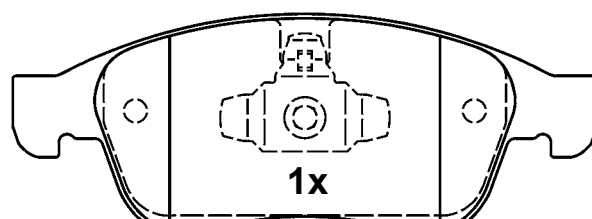

1x

24914 17,9

155,1 x 59,4 x 17,9

## 13.0460-7265.2 607265



FIAT, LANCIA



ATE

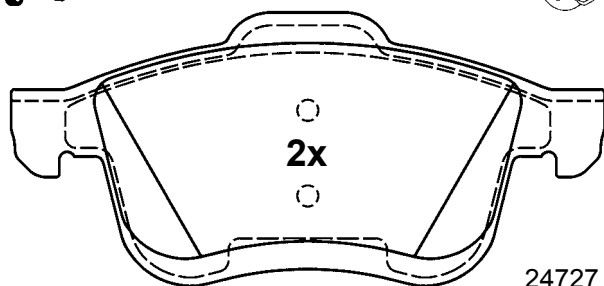

2x

24727 20,7

156,3 x 71,5 x 20,7

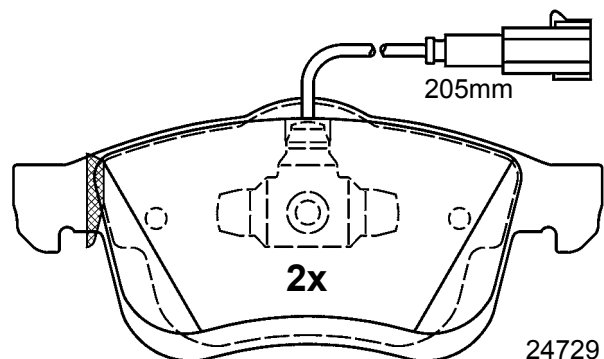

2x

24729 20,7

155,1 x 69,0 x 20,7

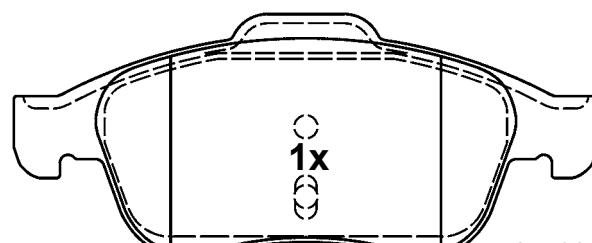

1x

24538 17,9

155,1 x 64,7 x 17,9

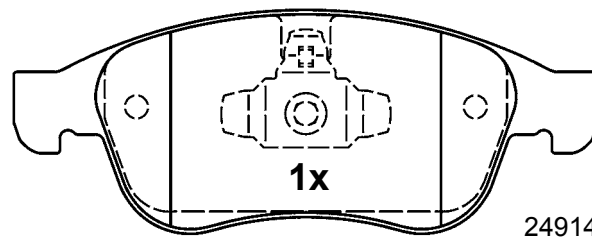

1x

24914 17,9

155,1 x 59,4 x 17,9



# Abbildungen Scheibenbremsbeläge

Illustrations disc brake pads - Illustrazioni pastiglie freno -

Illustrations plaquettes de frein - Ilustraciones pastillas de freno

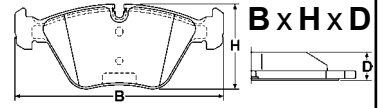

Maßstab - scale - scala - échelle - escala 1:2

## 13.0460-7267.2 607267



BMW



ATE

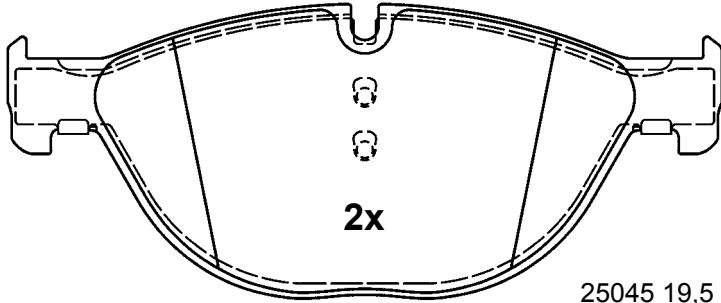

2x

25045 19,5

192,2 x 79,2 x 19,5

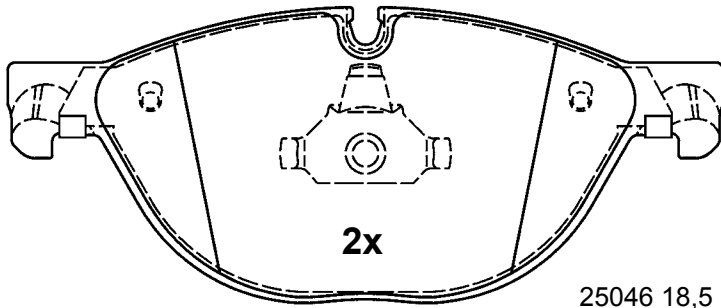

2x

25046 18,5

193,0 x 79,2 x 18,5

## 13.0460-7269.2 607269



ALFA ROMEO



ATE

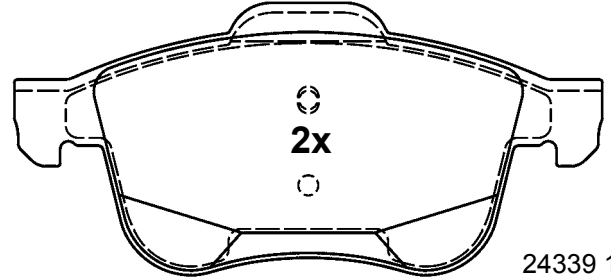

2x

24339 19,5

155,1 x 71,5 x 19,5

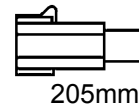

205mm

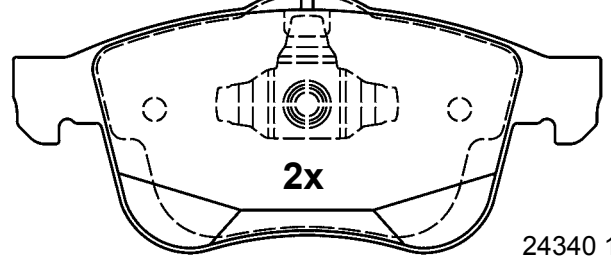

2x

24340 19,5

155,1 x 69,0 x 19,5

## 13.0460-7268.2 607268



BMW



ATE

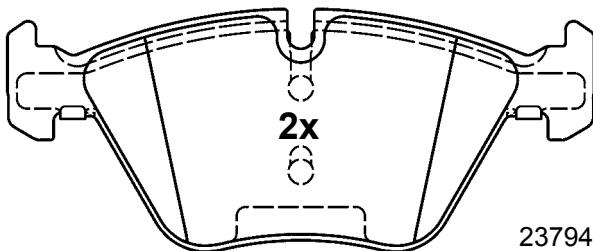

2x

23794 20,3

154,6 x 63,5 x 20,3

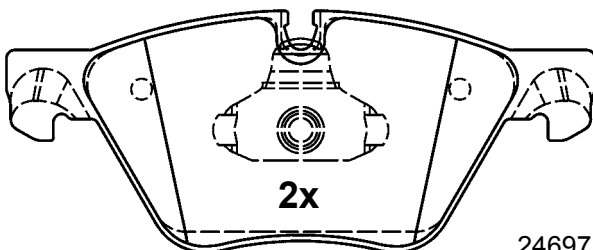

2x

24697 19,3

155,1 x 63,5 x 19,3

## 13.0460-7270.2 607270



DACIA, RENAULT



ATE

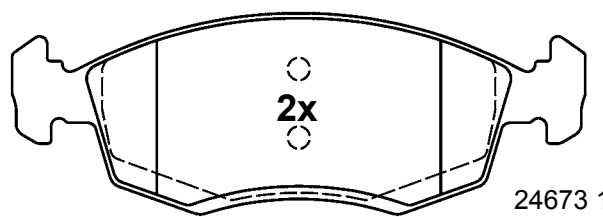

2x

24673 17,5

151,3 x 52,5 x 17,5

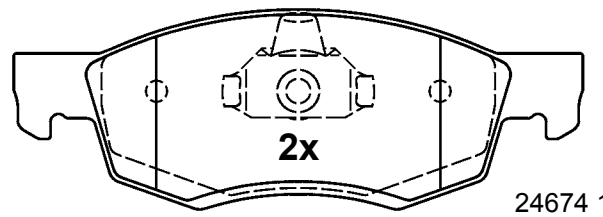

2x

24674 17,5

150,1 x 52,5 x 17,5

# Abbildungen Scheibenbremsbeläge

Illustrations disc brake pads - Illustrazioni pastiglie freno -

Illustrations plaquettes de frein - Ilustraciones pastillas de freno

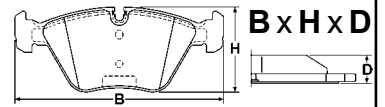

Maßstab - scale - scala - échelle - escala 1:2

**13.0460-7271.2 607271**



MERCEDES BENZ



ATE

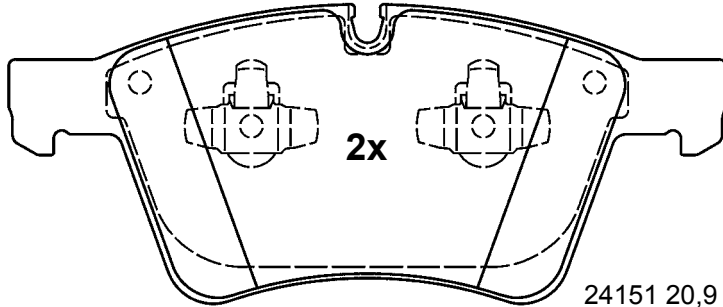

2x

24151 20,9

193,1 x 80,4 x 20,9

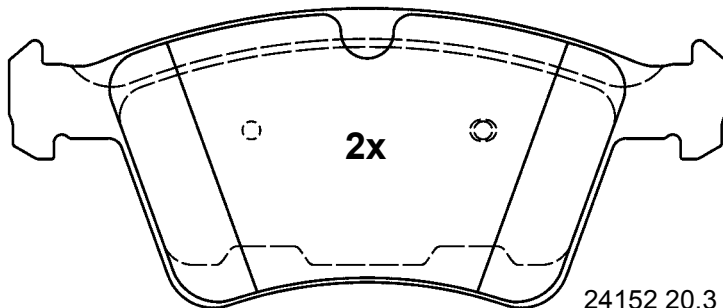

2x

24152 20,3

193,0 x 80,4 x 20,3

**13.0460-7273.2 607273**



ALFA ROMEO



ATE

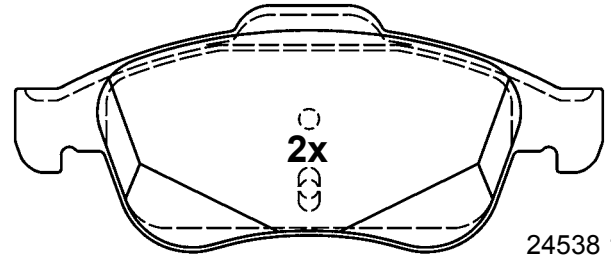

2x

24538 19,4

155,1 x 64,7 x 19,4

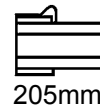

205mm

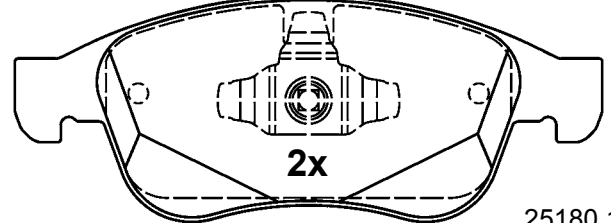

2x

25180 19,0

155,1 x 59,4 x 19,0

**13.0460-7272.2 607272**



VOLVO



ATE

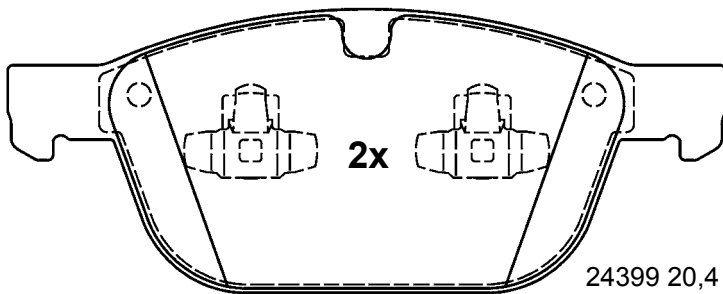

2x

24399 20,4

193,1 x 76,2 x 20,4

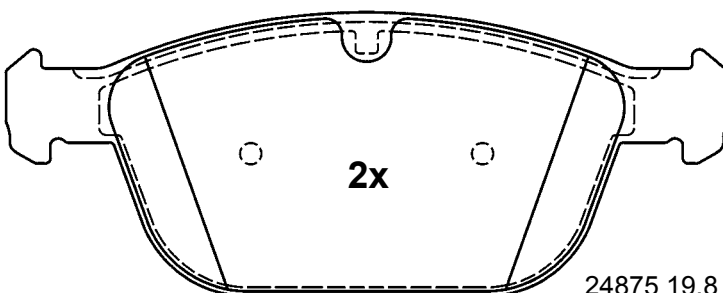

2x

24875 19,8

194,3 x 76,2 x 19,8

**13.0460-7274.2 607274**



BMW



ATE

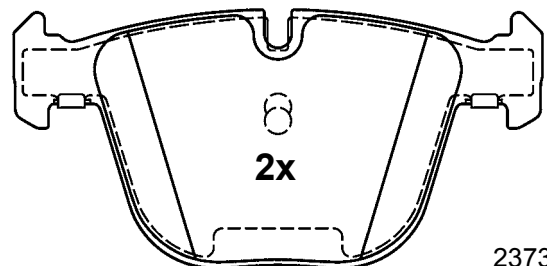

2x

23731 17,3

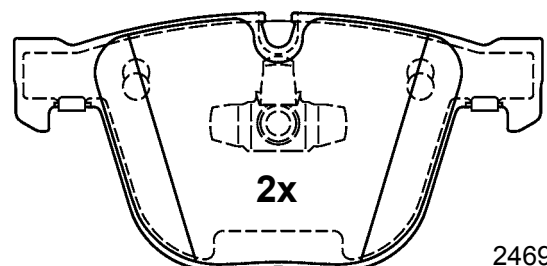

2x

24695 17,3

139,5 x 67,8 x 17,3

# Abbildungen Scheibenbremsbeläge

Illustrations disc brake pads - Illustrazioni pastiglie freno -

Illustrations plaquettes de frein - Ilustraciones pastillas de freno



Maßstab - scale - scala - échelle - escala 1:2

**13.0460-7275.2 607275**



BMW



ATE

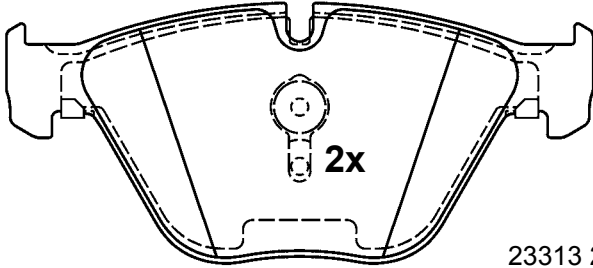

2x

23313 20,2

154,1 x 68,4 x 20,2

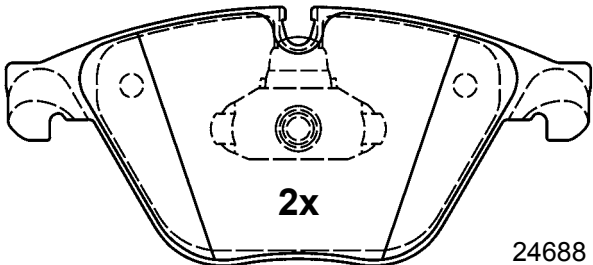

2x

24688 19,2

154,1 x 68,4 x 19,2

**13.0460-7277.2 607277**



PEUGEOT



ATE

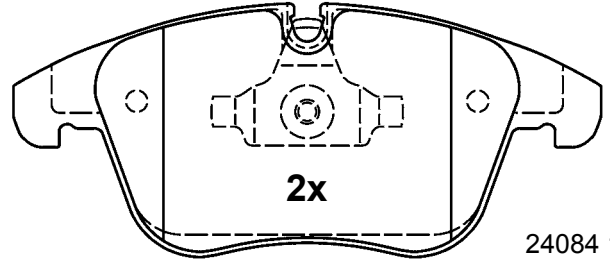

2x

24084 19,3

155,1 x 66,5 x 19,3

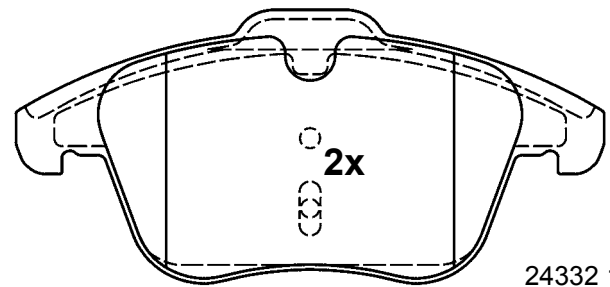

2x

24332 18,3

155,1 x 72,0 x 18,3

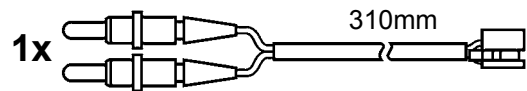

1x

310mm

**13.0460-7276.2 607276**



PEUGEOT



ATE

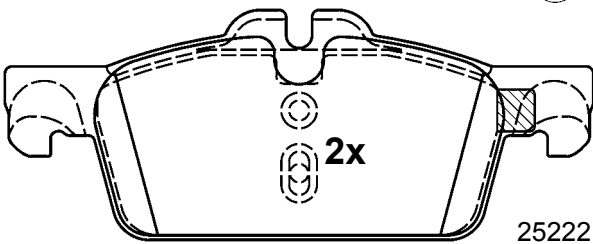

2x

25222 17,3

155,1 x 60,3 x 17,3

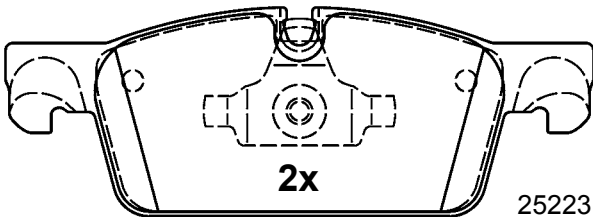

2x

25223 17,3

155,1 x 55,0 x 17,3

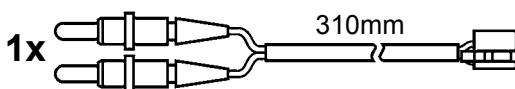

1x

310mm

**13.0460-7278.2 607278**



PEUGEOT



ATE

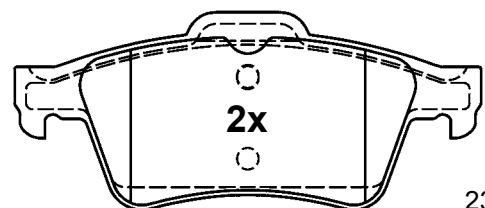

2x

23482 16,6

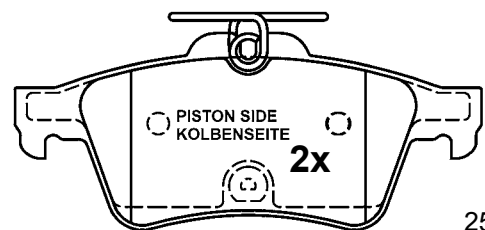

2x

25218 16,6

123,0 x 52,0 x 16,6

# Abbildungen Scheibenbremsbeläge

Illustrations disc brake pads - Illustrazioni pastiglie freno -

Illustrations plaquettes de frein - Ilustraciones pastillas de freno

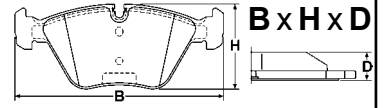

Maßstab - scale - scala - échelle - escala 1:2

**13.0460-7279.2 607279**



CITROEN, PEUGEOT



ATE

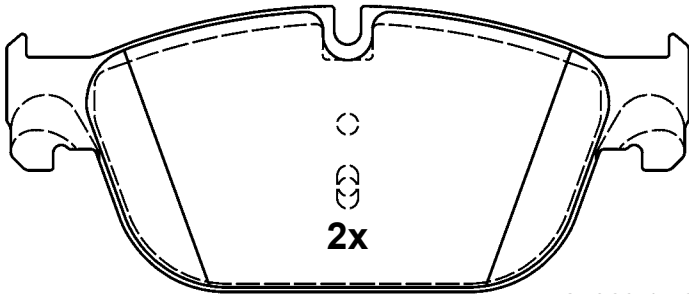

25069 17,3

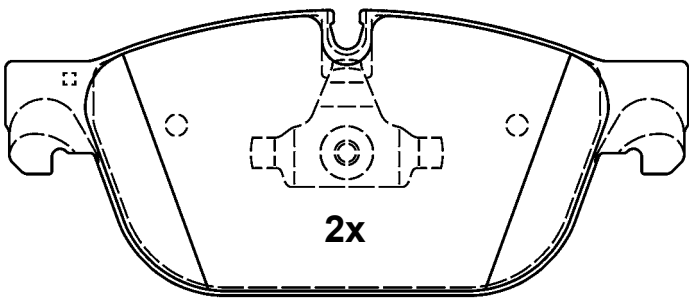

25070 17,3

180,1 x 74,9 x 17,3

1x

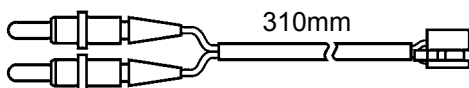

**13.0460-7280.2 607280**



AUDI



ATE

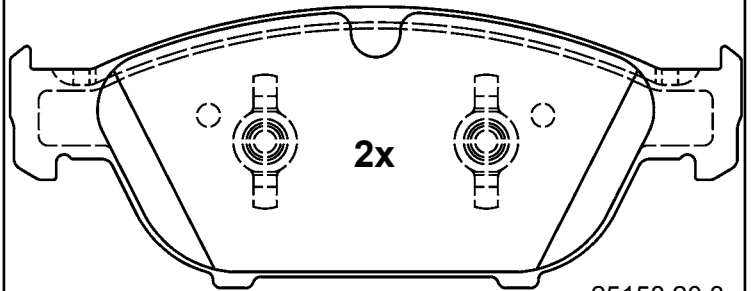

25158 20,3

193,0 x 74,0 x 20,3

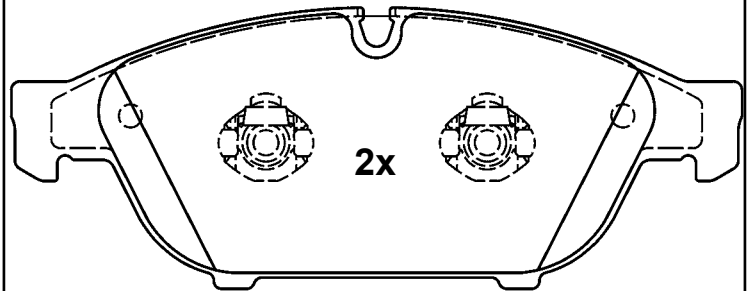

25159 20,3

193,0 x 74,0 x 20,3

2x

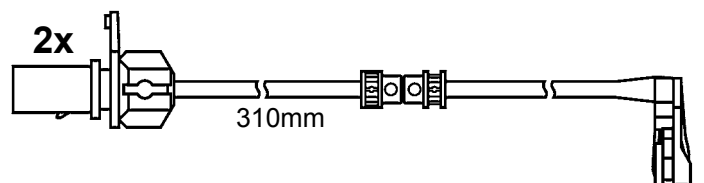

# Abbildungen Scheibenbremsbeläge

Illustrations disc brake pads - Illustrazioni pastiglie freno -

Illustrations plaquettes de frein - Ilustraciones pastillas de freno

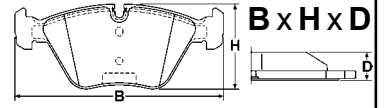

Maßstab - scale - scala - échelle - escala 1:2

**13.0460-7281.2 607281**



AUDI



ATE

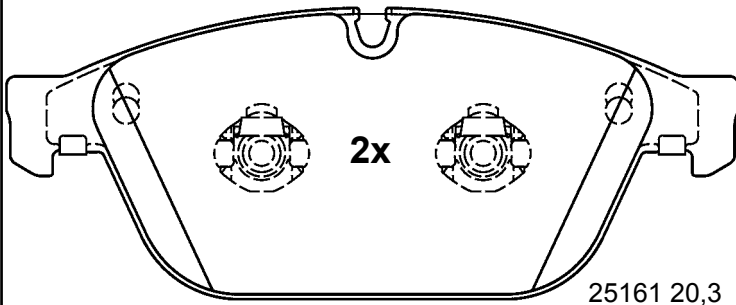
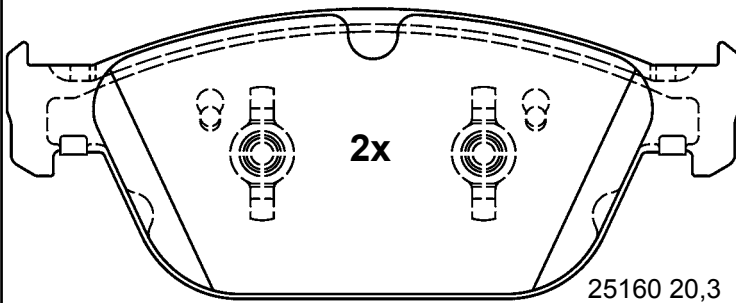

**193,0 x 76,5 x 20,3**

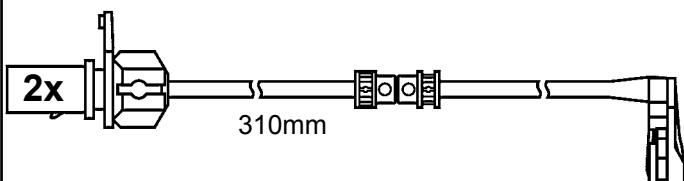

**13.0460-7282.2 607282**



CHRYSLER, JEEP,  
MERCEDES BENZ



ATE

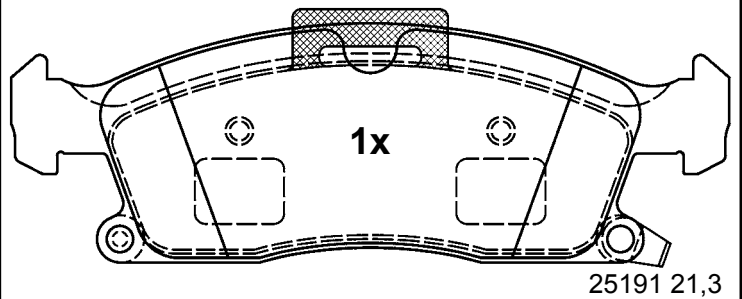
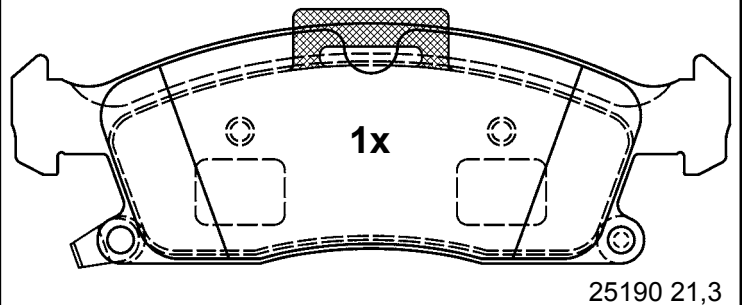
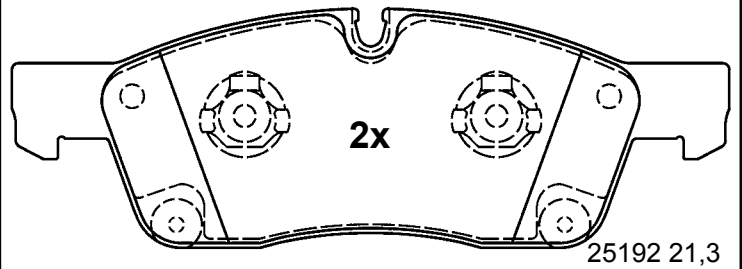

**193,1 x 64,1 x 21,3**

# Abbildungen Scheibenbremsbeläge

Illustrations disc brake pads - Illustrazioni pastiglie freno -

Illustrations plaquettes de frein - Ilustraciones pastillas de freno

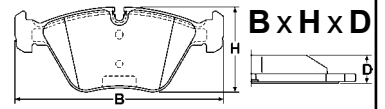

Maßstab - scale - scala - échelle - escala 1:2

## 13.0460-7283.2 607283



MERCEDES BENZ



ATE

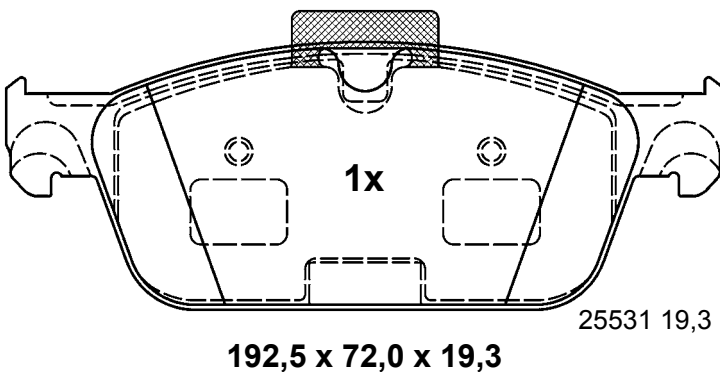
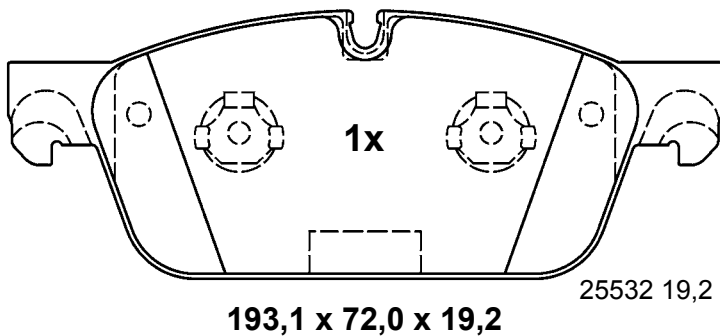
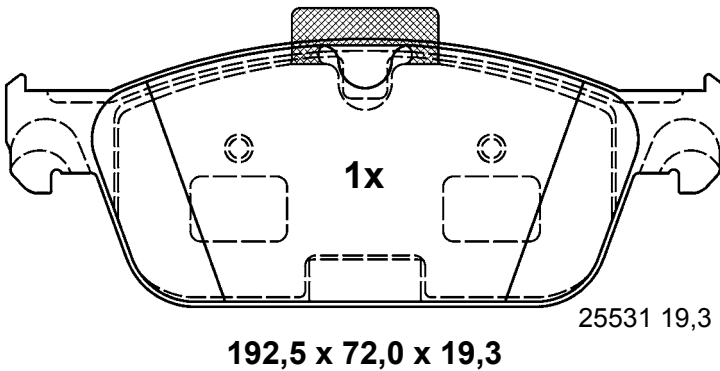
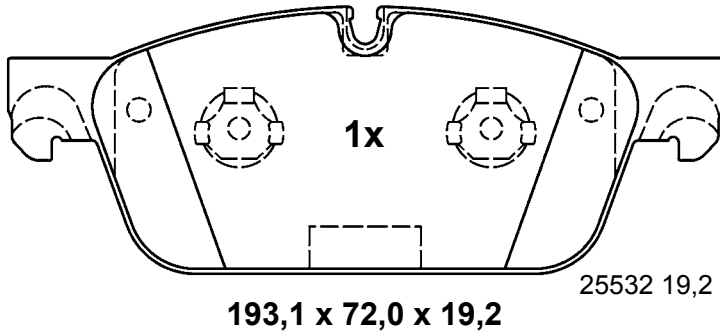

## 13.0460-7284.2 607284



HONDA



ATE

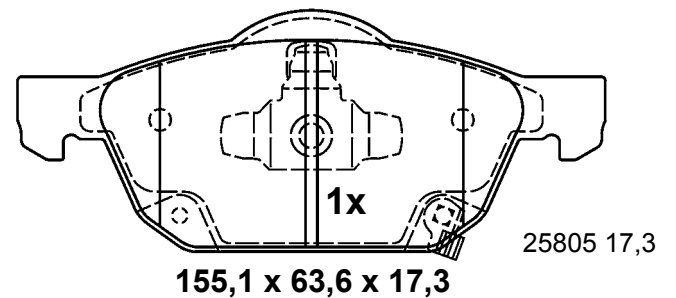
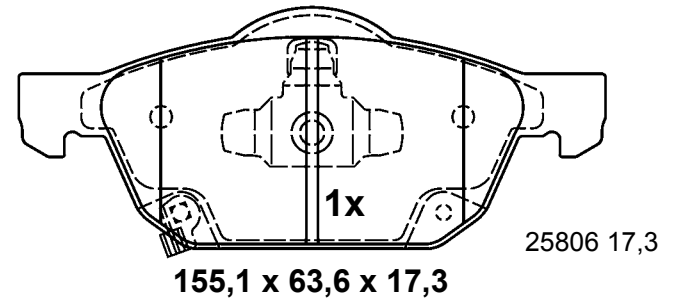
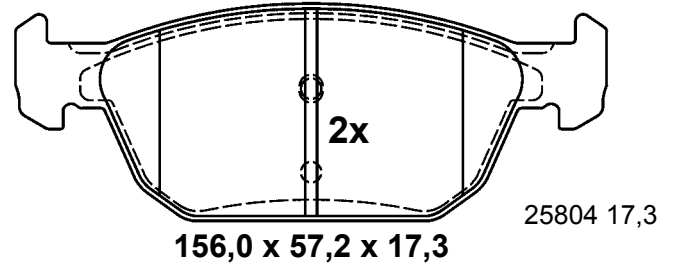

## 13.0460-7285.2 607285



VOLKSWAGEN



ATE

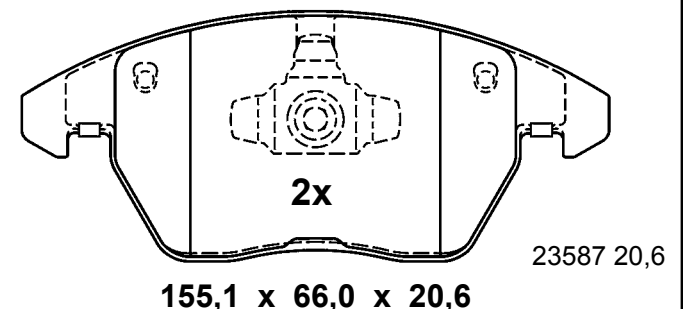
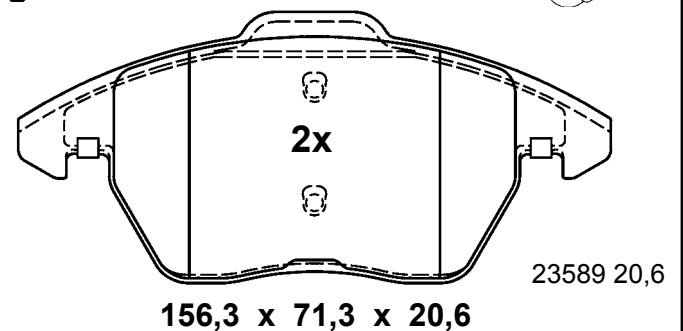



# Abbildungen Scheibenbremsbeläge

Illustrations disc brake pads - Illustrazioni pastiglie freno -

Illustrations plaquettes de frein - Ilustraciones pastillas de freno

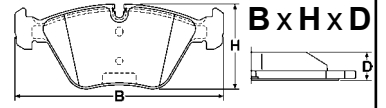

Maßstab - scale - scala - échelle - escala 1:2

**13.0460-7286.2 607286**



VOLKSWAGEN



ATE

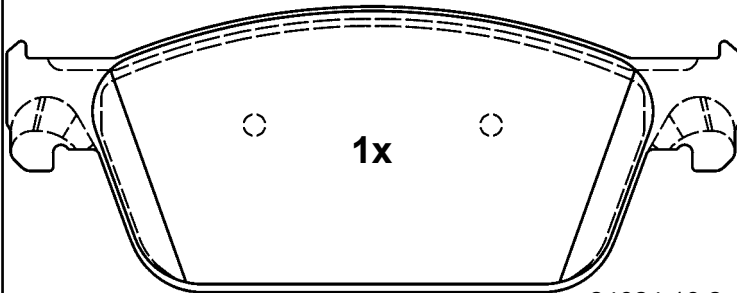

24624 18,2

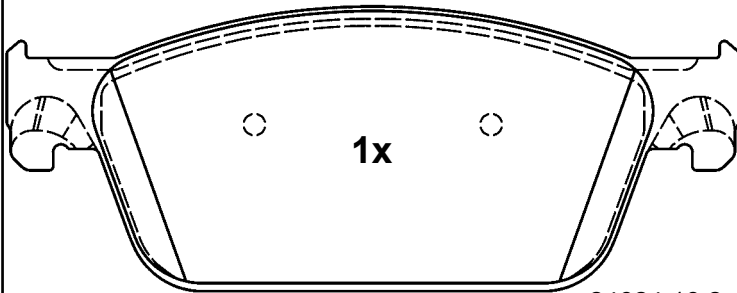

24624 18,2

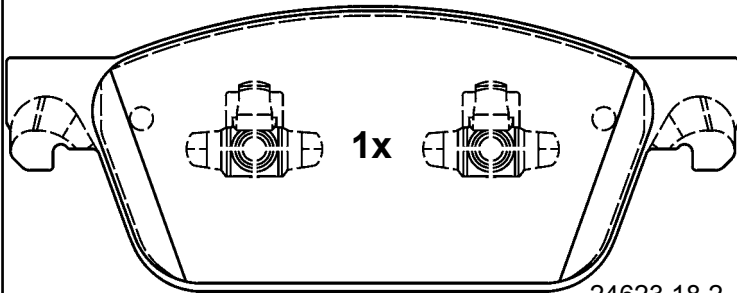

24623 18,2

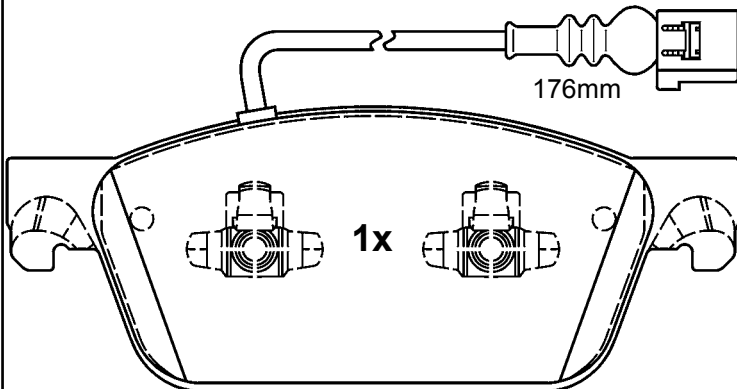

24625 18,2

**193,1 x 75,0 x 18,2**

**13.0460-7287.2 607287**



RENAULT



ATE

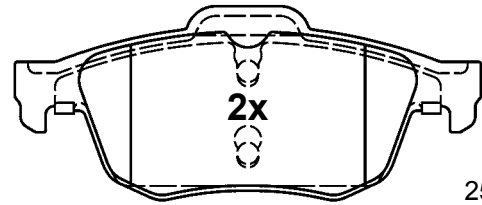

25265 16,6

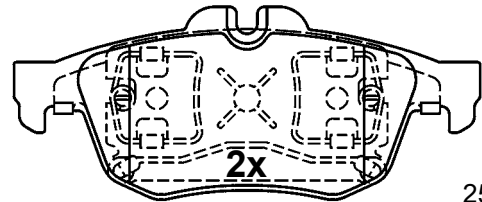

25266 16,6

**123,0 x 50,5 x 16,6**

**13.0460-7288.2 607288**



FIAT



ATE

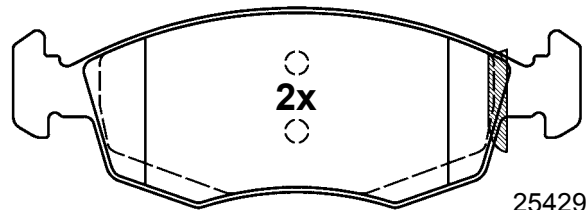

25429 17,6

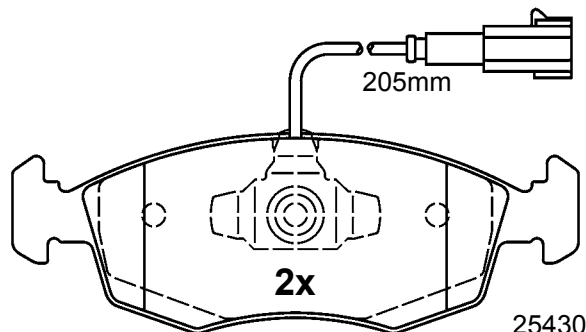

25430 17,6

**149,2 x 52,5 x 17,6**

# Abbildungen Scheibenbremsbeläge

Illustrations disc brake pads - Illustrazioni pastiglie freno -

Illustrations plaquettes de frein - Ilustraciones pastillas de freno

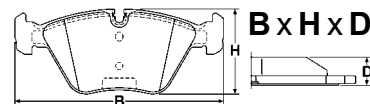

Maßstab - scale - scala - échelle - escala 1:2

## 13.0460-7289.2 607289



FIAT



ATE

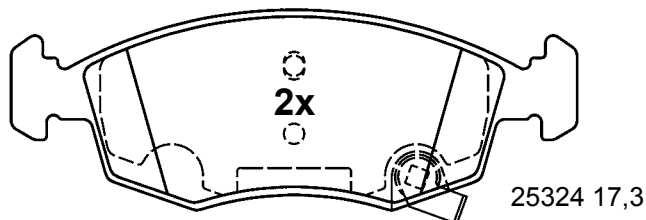

25324 17,3

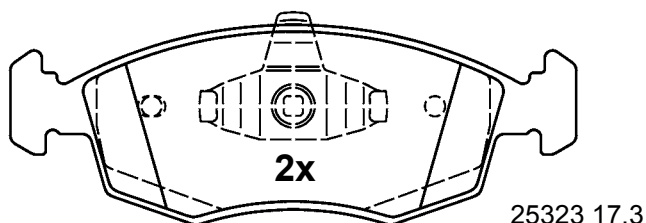

25323 17,3

149,4 x 52,6 x 17,3

## 13.0460-7293.2 607293



AUDI, VOLKSWAGEN



ATE

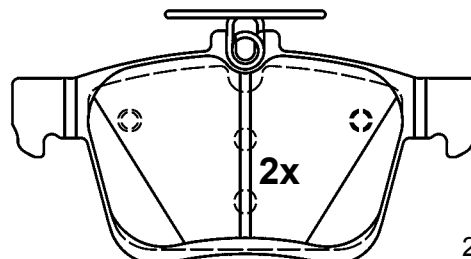

25008 16,3

123,0 x 61,2 x 16,3

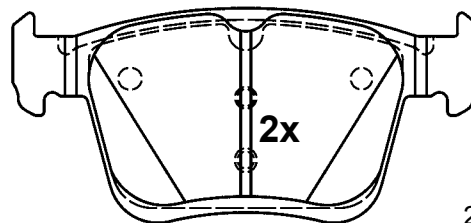

25010 16,3

123,0 x 56,2 x 16,3

## 13.0460-7290.2 607290



HONDA



ATE

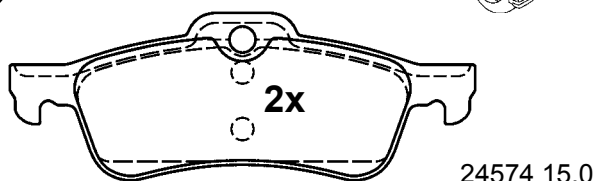

24574 15,0

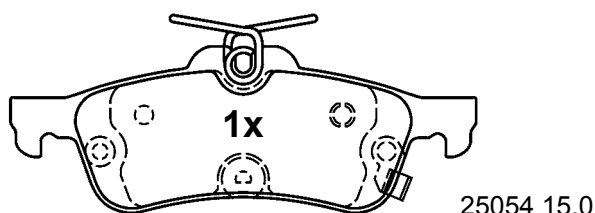

25054 15,0

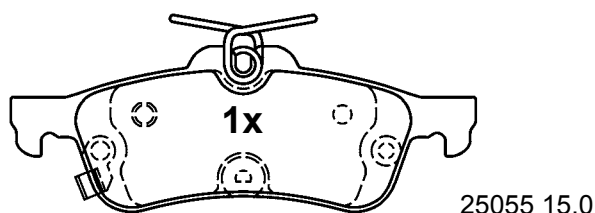

25055 15,0

123,1 x 43,8 x 15,0

## 13.0460-7294.2 607294



AUDI, SKODA, VOLKSWAGEN



ATE

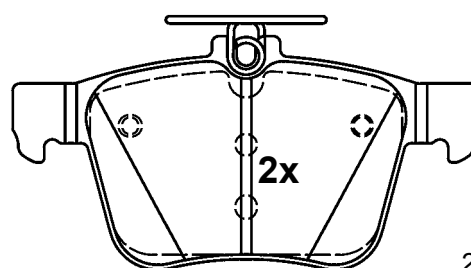

25009 16,4

123,0 x 61,2 x 16,4

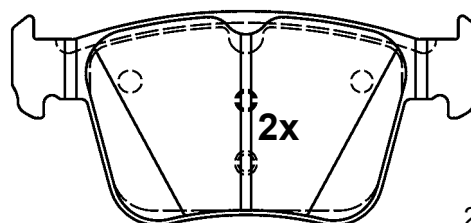

25011 16,4

123,0 x 56,2 x 16,4

# Abbildungen Scheibenbremsbeläge

Illustrations disc brake pads - Illustrazioni pastiglie freno -

Illustrations plaquettes de frein - Ilustraciones pastillas de freno

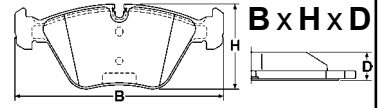

Maßstab - scale - scala - échelle - escala 1:2

## 13.0460-7295.2 607295



PEUGEOT



ATE

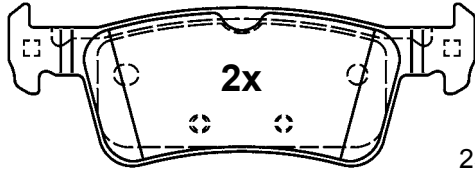

25968 16,1

123,0 x 41,2 x 16,1

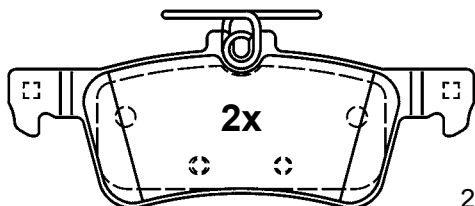

25969 16,1

123,0 x 46,2 x 16,1

## 13.0460-7298.2 607298



DACIA, RENAULT, SMART



ATE

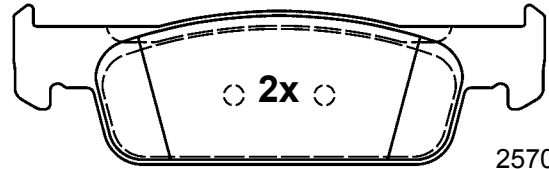

25702 18,2

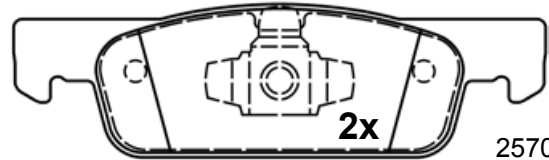

25703 18,2

140,1 x 40,0 x 18,2

## 13.0460-7296.2 607296



BMW



ATE

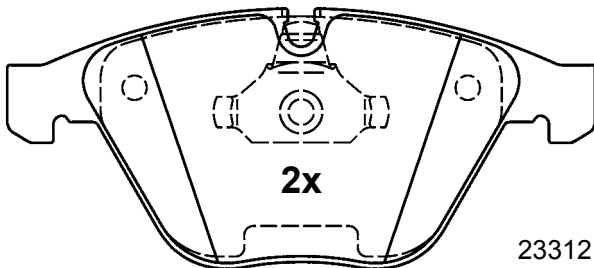

23312 20,3

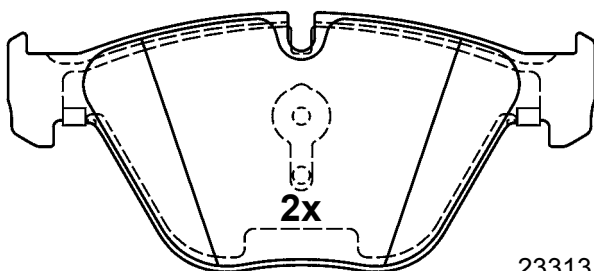

23313 20,3

155,1 x 68,3 x 20,3

## 13.0460-7300.2 607300



CITROEN, PEUGEOT



ATE

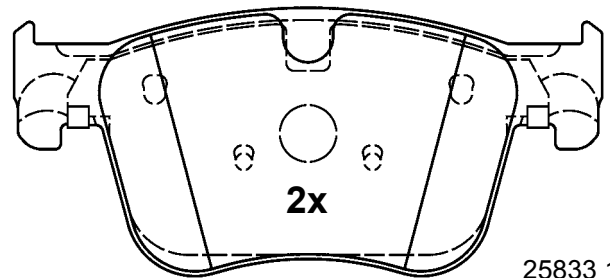

25833 17,3

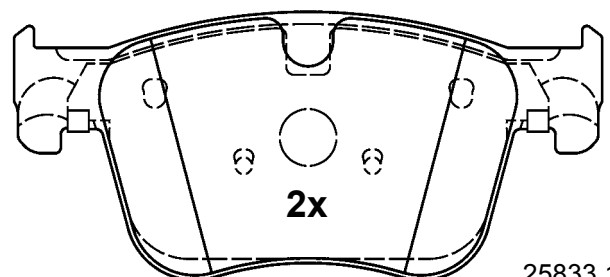

25833 17,3

155,1 x 70,5 x 17,3

# Abbildungen Scheibenbremsbeläge

Illustrations disc brake pads - Illustrazioni pastiglie freno -

Illustrations plaquettes de frein - Ilustraciones pastillas de freno

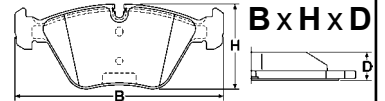

Maßstab - scale - scala - échelle - escala 1:2

## 13.0460-7301.2 607301



PEUGEOT



ATE

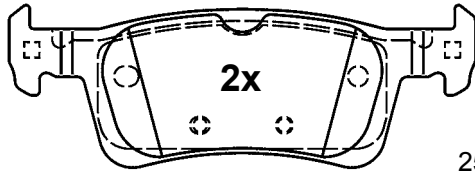

25841 16,1

123,0 x 41,2 x 16,1

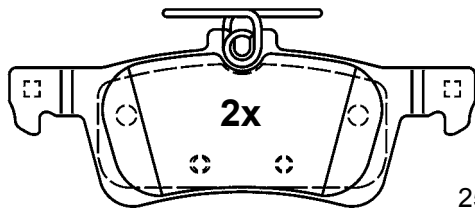

25842 16,1

123,0 x 46,2 x 16,1

## 13.0460-7305.2 607305



CITROEN



ATE

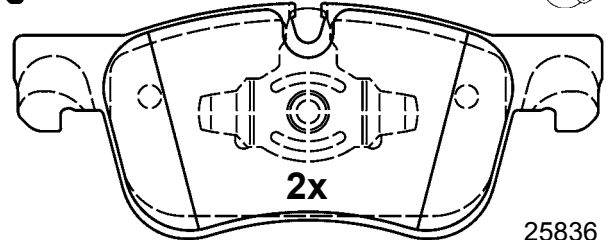

25836 17,0

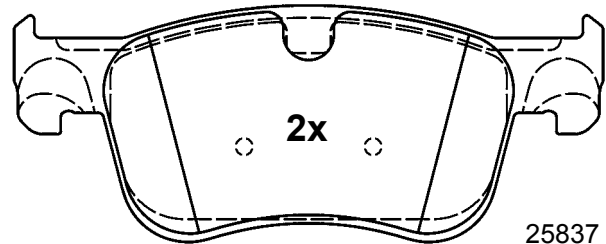

25837 17,0

155,1 x 61,9 x 17,0

## 13.0460-7303.2 607303



AUDI, SEAT, SKODA,  
VOLKSWAGEN



ATE

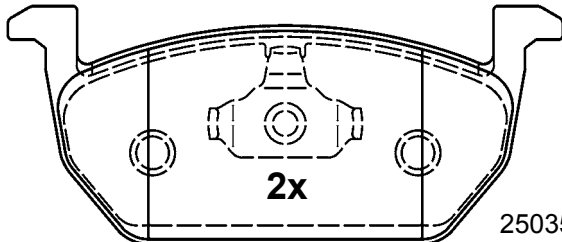

25035 17,5

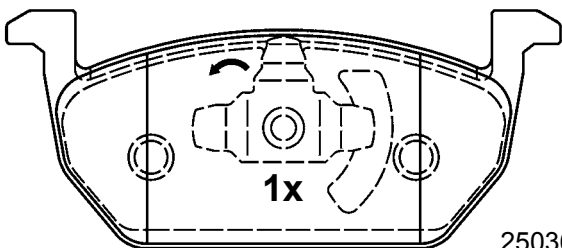

25036 17,5

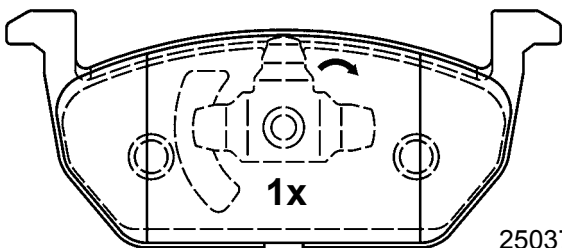

25037 17,5

146,0 x 62,4 x 17,5

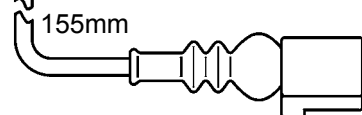

## 13.0460-7307.2 607307



AUDI



ATE

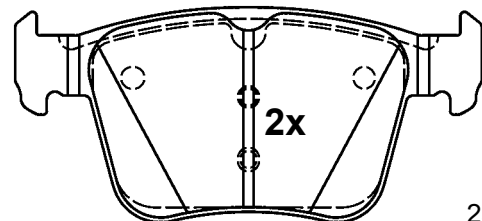

25011 16,4

123,0 x 56,2 x 16,4

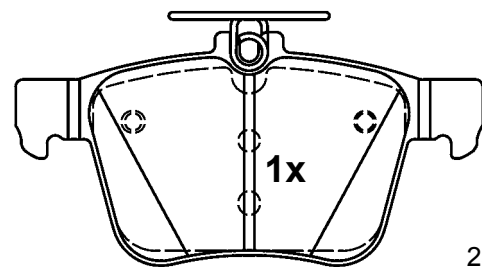

25009 16,4

123,0 x 61,2 x 16,4

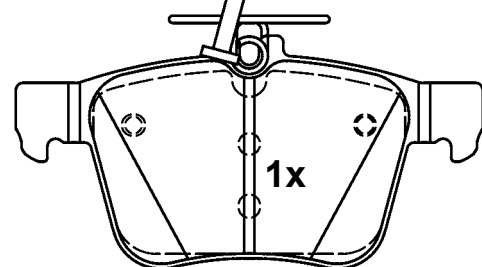
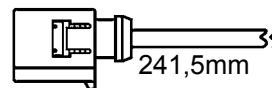

16,4

123,0 x 61,2 x 16,4

# Abbildungen Scheibenbremsbeläge

Illustrations disc brake pads - Illustrazioni pastiglie freno -

Illustrations plaquettes de frein - Ilustraciones pastillas de freno

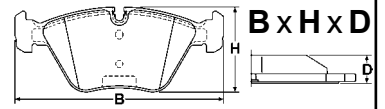

Maßstab - scale - scala - échelle - escala 1:2

## 13.0460-7903.2 607903

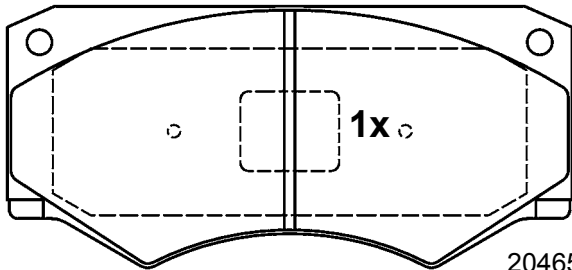

20465 18,0

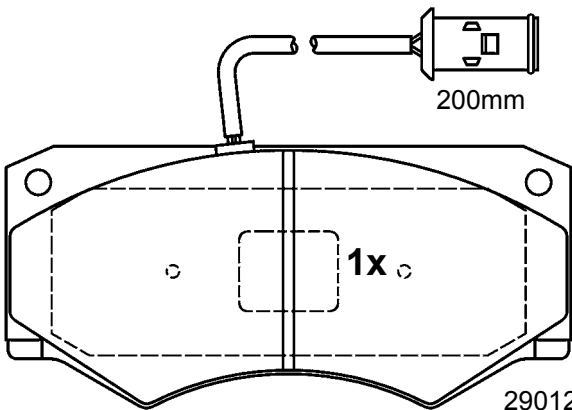

29012 18,0

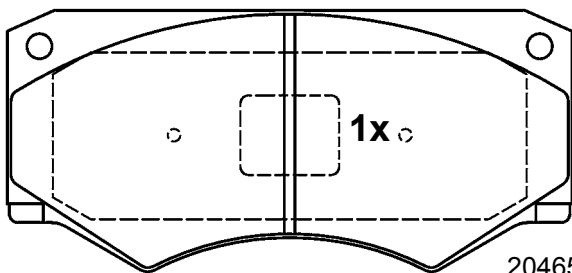

20465 18,0

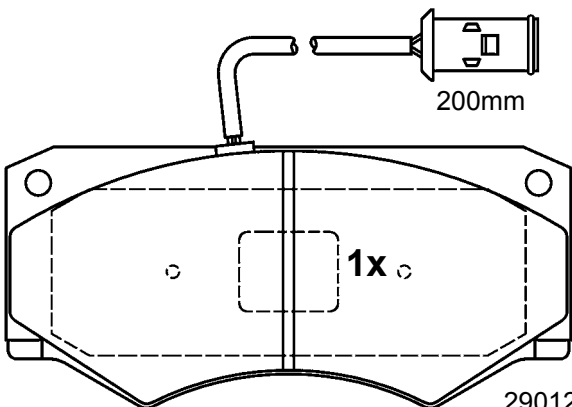

29012 18,0

149,0 x 69,0 x 18,0

## 13.0460-7906.2 607906

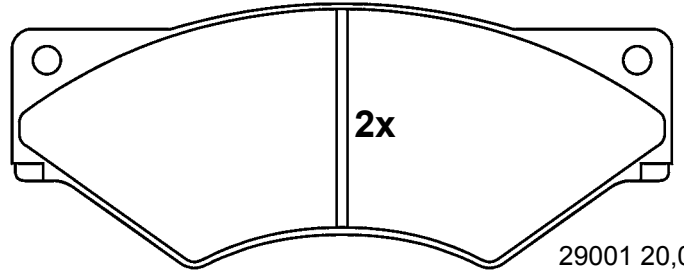

29001 20,0

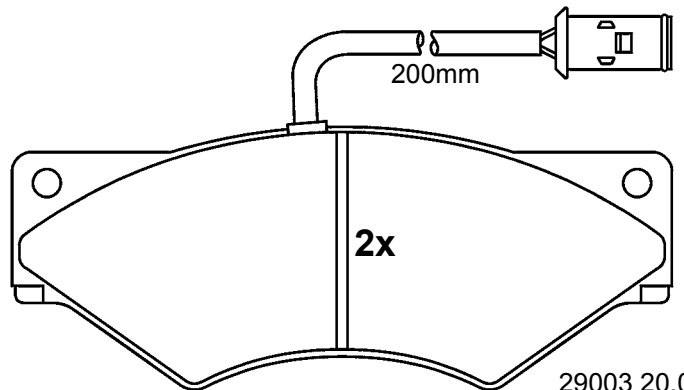

29003 20,0

174,5 x 69,2 x 20,0

## 13.0460-7909.2 607909



MERCEDES BENZ, VOLKSWAGEN

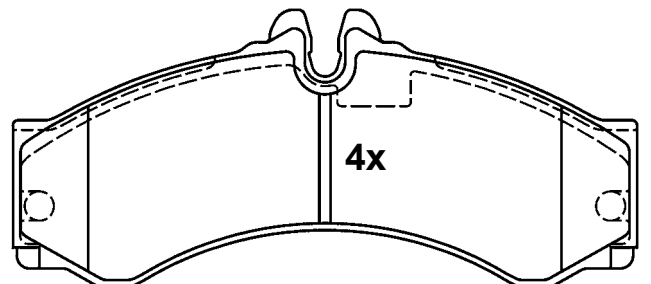

29153 20,0

164,6 x 73,0 x 20,0



M8x21



4x

# Abbildungen Scheibenbremsbeläge

Illustrations disc brake pads - Illustrazioni pastiglie freno -

Illustrations plaquettes de frein - Ilustraciones pastillas de freno

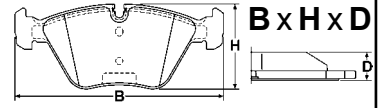

Maßstab - scale - scala - échelle - escala 1:2

## 13.0460-8002.2 608002



CHEVROLET, OPEL, PONTIAC,  
VAUXHALL

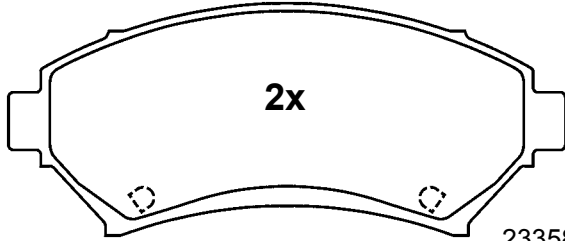

23358 18,0

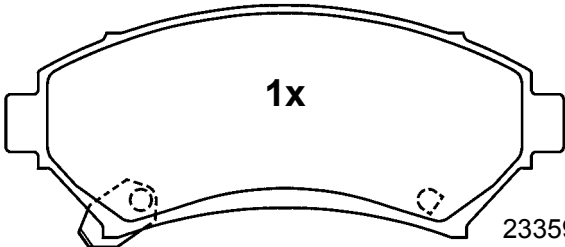

23359 18,0

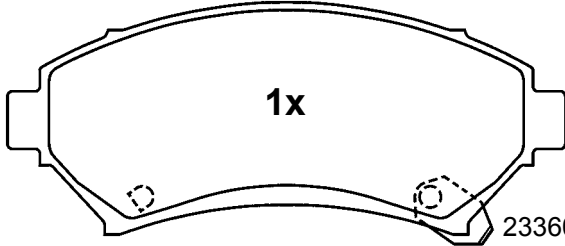

23360 18,0

148,0 x 61,2 x 18,0

## 13.0460-8004.2 608004



MERCEDES BENZ

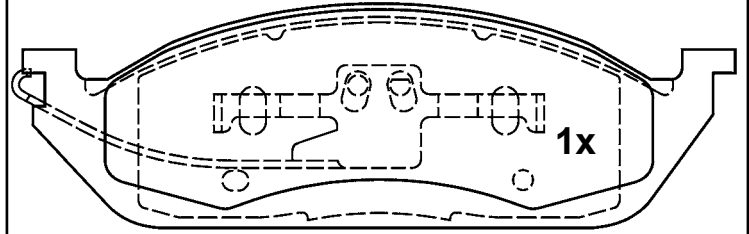

23193 16,4

187,9 x 59,1 x 16,4

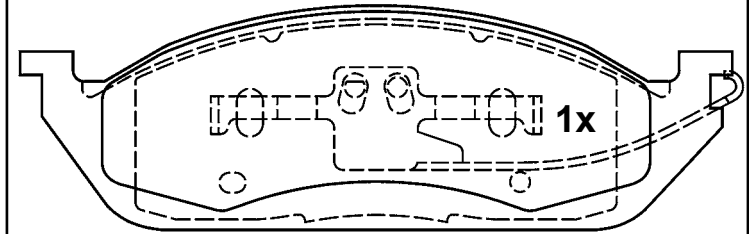

23194 16,4

187,9 x 59,1 x 16,4

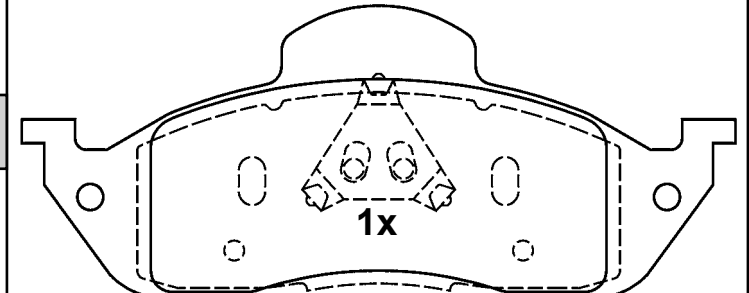

23195 17,4

187,9 x 77,3 x 17,4

## 13.0460-8003.2 608003



CHRYSLER

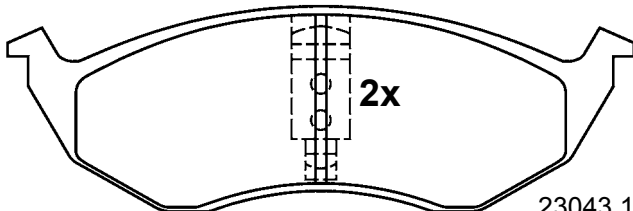

23043 16,0

165,4 x 54,4 x 16,0

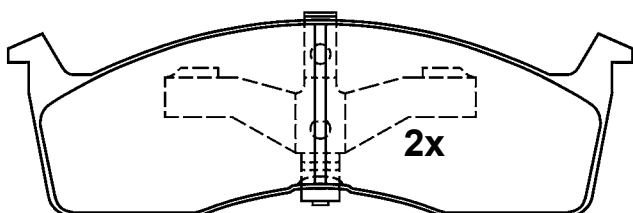

23044 16,0

165,4 x 51,3 x 16,0

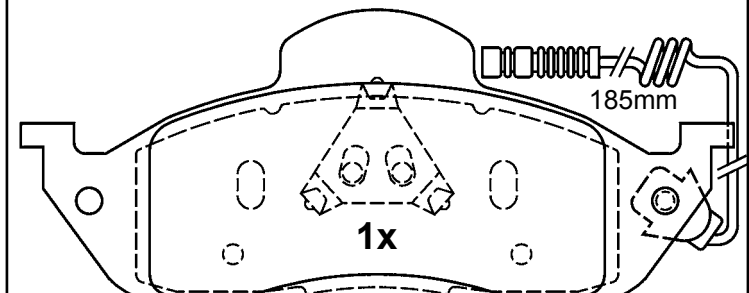

23196 17,4

187,9 x 77,3 x 17,4

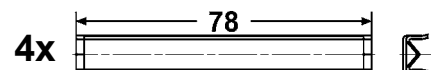



# Abbildungen Scheibenbremsbeläge

Illustrations disc brake pads - Illustrazioni pastiglie freno -

Illustrations plaquettes de frein - Ilustraciones pastillas de freno

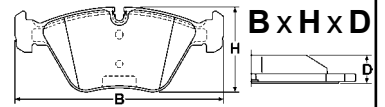

Maßstab - scale - scala - échelle - escala 1:2

## 13.0460-8005.2 608005

MERCEDES BENZ

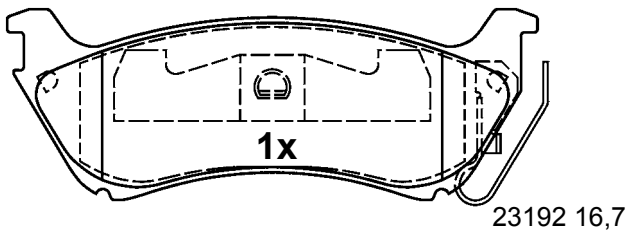
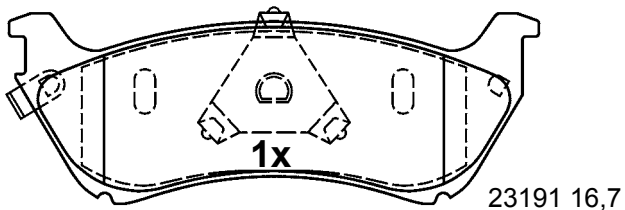
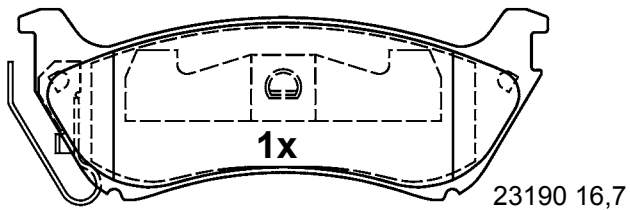
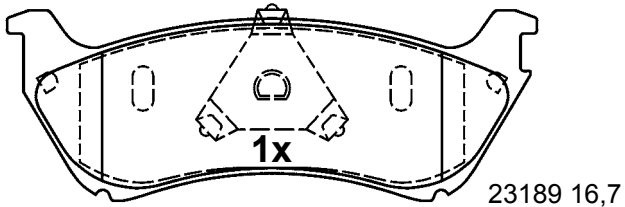

140,1 x 50,0 x 16,7

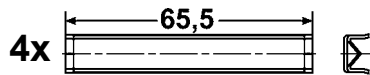

## 13.0460-8007.2 608007

MERCEDES BENZ

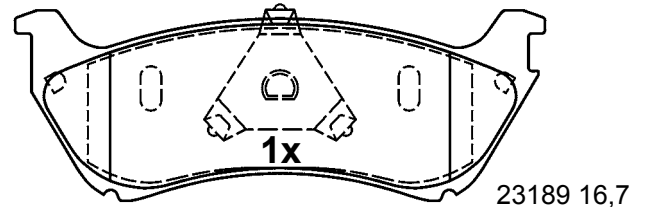

140,1 x 50,0 x 16,7

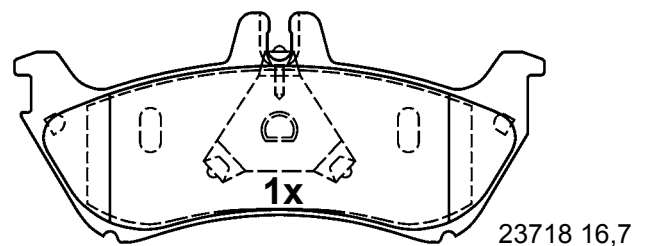

140,1 x 61,0 x 16,7

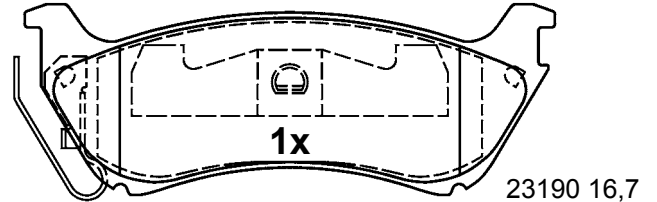

140,1 x 50,0 x 16,7

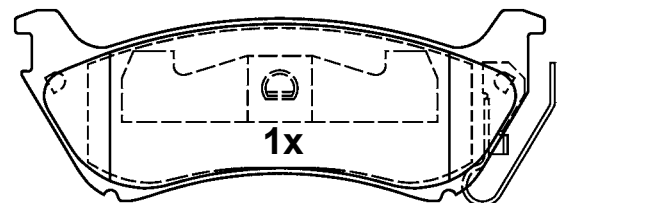

140,1 x 50,0 x 16,7

## 13.0460-8006.2 608006

LADA

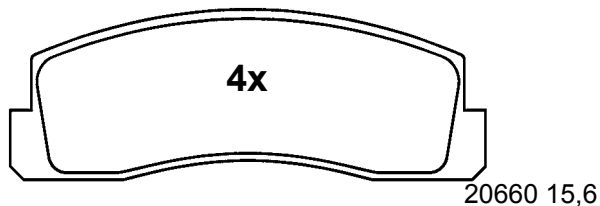

126,0 x 45,1 x 15,6

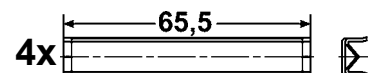
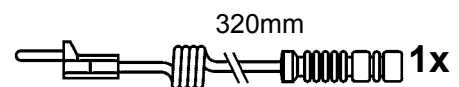

# Abbildungen Scheibenbremsbeläge

Illustrations disc brake pads - Illustrazioni pastiglie freno -

Illustrations plaquettes de frein - Ilustraciones pastillas de freno

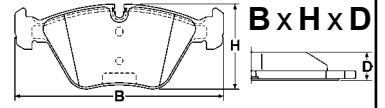

Maßstab - scale - scala - échelle - escala 1:2

## 13.0460-8008.2 608008

CHRYSLER

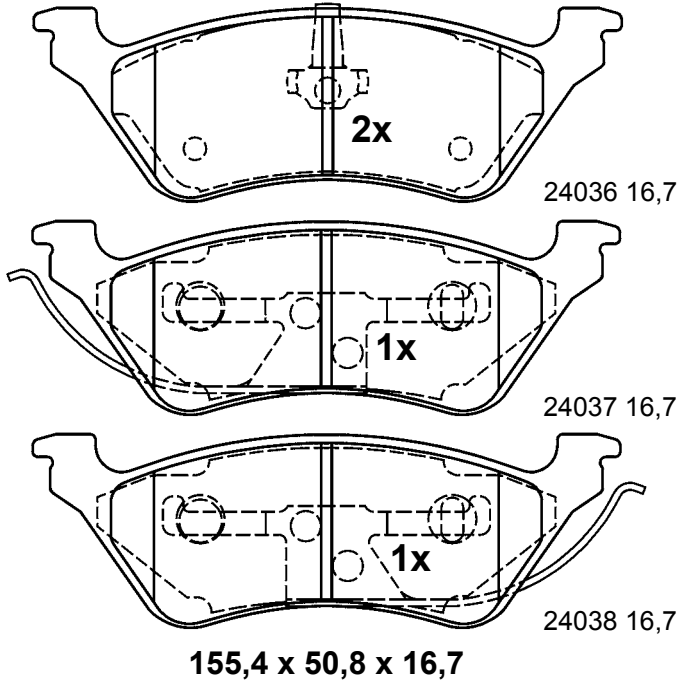

## 13.0460-8010.2 608010

CHRYSLER

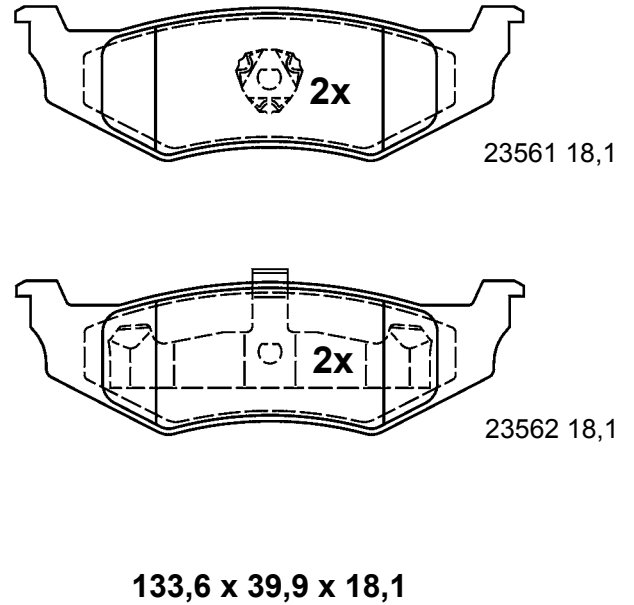

## 13.0460-8009.2 608009

CHRYSLER

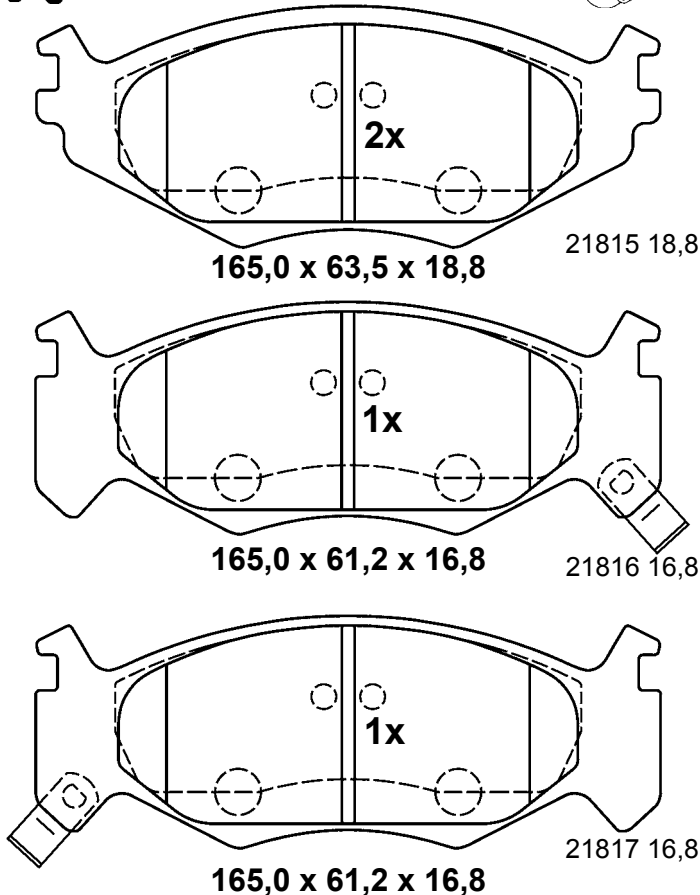

## 13.0460-8011.2 608011

OPEL, VAUXHALL

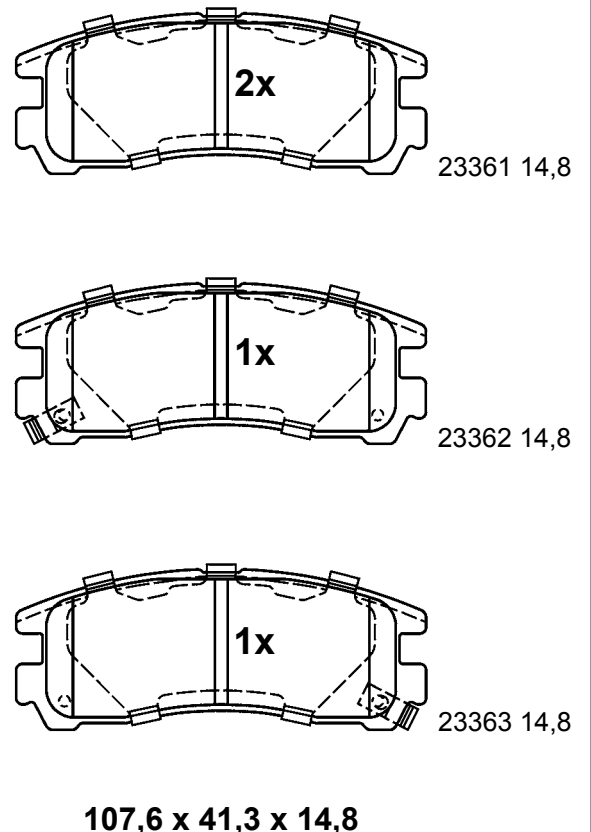

# Abbildungen Scheibenbremsbeläge

Illustrations disc brake pads - Illustrazioni pastiglie freno -

Illustrations plaquettes de frein - Ilustraciones pastillas de freno

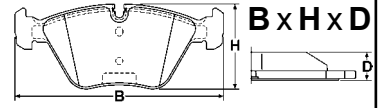

Maßstab - scale - scala - échelle - escala 1:2

**13.0460-8013.2 608013**

**13.0460-8014.2 608014**



JEEP



BOS



FORD

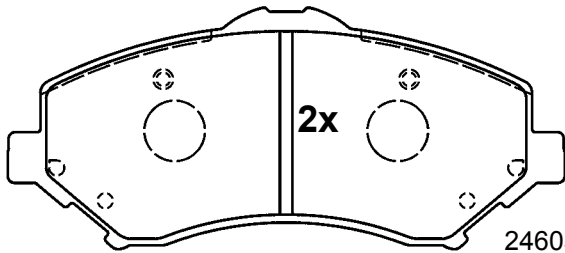

24605 16,5

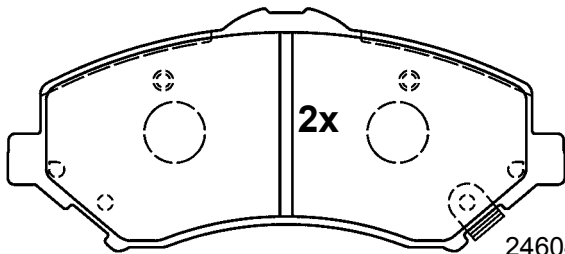

24604 16,5

**146,7 x 63,8 x 16,5**

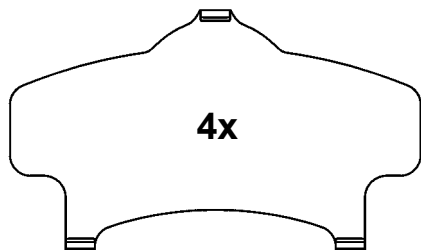

**D = 0,6**

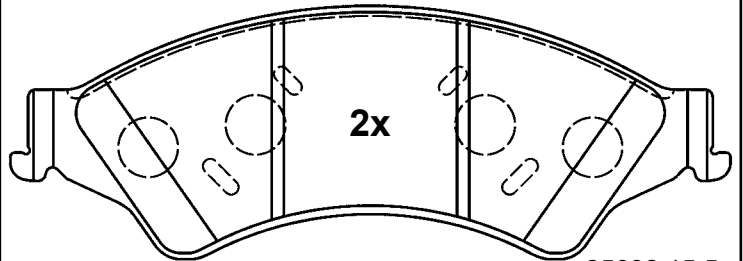

25632 15,5

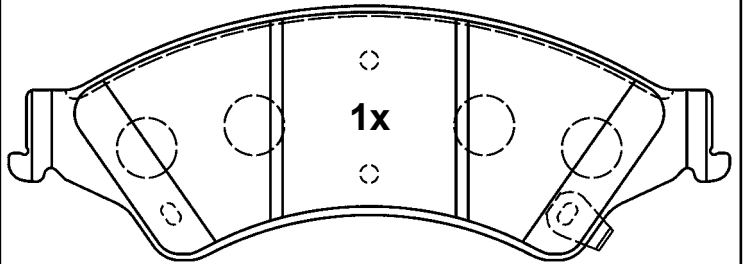

25633 15,5

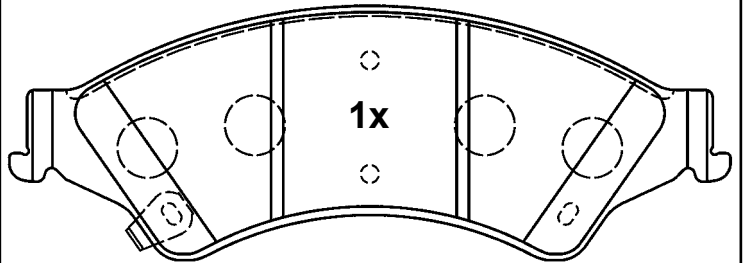

25634 15,5

**194,0 x 68,1 x 15,5**

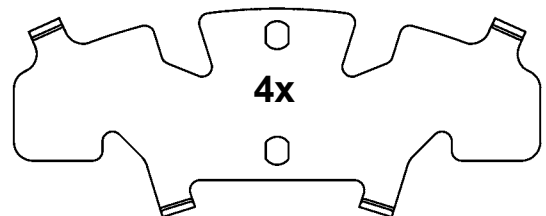

**139,2 x 54,9 x 0,6**

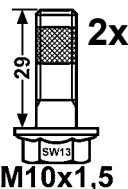

**M10x1,5**

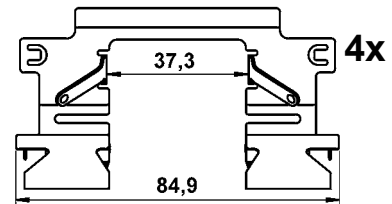

**4x**



# Abbildungen Scheibenbremsbeläge

Illustrations disc brake pads - Illustrazioni pastiglie freno -

Illustrations plaquettes de frein - Ilustraciones pastillas de freno

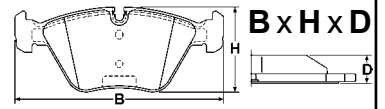

Maßstab - scale - scala - échelle - escala 1:2

**13.0460-9028.2 609028**



MERCEDES BENZ



ATE

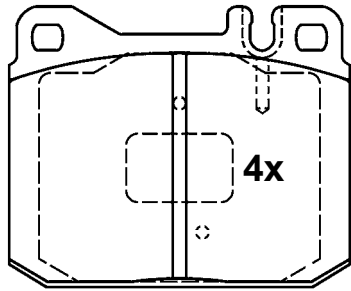

20392 15,0

89,8 x 73,8 x 15,0

**13.0460-9030.2 609030**



BMW



ATE

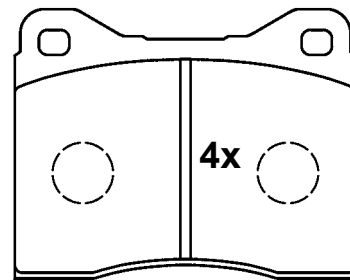

20092 15,0

89,8 x 70,5 x 15,0

**13.0460-9029.2 609029**



MERCEDES BENZ



ATE

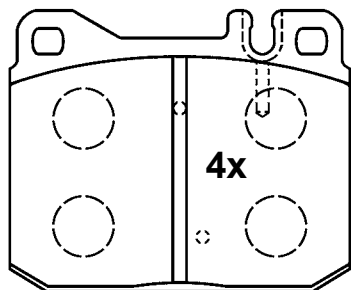

20341 16,7

89,6 x 73,5 x 16,7

**13.0460-9031.2 609031**



BMW



ATE

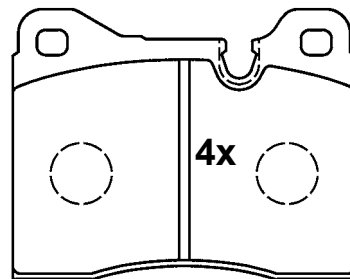

20437 19,0

89,7 x 70,5 x 19,0

# Abbildungen Scheibenbremsbeläge

Illustrations disc brake pads - Illustrazioni pastiglie freno -

Illustrations plaquettes de frein - Ilustraciones pastillas de freno

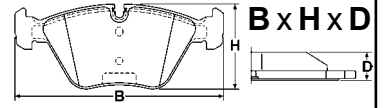

Maßstab - scale - scala - échelle - escala 1:2

**13.0460-9033.2 609033**



MERCEDES BENZ



ATE

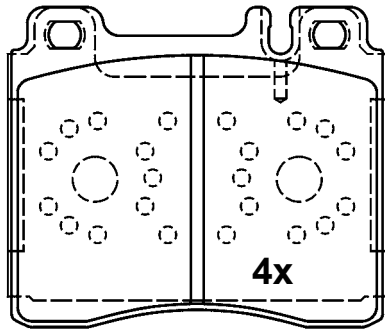

21303 18,9

99,6 x 84,5 x 18,9

**13.0460-9037.2 609037**



BMW



ATE

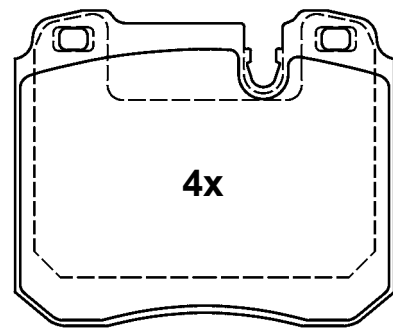

20309 17,9

99,8 x 83,0 x 17,9

**13.0460-9034.2 609034**



ALFA ROMEO



ATE

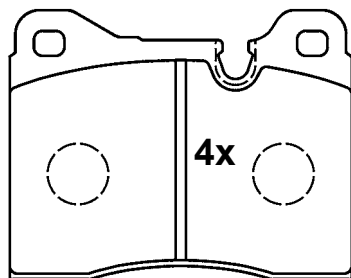

20437 15,0

89,8 x 70,5 x 15,0

**13.0462-4855.2 600018**



PORSCHE



ATE

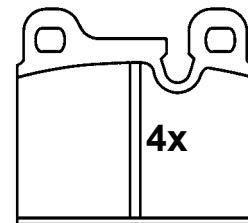

20910 15,0

61,5 x 56,5 x 15,0







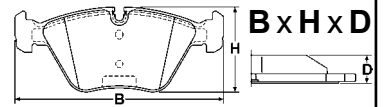





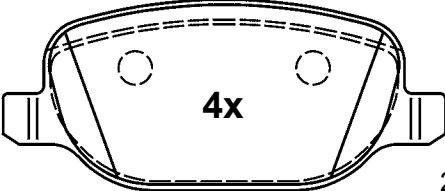



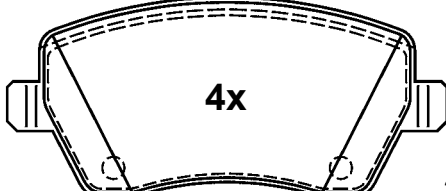

# Abbildungen Scheibenbremsbeläge

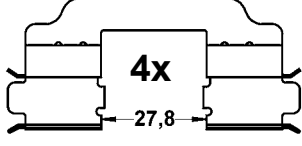
Illustrations disc brake pads - Illustrazioni pastiglie freno -

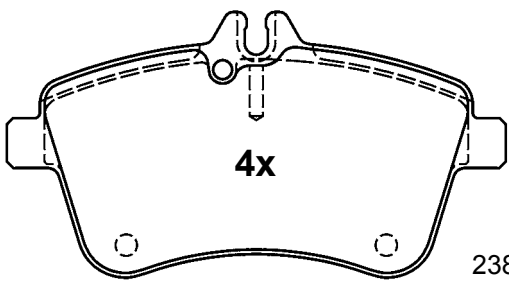
Illustrations plaquettes de frein - Ilustraciones pastillas de freno

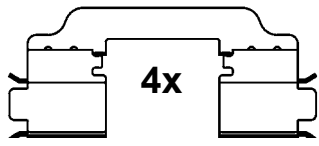

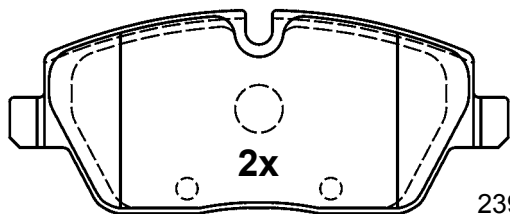
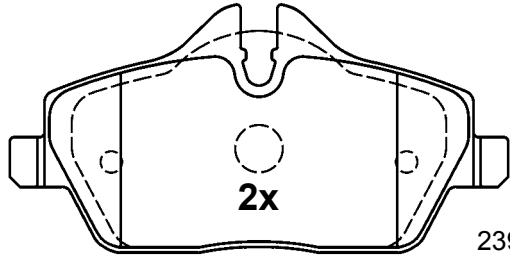
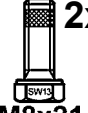
Maßstab - scale - scala - échelle - escala 1:2

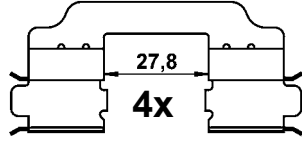
| <b>13.0470-2707.2 LD2707</b> ATE Ceramic   | <b>13.0470-2709.2 LD2709</b> ATE Ceramic   |
|--|--|
| <p>  ALFA ROMEO, LANCIA                              TRW                         </p>  <p style="text-align: right;">23760 17,7</p> <p style="text-align: center;"><b>116,8 x 49,8 x 17,7</b></p> <p>  <b>4x</b><br/>  M8x22                              </p>    | <p>  DACIA, MERCEDES BENZ, NISSAN, RENAULT                              TRW                         </p>  <p style="text-align: right;">23973 17,4</p> <p style="text-align: center;"><b>116,4 x 52,4 x 17,4</b></p> <p>  <b>2x</b><br/>  M8x21                              </p>   |
| <b>13.0470-2708.2 LD2708</b> ATE Ceramic   | <b>13.0470-2710.2 LD2710</b> ATE Ceramic   |
| <p>  MERCEDES BENZ                              TRW                         </p>  <p style="text-align: right;">23881 20,0</p> <p style="text-align: center;"><b>131,3 x 69,8 x 20,0</b></p> <p>  <b>2x</b><br/>  M8x21                              </p> | <p>  BMW, MINI                              TRW                         </p>  <p style="text-align: right;">23915 17,6</p> <p style="text-align: center;"><b>131,3 x 53,2 x 17,6</b></p>  <p style="text-align: right;">23916 17,6</p> <p style="text-align: center;"><b>131,3 x 65,3 x 17,6</b></p> <p>  <b>2x</b><br/>  M8x21                              </p> |









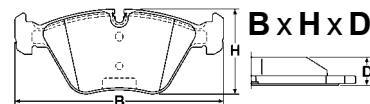





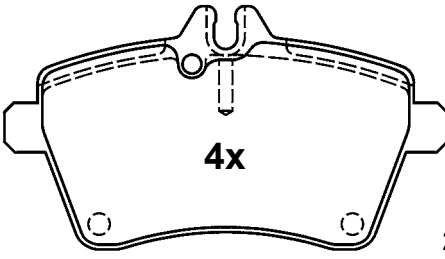
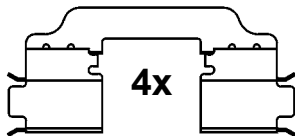

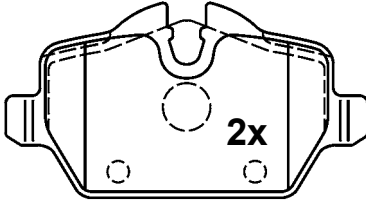
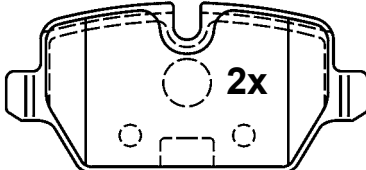
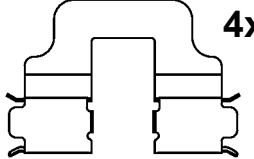

# Abbildungen Scheibenbremsbeläge

Illustrations disc brake pads - Illustrazioni pastiglie freno -

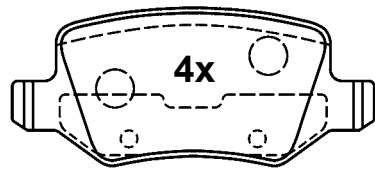
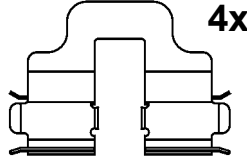
Illustrations plaquettes de frein - Ilustraciones pastillas de freno

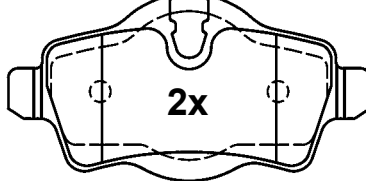
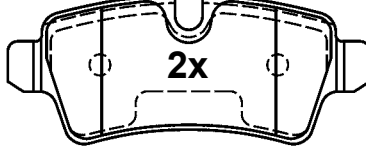
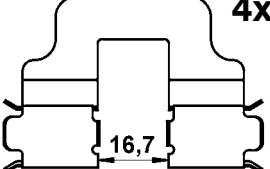

Maßstab - scale - scala - échelle - escala 1:2

| <b>13.0470-2711.2 LD2711</b> ATE Ceramic  | <b>13.0470-2713.2 LD2713</b> ATE Ceramic   |
|---|--|
| <p> <b>MERCEDES BENZ</b> </p>  <p style="text-align: center;"><b>4x</b></p> <p style="text-align: right;">24077 19,1</p> <p style="text-align: center;"><b>116,4 x 63,8 x 19,1</b></p>  <p style="text-align: center;"><b>4x</b></p>  <p><b>4x</b><br/>M8x21</p>       | <p> <b>BMW, MINI</b> </p>  <p style="text-align: center;"><b>2x</b></p> <p style="text-align: center;"><b>95,2 x 51,0 x 17,4</b></p> <p style="text-align: right;">23623 17,4</p>  <p style="text-align: center;"><b>2x</b></p> <p style="text-align: center;"><b>95,2 x 44,6 x 17,4</b></p> <p style="text-align: right;">23624 17,4</p>  <p style="text-align: center;"><b>4x</b></p>  <p><b>2x</b><br/>M8x21</p>   |
| <b>13.0470-2712.2 LD2712</b> ATE Ceramic  | <b>13.0470-2714.2 LD2714</b> ATE Ceramic   |
| <p> <b>MERCEDES BENZ</b> </p>  <p style="text-align: center;"><b>4x</b></p> <p style="text-align: right;">23138 14,6</p> <p style="text-align: center;"><b>95,7 x 41,3 x 14,6</b></p>  <p style="text-align: center;"><b>4x</b></p>  <p><b>2x</b><br/>M8x21</p> | <p> <b>MINI</b> </p>  <p style="text-align: center;"><b>2x</b></p> <p style="text-align: center;"><b>95,3 x 48,3 x 16,9</b></p> <p style="text-align: right;">24289 16,9</p>  <p style="text-align: center;"><b>2x</b></p> <p style="text-align: center;"><b>95,3 x 39,0 x 16,9</b></p> <p style="text-align: right;">24290 16,9</p>  <p style="text-align: center;"><b>4x</b></p> <p style="text-align: center;">16,7</p>  <p><b>2x</b><br/>M8x22</p> |

# Abbildungen Scheibenbremsbeläge

Illustrations disc brake pads - Illustrazioni pastiglie freno -

Illustrations plaquettes de frein - Ilustraciones pastillas de freno

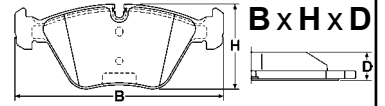

Maßstab - scale - scala - échelle - escala 1:2

**13.0470-2716.2 LD2716** ATE Ceramic

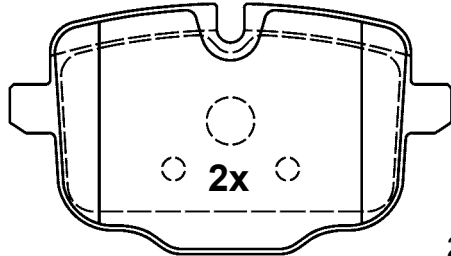

24703 17,8

116,0 x 65,5 x 17,8

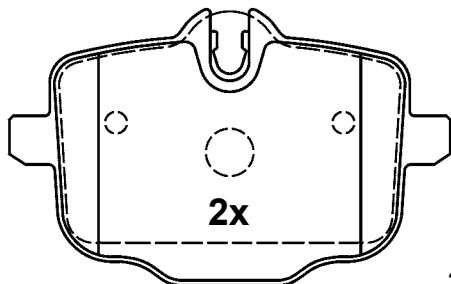

24704 17,8

116,0 x 72,4 x 17,8

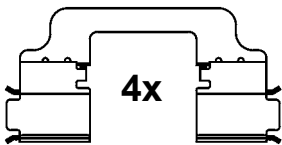

**13.0470-2722.2 LD2722** ATE Ceramic

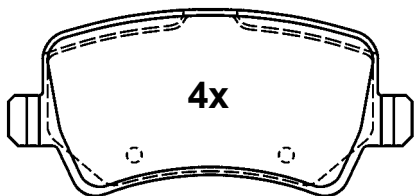

24496 17,3

106,0 x 48,7 x 17,3

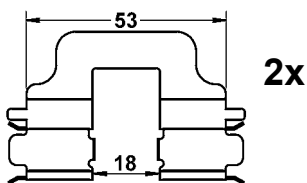

2x

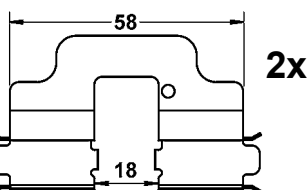

2x



**13.0470-2723.2 LD2723** ATE Ceramic

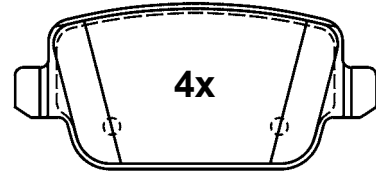

24537 16,1

95,1 x 43,2 x 16,1

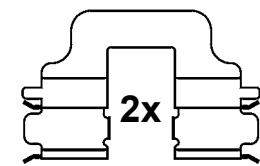

2x

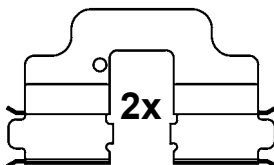

2x



**13.0470-2725.2 LD2725** ATE Ceramic

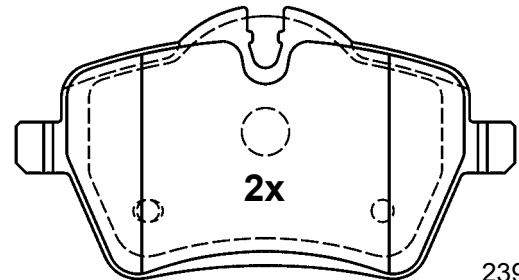

23984 17,8

131,6 x 71,3 x 17,8

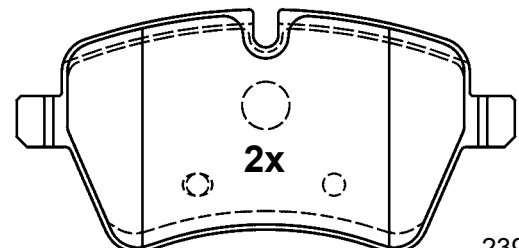

23985 17,8

131,6 x 63,9 x 17,8

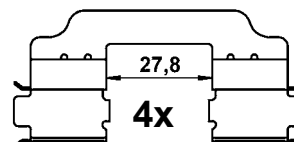

2x

27,8

4x

# Abbildungen Scheibenbremsbeläge

Illustrations disc brake pads - Illustrazioni pastiglie freno -

Illustrations plaquettes de frein - Ilustraciones pastillas de freno



Maßstab - scale - scala - échelle - escala 1:2

**13.0470-2726.2 LD2726** ATE Ceramic



MERCEDES BENZ



TRW

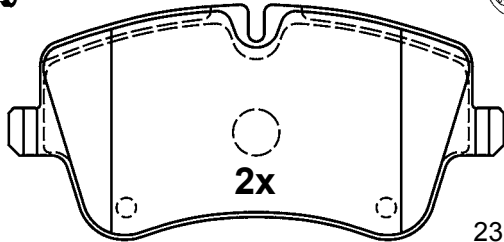

2x

23145 19,8

131,1 x 69,8 x 19,8

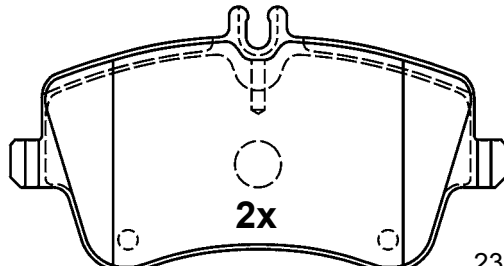

2x

23144 19,8

131,1 x 62,1 x 19,8

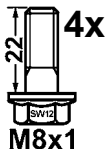

4x

M8x1

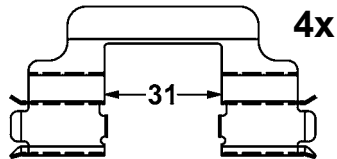

4x

31

**13.0470-2732.2 LD2732** ATE Ceramic



MERCEDES BENZ



TRW

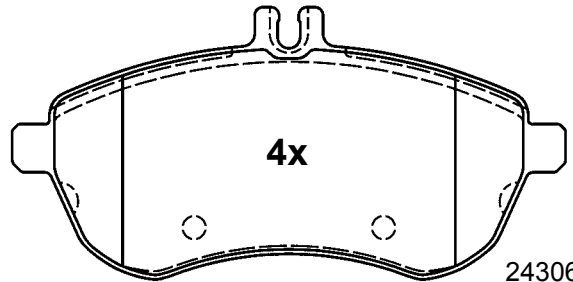

4x

24306 20,3

146,0 x 71,5 x 20,3



4x

M8x22

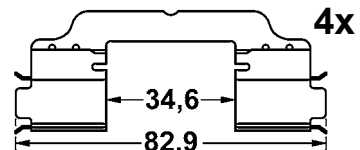

4x

34,6

82,9

**13.0470-2727.2 LD2727** ATE Ceramic



MERCEDES BENZ



TRW

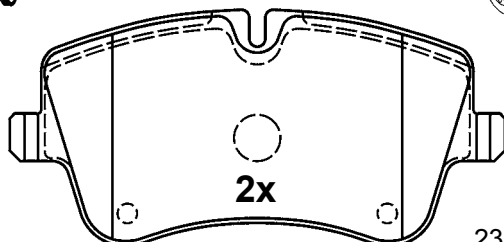

2x

23145 19,8

131,1 x 69,8 x 19,8

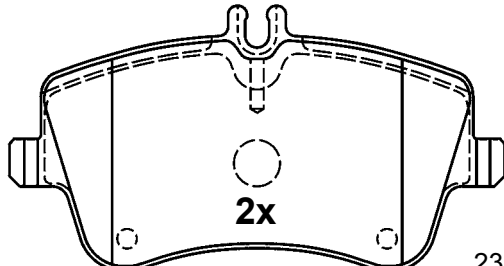

2x

23144 19,8

131,1 x 62,1 x 19,8

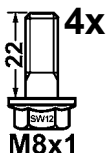

4x

M8x1

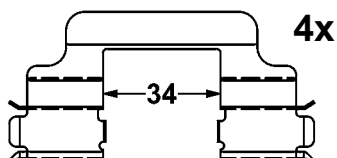

4x

34

**13.0470-2733.2 LD2733** ATE Ceramic



MERCEDES BENZ



TRW

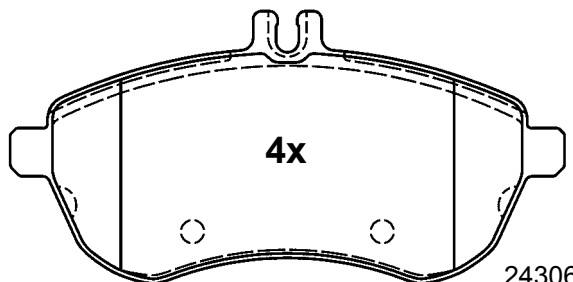

4x

24306 20,3

146,0 x 71,5 x 20,3

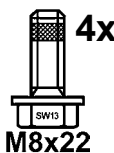

4x

M8x22

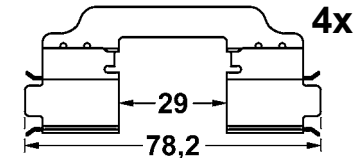

4x

29

78,2



# Abbildungen Scheibenbremsbeläge

Illustrations disc brake pads - Illustrazioni pastiglie freno -

Illustrations plaquettes de frein - Ilustraciones pastillas de freno

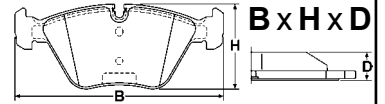

Maßstab - scale - scala - échelle - escala 1:2

**13.0470-2734.2 LD2734** ATE Ceramic



MERCEDES BENZ



TRW

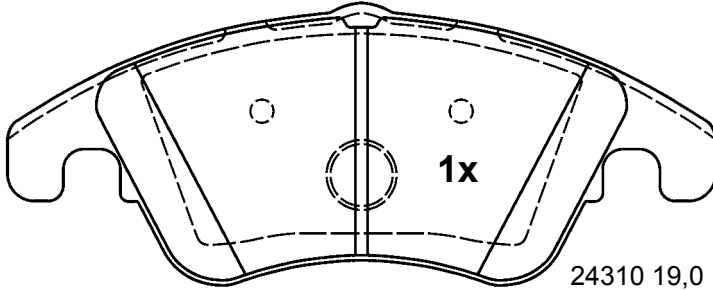

1x

24310 19,0

188,0 x 73,7 x 19,0

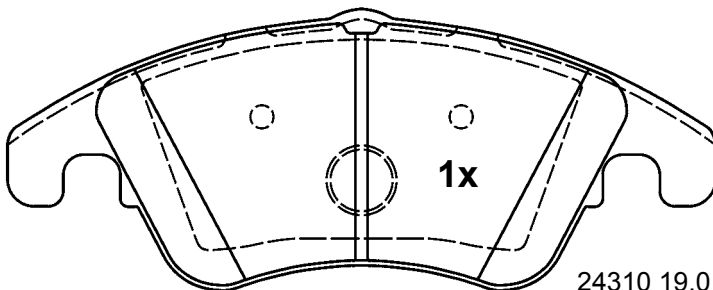

1x

24310 19,0

188,0 x 73,7 x 19,0

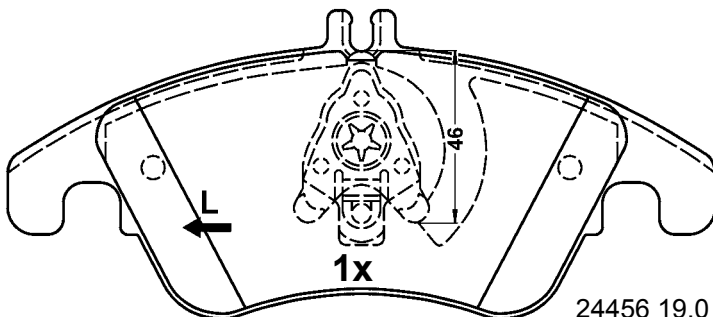

1x

24456 19,0

188,0 x 80,8 x 19,0

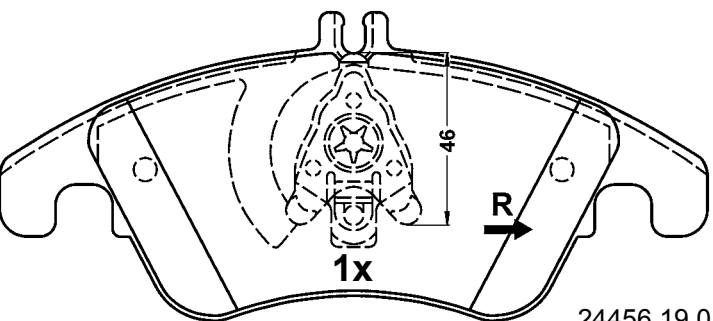

1x

24456 19,0

188,0 x 80,8 x 19,0

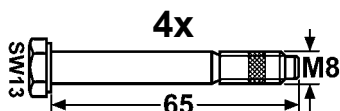

4x

SW13

M8

65

**13.0470-2736.2 LD2736** ATE Ceramic



VOLVO



TRW

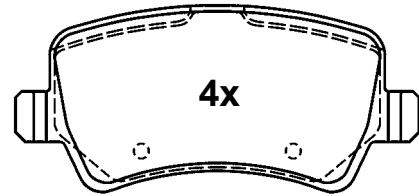

4x

24496 17,3

106,1 x 48,7 x 17,3

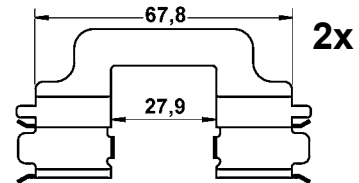

2x

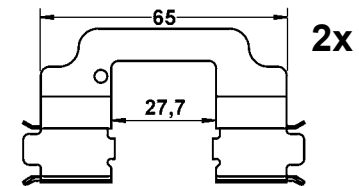

2x



M8x21

**13.0470-2740.2 LD2740** ATE Ceramic



CITROEN, PEUGEOT, RENAULT



TRW

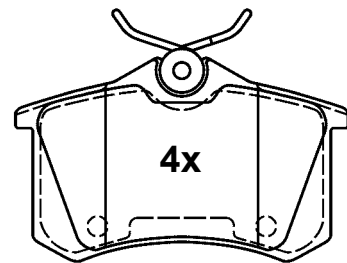

4x

23554 17,2

87,2 x 53,0 x 17,2



M8x22

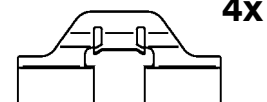

4x

# Abbildungen Scheibenbremsbeläge

Illustrations disc brake pads - Illustrazioni pastiglie freno -

Illustrations plaquettes de frein - Ilustraciones pastillas de freno



Maßstab - scale - scala - échelle - escala 1:2

**13.0470-2746.2 LD2746** ATE Ceramic

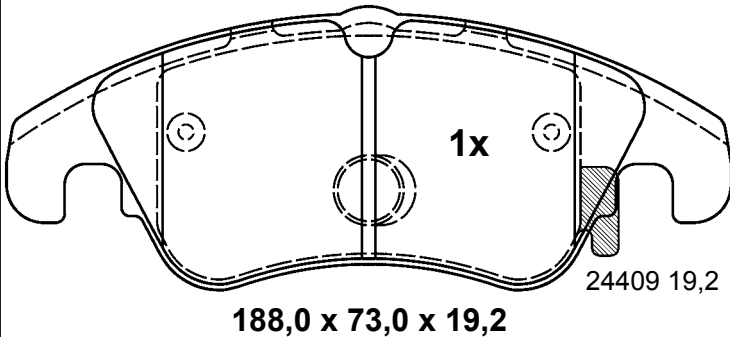
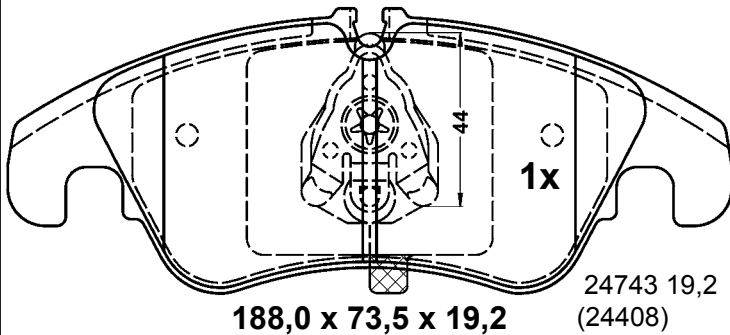
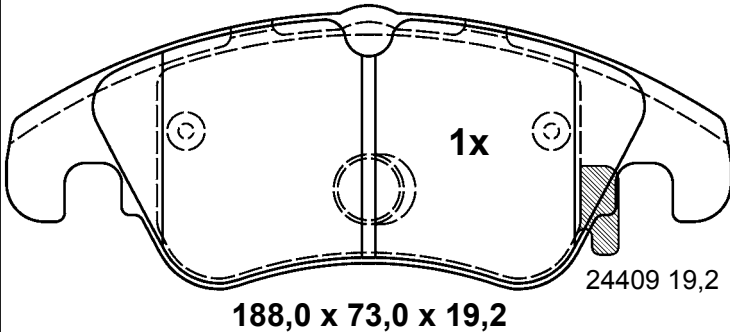
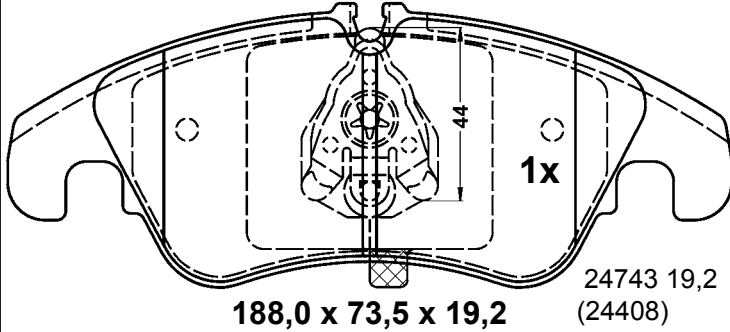

**13.0470-2747.2 LD2747** ATE Ceramic

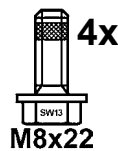
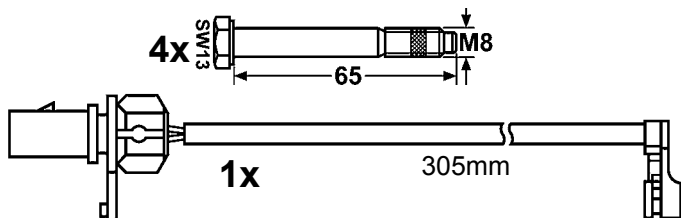
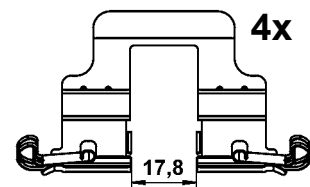
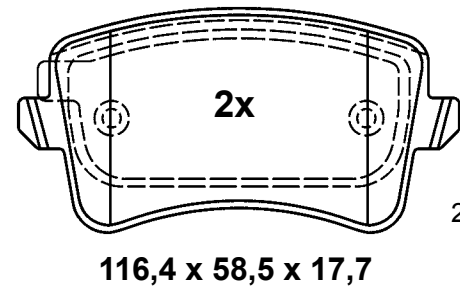
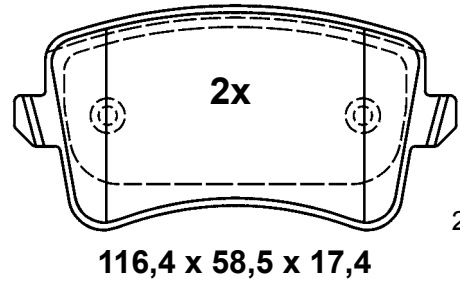

# Abbildungen Scheibenbremsbeläge

Illustrations disc brake pads - Illustrazioni pastiglie freno -

Illustrations plaquettes de frein - Ilustraciones pastillas de freno

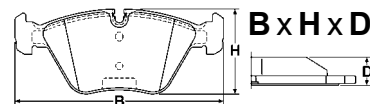

Maßstab - scale - scala - échelle - escala 1:2

**13.0470-2748.2 LD2748** ATE Ceramic

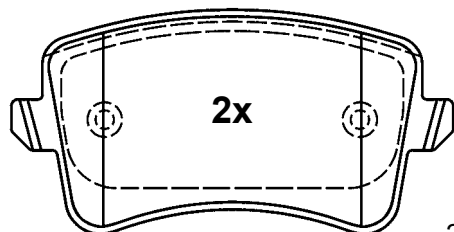

116,4 x 58,5 x 17,4

24606 17,4

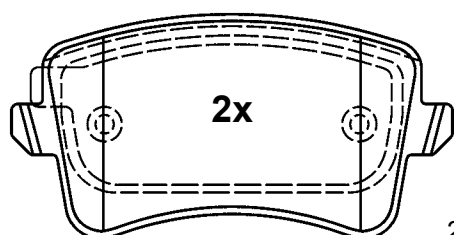

116,4 x 58,5 x 17,7

24606 17,7

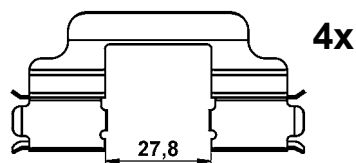

**13.0470-2758.2 LD2758** ATE Ceramic

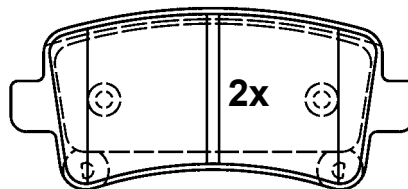

24421 17,2

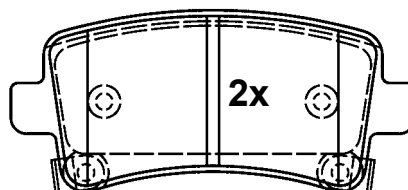

106,3 x 47,1 x 17,2

24422 17,2

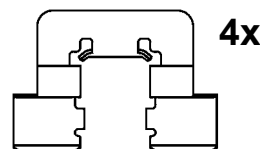

**13.0470-2755.2 LD2755** ATE Ceramic

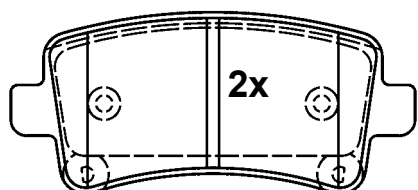

24421 17,2

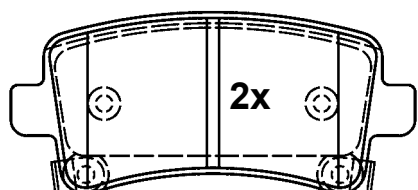

106,3 x 47,1 x 17,2

24422 17,2

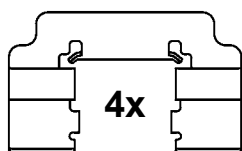

**13.0470-2760.2 LD2760** ATE Ceramic

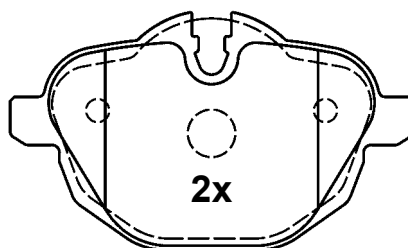

24561 17,7

106,0 x 63,2 x 17,7

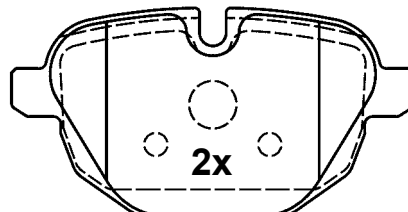

106,0 x 56,2 x 17,7

24562 17,7

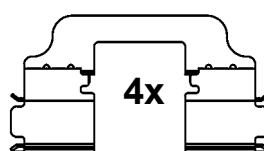



# Abbildungen Scheibenbremsbeläge

Illustrations disc brake pads - Illustrazioni pastiglie freno -

Illustrations plaquettes de frein - Ilustraciones pastillas de freno

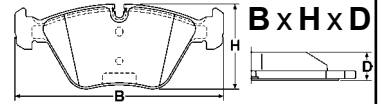

Maßstab - scale - scala - échelle - escala 1:2

**13.0470-2764.2 LD2764** ATE Ceramic



AUDI, SEAT, SKODA,  
VOLKSWAGEN



TRW

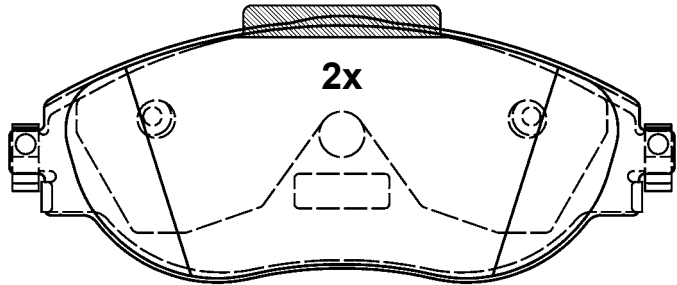

24738 20,0

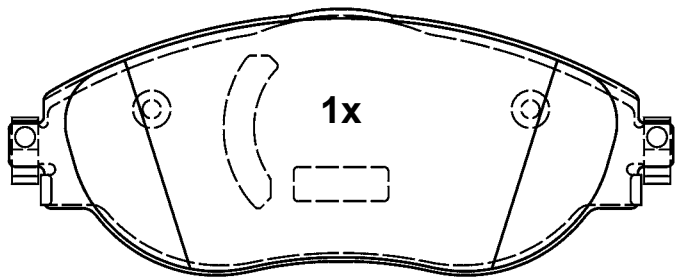

24738 20,0

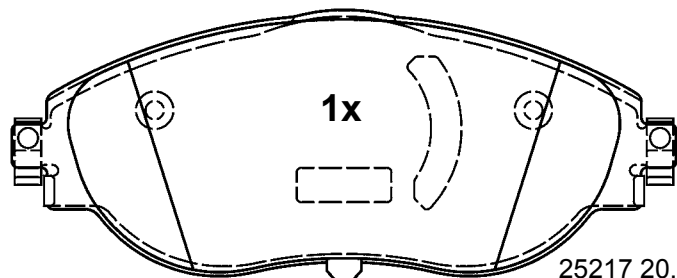

25217 20,0

185mm

175,0 x 70,0 x 20,0

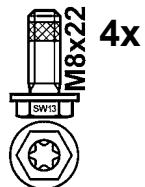

4x

**13.0470-2765.2 LD2765** ATE Ceramic



AUDI



TRW

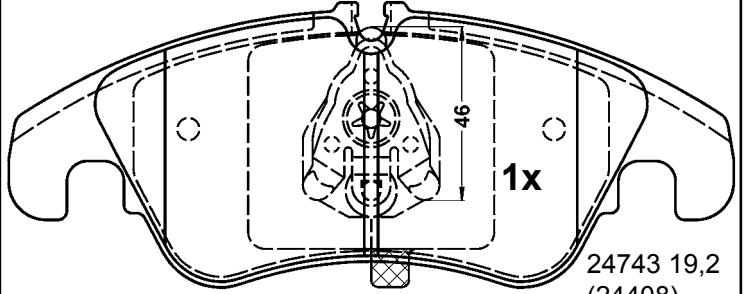

188,0 x 73,5 x 19,2

24743 19,2  
(24408)

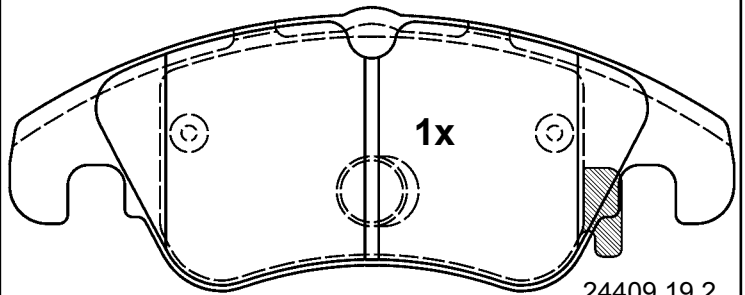

188,0 x 73,0 x 19,2

24409 19,2

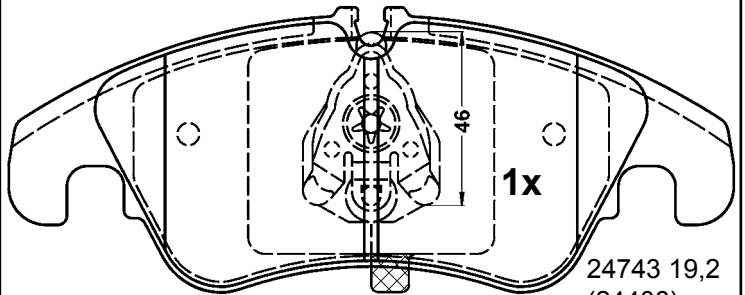

188,0 x 73,5 x 19,2

24743 19,2  
(24408)

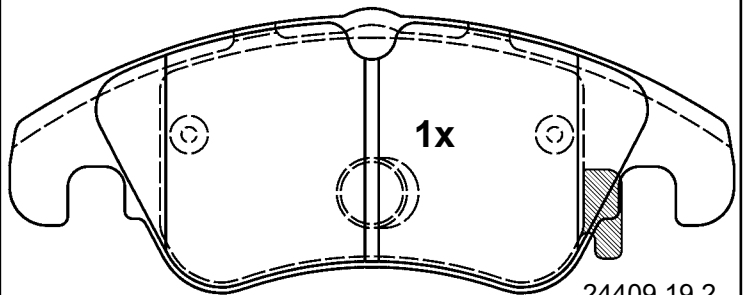

188,0 x 73,0 x 19,2

24409 19,2

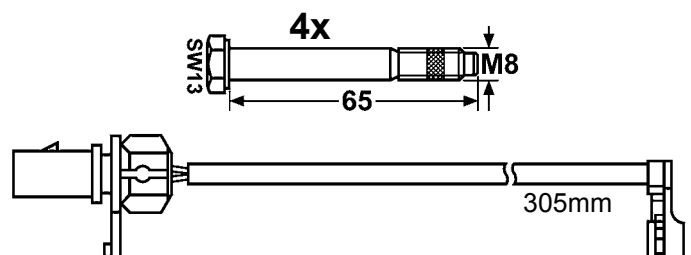

4x

SW13

65

M8

305mm

# Abbildungen Scheibenbremsbeläge

Illustrations disc brake pads - Illustrazioni pastiglie freno -

Illustrations plaquettes de frein - Ilustraciones pastillas de freno

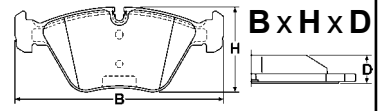

Maßstab - scale - scala - échelle - escala 1:2

**13.0470-2767.2 LD2767**

ATE  
Ceramic



ALFA ROMEO



TRW

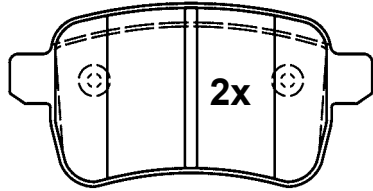

25156 17,4

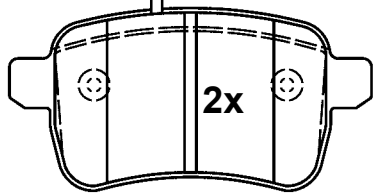
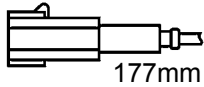

25157 17,4

95,6 x 48,1 x 17,4

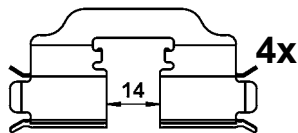
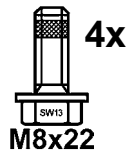

**13.0470-2768.2 LD2768**

ATE  
Ceramic



ALFA ROMEO



TRW

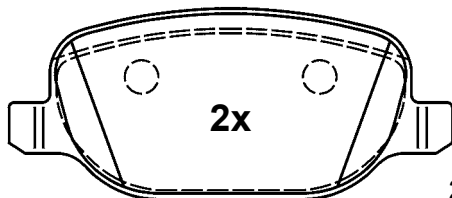

23811 17,7

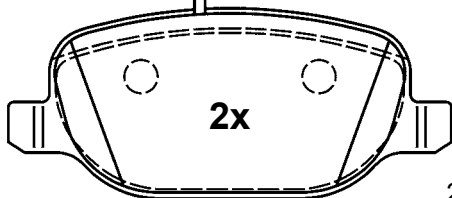
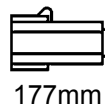

24788 17,7

116,8 x 49,8 x 17,7

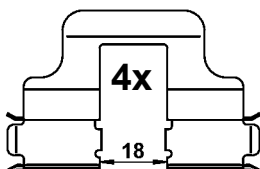
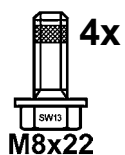

**13.0470-2769.2 LD2769**

ATE  
Ceramic



AUDI



TRW

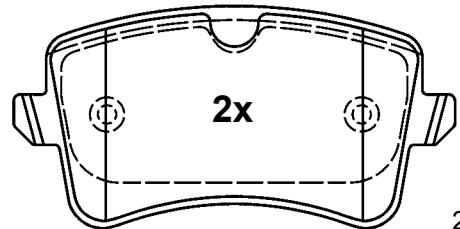

24606 17,4

116,4 x 58,5 x 17,4

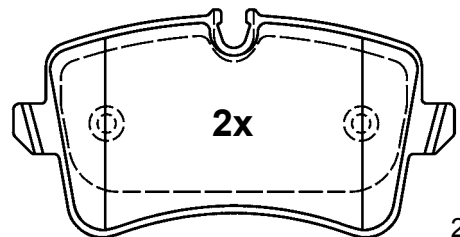

25214 17,4

116,4 x 59,8 x 17,4

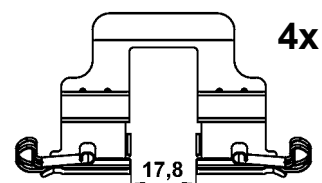
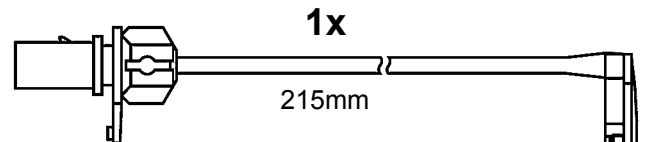

# Abbildungen Scheibenbremsbeläge

Illustrations disc brake pads - Illustrazioni pastiglie freno -

Illustrations plaquettes de frein - Ilustraciones pastillas de freno

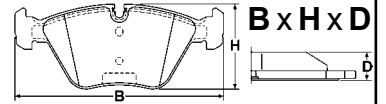

Maßstab - scale - scala - échelle - escala 1:2

**13.0470-2770.2 LD2770** ATE Ceramic

AUDI, PORSCHE

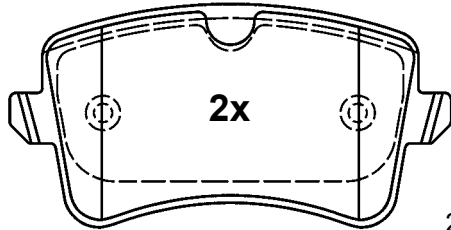

24606 17,4

**116,4 x 58,5 x 17,4**

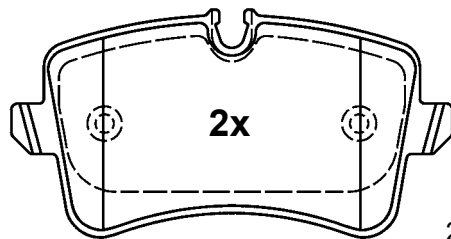

25214 17,4

**116,4 x 59,8 x 17,4**

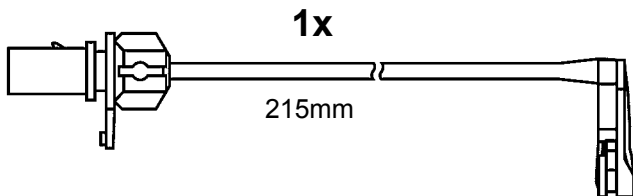

**1x**

215mm



**4x**

**M8x21**

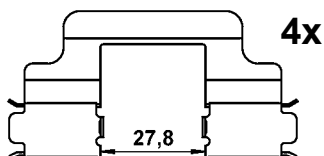

**4x**

27,8

**13.0470-2773.2 LD2773** ATE Ceramic

AUDI

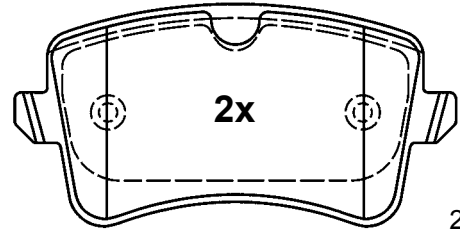

24606 17,4

**116,4 x 58,5 x 17,4**

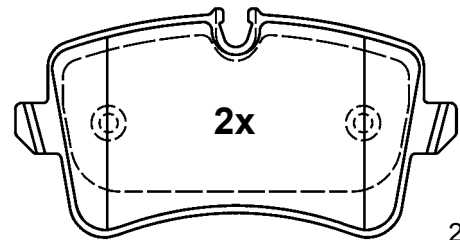

25214 17,4

**116,4 x 59,8 x 17,4**

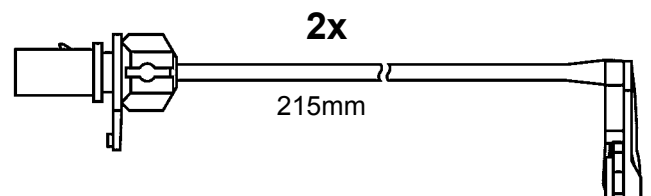

**2x**

215mm



**4x**

**M8x21**

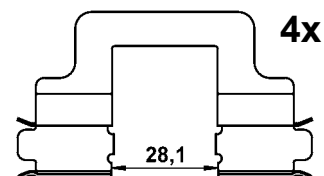

**4x**

28,1



# Abbildungen Scheibenbremsbeläge

Illustrations disc brake pads - Illustrazioni pastiglie freno -

Illustrations plaquettes de frein - Ilustraciones pastillas de freno

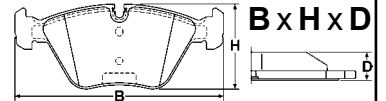

Maßstab - scale - scala - échelle - escala 1:2

**13.0470-2776.2 LD2776** ATE Ceramic

MERCEDES BENZ

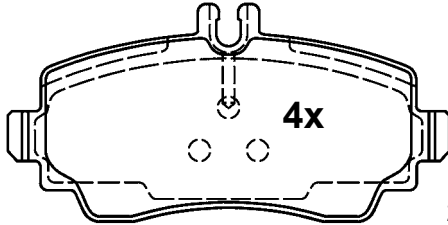

23070 17,0

116,5 x 57,1 x 17,0

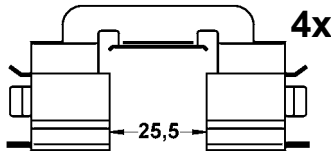
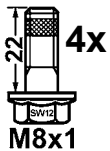

**13.0470-2779.2 LD2779** ATE Ceramic

MERCEDES BENZ

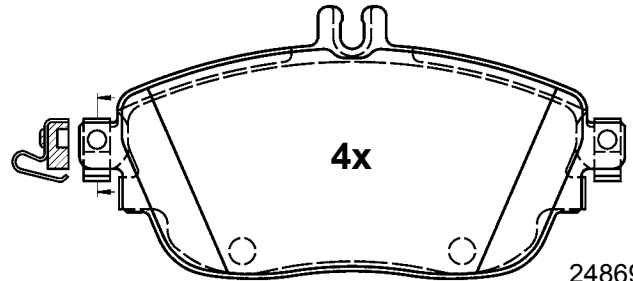

24869 19,3

144,0 x 71,6 x 19,3

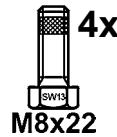

**13.0470-2778.2 LD2778** ATE Ceramic

MERCEDES BENZ

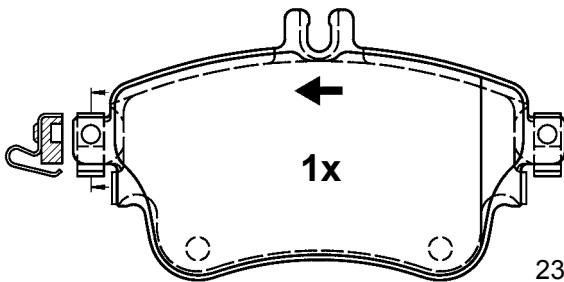

23526 19,3

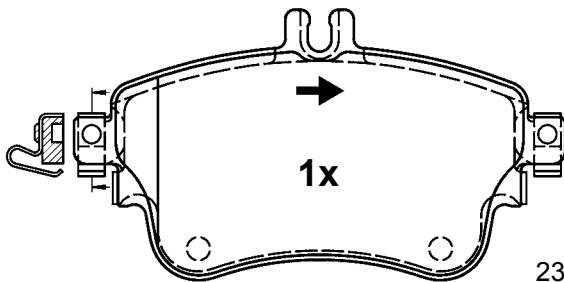

23526 19,3

129,0 x 71,3 x 19,3



**13.0470-2781.2 LD2781** ATE Ceramic

MERCEDES BENZ

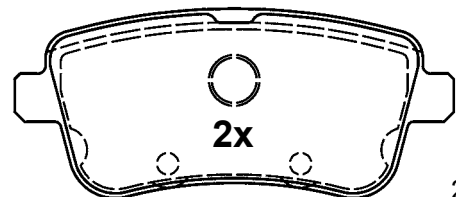

25215 18,6

116,3 x 49,8 x 18,6

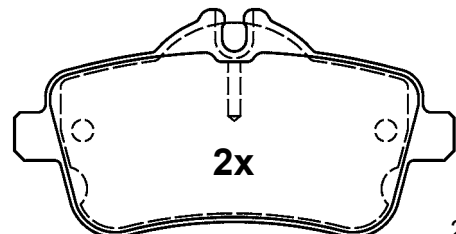

25216 18,6

116,3 x 59,8 x 18,6

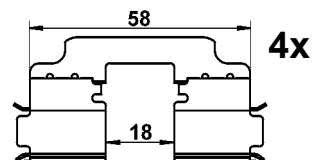
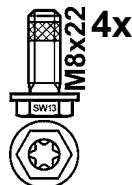

# Abbildungen Scheibenbremsbeläge

Illustrations disc brake pads - Illustrazioni pastiglie freno -

Illustrations plaquettes de frein - Ilustraciones pastillas de freno

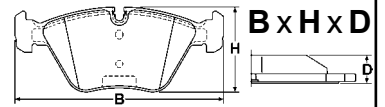

Maßstab - scale - scala - échelle - escala 1:2

## 13.0470-2782.2 LD2782 ATE Ceramic



MERCEDES BENZ

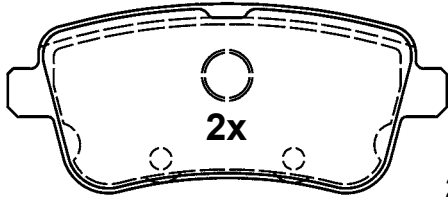

25215 18,6

116,3 x 49,8 x 18,6

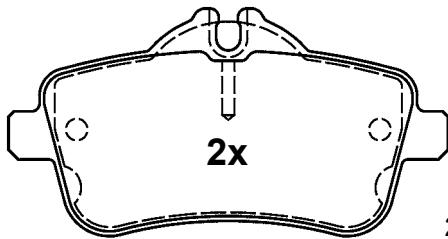

25216 18,6

116,3 x 59,8 x 18,6

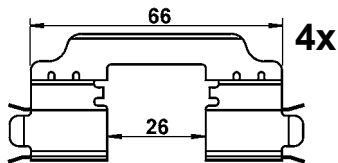
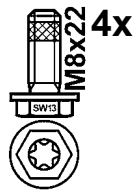

## 13.0470-2785.2 LD2785 ATE Ceramic



AUDI, SEAT, SKODA,  
VOLKSWAGEN

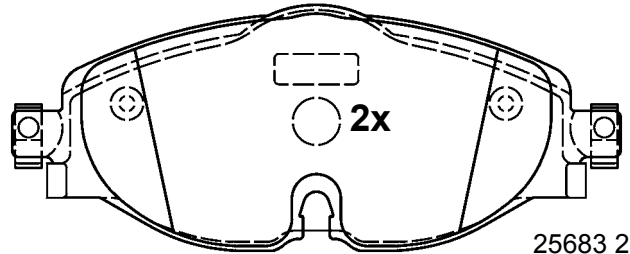

25683 20,4

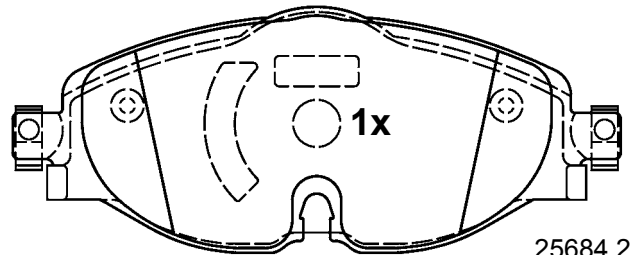

25684 20,4

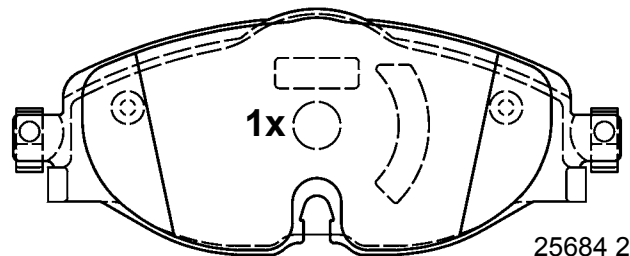

25684 20,4

160,0 x 64,5 x 20,4

## 13.0470-2784.2 LD2784 ATE Ceramic



FORD

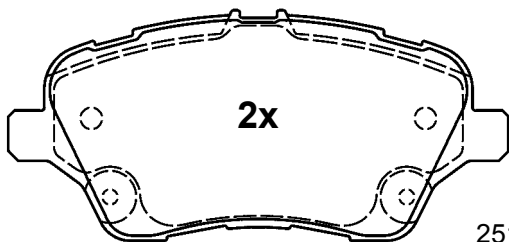

25134 17,2

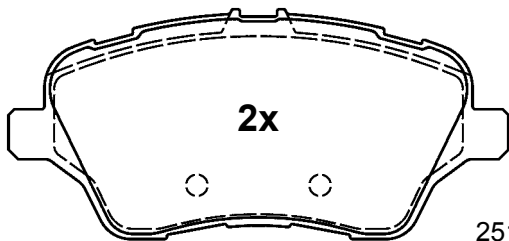

25135 17,2

131,5 x 60,0 x 17,2

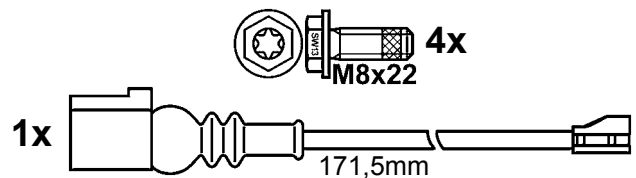
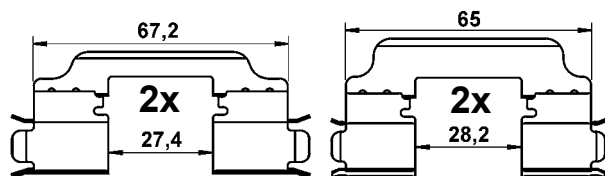

## 13.0470-2786.2 LD2786 ATE Ceramic



MERCEDES BENZ

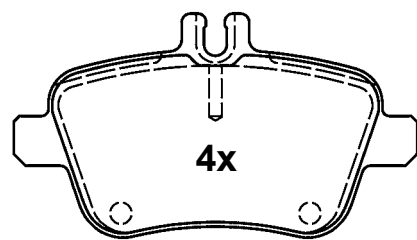

24848 18,3

106,4 x 58,9 x 18,3

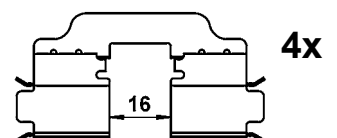







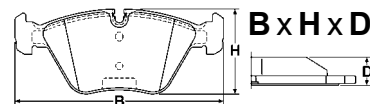





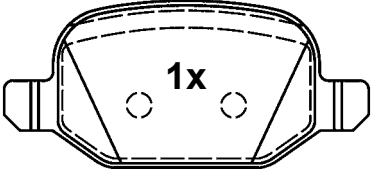
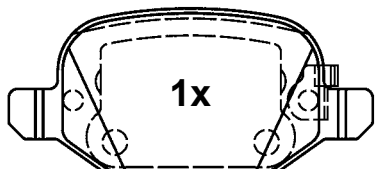
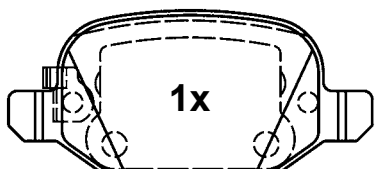
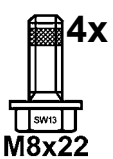
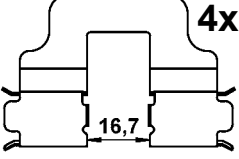

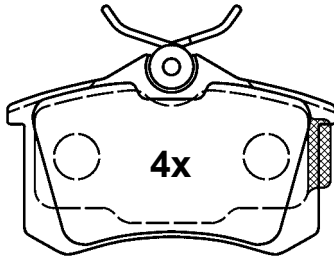
# Abbildungen Scheibenbremsbeläge

Illustrations disc brake pads - Illustrazioni pastiglie freno -

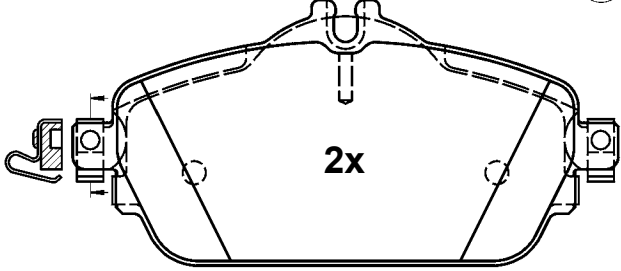
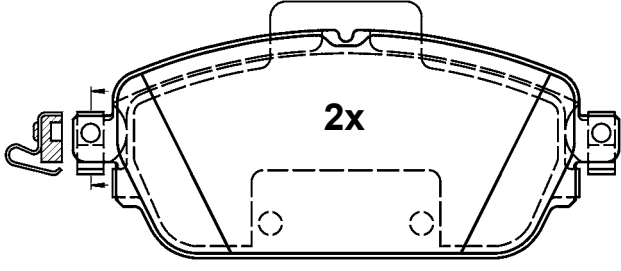
Illustrations plaquettes de frein - Ilustraciones pastillas de freno

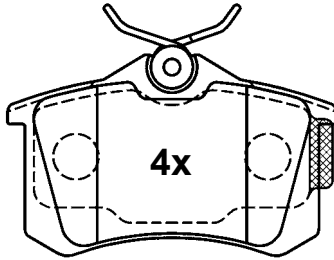
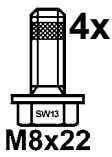

Maßstab - scale - scala - échelle - escala 1:2

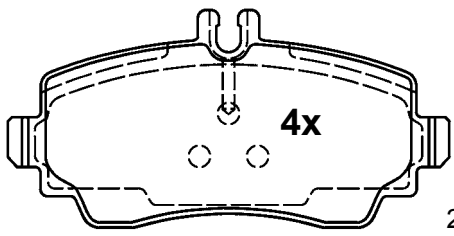
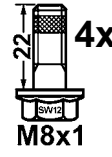
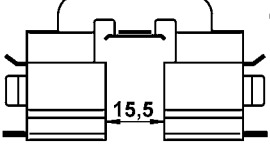
| 13.0470-2789.2 LD2789 ATE Ceramic   | 13.0470-2820.2 LD2820 ATE Ceramic   |
|---|---|
| <p> <b>FIAT</b> </p> <p> 1x<br/>25652 17,1</p> <p> 1x<br/>25653 17,1</p> <p> 1x<br/>25654 17,1</p> <p><b>95,8 x 43,8 x 17,1</b></p> <p> 4x<br/>M8x22</p> <p> 4x<br/>16,7</p> | <p> <b>AUDI, SEAT, SKODA, VOLKSWAGEN</b> </p> <p> 4x<br/>20961 17,6</p> <p><b>87,6 x 52,9 x 17,6</b></p> <p> 4x<br/>M8x22</p>  |
| <p><b>13.0470-2792.2 LD2792</b> ATE Ceramic </p> <p> <b>MERCEDES BENZ</b></p> <p> 2x<br/>19,6</p> <p><b>144,0 x 70,0 x 19,6</b></p> <p> 2x<br/>19,6</p> <p><b>144,0 x 60,0 x 19,6</b></p> <p> 4x<br/>M8x22</p>   | <p><b>13.0470-2823.2 LD2823</b> ATE Ceramic </p> <p> <b>CITROEN, PEUGEOT, VOLKSWAGEN</b></p> <p> 4x<br/>23554 17,2</p> <p><b>86,8 x 52,9 x 17,2</b></p> <p> 4x<br/>M8x22</p> |
| <p><b>13.0470-2833.2 LD2833</b> ATE Ceramic </p> <p> <b>MERCEDES BENZ</b></p> <p> 4x<br/>23070 17,0</p> <p><b>116,5 x 57,1 x 17,0</b></p> <p> 4x<br/>M8x1</p> <p> 4x<br/>15,5</p>   |   |



# Abbildungen Scheibenbremsbeläge

Illustrations disc brake pads - Illustrazioni pastiglie freno -

Illustrations plaquettes de frein - Ilustraciones pastillas de freno

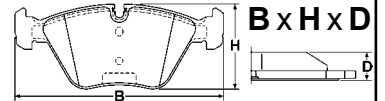

Maßstab - scale - scala - échelle - escala 1:2

**13.0470-2837.2 LD2837** ATE Ceramic

AUDI, SEAT, VOLKSWAGEN

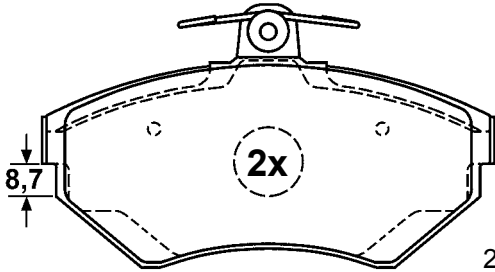

21945 19,6

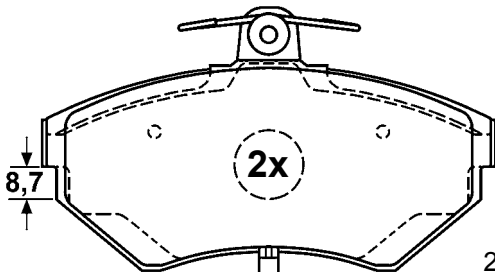

23393 19,6

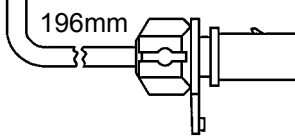

119,1 x 69,5 x 19,6



**13.0470-2845.2 LD2845** ATE Ceramic

RENAULT

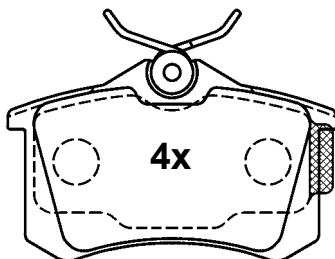

23554 16,4

86,8 x 52,9 x 16,4

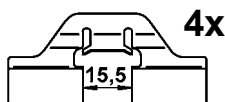
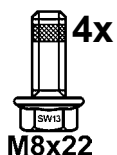

**13.0470-2855.2 LD2855** ATE Ceramic

MERCEDES BENZ

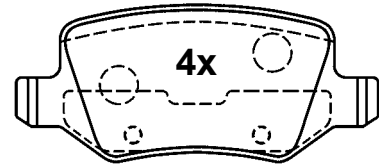

23138 14,6

95,7 x 41,3 x 14,6

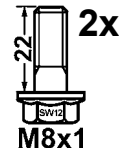

**13.0470-2857.2 LD2857** ATE Ceramic

OPEL, VAUXHALL

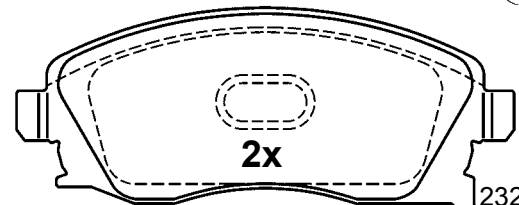

23225 17,0

131,5 x 52,3 x 17,0

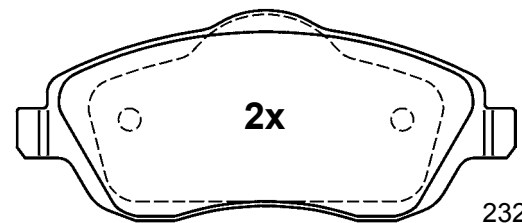

23226 17,0

131,5 x 55,4 x 17,0

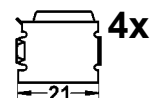
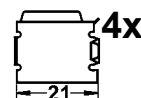
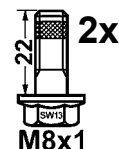
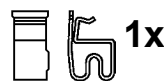

# Abbildungen Scheibenbremsbeläge

Illustrations disc brake pads - Illustrazioni pastiglie freno -

Illustrations plaquettes de frein - Ilustraciones pastillas de freno

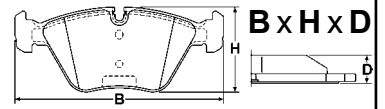

Maßstab - scale - scala - échelle - escala 1:2

**13.0470-2858.2 LD2858** ATE Ceramic

OPEL, VAUXHALL

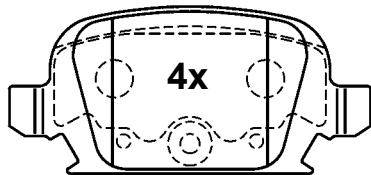

23284 14,0

95,6 x 43,8 x 14,0

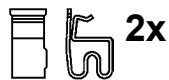
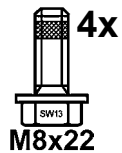

**13.0470-2867.2 LD2867** ATE Ceramic

ALFA ROMEO, FIAT, LANCIA

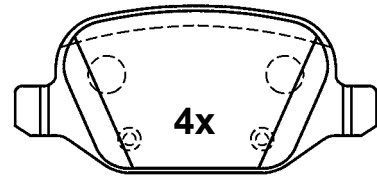

23517 16,6

95,6 x 43,9 x 16,6



**13.0470-2868.2 LD2868** ATE Ceramic

KIA, OPEL, VAUXHALL

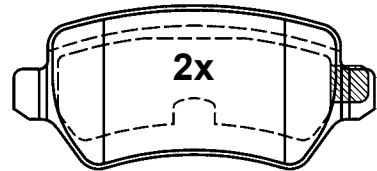

23417 15,3

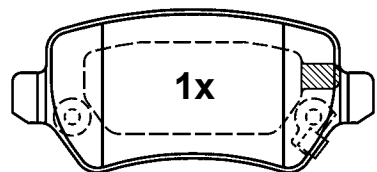

23654 15,3

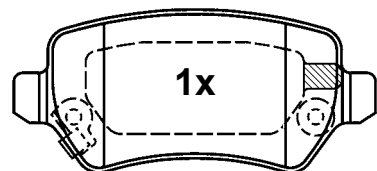

23655 15,3

95,3 x 42,8 x 15,3

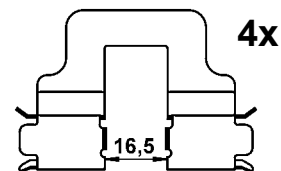

**13.0470-2860.2 LD2860** ATE Ceramic

AUDI

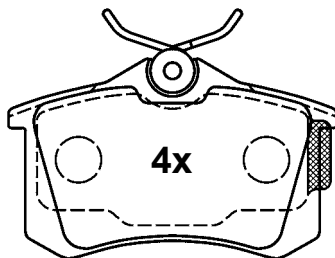

23554 16,3

86,8 x 52,9 x 16,3



# Abbildungen Scheibenbremsbeläge

Illustrations disc brake pads - Illustrazioni pastiglie freno -

Illustrations plaquettes de frein - Ilustraciones pastillas de freno



Maßstab - scale - scala - échelle - escala 1:2

**13.0470-2877.2 LD2877** ATE Ceramic

SEAT, VOLKSWAGEN

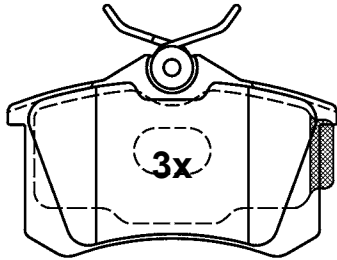

23554 17,2

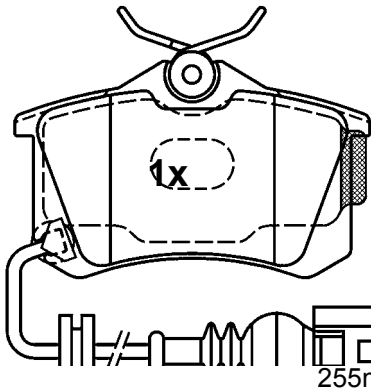

23823 17,2

87,2 x 52,9 x 17,2

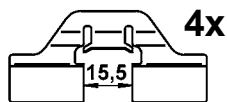
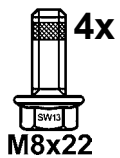

**13.0470-2879.2 LD2879** ATE Ceramic

FIAT, LANCIA

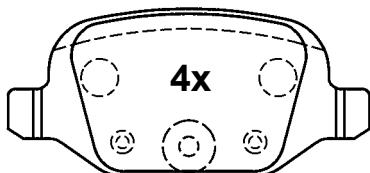

23601 13,7

95,6 x 43,9 x 13,7



**13.0470-2880.2 LD2880** ATE Ceramic

AUDI, SEAT, SKODA, VOLKSWAGEN

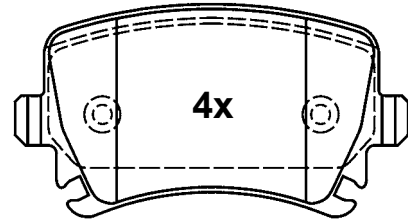

23914 17,1

105,3 x 55,9 x 17,1

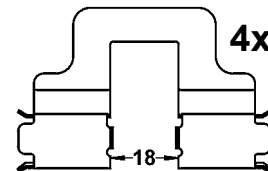

**13.0470-2884.2 LD2884** ATE Ceramic

SEAT, SKODA, VOLKSWAGEN

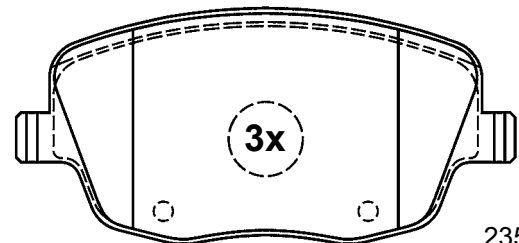

23581 18,8

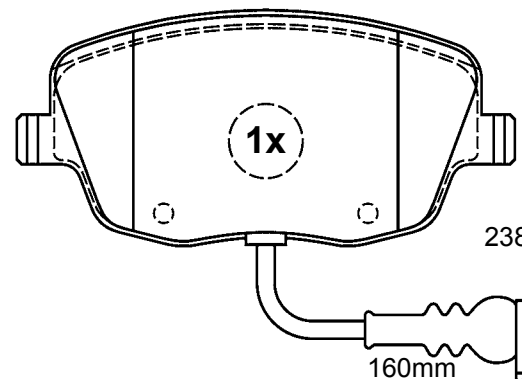

23843 18,8

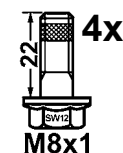

131,4 x 62,0 x 18,8







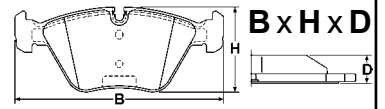





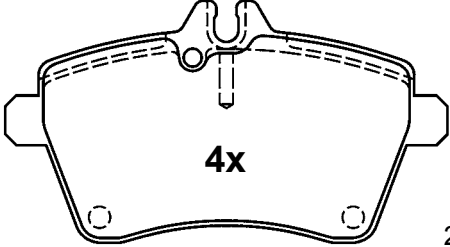

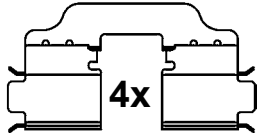

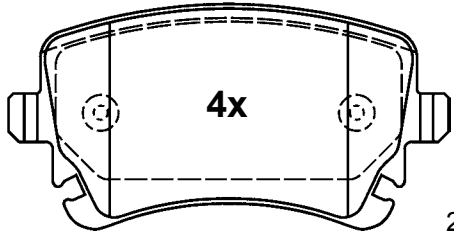

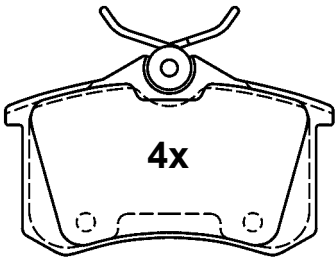
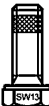

# Abbildungen Scheibenbremsbeläge

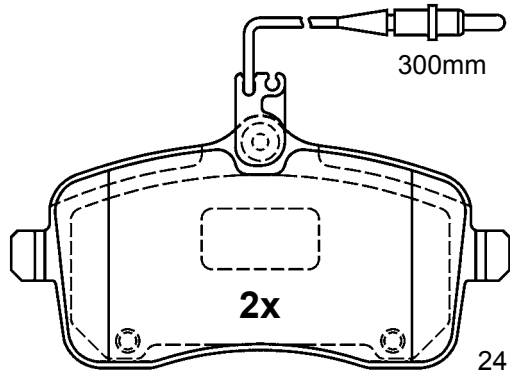
Illustrations disc brake pads - Illustrazioni pastiglie freno -

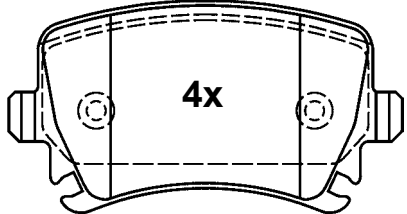
Illustrations plaquettes de frein - Ilustraciones pastillas de freno

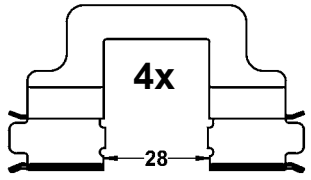

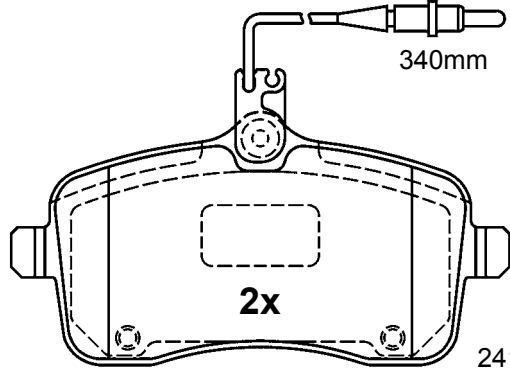
Maßstab - scale - scala - échelle - escala 1:2

| 13.0470-2885.2 LD2885 ATE Ceramic  | 13.0470-2888.2 LD2888 ATE Ceramic   |
|--|---|
| <p> MERCEDES BENZ </p>  <p>4x</p> <p>24077 19,1</p> <p>116,3 x 63,8 x 19,1</p> <p> 2x<br/>M8x21</p>  <p>4x</p>                        | <p> AUDI </p>  <p>4x</p> <p>23326 17,4</p> <p>116,1 x 59,0 x 17,4</p> <p> 4x<br/>M8x21</p>                         |
| <p> AUDI, SEAT, SKODA, VOLKSWAGEN </p>  <p>4x</p> <p>20961 16,2</p> <p>87,5 x 52,9 x 16,2</p> <p> 4x<br/>M8x21</p>   | <p> PEUGEOT </p>  <p>300mm</p> <p>2x</p> <p>24134 19,6</p>  |
| <p> AUDI, VOLKSWAGEN </p>  <p>4x</p> <p>23914 17,1</p> <p>105,3 x 55,9 x 17,1</p> <p> 4x<br/>M8x21</p>  <p>4x</p> <p>28</p> | <p> PEUGEOT </p>  <p>340mm</p> <p>2x</p> <p>24175 19,6</p> <p>131,4 x 67,5 x 19,6</p> <p> 4x<br/>M8x21</p> |

# Abbildungen Scheibenbremsbeläge

Illustrations disc brake pads - Illustrazioni pastiglie freno -

Illustrations plaquettes de frein - Ilustraciones pastillas de freno



Maßstab - scale - scala - échelle - escala 1:2

**13.0470-2892.2 LD2892** ATE Ceramic



CITROEN, PEUGEOT



TRW

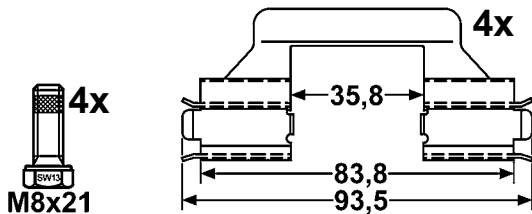
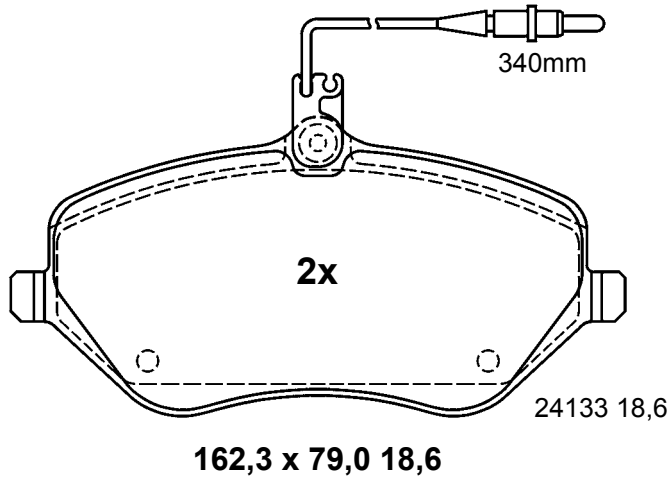
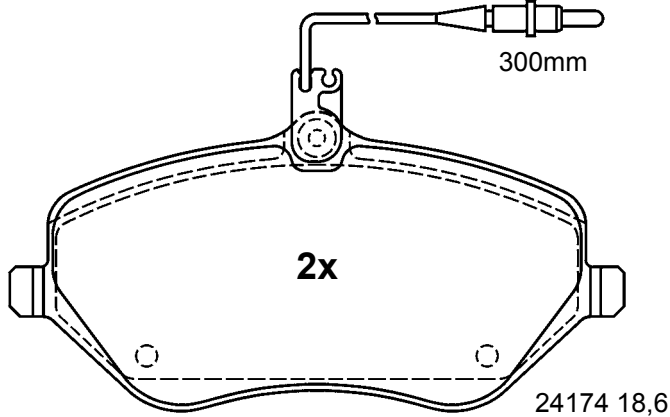

**13.0470-2893.2 LD2893** ATE Ceramic



CITROEN, PEUGEOT



TRW

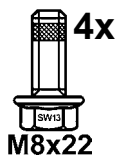
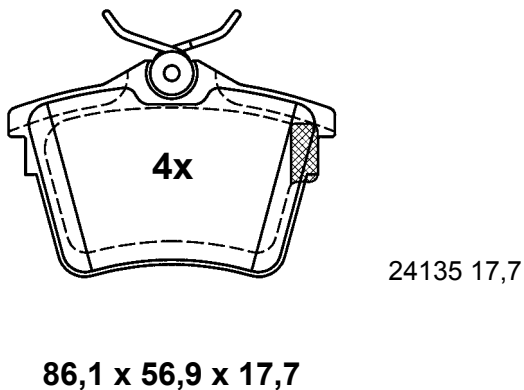

**13.0470-2894.2 LD2894** ATE Ceramic



AUDI, SEAT, SKODA  
VOLKSWAGEN



TRW

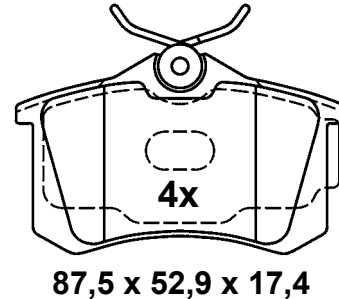

20961 17,4

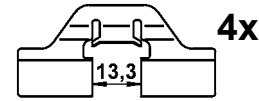

**13.0470-2927.2 LD2927** ATE Ceramic



MERCEDES BENZ



TRW

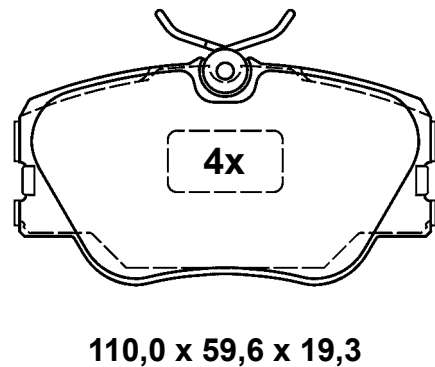

**13.0470-2975.2 LD2975** ATE Ceramic



MERCEDES BENZ



TRW

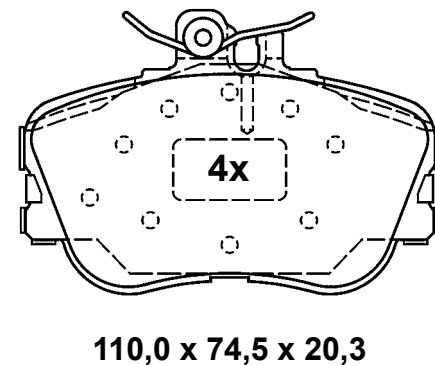







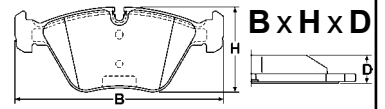





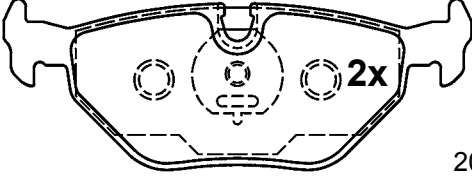
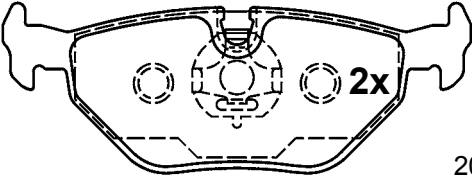

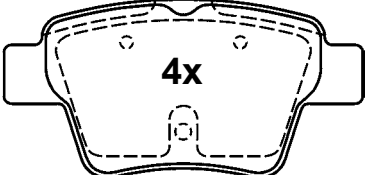
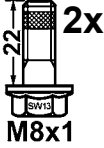
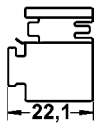
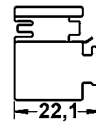



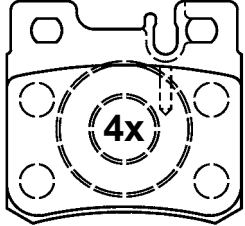

# Abbildungen Scheibenbremsbeläge

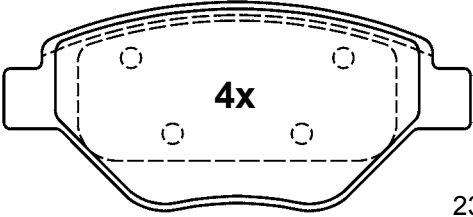
Illustrations disc brake pads - Illustrazioni pastiglie freno -

Illustrations plaquettes de frein - Ilustraciones pastillas de freno

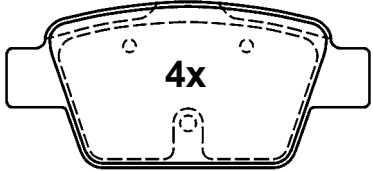
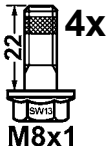

Maßstab - scale - scala - échelle - escala 1:2

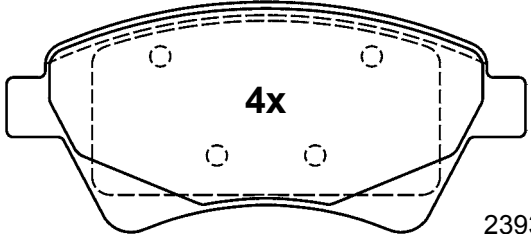
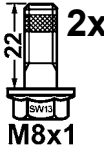
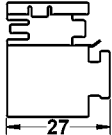
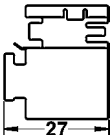
| <b>13.0470-3605.2 LD3605</b> ATE Ceramic  | <b>13.0470-3813.2 LD3813</b> ATE Ceramic  |
|---|---|
| <p>  BMW, MG, ROVER, SAAB                              ATE                         </p>  <p>20180 17,3</p>  <p>20181 17,3</p> <p><b>123,0 x 44,9 x 17,3</b></p>  | <p>  CITROEN, PEUGEOT                              BOS                         </p>  <p>4x</p> <p>24150 17,6</p> <p><b>94,8 x 46,9 x 17,6</b></p>  2x<br>M8x1  4x<br>22,1  4x<br>22,1   |
| <p> <b>13.0470-3805.2 LD3805</b> ATE Ceramic                              ATE                         </p> <p>  MERCEDES BENZ                              ATE                         </p>  <p>21197 15,0</p> <p><b>61,8 x 58,6 x 15,0</b></p>   | <p> <b>13.0470-3814.2 LD3814</b> ATE Ceramic                              BOS                         </p> <p>  RENAULT                              BOS                         </p>  <p>4x</p> <p>23934 18,2</p> <p><b>122,8 x 54,3 x 18,2</b></p>  2x<br>M8x21  |
| <p> <b>13.0470-3812.2 LD3812</b> ATE Ceramic                              BOS                         </p> <p>  ALFA ROMEO, FIAT, LANCIA                              BOS                         </p>  <p>23714 17,6</p> <p><b>94,8 x 42,9 x 17,6</b></p>  4x<br>M8x1 | <p> <b>13.0470-3815.2 LD3815</b> ATE Ceramic                              BOS                         </p> <p>  RENAULT                              BOS                         </p>  <p>4x</p> <p>23930 18,2</p> <p><b>136,8 x 59,5 x 18,2</b></p>  2x<br>M8x1  4x<br>27  4x<br>27 |



# Abbildungen Scheibenbremsbeläge

Illustrations disc brake pads - Illustrazioni pastiglie freno -

Illustrations plaquettes de frein - Ilustraciones pastillas de freno

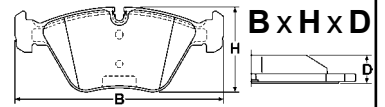

Maßstab - scale - scala - échelle - escala 1:2

**13.0470-3826.2 LD3826** ATE Ceramic

ALFA ROMEO, FIAT

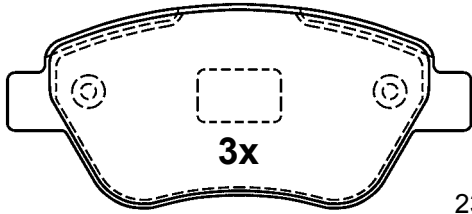

3x

23707 18,0



198mm

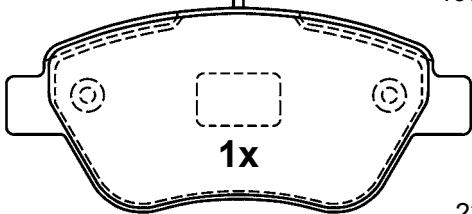

1x

23706 18,0

122,8 x 53,3 x 18,0

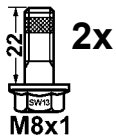

2x

M8x1

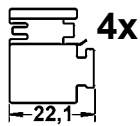

4x

22,1

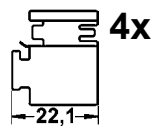

4x

22,1

**13.0470-3828.2 LD3828** ATE Ceramic

FIAT

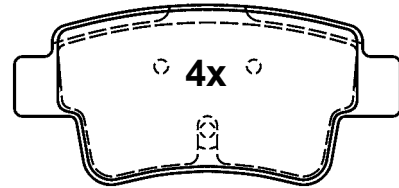

4x

24349 17,5

101,8 x 47,1 x 17,5

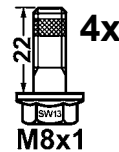

4x

M8x1

**13.0470-3827.2 LD3827** ATE Ceramic

FIAT, LANCIA, OPEL, VAUXHALL

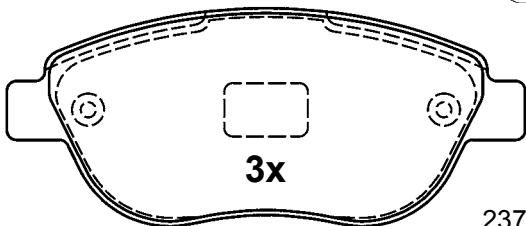

3x

23710 19,6



198mm

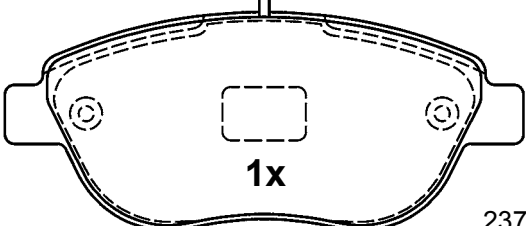

1x

23709 19,6

136,8 x 57,4 x 19,6

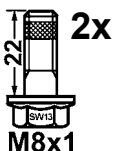

2x

M8x1

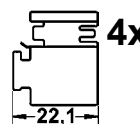

4x

22,1

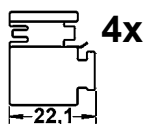

4x

22,1

**13.0470-3831.2 LD3831** ATE Ceramic

FORD, JAGUAR

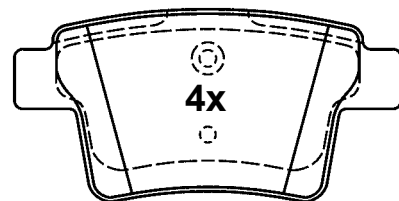

4x

24260 17,3

101,8 x 50,5 x 17,3

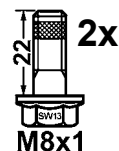

2x

M8x1



4x

22,1



4x

22,1



# Abbildungen Scheibenbremsbeläge

Illustrations disc brake pads - Illustrazioni pastiglie freno -

Illustrations plaquettes de frein - Ilustraciones pastillas de freno

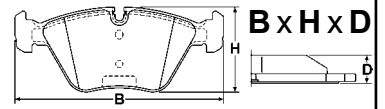

Maßstab - scale - scala - échelle - escala 1:2

**13.0470-3836.2 LD3836** ATE Ceramic



CITROEN



BOS

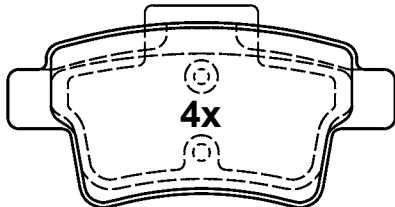

4x

24540 16,3

101,8 x 48,3 x 16,3

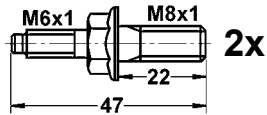

2x

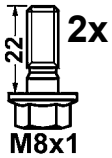

2x

M8x1

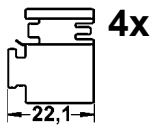

4x

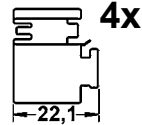

4x

**13.0470-3838.2 LD3838** ATE Ceramic



FIAT, FORD



BOS

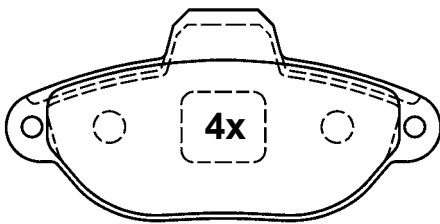

4x

21436 17,0

114,8 x 55,5 x 17,0

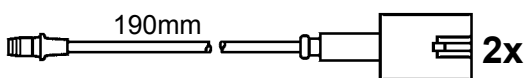

2x



2x

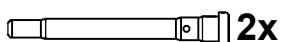

2x

**13.0470-3839.2 LD3839** ATE Ceramic



OPEL, VAUXHALL



BOS

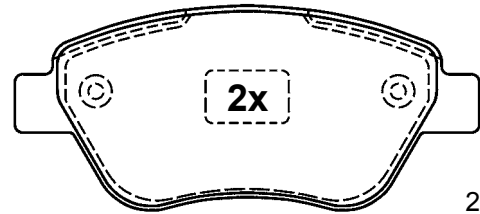

2x

23982 18,1

122,8 x 53,3 x 18,1

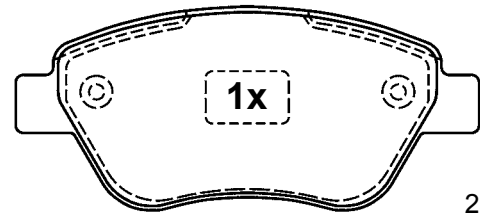

1x

23707 17,9

122,8 x 53,3 x 17,9

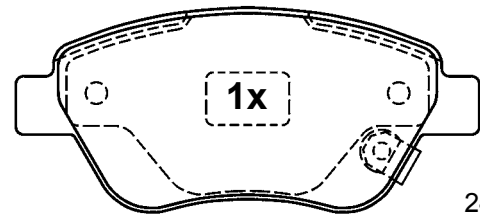

1x

24288 17,9

122,8 x 53,3 x 17,9

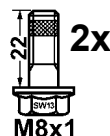

2x

M8x1

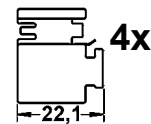

4x

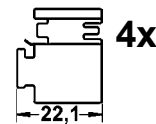

4x

# Abbildungen Scheibenbremsbeläge

Illustrations disc brake pads - Illustrazioni pastiglie freno -

Illustrations plaquettes de frein - Ilustraciones pastillas de freno

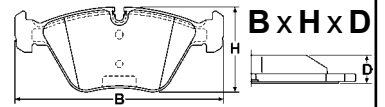

Maßstab - scale - scala - échelle - escala 1:2

**13.0470-3840.2 LD3840** ATE Ceramic

FIAT, OPEL, VAUXHALL

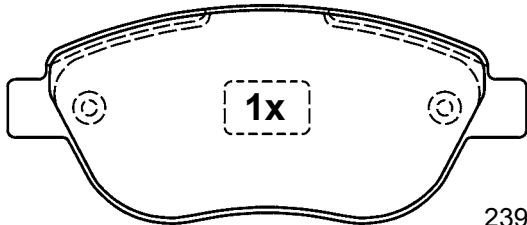

23981 19,6

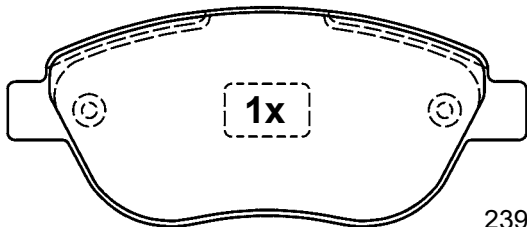

23981 19,6

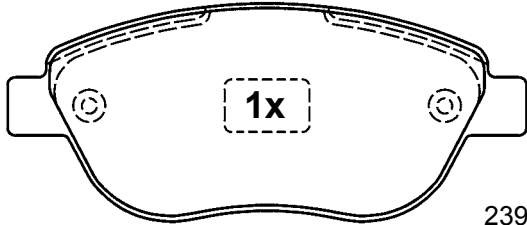

23981 19,6

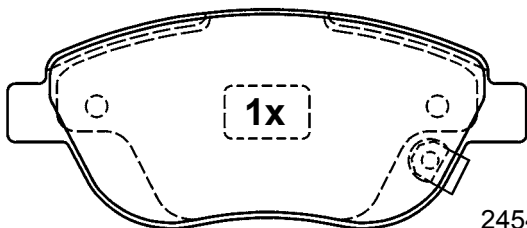

24549 19,6

136,9 x 57,4 x 19,6

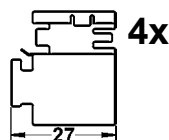
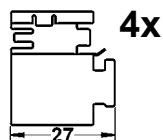
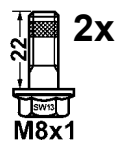

**13.0470-3846.2 LD3846** ATE Ceramic

FIAT, FORD

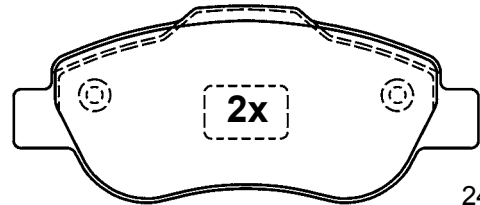

24072 17,9

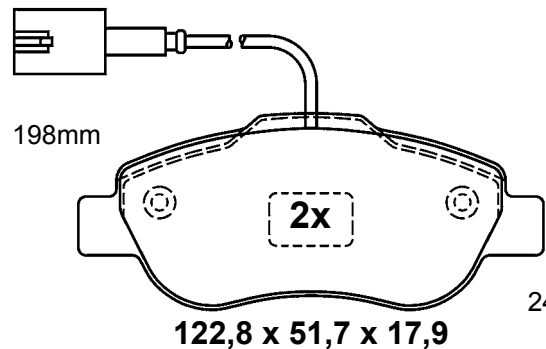

198mm

122,8 x 51,7 x 17,9

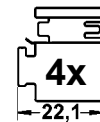
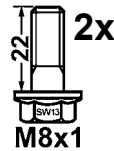

**13.0470-3847.2 LD3847** ATE Ceramic

PEUGEOT

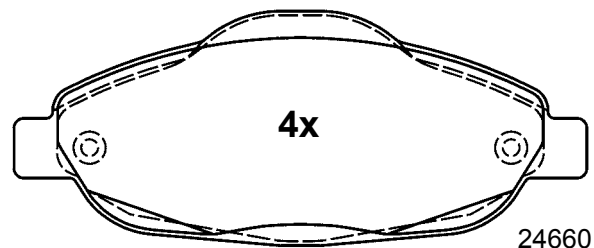

24660 17,8

151,0 x 62,0 x 17,8

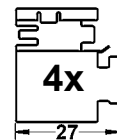
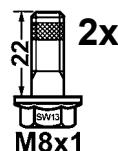

# Abbildungen Scheibenbremsbeläge

Illustrations disc brake pads - Illustrazioni pastiglie freno -

Illustrations plaquettes de frein - Ilustraciones pastillas de freno

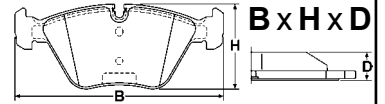

Maßstab - scale - scala - échelle - escala 1:2

**13.0470-3852.2 LD3852** ATE Ceramic



MERCEDES BENZ



BOS

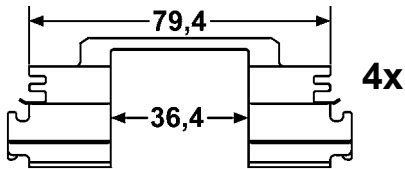
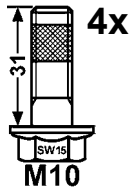
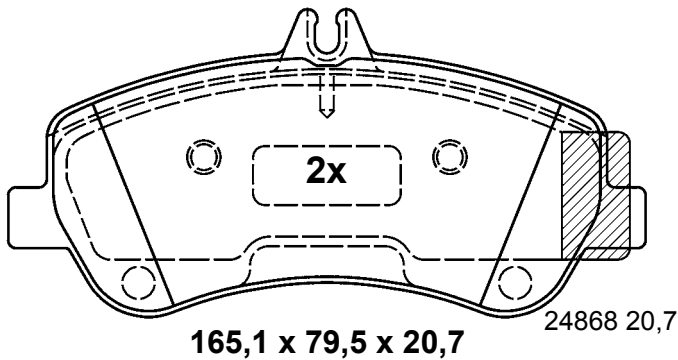
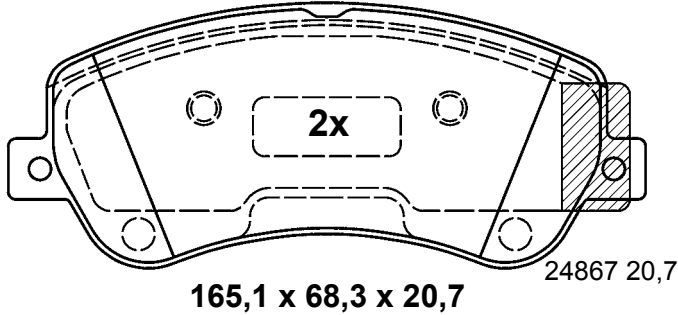

**13.0470-3857.2 LD3857** ATE Ceramic



BMW



BOS

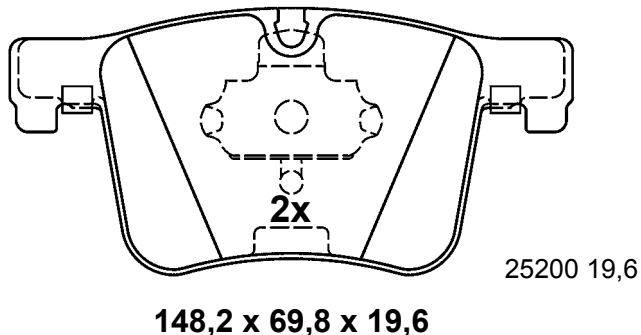
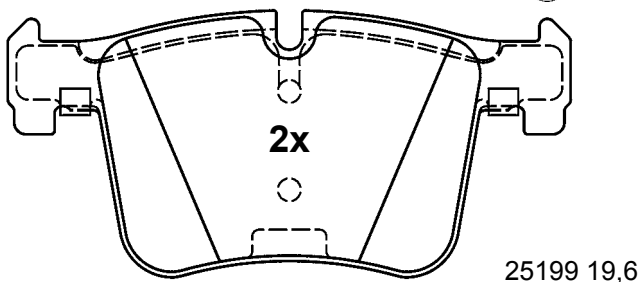

**13.0470-3858.2 LD3858** ATE Ceramic



AUDI, SEAT,  
SKODA, VOLKSWAGEN



BOS

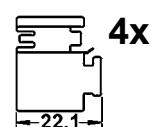
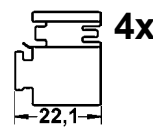
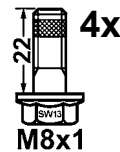
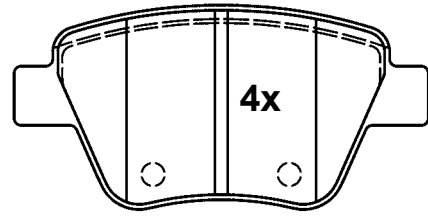

**13.0470-3859.2 LD3859** ATE Ceramic



BMW



BOS

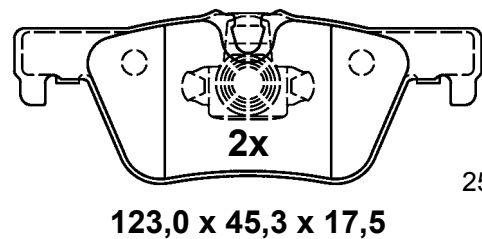
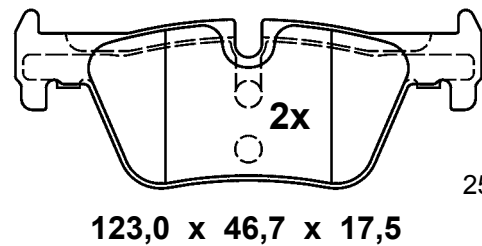

# Abbildungen Scheibenbremsbeläge

Illustrations disc brake pads - Illustrazioni pastiglie freno -

Illustrations plaquettes de frein - Ilustraciones pastillas de freno



Maßstab - scale - scala - échelle - escala 1:2

**13.0470-3860.2 LD3860** ATE Ceramic

VOLKSWAGEN

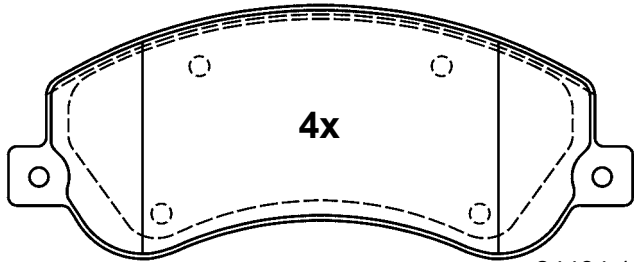

4x

24484 18,8

164,8 x 66,8 x 18,8

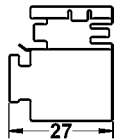
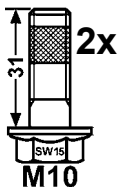

4x

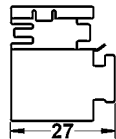

4x

**13.0470-3866.2 LD3866** ATE Ceramic

BMW

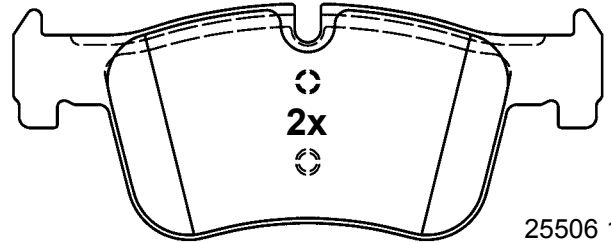

2x

25506 18,2

155,7 x 61,6 x 18,2

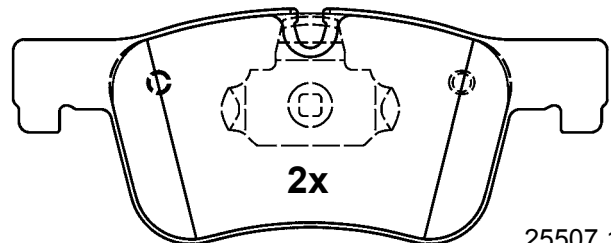

2x

25507 18,2

156,7 x 61,6 x 18,2

**13.0470-3865.2 LD3865** ATE Ceramic

BMW

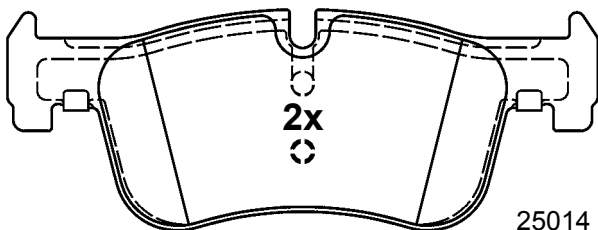

2x

25014 18,2

155,7 x 57,8 x 18,2

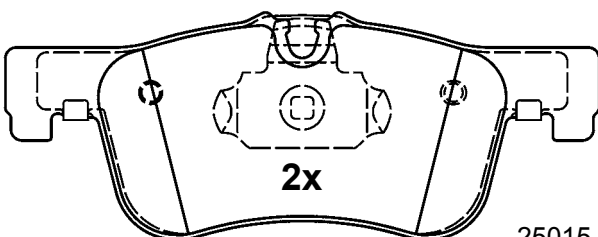

2x

25015 18,2

156,7 x 59,7 x 18,2

**13.0470-3870.2 LD3870** ATE Ceramic

PEUGEOT

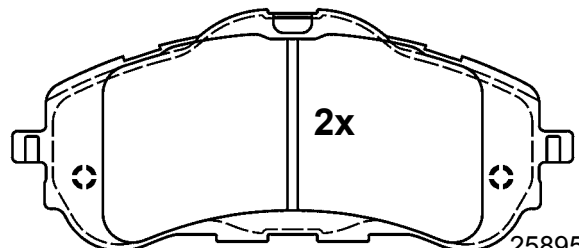

2x

25895 18,5

147,8 x 63,5 x 18,5

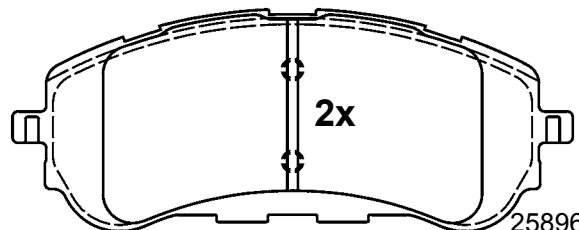

2x

25896 18,5

147,8 x 58,3 x 18,5

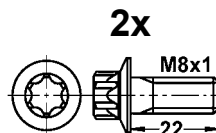

2x

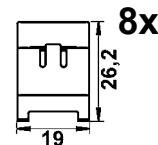

8x

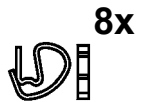

8x



# Abbildungen Scheibenbremsbeläge

Illustrations disc brake pads - Illustrazioni pastiglie freno -

Illustrations plaquettes de frein - Ilustraciones pastillas de freno

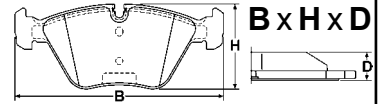

Maßstab - scale - scala - échelle - escala 1:2

**13.0470-3871.2 LD3871** ATE Ceramic

CITROEN, PEUGEOT

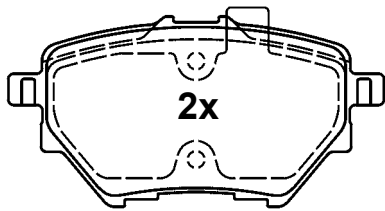

25839 17,8

98,8 x 49,9 x 17,8

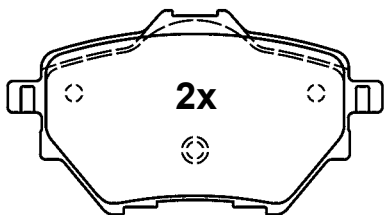

25840 17,8

98,8 x 53,5 x 17,8

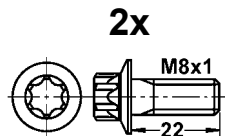

2x



M8x1  
22

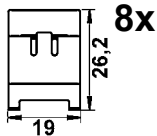

8x

19

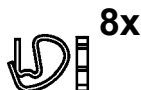

8x

**13.0470-3872.2 LD3872** ATE Ceramic

CITROEN, PEUGEOT

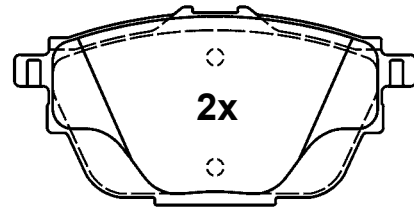

25827 17,7

105,8 x 51,9 x 17,7

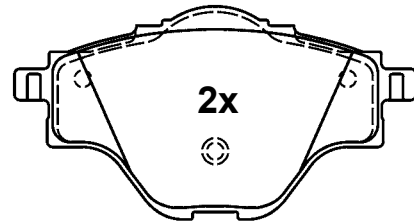

25828 17,7

105,8 x 55,4 x 17,7

2x

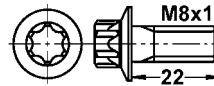

M8x1  
22

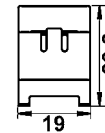

8x

19



8x

**13.0470-3966.2 LD3966** ATE Ceramic

CITROEN, PEUGEOT

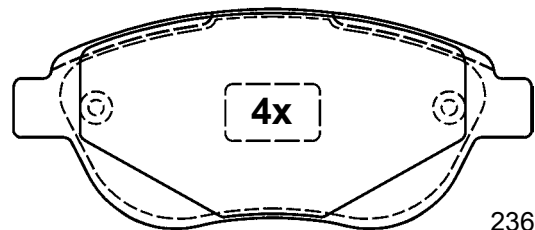

23600 19,4

136,8 x 57,5 x 19,4

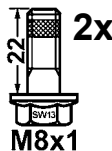

2x

M8x1

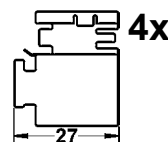

4x

27

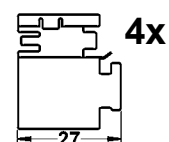

4x

27



# Abbildungen Scheibenbremsbeläge

Illustrations disc brake pads - Illustrazioni pastiglie freno -

Illustrations plaquettes de frein - Ilustraciones pastillas de freno

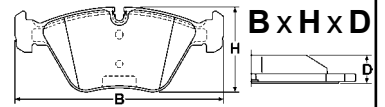

Maßstab - scale - scala - échelle - escala 1:2

**13.0470-3982.2 LD3982** ATE Ceramic

**13.0470-3983.2 LD3983** ATE Ceramic



FIAT



BOS



FIAT, LANCIA



BOS

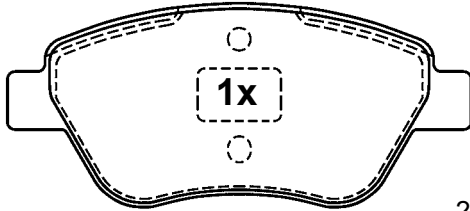

23705 18,1

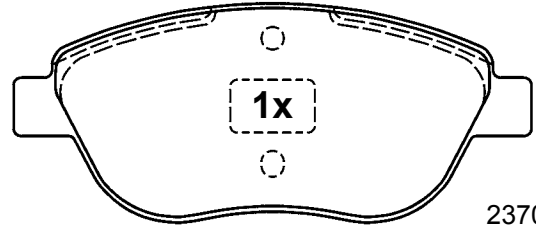

23708 19,4

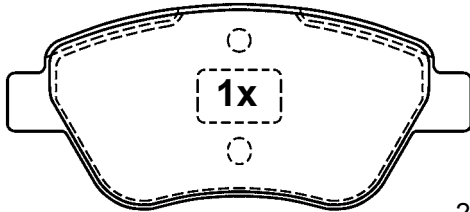

23705 18,1

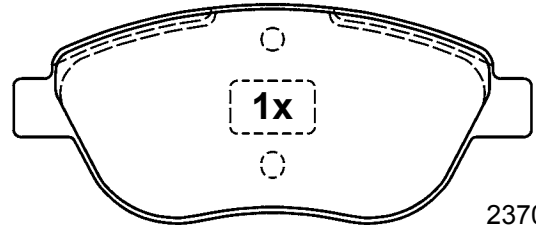

23708 19,4

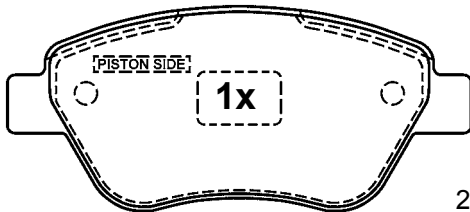

23707 18,1

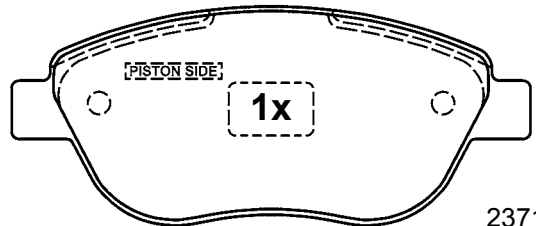

23710 19,4

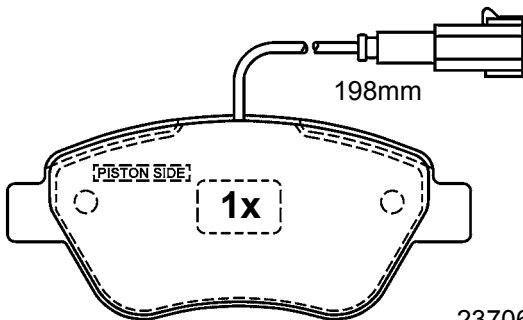

23706 18,1

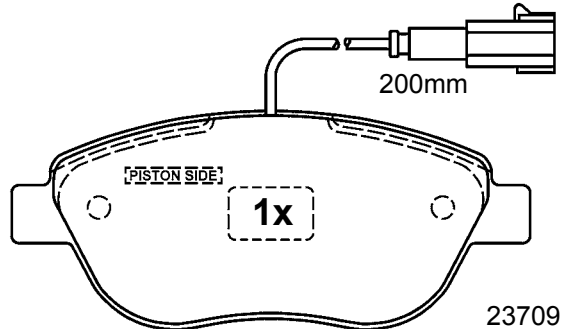

23709 19,4

**122,8 x 53,3 x 18,1**

**136,8 x 57,4 x 19,4**

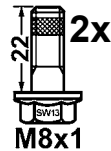
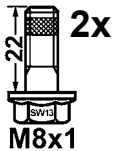

# Abbildungen Scheibenbremsbeläge

Illustrations disc brake pads - Illustrazioni pastiglie freno -

Illustrations plaquettes de frein - Ilustraciones pastillas de freno

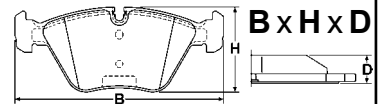

Maßstab - scale - scala - échelle - escala 1:2

**13.0470-3984.2 LD3984** ATE Ceramic



ALFA ROMEO, FIAT, LANCIA



BOS

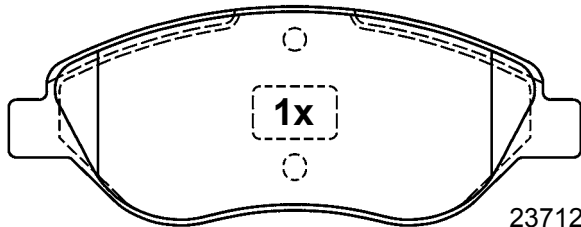

23712 19,4

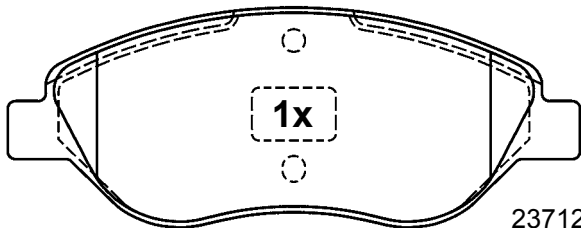

23712 19,4

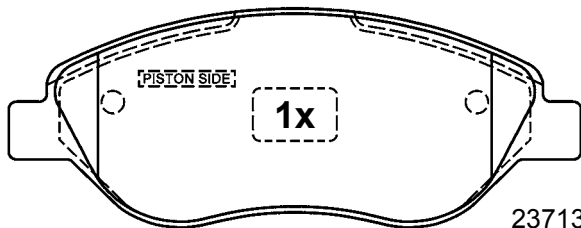

23713 19,4

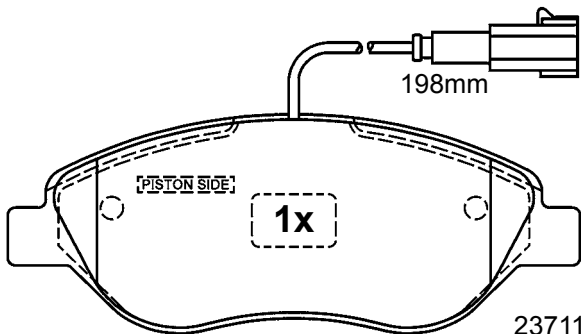

23711 19,4

150,8 x 57,4 x 19,4

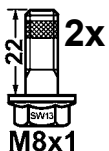

**13.0470-3987.2 LD3987** ATE Ceramic



FORD, JAGUAR



BOS

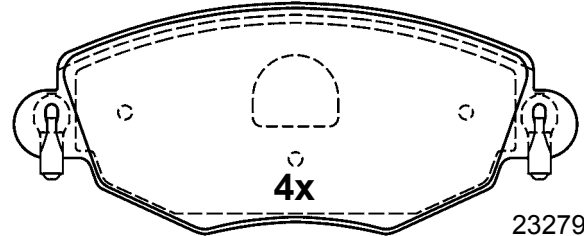

23279 18,4

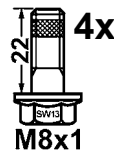

148,8 x 60,5 x 18,4

**13.0470-3988.2 LD3988** ATE Ceramic



FORD, JAGUAR, RENAULT



BOS

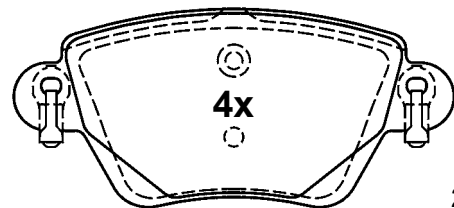

23557 17,2



115,7 x 52 x 17,2

**13.0470-3994.2 LD3994** ATE Ceramic



CITROEN, PEUGEOT



BOS

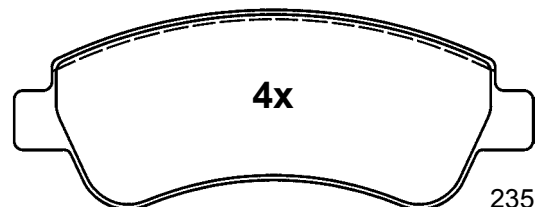

23599 19,0

136,8 x 52,0 x 19,0

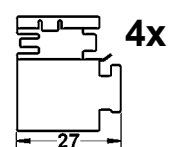
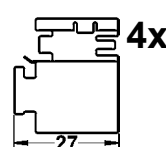
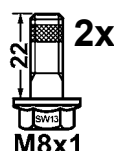

# Abbildungen Scheibenbremsbeläge

Illustrations disc brake pads - Illustrazioni pastiglie freno -

Illustrations plaquettes de frein - Ilustraciones pastillas de freno

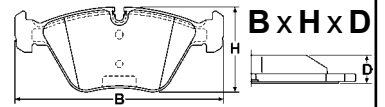

Maßstab - scale - scala - échelle - escala 1:2

**13.0470-3999.2 LD3999** ATE Ceramic



MERCEDES BENZ



BOS

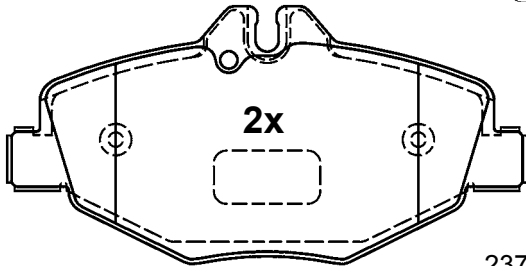

23743 20,1

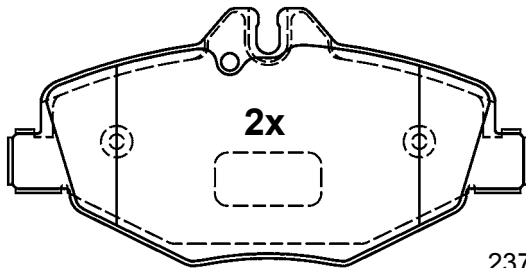
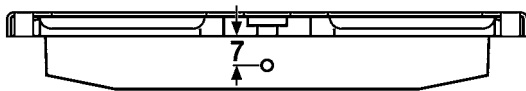

23744 20,1

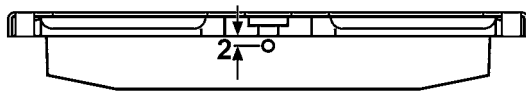

137,0 x 67,8 x 20,1

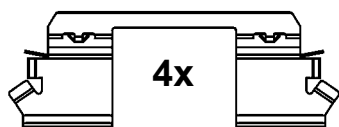
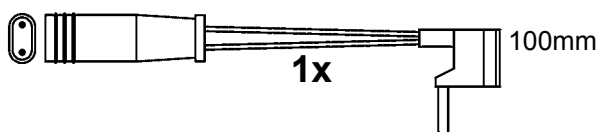
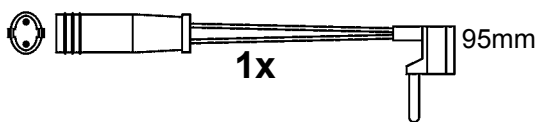
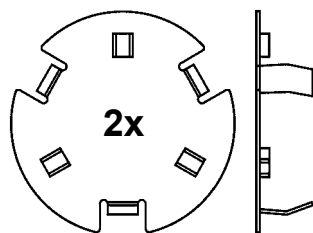

**13.0470-4044.2 LD4044** ATE Ceramic



VOLVO



ATE

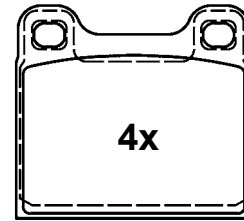

61,8 x 56,5 x 15,1

20755 15,1

**13.0470-4047.2 LD4047** ATE Ceramic



CHRYSLER, MERCEDES BENZ



ATE

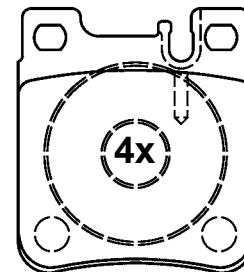

61,7 x 69,5 x 15,7

21305 15,7

**13.0470-4064.2 LD4064** ATE Ceramic



CHRYSLER, MERCEDES BENZ



ATE

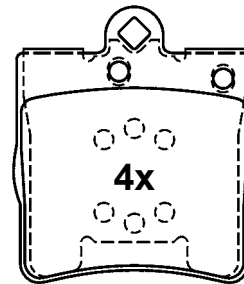
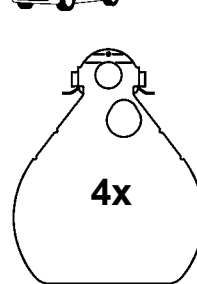

63,8 x 72,8 x 15,3

21919 15,3

**13.0470-4065.2 LD4065** ATE Ceramic



MERCEDES BENZ



ATE

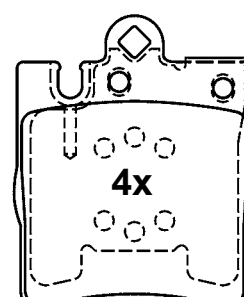
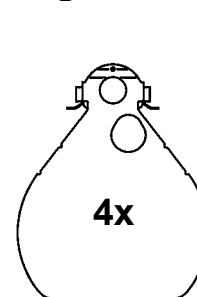

63,7 x 78,0 x 15,3

21899 15,3

# Abbildungen Scheibenbremsbeläge

Illustrations disc brake pads - Illustrazioni pastiglie freno -

Illustrations plaquettes de frein - Ilustraciones pastillas de freno

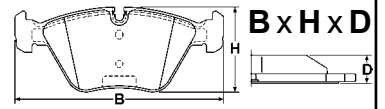

Maßstab - scale - scala - échelle - escala 1:2

**13.0470-4803.2 LD4803** ATE Ceramic



ALFA ROMEO



BRE

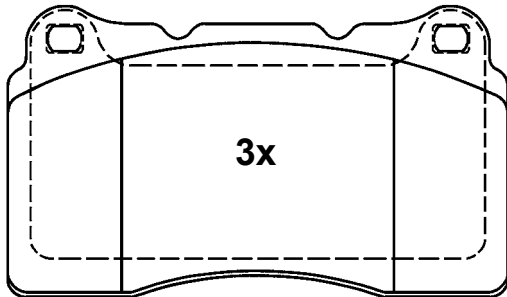

3x

23092 15,6

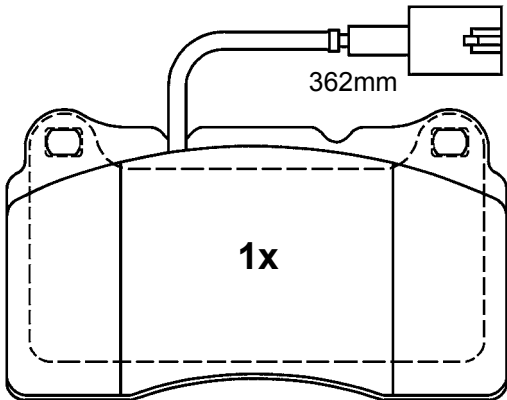

362mm

1x

23111 15,6

131,8 x 77,2 x 15,6

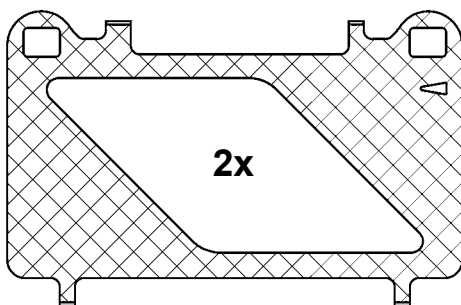

2x

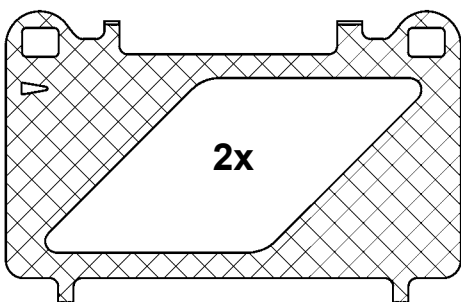

2x

**13.0470-4814.2 LD4814** ATE Ceramic



PORSCHE



BRE

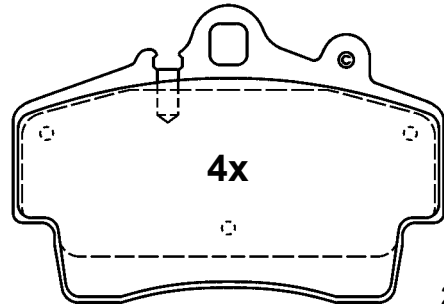

4x

21937 15,5

114,0 x 78,0 x 15,5

**13.0470-4833.2 LD4833** ATE Ceramic



SEAT, VOLKSWAGEN



BRE

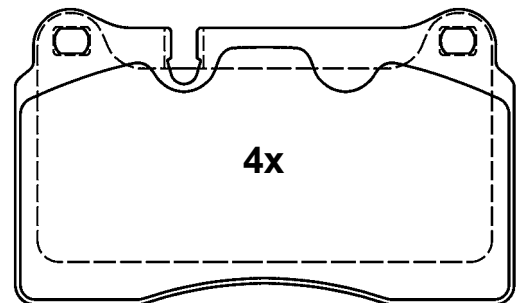

4x

24098 17,1

131,6 x 77,3 x 17,1

# Abbildungen Scheibenbremsbeläge

Illustrations disc brake pads - Illustrazioni pastiglie freno -

Illustrations plaquettes de frein - Ilustraciones pastillas de freno

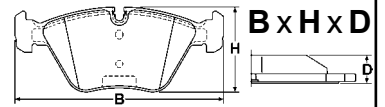

Maßstab - scale - scala - échelle - escala 1:2

**13.0470-4834.2 LD4834** ATE Ceramic

VOLKSWAGEN

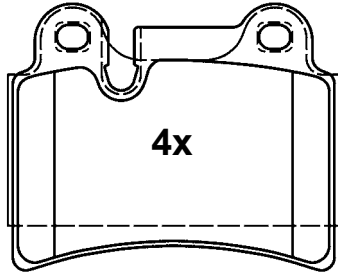

24097 17,1

86,8 x 70,1 x 17,1

**13.0470-4851.2 LD4851** ATE Ceramic

ALFA ROMEO

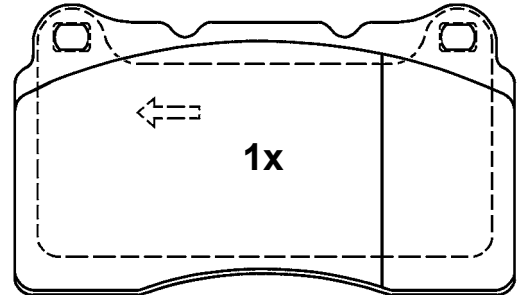

23092 16,0

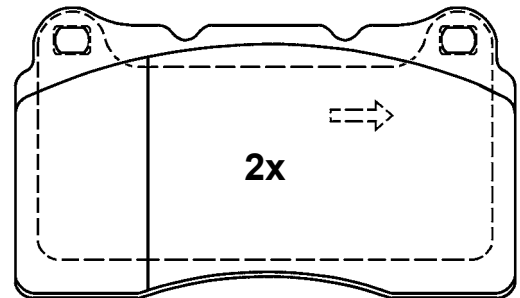

23092 16,0

**13.0470-4850.2 LD4850** ATE Ceramic

AUDI, PORSCHE, VOLKSWAGEN

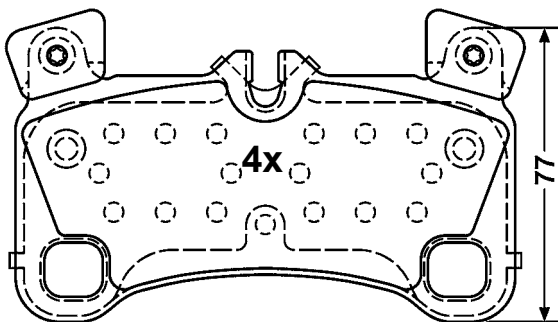

24296 16,3

132,1 x 77,0 x 16,3

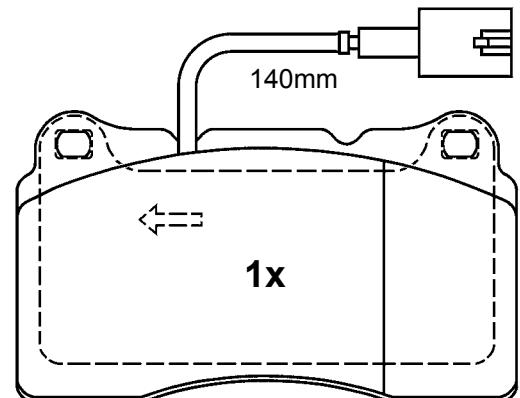

23111 16,0

131,8 x 77,2 x 16,0



# Abbildungen Scheibenbremsbeläge

Illustrations disc brake pads - Illustrazioni pastiglie freno -

Illustrations plaquettes de frein - Ilustraciones pastillas de freno

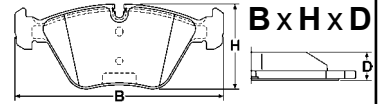

Maßstab - scale - scala - échelle - escala 1:2

**13.0470-4853.2 LD4853** ATE Ceramic

ALFA ROMEO, FIAT

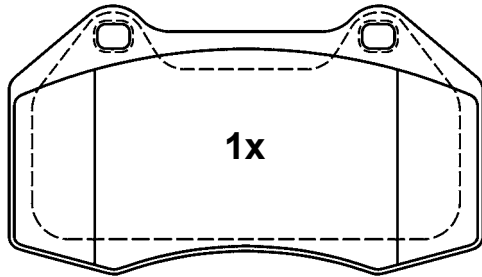

24162 15,2

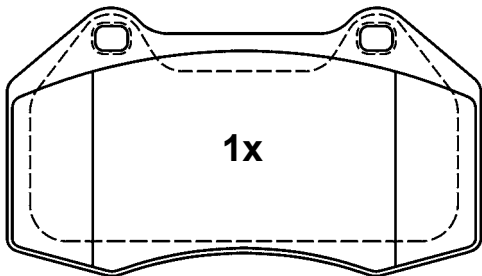

24162 15,2

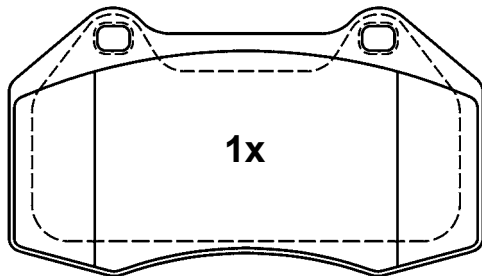

24162 15,2

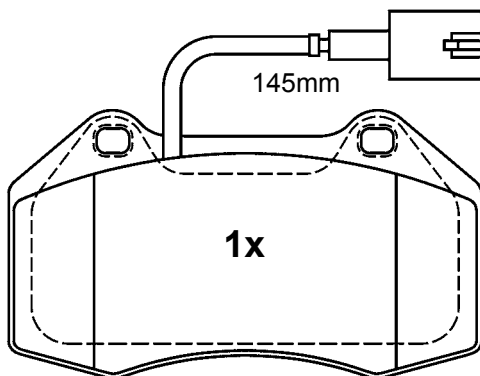

24687 15,2

**124,6 x 70,4 x 15,2**

**13.0470-4854.2 LD4854** ATE Ceramic

ALFA ROMEO

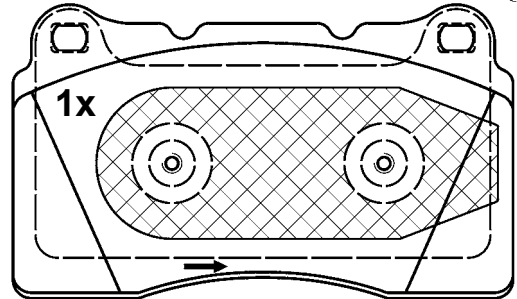

23092 16,3

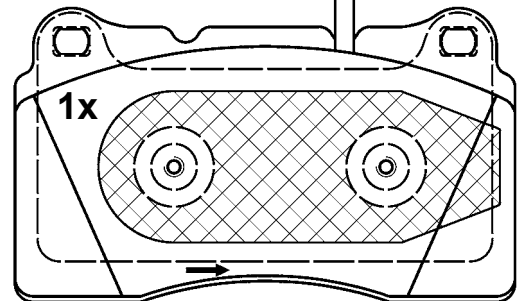
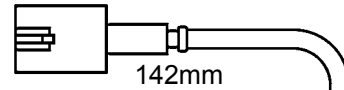

23756 16,3

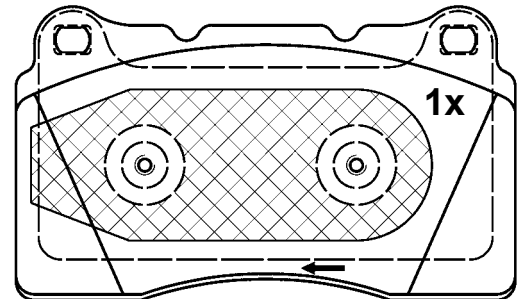

23092 16,3

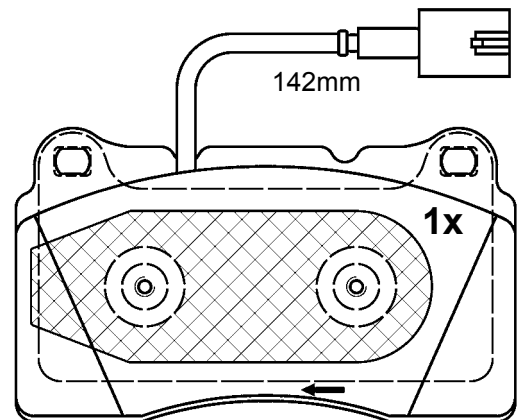

23756 16,3

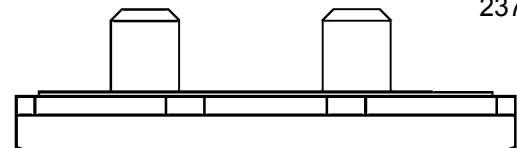

**131,8 x 77,2 x 16,3**



# Abbildungen Scheibenbremsbeläge

Illustrations disc brake pads - Illustrazioni pastiglie freno -

Illustrations plaquettes de frein - Ilustraciones pastillas de freno

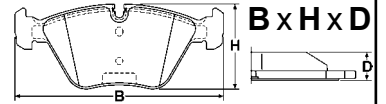

Maßstab - scale - scala - échelle - escala 1:2

**13.0470-4867.2 LD4867** ATE Ceramic

ALFA ROMEO

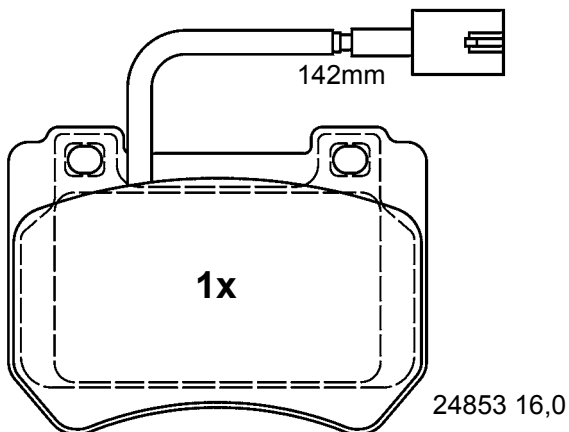
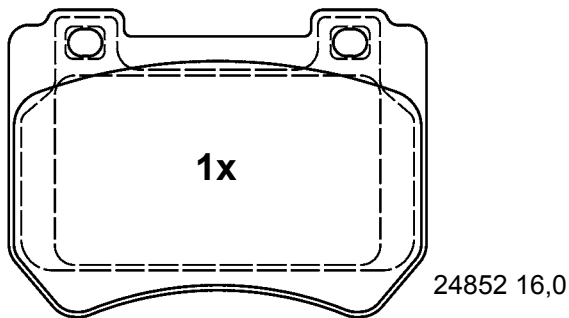
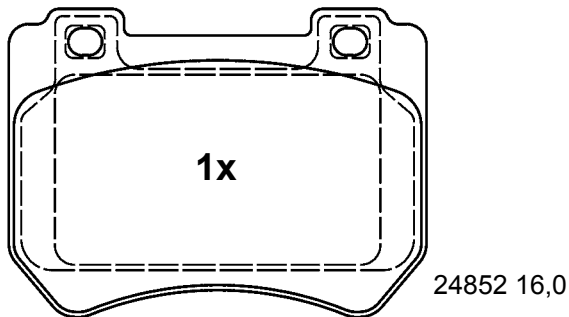
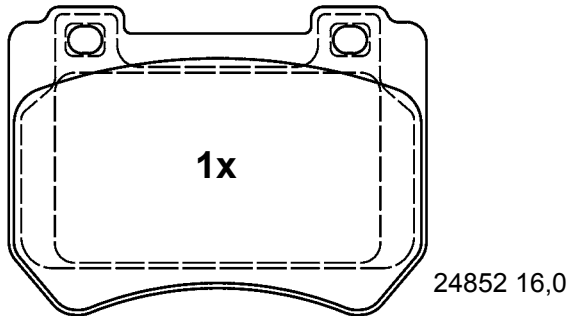

**109,8 x 80,8 x 16,0**

**13.0470-4872.2 LD4872** ATE Ceramic

VOLKSWAGEN

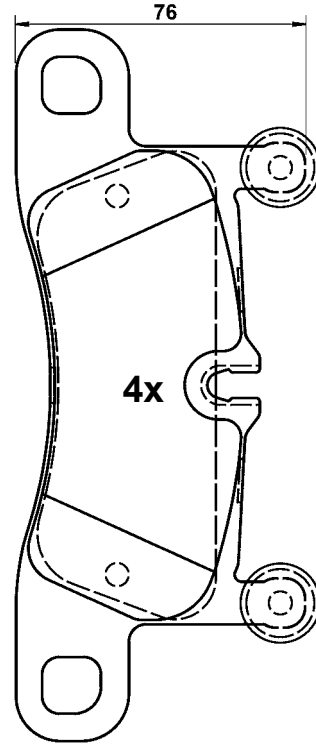

**187,5 x 76,0 x 16,9**

**13.0470-4879.2 LD4879** ATE Ceramic

AUDI, PORSCHE

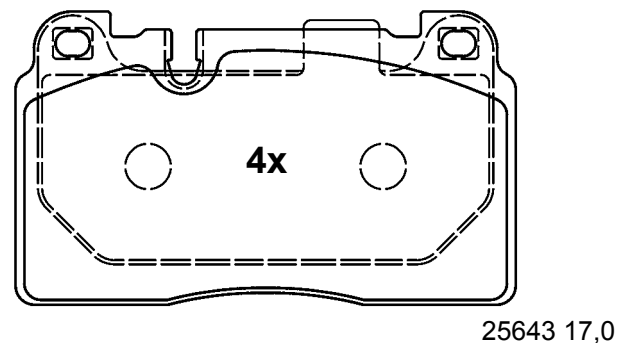

**131,8 x 77,2 x 17,0**



# Abbildungen Scheibenbremsbeläge

Illustrations disc brake pads - Illustrazioni pastiglie freno -

Illustrations plaquettes de frein - Ilustraciones pastillas de freno

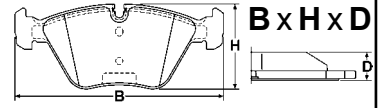

Maßstab - scale - scala - échelle - escala 1:2

**13.0470-4971.2 LD4971** ATE Ceramic



ALFA ROMEO, LANCIA



BRE

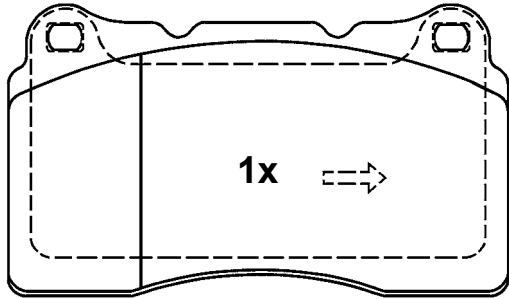

23092 16,0

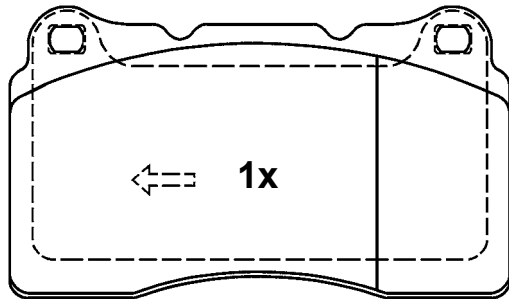

23092 16,0

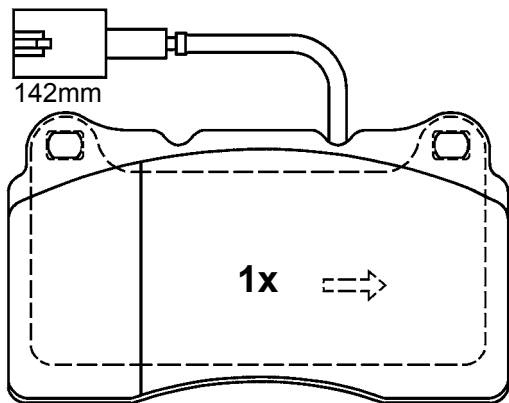

23110 16,0

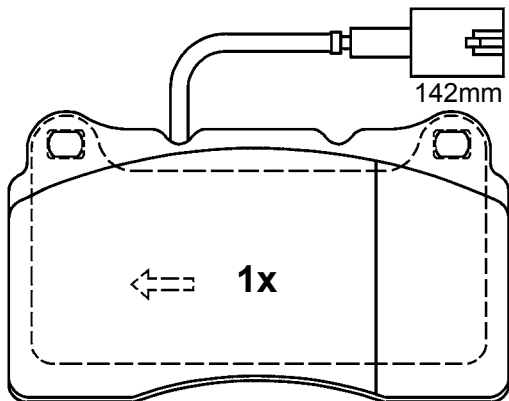

23111 16,0

**131,8 x 77,2 x 16,0**

**13.0470-4976.2 LD4976** ATE Ceramic



AUDI, PORSCHE, VOLKSWAGEN



BRE

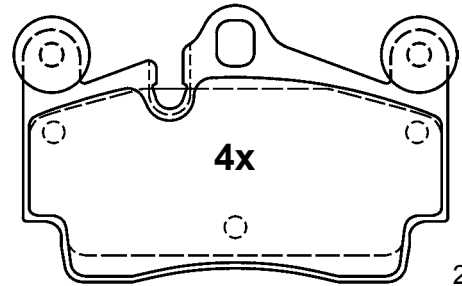

23694 16,7

**112,0 x 73,0 x 16,7**

**13.0470-4977.2 LD4977** ATE Ceramic



MERCEDES BENZ



BRE

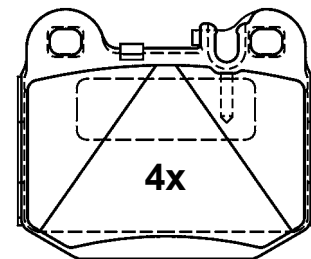

23157 15,8

**76,5 x 65,5 x 15,8**

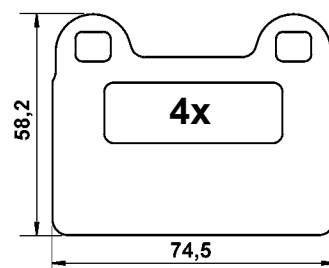

# Abbildungen Scheibenbremsbeläge

Illustrations disc brake pads - Illustrazioni pastiglie freno -

Illustrations plaquettes de frein - Ilustraciones pastillas de freno

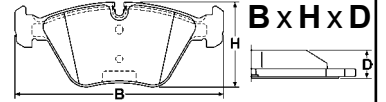

Maßstab - scale - scala - échelle - escala 1:2

**13.0470-4984.2 LD4984** ATE Ceramic



MERCEDES BENZ



BRE

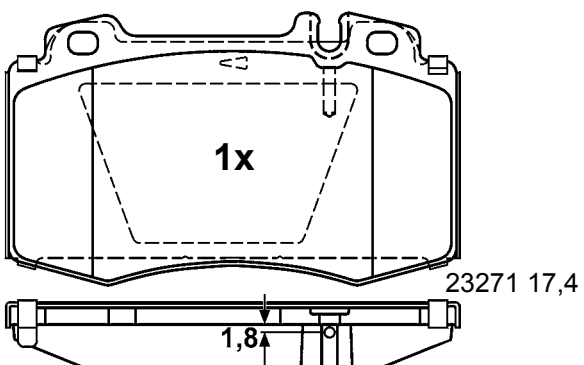
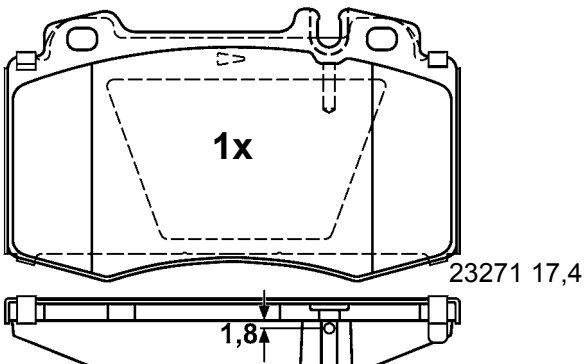
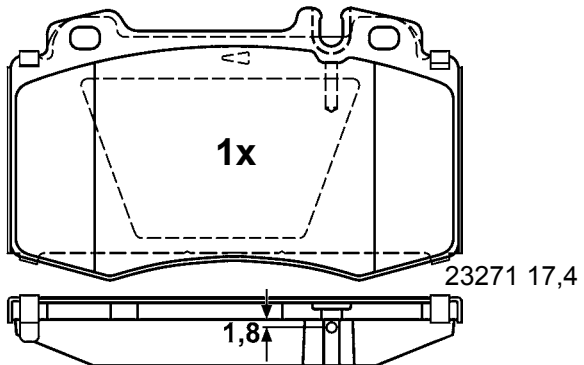
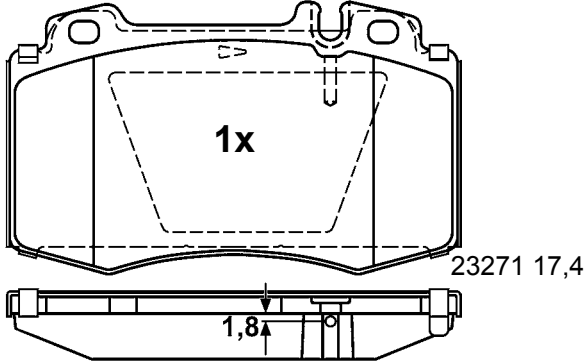

**119,5 x 71,7 x 17,4**

**13.0470-4990.2 LD4990** ATE Ceramic



MERCEDES BENZ



BRE

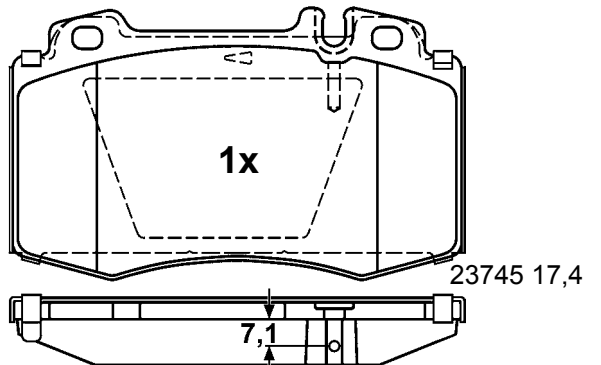
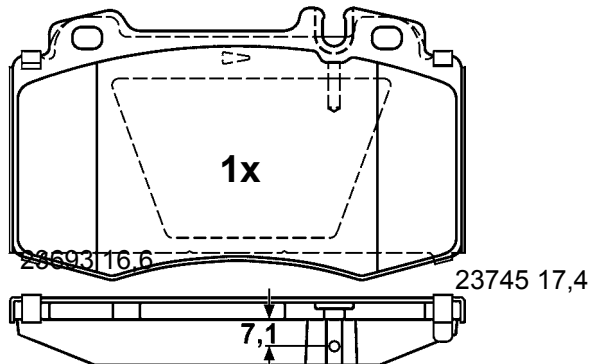
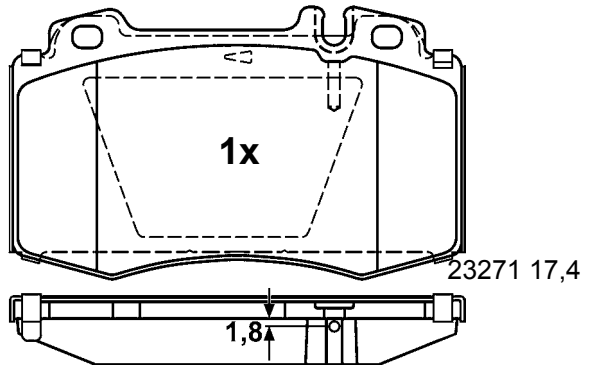
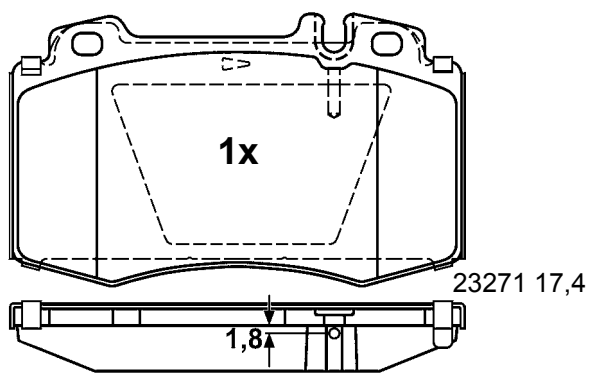

**119,5 x 71,7 x 17,4**



# Abbildungen Scheibenbremsbeläge

Illustrations disc brake pads - Illustrazioni pastiglie freno -

Illustrations plaquettes de frein - Ilustraciones pastillas de freno

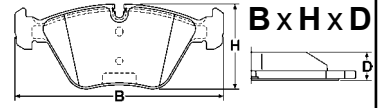

Maßstab - scale - scala - échelle - escala 1:2

**13.0470-4992.2 LD4992** ATE Ceramic

PORSCHE, VOLKSWAGEN

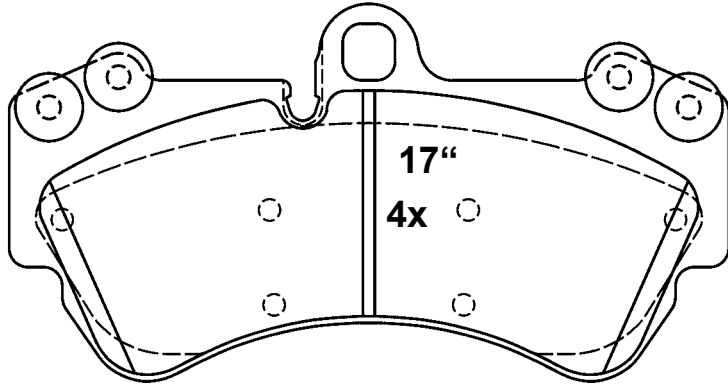

23692 16,6

190 x 99,4 x 16,6

**13.0470-4994.2 LD4994** ATE Ceramic

MERCEDES BENZ

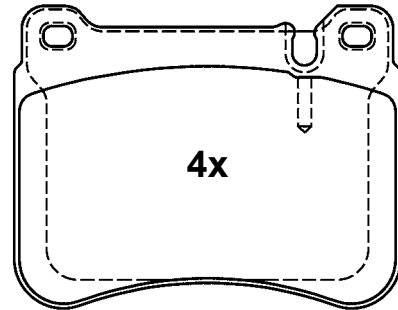

23945 16,5

101,7 x 79,3 x 16,5

**13.0470-5405.2 LD5405** ATE Ceramic

BMW

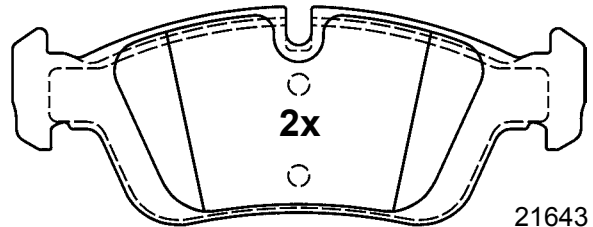

21643 17,8

151,3 x 57,3 x 17,8

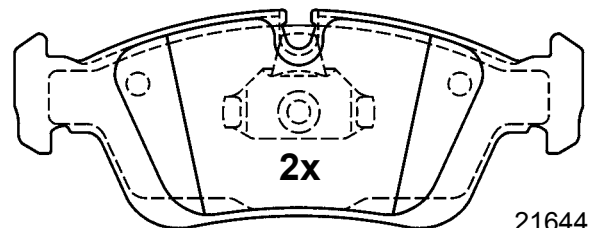

21644 17,8

150,1 x 57,3 x 17,8

**13.0470-4993.2 LD4993** ATE Ceramic

AUDI, PORSCHE, VOLKSWAGEN

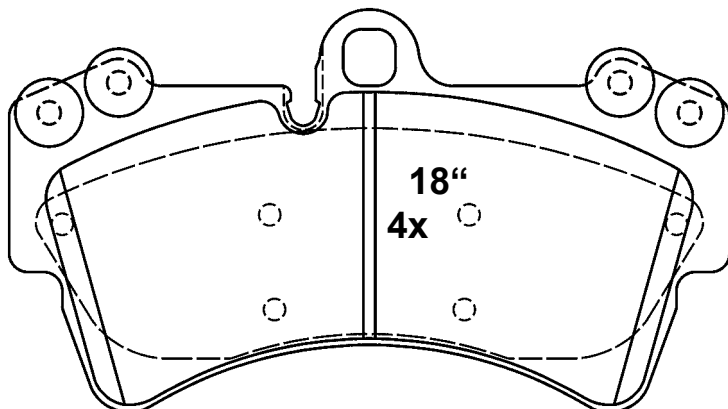

23693 16,6

190,0 x 106,4 x 16,6

# Abbildungen Scheibenbremsbeläge

Illustrations disc brake pads - Illustrazioni pastiglie freno -

Illustrations plaquettes de frein - Ilustraciones pastillas de freno

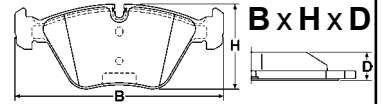

Maßstab - scale - scala - échelle - escala 1:2

**13.0470-5611.2 LD5611** ATE Ceramic

 CHEVROLET ,OPEL,  
SAAB, VAUXHALL

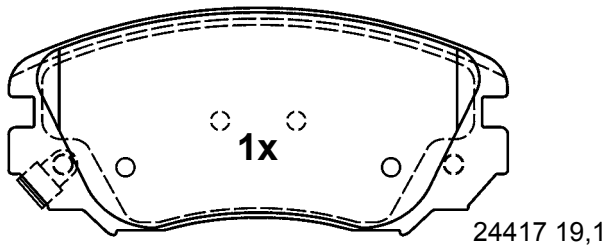
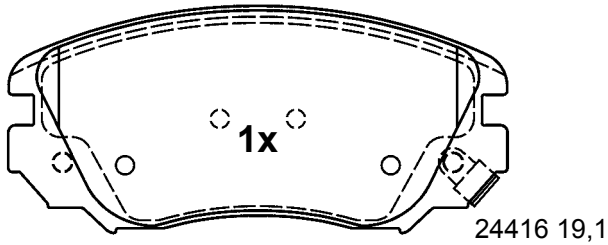
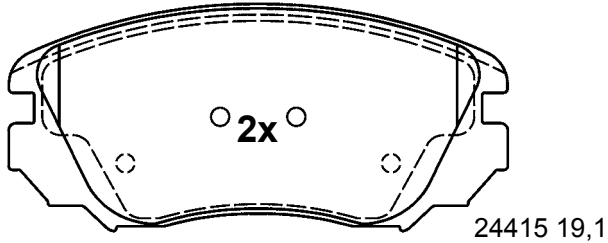

**131,4 x 59,7 x 19,1**

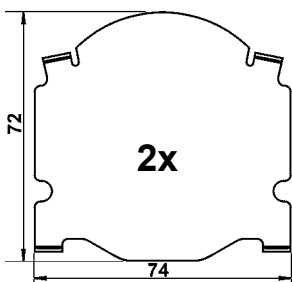
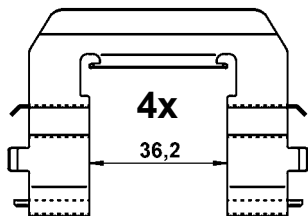

**13.0470-5612.2 LD5612** ATE Ceramic

 CHEVROLET ,OPEL,  
SAAB, VAUXHALL

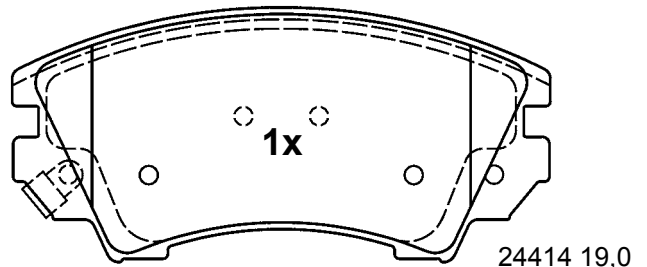
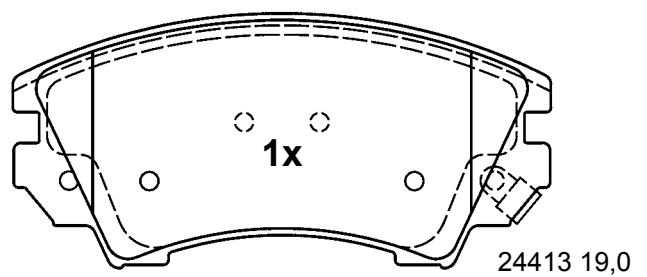
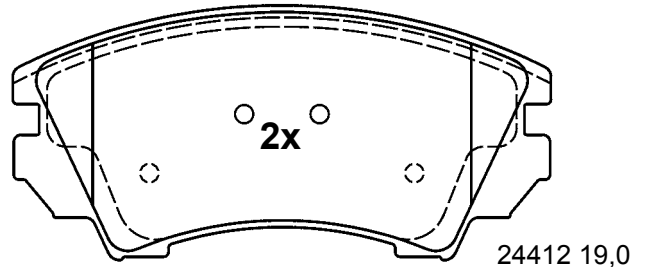

**141,9 x 66,7 x 19,0**

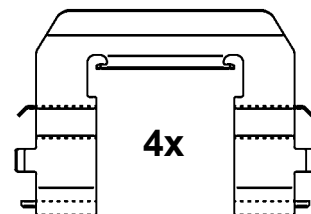
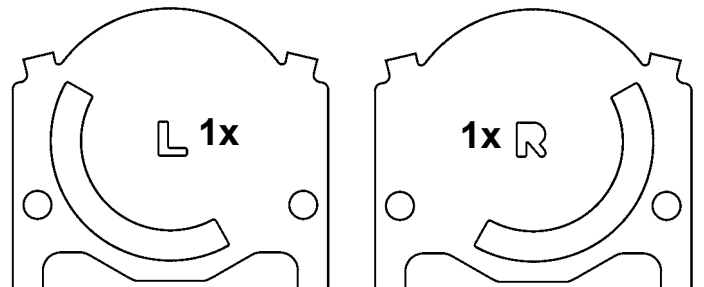

# Abbildungen Scheibenbremsbeläge

Illustrations disc brake pads - Illustrazioni pastiglie freno -

Illustrations plaquettes de frein - Ilustraciones pastillas de freno

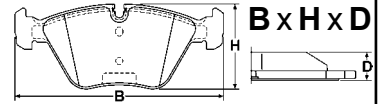

Maßstab - scale - scala - échelle - escala 1:2

**13.0470-5634.2 LD5634** ATE Ceramic



LEXUS



ADV

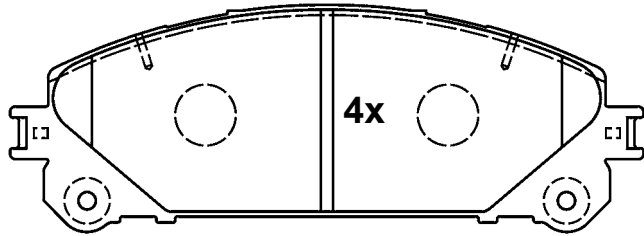

24452 17,5

167,0 x 59,4 x 17,5



4x

**13.0470-5786.2 LD5786** ATE Ceramic



HYUNDAI, KIA



AKE

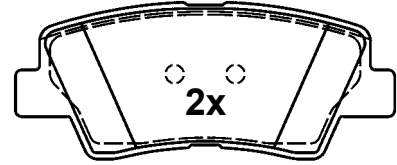

24934 15,5

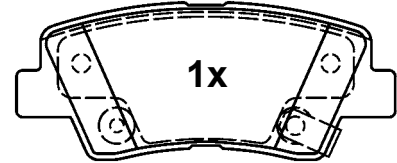

24935 15,5

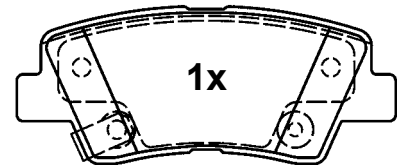

24936 15,5

99,8 x 41,1 x 16,6

**13.0470-5635.2 LD5635** ATE Ceramic



LEXUS, TOYOTA



AKE

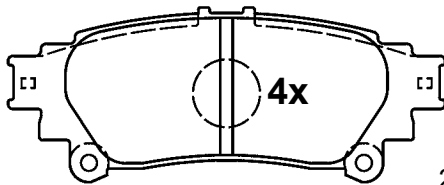

24918 15,0

115,2 x 45,7 x 15,0

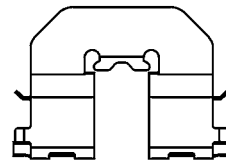

4x

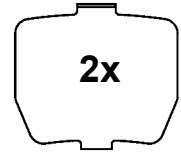

2x

**13.0470-7053.2 LD7053** ATE Ceramic



VOLVO



ATE

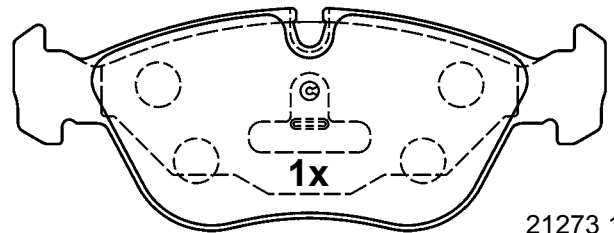

21273 19,5

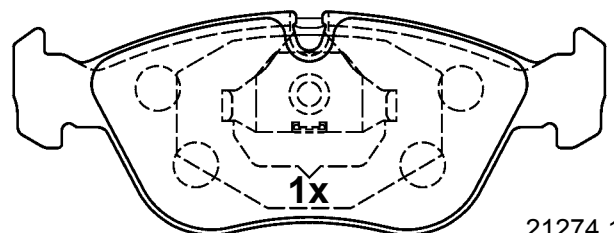

21274 19,5

156,3 x 58,5 x 19,5

**13.0470-5752.2 LD5752** ATE Ceramic



NISSAN



ATE

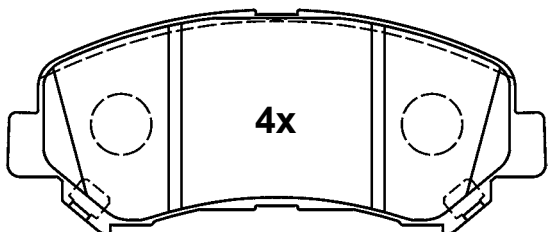

24632 17,0

142,0 x 59,0 x 17,0









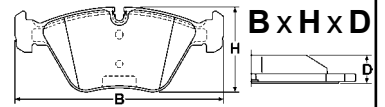

# Abbildungen Scheibenbremsbeläge

Illustrations disc brake pads - Illustrazioni pastiglie freno -

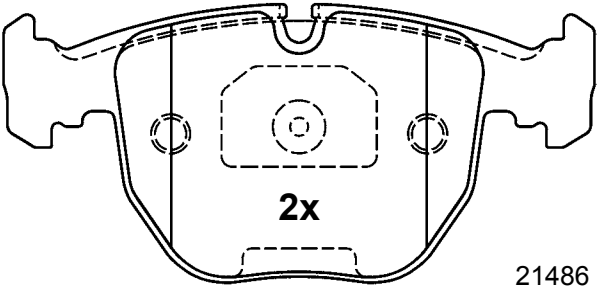
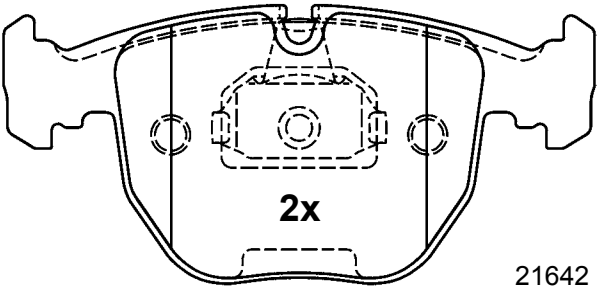
Illustrations plaquettes de frein - Ilustraciones pastillas de freno

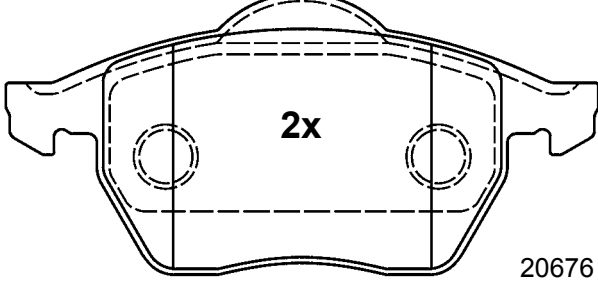
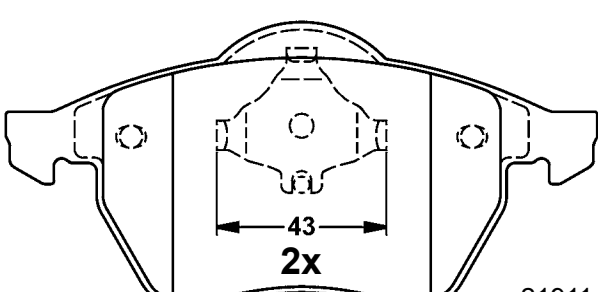

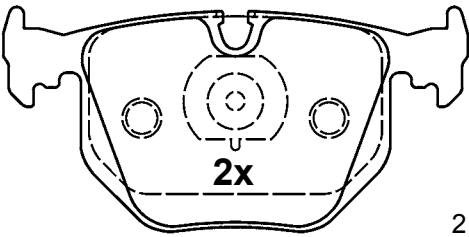
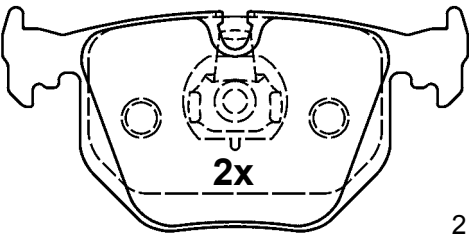
Maßstab - scale - scala - échelle - escala 1:2

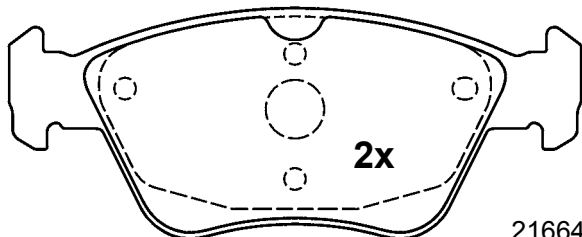
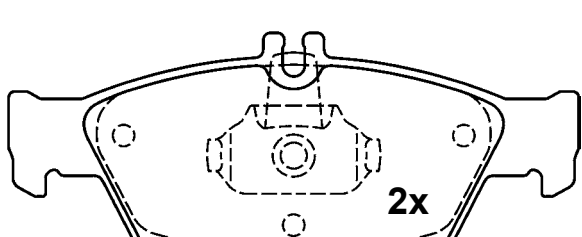
| <b>13.0470-7078.2 LD7078</b> ATE Ceramic   | <b>13.0470-7081.2 LD7081</b> ATE Ceramic  |
|--|---|
| <p> <b>BMW</b> </p>  <p style="text-align: center;"><b>2x</b></p> <p style="text-align: right;">21486 19,3</p>  <p style="text-align: center;"><b>2x</b></p> <p style="text-align: right;">21642 19,3</p> <p style="text-align: center;"><b>156,3 x 73,2 x 19,3</b></p>                    | <p> <b>AUDI, SEAT, SKODA, VOLKSWAGEN</b> </p>  <p style="text-align: center;"><b>2x</b></p> <p style="text-align: right;">20676 19,8</p> <p style="text-align: center;"><b>156,3 x 74,0 x 19,8</b></p>  <p style="text-align: center;"><b>43</b></p> <p style="text-align: center;"><b>2x</b></p> <p style="text-align: right;">21911 20,3</p> <p style="text-align: center;"><b>156,3 x 74,0 x 20,3</b></p> |
| <b>13.0470-7079.2 LD7079</b> ATE Ceramic   | <b>13.0470-7086.2 LD7086</b> ATE Ceramic  |
| <p> <b>BMW, LAND ROVER</b> </p>  <p style="text-align: center;"><b>2x</b></p> <p style="text-align: right;">21282 17,3</p>  <p style="text-align: center;"><b>2x</b></p> <p style="text-align: right;">21487 17,3</p> <p style="text-align: center;"><b>123,0 x 59,2 x 17,3</b></p> | <p> <b>MERCEDES BENZ</b> </p>  <p style="text-align: center;"><b>2x</b></p> <p style="text-align: right;">21664 19,8</p> <p style="text-align: center;"><b>151,3 x 59,8 x 19,8</b></p>  <p style="text-align: center;"><b>2x</b></p> <p style="text-align: right;">21795 19,8</p> <p style="text-align: center;"><b>150,1 x 66,2 x 19,8</b></p>   |



# Abbildungen Scheibenbremsbeläge

Illustrations disc brake pads - Illustrazioni pastiglie freno -

Illustrations plaquettes de frein - Ilustraciones pastillas de freno

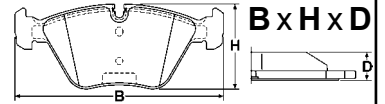

Maßstab - scale - scala - échelle - escala 1:2

**13.0470-7087.2 LD7087** ATE Ceramic



CHRYSLER, MERCEDES BENZ



ATE

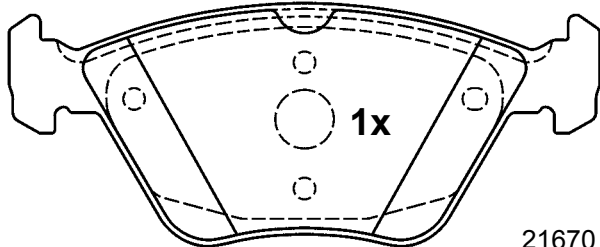

1x

21670 19,4

156,3 x 63,5 x 19,4

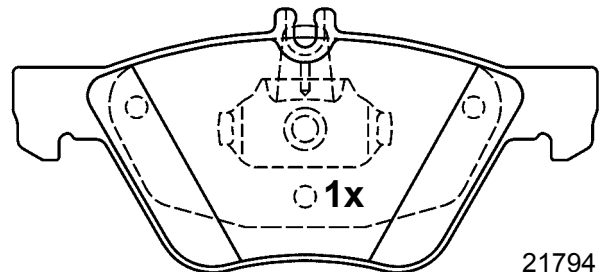

1x

21794 19,4

155,1 x 69,3 x 19,4

**13.0470-7089.2 LD7089** ATE Ceramic



BMW



ATE

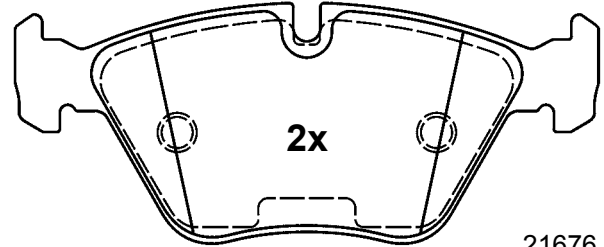

2x

21676 20,3

154,6 x 63,5 x 20,3

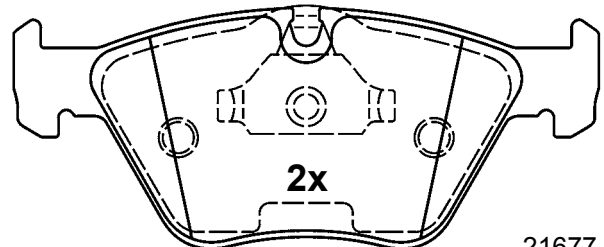

2x

21677 20,3

155,1 x 63,5 x 20,3

**13.0470-7090.2 LD7090** ATE Ceramic



BMW



ATE

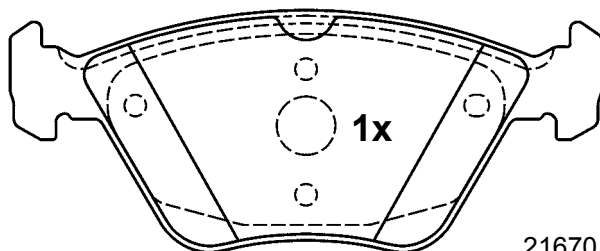

1x

21670 19,4

156,3 x 63,5 x 19,4

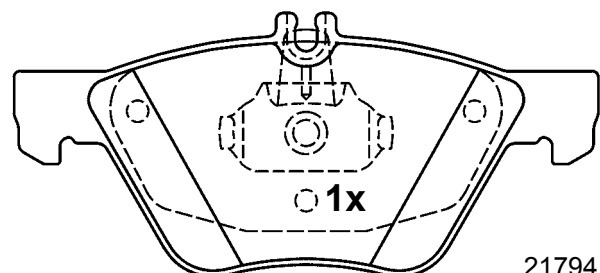

1x

21794 19,4

155,1 x 69,3 x 19,4

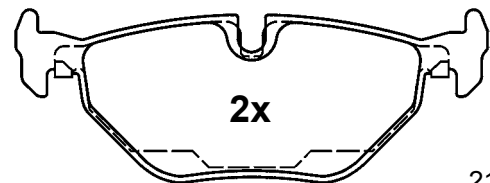

2x

21891 17,3

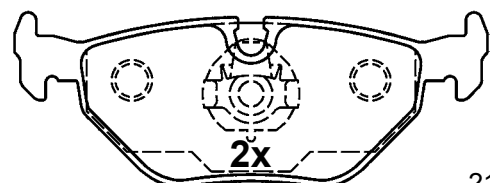

2x

21691 17,3

123,0 x 44,9 x 17,3

# Abbildungen Scheibenbremsbeläge

Illustrations disc brake pads - Illustrazioni pastiglie freno -

Illustrations plaquettes de frein - Ilustraciones pastillas de freno



Maßstab - scale - scala - échelle - escala 1:2

**13.0470-7100.2 LD7100** ATE Ceramic

SEAT, SKODA, VOLKSWAGEN

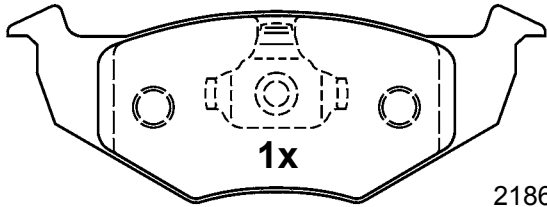

21866 17,2

**141,8 x 51,2 x 17,2**

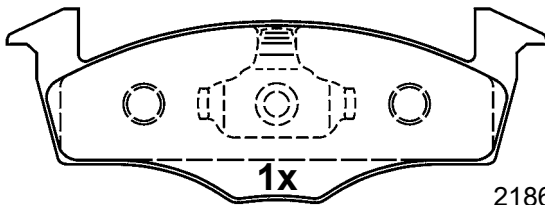

21868 17,2

**141,8 x 50,6 x 17,2**

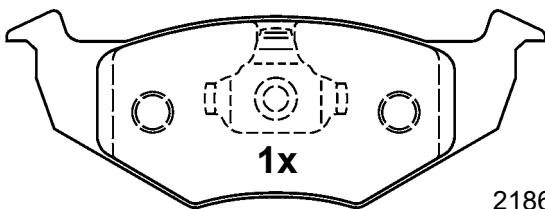

21866 17,2

**141,8 x 51,2 x 17,2**

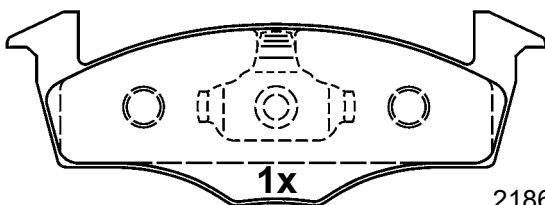

21868 17,2

**141,8 x 50,6 x 17,2**

**13.0470-7110.2 LD7110** ATE Ceramic

AUDI, SEAT, SKODA, VOLKSWAGEN

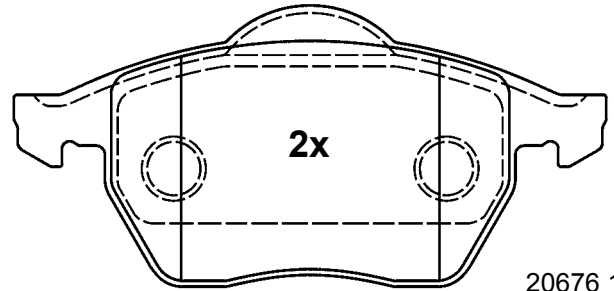

20676 19,8

**156,3 x 74,0 x 19,8**

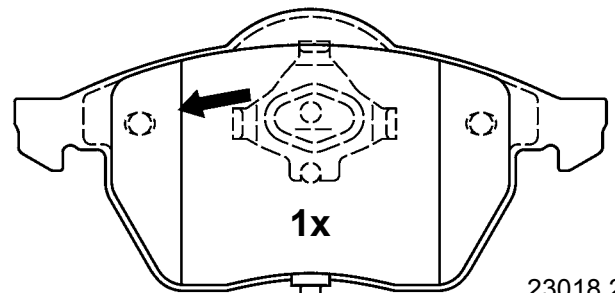

23018 20,3

200mm

**156,3 x 74,0 x 20,3**

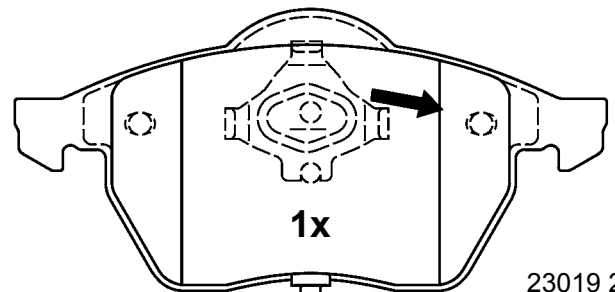

23019 20,3

200mm

**156,3 x 74,0 x 20,3**

# Abbildungen Scheibenbremsbeläge

Illustrations disc brake pads - Illustrazioni pastiglie freno -

Illustrations plaquettes de frein - Ilustraciones pastillas de freno



Maßstab - scale - scala - échelle - escala 1:2

**13.0470-7111.2 LD7111** ATE Ceramic



AUDI, SEAT, SKODA,  
VOLKSWAGEN



VW

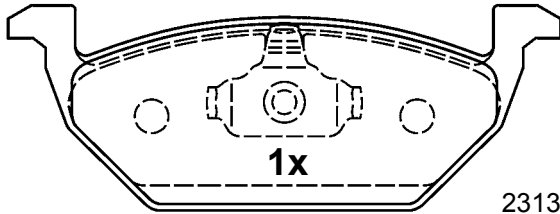

1x

23130 19,6

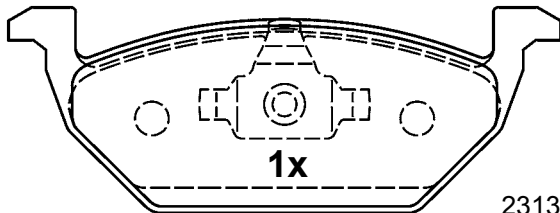

1x

23131 19,6

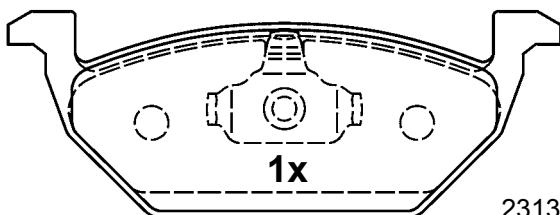

1x

23130 19,6

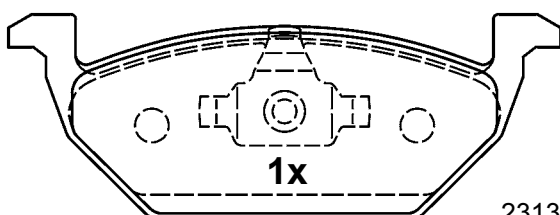

1x

23131 19,6

**146,0 x 54,7 x 19,6**

**13.0470-7115.2 LD7115** ATE Ceramic



OPEL, VAUXHALL



ATE

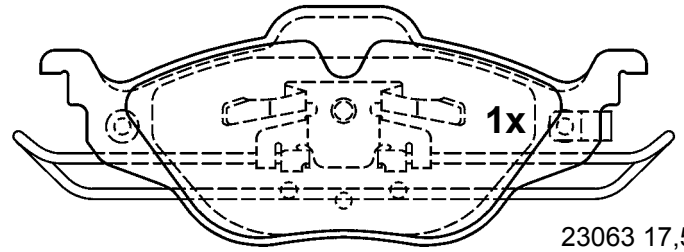

1x

23063 17,5

**160,0 x 63,0 x 17,5**

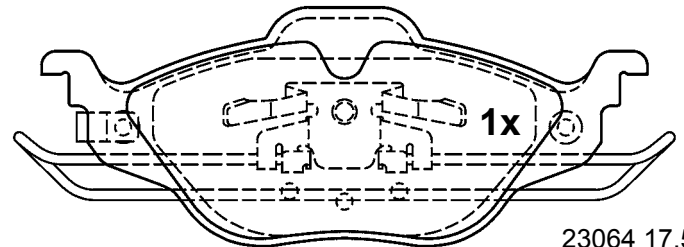

1x

23064 17,5

**160,0 x 63,0 x 17,5**

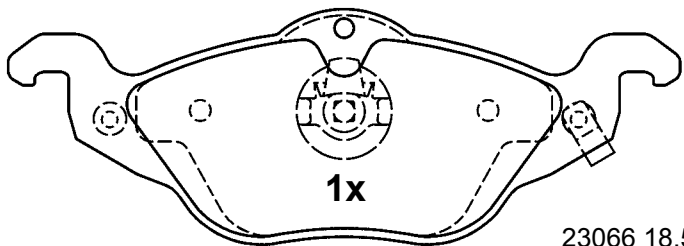

1x

23066 18,5

**177,6 x 62,0 x 18,5**

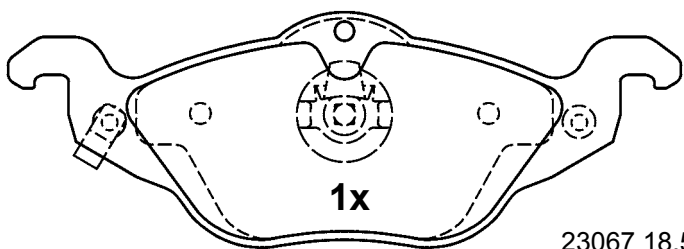

1x

23067 18,5

**177,6 x 62,0 x 18,5**

# Abbildungen Scheibenbremsbeläge

Illustrations disc brake pads - Illustrazioni pastiglie freno -

Illustrations plaquettes de frein - Ilustraciones pastillas de freno

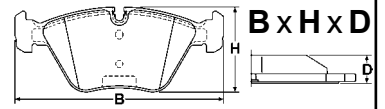

Maßstab - scale - scala - échelle - escala 1:2

**13.0470-7116.2 LD7116** ATE Ceramic



OPEL, VAUXHALL



ATE

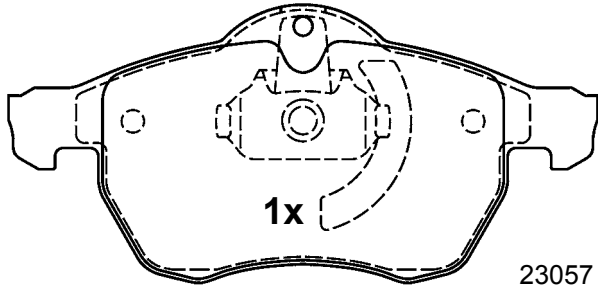

1x

23057 20,2

155,1 x 71,4 x 20,2

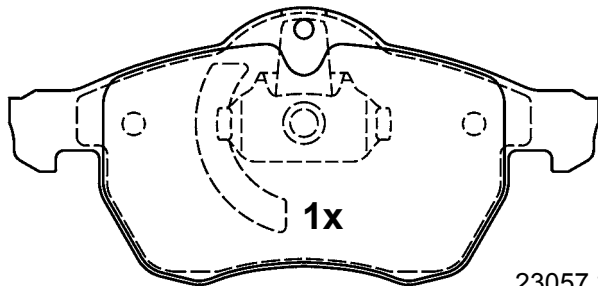

1x

23057 20,2

155,1 x 71,4 x 20,2

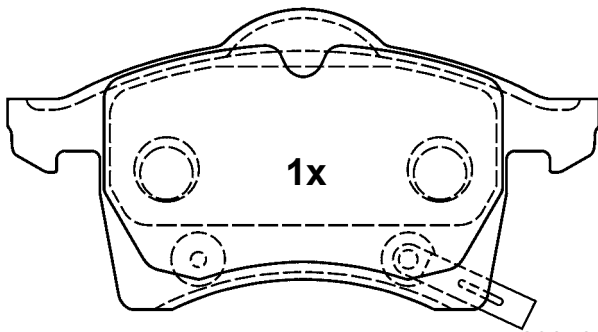

1x

23058 19,6

156,3 x 78,5 x 19,6

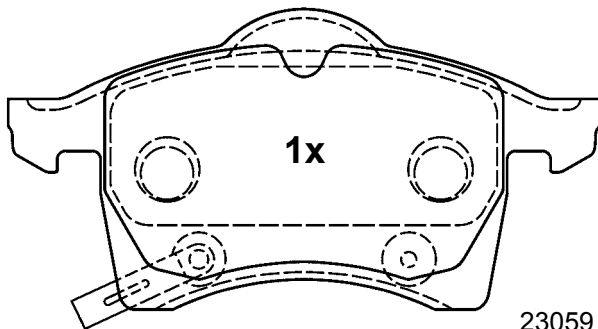

1x

23059 19,6

156,3 x 78,5 x 19,6

**13.0470-7117.2 LD7117** ATE Ceramic



AUDI, SEAT, SKODA,  
VOLKSWAGEN



VW

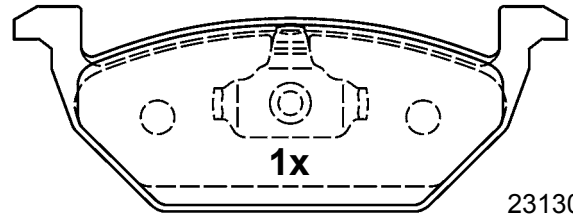

1x

23130 19,6

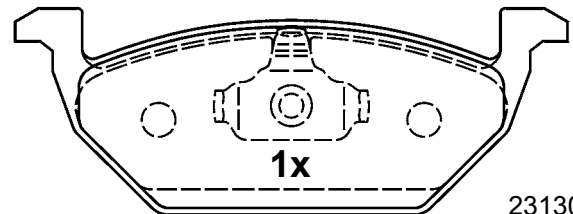

1x

23130 19,6

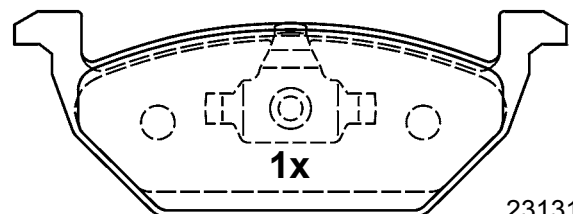

1x

23131 19,6

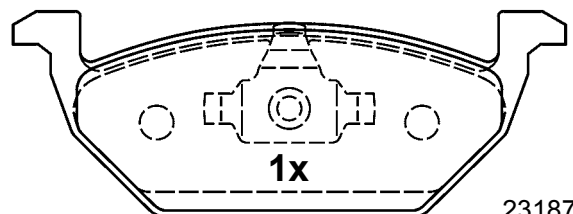

1x

23187 19,6

145mm

146,0 x 54,7 x 19,6

# Abbildungen Scheibenbremsbeläge

Illustrations disc brake pads - Illustrazioni pastiglie freno -

Illustrations plaquettes de frein - Ilustraciones pastillas de freno

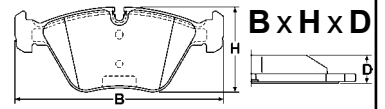

Maßstab - scale - scala - échelle - escala 1:2

## 13.0470-7122.2 LD7122 ATE Ceramic



AUDI, SEAT, SKODA, VW



ATE

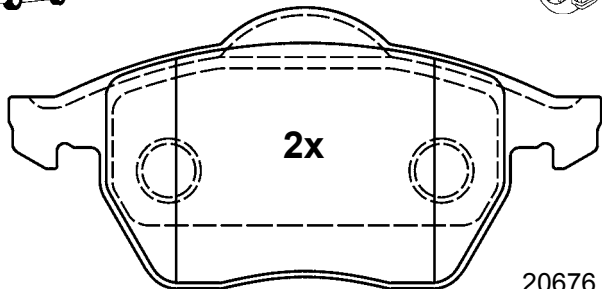

2x

156,3 x 74,0 x 19,8

20676 19,8

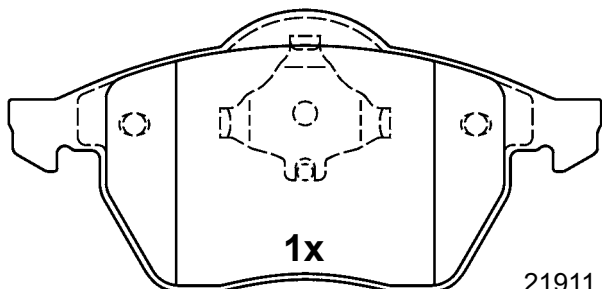

1x

156,3 x 74,0 x 20,3

21911 20,3

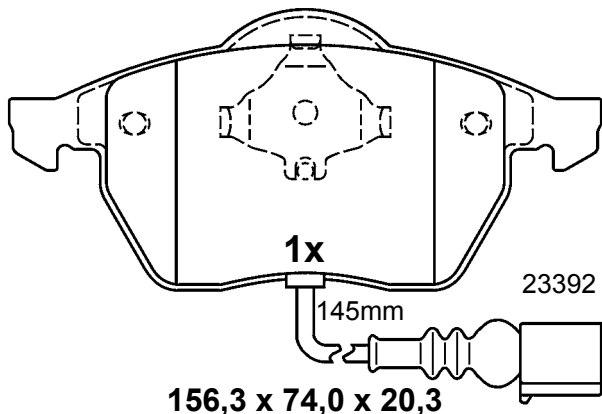

1x

156,3 x 74,0 x 20,3

23392 20,3

145mm

## 13.0470-7137.2 LD7137 ATE Ceramic



NISSAN, RENAULT



ATE

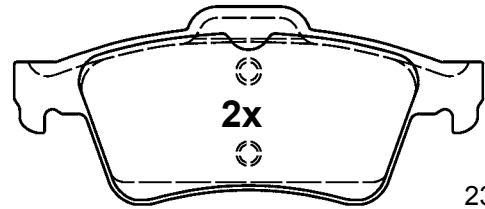

2x

23482 15,8

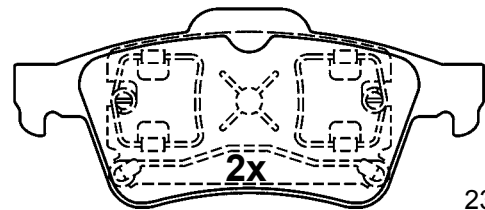

2x

123,0 x 51,9 x 15,8

23483 15,8

## 13.0470-7139.2 LD7139 ATE Ceramic



ALFA ROMEO, LANCIA



ATE

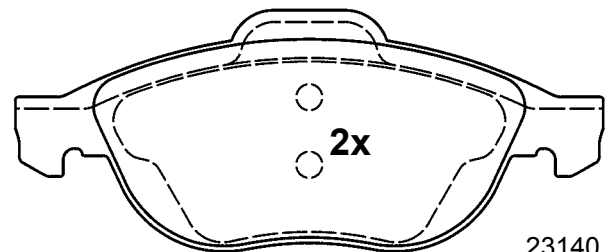

2x

156,3 x 63,8 x 19,4

23140 19,4

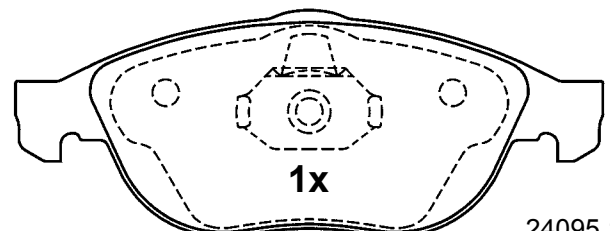

1x

155,1 x 59,3 x 19,4

24095 19,4



198mm

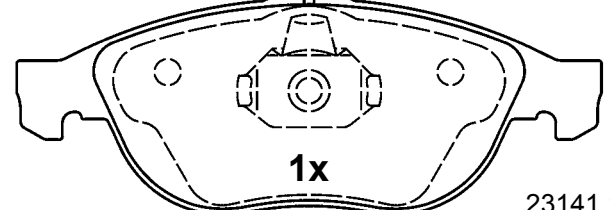

1x

155,1 x 59,3 x 19,4

23141 19,4

## 13.0470-7135.2 LD7135 ATE Ceramic



VOLVO



ATE

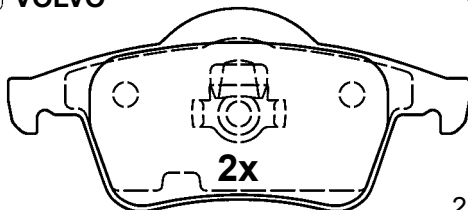

2x

122,4 x 53,7 x 17,5

23076 17,5

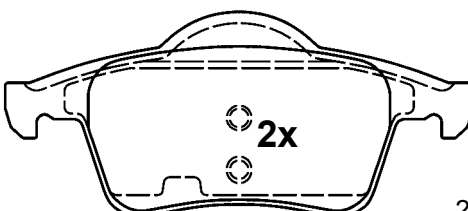

2x

123,6 x 53,7 x 17,5

23077 17,5



# Abbildungen Scheibenbremsbeläge

Illustrations disc brake pads - Illustrazioni pastiglie freno -

Illustrations plaquettes de frein - Ilustraciones pastillas de freno

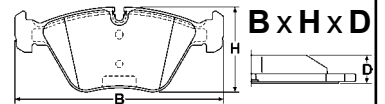

Maßstab - scale - scala - échelle - escala 1:2

**13.0470-7140.2 LD7140** ATE Ceramic



ALFA ROMEO, FIAT, LANCIA



ATE

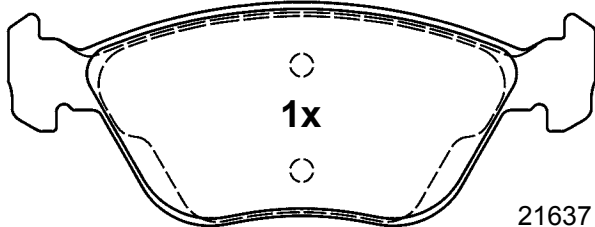

1x

21637 19,3

156,3 x 59,1 x 19,3

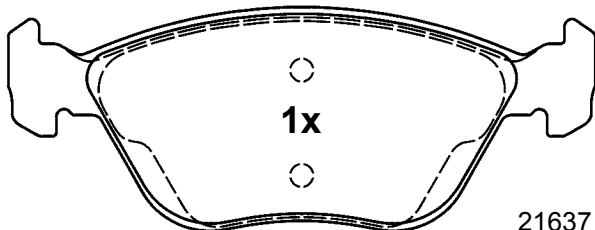

1x

21637 19,3

156,3 x 59,1 x 19,3

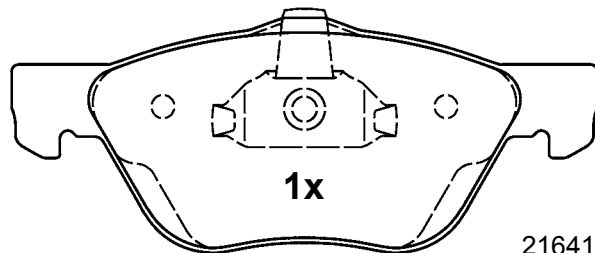

1x

21641 19,3

155,1 x 61,8 x 19,3

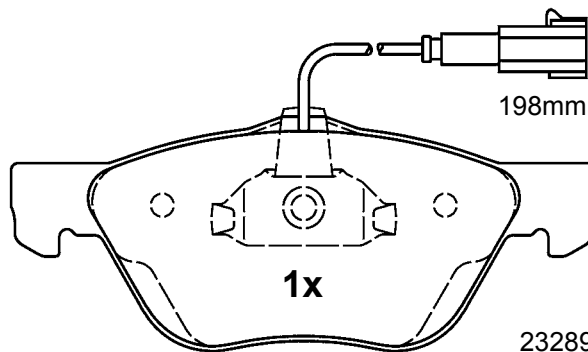

198mm

1x

23289 19,3

155,1 x 61,8 x 19,3

**13.0470-7145.2 LD7145** ATE Ceramic



VOLVO



ATE

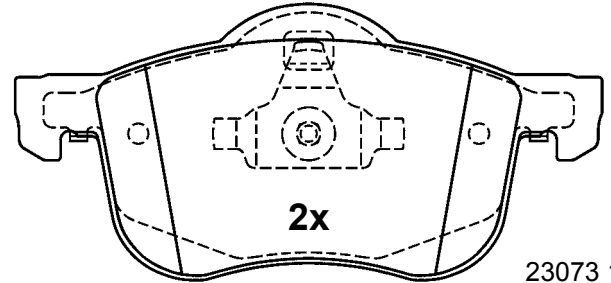

2x

23073 18,8

155,1 x 72,5 x 18,8

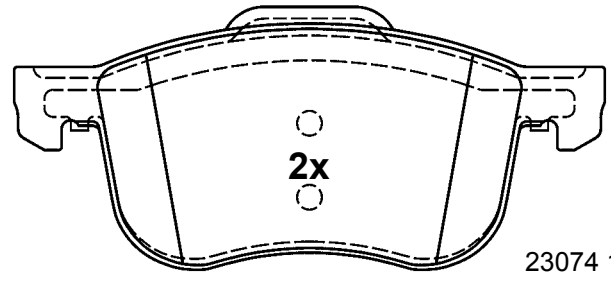

2x

23074 18,8

156,3 x 69,1 x 18,8

**13.0470-7155.2 LD7155** ATE Ceramic



BMW, MG



ATE

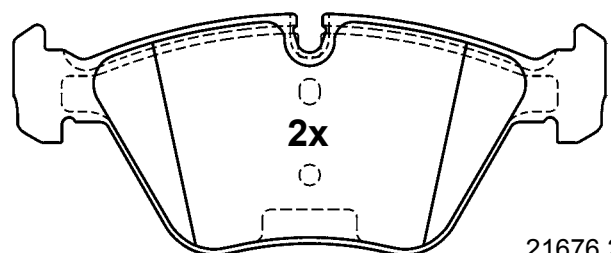

2x

21676 20,3

156,3 x 63,5 x 20,3

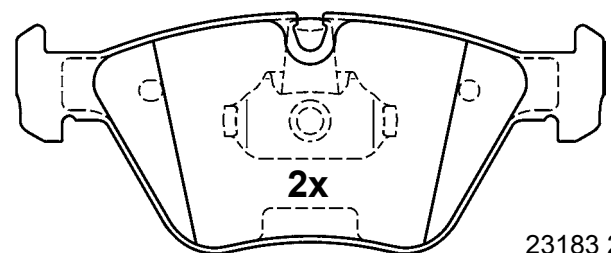

2x

23183 20,3

155,1 x 63,5 x 20,3

# Abbildungen Scheibenbremsbeläge

Illustrations disc brake pads - Illustrazioni pastiglie freno -

Illustrations plaquettes de frein - Ilustraciones pastillas de freno

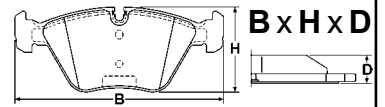

Maßstab - scale - scala - échelle - escala 1:2

**13.0470-7157.2 LD7157** ATE Ceramic

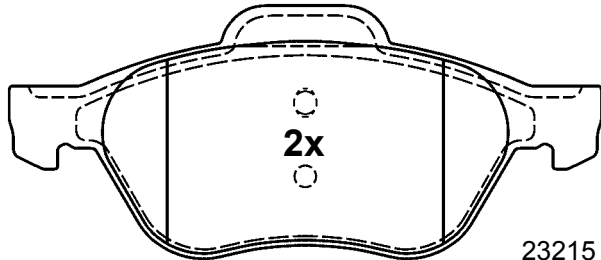

**156,3 x 66,8 x 18,3**

23215 18,3

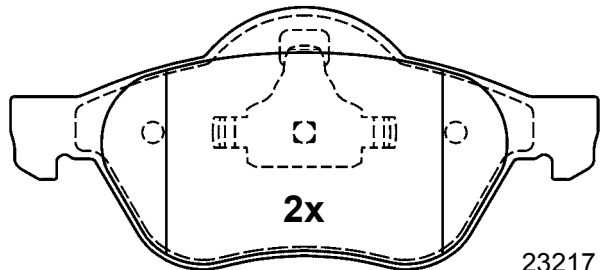

**155,1 x 68,9 x 18,3**

23217 18,3

**13.0470-7159.2 LD7159** ATE Ceramic

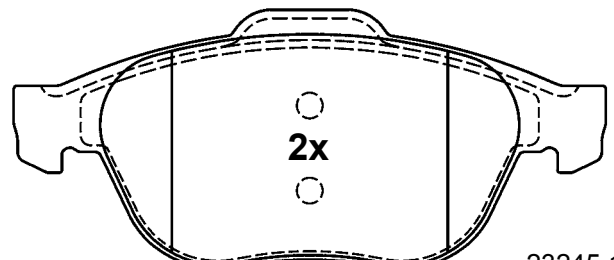

**156,3 x 68,3 x 18,3**

23245 18,3

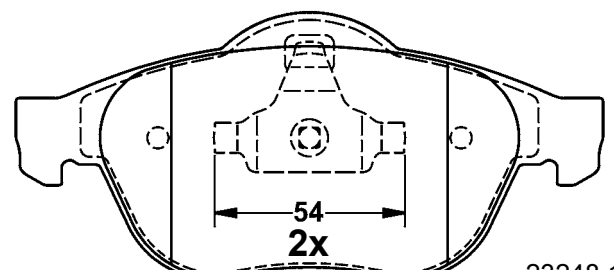

**155,1 x 70,8 x 18,3**

23248 18,3

**13.0470-7158.2 LD7158** ATE Ceramic

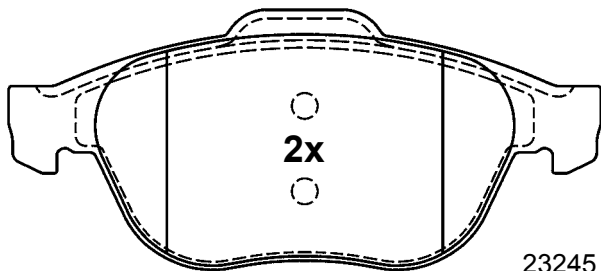

**156,3 x 68,3 x 18,3**

23245 18,3

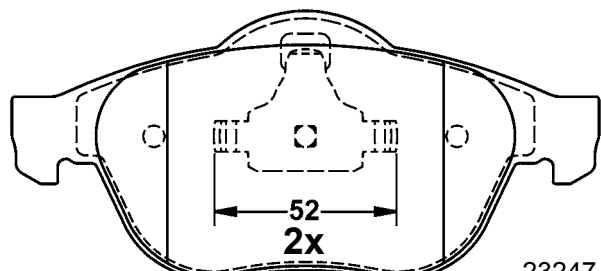

**155,1 x 70,8 x 18,3**

23247 18,3

**13.0470-7161.2 LD7161** ATE Ceramic

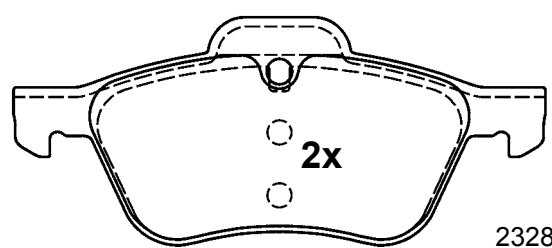

**140,1 x 59,8 x 18,3**

23281 18,3

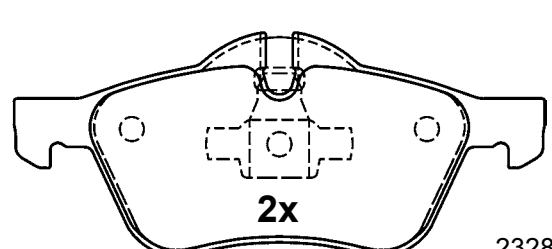

**140,1 x 58,7 x 18,3**

23282 18,3

# Abbildungen Scheibenbremsbeläge

Illustrations disc brake pads - Illustrazioni pastiglie freno -

Illustrations plaquettes de frein - Ilustraciones pastillas de freno

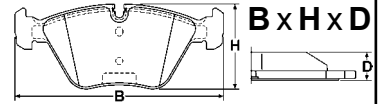

Maßstab - scale - scala - échelle - escala 1:2

**13.0470-7162.2 LD7162** ATE Ceramic



MINI

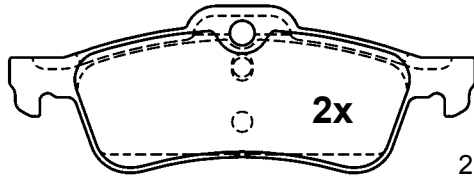

23716 15,8

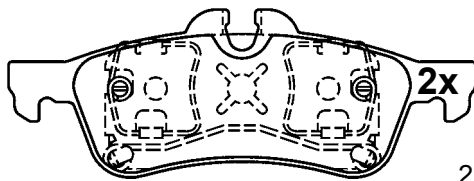

23717 15,8

123,0 x 43,8 x 15,8

**13.0470-7167.2 LD7167** ATE Ceramic



BMW

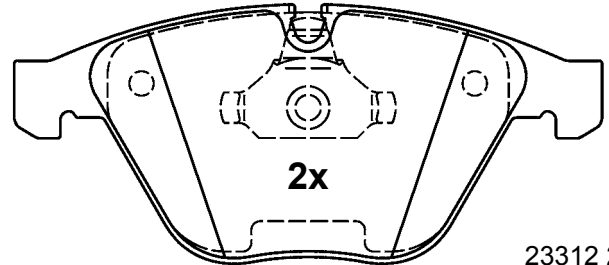

23312 20,3

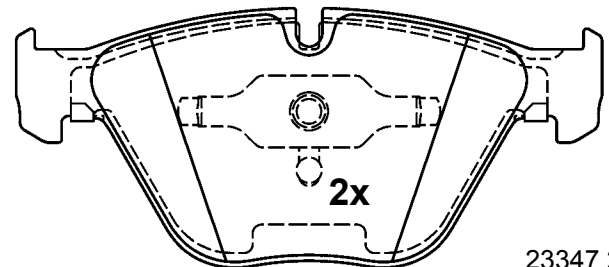

23347 20,3

155,1 x 68,3 x 20,3

**13.0470-7166.2 LD7166** ATE Ceramic



AUDI

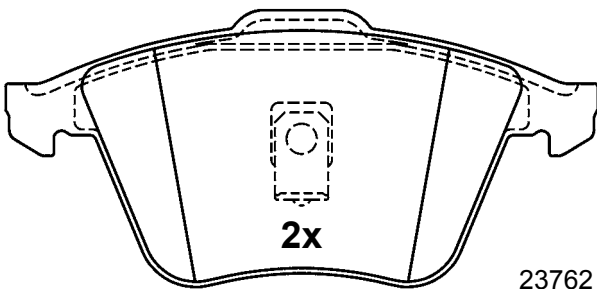

23762 20,4

156,3 x 72,9 x 20,4

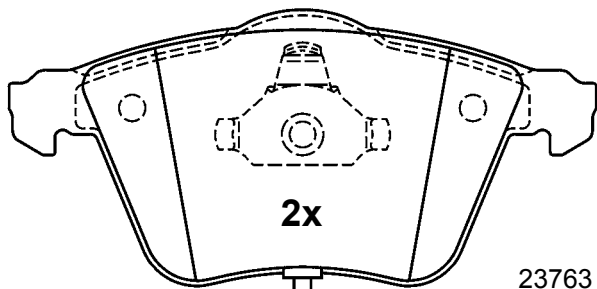

23763 20,4

200mm

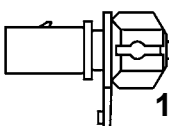

155,1 x 72,9 x 20,4

**13.0470-7168.2 LD7168** ATE Ceramic



BMW

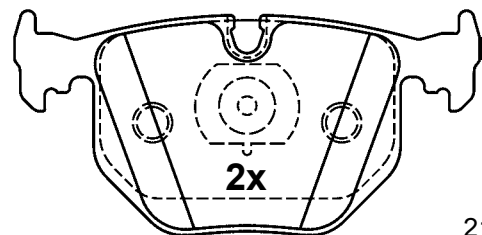

21282 17,3

123,0 x 59,2 x 17,3

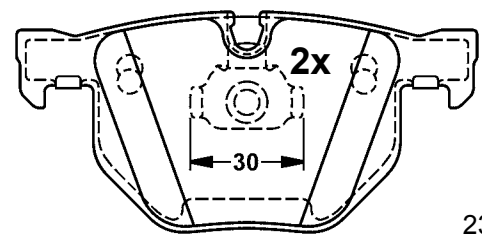

23447 17,3

121,8 x 57,8 x 17,3

# Abbildungen Scheibenbremsbeläge

Illustrations disc brake pads - Illustrazioni pastiglie freno -

Illustrations plaquettes de frein - Ilustraciones pastillas de freno



Maßstab - scale - scala - échelle - escala 1:2

**13.0470-7169.2 LD7169** ATE Ceramic

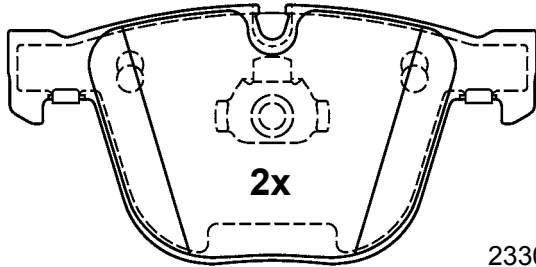

23309 17,3

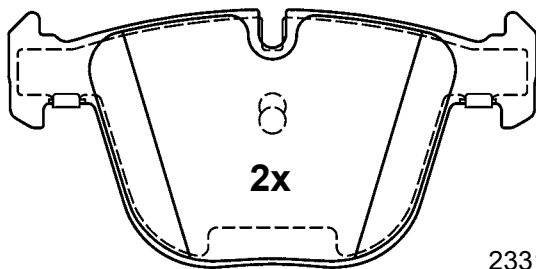

23310 17,3

139,5 x 67,8 x 17,3

**13.0470-7172.2 LD7172** ATE Ceramic

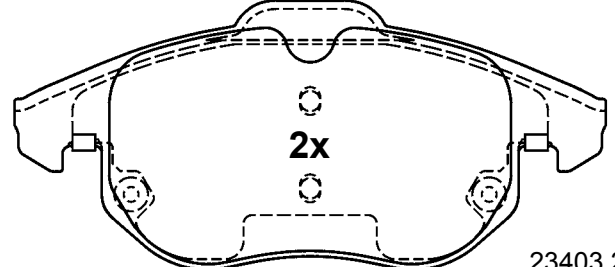

23403 20,1

156,3 x 70,7 x 20,1

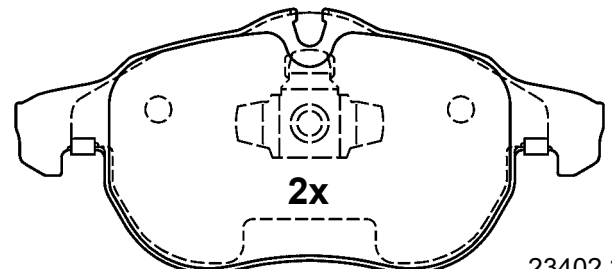

23402 20,1

155,1 x 69,6 x 20,1

**13.0470-7171.2 LD7171** ATE Ceramic



MERCEDES BENZ

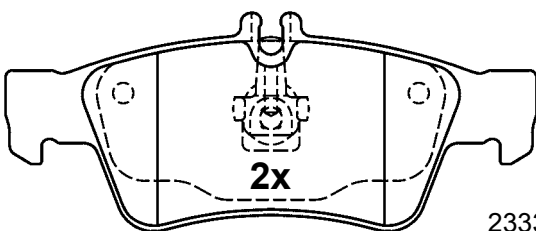

23334 16,7

140,1 x 57,5 x 16,7

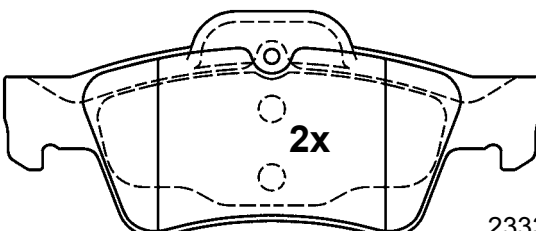

23335 16,7

141,3 x 59,4 x 16,7

**13.0470-7174.2 LD7174** ATE Ceramic



BMW

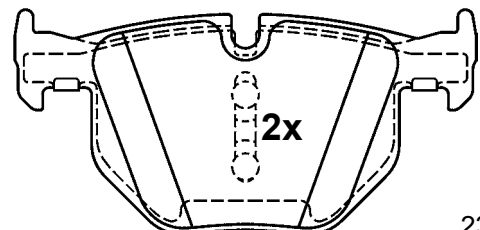

23732 17,3

121,8 x 59,2 x 17,3

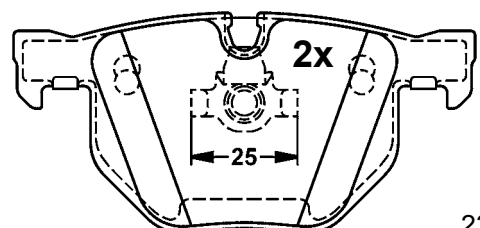

23737 17,3

121,8 x 57,8 x 17,3

# Abbildungen Scheibenbremsbeläge

Illustrations disc brake pads - Illustrazioni pastiglie freno -

Illustrations plaquettes de frein - Ilustraciones pastillas de freno

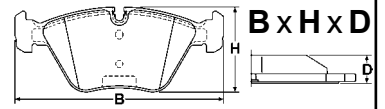

Maßstab - scale - scala - échelle - escala 1:2

**13.0470-7176.2 LD7176** ATE Ceramic

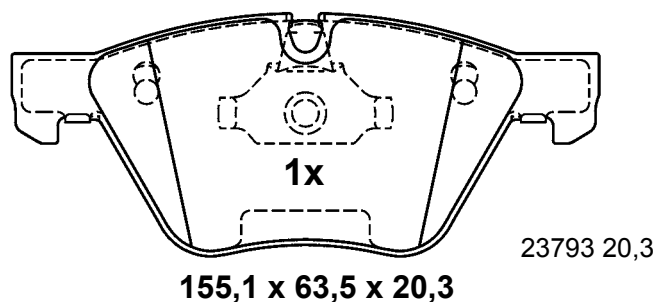
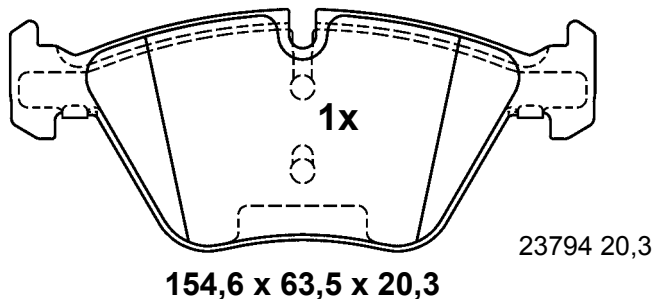
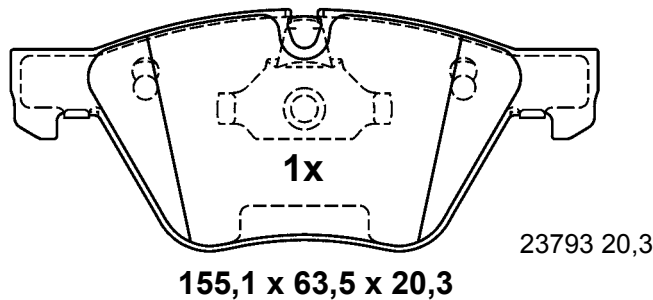
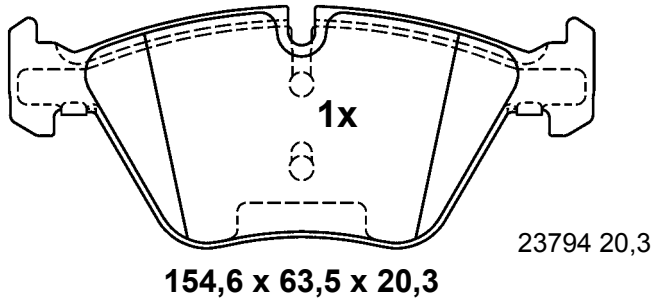

**13.0470-7179.2 LD7179** ATE Ceramic

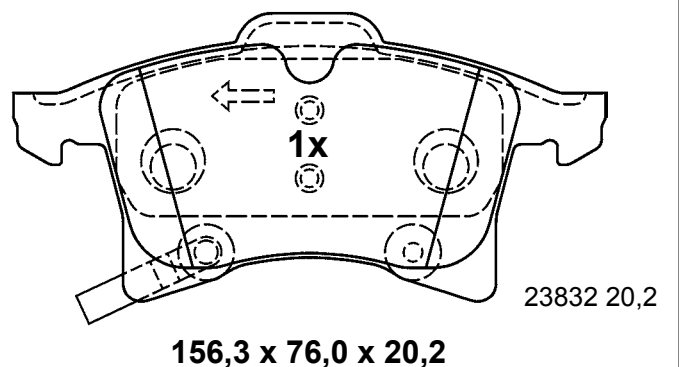
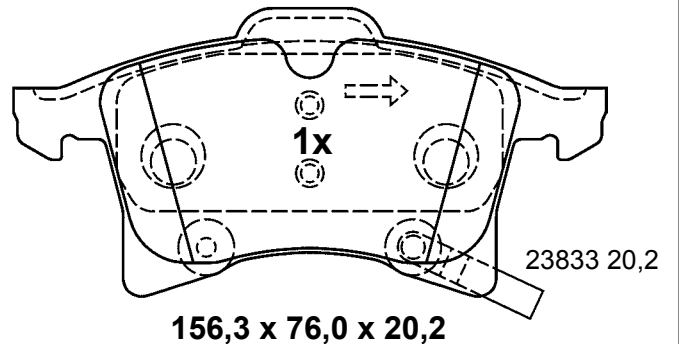
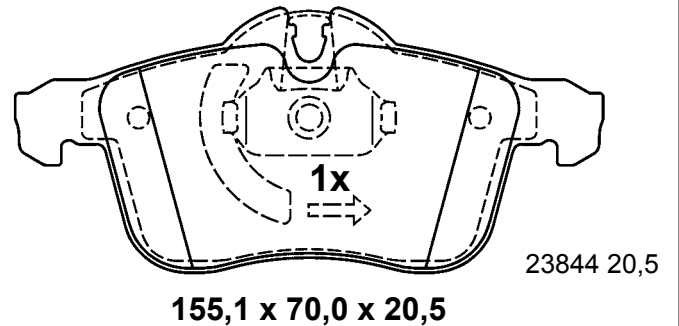
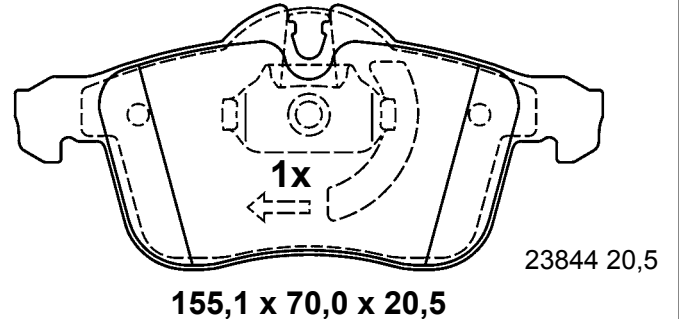

# Abbildungen Scheibenbremsbeläge

Illustrations disc brake pads - Illustrazioni pastiglie freno -

Illustrations plaquettes de frein - Ilustraciones pastillas de freno

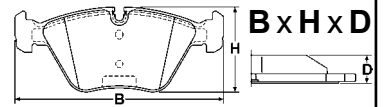

Maßstab - scale - scala - échelle - escala 1:2

**13.0470-7181.2 LD7181** ATE Ceramic

ALFA ROMEO

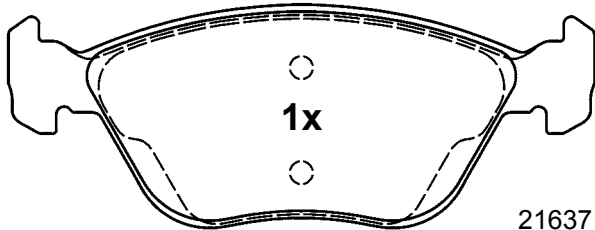

1x

21637 19,3

156,3 x 59,1 x 19,3

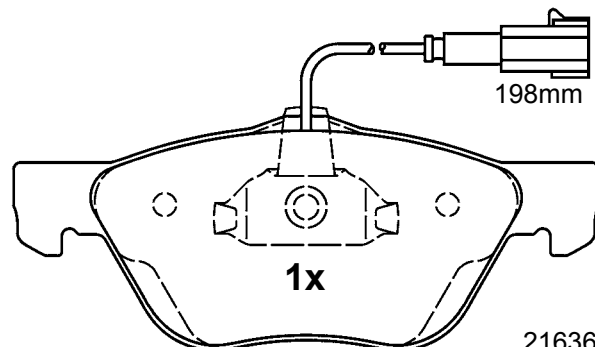

198mm

1x

21636 19,3

155,1 x 61,8 x 19,3

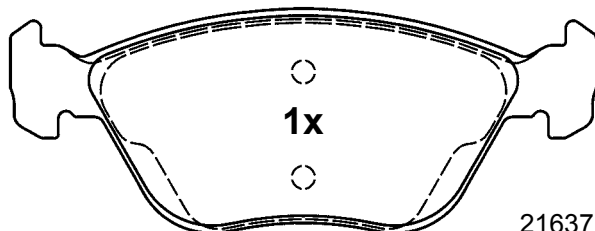

1x

21637 19,3

156,3 x 59,1 x 19,3

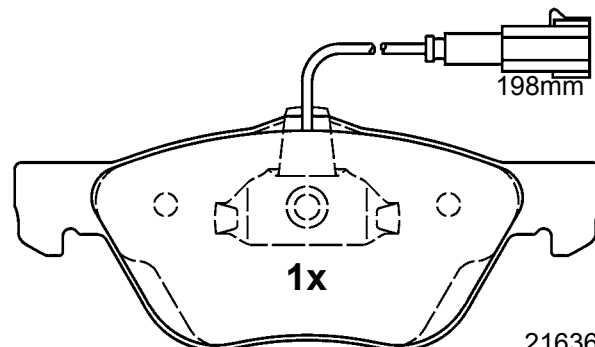

198mm

1x

21636 19,3

155,1 x 61,8 x 19,3

**13.0470-7184.2 LD7184** ATE Ceramic

AUDI, SEAT, SKODA  
VOLKSWAGEN

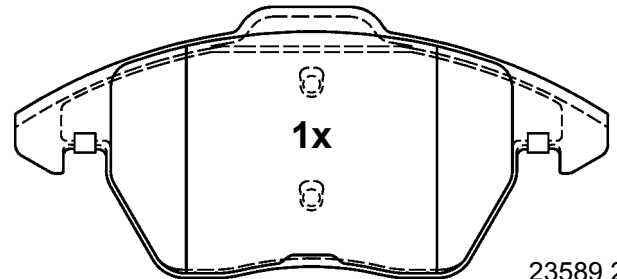

1x

23589 20,6

156,3 x 71,3 x 20,6

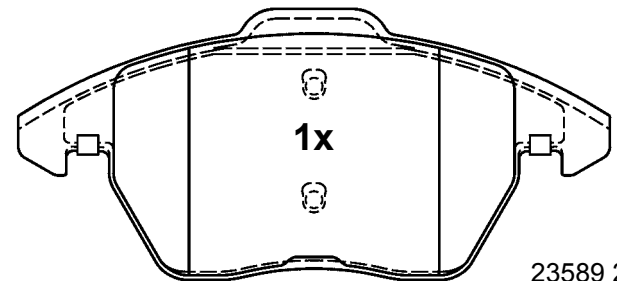

1x

23589 20,6

156,3 x 71,3 x 20,6

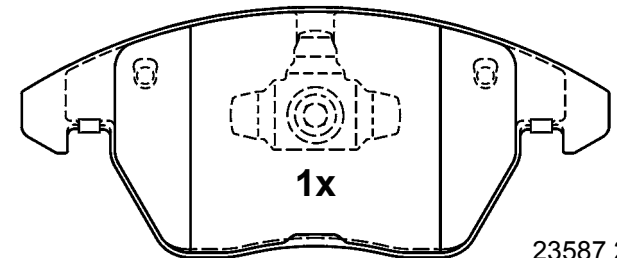

1x

23587 20,6

155,1 x 66,0 x 20,6

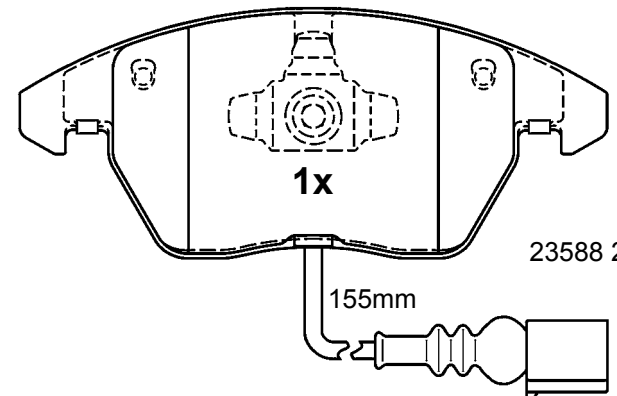

1x

23588 20,6

155mm

155,1 x 66,0 x 20,6



# Abbildungen Scheibenbremsbeläge

Illustrations disc brake pads - Illustrazioni pastiglie freno -

Illustrations plaquettes de frein - Ilustraciones pastillas de freno

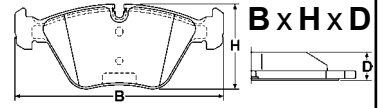

Maßstab - scale - scala - échelle - escala 1:2

**13.0470-7187.2 LD7187** ATE Ceramic

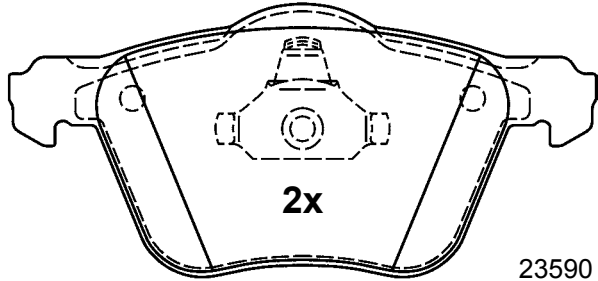

2x

23590 19,5

155,1 x 72,0 x 19,5

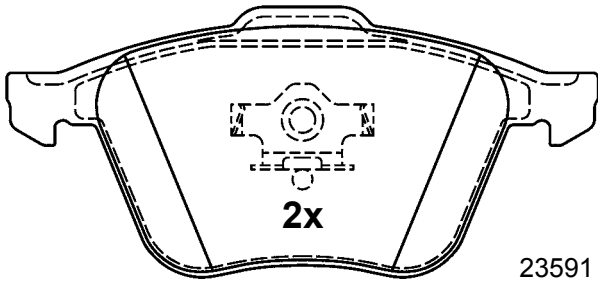

2x

23591 18,0

156,3 x 71,0 x 18,0

**13.0470-7190.2 LD7190** ATE Ceramic

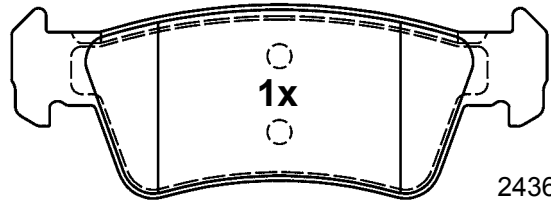

1x

24367 19,1

141,3 x 50,9 x 19,1

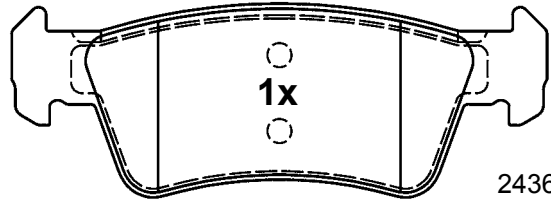

1x

24367 19,1

141,3 x 50,9 x 19,1

**13.0470-7188.2 LD7188** ATE Ceramic

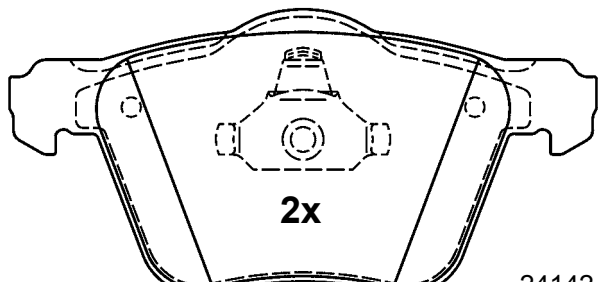

2x

24142 20,6

155,1 x 75,1 x 20,6

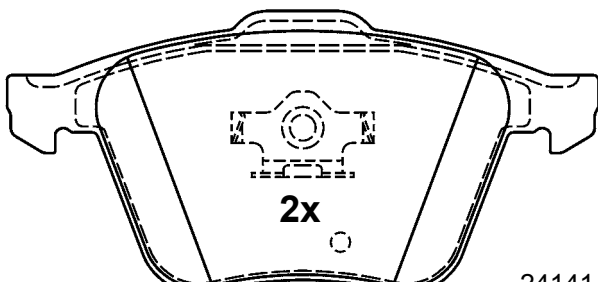

2x

24141 19,1

156,3 x 74,1 x 19,1

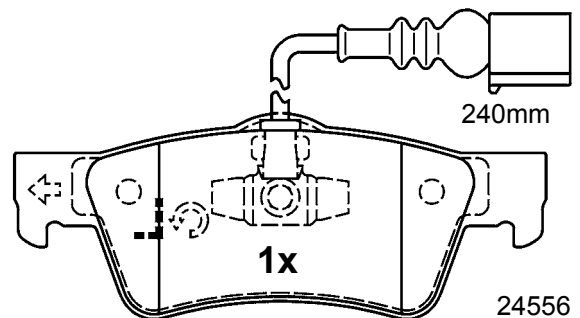

240mm

1x

24556 19,1

140,7 x 53,9 x 19,1

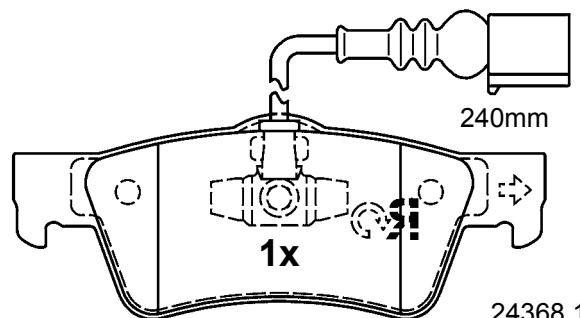

240mm

1x

24368 19,1

140,7 x 53,9 x 19,1



# Abbildungen Scheibenbremsbeläge

Illustrations disc brake pads - Illustrazioni pastiglie freno -

Illustrations plaquettes de frein - Ilustraciones pastillas de freno

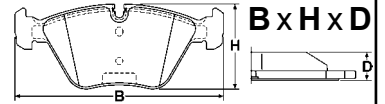

Maßstab - scale - scala - échelle - escala 1:2

**13.0470-7191.2 LD7191** ATE Ceramic



VOLKSWAGEN



ATE

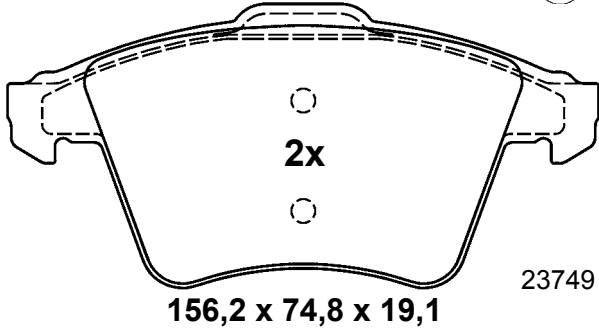

156,2 x 74,8 x 19,1

23749 19,1

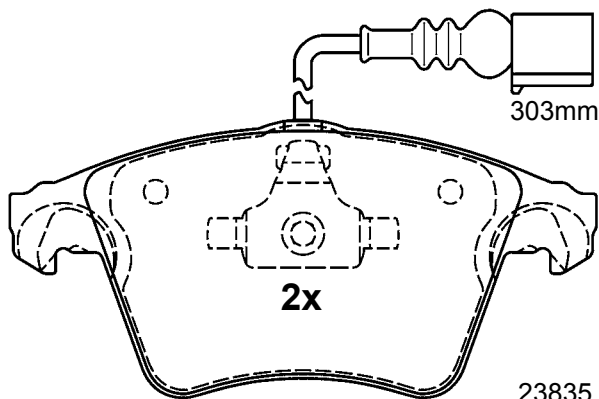

155,0 x 73,3 x 19,6

23835 19,6

**13.0470-7194.2 LD7194** ATE Ceramic



FORD, OPEL, SAAB, VAUXHALL



ATE

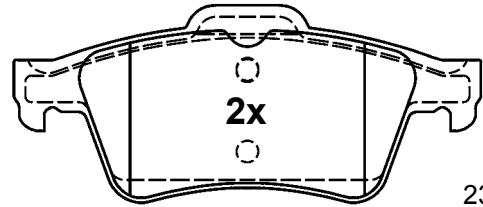

23482 16,6

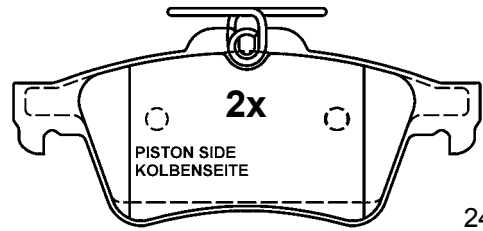

24137 16,6

123,0 x 52,0 x 16,6

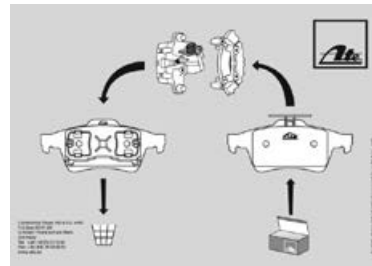

**13.0470-7193.2 LD7193** ATE Ceramic



FORD, MAZDA, VOLVO



ATE

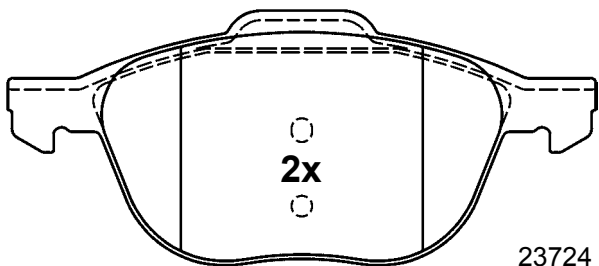

156,3 x 67,0 x 17,5

23724 18,1

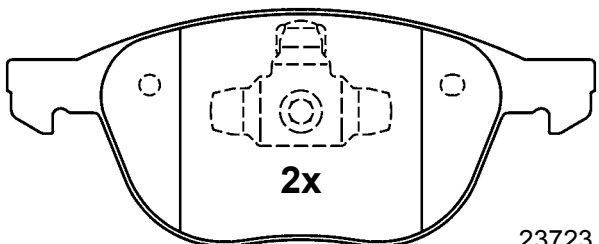

155,1 x 62,4 x 18,1

23723 18,1

**13.0470-7195.2 LD7195** ATE Ceramic



FORD, MAZDA, OPEL, SAAB, VAUXHALL, VOLVO



ATE

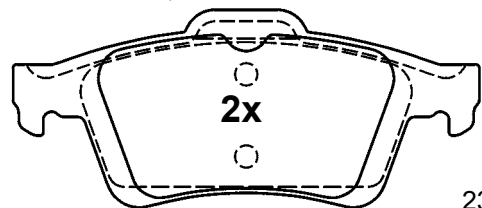

23482 16,6

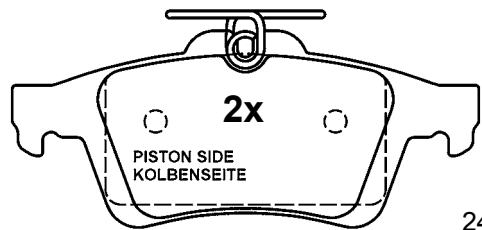

24137 16,6

123,0 x 52,0 x 16,6

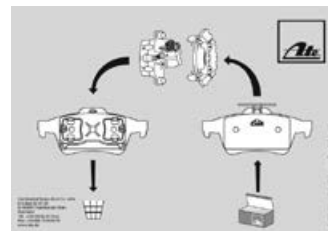

# Abbildungen Scheibenbremsbeläge

Illustrations disc brake pads - Illustrazioni pastiglie freno -

Illustrations plaquettes de frein - Ilustraciones pastillas de freno

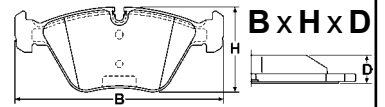

Maßstab - scale - scala - échelle - escala 1:2

**13.0470-7200.2 LD7200** ATE Ceramic



AUDI, SEAT, SKODA,  
VOLKSWAGEN



ATE

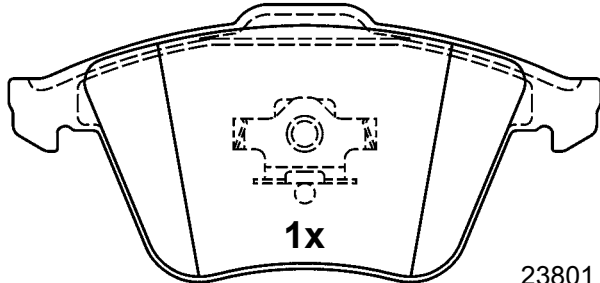

1x

23801 20,3

156,3 x 72,9 x 20,3

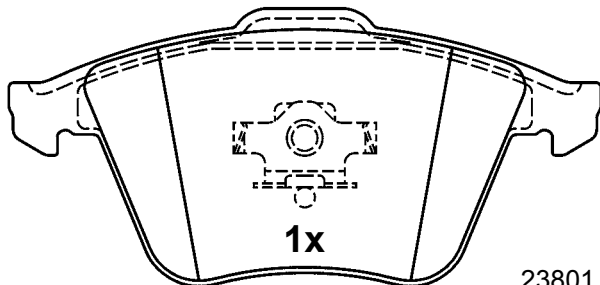

1x

23801 20,3

156,3 x 72,9 x 20,3

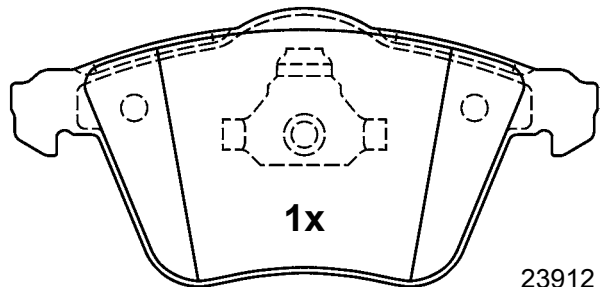

1x

23912 20,3

155,1 x 72,9 x 20,3

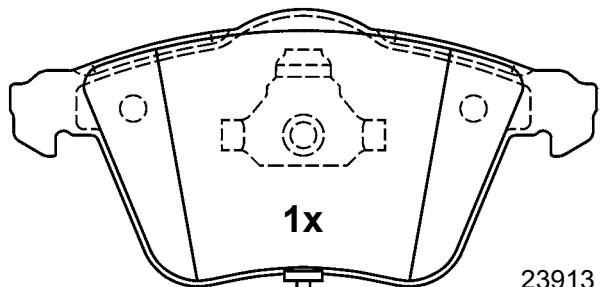

1x

23913 20,3

177,5mm

155,1 x 72,9 x 20,3

**13.0470-7201.2 LD7201** ATE Ceramic



AUDI, SEAT



ATE

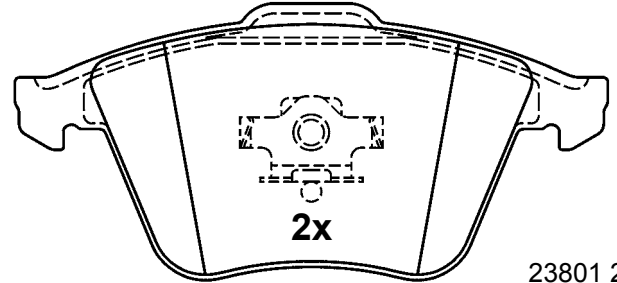

2x

23801 20,3

156,3 x 72,9 x 20,3

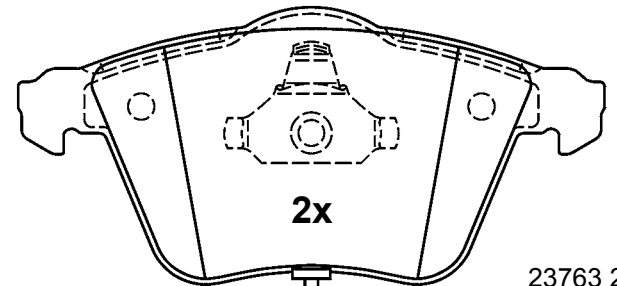

2x

23763 20,3

242,5mm

155,1 x 72,9 x 20,3

**13.0470-7202.2 LD7202** ATE Ceramic



CITROEN, PEUGEOT



ATE

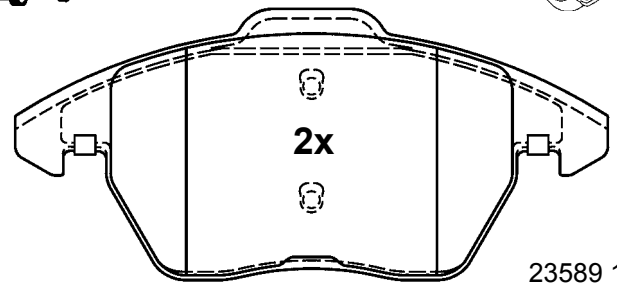

2x

23589 19,1

156,3 x 71,3 x 19,1

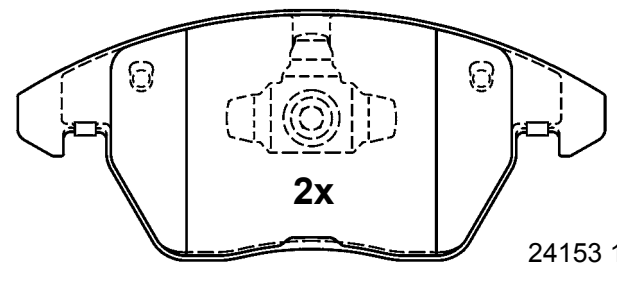

2x

24153 19,1

155,1 x 66,0 x 19,1

# Abbildungen Scheibenbremsbeläge

Illustrations disc brake pads - Illustrazioni pastiglie freno -

Illustrations plaquettes de frein - Ilustraciones pastillas de freno

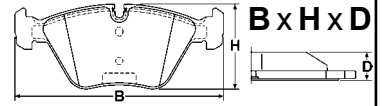

Maßstab - scale - scala - échelle - escala 1:2

**13.0470-7203.2 LD7203** ATE Ceramic



MERCEDES BENZ



ATE

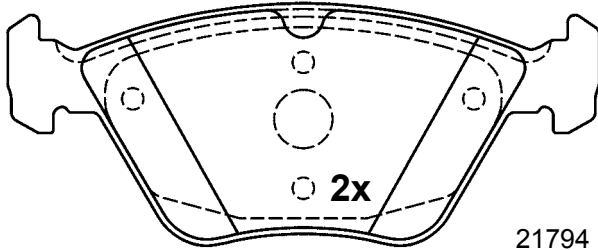

2x

21794 19,3

156,3 x 63,1 x 19,3

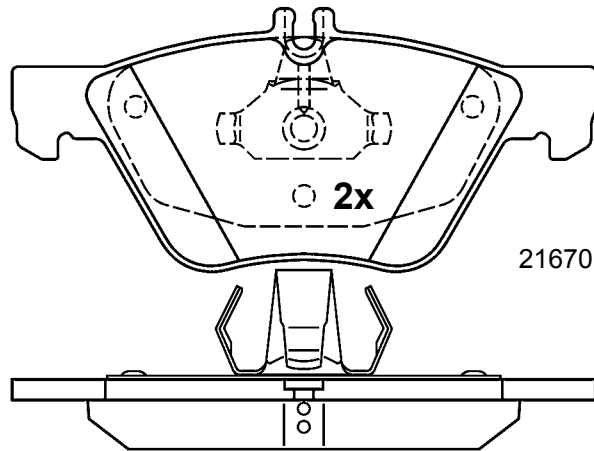

2x

21670 19,3

155,1 x 69,3 x 19,3

**13.0470-7210.2 LD7210** ATE Ceramic



BMW



ATE

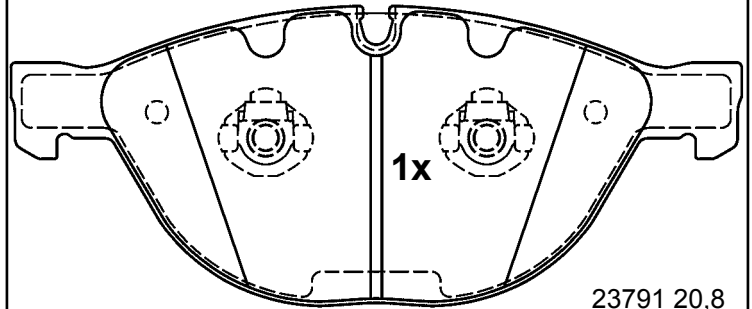

1x

23791 20,8

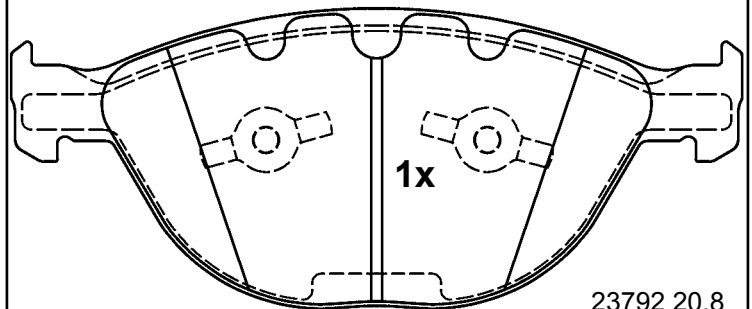

1x

23792 20,8

**13.0470-7204.2 LD7204** ATE Ceramic



FORD, MAZDA, SAAB, VOLVO



ATE

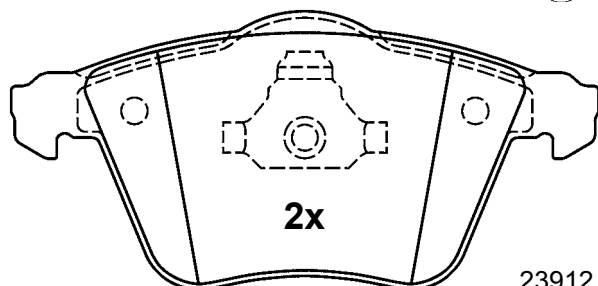

2x

23912 18,8

155,1 x 72,9 x 18,8

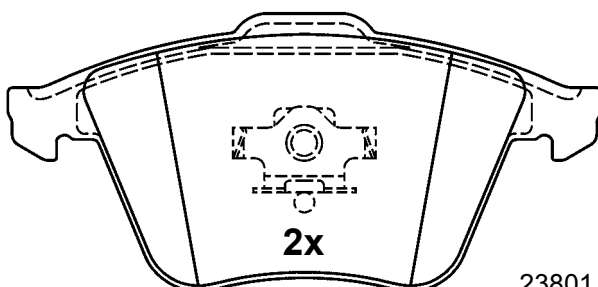

2x

23801 18,8

156,3 x 72,9 x 18,8

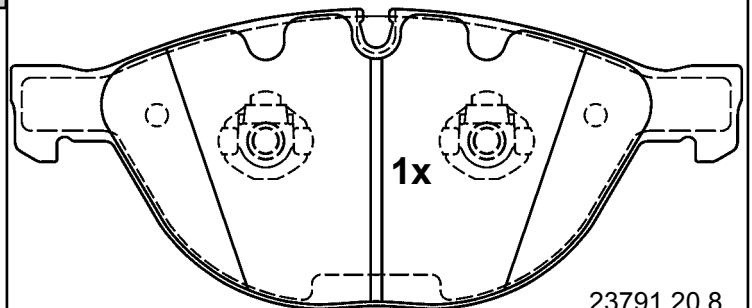

1x

23791 20,8

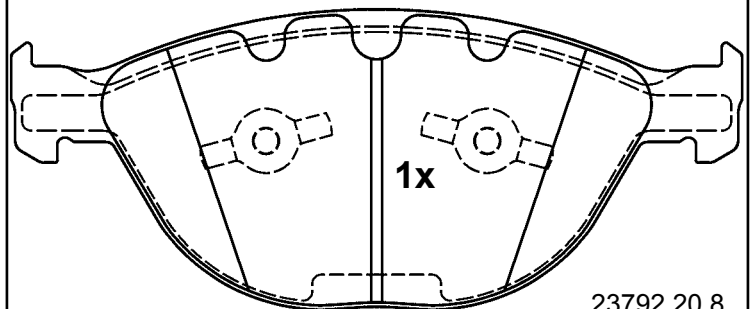

1x

23792 20,8

193,0 x 79,0 x 20,8

# Abbildungen Scheibenbremsbeläge

Illustrations disc brake pads - Illustrazioni pastiglie freno -

Illustrations plaquettes de frein - Ilustraciones pastillas de freno

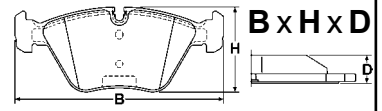

Maßstab - scale - scala - échelle - escala 1:2

**13.0470-7211.2 LD7211** ATE Ceramic

ALFA ROMEO

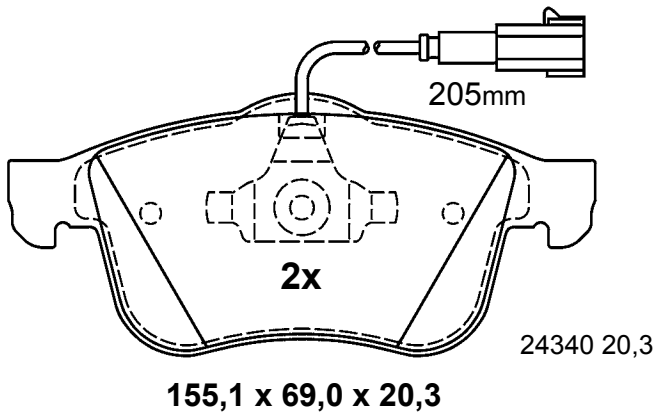
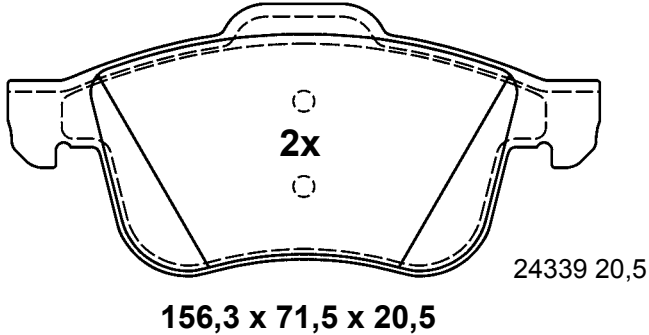

**13.0470-7216.2 LD7216** ATE Ceramic

BMW

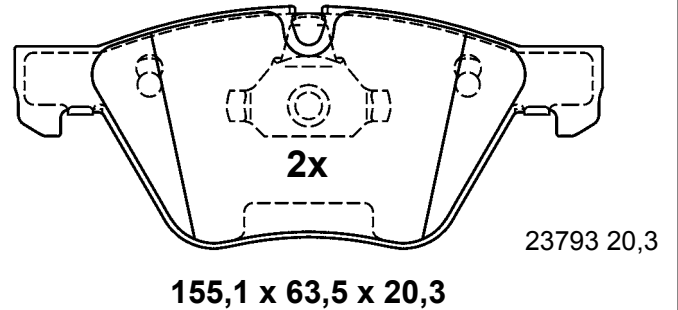
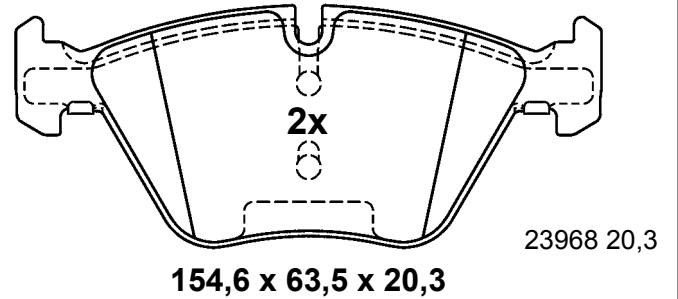

**13.0470-7215.2 LD7215** ATE Ceramic

BMW

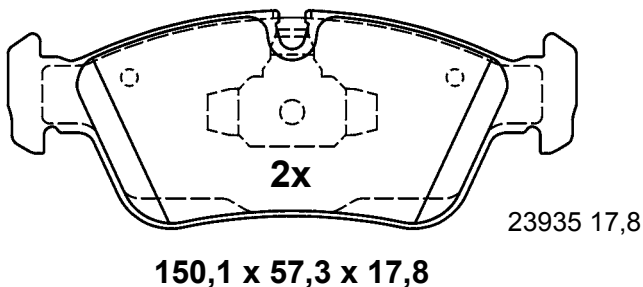
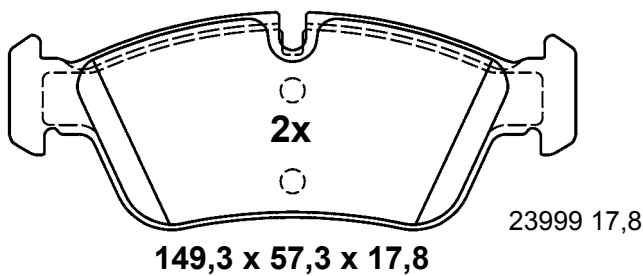

**13.0470-7217.2 LD7217** ATE Ceramic

BMW

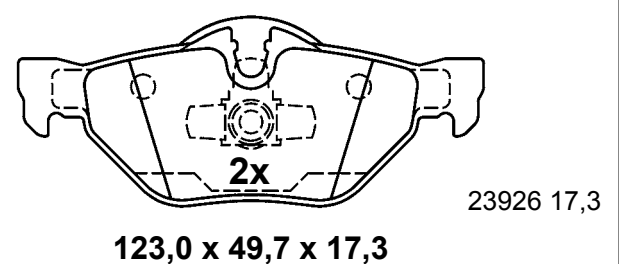
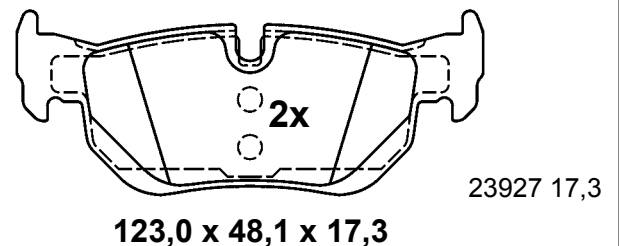

# Abbildungen Scheibenbremsbeläge

Illustrations disc brake pads - Illustrazioni pastiglie freno -

Illustrations plaquettes de frein - Ilustraciones pastillas de freno

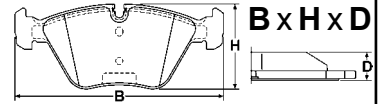

Maßstab - scale - scala - échelle - escala 1:2

**13.0470-7219.2 LD7219** ATE Ceramic



MERCEDES BENZ



ATE

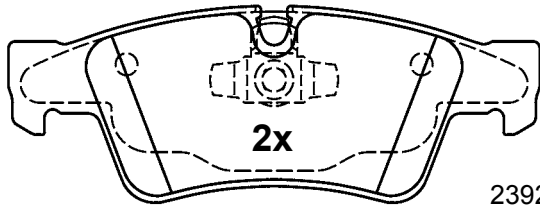

140,1 x 51,6 x 17,6

23923 17,6

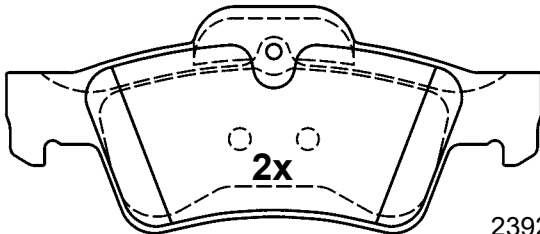

141,3 x 59,6 x 17,6

23924 17,6

**13.0470-7221.2 LD7221** ATE Ceramic



RENAULT



ATE

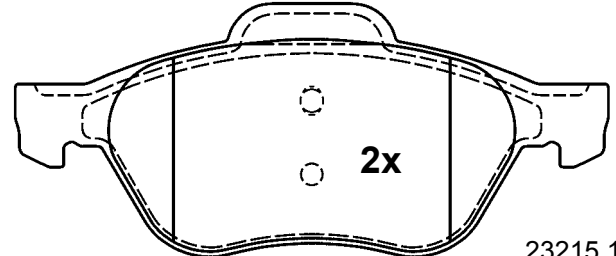

156,3 x 66,8 x 18,3

23215 18,3

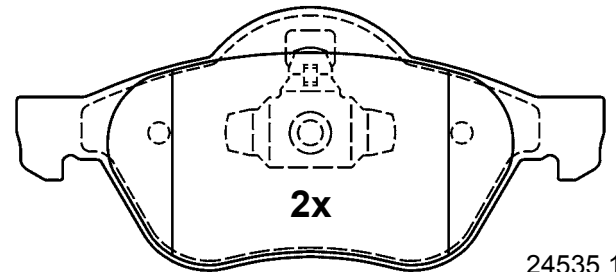

155,1 x 68,9 x 18,3

24535 18,3

**13.0470-7220.2 LD7220** ATE Ceramic



MERCEDES BENZ



ATE

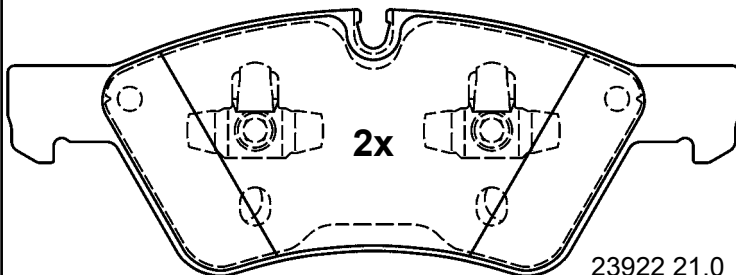

192,9 x 69,9 x 21,0

23922 21,0

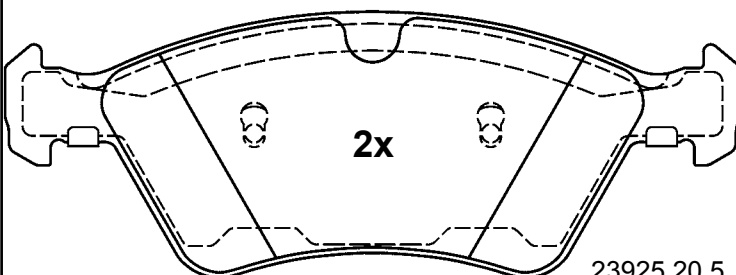

194,3 x 70,0 x 20,5

23925 20,5

**13.0470-7223.2 LD7223** ATE Ceramic



BMW



ATE

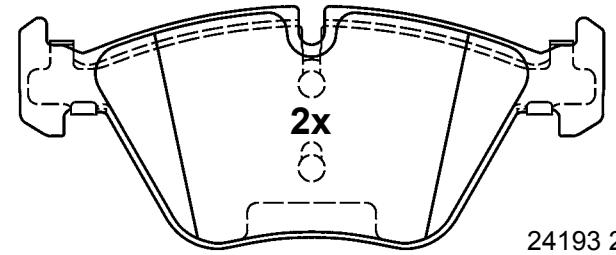

154,6 x 63,5 x 20,3

24193 20,3

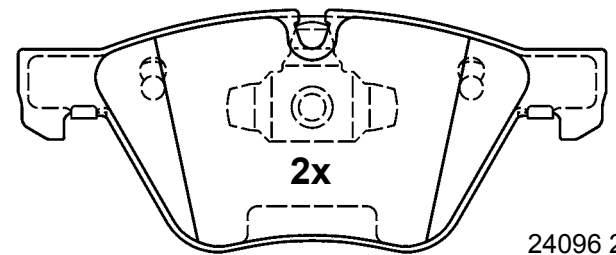

155,1 x 63,5 x 20,3

24096 20,3



# Abbildungen Scheibenbremsbeläge

Illustrations disc brake pads - Illustrazioni pastiglie freno -

Illustrations plaquettes de frein - Ilustraciones pastillas de freno



Maßstab - scale - scala - échelle - escala 1:2

**13.0470-7225.2 LD7225** ATE Ceramic

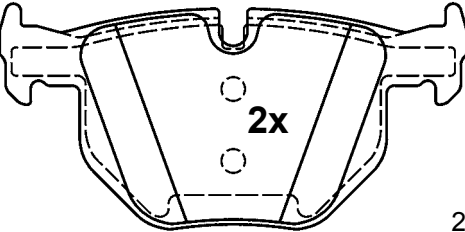

2x  
123,0 x 59,2 x 17,3

23551 17,3

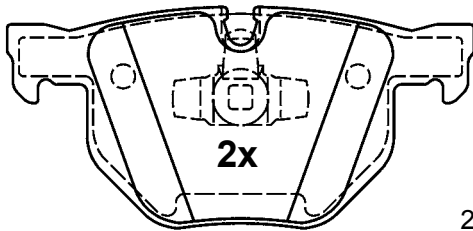

2x  
123,0 x 58,0 x 17,3

23550 17,3



**13.0470-7227.2 LD7227** ATE Ceramic



AUDI, SEAT, VOLKSWAGEN

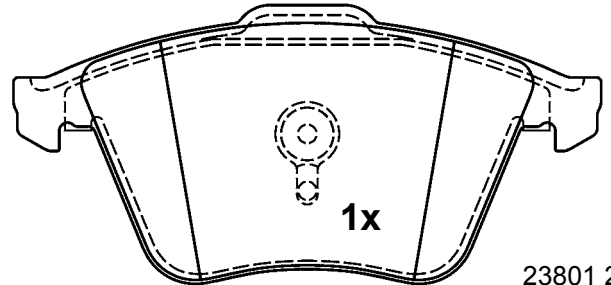

1x  
156,3 x 72,9 x 20,3

23801 20,3

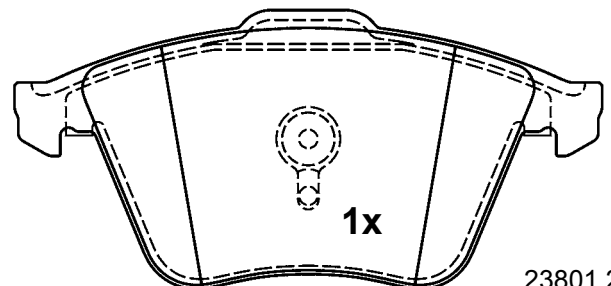

1x  
156,3 x 72,9 x 20,3

23801 20,3

**13.0470-7226.2 LD7226** ATE Ceramic

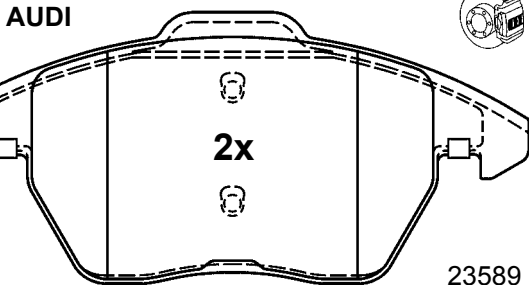

2x  
155,1 x 71,3 x 20,4

23589 20,4

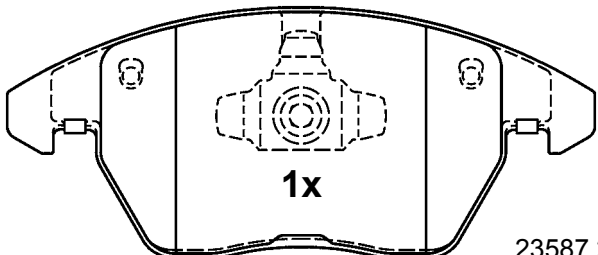

1x  
155,1 x 66,0 x 20,8

23587 20,8

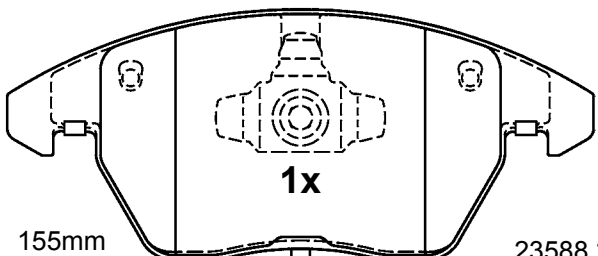

155mm  
1x  
155,1 x 66,0 x 20,8

23588 20,8

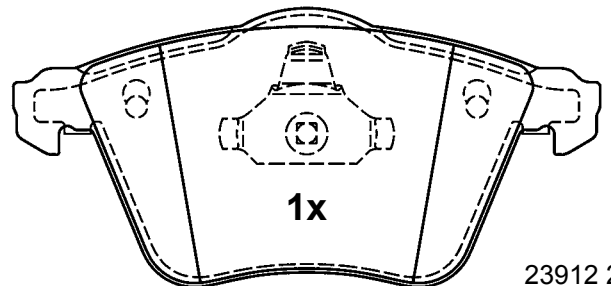

1x  
155,1 x 72,9 x 20,3

23912 20,3

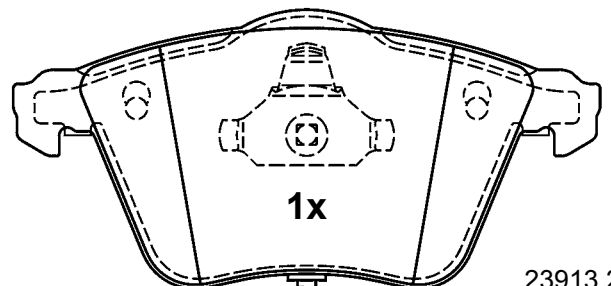

1x  
155,1 x 72,9 x 20,3

23913 20,3

175mm







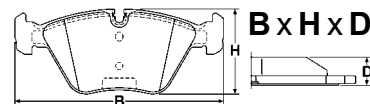

# Abbildungen Scheibenbremsbeläge

Illustrations disc brake pads - Illustrazioni pastiglie freno -

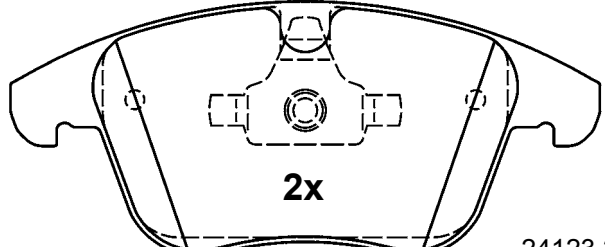
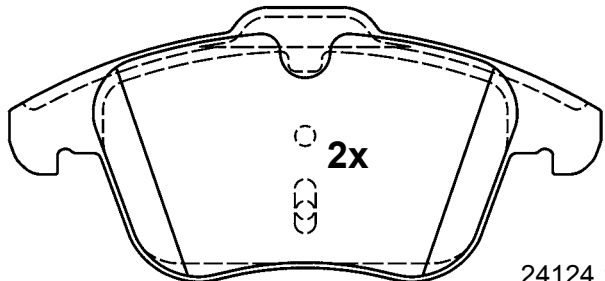
Illustrations plaquettes de frein - Ilustraciones pastillas de freno

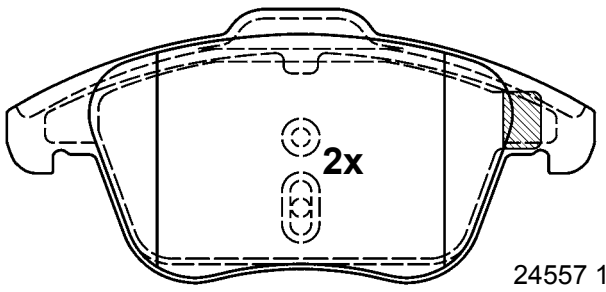
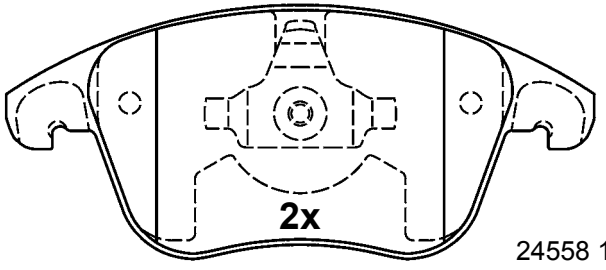

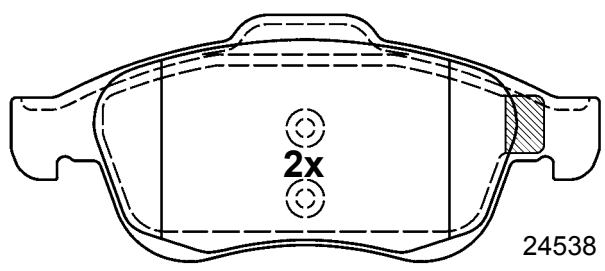
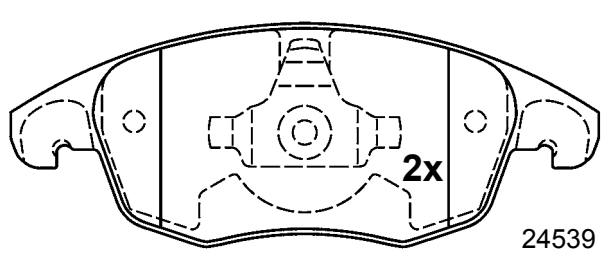
Maßstab - scale - scala - échelle - escala 1:2

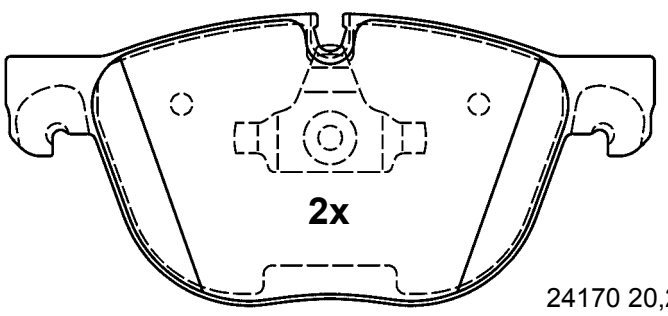
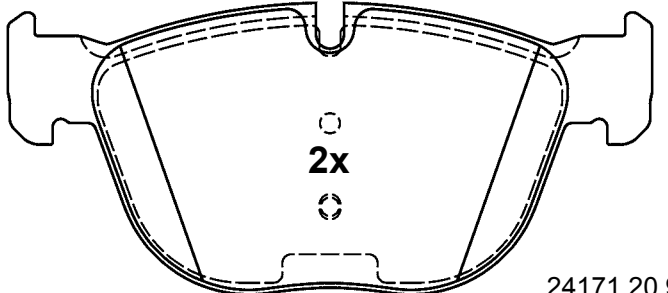
| <b>13.0470-7228.2 LD7228</b> ATE Ceramic   | <b>13.0470-7230.2 LD7230</b> ATE Ceramic   |
|--|--|
| <p>  FORD, LAND ROVER, VOLVO                              ATE                         </p>  <p style="text-align: center;"><b>2x</b></p> <p style="text-align: right;">24123 20,3</p> <p style="text-align: center;"><b>155,1 x 66,6 x 20,3</b></p>  <p style="text-align: center;"><b>2x</b></p> <p style="text-align: right;">24124 19,3</p> <p style="text-align: center;"><b>156,3 x 72,0 x 19,3</b></p> | <p>  CITROEN, PEUGEOT                              ATE                         </p>  <p style="text-align: center;"><b>2x</b></p> <p style="text-align: right;">24557 19,4</p> <p style="text-align: center;"><b>155,1 x 72,0 x 19,4</b></p>  <p style="text-align: center;"><b>2x</b></p> <p style="text-align: right;">24558 18,7</p> <p style="text-align: center;"><b>155,1 x 66,6 x 18,7</b></p> |
| <b>13.0470-7229.2 LD7229</b> ATE Ceramic   | <b>13.0470-7231.2 LD7231</b> ATE Ceramic   |
| <p>  CITROEN, PEUGEOT                              ATE                         </p>  <p style="text-align: center;"><b>2x</b></p> <p style="text-align: right;">24538 18,5</p> <p style="text-align: center;"><b>155,1 x 64,7 x 18,5</b></p>  <p style="text-align: center;"><b>2x</b></p> <p style="text-align: right;">24539 18,5</p> <p style="text-align: center;"><b>155,1 x 58,3 x 18,5</b></p> | <p>  BMW                              ATE                         </p>  <p style="text-align: center;"><b>2x</b></p> <p style="text-align: right;">24170 20,2</p> <p style="text-align: center;"><b>171,1 x 76,8 x 20,2</b></p>  <p style="text-align: center;"><b>2x</b></p> <p style="text-align: right;">24171 20,9</p> <p style="text-align: center;"><b>170,2 x 76,8 x 20,9</b></p>       |

# Abbildungen Scheibenbremsbeläge

Illustrations disc brake pads - Illustrazioni pastiglie freno -

Illustrations plaquettes de frein - Ilustraciones pastillas de freno

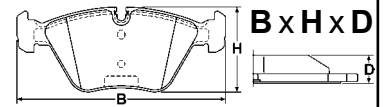

Maßstab - scale - scala - échelle - escala 1:2

| <b>13.0470-7232.2 LD7232</b> ATE Ceramic   | <b>13.0470-7238.2 LD7238</b> ATE Ceramic   |
|--|--|
| <div data-bbox="71 324 268 380">  BMW                 </div> <div data-bbox="651 324 782 380">  ATE                 </div> <div data-bbox="188 380 657 616"> <p>2x</p> </div> <div data-bbox="635 582 778 616"> <p>21282 17,3</p> </div> <div data-bbox="284 627 566 667"> <p>121,8 x 59,2 x 17,3</p> </div> <div data-bbox="188 750 657 974"> <p>30<br/>2x</p> </div> <div data-bbox="635 952 778 985"> <p>23447 17,3</p> </div> <div data-bbox="284 996 566 1041"> <p>121,8 x 57,8 x 17,3</p> </div> | <div data-bbox="813 324 1010 380">  BMW                 </div> <div data-bbox="1396 324 1527 380">  ATE                 </div> <div data-bbox="869 403 1468 672"> <p>2x</p> </div> <div data-bbox="1380 638 1524 672"> <p>23313 20,3</p> </div> <div data-bbox="869 772 1468 1041"> <p>2x</p> </div> <div data-bbox="1380 1008 1524 1041"> <p>24255 20,3</p> </div> <div data-bbox="1029 1075 1308 1120"> <p>155,1 x 68,3 x 20,3</p> </div>  |
| <b>13.0470-7237.2 LD7237</b> ATE Ceramic   | <b>13.0470-7239.2 LD7239</b> ATE Ceramic   |
| <div data-bbox="71 1220 268 1276">  BMW                 </div> <div data-bbox="651 1220 782 1276">  ATE                 </div> <div data-bbox="127 1332 726 1601"> <p>2x</p> </div> <div data-bbox="635 1568 778 1601"> <p>23347 20,3</p> </div> <div data-bbox="127 1713 726 1982"> <p>2x</p> </div> <div data-bbox="635 1960 778 1993"> <p>24161 20,3</p> </div> <div data-bbox="284 2072 566 2116"> <p>155,1 x 68,3 x 20,3</p> </div>   | <div data-bbox="813 1220 1010 1276">  BMW                 </div> <div data-bbox="1396 1220 1527 1276">  ATE                 </div> <div data-bbox="798 1332 1540 1635"> <p>2x</p> </div> <div data-bbox="1380 1601 1524 1635"> <p>24173 20,0</p> </div> <div data-bbox="1029 1646 1308 1680"> <p>193,0 x 79,0 x 20,0</p> </div> <div data-bbox="798 1713 1540 2016"> <p>2x</p> </div> <div data-bbox="1380 1993 1524 2027"> <p>24172 19,0</p> </div> <div data-bbox="1029 2038 1308 2072"> <p>193,0 x 79,0 x 19,0</p> </div> |



# Abbildungen Scheibenbremsbeläge

Illustrations disc brake pads - Illustrazioni pastiglie freno -

Illustrations plaquettes de frein - Ilustraciones pastillas de freno



Maßstab - scale - scala - échelle - escala 1:2

**13.0470-7242.2 LD7242** ATE Ceramic

AUDI, SEAT, VOLKSWAGEN

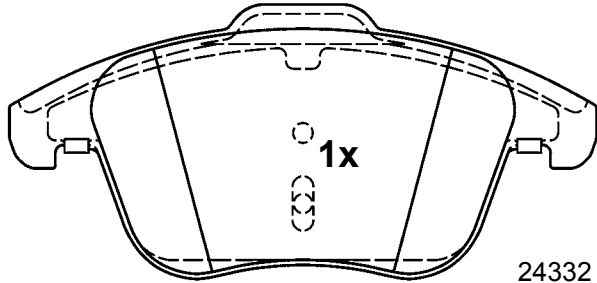

155,1 x 72,0 x 19,8

24332 19,8

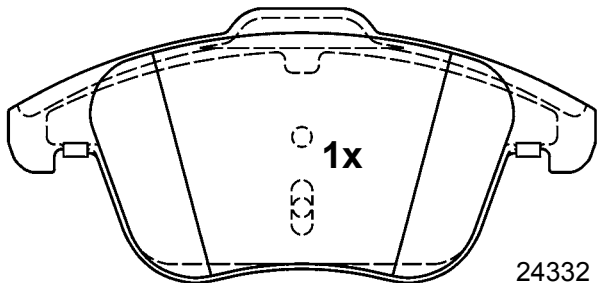

155,1 x 72,0 x 19,8

24332 19,8

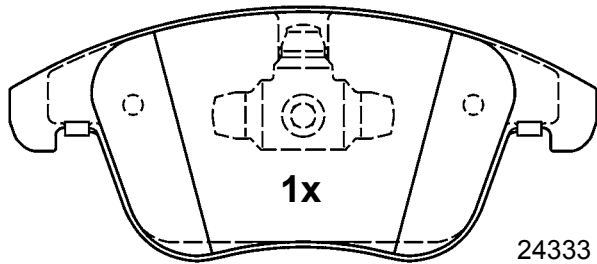

155,1 x 67,0 x 21,3

24333 21,3

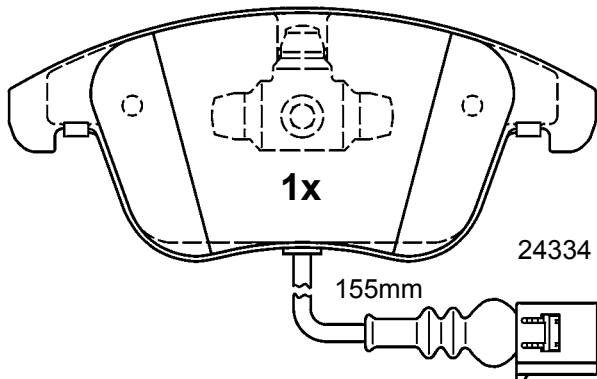

155,1 x 67,0 x 21,3

24334 21,3

**13.0470-7243.2 LD7243** ATE Ceramic

FORD, VOLVO

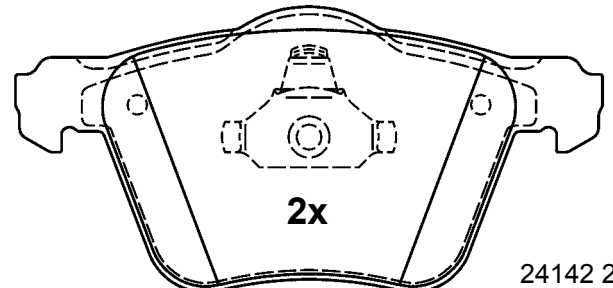

155,1 x 75,3 x 20,6

24142 20,6

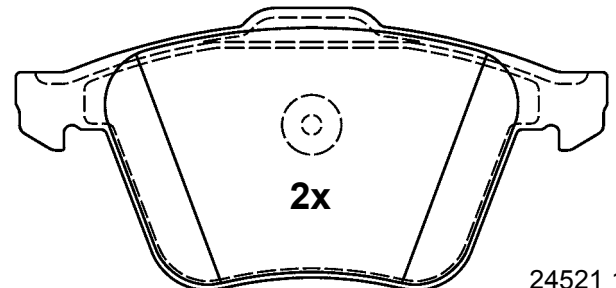

156,4 x 74,3 x 19,1

24521 19,1

**13.0470-7244.2 LD7244** ATE Ceramic

MERCEDES BENZ

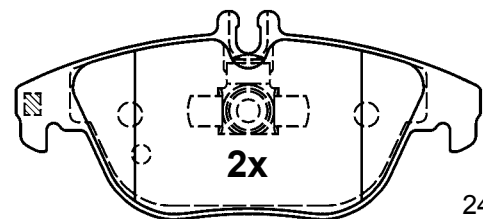

122,5 x 54,4 x 17,8

24253 17,8

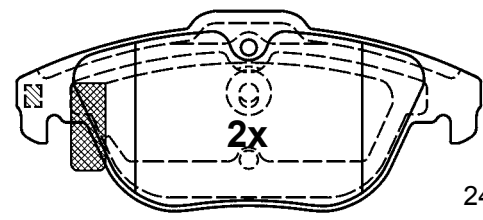

122,5 x 52,3 x 18,0

24254 18,0

# Abbildungen Scheibenbremsbeläge

Illustrations disc brake pads - Illustrazioni pastiglie freno -

Illustrations plaquettes de frein - Ilustraciones pastillas de freno

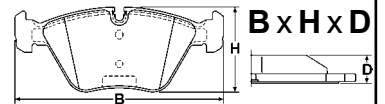

Maßstab - scale - scala - échelle - escala 1:2

**13.0470-7249.2 LD7249** ATE Ceramic

RENAULT

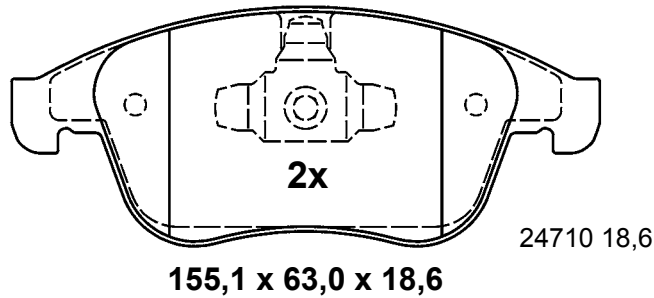
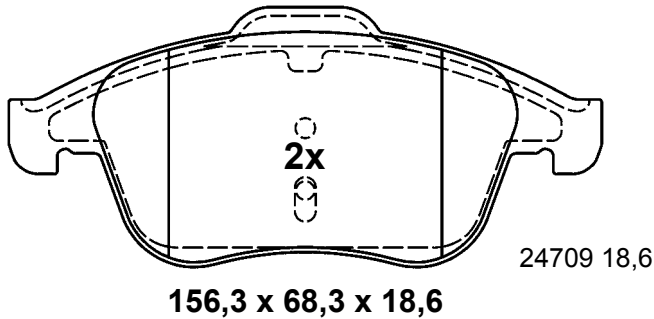

**13.0470-7252.2 LD7252** ATE Ceramic

CITROEN, PEUGEOT

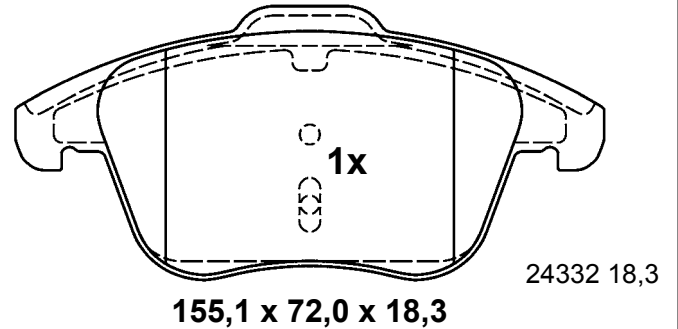
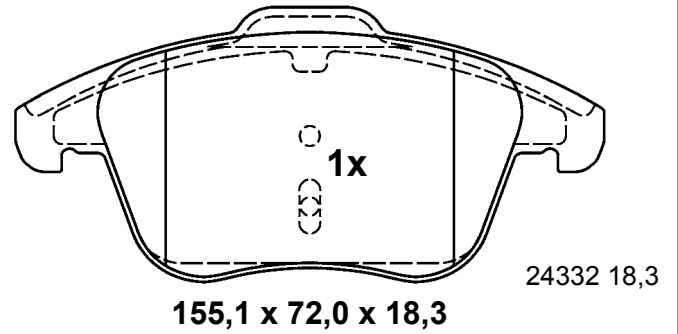

**13.0470-7251.2 LD7251** ATE Ceramic

RENAULT

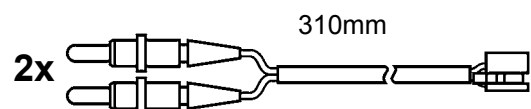
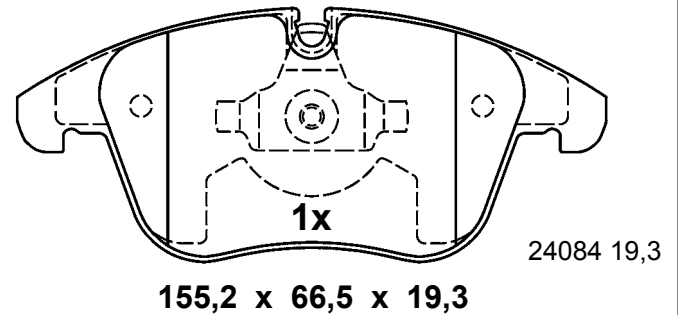
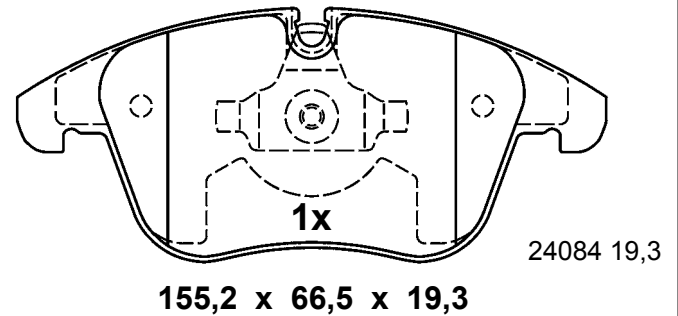
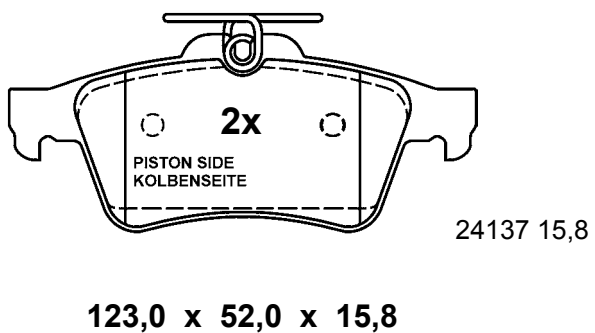
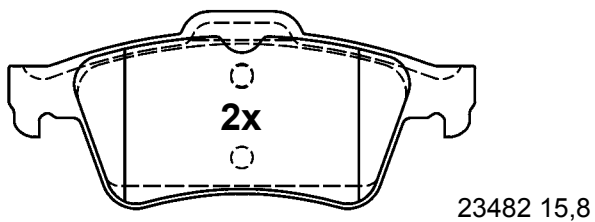

# Abbildungen Scheibenbremsbeläge

Illustrations disc brake pads - Illustrazioni pastiglie freno -

Illustrations plaquettes de frein - Ilustraciones pastillas de freno

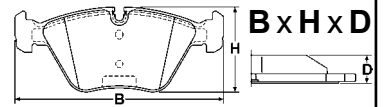

Maßstab - scale - scala - échelle - escala 1:2

**13.0470-7256.2 LD7256** ATE Ceramic

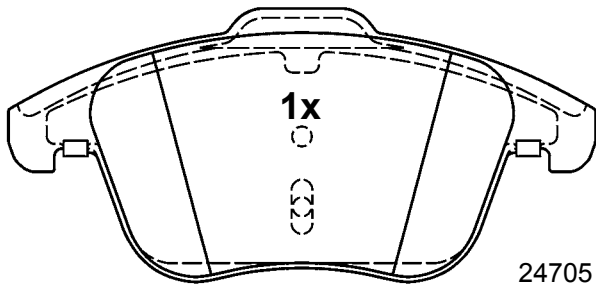

155,1 x 72,0 x 19,8

24705 19,8

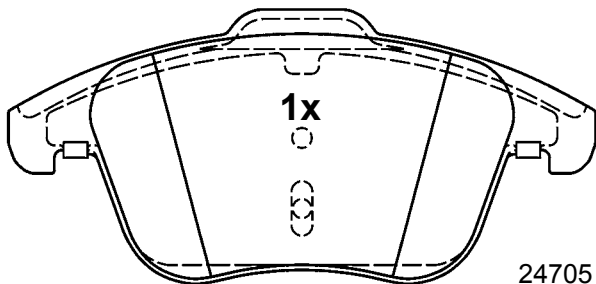

155,1 x 72,0 x 19,8

24705 19,8

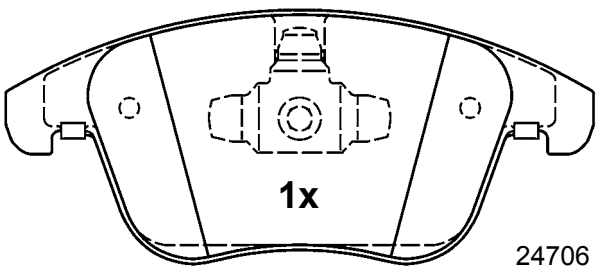

155,1 x 67,0 x 21,3

24706 21,3

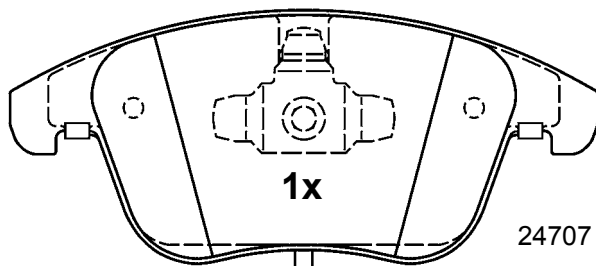

155,1 x 67,0 x 21,3

24707 21,3

281mm

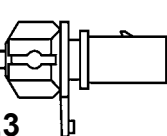

**13.0470-7257.2 LD7257** ATE Ceramic

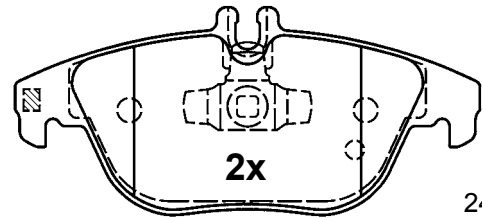

122,5 x 54,4 x 18,0

24253 18,0

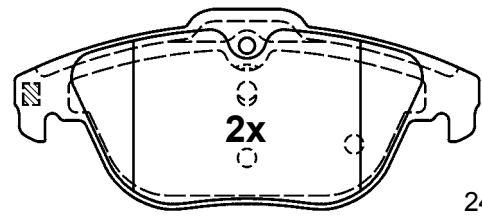

122,5 x 52,3 x 18,0

24254 18,0

**13.0470-7259.2 LD7259** ATE Ceramic

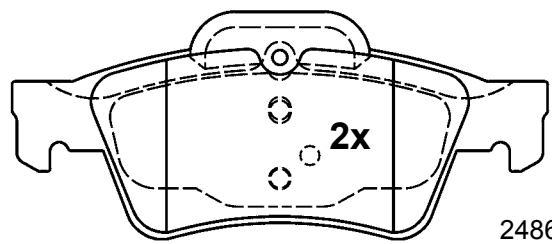

141,1 x 59,6 x 16,7

24862 16,7

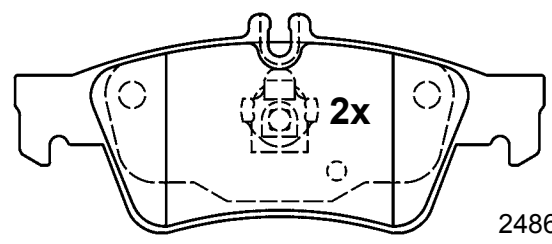

139,8 x 57,5 x 16,7

24863 16,7



# Abbildungen Scheibenbremsbeläge

Illustrations disc brake pads - Illustrazioni pastiglie freno -

Illustrations plaquettes de frein - Ilustraciones pastillas de freno

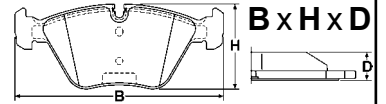

Maßstab - scale - scala - échelle - escala 1:2

**13.0470-7262.2 LD7262** ATE Ceramic



CHEVROLET, OPEL, VAUXHALL



ATE

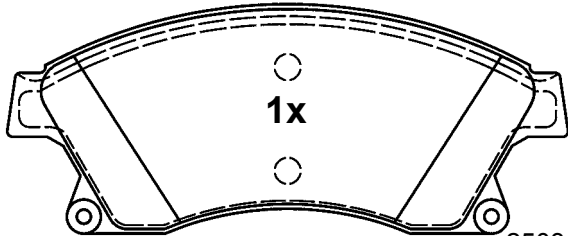

25031 19,1

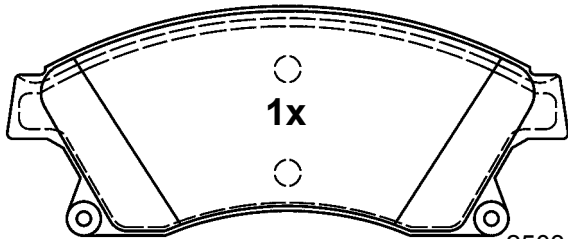

25031 19,1

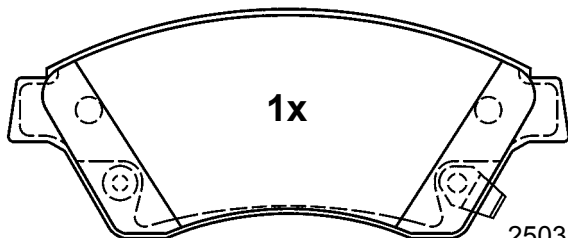

25032 19,1

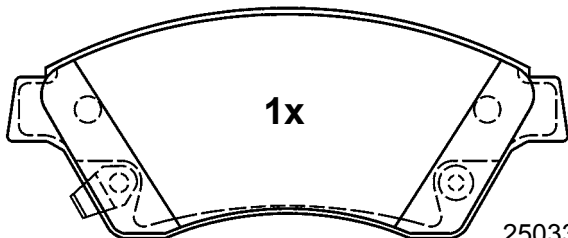

25033 19,1

148,2 x 60,1 x 19,1

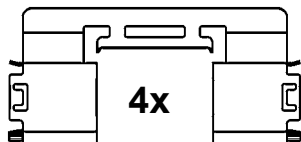

4x

**13.0470-7263.2 LD7263** ATE Ceramic



CHEVROLET, OPEL, VAUXHALL



ATE

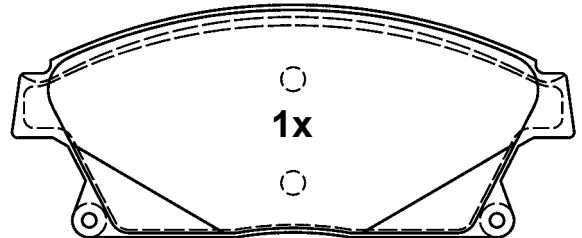

25034 19,1

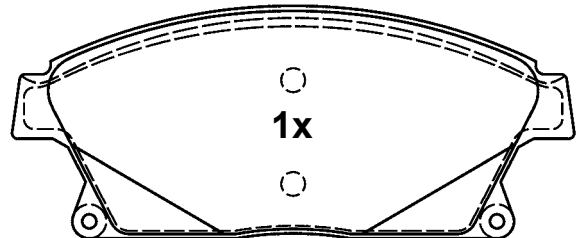

25034 19,1

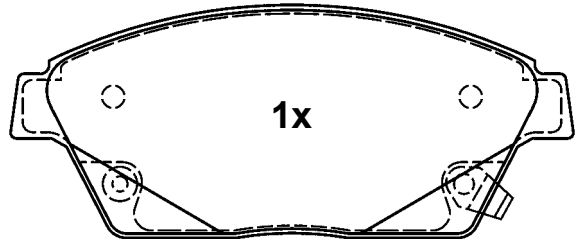

25035 19,1

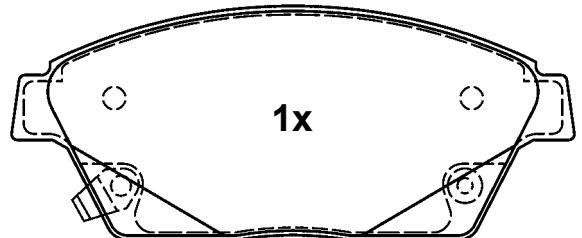

25036 19,1

148,2 x 61,1 x 19,1

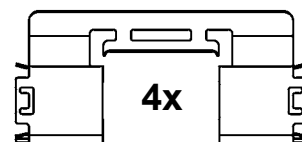

4x

# Abbildungen Scheibenbremsbeläge

Illustrations disc brake pads - Illustrazioni pastiglie freno -

Illustrations plaquettes de frein - Ilustraciones pastillas de freno

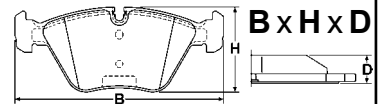

Maßstab - scale - scala - échelle - escala 1:2

**13.0470-7264.2 LD7264** ATE Ceramic



CHEVROLET, OPEL, VAUXHAL



ATE

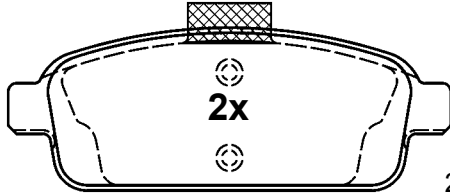

2x

25096 17,0

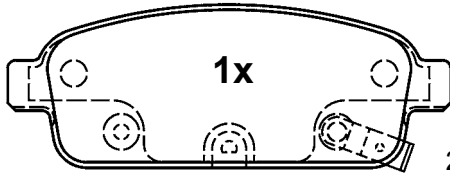

1x

25097 17,0

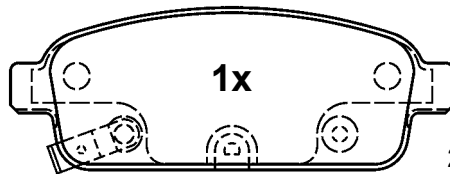

1x

25098 17,0

116,5 x 42,7 x 17,0

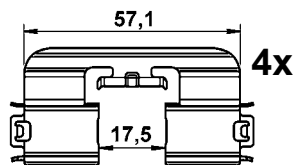

4x

**13.0470-7267.2 LD7267** ATE Ceramic



BMW



ATE

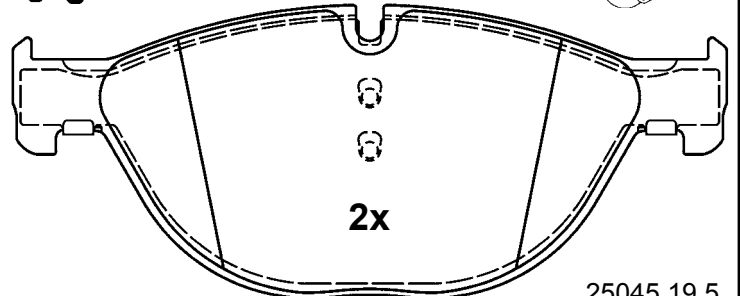

2x

25045 19,5

192,2 x 79,2 x 19,5

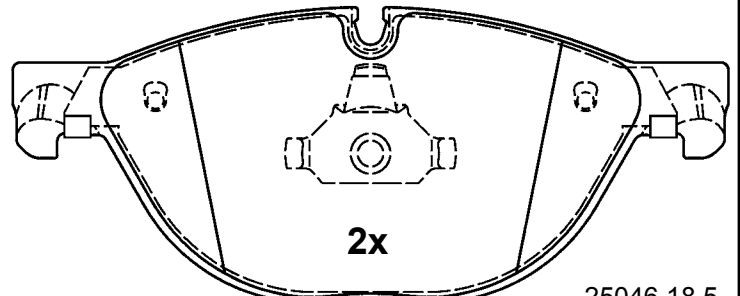

2x

25046 18,5

193,0 x 79,2 x 18,5

**13.0470-7266.2 LD7266** ATE Ceramic



DACIA, RENAULT



ATE

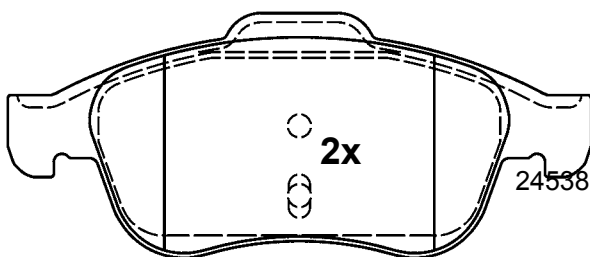

2x

24538 17,9

155,1 x 64,7 x 17,9

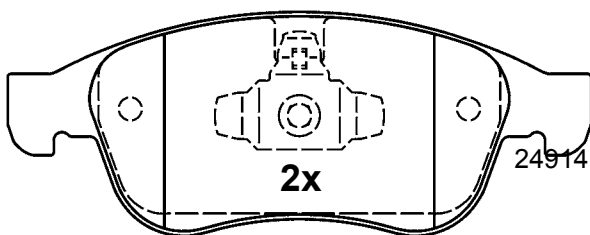

2x

24914 17,9

155,1 x 59,4 x 17,9

**13.0470-7268.2 LD7268** ATE Ceramic



BMW



ATE

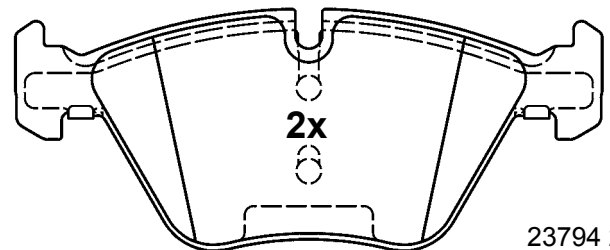

2x

23794 20,3

154,6 x 63,5 x 20,3

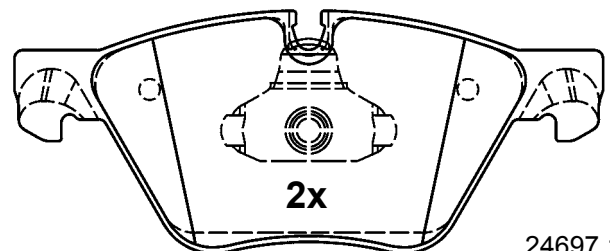

2x

24697 19,3

155,1 x 63,5 x 19,3

# Abbildungen Scheibenbremsbeläge

Illustrations disc brake pads - Illustrazioni pastiglie freno -

Illustrations plaquettes de frein - Ilustraciones pastillas de freno



Maßstab - scale - scala - échelle - escala 1:2

**13.0470-7269.2 LD7269** ATE Ceramic



ALFA ROMEO



ATE

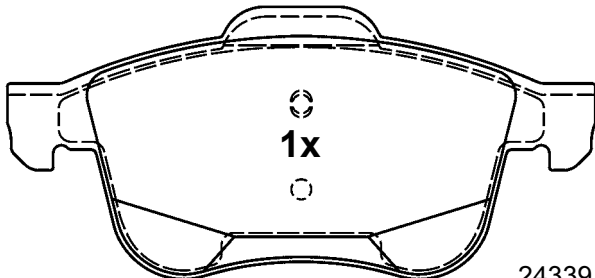

1x

155,1 x 71,5 x 19,5

24339 19,5

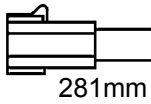

281mm

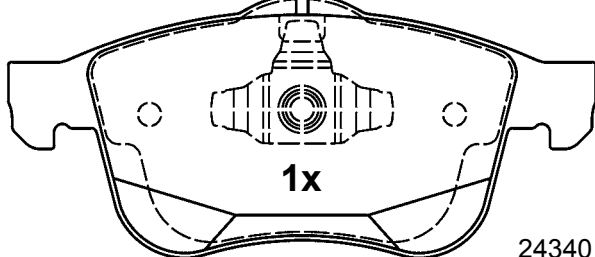

1x

155,1 x 69,0 x 19,5

24340 19,5

**13.0470-7273.2 LD7273** ATE Ceramic



ALFA ROMEO



ATE

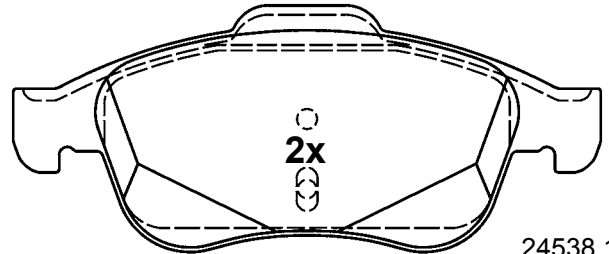

2x

155,1 x 64,7 x 19,4

24538 19,4

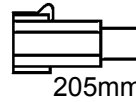

205mm

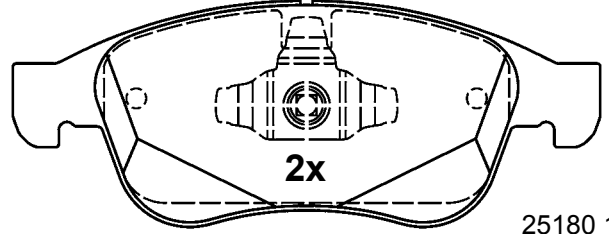

2x

155,1 x 59,4 x 19,0

25180 19,0

**13.0470-7275.2 LD7275** ATE Ceramic



BMW



ATE

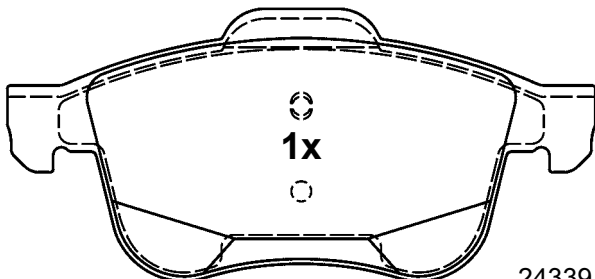

1x

155,1 x 71,5 x 19,5

24339 19,5

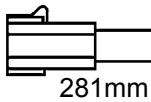

281mm

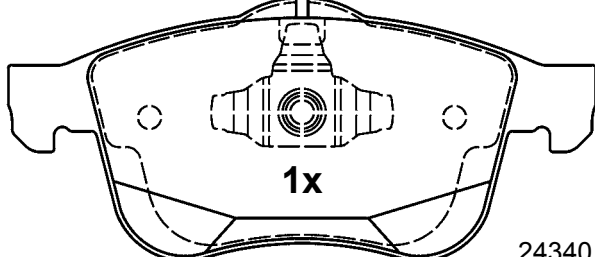

1x

155,1 x 69,0 x 19,5

24340 19,5

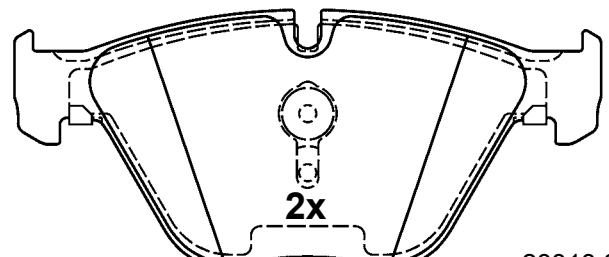

2x

154,1 x 68,4 x 20,2

23313 20,2

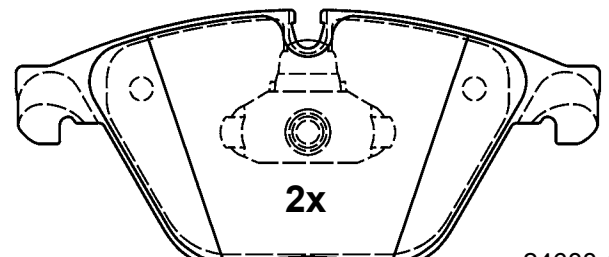

2x

154,1 x 68,4 x 19,2

24688 19,2



# Abbildungen Scheibenbremsbeläge

Illustrations disc brake pads - Illustrazioni pastiglie freno -

Illustrations plaquettes de frein - Ilustraciones pastillas de freno



Maßstab - scale - scala - échelle - escala 1:2

**13.0470-7280.2 LD7280** ATE Ceramic

**13.0470-7281.2 LD7281** ATE Ceramic

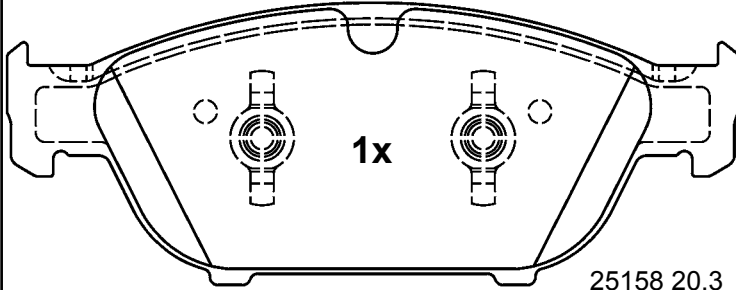

1x

25158 20,3

193,0 x 74,0 x 20,3

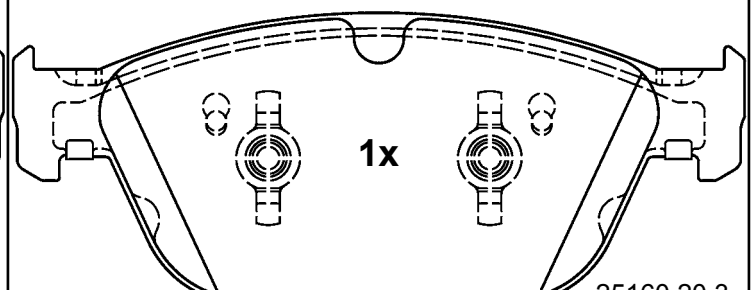

1x

25160 20,3

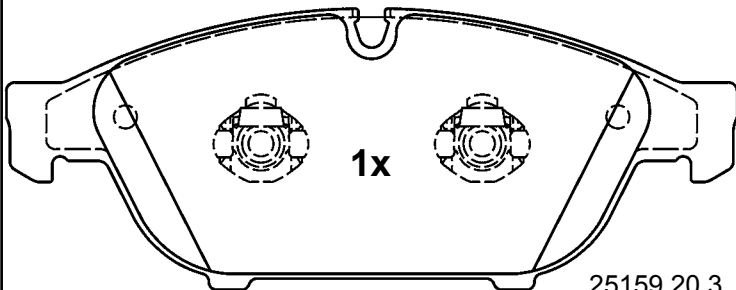

1x

25159 20,3

193,0 x 74,0 x 20,3

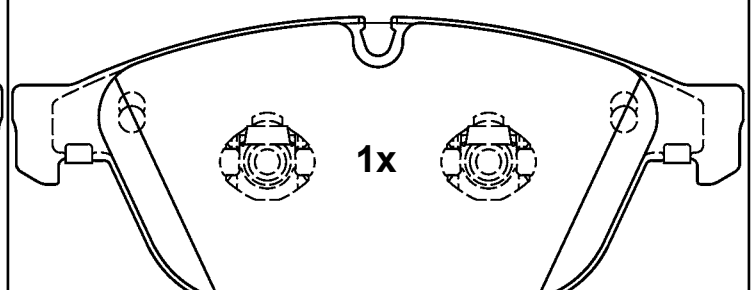

1x

25161 20,3

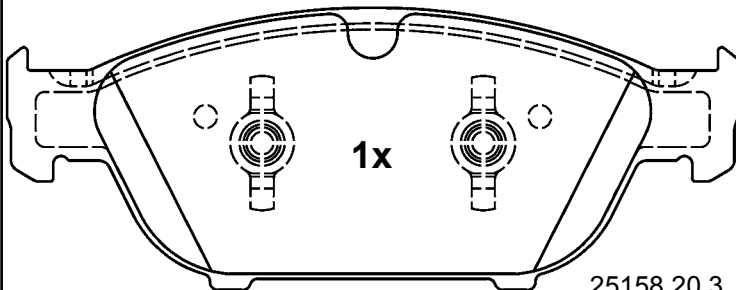

1x

25158 20,3

193,0 x 74,0 x 20,3

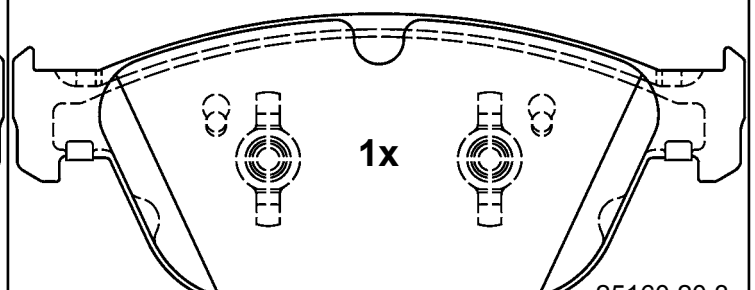

1x

25160 20,3

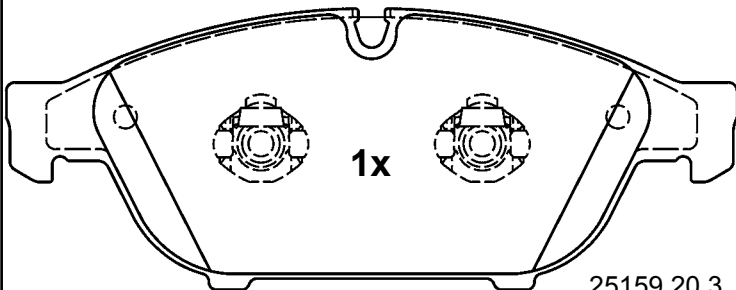

1x

25159 20,3

193,0 x 74,0 x 20,3

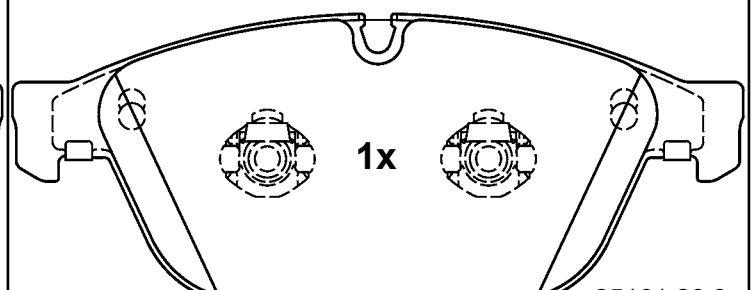

1x

25161 20,3

193,0 x 76,5 x 20,3

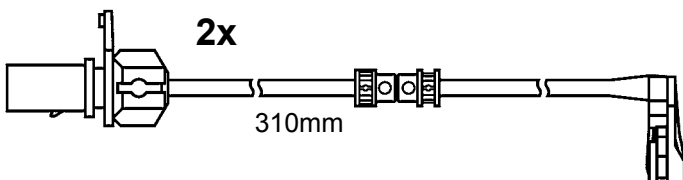

2x

310mm

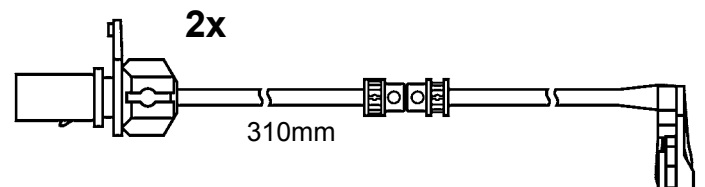

2x

310mm

# Abbildungen Scheibenbremsbeläge

Illustrations disc brake pads - Illustrazioni pastiglie freno -

Illustrations plaquettes de frein - Ilustraciones pastillas de freno



Maßstab - scale - scala - échelle - escala 1:2

**13.0470-7282.2 LD7282** ATE Ceramic



JEEP, MERCEDES BENZ



ATE

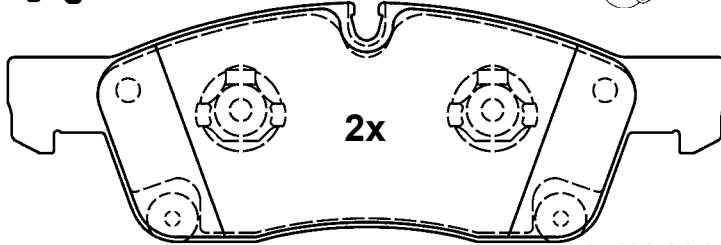

25192 21,3

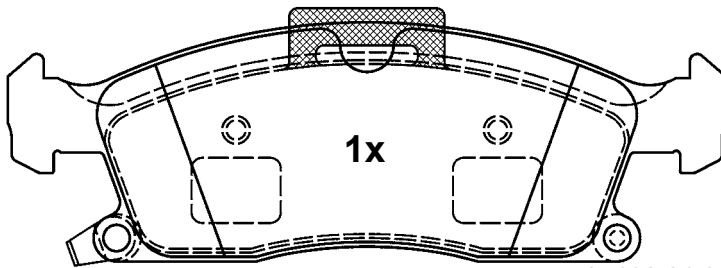

25190 21,3

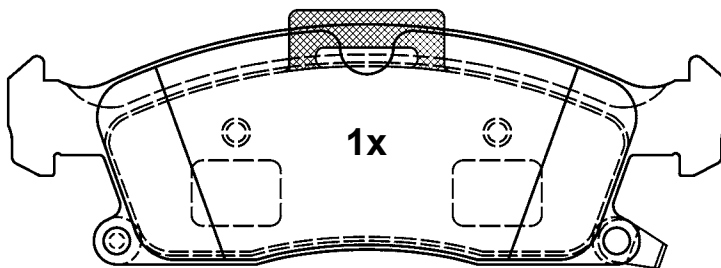

25191 21,3

193,1 x 64,1 x 21,3

**13.0470-7288.2 LD7288** ATE Ceramic



FIAT



ATE

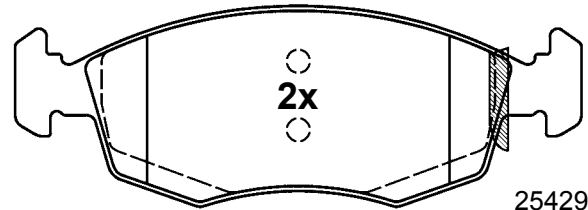

25429 17,6

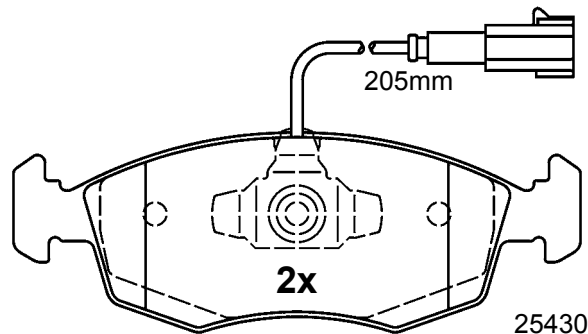

25430 17,6

149,2 x 52,5 x 17,6

**13.0470-7285.2 LD7285** ATE Ceramic



VOLKSWAGEN



ATE

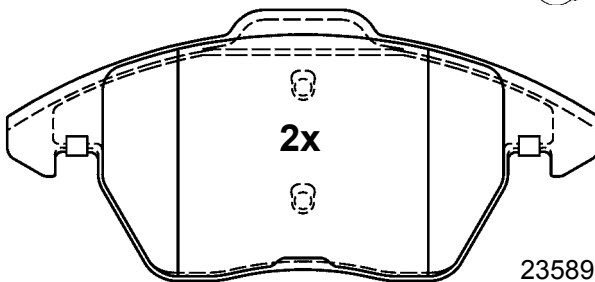

23589 20,6

156,3 x 71,3 x 20,6

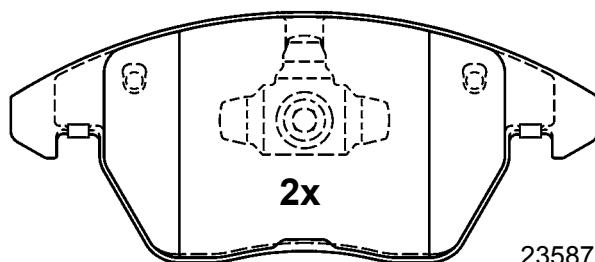

23587 20,6

155,1 x 66,0 x 20,6

**13.0470-7294.2 LD7294** ATE Ceramic



AUDI, SKODA, VOLKSWAGEN



ATE

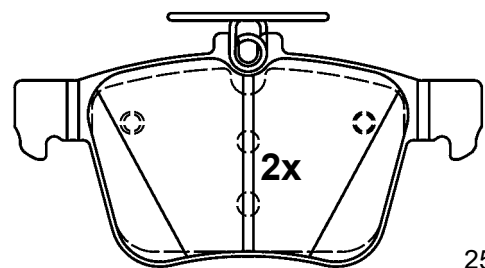

25009 16,4

123,0 x 61,2 x 16,4

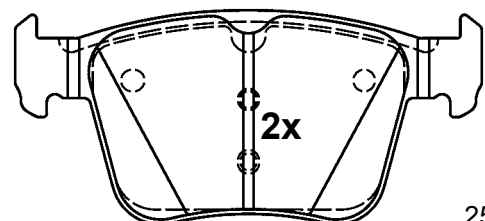

25011 16,4

123,0 x 56,2 x 16,4

# Abbildungen Scheibenbremsbeläge

Illustrations disc brake pads - Illustrazioni pastiglie freno -

Illustrations plaquettes de frein - Ilustraciones pastillas de freno

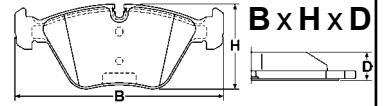

Maßstab - scale - scala - échelle - escala 1:2

**13.0470-7295.2 LD7295** ATE Ceramic

PEUGEOT

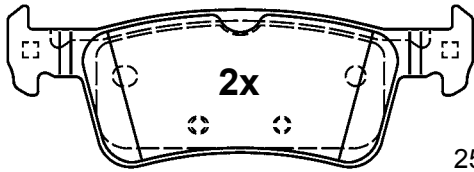

25968 16,1

123,0 x 42,4 x 16,1

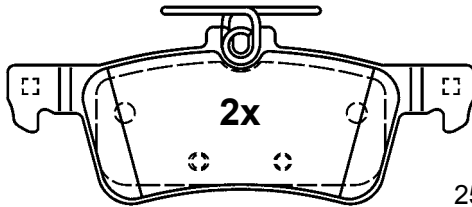

25969 16,1

123,0 x 46,2 x 16,1

**13.0470-7300.2 LD7300** ATE Ceramic

CITROEN, PEUGEOT

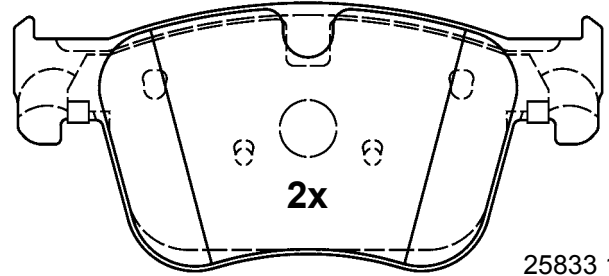

25833 17,3

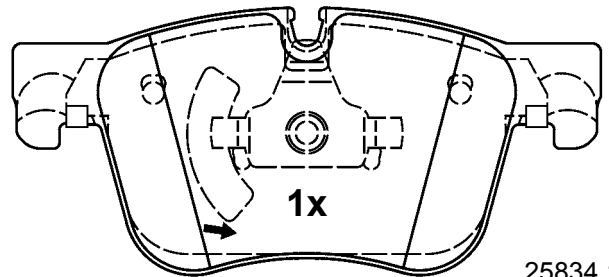

25834 17,3

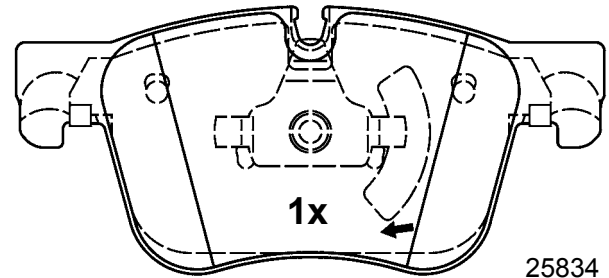

25834 17,3

155,1 x 70,5 x 17,3

**13.0470-7296.2 LD7296** ATE Ceramic

BMW

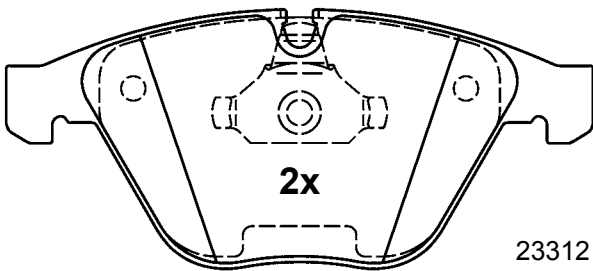

23312 20,3

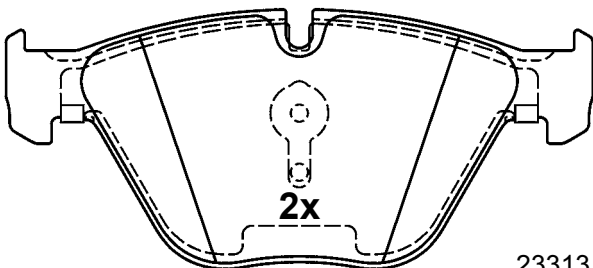

23313 20,3

155,1 x 68,3 x 20,3

**13.0470-7301.2 LD7301** ATE Ceramic

PEUGEOT

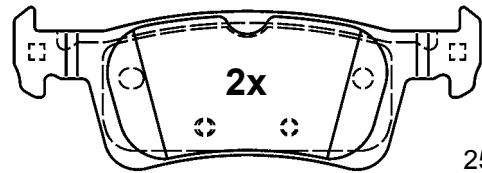

25841 16,1

123,0 x 42,4 x 16,1

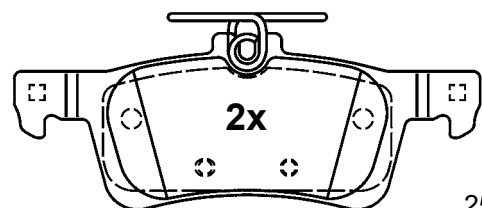

25842 16,1

123,0 x 46,2 x 16,1



# Abbildungen Scheibenbremsbeläge

Illustrations disc brake pads - Illustrazioni pastiglie freno -

Illustrations plaquettes de frein - Ilustraciones pastillas de freno



Maßstab - scale - scala - échelle - escala 1:2

## 13.0470-7303.2 LD7303 ATE Ceramic



AUDI, SEAT, SKODA,  
VOLKSWAGEN



ATE

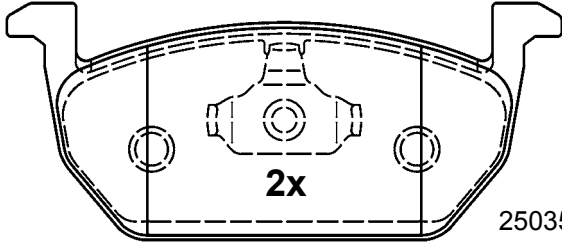

25035 17,5

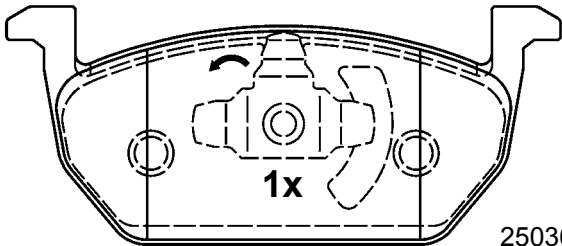

25036 17,5

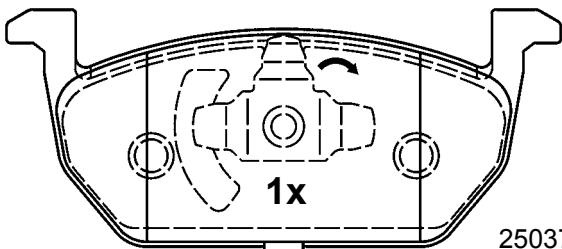

25037 17,5

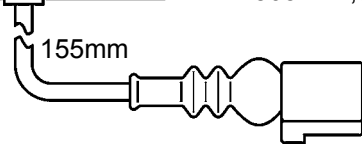

146,0 x 62,4 x 17,5

## 13.0470-7305.2 LD7305 ATE Ceramic



CITROEN



ATE

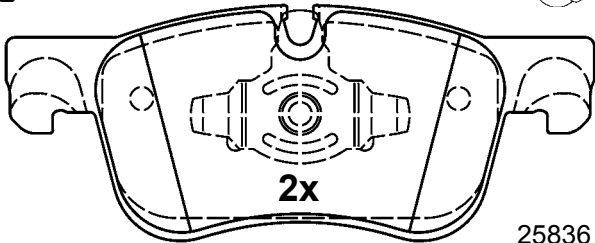

25836 17,0

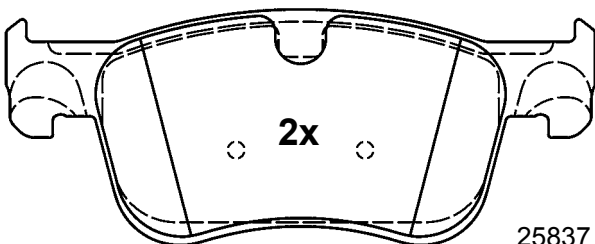

25837 17,0

155,1 x 61,9 x 17,0

## 13.0470-9000.2 LD9000 ATE Ceramic



MERCEDES BENZ



ATE

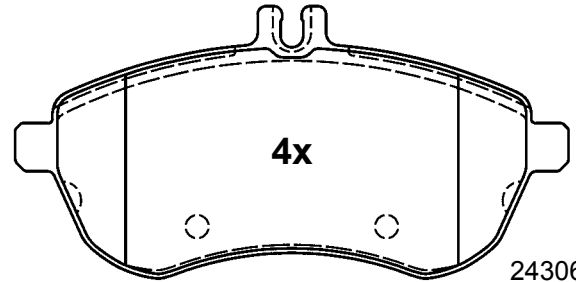

24306 20,3

146,0 x 71,5 x 20,3

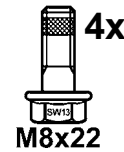

M8x22

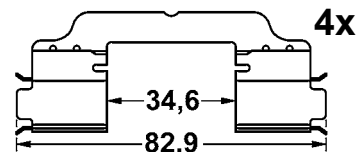

## 13.0470-9001.2 LD9001 ATE Ceramic



MERCEDES BENZ



ATE

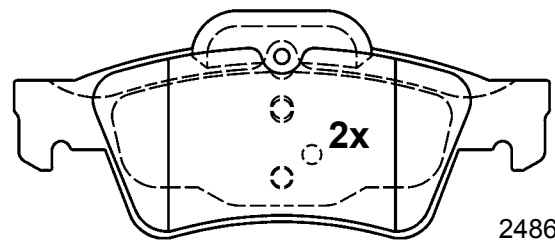

24862 16,7

141,1 x 59,6 x 16,7

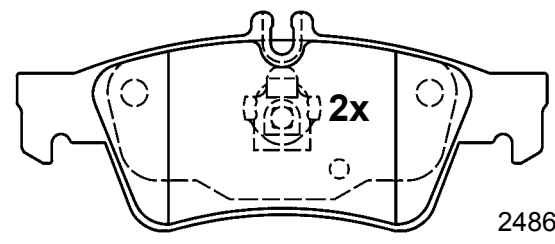

24863 16,7

139,8 x 57,5 x 16,7



- D** Abbildungen Bremsbelag-Einbausätze
- EN** Illustrations brake pad installation kits
- FR** Illustrations Lots de montage pour plaquettes de frein à disque
- IT** Illustrazioni kit installazione pastiglie freno
- ES** Ilustraciones juegos de montaje pastillas
- NL** Afbeeldingen inbouwsets voor remblokjes
- DA** Tegning monteringsæt for bremsebakker
- SV** Avbildningar bromsbelägg monteringsatts
- HU** Ábrák - fékbetét-szerelőkészletek
- PT** Figuras Kits de instalação do calço do travão de disco
- RU** Изображения монтажных комплектов для тормозных накладок
- CZ** Zobrazení vestavných sad brzdového obložení
- PL** Rysunki zestawów montażowych szczęk hamulca bębnowego
- EL** Εικόνες σετ τοποθέτησης τακάκιών φρένων
- TR** Fren kaplaması montaj takımları resimleri
- ZH** 制动摩擦片——安祥组件图片(新)
- JA** 図版 ブレーキパッド組み込みキット
- AR** صور طواقم ترأيب مزلاقات المكابح

# K24-F

# Abbildungen Belagsatz-Zubehör

Illustrations accessories for brake pad set - Illustrazioni accessori per kit di guarnizioni - Illustrations accessoires pour jeux de garnitures - Ilustraciones accesorios para juego de pastillas

| 13.0460-0014.2 610014 | 13.0460-0017.2 610017 | 13.0460-0018.2 610018 |
|-----------------------|-----------------------|-----------------------|
|                       |                       |                       |
| 13.0460-0023.2 610023 | 13.0460-0024.2 610024 | 13.0460-0026.2 610026 |
|                       |                       |                       |
| 13.0460-0027.2 610027 | 13.0460-0029.2 610029 | 13.0460-0035.2 610035 |
|                       |                       |                       |





# Abbildungen Belagsatz-Zubehör

Illustrations accessories for brake pad set - Illustrazioni accessori per kit di guarnizioni - Illustrations accessoires pour jeux de garnitures - Ilustraciones accesorios para juego de pastillas

| 13.0460-0038.2 610038 | 13.0460-0060.2 610060 | 13.0460-0072.2 610072 |
|-----------------------|-----------------------|-----------------------|
|                       |                       |                       |
| 13.0460-0073.2 610073 | 13.0460-0074.2 610074 | 13.0460-0075.2 610075 |
|                       |                       |                       |
| 13.0460-0077.2 610077 | 13.0460-0088.2 610088 | 13.0460-0091.2 610091 |
|                       |                       |                       |

# Abbildungen Belagsatz-Zubehör

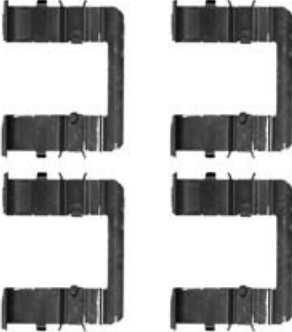
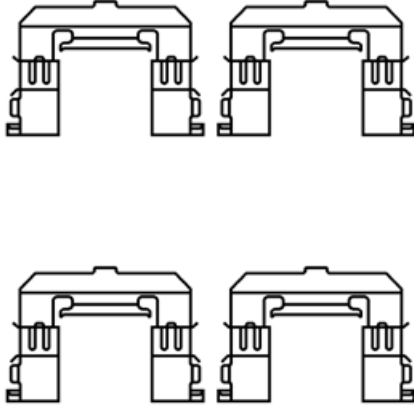
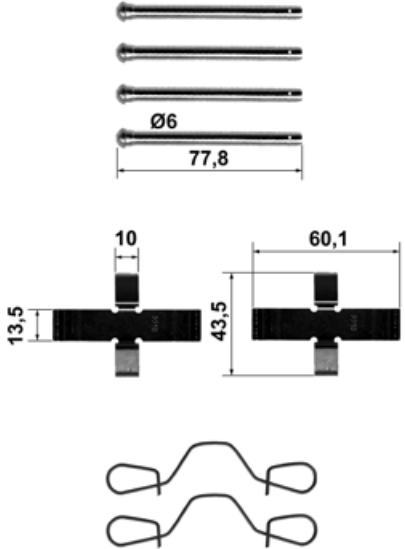
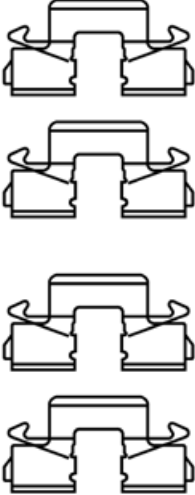
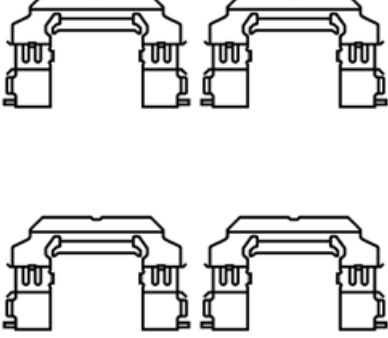

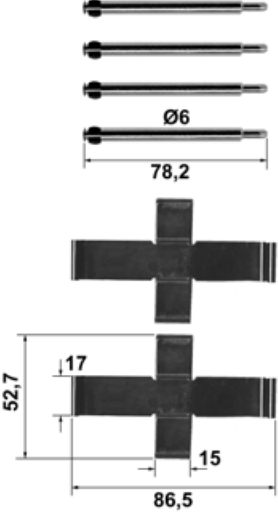
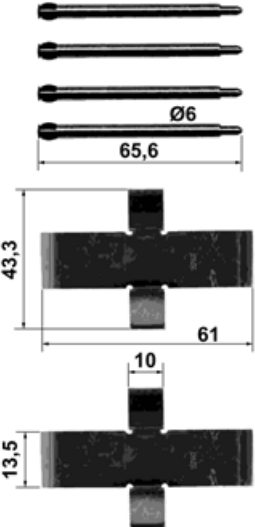
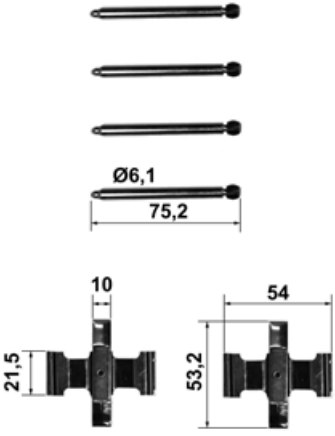



Illustrations accessories for brake pad set - Illustrazioni accessori per kit di guarnizioni - Illustrations accessoires pour jeux de garnitures - Ilustraciones accesorios para juego de pastillas

| 13.0460-0107.2 610107   | 13.0460-0112.2 610112   | 13.0460-0115.2 610115   |
|---|---|---|
|    |   |    |
| 13.0460-0116.2 610116   | 13.0460-0117.2 610117   | 13.0460-0121.2 610121   |
|   |  |   |
| 13.0460-0122.2 610122   | 13.0460-0123.2 610123   | 13.0460-0125.2 610125   |
|  |  |  |

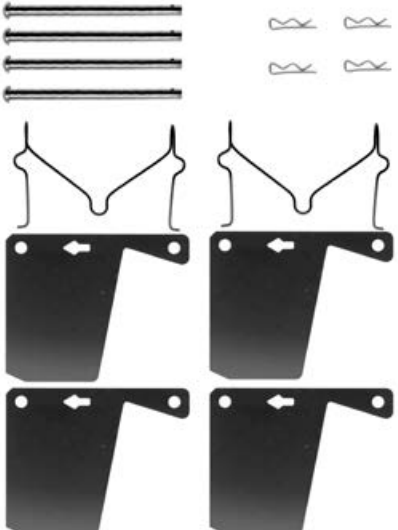

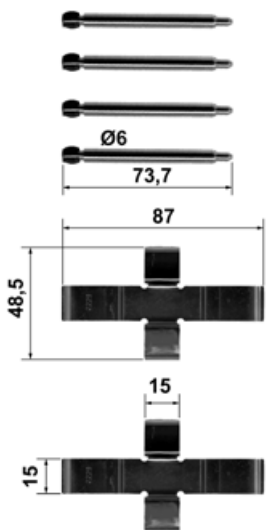
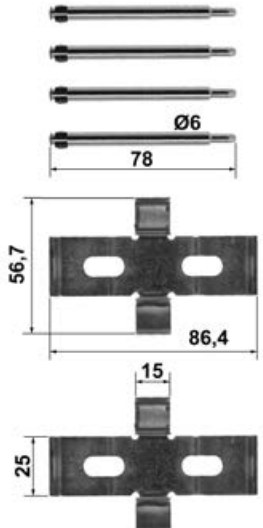
# Abbildungen Belagsatz-Zubehör

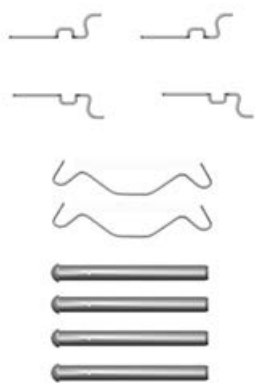





Illustrations accessories for brake pad set - Illustrazioni accessori per kit di guarnizioni - Illustrations accessoires pour jeux de garnitures - Ilustraciones accesorios para juego de pastillas

| 13.0460-0126.2 610126   | 13.0460-0127.2 610127   | 13.0460-0131.2 610131   |
|---|---|---|
|    |    |    |
| 13.0460-0132.2 610132   | 13.0460-0134.2 610134   | 13.0460-0135.2 610135   |
|   |   |  |
| 13.0460-0136.2 610136   | 13.0460-0137.2 610137   | 13.0460-0138.2 610138   |
|  |  |  |

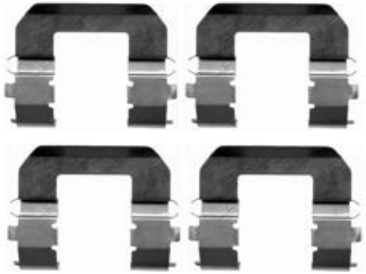
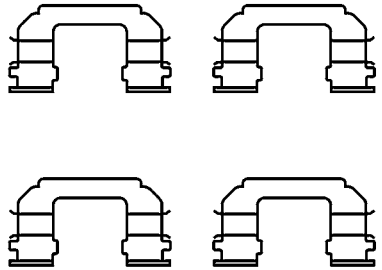

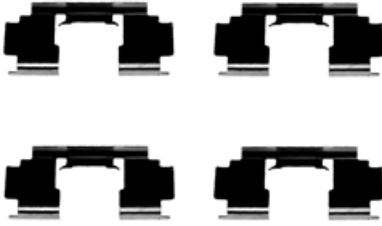

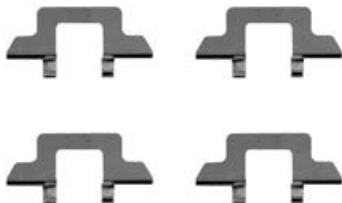

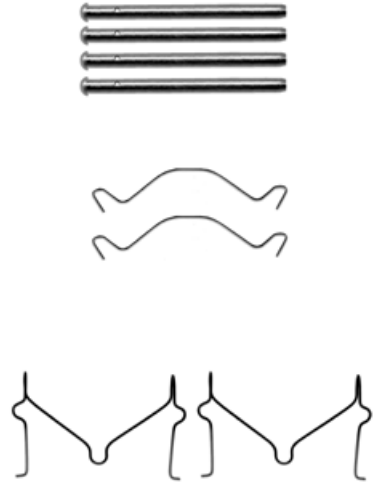

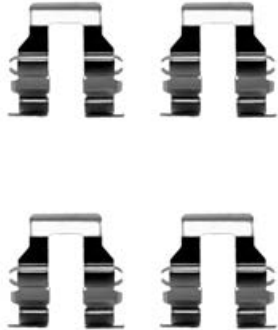

# Abbildungen Belagsatz-Zubehör

Illustrations accessories for brake pad set - Illustrazioni accessori per kit di guarnizioni - Illustrations accessoires pour jeux de garnitures - Ilustraciones accesorios para juego de pastillas

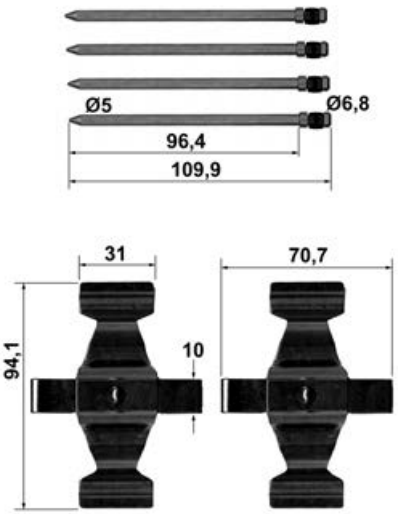
| 13.0460-0139.2 610139   | 13.0460-0140.2 610140   | 13.0460-0141.2 610141   |
|---|---|---|
|    |    |    |
| 13.0460-0142.2 610142   | 13.0460-0143.2 610143   | 13.0460-0144.2 610144   |
|  |  |  |
| 13.0460-0146.2 610146   | 13.0460-0148.2 610148   | 13.0460-0149.2 610149   |
|  |  |  |

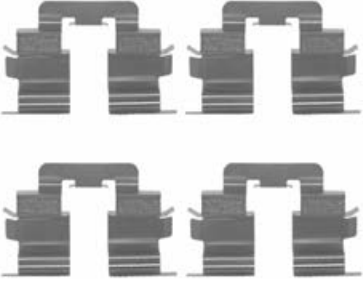

# Abbildungen Belagsatz-Zubehör

Illustrations accessories for brake pad set - Illustrazioni accessori per kit di guarnizioni - Illustrations accessoires pour jeux de garnitures - Ilustraciones accesorios para juego de pastillas

| 13.0460-0150.2 610150   | 13.0460-0154.2 610154   | 13.0460-0155.2 610155   |
|---|---|---|
|    |    |    |
| 13.0460-0157.2 610157   | 13.0460-0158.2 610158   | 13.0460-0160.2 610160   |
|   |  |   |
| 13.0460-0163.2 610163   | 13.0460-0165.2 610165   | 13.0460-0170.2 610170   |
|  |  |  |

# Abbildungen Belagsatz-Zubehör



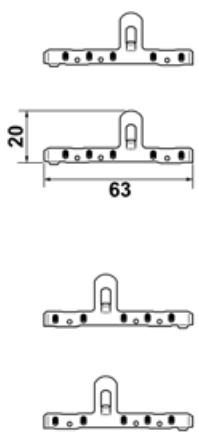
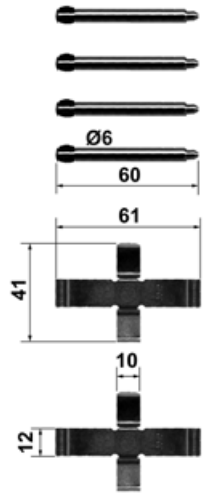
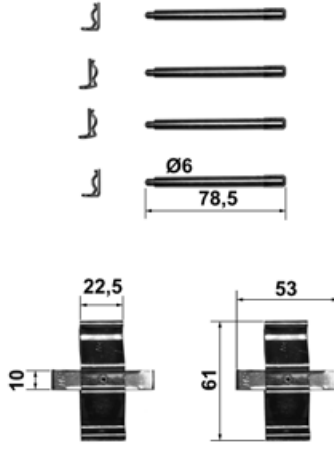
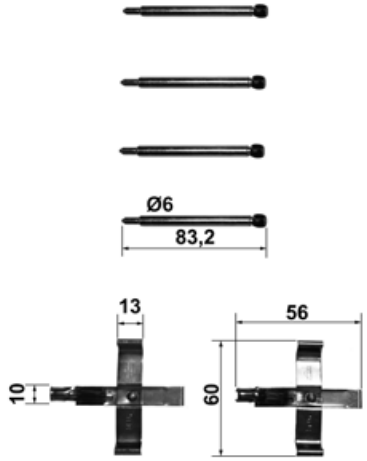
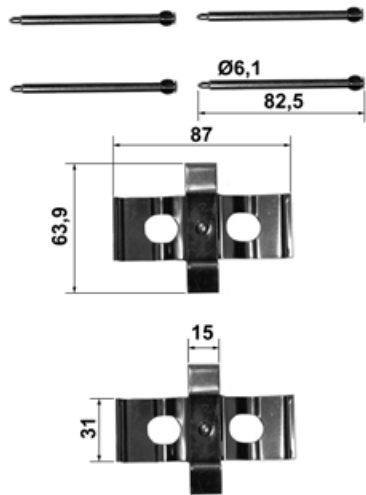
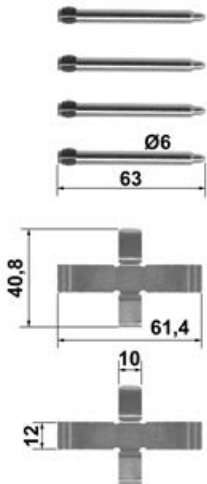
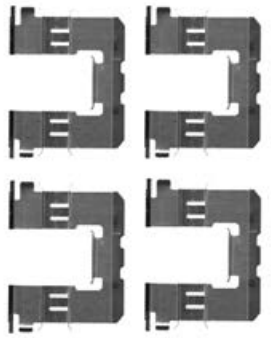



Illustrations accessories for brake pad set - Illustrazioni accessori per kit di guarnizioni - Illustrations accessoires pour jeux de garnitures - Ilustraciones accesorios para juego de pastillas

| 13.0460-0171.2 610171   | 13.0460-0175.2 610175   | 13.0460-0184.2 610184   |
|---|---|---|
|    |    |    |
| 13.0460-0186.2 610186   | 13.0460-0192.2 610192   | 13.0460-0193.2 610193   |
|   |   |   |
| 13.0460-0197.2 610197   | 13.0460-0198.2 610198   | 13.0460-0203.2 610203   |
|  |  |  |





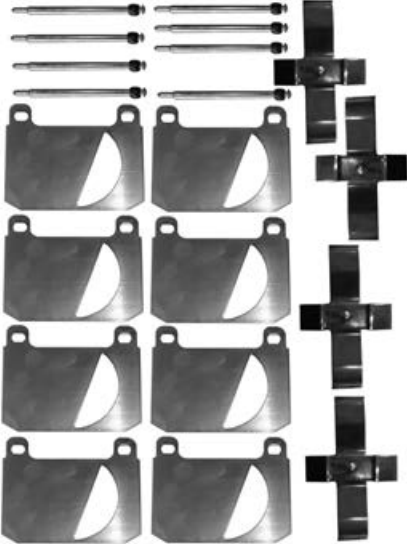
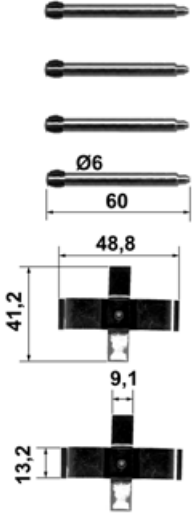
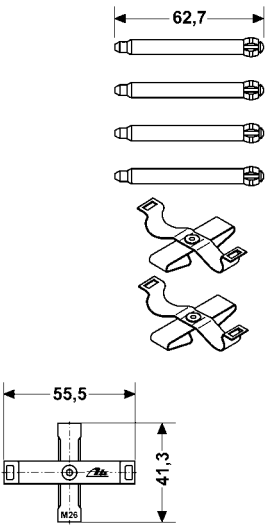
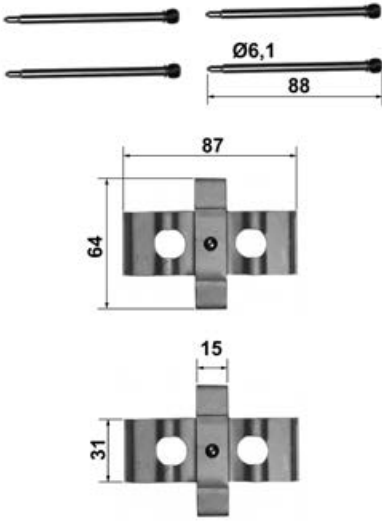



# Abbildungen Belagsatz-Zubehör

Illustrations accessories for brake pad set - Illustrazioni accessori per kit di guarnizioni - Illustrations accessoires pour jeux de garnitures - Ilustraciones accesorios para juego de pastillas

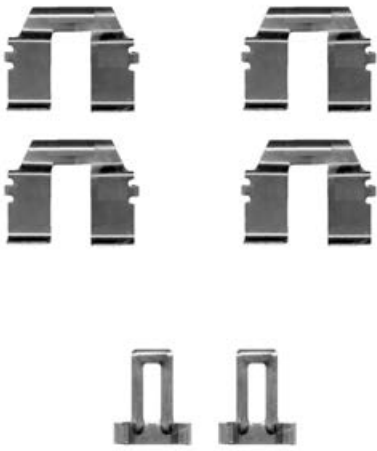
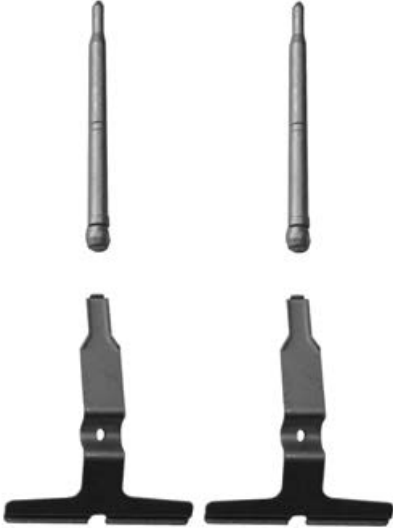
| 13.0460-0205.2 610205   | 13.0460-0206.2 610206   | 13.0460-0212.2 610212   |
|---|---|---|
|    |    |    |
| 13.0460-0213.2 610213   | 13.0460-0214.2 610214   | 13.0460-0215.2 610215   |
|  |  |   |
| 13.0460-0217.2 610217   | 13.0460-0219.2 610219   | 13.0460-0222.2 610222   |
|  |  |  |

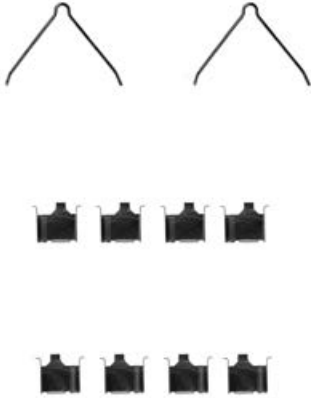
# Abbildungen Belagsatz-Zubehör









Illustrations accessories for brake pad set - Illustrazioni accessori per kit di guarnizioni - Illustrations accessoires pour jeux de garnitures - Ilustraciones accesorios para juego de pastillas

| 13.0460-0225.2 610225   | 13.0460-0229.2 610229   | 13.0460-0231.2 610231   |
|---|---|---|
|    |    |    |
| 13.0460-0233.2 610233   | 13.0460-0234.2 610234   | 13.0460-0235.2 610235   |
|  |  |  |
| 13.0460-0236.2 610236   | 13.0460-0237.2 610237   | 13.0460-0238.2 610238   |
|  |  |  |

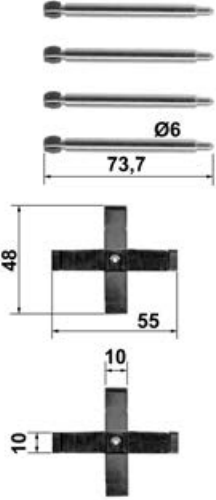

# Abbildungen Belagsatz-Zubehör

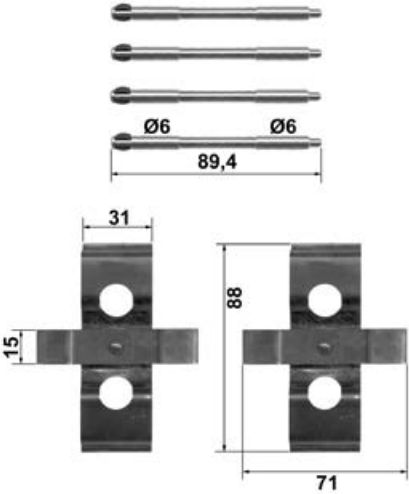



Illustrations accessories for brake pad set - Illustrazioni accessori per kit di guarnizioni - Illustrations accessoires pour jeux de garnitures - Ilustraciones accesorios para juego de pastillas

| 13.0460-0239.2 610239  | 13.0460-0245.2 610245   | 13.0460-0246.2 610246   |
|--|---|---|
|   |    |    |
| 13.0460-0248.2 610248  | 13.0460-0250.2 610250   | 13.0460-0252.2 610252   |
|  |  |   |
| 13.0460-0254.2 610254  | 13.0460-0256.2 610256   | 13.0460-0257.2 610257   |
|  |  |  |

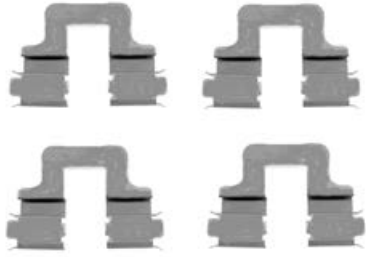
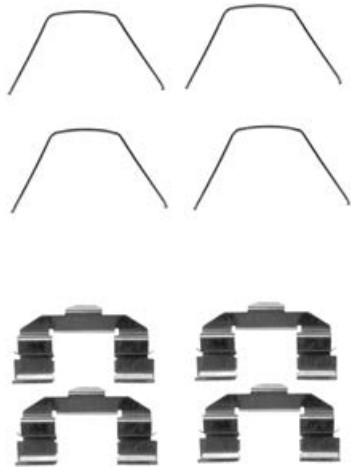
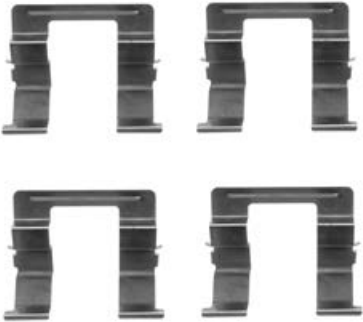

# Abbildungen Belagsatz-Zubehör

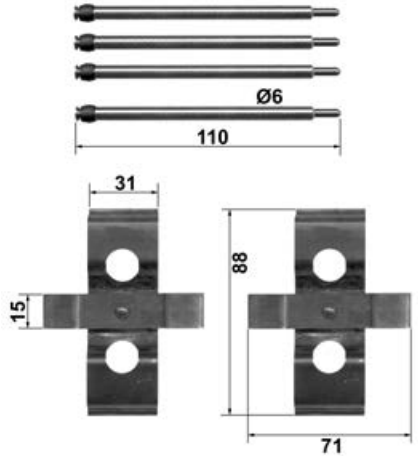
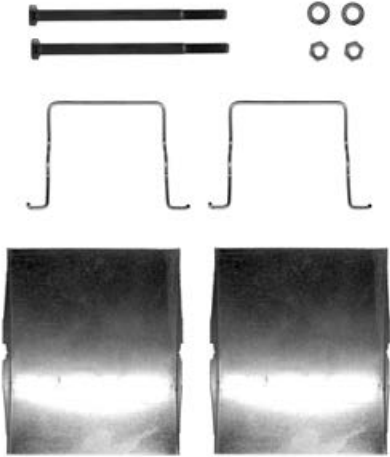
Illustrations accessories for brake pad set - Illustrazioni accessori per kit di guarnizioni - Illustrations accessoires pour jeux de garnitures - Ilustraciones accesorios para juego de pastillas

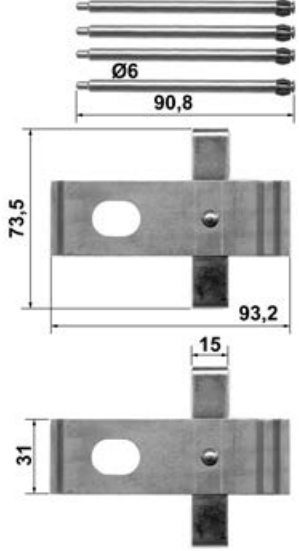
| 13.0460-0258.2 610258   | 13.0460-0259.2 610259   | 13.0460-0260.2 610260   |
|---|---|---|
|    |    |    |
| 13.0460-0261.2 610261   | 13.0460-0262.2 610262   | 13.0460-0263.2 610263   |
|  |  |   |
| 13.0460-0264.2 610264   | 13.0460-0265.2 610265   | 13.0460-0267.2 610267   |
|   |  |  |









# Abbildungen Belagsatz-Zubehör

Illustrations accessories for brake pad set - Illustrazioni accessori per kit di guarnizioni - Illustrations accessoires pour jeux de garnitures - Ilustraciones accesorios para juego de pastillas

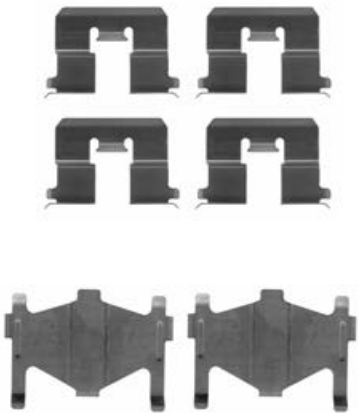
| 13.0460-0268.2 610268 | 13.0460-0269.2 610269 | 13.0460-0275.2 610275 |
|-----------------------|-----------------------|-----------------------|
|                       |                       |                       |
| 13.0460-0278.2 610278 | 13.0460-0279.2 610279 | 13.0460-0280.2 610280 |
|                       |                       |                       |
| 13.0460-0281.2 610281 | 13.0460-0282.2 610282 | 13.0460-0283.2 610283 |
|                       |                       |                       |

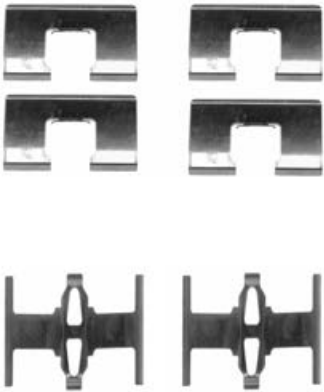
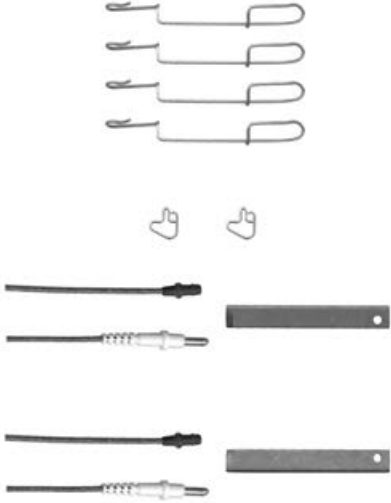

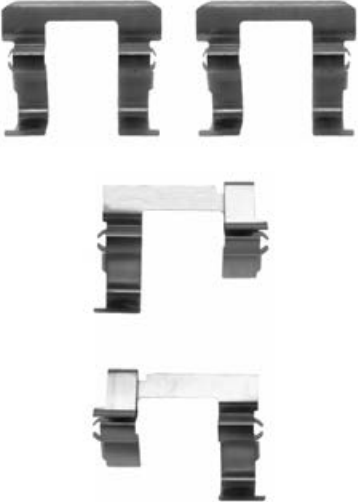
# Abbildungen Belagsatz-Zubehör

Illustrations accessories for brake pad set - Illustrazioni accessori per kit di guarnizioni - Illustrations accessoires pour jeux de garnitures - Ilustraciones accesorios para juego de pastillas

| 13.0460-0284.2 610284   | 13.0460-0285.2 610285   | 13.0460-0286.2 610286   |
|---|---|---|
|    |    |    |
| 13.0460-0287.2 610287   | 13.0460-0288.2 610288   | 13.0460-0289.2 610289   |
|   |   |   |
| 13.0460-0291.2 610291   | 13.0460-0294.2 610294   | 13.0460-0295.2 610295   |
|  |  |  |



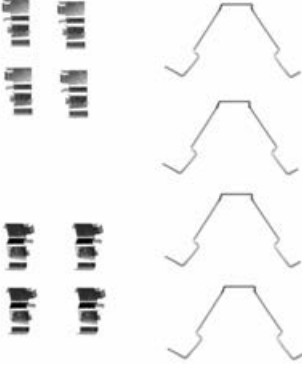
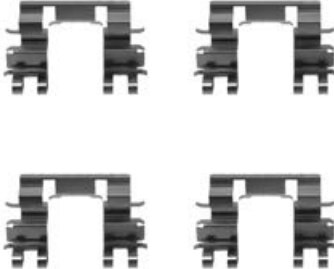
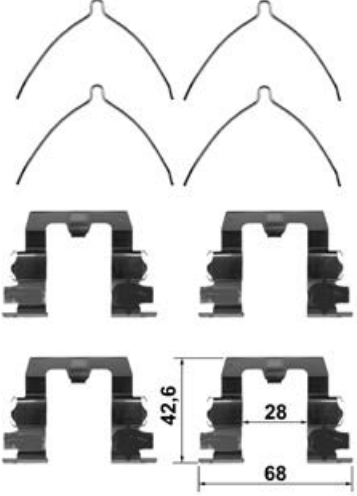

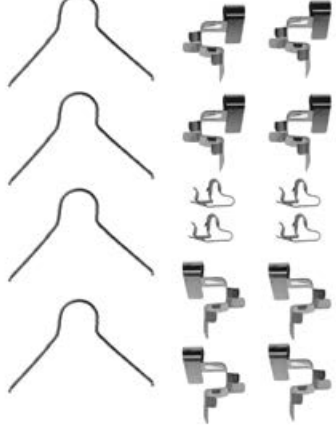
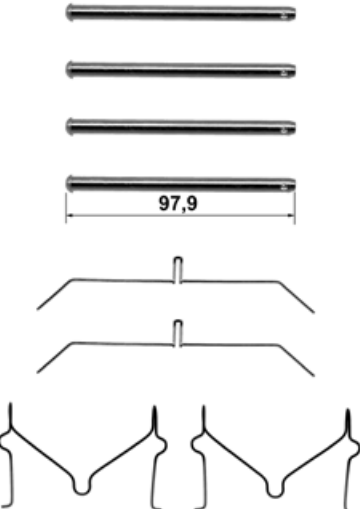
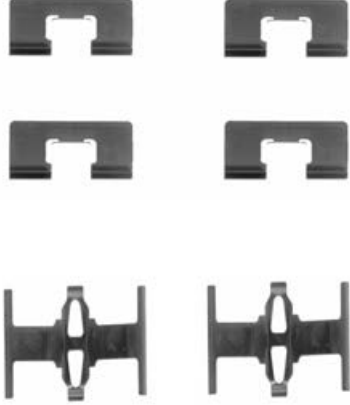
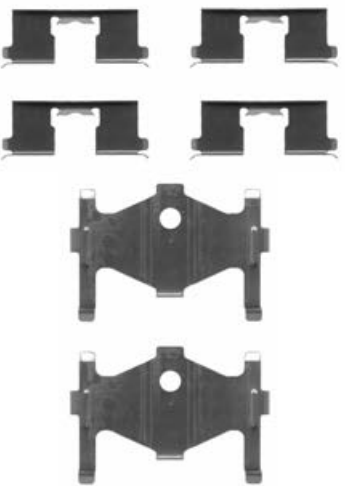
# Abbildungen Belagsatz-Zubehör

Illustrations accessories for brake pad set - Illustrazioni accessori per kit di guarnizioni - Illustrations accessoires pour jeux de garnitures - Ilustraciones accesorios para juego de pastillas

| 13.0460-0296.2 610296   | 13.0460-0308.2 610308   | 13.0460-0313.2 610313   |
|---|---|---|
|    |    |    |
| 13.0460-0319.2 610319   | 13.0460-0322.2 610322   | 13.0460-0325.2 610325   |
|  |   |  |
| 13.0460-0327.2 610327   | 13.0460-0329.2 610329   | 13.0460-0332.2 610332   |
|  |  |  |

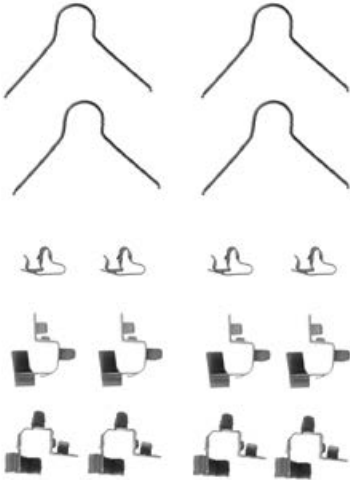
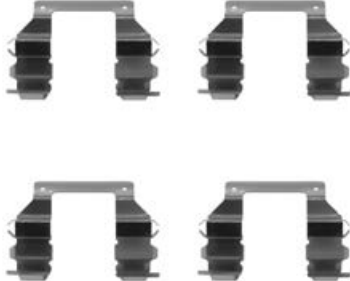
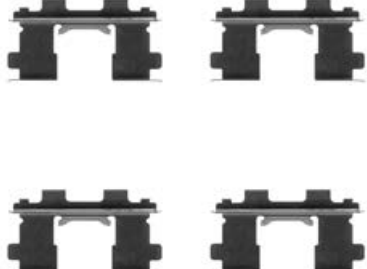
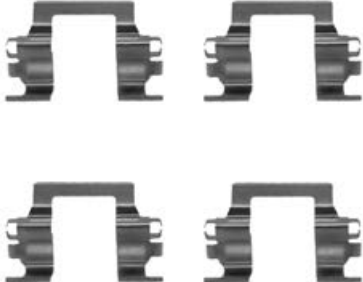
# Abbildungen Belagsatz-Zubehör

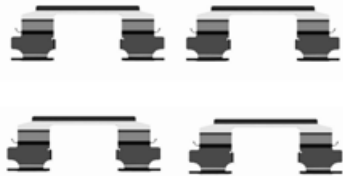
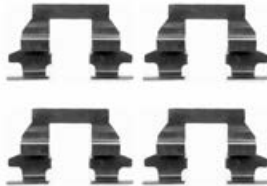

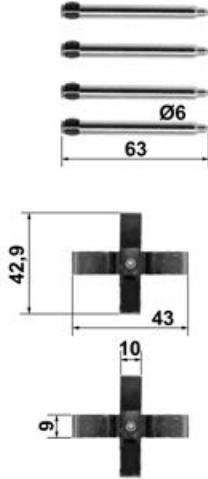
Illustrations accessories for brake pad set - Illustrazioni accessori per kit di guarnizioni - Illustrations accessoires pour jeux de garnitures - Ilustraciones accesorios para juego de pastillas

| 13.0460-0333.2 610333   | 13.0460-0335.2 610335   | 13.0460-0336.2 610336   |
|---|---|---|
|    |    |    |
| 13.0460-0337.2 610337   | 13.0460-0339.2 610339   | 13.0460-0340.2 610340   |
|  |   |  |
| 13.0460-0341.2 610341   | 13.0460-0344.2 610344   | 13.0460-0347.2 610347   |
|  |  |  |



# Abbildungen Belagsatz-Zubehör

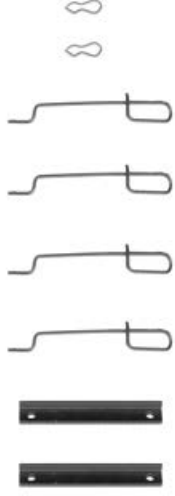

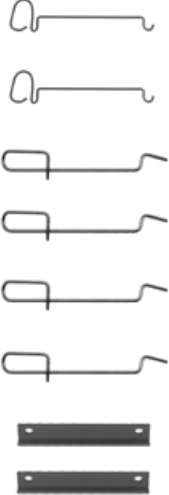
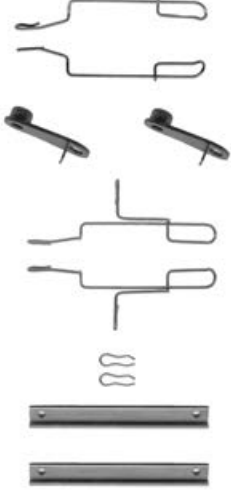
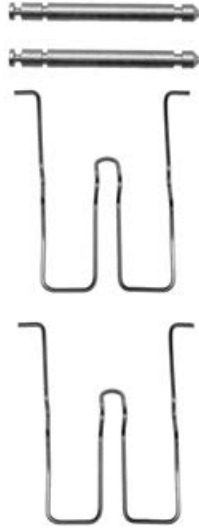
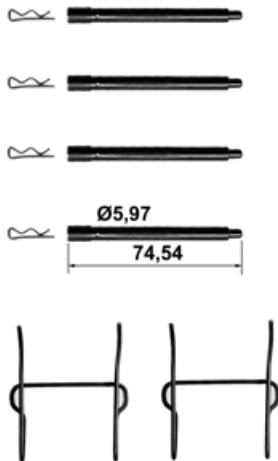
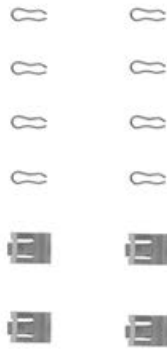
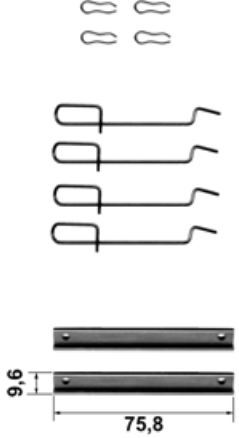



Illustrations accessories for brake pad set - Illustrazioni accessori per kit di guarnizioni - Illustrations accessoires pour jeux de garnitures - Ilustraciones accesorios para juego de pastillas

| 13.0460-0400.2 610400   | 13.0460-0402.2 610402   | 13.0460-0403.2 610403   |
|---|---|---|
|    |    |    |
| 13.0460-0404.2 610404   | 13.0460-0406.2 610406   | 13.0460-0408.2 610408   |
|   |   |   |
| 13.0460-0409.2 610409   | 13.0460-0410.2 610410   | 13.0460-0411.2 610411   |
|  |  |  |



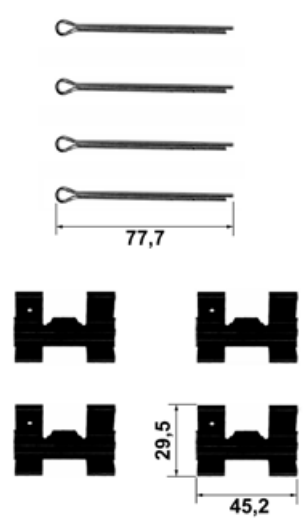
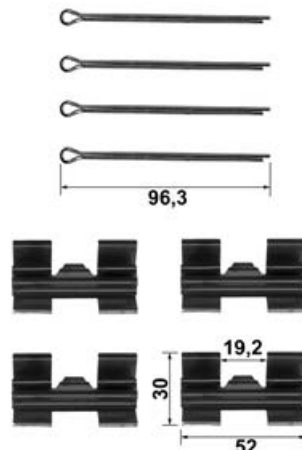

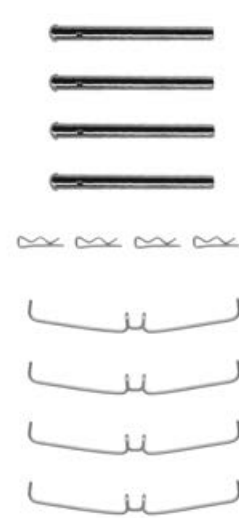

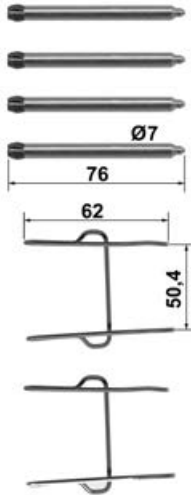
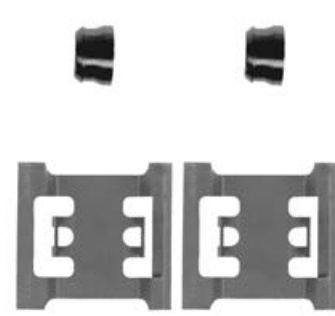
# Abbildungen Belagsatz-Zubehör

Illustrations accessories for brake pad set - Illustrazioni accessori per kit di guarnizioni - Illustrations accessoires pour jeux de garnitures - Ilustraciones accesorios para juego de pastillas

| 13.0460-0412.2 610412   | 13.0460-0413.2 610413   | 13.0460-0414.2 610414   |
|---|---|---|
|    |    |    |
| 13.0460-0415.2 610415   | 13.0460-0419.2 610419   | 13.0460-0422.2 610422   |
|   |  |   |
| 13.0460-0423.2 610423   | 13.0460-0424.2 610424   | 13.0460-0427.2 610427   |
|  |  |  |

# Abbildungen Belagsatz-Zubehör

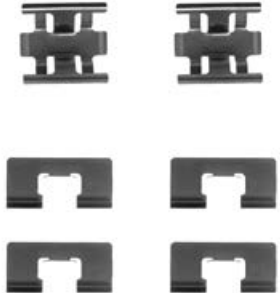
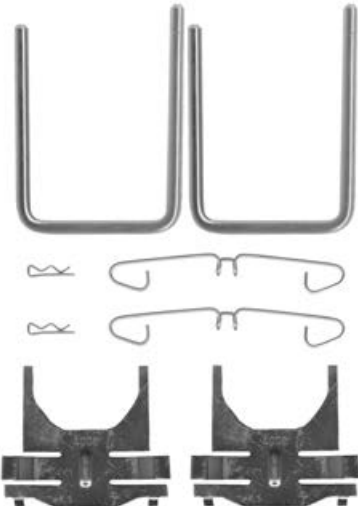
Illustrations accessories for brake pad set - Illustrazioni accessori per kit di guarnizioni - Illustrations accessoires pour jeux de garnitures - Ilustraciones accesorios para juego de pastillas

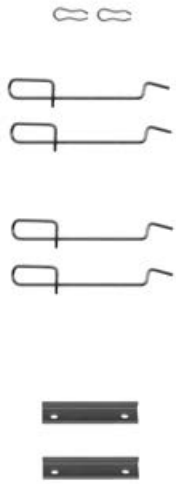
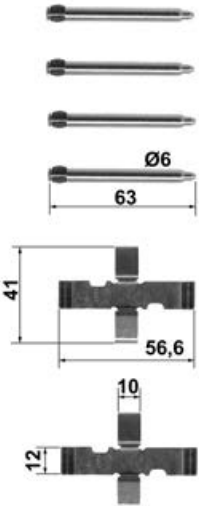
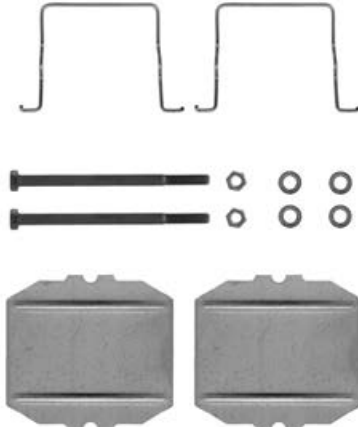
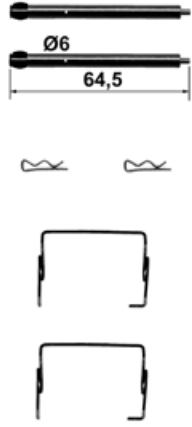
| 13.0460-0428.2 610428   | 13.0460-0429.2 610429   | 13.0460-0430.2 610430   |
|---|---|---|
|    |    |    |
| 13.0460-0431.2 610431   | 13.0460-0434.2 610434   | 13.0460-0435.2 610435   |
|   |   |   |
| 13.0460-0436.2 610436   | 13.0460-0437.2 610437   | 13.0460-0438.2 610438   |
|  |  |  |

# Abbildungen Belagsatz-Zubehör

Illustrations accessories for brake pad set - Illustrazioni accessori per kit di guarnizioni - Illustrations accessoires pour jeux de garnitures - Ilustraciones accesorios para juego de pastillas

13.0460-0439.2 610439



13.0460-0440.2 610440



13.0460-0441.2 610441

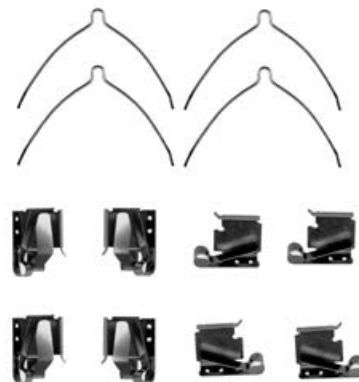

13.0460-0442.2 610442

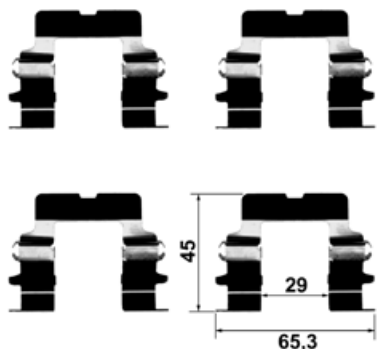

13.0460-0443.2 610443

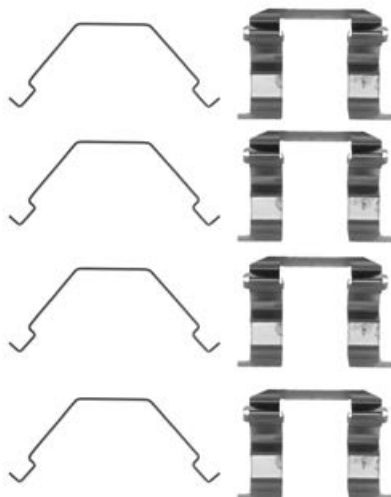

13.0460-0446.2 610446

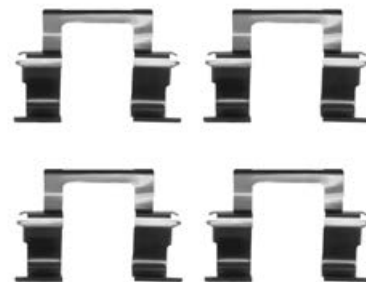

13.0460-0447.2 610447



13.0460-0448.2 610448





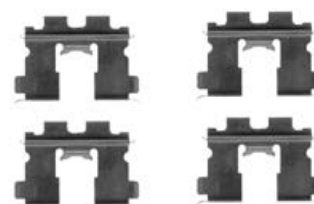

13.0460-0449.2 610449



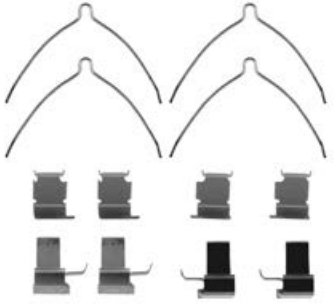
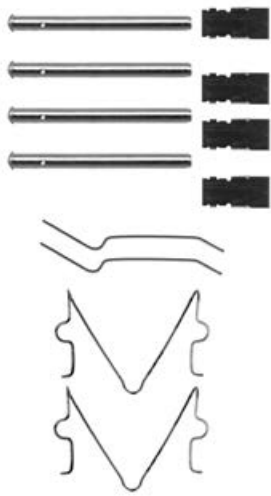
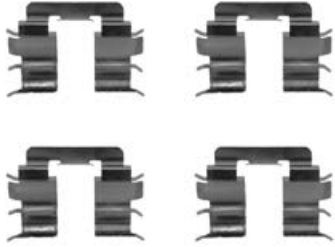

# Abbildungen Belagsatz-Zubehör

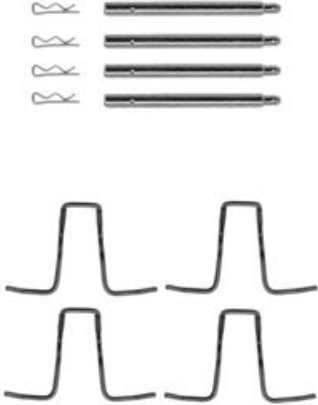
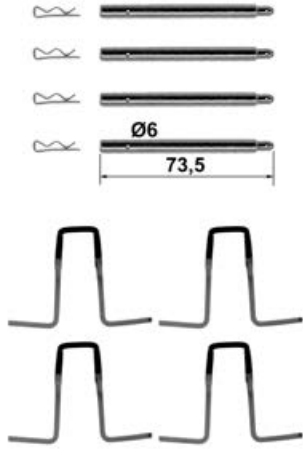
Illustrations accessories for brake pad set - Illustrazioni accessori per kit di guarnizioni - Illustrations accessoires pour jeux de garnitures - Ilustraciones accesorios para juego de pastillas

| 13.0460-0450.2 610450   | 13.0460-0451.2 610451   | 13.0460-0452.2 610452   |
|---|---|---|
|    |    |    |
| 13.0460-0453.2 610453   | 13.0460-0454.2 610454   | 13.0460-0905.2 610905   |
|   |  |   |
| 13.0460-0908.2 610908   | 13.0460-0910.2 610910   | 13.0460-0911.2 610911   |
|  |  |  |

# Abbildungen Belagsatz-Zubehör

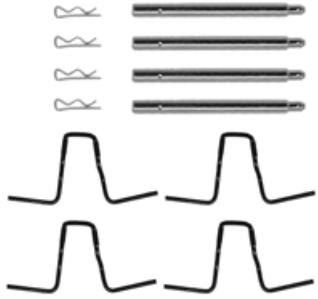
Illustrations accessories for brake pad set - Illustrazioni accessori per kit di guarnizioni - Illustrations accessoires pour jeux de garnitures - Ilustraciones accesorios para juego de pastillas

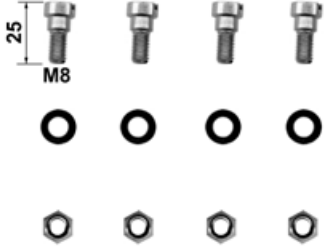
| 13.0460-0912.2 610912   | 13.0460-0916.2 610916   | 13.0460-0918.2 610918   |
|---|---|---|
|  |  |  |
|   |   |   |
|   |   |   |
|   |   |   |
|   |   |   |















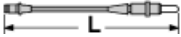

- D** Abbildungen Warnkontakte
- EN** Illustrations wear indicators
- FR** Illustrations témoins d'usure
- IT** Illustrazioni rilevatori usura
- ES** Ilustraciones contactos de desgaste
- NL** Afbeeldingen waarschuwingscontacten
- DA** Tegning advarselskontakter
- SV** Avbildningar varningskontakter
- HU** Ábrák figyelmeztető érintkező
- PT** Figuras avisador de desgaste
- RU** Изображение контактов предупредительного сигнала
- CZ** Zobrazení kontaktů indikátoru opotřebení
- PL** Rysunki styki ostrzegawcze
- EL** Εικόνες επαφών προειδοποίησης
- TR** İkaz kontakçı resimleri
- ZH** 警示触点的图示
- JA** 図: ウェアインジケーター
- AR** صور تماس جهاز الإنذار

# K24-F









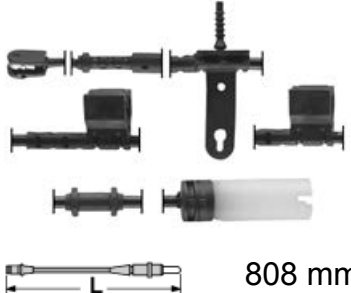

# Abbildungen Warnkontakte

Illustrations wear indicators - Illustrazioni rilevatori usura - Illustrations Témoins d'usure - Ilustraciones contactos de desgaste

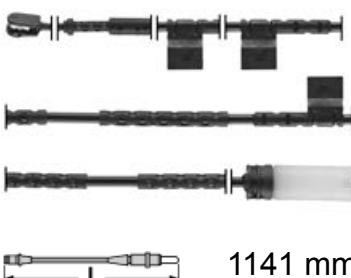
| 24.8190-0005.2   |   | 620005 |    | OE - #          |
|--|---|--------|---|-----------------|
| <br> 84 mm       | <b>MERCEDES BENZ</b><br>Transporter (BM 906) SPRINTER (06-) |        | 2x  | 906 540 13 17   |
|  | <b>VOLKSWAGEN</b><br>CRAFTER (06-)                          |        | 2x 2x   | 2E0 906 206 B   |
| 24.8190-0006.2   |   | 620006 |    | OE - #          |
| <br> 675 mm    | <b>BMW</b><br>1er Reihe/F20/F21 Limousine (11-)             |        | 1x  | 34 35 6 792 289 |
|  | 2er Reihe/F22 Coupe (13-)                                   |        | 1x  |                 |
|  | 2er Reihe/F23 Cabrio (14-)                                  |        | 1x  |                 |
|  | 3er Reihe/F30 Limousine (11-)                               |        | 1x  |                 |
|  | 3er Reihe/F31 Touring (12-)                                 |        | 1x  |                 |
|  | 3er Reihe/F34 GT (13-)                                      |        | 1x  |                 |
|  | 4er Reihe/F32 Coupe (13-)                                   |        | 1x  |                 |
|  | 4er Reihe/F33 Cabrio (14-)                                  |        | 1x  |                 |
|  | 4er Reihe/F36 Gran Coupe (14-)                              |        | 1x  |                 |
| 24.8190-0007.2   |   | 620007 |  | OE - #          |
| <br> 1045 mm | <b>BMW</b><br>1er Reihe/F20/F21 Limousine (11-)             |        | 1x  | 34 35 6 792 292 |
|  | 2er Reihe/F22 Coupe (13-)                                   |        | 1x  |                 |
|  | 2er Reihe/F23 Cabrio (14-)                                  |        | 1x  |                 |
|  | 3er Reihe/F30 Limousine (11-)                               |        | 1x  |                 |
|  | 3er Reihe/F31 Touring (12-)                                 |        | 1x  |                 |
|  | 3er Reihe/F34 GT (13-)                                      |        | 1x  |                 |
|  | 4er Reihe/F32 Coupe (13-)                                   |        | 1x  |                 |
|  | 4er Reihe/F33 Cabrio (14-)                                  |        | 1x  |                 |
| 4er Reihe/F36 Gran Coupe (14-)   |   | 1x     |   |                 |
| 24.8190-0008.2   |   | 620008 |  | OE - #          |
| <br> 1000 mm | <b>BMW</b><br>5er Reihe/F10 Limousine (10-)                 |        | 1x  | 34 35 2 284 343 |
|  | 6er Reihe/F06 Gran Coupe (11-)                              |        | 1x  |                 |
|  | 6er Reihe/F12 Cabrio (11-)                                  |        | 1x  |                 |
|  | 6er Reihe/F13 Coupe (11-)                                   |        | 1x  |                 |





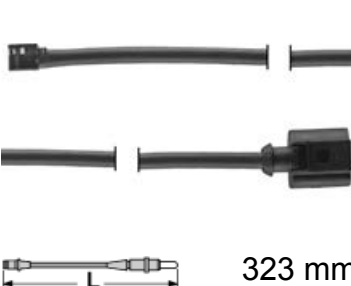









# Abbildungen Warnkontakte

Illustrations wear indicators - Illustrazioni rilevatori usura - Illustrations Témoins d'usure - Ilustraciones contactos de desgaste

| 24.8190-0009.2   | 620009   |    | OE - #                 |
|--|--|---|------------------------|
|  <p>808 mm</p>     | <p><b>MINI</b><br/>                     R55 Clubvan (12-)<br/>                     R58 Coupe (11-)<br/>                     R59 Roadster (12-)</p>   | <p>1x<br/>1x<br/>1x</p>   | <p>34 35 6 792 572</p> |
| 24.8190-0010.2   | 620010   |    | OE - #                 |
|  <p>1141 mm</p>    | <p><b>MINI</b><br/>                     R55 Clubman (07-14)<br/>                     R55 Clubvan (12-)<br/>                     R56 (06-14)<br/>                     R57 Cabrio (09-14)<br/>                     R58 Coupe (11-)<br/>                     R59 Roadster (12-)</p> | <p>1x<br/>1x<br/>1x<br/>1x<br/>1x<br/>1x</p>  | <p>34 35 6 792 573</p> |
| 24.8190-0011.2   | 620011   |   | OE - #                 |
|  <p>362,5 mm</p> | <p><b>AUDI</b><br/>                     Q7 (06-15)</p>   | <p>2x</p>   | <p>4L0 615 437</p>     |
| 24.8190-0012.2   | 620012   |  | OE - #                 |
|  <p>272,4 mm</p> | <p><b>AUDI</b><br/>                     Q7 (06-15)</p>   | <p>2x</p>   | <p>4L0 615 437 A</p>   |
| 24.8190-0013.2   | 620013   |  | OE - #                 |
|  <p>323 mm</p>   | <p><b>VOLKSWAGEN</b><br/>                     TOUAREG II (10-)</p>   | <p>2x</p>   | <p>7P0 907 637</p>     |



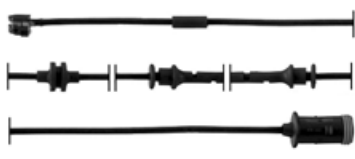





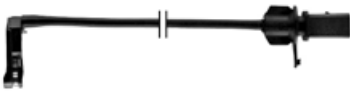

# Abbildungen Warnkontakte

Illustrations wear indicators - Illustrazioni rilevatori usura - Illustrations Témoins d'usure - Ilustraciones contactos de desgaste

| 24.8190-0014.2  | 620014   |    | OE - #                          |
|---|--|---|---------------------------------|
| <br> 296 mm       | <b>PORSCHE</b><br>CAYENNE II (10-)<br>PANAMERA (10-)<br><b>VOLKSWAGEN</b><br>TOUAREG II (10-)        | 2x<br>2x<br>2x  | 958 612 365 00<br>7P0 907 637 A |
| 24.8190-0015.2  | 620015   |    | OE - #                          |
| <br> 138 mm       | <b>PORSCHE</b><br>CAYENNE II (10-)<br>PANAMERA (10-)<br><b>VOLKSWAGEN</b><br>TOUAREG II (10-)        | 2x<br>2x<br>2x  | 958 612 365 50<br>7P0 907 637 C |
| 24.8190-0016.2  | 620016   |   | OE - #                          |
| <br> 359,6 mm | <b>PORSCHE</b><br>911 CABRIO (997) (05-13)<br>911 COUPE (997) (04-13)                                | 2x<br>2x  | 997 612 769 00                  |
| 24.8190-0017.2  | 620017   |  | OE - #                          |
| <br> 388,3 mm | <b>AUDI</b><br>A4 (B8) Avant (08-)<br>A4 Cabrio (02-08)<br>A5 Cabrio (09-)<br>R8 / R8 Spyder (07-15) | 1x<br>2x<br>1x<br>1x  | 8E0 615 437                     |
| 24.8190-0018.2  | 620018   |  | OE - #                          |
| <br> 755 mm   | <b>OPEL</b><br>ASTRA G / Vauxhall Astra MKIV (98-05)<br>ZAFIRA I / Vauxhall Zafira I (99-05)         | 2x<br>2x  | 13153473<br>62 35 674           |















# Abbildungen Warnkontakte

Illustrations wear indicators - Illustrazioni rilevatori usura - Illustrations Témoins d'usure - Ilustraciones contactos de desgaste

| 24.8190-0019.2  | 620019  |    | OE - #                   |
|---|---|---|--------------------------|
| <br><br> 254 mm       | <b>AUDI</b><br>A6 (4G2/C7) Limousine (11-)<br>A6 (4G5/C7) Avant (11-)<br>A7 Sportback (10-)<br>A8 (09-) | 2x<br>2x<br>2x<br>2x  | 4H0 615 121 P            |
| 24.8190-0020.2  | 620020  |    | OE - #                   |
| <br><br> 443,3 mm   | <b>AUDI</b><br>A6 (4G2/C7) Limousine (11-)<br>A6 (4G5/C7) Avant (11-)<br>A7 Sportback (10-)<br>A8 (09-) | 2x<br>2x<br>2x<br>2x  | 4H0 615 121 Q            |
| 24.8190-0021.2  | 620021  |  | OE - #                   |
| <br><br> 478 mm   | <b>FORD</b><br>TRANSIT CUSTOM / TOURNEO CUSTOM (12-)  | 2x 2x   | 1792658<br>BK21-2N248-BC |
| 24.8190-0023.2  | 620023  |  | OE - #                   |
| <br><br> 484,6 mm | <b>PORSCHE</b><br>911 CABRIO (997) (05-13)<br>911 COUPE (997) (04-13)<br>911 TARGA (997) (06-13)        | 2x<br>2x<br>2x  | 997 612 754 00           |





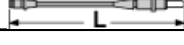



# Abbildungen Warnkontakte

Illustrations wear indicators - Illustrazioni rilevatori usura - Illustrations Témoins d'usure - Ilustraciones contactos de desgaste

| 24.8190-0024.2  | 620024  |    | OE - #                   |
|---|---|---|--------------------------|
| <br><br> 369,6 mm     | <b>PORSCHE</b><br>911 COUPE (997) (04-13)<br>BOXSTER (987) (05-11)<br>CAYMAN (987C) (05-12) | 1x<br>1x<br>1x  | 997 612 759 00           |
| 24.8190-0025.2  | 620025  |    | OE - #                   |
| <br><br> 349,6 mm    | <b>PORSCHE</b><br>911 COUPE (997) (04-13)<br>BOXSTER (987) (05-11)<br>CAYMAN (987C) (05-12) | 1x<br>1x<br>1x  | 997 612 756 00           |
| 24.8190-0026.2  | 620026  |  | OE - #                   |
| <br><br> 312 mm   | <b>FORD</b><br>TRANSIT (14-)<br>TRANSIT CUSTOM / TOURNEO CUSTOM (12-)                       | 2x<br>1x  | 1781726<br>BK21-2N248-AB |
| 24.8190-0027.2  | 620027  |  | OE - #                   |
| <br><br> 514,6 mm | <b>PORSCHE</b><br>911 TARGA (997) (06-13)   | 2x  | 997 612 770 00           |
| 24.8190-0028.2  | 620028  |  | OE - #                   |
| <br><br> 977 mm   | <b>BMW</b><br>X5/E70 (07-13)<br>X5/F15 (13-)<br>X6/E71/E72 (08-14)<br>X6/F16 (14-)          | 1x<br>1x<br>1x<br>1x  | 34 35 6 854 168          |

# Abbildungen Warnkontakte













Illustrations wear indicators - Illustrazioni rilevatori usura - Illustrations Témoins d'usure - Ilustraciones contactos de desgaste

| 24.8190-0065.2  | 620065   |            | OE - #             |
|---|--|---|--------------------|
| <br><br> 172 mm       | <b>AUDI</b><br>A3 / A3 (8V) Sportback (12-)<br>TT (14-)<br><b>SEAT</b><br>ATECA (16-)<br><b>SKODA</b><br>SUPERB III (15-)<br>SUPERB III Combi (15-)<br><b>VOLKSWAGEN</b><br>PASSAT / PASSAT VARIANT (14-)<br>PASSAT ALLTRACK (15-)<br>TIGUAN (16-)<br>TOURAN II (15-)  | <br>1x<br>1x<br><br>1x<br><br>1x<br>1x<br><br>1x<br>1x<br>1x<br>1x                            | <br>8V0 615 437    |
| 24.8190-0066.2  | 620066   |          | OE - #             |
| <br><br> 397,4 mm | <b>PORSCHE</b><br>CAYENNE I (03-10)  | <br>2x  | <br>955 612 365 50 |
| 24.8190-0067.2  | 620067   |          | OE - #             |
| <br><br> 92,5 mm  | <b>MERCEDES BENZ</b><br>A-Klasse (W176 ) (12-)<br>B-Klasse (W246/W242) (11-)<br>C-Klasse (W205) Limousine (14-)<br>C-Klasse (C205) Coupe (15-)<br>C-Klasse (S205) Kombi (14-)<br>CLA-Klasse (C117) Coupe (13-)<br>CLA-Klasse (X117) Shooting Brake (15-)<br>E-Klasse (W213) Limousine (16-)<br>E-Klasse (S213) Kombi (16-)<br>GLA-Klasse (X156) (13-)<br>GLC-Klasse (X253) (15-) | <br>1x<br>1x<br>1x 1x<br>1x 1x<br>1x 1x<br><br>1x<br>1x<br><br>1x 1x<br>1x 1x<br><br>1x<br>1x | <br>169 540 16 17  |

















# Abbildungen Warnkontakte

Illustrations wear indicators - Illustrazioni rilevatori usura - Illustrations Témoins d'usure - Ilustraciones contactos de desgaste

| 24.8190-0068.2   | 620068   |    | OE - #          |
|--|--|---|-----------------|
| <br><br> 332 mm      | <b>AUDI</b><br>A7 Sportback (10-)<br>Q5 (08-)  | 1x<br>1x  | 8R0 615 121 A   |
| 24.8190-0069.2   | 620069   |    | OE - #          |
| <br><br> 248 mm    | <b>PORSCHE</b><br>911 CABRIO (991) (12-)<br>911 COUPE (991) (11-)<br>911 TARGA (991) (14-)<br>BOXSTER (981) (12-)<br>CAYMAN (981C) (13-) | 2x<br>2x<br>2x<br>2x<br>2x  | 991 609 161 00  |
| 24.8190-0070.2   | 620070   |  | OE - #          |
| <br><br> 268 mm  | <b>PORSCHE</b><br>718 BOXSTER (982) (16-)<br>718 CAYMAN (982) (16-)<br>BOXSTER (981) (12-)<br>CAYMAN (981C) (13-)                        | 2x<br>2x<br>2x<br>2x  | 981 609 163 00  |
| 24.8190-0071.2   | 620071   |  | OE - #          |
| <br><br> 945 mm | <b>BMW</b><br>X5/E70 (07-13)<br>X5/F15 (13-)<br>X6/E71/E72 (08-14)<br>X6/F16 (14-)   | 1x<br>1x<br>1x<br>1x  | 34 35 6 860 181 |









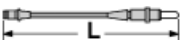

# Abbildungen Warnkontakte

Illustrations wear indicators - Illustrazioni rilevatori usura - Illustrations Témoins d'usure - Ilustraciones contactos de desgaste

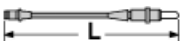
| 24.8190-0105.2  | 620105  |    | OE - #          |
|---|---|---|-----------------|
| <br> 240 mm     | <b>AUDI</b><br>100 Quattro (91-94)<br>AUDI V8 (88-94)   | 2x<br>2x  | 441 919 351 A   |
| 24.8190-0106.2  | 620106  |    | OE - #          |
| <br> 270 mm     | <b>AUDI</b><br>TT Coupe (98-06)<br>TT Roadster (99-06)<br><b>VOLKSWAGEN</b><br>GOLF IV (98-05)  | 1x<br>1x<br>1x  | 1J0 615 121     |
| 24.8190-0107.2  | 620107  |   | OE - #          |
| <br> 235 mm | <b>VOLKSWAGEN</b><br>PASSAT (97-05)   | 1x  | 3B7 615 121     |
| 24.8190-0201.2  | 620201  |  | OE - #          |
| <br> 235 mm | <b>BMW</b><br>3er Reihe/E30 (82-93)<br>Z1 (88-91)   | 1x<br>1x  | 34 35 9 058 889 |
| 24.8190-0206.2  | 620206  |  | OE - #          |
| <br> 790 mm | <b>BMW</b><br>3er Reihe/E36 Limousine (90-98)<br>3er Reihe/E36 Cabrio (93-99)<br>3er Reihe/E36 Coupe (92-99)<br>3er Reihe/E36 Touring (95-99) | 1x<br>1x<br>1x<br>1x  | 34 35 1 181 342 |











# Abbildungen Warnkontakte

Illustrations wear indicators - Illustrazioni rilevatori usura - Illustrations Témoins d'usure - Ilustraciones contactos de desgaste

| 24.8190-0207.2  | 620207  |    | OE - #          |
|---|---|---|-----------------|
| <br> 786 mm     | <b>BMW</b><br>3er Reihe/E36 Limousine (90-98) | 1x  | 34 35 1 181 338 |
|   | 3er Reihe/E36 Cabrio (93-99)                  | 1x  |                 |
|   | 3er Reihe/E36 Compact (94-00)                 | 1x  |                 |
|   | 3er Reihe/E36 Coupe (92-99)                   | 1x  |                 |
|   | 3er Reihe/E36 Touring (95-99)                 | 1x  |                 |
|   | Z3/E36 (95-02)                                | 1x  |                 |
| 24.8190-0208.2  | 620208  |    | OE - #          |
| <br> 569 mm  | <b>BMW</b><br>7er Reihe/E38 (93-01)           | 1x  | 34 35 1 182 064 |
|   |   |   |                 |
| 24.8190-0209.2  | 620209  |  | OE - #          |
| <br> 620 mm | <b>BMW</b><br>7er Reihe/E38 (93-01)           | 1x  | 34 35 1 182 065 |
|   |   |   |                 |
| 24.8190-0210.2  | 620210  |  | OE - #          |
| <br> 810 mm | <b>BMW</b><br>3er Reihe/E36 Limousine (90-98) | 1x  | 34 35 2 227 385 |
|   | 3er Reihe/E36 Cabrio (93-99)                  | 1x  |                 |
|   | 3er Reihe/E36 Coupe (92-99)                   | 1x  |                 |
|   | Z3/E36 (95-02)                                | 1x  |                 |

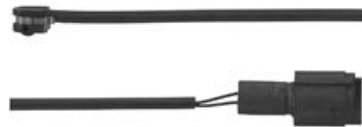





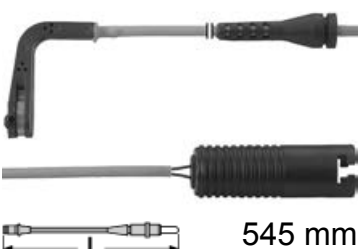

# Abbildungen Warnkontakte

Illustrations wear indicators - Illustrazioni rilevatori usura - Illustrations Témoins d'usure - Ilustraciones contactos de desgaste

| 24.8190-0211.2  |                       | 620211                        |    |                 | OE - #          |
|---|-----------------------|-------------------------------|---|-----------------|-----------------|
| <br> 840 mm     | <b>BMW</b>            | 3er Reihe/E36 Compact (94-00) | 1x  | 34 35 1 182 533 |                 |
|   |                       | Z3/E36 (95-02)                | 1x  |                 |                 |
| 24.8190-0213.2  |                       | 620213                        |    |                 | OE - #          |
| <br> 262 mm   | <b>BMW</b>            | 3er Reihe/E30 (82-93)         | 1x  | 34 35 1 179 819 |                 |
|   |                       | 5er Reihe/E28 (81-87)         | 1x  |                 |                 |
|   | 6er Reihe/E24 (76-89) | 1x                            | 1x  |                 |                 |
|   | Z1 (88-91)            |                               |   |                 |                 |
| 24.8190-0214.2  |                       | 620214                        |  |                 | OE - #          |
| <br> 235 mm | <b>BMW</b>            | 5er Reihe/E28 (81-87)         | 1x  | 34 35 1 179 820 |                 |
|   |                       | 5er Reihe/E34 (88-96)         | 1x  |                 | 34 35 1 180 432 |
|   |                       | 6er Reihe/E24 (76-89)         | 1x  |                 |                 |
|   |                       | 7er Reihe/E32 (86-94)         | 1x  | 1x              |                 |
|   |                       | 8er Reihe/E31 (90-99)         | 1x  | 1x              |                 |
| 24.8190-0215.2  |                       | 620215                        |  |                 | OE - #          |
| <br> 162 mm | <b>BMW</b>            | 3er Reihe/E21 (75-83)         | 1x  | 34 21 2 225 229 |                 |
|   |                       | 5er Reihe/E12 (72-81)         | 1x  |                 | 34 35 1 179 821 |
|   |                       | 5er Reihe/E28 (81-87)         |   | 1x              |                 |
|   |                       | 6er Reihe/E24 (76-89)         | 1x  | 1x              |                 |
|   |                       | 7er Reihe/E23 (77-86)         | 1x  | 1x              |                 |

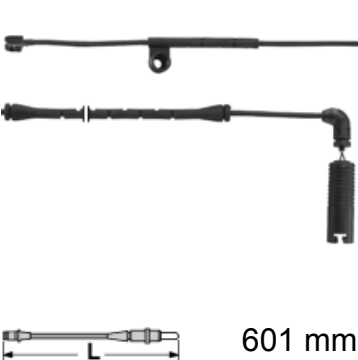

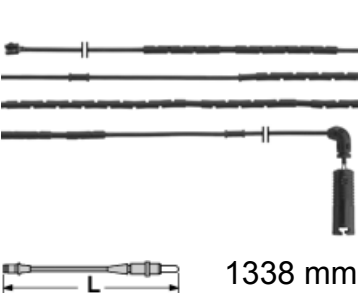



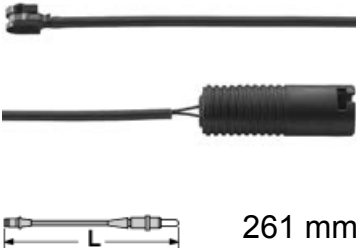

# Abbildungen Warnkontakte

Illustrations wear indicators - Illustrazioni rilevatori usura - Illustrations Témoins d'usure - Ilustraciones contactos de desgaste

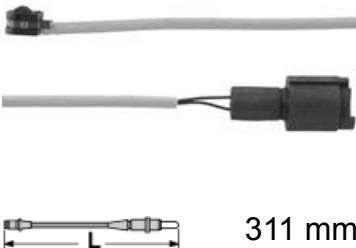
| 24.8190-0218.2  | 620218  |    | OE - #          |
|---|---|---|-----------------|
|  <p>545 mm</p>    | <b>BMW</b><br>5er Reihe/E39 (96-03)<br>Z8/E52 (00-03)   | 1x<br>1x  | 34 35 1 163 066 |
| 24.8190-0219.2  | 620219  |    | OE - #          |
|  <p>764 mm</p>    | <b>BMW</b><br>5er Reihe/E39 (96-03)   | 1x  | 34 35 2 229 018 |
| 24.8190-0220.2  | 620220  |   | OE - #          |
|  <p>601 mm</p>  | <b>BMW</b><br>3er Reihe/E46 Limousine (98-05)<br>3er Reihe/E46 Cabrio (00-06)<br>3er Reihe/E46 Compact (01-05)<br>3er Reihe/E46 Coupe (99-06)<br>3er Reihe/E46 Touring (99-05)<br>Z4 Roadster/E85 (03-08) | 1x<br>1x<br>1x<br>1x<br>1x<br>1x  | 34 35 1 164 371 |
| 24.8190-0221.2  | 620221  |  | OE - #          |
|  <p>1338 mm</p> | <b>BMW</b><br>3er Reihe/E46 Limousine (98-05)<br>3er Reihe/E46 Cabrio (00-06)<br>3er Reihe/E46 Compact (01-05)<br>3er Reihe/E46 Coupe (99-06)<br>3er Reihe/E46 Touring (99-05)                            | 1x<br>1x<br>1x<br>1x<br>1x  | 34 35 1 164 372 |
| 24.8190-0222.2  | 620222  |  | OE - #          |
|  <p>1090 mm</p> | <b>BMW</b><br>5er Reihe/E39 (96-03)   | 1x  | 34 35 1 163 207 |

# Abbildungen Warnkontakte

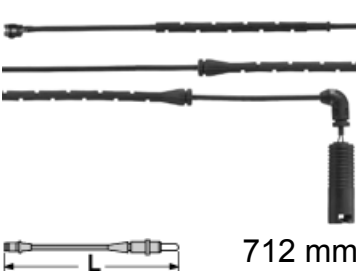

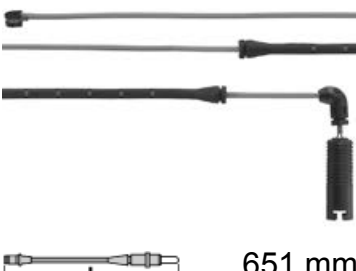









Illustrations wear indicators - Illustrazioni rilevatori usura - Illustrations Témoins d'usure - Ilustraciones contactos de desgaste

| 24.8190-0223.2   | 620223   |    | OE - #                 |
|--|--|---|------------------------|
|  <p>261 mm</p>   | <p><b>BMW</b><br/>8er Reihe/E31 (90-99)</p>  | <p>1x</p>   | <p>34 35 1 181 823</p> |
| 24.8190-0224.2   | 620224   |    | OE - #                 |
|  <p>311 mm</p>   | <p><b>BMW</b><br/>5er Reihe/E34 (88-96)</p>  | <p>1x</p>   | <p>34 35 1 181 802</p> |
| 24.8190-0225.2   | 620225   |   | OE - #                 |
|  <p>794 mm</p> | <p><b>BMW</b><br/>X5/E53 (00-07)</p>   | <p>1x</p>   | <p>34 35 1 165 579</p> |
| 24.8190-0226.2   | 620226   |  | OE - #                 |
|  <p>712 mm</p> | <p><b>BMW</b><br/>X5/E53 (00-07)</p>   | <p>1x</p>   | <p>34 35 1 165 580</p> |
| 24.8190-0227.2   | 620227   |  | OE - #                 |
|  <p>651 mm</p> | <p><b>BMW</b><br/>3er Reihe/E46 Limousine (98-05)<br/>3er Reihe/E46 Cabrio (00-06)<br/>3er Reihe/E46 Coupe (99-06)<br/>3er Reihe/E46 Touring (99-05)</p> | <p>1x<br/>1x<br/>1x<br/>1x</p>  | <p>34 35 6 751 311</p> |

















# Abbildungen Warnkontakte

Illustrations wear indicators - Illustrazioni rilevatori usura - Illustrations Témoins d'usure - Ilustraciones contactos de desgaste

| 24.8190-0228.2  | 620228  |    | OE - #                             |
|---|---|---|------------------------------------|
| <br> 1353 mm    | <b>BMW</b><br>3er Reihe/E46 Cabrio (00-06)<br>3er Reihe/E46 Coupe (99-06) | 1x<br>1x  | 34 35 2 229 780                    |
| 24.8190-0229.2  | 620229  |    | OE - #                             |
| <br> 1143 mm | <b>BMW</b><br>Z4 Coupe/E86 (06-08)<br>Z4 Roadster/E85 (03-08)             | 1x<br>1x  | 34 35 6 757 896                    |
| 24.8190-0230.2  | 620230  |  | OE - #                             |
| <br> 814 mm | <b>BMW</b><br>7er Reihe/E65/66 (02-08)                                    | 1x  | 34 35 6 755 266<br>34 35 6 778 037 |
| 24.8190-0231.2  | 620231  |  | OE - #                             |
| <br> 830 mm | <b>BMW</b><br>7er Reihe/E65/66 (02-08)                                    | 1x  | 34 35 6 755 267<br>34 35 6 778 038 |



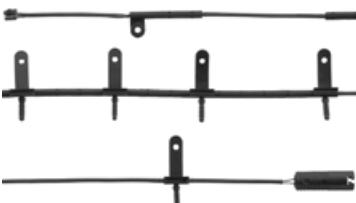







# Abbildungen Warnkontakte

Illustrations wear indicators - Illustrazioni rilevatori usura - Illustrations Témoins d'usure - Ilustraciones contactos de desgaste

| 24.8190-0232.2  | 620232   |                | OE - #          |
|---|--|---|-----------------|
| <br><br> 578 mm     | <b>BMW</b><br>7er Reihe/E38 (93-01)                    | <br>1x         | 34 35 1 163 117 |
| 24.8190-0233.2  | 620233   |                | OE - #          |
| <br><br> 758 mm   | <b>BMW</b><br>Z8/E52 (00-03)                           | <br>1x         | 34 35 1 166 057 |
| 24.8190-0234.2  | 620234   |              | OE - #          |
| <br><br> 585 mm | <b>BMW</b><br>7er Reihe/E38 (93-01)                    | <br>1x       | 34 35 1 165 729 |
| 24.8190-0235.2  | 620235   |              | OE - #          |
| <br><br> 883 mm | <b>MINI</b><br>R50 / R53 (00-06)<br>R52 Cabrio (04-08) | <br>1x<br>1x | 34 35 6 761 447 |

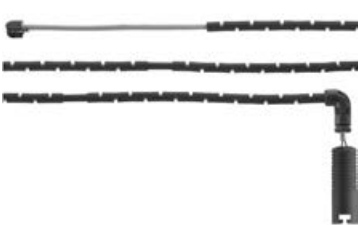







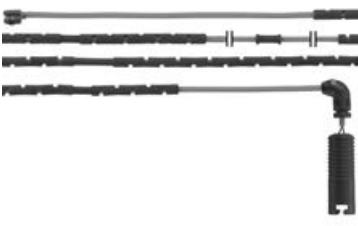

# Abbildungen Warnkontakte

Illustrations wear indicators - Illustrazioni rilevatori usura - Illustrations Témoins d'usure - Ilustraciones contactos de desgaste

| 24.8190-0236.2   | 620236  |    | OE - #          |
|--|---|---|-----------------|
| <br><br> 1130 mm     | <b>MINI</b><br>R50 / R53 (00-06)<br>R52 Cabrio (04-08)        | 1x<br>1x  | 34 35 6 761 448 |
| 24.8190-0240.2   | 620240  |    | OE - #          |
| <br><br> 735 mm   | <b>BMW</b><br>X3/E83 (03-10)                                  | 1x  | 34 35 3 411 756 |
| 24.8190-0241.2   | 620241  |  | OE - #          |
| <br><br> 1055 mm | <b>BMW</b><br>X3/E83 (03-10)                                  | 1x  | 34 35 3 411 757 |
| 24.8190-0244.2   | 620244  |  | OE - #          |
| <br><br> 611 mm  | <b>BMW</b><br>Z4 Coupe/E86 (06-08)<br>Z4 Roadster/E85 (03-08) | 1x<br>1x  | 34 35 7 836 795 |











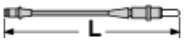

# Abbildungen Warnkontakte

Illustrations wear indicators - Illustrazioni rilevatori usura - Illustrations Témoins d'usure - Ilustraciones contactos de desgaste

| 24.8190-0245.2   | 620245   |    | OE - #          |
|--|--|---|-----------------|
| <br><br> 1163 mm     | <b>BMW</b><br>Z4 Coupe/E86 (06-08)<br>Z4 Roadster/E85 (03-08)                          | 1x<br>1x  | 34 35 7 836 969 |
| 24.8190-0254.2   | 620254   |    | OE - #          |
| <br><br> 745 mm   | <b>BMW</b><br>X3/E83 (03-10)   | 1x  | 34 35 3 414 662 |
| 24.8190-0260.2   | 620260   |  | OE - #          |
| <br><br> 1060 mm | <b>BMW</b><br>5er Reihe/F07 GT GRAN TURISMO (09-)<br>7er Reihe/F01/F02/F03/F04 (08-15) | 1x<br>1x  | 34 35 6 775 850 |
| 24.8190-0261.2   | 620261   |  | OE - #          |
| <br><br> 1045 mm | <b>BMW</b><br>7er Reihe/F01/F02/F03/F04 (08-15)  | 1x  | 34 35 6 775 858 |









# Abbildungen Warnkontakte

Illustrations wear indicators - Illustrazioni rilevatori usura - Illustrations Témoins d'usure - Ilustraciones contactos de desgaste

| 24.8190-0262.2  | 620262  |    | OE - #          |
|---|---|---|-----------------|
| <br><br> 1338 mm    | <b>BMW</b><br>Z4 Roadster/E89 (09-)   | <br>1x                                       | 34 35 6 789 446 |
| 24.8190-0263.2  | 620263  |    | OE - #          |
| <br><br> 969 mm  | <b>BMW</b><br>Z4 Roadster/E89 (09-)   | <br>1x                                       | 34 35 6 789 444 |
| 24.8190-0264.2  | 620264  |    | OE - #          |
| <br><br> 630 mm | <b>BMW</b><br>1er Reihe/E81/E87 Limousine (04-11)<br>1er Reihe/E82 Coupe (07-13)<br>1er Reihe/E88 Cabrio (08-13)<br>3er Reihe/E90 Limousine (05-12)<br>3er Reihe/E91 Touring (05-12)<br>3er Reihe/E92 Coupe (06-13)<br>3er Reihe/E93 Cabrio (07-13) | <br>1x<br>1x<br>1x<br>1x<br>1x<br>1x<br>1x | 34 35 6 789 439 |

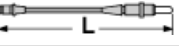
# Abbildungen Warnkontakte











Illustrations wear indicators - Illustrazioni rilevatori usura - Illustrations Témoins d'usure - Ilustraciones contactos de desgaste

| 24.8190-0265.2  | 620265   |    | OE - #                 |
|---|--|---|------------------------|
| <br><br> 1086 mm    | <p><b>BMW</b></p> <p>1er Reihe/E81/E87 Limousine (04-11)</p> <p>1er Reihe/E82 Coupe (07-13)</p> <p>1er Reihe/E88 Cabrio (08-13)</p> <p>3er Reihe/E90 Limousine (05-12)</p> <p>3er Reihe/E91 Touring (05-12)</p> <p>3er Reihe/E92 Coupe (06-13)</p> <p>3er Reihe/E93 Cabrio (07-13)</p> | <p>1x</p> <p>1x</p> <p>1x</p> <p>1x</p> <p>1x</p> <p>1x</p> <p>1x</p>                 | <p>34 35 6 789 445</p> |
| 24.8190-0266.2  | 620266   |    | OE - #                 |
| <br><br> 840 mm  | <p><b>BMW</b></p> <p>3er Reihe/E90 Limousine (05-12)</p> <p>3er Reihe/E91 Touring (05-12)</p> <p>3er Reihe/E92 Coupe (06-13)</p> <p>X1/E84 (09-)</p>   | <p>1x</p> <p>1x</p> <p>1x</p> <p>1x</p>   | <p>34 35 6 789 441</p> |
| 24.8190-0267.2  | 620267   |  | OE - #                 |
| <br><br> 679 mm | <p><b>BMW</b></p> <p>1er Reihe/E81/E87 Limousine (04-11)</p> <p>1er Reihe/E82 Coupe (07-13)</p> <p>1er Reihe/E88 Cabrio (08-13)</p> <p>3er Reihe/E90 Limousine (05-12)</p> <p>3er Reihe/E91 Touring (05-12)</p> <p>3er Reihe/E92 Coupe (06-13)</p> <p>3er Reihe/E93 Cabrio (07-13)</p> | <p>1x</p> <p>1x</p> <p>1x</p> <p>1x</p> <p>1x</p> <p>1x</p> <p>1x</p>                 | <p>34 35 6 789 440</p> |

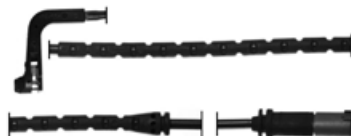
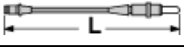











# Abbildungen Warnkontakte

Illustrations wear indicators - Illustrazioni rilevatori usura - Illustrations Témoins d'usure - Ilustraciones contactos de desgaste

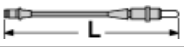
| 24.8190-0268.2  | 620268  |    | OE - #                             |
|---|---|---|------------------------------------|
| <br><br> 905 mm     | <b>BMW</b><br>X5/E70 (07-13)<br>X6/E71/E72 (08-14)  | 1x<br>1x  | 34 35 6 789 501                    |
| 24.8190-0269.2  | 620269  |    | OE - #                             |
| <br><br> 965 mm   | <b>BMW</b><br>X5/E70 (07-13)<br>X6/E71/E72 (08-14)  | 1x<br>1x  | 34 35 6 771 766<br>34 35 6 789 505 |
| 24.8190-0270.2  | 620270  |  | OE - #                             |
| <br><br> 898 mm | <b>BMW</b><br>X5/E70 (07-13)<br>X6/E71/E72 (08-14)  | 1x<br>1x  | 34 35 6 789 502                    |
| 24.8190-0271.2  | 620271  |  | OE - #                             |
| <br><br> 659 mm | <b>BMW</b><br>1er Reihe/E82 Coupe (07-13)<br>3er Reihe/E90 Limousine (05-12)<br>3er Reihe/E92 Coupe (06-13)<br>3er Reihe/E93 Cabrio (07-13) | 1x<br>1x<br>1x<br>1x  | 34 35 2 283 335                    |













# Abbildungen Warnkontakte

Illustrations wear indicators - Illustrazioni rilevatori usura - Illustrations Témoins d'usure - Ilustraciones contactos de desgaste

| 24.8190-0272.2  | 620272  |    | OE - #          |
|---|---|---|-----------------|
| <br><br> 672 mm     | <b>BMW</b><br>3er Reihe/E90 Limousine (05-12)<br>3er Reihe/E92 Coupe (06-13)<br>3er Reihe/E93 Cabrio (07-13)                                  | 1x<br>1x<br>1x  | 34 35 2 283 405 |
| 24.8190-0273.2  | 620273  |    | OE - #          |
| <br><br> 662 mm   | <b>BMW</b><br>5er Reihe/E60 Limousine (03-10)<br>5er Reihe/E61 Touring (04-10)<br>6er Reihe/E63 Coupe (04-11)<br>6er Reihe/E64 Cabrio (04-11) | 1x<br>1x<br>1x<br>1x  | 34 35 6 789 492 |
| 24.8190-0274.2  | 620274  |  | OE - #          |
| <br><br> 664 mm | <b>BMW</b><br>5er Reihe/E60 Limousine (03-10)<br>6er Reihe/E63 Coupe (04-11)<br>6er Reihe/E64 Cabrio (04-11)                                  | 1x<br>1x<br>1x  | 34 35 6 789 493 |
| 24.8190-0275.2  | 620275  |  | OE - #          |
| <br><br> 872 mm | <b>BMW</b><br>5er Reihe/E61 Touring (04-10)   | 1x  | 34 35 6 789 494 |













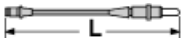

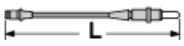

# Abbildungen Warnkontakte

Illustrations wear indicators - Illustrazioni rilevatori usura - Illustrations Témoins d'usure - Ilustraciones contactos de desgaste

| 24.8190-0276.2   | 620276   |    | OE - #                             |
|--|--|---|------------------------------------|
| <br><br> 674 mm      | <b>BMW</b><br>5er Reihe/E61 Touring (04-10)<br>6er Reihe/E63 Coupe (04-11)<br>6er Reihe/E64 Cabrio (04-11) | 1x<br>1x<br>1x  | 34 35 2 282 935                    |
| 24.8190-0277.2   | 620277   |    | OE - #                             |
| <br><br> 802 mm    | <b>MINI</b><br>R55 Clubman (07-14)<br>R56 (06-14)<br>R57 Cabrio (09-14)                                    | 1x<br>1x<br>1x  | 34 35 6 789 329                    |
| 24.8190-0278.2   | 620278   |  | OE - #                             |
| <br><br> 1130 mm | <b>MINI</b><br>R55 Clubman (07-)<br>R56 (06-)<br>R57 Cabrio (09-14)  | 1x<br>1x<br>1x  | 34 35 6 773 018<br>34 35 6 789 330 |
| 24.8190-0279.2   | 620279   |  | OE - #                             |
| <br><br> 992 mm  | <b>BMW</b><br>5er Reihe/E61 Touring (04-10)  | 1x  | 34 35 2 283 035                    |











# Abbildungen Warnkontakte

Illustrations wear indicators - Illustrazioni rilevatori usura - Illustrations Témoins d'usure - Ilustraciones contactos de desgaste

| 24.8190-0280.2   | 620280   |          | OE - #          |
|--|--|---|-----------------|
| <br> 930 mm      | <b>BMW</b><br>X6/E71/E72 (08-14)                   | <br>1x   | 34 35 6 789 503 |
| 24.8190-0281.2   | 620281   |          | OE - #          |
| <br> 962 mm    | <b>BMW</b><br>X5/E70 (07-13)<br>X6/E71/E72 (08-14) | <br>1x   | 34 35 6 789 080 |
| 24.8190-0282.2   | 620282   |        | OE - #          |
| <br> 1120 mm | <b>BMW</b><br>X1/E84 (09-)                         | <br>1x | 34 35 6 790 341 |
| 24.8190-0283.2   | 620283   |        | OE - #          |
| <br> 632 mm  | <b>BMW</b><br>X1/E84 (09-)                         | <br>1x | 34 35 6 790 340 |



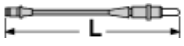

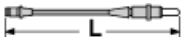







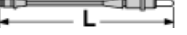

# Abbildungen Warnkontakte

Illustrations wear indicators - Illustrazioni rilevatori usura - Illustrations Témoins d'usure - Ilustraciones contactos de desgaste

| 24.8190-0284.2  |                                     | 620284 |    | OE - #          |
|---|-------------------------------------|--------|---|-----------------|
| <br> 650 mm     | <b>BMW</b>                          |        |   |                 |
|   | 1er Reihe/E81/E87 Limousine (04-11) | 1x     |   | 34 35 6 792 559 |
|   | 1er Reihe/E82 Coupe (07-13)         | 1x     |   |                 |
|   | 1er Reihe/E88 Cabrio (08-13)        | 1x     |   |                 |
|   | 3er Reihe/E90 Limousine (05-12)     | 1x     |   |                 |
|   | 3er Reihe/E91 Touring (05-12)       | 1x     |   |                 |
|   | 3er Reihe/E92 Coupe (06-13)         | 1x     |   |                 |
| 3er Reihe/E93 Cabrio (07-13)  | 1x                                  |        |   |                 |
| 24.8190-0285.2  |                                     | 620285 |    | OE - #          |
| <br> 1107 mm  | <b>BMW</b>                          |        |   |                 |
|   | 1er Reihe/E81/E87 Limousine (04-11) | 1x     |   | 34 35 6 792 564 |
|   | 1er Reihe/E82 Coupe (07-13)         | 1x     |   |                 |
|   | 1er Reihe/E88 Cabrio (08-13)        | 1x     |   |                 |
|   | 3er Reihe/E90 Limousine (05-12)     | 1x     |   |                 |
|   | 3er Reihe/E91 Touring (05-12)       | 1x     |   |                 |
|   | 3er Reihe/E92 Coupe (06-13)         | 1x     |   |                 |
| 3er Reihe/E93 Cabrio (07-13)  | 1x                                  |        |   |                 |
| 24.8190-0286.2  |                                     | 620286 |  | OE - #          |
| <br> 867 mm | <b>BMW</b>                          |        |   |                 |
|   | 3er Reihe/E90 Limousine (05-12)     | 1x     |   | 34 35 6 792 561 |
|   | 3er Reihe/E91 Touring (05-12)       | 1x     |   |                 |
|   | 3er Reihe/E92 Coupe (06-13)         | 1x     |   |                 |
|   | X1/E84 (09-)                        | 1x     |   |                 |
| 24.8190-0287.2  |                                     | 620287 |  | OE - #          |
| <br> 723 mm | <b>BMW</b>                          |        |   |                 |
|   | 1er Reihe/E81/E87 Limousine (04-11) | 1x     |   | 34 35 6 792 560 |
|   | 1er Reihe/E82 Coupe (07-13)         | 1x     |   |                 |
|   | 1er Reihe/E88 Cabrio (08-13)        | 1x     |   |                 |
|   | 3er Reihe/E90 Limousine (05-12)     | 1x     |   |                 |
|   | 3er Reihe/E91 Touring (05-12)       | 1x     |   |                 |
|   | 3er Reihe/E92 Coupe (06-13)         | 1x     |   |                 |
| 3er Reihe/E93 Cabrio (07-13)  | 1x                                  |        |   |                 |

# Abbildungen Warnkontakte

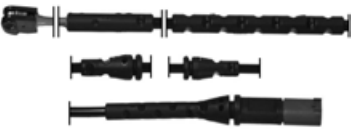





Illustrations wear indicators - Illustrazioni rilevatori usura - Illustrations Témoins d'usure - Ilustraciones contactos de desgaste

| 24.8190-0288.2   | 620288   |                            | OE - #          |
|--|--|---|-----------------|
| <br><br> 698 mm      | <b>BMW</b><br>1er Reihe/E88 Cabrio (08-13)   | <br>1x                     | 34 35 6 794 285 |
| 24.8190-0289.2   | 620289   |                            | OE - #          |
| <br><br> 938 mm   | <b>BMW</b><br>X5/E70 (07-13)<br>X5/F15 (13-)<br>X6/E71/E72 (08-14)<br>X6/F16 (14-) | <br>1x<br>1x<br>1x<br>1x   | 34 35 6 792 567 |
| 24.8190-0290.2   | 620290   |                          | OE - #          |
| <br><br> 1002 mm | <b>BMW</b><br>X5/E70 (07-13)<br>X5/F15 (13-)<br>X6/E71/E72 (08-14)<br>X6/F16 (14-) | <br>1x<br>1x<br>1x<br>1x | 34 35 6 792 571 |
| 24.8190-0291.2   | 620291   |                          | OE - #          |
| <br><br> 974 mm  | <b>BMW</b><br>X5/E70 (07-13)<br>X5/F15 (13-)<br>X6/E71/E72 (08-14)<br>X6/F16 (14-) | <br>1x<br>1x<br>1x<br>1x | 34 35 6 792 568 |

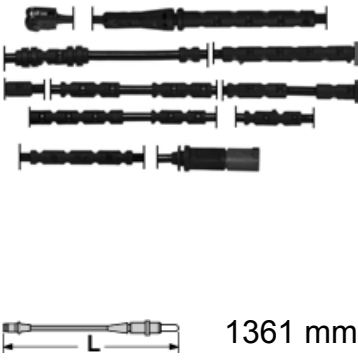

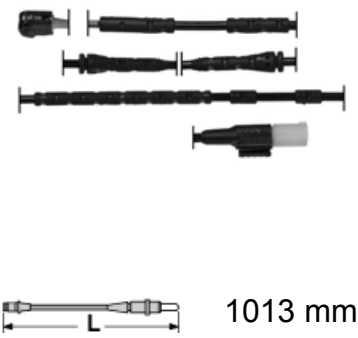









# Abbildungen Warnkontakte

Illustrations wear indicators - Illustrazioni rilevatori usura - Illustrations Témoins d'usure - Ilustraciones contactos de desgaste

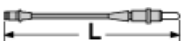
| 24.8190-0294.2  | 620294                                      |    | OE - #                 |
|---|---|---|------------------------|
|  <p>1361 mm</p>   | <p><b>BMW</b><br/>Z4 Roadster/E89 (09-)</p> | <p>1x</p>   | <p>34 35 6 792 566</p> |
| 24.8190-0295.2  | 620295                                      |    | OE - #                 |
|  <p>1013 mm</p>  | <p><b>BMW</b><br/>Z4 Roadster/E89 (09-)</p> | <p>1x</p>   | <p>34 35 6 792 563</p> |
| 24.8190-0296.2  | 620296                                      |  | OE - #                 |
|  <p>1141 mm</p> | <p><b>BMW</b><br/>X1/E84 (09-)</p>          | <p>1x</p>   | <p>34 35 6 792 565</p> |
| 24.8190-0297.2  | 620297                                      |  | OE - #                 |
|  <p>676 mm</p>  | <p><b>BMW</b><br/>X1/E84 (09-)</p>          | <p>1x</p>   | <p>34 35 6 792 562</p> |













# Abbildungen Warnkontakte

Illustrations wear indicators - Illustrazioni rilevatori usura - Illustrations Témoins d'usure - Ilustraciones contactos de desgaste

| 24.8190-0298.2  |                                     | 620298 |    | OE - # |
|---|-------------------------------------|--------|---|--------|
| <br> 1087 mm      | <b>BMW</b>                          |        |   |        |
|   | 5er Reihe/F07 GT GRAN TURISMO (09-) | 1x     | 34 35 6 791 958   |        |
|   | 5er Reihe/F10 Limousine (10-)       | 1x     |   |        |
|   | 5er Reihe/F11 Touring (10-)         | 1x     |   |        |
|   | 6er Reihe/F06 Gran Coupé (12-)      | 1x     |   |        |
|   | 6er Reihe/F12 Cabrio (11-)          | 1x     |   |        |
|   | 6er Reihe/F13 Coupe (11-)           | 1x     |   |        |
| 7er Reihe/F01/F02/F03/F04 (08-15)   | 1x                                  |        |   |        |
| 24.8190-0299.2  |                                     | 620299 |    | OE - # |
| <br> 1065 mm   | <b>BMW</b>                          |        |   |        |
|   | 7er Reihe/F01/F02/F03/F04 (08-15)   | 1x     | 34 35 6 791 960   |        |
| 24.8190-0300.2  |                                     | 620300 |  | OE - # |
| <br> 1054 mm  | <b>BMW</b>                          |        |   |        |
|   | 5er Reihe/F07 GT GRAN TURISMO (09-) | 1x     | 34 35 6 791 961   |        |
| 24.8190-0301.2  |                                     | 620301 |  | OE - # |
| <br> 311,6 mm | <b>AUDI</b>                         |        |   |        |
|   | A6 (4G2/C7) Limousine (11-)         | 1x     | 4H0 615 121 J   |        |
|   | A6 (4G5/C7) Avant (11-)             | 1x     |   |        |
|   | A6 Allroad (12-)                    | 1x     |   |        |
|   | A7 Sportback (10-)                  | 2x     |   |        |
|   | A8 (09-)                            | 2x     |   |        |
| Q5 (08-)  | 1x                                  |        |   |        |













# Abbildungen Warnkontakte

Illustrations wear indicators - Illustrazioni rilevatori usura - Illustrations Témoins d'usure - Ilustraciones contactos de desgaste

| 24.8190-0302.2   | 620302   |    | OE - #               |
|--|--|---|----------------------|
| <br><br> 367,4 mm    | <p><b>AUDI</b><br/>           A3 / A3 Sportback (03-13)<br/>           TT Coupe (06-14)<br/>           TT Roadster (07-14)</p> <p><b>SEAT</b><br/>           LEON III (5F) / SC / ST (12-)</p> | <p>1x<br/>1x<br/>1x<br/>1x</p>  | <p>8J0 615 437</p>   |
| 24.8190-0303.2   | 620303   |    | OE - #               |
| <br><br> 296,6 mm  | <p><b>AUDI</b><br/>           A8 (09-)</p>   | <p>2x</p>   | <p>4H0 615 121 E</p> |
| 24.8190-0304.2   | 620304   |  | OE - #               |
| <br><br> 724 mm  | <p><b>LAND ROVER</b><br/>           RANGE ROVER III (LM) (02-12)</p>   | <p>1x</p>   | <p>SEM000012</p>     |
| 24.8190-0305.2   | 620305   |  | OE - #               |
| <br><br> 1158 mm | <p><b>LAND ROVER</b><br/>           RANGE ROVER III (LM) (02-12)</p>   | <p>1x</p>   | <p>SOE500030</p>     |









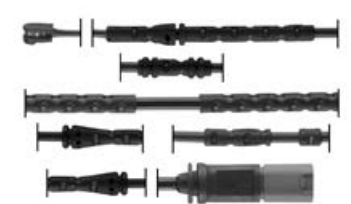
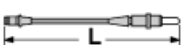

# Abbildungen Warnkontakte

Illustrations wear indicators - Illustrazioni rilevatori usura - Illustrations Témoins d'usure - Ilustraciones contactos de desgaste

| 24.8190-0306.2   | 620306   |    | OE - #          |
|--|--|---|-----------------|
| <br> 908 mm      | <b>MINI</b><br>R60 Countryman (10-)<br>R61 Paceman (12-) | 1x<br>1x  | 34 35 9 804 833 |
| 24.8190-0307.2   | 620307   |    | OE - #          |
| <br> 957 mm    | <b>MINI</b><br>R60 Countryman (10-)<br>R61 Paceman (12-) | 1x<br>2x  | 34 35 9 804 834 |
| 24.8190-0308.2   | 620308   |  | OE - #          |
| <br> 1110 mm | <b>BMW</b><br>5er Reihe/F11 Touring (10-)                | 1x  | 34 35 6 791 963 |
| 24.8190-0309.2   | 620309   |  | OE - #          |
| <br> 954 mm  | <b>BMW</b><br>X3/F25 (10-)<br>X4/F26 (14-)               | 1x<br>1x  | 34 35 6 790 303 |



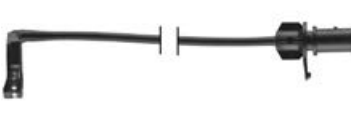



# Abbildungen Warnkontakte

Illustrations wear indicators - Illustrazioni rilevatori usura - Illustrations Témoins d'usure - Ilustraciones contactos de desgaste

| 24.8190-0310.2  | 620310   |    | OE - #              |
|---|--|---|---------------------|
| <br><br> 1243 mm    | <b>BMW</b><br>X3/F25 (10-)<br>X4/F26 (14-)   | <br>1x<br>1x  | <br>34 35 6 790 304 |
| 24.8190-0311.2  | 620311   |    | OE - #              |
| <br><br> 300 mm   | <b>AUDI</b><br>A6 (4G5/C7) Avant (11-)<br>A6 Allroad (12-)<br>A7 Sportback (10-)<br>Q5 (08-)   | <br>1x<br>1x<br>2x<br>1x  | <br>8K0 615 121     |
| 24.8190-0312.2  | 620312   |  | OE - #              |
| <br><br> 915 mm | <b>BMW</b><br>5er Reihe/F10 Limousine (10-)<br>6er Reihe/F06 Gran Coupe (11-)<br>6er Reihe/F12 Cabrio (11-)<br>6er Reihe/F13 Coupe (11-)         | <br>1x<br>1x<br>1x<br>1x  | <br>34 35 6 791 962 |
| 24.8190-0313.2  | 620313   |  | OE - #              |
| <br><br> 217 mm | <b>AUDI</b><br>A6 (4G2/C7) Limousine (11-)<br>A6 (4G5/C7) Avant (11-)<br>A6 Allroad (12-)<br>A7 Sportback (10-)<br><b>PORSCHE</b><br>MACAN (13-) | <br>1x<br>1x<br>1x<br>1x<br>2x  | <br>4G0 615 121     |

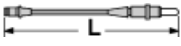
# Abbildungen Warnkontakte









Illustrations wear indicators - Illustrazioni rilevatori usura - Illustrations Témoins d'usure - Ilustraciones contactos de desgaste

| 24.8190-0401.2   | 620401   |    | OE - #                         |
|--|--|---|--------------------------------|
| <br><br> 95 mm                 | <b>MERCEDES BENZ</b><br>((R107) 280 SL-560 SL (71-89)<br>(R129) SL-Klasse (89-93)<br>(W116) 280 S-450 SEL 6,9 (72-80)<br>(W123) 200-300 TD Turbo (76-85)<br>(W124) E-Klasse (85-93)/(W126) 260 SE-560 SEC (80-91)<br>(W201) 190-190 E 2,6 (82-93)<br>A-Klasse (W168) (97-04)<br>C-Klasse (W202) Limousine (93-00)/(S202) Kombi (96-01)<br>CLK-Klasse (A208) Cabrio (98-03)/(C208) Coupe (97-02)<br>CL-Klasse (C140) Coupe (96-99)<br>E-Klasse (A124) Cabrio (93-98)/(C124) Coupe (93-97)<br>E-Klasse (S124) Kombi (93-96)<br>E-Klasse (S210) Kombi (96-03)<br>E-Klasse (W124) Limousine (93-95)<br>E-Klasse (W210) Limousine (95-02)<br>G-Klasse (W460) (79-93)<br>S-Klasse (W140) (91-93)<br>S-Klasse (W140) (93-98)<br>SLK-Klasse (R170) (96-04)<br>SL-Klasse (R129) (93-01)<br>Transporter (BM 601) 207 D-210 D/(BM 602) 307 D-310 D<br>Transporter (BM 611) 407 D-410 D/(BM 667) 507 D-510 | 4x<br>4x 4x<br>4x<br>4x<br>4x 4x<br>4x 4x<br>1x<br>2x 1x<br>2x 1x<br>4x 4x<br>2x 2x<br>2x 2x<br>2x 2x<br>2x 4x<br>2x 2x<br>4x<br>4x 4x<br>4x 4x<br>2x 2x<br>2x 4x<br>4x<br>4x | 126 540 20 17<br>140 540 12 17 |
| 24.8190-0402.2   | 620402   |    | OE - #                         |
| <br><br> 68 mm<br>(150)mm | <b>MERCEDES BENZ</b><br>(W124) E-Klasse (85-93)<br>(W201) 190-190 E 2,6 (82-93)<br>E-Klasse (A124) Cabrio (93-98)<br>E-Klasse (C124) Coupe (93-97)<br>E-Klasse (S124) Kombi (93-96)<br>E-Klasse (W124) Limousine (93-95)   | 2x<br>2x<br>2x<br>2x<br>2x<br>2x  | 201 540 03 17                  |



# Abbildungen Warnkontakte

Illustrations wear indicators - Illustrazioni rilevatori usura - Illustrations Témoins d'usure - Ilustraciones contactos de desgaste

| 24.8190-0403.2  | 620403   |                    | OE - #  |
|---|--|---|---|
| <br><br> 315 mm               | <b>MERCEDES BENZ</b><br>MB-TRAC (BM 440) 65/70/700/800/900<br>MB-TRAC (BM 441) 1000<br>UNIMOG (BM 403) 54/66/72/800<br>UNIMOG (BM 406) 65/70/80/84/900/(BM 413) 72/80/800 L<br>UNIMOG (BM 416) 80/90/100/110/1100/1100 L<br>UNIMOG (BM 417) 800-1150/(BM 424) 1000/1200<br>UNIMOG (BM 427) 1000-1650<br>UNIMOG (BM 435) 435/1300 L/1700/1700 L<br>UNIMOG (BM 436) 1300/1700/(BM 437.1) 1350-2450<br>UNIMOG 20 (BM 405.050) (07-)<br>UNIMOG 3000-5000 (BM 437.4) (02-)<br>UNIMOG 300-400 (BM 405.1) (00-) | 2x 2x<br>4x 2x<br>4x 2x<br>4x 2x<br>4x 2x<br>4x 2x<br>4x 2x<br>4x<br>4x 2x<br>4x 4x<br>2x 4x<br>4x 4x | 435 542 00 17   |
| 24.8190-0406.2  | 620406   |                  | OE - #  |
| <br><br> 261 mm           | <b>MERCEDES BENZ</b><br>G-Klasse (W460) (79-93)<br>G-Klasse (W461) (90-)<br>G-Klasse (W463) (90-)<br>G-Klasse (W463) Cabrio (90-)  | 2x<br>2x<br>2x<br>2x  | 460 540 06 17   |
| 24.8190-0407.2  | 620407   |                  | OE - #  |
| <br><br> 84 mm<br>(185)mm | <b>MERCEDES BENZ</b><br>G-Klasse (W461) (90-)<br>G-Klasse (W463) (90-)<br>G-Klasse (W463) Cabrio (90-)<br>V-Klasse (BM638) (96-03)<br>VITO (BM638) (96-03)<br>Transporter (BM 901/902) SPRINTER (95-06)<br>Transporter (BM 903/904) SPRINTER (95-06)<br><br><b>VOLKSWAGEN</b><br>LT/- 4x4 (96-06)  | 2x<br>2x<br>2x<br>2x<br>2x<br>2x 2x<br>2x 2x<br>2x<br>2x 2x   | 901 540 00 17<br>901 540 01 17<br><br><br><br><br><br><br><br><br>2D0 919 351 |



# Abbildungen Warnkontakte

Illustrations wear indicators - Illustrazioni rilevatori usura - Illustrations Témoins d'usure - Ilustraciones contactos de desgaste

24.8190-0410.2

620410



OE - #













97,5 mm

## MERCEDES BENZ

|  |       |               |
|--|-------|---------------|
| A-Klasse (W169 ) (04-12)/B-Klasse (W245) (05-11)       | 1x    | 211 540 17 17 |
| C-Klasse (C204) Coupe (11-)                            | 2x 2x |               |
| C-Klasse (C205) Coupe (15-)                            | 1x    |               |
| C-Klasse (CL203) Sportcoupe (01-08)                    | 2x 1x |               |
| C-Klasse (CLC203) Coupe (08-10)                        | 1x 1x |               |
| C-Klasse (W203) Limousine (00-07)                      | 2x 2x |               |
| C-Klasse (S203) Kombi (01-07)                          | 2x 1x |               |
| C-Klasse (W204) Limousine (07-14)/(S204) Kombi (07-14) | 1x 1x |               |
| C-Klasse (W205) Limousine (14-)                        | 1x    |               |
| CLK-Klasse (A209) Cabrio (03-09)/(C209) Coupe (02-09)  | 2x 1x |               |
| CL-Klasse (C215) Coupe (99-06)                         | 2x 1x |               |
| CL-Klasse (C216) Coupe (06-14)                         | 1x 1x |               |
| CLS-Klasse (C218) Coupe (10-)                          | 1x 1x |               |
| CLS-Klasse (C219) Coupe (04-10)                        | 2x 1x |               |
| CLS-Klasse (X218) Shooting Brake (12-)                 | 1x 1x |               |
| E-Klasse (A207) Cabrio (10-)                           | 2x 1x |               |
| E-Klasse (C207) Coupe (09-)                            | 1x 1x |               |
| E-Klasse (W211) Limousine (02-09)/(S211) Kombi (03-09) | 1x 1x |               |
| E-Klasse (W212) Limousine (09-)                        | 1x 1x |               |
| E-Klasse (S212) Kombi (09-)                            | 2x 1x |               |
| GLE-Klasse (C292) Coupe (15-)                          | 1x    |               |
| GLK-Klasse (X204) (08-15)                              | 1x 1x |               |
| GL-/GLS-(X166) (12-)/M-/GLE-Klasse (W166) (11-)        | 1x    |               |
| S-Klasse (A217) Cabrio (15-)/(C217) Coupe (14-)        | 1x    |               |
| S-Klasse (W220) (98-06)                                | 2x 1x |               |
| S-Klasse (W221) (06-13)                                | 1x 1x |               |
| S-Klasse (W222) (13-)                                  | 2x    |               |
| SLK-Klasse (R171) (04-11)                              | 2x 1x |               |
| SLK-Klasse / SLC-Klasse (R172) (11-)                   | 1x 1x |               |
| SL-Klasse (R230) (01-11)                               | 2x 1x |               |
| SL-Klasse (R231) (12-)                                 | 1x    |               |
| SLR-Klasse (C199) Coupe (04-09)                        | 2x    |               |
| VANEO (BM414) (02-05)                                  | 1x    |               |

# Abbildungen Warnkontakte

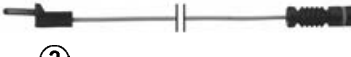
Illustrations wear indicators - Illustrazioni rilevatori usura - Illustrations Témoins d'usure - Ilustraciones contactos de desgaste

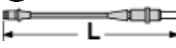
| 24.8190-0411.2   | 620411   |        | OE - #                         |
|--|--|---|--------------------------------|
| <br><br> 72 mm   | <b>MERCEDES BENZ</b><br>M-Klasse (W163) (98-05)  | <br>2x | 202 540 07 17                  |
| 24.8190-0412.2   | 620412   |        | OE - #                         |
| <br><br> 114 mm   | <b>MERCEDES BENZ</b><br>M-Klasse (W163) (98-05)  | 2x  | 163 540 15 17<br>163 540 17 17 |
| 24.8190-0415.2   | 620415   |      | OE - #                         |
|  ①<br> ②<br><br> 148 mm<br> 238 mm | <b>MERCEDES BENZ</b><br>Transporter (BM 668) 609 D<br>Transporter (BM 669) 709 D/711 D<br>Transporter (BM 670) 809 D-814 D<br>Transporter (BM 905) SPRINTER (01-06)<br>Transporter VARIO (96-13) | 2x<br>2x<br>2x<br>2x<br>2x  | 669 540 04 17                  |

























# Abbildungen Warnkontakte

Illustrations wear indicators - Illustrazioni rilevatori usura - Illustrations Témoins d'usure - Ilustraciones contactos de desgaste

| 24.8190-0416.2   | 620416  | <br> |  | OE - #                         |
|--|---|------|--|--------------------------------|
| <div style="text-align: right; margin-top: 100px;">  100 mm           </div>                         | <b>MERCEDES BENZ</b><br>CLK-Klasse (A209) Cabrio (03-09)<br>CLS-Klasse (C219) Coupe (04-10)<br>E-Klasse (W211) Limousine (02-09)<br>E-Klasse (S211) Kombi (03-09)<br>S-Klasse (W220) (98-06)                |      |  | 211 540 07 17                  |
| 24.8190-0417.2   | 620417  | <br> |  | OE - #                         |
| <div style="text-align: right; margin-top: 100px;">  99 mm<br/>             (167)mm           </div> | <b>MERCEDES BENZ</b><br>V-Klasse (BM638) (96-03)<br>VITO (BM638) (96-03)<br>Transporter (BM 901/902) SPRINTER (95-06)<br>Transporter (BM 903/904) SPRINTER (95-06)<br>Transporter (BM 905) SPRINTER (01-06) |      |  | 901 540 02 17<br>901 540 03 17 |
|  | <b>VOLKSWAGEN</b><br>LT/- 4x4 (96-06)   |      |  | 2x 2x                          |

# Abbildungen Warnkontakte

Illustrations wear indicators - Illustrazioni rilevatori usura - Illustrations Témoins d'usure - Ilustraciones contactos de desgaste









| 24.8190-0418.2   | 620418  |   | OE - #  |
|--|---|--|---|
| <br> 95 mm   | <p><b>MERCEDES BENZ</b></p> <p>VIANO (BM639) (03-14)<br/>VITO (BM639) (03-14)<br/>Transporter (BM 906) SPRINTER (06-)</p> <p><b>VOLKSWAGEN</b></p> <p>CRAFTER (06-)</p>   | <p> 2x  2x<br/> 2x  2x<br/><br/>2x<br/><br/><br/><br/><br/><br/><br/><br/><br/><br/>2x</p>   | <p>639 540 14 17<br/>639 540 15 17<br/><br/><br/><br/><br/><br/><br/><br/><br/><br/>2E0 906 206 G</p> |
| 24.8190-0419.2   | 620419  |   | OE - #  |
| <br> 74 mm | <p><b>MERCEDES BENZ</b></p> <p>C-Klasse (W202) Limousine (93-00)<br/>C-Klasse (S202) Kombi (96-01)<br/>CLK-Klasse (A208) Cabrio (98-03)<br/>CLK-Klasse (C208) Coupe (97-02)<br/>E-Klasse (W210) Limousine (95-02)<br/>E-Klasse (S210) Kombi (96-03)<br/>SLK-Klasse (R170) (96-04)</p> | <p> 2x  2x<br/> 2x  2x<br/> 2x  2x<br/> 2x  2x<br/> 2x  2x<br/> 2x  2x<br/> 2x  2x</p> | <p>210 540 11 17</p>  |



















# Abbildungen Warnkontakte

Illustrations wear indicators - Illustrazioni rilevatori usura - Illustrations Témoins d'usure - Ilustraciones contactos de desgaste

| 24.8190-0424.2  | 620424  |   | OE - #   |
|---|---|--|--|
| <br><br> 103,2 mm   | <p><b>MERCEDES BENZ</b></p> <p>V-Klasse (BM447) (14-)<br/>           VIANO (BM639) (03-14)<br/>           VITO (BM639) (03-14)<br/>           VITO (W447) (14-)<br/>           Transporter (BM 906) SPRINTER (06-)</p> <p><b>VOLKSWAGEN</b></p> <p>CRAFTER (06-)</p>  | <p>1x<br/>           2x<br/>           2x<br/>           1x 1x<br/>           2x<br/>           2x</p>   | <p>906 540 15 17<br/><br/><br/><br/><br/><br/><br/><br/><br/><br/>           2E0 906 206 C</p> |
| 24.8190-0425.2  | 620425  |   | OE - #   |
| <br><br> 98 mm  | <p><b>MERCEDES BENZ</b></p> <p>E-Klasse (W211) Limousine (02-09)<br/>           E-Klasse (S211) Kombi (03-09)<br/>           G-Klasse (W463) (90-)<br/>           GL-Klasse (X164) (06-12)<br/>           GL-Klasse (X166) (12-)<br/>           GLE-Klasse (C292) Coupe (15-)<br/>           M-Klasse (W164) (05-11)<br/>           M-Klasse/GLE-Klasse (W166) (11-)<br/>           R-Klasse (W251,V251) (06-12)<br/>           S-Klasse (W220) (98-06)</p> | <p>1x<br/>           1x<br/>           2x<br/>           1x 1x<br/>           1x<br/>           1x<br/>           1x 1x<br/>           1x<br/>           1x 1x<br/>           1x</p> | <p>164 540 10 17</p>   |
| 24.8190-0701.2  | 620701  |   | OE - #   |
| <br><br> 950 mm | <p><b>OPEL</b></p> <p>KADETT E / Vau. Astra E/Belmont (84-93)<br/>           Delco</p>  | <p>2x</p>  | <p>12 38 353</p>   |









# Abbildungen Warnkontakte

Illustrations wear indicators - Illustrazioni rilevatori usura - Illustrations Témoins d'usure - Ilustraciones contactos de desgaste

| 24.8190-0702.2  | 620702  |    | OE - #  |
|---|---|---|---|
| <br> 860 mm     | <b>OPEL</b><br>OMEGA A / Vauxhall Carlton (87-93)<br>Delco  | 2x  | 12 38 343<br>90250705   |
| 24.8190-0703.2  | 620703  |    | OE - #  |
| <br> 860 mm     | <b>OPEL</b><br>OMEGA A / Vauxhall Carlton (87-93)<br>SENATOR B / Vauxhall Royal (88-93)   | 2x<br>2x  | 12 38 369<br>90342177   |
| 24.8190-0704.2  |   |   |  OE - # |
| <br> 660 mm | <b>OPEL</b><br>VECTRA A / Vauxhall Cavalier (89-95)   | 2x  | 12 38 349<br>90335785   |
| 24.8190-0705.2  | 620705  |  | OE - #  |
| <br> 670 mm | <b>OPEL</b><br>ASTRA F / Vauxhall Astra MKIII (91-01)<br>CALIBRA / Vauxhall Calibra (89-97)<br>VECTRA A / Vauxhall Cavalier (89-95) | 2x<br>2x<br>2x  | 12 38 348<br>90335784   |
| 24.8190-0706.2  | 620706  |  | OE - #  |
| <br> 660 mm | <b>OPEL</b><br>OMEGA A / Vauxhall Carlton (87-93)   | 2x  | 12 38 403<br>90305792   |



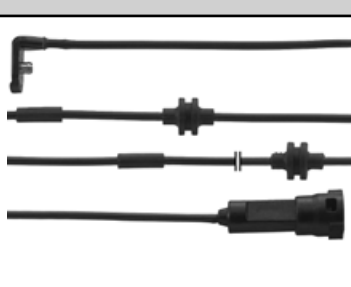







# Abbildungen Warnkontakte

Illustrations wear indicators - Illustrazioni rilevatori usura - Illustrations Témoins d'usure - Ilustraciones contactos de desgaste

| 24.8190-0707.2   | 620707  |    | OE - #                        |
|--|---|---|-------------------------------|
|  <p>685 mm</p>   | <p><b>OPEL</b><br/>           ASTRA F / Vauxhall Astra MKIII (91-01)<br/>           ASTRA F CLASSIC (98-02)<br/>           CALIBRA / Vauxhall Calibra (89-97)<br/>           VECTRA A / Vauxhall Cavalier (89-95)</p> | <p>2x<br/>2x<br/>2x<br/>2x</p>  | <p>12 38 984<br/>90425491</p> |
| 24.8190-0708.2   | 620708  |    | OE - #                        |
|  <p>950 mm</p>   | <p><b>OPEL</b><br/>           KADETT E / Vau. Astra E/Belmont (84-93)</p>   | <p>2x</p>   | <p>12 38 404<br/>90305918</p> |
| 24.8190-0709.2   | 620709  |   | OE - #                        |
|  <p>660 mm</p> | <p><b>OPEL</b><br/>           SENATOR B / Vauxhall Royal (88-93)</p>  | <p>2x</p>   | <p>12 38 409<br/>90343961</p> |
| 24.8190-0710.2   | 620710  |  | OE - #                        |
|  <p>730 mm</p> | <p><b>OPEL</b><br/>           OMEGA B / Vauxhall Omega (94-03)</p>  | <p>2x</p>   | <p>62 38 322<br/>90495145</p> |
| 24.8190-0711.2   | 620711  |  | OE - #                        |
|  <p>730 mm</p> | <p><b>OPEL</b><br/>           OMEGA B / Vauxhall Omega (94-03)</p>  | <p>2x</p>   | <p>62 38 323<br/>90495144</p> |









# Abbildungen Warnkontakte

Illustrations wear indicators - Illustrazioni rilevatori usura - Illustrations Témoins d'usure - Ilustraciones contactos de desgaste

| 24.8190-0712.2   | 620712   |    | OE - #                        |
|--|--|---|-------------------------------|
|  <p>660 mm</p>   | <p><b>OPEL</b><br/>OMEGA A / Vauxhall Carlton (87-93)</p>  | 2x  | <p>12 38 408<br/>90343962</p> |
| 24.8190-0713.2   | 620713   |    | OE - #                        |
|  <p>685 mm</p>   | <p><b>OPEL</b><br/>CALIBRA / Vauxhall Calibra (89-97)</p>  | 2x  | <p>62 38 399<br/>90538302</p> |
| 24.8190-0714.2   | 620714   |   | OE - #                        |
|  <p>660 mm</p> | <p><b>OPEL</b><br/>VECTRA B / Vauxhall Vectra (96-02)</p>  | 2x  | <p>62 38 388<br/>90497051</p> |
| 24.8190-0715.2   | 620715   |  | OE - #                        |
|  <p>660 mm</p> | <p><b>OPEL</b><br/>VECTRA B / Vauxhall Vectra (96-02)</p>  | 2x  | <p>62 38 389<br/>90497052</p> |
| 24.8190-0716.2   | 620716   |  | OE - #                        |
|  <p>680 mm</p> | <p><b>OPEL</b><br/>OMEGA A / Vauxhall Carlton (87-93)<br/>SENATOR B / Vauxhall Royal (88-93)</p> | <p>2x<br/>2x</p>  | <p>12 38 783<br/>90345102</p> |









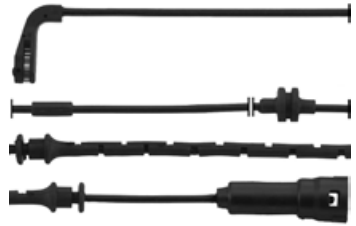

# Abbildungen Warnkontakte

Illustrations wear indicators - Illustrazioni rilevatori usura - Illustrations Témoins d'usure - Ilustraciones contactos de desgaste

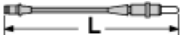
| 24.8190-0718.2  | 620718  |    | OE - #                        |
|---|---|---|-------------------------------|
| <br><br> 720 mm   | <p><b>OPEL</b><br/>           ASTRA G / Vauxhall Astra MKIV (98-05)<br/>           ZAFIRA I / Vauxhall Zafira I (99-05)</p> <p><b>SAAB</b><br/>           9-3 (YS3D) (98-02)<br/>           9-3 Cabriolet (YS3D) (98-03)<br/>           9-5 Limousine (YS3E) (97-10)<br/>           9-5 Kombi (YS3E) (98-10)<br/>           900 (94-98)</p>   | <p>2x<br/>2x<br/>2x<br/>2x<br/>2x<br/>2x<br/>2x</p>                                   | <p>12 38 442<br/>13122323</p> |
| 24.8190-0719.2  | 620719  |  | OE - #                        |
| <br><br> 686 mm | <p><b>FIAT</b><br/>           CROMA (05-10)</p> <p><b>OPEL</b><br/>           SIGNUM / Vauxhall Signum (03-08)<br/>           VECTRA C (F68,F69)/Vau. Vectra MK II (02-08)<br/>           VECTRA C Caravan (F35) / Vau. MK II (03-08)</p>   | <p>1x<br/>1x<br/>1x<br/>1x</p>  | <p>62 38 230<br/>24427919</p> |
| 24.8190-0720.2  | 620720  |  | OE - #                        |
| <br><br> 287 mm | <p><b>OPEL</b><br/>           ASTRA H / GTC / Vauxhall Astra MKV (04-10)<br/>           ASTRA H Caravan/VauAstra MKV Esate(04-10)<br/>           ASTRA H TwinTop (06-10)<br/>           SIGNUM / Vauxhall Signum (03-08)<br/>           VECTRA C (F68,F69)/Vau. Vectra MK II (02-08)<br/>           VECTRA C Caravan (F35) / Vau. MK II (03-08)<br/>           ZAFIRA II / Vauxhall Zafira II (05-)</p> | <p>1x<br/>1x<br/>1x<br/>1x<br/>1x<br/>1x<br/>1x</p>                                   | <p>62 35 647<br/>13116560</p> |

# Abbildungen Warnkontakte









Illustrations wear indicators - Illustrazioni rilevatori usura - Illustrations Témoins d'usure - Ilustraciones contactos de desgaste

| 24.8190-0721.2   | 620721   |    | OE - #   |
|--|--|---|--|
| <br> 700 mm      | <b>OPEL</b><br>SIGNUM / Vauxhall Signum (03-08)<br>VECTRA C (F68,F69)/Vau. Vectra MK II (02-08)<br>VECTRA C Caravan (F35) / Vau. MK II (03-08) | 1x<br>1x<br>1x  | 62 35 623<br>13131256                              |
| 24.8190-0722.2   | 620722   |    | OE - #   |
| <br> 302 mm    | <b>OPEL</b><br>SIGNUM / Vauxhall Signum (03-08)<br>VECTRA C (F68,F69)/Vau. Vectra MK II (02-08)<br>VECTRA C Caravan (F35) / Vau. MK II (03-08) | 1x<br>1x<br>1x  | 62 35 648<br>13139260                              |
| 24.8190-0903.2   | 620903   |  | OE - #   |
| <br> 1005 mm | <b>PORSCHE</b><br>928 (77-95)  | 2x  | 928 612 311 01<br>928 612 311 02<br>928 612 311 03 |
| 24.8190-0904.2   | 620904   |  | OE - #   |
| <br> 275 mm  | <b>PORSCHE</b><br>911 (63-90)<br>944 (81-91)   | 2x 2x<br>2x   | 944 612 211 00<br>944 612 211 02                   |

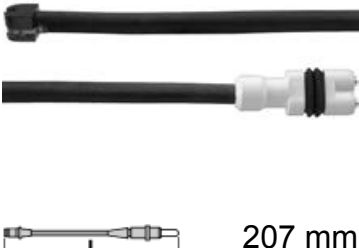

















# Abbildungen Warnkontakte

Illustrations wear indicators - Illustrazioni rilevatori usura - Illustrations Témoins d'usure - Ilustraciones contactos de desgaste

| 24.8190-0905.2   |                               | 620905 |    | OE - # |
|--|-------------------------------|--------|---|--------|
|  <p>357 mm</p>   | <b>PORSCHE</b><br>944 (81-91) | 2x     | 944 612 211 01  |        |
| 24.8190-0909.2   |                               | 620909 |    | OE - # |
|  <p>207 mm</p>   | <b>PORSCHE</b><br>928 (77-95) | 2x     | 928 612 315 02  |        |
| 24.8190-0910.2   |                               | 620910 |   | OE - # |
|  <p>515 mm</p> | <b>PORSCHE</b><br>928 (77-95) | 2x     | 928 612 313 02  |        |
| 24.8190-0913.2   |                               | 620913 |  | OE - # |
|  <p>308 mm</p> | <b>PORSCHE</b><br>944 (81-91) | 2x     | 944 612 212 01  |        |
| 24.8190-0915.2   |                               | 620915 |  | OE - # |
|  <p>333 mm</p> | <b>PORSCHE</b><br>928 (77-95) | 2x     | 928 612 365 01  |        |







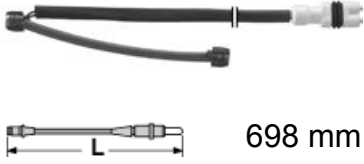

# Abbildungen Warnkontakte

Illustrations wear indicators - Illustrazioni rilevatori usura - Illustrations Témoins d'usure - Ilustraciones contactos de desgaste

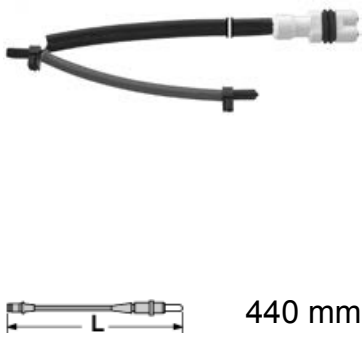
| 24.8190-0916.2   |   | 620916 |    | OE - #                           |
|--|---|--------|---|----------------------------------|
| <br><br>     | <b>PORSCHE</b><br>944 (81-91)<br>968 COUPE (91-95)<br>968 CABRIO (91-95)  |        | 2x 2x   | 944 612 365 01                   |
|  |   |        | 2x 2x   |                                  |
| <br>395 mm   |   |        | 2x 2x   |                                  |
| 24.8190-0917.2   |   | 620917 |    | OE - #                           |
| <br><br>   | <b>PORSCHE</b><br>911 (964) (88-93)<br>911 CABRIO (964) (89-94)<br>911 (993) (93-97)<br>911 TARGA (993) (95-97)<br>911 CABRIO (993) (94-97) |        | 2x  | 964 612 363 01                   |
|  |   |        | 2x  |                                  |
| <br>518 mm   |   |        | 2x  |                                  |
| 24.8190-0918.2   |   | 620918 |  | OE - #                           |
| <br><br> | <b>PORSCHE</b><br>911 (964) (88-93)<br>911 CABRIO (964) (89-94)   |        | 2x  | 964 612 365 01                   |
|  |   |        | 2x  |                                  |
| <br>440 mm   |   |        |   |                                  |
| 24.8190-0919.2   |   | 620919 |  | OE - #                           |
| <br><br> | <b>PORSCHE</b><br>928 (77-95)   |        | 2x  | 928 612 363 00<br>928 612 363 01 |
|  |   |        |   |                                  |
| <br>638 mm   |   |        |   |                                  |



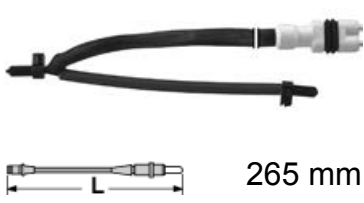

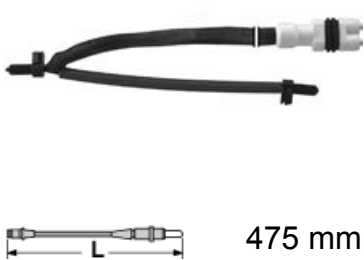







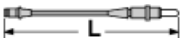

# Abbildungen Warnkontakte

Illustrations wear indicators - Illustrazioni rilevatori usura - Illustrations Témoins d'usure - Ilustraciones contactos de desgaste

| 24.8190-0920.2   |                          | 620920 |    | OE - #         |
|--|--------------------------|--------|---|----------------|
|  <p>698 mm</p>   | <b>PORSCHE</b>           |        |   |                |
|  | 911 (993) (93-97)        |        | 2x  | 993 612 365 01 |
|  | 911 TARGA (993) (95-97)  |        | 2x  |                |
|  | 911 CABRIO (993) (94-97) |        | 2x  |                |
| 24.8190-0921.2   |                          | 620921 |    | OE - #         |
|  <p>440 mm</p>  | <b>PORSCHE</b>           |        |   |                |
|  | 911 (996) (97-05)        |        | 2x 2x   | 996 612 365 00 |
|  | 911 TARGA (996) (01-05)  |        | 2x 2x   |                |
|  | 911 CABRIO (996) (98-05) |        | 2x 2x   |                |
|  | 911 COUPE (997) (04-13)  |        | 2x  |                |
|  | 911 CABRIO (997) (05-13) |        | 2x  |                |
| BOXSTER (986) (96-04)  |                          | 2x     |   |                |
| 24.8190-0922.2   |                          | 620922 |  | OE - #         |
|  <p>440 mm</p> | <b>PORSCHE</b>           |        |   |                |
|  | BOXSTER (986) (96-04)    |        | 2x  | 986 612 365 00 |
|  | BOXSTER (987) (05-11)    |        | 2x  |                |
|  | CAYMAN (987C) (05-12)    |        | 2x  |                |
| 24.8190-0925.2   |                          | 620925 |  | OE - #         |
|  <p>265 mm</p> | <b>PORSCHE</b>           |        |   |                |
|  | 928 (77-95)              |        | 2x  | 928 612 366 00 |
| 24.8190-0926.2   |                          | 620926 |  | OE - #         |
|  <p>475 mm</p> | <b>PORSCHE</b>           |        |   |                |
|  | 911 (964) (88-93)        |        | 2x  | 993 612 368 00 |
|  | 911 (993) (93-97)        |        | 2x  |                |
|  | 911 CABRIO (993) (94-97) |        | 2x  |                |







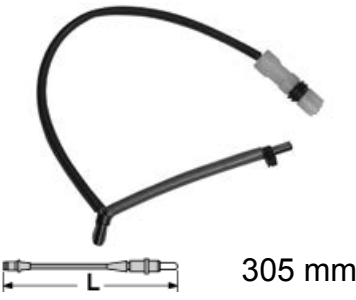

# Abbildungen Warnkontakte

Illustrations wear indicators - Illustrazioni rilevatori usura - Illustrations Témoins d'usure - Ilustraciones contactos de desgaste

| 24.8190-0927.2  |  | 620927 |    | OE - #                           |
|---|--|--------|---|----------------------------------|
| <br> 276 mm       | <b>PORSCHE</b><br>911 (63-90)                                    |        | 2x  | 993 612 965 01                   |
| 24.8190-0929.2  |  | 620929 |    | OE - #                           |
| <br> 417,4 mm     | <b>AUDI</b><br>Q7 (06-15)  |        | 2x  | 7L0 907 637                      |
|   | <b>PORSCHE</b><br>CAYENNE I (03-10)                              |        | 2x  | 955 612 365 00                   |
|   | <b>VOLKSWAGEN</b><br>TOUAREG I (03-10)                           |        | 2x  | 7L0 907 637                      |
| 24.8190-0930.2  |  | 620930 |   | OE - #                           |
| <br> 252,4 mm | <b>AUDI</b><br>Q7 (06-15)  |        | 2x  | 7L0 907 637 C                    |
|   | <b>PORSCHE</b><br>CAYENNE I (03-10)                              |        | 2x  | 955 612 365 20<br>955 612 365 30 |
|   | <b>VOLKSWAGEN</b><br>TOUAREG I (03-10)                           |        | 2x  | 7L0 907 637 C                    |
|   |  |        |   |                                  |
| 24.8190-0931.2  |  | 620931 |  | OE - #                           |
| <br> 336 mm   | <b>PORSCHE</b><br>911 COUPE (997) (04-13)                        |        | 1x  | 997 612 678 00                   |
|   | 911 CABRIO (997) (05-13)   |        | 2x  |                                  |
| 24.8190-0932.2  |  | 620932 |  | OE - #                           |
| <br> 461 mm   | <b>PORSCHE</b><br>BOXSTER (987) (05-11)<br>CAYMAN (987C) (05-12) |        | 2x<br>2x  | 987 612 676 01                   |



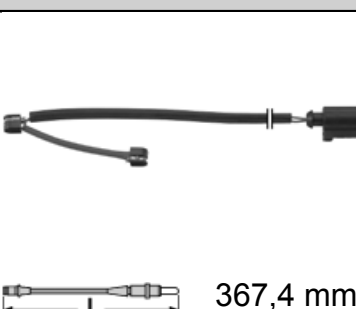











# Abbildungen Warnkontakte

Illustrations wear indicators - Illustrazioni rilevatori usura - Illustrations Témoins d'usure - Ilustraciones contactos de desgaste

| 24.8190-0933.2   | 620933   |    | OE - #                                  |
|--|--|---|---|
|  <p>305 mm</p>     | <p><b>PORSCHE</b><br/>           911 COUPE (997) (04-13)<br/>           911 CABRIO (997) (05-13)<br/>           BOXSTER (987) (05-11)<br/>           CAYMAN (987C) (05-12)</p> | <p>1x<br/>1x<br/>2x<br/>1x</p>  | <p>997 612 757 00</p>                   |
| 24.8190-0934.2   | 620934   |    | OE - #                                  |
|  <p>295 mm</p>     | <p><b>PORSCHE</b><br/>           BOXSTER (987) (05-11)<br/>           CAYMAN (987C) (05-12)</p>  | <p>2x<br/>1x</p>  | <p>997 612 755 00</p>                   |
| 24.8190-0935.2   | 620935   |   | OE - #                                  |
|  <p>315 mm</p>   | <p><b>PORSCHE</b><br/>           CAYMAN (987C) (05-12)</p>   | <p>1x</p>   | <p>997 612 758 00</p>                   |
| 24.8190-0936.2   | 620936   |  | OE - #                                  |
|  <p>367,4 mm</p> | <p><b>PORSCHE</b><br/>           CAYENNE I (03-10)<br/> <b>VOLKSWAGEN</b><br/>           TOUAREG I (03-10)</p>   | <p>2x<br/>2x</p>  | <p>955 612 365 60<br/>7L5 907 637 A</p> |
| 24.8190-0937.2   | 620937   |  | OE - #                                  |
|  <p>247,4 mm</p> | <p><b>AUDI</b><br/>           Q7 (06-15)<br/> <b>PORSCHE</b><br/>           CAYENNE I (03-10)</p>  | <p>2x<br/>2x</p>  | <p>7L5 907 637 B<br/>955 612 365 70</p> |

# Abbildungen Warnkontakte











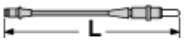

Illustrations wear indicators - Illustrazioni rilevatori usura - Illustrations Témoins d'usure - Ilustraciones contactos de desgaste

| 24.8190-0938.2  |  | 620938 |    | OE - #          |
|---|--|--------|---|-----------------|
| <br> 495 mm       | <b>PORSCHE</b><br>911 COUPE (997) (04-13)<br>911 CABRIO (997) (05-13)<br>CARRERA GT (980) (03-07)  |        | 2x<br>2x<br>2x  | 997 612 677 00  |
|   | <b>PORSCHE</b><br>CAYENNE II (10-)<br>PANAMERA (10-)   |        | 2x<br>2x  | 970 609 143 00  |
| 24.8190-0939.2  |  | 620939 |    | OE - #          |
| <br> 372,4 mm     | <b>PORSCHE</b><br>CAYENNE II (10-)<br>PANAMERA (10-)   |        | 2x<br>2x  | 970 609 143 00  |
|   | <b>PORSCHE</b><br>CAYENNE II (10-)<br>PANAMERA (10-)   |        | 2x<br>2x  | 970 609 145 00  |
| 24.8190-0940.2  |  | 620940 |   | OE - #          |
| <br> 227,4 mm | <b>PORSCHE</b><br>CAYENNE II (10-)<br>PANAMERA (10-)   |        | 2x<br>2x  | 970 609 145 00  |
|   | <b>PORSCHE</b><br>CAYENNE II (10-)<br>PANAMERA (10-)   |        | 2x<br>2x  | 970 609 145 00  |
| 24.8190-0941.2  |  | 620941 |  | OE - #          |
| <br> 648 mm   | <b>MINI</b><br>F55 (14-)<br>F56 (13-)  |        | 1x<br>1x  | 34 35 6 865 611 |
|   | <b>MINI</b><br>F54 Clubman (15-) / F55 (14-)<br>F56 (13-) / F57 Cabrio (15-)                       |        | 1x<br>1x<br>1x  | 34 35 6 865 612 |
| 24.8190-0942.2  |  | 620942 |  | OE - #          |
| <br> 641 mm   | <b>BMW</b><br>2er Reihe/F45 Active Tourer (14-)<br>2er Reihe/F46 Gran Tourer (15-)<br>X1/F48 (15-) |        | 1x<br>1x<br>1x  | 34 35 6 865 612 |
|   | <b>MINI</b><br>F54 Clubman (15-) / F55 (14-)<br>F56 (13-) / F57 Cabrio (15-)                       |        | 1x<br>1x  | 34 35 6 865 612 |



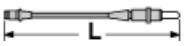











# Abbildungen Warnkontakte

Illustrations wear indicators - Illustrazioni rilevatori usura - Illustrations Témoins d'usure - Ilustraciones contactos de desgaste

| 24.8190-0943.2   | 620943  |    | OE - #         |
|--|---|---|----------------|
| <br><br> 504,6 mm    | <b>PORSCHE</b><br>911 COUPE (997) (04-13)<br>911 CABRIO (997) (05-13) | 2x<br>2x  | 997 612 676 01 |
| 24.8190-0944.2   | 620944  |    | OE - #         |
| <br><br> 841,5 mm  | <b>LAND ROVER</b><br>RANGE ROVER III (LM) (02-12)                     | 1x  | SEM500050      |
| 24.8190-0945.2   | 620945  |  | OE - #         |
| <br><br> 1227 mm | <b>LAND ROVER</b><br>RANGE ROVER SPORT (LS) (05-13)                   | 1x  | SEM500062      |
| 24.8190-0946.2   | 620946  |  | OE - #         |
| <br><br> 1175 mm | <b>LAND ROVER</b><br>DISCOVERY III (04-09)                            | 1x  | SEM500070      |













# Abbildungen Warnkontakte

Illustrations wear indicators - Illustrazioni rilevatori usura - Illustrations Témoins d'usure - Ilustraciones contactos de desgaste

| 24.8190-0947.2   | 620947   |    | OE - #                |
|--|--|---|-----------------------|
| <br> 865 mm      | <b>OPEL</b><br>OMEGA A / Vauxhall Carlton (87-93) ATE  | 2x  | 12 38 421<br>90372058 |
| 24.8190-0948.2   | 620948   |    | OE - #                |
| <br> 1212 mm   | <b>LAND ROVER</b><br>RANGE ROVER SPORT (LS) (05-13)  | 1x  | SEM500090             |
| 24.8190-0949.2   | 620949   |  | OE - #                |
| <br> 1228 mm | <b>LAND ROVER</b><br>RANGE ROVER SPORT (LS) (05-13)  | 1x  | SEM500080             |
| 24.8190-0950.2   | 620950   |  | OE - #                |
| <br> 525 mm  | <b>PORSCHE</b><br>911 COUPE (997) (04-13)<br>911 CABRIO (997) (05-13)<br>911 TARGA (997) (06-13) | 2x<br>2x<br>2x  | 997 612 680 00        |









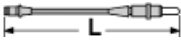

# Abbildungen Warnkontakte

Illustrations wear indicators - Illustrazioni rilevatori usura - Illustrations Témoins d'usure - Ilustraciones contactos de desgaste

| 24.8190-0951.2  | 620951  |    | OE - #         |
|---|---|---|----------------|
| <br><br> 500 mm     | <b>PORSCHE</b><br>911 COUPE (997) (04-13)   | 2x  | 997 612 677 90 |
| 24.8190-0952.2  | 620952  |    | OE - #         |
| <br><br> 300 mm   | <b>PORSCHE</b><br>718 BOXSTER (982) (16-)<br>718 CAYMAN (982) (16-)<br>911 CABRIO (991) (12-)<br>911 COUPE (991) (11-)<br>911 TARGA (991) (14-)<br>BOXSTER (981) (12-)<br>BOXSTER Spyder (981) (15-)<br>CAYMAN (981C) (13-) | 2x<br>2x<br>2x<br>2x<br>2x<br>2x<br>2x 2x<br>2x 2x                                    | 991 609 181 00 |
| 24.8190-0953.2  | 620953  |  | OE - #         |
| <br><br> 215 mm | <b>PORSCHE</b><br>911 CABRIO (991) (12-)<br>911 COUPE (991) (11-)<br>911 TARGA (991) (14-)<br>BOXSTER Spyder (981) (15-)  | 2x<br>2x<br>2x<br>2x  | 991 609 183 00 |
| 24.8190-0954.2  | 620954  |  | OE - #         |
| <br><br> 365 mm | <b>PORSCHE</b><br>CAYENNE I (03-10)   | 2x  | 955 612 365 81 |





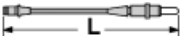







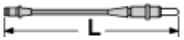



# Abbildungen Warnkontakte

Illustrations wear indicators - Illustrazioni rilevatori usura - Illustrations Témoins d'usure - Ilustraciones contactos de desgaste

| 24.8190-0955.2  | 620955   |    | OE - #         |
|---|--|---|----------------|
| <br><br> 100 mm       | <b>MERCEDES BENZ</b><br>E-Klasse (W211) Limousine (02-09)<br>E-Klasse (S211) Kombi (03-09)   | 1x<br>1x  | 211 540 15 17  |
| 24.8190-0956.2  | 620956   |    | OE - #         |
| <br><br> 454,6 mm   | <b>PORSCHE</b><br>911 COUPE (997) (04-13)<br>CAYMAN (987C) (05-12)   | 1x<br>1x  | 997 612 679 00 |
| 24.8190-0957.2  | 620957   |  | OE - #         |
| <br><br> 394,6 mm | <b>PORSCHE</b><br>911 COUPE (997) (04-13)<br>CAYMAN (987C) (05-12)   | 1x<br>1x  | 997 612 675 01 |
| 24.8190-0959.2  | 620959   |  | OE - #         |
| <br><br> 102 mm   | <b>MERCEDES BENZ</b><br>S-Klasse (A217) Cabrio (15-)<br>S-Klasse (C217) Coupe (14-)<br>S-Klasse (W222) (13-)<br>SL-Klasse (R231) (12-) | 1x<br>1x<br>2x<br>1x  | 231 905 00 14  |







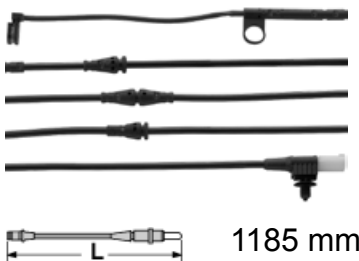

# Abbildungen Warnkontakte

Illustrations wear indicators - Illustrazioni rilevatori usura - Illustrations Témoins d'usure - Ilustraciones contactos de desgaste

| 24.8190-1302.2  |   | 621302                     |    | OE - #    |   |         |
|---|---|----------------------------|---|-----------|---|---------|
| <br> 276 mm       | <b>DAIMLER</b><br>XJ (40,81) (89-94)  | 2x                         |    | DBC 6595  |   |         |
|   | <b>JAGUAR</b><br>XJ (XJ40,81) (86-96)<br>XJS (88-96)<br>XJ (X300) (94-97)<br>XK8 Convertible (QDV) (96-05)<br>XK8 Coupe (QEV) (96-05) | 2x<br>2x<br>2x<br>2x<br>2x |   |           |   |         |
| 24.8190-1304.2  |   | 621304                     |   |           |    | OE - #  |
| <br> 289 mm   | <b>IVECO</b><br>DAILY I / GRINTA (78-99)<br>DAILY II (99-06)  | 2x 2x<br>2x 2x             |   |           |    | 1908407 |
|   |   |                            |   |           |   |         |
| 24.8190-1305.2  |   | 621305                     |   |           |  | OE - #  |
| <br> 1147 mm | <b>LAND ROVER</b><br>DISCOVERY III (04-09)  | 1x                         |  | SEM000024 |   |         |
|   |   |                            |   |           |   |         |
| 24.8190-1306.2  |   | 621306                     |  | OE - #    |   |         |
| <br> 1156 mm | <b>LAND ROVER</b><br>DISCOVERY III (04-09)<br>DISCOVERY IV (09-)<br>RANGE ROVER SPORT (LS) (05-13)                                    | 1x<br>1x<br>1x             |  | SOE000025 |   |         |
|   |   |                            |   |           |   |         |

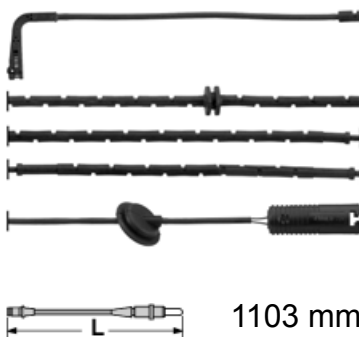
# Abbildungen Warnkontakte

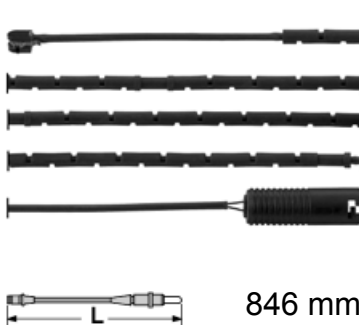
Illustrations wear indicators - Illustrazioni rilevatori usura - Illustrations Témoins d'usure - Ilustraciones contactos de desgaste

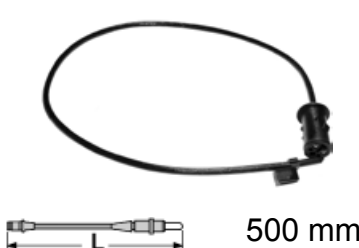
| 24.8190-1307.2  | 621307  |    | OE - #    |
|---|---|---|-----------|
|  <p>1185 mm</p>   | <b>LAND ROVER</b><br>RANGE ROVER SPORT (LS) (05-13)   | 1x  | SEM500026 |
| 24.8190-1308.2  | 621308  |    | OE - #    |
|  <p>1118 mm</p>   | <b>LAND ROVER</b><br>RANGE ROVER III (LM) (02-12)   | 1x  | SOE000011 |
| 24.8190-2801.2  | 622801  |   | OE - #    |
|  <p>1103 mm</p> | <b>MG</b><br>ZT Limousine (01-05)<br>ZT-T Kombi (01-05)<br><b>ROVER</b><br>75-Serie (RJ/RX) (99-05) | 1x<br>1x<br>1x  | SOM100030 |
| 24.8190-2802.2  | 622802  |  | OE - #    |
|  <p>846 mm</p>  | <b>MG</b><br>ZT Limousine (01-05)<br>ZT-T Kombi (01-05)<br><b>ROVER</b><br>75-Serie (RJ/RX) (99-05) | 1x<br>1x<br>1x  | SOE100010 |
| 24.8190-2901.2  | 622901  |  | OE - #    |
|  <p>500 mm</p>  | <b>IVECO</b><br>EUROCARGO<br>Z-REIHE / ZETA   | 2x 2x<br>2x   | 1907942   |







- D** Abbildungen Trommelbremsbacken
- EN** Illustrations drum brake shoes
- FR** Illustrations Mâchoires de frein à tambour
- IT** Illustrazioni ganasce freno
- ES** Ilustraciones zapatas freno de tambor
- NL** Afbeeldingen trommelremschoenen
- DA** Tegning bremsebakker
- SV** Avbildningar trumbromsbackar
- HU** Ábrák - fékpofa dobfékhez
- PT** Figuras Calços de travão de tambor
- RU** Рисунки барабанных колодок
- CZ** Zobrazení čelistí bubnových brzd
- PL** Rysunki szczęk hamulca bębnowego
- EL** Εικόνες σιαγόνων τυλίπώνων πέδησης
- TR** Fren pabuçları resimleri
- ZH** 制动摩擦片图片
- JA** 図版 ドラムブレーキシュー
- AR** صور فكي المكبح الطبلي

# K24-F

# Abbildungen Trommelbremsbacken

Illustrations drum brake shoes - Illustrazioni ganasce freno - Illustrations Mâchoires de frein à tambour - Ilustraciones zapatas freno de tambor

**03.0137-0009.2 650009**

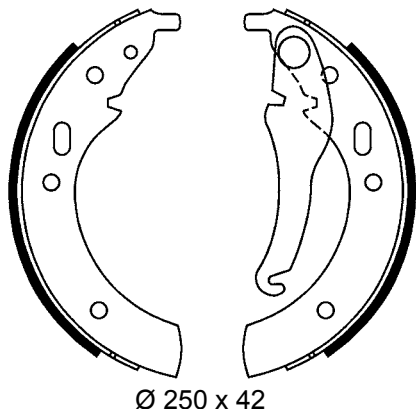

Ø 250 x 42

**03.0137-0015.2 650015**

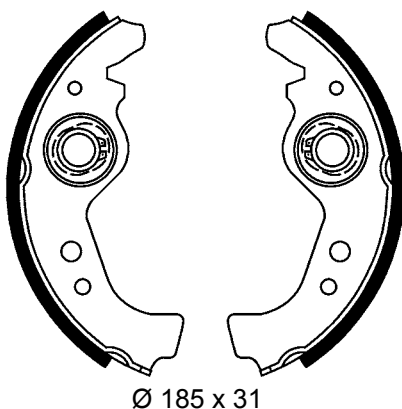

Ø 185 x 31

**03.0137-0036.2 650036**

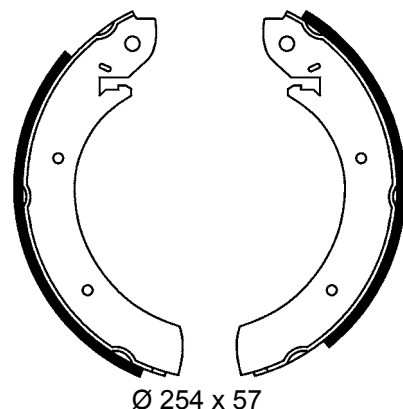

Ø 254 x 57

**03.0137-0041.2 650041**

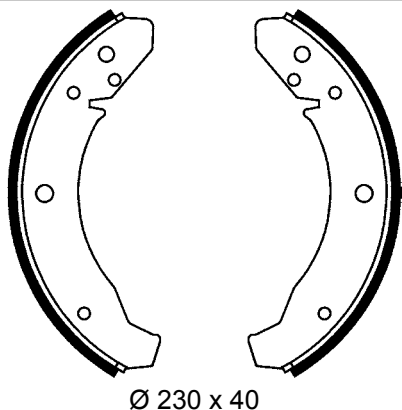

Ø 230 x 40

**03.0137-0055.2 650055**

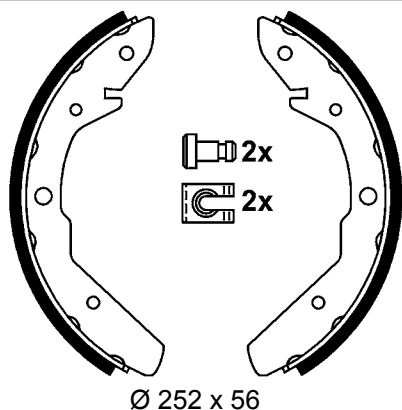

Ø 252 x 56

**03.0137-0073.2 650073**

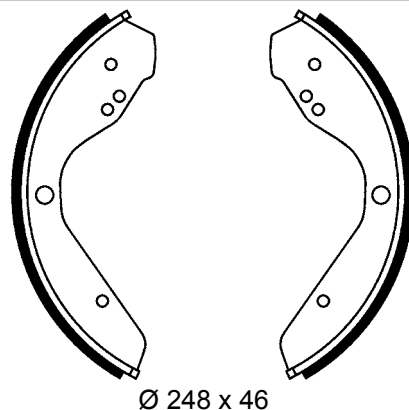

Ø 248 x 46

**03.0137-0080.2 650080**

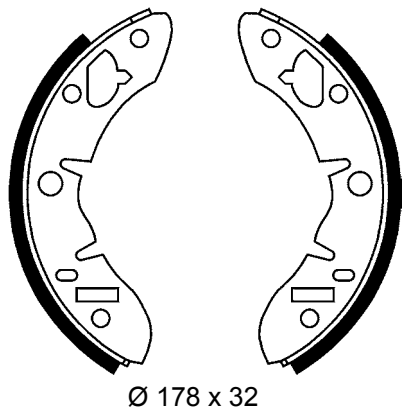

Ø 178 x 32

**03.0137-0082.2 650082**

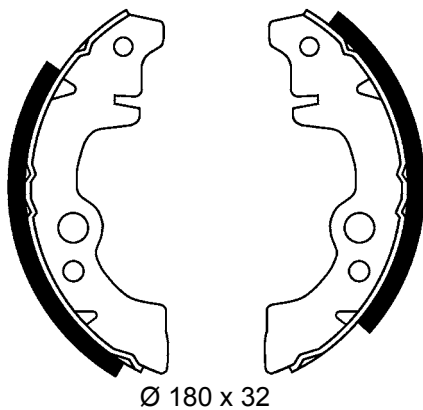

Ø 180 x 32

**03.0137-0092.2 650092**

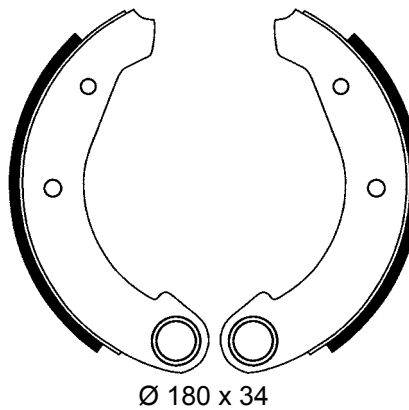

Ø 180 x 34

**03.0137-0108.2 650108**

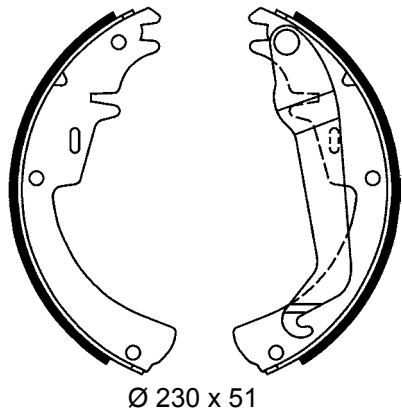

Ø 230 x 51

**03.0137-0124.2 650124**

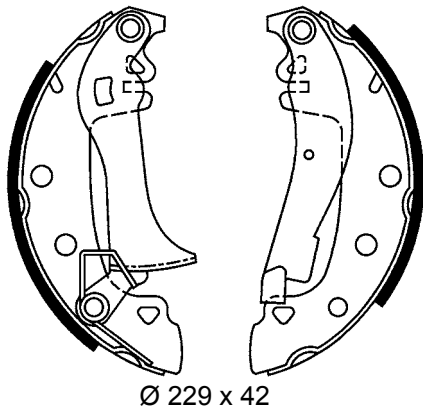

Ø 229 x 42

**03.0137-0126.2 650126**

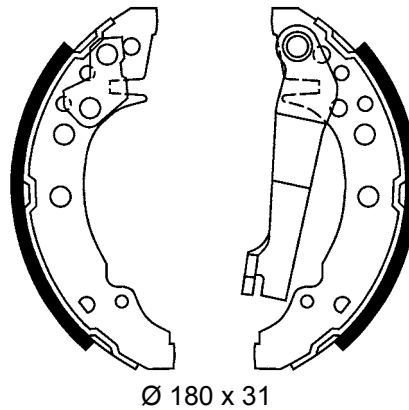

Ø 180 x 31

# Abbildungen Trommelbremsbacken

Illustrations drum brake shoes - Illustrazioni ganasce freno - Illustrations Mâchoires de frein à tambour - Ilustraciones zapatas freno de tambor

**03.0137-0128.2 650128**

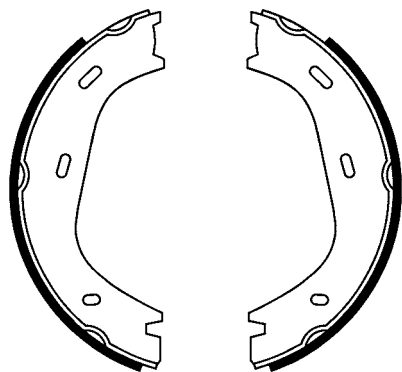

Ø 160 x 25

**03.0137-0138.2 650138**

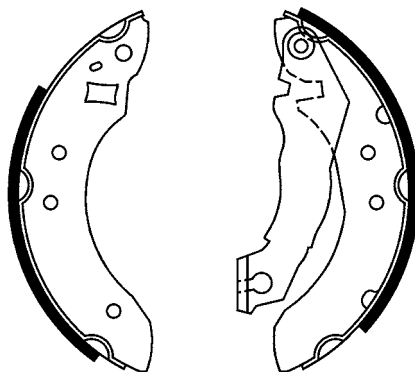

Ø 180 x 32

**03.0137-0139.2 650139**

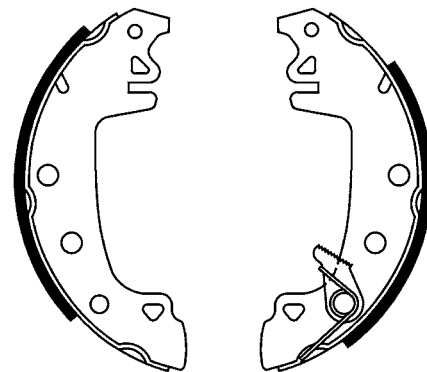

Ø 229 x 42

**03.0137-0143.2 650143**

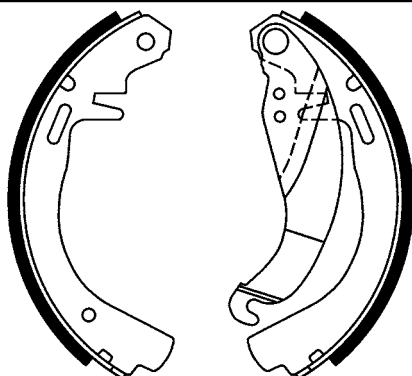

Ø 200 x 29

**03.0137-0146.2 650146**

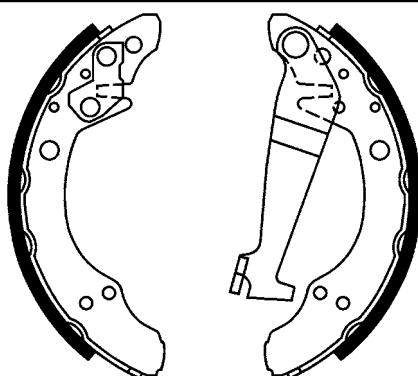

Ø 200 x 40

**03.0137-0148.2 650148**

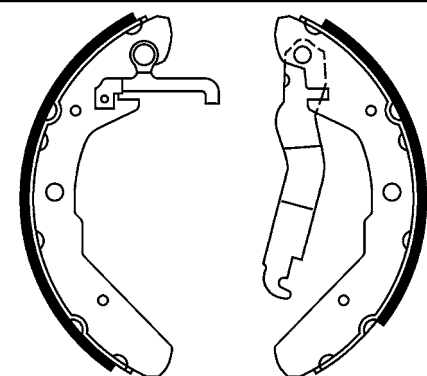

Ø 252 x 56

**03.0137-0149.2 650149**

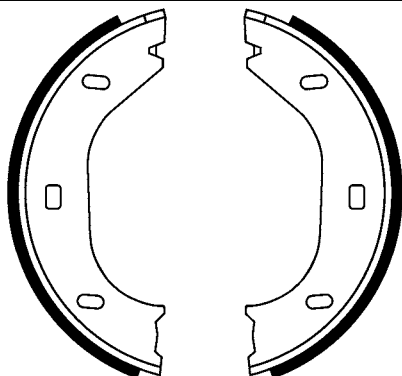

Ø 160 x 25

**03.0137-0150.2 650150**

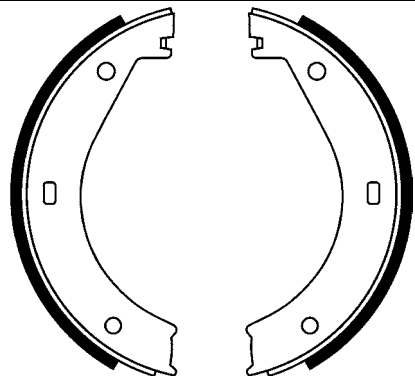

Ø 180 x 25

**03.0137-0151.2 650151**

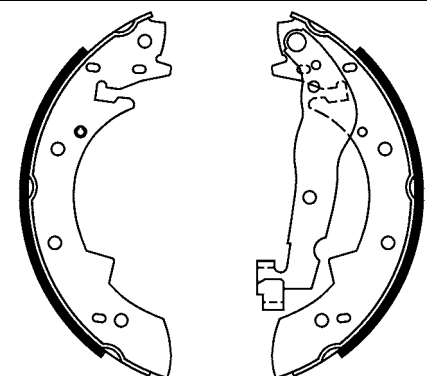

Ø 229 x 42

**03.0137-0152.2 650152**

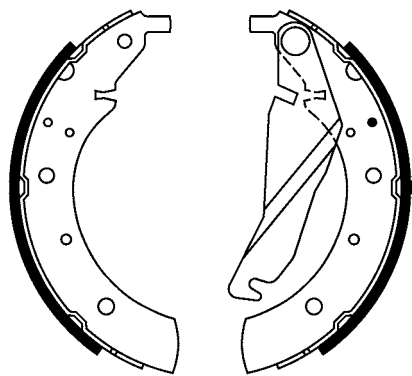

Ø 250 x 42

**03.0137-0153.2 650153**

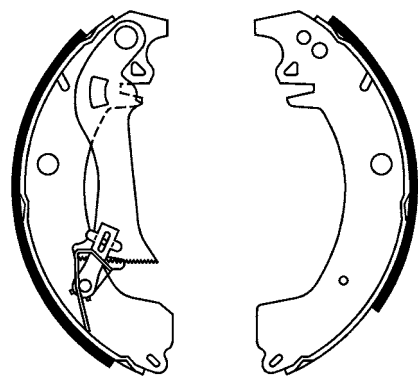

Ø 255 x 46

**03.0137-0157.2 650157**

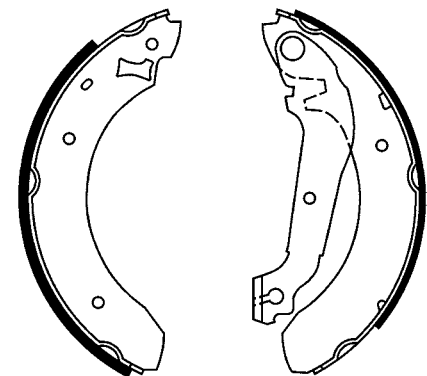

Ø 229 x 58

# Abbildungen Trommelbremsbacken

Illustrations drum brake shoes - Illustrazioni ganasce freno - Illustrations Mâchoires de frein à tambour - Ilustraciones zapatas freno de tambor

**03.0137-0164.2 650164**

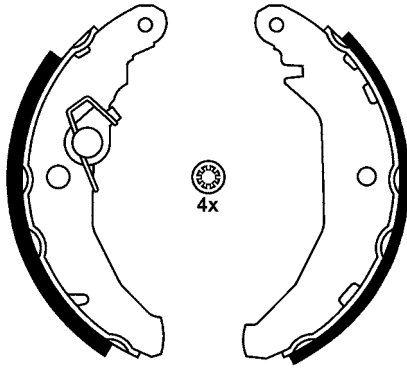

Ø 178 x 32

**03.0137-0165.2 650165**

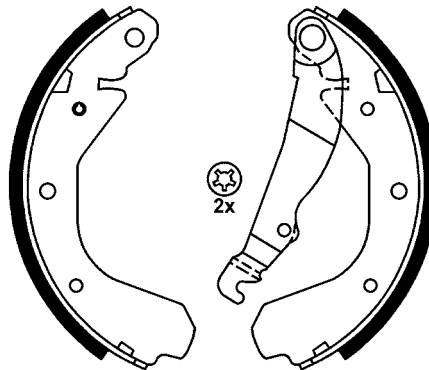

Ø 200 x 29

**03.0137-0166.2 650166**

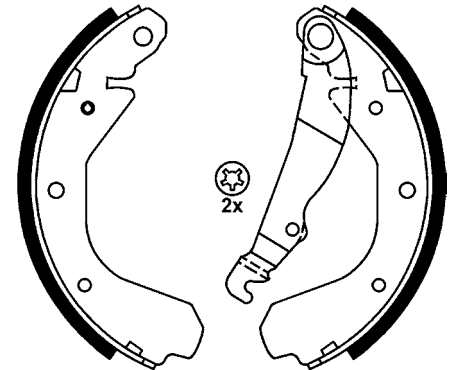

Ø 200 x 46

**03.0137-0167.2 650167**

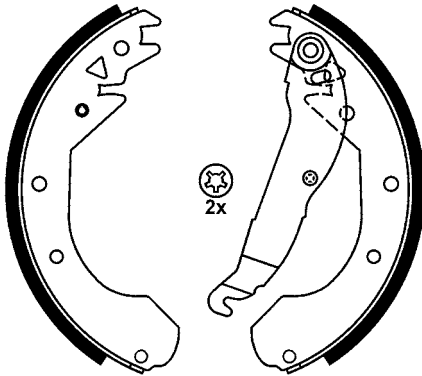

Ø 230 x 51

**03.0137-0169.2 650169**

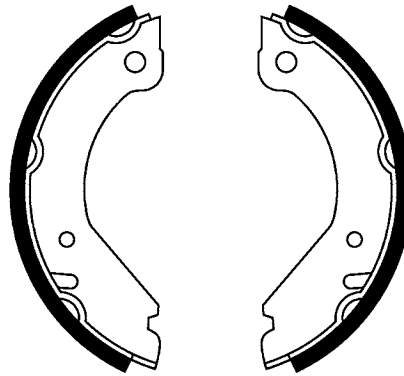

Ø 160 x 25

**03.0137-0170.2 650170**

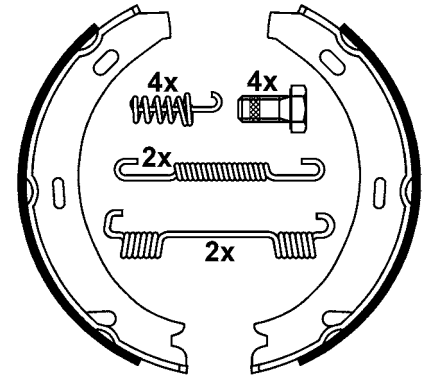

Ø 164 x 20

**03.0137-0171.2 650171**

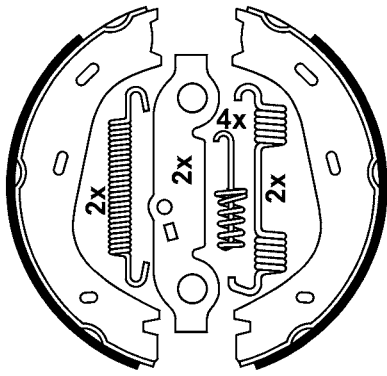

Ø 160 x 25

**03.0137-0172.2 650172**

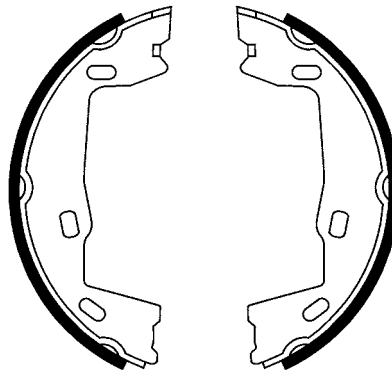

Ø 160 x 25

**03.0137-0179.2 650179**

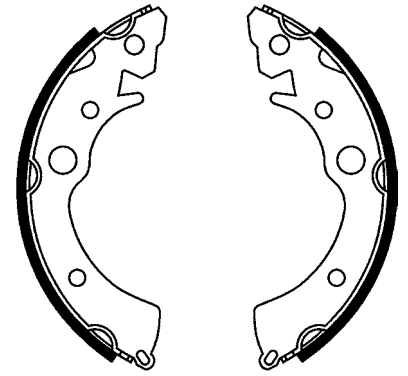

Ø 180 x 31

**03.0137-0184.2 650184**

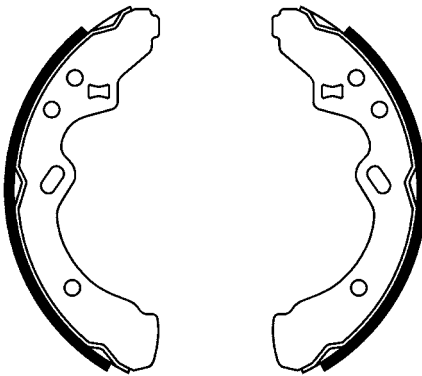

Ø 229 x 26

**03.0137-0185.2 650185**

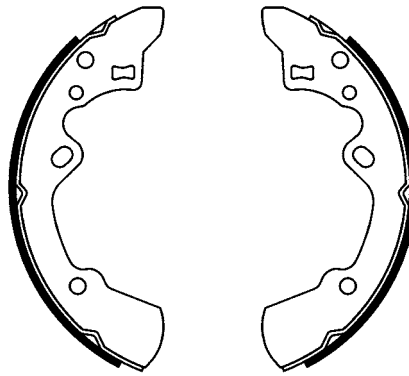

Ø 229 x 32

**03.0137-0186.2 650186**

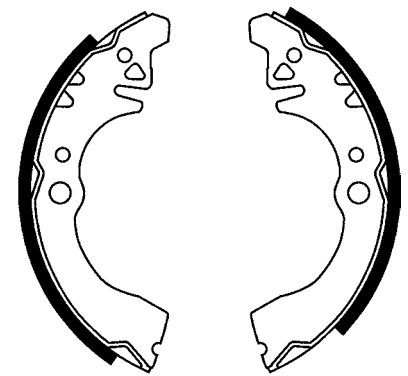

Ø 180 x 28

# Abbildungen Trommelbremsbacken

Illustrations drum brake shoes - Illustrazioni ganasce freno - Illustrations Mâchoires de frein à tambour - Ilustraciones zapatas freno de tambor

**03.0137-0188.2 650188**

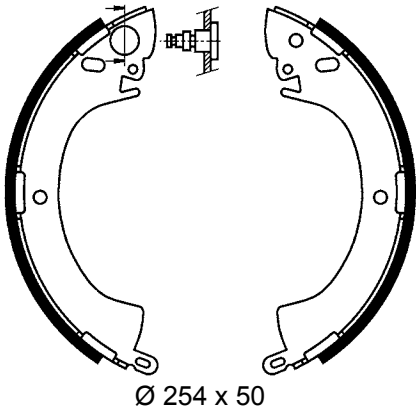

Ø 254 x 50

**03.0137-0193.2 650193**

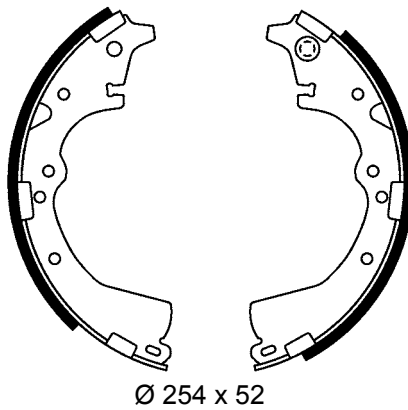

Ø 254 x 52

**03.0137-0195.2 650195**

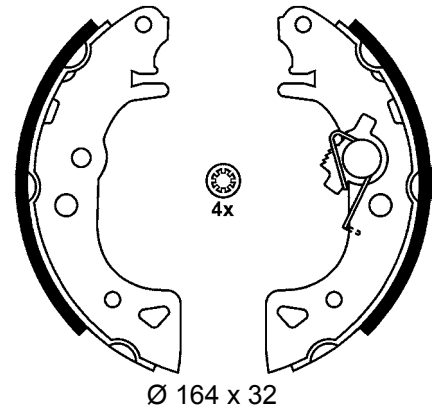

Ø 164 x 32

**03.0137-0196.2 650196**

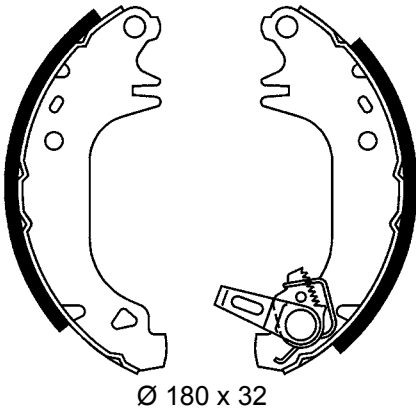

Ø 180 x 32

**03.0137-0197.2 650197**

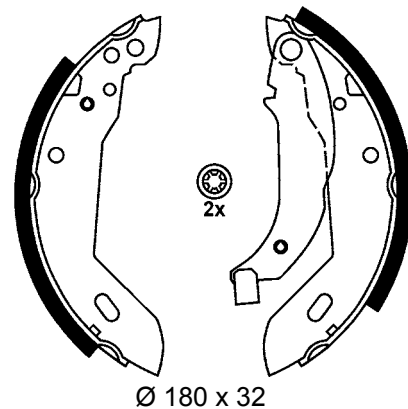

Ø 180 x 32

**03.0137-0201.2 650201**

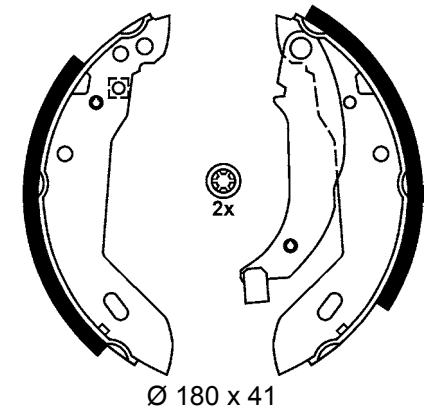

Ø 180 x 41

**03.0137-0202.2 650202**

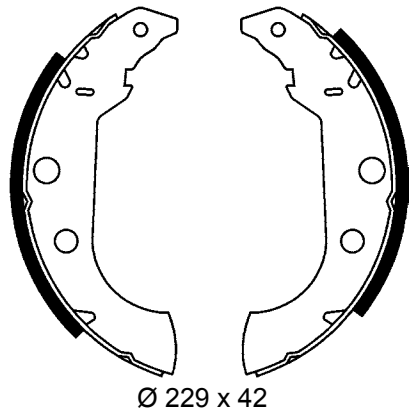

Ø 229 x 42

**03.0137-0203.2 650203**

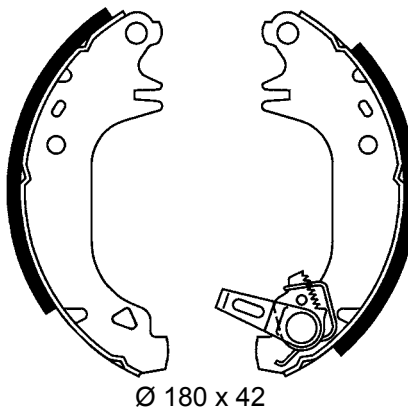

Ø 180 x 42

**03.0137-0204.2 650204**

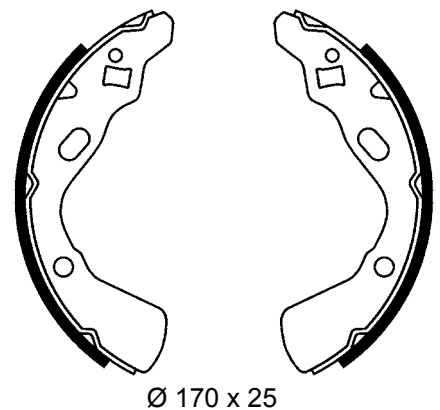

Ø 170 x 25

**03.0137-0207.2 650207**

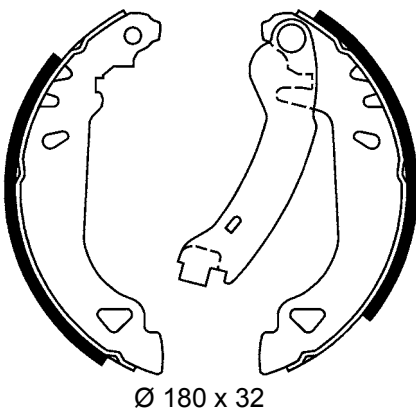

Ø 180 x 32

**03.0137-0208.2 650208**

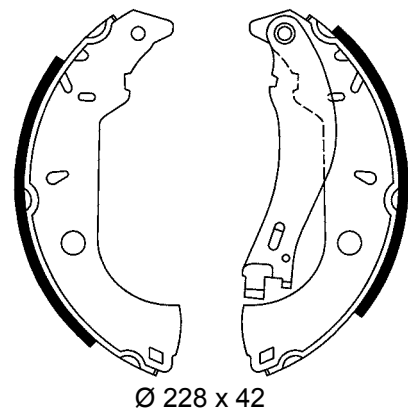

Ø 228 x 42

**03.0137-0209.2 650209**

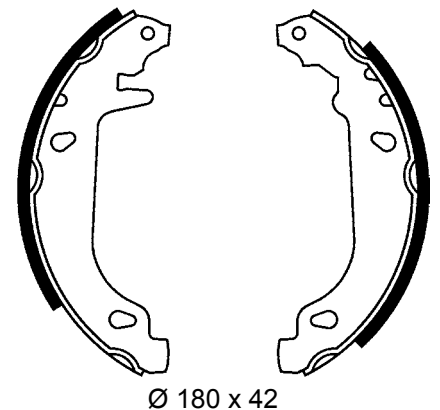

Ø 180 x 42



# Abbildungen Trommelbremsbacken

Illustrations drum brake shoes - Illustrazioni ganasce freno - Illustrations Mâchoires de frein à tambour - Ilustraciones zapatas freno de tambor

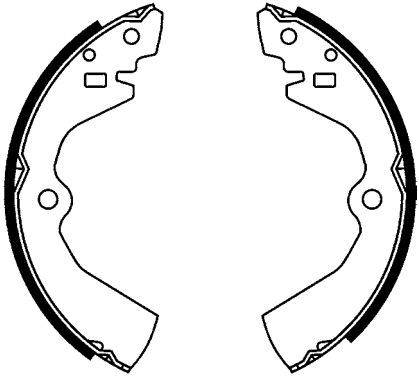
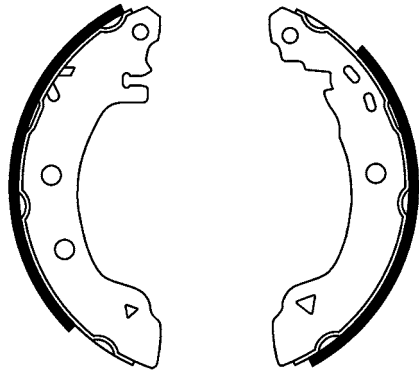
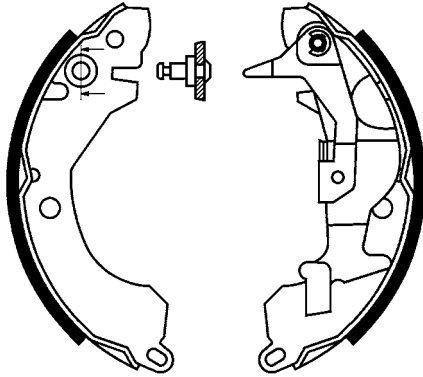
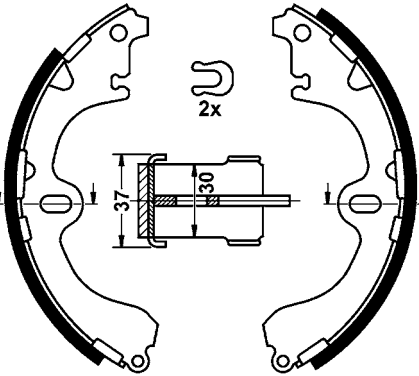
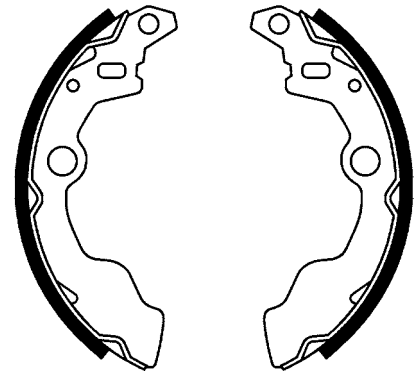
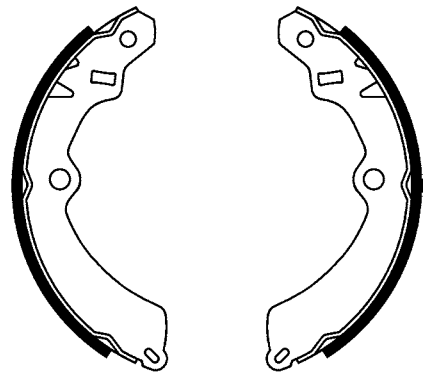
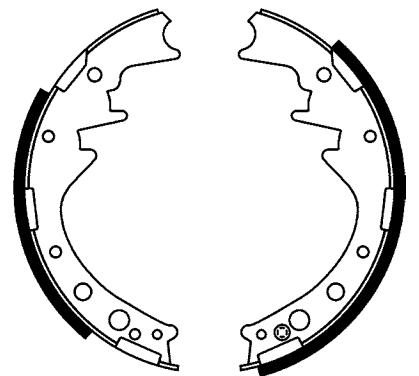
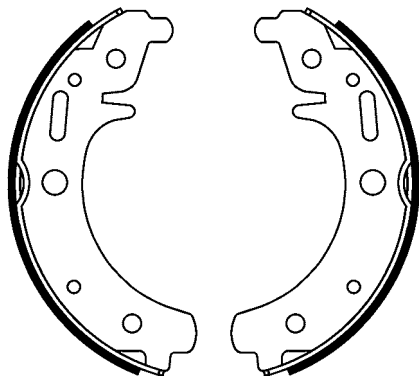
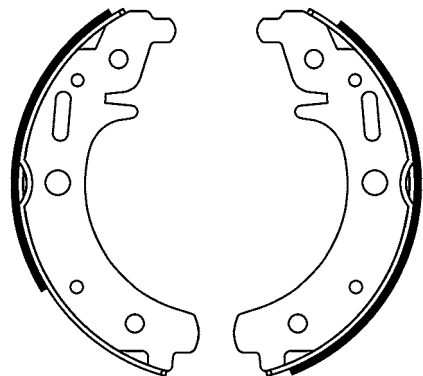
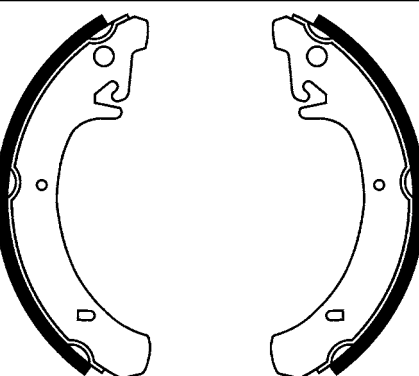
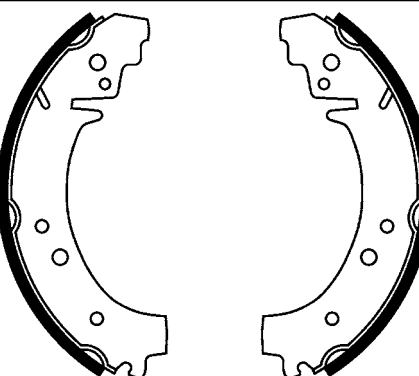
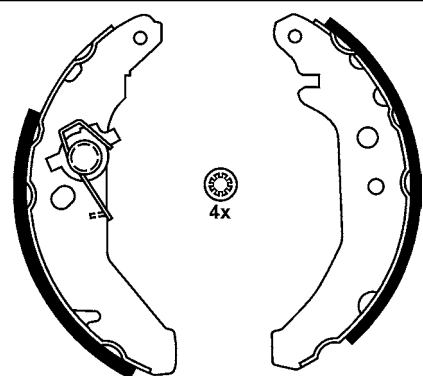
|  |  |   |
|--|--|---|
| <b>03.0137-0210.2 650210</b>   | <b>03.0137-0211.2 650211</b>   | <b>03.0137-0216.2 650216</b>  |
|  <p>Ø 229 x 41</p>     |  <p>Ø 203 x 39</p>   |  <p>Ø 180 x 37</p>   |
| <b>03.0137-0221.2 650221</b>   | <b>03.0137-0222.2 650222</b>   | <b>03.0137-0224.2 650224</b>  |
|  <p>Ø 200 x 37/30</p> |  <p>Ø 180 x 31</p>  |  <p>Ø 220 x 36</p>  |
| <b>03.0137-0226.2 650226</b>   | <b>03.0137-0227.2 650227</b>   | <b>03.0137-0228.2 650228</b>  |
|  <p>Ø 254 x 58</p>   |  <p>Ø 200 x 30</p> |  <p>Ø 200 x 30</p> |
| <b>03.0137-0231.2 650231</b>   | <b>03.0137-0232.2 650232</b>   | <b>03.0137-0235.2 650235</b>  |
|  <p>Ø 200 x 41</p>   |  <p>Ø 250 x 51</p> |  <p>Ø 180 x 32</p> |

# Abbildungen Trommelbremsbacken

Illustrations drum brake shoes - Illustrazioni ganasce freno - Illustrations Mâchoires de frein à tambour - Ilustraciones zapatas freno de tambor

03.0137-0236.2 650236

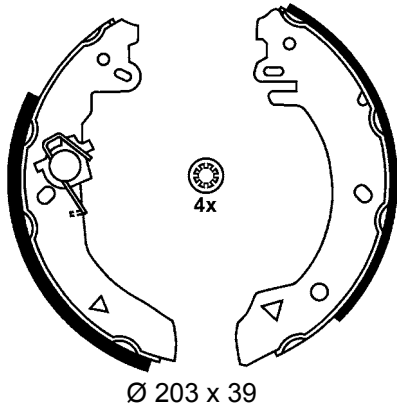

Ø 203 x 39

03.0137-0237.2 650237

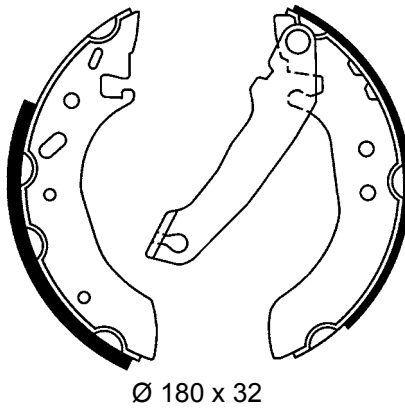

Ø 180 x 32

03.0137-0238.2 650238

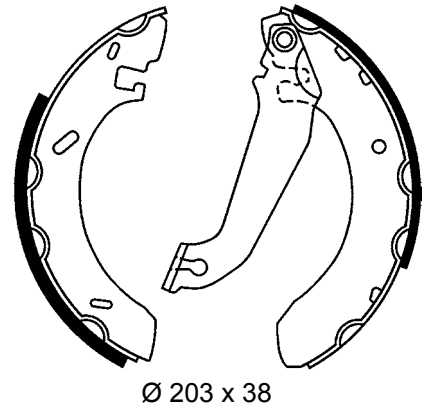

Ø 203 x 38

03.0137-0239.2 650239

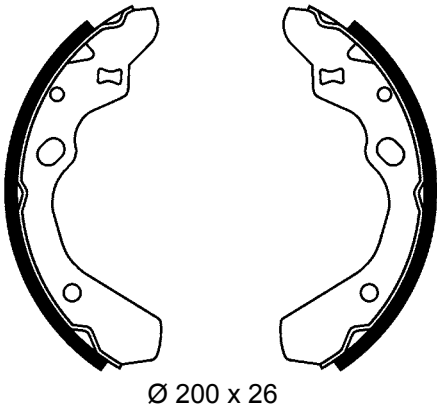

Ø 200 x 26

03.0137-0244.2 650244

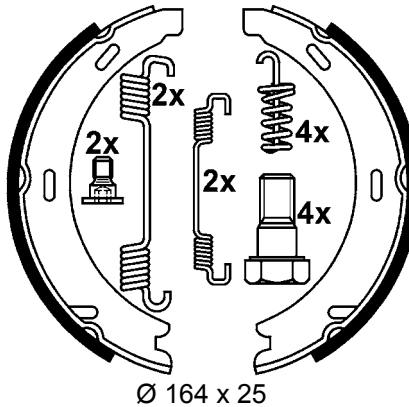

Ø 164 x 25

03.0137-0245.2 650245

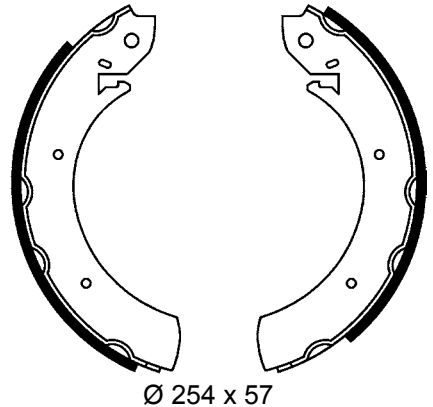

Ø 254 x 57

03.0137-0247.2 650247

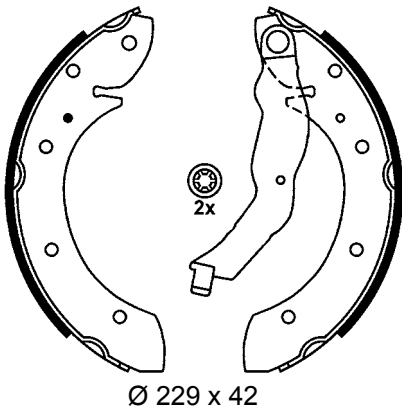

Ø 229 x 42

03.0137-0248.2 650248

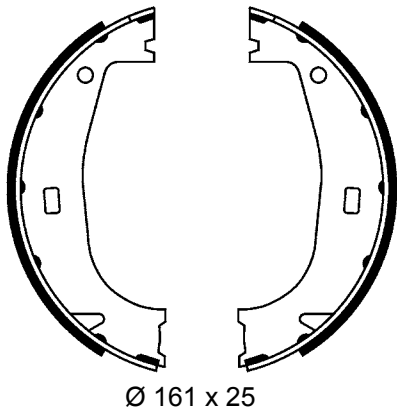

Ø 161 x 25

03.0137-0252.2 650252

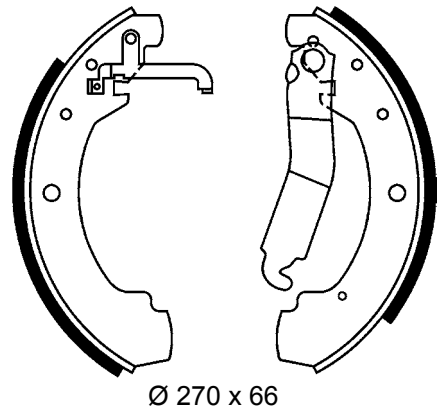

Ø 270 x 66

03.0137-0253.2 650253

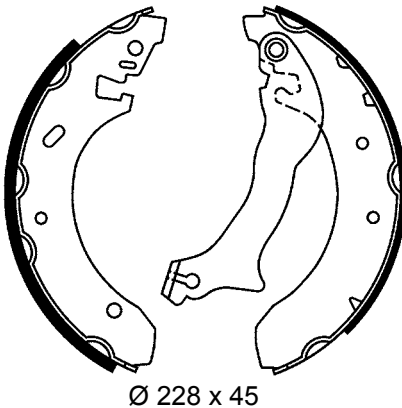

Ø 228 x 45

03.0137-0254.2 650254

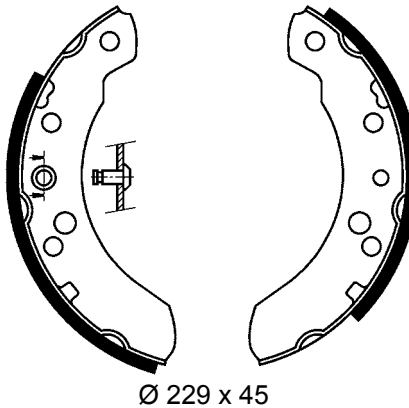

Ø 229 x 45

03.0137-0255.2 650255

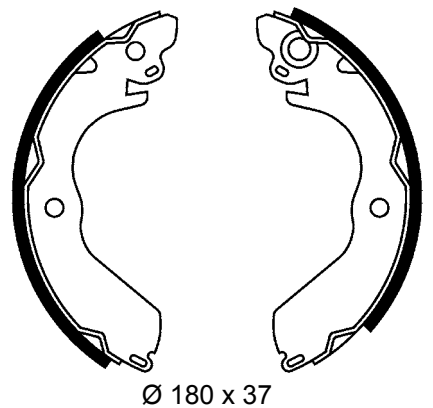

Ø 180 x 37

# Abbildungen Trommelbremsbacken

Illustrations drum brake shoes - Illustrazioni ganasce freno - Illustrations Mâchoires de frein à tambour - Ilustraciones zapatas freno de tambor

**03.0137-0256.2 650256**

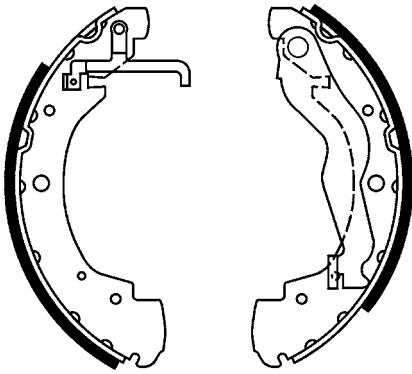

Ø 268 x 56

**03.0137-0257.2 650257**

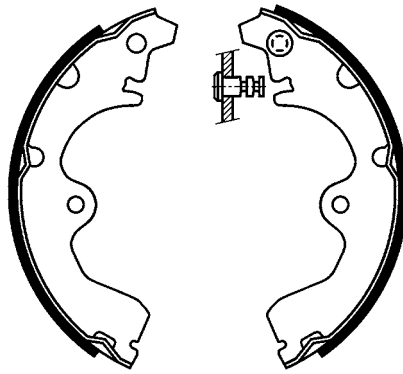

Ø 180 x 28

**03.0137-0258.2 650258**

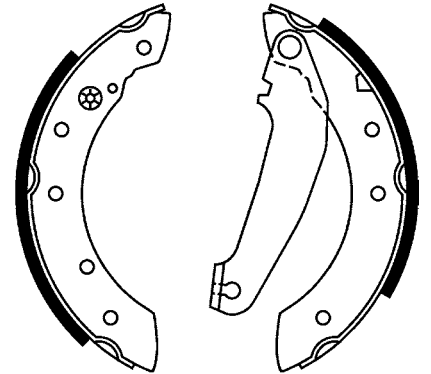

Ø 203 x 38

**03.0137-0259.2 650259**

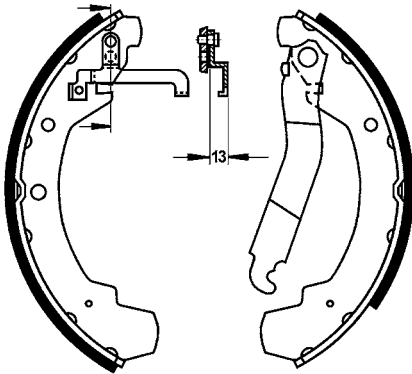

Ø 252 x 56

**03.0137-0260.2 650260**

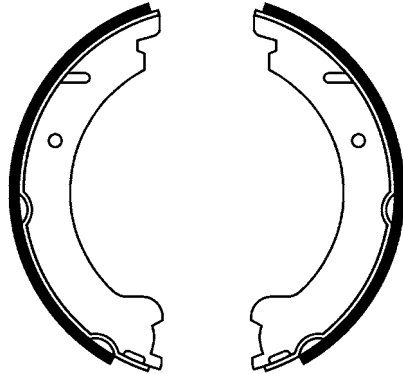

Ø 178 x 25

**03.0137-0261.2 650261**

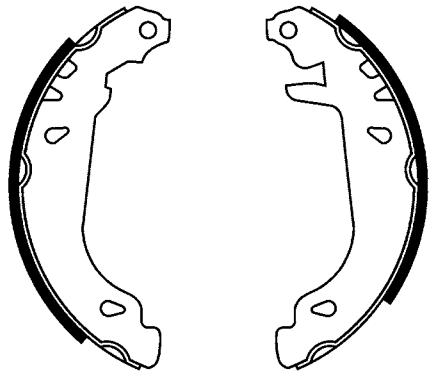

Ø 180 x 32

**03.0137-0262.2 650262**

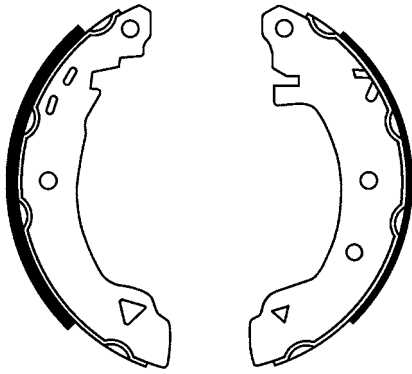

Ø 203 x 39

**03.0137-0263.2 650263**

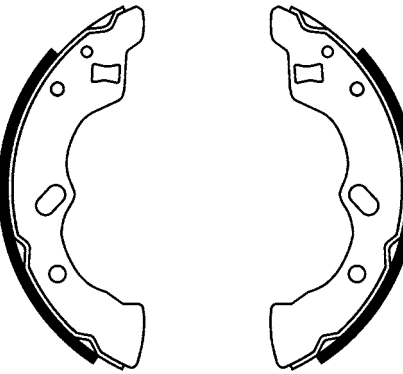

Ø 180 x 31

**03.0137-0264.2 650264**

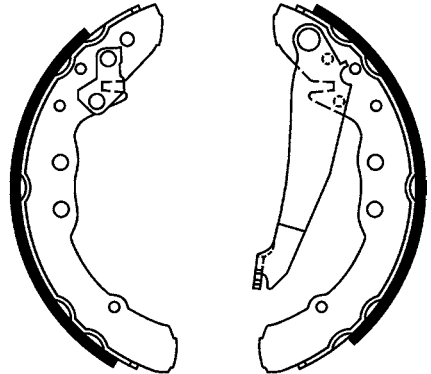

Ø 230 x 40

**03.0137-0265.2 650265**

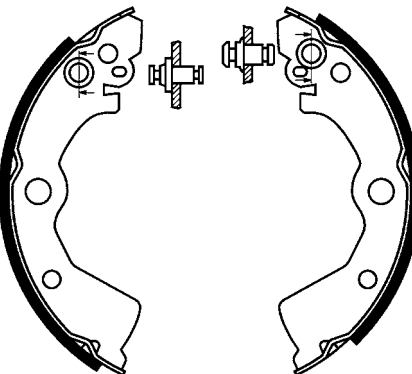

Ø 180 x 31

**03.0137-0266.2 650266**

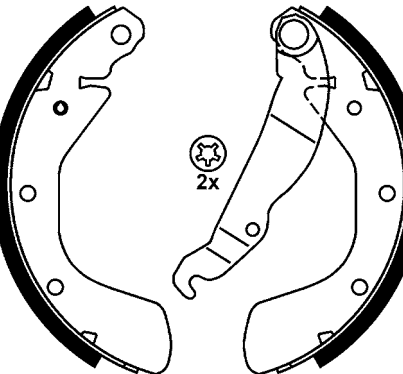

Ø 200 x 29

**03.0137-0267.2 650267**

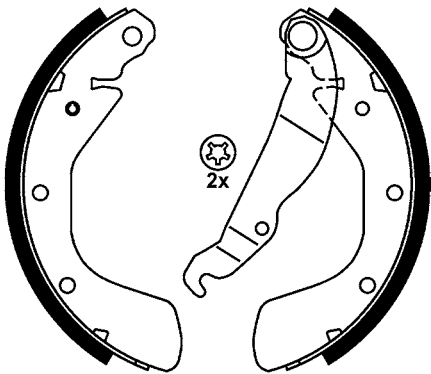

Ø 200 x 46

# Abbildungen Trommelbremsbacken

Illustrations drum brake shoes - Illustrazioni ganasce freno - Illustrations Mâchoires de frein à tambour - Ilustraciones zapatas freno de tambor

**03.0137-0268.2 650268**

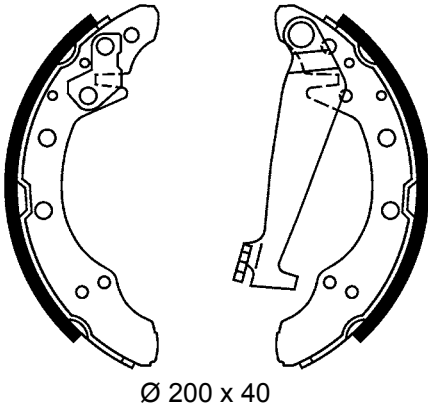

Ø 200 x 40

**03.0137-0269.2 650269**

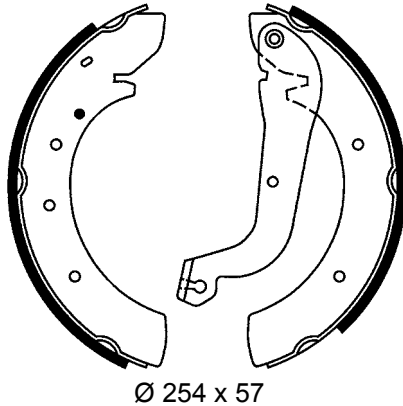

Ø 254 x 57

**03.0137-0271.2 650271**

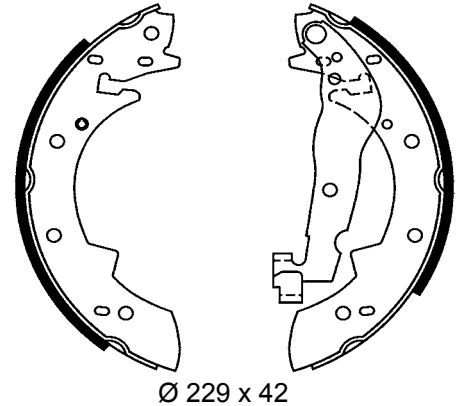

Ø 229 x 42

**03.0137-0272.2 650272**

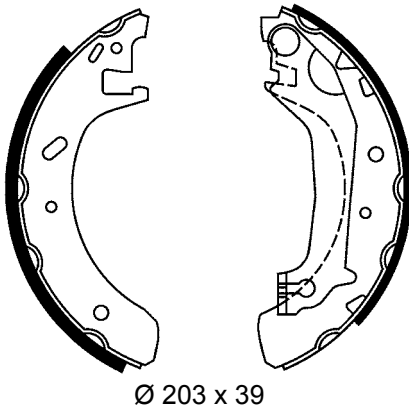

Ø 203 x 39

**03.0137-0273.2 650273**

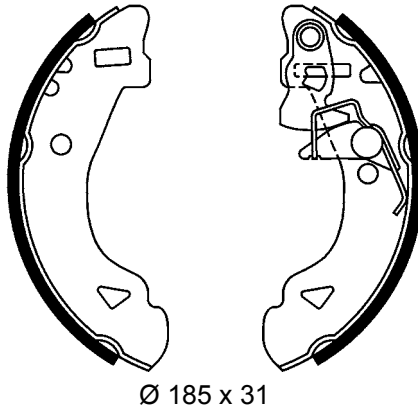

Ø 185 x 31

**03.0137-0274.2 650274**

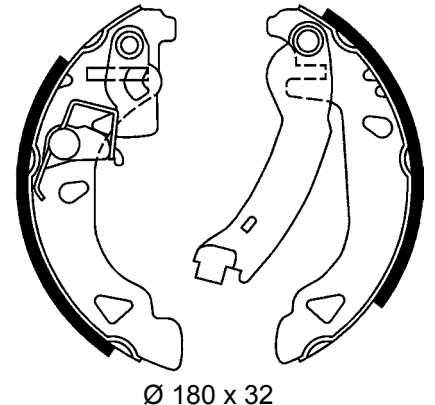

Ø 180 x 32

**03.0137-0275.2 650275**

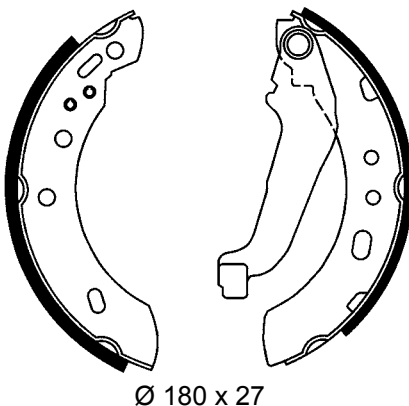

Ø 180 x 27

**03.0137-0276.2 650276**

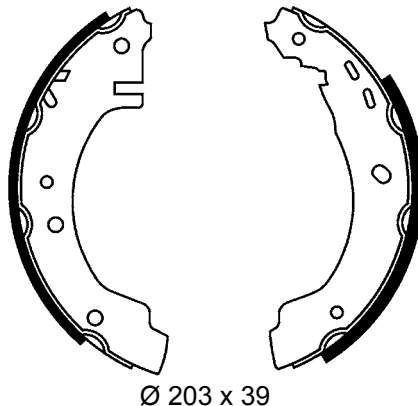

Ø 203 x 39

**03.0137-0278.2 650278**

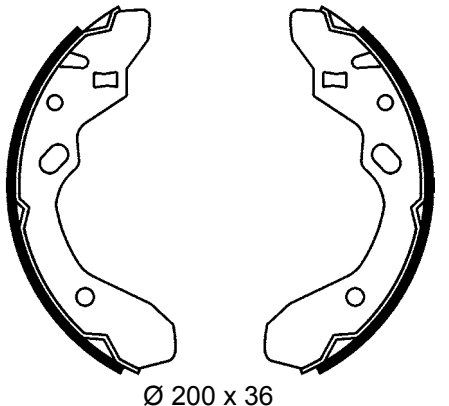

Ø 200 x 36

**03.0137-0282.2 650282**

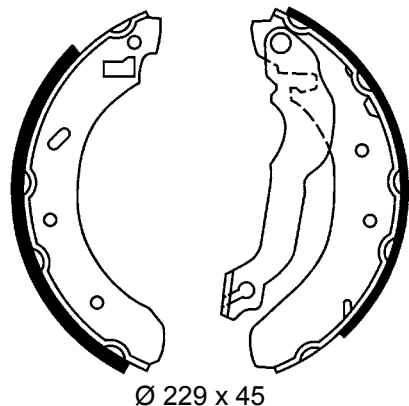

Ø 229 x 45

**03.0137-0283.2 650283**

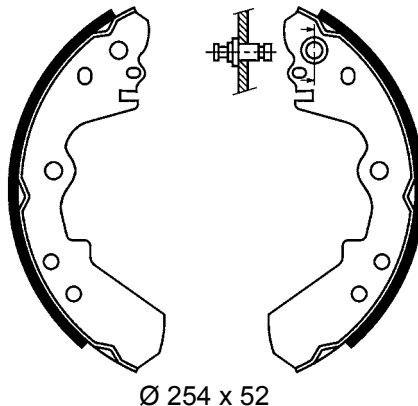

Ø 254 x 52

**03.0137-0284.2 650284**

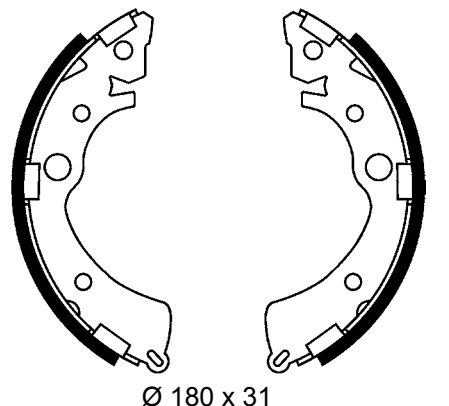

Ø 180 x 31

# Abbildungen Trommelbremsbacken

Illustrations drum brake shoes - Illustrazioni ganasce freno - Illustrations Mâchoires de frein à tambour - Ilustraciones zapatas freno de tambor

**03.0137-0285.2 650285**

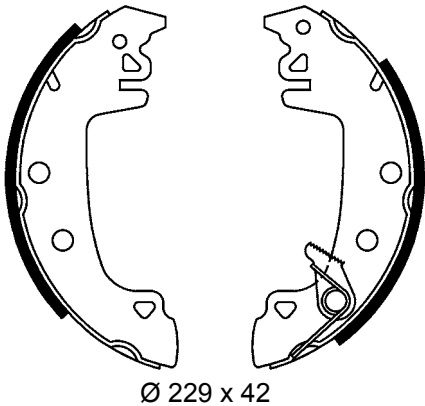

Ø 229 x 42

**03.0137-0286.2 650286**

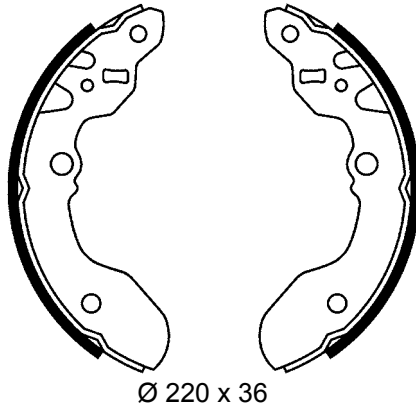

Ø 220 x 36

**03.0137-0287.2 650287**

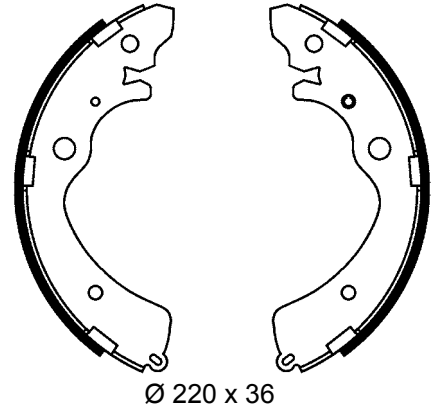

Ø 220 x 36

**03.0137-0288.2 650288**

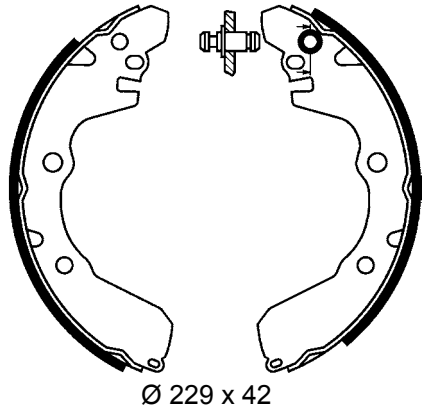

Ø 229 x 42

**03.0137-0289.2 650289**

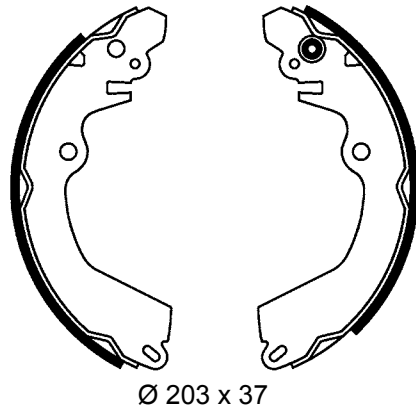

Ø 203 x 37

**03.0137-0290.2 650290**

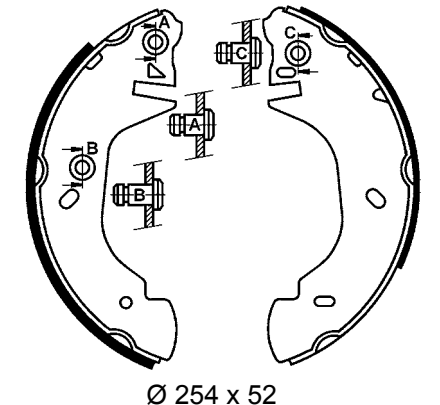

Ø 254 x 52

**03.0137-0291.2 650291**

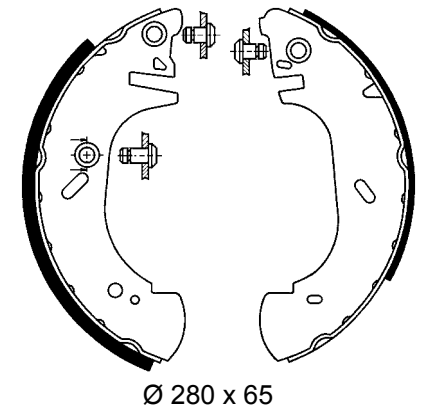

Ø 280 x 65

**03.0137-0292.2 650292**

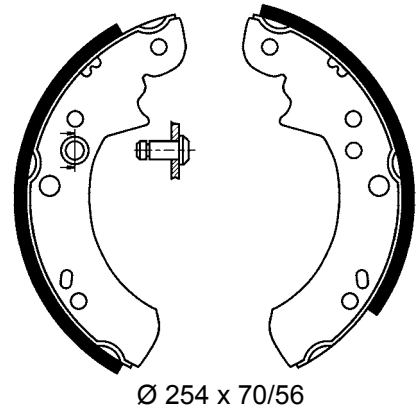

Ø 254 x 70/56

**03.0137-0294.2 650294**

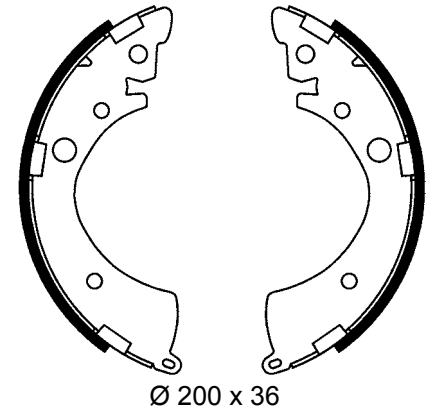

Ø 200 x 36

**03.0137-0297.2 650297**

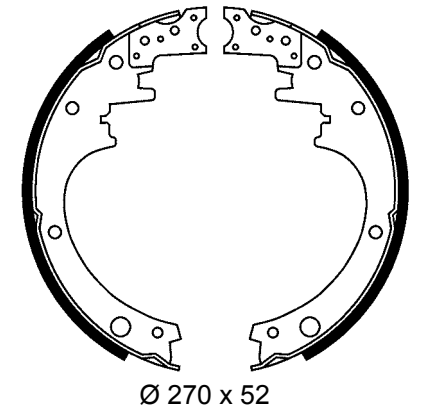

Ø 270 x 52

**03.0137-0299.2 650299**

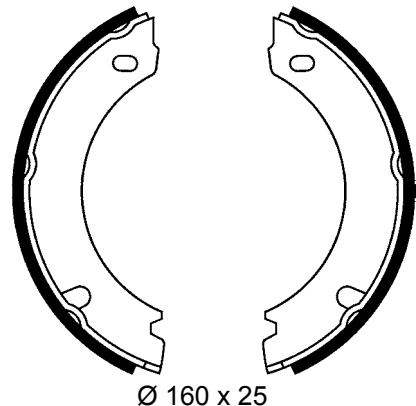

Ø 160 x 25

**03.0137-0300.2 650300**

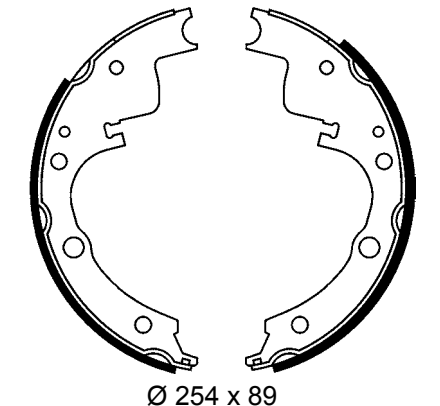

Ø 254 x 89

# Abbildungen Trommelbremsbacken

Illustrations drum brake shoes - Illustrazioni ganasce freno - Illustrations Mâchoires de frein à tambour - Ilustraciones zapatas freno de tambor

**03.0137-0302.2 650302**

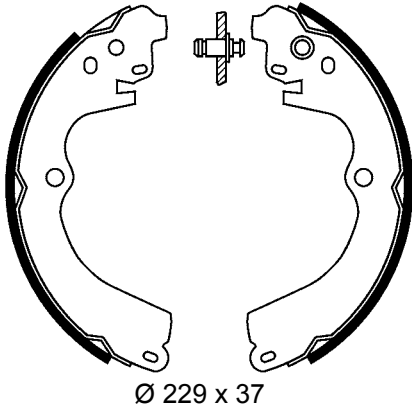

Ø 229 x 37

**03.0137-0305.2 650305**

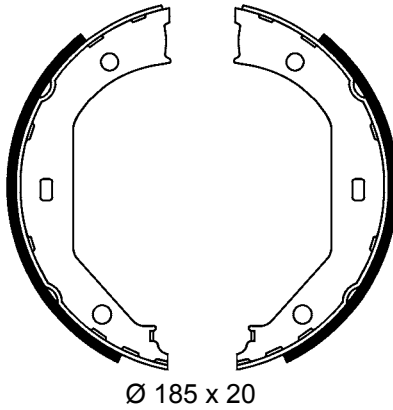

Ø 185 x 20

**03.0137-0306.2 650306**

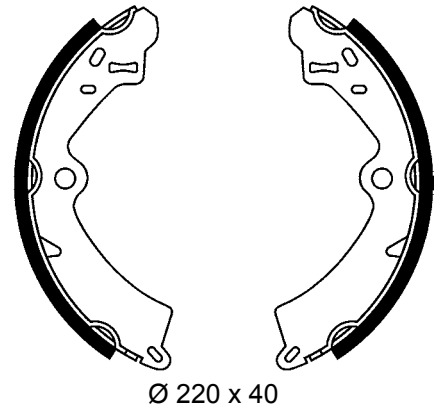

Ø 220 x 40

**03.0137-0308.2 650308**

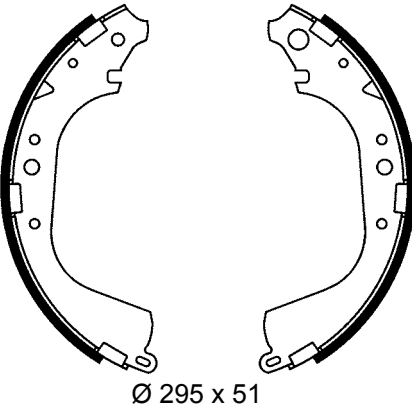

Ø 295 x 51

**03.0137-0309.2 650309**

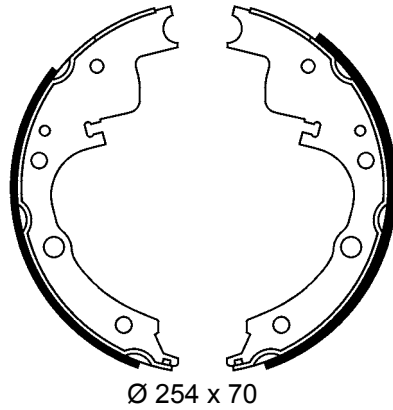

Ø 254 x 70

**03.0137-0310.2 650310**

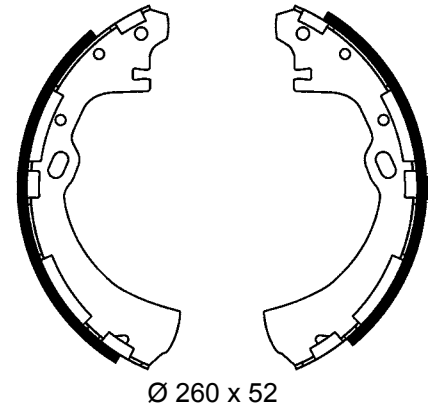

Ø 260 x 52

**03.0137-0312.2 650312**

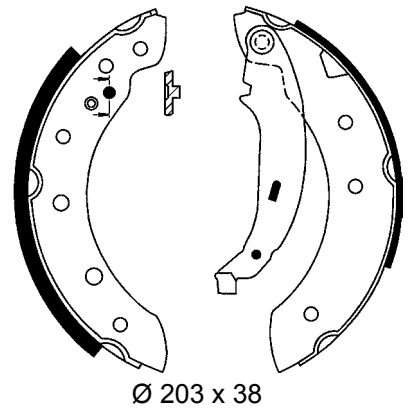

Ø 203 x 38

**03.0137-0313.2 650313**

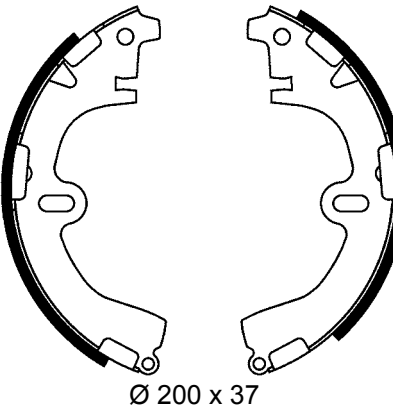

Ø 200 x 37

**03.0137-0314.2 650314**

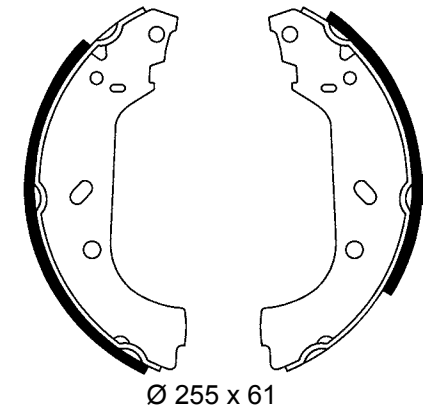

Ø 255 x 61

**03.0137-0315.2 650315**

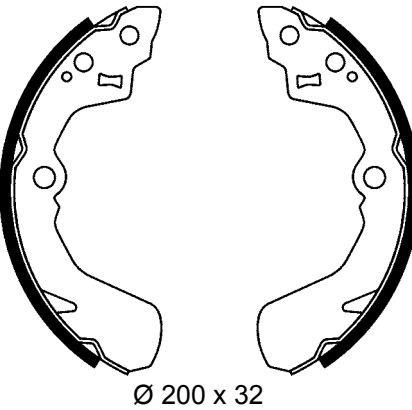

Ø 200 x 32

**03.0137-0316.2 650316**

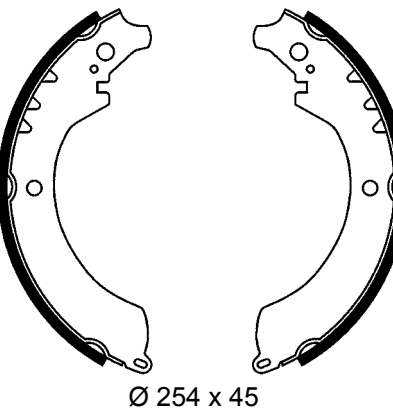

Ø 254 x 45

**03.0137-0318.2 650318**

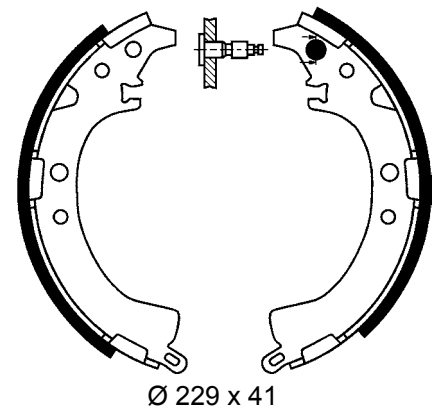

Ø 229 x 41



# Abbildungen Trommelbremsbacken

Illustrations drum brake shoes - Illustrazioni ganasce freno - Illustrations Mâchoires de frein à tambour - Ilustraciones zapatas freno de tambor

**03.0137-0319.2 650319**

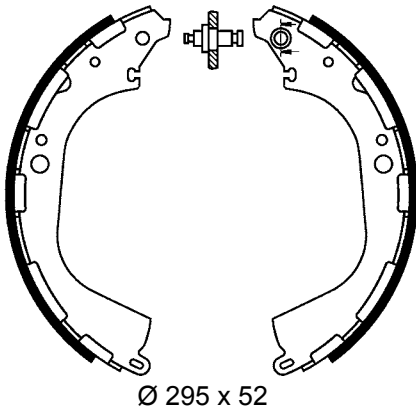

Ø 295 x 52

**03.0137-0322.2 650322**

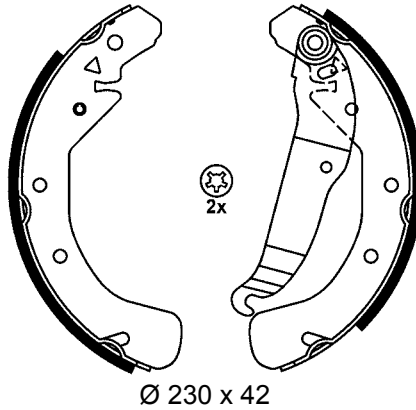

Ø 230 x 42

**03.0137-0330.2 650330**

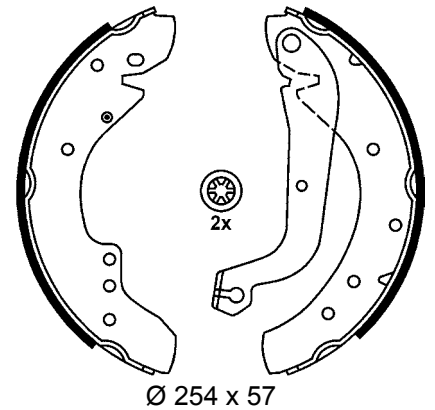

Ø 254 x 57

**03.0137-0331.2 650331**

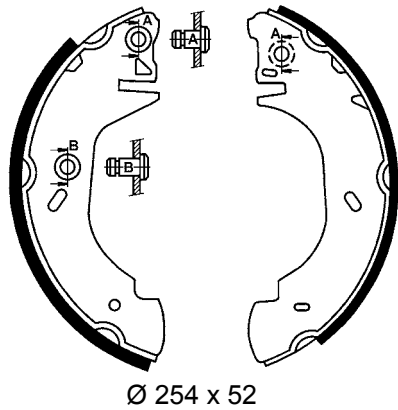

Ø 254 x 52

**03.0137-0332.2 650332**

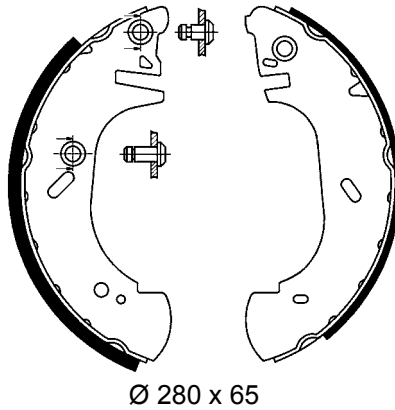

Ø 280 x 65

**03.0137-0333.2 650333**

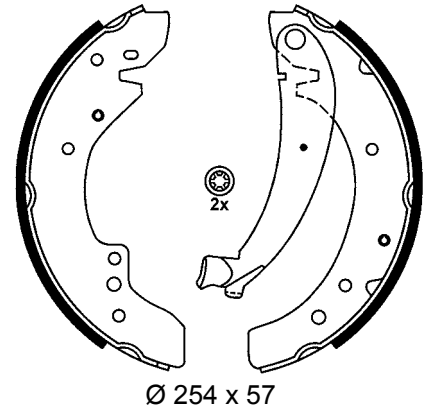

Ø 254 x 57

**03.0137-0334.2 650334**

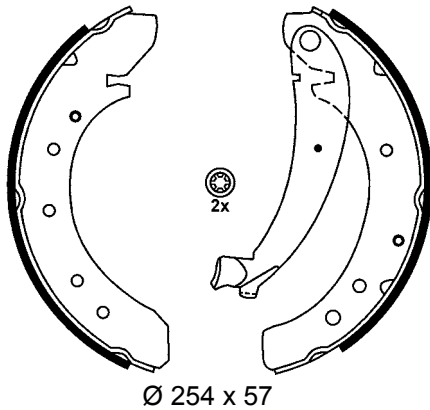

Ø 254 x 57

**03.0137-0335.2 650335**

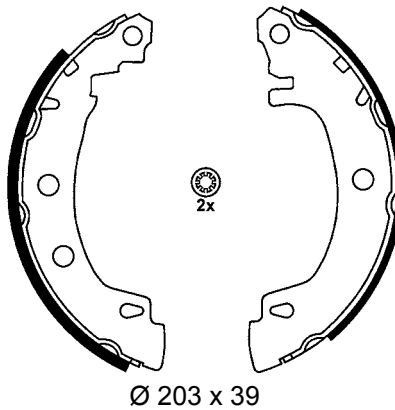

Ø 203 x 39

**03.0137-0336.2 650336**

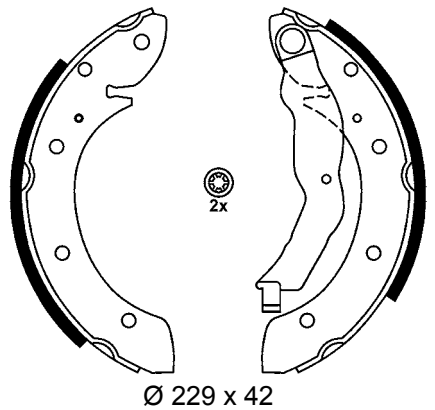

Ø 229 x 42

**03.0137-0337.2 650337**

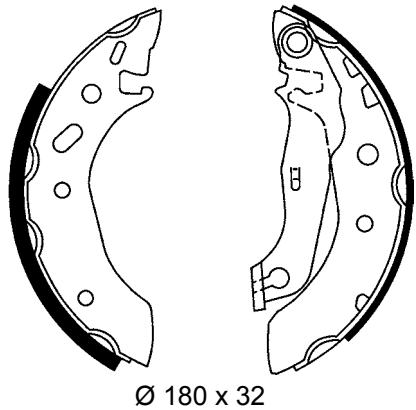

Ø 180 x 32

**03.0137-0338.2 650338**

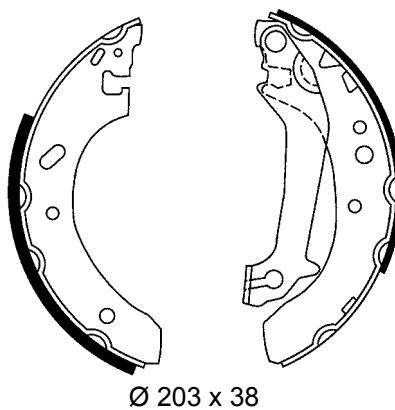

Ø 203 x 38

**03.0137-0339.2 650339**

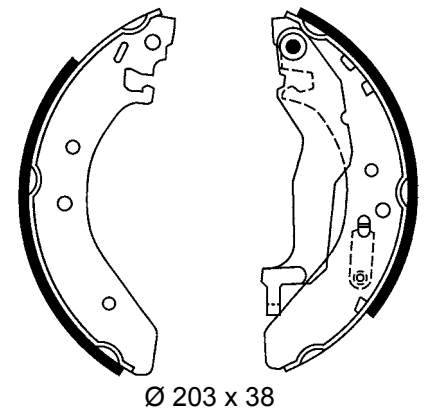

Ø 203 x 38

# Abbildungen Trommelbremsbacken

Illustrations drum brake shoes - Illustrazioni ganasce freno - Illustrations Mâchoires de frein à tambour - Ilustraciones zapatas freno de tambor

**03.0137-0340.2 650340**

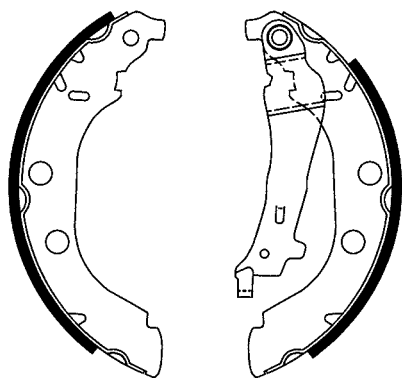

Ø 229 x 42

**03.0137-0341.2 650341**

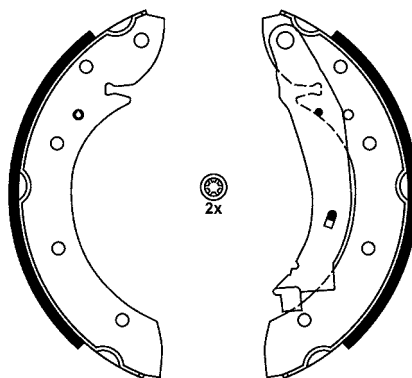

Ø 229 x 42

**03.0137-0345.2 650345**

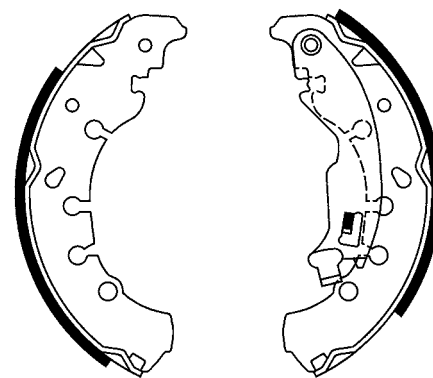

Ø 203 x 38

**03.0137-0346.2 650346**

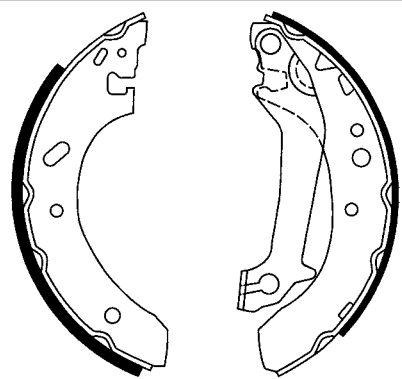

Ø 203 x 38

**03.0137-0347.2 650347**

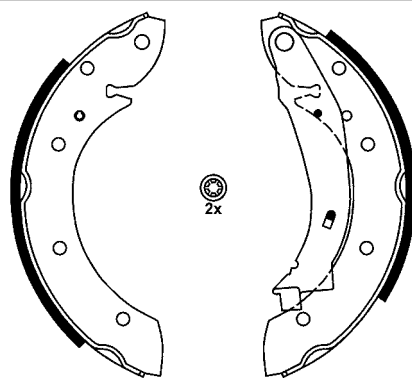

Ø 229 x 42

**03.0137-0349.2 650349**

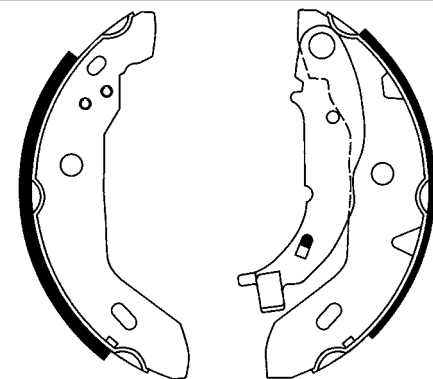

Ø 180 x 42

**03.0137-0350.2 650350**

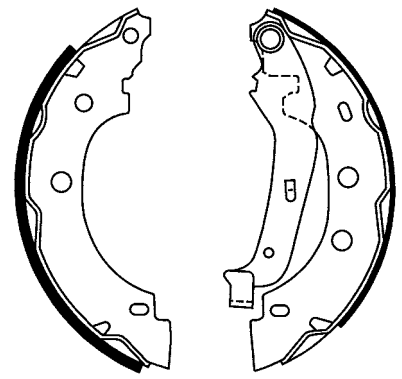

Ø 203 x 39

**03.0137-0351.2 650351**

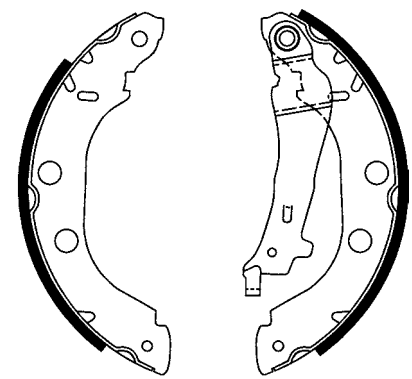

Ø 229 x 42

**03.0137-0352.2 650352**

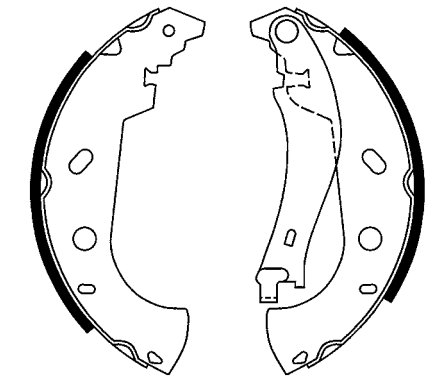

Ø 228 x 43

**03.0137-0354.2 650354**

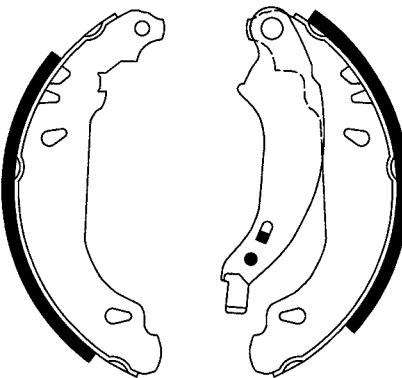

Ø 180 x 32

**03.0137-0356.2 650356**

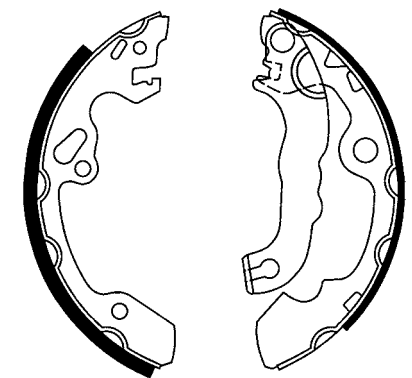

Ø 203 x 38

**03.0137-0357.2 650357**

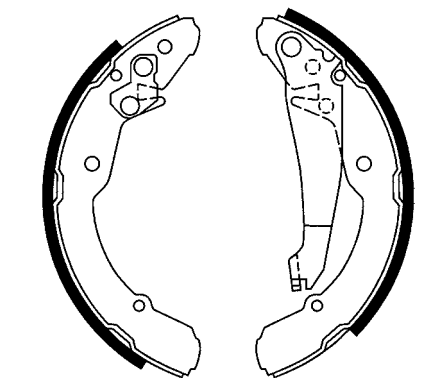

Ø 230 x 32

# Abbildungen Trommelbremsbacken

Illustrations drum brake shoes - Illustrazioni ganasce freno - Illustrations Mâchoires de frein à tambour - Ilustraciones zapatas freno de tambor

**03.0137-0358.2 650358**

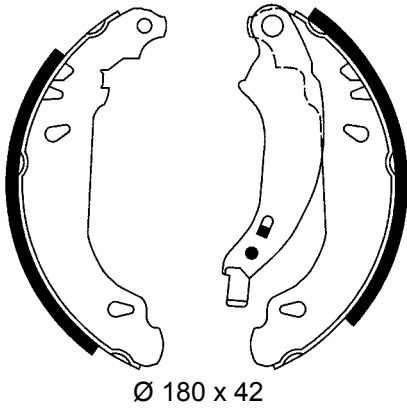

Ø 180 x 42

**03.0137-0359.2 650359**

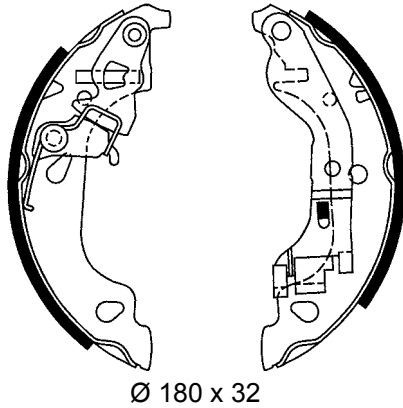

Ø 180 x 32

**03.0137-0360.2 650360**

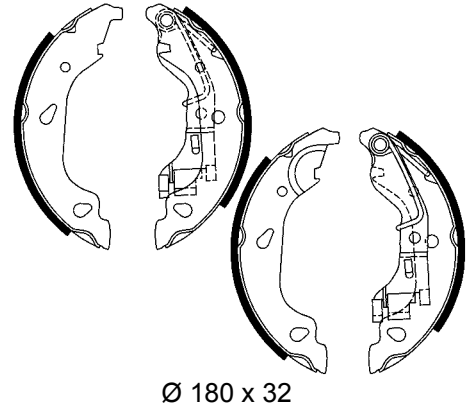

Ø 180 x 32

**03.0137-0361.2 650361**

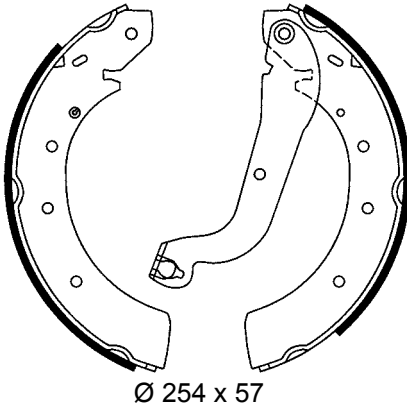

Ø 254 x 57

**03.0137-0363.2 650363**

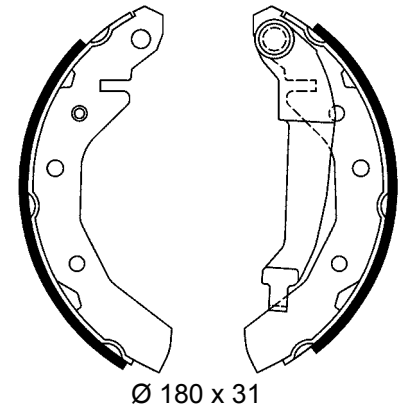

Ø 180 x 31

**03.0137-0364.2 650364**

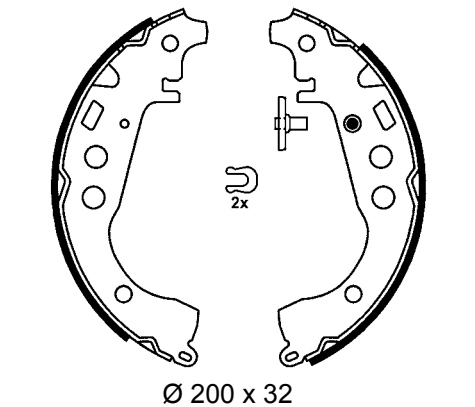

Ø 200 x 32

**03.0137-0365.2 650365**

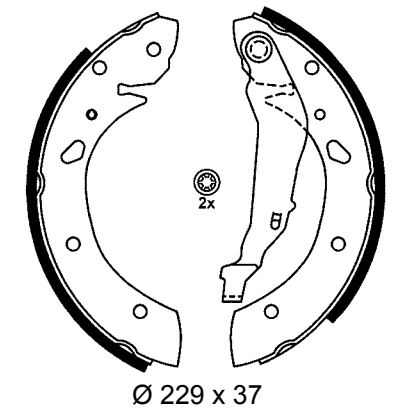

Ø 229 x 37

**03.0137-0366.2 650366**

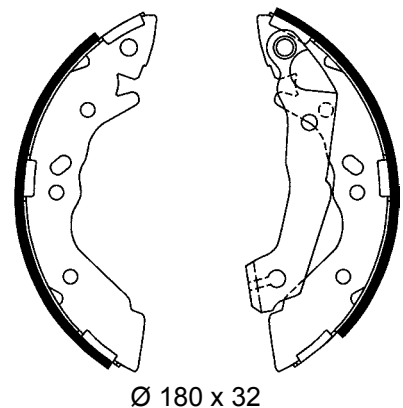

Ø 180 x 32

**03.0137-0367.2 650367**

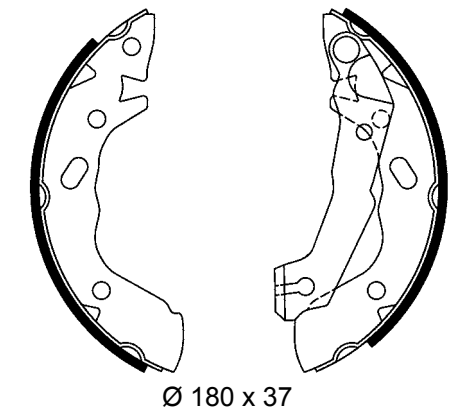

Ø 180 x 37

**03.0137-0369.2 650369**

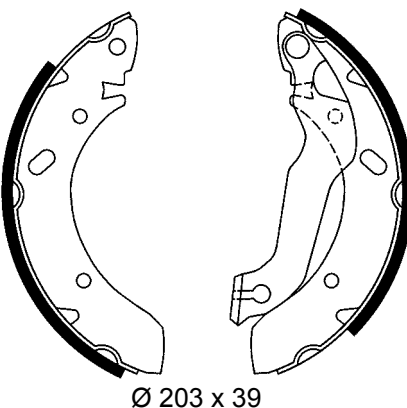

Ø 203 x 39

**03.0137-0370.2 650370**

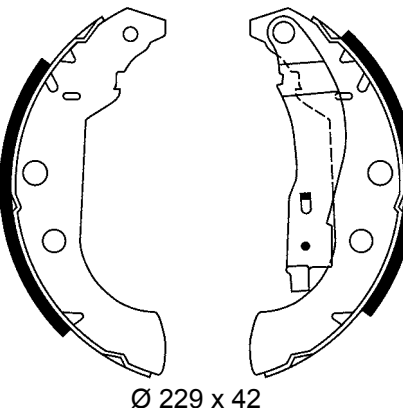

Ø 229 x 42

**03.0137-0375.2 650375**

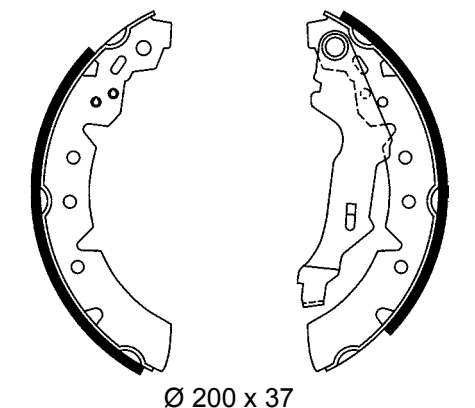

Ø 200 x 37

# Abbildungen Trommelbremsbacken

Illustrations drum brake shoes - Illustrazioni ganasce freno - Illustrations Mâchoires de frein à tambour - Ilustraciones zapatas freno de tambor

**03.0137-0376.2 650376**

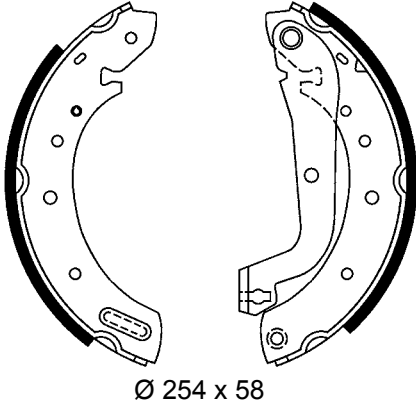

Ø 254 x 58

**03.0137-0377.2 650377**

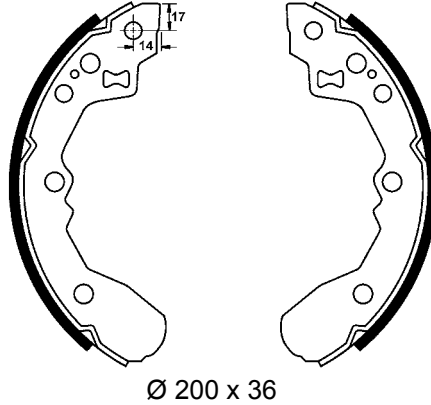

Ø 200 x 36

**03.0137-0379.2 650379**

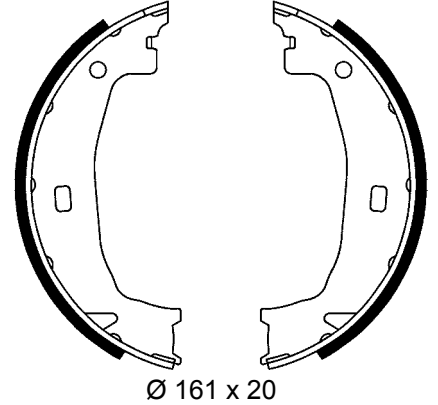

Ø 161 x 20

**03.0137-0382.2 650382**

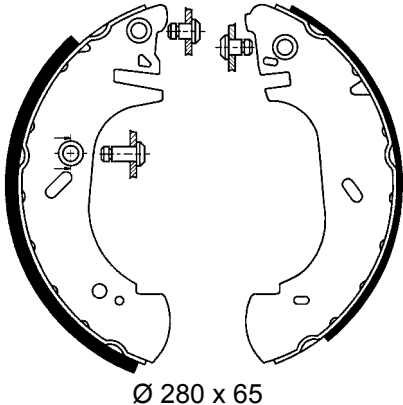

Ø 280 x 65

**03.0137-0386.2 650386**

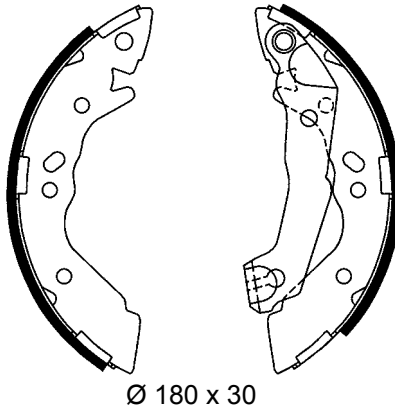

Ø 180 x 30

**03.0137-0387.2 650387**

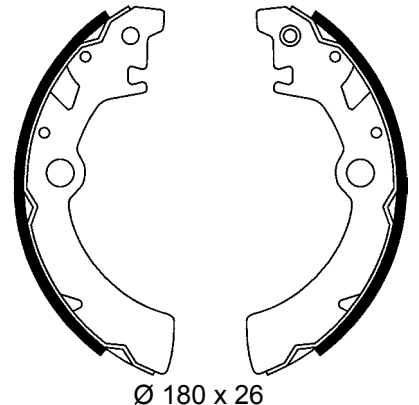

Ø 180 x 26

**03.0137-0389.2 650389**

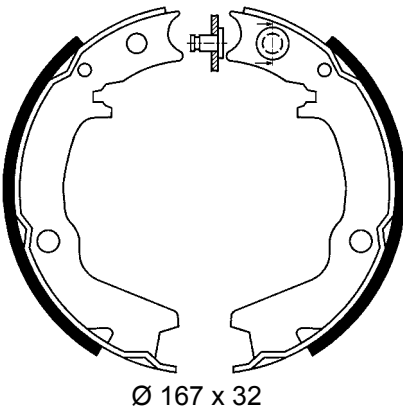

Ø 167 x 32

**03.0137-0390.2 650390**

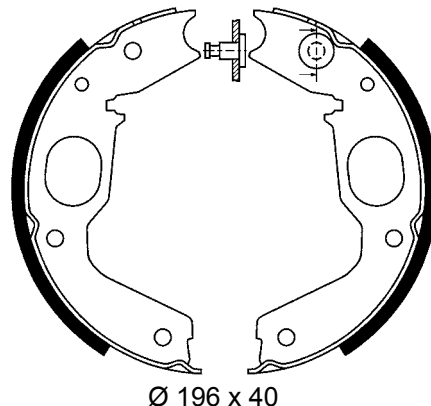

Ø 196 x 40

**03.0137-0393.2 650393**

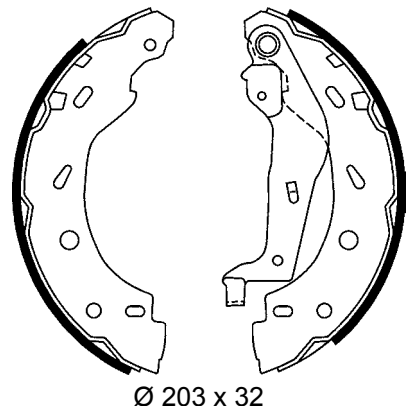

Ø 203 x 32

**03.0137-0394.2 650394**

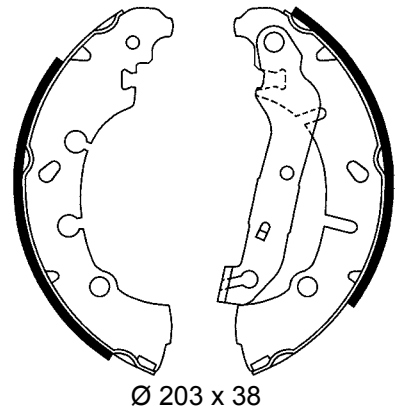

Ø 203 x 38

**03.0137-0395.2 650395**

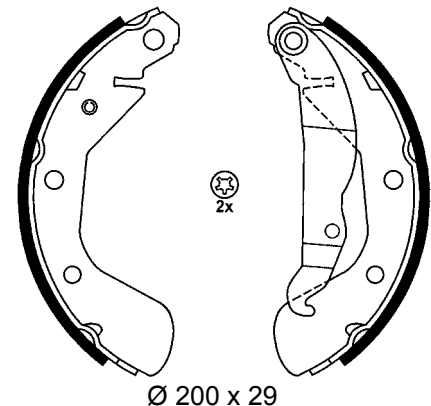

Ø 200 x 29

**03.0137-0396.2 650396**

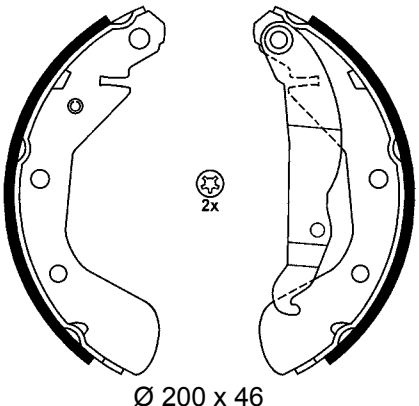

Ø 200 x 46

# Abbildungen Trommelbremsbacken

Illustrations drum brake shoes - Illustrazioni ganasce freno - Illustrations Mâchoires de frein à tambour - Ilustraciones zapatas freno de tambor

**03.0137-0397.2 650397**

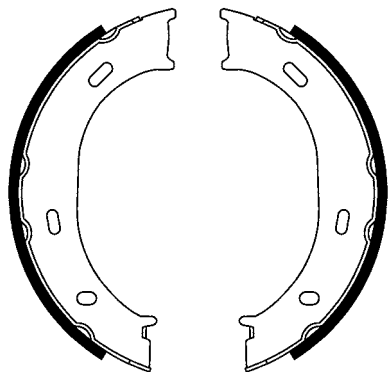

Ø 160 x 40

**03.0137-0398.2 650398**

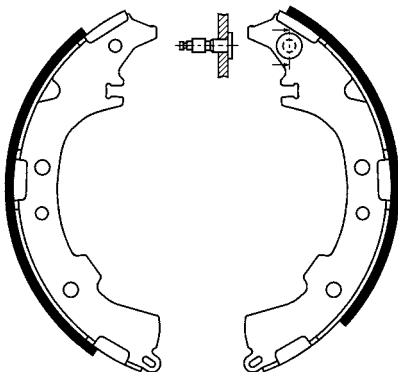

Ø 229 x 42

**03.0137-0399.2 650399**

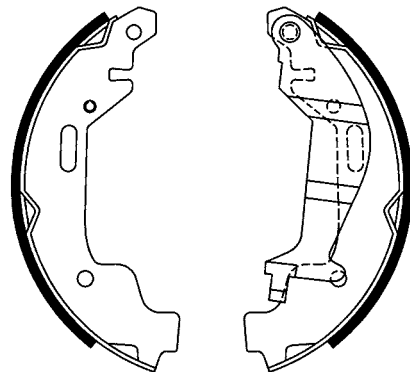

Ø 180 x 26

**03.0137-0400.2 650400**

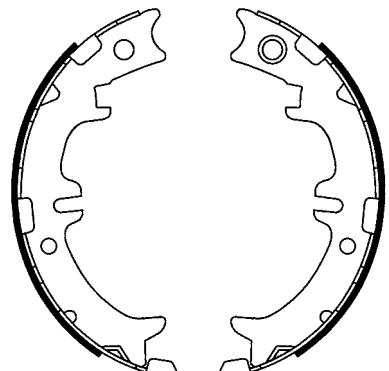

Ø 190 x 45

**03.0137-0401.2 650401**

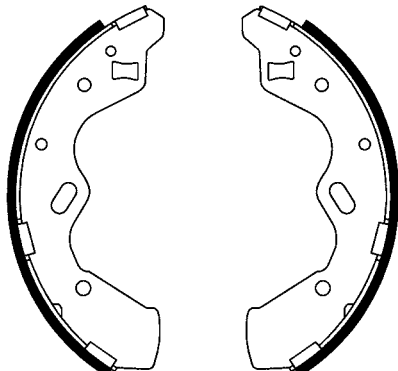

Ø 200 x 31

**03.0137-0402.2 650402**

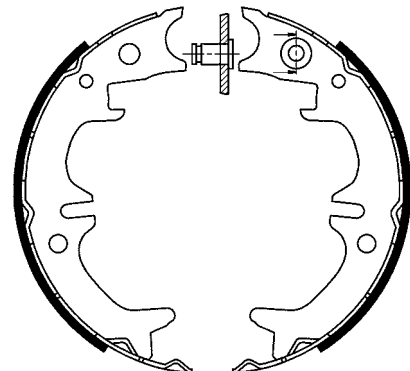

Ø 170 x 40

**03.0137-0404.2 650404**

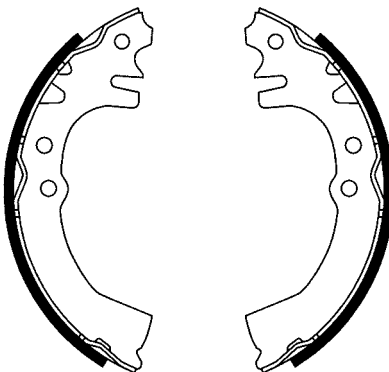

Ø 165 x 28

**03.0137-0406.2 650406**

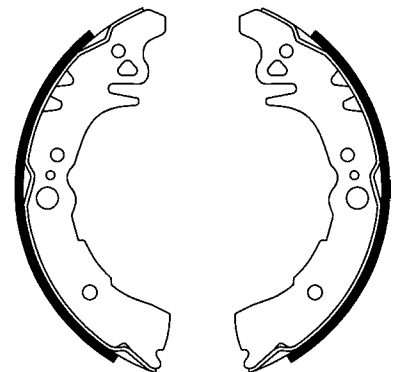

Ø 180 x 38

**03.0137-0407.2 650407**

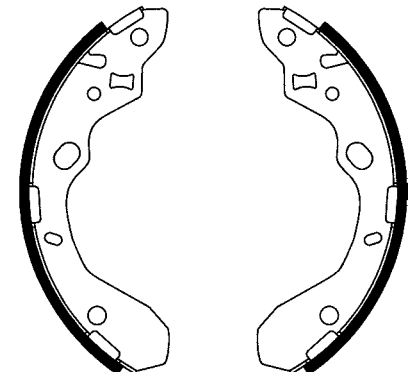

Ø 200 x 36

**03.0137-0408.2 650408**

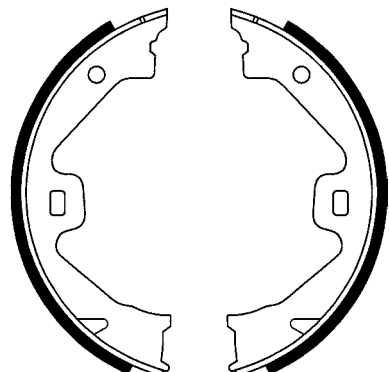

Ø 160 x 20

**03.0137-0409.2 650409**

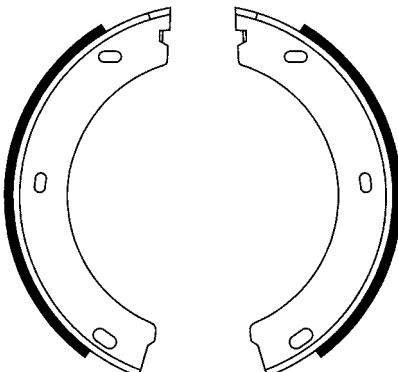

Ø 186 x 20

**03.0137-0411.2 650411**

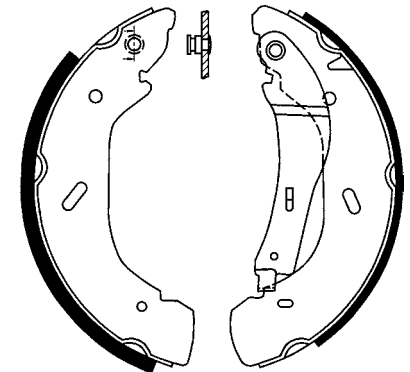

Ø 280 x 65

# Abbildungen Trommelbremsbacken

Illustrations drum brake shoes - Illustrazioni ganasce freno - Illustrations Mâchoires de frein à tambour - Ilustraciones zapatas freno de tambor

**03.0137-0412.2 650412**

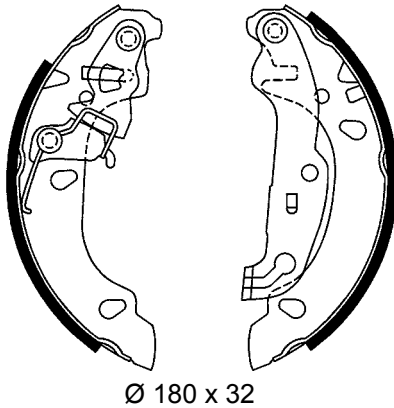

Ø 180 x 32

**03.0137-0413.2 650413**

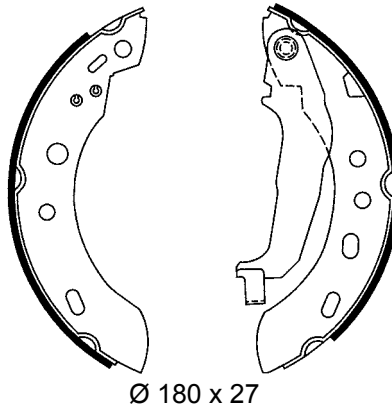

Ø 180 x 27

**03.0137-0414.2 650414**

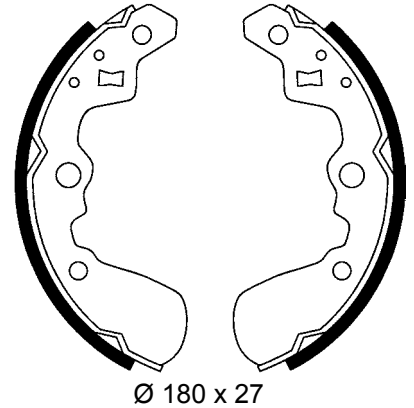

Ø 180 x 27

**03.0137-0415.2 650415**

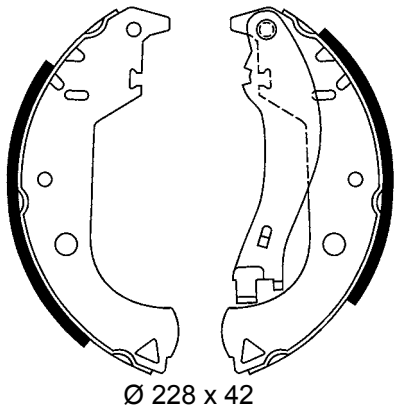

Ø 228 x 42

**03.0137-0416.2 650416**

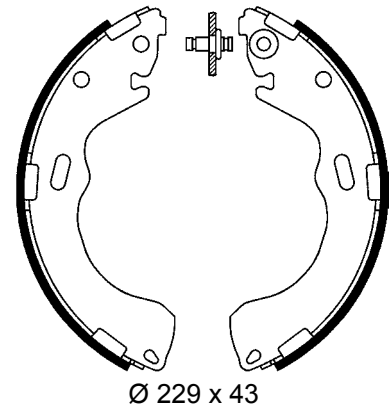

Ø 229 x 43

**03.0137-0417.2 650417**

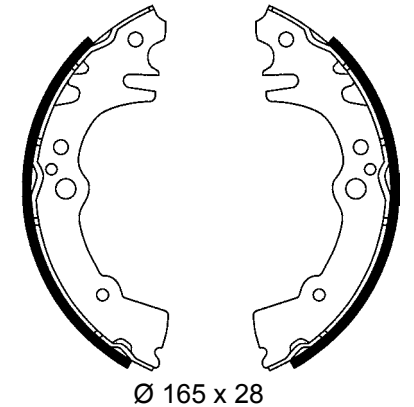

Ø 165 x 28

**03.0137-0419.2 650419**

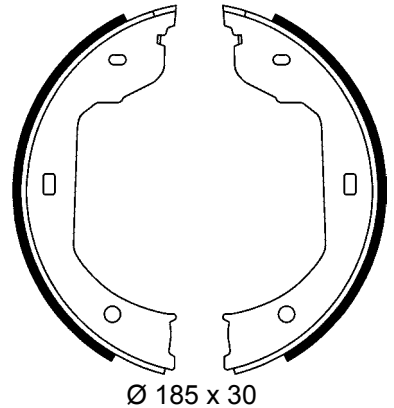

Ø 185 x 30

**03.0137-0421.2 650421**

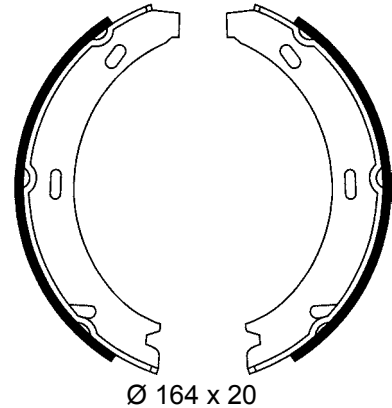

Ø 164 x 20

**03.0137-0422.2 650422**

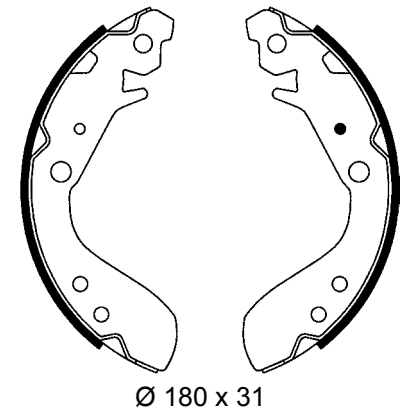

Ø 180 x 31

**03.0137-0423.2 650423**

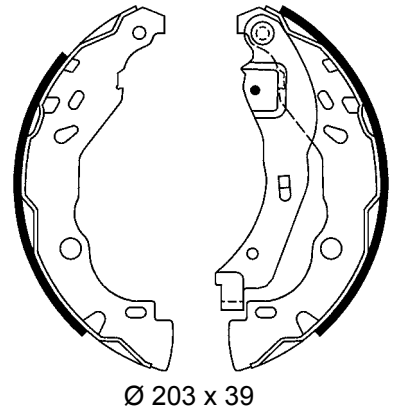

Ø 203 x 39

**03.0137-0424.2 650424**

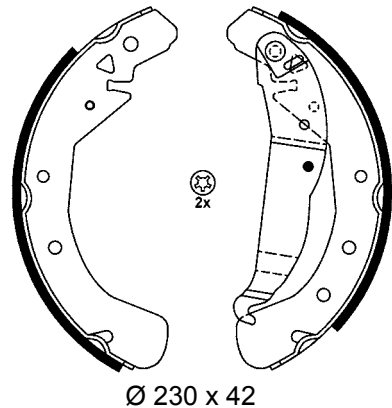

Ø 230 x 42

**03.0137-0425.2 650425**

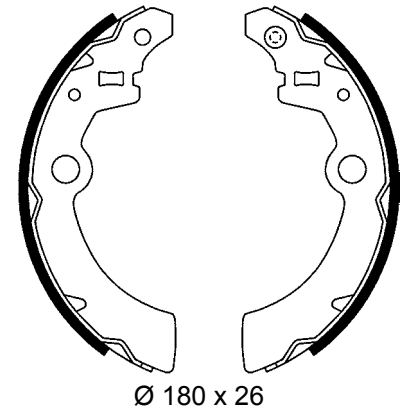

Ø 180 x 26



# Abbildungen Trommelbremsbacken

Illustrations drum brake shoes - Illustrazioni ganasce freno - Illustrations Mâchoires de frein à tambour - Ilustraciones zapatas freno de tambor

**03.0137-0426.2 650426**

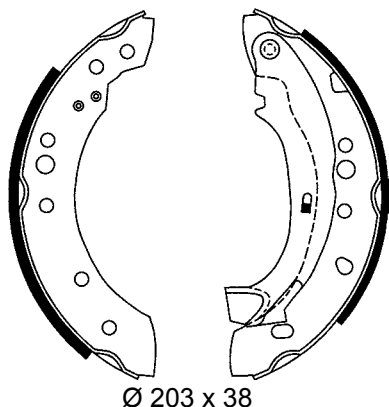

Ø 203 x 38

**03.0137-0427.2 650427**

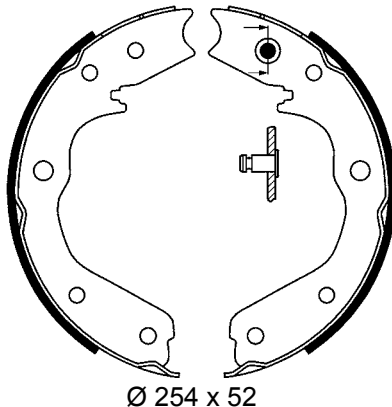

Ø 254 x 52

**03.0137-0428.2 650428**

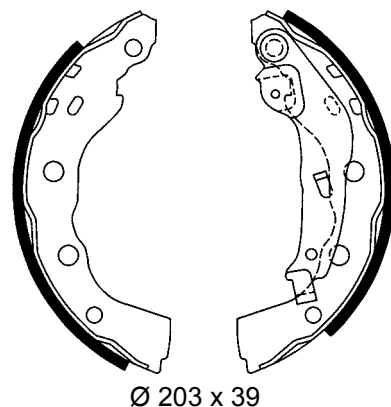

Ø 203 x 39

**03.0137-0429.2 650429**

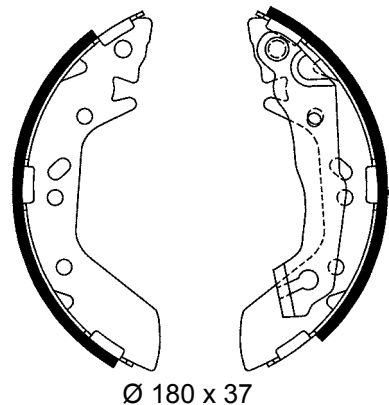

Ø 180 x 37

**03.0137-0430.2 650430**

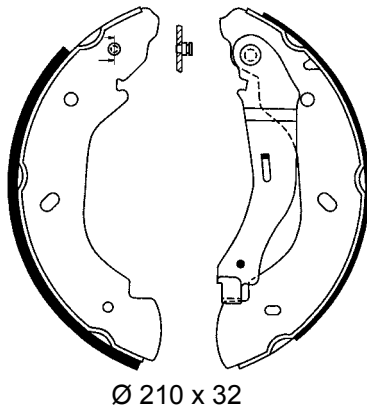

Ø 210 x 32

**03.0137-0431.2 650431**

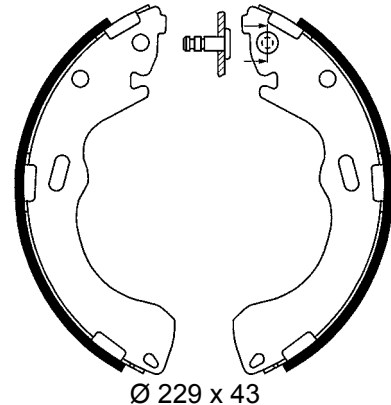

Ø 229 x 43

**03.0137-0432.2 650432**

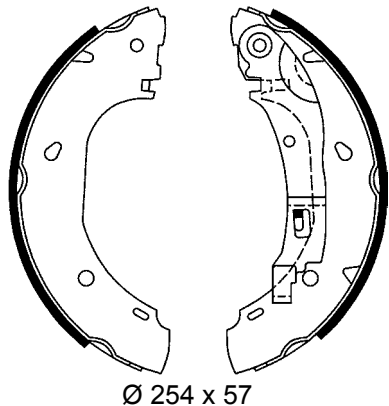

Ø 254 x 57

**03.0137-0433.2 650433**

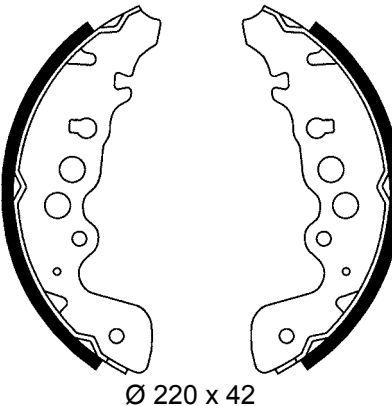

Ø 220 x 42

**03.0137-0434.2 650434**

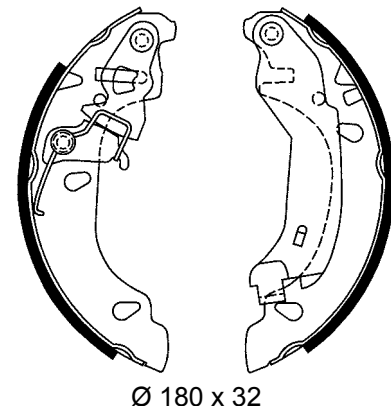

Ø 180 x 32

**03.0137-0436.2 650436**

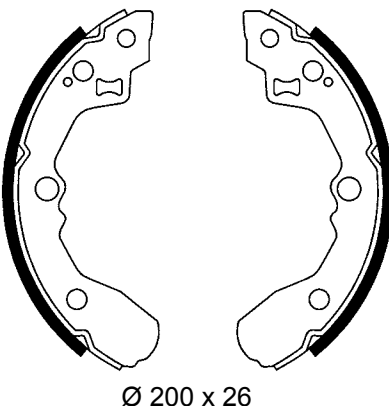

Ø 200 x 26

**03.0137-0437.2 650437**

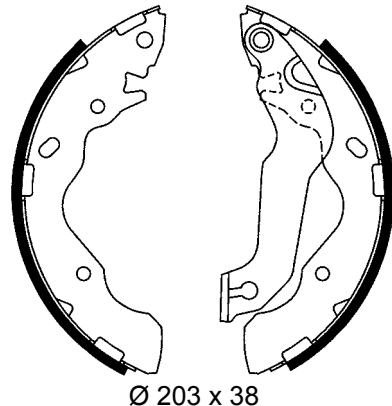

Ø 203 x 38

**03.0137-0438.2 650438**

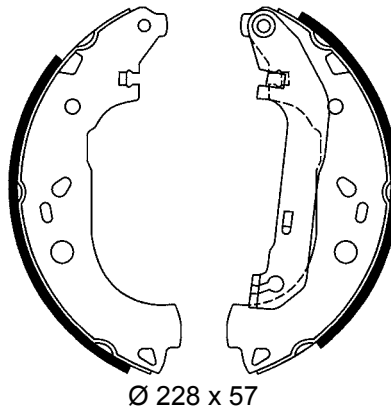

Ø 228 x 57

# Abbildungen Trommelbremsbacken

Illustrations drum brake shoes - Illustrazioni ganasce freno - Illustrations Mâchoires de frein à tambour - Ilustraciones zapatas freno de tambor

**03.0137-0439.2 650439**

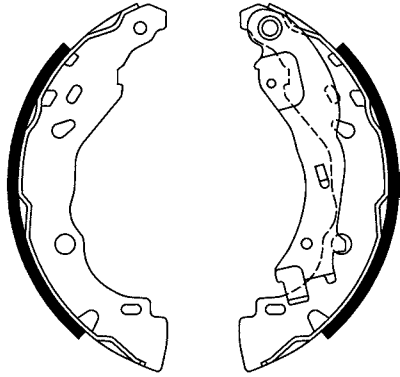

Ø 203 x 39

**03.0137-0440.2 650440**

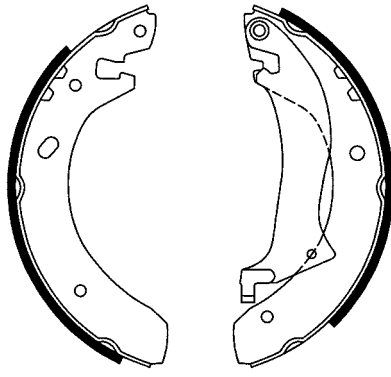

Ø 254 x 39

**03.0137-0442.2 650442**

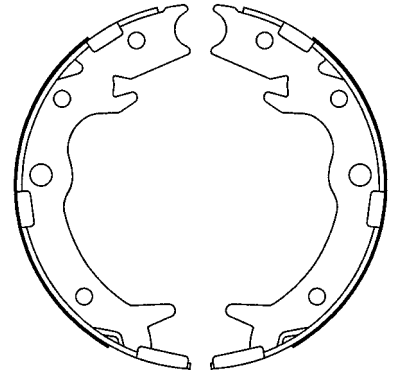

Ø 167 x 35

**03.0137-0443.2 650443**

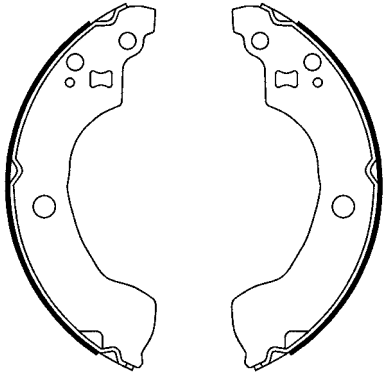

Ø 203 x 37

**03.0137-0444.2 650444**

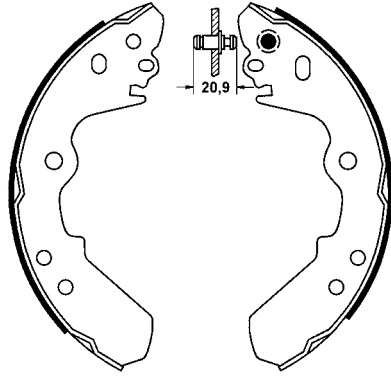

Ø 254 x 51

**03.0137-0445.2 650445**

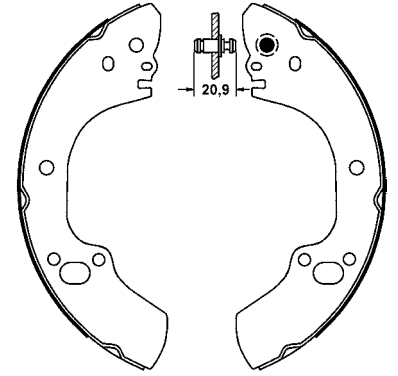

Ø 294 x 47

**03.0137-0446.2 650446**

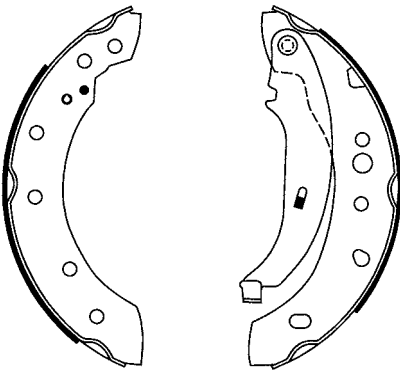

Ø 203 x 39

**03.0137-0448.2 650448**

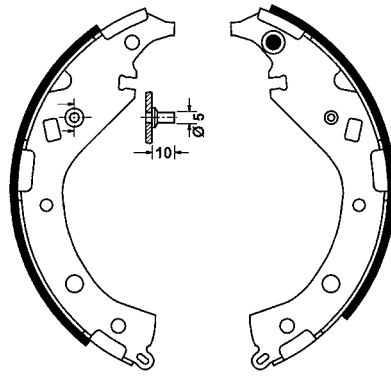

Ø 228 x 42

**03.0137-0449.2 650449**

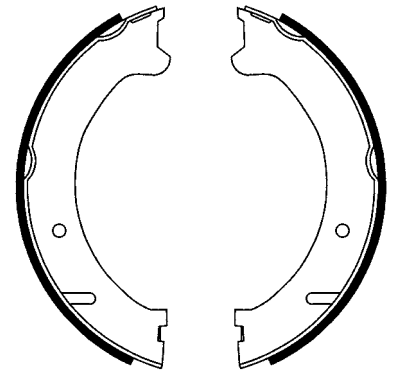

Ø 178 x 25

**03.0137-0450.2 650450**

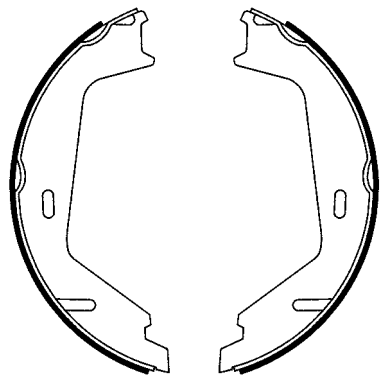

Ø 178 x 25

**03.0137-0451.2 650451**

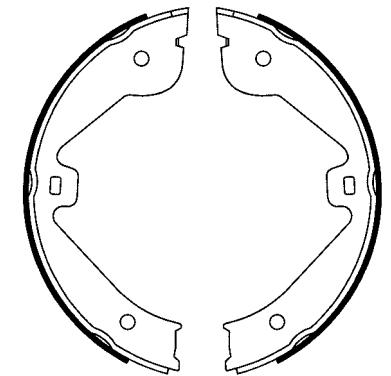

Ø 210 x 30

**03.0137-0452.2 650452**

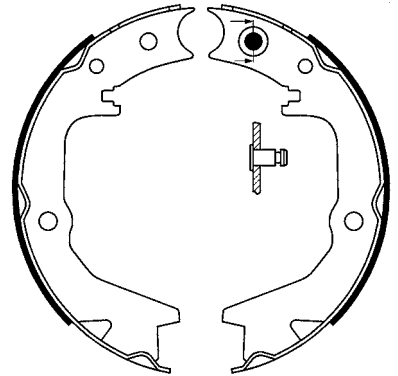

Ø 167 x 32

# Abbildungen Trommelbremsbacken

Illustrations drum brake shoes - Illustrazioni ganasce freno - Illustrations Mâchoires de frein à tambour - Ilustraciones zapatas freno de tambor

**03.0137-0453.2 650453**

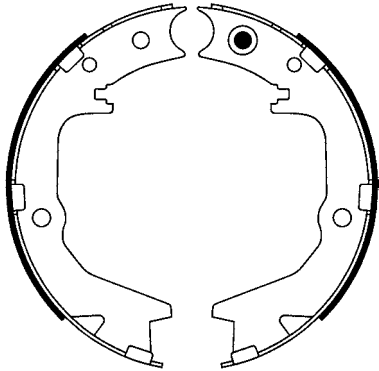

Ø 167 x 32

**03.0137-0454.2 650454**

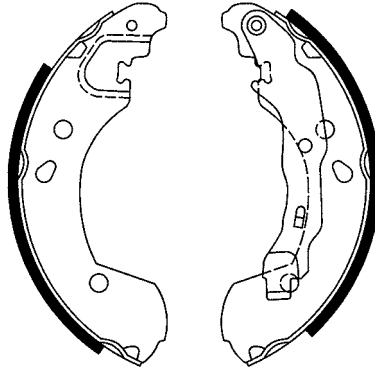

Ø 203 x 38

**03.0137-0455.2 650455**

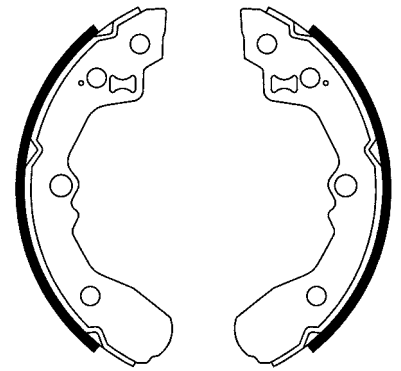

Ø 200 x 31

**03.0137-0456.2 650456**

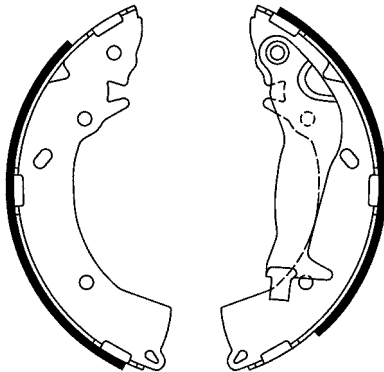

Ø 203 x 32

**03.0137-0457.2 650457**

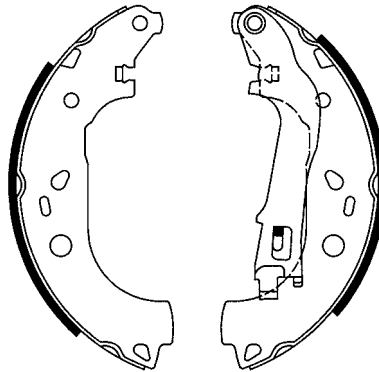

Ø 228 x 42

**03.0137-0459.2 650459**

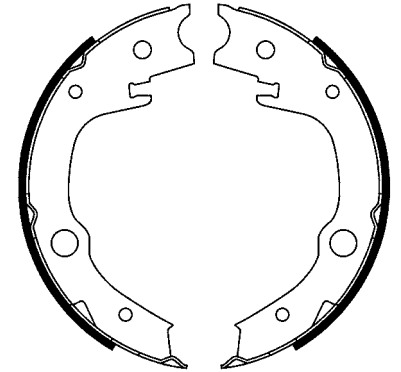

Ø 172 x 32

**03.0137-0460.2 650460**

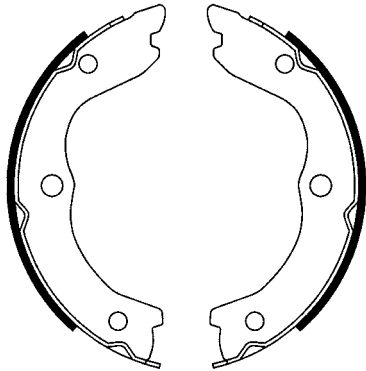

Ø 172 x 22

**03.0137-0462.2 650462**

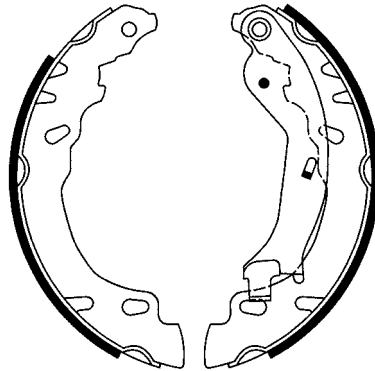

Ø 180 x 32

**03.0137-0464.2 650464**

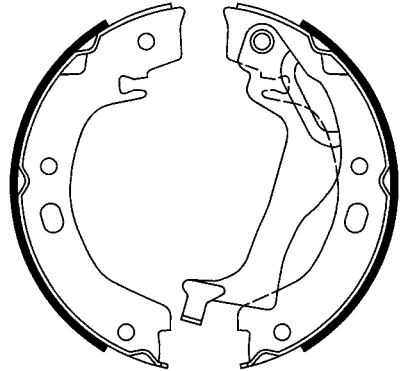

Ø 172 x 22

**03.0137-0465.2 650465**

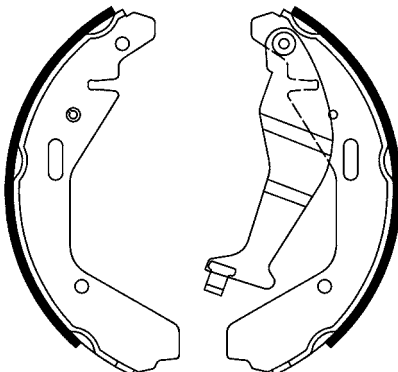

Ø 200 x 29

**03.0137-0466.2 650466**

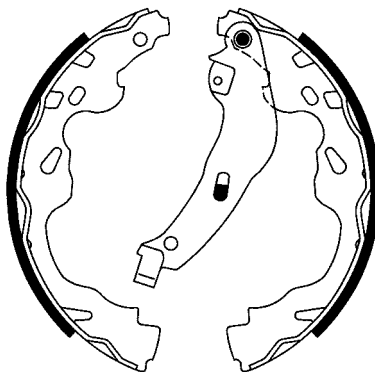

Ø 200 x 32

**03.0137-0467.2 650467**

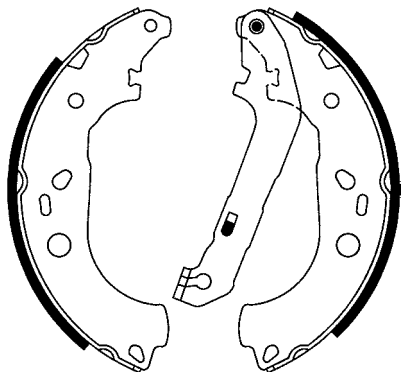

Ø 228 x 42

# Abbildungen Trommelbremsbacken

Illustrations drum brake shoes - Illustrazioni ganasce freno - Illustrations Mâchoires de frein à tambour - Ilustraciones zapatas freno de tambor

**03.0137-0468.2 650468**

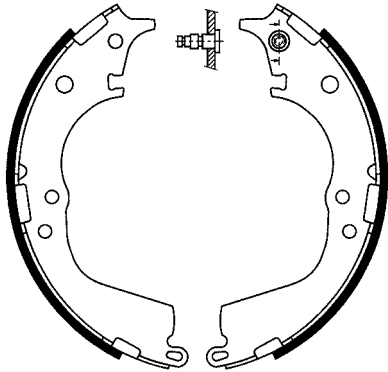

Ø 270 x 55

**03.0137-0469.2 650469**

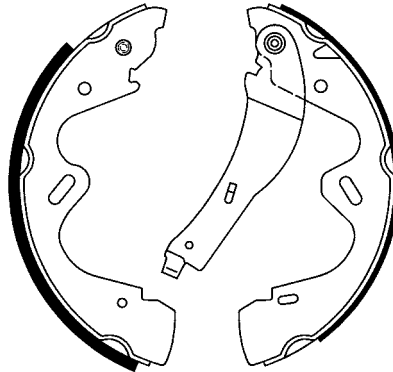

Ø 280 x 65

**03.0137-0470.2 650470**

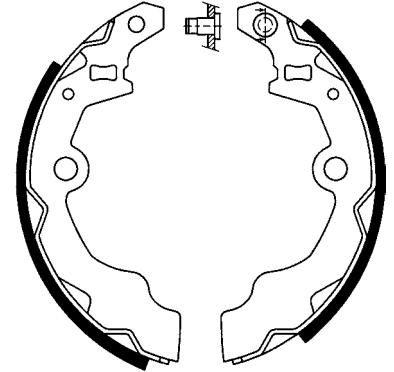

Ø 180 x 31

**03.0137-0471.2 650471**

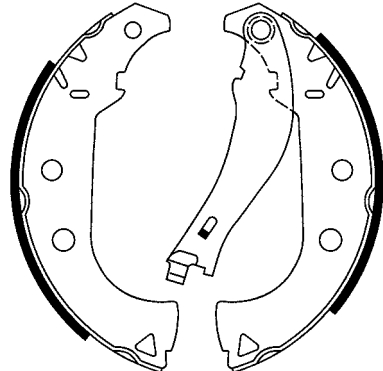

Ø 228 x 42

**03.0137-0472.2 650472**

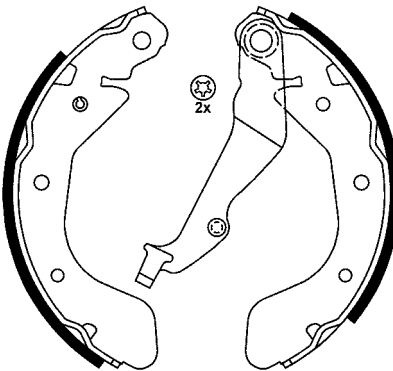

Ø 200 x 36

**03.0137-0473.2 650473**

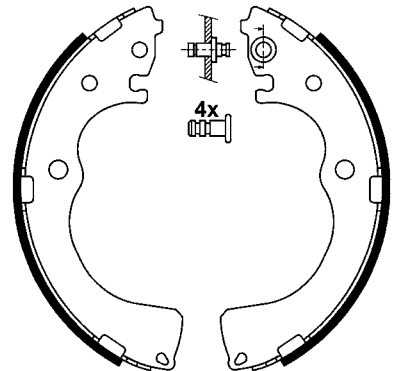

Ø 254 x 52

**03.0137-0474.2 650474**

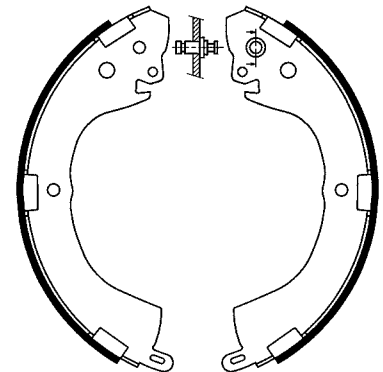

Ø 270 x 52

**03.0137-0475.2 650475**

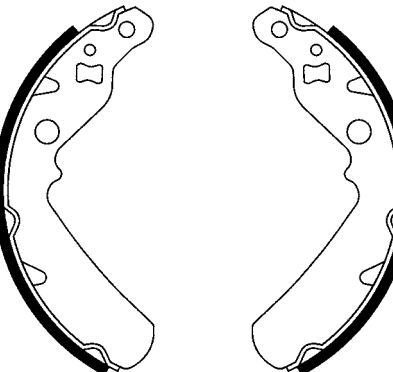

Ø 165 x 26

**03.0137-0477.2 650477**

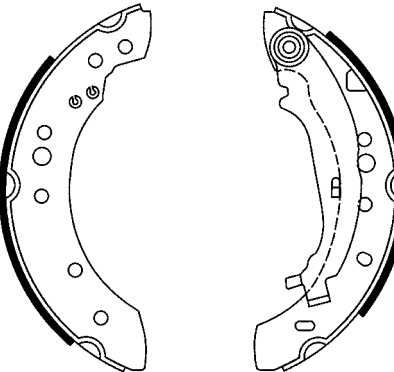

Ø 203 x 38

**03.0137-0478.2 650478**

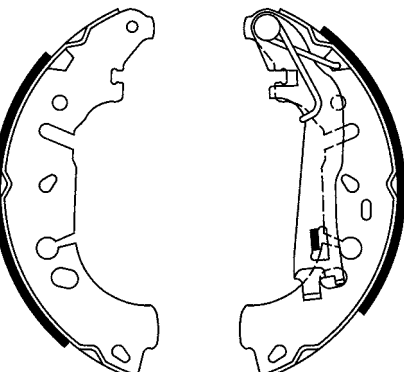

Ø 228 x 42

**03.0137-0479.2 650479**

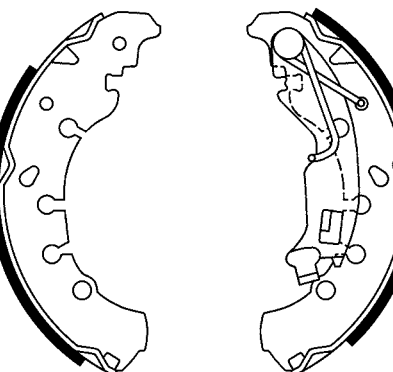

Ø 203 x 38

**03.0137-0480.2 650480**

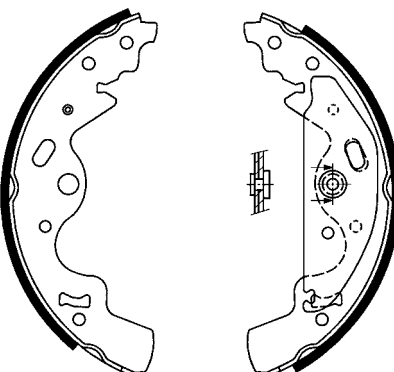

Ø 254 x 45

# Abbildungen Trommelbremsbacken

Illustrations drum brake shoes - Illustrazioni ganasce freno - Illustrations Mâchoires de frein à tambour - Ilustraciones zapatas freno de tambor

**03.0137-0482.2 650482**

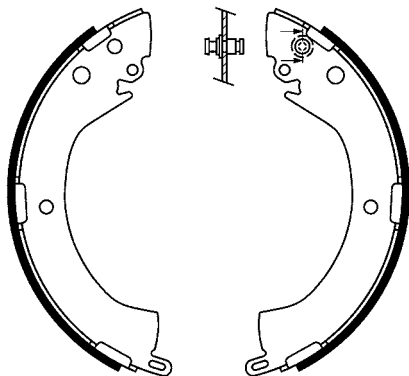

Ø 254 x 52

**03.0137-0483.2 650483**

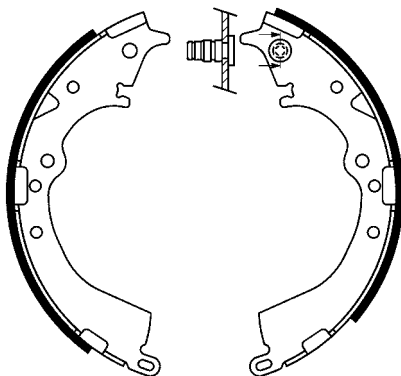

Ø 254 x 51

**03.0137-0484.2 650484**

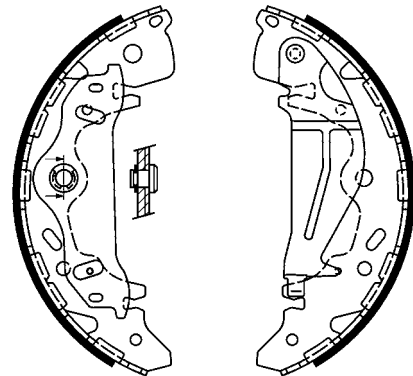

Ø 295 x 53

**03.0137-0485.2 650485**

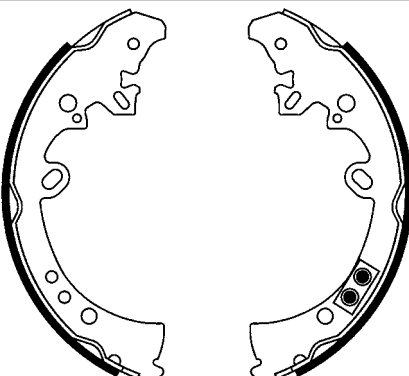

Ø 295 x 62

**03.0137-0486.2 650486**

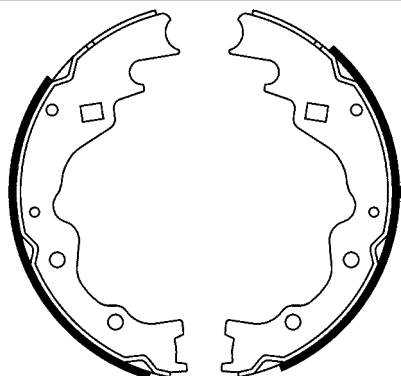

Ø 260 x 51

**03.0137-0487.2 650487**

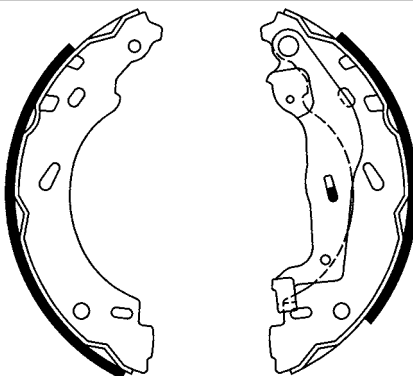

Ø 203 x 32

**03.0137-0488.2 650488**

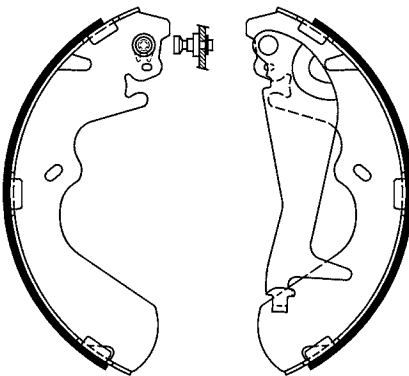

Ø 270 x 53

**03.0137-0489.2 650489**

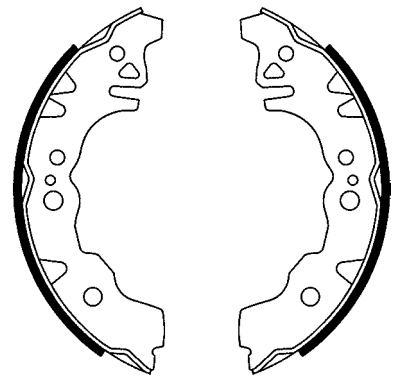

Ø 180 x 28

**03.0137-0490.2 650490**

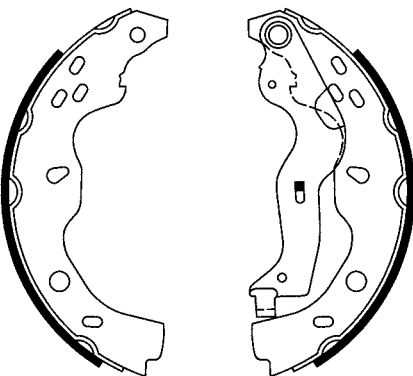

Ø 220 x 35

**03.0137-0491.2 650491**

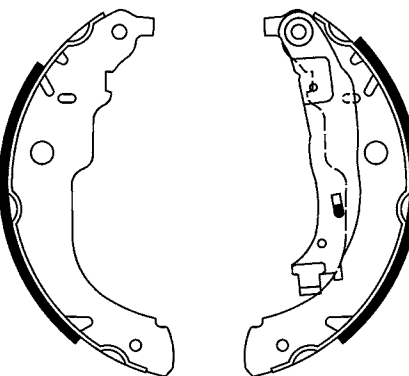

Ø 228 x 42

**03.0137-0492.2 650492**

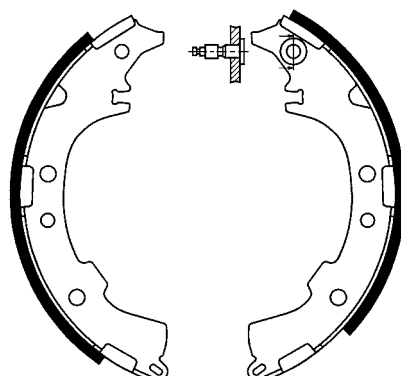

Ø 228 x 42

**03.0137-0493.2 650493**

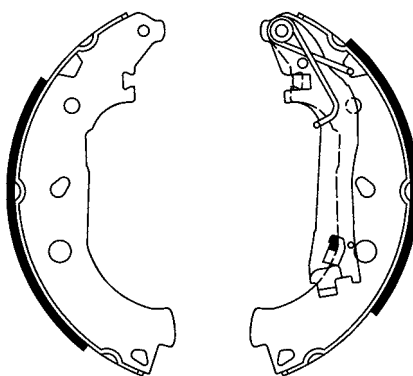

Ø 228 x 42



# Abbildungen Trommelbremsbacken

Illustrations drum brake shoes - Illustrazioni ganasce freno - Illustrations Mâchoires de frein à tambour - Ilustraciones zapatas freno de tambor

**03.0137-0494.2 650494**

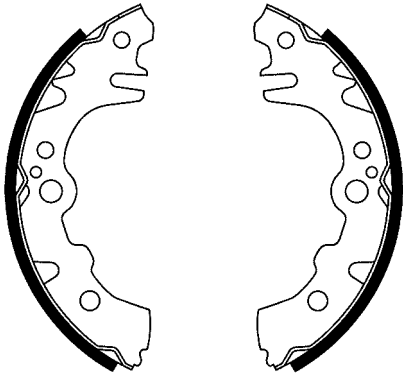

Ø 165 x 28

**03.0137-0495.2 650495**

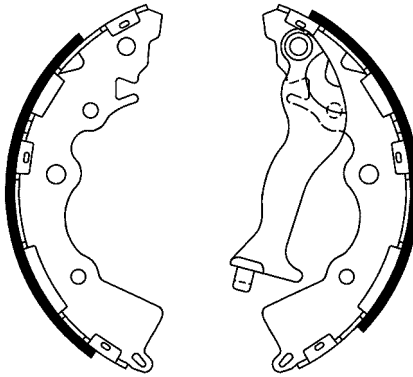

Ø 203 x 32

**03.0137-0496.2 650496**

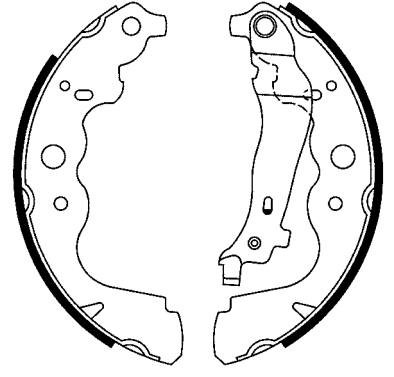

Ø 228 x 42

**03.0137-0497.2 650497**

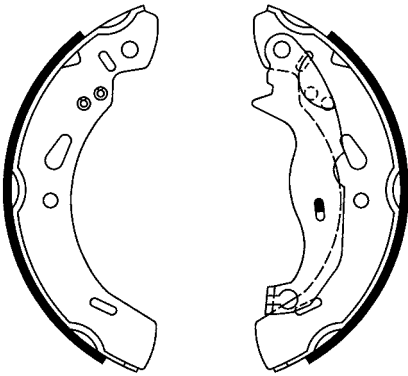

Ø 200 x 32

**03.0137-0498.2 650498**

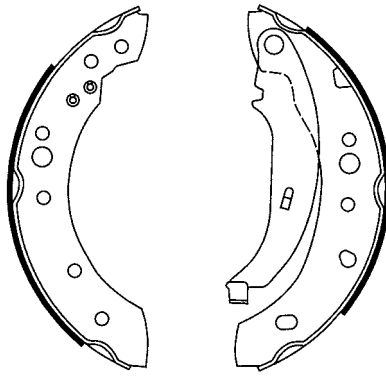

Ø 203 x 38

**03.0137-0499.2 650499**

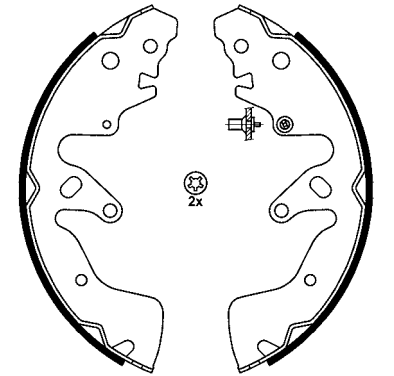

Ø 254 x 41

**03.0137-0500.2 650500**

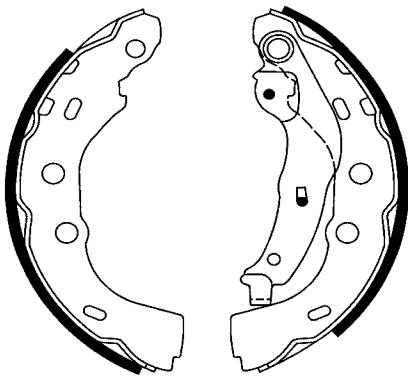

Ø 200 x 32

**03.0137-0501.2 650501**

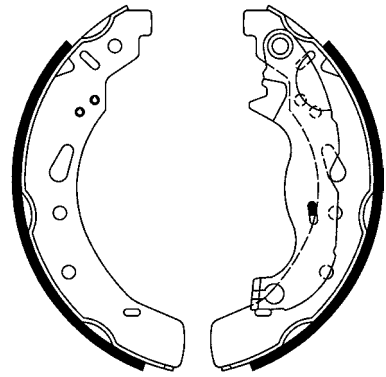

Ø 200 x 32

**03.0137-0502.2 650502**

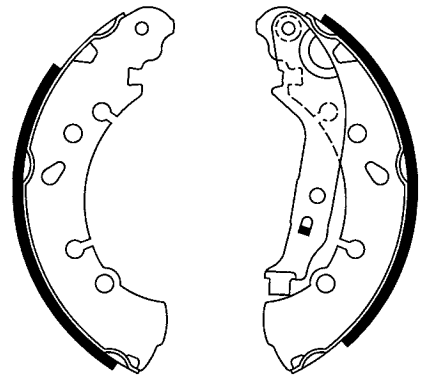

Ø 203 x 38

**03.0137-0503.2 650503**

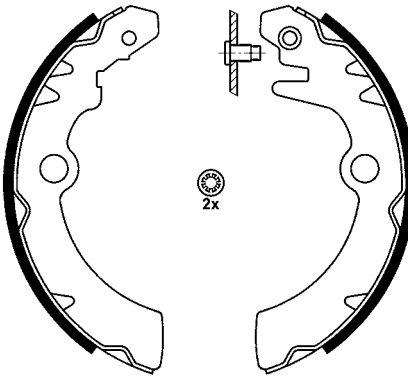

Ø 180 x 26

**03.0137-0504.2 650504**

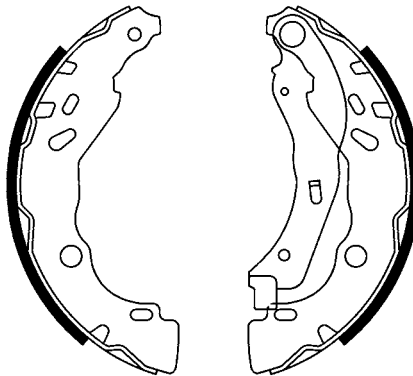

Ø 203 x 39

**03.0137-0505.2 650505**

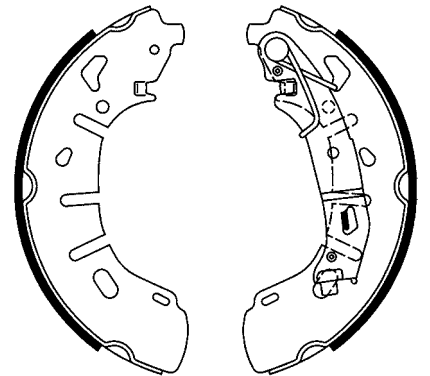

Ø 254 x 57



# Abbildungen Trommelbremsbacken

Illustrations drum brake shoes - Illustrazioni ganasce freno - Illustrations Mâchoires de frein à tambour - Ilustraciones zapatas freno de tambor

**03.0137-0506.2 650506**

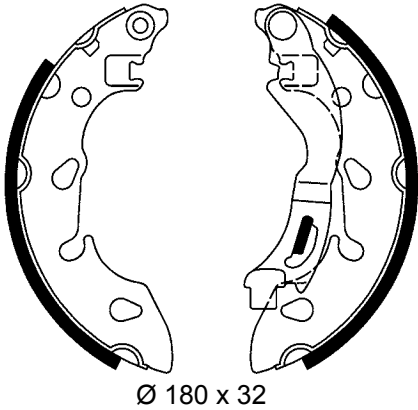

Ø 180 x 32

**03.0137-0508.2 650508**

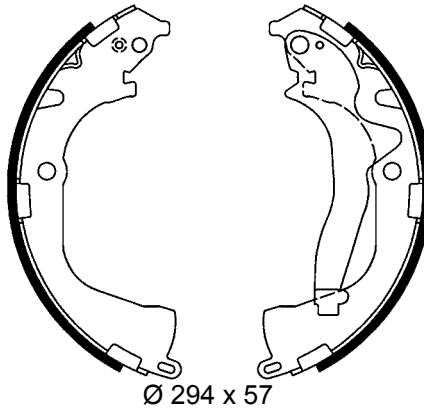

Ø 294 x 57

**03.0137-0509.2 650509**

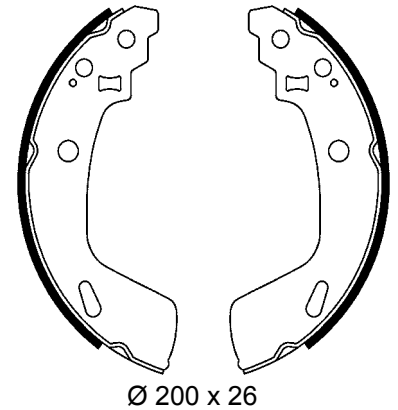

Ø 200 x 26

**03.0137-0510.2 650510**

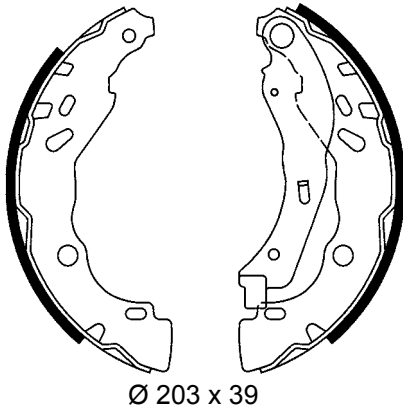

Ø 203 x 39

**03.0137-0511.2 650511**

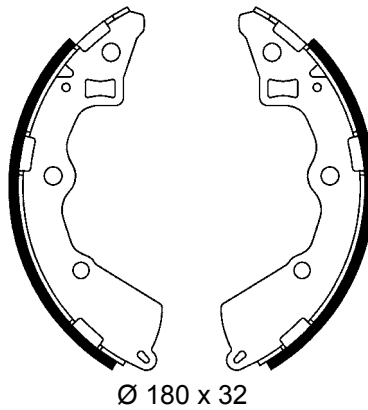

Ø 180 x 32

**03.0137-0512.2 650512**

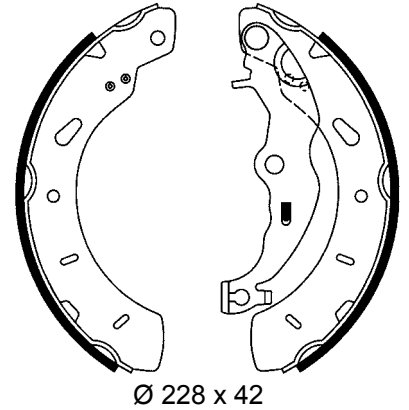

Ø 228 x 42

**03.0137-0516.2 650516**

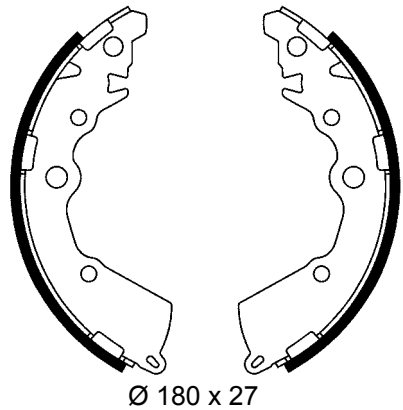

Ø 180 x 27

**03.0137-0519.2 650519**

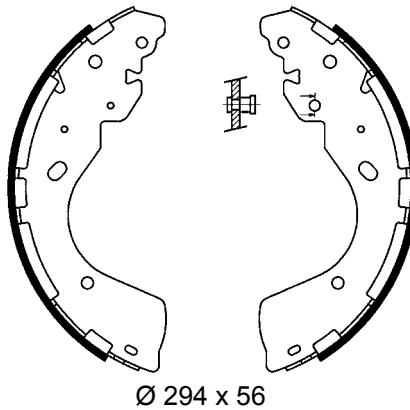

Ø 294 x 56

**03.0137-0521.2 650521**

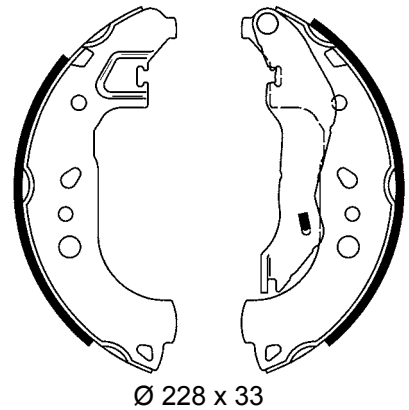

Ø 228 x 33

**03.0137-0532.2 650532**

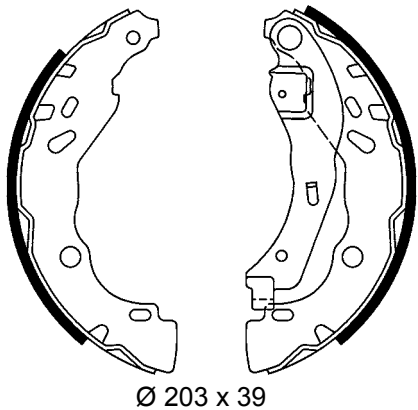

Ø 203 x 39

**03.0137-3002.2 653002**

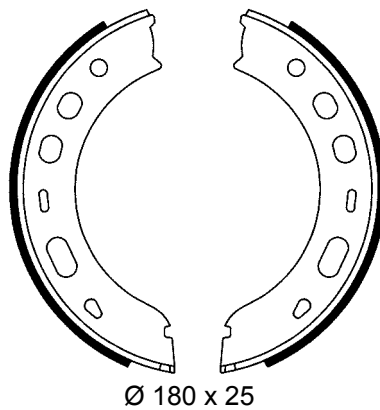

Ø 180 x 25

**03.0137-3003.2 653003**

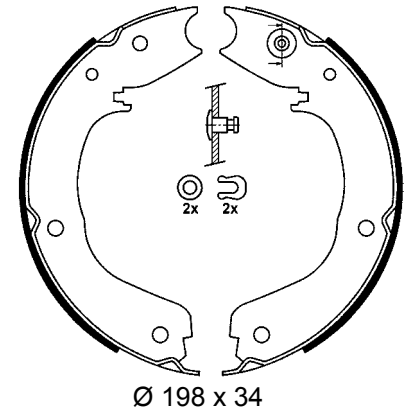

Ø 198 x 34

# Abbildungen Trommelbremsbacken

Illustrations drum brake shoes - Illustrazioni ganasce freno - Illustrations Mâchoires de frein à tambour - Ilustraciones zapatas freno de tambor

**03.0137-3004.2 653004**

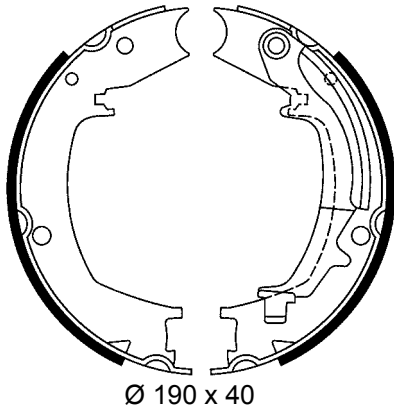

Ø 190 x 40

**03.0137-3005.2 653005**

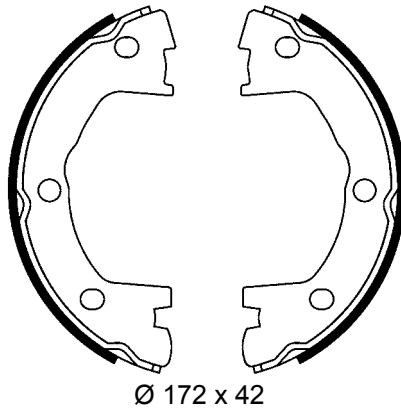

Ø 172 x 42

**03.0137-3006.2 653006**

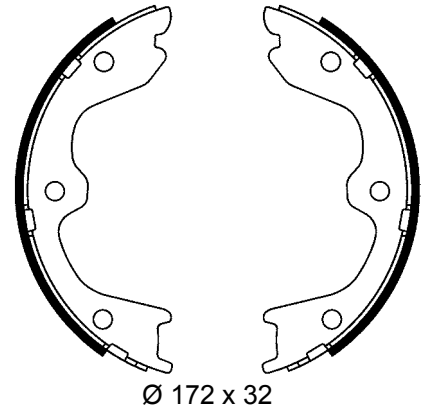

Ø 172 x 32

**03.0137-3007.2 653007**

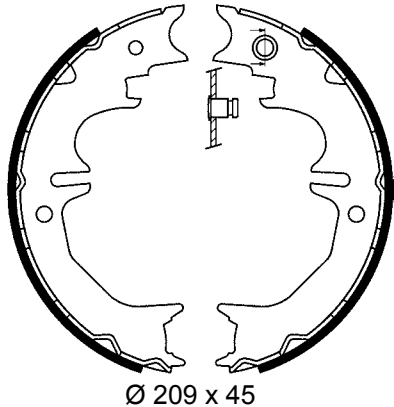

Ø 209 x 45

**03.0137-3008.2 653008**

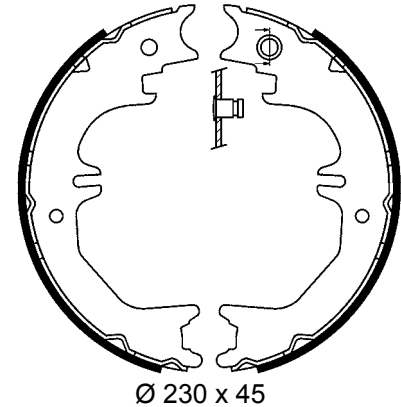

Ø 230 x 45

**03.0137-3009.2 653009**

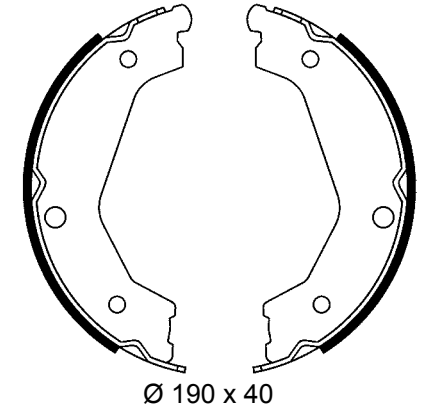

Ø 190 x 40

**03.0137-3010.2 653010**

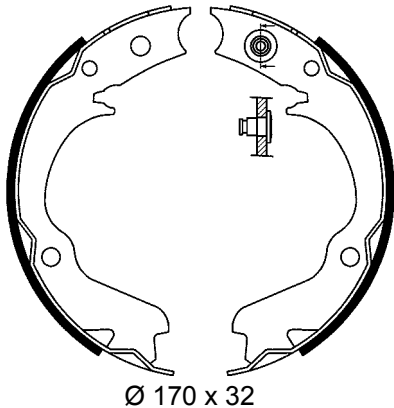

Ø 170 x 32

**03.0137-3011.2 653011**

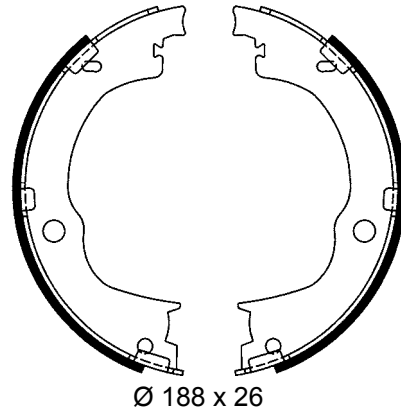

Ø 188 x 26

**03.0137-3012.2 653012**

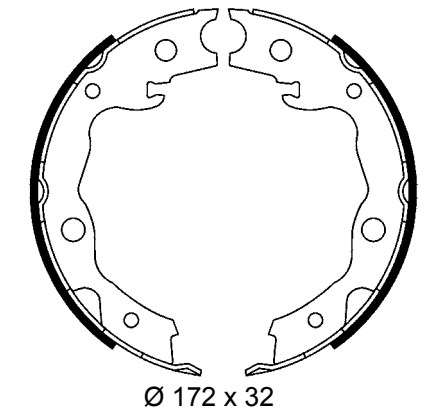

Ø 172 x 32

**03.0137-3014.2 653014**

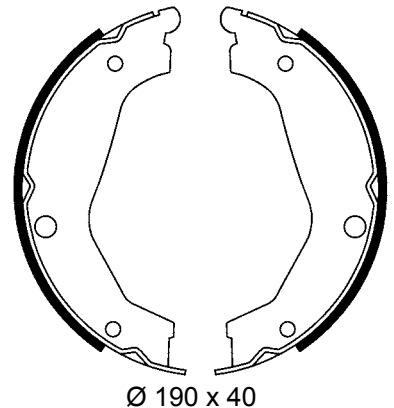

Ø 190 x 40

**03.0137-3015.2 653015**

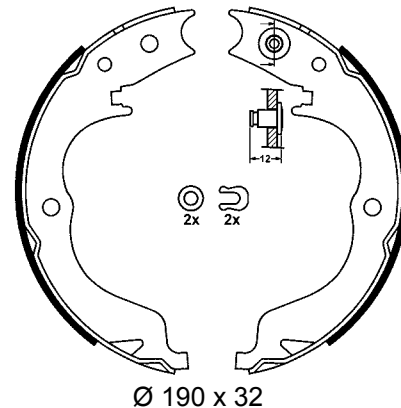

Ø 190 x 32

**03.0137-3016.2 653016**

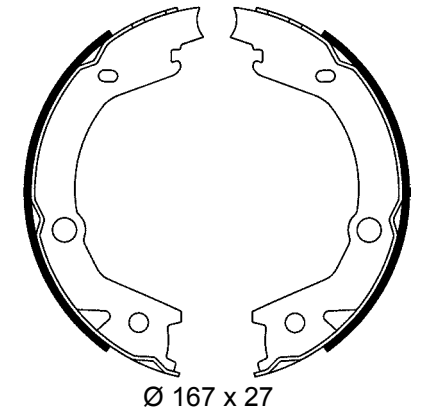

Ø 167 x 27

# Abbildungen Trommelbremsbacken

Illustrations drum brake shoes - Illustrazioni ganasce freno - Illustrations Mâchoires de frein à tambour - Ilustraciones zapatas freno de tambor

**03.0137-3017.2 653017**

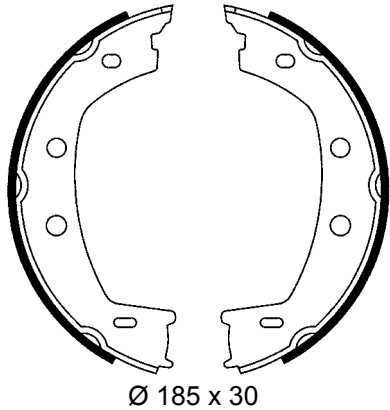

Ø 185 x 30

**03.0137-3018.2 653018**

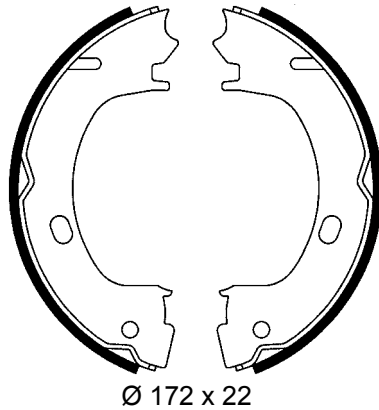

Ø 172 x 22

**03.0137-3019.2 653019**

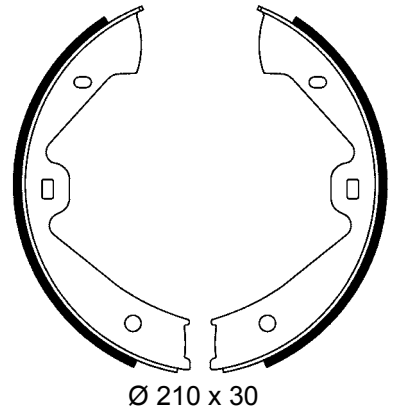

Ø 210 x 30

**03.0137-3020.2 653020**

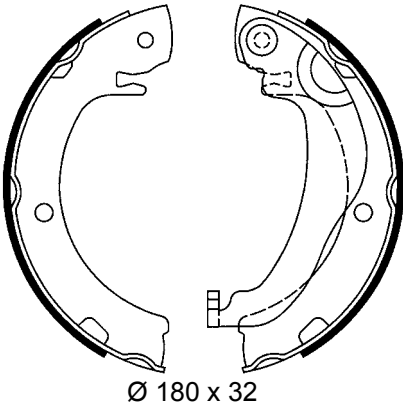

Ø 180 x 32

**03.0137-3021.2 653021**

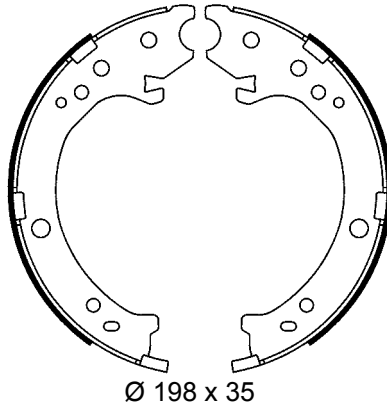

Ø 198 x 35

**03.0137-3022.2 653022**

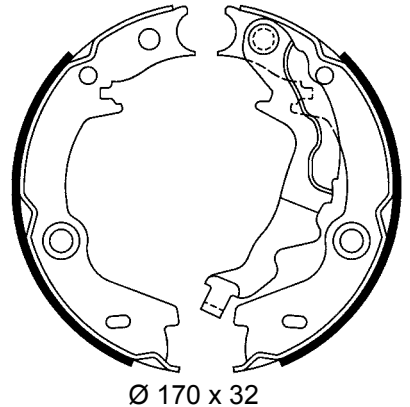

Ø 170 x 32

**03.0137-3023.2 653023**

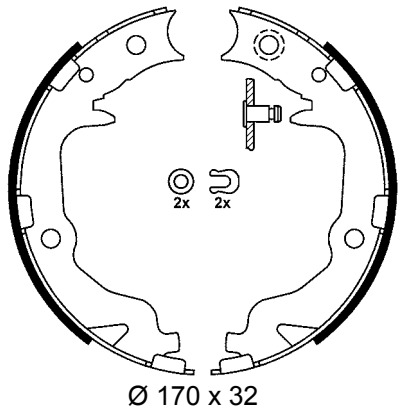

Ø 170 x 32

**03.0137-3024.2 653024**

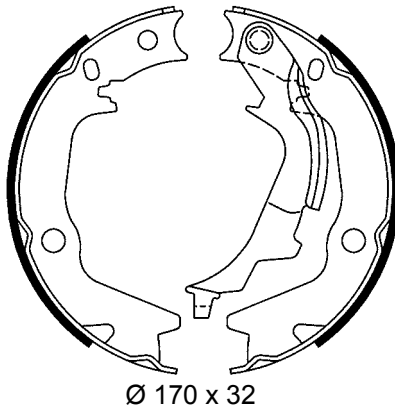

Ø 170 x 32

**03.0137-3025.2 653025**

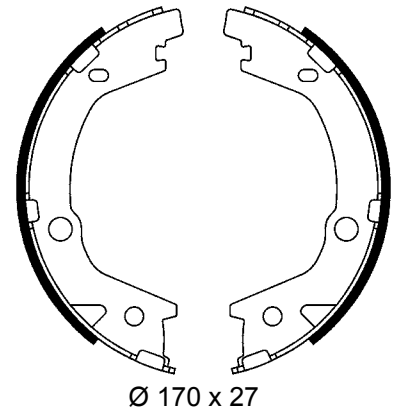

Ø 170 x 27

**03.0137-3026.2 653026**

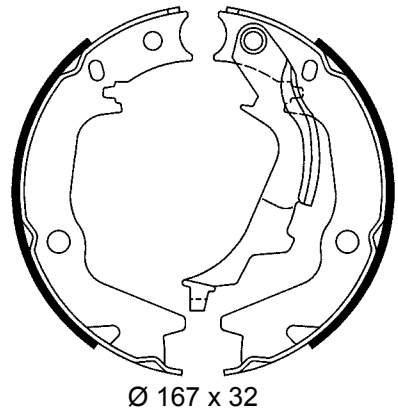

Ø 167 x 32

**03.0137-3027.2 653023**

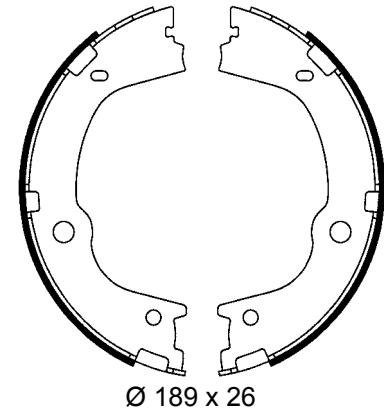

Ø 189 x 26

**03.0137-3028.2 653028**

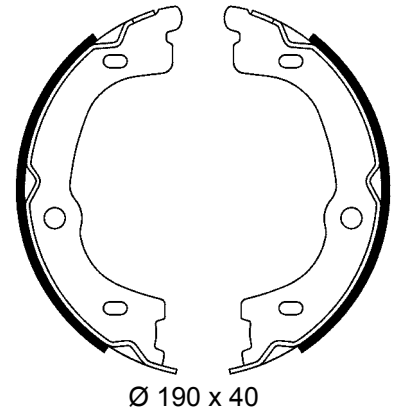

Ø 190 x 40

# Abbildungen Trommelbremsbacken

Illustrations drum brake shoes - Illustrazioni ganasce freno - Illustrations Mâchoires de frein à tambour - Ilustraciones zapatas freno de tambor

03.0137-3029.2 653029

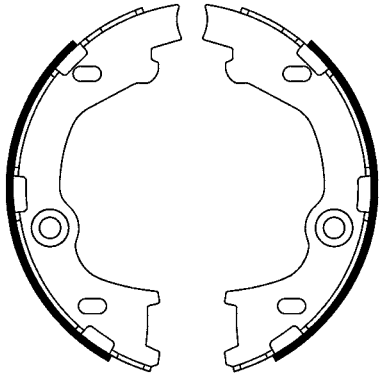

Ø 167 x 26

03.0137-3030.2 653030

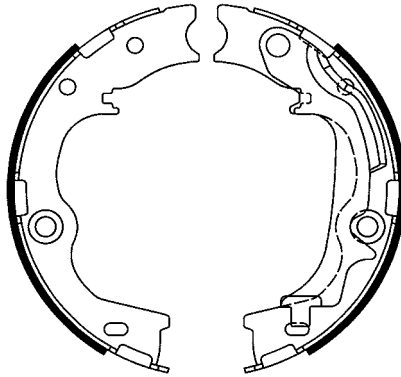

Ø 189 x 40

03.0137-3031.2 653031

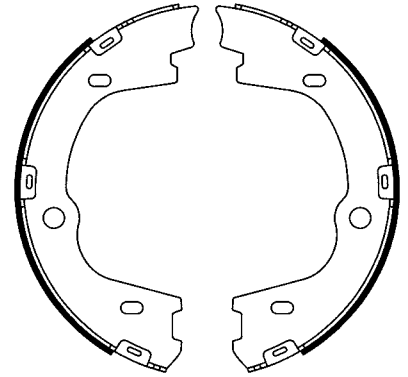

Ø 209 x 40

03.0137-3032.2 653032

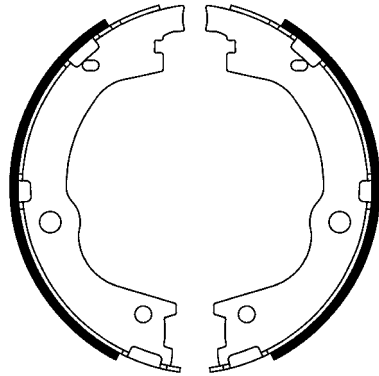

Ø 189 x 31

03.0137-3034.2 653034

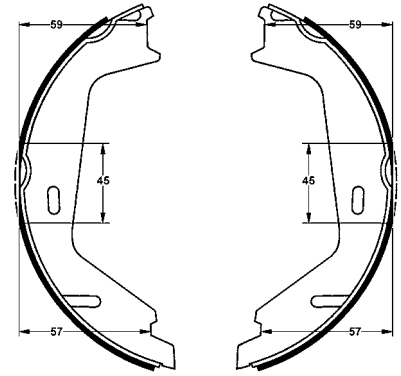

Ø 178 x 25

03.0137-3037.2 653037

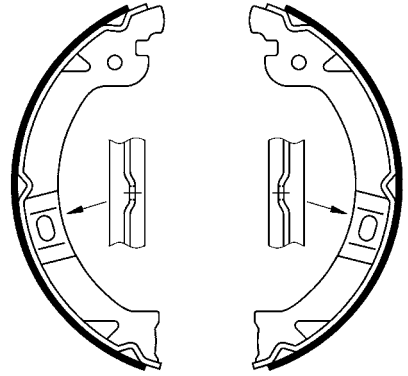

Ø 180 x 30

03.0137-3038.2 653038

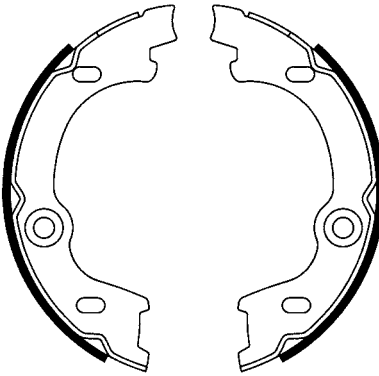

Ø 167 x 32

03.0137-3040.2 653040

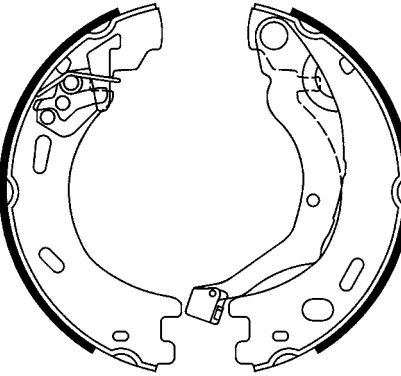

Ø 203 x 39

03.0137-3041.2 653041

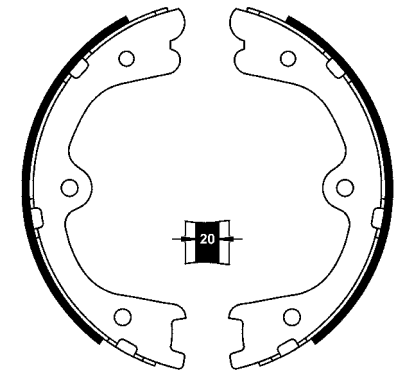

Ø 190 x 33/20

03.0137-3042.2 653042

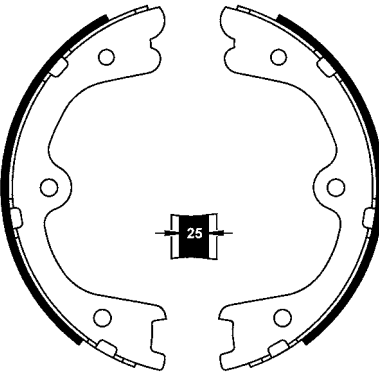

Ø 203 x 39

03.0137-3045.2 653045

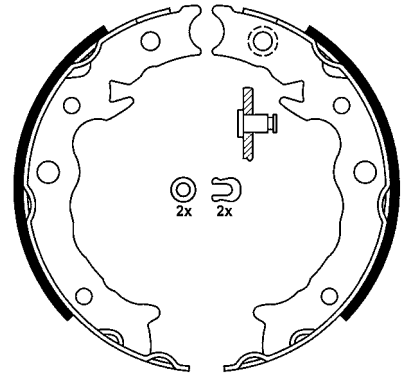

Ø 170 x 35

03.0137-3046.2 653046

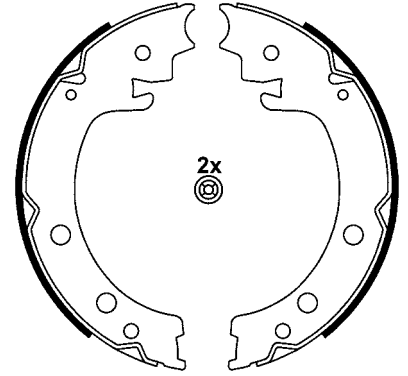

Ø 200 x 37

# Abbildungen Trommelbremsbacken

Illustrations drum brake shoes - Illustrazioni ganasce freno - Illustrations Mâchoires de frein à tambour - Ilustraciones zapatas freno de tambor

03.0137-4001.2 654001

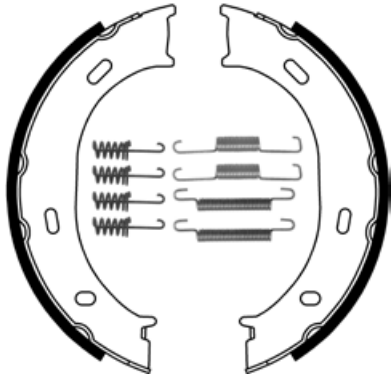

Ø 160 x 40

03.0137-4002.2 654002

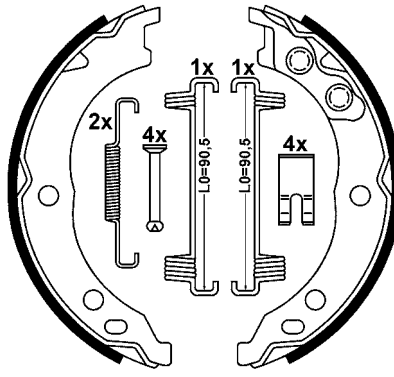

Ø 172 x 42

03.0137-4003.2 654003

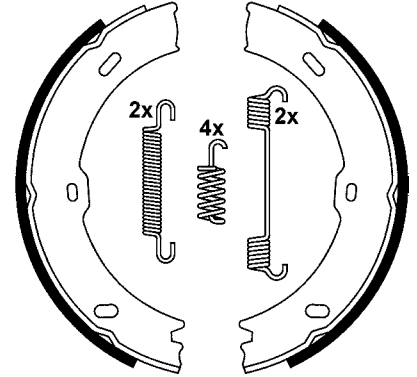

Ø 180 x 25

03.0137-4004.2 654004

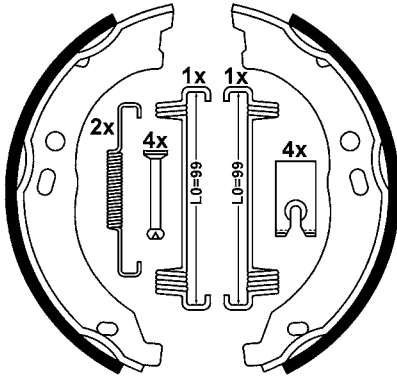

Ø 172 x 42

03.0137-4005.2 654005

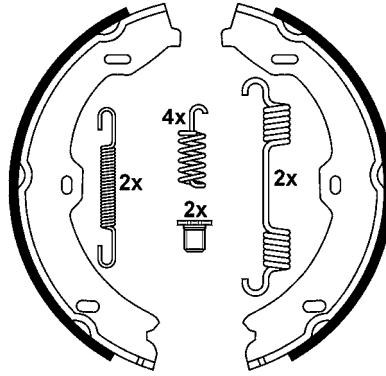

Ø 164 x 25

03.0137-4006.2 654006

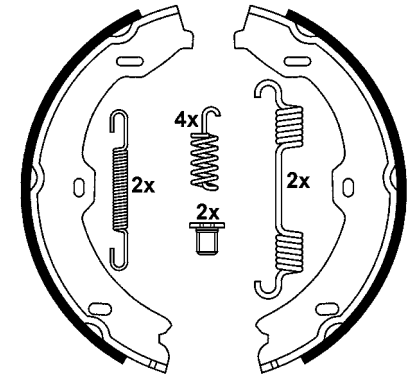

Ø 180 x 25

03.0137-4007.2 654007

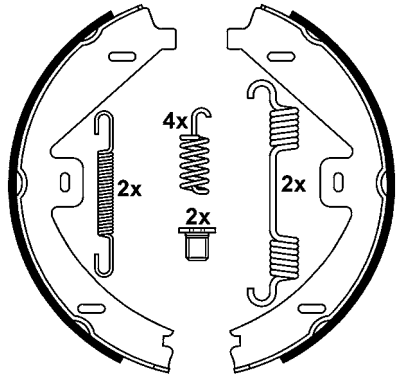

Ø 180 x 25

03.0137-4008.2 654008

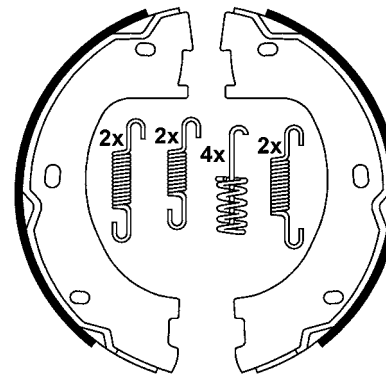

Ø 172 x 42

03.0137-4009.2 654009

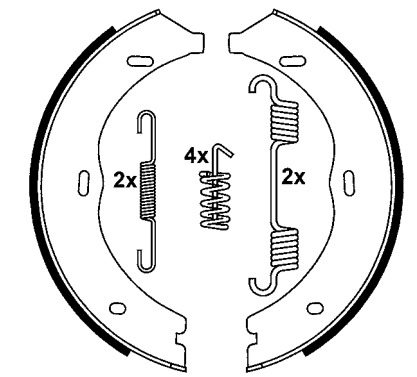

Ø 186 x 20

03.0137-4010.2 654010

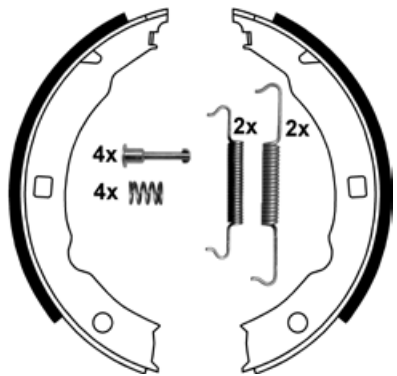

Ø 180 x 30

03.0137-4011.2 654011

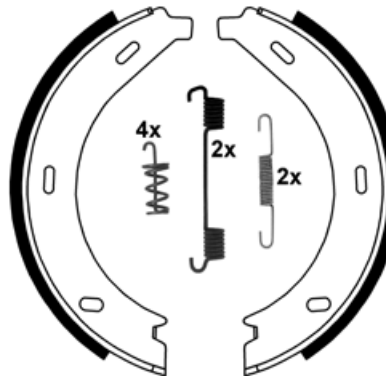

Ø 178 x 20

03.0137-4012.2 654012

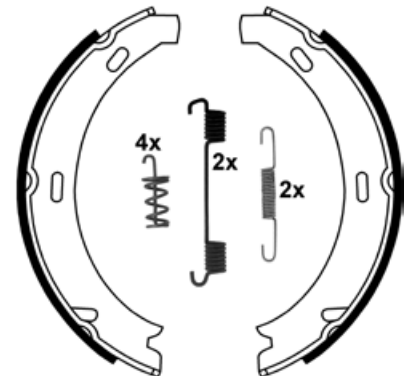

Ø 164 x 25



# Abbildungen Trommelbremsbacken

Illustrations drum brake shoes - Illustrazioni ganasce freno - Illustrations Mâchoires de frein à tambour - Ilustraciones zapatas freno de tambor

03.0137-4013.2 654013

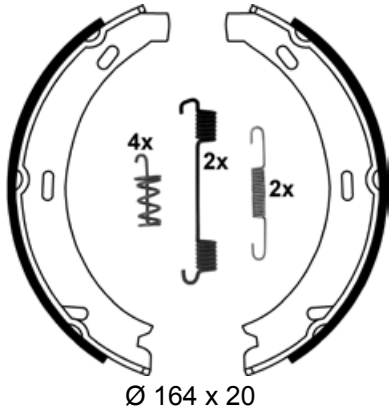

Ø 164 x 20

03.0137-4014.2 654014

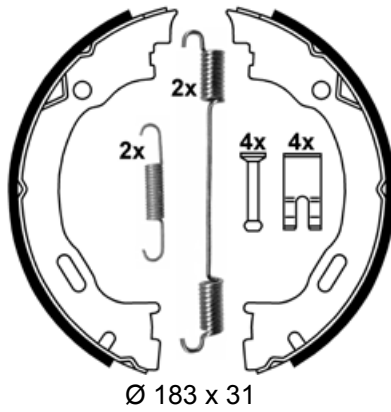

Ø 183 x 31

03.0137-4015.2 654015

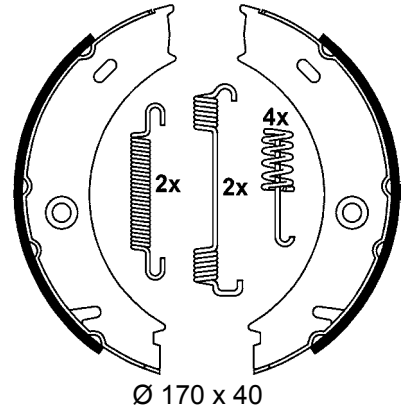

Ø 170 x 40

03.0137-4016.2 654016

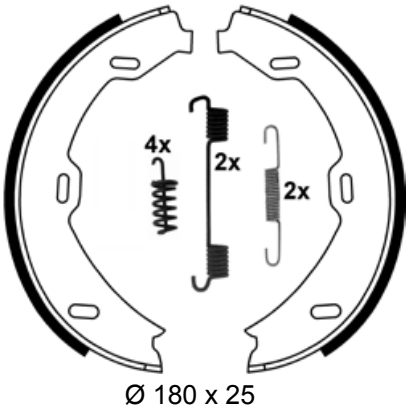

Ø 180 x 25

03.0137-4017.2 654017

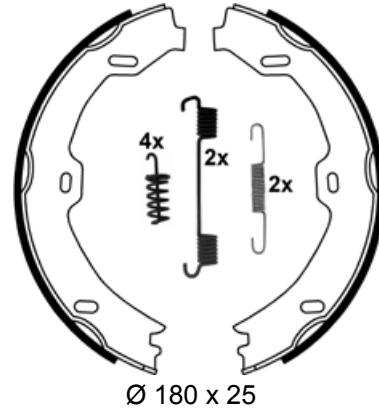

Ø 180 x 25

03.0137-4018.2 654018

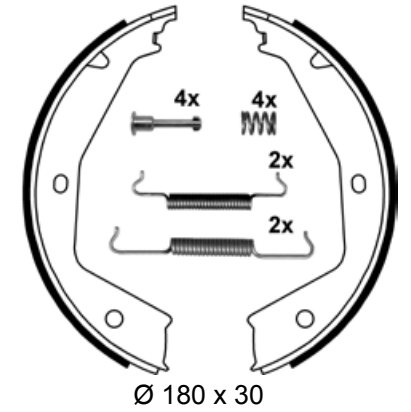

Ø 180 x 30

03.0137-4019.2 654019

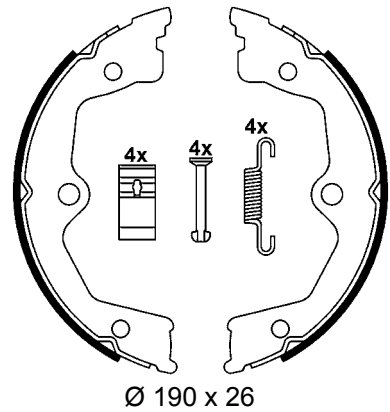

Ø 190 x 26







- D** Abbildungen Trommelbremsbacken Einbausätze
- EN** Illustration drum brake shoes installation kits
- FR** Illustrations Lots de montage pour mâchoires de frein à tambour
- IT** Illustrazioni kit installazione ganasce freno
- ES** Ilustraciones juegos de montaje zapatas freno de tambor
- NL** Afbeeldingen inbouwsets voor trommelremschoenen
- DA** Tegning monteringsæt for bremsebakker
- SV** Avbildningar trumbromsbackar monteringsatser
- HU** Ábrák - dobfékpofa-szerelőkészletek
- PT** Figuras Kits de instalação de calços de travões de tambor
- RU** Изображения монтажных комплектов барабанных колодок
- CZ** Zobrazení vestavných sad čelistí bubnových brzd
- PL** Rysunki zestawów montażowych szczęk hamulca bębnowego
- EL** Εικόνες σετ τοποθέτησης σιαγόνων ταίπούρων φρένων
- TR** TBB montaj takımları resimleri
- ZH** 制动渐缴棍安祥组件图片(新)
- JA** 図版 TBB組み溝みキット
- AR** صور طواقم الترابيب لفكي المكبح الطبلي

# K24-F



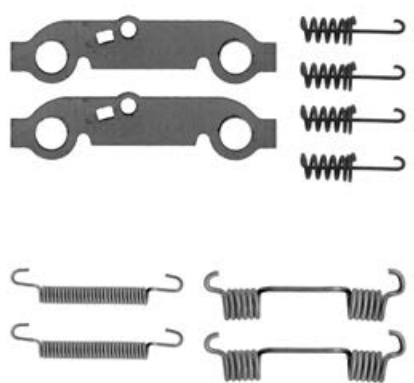
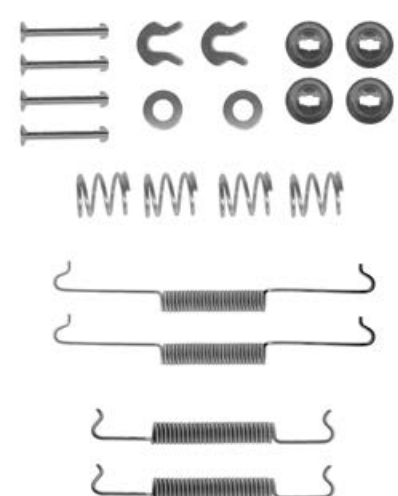
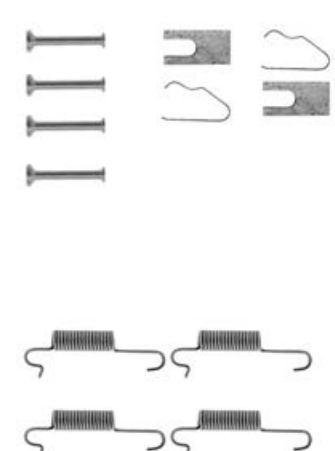
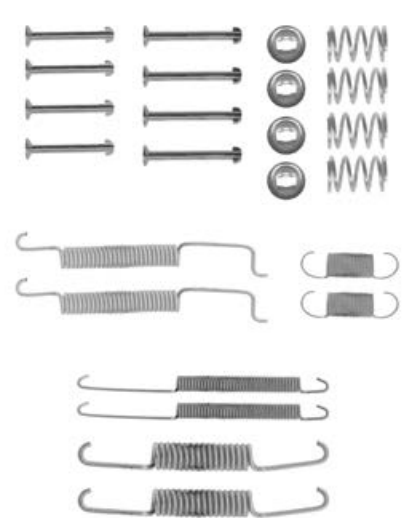
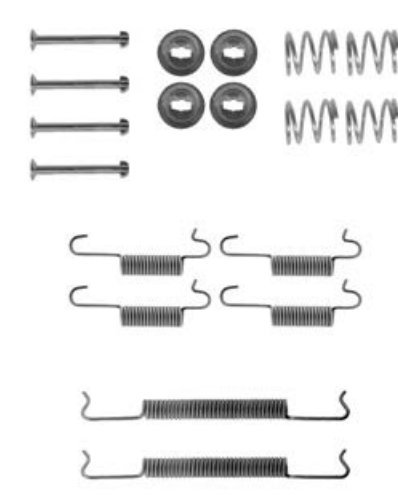
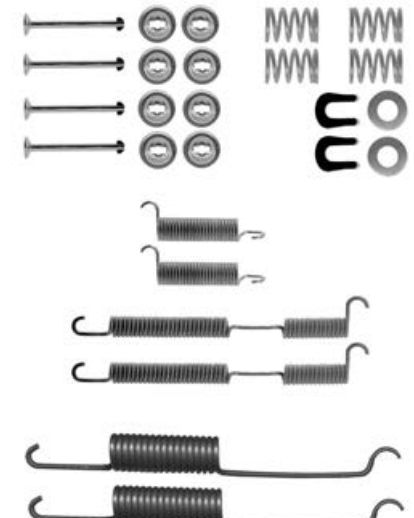
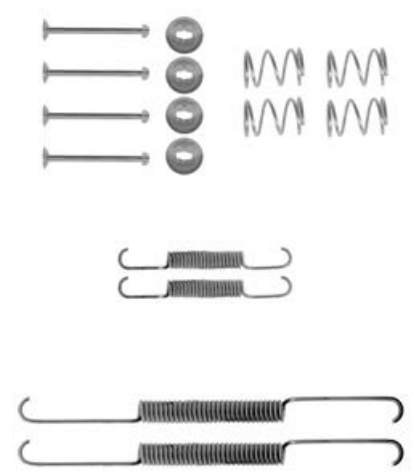
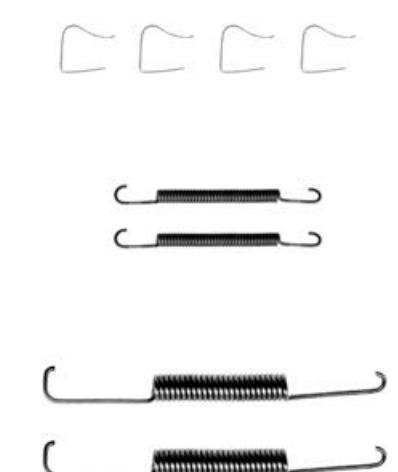
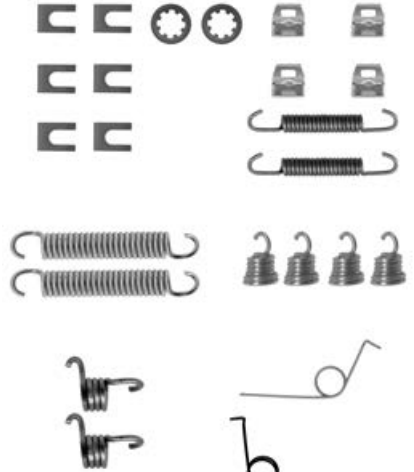

# Abbildungen Bremsbacken-Zubehör

Illustrations brake shoe accessories - Illustrazioni accessori per ganasce freni - Illustrations Accessoires pour mâchoires de frein - Ilustraciones Accesorios para zapatas de freno

| 03.0137-9002.2 669002  | 03.0137-9005.2 669005   | 03.0137-9006.2 669006   |
|--|---|---|
|    |    |    |
| 03.0137-9008.2 669008  | 03.0137-9009.2 669009   | 03.0137-9013.2 669013   |
|   |   |   |
| 03.0137-9014.2 669014  | 03.0137-9015.2 669015   | 03.0137-9020.2 669020   |
|  |  |  |

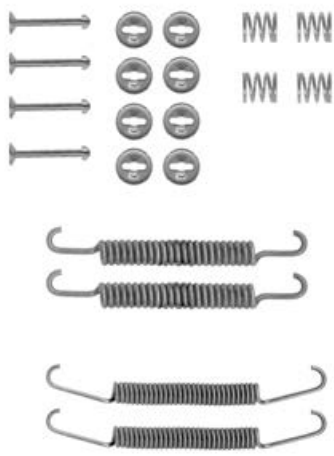
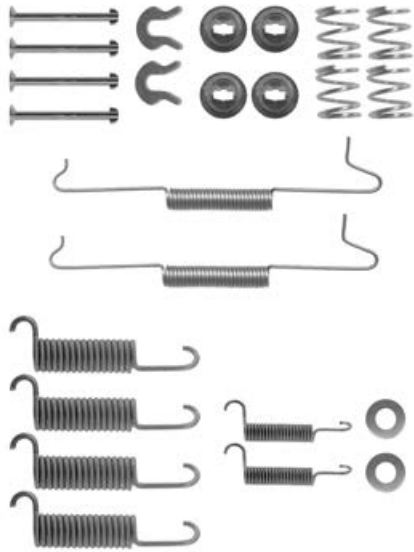
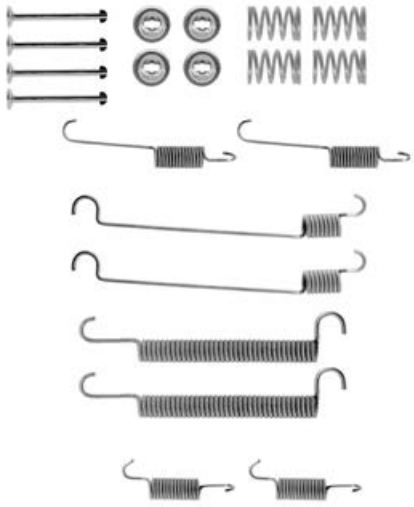
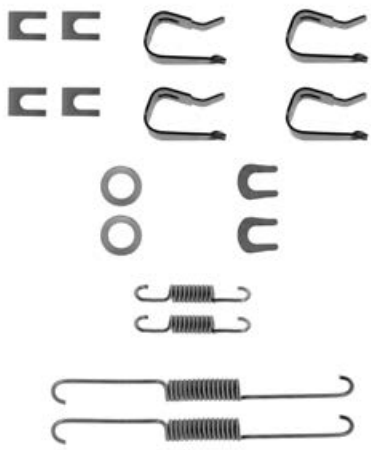
# Abbildungen Bremsbacken-Zubehör

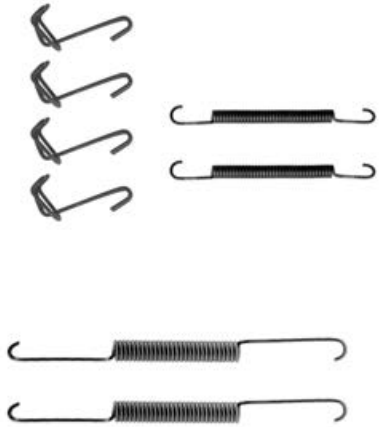
Illustrations brake shoe accessories - Illustrazioni accessori per ganasce freni - Illustrations Accessoires pour mâchoires de frein - Ilustraciones Accesorios para zapatas de freno

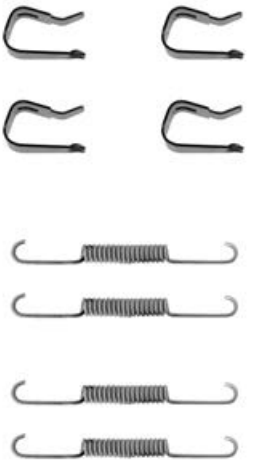
| 03.0137-9021.2 669021   | 03.0137-9024.2 669024  | 03.0137-9027.2 669027   |
|---|--|---|
|    |    |    |
| 03.0137-9028.2 669028   | 03.0137-9031.2 669031  | 03.0137-9032.2 669032   |
|   |    |   |
| 03.0137-9034.2 669034   | 03.0137-9035.2 669035  | 03.0137-9039.2 669039   |
|  |  |  |

# Abbildungen Bremsbacken-Zubehör

Illustrations brake shoe accessories - Illustrazioni accessori per ganasce freni - Illustrations Accessoires pour mâchoires de frein - Ilustraciones Accesorios para zapatas de freno

**03.0137-9041.2 669041**

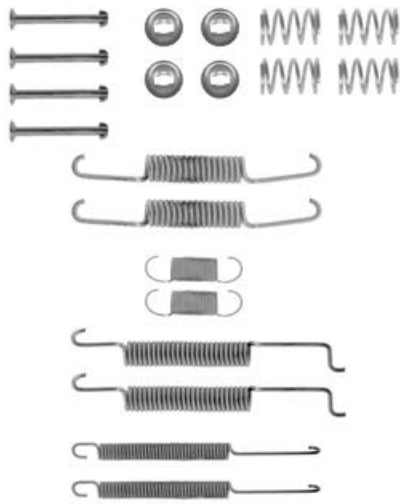

**03.0137-9043.2 669043**

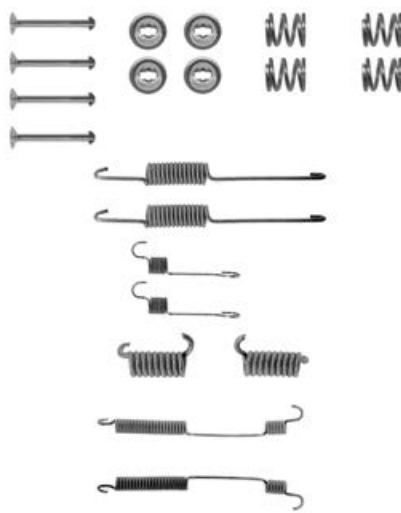

**03.0137-9044.2 669044**

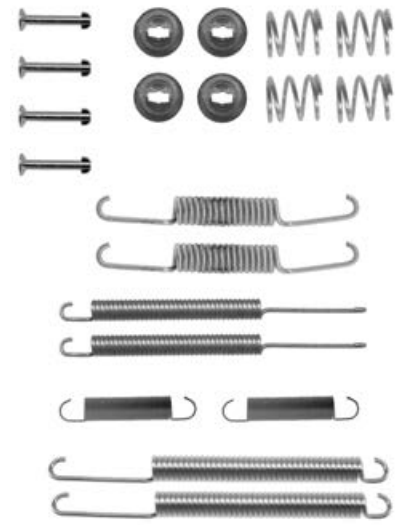

**03.0137-9046.2 669046**

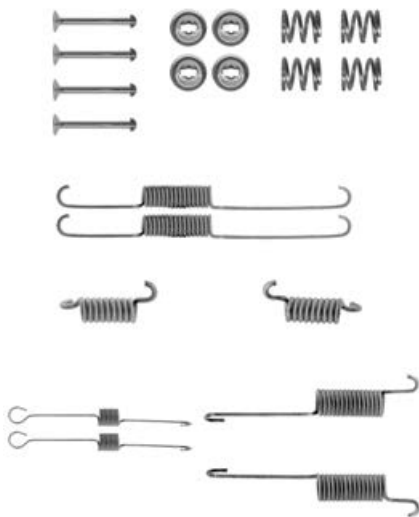

**03.0137-9053.2 669053**

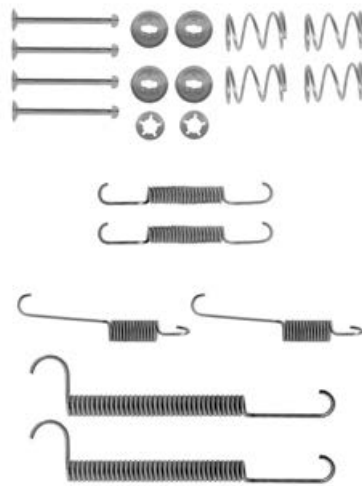

**03.0137-9054.2 669054**

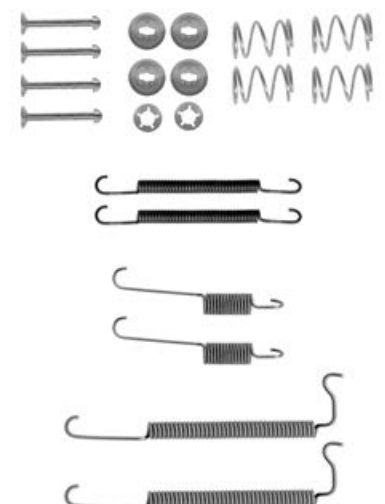

**03.0137-9055.2 669055**

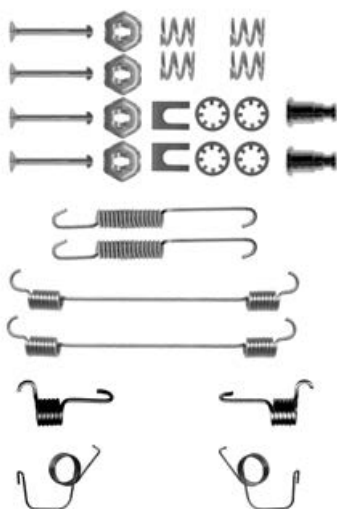

**03.0137-9056.2 669056**



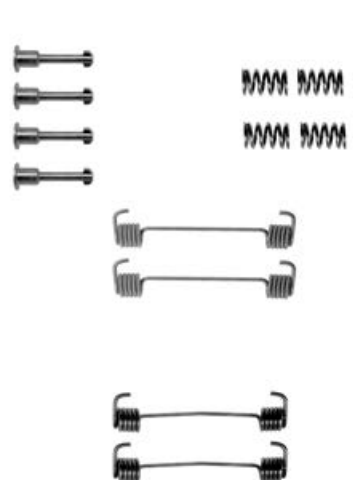

**03.0137-9058.2 669058**



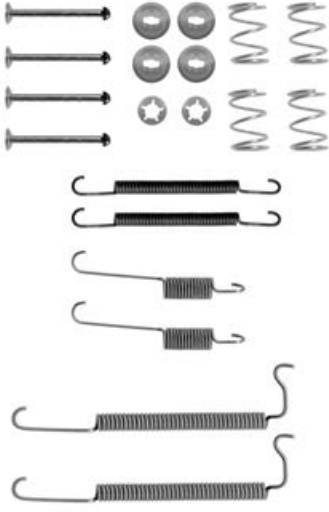
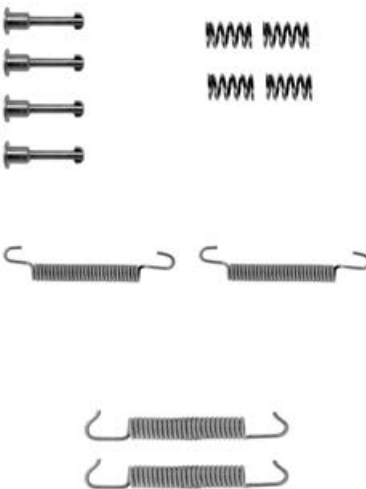

# Abbildungen Bremsbacken-Zubehör

Illustrations brake shoe accessories - Illustrazioni accessori per ganasce freni - Illustrations Accessoires pour mâchoires de frein - Ilustraciones Accesorios para zapatas de freno

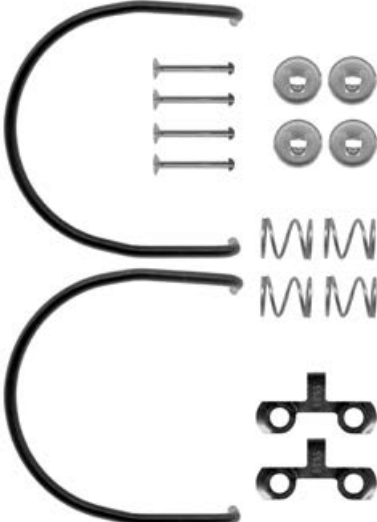
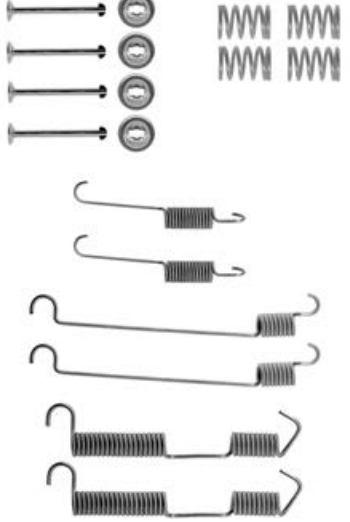
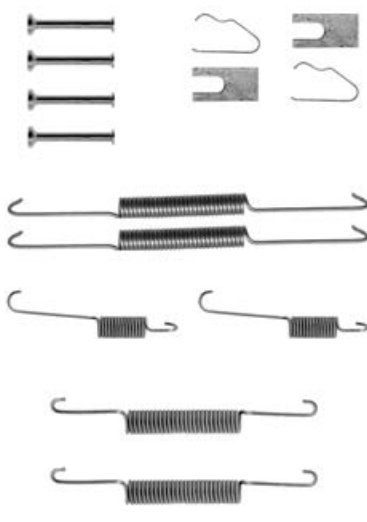
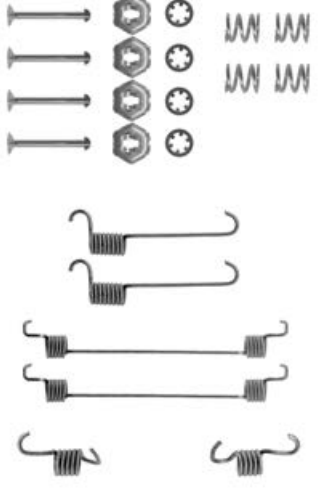
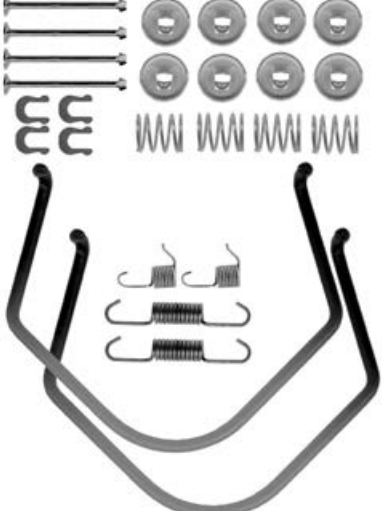
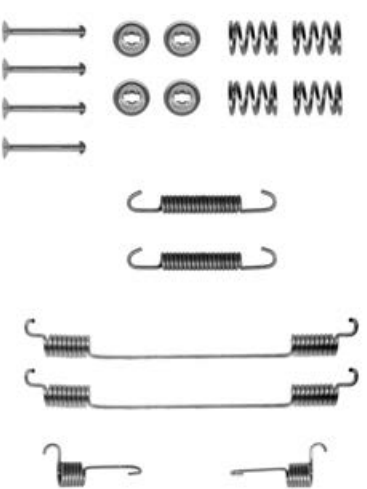
| 03.0137-9060.2 669060   | 03.0137-9062.2 669062   | 03.0137-9065.2 669065   |
|---|---|---|
|    |    |    |
| 03.0137-9070.2 669070   | 03.0137-9076.2 669076   | 03.0137-9077.2 669077   |
|   |   |   |
| 03.0137-9079.2 669079   | 03.0137-9080.2 669080   | 03.0137-9081.2 669081   |
|  |  |  |



# Abbildungen Bremsbacken-Zubehör

Illustrations brake shoe accessories - Illustrazioni accessori per ganasce freni - Illustrations Accessoires pour mâchoires de frein - Ilustraciones Accesorios para zapatas de freno

| 03.0137-9082.2 669082 | 03.0137-9085.2 669085 | 03.0137-9086.2 669086 |
|-----------------------|-----------------------|-----------------------|
|                       |                       |                       |
| 03.0137-9088.2 669088 | 03.0137-9089.2 669089 | 03.0137-9091.2 669091 |
|                       |                       |                       |
| 03.0137-9092.2 669092 | 03.0137-9096.2 669096 | 03.0137-9097.2 669097 |
|                       |                       |                       |



# Abbildungen Bremsbacken-Zubehör

Illustrations brake shoe accessories - Illustrazioni accessori per ganasce freni - Illustrations Accessoires pour mâchoires de frein - Ilustraciones Accesorios para zapatas de freno

03.0137-9102.2 669102

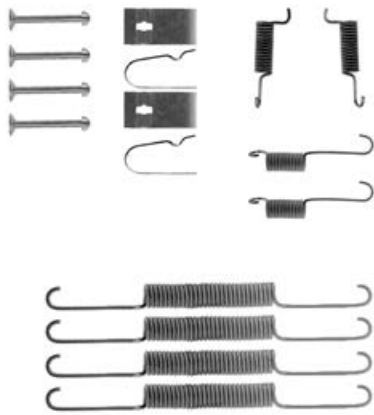

03.0137-9103.2 669103

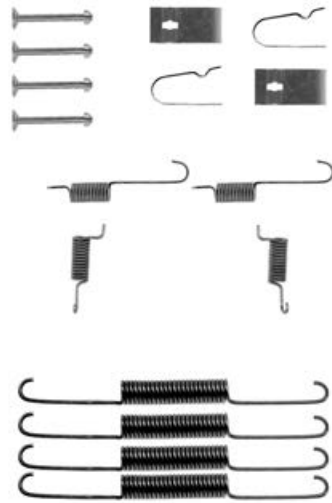

03.0137-9105.2 669105

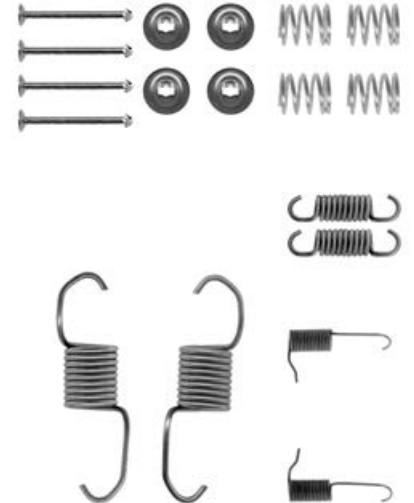

03.0137-9107.2 669107

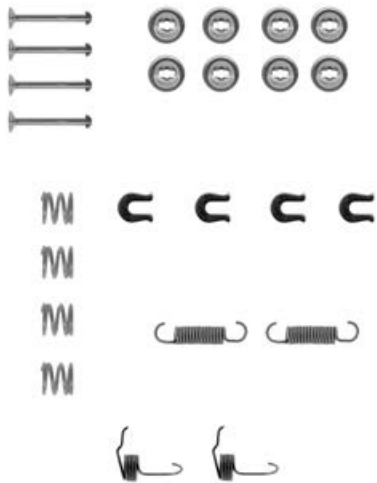

03.0137-9111.2 669111

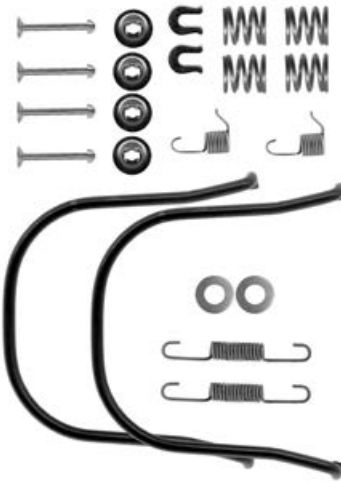

03.0137-9112.2 669112

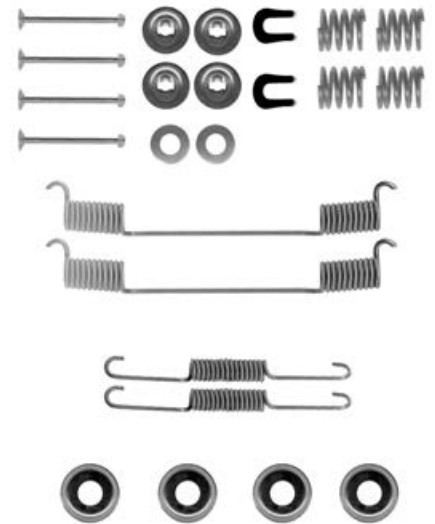

03.0137-9113.2 669113

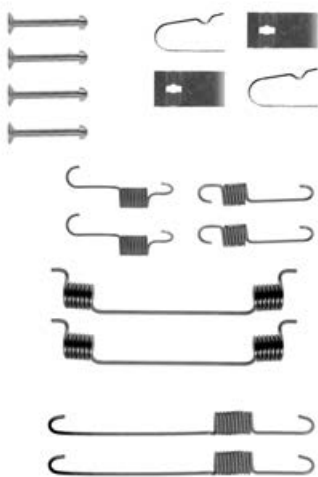

03.0137-9114.2 669114

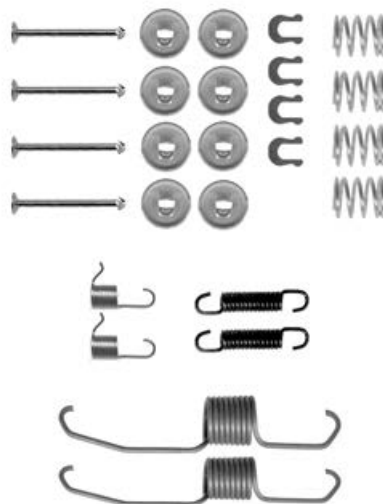

03.0137-9115.2 669115

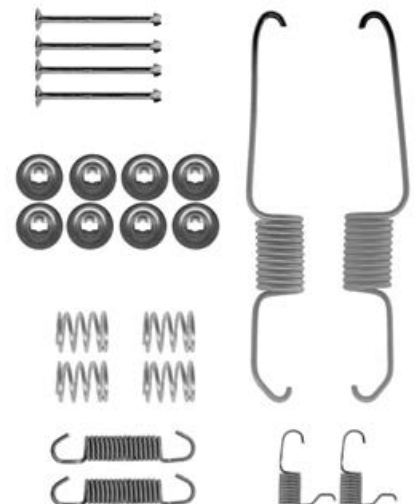

# Abbildungen Bremsbacken-Zubehör

Illustrations brake shoe accessories - Illustrazioni accessori per ganasce freni - Illustrations Accessoires pour mâchoires de frein - Ilustraciones Accesorios para zapatas de freno

03.0137-9117.2 669117

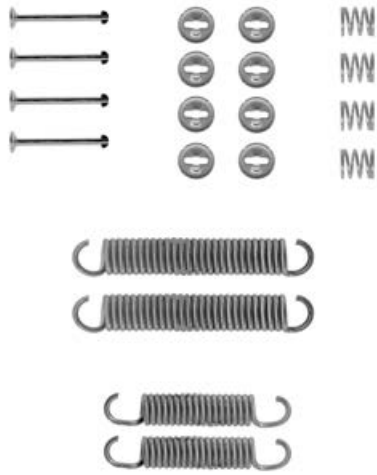

03.0137-9118.2 669118



03.0137-9120.2 669120



03.0137-9121.2 669121

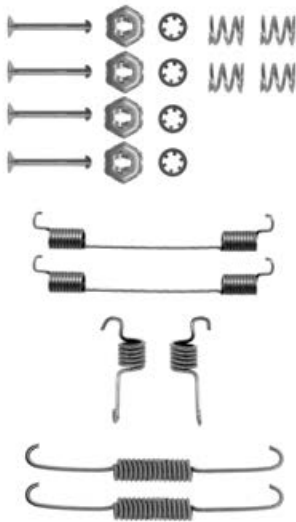

03.0137-9122.2 669122

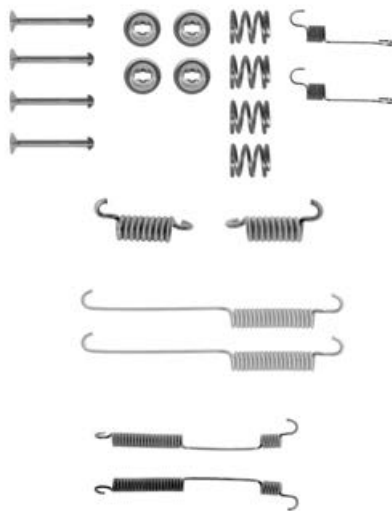

03.0137-9124.2 669124

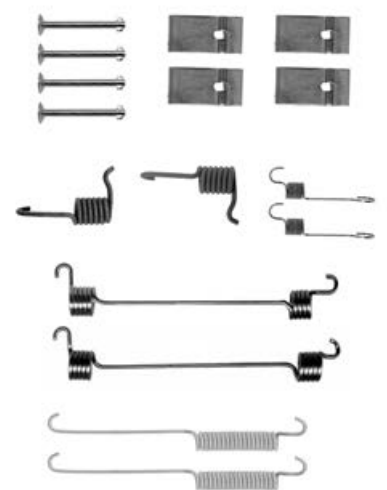

03.0137-9125.2 669125

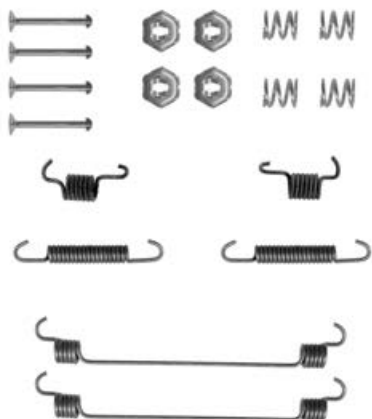

03.0137-9126.2 669126

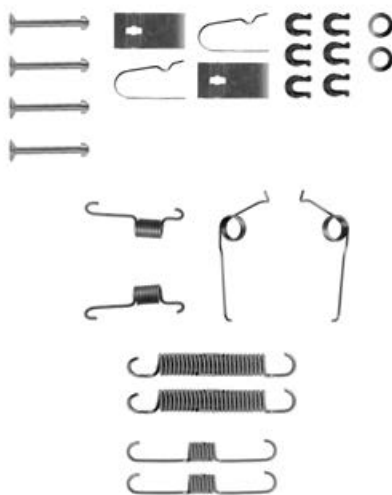

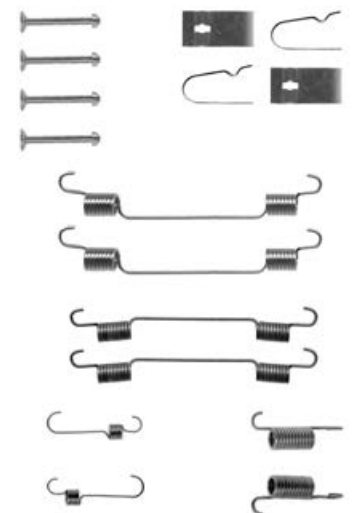

03.0137-9127.2 669127

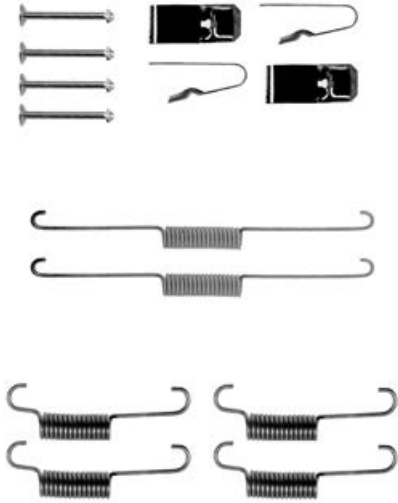
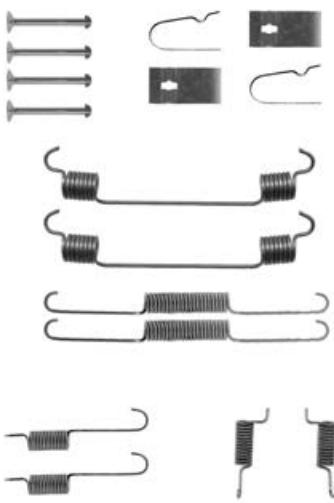
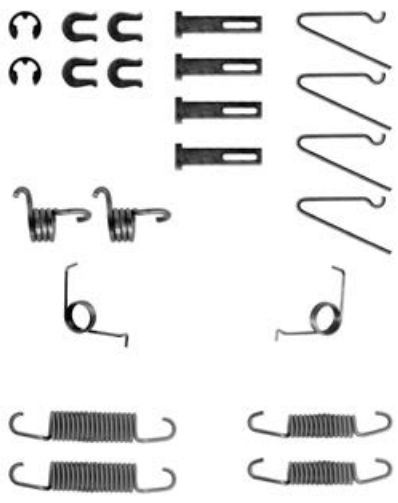

# Abbildungen Bremsbacken-Zubehör

Illustrations brake shoe accessories - Illustrazioni accessori per ganasce freni - Illustrations Accessoires pour mâchoires de frein - Ilustraciones Accesorios para zapatas de freno

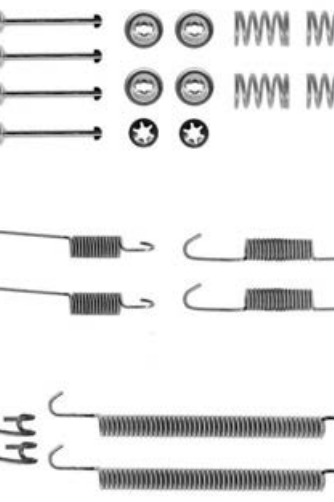
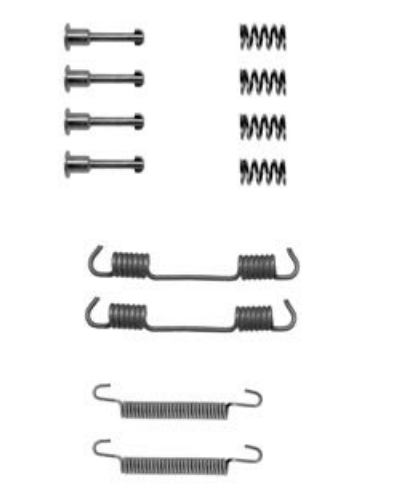
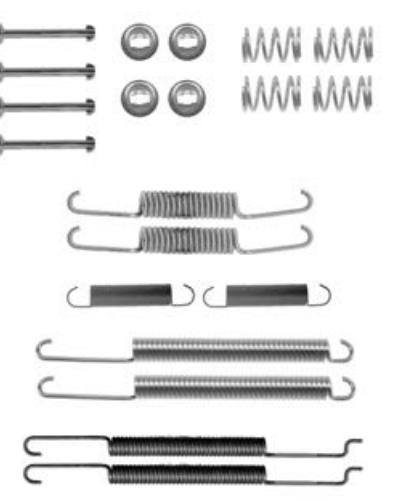
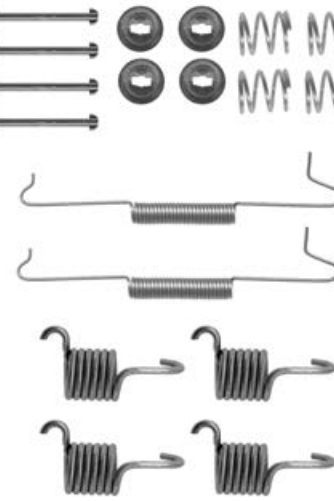
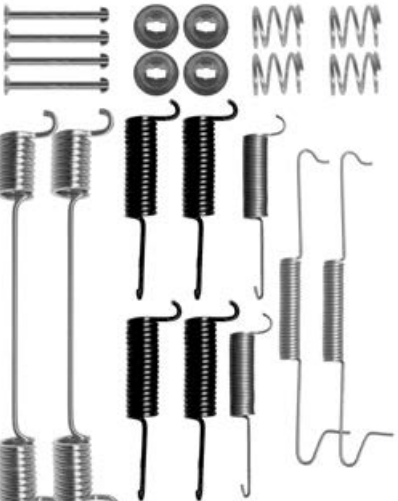
| 03.0137-9128.2 669128   | 03.0137-9131.2 669131   | 03.0137-9133.2 669133   |
|---|---|---|
|    |    |    |
| 03.0137-9145.2 669145   | 03.0137-9147.2 669147   | 03.0137-9148.2 669148   |
|   |   |   |
| 03.0137-9149.2 669149   | 03.0137-9151.2 669151   | 03.0137-9152.2 669152   |
|  |  |  |



# Abbildungen Bremsbacken-Zubehör

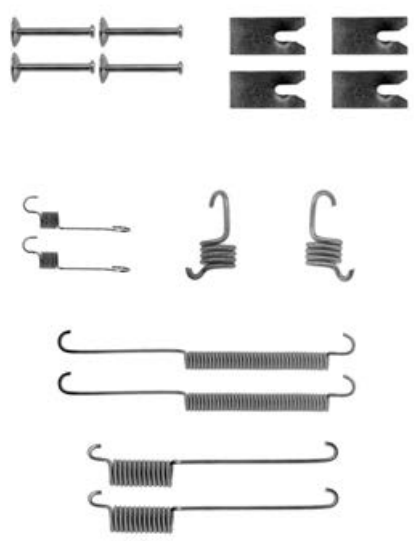
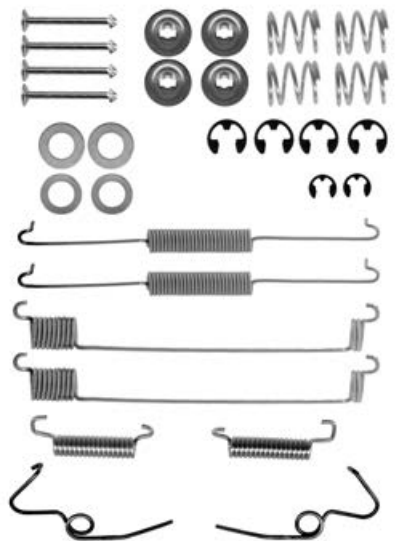
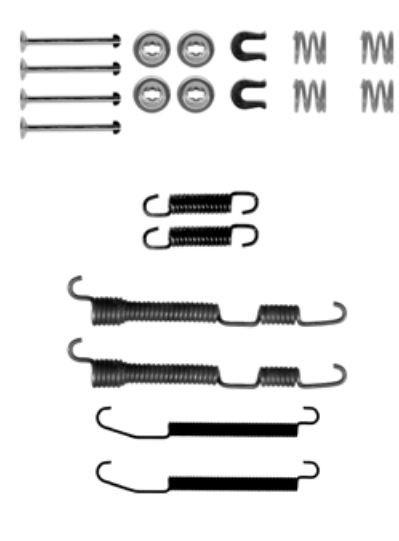
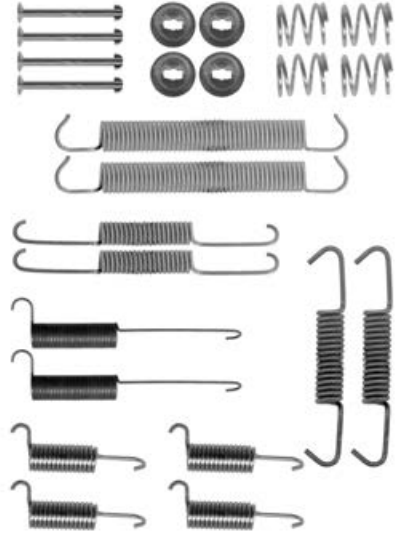
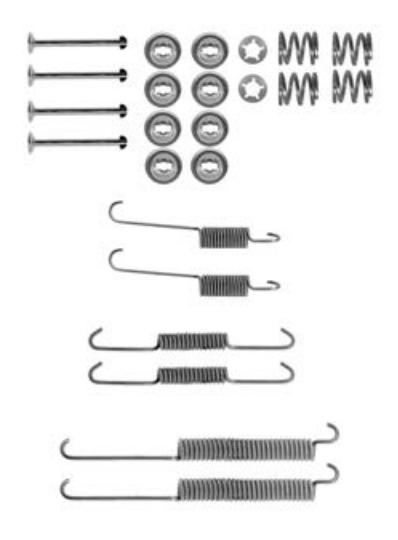
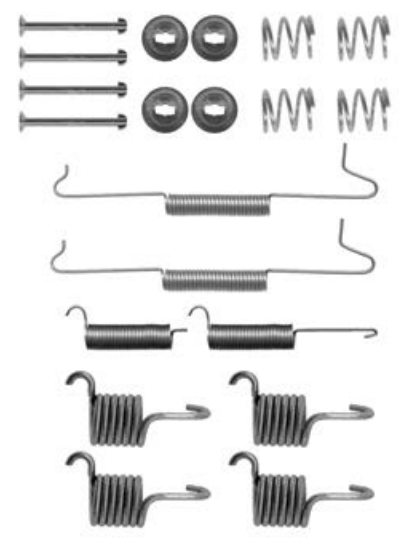
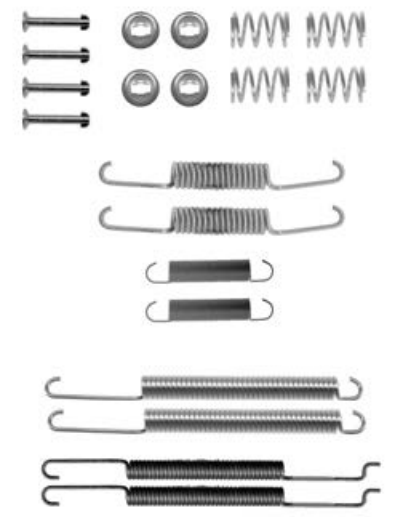
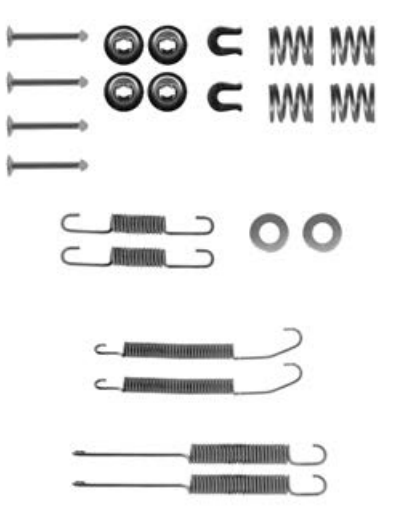
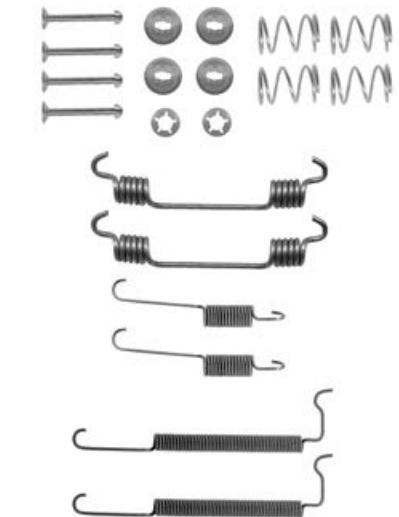

Illustrations brake shoe accessories - Illustrazioni accessori per ganasce freni - Illustrations Accessoires pour mâchoires de frein - Ilustraciones Accesorios para zapatas de freno

| 03.0137-9153.2 669153  | 03.0137-9154.2 669154  | 03.0137-9155.2 669155   |
|--|--|---|
|    |    |    |
| 03.0137-9156.2 669156  | 03.0137-9158.2 669158  | 03.0137-9159.2 669159   |
|   |   |   |
| 03.0137-9164.2 669164  | 03.0137-9165.2 669165  | 03.0137-9166.2 669166   |
|  |  |  |



# Abbildungen Bremsbacken-Zubehör

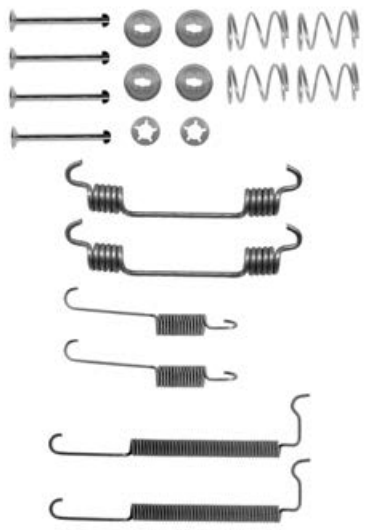
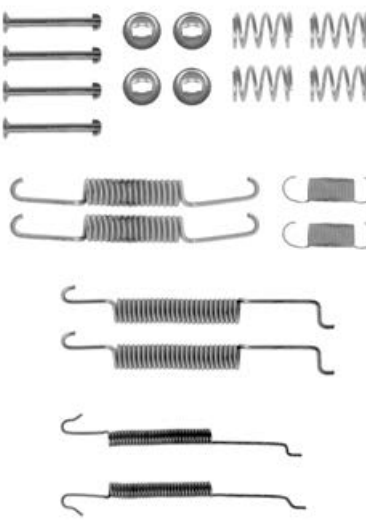
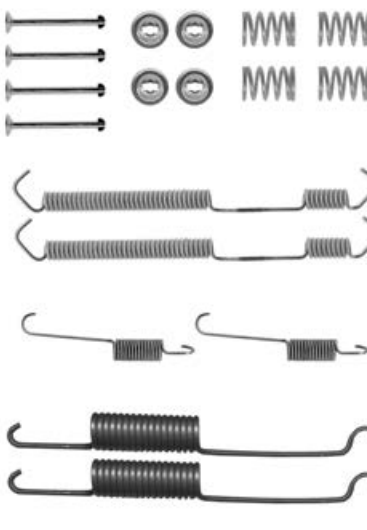
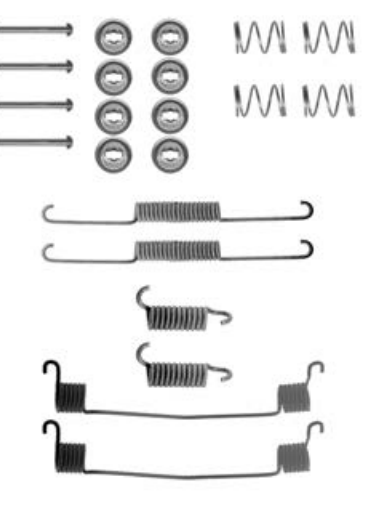
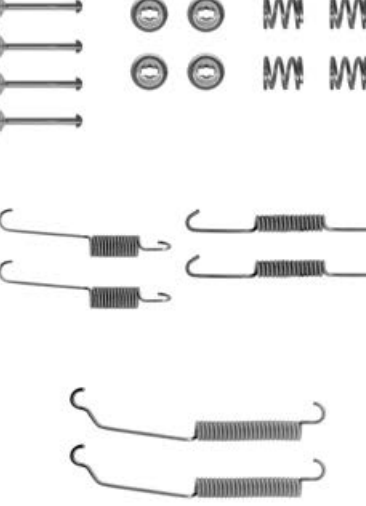

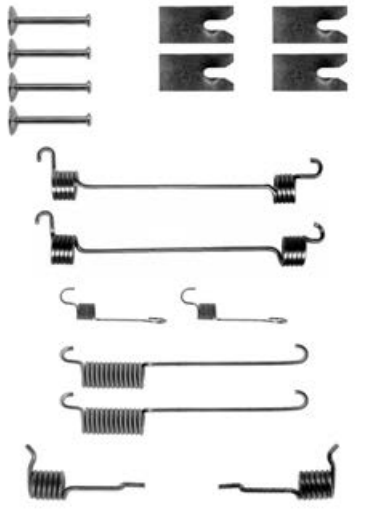
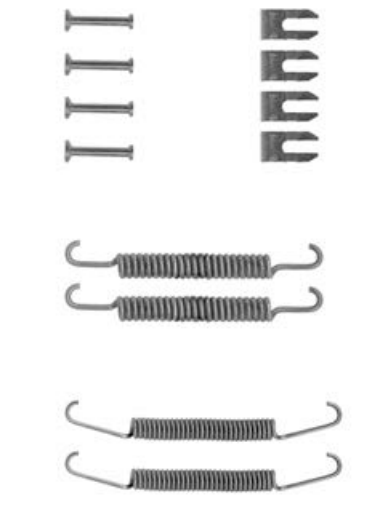
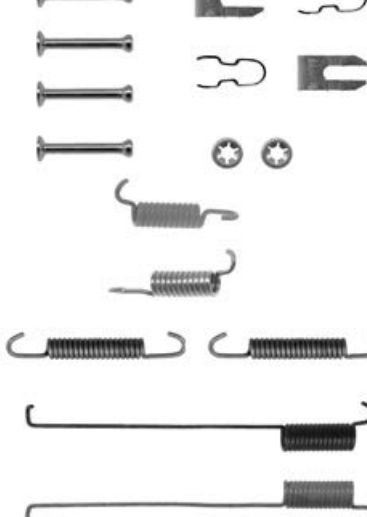
Illustrations brake shoe accessories - Illustrazioni accessori per ganasce freni - Illustrations Accessoires pour mâchoires de frein - Ilustraciones Accesorios para zapatas de freno

| 03.0137-9167.2 669167   | 03.0137-9168.2 669168   | 03.0137-9169.2 669169   |
|---|---|---|
|    |    |    |
| 03.0137-9173.2 669173   | 03.0137-9175.2 669175   | 03.0137-9176.2 669176   |
|   |   |   |
| 03.0137-9177.2 669177   | 03.0137-9178.2 669178   | 03.0137-9179.2 669179   |
|  |  |  |





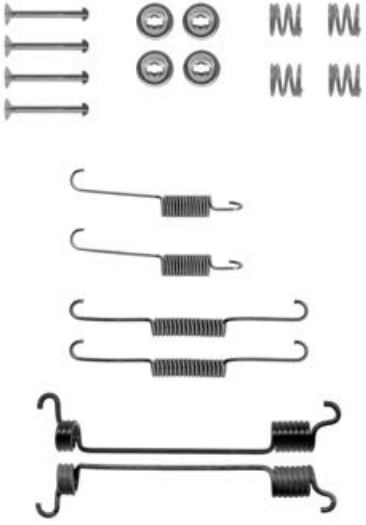
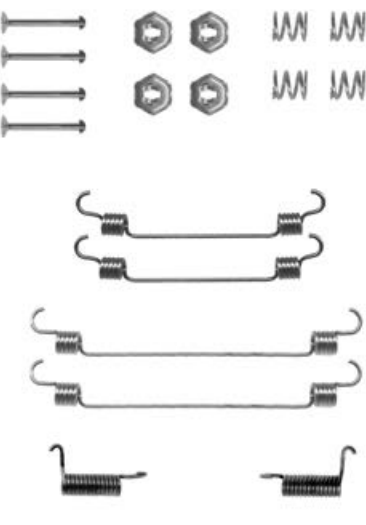
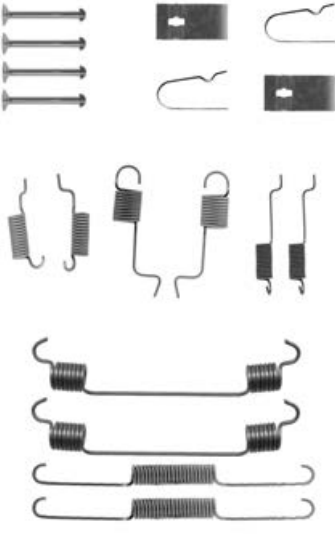
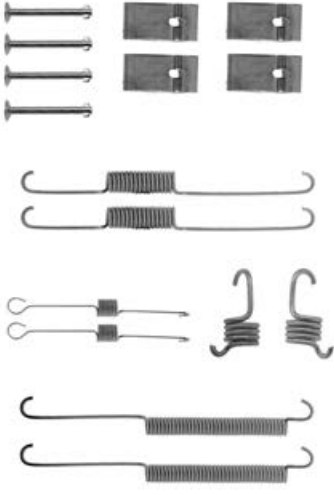
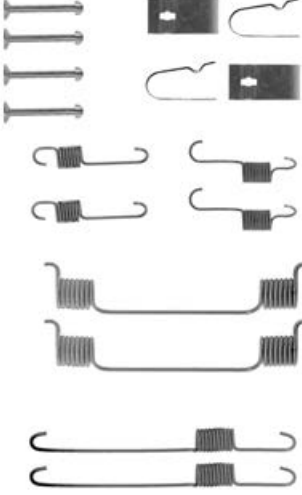

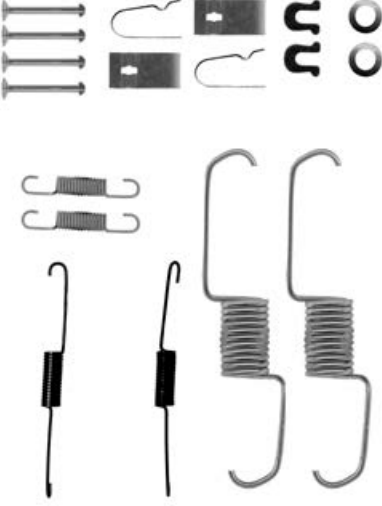
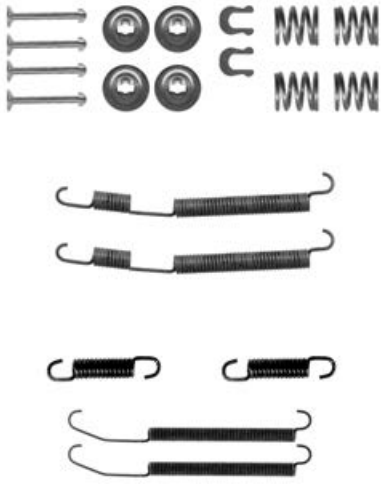
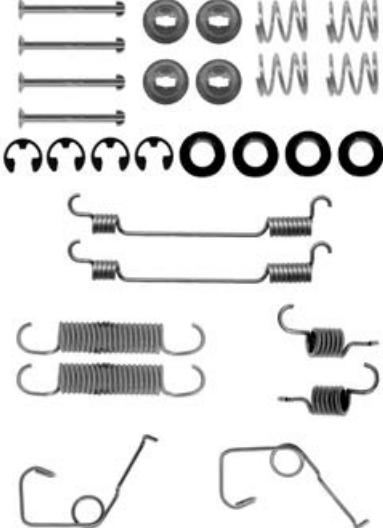

# Abbildungen Bremsbacken-Zubehör

Illustrations brake shoe accessories - Illustrazioni accessori per ganasce freni - Illustrations Accessoires pour mâchoires de frein - Ilustraciones Accesorios para zapatas de freno

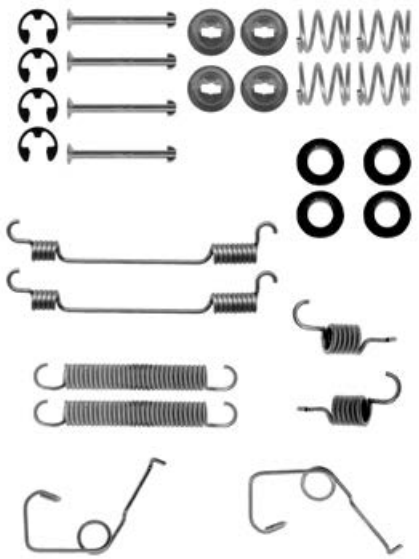
| 03.0137-9180.2 669180   | 03.0137-9181.2 669181   | 03.0137-9182.2 669182   |
|---|---|---|
|    |    |    |
| 03.0137-9184.2 669184   | 03.0137-9186.2 669186   | 03.0137-9188.2 669188   |
|   |   |   |
| 03.0137-9190.2 669190   | 03.0137-9192.2 669192   | 03.0137-9193.2 669193   |
|  |  |  |

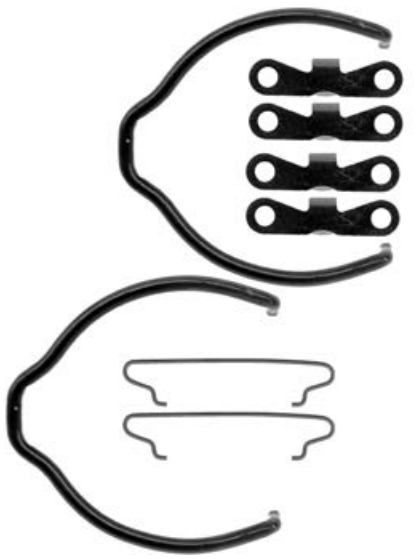
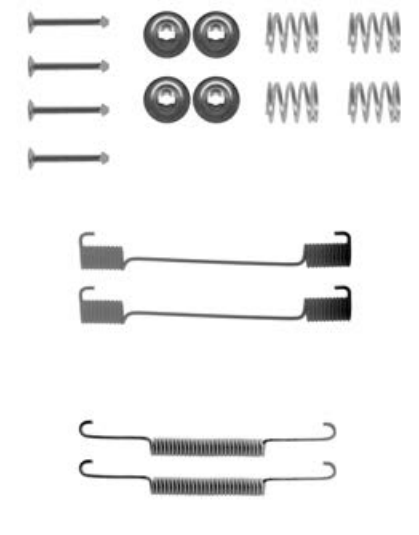
# Abbildungen Bremsbacken-Zubehör

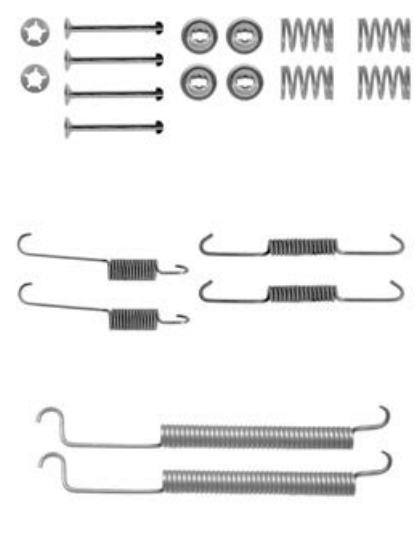
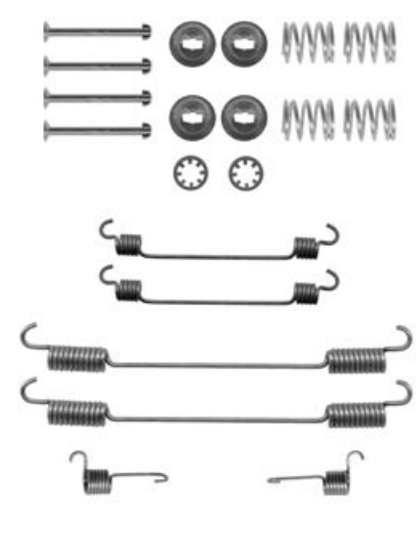
Illustrations brake shoe accessories - Illustrazioni accessori per ganasce freni - Illustrations Accessoires pour mâchoires de frein - Ilustraciones Accesorios para zapatas de freno

| 03.0137-9194.2 669194  | 03.0137-9195.2 669195  | 03.0137-9199.2 669199   |
|--|--|---|
|    |    |    |
| 03.0137-9200.2 669200  | 03.0137-9203.2 669203  | 03.0137-9205.2 669205   |
|   |   |   |
| 03.0137-9206.2 669206  | 03.0137-9208.2 669208  | 03.0137-9211.2 669211   |
|  |  |  |



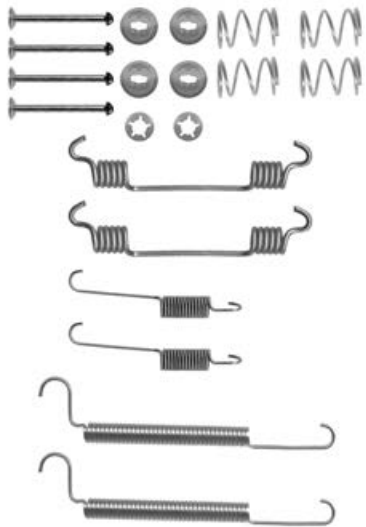
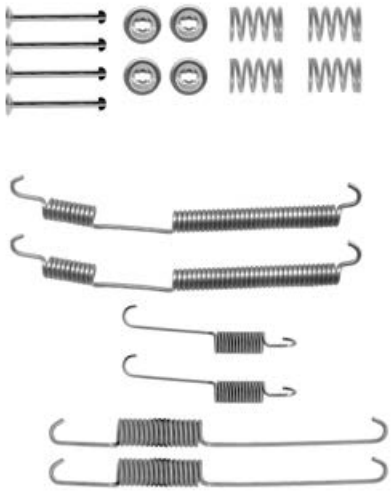
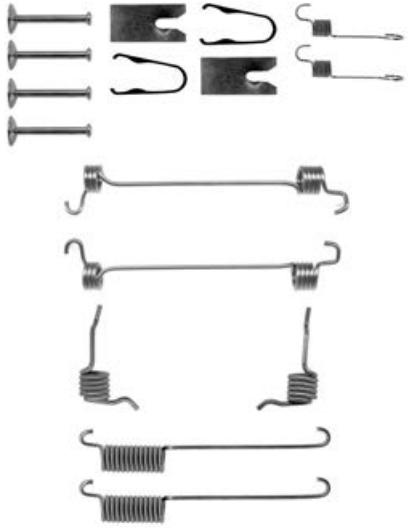
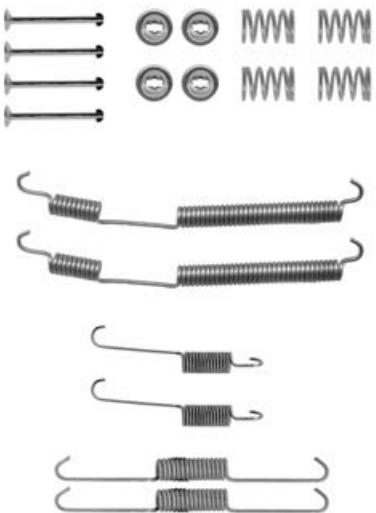
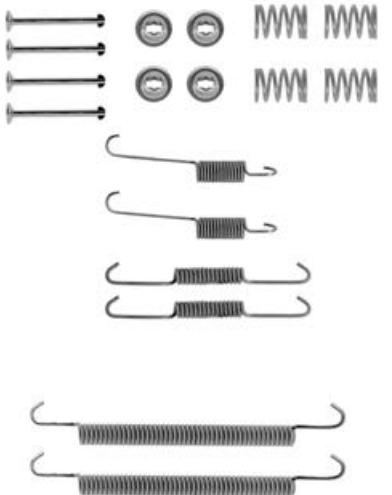
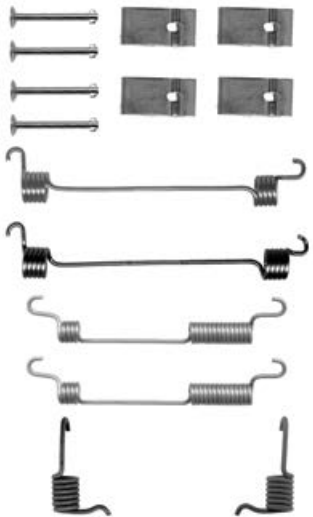
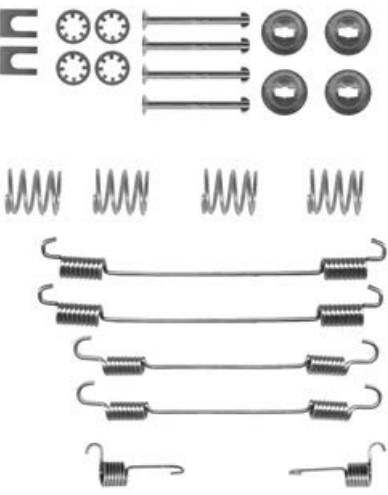
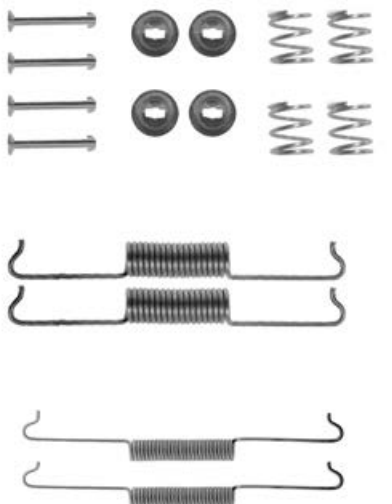
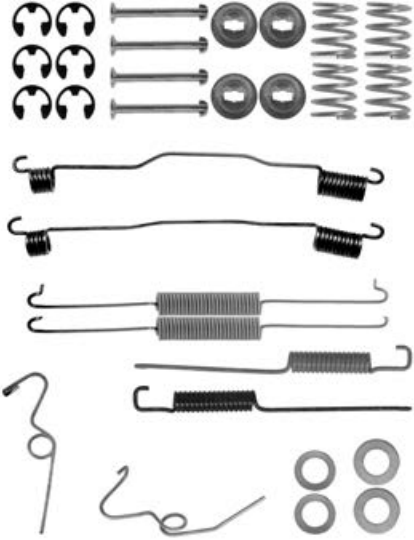

# Abbildungen Bremsbacken-Zubehör

Illustrations brake shoe accessories - Illustrazioni accessori per ganasce freni - Illustrations Accessoires pour mâchoires de frein - Ilustraciones Accesorios para zapatas de freno

| 03.0137-9215.2 669215   | 03.0137-9216.2 669216  | 03.0137-9217.2 669217   |
|---|--|---|
|    |    |    |
| 03.0137-9219.2 669219   | 03.0137-9220.2 669220  | 03.0137-9221.2 669221   |
|   |   |   |
| 03.0137-9228.2 669228   | 03.0137-9229.2 669229  | 03.0137-9230.2 669230   |
|  |  |  |

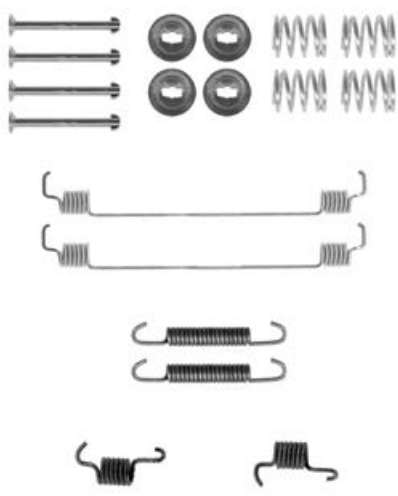
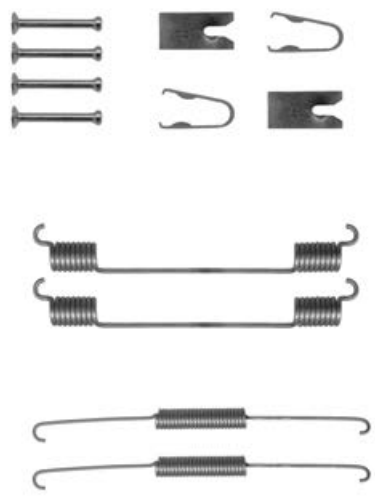
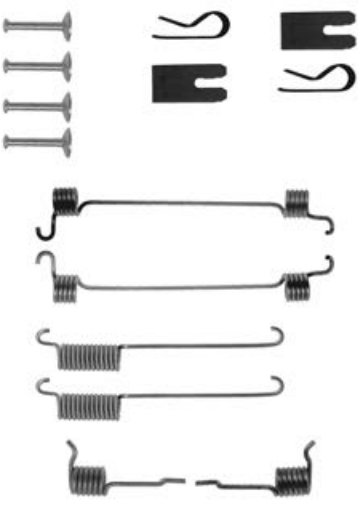
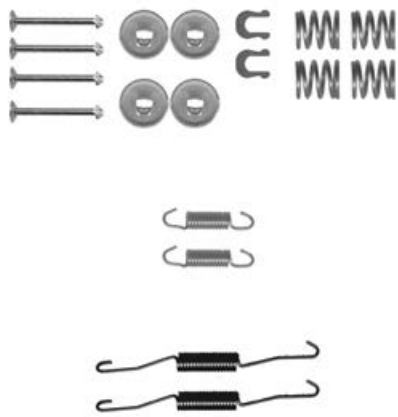
# Abbildungen Bremsbacken-Zubehör

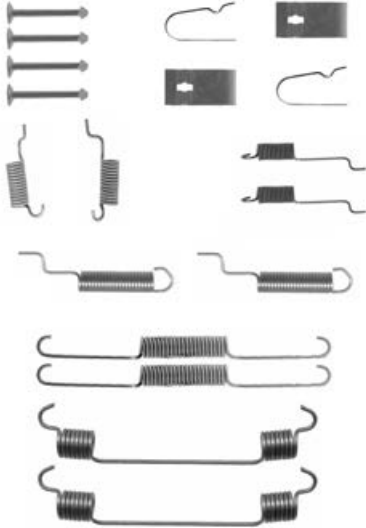
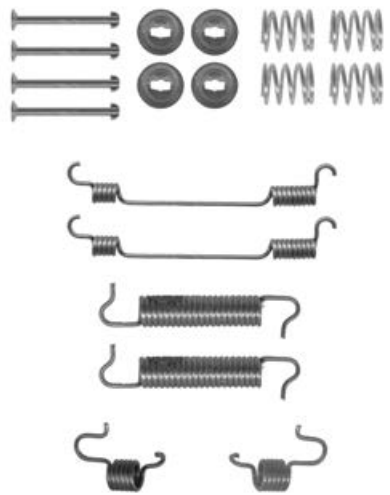



Illustrations brake shoe accessories - Illustrazioni accessori per ganasce freni - Illustrations Accessoires pour mâchoires de frein - Ilustraciones Accesorios para zapatas de freno

| 03.0137-9232.2 669232   | 03.0137-9233.2 669233   | 03.0137-9234.2 669234   |
|---|---|---|
|    |   |    |
| 03.0137-9235.2 669235   | 03.0137-9236.2 669236   | 03.0137-9237.2 669237   |
|   |   |   |
| 03.0137-9239.2 669239   | 03.0137-9240.2 669240   | 03.0137-9241.2 669241   |
|  |  |  |



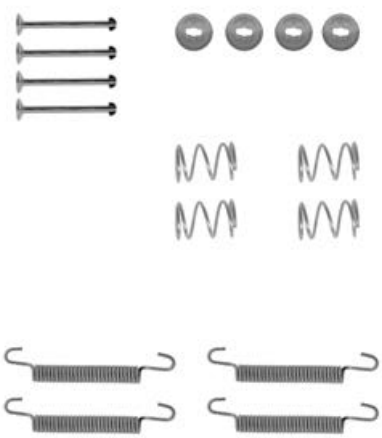
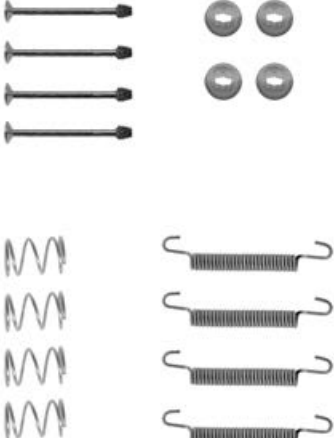

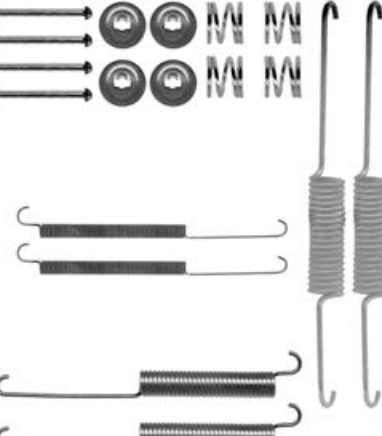
# Abbildungen Bremsbacken-Zubehör

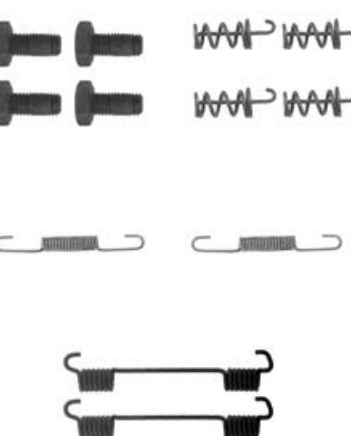
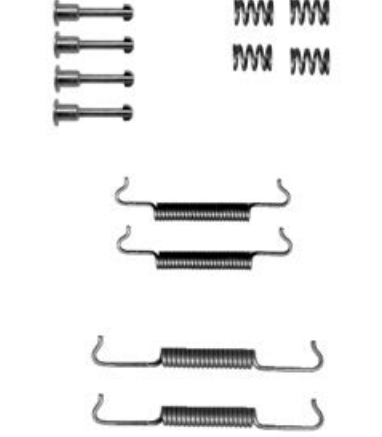
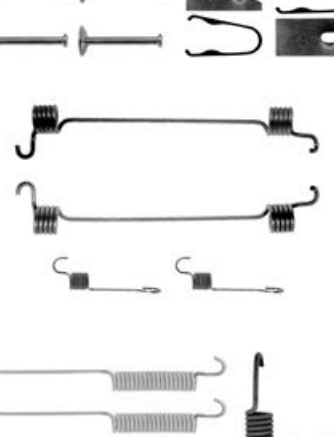
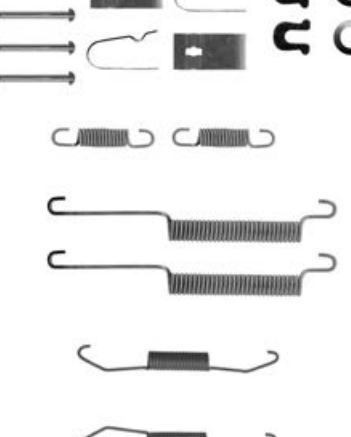
Illustrations brake shoe accessories - Illustrazioni accessori per ganasce freni - Illustrations Accessoires pour mâchoires de frein - Ilustraciones Accesorios para zapatas de freno

| 03.0137-9242.2 669242   | 03.0137-9243.2 669243   | 03.0137-9244.2 669244   |
|---|---|---|
|    |    |    |
| 03.0137-9245.2 669245   | 03.0137-9247.2 669247   | 03.0137-9248.2 669248   |
|   |   |   |
| 03.0137-9249.2 669249   | 03.0137-9251.2 669251   | 03.0137-9252.2 669252   |
|  |  |  |

# Abbildungen Bremsbacken-Zubehör

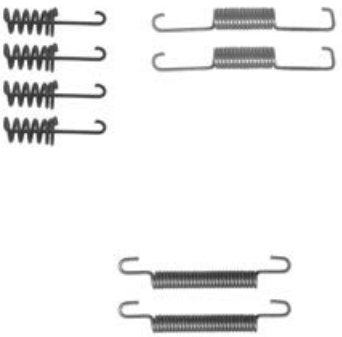
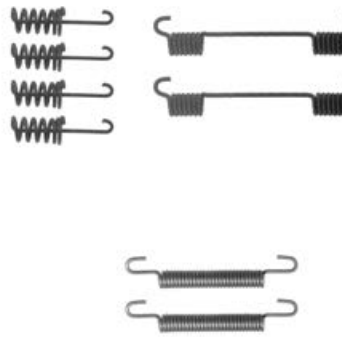
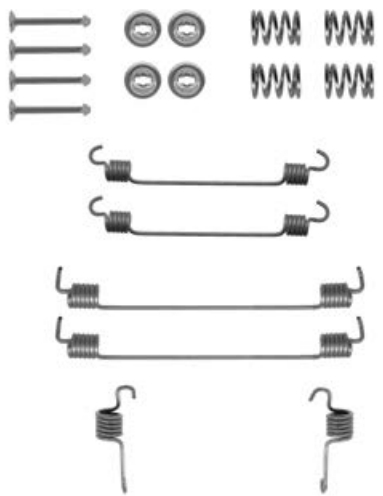
Illustrations brake shoe accessories - Illustrazioni accessori per ganasce freni - Illustrations Accessoires pour mâchoires de frein - Ilustraciones Accesorios para zapatas de freno

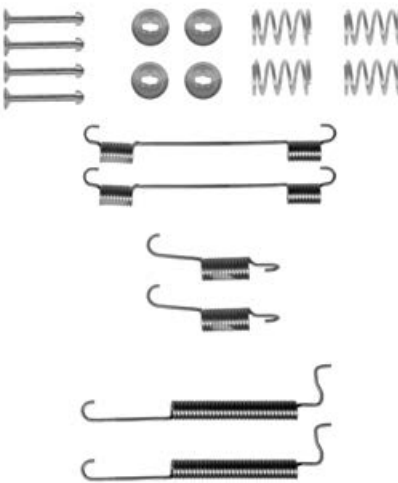
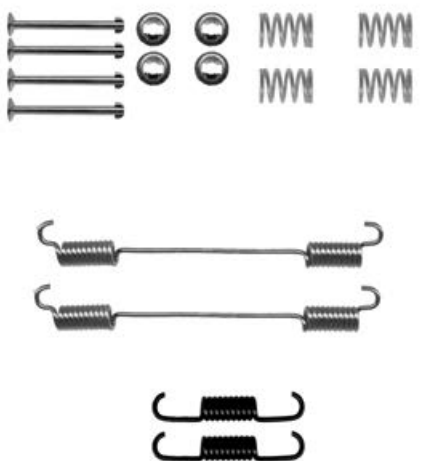
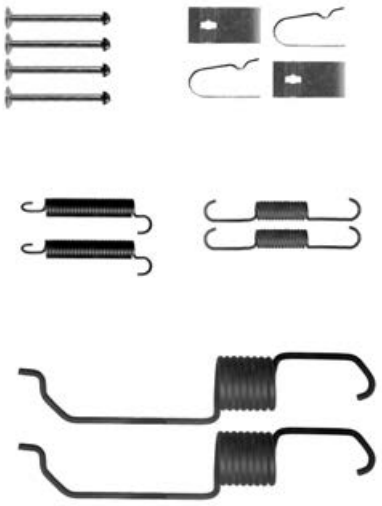
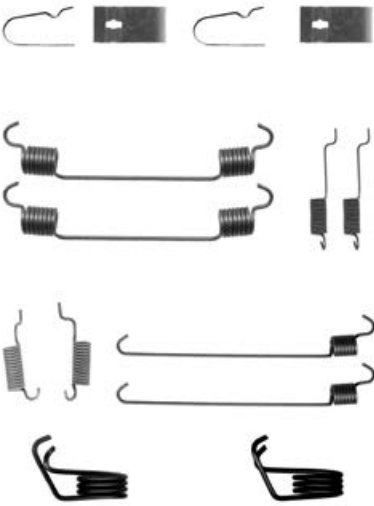
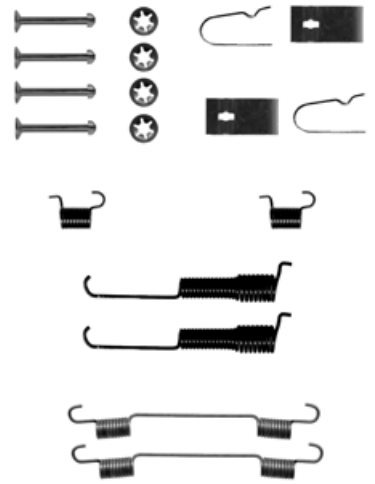
| 03.0137-9255.2 669255   | 03.0137-9256.2 669256   | 03.0137-9257.2 669257   |
|---|---|---|
|    |    |    |
| 03.0137-9259.2 669259   | 03.0137-9260.2 669260   | 03.0137-9261.2 669261   |
|   |   |   |
| 03.0137-9262.2 669262   | 03.0137-9263.2 669263   | 03.0137-9264.2 669264   |
|  |  |  |



# Abbildungen Bremsbacken-Zubehör

Illustrations brake shoe accessories - Illustrazioni accessori per ganasce freni - Illustrations Accessoires pour mâchoires de frein - Ilustraciones Accesorios para zapatas de freno

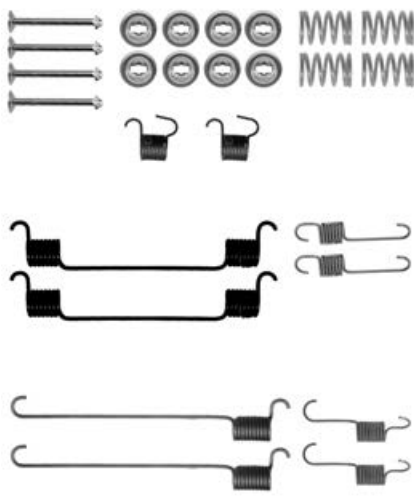
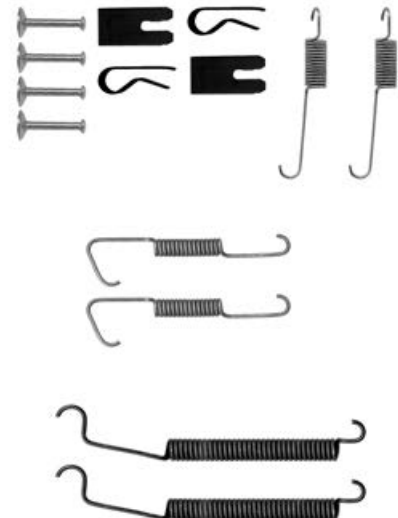
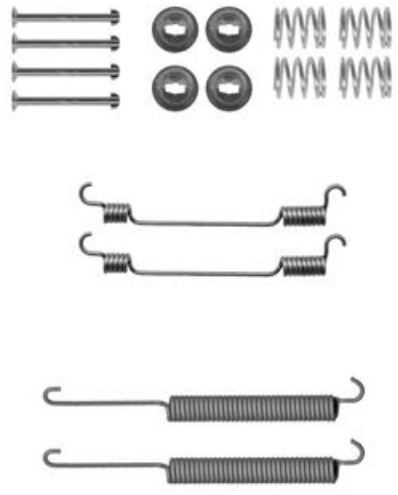
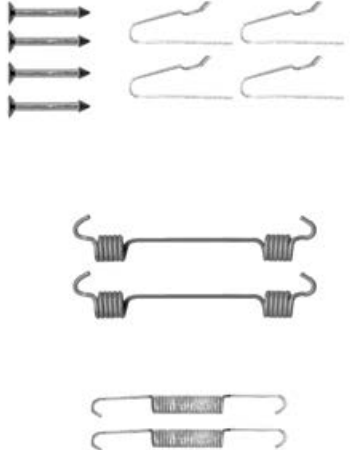
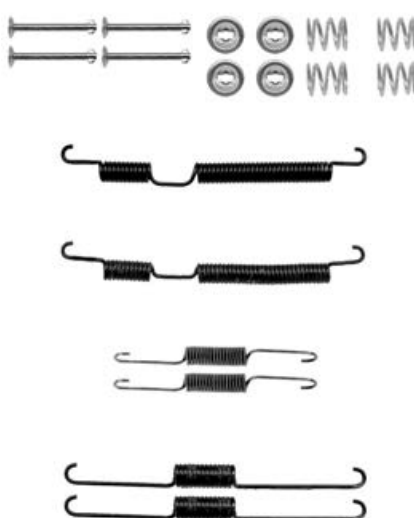
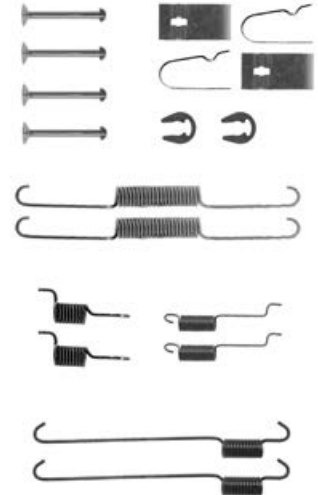
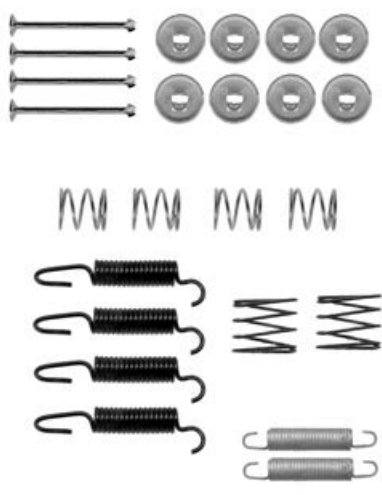
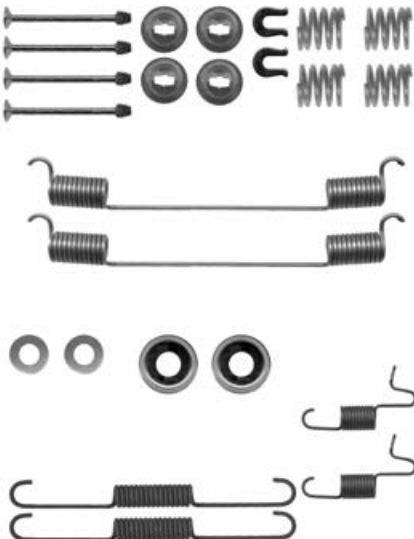
| 03.0137-9265.2 669265   | 03.0137-9266.2 669266   | 03.0137-9267.2 669267   |
|---|---|---|
|    |   |    |
| 03.0137-9268.2 669268   | 03.0137-9269.2 669269   | 03.0137-9270.2 669270   |
|    |   |   |
| 03.0137-9271.2 669271   | 03.0137-9272.2 669272   | 03.0137-9273.2 669273   |
|  |  |  |



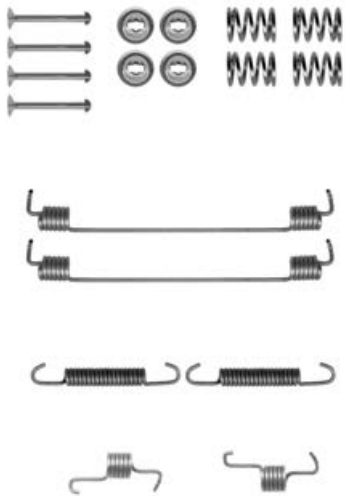
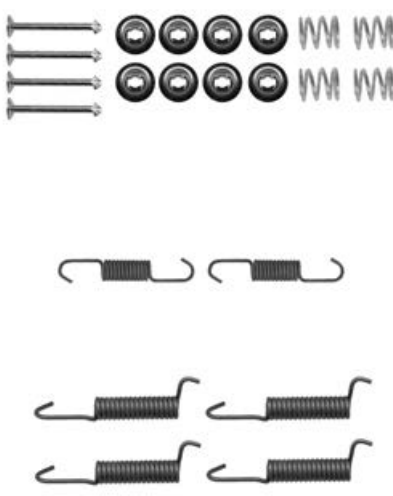
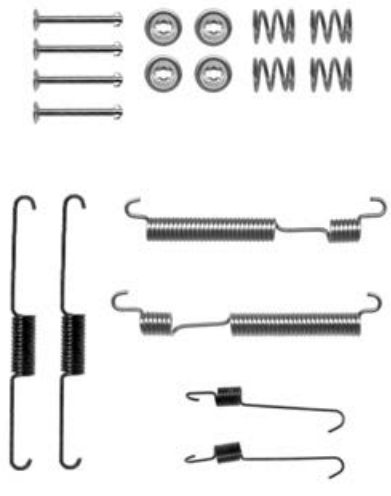
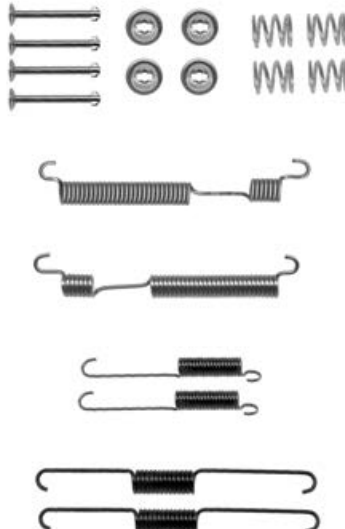
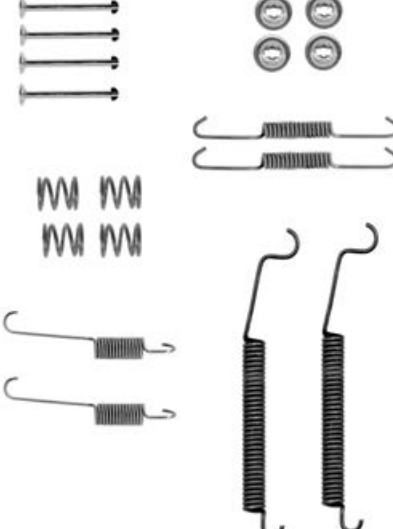
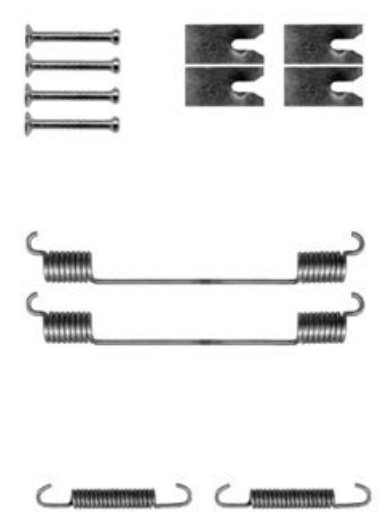
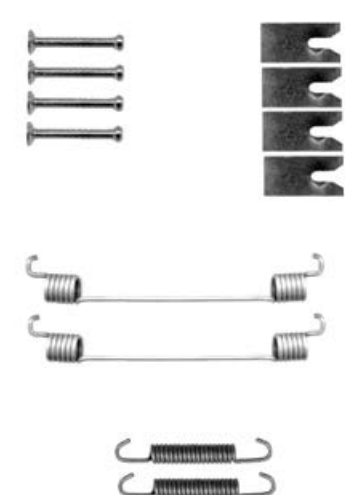
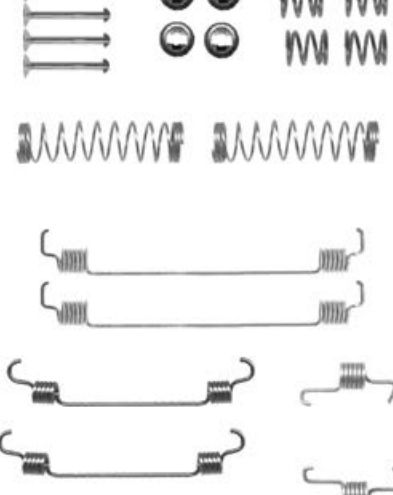
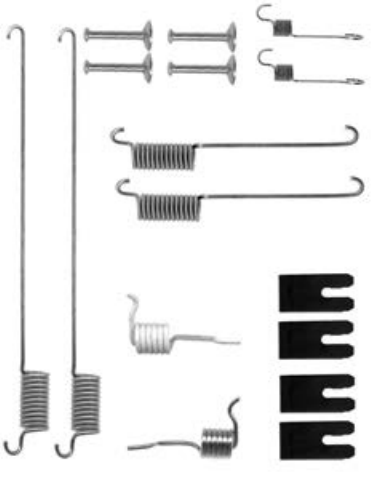

# Abbildungen Bremsbacken-Zubehör

Illustrations brake shoe accessories - Illustrazioni accessori per ganasce freni - Illustrations Accessoires pour mâchoires de frein - Ilustraciones Accesorios para zapatas de freno

| 03.0137-9274.2 669274   | 03.0137-9275.2 669275   | 03.0137-9276.2 669276   |
|---|---|---|
|    |    |    |
| 03.0137-9277.2 669277   | 03.0137-9278.2 669278   | 03.0137-9279.2 669279   |
|   |   |   |
| 03.0137-9280.2 669280   | 03.0137-9281.2 669281   | 03.0137-9282.2 669282   |
|  |  |  |

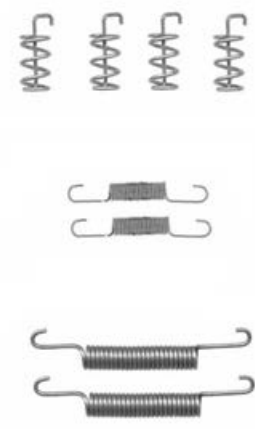
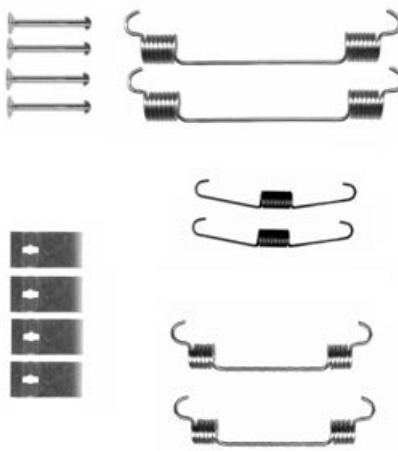
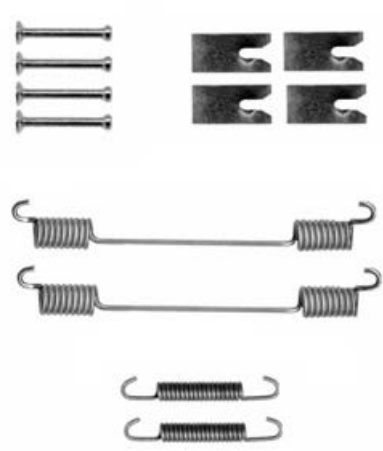
# Abbildungen Bremsbacken-Zubehör

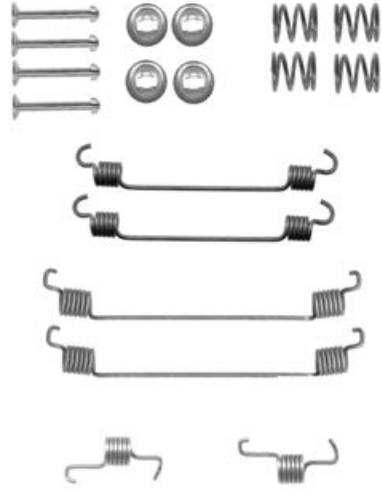
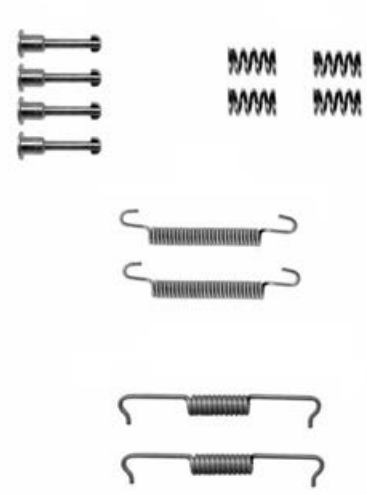
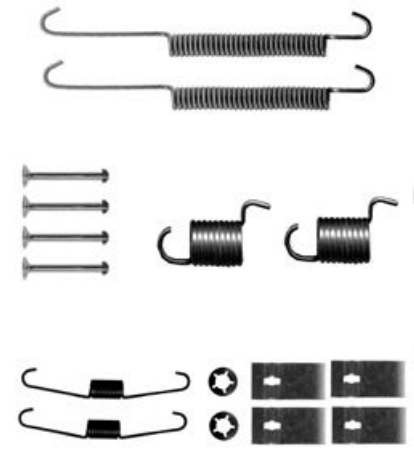
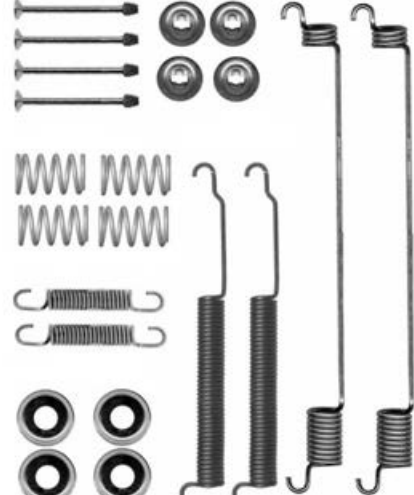

Illustrations brake shoe accessories - Illustrazioni accessori per ganasce freni - Illustrations Accessoires pour mâchoires de frein - Ilustraciones Accesorios para zapatas de freno

| 03.0137-9283.2 669283  | 03.0137-9284.2 669284  | 03.0137-9285.2 669285   |
|--|--|---|
|   |    |    |
| 03.0137-9286.2 669286  | 03.0137-9287.2 669287  | 03.0137-9288.2 669288   |
|  |    |   |
| 03.0137-9289.2 669289  | 03.0137-9290.2 669290  | 03.0137-9291.2 669291   |
|  |  |  |

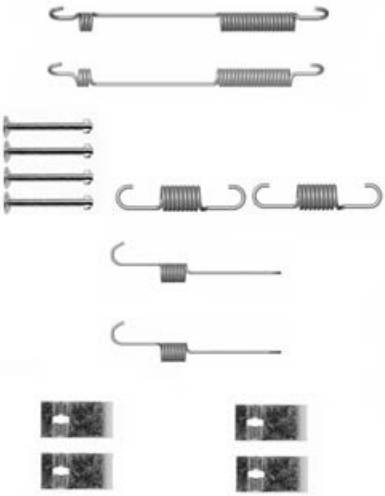
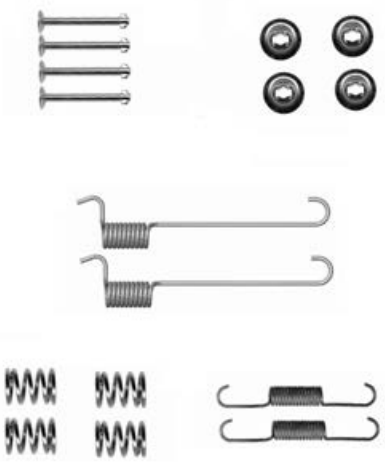
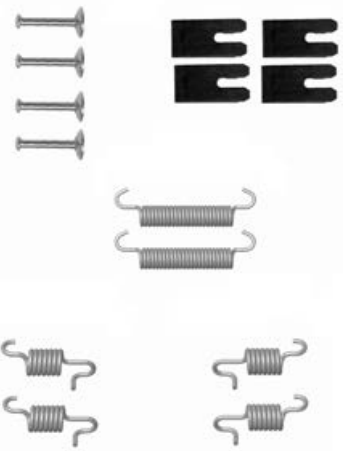
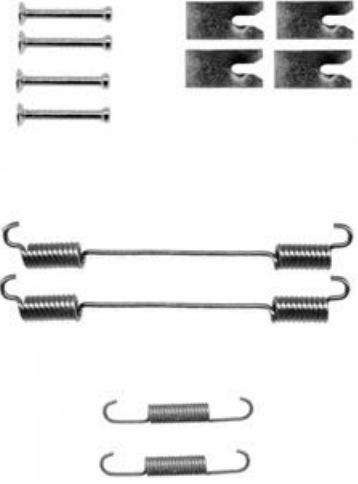
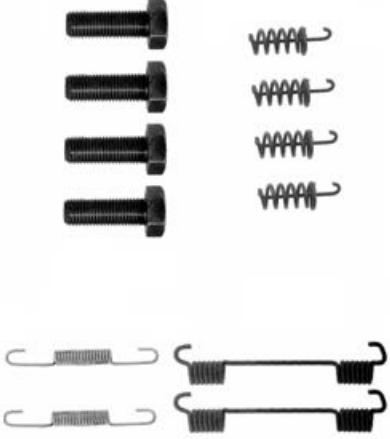
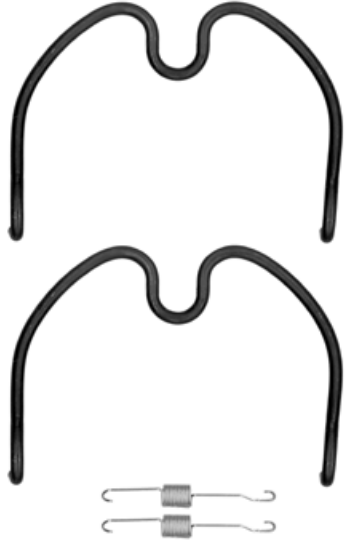
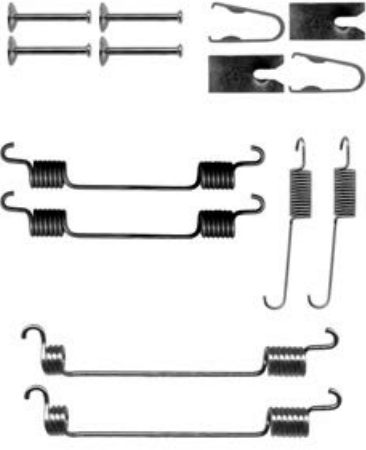
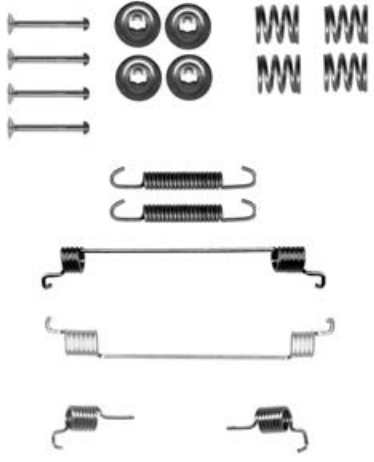

# Abbildungen Bremsbacken-Zubehör

Illustrations brake shoe accessories - Illustrazioni accessori per ganasce freni - Illustrations Accessoires pour mâchoires de frein - Ilustraciones Accesorios para zapatas de freno

| 03.0137-9292.2 669292   | 03.0137-9293.2 669293   | 03.0137-9294.2 669294   |
|---|---|---|
|    |    |    |
| 03.0137-9296.2 669296   | 03.0137-9297.2 669297   | 03.0137-9300.2 669300   |
|   |   |   |
| 03.0137-9301.2 669301   | 03.0137-9303.2 669303   | 03.0137-9304.2 669304   |
|  |  |  |

# Abbildungen Bremsbacken-Zubehör

Illustrations brake shoe accessories - Illustrazioni accessori per ganasce freni - Illustrations Accessoires pour mâchoires de frein - Ilustraciones Accesorios para zapatas de freno

**03.0137-9307.2 669307**

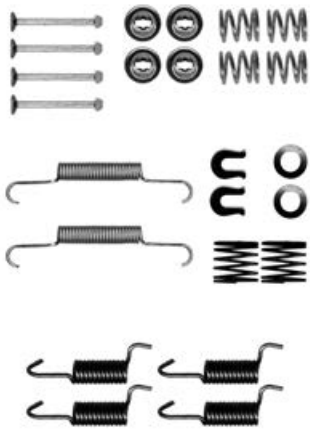

**03.0137-9308.2 669308**

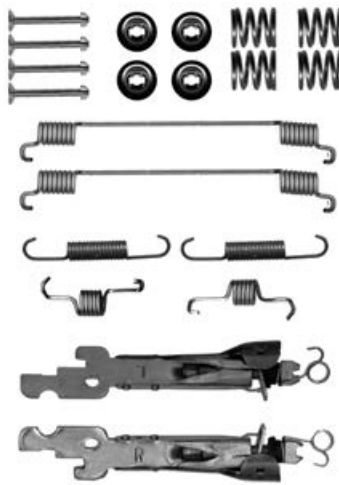

**03.0137-9309.2 669309**



**03.0137-9310.2 669310**



**03.0137-9312.2 669312**

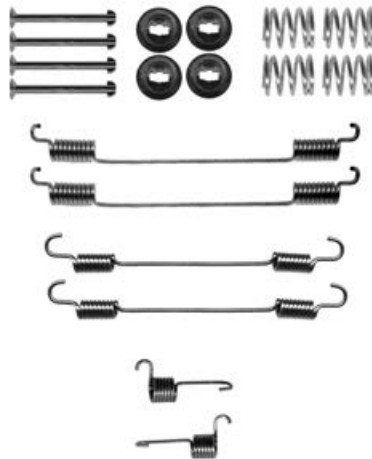

**03.0137-9313.2 669313**

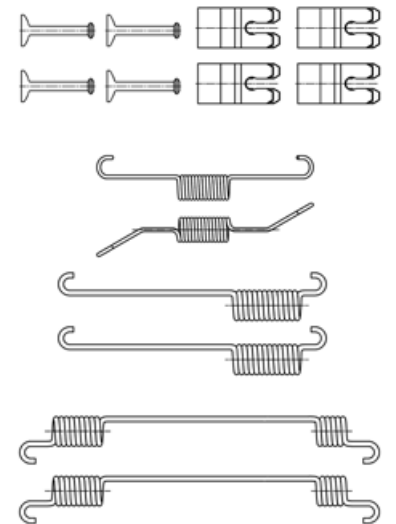

**03.0137-9314.2 669314**

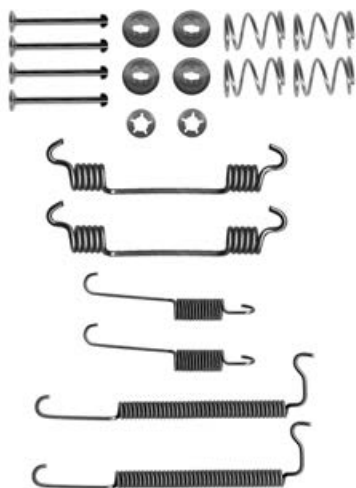

**03.0137-9317.2 669317**

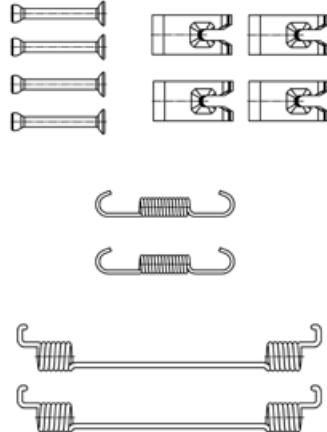

**03.0137-9319.2 669319**

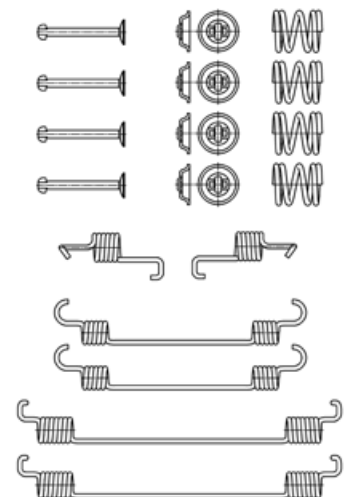



# Abbildungen Bremsbacken-Zubehör

Illustrations brake shoe accessories - Illustrazioni accessori per ganasce freni - Illustrations Accessoires pour mâchoires de frein - Ilustraciones Accesorios para zapatas de freno

03.0137-9700.2 669700

03.0137-9701.2 669701

03.0137-9702.2 669702

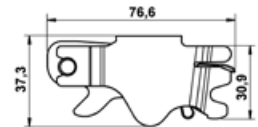
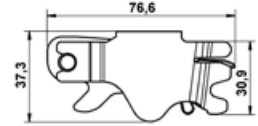
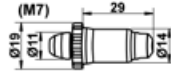
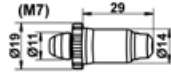
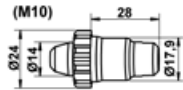
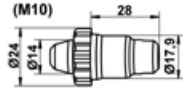







- D** Abbildungen Bremstrommeln
- EN** Illustrations brake drums
- FR** Illustrations Tambours de frein
- IT** Illustrazioni tamburi freno
- ES** Ilustraciones tambores
- NL** Afbeeldingen remtrommels
- DA** Tegning bremsetromler
- SV** Avbildningar bromstrummor
- HU** Ábrák - fékdobok
- PT** Figuras Tambores do travão
- RU** Рисунки тормозных барабанов
- CZ** Zobrazení brzdových bubnů
- PL** Rysunki bębnow hamulcowych
- EL** Εικόνες τυμπάνων πέδησης
- TR** Fren kampanasi resimleri
- ZH** 制动鼓图片
- JA** 図版 ブレーキドラム
- AR** صورطبلات المكبح

# K24-F

# Abbildungen Bremstrommeln

Illustrations brake drums - Illustrazioni tamburi freno - Illustrations Tambours de frein - Ilustraciones tambores de freno

**24.0216-5001.1 480001** Ø 165/166 x 38,5

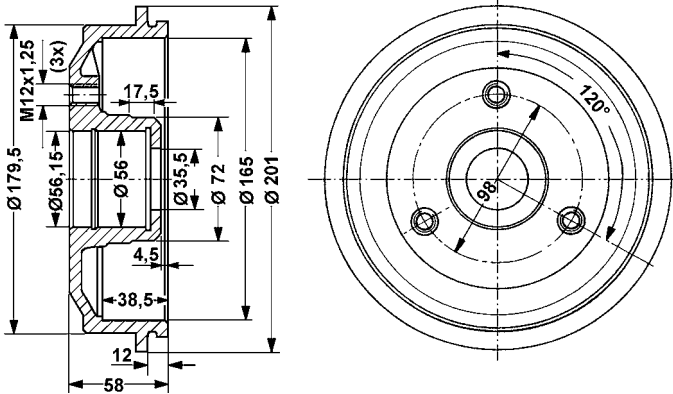

**24.0216-5004.2 480183** Ø 165/166 x 33,5

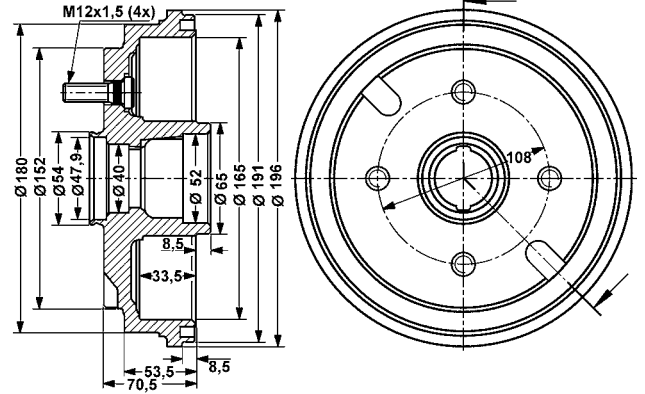

**24.0216-5701.2 480212** Ø 165/166 x 38,5

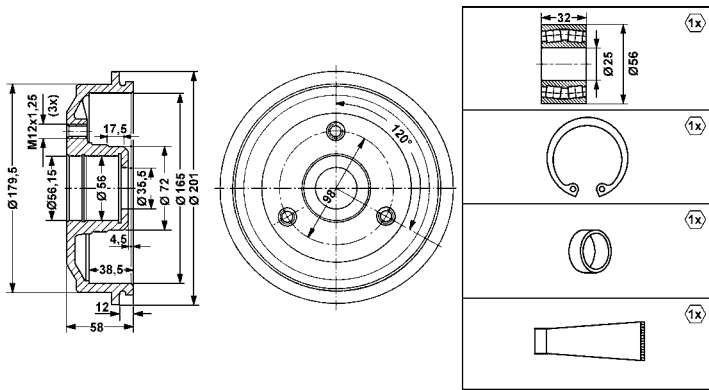

**24.0217-0001.1 480198** Ø 170/171,5 x 34,5

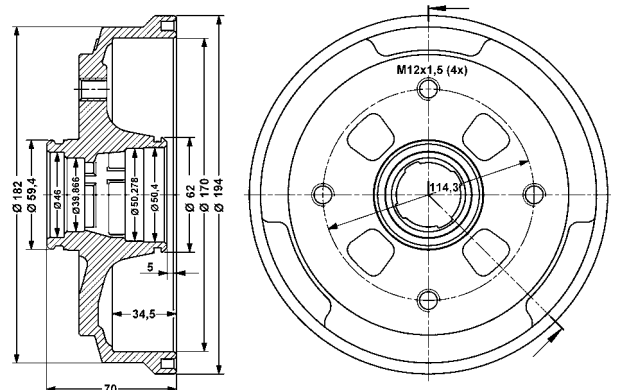

**24.0217-8001.1 480002** Ø 178/179 x 37

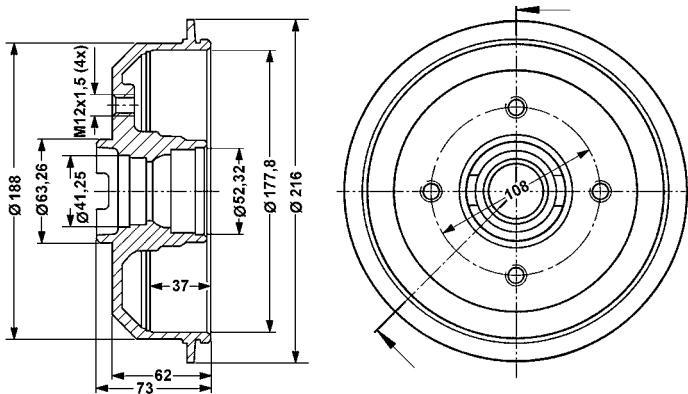

**24.0218-0007.1 480003** Ø 180/181 x 38,5

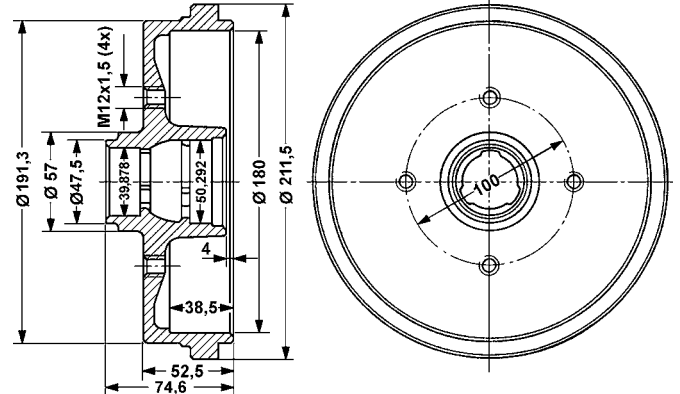

**24.0218-0008.1 480313** Ø 180/182 x 45,1

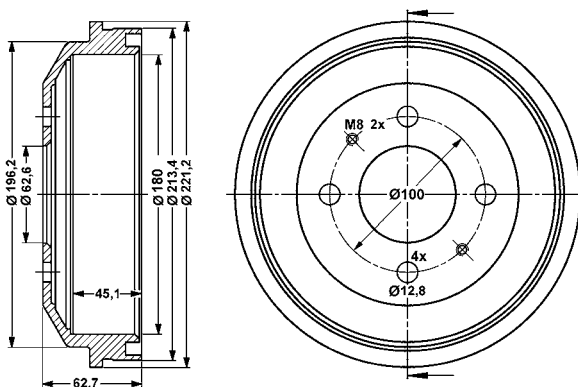

**24.0218-0010.2 480005** Ø 180/181,3 x 41,5

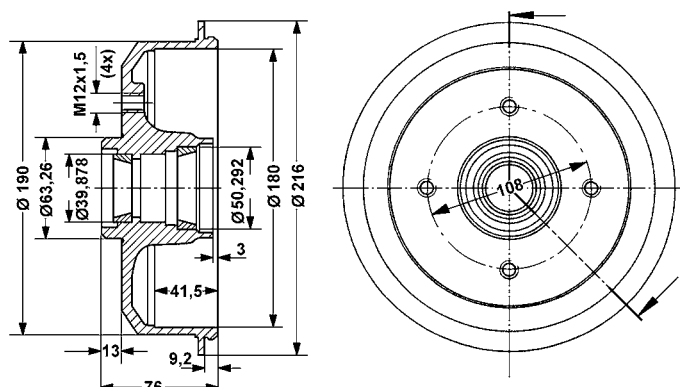

# Abbildungen Bremstrommeln

Illustrations brake drums - Illustrazioni tamburi freno - Illustrations Tambours de frein - Ilustraciones tambores de freno

**24.0218-0011.1 480006** Ø 180/181,4 x 40

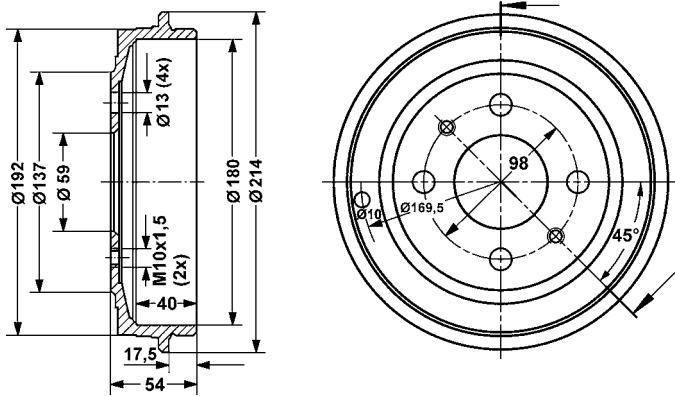

**24.0218-0013.1 480008** Ø 180/181,3 x 53

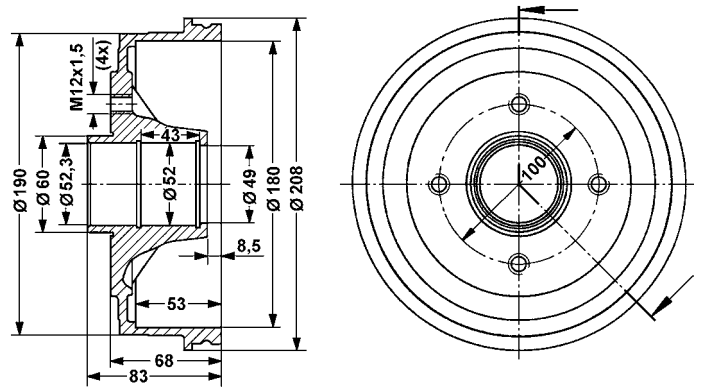

**24.0218-0014.1 480009** Ø 180/181 x 43

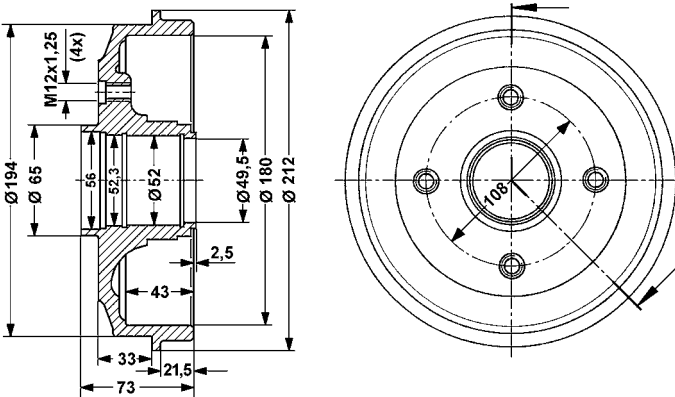

**24.0218-0015.1 480010** Ø 180/181 x 53,5

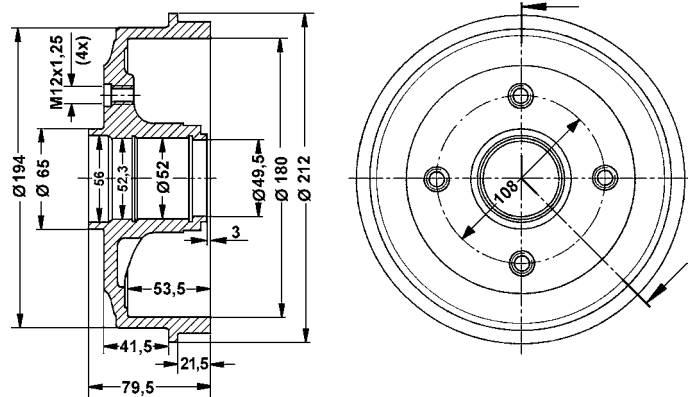

**24.0218-0016.1 480011** Ø 180/181 x 44,5

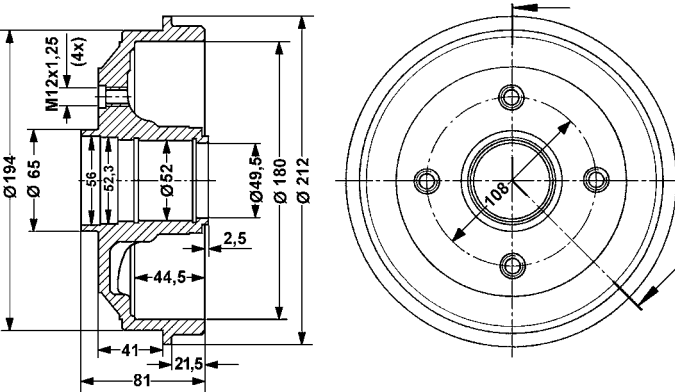

**24.0218-0017.1 480060** Ø 180/181 x 40,5

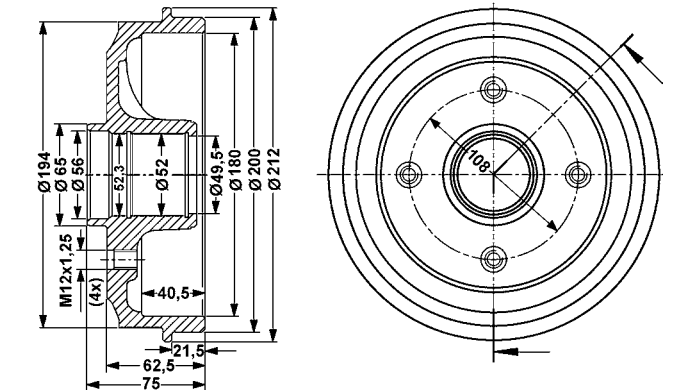

**24.0218-0018.1 480063** Ø 180/181 x 38

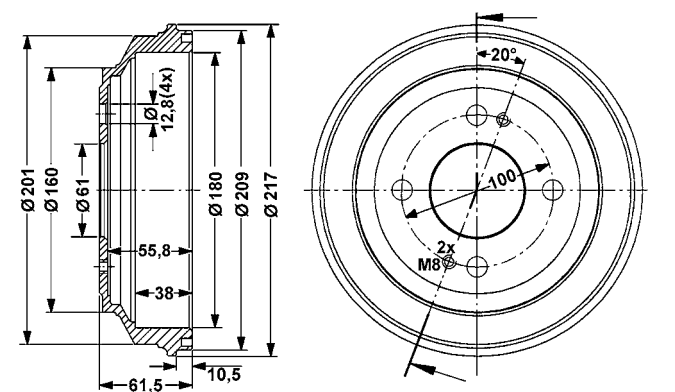

**24.0218-0020.1 480074** Ø 180/181 x 46

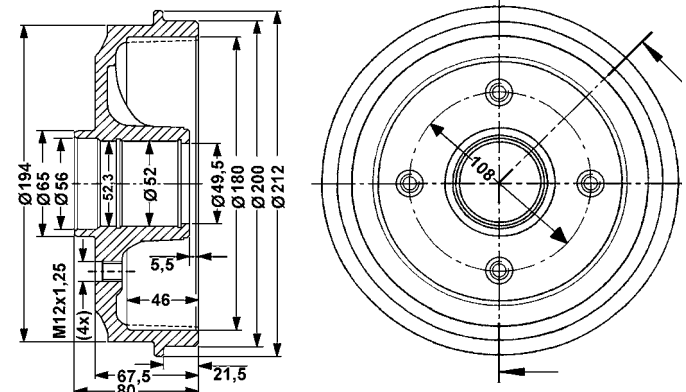

# Abbildungen Bremstrommeln

Illustrations brake drums - Illustrazioni tamburi freno - Illustrations Tambours de frein - Ilustraciones tambores de freno

**24.0218-0021.1 480067** Ø 180/181 x 31,5

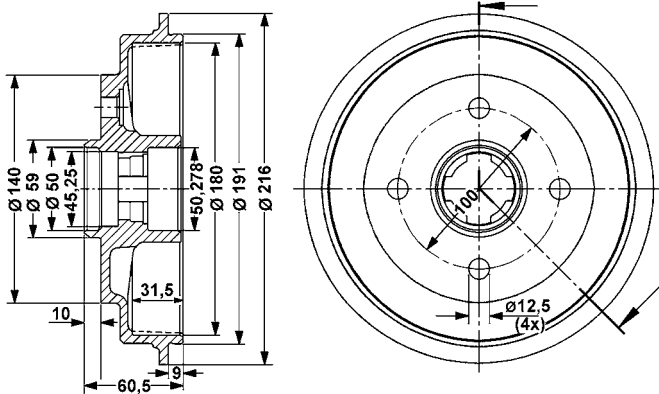

**24.0218-0022.1 480076** Ø 180/181 x 32,5

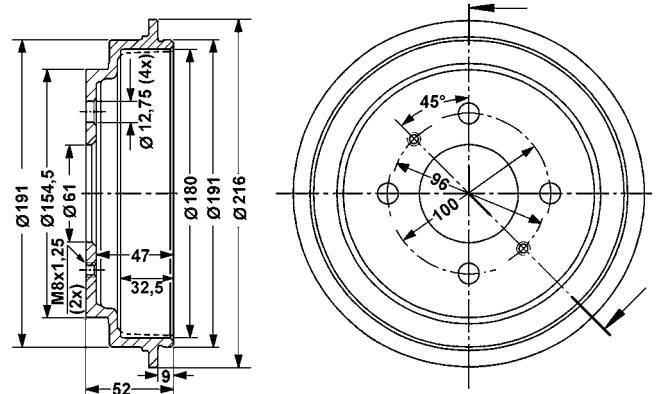

**24.0218-0023.1 480077** Ø 180/181,2 x 48

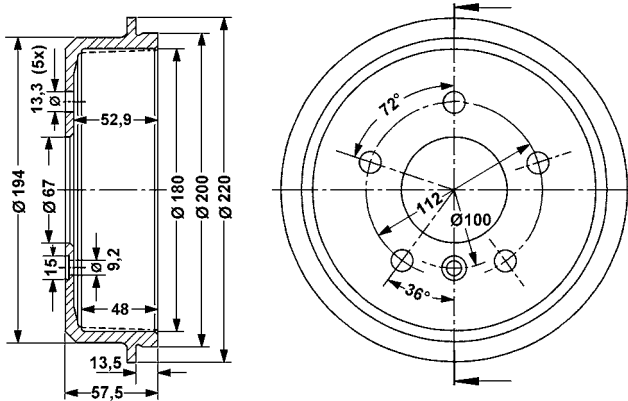

**24.0218-0024.2 480079** Ø 180/181 x 44

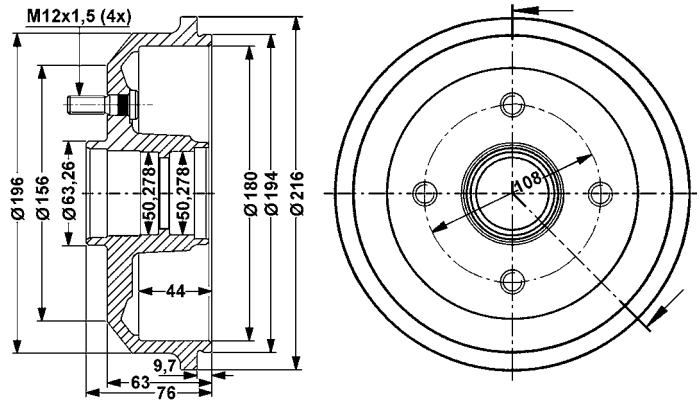

**24.0218-0025.1 480082** Ø 180/181 x 37,5

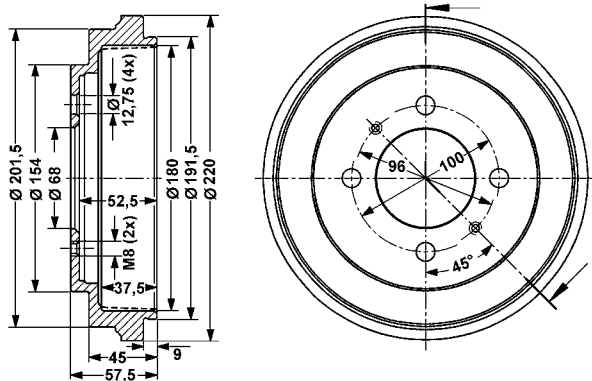

**24.0218-0027.1 480099** Ø 180/182 x 44

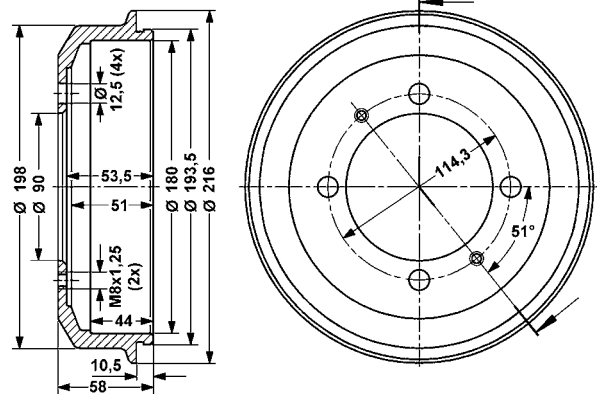

**24.0218-0028.1 480100** Ø 180/181 x 32

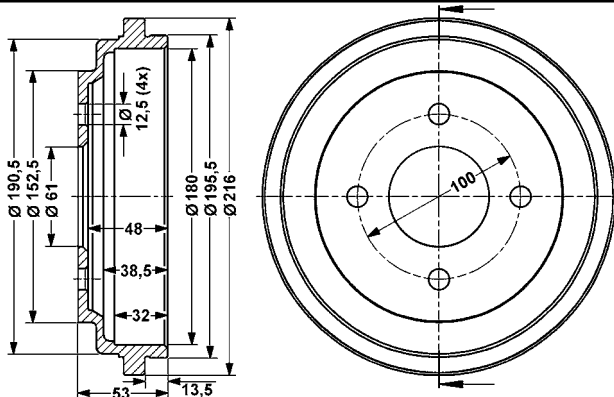

**24.0218-0032.1 480118** Ø 180/181 x 53,5

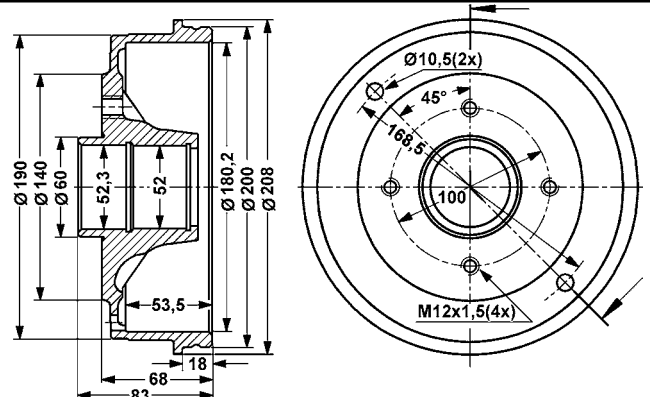



# Abbildungen Bremstrommeln

Illustrations brake drums - Illustrazioni tamburi freno - Illustrations Tambours de frein - Ilustraciones tambores de freno

**24.0218-0034.1 480129** Ø 180/182 x 44,6

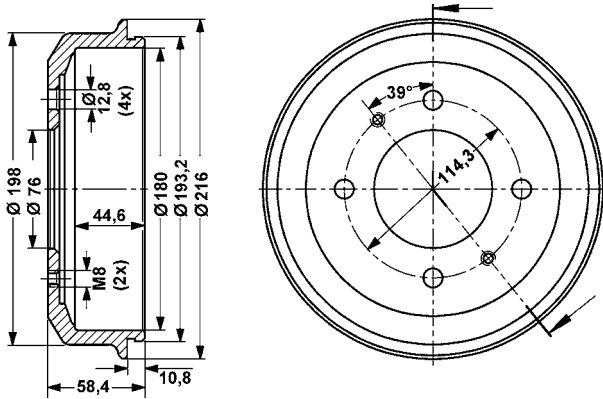

**24.0218-0035.1 480146** Ø 180/182 x 40

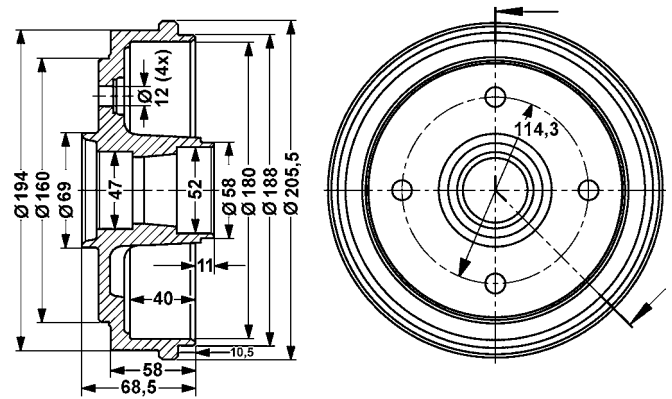

**24.0218-0036.1 480147** Ø 180/181,5 x 41

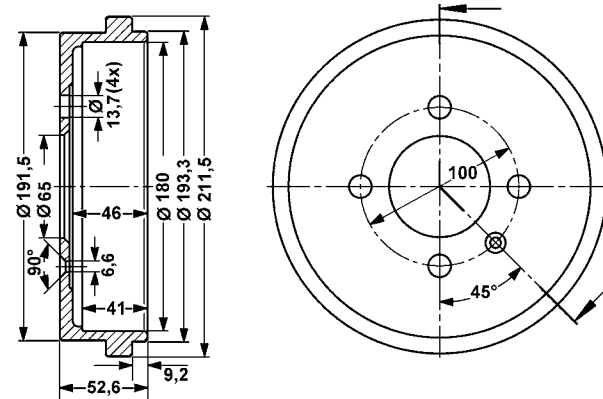

**24.0218-0039.1 480160** Ø 180/182 x 34,5

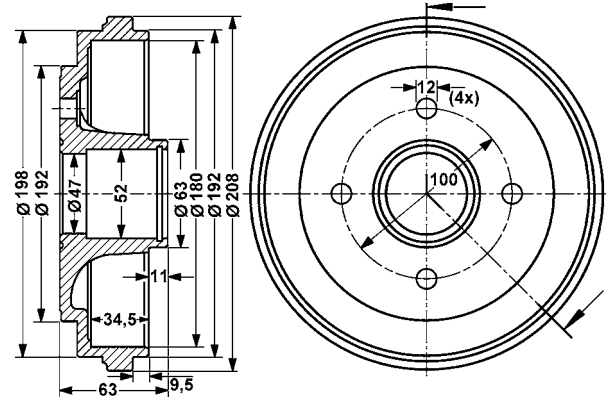

**24.0218-0042.1 480164** Ø 180/182 x 36

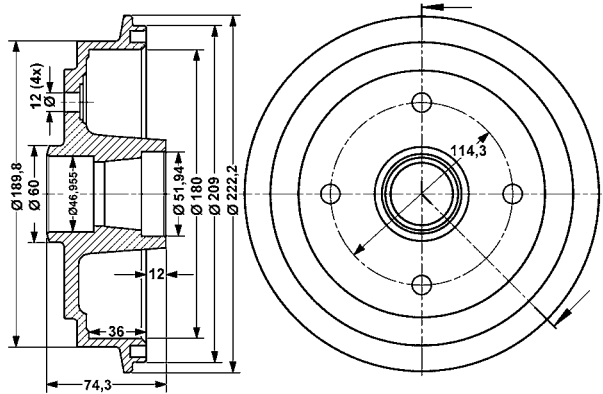

**24.0218-0043.1 480165** Ø 180/181 x 38,6

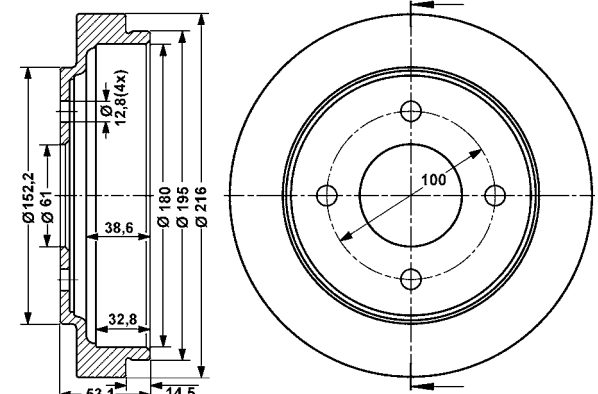

**24.0218-0044.2 480174** Ø 180/182 x 36

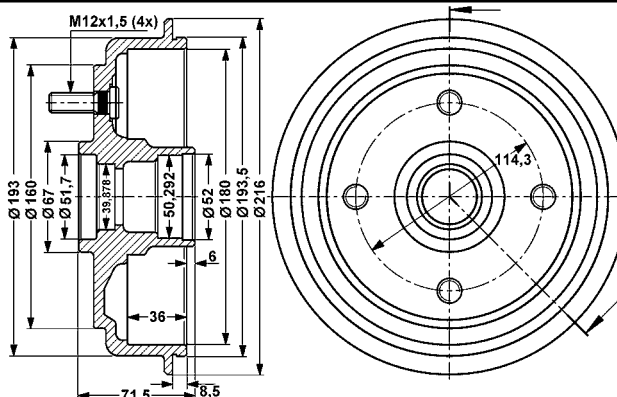

**24.0218-0046.1 480184** Ø 180/182 x 45,2

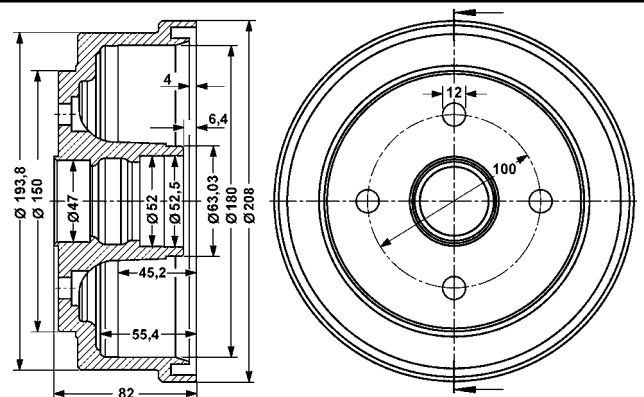



# Abbildungen Bremstrommeln

Illustrations brake drums - Illustrazioni tamburi freno - Illustrations Tambours de frein - Ilustraciones tambores de freno

**24.0218-0047.1 480194** Ø 180/182 x 44,2

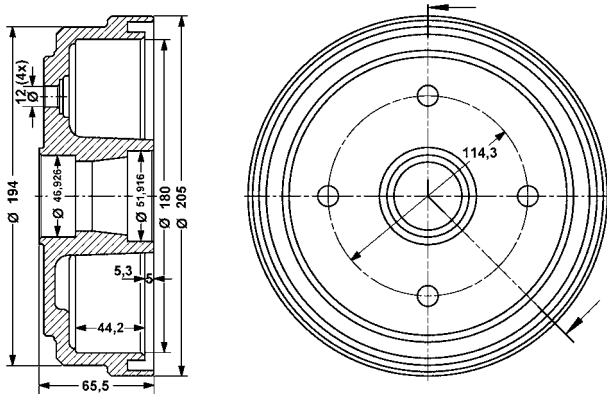

**24.0218-0048.1 480314** Ø 180/181 x 39

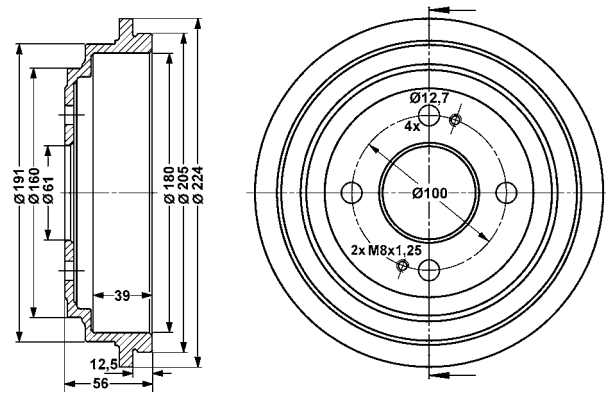

**24.0218-0707.2 480211** Ø 180/181 x 38,5

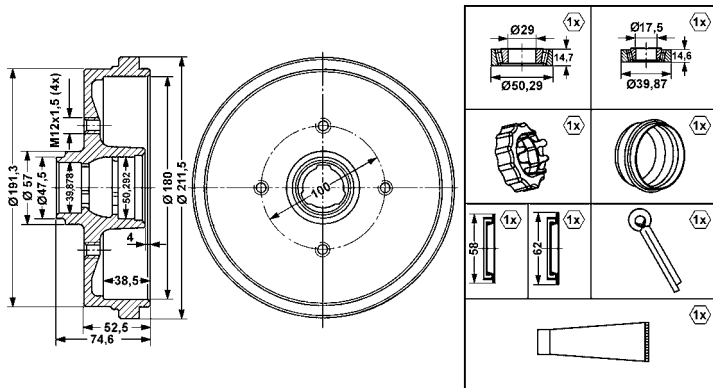

**24.0218-0716.2 480203** Ø 180/181 x 44,5

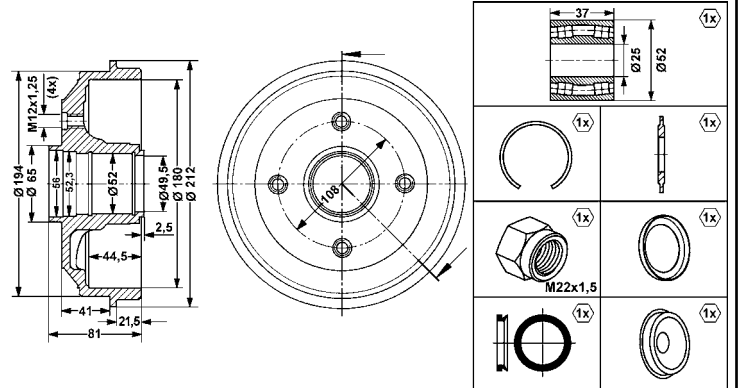

**24.0218-0720.2 480205** Ø 180/181 x 46

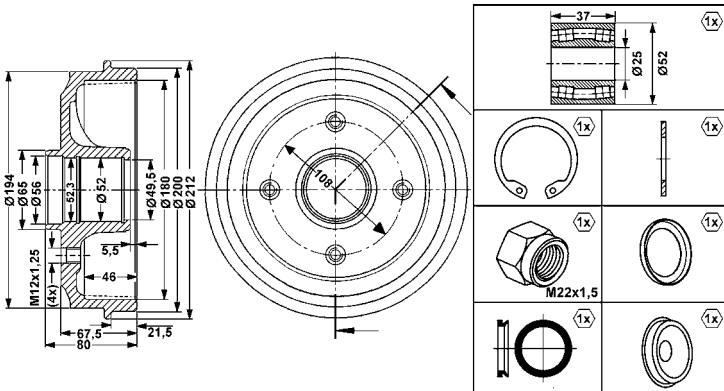

**24.0218-0724.2 480206** Ø 180/181 x 44

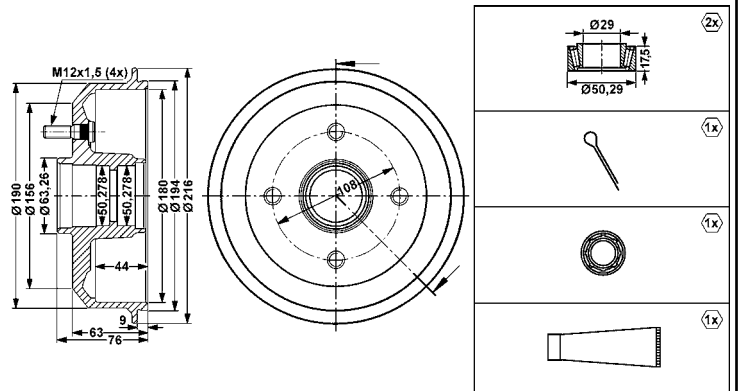

**24.0218-0732.2 480207** Ø 180/181 x 53,5

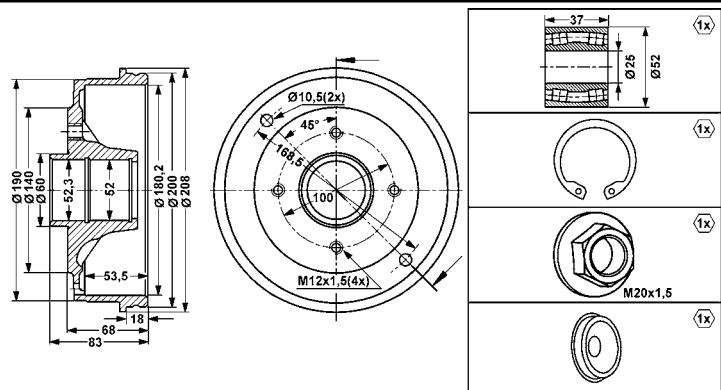

**24.0218-5001.1 480012** Ø 185/186,8 x 37

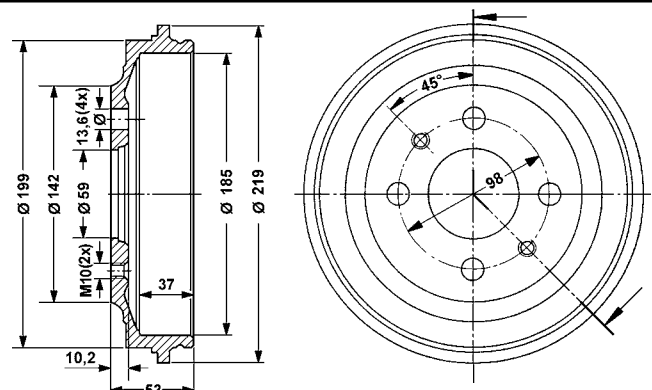

# Abbildungen Bremstrommeln

Illustrations brake drums - Illustrazioni tamburi freno - Illustrations Tambours de frein - Ilustraciones tambores de freno

**24.0218-5002.1 480117** Ø 185/186,8 x 36,5

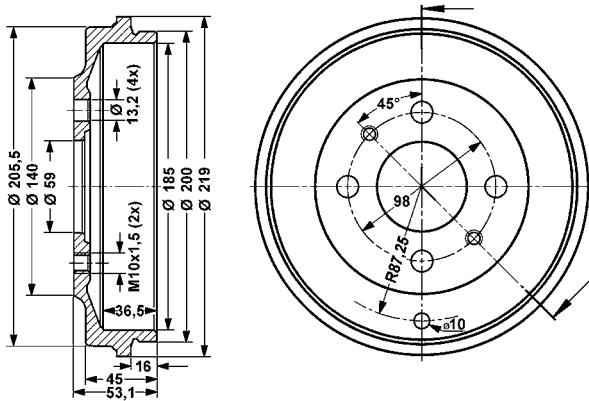

**24.0220-0001.2 480013** Ø 200/201 x 53,5

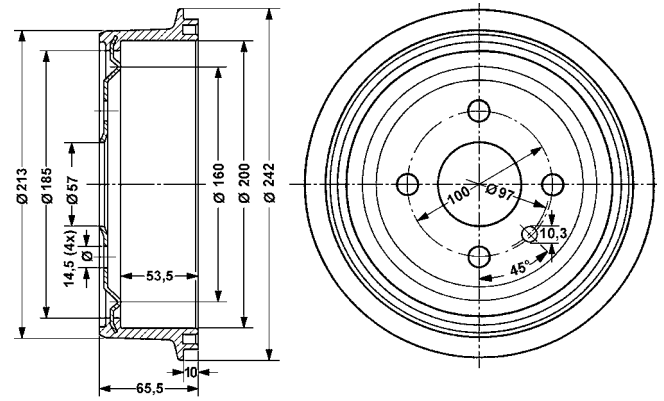

**24.0220-0006.1 480309** Ø 200/201 x 31

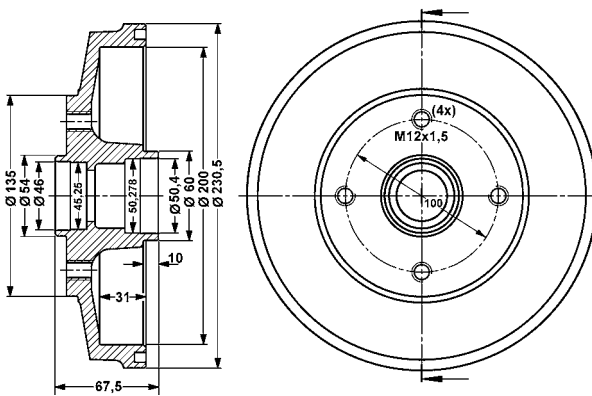

**24.0220-0007.1 480015** Ø 200/201 x 45

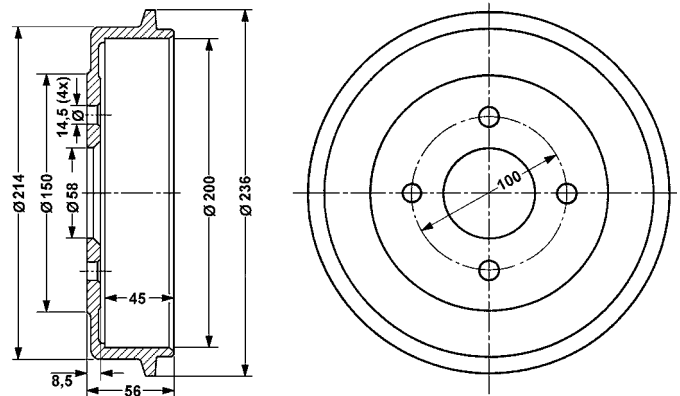

**24.0220-0009.1 480317** Ø 200/201,5 x 40,3

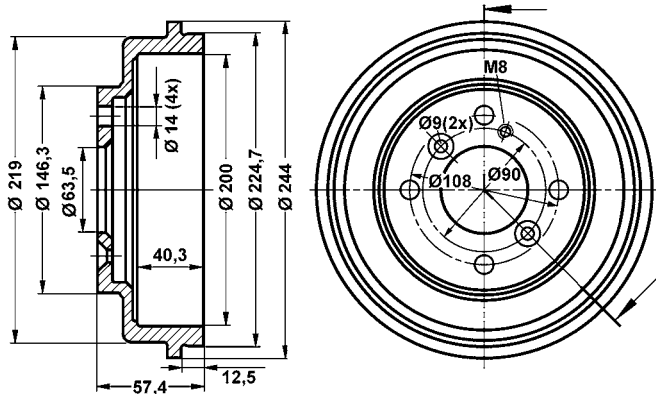

**24.0220-0011.2 480016** Ø 200/201 x 37,4

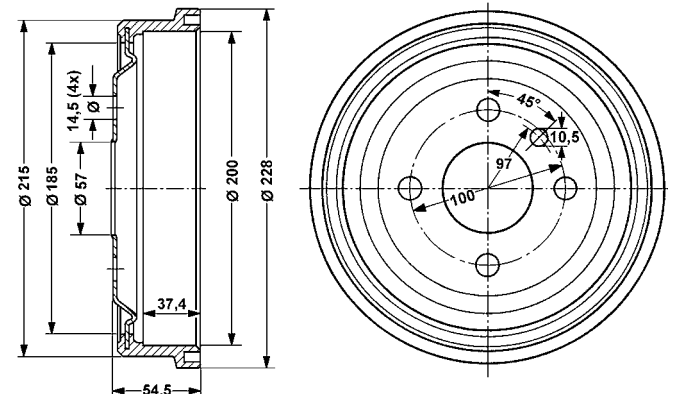

**24.0220-0012.1 480017** Ø 200/201 x 35

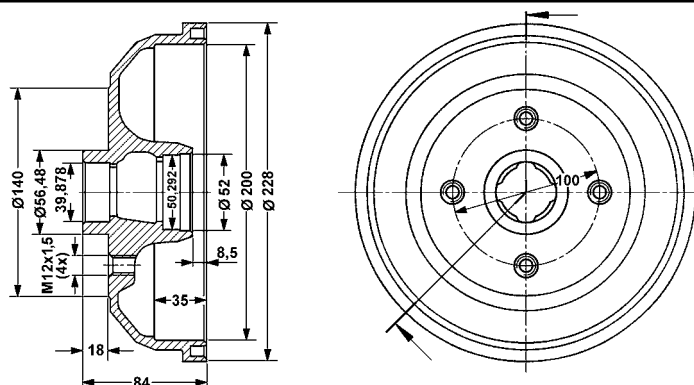

**24.0220-0016.1 480018** Ø 200/201 x 52

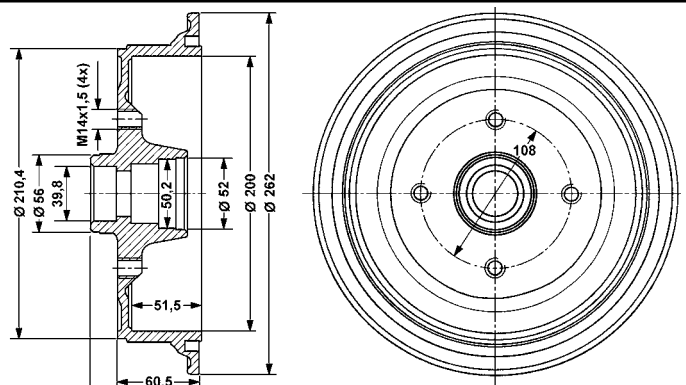

# Abbildungen Bremstrommeln

Illustrations brake drums - Illustrazioni tamburi freno - Illustrations Tambours de frein - Ilustraciones tambores de freno

**24.0220-0017.1 480053** Ø 200/201 x 52

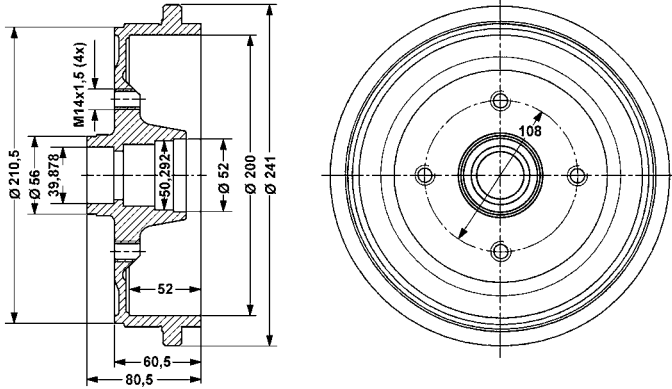

**24.0220-0018.1 480019** Ø 200/201 x 50

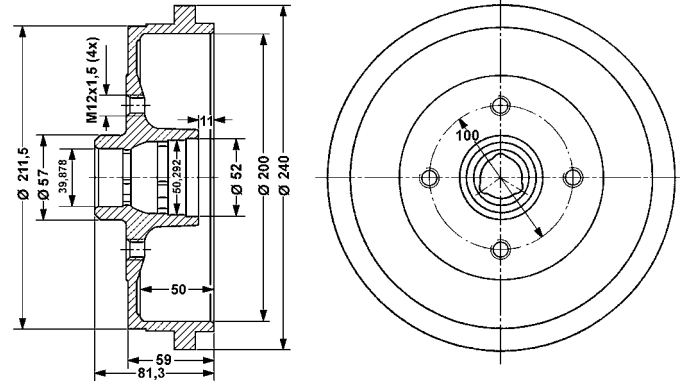

**24.0220-0020.1 480059** Ø 200/201,5 x 50

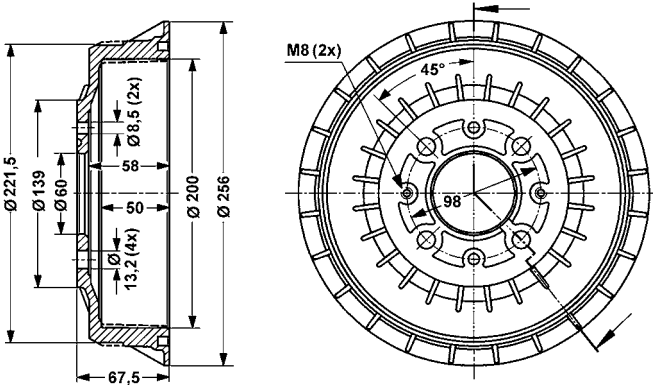

**24.0220-0022.1 480083** Ø 200/201 x 55

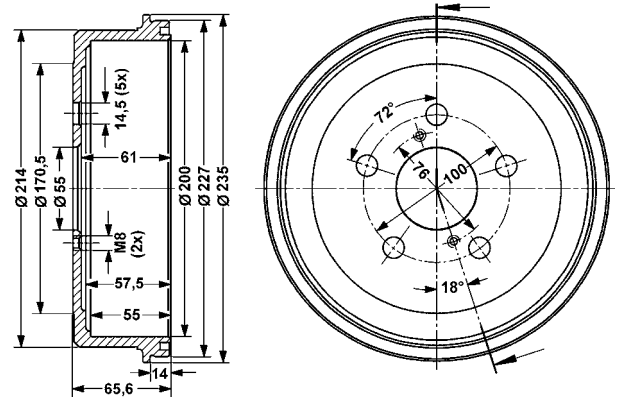

**24.0220-0023.1 480084** Ø 200/201 x 56

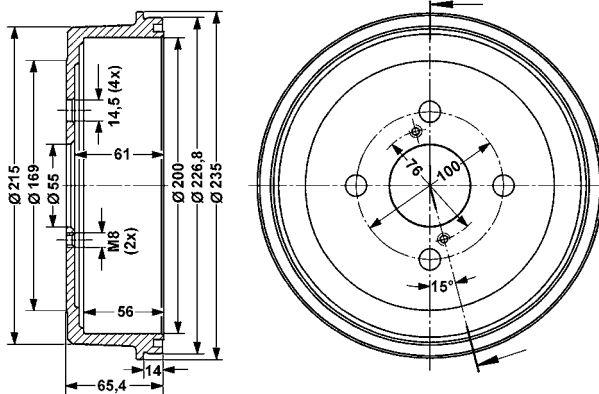

**24.0220-0026.1 480104** Ø 200/201 x 42

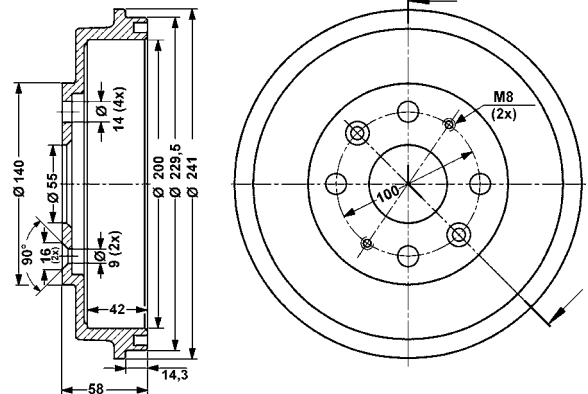

**24.0220-0029.1 480120** Ø 200/201 x 32

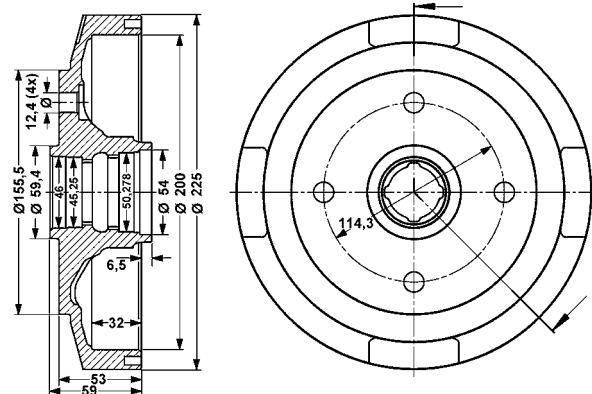

**24.0220-0031.1 480125** Ø 200/201 x 41,5

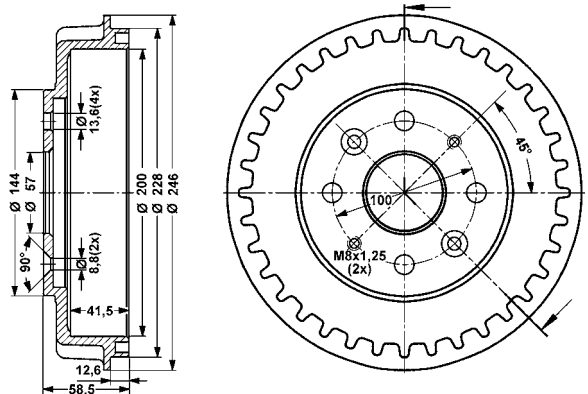

# Abbildungen Bremstrommeln

Illustrations brake drums - Illustrazioni tamburi freno - Illustrations Tambours de frein - Ilustraciones tambores de freno

**24.0220-0032.1 480130** Ø 200/201,5 x 50,1

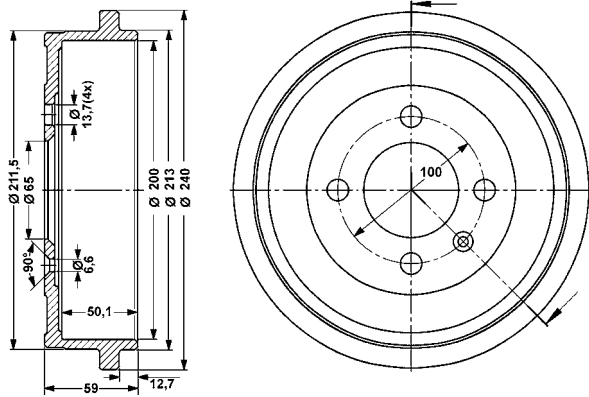

**24.0220-0033.2 480132** Ø 200/201 x 35

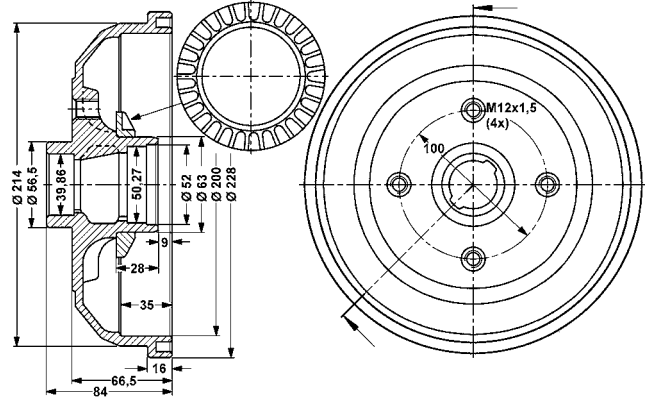

**24.0220-0036.1 480149** Ø 200/201 x 52,5

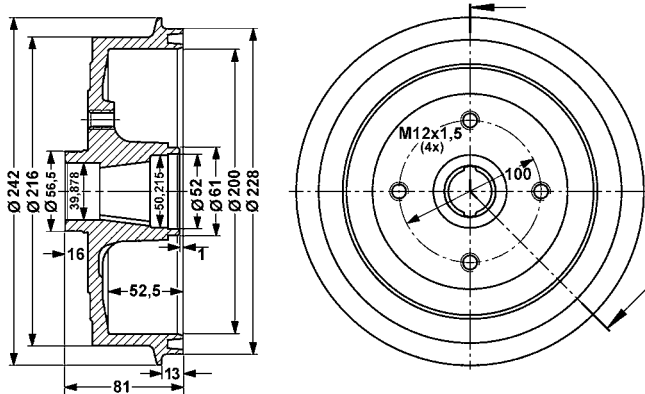

**24.0220-0037.1 480161** Ø 200/201,5 x 50,5

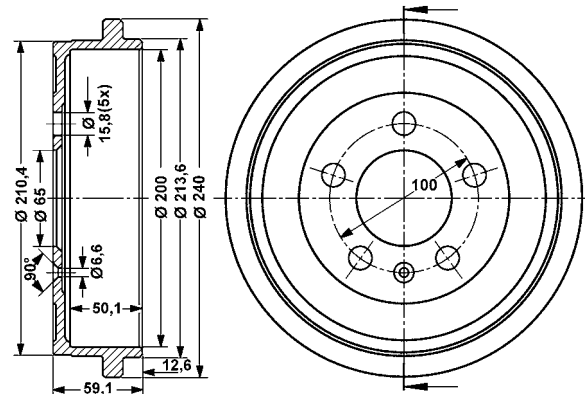

**24.0220-0038.1 480162** Ø 200/201 x 54

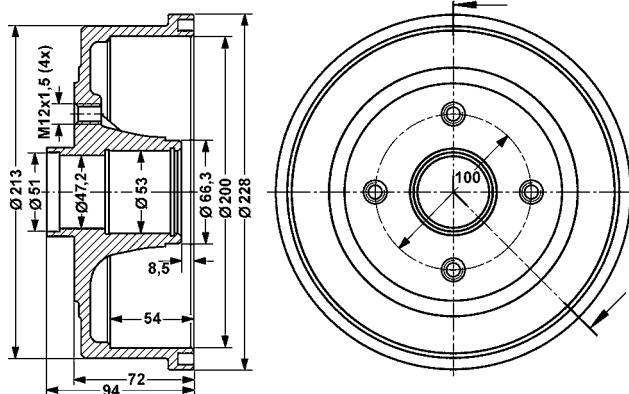

**24.0220-0039.1 480163** Ø 200/201 x 35

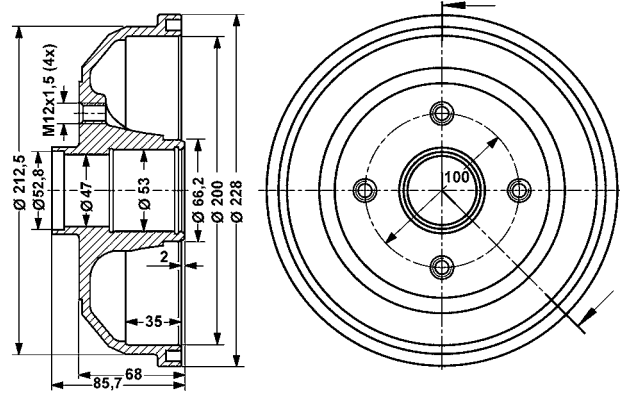

**24.0220-0040.1 480166** Ø 200/202 x 40

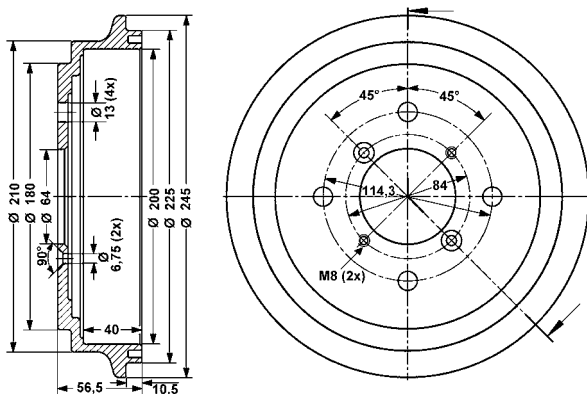

**24.0220-0041.1 480167** Ø 200/201 x 41,8

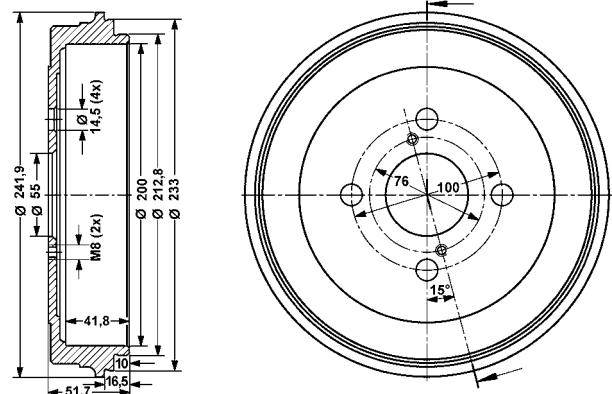



# Abbildungen Bremstrommeln

Illustrations brake drums - Illustrazioni tamburi freno - Illustrations Tambours de frein - Ilustraciones tambores de freno

**24.0220-0043.1 480185** Ø 200/201 x 44,5

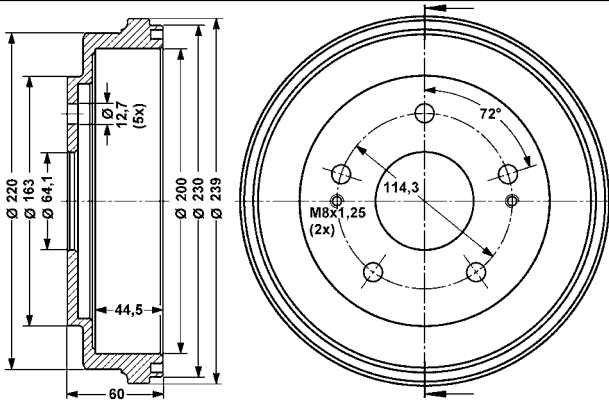

**24.0220-0044.1 480192** Ø 200/202 x 40,2

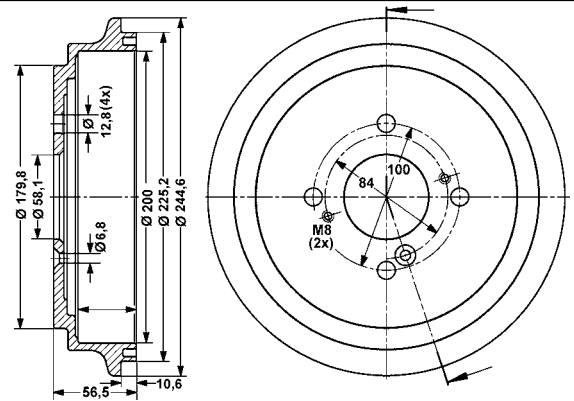

**24.0220-0045.1 480189** Ø 200/202 x 38

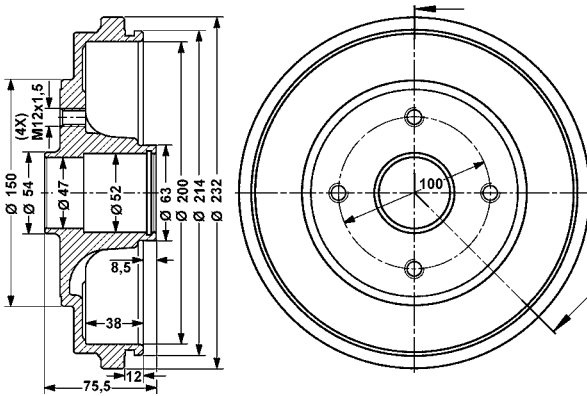

**24.0220-0046.1 480193** Ø 200/201 x 44

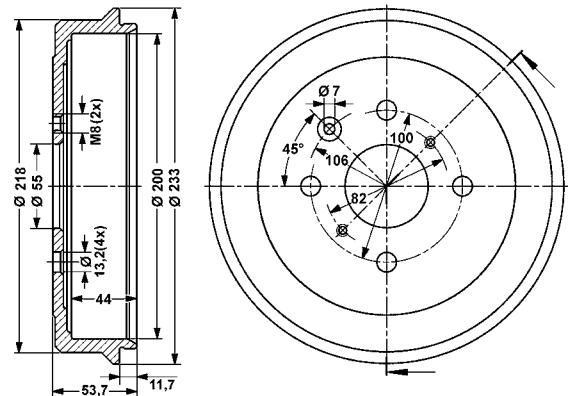

**24.0220-0047.1 480199** Ø 200/201 x 41

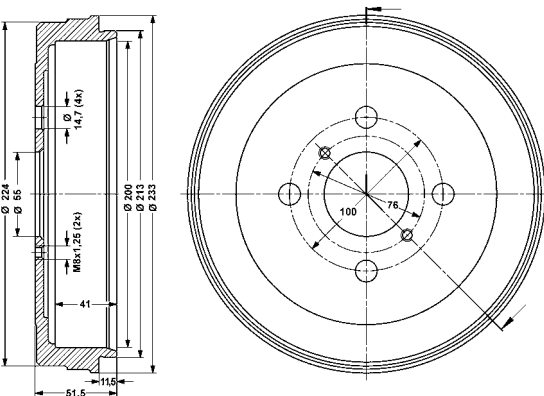

**24.0220-0706.2 480215** Ø 200/201 x 31

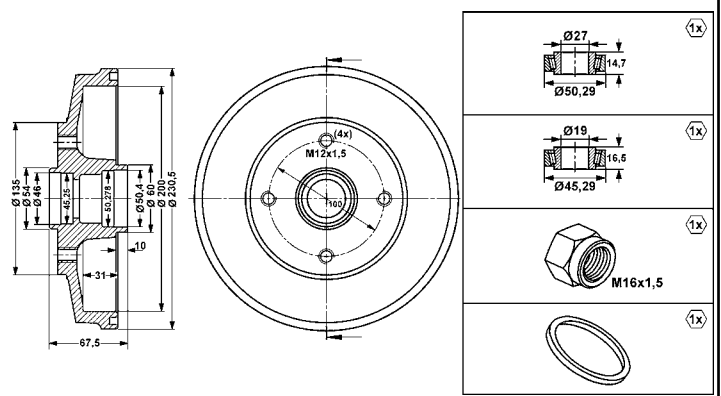

**24.0220-0712.2 480208** Ø 200/201 x 35

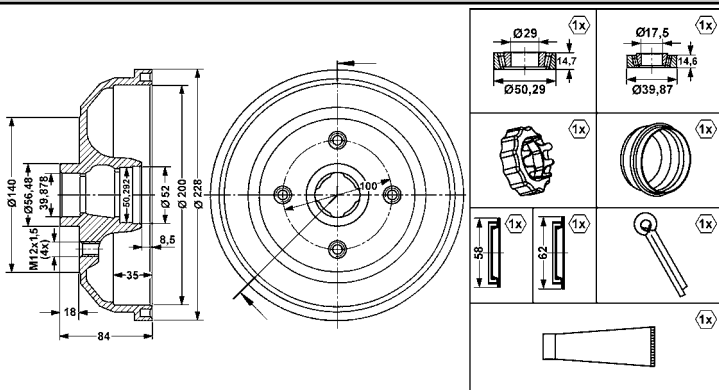

**24.0220-0718.2 480209** Ø 200/201,5 x 50

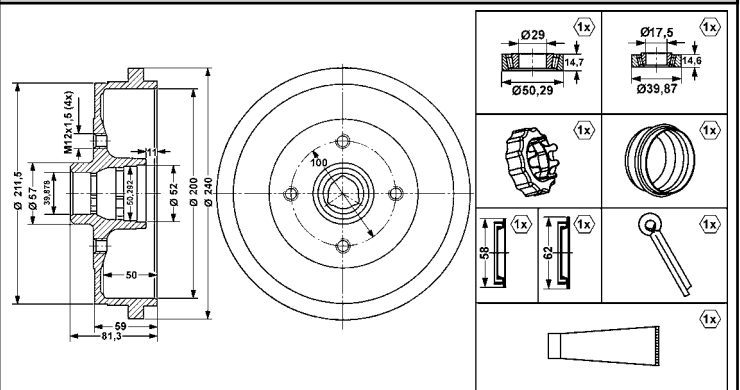

# Abbildungen Bremstrommeln

Illustrations brake drums - Illustrazioni tamburi freno - Illustrations Tambours de frein - Ilustraciones tambores de freno

**24.0220-0738.2 480214** Ø 200/201 x 54

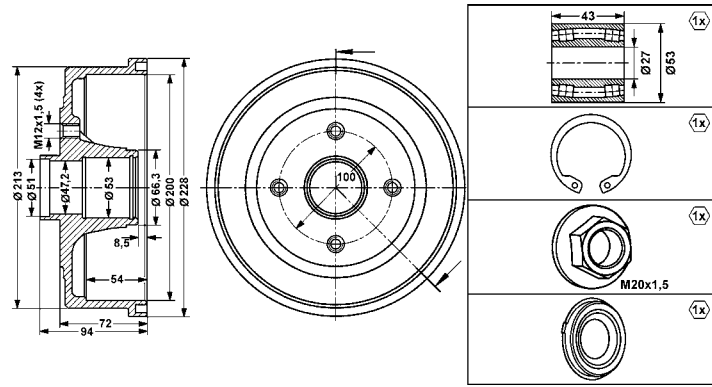

**24.0220-2001.1 480307** Ø 203/204,7 x 48,5

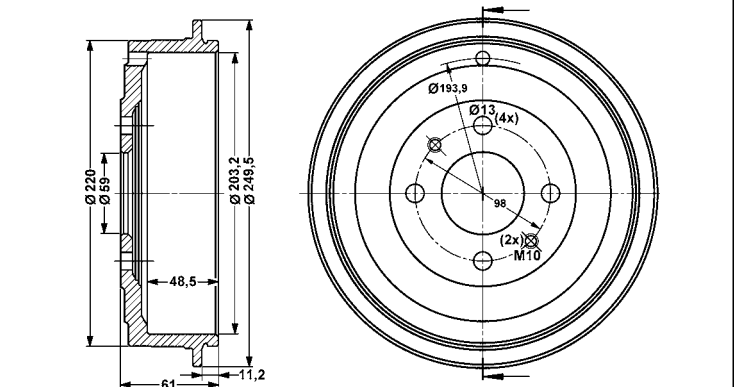

**24.0220-3001.2 480020** Ø 203/204 x 45

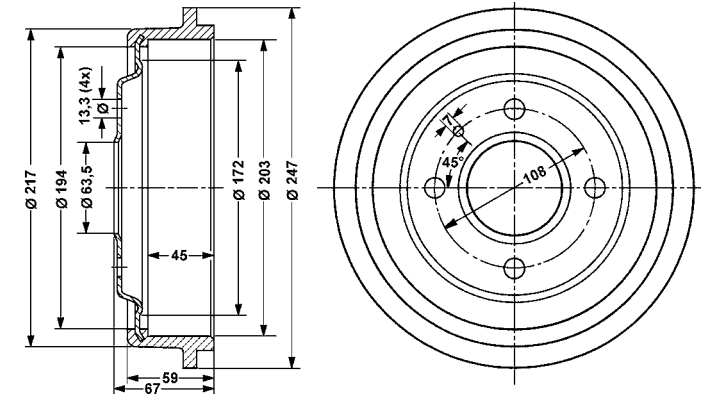

**24.0220-3002.2 480021** Ø 203/204 x 46,5

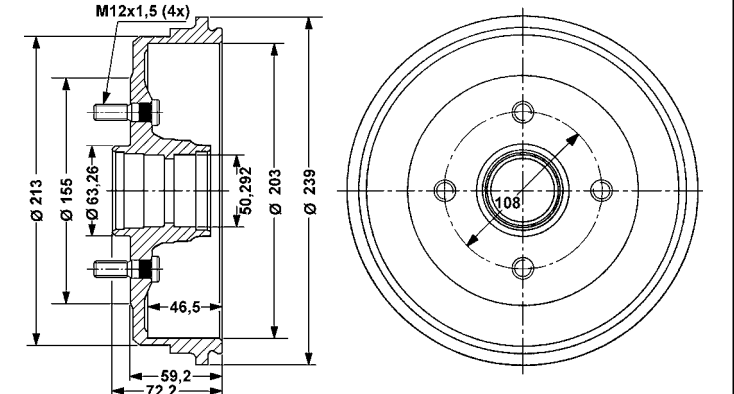

**24.0220-3004.2 480023** Ø 203/204 x 49

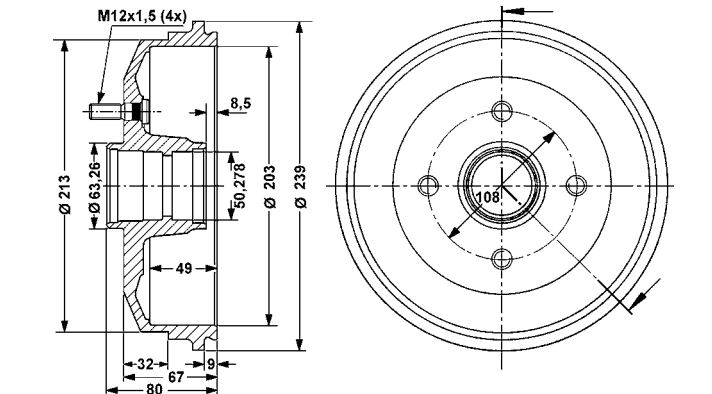

**24.0220-3005.1 480054** Ø 203/204,5 x 50,5

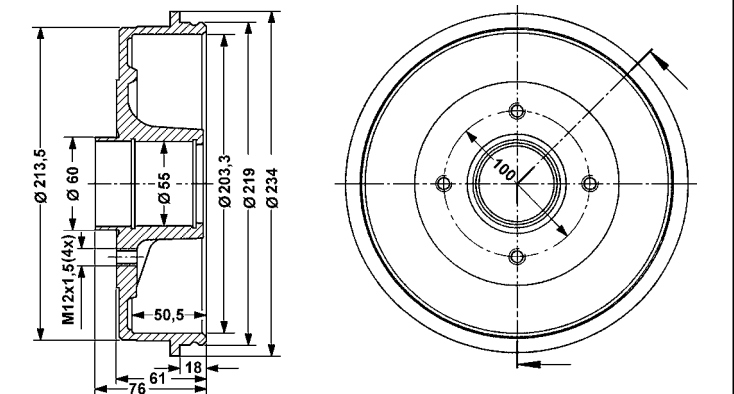

**24.0220-3006.1 480062** Ø 203/204,5 x 48,5

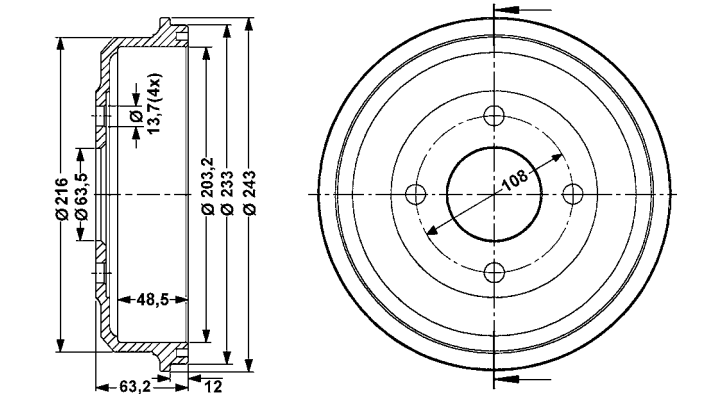

**24.0220-3007.1 480064** Ø 203/204,7 x 48,5

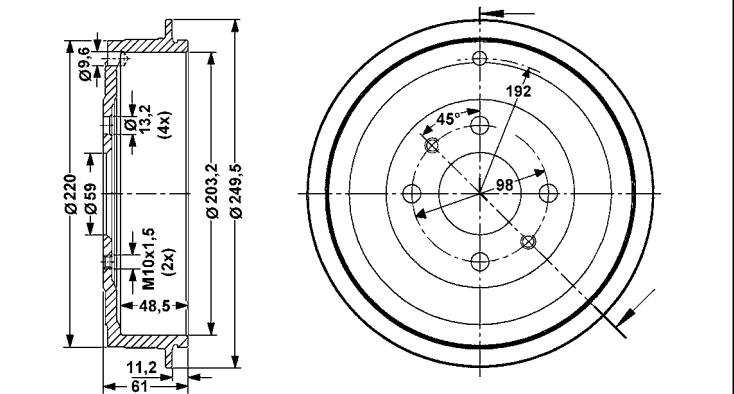



# Abbildungen Bremstrommeln

Illustrations brake drums - Illustrazioni tamburi freno - Illustrations Tambours de frein - Ilustraciones tambores de freno

**24.0220-3008.2 480075** Ø 203/204 x 45

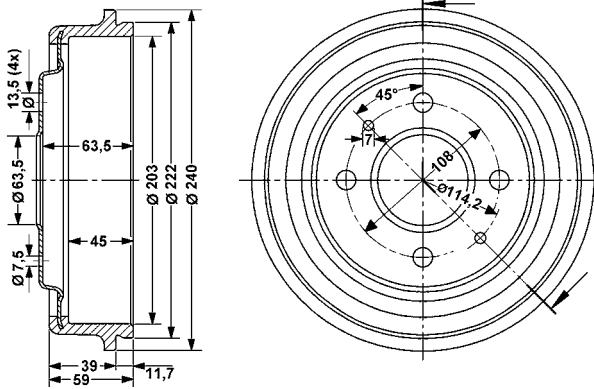

**24.0220-3009.2 480080** Ø 203/204 x 49

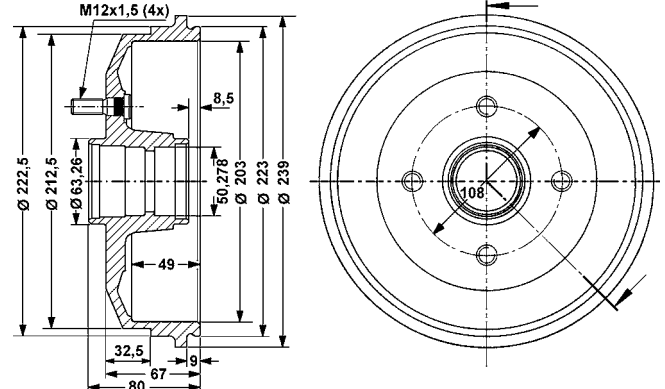

**24.0220-3010.1 480081** Ø 203/204,4 x 50,5

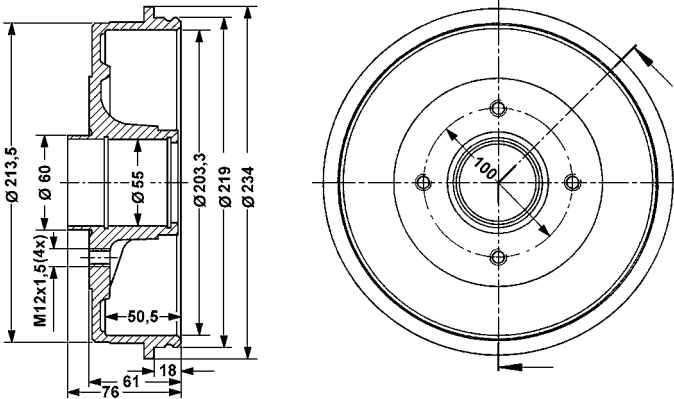

**24.0220-3012.1 480088** Ø 203/204,4 x 50

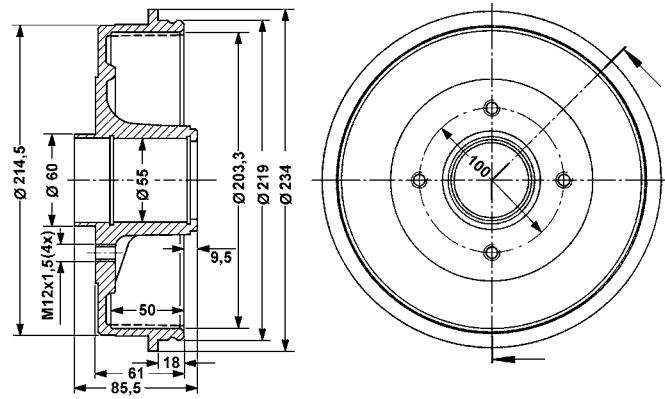

**24.0220-3013.1 480089** Ø 203/204,5 x 46,5

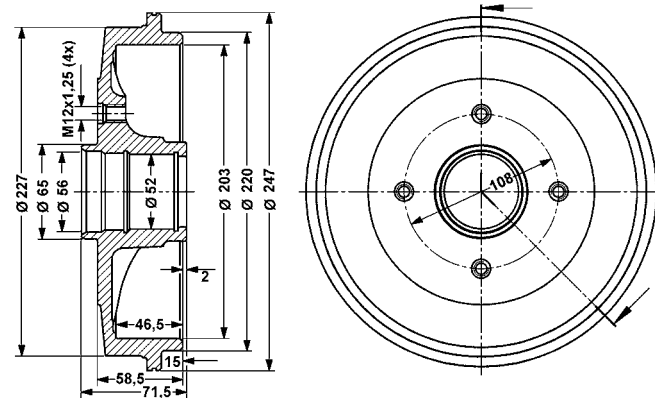

**24.0220-3014.1 480090** Ø 203/204,4 x 46,5

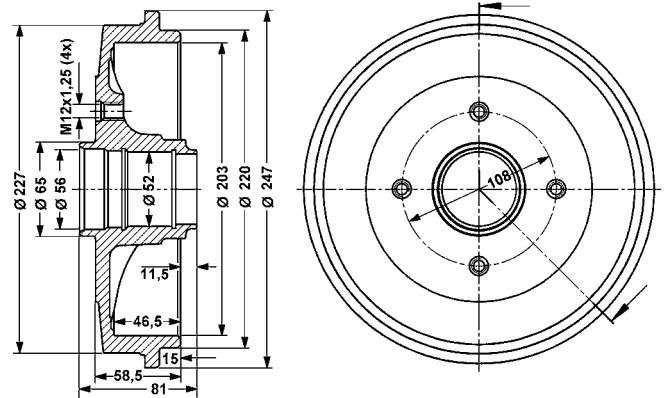

**24.0220-3015.1 480091** Ø 203/204,5 x 46,5

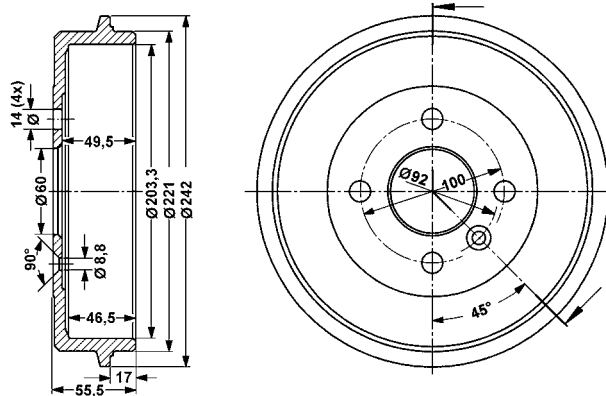

**24.0220-3016.1 480107** Ø 203/204 x 45,5

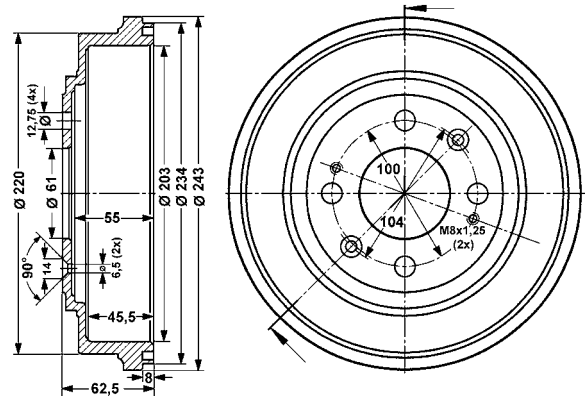

# Abbildungen Bremstrommeln

Illustrations brake drums - Illustrazioni tamburi freno - Illustrations Tambours de frein - Ilustraciones tambores de freno

**24.0220-3017.1 480108** Ø 203/205 x 42

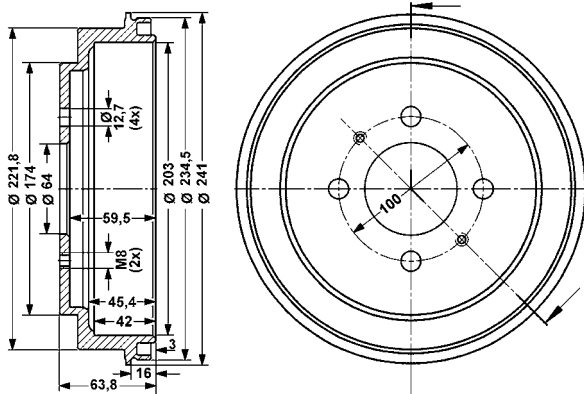

**24.0220-3018.2 480121** Ø 203/205 x 42,5

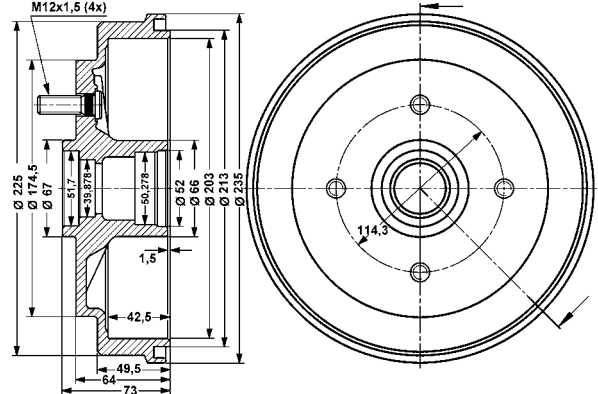

**24.0220-3020.2 480131** Ø 203/204,3 x 44,5

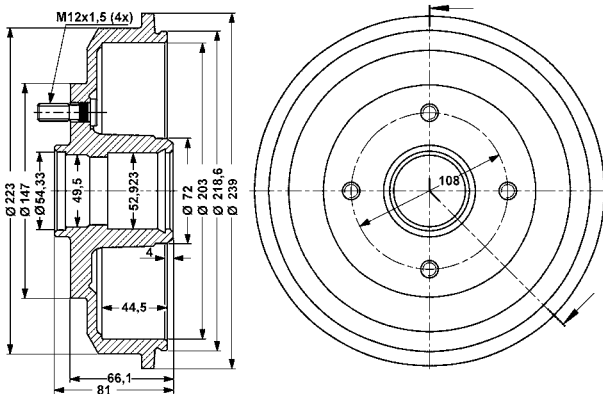

**24.0220-3021.1 480127** Ø 203/204,5 x 48

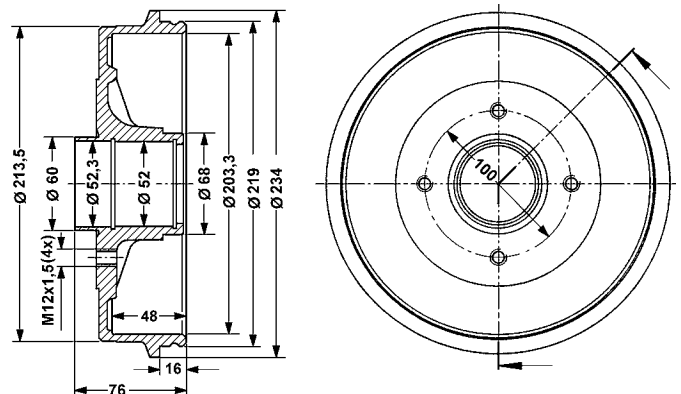

**24.0220-3026.2 480175** Ø 203/204,3 x 44,5

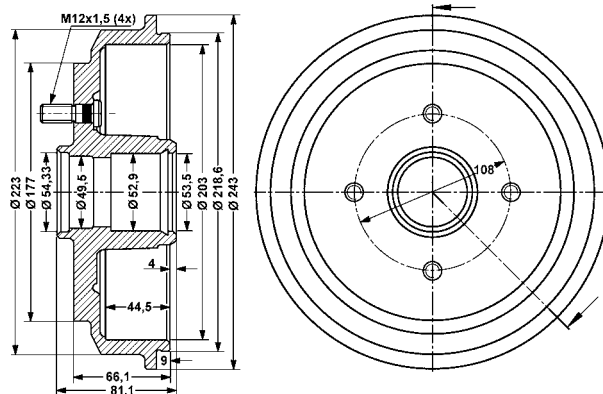

**24.0220-3027.1 480168** Ø 203/204,5 x 39,6

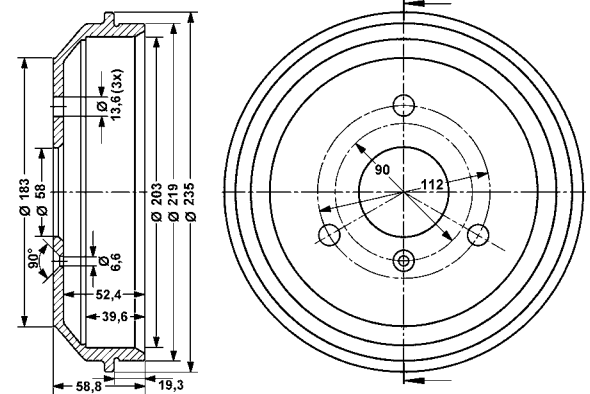

**24.0220-3028.1 480169** Ø 203/205 x 41,8

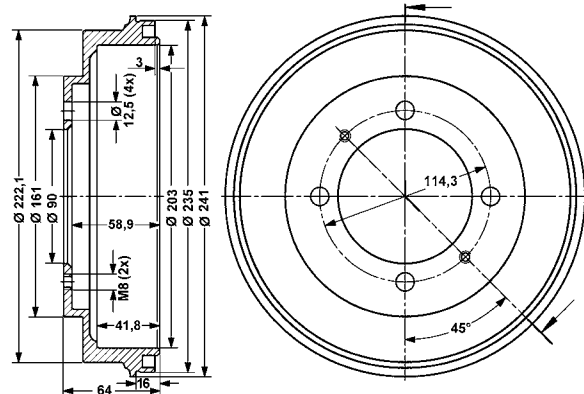

**24.0220-3029.1 480179** Ø 203/204,5 x 42

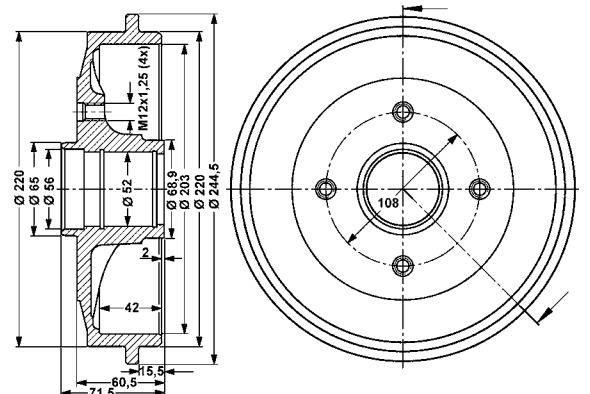

# Abbildungen Bremstrommeln

Illustrations brake drums - Illustrazioni tamburi freno - Illustrations Tambours de frein - Ilustraciones tambores de freno

**24.0220-3030.1 480180**  $\varnothing$  203/204,5 x 50,5

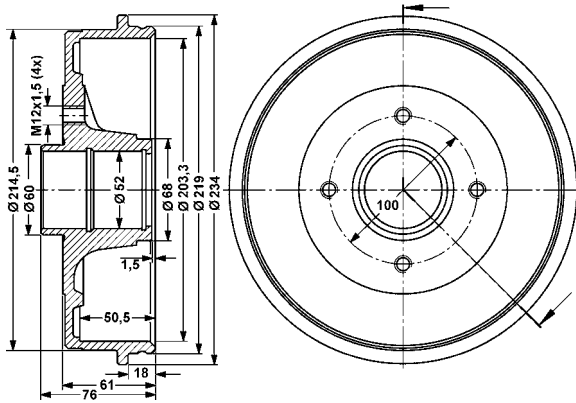

**24.0220-3033.1 480195**  $\varnothing$  203/204,5 x 50,5

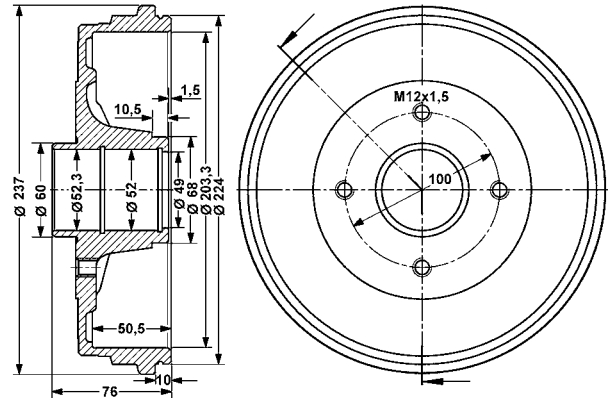

**24.0220-3034.1 480190**  $\varnothing$  203/205,5 x 43

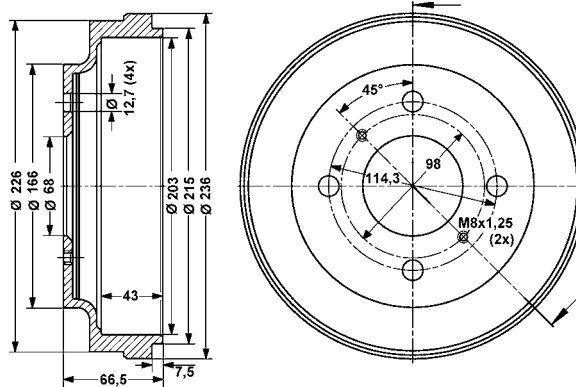

**24.0220-3035.1 480300**  $\varnothing$  203/204,7 x 47

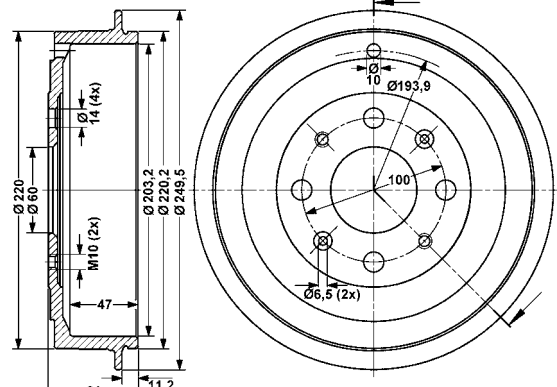

**24.0220-3036.1 480301**  $\varnothing$  203/204,5 x 50,5

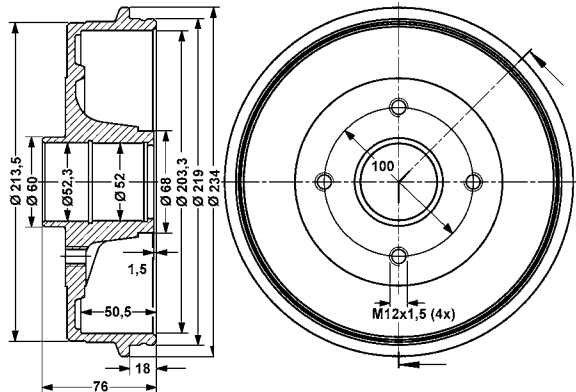

**24.0220-3037.1 480308**  $\varnothing$  203/204,5 x 48

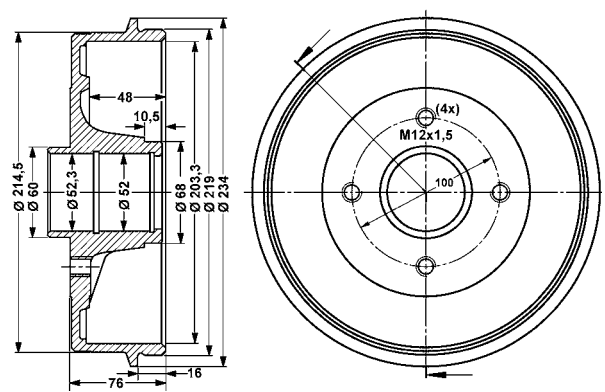

**24.0220-3038.1 480315**  $\varnothing$  203/205,2 x 38,5

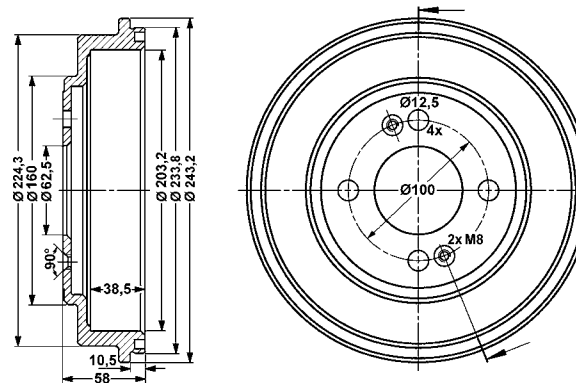

**24.0220-3045.1 480191**  $\varnothing$  203/204,5 x 45,5

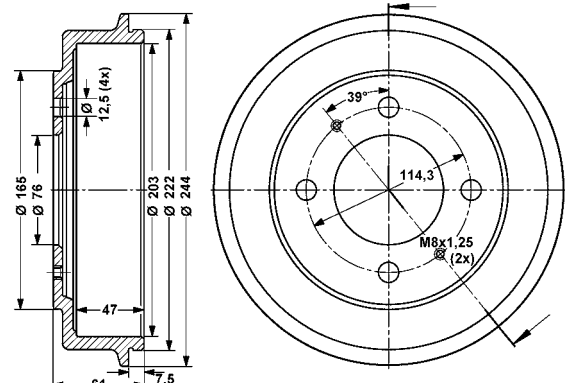

# Abbildungen Bremstrommeln

Illustrations brake drums - Illustrazioni tamburi freno - Illustrations Tambours de frein - Ilustraciones tambores de freno

**24.0220-3720.2 480210** Ø 203/204,3 x 44,5

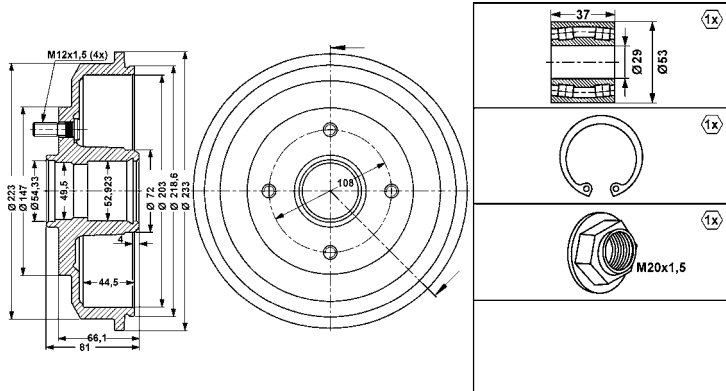

**24.0220-3726.2 480216** Ø 203/204,3 x 44,5

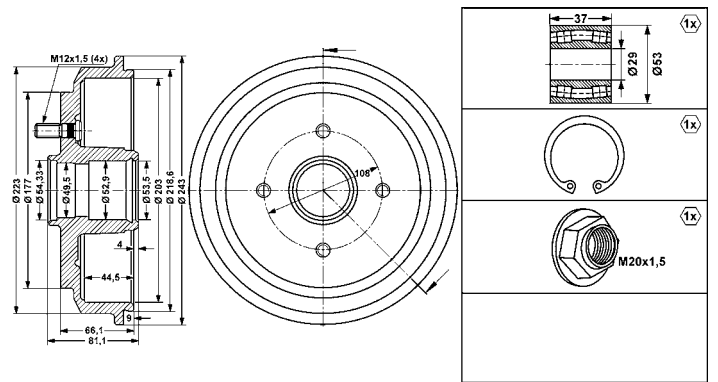

**24.0220-3729.2 480217** Ø 203/204,5 x 42

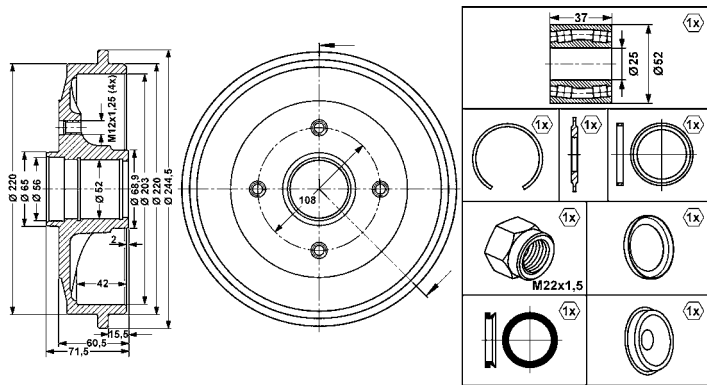

**24.0220-3737.2 480218** Ø 203/204,5 x 48

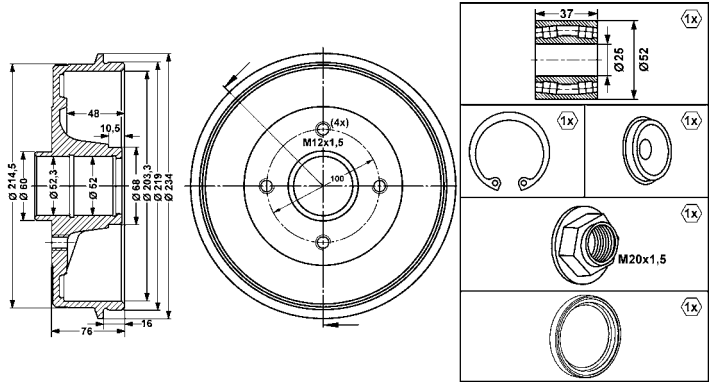

**24.0222-0001.1 480123** Ø 220/221 x 44,5

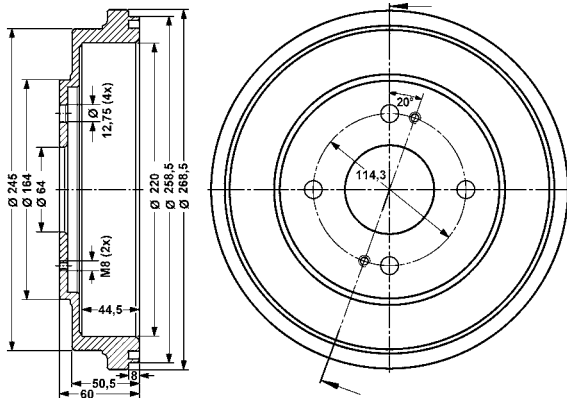

**24.0222-0002.1 480141** Ø 220/221 x 44,5

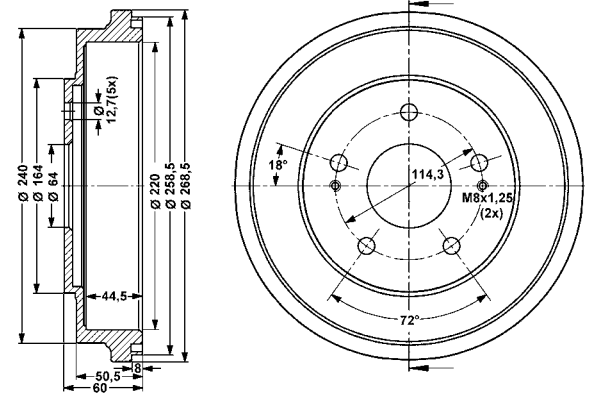

**24.0222-8008.1 480304** Ø 229/230,6 x 52,1

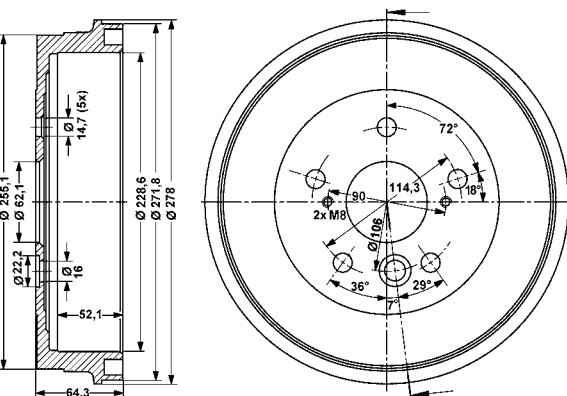

**24.0222-8009.1 480026** Ø 229/229,5 x 46,4

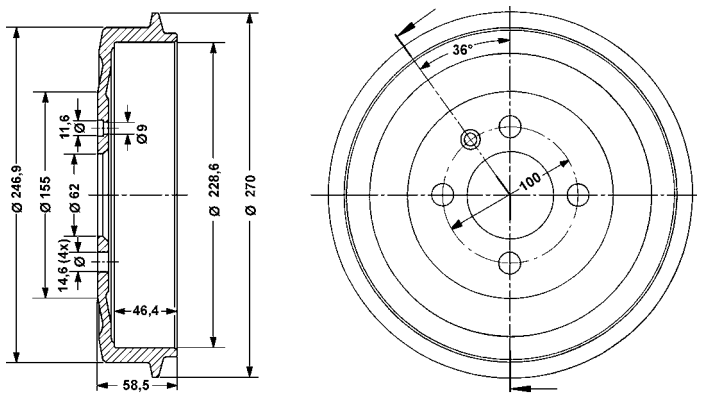



# Abbildungen Bremstrommeln

Illustrations brake drums - Illustrazioni tamburi freno - Illustrations Tambours de frein - Ilustraciones tambores de freno

**24.0222-8010.2 480027** Ø 229/229,4 x 64

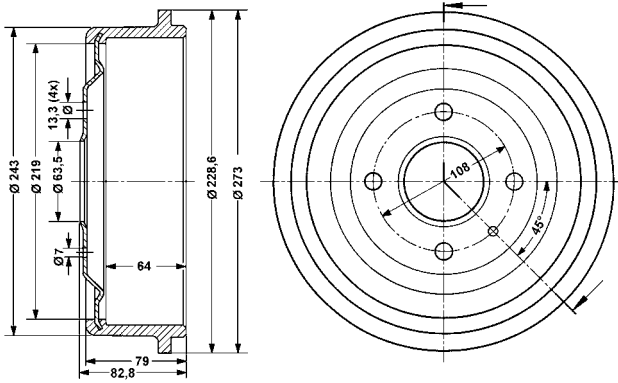

**24.0222-8011.1 480028** Ø 229/230 x 54

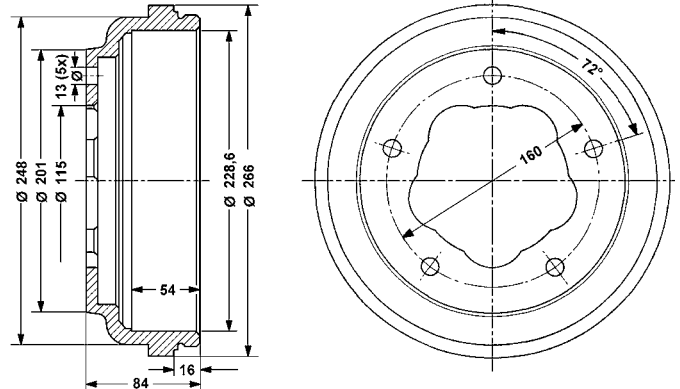

**24.0222-8013.1 480030** Ø 229/229,5 x 47

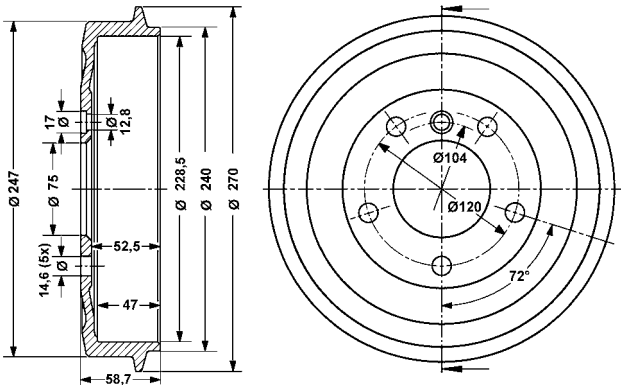

**24.0222-8014.1 480031** Ø 229/230,1 x 54

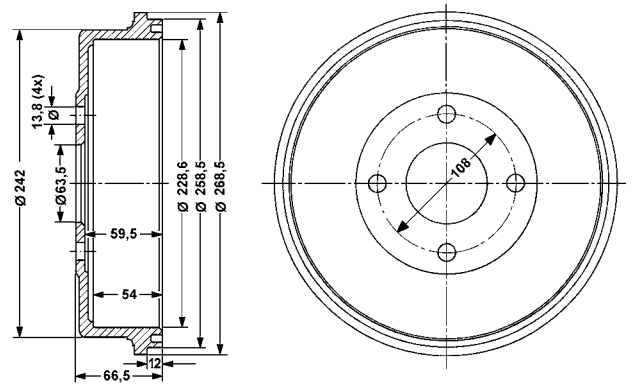

**24.0222-8015.1 480055** Ø 229/229,5 x 52,5

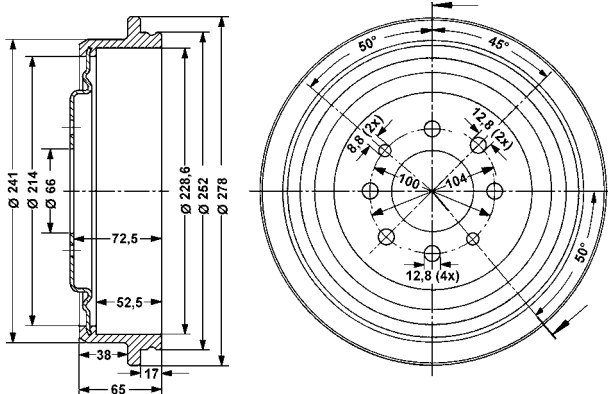

**24.0222-8017.1 480071** Ø 229/230 x 50,8

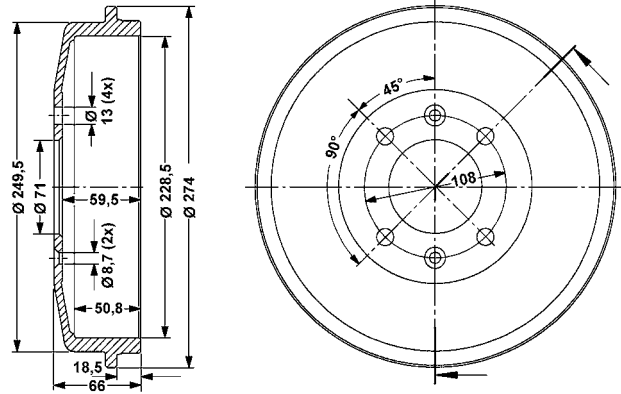

**24.0222-8018.1 480078** Ø 228/230 x 48

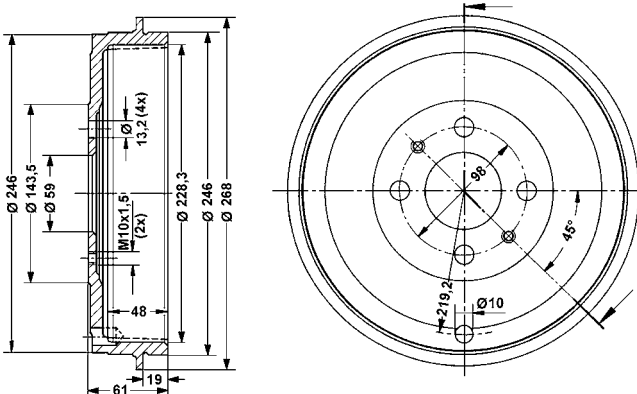

**24.0222-8019.2 480087** Ø 229/229,5 x 52,5

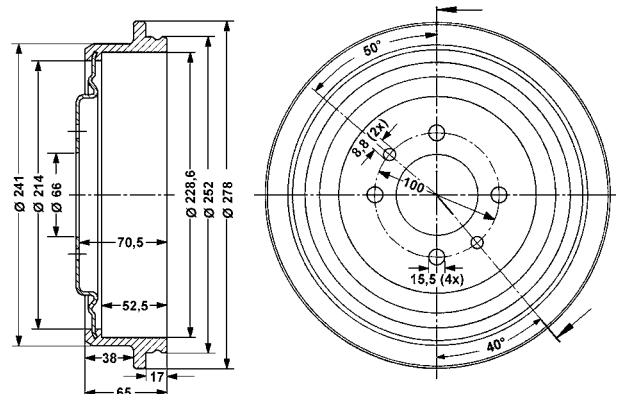

# Abbildungen Bremstrommeln

Illustrations brake drums - Illustrazioni tamburi freno - Illustrations Tambours de frein - Ilustraciones tambores de freno

**24.0222-8021.1 480092**  $\varnothing$  229/230 x 54,5

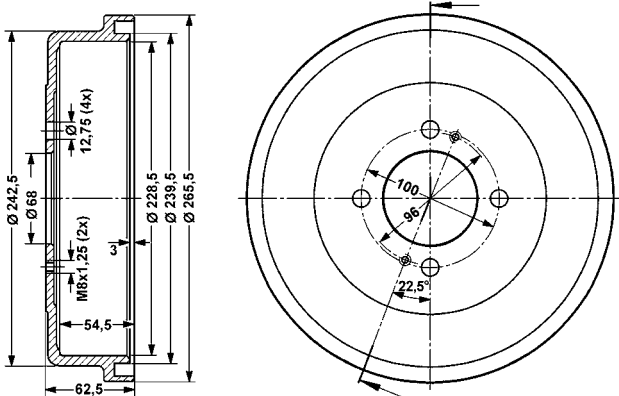

**24.0222-8023.1 480094**  $\varnothing$  229/230 x 43,5

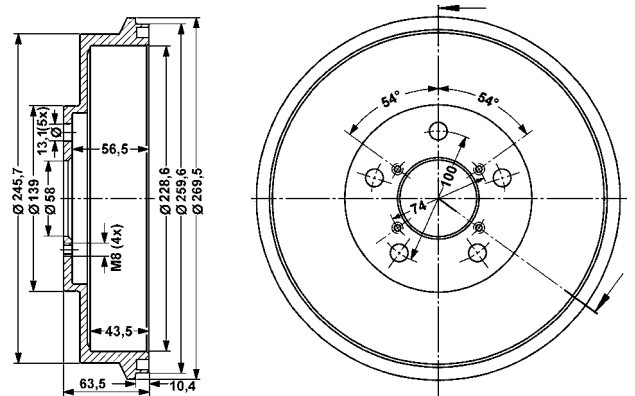

**24.0222-8025.2 480109**  $\varnothing$  229/230 x 47

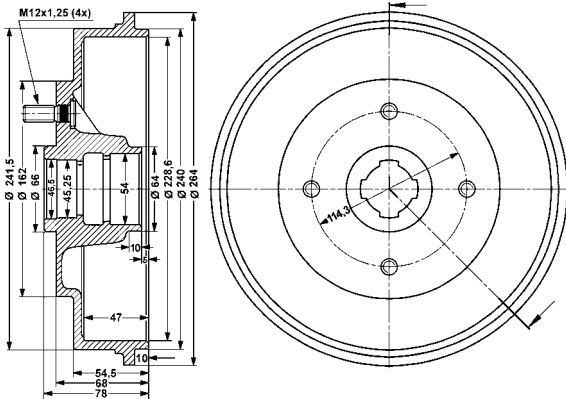

**24.0222-8028.1 480143**  $\varnothing$  229/230 x 37

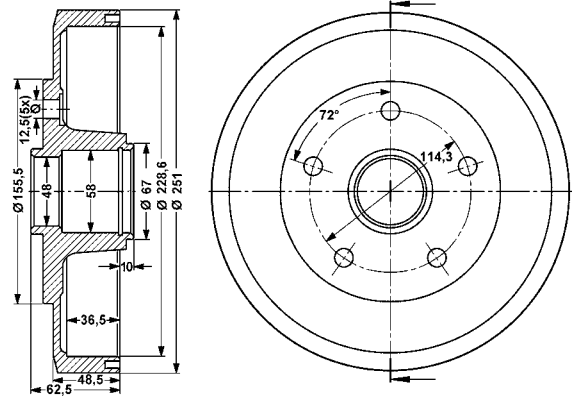

**24.0222-8031.1 480152**  $\varnothing$  229/229,6 x 58

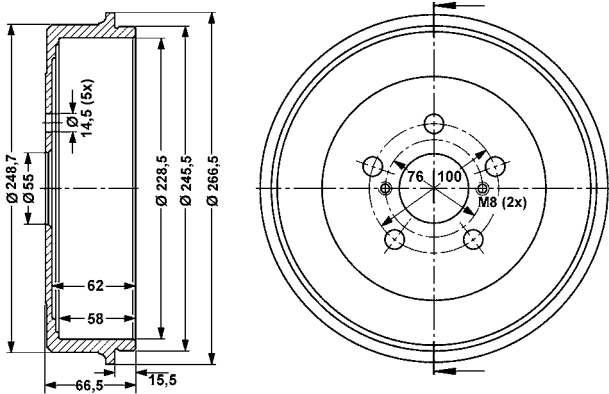

**24.0222-8032.1 480170**  $\varnothing$  229/229,5 x 52,5

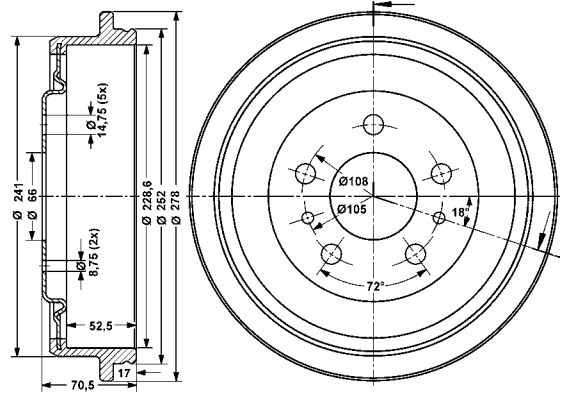

**24.0222-8033.1 480181**  $\varnothing$  228,3/229,6 x 68

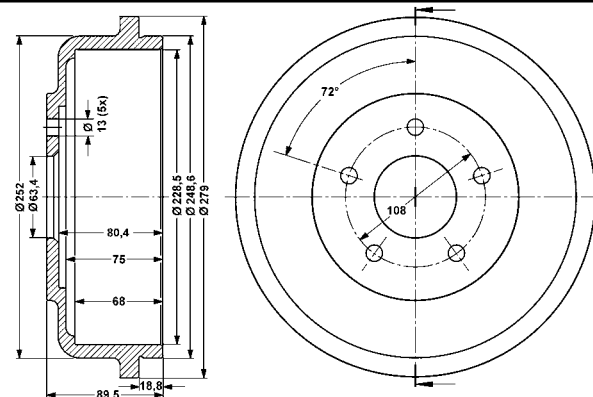

**24.0222-8034.1 480187**  $\varnothing$  229/230,6 x 58

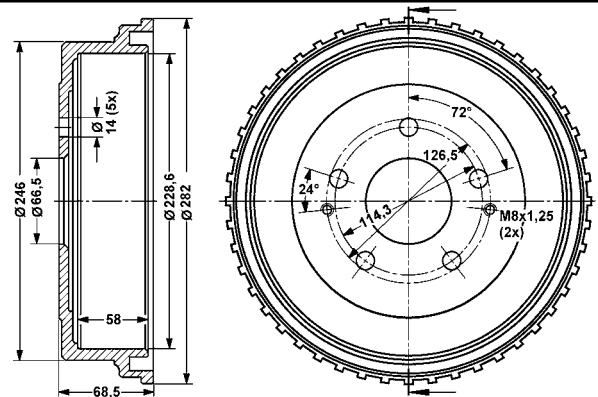



# Abbildungen Bremstrommeln

Illustrations brake drums - Illustrazioni tamburi freno - Illustrations Tambours de frein - Ilustraciones tambores de freno

**24.0222-8035.1 480188** Ø 229/230,3 x 50,4

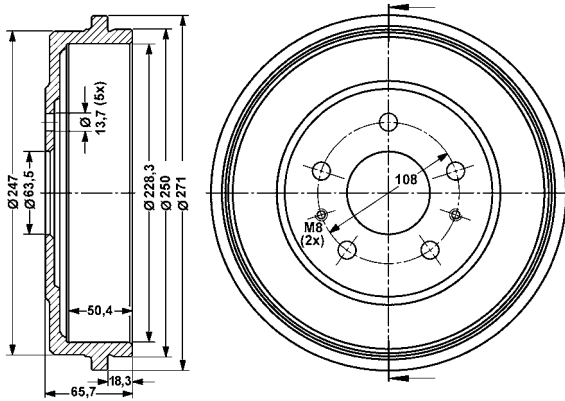

**24.0222-8036.1 480196** Ø 229/230,6 x 58

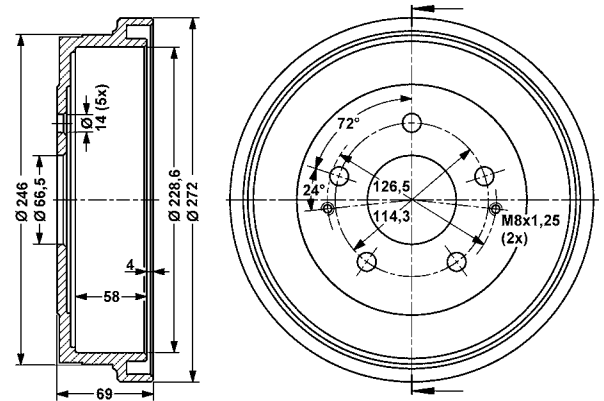

**24.0222-8037.1 480302** Ø 228/230 x 48

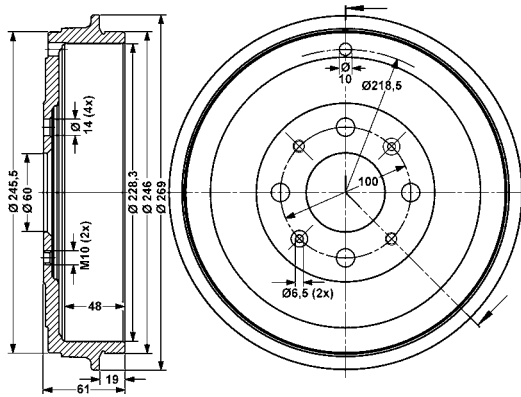

**24.0222-8038.1 480316** Ø 228/230 x 48

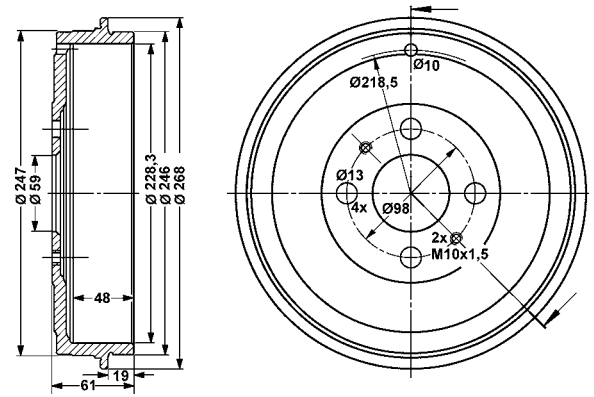

**24.0223-0002.1 480032** Ø 230/231 x 47

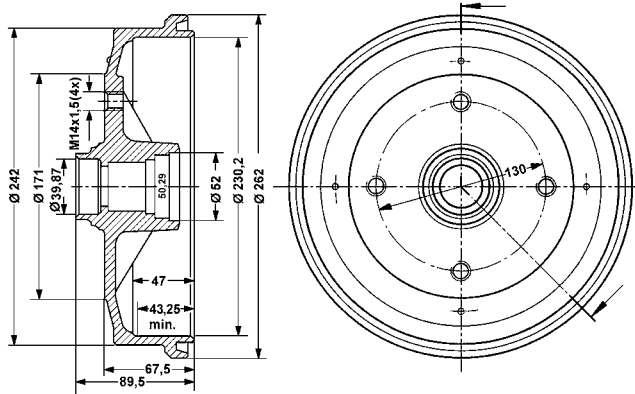

**24.0223-0003.1 480033** Ø 230/231 x 50,5

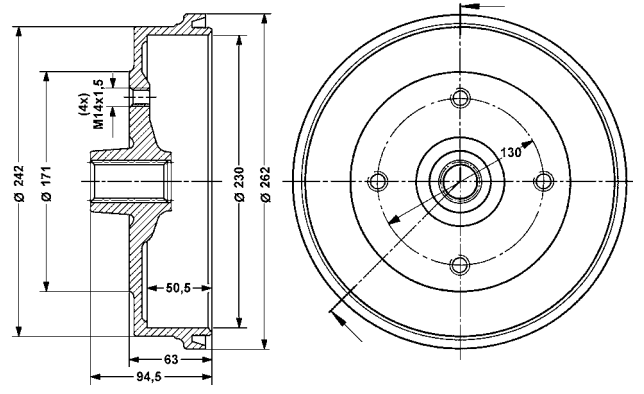

**24.0223-0004.1 480034** Ø 230/231 x 50,2

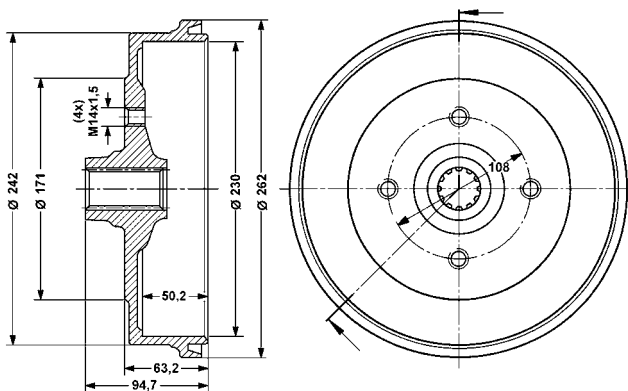

**24.0223-0005.1 480035** Ø 230/231 x 46,5

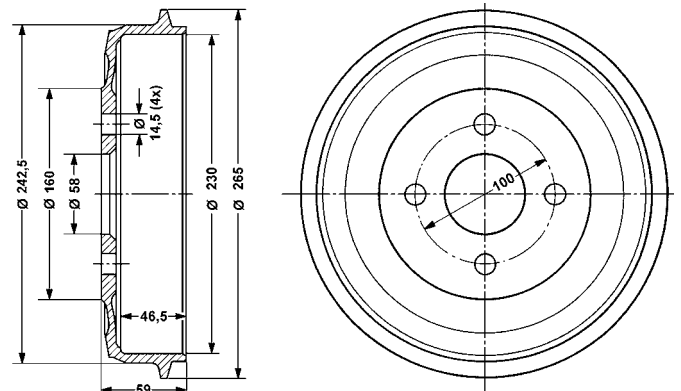

# Abbildungen Bremstrommeln

Illustrations brake drums - Illustrazioni tamburi freno - Illustrations Tambours de frein - Ilustraciones tambores de freno

**24.0223-0007.1 480037** Ø 230/231 x 46

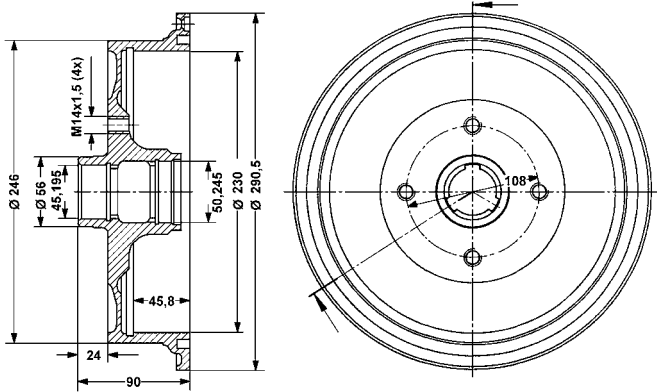

**24.0223-0008.2 480038** Ø 230/230,9 x 60

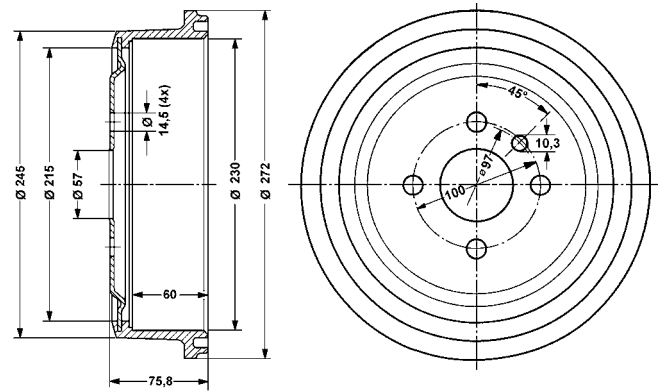

**24.0223-0009.1 480039** Ø 230/231 x 43

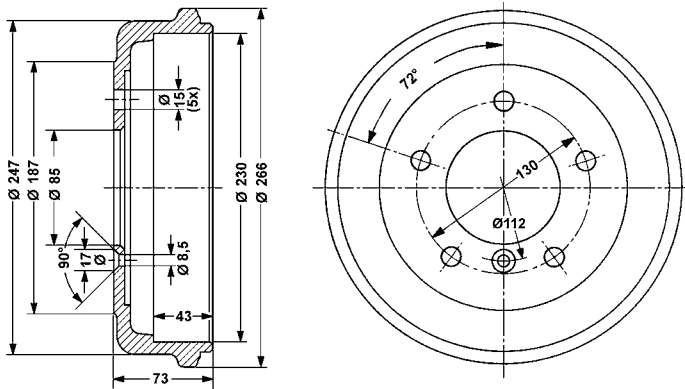

**24.0223-0011.1 480041** Ø 230/231 x 46

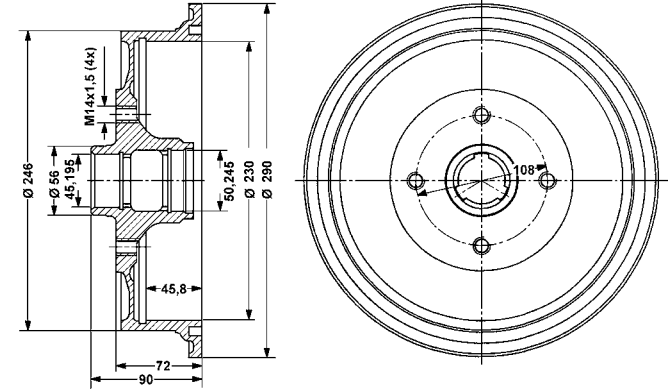

**24.0223-0012.1 480042** Ø 230/231,5 x 53,4

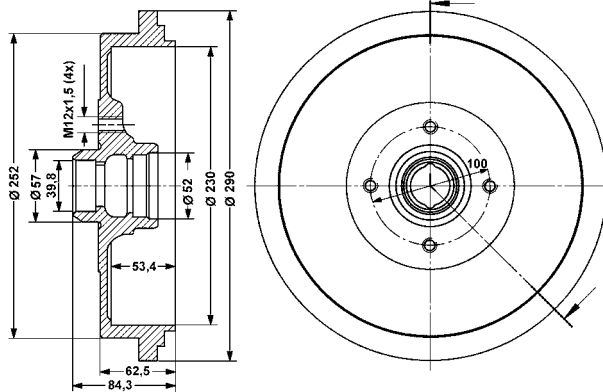

**24.0223-0013.2 480061** Ø 230/231 x 50

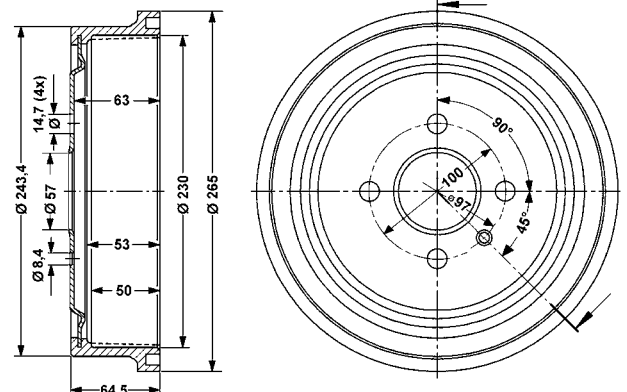

**24.0223-0014.1 480065** Ø 230/231 x 51

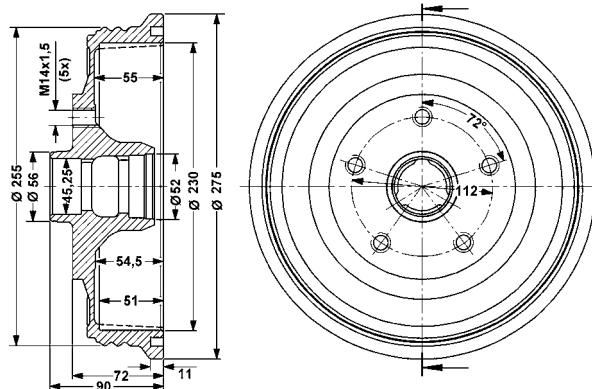

**24.0223-0015.1 480073** Ø 230/231 x 51

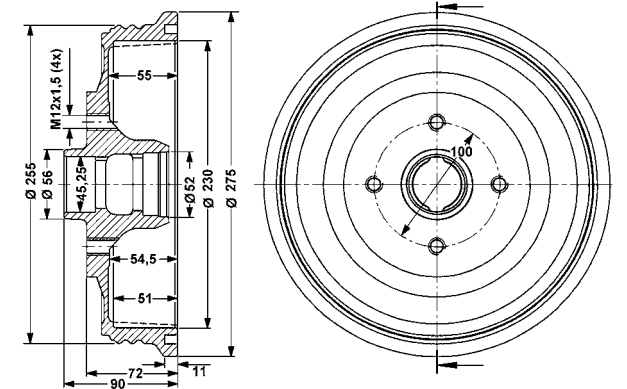

# Abbildungen Bremstrommeln

Illustrations brake drums - Illustrazioni tamburi freno - Illustrations Tambours de frein - Ilustraciones tambores de freno

**24.0223-0016.1 480111**  $\varnothing$  230/231,5 x 39

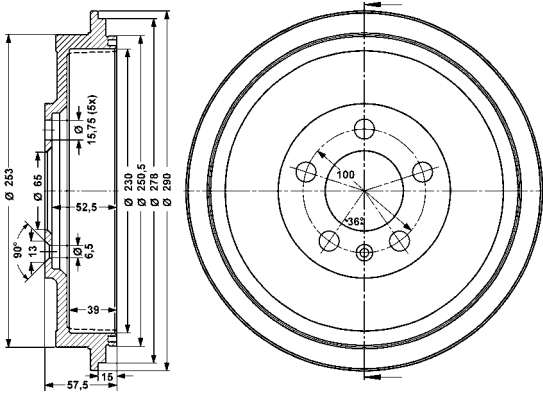

**24.0223-0017.1 480135**  $\varnothing$  230/231,5 x 48,5

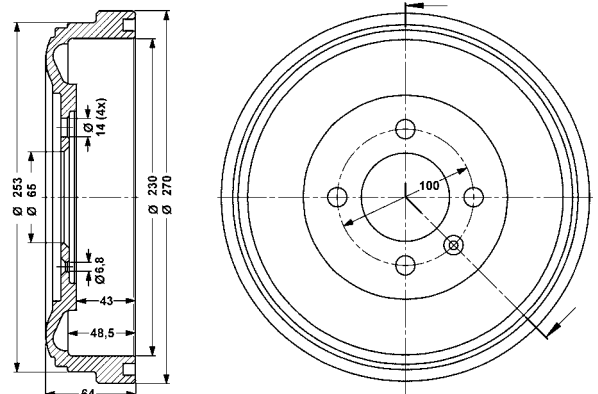

**24.0223-0018.2 480136**  $\varnothing$  230/231,5 x 49,3

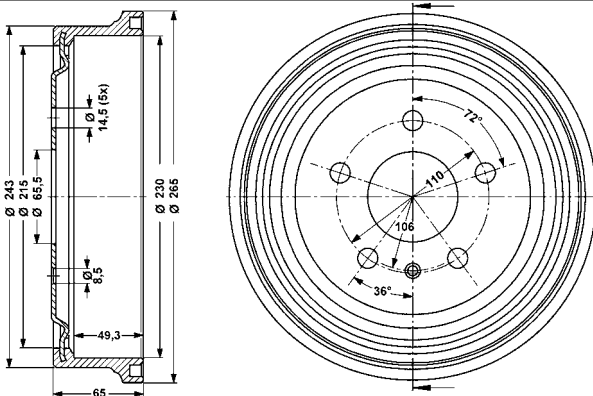

**24.0223-0019.1 480176**  $\varnothing$  230/231 x 50,5

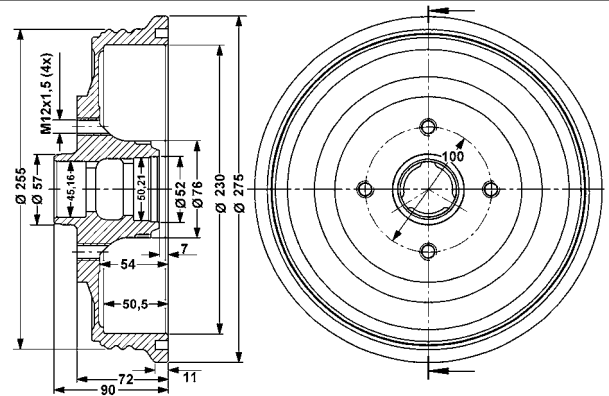

**24.0223-0020.1 480177**  $\varnothing$  230/231,5 x 39,7

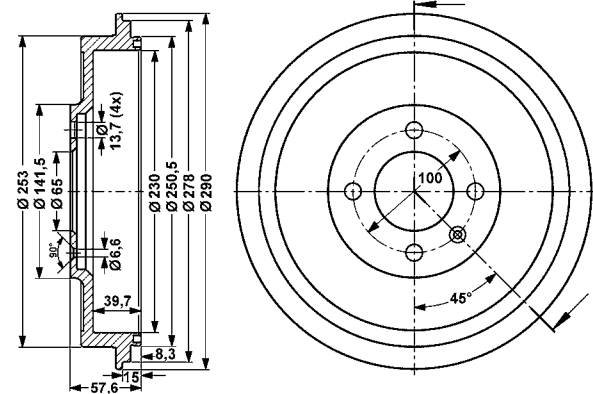

**24.0223-0021.1 480186**  $\varnothing$  230/231 x 50

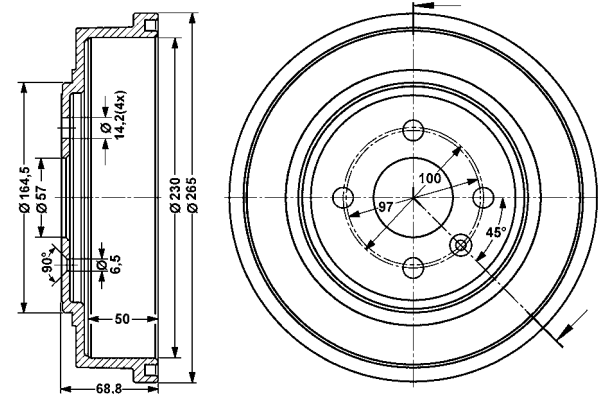

**24.0225-0001.1 480043**  $\varnothing$  250/251 x 47

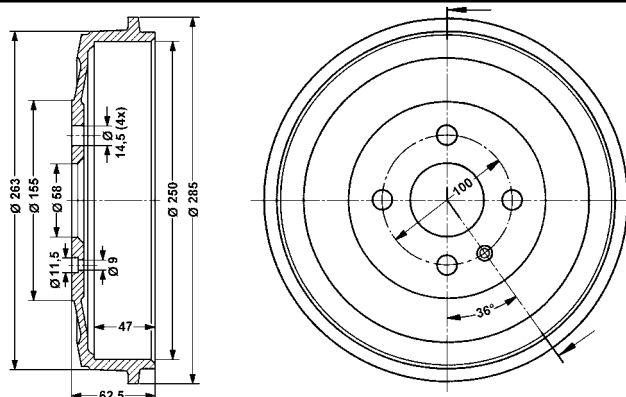

**24.0225-0004.1 480058**  $\varnothing$  250/251,5 x 57,5

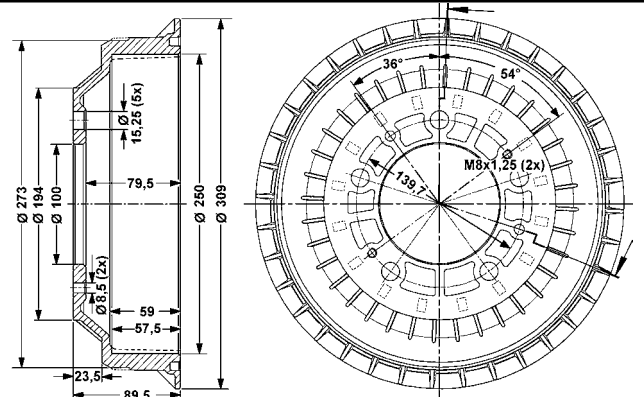

# Abbildungen Bremstrommeln

Illustrations brake drums - Illustrazioni tamburi freno - Illustrations Tambours de frein - Ilustraciones tambores de freno

**24.0225-2001.2 480045** Ø 252/253,5 x 60

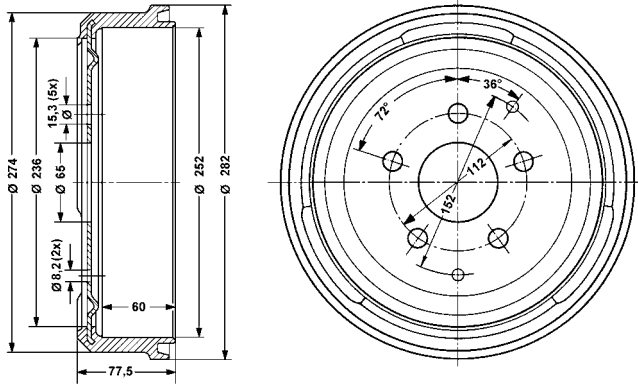

**24.0225-2002.2 480046** Ø 252/253,5 x 61

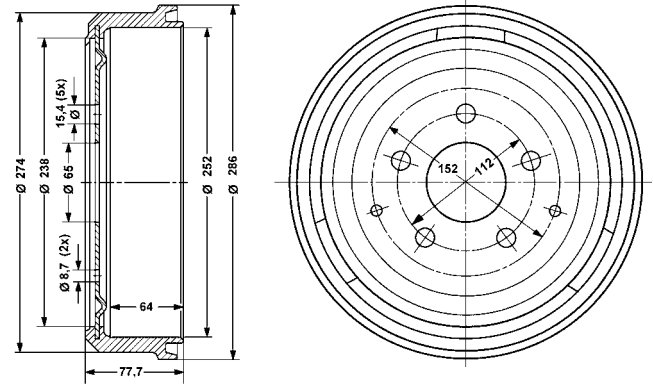

**24.0225-2003.1 480047** Ø 252/253,5 x 66

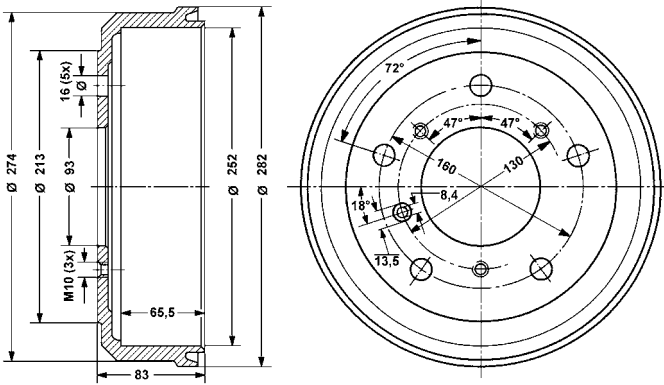

**24.0225-4002.1 480048** Ø 254/255 x 63,5

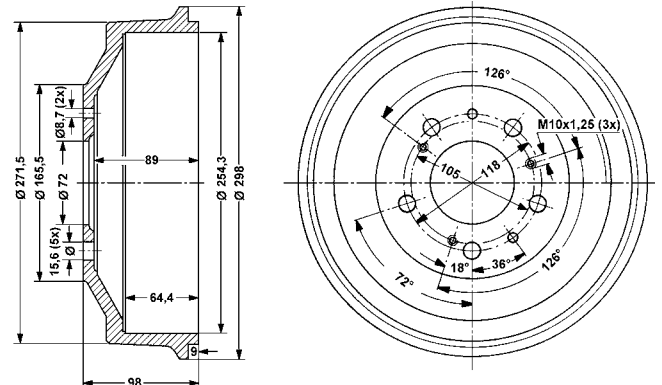

**24.0225-4003.1 480049** Ø 254/255 x 65

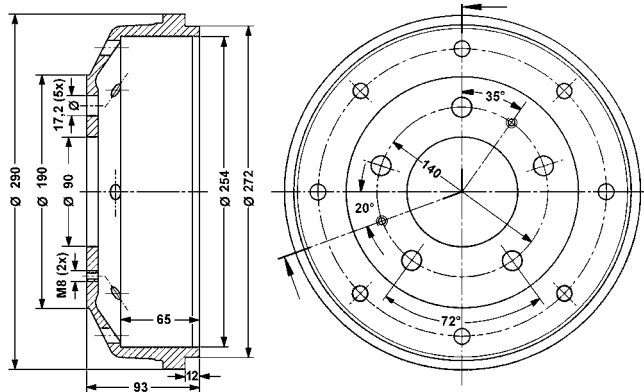

**24.0225-4004.1 480069** Ø 254/256 x 57,5

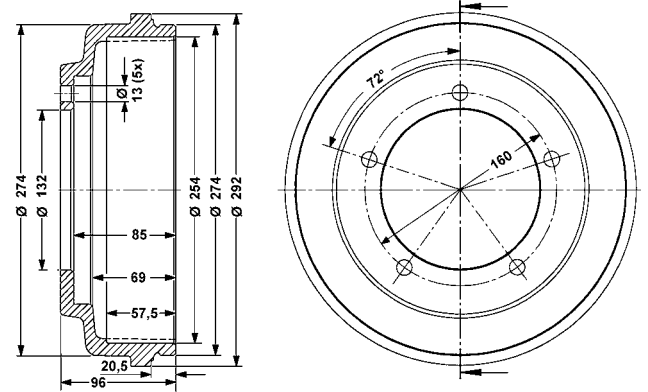

**24.0225-4005.1 480070** Ø 254/255,6 x 64,5

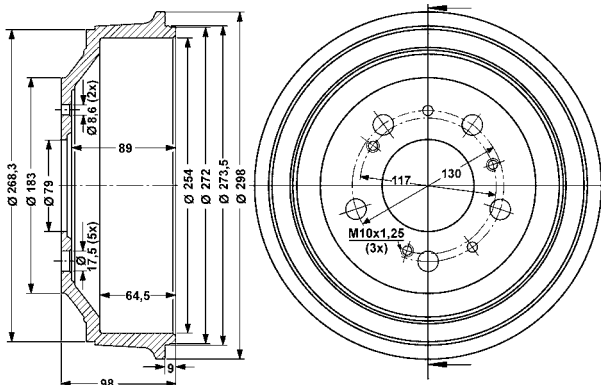

**24.0225-4010.1 480126** Ø 254/256 x 63

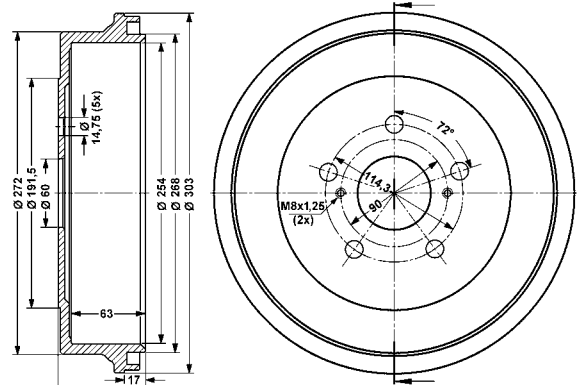



# Abbildungen Bremstrommeln

Illustrations brake drums - Illustrazioni tamburi freno - Illustrations Tambours de frein - Ilustraciones tambores de freno

**24.0225-4012.1 480153** Ø 254/255,5 x 67

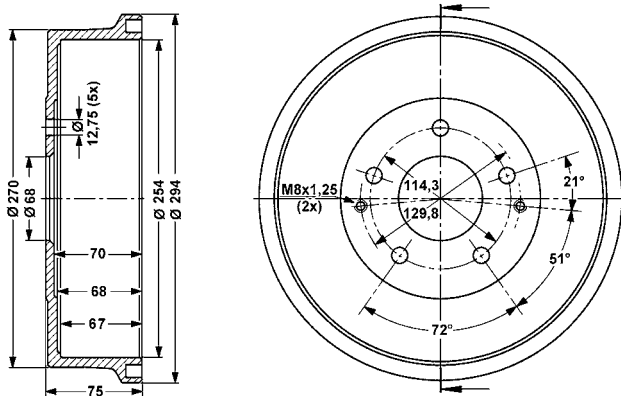

**24.0225-4014.1 480155** Ø 254/255,5 x 65

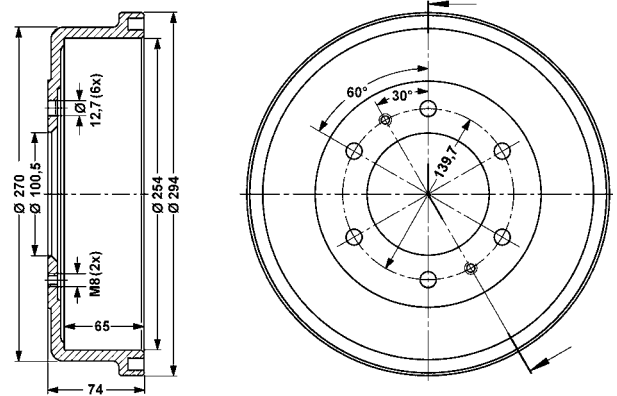

**24.0225-4015.2 480178** Ø 254/254,8 x 70

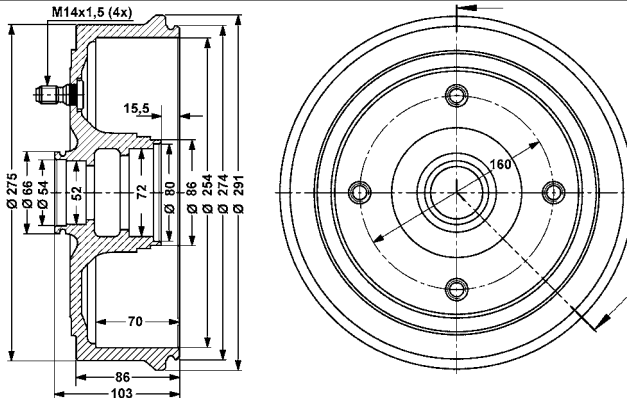

**24.0225-4016.1 480171** Ø 254/256 x 60,1

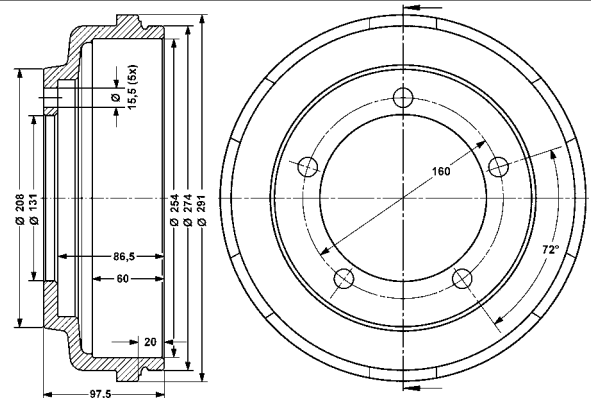

**24.0225-4017.1 480182** Ø 254/255,5 x 47

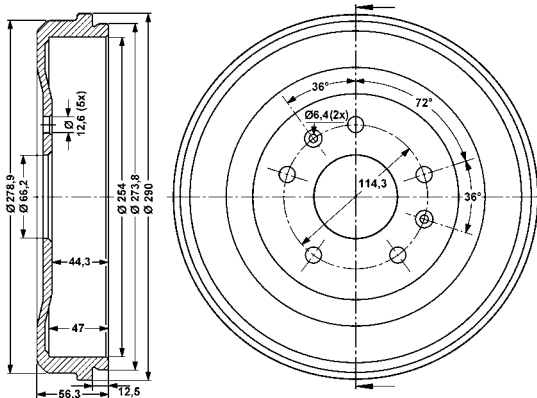

**24.0225-4018.1 480197** Ø 254/256 x 62

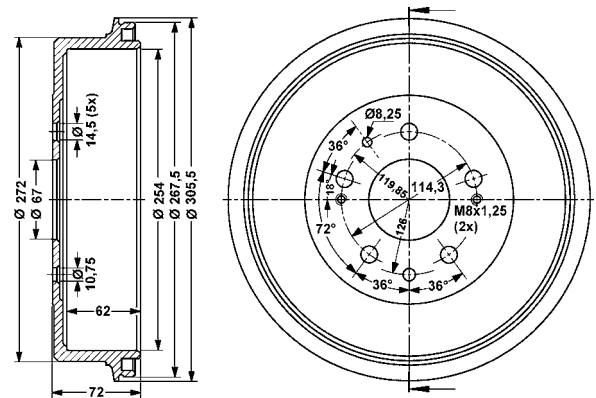

**24.0225-4019.1 480305** Ø 254/254,8 x 70

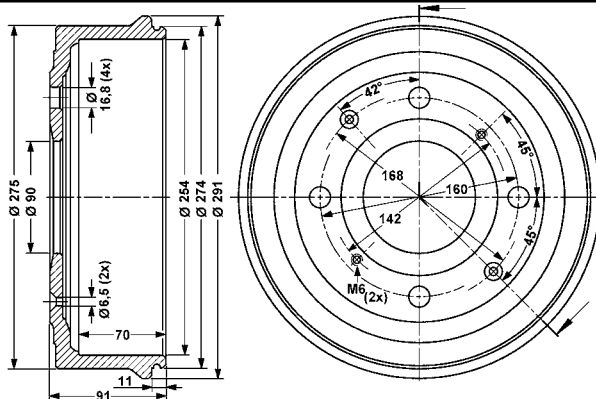

**24.0225-4020.1 480310** Ø 254/255,5 x 57,3

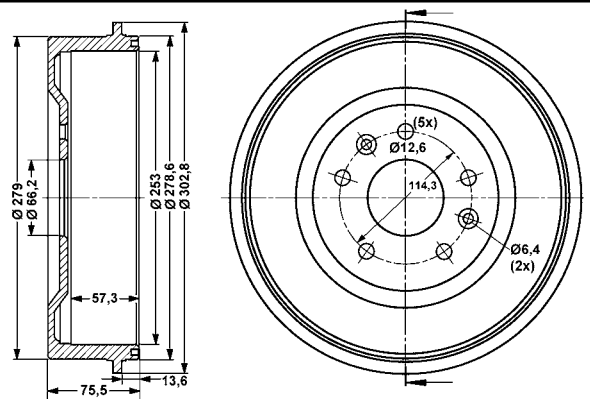

# Abbildungen Bremstrommeln

Illustrations brake drums - Illustrazioni tamburi freno - Illustrations Tambours de frein - Ilustraciones tambores de freno

**24.0225-4021.1 480311**  $\varnothing$  254/256,2 x 68

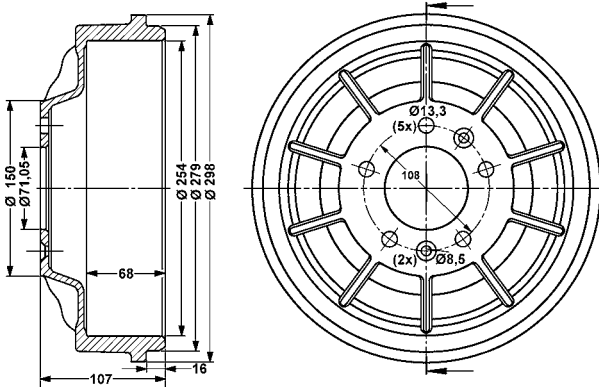

**24.0225-5003.1 480066**  $\varnothing$  255/256 x 67

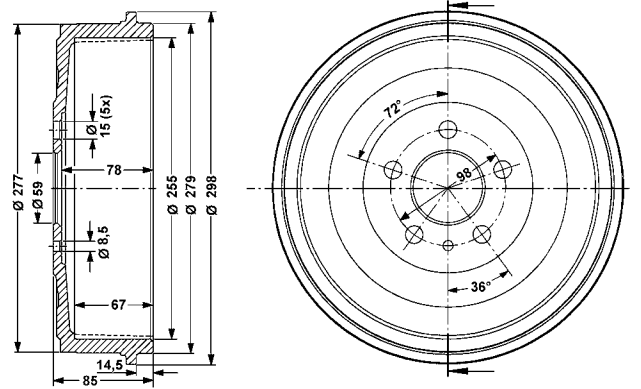

**24.0226-0001.1 480050**  $\varnothing$  260/261 x 63,5

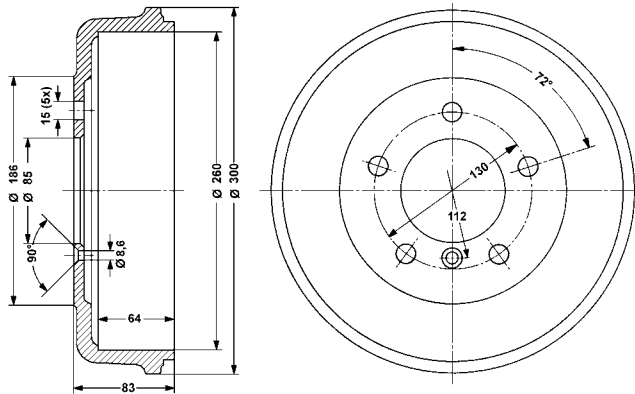

**24.0226-8001.1 480051**  $\varnothing$  268/269,5 x 68,4

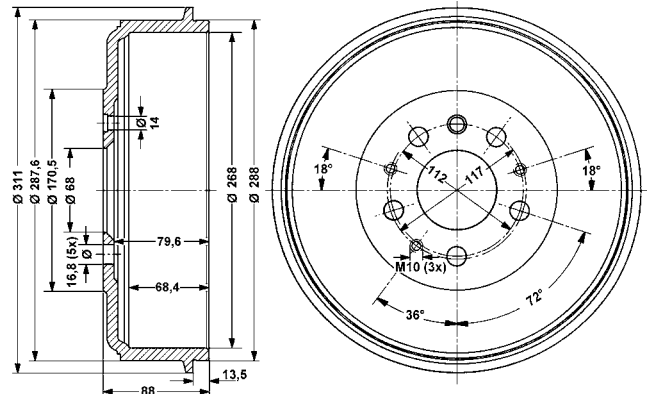

**24.0227-0001.1 480052**  $\varnothing$  270/271,5 x 71

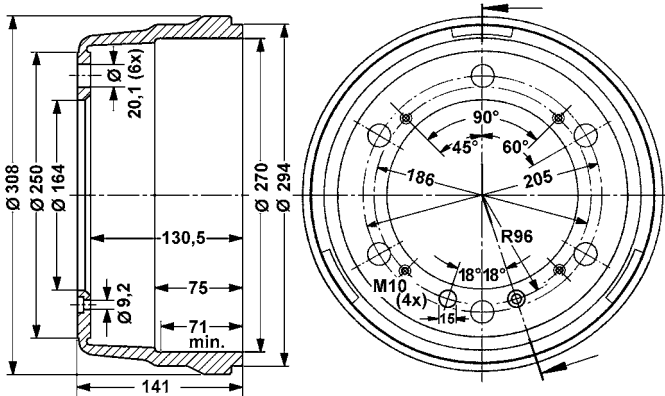

**24.0227-0004.1 480303**  $\varnothing$  270/272 x 66,5

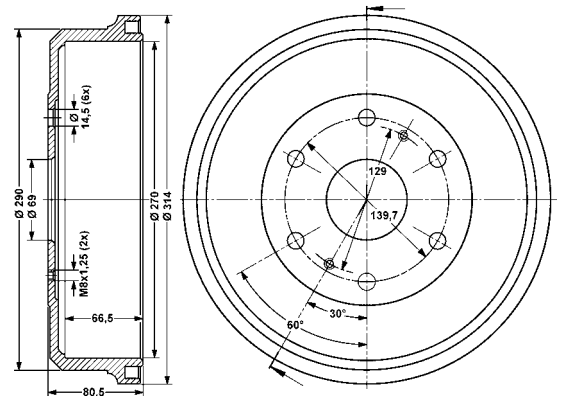

**24.0228-0001.1 480068**  $\varnothing$  280/282 x 75,5

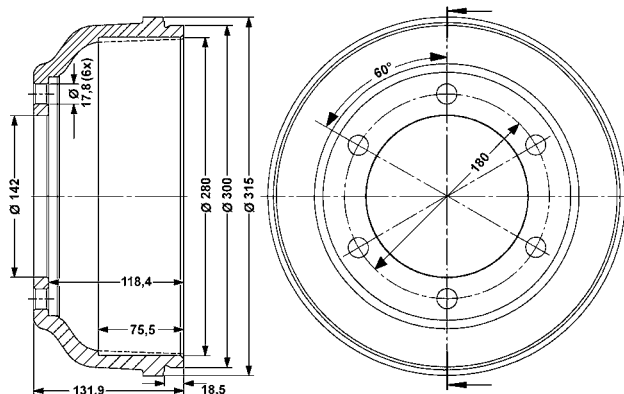

**24.0228-0002.1 480159**  $\varnothing$  280/282 x 69,5

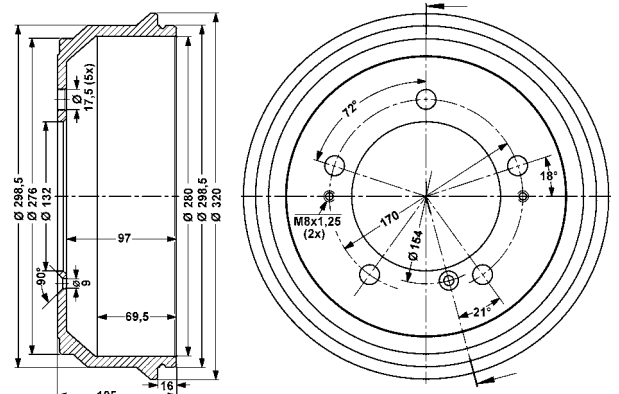



# Abbildungen Bremstrommeln

Illustrations brake drums - Illustrazioni tamburi freno - Illustrations Tambours de frein - Ilustraciones tambores de freno

**24.0228-0003.1 480172** Ø 280/282 x 75,5

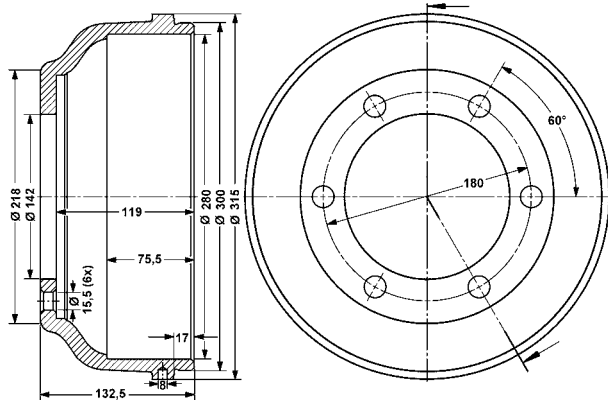

**24.0228-0004.1 480173** Ø 280/282 x 80,3

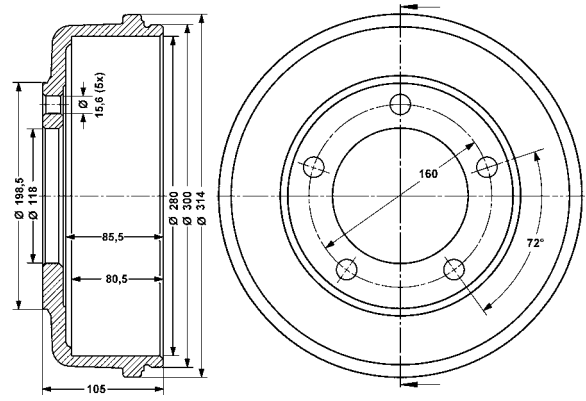

**24.0229-5003.1 480306** Ø 295/297 x 67

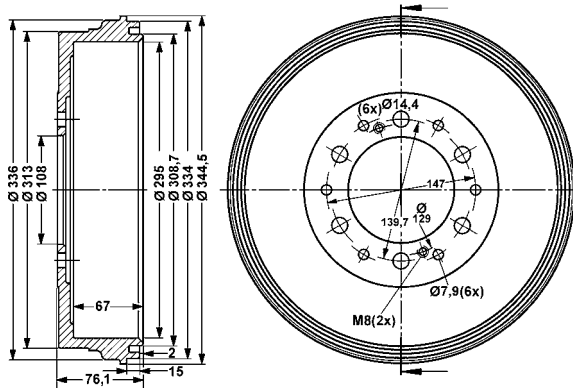

**24.0229-5004.1 480312** Ø 295/297 x 67

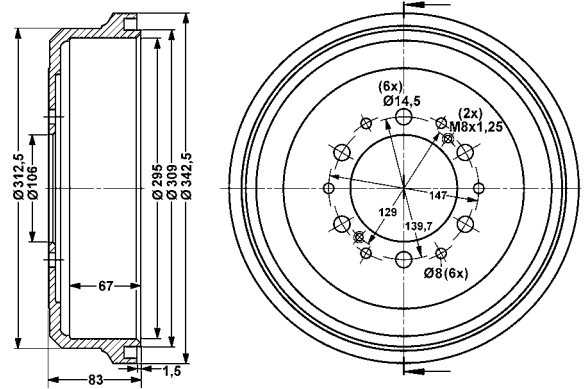



- D** Abmessungen Bremsscheiben
- EN** Dimensions brake discs
- FR** Dimensions Disques de frein
- IT** Misura dischi freno
- ES** Medidas disco de freno
- NL** Afmetingen remschijven
- DA** Mål på bremseskiver
- SV** Dimensioner bromsskivor
- HU** Féktárcsák méretei
- PT** Dimensões dos discos dos travões
- RU** Размеры тормозных дисков
- CZ** Rozměry brzdových kotoučů
- PL** Wymiary tarcz hamulcowych
- EL** Διαστάσεις δίσκων φρένων
- TR** Fren disk ölçümleri
- ZH** 制动盘测澁
- JA** 寸法 ブレーキディスク
- AR** مقاييس أقراص المكابح

# K24-F

# Abmessungen Bremsscheiben

## Dimensions brake discs - Misure dischi freno -

## Dimensions Disques de frein - Medidas disco de freno

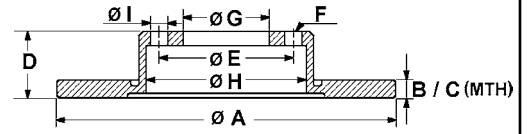

S Fixierschraube - fixing screw - vite di riparazione - vis de fixation - tornillo quefija

B beschichtet - coated - rivestito - revêtu - recubierto

HC hochgekohlt - high carbon - ad alto tenore di carbonio - à haute teneur en carbone - altamente carbonizado

L legiert - alloyed - alligato/legato - allié - aleado

V ventiliert - ventilated - ventilato - ventilé - ventilado

● gelocht - perforated - perforato - poinçonné - perforado

|                |        | S | B | H | C | L  | V | A     | B   | C   | D    | E     | F | G    | H     | I        | OE                 | #   |
|----------------|--------|---|---|---|---|----|---|-------|-----|-----|------|-------|---|------|-------|----------|--------------------|---|
| 24.0107-0100.1 | 407100 |   |   |   |   |    |   | 244,0 | 7,0 | 6,3 | 47,0 | 108,0 | 6 | 86,7 | 128,0 | 9,5      | CITROEN            | 95 599 322  |
| 24.0107-0104.1 | 407104 |   |   |   |   |    |   | 178,0 | 7,0 | 6,3 | 14,5 | 63,0  | 4 | 45,6 | 85,5  | 9,4      | CITROEN            | 2G 5 448 826 V<br>5 448 826   |
| 24.0107-0105.2 | 407105 |   |   |   |   |    |   | 224,0 | 7,0 | 5,0 | 56,5 | 108,0 | 4 | 71,0 | 133,0 | 13,0     | CITROEN            | 95 582 061<br>95 661 849  |
| 24.0107-0108.1 | 407108 |   |   |   |   |    |   | 234,0 | 7,0 | 6,0 | 39,5 | 100,0 | 4 | 68,0 | 140,0 | 12,8     | NISSAN             | 43206-58Y01   |
| 24.0107-0109.1 | 407109 |   | B |   |   |    |   | 240,0 | 7,0 | 6,0 | 41,0 | 100,0 | 4 | 61,0 | 140,0 | 12,6     | NISSAN             | 43206-5F001   |
| 24.0108-0100.1 | 408100 |   |   |   |   |    |   | 239,0 | 8,0 | 7,0 | 44,0 | 100,0 | 4 | 65,0 | 124,5 | 12,9     | AUDI/VW            | 861 615 301 B   |
| 24.0108-0104.1 | 408104 |   | S | B |   |    |   | 238,0 | 8,2 | 7,0 | 41,0 | 100,0 | 4 | 61,0 | 129,5 | 12,4     | RENAULT            | 77 01 204 285   |
| 24.0108-0105.1 | 408105 |   |   |   |   |    |   | 247,5 | 8,0 | 6,5 | 20,3 | 108,0 | 4 | 71,0 | 133,0 | 13,0     | PEUGEOT            | 4246 H0   |
| 24.0108-0106.1 | 408106 |   | S | B |   |    |   | 247,0 | 8,0 | 6,0 | 25,3 | 108,0 | 4 | 71,1 | 133,5 | 13,0     | CITROEN            | 4249 F5   |
|                |        |   |   |   |   |    |   |       |     |     |      |       |   |      |       |          | PEUGEOT            | 4249 F5   |
| 24.0108-0107.1 | 408107 |   | S | B |   |    |   | 238,0 | 8,0 | 6,0 | 29,0 | 98,0  | 3 | 57,0 | 124,5 | 13,0     | CITROEN            | 95 027 199<br>95 661 810  |
|                |        |   |   |   |   |    |   |       |     |     |      |       |   |      |       |          | PEUGEOT            | 4246 G0   |
| 24.0108-0108.1 | 408108 |   |   | B |   |    |   | 238,0 | 8,0 | 7,0 | 74,6 | 100,0 | 4 | 52,0 | 52,3  | M12x1,5  | RENAULT            | 77 00 780 077<br>77 00 780 078<br>77 00 829 553<br>77 01 204 293<br>77 01 204 294<br>77 01 204 523<br>77 01 204 901 |
| 24.0108-0109.1 | 408109 |   |   |   |   |    |   | 238,0 | 8,0 | 7,0 | 74,6 | 100,0 | 4 | 52,0 | 52,3  | M12x1,5  | RENAULT            | 77 00 805 006<br>77 00 805 148<br>77 01 204 302<br>77 01 204 303  |
| 24.0108-0111.1 | 408111 |   |   | B |   |    |   | 258,0 | 8,0 | 7,0 | 55,3 | 112,0 | 5 | 67,0 | 164,0 | 13,0     | MERCEDES BENZ      | 168 423 02 12   |
| 24.0108-0113.1 | 408113 |   | S | B |   |    |   | 258,0 | 8,0 | 7,0 | 57,3 | 112,0 | 5 | 67,0 | 164,0 | 15,0     | MERCEDES BENZ      | 169 423 09 12   |
| 24.0108-0114.2 | 408114 |   |   | B |   |    |   | 240,0 | 8,0 | 7,0 | 80,6 | 100,0 | 4 | 52,3 | 55,0  | M12x1,5  | RENAULT            | 77 01 207 823<br>86 60 001 811<br>86 71 018 106   |
| 24.0108-0116.2 | 408116 |   |   | B |   |    |   | 260,0 | 8,0 | 7,0 | 86,2 | 114,3 | 5 | 52,3 | 55,0  | M12x1,5  | RENAULT            | 43 20 015 39R<br>43 20 075 95R  |
| 24.0108-0117.2 | 408117 |   |   | B |   |    |   | 238,0 | 8,0 | 7,0 | 74,6 | 100,0 | 4 | 52,3 | 52,0  | M12x1,5  | RENAULT            | 77 01 207 611   |
| 24.0108-0118.2 | 408118 |   |   | B |   |    |   | 260,0 | 8,0 | 7,0 | 86,2 | 114,3 | 5 | 52,3 | 62,0  | M12x1,5  | RENAULT            | 43 20 065 06R<br>43 20 075 56R  |
| 24.0109-0100.2 | 409100 |   |   | B |   |    |   | 249,0 | 9,0 | 7,0 | 69,2 | 108,0 | 4 | 56,0 | 62,0  | M12x1,25 | CITROEN            | 4249 32   |
|                |        |   |   |   |   |    |   |       |     |     |      |       |   |      |       |          | PEUGEOT            | 4249 19<br>4249 32  |
| 24.0109-0101.1 | 409101 |   |   |   |   |    |   | 267,0 | 9,4 | 7,5 | 65,3 | 108,0 | 4 | 70,0 | 160,0 | 12,8     | ALFA ROMEO         | 60516948  |
| 24.0109-0103.1 | 409103 |   |   | B |   |    |   | 278,0 | 9,0 | 7,3 | 58,5 | 112,0 | 5 | 67,0 | 164,0 | 15,0     | MERCEDES BENZ      | 129 423 00 12   |
| 24.0109-0108.1 | 409108 |   |   |   |   |    |   | 244,5 | 9,0 | 7,0 | 43,8 | 86,0  | 3 | 62,0 | 109,0 | 10,0     | CITROEN            | 75 485 825  |
| 24.0109-0111.1 | 409111 |   |   | S | B |    |   | 239,0 | 9,0 | 8,0 | 47,6 | 100,0 | 4 | 61,0 | 155,0 | 13,0     | HONDA              | 42510-SR3-A11<br>42510-SR3-J00  |
| 24.0109-0114.1 | 409114 |   |   | S | B |    |   | 278,0 | 9,0 | 7,3 | 55,5 | 112,0 | 5 | 67,0 | 164,0 | 13,2     | CHRYSLER           | 0 5098 066AA  |
|                |        |   |   |   |   |    |   |       |     |     |      |       |   |      |       |          | MERCEDES BENZ      | 203 423 01 12<br>210 423 01 12<br>210 423 04 12<br>210 423 09 12  |
| 24.0109-0120.1 | 409120 |   |   | S | B |    |   | 258,0 | 9,0 | 7,3 | 55,5 | 112,0 | 5 | 67,0 | 164,0 | 12,8     | MERCEDES BENZ      | 202 423 00 12   |
| 24.0109-0121.2 | 409121 |   |   |   |   |    |   | 224,0 | 9,0 | 8,0 | 63,2 | 108,0 | 5 | 71,0 | 135,0 | 13,0     | CITROEN            | 4246 T3<br>95 661 814   |
| 24.0109-0122.1 | 409122 |   |   | B |   |    |   | 224,0 | 9,0 | 7,0 | 57,5 | 108,0 | 4 | 71,1 | 132,7 | 13,0     | CITROEN            | 95 667 811<br>E169114   |
| 24.0109-0123.1 | 409123 |   |   | S | B |    |   | 230,0 | 9,0 | 7,0 | 40,6 | 100,0 | 5 | 65,0 | 125,8 | 15,6     | AUDI/SEAT/SKODA/VW | 1J0 615 601 C<br>1J0 615 601 P  |
| 24.0109-0124.1 | 409124 |   |   | B |   |    |   | 232,0 | 9,0 | 7,0 | 39,5 | 100,0 | 4 | 65,0 | 125,0 | 13,6     | SEAT/VW            | 6N0 615 601 A<br>6N0 615 601 B  |
| 24.0109-0125.1 | 409125 |   |   |   |   |    |   | 228,0 | 9,0 | 8,0 | 39,5 | 100,0 | 4 | 60,0 | 127,0 | 13,5     | VOLVO              | 3432618<br>3450386  |
| 24.0109-0127.1 | 409127 |   |   |   |   |    |   | 231,0 | 9,0 | 8,0 | 34,5 | 100,0 | 4 | 65,0 | 125,0 | 13,0     | MAZDA              | B4Y2-26-251C  |
| 24.0109-0128.1 | 409128 |   |   |   |   |    |   | 242,0 | 9,0 | 8,0 | 36,4 | 100,0 | 4 | 54,0 | 130,9 | 14,5     | TOYOTA             | 42431-12090<br>42431-12120  |
| 24.0109-0129.1 | 409129 |   |   |   |   |    |   | 258,0 | 9,0 | 8,0 | 44,5 | 114,3 | 4 | 68,0 | 154,0 | 12,8     | NISSAN             | 43206-42R05   |
| 24.0109-0130.1 | 409130 |   |   |   |   |    |   | 258,0 | 9,0 | 7,5 | 43,5 | 108,0 | 4 | 68,0 | 160,7 | 15,5     | SAAB               | 8970717   |
| 24.0109-0131.1 | 409131 |   |   | B |   |    |   | 251,0 | 9,0 | 8,0 | 34,5 | 100,0 | 4 | 55,0 | 125,0 | 13,0     | MAZDA              | BB4C-26-251C<br>BR74-26-251A  |
| 24.0109-0132.1 | 409132 |   |   |   |   |    |   | 282,0 | 9,0 | 7,5 | 61,0 | 114,3 | 5 | 70,0 | 170,0 | 12,6     | HONDA              | 42510-SP0-000<br>42510-SX0-000  |
| 24.0109-0133.1 | 409133 |   |   | S | B |    |   | 239,0 | 8,9 | 7,0 | 33,4 | 100,0 | 5 | 65,0 | 132,5 | 15,8     | AUDI/VW/SKODA      | 1J0 615 601 D   |
| 24.0109-0136.1 | 409136 |   |   | S | B | HC |   | 280,0 | 9,0 | 8,0 | 38,0 | 112,0 | 3 | 58,0 | 153,5 | 12,5     | SMART              | 000 4341 V002 000000  |



# Abmessungen Bremsscheiben

## Dimensions brake discs - Misure dischi freno -

## Dimensions Disques de frein - Medidas disco de freno

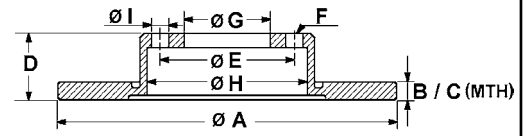

S Fixierschraube - fixing screw - vite di riparazione - vis de fixation - tornillo quefija

B beschichtet - coated - rivestito - revêtu - recubierto

HC hochgekohlt - high carbon - ad alto tenore di carbonio - à haute teneur en carbone - altamente carbonizado

L legiert - alloyed - alligato/legato - allié - aleado

V ventiliert - ventilated - ventilato - ventilé - ventilado

● gelocht - perforated - perforato - poinçonné - perforado

|                |        | S | B | HC | L | V | A     | B    | C   | D    | E     | F | G    | H     | I        | OE              | #  |
|----------------|--------|---|---|----|---|---|-------|------|-----|------|-------|---|------|-------|----------|-----------------|--|
| 24.0109-0137.1 | 409137 | S | B |    |   |   | 247,0 | 9,0  | 8,0 | 35,0 | 108,0 | 4 | 71,1 | 133,0 | 13,0     | CITROEN         | 4246 X8<br>4259 53<br>4249 90  |
|                |        |   |   |    |   |   |       |      |     |      |       |   |      |       |          | PEUGEOT         | 4246 W9<br>4259 52<br>4249 90  |
| 24.0109-0138.1 | 409138 |   | B |    |   |   | 258,0 | 9,0  | 8,0 | 55,5 | 100,0 | 4 | 55,0 | 172,0 | 14,5     | TOYOTA          | 42431-02070  |
| 24.0109-0139.1 | 409139 |   | B |    |   |   | 269,0 | 9,0  | 8,0 | 56,0 | 100,0 | 4 | 55,0 | 173,0 | 14,5     | TOYOTA          | 42431-12250<br>42431-52050<br>42431-47020  |
| 24.0109-0140.1 | 409140 |   | B |    |   |   | 279,0 | 9,0  | 8,0 | 55,5 | 100,0 | 4 | 55,0 | 172,0 | 14,5     | TOYOTA          | 42431-02080<br>42431-02081   |
| 24.0109-0141.1 | 409141 | S |   |    |   |   | 260,0 | 9,0  | 8,0 | 42,3 | 114,3 | 4 | 64,1 | 157,0 | 12,6     | HONDA           | 42510-S30-900  |
| 24.0109-0142.1 | 409142 |   | B |    |   |   | 278,0 | 9,0  | 7,0 | 24,7 | 100,0 | 4 | 55,0 | 147,0 | 14,3     | DAIHATSU        | 42431-0D060  |
|                |        |   |   |    |   |   |       |      |     |      |       |   |      |       |          | TOYOTA          | 42431-0D060  |
| 24.0109-0143.1 | 409143 | S |   |    |   |   | 260,0 | 9,0  | 8,0 | 48,2 | 100,0 | 4 | 61,0 | 156,0 | 13,0     | HONDA           | 42510-S5A-A00  |
| 24.0109-0144.1 | 409144 |   | S | B  |   |   | 282,0 | 9,0  | 8,0 | 58,3 | 114,3 | 5 | 64,1 | 170,0 | 12,5     | HONDA           | 42510-S9A-N00  |
| 24.0109-0145.1 | 409145 |   |   |    |   |   | 260,0 | 9,0  | 8,0 | 48,1 | 114,3 | 4 | 64,1 | 157,0 | 12,6     | HONDA           | 42510-S84-A50  |
| 24.0109-0146.1 | 409146 |   | B |    |   |   | 270,0 | 9,0  | 7,3 | 53,3 | 100,0 | 5 | 57,5 | 172,0 | 14,5     | CHRYSLER        | 4509 553<br>4509 553AB<br>4509 553AC   |
| 24.0109-0147.1 | 409147 |   |   |    |   |   | 258,0 | 9,0  | 8,0 | 46,5 | 114,3 | 5 | 68,0 | 154,0 | 12,5     | NISSAN          | 43206-74F00  |
| 24.0109-0148.1 | 409148 |   |   |    |   |   | 269,0 | 9,0  | 8,0 | 65,0 | 100,0 | 5 | 55,0 | 170,0 | 14,5     | TOYOTA          | 42431-20360  |
| 24.0109-0150.2 | 409150 |   | B |    |   |   | 249,0 | 9,0  | 8,0 | 67,1 | 108,0 | 4 | 55,9 | 60,0  | M12x1,25 | CITROEN         | 4246 Z9<br>4249 34<br>4246 Z9  |
|                |        |   |   |    |   |   |       |      |     |      |       |   |      |       |          | PEUGEOT         |  |
| 24.0109-0151.1 | 409151 | S | B |    |   |   | 304,5 | 9,0  | 7,5 | 61,0 | 114,3 | 5 | 64,1 | 200,0 | 12,8     | HONDA           | 42510-SCA-E50  |
| 24.0109-0152.1 | 409152 |   | B |    |   |   | 303,0 | 9,0  | 8,0 | 62,1 | 114,3 | 5 | 62,0 | 190,0 | 14,5     | TOYOTA          | 42431-42041  |
| 24.0109-0154.1 | 409154 | S | B |    |   |   | 278,0 | 9,0  | 7,3 | 57,5 | 112,0 | 5 | 67,0 | 164,0 | 15,0     | MERCEDES BENZ   | 000 423 13 12  |
| 24.0109-0155.1 | 409155 |   | B |    |   |   | 259,0 | 9,0  | 7,5 | 30,5 | 114,3 | 5 | 62,0 | 156,0 | 14,8     | TOYOTA          | 42431-02190<br>42431-12260   |
| 24.0109-0156.1 | 409156 |   | B |    |   |   | 259,0 | 9,0  | 7,5 | 30,0 | 100,0 | 4 | 55,0 | 156,0 | 14,5     | ASTON MARTIN    | 42431-52080  |
|                |        |   |   |    |   |   |       |      |     |      |       |   |      |       |          | TOYOTA          | 42431-52080  |
| 24.0109-0157.1 | 409157 |   | B |    |   |   | 291,5 | 9,0  | 8,0 | 62,0 | 114,3 | 5 | 68,0 | 172,0 | 12,7     | NISSAN          | 43206-JD00A  |
| 24.0109-0158.1 | 409158 | S | B |    |   |   | 260,0 | 9,0  | 8,0 | 42,2 | 114,3 | 5 | 64,2 | 140,5 | 12,6     | HONDA           | 42510-SMG-E20<br>42510-SNA-A00   |
| 24.0109-0159.1 | 409159 |   | B |    |   |   | 266,0 | 9,0  | 8,0 | 36,2 | 100,0 | 4 | 55,0 | 131,0 | 14,5     | TOYOTA          | 42431-12150<br>42431-12170   |
| 24.0109-0160.1 | 409160 |   | B |    |   |   | 278,0 | 9,0  | 8,0 | 43,1 | 114,3 | 5 | 62,0 | 169,0 | 12,7     | SUZUKI          | 55611-80J10  |
| 24.0109-0161.1 | 409161 |   | B |    |   |   | 282,0 | 9,0  | 7,5 | 61,1 | 114,3 | 5 | 64,2 | 170,0 | 12,6     | HONDA           | 42510-SZ3-J00  |
| 24.0109-0162.1 | 409162 | S | B |    |   |   | 260,0 | 9,0  | 8,0 | 31,1 | 100,0 | 4 | 61,0 | 142,4 | 12,6     | HONDA           | 42510-TM8-G00  |
| 24.0109-0163.1 | 409163 |   | B |    |   |   | 259,0 | 9,0  | 7,5 | 30,2 | 100,0 | 5 | 55,0 | 156,2 | 14,5     | SUBARU          | 4243112310   |
|                |        |   |   |    |   |   |       |      |     |      |       |   |      |       |          | TOYOTA          | 42431-12310  |
| 24.0109-0166.1 | 409166 |   | B |    |   |   | 292,0 | 9,0  | 8,0 | 62,0 | 114,3 | 4 | 68,0 | 172,0 | 12,5     | NISSAN          | 43206-EM10A  |
| 24.0109-0167.1 | 409167 |   | B |    |   |   | 278,0 | 9,0  | 8,0 | 43,2 | 114,3 | 5 | 62,0 | 169,0 | 14,0     | FIAT            | 71768089   |
|                |        |   |   |    |   |   |       |      |     |      |       |   |      |       |          | SUZUKI          | 55611-55L00<br>55611-80J01   |
| 24.0109-0168.1 | 409168 | S | B |    |   |   | 239,0 | 9,0  | 8,0 | 47,7 | 100,0 | 4 | 61,0 | 151,1 | 13,0     | HONDA           | 42510-SEL-T50  |
| 24.0109-0169.1 | 409169 | S | B |    |   |   | 282,0 | 9,0  | 8,0 | 48,7 | 114,3 | 5 | 64,2 | 157,0 | 12,5     | HONDA           | 42510-TA0-A01  |
| 24.0109-0170.1 | 409170 |   | B |    |   |   | 259,0 | 9,0  | 7,5 | 40,8 | 100,0 | 5 | 55,0 | 156,0 | 16,5     | TOYOTA          | 42431-52150  |
| 24.0109-0171.2 | 409171 |   | B |    |   |   | 249,0 | 9,0  | 8,0 | 73,2 | 108,0 | 4 | 56,0 | 62,0  | M12x1,25 | CITROEN/PEUGEOT | 4249 66  |
| 24.0109-0173.1 | 409173 | S | B | HC |   |   | 276,0 | 9,0  | 7,3 | 44,0 | 112,0 | 5 | 67,0 | 153,0 | 15,0     | MERCEDES BENZ   | 246 423 04 12  |
| 24.0109-0174.1 | 409174 | S | B |    |   |   | 232,0 | 9,0  | 7,0 | 39,6 | 100,0 | 5 | 65,0 | 123,8 | 15,6     | VOLKSWAGEN      | 1JE 615 601  |
| 24.0109-0175.1 | 409175 |   | B |    |   |   | 259,0 | 9,0  | 8,0 | 43,2 | 100,0 | 4 | 62,0 | 150,0 | 14,0     | SUZUKI          | 55611-68L00  |
| 24.0109-0181.1 | 409181 |   | B |    |   |   | 265,0 | 9,0  | 7,0 | 39,0 | 114,3 | 5 | 68,0 | 143,0 | 13,0     | MAZDA           | B45G-26-251A<br>BJS7-26-251B   |
| 24.0109-0182.1 | 409182 |   | B |    |   |   | 259,4 | 9,0  | 8,0 | 43,2 | 114,3 | 5 | 62,0 | 146,6 | 14,0     | SUZUKI          | 55611-61M00  |
| 24.0109-0709.1 | 409709 |   |   |    |   |   | 260,0 | 9,0  | 8,0 | 48,1 | 114,3 | 5 | 64,1 | 157,0 | 12,6     | HONDA           | 42510-S87-A00  |
| 24.0109-0711.1 | 409711 |   | B |    |   |   | 269,0 | 9,0  | 7,5 | 56,0 | 100,0 | 5 | 55,0 | 173,0 | 14,5     | TOYOTA          | 42431-20420<br>42431-47030   |
| 24.0110-0109.1 | 410109 |   |   |    |   |   | 240,0 | 10,0 | 8,4 | 58,5 | 80,0  | 4 | 63,0 | 106,0 | 10,2     | BMW             | 34 11 1 117 422  |
| 24.0110-0110.1 | 410110 |   |   |    |   |   | 272,0 | 9,5  | 7,9 | 61,5 | 120,0 | 5 | 75,0 | 160,0 | 14,5     | BMW             | 34 21 1 163 132  |
| 24.0110-0111.1 | 410111 |   | B |    |   |   | 226,0 | 10,0 | 8,0 | 71,2 | 100,0 | 4 | 39,8 | 121,4 | M12x1,5  | SEAT/VW         | 357 615 601  |
|                |        |   |   |    |   |   |       |      |     |      |       |   |      |       |          | VOLKSWAGEN      | 6N0 615 601  |
| 24.0110-0115.1 | 410115 |   | B |    |   |   | 253,0 | 10,2 | 8,9 | 33,0 | 108,0 | 4 | 63,5 | 155,0 | 13,7     | FORD            | 1514237<br>1756882<br>1780880<br>4083484<br>5022666<br>5030658<br>95GJ-2A315-EC<br>C1BC-2A315-AA |
| 24.0110-0116.1 | 410116 |   | B |    |   |   | 245,0 | 10,0 | 8,0 | 46,5 | 112,0 | 5 | 68,0 | 135,5 | 15,4     | AUDI            | 443 615 601 B  |
| 24.0110-0117.1 | 410117 | S | B | HC |   |   | 300,0 | 10,0 | 8,4 | 61,0 | 120,0 | 5 | 75,0 | 180,0 | 14,5     | BMW             | 34 21 1 162 305  |

# Abmessungen Bremsscheiben

## Dimensions brake discs - Misure dischi freno -

## Dimensions Disques de frein - Medidas disco de freno

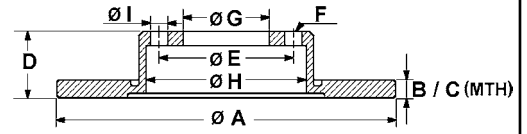

S Fixierschraube - fixing screw - vite di riparazione - vis de fixation - tornillo quejija  
 L legiert - alloyed - alligato/legato - allié - aleado  
 ● gelocht - perforated - perforato - poinçonné - perforado  
 B beschichtet - coated - rivestito - revêtu - recubierto  
 V ventiliert - ventilated - ventilato - ventilé - ventilado  
 HC hochgekohlt - high carbon - ad alto tenore di carbonio - à haute teneur en carbone - altamente carbonizado

|                |        | S | B | HC | L | V | A     | B    | C   | D    | E     | F   | G     | H     | I        | OE - #             |   |
|----------------|--------|---|---|----|---|---|-------|------|-----|------|-------|-----|-------|-------|----------|--------------------|---|
| 24.0110-0118.1 | 410118 |   |   |    |   |   | 300,0 | 9,9  | 8,4 | 67,9 | 120,0 | 5   | 75,0  | 180,0 | 14,5     | BMW                | 34 21 1 165 259   |
| 24.0110-0136.1 | 410136 |   |   |    |   |   | 215,0 | 10,0 | 8,0 | 33,0 | 102,0 | 4   | 86,0  | 106,0 | M10x1,25 | SUZUKI             | 55511-82001   |
| 24.0110-0139.1 | 410139 |   |   |    |   |   | 228,0 | 10,0 | 9,0 | 38,5 | 99,0  | 6   | 83,0  | 102,5 | M8       | RENAULT            | 77 01 466 540   |
| 24.0110-0142.1 | 410142 |   |   |    |   |   | 278,0 | 9,5  | 8,0 | 83,8 | 130,0 | 4   | 39,8  | 160,0 | M14x1,5  | VOLKSWAGEN         | 113 407 075<br>311 405 583 A  |
| 24.0110-0144.1 | 410144 |   |   |    |   |   | 261,0 | 9,9  | 8,0 | 82,1 | 100,0 | 4   | 39,8  | 160,0 | M12x1,5  | OPEL/VAUXHALL      | 5 69 204/90348319   |
| 24.0110-0147.1 | 410147 |   |   |    |   |   | 280,0 | 10,0 | 8,4 | 68,1 | 120,0 | 5   | 75,0  | 160,0 | 14,5     | BMW                | 34 21 1 165 255   |
| 24.0110-0148.1 | 410148 |   |   |    |   |   | 221,0 | 10,0 | 8,7 | 42,0 | 108,0 | 4   | 72,0  | 131,0 | 13,4     | FORD               | 1575877<br>5022650<br>5022651<br>6119634  |
| 24.0110-0150.1 | 410150 |   | B |    |   |   | 258,0 | 10,0 | 8,4 | 60,0 | 100,0 | 4   | 62,0  | 160,8 | 14,5     | BMW                | 34 21 6 755 407   |
| 24.0110-0151.1 | 410151 | S | B |    |   |   | 239,0 | 10,0 | 8,0 | 38,9 | 100,0 | 4   | 65,0  | 124,5 | 13,6     | AUDI/SEAT/VW       | 811 615 301   |
| 24.0110-0152.1 | 410152 | S | B |    |   |   | 236,0 | 10,0 | 7,0 | 41,0 | 100,0 | 4/6 | 60,0  | 123,0 | 14,0     | OPEL/VAUXHALL      | 5 69 028/90008003   |
| 24.0110-0154.1 | 410154 |   |   |    |   |   | 245,0 | 10,0 | 8,0 | 59,5 | 112,0 | 5   | 68,0  | 135,8 | 15,4     | AUDI               | 437 615 601   |
| 24.0110-0166.1 | 410166 |   |   |    |   |   | 250,0 | 9,9  | 8,0 | 21,0 | 80,0  | 6   | 62,0  | 134,0 | 8,5      | ALFA ROMEO         | 60526121  |
| 24.0110-0174.1 | 410174 |   |   |    |   |   | 284,0 | 10,0 | 8,4 | 61,0 | 120,0 | 5   | 75,0  | 180,0 | 14,5     | BMW                | 34 21 1 162 968   |
| 24.0110-0176.1 | 410176 |   |   |    |   |   | 284,0 | 10,0 | 8,4 | 68,0 | 120,0 | 5   | 75,0  | 180,0 | 14,5     | BMW                | 34 21 1 163 150   |
| 24.0110-0178.1 | 410178 |   | B |    |   |   | 245,0 | 10,0 | 8,0 | 59,5 | 108,0 | 4   | 68,0  | 135,8 | 15,4     | AUDI               | 443 615 601   |
| 24.0110-0179.1 | 410179 |   |   |    |   |   | 250,0 | 9,9  | 8,0 | 21,0 | 80,0  | 6   | 62,0  | 134,0 | 10,5     | ALFA ROMEO         | 60533971  |
| 24.0110-0181.1 | 410181 |   |   |    |   |   | 259,0 | 10,0 | 8,0 | 72,0 | 114,3 | 5   | 48,0  | 58,0  | 12,5     | FORD<br>MAZDA      | E92Z2C026A<br>GJ25-26-251<br>GJ25-26-251A<br>GJ25-26-251B<br>GW55-26-251        |
| 24.0110-0182.1 | 410182 |   | B |    |   |   | 245,0 | 10,0 | 8,0 | 40,1 | 108,0 | 4   | 68,0  | 135,5 | 15,4     | AUDI               | 8A0 615 601   |
| 24.0110-0183.1 | 410183 |   |   |    |   |   | 266,0 | 10,0 | 8,0 | 27,0 | 108,0 | 4   | 66,0  | 133,2 | 13,0     | CITROEN<br>PEUGEOT | 95 661 746<br>4246 A9   |
| 24.0110-0185.1 | 410185 | S | B |    |   |   | 279,0 | 10,0 | 8,3 | 71,7 | 112,0 | 5   | 67,0  | 160,0 | 15,0     | MERCEDES BENZ      | 126 423 00 12   |
| 24.0110-0186.1 | 410186 |   | B |    |   |   | 252,7 | 10,2 | 8,9 | 33,0 | 112,0 | 5   | 63,5  | 155,0 | 13,7     | FORD               | 5027464<br>5027465  |
| 24.0110-0187.1 | 410187 | S | B |    |   |   | 247,0 | 10,0 | 9,0 | 34,2 | 108,0 | 4   | 66,0  | 133,0 | 13,0     | CITROEN<br>PEUGEOT | 95 661 748<br>4246 A5<br>4249 95  |
| 24.0110-0189.1 | 410189 |   | B |    |   |   | 281,0 | 9,6  | 8,4 | 73,2 | 108,0 | 5   | 68,0  | 160,0 | 16,5     | VOLVO              | 270736  |
| 24.0110-0190.1 | 410190 |   | B |    |   |   | 251,5 | 10,0 | 9,0 | 50,7 | 98,0  | 4   | 59,0  | 127,5 | 13,0     | ALFA/FIAT/LANCIA   | 46758715<br>46831042<br>82434070<br>71738913                                    |
| 24.0110-0191.1 | 410191 |   | B |    |   |   | 270,0 | 10,0 | 8,0 | 67,0 | 110,0 | 5   | 65,5  | 160,0 | 14,0     | OPEL/VAUXHALL      | 5 69 101/90272328   |
| 24.0110-0192.1 | 410192 |   |   |    |   |   | 289,8 | 10,0 | 9,0 | 46,0 | 140,0 | 5   | 107,0 | 177,0 | 13,0     | SUZUKI             | 55211-80000   |
| 24.0110-0193.1 | 410193 |   |   |    |   |   | 239,5 | 10,2 | 8,7 | 58,1 | 108,0 | 4   | 63,5  | 136,0 | 13,7     | FORD               | 5022947<br>5024744  |
| 24.0110-0196.1 | 410196 |   | B |    |   |   | 239,7 | 10,0 | 8,0 | 43,0 | 108,0 | 4   | 63,6  | 136,0 | 13,8     | FORD               | 5022652<br>5022653  |
| 24.0110-0197.1 | 410197 |   |   |    |   |   | 238,0 | 10,0 | 9,0 | 29,0 | 98,0  | 3   | 57,0  | 124,3 | 12,8     | CITROEN            | 95 638 635<br>95 661 848  |
| 24.0110-0198.1 | 410198 |   |   |    |   |   | 258,0 | 10,0 | 9,0 | 29,0 | 98,0  | 3   | 57,0  | 124,3 | 13,0     | CITROEN            | 95 669 226  |
| 24.0110-0199.1 | 410199 |   |   |    |   |   | 247,0 | 10,0 | 8,0 | 34,3 | 108,0 | 4   | 71,0  | 133,0 | 13,0     | PEUGEOT            | 4246 G9   |
| 24.0110-0200.1 | 410200 |   |   |    |   |   | 245,0 | 10,0 | 8,0 | 65,5 | 108,0 | 4   | 68,0  | 135,5 | 15,4     | AUDI               | 443 615 601 E   |
| 24.0110-0201.1 | 410201 |   | B |    |   |   | 245,0 | 10,0 | 8,0 | 64,2 | 112,0 | 5   | 68,0  | 135,5 | 15,4     | AUDI/SKODA/VW      | 4A0 615 601 A   |
| 24.0110-0202.1 | 410202 | S | B | HC |   |   | 280,0 | 10,0 | 8,4 | 60,0 | 120,0 | 5   | 75,0  | 160,8 | 14,5     | BMW                | 34 21 1 165 457<br>34 21 6 864 051  |
| 24.0110-0203.1 | 410203 |   | B |    |   |   | 226,0 | 10,0 | 8,0 | 71,2 | 100,0 | 5   | 39,8  | 50,2  | M14x1,5  | SEAT/VW            | 357 615 601 B   |
| 24.0110-0204.1 | 410204 |   | B |    |   |   | 260,0 | 10,0 | 8,0 | 69,2 | 100,0 | 4   | 57,0  | 160,0 | 14,0     | OPEL/VAUXHALL      | 5 69 206/90421872   |
| 24.0110-0205.1 | 410205 |   | B |    |   |   | 270,0 | 9,9  | 8,0 | 77,0 | 100,0 | 4   | 57,0  | 160,0 | 14,0     | OPEL/VAUXHALL      | 5 69 102/90297932   |
| 24.0110-0206.1 | 410206 |   |   |    |   |   | 265,0 | 10,0 | 8,0 | 53,0 | 108,0 | 5   | 68,0  | 160,0 | 16,0     | VOLVO              | 1359290   |
| 24.0110-0207.1 | 410207 |   |   |    |   |   | 245,0 | 10,0 | 8,0 | 46,5 | 108,0 | 4   | 68,0  | 135,5 | 15,4     | AUDI               | 443 615 601 A   |
| 24.0110-0208.1 | 410208 |   |   |    |   |   | 247,0 | 10,0 | 9,0 | 32,5 | 98,0  | 3   | 57,0  | 124,5 | 13,0     | CITROEN            | 95 661 811<br>96 047 276  |
| 24.0110-0209.1 | 410209 |   | B |    |   |   | 251,4 | 10,0 | 9,0 | 50,5 | 98,0  | 5   | 59,0  | 127,5 | 13,0     | ALFA/FIAT/LANCIA   | 7789267<br>60569164<br>60653479<br>71738912<br>60801787<br>82439939<br>82440275 |
| 24.0110-0210.1 | 410210 |   | B |    |   |   | 245,0 | 10,0 | 8,0 | 83,6 | 112,0 | 5   | 45,2  | 135,5 | M14x1,5  | AUDI               | 8D0 615 601 B   |
| 24.0110-0211.1 | 410211 | S | B | HC |   |   | 272,0 | 10,0 | 8,4 | 78,0 | 120,0 | 5   | 75,0  | 160,8 | 14,5     | BMW                | 34 21 6 758 552<br>34 21 6 758 553  |





# Abmessungen Bremsscheiben

## Dimensions brake discs - Misure dischi freno -

## Dimensions Disques de frein - Medidas disco de freno

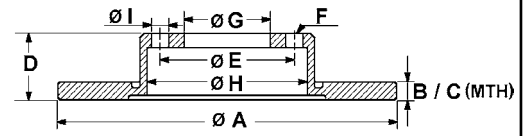

S Fixierschraube - fixing screw - vite di riparazione - vis de fixation - tornillo quefija

B beschichtet - coated - rivestito - revêtu - recubierto

HC hochgekohlt - high carbon - ad alto tenore di carbonio - à haute teneur en carbone - altamente carbonizado

L legiert - alloyed - alligato/legato - allié - aleado

V ventiliert - ventilated - ventilato - ventilé - ventilado

● gelocht - perforated - perforato - poinçonné - perforado

|                |        | S | B | H  | C | L | V | A     | B    | C   | D    | E     | F | G     | H     | I        | OE - #  |
|----------------|--------|---|---|----|---|---|---|-------|------|-----|------|-------|---|-------|-------|----------|---|
| 24.0110-0212.1 | 410212 | S | B |    |   |   |   | 238,5 | 10,0 | 8,0 | 48,1 | 100,0 | 4 | 61,0  | 154,5 | 13,0     | HONDA<br>42510-SE0-010<br>42510-SH3-G00<br>42510-SK3-305<br>42510-SK3-E00<br>ROVER<br>GBD90817<br>EGP1254                   |
| 24.0110-0213.1 | 410213 |   |   |    |   |   |   | 270,0 | 10,0 | 8,6 | 62,6 | 108,0 | 4 | 63,5  | 180,0 | 13,7     | FORD<br>5025951   |
| 24.0110-0214.1 | 410214 |   | B |    |   |   |   | 295,0 | 9,6  | 8,4 | 72,0 | 108,0 | 5 | 68,0  | 178,0 | 14,5     | VOLVO<br>271794   |
| 24.0110-0215.1 | 410215 |   | B |    |   |   |   | 258,0 | 10,0 | 9,0 | 45,0 | 114,3 | 4 | 68,0  | 154,0 | 12,6     | NISSAN<br>43206-99J01   |
| 24.0110-0216.1 | 410216 |   |   |    |   |   |   | 295,0 | 9,6  | 8,4 | 72,0 | 108,0 | 4 | 68,0  | 178,0 | 14,5     | VOLVO<br>271497   |
| 24.0110-0217.1 | 410217 | S | B |    |   |   |   | 290,0 | 10,0 | 8,3 | 55,5 | 112,0 | 5 | 67,0  | 164,0 | 13,3     | MERCEDES BENZ<br>210 423 10 12  |
| 24.0110-0218.1 | 410218 |   | B |    |   |   |   | 295,0 | 10,0 | 8,0 | 56,0 | 98,0  | 5 | 59,0  | 180,0 | 15,0     | CITROEN<br>FIAT/LANCIA<br>PEUGEOT<br>4246 J6<br>9566928380<br>4246 J5   |
| 24.0110-0219.1 | 410219 |   | B |    |   |   |   | 265,0 | 10,5 | 9,5 | 44,3 | 100,0 | 4 | 66,0  | 149,6 | 13,5     | RENAULT<br>77 01 205 844<br>86 71 005 980   |
| 24.0110-0220.1 | 410220 |   | B |    |   |   |   | 265,0 | 10,5 | 9,5 | 44,3 | 108,0 | 5 | 66,0  | 149,6 | 14,5     | RENAULT<br>77 01 205 845<br>86 71 005 979   |
| 24.0110-0223.1 | 410223 | S | B |    |   |   |   | 268,0 | 10,0 | 8,0 | 45,8 | 112,0 | 5 | 68,2  | 154,5 | 16,8     | FORD<br>1001094<br>1045995  |
| 24.0110-0224.1 | 410224 |   | B |    |   |   |   | 245,0 | 10,0 | 8,0 | 48,0 | 112,0 | 5 | 68,0  | 135,5 | 15,4     | SEAT/VW<br>AUDI/VW<br>7M0 615 601 C<br>8D0 615 601 A<br>8E0 615 601 A   |
| 24.0110-0225.1 | 410225 | S | B |    |   |   |   | 270,0 | 10,0 | 8,0 | 69,3 | 100,0 | 4 | 57,0  | 160,0 | 14,0     | OPEL/VAUXHALL<br>5 69 209/90512909  |
| 24.0110-0226.1 | 410226 | S | B |    |   |   |   | 286,0 | 10,0 | 8,0 | 69,3 | 110,0 | 5 | 65,5  | 160,0 | 14,0     | OPEL/VAUXHALL<br>SAAB<br>5 69 210/90512910<br>4565693<br>5391578  |
| 24.0110-0227.1 | 410227 | S | B | HC |   |   |   | 298,0 | 10,0 | 8,4 | 61,0 | 120,0 | 5 | 75,0  | 185,0 | 14,5     | BMW<br>34 21 1 163 835<br>34 21 6 767 049   |
| 24.0110-0228.1 | 410228 | S | B | HC | L |   |   | 280,0 | 10,0 | 8,0 | 65,2 | 112,0 | 5 | 67,0  | 178,0 | 15,0     | MERCEDES BENZ<br>638 423 01 12  |
| 24.0110-0229.1 | 410229 |   | B |    |   |   |   | 260,0 | 10,0 | 8,4 | 41,0 | 114,3 | 4 | 90,0  | 154,0 | 12,6     | MITSUBISHI<br>MB699288<br>MR249356<br>MR913846<br>30872940  |
| 24.0110-0230.1 | 410230 |   | B |    |   |   |   | 290,5 | 10,0 | 8,0 | 60,0 | 108,0 | 4 | 71,0  | 185,0 | 13,0     | VOLVO<br>PEUGEOT<br>4246 L7<br>4246 T6<br>4246 T7   |
| 24.0110-0231.1 | 410231 |   |   |    |   |   |   | 290,0 | 10,0 | 8,0 | 40,0 | 108,0 | 5 | 71,0  | 185,0 | 13,0     | PEUGEOT<br>4246 F1<br>4246 K9   |
| 24.0110-0232.1 | 410232 | S | B |    |   |   |   | 239,0 | 9,9  | 8,0 | 33,6 | 100,0 | 4 | 65,0  | 125,0 | 13,8     | SEAT/VW<br>6N0 615 301  |
| 24.0110-0233.1 | 410233 | S | B |    |   |   |   | 260,0 | 10,0 | 8,0 | 48,7 | 114,3 | 4 | 64,1  | 155,0 | 12,8     | HONDA<br>42510-SN7-000<br>42510-SV1-A00<br>42510-SV4-A00  |
| 24.0110-0234.1 | 410234 |   | B |    |   |   |   | 261,0 | 10,0 | 8,0 | 40,0 | 114,3 | 5 | 72,0  | 142,5 | 13,0     | ROVER<br>FORD<br>MAZDA<br>GBD90835<br>3415598<br>GA5Y-26-251C<br>GA5Y-26-251D<br>GA7Y-26-251<br>GA8Y-26-251<br>GTYF-26-251C |
| 24.0110-0235.1 | 410235 |   |   |    |   |   |   | 211,0 | 10,0 | 9,0 | 35,0 | 88,0  | 4 | 70,0  | 98,0  | M10x1,25 | DAIHATSU<br>43512-87216-000   |
| 24.0110-0237.1 | 410237 |   | B |    |   |   |   | 266,0 | 10,0 | 8,5 | 65,8 | 100,0 | 5 | 58,0  | 170,0 | 12,8     | SUBARU<br>26310AA051<br>26700FE010<br>26710AC020<br>26700FE080  |
| 24.0110-0238.1 | 410238 |   |   |    |   |   |   | 265,0 | 10,0 | 8,4 | 49,0 | 114,3 | 4 | 90,0  | 154,0 | 12,6     | MITSUBISHI<br>MB500555<br>MB500556  |
| 24.0110-0239.1 | 410239 |   |   |    |   |   |   | 213,5 | 9,6  | 8,6 | 61,2 | 73,0  | 4 | 55,6  | 85,0  | 3/8"     | AUSTIN/ROVER<br>GBD90806  |
| 24.0110-0240.1 | 410240 |   | B |    |   |   |   | 262,0 | 10,0 | 8,4 | 60,1 | 114,3 | 4 | 90,0  | 168,0 | 12,6     | MITSUBISHI<br>MB668083<br>MB857978  |
| 24.0110-0241.1 | 410241 |   |   |    |   |   |   | 269,0 | 10,0 | 9,0 | 64,5 | 100,0 | 5 | 54,0  | 188,5 | 14,5     | TOYOTA<br>42431-20160   |
| 24.0110-0242.1 | 410242 |   | B |    |   |   |   | 290,0 | 10,0 | 8,0 | 46,2 | 139,5 | 5 | 107,0 | 182,5 | 13,0     | SUZUKI<br>55211-60A00   |
| 24.0110-0243.1 | 410243 |   |   |    |   |   |   | 265,0 | 10,0 | 8,4 | 49,0 | 114,3 | 5 | 90,0  | 154,0 | 12,6     | MITSUBISHI<br>MB587433  |
| 24.0110-0244.1 | 410244 |   |   |    |   |   |   | 258,0 | 10,0 | 9,0 | 45,0 | 114,3 | 5 | 68,0  | 154,0 | 12,6     | NISSAN<br>43206-88E03   |
| 24.0110-0249.1 | 410249 |   |   |    |   |   |   | 260,0 | 10,0 | 8,0 | 69,2 | 110,0 | 5 | 65,5  | 160,0 | 14,3     | OPEL/VAUXHALL<br>SAAB<br>5 69 105/90509590<br>4241477   |
| 24.0110-0250.1 | 410250 | S | B |    |   |   |   | 264,0 | 9,8  | 8,0 | 42,0 | 110,0 | 5 | 65,5  | 145,0 | 14,0     | OPEL/VAUXHALL<br>5 69 109/9117772   |
| 24.0110-0251.1 | 410251 | S | B |    |   |   |   | 240,0 | 9,8  | 8,0 | 42,0 | 100,0 | 4 | 57,0  | 140,8 | 14,0     | OPEL/VAUXHALL<br>5 69 111/9196587   |
| 24.0110-0253.1 | 410253 |   |   |    |   |   |   | 270,0 | 10,0 | 8,0 | 77,0 | 110,0 | 5 | 65,5  | 160,1 | 12,8     | OPEL/VAUXHALL<br>5 69 207/90442651  |
| 24.0110-0255.1 | 410255 |   |   |    |   |   |   | 260,0 | 10,0 | 8,0 | 43,1 | 114,3 | 4 | 64,1  | 158,8 | 12,5     | HONDA<br>42510-SG9-000<br>42510-SG9-010   |
| 24.0110-0256.1 | 410256 |   |   |    |   |   |   | 259,0 | 10,0 | 8,0 | 72,0 | 114,3 | 5 | 47,9  | 63,9  | 12,5     | ROVER<br>MAZDA<br>GBD90802<br>G311-26-251A<br>GM09-26-251B  |



# Abmessungen Bremsscheiben

## Dimensions brake discs - Misure dischi freno -

## Dimensions Disques de frein - Medidas disco de freno

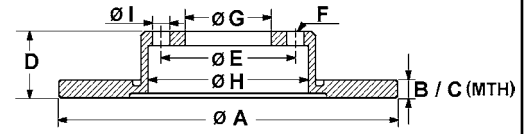

S Fixierschraube - fixing screw - vite di riparazione - vis de fixation - tornillo quefija

B beschichtet - coated - rivestito - revêtu - recubierto

HC hochgekohlt - high carbon - ad alto tenore di carbonio - à haute teneur en carbone - altamente carbonizado

L legiert - alloyed - alligato/legato - allié - aleado

V ventiliert - ventilated - ventilato - ventilé - ventilado

● gelocht - perforated - perforato - poinçonné - perforado

|                |        | S | B | H  | C  | L | V | A     | B    | C   | D    | E     | F   | G    | H     | I       | OE - #                |   |
|----------------|--------|---|---|----|----|---|---|-------|------|-----|------|-------|-----|------|-------|---------|-----------------------|---|
| 24.0110-0258.1 | 410258 |   | B |    |    |   |   | 245,0 | 10,0 | 8,0 | 54,1 | 112,0 | 5   | 68,0 | 135,5 | 15,3    | AUDI                  | 4B0 615 601   |
| 24.0110-0259.1 | 410259 |   | B |    |    |   |   | 255,0 | 10,0 | 8,0 | 54,1 | 112,0 | 5   | 68,0 | 144,5 | 15,3    | AUDI                  | 4B0 615 601 A   |
| 24.0110-0260.1 | 410260 |   | B |    |    |   |   | 255,0 | 10,0 | 8,0 | 48,1 | 112,0 | 5   | 68,0 | 144,5 | 15,3    | AUDI                  | 4B0 615 601 B   |
| 24.0110-0261.1 | 410261 |   | S | B  |    |   |   | 245,0 | 10,0 | 8,0 | 40,0 | 112,0 | 5/9 | 68,0 | 135,5 | 15,3    | AUDI                  | 8E0 615 601 B<br>8E0 615 601 P  |
| 24.0110-0262.1 | 410262 |   |   |    |    |   |   | 300,0 | 10,0 | 8,4 | 95,0 | 120,0 | 5   | 75,0 | 180,0 | 14,5    | BMW                   | 34 21 1 158 576   |
| 24.0110-0263.1 | 410263 |   |   |    |    |   |   | 258,0 | 10,0 | 8,4 | 74,5 | 100,0 | 4   | 62,0 | 161,0 | 14,5    | BMW                   | 34 21 1 163 145   |
| 24.0110-0264.1 | 410264 |   | B |    |    |   |   | 258,0 | 10,0 | 8,0 | 40,4 | 114,3 | 4   | 76,0 | 154,0 | 12,6    | HYUNDAI               | 58411-29310   |
| 24.0110-0266.1 | 410266 |   |   |    |    |   |   | 236,0 | 10,0 | 8,4 | 41,0 | 100,0 | 4   | 64,0 | 144,0 | 12,6    | MITSUBISHI            | MB857763<br>MR249357  |
| 24.0110-0267.1 | 410267 |   |   |    |    |   |   | 260,0 | 10,0 | 8,0 | 43,2 | 114,3 | 4   | 64,1 | 159,0 | 12,6    | HONDA                 | 42510-SD4-000<br>42510-SS0-000<br>42510-SS0-J00                           |
| 24.0110-0268.1 | 410268 |   | B |    |    |   |   | 240,0 | 10,2 | 8,2 | 40,5 | 100,0 | 4   | 57,0 | 126,0 | 14,0    | OPEL/VAUXHALL         | 5 69 112/9196592  |
| 24.0110-0269.1 | 410269 |   | B |    |    |   |   | 261,0 | 10,0 | 8,0 | 39,9 | 100,0 | 4   | 55,0 | 124,3 | 13,0    | MAZDA                 | B26Y-26-251   |
| 24.0110-0270.1 | 410270 |   | B |    |    |   |   | 280,0 | 10,0 | 8,0 | 61,9 | 100,0 | 5   | 64,0 | 161,0 | 15,0    | ROVER                 | GBD90847<br>SDB000870<br>SDB101100  |
| 24.0110-0271.1 | 410271 |   | B |    |    |   |   | 259,0 | 10,0 | 8,4 | 44,1 | 100,0 | 4   | 64,2 | 163,0 | 16,0    | MINI                  | 34 21 1 503 070<br>34 21 6 774 987  |
| 24.0110-0272.1 | 410272 |   |   |    |    |   |   | 290,0 | 10,0 | 8,0 | 51,0 | 108,0 | 5   | 71,0 | 185,0 | 13,0    | PEUGEOT               | 4246 V7   |
| 24.0110-0273.1 | 410273 |   | S | B  | HC |   |   | 272,0 | 10,0 | 8,4 | 83,0 | 120,0 | 5   | 75,0 | 161,0 | 14,5    | BMW                   | 34 21 6 794 298   |
| 24.0110-0274.1 | 410274 |   | S | B  |    |   |   | 286,0 | 10,0 | 8,0 | 69,0 | 110,0 | 5   | 65,5 | 160,0 | 14,0    | SAAB                  | 5391537<br>12763591   |
| 24.0110-0275.2 | 410275 |   | B |    |    |   |   | 226,0 | 10,0 | 8,0 | 71,5 | 100,0 | 4   | 39,9 | 121,5 | M12x1,5 | SEAT/VW<br>VOLKSWAGEN | 357 615 601<br>6N0 615 601  |
| 24.0110-0276.2 | 410276 |   | B |    |    |   |   | 226,0 | 10,0 | 8,0 | 71,5 | 100,0 | 5   | 39,9 | 121,5 | M14x1,5 | SEAT/VW               | 357 615 601 B   |
| 24.0110-0277.1 | 410277 |   | S | B  |    |   |   | 253,0 | 10,0 | 8,0 | 51,6 | 112,0 | 5/9 | 65,0 | 140,0 | 15,3    | AUDI/SEAT/SKODA/VW    | 1K0 615 601 K<br>1K0 615 601 AB<br>5C0 615 601                            |
| 24.0110-0278.1 | 410278 |   | S | B  |    |   |   | 300,0 | 10,0 | 8,3 | 68,3 | 112,0 | 5   | 67,0 | 180,0 | 15,3    | MERCEDES BENZ         | 000 423 10 12<br>211 423 07 12  |
| 24.0110-0279.1 | 410279 |   | S | B  |    |   |   | 260,0 | 10,0 | 8,0 | 48,7 | 114,3 | 5   | 64,2 | 157,0 | 12,6    | HONDA                 | 42510-S5T-E00   |
| 24.0110-0280.1 | 410280 |   | S | B  |    |   |   | 296,0 | 10,0 | 8,0 | 57,7 | 112,0 | 5   | 67,0 | 186,0 | 15,0    | MERCEDES BENZ         | 639 423 01 12   |
| 24.0110-0281.1 | 410281 |   |   |    |    |   |   | 262,0 | 9,5  | 8,4 | 60,1 | 114,3 | 5   | 90,0 | 168,0 | 12,6    | MITSUBISHI            | MR493489  |
| 24.0110-0282.1 | 410282 |   |   |    |    |   |   | 258,0 | 10,3 | 8,0 | 64,7 | 114,3 | 5   | 57,0 | 168,0 | 13,0    | DAEWOO                | 96219485  |
| 24.0110-0283.1 | 410283 |   | B |    |    |   |   | 276,0 | 10,0 | 9,0 | 45,7 | 98,0  | 5   | 59,0 | 138,0 | 13,2    | ALFA ROMEO            | 46469908<br>46542702  |
| 24.0110-0284.1 | 410284 |   | B |    |    |   |   | 271,0 | 10,0 | 9,0 | 60,7 | 100,0 | 5   | 55,0 | 151,0 | 14,5    | TOYOTA                | 42431-05040   |
| 24.0110-0285.1 | 410285 |   | B |    |    |   |   | 278,0 | 10,0 | 9,0 | 45,0 | 114,3 | 5   | 68,0 | 154,0 | 12,5    | NISSAN                | 43206-4U101<br>43206-4U103  |
| 24.0110-0286.1 | 410286 |   | B |    |    |   |   | 284,0 | 10,0 | 8,4 | 61,0 | 114,3 | 5   | 76,0 | 190,0 | 12,6    | HYUNDAI               | 58411-2Y300<br>58411-3A300<br>58411-3A300                                 |
| 24.0110-0287.1 | 410287 |   | S | B  | HC |   |   | 280,0 | 10,0 | 8,4 | 75,0 | 120,0 | 5   | 75,0 | 160,8 | 14,7    | KIA<br>BMW            | 34 21 6 766 225<br>34 21 6 794 306  |
| 24.0110-0289.1 | 410289 |   |   |    |    |   |   | 265,0 | 10,0 | 8,0 | 71,0 | 108,0 | 5   | 68,0 | 160,1 | 16,0    | VOLVO                 | 271895  |
| 24.0110-0290.1 | 410290 |   | B |    |    |   |   | 276,0 | 10,0 | 9,0 | 51,5 | 108,0 | 5   | 59,0 | 138,0 | 14,7    | ALFA/LANCIA           | 82488240<br>71739570  |
| 24.0110-0291.1 | 410291 |   | S | B  |    |   |   | 264,0 | 10,0 | 8,0 | 42,0 | 100,0 | 4   | 57,0 | 145,0 | 14,0    | OPEL/VAUXHALL         | 5 69 116/93176548   |
| 24.0110-0292.1 | 410292 |   |   |    |    |   |   | 283,0 | 10,0 | 8,0 | 62,0 | 108,0 | 5   | 68,0 | 190,0 | 16,0    | VOLVO                 | 272248  |
| 24.0110-0293.1 | 410293 |   | B | HC | L  |   |   | 290,0 | 10,0 | 8,3 | 57,0 | 112,0 | 5   | 67,0 | 164,0 | 13,2    | MERCEDES BENZ         | 129 423 04 12   |
| 24.0110-0295.1 | 410295 |   | B |    |    |   |   | 260,0 | 10,0 | 8,0 | 63,7 | 114,3 | 4   | 64,1 | 155,0 | 12,7    | HONDA                 | 42510-S1A-E10   |
| 24.0110-0298.1 | 410298 |   |   |    |    |   |   | 258,0 | 10,0 | 8,0 | 45,3 | 114,3 | 5   | 76,0 | 154,0 | 12,6    | HYUNDAI               | 58411-2C000   |
| 24.0110-0299.1 | 410299 |   |   |    |    |   |   | 305,0 | 10,0 | 8,5 | 75,2 | 127,0 | 5   | 72,2 | 194,5 | 15,5    | JEEP                  | 5209 8666   |
| 24.0110-0300.1 | 410300 |   |   |    |    |   |   | 270,0 | 10,0 | 8,0 | 61,0 | 100,0 | 4   | 57,0 | 180,0 | 13,0    | KIA                   | 0K20H-26-251  |
| 24.0110-0301.1 | 410301 |   | B |    |    |   |   | 261,0 | 10,0 | 8,0 | 39,9 | 100,0 | 4   | 57,0 | 142,8 | 13,0    | KIA                   | 0K2AA-26-251B   |
| 24.0110-0302.1 | 410302 |   | B |    |    |   |   | 280,0 | 10,0 | 8,0 | 40,2 | 114,3 | 5   | 72,0 | 142,0 | 13,0    | MAZDA                 | GF3Y-26-251A<br>GFYY-26-251<br>N123-26-251<br>N123-26-251A<br>NF47-26-251 |
| 24.0110-0304.1 | 410304 |   | B |    |    |   |   | 250,0 | 10,0 | 8,0 | 38,6 | 114,3 | 4   | 69,0 | 147,0 | 12,6    | MITSUBISHI            | 4605A076  |
| 24.0110-0305.1 | 410305 |   | B |    |    |   |   | 288,0 | 10,0 | 8,5 | 64,9 | 100,0 | 5   | 55,0 | 170,0 | 14,5    | SMART<br>TOYOTA       | 454 420 00 72<br>42431-20430  |
| 24.0110-0307.1 | 410307 |   |   |    |    |   |   | 276,0 | 10,0 | 8,0 | 34,9 | 100,0 | 4   | 55,0 | 125,0 | 13,0    | MAZDA                 | N06Y-26-251B<br>N0YY-26-251B  |
| 24.0110-0308.1 | 410308 |   | S | B  |    |   |   | 261,0 | 10,0 | 8,0 | 40,0 | 114,3 | 4   | 72,0 | 142,5 | 13,0    | KIA                   | 0K9AA-26-251<br>0K9AA-26-251A<br>0K9AA-26-251B<br>0K9AA-26-251C           |
| 24.0110-0310.1 | 410310 |   | B |    |    |   |   | 278,0 | 10,0 | 9,0 | 45,0 | 114,3 | 4   | 68,0 | 154,0 | 12,6    | NISSAN                | 43206-99J04   |
| 24.0110-0311.1 | 410311 |   | B |    |    |   |   | 280,0 | 10,0 | 9,0 | 56,0 | 100,0 | 5   | 55,0 | 173,0 | 14,7    | TOYOTA                | 42431-05030   |
| 24.0110-0312.1 | 410312 |   | B |    |    |   |   | 262,0 | 10,0 | 8,4 | 64,0 | 100,0 | 4   | 62,5 | 168,0 | 12,6    | HYUNDAI/KIA           | 58411-1C800   |



# Abmessungen Bremsscheiben

## Dimensions brake discs - Misure dischi freno -

## Dimensions Disques de frein - Medidas disco de freno

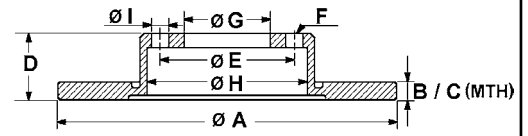

S Fixierschraube - fixing screw - vite di riparazione - vis de fixation - tornillo quefija  
 L legiert - alloyed - alligato/legato - allié - aleado  
 ● gelocht - perforated - perforato - poinçonné - perforado  
 B beschichtet - coated - rivestito - revêtu - recubierto  
 V ventiliert - ventilated - ventilato - ventilé - ventilado  
 HC hochgekohlt - high carbon - ad alto tenore di carbonio - à haute teneur en carbone - altamente carbonizado

|                |        | S | B | HC   | L    | V | A     | B    | C   | D    | E     | F   | G     | H     | I         | OE - #                           |  |
|----------------|--------|---|---|------|------|---|-------|------|-----|------|-------|-----|-------|-------|-----------|----------------------------------|--|
| 24.0110-0313.1 | 410313 | S | B | HC   |      |   | 280,0 | 10,2 | 8,9 | 33,0 | 108,0 | 4   | 63,5  | 155,0 | 13,7      | FORD                             | 4411312  |
| 24.0110-0314.1 | 410314 | S | B | HC   |      |   | 280,0 | 10,0 | 8,4 | 65,5 | 120,0 | 5   | 75,0  | 160,8 | 14,5      | BMW                              | 34 21 6 855 001  |
| 24.0110-0315.1 | 410315 | S | B | HC   |      |   | 296,0 | 10,4 | 8,9 | 65,5 | 120,0 | 5   | 75,0  | 160,8 | 14,5      | BMW                              | 34 21 4 031 725<br>34 21 6 764 649<br>34 21 6 855 002          |
| 24.0110-0316.1 | 410316 |   | B |      |      |   | 288,0 | 10,0 | 8,5 | 69,8 | 114,3 | 5   | 62,0  | 190,0 | 14,5      | LEXUS                            | 42431-48041  |
| 24.0110-0317.1 | 410317 |   | B |      |      |   | 262,0 | 10,0 | 8,4 | 61,0 | 114,3 | 4   | 76,0  | 168,0 | 12,8      | HYUNDAI<br>KIA                   | 58411-38310<br>58411-3C000                                     |
| 24.0110-0318.1 | 410318 |   | B |      |      |   | 262,0 | 10,0 | 8,4 | 61,0 | 114,3 | 5   | 76,0  | 168,0 | 12,6      | HYUNDAI<br>KIA                   | 58411-39600<br>58411-39600                                     |
| 24.0110-0319.1 | 410319 |   |   |      |      |   | 295,0 | 10,0 | 8,8 | 88,0 | 120,7 | 5   | 73,8  | 180,0 | 13,4      | JAGUAR                           | JLM 10601<br>JLM 12424<br>JLM 1830                             |
| 24.0110-0320.1 | 410320 |   | B |      |      |   | 290,0 | 10,0 | 8,5 | 56,8 | 114,3 | 5   | 62,0  | 180,0 | 14,5      | TOYOTA                           | 42431-0F010  |
| 24.0110-0321.1 | 410321 |   | B |      |      |   | 260,0 | 10,0 | 8,0 | 49,0 | 114,3 | 5   | 64,2  | 140,4 | 12,6      | HONDA                            | 42510-SEA-E00<br>42510-SEA-E50                                 |
| 24.0110-0323.1 | 410323 |   | B |      |      |   | 264,0 | 10,0 | 8,0 | 40,5 | 100,0 | 4/6 | 60,0  | 136,8 | 14,0      | FIAT                             | 55700592<br>55700593   |
| 24.0110-0324.1 | 410324 |   | B |      |      |   | 234,0 | 10,0 | 8,0 | 37,5 | 100,0 | 4   | 62,5  | 142,0 | 12,6      | OPEL<br>HYUNDAI<br>KIA           | 5 69 097/93167282<br>58411-0X500<br>58411-07300<br>58411-07500 |
| 24.0110-0325.2 | 410325 |   | B |      |      |   | 270,0 | 10,0 | 9,0 | 80,7 | 100,0 | 4   | 55,0  | 52,3  | M12x1,5   | RENAULT                          | 77 01 207 898<br>86 71 018 107<br>86 60 001 812                |
| 24.0110-0326.1 | 410326 |   |   |      |      |   | 260,0 | 10,0 | 8,0 | 48,5 | 100,0 | 4   | 61,0  | 148,5 | 12,6      | MG                               | SDB000290  |
| 24.0110-0328.1 | 410328 |   | S | B    |      |   | 300,0 | 10,0 | 8,3 | 57,5 | 112,0 | 5   | 67,0  | 164,0 | 15,3      | MERCEDES BENZ                    | 204 423 15 12  |
| 24.0110-0329.1 | 410329 |   | S | B    |      |   | 302,0 | 10,0 | 8,0 | 61,0 | 114,3 | 5   | 64,1  | 200,0 | 12,5      | HONDA                            | 42510-SWW-G01<br>42510-T1G-G01                                 |
| 24.0110-0330.1 | 410330 |   | B |      |      |   | 302,0 | 10,0 | 8,4 | 58,7 | 114,3 | 5   | 80,0  | 190,0 | 12,6      | CITROEN<br>MITSUBISHI<br>PEUGEOT | 4249 62<br>4615A035<br>4249 F4                                 |
| 24.0110-0331.1 | 410331 |   | S | B    | HC   |   | 280,0 | 9,6  | 8,0 | 38,0 | 112,0 | 3   | 58,0  | 153,5 | 12,5      | SMART                            | 451 421 01 12  |
| 24.0110-0332.1 | 410332 |   | B |      |      |   | 262,0 | 10,0 | 8,0 | 61,1 | 114,3 | 5   | 76,0  | 168,0 | 12,5      | HYUNDAI                          | 58411-1H100<br>58411-1H300<br>58411-1H100<br>58411-1H300       |
| 24.0110-0333.1 | 410333 |   | B |      |      |   | 280,0 | 10,0 | 8,5 | 59,2 | 114,3 | 5   | 62,0  | 173,0 | 14,7      | TOYOTA                           | 42431-05050  |
| 24.0110-0334.1 | 410334 |   | B |      |      |   | 258,0 | 10,0 | 8,0 | 41,4 | 114,3 | 4   | 76,0  | 154,0 | 13,0      | KIA                              | 58411-2F100  |
| 24.0110-0335.1 | 410335 |   | B |      |      |   | 291,0 | 10,0 | 8,5 | 61,3 | 114,3 | 5   | 62,0  | 190,0 | 14,5      | LEXUS                            | 43431-30280  |
| 24.0110-0336.1 | 410336 |   | B |      |      |   | 284,0 | 10,0 | 8,4 | 54,5 | 114,3 | 5   | 76,0  | 190,0 | 12,6      | HYUNDAI/KIA                      | 58411-3L000<br>58411-3L010                                     |
| 24.0110-0337.1 | 410337 |   | B |      |      |   | 270,0 | 9,9  | 8,0 | 36,8 | 114,3 | 5   | 62,0  | 166,0 | 14,8      | TOYOTA                           | 42431-02170<br>42431-12280                                     |
| 24.0110-0338.1 | 410338 |   | B |      |      |   | 262,0 | 10,0 | 8,4 | 61,0 | 114,3 | 5   | 76,0  | 168,0 | 12,5      | HYUNDAI                          | 58411-2H300  |
| 24.0110-0339.1 | 410339 |   | S | B    |      |   | 278,0 | 10,0 | 8,0 | 42,0 | 110,0 | 5/7 | 65,5  | 149,0 | 14,0      | OPEL/VAUXHALL                    | 5 69 122/93184247  |
| 24.0110-0340.1 | 410340 |   | S | B    |      |   | 258,0 | 10,5 | 8,0 | 57,2 | 114,3 | 4   | 60,0  | 168,0 | 12,6      | CHEVROLET<br>DAEWOO              | 96549630<br>96549630   |
| 24.0110-0341.1 | 410341 |   | B |      |      |   | 275,0 | 10,0 | 8,4 | 61,0 | 114,3 | 5   | 76,0  | 168,0 | 12,5      | KIA                              | 58411-1D000  |
| 24.0110-0344.1 | 410344 |   | B |      |      |   | 302,0 | 10,0 | 8,4 | 58,7 | 114,3 | 5   | 69,0  | 190,0 | 12,5      | MITSUBISHI                       | MR955407   |
| 24.0110-0345.1 | 410345 |   | B |      |      |   | 262,0 | 10,0 | 8,4 | 60,1 | 114,3 | 5   | 80,0  | 168,0 | 12,5      | MITSUBISHI                       | MN116332<br>4615A119   |
| 24.0110-0346.1 | 410346 |   | B |      |      |   | 298,0 | 10,0 | 8,5 | 64,4 | 114,3 | 5   | 62,0  | 190,0 | 14,5      | TOYOTA                           | 42431-28130  |
| 24.0110-0347.1 | 410347 |   | B |      |      |   | 264,0 | 10,0 | 8,0 | 40,5 | 110,0 | 5   | 70,0  | 136,8 | 14,0      | OPEL/VAUXHALL                    | 5 69 418/93190227  |
| 24.0110-0349.1 | 410349 |   | B |      |      |   | 251,0 | 10,0 | 9,0 | 40,5 | 98,0  | 4   | 59,0  | 128,0 | 13,2      | ALFA ROMEO                       | 51805559<br>51813705<br>51865104<br>51865132                   |
| 24.0110-0350.1 | 410350 |   | B |      |      |   | 269,0 | 10,0 | 9,0 | 64,7 | 100,0 | 5   | 55,0  | 170,0 | 14,5      | TOYOTA                           | 42431-20320  |
| 24.0110-0351.1 | 410351 |   | S | B    | HC L |   | 300,0 | 10,0 | 8,3 | 58,3 | 112,0 | 5   | 67,0  | 180,0 | 15,3      | MERCEDES BENZ                    | 230 423 07 12  |
| 24.0110-0352.1 | 410352 |   | B | HC L |      |   | 299,0 | 10,4 | 8,5 | 67,6 | 139,5 | 6   | 105,6 | 190,0 | 16,0      | SSANG YONG                       | 4840105101<br>4840105110                                       |
| 24.0110-0355.1 | 410355 |   | B |      |      |   | 290,0 | 10,0 | 8,0 | 46,0 | 139,5 | 5   | 108,2 | 183,0 | 12,8      | SUZUKI                           | 55211-76J00<br>55211-76J01                                     |
| 24.0110-0356.1 | 410356 |   | S | B    |      |   | 272,0 | 9,7  | 8,0 | 48,2 | 112,0 | 9   | 65,0  | 174,5 | 15,3      | AUDI/SEAT/SKODA/VW               | 1K0 615 601 AA   |
| 24.0110-0357.1 | 410357 |   | B |      |      |   | 258,0 | 10,0 | 8,0 | 40,5 | 114,3 | 5   | 76,0  | 154,0 | 12,5      | HYUNDAI/KIA                      | 58411-1P300  |
| 24.0110-0358.1 | 410358 |   | S | B    |      |   | 280,0 | 10,0 | 8,4 | 50,2 | 120,0 | 5   | 79,0  | 151,8 | 16,5      | MINI                             | 34 21 9 811 539  |
| 24.0110-0359.1 | 410359 |   | S | B    |      |   | 264,0 | 10,0 | 8,0 | 40,5 | 110,0 | 5/5 | 70,0  | 136,8 | 14,0/11,0 | ALFA ROMEO                       | 51806283<br>51815313   |
| 24.0110-0360.1 | 410360 |   | B |      |      |   | 302,0 | 10,0 | 8,4 | 60,1 | 114,3 | 5   | 80,0  | 168,0 | 12,6      | CITROEN<br>MITSUBISHI<br>PEUGEOT | 16 062 920 80<br>4615A121<br>16 062 920 80                     |

# Abmessungen Bremsscheiben

## Dimensions brake discs - Misure dischi freno -

## Dimensions Disques de frein - Medidas disco de freno

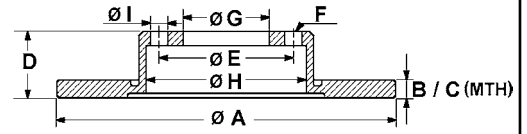

S Fixierschraube - fixing screw - vite di riparazione - vis de fixation - tornillo quefija

B beschichtet - coated - rivestito - revêtu - recubierto

HC hochgekohlt - high carbon - ad alto tenore di carbonio - à haute teneur en carbone - altamente carbonizado

L legiert - alloyed - alligato/legato - allié - aleado

V ventiliert - ventilated - ventilato - ventilé - ventilado

● gelocht - perforated - perforato - poinçonné - perforado

|                |        | S | B | HC | L  | V | A     | B    | C   | D    | E     | F   | G    | H     | I       | OE - #  |
|----------------|--------|---|---|----|----|---|-------|------|-----|------|-------|-----|------|-------|---------|---|
| 24.0110-0361.1 | 410361 |   | B |    |    |   | 302,0 | 10,0 | 8,4 | 61,3 | 114,3 | 5   | 80,0 | 168,0 | 12,6    | CHRYSLER<br>FIAT<br>JEEP<br>LANCIA<br>4743 999AA<br>K04743999AA<br>4743 999AA<br>K04743999AA  |
| 24.0110-0362.1 | 410362 |   | B |    |    |   | 262,0 | 10,0 | 8,4 | 63,8 | 114,3 | 5   | 76,0 | 168,0 | 12,6    | KIA<br>58411-2K300  |
| 24.0110-0363.1 | 410363 |   | B |    |    |   | 262,0 | 10,0 | 8,4 | 60,2 | 114,3 | 5   | 80,0 | 168,0 | 12,6    | CHRYSLER<br>JEEP<br>5105 515AA<br>5105 515AA  |
| 24.0110-0364.1 | 410364 |   | B |    |    |   | 279,0 | 10,0 | 8,5 | 30,6 | 100,0 | 5   | 55,0 | 155,8 | 14,5    | LEXUS<br>42431-52160  |
| 24.0110-0366.1 | 410366 |   | B |    |    |   | 286,0 | 10,0 | 8,5 | 63,5 | 100,0 | 5   | 58,0 | 190,0 | 13,0    | SUBARU<br>26700FG000  |
| 24.0110-0367.1 | 410367 |   | B |    |    |   | 284,0 | 10,0 | 8,4 | 54,3 | 114,3 | 5   | 76,0 | 168,0 | 12,5    | HYUNDAI<br>58411-3K110  |
| 24.0110-0368.1 | 410368 |   | B |    |    |   | 262,0 | 10,0 | 8,4 | 45,9 | 114,3 | 5   | 76,0 | 162,3 | 12,5    | HYUNDAI<br>58411-3X300  |
| 24.0110-0369.1 | 410369 |   | B |    |    |   | 300,0 | 10,0 | 8,4 | 24,5 | 114,3 | 5   | 76,0 | 155,0 | 12,5    | HYUNDAI<br>58411-3Z700  |
| 24.0110-0370.1 | 410370 |   | B |    |    |   | 284,0 | 10,0 | 8,4 | 24,7 | 114,3 | 5   | 76,0 | 154,5 | 12,5    | HYUNDAI<br>58411-3Z100  |
| 24.0110-0378.1 | 410378 |   | B |    |    |   | 251,0 | 10,0 | 9,0 | 40,5 | 98,0  | 5   | 59,0 | 128,0 | 13,2    | FIAT<br>51808471<br>51885409  |
| 24.0110-0379.1 | 410379 |   | B | HC | L  |   | 262,0 | 10,0 | 8,4 | 45,1 | 114,3 | 5   | 76,0 | 162,0 | 12,5    | HYUNDAI<br>KIA<br>58411-A6300<br>58411-A6300  |
| 24.0110-0380.1 | 410380 |   | B |    |    |   | 276,0 | 10,0 | 8,0 | 31,6 | 114,3 | 5   | 64,0 | 143,0 | 12,7    | HONDA<br>42510-TV0-E01  |
| 24.0110-0381.1 | 410381 |   | B |    |    |   | 303,0 | 10,0 | 8,0 | 39,8 | 114,3 | 5   | 68,0 | 143,0 | 13,0    | MAZDA<br>K011-26-251B   |
| 24.0110-0382.1 | 410382 |   | S | B  |    |   | 295,0 | 10,0 | 8,3 | 44,0 | 112,0 | 5   | 67,0 | 161,0 | 15,2    | MERCEDES BENZ<br>246 423 01 12<br>246 423 07 12   |
| 24.0110-0383.1 | 410383 |   | B | HC | L  |   | 284,0 | 10,0 | 8,4 | 25,9 | 114,3 | 5   | 76,0 | 155,2 | 12,5    | HYUNDAI/KIA<br>58411-A6200  |
| 24.0110-0384.1 | 410384 |   | B |    |    |   | 273,8 | 10,0 | 8,5 | 63,4 | 100,0 | 5   | 58,0 | 170,0 | 13,0    | SUBARU<br>26700FJ000  |
| 24.0110-0388.1 | 410388 |   | B | HC | L  |   | 284,0 | 10,0 | 8,4 | 55,3 | 114,3 | 5   | 76,0 | 168,0 | 12,5    | HYUNDAI/KIA<br>58411-3S100  |
| 24.0110-0389.2 | 410389 |   | B |    |    |   | 270,0 | 10,0 | 9,0 | 80,7 | 108,0 | 5   | 52,0 | 55,0  | M12x1,5 | RENAULT<br>77 01 208 850  |
| 24.0110-0391.1 | 410391 |   | S | B  | HC | L | 300,0 | 10,0 | 8,3 | 43,0 | 112,0 | 5   | 67,0 | 161,0 | 15,2    | MERCEDES BENZ<br>000 423 16 12<br>172 423 02 12   |
| 24.0110-0392.1 | 410392 |   | B |    |    |   | 284,0 | 10,0 | 8,4 | 45,0 | 114,3 | 5   | 76,0 | 184,2 | 12,5    | KIA<br>58411-A4000  |
| 24.0110-0393.1 | 410393 |   | B |    |    |   | 264,0 | 10,0 | 8,0 | 40,5 | 98,0  | 5   | 59,0 | 137,0 | 13,0    | FIAT<br>51914664  |
| 24.0110-0394.1 | 410394 |   | B |    |    |   | 234,0 | 10,0 | 8,4 | 44,9 | 100,0 | 4   | 62,4 | 142,0 | 13,0    | HYUNDAI<br>58411-B4300<br>58411-B9000   |
| 24.0110-0396.1 | 410396 |   | S | B  | HC |   | 259,0 | 10,0 | 8,4 | 50,6 | 112,0 | 5   | 67,0 | 155,0 | 16,5    | MINI<br>34 21 6 799 383   |
| 24.0110-0398.1 | 410398 |   | B | HC |    |   | 262,0 | 10,0 | 8,4 | 44,0 | 100,0 | 4   | 62,5 | 162,0 | 12,6    | HYUNDAI<br>KIA<br>58411-0U300<br>58411-0U300  |
| 24.0110-0700.1 | 410700 |   |   |    |    |   | 269,0 | 10,0 | 9,0 | 64,8 | 114,3 | 5   | 62,0 | 170,0 | 14,5    | TOYOTA<br>42431-33010   |
| 24.0110-0704.1 | 410704 |   | B |    |    |   | 262,0 | 10,0 | 8,4 | 60,1 | 114,3 | 5   | 90,0 | 168,0 | 12,5    | MITSUBISHI<br>MB895200<br>MB928716  |
| 24.0110-0712.1 | 410712 |   | B |    |    |   | 288,0 | 10,0 | 8,5 | 60,0 | 114,3 | 5   | 62,0 | 170,0 | 14,5    | LEXUS<br>42431-33080<br>42431-33140   |
| 24.0110-0714.1 | 410714 |   |   |    |    |   | 258,0 | 10,3 | 8,0 | 64,7 | 100,0 | 4   | 57,0 | 168,0 | 13,0    | CHEVROLET<br>DAEWOO<br>96312560<br>96312560   |
| 24.0110-0728.1 | 410728 |   | B |    |    |   | 273,8 | 10,0 | 8,5 | 67,5 | 100,0 | 5   | 58,0 | 170,0 | 13,0    | SUBARU<br>26700AG001  |
| 24.0111-0100.2 | 411100 |   | B |    |    |   | 300,0 | 11,0 | 9,5 | 84,7 | 108,0 | 5   | 62,0 | 52,3  | M14x1,5 | RENAULT<br>82 00 649 353  |
| 24.0111-0101.2 | 411101 |   | B |    |    |   | 274,0 | 10,9 | 9,5 | 82,2 | 108,0 | 5   | 62,0 | 52,3  | M12x1,5 | RENAULT<br>82 00 655 249<br>86 71 018 108<br>86 60 001 813  |
| 24.0111-0115.1 | 411115 |   | B |    |    |   | 252,5 | 10,0 | 9,0 | 65,0 | 98,0  | 4   | 68,0 | 118,0 | 13,0    | LADA<br>2101-3103002<br>2101-3501070  |
| 24.0111-0116.1 | 411116 |   |   |    |    |   | 238,0 | 11,0 | 8,0 | 55,5 | 92,0  | 4   | 73,0 | 112,5 | 10,5    | OPEL/VAUXHALL<br>5 69 041/90272326  |
| 24.0111-0119.1 | 411119 |   | B |    |    |   | 240,5 | 11,0 | 9,2 | 40,0 | 98,0  | 4   | 59,0 | 123,0 | 13,0    | ALFA/FIAT/LANCIA<br>7663465<br>7685656<br>46403960<br>51876438<br>60811879<br>71769481<br>71772238<br>51859078<br>71738421<br>1715410<br>BS51-1125-AA |
| 24.0111-0120.1 | 411120 |   |   |    |    |   | 269,5 | 10,5 | 9,5 | 65,9 | 114,3 | 4   | 86,0 | 145,0 | 13,6    | SAAB<br>8904575   |
| 24.0111-0122.1 | 411122 |   |   |    |    |   | 255,0 | 10,5 | 9,5 | 30,6 | 100,0 | 4   | 66,0 | 134,0 | 12,6    | RENAULT<br>77 00 764 192<br>77 01 204 288   |
| 24.0111-0125.1 | 411125 |   | B |    |    |   | 230,0 | 11,0 | 8,4 | 43,8 | 114,3 | 4   | 67,4 | 142,0 | 12,6    | HYUNDAI<br>51712-02110  |
| 24.0111-0127.1 | 411127 |   | B |    |    |   | 279,0 | 10,4 | 8,5 | 83,2 | 120,0 | 5/5 | 70,0 | 160,0 | 12,6    | OPEL/VAUXHALL<br>5 69 201/90272329<br>5 69 203/90272330   |
| 24.0111-0129.1 | 411129 |   |   |    |    |   | 251,0 | 11,0 | 9,5 | 51,0 | 98,0  | 4   | 62,0 | 135,0 | 13,0    | FIAT<br>4377102   |
| 24.0111-0130.1 | 411130 |   | B |    |    |   | 227,0 | 10,8 | 9,0 | 45,8 | 98,0  | 4   | 62,0 | 117,0 | 13,0    | SEAT<br>SE022165002B  |
| 24.0111-0133.1 | 411133 |   | B |    |    |   | 278,0 | 11,0 | 9,0 | 50,2 | 117,8 | 5   | 70,7 | 175,3 | 16,2    | AUTOB/FIAT/LANCIA<br>4385812<br>16500253<br>SE022165002A  |
| 24.0111-0137.1 | 411137 |   | S | B  |    |   | 262,0 | 11,0 | 9,0 | 45,5 | 112,0 | 5   | 67,0 | 142,5 | 15,0    | OPEL/VAUXHALL<br>5 69 110/9195294<br>MERCEDES BENZ<br>201 421 12 12   |



# Abmessungen Bremsscheiben

## Dimensions brake discs - Misure dischi freno -

## Dimensions Disques de frein - Medidas disco de freno

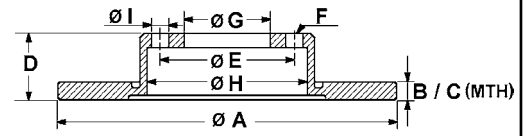

S Fixierschraube - fixing screw - vite di riparazione - vis de fixation - tornillo quefija

B beschichtet - coated - rivestito - revêtu - recubierto

HC hochgekohlt - high carbon - ad alto tenore di carbonio - à haute teneur en carbone - altamente carbonizado

L legiert - alloyed - alligato/legato - allié - aleado

V ventiliert - ventilated - ventilato - ventilé - ventilado

● gelocht - perforated - perforato - poinçonné - perforado

S B H C L V A B C D E F G H I OE - #

| S              | B      | H      | C | L | V | A     | B    | C    | D     | E     | F   | G    | H     | I       | OE            | #   |
|----------------|--------|--------|---|---|---|-------|------|------|-------|-------|-----|------|-------|---------|---------------|---|
| 24.0111-0139.1 | 411139 |        |   |   |   | 234,0 | 11,0 | 10,0 | 47,0  | 100,0 | 4   | 56,0 | 128,5 | 13,4    | DAIHATSU      | 43512-87709-000<br>43512-87717-000<br>43512-87727-000                                 |
| 24.0111-0141.1 | 411141 |        |   |   |   | 256,0 | 10,8 | 8,0  | 41,1  | 100,0 | 6   | 60,0 | 123,0 | 14,3    | OPEL/VAUXHALL | 5 69 058/9117676  |
| 24.0111-0142.1 | 411142 | B      |   |   |   | 240,5 | 11,0 | 9,2  | 40,0  | 98,0  | 5   | 59,0 | 123,0 | 13,0    | ALFA ROMEO    | 60670804<br>71739571  |
| 24.0111-0144.1 | 411144 | B      |   |   |   | 265,0 | 10,5 | 9,5  | 44,3  | 108,0 | 5   | 61,0 | 149,5 | 15,5    | RENAULT       | 77 01 205 846<br>86 71 019 317  |
| 24.0111-0145.1 | 411145 | S B    |   |   |   | 302,0 | 10,9 | 9,0  | 50,8  | 108,0 | 5   | 63,5 | 177,6 | 15,8    | FORD          | 1379931<br>1385590<br>1405500<br>LR027123   |
| 24.0111-0146.1 | 411146 | B      |   |   |   | 302,0 | 11,0 | 9,4  | 71,5  | 114,3 | 5   | 69,0 | 190,0 | 12,5    | HYUNDAI       | 58411-2B000   |
| 24.0111-0147.1 | 411147 | S B    |   |   |   | 302,0 | 11,0 | 9,0  | 40,8  | 108,0 | 5   | 63,5 | 177,6 | 16,0    | VOLVO         | 30769059  |
| 24.0111-0148.2 | 411148 | B      |   |   |   | 274,0 | 10,9 | 9,5  | 82,2  | 100,0 | 4   | 62,0 | 52,3  | M12x1,5 | RENAULT       | 77 01 208 230   |
| 24.0111-0149.1 | 411149 |        |   |   |   | 240,5 | 11,0 | 9,2  | 40,0  | 98,0  | 4   | 59,0 | 124,5 | 13,0    | ALFA ROMEO    | 60576335<br>60805117  |
| 24.0111-0150.1 | 411150 |        |   |   |   | 257,0 | 10,5 | 9,5  | 35,3  | 100,0 | 4   | 61,0 | 134,0 | 12,6    | RENAULT       | 77 01 204 291   |
| 24.0111-0151.1 | 411151 | B      |   |   |   | 265,0 | 10,5 | 9,5  | 54,3  | 108,0 | 5   | 66,0 | 149,6 | 15,5    | RENAULT       | 60 25 304 079<br>60 25 370 406<br>86 71 012 048                                       |
| 24.0111-0152.1 | 411152 | B      |   |   |   | 240,0 | 11,0 | 8,0  | 41,0  | 100,0 | 4/6 | 60,0 | 126,0 | 14,5    | OPEL/VAUXHALL | 5 69 020/9195981  |
| 24.0111-0153.1 | 411153 | B      |   |   |   | 300,0 | 11,0 | 9,3  | 58,5  | 112,0 | 5   | 67,0 | 180,0 | 15,0    | MERCEDES BENZ | 220 423 01 12   |
| 24.0111-0154.1 | 411154 | B      |   |   |   | 278,0 | 11,0 | 9,0  | 53,7  | 108,0 | 5   | 63,5 | 146,0 | 13,7    | FORD          | 1362867<br>1362868<br>4367107<br>4457989<br>4475316<br>2T14-2A315-AC<br>2T14-2A315-BC |
| 24.0111-0155.1 | 411155 | B      |   |   |   | 265,0 | 11,0 | 9,0  | 40,8  | 108,0 | 5   | 63,5 | 152,0 | 13,7    | FORD          | 1223540<br>1253728<br>1373360<br>1575733<br>1748745<br>9M51-2A315-BA<br>9M51-2A315-BB |
| 24.0111-0158.1 | 411158 | S B    |   |   |   | 280,0 | 11,0 | 9,0  | 41,0  | 108,0 | 5   | 63,5 | 192,0 | 13,7    | FORD          | 1253962<br>1373361<br>1500156<br>7M51-2A315-BA<br>30769113<br>31341645                |
| 24.0111-0159.1 | 411159 | B      |   |   |   | 211,0 | 11,0 | 10,0 | 40,9  | 100,0 | 4   | 55,1 | 125,0 | 13,2    | DAIHATSU      | 43512-97204-000<br>43512-97207-000<br>43512-B2100-000                                 |
| 24.0111-0160.1 | 411160 | B      |   |   |   | 280,0 | 11,0 | 9,0  | 40,8  | 114,3 | 5   | 72,0 | 154,0 | 14,0    | MAZDA         | BP6Y-26-251D<br>C25Y-26-251A<br>C25Y-26-251B<br>BP4Y-26-251C<br>C24Y-26-251C          |
| 24.0111-0164.1 | 411164 | B      |   |   |   | 265,0 | 11,0 | 9,0  | 40,7  | 114,3 | 5   | 72,0 | 152,0 | 14,0    | MAZDA         | C26Y-26-251A  |
| 24.0111-0165.1 | 411165 | B      |   |   |   | 302,0 | 11,0 | 9,0  | 40,8  | 114,3 | 5   | 72,0 | 153,0 | 13,7    | MAZDA         | 86 60 001 815   |
| 24.0111-0166.2 | 411166 | B      |   |   |   | 274,0 | 10,9 | 9,5  | 82,2  | 100,0 | 4   | 62,0 | 52,3  | M12x1,5 | RENAULT       | 82 00 663 193   |
| 24.0111-0167.2 | 411167 | B      |   |   |   | 300,0 | 11,0 | 9,5  | 84,7  | 108,0 | 5   | 62,0 | 52,3  | M12x1,5 | RENAULT       | 86 71 018 264<br>86 71 019 319  |
| 24.0111-0168.1 | 411168 | B      |   |   |   | 297,0 | 11,0 | 9,0  | 58,5  | 114,3 | 5   | 62,0 | 180,0 | 14,5    | TOYOTA        | 42431-0F020   |
| 24.0111-0169.1 | 411169 | B      |   |   |   | 290,0 | 11,0 | 9,0  | 33,7  | 114,3 | 5   | 62,0 | 155,0 | 14,5    | TOYOTA        | 42431-05070   |
| 24.0111-0170.1 | 411170 | B HC L |   |   |   | 302,0 | 11,0 | 9,4  | 71,5  | 114,3 | 5   | 69,0 | 190,0 | 12,5    | HYUNDAI       | 58411-2P000   |
| 24.0111-0171.1 | 411171 | B      |   |   |   | 271,0 | 11,0 | 9,0  | 40,7  | 108,0 | 5   | 63,5 | 152,0 | 13,8    | KIA           | 58411-2P000   |
| 24.0111-0172.1 | 411172 | B      |   |   |   | 280,0 | 11,0 | 9,0  | 50,7  | 108,0 | 5   | 63,5 | 153,5 | 13,7    | FORD          | 1704765<br>1683383<br>AV61-2A315-BA<br>1683384<br>AV61-2A315-AA                       |
| 24.0111-0173.2 | 411173 | B      |   |   |   | 300,0 | 11,0 | 9,5  | 81,7  | 114,3 | 5   | 52,0 | 62,0  | M14x1,5 | RENAULT       | 40 20 200 03R<br>40 20 222 91R<br>43 20 000 15R<br>82 00 381 148                      |
| 24.0111-0174.2 | 411174 | B      |   |   |   | 274,0 | 11,0 | 9,5  | 88,2  | 108,0 | 5   | 52,0 | 62,0  | M12x1,5 | RENAULT       | 34 21 6 792 225   |
| 24.0111-0175.1 | 411175 | S B HC |   |   |   | 290,0 | 11,0 | 9,4  | 66,0  | 120,0 | 5   | 75,0 | 160,8 | 16,5    | BMW           | 40 20 296 46R   |
| 24.0111-0180.2 | 411180 | B      |   |   |   | 274,0 | 11,0 | 9,5  | 86,2  | 114,3 | 5   | 52,3 | 62,0  | M12x1,5 | RENAULT       | 40 20 200 05R   |
| 24.0111-0181.2 | 411181 | B      |   |   |   | 300,0 | 11,0 | 9,5  | 101,7 | 114,3 | 5   | 52,0 | 62,0  | M14x1,5 | RENAULT       |   |

# Abmessungen Bremsscheiben

## Dimensions brake discs - Misure dischi freno -

## Dimensions Disques de frein - Medidas disco de freno

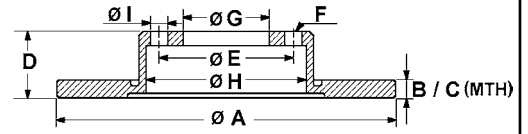

S Fixierschraube - fixing screw - vite di riparazione - vis de fixation - tornillo quejija  
 B beschichtet - coated - rivestito - revêtu - recubierto  
 HC hochgekohlt - high carbon - ad alto tenore di carbonio - à haute teneur en carbone - altamente carbonizado  
 L legiert - alloyed - alligato/legato - allié - aleado  
 V ventiliert - ventilated - ventilato - ventilé - ventilado  
 ● gelocht - perforated - perforato - poinçonné - perforado

|                |        | S | B | HC | L  | V | A     | B    | C    | D     | E     | F   | G     | H     | I       | OE - #   |
|----------------|--------|---|---|----|----|---|-------|------|------|-------|-------|-----|-------|-------|---------|--|
| 24.0111-0182.2 | 411182 |   | B |    |    |   | 274,0 | 11,0 | 9,5  | 88,2  | 108,0 | 5   | 52,0  | 62,0  | M12x1,5 | MERCEDES BENZ<br>RENAULT<br>415 420 01 02<br>40 20 240 76R<br>43 20 043 27R                                    |
| 24.0111-0183.2 | 411183 |   | B |    |    |   | 300,0 | 11,0 | 9,5  | 102,2 | 108,0 | 5   | 52,3  | 62,0  | M14x1,5 | RENAULT<br>82 00 736 267   |
| 24.0111-0184.2 | 411184 |   | B |    |    |   | 290,0 | 11,0 | 9,5  | 90,2  | 114,3 | 5   | 52,3  | 62,0  | M12x1,5 | RENAULT<br>43 20 200 16R<br>40 20 205 36R  |
| 24.0111-0185.1 | 411185 |   | B |    |    |   | 204,0 | 11,0 | 9,5  | 50,8  | 108,0 | 5   | 63,5  | 177,3 | 13,8    | FORD<br>5202204<br>DG9C-2A315-BC   |
| 24.0112-0102.1 | 412102 |   |   |    |    |   | 231,0 | 12,0 | 10,0 | 44,0  | 100,0 | 4   | 61,0  | 124,0 | 12,6    | HONDA<br>45251-SB2-030<br>45251-SB2-732<br>ROVER<br>DBP3169<br>GBD90810<br>GBD90818<br>GBD90827                |
| 24.0112-0106.1 | 412106 |   | S | B  |    |   | 239,0 | 12,0 | 10,0 | 35,4  | 100,0 | 4   | 65,0  | 124,5 | 13,6    | AUDI/SEAT/VW<br>AUDI/VW<br>321 615 301<br>175 615 301  |
| 24.0112-0111.1 | 412111 |   |   |    |    |   | 284,0 | 12,0 | 10,4 | 76,0  | 120,0 | 5   | 79,0  | 146,0 | 14,5    | BMW<br>34 11 1 163 134   |
| 24.0112-0112.1 | 412112 |   |   |    |    |   | 257,0 | 12,0 | 10,8 | 51,5  | 98,0  | 4   | 62,0  | 135,0 | 13,0    | FIAT/LANCIA<br>4448411   |
| 24.0112-0115.1 | 412115 |   |   |    |    |   | 239,8 | 12,0 | 11,0 | 35,0  | 96,0  | 4   | 76,0  | 128,8 | 8,3     | NISSAN<br>40206-05A01  |
| 24.0112-0116.1 | 412116 |   | S | B  |    |   | 238,0 | 12,0 | 10,5 | 41,0  | 100,0 | 4   | 61,0  | 129,5 | 13,5    | DACIA<br>60 01 549 211<br>RENAULT<br>60 01 549 211<br>77 01 204 282<br>86 71 000 083                           |
| 24.0112-0117.1 | 412117 |   | S | B  |    |   | 284,0 | 12,0 | 10,0 | 46,5  | 112,0 | 5   | 67,0  | 154,3 | 15,0    | MERCEDES BENZ<br>124 421 13 12   |
| 24.0112-0120.1 | 412120 |   |   | HC |    |   | 300,0 | 12,0 | 10,4 | 67,9  | 120,0 | 5   | 75,0  | 180,0 | 14,5    | BMW<br>34 21 1 165 257   |
| 24.0112-0121.1 | 412121 |   |   |    |    |   | 214,0 | 12,0 | 10,0 | 43,2  | 100,0 | 4   | 59,0  | 125,5 | 12,5    | NISSAN<br>40206-01B00<br>40206-01B01   |
| 24.0112-0122.1 | 412122 |   |   |    |    |   | 240,0 | 12,0 | 10,8 | 46,5  | 98,0  | 4   | 59,0  | 127,5 | 13,0    | AUTOB/FIAT/LANCIA<br>71738423  |
| 24.0112-0123.1 | 412123 |   |   |    |    |   | 240,3 | 12,0 | 11,0 | 45,1  | 100,0 | 4   | 61,0  | 126,5 | 12,6    | NISSAN<br>40206-61A01<br>40206-61A11   |
| 24.0112-0124.1 | 412124 |   | S | B  | HC |   | 302,0 | 12,0 | 10,4 | 76,0  | 120,0 | 5   | 79,0  | 149,0 | 14,5    | BMW<br>34 11 1 161 693   |
| 24.0112-0125.1 | 412125 |   |   |    |    |   | 239,0 | 12,0 | 10,8 | 42,5  | 98,0  | 4   | 58,5  | 127,0 | 13,1    | LADA<br>2108-3501070   |
| 24.0112-0126.1 | 412126 |   | S | B  |    |   | 286,0 | 12,0 | 10,4 | 51,5  | 120,0 | 5   | 79,0  | 148,0 | 14,5    | BMW<br>34 11 6 757 750<br>34 11 6 757 751  |
| 24.0112-0127.1 | 412127 |   |   |    |    |   | 257,5 | 12,0 | 10,2 | 40,5  | 98,0  | 4   | 59,0  | 123,0 | 13,0    | ALFA/FIAT/LANCIA<br>7663466<br>46820655<br>51859075<br>51866265<br>60808872<br>51866264                        |
| 24.0112-0128.1 | 412128 |   | S | B  |    |   | 284,0 | 12,0 | 10,0 | 43,5  | 112,0 | 5   | 67,0  | 154,3 | 12,8    | FIAT<br>MERCEDES BENZ<br>202 421 02 12   |
| 24.0112-0129.1 | 412129 |   |   | HC |    |   | 290,0 | 12,0 | 9,8  | 60,0  | 112,0 | 5   | 67,0  | 164,0 | 17,0    | MERCEDES BENZ<br>140 423 06 12   |
| 24.0112-0130.1 | 412130 |   |   |    |    |   | 272,0 | 11,0 | 9,9  | 50,5  | 140,0 | 5   | 108,0 | 157,0 | 14,5    | LADA<br>2121-3501070   |
| 24.0112-0131.1 | 412131 |   |   |    |    |   | 286,0 | 12,0 | 10,0 | 69,5  | 110,0 | 5   | 65,5  | 160,0 | 14,0    | OPEL/VAUXHALL<br>5 69 208/90444513   |
| 24.0112-0132.1 | 412132 |   | S | B  | HC |   | 324,0 | 12,0 | 10,4 | 61,0  | 120,0 | 5   | 75,0  | 180,0 | 14,5    | BMW<br>34 21 6 757 748   |
| 24.0112-0133.1 | 412133 |   |   |    |    |   | 253,8 | 12,0 | 10,5 | 54,2  | 108,0 | 5   | 66,0  | 134,0 | 14,7    | RENAULT<br>77 01 467 307   |
| 24.0112-0134.1 | 412134 |   |   |    |    |   | 253,8 | 12,0 | 10,5 | 54,2  | 100,0 | 4   | 66,0  | 134,0 | 12,6    | RENAULT<br>77 01 467 306   |
| 24.0112-0135.1 | 412135 |   |   |    |    |   | 260,0 | 12,0 | 10,8 | 40,0  | 100,0 | 4/6 | 61,0  | 127,0 | 13,0    | VOLVO<br>3459661   |
| 24.0112-0136.2 | 412136 |   |   |    |    |   | 251,0 | 12,0 | 10,8 | 62,3  | 108,0 | 5   | 71,0  | 134,7 | 13,0    | CITROEN<br>95 661 796  |
| 24.0112-0137.1 | 412137 |   |   |    |    |   | 234,0 | 12,0 | 10,0 | 45,2  | 100,0 | 4   | 59,0  | 129,5 | 12,5    | NISSAN<br>40206-5F003  |
| 24.0112-0138.1 | 412138 |   | S | B  |    |   | 280,0 | 12,0 | 10,0 | 40,4  | 112,0 | 5   | 68,2  | 153,0 | 16,5    | VOLKSWAGEN<br>701 615 601 A<br>7D0 615 601<br>7D0 615 601 B<br>40206-21B01                                     |
| 24.0112-0139.1 | 412139 |   |   |    |    |   | 214,0 | 12,0 | 10,0 | 46,2  | 100,0 | 4   | 61,0  | 126,6 | 12,6    | NISSAN<br>40206-21B01  |
| 24.0112-0141.1 | 412141 |   |   |    |    |   | 239,5 | 12,0 | 10,0 | 42,9  | 108,0 | 4   | 63,5  | 136,0 | 13,7    | FORD<br>1013581<br>1019598<br>1112542<br>MAZDA<br>1E03-33-251<br>1E03-33-251A<br>1E04-33-251                   |
| 24.0112-0142.1 | 412142 |   | S | B  | HC | L | 258,0 | 12,0 | 10,0 | 96,7  | 130,0 | 5   | 85,0  | 160,0 | 15,0    | MERCEDES BENZ<br>901 423 06 12<br>901 423 08 12<br>901 423 10 12<br>VOLKSWAGEN<br>2D0 615 601<br>2D0 615 601 C |
| 24.0112-0143.1 | 412143 |   |   |    |    |   | 251,0 | 12,0 | 10,8 | 62,4  | 108,0 | 4   | 71,1  | 135,0 | 13,0    | CITROEN<br>4246 L6   |
| 24.0112-0144.1 | 412144 |   | S | B  | HC | L | 260,0 | 12,0 | 10,0 | 40,4  | 112,0 | 5   | 67,0  | 145,0 | 13,3    | MERCEDES BENZ<br>168 421 01 12   |
| 24.0112-0145.1 | 412145 |   |   |    |    |   | 265,6 | 12,0 | 10,6 | 48,0  | 139,7 | 6   | 96,5  | 171,6 | 12,6    | ISUZU<br>8-94173-244-0<br>8-94173-244-2  |
| 24.0112-0147.1 | 412147 |   |   |    |    |   | 234,5 | 12,0 | 10,0 | 45,0  | 100,0 | 4   | 55,0  | 124,5 | 13,0    | MAZDA<br>DB0Y-33-251   |
| 24.0112-0148.1 | 412148 |   |   |    |    |   | 255,0 | 12,0 | 10,0 | 40,0  | 112,0 | 5/9 | 68,0  | 144,5 | 15,3    | AUDI<br>8E0 615 601 D<br>8E0 615 601 Q   |
| 24.0112-0149.1 | 412149 |   |   |    |    |   | 290,0 | 12,0 | 10,3 | 56,0  | 112,0 | 5   | 67,0  | 164,0 | 13,0    | MERCEDES BENZ<br>210 423 05 12   |
| 24.0112-0150.1 | 412150 |   | B |    |    |   | 277,0 | 11,9 | 10,0 | 71,0  | 108,0 | 5   | 68,0  | 160,0 | 16,5    | VOLVO<br>272301  |





# Abmessungen Bremsscheiben

## Dimensions brake discs - Misure dischi freno -

## Dimensions Disques de frein - Medidas disco de freno

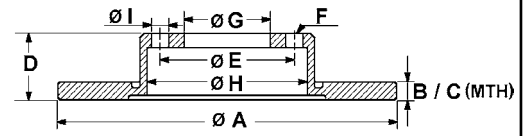

S Fixierschraube - fixing screw - vite di riparazione - vis de fixation - tornillo quefija

B beschichtet - coated - rivestito - revêtu - recubierto

HC hochgekohlt - high carbon - ad alto tenore di carbonio - à haute teneur en carbone - altamente carbonizado

L legiert - alloyed - alligato/legato - allié - aleado

V ventiliert - ventilated - ventilato - ventilé - ventilado

● gelocht - perforated - perforato - poinçonné - perforado

|                |        | S | B  | HC | L | V | A     | B    | C    | D     | E     | F   | G    | H     | I       | OE                                 | #  |
|----------------|--------|---|----|----|---|---|-------|------|------|-------|-------|-----|------|-------|---------|------------------------------------|--|
| 24.0112-0151.1 | 412151 | B |    |    |   |   | 288,0 | 11,9 | 10,0 | 64,8  | 108,0 | 5   | 68,0 | 178,0 | 16,5    | VOLVO                              | 9434167  |
| 24.0112-0152.1 | 412152 | B | HC |    |   |   | 324,0 | 12,0 | 10,4 | 80,2  | 120,0 | 5   | 75,0 | 185,0 | 16,8    | BMW                                | 34 21 6 859 678                                      |
| 24.0112-0153.1 | 412153 | B |    |    |   |   | 247,0 | 12,0 | 10,5 | 44,0  | 100,0 | 4   | 60,0 | 125,0 | 12,8    | OPEL/VAUXHALL<br>SUZUKI            | 47 00 711/9193872<br>55311-83E00                     |
| 24.0112-0154.1 | 412154 | B |    |    |   |   | 280,0 | 12,0 | 10,0 | 34,0  | 108,0 | 5   | 63,5 | 151,0 | 13,7    | FORD                               | 1676983<br>4176921<br>4179406<br>7S7J-2A315-BB       |
| 24.0112-0155.1 | 412155 | S | B  |    |   |   | 305,0 | 12,0 | 10,5 | 66,8  | 130,0 | 5   | 90,0 | 169,5 | 15,5    | JAGUAR                             | C2S 49730<br>C2S 52088                               |
| 24.0112-0156.1 | 412156 | B |    |    |   |   | 272,0 | 12,0 | 10,0 | 28,0  | 98,0  | 5   | 59,0 | 134,0 | 15,0    | NISSAN<br>OPEL/VAUXHALL<br>RENAULT | 43206-00QAA<br>44 03 045/9111045<br>77 00 314 107    |
| 24.0112-0157.1 | 412157 | S | B  |    |   |   | 278,0 | 11,9 | 10,0 | 41,4  | 110,0 | 5   | 65,5 | 145,2 | 14,0    | CITROEN<br>FIAT/LANCIA             | 4249 C0<br>9464222687<br>9464222688                  |
| 24.0112-0158.1 | 412158 | S | B  |    |   |   | 256,0 | 12,0 | 10,0 | 48,6  | 112,0 | 5/9 | 65,0 | 140,0 | 15,3    | PEUGEOT                            | 4249 C0<br>46836489<br>71772552                      |
| 24.0112-0159.1 | 412159 | S | B  |    |   |   | 302,0 | 12,0 | 10,0 | 49,4  | 112,0 | 5/9 | 68,0 | 177,0 | 15,3    | OPEL/VAUXHALL<br>SAAB              | 5 69 115/93171848<br>9156785<br>12762290             |
| 24.0112-0160.1 | 412160 | B |    |    |   |   | 280,5 | 12,0 | 11,0 | 45,1  | 100,0 | 4   | 61,0 | 149,0 | 13,5    | AUDI/SKODA/VW                      | 1K0 615 601 AC<br>1K0 615 601 L                      |
| 24.0112-0162.1 | 412162 | S | B  |    |   |   | 290,0 | 12,0 | 10,0 | 35,0  | 108,0 | 5   | 71,1 | 151,2 | 13,0    | AUDI                               | 4F0 615 601 E  |
| 24.0112-0164.1 | 412164 | B |    |    |   |   | 291,0 | 12,0 | 10,5 | 68,4  | 114,3 | 5   | 62,0 | 190,0 | 14,5    | RENAULT                            | 77 01 207 227<br>86 71 019 318                       |
| 24.0112-0165.1 | 412165 | B |    |    |   |   | 288,0 | 12,0 | 10,0 | 62,0  | 108,0 | 5   | 68,0 | 178,0 | 16,0    | CITROEN                            | 4249 72<br>4249 C1                                   |
| 24.0112-0166.1 | 412166 | B |    |    |   |   | 288,0 | 12,0 | 10,0 | 36,0  | 112,0 | 5   | 68,0 | 162,0 | 15,3    | PEUGEOT                            | 4246 P9<br>4249 C1                                   |
| 24.0112-0167.1 | 412167 | S | B  | HC | L |   | 276,0 | 12,0 | 10,0 | 44,5  | 112,0 | 5   | 67,0 | 145,0 | 15,3    | TOYOTA                             | 42431-28091<br>42431-28120                           |
| 24.0112-0168.1 | 412168 | B |    |    |   |   | 354,0 | 11,9 | 10,4 | 74,9  | 120,0 | 5   | 79,0 | 210,0 | 16,6    | VOLVO                              | 272429   |
| 24.0112-0169.1 | 412169 | S | B  |    |   |   | 282,0 | 12,0 | 10,0 | 48,6  | 112,0 | 5/9 | 65,0 | 159,0 | 15,3    | AUDI                               | 8E0 615 601 M  |
| 24.0112-0170.1 | 412170 | S | B  |    |   |   | 278,0 | 12,0 | 10,0 | 43,2  | 110,0 | 5   | 70,0 | 139,0 | 16,6    | MERCEDES BENZ                      | 169 421 00 12  |
| 24.0112-0171.1 | 412171 | S | B  |    |   |   | 259,0 | 12,0 | 10,6 | 40,9  | 100,0 | 4   | 61,0 | 130,0 | 13,5    | LAND ROVER                         | SDB000211  |
| 24.0112-0172.1 | 412172 | S |    |    |   |   | 282,0 | 12,0 | 10,0 | 58,5  | 114,3 | 5   | 64,2 | 170,0 | 12,8    | AUDI/SKODA/VW                      | 1K0 615 601 AD<br>1K0 615 601 M                      |
| 24.0112-0173.1 | 412173 | B |    |    |   |   | 232,0 | 12,0 | 9,5  | 51,0  | 114,3 | 4   | 64,0 | 137,0 | 12,7    | ALFA ROMEO                         | 51760273<br>51767378                                 |
| 24.0112-0174.1 | 412174 | B |    |    |   |   | 290,0 | 12,0 | 10,0 | 50,0  | 108,0 | 5   | 71,1 | 144,0 | 13,0    | FIAT                               | 51964082   |
| 24.0112-0175.1 | 412175 | S | B  |    |   |   | 286,0 | 12,0 | 10,0 | 58,6  | 112,0 | 5   | 65,0 | 140,0 | 15,3    | JEEP                               | 51963547   |
| 24.0112-0176.1 | 412176 | B | HC | L  |   |   | 302,0 | 12,0 | 10,0 | 42,4  | 112,0 | 5/9 | 68,0 | 176,5 | 15,3    | DACIA                              | 60 01 547 683<br>77 01 208 252                       |
| 24.0112-0177.2 | 412177 | B |    |    |   |   | 280,0 | 12,0 | 10,0 | 102,2 | 118,0 | 5   | 68,0 | 64,5  | M14x1,5 | RENAULT                            | 60 01 547 683<br>77 01 208 252                       |
| 24.0112-0178.1 | 412178 | S | B  |    |   |   | 300,0 | 12,0 | 10,0 | 36,4  | 112,0 | 5   | 68,0 | 169,0 | 15,3    | SMART                              | 453 420 00 00  |
| 24.0112-0180.1 | 412180 | S | B  |    |   |   | 302,0 | 12,0 | 10,0 | 69,2  | 108,0 | 5   | 63,5 | 178,0 | 15,8    | HONDA                              | 42510-S7A-J50  |
| 24.0112-0181.1 | 412181 | B |    |    |   |   | 302,0 | 12,0 | 11,0 | 56,1  | 114,3 | 5   | 72,0 | 185,0 | 14,2    | HONDA                              | 55311-60B21<br>55311-60B22                           |
| 24.0112-0183.1 | 412183 | S | B  |    |   |   | 300,0 | 12,0 | 10,0 | 58,3  | 112,0 | 5   | 67,0 | 180,0 | 15,3    | PEUGEOT                            | 4249 14  |
| 24.0112-0184.1 | 412184 | S | B  |    |   |   | 257,0 | 12,0 | 10,0 | 40,5  | 100,0 | 4/6 | 60,0 | 127,0 | 14,3    | AUDI                               | 8J0 615 601  |
| 24.0112-0185.1 | 412185 |   |    |    |   |   | 324,0 | 11,9 | 10,4 | 69,5  | 139,6 | 6   | 96,3 | 210,0 | 12,5    | AUDI                               | 4F0 615 601 G  |
| 24.0112-0186.1 | 412186 | B |    |    |   |   | 302,0 | 12,0 | 10,0 | 66,0  | 108,0 | 5   | 63,6 | 185,0 | 15,7    | NISSAN                             | 43206-00QAB<br>43206-00QAC<br>43206-00QAD            |
|                |        |   |    |    |   |   |       |      |      |       |       |     |      |       |         | OPEL/VAUXHALL<br>RENAULT           | 44 13 736/93161254<br>77 11 130 076<br>86 71 019 313 |
|                |        |   |    |    |   |   |       |      |      |       |       |     |      |       |         | AUDI                               | 8K0 615 601 B  |
|                |        |   |    |    |   |   |       |      |      |       |       |     |      |       |         | VOLVO                              | 30769058   |
|                |        |   |    |    |   |   |       |      |      |       |       |     |      |       |         | FORD                               | 4659167  |
|                |        |   |    |    |   |   |       |      |      |       |       |     |      |       |         | MAZDA                              | EF91-26-251  |
|                |        |   |    |    |   |   |       |      |      |       |       |     |      |       |         | MERCEDES BENZ                      | 221 423 11 12  |
|                |        |   |    |    |   |   |       |      |      |       |       |     |      |       |         | FIAT                               | 51806099<br>51806103<br>55700398<br>55700918         |
|                |        |   |    |    |   |   |       |      |      |       |       |     |      |       |         | OPEL/VAUXHALL                      | 5 69 022/93188916                                    |
|                |        |   |    |    |   |   |       |      |      |       |       |     |      |       |         | KIA                                | 58411-4D000  |
|                |        |   |    |    |   |   |       |      |      |       |       |     |      |       |         | LAND ROVER                         | LR001018   |



# Abmessungen Bremsscheiben

## Dimensions brake discs - Misure dischi freno -

## Dimensions Disques de frein - Medidas disco de freno

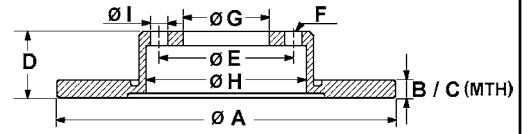

S Fixierschraube - fixing screw - vite di riparazione - vis de fixation - tornillo quejija  
 B beschichtet - coated - rivestito - revêtu - recubierto  
 HC hochgekohlt - high carbon - ad alto tenore di carbonio - à haute teneur en carbone - altamente carbonizado  
 L legiert - alloyed - alligato/legato - allié - aleado  
 V ventiliert - ventilated - ventilato - ventilé - ventilado  
 ● gelocht - perforated - perforato - poinçonné - perforado

|                |        | S | B | HC | L  | V | A     | B    | C    | D     | E     | F   | G     | H     | I        | OE - #                             |   |
|----------------|--------|---|---|----|----|---|-------|------|------|-------|-------|-----|-------|-------|----------|------------------------------------|---|
| 24.0112-0187.1 | 412187 | S | B |    |    |   | 292,0 | 12,0 | 10,5 | 48,0  | 120,0 | 5   | 67,4  | 171,5 | 16,3     | OPEL/VAUXHALL<br>SAAB<br>CHEVROLET | 5 69 025/13501302<br>5 69 127/13502198<br>13502198<br>13502135/13502136 |
| 24.0112-0188.1 | 412188 | S | B |    |    |   | 268,0 | 12,0 | 10,0 | 44,9  | 105,0 | 5   | 60,0  | 147,0 | 14,2     | OPEL/VAUXHALL<br>CHEVROLET         | 5 69 074/13502134<br>13502139   |
| 24.0112-0189.1 | 412189 | S | B |    |    |   | 292,0 | 12,0 | 10,0 | 45,0  | 115,0 | 5   | 70,7  | 157,0 | 14,2     | OPEL/VAUXHALL                      | 5 69 071/13502138<br>5 69 075/13502137<br>5 69 085/13504280             |
| 24.0112-0190.1 | 412190 | S | B | HC | L  |   | 305,0 | 12,0 | 10,0 | 71,5  | 130,0 | 5   | 91,0  | 167,5 | 17,0     | OPEL/VAUXHALL<br>NISSAN<br>RENAULT | 44 21 080/93168847<br>43206-00Q0B<br>43 20 640 87R                      |
| 24.0112-0191.1 | 412191 | S | B | HC | L  |   | 305,0 | 12,0 | 10,0 | 71,4  | 130,0 | 5   | 90,0  | 167,0 | 15,5     | NISSAN<br>OPEL/VAUXHALL<br>RENAULT | 43206-00Q0A<br>44 19 362/93197406<br>43 20 003 67R                      |
| 24.0112-0193.1 | 412193 |   | B |    |    |   | 316,0 | 12,0 | 10,4 | 68,6  | 127,0 | 5   | 72,0  | 206,0 | 16,6     | JEEP                               | 5206 0147AA   |
| 24.0112-0194.2 | 412194 |   | B |    |    |   | 268,0 | 12,0 | 10,0 | 73,2  | 108,0 | 4   | 56,0  | 62,0  | M12x1,25 | CITROEN/PEUGEOT                    | 4249 46   |
| 24.0112-0195.1 | 412195 |   | B |    |    |   | 278,0 | 12,0 | 11,0 | 46,0  | 114,3 | 5   | 62,0  | 169,2 | 12,8     | SUZUKI                             | 55611-57L00   |
| 24.0112-0197.1 | 412197 |   | S | B  |    |   | 290,0 | 12,0 | 10,0 | 44,0  | 108,0 | 5   | 71,1  | 136,0 | 13,0     | PEUGEOT                            | 4249 G2   |
| 24.0112-0198.1 | 412198 |   | S | B  |    |   | 290,0 | 12,0 | 10,0 | 35,0  | 108,0 | 4   | 71,1  | 151,2 | 13,0     | CITROEN/PEUGEOT                    | 4249 F7   |
| 24.0112-0199.1 | 412199 |   | B | HC |    |   | 305,0 | 12,0 | 10,4 | 33,0  | 127,0 | 5   | 72,5  | 167,5 | 14,0     | FIAT                               | K04721996AB   |
| 24.0112-0202.1 | 412202 |   | B |    |    |   | 292,0 | 12,0 | 10,5 | 48,0  | 120,0 | 5   | 67,4  | 171,5 | 16,3     | CHEVROLET                          | 13501313  |
| 24.0112-0210.1 | 412210 |   | S | B  |    |   | 300,0 | 12,0 | 10,0 | 48,2  | 112,0 | 5/9 | 65,0  | 173,0 | 15,3     | VOLKSWAGEN                         | 3Q0 615 601   |
| 24.0112-0211.1 | 412211 |   | S | B  |    |   | 268,0 | 12,0 | 10,0 | 35,0  | 108,0 | 5   | 71,1  | 133,0 | 13,2     | CITROEN/PEUGEOT                    | 16 095 828 80   |
| 24.0112-0212.1 | 412212 |   | S | B  |    |   | 290,0 | 12,0 | 10,0 | 35,0  | 108,0 | 5   | 71,1  | 133,0 | 13,2     | CITROEN/PEUGEOT                    | 16 095 830 80   |
| 24.0112-0213.1 | 412213 |   | S | B  | HC | L | 300,0 | 12,0 | 9,0  | 57,9  | 112,0 | 5   | 67,0  | 186,0 | 15,3     | MERCEDES BENZ                      | 447 423 00 12   |
| 24.0112-0214.1 | 412214 |   | S | B  |    |   | 278,0 | 12,0 | 10,4 | 33,2  | 110,0 | 5/5 | 70,0  | 137,0 | 15,7     | JEEP                               | 0 4779 885AB<br>4779 885AB  |
| 24.0112-0703.1 | 412703 |   | B |    |    |   | 306,6 | 12,0 | 10,5 | 63,2  | 114,3 | 5   | 62,0  | 190,0 | 14,5     | LEXUS<br>TOYOTA                    | 42431-30260<br>42431-53011  |
| 24.0112-0707.1 | 412707 |   | B |    |    |   | 282,0 | 12,0 | 10,0 | 39,7  | 114,3 | 5   | 64,2  | 142,0 | 12,6     | HONDA                              | 42510-S2A-000   |
| 24.0112-0714.1 | 412714 |   | B |    |    |   | 281,0 | 12,0 | 10,5 | 55,0  | 114,3 | 5   | 62,0  | 173,0 | 14,4     | TOYOTA                             | 42431-42060   |
| 24.0113-0102.2 | 413102 |   |   |    |    |   | 272,0 | 12,7 | 10,7 | 68,5  | 108,0 | 4   | 82,0  | 126,5 | M12x1,5  | ALFA ROMEO                         | 60516371  |
| 24.0113-0105.1 | 413105 |   |   |    |    |   | 302,0 | 12,5 | 11,5 | 48,0  | 139,5 | 6   | 100,0 | 168,5 | 15,0     | TOYOTA                             | 43512-35070   |
| 24.0113-0111.1 | 413111 |   |   |    |    |   | 253,0 | 12,7 | 11,1 | 67,5  | 88,5  | 5   | 69,5  | 109,5 | 12,2     | MERCEDES BENZ                      | 110 421 01 12   |
| 24.0113-0112.1 | 413112 |   |   |    |    |   | 273,0 | 12,6 | 11,0 | 63,3  | 112,0 | 5   | 69,5  | 127,5 | 15,0     | MERCEDES BENZ                      | 115 421 11 12   |
| 24.0113-0113.1 | 413113 |   |   |    |    |   | 273,5 | 12,6 | 11,0 | 63,3  | 112,0 | 5   | 80,0  | 127,5 | 15,0     | MERCEDES BENZ                      | 115 421 13 12   |
| 24.0113-0117.1 | 413117 |   |   |    |    |   | 280,0 | 12,7 | 11,7 | 65,4  | 114,3 | 4   | 86,1  | 145,5 | 13,6     | SAAB                               | 32000298  |
| 24.0113-0118.1 | 413118 |   |   |    |    |   | 244,6 | 12,7 | 11,4 | 27,0  | 92,5  | 4   | 68,3  | 116,1 | 10,3     | FORD                               | 5022671<br>5023732<br>5022829   |
| 24.0113-0122.1 | 413122 |   |   |    |    |   | 247,6 | 12,7 | 11,4 | 26,9  | 92,5  | 4   | 68,3  | 118,1 | 10,5     | FORD<br>HYUNDAI                    | 58161-31000<br>58161-31010  |
| 24.0113-0125.1 | 413125 |   |   |    |    |   | 246,0 | 12,7 | 9,7  | 55,5  | 92,0  | 4   | 73,0  | 114,0 | 10,5     | OPEL/VAUXHALL                      | 5 69 026/90008001   |
| 24.0113-0126.1 | 413126 |   |   |    |    |   | 271,0 | 12,7 | 9,7  | 59,4  | 108,0 | 5   | 88,0  | 130,0 | 10,5     | OPEL/VAUXHALL                      | 5 69 027/90008002   |
| 24.0113-0128.1 | 413128 |   |   |    |    |   | 273,0 | 13,0 | 10,7 | 43,0  | 98,0  | 4   | 76,0  | 132,0 | 10,3     | PEUGEOT/TALBOT                     | 4246 B2   |
| 24.0113-0132.1 | 413132 |   |   |    |    |   | 278,2 | 13,0 | 11,0 | 85,8  | 112,0 | 5   | 66,1  | 137,0 | 16,0     | VOLKSWAGEN                         | 211 615 301 B   |
| 24.0113-0137.1 | 413137 |   | B |    |    |   | 278,0 | 12,6 | 10,6 | 63,3  | 112,0 | 5   | 80,0  | 127,5 | 15,2     | MERCEDES BENZ                      | 123 421 00 12   |
| 24.0113-0138.1 | 413138 |   |   |    |    |   | 255,0 | 12,7 | 11,1 | 75,0  | 100,0 | 4   | 63,0  | 128,0 | 14,5     | BMW                                | 34 11 1 163 128   |
| 24.0113-0139.1 | 413139 |   |   |    |    |   | 280,0 | 12,7 | 11,1 | 78,0  | 120,0 | 5   | 74,0  | 143,0 | 14,5     | BMW                                | 34 11 1 163 144   |
| 24.0113-0141.1 | 413141 |   |   |    |    |   | 280,0 | 12,7 | 11,7 | 47,4  | 114,3 | 4   | 86,0  | 147,5 | 11,0     | SAAB                               | 8934036   |
| 24.0113-0142.1 | 413142 |   |   |    |    |   | 278,0 | 13,0 | 11,0 | 118,5 | 112,0 | 5   | 45,2  | 68,0  | M14x1,5  | VOLKSWAGEN                         | 251 407 617<br>251 407 617 A  |
| 24.0113-0159.1 | 413159 |   |   |    |    |   | 243,0 | 12,7 | 11,4 | 33,7  | 104,0 | 4   | 86,0  | 127,5 | 10,6     | MITSUBISHI                         | MB316676  |
| 24.0113-0160.1 | 413160 |   | B |    |    |   | 256,0 | 13,0 | 11,0 | 46,5  | 108,0 | 4   | 68,0  | 135,5 | 15,4     | AUDI                               | 443 615 301   |
| 24.0113-0161.1 | 413161 |   | S | B  |    |   | 236,0 | 12,7 | 9,7  | 41,0  | 100,0 | 4/6 | 60,0  | 123,0 | 14,0     | OPEL/VAUXHALL                      | 5 69 020/90008005<br>5 69 030/90008031<br>5 69 013/93182290             |
| 24.0113-0165.1 | 413165 |   |   |    |    |   | 219,0 | 13,0 | 11,0 | 37,0  | 94,0  | 4   | 75,0  | 119,0 | 10,5     | KIA                                | KK150-33-251<br>MDA01-33-251  |
| 24.0113-0166.1 | 413166 |   | B |    |    |   | 256,0 | 13,0 | 11,0 | 56,5  | 108,0 | 4   | 68,0  | 134,5 | 15,4     | MAZDA<br>AUDI                      | DA01-33-251<br>895 615 301  |
| 24.0113-0167.1 | 413167 |   | B |    |    |   | 260,0 | 12,7 | 11,1 | 35,0  | 100,0 | 4   | 66,0  | 137,5 | 14,5     | BMW                                | 34 11 6 752 434   |
| 24.0113-0168.1 | 413168 |   |   |    |    |   | 256,0 | 13,0 | 11,0 | 61,0  | 118,0 | 5   | 72,0  | 141,0 | 15,0     | CITROEN                            | 75 685 01<br>ZF 07 568 501  |
| 24.0113-0169.1 | 413169 |   |   |    |    |   | 236,0 | 12,8 | 11,4 | 45,6  | 98,0  | 4   | 62,0  | 124,6 | 13,0     | FIAT<br>PEUGEOT                    | 4450931<br>7568501<br>4246 85<br>4246 B3                                |
| 24.0113-0170.1 | 413170 |   |   |    |    |   | 257,0 | 13,0 | 11,5 | 84,0  | 108,0 | 4   | 39,84 | 50,25 | M14x1,5  | SKODA                              | 115 430 210<br>115 430 211  |
| 24.0113-0171.1 | 413171 |   |   |    |    |   | 239,0 | 12,6 | 9,0  | 46,0  | 98,0  | 4   | 58,5  | 128,0 | 13,0     | PORSCHE                            | 477 405 583 B   |
| 24.0113-0172.1 | 413172 |   |   |    |    |   | 238,9 | 12,8 | 11,4 | 29,2  | 86,0  | 4   | 69,0  | 107,0 | 10,4     | ALFA ROMEO<br>VOLVO                | 60501453<br>3210674   |



# Abmessungen Bremsscheiben

## Dimensions brake discs - Misure dischi freno -

## Dimensions Disques de frein - Medidas disco de freno

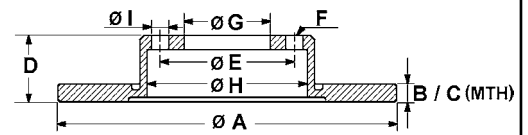

S Fixierschraube - fixing screw - vite di riparazione - vis de fixation - tornillo quefija

B beschichtet - coated - rivestito - revêtu - recubierto

HC hochgekohlt - high carbon - ad alto tenore di carbonio - à haute teneur en carbone - altamente carbonizado

L legiert - alloyed - alligato/legato - allié - aleado

V ventiliert - ventilated - ventilato - ventilé - ventilado

● gelocht - perforated - perforato - poinçonné - perforado

|                |        | S | B | HC | L | V | A     | B    | C    | D     | E     | F   | G     | H     | I        | OE - #        |                   |
|----------------|--------|---|---|----|---|---|-------|------|------|-------|-------|-----|-------|-------|----------|---------------|-------------------|
| 24.0113-0174.1 | 413174 |   |   |    |   |   | 258,0 | 12,6 | 9,7  | 58,4  | 110,0 | 5   | 70,0  | 139,0 | 14,0     | OPEL/VAUXHALL | 5 69 040/90271135 |
| 24.0113-0178.1 | 413178 | S | B |    |   |   | 255,6 | 12,9 | 11,0 | 39,2  | 100,0 | 4   | 65,0  | 135,5 | 13,6     | SEAT/VW       | 357 615 301       |
| 24.0113-0179.1 | 413179 | B |   | HC |   |   | 280,0 | 13,0 | 11,0 | 56,5  | 108,0 | 4   | 68,0  | 159,0 | 15,4     | AUDI          | 8A0 615 301       |
|                |        |   |   |    |   |   |       |      |      |       |       |     |       |       |          |               | 8A0 615 301 D     |
| 24.0113-0181.1 | 413181 | B |   | HC |   |   | 280,0 | 13,0 | 11,0 | 46,5  | 112,0 | 5   | 68,0  | 159,0 | 15,4     | AUDI          | 8D0 615 301 A     |
| 24.0113-0182.1 | 413182 | B |   |    |   |   | 236,0 | 12,8 | 11,4 | 45,7  | 100,0 | 4   | 62,0  | 125,5 | 14,8     | SKODA/VW      | 6U0 615 301       |
| 24.0113-0183.1 | 413183 |   |   |    |   |   | 234,0 | 13,0 | 11,4 | 34,0  | 104,0 | 4   | 86,0  | 126,0 | 10,6     | MINISUBISHI   | MB618737          |
| 24.0113-0184.1 | 413184 | S | B |    |   |   | 266,0 | 13,0 | 11,0 | 27,2  | 108,0 | 4   | 66,0  | 133,0 | 13,0     | CITROEN       | 16 086 916 80     |
|                |        |   |   |    |   |   |       |      |      |       |       |     |       |       |          |               | 4246 R4           |
|                |        |   |   |    |   |   |       |      |      |       |       |     |       |       |          |               | 4249 82           |
|                |        |   |   |    |   |   |       |      |      |       |       |     |       |       |          |               | PEUGEOT           |
|                |        |   |   |    |   |   |       |      |      |       |       |     |       |       |          |               | 16 086 916 80     |
|                |        |   |   |    |   |   |       |      |      |       |       |     |       |       |          |               | 4246 R2           |
| 24.0113-0185.1 | 413185 | S | B |    |   |   | 247,5 | 13,0 | 11,0 | 34,2  | 108,0 | 4   | 66,0  | 133,0 | 13,0     | CITROEN       | 4246 R9           |
|                |        |   |   |    |   |   |       |      |      |       |       |     |       |       |          |               | PEUGEOT           |
|                |        |   |   |    |   |   |       |      |      |       |       |     |       |       |          |               | 4246 R8           |
|                |        |   |   |    |   |   |       |      |      |       |       |     |       |       |          |               | 4249 A5           |
| 24.0113-0186.1 | 413186 |   |   |    |   |   | 234,0 | 13,0 | 11,4 | 45,0  | 100,0 | 4   | 64,0  | 126,0 | 12,6     | MINISUBISHI   | MB699281          |
| 24.0113-0188.1 | 413188 |   |   |    |   |   | 238,0 | 12,7 | 10,7 | 47,2  | 100,0 | 4   | 61,0  | 123,0 | 13,0     | PROTON        | MB699281          |
|                |        |   |   |    |   |   |       |      |      |       |       |     |       |       |          |               | ROVER             |
|                |        |   |   |    |   |   |       |      |      |       |       |     |       |       |          |               | GBD90819          |
| 24.0113-0189.1 | 413189 | B |   |    |   |   | 290,0 | 12,5 | 11,7 | 61,5  | 127,0 | 5   | 101,6 | 160,5 | 10,0     | LAND ROVER    | FRC9831           |
| 24.0113-0190.1 | 413190 |   |   |    |   |   | 240,0 | 12,8 | 11,6 | 43,0  | 95,2  | 4   | 66,0  | 122,0 | 13,0     | ROVER         | FTC1381           |
|                |        |   |   |    |   |   |       |      |      |       |       |     |       |       |          |               | FAM8405           |
|                |        |   |   |    |   |   |       |      |      |       |       |     |       |       |          |               | GBD90811          |
|                |        |   |   |    |   |   |       |      |      |       |       |     |       |       |          |               | NAM8415           |
| 24.0113-0193.1 | 413193 |   |   |    |   |   | 236,0 | 12,8 | 11,4 | 48,9  | 100,0 | 4   | 62,0  | 124,7 | 13,0     | SKODA         | 115 430 212       |
| 24.0113-0194.1 | 413194 | B |   |    |   |   | 294,0 | 13,5 | 11,5 | 41,0  | 112,0 | 5   | 68,2  | 165,0 | 16,5     | FORD          | 1140278           |
| 24.0113-0195.1 | 413195 | B |   |    |   |   | 236,0 | 12,6 | 9,7  | 35,4  | 102,0 | 4   | 86,0  | 107,5 | M10x1,25 | SEAT/VW       | 7D0 615 601 C     |
|                |        |   |   |    |   |   |       |      |      |       |       |     |       |       |          |               | CHEVROLET         |
|                |        |   |   |    |   |   |       |      |      |       |       |     |       |       |          |               | 96284392          |
|                |        |   |   |    |   |   |       |      |      |       |       |     |       |       |          |               | 96455424          |
| 24.0113-0196.1 | 413196 | B |   |    |   |   | 290,0 | 12,5 | 11,3 | 56,0  | 114,3 | 5   | 72,0  | 180,0 | 14,5     | DAEWOO        | 96284392          |
|                |        |   |   |    |   |   |       |      |      |       |       |     |       |       |          |               | CHRYSLER          |
|                |        |   |   |    |   |   |       |      |      |       |       |     |       |       |          |               | 4721 023          |
|                |        |   |   |    |   |   |       |      |      |       |       |     |       |       |          |               | 4721 023AF        |
|                |        |   |   |    |   |   |       |      |      |       |       |     |       |       |          |               | 4721 023AG        |
| 24.0113-0197.1 | 413197 | B |   |    |   |   | 304,5 | 12,6 | 11,7 | 62,8  | 120,0 | 5   | 70,0  | 161,5 | 14,3     | LAND ROVER    | NTC8781           |
|                |        |   |   |    |   |   |       |      |      |       |       |     |       |       |          |               | SDB000210         |
|                |        |   |   |    |   |   |       |      |      |       |       |     |       |       |          |               | SDB000470         |
| 24.0113-0198.1 | 413198 | B |   |    |   |   | 262,0 | 13,0 | 11,0 | 44,5  | 100,0 | 4   | 64,2  | 141,0 | 13,0     | ROVER         | GBD90841          |
|                |        |   |   |    |   |   |       |      |      |       |       |     |       |       |          |               | SDB100500         |
| 24.0113-0200.1 | 413200 | B |   |    |   |   | 290,0 | 13,0 | 11,0 | 47,0  | 114,3 | 5   | 68,0  | 158,0 | 12,7     | NISSAN        | 43206-4EA0A       |
|                |        |   |   |    |   |   |       |      |      |       |       |     |       |       |          |               | RENAULT           |
|                |        |   |   |    |   |   |       |      |      |       |       |     |       |       |          |               | FORD              |
| 24.0114-0100.1 | 414100 |   |   |    |   |   | 270,0 | 14,3 | 12,9 | 71,2  | 100,0 | 5   | 78,5  | 120,0 | M10      |               | 5022674           |
|                |        |   |   |    |   |   |       |      |      |       |       |     |       |       |          |               |                   |
|                |        |   |   |    |   |   |       |      |      |       |       |     |       |       |          |               |                   |
| 24.0114-0101.1 | 414101 |   |   |    |   |   | 263,0 | 14,3 | 12,7 | 65,0  | 108,0 | 5   | 68,1  | 139,0 | 16,3     | VOLVO         | 270737            |
| 24.0114-0102.1 | 414102 |   |   |    |   |   | 257,5 | 14,0 | 12,8 | 50,7  | 98,0  | 4   | 59,0  | 128,7 | 13,2     | FIAT/LANCIA   | 82434169          |
| 24.0114-0103.1 | 414103 |   |   |    |   |   | 254,0 | 14,3 | 12,9 | 31,5  | 100,0 | 5   | 78,5  | 138,0 | M10      |               | FORD              |
| 24.0114-0107.1 | 414107 |   |   |    |   |   | 280,0 | 14,0 | 12,6 | 55,5  | 138,0 | 5   | 112,0 | 150,0 | M10x1,5  |               | PEUGEOT           |
|                |        |   |   |    |   |   |       |      |      |       |       |     |       |       |          |               | 4246 69           |
|                |        |   |   |    |   |   |       |      |      |       |       |     |       |       |          |               | 4246 B8           |
| 24.0114-0108.1 | 414108 | B |   |    |   |   | 298,5 | 14,0 | 13,0 | 70,0  | 127,0 | 5   | 101,6 | 160,5 | 10,0     | LAND ROVER    | FRC7329           |
|                |        |   |   |    |   |   |       |      |      |       |       |     |       |       |          |               | FRC7392           |
|                |        |   |   |    |   |   |       |      |      |       |       |     |       |       |          |               | FTC3846           |
| 24.0114-0110.2 | 414110 |   |   |    |   |   | 267,0 | 14,2 | 12,8 | 111,0 | 170,0 | 6   | 58,3  | 115,0 | M18x1,5  |               | IVECO             |
| 24.0114-0111.1 | 414111 | B |   |    |   |   | 331,0 | 13,9 | 12,3 | 55,3  | 112,0 | 5   | 67,0  | 184,0 | 15,3     | MERCEDES BENZ | 163 423 00 12     |
| 24.0114-0112.1 | 414112 | S | B |    |   |   | 276,0 | 14,0 | 12,0 | 62,0  | 108,0 | 4   | 71,0  | 136,5 | 13,0     | CITROEN       | 4246 W4           |
| 24.0114-0113.1 | 414113 | B |   |    |   |   | 262,0 | 14,0 | 11,0 | 51,0  | 114,3 | 5   | 66,1  | 140,8 | 12,6     | LAND ROVER    | SDB100830         |
| 24.0114-0114.1 | 414114 | S | B | HC | L |   | 330,0 | 14,0 | 11,4 | 63,0  | 112,0 | 5   | 67,0  | 210,0 | 15,2     | MERCEDES BENZ | 164 423 05 12     |
|                |        |   |   |    |   |   |       |      |      |       |       |     |       |       |          |               | 164 423 12 12     |
| 24.0114-0115.1 | 414115 |   |   |    |   |   | 298,0 | 14,0 | 13,0 | 59,0  | 127,0 | 5   | 101,6 | 159,6 | 10,2     | LAND ROVER    | SDB000330         |
|                |        |   |   |    |   |   |       |      |      |       |       |     |       |       |          |               | SDB100980         |
| 24.0114-0116.1 | 414116 | S | B |    |   |   | 290,0 | 14,0 | 12,0 | 49,0  | 108,0 | 5   | 71,0  | 143,7 | 13,2     | CITROEN       | 4249 23           |
|                |        |   |   |    |   |   |       |      |      |       |       |     |       |       |          |               | 4249 91           |
|                |        |   |   |    |   |   |       |      |      |       |       |     |       |       |          |               | 16 118 410 80     |
|                |        |   |   |    |   |   |       |      |      |       |       |     |       |       |          |               | 9467548487        |
|                |        |   |   |    |   |   |       |      |      |       |       |     |       |       |          |               | 9404249918        |
|                |        |   |   |    |   |   |       |      |      |       |       |     |       |       |          |               | PEUGEOT           |
|                |        |   |   |    |   |   |       |      |      |       |       |     |       |       |          |               | 4249 22           |
|                |        |   |   |    |   |   |       |      |      |       |       |     |       |       |          |               | 4249 91           |
|                |        |   |   |    |   |   |       |      |      |       |       |     |       |       |          |               | TOYOTA            |
|                |        |   |   |    |   |   |       |      |      |       |       |     |       |       |          |               | SU001-A1062       |
| 24.0114-0118.1 | 414118 | B |   |    |   |   | 320,0 | 14,0 | 12,5 | 66,3  | 127,0 | 5   | 72,0  | 205,0 | 16,2     | JEEP          | 5208 9275AB       |
| 24.0114-0119.1 | 414119 | S | B | HC | L |   | 325,0 | 14,0 | 11,4 | 54,0  | 112,0 | 5   | 67,0  | 183,0 | 15,0     | MERCEDES BENZ | 166 423 00 12     |
| 24.0115-0105.1 | 415105 | B |   | HC |   |   | 288,0 | 15,0 | 13,0 | 46,5  | 112,0 | 5   | 68,0  | 135,5 | 15,4     | AUDI          | 4A0 615 301 B     |
| 24.0115-0106.1 | 415106 |   |   |    |   | V | 214,0 | 15,0 | 13,0 | 46,2  | 100,0 | 4   | 61,0  | 126,5 | 12,6     | NISSAN        | 40206-27B01       |
| 24.0115-0108.1 | 415108 | B |   |    |   |   | 281,0 | 15,0 | 13,2 | 44,7  | 98,0  | 5   | 59,0  | 127,0 | 13,0     | ALFA ROMEO    | 60658567          |
| 24.0115-0109.1 | 415109 | B |   | HC |   | V | 239,0 | 15,0 | 13,0 | 34,5  | 100,0 | 4/6 | 65,0  | 124,7 | 13,6     | AUDI/VW       | 6E0 615 301       |
| 24.0115-0111.1 | 415111 | B |   |    |   |   | 285,0 | 15,0 | 13,0 | 52,5  | 112,0 | 5   | 67,0  | 184,0 | 15,0     | MERCEDES BENZ | 163 421 01 12     |
| 24.0115-0112.1 | 415112 |   |   |    |   |   | 281,0 | 15,0 | 13,2 | 44,7  | 98,0  | 4   | 59,0  | 127,0 | 13,0     | LANCIA        | 46763837          |

# Abmessungen Bremsscheiben

## Dimensions brake discs - Misure dischi freno -

## Dimensions Disques de frein - Medidas disco de freno

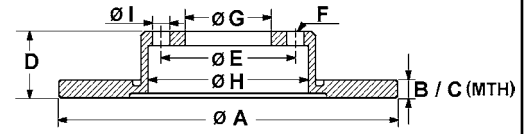

S Fixierschraube - fixing screw - vite di riparazione - vis de fixation - tornillo quefija

B beschichtet - coated - rivestito - revêtu - recubierto

HC hochgekohlt - high carbon - ad alto tenore di carbonio - à haute teneur en carbone - altamente carbonizado

L legiert - alloyed - alligato/legato - allié - aleado

V ventiliert - ventilated - ventilato - ventilé - ventilado

● gelocht - perforated - perforato - poinçonné - perforado

|                |        | S | B | HC | L | V | A     | B    | C    | D    | E     | F    | G     | H     | I        | OE - #                      |  |
|----------------|--------|---|---|----|---|---|-------|------|------|------|-------|------|-------|-------|----------|-----------------------------|--|
| 24.0116-0100.1 | 416100 |   | B |    |   |   | 280,0 | 16,0 | 13,0 | 78,6 | 112,0 | 5    | 88,0  | 133,5 | 12,5     | MERCEDES BENZ               | 601 420 02 72<br>601 421 04 12                           |
| 24.0116-0104.1 | 416104 |   | B |    |   |   | 258,0 | 16,0 | 13,0 | 95,5 | 112,0 | 5    | 45,2  | 67,9  | M14x1,5  | VOLKSWAGEN                  | 251 407 617 M  |
| 24.0116-0105.1 | 416105 |   | B |    |   |   | 256,0 | 16,1 | 13,5 | 64,1 | 118,0 | 5    | 73,0  | 141,0 | 15,5     | ALFA/FIAT                   | 7531819<br>60809894<br>93500520                          |
|                |        |   |   |    |   |   |       |      |      |      |       |      |       |       |          | CITROEN<br>PEUGEOT          | 4246 N5<br>4246 B4<br>4249 L1                            |
| 24.0116-0106.1 | 416106 |   |   |    |   |   | 290,0 | 16,0 | 14,8 | 61,0 | 118,0 | 5    | 73,0  | 141,0 | 15,5     | CITROEN<br>FIAT<br>PEUGEOT  | ZF 93 500 521<br>93500521<br>4246 H3                     |
| 24.0116-0107.2 | 416107 |   | B |    |   |   | 238,5 | 16,0 | 14,5 | 79,0 | 140,0 | 5    | 102,0 | 138,0 | M14x1,5  | MERCEDES BENZ               | 631 420 03 72  |
| 24.0116-0108.1 | 416108 |   |   |    |   |   | 260,0 | 16,0 | 13,0 | 64,0 | 112,0 | 5    | 68,2  | 144,0 | 16,5     | VOLKSWAGEN                  | 701 615 301 C  |
| 24.0116-0109.1 | 416109 |   |   |    |   |   | 258,0 | 16,0 | 13,0 | 57,5 | 112,0 | 5    | 67,0  | 135,0 | 15,5     | VOLKSWAGEN                  | 251 407 615 Q  |
| 24.0116-0110.1 | 416110 | S | B | HC | L |   | 272,0 | 16,0 | 14,0 | 96,7 | 130,0 | 5    | 85,0  | 160,0 | 15,0     | MERCEDES BENZ               | 902 423 03 12<br>902 423 05 12                           |
|                |        |   |   |    |   |   |       |      |      |      |       |      |       |       |          | VOLKSWAGEN                  | 2D0 615 601 A<br>2D0 615 601 D                           |
| 24.0116-0116.2 | 416116 |   | B |    |   |   | 280,0 | 16,0 | 13,0 | 68,7 | 160,0 | 5    | 96,0  | 120,0 | M10x1,5  | FORD                        | 1451161  |
| 24.0116-0117.1 | 416117 |   | B |    |   |   | 273,0 | 16,0 | 15,0 | 37,5 | 114,3 | 5    | 66,5  | 162,0 | 14,0     | DAIHATSU                    | 43512-87402-000  |
| 24.0116-0118.1 | 416118 |   |   |    |   | V | 234,0 | 16,0 | 14,0 | 37,0 | 88,0  | 4    | 70,0  | 111,0 | M10      | DAIHATSU                    | 43512-87220-000  |
| 24.0116-0119.1 | 416119 |   | B |    |   | V | 292,0 | 16,0 | 14,0 | 62,0 | 114,3 | 5    | 68,0  | 172,0 | 12,7     | NISSAN                      | 43206-8H305<br>43206-8H700<br>43206-8H701<br>43206-8H702 |
|                |        |   |   |    |   |   |       |      |      |      |       |      |       |       |          | RENAULT                     | 43 20 031 12R  |
| 24.0116-0120.1 | 416120 |   | B |    |   | V | 234,0 | 16,0 | 15,0 | 40,9 | 100,0 | 4    | 55,1  | 125,0 | 13,2     | DAIHATSU                    | 43512-97202-000  |
| 24.0116-0121.1 | 416121 | S | B |    |   |   | 298,0 | 16,0 | 14,0 | 71,0 | 130,0 | 6    | 85,0  | 180,0 | 15,0     | MERCEDES BENZ<br>VOLKSWAGEN | 906 423 00 12<br>2E0 615 601 A                           |
| 24.0116-0122.1 | 416122 |   | B |    |   | V | 308,0 | 16,0 | 14,0 | 62,0 | 114,3 | 5    | 68,0  | 190,0 | 12,8     | NISSAN                      | 43206-CA000  |
| 24.0116-0123.1 | 416123 |   | B |    |   |   | 300,0 | 16,0 | 14,2 | 80,0 | 130,0 | 5    | 79,0  | 172,0 | 17,5     | CITROEN                     | 4249 42<br>4249 K6                                       |
|                |        |   |   |    |   |   |       |      |      |      |       |      |       |       |          | FIAT                        | 51740250<br>51749555                                     |
|                |        |   |   |    |   |   |       |      |      |      |       |      |       |       |          | PEUGEOT                     | 4249 41<br>4249 K6<br>16 078 806 80                      |
| 24.0116-0124.1 | 416124 |   | B |    |   |   | 280,0 | 16,0 | 14,2 | 82,0 | 118,0 | 5    | 72,0  | 172,0 | 15,6     | CITROEN                     | 4246 Y7<br>4249 K7<br>4249 L0                            |
|                |        |   |   |    |   |   |       |      |      |      |       |      |       |       |          | FIAT                        | 46833806<br>51740245<br>51749274<br>51848617             |
|                |        |   |   |    |   |   |       |      |      |      |       |      |       |       |          | PEUGEOT                     | 4246 Y9<br>4249 K7<br>4249 L0<br>16 078 804 80           |
| 24.0116-0125.1 | 416125 |   | B |    |   |   | 280,0 | 16,0 | 14,2 | 82,0 | 130,0 | 5    | 79,0  | 172,0 | 17,5     | CITROEN                     | 4246 Z1<br>4249 K8<br>4249 K9                            |
|                |        |   |   |    |   |   |       |      |      |      |       |      |       |       |          | FIAT                        | 46833807<br>51740248<br>51749275<br>51856412             |
|                |        |   |   |    |   |   |       |      |      |      |       |      |       |       |          | PEUGEOT                     | 4246 Z3<br>4249 K8<br>4249 K9<br>16 078 805 80           |
| 24.0116-0126.1 | 416126 |   | B |    |   |   | 280,0 | 16,0 | 13,0 | 16,3 | 124,0 | 5/10 | 107,5 | 144,5 | 10,7     | FORD                        | 1464031  |
| 24.0116-0127.1 | 416127 |   |   |    |   | V | 211,0 | 16,0 | 14,0 | 41,0 | 88,0  | 4    | 70,0  | 97,0  | M10x1,25 | DAIHATSU                    | 43512-87215-000  |
| 24.0116-0128.1 | 416128 |   |   |    |   |   | 276,0 | 16,0 | 13,0 | 69,5 | 118,0 | 5    | 73,0  | 145,0 | 15,5     | IVECO                       | 42471034   |
| 24.0116-0129.1 | 416129 |   |   |    |   |   | 276,0 | 16,0 | 13,0 | 69,5 | 118,0 | 5    | 73,0  | 145,0 | 15,5     | IVECO                       | 2991646  |
| 24.0116-0130.1 | 416130 |   | B |    |   | V | 234,0 | 16,0 | 15,0 | 41,0 | 100,0 | 4    | 55,0  | 125,0 | 14,0     | DAIHATSU<br>SUBARU          | 43512-B1050-000<br>43512B1050                            |
| 24.0116-0132.1 | 416132 |   | B |    |   |   | 280,0 | 16,0 | 13,0 | 62,1 | 127,0 | 6    | 108,0 | 164,5 | 10,8     | NISSAN                      | 43206-MB600  |
| 24.0116-0133.1 | 416133 | S | B |    |   |   | 303,0 | 16,0 | 13,0 | 83,0 | 130,0 | 5    | 85,0  | 158,5 | 15,0     | MERCEDES BENZ               | 461 421 00 12<br>461 421 00 12                           |
| 24.0116-0134.1 | 416134 |   | B |    |   |   | 284,0 | 16,0 | 13,0 | 43,9 | 124,0 | 10   | 107,1 | 148,0 | 10,7     | FORD                        | 1488311<br>8C1V-2A315-AA                                 |



# Abmessungen Bremsscheiben

## Dimensions brake discs - Misure dischi freno -

## Dimensions Disques de frein - Medidas disco de freno

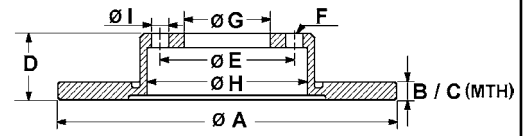

S Fixierschraube - fixing screw - vite di riparazione - vis de fixation - tornillo quefija

B beschichtet - coated - rivestito - revêtu - recubierto

HC hochgekohlt - high carbon - ad alto tenore di carbonio - à haute teneur en carbone - altamente carbonizado

L legiert - alloyed - alligato/legato - allié - aleado

V ventiliert - ventilated - ventilato - ventilé - ventilado

● gelocht - perforated - perforato - poinçonné - perforado

|                |        | S | B | HC | L | V | A     | B    | C    | D    | E     | F | G     | H     | I        | OE            | #  |
|----------------|--------|---|---|----|---|---|-------|------|------|------|-------|---|-------|-------|----------|---------------|--|
| 24.0117-0101.1 | 417101 |   |   |    |   | V | 231,0 | 17,0 | 15,0 | 44,0 | 100,0 | 4 | 61,0  | 124,0 | 12,6     | HONDA         | 45251-SB2-932  |
|                |        |   |   |    |   |   |       |      |      |      |       |   |       |       |          | ROVER         | 45251-SB2-940<br>DBP7954<br>GBD90803<br>GBD90814<br>GBD90825                           |
| 24.0117-0103.1 | 417103 | B |   |    |   | V | 231,2 | 17,0 | 15,0 | 50,0 | 114,3 | 4 | 64,0  | 137,5 | 12,8     | SUBARU        | 5531180F03   |
|                |        |   |   |    |   |   |       |      |      |      |       |   |       |       |          | SUZUKI        | 55311-60B20<br>55311-72F00<br>55311M72F00  |
| 24.0117-0104.1 | 417104 |   |   |    |   | V | 287,0 | 17,0 | 15,0 | 46,1 | 140,0 | 5 | 107,0 | 183,0 | 13,0     | SUZUKI        | 55211-56B00  |
| 24.0117-0105.1 | 417105 | B |   |    |   | V | 231,0 | 17,0 | 15,0 | 49,2 | 100,0 | 4 | 60,0  | 125,0 | 12,8     | SUZUKI        | 55311-75F00<br>55311-M75F00  |
| 24.0117-0106.1 | 417106 | B |   |    |   | V | 253,0 | 17,0 | 15,0 | 49,0 | 100,0 | 4 | 60,0  | 153,0 | 12,5     | OPEL/VAUXHALL | 47 06 749/93176389<br>47 07 288/93179462   |
|                |        |   |   |    |   |   |       |      |      |      |       |   |       |       |          | SUBARU        | 5531186G02   |
|                |        |   |   |    |   |   |       |      |      |      |       |   |       |       |          | SUZUKI        | 55311-84E01<br>55311-86G02   |
| 24.0117-0107.1 | 417107 | B |   |    |   | V | 246,0 | 17,0 | 16,0 | 41,9 | 100,0 | 4 | 55,1  | 137,0 | 13,2     | DAIHATSU      | 43512-97402-000  |
| 24.0117-0108.1 | 417108 | B |   |    |   | V | 257,0 | 17,0 | 15,0 | 49,2 | 100,0 | 4 | 60,0  | 151,0 | 12,7     | SUZUKI        | 55311-80G02  |
| 24.0117-0109.1 | 417109 |   |   |    |   | V | 287,0 | 17,0 | 15,0 | 29,0 | 140,0 | 5 | 108,2 | 181,7 | 13,0     | SUZUKI        | 55211-65D01  |
| 24.0117-0110.1 | 417110 | B |   |    |   | V | 257,0 | 17,0 | 15,0 | 38,3 | 100,0 | 4 | 64,0  | 123,5 | 12,6     | CITROEN       | 4249 L5  |
|                |        |   |   |    |   |   |       |      |      |      |       |   |       |       |          | MITSUBISHI    | 4615A093   |
|                |        |   |   |    |   |   |       |      |      |      |       |   |       |       |          | PEUGEOT       | 4249 L5  |
| 24.0118-0101.1 | 418101 |   |   |    |   | V | 238,0 | 18,0 | 16,0 | 31,0 | 94,0  | 4 | 75,0  | 143,5 | 10,5     | MAZDA         | B107-33-251<br>BF68-33-251A  |
| 24.0118-0104.1 | 418104 |   |   |    |   | V | 242,0 | 18,0 | 16,0 | 43,9 | 90,0  | 4 | 70,0  | 100,0 | M10      | SUBARU        | 25431GA171<br>25431GA200   |
| 24.0118-0105.1 | 418105 | B |   |    |   |   | 282,0 | 18,0 | 15,0 | 64,5 | 112,0 | 5 | 68,2  | 144,0 | 16,5     | VOLKSWAGEN    | 701 615 301 E  |
| 24.0118-0106.1 | 418106 | S | B | HC |   | V | 239,0 | 18,0 | 16,0 | 34,5 | 100,0 | 4 | 65,0  | 125,0 | 13,6     | SEAT/VW       | 6N0 615 301 C  |
|                |        |   |   |    |   |   |       |      |      |      |       |   |       |       |          | VOLKSWAGEN    | 6N0 615 301 F  |
| 24.0118-0107.1 | 418107 | B |   |    |   | V | 240,0 | 18,0 | 16,0 | 45,2 | 100,0 | 4 | 61,0  | 130,0 | 12,6     | NISSAN        | 40206-58A00<br>40206-58A01<br>40206-60Y01  |
| 24.0118-0108.1 | 418108 | B |   |    |   |   | 280,0 | 18,0 | 15,9 | 65,5 | 118,0 | 5 | 73,0  | 141,3 | 15,5     | CITROEN       | 4246 J9  |
|                |        |   |   |    |   |   |       |      |      |      |       |   |       |       |          | FIAT          | 1300500080   |
|                |        |   |   |    |   |   |       |      |      |      |       |   |       |       |          | PEUGEOT       | 4246 J8  |
| 24.0118-0109.1 | 418109 |   |   |    |   | V | 242,0 | 18,0 | 16,4 | 34,0 | 104,0 | 4 | 86,0  | 126,0 | 10,6     | MITSUBISHI    | MB316677<br>MB366434   |
| 24.0118-0110.1 | 418110 |   |   |    |   | V | 238,0 | 18,0 | 17,0 | 48,2 | 100,0 | 4 | 54,1  | 127,0 | 14,5     | TOYOTA        | 43512-12250<br>43512-12300<br>43512-12310<br>43512-12330<br>43512-12440<br>43512-12480 |
| 24.0118-0111.1 | 418111 | S | B | HC |   |   | 282,0 | 18,0 | 15,0 | 55,0 | 112,0 | 5 | 68,2  | 144,0 | 16,5     | VOLKSWAGEN    | 701 615 301 G  |
| 24.0118-0112.1 | 418112 |   |   |    |   | V | 236,0 | 18,0 | 16,4 | 34,0 | 104,0 | 4 | 86,0  | 141,0 | 10,6     | MITSUBISHI    | MB618734<br>MB618735   |
| 24.0118-0113.1 | 418113 | B |   |    |   | V | 235,0 | 18,0 | 16,0 | 45,0 | 100,0 | 4 | 55,0  | 125,0 | 13,0     | MAZDA         | NA01-33-25X<br>NA01-33-25XA<br>NA01-33-25XC  |
| 24.0118-0115.1 | 418115 |   |   |    |   | V | 212,0 | 18,0 | 15,5 | 36,5 | 94,0  | 4 | 65,1  | 99,0  | M10x1,25 | SUBARU        | 725431150<br>725431312   |
| 24.0118-0116.1 | 418116 |   |   |    |   | V | 240,0 | 18,0 | 15,5 | 36,5 | 94,0  | 4 | 65,1  | 150,5 | M10x1,25 | SUBARU        | 725431321  |
| 24.0118-0117.1 | 418117 |   |   |    |   | V | 247,0 | 18,0 | 16,0 | 45,2 | 100,0 | 4 | 61,0  | 130,0 | 12,7     | NISSAN        | 40206-0M802  |
| 24.0118-0118.1 | 418118 |   |   |    |   | V | 232,0 | 18,0 | 16,0 | 45,2 | 100,0 | 4 | 61,0  | 130,0 | 12,8     | NISSAN        | 40206-0M602  |
| 24.0118-0119.1 | 418119 |   |   |    |   | V | 291,0 | 18,0 | 17,0 | 68,4 | 114,3 | 5 | 60,0  | 190,0 | 14,5     | TOYOTA        | 42431-14110  |
| 24.0118-0120.1 | 418120 | B |   |    |   | V | 236,0 | 18,0 | 16,4 | 45,0 | 100,0 | 4 | 64,0  | 126,0 | 12,6     | MITSUBISHI    | MB699283<br>MB950922<br>MR449769<br>MB699283   |
| 24.0118-0121.1 | 418121 |   |   |    |   | V | 277,0 | 18,0 | 17,0 | 32,5 | 118,0 | 5 | 96,0  | 176,0 | 10,6     | PROTON        | 43512-87608-000  |
| 24.0118-0122.1 | 418122 | B |   |    |   | V | 313,5 | 18,0 | 16,6 | 80,2 | 139,6 | 6 | 101,0 | 210,0 | 12,6     | DAIHATSU      | 97034036   |
|                |        |   |   |    |   |   |       |      |      |      |       |   |       |       |          | ISUZU         | 5 69 104/97034036  |
|                |        |   |   |    |   |   |       |      |      |      |       |   |       |       |          | OPEL/VAUXHALL | 5 69 106/91151563  |
| 24.0118-0124.1 | 418124 | B |   |    |   | V | 238,0 | 18,0 | 17,0 | 42,8 | 100,0 | 4 | 55,0  | 127,0 | 14,6     | TOYOTA        | 43512-16070<br>43512-16120   |
| 24.0118-0125.1 | 418125 |   |   |    |   | V | 242,0 | 18,0 | 16,0 | 52,5 | 100,0 | 5 | 58,0  | 128,0 | 13,0     | SUBARU        | 26310AA012   |
| 24.0118-0126.1 | 418126 |   |   |    |   | V | 234,5 | 18,0 | 17,0 | 47,0 | 100,0 | 4 | 56,0  | 128,5 | 13,0     | DAIHATSU      | 43512-87710-000<br>43512-87718-000<br>43512-87725-000                                  |
| 24.0118-0129.1 | 418129 | B |   |    |   | V | 302,0 | 18,0 | 16,0 | 46,2 | 114,3 | 5 | 62,0  | 156,7 | 14,6     | TOYOTA        | 43512-42010  |
| 24.0118-0131.1 | 418131 | B |   |    |   | V | 235,0 | 17,9 | 16,0 | 43,2 | 100,0 | 4 | 55,0  | 129,5 | 14,5     | TOYOTA        | 43512-0D010<br>43512-52050   |



# Abmessungen Bremsscheiben

## Dimensions brake discs - Misure dischi freno -

## Dimensions Disques de frein - Medidas disco de freno

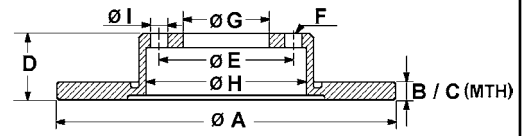

S Fixierschraube - fixing screw - vite di riparazione - vis de fixation - tornillo quejija  
 B beschichtet - coated - rivestito - revêtu - recubierto  
 HC hochgekohlt - high carbon - ad alto tenore di carbonio - à haute teneur en carbone - altamente carbonizado  
 L legiert - alloyed - alligato/legato - allié - aleado  
 V ventiliert - ventilated - ventilato - ventilé - ventilado  
 ● gelocht - perforated - perforato - poinçonné - perforado

|                |        | S | B | HC | L | V | A     | B    | C    | D     | E     | F   | G     | H     | I        | OE - #  |
|----------------|--------|---|---|----|---|---|-------|------|------|-------|-------|-----|-------|-------|----------|---|
| 24.0118-0136.1 | 418136 |   |   |    |   | V | 316,0 | 18,0 | 16,0 | 80,0  | 139,7 | 6   | 111,0 | 189,0 | 12,8     | NISSAN<br>43206-05J04<br>43206-VB000  |
| 24.0118-0137.1 | 418137 | S | B | HC |   | V | 239,0 | 18,0 | 16,0 | 35,0  | 100,0 | 5   | 65,0  | 125,0 | 15,6     | SKODA/VW<br>VOLKSWAGEN<br>6Q0 615 301<br>6Q0 615 301 A  |
| 24.0118-0138.1 | 418138 |   | B |    |   | V | 234,0 | 18,0 | 16,0 | 50,7  | 100,0 | 4   | 62,2  | 126,0 | 12,6     | HYUNDAI<br>51712-02551  |
| 24.0118-0139.1 | 418139 |   | B |    |   | V | 238,0 | 18,0 | 16,0 | 46,2  | 100,0 | 4   | 59,0  | 130,0 | 12,5     | NISSAN<br>40206-1F500<br>40206-72B00  |
| 24.0118-0140.1 | 418140 |   | B |    |   | V | 315,0 | 18,0 | 16,4 | 84,2  | 139,7 | 6   | 108,0 | 197,0 | 12,5     | NISSAN<br>40206-1F500<br>40206-72B00  |
| 24.0118-0141.1 | 418141 |   |   |    |   | V | 266,0 | 18,0 | 16,4 | 60,2  | 114,3 | 4   | 90,0  | 168,0 | 12,6     | HYUNDAI<br>58411-M2050<br>58411-M2050   |
| 24.0118-0143.1 | 418143 |   | B |    |   | V | 329,2 | 18,0 | 16,0 | 102,6 | 150,0 | 5   | 110,0 | 230,0 | 16,7     | LEXUS/TOYOTA<br>42431-60220<br>42431-60221<br>42431-60280<br>42431-60281                                |
| 24.0118-0144.1 | 418144 |   | B |    |   | V | 252,0 | 18,0 | 16,0 | 49,0  | 100,0 | 4   | 62,2  | 126,0 | 12,6     | HYUNDAI<br>51712-0X700<br>51712-B9000<br>51712-07700  |
| 24.0118-0145.1 | 418145 |   | B |    |   | V | 241,0 | 18,0 | 16,0 | 49,0  | 100,0 | 4   | 62,2  | 126,0 | 12,6     | HYUNDAI<br>51712-0X500<br>51712-07500   |
| 24.0118-0146.1 | 418146 |   | B |    |   | V | 332,0 | 18,0 | 16,0 | 74,4  | 139,7 | 6   | 94,0  | 210,0 | 12,8     | NISSAN<br>43206-00Q0C<br>43 20 679 43R  |
| 24.0118-0147.1 | 418147 |   | B |    |   | V | 310,0 | 18,0 | 16,5 | 67,2  | 114,3 | 5   | 62,0  | 190,0 | 14,5     | LEXUS<br>42431-30290  |
| 24.0118-0148.1 | 418148 |   | B |    |   | V | 286,0 | 18,0 | 16,0 | 58,7  | 114,3 | 5   | 72,0  | 190,0 | 13,0     | MAZDA<br>LE44-26-251A   |
| 24.0118-0149.1 | 418149 |   | B |    |   | V | 302,0 | 18,0 | 16,0 | 43,3  | 114,3 | 5   | 72,0  | 142,8 | 13,0     | MAZDA<br>F151-26-251A   |
| 24.0118-0150.1 | 418150 |   | B |    |   | V | 301,6 | 18,0 | 16,0 | 56,6  | 114,3 | 5   | 72,0  | 190,0 | 13,0     | MAZDA<br>L206-26-251B   |
| 24.0118-0151.1 | 418151 |   | B |    |   | V | 256,0 | 18,0 | 16,0 | 46,9  | 100,0 | 4   | 62,2  | 126,0 | 12,5     | HYUNDAI<br>51712-1J500  |
| 24.0118-0153.1 | 418153 |   | B |    |   | V | 302,0 | 18,0 | 15,0 | 51,0  | 140,0 | 8   | 120,0 | 164,0 | 10,9     | OPEL/VAUXHALL<br>44 21 180/93168942<br>NISSAN<br>43206-00Q0C<br>RENAULT<br>43 20 679 43R                |
| 24.0118-0154.1 | 418154 |   | B |    |   | V | 324,0 | 18,0 | 16,0 | 67,0  | 114,3 | 5   | 69,0  | 210,0 | 12,5     | HYUNDAI<br>58411-3J500  |
| 24.0118-0158.1 | 418158 |   | B |    |   | V | 324,6 | 18,0 | 16,0 | 56,7  | 114,3 | 5   | 72,0  | 190,0 | 13,0     | MAZDA<br>L232-26-251C   |
| 24.0118-0709.1 | 418709 |   | B |    |   | V | 312,0 | 18,0 | 16,0 | 68,0  | 139,7 | 6   | 106,0 | 210,0 | 14,5     | TOYOTA<br>42431-60200<br>LEXUS/TOYOTA<br>42431-60201  |
| 24.0118-0724.1 | 418724 |   | B |    |   | V | 308,0 | 18,0 | 16,0 | 62,7  | 114,3 | 5   | 68,0  | 190,0 | 12,7     | NISSAN<br>43206-EB300   |
| 24.0118-0725.1 | 418725 |   | B |    |   | V | 290,0 | 18,0 | 16,0 | 67,4  | 100,0 | 5   | 58,0  | 170,0 | 13,0     | SUBARU<br>26700AE080<br>26700AE081  |
| 24.0119-0104.1 | 419104 |   |   |    |   | V | 242,0 | 19,0 | 17,0 | 49,6  | 100,0 | 4   | 61,0  | 126,7 | 12,6     | HONDA<br>45251-SE0-010  |
| 24.0119-0106.1 | 419106 |   |   |    |   | V | 242,0 | 19,0 | 17,0 | 44,1  | 100,0 | 4   | 61,0  | 122,0 | 12,6     | HONDA<br>45251-SB2-990  |
| 24.0119-0107.1 | 419107 | S | B | HC |   | V | 276,0 | 19,0 | 17,4 | 60,3  | 120,0 | 5   | 75,0  | 160,8 | 14,5     | BMW<br>34 21 6 855 155<br>34 21 6 864 903<br>34 21 1 165 563<br>34 21 6 864 056                         |
| 24.0119-0108.1 | 419108 | S | B | HC |   | V | 294,0 | 18,9 | 17,4 | 59,7  | 120,0 | 5   | 75,0  | 160,8 | 14,8     | BMW<br>34 21 1 165 563<br>34 21 6 864 056   |
| 24.0119-0109.1 | 419109 |   | B |    |   | V | 242,0 | 19,1 | 17,0 | 40,5  | 104,0 | 4   | 86,0  | 143,0 | M10x1,25 | HYUNDAI<br>51712-24100  |
| 24.0119-0111.1 | 419111 |   |   |    |   | V | 242,0 | 19,2 | 17,0 | 37,2  | 104,0 | 4   | 86,0  | 126,0 | 10,4     | HYUNDAI<br>51712-28000<br>51712-28000D  |
| 24.0119-0112.1 | 419112 | S | B | HC |   | V | 294,0 | 19,0 | 17,4 | 74,7  | 120,0 | 5   | 75,0  | 160,8 | 14,7     | BMW<br>34 21 6 794 303  |
| 24.0119-0113.1 | 419113 | S | B | HC |   | V | 294,0 | 19,0 | 17,4 | 60,5  | 120,0 | 5   | 75,0  | 184,0 | 14,7     | BMW<br>34 21 1 166 165  |
| 24.0119-0114.1 | 419114 |   | B |    |   | V | 241,0 | 19,0 | 17,0 | 52,1  | 100,0 | 4   | 62,2  | 126,0 | 12,5     | HYUNDAI<br>51712-25060<br>51712-25061   |
| 24.0119-0115.1 | 419115 |   | B |    |   | V | 241,0 | 19,0 | 17,0 | 47,8  | 100,0 | 4   | 62,2  | 126,0 | 12,5     | NISSAN<br>51712-1C000   |
| 24.0119-0116.1 | 419116 |   | B |    |   | V | 256,0 | 19,0 | 17,0 | 47,9  | 100,0 | 4   | 62,2  | 125,0 | 12,5     | HYUNDAI<br>51712-1C050  |
| 24.0120-0103.1 | 420103 |   |   | HC | L | V | 282,5 | 20,5 | 19,1 | 35,3  | 126,0 | 5   | 107,0 | 145,0 | 8,4      | PORSCHE<br>477 405 083 A<br>911 351 041 20  |
| 24.0120-0104.1 | 420104 |   |   | HC | L | V | 289,0 | 20,0 | 18,6 | 100,0 | 130,0 | 5   | 103,0 | 180,0 | 15,4     | PORSCHE<br>944 352 041 03   |
| 24.0120-0108.1 | 420108 |   |   |    |   | V | 260,0 | 20,0 | 18,0 | 54,0  | 98,0  | 5   | 58,0  | 127,0 | 13,0     | PORSCHE<br>5 429 669 S<br>75 529 364  |
| 24.0120-0112.1 | 420112 |   | B | HC | L | V | 289,0 | 19,9 | 18,7 | 71,2  | 130,0 | 5   | 102,8 | 180,0 | 15,6     | PORSCHE<br>944 352 041 02   |
| 24.0120-0113.1 | 420113 |   |   | HC |   | V | 300,0 | 20,0 | 18,4 | 68,0  | 120,0 | 5   | 75,0  | 180,0 | 14,5     | BMW<br>34 21 1 162 967  |
| 24.0120-0114.2 | 420114 |   | B |    |   | V | 281,0 | 19,9 | 18,0 | 80,5  | 115,0 | 5   | 91,0  | 128,5 | M14x1,5  | VOLKSWAGEN<br>281 615 283 A   |
| 24.0120-0115.1 | 420115 | S | B | HC | L | V | 236,0 | 20,0 | 17,0 | 41,0  | 100,0 | 4/6 | 60,0  | 123,0 | 14,0     | CHEVROLET<br>90121445<br>DAEWOO<br>90121445   |
| 24.0120-0119.1 | 420119 |   |   |    |   | V | 295,0 | 20,0 | 18,0 | 29,0  | 137,0 | 6   | 104,0 | 178,0 | M12x1,25 | OPEL/VAUXHALL<br>5 69 054/9051111<br>NISSAN<br>40206-37J01<br>40206-C7000<br>40206-C7001<br>40206-G9500 |
| 24.0120-0120.1 | 420120 |   |   | HC |   | V | 256,0 | 20,0 | 18,0 | 41,9  | 108,0 | 4   | 68,0  | 134,0 | 15,4     | AUDI<br>853 615 301 A<br>853 615 301 C  |
| 24.0120-0122.1 | 420122 |   | B |    |   | V | 308,0 | 20,0 | 18,0 | 64,5  | 108,0 | 5   | 68,0  | 178,0 | 16,5     | VOLVO<br>8624926  |
| 24.0120-0123.1 | 420123 | S | B | HC | L | V | 239,0 | 20,0 | 18,0 | 39,0  | 100,0 | 4   | 65,0  | 123,8 | 13,6     | AUDI/SEAT/VW<br>321 615 301 C   |
| 24.0120-0125.1 | 420125 | S | B |    |   | V | 238,0 | 20,1 | 17,7 | 41,0  | 100,0 | 4   | 61,0  | 128,0 | 12,5     | NISSAN<br>40206-00QAJ<br>RENAULT<br>77 01 204 286<br>86 71 000 085                                      |
| 24.0120-0126.1 | 420126 |   | B |    |   | V | 259,0 | 20,2 | 17,7 | 46,4  | 100,0 | 4   | 61,0  | 130,0 | 12,8     | RENAULT<br>77 00 715 081<br>77 01 204 283   |



# Abmessungen Bremsscheiben

## Dimensions brake discs - Misure dischi freno -

## Dimensions Disques de frein - Medidas disco de freno

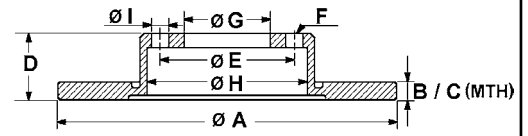

S Fixierschraube - fixing screw - vite di riparazione - vis de fixation - tornillo quefija

B beschichtet - coated - rivestito - revêtu - recubierto

HC hochgekohlt - high carbon - ad alto tenore di carbonio - à haute teneur en carbone - altamente carbonizado

L legiert - alloyed - alligato/legato - allié - aleado

V ventiliert - ventilated - ventilato - ventilé - ventilado

● gelocht - perforated - perforato - poinçonné - perforado

|                |        | S | B | HC | L | V | A     | B    | C    | D    | E     | F    | G     | H     | I    | OE - #  |
|----------------|--------|---|---|----|---|---|-------|------|------|------|-------|------|-------|-------|------|---|
| 24.0120-0128.1 | 420128 |   |   |    |   |   | 256,0 | 20,0 | 18,0 | 38,8 | 100,0 | 4    | 65,0  | 131,5 | 13,8 | SEAT/VW<br>321 615 301 D<br>6N0 615 301 D   |
| 24.0120-0129.1 | 420129 |   |   |    |   |   | 257,4 | 20,0 | 18,2 | 51,7 | 98,0  | 4    | 59,0  | 127,0 | 13,0 | ALFA/FIAT/LANCIA<br>60810227<br>82464702  |
| 24.0120-0130.1 | 420130 |   |   |    |   |   | 255,0 | 20,0 | 18,4 | 45,0 | 108,0 | 6    | 87,0  | 115,0 | 10,5 | MITSUBISHI<br>MB151387  |
| 24.0120-0131.1 | 420131 |   |   |    |   |   | 247,0 | 20,4 | 18,5 | 44,2 | 108,0 | 4    | 66,0  | 133,2 | 12,8 | CITROEN<br>91 517 694<br>4246 A6  |
| 24.0120-0132.1 | 420132 | S | B |    |   |   | 247,0 | 20,4 | 18,5 | 34,2 | 108,0 | 4    | 66,0  | 133,2 | 12,8 | PEUGEOT<br>CITROEN<br>95 661 747<br>4246 A7<br>4249 96  |
| 24.0120-0133.1 | 420133 | S | B |    |   |   | 266,0 | 20,5 | 18,5 | 27,6 | 108,0 | 4    | 66,0  | 133,0 | 13,0 | CITROEN<br>4249 F0<br>E169002<br>PEUGEOT<br>4246 97<br>4249 F0                                      |
| 24.0120-0134.1 | 420134 |   |   |    |   |   | 265,0 | 20,5 | 17,7 | 31,6 | 100,0 | 4    | 61,0  | 127,0 | 12,8 | RENAULT<br>77 00 764 193<br>77 01 467 955   |
| 24.0120-0135.1 | 420135 |   |   |    |   |   | 244,0 | 20,5 | 17,7 | 31,6 | 100,0 | 4    | 61,0  | 127,0 | 12,5 | RENAULT<br>77 00 758 901<br>77 01 204 954<br>77 01 467 954  |
| 24.0120-0137.1 | 420137 |   | B |    |   |   | 269,0 | 19,9 | 18,0 | 46,0 | 112,0 | 5    | 68,0  | 156,0 | 15,5 | AUDI<br>447 615 601 A   |
| 24.0120-0139.1 | 420139 |   |   |    |   |   | 255,5 | 20,0 | 18,4 | 33,5 | 104,0 | 5    | 84,0  | 84,5  | 10,6 | MITSUBISHI<br>MB238495  |
| 24.0120-0140.1 | 420140 | S | B | HC | L |   | 256,0 | 20,0 | 17,0 | 41,0 | 100,0 | 4/6  | 60,0  | 123,0 | 14,0 | OPEL/VAUXHALL<br>5 69 055/90511128  |
| 24.0120-0142.1 | 420142 |   | B | HC | L |   | 257,5 | 20,0 | 18,2 | 40,5 | 98,0  | 4    | 59,0  | 126,7 | 13,0 | ALFA/FIAT/LANCIA<br>7779409<br>71738145<br>51749124<br>60806137<br>60810076<br>60811256<br>60811266 |
| 24.0120-0143.1 | 420143 |   |   |    |   |   | 240,0 | 20,0 | 18,2 | 46,5 | 98,0  | 4    | 59,0  | 124,5 | 13,0 | FIAT<br>7650707   |
| 24.0120-0146.1 | 420146 |   | B |    |   |   | 253,0 | 20,0 | 18,0 | 43,7 | 108,0 | 4    | 63,5  | 153,0 | 13,7 | FORD<br>4115996<br>5026786  |
| 24.0120-0147.1 | 420147 |   | B |    |   |   | 239,5 | 20,0 | 18,0 | 43,0 | 108,0 | 4    | 63,5  | 136,0 | 13,7 | FORD/MAZDA<br>1019604<br>1066271<br>1320581<br>1320582<br>5028281                                   |
| 24.0120-0148.1 | 420148 |   |   |    |   |   | 238,0 | 20,1 | 17,7 | 46,0 | 100,0 | 4    | 61,0  | 132,0 | 12,5 | RENAULT<br>77 01 466 782  |
| 24.0120-0152.1 | 420152 |   |   |    |   |   | 242,0 | 20,0 | 18,0 | 49,2 | 114,3 | 4    | 68,0  | 138,0 | 12,5 | NISSAN<br>40206-90J01   |
| 24.0120-0153.1 | 420153 |   |   |    |   |   | 302,0 | 20,0 | 19,0 | 48,0 | 139,7 | 6    | 100,0 | 166,5 | 15,0 | TOYOTA<br>43512-60011<br>43512-60040<br>43512-69015<br>43512-69016                                  |
| 24.0120-0154.1 | 420154 | S | B | HC |   |   | 298,0 | 20,0 | 18,4 | 61,3 | 120,0 | 5    | 75,0  | 185,0 | 14,5 | BMW<br>34 21 1 164 175<br>34 21 6 767 060   |
| 24.0120-0155.1 | 420155 |   | B | HC | L |   | 257,5 | 20,0 | 18,2 | 40,5 | 98,0  | 5    | 59,0  | 126,7 | 16,5 | CITROEN<br>4249 L4<br>FIAT<br>1316323080<br>PEUGEOT<br>4246 H8                                      |
| 24.0120-0157.1 | 420157 |   |   |    |   |   | 251,0 | 20,0 | 18,0 | 45,8 | 98,0  | 4    | 62,0  | 159,5 | 13,0 | SEAT<br>SE021165002A  |
| 24.0120-0159.1 | 420159 |   |   |    |   |   | 257,0 | 20,0 | 18,2 | 40,5 | 98,0  | 5    | 59,0  | 126,4 | 13,2 | ALFA/FIAT<br>46425960   |
| 24.0120-0162.1 | 420162 |   |   |    |   |   | 243,0 | 20,0 | 18,0 | 42,5 | 100,0 | 4    | 57,0  | 136,0 | 13,0 | KIA<br>0K20A-33-251A  |
| 24.0120-0163.1 | 420163 |   |   |    |   |   | 235,0 | 20,0 | 18,0 | 49,5 | 100,0 | 4    | 60,0  | 125,2 | 12,7 | SUZUKI<br>55311-61G01   |
| 24.0120-0166.1 | 420166 |   |   |    |   |   | 253,0 | 20,0 | 18,4 | 28,6 | 104,0 | 5    | 84,0  | 148,0 | 10,6 | HYUNDAI<br>58129-44010  |
| 24.0120-0168.1 | 420168 |   |   |    |   |   | 289,0 | 20,0 | 18,0 | 64,2 | 127,0 | 6    | 100,0 | 156,0 | 10,7 | TOYOTA<br>43512-35190<br>VOLKSWAGEN<br>J43 512 351 90<br>MAZDA<br>N026-33-25X                       |
| 24.0120-0169.1 | 420169 |   | B |    |   |   | 255,0 | 20,0 | 18,0 | 45,0 | 100,0 | 4    | 55,0  | 125,0 | 13,0 | OPEL/VAUXHALL<br>5 69 100/9195052   |
| 24.0120-0171.1 | 420171 |   | B |    |   |   | 286,0 | 20,0 | 18,0 | 67,0 | 110,0 | 5    | 65,5  | 160,0 | 14,0 | AUDI<br>857 615 601   |
| 24.0120-0172.1 | 420172 |   | B | HC | L |   | 269,0 | 19,9 | 18,0 | 59,5 | 112,0 | 5/10 | 68,0  | 156,0 | 15,3 | FIAT<br>46836490<br>71772548  |
| 24.0120-0173.1 | 420173 | S | B |    |   |   | 292,0 | 19,9 | 18,0 | 41,4 | 110,0 | 5    | 65,5  | 162,5 | 14,0 | OPEL/VAUXHALL<br>5 69 114/93171778<br>SAAB<br>9191336<br>12762291                                   |
| 24.0120-0174.1 | 420174 | S | B |    |   |   | 240,0 | 20,0 | 17,0 | 41,0 | 100,0 | 4/6  | 60,0  | 126,0 | 14,0 | OPEL/VAUXHALL<br>5 69 021/9195985   |
| 24.0120-0175.1 | 420175 |   | B |    |   |   | 255,0 | 20,0 | 18,0 | 43,1 | 100,0 | 4    | 55,0  | 129,0 | 14,5 | TOYOTA<br>43512-0D050<br>43512-17120<br>43512-17130<br>43512-17131<br>43512-52040<br>43512-52090    |
| 24.0120-0176.1 | 420176 |   | B | HC | L |   | 292,0 | 20,0 | 18,0 | 67,0 | 130,0 | 5    | 98,0  | 164,0 | 15,4 | PORSCHE<br>986 352 401 04   |
| 24.0120-0177.1 | 420177 |   |   |    |   |   | 242,0 | 20,0 | 18,0 | 43,5 | 100,0 | 4    | 57,0  | 136,0 | 13,0 | KIA<br>0K2AA-33-251A<br>0K2AA-33-251B<br>0K2AA-33-251C  |



# Abmessungen Bremsscheiben

## Dimensions brake discs - Misure dischi freno -

## Dimensions Disques de frein - Medidas disco de freno

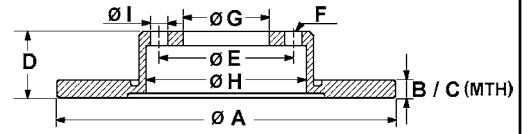

S Fixierschraube - fixing screw - vite di riparazione - vis de fixation - tornillo quefija

B beschichtet - coated - rivestito - revêtu - recubierto

HC hochgekohlt - high carbon - ad alto tenore di carbonio - à haute teneur en carbone - altamente carbonizado

L legiert - alloyed - alligato/legato - allié - aleado

V ventiliert - ventilated - ventilato - ventilé - ventilado

● gelocht - perforated - perforato - poinçonné - perforado

|                |        | S | B | HC | L  | V  | A     | B     | C    | D    | E     | F     | G    | H     | I     | OE - #           |                                     |               |
|----------------|--------|---|---|----|----|----|-------|-------|------|------|-------|-------|------|-------|-------|------------------|-------------------------------------|---------------|
| 24.0120-0178.1 | 420178 |   | B | HC |    | V  | 324,0 | 20,0  | 18,4 | 67,0 | 120,0 | 5     | 79,0 | 185,0 | 16,5  | BMW              | 34 21 1 166 127                     |               |
| 24.0120-0180.1 | 420180 |   | S |    |    | V  | 247,0 | 20,0  | 18,0 | 35,3 | 100,0 | 4     | 55,0 | 129,0 | 13,2  | CITROEN          | 4246 J0<br>4259 55<br>4249 94       |               |
|                |        |   |   |    |    |    |       |       |      |      |       |       |      |       |       | PEUGEOT          | 4246 F0<br>4249 54<br>4249 94       |               |
|                |        |   |   |    |    |    |       |       |      |      |       |       |      |       |       | TOYOTA           | 43512-0H010<br>43512-0H020          |               |
| 24.0120-0181.1 | 420181 |   | B | HC |    | V  | 300,0 | 20,0  | 18,4 | 61,0 | 120,0 | 5     | 75,0 | 180,0 | 14,5  | BMW              | 34 21 1 165 265                     |               |
| 24.0120-0182.1 | 420182 |   | S | B  | HC | V  | 328,0 | 20,0  | 18,4 | 61,0 | 120,0 | 5     | 75,0 | 180,0 | 14,5  | BMW              | 34 21 6 767 062                     |               |
| 24.0120-0183.1 | 420183 |   | S | B  | HC | V  | 320,0 | 20,0  | 18,4 | 63,2 | 120,0 | 5     | 75,0 | 185,0 | 14,5  | BMW              | 34 21 6 772 085                     |               |
| 24.0120-0184.1 | 420184 |   |   |    |    | V  | 240,5 | 20,0  | 18,2 | 40,5 | 98,0  | 4     | 59,0 | 146,5 | 13,0  | FIAT             | 46788929<br>51742727                |               |
|                |        |   |   |    |    |    |       |       |      |      |       |       |      |       |       | FORD             | 1541806<br>9S51 1125-DA             |               |
| 24.0120-0185.1 | 420185 |   |   | HC | L  | V  | 290,0 | 20,0  | 18,7 | 83,0 | 130,0 | 5     | 90,0 | 180,0 | 15,4  | PORSCHE          | 901 352 041 14                      |               |
| 24.0120-0186.1 | 420186 |   |   |    |    | V  | 239,0 | 19,5  | 18,0 | 41,8 | 98,0  | 4     | 58,5 | 154,0 | 13,0  | LADA             | 2110-3501070                        |               |
| 24.0120-0187.1 | 420187 |   |   |    |    | V  | 260,0 | 20,0  | 18,5 | 42,0 | 98,0  | 4     | 58,5 | 174,0 | 13,0  | LADA             | 2112-3501070                        |               |
| 24.0120-0188.1 | 420188 |   |   |    |    | V  | 305,0 | 20,0  | 18,5 | 67,9 | 120,7 | 5     | 73,8 | 180,0 | 13,3  | JAGUAR           | JLM 11904<br>JLM 12428<br>JLM 20342 |               |
| 24.0120-0189.1 | 420189 |   | S | B  | HC | V  | 312,0 | 20,0  | 18,4 | 61,0 | 120,0 | 5     | 75,0 | 180,0 | 14,5  | BMW              | 34 21 2 227 177                     |               |
| 24.0120-0190.1 | 420190 |   | S | B  | HC | V  | 312,0 | 20,0  | 18,4 | 61,0 | 120,0 | 5     | 75,0 | 180,0 | 14,5  | BMW              | 34 21 2 227 178                     |               |
| 24.0120-0191.1 | 420191 |   |   |    |    | V  | 324,0 | 20,0  | 18,4 | 80,3 | 120,0 | 5     | 75,0 | 185,0 | 16,6  | BMW              | 34 21 6 756 849                     |               |
| 24.0120-0193.1 | 420193 |   |   |    |    | V  | 240,0 | 20,0  | 18,2 | 46,5 | 98,0  | 4     | 59,0 | 124,5 | 13,2  | FIAT             | 46419204                            |               |
| 24.0120-0195.1 | 420195 |   | S | B  | HC | V  | 300,0 | 20,0  | 18,4 | 66,0 | 120,0 | 5     | 75,0 | 160,8 | 14,5  | BMW              | 34 21 6 855 007                     |               |
| 24.0120-0196.1 | 420196 |   | S |    |    | V  | 300,0 | 20,0  | 18,0 | 69,1 | 110,0 | 5     | 65,5 | 160,0 | 14,2  | SAAB             | 5232756<br>12763593                 |               |
| 24.0120-0197.1 | 420197 |   |   |    |    | V  | 246,0 | 20,0  | 18,0 | 50,0 | 100,0 | 4     | 60,0 | 125,0 | 12,8  | SUZUKI           | 55311-62G02<br>55311-62G03          |               |
| 24.0120-0199.1 | 420199 |   |   | HC | L  | V  | 278,0 | 19,9  | 17,4 | 55,2 | 112,0 | 5     | 67,0 | 164,0 | 15,0  | MERCEDES BENZ    | 124 423 10 12                       |               |
| 24.0120-0200.1 | 420200 |   |   | HC | L  | V  | 354,0 | 20,0  | 17,0 | 74,9 | 120,0 | 5     | 79,0 | 210,0 | 16,6  | LAND ROVER       | SDB500201<br>SDB500202<br>LR031844  |               |
| 24.0120-0201.1 | 420201 |   |   |    |    | V  | 350,0 | 20,0  | 17,0 | 59,0 | 120,0 | 5     | 79,0 | 210,0 | 15,0  | LAND ROVER       | SDB000644<br>SDB000645<br>SDB000646 |               |
| 24.0120-0202.1 | 420202 |   |   |    |    | V  | 315,0 | 20,0  | 18,4 | 87,5 | 139,7 | 5     | 96,3 | 190,0 | 12,5  | KIA              | 58411-3E300                         |               |
| 24.0120-0203.1 | 420203 |   |   |    |    | V  | 252,0 | 20,0  | 18,0 | 45,2 | 100,0 | 4     | 61,0 | 144,0 | 12,6  | NISSAN           | 40206-2N301                         |               |
| 24.0120-0204.1 | 420204 |   | S | B  | HC | V  | 300,0 | 20,0  | 18,4 | 66,1 | 120,0 | 5     | 75,0 | 185,0 | 14,5  | BMW              | 34 21 6 864 901                     |               |
| 24.0120-0206.1 | 420206 |   | S | B  | HC | V  | 320,0 | 19,9  | 18,4 | 78,5 | 120,0 | 5     | 75,0 | 185,0 | 16,5  | BMW              | 34 21 6 868 940                     |               |
| 24.0120-0207.1 | 420207 |   |   |    |    | V  | 315,0 | 20,0  | 18,4 | 78,5 | 139,7 | 5     | 96,3 | 190,0 | 12,5  | KIA              | 58411-3E500                         |               |
| 24.0120-0208.1 | 420208 |   | S | B  | HC | L  | V     | 300,0 | 22,0 | 19,4 | 57,5  | 112,0 | 5    | 67,0  | 164,0 | 15,3             | MERCEDES BENZ                       | 000 423 12 12 |
| 24.0120-0209.1 | 420209 |   |   | HC | L  | V  | 303,0 | 20,0  | 18,4 | 71,6 | 115,0 | 5     | 70,7 | 190,0 | 12,8  | CHEVROLET        | 96625873<br>20968395<br>4801857     |               |
| 24.0120-0210.1 | 420210 |   |   |    |    | V  | 325,0 | 20,0  | 17,0 | 59,0 | 120,0 | 5     | 79,0 | 210,0 | 15,0  | OPEL/VAUXHALL    | 48 04 637/96625873                  |               |
|                |        |   |   |    |    |    |       |       |      |      |       |       |      |       |       | LAND ROVER       | SDB000634<br>SDB000635<br>SDB000636 |               |
| 24.0120-0211.1 | 420211 |   | S |    |    | V  | 252,0 | 20,0  | 18,0 | 40,0 | 100,0 | 4     | 60,0 | 127,0 | 12,5  | OPEL/VAUXHALL    | 47 00 455/95513700                  |               |
| 24.0120-0212.1 | 420212 |   |   | HC | L  | V● | 299,0 | 20,0  | 18,0 | 67,0 | 130,0 | 5     | 98,0 | 180,0 | 15,4  | SUZUKI           | 55311-62J00                         |               |
| 24.0120-0213.1 | 420213 |   | S | B  | HC | V  | 320,0 | 20,0  | 18,4 | 86,1 | 120,0 | 5     | 75,0 | 185,0 | 14,5  | PORSCHE          | 987 352 401 01                      |               |
| 24.0120-0214.1 | 420214 |   | S | B  | HC | V  | 300,0 | 20,0  | 18,4 | 76,0 | 120,0 | 5     | 75,0 | 160,8 | 14,5  | BMW              | 34 21 6 763 345                     |               |
| 24.0120-0215.1 | 420215 |   | S | B  | HC | V  | 300,0 | 20,0  | 18,4 | 76,2 | 120,0 | 5     | 75,0 | 185,0 | 14,5  | BMW              | 34 21 6 855 005                     |               |
| 24.0120-0216.1 | 420216 |   |   |    |    | V  | 276,0 | 20,0  | 18,0 | 40,0 | 114,3 | 5     | 62,0 | 146,5 | 12,7  | BMW              | 34 21 6 778 049                     |               |
|                |        |   |   |    |    |    |       |       |      |      |       |       |      |       |       | SUZUKI           | 55311-57K01<br>55312-57K01          |               |
| 24.0120-0217.1 | 420217 |   |   | HC |    | V  | 324,0 | 20,0  | 18,4 | 74,0 | 120,0 | 5     | 79,0 | 185,0 | 16,5  | BMW              | 34 21 6 765 887                     |               |
| 24.0120-0218.1 | 420218 |   |   |    |    | V  | 302,0 | 20,0  | 18,0 | 66,0 | 108,0 | 5     | 63,6 | 185,0 | 15,8  | LAND ROVER       | LR001019                            |               |
| 24.0120-0219.1 | 420219 |   |   |    |    | V  | 255,0 | 20,0  | 18,0 | 46,2 | 100,0 | 4     | 55,0 | 131,0 | 14,5  | ASTON MARTIN     | 43512-74010                         |               |
|                |        |   |   |    |    |    |       |       |      |      |       |       |      |       |       | TOYOTA           | 43512-74010                         |               |
| 24.0120-0221.2 | 420221 |   | S | B  | HC | V● | 328,0 | 20,0  | 18,4 | 61,0 | 120,0 | 5     | 75,0 | 185,0 | 14,5  | BMW              | 34 21 2 282 303                     |               |
| 24.0120-0222.2 | 420222 |   | S | B  | HC | V● | 328,0 | 20,0  | 18,4 | 61,0 | 120,0 | 5     | 75,0 | 185,0 | 14,5  | BMW              | 34 21 2 282 304                     |               |
| 24.0120-0225.1 | 420225 |   |   |    |    | V  | 231,0 | 20,0  | 18,0 | 51,4 | 100,0 | 4     | 60,0 | 125,0 | 12,7  | NISSAN           | 40206-4A00G                         |               |
|                |        |   |   |    |    |    |       |       |      |      |       |       |      |       |       | SUZUKI           | 55311M68K10                         |               |
| 24.0120-0226.1 | 420226 |   | S | B  | HC | V  | 300,0 | 20,0  | 18,4 | 54,2 | 120,0 | 5     | 75,0 | 174,0 | 14,5  | BMW              | 34 21 6 782 605                     |               |
| 24.0120-0227.1 | 420227 |   | S | B  | HC | V  | 236,0 | 20,0  | 18,0 | 41,0 | 100,0 | 6     | 59,0 | 123,0 | 12,4  | CHEVROLET/DAEWOO | 96471274                            |               |
| 24.0120-0228.1 | 420228 |   | S | B  | HC | V  | 324,0 | 20,0  | 18,4 | 54,1 | 120,0 | 5     | 75,0 | 174,0 | 14,5  | BMW              | 34 21 6 782 607                     |               |
| 24.0120-0229.2 | 420229 |   | S | B  | HC | V  | 330,0 | 20,0  | 18,4 | 68,8 | 120,0 | 5     | 75,0 | 185,0 | 16,5  | BMW              | 34 21 6 775 287                     |               |
| 24.0120-0232.1 | 420232 |   |   |    |    | V  | 303,0 | 20,0  | 18,4 | 92,5 | 120,0 | 5     | 79,0 | 190,0 | 14,5  | HYUNDAI          | 58329-4A350                         |               |
| 24.0120-0234.1 | 420234 |   | S | B  | HC | V  | 330,0 | 20,0  | 18,4 | 71,0 | 120,0 | 5     | 75,0 | 154,0 | 16,5  | BMW              | 34 20 6 868 936                     |               |
| 24.0120-0235.1 | 420235 |   |   |    |    | V  | 303,0 | 20,0  | 18,4 | 92,5 | 140,0 | 6     | 75,0 | 190,0 | 12,3  | HYUNDAI          | 58329-4A450                         |               |



# Abmessungen Bremsscheiben

## Dimensions brake discs - Misure dischi freno -

## Dimensions Disques de frein - Medidas disco de freno

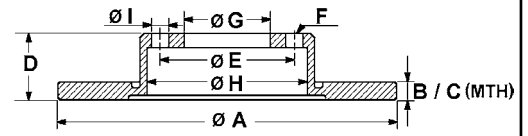

S Fixierschraube - fixing screw - vite di riparazione - vis de fixation - tornillo quefija  
 L legiert - alloyed - alligato/legato - allié - aleado ● gelocht - perforated - perforato - poinçonné - perforado  
 B beschichtet - coated - rivestito - revêtu - recubierto  
 V ventiliert - ventilated - ventilato - ventilé - ventilado  
 HC hochgekohlt - high carbon - ad alto tenore di carbonio - à haute teneur en carbone - altamente carbonizado

|                |        | S | B | HC | L | V | A     | B    | C    | D    | E     | F | G     | H     | I       | OE - #                           |  |
|----------------|--------|---|---|----|---|---|-------|------|------|------|-------|---|-------|-------|---------|----------------------------------|--|
| 24.0120-0237.1 | 420237 | S | B | HC |   | V | 300,0 | 20,0 | 18,4 | 66,0 | 120,0 | 5 | 75,0  | 160,8 | 16,5    | BMW                              | 34 21 6 792 227  |
| 24.0120-0238.1 | 420238 |   | B | HC |   | V | 326,0 | 20,0 | 18,0 | 38,0 | 108,0 | 5 | 64,5  | 160,4 | 14,0    | JAGUAR                           | C2C 25339<br>C2D 26352   |
| 24.0120-0240.1 | 420240 | S | B | HC |   | V | 300,0 | 20,0 | 18,4 | 66,0 | 120,0 | 5 | 75,0  | 185,0 | 16,5    | BMW                              | 34 21 6 792 229<br>34 21 6 864 900   |
| 24.0120-0243.1 | 420243 | S | B | HC |   | V | 330,0 | 20,0 | 18,4 | 66,2 | 120,0 | 5 | 75,0  | 185,0 | 16,5    | BMW                              | 34 21 6 864 899  |
| 24.0120-0708.1 | 420708 |   | B |    |   | V | 288,0 | 20,0 | 18,5 | 32,5 | 108,0 | 5 | 64,5  | 160,0 | 14,0    | JAGUAR                           | JLM 20802<br>XR8 27087   |
| 24.0121-0100.1 | 421100 |   |   |    |   | V | 285,0 | 21,0 | 19,0 | 51,2 | 114,3 | 4 | 64,1  | 141,0 | 12,7    | HONDA<br>ROVER                   | 45251-SG9-000<br>GBD90800<br>GBD90822  |
| 24.0121-0101.1 | 421101 |   |   |    |   | V | 285,0 | 21,0 | 19,0 | 31,8 | 108,0 | 5 | 61,0  | 134,0 | 14,5    | RENAULT                          | 77 00 801 101<br>77 01 204 298   |
| 24.0121-0102.1 | 421102 |   |   |    |   | V | 262,0 | 21,0 | 19,0 | 51,2 | 100,0 | 4 | 64,2  | 141,0 | 12,6    | HONDA                            | 45251-SF0-000  |
| 24.0121-0103.1 | 421103 |   |   |    |   | V | 285,0 | 21,0 | 19,0 | 31,8 | 100,0 | 4 | 61,0  | 134,0 | 12,5    | RENAULT                          | 77 00 801 213<br>77 01 204 299   |
| 24.0121-0104.1 | 421104 | S | B |    |   | V | 240,0 | 21,0 | 19,0 | 44,8 | 100,0 | 4 | 61,0  | 126,0 | 13,0    | HONDA                            | 45251-SH1-A00<br>45251-SH3-A00<br>45251-SR3-A10  |
| 24.0121-0105.1 | 421105 | S | B |    |   | V | 262,0 | 21,0 | 19,0 | 44,7 | 100,0 | 4 | 64,1  | 141,0 | 13,0    | HONDA                            | 45251-S5D-A10<br>45251-S6D-E10<br>45251-SCC-901<br>45251-SK7-A00<br>45251-SK7-A10<br>45251-SR0-A00<br>45251-SR0-A10<br>45251-ST3-E10<br>45251-TF3-E00<br>45251-TG5-H00 |
| 24.0121-0106.1 | 421106 | S | B |    |   | V | 259,0 | 20,7 | 17,7 | 41,0 | 100,0 | 4 | 61,0  | 130,0 | 12,7    | ROVER<br>NISSAN<br>DACIA/RENAULT | GBD90840<br>SDB000990<br>40206-00QAA<br>60 01 548 578<br>77 00 842 131<br>77 01 204 828<br>77 01 206 339<br>77 11 130 038<br>86 71 005 976                             |
| 24.0121-0107.1 | 421107 |   |   |    |   | V | 262,0 | 21,0 | 19,0 | 47,2 | 100,0 | 4 | 64,1  | 141,0 | 13,0    | HONDA<br>ROVER                   | 45251-SK3-E00<br>GBD90830  |
| 24.0121-0110.1 | 421110 |   |   |    |   | V | 262,0 | 21,0 | 18,0 | 51,0 | 114,3 | 4 | 64,1  | 141,0 | 12,6    | ROVER                            | GBD90801   |
| 24.0121-0112.1 | 421112 |   | B | HC | L | V | 282,0 | 20,5 | 19,0 | 74,2 | 130,0 | 5 | 103,0 | 155,0 | 15,4    | PORSCHE                          | 944 351 041 05   |
| 24.0121-0113.1 | 421113 | S | B |    |   | V | 240,0 | 21,0 | 19,0 | 39,2 | 100,0 | 4 | 61,0  | 126,5 | 13,0    | HONDA                            | 45251-S50-G00<br>45251-SAA-G11   |
| 24.0121-0114.1 | 421114 |   | B |    |   | V | 277,0 | 21,0 | 18,0 | 51,0 | 114,3 | 5 | 66,1  | 141,0 | 12,5    | LAND ROVER                       | SDB101070  |
| 24.0121-0115.1 | 421115 | S | B |    |   | V | 258,0 | 21,0 | 19,0 | 39,2 | 100,0 | 4 | 64,1  | 141,3 | 12,6    | HONDA                            | 45251-SAA-G50  |
| 24.0121-0702.1 | 421702 | S | B |    |   | V | 262,0 | 21,0 | 19,0 | 47,2 | 114,3 | 5 | 64,2  | 141,0 | 12,6    | HONDA                            | 45251-S6M-000<br>45251-SNA-000   |
| 24.0122-0100.1 | 422100 |   | B | HC |   | V | 280,0 | 22,0 | 20,0 | 28,5 | 100,0 | 5 | 65,0  | 141,0 | 15,6    | SEAT/VW                          | 1H0 615 301 A  |
| 24.0122-0101.1 | 422101 |   | B | HC |   | V | 280,0 | 22,0 | 20,0 | 39,5 | 100,0 | 4 | 65,0  | 137,0 | 13,6    | SEAT/VW                          | 535 615 301  |
| 24.0122-0103.1 | 422103 | S | B | HC |   | V | 302,0 | 22,0 | 20,4 | 76,0 | 120,0 | 5 | 79,0  | 149,0 | 14,5    | BMW                              | 34 11 1 160 936  |
| 24.0122-0106.1 | 422106 |   |   |    |   | V | 278,0 | 22,0 | 20,0 | 66,3 | 112,0 | 5 | 80,0  | 127,5 | 15,0    | MERCEDES BENZ                    | 116 420 02 05  |
| 24.0122-0107.1 | 422107 |   | B |    |   | V | 284,0 | 22,0 | 20,2 | 39,4 | 98,0  | 4 | 59,0  | 127,0 | 13,0    | ALFA/FIAT/LANCIA                 | 46403958<br>46427947<br>46427949<br>60811890<br>60812067<br>60812137   |
| 24.0122-0108.1 | 422108 |   | B | HC |   | V | 256,0 | 22,0 | 20,0 | 56,5 | 108,0 | 4 | 68,0  | 132,7 | 15,4    | AUDI                             | 895 615 301 A  |
| 24.0122-0109.1 | 422109 |   |   |    |   | V | 271,0 | 22,0 | 19,0 | 59,4 | 108,0 | 5 | 88,0  | 130,0 | 10,5    | OPEL/VAUXHALL                    | 5 69 029/90008004  |
| 24.0122-0111.1 | 422111 |   |   |    |   | V | 280,0 | 22,0 | 20,4 | 78,0 | 120,0 | 5 | 74,0  | 143,0 | 14,5    | BMW                              | 34 11 1 119 563<br>34 11 1 163 130   |
| 24.0122-0112.1 | 422112 |   |   |    |   | V | 255,0 | 22,0 | 20,4 | 75,0 | 100,0 | 4 | 63,0  | 128,0 | 14,5    | BMW                              | 34 11 1 163 126  |
| 24.0122-0115.1 | 422115 | S | B | HC |   | V | 286,0 | 22,0 | 20,4 | 51,5 | 120,0 | 5 | 79,0  | 147,5 | 14,5    | BMW                              | 34 11 1 165 455<br>34 11 6 766 239<br>34 11 6 794 301<br>34 11 6 864 060   |
| 24.0122-0116.1 | 422116 |   |   |    |   | V | 278,0 | 22,0 | 19,4 | 68,3 | 112,0 | 5 | 80,0  | 127,5 | 15,0    | MERCEDES BENZ                    | 126 420 00 05<br>126 421 00 12   |
| 24.0122-0118.1 | 422118 |   | B |    |   | V | 256,0 | 22,0 | 20,0 | 46,5 | 108,0 | 4 | 68,0  | 132,7 | 15,4    | AUDI                             | 443 615 301 B  |
| 24.0122-0119.2 | 422119 |   |   |    |   | V | 269,0 | 22,0 | 20,0 | 51,5 | 98,0  | 5 | 72,0  | 120,0 | M12x1,5 | ALFA ROMEO                       | 60522092   |
| 24.0122-0120.1 | 422120 |   |   | HC | L | V | 280,0 | 22,0 | 20,0 | 46,5 | 112,0 | 5 | 68,0  | 158,0 | 15,4    | AUDI                             | 437 615 301 A  |
| 24.0122-0122.1 | 422122 |   | B | HC | L | V | 260,0 | 22,0 | 20,4 | 35,0 | 100,0 | 4 | 66,0  | 138,0 | 14,5    | BMW                              | 34 11 1 160 915  |

# Abmessungen Bremsscheiben

## Dimensions brake discs - Misure dischi freno -

## Dimensions Disques de frein - Medidas disco de freno

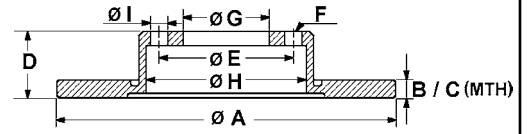

S Fixierschraube - fixing screw - vite di riparazione - vis de fixation - tornillo quefija L legiert - alloyed - alligato/legato - allié - aleado ● gelocht - perforated - perforato - poinçonné - perforado  
 B beschichtet - coated - rivestito - revêtu - recubierto V ventiliert - ventilated - ventilato - ventilé - ventilado  
 HC hochgekohlt - high carbon - ad alto tenore di carbonio - à haute teneur en carbone - altamente carbonizado

|                |        | S | B | HC | L | V | A     | B    | C    | D    | E     | F   | G    | H     | I        | OE - #  |
|----------------|--------|---|---|----|---|---|-------|------|------|------|-------|-----|------|-------|----------|---|
| 24.0122-0123.1 | 422123 | S | B | HC | L | V | 284,0 | 22,0 | 19,4 | 43,5 | 112,0 | 5   | 67,0 | 154,3 | 15,0     | MERCEDES BENZ<br>124 421 16 12<br>124 421 27 12   |
| 24.0122-0124.1 | 422124 |   | B | HC | L | V | 262,0 | 22,0 | 19,4 | 44,5 | 112,0 | 5   | 67,0 | 142,5 | 15,0     | MERCEDES BENZ<br>201 421 15 12  |
| 24.0122-0126.1 | 422126 |   |   |    |   | V | 271,0 | 22,0 | 19,0 | 59,4 | 108,0 | 5   | 94,0 | 130,0 | 10,5     | OPEL/VAUXHALL<br>5 69 032/90008007  |
| 24.0122-0127.1 | 422127 |   |   |    |   | V | 263,0 | 22,0 | 20,4 | 67,3 | 108,0 | 5   | 68,0 | 139,0 | 16,5     | VOLVO<br>270739   |
| 24.0122-0128.1 | 422128 |   |   |    |   | V | 239,2 | 22,0 | 20,2 | 46,1 | 98,0  | 4   | 58,5 | 127,4 | 13,0     | ALFA ROMEO<br>60514881  |
| 24.0122-0129.1 | 422129 |   |   |    |   | V | 250,0 | 22,0 | 20,0 | 49,2 | 114,3 | 4   | 68,0 | 144,0 | 12,5     | NISSAN<br>40206-15E00<br>40206-15E01  |
| 24.0122-0130.1 | 422130 |   |   |    |   | V | 257,2 | 22,0 | 20,2 | 50,7 | 98,0  | 4   | 59,0 | 127,0 | 13,2     | ALFA/FIAT/LANCIA<br>46445005<br>60805172<br>60807625  |
| 24.0122-0132.1 | 422132 | S | B | HC | L | V | 284,0 | 22,0 | 19,4 | 43,5 | 112,0 | 5   | 67,0 | 154,3 | 12,8     | MERCEDES BENZ<br>202 421 09 12  |
| 24.0122-0133.1 | 422133 |   |   | HC |   | V | 300,0 | 22,0 | 19,4 | 60,0 | 112,0 | 5   | 67,0 | 164,0 | 17,0     | MERCEDES BENZ<br>140 423 04 12  |
| 24.0122-0134.1 | 422134 |   | B | HC | L | V | 284,0 | 22,0 | 19,4 | 43,5 | 112,0 | 5   | 67,0 | 152,0 | 15,0     | MERCEDES BENZ<br>124 421 23 12  |
| 24.0122-0135.1 | 422135 |   |   |    |   | V | 284,0 | 22,0 | 20,4 | 76,0 | 120,0 | 5   | 79,0 | 147,0 | 14,5     | BMW<br>34 11 1 163 136  |
| 24.0122-0136.1 | 422136 |   | B | HC | L | V | 295,0 | 22,0 | 19,4 | 49,5 | 112,0 | 5   | 67,0 | 154,3 | 15,0     | MERCEDES BENZ<br>124 421 15 12  |
| 24.0122-0137.1 | 422137 |   |   |    |   | V | 287,0 | 22,0 | 20,0 | 56,0 | 108,0 | 5   | 68,0 | 157,0 | 14,0     | VOLVO<br>1359908  |
| 24.0122-0138.1 | 422138 |   |   |    |   | V | 262,5 | 22,0 | 20,0 | 56,0 | 108,0 | 5   | 68,0 | 139,0 | 14,0     | VOLVO<br>1359906  |
| 24.0122-0139.1 | 422139 |   | B | HC |   | V | 280,0 | 22,0 | 20,0 | 56,5 | 108,0 | 4   | 68,0 | 146,0 | 15,4     | AUDI<br>8A0 615 301 E   |
| 24.0122-0140.1 | 422140 |   |   | HC |   |   | 280,0 | 22,0 | 19,0 | 78,6 | 112,0 | 5   | 88,0 | 133,5 | 12,5     | MERCEDES BENZ<br>601 420 03 72<br>601 421 05 12   |
| 24.0122-0141.1 | 422141 |   |   |    |   | V | 276,0 | 22,0 | 20,0 | 48,0 | 108,0 | 5   | 71,0 | 130,5 | 13,0     | CITROEN<br>PEUGEOT<br>4246 E8   |
| 24.0122-0142.1 | 422142 |   | B | HC | L | V | 283,0 | 22,0 | 20,0 | 28,2 | 108,0 | 4   | 66,1 | 133,5 | 13,0     | CITROEN<br>4249 97<br>4246 V0<br>4246 V3  |
| 24.0122-0143.1 | 422143 |   |   |    |   | V | 280,0 | 22,0 | 20,0 | 58,0 | 108,0 | 5   | 61,0 | 131,5 | 14,7     | PEUGEOT<br>RENAULT<br>77 00 767 602<br>77 01 204 289  |
| 24.0122-0145.1 | 422145 |   | B |    |   | V | 284,0 | 22,0 | 20,2 | 43,5 | 98,0  | 5   | 59,0 | 127,0 | 13,0     | ALFA/FIAT/LANCIA<br>46445006<br>60569163<br>60571548<br>60653478<br>60699518<br>71739567<br>71739568                                    |
| 24.0122-0146.1 | 422146 |   | B |    |   | V | 257,0 | 22,0 | 20,0 | 49,2 | 114,3 | 4   | 68,0 | 144,0 | 12,6     | OPEL/VAUXHALL<br>NISSAN<br>5 69 086/95511282<br>40206-71E02<br>40206-71E05<br>40206-71E06<br>40206-93J01                                |
| 24.0122-0147.1 | 422147 |   | B |    |   | V | 284,0 | 22,0 | 20,2 | 43,5 | 98,0  | 4   | 59,0 | 127,0 | 13,0     | ALFA/FIAT/LANCIA<br>46403959<br>46448168<br>46455892<br>46455892<br>46758714<br>60810404<br>82450657                                    |
| 24.0122-0148.1 | 422148 | S | B | HC | L | V | 262,0 | 22,0 | 19,8 | 44,0 | 100,0 | 4   | 61,0 | 132,0 | 13,5     | CITROEN<br>PEUGEOT<br>4249 76   |
| 24.0122-0149.1 | 422149 |   |   | HC | L | V | 262,0 | 22,0 | 19,8 | 44,0 | 108,0 | 5   | 61,0 | 132,0 | 15,5     | RENAULT<br>77 01 205 840  |
| 24.0122-0150.1 | 422150 | S | B | HC |   | V | 280,0 | 22,0 | 19,0 | 36,7 | 100,0 | 5   | 65,0 | 133,5 | 15,6     | RENAULT<br>77 01 205 841  |
| 24.0122-0151.1 | 422151 | S | B | HC |   | V | 256,0 | 22,0 | 19,0 | 36,7 | 100,0 | 5   | 65,0 | 133,5 | 15,6     | AUDI/SEAT/SKODA/VW<br>1J0 615 301 E<br>1J0 615 301 M<br>1J0 615 301 P<br>1J0 615 301 D<br>1J0 615 301 L<br>6R0 615 301<br>8Z0 615 301 D |
| 24.0122-0152.1 | 422152 | S | B | HC |   | V | 280,0 | 22,0 | 20,0 | 46,3 | 112,0 | 5/9 | 68,0 | 146,5 | 15,3     | AUDI/VW<br>AUDI/VW<br>8E0 615 301 B<br>8E0 615 301 D<br>8E0 615 301 P   |
| 24.0122-0153.1 | 422153 |   |   |    |   | V | 238,0 | 22,0 | 21,0 | 47,9 | 100,0 | 4   | 54,0 | 127,0 | 14,5     | TOYOTA<br>43512-20260   |
| 24.0122-0154.1 | 422154 |   |   |    |   | V | 255,0 | 22,0 | 21,0 | 47,9 | 100,0 | 5   | 54,0 | 131,0 | 14,5     | TOYOTA<br>43512-32090<br>43512-32180  |
| 24.0122-0155.1 | 422155 |   |   |    |   | V | 258,0 | 22,0 | 20,4 | 33,5 | 104,0 | 5   | 84,0 | 153,5 | 10,8     | MITSUBISHI<br>MB407030  |
| 24.0122-0156.1 | 422156 |   |   |    |   | V | 257,0 | 22,0 | 20,6 | 36,0 | 109,0 | 6   | 88,0 | 152,5 | M12x1,25 | ISUZU<br>8-94172-376-1  |
| 24.0122-0158.1 | 422158 |   | B |    |   | V | 255,0 | 22,0 | 20,0 | 48,1 | 100,0 | 4   | 55,0 | 131,1 | 14,5     | OPEL/VAUXHALL<br>TOYOTA<br>43512-12550  |
| 24.0122-0159.1 | 422159 | S | B | HC |   | V | 296,0 | 22,0 | 20,4 | 76,3 | 120,0 | 5   | 79,0 | 148,8 | 14,5     | BMW<br>34 11 6 767 061  |
| 24.0122-0160.1 | 422160 | S | B | HC |   | V | 300,0 | 22,0 | 20,4 | 51,8 | 120,0 | 5   | 79,0 | 164,0 | 14,5     | BMW<br>34 11 1 164 539<br>34 11 6 757 526<br>34 11 6 766 224<br>34 11 6 864 058<br>34 11 6 794 302                                      |



# Abmessungen Bremsscheiben

## Dimensions brake discs - Misure dischi freno -

## Dimensions Disques de frein - Medidas disco de freno

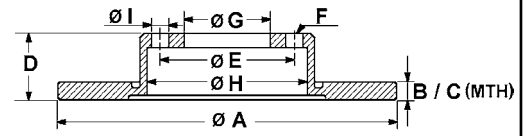

S Fixierschraube - fixing screw - vite di riparazione - vis de fixation - tornillo quefija

B beschichtet - coated - rivestito - revêtu - recubierto

HC hochgekohlt - high carbon - ad alto tenore di carbonio - à haute teneur en carbone - altamente carbonizado

L legiert - alloyed - alligato/legato - allié - aleado

V ventiliert - ventilated - ventilato - ventilé - ventilado

● gelocht - perforated - perforato - poinçonné - perforado

|                |        | S | B  | HC | L | V | A     | B    | C    | D    | E     | F    | G     | H     | I        | OE - #                      |   |
|----------------|--------|---|----|----|---|---|-------|------|------|------|-------|------|-------|-------|----------|-----------------------------|---|
| 24.0122-0161.1 | 422161 | S | B  | HC | L | V | 276,0 | 22,0 | 19,0 | 77,2 | 130,0 | 5    | 85,0  | 156,3 | 15,0     | MERCEDES BENZ<br>VOLKSWAGEN | 902 421 06 12<br>902 421 07 12<br>902 421 09 12<br>2D0 615 301 C<br>2D0 615 301 D |
| 24.0122-0162.1 | 422162 | S | B  | HC | L | V | 276,0 | 22,0 | 19,0 | 60,0 | 112,0 | 5    | 67,0  | 153,0 | 15,0     | MERCEDES BENZ               | 638 421 01 12   |
| 24.0122-0163.1 | 422163 | B | HC |    |   | V | 256,0 | 22,0 | 20,0 | 36,6 | 100,0 | 5    | 65,0  | 135,0 | 15,6     | AUDI/SEAT/SKODA/VW          | 8N0 615 601 B   |
| 24.0122-0164.1 | 422164 |   |    |    |   | V | 256,0 | 22,0 | 20,0 | 40,0 | 100,0 | 4/6  | 61,0  | 149,5 | 13,0     | VOLVO                       | 3455719   |
| 24.0122-0165.1 | 422165 |   |    |    |   | V | 257,0 | 22,0 | 20,0 | 45,0 | 100,0 | 4    | 55,0  | 125,0 | 13,0     | MAZDA                       | BB7E-33-25XD<br>BR74-33-25X   |
| 24.0122-0166.1 | 422166 |   | B  |    |   | V | 235,0 | 22,0 | 20,0 | 45,0 | 100,0 | 4    | 55,0  | 125,0 | 13,0     | MAZDA                       | BR70-33-25XF  |
| 24.0122-0167.1 | 422167 |   |    |    |   | V | 250,0 | 22,0 | 20,0 | 30,0 | 95,0  | 4    | 73,0  | 140,0 | 10,8     | NISSAN                      | 40206-04C01<br>40206-Y9503  |
| 24.0122-0168.1 | 422168 | S | B  | HC | L | V | 260,0 | 22,0 | 19,4 | 40,4 | 112,0 | 5    | 67,0  | 145,0 | 13,3     | MERCEDES BENZ               | 168 421 02 12<br>168 421 08 12  |
| 24.0122-0169.1 | 422169 |   |    |    |   | V | 257,0 | 22,0 | 20,0 | 44,0 | 114,3 | 4    | 69,0  | 160,0 | 12,6     | HYUNDAI                     | 51712-33001   |
| 24.0122-0170.1 | 422170 |   |    |    |   | V | 257,0 | 22,0 | 20,0 | 34,0 | 104,0 | 4    | 86,0  | 160,5 | 10,6     | HYUNDAI                     | 51712-28300   |
| 24.0122-0172.1 | 422172 |   | B  |    |   | V | 258,0 | 22,0 | 20,0 | 43,4 | 108,0 | 4    | 63,5  | 136,0 | 13,7     | FORD                        | 1808479   |
|                |        |   |    |    |   |   |       |      |      |      |       |      |       |       |          | MAZDA                       | 98AX-1125-B1F<br>DD32-33-25X<br>DD59-33-25X<br>DD63-33-25XA                       |
| 24.0122-0174.1 | 422174 |   |    |    |   | V | 280,0 | 22,0 | 20,0 | 49,0 | 114,3 | 5    | 68,0  | 160,5 | 12,6     | NISSAN                      | 40206-2L903<br>40206-88E01<br>40206-88E04   |
| 24.0122-0175.1 | 422175 |   |    |    |   | V | 277,0 | 22,0 | 20,4 | 45,0 | 108,0 | 6    | 87,0  | 87,5  | 11,0     | HYUNDAI<br>MITSUBISHI       | MN116706<br>MB407038<br>MB407039<br>MN116706                                      |
| 24.0122-0177.1 | 422177 |   | B  |    |   | V | 240,5 | 22,0 | 20,0 | 43,0 | 95,2  | 4    | 66,0  | 122,0 | 13,0     | MG/ROVER                    | NAM7806   |
| 24.0122-0178.1 | 422178 |   |    |    |   | V | 255,0 | 22,0 | 20,0 | 46,5 | 100,0 | 5    | 54,0  | 148,5 | 14,5     | TOYOTA                      | 43512-20360<br>43512-20380  |
| 24.0122-0179.1 | 422179 |   | B  |    |   | V | 280,0 | 22,0 | 20,0 | 49,2 | 114,3 | 4    | 68,0  | 143,5 | 12,5     | NISSAN                      | 40206-2F501<br>40206-55F01<br>40206-55F03   |
| 24.0122-0180.1 | 422180 |   |    |    |   | V | 267,0 | 22,0 | 20,0 | 39,5 | 124,0 | 6    | 100,0 | 167,0 | M10x1,25 | NISSAN                      | 40206-10W00<br>40206-10W01<br>40206-35G00<br>40206-35G01                          |
| 24.0122-0181.1 | 422181 |   |    |    |   | V | 280,0 | 22,2 | 20,7 | 77,0 | 114,0 | 5    | 72,0  | 147,5 | 15,5     | JEEP                        | 83 03 251 156<br>98 83 251 156<br>J325 1156                                       |
| 24.0122-0183.1 | 422183 |   | B  |    |   | V | 279,0 | 22,0 | 20,0 | 52,5 | 114,3 | 5    | 62,0  | 147,0 | 14,6     | TOYOTA                      | 43512-28080   |
| 24.0122-0185.1 | 422185 |   |    |    |   | V | 319,0 | 22,0 | 20,0 | 70,2 | 139,7 | 6    | 108,0 | 173,0 | 14,6     | TOYOTA                      | 43512-35210   |
| 24.0122-0188.1 | 422188 |   |    |    |   | V | 258,0 | 22,0 | 21,0 | 48,0 | 100,0 | 4    | 54,0  | 131,0 | 14,6     | TOYOTA                      | 43512-12490   |
| 24.0122-0191.1 | 422191 |   |    |    |   | V | 281,0 | 22,0 | 20,2 | 47,5 | 108,0 | 5/10 | 59,0  | 134,0 | 14,7     | LANCIA                      | 46449389<br>82487489  |
| 24.0122-0192.1 | 422192 |   | B  | HC | L | V | 300,0 | 22,0 | 19,4 | 58,5 | 112,0 | 5    | 67,0  | 180,0 | 15,0     | MERCEDES BENZ               | 220 423 02 12   |
| 24.0122-0193.1 | 422193 |   |    |    |   | V | 250,0 | 22,0 | 20,0 | 50,2 | 114,3 | 5    | 68,0  | 140,0 | 12,7     | NISSAN                      | 40206-9C001   |
| 24.0122-0194.1 | 422194 | S | B  |    |   | V | 266,0 | 22,0 | 20,0 | 34,2 | 108,0 | 4    | 66,0  | 133,1 | 13,0     | CITROEN                     | 4246 W1<br>4249 83<br>4249 G1<br>4246 W7<br>4249 83<br>4249 G1                    |
| 24.0122-0196.1 | 422196 |   | B  | HC | L | V | 285,0 | 21,9 | 19,0 | 93,0 | 145,0 | 6    | 120,0 | 169,0 | 15,0     | MERCEDES BENZ<br>VOLKSWAGEN | 904 423 03 12<br>2D0 615 601 B  |
| 24.0122-0197.1 | 422197 |   | B  |    |   | V | 257,5 | 22,0 | 20,2 | 40,5 | 98,0  | 4    | 59,0  | 127,0 | 13,0     | CITROEN                     | 4249 74<br>4249 L2  |
|                |        |   |    |    |   |   |       |      |      |      |       |      |       |       |          | FIAT/LANCIA                 | 46401356<br>46542383<br>46831041<br>51896287<br>51896288                          |
|                |        |   |    |    |   |   |       |      |      |      |       |      |       |       |          | PEUGEOT                     | 4249 73<br>4249 L2  |
| 24.0122-0198.1 | 422198 |   | B  | HC |   | V | 269,0 | 21,9 | 20,0 | 46,4 | 112,0 | 5    | 68,0  | 135,0 | 15,3     | AUDI                        | 4D0 615 601 B   |
| 24.0122-0199.1 | 422199 |   | B  | HC | L | V | 270,0 | 22,0 | 19,4 | 35,5 | 112,0 | 5    | 67,0  | 145,0 | 13,3     | MERCEDES BENZ               | 414 421 00 12   |
| 24.0122-0200.1 | 422200 |   |    |    |   | V | 310,0 | 22,0 | 20,0 | 29,0 | 140,0 | 5    | 108,3 | 181,2 | 13,0     | SUZUKI                      | 55211-65D12   |
| 24.0122-0201.1 | 422201 | S | B  |    |   | V | 300,0 | 22,0 | 19,4 | 68,0 | 112,0 | 5    | 67,0  | 180,0 | 15,3     | MERCEDES BENZ               | 000 423 09 12   |
| 24.0122-0202.1 | 422202 |   | B  | HC |   | V | 280,0 | 22,0 | 20,0 | 42,4 | 112,0 | 5    | 68,0  | 158,5 | 15,3     | AUDI/VW                     | 4E0 615 601<br>4E0 615 601 E<br>4E0 615 601 J                                     |
| 24.0122-0203.1 | 422203 |   | B  | HC |   | V | 269,0 | 22,0 | 20,0 | 47,9 | 112,0 | 5/10 | 68,0  | 135,0 | 15,3     | AUDI                        | 4Z7 615 601   |



# Abmessungen Bremsscheiben

## Dimensions brake discs - Misure dischi freno -

## Dimensions Disques de frein - Medidas disco de freno

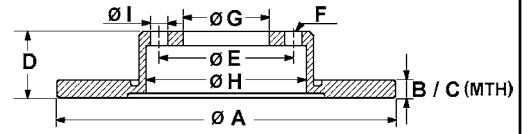

S Fixierschraube - fixing screw - vite di riparazione - vis de fixation - tornillo quefija

B beschichtet - coated - rivestito - revêtu - recubierto

HC hochgekohlt - high carbon - ad alto tenore di carbonio - à haute teneur en carbone - altamente carbonizado

L legiert - alloyed - alligato/legato - allié - aleado

V ventiliert - ventilated - ventilato - ventilé - ventilado

● gelocht - perforated - perforato - poinçonné - perforado

|                |        | S | B | HC | L  | V | A     | B    | C    | D    | E     | F   | G     | H     | I       | OE - #                           |  |
|----------------|--------|---|---|----|----|---|-------|------|------|------|-------|-----|-------|-------|---------|----------------------------------|--|
| 24.0122-0204.1 | 422204 |   | B | HC |    | V | 276,0 | 22,0 | 20,4 | 44,2 | 100,0 | 4   | 64,2  | 150,0 | 14,7    | MINI                             | 34 11 6 774 984  |
| 24.0122-0206.1 | 422206 |   | B |    |    | V | 284,0 | 22,0 | 19,0 | 38,2 | 100,0 | 5   | 64,2  | 142,0 | 15,3    | ROVER                            | GBD90844<br>SDB000880<br>SDB100940                                       |
| 24.0122-0207.1 | 422207 |   | B |    |    | V | 235,0 | 22,0 | 20,0 | 46,0 | 100,0 | 4   | 55,0  | 125,0 | 13,0    | MAZDA                            | B26Y-33-25XA   |
| 24.0122-0208.1 | 422208 |   | B | HC | L  | V | 276,0 | 22,0 | 19,4 | 35,5 | 112,0 | 5   | 67,0  | 145,0 | 13,3    | MERCEDES BENZ                    | 168 421 06 12  |
| 24.0122-0209.1 | 422209 |   | S | B  | HC | V | 320,0 | 22,0 | 20,4 | 60,5 | 120,0 | 5   | 75,0  | 185,0 | 14,5    | BMW                              | 34 20 1 166 073  |
| 24.0122-0210.1 | 422210 |   | S | B  | HC | V | 280,0 | 22,0 | 19,0 | 49,9 | 112,0 | 5/9 | 65,0  | 144,0 | 15,3    | AUDI/SEAT/SKODA/VW<br>VOLKSWAGEN | 1K0 615 301 AK<br>5C0 615 301<br>JZW 615 301 A                           |
| 24.0122-0211.1 | 422211 |   | S | B  | HC | V | 294,0 | 21,9 | 19,5 | 44,4 | 120,0 | 5   | 76,0  | 154,6 | 16,6    | VOLKSWAGEN                       | 7H0 615 601 B  |
| 24.0122-0212.1 | 422212 |   | B | HC |    | V | 310,0 | 22,0 | 20,0 | 42,4 | 112,0 | 5   | 68,0  | 178,0 | 15,3    | AUDI                             | 4E0 615 601 K  |
| 24.0122-0213.1 | 422213 |   | B | HC | L  | V | 315,0 | 22,0 | 19,4 | 59,3 | 112,0 | 5   | 67,0  | 180,0 | 15,0    | VOLKSWAGEN<br>MERCEDES BENZ      | 3D0 615 601 D<br>220 423 03 12   |
| 24.0122-0214.1 | 422214 |   | B | HC |    | V | 335,0 | 22,0 | 20,0 | 42,4 | 112,0 | 5   | 68,0  | 191,5 | 15,3    | AUDI/VW<br>VOLKSWAGEN            | 4E0 615 601 L<br>3D0 615 601 C   |
| 24.0122-0215.1 | 422215 |   | S | B  | HC | V | 314,0 | 22,0 | 18,0 | 75,5 | 120,0 | 5   | 76,0  | 185,0 | 16,6    | VOLKSWAGEN                       | 7L6 615 601 G  |
| 24.0122-0216.1 | 422216 |   | S | B  | HC | V | 260,0 | 22,0 | 19,8 | 44,0 | 100,0 | 4   | 61,0  | 125,0 | 13,6    | NISSAN                           | 40206-AX600<br>40206-AX603<br>77 01 207 795                              |
| 24.0122-0217.2 | 422217 |   |   |    |    | V | 262,5 | 22,0 | 20,0 | 72,0 | 108,0 | 5   | 46,0  | 60,0  | M12x1,5 | RENAULT<br>VOLVO                 | 270876   |
| 24.0122-0218.1 | 422218 |   | B | HC | L  | V | 300,0 | 22,0 | 19,4 | 57,5 | 112,0 | 5   | 67,0  | 164,0 | 15,0    | MERCEDES BENZ                    | 129 423 03 12  |
| 24.0122-0219.1 | 422219 |   | B | HC |    | V | 310,0 | 22,0 | 20,0 | 48,5 | 112,0 | 5/9 | 65,0  | 169,0 | 15,3    | AUDI/SEAT/SKODA/VW               | 1K0 615 601 N  |
| 24.0122-0220.1 | 422220 |   | B | HC |    | V | 300,0 | 22,0 | 20,0 | 36,2 | 112,0 | 5/9 | 68,0  | 172,0 | 15,3    | AUDI                             | 8E0 615 601 R  |
| 24.0122-0221.1 | 422221 |   | B | HC |    | V | 256,0 | 22,0 | 20,0 | 48,1 | 112,0 | 5   | 68,0  | 135,0 | 15,3    | AUDI/VW                          | 8D0 615 601 D  |
| 24.0122-0222.1 | 422222 |   | B | HC |    | V | 269,0 | 22,0 | 20,0 | 54,1 | 112,0 | 5   | 68,0  | 135,0 | 15,4    | AUDI/VW                          | 4B3 615 601  |
| 24.0122-0223.1 | 422223 |   | B | HC |    | V | 330,0 | 22,0 | 20,0 | 49,4 | 112,0 | 5   | 68,0  | 138,0 | 15,3    | AUDI                             | 4F0 615 601 F  |
| 24.0122-0224.1 | 422224 |   | S | B  | HC | V | 320,0 | 22,0 | 20,4 | 79,7 | 120,0 | 5   | 75,0  | 185,0 | 16,5    | BMW                              | 34 21 3 332 217  |
| 24.0122-0225.1 | 422225 |   |   |    |    | V | 284,0 | 22,0 | 20,2 | 39,4 | 98,0  | 5   | 59,0  | 127,0 | 13,0    | ALFA ROMEO                       | 46427948<br>60606170   |
| 24.0122-0226.1 | 422226 |   | S | B  | HC | L | 330,0 | 22,0 | 19,4 | 63,0 | 112,0 | 5   | 67,0  | 210,0 | 15,2    | MERCEDES BENZ                    | 164 423 13 12  |
| 24.0122-0227.1 | 422227 |   |   |    |    | V | 235,0 | 22,0 | 20,0 | 45,0 | 100,0 | 4   | 55,0  | 124,5 | 13,0    | KIA                              | MDX74-33-251   |
| 24.0122-0228.1 | 422228 |   | B | HC | L  | V | 300,0 | 22,0 | 19,4 | 55,3 | 112,0 | 5   | 67,0  | 164,0 | 13,2    | CHRYSLER                         | 5135 505AA   |
| 24.0122-0229.1 | 422229 |   | B | HC | L  | V | 300,0 | 22,0 | 19,4 | 58,3 | 112,0 | 5   | 67,0  | 180,0 | 15,2    | MERCEDES BENZ                    | 210 423 08 12  |
| 24.0122-0230.1 | 422230 |   | B |    |    | V | 285,0 | 22,0 | 20,4 | 38,5 | 114,3 | 5   | 69,0  | 145,0 | 12,5    | MERCEDES BENZ                    | 230 423 04 12  |
| 24.0122-0231.1 | 422231 |   | S | B  |    | V | 257,0 | 22,0 | 20,0 | 40,5 | 100,0 | 4/6 | 60,0  | 126,0 | 14,5    | MITSUBISHI                       | MR334996   |
| 24.0122-0232.1 | 422232 |   | S | B  | HC | L | 276,0 | 22,0 | 19,4 | 44,5 | 112,0 | 5   | 67,0  | 145,0 | 15,3    | FIAT                             | 55700920<br>55700921   |
| 24.0122-0233.1 | 422233 |   | S | B  |    | V | 292,0 | 22,0 | 20,0 | 43,2 | 110,0 | 5   | 70,0  | 139,0 | 16,6    | OPEL/VAUXHALL                    | 5 69 024/93188917<br>5 69 065/9319724                                    |
| 24.0122-0234.1 | 422234 |   |   |    |    | V | 281,0 | 22,0 | 20,2 | 47,5 | 108,0 | 5   | 59,0  | 133,8 | 14,7    | MERCEDES BENZ                    | 169 421 08 12  |
| 24.0122-0235.1 | 422235 |   |   |    |    | V | 270,0 | 22,0 | 20,0 | 46,0 | 100,0 | 4   | 55,0  | 125,0 | 13,0    | ALFA ROMEO                       | 51760274<br>51767380   |
| 24.0122-0236.1 | 422236 |   | S | B  | HC | V | 336,0 | 22,0 | 20,4 | 67,3 | 120,0 | 5   | 75,0  | 185,0 | 14,5    | LANCIA                           | 46469907   |
| 24.0122-0237.1 | 422237 |   | B |    |    | V | 277,0 | 22,0 | 20,4 | 45,5 | 108,0 | 6   | 87,0  | 170,0 | 10,5    | MAZDA                            | N0YY-33-25X  |
| 24.0122-0238.1 | 422238 |   | S | B  | HC | V | 292,0 | 22,0 | 20,4 | 73,3 | 120,0 | 5   | 79,0  | 151,5 | 14,5    | BMW                              | 34 21 6 855 004  |
| 24.0122-0239.1 | 422239 |   | S | B  | HC | V | 284,0 | 22,0 | 20,4 | 73,3 | 120,0 | 5   | 79,0  | 151,5 | 16,6    | HYUNDAI                          | HQ232405<br>HQ232405   |
| 24.0122-0240.1 | 422240 |   | B |    |    | V | 258,0 | 22,0 | 20,0 | 46,0 | 100,0 | 4   | 55,0  | 131,0 | 14,3    | MITSUBISHI                       | 34 11 6 854 997<br>34 11 6 792 215<br>34 11 6 854 996                    |
| 24.0122-0241.1 | 422241 |   | S | B  |    | V | 284,0 | 22,0 | 20,0 | 43,5 | 100,0 | 4/6 | 60,0  | 127,0 | 14,2    | DAIHATSU                         | 43512-0D060  |
| 24.0122-0242.1 | 422242 |   | S | B  | HC | V | 310,0 | 22,0 | 20,0 | 58,6 | 112,0 | 5   | 65,0  | 140,0 | 15,3    | TOYOTA                           | 43512-0D060  |
| 24.0122-0243.1 | 422243 |   | B | HC |    | V | 330,0 | 22,0 | 20,0 | 42,5 | 112,0 | 5   | 68,0  | 146,0 | 15,3    | FIAT                             | 55700922<br>55700923   |
| 24.0122-0244.1 | 422244 |   | B | HC |    | V | 294,0 | 22,0 | 20,4 | 44,2 | 100,0 | 4   | 64,2  | 150,0 | 14,7    | OPEL/VAUXHALL                    | 55 69 025/93188918   |
| 24.0122-0245.1 | 422245 |   | B | HC | L  | V | 285,0 | 22,0 | 19,0 | 72,0 | 130,0 | 5   | 85,0  | 156,3 | 15,0    | AUDI                             | 8J0 615 601 A  |
| 24.0122-0246.1 | 422246 |   | B |    |    | V | 255,0 | 22,0 | 19,0 | 46,3 | 100,0 | 4   | 55,0  | 131,0 | 14,5    | AUDI                             | 4F0 615 601 B  |
| 24.0122-0247.1 | 422247 |   | B | HC |    | V | 294,0 | 22,0 | 20,4 | 44,2 | 100,0 | 4   | 64,2  | 150,0 | 16,2    | MINI                             | 34 11 6 768 933  |
| 24.0122-0248.1 | 422248 |   | B | HC |    | V | 280,0 | 22,0 | 20,4 | 44,2 | 100,0 | 4   | 64,2  | 150,0 | 16,2    | MERCEDES BENZ                    | 903 421 01 12  |
| 24.0122-0249.1 | 422249 |   | B |    |    | V | 290,0 | 22,0 | 20,0 | 45,0 | 114,3 | 5   | 72,0  | 142,8 | 13,0    | TOYOTA                           | 43512-52120  |
| 24.0122-0250.1 | 422250 |   | S | B  | HC | V | 330,0 | 22,0 | 20,0 | 36,4 | 112,0 | 5   | 68,0  | 154,0 | 15,3    | MINI                             | 34 11 6 774 986<br>34 11 6 858 652<br>34 11 6 774 985<br>34 11 6 858 651 |
| 24.0122-0252.1 | 422252 |   | B |    |    | V | 280,0 | 22,0 | 20,0 | 47,0 | 114,3 | 5   | 62,0  | 146,3 | 12,7    | MAZDA                            | NF4Y-33-25X<br>N12Y-33-25X   |
| 24.0122-0253.1 | 422253 |   |   |    |    | V | 297,0 | 22,0 | 20,0 | 70,2 | 139,7 | 6   | 108,0 | 170,0 | 14,5    | AUDI                             | 8K0 615 601 C  |
|                |        |   |   |    |    |   |       |      |      |      |       |     |       |       |         | FIAT                             | 71768306   |
|                |        |   |   |    |    |   |       |      |      |      |       |     |       |       |         | SUZUKI                           | 55311-79J01<br>55311-79J02<br>55311-80J02                                |
|                |        |   |   |    |    |   |       |      |      |      |       |     |       |       |         | TOYOTA                           | 43512-35280<br>43512-35310   |



# Abmessungen Bremsscheiben

## Dimensions brake discs - Misure dischi freno -

## Dimensions Disques de frein - Medidas disco de freno

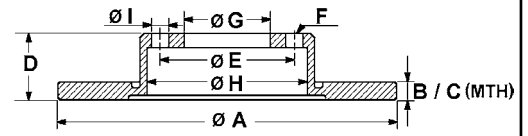

S Fixierschraube - fixing screw - vite di riparazione - vis de fixation - tornillo quefija

B beschichtet - coated - rivestito - revêtu - recubierto

HC hochgekohlt - high carbon - ad alto tenore di carbonio - à haute teneur en carbone - altamente carbonizado

L legiert - alloyed - alligato/legato - allié - aleado

V ventiliert - ventilated - ventilato - ventilé - ventilado

● gelocht - perforated - perforato - poinçonné - perforado

|                |        | S | B | HC | L  | V  | A     | B     | C    | D    | E     | F     | G     | H     | I        | OE - #        |                   |                 |               |
|----------------|--------|---|---|----|----|----|-------|-------|------|------|-------|-------|-------|-------|----------|---------------|-------------------|-----------------|---------------|
| 24.0122-0254.1 | 422254 |   | B |    |    | V  | 275,0 | 22,0  | 19,0 | 46,5 | 100,0 | 4     | 55,0  | 131,0 | 14,5     | TOYOTA        | 43512-52130       |                 |               |
| 24.0122-0255.1 | 422255 |   |   |    |    | V  | 302,0 | 22,0  | 20,0 | 35,0 | 108,0 | 5     | 71,1  | 132,7 | 13,0     | CITROEN       | 96 879 907 80     |                 |               |
| 24.0122-0256.1 | 422256 |   | B |    |    | V  | 275,0 | 22,0  | 19,0 | 46,3 | 114,3 | 5     | 62,0  | 145,0 | 14,8     | TOYOTA        | 43512-12670       |                 |               |
| 24.0122-0257.1 | 422257 |   | S | B  | HC | V  | 324,0 | 22,0  | 20,4 | 77,3 | 120,0 | 5     | 75,0  | 185,0 | 14,5     | BMW           | 34 21 6 778 649   |                 |               |
| 24.0122-0258.1 | 422258 |   | B |    |    | V  | 255,0 | 22,0  | 20,0 | 49,3 | 100,0 | 5     | 55,0  | 131,0 | 14,5     | TOYOTA        | 43512-47030       |                 |               |
| 24.0122-0259.1 | 422259 |   | S | B  | HC | V  | 302,0 | 22,0  | 20,0 | 40,8 | 108,0 | 5     | 63,5  | 165,0 | 15,8     | VOLVO         | 31341483          |                 |               |
| 24.0122-0260.1 | 422260 |   | B |    |    | V  | 256,0 | 22,0  | 20,0 | 46,6 | 100,0 | 4     | 62,2  | 126,0 | 12,5     | HYUNDAI       | 51712-1G000       |                 |               |
|                |        |   |   |    |    |    |       |       |      |      |       |       |       |       |          | KIA           | 51712-1G000       |                 |               |
|                |        |   |   |    |    |    |       |       |      |      |       |       |       |       |          |               |                   | 51712-1W250     |               |
| 24.0122-0261.1 | 422261 |   | B |    | HC | V  | 302,0 | 22,0  | 20,0 | 50,7 | 108,0 | 5     | 63,5  | 165,0 | 15,7     | VOLVO         | 31471033          |                 |               |
| 24.0122-0262.1 | 422262 |   |   |    |    | V  | 276,0 | 22,0  | 19,0 | 72,5 | 118,0 | 5     | 73,0  | 145,0 | 15,5     | IVECO         | 42470836          |                 |               |
| 24.0122-0263.1 | 422263 |   | B |    |    | V  | 254,0 | 22,0  | 20,0 | 42,0 | 100,0 | 4     | 55,0  | 137,0 | 13,0     | DAIHATSU      | 43512-B1030-000   |                 |               |
|                |        |   |   |    |    |    |       |       |      |      |       |       |       |       |          | SUBARU        | 43512B1030        |                 |               |
| 24.0122-0264.1 | 422264 |   | B |    |    | V  | 290,0 | 22,0  | 19,0 | 78,0 | 127,0 | 8     | 110,0 | 172,0 | 10,7     | NISSAN        | 43206-MA50A       |                 |               |
|                |        |   |   |    |    |    |       |       |      |      |       |       |       |       |          |               |                   | 43207-9X100     |               |
| 24.0122-0266.1 | 422266 |   | B | HC | L  | V  | 290,0 | 22,0  | 19,0 | 42,5 | 120,0 | 10    | 102,0 | 144,3 | 10,5     | RENAULT       | 50 10 260 604     |                 |               |
| 24.0122-0267.1 | 422267 |   | B | HC | L  | V  | 290,0 | 22,0  | 19,0 | 78,0 | 132,0 | 8     | 115,0 | 172,0 | 10,8     | RENAULT       | 50 10 260 609     |                 |               |
| 24.0122-0268.1 | 422268 |   | B |    |    | V  | 322,0 | 22,0  | 20,2 | 62,0 | 114,3 | 5     | 68,0  | 172,0 | 12,7     | NISSAN        | 43206-CD005       |                 |               |
| 24.0122-0270.1 | 422270 |   | S | B  | HC | V  | 258,0 | 22,0  | 19,8 | 44,0 | 100,0 | 4     | 61,0  | 125,3 | 13,5     | MERCEDES BENZ | 415 420 01 01     |                 |               |
|                |        |   |   |    |    |    |       |       |      |      |       |       |       |       |          | DACIA         | 40 20 612 00R     |                 |               |
|                |        |   |   |    |    |    |       |       |      |      |       |       |       |       |          | RENAULT       | 40 20 670 16R     |                 |               |
|                |        |   |   |    |    |    |       |       |      |      |       |       |       |       |          |               |                   | 77 01 210 081   |               |
|                |        |   |   |    |    |    |       |       |      |      |       |       |       |       |          |               |                   | 40 20 612 00R   |               |
|                |        |   |   |    |    |    |       |       |      |      |       |       |       |       |          |               |                   | 40 20 675 01R   |               |
| 24.0122-0271.1 | 422271 |   | S | B  | HC | V  | 294,0 | 22,0  | 20,4 | 45,2 | 120,0 | 5     | 79,0  | 152,0 | 16,5     | MINI          | 34 11 9 804 828   |                 |               |
|                |        |   |   |    |    |    |       |       |      |      |       |       |       |       |          |               |                   | 34 11 9 811 537 |               |
| 24.0122-0272.1 | 422272 |   | S | B  | HC | V  | 330,0 | 21,9  | 20,0 | 36,0 | 112,0 | 5     | 68,0  | 147,7 | 15,3     | AUDI          | 4H0 615 601 D     |                 |               |
|                |        |   |   |    |    |    |       |       |      |      |       |       |       |       |          |               |                   | 4H0 615 601 H   |               |
|                |        |   |   |    |    |    |       |       |      |      |       |       |       |       |          |               |                   | 4H0 615 601 K   |               |
|                |        |   |   |    |    |    |       |       |      |      |       |       |       |       |          |               |                   | 95B 615 601 A   |               |
| 24.0122-0273.1 | 422273 |   | S | B  | HC | V  | 356,0 | 22,0  | 20,0 | 36,2 | 112,0 | 5     | 68,0  | 159,8 | 15,3     | AUDI          | 4H0 615 601 F     |                 |               |
| 24.0122-0276.1 | 422276 |   | B |    |    | V  | 275,0 | 22,0  | 19,0 | 46,3 | 100,0 | 5     | 55,0  | 131,0 | 14,5     | SUBARU        | 4351212710        |                 |               |
|                |        |   |   |    |    |    |       |       |      |      |       |       |       |       |          |               |                   | TOYOTA          | 43512-12710   |
| 24.0122-0277.1 | 422277 |   | B |    |    | V  | 260,0 | 22,0  | 20,0 | 44,0 | 100,0 | 4     | 61,0  | 130,0 | 12,8     | NISSAN        | 40206-1HA0A       |                 |               |
| 24.0122-0278.1 | 422278 |   | S | B  | HC | V  | 300,0 | 22,0  | 20,4 | 73,0 | 120,0 | 5     | 79,0  | 152,0 | 16,5     | BMW           | 34 11 6 792 217   |                 |               |
| 24.0122-0280.1 | 422280 |   | B |    |    | V  | 256,0 | 22,0  | 20,0 | 40,2 | 100,0 | 4     | 60,0  | 132,8 | 12,5     | SUZUKI        | 55311-68L00       |                 |               |
| 24.0122-0281.1 | 422281 |   | S | B  | HC | V  | 256,0 | 22,0  | 19,0 | 36,7 | 100,0 | 4     | 65,0  | 132,0 | 13,8     | SEAT/SKODA/VW | 1S0 615 301 H     |                 |               |
| 24.0122-0282.1 | 422282 |   | B |    |    | V  | 272,0 | 22,0  | 20,0 | 40,2 | 100,0 | 4     | 60,0  | 150,0 | 12,5     | SUZUKI        | 55311-68L50       |                 |               |
| 24.0122-0283.1 | 422283 |   | B |    |    | V● | 284,0 | 22,0  | 20,2 | 43,5 | 98,0  | 4     | 59,0  | 127,0 | 13,2     | FIAT          | 5741446           |                 |               |
| 24.0122-0286.1 | 422286 |   | B |    |    | V  | 284,0 | 22,0  | 20,0 | 43,5 | 98,0  | 5     | 59,0  | 127,0 | 13,5     | FIAT          | 51937217          |                 |               |
|                |        |   |   |    |    |    |       |       |      |      |       |       |       |       |          |               |                   | 51937218        |               |
| 24.0122-0287.1 | 422287 |   | S | B  | HC | L  | ●     | 330,0 | 22,0 | 19,4 | 54,0  | 112,0 | 5     | 67,0  | 184,0    | 15,0          | MERCEDES BENZ     | 166 423 04 12   |               |
| 24.0122-0288.1 | 422288 |   | S | B  | HC | L  | ●     | 330,0 | 22,0 | 19,4 | 54,0  | 112,0 | 5     | 67,0  | 184,0    | 15,0          | MERCEDES BENZ     | 166 423 01 12   |               |
| 24.0122-0289.1 | 422289 |   | S | B  | HC | L  | V     | 258,0 | 22,0 | 19,8 | 43,9  | 100,0 | 4     | 61,0  | 126,5    | 13,5          | DACIA             | 40 20 631 49R   |               |
|                |        |   |   |    |    |    |       |       |      |      |       |       |       |       |          |               |                   | RENAULT         | 40 20 622 12R |
|                |        |   |   |    |    |    |       |       |      |      |       |       |       |       |          |               |                   | 40 20 676 15R   |               |
|                |        |   |   |    |    |    |       |       |      |      |       |       |       |       |          |               |                   | SMART           | 453 420 01 00 |
| 24.0122-0290.1 | 422290 |   | B |    |    | V  | 280,0 | 22,0  | 20,0 | 47,0 | 114,3 | 5     | 62,0  | 146,3 | 12,7     | SUZUKI        | 55311-61M00       |                 |               |
| 24.0122-0292.1 | 422292 |   | S | B  | HC | V  | 280,0 | 22,0  | 20,4 | 45,1 | 112,0 | 5     | 67,0  | 150,5 | 16,5     | BMW/MINI      | 34 11 6 866 295   |                 |               |
| 24.0122-0724.1 | 422724 |   | B |    |    | V  | 300,0 | 22,0  | 20,4 | 72,3 | 139,7 | 6     | 94,0  | 199,0 | 12,6     | MITSUBISHI    | MR418067          |                 |               |
| 24.0123-0100.1 | 423100 |   |   |    |    | V  | 246,0 | 23,0  | 21,0 | 55,5 | 92,0  | 4     | 73,0  | 115,0 | 10,6     | OPEL/VAUXHALL | 5 69 036/90009433 |                 |               |
| 24.0123-0101.1 | 423101 |   |   |    |    | V  | 280,0 | 23,4  | 21,5 | 43,5 | 108,0 | 4     | 68,0  | 152,8 | 15,0     | SAAB          | 4002150           |                 |               |
|                |        |   |   |    |    |    |       |       |      |      |       |       |       |       |          |               |                   | 8965550         |               |
| 24.0123-0102.1 | 423102 |   |   |    |    | V  | 282,0 | 23,0  | 21,0 | 34,0 | 114,3 | 4     | 92,0  | 160,0 | M10x1,25 | HONDA         | 45251-SM4-G02     |                 |               |
|                |        |   |   |    |    |    |       |       |      |      |       |       |       |       |          |               |                   | ROVER           | GBD90837      |
| 24.0123-0103.1 | 423103 |   |   |    |    | V  | 260,0 | 23,0  | 21,0 | 34,0 | 114,3 | 4     | 92,0  | 160,0 | M10x1,25 | HONDA         | 45251-SM4-020     |                 |               |
|                |        |   |   |    |    |    |       |       |      |      |       |       |       |       |          |               |                   | ROVER           | GBD90836      |
| 24.0123-0104.1 | 423104 |   | S | B  |    | V  | 282,0 | 23,0  | 21,0 | 47,1 | 114,3 | 5     | 70,2  | 148,5 | 12,6     | HONDA         | 45251-S2H-N00     |                 |               |
|                |        |   |   |    |    |    |       |       |      |      |       |       |       |       |          |               |                   |                 | 45251-SP0-000 |
|                |        |   |   |    |    |    |       |       |      |      |       |       |       |       |          |               |                   |                 | 45251-SZ3-000 |
|                |        |   |   |    |    |    |       |       |      |      |       |       |       |       |          |               |                   |                 | 45251-SZ3-E00 |
| 24.0123-0105.1 | 423105 |   |   |    |    | V  | 260,0 | 23,0  | 21,0 | 47,2 | 114,3 | 4     | 64,1  | 141,0 | 12,8     | HONDA         | 45251-S1A-G60     |                 |               |
|                |        |   |   |    |    |    |       |       |      |      |       |       |       |       |          |               |                   |                 | 45251-SS0-000 |
| 24.0123-0106.1 | 423106 |   |   |    |    | V  | 282,0 | 23,0  | 21,0 | 47,2 | 114,3 | 4     | 64,1  | 141,0 | 13,0     | HONDA         | 45251-SS0-A00     |                 |               |
|                |        |   |   |    |    |    |       |       |      |      |       |       |       |       |          |               |                   |                 | 45251-ST3-E60 |
| 24.0123-0108.1 | 423108 |   |   |    |    | V  | 295,0 | 22,5  | 21,0 | 66,5 | 120,7 | 5     | 80,0  | 154,3 | 13,4     | JAGUAR        | JLM 1305          |                 |               |
| 24.0123-0109.1 | 423109 |   | S | B  |    | V  | 282,0 | 23,0  | 21,0 | 47,1 | 114,3 | 5     | 64,1  | 141,0 | 12,5     | HONDA         | 45251-S7A-N10     |                 |               |
|                |        |   |   |    |    |    |       |       |      |      |       |       |       |       |          |               |                   |                 | 45251-SCA-E00 |
| 24.0123-0110.1 | 423110 |   | S | B  |    | V  | 282,0 | 23,0  | 21,0 | 47,2 | 114,3 | 5     | 64,2  | 141,0 | 12,6     | HONDA         | 45251-S7A-E10     |                 |               |
|                |        |   |   |    |    |    |       |       |      |      |       |       |       |       |          |               |                   |                 | 45251-SMG-G10 |
|                |        |   |   |    |    |    |       |       |      |      |       |       |       |       |          |               |                   |                 | 45251-SMG-E31 |
| 24.0123-0111.1 | 423111 |   | S | B  |    | V  | 260,0 | 23,0  | 21,0 | 44,5 | 100,0 | 4     | 64,1  | 141,5 | 13,0     | HONDA         | 45251-S6F-E10     |                 |               |
| 24.0123-0112.1 | 423112 |   | B | HC |    | V  | 258,0 | 23,0  | 21,0 | 43,9 | 100,0 | 4     | 55,0  | 135,8 | 13,0     | MAZDA         | DF71-33-251       |                 |               |



# Abmessungen Bremsscheiben

## Dimensions brake discs - Misure dischi freno -

## Dimensions Disques de frein - Medidas disco de freno

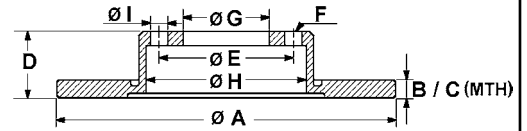

S Fixierschraube - fixing screw - vite di riparazione - vis de fixation - tornillo quefija

B beschichtet - coated - rivestito - revêtu - recubierto

HC hochgekohlt - high carbon - ad alto tenore di carbonio - à haute teneur en carbone - altamente carbonizado

L legiert - alloyed - alligato/legato - allié - aleado

V ventiliert - ventilated - ventilato - ventilé - ventilado

● gelocht - perforated - perforato - poinçonné - perforado

|                |        | S | B | HC | L  | V | A     | B     | C    | D     | E     | F     | G     | H     | I       | OE - #                     |  |                               |
|----------------|--------|---|---|----|----|---|-------|-------|------|-------|-------|-------|-------|-------|---------|----------------------------|--|-------------------------------|
| 24.0123-0113.1 | 423113 |   | B | HC |    | V | 258,0 | 23,0  | 21,0 | 43,8  | 108,0 | 4     | 63,5  | 136,0 | 13,0    | FORD                       | 1523795<br>1535924<br>1546835<br>1679853<br>8V51-1125-AC<br>8V51-1125-AD   |                               |
| 24.0123-0114.1 | 423114 |   | S | B  |    | V | 315,0 | 22,9  | 21,5 | 48,0  | 120,0 | 5     | 67,4  | 172,0 | 16,3    | CHEVROLET<br>OPEL/VAUXHALL | 13501314<br>5 69 062/13501303<br>5 69 128/13502199<br>13502199   |                               |
| 24.0123-0116.1 | 423116 |   | S | B  |    | V | 315,0 | 23,0  | 20,0 | 45,0  | 115,0 | 5     | 70,7  | 172,0 | 14,2    | OPEL                       | 5 69 093/13586855  |                               |
| 24.0123-0119.1 | 423119 |   | S | B  | HC | V | 269,0 | 22,5  | 19,8 | 44,1  | 114,3 | 5     | 68,0  | 141,0 | 15,7    | DACIA/RENAULT              | 40 20 663 00R  |                               |
| 24.0123-0122.1 | 423122 |   |   | B  |    | V | 278,0 | 23,0  | 21,0 | 43,9  | 108,0 | 4     | 63,5  | 136,0 | 13,0    | FORD                       | 1751584<br>AY11-1125-AA<br>1833857<br>EY16-1125-AA   |                               |
| 24.0123-0123.1 | 423123 |   | B | HC |    | V | 280,0 | 23,1  | 21,0 | 44,4  | 114,3 | 5     | 69,0  | 143,4 | 12,7    | HYUNDAI/KIA                | 51712-A6000  |                               |
| 24.0124-0103.1 | 424103 |   |   | B  |    | V | 252,5 | 24,0  | 22,0 | 53,5  | 95,0  | 6     | 76,0  | 105,0 | M10x1,5 | OPEL/VAUXHALL<br>RENAULT   | 44 03 283/9111283<br>77 01 204 281   |                               |
| 24.0124-0105.1 | 424105 |   |   |    |    | V | 264,0 | 24,0  | 22,0 | 46,5  | 114,3 | 5     | 64,0  | 137,0 | 12,6    | FORD<br>MAZDA              | E92Z 1125A<br>GJ25-33-25XD<br>GJ55-33-25XC   |                               |
| 24.0124-0107.1 | 424107 |   |   |    |    | V | 270,0 | 24,0  | 22,6 | 71,2  | 100,0 | 5     | 78,6  | 138,5 | M10     | FORD                       | 5022675  |                               |
| 24.0124-0109.1 | 424109 |   |   |    |    | V | 260,0 | 24,2  | 22,2 | 51,6  | 112,0 | 5     | 72,0  | 137,0 | 13,7    | FORD                       | 6158214  |                               |
| 24.0124-0110.1 | 424110 |   |   |    |    | V | 280,0 | 24,0  | 21,0 | 58,4  | 110,0 | 5     | 70,0  | 139,0 | 14,0    | OPEL/VAUXHALL              | 5 69 038/90271133  |                               |
| 24.0124-0111.1 | 424111 |   |   | B  |    | V | 258,0 | 24,0  | 21,0 | 58,4  | 110,0 | 5     | 70,0  | 139,0 | 14,0    | OPEL/VAUXHALL              | 5 69 039/90271134  |                               |
| 24.0124-0112.1 | 424112 |   |   | B  |    | V | 239,5 | 24,2  | 22,2 | 58,1  | 108,0 | 4     | 63,5  | 136,0 | 13,7    | FORD                       | 5022659<br>5022660<br>5022948<br>5023573   |                               |
| 24.0124-0113.1 | 424113 |   |   |    |    | V | 260,0 | 24,2  | 22,2 | 58,1  | 108,0 | 4     | 63,5  | 136,0 | 13,7    | FORD                       | 1102560<br>5022663   |                               |
| 24.0124-0114.1 | 424114 |   |   |    |    | V | 266,0 | 24,0  | 22,4 | 45,2  | 114,3 | 4     | 69,0  | 144,0 | 12,6    | MITSUBISHI                 | MB366080<br>MB500968<br>MB500969   |                               |
| 24.0124-0115.1 | 424115 |   | S | B  | HC | L | V     | 256,0 | 24,0 | 21,0  | 41,0  | 100,0 | 4/6   | 60,0  | 123,0   | 14,0                       | DAEWOO<br>OPEL/VAUXHALL  | 96179110<br>5 69 001/90487402 |
| 24.0124-0116.1 | 424116 |   |   | HC | L  | V | 299,0 | 24,0  | 22,0 | 71,0  | 130,0 | 5     | 103,0 | 180,0 | 15,4    | PORSCHE                    | 951 352 041 01   |                               |
| 24.0124-0117.1 | 424117 |   |   | HC | L  | V | 299,0 | 24,0  | 22,0 | 100,0 | 130,0 | 5     | 103,0 | 180,0 | 15,4    | PORSCHE                    | 951 352 041 02   |                               |
| 24.0124-0118.1 | 424118 |   | B | HC | L  | V | 280,0 | 24,0  | 20,0 | 64,5  | 112,0 | 5     | 68,2  | 144,0 | 16,5    | VOLKSWAGEN                 | 701 615 301 D  |                               |
| 24.0124-0119.1 | 424119 |   | B | HC | L  | V | 286,0 | 24,0  | 21,0 | 58,4  | 110,0 | 5     | 70,0  | 139,0 | 14,0    | OPEL/VAUXHALL              | 5 69 053/90487103  |                               |
| 24.0124-0120.1 | 424120 |   |   | B  |    | V | 260,0 | 24,0  | 22,2 | 47,0  | 108,0 | 4     | 63,5  | 136,0 | 13,6    | FORD                       | 4070865<br>5026784   |                               |
| 24.0124-0121.1 | 424121 |   |   |    |    | V | 260,0 | 24,2  | 22,2 | 53,1  | 112,0 | 5     | 63,5  | 138,0 | 13,7    | FORD                       | 5027462<br>5027463   |                               |
| 24.0124-0125.1 | 424125 |   |   |    |    | V | 260,0 | 24,2  | 22,2 | 44,0  | 108,0 | 4     | 63,5  | 136,0 | 13,7    | FORD                       | 5025950  |                               |
| 24.0124-0127.1 | 424127 |   |   | B  |    | V | 280,0 | 24,0  | 21,9 | 67,6  | 118,0 | 5     | 73,0  | 142,0 | 15,5    | CITROEN                    | 4246 Y1<br>4249 99<br>4249 K3<br>4249 H8<br>16 078 720 80  |                               |
| 24.0124-0128.1 | 424128 |   | S | B  | HC | V | 280,0 | 24,0  | 20,0 | 55,2  | 112,0 | 5     | 68,2  | 144,0 | 16,5    | VOLKSWAGEN                 | 7D0 615 301 C  |                               |
| 24.0124-0129.1 | 424129 |   |   | B  |    | V | 258,0 | 24,0  | 22,0 | 48,6  | 114,3 | 5     | 72,0  | 142,5 | 13,0    | FORD<br>MAZDA              | 3958455<br>GA2Y-33-25X<br>GA4Y-33-25X<br>GA4Y-33-25XC<br>GA4Y-33-25XD<br>GA4Y-33-25XJ<br>GA5Y-33-25X<br>GA5Y-33-25XD |                               |
| 24.0124-0131.1 | 424131 |   |   | B  |    | V | 254,0 | 24,2  | 22,2 | 43,0  | 100,0 | 5     | 78,5  | 104,0 | M10     | FORD                       | 5025610<br>5029815   |                               |
| 24.0124-0132.1 | 424132 |   |   | B  |    | V | 270,0 | 24,2  | 22,2 | 43,0  | 100,0 | 5     | 78,5  | 104,0 | M10     | FORD                       | 5029816  |                               |
| 24.0124-0133.1 | 424133 |   |   | HC | L  | V | 284,0 | 24,0  | 21,0 | 41,0  | 110,0 | 5/8   | 70,0  | 145,0 | 14,0    | OPEL/VAUXHALL<br>SAAB      | 5 69 047/90442513<br>4241428   |                               |



# Abmessungen Bremsscheiben

## Dimensions brake discs - Misure dischi freno -

## Dimensions Disques de frein - Medidas disco de freno

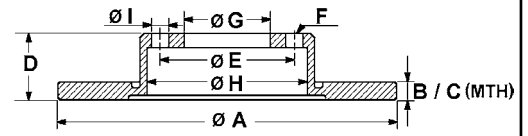

S Fixierschraube - fixing screw - vite di riparazione - vis de fixation - tornillo quefija

B beschichtet - coated - rivestito - revêtu - recubierto

HC hochgekohlt - high carbon - ad alto tenore di carbonio - à haute teneur en carbone - altamente carbonizado

L legiert - alloyed - alligato/legato - allié - aleado

V ventiliert - ventilated - ventilato - ventilé - ventilado

● gelocht - perforated - perforato - poinçonné - perforado

|                |        | S | B | HC | L | V | A     | B    | C    | D    | E     | F   | G     | H     | I       | OE - #                    |  |
|----------------|--------|---|---|----|---|---|-------|------|------|------|-------|-----|-------|-------|---------|---------------------------|--|
| 24.0124-0136.1 | 424136 |   | B |    |   | V | 256,0 | 24,0 | 21,5 | 45,5 | 114,3 | 4   | 69,0  | 145,0 | 12,6    | HYUNDAI/KIA<br>MITSUBISHI | 51712-M2000<br>MB407639<br>MB928995<br>MR128153<br>MR205584<br>MR205585<br>30872926            |
| 24.0124-0137.1 | 424137 |   |   |    |   | V | 278,0 | 24,0 | 22,0 | 70,0 | 120,0 | 6   | 95,0  | 136,0 | M12x1   | VOLVO<br>RENAULT          | 50 00 388 057  |
| 24.0124-0138.1 | 424138 |   | B |    |   | V | 300,0 | 24,0 | 21,9 | 65,5 | 130,0 | 5   | 80,0  | 161,0 | 17,5    | CITROEN                   | 4249 H2<br>4249 H9<br>16 078 722 80  |
|                |        |   |   |    |   |   |       |      |      |      |       |     |       |       |         | FIAT                      | 46806234<br>51728378<br>51740247<br>51858363   |
|                |        |   |   |    |   |   |       |      |      |      |       |     |       |       |         | PEUGEOT                   | 4246 Y5<br>4249 H2<br>4249 H9<br>16 078 722 80   |
| 24.0124-0139.1 | 424139 | S | B |    |   | V | 260,0 | 24,0 | 22,0 | 28,0 | 108,0 | 4   | 66,0  | 133,5 | 13,0    | PEUGEOT                   | 4246 L9  |
| 24.0124-0140.1 | 424140 |   | B |    |   | V | 276,0 | 24,0 | 22,4 | 45,1 | 108,0 | 6   | 87,0  | 136,0 | 10,6    | MITSUBISHI                | MB618716<br>MB928120<br>MB928697<br>MR129648<br>MR129649                                       |
| 24.0124-0141.1 | 424141 |   | B |    |   | V | 260,0 | 24,0 | 22,0 | 56,8 | 100,0 | 5   | 58,0  | 129,0 | 12,8    | SUBARU                    | 26300AE091<br>26310AA021<br>26310AA031<br>26310AA032<br>26310AC060                             |
| 24.0124-0142.1 | 424142 |   |   |    |   | V | 256,0 | 24,0 | 22,4 | 45,3 | 114,3 | 5   | 69,0  | 145,0 | 12,6    | MITSUBISHI                | MB618799<br>MB668108   |
| 24.0124-0143.1 | 424143 |   | B |    |   | V | 298,5 | 24,0 | 22,0 | 70,0 | 127,0 | 5   | 101,6 | 158,0 | 10,0    | LAND ROVER                | FTC902   |
| 24.0124-0144.1 | 424144 |   |   |    |   | V | 276,0 | 24,0 | 22,4 | 45,2 | 114,3 | 5   | 69,0  | 165,0 | 12,6    | MITSUBISHI                | MB618344<br>MB858799   |
| 24.0124-0145.1 | 424145 |   | B |    |   | V | 277,0 | 24,0 | 22,0 | 56,5 | 100,0 | 5   | 58,0  | 129,0 | 13,0    | SUBARU                    | 26300AE050<br>26300AE070<br>26300AE071<br>26310AA091<br>26310AA092<br>26310AA120<br>26310AA121 |
| 24.0124-0146.1 | 424146 |   | B |    |   | V | 256,0 | 24,0 | 22,4 | 45,3 | 114,3 | 4   | 69,0  | 145,0 | 12,6    | HYUNDAI/KIA<br>MITSUBISHI | 51712-M2010<br>MB668886<br>MB950570  |
| 24.0124-0147.1 | 424147 |   |   |    |   | V | 256,0 | 24,0 | 22,4 | 45,3 | 114,3 | 5   | 69,0  | 145,0 | 12,6    | MITSUBISHI                | MB699761   |
| 24.0124-0148.1 | 424148 |   |   |    |   | V | 278,0 | 24,0 | 22,2 | 35,5 | 108,0 | 4   | 63,5  | 137,0 | 13,7    | FORD                      | 5024174<br>5026674   |
| 24.0124-0149.1 | 424149 |   | B |    |   | V | 278,0 | 24,1 | 22,2 | 46,9 | 108,0 | 4   | 63,5  | 136,0 | 13,6    | FORD                      | 4070864<br>5026785   |
| 24.0124-0151.1 | 424151 |   |   |    |   | V | 260,0 | 24,3 | 22,8 | 53,0 | 108,0 | 4   | 63,5  | 137,0 | 13,8    | FORD                      | 5022664  |
| 24.0124-0152.1 | 424152 | S | B | HC | L | V | 256,0 | 23,8 | 21,0 | 41,1 | 100,0 | 4   | 60,0  | 123,0 | 14,3    | OPEL/VAUXHALL             | 5 69 059/9117677   |
| 24.0124-0158.1 | 424158 | S | B | HC | L | V | 280,0 | 24,0 | 21,8 | 44,0 | 100,0 | 4   | 61,0  | 140,0 | 13,6    | RENAULT                   | 77 01 207 829<br>86 71 005 975   |
| 24.0124-0159.1 | 424159 |   | B |    |   | V | 281,0 | 23,9 | 21,5 | 45,7 | 114,3 | 4   | 69,0  | 146,5 | 12,5    | MITSUBISHI<br>VOLVO       | M818027<br>30818027  |
| 24.0124-0161.1 | 424161 |   | B |    |   | V | 300,0 | 23,9 | 22,0 | 47,0 | 108,0 | 5   | 63,5  | 155,0 | 13,7    | FORD                      | 1376118<br>4179398<br>4181042  |
|                |        |   |   |    |   |   |       |      |      |      |       |     |       |       |         | JAGUAR                    | C2S 35270<br>C2S 42667<br>C2S 52091  |
| 24.0124-0162.1 | 424162 |   | B |    |   | V | 280,0 | 24,0 | 21,0 | 61,5 | 110,0 | 6   | 79,5  | 119,0 | M10x1,5 | OPEL/VAUXHALL<br>RENAULT  | 45 00 098/9160398<br>77 00 302 128<br>86 71 017 103  |
| 24.0124-0163.1 | 424163 | S |   |    |   | V | 256,0 | 24,0 | 22,0 | 47,1 | 100,0 | 4/6 | 60,0  | 134,0 | 13,2    | CHEVROLET                 | 96286933<br>96312559   |
|                |        |   |   |    |   |   |       |      |      |      |       |     |       |       |         | DAEWOO                    | 96286933<br>96312559   |
| 24.0124-0164.1 | 424164 |   | B |    |   | V | 258,0 | 24,0 | 22,0 | 47,0 | 100,0 | 4   | 55,0  | 125,0 | 13,0    | MAZDA                     | BJ1Y-33-25X  |
| 24.0124-0165.1 | 424165 |   | B | HC | L | V | 298,0 | 24,0 | 22,0 | 67,0 | 130,0 | 5   | 98,0  | 164,0 | 15,4    | PORSCHE                   | 986 351 401 05   |
| 24.0124-0166.1 | 424166 | S | B | HC | L | V | 260,0 | 24,0 | 21,0 | 41,0 | 100,0 | 4/6 | 60,0  | 126,0 | 14,5    | OPEL/VAUXHALL             | 5 69 000/9196050   |
| 24.0124-0167.1 | 424167 |   | B |    |   | V | 276,0 | 24,5 | 22,1 | 43,0 | 100,0 | 5   | 82,0  | 136,0 | M10     | FORD                      | 1738807<br>1C1J-1125-A2D   |

# Abmessungen Bremsscheiben

## Dimensions brake discs - Misure dischi freno -

## Dimensions Disques de frein - Medidas disco de freno

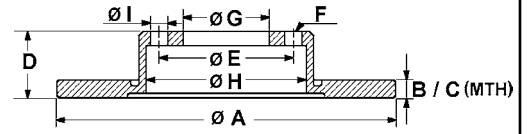

S Fixierschraube - fixing screw - vite di riparazione - vis de fixation - tornillo quefija  
 L legiert - alloyed - alligato/legato - allié - aleado ● gelocht - perforated - perforato - poinçonné - perforado  
 B beschichtet - coated - rivestito - revêtu - recubierto  
 V ventiliert - ventilated - ventilato - ventilé - ventilado  
 HC hochgekohlt - high carbon - ad alto tenore di carbonio - à haute teneur en carbone - altamente carbonizado

|                |        | S | B | H  | C | L | V  | A     | B    | C    | D    | E     | F | G     | H     | I    | OE - #   |
|----------------|--------|---|---|----|---|---|----|-------|------|------|------|-------|---|-------|-------|------|--|
| 24.0124-0168.1 | 424168 |   | B |    |   |   | V  | 294,0 | 24,5 | 22,1 | 43,0 | 100,0 | 5 | 82,0  | 136,0 | M10  | FORD<br>1738815<br>YC1J-1125-B2B   |
| 24.0124-0169.1 | 424169 |   | B | HC |   |   | V  | 280,0 | 24,0 | 21,8 | 46,9 | 108,0 | 5 | 61,0  | 139,8 | 13,5 | RENAULT<br>82 00 007 121<br>86 71 017 410  |
| 24.0124-0170.1 | 424170 |   | B |    |   |   | V  | 276,0 | 24,0 | 22,4 | 45,0 | 114,3 | 4 | 69,0  | 145,0 | 12,5 | MITSUBISHI<br>MR389725<br>MR475331   |
| 24.0124-0171.1 | 424171 | S | B | HC | L |   | V  | 280,0 | 24,0 | 21,8 | 44,0 | 108,0 | 5 | 61,0  | 140,0 | 15,5 | RENAULT<br>77 01 206 198   |
| 24.0124-0172.1 | 424172 |   |   |    |   |   | V  | 284,5 | 24,0 | 22,4 | 51,0 | 139,6 | 5 | 96,3  | 171,0 | 12,5 | KIA<br>0K011-33-251D<br>0K01A-33-251C<br>0K01A-33-25XB   |
| 24.0124-0173.1 | 424173 |   |   |    |   |   | V  | 258,0 | 24,0 | 22,0 | 48,6 | 114,3 | 4 | 72,0  | 143,7 | 13,0 | KIA<br>0K9AA-33-251<br>0K9AA-33-251B<br>0K9AA-33-251C  |
| 24.0124-0174.1 | 424174 |   |   |    |   |   | V  | 284,0 | 24,2 | 22,9 | 60,5 | 111,1 | 5 | 82,6  | 138,5 | 11,5 | JAGUAR<br>JLM 727<br>JLM 776   |
| 24.0124-0175.1 | 424175 |   | B |    |   |   | V  | 273,5 | 24,0 | 22,0 | 47,5 | 114,3 | 5 | 72,0  | 143,0 | 13,0 | MAZDA<br>GF3Y-33-25XA  |
| 24.0124-0176.1 | 424176 |   | B | HC | L |   | V● | 299,0 | 24,0 | 22,0 | 75,0 | 130,0 | 5 | 98,0  | 180,0 | 15,4 | PORSCHE<br>996 352 401 05  |
| 24.0124-0177.1 | 424177 |   | B | HC |   |   | V  | 345,0 | 24,0 | 22,4 | 67,0 | 120,0 | 5 | 79,0  | 185,0 | 16,5 | BMW<br>34 21 1 166 129   |
| 24.0124-0178.1 | 424178 |   | B |    |   |   | V  | 282,5 | 24,0 | 22,4 | 38,0 | 114,3 | 5 | 73,5  | 159,3 | 14,0 | CHRYSLER<br>4721 820AE   |
| 24.0124-0179.1 | 424179 |   | B |    |   |   | V  | 278,0 | 24,0 | 22,0 | 44,5 | 108,0 | 5 | 63,5  | 136,0 | 13,7 | FORD<br>1361298<br>1361300<br>4367104<br>4367106<br>4455980<br>4457985<br>2T14-1125-CC<br>2T14-1125-EC |
| 24.0124-0181.1 | 424181 | S | B | HC |   |   | V  | 310,0 | 24,0 | 22,4 | 77,0 | 120,0 | 5 | 79,0  | 161,0 | 14,5 | BMW<br>34 11 6 764 021   |
| 24.0124-0182.1 | 424182 |   |   |    |   |   | V  | 276,0 | 24,0 | 22,4 | 45,0 | 114,3 | 5 | 69,0  | 145,0 | 12,5 | MITSUBISHI<br>MR449817<br>MR449818   |
| 24.0124-0183.1 | 424183 |   | B | HC | L |   | V● | 299,0 | 24,0 | 22,0 | 65,0 | 130,0 | 5 | 103,0 | 180,0 | 15,4 | PORSCHE<br>993 352 041 02  |
| 24.0124-0184.1 | 424184 |   | B |    |   |   | V  | 257,0 | 24,0 | 22,1 | 46,7 | 114,3 | 4 | 69,0  | 141,5 | 12,7 | HYUNDAI<br>51712-2D310   |
| 24.0124-0185.1 | 424185 |   | B |    |   |   | V  | 258,0 | 24,0 | 22,0 | 48,5 | 100,0 | 4 | 57,0  | 143,6 | 13,0 | KIA<br>0K2N1-33-251  |
| 24.0124-0186.1 | 424186 |   |   | HC |   |   | V  | 370,0 | 24,0 | 22,4 | 67,0 | 120,0 | 5 | 79,0  | 185,0 | 16,5 | BMW<br>34 21 1 166 131   |
| 24.0124-0187.1 | 424187 |   | B |    |   |   | V  | 254,0 | 24,0 | 22,0 | 50,7 | 100,0 | 4 | 55,0  | 141,0 | 13,0 | KIA<br>41712-FD-300  |
| 24.0124-0188.1 | 424188 |   | B | HC | L |   | V  | 278,0 | 24,0 | 21,4 | 55,5 | 112,0 | 5 | 67,0  | 164,0 | 15,0 | MERCEDES BENZ<br>124 423 08 12   |
| 24.0124-0189.1 | 424189 |   |   | HC | L |   | V  | 282,5 | 24,0 | 22,6 | 35,0 | 126,0 | 5 | 107,0 | 145,0 | 8,4  | PORSCHE<br>911 351 041 22  |
| 24.0124-0190.1 | 424190 |   |   | HC | L |   | V  | 290,0 | 24,0 | 22,6 | 83,0 | 130,0 | 5 | 90,0  | 180,0 | 15,4 | PORSCHE<br>911 352 041 08  |
| 24.0124-0191.1 | 424191 | S | B | HC |   |   | V  | 300,0 | 24,0 | 21,8 | 43,9 | 100,0 | 4 | 61,0  | 139,8 | 13,5 | RENAULT<br>77 01 207 897<br>86 71 017 844  |
| 24.0124-0192.1 | 424192 |   | B |    |   |   | V  | 256,0 | 24,0 | 21,5 | 45,6 | 114,3 | 4 | 69,0  | 139,0 | 12,7 | MITSUBISHI<br>4605A068<br>SMART<br>454 420 00 01   |
| 24.0124-0193.1 | 424193 |   |   |    |   |   | V  | 282,5 | 24,0 | 22,4 | 38,0 | 114,3 | 5 | 73,5  | 144,0 | 14,0 | CHRYSLER<br>4509 340   |
| 24.0124-0194.1 | 424194 |   | B | HC | L |   | V● | 299,0 | 24,0 | 22,0 | 67,0 | 130,0 | 5 | 98,0  | 180,0 | 15,4 | PORSCHE<br>986 352 403 01<br>987 352 403 00  |
| 24.0124-0195.1 | 424195 |   |   |    |   |   | V  | 274,0 | 24,1 | 22,0 | 40,4 | 114,3 | 5 | 72,0  | 142,5 | 13,0 | KIA<br>0K552-33-251<br>0K552-33-251A<br>0K56A-33-251<br>KJ002-33-251C                                  |
| 24.0124-0196.1 | 424196 |   | B |    |   |   | V  | 293,5 | 24,0 | 22,0 | 56,7 | 100,0 | 5 | 58,0  | 129,0 | 13,0 | SUBARU<br>26300AE061<br>26300SA001   |
| 24.0124-0197.1 | 424197 | S | B | HC |   |   | V  | 300,0 | 24,0 | 22,4 | 73,5 | 120,0 | 5 | 79,0  | 152,0 | 14,5 | BMW<br>34 11 6 764 643<br>34 11 6 854 998  |
| 24.0124-0198.1 | 424198 |   |   |    |   |   | V  | 300,0 | 24,0 | 22,0 | 44,5 | 108,0 | 4 | 63,5  | 156,5 | 13,7 | FORD<br>4328921<br>4410264   |
| 24.0124-0199.1 | 424199 | S | B |    |   |   | V  | 256,0 | 24,0 | 21,0 | 46,8 | 114,3 | 4 | 60,0  | 141,0 | 12,6 | CHEVROLET/DAEWOO<br>96264591<br>96328338<br>96549782   |
| 24.0124-0200.1 | 424200 | S | B | HC |   |   | V  | 330,0 | 24,0 | 22,4 | 73,3 | 120,0 | 5 | 79,0  | 174,0 | 14,5 | BMW<br>34 11 6 854 999   |
| 24.0124-0201.2 | 424201 | S | B | HC |   |   | V  | 345,0 | 24,0 | 22,4 | 63,2 | 120,0 | 5 | 75,0  | 185,0 | 14,5 | BMW<br>34 21 6 763 827   |
| 24.0124-0202.1 | 424202 |   |   |    |   |   | V  | 276,0 | 24,0 | 22,4 | 45,2 | 114,3 | 6 | 93,0  | 137,0 | 10,6 | MITSUBISHI<br>MB895730   |
| 24.0124-0203.1 | 424203 | S | B | HC |   |   | V  | 312,0 | 23,9 | 22,4 | 73,1 | 120,0 | 5 | 79,0  | 152,0 | 16,5 | BMW<br>34 11 6 792 219<br>34 11 6 855 006  |
| 24.0124-0207.1 | 424207 |   |   |    |   |   | V  | 254,0 | 24,0 | 22,4 | 39,0 | 108,0 | 6 | 67,0  | 132,6 | 10,6 | MITSUBISHI<br>MB950958   |
| 24.0124-0210.1 | 424210 |   | B | HC | L |   | V● | 298,0 | 24,0 | 22,0 | 67,0 | 130,0 | 5 | 98,0  | 164,0 | 15,4 | PORSCHE<br>987 351 402 01  |
| 24.0124-0211.1 | 424211 |   | B | HC | L |   | V● | 298,0 | 24,0 | 22,0 | 67,0 | 130,0 | 5 | 98,0  | 164,0 | 15,4 | PORSCHE<br>987 351 401 01  |
| 24.0124-0212.1 | 424212 | S | B | HC | L |   | V  | 320,0 | 24,0 | 21,4 | 58,2 | 112,0 | 5 | 67,0  | 180,0 | 15,2 | MERCEDES BENZ<br>221 423 10 12   |
| 24.0124-0213.1 | 424213 |   | B | HC |   |   | V  | 345,0 | 24,0 | 22,4 | 74,0 | 120,0 | 5 | 79,0  | 185,0 | 16,5 | BMW<br>34 21 6 864 054   |
| 24.0124-0214.1 | 424214 |   | B | HC |   |   | V  | 370,0 | 24,0 | 22,4 | 74,0 | 120,0 | 5 | 79,0  | 185,0 | 16,5 | BMW<br>34 21 6 765 891   |



# Abmessungen Bremsscheiben

## Dimensions brake discs - Misure dischi freno -

## Dimensions Disques de frein - Medidas disco de freno

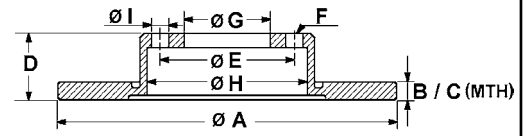

S Fixierschraube - fixing screw - vite di riparazione - vis de fixation - tornillo quejija

B beschichtet - coated - rivestito - revêtu - recubierto

HC hochgekohlt - high carbon - ad alto tenore di carbonio - à haute teneur en carbone - altamente carbonizado

L legiert - alloyed - alligato/legato - allié - aleado

V ventiliert - ventilated - ventilato - ventilé - ventilado

● gelocht - perforated - perforato - poinçonné - perforado

|                |        | S | B | HC | L | V  | A     | B    | C    | D    | E     | F   | G    | H     | I       | OE - #   |
|----------------|--------|---|---|----|---|----|-------|------|------|------|-------|-----|------|-------|---------|--|
| 24.0124-0215.1 | 424215 |   | B |    |   | V  | 294,0 | 24,0 | 22,4 | 45,5 | 114,3 | 5   | 69,0 | 147,8 | 12,6    | CITROEN<br>16 063 757 80<br>16 114 298 80<br>4249 59<br>MITSUBISHI<br>4615A006<br>MR128659<br>MR205215<br>PEUGEOT<br>16 063 757 80<br>16 114 298 80<br>4249 59 |
| 24.0124-0216.1 | 424216 | S | B | HC |   | V  | 345,0 | 24,0 | 22,4 | 78,5 | 120,0 | 5   | 75,0 | 185,0 | 16,5    | BMW<br>34 21 6 793 246   |
| 24.0124-0217.1 | 424217 |   | B |    |   | V  | 302,5 | 24,0 | 22,0 | 45,0 | 114,3 | 5   | 72,0 | 144,0 | 13,0    | MAZDA<br>F152-33-251A  |
| 24.0124-0218.1 | 424218 |   | B |    |   | V  | 322,6 | 24,0 | 22,0 | 45,0 | 114,3 | 5   | 72,0 | 144,0 | 13,0    | MAZDA<br>F160-33-251A  |
| 24.0124-0219.2 | 424219 | S | B | HC |   | V  | 385,0 | 24,0 | 22,4 | 78,5 | 120,0 | 5   | 75,0 | 185,0 | 16,5    | BMW<br>34 21 6 779 535   |
| 24.0124-0220.1 | 424220 |   | B |    |   | V  | 254,0 | 24,0 | 22,4 | 40,0 | 108,0 | 5   | 87,0 | 153,5 | 10,6    | HYUNDAI<br>58129-4A000   |
| 24.0124-0221.1 | 424221 | S | B | HC |   | V  | 280,0 | 24,0 | 21,8 | 44,0 | 114,3 | 5   | 68,0 | 140,0 | 15,8    | DACIA<br>40 20 641 51R<br>RENAULT<br>40 20 600 10R   |
| 24.0124-0222.1 | 424222 | S | B | HC |   | V  | 280,0 | 24,0 | 21,8 | 44,0 | 108,0 | 5   | 61,0 | 140,0 | 15,8    | MERCEDES BENZ<br>415 420 00 01<br>415 420 07 01<br>82 01 464 604<br>RENAULT<br>77 01 208 848<br>RENAULT<br>77 01 208 849                                       |
| 24.0124-0223.1 | 424223 | S | B | HC |   | V  | 280,0 | 24,0 | 21,8 | 44,0 | 108,0 | 5   | 61,0 | 140,0 | 15,8    | RENAULT<br>77 01 208 848   |
| 24.0124-0224.1 | 424224 | S | B | HC |   | V  | 300,0 | 24,0 | 21,8 | 44,0 | 108,0 | 5   | 61,0 | 140,0 | 15,8    | RENAULT<br>77 01 208 849   |
| 24.0124-0226.1 | 424226 | S | B | HC | L | V● | 320,0 | 24,0 | 22,0 | 58,2 | 112,0 | 5   | 67,0 | 180,0 | 15,2    | MERCEDES BENZ<br>230 423 15 12   |
| 24.0124-0228.1 | 424228 |   | B |    |   | V  | 294,0 | 24,0 | 21,0 | 87,5 | 108,0 | 8   | 84,0 | 142,0 | 10,5    | IVECO<br>2996043   |
| 24.0124-0229.1 | 424229 |   | B |    |   | V  | 263,0 | 24,0 | 22,0 | 53,0 | 118,0 | 6   | 96,0 | 144,0 | M12x1,5 | NISSAN<br>40206-F3901  |
| 24.0124-0231.2 | 424231 | S | B | HC |   | V● | 350,0 | 24,0 | 22,4 | 66,5 | 120,0 | 5   | 75,0 | 185,0 | 14,5    | BMW<br>34 21 2 283 803   |
| 24.0124-0232.2 | 424232 | S | B | HC |   | V● | 350,0 | 24,0 | 22,4 | 66,5 | 120,0 | 5   | 75,0 | 185,0 | 14,5    | BMW<br>34 21 2 283 804   |
| 24.0124-0233.2 | 424233 | S | B | HC |   | V  | 345,0 | 24,0 | 22,4 | 69,0 | 120,0 | 5   | 75,0 | 185,0 | 16,5    | BMW<br>34 21 6 775 289   |
| 24.0124-0234.2 | 424234 | S | B | HC |   | V● | 370,0 | 24,0 | 22,4 | 61,6 | 120,0 | 5   | 75,0 | 185,0 | 14,5    | BMW<br>34 21 2 282 808   |
| 24.0124-0235.2 | 424235 | S | B | HC |   | V● | 370,0 | 24,0 | 22,4 | 61,6 | 120,0 | 5   | 75,0 | 185,0 | 14,5    | BMW<br>34 21 2 282 807   |
| 24.0124-0236.1 | 424236 | S | B | HC | L | V  | 320,0 | 24,0 | 21,4 | 68,2 | 112,0 | 5   | 67,0 | 180,0 | 15,2    | MERCEDES BENZ<br>000 423 11 12<br>219 423 00 12  |
| 24.0124-0237.1 | 424237 |   | B |    |   | V  | 278,0 | 24,0 | 22,0 | 47,3 | 114,3 | 4   | 60,0 | 141,0 | 12,5    | CHEVROLET<br>96329364  |
| 24.0124-0238.1 | 424238 |   | B |    |   | V  | 280,0 | 24,0 | 22,0 | 44,0 | 114,3 | 4   | 68,0 | 143,2 | 13,0    | NISSAN<br>40206-EM10A<br>40206-ET01C   |
| 24.0124-0239.2 | 424239 | S | B | HC |   | V  | 330,0 | 24,0 | 22,4 | 66,0 | 120,0 | 5   | 75,0 | 172,0 | 16,5    | BMW<br>34 11 6 794 429   |
| 24.0124-0240.1 | 424240 | S | B | HC |   | V  | 307,0 | 24,0 | 22,4 | 45,2 | 120,0 | 5   | 79,0 | 152,0 | 16,5    | MINI<br>34 11 9 804 829  |
| 24.0124-0241.1 | 424241 | S | B | HC |   | V  | 370,0 | 23,9 | 22,4 | 69,0 | 120,0 | 5   | 75,0 | 185,0 | 16,6    | BMW<br>34 21 6 775 291   |
| 24.0124-0242.2 | 424242 | S | B | HC |   | V  | 330,0 | 24,0 | 22,4 | 73,1 | 120,0 | 5   | 79,0 | 171,8 | 14,5    | BMW<br>34 11 6 782 601   |
| 24.0124-0243.1 | 424243 |   | B | HC | L | V  | 254,5 | 24,0 | 22,4 | 40,0 | 108,0 | 5   | 87,0 | 152,5 | 10,6    | HYUNDAI<br>58129-4A100   |
| 24.0124-0245.1 | 424245 |   | B | HC |   | V  | 256,0 | 24,0 | 22,0 | 24,0 | 108,0 | 6   | 86,0 | 155,0 | 10,8    | FORD<br>4883102<br>6M34-1027-CA  |
| 24.0124-0247.1 | 424247 |   | B |    |   | V  | 280,0 | 24,0 | 22,0 | 44,0 | 114,3 | 5   | 68,0 | 144,0 | 12,7    | NISSAN<br>40206-1KA3A  |
| 24.0124-0250.2 | 424250 | S | B | HC |   | V  | 345,0 | 24,0 | 22,4 | 66,1 | 120,0 | 5   | 75,0 | 160,8 | 16,5    | BMW<br>34 20 6 797 605   |
| 24.0124-0251.2 | 424251 | S | B | HC |   | V  | 345,0 | 24,0 | 22,4 | 66,2 | 120,0 | 5   | 75,0 | 185,0 | 16,5    | BMW<br>34 20 6 797 607   |
| 24.0124-0253.1 | 424253 | S | B | HC |   | V  | 280,0 | 24,0 | 21,8 | 44,0 | 100,0 | 4   | 61,0 | 140,0 | 13,5    | DACIA/RENAULT<br>40 20 605 40R<br>40 20 695 18R  |
| 24.0124-0258.1 | 424258 | S | B | HC |   | V  | 276,0 | 24,0 | 21,0 | 49,7 | 112,0 | 9   | 65,0 | 144,0 | 15,3    | SEAT/SKODA/VW<br>5Q0 615 301 A   |
| 24.0124-0259.1 | 424259 | S | B | HC |   | V  | 330,0 | 24,0 | 22,4 | 45,1 | 112,0 | 5   | 67,0 | 151,4 | 16,5    | BMW<br>34 11 6 865 713   |
| 24.0124-0260.1 | 424260 | S | B | HC |   | V  | 307,0 | 24,0 | 22,4 | 45,1 | 112,0 | 5   | 67,0 | 151,0 | 16,5    | BMW<br>34 11 6 799 351   |
| 24.0124-0702.1 | 424702 |   | B |    |   | V  | 280,0 | 24,0 | 22,7 | 81,5 | 114,3 | 5   | 72,0 | 159,0 | 15,5    | JEEP<br>5015 965AA   |
| 24.0124-0706.1 | 424706 |   | B |    |   | V  | 257,0 | 24,0 | 22,4 | 45,5 | 114,3 | 4   | 69,0 | 141,5 | 12,5    | HYUNDAI<br>51712-38100   |
| 24.0124-0723.1 | 424723 |   | B |    |   | V  | 256,0 | 24,0 | 21,0 | 46,8 | 114,3 | 5   | 60,0 | 137,0 | 12,6    | DAEWOO<br>96238673   |
| 24.0124-0724.1 | 424724 |   | B |    |   | V  | 314,0 | 24,0 | 22,4 | 45,2 | 108,0 | 6   | 87,0 | 136,0 | 10,6    | MITSUBISHI<br>MB699716   |
| 24.0124-0735.1 | 424735 |   | B |    |   | V  | 278,0 | 24,0 | 22,0 | 47,0 | 114,3 | 5   | 72,0 | 143,0 | 14,2    | FORD<br>4096352<br>4668068<br>MAZDA<br>EC02-33-25X<br>EF9Y-33-25X  |
| 24.0125-0100.1 | 425100 |   |   | HC |   | V  | 280,0 | 25,0 | 23,4 | 78,0 | 120,0 | 5   | 74,0 | 144,0 | 14,5    | BMW<br>34 11 1 121 902<br>34 11 1 152 296<br>34 11 1 163 141   |
| 24.0125-0102.1 | 425102 |   |   | HC | L | V  | 276,0 | 25,0 | 23,0 | 46,5 | 112,0 | 5   | 68,0 | 135,0 | 15,4    | AUDI<br>447 615 301 A<br>447 615 301 B   |
| 24.0125-0104.1 | 425104 |   |   | HC |   | V  | 282,0 | 25,0 | 23,4 | 76,0 | 120,0 | 5   | 79,0 | 146,0 | 14,5    | BMW<br>34 11 1 163 147   |
| 24.0125-0105.1 | 425105 | S | B | HC |   | V  | 288,0 | 25,0 | 23,0 | 46,5 | 112,0 | 5/9 | 68,0 | 135,0 | 15,4    | AUDI/SEAT/SKODA<br>4A0 615 301 C<br>4A0 615 301 D<br>8E0 615 301 Q   |
| 24.0125-0106.1 | 425106 |   | B | HC |   | V  | 276,0 | 25,0 | 23,0 | 56,5 | 108,0 | 4   | 68,0 | 135,0 | 15,4    | AUDI<br>895 615 301 B  |
| 24.0125-0107.1 | 425107 |   | B | HC | L | V  | 294,0 | 25,0 | 22,4 | 49,5 | 112,0 | 5   | 67,0 | 154,3 | 15,0    | MERCEDES BENZ<br>124 421 24 12   |
| 24.0125-0108.1 | 425108 |   | B | HC |   | V  | 288,0 | 25,0 | 23,0 | 28,5 | 100,0 | 5   | 65,0 | 136,0 | 15,6    | VOLKSWAGEN<br>3A0 615 301 A  |
| 24.0125-0110.1 | 425110 | S | B | HC | L | V  | 288,0 | 25,0 | 22,4 | 46,5 | 112,0 | 5   | 67,0 | 154,3 | 13,2    | CHRYSLER<br>5098 063AA<br>MERCEDES BENZ<br>203 421 03 12<br>210 421 07 12<br>210 421 24 12   |

# Abmessungen Bremsscheiben

## Dimensions brake discs - Misure dischi freno -

## Dimensions Disques de frein - Medidas disco de freno

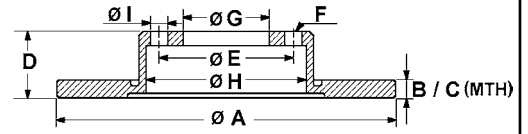

S Fixierschraube - fixing screw - vite di riparazione - vis de fixation - tornillo quefija

B beschichtet - coated - rivestito - revêtu - recubierto

HC hochgekohlt - high carbon - ad alto tenore di carbonio - à haute teneur en carbone - altamente carbonizado

L legiert - alloyed - alligato/legato - allié - aleado

V ventiliert - ventilated - ventilato - ventilé - ventilado

● gelocht - perforated - perforato - poinçonné - perforado

|                |        | S | B | HC | L | V | A     | B    | C    | D    | E     | F   | G     | H     | I        | OE - #  |
|----------------|--------|---|---|----|---|---|-------|------|------|------|-------|-----|-------|-------|----------|---|
| 24.0125-0113.1 | 425113 | S | B | HC |   | V | 288,0 | 25,0 | 22,0 | 34,5 | 100,0 | 5   | 65,0  | 136,0 | 15,6     | AUDI/SEAT/SKODA/VW<br>1J0 615 301 R<br>1J0 615 301 S<br>6R0 615 301 A                         |
| 24.0125-0114.1 | 425114 | S | B | HC |   | V | 288,0 | 25,1 | 21,0 | 55,4 | 112,0 | 5   | 68,2  | 144,2 | 16,5     | FORD<br>SEAT/VW<br>VOLKSWAGEN<br>1045994<br>7M0 615 301 G<br>8E0 615 301 A<br>8E0 615 301 C   |
| 24.0125-0115.1 | 425115 |   | B | HC |   | V | 282,5 | 25,0 | 23,0 | 46,5 | 112,0 | 5   | 68,0  | 135,0 | 15,3     | TOYOTA<br>43512-28060   |
| 24.0125-0116.1 | 425116 |   |   |    |   | V | 255,0 | 25,0 | 23,0 | 52,6 | 114,3 | 5   | 62,0  | 147,0 | 14,4     | FORD<br>1373369   |
| 24.0125-0117.1 | 425117 |   | B | HC |   | V | 278,0 | 25,0 | 23,0 | 48,5 | 108,0 | 5   | 63,5  | 140,0 | 13,7     | 1734696<br>AV61-1125-BB<br>31262718   |
| 24.0125-0118.1 | 425118 |   |   |    |   | V | 257,0 | 25,0 | 23,0 | 46,6 | 110,0 | 5   | 84,0  | 145,0 | M10x1,25 | 43512-26040<br>43512-26070<br>43512-35170<br>43512-35180<br>VOLVO<br>TOYOTA<br>J43 512 351 80 |
| 24.0125-0119.1 | 425119 | S | B | HC | L | V | 288,0 | 25,0 | 22,0 | 42,0 | 110,0 | 5/7 | 70,0  | 139,0 | 14,0     | VOLKSWAGEN<br>OPEL/VAUXHALL<br>SAAB<br>5 69 056/90512029<br>32025723<br>5390786               |
| 24.0125-0123.1 | 425123 | S | B | HC |   | V | 310,0 | 25,0 | 22,0 | 34,5 | 100,0 | 5/9 | 65,0  | 185,0 | 15,6     | AUDI/SEAT/SKODA/VW<br>6R0 615 301 B<br>8N0 615 301 A<br>8L0 615 301                           |
| 24.0125-0124.1 | 425124 |   | B |    |   | V | 255,0 | 24,9 | 24,0 | 49,2 | 100,0 | 5   | 55,0  | 156,0 | 14,5     | AUDI/VW<br>TOYOTA<br>43512-20470<br>43512-20580<br>43512-20700                                |
| 24.0125-0125.1 | 425125 |   |   |    |   | V | 280,0 | 25,0 | 23,0 | 44,0 | 108,0 | 4   | 68,0  | 144,0 | 15,0     | SAAB<br>4002143   |
| 24.0125-0126.1 | 425126 |   |   |    |   | V | 271,0 | 25,0 | 23,0 | 52,8 | 114,3 | 5   | 62,0  | 147,0 | 14,6     | TOYOTA<br>43512-28100   |
| 24.0125-0129.1 | 425129 |   |   |    |   | V | 258,0 | 25,0 | 24,0 | 47,0 | 114,3 | 5   | 62,0  | 161,5 | 14,5     | TOYOTA<br>43512-17070   |
| 24.0125-0130.1 | 425130 |   |   |    |   | V | 282,0 | 25,0 | 23,0 | 34,5 | 114,3 | 4   | 92,0  | 171,0 | M10x1,25 | HONDA<br>45251-SM5-A00  |
| 24.0125-0131.1 | 425131 | S | B | HC | L | V | 280,0 | 24,8 | 22,0 | 42,0 | 110,0 | 5/7 | 70,0  | 139,0 | 14,0     | OPEL/VAUXHALL<br>5 69 066/93197592  |
| 24.0125-0135.1 | 425135 |   |   |    |   | V | 291,0 | 25,0 | 23,0 | 65,8 | 127,0 | 6   | 100,0 | 155,0 | 10,7     | TOYOTA<br>43512-35200   |
| 24.0125-0136.1 | 425136 |   |   | HC |   | V | 256,0 | 25,0 | 23,0 | 39,5 | 100,0 | 4   | 65,0  | 132,2 | 13,6     | VOLKSWAGEN<br>6N0 615 301 E   |
| 24.0125-0137.1 | 425137 | S | B | HC |   | V | 312,0 | 25,0 | 23,0 | 46,5 | 112,0 | 5   | 68,0  | 158,0 | 15,3     | AUDI/SEAT/SKODA<br>4B0 615 301 A<br>8E0 615 301 R   |
| 24.0125-0138.1 | 425138 | S | B | HC |   | V | 325,0 | 24,9 | 23,4 | 52,6 | 120,0 | 5   | 79,0  | 174,0 | 14,5     | BMW<br>34 10 1 166 071<br>34 11 6 864 047   |
| 24.0125-0139.1 | 425139 |   | B | HC | L | V | 276,0 | 24,9 | 23,0 | 56,5 | 112,0 | 5   | 68,0  | 135,0 | 15,5     | AUDI<br>895 615 301 D   |
| 24.0125-0140.1 | 425140 |   | B |    |   | V | 260,0 | 25,0 | 23,0 | 49,2 | 100,0 | 5   | 55,0  | 131,0 | 14,5     | TOYOTA<br>43512-05030   |
| 24.0125-0141.1 | 425141 | S | B | HC |   | V | 285,0 | 24,9 | 22,0 | 42,1 | 110,0 | 5/7 | 70,0  | 139,0 | 14,0     | FIAT<br>51819733<br>71772553  |
| 24.0125-0142.1 | 425142 | S | B | HC | L | V | 308,0 | 25,0 | 22,0 | 42,0 | 110,0 | 5/8 | 70,0  | 139,0 | 14,0     | OPEL/VAUXHALL<br>SAAB<br>5 69 003/93171497<br>9156807<br>93171497                             |
| 24.0125-0143.1 | 425143 |   | B |    |   | V | 275,0 | 25,0 | 23,0 | 49,3 | 114,3 | 5   | 62,0  | 144,0 | 14,5     | TOYOTA<br>43512-42030   |
| 24.0125-0144.1 | 425144 |   |   |    |   | V | 277,0 | 25,0 | 23,0 | 46,2 | 100,0 | 5   | 54,0  | 131,0 | 14,5     | TOYOTA<br>43512-20390   |
| 24.0125-0145.1 | 425145 | S | B | HC |   | V | 288,0 | 25,0 | 22,0 | 49,9 | 112,0 | 5/9 | 65,0  | 144,0 | 15,3     | AUDI/SEAT/SKODA/VW<br>1K0 615 301 T<br>JZW 615 301 J  |
| 24.0125-0146.1 | 425146 |   | B |    |   | V | 282,0 | 25,0 | 23,0 | 47,0 | 114,3 | 4   | 64,0  | 142,5 | 13,0     | VOLKSWAGEN<br>5C0 615 301 A   |
| 24.0125-0147.1 | 425147 |   | B |    |   | V | 282,5 | 25,0 | 23,0 | 48,5 | 114,3 | 5   | 72,0  | 142,0 | 13,0     | HONDA<br>45251-S1A-G00<br>MAZDA<br>GJ6Y-33-25XA   |
| 24.0125-0148.1 | 425148 | S | B | HC | L | V | 280,0 | 25,0 | 22,0 | 42,0 | 100,0 | 4/6 | 60,0  | 139,0 | 14,5     | OPEL/VAUXHALL<br>5 69 006/93175376  |
| 24.0125-0149.1 | 425149 |   | B | HC |   | V | 314,0 | 25,0 | 23,0 | 59,7 | 112,0 | 5   | 68,0  | 144,0 | 15,3     | AUDI<br>4F0 615 301 D   |
| 24.0125-0155.1 | 425155 |   | B |    |   | V | 255,0 | 25,0 | 23,0 | 49,3 | 100,0 | 4   | 55,0  | 131,0 | 14,5     | TOYOTA<br>43512-02070<br>43512-13030<br>43512-47020   |
| 24.0125-0156.1 | 425156 |   | B |    |   | V | 276,0 | 25,0 | 23,0 | 49,2 | 100,0 | 5   | 55,0  | 131,0 | 14,5     | TOYOTA<br>43512-20730   |
| 24.0125-0157.1 | 425157 |   | B |    |   | V | 275,0 | 25,0 | 23,0 | 49,2 | 100,0 | 4   | 55,0  | 129,0 | 14,5     | TOYOTA<br>43512-02080   |
| 24.0125-0158.1 | 425158 | S | B | HC |   | V | 312,0 | 25,0 | 22,0 | 49,9 | 112,0 | 5/9 | 65,0  | 146,0 | 15,3     | AUDI/VW/SKODA<br>1K0 615 301 AA<br>JZW 615 301 H  |
| 24.0125-0160.1 | 425160 | S | B | HC |   | V | 325,0 | 25,0 | 23,4 | 62,2 | 120,0 | 5   | 75,0  | 174,0 | 16,5     | VOLKSWAGEN<br>5C0 615 301 B   |
| 24.0125-0161.1 | 425161 |   |   |    |   | V | 282,0 | 25,0 | 23,0 | 44,5 | 100,0 | 4   | 64,2  | 143,0 | 12,6     | BMW<br>34 11 3 400 151<br>MG<br>SDB000440   |





# Abmessungen Bremsscheiben

## Dimensions brake discs - Misure dischi freno -

## Dimensions Disques de frein - Medidas disco de freno

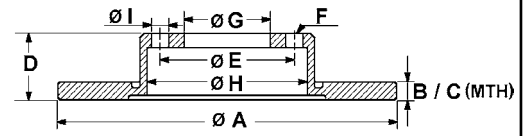

S Fixierschraube - fixing screw - vite di riparazione - vis de fixation - tornillo quefija

B beschichtet - coated - rivestito - revêtu - recubierto

HC hochgekohlt - high carbon - ad alto tenore di carbonio - à haute teneur en carbone - altamente carbonizado

L legiert - alloyed - alligato/legato - allié - aleado

V ventiliert - ventilated - ventilato - ventilé - ventilado

● gelocht - perforated - perforato - poinçonné - perforado

|                |        | S | B | HC | L | V | A     | B    | C    | D    | E     | F    | G    | H     | I    | OE - #                 |  |
|----------------|--------|---|---|----|---|---|-------|------|------|------|-------|------|------|-------|------|------------------------|--|
| 24.0125-0162.1 | 425162 |   | B | HC |   | V | 300,0 | 25,0 | 23,0 | 48,5 | 108,0 | 5    | 63,5 | 140,0 | 13,7 | FORD<br>VOLVO          | 1253965<br>1373370<br>1520297<br>1797226<br>DV61-1125-DA<br>274510<br>31341643<br>31362412<br>31381375<br>31400937<br>31400941 |
| 24.0125-0164.1 | 425164 |   | B |    |   | V | 297,0 | 25,0 | 22,0 | 64,7 | 120,0 | 5    | 70,0 | 161,5 | 14,3 | LAND ROVER             | NTC8780  |
| 24.0125-0165.1 | 425165 |   | B | HC |   | V | 278,0 | 25,0 | 23,0 | 48,5 | 114,3 | 5    | 72,0 | 140,0 | 14,0 | MAZDA                  | BP4Y-33-25XC<br>C24Y-33-25XB<br>C24Y-33-25XC<br>C24Y-33-25XD   |
| 24.0125-0167.1 | 425167 | S | B | HC | L | V | 288,0 | 25,0 | 22,4 | 44,5 | 112,0 | 5    | 67,0 | 154,3 | 15,3 | MERCEDES BENZ          | 169 421 11 12  |
| 24.0125-0168.1 | 425168 |   | B |    |   | V | 275,0 | 25,0 | 23,0 | 49,2 | 100,0 | 4    | 55,0 | 131,0 | 14,6 | TOYOTA                 | 43512-13022  |
| 24.0125-0170.1 | 425170 |   | B | HC |   | V | 300,0 | 25,0 | 23,0 | 48,5 | 114,3 | 5    | 72,0 | 140,0 | 14,0 | MAZDA                  | BP6Y-33-25XE<br>C26Y-33-25XB   |
| 24.0125-0171.1 | 425171 |   | B | HC |   | V | 288,0 | 25,0 | 23,0 | 46,5 | 112,0 | 5/10 | 68,0 | 137,0 | 15,3 | SKODA/VW               | 4B0 615 301 B  |
| 24.0125-0172.1 | 425172 |   | B | HC |   | V | 312,0 | 25,0 | 23,0 | 46,5 | 112,0 | 5/10 | 68,0 | 140,0 | 15,3 | SKODA/VW               | 4B0 615 301 C  |
| 24.0125-0173.1 | 425173 | S | B |    |   | V | 300,0 | 25,0 | 23,0 | 47,2 | 114,3 | 5    | 64,1 | 141,0 | 12,7 | HONDA                  | 45251-SM6-A10  |
| 24.0125-0174.1 | 425174 |   | B |    |   | V | 300,0 | 25,0 | 23,0 | 47,2 | 114,3 | 5    | 64,2 | 142,0 | 12,6 | HONDA                  | 45251-SEA-E30  |
| 24.0125-0176.1 | 425176 |   | B |    |   | V | 297,5 | 25,0 | 22,0 | 91,5 | 120,0 | 5    | 70,1 | 161,1 | 14,3 | LAND ROVER             | SDB000380  |
| 24.0125-0177.1 | 425177 |   | B |    |   | V | 257,0 | 24,5 | 22,4 | 47,6 | 114,3 | 4    | 69,0 | 141,5 | 12,5 | KIA                    | 51712-3C000  |
| 24.0125-0178.1 | 425178 |   | B |    |   | V | 275,0 | 25,0 | 22,0 | 46,5 | 114,3 | 5    | 62,0 | 145,0 | 14,5 | TOYOTA                 | 43512-42040  |
| 24.0125-0179.1 | 425179 | S | B | HC | L | V | 288,0 | 25,0 | 22,4 | 64,5 | 112,0 | 5    | 67,0 | 154,3 | 15,2 | MERCEDES BENZ          | 000 421 19 12  |
| 24.0125-0182.1 | 425182 | S |   |    |   | V | 300,0 | 25,0 | 23,0 | 47,1 | 114,3 | 5    | 64,1 | 141,0 | 12,7 | HONDA                  | 45251-S9A-E50  |
| 24.0125-0183.1 | 425183 |   |   |    |   | V | 282,0 | 25,0 | 23,0 | 47,0 | 114,3 | 5    | 64,1 | 142,5 | 13,0 | HONDA                  | 45251-S1A-E40<br>45251-S9A-E50   |
| 24.0125-0184.1 | 425184 | S | B | HC |   | V | 314,0 | 25,0 | 23,0 | 52,4 | 112,0 | 5    | 68,0 | 154,0 | 15,3 | AUDI                   | 8K0 615 301  |
| 24.0125-0187.1 | 425187 |   | B |    |   | V | 280,0 | 25,0 | 23,0 | 47,2 | 114,3 | 5    | 64,1 | 142,2 | 13,0 | HONDA                  | 45251-SEA-E00  |
| 24.0125-0188.1 | 425188 |   | B |    |   | V | 299,0 | 25,0 | 23,0 | 48,4 | 114,3 | 5    | 72,0 | 142,8 | 13,0 | MAZDA                  | G33Y-33-25X  |
| 24.0125-0189.1 | 425189 | S | B |    |   | V | 281,5 | 25,0 | 23,0 | 47,2 | 114,3 | 5    | 64,1 | 142,5 | 12,5 | HONDA                  | 45251-SJH-E10  |
| 24.0125-0190.1 | 425190 |   | B |    |   | V | 294,5 | 25,0 | 23,0 | 49,0 | 114,3 | 5    | 62,0 | 154,0 | 12,6 | SUZUKI                 | 55211-65J00  |
| 24.0125-0195.1 | 425195 |   | B | HC |   | V | 320,0 | 25,0 | 23,0 | 48,5 | 114,3 | 5    | 72,0 | 148,0 | 13,7 | MAZDA                  | B37F-33-25XA   |
| 24.0125-0196.1 | 425196 |   | B |    |   | V | 255,0 | 25,0 | 22,0 | 49,2 | 100,0 | 5    | 55,0 | 136,0 | 14,5 | TOYOTA                 | 43512-47040  |
| 24.0125-0197.1 | 425197 |   | B | HC |   | V | 320,0 | 25,0 | 23,0 | 48,5 | 108,0 | 5    | 63,5 | 148,0 | 13,7 | FORD<br>VOLVO          | 1724956<br>3M51-2C375-CE<br>31302573<br>31329122<br>31341644<br>31381376<br>31400818<br>31400938<br>31400942                   |
| 24.0125-0198.1 | 425198 | S | B | HC | L | V | 280,0 | 25,0 | 22,0 | 43,2 | 100,0 | 4/6  | 60,0 | 139,0 | 14,5 | OPEL/VAUXHALL          | 5 69 007/93181113<br>5 69 067/93197712   |
| 24.0125-0199.1 | 425199 |   | B | HC |   | V | 278,0 | 25,0 | 23,0 | 48,5 | 108,0 | 5    | 63,5 | 140,0 | 13,7 | FORD                   | 1790221  |
| 24.0125-0200.1 | 425200 | S | B | HC | L | V | 280,0 | 25,0 | 22,4 | 51,0 | 112,0 | 5    | 67,0 | 144,5 | 15,0 | MERCEDES BENZ          | AV61-1125-DB<br>246 421 11 12  |
| 24.0125-0208.1 | 425208 |   | B |    |   | V | 295,0 | 25,0 | 23,0 | 51,5 | 114,3 | 5    | 68,0 | 143,0 | 13,0 | MAZDA                  | B45G-33-251A<br>BJT2-33-251A   |
| 24.0125-0209.1 | 425209 |   | B | HC |   | V | 320,0 | 25,0 | 23,0 | 48,7 | 108,0 | 5    | 63,5 | 148,0 | 13,7 | FORD                   | 1770767<br>1829608<br>CV61-1125-GA<br>DV61-1125-FA   |
| 24.0125-0210.1 | 425210 |   | B |    |   | V | 278,0 | 25,0 | 23,0 | 39,8 | 108,0 | 4    | 63,5 | 136,2 | 14,0 | FORD                   | 1854394<br>CN15-1125-CA  |
| 24.0125-0700.1 | 425700 |   |   |    |   | V | 275,0 | 25,0 | 23,0 | 49,2 | 100,0 | 5    | 55,0 | 129,0 | 14,5 | TOYOTA                 | 42512-20711  |
| 24.0125-0706.1 | 425706 |   |   |    |   | V | 300,0 | 25,0 | 23,0 | 39,7 | 114,3 | 5    | 70,2 | 142,5 | 12,6 | HONDA                  | 45251-S2A-000  |
| 24.0126-0100.1 | 426100 |   |   | HC | L | V | 283,0 | 26,0 | 24,0 | 48,0 | 108,0 | 5    | 71,0 | 130,5 | 13,0 | CITROEN                | 95 661 813<br>96 099 616   |
| 24.0126-0101.1 | 426101 |   | B |    |   | V | 280,3 | 26,0 | 23,0 | 50,3 | 108,0 | 4    | 68,0 | 139,0 | 14,5 | PEUGEOT                | 4246 N8  |
| 24.0126-0102.1 | 426102 |   | B |    |   | V | 280,3 | 26,0 | 23,0 | 50,3 | 108,0 | 5    | 68,0 | 139,0 | 14,5 | VOLVO                  | 271590<br>271788<br>272312   |
| 24.0126-0103.1 | 426103 |   |   |    |   | V | 281,0 | 26,0 | 24,2 | 43,7 | 98,0  | 5    | 59,0 | 127,0 | 13,0 | ALFA ROMEO             | 60621051   |
| 24.0126-0104.1 | 426104 |   | B |    |   | V | 281,0 | 26,0 | 24,2 | 43,7 | 98,0  | 5    | 59,0 | 127,0 | 16,5 | CITROEN                | 4246 J3<br>4249 H5   |
|                |        |   |   |    |   |   |       |      |      |      |       |      |      |       |      | FIAT/LANCIA<br>PEUGEOT | 1317651080<br>4246 J2<br>4249 H5   |



# Abmessungen Bremsscheiben

## Dimensions brake discs - Misure dischi freno -

## Dimensions Disques de frein - Medidas disco de freno

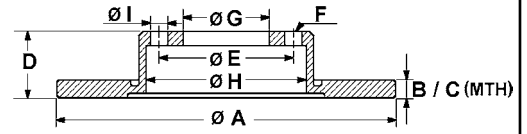

S Fixierschraube - fixing screw - vite di riparazione - vis de fixation - tornillo quefija

B beschichtet - coated - rivestito - revêtu - recubierto

HC hochgekohlt - high carbon - ad alto tenore di carbonio - à haute teneur en carbone - altamente carbonizado

L legiert - alloyed - alligato/legato - allié - aleado

V ventiliert - ventilated - ventilato - ventilé - ventilado

● gelocht - perforated - perforato - poinçonné - perforado

|                |        | S | B | HC | L | V  | A     | B    | C    | D    | E     | F    | G     | H     | I        | OE - #                   |  |
|----------------|--------|---|---|----|---|----|-------|------|------|------|-------|------|-------|-------|----------|--------------------------|--|
| 24.0126-0105.1 | 426105 |   | B |    |   | V  | 280,0 | 26,0 | 23,0 | 56,3 | 108,0 | 5    | 68,0  | 139,0 | 14,0     | VOLVO                    | 31262209<br>3516567<br>6848902                             |
| 24.0126-0106.1 | 426106 | S | B |    |   | V  | 283,0 | 26,0 | 24,2 | 28,2 | 108,0 | 4    | 66,0  | 133,5 | 13,0     | CITROEN<br>PEUGEOT       | 4246 L8<br>4246 R7   |
| 24.0126-0107.1 | 426107 |   | B | HC |   | V  | 302,0 | 26,0 | 23,0 | 50,0 | 108,0 | 5    | 68,0  | 151,0 | 14,4     | VOLVO                    | 272276   |
| 24.0126-0108.1 | 426108 |   | B |    |   | V  | 257,0 | 26,0 | 24,0 | 52,5 | 114,3 | 5    | 68,0  | 139,5 | 12,8     | NISSAN                   | 40206-9C100<br>40206-9C101                                 |
| 24.0126-0109.1 | 426109 |   | B |    |   | V  | 277,0 | 26,0 | 24,0 | 39,0 | 124,0 | 6    | 100,0 | 164,0 | M10x1,25 | FORD<br>NISSAN           | 1954433<br>40206-0F000<br>40206-0F001<br>40206-31G01       |
| 24.0126-0111.1 | 426111 |   | B |    |   | V  | 280,0 | 26,0 | 24,6 | 36,0 | 109,0 | 6    | 88,0  | 175,0 | M12x1,25 | ISUZU                    | 97034034<br>97034035                                       |
|                |        |   |   |    |   |    |       |      |      |      |       |      |       |       |          | OPEL/AUXHALL             | 5 69 050/97034034<br>5 69 051/97034035                     |
| 24.0126-0112.1 | 426112 |   |   |    |   | V  | 257,0 | 26,0 | 24,0 | 45,5 | 100,0 | 4    | 61,0  | 148,0 | 12,8     | NISSAN                   | 40206-54C01  |
| 24.0126-0114.1 | 426114 |   |   |    |   | V  | 281,0 | 26,0 | 24,2 | 54,2 | 98,0  | 5    | 59,0  | 127,0 | 13,2     | LANCIA                   | 82476515   |
| 24.0126-0115.1 | 426115 |   | B | HC |   | V  | 300,0 | 26,0 | 22,0 | 56,0 | 112,0 | 5    | 68,2  | 144,0 | 16,5     | FORD                     | 1141782  |
| 24.0126-0116.1 | 426116 |   | B | HC |   | V  | 303,0 | 26,0 | 23,0 | 51,5 | 112,0 | 5    | 67,0  | 168,0 | 15,0     | SEAT/VW<br>MERCEDES BENZ | 7M3 615 301 A<br>163 421 02 12<br>163 421 04 12            |
| 24.0126-0119.1 | 426119 |   | B | HC |   | V  | 313,0 | 25,9 | 22,0 | 56,2 | 112,0 | 5    | 68,2  | 148,0 | 16,5     | FORD<br>SEAT/VW          | 1108038<br>7M3 615 301                                     |
| 24.0126-0120.1 | 426120 | S | B |    |   | V  | 283,0 | 26,0 | 24,0 | 34,2 | 108,0 | 4    | 66,0  | 133,5 | 13,0     | CITROEN                  | 4246 W2<br>4249 18<br>4249 84<br>4249 J6<br>16 064 014 80  |
|                |        |   |   |    |   |    |       |      |      |      |       |      |       |       |          | PEUGEOT                  | 4246 W8<br>4249 17<br>4249 84<br>4249 J6                   |
| 24.0126-0121.1 | 426121 | S | B | HC | L | V  | 283,0 | 26,0 | 24,0 | 48,3 | 108,0 | 5    | 71,1  | 133,0 | 13,2     | PEUGEOT                  | 4246 P7<br>4246 V4<br>4249 L3                              |
| 24.0126-0122.1 | 426122 |   | B |    |   | V  | 285,5 | 26,0 | 23,0 | 50,3 | 108,0 | 5    | 68,0  | 139,0 | 16,5     | VOLVO                    | 272403<br>946133   |
| 24.0126-0123.1 | 426123 |   | B | HC |   | V  | 300,0 | 26,0 | 22,8 | 47,0 | 108,0 | 5    | 61,0  | 139,6 | 13,5     | RENAULT                  | 82 00 007 122<br>86 71 016 878                             |
| 24.0126-0125.1 | 426125 |   | B |    |   | V  | 281,0 | 26,0 | 24,2 | 43,5 | 98,0  | 4    | 59,0  | 127,0 | 13,0     | FIAT                     | 46535086<br>46765546                                       |
| 24.0126-0126.1 | 426126 |   | B |    |   | V  | 276,0 | 26,0 | 24,0 | 46,2 | 114,3 | 5    | 69,0  | 141,5 | 12,6     | HYUNDAI                  | 51712-3B000  |
| 24.0126-0127.1 | 426127 |   | B |    |   | V  | 294,0 | 26,0 | 24,4 | 46,1 | 114,3 | 5    | 69,0  | 145,0 | 12,6     | HYUNDAI                  | 51712-26100  |
| 24.0126-0128.1 | 426128 |   | B | HC | L | V  | 280,0 | 26,0 | 24,4 | 47,4 | 114,3 | 5    | 69,0  | 141,5 | 12,5     | HYUNDAI<br>KIA           | 51712-3K050<br>51712-1F000<br>51712-2C000<br>51712-3K050   |
| 24.0126-0129.1 | 426129 |   | B |    |   | V  | 280,0 | 26,0 | 24,4 | 47,3 | 114,3 | 4    | 69,0  | 141,4 | 12,7     | HYUNDAI                  | 51712-3C100<br>51712-3D300                                 |
| 24.0126-0130.1 | 426130 |   | B |    |   | V  | 305,0 | 26,0 | 24,5 | 63,5 | 127,0 | 5    | 72,0  | 170,0 | 15,5     | JEEP                     | 5209 8672  |
| 24.0126-0131.1 | 426131 |   | B |    |   | V  | 276,0 | 26,0 | 24,4 | 45,5 | 114,3 | 4    | 69,0  | 145,0 | 12,5     | NISSAN                   | MR510742   |
| 24.0126-0133.1 | 426133 |   |   |    |   | V  | 281,0 | 26,0 | 24,2 | 47,2 | 108,0 | 5/10 | 59,0  | 134,0 | 14,5     | ALFA/FIAT                | 46449390<br>60814639<br>71739635                           |
| 24.0126-0134.1 | 426134 |   | B |    |   | V  | 276,0 | 26,0 | 24,4 | 45,5 | 114,3 | 5    | 69,0  | 145,0 | 12,5     | NISSAN                   | MR510966   |
| 24.0126-0135.1 | 426135 |   | B |    |   | V  | 274,0 | 26,2 | 24,0 | 48,5 | 114,3 | 5    | 72,0  | 140,5 | 13,0     | KIA                      | 0K55A-33-251<br>0K55B-33-251                               |
| 24.0126-0136.1 | 426136 |   | B | HC | L | V● | 330,0 | 26,0 | 24,0 | 68,2 | 112,0 | 5    | 67,0  | 180,0 | 15,0     | MERCEDES BENZ            | 211 423 11 12  |
| 24.0126-0137.1 | 426137 |   | B | HC | L | V● | 330,0 | 26,0 | 24,0 | 61,0 | 112,0 | 5    | 67,0  | 180,0 | 17,0     | MERCEDES BENZ            | 220 423 09 12  |
| 24.0126-0138.1 | 426138 |   | B |    |   | V  | 295,0 | 26,0 | 24,0 | 49,2 | 114,3 | 5    | 62,0  | 141,0 | 14,5     | TOYOTA                   | 43512-0F010<br>43512-05080                                 |
| 24.0126-0139.1 | 426139 |   | B |    |   | V  | 277,0 | 26,0 | 24,0 | 49,5 | 100,0 | 5    | 55,0  | 129,0 | 14,5     | TOYOTA                   | 43512-05040  |
| 24.0126-0140.1 | 426140 | S | B |    |   | V  | 302,0 | 26,0 | 24,0 | 34,2 | 108,0 | 4    | 66,0  | 133,0 | 13,0     | CITROEN                  | 4249 33<br>96 876 021 80<br>96 876 021 80<br>98 092 662 80 |
|                |        |   |   |    |   |    |       |      |      |      |       |      |       |       |          | PEUGEOT                  | 43512-05050<br>43512-05070                                 |
| 24.0126-0141.1 | 426141 |   | B |    |   | V  | 295,0 | 26,0 | 24,0 | 49,5 | 100,0 | 5    | 55,0  | 141,0 | 14,5     | TOYOTA                   | 43512-05050<br>43512-05070                                 |
| 24.0126-0142.1 | 426142 |   |   | HC |   | V  | 300,0 | 26,0 | 22,8 | 44,0 | 108,0 | 5    | 61,0  | 139,6 | 15,6     | RENAULT                  | 82 00 196 263  |
| 24.0126-0143.1 | 426143 | S | B | HC | L | V  | 280,0 | 26,0 | 24,0 | 48,5 | 114,3 | 4    | 72,0  | 143,5 | 13,0     | KIA                      | 0K2FA-33-251   |
| 24.0126-0144.1 | 426144 |   |   | HC | L | V  | 290,0 | 26,0 | 23,0 | 70,0 | 96,0  | 8    | 70,0  | 135,0 | 14,5     | MERCEDES BENZ            | 905 421 00 12  |



# Abmessungen Bremsscheiben

## Dimensions brake discs - Misure dischi freno -

## Dimensions Disques de frein - Medidas disco de freno

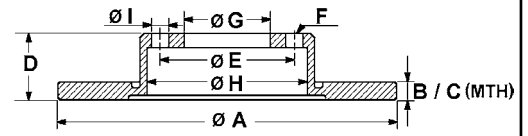

S Fixierschraube - fixing screw - vite di riparazione - vis de fixation - tornillo quefija

B beschichtet - coated - rivestito - revêtu - recubierto

HC hochgekohlt - high carbon - ad alto tenore di carbonio - à haute teneur en carbone - altamente carbonizado

L legiert - alloyed - alligato/legato - allié - aleado

V ventiliert - ventilated - ventilato - ventilé - ventilado

● gelocht - perforated - perforato - poinçonné - perforado

|                |        | S | B | HC | L  | V | A     | B     | C    | D    | E     | F     | G     | H     | I         | OE            | #   |                 |
|----------------|--------|---|---|----|----|---|-------|-------|------|------|-------|-------|-------|-------|-----------|---------------|---|-----------------|
| 24.0126-0145.1 | 426145 |   | B |    |    | V | 290,0 | 26,0  | 24,4 | 46,3 | 139,7 | 6     | 94,0  | 171,0 | 12,8      | MITSUBISHI    | 4615A061<br>MR407116<br>MR407289                            |                 |
| 24.0126-0146.1 | 426146 |   | B | HC | L  | V | 278,0 | 26,0  | 23,0 | 43,3 | 110,0 | 5/7   | 70,0  | 136,0 | 14,0      | OPEL/VAUXHALL | 55 69 026/93188919  |                 |
| 24.0126-0148.1 | 426148 |   | B |    |    | V | 273,0 | 26,0  | 23,0 | 49,2 | 114,3 | 5     | 62,0  | 142,0 | 14,8      | TOYOTA        | 43512-02180   |                 |
| 24.0126-0149.1 | 426149 |   | S | B  | HC | L | V     | 330,0 | 26,0 | 23,4 | 58,2  | 112,0 | 5     | 67,0  | 180,0     | 15,0          | MERCEDES BENZ   | 230 423 08 12   |
| 24.0126-0150.1 | 426150 |   | B | HC | L  | V | 280,0 | 26,0  | 24,4 | 47,2 | 114,3 | 5     | 69,0  | 143,5 | 12,5      | HYUNDAI/KIA   | 51712-1H000<br>51712-1H100<br>51712-2K100                   |                 |
| 24.0126-0151.1 | 426151 |   | B |    |    | V | 303,0 | 26,0  | 24,0 | 47,0 | 114,3 | 5     | 72,0  | 159,0 | 14,0      | KIA           | 4668070   |                 |
| 24.0126-0152.2 | 426152 |   | S | B  | HC |   | V     | 338,0 | 25,9 | 24,4 | 73,0  | 120,0 | 5     | 79,0  | 171,5     | 14,5          | FORD  | 34 11 6 778 647 |
| 24.0126-0154.1 | 426154 |   | B |    |    | V | 295,5 | 26,0  | 24,0 | 44,0 | 114,3 | 5     | 68,0  | 146,5 | 12,7      | BMW           | 40206-JD00A<br>40206-JG00A                                  |                 |
| 24.0126-0155.1 | 426155 |   | S | B  |    | V | 275,0 | 26,0  | 24,0 | 47,3 | 114,3 | 4     | 69,0  | 141,6 | 13,0      | NISSAN        | 51712-2F100   |                 |
| 24.0126-0156.1 | 426156 |   | B |    |    | V | 295,0 | 26,0  | 23,0 | 49,1 | 114,3 | 5     | 62,0  | 143,2 | 14,8      | KIA           | 43512-02190   |                 |
| 24.0126-0157.1 | 426157 |   | B |    |    | V | 275,0 | 26,0  | 24,0 | 47,4 | 114,3 | 5     | 69,0  | 143,3 | 12,5      | TOYOTA        | 43512-0F030<br>43512-12680                                  |                 |
| 24.0126-0158.1 | 426158 |   | S | B  | HC | L | V     | 296,0 | 26,0 | 23,4 | 44,0  | 114,3 | 5     | 68,0  | 147,7     | 15,8          | HYUNDAI   | 51712-2H000     |
| 24.0126-0159.1 | 426159 |   | S | B  |    | V | 302,0 | 26,0  | 24,0 | 34,2 | 108,0 | 4     | 66,0  | 133,2 | 13,0      | RENAULT       | 40 20 600 02R<br>40 20 668 13R<br>40 20 670 23R             |                 |
| 24.0126-0160.1 | 426160 |   | B |    |    | V | 320,0 | 26,0  | 23,0 | 49,3 | 114,3 | 5     | 62,0  | 143,0 | 14,5      | CITROEN       | 4249 81<br>4249 86<br>4249 J8                               |                 |
| 24.0126-0161.1 | 426161 |   | B | HC | L  | V | 290,0 | 26,0  | 23,0 | 42,5 | 120,0 | 10    | 102,0 | 144,5 | 10,5      | PEUGEOT       | 4249 64<br>4249 80<br>4249 81<br>4249 86<br>4249 J8         |                 |
| 24.0126-0162.1 | 426162 |   | B |    |    | V | 290,0 | 26,0  | 24,4 | 45,8 | 114,3 | 5     | 69,0  | 145,5 | 12,6      | TOYOTA        | 43512-05090   |                 |
| 24.0126-0163.1 | 426163 |   | B |    |    | V | 290,0 | 26,0  | 23,0 | 53,0 | 118,0 | 6     | 96,0  | 134,0 | M12x1,5   | RENAULT       | 50 10 260 603   |                 |
| 24.0126-0164.1 | 426164 |   | B |    |    | V | 276,0 | 26,0  | 24,4 | 45,5 | 114,3 | 5     | 69,0  | 146,0 | 12,5      | MITSUBISHI    | MN116979  |                 |
| 24.0126-0165.1 | 426165 |   | S | B  |    | V | 276,0 | 26,0  | 23,0 | 45,5 | 105,0 | 5     | 60,0  | 139,0 | 14,2      | NISSAN        | 40206-9X403<br>40206-9X40B<br>50 01 871 214                 |                 |
| 24.0126-0166.1 | 426166 |   | S | B  | HC | V | 300,0 | 26,0  | 23,0 | 45,5 | 115,0 | 5     | 70,7  | 149,0 | 14,2      | RENAULT       | 50 01 871 214   |                 |
| 24.0126-0168.1 | 426168 |   | S | B  |    | V | 281,0 | 26,2  | 24,2 | 39,8 | 110,0 | 5/5   | 70,0  | 138,0 | 16,6/11,0 | CHEVROLET     | 13502045<br>13502824  |                 |
| 24.0126-0169.1 | 426169 |   | B |    |    | V | 274,0 | 26,0  | 24,4 | 44,2 | 108,0 | 5     | 87,0  | 132,0 | 10,5      | OPEL/VAUXHALL | 5 69 073/13502044   |                 |
| 24.0126-0170.1 | 426170 |   | B |    |    | V | 294,0 | 26,0  | 24,4 | 45,8 | 114,3 | 5     | 69,0  | 145,0 | 13,1      | CHEVROLET     | 13502052  |                 |
| 24.0126-0171.1 | 426171 |   | B | HC | L  | V | 280,0 | 26,0  | 24,0 | 47,3 | 114,3 | 5     | 69,0  | 141,5 | 12,6      | OPEL/VAUXHALL | 5 69 070/13502052<br>5 69 076/13502051<br>5 69 082/13503988 |                 |
| 24.0126-0172.1 | 426172 |   | B |    |    | V | 300,0 | 26,0  | 24,0 | 49,5 | 114,3 | 5     | 62,0  | 150,2 | 12,8      | FIAT          | 51806278<br>51815312<br>51937306                            |                 |
| 24.0126-0174.1 | 426174 |   | B | HC | L  | V | 376,0 | 26,0  | 24,0 | 42,0 | 108,0 | 5     | 64,5  | 167,6 | 14,0      | JEEP          | 51962485  |                 |
| 24.0126-0175.1 | 426175 |   | B |    |    | V | 257,0 | 26,0  | 24,0 | 53,7 | 114,3 | 4     | 68,0  | 144,0 | 12,8      | HYUNDAI       | 58129-4A200   |                 |
| 24.0126-0176.1 | 426176 |   | S | B  | HC | L | V     | 302,0 | 26,0 | 24,0 | 34,2  | 108,0 | 5     | 66,0  | 133,5     | 13,2          | CITROEN   | 16 075 005 80   |
| 24.0126-0177.1 | 426177 |   | B |    |    | V | 296,0 | 26,0  | 24,0 | 44,0 | 114,3 | 5     | 68,0  | 146,0 | 12,7      | CHRYSLER      | 5105 514AA<br>5105 514AA                                    |                 |
| 24.0126-0180.1 | 426180 |   | S | B  | HC | L | V     | 280,0 | 26,0 | 23,8 | 45,0  | 108,0 | 5     | 61,0  | 139,8     | 15,8          | NISSAN  | 4615A117        |
| 24.0126-0182.1 | 426182 |   | S | B  | HC | V | 300,0 | 26,0  | 23,0 | 45,2 | 105,0 | 5     | 60,0  | 149,0 | 14,2      | PEUGEOT       | 16 075 005 80   |                 |
| 24.0126-0183.1 | 426183 |   | S | B  | HC | L | V     | 283,0 | 26,0 | 24,0 | 48,0  | 108,0 | 5     | 71,0  | 134,0     | 13,3          | PEUGEOT   | 40206-3LG0A     |
| 24.0126-0184.1 | 426184 |   | B |    |    | V | 277,0 | 26,0  | 23,0 | 49,3 | 114,3 | 5     | 62,0  | 142,0 | 14,6      | NISSAN        | 40206-3L000   |                 |
| 24.0126-0185.1 | 426185 |   | B | HC | L  | V | 296,0 | 26,0  | 24,0 | 44,0 | 114,3 | 5     | 68,0  | 148,0 | 12,8      | KIA           | 51712-1D100   |                 |
| 24.0126-0186.1 | 426186 |   | S | B  | HC | V | 280,0 | 26,0  | 23,8 | 45,0 | 108,0 | 5     | 61,0  | 139,7 | 15,8      | SUZUKI        | 55311-57L00   |                 |
|                |        |   |   |    |    |   |       |       |      |      |       |       |       |       |           | JAGUAR        | C2P 13648   |                 |
|                |        |   |   |    |    |   |       |       |      |      |       |       |       |       |           | NISSAN        | 40206-JX00A<br>40206-3L00A                                  |                 |
|                |        |   |   |    |    |   |       |       |      |      |       |       |       |       |           | PEUGEOT       | 4249 F8   |                 |
|                |        |   |   |    |    |   |       |       |      |      |       |       |       |       |           | NISSAN        | 40206-1KC1A<br>40206-1KC3A                                  |                 |
|                |        |   |   |    |    |   |       |       |      |      |       |       |       |       |           | MERCEDES BENZ | 415 421 04 12   |                 |
|                |        |   |   |    |    |   |       |       |      |      |       |       |       |       |           | CHEVROLET     | 13502059  |                 |
|                |        |   |   |    |    |   |       |       |      |      |       |       |       |       |           | OPEL/VAUXHALL | 5 69 091/13502059   |                 |
|                |        |   |   |    |    |   |       |       |      |      |       |       |       |       |           | CITROEN       | 98 059 614 80   |                 |
|                |        |   |   |    |    |   |       |       |      |      |       |       |       |       |           | PEUGEOT       | 98 039 181 80   |                 |
|                |        |   |   |    |    |   |       |       |      |      |       |       |       |       |           | TOYOTA        | 43512-02330   |                 |
|                |        |   |   |    |    |   |       |       |      |      |       |       |       |       |           | NISSAN        | 40206-4EA0A<br>40206-4BA0A                                  |                 |
|                |        |   |   |    |    |   |       |       |      |      |       |       |       |       |           | RENAULT       | 40 20 666 24R   |                 |
|                |        |   |   |    |    |   |       |       |      |      |       |       |       |       |           | RENAULT       | 40 20 682 34R   |                 |

# Abmessungen Bremsscheiben

## Dimensions brake discs - Misure dischi freno -

## Dimensions Disques de frein - Medidas disco de freno

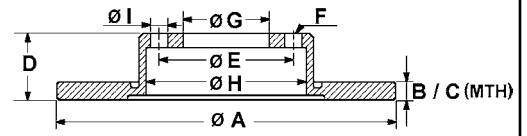

S Fixierschraube - fixing screw - vite di riparazione - vis de fixation - tornillo quefija

B beschichtet - coated - rivestito - revêtu - recubierto

HC hochgekohlt - high carbon - ad alto tenore di carbonio - à haute teneur en carbone - altamente carbonizado

L legiert - alloyed - alligato/legato - allié - aleado

V ventiliert - ventilated - ventilato - ventilé - ventilado

● gelocht - perforated - perforato - poinçonné - perforado

|                |        | S | B | HC | L | V | A     | B    | C    | D    | E     | F    | G    | H     | I    | OE - #        |   |
|----------------|--------|---|---|----|---|---|-------|------|------|------|-------|------|------|-------|------|---------------|---|
| 24.0127-0100.1 | 427100 |   | B |    |   | V | 281,0 | 27,0 | 25,4 | 42,7 | 108,0 | 6    | 87,0 | 136,0 | 10,6 | HYUNDAI       | 51712-H1000   |
| 24.0127-0101.1 | 427101 |   |   |    |   | V | 276,0 | 27,0 | 25,4 | 45,2 | 108,0 | 6    | 87,0 | 136,0 | 10,6 | MITSUBISHI    | MB928120  |
| 24.0128-0100.1 | 428100 | S | B | HC | L | ● | 295,0 | 28,0 | 26,0 | 64,5 | 112,0 | 5    | 67,0 | 154,3 | 15,2 | MERCEDES BENZ | 204 421 36 12   |
| 24.0128-0101.1 | 428101 |   | B | HC |   | V | 302,0 | 28,0 | 26,4 | 75,9 | 120,0 | 5    | 79,0 | 149,0 | 14,5 | BMW           | 34 11 6 756 090   |
| 24.0128-0102.1 | 428102 |   | B | HC | L | V | 300,0 | 28,0 | 25,4 | 68,3 | 112,0 | 5    | 80,0 | 145,0 | 15,0 | MERCEDES BENZ | 126 421 05 12   |
| 24.0128-0103.1 | 428103 |   | B | HC | L | V | 300,0 | 28,0 | 25,4 | 45,5 | 112,0 | 5    | 67,0 | 154,3 | 15,0 | MERCEDES BENZ | 129 421 20 12   |
| 24.0128-0104.1 | 428104 | S | B | HC | L | V | 296,0 | 28,0 | 25,0 | 58,4 | 110,0 | 5    | 70,0 | 139,0 | 14,0 | OPEL/VAUXHALL | 5 69 044/90392559<br>5 69 016/93182283  |
| 24.0128-0105.1 | 428105 | S | B | HC |   | V | 316,0 | 28,0 | 26,4 | 77,0 | 120,0 | 5    | 79,0 | 159,0 | 14,5 | BMW           | 34 11 6 757 752   |
| 24.0128-0106.1 | 428106 | S | B | HC | L | V | 300,0 | 28,0 | 25,4 | 46,5 | 112,0 | 5    | 67,0 | 154,0 | 13,3 | CHRYSLER      | 5098 064AC  |
|                |        |   |   |    |   |   |       |      |      |      |       |      |      |       |      | MERCEDES BENZ | 203 421 05 12<br>210 421 22 12<br>210 421 25 12   |
| 24.0128-0113.1 | 428113 |   |   |    |   | V | 255,0 | 28,0 | 26,0 | 49,2 | 100,0 | 5    | 55,0 | 131,0 | 14,5 | TOYOTA        | 43512-05010   |
| 24.0128-0114.1 | 428114 |   |   |    |   | V | 255,0 | 28,0 | 26,0 | 49,1 | 114,3 | 5    | 62,0 | 146,5 | 14,6 | TOYOTA        | 43512-33020   |
| 24.0128-0115.1 | 428115 |   | B |    |   | V | 275,0 | 28,0 | 26,0 | 49,2 | 114,3 | 5    | 62,0 | 158,5 | 14,8 | TOYOTA        | 43512-07020<br>43512-33040<br>43512-33041<br>43512-33042<br>43512-33060<br>43512-44021<br>43512-05020 |
| 24.0128-0116.1 | 428116 |   |   |    |   | V | 255,0 | 28,0 | 26,0 | 49,3 | 100,0 | 5    | 55,0 | 155,5 | 14,5 | TOYOTA        | 43512-05010   |
| 24.0128-0118.1 | 428118 |   |   |    |   | V | 310,0 | 28,0 | 26,0 | 47,3 | 108,0 | 5/10 | 59,0 | 141,5 | 14,7 | ALFA ROMEO    | 60629865  |
| 24.0128-0119.1 | 428119 |   |   |    |   | V | 305,0 | 28,0 | 26,0 | 44,7 | 98,0  | 5    | 59,0 | 151,0 | 13,2 | ALFA ROMEO    | 60652186<br>60670801  |
| 24.0128-0120.1 | 428120 |   |   |    |   | V | 305,0 | 28,0 | 26,0 | 44,7 | 98,0  | 4    | 59,0 | 151,0 | 13,2 | FIAT          | 46465088<br>71738914  |
| 24.0128-0122.1 | 428122 |   | B | HC |   | V | 296,0 | 28,0 | 26,4 | 55,0 | 120,0 | 5    | 79,0 | 145,5 | 14,5 | BMW           | 34 11 1 165 263   |
| 24.0128-0123.1 | 428123 |   | B |    |   | V | 305,0 | 27,9 | 25,0 | 50,3 | 108,0 | 5    | 68,0 | 139,0 | 16,5 | VOLVO         | 274170<br>274559<br>9492715   |
| 24.0128-0125.1 | 428125 |   | B | HC | L | ● | 312,0 | 28,0 | 26,0 | 76,0 | 112,0 | 5    | 67,0 | 154,0 | 15,0 | MERCEDES BENZ | 220 421 09 12   |
| 24.0128-0126.1 | 428126 |   | B | HC | L | V | 316,0 | 28,0 | 25,4 | 46,5 | 112,0 | 5    | 67,0 | 154,3 | 13,0 | MERCEDES BENZ | 210 421 20 12   |
| 24.0128-0127.1 | 428127 |   | B | HC | L | V | 310,0 | 28,0 | 25,4 | 82,0 | 112,0 | 5    | 67,0 | 154,0 | 17,0 | MERCEDES BENZ | 140 421 03 12   |
| 24.0128-0128.1 | 428128 | S | B |    |   | V | 288,0 | 28,0 | 26,0 | 34,0 | 108,0 | 4    | 66,0 | 133,0 | 13,0 | CITROEN       | 4246 T8<br>4246 W3  |
| 24.0128-0129.1 | 428129 | S | B |    |   | V | 305,5 | 28,0 | 25,0 | 77,8 | 130,0 | 5    | 90,0 | 157,0 | 15,8 | NISSAN        | 40206-00QAD   |
|                |        |   |   |    |   |   |       |      |      |      |       |      |      |       |      | OPEL/VAUXHALL | 44 03 038/9111038   |
|                |        |   |   |    |   |   |       |      |      |      |       |      |      |       |      | RENAULT       | 77 00 314 064   |
| 24.0128-0130.1 | 428130 |   | B | HC | L | ● | 318,0 | 28,0 | 26,0 | 67,0 | 130,0 | 5    | 98,0 | 158,8 | 15,4 | PORSCHE       | 996 351 406 02  |
| 24.0128-0131.1 | 428131 |   | B | HC | L | ● | 318,0 | 28,0 | 26,0 | 67,0 | 130,0 | 5    | 98,0 | 158,8 | 15,4 | PORSCHE       | 996 351 405 02  |
| 24.0128-0132.1 | 428132 | S | B | HC |   | V | 305,0 | 28,0 | 24,0 | 49,7 | 118,0 | 5    | 72,0 | 154,0 | 15,5 | NISSAN        | 40206-00QAE<br>40206-00QAF<br>40206-00QAG<br>40206-00QAH  |
|                |        |   |   |    |   |   |       |      |      |      |       |      |      |       |      | OPEL/VAUXHALL | 44 14 632/91165426  |
| 24.0128-0133.1 | 428133 |   | B | HC |   | V | 324,0 | 28,0 | 25,4 | 47,0 | 108,0 | 5    | 61,0 | 150,0 | 15,5 | RENAULT       | 77 11 130 077<br>82 00 242 318<br>82 00 570 191<br>86 71 019 275                                      |
| 24.0128-0134.1 | 428134 |   | B |    |   | V | 305,0 | 28,0 | 26,0 | 44,0 | 108,0 | 5    | 61,0 | 132,0 | 15,5 | RENAULT       | 77 01 206 673<br>86 71 012 049  |
| 24.0128-0135.1 | 428135 |   | B | HC |   | V | 308,0 | 28,0 | 25,8 | 47,0 | 108,0 | 5    | 61,0 | 140,0 | 15,5 | RENAULT       | 82 00 242 317<br>82 00 570 677  |
| 24.0128-0136.1 | 428136 |   | B |    |   | V | 285,0 | 28,0 | 26,0 | 43,7 | 98,0  | 5    | 59,0 | 127,0 | 16,5 | CITROEN       | 4246 P2<br>16 063 092 80  |
|                |        |   |   |    |   |   |       |      |      |      |       |      |      |       |      | FIAT/LANCIA   | 1325772080  |
|                |        |   |   |    |   |   |       |      |      |      |       |      |      |       |      | PEUGEOT       | 4249 H7<br>16 063 092 80  |
| 24.0128-0137.1 | 428137 | S | B | HC |   | V | 302,0 | 28,0 | 25,0 | 45,0 | 110,0 | 5/7  | 70,0 | 139,0 | 14,0 | OPEL/VAUXHALL | 5 69 004/93171500   |
|                |        |   |   |    |   |   |       |      |      |      |       |      |      |       |      | SAAB          | 9191247<br>93171500   |
| 24.0128-0138.1 | 428138 |   | B |    |   | V | 291,0 | 28,1 | 26,0 | 64,8 | 120,7 | 5    | 80,0 | 175,0 | 13,5 | JAGUAR        | JLM 20341   |
| 24.0128-0139.1 | 428139 |   |   |    |   | V | 275,0 | 28,0 | 26,0 | 50,8 | 114,3 | 5    | 60,1 | 143,5 | 14,5 | LEXUS         | 43512-50060   |
| 24.0128-0140.1 | 428140 |   | B |    |   | V | 280,0 | 28,0 | 26,0 | 49,1 | 114,3 | 5    | 68,0 | 144,0 | 12,8 | NISSAN        | 40206-3Y502<br>40206-3Y503<br>40206-4U101<br>40206-4U103<br>40206-4U107                               |
| 24.0128-0142.1 | 428142 |   | B | HC | L | V | 312,0 | 28,0 | 25,4 | 64,5 | 112,0 | 5    | 67,0 | 154,0 | 15,3 | MERCEDES BENZ | 211 421 09 12   |
| 24.0128-0143.1 | 428143 |   |   |    |   | V | 305,0 | 28,0 | 26,0 | 28,0 | 108,0 | 4    | 66,0 | 132,9 | 13,0 | PEUGEOT       | 4246 V1   |
| 24.0128-0144.1 | 428144 |   | B | HC |   | V | 316,0 | 28,0 | 25,0 | 50,0 | 108,0 | 5    | 68,0 | 144,0 | 16,5 | VOLVO         | 30636074<br>30736406  |



# Abmessungen Bremsscheiben

## Dimensions brake discs - Misure dischi freno -

## Dimensions Disques de frein - Medidas disco de freno

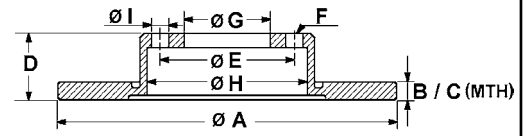

S Fixierschraube - fixing screw - vite di riparazione - vis de fixation - tornillo quefija  
 B beschichtet - coated - rivestito - revêtu - recubierto  
 HC hochgekohlt - high carbon - ad alto tenore di carbonio - à haute teneur en carbone - altamente carbonizado  
 L legiert - alloyed - alligato/legato - allié - aleado  
 V ventiliert - ventilated - ventilato - ventilé - ventilado  
 ● gelocht - perforated - perforato - poinçonné - perforado

|                |        | S | B | HC | L | V  | A     | B    | C    | D    | E     | F    | G     | H     | I       | OE                           | - #  |
|----------------|--------|---|---|----|---|----|-------|------|------|------|-------|------|-------|-------|---------|------------------------------|--|
| 24.0128-0145.1 | 428145 | S | B | HC | L | V  | 300,0 | 28,0 | 25,0 | 58,5 | 112,0 | 5    | 67,0  | 153,0 | 15,0    | MERCEDES BENZ                | 447 421 05 12<br>639 421 00 12<br>639 421 03 12  |
| 24.0128-0147.1 | 428147 |   | B | HC |   | V  | 302,0 | 28,0 | 26,5 | 39,0 | 114,3 | 5    | 73,5  | 146,3 | 14,0    | CHRYSLER                     | 4683 918AB   |
| 24.0128-0148.1 | 428148 |   |   |    |   | V  | 281,0 | 28,0 | 25,3 | 38,0 | 114,3 | 5    | 73,5  | 146,0 | 14,0    | CHRYSLER                     | 5073 069AA<br>4721 820AG   |
| 24.0128-0149.1 | 428149 | S | B | HC |   | V  | 330,0 | 28,0 | 26,0 | 73,5 | 130,0 | 5    | 85,0  | 210,0 | 15,4    | PORSCHE                      | 955 352 401 30<br>955 352 401 31   |
| 24.0128-0153.1 | 428153 |   | B | HC |   | V  | 320,0 | 28,0 | 26,0 | 49,0 | 114,3 | 5    | 68,0  | 144,5 | 13,0    | INFINITI<br>NISSAN<br>NISSAN | 7L6 615 601 J<br>7L8 615 601 C<br>40206-EG000<br>40206-CA010<br>40206-EG000  |
| 24.0128-0154.1 | 428154 | S | B | HC |   | V  | 300,0 | 28,0 | 26,0 | 52,0 | 108,0 | 5    | 63,5  | 140,0 | 15,8    | FORD                         | 1420601<br>1469085<br>1500158<br>1517696<br>6G91-2C375-F1B<br>7G91-1125-BA<br>LR000571<br>LR007055<br>30769056<br>31202331<br>31341382 |
| 24.0128-0155.1 | 428155 | S | B | HC | L | V  | 295,0 | 28,0 | 25,4 | 64,5 | 112,0 | 5    | 67,0  | 154,3 | 15,2    | MERCEDES BENZ                | 212 421 13 12  |
| 24.0128-0156.1 | 428156 | S | B |    |   | V  | 280,0 | 28,0 | 25,0 | 54,5 | 111,0 | 5    | 93,0  | 136,0 | M10x1,5 | FORD                         | 1371394<br>1503290<br>1547061<br>6C11-1125-B1B<br>6C11-1125-BB   |
| 24.0128-0157.1 | 428157 | S | B |    |   | V  | 300,0 | 28,0 | 25,0 | 54,5 | 111,0 | 5    | 93,0  | 136,0 | M10x1,5 | FORD                         | 1371393<br>1503287<br>1546747  |
| 24.0128-0158.1 | 428158 |   | B |    |   | V  | 321,0 | 28,0 | 26,4 | 49,1 | 114,3 | 5    | 69,0  | 143,0 | 12,5    | HYUNDAI                      | 51712-2B700  |
| 24.0128-0159.1 | 428159 |   | B |    |   | V  | 296,0 | 28,0 | 25,0 | 49,2 | 114,3 | 5    | 62,0  | 145,0 | 14,5    | LEXUS<br>TOYOTA<br>TOYOTA    | 43512-33140<br>43512-42050<br>43512-42090  |
| 24.0128-0162.1 | 428162 | S | B | HC |   | V  | 316,0 | 28,0 | 26,0 | 52,0 | 108,0 | 5    | 63,5  | 144,0 | 16,0    | FORD                         | 1434812<br>1434815<br>LR000470<br>30769061   |
| 24.0128-0163.1 | 428163 |   | B | HC | L | V● | 312,0 | 28,0 | 26,0 | 64,5 | 112,0 | 5    | 67,0  | 155,2 | 15,0    | MERCEDES BENZ                | 230 421 04 12  |
| 24.0128-0164.1 | 428164 | S | B | HC |   | V  | 314,0 | 28,0 | 25,0 | 44,9 | 110,0 | 5/7  | 70,0  | 139,0 | 14,0    | OPEL/VAUXHALL<br>SAAB        | 5 69 005/93175606<br>24435132<br>93175606  |
| 24.0128-0165.1 | 428165 |   | B | HC | L | V  | 298,0 | 28,0 | 26,0 | 50,0 | 126,0 | 5    | 107,0 | 156,0 | 8,4     | PORSCHE                      | 951 351 041 00   |
| 24.0128-0166.1 | 428166 |   |   |    |   | V  | 300,0 | 28,0 | 26,0 | 38,0 | 124,0 | 6    | 100,0 | 184,0 | M10x1   | NISSAN                       | 40206-1W600<br>40206-6W500   |
| 24.0128-0167.1 | 428167 |   | B | HC | L | V  | 298,0 | 28,0 | 26,0 | 74,0 | 130,0 | 5    | 103,0 | 157,0 | 15,4    | PORSCHE                      | 951 351 041 01<br>951 351 041 02   |
| 24.0128-0169.1 | 428169 |   | B | HC | L | V  | 358,0 | 28,0 | 26,0 | 73,5 | 130,0 | 5    | 85,0  | 210,0 | 15,4    | AUDI/VOLKSWAGEN              | 7L8 615 601 A<br>7L8 615 601 D<br>7L8 615 601 E<br>955 352 403 00<br>958 352 401 50  |
| 24.0128-0171.1 | 428171 |   | B | HC | L | V● | 309,0 | 28,0 | 26,0 | 83,0 | 130,0 | 5    | 103,0 | 180,0 | 15,4    | PORSCHE                      | 930 352 045 01   |
| 24.0128-0172.1 | 428172 |   | B | HC | L | V● | 309,0 | 28,0 | 26,0 | 83,0 | 130,0 | 5    | 103,0 | 180,0 | 15,4    | PORSCHE                      | 930 352 046 01   |
| 24.0128-0174.1 | 428174 |   |   | HC | L | V  | 298,0 | 28,0 | 26,0 | 80,0 | 130,0 | 5    | 103,0 | 161,0 | 15,4    | PORSCHE                      | 964 351 041 02   |
| 24.0128-0175.1 | 428175 |   |   |    |   | V  | 273,5 | 28,0 | 26,0 | 51,0 | 114,3 | 5    | 72,0  | 142,8 | 13,0    | MAZDA                        | T002-33-25XA<br>TY01-33-25X  |
| 24.0128-0176.1 | 428176 | S | B | HC | L | V  | 295,0 | 28,0 | 25,4 | 54,5 | 112,0 | 5    | 67,0  | 154,0 | 15,3    | MERCEDES BENZ                | 211 421 08 12  |
| 24.0128-0177.1 | 428177 |   | B | HC | L | V● | 330,0 | 28,0 | 26,0 | 46,5 | 112,0 | 5    | 67,0  | 154,0 | 13,0    | MERCEDES BENZ                | 203 421 13 12  |
| 24.0128-0178.1 | 428178 |   |   |    |   | V  | 288,0 | 28,0 | 26,0 | 50,0 | 108,0 | 5    | 71,0  | 130,5 | 13,0    | CITROEN                      | 4246 T2  |
| 24.0128-0179.1 | 428179 |   | B |    |   | V  | 305,5 | 28,0 | 26,0 | 44,8 | 108,0 | 5/10 | 59,0  | 138,9 | 14,6    | LANCIA                       | 46776750   |
| 24.0128-0180.1 | 428180 |   |   |    |   | V  | 296,0 | 28,0 | 26,0 | 51,0 | 114,3 | 5    | 72,0  | 142,8 | 13,0    | MAZDA                        | L12Y-33-25X  |
| 24.0128-0182.1 | 428182 |   | B | HC |   | V  | 308,0 | 28,0 | 25,4 | 47,0 | 108,0 | 5    | 61,0  | 140,0 | 13,5    | RENAULT                      | 82 00 019 581  |
| 24.0128-0183.1 | 428183 |   | B |    |   | V  | 275,0 | 28,0 | 26,0 | 49,2 | 100,0 | 5    | 55,0  | 132,0 | 14,5    | TOYOTA                       | 43512-20601  |
| 24.0128-0184.1 | 428184 |   | B | HC |   | V  | 320,0 | 28,0 | 25,0 | 50,0 | 108,0 | 5    | 68,0  | 151,0 | 16,5    | VOLVO                        | 9475266  |
| 24.0128-0185.1 | 428185 |   | B | HC |   | V  | 305,0 | 28,0 | 26,0 | 44,7 | 110,0 | 5/7  | 70,0  | 138,0 | 14,2    | FIAT                         | 51757229<br>71772547   |
| 24.0128-0186.1 | 428186 |   | B |    |   | V  | 296,0 | 28,0 | 26,0 | 49,3 | 114,3 | 5    | 62,0  | 141,0 | 14,7    | LEXUS                        | 43512-48020<br>43512-48050   |
| 24.0128-0188.1 | 428188 | S | B | HC | L | V  | 330,0 | 28,0 | 26,0 | 46,5 | 112,0 | 5    | 67,0  | 154,0 | 13,0    | MERCEDES BENZ                | 203 421 04 12  |



# Abmessungen Bremsscheiben

## Dimensions brake discs - Misure dischi freno -

## Dimensions Disques de frein - Medidas disco de freno

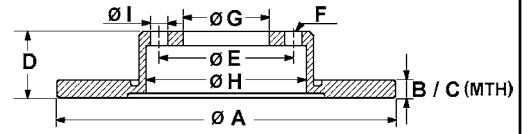

S Fixierschraube - fixing screw - vite di riparazione - vis de fixation - tornillo quefija  
 L legiert - alloyed - alligato/legato - allié - aleado  
 ● gelocht - perforated - perforato - poinçonné - perforado  
 B beschichtet - coated - rivestito - revêtu - recubierto  
 V ventiliert - ventilated - ventilato - ventilé - ventilado  
 HC hochgekohlt - high carbon - ad alto tenore di carbonio - à haute teneur en carbone - altamente carbonizado

|                |        | S | B | H  | C | L | V  | A     | B    | C    | D    | E     | F   | G     | H     | I        | OE - #   |
|----------------|--------|---|---|----|---|---|----|-------|------|------|------|-------|-----|-------|-------|----------|--|
| 24.0128-0189.1 | 428189 |   |   |    |   |   | V  | 285,0 | 28,0 | 26,0 | 45,5 | 127,0 | 6   | 84,0  | 149,0 | M10x1,25 | TOYOTA<br>43512-26140<br>43512-26160   |
| 24.0128-0190.1 | 428190 |   |   |    |   |   | V  | 296,0 | 28,0 | 26,0 | 49,2 | 114,3 | 5   | 62,0  | 156,0 | 14,7     | TOYOTA<br>43512-33100<br>43512-28180<br>43512-28181  |
| 24.0128-0191.1 | 428191 | S | B |    |   |   | V  | 330,0 | 28,0 | 26,0 | 39,7 | 110,0 | 5   | 70,0  | 151,0 | 16,6     | ALFA ROMEO<br>51760622<br>51767384<br>JEEP<br>0 4779 884AC<br>4779 884AC                                     |
| 24.0128-0192.1 | 428192 | S | B |    |   |   | V  | 305,0 | 28,0 | 26,0 | 39,7 | 110,0 | 5   | 70,0  | 138,0 | 16,6     | ALFA ROMEO<br>51760621<br>51767381<br>51767382   |
| 24.0128-0194.1 | 428194 |   | B |    |   |   | V  | 338,0 | 28,0 | 26,0 | 67,5 | 139,7 | 6   | 108,0 | 172,0 | 14,5     | LEXUS/TOYOTA<br>43512-60150<br>43512-60151   |
| 24.0128-0195.1 | 428195 |   |   |    |   |   | V  | 295,0 | 28,0 | 26,0 | 50,0 | 108,0 | 5   | 71,0  | 130,6 | 13,0     | PEUGEOT<br>4246 L0   |
| 24.0128-0196.1 | 428196 |   | B | HC | L |   | V● | 330,0 | 28,0 | 26,0 | 75,0 | 130,0 | 5   | 98,0  | 180,0 | 15,4     | PORSCHE<br>996 352 406 00<br>996 352 406 01<br>996 352 406 02<br>996 352 406 03                              |
| 24.0128-0197.1 | 428197 |   | B | HC | L |   | V● | 330,0 | 28,0 | 26,0 | 75,0 | 130,0 | 5   | 98,0  | 180,0 | 15,4     | PORSCHE<br>996 352 405 00<br>996 352 405 01<br>996 352 405 02<br>996 352 405 03                              |
| 24.0128-0198.1 | 428198 | S | B | HC |   |   | V  | 315,0 | 28,0 | 26,4 | 52,5 | 120,0 | 5   | 79,0  | 152,0 | 14,5     | BMW<br>34 11 2 227 171   |
| 24.0128-0199.1 | 428199 | S | B | HC |   |   | V  | 315,0 | 28,0 | 26,4 | 52,5 | 120,0 | 5   | 79,0  | 152,0 | 14,5     | BMW<br>34 11 2 227 172   |
| 24.0128-0200.1 | 428200 |   | B |    |   |   | V  | 302,0 | 28,0 | 26,0 | 54,0 | 139,6 | 5   | 96,3  | 163,0 | 12,5     | KIA<br>51712-3E000   |
| 24.0128-0201.1 | 428201 |   | B | HC | L |   | V  | 321,0 | 28,0 | 25,0 | 44,0 | 110,0 | 5/7 | 70,0  | 139,0 | 14,0     | OPEL/AUXHALL<br>5 69 017/93185814  |
| 24.0128-0202.1 | 428202 |   | B | HC | L |   | V  | 303,0 | 28,0 | 25,0 | 93,0 | 145,0 | 6   | 120,0 | 172,0 | 15,0     | MERCEDES BENZ<br>906 421 01 12<br>VOLKSWAGEN<br>2E0 615 601  |
| 24.0128-0203.1 | 428203 | S | B | HC | L |   | V  | 300,0 | 28,0 | 25,0 | 68,5 | 130,0 | 6   | 85,0  | 155,0 | 15,0     | MERCEDES BENZ<br>906 421 00 12<br>VOLKSWAGEN<br>2E0 615 301  |
| 24.0128-0204.2 | 428204 | S | B | HC |   |   | V  | 315,0 | 28,0 | 26,4 | 52,5 | 120,0 | 5   | 79,0  | 155,0 | 14,5     | BMW<br>34 11 2 227 737   |
| 24.0128-0205.2 | 428205 | S | B | HC |   |   | V  | 315,0 | 28,0 | 26,4 | 52,5 | 120,0 | 5   | 79,0  | 155,0 | 14,5     | BMW<br>34 11 2 227 738   |
| 24.0128-0206.2 | 428206 | S | B | HC |   |   | V● | 325,0 | 28,0 | 26,4 | 52,5 | 120,0 | 5   | 79,0  | 154,8 | 14,5     | BMW<br>34 11 2 282 801   |
| 24.0128-0207.2 | 428207 | S | B | HC |   |   | V● | 325,0 | 28,0 | 26,4 | 52,5 | 120,0 | 5   | 79,0  | 154,8 | 14,5     | BMW<br>34 11 2 282 802   |
| 24.0128-0208.2 | 428208 | S | B | HC |   |   | V● | 345,0 | 28,0 | 26,4 | 52,5 | 120,0 | 5   | 79,0  |       | 14,5     | BMW<br>34 11 2 282 445   |
| 24.0128-0209.2 | 428209 | S | B | HC |   |   | V● | 345,0 | 28,0 | 26,4 | 52,5 | 120,0 | 5   | 79,0  |       | 14,5     | BMW<br>34 11 2 282 446   |
| 24.0128-0210.1 | 428210 | S | B | HC |   |   | V  | 336,0 | 28,0 | 26,0 | 52,0 | 108,0 | 5   | 63,5  | 152,0 | 16,0     | VOLVO<br>30769057  |
| 24.0128-0211.1 | 428211 |   | B |    |   |   | V  | 274,0 | 28,3 | 26,0 | 50,6 | 114,3 | 5   | 72,0  | 140,0 | 13,0     | KIA<br>0K58B-33-251  |
| 24.0128-0212.1 | 428212 |   |   |    |   |   | V  | 296,0 | 28,0 | 26,0 | 49,5 | 114,3 | 5   | 62,0  | 141,3 | 14,5     | TOYOTA<br>43512-48011  |
| 24.0128-0213.1 | 428213 |   | B |    |   |   | V  | 280,0 | 28,0 | 25,9 | 71,5 | 118,0 | 5   | 73,0  | 142,0 | 15,5     | CITROEN<br>4249 K2<br>16 078 721 80<br>FIAT<br>51705749<br>51740246<br>51848621                              |
| 24.0128-0214.1 | 428214 | S | B |    |   |   | V  | 280,0 | 28,0 | 26,0 | 48,0 | 108,0 | 5   | 71,1  | 152,0 | 13,2     | PEUGEOT<br>4249 K2<br>16 078 721 80<br>CITROEN<br>4249 J9<br>FIAT<br>9467548387                              |
| 24.0128-0215.1 | 428215 |   | B |    |   |   | V  | 332,0 | 28,0 | 26,0 | 56,3 | 139,7 | 6   | 94,0  | 171,0 | 12,8     | PEUGEOT<br>4249 K2<br>16 078 721 80<br>CITROEN<br>4249 J9<br>FIAT<br>9467548387<br>TOYOTA<br>SU001-A1063     |
| 24.0128-0216.1 | 428216 | S | B |    |   |   | V  | 304,0 | 28,0 | 26,0 | 48,0 | 108,0 | 5   | 71,0  | 145,5 | 13,2     | MITSUBISHI<br>4615A038<br>CITROEN<br>4249 25<br>4249 K0<br>16 118 419 80<br>FIAT<br>9467548587<br>9467548588 |
| 24.0128-0217.1 | 428217 | S | B |    |   |   | V  | 293,0 | 28,0 | 26,0 | 47,1 | 114,3 | 5   | 64,1  | 155,0 | 12,7     | PEUGEOT<br>4249 24<br>4249 K0<br>TOYOTA<br>SU001-A1064   |
| 24.0128-0219.1 | 428219 |   | B |    |   |   | V  | 305,0 | 28,0 | 26,0 | 44,7 | 100,0 | 4   | 60,0  | 139,0 | 14,2     | HONDA<br>45251-T1E-G01<br>FIAT<br>51822457   |
| 24.0128-0220.1 | 428220 |   | B |    |   |   | V  | 300,0 | 28,0 | 26,0 | 54,0 | 139,6 | 6   | 96,3  | 163,0 | 12,5     | KIA<br>51712-4D200   |
| 24.0128-0223.1 | 428223 | S | B | HC |   |   | V  | 312,5 | 28,0 | 26,0 | 63,0 | 100,0 | 5   | 61,0  | 151,0 | 15,5     | RENAULT<br>77 01 208 130   |
| 24.0128-0224.1 | 428224 |   | B |    |   |   | V  | 303,5 | 28,0 | 26,4 | 42,7 | 108,0 | 6   | 87,0  | 147,0 | 10,6     | HYUNDAI<br>51712-H1030   |
| 24.0128-0226.1 | 428226 |   | B | HC | L |   | V  | 289,0 | 28,0 | 26,0 | 70,2 | 140,0 | 6   | 98,0  | 164,0 | 13,0     | FORD<br>1490412<br>6M34-1027-DA<br>UR61-33-251   |
| 24.0128-0227.1 | 428227 |   | B |    |   |   | V  | 302,0 | 28,0 | 26,4 | 54,0 | 139,6 | 5   | 96,3  | 163,0 | 12,5     | MAZDA<br>51712-3E500   |
| 24.0128-0228.1 | 428228 |   | B |    |   |   | V  | 295,6 | 28,0 | 26,0 | 48,2 | 114,3 | 5   | 72,0  | 142,8 | 13,0     | MAZDA<br>L206-33-25XA  |
| 24.0128-0229.1 | 428229 |   | B |    |   |   | V  | 325,0 | 28,3 | 26,0 | 49,5 | 120,7 | 5   | 73,8  | 155,0 | 13,5     | JAGUAR<br>JLM 20617  |
| 24.0128-0231.1 | 428231 |   | B | HC |   |   | V  | 305,0 | 28,0 | 26,0 | 44,8 | 98,0  | 4   | 59,0  | 139,0 | 13,2     | FIAT<br>51738833<br>51813785   |
| 24.0128-0232.1 | 428232 |   | B |    |   |   | V  | 296,0 | 28,0 | 25,0 | 49,2 | 114,3 | 5   | 62,0  | 154,0 | 14,5     | FIAT<br>TOYOTA<br>43512-28190  |



# Abmessungen Bremsscheiben

## Dimensions brake discs - Misure dischi freno -

## Dimensions Disques de frein - Medidas disco de freno

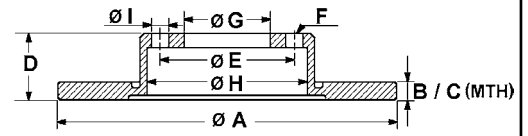

S Fixierschraube - fixing screw - vite di riparazione - vis de fixation - tornillo quefija

B beschichtet - coated - rivestito - revêtu - recubierto

HC hochgekohlt - high carbon - ad alto tenore di carbonio - à haute teneur en carbone - altamente carbonizado

L legiert - alloyed - alligato/legato - allié - aleado

V ventiliert - ventilated - ventilato - ventilé - ventilado

● gelocht - perforated - perforato - poinçonné - perforado

|                |        | S | B | HC | L  | V  | A     | B     | C    | D    | E     | F     | G    | H     | I       | OE - #        |  |                                 |
|----------------|--------|---|---|----|----|----|-------|-------|------|------|-------|-------|------|-------|---------|---------------|--|---------------------------------|
| 24.0128-0233.1 | 428233 |   | B |    |    | V  | 320,0 | 28,0  | 26,0 | 48,2 | 114,3 | 5     | 72,0 | 143,0 | 13,0    | MAZDA         | EH14-33-25XA   |                                 |
| 24.0128-0234.1 | 428234 |   | B |    |    | V  | 300,0 | 28,0  | 26,4 | 47,3 | 114,3 | 5     | 69,0 | 141,5 | 12,5    | HYUNDAI       | 51712-2L500  |                                 |
| 24.0128-0238.1 | 428238 |   | B |    |    | V  | 300,0 | 28,0  | 25,0 | 74,5 | 125,0 | 6     | 78,0 | 156,0 | 15,5    | IVECO         | 2996131  |                                 |
| 24.0128-0239.1 | 428239 |   | B |    |    | V  | 290,0 | 28,0  | 25,0 | 46,0 | 95,0  | 9     | 64,0 | 123,0 | 12,5    | IVECO         | 2996121  |                                 |
| 24.0128-0240.1 | 428240 |   | B | HC | L  | V  | 320,0 | 28,0  | 26,0 | 38,0 | 114,3 | 5     | 68,0 | 175,0 | 12,8    | NISSAN        | 40206-EB320<br>40206-3X00B<br>40206-5X00A                |                                 |
| 24.0128-0241.1 | 428241 |   | B | HC | L  | V  | 296,0 | 28,0  | 26,0 | 38,0 | 114,3 | 6     | 68,0 | 161,0 | 12,8    | NISSAN        | 40206-EB300  |                                 |
| 24.0128-0242.1 | 428242 |   | B |    |    | V  | 320,0 | 28,0  | 26,0 | 44,0 | 114,3 | 5     | 68,0 | 146,5 | 12,7    | NISSAN        | 40206-ET01A  |                                 |
| 24.0128-0243.1 | 428243 |   | B | HC | L  | V  | 305,0 | 28,0  | 26,0 | 44,7 | 98,0  | 4     | 59,0 | 191,0 | 13,0    | RENAULT       | 40 20 698 28R  |                                 |
| 24.0128-0244.1 | 428244 |   | B | HC | L  | V  | 276,0 | 28,0  | 26,0 | 45,2 | 118,0 | 5     | 94,0 | 151,5 | M12x1,5 | FIAT          | 51817217   |                                 |
| 24.0128-0245.1 | 428245 |   | S | B  | HC | L  | V     | 320,0 | 28,0 | 25,4 | 44,0  | 114,3 | 5    | 68,0  | 147,7   | 15,8          | NISSAN   | 40206-MB600                     |
| 24.0128-0246.1 | 428246 |   | B | HC | L  | V● | 330,0 | 28,0  | 26,0 | 69,0 | 130,0 | 5     | 98,0 | 159,7 | 15,4    | RENAULT       | 50 01 871 213  |                                 |
| 24.0128-0247.1 | 428247 |   | B | HC | L  | V● | 330,0 | 28,0  | 26,0 | 69,0 | 130,0 | 5     | 98,0 | 159,7 | 15,4    | RENAULT       | 40 20 600 03R<br>40 20 641 55R                           |                                 |
| 24.0128-0248.1 | 428248 |   | B | HC | L  | V  | 321,0 | 28,0  | 26,4 | 49,1 | 114,3 | 5     | 69,0 | 143,0 | 12,5    | PORSCHE       | 997 351 402 00<br>997 351 402 01                         |                                 |
| 24.0128-0249.1 | 428249 |   | B |    |    | V  | 258,0 | 28,0  | 26,0 | 58,6 | 114,3 | 5     | 62,0 | 141,0 | 14,5    | PORSCHE       | 997 351 401 00<br>997 351 401 01                         |                                 |
| 24.0128-0250.1 | 428250 |   | B | HC |    | V  | 300,0 | 28,0  | 26,0 | 52,0 | 108,0 | 5     | 63,5 | 140,0 | 13,8    | HYUNDAI       | 51712-2P700<br>51712-2W700                               |                                 |
| 24.0128-0251.1 | 428251 |   | B | HC |    | V  | 303,0 | 28,0  | 26,0 | 56,9 | 120,0 | 5     | 76,0 | 165,2 | 16,6    | HYUNDAI       | 51712-2P700  |                                 |
| 24.0128-0252.1 | 428252 |   | S | B  |    | V  | 302,0 | 28,0  | 24,5 | 69,9 | 130,0 | 5     | 90,0 | 160,5 | 17,4    | TOYOTA        | 43512-0K010<br>43512-0K030                               |                                 |
| 24.0128-0253.1 | 428253 |   | B | HC | L  | V  | 305,0 | 28,0  | 26,0 | 45,7 | 98,0  | 5     | 59,2 | 127,0 | 13,0    | FORD          | 1500159<br>7G91-1125-EA                                  |                                 |
| 24.0128-0254.1 | 428254 |   | S | B  | HC | V  | 328,0 | 28,0  | 26,4 | 73,1 | 120,0 | 5     | 75,0 | 153,8 | 16,5    | VOLKSWAGEN    | 2H0 615 301 A  |                                 |
| 24.0128-0255.1 | 428255 |   | B |    |    | V  | 350,0 | 28,0  | 26,0 | 68,1 | 127,0 | 5     | 72,0 | 205,0 | 16,2    | NISSAN        | 40206-00Q0G  |                                 |
| 24.0128-0256.1 | 428256 |   | B | HC | L  | V  | 300,0 | 28,0  | 26,4 | 47,3 | 114,3 | 5     | 69,0 | 142,5 | 12,5    | OPEL/VAUXHALL | 44 19 359/93197403                                       |                                 |
| 24.0128-0258.1 | 428258 |   | B | HC | L  | V  | 320,0 | 28,1  | 26,4 | 47,3 | 114,3 | 5     | 69,0 | 145,0 | 12,5    | RENAULT       | 82 00 688 880  |                                 |
| 24.0128-0260.1 | 428260 |   | B | HC | L  | V● | 315,0 | 28,0  | 26,0 | 69,0 | 130,0 | 5     | 98,0 | 159,0 | 15,4    | FIAT          | 51897455<br>51914663                                     |                                 |
| 24.0128-0262.1 | 428262 |   | S | B  | HC | L  | V●    | 295,0 | 28,0 | 26,0 | 51,1  | 112,0 | 5    | 67,0  | 154,6   | 15,0          | OPEL/VAUXHALL  | 5 69 087/95511283               |
| 24.0128-0263.1 | 428263 |   | B | HC |    | V  | 302,0 | 28,0  | 26,4 | 38,2 | 127,0 | 5     | 72,5 | 166,0 | 14,0    | BMW           | 34 10 6 787 490  |                                 |
| 24.0128-0264.1 | 428264 |   | B | HC | L  | V● | 350,0 | 28,0  | 26,0 | 75,0 | 130,0 | 5     | 98,0 | 180,0 | 15,4    | JEEP          | 5290 731AB   |                                 |
| 24.0128-0265.1 | 428265 |   | B | HC | L  | V● | 350,0 | 28,0  | 26,0 | 75,0 | 130,0 | 5     | 98,0 | 180,0 | 15,4    | HYUNDAI       | 51712-3K150<br>51712-3K160                               |                                 |
| 24.0128-0269.1 | 428269 |   | S | B  | HC | V  | 304,0 | 28,0  | 26,0 | 48,0 | 108,0 | 5     | 71,0 | 133,2 | 13,2    | HYUNDAI       | 51712-3K160<br>51712-3K160                               |                                 |
| 24.0128-0273.1 | 428273 |   | B | HC | L  | V● | 315,0 | 28,0  | 26,0 | 69,0 | 130,0 | 5     | 98,0 | 159,0 | 15,4    | KIA           | 51712-2Y000  |                                 |
| 24.0128-0275.1 | 428275 |   | S | B  | HC | L  | V     | 295,0 | 28,0 | 25,4 | 51,1  | 112,0 | 5    | 67,0  | 154,6   | 15,0          | HYUNDAI/KIA  | 51712-2T100                     |
| 24.0128-0276.1 | 428276 |   | S | B  | HC | L  | V     | 295,0 | 28,0 | 25,4 | 51,0  | 112,0 | 5    | 67,0  | 155,0   | 15,0          | PORSCHE  | 981 351 402 01                  |
| 24.0128-0280.1 | 428280 |   | B | HC | L  | V  | 300,0 | 28,0  | 26,4 | 47,2 | 114,3 | 5     | 69,0 | 142,5 | 12,5    | MERCEDES BENZ | 246 421 25 12  |                                 |
| 24.0128-0282.1 | 428282 |   | S | B  | HC | L  | V     | 330,0 | 28,0 | 26,0 | 75,0  | 130,0 | 5    | 98,0  | 180,0   | 15,4          | MERCEDES BENZ  | 246 421 01 12                   |
| 24.0128-0283.1 | 428283 |   | S | B  | HC | L  | V     | 330,0 | 28,0 | 26,0 | 75,0  | 130,0 | 5    | 98,0  | 180,0   | 15,4          | KIA  | 51712-0Z000                     |
| 24.0128-0286.1 | 428286 |   | B | HC | L  | V  | 300,0 | 28,0  | 26,5 | 50,9 | 108,0 | 5     | 63,5 | 139,7 | 13,8    | PORSCHE       | 970 352 403 00<br>298 615 601 A                          |                                 |
| 24.0128-0288.1 | 428288 |   | S | B  | HC | L  | V     | 340,0 | 28,0 | 26,0 | 63,0  | 114,3 | 5    | 68,0  | 162,0   | 13,5          | PORSCHE  | 970 352 404 00<br>298 615 602 A |
| 24.0128-0291.1 | 428291 |   | B |    |    | V  | 320,0 | 28,0  | 26,0 | 44,0 | 114,3 | 5     | 68,0 | 153,7 | 12,7    | FORD          | 5202199  |                                 |
| 24.0128-0708.1 | 428708 |   |   | HC |    | V  | 288,0 | 28,0  | 26,0 | 64,8 | 114,3 | 5     | 72,0 | 158,0 | 15,5    | FORD          | DG9C-1125-AC   |                                 |
| 24.0128-0722.1 | 428722 |   |   |    |    | V  | 282,0 | 28,0  | 26,0 | 47,0 | 114,3 | 5     | 70,2 | 148,2 | 12,6    | RENAULT       | 40 20 600 19R  |                                 |
| 24.0128-0740.1 | 428740 |   | B |    |    | V  | 296,0 | 28,0  | 26,0 | 49,2 | 114,3 | 5     | 62,0 | 149,0 | 14,5    | NISSAN        | 40206-4CE0A  |                                 |
| 24.0128-0753.1 | 428753 |   | B |    |    | V  | 319,0 | 28,0  | 26,0 | 49,3 | 114,3 | 5     | 62,0 | 178,5 | 14,7    | JEEP          | 5212 8247AA<br>5212 8247AB<br>5212 8247AC                |                                 |
| 24.0129-0100.1 | 429100 |   | B |    |    | V  | 305,0 | 28,5  | 26,0 | 49,5 | 120,7 | 5     | 73,8 | 154,5 | 13,4    | HONDA         | 45251-SP0-E00  |                                 |
| 24.0129-0101.1 | 429101 |   | B | HC | L  | V  | 296,0 | 29,0  | 27,5 | 51,6 | 115,0 | 5     | 70,7 | 154,5 | 12,8    | LEXUS         | 43512-30310<br>43512-48080<br>43512-48081<br>43512-48100 |                                 |
|                |        |   |   |    |    |    |       |       |      |      |       |       |      |       |         | JAGUAR        | JLM 20150  |                                 |
|                |        |   |   |    |    |    |       |       |      |      |       |       |      |       |         | CHEVROLET     | 96625948<br>20955857<br>4801850                          |                                 |
|                |        |   |   |    |    |    |       |       |      |      |       |       |      |       |         | OPEL/VAUXHALL | 48 08 848/96625948                                       |                                 |



# Abmessungen Bremsscheiben

## Dimensions brake discs - Misure dischi freno -

## Dimensions Disques de frein - Medidas disco de freno

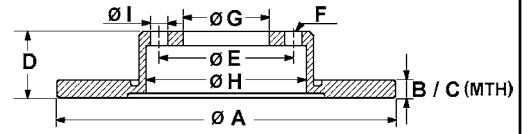

S Fixierschraube - fixing screw - vite di riparazione - vis de fixation - tornillo quefija  
 B beschichtet - coated - rivestito - revêtu - recubierto  
 HC hochgekohlt - high carbon - ad alto tenore di carbonio - à haute teneur en carbone - altamente carbonizado  
 L legiert - alloyed - alligato/legato - allié - aleado  
 V ventiliert - ventilated - ventilato - ventilé - ventilado  
 ● gelocht - perforated - perforato - poinçonné - perforado

|                |        | S | B | HC | L | V  | A     | B    | C    | D     | E     | F    | G     | H     | I       | OE - #                |                                     |
|----------------|--------|---|---|----|---|----|-------|------|------|-------|-------|------|-------|-------|---------|-----------------------|-------------------------------------|
| 24.0129-0102.1 | 429102 | S | B | HC |   | V  | 345,0 | 29,5 | 28,0 | 52,1  | 112,0 | 5    | 68,0  | 154,0 | 15,3    | AUDI                  | 8K0 615 301 M                       |
| 24.0130-0100.1 | 430100 |   | B | HC | L | V  | 320,0 | 30,0 | 27,4 | 82,0  | 112,0 | 5    | 67,0  | 154,3 | 15,2    | MERCEDES BENZ         | 140 421 09 12<br>140 421 10 12      |
| 24.0130-0101.1 | 430101 | S | B | HC |   | V  | 324,0 | 30,0 | 28,4 | 77,0  | 120,0 | 5    | 79,0  | 149,0 | 14,5    | BMW                   | 34 11 6 757 746                     |
| 24.0130-0103.1 | 430103 |   | B | HC | L | V  | 324,0 | 30,0 | 26,0 | 91,0  | 140,0 | 6    | 118,0 | 122,0 | M12x1,5 | MERCEDES BENZ         | 668 421 02 12<br>670 421 03 12      |
| 24.0130-0104.1 | 430104 |   | B | HC |   | V  | 314,0 | 30,0 | 28,0 | 59,7  | 112,0 | 5/10 | 68,0  | 136,0 | 15,3    | AUDI                  | 441 615 301 AA                      |
| 24.0130-0105.1 | 430105 |   |   |    |   | V  | 322,0 | 30,0 | 27,4 | 126,0 | 205,0 | 6    | 148,0 | 178,0 | 21,0    | FORD                  | 6172906                             |
| 24.0130-0107.1 | 430107 | S | B | HC |   | V  | 324,0 | 29,9 | 28,4 | 73,7  | 120,0 | 5    | 79,0  | 149,0 | 14,8    | BMW                   | 34 11 6 767 059                     |
| 24.0130-0109.1 | 430109 | S | B | HC |   | V  | 332,0 | 29,9 | 28,4 | 62,1  | 120,0 | 5    | 75,0  | 158,0 | 16,5    | BMW                   | 34 11 6 766 036<br>34 11 6 859 679  |
| 24.0130-0113.1 | 430113 | S | B | HC |   | V  | 320,0 | 30,0 | 28,0 | 46,5  | 112,0 | 5/9  | 68,0  | 137,0 | 15,3    | AUDI                  | 8D0 615 301 M<br>8E0 615 301 AD     |
| 24.0130-0114.1 | 430114 |   | B | HC |   | V  | 308,0 | 29,5 | 25,5 | 55,6  | 120,0 | 5    | 76,0  | 154,6 | 16,6    | VOLKSWAGEN            | 7E0 615 301 D<br>JZW 615 301 E      |
| 24.0130-0115.1 | 430115 |   | B | HC |   | V  | 345,0 | 30,0 | 27,0 | 49,9  | 112,0 | 5/9  | 65,0  | 140,0 | 15,3    | AUDI/SKODA/VW         | 1K0 615 301 M                       |
| 24.0130-0116.1 | 430116 |   | B | HC |   | V  | 336,0 | 30,0 | 27,0 | 51,0  | 108,0 | 5    | 68,0  | 150,0 | 16,5    | VOLVO                 | 30657301                            |
| 24.0130-0117.1 | 430117 |   | B | HC |   | V  | 324,0 | 30,0 | 28,4 | 81,0  | 120,0 | 5    | 79,0  | 169,0 | 16,5    | BMW                   | 34 11 6 750 265                     |
| 24.0130-0118.1 | 430118 |   | B | HC |   | V  | 348,0 | 30,0 | 28,4 | 81,0  | 120,0 | 5    | 79,0  | 164,0 | 16,5    | BMW                   | 34 11 6 750 267<br>34 11 6 864 057  |
| 24.0130-0119.1 | 430119 |   | B | HC |   | V  | 345,0 | 30,0 | 28,0 | 46,5  | 112,0 | 5/9  | 68,0  | 142,0 | 15,3    | AUDI                  | 8E0 615 301 K<br>8E0 615 301 T      |
| 24.0130-0120.1 | 430120 |   | B |    |   | V  | 300,0 | 30,0 | 28,0 | 43,0  | 108,0 | 5    | 71,0  | 143,5 | 14,0    | JAGUAR                | JLM 20801                           |
| 24.0130-0121.1 | 430121 |   | B | HC | L | V  | 320,0 | 30,0 | 28,0 | 50,5  | 112,0 | 5    | 67,0  | 154,0 | 13,0    | MERCEDES BENZ         | 129 421 15 12<br>129 421 17 12      |
| 24.0130-0122.1 | 430122 |   | B | HC | L | V  | 320,0 | 30,0 | 28,0 | 50,5  | 112,0 | 5    | 67,0  | 154,0 | 13,0    | MERCEDES BENZ         | 129 421 16 12<br>129 421 18 12      |
| 24.0130-0171.1 | 430171 |   | B | HC | L | V  | 345,0 | 30,0 | 27,4 | 46,5  | 112,0 | 5    | 67,0  | 154,0 | 13,0    | MERCEDES BENZ         | 209 421 00 12                       |
| 24.0130-0172.1 | 430172 |   | B | HC | L | V● | 304,0 | 30,0 | 27,4 | 47,5  | 112,0 | 5    | 67,0  | 154,0 | 15,0    | MERCEDES BENZ         | 220 421 17 12                       |
| 24.0130-0173.1 | 430173 | S | B | HC |   | V  | 324,0 | 30,0 | 28,4 | 77,0  | 120,0 | 5    | 79,0  | 165,0 | 14,5    | BMW                   | 34 11 6 753 221                     |
| 24.0130-0174.1 | 430174 |   | B | HC |   | V  | 321,0 | 30,0 | 28,0 | 52,5  | 112,0 | 5/10 | 68,0  | 135,0 | 15,3    | AUDI                  | 4B3 615 301                         |
| 24.0130-0175.1 | 430175 | S | B | HC |   | V  | 321,0 | 30,0 | 28,0 | 59,7  | 112,0 | 5    | 68,0  | 144,8 | 15,3    | AUDI                  | 4F0 615 301 E                       |
| 24.0130-0176.1 | 430176 | S | B | HC |   | V  | 347,0 | 30,0 | 28,0 | 59,7  | 112,0 | 5    | 68,0  | 158,0 | 15,3    | AUDI                  | 4F0 615 301 G                       |
| 24.0130-0177.1 | 430177 |   | B | HC |   | V  | 345,0 | 30,0 | 28,0 | 59,7  | 112,0 | 5/10 | 68,0  | 135,0 | 15,3    | AUDI                  | 4D0 615 301 B                       |
| 24.0130-0178.1 | 430178 |   | B |    |   | V  | 317,0 | 30,0 | 27,0 | 62,0  | 120,0 | 5    | 79,0  | 165,0 | 15,0    | LAND ROVER            | SDB000602<br>SDB000603<br>SDB000604 |
| 24.0130-0179.1 | 430179 |   | B | HC | L | V  | 304,0 | 30,0 | 27,4 | 41,0  | 112,0 | 5    | 67,0  | 154,0 | 15,0    | MERCEDES BENZ         | 211 421 12 12                       |
| 24.0130-0180.1 | 430180 |   | B | HC | L | V● | 345,0 | 30,0 | 28,0 | 46,5  | 112,0 | 5    | 67,0  | 154,2 | 13,1    | MERCEDES BENZ         | 203 421 09 12                       |
| 24.0130-0181.1 | 430181 | S | B |    |   | V  | 330,0 | 30,0 | 28,0 | 48,0  | 108,0 | 5    | 71,1  | 171,8 | 13,2    | CITROEN               | 4246 K0<br>4249 44<br>4249 A9       |
|                |        |   |   |    |   |    |       |      |      |       |       |      |       |       |         | PEUGEOT               | 4246 E0<br>4249 A9<br>4249 43       |
| 24.0130-0182.1 | 430182 |   | B |    |   | V  | 320,0 | 30,0 | 28,4 | 43,0  | 108,0 | 5    | 71,0  | 143,5 | 14,0    | JAGUAR                | C2C 8354                            |
| 24.0130-0183.1 | 430183 |   | B | HC |   | V  | 323,0 | 30,0 | 28,0 | 59,7  | 112,0 | 5/9  | 68,0  | 144,0 | 15,3    | AUDI/VW               | 3D0 615 301 G<br>4D0 615 301 J      |
| 24.0130-0184.1 | 430184 |   | B | HC |   | V  | 344,0 | 29,9 | 28,4 | 75,9  | 120,0 | 5    | 79,0  | 172,8 | 16,6    | LAND ROVER            | SDB000200<br>SDB000201              |
| 24.0130-0185.1 | 430185 |   | B | HC |   | V● | 320,0 | 30,0 | 28,0 | 46,5  | 112,0 | 5/9  | 68,0  | 137,0 | 15,3    | AUDI                  | 8E0 615 301 AE                      |
| 24.0130-0186.2 | 430186 | S | B | HC |   | V  | 348,0 | 30,0 | 28,4 | 77,1  | 120,0 | 5    | 79,0  | 187,3 | 14,5    | BMW                   | 34 11 6 763 824                     |
| 24.0130-0187.1 | 430187 | S | B | HC |   | V  | 340,0 | 30,0 | 28,0 | 49,9  | 112,0 | 5    | 65,0  | 140,0 | 15,3    | AUDI                  | 8J0 615 301                         |
| 24.0130-0188.1 | 430188 |   | B |    |   | V  | 337,5 | 30,0 | 27,0 | 62,0  | 120,0 | 5    | 79,0  | 166,0 | 15,0    | LAND ROVER            | SDB000612<br>SDB000613<br>SDB000614 |
| 24.0130-0189.1 | 430189 |   | B | HC |   | V  | 345,0 | 29,9 | 27,5 | 45,3  | 110,0 | 5    | 70,0  | 142,4 | 14,2    | OPEL/VAUXHALL<br>SAAB | 5 69 154/93188445<br>93188445       |
| 24.0130-0190.1 | 430190 |   |   | HC | L | V  | 304,0 | 29,9 | 26,0 | 120,5 | 192,0 | 6    | 157,0 | 134,0 | M12x1,5 | MERCEDES BENZ         | 668 423 00 12                       |
| 24.0130-0191.1 | 430191 |   |   | HC | L | V  | 324,0 | 29,9 | 26,0 | 120,5 | 192,0 | 6    | 157,0 | 134,0 | M12x1,5 | MERCEDES BENZ         | 668 423 01 12                       |
| 24.0130-0192.1 | 430192 | S | B | HC |   | V  | 348,0 | 30,0 | 28,4 | 73,1  | 120,0 | 5    | 79,0  | 186,8 | 14,5    | BMW                   | 34 11 6 855 000                     |
| 24.0130-0193.1 | 430193 | S | B | HC |   | V  | 320,0 | 30,0 | 28,0 | 52,4  | 112,0 | 5    | 68,0  | 153,4 | 15,3    | AUDI                  | 8K0 615 301 A                       |
| 24.0130-0195.1 | 430195 |   | B |    |   | V  | 360,0 | 30,0 | 27,0 | 62,0  | 120,0 | 5    | 79,0  | 175,0 | 15,0    | LAND ROVER            | SDB000622<br>SDB000623<br>SDB000624 |
| 24.0130-0196.1 | 430196 |   | B |    |   | V  | 344,0 | 30,0 | 27,0 | 76,0  | 120,0 | 5    | 79,0  | 172,0 | 16,6    | LAND ROVER            | SDB500181<br>SDB500182              |
| 24.0130-0197.1 | 430197 |   | B |    |   | V  | 360,0 | 30,0 | 27,0 | 81,0  | 120,0 | 5    | 79,0  | 175,0 | 16,6    | LAND ROVER            | SDB500192<br>SDB500193              |
| 24.0130-0198.1 | 430198 |   |   | HC | L | V  | 304,0 | 30,0 | 26,0 | 91,0  | 140,0 | 6    | 118,0 | 122,0 | M12x1,5 | MERCEDES BENZ         | 668 421 01 12<br>668 421 06 12      |
| 24.0130-0199.1 | 430199 | S | B | HC |   | V  | 348,0 | 29,9 | 28,4 | 62,1  | 120,0 | 5    | 75,0  | 154,0 | 16,5    | BMW                   | 34 11 6 793 244<br>34 11 6 868 938  |
| 24.0130-0200.1 | 430200 | S | B | HC |   | V  | 332,0 | 29,9 | 28,4 | 62,1  | 120,0 | 5    | 75,0  | 153,0 | 16,5    | BMW                   | 34 11 6 868 939                     |



# Abmessungen Bremsscheiben

## Dimensions brake discs - Misure dischi freno -

## Dimensions Disques de frein - Medidas disco de freno

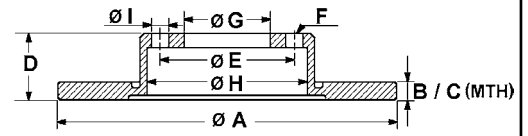

S Fixierschraube - fixing screw - vite di riparazione - vis de fixation - tornillo quefija

B beschichtet - coated - rivestito - revêtu - recubierto

HC hochgekohlt - high carbon - ad alto tenore di carbonio - à haute teneur en carbone - altamente carbonizado

L legiert - alloyed - alligato/legato - allié - aleado

V ventiliert - ventilated - ventilato - ventilé - ventilado

● gelocht - perforated - perforato - poinçonné - perforado

|                |        | S | B | HC | L | V  | A     | B    | C    | D    | E     | F   | G     | H     | I        | OE - #          |                     |                |                |            |
|----------------|--------|---|---|----|---|----|-------|------|------|------|-------|-----|-------|-------|----------|-----------------|---------------------|----------------|----------------|------------|
| 24.0130-0201.1 | 430201 |   | B |    |   | V  | 334,0 | 30,0 | 27,0 | 51,0 | 114,3 | 5   | 62,0  | 143,5 | 14,5     | LEXUS           | 43516-22010         |                |                |            |
| 24.0130-0202.1 | 430202 |   | B |    |   | V  | 334,0 | 30,0 | 27,0 | 51,0 | 114,3 | 5   | 62,0  | 143,5 | 14,5     | LEXUS           | 43512-22260         |                |                |            |
| 24.0130-0203.1 | 430203 |   | B |    |   | V  | 326,0 | 30,0 | 28,0 | 52,7 | 114,3 | 5   | 58,0  | 148,0 | 12,8     | SUBARU          | 26300FE070          |                |                |            |
| 24.0130-0204.1 | 430204 |   | B |    |   | V  | 316,0 | 30,0 | 28,0 | 56,8 | 100,0 | 5   | 58,0  | 149,0 | 13,0     | SUBARU          | 26300AG001          |                |                |            |
| 24.0130-0206.1 | 430206 | S | B | HC | L | V  | 330,0 | 30,0 | 28,0 | 48,0 | 108,0 | 5   | 71,1  | 138,0 | 13,0     | CITROEN         | 4249 A7             |                |                |            |
|                |        |   |   |    |   |    |       |      |      |      |       |     |       |       |          | PEUGEOT         | 4249 A7             |                |                |            |
| 24.0130-0207.1 | 430207 | S | B | HC | L | V  | 296,0 | 30,0 | 27,0 | 51,0 | 120,0 | 5   | 67,4  | 163,7 | 16,3     | CHEVROLET       | 13501307            |                |                |            |
|                |        |   |   |    |   |    |       |      |      |      |       |     |       |       |          | OPEL/VAUXHALL   | 5 69 078/13579147   |                |                |            |
|                |        |   |   |    |   |    |       |      |      |      |       |     |       |       |          | SAAB            | 13502213            |                |                |            |
| 24.0130-0208.1 | 430208 | S | B | HC |   | V  | 337,0 | 30,0 | 27,0 | 51,0 | 120,0 | 5   | 67,4  | 159,7 | 16,3     | OPEL/VAUXHALL   | 5 69 081/13579153   |                |                |            |
|                |        |   |   |    |   |    |       |      |      |      |       |     |       |       |          | SAAB            | 13576781            |                |                |            |
| 24.0130-0209.1 | 430209 | S | B | HC |   | V  | 321,0 | 30,0 | 27,0 | 51,0 | 120,0 | 5   | 67,4  | 160,0 | 16,3     | CHEVROLET       | 13501320, 135799150 |                |                |            |
|                |        |   |   |    |   |    |       |      |      |      |       |     |       |       |          | OPEL/VAUXHALL   | 5 69 083/135799150  |                |                |            |
|                |        |   |   |    |   |    |       |      |      |      |       |     |       |       |          | SAAB            | 135799150           |                |                |            |
| 24.0130-0212.1 | 430212 |   | B | HC |   | V  | 328,0 | 30,0 | 28,0 | 52,0 | 108,0 | 5   | 63,5  | 165,5 | 15,7     | VOLVO           | 31277342            |                |                |            |
| 24.0130-0213.2 | 430213 | S | B | HC |   | V● | 360,0 | 30,0 | 28,4 | 62,3 | 120,0 | 5   | 79,0  | 185,0 | 14,5     | BMW             | 34 11 2 283 802     |                |                |            |
| 24.0130-0214.2 | 430214 | S | B | HC |   | V● | 360,0 | 30,0 | 28,4 | 62,3 | 120,0 | 5   | 79,0  | 185,0 | 14,5     | BMW             | 34 11 2 283 801     |                |                |            |
| 24.0130-0215.1 | 430215 |   | B | HC |   | V  | 324,0 | 30,0 | 28,4 | 49,0 | 114,3 | 5   | 68,0  | 152,0 | 12,7     | NISSAN          | 40206-CD005         |                |                |            |
| 24.0130-0216.2 | 430216 | S | B | HC |   | V  | 348,0 | 30,0 | 28,4 | 73,0 | 120,0 | 5   | 79,0  | 186,8 | 14,5     | BMW             | 34 11 6 782 593     |                |                |            |
| 24.0130-0217.1 | 430217 | S | B | HC | L | V  | 315,0 | 30,0 | 27,4 | 83,0 | 130,0 | 5   | 85,0  | 157,0 | 15,0     | MERCEDES BENZ   | 463 421 00 12       |                |                |            |
|                |        |   |   |    |   |    |       |      |      |      |       |     |       |       |          |                 | 463 421 01 12       |                |                |            |
|                |        |   |   |    |   |    |       |      |      |      |       |     |       |       |          |                 | 463 421 03 12       |                |                |            |
| 24.0130-0218.2 | 430218 | S | B | HC |   | V  | 348,0 | 30,0 | 28,4 | 66,0 | 120,0 | 5   | 75,0  | 186,8 | 16,5     | BMW             | 34 11 6 775 277     |                |                |            |
| 24.0130-0219.1 | 430219 | S | B | HC |   | V  | 340,0 | 30,0 | 28,0 | 49,5 | 112,0 | 5   | 65,0  | 139,7 | 15,3     | AUDI            | 8J0 615 301 G       |                |                |            |
| 24.0130-0220.1 | 430220 | S | B | HC |   | V  | 314,0 | 30,0 | 27,0 | 49,6 | 112,0 | 9   | 65,0  | 145,0 | 15,3     | SEAT/VW         | 1K0 615 301 AJ      |                |                |            |
| 24.0130-0221.1 | 430221 | S | B | HC |   | V  | 320,0 | 30,0 | 28,0 | 52,2 | 112,0 | 5   | 68,0  | 149,3 | 15,3     | AUDI            | 8R0 615 301         |                |                |            |
| 24.0130-0222.1 | 430222 | S | B | HC |   | V  | 345,0 | 30,0 | 28,0 | 52,1 | 112,0 | 5   | 68,0  | 164,6 | 15,3     | AUDI            | 4G0 615 301         |                |                |            |
|                |        |   |   |    |   |    |       |      |      |      |       |     |       |       |          |                 | 4G0 615 301 G       |                |                |            |
|                |        |   |   |    |   |    |       |      |      |      |       |     |       |       |          |                 | 95B 615 301 B       |                |                |            |
| 24.0130-0223.1 | 430223 |   | B |    |   | V  | 328,0 | 30,0 | 28,5 | 53,0 | 127,0 | 5   | 72,0  | 177,0 | 16,2     | PORSCHE         | 0 5208 9269AB       |                |                |            |
|                |        |   |   |    |   |    |       |      |      |      |       |     |       |       |          |                 | JEEP                | 5208 9269AB    |                |            |
| 24.0130-0224.1 | 430224 | S | B | HC |   | V  | 321,0 | 30,0 | 27,0 | 45,5 | 115,0 | 5   | 70,7  | 160,0 | 14,2     | OPEL/VAUXHALL   | 5 69 092/13586854   |                |                |            |
| 24.0130-0225.1 | 430225 | S | B | HC |   | V  | 340,0 | 30,0 | 27,0 | 49,6 | 112,0 | 5/9 | 65,0  | 145,0 | 15,3     | AUDI            | 8S0 615 301         |                |                |            |
|                |        |   |   |    |   |    |       |      |      |      |       |     |       |       |          |                 | AUDI/SEAT/SKODA/VW  | 1K0 615 301 AD |                |            |
|                |        |   |   |    |   |    |       |      |      |      |       |     |       |       |          |                 |                     | 3C0 615 301 C  |                |            |
| 24.0130-0226.1 | 430226 |   | B | HC |   | V  | 326,0 | 30,0 | 28,0 | 46,0 | 108,0 | 5   | 71,0  | 161,0 | 14,0     | JAGUAR          | C2C 25336           |                |                |            |
| 24.0130-0227.1 | 430227 | S | B | HC | L | V  | 340,0 | 30,0 | 28,0 | 48,0 | 108,0 | 5   | 71,1  | 136,0 | 13,2     | CITROEN/PEUGEOT | 4249 88             |                |                |            |
| 24.0130-0229.1 | 430229 | S | B | HC | L | V  | 340,0 | 30,0 | 28,0 | 34,2 | 108,0 | 5   | 71,1  | 133,0 | 13,2     | PEUGEOT         | 4249 F9             |                |                |            |
| 24.0130-0230.1 | 430230 | S | B | HC | L | V  | 340,0 | 30,0 | 28,0 | 34,2 | 108,0 | 4   | 71,1  | 133,0 | 13,2     | CITROEN/PEUGEOT | 4249 F6             |                |                |            |
|                |        |   |   |    |   |    |       |      |      |      |       |     |       |       |          |                 |                     | 16 118 414 80  |                |            |
| 24.0130-0233.2 | 430233 | S | B | HC |   | V  | 340,0 | 30,0 | 28,4 | 73,2 | 120,0 | 5   | 79,0  | 153,7 | 16,5     | BMW             | 34 11 6 792 223     |                |                |            |
| 24.0130-0234.2 | 430234 | S | B | HC |   | V  | 370,0 | 30,0 | 28,4 | 73,1 | 120,0 | 5   | 79,0  | 184,0 | 16,5     | BMW             | 34 10 6 797 606     |                |                |            |
| 24.0130-0237.1 | 430237 | S | B | HC | L | V  | 320,0 | 30,0 | 28,0 | 51,0 | 112,0 | 5   | 67,0  | 154,0 | 15,0     | MERCEDES BENZ   | 246 421 26 12       |                |                |            |
| 24.0130-0238.1 | 430238 | S | B | HC | L | V● | 320,0 | 30,0 | 28,0 | 51,0 | 112,0 | 5   | 67,0  | 154,0 | 15,0     | MERCEDES BENZ   | 246 421 27 12       |                |                |            |
| 24.0132-0100.1 | 432100 | S | B | HC | L | V● | 322,0 | 32,0 | 30,0 | 64,5 | 112,0 | 5   | 67,0  | 154,3 | 15,2     | MERCEDES BENZ   | 000 421 11 12       |                |                |            |
|                |        |   |   |    |   |    |       |      |      |      |       |     |       |       |          |                 |                     | 204 421 10 12  |                |            |
|                |        |   |   |    |   |    |       |      |      |      |       |     |       |       |          |                 |                     | 000 421 30 12  |                |            |
| 24.0132-0101.1 | 432101 | S | B | HC | L | V  | 322,0 | 32,0 | 29,4 | 64,5 | 112,0 | 5   | 67,0  | 154,3 | 15,2     | MERCEDES BENZ   | 000 421 12 12       |                |                |            |
| 24.0132-0110.1 | 432110 |   |   |    |   | V  | 278,0 | 32,2 | 30,7 | 52,0 | 118,0 | 5   | 70,6  | 150,0 | 16,2     | OPEL/VAUXHALL   | 5 69 019/9195293    |                |                |            |
| 24.0132-0111.1 | 432111 |   |   |    |   | V  | 311,0 | 32,0 | 30,0 | 58,0 | 139,7 | 6   | 105,0 | 204,0 | M12x1,25 | TOYOTA          | 43512-60090         |                |                |            |
| 24.0132-0113.1 | 432113 | S | B | HC |   | V  | 334,0 | 31,9 | 30,4 | 76,9 | 120,0 | 5   | 79,0  | 159,0 | 14,8     | BMW             | 34 11 6 757 756     |                |                |            |
| 24.0132-0114.1 | 432114 |   | B | HC |   | V  | 345,0 | 31,9 | 30,0 | 51,0 | 112,0 | 5   | 67,0  | 156,5 | 15,3     | MERCEDES BENZ   | 163 421 05 12       |                |                |            |
| 24.0132-0115.1 | 432115 |   | B | HC | L | V● | 330,0 | 32,0 | 30,0 | 76,0 | 112,0 | 5   | 67,0  | 154,0 | 15,0     | MERCEDES BENZ   | 220 421 25 12       |                |                |            |
| 24.0132-0116.1 | 432116 | S | B | HC |   | V  | 333,0 | 32,5 | 28,5 | 55,6 | 120,0 | 5   | 76,0  | 154,6 | 16,6     | VOLKSWAGEN      | 7H0 615 301 F       |                |                |            |
| 24.0132-0117.1 | 432117 | S | B | HC | L | V  | 330,0 | 32,0 | 30,0 | 68,5 | 130,0 | 5   | 85,0  | 174,0 | 15,4     | PORSCHE         | 955 351 401 40      |                |                |            |
|                |        |   |   |    |   |    |       |      |      |      |       |     |       |       |          |                 |                     | 955 351 401 41 |                |            |
|                |        |   |   |    |   |    |       |      |      |      |       |     |       |       |          |                 |                     | VOLKSWAGEN     | 7L6 615 301 N  |            |
| 24.0132-0118.1 | 432118 | S | B | HC | L | V  | 330,0 | 32,0 | 30,0 | 68,5 | 130,0 | 5   | 85,0  | 174,0 | 15,4     | PORSCHE         | 955 351 402 40      |                |                |            |
|                |        |   |   |    |   |    |       |      |      |      |       |     |       |       |          |                 |                     |                | 955 351 402 41 |            |
|                |        |   |   |    |   |    |       |      |      |      |       |     |       |       |          |                 |                     |                | 7L6 615 302 N  |            |
| 24.0132-0125.1 | 432125 |   | B | HC | L | V● | 345,0 | 32,0 | 30,0 | 76,0 | 112,0 | 5   | 67,0  | 154,0 | 15,0     | MERCEDES BENZ   | 220 421 11 12       |                |                |            |
| 24.0132-0126.1 | 432126 |   |   |    |   | V  | 310,0 | 32,0 | 30,0 | 43,8 | 98,0  | 5   | 59,0  | 138,0 | 16,5     | CITROEN         | 4249 A8             |                |                |            |
|                |        |   |   |    |   |    |       |      |      |      |       |     |       |       |          |                 |                     |                | 4249 F2        |            |
|                |        |   |   |    |   |    |       |      |      |      |       |     |       |       |          |                 |                     |                | FIAT           | 1355376080 |
|                |        |   |   |    |   |    |       |      |      |      |       |     |       |       |          |                 |                     |                |                | 9464640587 |
|                |        |   |   |    |   |    |       |      |      |      |       |     |       |       |          |                 |                     |                |                | 4249 A8    |
| 24.0132-0127.1 | 432127 |   |   | HC | L | V  | 282,0 | 32,0 | 30,6 | 60,0 | 130,0 | 5   | 90,0  | 156,0 | 15,4     | PORSCHE         | 928 351 043 01      |                |                |            |
| 24.0132-0128.1 | 432128 |   |   | HC | L | V  | 282,0 | 32,0 | 30,6 | 60,0 | 130,0 | 5   | 90,0  | 156,0 | 15,4     | PORSCHE         | 928 351 044 01      |                |                |            |
| 24.0132-0129.1 | 432129 |   |   | HC |   | V  | 330,0 | 32,0 | 30,0 | 44,7 | 98,0  | 5   | 59,0  | 149,0 | 13,0     | ALFA ROMEO      | 51768587            |                |                |            |

# Abmessungen Bremsscheiben

## Dimensions brake discs - Misure dischi freno -

## Dimensions Disques de frein - Medidas disco de freno

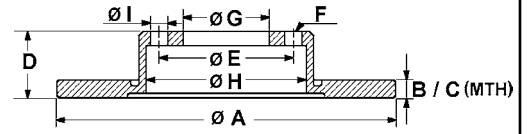

S Fixierschraube - fixing screw - vite di riparazione - vis de fixation - tornillo quefija

B beschichtet - coated - rivestito - revêtu - recubierto

HC hochgekohlt - high carbon - ad alto tenore di carbonio - à haute teneur en carbone - altamente carbonizado

L legiert - alloyed - alligato/legato - allié - aleado

V ventiliert - ventilated - ventilato - ventilé - ventilado

● gelocht - perforated - perforato - poinçonné - perforado

|                |        | S | B | HC | L | V  | A     | B    | C    | D    | E     | F   | G     | H     | I       | OE - #                     |  |
|----------------|--------|---|---|----|---|----|-------|------|------|------|-------|-----|-------|-------|---------|----------------------------|--|
| 24.0132-0131.1 | 432131 |   | B |    |   | V  | 300,0 | 32,0 | 29,9 | 73,5 | 130,0 | 5   | 80,0  | 161,0 | 18,0    | CITROEN<br>FIAT<br>PEUGEOT | 4249 38<br>4249 A6<br>16 078 723 80<br>51705758<br>51740249<br>4249 37<br>4249 A6<br>16 078 723 80 |
| 24.0132-0136.1 | 432136 |   | B | HC | L | V● | 330,0 | 32,0 | 30,0 | 47,5 | 112,0 | 5   | 67,0  | 154,0 | 15,0    | MERCEDES BENZ              | 220 421 18 12  |
| 24.0132-0137.1 | 432137 | S | B | HC | L | V● | 335,0 | 32,0 | 30,0 | 64,5 | 112,0 | 5   | 67,0  | 154,0 | 15,2    | MERCEDES BENZ              | 221 421 17 12  |
| 24.0132-0138.1 | 432138 | S | B | HC | L | V● | 350,0 | 32,0 | 30,0 | 64,5 | 112,0 | 5   | 67,0  | 154,0 | 15,2    | MERCEDES BENZ              | 221 421 00 12<br>221 421 16 12   |
| 24.0132-0139.1 | 432139 | S | B | HC | L | V  | 350,0 | 32,0 | 29,4 | 64,5 | 112,0 | 5   | 67,0  | 154,0 | 15,2    | MERCEDES BENZ              | 219 421 01 12  |
| 24.0132-0140.1 | 432140 |   | B | HC | L | V  | 304,0 | 32,0 | 30,6 | 56,7 | 126,0 | 5   | 107,0 | 172,0 | 8,4     | PORSCHE                    | 930 351 047 02   |
| 24.0132-0142.1 | 432142 |   | B | HC | L | V● | 304,0 | 32,0 | 30,0 | 72,0 | 130,0 | 5   | 103,0 | 161,0 | 15,4    | PORSCHE                    | 993 351 043 01   |
| 24.0132-0143.1 | 432143 |   | B | HC | L | V● | 304,0 | 32,0 | 30,0 | 72,0 | 130,0 | 5   | 103,0 | 161,0 | 15,4    | PORSCHE                    | 993 351 044 01   |
| 24.0132-0144.1 | 432144 | S | B | HC | L | V  | 330,0 | 32,0 | 29,4 | 64,5 | 112,0 | 5   | 67,0  | 154,0 | 15,0    | MERCEDES BENZ              | 204 421 29 12<br>211 421 10 12<br>211 421 13 12<br>211 421 14 12                                   |
| 24.0132-0146.1 | 432146 |   | B | HC | L | V● | 304,0 | 32,0 | 30,6 | 56,7 | 126,0 | 5   | 107,0 | 172,0 | 8,4     | PORSCHE                    | 930 351 048 02   |
| 24.0132-0147.1 | 432147 |   | B | HC | L | V● | 334,0 | 32,0 | 30,0 | 51,5 | 112,0 | 5   | 67,0  | 154,0 | 13,0    | MERCEDES BENZ              | 129 421 23 12  |
| 24.0132-0148.1 | 432148 |   | B |    |   | V  | 313,0 | 32,0 | 30,0 | 70,0 | 144,0 | 5   | 115,0 | 172,5 | 12,5    | LEXUS/TOYOTA               | 43512-60130<br>43512-60170   |
| 24.0132-0150.1 | 432150 |   | B | HC | L | V  | 304,0 | 32,0 | 30,0 | 77,0 | 130,0 | 5   | 103,0 | 161,0 | 15,4    | PORSCHE                    | 928 351 044 03<br>928 351 044 60   |
| 24.0132-0151.1 | 432151 |   | B | HC | L | V  | 304,0 | 32,0 | 30,0 | 77,0 | 130,0 | 5   | 103,0 | 161,0 | 15,4    | PORSCHE                    | 928 351 043 03<br>928 351 043 60   |
| 24.0132-0152.1 | 432152 |   |   |    |   | V  | 309,0 | 32,0 | 30,0 | 43,1 | 108,0 | 5   | 71,1  | 136,0 | 13,0    | PEUGEOT                    | 4246 V5  |
| 24.0132-0153.1 | 432153 | S | B | HC | L | V● | 330,0 | 32,0 | 30,0 | 64,5 | 112,0 | 5   | 67,0  | 154,0 | 15,0    | MERCEDES BENZ              | 230 421 08 12  |
| 24.0132-0154.1 | 432154 |   | B | HC | L | V  | 330,0 | 32,0 | 29,4 | 47,5 | 112,0 | 5   | 67,0  | 154,0 | 15,0    | MERCEDES BENZ              | 211 421 11 12  |
| 24.0132-0157.1 | 432157 | S | B | HC | L | V  | 350,0 | 32,0 | 29,4 | 54,5 | 112,0 | 5   | 67,0  | 156,3 | 15,2    | MERCEDES BENZ              | 164 421 05 12<br>164 421 14 12   |
| 24.0132-0158.1 | 432158 | S | B | HC | L | V  | 330,0 | 32,0 | 29,4 | 54,5 | 112,0 | 5   | 67,0  | 156,3 | 15,2    | MERCEDES BENZ              | 164 421 04 12<br>164 421 13 12   |
| 24.0132-0159.1 | 432159 |   | B | HC | L | V  | 330,0 | 32,0 | 29,4 | 46,5 | 112,0 | 5   | 67,0  | 154,0 | 13,0    | CHRYSLER<br>MERCEDES BENZ  | 5135 475AA<br>210 421 23 12  |
| 24.0132-0160.1 | 432160 | S | B | HC |   | V  | 334,0 | 31,9 | 30,4 | 62,9 | 120,0 | 5   | 79,0  | 159,0 | 14,8    | BMW                        | 34 11 1 165 072  |
| 24.0132-0161.2 | 432161 | S | B | HC |   | V  | 345,0 | 32,0 | 30,4 | 77,0 | 120,0 | 5   | 79,0  | 159,5 | 14,5    | BMW                        | 34 11 2 282 803  |
| 24.0132-0162.2 | 432162 | S | B | HC |   | V  | 345,0 | 32,0 | 30,4 | 77,0 | 120,0 | 5   | 79,0  | 159,5 | 14,5    | BMW                        | 34 11 2 282 804  |
| 24.0132-0163.2 | 432163 |   | B | HC | L | V● | 322,0 | 32,0 | 30,0 | 72,0 | 130,0 | 5   | 103,0 | 157,0 | 15,4    | PORSCHE                    | 993 351 045 10   |
| 24.0132-0164.2 | 432164 |   | B | HC | L | V● | 322,0 | 32,0 | 30,0 | 72,0 | 130,0 | 5   | 103,0 | 157,0 | 15,4    | PORSCHE                    | 993 351 046 10   |
| 24.0132-0165.2 | 432165 |   | B | HC |   | V  | 334,0 | 32,0 | 30,0 | 35,0 | 100,0 | 5/9 | 65,0  | 146,0 | 15,6    | AUDI<br>VOLKSWAGEN         | 8N0 615 302 B<br>1J0 615 302 A   |
| 24.0132-0166.2 | 432166 |   | B | HC |   | V  | 334,0 | 32,0 | 30,0 | 35,0 | 100,0 | 5/9 | 65,0  | 146,0 | 15,6    | AUDI<br>VOLKSWAGEN         | 8N0 615 301 B<br>1J0 615 301 AA  |
| 24.0132-0167.1 | 432167 | S | B | HC | L | V  | 375,0 | 32,0 | 29,4 | 54,5 | 112,0 | 5   | 67,0  | 156,3 | 15,2    | MERCEDES BENZ              | 164 421 15 12  |
| 24.0132-0168.1 | 432168 | S | B | HC | L | V● | 344,0 | 32,0 | 30,0 | 64,5 | 112,0 | 5   | 67,0  | 154,3 | 15,0    | MERCEDES BENZ              | 204 421 11 12<br>000 421 14 12<br>000 421 15 12  |
| 24.0132-0169.1 | 432169 |   | B | HC |   | V  | 321,0 | 32,0 | 30,0 | 51,0 | 114,3 | 5   | 69,0  | 143,0 | 12,5    | HYUNDAI                    | 51712-3J500  |
| 24.0132-0170.1 | 432170 | S | B | HC | L | V● | 322,0 | 32,0 | 30,0 | 51,5 | 112,0 | 5   | 67,0  | 154,2 | 15,2    | MERCEDES BENZ              | 000 421 18 12<br>218 421 03 12   |
| 24.0132-0172.1 | 432172 | S | B | HC |   | V  | 320,0 | 32,0 | 30,0 | 47,2 | 114,3 | 5   | 64,2  | 151,0 | 12,6    | HONDA                      | 45251-TL0-G51  |
| 24.0132-0175.1 | 432175 | S | B | HC | L | V● | 344,0 | 32,0 | 30,0 | 64,5 | 112,0 | 5   | 67,0  | 154,3 | 15,2    | MERCEDES BENZ              | 000 421 16 12  |
| 24.0132-0178.1 | 432178 | S | B | HC | L | V  | 330,0 | 32,0 | 29,4 | 54,5 | 112,0 | 5   | 67,0  | 158,0 | 15,0    | MERCEDES BENZ              | 166 421 06 12  |
| 24.0132-0179.1 | 432179 | S | B | HC | L | V● | 350,0 | 32,0 | 29,4 | 54,0 | 112,0 | 5   | 67,0  | 158,0 | 15,0    | MERCEDES BENZ              | 166 421 10 12  |
| 24.0132-0701.1 | 432701 |   | B |    |   | V  | 296,0 | 32,0 | 30,0 | 50,8 | 114,3 | 5   | 62,0  | 143,5 | 14,5    | LEXUS                      | 43512-30180<br>43512-30181<br>43512-50100<br>43512-50110<br>43512-53010<br>43512-53020             |
| 24.0133-0100.1 | 433100 | S | B | HC |   | V  | 340,0 | 32,6 | 29,5 | 55,6 | 120,0 | 5   | 76,0  | 154,8 | 16,6    | VOLKSWAGEN                 | 7E0 615 301 C  |
| 24.0133-0101.1 | 433101 | S | B | HC | L | V  | 288,0 | 33,0 | 30,0 | 55,3 | 111,0 | 5   | 93,1  | 136,0 | M10x1,5 | FORD                       | 1842994<br>BK21-1125-BC<br>3D0 615 301 F<br>4E0 615 301 P  |
| 24.0134-0100.1 | 434100 |   | B | HC |   | V  | 360,0 | 34,0 | 31,0 | 59,7 | 112,0 | 5   | 68,0  | 135,0 | 15,0    | AUDI/VW                    | 996 351 409 02<br>996 351 409 03<br>996 351 409 05   |
| 24.0134-0101.1 | 434101 |   | B | HC | L | V● | 330,0 | 34,0 | 32,0 | 69,5 | 130,0 | 5   | 98,0  | 173,5 | 15,4    | PORSCHE                    | 996 351 409 02<br>996 351 410 02<br>996 351 410 03<br>996 351 410 05                               |
| 24.0134-0102.1 | 434102 |   | B | HC | L | V● | 330,0 | 34,0 | 32,0 | 69,5 | 130,0 | 5   | 98,0  | 173,5 | 15,4    | PORSCHE                    | 996 351 410 02<br>996 351 410 03<br>996 351 410 05   |



# Abmessungen Bremsscheiben

## Dimensions brake discs - Misure dischi freno -

## Dimensions Disques de frein - Medidas disco de freno

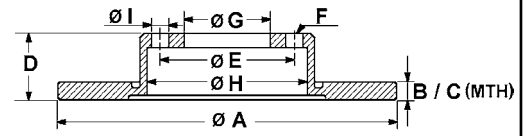

S Fixierschraube - fixing screw - vite di riparazione - vis de fixation - tornillo quefija

B beschichtet - coated - rivestito - revêtu - recubierto

HC hochgekohlt - high carbon - ad alto tenore di carbonio - à haute teneur en carbone - altamente carbonizado

L legiert - alloyed - alligato/legato - allié - aleado

V ventiliert - ventilated - ventilato - ventilé - ventilado

● gelocht - perforated - perforato - poinçonné - perforado

|                |        | S | B | HC | L | V  | A     | B    | C    | D    | E     | F | G    | H     | I    | OE - #        |                 |                |
|----------------|--------|---|---|----|---|----|-------|------|------|------|-------|---|------|-------|------|---------------|-----------------|----------------|
| 24.0134-0103.1 | 434103 | S | B | HC |   | V  | 356,0 | 34,0 | 31,5 | 52,4 | 112,0 | 5 | 68,0 | 149,0 | 15,3 | AUDI          | 4G0 615 301 K   |                |
| 24.0134-0105.1 | 434105 |   | B | HC | L | V● | 350,0 | 34,0 | 32,0 | 67,5 | 130,0 | 5 | 98,0 | 185,0 | 15,4 | PORSCHE       | 997 351 409 90  |                |
| 24.0134-0106.1 | 434106 |   | B | HC | L | V● | 350,0 | 34,0 | 32,0 | 67,5 | 130,0 | 5 | 98,0 | 185,0 | 15,4 | PORSCHE       | 997 351 410 90  |                |
| 24.0134-0123.1 | 434123 |   | B | HC | L | V  | 350,0 | 34,0 | 32,0 | 68,5 | 130,0 | 5 | 85,0 | 185,0 | 15,4 | AUDI/VW       | 7L6 615 301 K   |                |
|                |        |   |   |    |   |    |       |      |      |      |       |   |      |       |      |               | 7L8 615 301     |                |
|                |        |   |   |    |   |    |       |      |      |      |       |   |      |       |      | PORSCHE       | 995 351 40 150  |                |
|                |        |   |   |    |   |    |       |      |      |      |       |   |      |       |      |               | 955 351 401 51  |                |
| 24.0134-0124.1 | 434124 |   | B | HC | L | V  | 350,0 | 34,0 | 32,0 | 68,5 | 130,0 | 5 | 85,0 | 185,0 | 15,4 | AUDI/VW       | 7L6 615 302 K   |                |
|                |        |   |   |    |   |    |       |      |      |      |       |   |      |       |      |               | 7L8 615 302     |                |
|                |        |   |   |    |   |    |       |      |      |      |       |   |      |       |      | PORSCHE       | 995 351 40 250  |                |
|                |        |   |   |    |   |    |       |      |      |      |       |   |      |       |      |               | 955 351 402 51  |                |
| 24.0136-0101.1 | 436101 |   | B | HC |   | V  | 374,0 | 36,0 | 34,4 | 81,0 | 120,0 | 5 | 79,0 | 187,0 | 16,5 | BMW           | 34 11 6 766 107 |                |
| 24.0136-0102.1 | 436102 |   | B | HC | L | V● | 360,0 | 36,0 | 34,0 | 64,5 | 112,0 | 5 | 67,0 | 154,0 | 15,2 | MERCEDES BENZ | 221 421 18 12   |                |
| 24.0136-0103.1 | 436103 |   | B | HC |   | V  | 385,0 | 36,0 | 33,5 | 59,7 | 112,0 | 5 | 68,0 | 135,0 | 15,3 | AUDI          | 4E0 615 301 K   |                |
| 24.0136-0104.1 | 436104 |   | B | HC |   | V  | 356,0 | 36,0 | 34,4 | 61,9 | 120,0 | 5 | 75,0 | 158,0 | 16,5 | BMW           | 34 11 6 756 847 |                |
| 24.0136-0105.1 | 436105 |   | B | HC | L | V● | 360,0 | 36,0 | 34,0 | 76,0 | 112,0 | 5 | 67,0 | 154,0 | 15,0 | MERCEDES BENZ | 220 421 19 12   |                |
| 24.0136-0106.2 | 436106 | S | B | HC |   | V  | 348,0 | 36,0 | 34,4 | 77,0 | 120,0 | 5 | 79,0 | 154,3 | 14,5 | BMW           | 34 11 6 766 871 |                |
|                |        |   |   |    |   |    |       |      |      |      |       |   |      |       |      |               | 34 11 6 779 467 |                |
| 24.0136-0107.1 | 436107 |   | B | HC |   | V  | 385,0 | 36,0 | 33,5 | 61,4 | 112,0 | 5 | 68,0 | 135,0 | 15,2 | AUDI          | 4F0 615 301 J   |                |
| 24.0136-0108.1 | 436108 | S | B | HC | L | V● | 360,0 | 36,0 | 34,0 | 64,5 | 112,0 | 5 | 67,0 | 154,0 | 15,2 | MERCEDES BENZ | 000 421 20 12   |                |
|                |        |   |   |    |   |    |       |      |      |      |       |   |      |       |      |               | 221 421 08 12   |                |
| 24.0136-0109.1 | 436109 | S | B | HC |   | V  | 365,0 | 36,0 | 34,4 | 62,0 | 120,0 | 5 | 75,0 | 168,0 | 16,5 | BMW           | 34 11 6 793 243 |                |
| 24.0136-0110.1 | 436110 |   | B | HC |   | V  | 348,0 | 35,9 | 34,4 | 80,9 | 120,0 | 5 | 79,0 | 154,0 | 16,5 | BMW           | 34 11 6 767 353 |                |
| 24.0136-0111.1 | 436111 |   | B | HC |   | V  | 368,0 | 36,0 | 34,0 | 68,7 | 130,0 | 5 | 85,0 | 157,0 | 15,4 | PORSCHE       | 955 351 403 00  |                |
|                |        |   |   |    |   |    |       |      |      |      |       |   |      |       |      |               | VOLKSWAGEN      |                |
|                |        |   |   |    |   |    |       |      |      |      |       |   |      |       |      |               |                 | 7L8 615 301 A  |
| 24.0136-0112.2 | 436112 | S | B | HC |   | V  | 385,0 | 36,0 | 34,4 | 62,0 | 120,0 | 5 | 75,0 | 153,7 | 16,5 | BMW           | 34 11 6 782 068 |                |
| 24.0136-0113.2 | 436113 | S | B | HC |   | V  | 385,0 | 36,0 | 34,4 | 62,0 | 120,0 | 5 | 75,0 | 153,7 | 16,5 | BMW           | 34 11 6 782 067 |                |
| 24.0136-0114.2 | 436114 | S | B | HC |   | V  | 348,0 | 36,0 | 34,4 | 66,0 | 120,0 | 5 | 75,0 | 153,7 | 16,5 | BMW           | 34 11 6 785 670 |                |
| 24.0136-0115.2 | 436115 | S | B | HC |   | V  | 348,0 | 36,0 | 34,4 | 66,0 | 120,0 | 5 | 75,0 | 153,7 | 16,5 | BMW           | 34 11 6 785 669 |                |
| 24.0136-0116.2 | 436116 | S | B | HC |   | V● | 374,0 | 36,0 | 34,4 | 77,0 | 120,0 | 5 | 79,0 | 174,0 | 14,5 | BMW           | 34 11 2 282 806 |                |
| 24.0136-0117.2 | 436117 | S | B | HC |   | V● | 374,0 | 36,0 | 34,4 | 77,0 | 120,0 | 5 | 79,0 | 174,0 | 14,5 | BMW           | 34 11 2 282 805 |                |
| 24.0136-0118.2 | 436118 | S | B | HC |   | V  | 374,0 | 36,0 | 34,4 | 66,0 | 120,0 | 5 | 75,0 | 186,8 | 16,5 | BMW           | 34 11 6 785 676 |                |
| 24.0136-0119.2 | 436119 | S | B | HC |   | V  | 374,0 | 36,0 | 34,4 | 66,0 | 120,0 | 5 | 75,0 | 186,8 | 16,5 | BMW           | 34 11 6 785 675 |                |
| 24.0136-0120.2 | 436120 | S | B | HC |   | V  | 374,0 | 36,0 | 34,4 | 66,0 | 120,0 | 5 | 75,0 | 153,8 | 16,5 | BMW           | 34 11 6 789 544 |                |
| 24.0136-0121.2 | 436121 | S | B | HC |   | V  | 374,0 | 36,0 | 34,4 | 66,0 | 120,0 | 5 | 75,0 | 153,8 | 16,5 | BMW           | 34 11 6 789 543 |                |
| 24.0136-0122.1 | 436122 |   | B | HC |   | V  | 380,0 | 36,0 | 34,0 | 48,0 | 108,0 | 5 | 71,0 | 200,0 | 14,0 | JAGUAR        | C2P 12622       |                |
| 24.0136-0123.1 | 436123 | S | B | HC |   | V  | 360,0 | 36,0 | 34,0 | 68,5 | 130,0 | 5 | 85,0 | 160,0 | 15,4 | PORSCHE       | 958 351 403 01  |                |
|                |        |   |   |    |   |    |       |      |      |      |       |   |      |       |      |               | 958 351 403 00  |                |
|                |        |   |   |    |   |    |       |      |      |      |       |   |      |       |      |               | VOLKSWAGEN      |                |
|                |        |   |   |    |   |    |       |      |      |      |       |   |      |       |      |               |                 | 7P6 615 301 A  |
| 24.0136-0124.1 | 436124 | S | B | HC |   | V  | 360,0 | 36,0 | 34,0 | 68,5 | 130,0 | 5 | 85,0 | 160,0 | 15,4 | PORSCHE       | 958 351 404 01  |                |
|                |        |   |   |    |   |    |       |      |      |      |       |   |      |       |      |               |                 | 958 351 404 00 |
|                |        |   |   |    |   |    |       |      |      |      |       |   |      |       |      |               |                 | VOLKSWAGEN     |
|                |        |   |   |    |   |    |       |      |      |      |       |   |      |       |      |               |                 | 7P6 615 302 A  |
| 24.0136-0125.2 | 436125 | S | B | HC |   | V● | 400,0 | 36,0 | 34,4 | 63,2 | 120,0 | 5 | 75,0 | 198,0 | 16,5 | BMW           | 34 11 2 284 102 |                |
| 24.0136-0126.2 | 436126 | S | B | HC |   | V● | 400,0 | 36,0 | 34,4 | 63,2 | 120,0 | 5 | 75,0 | 198,0 | 16,5 | BMW           | 34 11 2 284 101 |                |
| 24.0136-0127.1 | 436127 | S | B | HC | L | V  | 360,0 | 36,0 | 34,0 | 68,6 | 130,0 | 5 | 98,0 | 160,0 | 15,4 | PORSCHE       | 970 351 404 00  |                |
|                |        |   |   |    |   |    |       |      |      |      |       |   |      |       |      |               |                 | 298 615 302 B  |
| 24.0136-0128.1 | 436128 | S | B | HC | L | V  | 360,0 | 36,0 | 34,0 | 68,6 | 130,0 | 5 | 98,0 | 160,0 | 15,4 | PORSCHE       | 970 351 403 00  |                |
|                |        |   |   |    |   |    |       |      |      |      |       |   |      |       |      |               |                 | 298 615 301 B  |





# Abmessungen PowerDisc

## Dimensions PowerDisc - Misure PowerDisc - Dimensions PowerDisc - Medidas PowerDisc

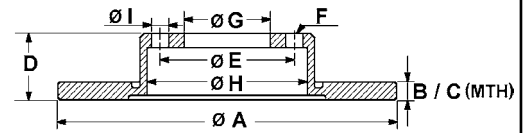

S Fixierschraube - fixing screw - vite di riparazione - vis de fixation - tornillo quefija

B beschichtet - coated - rivestito - revêtu - recubierto

HC hochgekohlt - high carbon - ad alto tenore di carbonio - à haute teneur en carbone - altamente carbonizado

L legiert - alloyed - alligato/legato - allié - aleado

V ventiliert - ventilated - ventilato - ventilé - ventilado

|                |        | S | B | HC | L  | V | A     | B    | C    | D    | E     | F   | G    | H     | I    | OE - #  |
|----------------|--------|---|---|----|----|---|-------|------|------|------|-------|-----|------|-------|------|---|
| 24.0311-0158.1 | 511158 |   | B |    |    |   | 280,0 | 11,0 | 9,0  | 41,0 | 108,0 | 5   | 63,5 | 192,0 | 13,7 | FORD<br>1253962<br>1373361<br>1500156<br>7M51-2A315-BA<br>VOLVO<br>30769113<br>31341645               |
| 24.0311-0171.1 | 511171 |   | B |    |    |   | 271,0 | 11,0 | 9,0  | 40,7 | 108,0 | 5   | 63,5 | 152,0 | 13,8 | FORD<br>1704765   |
| 24.0312-0106.1 | 512106 |   | S | B  |    |   | 239,0 | 12,0 | 10,0 | 35,4 | 100,0 | 4   | 65,0 | 124,5 | 13,6 | AUDI/SEAT/VW<br>321 615 301<br>AUDI/VW<br>175 615 301   |
| 24.0312-0125.1 | 512125 |   | B |    |    |   | 239,0 | 12,0 | 10,8 | 42,5 | 98,0  | 4   | 58,5 | 127,0 | 13,1 | LADA<br>2108-3501070  |
| 24.0312-0126.1 | 512126 |   | S | B  |    |   | 286,0 | 12,0 | 9,6  | 51,5 | 120,0 | 5   | 79,0 | 148,0 | 14,5 | BMW<br>34 11 6 757 750<br>34 11 6 757 751   |
| 24.0312-0141.1 | 512141 |   | B |    |    |   | 239,5 | 12,0 | 10,0 | 42,9 | 108,0 | 4   | 63,5 | 136,0 | 13,7 | FORD<br>1013581<br>1019598<br>1112542<br>MAZDA<br>1E03-33-251<br>1E03-33-251A<br>1E04-33-251          |
| 24.0312-0144.1 | 512144 |   | S | B  | HC | L | 260,0 | 12,0 | 10,0 | 40,4 | 112,0 | 5   | 67,0 | 145,0 | 13,3 | MERCEDES BENZ<br>168 421 01 12  |
| 24.0312-0148.1 | 512148 |   | B |    |    |   | 255,0 | 12,0 | 10,0 | 40,0 | 112,0 | 5/9 | 68,0 | 144,5 | 15,3 | AUDI<br>8E0 615 601 D<br>8E0 615 601 Q  |
| 24.0312-0151.1 | 512151 |   | B |    |    |   | 288,0 | 11,9 | 10,0 | 64,8 | 108,0 | 5   | 68,0 | 178,0 | 16,5 | VOLVO<br>9434167  |
| 24.0312-0152.1 | 512152 |   | B | HC |    |   | 324,0 | 12,0 | 9,6  | 80,2 | 120,0 | 5   | 75,0 | 185,0 | 16,8 | BMW<br>34 21 6 859 678  |
| 24.0312-0154.1 | 512154 |   | B |    |    |   | 280,0 | 12,0 | 10,0 | 34,0 | 108,0 | 5   | 63,5 | 151,0 | 13,7 | FORD<br>1676983<br>4176921<br>4179406<br>7S7J-2A315-BB<br>JAGUAR<br>C2S 49730<br>C2S 52088            |
| 24.0312-0157.1 | 512157 |   | S | B  |    |   | 278,0 | 11,9 | 10,0 | 41,4 | 110,0 | 5   | 65,5 | 145,2 | 14,0 | FIAT<br>46836489<br>71772552<br>OPEL/VAUXHALL<br>5 69 115/93171848<br>SAAB<br>9156785<br>12762290     |
| 24.0312-0158.1 | 512158 |   | B |    |    |   | 256,0 | 12,0 | 10,0 | 48,6 | 112,0 | 5/9 | 65,0 | 140,0 | 15,3 | AUDI/SKODA/VW<br>1K0 615 601 L<br>1K0 615 601 AC  |
| 24.0312-0159.1 | 512159 |   | B |    |    |   | 302,0 | 12,0 | 10,0 | 49,4 | 112,0 | 5/9 | 68,0 | 177,0 | 15,3 | AUDI<br>4F0 615 601 E   |
| 24.0312-0166.1 | 512166 |   | B |    |    |   | 288,0 | 12,0 | 10,0 | 36,0 | 112,0 | 5   | 68,0 | 162,0 | 15,3 | AUDI<br>8E0 615 601 M   |
| 24.0312-0167.1 | 512167 |   | S | B  | HC | L | 276,0 | 12,0 | 10,0 | 44,5 | 112,0 | 5   | 67,0 | 145,0 | 15,3 | MERCEDES BENZ<br>169 421 00 12  |
| 24.0312-0169.1 | 512169 |   | S | B  |    |   | 282,0 | 12,0 | 10,0 | 48,6 | 112,0 | 5/9 | 65,0 | 159,0 | 15,3 | AUDI/SKODA/VW<br>1K0 615 601 AD<br>1K0 615 601 M  |
| 24.0312-0178.1 | 512178 |   | S | B  |    |   | 300,0 | 12,0 | 10,0 | 36,4 | 112,0 | 5   | 68,0 | 169,0 | 15,3 | AUDI<br>8K0 615 601 B   |
| 24.0312-0187.1 | 512187 |   | S | B  |    |   | 292,0 | 12,0 | 10,5 | 48,0 | 120,0 | 5   | 67,4 | 171,5 | 16,3 | OPEL/VAUXHALL<br>5 69 025/13501302<br>5 69 127/13502198<br>13502198<br>SAAB<br>13502135/13502136      |
| 24.0312-0188.1 | 512188 |   | S | B  |    |   | 268,0 | 12,0 | 10,0 | 44,9 | 105,0 | 5   | 60,0 | 147,0 | 14,2 | CHEVROLET<br>13502135/13502136<br>OPEL/VAUXHALL<br>5 69 074/13502134                                  |
| 24.0312-0189.1 | 512189 |   | S | B  |    |   | 292,0 | 12,0 | 10,0 | 45,0 | 115,0 | 5   | 70,7 | 157,0 | 14,2 | CHEVROLET<br>13502139<br>OPEL/VAUXHALL<br>5 69 071/13502138<br>5 69 075/13502137<br>5 69 085/13504280 |
| 24.0313-0161.1 | 513161 |   | S | B  |    |   | 236,0 | 12,7 | 9,7  | 41,0 | 100,0 | 4/6 | 60,0 | 123,0 | 14,0 | OPEL/VAUXHALL<br>5 69 020/90008005<br>5 69 030/90008031<br>5 69 013/93182290                          |
| 24.0313-0178.1 | 513178 |   | S | B  |    |   | 255,6 | 12,9 | 11,0 | 39,2 | 100,0 | 4   | 65,0 | 135,5 | 13,6 | SEAT/VW<br>357 615 301  |
| 24.0313-0181.1 | 513181 |   | B | HC |    |   | 280,0 | 13,0 | 11,0 | 46,5 | 112,0 | 5   | 68,0 | 159,0 | 15,4 | AUDI<br>8D0 615 301 A   |
| 24.0313-0184.1 | 513184 |   | S | B  |    |   | 266,0 | 13,0 | 11,0 | 27,2 | 108,0 | 4   | 66,0 | 133,0 | 13,0 | CITROEN<br>16 086 916 80<br>4246 R4<br>4249 82<br>PEUGEOT<br>16 086 916 80<br>4246 R2                 |
| 24.0313-0185.1 | 513185 |   | S | B  |    |   | 247,5 | 13,0 | 11,0 | 34,2 | 108,0 | 4   | 66,0 | 133,0 | 13,0 | CITROEN<br>4246 R9<br>PEUGEOT<br>4246 R8<br>4249 A5   |
| 24.0315-0105.1 | 515105 |   | B | HC |    |   | 288,0 | 15,0 | 13,0 | 46,5 | 112,0 | 5   | 68,0 | 135,5 | 15,4 | AUDI<br>4A0 615 301 B   |
| 24.0318-0106.1 | 518106 |   | S | B  | HC | V | 239,0 | 18,0 | 16,0 | 34,5 | 100,0 | 4   | 65,0 | 125,0 | 13,6 | SEAT/VW<br>6N0 615 301 C<br>VOLKSWAGEN<br>6N0 615 301 F   |
| 24.0318-0137.1 | 518137 |   | S | B  | HC | V | 239,0 | 18,0 | 16,0 | 35,0 | 100,0 | 5   | 65,0 | 125,0 | 15,6 | SKODA/VW<br>6Q0 615 301<br>VOLKSWAGEN<br>6Q0 615 301 A  |
| 24.0319-0107.1 | 519107 |   | S | B  | HC | V | 276,0 | 19,0 | 16,6 | 60,3 | 120,0 | 5   | 75,0 | 160,8 | 14,5 | BMW<br>34 21 6 855 155<br>34 21 6 864 903   |
| 24.0319-0108.1 | 519108 |   | S | B  | HC | V | 294,0 | 18,9 | 17,4 | 59,7 | 120,0 | 5   | 75,0 | 160,8 | 14,8 | BMW<br>34 21 1 165 563<br>34 21 6 864 056   |



# Abmessungen PowerDisc

## Dimensions PowerDisc - Misure PowerDisc -

## Dimensiones PowerDisc - Medidas PowerDisc

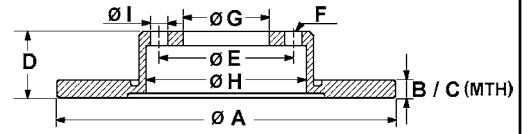

S Fixierschraube - fixing screw - vite di riparazione - vis de fixation - tornillo quefija

B beschichtet - coated - rivestito - revêtu - recubierto

HC hochgekohlt - high carbon - ad alto tenore di carbonio - à haute teneur en carbone - altamente carbonizado

L legiert - alloyed - alligato/legato - allié - aleado

V ventiliert - ventilated - ventilato - ventilé - ventilado

|                |        | S | B | HC | L | V | A     | B    | C    | D    | E     | F   | G    | H     | I    | OE - #                               |  |
|----------------|--------|---|---|----|---|---|-------|------|------|------|-------|-----|------|-------|------|--------------------------------------|--|
| 24.0320-0115.1 | 520115 | S | B | HC | L | V | 236,0 | 20,0 | 17,0 | 41,0 | 100,0 | 4/6 | 60,0 | 123,0 | 14,0 | CHEVROLET<br>DAEWOO<br>OPEL/VAUXHALL | 90121445<br>90121445<br>5 69 054/90511111  |
| 24.0320-0123.1 | 520123 | S | B | HC | L | V | 239,0 | 20,0 | 18,0 | 39,0 | 100,0 | 4   | 65,0 | 123,8 | 13,6 | AUDI/SEAT/VW<br>AUDI/VW              | 321 615 301 C<br>321 615 301 A   |
| 24.0320-0128.1 | 520128 | S | B | HC | L | V | 256,0 | 20,0 | 18,0 | 38,8 | 100,0 | 4   | 65,0 | 131,5 | 13,8 | SEAT/VW                              | 321 615 301 D<br>6N0 615 301 D   |
| 24.0320-0132.1 | 520132 | S | B |    |   | V | 247,0 | 20,4 | 18,5 | 34,2 | 108,0 | 4   | 66,0 | 133,2 | 12,8 | CITROEN<br>PEUGEOT                   | 95 661 747<br>4246 A7<br>4249 96   |
| 24.0320-0133.1 | 520133 | S | B |    |   | V | 266,0 | 20,5 | 18,5 | 27,6 | 108,0 | 4   | 66,0 | 133,0 | 13,0 | CITROEN<br>PEUGEOT                   | 4249 F0<br>4246 97<br>4249 F0  |
| 24.0320-0142.1 | 520142 |   | B | HC | L | V | 257,5 | 20,0 | 18,2 | 40,5 | 98,0  | 4   | 59,0 | 126,7 | 13,0 | ALFA/FIAT/LANCIA                     | 7779409<br>71738145<br>51749124<br>60806137<br>60810076<br>60811256<br>60811266                  |
| 24.0320-0146.1 | 520146 |   | B |    |   | V | 253,0 | 20,0 | 18,0 | 43,7 | 108,0 | 4   | 63,5 | 153,0 | 13,7 | FORD                                 | 4115996<br>5026786   |
| 24.0320-0147.1 | 520147 |   | B |    |   | V | 239,5 | 20,0 | 18,0 | 43,0 | 108,0 | 4   | 63,5 | 136,0 | 13,7 | FORD/MAZDA                           | 1019604<br>1066271<br>1320581<br>1320582<br>5028281  |
| 24.0320-0154.1 | 520154 | S | B | HC |   | V | 298,0 | 20,0 | 17,6 | 61,3 | 120,0 | 5   | 75,0 | 185,0 | 14,5 | BMW                                  | 34 21 1 164 175<br>34 21 6 767 060   |
| 24.0320-0173.1 | 520173 | S | B |    |   | V | 292,0 | 19,9 | 18,0 | 41,4 | 110,0 | 5   | 65,5 | 162,5 | 14,0 | FIAT<br>OPEL/VAUXHALL<br>SAAB        | 46836490<br>71772548<br>5 69 114/93171778<br>9191336<br>12762291                                 |
| 24.0320-0175.1 | 520175 |   | B |    |   | V | 255,0 | 20,0 | 18,0 | 43,1 | 100,0 | 4   | 55,0 | 129,0 | 14,5 | TOYOTA                               | 43512-0D050<br>43512-17120<br>43512-17130<br>43512-17131<br>43512-52040<br>43512-52090           |
| 24.0320-0183.1 | 520183 | S | B | HC |   | V | 320,0 | 20,0 | 18,4 | 63,2 | 120,0 | 5   | 75,0 | 185,0 | 14,5 | BMW                                  | 34 21 6 772 085  |
| 24.0320-0195.1 | 520195 | S | B | HC |   | V | 300,0 | 20,0 | 18,4 | 66,0 | 120,0 | 5   | 75,0 | 160,8 | 14,5 | BMW                                  | 34 21 6 855 007  |
| 24.0320-0204.1 | 520204 | S | B | HC |   | V | 300,0 | 20,0 | 18,4 | 66,1 | 120,0 | 5   | 75,0 | 185,0 | 14,5 | BMW                                  | 34 21 6 864 901  |
| 24.0320-0213.1 | 520213 | S | B | HC |   | V | 320,0 | 20,0 | 18,4 | 86,1 | 120,0 | 5   | 75,0 | 185,0 | 14,5 | BMW                                  | 34 21 6 763 345  |
| 24.0320-0234.1 | 520234 | S | B | HC |   | V | 330,0 | 20,0 | 18,4 | 71,0 | 120,0 | 5   | 75,0 | 154,0 | 16,5 | BMW                                  | 34 20 6 868 936  |
| 24.0322-0100.1 | 522100 |   | B | HC |   | V | 280,0 | 22,0 | 20,0 | 28,5 | 100,0 | 5   | 65,0 | 141,0 | 15,6 | SEAT/VW                              | 1H0 615 301 A  |
| 24.0322-0103.1 | 522103 | S | B | HC |   | V | 302,0 | 22,0 | 19,6 | 76,0 | 120,0 | 5   | 79,0 | 149,0 | 14,5 | BMW                                  | 34 11 1 160 936  |
| 24.0322-0115.1 | 522115 | S | B | HC |   | V | 286,0 | 22,0 | 19,6 | 51,5 | 120,0 | 5   | 79,0 | 147,5 | 14,5 | BMW                                  | 34 11 1 165 455<br>34 11 6 766 239<br>34 11 6 794 301<br>34 11 6 864 060                         |
| 24.0322-0122.1 | 522122 |   | B | HC | L | V | 260,0 | 22,0 | 19,6 | 35,0 | 100,0 | 4   | 66,0 | 138,0 | 14,5 | BMW                                  | 34 11 1 160 915  |
| 24.0322-0132.1 | 522132 | S | B | HC | L | V | 284,0 | 22,0 | 19,4 | 43,5 | 112,0 | 5   | 67,0 | 154,3 | 12,8 | MERCEDES BENZ                        | 202 421 09 12  |
| 24.0322-0150.1 | 522150 | S | B | HC |   | V | 280,0 | 22,0 | 19,0 | 36,7 | 100,0 | 5   | 65,0 | 133,5 | 15,6 | AUDI/SEAT/SKODA/VW                   | 1J0 615 301 E<br>1J0 615 301 M<br>1J0 615 301 P<br>1J0 615 301 D<br>1J0 615 301 L<br>6R0 615 301 |
| 24.0322-0151.1 | 522151 | S | B | HC |   | V | 256,0 | 22,0 | 19,0 | 36,7 | 100,0 | 5   | 65,0 | 133,5 | 15,6 | AUDI/SEAT/SKODA/VW                   | 1J0 615 301 D<br>1J0 615 301 L<br>6R0 615 301  |
| 24.0322-0152.1 | 522152 |   | B | HC |   | V | 280,0 | 22,0 | 20,0 | 46,3 | 112,0 | 5/9 | 68,0 | 146,5 | 15,3 | AUDI/VW<br>AUDI/VW                   | 8Z0 615 301 D<br>8E0 615 301 B<br>8E0 615 301 D<br>8E0 615 301 P                                 |
| 24.0322-0159.1 | 522159 | S | B | HC |   | V | 296,0 | 22,0 | 19,6 | 76,3 | 120,0 | 5   | 79,0 | 148,8 | 14,5 | BMW                                  | 34 11 6 767 061  |
| 24.0322-0160.1 | 522160 | S | B | HC |   | V | 300,0 | 22,0 | 19,6 | 51,8 | 120,0 | 5   | 79,0 | 164,0 | 14,5 | BMW                                  | 34 11 1 164 539<br>34 11 6 757 526<br>34 11 6 766 224<br>34 11 6 864 058<br>34 11 6 794 302      |
| 24.0322-0161.1 | 522161 | S | B | HC | L | V | 276,0 | 22,0 | 19,0 | 77,2 | 130,0 | 5   | 85,0 | 156,3 | 15,0 | MERCEDES BENZ<br><br>VOLKSWAGEN      | 902 421 06 12<br>902 421 07 12<br>902 421 09 12<br>2D0 615 301 C<br>2D0 615 301 D                |



# Abmessungen PowerDisc

## Dimensions PowerDisc - Misure PowerDisc - Dimensions PowerDisc - Medidas PowerDisc

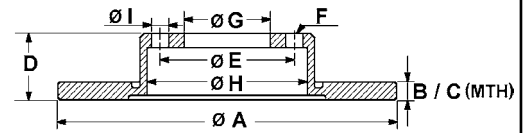

S Fixierschraube - fixing screw - vite di riparazione - vis de fixation - tornillo quejija

B beschichtet - coated - rivestito - revêtu - recubierto

HC hochgekohlt - high carbon - ad alto tenore di carbonio - à haute teneur en carbone - altamente carbonizado

L legiert - alloyed - alligato/legato - allié - aleado

V ventiliert - ventilated - ventilato - ventilé - ventilado

|                |        | S | B  | HC | L | V | A     | B    | C    | D    | E     | F   | G    | H     | I    | OE - #                     |  |
|----------------|--------|---|----|----|---|---|-------|------|------|------|-------|-----|------|-------|------|----------------------------|--|
| 24.0322-0162.1 | 522162 | S | B  | HC | L | V | 276,0 | 22,0 | 19,0 | 60,0 | 112,0 | 5   | 67,0 | 153,0 | 15,0 | MERCEDES BENZ              | 638 421 01 12  |
| 24.0322-0163.1 | 522163 | B | HC |    |   | V | 256,0 | 22,0 | 20,0 | 36,6 | 100,0 | 5   | 65,0 | 135,0 | 15,6 | AUDI/VW                    | 8N0 615 601 B  |
| 24.0322-0168.1 | 522168 | S | B  | HC | L | V | 260,0 | 22,0 | 19,4 | 40,4 | 112,0 | 5   | 67,0 | 145,0 | 13,3 | MERCEDES BENZ              | 168 421 02 12<br>168 421 08 12   |
| 24.0322-0170.1 | 522170 |   |    |    |   | V | 257,0 | 22,0 | 20,0 | 34,0 | 104,0 | 4   | 86,0 | 160,5 | 10,6 | HYUNDAI                    | 51712-28300  |
| 24.0322-0172.1 | 522172 | B |    |    |   | V | 258,0 | 22,0 | 20,0 | 43,4 | 108,0 | 4   | 63,5 | 136,0 | 13,7 | FORD/MAZDA                 | 1808479<br>98AX-1125-B1F   |
| 24.0322-0197.1 | 522197 | B |    |    |   | V | 257,5 | 22,0 | 20,2 | 40,5 | 98,0  | 4   | 59,0 | 127,0 | 13,0 | CITROEN                    | 4249 74<br>4249 L2   |
|                |        |   |    |    |   |   |       |      |      |      |       |     |      |       |      | FIAT/LANCIA                | 46401356<br>46542383<br>46831041<br>51896287<br>51896288<br>4249 73<br>4249 L2 |
| 24.0322-0199.1 | 522199 | B | HC | L  |   | V | 270,0 | 22,0 | 19,4 | 35,5 | 112,0 | 5   | 67,0 | 145,0 | 13,3 | MERCEDES BENZ              | 414 421 00 12  |
| 24.0322-0204.1 | 522204 | B | HC |    |   | V | 276,0 | 22,0 | 19,6 | 44,2 | 100,0 | 4   | 64,2 | 150,0 | 14,7 | MINI                       | 34 11 6 774 984  |
| 24.0322-0209.1 | 522209 | S | B  | HC |   | V | 320,0 | 22,0 | 20,4 | 60,5 | 120,0 | 5   | 75,0 | 185,0 | 14,5 | BMW                        | 34 20 1 166 073  |
| 24.0322-0210.1 | 522210 | S | B  | HC |   | V | 280,0 | 22,0 | 19,0 | 49,9 | 112,0 | 5/9 | 65,0 | 144,0 | 15,3 | AUDI/SEAT/VW               | 1K0 615 301 AK   |
| 24.0322-0223.1 | 522223 | B | HC |    |   | V | 330,0 | 22,0 | 20,0 | 49,4 | 112,0 | 5   | 68,0 | 138,0 | 15,3 | AUDI                       | 4F0 615 601 F  |
| 24.0322-0224.1 | 522224 | S | B  | HC |   | V | 320,0 | 22,0 | 20,4 | 79,7 | 120,0 | 5   | 75,0 | 185,0 | 16,5 | BMW                        | 34 21 3 332 217  |
| 24.0322-0231.1 | 522231 | S | B  |    |   | V | 257,0 | 22,0 | 20,0 | 40,5 | 100,0 | 4/6 | 60,0 | 126,0 | 14,5 | FIAT                       | 55700920<br>55700921<br>5 69 024/93188917<br>5 69 065/9319724                  |
|                |        |   |    |    |   |   |       |      |      |      |       |     |      |       |      | OPEL/VAUXHALL              |  |
| 24.0322-0232.1 | 522232 | S | B  | HC | L | V | 276,0 | 22,0 | 19,4 | 44,5 | 112,0 | 5   | 67,0 | 145,0 | 15,3 | MERCEDES BENZ              | 169 421 08 12  |
| 24.0322-0236.1 | 522236 | S | B  | HC |   | V | 336,0 | 22,0 | 20,4 | 67,3 | 120,0 | 5   | 75,0 | 185,0 | 14,5 | BMW                        | 34 21 6 855 004  |
| 24.0322-0238.1 | 522238 | S | B  | HC |   | V | 292,0 | 22,0 | 19,6 | 73,3 | 120,0 | 5   | 79,0 | 151,5 | 14,5 | BMW                        | 34 11 6 854 997  |
| 24.0322-0239.1 | 522239 | S | B  | HC |   | V | 284,0 | 22,0 | 19,6 | 73,3 | 120,0 | 5   | 79,0 | 151,5 | 16,6 | BMW                        | 34 11 6 792 215<br>34 11 6 854 996<br>34 11 6 774 986<br>34 11 6 858 652       |
| 24.0322-0247.1 | 522247 | B | HC |    |   | V | 294,0 | 22,0 | 20,4 | 44,2 | 100,0 | 4   | 64,2 | 150,0 | 16,2 | MINI                       | 34 11 6 774 986<br>34 11 6 858 652   |
| 24.0322-0248.1 | 522248 | B | HC |    |   | V | 280,0 | 22,0 | 20,4 | 44,2 | 100,0 | 4   | 64,2 | 150,0 | 16,2 | MINI                       | 34 11 6 774 985<br>34 11 6 858 651   |
| 24.0323-0113.1 | 523113 | B | HC |    |   | V | 258,0 | 23,0 | 21,0 | 43,8 | 108,0 | 4   | 63,5 | 136,0 | 13,0 | FORD                       | 1523795<br>1535924<br>1546835<br>1679853<br>8V51-1125-AC<br>8V51-1125-AD       |
| 24.0323-0114.1 | 523114 | S | B  |    |   | V | 315,0 | 22,9 | 21,5 | 48,0 | 120,0 | 5   | 67,4 | 172,0 | 16,3 | CHEVROLET<br>OPEL/VAUXHALL | 13501314<br>5 69 062/13501303<br>5 69 128/13502199<br>13502199                 |
| 24.0324-0115.1 | 524115 | S | B  | HC | L | V | 256,0 | 24,0 | 21,0 | 41,0 | 100,0 | 4/6 | 60,0 | 123,0 | 14,0 | DAEWOO<br>OPEL/VAUXHALL    | 96179110<br>5 69 001/90487402  |
| 24.0324-0120.1 | 524120 | B |    |    |   | V | 260,0 | 24,0 | 22,2 | 47,0 | 108,0 | 4   | 63,5 | 136,0 | 13,6 | FORD                       | 4070865<br>5026784   |
| 24.0324-0152.1 | 524152 | S | B  | HC | L | V | 256,0 | 23,8 | 21,0 | 41,1 | 100,0 | 4   | 60,0 | 123,0 | 14,3 | OPEL/VAUXHALL              | 5 69 059/9117677   |
| 24.0324-0158.1 | 524158 | S | B  | HC | L | V | 280,0 | 24,0 | 21,8 | 44,0 | 100,0 | 4   | 61,0 | 140,0 | 13,6 | RENAULT                    | 77 01 207 829<br>86 71 005 975   |
| 24.0324-0159.1 | 524159 | B |    |    |   | V | 281,0 | 23,9 | 21,5 | 45,7 | 114,3 | 4   | 69,0 | 146,5 | 12,5 | MITSUBISHI<br>VOLVO        | M818027<br>30818027  |
| 24.0324-0161.1 | 524161 | B |    |    |   | V | 300,0 | 23,9 | 22,0 | 47,0 | 108,0 | 5   | 63,5 | 155,0 | 13,7 | FORD                       | 1376118<br>4179398<br>4181042  |
|                |        |   |    |    |   |   |       |      |      |      |       |     |      |       |      | JAGUAR                     | C2S 35270<br>C2S 42667<br>C2S 52091  |
| 24.0324-0166.1 | 524166 | B | HC | L  |   | V | 260,0 | 24,0 | 21,0 | 41,0 | 100,0 | 4/6 | 60,0 | 126,0 | 14,5 | OPEL/VAUXHALL              | 5 69 000/9196050   |
| 24.0324-0171.1 | 524171 | S | B  | HC | L | V | 280,0 | 24,0 | 21,8 | 44,0 | 108,0 | 5   | 61,0 | 140,0 | 15,5 | RENAULT                    | 77 01 206 198  |
| 24.0324-0181.1 | 524181 | S | B  | HC |   | V | 310,0 | 24,0 | 21,6 | 77,0 | 120,0 | 5   | 79,0 | 161,0 | 14,5 | BMW                        | 34 11 6 764 021  |
| 24.0324-0197.1 | 524197 | S | B  | HC |   | V | 300,0 | 24,0 | 21,6 | 73,5 | 120,0 | 5   | 79,0 | 152,0 | 14,5 | BMW                        | 34 11 6 764 643<br>34 11 6 854 998   |
| 24.0324-0200.1 | 524200 | S | B  | HC |   | V | 330,0 | 24,0 | 21,6 | 73,3 | 120,0 | 5   | 79,0 | 174,0 | 14,5 | BMW                        | 34 11 6 854 999  |
| 24.0324-0203.1 | 524203 | S | B  | HC |   | V | 312,0 | 23,9 | 22,4 | 73,1 | 120,0 | 5   | 79,0 | 152,0 | 16,5 | BMW                        | 34 11 6 792 219<br>34 11 6 855 006   |
| 24.0325-0105.1 | 525105 | B | HC |    |   | V | 288,0 | 25,0 | 23,0 | 46,5 | 112,0 | 5/9 | 68,0 | 135,0 | 15,4 | AUDI/SEAT/SKODA            | 4A0 615 301 C<br>4A0 615 301 D<br>8E0 615 301 Q                                |
| 24.0325-0110.1 | 525110 | S | B  | HC | L | V | 288,0 | 25,0 | 22,4 | 46,5 | 112,0 | 5   | 67,0 | 154,3 | 13,2 | MERCEDES BENZ              | 203 421 03 12<br>210 421 07 12<br>210 421 24 12                                |

# Abmessungen PowerDisc

## Dimensions PowerDisc - Misure PowerDisc - Dimensiones PowerDisc - Medidas PowerDisc

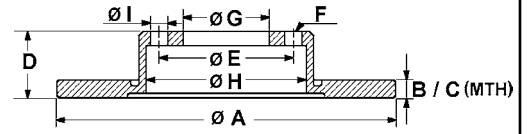

S Fixierschraube - fixing screw - vite di riparazione - vis de fixation - tornillo quefija

B beschichtet - coated - rivestito - revêtu - recubierto

HC hochgekohlt - high carbon - ad alto tenore di carbonio - à haute teneur en carbone - altamente carbonizado

L legiert - alloyed - alligato/legato - allié - aleado

V ventiliert - ventilated - ventilato - ventilé - ventilado

|                |        | S | B | HC | L | V | A     | B    | C    | D    | E     | F    | G    | H     | I    | OE - #                        |  |
|----------------|--------|---|---|----|---|---|-------|------|------|------|-------|------|------|-------|------|-------------------------------|--|
| 24.0325-0113.1 | 525113 | S | B | HC |   | V | 288,0 | 25,0 | 22,0 | 34,5 | 100,0 | 5    | 65,0 | 136,0 | 15,6 | AUDI/SEAT/SKODA/VW            | 1J0 615 301 R<br>1J0 615 301 S<br>6R0 615 301 A  |
| 24.0325-0114.1 | 525114 | S | B | HC |   | V | 288,0 | 25,1 | 21,0 | 55,4 | 112,0 | 5    | 68,2 | 144,2 | 16,5 | FORD<br>SEAT/VW               | 1045994<br>7M0 615 301 G   |
| 24.0325-0115.1 | 525115 |   | B | HC |   | V | 282,5 | 25,0 | 23,0 | 46,5 | 112,0 | 5    | 68,0 | 135,0 | 15,3 | VOLKSWAGEN                    | 8E0 615 301 A<br>8E0 615 301 C   |
| 24.0325-0117.1 | 525117 |   | B | HC |   | V | 278,0 | 25,0 | 23,0 | 48,5 | 108,0 | 5    | 63,5 | 140,0 | 13,7 | FORD                          | 1373369<br>1734696<br>AV61-1125-BB   |
| 24.0325-0119.1 | 525119 | S | B | HC | L | V | 288,0 | 25,0 | 22,0 | 42,0 | 110,0 | 5/7  | 70,0 | 139,0 | 14,0 | VOLVO<br>OPEL/VAUXHALL        | 31262718<br>5 69 056/90512029  |
| 24.0325-0123.1 | 525123 |   | B | HC |   | V | 310,0 | 25,0 | 22,0 | 34,5 | 100,0 | 5/9  | 65,0 | 185,0 | 15,6 | AUDI/SEAT/SKODA/VW            | 5390786<br>6R0 615 301 B<br>8N0 615 301 A<br>8L0 615 301   |
| 24.0325-0131.1 | 525131 | S | B | HC | L | V | 280,0 | 24,8 | 22,0 | 42,0 | 110,0 | 5/7  | 70,0 | 139,0 | 14,0 | AUDI/VW<br>OPEL/VAUXHALL      | 5 69 066/93197592<br>4B0 615 301 A   |
| 24.0325-0137.1 | 525137 |   | B | HC |   | V | 312,0 | 25,0 | 23,0 | 46,5 | 112,0 | 5    | 68,0 | 158,0 | 15,3 | AUDI/SKODA                    | 8E0 615 301 R  |
| 24.0325-0138.1 | 525138 | S | B | HC |   | V | 325,0 | 24,9 | 22,5 | 52,6 | 120,0 | 5    | 79,0 | 174,0 | 14,5 | BMW                           | 34 10 1 166 071<br>34 11 6 864 047   |
| 24.0325-0141.1 | 525141 | S | B | HC |   | V | 285,0 | 24,9 | 22,0 | 42,1 | 110,0 | 5/7  | 70,0 | 139,0 | 14,0 | FIAT<br>OPEL/VAUXHALL<br>SAAB | 51819733<br>71772553<br>5 69 003/93171497<br>9156807<br>93171497   |
| 24.0325-0142.1 | 525142 | S | B | HC | L | V | 308,0 | 25,0 | 22,0 | 42,0 | 110,0 | 5/8  | 70,0 | 139,0 | 14,0 | OPEL/VAUXHALL<br>SAAB         | 5 69 061/9194477<br>5391560<br>9184405   |
| 24.0325-0145.1 | 525145 | S | B | HC |   | V | 288,0 | 25,0 | 22,0 | 49,9 | 112,0 | 5/9  | 65,0 | 144,0 | 15,3 | AUDI/SEAT/SKODA/VW            | 1K0 615 301 T<br>JZW 615 301 J   |
| 24.0325-0148.1 | 525148 | S | B | HC | L | V | 280,0 | 25,0 | 22,0 | 42,0 | 100,0 | 4/6  | 60,0 | 139,0 | 14,5 | OPEL/VAUXHALL                 | 5 69 006/93175376  |
| 24.0325-0149.1 | 525149 |   | B | HC |   | V | 314,0 | 25,0 | 23,0 | 59,7 | 112,0 | 5    | 68,0 | 144,0 | 15,3 | AUDI                          | 4F0 615 301 D  |
| 24.0325-0158.1 | 525158 | S | B | HC |   | V | 312,0 | 25,0 | 22,0 | 49,9 | 112,0 | 5/9  | 65,0 | 146,0 | 15,3 | AUDI/VW/SKODA                 | 1K0 615 301 AA<br>JZW 615 301 H  |
| 24.0325-0160.1 | 525160 | S | B | HC |   | V | 325,0 | 25,0 | 22,6 | 62,2 | 120,0 | 5    | 75,0 | 174,0 | 16,5 | BMW                           | 34 11 3 400 151  |
| 24.0325-0162.1 | 525162 |   | B | HC |   | V | 300,0 | 25,0 | 23,0 | 48,5 | 108,0 | 5    | 63,5 | 140,0 | 13,7 | FORD<br>VOLVO                 | 1253965<br>1373370<br>1520297<br>1797226<br>DV61-1125-DA<br>274510<br>31341643<br>31362412<br>31381375<br>31400937<br>31400941 |
| 24.0325-0167.1 | 525167 | S | B | HC | L | V | 288,0 | 25,0 | 22,4 | 44,5 | 112,0 | 5    | 67,0 | 154,3 | 15,3 | MERCEDES BENZ                 | 169 421 11 12  |
| 24.0325-0171.1 | 525171 |   | B | HC |   | V | 288,0 | 25,0 | 23,0 | 46,5 | 112,0 | 5/10 | 68,0 | 137,0 | 15,3 | SKODA/VW                      | 4B0 615 301 B  |
| 24.0325-0172.1 | 525172 |   | B | HC |   | V | 312,0 | 25,0 | 23,0 | 46,5 | 112,0 | 5/10 | 68,0 | 140,0 | 15,3 | SKODA/VW                      | 4B0 615 301 C  |
| 24.0325-0179.1 | 525179 | S | B | HC | L | V | 288,0 | 25,0 | 22,4 | 64,5 | 112,0 | 5    | 67,0 | 154,3 | 15,2 | MERCEDES BENZ                 | 000 421 19 12  |
| 24.0325-0184.1 | 525184 | S | B | HC |   | V | 314,0 | 25,0 | 23,0 | 52,4 | 112,0 | 5    | 68,0 | 154,0 | 15,3 | AUDI                          | 8K0 615 301  |
| 24.0325-0197.1 | 525197 |   | B | HC |   | V | 320,0 | 25,0 | 23,0 | 48,5 | 108,0 | 5    | 63,5 | 148,0 | 13,7 | FORD<br>VOLVO                 | 1724956<br>3M51-2C375-CE<br>31302573<br>31329122<br>31341644<br>31381376<br>31400818<br>31400942                               |
| 24.0325-0198.1 | 525198 | S | B | HC | L | V | 280,0 | 25,0 | 22,0 | 43,2 | 100,0 | 4/6  | 60,0 | 139,0 | 14,5 | OPEL/VAUXHALL                 | 5 69 007/93181113<br>5 69 067/93197712   |
| 24.0325-0199.1 | 525199 |   | B | HC |   | V | 278,0 | 25,0 | 23,0 | 48,5 | 108,0 | 5    | 63,5 | 140,0 | 13,7 | FORD                          | 1790221<br>AV61-1125-DB  |
| 24.0326-0106.1 | 526106 | S | B |    |   | V | 283,0 | 26,0 | 24,2 | 28,2 | 108,0 | 4    | 66,0 | 133,5 | 13,0 | CITROEN<br>PEUGEOT            | 4246 L8<br>4246 R7   |
| 24.0326-0107.1 | 526107 |   | B | HC |   | V | 302,0 | 26,0 | 23,0 | 50,0 | 108,0 | 5    | 68,0 | 151,0 | 14,4 | VOLVO                         | 272276   |
| 24.0326-0115.1 | 526115 |   | B | HC |   | V | 300,0 | 26,0 | 22,0 | 56,0 | 112,0 | 5    | 68,2 | 144,0 | 16,5 | FORD<br>SEAT/VW               | 1141782<br>7M3 615 301 A   |
| 24.0326-0119.1 | 526119 |   | B | HC |   | V | 313,0 | 25,9 | 22,0 | 56,2 | 112,0 | 5    | 68,2 | 148,0 | 16,5 | FORD<br>SEAT/VW               | 1108038<br>7M3 615 301   |



# Abmessungen PowerDisc

## Dimensions PowerDisc - Misure PowerDisc -

## Dimensions PowerDisc - Medidas PowerDisc

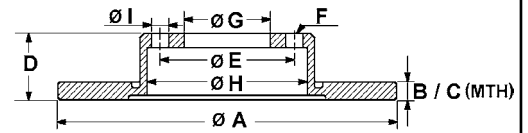

S Fixierschraube - fixing screw - vite di riparazione - vis de fixation - tornillo quefija

B beschichtet - coated - rivestito - revêtu - recubierto

HC hochgekohlt - high carbon - ad alto tenore di carbonio - à haute teneur en carbone - altamente carbonizado

L legiert - alloyed - alligato/legato - allié - aleado

V ventiliert - ventilated - ventilato - ventilé - ventilado

**S B H C L V A B C D E F G H I OE - #**

|                |        |   |   |    |   |       |       |      |      |       |       |      |       |       |               |  |          |
|----------------|--------|---|---|----|---|-------|-------|------|------|-------|-------|------|-------|-------|---------------|--|----------|
| 24.0326-0120.1 | 526120 | S | B |    | V | 283,0 | 26,0  | 24,0 | 34,2 | 108,0 | 4     | 66,0 | 133,5 | 13,0  | CITROEN       | 4246 W2<br>4249 18<br>4249 84 / 4249 J6<br>16 064 014 80                 |          |
|                |        |   |   |    |   |       |       |      |      |       |       |      |       |       | PEUGEOT       | 4246 W8<br>4249 17<br>4249 84 / 4249 J6                                  |          |
| 24.0326-0123.1 | 526123 |   | B | HC | V | 300,0 | 26,0  | 22,8 | 47,0 | 108,0 | 5     | 61,0 | 139,6 | 13,5  | RENAULT       | 82 00 007 122<br>86 71 016 878   |          |
| 24.0326-0165.1 | 526165 | S | B | HC | V | 276,0 | 26,0  | 23,0 | 45,5 | 105,0 | 5     | 60,0 | 139,0 | 14,2  | CHEVROLET     | 13502045<br>13502824   |          |
|                |        |   |   |    |   |       |       |      |      |       |       |      |       |       | OPEL/VAUXHALL | 5 69 073/13502044  |          |
| 24.0326-0166.1 | 526166 | S | B | HC | V | 300,0 | 26,0  | 23,0 | 45,5 | 115,0 | 5     | 70,7 | 149,0 | 14,2  | CHEVROLET     | 13502052   |          |
|                |        |   |   |    |   |       |       |      |      |       |       |      |       |       | OPEL/VAUXHALL | 5 69 070/13502052<br>5 69 076/13502051<br>5 69 082/13503988              |          |
| 24.0328-0106.1 | 528106 | S | B | HC | L | V     | 300,0 | 28,0 | 25,4 | 46,5  | 5     | 67,0 | 154,0 | 13,3  | MERCEDES BENZ | 203 421 05 12<br>210 421 22 12<br>210 421 25 12                          |          |
| 24.0328-0123.1 | 528123 |   | B |    | V | 305,0 | 27,9  | 25,0 | 50,3 | 108,0 | 5     | 68,0 | 139,0 | 16,5  | VOLVO         | 274170 / 274559<br>9492715   |          |
| 24.0328-0129.1 | 528129 | S | B |    | V | 305,5 | 28,0  | 25,0 | 77,8 | 130,0 | 5     | 90,0 | 157,0 | 15,8  | NISSAN        | 40206-00QAD  |          |
|                |        |   |   |    |   |       |       |      |      |       |       |      |       |       | OPEL/VAUXHALL | 44 03 038/9111038  |          |
|                |        |   |   |    |   |       |       |      |      |       |       |      |       |       | RENAULT       | 77 00 314 064  |          |
| 24.0328-0136.1 | 528136 |   | B |    | V | 285,0 | 28,0  | 26,0 | 43,7 | 98,0  | 5     | 59,0 | 127,0 | 16,5  | CITROEN       | 4246 P2<br>16 063 092 80   |          |
|                |        |   |   |    |   |       |       |      |      |       |       |      |       |       | FIAT/LANCIA   | 1325772080   |          |
|                |        |   |   |    |   |       |       |      |      |       |       |      |       |       | PEUGEOT       | 4249 H7<br>16 063 092 80   |          |
| 24.0328-0137.1 | 528137 | S | B | HC | V | 302,0 | 28,0  | 25,0 | 45,0 | 110,0 | 5/7   | 70,0 | 139,0 | 14,0  | OPEL/VAUXHALL | 5 69 004/93171500  |          |
|                |        |   |   |    |   |       |       |      |      |       |       |      |       |       | SAAB          | 9191247<br>93171500  |          |
| 24.0328-0142.1 | 528142 |   | B | HC | L | V     | 312,0 | 28,0 | 25,4 | 64,5  | 5     | 67,0 | 154,0 | 15,3  | MERCEDES BENZ | 211 421 09 12  |          |
| 24.0328-0154.1 | 528154 | S | B | HC | V | 300,0 | 28,0  | 26,0 | 52,0 | 108,0 | 5     | 63,5 | 140,0 | 15,8  | FORD          | 1420601 / 1469085<br>1500158 / 1517696<br>6G91-2C375-F1B<br>7G91-1125-BA |          |
|                |        |   |   |    |   |       |       |      |      |       |       |      |       |       | LAND ROVER    | LR000571<br>LR007055   |          |
|                |        |   |   |    |   |       |       |      |      |       |       |      |       |       | VOLVO         | 30769056 / 31202331<br>31341382  |          |
| 24.0328-0162.1 | 528162 | S | B | HC | V | 316,0 | 28,0  | 26,0 | 52,0 | 108,0 | 5     | 63,5 | 144,0 | 16,0  | FORD          | 1434812<br>1434815   |          |
|                |        |   |   |    |   |       |       |      |      |       |       |      |       |       | LAND ROVER    | LR000470   |          |
|                |        |   |   |    |   |       |       |      |      |       |       |      |       |       | VOLVO         | 30769061   |          |
| 24.0328-0176.1 | 528176 |   | B | HC | L | V     | 295,0 | 28,0 | 25,4 | 54,5  | 5     | 67,0 | 154,0 | 15,3  | MERCEDES BENZ | 211 421 08 12  |          |
| 24.0328-0198.1 | 528198 | S | B | HC | V | 315,0 | 28,0  | 26,4 | 52,5 | 120,0 | 5     | 79,0 | 152,0 | 14,5  | BMW           | 34 11 2 227 171  |          |
| 24.0328-0199.1 | 528199 | S | B | HC | V | 315,0 | 28,0  | 26,4 | 52,5 | 120,0 | 5     | 79,0 | 152,0 | 14,5  | BMW           | 34 11 2 227 172  |          |
| 24.0328-0250.1 | 528250 |   | B | HC | V | 300,0 | 28,0  | 26,0 | 52,0 | 108,0 | 5     | 63,5 | 140,0 | 13,8  | FORD          | 1500159<br>7G91-1125-EA  |          |
| 24.0328-0254.1 | 528254 | S | B | HC | V | 328,0 | 28,0  | 26,4 | 73,1 | 120,0 | 5     | 75,0 | 153,8 | 16,5  | BMW           | 34 10 6 787 490  |          |
| 24.0330-0107.1 | 530107 | S | B | HC | V | 324,0 | 29,9  | 27,6 | 73,7 | 120,0 | 5     | 79,0 | 149,0 | 14,8  | BMW           | 34 11 6 767 059  |          |
| 24.0330-0109.1 | 530109 | S | B | HC | V | 332,0 | 29,9  | 27,6 | 62,1 | 120,0 | 5     | 75,0 | 158,0 | 16,5  | BMW           | 34 11 6 766 036<br>34 11 6 859 679                                       |          |
| 24.0330-0113.1 | 530113 |   | B | HC | V | 320,0 | 30,0  | 28,0 | 46,5 | 112,0 | 5/9   | 68,0 | 137,0 | 15,3  | AUDI          | 8D0 615 301 M<br>8E0 615 301 AD  |          |
| 24.0330-0115.1 | 530115 |   | B | HC | V | 345,0 | 30,0  | 27,0 | 49,9 | 112,0 | 5/9   | 65,0 | 140,0 | 15,3  | AUDI/SKODAVW  | 1K0 615 301 M  |          |
| 24.0330-0173.1 | 530173 | S | B | HC | V | 324,0 | 30,0  | 27,6 | 77,0 | 120,0 | 5     | 79,0 | 165,0 | 14,5  | BMW           | 34 11 6 753 221  |          |
| 24.0330-0175.1 | 530175 | S | B | HC | V | 321,0 | 30,0  | 28,0 | 59,7 | 112,0 | 5     | 68,0 | 144,8 | 15,3  | AUDI          | 4F0 615 301 E  |          |
| 24.0330-0176.1 | 530176 | S | B | HC | V | 347,0 | 30,0  | 28,0 | 59,7 | 112,0 | 5     | 68,0 | 158,0 | 15,3  | AUDI          | 4F0 615 301 G  |          |
| 24.0330-0193.1 | 530193 | S | B | HC | V | 320,0 | 30,0  | 28,0 | 52,4 | 112,0 | 5     | 68,0 | 153,4 | 15,3  | AUDI          | 8K0 615 301 A  |          |
| 24.0330-0207.1 | 530207 | S | B | HC | L | V     | 296,0 | 30,0 | 27,0 | 51,0  | 120,0 | 5    | 67,4  | 163,7 | 16,3          | CHEVROLET  | 13501307 |
|                |        |   |   |    |   |       |       |      |      |       |       |      |       |       | OPEL/VAUXHALL | 5 69 078/13579147  |          |
|                |        |   |   |    |   |       |       |      |      |       |       |      |       |       | SAAB          | 13502213   |          |
| 24.0330-0209.1 | 530209 | S | B | HC | V | 321,0 | 30,0  | 27,0 | 51,0 | 120,0 | 5     | 67,4 | 160,0 | 16,3  | CHEVROLET     | 13501320, 135799150  |          |
|                |        |   |   |    |   |       |       |      |      |       |       |      |       |       | OPEL/VAUXHALL | 5 69 083/135799150   |          |
|                |        |   |   |    |   |       |       |      |      |       |       |      |       |       | SAAB          | 135799150  |          |
| 24.0332-0101.1 | 532101 | S | B | HC | L | V     | 322,0 | 32,0 | 29,4 | 64,5  | 5     | 67,0 | 154,3 | 15,2  | MERCEDES BENZ | 000 421 12 12  |          |
| 24.0332-0144.1 | 532144 | S | B | HC | L | V     | 330,0 | 32,0 | 29,4 | 64,5  | 5     | 67,0 | 154,0 | 15,0  | MERCEDES BENZ | 204 421 29 12<br>211 421 10 12<br>211 421 13 12<br>211 421 14 12         |          |
| 24.0332-0158.1 | 532158 | S | B | HC | L | V     | 330,0 | 32,0 | 29,4 | 54,5  | 5     | 67,0 | 156,3 | 15,2  | MERCEDES BENZ | 164 421 04 12<br>164 421 13 12   |          |





- D** Vergleichsliste WVA
- EN** WVA Cross reference list
- FR** Liste des correspondances WVA
- IT** Tabella di conversione codici WVA
- ES** Lista comparativa WVA
- NL** Vergelijgingslijst WVA
- DA** Omsætningsliste WVA
- SV** Jämförelselista WVA
- HU** WVA összehasonlító lista
- PT** Lista de comparação WVA
- RU** Сравнительный перечень номеров WVA
- CZ** Porovnávací seznam čísel
- PL** Lista porównawcza numerów WVA
- EL** Λίστα σύγκρισης αριθμών WVA
- TR** Karşılaştırma listesi WVA
- ZH** 对比清单WVA
- JA** WVA比烽
- AR** قائمة المقارنة WVA

# K24-F





# Vergleichsliste WVA → ATE

Cross reference list WVA → ATE - Tabella di conversione codici WVA → ATE

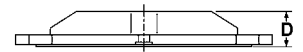
Liste des correspondances WVA → ATE - Lista referencias WVA → ATE



| WVA   | D    |  | WVA    | D     |  | WVA            | D      |  |      |                |        |
|-------|------|---|--------|-------|---|----------------|--------|---|------|----------------|--------|
| 20002 | 15,0 | 13.0460-5806.2  | 605806 | 20309 | 17,9  | 13.0460-9037.2 | 609037 | 20676   | 19,8 | 13.0460-7077.2 | 607077 |
| 20008 | 13,0 | 13.0460-5824.2  | 605824 | 20323 | 16,5  | 13.0460-5030.2 | 605030 | 20676   | 19,8 | 13.0460-7081.2 | 607081 |
| 20009 | 15,0 | 13.0460-3010.2  | 603010 | 20325 | 17,2  | 13.0460-5789.2 | 605789 | 20676   | 19,8 | 13.0460-7110.2 | 607110 |
| 20011 | 15,0 | 13.0460-4048.2  | 604048 | 20332 | 17,0  | 13.0460-2968.2 | 602968 | 20676   | 19,8 | 13.0460-7122.2 | 607122 |
| 20011 | 15,0 | 13.0460-6027.2  | 606027 | 20336 | 14,0  | 13.0460-3961.2 | 603961 | 20676   | 19,8 | 13.0470-7081.2 | LD7081 |
| 20011 | 18,5 | 13.0460-6028.2  | 606028 | 20337 | 14,0  | 13.0460-3961.2 | 603961 | 20676   | 19,8 | 13.0470-7110.2 | LD7110 |
| 20034 | 15,0 | 13.0460-4019.2  | 604019 | 20341 | 16,7  | 13.0460-9029.2 | 609029 | 20676   | 19,8 | 13.0470-7122.2 | LD7122 |
| 20034 | 15,0 | 13.0460-4033.2  | 604033 | 20359 | 18,0  | 13.0460-6911.2 | 606911 | 20678   | 19,5 | 13.0460-7050.2 | 607050 |
| 20035 | 17,0 | 13.0460-3902.2  | 603902 | 20359 | 19,2  | 13.0460-6926.2 | 606926 | 20687   | 13,5 | 13.0460-4030.2 | 604030 |
| 20036 | 17,0 | 13.0460-3902.2  | 603902 | 20364 | 15,0  | 13.0460-6910.2 | 606910 | 20687   | 15,5 | 13.0460-4034.2 | 604034 |
| 20038 | 14,0 | 13.0460-6914.2  | 606914 | 20365 | 15,0  | 13.0460-6910.2 | 606910 | 20708   | 14,5 | 13.0460-5720.2 | 605720 |
| 20073 | 17,3 | 13.0460-3936.2  | 603936 | 20371 | 8,1   | 13.0460-4900.2 | 604900 | 20708   | 15,8 | 13.0460-2997.2 | 602997 |
| 20076 | 15,5 | 13.0460-5835.2  | 605835 | 20380 | 15,6  | 13.0460-2824.2 | 602824 | 20731   | 15,3 | 13.0460-5916.2 | 605916 |
| 20077 | 15,5 | 13.0460-5835.2  | 605835 | 20387 | 15,0  | 13.0460-3014.2 | 603014 | 20741   | 15,0 | 13.0460-2750.2 | 602750 |
| 20087 | 14,6 | 13.0460-2800.2  | 602800 | 20389 | 15,4  | 13.0460-4911.2 | 604911 | 20741   | 19,0 | 13.0460-2901.2 | 602901 |
| 20088 | 14,3 | 13.0460-2954.2  | 602954 | 20392 | 15,0  | 13.0460-9028.2 | 609028 | 20753   | 17,5 | 13.0460-7071.2 | 607071 |
| 20091 | 14,6 | 13.0460-2800.2  | 602800 | 20392 | 18,5  | 13.0460-5701.2 | 605701 | 20755   | 14,4 | 13.0460-3401.2 | 603401 |
| 20092 | 15,0 | 13.0460-9030.2  | 609030 | 20410 | 15,0  | 13.0460-4957.2 | 604957 | 20755   | 14,4 | 13.0460-3403.2 | 603403 |
| 20099 | 15,0 | 13.0460-5918.2  | 605918 | 20423 | 15,0  | 13.0460-4957.2 | 604957 | 20755   | 15,1 | 13.0460-4044.2 | 604044 |
| 20104 | 15,0 | 13.0460-5918.2  | 605918 | 20436 | 15,0  | 13.0460-3024.2 | 603024 | 20755   | 15,1 | 13.0470-4044.2 | LD4044 |
| 20108 | 15,0 | 13.0460-5918.2  | 605918 | 20437 | 15,0  | 13.0460-9034.2 | 609034 | 20756   | 16,5 | 13.0460-7036.2 | 607036 |
| 20112 | 18,0 | 13.0460-5991.2  | 605991 | 20437 | 19,0  | 13.0460-9031.2 | 609031 | 20756   | 16,5 | 13.0460-7047.2 | 607047 |
| 20113 | 18,0 | 13.0460-5991.2  | 605991 | 20465 | 18,0  | 13.0460-7903.2 | 607903 | 20757   | 20,3 | 13.0460-7046.2 | 607046 |
| 20124 | 18,9 | 13.0460-2972.2  | 602972 | 20480 | 15,5  | 13.0460-2967.2 | 602967 | 20772   | 18,0 | 13.0460-2955.2 | 602955 |
| 20126 | 15,0 | 13.0460-5029.2  | 605029 | 20482 | 18,5  | 13.0460-3612.2 | 603612 | 20775   | 18,0 | 13.0460-3939.2 | 603939 |
| 20140 | 14,0 | 13.0460-3928.2  | 603928 | 20488 | 18,5  | 13.0460-3968.2 | 603968 | 20775   | 18,0 | 13.0460-3940.2 | 603940 |
| 20141 | 14,0 | 13.0460-3928.2  | 603928 | 20489 | 18,5  | 13.0460-3968.2 | 603968 | 20776   | 18,0 | 13.0460-3940.2 | 603940 |
| 20147 | 17,0 | 13.0460-7146.2  | 607146 | 20491 | 15,0  | 13.0460-7042.2 | 607042 | 20777   | 18,0 | 13.0460-3940.2 | 603940 |
| 20149 | 17,0 | 13.0460-7146.2  | 607146 | 20547 | 16,5  | 13.0460-7051.2 | 607051 | 20778   | 19,0 | 13.0460-2934.2 | 602934 |
| 20162 | 15,4 | 13.0460-4956.2  | 604956 | 20547 | 16,5  | 13.0460-7241.2 | 607241 | 20783   | 17,5 | 13.0460-7027.2 | 607027 |
| 20164 | 18,2 | 13.0460-2985.2  | 602985 | 20570 | 18,5  | 13.0460-3968.2 | 603968 | 20784   | 18,0 | 13.0460-4401.2 | 604401 |
| 20166 | 16,0 | 13.0460-2966.2  | 602966 | 20571 | 18,5  | 13.0460-3968.2 | 603968 | 20787   | 19,0 | 13.0460-2901.2 | 602901 |
| 20168 | 16,0 | 13.0460-2957.2  | 602957 | 20574 | 15,3  | 13.0460-2936.2 | 602936 | 20833   | 17,0 | 13.0460-2949.2 | 602949 |
| 20168 | 19,3 | 13.0460-2806.2  | 602806 | 20588 | 16,5  | 13.0460-5032.2 | 605032 | 20834   | 17,0 | 13.0460-2949.2 | 602949 |
| 20168 | 19,3 | 13.0460-2958.2  | 602958 | 20629 | 20,3  | 13.0460-7046.2 | 607046 | 20838   | 17,0 | 13.0460-2941.2 | 602941 |
| 20173 | 15,0 | 13.0460-4035.2  | 604035 | 20634 | 15,0  | 13.0460-3953.2 | 603953 | 20838   | 17,0 | 13.0460-2949.2 | 602949 |
| 20180 | 17,3 | 13.0460-3605.2  | 603605 | 20634 | 15,0  | 13.0460-3955.2 | 603955 | 20839   | 17,0 | 13.0460-2941.2 | 602941 |
| 20180 | 17,3 | 13.0470-3605.2  | LD3605 | 20635 | 18,0  | 13.0460-3915.2 | 603915 | 20841   | 12,0 | 13.0460-3942.2 | 603942 |
| 20181 | 17,3 | 13.0460-3605.2  | 603605 | 20636 | 18,0  | 13.0460-3915.2 | 603915 | 20852   | 15,5 | 13.0460-5935.2 | 605935 |
| 20181 | 17,3 | 13.0470-3605.2  | LD3605 | 20640 | 17,5  | 13.0460-7027.2 | 607027 | 20857   | 17,5 | 13.0460-7005.2 | 607005 |
| 20191 | 15,0 | 13.0460-5806.2  | 605806 | 20640 | 17,5  | 13.0460-7071.2 | 607071 | 20858   | 17,5 | 13.0460-7005.2 | 607005 |
| 20192 | 15,0 | 13.0460-5806.2  | 605806 | 20641 | 15,0  | 13.0460-3011.2 | 603011 | 20859   | 18,0 | 13.0460-3915.2 | 603915 |
| 20193 | 15,0 | 13.0460-5919.2  | 605919 | 20641 | 15,0  | 13.0460-3013.2 | 603013 | 20860   | 18,0 | 13.0460-3915.2 | 603915 |
| 20194 | 15,0 | 13.0460-5919.2  | 605919 | 20641 | 15,0  | 13.0460-3014.2 | 603014 | 20861   | 17,5 | 13.0460-2964.2 | 602964 |
| 20200 | 16,0 | 13.0460-2953.2  | 602953 | 20642 | 15,0  | 13.0460-3011.2 | 603011 | 20861   | 17,7 | 13.0460-2912.2 | 602912 |
| 20207 | 12,0 | 13.0460-4906.2  | 604906 | 20642 | 15,0  | 13.0460-3013.2 | 603013 | 20863   | 16,5 | 13.0460-5960.2 | 605960 |
| 20217 | 17,1 | 13.0460-4837.2  | 604837 | 20642 | 15,0  | 13.0460-3014.2 | 603014 | 20870   | 15,0 | 13.0460-5976.2 | 605976 |
| 20228 | 15,3 | 13.0460-4028.2  | 604028 | 20651 | 18,0  | 13.0460-2973.2 | 602973 | 20887   | 15,3 | 13.0460-7033.2 | 607033 |
| 20228 | 18,5 | 13.0460-4029.2  | 604029 | 20651 | 18,3  | 13.0460-2839.2 | 602839 | 20887   | 17,3 | 13.0460-7059.2 | 607059 |
| 20236 | 18,0 | 13.0460-2810.2  | 602810 | 20660 | 15,6  | 13.0460-8006.2 | 608006 | 20887   | 19,7 | 13.0460-7032.2 | 607032 |
| 20238 | 18,0 | 13.0460-2810.2  | 602810 | 20668 | 16,6  | 13.0460-2962.2 | 602962 | 20888   | 15,3 | 13.0460-7033.2 | 607033 |
| 20247 | 18,0 | 13.0460-2810.2  | 602810 | 20669 | 15,7  | 13.0460-2926.2 | 602926 | 20888   | 17,3 | 13.0460-7059.2 | 607059 |
| 20261 | 19,0 | 13.0460-2863.2  | 602863 | 20669 | 19,0  | 13.0460-2925.2 | 602925 | 20888   | 19,7 | 13.0460-7032.2 | 607032 |
| 20261 | 19,0 | 13.0460-3824.2  | 603824 | 20669 | 19,0  | 13.0460-2934.2 | 602934 | 20889   | 17,3 | 13.0460-7030.2 | 607030 |
| 20267 | 19,0 | 13.0460-2863.2  | 602863 | 20675 | 16,5  | 13.0460-7036.2 | 607036 | 20895   | 15,0 | 13.0460-5999.2 | 605999 |
| 20285 | 7,1  | 13.0460-4910.2  | 604910 | 20675 | 16,5  | 13.0460-7047.2 | 607047 | 20901   | 19,0 | 13.0460-2925.2 | 602925 |
| 20286 | 16,2 | 13.0460-2905.2  | 602905 | 20676 | 19,5  | 13.0460-7050.2 | 607050 | 20905   | 18,0 | 13.0460-3911.2 | 603911 |





# Vergleichsliste WVA → ATE

Cross reference list WVA → ATE - Tabella di conversione codici WVA → ATE

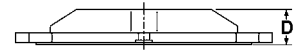
Liste des correspondances WVA → ATE - Lista referencias WVA → ATE







| WVA   | D    |  | WVA    | D     |  | WVA            | D      |  |      |                |        |
|-------|------|---|--------|-------|---|----------------|--------|---|------|----------------|--------|
| 20905 | 18,0 | 13.0460-3943.2  | 603943 | 20987 | 18,0  | 13.0460-3911.2 | 603911 | 21155   | 19,5 | 13.0460-5703.2 | 605703 |
| 20905 | 18,0 | 13.0460-3952.2  | 603952 | 20989 | 17,7  | 13.0460-2956.2 | 602956 | 21158   | 15,5 | 13.0460-5938.2 | 605938 |
| 20905 | 18,0 | 13.0460-3962.2  | 603962 | 20995 | 17,3  | 13.0460-3803.2 | 603803 | 21160   | 19,2 | 13.0460-6926.2 | 606926 |
| 20906 | 18,0 | 13.0460-3911.2  | 603911 | 20996 | 17,3  | 13.0460-3803.2 | 603803 | 21163   | 14,5 | 13.0460-4070.2 | 604070 |
| 20906 | 18,0 | 13.0460-3943.2  | 603943 | 21010 | 15,8  | 13.0460-2846.2 | 602846 | 21165   | 16,8 | 13.0460-2969.2 | 602969 |
| 20906 | 18,0 | 13.0460-3952.2  | 603952 | 21012 | 15,0  | 13.0460-5872.2 | 605872 | 21166   | 16,8 | 13.0460-2969.2 | 602969 |
| 20906 | 18,0 | 13.0460-3962.2  | 603962 | 21012 | 15,0  | 13.0460-5936.2 | 605936 | 21168   | 15,0 | 13.0460-5934.2 | 605934 |
| 20907 | 18,0 | 13.0460-7040.2  | 607040 | 21016 | 17,0  | 13.0460-3933.2 | 603933 | 21170   | 17,3 | 13.0460-2965.2 | 602965 |
| 20907 | 18,0 | 13.0460-7041.2  | 607041 | 21022 | 17,7  | 13.0460-2956.2 | 602956 | 21171   | 18,0 | 13.0460-3965.2 | 603965 |
| 20907 | 18,1 | 13.0460-7108.2  | 607108 | 21023 | 17,7  | 13.0460-2956.2 | 602956 | 21173   | 17,0 | 13.0460-2921.2 | 602921 |
| 20907 | 18,1 | 13.0460-7126.2  | 607126 | 21024 | 17,5  | 13.0460-4037.2 | 604037 | 21179   | 16,8 | 13.0460-4041.2 | 604041 |
| 20907 | 18,1 | 13.0460-7129.2  | 607129 | 21028 | 19,3  | 13.0460-2927.2 | 602927 | 21182   | 19,4 | 13.0460-2809.2 | 602809 |
| 20907 | 18,1 | 13.0460-7141.2  | 607141 | 21028 | 19,3  | 13.0470-2927.2 | LD2927 | 21182   | 19,4 | 13.0460-2952.2 | 602952 |
| 20908 | 18,0 | 13.0460-7040.2  | 607040 | 21035 | 15,0  | 13.0460-3804.2 | 603804 | 21183   | 19,4 | 13.0460-2809.2 | 602809 |
| 20909 | 18,0 | 13.0460-7041.2  | 607041 | 21035 | 15,0  | 13.0460-4036.2 | 604036 | 21185   | 19,4 | 13.0460-2952.2 | 602952 |
| 20910 | 15,0 | 13.0462-4855.2  | 600018 | 21041 | 15,0  | 13.0460-5934.2 | 605934 | 21190   | 17,5 | 13.0460-7052.2 | 607052 |
| 20911 | 15,0 | 13.0460-4019.2  | 604019 | 21048 | 18,3  | 13.0460-4918.2 | 604918 | 21191   | 16,8 | 13.0460-4042.2 | 604042 |
| 20912 | 15,0 | 13.0460-3013.2  | 603013 | 21048 | 18,3  | 13.0460-4955.2 | 604955 | 21193   | 18,0 | 13.0460-5409.2 | 605409 |
| 20919 | 18,0 | 13.0460-2983.2  | 602983 | 21049 | 18,3  | 13.0460-4955.2 | 604955 | 21193   | 18,0 | 13.0460-5410.2 | 605410 |
| 20926 | 18,5 | 13.0460-3969.2  | 603969 | 21050 | 15,8  | 13.0460-4040.2 | 604040 | 21193   | 18,0 | 13.0460-7063.2 | 607063 |
| 20927 | 18,5 | 13.0460-3969.2  | 603969 | 21055 | 17,0  | 13.0460-2923.2 | 602923 | 21193   | 18,0 | 13.0460-7131.2 | 607131 |
| 20928 | 18,5 | 13.0460-3969.2  | 603969 | 21063 | 14,8  | 13.0460-7055.2 | 607055 | 21194   | 18,0 | 13.0460-5409.2 | 605409 |
| 20929 | 18,5 | 13.0460-3969.2  | 603969 | 21064 | 20,3  | 13.0460-6033.2 | 606033 | 21194   | 18,0 | 13.0460-7131.2 | 607131 |
| 20932 | 14,0 | 13.0460-3945.2  | 603945 | 21064 | 20,3  | 13.0460-7185.2 | 607185 | 21195   | 18,0 | 13.0460-5410.2 | 605410 |
| 20934 | 14,0 | 13.0460-3945.2  | 603945 | 21068 | 17,0  | 13.0460-2811.2 | 602811 | 21197   | 15,0 | 13.0460-3805.2 | 603805 |
| 20937 | 18,0 | 13.0460-2955.2  | 602955 | 21079 | 13,8  | 13.0460-2933.2 | 602933 | 21197   | 15,0 | 13.0470-3805.2 | LD3805 |
| 20938 | 18,0 | 13.0460-2955.2  | 602955 | 21086 | 17,0  | 13.0460-3933.2 | 603933 | 21201   | 17,5 | 13.0460-7052.2 | 607052 |
| 20939 | 15,8 | 13.0460-7048.2  | 607048 | 21087 | 17,0  | 13.0460-3933.2 | 603933 | 21202   | 16,9 | 13.0460-7073.2 | 607073 |
| 20941 | 19,3 | 13.0460-2927.2  | 602927 | 21089 | 15,0  | 13.0460-3306.2 | 603306 | 21203   | 16,9 | 13.0460-7073.2 | 607073 |
| 20941 | 19,3 | 13.0470-2927.2  | LD2927 | 21090 | 15,0  | 13.0460-3306.2 | 603306 | 21205   | 19,0 | 13.0460-2902.2 | 602902 |
| 20944 | 14,8 | 13.0460-7055.2  | 607055 | 21096 | 15,0  | 13.0460-3955.2 | 603955 | 21206   | 19,0 | 13.0460-2902.2 | 602902 |
| 20957 | 16,0 | 13.0460-5962.2  | 605962 | 21097 | 15,0  | 13.0460-3955.2 | 603955 | 21209   | 18,5 | 13.0460-2971.2 | 602971 |
| 20958 | 16,0 | 13.0460-5963.2  | 605963 | 21098 | 14,8  | 13.0460-7055.2 | 607055 | 21210   | 18,5 | 13.0460-2971.2 | 602971 |
| 20959 | 15,0 | 13.0460-5919.2  | 605919 | 21099 | 17,0  | 13.0460-5881.2 | 605881 | 21211   | 18,7 | 13.0460-5403.2 | 605403 |
| 20961 | 15,2 | 13.0460-2842.2  | 602842 | 21100 | 16,7  | 13.0460-2948.2 | 602948 | 21212   | 18,7 | 13.0460-5403.2 | 605403 |
| 20961 | 15,2 | 13.0460-2937.2  | 602937 | 21103 | 14,2  | 13.0460-2951.2 | 602951 | 21217   | 18,0 | 13.0460-2812.2 | 602812 |
| 20961 | 16,2 | 13.0460-2886.2  | 602886 | 21105 | 16,7  | 13.0460-2948.2 | 602948 | 21219   | 17,8 | 13.0460-2847.2 | 602847 |
| 20961 | 16,2 | 13.0470-2886.2  | LD2886 | 21107 | 12,0  | 13.0460-3904.2 | 603904 | 21229   | 17,0 | 13.0460-5937.2 | 605937 |
| 20961 | 17,2 | 13.0460-2859.2  | 602859 | 21110 | 15,6  | 13.0460-2824.2 | 602824 | 21233   | 16,7 | 13.0460-3914.2 | 603914 |
| 20961 | 17,2 | 13.0460-2984.2  | 602984 | 21119 | 17,0  | 13.0460-5937.2 | 605937 | 21237   | 15,5 | 13.0460-6917.2 | 606917 |
| 20961 | 17,4 | 13.0460-2864.2  | 602864 | 21127 | 15,0  | 13.0460-5999.2 | 605999 | 21238   | 15,5 | 13.0460-6917.2 | 606917 |
| 20961 | 17,4 | 13.0460-2894.2  | 602894 | 21130 | 17,0  | 13.0460-5937.2 | 605937 | 21243   | 14,0 | 13.0460-5816.2 | 605816 |
| 20961 | 17,4 | 13.0470-2894.2  | LD2894 | 21131 | 14,7  | 13.0460-3905.2 | 603905 | 21252   | 15,0 | 13.0460-5961.2 | 605961 |
| 20961 | 17,6 | 13.0460-2819.2  | 602819 | 21132 | 14,7  | 13.0460-3905.2 | 603905 | 21253   | 15,0 | 13.0460-5961.2 | 605961 |
| 20961 | 17,6 | 13.0460-2820.2  | 602820 | 21133 | 14,7  | 13.0460-3905.2 | 603905 | 21266   | 17,0 | 13.0460-2943.2 | 602943 |
| 20961 | 17,6 | 13.0470-2820.2  | LD2820 | 21138 | 18,8  | 13.0460-2963.2 | 602963 | 21267   | 16,8 | 13.0460-4042.2 | 604042 |
| 20968 | 17,5 | 13.0460-7138.2  | 607138 | 21140 | 15,0  | 13.0460-4043.2 | 604043 | 21271   | 17,0 | 13.0460-2968.2 | 602968 |
| 20968 | 20,3 | 13.0460-6033.2  | 606033 | 21141 | 18,0  | 13.0460-3944.2 | 603944 | 21273   | 19,5 | 13.0460-7053.2 | 607053 |
| 20968 | 20,3 | 13.0460-7185.2  | 607185 | 21142 | 15,0  | 13.0460-5966.2 | 605966 | 21273   | 19,5 | 13.0470-7053.2 | LD7053 |
| 20973 | 11,0 | 13.0460-3954.2  | 603954 | 21144 | 15,8  | 13.0460-3602.2 | 603602 | 21274   | 19,5 | 13.0460-7053.2 | 607053 |
| 20974 | 10,8 | 13.0460-3926.2  | 603926 | 21147 | 19,0  | 13.0460-2979.2 | 602979 | 21274   | 19,5 | 13.0470-7053.2 | LD7053 |
| 20974 | 11,0 | 13.0460-3823.2  | 603823 | 21147 | 19,0  | 13.0460-2980.2 | 602980 | 21275   | 17,0 | 13.0460-7061.2 | 607061 |
| 20974 | 11,0 | 13.0460-3954.2  | 603954 | 21147 | 19,0  | 13.0460-2987.2 | 602987 | 21275   | 17,0 | 13.0460-7246.2 | 607246 |
| 20979 | 19,4 | 13.0460-2903.2  | 602903 | 21148 | 19,0  | 13.0460-2980.2 | 602980 | 21276   | 17,0 | 13.0460-7061.2 | 607061 |
| 20981 | 13,8 | 13.0460-2928.2  | 602928 | 21153 | 16,0  | 13.0460-4202.2 | 604202 | 21276   | 17,0 | 13.0460-7246.2 | 607246 |
| 20981 | 13,8 | 13.0460-2933.2  | 602933 | 21153 | 17,5  | 13.0460-4201.2 | 604201 | 21278   | 16,4 | 13.0460-4014.2 | 604014 |
| 20986 | 18,0 | 13.0460-3911.2  | 603911 | 21154 | 19,5  | 13.0460-5703.2 | 605703 | 21278   | 16,4 | 13.0460-4059.2 | 604059 |

# Vergleichsliste WVA → ATE

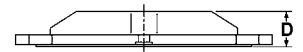
Cross reference list WVA → ATE - Tabella di conversione codici WVA → ATE

Liste des correspondances WVA → ATE - Lista referencias WVA → ATE



| WVA   | D    |  | WVA    | D     |  | WVA            | D      |  |      |                |        |
|-------|------|---|--------|-------|---|----------------|--------|---|------|----------------|--------|
| 21278 | 16,4 | 13.0460-7107.2  | 607107 | 21378 | 15,0  | 13.0460-5932.2 | 605932 | 21497   | 18,0 | 13.0460-5818.2 | 605818 |
| 21278 | 16,4 | 13.0460-7134.2  | 607134 | 21379 | 16,0  | 13.0460-5932.2 | 605932 | 21498   | 18,0 | 13.0460-5818.2 | 605818 |
| 21278 | 16,9 | 13.0460-7085.2  | 607085 | 21380 | 16,0  | 13.0460-5932.2 | 605932 | 21499   | 18,0 | 13.0460-5818.2 | 605818 |
| 21279 | 16,4 | 13.0460-4014.2  | 604014 | 21381 | 15,0  | 13.0460-4801.2 | 604801 | 21500   | 15,0 | 13.0460-5967.2 | 605967 |
| 21279 | 16,4 | 13.0460-4059.2  | 604059 | 21381 | 15,0  | 13.0460-4964.2 | 604964 | 21501   | 15,0 | 13.0460-5967.2 | 605967 |
| 21280 | 16,0 | 13.0460-5949.2  | 605949 | 21381 | 17,3  | 13.0460-4958.2 | 604958 | 21502   | 15,0 | 13.0460-5967.2 | 605967 |
| 21282 | 17,3 | 13.0460-7079.2  | 607079 | 21381 | 18,0  | 13.0460-4832.2 | 604832 | 21503   | 17,0 | 13.0460-5978.2 | 605978 |
| 21282 | 17,3 | 13.0460-7168.2  | 607168 | 21381 | 18,0  | 13.0460-4968.2 | 604968 | 21505   | 17,0 | 13.0460-3947.2 | 603947 |
| 21282 | 17,3 | 13.0460-7232.2  | 607232 | 21381 | 18,0  | 13.0460-4985.2 | 604985 | 21508   | 17,0 | 13.0460-3948.2 | 603948 |
| 21282 | 17,3 | 13.0470-7079.2  | LD7079 | 21382 | 17,3  | 13.0460-4958.2 | 604958 | 21509   | 17,0 | 13.0460-3947.2 | 603947 |
| 21282 | 17,3 | 13.0470-7168.2  | LD7168 | 21385 | 13,8  | 13.0460-2935.2 | 602935 | 21509   | 17,0 | 13.0460-3948.2 | 603948 |
| 21282 | 17,3 | 13.0470-7232.2  | LD7232 | 21388 | 18,0  | 13.0460-2983.2 | 602983 | 21510   | 17,0 | 13.0460-3947.2 | 603947 |
| 21284 | 19,1 | 13.0460-7147.2  | 607147 | 21394 | 17,5  | 13.0460-7057.2 | 607057 | 21512   | 17,0 | 13.0460-3948.2 | 603948 |
| 21285 | 19,1 | 13.0460-7147.2  | 607147 | 21396 | 17,5  | 13.0460-7056.2 | 607056 | 21513   | 17,0 | 13.0460-3947.2 | 603947 |
| 21288 | 18,8 | 13.0460-2963.2  | 602963 | 21396 | 17,5  | 13.0460-7057.2 | 607057 | 21513   | 17,0 | 13.0460-3948.2 | 603948 |
| 21289 | 16,8 | 13.0460-4041.2  | 604041 | 21396 | 17,5  | 13.0460-7060.2 | 607060 | 21514   | 15,5 | 13.0460-6917.2 | 606917 |
| 21296 | 16,5 | 13.0460-3916.2  | 603916 | 21402 | 17,5  | 13.0460-4056.2 | 604056 | 21515   | 17,5 | 13.0460-2803.2 | 602803 |
| 21297 | 16,5 | 13.0460-3916.2  | 603916 | 21411 | 17,5  | 13.0460-7080.2 | 607080 | 21516   | 17,5 | 13.0460-2803.2 | 602803 |
| 21299 | 15,9 | 13.0460-3916.2  | 603916 | 21413 | 18,3  | 13.0460-7080.2 | 607080 | 21517   | 17,5 | 13.0460-2803.2 | 602803 |
| 21299 | 17,0 | 13.0460-3902.2  | 603902 | 21418 | 15,5  | 13.0460-2751.2 | 602751 | 21518   | 17,0 | 13.0460-2804.2 | 602804 |
| 21300 | 15,9 | 13.0460-3916.2  | 603916 | 21430 | 17,3  | 13.0460-7058.2 | 607058 | 21519   | 17,8 | 13.0460-6925.2 | 606925 |
| 21300 | 17,0 | 13.0460-3902.2  | 603902 | 21430 | 17,3  | 13.0460-7088.2 | 607088 | 21520   | 17,5 | 13.0460-2805.2 | 602805 |
| 21301 | 15,5 | 13.0460-3504.2  | 603504 | 21432 | 17,3  | 13.0460-7058.2 | 607058 | 21521   | 17,5 | 13.0460-2805.2 | 602805 |
| 21303 | 18,9 | 13.0460-9033.2  | 609033 | 21436 | 16,2  | 13.0460-3951.2 | 603951 | 21522   | 17,5 | 13.0460-2805.2 | 602805 |
| 21304 | 18,5 | 13.0460-6036.2  | 606036 | 21436 | 17,0  | 13.0460-3807.2 | 603807 | 21539   | 15,0 | 13.0460-5974.2 | 605974 |
| 21305 | 15,7 | 13.0460-4047.2  | 604047 | 21436 | 17,0  | 13.0460-3838.2 | 603838 | 21540   | 15,0 | 13.0460-5974.2 | 605974 |
| 21305 | 15,7 | 13.0470-4047.2  | LD4047 | 21436 | 17,0  | 13.0460-3950.2 | 603950 | 21541   | 15,0 | 13.0460-5974.2 | 605974 |
| 21306 | 16,8 | 13.0460-2847.2  | 602847 | 21436 | 17,0  | 13.0470-3838.2 | LD3838 | 21543   | 16,5 | 13.0460-5942.2 | 605942 |
| 21312 | 12,8 | 13.0460-5998.2  | 605998 | 21439 | 20,3  | 13.0460-2975.2 | 602975 | 21544   | 16,5 | 13.0460-5942.2 | 605942 |
| 21313 | 12,8 | 13.0460-5998.2  | 605998 | 21439 | 20,3  | 13.0470-2975.2 | LD2975 | 21545   | 14,9 | 13.0460-5986.2 | 605986 |
| 21314 | 12,8 | 13.0460-5998.2  | 605998 | 21452 | 18,5  | 13.0460-2700.2 | 602700 | 21546   | 16,7 | 13.0460-5950.2 | 605950 |
| 21319 | 14,9 | 13.0460-5625.2  | 605625 | 21452 | 18,5  | 13.0460-2701.2 | 602701 | 21552   | 14,5 | 13.0460-5979.2 | 605979 |
| 21320 | 14,9 | 13.0460-5625.2  | 605625 | 21452 | 18,5  | 13.0460-2705.2 | 602705 | 21553   | 14,0 | 13.0460-5874.2 | 605874 |
| 21321 | 14,9 | 13.0460-5625.2  | 605625 | 21452 | 18,5  | 13.0460-2717.2 | 602717 | 21554   | 14,0 | 13.0460-5874.2 | 605874 |
| 21322 | 15,0 | 13.0460-5920.2  | 605920 | 21454 | 17,0  | 13.0460-2700.2 | 602700 | 21555   | 14,0 | 13.0460-5874.2 | 605874 |
| 21323 | 15,0 | 13.0460-5920.2  | 605920 | 21454 | 17,0  | 13.0460-2701.2 | 602701 | 21557   | 19,0 | 13.0460-2979.2 | 602979 |
| 21324 | 15,0 | 13.0460-5920.2  | 605920 | 21454 | 17,0  | 13.0460-2705.2 | 602705 | 21558   | 13,0 | 13.0460-5995.2 | 605995 |
| 21333 | 15,0 | 13.0460-5985.2  | 605985 | 21454 | 17,0  | 13.0460-2717.2 | 602717 | 21559   | 11,5 | 13.0460-5972.2 | 605972 |
| 21334 | 15,0 | 13.0460-5985.2  | 605985 | 21459 | 17,5  | 13.0460-6922.2 | 606922 | 21561   | 17,0 | 13.0460-5716.2 | 605716 |
| 21335 | 15,0 | 13.0460-5985.2  | 605985 | 21459 | 18,5  | 13.0460-6916.2 | 606916 | 21562   | 17,0 | 13.0460-5716.2 | 605716 |
| 21347 | 17,0 | 13.0460-5957.2  | 605957 | 21460 | 18,0  | 13.0460-2981.2 | 602981 | 21562   | 17,0 | 13.0460-5716.2 | 605716 |
| 21348 | 17,0 | 13.0460-5957.2  | 605957 | 21463 | 18,0  | 13.0460-2834.2 | 602834 | 21569   | 14,9 | 13.0460-5627.2 | 605627 |
| 21349 | 17,0 | 13.0460-5957.2  | 605957 | 21463 | 18,0  | 13.0460-2834.2 | 602834 | 21570   | 15,9 | 13.0460-5627.2 | 605627 |
| 21353 | 16,5 | 13.0460-7051.2  | 607051 | 21468 | 15,5  | 13.0460-5722.2 | 605722 | 21576   | 20,7 | 13.0460-7196.2 | 607196 |
| 21355 | 13,5 | 13.0460-5970.2  | 605970 | 21469 | 18,0  | 13.0460-3959.2 | 603959 | 21577   | 20,7 | 13.0460-7196.2 | 607196 |
| 21356 | 13,5 | 13.0460-5970.2  | 605970 | 21470 | 18,0  | 13.0460-3960.2 | 603960 | 21579   | 19,8 | 13.0460-7165.2 | 607165 |
| 21356 | 13,5 | 13.0460-5970.2  | 605970 | 21471 | 18,0  | 13.0460-4965.2 | 604965 | 21579   | 19,8 | 13.0460-7165.2 | 607165 |
| 21357 | 13,5 | 13.0460-5970.2  | 605970 | 21471 | 18,0  | 13.0460-4965.2 | 604965 | 21580   | 14,6 | 13.0460-4974.2 | 604974 |
| 21357 | 13,5 | 13.0460-5970.2  | 605970 | 21479 | 19,2  | 13.0460-2838.2 | 602838 | 21582   | 17,5 | 13.0460-7056.2 | 607056 |
| 21358 | 19,8 | 13.0460-7163.2  | 607163 | 21479 | 19,2  | 13.0460-2982.2 | 602982 | 21586   | 15,0 | 13.0460-3963.2 | 603963 |
| 21358 | 19,8 | 13.0460-7165.2  | 607165 | 21479 | 19,2  | 13.0460-2982.2 | 602982 | 21586   | 15,0 | 13.0460-3964.2 | 603964 |
| 21358 | 19,8 | 13.0460-7165.2  | 607165 | 21481 | 15,5  | 13.0460-5959.2 | 605959 | 21586   | 15,0 | 13.0460-3964.2 | 603964 |
| 21363 | 15,8 | 13.0460-5958.2  | 605958 | 21484 | 20,5  | 13.0460-7183.2 | 607183 | 21592   | 18,8 | 13.0460-7084.2 | 607084 |
| 21365 | 17,0 | 13.0460-3949.2  | 603949 | 21484 | 20,5  | 13.0460-7183.2 | 607183 | 21592   | 18,8 | 13.0460-7084.2 | 607084 |
| 21366 | 19,3 | 13.0460-2806.2  | 602806 | 21485 | 20,5  | 13.0460-7183.2 | 607183 | 21593   | 18,8 | 13.0460-7084.2 | 607084 |
| 21368 | 18,3 | 13.0460-2815.2  | 602815 | 21486 | 19,3  | 13.0460-7078.2 | 607078 | 21595   | 18,3 | 13.0460-2836.2 | 602836 |
| 21368 | 18,3 | 13.0460-2815.2  | 602815 | 21486 | 19,3  | 13.0460-7078.2 | 607078 | 21596   | 18,3 | 13.0460-2836.2 | 602836 |
| 21369 | 15,5 | 13.0460-5968.2  | 605968 | 21486 | 19,3  | 13.0470-7078.2 | LD7078 | 21596   | 18,3 | 13.0460-2836.2 | 602836 |
| 21373 | 16,0 | 13.0460-5940.2  | 605940 | 21487 | 17,3  | 13.0460-7079.2 | 607079 | 21597   | 11,0 | 13.0460-3822.2 | 603822 |
| 21374 | 16,0 | 13.0460-5940.2  | 605940 | 21487 | 17,3  | 13.0460-7079.2 | 607079 | 21597   | 11,0 | 13.0460-3822.2 | 603822 |
| 21374 | 16,0 | 13.0460-5940.2  | 605940 | 21487 | 17,3  | 13.0470-7079.2 | LD7079 | 21600   | 11,0 | 13.0460-3822.2 | 603822 |
| 21375 | 16,0 | 13.0460-5940.2  | 605940 | 21495 | 17,0  | 13.0460-5978.2 | 605978 | 21601   | 17,5 | 13.0460-5951.2 | 605951 |
| 21375 | 16,0 | 13.0460-5940.2  | 605940 | 21496 | 17,0  | 13.0460-5978.2 | 605978 | 21602   | 17,5 | 13.0460-5951.2 | 605951 |







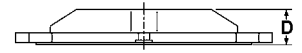

# Vergleichsliste WVA → ATE

Cross reference list WVA → ATE - Tabella di conversione codici WVA → ATE

Liste des correspondances WVA → ATE - Lista referencias WVA → ATE







| WVA   | D    |  | WVA    | D     |  | WVA            | D      |  |      |                |        |
|-------|------|---|--------|-------|---|----------------|--------|---|------|----------------|--------|
| 21603 | 17,5 | 13.0460-5951.2  | 605951 | 21676 | 20,3  | 13.0460-7089.2 | 607089 | 21795   | 19,8 | 13.0460-7086.2 | 607086 |
| 21606 | 16,7 | 13.0460-2827.2  | 602827 | 21676 | 20,3  | 13.0460-7155.2 | 607155 | 21795   | 19,8 | 13.0470-7086.2 | LD7086 |
| 21613 | 18,0 | 13.0460-2981.2  | 602981 | 21676 | 20,3  | 13.0470-7089.2 | LD7089 | 21797   | 19,7 | 13.0460-2850.2 | 602850 |
| 21614 | 17,7 | 13.0460-2825.2  | 602825 | 21676 | 20,3  | 13.0470-7155.2 | LD7155 | 21797   | 19,7 | 13.0460-2976.2 | 602976 |
| 21615 | 17,7 | 13.0460-2825.2  | 602825 | 21677 | 20,3  | 13.0460-7089.2 | 607089 | 21798   | 19,7 | 13.0460-2976.2 | 602976 |
| 21616 | 17,7 | 13.0460-2825.2  | 602825 | 21677 | 20,3  | 13.0470-7089.2 | LD7089 | 21799   | 19,7 | 13.0460-2852.2 | 602852 |
| 21621 | 17,3 | 13.0460-7083.2  | 607083 | 21679 | 15,0  | 13.0460-5992.2 | 605992 | 21799   | 19,7 | 13.0460-2977.2 | 602977 |
| 21622 | 17,3 | 13.0460-7083.2  | 607083 | 21680 | 15,0  | 13.0460-5992.2 | 605992 | 21800   | 19,7 | 13.0460-2977.2 | 602977 |
| 21624 | 20,3 | 13.0460-7077.2  | 607077 | 21681 | 15,0  | 13.0460-5992.2 | 605992 | 21801   | 19,0 | 13.0460-2978.2 | 602978 |
| 21626 | 15,0 | 13.0460-5956.2  | 605956 | 21688 | 15,3  | 13.0460-5862.2 | 605862 | 21802   | 19,0 | 13.0460-2978.2 | 602978 |
| 21631 | 17,0 | 13.0460-3956.2  | 603956 | 21689 | 15,5  | 13.0460-5892.2 | 605892 | 21815   | 18,8 | 13.0460-8009.2 | 608009 |
| 21632 | 16,0 | 13.0460-3972.2  | 603972 | 21691 | 17,3  | 13.0460-7090.2 | 607090 | 21816   | 16,8 | 13.0460-8009.2 | 608009 |
| 21635 | 18,0 | 13.0460-2973.2  | 602973 | 21691 | 17,3  | 13.0470-7090.2 | LD7090 | 21817   | 16,8 | 13.0460-8009.2 | 608009 |
| 21635 | 18,7 | 13.0460-2839.2  | 602839 | 21694 | 16,3  | 13.0460-5820.2 | 605820 | 21822   | 17,5 | 13.0460-5897.2 | 605897 |
| 21636 | 19,3 | 13.0460-7069.2  | 607069 | 21695 | 16,3  | 13.0460-5820.2 | 605820 | 21823   | 17,5 | 13.0460-5897.2 | 605897 |
| 21636 | 19,3 | 13.0460-7181.2  | 607181 | 21696 | 16,3  | 13.0460-5820.2 | 605820 | 21824   | 17,5 | 13.0460-5897.2 | 605897 |
| 21636 | 19,3 | 13.0470-7181.2  | LD7181 | 21697 | 15,0  | 13.0460-5943.2 | 605943 | 21825   | 17,5 | 13.0460-5897.2 | 605897 |
| 21637 | 19,3 | 13.0460-7069.2  | 607069 | 21698 | 15,0  | 13.0460-5943.2 | 605943 | 21827   | 17,3 | 13.0460-7088.2 | 607088 |
| 21637 | 19,3 | 13.0460-7112.2  | 607112 | 21699 | 15,0  | 13.0460-5943.2 | 605943 | 21829   | 20,3 | 13.0460-7091.2 | 607091 |
| 21637 | 19,3 | 13.0460-7140.2  | 607140 | 21703 | 15,0  | 13.0460-5850.2 | 605850 | 21829   | 20,3 | 13.0460-7173.2 | 607173 |
| 21637 | 19,3 | 13.0460-7180.2  | 607180 | 21704 | 15,0  | 13.0460-5850.2 | 605850 | 21832   | 14,9 | 13.0460-4058.2 | 604058 |
| 21637 | 19,3 | 13.0460-7181.2  | 607181 | 21705 | 15,0  | 13.0460-5850.2 | 605850 | 21832   | 14,9 | 13.0460-5924.2 | 605924 |
| 21637 | 19,3 | 13.0470-7140.2  | LD7140 | 21706 | 15,5  | 13.0460-5980.2 | 605980 | 21833   | 15,0 | 13.0460-5840.2 | 605840 |
| 21637 | 19,3 | 13.0470-7181.2  | LD7181 | 21707 | 15,5  | 13.0460-5980.2 | 605980 | 21834   | 15,0 | 13.0460-5840.2 | 605840 |
| 21638 | 17,5 | 13.0460-7060.2  | 607060 | 21708 | 15,5  | 13.0460-5980.2 | 605980 | 21840   | 14,4 | 13.0460-5981.2 | 605981 |
| 21641 | 19,3 | 13.0460-7140.2  | 607140 | 21713 | 16,0  | 13.0460-5626.2 | 605626 | 21841   | 14,4 | 13.0460-5981.2 | 605981 |
| 21641 | 19,3 | 13.0470-7140.2  | LD7140 | 21713 | 16,5  | 13.0460-5983.2 | 605983 | 21842   | 14,4 | 13.0460-5981.2 | 605981 |
| 21642 | 19,3 | 13.0460-7078.2  | 607078 | 21714 | 16,0  | 13.0460-5626.2 | 605626 | 21845   | 16,5 | 13.0460-5926.2 | 605926 |
| 21642 | 19,3 | 13.0470-7078.2  | LD7078 | 21715 | 16,0  | 13.0460-5626.2 | 605626 | 21846   | 16,5 | 13.0460-5926.2 | 605926 |
| 21643 | 17,8 | 13.0460-5405.2  | 605405 | 21716 | 16,0  | 13.0460-5808.2 | 605808 | 21847   | 16,5 | 13.0460-5926.2 | 605926 |
| 21643 | 17,8 | 13.0470-5405.2  | LD5405 | 21717 | 16,0  | 13.0460-5808.2 | 605808 | 21847   | 19,8 | 13.0460-7076.2 | 607076 |
| 21644 | 17,8 | 13.0460-5405.2  | 605405 | 21718 | 16,0  | 13.0460-5808.2 | 605808 | 21848   | 19,8 | 13.0460-7143.2 | 607143 |
| 21644 | 17,8 | 13.0470-5405.2  | LD5405 | 21719 | 15,0  | 13.0460-5929.2 | 605929 | 21848   | 19,8 | 13.0460-7143.2 | 607143 |
| 21646 | 20,3 | 13.0460-7077.2  | 607077 | 21720 | 15,0  | 13.0460-5929.2 | 605929 | 21849   | 20,3 | 13.0460-7076.2 | 607076 |
| 21647 | 16,0 | 13.0460-5952.2  | 605952 | 21721 | 15,0  | 13.0460-5929.2 | 605929 | 21849   | 20,3 | 13.0460-7143.2 | 607143 |
| 21648 | 16,0 | 13.0460-5952.2  | 605952 | 21724 | 19,3  | 13.0460-2816.2 | 602816 | 21854   | 15,0 | 13.0460-5640.2 | 605640 |
| 21649 | 16,0 | 13.0460-5952.2  | 605952 | 21725 | 16,8  | 13.0460-5933.2 | 605933 | 21856   | 15,0 | 13.0460-5640.2 | 605640 |
| 21650 | 15,0 | 13.0460-5889.2  | 605889 | 21726 | 16,8  | 13.0460-5933.2 | 605933 | 21857   | 17,7 | 13.0460-4066.2 | 604066 |
| 21650 | 15,0 | 13.0460-5953.2  | 605953 | 21727 | 16,8  | 13.0460-5933.2 | 605933 | 21861   | 15,2 | 13.0460-2831.2 | 602831 |
| 21650 | 15,5 | 13.0460-5713.2  | 605713 | 21730 | 14,0  | 13.0460-5763.2 | 605763 | 21861   | 15,2 | 13.0460-2897.2 | 602897 |
| 21651 | 17,5 | 13.0460-5982.2  | 605982 | 21730 | 14,9  | 13.0460-5763.2 | 605763 | 21866   | 15,3 | 13.0460-7101.2 | 607101 |
| 21652 | 17,5 | 13.0460-5982.2  | 605982 | 21738 | 13,5  | 13.0460-5731.2 | 605731 | 21866   | 17,2 | 13.0460-7100.2 | 607100 |
| 21653 | 17,5 | 13.0460-5982.2  | 605982 | 21749 | 19,3  | 13.0460-2816.2 | 602816 | 21866   | 17,2 | 13.0460-7164.2 | 607164 |
| 21654 | 15,0 | 13.0460-5944.2  | 605944 | 21766 | 13,5  | 13.0460-5973.2 | 605973 | 21866   | 17,2 | 13.0470-7100.2 | LD7100 |
| 21655 | 15,0 | 13.0460-5944.2  | 605944 | 21768 | 15,8  | 13.0460-5958.2 | 605958 | 21866   | 19,7 | 13.0460-7072.2 | 607072 |
| 21656 | 15,0 | 13.0460-5944.2  | 605944 | 21768 | 15,8  | 13.0460-5958.2 | 605958 | 21868   | 15,3 | 13.0460-7101.2 | 607101 |
| 21657 | 16,4 | 13.0460-5941.2  | 605941 | 21769 | 15,8  | 13.0460-5958.2 | 605958 | 21868   | 17,2 | 13.0460-7100.2 | 607100 |
| 21658 | 16,4 | 13.0460-5941.2  | 605941 | 21773 | 15,0  | 13.0460-5872.2 | 605872 | 21868   | 17,2 | 13.0460-7100.2 | 607100 |
| 21658 | 16,4 | 13.0460-5941.2  | 605941 | 21774 | 15,0  | 13.0460-5872.2 | 605872 | 21868   | 17,2 | 13.0460-7164.2 | 607164 |
| 21659 | 16,4 | 13.0460-5941.2  | 605941 | 21775 | 15,0  | 13.0460-5745.2 | 605745 | 21868   | 19,7 | 13.0460-7072.2 | 607072 |
| 21664 | 19,8 | 13.0460-7086.2  | 607086 | 21776 | 15,0  | 13.0460-5745.2 | 605745 | 21872   | 14,5 | 13.0460-5826.2 | 605826 |
| 21664 | 19,8 | 13.0470-7086.2  | LD7086 | 21780 | 15,5  | 13.0460-5968.2 | 605968 | 21873   | 14,5 | 13.0460-5826.2 | 605826 |
| 21670 | 19,3 | 13.0460-7203.2  | 607203 | 21781 | 15,5  | 13.0460-5968.2 | 605968 | 21874   | 14,5 | 13.0460-5826.2 | 605826 |
| 21670 | 19,3 | 13.0470-7203.2  | LD7203 | 21792 | 15,2  | 13.0460-4988.2 | 604988 | 21875   | 16,0 | 13.0460-5927.2 | 605927 |
| 21670 | 19,4 | 13.0460-7087.2  | 607087 | 21794 | 19,3  | 13.0460-7203.2 | 607203 | 21876   | 16,0 | 13.0460-5927.2 | 605927 |
| 21670 | 19,4 | 13.0470-7087.2  | LD7087 | 21794 | 19,3  | 13.0470-7203.2 | LD7203 | 21877   | 16,0 | 13.0460-5927.2 | 605927 |
| 21674 | 19,0 | 13.0460-2817.2  | 602817 | 21794 | 19,4  | 13.0460-7087.2 | 607087 | 21879   | 18,6 | 13.0460-5955.2 | 605955 |
| 21674 | 19,4 | 13.0460-2844.2  | 602844 | 21794 | 19,4  | 13.0470-7087.2 | LD7087 | 21880   | 18,6 | 13.0460-5955.2 | 605955 |

# Vergleichsliste WVA → ATE

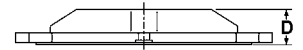
Cross reference list WVA → ATE - Tabella di conversione codici WVA → ATE

Liste des correspondances WVA → ATE - Lista referencias WVA → ATE



| WVA   | D    |  | WVA    | D     |  | WVA            | D      |  |      |                |        |
|-------|------|---|--------|-------|---|----------------|--------|---|------|----------------|--------|
| 21881 | 18,6 | 13.0460-5955.2  | 605955 | 21961 | 15,5  | 13.0460-5845.2 | 605845 | 23070   | 17,0 | 13.0460-2833.2 | 602833 |
| 21883 | 19,8 | 13.0460-7102.2  | 607102 | 21962 | 18,0  | 13.0460-7063.2 | 607063 | 23070   | 17,0 | 13.0470-2776.2 | LD2776 |
| 21883 | 19,8 | 13.0460-7124.2  | 607124 | 21965 | 15,0  | 13.0460-4986.2 | 604986 | 23070   | 17,0 | 13.0470-2833.2 | LD2833 |
| 21885 | 20,4 | 13.0460-7102.2  | 607102 | 21966 | 15,0  | 13.0460-4986.2 | 604986 | 23070   | 19,5 | 13.0460-2828.2 | 602828 |
| 21885 | 20,4 | 13.0460-7124.2  | 607124 | 21975 | 18,2  | 13.0460-5809.2 | 605809 | 23073   | 18,8 | 13.0460-7145.2 | 607145 |
| 21886 | 19,0 | 13.0460-2817.2  | 602817 | 21976 | 18,2  | 13.0460-5809.2 | 605809 | 23073   | 18,8 | 13.0470-7145.2 | LD7145 |
| 21886 | 19,4 | 13.0460-2844.2  | 602844 | 21977 | 18,2  | 13.0460-5809.2 | 605809 | 23074   | 18,8 | 13.0460-7145.2 | 607145 |
| 21888 | 18,1 | 13.0460-2832.2  | 602832 | 21980 | 18,0  | 13.0460-3977.2 | 603977 | 23074   | 18,8 | 13.0470-7145.2 | LD7145 |
| 21889 | 18,1 | 13.0460-2832.2  | 602832 | 21981 | 18,0  | 13.0460-3977.2 | 603977 | 23076   | 17,5 | 13.0460-7135.2 | 607135 |
| 21891 | 17,3 | 13.0460-7090.2  | 607090 | 21983 | 17,2  | 13.0460-2853.2 | 602853 | 23076   | 17,5 | 13.0470-7135.2 | LD7135 |
| 21891 | 17,3 | 13.0470-7090.2  | LD7090 | 21999 | 15,8  | 13.0460-3979.2 | 603979 | 23077   | 17,5 | 13.0460-7135.2 | 607135 |
| 21897 | 18,5 | 13.0460-6916.2  | 606916 | 22035 | 17,5  | 13.0460-7303.2 | 607303 | 23077   | 17,5 | 13.0470-7135.2 | LD7135 |
| 21899 | 15,3 | 13.0460-4065.2  | 604065 | 22035 | 17,5  | 13.0470-7303.2 | LD7303 | 23078   | 15,9 | 13.0460-4069.2 | 604069 |
| 21899 | 15,3 | 13.0470-4065.2  | LD4065 | 22036 | 17,5  | 13.0460-7303.2 | 607303 | 23080   | 15,0 | 13.0460-5987.2 | 605987 |
| 21900 | 15,0 | 13.0460-4060.2  | 604060 | 22036 | 17,5  | 13.0470-7303.2 | LD7303 | 23081   | 18,0 | 13.0460-5718.2 | 605718 |
| 21904 | 16,9 | 13.0460-7085.2  | 607085 | 22037 | 17,5  | 13.0460-7303.2 | 607303 | 23082   | 18,0 | 13.0460-5718.2 | 605718 |
| 21907 | 15,5 | 13.0460-5864.2  | 605864 | 22037 | 17,5  | 13.0470-7303.2 | LD7303 | 23083   | 18,0 | 13.0460-5718.2 | 605718 |
| 21908 | 15,5 | 13.0460-5864.2  | 605864 | 22062 | 20,7  | 13.0460-4884.2 | 604884 | 23092   | 15,6 | 13.0460-4803.2 | 604803 |
| 21909 | 15,5 | 13.0460-5864.2  | 605864 | 22102 | 18,2  | 13.0460-4882.2 | 604882 | 23092   | 15,6 | 13.0460-4804.2 | 604804 |
| 21910 | 19,8 | 13.0460-7163.2  | 607163 | 23001 | 15,8  | 13.0460-3979.2 | 603979 | 23092   | 15,6 | 13.0470-4803.2 | LD4803 |
| 21911 | 20,3 | 13.0460-7081.2  | 607081 | 23004 | 15,9  | 13.0460-5988.2 | 605988 | 23092   | 16,0 | 13.0460-4851.2 | 604851 |
| 21911 | 20,3 | 13.0460-7122.2  | 607122 | 23005 | 15,9  | 13.0460-5988.2 | 605988 | 23092   | 16,0 | 13.0460-4971.2 | 604971 |
| 21911 | 20,3 | 13.0470-7081.2  | LD7081 | 23006 | 15,9  | 13.0460-5988.2 | 605988 | 23092   | 16,0 | 13.0460-4973.2 | 604973 |
| 21911 | 20,3 | 13.0470-7122.2  | LD7122 | 23018 | 20,3  | 13.0460-7110.2 | 607110 | 23092   | 16,0 | 13.0460-4991.2 | 604991 |
| 21915 | 17,2 | 13.0460-5851.2  | 605851 | 23018 | 20,3  | 13.0470-7110.2 | LD7110 | 23092   | 16,0 | 13.0470-4851.2 | LD4851 |
| 21919 | 15,3 | 13.0460-4064.2  | 604064 | 23019 | 20,3  | 13.0460-7110.2 | 607110 | 23092   | 16,0 | 13.0470-4971.2 | LD4971 |
| 21919 | 15,3 | 13.0470-4064.2  | LD4064 | 23019 | 20,3  | 13.0470-7110.2 | LD7110 | 23092   | 16,3 | 13.0460-4854.2 | 604854 |
| 21920 | 14,6 | 13.0460-2830.2  | 602830 | 23020 | 17,9  | 13.0460-3985.2 | 603985 | 23092   | 16,3 | 13.0470-4854.2 | LD4854 |
| 21920 | 16,6 | 13.0460-2896.2  | 602896 | 23021 | 18,9  | 13.0460-3990.2 | 603990 | 23093   | 16,6 | 13.0460-5807.2 | 605807 |
| 21927 | 17,9 | 13.0460-7065.2  | 607065 | 23022 | 20,9  | 13.0460-3980.2 | 603980 | 23094   | 16,5 | 13.0460-5825.2 | 605825 |
| 21927 | 17,9 | 13.0460-7067.2  | 607067 | 23023 | 14,8  | 13.0460-5841.2 | 605841 | 23097   | 17,1 | 13.0460-5861.2 | 605861 |
| 21927 | 17,9 | 13.0460-7133.2  | 607133 | 23024 | 14,8  | 13.0460-5841.2 | 605841 | 23099   | 18,4 | 13.0460-2735.2 | 602735 |
| 21928 | 17,9 | 13.0460-7065.2  | 607065 | 23025 | 14,8  | 13.0460-5841.2 | 605841 | 23099   | 18,4 | 13.0460-2870.2 | 602870 |
| 21928 | 17,9 | 13.0460-7133.2  | 607133 | 23034 | 18,8  | 13.0460-7123.2 | 607123 | 23100   | 18,4 | 13.0460-2735.2 | 602735 |
| 21929 | 17,9 | 13.0460-7065.2  | 607065 | 23034 | 18,8  | 13.0460-7154.2 | 607154 | 23110   | 16,0 | 13.0460-4971.2 | 604971 |
| 21929 | 17,9 | 13.0460-7067.2  | 607067 | 23034 | 19,4  | 13.0460-7156.2 | 607156 | 23110   | 16,0 | 13.0470-4971.2 | LD4971 |
| 21930 | 17,9 | 13.0460-7064.2  | 607064 | 23036 | 19,4  | 13.0460-7123.2 | 607123 | 23111   | 15,6 | 13.0460-4803.2 | 604803 |
| 21930 | 17,9 | 13.0460-7068.2  | 607068 | 23042 | 19,0  | 13.0460-3957.2 | 603957 | 23111   | 15,6 | 13.0470-4803.2 | LD4803 |
| 21930 | 17,9 | 13.0460-7114.2  | 607114 | 23043 | 16,0  | 13.0460-8003.2 | 608003 | 23111   | 16,0 | 13.0460-4851.2 | 604851 |
| 21930 | 17,9 | 13.0460-7125.2  | 607125 | 23044 | 16,0  | 13.0460-8003.2 | 608003 | 23111   | 16,0 | 13.0460-4971.2 | 604971 |
| 21931 | 17,9 | 13.0460-7064.2  | 607064 | 23057 | 20,2  | 13.0460-7116.2 | 607116 | 23111   | 16,0 | 13.0470-4851.2 | LD4851 |
| 21931 | 17,9 | 13.0460-7125.2  | 607125 | 23057 | 20,2  | 13.0470-7116.2 | LD7116 | 23111   | 16,0 | 13.0470-4971.2 | LD4971 |
| 21932 | 17,9 | 13.0460-7064.2  | 607064 | 23058 | 19,6  | 13.0460-7116.2 | 607116 | 23112   | 19,1 | 13.0460-7144.2 | 607144 |
| 21932 | 17,9 | 13.0460-7068.2  | 607068 | 23058 | 19,6  | 13.0470-7116.2 | LD7116 | 23114   | 19,1 | 13.0460-7144.2 | 607144 |
| 21932 | 17,9 | 13.0460-7068.2  | 607068 | 23059 | 19,6  | 13.0460-7116.2 | 607116 | 23115   | 19,8 | 13.0460-7091.2 | 607091 |
| 21937 | 15,5 | 13.0460-4814.2  | 604814 | 23059 | 19,6  | 13.0470-7116.2 | LD7116 | 23116   | 19,6 | 13.0460-7173.2 | 607173 |
| 21937 | 15,5 | 13.0460-4815.2  | 604815 | 23063 | 17,5  | 13.0460-7115.2 | 607115 | 23117   | 19,6 | 13.0460-7173.2 | 607173 |
| 21937 | 15,5 | 13.0470-4814.2  | LD4814 | 23063 | 17,5  | 13.0470-7115.2 | LD7115 | 23119   | 17,5 | 13.0460-2875.2 | 602875 |
| 21945 | 16,0 | 13.0460-2821.2  | 602821 | 23064 | 17,5  | 13.0460-7115.2 | 607115 | 23119   | 17,5 | 13.0460-2876.2 | 602876 |
| 21945 | 19,6 | 13.0460-2822.2  | 602822 | 23064 | 17,5  | 13.0470-7115.2 | LD7115 | 23124   | 19,0 | 13.0460-2829.2 | 602829 |
| 21945 | 19,6 | 13.0460-2837.2  | 602837 | 23065 | 17,5  | 13.0460-7115.2 | 607115 | 23125   | 19,0 | 13.0460-2829.2 | 602829 |
| 21945 | 19,6 | 13.0470-2837.2  | LD2837 | 23065 | 17,5  | 13.0470-7115.2 | LD7115 | 23126   | 17,5 | 13.0460-7138.2 | 607138 |
| 21947 | 15,4 | 13.0460-5744.2  | 605744 | 23065 | 17,5  | 13.0460-7115.2 | 607115 | 23130   | 19,6 | 13.0460-7111.2 | 607111 |
| 21948 | 13,5 | 13.0460-5969.2  | 605969 | 23066 | 18,5  | 13.0460-7115.2 | 607115 | 23130   | 19,6 | 13.0460-7117.2 | 607117 |
| 21949 | 13,5 | 13.0460-5969.2  | 605969 | 23066 | 18,5  | 13.0470-7115.2 | LD7115 | 23130   | 19,6 | 13.0470-7111.2 | LD7111 |
| 21952 | 15,0 | 13.0460-5898.2  | 605898 | 23067 | 18,5  | 13.0460-7115.2 | 607115 | 23130   | 19,6 | 13.0470-7117.2 | LD7117 |
| 21953 | 15,0 | 13.0460-5898.2  | 605898 | 23067 | 18,5  | 13.0470-7115.2 | LD7115 | 23130   | 19,6 | 13.0470-7117.2 | LD7117 |
| 21954 | 15,0 | 13.0460-5898.2  | 605898 | 23070 | 17,0  | 13.0460-2776.2 | 602776 | 23131   | 19,6 | 13.0460-7111.2 | 607111 |





# Vergleichsliste WVA → ATE

Cross reference list WVA → ATE - Tabella di conversione codici WVA → ATE

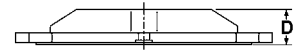
Liste des correspondances WVA → ATE - Lista referencias WVA → ATE



| WVA   | D    |  | WVA    | D     |  | WVA            | D      |  |      |                |        |
|-------|------|---|--------|-------|---|----------------|--------|---|------|----------------|--------|
| 23131 | 19,6 | 13.0460-7117.2  | 607117 | 23196 | 17,4  | 13.0460-8004.2 | 608004 | 23258   | 16,5 | 13.0460-3976.2 | 603976 |
| 23131 | 19,6 | 13.0470-7111.2  | LD7111 | 23200 | 18,0  | 13.0460-7148.2 | 607148 | 23259   | 16,5 | 13.0460-3976.2 | 603976 |
| 23131 | 19,6 | 13.0470-7117.2  | LD7117 | 23201 | 18,0  | 13.0460-7148.2 | 607148 | 23262   | 16,5 | 13.0460-3976.2 | 603976 |
| 23135 | 18,0 | 13.0460-3986.2  | 603986 | 23202 | 17,8  | 13.0460-7213.2 | 607213 | 23263   | 16,5 | 13.0460-3976.2 | 603976 |
| 23137 | 18,0 | 13.0460-3986.2  | 603986 | 23202 | 18,3  | 13.0460-7142.2 | 607142 | 23269   | 19,8 | 13.0460-7153.2 | 607153 |
| 23138 | 14,6 | 13.0460-2712.2  | 602712 | 23206 | 18,0  | 13.0460-4968.2 | 604968 | 23270   | 19,8 | 13.0460-7153.2 | 607153 |
| 23138 | 14,6 | 13.0460-2855.2  | 602855 | 23206 | 18,0  | 13.0460-4985.2 | 604985 | 23271   | 17,4 | 13.0460-4984.2 | 604984 |
| 23138 | 14,6 | 13.0470-2712.2  | LD2712 | 23207 | 18,0  | 13.0460-4968.2 | 604968 | 23271   | 17,4 | 13.0460-4990.2 | 604990 |
| 23138 | 14,6 | 13.0470-2855.2  | LD2855 | 23207 | 18,0  | 13.0460-4985.2 | 604985 | 23271   | 17,4 | 13.0470-4984.2 | LD4984 |
| 23140 | 19,4 | 13.0460-7105.2  | 607105 | 23212 | 20,3  | 13.0460-7296.2 | 607296 | 23271   | 17,4 | 13.0470-4990.2 | LD4990 |
| 23140 | 19,4 | 13.0460-7139.2  | 607139 | 23212 | 20,3  | 13.0470-7296.2 | LD7296 | 23273   | 17,8 | 13.0460-3998.2 | 603998 |
| 23140 | 19,4 | 13.0470-7139.2  | LD7139 | 23213 | 20,3  | 13.0460-7296.2 | 607296 | 23276   | 17,2 | 13.0460-3996.2 | 603996 |
| 23141 | 19,4 | 13.0460-7105.2  | 607105 | 23213 | 20,3  | 13.0470-7296.2 | LD7296 | 23277   | 17,7 | 13.0460-3997.2 | 603997 |
| 23141 | 19,4 | 13.0460-7139.2  | 607139 | 23215 | 17,5  | 13.0460-7248.2 | 607248 | 23279   | 18,4 | 13.0460-3987.2 | 603987 |
| 23141 | 19,4 | 13.0470-7139.2  | LD7139 | 23215 | 18,3  | 13.0460-7157.2 | 607157 | 23279   | 18,4 | 13.0470-3987.2 | LD3987 |
| 23142 | 15,1 | 13.0460-4818.2  | 604818 | 23215 | 18,3  | 13.0460-7221.2 | 607221 | 23280   | 17,5 | 13.0460-2875.2 | 602875 |
| 23143 | 15,1 | 13.0460-4818.2  | 604818 | 23215 | 18,3  | 13.0470-7157.2 | LD7157 | 23280   | 17,5 | 13.0460-2876.2 | 602876 |
| 23144 | 19,8 | 13.0460-2726.2  | 602726 | 23215 | 18,3  | 13.0470-7221.2 | LD7221 | 23281   | 18,3 | 13.0460-7161.2 | 607161 |
| 23144 | 19,8 | 13.0460-2727.2  | 602727 | 23217 | 17,5  | 13.0460-7248.2 | 607248 | 23281   | 18,3 | 13.0470-7161.2 | LD7161 |
| 23144 | 19,8 | 13.0470-2726.2  | LD2726 | 23217 | 18,3  | 13.0460-7157.2 | 607157 | 23282   | 18,3 | 13.0460-7161.2 | 607161 |
| 23144 | 19,8 | 13.0470-2727.2  | LD2727 | 23217 | 18,3  | 13.0470-7157.2 | LD7157 | 23282   | 18,3 | 13.0470-7161.2 | LD7161 |
| 23145 | 19,8 | 13.0460-2726.2  | 602726 | 23218 | 18,0  | 13.0460-7113.2 | 607113 | 23284   | 14,0 | 13.0460-2858.2 | 602858 |
| 23145 | 19,8 | 13.0460-2727.2  | 602727 | 23218 | 18,0  | 13.0460-7128.2 | 607128 | 23284   | 14,0 | 13.0470-2858.2 | LD2858 |
| 23145 | 19,8 | 13.0470-2726.2  | LD2726 | 23218 | 18,0  | 13.0460-7132.2 | 607132 | 23289   | 19,3 | 13.0460-7140.2 | 607140 |
| 23145 | 19,8 | 13.0470-2727.2  | LD2727 | 23220 | 18,0  | 13.0460-7113.2 | 607113 | 23289   | 19,3 | 13.0470-7140.2 | LD7140 |
| 23146 | 17,0 | 13.0460-3973.2  | 603973 | 23220 | 18,0  | 13.0460-7128.2 | 607128 | 23290   | 15,5 | 13.0460-5890.2 | 605890 |
| 23154 | 19,0 | 13.0460-7121.2  | 607121 | 23222 | 19,3  | 13.0460-7112.2 | 607112 | 23296   | 14,5 | 13.0460-5837.2 | 605837 |
| 23155 | 19,0 | 13.0460-7121.2  | 607121 | 23222 | 19,3  | 13.0460-7180.2 | 607180 | 23297   | 14,5 | 13.0460-5837.2 | 605837 |
| 23157 | 15,8 | 13.0460-4977.2  | 604977 | 23224 | 16,5  | 13.0460-2872.2 | 602872 | 23298   | 14,5 | 13.0460-5837.2 | 605837 |
| 23157 | 15,8 | 13.0470-4977.2  | LD4977 | 23224 | 16,5  | 13.0460-2874.2 | 602874 | 23299   | 14,5 | 13.0460-5837.2 | 605837 |
| 23158 | 17,5 | 13.0460-5830.2  | 605830 | 23225 | 17,0  | 13.0460-2857.2 | 602857 | 23300   | 18,0 | 13.0460-3965.2 | 603965 |
| 23160 | 17,3 | 13.0460-5727.2  | 605727 | 23225 | 17,0  | 13.0470-2857.2 | LD2857 | 23301   | 18,0 | 13.0460-3965.2 | 603965 |
| 23163 | 20,4 | 13.0460-7124.2  | 607124 | 23226 | 17,0  | 13.0460-2857.2 | 602857 | 23302   | 18,0 | 13.0460-3946.2 | 603946 |
| 23164 | 17,3 | 13.0460-5727.2  | 605727 | 23226 | 17,0  | 13.0470-2857.2 | LD2857 | 23305   | 15,2 | 13.0460-4921.2 | 604921 |
| 23168 | 19,0 | 13.0460-2987.2  | 602987 | 23228 | 18,1  | 13.0460-7108.2 | 607108 | 23309   | 17,3 | 13.0460-7169.2 | 607169 |
| 23169 | 19,4 | 13.0460-2869.2  | 602869 | 23229 | 18,1  | 13.0460-7129.2 | 607129 | 23309   | 17,3 | 13.0470-7169.2 | LD7169 |
| 23172 | 18,0 | 13.0460-2895.2  | 602895 | 23234 | 16,8  | 13.0460-5863.2 | 605863 | 23310   | 17,3 | 13.0460-7169.2 | 607169 |
| 23176 | 18,7 | 13.0460-2839.2  | 602839 | 23234 | 16,8  | 13.0460-5994.2 | 605994 | 23310   | 17,3 | 13.0470-7169.2 | LD7169 |
| 23177 | 14,2 | 13.0460-2826.2  | 602826 | 23234 | 16,9  | 13.0460-5859.2 | 605859 | 23312   | 20,3 | 13.0460-7167.2 | 607167 |
| 23178 | 16,6 | 13.0460-5755.2  | 605755 | 23235 | 16,8  | 13.0460-5863.2 | 605863 | 23312   | 20,3 | 13.0470-7167.2 | LD7167 |
| 23181 | 17,9 | 13.0460-7114.2  | 607114 | 23235 | 16,9  | 13.0460-5859.2 | 605859 | 23313   | 20,2 | 13.0460-7275.2 | 607275 |
| 23183 | 20,3 | 13.0460-7155.2  | 607155 | 23236 | 16,8  | 13.0460-5863.2 | 605863 | 23313   | 20,2 | 13.0470-7275.2 | LD7275 |
| 23183 | 20,3 | 13.0470-7155.2  | LD7155 | 23236 | 16,9  | 13.0460-5859.2 | 605859 | 23313   | 20,3 | 13.0460-7238.2 | 607238 |
| 23184 | 14,8 | 13.0460-5880.2  | 605880 | 23237 | 14,5  | 13.0460-5993.2 | 605993 | 23313   | 20,3 | 13.0470-7238.2 | LD7238 |
| 23185 | 14,8 | 13.0460-5880.2  | 605880 | 23238 | 16,0  | 13.0460-5803.2 | 605803 | 23314   | 15,0 | 13.0460-5857.2 | 605857 |
| 23187 | 19,6 | 13.0460-7117.2  | 607117 | 23239 | 16,0  | 13.0460-5803.2 | 605803 | 23323   | 14,6 | 13.0460-4974.2 | 604974 |
| 23187 | 19,6 | 13.0470-7117.2  | LD7117 | 23240 | 16,0  | 13.0460-5803.2 | 605803 | 23324   | 20,3 | 13.0460-7143.2 | 607143 |
| 23189 | 16,7 | 13.0460-8005.2  | 608005 | 23241 | 16,1  | 13.0460-5996.2 | 605996 | 23325   | 16,0 | 13.0460-4973.2 | 604973 |
| 23189 | 16,7 | 13.0460-8007.2  | 608007 | 23245 | 18,3  | 13.0460-7158.2 | 607158 | 23325   | 16,4 | 13.0460-4855.2 | 604855 |
| 23190 | 16,7 | 13.0460-8005.2  | 608005 | 23245 | 18,3  | 13.0460-7159.2 | 607159 | 23326   | 17,4 | 13.0460-2882.2 | 602882 |
| 23190 | 16,7 | 13.0460-8007.2  | 608007 | 23245 | 18,3  | 13.0460-7222.2 | 607222 | 23326   | 17,4 | 13.0460-2888.2 | 602888 |
| 23191 | 16,7 | 13.0460-8005.2  | 608005 | 23245 | 18,3  | 13.0470-7158.2 | LD7158 | 23326   | 17,4 | 13.0460-2889.2 | 602889 |
| 23192 | 16,7 | 13.0460-8005.2  | 608005 | 23245 | 18,3  | 13.0470-7159.2 | LD7159 | 23326   | 17,4 | 13.0460-2890.2 | 602890 |
| 23192 | 16,7 | 13.0460-8007.2  | 608007 | 23247 | 18,3  | 13.0460-7158.2 | 607158 | 23326   | 17,4 | 13.0470-2888.2 | LD2888 |
| 23193 | 16,4 | 13.0460-8004.2  | 608004 | 23247 | 18,3  | 13.0470-7158.2 | LD7158 | 23329   | 17,0 | 13.0460-4987.2 | 604987 |
| 23194 | 16,4 | 13.0460-8004.2  | 608004 | 23248 | 18,3  | 13.0460-7159.2 | 607159 | 23330   | 17,0 | 13.0460-4999.2 | 604999 |
| 23195 | 17,4 | 13.0460-8004.2  | 608004 | 23248 | 18,3  | 13.0470-7159.2 | LD7159 | 23332   | 18,0 | 13.0460-3978.2 | 603978 |





# Vergleichsliste WVA → ATE

Cross reference list WVA → ATE - Tabella di conversione codici WVA → ATE

Liste des correspondances WVA → ATE - Lista referencias WVA → ATE



| WVA   | D    |  | WVA    | D     |  | WVA            | D      |  |      |                |        |
|-------|------|---|--------|-------|---|----------------|--------|---|------|----------------|--------|
| 23333 | 18,0 | 13.0460-3978.2  | 603978 | 23417 | 15,3  | 13.0470-2868.2 | LD2868 | 23483   | 16,7 | 13.0460-7160.2 | 607160 |
| 23334 | 16,7 | 13.0460-7171.2  | 607171 | 23418 | 19,4  | 13.0460-7154.2 | 607154 | 23487   | 15,5 | 13.0460-5854.2 | 605854 |
| 23334 | 16,7 | 13.0470-7171.2  | LD7171 | 23418 | 19,4  | 13.0460-7156.2 | 607156 | 23488   | 15,4 | 13.0460-5853.2 | 605853 |
| 23335 | 16,7 | 13.0460-7171.2  | 607171 | 23419 | 19,4  | 13.0460-7154.2 | 607154 | 23489   | 16,3 | 13.0460-4841.2 | 604841 |
| 23335 | 16,7 | 13.0470-7171.2  | LD7171 | 23420 | 16,5  | 13.0460-5842.2 | 605842 | 23490   | 15,4 | 13.0460-5802.2 | 605802 |
| 23340 | 17,0 | 13.0460-5800.2  | 605800 | 23423 | 17,8  | 13.0460-2729.2 | 602729 | 23497   | 15,0 | 13.0460-5852.2 | 605852 |
| 23341 | 17,0 | 13.0460-5800.2  | 605800 | 23424 | 17,6  | 13.0460-2730.2 | 602730 | 23498   | 14,8 | 13.0460-5852.2 | 605852 |
| 23342 | 17,0 | 13.0460-5800.2  | 605800 | 23429 | 15,5  | 13.0460-5748.2 | 605748 | 23502   | 16,0 | 13.0460-5717.2 | 605717 |
| 23343 | 13,5 | 13.0460-5731.2  | 605731 | 23434 | 18,0  | 13.0460-3856.2 | 603856 | 23502   | 16,0 | 13.0460-5751.2 | 605751 |
| 23344 | 13,5 | 13.0460-5731.2  | 605731 | 23434 | 18,7  | 13.0460-3992.2 | 603992 | 23503   | 16,0 | 13.0460-5717.2 | 605717 |
| 23346 | 19,0 | 13.0460-2862.2  | 602862 | 23435 | 18,0  | 13.0460-3856.2 | 603856 | 23503   | 16,0 | 13.0460-5751.2 | 605751 |
| 23347 | 20,3 | 13.0460-7167.2  | 607167 | 23435 | 18,7  | 13.0460-3992.2 | 603992 | 23504   | 16,0 | 13.0460-5717.2 | 605717 |
| 23347 | 20,3 | 13.0460-7237.2  | 607237 | 23436 | 18,0  | 13.0460-3856.2 | 603856 | 23504   | 16,0 | 13.0460-5751.2 | 605751 |
| 23347 | 20,3 | 13.0470-7167.2  | LD7167 | 23437 | 18,0  | 13.0460-3856.2 | 603856 | 23507   | 15,2 | 13.0460-5887.2 | 605887 |
| 23347 | 20,3 | 13.0470-7237.2  | LD7237 | 23440 | 17,6  | 13.0460-7186.2 | 607186 | 23508   | 15,2 | 13.0460-5887.2 | 605887 |
| 23348 | 16,5 | 13.0460-5811.2  | 605811 | 23441 | 18,1  | 13.0460-7186.2 | 607186 | 23509   | 15,2 | 13.0460-5887.2 | 605887 |
| 23349 | 16,5 | 13.0460-5811.2  | 605811 | 23442 | 15,3  | 13.0460-5896.2 | 605896 | 23510   | 16,5 | 13.0460-5810.2 | 605810 |
| 23350 | 16,5 | 13.0460-5811.2  | 605811 | 23443 | 15,3  | 13.0460-5896.2 | 605896 | 23511   | 16,5 | 13.0460-5810.2 | 605810 |
| 23353 | 14,8 | 13.0460-2835.2  | 602835 | 23444 | 15,3  | 13.0460-5896.2 | 605896 | 23512   | 16,5 | 13.0460-5810.2 | 605810 |
| 23354 | 13,0 | 13.0460-5834.2  | 605834 | 23445 | 19,2  | 13.0460-2838.2 | 602838 | 23513   | 17,0 | 13.0460-5891.2 | 605891 |
| 23358 | 18,0 | 13.0460-8002.2  | 608002 | 23446 | 16,5  | 13.0460-2872.2 | 602872 | 23514   | 15,9 | 13.0460-5627.2 | 605627 |
| 23359 | 18,0 | 13.0460-8002.2  | 608002 | 23446 | 16,5  | 13.0460-2874.2 | 602874 | 23515   | 15,8 | 13.0460-5884.2 | 605884 |
| 23360 | 18,0 | 13.0460-8002.2  | 608002 | 23447 | 17,3  | 13.0460-7168.2 | 607168 | 23516   | 17,2 | 13.0460-2859.2 | 602859 |
| 23361 | 14,8 | 13.0460-8011.2  | 608011 | 23447 | 17,3  | 13.0460-7232.2 | 607232 | 23517   | 16,6 | 13.0460-2867.2 | 602867 |
| 23362 | 14,8 | 13.0460-8011.2  | 608011 | 23447 | 17,3  | 13.0470-7168.2 | LD7168 | 23517   | 16,6 | 13.0470-2867.2 | LD2867 |
| 23363 | 14,8 | 13.0460-8011.2  | 608011 | 23447 | 17,3  | 13.0470-7232.2 | LD7232 | 23517   | 17,2 | 13.0460-2763.2 | 602763 |
| 23378 | 20,1 | 13.0460-7172.2  | 607172 | 23448 | 20,8  | 13.0460-7170.2 | 607170 | 23518   | 17,0 | 13.0460-5885.2 | 605885 |
| 23378 | 20,1 | 13.0470-7172.2  | LD7172 | 23449 | 20,8  | 13.0460-7170.2 | 607170 | 23519   | 17,0 | 13.0460-5885.2 | 605885 |
| 23379 | 20,1 | 13.0460-7172.2  | 607172 | 23450 | 17,5  | 13.0460-5712.2 | 605712 | 23520   | 17,0 | 13.0460-5885.2 | 605885 |
| 23379 | 20,1 | 13.0470-7172.2  | LD7172 | 23451 | 17,5  | 13.0460-5712.2 | 605712 | 23521   | 14,0 | 13.0460-5812.2 | 605812 |
| 23384 | 18,3 | 13.0460-5923.2  | 605923 | 23452 | 19,0  | 13.0460-2720.2 | 602720 | 23522   | 14,0 | 13.0460-5812.2 | 605812 |
| 23385 | 18,3 | 13.0460-5923.2  | 605923 | 23454 | 14,9  | 13.0460-5989.2 | 605989 | 23523   | 14,0 | 13.0460-5812.2 | 605812 |
| 23387 | 12,6 | 13.0460-5865.2  | 605865 | 23455 | 13,7  | 13.0460-5871.2 | 605871 | 23524   | 17,4 | 13.0460-5746.2 | 605746 |
| 23388 | 12,6 | 13.0460-5865.2  | 605865 | 23456 | 13,7  | 13.0460-5871.2 | 605871 | 23525   | 17,4 | 13.0460-5746.2 | 605746 |
| 23389 | 12,6 | 13.0460-5865.2  | 605865 | 23457 | 13,7  | 13.0460-5871.2 | 605871 | 23526   | 17,5 | 13.0460-5817.2 | 605817 |
| 23392 | 20,3 | 13.0460-7122.2  | 607122 | 23458 | 15,6  | 13.0460-2721.2 | 602721 | 23527   | 14,5 | 13.0460-5827.2 | 605827 |
| 23392 | 20,3 | 13.0470-7122.2  | LD7122 | 23463 | 16,6  | 13.0460-5807.2 | 605807 | 23528   | 17,1 | 13.0460-5861.2 | 605861 |
| 23393 | 19,6 | 13.0460-2837.2  | 602837 | 23471 | 14,5  | 13.0460-6923.2 | 606923 | 23529   | 17,1 | 13.0460-5861.2 | 605861 |
| 23393 | 19,6 | 13.0470-2837.2  | LD2837 | 23471 | 17,5  | 13.0460-6924.2 | 606924 | 23530   | 16,6 | 13.0460-5755.2 | 605755 |
| 23394 | 13,7 | 13.0460-7177.2  | 607177 | 23478 | 14,6  | 13.0460-4819.2 | 604819 | 23531   | 16,6 | 13.0460-5755.2 | 605755 |
| 23394 | 13,7 | 13.0460-7178.2  | 607178 | 23478 | 16,5  | 13.0460-4998.2 | 604998 | 23532   | 20,1 | 13.0460-2959.2 | 602959 |
| 23395 | 13,7 | 13.0460-7177.2  | 607177 | 23480 | 19,3  | 13.0460-5813.2 | 605813 | 23533   | 20,1 | 13.0460-2959.2 | 602959 |
| 23395 | 13,7 | 13.0460-7178.2  | 607178 | 23481 | 19,3  | 13.0460-5813.2 | 605813 | 23534   | 20,1 | 13.0460-2959.2 | 602959 |
| 23397 | 19,4 | 13.0460-7224.2  | 607224 | 23482 | 15,8  | 13.0460-7137.2 | 607137 | 23536   | 17,6 | 13.0460-5792.2 | 605792 |
| 23399 | 19,4 | 13.0460-7224.2  | 607224 | 23482 | 15,8  | 13.0460-7251.2 | 607251 | 23537   | 17,6 | 13.0460-5792.2 | 605792 |
| 23400 | 15,5 | 13.0460-5838.2  | 605838 | 23482 | 15,8  | 13.0460-7253.2 | 607253 | 23538   | 17,6 | 13.0460-5792.2 | 605792 |
| 23402 | 20,1 | 13.0460-7172.2  | 607172 | 23482 | 15,8  | 13.0470-7137.2 | LD7137 | 23539   | 17,3 | 13.0460-5749.2 | 605749 |
| 23402 | 20,1 | 13.0470-7172.2  | LD7172 | 23482 | 15,8  | 13.0470-7251.2 | LD7251 | 23543   | 14,4 | 13.0460-5833.2 | 605833 |
| 23403 | 20,1 | 13.0460-7172.2  | 607172 | 23482 | 16,6  | 13.0460-7194.2 | 607194 | 23544   | 14,4 | 13.0460-5833.2 | 605833 |
| 23403 | 20,1 | 13.0470-7172.2  | LD7172 | 23482 | 16,6  | 13.0460-7195.2 | 607195 | 23545   | 14,4 | 13.0460-5833.2 | 605833 |
| 23404 | 20,6 | 13.0460-7199.2  | 607199 | 23482 | 16,6  | 13.0460-7209.2 | 607209 | 23550   | 17,3 | 13.0460-7225.2 | 607225 |
| 23405 | 20,1 | 13.0460-7199.2  | 607199 | 23482 | 16,6  | 13.0460-7278.2 | 607278 | 23550   | 17,3 | 13.0470-7225.2 | LD7225 |
| 23407 | 19,0 | 13.0460-2871.2  | 602871 | 23482 | 16,6  | 13.0470-7194.2 | LD7194 | 23551   | 17,3 | 13.0460-7225.2 | 607225 |
| 23409 | 19,3 | 13.0460-2881.2  | 602881 | 23482 | 16,6  | 13.0470-7195.2 | LD7195 | 23551   | 17,3 | 13.0470-7225.2 | LD7225 |
| 23410 | 15,0 | 13.0460-3964.2  | 603964 | 23482 | 16,7  | 13.0460-7160.2 | 607160 | 23552   | 18,1 | 13.0460-7126.2 | 607126 |
| 23411 | 15,0 | 13.0460-3964.2  | 603964 | 23483 | 15,8  | 13.0460-7137.2 | 607137 | 23554   | 16,0 | 13.0460-2753.2 | 602753 |
| 23417 | 15,3 | 13.0460-2868.2  | 602868 | 23483 | 15,8  | 13.0470-7137.2 | LD7137 | 23554   | 16,3 | 13.0460-2775.2 | 602775 |





# Vergleichsliste WVA → ATE

Cross reference list WVA → ATE - Tabella di conversione codici WVA → ATE

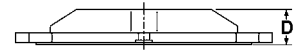
Liste des correspondances WVA → ATE - Lista referencias WVA → ATE







| WVA   | D    |  | WVA    | D     |  | WVA            | D      |  |      |                |        |
|-------|------|---|--------|-------|---|----------------|--------|---|------|----------------|--------|
| 23554 | 16,3 | 13.0460-2860.2  | 602860 | 23589 | 20,6  | 13.0460-7285.2 | 607285 | 23692   | 16,6 | 13.0470-4992.2 | LD4992 |
| 23554 | 16,3 | 13.0470-2860.2  | LD2860 | 23589 | 20,6  | 13.0470-7184.2 | LD7184 | 23693   | 16,6 | 13.0460-4993.2 | 604993 |
| 23554 | 16,4 | 13.0460-2845.2  | 602845 | 23589 | 20,6  | 13.0470-7285.2 | LD7285 | 23693   | 16,6 | 13.0470-4993.2 | LD4993 |
| 23554 | 16,4 | 13.0470-2845.2  | LD2845 | 23590 | 19,5  | 13.0460-7187.2 | 607187 | 23694   | 16,4 | 13.0470-4976.2 | LD4976 |
| 23554 | 17,2 | 13.0460-2740.2  | 602740 | 23590 | 19,5  | 13.0470-7187.2 | LD7187 | 23694   | 16,7 | 13.0460-4976.2 | 604976 |
| 23554 | 17,2 | 13.0460-2775.2  | 602775 | 23591 | 18,0  | 13.0460-7187.2 | 607187 | 23698   | 16,8 | 13.0460-5778.2 | 605778 |
| 23554 | 17,2 | 13.0460-2823.2  | 602823 | 23591 | 18,0  | 13.0470-7187.2 | LD7187 | 23699   | 16,8 | 13.0460-5778.2 | 605778 |
| 23554 | 17,2 | 13.0460-2877.2  | 602877 | 23597 | 18,0  | 13.0460-3975.2 | 603975 | 23702   | 15,1 | 13.0460-5738.2 | 605738 |
| 23554 | 17,2 | 13.0470-2740.2  | LD2740 | 23598 | 18,0  | 13.0460-3975.2 | 603975 | 23703   | 17,9 | 13.0460-5882.2 | 605882 |
| 23554 | 17,2 | 13.0470-2823.2  | LD2823 | 23599 | 19,0  | 13.0460-3994.2 | 603994 | 23705   | 18,1 | 13.0460-3810.2 | 603810 |
| 23554 | 17,2 | 13.0470-2877.2  | LD2877 | 23599 | 19,0  | 13.0470-3994.2 | LD3994 | 23705   | 18,1 | 13.0460-3982.2 | 603982 |
| 23554 | 17,3 | 13.0460-2787.2  | 602787 | 23600 | 19,4  | 13.0460-3966.2 | 603966 | 23705   | 18,1 | 13.0470-3982.2 | LD3982 |
| 23556 | 17,2 | 13.0460-2877.2  | 602877 | 23600 | 19,4  | 13.0470-3966.2 | LD3966 | 23706   | 18,0 | 13.0460-3826.2 | 603826 |
| 23556 | 17,2 | 13.0470-2877.2  | LD2877 | 23601 | 13,7  | 13.0460-2879.2 | 602879 | 23706   | 18,0 | 13.0460-3863.2 | 603863 |
| 23557 | 17,2 | 13.0460-3988.2  | 603988 | 23601 | 13,7  | 13.0470-2879.2 | LD2879 | 23706   | 18,0 | 13.0470-3826.2 | LD3826 |
| 23557 | 17,2 | 13.0470-3988.2  | LD3988 | 23602 | 19,7  | 13.0460-2850.2 | 602850 | 23706   | 18,1 | 13.0460-3818.2 | 603818 |
| 23558 | 17,2 | 13.0460-5851.2  | 605851 | 23603 | 19,7  | 13.0460-2852.2 | 602852 | 23706   | 18,1 | 13.0460-3982.2 | 603982 |
| 23559 | 17,2 | 13.0460-5851.2  | 605851 | 23604 | 18,3  | 13.0460-7142.2 | 607142 | 23706   | 18,1 | 13.0470-3982.2 | LD3982 |
| 23560 | 17,2 | 13.0460-5851.2  | 605851 | 23605 | 15,7  | 13.0460-3995.2 | 603995 | 23707   | 17,9 | 13.0460-3839.2 | 603839 |
| 23561 | 18,1 | 13.0460-8010.2  | 608010 | 23607 | 15,7  | 13.0460-3995.2 | 603995 | 23707   | 17,9 | 13.0470-3839.2 | LD3839 |
| 23562 | 18,1 | 13.0460-8010.2  | 608010 | 23611 | 18,8  | 13.0460-5879.2 | 605879 | 23707   | 18,0 | 13.0460-3826.2 | 603826 |
| 23563 | 16,5 | 13.0460-5825.2  | 605825 | 23613 | 17,7  | 13.0460-3800.2 | 603800 | 23707   | 18,0 | 13.0460-3850.2 | 603850 |
| 23564 | 16,5 | 13.0460-5825.2  | 605825 | 23615 | 18,3  | 13.0460-2718.2 | 602718 | 23707   | 18,0 | 13.0460-3863.2 | 603863 |
| 23569 | 16,5 | 13.0460-5832.2  | 605832 | 23620 | 16,4  | 13.0460-5814.2 | 605814 | 23707   | 18,0 | 13.0470-3826.2 | LD3826 |
| 23570 | 16,5 | 13.0460-5832.2  | 605832 | 23621 | 16,4  | 13.0460-5814.2 | 605814 | 23707   | 18,1 | 13.0460-3818.2 | 603818 |
| 23571 | 16,5 | 13.0460-5832.2  | 605832 | 23622 | 16,4  | 13.0460-5814.2 | 605814 | 23707   | 18,1 | 13.0460-3982.2 | 603982 |
| 23575 | 15,6 | 13.0460-4995.2  | 604995 | 23623 | 17,4  | 13.0460-2713.2 | 602713 | 23707   | 18,1 | 13.0470-3982.2 | LD3982 |
| 23575 | 16,0 | 13.0460-4972.2  | 604972 | 23623 | 17,4  | 13.0470-2713.2 | LD2713 | 23708   | 19,2 | 13.0460-3811.2 | 603811 |
| 23576 | 15,6 | 13.0460-4995.2  | 604995 | 23624 | 17,4  | 13.0460-2713.2 | 602713 | 23708   | 19,4 | 13.0460-3983.2 | 603983 |
| 23576 | 16,0 | 13.0460-4972.2  | 604972 | 23624 | 17,4  | 13.0470-2713.2 | LD2713 | 23708   | 19,4 | 13.0470-3983.2 | LD3983 |
| 23577 | 18,7 | 13.0460-3993.2  | 603993 | 23631 | 18,6  | 13.0460-7206.2 | 607206 | 23709   | 19,4 | 13.0460-3983.2 | 603983 |
| 23578 | 18,7 | 13.0460-3993.2  | 603993 | 23632 | 18,6  | 13.0460-7206.2 | 607206 | 23709   | 19,4 | 13.0470-3983.2 | LD3983 |
| 23579 | 18,7 | 13.0460-3993.2  | 603993 | 23633 | 18,6  | 13.0460-7206.2 | 607206 | 23709   | 19,6 | 13.0460-3827.2 | 603827 |
| 23580 | 18,7 | 13.0460-3993.2  | 603993 | 23638 | 18,3  | 13.0460-2899.2 | 602899 | 23709   | 19,6 | 13.0460-3864.2 | 603864 |
| 23581 | 18,8 | 13.0460-2883.2  | 602883 | 23639 | 18,3  | 13.0460-2899.2 | 602899 | 23709   | 19,6 | 13.0470-3827.2 | LD3827 |
| 23581 | 18,8 | 13.0460-2884.2  | 602884 | 23646 | 16,5  | 13.0460-5847.2 | 605847 | 23710   | 19,4 | 13.0460-3983.2 | 603983 |
| 23581 | 18,8 | 13.0470-2884.2  | LD2884 | 23647 | 16,5  | 13.0460-5847.2 | 605847 | 23710   | 19,4 | 13.0470-3983.2 | LD3983 |
| 23582 | 16,0 | 13.0460-5855.2  | 605855 | 23648 | 16,5  | 13.0460-5847.2 | 605847 | 23710   | 19,6 | 13.0460-3827.2 | 603827 |
| 23583 | 16,0 | 13.0460-5855.2  | 605855 | 23649 | 17,2  | 13.0460-5725.2 | 605725 | 23710   | 19,6 | 13.0460-3864.2 | 603864 |
| 23584 | 16,4 | 13.0460-5760.2  | 605760 | 23650 | 17,2  | 13.0460-5725.2 | 605725 | 23710   | 19,6 | 13.0470-3827.2 | LD3827 |
| 23585 | 17,4 | 13.0460-5848.2  | 605848 | 23651 | 17,2  | 13.0460-5725.2 | 605725 | 23711   | 19,4 | 13.0460-3984.2 | 603984 |
| 23586 | 17,4 | 13.0460-5848.2  | 605848 | 23652 | 15,7  | 13.0460-5711.2 | 605711 | 23711   | 19,4 | 13.0470-3984.2 | LD3984 |
| 23587 | 20,6 | 13.0460-7184.2  | 607184 | 23653 | 15,7  | 13.0460-5711.2 | 605711 | 23712   | 19,4 | 13.0460-3984.2 | 603984 |
| 23587 | 20,6 | 13.0460-7285.2  | 607285 | 23654 | 15,3  | 13.0460-2868.2 | 602868 | 23712   | 19,4 | 13.0470-3984.2 | LD3984 |
| 23587 | 20,6 | 13.0470-7184.2  | LD7184 | 23654 | 15,3  | 13.0470-2868.2 | LD2868 | 23713   | 19,4 | 13.0460-3984.2 | 603984 |
| 23587 | 20,6 | 13.0470-7285.2  | LD7285 | 23655 | 15,3  | 13.0460-2868.2 | 602868 | 23713   | 19,4 | 13.0470-3984.2 | LD3984 |
| 23587 | 20,8 | 13.0460-7226.2  | 607226 | 23655 | 15,3  | 13.0470-2868.2 | LD2868 | 23714   | 16,6 | 13.0460-3991.2 | 603991 |
| 23587 | 20,8 | 13.0470-7226.2  | LD7226 | 23656 | 14,0  | 13.0460-5849.2 | 605849 | 23714   | 17,6 | 13.0460-3861.2 | 603861 |
| 23588 | 20,6 | 13.0460-7184.2  | 607184 | 23657 | 14,0  | 13.0460-5849.2 | 605849 | 23714   | 17,6 | 13.0470-3812.2 | LD3812 |
| 23588 | 20,6 | 13.0470-7184.2  | LD7184 | 23658 | 14,0  | 13.0460-5849.2 | 605849 | 23716   | 15,8 | 13.0460-7162.2 | 607162 |
| 23588 | 20,8 | 13.0460-7226.2  | 607226 | 23662 | 15,0  | 13.0460-5836.2 | 605836 | 23716   | 15,8 | 13.0470-7162.2 | LD7162 |
| 23588 | 20,8 | 13.0470-7226.2  | LD7226 | 23669 | 16,8  | 13.0460-3806.2 | 603806 | 23717   | 15,8 | 13.0460-7162.2 | 607162 |
| 23589 | 19,1 | 13.0460-7202.2  | 607202 | 23672 | 14,8  | 13.0460-5880.2 | 605880 | 23717   | 15,8 | 13.0470-7162.2 | LD7162 |
| 23589 | 19,1 | 13.0470-7202.2  | LD7202 | 23673 | 15,9  | 13.0460-5623.2 | 605623 | 23718   | 16,7 | 13.0460-8007.2 | 608007 |
| 23589 | 20,4 | 13.0460-7226.2  | 607226 | 23674 | 15,9  | 13.0460-5623.2 | 605623 | 23720   | 17,5 | 13.0460-5714.2 | 605714 |
| 23589 | 20,4 | 13.0470-7226.2  | LD7226 | 23675 | 15,9  | 13.0460-5623.2 | 605623 | 23723   | 18,1 | 13.0460-7193.2 | 607193 |
| 23589 | 20,6 | 13.0460-7184.2  | 607184 | 23692 | 16,6  | 13.0460-4992.2 | 604992 | 23723   | 18,1 | 13.0470-7193.2 | LD7193 |

# Vergleichsliste WVA → ATE

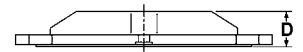
Cross reference list WVA → ATE - Tabella di conversione codici WVA → ATE

Liste des correspondances WVA → ATE - Lista referencias WVA → ATE



| WVA   | D    |  | WVA    | D     |  | WVA                   | D      |  |      |                       |        |
|-------|------|---|--------|-------|---|-----------------------|--------|---|------|-----------------------|--------|
| 23724 | 18,1 | <b>13.0460-7193.2</b>   | 607193 | 23778 | 17,0  | <b>13.0460-5831.2</b> | 605831 | 23843   | 18,8 | <b>13.0460-2884.2</b> | 602884 |
| 23724 | 18,1 | <b>13.0470-7193.2</b>   | LD7193 | 23779 | 17,0  | <b>13.0460-5831.2</b> | 605831 | 23843   | 18,8 | <b>13.0470-2884.2</b> | LD2884 |
| 23726 | 16,5 | <b>13.0460-5622.2</b>   | 605622 | 23780 | 16,7  | <b>13.0460-5895.2</b> | 605895 | 23844   | 20,5 | <b>13.0460-7179.2</b> | 607179 |
| 23727 | 16,5 | <b>13.0460-5622.2</b>   | 605622 | 23783 | 14,0  | <b>13.0460-5710.2</b> | 605710 | 23844   | 20,5 | <b>13.0470-7179.2</b> | LD7179 |
| 23728 | 16,5 | <b>13.0460-5622.2</b>   | 605622 | 23787 | 19,0  | <b>13.0460-7205.2</b> | 607205 | 23845   | 15,8 | <b>13.0460-5954.2</b> | 605954 |
| 23729 | 16,9 | <b>13.0460-5878.2</b>   | 605878 | 23788 | 19,0  | <b>13.0460-7205.2</b> | 607205 | 23846   | 15,8 | <b>13.0460-5954.2</b> | 605954 |
| 23731 | 17,3 | <b>13.0460-7274.2</b>   | 607274 | 23791 | 20,8  | <b>13.0460-7210.2</b> | 607210 | 23847   | 15,8 | <b>13.0460-5954.2</b> | 605954 |
| 23732 | 17,3 | <b>13.0460-7174.2</b>   | 607174 | 23791 | 20,8  | <b>13.0470-7210.2</b> | LD7210 | 23863   | 14,3 | <b>13.0460-5867.2</b> | 605867 |
| 23732 | 17,3 | <b>13.0470-7174.2</b>   | LD7174 | 23792 | 20,8  | <b>13.0460-7210.2</b> | 607210 | 23865   | 17,6 | <b>13.0460-5787.2</b> | 605787 |
| 23734 | 16,8 | <b>13.0460-5750.2</b>   | 605750 | 23792 | 20,8  | <b>13.0470-7210.2</b> | LD7210 | 23867   | 17,6 | <b>13.0460-5787.2</b> | 605787 |
| 23736 | 15,7 | <b>13.0460-5711.2</b>   | 605711 | 23793 | 20,3  | <b>13.0460-7176.2</b> | 607176 | 23868   | 17,1 | <b>13.0460-5860.2</b> | 605860 |
| 23737 | 17,3 | <b>13.0460-7174.2</b>   | 607174 | 23793 | 20,3  | <b>13.0470-7176.2</b> | LD7176 | 23869   | 17,1 | <b>13.0460-5860.2</b> | 605860 |
| 23737 | 17,3 | <b>13.0470-7174.2</b>   | LD7174 | 23794 | 20,3  | <b>13.0460-7176.2</b> | 607176 | 23870   | 17,1 | <b>13.0460-5860.2</b> | 605860 |
| 23738 | 20,1 | <b>13.0460-7212.2</b>   | 607212 | 23794 | 20,3  | <b>13.0460-7216.2</b> | 607216 | 23871   | 14,3 | <b>13.0460-5843.2</b> | 605843 |
| 23739 | 20,1 | <b>13.0460-7212.2</b>   | 607212 | 23794 | 20,3  | <b>13.0460-7223.2</b> | 607223 | 23872   | 14,3 | <b>13.0460-5843.2</b> | 605843 |
| 23743 | 20,1 | <b>13.0460-3999.2</b>   | 603999 | 23794 | 20,3  | <b>13.0460-7268.2</b> | 607268 | 23873   | 15,8 | <b>13.0460-5868.2</b> | 605868 |
| 23743 | 20,1 | <b>13.0470-3999.2</b>   | LD3999 | 23794 | 20,3  | <b>13.0470-7176.2</b> | LD7176 | 23874   | 15,8 | <b>13.0460-5868.2</b> | 605868 |
| 23744 | 20,1 | <b>13.0460-3999.2</b>   | 603999 | 23794 | 20,3  | <b>13.0470-7216.2</b> | LD7216 | 23875   | 15,8 | <b>13.0460-5868.2</b> | 605868 |
| 23744 | 20,1 | <b>13.0470-3999.2</b>   | LD3999 | 23794 | 20,3  | <b>13.0470-7223.2</b> | LD7223 | 23876   | 12,4 | <b>13.0460-5866.2</b> | 605866 |
| 23745 | 17,4 | <b>13.0460-4990.2</b>   | 604990 | 23794 | 20,3  | <b>13.0470-7268.2</b> | LD7268 | 23878   | 12,4 | <b>13.0460-5866.2</b> | 605866 |
| 23745 | 17,4 | <b>13.0470-4990.2</b>   | LD4990 | 23795 | 15,0  | <b>13.0460-5839.2</b> | 605839 | 23881   | 20,0 | <b>13.0460-2708.2</b> | 602708 |
| 23746 | 18,1 | <b>13.0460-7240.2</b>   | 607240 | 23796 | 15,0  | <b>13.0460-5839.2</b> | 605839 | 23881   | 20,0 | <b>13.0470-2708.2</b> | LD2708 |
| 23746 | 19,7 | <b>13.0460-7236.2</b>   | 607236 | 23797 | 15,0  | <b>13.0460-5839.2</b> | 605839 | 23891   | 16,9 | <b>13.0460-5873.2</b> | 605873 |
| 23747 | 18,1 | <b>13.0460-7240.2</b>   | 607240 | 23801 | 18,8  | <b>13.0460-7204.2</b> | 607204 | 23892   | 16,9 | <b>13.0460-5873.2</b> | 605873 |
| 23747 | 19,6 | <b>13.0460-7245.2</b>   | 607245 | 23801 | 18,8  | <b>13.0470-7204.2</b> | LD7204 | 23893   | 16,9 | <b>13.0460-5873.2</b> | 605873 |
| 23747 | 19,7 | <b>13.0460-7236.2</b>   | 607236 | 23801 | 20,3  | <b>13.0460-7200.2</b> | 607200 | 23896   | 20,6 | <b>13.0460-7182.2</b> | 607182 |
| 23749 | 17,6 | <b>13.0460-7240.2</b>   | 607240 | 23801 | 20,3  | <b>13.0460-7201.2</b> | 607201 | 23897   | 20,6 | <b>13.0460-7182.2</b> | 607182 |
| 23749 | 18,7 | <b>13.0460-7236.2</b>   | 607236 | 23801 | 20,3  | <b>13.0460-7227.2</b> | 607227 | 23904   | 16,5 | <b>13.0460-5810.2</b> | 605810 |
| 23749 | 19,1 | <b>13.0460-7191.2</b>   | 607191 | 23801 | 20,3  | <b>13.0470-7200.2</b> | LD7200 | 23905   | 16,5 | <b>13.0460-5810.2</b> | 605810 |
| 23749 | 19,1 | <b>13.0460-7245.2</b>   | 607245 | 23801 | 20,3  | <b>13.0470-7201.2</b> | LD7201 | 23906   | 16,5 | <b>13.0460-5810.2</b> | 605810 |
| 23749 | 19,1 | <b>13.0470-7191.2</b>   | LD7191 | 23801 | 20,4  | <b>13.0470-7227.2</b> | LD7227 | 23907   | 16,5 | <b>13.0460-5810.2</b> | 605810 |
| 23751 | 17,0 | <b>13.0460-4800.2</b>   | 604800 | 23807 | 18,6  | <b>13.0460-7207.2</b> | 607207 | 23908   | 18,0 | <b>13.0460-2898.2</b> | 602898 |
| 23752 | 17,2 | <b>13.0460-7164.2</b>   | 607164 | 23811 | 17,7  | <b>13.0460-2768.2</b> | 602768 | 23912   | 18,8 | <b>13.0460-7204.2</b> | 607204 |
| 23753 | 18,0 | <b>13.0460-4969.2</b>   | 604969 | 23811 | 17,7  | <b>13.0470-2768.2</b> | LD2768 | 23912   | 18,8 | <b>13.0470-7204.2</b> | LD7204 |
| 23754 | 18,0 | <b>13.0460-4969.2</b>   | 604969 | 23816 | 16,0  | <b>13.0460-5819.2</b> | 605819 | 23912   | 20,3 | <b>13.0460-7200.2</b> | 607200 |
| 23756 | 16,3 | <b>13.0460-4854.2</b>   | 604854 | 23817 | 16,6  | <b>13.0460-5888.2</b> | 605888 | 23912   | 20,3 | <b>13.0460-7227.2</b> | 607227 |
| 23756 | 16,3 | <b>13.0470-4854.2</b>   | LD4854 | 23818 | 17,8  | <b>13.0460-5815.2</b> | 605815 | 23912   | 20,3 | <b>13.0470-7200.2</b> | LD7200 |
| 23757 | 16,3 | <b>13.0460-4854.2</b>   | 604854 | 23819 | 17,8  | <b>13.0460-5815.2</b> | 605815 | 23912   | 20,3 | <b>13.0470-7227.2</b> | LD7227 |
| 23757 | 16,3 | <b>13.0470-4854.2</b>   | LD4854 | 23823 | 17,2  | <b>13.0460-2877.2</b> | 602877 | 23913   | 20,3 | <b>13.0460-7200.2</b> | 607200 |
| 23759 | 17,0 | <b>13.0460-5894.2</b>   | 605894 | 23823 | 17,2  | <b>13.0470-2877.2</b> | LD2877 | 23913   | 20,3 | <b>13.0460-7227.2</b> | 607227 |
| 23760 | 17,7 | <b>13.0460-2707.2</b>   | 602707 | 23824 | 13,7  | <b>13.0460-7178.2</b> | 607178 | 23913   | 20,3 | <b>13.0470-7200.2</b> | LD7200 |
| 23760 | 17,7 | <b>13.0470-2707.2</b>   | LD2707 | 23825 | 18,5  | <b>13.0460-2700.2</b> | 602700 | 23913   | 20,3 | <b>13.0470-7227.2</b> | LD7227 |
| 23761 | 18,8 | <b>13.0460-2704.2</b>   | 602704 | 23825 | 18,5  | <b>13.0460-2717.2</b> | 602717 | 23914   | 17,1 | <b>13.0460-2880.2</b> | 602880 |
| 23762 | 20,4 | <b>13.0460-7166.2</b>   | 607166 | 23828 | 17,5  | <b>13.0460-2876.2</b> | 602876 | 23914   | 17,1 | <b>13.0460-2887.2</b> | 602887 |
| 23762 | 20,4 | <b>13.0470-7166.2</b>   | LD7166 | 23829 | 18,5  | <b>13.0460-2701.2</b> | 602701 | 23914   | 17,1 | <b>13.0470-2880.2</b> | LD2880 |
| 23763 | 20,3 | <b>13.0460-7201.2</b>   | 607201 | 23830 | 17,5  | <b>13.0460-2875.2</b> | 602875 | 23914   | 17,1 | <b>13.0470-2887.2</b> | LD2887 |
| 23763 | 20,3 | <b>13.0470-7201.2</b>   | LD7201 | 23832 | 20,2  | <b>13.0460-7179.2</b> | 607179 | 23915   | 17,6 | <b>13.0460-2710.2</b> | 602710 |
| 23763 | 20,4 | <b>13.0460-7166.2</b>   | 607166 | 23832 | 20,2  | <b>13.0470-7179.2</b> | LD7179 | 23915   | 17,6 | <b>13.0470-2710.2</b> | LD2710 |
| 23763 | 20,4 | <b>13.0470-7166.2</b>   | LD7166 | 23833 | 20,2  | <b>13.0460-7179.2</b> | 607179 | 23916   | 17,6 | <b>13.0460-2710.2</b> | 602710 |
| 23764 | 17,0 | <b>13.0460-4800.2</b>   | 604800 | 23833 | 20,2  | <b>13.0470-7179.2</b> | LD7179 | 23916   | 17,6 | <b>13.0470-2710.2</b> | LD2710 |
| 23765 | 17,0 | <b>13.0460-4800.2</b>   | 604800 | 23835 | 19,6  | <b>13.0460-7191.2</b> | 607191 | 23917   | 19,3 | <b>13.0460-4978.2</b> | 604978 |
| 23766 | 17,8 | <b>13.0460-5815.2</b>   | 605815 | 23835 | 19,6  | <b>13.0460-7245.2</b> | 607245 | 23918   | 19,3 | <b>13.0460-4978.2</b> | 604978 |
| 23768 | 19,3 | <b>13.0460-5813.2</b>   | 605813 | 23835 | 19,6  | <b>13.0470-7191.2</b> | LD7191 | 23919   | 19,3 | <b>13.0460-4979.2</b> | 604979 |
| 23773 | 17,5 | <b>13.0460-4802.2</b>   | 604802 | 23836 | 17,0  | <b>13.0460-5846.2</b> | 605846 | 23920   | 19,3 | <b>13.0460-4979.2</b> | 604979 |
| 23774 | 17,5 | <b>13.0460-4802.2</b>   | 604802 | 23840 | 18,7  | <b>13.0460-3992.2</b> | 603992 | 23921   | 20,1 | <b>13.0460-4859.2</b> | 604859 |
| 23775 | 18,0 | <b>13.0460-7132.2</b>   | 607132 | 23841 | 18,7  | <b>13.0460-3992.2</b> | 603992 | 23921   | 20,3 | <b>13.0460-4980.2</b> | 604980 |
| 23777 | 16,0 | <b>13.0460-5831.2</b>   | 605831 | 23842 | 18,1  | <b>13.0460-7141.2</b> | 607141 | 23922   | 21,0 | <b>13.0460-7220.2</b> | 607220 |







# Vergleichsliste WVA → ATE

Cross reference list WVA → ATE - Tabella di conversione codici WVA → ATE

Liste des correspondances WVA → ATE - Lista referencias WVA → ATE







| WVA   | D    |  | WVA    | D     |  | WVA                   | D      |  |      |                       |        |
|-------|------|---|--------|-------|---|-----------------------|--------|---|------|-----------------------|--------|
| 23922 | 21,0 | <b>13.0470-7220.2</b>   | LD7220 | 23998 | 17,5  | <b>13.0460-5844.2</b> | 605844 | 24077   | 19,1 | <b>13.0470-2711.2</b> | LD2711 |
| 23923 | 17,6 | <b>13.0460-7219.2</b>   | 607219 | 23999 | 17,8  | <b>13.0460-7215.2</b> | 607215 | 24077   | 19,1 | <b>13.0470-2885.2</b> | LD2885 |
| 23923 | 17,6 | <b>13.0470-7219.2</b>   | LD7219 | 23999 | 17,8  | <b>13.0470-7215.2</b> | LD7215 | 24084   | 19,3 | <b>13.0460-7252.2</b> | 607252 |
| 23924 | 17,6 | <b>13.0460-7219.2</b>   | 607219 | 24007 | 20,8  | <b>13.0460-3819.2</b> | 603819 | 24084   | 19,3 | <b>13.0460-7277.2</b> | 607277 |
| 23924 | 17,6 | <b>13.0470-7219.2</b>   | LD7219 | 24008 | 18,3  | <b>13.0460-3821.2</b> | 603821 | 24084   | 19,3 | <b>13.0470-7252.2</b> | LD7252 |
| 23925 | 20,5 | <b>13.0460-7220.2</b>   | 607220 | 24009 | 17,5  | <b>13.0460-5844.2</b> | 605844 | 24086   | 15,8 | <b>13.0460-5757.2</b> | 605757 |
| 23925 | 20,5 | <b>13.0470-7220.2</b>   | LD7220 | 24011 | 18,7  | <b>13.0460-7189.2</b> | 607189 | 24087   | 17,4 | <b>13.0460-5756.2</b> | 605756 |
| 23926 | 17,3 | <b>13.0460-7217.2</b>   | 607217 | 24012 | 18,7  | <b>13.0460-7189.2</b> | 607189 | 24092   | 17,1 | <b>13.0460-5772.2</b> | 605772 |
| 23926 | 17,3 | <b>13.0470-7217.2</b>   | LD7217 | 24013 | 14,9  | <b>13.0460-5869.2</b> | 605869 | 24095   | 19,4 | <b>13.0460-7139.2</b> | 607139 |
| 23927 | 17,3 | <b>13.0460-7217.2</b>   | 607217 | 24014 | 16,0  | <b>13.0460-5735.2</b> | 605735 | 24095   | 19,4 | <b>13.0470-7139.2</b> | LD7139 |
| 23927 | 17,3 | <b>13.0470-7217.2</b>   | LD7217 | 24015 | 16,0  | <b>13.0460-5735.2</b> | 605735 | 24096   | 20,3 | <b>13.0460-7223.2</b> | 607223 |
| 23928 | 17,3 | <b>13.0460-5743.2</b>   | 605743 | 24020 | 14,9  | <b>13.0460-5869.2</b> | 605869 | 24096   | 20,3 | <b>13.0470-7223.2</b> | LD7223 |
| 23930 | 18,2 | <b>13.0460-3815.2</b>   | 603815 | 24022 | 17,8  | <b>13.0460-7213.2</b> | 607213 | 24097   | 17,1 | <b>13.0460-4834.2</b> | 604834 |
| 23930 | 18,2 | <b>13.0470-3815.2</b>   | LD3815 | 24023 | 17,8  | <b>13.0460-7213.2</b> | 607213 | 24097   | 17,1 | <b>13.0470-4834.2</b> | LD4834 |
| 23934 | 18,2 | <b>13.0460-3814.2</b>   | 603814 | 24024 | 17,0  | <b>13.0460-5747.2</b> | 605747 | 24098   | 17,1 | <b>13.0460-4833.2</b> | 604833 |
| 23934 | 18,2 | <b>13.0470-3814.2</b>   | LD3814 | 24025 | 17,0  | <b>13.0460-5747.2</b> | 605747 | 24098   | 17,1 | <b>13.0470-4833.2</b> | LD4833 |
| 23935 | 17,8 | <b>13.0460-7215.2</b>   | 607215 | 24026 | 17,0  | <b>13.0460-5747.2</b> | 605747 | 24122   | 19,0 | <b>13.0460-5602.2</b> | 605602 |
| 23935 | 17,8 | <b>13.0470-7215.2</b>   | LD7215 | 24029 | 12,5  | <b>13.0460-5732.2</b> | 605732 | 24123   | 20,3 | <b>13.0460-7228.2</b> | 607228 |
| 23943 | 17,5 | <b>13.0460-4997.2</b>   | 604997 | 24030 | 12,5  | <b>13.0460-5732.2</b> | 605732 | 24123   | 20,3 | <b>13.0470-7228.2</b> | LD7228 |
| 23944 | 17,5 | <b>13.0460-4997.2</b>   | 604997 | 24031 | 17,7  | <b>13.0460-5875.2</b> | 605875 | 24124   | 19,3 | <b>13.0460-7228.2</b> | 607228 |
| 23945 | 16,5 | <b>13.0460-4994.2</b>   | 604994 | 24032 | 17,7  | <b>13.0460-5875.2</b> | 605875 | 24124   | 19,3 | <b>13.0470-7228.2</b> | LD7228 |
| 23945 | 16,5 | <b>13.0470-4994.2</b>   | LD4994 | 24033 | 17,7  | <b>13.0460-5875.2</b> | 605875 | 24132   | 18,8 | <b>13.0460-5879.2</b> | 605879 |
| 23950 | 20,3 | <b>13.0460-7201.2</b>   | 607201 | 24034 | 16,6  | <b>13.0460-5888.2</b> | 605888 | 24133   | 18,6 | <b>13.0460-2892.2</b> | 602892 |
| 23950 | 20,3 | <b>13.0470-7201.2</b>   | LD7201 | 24034 | 19,1  | <b>13.0460-7263.2</b> | 607263 | 24133   | 18,6 | <b>13.0470-2892.2</b> | LD2892 |
| 23955 | 16,2 | <b>13.0460-4806.2</b>   | 604806 | 24034 | 19,1  | <b>13.0470-7263.2</b> | LD7263 | 24134   | 19,6 | <b>13.0460-2891.2</b> | 602891 |
| 23959 | 17,0 | <b>13.0460-3829.2</b>   | 603829 | 24035 | 16,6  | <b>13.0460-5888.2</b> | 605888 | 24134   | 19,6 | <b>13.0470-2891.2</b> | LD2891 |
| 23960 | 18,3 | <b>13.0460-4817.2</b>   | 604817 | 24035 | 19,1  | <b>13.0460-7263.2</b> | 607263 | 24135   | 17,7 | <b>13.0460-2893.2</b> | 602893 |
| 23961 | 16,8 | <b>13.0460-4840.2</b>   | 604840 | 24035 | 19,1  | <b>13.0470-7263.2</b> | LD7263 | 24135   | 17,7 | <b>13.0470-2893.2</b> | LD2893 |
| 23966 | 17,7 | <b>13.0460-5742.2</b>   | 605742 | 24036 | 16,7  | <b>13.0460-8008.2</b> | 608008 | 24137   | 15,8 | <b>13.0460-7251.2</b> | 607251 |
| 23967 | 15,1 | <b>13.0460-5734.2</b>   | 605734 | 24036 | 19,1  | <b>13.0460-7263.2</b> | 607263 | 24137   | 15,8 | <b>13.0460-7253.2</b> | 607253 |
| 23968 | 20,3 | <b>13.0460-7216.2</b>   | 607216 | 24036 | 19,1  | <b>13.0470-7263.2</b> | LD7263 | 24137   | 15,8 | <b>13.0470-7251.2</b> | LD7251 |
| 23968 | 20,3 | <b>13.0470-7216.2</b>   | LD7216 | 24037 | 16,7  | <b>13.0460-8008.2</b> | 608008 | 24137   | 16,6 | <b>13.0460-7194.2</b> | 607194 |
| 23969 | 18,6 | <b>13.0460-7207.2</b>   | 607207 | 24038 | 16,7  | <b>13.0460-8008.2</b> | 608008 | 24137   | 16,6 | <b>13.0460-7195.2</b> | 607195 |
| 23970 | 16,8 | <b>13.0460-5632.2</b>   | 605632 | 24039 | 14,4  | <b>13.0460-5856.2</b> | 605856 | 24137   | 16,6 | <b>13.0460-7209.2</b> | 607209 |
| 23971 | 16,8 | <b>13.0460-5632.2</b>   | 605632 | 24040 | 14,4  | <b>13.0460-5856.2</b> | 605856 | 24137   | 16,6 | <b>13.0470-7194.2</b> | LD7194 |
| 23972 | 16,8 | <b>13.0460-5632.2</b>   | 605632 | 24041 | 14,4  | <b>13.0460-5856.2</b> | 605856 | 24137   | 16,6 | <b>13.0470-7195.2</b> | LD7195 |
| 23973 | 17,0 | <b>13.0460-5700.2</b>   | 605700 | 24042 | 16,3  | <b>13.0460-5877.2</b> | 605877 | 24141   | 19,1 | <b>13.0460-7188.2</b> | 607188 |
| 23973 | 17,4 | <b>13.0460-2709.2</b>   | 602709 | 24045 | 13,7  | <b>13.0460-5804.2</b> | 605804 | 24141   | 19,1 | <b>13.0470-7188.2</b> | LD7188 |
| 23973 | 17,4 | <b>13.0460-2774.2</b>   | 602774 | 24046 | 18,6  | <b>13.0460-5821.2</b> | 605821 | 24142   | 20,6 | <b>13.0460-7188.2</b> | 607188 |
| 23973 | 17,4 | <b>13.0460-5801.2</b>   | 605801 | 24047 | 18,6  | <b>13.0460-5821.2</b> | 605821 | 24142   | 20,6 | <b>13.0460-7243.2</b> | 607243 |
| 23973 | 17,4 | <b>13.0470-2709.2</b>   | LD2709 | 24048 | 18,6  | <b>13.0460-5821.2</b> | 605821 | 24142   | 20,6 | <b>13.0470-7188.2</b> | LD7188 |
| 23974 | 17,6 | <b>13.0460-5899.2</b>   | 605899 | 24049 | 17,0  | <b>13.0460-4842.2</b> | 604842 | 24142   | 20,6 | <b>13.0470-7243.2</b> | LD7243 |
| 23980 | 16,5 | <b>13.0460-2840.2</b>   | 602840 | 24054 | 16,9  | <b>13.0460-5878.2</b> | 605878 | 24143   | 15,0 | <b>13.0460-4801.2</b> | 604801 |
| 23981 | 19,6 | <b>13.0460-3840.2</b>   | 603840 | 24055 | 16,9  | <b>13.0460-5878.2</b> | 605878 | 24150   | 17,6 | <b>13.0460-3813.2</b> | 603813 |
| 23981 | 19,6 | <b>13.0470-3840.2</b>   | LD3840 | 24058 | 15,5  | <b>13.0460-5773.2</b> | 605773 | 24150   | 17,6 | <b>13.0460-3851.2</b> | 603851 |
| 23982 | 18,1 | <b>13.0460-3839.2</b>   | 603839 | 24059 | 16,7  | <b>13.0460-5886.2</b> | 605886 | 24150   | 17,6 | <b>13.0470-3813.2</b> | LD3813 |
| 23982 | 18,1 | <b>13.0470-3839.2</b>   | LD3839 | 24060 | 16,7  | <b>13.0460-5886.2</b> | 605886 | 24151   | 21,0 | <b>13.0460-7271.2</b> | 607271 |
| 23983 | 17,0 | <b>13.0460-5770.2</b>   | 605770 | 24061 | 16,7  | <b>13.0460-5886.2</b> | 605886 | 24152   | 20,3 | <b>13.0460-7271.2</b> | 607271 |
| 23984 | 17,8 | <b>13.0460-2725.2</b>   | 602725 | 24067 | 19,3  | <b>13.0460-7180.2</b> | 607180 | 24153   | 19,1 | <b>13.0460-7202.2</b> | 607202 |
| 23984 | 17,8 | <b>13.0470-2725.2</b>   | LD2725 | 24071 | 14,6  | <b>13.0460-5739.2</b> | 605739 | 24153   | 19,1 | <b>13.0470-7202.2</b> | LD7202 |
| 23985 | 17,8 | <b>13.0460-2725.2</b>   | 602725 | 24072 | 17,9  | <b>13.0460-3809.2</b> | 603809 | 24161   | 20,3 | <b>13.0460-7237.2</b> | 607237 |
| 23985 | 17,8 | <b>13.0470-2725.2</b>   | LD2725 | 24072 | 17,9  | <b>13.0460-3846.2</b> | 603846 | 24161   | 20,3 | <b>13.0470-7237.2</b> | LD7237 |
| 23987 | 17,7 | <b>13.0460-5742.2</b>   | 605742 | 24072 | 17,9  | <b>13.0470-3846.2</b> | LD3846 | 24162   | 15,2 | <b>13.0460-4805.2</b> | 604805 |
| 23988 | 17,7 | <b>13.0460-5742.2</b>   | 605742 | 24073 | 16,7  | <b>13.0460-2724.2</b> | 602724 | 24162   | 15,2 | <b>13.0460-4853.2</b> | 604853 |
| 23993 | 15,5 | <b>13.0460-5773.2</b>   | 605773 | 24073 | 16,7  | <b>13.0460-2878.2</b> | 602878 | 24162   | 15,2 | <b>13.0470-4853.2</b> | LD4853 |
| 23996 | 17,5 | <b>13.0460-5844.2</b>   | 605844 | 24077 | 19,1  | <b>13.0460-2711.2</b> | 602711 | 24170   | 20,2 | <b>13.0460-7231.2</b> | 607231 |
| 23997 | 15,5 | <b>13.0460-5773.2</b>   | 605773 | 24077 | 19,1  | <b>13.0460-2885.2</b> | 602885 | 24170   | 20,2 | <b>13.0470-7231.2</b> | LD7231 |

# Vergleichsliste WVA → ATE

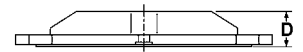
Cross reference list WVA → ATE - Tabella di conversione codici WVA → ATE

Liste des correspondances WVA → ATE - Lista referencias WVA → ATE



| WVA   | D    |  | WVA    | D     |  | WVA                   | D      |  |      |                       |        |
|-------|------|---|--------|-------|---|-----------------------|--------|---|------|-----------------------|--------|
| 24171 | 20,9 | <b>13.0460-7231.2</b>   | 607231 | 24276 | 14,8  | <b>13.0460-5775.2</b> | 605775 | 24347   | 17,5 | <b>13.0460-5768.2</b> | 605768 |
| 24171 | 20,9 | <b>13.0470-7231.2</b>   | LD7231 | 24277 | 16,0  | <b>13.0460-5829.2</b> | 605829 | 24348   | 17,1 | <b>13.0460-3825.2</b> | 603825 |
| 24172 | 19,0 | <b>13.0460-7239.2</b>   | 607239 | 24283 | 15,5  | <b>13.0460-5794.2</b> | 605794 | 24349   | 17,5 | <b>13.0460-3828.2</b> | 603828 |
| 24172 | 19,0 | <b>13.0470-7239.2</b>   | LD7239 | 24284 | 15,5  | <b>13.0460-5794.2</b> | 605794 | 24349   | 17,5 | <b>13.0470-3828.2</b> | LD3828 |
| 24173 | 20,0 | <b>13.0460-7239.2</b>   | 607239 | 24285 | 15,5  | <b>13.0460-5794.2</b> | 605794 | 24349   | 17,6 | <b>13.0460-3848.2</b> | 603848 |
| 24173 | 20,0 | <b>13.0470-7239.2</b>   | LD7239 | 24288 | 17,9  | <b>13.0460-3839.2</b> | 603839 | 24349   | 17,6 | <b>13.0460-3862.2</b> | 603862 |
| 24174 | 18,6 | <b>13.0460-2892.2</b>   | 602892 | 24288 | 17,9  | <b>13.0470-3839.2</b> | LD3839 | 24350   | 17,3 | <b>13.0460-5764.2</b> | 605764 |
| 24174 | 18,6 | <b>13.0470-2892.2</b>   | LD2892 | 24289 | 16,9  | <b>13.0460-2714.2</b> | 602714 | 24351   | 16,3 | <b>13.0460-5777.2</b> | 605777 |
| 24175 | 19,6 | <b>13.0460-2891.2</b>   | 602891 | 24289 | 16,9  | <b>13.0470-2714.2</b> | LD2714 | 24353   | 16,0 | <b>13.0460-5795.2</b> | 605795 |
| 24175 | 19,6 | <b>13.0470-2891.2</b>   | LD2891 | 24290 | 16,9  | <b>13.0460-2714.2</b> | 602714 | 24367   | 19,1 | <b>13.0460-7190.2</b> | 607190 |
| 24178 | 17,1 | <b>13.0460-5772.2</b>   | 605772 | 24290 | 16,9  | <b>13.0470-2714.2</b> | LD2714 | 24367   | 19,1 | <b>13.0460-7218.2</b> | 607218 |
| 24179 | 17,1 | <b>13.0460-5772.2</b>   | 605772 | 24294 | 19,0  | <b>13.0460-3824.2</b> | 603824 | 24367   | 19,1 | <b>13.0470-7190.2</b> | LD7190 |
| 24191 | 18,1 | <b>13.0460-2728.2</b>   | 602728 | 24296 | 15,5  | <b>13.0460-4850.2</b> | 604850 | 24367   | 19,2 | <b>13.0460-7247.2</b> | 607247 |
| 24192 | 17,1 | <b>13.0460-2731.2</b>   | 602731 | 24296 | 15,5  | <b>13.0470-4850.2</b> | LD4850 | 24368   | 19,1 | <b>13.0460-7190.2</b> | 607190 |
| 24192 | 17,4 | <b>13.0460-2719.2</b>   | 602719 | 24297 | 14,4  | <b>13.0460-5761.2</b> | 605761 | 24368   | 19,1 | <b>13.0460-7218.2</b> | 607218 |
| 24193 | 20,3 | <b>13.0460-7223.2</b>   | 607223 | 24298 | 14,0  | <b>13.0460-5762.2</b> | 605762 | 24368   | 19,1 | <b>13.0470-7190.2</b> | LD7190 |
| 24193 | 20,3 | <b>13.0470-7223.2</b>   | LD7223 | 24299 | 14,0  | <b>13.0460-5762.2</b> | 605762 | 24368   | 19,2 | <b>13.0460-7247.2</b> | 607247 |
| 24204 | 19,2 | <b>13.0460-5603.2</b>   | 605603 | 24306 | 20,3  | <b>13.0460-2732.2</b> | 602732 | 24369   | 17,2 | <b>13.0460-5876.2</b> | 605876 |
| 24213 | 17,5 | <b>13.0460-5714.2</b>   | 605714 | 24306 | 20,3  | <b>13.0460-2733.2</b> | 602733 | 24372   | 17,3 | <b>13.0460-5793.2</b> | 605793 |
| 24214 | 17,5 | <b>13.0460-5714.2</b>   | 605714 | 24306 | 20,3  | <b>13.0470-2732.2</b> | LD2732 | 24373   | 17,2 | <b>13.0460-5876.2</b> | 605876 |
| 24215 | 15,7 | <b>13.0460-5736.2</b>   | 605736 | 24306 | 20,3  | <b>13.0470-2733.2</b> | LD2733 | 24374   | 17,2 | <b>13.0460-5876.2</b> | 605876 |
| 24216 | 15,7 | <b>13.0460-5736.2</b>   | 605736 | 24306 | 20,3  | <b>13.0470-9000.2</b> | LD9000 | 24375   | 17,5 | <b>13.0460-5639.2</b> | 605639 |
| 24217 | 15,7 | <b>13.0460-5736.2</b>   | 605736 | 24310 | 19,0  | <b>13.0460-2734.2</b> | 602734 | 24376   | 17,5 | <b>13.0460-5639.2</b> | 605639 |
| 24218 | 17,5 | <b>13.0460-5791.2</b>   | 605791 | 24310 | 19,0  | <b>13.0470-2734.2</b> | LD2734 | 24386   | 17,9 | <b>13.0460-5618.2</b> | 605618 |
| 24219 | 17,5 | <b>13.0460-5791.2</b>   | 605791 | 24315 | 16,2  | <b>13.0460-4849.2</b> | 604849 | 24391   | 16,6 | <b>13.0460-2715.2</b> | 602715 |
| 24220 | 17,5 | <b>13.0460-5791.2</b>   | 605791 | 24316 | 16,9  | <b>13.0460-4848.2</b> | 604848 | 24392   | 16,6 | <b>13.0460-2715.2</b> | 602715 |
| 24222 | 16,9 | <b>13.0460-5797.2</b>   | 605797 | 24317 | 17,6  | <b>13.0460-5779.2</b> | 605779 | 24393   | 17,9 | <b>13.0460-3849.2</b> | 603849 |
| 24223 | 16,9 | <b>13.0460-5797.2</b>   | 605797 | 24318 | 17,6  | <b>13.0460-5779.2</b> | 605779 | 24394   | 17,9 | <b>13.0460-5618.2</b> | 605618 |
| 24224 | 16,9 | <b>13.0460-5797.2</b>   | 605797 | 24319 | 17,6  | <b>13.0460-5779.2</b> | 605779 | 24395   | 17,9 | <b>13.0460-5618.2</b> | 605618 |
| 24225 | 16,9 | <b>13.0460-5797.2</b>   | 605797 | 24320 | 15,3  | <b>13.0460-5780.2</b> | 605780 | 24396   | 17,2 | <b>13.0460-5789.2</b> | 605789 |
| 24227 | 16,7 | <b>13.0460-5783.2</b>   | 605783 | 24321 | 15,3  | <b>13.0460-5780.2</b> | 605780 | 24397   | 16,0 | <b>13.0460-5829.2</b> | 605829 |
| 24228 | 16,7 | <b>13.0460-5783.2</b>   | 605783 | 24322 | 15,3  | <b>13.0460-5780.2</b> | 605780 | 24398   | 16,0 | <b>13.0460-5829.2</b> | 605829 |
| 24229 | 14,8 | <b>13.0460-5709.2</b>   | 605709 | 24323 | 15,5  | <b>13.0460-5790.2</b> | 605790 | 24399   | 20,4 | <b>13.0460-7272.2</b> | 607272 |
| 24230 | 15,3 | <b>13.0460-5709.2</b>   | 605709 | 24324 | 15,5  | <b>13.0460-5790.2</b> | 605790 | 24403   | 17,0 | <b>13.0460-5700.2</b> | 605700 |
| 24240 | 16,6 | <b>13.0460-5784.2</b>   | 605784 | 24325 | 15,5  | <b>13.0460-5790.2</b> | 605790 | 24403   | 17,4 | <b>13.0460-2774.2</b> | 602774 |
| 24242 | 16,6 | <b>13.0460-5784.2</b>   | 605784 | 24331 | 13,8  | <b>13.0460-5628.2</b> | 605628 | 24405   | 17,4 | <b>13.0460-5756.2</b> | 605756 |
| 24243 | 16,6 | <b>13.0460-5784.2</b>   | 605784 | 24332 | 18,3  | <b>13.0460-7252.2</b> | 607252 | 24406   | 17,4 | <b>13.0460-5756.2</b> | 605756 |
| 24244 | 18,5 | <b>13.0460-5608.2</b>   | 605608 | 24332 | 18,3  | <b>13.0460-7277.2</b> | 607277 | 24408   | 19,2 | <b>13.0460-2746.2</b> | 602746 |
| 24245 | 18,5 | <b>13.0460-5607.2</b>   | 605607 | 24332 | 18,3  | <b>13.0470-7252.2</b> | LD7252 | 24408   | 19,2 | <b>13.0470-2746.2</b> | LD2746 |
| 24246 | 16,8 | <b>13.0460-5822.2</b>   | 605822 | 24332 | 19,8  | <b>13.0460-7242.2</b> | 607242 | 24409   | 19,2 | <b>13.0460-2746.2</b> | 602746 |
| 24248 | 16,8 | <b>13.0460-5822.2</b>   | 605822 | 24332 | 19,8  | <b>13.0470-7242.2</b> | LD7242 | 24409   | 19,2 | <b>13.0460-2765.2</b> | 602765 |
| 24249 | 16,8 | <b>13.0460-5822.2</b>   | 605822 | 24333 | 21,3  | <b>13.0460-7242.2</b> | 607242 | 24409   | 19,2 | <b>13.0470-2746.2</b> | LD2746 |
| 24253 | 17,8 | <b>13.0460-7244.2</b>   | 607244 | 24333 | 21,3  | <b>13.0470-7242.2</b> | LD7242 | 24409   | 19,2 | <b>13.0470-2765.2</b> | LD2765 |
| 24253 | 17,8 | <b>13.0470-7244.2</b>   | LD7244 | 24334 | 21,3  | <b>13.0460-7242.2</b> | 607242 | 24410   | 16,5 | <b>13.0460-5776.2</b> | 605776 |
| 24253 | 18,0 | <b>13.0460-7257.2</b>   | 607257 | 24334 | 21,3  | <b>13.0470-7242.2</b> | LD7242 | 24411   | 16,5 | <b>13.0460-5776.2</b> | 605776 |
| 24253 | 18,0 | <b>13.0470-7257.2</b>   | LD7257 | 24336 | 17,5  | <b>13.0460-5767.2</b> | 605767 | 24412   | 19,0 | <b>13.0460-5612.2</b> | 605612 |
| 24254 | 18,0 | <b>13.0460-7244.2</b>   | 607244 | 24337 | 17,5  | <b>13.0460-5766.2</b> | 605766 | 24412   | 19,0 | <b>13.0470-5612.2</b> | LD5612 |
| 24254 | 18,0 | <b>13.0460-7257.2</b>   | 607257 | 24338 | 15,5  | <b>13.0460-5765.2</b> | 605765 | 24413   | 19,0 | <b>13.0460-5612.2</b> | 605612 |
| 24254 | 18,0 | <b>13.0470-7244.2</b>   | LD7244 | 24339 | 19,5  | <b>13.0460-7269.2</b> | 607269 | 24413   | 19,0 | <b>13.0470-5612.2</b> | LD5612 |
| 24254 | 18,0 | <b>13.0470-7257.2</b>   | LD7257 | 24339 | 19,5  | <b>13.0470-7269.2</b> | LD7269 | 24414   | 19,0 | <b>13.0460-5612.2</b> | 605612 |
| 24255 | 20,3 | <b>13.0460-7238.2</b>   | 607238 | 24339 | 20,5  | <b>13.0460-7211.2</b> | 607211 | 24414   | 19,0 | <b>13.0470-5612.2</b> | LD5612 |
| 24255 | 20,3 | <b>13.0470-7238.2</b>   | LD7238 | 24339 | 20,5  | <b>13.0470-7211.2</b> | LD7211 | 24415   | 19,1 | <b>13.0460-5611.2</b> | 605611 |
| 24260 | 17,3 | <b>13.0460-3831.2</b>   | 603831 | 24340 | 19,5  | <b>13.0460-7269.2</b> | 607269 | 24415   | 19,1 | <b>13.0470-5611.2</b> | LD5611 |
| 24260 | 17,3 | <b>13.0470-3831.2</b>   | LD3831 | 24340 | 19,5  | <b>13.0470-7269.2</b> | LD7269 | 24416   | 19,1 | <b>13.0460-5611.2</b> | 605611 |
| 24273 | 16,0 | <b>13.0460-4991.2</b>   | 604991 | 24340 | 20,3  | <b>13.0460-7211.2</b> | 607211 | 24416   | 19,1 | <b>13.0470-5611.2</b> | LD5611 |
| 24274 | 16,0 | <b>13.0460-4991.2</b>   | 604991 | 24340 | 20,3  | <b>13.0470-7211.2</b> | LD7211 | 24417   | 19,1 | <b>13.0460-5611.2</b> | 605611 |
| 24275 | 16,5 | <b>13.0460-5776.2</b>   | 605776 | 24346 | 16,4  | <b>13.0460-5609.2</b> | 605609 | 24417   | 19,1 | <b>13.0470-5611.2</b> | LD5611 |







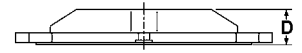

# Vergleichsliste WVA → ATE

Cross reference list WVA → ATE - Tabella di conversione codici WVA → ATE

Liste des correspondances WVA → ATE - Lista referencias WVA → ATE



| WVA   | D    |  | WVA    | D     |  | WVA            | D      |  |      |                |        |
|-------|------|---|--------|-------|---|----------------|--------|---|------|----------------|--------|
| 24418 | 17,0 | 13.0460-2754.2  | 602754 | 24496 | 17,3  | 13.0470-2736.2 | LD2736 | 24569   | 16,3 | 13.0460-5777.2 | 605777 |
| 24419 | 17,0 | 13.0460-2754.2  | 602754 | 24498 | 14,7  | 13.0460-5788.2 | 605788 | 24574   | 15,0 | 13.0460-7214.2 | 607214 |
| 24420 | 17,0 | 13.0460-2754.2  | 602754 | 24499 | 14,7  | 13.0460-5788.2 | 605788 | 24574   | 15,0 | 13.0460-7290.2 | 607290 |
| 24421 | 17,2 | 13.0460-2755.2  | 602755 | 24500 | 14,7  | 13.0460-5788.2 | 605788 | 24575   | 14,8 | 13.0460-7214.2 | 607214 |
| 24421 | 17,2 | 13.0460-2758.2  | 602758 | 24501 | 16,7  | 13.0460-5600.2 | 605600 | 24576   | 14,8 | 13.0460-7214.2 | 607214 |
| 24421 | 17,2 | 13.0470-2755.2  | LD2755 | 24502 | 16,7  | 13.0460-5600.2 | 605600 | 24578   | 16,5 | 13.0460-2739.2 | 602739 |
| 24421 | 17,2 | 13.0470-2758.2  | LD2758 | 24503 | 16,7  | 13.0460-5600.2 | 605600 | 24582   | 17,4 | 13.0460-5610.2 | 605610 |
| 24422 | 17,2 | 13.0460-2755.2  | 602755 | 24510 | 17,0  | 13.0460-5785.2 | 605785 | 24589   | 20,1 | 13.0460-4859.2 | 604859 |
| 24422 | 17,2 | 13.0460-2758.2  | 602758 | 24511 | 17,0  | 13.0460-5785.2 | 605785 | 24590   | 19,0 | 13.0460-5602.2 | 605602 |
| 24422 | 17,2 | 13.0470-2755.2  | LD2755 | 24512 | 17,0  | 13.0460-5785.2 | 605785 | 24591   | 19,0 | 13.0460-5602.2 | 605602 |
| 24422 | 17,2 | 13.0470-2758.2  | LD2758 | 24515 | 16,7  | 13.0460-2724.2 | 602724 | 24595   | 18,5 | 13.0460-2738.2 | 602738 |
| 24423 | 14,6 | 13.0460-5621.2  | 605621 | 24518 | 15,8  | 13.0460-5757.2 | 605757 | 24597   | 17,7 | 13.0460-5799.2 | 605799 |
| 24435 | 14,8 | 13.0460-5648.2  | 605648 | 24519 | 15,8  | 13.0460-5757.2 | 605757 | 24598   | 17,7 | 13.0460-5799.2 | 605799 |
| 24436 | 19,7 | 13.0460-7261.2  | 607261 | 24521 | 19,1  | 13.0460-7243.2 | 607243 | 24599   | 14,9 | 13.0460-5636.2 | 605636 |
| 24437 | 20,2 | 13.0460-7261.2  | 607261 | 24521 | 19,1  | 13.0470-7243.2 | LD7243 | 24599   | 14,9 | 13.0460-5771.2 | 605771 |
| 24438 | 16,1 | 13.0460-7234.2  | 607234 | 24529 | 16,0  | 13.0460-5631.2 | 605631 | 24600   | 14,9 | 13.0460-5636.2 | 605636 |
| 24439 | 16,1 | 13.0460-7234.2  | 607234 | 24530 | 16,0  | 13.0460-5631.2 | 605631 | 24600   | 14,9 | 13.0460-5771.2 | 605771 |
| 24451 | 15,6 | 13.0460-5617.2  | 605617 | 24535 | 18,3  | 13.0460-7221.2 | 607221 | 24601   | 18,0 | 13.0460-5614.2 | 605614 |
| 24452 | 17,5 | 13.0460-5634.2  | 605634 | 24535 | 18,3  | 13.0470-7221.2 | LD7221 | 24602   | 16,0 | 13.0460-5629.2 | 605629 |
| 24452 | 17,5 | 13.0470-5634.2  | LD5634 | 24536 | 18,3  | 13.0460-7222.2 | 607222 | 24603   | 16,0 | 13.0460-5629.2 | 605629 |
| 24455 | 16,8 | 13.0460-4839.2  | 604839 | 24537 | 15,8  | 13.0460-2737.2 | 602737 | 24604   | 16,5 | 13.0460-8013.2 | 608013 |
| 24455 | 16,8 | 13.0460-4864.2  | 604864 | 24537 | 16,1  | 13.0460-2723.2 | 602723 | 24604   | 18,7 | 13.0460-2766.2 | 602766 |
| 24456 | 19,0 | 13.0460-2734.2  | 602734 | 24537 | 16,1  | 13.0470-2723.2 | LD2723 | 24605   | 16,5 | 13.0460-8013.2 | 608013 |
| 24456 | 19,0 | 13.0470-2734.2  | LD2734 | 24538 | 17,9  | 13.0460-7266.2 | 607266 | 24605   | 18,7 | 13.0460-2766.2 | 602766 |
| 24458 | 17,3 | 13.0460-7260.2  | 607260 | 24538 | 17,9  | 13.0470-7266.2 | LD7266 | 24606   | 17,4 | 13.0460-2747.2 | 602747 |
| 24462 | 16,7 | 13.0460-2706.2  | 602706 | 24538 | 18,5  | 13.0460-7229.2 | 607229 | 24606   | 17,4 | 13.0460-2748.2 | 602748 |
| 24465 | 19,2 | 13.0460-4812.2  | 604812 | 24538 | 18,5  | 13.0470-7229.2 | LD7229 | 24606   | 17,4 | 13.0460-2769.2 | 602769 |
| 24466 | 19,1 | 13.0460-4810.2  | 604810 | 24538 | 19,4  | 13.0460-7273.2 | 607273 | 24606   | 17,4 | 13.0460-2770.2 | 602770 |
| 24466 | 19,1 | 13.0460-4811.2  | 604811 | 24538 | 19,4  | 13.0470-7273.2 | LD7273 | 24606   | 17,4 | 13.0460-2773.2 | 602773 |
| 24467 | 19,1 | 13.0460-4810.2  | 604810 | 24539 | 18,5  | 13.0460-7229.2 | 607229 | 24606   | 17,4 | 13.0470-2747.2 | LD2747 |
| 24467 | 19,1 | 13.0460-4811.2  | 604811 | 24539 | 18,5  | 13.0470-7229.2 | LD7229 | 24606   | 17,4 | 13.0470-2748.2 | LD2748 |
| 24468 | 19,1 | 13.0460-4807.2  | 604807 | 24540 | 16,3  | 13.0460-3836.2 | 603836 | 24606   | 17,4 | 13.0470-2769.2 | LD2769 |
| 24468 | 19,1 | 13.0460-4809.2  | 604809 | 24540 | 16,3  | 13.0470-3836.2 | LD3836 | 24606   | 17,4 | 13.0470-2770.2 | LD2770 |
| 24469 | 19,1 | 13.0460-4807.2  | 604807 | 24541 | 15,5  | 13.0460-4816.2 | 604816 | 24606   | 17,4 | 13.0470-2773.2 | LD2773 |
| 24469 | 19,1 | 13.0460-4809.2  | 604809 | 24544 | 18,1  | 13.0460-5606.2 | 605606 | 24606   | 17,7 | 13.0460-2747.2 | 602747 |
| 24479 | 14,8 | 13.0460-5775.2  | 605775 | 24545 | 16,9  | 13.0460-5605.2 | 605605 | 24606   | 17,7 | 13.0460-2748.2 | 602748 |
| 24480 | 14,8 | 13.0460-5775.2  | 605775 | 24549 | 19,6  | 13.0460-3840.2 | 603840 | 24606   | 17,7 | 13.0470-2747.2 | LD2747 |
| 24483 | 16,9 | 13.0470-2880.2  | LD2880 | 24549 | 19,6  | 13.0470-3840.2 | LD3840 | 24606   | 17,7 | 13.0470-2748.2 | LD2748 |
| 24484 | 18,8 | 13.0460-3860.2  | 603860 | 24550 | 19,5  | 13.0460-3841.2 | 603841 | 24608   | 18,5 | 13.0460-2738.2 | 602738 |
| 24484 | 18,8 | 13.0470-3860.2  | LD3860 | 24551 | 19,5  | 13.0460-3841.2 | 603841 | 24609   | 17,7 | 13.0460-5799.2 | 605799 |
| 24484 | 19,0 | 13.0460-3834.2  | 603834 | 24553 | 15,8  | 13.0460-4852.2 | 604852 | 24610   | 15,0 | 13.0460-5769.2 | 605769 |
| 24485 | 19,0 | 13.0460-3833.2  | 603833 | 24556 | 19,1  | 13.0460-7190.2 | 607190 | 24611   | 15,0 | 13.0460-5769.2 | 605769 |
| 24486 | 17,9 | 13.0460-3835.2  | 603835 | 24556 | 19,1  | 13.0470-7190.2 | LD7190 | 24612   | 15,0 | 13.0460-5769.2 | 605769 |
| 24487 | 16,5 | 13.0460-7241.2  | 607241 | 24557 | 19,4  | 13.0460-7230.2 | 607230 | 24618   | 17,5 | 13.0460-5639.2 | 605639 |
| 24488 | 14,9 | 13.0460-5637.2  | 605637 | 24557 | 19,4  | 13.0470-7230.2 | LD7230 | 24619   | 17,5 | 13.0460-5639.2 | 605639 |
| 24488 | 14,9 | 13.0460-5782.2  | 605782 | 24558 | 18,7  | 13.0460-7230.2 | 607230 | 24620   | 17,5 | 13.0460-5639.2 | 605639 |
| 24489 | 14,9 | 13.0460-5637.2  | 605637 | 24558 | 18,7  | 13.0470-7230.2 | LD7230 | 24623   | 18,2 | 13.0460-7286.2 | 607286 |
| 24489 | 14,9 | 13.0460-5782.2  | 605782 | 24559 | 17,8  | 13.0460-2759.2 | 602759 | 24624   | 18,2 | 13.0460-7286.2 | 607286 |
| 24490 | 14,9 | 13.0460-5637.2  | 605637 | 24560 | 17,8  | 13.0460-2759.2 | 602759 | 24625   | 18,2 | 13.0460-7286.2 | 607286 |
| 24490 | 14,9 | 13.0460-5782.2  | 605782 | 24561 | 17,7  | 13.0460-2760.2 | 602760 | 24629   | 17,4 | 13.0460-5610.2 | 605610 |
| 24491 | 16,0 | 13.0460-5601.2  | 605601 | 24561 | 17,7  | 13.0470-2760.2 | LD2760 | 24630   | 17,4 | 13.0460-5610.2 | 605610 |
| 24492 | 16,0 | 13.0460-5601.2  | 605601 | 24562 | 17,7  | 13.0460-2760.2 | 602760 | 24632   | 17,0 | 13.0460-5752.2 | 605752 |
| 24493 | 16,0 | 13.0460-5601.2  | 605601 | 24562 | 17,7  | 13.0470-2760.2 | LD2760 | 24632   | 17,0 | 13.0470-5752.2 | LD5752 |
| 24495 | 17,3 | 13.0460-7260.2  | 607260 | 24563 | 17,7  | 13.0460-3858.2 | 603858 | 24635   | 16,6 | 13.0460-5754.2 | 605754 |
| 24496 | 17,3 | 13.0460-2722.2  | 602722 | 24563 | 17,7  | 13.0470-3858.2 | LD3858 | 24636   | 16,6 | 13.0460-5754.2 | 605754 |
| 24496 | 17,3 | 13.0460-2736.2  | 602736 | 24567 | 16,0  | 13.0460-5616.2 | 605616 | 24637   | 16,9 | 13.0460-5754.2 | 605754 |
| 24496 | 17,3 | 13.0470-2722.2  | LD2722 | 24568 | 16,3  | 13.0460-5777.2 | 605777 | 24638   | 20,0 | 13.0460-5753.2 | 605753 |





# Vergleichsliste WVA → ATE

Cross reference list WVA → ATE - Tabella di conversione codici WVA → ATE

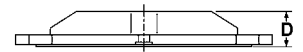
Liste des correspondances WVA → ATE - Lista referencias WVA → ATE



| WVA   | D    |  | WVA    | D     |  | WVA                   | D      |  |      |                       |        |
|-------|------|---|--------|-------|---|-----------------------|--------|---|------|-----------------------|--------|
| 24639 | 19,3 | <b>13.0460-5753.2</b>   | 605753 | 24765 | 16,5  | <b>13.0460-2745.2</b> | 602745 | 24948   | 19,6 | <b>13.0460-5615.2</b> | 605615 |
| 24640 | 19,3 | <b>13.0460-5753.2</b>   | 605753 | 24778 | 16,5  | <b>13.0460-5810.2</b> | 605810 | 24974   | 16,8 | <b>13.0460-6921.2</b> | 606921 |
| 24645 | 19,1 | <b>13.0460-7218.2</b>   | 607218 | 24779 | 16,5  | <b>13.0460-5810.2</b> | 605810 | 24976   | 17,5 | <b>13.0460-4863.2</b> | 604863 |
| 24645 | 19,2 | <b>13.0460-7247.2</b>   | 607247 | 24780 | 16,5  | <b>13.0460-5810.2</b> | 605810 | 24979   | 15,9 | <b>13.0460-5620.2</b> | 605620 |
| 24653 | 17,3 | <b>13.0460-5619.2</b>   | 605619 | 24781 | 16,5  | <b>13.0460-5810.2</b> | 605810 | 24980   | 15,9 | <b>13.0460-5620.2</b> | 605620 |
| 24660 | 17,8 | <b>13.0460-3847.2</b>   | 603847 | 24788 | 17,7  | <b>13.0460-2768.2</b> | 602768 | 24981   | 15,9 | <b>13.0460-5620.2</b> | 605620 |
| 24660 | 17,8 | <b>13.0470-3847.2</b>   | LD3847 | 24788 | 17,7  | <b>13.0470-2768.2</b> | LD2768 | 25008   | 16,3 | <b>13.0460-7293.2</b> | 607293 |
| 24661 | 14,8 | <b>13.0460-5648.2</b>   | 605648 | 24820 | 16,1  | <b>13.0460-2756.2</b> | 602756 | 25009   | 16,4 | <b>13.0460-7294.2</b> | 607294 |
| 24662 | 14,8 | <b>13.0460-5648.2</b>   | 605648 | 24820 | 16,1  | <b>13.0460-2757.2</b> | 602757 | 25009   | 16,4 | <b>13.0460-7307.2</b> | 607307 |
| 24664 | 15,2 | <b>13.0460-5604.2</b>   | 605604 | 24822 | 15,7  | <b>13.0460-2771.2</b> | 602771 | 25009   | 16,4 | <b>13.0470-7294.2</b> | LD7294 |
| 24665 | 15,2 | <b>13.0460-5604.2</b>   | 605604 | 24823 | 15,7  | <b>13.0460-2771.2</b> | 602771 | 25010   | 16,3 | <b>13.0460-7293.2</b> | 607293 |
| 24666 | 15,2 | <b>13.0460-5604.2</b>   | 605604 | 24824 | 15,7  | <b>13.0460-2771.2</b> | 602771 | 25011   | 16,4 | <b>13.0460-7294.2</b> | 607294 |
| 24670 | 18,0 | <b>13.0460-7235.2</b>   | 607235 | 24830 | 16,1  | <b>13.0460-5774.2</b> | 605774 | 25011   | 16,4 | <b>13.0460-7307.2</b> | 607307 |
| 24671 | 18,0 | <b>13.0460-7235.2</b>   | 607235 | 24831 | 16,1  | <b>13.0460-5774.2</b> | 605774 | 25011   | 16,4 | <b>13.0470-7294.2</b> | LD7294 |
| 24672 | 16,0 | <b>13.0460-5795.2</b>   | 605795 | 24839 | 19,4  | <b>13.0460-2752.2</b> | 602752 | 25014   | 18,2 | <b>13.0460-3865.2</b> | 603865 |
| 24673 | 18,0 | <b>13.0460-7270.2</b>   | 607270 | 24840 | 19,4  | <b>13.0460-2752.2</b> | 602752 | 25014   | 18,2 | <b>13.0470-3865.2</b> | LD3865 |
| 24674 | 18,0 | <b>13.0460-7270.2</b>   | 607270 | 24847 | 17,0  | <b>13.0460-4873.2</b> | 604873 | 25015   | 18,2 | <b>13.0460-3865.2</b> | 603865 |
| 24686 | 14,9 | <b>13.0460-5636.2</b>   | 605636 | 24848 | 18,3  | <b>13.0460-2786.2</b> | 602786 | 25015   | 18,2 | <b>13.0470-3865.2</b> | LD3865 |
| 24686 | 14,9 | <b>13.0460-5771.2</b>   | 605771 | 24848 | 18,3  | <b>13.0470-2786.2</b> | LD2786 | 25021   | 18,5 | <b>13.0460-2762.2</b> | 602762 |
| 24687 | 15,2 | <b>13.0460-4853.2</b>   | 604853 | 24852 | 16,0  | <b>13.0460-4867.2</b> | 604867 | 25022   | 18,5 | <b>13.0460-2762.2</b> | 602762 |
| 24687 | 15,2 | <b>13.0470-4853.2</b>   | LD4853 | 24852 | 16,0  | <b>13.0470-4867.2</b> | LD4867 | 25028   | 18,0 | <b>13.0460-4875.2</b> | 604875 |
| 24688 | 19,2 | <b>13.0460-7275.2</b>   | 607275 | 24853 | 16,0  | <b>13.0460-4867.2</b> | 604867 | 25029   | 16,7 | <b>13.0460-4874.2</b> | 604874 |
| 24688 | 19,2 | <b>13.0470-7275.2</b>   | LD7275 | 24853 | 16,0  | <b>13.0470-4867.2</b> | LD4867 | 25031   | 19,1 | <b>13.0460-7262.2</b> | 607262 |
| 24690 | 19,2 | <b>13.0460-5603.2</b>   | 605603 | 24862 | 16,7  | <b>13.0460-7259.2</b> | 607259 | 25031   | 19,1 | <b>13.0470-7262.2</b> | LD7262 |
| 24691 | 19,2 | <b>13.0460-5603.2</b>   | 605603 | 24862 | 16,7  | <b>13.0470-7259.2</b> | LD7259 | 25032   | 19,1 | <b>13.0460-7262.2</b> | 607262 |
| 24692 | 15,9 | <b>13.0460-2744.2</b>   | 602744 | 24862 | 16,7  | <b>13.0470-9001.2</b> | LD9001 | 25032   | 19,1 | <b>13.0470-7262.2</b> | LD7262 |
| 24693 | 17,5 | <b>13.0460-2742.2</b>   | 602742 | 24863 | 16,7  | <b>13.0460-7259.2</b> | 607259 | 25033   | 19,1 | <b>13.0460-7262.2</b> | 607262 |
| 24693 | 17,5 | <b>13.0460-2743.2</b>   | 602743 | 24863 | 16,7  | <b>13.0470-7259.2</b> | LD7259 | 25033   | 19,1 | <b>13.0470-7262.2</b> | LD7262 |
| 24693 | 18,5 | <b>13.0460-2741.2</b>   | 602741 | 24863 | 16,7  | <b>13.0470-9001.2</b> | LD9001 | 25045   | 19,5 | <b>13.0460-7267.2</b> | 607267 |
| 24695 | 17,3 | <b>13.0460-7274.2</b>   | 607274 | 24867 | 20,7  | <b>13.0460-3852.2</b> | 603852 | 25045   | 19,5 | <b>13.0470-7267.2</b> | LD7267 |
| 24697 | 19,3 | <b>13.0460-7268.2</b>   | 607268 | 24867 | 20,7  | <b>13.0470-3852.2</b> | LD3852 | 25046   | 18,5 | <b>13.0460-7267.2</b> | 607267 |
| 24697 | 19,3 | <b>13.0470-7268.2</b>   | LD7268 | 24868 | 20,7  | <b>13.0460-3852.2</b> | 603852 | 25046   | 18,5 | <b>13.0470-7267.2</b> | LD7267 |
| 24703 | 17,8 | <b>13.0460-2716.2</b>   | 602716 | 24868 | 20,7  | <b>13.0470-3852.2</b> | LD3852 | 25054   | 15,0 | <b>13.0460-7290.2</b> | 607290 |
| 24703 | 17,8 | <b>13.0470-2716.2</b>   | LD2716 | 24869 | 19,3  | <b>13.0460-2779.2</b> | 602779 | 25055   | 15,0 | <b>13.0460-7290.2</b> | 607290 |
| 24704 | 17,8 | <b>13.0460-2716.2</b>   | 602716 | 24869 | 19,3  | <b>13.0470-2779.2</b> | LD2779 | 25069   | 17,3 | <b>13.0460-7279.2</b> | 607279 |
| 24704 | 17,8 | <b>13.0470-2716.2</b>   | LD2716 | 24870 | 17,5  | <b>13.0460-7250.2</b> | 607250 | 25070   | 17,3 | <b>13.0460-7279.2</b> | 607279 |
| 24705 | 19,8 | <b>13.0460-7256.2</b>   | 607256 | 24875 | 19,8  | <b>13.0460-7272.2</b> | 607272 | 25071   | 18,8 | <b>13.0460-2780.2</b> | 602780 |
| 24705 | 19,8 | <b>13.0470-7256.2</b>   | LD7256 | 24883 | 18,0  | <b>13.0460-3855.2</b> | 603855 | 25072   | 18,8 | <b>13.0460-2780.2</b> | 602780 |
| 24706 | 21,3 | <b>13.0460-7256.2</b>   | 607256 | 24885 | 16,8  | <b>13.0460-3853.2</b> | 603853 | 25096   | 17,0 | <b>13.0460-7264.2</b> | 607264 |
| 24706 | 21,3 | <b>13.0470-7256.2</b>   | LD7256 | 24886 | 16,8  | <b>13.0460-3853.2</b> | 603853 | 25096   | 17,0 | <b>13.0470-7264.2</b> | LD7264 |
| 24707 | 21,3 | <b>13.0460-7256.2</b>   | 607256 | 24887 | 16,8  | <b>13.0460-3853.2</b> | 603853 | 25097   | 17,0 | <b>13.0460-7264.2</b> | 607264 |
| 24707 | 21,3 | <b>13.0470-7256.2</b>   | LD7256 | 24914 | 17,9  | <b>13.0460-7266.2</b> | 607266 | 25097   | 17,0 | <b>13.0470-7264.2</b> | LD7264 |
| 24709 | 17,5 | <b>13.0460-7250.2</b>   | 607250 | 24914 | 17,9  | <b>13.0470-7266.2</b> | LD7266 | 25098   | 17,0 | <b>13.0460-7264.2</b> | 607264 |
| 24709 | 18,6 | <b>13.0460-7249.2</b>   | 607249 | 24918 | 15,0  | <b>13.0460-5635.2</b> | 605635 | 25098   | 17,0 | <b>13.0470-7264.2</b> | LD7264 |
| 24709 | 18,6 | <b>13.0470-7249.2</b>   | LD7249 | 24918 | 15,0  | <b>13.0470-5635.2</b> | LD5635 | 25112   | 18,4 | <b>13.0460-4858.2</b> | 604858 |
| 24710 | 18,6 | <b>13.0460-7249.2</b>   | 607249 | 24922 | 17,5  | <b>13.0460-2761.2</b> | 602761 | 25113   | 18,4 | <b>13.0460-4858.2</b> | 604858 |
| 24710 | 18,6 | <b>13.0470-7249.2</b>   | LD7249 | 24926 | 16,5  | <b>13.0460-3854.2</b> | 603854 | 25114   | 15,8 | <b>13.0460-7255.2</b> | 607255 |
| 24727 | 20,7 | <b>13.0460-7265.2</b>   | 607265 | 24927 | 17,1  | <b>13.0460-3854.2</b> | 603854 | 25115   | 15,8 | <b>13.0460-7255.2</b> | 607255 |
| 24729 | 20,4 | <b>13.0460-7265.2</b>   | 607265 | 24928 | 17,1  | <b>13.0460-3854.2</b> | 603854 | 25119   | 16,9 | <b>13.0460-5638.2</b> | 605638 |
| 24738 | 20,0 | <b>13.0460-2764.2</b>   | 602764 | 24934 | 15,0  | <b>13.0460-5786.2</b> | 605786 | 25134   | 17,2 | <b>13.0460-2784.2</b> | 602784 |
| 24738 | 20,0 | <b>13.0470-2764.2</b>   | LD2764 | 24934 | 15,0  | <b>13.0470-5786.2</b> | LD5786 | 25134   | 17,2 | <b>13.0470-2784.2</b> | LD2784 |
| 24743 | 19,2 | <b>13.0460-2746.2</b>   | 602746 | 24935 | 15,0  | <b>13.0460-5786.2</b> | 605786 | 25135   | 17,2 | <b>13.0460-2784.2</b> | 602784 |
| 24743 | 19,2 | <b>13.0460-2765.2</b>   | 602765 | 24935 | 15,0  | <b>13.0470-5786.2</b> | LD5786 | 25135   | 17,2 | <b>13.0470-2784.2</b> | LD2784 |
| 24743 | 19,2 | <b>13.0470-2746.2</b>   | LD2746 | 24936 | 15,0  | <b>13.0460-5786.2</b> | 605786 | 25147   | 18,4 | <b>13.0460-4856.2</b> | 604856 |
| 24743 | 19,2 | <b>13.0470-2765.2</b>   | LD2765 | 24936 | 15,0  | <b>13.0470-5786.2</b> | LD5786 | 25148   | 18,4 | <b>13.0460-4856.2</b> | 604856 |
| 24764 | 17,9 | <b>13.0460-3846.2</b>   | 603846 | 24946 | 19,0  | <b>13.0460-5615.2</b> | 605615 | 25156   | 17,4 | <b>13.0460-2767.2</b> | 602767 |
| 24764 | 17,9 | <b>13.0470-3846.2</b>   | LD3846 | 24947 | 19,6  | <b>13.0460-5615.2</b> | 605615 | 25156   | 17,4 | <b>13.0470-2767.2</b> | LD2767 |





# Vergleichsliste WVA → ATE

Cross reference list WVA → ATE - Tabella di conversione codici WVA → ATE

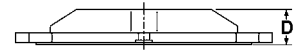
Liste des correspondances WVA → ATE - Lista referencias WVA → ATE



| WVA   | D    |  | WVA    | D     |  | WVA            | D      |  |      |                |        |
|-------|------|---|--------|-------|---|----------------|--------|---|------|----------------|--------|
| 25157 | 17,4 | 13.0460-2767.2  | 602767 | 25270 | 17,8  | 13.0460-5642.2 | 605642 | 25703   | 18,2 | 13.0460-7298.2 | 607298 |
| 25157 | 17,4 | 13.0470-2767.2  | LD2767 | 25273 | 15,0  | 13.0460-5613.2 | 605613 | 25778   | 14,3 | 13.0460-5843.2 | 605843 |
| 25158 | 20,3 | 13.0460-7280.2  | 607280 | 25274 | 15,0  | 13.0460-5613.2 | 605613 | 25804   | 17,3 | 13.0460-7284.2 | 607284 |
| 25158 | 20,3 | 13.0470-7280.2  | LD7280 | 25291 | 17,5  | 13.0460-2743.2 | 602743 | 25805   | 17,3 | 13.0460-7284.2 | 607284 |
| 25159 | 20,3 | 13.0460-7280.2  | 607280 | 25307 | 17,5  | 13.0460-3859.2 | 603859 | 25806   | 17,3 | 13.0460-7284.2 | 607284 |
| 25159 | 20,3 | 13.0470-7280.2  | LD7280 | 25307 | 17,5  | 13.0470-3859.2 | LD3859 | 25827   | 17,7 | 13.0460-3872.2 | 603872 |
| 25160 | 20,3 | 13.0460-7281.2  | 607281 | 25308 | 17,5  | 13.0460-3859.2 | 603859 | 25827   | 17,7 | 13.0470-3872.2 | LD3872 |
| 25160 | 20,3 | 13.0470-7281.2  | LD7281 | 25308 | 17,5  | 13.0470-3859.2 | LD3859 | 25828   | 17,7 | 13.0460-3872.2 | 603872 |
| 25161 | 20,3 | 13.0460-7281.2  | 607281 | 25323 | 17,3  | 13.0460-7289.2 | 607289 | 25828   | 17,7 | 13.0470-3872.2 | LD3872 |
| 25161 | 20,3 | 13.0470-7281.2  | LD7281 | 25324 | 17,3  | 13.0460-7289.2 | 607289 | 25833   | 17,3 | 13.0460-7300.2 | 607300 |
| 25172 | 18,4 | 13.0460-4857.2  | 604857 | 25326 | 19,3  | 13.0460-2778.2 | 602778 | 25833   | 17,3 | 13.0470-7300.2 | LD7300 |
| 25173 | 18,4 | 13.0460-4857.2  | 604857 | 25326 | 19,3  | 13.0470-2778.2 | LD2778 | 25834   | 17,3 | 13.0460-7300.2 | 607300 |
| 25179 | 17,8 | 13.0460-4870.2  | 604870 | 25348 | 17,8  | 13.0460-5646.2 | 605646 | 25834   | 17,3 | 13.0470-7300.2 | LD7300 |
| 25180 | 19,0 | 13.0460-7273.2  | 607273 | 25349 | 17,8  | 13.0460-5646.2 | 605646 | 25836   | 17,0 | 13.0460-7305.2 | 607305 |
| 25180 | 19,0 | 13.0470-7273.2  | LD7273 | 25350 | 17,8  | 13.0460-5646.2 | 605646 | 25836   | 17,0 | 13.0470-7305.2 | LD7305 |
| 25183 | 17,9 | 13.0460-4869.2  | 604869 | 25357 | 17,6  | 13.0460-3862.2 | 603862 | 25837   | 17,0 | 13.0460-7305.2 | 607305 |
| 25184 | 19,5 | 13.0460-2772.2  | 602772 | 25365 | 16,0  | 13.0460-5649.2 | 605649 | 25837   | 17,0 | 13.0470-7305.2 | LD7305 |
| 25185 | 19,4 | 13.0460-2772.2  | 602772 | 25366 | 16,0  | 13.0460-5649.2 | 605649 | 25839   | 17,8 | 13.0460-3871.2 | 603871 |
| 25186 | 19,4 | 13.0460-2772.2  | 602772 | 25367 | 16,0  | 13.0460-5649.2 | 605649 | 25839   | 17,8 | 13.0470-3871.2 | LD3871 |
| 25187 | 17,8 | 13.0460-5641.2  | 605641 | 25410 | 14,4  | 13.0460-2783.2 | 602783 | 25840   | 17,8 | 13.0460-3871.2 | 603871 |
| 25188 | 17,8 | 13.0460-5641.2  | 605641 | 25411 | 14,4  | 13.0460-2783.2 | 602783 | 25840   | 17,8 | 13.0470-3871.2 | LD3871 |
| 25189 | 17,8 | 13.0460-5641.2  | 605641 | 25412 | 14,4  | 13.0460-2783.2 | 602783 | 25841   | 16,1 | 13.0460-7301.2 | 607301 |
| 25190 | 21,3 | 13.0460-7282.2  | 607282 | 25429 | 17,5  | 13.0460-7288.2 | 607288 | 25841   | 16,1 | 13.0470-7301.2 | LD7301 |
| 25190 | 21,3 | 13.0470-7282.2  | LD7282 | 25429 | 17,5  | 13.0470-7288.2 | LD7288 | 25842   | 16,1 | 13.0460-7301.2 | 607301 |
| 25191 | 21,3 | 13.0460-7282.2  | 607282 | 25430 | 17,5  | 13.0460-7288.2 | 607288 | 25842   | 16,1 | 13.0470-7301.2 | LD7301 |
| 25191 | 21,3 | 13.0470-7282.2  | LD7282 | 25430 | 17,5  | 13.0470-7288.2 | LD7288 | 25889   | 16,9 | 13.0460-5638.2 | 605638 |
| 25192 | 21,3 | 13.0460-7282.2  | 607282 | 25451 | 17,6  | 13.0460-3862.2 | 603862 | 25890   | 16,9 | 13.0460-5638.2 | 605638 |
| 25192 | 21,3 | 13.0470-7282.2  | LD7282 | 25506 | 18,2  | 13.0460-3866.2 | 603866 | 25895   | 18,5 | 13.0460-3870.2 | 603870 |
| 25199 | 19,6 | 13.0460-3857.2  | 603857 | 25506 | 18,2  | 13.0470-3866.2 | LD3866 | 25895   | 18,5 | 13.0470-3870.2 | LD3870 |
| 25199 | 19,6 | 13.0470-3857.2  | LD3857 | 25507 | 18,2  | 13.0460-3866.2 | 603866 | 25896   | 18,5 | 13.0460-3870.2 | 603870 |
| 25200 | 19,6 | 13.0460-3857.2  | 603857 | 25507 | 18,2  | 13.0470-3866.2 | LD3866 | 25896   | 18,5 | 13.0470-3870.2 | LD3870 |
| 25200 | 19,6 | 13.0470-3857.2  | LD3857 | 25520 | 15,8  | 13.0460-5633.2 | 605633 | 25962   | 18,0 | 13.0460-7131.2 | 607131 |
| 25203 | 18,5 | 13.0460-2762.2  | 602762 | 25521 | 15,8  | 13.0460-5633.2 | 605633 | 25965   | 15,0 | 13.0460-2600.2 | 602600 |
| 25204 | 18,5 | 13.0460-2762.2  | 602762 | 25522 | 15,8  | 13.0460-5633.2 | 605633 | 25966   | 15,0 | 13.0460-2600.2 | 602600 |
| 25214 | 17,4 | 13.0460-2769.2  | 602769 | 25526 | 17,6  | 13.0460-3861.2 | 603861 | 25967   | 15,0 | 13.0460-2600.2 | 602600 |
| 25214 | 17,4 | 13.0460-2770.2  | 602770 | 25527 | 17,6  | 13.0460-3861.2 | 603861 | 25968   | 16,1 | 13.0460-7295.2 | 607295 |
| 25214 | 17,4 | 13.0460-2773.2  | 602773 | 25531 | 19,3  | 13.0460-7283.2 | 607283 | 25968   | 16,1 | 13.0470-7295.2 | LD7295 |
| 25214 | 17,4 | 13.0470-2769.2  | LD2769 | 25532 | 19,2  | 13.0460-7283.2 | 607283 | 25969   | 16,1 | 13.0460-7295.2 | 607295 |
| 25214 | 17,4 | 13.0470-2770.2  | LD2770 | 25632 | 15,5  | 13.0460-8014.2 | 608014 | 25969   | 16,1 | 13.0470-7295.2 | LD7295 |
| 25214 | 17,4 | 13.0470-2773.2  | LD2773 | 25633 | 15,5  | 13.0460-8014.2 | 608014 | 25973   | 17,2 | 13.0460-2793.2 | 602793 |
| 25215 | 18,6 | 13.0460-2781.2  | 602781 | 25634 | 15,5  | 13.0460-8014.2 | 608014 | 25974   | 17,2 | 13.0460-2793.2 | 602793 |
| 25215 | 18,6 | 13.0470-2781.2  | LD2781 | 25643 | 16,8  | 13.0460-4879.2 | 604879 | 25975   | 17,2 | 13.0460-2793.2 | 602793 |
| 25216 | 18,6 | 13.0460-2781.2  | 602781 | 25643 | 17,0  | 13.0470-4879.2 | LD4879 | 29001   | 20,0 | 13.0460-7906.2 | 607906 |
| 25216 | 18,6 | 13.0470-2781.2  | LD2781 | 25652 | 17,1  | 13.0460-2789.2 | 602789 | 29003   | 20,0 | 13.0460-7906.2 | 607906 |
| 25217 | 20,0 | 13.0460-2764.2  | 602764 | 25652 | 17,1  | 13.0470-2789.2 | LD2789 | 29012   | 18,0 | 13.0460-7903.2 | 607903 |
| 25217 | 20,0 | 13.0470-2764.2  | LD2764 | 25653 | 17,1  | 13.0460-2789.2 | 602789 | 29037   | 18,3 | 13.0460-4913.2 | 604913 |
| 25218 | 16,6 | 13.0460-7278.2  | 607278 | 25653 | 17,1  | 13.0470-2789.2 | LD2789 | 29037   | 18,3 | 13.0460-4919.2 | 604919 |
| 25222 | 17,3 | 13.0460-7276.2  | 607276 | 25654 | 17,1  | 13.0460-2789.2 | 602789 | 29038   | 18,3 | 13.0460-4913.2 | 604913 |
| 25223 | 17,3 | 13.0460-7276.2  | 607276 | 25654 | 17,1  | 13.0470-2789.2 | LD2789 | 29067   | 22,3 | 13.0460-2843.2 | 602843 |
| 25237 | 17,2 | 13.0460-2763.2  | 602763 | 25683 | 20,4  | 13.0460-2785.2 | 602785 | 29121   | 20,3 | 13.0460-4860.2 | 604860 |
| 25250 | 18,9 | 13.0460-3867.2  | 603867 | 25683 | 20,4  | 13.0470-2785.2 | LD2785 | 29121   | 20,3 | 13.0460-4861.2 | 604861 |
| 25251 | 18,9 | 13.0460-3867.2  | 603867 | 25684 | 20,4  | 13.0460-2785.2 | 602785 | 29121   | 20,3 | 13.0460-4966.2 | 604966 |
| 25262 | 15,0 | 13.0460-5613.2  | 605613 | 25684 | 20,4  | 13.0470-2785.2 | LD2785 | 29122   | 22,1 | 13.0460-4828.2 | 604828 |
| 25265 | 16,6 | 13.0460-7287.2  | 607287 | 25692 | 17,2  | 13.0460-5645.2 | 605645 | 29122   | 22,3 | 13.0460-4914.2 | 604914 |
| 25266 | 16,6 | 13.0460-7287.2  | 607287 | 25693 | 17,2  | 13.0460-5645.2 | 605645 | 29123   | 20,3 | 13.0460-4862.2 | 604862 |
| 25268 | 17,8 | 13.0460-5642.2  | 605642 | 25694 | 17,2  | 13.0460-5645.2 | 605645 | 29123   | 20,3 | 13.0460-4996.2 | 604996 |
| 25269 | 17,8 | 13.0460-5642.2  | 605642 | 25702 | 18,2  | 13.0460-7298.2 | 607298 | 29139   | 18,3 | 13.0460-4919.2 | 604919 |







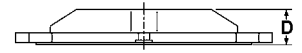

# Vergleichsliste ATE → WVA

Cross reference list ATE → WVA - Tabella di conversione codici ATE → WVA

Liste des correspondances ATE → WVA - Lista referencias ATE → WVA







|  | WVA    | D     |  | WVA            | D      |  | WVA  | D              |        |       |      |
|---|--------|-------|---|----------------|--------|---|------|----------------|--------|-------|------|
| 13.0460-2600.2  | 602600 | 25965 | 15,0  | 13.0460-2738.2 | 602738 | 24595   | 18,5 | 13.0460-2771.2 | 602771 | 24823 | 15,7 |
| 13.0460-2600.2  | 602600 | 25966 | 15,0  | 13.0460-2738.2 | 602738 | 24608   | 18,5 | 13.0460-2771.2 | 602771 | 24824 | 15,7 |
| 13.0460-2600.2  | 602600 | 25967 | 15,0  | 13.0460-2739.2 | 602739 | 24578   | 16,5 | 13.0460-2772.2 | 602772 | 25184 | 19,5 |
| 13.0460-2700.2  | 602700 | 21452 | 18,5  | 13.0460-2740.2 | 602740 | 23554   | 17,2 | 13.0460-2772.2 | 602772 | 25185 | 19,4 |
| 13.0460-2700.2  | 602700 | 21454 | 17,0  | 13.0460-2741.2 | 602741 | 24693   | 18,5 | 13.0460-2772.2 | 602772 | 25186 | 19,4 |
| 13.0460-2700.2  | 602700 | 23825 | 18,5  | 13.0460-2742.2 | 602742 | 24693   | 17,5 | 13.0460-2773.2 | 602773 | 24606 | 17,4 |
| 13.0460-2701.2  | 602701 | 21452 | 18,5  | 13.0460-2743.2 | 602743 | 24693   | 17,5 | 13.0460-2773.2 | 602773 | 25214 | 17,4 |
| 13.0460-2701.2  | 602701 | 21454 | 17,0  | 13.0460-2743.2 | 602743 | 25291   | 17,5 | 13.0460-2774.2 | 602774 | 23973 | 17,4 |
| 13.0460-2701.2  | 602701 | 23829 | 18,5  | 13.0460-2744.2 | 602744 | 24692   | 15,9 | 13.0460-2774.2 | 602774 | 24403 | 17,4 |
| 13.0460-2704.2  | 602704 | 23761 | 18,8  | 13.0460-2745.2 | 602745 | 24765   | 16,5 | 13.0460-2775.2 | 602775 | 23554 | 16,3 |
| 13.0460-2705.2  | 602705 | 21452 | 18,5  | 13.0460-2746.2 | 602746 | 24408   | 19,2 | 13.0460-2775.2 | 602775 | 23554 | 17,2 |
| 13.0460-2705.2  | 602705 | 21454 | 17,0  | 13.0460-2746.2 | 602746 | 24409   | 19,2 | 13.0460-2776.2 | 602776 | 23070 | 17,0 |
| 13.0460-2706.2  | 602706 | 24462 | 16,7  | 13.0460-2746.2 | 602746 | 24743   | 19,2 | 13.0460-2778.2 | 602778 | 25326 | 19,3 |
| 13.0460-2707.2  | 602707 | 23760 | 17,7  | 13.0460-2747.2 | 602747 | 24606   | 17,4 | 13.0460-2779.2 | 602779 | 24869 | 19,3 |
| 13.0460-2708.2  | 602708 | 23881 | 20,0  | 13.0460-2747.2 | 602747 | 24606   | 17,7 | 13.0460-2780.2 | 602780 | 25071 | 18,8 |
| 13.0460-2709.2  | 602709 | 23973 | 17,4  | 13.0460-2748.2 | 602748 | 24606   | 17,4 | 13.0460-2780.2 | 602780 | 25072 | 18,8 |
| 13.0460-2710.2  | 602710 | 23915 | 17,6  | 13.0460-2748.2 | 602748 | 24606   | 17,7 | 13.0460-2781.2 | 602781 | 25215 | 18,6 |
| 13.0460-2710.2  | 602710 | 23916 | 17,6  | 13.0460-2750.2 | 602750 | 20741   | 15,0 | 13.0460-2781.2 | 602781 | 25216 | 18,6 |
| 13.0460-2711.2  | 602711 | 24077 | 19,1  | 13.0460-2751.2 | 602751 | 21418   | 15,5 | 13.0460-2783.2 | 602783 | 25410 | 14,4 |
| 13.0460-2712.2  | 602712 | 23138 | 14,6  | 13.0460-2752.2 | 602752 | 24839   | 19,4 | 13.0460-2783.2 | 602783 | 25411 | 14,4 |
| 13.0460-2713.2  | 602713 | 23623 | 17,4  | 13.0460-2752.2 | 602752 | 24840   | 19,4 | 13.0460-2783.2 | 602783 | 25412 | 14,4 |
| 13.0460-2713.2  | 602713 | 23624 | 17,4  | 13.0460-2753.2 | 602753 | 23554   | 16,0 | 13.0460-2784.2 | 602784 | 25134 | 17,2 |
| 13.0460-2714.2  | 602714 | 24289 | 16,9  | 13.0460-2754.2 | 602754 | 24418   | 17,0 | 13.0460-2784.2 | 602784 | 25135 | 17,2 |
| 13.0460-2714.2  | 602714 | 24290 | 16,9  | 13.0460-2754.2 | 602754 | 24419   | 17,0 | 13.0460-2785.2 | 602785 | 25683 | 20,4 |
| 13.0460-2715.2  | 602715 | 24391 | 16,6  | 13.0460-2754.2 | 602754 | 24420   | 17,0 | 13.0460-2785.2 | 602785 | 25684 | 20,4 |
| 13.0460-2715.2  | 602715 | 24392 | 16,6  | 13.0460-2755.2 | 602755 | 24421   | 17,2 | 13.0460-2786.2 | 602786 | 24848 | 18,3 |
| 13.0460-2716.2  | 602716 | 24703 | 17,8  | 13.0460-2755.2 | 602755 | 24422   | 17,2 | 13.0460-2787.2 | 602787 | 23554 | 17,3 |
| 13.0460-2716.2  | 602716 | 24704 | 17,8  | 13.0460-2756.2 | 602756 | 24820   | 16,1 | 13.0460-2789.2 | 602789 | 25652 | 17,1 |
| 13.0460-2717.2  | 602717 | 21452 | 18,5  | 13.0460-2757.2 | 602757 | 24820   | 16,1 | 13.0460-2789.2 | 602789 | 25653 | 17,1 |
| 13.0460-2717.2  | 602717 | 21454 | 17,0  | 13.0460-2758.2 | 602758 | 24421   | 17,2 | 13.0460-2789.2 | 602789 | 25654 | 17,1 |
| 13.0460-2717.2  | 602717 | 23825 | 18,5  | 13.0460-2758.2 | 602758 | 24422   | 17,2 | 13.0460-2793.2 | 602793 | 25973 | 17,2 |
| 13.0460-2718.2  | 602718 | 23615 | 18,3  | 13.0460-2759.2 | 602759 | 24559   | 17,8 | 13.0460-2793.2 | 602793 | 25974 | 17,2 |
| 13.0460-2719.2  | 602719 | 24192 | 17,4  | 13.0460-2759.2 | 602759 | 24560   | 17,8 | 13.0460-2793.2 | 602793 | 25975 | 17,2 |
| 13.0460-2720.2  | 602720 | 23452 | 19,0  | 13.0460-2760.2 | 602760 | 24561   | 17,7 | 13.0460-2800.2 | 602800 | 20087 | 14,6 |
| 13.0460-2721.2  | 602721 | 23458 | 15,6  | 13.0460-2760.2 | 602760 | 24562   | 17,7 | 13.0460-2800.2 | 602800 | 20091 | 14,6 |
| 13.0460-2722.2  | 602722 | 24496 | 17,3  | 13.0460-2761.2 | 602761 | 24922   | 17,5 | 13.0460-2803.2 | 602803 | 21515 | 17,5 |
| 13.0460-2723.2  | 602723 | 24537 | 16,1  | 13.0460-2762.2 | 602762 | 25021   | 18,5 | 13.0460-2803.2 | 602803 | 21516 | 17,5 |
| 13.0460-2724.2  | 602724 | 24073 | 16,7  | 13.0460-2762.2 | 602762 | 25022   | 18,5 | 13.0460-2803.2 | 602803 | 21517 | 17,5 |
| 13.0460-2724.2  | 602724 | 24515 | 16,7  | 13.0460-2762.2 | 602762 | 25203   | 18,5 | 13.0460-2804.2 | 602804 | 21518 | 17,0 |
| 13.0460-2725.2  | 602725 | 23984 | 17,8  | 13.0460-2762.2 | 602762 | 25204   | 18,5 | 13.0460-2805.2 | 602805 | 21520 | 17,5 |
| 13.0460-2725.2  | 602725 | 23985 | 17,8  | 13.0460-2763.2 | 602763 | 23517   | 17,2 | 13.0460-2805.2 | 602805 | 21521 | 17,5 |
| 13.0460-2726.2  | 602726 | 23144 | 19,8  | 13.0460-2763.2 | 602763 | 25237   | 17,2 | 13.0460-2805.2 | 602805 | 21522 | 17,5 |
| 13.0460-2726.2  | 602726 | 23145 | 19,8  | 13.0460-2764.2 | 602764 | 24738   | 20,0 | 13.0460-2806.2 | 602806 | 20168 | 19,3 |
| 13.0460-2727.2  | 602727 | 23144 | 19,8  | 13.0460-2764.2 | 602764 | 25217   | 20,0 | 13.0460-2806.2 | 602806 | 21366 | 19,3 |
| 13.0460-2727.2  | 602727 | 23145 | 19,8  | 13.0460-2765.2 | 602765 | 24409   | 19,2 | 13.0460-2809.2 | 602809 | 21182 | 19,4 |
| 13.0460-2728.2  | 602728 | 24191 | 18,1  | 13.0460-2765.2 | 602765 | 24743   | 19,2 | 13.0460-2809.2 | 602809 | 21183 | 19,4 |
| 13.0460-2729.2  | 602729 | 23423 | 17,8  | 13.0460-2766.2 | 602766 | 24604   | 18,7 | 13.0460-2810.2 | 602810 | 20236 | 18,0 |
| 13.0460-2730.2  | 602730 | 23424 | 17,6  | 13.0460-2766.2 | 602766 | 24605   | 18,7 | 13.0460-2810.2 | 602810 | 20238 | 18,0 |
| 13.0460-2731.2  | 602731 | 24192 | 17,1  | 13.0460-2767.2 | 602767 | 25156   | 17,4 | 13.0460-2810.2 | 602810 | 20247 | 18,0 |
| 13.0460-2732.2  | 602732 | 24306 | 20,3  | 13.0460-2767.2 | 602767 | 25157   | 17,4 | 13.0460-2811.2 | 602811 | 21068 | 17,0 |
| 13.0460-2733.2  | 602733 | 24306 | 20,3  | 13.0460-2768.2 | 602768 | 23811   | 17,7 | 13.0460-2812.2 | 602812 | 21217 | 18,0 |
| 13.0460-2734.2  | 602734 | 24310 | 19,0  | 13.0460-2768.2 | 602768 | 24788   | 17,7 | 13.0460-2815.2 | 602815 | 21368 | 18,3 |
| 13.0460-2734.2  | 602734 | 24456 | 19,0  | 13.0460-2769.2 | 602769 | 24606   | 17,4 | 13.0460-2816.2 | 602816 | 21724 | 19,3 |
| 13.0460-2735.2  | 602735 | 23099 | 18,4  | 13.0460-2769.2 | 602769 | 25214   | 17,4 | 13.0460-2816.2 | 602816 | 21749 | 19,3 |
| 13.0460-2735.2  | 602735 | 23100 | 18,4  | 13.0460-2770.2 | 602770 | 24606   | 17,4 | 13.0460-2817.2 | 602817 | 21674 | 19,0 |
| 13.0460-2736.2  | 602736 | 24496 | 17,3  | 13.0460-2770.2 | 602770 | 25214   | 17,4 | 13.0460-2817.2 | 602817 | 21886 | 19,0 |
| 13.0460-2737.2  | 602737 | 24537 | 15,8  | 13.0460-2771.2 | 602771 | 24822   | 15,7 | 13.0460-2819.2 | 602819 | 20961 | 17,6 |

# Vergleichsliste ATE → WVA

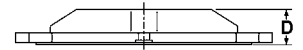
Cross reference list ATE → WVA - Tabella di conversione codici ATE → WVA

Liste des correspondances ATE → WVA - Lista referencias ATE → WVA



|  | WVA    | D          |  | WVA    | D          |  | WVA    | D          |
|---|--------|------------|---|--------|------------|---|--------|------------|
| 13.0460-2820.2  | 602820 | 20961 17,6 | 13.0460-2868.2  | 602868 | 23654 15,3 | 13.0460-2927.2  | 602927 | 21028 19,3 |
| 13.0460-2821.2  | 602821 | 21945 16,0 | 13.0460-2868.2  | 602868 | 23655 15,3 | 13.0460-2928.2  | 602928 | 20981 13,8 |
| 13.0460-2822.2  | 602822 | 21945 19,6 | 13.0460-2869.2  | 602869 | 23169 19,4 | 13.0460-2933.2  | 602933 | 20981 13,8 |
| 13.0460-2823.2  | 602823 | 23554 17,2 | 13.0460-2870.2  | 602870 | 23099 18,4 | 13.0460-2933.2  | 602933 | 21079 13,8 |
| 13.0460-2824.2  | 602824 | 20380 15,6 | 13.0460-2871.2  | 602871 | 23407 19,0 | 13.0460-2934.2  | 602934 | 20669 19,0 |
| 13.0460-2824.2  | 602824 | 21110 15,6 | 13.0460-2872.2  | 602872 | 23224 16,5 | 13.0460-2934.2  | 602934 | 20778 19,0 |
| 13.0460-2825.2  | 602825 | 21614 17,7 | 13.0460-2872.2  | 602872 | 23446 16,5 | 13.0460-2935.2  | 602935 | 21385 13,8 |
| 13.0460-2825.2  | 602825 | 21615 17,7 | 13.0460-2874.2  | 602874 | 23224 16,5 | 13.0460-2936.2  | 602936 | 20574 15,3 |
| 13.0460-2825.2  | 602825 | 21616 17,7 | 13.0460-2874.2  | 602874 | 23446 16,5 | 13.0460-2937.2  | 602937 | 20961 15,2 |
| 13.0460-2826.2  | 602826 | 23177 14,2 | 13.0460-2875.2  | 602875 | 23119 17,5 | 13.0460-2941.2  | 602941 | 20838 17,0 |
| 13.0460-2827.2  | 602827 | 21606 16,7 | 13.0460-2875.2  | 602875 | 23280 17,5 | 13.0460-2941.2  | 602941 | 20839 17,0 |
| 13.0460-2828.2  | 602828 | 23070 19,5 | 13.0460-2875.2  | 602875 | 23830 17,5 | 13.0460-2943.2  | 602943 | 21266 17,0 |
| 13.0460-2829.2  | 602829 | 23124 19,0 | 13.0460-2876.2  | 602876 | 23119 17,5 | 13.0460-2948.2  | 602948 | 21100 16,7 |
| 13.0460-2829.2  | 602829 | 23125 19,0 | 13.0460-2876.2  | 602876 | 23280 17,5 | 13.0460-2948.2  | 602948 | 21105 16,7 |
| 13.0460-2830.2  | 602830 | 21920 14,6 | 13.0460-2876.2  | 602876 | 23828 17,5 | 13.0460-2949.2  | 602949 | 20833 17,0 |
| 13.0460-2831.2  | 602831 | 21861 15,2 | 13.0460-2877.2  | 602877 | 23554 17,2 | 13.0460-2949.2  | 602949 | 20834 17,0 |
| 13.0460-2832.2  | 602832 | 21888 18,1 | 13.0460-2877.2  | 602877 | 23556 17,2 | 13.0460-2949.2  | 602949 | 20838 17,0 |
| 13.0460-2832.2  | 602832 | 21889 18,1 | 13.0460-2877.2  | 602877 | 23823 17,2 | 13.0460-2951.2  | 602951 | 21103 14,2 |
| 13.0460-2833.2  | 602833 | 23070 17,0 | 13.0460-2878.2  | 602878 | 24073 16,7 | 13.0460-2952.2  | 602952 | 21182 19,4 |
| 13.0460-2834.2  | 602834 | 21463 18,0 | 13.0460-2879.2  | 602879 | 23601 13,7 | 13.0460-2952.2  | 602952 | 21185 19,4 |
| 13.0460-2835.2  | 602835 | 23353 14,8 | 13.0460-2880.2  | 602880 | 23914 17,1 | 13.0460-2953.2  | 602953 | 20200 16,0 |
| 13.0460-2836.2  | 602836 | 21595 18,3 | 13.0460-2881.2  | 602881 | 23409 19,3 | 13.0460-2954.2  | 602954 | 20088 14,3 |
| 13.0460-2836.2  | 602836 | 21596 18,3 | 13.0460-2882.2  | 602882 | 23326 17,4 | 13.0460-2955.2  | 602955 | 20772 18,0 |
| 13.0460-2837.2  | 602837 | 21945 19,6 | 13.0460-2883.2  | 602883 | 23581 18,8 | 13.0460-2955.2  | 602955 | 20937 18,0 |
| 13.0460-2837.2  | 602837 | 23393 19,6 | 13.0460-2884.2  | 602884 | 23581 18,8 | 13.0460-2955.2  | 602955 | 20938 18,0 |
| 13.0460-2838.2  | 602838 | 21479 19,2 | 13.0460-2884.2  | 602884 | 23843 18,8 | 13.0460-2956.2  | 602956 | 20989 17,7 |
| 13.0460-2838.2  | 602838 | 23445 19,2 | 13.0460-2885.2  | 602885 | 24077 19,1 | 13.0460-2956.2  | 602956 | 21022 17,7 |
| 13.0460-2839.2  | 602839 | 20651 18,3 | 13.0460-2886.2  | 602886 | 20961 16,2 | 13.0460-2956.2  | 602956 | 21023 17,7 |
| 13.0460-2839.2  | 602839 | 21635 18,7 | 13.0460-2887.2  | 602887 | 23914 17,1 | 13.0460-2957.2  | 602957 | 20168 16,0 |
| 13.0460-2839.2  | 602839 | 23176 18,7 | 13.0460-2888.2  | 602888 | 23326 17,4 | 13.0460-2958.2  | 602958 | 20168 19,3 |
| 13.0460-2840.2  | 602840 | 23980 16,5 | 13.0460-2889.2  | 602889 | 23326 17,4 | 13.0460-2959.2  | 602959 | 23532 20,1 |
| 13.0460-2842.2  | 602842 | 20961 15,2 | 13.0460-2890.2  | 602890 | 23326 17,4 | 13.0460-2959.2  | 602959 | 23533 20,1 |
| 13.0460-2843.2  | 602843 | 29067 22,3 | 13.0460-2891.2  | 602891 | 24134 19,6 | 13.0460-2959.2  | 602959 | 23534 20,1 |
| 13.0460-2844.2  | 602844 | 21674 19,4 | 13.0460-2891.2  | 602891 | 24175 19,6 | 13.0460-2962.2  | 602962 | 20668 16,6 |
| 13.0460-2844.2  | 602844 | 21886 19,4 | 13.0460-2892.2  | 602892 | 24133 18,6 | 13.0460-2963.2  | 602963 | 21138 18,8 |
| 13.0460-2845.2  | 602845 | 23554 16,4 | 13.0460-2892.2  | 602892 | 24174 18,6 | 13.0460-2963.2  | 602963 | 21288 18,8 |
| 13.0460-2846.2  | 602846 | 21010 15,8 | 13.0460-2893.2  | 602893 | 24135 17,7 | 13.0460-2964.2  | 602964 | 20861 17,5 |
| 13.0460-2847.2  | 602847 | 21219 17,8 | 13.0460-2894.2  | 602894 | 20961 17,4 | 13.0460-2965.2  | 602965 | 21170 17,3 |
| 13.0460-2847.2  | 602847 | 21306 16,8 | 13.0460-2895.2  | 602895 | 23172 18,0 | 13.0460-2966.2  | 602966 | 20166 16,0 |
| 13.0460-2850.2  | 602850 | 21797 19,7 | 13.0460-2896.2  | 602896 | 21920 16,6 | 13.0460-2967.2  | 602967 | 20480 15,5 |
| 13.0460-2850.2  | 602850 | 23602 19,7 | 13.0460-2897.2  | 602897 | 21861 15,2 | 13.0460-2968.2  | 602968 | 20332 17,0 |
| 13.0460-2852.2  | 602852 | 21799 19,7 | 13.0460-2898.2  | 602898 | 23908 18,0 | 13.0460-2968.2  | 602968 | 21271 17,0 |
| 13.0460-2852.2  | 602852 | 23603 19,7 | 13.0460-2899.2  | 602899 | 23638 18,3 | 13.0460-2969.2  | 602969 | 21165 16,8 |
| 13.0460-2853.2  | 602853 | 21983 17,2 | 13.0460-2899.2  | 602899 | 23639 18,3 | 13.0460-2969.2  | 602969 | 21166 16,8 |
| 13.0460-2855.2  | 602855 | 23138 14,6 | 13.0460-2901.2  | 602901 | 20741 19,0 | 13.0460-2971.2  | 602971 | 21209 18,5 |
| 13.0460-2857.2  | 602857 | 23225 17,0 | 13.0460-2901.2  | 602901 | 20787 19,0 | 13.0460-2971.2  | 602971 | 21210 18,5 |
| 13.0460-2857.2  | 602857 | 23226 17,0 | 13.0460-2902.2  | 602902 | 21205 19,0 | 13.0460-2972.2  | 602972 | 20124 18,9 |
| 13.0460-2858.2  | 602858 | 23284 14,0 | 13.0460-2902.2  | 602902 | 21206 19,0 | 13.0460-2973.2  | 602973 | 20651 18,0 |
| 13.0460-2859.2  | 602859 | 20961 17,2 | 13.0460-2903.2  | 602903 | 20979 19,4 | 13.0460-2973.2  | 602973 | 21635 18,0 |
| 13.0460-2859.2  | 602859 | 23516 17,2 | 13.0460-2905.2  | 602905 | 20286 16,2 | 13.0460-2975.2  | 602975 | 21439 20,3 |
| 13.0460-2860.2  | 602860 | 23554 16,3 | 13.0460-2912.2  | 602912 | 20861 17,7 | 13.0460-2976.2  | 602976 | 21797 19,7 |
| 13.0460-2862.2  | 602862 | 23346 19,0 | 13.0460-2921.2  | 602921 | 21173 17,0 | 13.0460-2976.2  | 602976 | 21798 19,7 |
| 13.0460-2863.2  | 602863 | 20261 19,0 | 13.0460-2923.2  | 602923 | 21055 17,0 | 13.0460-2977.2  | 602977 | 21799 19,7 |
| 13.0460-2863.2  | 602863 | 20267 19,0 | 13.0460-2925.2  | 602925 | 20669 19,0 | 13.0460-2977.2  | 602977 | 21800 19,7 |
| 13.0460-2864.2  | 602864 | 20961 17,4 | 13.0460-2925.2  | 602925 | 20901 19,0 | 13.0460-2978.2  | 602978 | 21801 19,0 |
| 13.0460-2867.2  | 602867 | 23517 16,6 | 13.0460-2926.2  | 602926 | 20669 15,7 | 13.0460-2978.2  | 602978 | 21802 19,0 |
| 13.0460-2868.2  | 602868 | 23417 15,3 | 13.0460-2927.2  | 602927 | 20941 19,3 | 13.0460-2979.2  | 602979 | 21147 19,0 |





# Vergleichsliste ATE → WVA

Cross reference list ATE → WVA - Tabella di conversione codici ATE → WVA

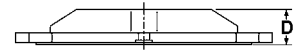
Liste des correspondances ATE → WVA - Lista referencias ATE → WVA



|  | WVA    | D     |  | WVA            | D      |  | WVA  | D              |        |       |      |
|---|--------|-------|---|----------------|--------|---|------|----------------|--------|-------|------|
| 13.0460-2979.2  | 602979 | 21557 | 19,0  | 13.0460-3827.2 | 603827 | 23709   | 19,6 | 13.0460-3865.2 | 603865 | 25015 | 18,2 |
| 13.0460-2980.2  | 602980 | 21147 | 19,0  | 13.0460-3827.2 | 603827 | 23710   | 19,6 | 13.0460-3866.2 | 603866 | 25506 | 18,2 |
| 13.0460-2980.2  | 602980 | 21148 | 19,0  | 13.0460-3828.2 | 603828 | 24349   | 17,5 | 13.0460-3866.2 | 603866 | 25507 | 18,2 |
| 13.0460-2981.2  | 602981 | 21460 | 18,0  | 13.0460-3829.2 | 603829 | 23959   | 17,0 | 13.0460-3867.2 | 603867 | 25250 | 18,9 |
| 13.0460-2981.2  | 602981 | 21613 | 18,0  | 13.0460-3831.2 | 603831 | 24260   | 17,3 | 13.0460-3867.2 | 603867 | 25251 | 18,9 |
| 13.0460-2982.2  | 602982 | 21479 | 19,2  | 13.0460-3832.2 | 603832 | 29190   | 20,2 | 13.0460-3870.2 | 603870 | 25895 | 18,5 |
| 13.0460-2983.2  | 602983 | 20919 | 18,0  | 13.0460-3833.2 | 603833 | 24485   | 19,0 | 13.0460-3870.2 | 603870 | 25896 | 18,5 |
| 13.0460-2983.2  | 602983 | 21388 | 18,0  | 13.0460-3834.2 | 603834 | 24484   | 19,0 | 13.0460-3871.2 | 603871 | 25839 | 17,8 |
| 13.0460-2984.2  | 602984 | 20961 | 17,2  | 13.0460-3835.2 | 603835 | 24486   | 17,9 | 13.0460-3871.2 | 603871 | 25840 | 17,8 |
| 13.0460-2985.2  | 602985 | 20164 | 18,2  | 13.0460-3836.2 | 603836 | 24540   | 16,3 | 13.0460-3872.2 | 603872 | 25827 | 17,7 |
| 13.0460-2987.2  | 602987 | 21147 | 19,0  | 13.0460-3837.2 | 603837 | 29190   | 20,2 | 13.0460-3872.2 | 603872 | 25828 | 17,7 |
| 13.0460-2987.2  | 602987 | 23168 | 19,0  | 13.0460-3838.2 | 603838 | 21436   | 17,0 | 13.0460-3902.2 | 603902 | 20035 | 17,0 |
| 13.0460-2997.2  | 602997 | 20708 | 15,8  | 13.0460-3839.2 | 603839 | 23707   | 17,9 | 13.0460-3902.2 | 603902 | 20036 | 17,0 |
| 13.0460-3010.2  | 603010 | 20009 | 15,0  | 13.0460-3839.2 | 603839 | 23982   | 18,1 | 13.0460-3902.2 | 603902 | 21299 | 17,0 |
| 13.0460-3011.2  | 603011 | 20641 | 15,0  | 13.0460-3839.2 | 603839 | 24288   | 17,9 | 13.0460-3902.2 | 603902 | 21300 | 17,0 |
| 13.0460-3011.2  | 603011 | 20642 | 15,0  | 13.0460-3840.2 | 603840 | 23981   | 19,6 | 13.0460-3904.2 | 603904 | 21107 | 12,0 |
| 13.0460-3013.2  | 603013 | 20641 | 15,0  | 13.0460-3840.2 | 603840 | 24549   | 19,6 | 13.0460-3905.2 | 603905 | 21131 | 14,7 |
| 13.0460-3013.2  | 603013 | 20642 | 15,0  | 13.0460-3841.2 | 603841 | 24550   | 19,5 | 13.0460-3905.2 | 603905 | 21132 | 14,7 |
| 13.0460-3013.2  | 603013 | 20912 | 15,0  | 13.0460-3841.2 | 603841 | 24551   | 19,5 | 13.0460-3905.2 | 603905 | 21133 | 14,7 |
| 13.0460-3014.2  | 603014 | 20387 | 15,0  | 13.0460-3842.2 | 603842 | 29217   | 20,5 | 13.0460-3911.2 | 603911 | 20905 | 18,0 |
| 13.0460-3014.2  | 603014 | 20641 | 15,0  | 13.0460-3842.2 | 603842 | 24072   | 17,9 | 13.0460-3911.2 | 603911 | 20906 | 18,0 |
| 13.0460-3014.2  | 603014 | 20642 | 15,0  | 13.0460-3846.2 | 603846 | 24764   | 17,9 | 13.0460-3911.2 | 603911 | 20986 | 18,0 |
| 13.0460-3024.2  | 603024 | 20436 | 15,0  | 13.0460-3847.2 | 603847 | 24660   | 17,8 | 13.0460-3911.2 | 603911 | 20987 | 18,0 |
| 13.0460-3306.2  | 603306 | 21089 | 15,0  | 13.0460-3848.2 | 603848 | 24349   | 17,6 | 13.0460-3914.2 | 603914 | 21233 | 16,7 |
| 13.0460-3306.2  | 603306 | 21090 | 15,0  | 13.0460-3849.2 | 603849 | 24393   | 17,9 | 13.0460-3915.2 | 603915 | 20635 | 18,0 |
| 13.0460-3401.2  | 603401 | 20755 | 14,4  | 13.0460-3850.2 | 603850 | 23707   | 18,0 | 13.0460-3915.2 | 603915 | 20636 | 18,0 |
| 13.0460-3403.2  | 603403 | 20755 | 14,4  | 13.0460-3851.2 | 603851 | 24150   | 17,6 | 13.0460-3915.2 | 603915 | 20859 | 18,0 |
| 13.0460-3504.2  | 603504 | 21301 | 15,5  | 13.0460-3852.2 | 603852 | 24867   | 20,7 | 13.0460-3915.2 | 603915 | 20860 | 18,0 |
| 13.0460-3602.2  | 603602 | 21144 | 15,8  | 13.0460-3852.2 | 603852 | 24868   | 20,7 | 13.0460-3916.2 | 603916 | 21296 | 16,5 |
| 13.0460-3605.2  | 603605 | 20180 | 17,3  | 13.0460-3853.2 | 603853 | 24885   | 16,8 | 13.0460-3916.2 | 603916 | 21297 | 16,5 |
| 13.0460-3605.2  | 603605 | 20181 | 17,3  | 13.0460-3853.2 | 603853 | 24886   | 16,8 | 13.0460-3916.2 | 603916 | 21299 | 15,9 |
| 13.0460-3612.2  | 603612 | 20482 | 18,5  | 13.0460-3853.2 | 603853 | 24887   | 16,8 | 13.0460-3916.2 | 603916 | 21300 | 15,9 |
| 13.0460-3800.2  | 603800 | 23613 | 17,7  | 13.0460-3854.2 | 603854 | 24926   | 16,5 | 13.0460-3926.2 | 603926 | 20974 | 10,8 |
| 13.0460-3803.2  | 603803 | 20995 | 17,3  | 13.0460-3854.2 | 603854 | 24927   | 17,1 | 13.0460-3928.2 | 603928 | 20140 | 14,0 |
| 13.0460-3803.2  | 603803 | 20996 | 17,3  | 13.0460-3854.2 | 603854 | 24928   | 17,1 | 13.0460-3928.2 | 603928 | 20141 | 14,0 |
| 13.0460-3804.2  | 603804 | 21035 | 15,0  | 13.0460-3855.2 | 603855 | 24883   | 18,0 | 13.0460-3933.2 | 603933 | 21016 | 17,0 |
| 13.0460-3805.2  | 603805 | 21197 | 15,0  | 13.0460-3856.2 | 603856 | 23434   | 18,0 | 13.0460-3933.2 | 603933 | 21086 | 17,0 |
| 13.0460-3806.2  | 603806 | 23669 | 16,8  | 13.0460-3856.2 | 603856 | 23435   | 18,0 | 13.0460-3933.2 | 603933 | 21087 | 17,0 |
| 13.0460-3807.2  | 603807 | 21436 | 17,0  | 13.0460-3856.2 | 603856 | 23436   | 18,0 | 13.0460-3936.2 | 603936 | 20073 | 17,3 |
| 13.0460-3809.2  | 603809 | 24072 | 17,9  | 13.0460-3856.2 | 603856 | 23437   | 18,0 | 13.0460-3939.2 | 603939 | 20775 | 18,0 |
| 13.0460-3810.2  | 603810 | 23705 | 18,1  | 13.0460-3857.2 | 603857 | 25199   | 19,6 | 13.0460-3940.2 | 603940 | 20775 | 18,0 |
| 13.0460-3811.2  | 603811 | 23708 | 19,2  | 13.0460-3857.2 | 603857 | 25200   | 19,6 | 13.0460-3940.2 | 603940 | 20776 | 18,0 |
| 13.0460-3813.2  | 603813 | 24150 | 17,6  | 13.0460-3858.2 | 603858 | 24563   | 17,7 | 13.0460-3940.2 | 603940 | 20777 | 18,0 |
| 13.0460-3814.2  | 603814 | 23934 | 18,2  | 13.0460-3859.2 | 603859 | 25307   | 17,5 | 13.0460-3942.2 | 603942 | 20841 | 12,0 |
| 13.0460-3815.2  | 603815 | 23930 | 18,2  | 13.0460-3859.2 | 603859 | 25308   | 17,5 | 13.0460-3943.2 | 603943 | 20905 | 18,0 |
| 13.0460-3818.2  | 603818 | 23706 | 18,1  | 13.0460-3860.2 | 603860 | 24484   | 18,8 | 13.0460-3943.2 | 603943 | 20906 | 18,0 |
| 13.0460-3818.2  | 603818 | 23707 | 18,1  | 13.0460-3861.2 | 603861 | 23714   | 17,6 | 13.0460-3944.2 | 603944 | 21141 | 18,0 |
| 13.0460-3819.2  | 603819 | 24007 | 20,8  | 13.0460-3861.2 | 603861 | 25526   | 17,6 | 13.0460-3945.2 | 603945 | 20932 | 14,0 |
| 13.0460-3821.2  | 603821 | 24008 | 18,3  | 13.0460-3861.2 | 603861 | 25527   | 17,6 | 13.0460-3945.2 | 603945 | 20934 | 14,0 |
| 13.0460-3822.2  | 603822 | 21597 | 11,0  | 13.0460-3862.2 | 603862 | 24349   | 17,6 | 13.0460-3946.2 | 603946 | 23302 | 18,0 |
| 13.0460-3822.2  | 603822 | 21600 | 11,0  | 13.0460-3862.2 | 603862 | 25357   | 17,6 | 13.0460-3947.2 | 603947 | 21505 | 17,0 |
| 13.0460-3823.2  | 603823 | 20974 | 11,0  | 13.0460-3862.2 | 603862 | 25451   | 17,6 | 13.0460-3947.2 | 603947 | 21509 | 17,0 |
| 13.0460-3824.2  | 603824 | 20261 | 19,0  | 13.0460-3863.2 | 603863 | 23706   | 18,0 | 13.0460-3947.2 | 603947 | 21510 | 17,0 |
| 13.0460-3824.2  | 603824 | 24294 | 19,0  | 13.0460-3863.2 | 603863 | 23707   | 18,0 | 13.0460-3947.2 | 603947 | 21513 | 17,0 |
| 13.0460-3825.2  | 603825 | 24348 | 17,1  | 13.0460-3864.2 | 603864 | 23709   | 19,6 | 13.0460-3948.2 | 603948 | 21508 | 17,0 |
| 13.0460-3826.2  | 603826 | 23706 | 18,0  | 13.0460-3864.2 | 603864 | 23710   | 19,6 | 13.0460-3948.2 | 603948 | 21509 | 17,0 |
| 13.0460-3826.2  | 603826 | 23707 | 18,0  | 13.0460-3865.2 | 603865 | 25014   | 18,2 | 13.0460-3948.2 | 603948 | 21512 | 17,0 |





# Vergleichsliste ATE → WVA

Cross reference list ATE → WVA - Tabella di conversione codici ATE → WVA

Liste des correspondances ATE → WVA - Lista referencias ATE → WVA



|  | WVA    | D     |  | WVA            | D      |  | WVA  | D              |        |       |      |
|---|--------|-------|---|----------------|--------|---|------|----------------|--------|-------|------|
| 13.0460-3948.2  | 603948 | 21513 | 17,0  | 13.0460-3984.2 | 603984 | 23711   | 19,4 | 13.0460-4201.2 | 604201 | 21153 | 17,5 |
| 13.0460-3949.2  | 603949 | 21365 | 17,0  | 13.0460-3984.2 | 603984 | 23712   | 19,4 | 13.0460-4202.2 | 604202 | 21153 | 16,0 |
| 13.0460-3950.2  | 603950 | 21436 | 17,0  | 13.0460-3984.2 | 603984 | 23713   | 19,4 | 13.0460-4401.2 | 604401 | 20784 | 18,0 |
| 13.0460-3951.2  | 603951 | 21436 | 16,2  | 13.0460-3985.2 | 603985 | 23020   | 17,9 | 13.0460-4800.2 | 604800 | 23751 | 17,0 |
| 13.0460-3952.2  | 603952 | 20905 | 18,0  | 13.0460-3986.2 | 603986 | 23135   | 18,0 | 13.0460-4800.2 | 604800 | 23764 | 17,0 |
| 13.0460-3952.2  | 603952 | 20906 | 18,0  | 13.0460-3986.2 | 603986 | 23137   | 18,0 | 13.0460-4800.2 | 604800 | 23765 | 17,0 |
| 13.0460-3953.2  | 603953 | 20634 | 15,0  | 13.0460-3987.2 | 603987 | 23279   | 18,4 | 13.0460-4801.2 | 604801 | 21381 | 15,0 |
| 13.0460-3954.2  | 603954 | 20973 | 11,0  | 13.0460-3988.2 | 603988 | 23557   | 17,2 | 13.0460-4801.2 | 604801 | 24143 | 15,0 |
| 13.0460-3954.2  | 603954 | 20974 | 11,0  | 13.0460-3990.2 | 603990 | 23021   | 18,9 | 13.0460-4802.2 | 604802 | 23773 | 17,5 |
| 13.0460-3955.2  | 603955 | 20634 | 15,0  | 13.0460-3991.2 | 603991 | 23714   | 16,6 | 13.0460-4802.2 | 604802 | 23774 | 17,5 |
| 13.0460-3955.2  | 603955 | 21096 | 15,0  | 13.0460-3992.2 | 603992 | 23434   | 18,7 | 13.0460-4803.2 | 604803 | 23092 | 15,6 |
| 13.0460-3955.2  | 603955 | 21097 | 15,0  | 13.0460-3992.2 | 603992 | 23435   | 18,7 | 13.0460-4803.2 | 604803 | 23111 | 15,6 |
| 13.0460-3956.2  | 603956 | 21631 | 17,0  | 13.0460-3992.2 | 603992 | 23840   | 18,7 | 13.0460-4804.2 | 604804 | 23092 | 15,6 |
| 13.0460-3957.2  | 603957 | 23042 | 19,0  | 13.0460-3992.2 | 603992 | 23841   | 18,7 | 13.0460-4805.2 | 604805 | 24162 | 15,2 |
| 13.0460-3959.2  | 603959 | 21469 | 18,0  | 13.0460-3993.2 | 603993 | 23577   | 18,7 | 13.0460-4806.2 | 604806 | 23955 | 16,2 |
| 13.0460-3960.2  | 603960 | 21470 | 18,0  | 13.0460-3993.2 | 603993 | 23578   | 18,7 | 13.0460-4807.2 | 604807 | 24468 | 19,1 |
| 13.0460-3961.2  | 603961 | 20336 | 14,0  | 13.0460-3993.2 | 603993 | 23579   | 18,7 | 13.0460-4807.2 | 604807 | 24469 | 19,1 |
| 13.0460-3961.2  | 603961 | 20337 | 14,0  | 13.0460-3993.2 | 603993 | 23580   | 18,7 | 13.0460-4809.2 | 604809 | 24468 | 19,1 |
| 13.0460-3962.2  | 603962 | 20905 | 18,0  | 13.0460-3994.2 | 603994 | 23599   | 19,0 | 13.0460-4809.2 | 604809 | 24469 | 19,1 |
| 13.0460-3962.2  | 603962 | 20906 | 18,0  | 13.0460-3995.2 | 603995 | 23605   | 15,7 | 13.0460-4810.2 | 604810 | 24466 | 19,1 |
| 13.0460-3963.2  | 603963 | 21586 | 15,0  | 13.0460-3995.2 | 603995 | 23607   | 15,7 | 13.0460-4810.2 | 604810 | 24467 | 19,1 |
| 13.0460-3964.2  | 603964 | 21586 | 15,0  | 13.0460-3996.2 | 603996 | 23276   | 17,2 | 13.0460-4811.2 | 604811 | 24466 | 19,1 |
| 13.0460-3964.2  | 603964 | 23410 | 15,0  | 13.0460-3997.2 | 603997 | 23277   | 17,7 | 13.0460-4811.2 | 604811 | 24467 | 19,1 |
| 13.0460-3964.2  | 603964 | 23411 | 15,0  | 13.0460-3998.2 | 603998 | 23273   | 17,8 | 13.0460-4812.2 | 604812 | 24465 | 19,2 |
| 13.0460-3965.2  | 603965 | 21171 | 18,0  | 13.0460-3999.2 | 603999 | 23743   | 20,1 | 13.0460-4814.2 | 604814 | 21937 | 15,5 |
| 13.0460-3965.2  | 603965 | 23300 | 18,0  | 13.0460-3999.2 | 603999 | 23744   | 20,1 | 13.0460-4815.2 | 604815 | 21937 | 15,5 |
| 13.0460-3965.2  | 603965 | 23301 | 18,0  | 13.0460-4014.2 | 604014 | 21278   | 16,4 | 13.0460-4816.2 | 604816 | 24541 | 15,5 |
| 13.0460-3966.2  | 603966 | 23600 | 19,4  | 13.0460-4014.2 | 604014 | 21279   | 16,4 | 13.0460-4817.2 | 604817 | 23960 | 18,3 |
| 13.0460-3968.2  | 603968 | 20488 | 18,5  | 13.0460-4019.2 | 604019 | 20034   | 15,0 | 13.0460-4818.2 | 604818 | 23142 | 15,1 |
| 13.0460-3968.2  | 603968 | 20489 | 18,5  | 13.0460-4019.2 | 604019 | 20911   | 15,0 | 13.0460-4818.2 | 604818 | 23143 | 15,1 |
| 13.0460-3968.2  | 603968 | 20570 | 18,5  | 13.0460-4028.2 | 604028 | 20228   | 15,3 | 13.0460-4819.2 | 604819 | 23478 | 14,6 |
| 13.0460-3968.2  | 603968 | 20571 | 18,5  | 13.0460-4029.2 | 604029 | 20228   | 18,5 | 13.0460-4823.2 | 604823 | 29232 | 21,0 |
| 13.0460-3969.2  | 603969 | 20926 | 18,5  | 13.0460-4030.2 | 604030 | 20687   | 13,5 | 13.0460-4826.2 | 604826 | 29192 | 20,7 |
| 13.0460-3969.2  | 603969 | 20927 | 18,5  | 13.0460-4033.2 | 604033 | 20034   | 15,0 | 13.0460-4827.2 | 604827 | 29200 | 21,0 |
| 13.0460-3969.2  | 603969 | 20928 | 18,5  | 13.0460-4034.2 | 604034 | 20687   | 15,5 | 13.0460-4828.2 | 604828 | 29122 | 22,1 |
| 13.0460-3969.2  | 603969 | 20929 | 18,5  | 13.0460-4035.2 | 604035 | 20173   | 15,0 | 13.0460-4829.2 | 604829 | 29231 | 22,7 |
| 13.0460-3972.2  | 603972 | 21632 | 16,0  | 13.0460-4036.2 | 604036 | 21035   | 15,0 | 13.0460-4830.2 | 604830 | 29229 | 20,7 |
| 13.0460-3973.2  | 603973 | 23146 | 17,0  | 13.0460-4037.2 | 604037 | 21024   | 17,5 | 13.0460-4832.2 | 604832 | 21381 | 18,0 |
| 13.0460-3975.2  | 603975 | 23597 | 18,0  | 13.0460-4040.2 | 604040 | 21050   | 15,8 | 13.0460-4833.2 | 604833 | 24098 | 17,1 |
| 13.0460-3975.2  | 603975 | 23598 | 18,0  | 13.0460-4041.2 | 604041 | 21179   | 16,8 | 13.0460-4834.2 | 604834 | 24097 | 17,1 |
| 13.0460-3976.2  | 603976 | 23258 | 16,5  | 13.0460-4041.2 | 604041 | 21289   | 16,8 | 13.0460-4837.2 | 604837 | 20217 | 17,1 |
| 13.0460-3976.2  | 603976 | 23259 | 16,5  | 13.0460-4042.2 | 604042 | 21191   | 16,8 | 13.0460-4839.2 | 604839 | 24455 | 16,8 |
| 13.0460-3976.2  | 603976 | 23262 | 16,5  | 13.0460-4042.2 | 604042 | 21267   | 16,8 | 13.0460-4840.2 | 604840 | 23961 | 16,8 |
| 13.0460-3976.2  | 603976 | 23263 | 16,5  | 13.0460-4043.2 | 604043 | 21140   | 15,0 | 13.0460-4841.2 | 604841 | 23489 | 16,3 |
| 13.0460-3977.2  | 603977 | 21980 | 18,0  | 13.0460-4044.2 | 604044 | 20755   | 15,1 | 13.0460-4842.2 | 604842 | 24049 | 17,0 |
| 13.0460-3977.2  | 603977 | 21981 | 18,0  | 13.0460-4047.2 | 604047 | 21305   | 15,7 | 13.0460-4844.2 | 604844 | 29256 | 27,0 |
| 13.0460-3978.2  | 603978 | 23332 | 18,0  | 13.0460-4048.2 | 604048 | 20011   | 15,0 | 13.0460-4847.2 | 604847 | 29160 | 20,3 |
| 13.0460-3978.2  | 603978 | 23333 | 18,0  | 13.0460-4056.2 | 604056 | 21402   | 17,5 | 13.0460-4848.2 | 604848 | 24316 | 16,9 |
| 13.0460-3979.2  | 603979 | 21999 | 15,8  | 13.0460-4058.2 | 604058 | 21832   | 14,9 | 13.0460-4849.2 | 604849 | 24315 | 16,2 |
| 13.0460-3979.2  | 603979 | 23001 | 15,8  | 13.0460-4059.2 | 604059 | 21278   | 16,4 | 13.0460-4850.2 | 604850 | 24296 | 15,5 |
| 13.0460-3980.2  | 603980 | 23022 | 20,9  | 13.0460-4059.2 | 604059 | 21279   | 16,4 | 13.0460-4851.2 | 604851 | 23092 | 16,0 |
| 13.0460-3982.2  | 603982 | 23705 | 18,1  | 13.0460-4060.2 | 604060 | 21900   | 15,0 | 13.0460-4851.2 | 604851 | 23111 | 16,0 |
| 13.0460-3982.2  | 603982 | 23706 | 18,1  | 13.0460-4064.2 | 604064 | 21919   | 15,3 | 13.0460-4852.2 | 604852 | 24553 | 15,8 |
| 13.0460-3982.2  | 603982 | 23707 | 18,1  | 13.0460-4065.2 | 604065 | 21899   | 15,3 | 13.0460-4853.2 | 604853 | 24162 | 15,2 |
| 13.0460-3983.2  | 603983 | 23708 | 19,4  | 13.0460-4066.2 | 604066 | 21857   | 17,7 | 13.0460-4853.2 | 604853 | 24687 | 15,2 |
| 13.0460-3983.2  | 603983 | 23709 | 19,4  | 13.0460-4069.2 | 604069 | 23078   | 15,9 | 13.0460-4854.2 | 604854 | 23092 | 16,3 |
| 13.0460-3983.2  | 603983 | 23710 | 19,4  | 13.0460-4070.2 | 604070 | 21163   | 14,5 | 13.0460-4854.2 | 604854 | 23756 | 16,3 |





# Vergleichsliste ATE → WVA

Cross reference list ATE → WVA - Tabella di conversione codici ATE → WVA

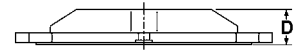
Liste des correspondances ATE → WVA - Lista referencias ATE → WVA



|  | WVA    | D     |  | WVA            | D      |  | WVA  | D              |        |       |      |
|---|--------|-------|---|----------------|--------|---|------|----------------|--------|-------|------|
| 13.0460-4854.2  | 604854 | 23757 | 16,3  | 13.0460-4969.2 | 604969 | 23754   | 18,0 | 13.0460-5601.2 | 605601 | 24492 | 16,0 |
| 13.0460-4855.2  | 604855 | 23325 | 16,4  | 13.0460-4971.2 | 604971 | 23092   | 16,0 | 13.0460-5601.2 | 605601 | 24493 | 16,0 |
| 13.0460-4856.2  | 604856 | 25147 | 18,4  | 13.0460-4971.2 | 604971 | 23110   | 16,0 | 13.0460-5602.2 | 605602 | 24122 | 19,0 |
| 13.0460-4856.2  | 604856 | 25148 | 18,4  | 13.0460-4971.2 | 604971 | 23111   | 16,0 | 13.0460-5602.2 | 605602 | 24590 | 19,0 |
| 13.0460-4857.2  | 604857 | 25172 | 18,4  | 13.0460-4972.2 | 604972 | 23575   | 16,0 | 13.0460-5602.2 | 605602 | 24591 | 19,0 |
| 13.0460-4857.2  | 604857 | 25173 | 18,4  | 13.0460-4972.2 | 604972 | 23576   | 16,0 | 13.0460-5603.2 | 605603 | 24204 | 19,2 |
| 13.0460-4858.2  | 604858 | 25112 | 18,4  | 13.0460-4973.2 | 604973 | 23092   | 16,0 | 13.0460-5603.2 | 605603 | 24690 | 19,2 |
| 13.0460-4858.2  | 604858 | 25113 | 18,4  | 13.0460-4973.2 | 604973 | 23325   | 16,0 | 13.0460-5603.2 | 605603 | 24691 | 19,2 |
| 13.0460-4859.2  | 604859 | 23921 | 20,1  | 13.0460-4974.2 | 604974 | 21580   | 14,6 | 13.0460-5604.2 | 605604 | 24664 | 15,2 |
| 13.0460-4859.2  | 604859 | 24589 | 20,1  | 13.0460-4974.2 | 604974 | 23323   | 14,6 | 13.0460-5604.2 | 605604 | 24665 | 15,2 |
| 13.0460-4860.2  | 604860 | 29121 | 20,3  | 13.0460-4975.2 | 604975 | 29160   | 20,8 | 13.0460-5604.2 | 605604 | 24666 | 15,2 |
| 13.0460-4861.2  | 604861 | 29121 | 20,3  | 13.0460-4976.2 | 604976 | 23694   | 16,7 | 13.0460-5605.2 | 605605 | 24545 | 16,9 |
| 13.0460-4861.2  | 604861 | 29260 | 20,3  | 13.0460-4977.2 | 604977 | 23157   | 15,8 | 13.0460-5606.2 | 605606 | 24544 | 18,1 |
| 13.0460-4862.2  | 604862 | 29123 | 20,3  | 13.0460-4978.2 | 604978 | 23917   | 19,3 | 13.0460-5607.2 | 605607 | 24245 | 18,5 |
| 13.0460-4863.2  | 604863 | 24976 | 17,5  | 13.0460-4978.2 | 604978 | 23918   | 19,3 | 13.0460-5608.2 | 605608 | 24244 | 18,5 |
| 13.0460-4864.2  | 604864 | 24455 | 16,8  | 13.0460-4979.2 | 604979 | 23919   | 19,3 | 13.0460-5609.2 | 605609 | 24346 | 16,4 |
| 13.0460-4865.2  | 604865 | 29160 | 20,3  | 13.0460-4979.2 | 604979 | 23920   | 19,3 | 13.0460-5610.2 | 605610 | 24582 | 17,4 |
| 13.0460-4865.2  | 604865 | 29327 | 20,3  | 13.0460-4980.2 | 604980 | 23921   | 20,3 | 13.0460-5610.2 | 605610 | 24629 | 17,4 |
| 13.0460-4866.2  | 604866 | 29229 | 20,7  | 13.0460-4984.2 | 604984 | 23271   | 17,4 | 13.0460-5610.2 | 605610 | 24630 | 17,4 |
| 13.0460-4866.2  | 604866 | 29230 | 20,7  | 13.0460-4985.2 | 604985 | 21381   | 18,0 | 13.0460-5611.2 | 605611 | 24415 | 19,1 |
| 13.0460-4867.2  | 604867 | 24852 | 16,0  | 13.0460-4985.2 | 604985 | 23206   | 18,0 | 13.0460-5611.2 | 605611 | 24416 | 19,1 |
| 13.0460-4867.2  | 604867 | 24853 | 16,0  | 13.0460-4985.2 | 604985 | 23207   | 18,0 | 13.0460-5611.2 | 605611 | 24417 | 19,1 |
| 13.0460-4869.2  | 604869 | 25183 | 17,9  | 13.0460-4986.2 | 604986 | 21965   | 15,0 | 13.0460-5612.2 | 605612 | 24412 | 19,0 |
| 13.0460-4870.2  | 604870 | 25179 | 17,8  | 13.0460-4986.2 | 604986 | 21966   | 15,0 | 13.0460-5612.2 | 605612 | 24413 | 19,0 |
| 13.0460-4873.2  | 604873 | 24847 | 17,0  | 13.0460-4987.2 | 604987 | 23329   | 17,0 | 13.0460-5612.2 | 605612 | 24414 | 19,0 |
| 13.0460-4874.2  | 604874 | 25029 | 16,7  | 13.0460-4988.2 | 604988 | 21792   | 15,2 | 13.0460-5613.2 | 605613 | 25262 | 15,0 |
| 13.0460-4875.2  | 604875 | 25028 | 18,0  | 13.0460-4989.2 | 604989 | 29212   | 17,3 | 13.0460-5613.2 | 605613 | 25273 | 15,0 |
| 13.0460-4877.2  | 604877 | 29192 | 20,3  | 13.0460-4990.2 | 604990 | 23271   | 17,4 | 13.0460-5613.2 | 605613 | 25274 | 15,0 |
| 13.0460-4879.2  | 604879 | 25643 | 16,8  | 13.0460-4990.2 | 604990 | 23745   | 17,4 | 13.0460-5614.2 | 605614 | 24601 | 18,0 |
| 13.0460-4882.2  | 604882 | 22102 | 18,2  | 13.0460-4991.2 | 604991 | 23092   | 16,0 | 13.0460-5615.2 | 605615 | 24946 | 19,0 |
| 13.0460-4884.2  | 604884 | 22062 | 20,7  | 13.0460-4991.2 | 604991 | 24273   | 16,0 | 13.0460-5615.2 | 605615 | 24947 | 19,6 |
| 13.0460-4900.2  | 604900 | 20371 | 8,1   | 13.0460-4991.2 | 604991 | 24274   | 16,0 | 13.0460-5615.2 | 605615 | 24948 | 19,6 |
| 13.0460-4906.2  | 604906 | 20207 | 12,0  | 13.0460-4992.2 | 604992 | 23692   | 16,6 | 13.0460-5616.2 | 605616 | 24567 | 16,0 |
| 13.0460-4910.2  | 604910 | 20285 | 7,1   | 13.0460-4993.2 | 604993 | 23693   | 16,6 | 13.0460-5617.2 | 605617 | 24451 | 15,6 |
| 13.0460-4911.2  | 604911 | 20389 | 15,4  | 13.0460-4994.2 | 604994 | 23945   | 16,5 | 13.0460-5618.2 | 605618 | 24386 | 17,9 |
| 13.0460-4913.2  | 604913 | 29037 | 18,3  | 13.0460-4995.2 | 604995 | 23575   | 15,6 | 13.0460-5618.2 | 605618 | 24394 | 17,9 |
| 13.0460-4913.2  | 604913 | 29038 | 18,3  | 13.0460-4995.2 | 604995 | 23576   | 15,6 | 13.0460-5618.2 | 605618 | 24395 | 17,9 |
| 13.0460-4914.2  | 604914 | 29122 | 22,3  | 13.0460-4996.2 | 604996 | 29123   | 20,3 | 13.0460-5619.2 | 605619 | 24653 | 17,3 |
| 13.0460-4918.2  | 604918 | 21048 | 18,3  | 13.0460-4997.2 | 604997 | 23943   | 17,5 | 13.0460-5620.2 | 605620 | 24979 | 15,9 |
| 13.0460-4918.2  | 604918 | 29140 | 18,3  | 13.0460-4997.2 | 604997 | 23944   | 17,5 | 13.0460-5620.2 | 605620 | 24980 | 15,9 |
| 13.0460-4919.2  | 604919 | 29037 | 18,3  | 13.0460-4998.2 | 604998 | 23478   | 16,5 | 13.0460-5620.2 | 605620 | 24981 | 15,9 |
| 13.0460-4919.2  | 604919 | 29139 | 18,3  | 13.0460-4999.2 | 604999 | 23330   | 17,0 | 13.0460-5621.2 | 605621 | 24423 | 14,6 |
| 13.0460-4921.2  | 604921 | 23305 | 15,2  | 13.0460-5029.2 | 605029 | 20126   | 15,0 | 13.0460-5622.2 | 605622 | 23726 | 16,5 |
| 13.0460-4955.2  | 604955 | 21048 | 18,3  | 13.0460-5030.2 | 605030 | 20323   | 16,5 | 13.0460-5622.2 | 605622 | 23727 | 16,5 |
| 13.0460-4955.2  | 604955 | 21049 | 18,3  | 13.0460-5032.2 | 605032 | 20588   | 16,5 | 13.0460-5622.2 | 605622 | 23728 | 16,5 |
| 13.0460-4956.2  | 604956 | 20162 | 15,4  | 13.0460-5403.2 | 605403 | 21211   | 18,7 | 13.0460-5623.2 | 605623 | 23673 | 15,9 |
| 13.0460-4957.2  | 604957 | 20410 | 15,0  | 13.0460-5403.2 | 605403 | 21212   | 18,7 | 13.0460-5623.2 | 605623 | 23674 | 15,9 |
| 13.0460-4957.2  | 604957 | 20423 | 15,0  | 13.0460-5405.2 | 605405 | 21643   | 17,8 | 13.0460-5623.2 | 605623 | 23675 | 15,9 |
| 13.0460-4958.2  | 604958 | 21381 | 17,3  | 13.0460-5405.2 | 605405 | 21644   | 17,8 | 13.0460-5625.2 | 605625 | 21319 | 14,9 |
| 13.0460-4958.2  | 604958 | 21382 | 17,3  | 13.0460-5409.2 | 605409 | 21193   | 18,0 | 13.0460-5625.2 | 605625 | 21320 | 14,9 |
| 13.0460-4964.2  | 604964 | 21381 | 15,0  | 13.0460-5409.2 | 605409 | 21194   | 18,0 | 13.0460-5625.2 | 605625 | 21321 | 14,9 |
| 13.0460-4965.2  | 604965 | 21471 | 18,0  | 13.0460-5410.2 | 605410 | 21193   | 18,0 | 13.0460-5626.2 | 605626 | 21713 | 16,0 |
| 13.0460-4966.2  | 604966 | 29121 | 20,3  | 13.0460-5410.2 | 605410 | 21195   | 18,0 | 13.0460-5626.2 | 605626 | 21714 | 16,0 |
| 13.0460-4968.2  | 604968 | 21381 | 18,0  | 13.0460-5600.2 | 605600 | 24501   | 16,7 | 13.0460-5626.2 | 605626 | 21715 | 16,0 |
| 13.0460-4968.2  | 604968 | 23206 | 18,0  | 13.0460-5600.2 | 605600 | 24502   | 16,7 | 13.0460-5627.2 | 605627 | 21569 | 14,9 |
| 13.0460-4968.2  | 604968 | 23207 | 18,0  | 13.0460-5600.2 | 605600 | 24503   | 16,7 | 13.0460-5627.2 | 605627 | 21570 | 15,9 |
| 13.0460-4969.2  | 604969 | 23753 | 18,0  | 13.0460-5601.2 | 605601 | 24491   | 16,0 | 13.0460-5627.2 | 605627 | 23514 | 15,9 |





# Vergleichsliste ATE → WVA

Cross reference list ATE → WVA - Tabella di conversione codici ATE → WVA

Liste des correspondances ATE → WVA - Lista referencias ATE → WVA



|  | WVA    | D     |  | WVA            | D      |  | WVA  | D              |        |       |      |
|---|--------|-------|---|----------------|--------|---|------|----------------|--------|-------|------|
| 13.0460-5628.2  | 605628 | 24331 | 13,8  | 13.0460-5711.2 | 605711 | 23736   | 15,7 | 13.0460-5754.2 | 605754 | 24635 | 16,6 |
| 13.0460-5629.2  | 605629 | 24602 | 16,0  | 13.0460-5712.2 | 605712 | 23450   | 17,5 | 13.0460-5754.2 | 605754 | 24636 | 16,6 |
| 13.0460-5629.2  | 605629 | 24603 | 16,0  | 13.0460-5712.2 | 605712 | 23451   | 17,5 | 13.0460-5754.2 | 605754 | 24637 | 16,9 |
| 13.0460-5631.2  | 605631 | 24529 | 16,0  | 13.0460-5713.2 | 605713 | 21650   | 15,5 | 13.0460-5755.2 | 605755 | 23178 | 16,6 |
| 13.0460-5631.2  | 605631 | 24530 | 16,0  | 13.0460-5714.2 | 605714 | 23720   | 17,5 | 13.0460-5755.2 | 605755 | 23530 | 16,6 |
| 13.0460-5632.2  | 605632 | 23970 | 16,8  | 13.0460-5714.2 | 605714 | 24213   | 17,5 | 13.0460-5755.2 | 605755 | 23531 | 16,6 |
| 13.0460-5632.2  | 605632 | 23971 | 16,8  | 13.0460-5714.2 | 605714 | 24214   | 17,5 | 13.0460-5756.2 | 605756 | 24087 | 17,4 |
| 13.0460-5632.2  | 605632 | 23972 | 16,8  | 13.0460-5716.2 | 605716 | 21561   | 17,0 | 13.0460-5756.2 | 605756 | 24405 | 17,4 |
| 13.0460-5633.2  | 605633 | 25520 | 15,8  | 13.0460-5716.2 | 605716 | 21562   | 17,0 | 13.0460-5756.2 | 605756 | 24406 | 17,4 |
| 13.0460-5633.2  | 605633 | 25521 | 15,8  | 13.0460-5717.2 | 605717 | 23502   | 16,0 | 13.0460-5757.2 | 605757 | 24086 | 15,8 |
| 13.0460-5633.2  | 605633 | 25522 | 15,8  | 13.0460-5717.2 | 605717 | 23503   | 16,0 | 13.0460-5757.2 | 605757 | 24518 | 15,8 |
| 13.0460-5634.2  | 605634 | 24452 | 17,5  | 13.0460-5717.2 | 605717 | 23504   | 16,0 | 13.0460-5757.2 | 605757 | 24519 | 15,8 |
| 13.0460-5635.2  | 605635 | 24918 | 15,0  | 13.0460-5718.2 | 605718 | 23081   | 18,0 | 13.0460-5760.2 | 605760 | 23584 | 16,4 |
| 13.0460-5636.2  | 605636 | 24599 | 14,9  | 13.0460-5718.2 | 605718 | 23082   | 18,0 | 13.0460-5761.2 | 605761 | 24297 | 14,4 |
| 13.0460-5636.2  | 605636 | 24600 | 14,9  | 13.0460-5718.2 | 605718 | 23083   | 18,0 | 13.0460-5762.2 | 605762 | 24298 | 14,0 |
| 13.0460-5636.2  | 605636 | 24686 | 14,9  | 13.0460-5720.2 | 605720 | 20708   | 14,5 | 13.0460-5762.2 | 605762 | 24299 | 14,0 |
| 13.0460-5637.2  | 605637 | 24488 | 14,9  | 13.0460-5722.2 | 605722 | 21468   | 15,5 | 13.0460-5763.2 | 605763 | 21730 | 14,0 |
| 13.0460-5637.2  | 605637 | 24489 | 14,9  | 13.0460-5725.2 | 605725 | 23649   | 17,2 | 13.0460-5763.2 | 605763 | 21730 | 14,9 |
| 13.0460-5637.2  | 605637 | 24490 | 14,9  | 13.0460-5725.2 | 605725 | 23650   | 17,2 | 13.0460-5764.2 | 605764 | 24350 | 17,3 |
| 13.0460-5638.2  | 605638 | 25119 | 16,9  | 13.0460-5725.2 | 605725 | 23651   | 17,2 | 13.0460-5765.2 | 605765 | 24338 | 15,5 |
| 13.0460-5638.2  | 605638 | 25889 | 16,9  | 13.0460-5727.2 | 605727 | 23160   | 17,3 | 13.0460-5766.2 | 605766 | 24337 | 17,5 |
| 13.0460-5638.2  | 605638 | 25890 | 16,9  | 13.0460-5727.2 | 605727 | 23164   | 17,3 | 13.0460-5767.2 | 605767 | 24336 | 17,5 |
| 13.0460-5639.2  | 605639 | 24375 | 17,5  | 13.0460-5731.2 | 605731 | 21738   | 13,5 | 13.0460-5768.2 | 605768 | 24347 | 17,5 |
| 13.0460-5639.2  | 605639 | 24376 | 17,5  | 13.0460-5731.2 | 605731 | 23343   | 13,5 | 13.0460-5769.2 | 605769 | 24610 | 15,0 |
| 13.0460-5639.2  | 605639 | 24618 | 17,5  | 13.0460-5731.2 | 605731 | 23344   | 13,5 | 13.0460-5769.2 | 605769 | 24611 | 15,0 |
| 13.0460-5639.2  | 605639 | 24619 | 17,5  | 13.0460-5732.2 | 605732 | 24029   | 12,5 | 13.0460-5769.2 | 605769 | 24612 | 15,0 |
| 13.0460-5639.2  | 605639 | 24620 | 17,5  | 13.0460-5732.2 | 605732 | 24030   | 12,5 | 13.0460-5770.2 | 605770 | 23983 | 17,0 |
| 13.0460-5640.2  | 605640 | 21854 | 15,0  | 13.0460-5734.2 | 605734 | 23967   | 15,1 | 13.0460-5771.2 | 605771 | 24599 | 14,9 |
| 13.0460-5640.2  | 605640 | 21856 | 15,0  | 13.0460-5735.2 | 605735 | 24014   | 16,0 | 13.0460-5771.2 | 605771 | 24600 | 14,9 |
| 13.0460-5641.2  | 605641 | 25187 | 17,8  | 13.0460-5735.2 | 605735 | 24015   | 16,0 | 13.0460-5771.2 | 605771 | 24686 | 14,9 |
| 13.0460-5641.2  | 605641 | 25188 | 17,8  | 13.0460-5736.2 | 605736 | 24215   | 15,7 | 13.0460-5772.2 | 605772 | 24092 | 17,1 |
| 13.0460-5641.2  | 605641 | 25189 | 17,8  | 13.0460-5736.2 | 605736 | 24216   | 15,7 | 13.0460-5772.2 | 605772 | 24178 | 17,1 |
| 13.0460-5642.2  | 605642 | 25268 | 17,8  | 13.0460-5736.2 | 605736 | 24217   | 15,7 | 13.0460-5772.2 | 605772 | 24179 | 17,1 |
| 13.0460-5642.2  | 605642 | 25269 | 17,8  | 13.0460-5738.2 | 605738 | 23702   | 15,1 | 13.0460-5773.2 | 605773 | 23993 | 15,5 |
| 13.0460-5642.2  | 605642 | 25270 | 17,8  | 13.0460-5739.2 | 605739 | 24071   | 14,6 | 13.0460-5773.2 | 605773 | 23997 | 15,5 |
| 13.0460-5645.2  | 605645 | 25692 | 17,2  | 13.0460-5742.2 | 605742 | 23966   | 17,7 | 13.0460-5773.2 | 605773 | 24058 | 15,5 |
| 13.0460-5645.2  | 605645 | 25693 | 17,2  | 13.0460-5742.2 | 605742 | 23987   | 17,7 | 13.0460-5774.2 | 605774 | 24830 | 16,1 |
| 13.0460-5645.2  | 605645 | 25694 | 17,2  | 13.0460-5742.2 | 605742 | 23988   | 17,7 | 13.0460-5774.2 | 605774 | 24831 | 16,1 |
| 13.0460-5646.2  | 605646 | 25348 | 17,8  | 13.0460-5743.2 | 605743 | 23928   | 17,3 | 13.0460-5775.2 | 605775 | 24276 | 14,8 |
| 13.0460-5646.2  | 605646 | 25349 | 17,8  | 13.0460-5744.2 | 605744 | 21947   | 15,4 | 13.0460-5775.2 | 605775 | 24479 | 14,8 |
| 13.0460-5646.2  | 605646 | 25350 | 17,8  | 13.0460-5745.2 | 605745 | 21775   | 15,0 | 13.0460-5775.2 | 605775 | 24480 | 14,8 |
| 13.0460-5648.2  | 605648 | 24435 | 14,8  | 13.0460-5745.2 | 605745 | 21776   | 15,0 | 13.0460-5776.2 | 605776 | 24275 | 16,5 |
| 13.0460-5648.2  | 605648 | 24661 | 14,8  | 13.0460-5746.2 | 605746 | 23524   | 17,4 | 13.0460-5776.2 | 605776 | 24410 | 16,5 |
| 13.0460-5648.2  | 605648 | 24662 | 14,8  | 13.0460-5746.2 | 605746 | 23525   | 17,4 | 13.0460-5776.2 | 605776 | 24411 | 16,5 |
| 13.0460-5649.2  | 605649 | 25365 | 16,0  | 13.0460-5747.2 | 605747 | 24024   | 17,0 | 13.0460-5777.2 | 605777 | 24351 | 16,3 |
| 13.0460-5649.2  | 605649 | 25366 | 16,0  | 13.0460-5747.2 | 605747 | 24025   | 17,0 | 13.0460-5777.2 | 605777 | 24568 | 16,3 |
| 13.0460-5649.2  | 605649 | 25367 | 16,0  | 13.0460-5747.2 | 605747 | 24026   | 17,0 | 13.0460-5777.2 | 605777 | 24569 | 16,3 |
| 13.0460-5700.2  | 605700 | 23973 | 17,0  | 13.0460-5748.2 | 605748 | 23429   | 15,5 | 13.0460-5778.2 | 605778 | 23698 | 16,8 |
| 13.0460-5700.2  | 605700 | 24403 | 17,0  | 13.0460-5749.2 | 605749 | 23539   | 17,3 | 13.0460-5778.2 | 605778 | 23699 | 16,8 |
| 13.0460-5701.2  | 605701 | 20392 | 18,5  | 13.0460-5750.2 | 605750 | 23734   | 16,8 | 13.0460-5779.2 | 605779 | 24317 | 17,6 |
| 13.0460-5703.2  | 605703 | 21154 | 19,5  | 13.0460-5751.2 | 605751 | 23502   | 16,0 | 13.0460-5779.2 | 605779 | 24318 | 17,6 |
| 13.0460-5703.2  | 605703 | 21155 | 19,5  | 13.0460-5751.2 | 605751 | 23503   | 16,0 | 13.0460-5779.2 | 605779 | 24319 | 17,6 |
| 13.0460-5709.2  | 605709 | 24229 | 14,8  | 13.0460-5751.2 | 605751 | 23504   | 16,0 | 13.0460-5780.2 | 605780 | 24320 | 15,3 |
| 13.0460-5709.2  | 605709 | 24230 | 15,3  | 13.0460-5752.2 | 605752 | 24632   | 17,0 | 13.0460-5780.2 | 605780 | 24321 | 15,3 |
| 13.0460-5710.2  | 605710 | 23783 | 14,0  | 13.0460-5753.2 | 605753 | 24638   | 20,0 | 13.0460-5780.2 | 605780 | 24322 | 15,3 |
| 13.0460-5711.2  | 605711 | 23652 | 15,7  | 13.0460-5753.2 | 605753 | 24639   | 19,3 | 13.0460-5782.2 | 605782 | 24488 | 14,9 |
| 13.0460-5711.2  | 605711 | 23653 | 15,7  | 13.0460-5753.2 | 605753 | 24640   | 19,3 | 13.0460-5782.2 | 605782 | 24489 | 14,9 |





# Vergleichsliste ATE → WVA

Cross reference list ATE → WVA - Tabella di conversione codici ATE → WVA

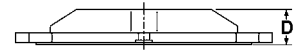
Liste des correspondances ATE → WVA - Lista referencias ATE → WVA



|  | WVA    | D     |  | WVA            | D      |  | WVA  | D              |        |       |      |
|---|--------|-------|---|----------------|--------|---|------|----------------|--------|-------|------|
| 13.0460-5782.2  | 605782 | 24490 | 14,9  | 13.0460-5808.2 | 605808 | 21718   | 16,0 | 13.0460-5831.2 | 605831 | 23777 | 16,0 |
| 13.0460-5783.2  | 605783 | 24227 | 16,7  | 13.0460-5809.2 | 605809 | 21975   | 18,2 | 13.0460-5831.2 | 605831 | 23778 | 17,0 |
| 13.0460-5783.2  | 605783 | 24228 | 16,7  | 13.0460-5809.2 | 605809 | 21976   | 18,2 | 13.0460-5831.2 | 605831 | 23779 | 17,0 |
| 13.0460-5784.2  | 605784 | 24240 | 16,6  | 13.0460-5809.2 | 605809 | 21977   | 18,2 | 13.0460-5832.2 | 605832 | 23569 | 16,5 |
| 13.0460-5784.2  | 605784 | 24242 | 16,6  | 13.0460-5810.2 | 605810 | 23510   | 16,5 | 13.0460-5832.2 | 605832 | 23570 | 16,5 |
| 13.0460-5784.2  | 605784 | 24243 | 16,6  | 13.0460-5810.2 | 605810 | 23511   | 16,5 | 13.0460-5832.2 | 605832 | 23571 | 16,5 |
| 13.0460-5785.2  | 605785 | 24510 | 17,0  | 13.0460-5810.2 | 605810 | 23512   | 16,5 | 13.0460-5833.2 | 605833 | 23543 | 14,4 |
| 13.0460-5785.2  | 605785 | 24511 | 17,0  | 13.0460-5810.2 | 605810 | 23904   | 16,5 | 13.0460-5833.2 | 605833 | 23544 | 14,4 |
| 13.0460-5785.2  | 605785 | 24512 | 17,0  | 13.0460-5810.2 | 605810 | 23905   | 16,5 | 13.0460-5833.2 | 605833 | 23545 | 14,4 |
| 13.0460-5786.2  | 605786 | 24934 | 15,0  | 13.0460-5810.2 | 605810 | 23906   | 16,5 | 13.0460-5834.2 | 605834 | 23354 | 13,0 |
| 13.0460-5786.2  | 605786 | 24935 | 15,0  | 13.0460-5810.2 | 605810 | 23907   | 16,5 | 13.0460-5835.2 | 605835 | 20076 | 15,5 |
| 13.0460-5786.2  | 605786 | 24936 | 15,0  | 13.0460-5810.2 | 605810 | 24778   | 16,5 | 13.0460-5835.2 | 605835 | 20077 | 15,5 |
| 13.0460-5787.2  | 605787 | 23865 | 17,6  | 13.0460-5810.2 | 605810 | 24779   | 16,5 | 13.0460-5836.2 | 605836 | 23662 | 15,0 |
| 13.0460-5787.2  | 605787 | 23867 | 17,6  | 13.0460-5810.2 | 605810 | 24780   | 16,5 | 13.0460-5837.2 | 605837 | 23296 | 14,5 |
| 13.0460-5788.2  | 605788 | 24498 | 14,7  | 13.0460-5810.2 | 605810 | 24781   | 16,5 | 13.0460-5837.2 | 605837 | 23297 | 14,5 |
| 13.0460-5788.2  | 605788 | 24499 | 14,7  | 13.0460-5811.2 | 605811 | 23348   | 16,5 | 13.0460-5837.2 | 605837 | 23298 | 14,5 |
| 13.0460-5788.2  | 605788 | 24500 | 14,7  | 13.0460-5811.2 | 605811 | 23349   | 16,5 | 13.0460-5837.2 | 605837 | 23299 | 14,5 |
| 13.0460-5789.2  | 605789 | 20325 | 17,2  | 13.0460-5811.2 | 605811 | 23350   | 16,5 | 13.0460-5838.2 | 605838 | 23400 | 15,5 |
| 13.0460-5789.2  | 605789 | 24396 | 17,2  | 13.0460-5812.2 | 605812 | 23521   | 14,0 | 13.0460-5839.2 | 605839 | 23795 | 15,0 |
| 13.0460-5790.2  | 605790 | 24323 | 15,5  | 13.0460-5812.2 | 605812 | 23522   | 14,0 | 13.0460-5839.2 | 605839 | 23796 | 15,0 |
| 13.0460-5790.2  | 605790 | 24324 | 15,5  | 13.0460-5812.2 | 605812 | 23523   | 14,0 | 13.0460-5839.2 | 605839 | 23797 | 15,0 |
| 13.0460-5790.2  | 605790 | 24325 | 15,5  | 13.0460-5813.2 | 605813 | 23480   | 19,3 | 13.0460-5840.2 | 605840 | 21833 | 15,0 |
| 13.0460-5791.2  | 605791 | 24218 | 17,5  | 13.0460-5813.2 | 605813 | 23481   | 19,3 | 13.0460-5840.2 | 605840 | 21834 | 15,0 |
| 13.0460-5791.2  | 605791 | 24219 | 17,5  | 13.0460-5813.2 | 605813 | 23768   | 19,3 | 13.0460-5841.2 | 605841 | 23023 | 14,8 |
| 13.0460-5791.2  | 605791 | 24220 | 17,5  | 13.0460-5814.2 | 605814 | 23620   | 16,4 | 13.0460-5841.2 | 605841 | 23024 | 14,8 |
| 13.0460-5792.2  | 605792 | 23536 | 17,6  | 13.0460-5814.2 | 605814 | 23621   | 16,4 | 13.0460-5841.2 | 605841 | 23025 | 14,8 |
| 13.0460-5792.2  | 605792 | 23537 | 17,6  | 13.0460-5814.2 | 605814 | 23622   | 16,4 | 13.0460-5842.2 | 605842 | 23420 | 16,5 |
| 13.0460-5792.2  | 605792 | 23538 | 17,6  | 13.0460-5815.2 | 605815 | 23766   | 17,8 | 13.0460-5843.2 | 605843 | 23871 | 14,3 |
| 13.0460-5793.2  | 605793 | 24372 | 17,3  | 13.0460-5815.2 | 605815 | 23818   | 17,8 | 13.0460-5843.2 | 605843 | 23872 | 14,3 |
| 13.0460-5794.2  | 605794 | 24283 | 15,5  | 13.0460-5815.2 | 605815 | 23819   | 17,8 | 13.0460-5843.2 | 605843 | 25778 | 14,3 |
| 13.0460-5794.2  | 605794 | 24284 | 15,5  | 13.0460-5816.2 | 605816 | 21243   | 14,0 | 13.0460-5844.2 | 605844 | 23996 | 17,5 |
| 13.0460-5794.2  | 605794 | 24285 | 15,5  | 13.0460-5817.2 | 605817 | 23526   | 17,5 | 13.0460-5844.2 | 605844 | 23998 | 17,5 |
| 13.0460-5795.2  | 605795 | 24353 | 16,0  | 13.0460-5818.2 | 605818 | 21497   | 18,0 | 13.0460-5844.2 | 605844 | 24009 | 17,5 |
| 13.0460-5795.2  | 605795 | 24672 | 16,0  | 13.0460-5818.2 | 605818 | 21498   | 18,0 | 13.0460-5845.2 | 605845 | 21961 | 15,5 |
| 13.0460-5797.2  | 605797 | 24222 | 16,9  | 13.0460-5818.2 | 605818 | 21499   | 18,0 | 13.0460-5846.2 | 605846 | 23836 | 17,0 |
| 13.0460-5797.2  | 605797 | 24223 | 16,9  | 13.0460-5819.2 | 605819 | 23816   | 16,0 | 13.0460-5847.2 | 605847 | 23646 | 16,5 |
| 13.0460-5797.2  | 605797 | 24224 | 16,9  | 13.0460-5820.2 | 605820 | 21694   | 16,3 | 13.0460-5847.2 | 605847 | 23647 | 16,5 |
| 13.0460-5797.2  | 605797 | 24225 | 16,9  | 13.0460-5820.2 | 605820 | 21695   | 16,3 | 13.0460-5847.2 | 605847 | 23648 | 16,5 |
| 13.0460-5799.2  | 605799 | 24597 | 17,7  | 13.0460-5820.2 | 605820 | 21696   | 16,3 | 13.0460-5848.2 | 605848 | 23585 | 17,4 |
| 13.0460-5799.2  | 605799 | 24598 | 17,7  | 13.0460-5821.2 | 605821 | 24046   | 18,6 | 13.0460-5848.2 | 605848 | 23586 | 17,4 |
| 13.0460-5799.2  | 605799 | 24609 | 17,7  | 13.0460-5821.2 | 605821 | 24047   | 18,6 | 13.0460-5849.2 | 605849 | 23656 | 14,0 |
| 13.0460-5800.2  | 605800 | 23340 | 17,0  | 13.0460-5821.2 | 605821 | 24048   | 18,6 | 13.0460-5849.2 | 605849 | 23657 | 14,0 |
| 13.0460-5800.2  | 605800 | 23341 | 17,0  | 13.0460-5822.2 | 605822 | 24246   | 16,8 | 13.0460-5849.2 | 605849 | 23658 | 14,0 |
| 13.0460-5800.2  | 605800 | 23342 | 17,0  | 13.0460-5822.2 | 605822 | 24248   | 16,8 | 13.0460-5850.2 | 605850 | 21703 | 15,0 |
| 13.0460-5801.2  | 605801 | 23973 | 17,4  | 13.0460-5822.2 | 605822 | 24249   | 16,8 | 13.0460-5850.2 | 605850 | 21704 | 15,0 |
| 13.0460-5802.2  | 605802 | 23490 | 15,4  | 13.0460-5824.2 | 605824 | 20008   | 13,0 | 13.0460-5850.2 | 605850 | 21705 | 15,0 |
| 13.0460-5803.2  | 605803 | 23238 | 16,0  | 13.0460-5825.2 | 605825 | 23094   | 16,5 | 13.0460-5851.2 | 605851 | 21915 | 17,2 |
| 13.0460-5803.2  | 605803 | 23239 | 16,0  | 13.0460-5825.2 | 605825 | 23563   | 16,5 | 13.0460-5851.2 | 605851 | 23558 | 17,2 |
| 13.0460-5803.2  | 605803 | 23240 | 16,0  | 13.0460-5825.2 | 605825 | 23564   | 16,5 | 13.0460-5851.2 | 605851 | 23559 | 17,2 |
| 13.0460-5804.2  | 605804 | 24045 | 13,7  | 13.0460-5826.2 | 605826 | 21872   | 14,5 | 13.0460-5851.2 | 605851 | 23560 | 17,2 |
| 13.0460-5806.2  | 605806 | 20002 | 15,0  | 13.0460-5826.2 | 605826 | 21873   | 14,5 | 13.0460-5852.2 | 605852 | 23497 | 15,0 |
| 13.0460-5806.2  | 605806 | 20191 | 15,0  | 13.0460-5826.2 | 605826 | 21874   | 14,5 | 13.0460-5852.2 | 605852 | 23498 | 14,8 |
| 13.0460-5806.2  | 605806 | 20192 | 15,0  | 13.0460-5827.2 | 605827 | 23527   | 14,5 | 13.0460-5853.2 | 605853 | 23488 | 15,4 |
| 13.0460-5807.2  | 605807 | 23093 | 16,6  | 13.0460-5829.2 | 605829 | 24277   | 16,0 | 13.0460-5854.2 | 605854 | 23487 | 15,5 |
| 13.0460-5807.2  | 605807 | 23463 | 16,6  | 13.0460-5829.2 | 605829 | 24397   | 16,0 | 13.0460-5855.2 | 605855 | 23582 | 16,0 |
| 13.0460-5808.2  | 605808 | 21716 | 16,0  | 13.0460-5829.2 | 605829 | 24398   | 16,0 | 13.0460-5855.2 | 605855 | 23583 | 16,0 |
| 13.0460-5808.2  | 605808 | 21717 | 16,0  | 13.0460-5830.2 | 605830 | 23158   | 17,5 | 13.0460-5856.2 | 605856 | 24039 | 14,4 |





# Vergleichsliste ATE → WVA

Cross reference list ATE → WVA - Tabella di conversione codici ATE → WVA

Liste des correspondances ATE → WVA - Lista referencias ATE → WVA



|  | WVA    | D     |  | WVA            | D      |  | WVA  | D              |        |       |      |
|---|--------|-------|---|----------------|--------|---|------|----------------|--------|-------|------|
| 13.0460-5856.2  | 605856 | 24040 | 14,4  | 13.0460-5881.2 | 605881 | 21099   | 17,0 | 13.0460-5933.2 | 605933 | 21725 | 16,8 |
| 13.0460-5856.2  | 605856 | 24041 | 14,4  | 13.0460-5882.2 | 605882 | 23703   | 17,9 | 13.0460-5933.2 | 605933 | 21726 | 16,8 |
| 13.0460-5857.2  | 605857 | 23314 | 15,0  | 13.0460-5884.2 | 605884 | 23515   | 15,8 | 13.0460-5933.2 | 605933 | 21727 | 16,8 |
| 13.0460-5859.2  | 605859 | 23234 | 16,9  | 13.0460-5885.2 | 605885 | 23518   | 17,0 | 13.0460-5934.2 | 605934 | 21041 | 15,0 |
| 13.0460-5859.2  | 605859 | 23235 | 16,9  | 13.0460-5885.2 | 605885 | 23519   | 17,0 | 13.0460-5934.2 | 605934 | 21168 | 15,0 |
| 13.0460-5859.2  | 605859 | 23236 | 16,9  | 13.0460-5885.2 | 605885 | 23520   | 17,0 | 13.0460-5935.2 | 605935 | 20852 | 15,5 |
| 13.0460-5860.2  | 605860 | 23868 | 17,1  | 13.0460-5886.2 | 605886 | 24059   | 16,7 | 13.0460-5936.2 | 605936 | 21012 | 15,0 |
| 13.0460-5860.2  | 605860 | 23869 | 17,1  | 13.0460-5886.2 | 605886 | 24060   | 16,7 | 13.0460-5937.2 | 605937 | 21119 | 17,0 |
| 13.0460-5860.2  | 605860 | 23870 | 17,1  | 13.0460-5886.2 | 605886 | 24061   | 16,7 | 13.0460-5937.2 | 605937 | 21130 | 17,0 |
| 13.0460-5861.2  | 605861 | 23097 | 17,1  | 13.0460-5887.2 | 605887 | 23507   | 15,2 | 13.0460-5937.2 | 605937 | 21229 | 17,0 |
| 13.0460-5861.2  | 605861 | 23528 | 17,1  | 13.0460-5887.2 | 605887 | 23508   | 15,2 | 13.0460-5938.2 | 605938 | 21158 | 15,5 |
| 13.0460-5861.2  | 605861 | 23529 | 17,1  | 13.0460-5887.2 | 605887 | 23509   | 15,2 | 13.0460-5940.2 | 605940 | 21373 | 16,0 |
| 13.0460-5862.2  | 605862 | 21688 | 15,3  | 13.0460-5888.2 | 605888 | 23817   | 16,6 | 13.0460-5940.2 | 605940 | 21374 | 16,0 |
| 13.0460-5863.2  | 605863 | 23234 | 16,8  | 13.0460-5888.2 | 605888 | 24034   | 16,6 | 13.0460-5940.2 | 605940 | 21375 | 16,0 |
| 13.0460-5863.2  | 605863 | 23235 | 16,8  | 13.0460-5888.2 | 605888 | 24035   | 16,6 | 13.0460-5941.2 | 605941 | 21657 | 16,4 |
| 13.0460-5863.2  | 605863 | 23236 | 16,8  | 13.0460-5889.2 | 605889 | 21650   | 15,0 | 13.0460-5941.2 | 605941 | 21658 | 16,4 |
| 13.0460-5864.2  | 605864 | 21907 | 15,5  | 13.0460-5890.2 | 605890 | 23290   | 15,5 | 13.0460-5941.2 | 605941 | 21659 | 16,4 |
| 13.0460-5864.2  | 605864 | 21908 | 15,5  | 13.0460-5891.2 | 605891 | 23513   | 17,0 | 13.0460-5942.2 | 605942 | 21543 | 16,5 |
| 13.0460-5864.2  | 605864 | 21909 | 15,5  | 13.0460-5892.2 | 605892 | 21689   | 15,5 | 13.0460-5942.2 | 605942 | 21544 | 16,5 |
| 13.0460-5865.2  | 605865 | 23387 | 12,6  | 13.0460-5894.2 | 605894 | 23759   | 17,0 | 13.0460-5943.2 | 605943 | 21697 | 15,0 |
| 13.0460-5865.2  | 605865 | 23388 | 12,6  | 13.0460-5895.2 | 605895 | 23780   | 16,7 | 13.0460-5943.2 | 605943 | 21698 | 15,0 |
| 13.0460-5865.2  | 605865 | 23389 | 12,6  | 13.0460-5896.2 | 605896 | 23442   | 15,3 | 13.0460-5943.2 | 605943 | 21699 | 15,0 |
| 13.0460-5866.2  | 605866 | 23876 | 12,4  | 13.0460-5896.2 | 605896 | 23443   | 15,3 | 13.0460-5944.2 | 605944 | 21654 | 15,0 |
| 13.0460-5866.2  | 605866 | 23878 | 12,4  | 13.0460-5896.2 | 605896 | 23444   | 15,3 | 13.0460-5944.2 | 605944 | 21655 | 15,0 |
| 13.0460-5867.2  | 605867 | 23863 | 14,3  | 13.0460-5897.2 | 605897 | 21822   | 17,5 | 13.0460-5944.2 | 605944 | 21656 | 15,0 |
| 13.0460-5868.2  | 605868 | 23873 | 15,8  | 13.0460-5897.2 | 605897 | 21823   | 17,5 | 13.0460-5949.2 | 605949 | 21280 | 16,0 |
| 13.0460-5868.2  | 605868 | 23874 | 15,8  | 13.0460-5897.2 | 605897 | 21824   | 17,5 | 13.0460-5950.2 | 605950 | 21546 | 16,7 |
| 13.0460-5868.2  | 605868 | 23875 | 15,8  | 13.0460-5897.2 | 605897 | 21825   | 17,5 | 13.0460-5951.2 | 605951 | 21601 | 17,5 |
| 13.0460-5869.2  | 605869 | 24013 | 14,9  | 13.0460-5898.2 | 605898 | 21952   | 15,0 | 13.0460-5951.2 | 605951 | 21602 | 17,5 |
| 13.0460-5869.2  | 605869 | 24020 | 14,9  | 13.0460-5898.2 | 605898 | 21953   | 15,0 | 13.0460-5951.2 | 605951 | 21603 | 17,5 |
| 13.0460-5871.2  | 605871 | 23455 | 13,7  | 13.0460-5898.2 | 605898 | 21954   | 15,0 | 13.0460-5952.2 | 605952 | 21647 | 16,0 |
| 13.0460-5871.2  | 605871 | 23456 | 13,7  | 13.0460-5899.2 | 605899 | 23974   | 17,6 | 13.0460-5952.2 | 605952 | 21648 | 16,0 |
| 13.0460-5871.2  | 605871 | 23457 | 13,7  | 13.0460-5916.2 | 605916 | 20731   | 15,3 | 13.0460-5952.2 | 605952 | 21649 | 16,0 |
| 13.0460-5872.2  | 605872 | 21012 | 15,0  | 13.0460-5918.2 | 605918 | 20099   | 15,0 | 13.0460-5953.2 | 605953 | 21650 | 15,0 |
| 13.0460-5872.2  | 605872 | 21773 | 15,0  | 13.0460-5918.2 | 605918 | 20104   | 15,0 | 13.0460-5954.2 | 605954 | 23845 | 15,8 |
| 13.0460-5872.2  | 605872 | 21774 | 15,0  | 13.0460-5918.2 | 605918 | 20108   | 15,0 | 13.0460-5954.2 | 605954 | 23846 | 15,8 |
| 13.0460-5873.2  | 605873 | 23891 | 16,9  | 13.0460-5919.2 | 605919 | 20193   | 15,0 | 13.0460-5954.2 | 605954 | 23847 | 15,8 |
| 13.0460-5873.2  | 605873 | 23892 | 16,9  | 13.0460-5919.2 | 605919 | 20194   | 15,0 | 13.0460-5955.2 | 605955 | 21879 | 18,6 |
| 13.0460-5873.2  | 605873 | 23893 | 16,9  | 13.0460-5919.2 | 605919 | 20959   | 15,0 | 13.0460-5955.2 | 605955 | 21880 | 18,6 |
| 13.0460-5874.2  | 605874 | 21553 | 14,0  | 13.0460-5920.2 | 605920 | 21322   | 15,0 | 13.0460-5955.2 | 605955 | 21881 | 18,6 |
| 13.0460-5874.2  | 605874 | 21554 | 14,0  | 13.0460-5920.2 | 605920 | 21323   | 15,0 | 13.0460-5956.2 | 605956 | 21626 | 15,0 |
| 13.0460-5874.2  | 605874 | 21555 | 14,0  | 13.0460-5920.2 | 605920 | 21324   | 15,0 | 13.0460-5957.2 | 605957 | 21347 | 17,0 |
| 13.0460-5875.2  | 605875 | 24031 | 17,7  | 13.0460-5923.2 | 605923 | 23384   | 18,3 | 13.0460-5957.2 | 605957 | 21348 | 17,0 |
| 13.0460-5875.2  | 605875 | 24032 | 17,7  | 13.0460-5923.2 | 605923 | 23385   | 18,3 | 13.0460-5957.2 | 605957 | 21349 | 17,0 |
| 13.0460-5875.2  | 605875 | 24033 | 17,7  | 13.0460-5924.2 | 605924 | 21832   | 14,9 | 13.0460-5958.2 | 605958 | 21363 | 15,8 |
| 13.0460-5876.2  | 605876 | 24369 | 17,2  | 13.0460-5926.2 | 605926 | 21845   | 16,5 | 13.0460-5958.2 | 605958 | 21768 | 15,8 |
| 13.0460-5876.2  | 605876 | 24373 | 17,2  | 13.0460-5926.2 | 605926 | 21846   | 16,5 | 13.0460-5958.2 | 605958 | 21769 | 15,8 |
| 13.0460-5876.2  | 605876 | 24374 | 17,2  | 13.0460-5926.2 | 605926 | 21847   | 16,5 | 13.0460-5959.2 | 605959 | 21481 | 15,5 |
| 13.0460-5877.2  | 605877 | 24042 | 16,3  | 13.0460-5927.2 | 605927 | 21875   | 16,0 | 13.0460-5960.2 | 605960 | 20863 | 16,5 |
| 13.0460-5878.2  | 605878 | 23729 | 16,9  | 13.0460-5927.2 | 605927 | 21876   | 16,0 | 13.0460-5961.2 | 605961 | 21252 | 15,0 |
| 13.0460-5878.2  | 605878 | 24054 | 16,9  | 13.0460-5927.2 | 605927 | 21877   | 16,0 | 13.0460-5961.2 | 605961 | 21253 | 15,0 |
| 13.0460-5878.2  | 605878 | 24055 | 16,9  | 13.0460-5929.2 | 605929 | 21719   | 15,0 | 13.0460-5962.2 | 605962 | 20957 | 16,0 |
| 13.0460-5879.2  | 605879 | 23611 | 18,8  | 13.0460-5929.2 | 605929 | 21720   | 15,0 | 13.0460-5963.2 | 605963 | 20958 | 16,0 |
| 13.0460-5879.2  | 605879 | 24132 | 18,8  | 13.0460-5929.2 | 605929 | 21721   | 15,0 | 13.0460-5966.2 | 605966 | 21142 | 15,0 |
| 13.0460-5880.2  | 605880 | 23184 | 14,8  | 13.0460-5932.2 | 605932 | 21378   | 15,0 | 13.0460-5967.2 | 605967 | 21500 | 15,0 |
| 13.0460-5880.2  | 605880 | 23185 | 14,8  | 13.0460-5932.2 | 605932 | 21379   | 16,0 | 13.0460-5967.2 | 605967 | 21501 | 15,0 |
| 13.0460-5880.2  | 605880 | 23672 | 14,8  | 13.0460-5932.2 | 605932 | 21380   | 16,0 | 13.0460-5967.2 | 605967 | 21502 | 15,0 |





# Vergleichsliste ATE → WVA

Cross reference list ATE → WVA - Tabella di conversione codici ATE → WVA

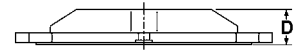
Liste des correspondances ATE → WVA - Lista referencias ATE → WVA



|  | WVA    |       | D    |  | WVA    |       | D    |  | WVA    |       | D    |
|---|--------|-------|------|---|--------|-------|------|---|--------|-------|------|
| 13.0460-5968.2  | 605968 | 21369 | 15,5 | 13.0460-6036.2  | 606036 | 21304 | 18,5 | 13.0460-7060.2  | 607060 | 21396 | 17,5 |
| 13.0460-5968.2  | 605968 | 21780 | 15,5 | 13.0460-6910.2  | 606910 | 20364 | 15,0 | 13.0460-7060.2  | 607060 | 21638 | 17,5 |
| 13.0460-5968.2  | 605968 | 21781 | 15,5 | 13.0460-6910.2  | 606910 | 20365 | 15,0 | 13.0460-7061.2  | 607061 | 21275 | 17,0 |
| 13.0460-5969.2  | 605969 | 21948 | 13,5 | 13.0460-6911.2  | 606911 | 20359 | 18,0 | 13.0460-7061.2  | 607061 | 21276 | 17,0 |
| 13.0460-5969.2  | 605969 | 21949 | 13,5 | 13.0460-6914.2  | 606914 | 20038 | 14,0 | 13.0460-7063.2  | 607063 | 21193 | 18,0 |
| 13.0460-5970.2  | 605970 | 21355 | 13,5 | 13.0460-6916.2  | 606916 | 21459 | 18,5 | 13.0460-7063.2  | 607063 | 21962 | 18,0 |
| 13.0460-5970.2  | 605970 | 21356 | 13,5 | 13.0460-6916.2  | 606916 | 21897 | 18,5 | 13.0460-7064.2  | 607064 | 21930 | 17,9 |
| 13.0460-5970.2  | 605970 | 21357 | 13,5 | 13.0460-6917.2  | 606917 | 21237 | 15,5 | 13.0460-7064.2  | 607064 | 21931 | 17,9 |
| 13.0460-5972.2  | 605972 | 21559 | 11,5 | 13.0460-6917.2  | 606917 | 21238 | 15,5 | 13.0460-7064.2  | 607064 | 21932 | 17,9 |
| 13.0460-5973.2  | 605973 | 21766 | 13,5 | 13.0460-6917.2  | 606917 | 21514 | 15,5 | 13.0460-7065.2  | 607065 | 21927 | 17,9 |
| 13.0460-5974.2  | 605974 | 21539 | 15,0 | 13.0460-6921.2  | 606921 | 24974 | 16,8 | 13.0460-7065.2  | 607065 | 21928 | 17,9 |
| 13.0460-5974.2  | 605974 | 21540 | 15,0 | 13.0460-6922.2  | 606922 | 21459 | 17,5 | 13.0460-7065.2  | 607065 | 21929 | 17,9 |
| 13.0460-5974.2  | 605974 | 21541 | 15,0 | 13.0460-6923.2  | 606923 | 23471 | 14,5 | 13.0460-7067.2  | 607067 | 21927 | 17,9 |
| 13.0460-5976.2  | 605976 | 20870 | 15,0 | 13.0460-6924.2  | 606924 | 23471 | 17,5 | 13.0460-7067.2  | 607067 | 21929 | 17,9 |
| 13.0460-5978.2  | 605978 | 21495 | 17,0 | 13.0460-6925.2  | 606925 | 21519 | 17,8 | 13.0460-7068.2  | 607068 | 21930 | 17,9 |
| 13.0460-5978.2  | 605978 | 21496 | 17,0 | 13.0460-6926.2  | 606926 | 20359 | 19,2 | 13.0460-7068.2  | 607068 | 21932 | 17,9 |
| 13.0460-5978.2  | 605978 | 21503 | 17,0 | 13.0460-6926.2  | 606926 | 21160 | 19,2 | 13.0460-7069.2  | 607069 | 21636 | 19,3 |
| 13.0460-5979.2  | 605979 | 21552 | 14,5 | 13.0460-7005.2  | 607005 | 20857 | 17,5 | 13.0460-7069.2  | 607069 | 21637 | 19,3 |
| 13.0460-5980.2  | 605980 | 21706 | 15,5 | 13.0460-7005.2  | 607005 | 20858 | 17,5 | 13.0460-7071.2  | 607071 | 20640 | 17,5 |
| 13.0460-5980.2  | 605980 | 21707 | 15,5 | 13.0460-7027.2  | 607027 | 20640 | 17,5 | 13.0460-7071.2  | 607071 | 20753 | 17,5 |
| 13.0460-5980.2  | 605980 | 21708 | 15,5 | 13.0460-7027.2  | 607027 | 20783 | 17,5 | 13.0460-7072.2  | 607072 | 21866 | 19,7 |
| 13.0460-5981.2  | 605981 | 21840 | 14,4 | 13.0460-7030.2  | 607030 | 20889 | 17,3 | 13.0460-7072.2  | 607072 | 21868 | 19,7 |
| 13.0460-5981.2  | 605981 | 21841 | 14,4 | 13.0460-7032.2  | 607032 | 20887 | 19,7 | 13.0460-7073.2  | 607073 | 21202 | 16,9 |
| 13.0460-5981.2  | 605981 | 21842 | 14,4 | 13.0460-7032.2  | 607032 | 20888 | 19,7 | 13.0460-7073.2  | 607073 | 21203 | 16,9 |
| 13.0460-5982.2  | 605982 | 21651 | 17,5 | 13.0460-7033.2  | 607033 | 20887 | 15,3 | 13.0460-7076.2  | 607076 | 21848 | 19,8 |
| 13.0460-5982.2  | 605982 | 21652 | 17,5 | 13.0460-7033.2  | 607033 | 20888 | 15,3 | 13.0460-7076.2  | 607076 | 21849 | 20,3 |
| 13.0460-5982.2  | 605982 | 21653 | 17,5 | 13.0460-7036.2  | 607036 | 20675 | 16,5 | 13.0460-7077.2  | 607077 | 20676 | 19,8 |
| 13.0460-5983.2  | 605983 | 21713 | 16,5 | 13.0460-7036.2  | 607036 | 20756 | 16,5 | 13.0460-7077.2  | 607077 | 21624 | 20,3 |
| 13.0460-5985.2  | 605985 | 21333 | 15,0 | 13.0460-7040.2  | 607040 | 20907 | 18,0 | 13.0460-7077.2  | 607077 | 21646 | 20,3 |
| 13.0460-5985.2  | 605985 | 21334 | 15,0 | 13.0460-7040.2  | 607040 | 20908 | 18,0 | 13.0460-7078.2  | 607078 | 21486 | 19,3 |
| 13.0460-5985.2  | 605985 | 21335 | 15,0 | 13.0460-7041.2  | 607041 | 20907 | 18,0 | 13.0460-7078.2  | 607078 | 21642 | 19,3 |
| 13.0460-5986.2  | 605986 | 21545 | 14,9 | 13.0460-7041.2  | 607041 | 20909 | 18,0 | 13.0460-7079.2  | 607079 | 21282 | 17,3 |
| 13.0460-5987.2  | 605987 | 23080 | 15,0 | 13.0460-7042.2  | 607042 | 20491 | 15,0 | 13.0460-7079.2  | 607079 | 21487 | 17,3 |
| 13.0460-5988.2  | 605988 | 23004 | 15,9 | 13.0460-7046.2  | 607046 | 20629 | 20,3 | 13.0460-7080.2  | 607080 | 21411 | 17,5 |
| 13.0460-5988.2  | 605988 | 23005 | 15,9 | 13.0460-7046.2  | 607046 | 20757 | 20,3 | 13.0460-7080.2  | 607080 | 21413 | 18,3 |
| 13.0460-5988.2  | 605988 | 23006 | 15,9 | 13.0460-7047.2  | 607047 | 20675 | 16,5 | 13.0460-7081.2  | 607081 | 20676 | 19,8 |
| 13.0460-5989.2  | 605989 | 23454 | 14,9 | 13.0460-7047.2  | 607047 | 20756 | 16,5 | 13.0460-7081.2  | 607081 | 21911 | 20,3 |
| 13.0460-5991.2  | 605991 | 20112 | 18,0 | 13.0460-7048.2  | 607048 | 20939 | 15,8 | 13.0460-7083.2  | 607083 | 21621 | 17,3 |
| 13.0460-5991.2  | 605991 | 20113 | 18,0 | 13.0460-7050.2  | 607050 | 20676 | 19,5 | 13.0460-7083.2  | 607083 | 21622 | 17,3 |
| 13.0460-5992.2  | 605992 | 21679 | 15,0 | 13.0460-7050.2  | 607050 | 20678 | 19,5 | 13.0460-7084.2  | 607084 | 21592 | 18,8 |
| 13.0460-5992.2  | 605992 | 21680 | 15,0 | 13.0460-7051.2  | 607051 | 20547 | 16,5 | 13.0460-7084.2  | 607084 | 21593 | 18,8 |
| 13.0460-5992.2  | 605992 | 21681 | 15,0 | 13.0460-7051.2  | 607051 | 21353 | 16,5 | 13.0460-7085.2  | 607085 | 21278 | 16,9 |
| 13.0460-5993.2  | 605993 | 23237 | 14,5 | 13.0460-7052.2  | 607052 | 21190 | 17,5 | 13.0460-7085.2  | 607085 | 21904 | 16,9 |
| 13.0460-5994.2  | 605994 | 23234 | 16,8 | 13.0460-7052.2  | 607052 | 21201 | 17,5 | 13.0460-7086.2  | 607086 | 21664 | 19,8 |
| 13.0460-5995.2  | 605995 | 21558 | 13,0 | 13.0460-7053.2  | 607053 | 21273 | 19,5 | 13.0460-7086.2  | 607086 | 21795 | 19,8 |
| 13.0460-5996.2  | 605996 | 23241 | 16,1 | 13.0460-7053.2  | 607053 | 21274 | 19,5 | 13.0460-7087.2  | 607087 | 21670 | 19,4 |
| 13.0460-5998.2  | 605998 | 21312 | 12,8 | 13.0460-7055.2  | 607055 | 20944 | 14,8 | 13.0460-7087.2  | 607087 | 21794 | 19,4 |
| 13.0460-5998.2  | 605998 | 21313 | 12,8 | 13.0460-7055.2  | 607055 | 21063 | 14,8 | 13.0460-7088.2  | 607088 | 21430 | 17,3 |
| 13.0460-5998.2  | 605998 | 21314 | 12,8 | 13.0460-7055.2  | 607055 | 21098 | 14,8 | 13.0460-7088.2  | 607088 | 21827 | 17,3 |
| 13.0460-5999.2  | 605999 | 20895 | 15,0 | 13.0460-7056.2  | 607056 | 21396 | 17,5 | 13.0460-7089.2  | 607089 | 21676 | 20,3 |
| 13.0460-5999.2  | 605999 | 21127 | 15,0 | 13.0460-7056.2  | 607056 | 21582 | 17,5 | 13.0460-7089.2  | 607089 | 21677 | 20,3 |
| 13.0460-6015.2  | 606015 | 29835 | 22,0 | 13.0460-7057.2  | 607057 | 21394 | 17,5 | 13.0460-7090.2  | 607090 | 21691 | 17,3 |
| 13.0460-6027.2  | 606027 | 20011 | 15,0 | 13.0460-7057.2  | 607057 | 21396 | 17,5 | 13.0460-7090.2  | 607090 | 21891 | 17,3 |
| 13.0460-6028.2  | 606028 | 20011 | 18,5 | 13.0460-7058.2  | 607058 | 21430 | 17,3 | 13.0460-7091.2  | 607091 | 21829 | 20,3 |
| 13.0460-6031.2  | 606031 | 29581 | 15,0 | 13.0460-7058.2  | 607058 | 21432 | 17,3 | 13.0460-7091.2  | 607091 | 23115 | 19,8 |
| 13.0460-6033.2  | 606033 | 20968 | 20,3 | 13.0460-7059.2  | 607059 | 20887 | 17,3 | 13.0460-7100.2  | 607100 | 21866 | 17,2 |
| 13.0460-6033.2  | 606033 | 21064 | 20,3 | 13.0460-7059.2  | 607059 | 20888 | 17,3 | 13.0460-7100.2  | 607100 | 21868 | 17,2 |





# Vergleichsliste ATE → WVA

Cross reference list ATE → WVA - Tabella di conversione codici ATE → WVA

Liste des correspondances ATE → WVA - Lista referencias ATE → WVA



|  | WVA    | D     |  | WVA            | D      |  | WVA  | D              |        |       |      |
|---|--------|-------|---|----------------|--------|---|------|----------------|--------|-------|------|
| 13.0460-7101.2  | 607101 | 21866 | 15,3  | 13.0460-7135.2 | 607135 | 23076   | 17,5 | 13.0460-7166.2 | 607166 | 23762 | 20,4 |
| 13.0460-7101.2  | 607101 | 21868 | 15,3  | 13.0460-7135.2 | 607135 | 23077   | 17,5 | 13.0460-7166.2 | 607166 | 23763 | 20,4 |
| 13.0460-7102.2  | 607102 | 21883 | 19,8  | 13.0460-7137.2 | 607137 | 23482   | 15,8 | 13.0460-7167.2 | 607167 | 23312 | 20,3 |
| 13.0460-7102.2  | 607102 | 21885 | 20,4  | 13.0460-7137.2 | 607137 | 23483   | 15,8 | 13.0460-7167.2 | 607167 | 23347 | 20,3 |
| 13.0460-7105.2  | 607105 | 23140 | 19,4  | 13.0460-7138.2 | 607138 | 20968   | 17,5 | 13.0460-7168.2 | 607168 | 21282 | 17,3 |
| 13.0460-7105.2  | 607105 | 23141 | 19,4  | 13.0460-7138.2 | 607138 | 23126   | 17,5 | 13.0460-7168.2 | 607168 | 23447 | 17,3 |
| 13.0460-7107.2  | 607107 | 21278 | 16,4  | 13.0460-7139.2 | 607139 | 23140   | 19,4 | 13.0460-7169.2 | 607169 | 23309 | 17,3 |
| 13.0460-7108.2  | 607108 | 20907 | 18,1  | 13.0460-7139.2 | 607139 | 23141   | 19,4 | 13.0460-7169.2 | 607169 | 23310 | 17,3 |
| 13.0460-7108.2  | 607108 | 23228 | 18,1  | 13.0460-7139.2 | 607139 | 24095   | 19,4 | 13.0460-7170.2 | 607170 | 23448 | 20,8 |
| 13.0460-7110.2  | 607110 | 20676 | 19,8  | 13.0460-7140.2 | 607140 | 21637   | 19,3 | 13.0460-7170.2 | 607170 | 23449 | 20,8 |
| 13.0460-7110.2  | 607110 | 23018 | 20,3  | 13.0460-7140.2 | 607140 | 21641   | 19,3 | 13.0460-7171.2 | 607171 | 23334 | 16,7 |
| 13.0460-7110.2  | 607110 | 23019 | 20,3  | 13.0460-7140.2 | 607140 | 23289   | 19,3 | 13.0460-7171.2 | 607171 | 23335 | 16,7 |
| 13.0460-7111.2  | 607111 | 23130 | 19,6  | 13.0460-7141.2 | 607141 | 20907   | 18,1 | 13.0460-7172.2 | 607172 | 23378 | 20,1 |
| 13.0460-7111.2  | 607111 | 23131 | 19,6  | 13.0460-7141.2 | 607141 | 23842   | 18,1 | 13.0460-7172.2 | 607172 | 23379 | 20,1 |
| 13.0460-7112.2  | 607112 | 21637 | 19,3  | 13.0460-7142.2 | 607142 | 23202   | 18,3 | 13.0460-7172.2 | 607172 | 23402 | 20,1 |
| 13.0460-7112.2  | 607112 | 23222 | 19,3  | 13.0460-7142.2 | 607142 | 23604   | 18,3 | 13.0460-7172.2 | 607172 | 23403 | 20,1 |
| 13.0460-7113.2  | 607113 | 23218 | 18,0  | 13.0460-7143.2 | 607143 | 21848   | 19,8 | 13.0460-7173.2 | 607173 | 21829 | 20,3 |
| 13.0460-7113.2  | 607113 | 23220 | 18,0  | 13.0460-7143.2 | 607143 | 21849   | 20,3 | 13.0460-7173.2 | 607173 | 23116 | 19,6 |
| 13.0460-7114.2  | 607114 | 21930 | 17,9  | 13.0460-7143.2 | 607143 | 23324   | 20,3 | 13.0460-7173.2 | 607173 | 23117 | 19,6 |
| 13.0460-7114.2  | 607114 | 23181 | 17,9  | 13.0460-7144.2 | 607144 | 23112   | 19,1 | 13.0460-7174.2 | 607174 | 23732 | 17,3 |
| 13.0460-7115.2  | 607115 | 23063 | 17,5  | 13.0460-7144.2 | 607144 | 23114   | 19,1 | 13.0460-7174.2 | 607174 | 23737 | 17,3 |
| 13.0460-7115.2  | 607115 | 23064 | 17,5  | 13.0460-7145.2 | 607145 | 23073   | 18,8 | 13.0460-7176.2 | 607176 | 23793 | 20,3 |
| 13.0460-7115.2  | 607115 | 23065 | 17,5  | 13.0460-7145.2 | 607145 | 23074   | 18,8 | 13.0460-7176.2 | 607176 | 23794 | 20,3 |
| 13.0460-7115.2  | 607115 | 23066 | 18,5  | 13.0460-7146.2 | 607146 | 20147   | 17,0 | 13.0460-7177.2 | 607177 | 23394 | 13,7 |
| 13.0460-7115.2  | 607115 | 23067 | 18,5  | 13.0460-7146.2 | 607146 | 20149   | 17,0 | 13.0460-7177.2 | 607177 | 23395 | 13,7 |
| 13.0460-7116.2  | 607116 | 23057 | 20,2  | 13.0460-7147.2 | 607147 | 21284   | 19,1 | 13.0460-7178.2 | 607178 | 23394 | 13,7 |
| 13.0460-7116.2  | 607116 | 23058 | 19,6  | 13.0460-7147.2 | 607147 | 21285   | 19,1 | 13.0460-7178.2 | 607178 | 23395 | 13,7 |
| 13.0460-7116.2  | 607116 | 23059 | 19,6  | 13.0460-7148.2 | 607148 | 23200   | 18,0 | 13.0460-7178.2 | 607178 | 23824 | 13,7 |
| 13.0460-7117.2  | 607117 | 23130 | 19,6  | 13.0460-7148.2 | 607148 | 23201   | 18,0 | 13.0460-7179.2 | 607179 | 23832 | 20,2 |
| 13.0460-7117.2  | 607117 | 23131 | 19,6  | 13.0460-7153.2 | 607153 | 23269   | 19,8 | 13.0460-7179.2 | 607179 | 23833 | 20,2 |
| 13.0460-7117.2  | 607117 | 23187 | 19,6  | 13.0460-7153.2 | 607153 | 23270   | 19,8 | 13.0460-7179.2 | 607179 | 23844 | 20,5 |
| 13.0460-7121.2  | 607121 | 23154 | 19,0  | 13.0460-7154.2 | 607154 | 23034   | 18,8 | 13.0460-7180.2 | 607180 | 21637 | 19,3 |
| 13.0460-7121.2  | 607121 | 23155 | 19,0  | 13.0460-7154.2 | 607154 | 23418   | 19,4 | 13.0460-7180.2 | 607180 | 23222 | 19,3 |
| 13.0460-7122.2  | 607122 | 20676 | 19,8  | 13.0460-7154.2 | 607154 | 23419   | 19,4 | 13.0460-7180.2 | 607180 | 24067 | 19,3 |
| 13.0460-7122.2  | 607122 | 21911 | 20,3  | 13.0460-7155.2 | 607155 | 21676   | 20,3 | 13.0460-7181.2 | 607181 | 21636 | 19,3 |
| 13.0460-7122.2  | 607122 | 23392 | 20,3  | 13.0460-7155.2 | 607155 | 23183   | 20,3 | 13.0460-7181.2 | 607181 | 21637 | 19,3 |
| 13.0460-7123.2  | 607123 | 23034 | 18,8  | 13.0460-7156.2 | 607156 | 23034   | 19,4 | 13.0460-7182.2 | 607182 | 23896 | 20,6 |
| 13.0460-7123.2  | 607123 | 23036 | 19,4  | 13.0460-7156.2 | 607156 | 23418   | 19,4 | 13.0460-7182.2 | 607182 | 23897 | 20,6 |
| 13.0460-7124.2  | 607124 | 21883 | 19,8  | 13.0460-7157.2 | 607157 | 23215   | 18,3 | 13.0460-7183.2 | 607183 | 21484 | 20,5 |
| 13.0460-7124.2  | 607124 | 21885 | 20,4  | 13.0460-7157.2 | 607157 | 23217   | 18,3 | 13.0460-7183.2 | 607183 | 21485 | 20,5 |
| 13.0460-7124.2  | 607124 | 23163 | 20,4  | 13.0460-7158.2 | 607158 | 23245   | 18,3 | 13.0460-7184.2 | 607184 | 23587 | 20,6 |
| 13.0460-7125.2  | 607125 | 21930 | 17,9  | 13.0460-7158.2 | 607158 | 23247   | 18,3 | 13.0460-7184.2 | 607184 | 23588 | 20,6 |
| 13.0460-7125.2  | 607125 | 21931 | 17,9  | 13.0460-7159.2 | 607159 | 23245   | 18,3 | 13.0460-7184.2 | 607184 | 23589 | 20,6 |
| 13.0460-7126.2  | 607126 | 20907 | 18,1  | 13.0460-7159.2 | 607159 | 23248   | 18,3 | 13.0460-7185.2 | 607185 | 20968 | 20,3 |
| 13.0460-7126.2  | 607126 | 23552 | 18,1  | 13.0460-7160.2 | 607160 | 23482   | 16,7 | 13.0460-7185.2 | 607185 | 21064 | 20,3 |
| 13.0460-7128.2  | 607128 | 23218 | 18,0  | 13.0460-7160.2 | 607160 | 23483   | 16,7 | 13.0460-7186.2 | 607186 | 23440 | 17,6 |
| 13.0460-7128.2  | 607128 | 23220 | 18,0  | 13.0460-7161.2 | 607161 | 23281   | 18,3 | 13.0460-7186.2 | 607186 | 23441 | 18,1 |
| 13.0460-7129.2  | 607129 | 20907 | 18,1  | 13.0460-7161.2 | 607161 | 23282   | 18,3 | 13.0460-7187.2 | 607187 | 23590 | 19,5 |
| 13.0460-7129.2  | 607129 | 23229 | 18,1  | 13.0460-7162.2 | 607162 | 23716   | 15,8 | 13.0460-7187.2 | 607187 | 23591 | 18,0 |
| 13.0460-7131.2  | 607131 | 21193 | 18,0  | 13.0460-7162.2 | 607162 | 23717   | 15,8 | 13.0460-7188.2 | 607188 | 24141 | 19,1 |
| 13.0460-7131.2  | 607131 | 21194 | 18,0  | 13.0460-7163.2 | 607163 | 21358   | 19,8 | 13.0460-7188.2 | 607188 | 24142 | 20,6 |
| 13.0460-7131.2  | 607131 | 25962 | 18,0  | 13.0460-7163.2 | 607163 | 21910   | 19,8 | 13.0460-7189.2 | 607189 | 24011 | 18,7 |
| 13.0460-7132.2  | 607132 | 23218 | 18,0  | 13.0460-7164.2 | 607164 | 21866   | 17,2 | 13.0460-7189.2 | 607189 | 24012 | 18,7 |
| 13.0460-7132.2  | 607132 | 23775 | 18,0  | 13.0460-7164.2 | 607164 | 21868   | 17,2 | 13.0460-7190.2 | 607190 | 24367 | 19,1 |
| 13.0460-7133.2  | 607133 | 21927 | 17,9  | 13.0460-7164.2 | 607164 | 23752   | 17,2 | 13.0460-7190.2 | 607190 | 24368 | 19,1 |
| 13.0460-7133.2  | 607133 | 21928 | 17,9  | 13.0460-7165.2 | 607165 | 21358   | 19,8 | 13.0460-7190.2 | 607190 | 24556 | 19,1 |
| 13.0460-7134.2  | 607134 | 21278 | 16,4  | 13.0460-7165.2 | 607165 | 21579   | 19,8 | 13.0460-7191.2 | 607191 | 23749 | 19,1 |





# Vergleichsliste ATE → WVA

Cross reference list ATE → WVA - Tabella di conversione codici ATE → WVA

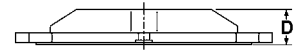
Liste des correspondances ATE → WVA - Lista referencias ATE → WVA







|  | WVA    | D     |  | WVA            | D      |  | WVA  | D              |        |       |      |
|---|--------|-------|---|----------------|--------|---|------|----------------|--------|-------|------|
| 13.0460-7191.2  | 607191 | 23835 | 19,6  | 13.0460-7221.2 | 607221 | 23215   | 18,3 | 13.0460-7247.2 | 607247 | 24367 | 19,2 |
| 13.0460-7193.2  | 607193 | 23723 | 18,1  | 13.0460-7221.2 | 607221 | 24535   | 18,3 | 13.0460-7247.2 | 607247 | 24368 | 19,2 |
| 13.0460-7193.2  | 607193 | 23724 | 18,1  | 13.0460-7222.2 | 607222 | 23245   | 18,3 | 13.0460-7247.2 | 607247 | 24645 | 19,2 |
| 13.0460-7194.2  | 607194 | 23482 | 16,6  | 13.0460-7222.2 | 607222 | 24536   | 18,3 | 13.0460-7248.2 | 607248 | 23215 | 17,5 |
| 13.0460-7194.2  | 607194 | 24137 | 16,6  | 13.0460-7223.2 | 607223 | 23794   | 20,3 | 13.0460-7248.2 | 607248 | 23217 | 17,5 |
| 13.0460-7195.2  | 607195 | 23482 | 16,6  | 13.0460-7223.2 | 607223 | 24096   | 20,3 | 13.0460-7249.2 | 607249 | 24709 | 18,6 |
| 13.0460-7195.2  | 607195 | 24137 | 16,6  | 13.0460-7223.2 | 607223 | 24193   | 20,3 | 13.0460-7249.2 | 607249 | 24710 | 18,6 |
| 13.0460-7196.2  | 607196 | 21576 | 20,7  | 13.0460-7224.2 | 607224 | 23397   | 19,4 | 13.0460-7250.2 | 607250 | 24709 | 17,5 |
| 13.0460-7196.2  | 607196 | 21577 | 20,7  | 13.0460-7224.2 | 607224 | 23399   | 19,4 | 13.0460-7250.2 | 607250 | 24870 | 17,5 |
| 13.0460-7199.2  | 607199 | 23404 | 20,6  | 13.0460-7225.2 | 607225 | 23550   | 17,3 | 13.0460-7251.2 | 607251 | 23482 | 15,8 |
| 13.0460-7199.2  | 607199 | 23405 | 20,1  | 13.0460-7225.2 | 607225 | 23551   | 17,3 | 13.0460-7251.2 | 607251 | 24137 | 15,8 |
| 13.0460-7200.2  | 607200 | 23801 | 20,3  | 13.0460-7226.2 | 607226 | 23587   | 20,8 | 13.0460-7252.2 | 607252 | 24084 | 19,3 |
| 13.0460-7200.2  | 607200 | 23912 | 20,3  | 13.0460-7226.2 | 607226 | 23588   | 20,8 | 13.0460-7252.2 | 607252 | 24332 | 18,3 |
| 13.0460-7200.2  | 607200 | 23913 | 20,3  | 13.0460-7226.2 | 607226 | 23589   | 20,4 | 13.0460-7253.2 | 607253 | 23482 | 15,8 |
| 13.0460-7201.2  | 607201 | 23763 | 20,3  | 13.0460-7227.2 | 607227 | 23801   | 20,3 | 13.0460-7253.2 | 607253 | 24137 | 15,8 |
| 13.0460-7201.2  | 607201 | 23801 | 20,3  | 13.0460-7227.2 | 607227 | 23912   | 20,3 | 13.0460-7255.2 | 607255 | 25114 | 15,8 |
| 13.0460-7201.2  | 607201 | 23950 | 20,3  | 13.0460-7227.2 | 607227 | 23913   | 20,3 | 13.0460-7255.2 | 607255 | 25115 | 15,8 |
| 13.0460-7202.2  | 607202 | 23589 | 19,1  | 13.0460-7228.2 | 607228 | 24123   | 20,3 | 13.0460-7256.2 | 607256 | 24705 | 19,8 |
| 13.0460-7202.2  | 607202 | 24153 | 19,1  | 13.0460-7228.2 | 607228 | 24124   | 19,3 | 13.0460-7256.2 | 607256 | 24706 | 21,3 |
| 13.0460-7203.2  | 607203 | 21670 | 19,3  | 13.0460-7229.2 | 607229 | 24538   | 18,5 | 13.0460-7256.2 | 607256 | 24707 | 21,3 |
| 13.0460-7203.2  | 607203 | 21794 | 19,3  | 13.0460-7229.2 | 607229 | 24539   | 18,5 | 13.0460-7257.2 | 607257 | 24253 | 18,0 |
| 13.0460-7204.2  | 607204 | 23801 | 18,8  | 13.0460-7230.2 | 607230 | 24557   | 19,4 | 13.0460-7257.2 | 607257 | 24254 | 18,0 |
| 13.0460-7204.2  | 607204 | 23912 | 18,8  | 13.0460-7230.2 | 607230 | 24558   | 18,7 | 13.0460-7259.2 | 607259 | 24862 | 16,7 |
| 13.0460-7205.2  | 607205 | 23787 | 19,0  | 13.0460-7231.2 | 607231 | 24170   | 20,2 | 13.0460-7259.2 | 607259 | 24863 | 16,7 |
| 13.0460-7205.2  | 607205 | 23788 | 19,0  | 13.0460-7231.2 | 607231 | 24171   | 20,9 | 13.0460-7260.2 | 607260 | 24458 | 17,3 |
| 13.0460-7206.2  | 607206 | 23631 | 18,6  | 13.0460-7232.2 | 607232 | 21282   | 17,3 | 13.0460-7260.2 | 607260 | 24495 | 17,3 |
| 13.0460-7206.2  | 607206 | 23632 | 18,6  | 13.0460-7232.2 | 607232 | 23447   | 17,3 | 13.0460-7261.2 | 607261 | 24436 | 19,7 |
| 13.0460-7206.2  | 607206 | 23633 | 18,6  | 13.0460-7234.2 | 607234 | 24438   | 16,1 | 13.0460-7261.2 | 607261 | 24437 | 20,2 |
| 13.0460-7207.2  | 607207 | 23807 | 18,6  | 13.0460-7234.2 | 607234 | 24439   | 16,1 | 13.0460-7262.2 | 607262 | 25031 | 19,1 |
| 13.0460-7207.2  | 607207 | 23969 | 18,6  | 13.0460-7235.2 | 607235 | 24670   | 18,0 | 13.0460-7262.2 | 607262 | 25032 | 19,1 |
| 13.0460-7209.2  | 607209 | 23482 | 16,6  | 13.0460-7235.2 | 607235 | 24671   | 18,0 | 13.0460-7262.2 | 607262 | 25033 | 19,1 |
| 13.0460-7209.2  | 607209 | 24137 | 16,6  | 13.0460-7236.2 | 607236 | 23746   | 19,7 | 13.0460-7263.2 | 607263 | 24034 | 19,1 |
| 13.0460-7210.2  | 607210 | 23791 | 20,8  | 13.0460-7236.2 | 607236 | 23747   | 19,7 | 13.0460-7263.2 | 607263 | 24035 | 19,1 |
| 13.0460-7210.2  | 607210 | 23792 | 20,8  | 13.0460-7236.2 | 607236 | 23749   | 18,7 | 13.0460-7263.2 | 607263 | 24036 | 19,1 |
| 13.0460-7211.2  | 607211 | 24339 | 20,5  | 13.0460-7237.2 | 607237 | 23347   | 20,3 | 13.0460-7264.2 | 607264 | 25096 | 17,0 |
| 13.0460-7211.2  | 607211 | 24340 | 20,3  | 13.0460-7237.2 | 607237 | 24161   | 20,3 | 13.0460-7264.2 | 607264 | 25097 | 17,0 |
| 13.0460-7212.2  | 607212 | 23738 | 20,1  | 13.0460-7238.2 | 607238 | 23313   | 20,3 | 13.0460-7264.2 | 607264 | 25098 | 17,0 |
| 13.0460-7212.2  | 607212 | 23739 | 20,1  | 13.0460-7238.2 | 607238 | 24255   | 20,3 | 13.0460-7265.2 | 607265 | 24727 | 20,7 |
| 13.0460-7213.2  | 607213 | 23202 | 17,8  | 13.0460-7239.2 | 607239 | 24172   | 19,0 | 13.0460-7265.2 | 607265 | 24729 | 20,4 |
| 13.0460-7213.2  | 607213 | 24022 | 17,8  | 13.0460-7239.2 | 607239 | 24173   | 20,0 | 13.0460-7266.2 | 607266 | 24538 | 17,9 |
| 13.0460-7213.2  | 607213 | 24023 | 17,8  | 13.0460-7240.2 | 607240 | 23746   | 18,1 | 13.0460-7266.2 | 607266 | 24914 | 17,9 |
| 13.0460-7214.2  | 607214 | 24574 | 15,0  | 13.0460-7240.2 | 607240 | 23747   | 18,1 | 13.0460-7267.2 | 607267 | 25045 | 19,5 |
| 13.0460-7214.2  | 607214 | 24575 | 14,8  | 13.0460-7240.2 | 607240 | 23749   | 17,6 | 13.0460-7267.2 | 607267 | 25046 | 18,5 |
| 13.0460-7214.2  | 607214 | 24576 | 14,8  | 13.0460-7241.2 | 607241 | 20547   | 16,5 | 13.0460-7268.2 | 607268 | 23794 | 20,3 |
| 13.0460-7215.2  | 607215 | 23935 | 17,8  | 13.0460-7241.2 | 607241 | 24487   | 16,5 | 13.0460-7268.2 | 607268 | 24697 | 19,3 |
| 13.0460-7215.2  | 607215 | 23999 | 17,8  | 13.0460-7242.2 | 607242 | 24332   | 19,8 | 13.0460-7269.2 | 607269 | 24339 | 19,5 |
| 13.0460-7216.2  | 607216 | 23794 | 20,3  | 13.0460-7242.2 | 607242 | 24333   | 21,3 | 13.0460-7269.2 | 607269 | 24340 | 19,5 |
| 13.0460-7216.2  | 607216 | 23968 | 20,3  | 13.0460-7242.2 | 607242 | 24334   | 21,3 | 13.0460-7270.2 | 607270 | 24673 | 18,0 |
| 13.0460-7217.2  | 607217 | 23926 | 17,3  | 13.0460-7243.2 | 607243 | 24142   | 20,6 | 13.0460-7270.2 | 607270 | 24674 | 18,0 |
| 13.0460-7217.2  | 607217 | 23927 | 17,3  | 13.0460-7243.2 | 607243 | 24521   | 19,1 | 13.0460-7271.2 | 607271 | 24151 | 21,0 |
| 13.0460-7218.2  | 607218 | 24367 | 19,1  | 13.0460-7244.2 | 607244 | 24253   | 17,8 | 13.0460-7271.2 | 607271 | 24152 | 20,3 |
| 13.0460-7218.2  | 607218 | 24368 | 19,1  | 13.0460-7244.2 | 607244 | 24254   | 18,0 | 13.0460-7272.2 | 607272 | 24399 | 20,4 |
| 13.0460-7218.2  | 607218 | 24645 | 19,1  | 13.0460-7245.2 | 607245 | 23747   | 19,6 | 13.0460-7272.2 | 607272 | 24875 | 19,8 |
| 13.0460-7219.2  | 607219 | 23923 | 17,6  | 13.0460-7245.2 | 607245 | 23749   | 19,1 | 13.0460-7273.2 | 607273 | 24538 | 19,4 |
| 13.0460-7219.2  | 607219 | 23924 | 17,6  | 13.0460-7245.2 | 607245 | 23835   | 19,6 | 13.0460-7273.2 | 607273 | 25180 | 19,0 |
| 13.0460-7220.2  | 607220 | 23922 | 21,0  | 13.0460-7246.2 | 607246 | 21275   | 17,0 | 13.0460-7274.2 | 607274 | 23731 | 17,3 |
| 13.0460-7220.2  | 607220 | 23925 | 20,5  | 13.0460-7246.2 | 607246 | 21276   | 17,0 | 13.0460-7274.2 | 607274 | 24695 | 17,3 |

# Vergleichsliste ATE → WVA

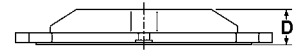
Cross reference list ATE → WVA - Tabella di conversione codici ATE → WVA

Liste des correspondances ATE → WVA - Lista referencias ATE → WVA



|  | WVA    | D     |  | WVA            | D      |  | WVA  | D              |        |       |      |
|---|--------|-------|---|----------------|--------|---|------|----------------|--------|-------|------|
| 13.0460-7275.2  | 607275 | 23313 | 20,2  | 13.0460-7903.2 | 607903 | 20465   | 18,0 | 13.0470-2714.2 | LD2714 | 24290 | 16,9 |
| 13.0460-7275.2  | 607275 | 24688 | 19,2  | 13.0460-7903.2 | 607903 | 29012   | 18,0 | 13.0470-2716.2 | LD2716 | 24703 | 17,8 |
| 13.0460-7276.2  | 607276 | 25222 | 17,3  | 13.0460-7906.2 | 607906 | 29001   | 20,0 | 13.0470-2716.2 | LD2716 | 24704 | 17,8 |
| 13.0460-7276.2  | 607276 | 25223 | 17,3  | 13.0460-7906.2 | 607906 | 29003   | 20,0 | 13.0470-2722.2 | LD2722 | 24496 | 17,3 |
| 13.0460-7277.2  | 607277 | 24084 | 19,3  | 13.0460-7909.2 | 607909 | 29153   | 20,0 | 13.0470-2723.2 | LD2723 | 24537 | 16,1 |
| 13.0460-7277.2  | 607277 | 24332 | 18,3  | 13.0460-8002.2 | 608002 | 23358   | 18,0 | 13.0470-2725.2 | LD2725 | 23984 | 17,8 |
| 13.0460-7278.2  | 607278 | 23482 | 16,6  | 13.0460-8002.2 | 608002 | 23359   | 18,0 | 13.0470-2725.2 | LD2725 | 23985 | 17,8 |
| 13.0460-7278.2  | 607278 | 25218 | 16,6  | 13.0460-8002.2 | 608002 | 23360   | 18,0 | 13.0470-2726.2 | LD2726 | 23144 | 19,8 |
| 13.0460-7279.2  | 607279 | 25069 | 17,3  | 13.0460-8003.2 | 608003 | 23043   | 16,0 | 13.0470-2726.2 | LD2726 | 23145 | 19,8 |
| 13.0460-7279.2  | 607279 | 25070 | 17,3  | 13.0460-8003.2 | 608003 | 23044   | 16,0 | 13.0470-2727.2 | LD2727 | 23144 | 19,8 |
| 13.0460-7280.2  | 607280 | 25158 | 20,3  | 13.0460-8004.2 | 608004 | 23193   | 16,4 | 13.0470-2727.2 | LD2727 | 23145 | 19,8 |
| 13.0460-7280.2  | 607280 | 25159 | 20,3  | 13.0460-8004.2 | 608004 | 23194   | 16,4 | 13.0470-2732.2 | LD2732 | 24306 | 20,3 |
| 13.0460-7281.2  | 607281 | 25160 | 20,3  | 13.0460-8004.2 | 608004 | 23195   | 17,4 | 13.0470-2733.2 | LD2733 | 24306 | 20,3 |
| 13.0460-7281.2  | 607281 | 25161 | 20,3  | 13.0460-8004.2 | 608004 | 23196   | 17,4 | 13.0470-2734.2 | LD2734 | 24310 | 19,0 |
| 13.0460-7282.2  | 607282 | 25190 | 21,3  | 13.0460-8005.2 | 608005 | 23189   | 16,7 | 13.0470-2734.2 | LD2734 | 24456 | 19,0 |
| 13.0460-7282.2  | 607282 | 25191 | 21,3  | 13.0460-8005.2 | 608005 | 23190   | 16,7 | 13.0470-2736.2 | LD2736 | 24496 | 17,3 |
| 13.0460-7282.2  | 607282 | 25192 | 21,3  | 13.0460-8005.2 | 608005 | 23191   | 16,7 | 13.0470-2740.2 | LD2740 | 23554 | 17,2 |
| 13.0460-7283.2  | 607283 | 25531 | 19,3  | 13.0460-8005.2 | 608005 | 23192   | 16,7 | 13.0470-2746.2 | LD2746 | 24408 | 19,2 |
| 13.0460-7283.2  | 607283 | 25532 | 19,2  | 13.0460-8006.2 | 608006 | 20660   | 15,6 | 13.0470-2746.2 | LD2746 | 24409 | 19,2 |
| 13.0460-7284.2  | 607284 | 25804 | 17,3  | 13.0460-8007.2 | 608007 | 23189   | 16,7 | 13.0470-2746.2 | LD2746 | 24743 | 19,2 |
| 13.0460-7284.2  | 607284 | 25805 | 17,3  | 13.0460-8007.2 | 608007 | 23190   | 16,7 | 13.0470-2747.2 | LD2747 | 24606 | 17,4 |
| 13.0460-7284.2  | 607284 | 25806 | 17,3  | 13.0460-8007.2 | 608007 | 23192   | 16,7 | 13.0470-2747.2 | LD2747 | 24606 | 17,7 |
| 13.0460-7285.2  | 607285 | 23587 | 20,6  | 13.0460-8007.2 | 608007 | 23718   | 16,7 | 13.0470-2748.2 | LD2748 | 24606 | 17,4 |
| 13.0460-7285.2  | 607285 | 23589 | 20,6  | 13.0460-8008.2 | 608008 | 24036   | 16,7 | 13.0470-2748.2 | LD2748 | 24606 | 17,7 |
| 13.0460-7286.2  | 607286 | 24623 | 18,2  | 13.0460-8008.2 | 608008 | 24037   | 16,7 | 13.0470-2755.2 | LD2755 | 24421 | 17,2 |
| 13.0460-7286.2  | 607286 | 24624 | 18,2  | 13.0460-8008.2 | 608008 | 24038   | 16,7 | 13.0470-2755.2 | LD2755 | 24422 | 17,2 |
| 13.0460-7286.2  | 607286 | 24625 | 18,2  | 13.0460-8009.2 | 608009 | 21815   | 18,8 | 13.0470-2758.2 | LD2758 | 24421 | 17,2 |
| 13.0460-7287.2  | 607287 | 25265 | 16,6  | 13.0460-8009.2 | 608009 | 21816   | 16,8 | 13.0470-2758.2 | LD2758 | 24422 | 17,2 |
| 13.0460-7287.2  | 607287 | 25266 | 16,6  | 13.0460-8009.2 | 608009 | 21817   | 16,8 | 13.0470-2760.2 | LD2760 | 24561 | 17,7 |
| 13.0460-7288.2  | 607288 | 25429 | 17,5  | 13.0460-8010.2 | 608010 | 23561   | 18,1 | 13.0470-2760.2 | LD2760 | 24562 | 17,7 |
| 13.0460-7288.2  | 607288 | 25430 | 17,5  | 13.0460-8010.2 | 608010 | 23562   | 18,1 | 13.0470-2764.2 | LD2764 | 24738 | 20,0 |
| 13.0460-7289.2  | 607289 | 25323 | 17,3  | 13.0460-8011.2 | 608011 | 23361   | 14,8 | 13.0470-2764.2 | LD2764 | 25217 | 20,0 |
| 13.0460-7289.2  | 607289 | 25324 | 17,3  | 13.0460-8011.2 | 608011 | 23362   | 14,8 | 13.0470-2765.2 | LD2765 | 24409 | 19,2 |
| 13.0460-7290.2  | 607290 | 24574 | 15,0  | 13.0460-8011.2 | 608011 | 23363   | 14,8 | 13.0470-2765.2 | LD2765 | 24743 | 19,2 |
| 13.0460-7290.2  | 607290 | 25054 | 15,0  | 13.0460-8013.2 | 608013 | 24604   | 16,5 | 13.0470-2767.2 | LD2767 | 25156 | 17,4 |
| 13.0460-7290.2  | 607290 | 25055 | 15,0  | 13.0460-8013.2 | 608013 | 24605   | 16,5 | 13.0470-2767.2 | LD2767 | 25157 | 17,4 |
| 13.0460-7293.2  | 607293 | 25008 | 16,3  | 13.0460-8014.2 | 608014 | 25632   | 15,5 | 13.0470-2768.2 | LD2768 | 23811 | 17,7 |
| 13.0460-7293.2  | 607293 | 25010 | 16,3  | 13.0460-8014.2 | 608014 | 25633   | 15,5 | 13.0470-2768.2 | LD2768 | 24788 | 17,7 |
| 13.0460-7294.2  | 607294 | 25009 | 16,4  | 13.0460-8014.2 | 608014 | 25634   | 15,5 | 13.0470-2769.2 | LD2769 | 24606 | 17,4 |
| 13.0460-7294.2  | 607294 | 25011 | 16,4  | 13.0460-9028.2 | 609028 | 20392   | 15,0 | 13.0470-2769.2 | LD2769 | 25214 | 17,4 |
| 13.0460-7295.2  | 607295 | 25968 | 16,1  | 13.0460-9029.2 | 609029 | 20341   | 16,7 | 13.0470-2770.2 | LD2770 | 24606 | 17,4 |
| 13.0460-7295.2  | 607295 | 25969 | 16,1  | 13.0460-9030.2 | 609030 | 20092   | 15,0 | 13.0470-2770.2 | LD2770 | 25214 | 17,4 |
| 13.0460-7296.2  | 607296 | 23212 | 20,3  | 13.0460-9031.2 | 609031 | 20437   | 19,0 | 13.0470-2773.2 | LD2773 | 24606 | 17,4 |
| 13.0460-7296.2  | 607296 | 23213 | 20,3  | 13.0460-9033.2 | 609033 | 21303   | 18,9 | 13.0470-2773.2 | LD2773 | 25214 | 17,4 |
| 13.0460-7298.2  | 607298 | 25702 | 18,2  | 13.0460-9034.2 | 609034 | 20437   | 15,0 | 13.0470-2776.2 | LD2776 | 23070 | 17,0 |
| 13.0460-7298.2  | 607298 | 25703 | 18,2  | 13.0460-9037.2 | 609037 | 20309   | 17,9 | 13.0470-2778.2 | LD2778 | 25326 | 19,3 |
| 13.0460-7300.2  | 607300 | 25833 | 17,3  | 13.0462-4855.2 | 600018 | 20910   | 15,0 | 13.0470-2779.2 | LD2779 | 24869 | 19,3 |
| 13.0460-7300.2  | 607300 | 25834 | 17,3  | 13.0470-2707.2 | LD2707 | 23760   | 17,7 | 13.0470-2781.2 | LD2781 | 25215 | 18,6 |
| 13.0460-7301.2  | 607301 | 25841 | 16,1  | 13.0470-2708.2 | LD2708 | 23881   | 20,0 | 13.0470-2781.2 | LD2781 | 25216 | 18,6 |
| 13.0460-7301.2  | 607301 | 25842 | 16,1  | 13.0470-2709.2 | LD2709 | 23973   | 17,4 | 13.0470-2784.2 | LD2784 | 25134 | 17,2 |
| 13.0460-7303.2  | 607303 | 22035 | 17,5  | 13.0470-2710.2 | LD2710 | 23915   | 17,6 | 13.0470-2784.2 | LD2784 | 25135 | 17,2 |
| 13.0460-7303.2  | 607303 | 22036 | 17,5  | 13.0470-2710.2 | LD2710 | 23916   | 17,6 | 13.0470-2785.2 | LD2785 | 25683 | 20,4 |
| 13.0460-7303.2  | 607303 | 22037 | 17,5  | 13.0470-2711.2 | LD2711 | 24077   | 19,1 | 13.0470-2785.2 | LD2785 | 25684 | 20,4 |
| 13.0460-7305.2  | 607305 | 25836 | 17,0  | 13.0470-2712.2 | LD2712 | 23138   | 14,6 | 13.0470-2786.2 | LD2786 | 24848 | 18,3 |
| 13.0460-7305.2  | 607305 | 25837 | 17,0  | 13.0470-2713.2 | LD2713 | 23623   | 17,4 | 13.0470-2789.2 | LD2789 | 25652 | 17,1 |
| 13.0460-7307.2  | 607307 | 25009 | 16,4  | 13.0470-2713.2 | LD2713 | 23624   | 17,4 | 13.0470-2789.2 | LD2789 | 25653 | 17,1 |
| 13.0460-7307.2  | 607307 | 25011 | 16,4  | 13.0470-2714.2 | LD2714 | 24289   | 16,9 | 13.0470-2789.2 | LD2789 | 25654 | 17,1 |







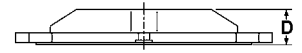

# Vergleichsliste ATE → WVA

Cross reference list ATE → WVA - Tabella di conversione codici ATE → WVA

Liste des correspondances ATE → WVA - Lista referencias ATE → WVA







|  | WVA    | D          |  | WVA    | D          |  | WVA    | D          |
|---|--------|------------|---|--------|------------|---|--------|------------|
| 13.0470-2820.2  | LD2820 | 20961 17,6 | 13.0470-3846.2  | LD3846 | 24764 17,9 | 13.0470-4971.2  | LD4971 | 23111 16,0 |
| 13.0470-2823.2  | LD2823 | 23554 17,2 | 13.0470-3847.2  | LD3847 | 24660 17,8 | 13.0470-4976.2  | LD4976 | 23694 16,4 |
| 13.0470-2833.2  | LD2833 | 23070 17,0 | 13.0470-3852.2  | LD3852 | 24867 20,7 | 13.0470-4977.2  | LD4977 | 23157 15,8 |
| 13.0470-2837.2  | LD2837 | 21945 19,6 | 13.0470-3852.2  | LD3852 | 24868 20,7 | 13.0470-4984.2  | LD4984 | 23271 17,4 |
| 13.0470-2837.2  | LD2837 | 23393 19,6 | 13.0470-3857.2  | LD3857 | 25199 19,6 | 13.0470-4990.2  | LD4990 | 23271 17,4 |
| 13.0470-2845.2  | LD2845 | 23554 16,4 | 13.0470-3857.2  | LD3857 | 25200 19,6 | 13.0470-4990.2  | LD4990 | 23745 17,4 |
| 13.0470-2855.2  | LD2855 | 23138 14,6 | 13.0470-3858.2  | LD3858 | 24563 17,7 | 13.0470-4992.2  | LD4992 | 23692 16,6 |
| 13.0470-2857.2  | LD2857 | 23225 17,0 | 13.0470-3859.2  | LD3859 | 25307 17,5 | 13.0470-4993.2  | LD4993 | 23693 16,6 |
| 13.0470-2857.2  | LD2857 | 23226 17,0 | 13.0470-3859.2  | LD3859 | 25308 17,5 | 13.0470-4994.2  | LD4994 | 23945 16,5 |
| 13.0470-2858.2  | LD2858 | 23284 14,0 | 13.0470-3860.2  | LD3860 | 24484 18,8 | 13.0470-5405.2  | LD5405 | 21643 17,8 |
| 13.0470-2860.2  | LD2860 | 23554 16,3 | 13.0470-3865.2  | LD3865 | 25014 18,2 | 13.0470-5405.2  | LD5405 | 21644 17,8 |
| 13.0470-2867.2  | LD2867 | 23517 16,6 | 13.0470-3865.2  | LD3865 | 25015 18,2 | 13.0470-5611.2  | LD5611 | 24415 19,1 |
| 13.0470-2868.2  | LD2868 | 23417 15,3 | 13.0470-3866.2  | LD3866 | 25506 18,2 | 13.0470-5611.2  | LD5611 | 24416 19,1 |
| 13.0470-2868.2  | LD2868 | 23654 15,3 | 13.0470-3866.2  | LD3866 | 25507 18,2 | 13.0470-5611.2  | LD5611 | 24417 19,1 |
| 13.0470-2868.2  | LD2868 | 23655 15,3 | 13.0470-3870.2  | LD3870 | 25895 18,5 | 13.0470-5612.2  | LD5612 | 24412 19,0 |
| 13.0470-2877.2  | LD2877 | 23554 17,2 | 13.0470-3870.2  | LD3870 | 25896 18,5 | 13.0470-5612.2  | LD5612 | 24413 19,0 |
| 13.0470-2877.2  | LD2877 | 23556 17,2 | 13.0470-3871.2  | LD3871 | 25839 17,8 | 13.0470-5612.2  | LD5612 | 24414 19,0 |
| 13.0470-2877.2  | LD2877 | 23823 17,2 | 13.0470-3871.2  | LD3871 | 25840 17,8 | 13.0470-5634.2  | LD5634 | 24452 17,5 |
| 13.0470-2879.2  | LD2879 | 23601 13,7 | 13.0470-3872.2  | LD3872 | 25827 17,7 | 13.0470-5635.2  | LD5635 | 24918 15,0 |
| 13.0470-2880.2  | LD2880 | 23914 17,1 | 13.0470-3872.2  | LD3872 | 25828 17,7 | 13.0470-5752.2  | LD5752 | 24632 17,0 |
| 13.0470-2880.2  | LD2880 | 24483 16,9 | 13.0470-3966.2  | LD3966 | 23600 19,4 | 13.0470-5786.2  | LD5786 | 24934 15,0 |
| 13.0470-2884.2  | LD2884 | 23581 18,8 | 13.0470-3982.2  | LD3982 | 23705 18,1 | 13.0470-5786.2  | LD5786 | 24935 15,0 |
| 13.0470-2884.2  | LD2884 | 23843 18,8 | 13.0470-3982.2  | LD3982 | 23706 18,1 | 13.0470-5786.2  | LD5786 | 24936 15,0 |
| 13.0470-2885.2  | LD2885 | 24077 19,1 | 13.0470-3982.2  | LD3982 | 23707 18,1 | 13.0470-7053.2  | LD7053 | 21273 19,5 |
| 13.0470-2886.2  | LD2886 | 20961 16,2 | 13.0470-3983.2  | LD3983 | 23708 19,4 | 13.0470-7053.2  | LD7053 | 21274 19,5 |
| 13.0470-2887.2  | LD2887 | 23914 17,1 | 13.0470-3983.2  | LD3983 | 23709 19,4 | 13.0470-7078.2  | LD7078 | 21486 19,3 |
| 13.0470-2888.2  | LD2888 | 23326 17,4 | 13.0470-3983.2  | LD3983 | 23710 19,4 | 13.0470-7078.2  | LD7078 | 21642 19,3 |
| 13.0470-2891.2  | LD2891 | 24134 19,6 | 13.0470-3984.2  | LD3984 | 23711 19,4 | 13.0470-7079.2  | LD7079 | 21282 17,3 |
| 13.0470-2891.2  | LD2891 | 24175 19,6 | 13.0470-3984.2  | LD3984 | 23712 19,4 | 13.0470-7079.2  | LD7079 | 21487 17,3 |
| 13.0470-2892.2  | LD2892 | 24133 18,6 | 13.0470-3984.2  | LD3984 | 23713 19,4 | 13.0470-7081.2  | LD7081 | 20676 19,8 |
| 13.0470-2892.2  | LD2892 | 24174 18,6 | 13.0470-3987.2  | LD3987 | 23279 18,4 | 13.0470-7081.2  | LD7081 | 21911 20,3 |
| 13.0470-2893.2  | LD2893 | 24135 17,7 | 13.0470-3988.2  | LD3988 | 23557 17,2 | 13.0470-7086.2  | LD7086 | 21664 19,8 |
| 13.0470-2894.2  | LD2894 | 20961 17,4 | 13.0470-3994.2  | LD3994 | 23599 19,0 | 13.0470-7086.2  | LD7086 | 21795 19,8 |
| 13.0470-2927.2  | LD2927 | 20941 19,3 | 13.0470-3999.2  | LD3999 | 23743 20,1 | 13.0470-7087.2  | LD7087 | 21670 19,4 |
| 13.0470-2927.2  | LD2927 | 21028 19,3 | 13.0470-3999.2  | LD3999 | 23744 20,1 | 13.0470-7087.2  | LD7087 | 21794 19,4 |
| 13.0470-2975.2  | LD2975 | 21439 20,3 | 13.0470-4044.2  | LD4044 | 20755 15,1 | 13.0470-7089.2  | LD7089 | 21676 20,3 |
| 13.0470-3605.2  | LD3605 | 20180 17,3 | 13.0470-4047.2  | LD4047 | 21305 15,7 | 13.0470-7089.2  | LD7089 | 21677 20,3 |
| 13.0470-3605.2  | LD3605 | 20181 17,3 | 13.0470-4064.2  | LD4064 | 21919 15,3 | 13.0470-7090.2  | LD7090 | 21691 17,3 |
| 13.0470-3805.2  | LD3805 | 21197 15,0 | 13.0470-4065.2  | LD4065 | 21899 15,3 | 13.0470-7090.2  | LD7090 | 21891 17,3 |
| 13.0470-3812.2  | LD3812 | 23714 17,6 | 13.0470-4803.2  | LD4803 | 23092 15,6 | 13.0470-7100.2  | LD7100 | 21866 17,2 |
| 13.0470-3813.2  | LD3813 | 24150 17,6 | 13.0470-4803.2  | LD4803 | 23111 15,6 | 13.0470-7100.2  | LD7100 | 21868 17,2 |
| 13.0470-3814.2  | LD3814 | 23934 18,2 | 13.0470-4814.2  | LD4814 | 21937 15,5 | 13.0470-7110.2  | LD7110 | 20676 19,8 |
| 13.0470-3815.2  | LD3815 | 23930 18,2 | 13.0470-4833.2  | LD4833 | 24098 17,1 | 13.0470-7110.2  | LD7110 | 23018 20,3 |
| 13.0470-3826.2  | LD3826 | 23706 18,0 | 13.0470-4834.2  | LD4834 | 24097 17,1 | 13.0470-7110.2  | LD7110 | 23019 20,3 |
| 13.0470-3826.2  | LD3826 | 23707 18,0 | 13.0470-4850.2  | LD4850 | 24296 15,5 | 13.0470-7111.2  | LD7111 | 23130 19,6 |
| 13.0470-3827.2  | LD3827 | 23709 19,6 | 13.0470-4851.2  | LD4851 | 23092 16,0 | 13.0470-7111.2  | LD7111 | 23131 19,6 |
| 13.0470-3827.2  | LD3827 | 23710 19,6 | 13.0470-4851.2  | LD4851 | 23111 16,0 | 13.0470-7115.2  | LD7115 | 23063 17,5 |
| 13.0470-3828.2  | LD3828 | 24349 17,5 | 13.0470-4853.2  | LD4853 | 24162 15,2 | 13.0470-7115.2  | LD7115 | 23064 17,5 |
| 13.0470-3831.2  | LD3831 | 24260 17,3 | 13.0470-4853.2  | LD4853 | 24687 15,2 | 13.0470-7115.2  | LD7115 | 23065 17,5 |
| 13.0470-3836.2  | LD3836 | 24540 16,3 | 13.0470-4854.2  | LD4854 | 23092 16,3 | 13.0470-7115.2  | LD7115 | 23066 18,5 |
| 13.0470-3838.2  | LD3838 | 21436 17,0 | 13.0470-4854.2  | LD4854 | 23756 16,3 | 13.0470-7115.2  | LD7115 | 23067 18,5 |
| 13.0470-3839.2  | LD3839 | 23707 17,9 | 13.0470-4854.2  | LD4854 | 23757 16,3 | 13.0470-7116.2  | LD7116 | 23057 20,2 |
| 13.0470-3839.2  | LD3839 | 23982 18,1 | 13.0470-4867.2  | LD4867 | 24852 16,0 | 13.0470-7116.2  | LD7116 | 23058 19,6 |
| 13.0470-3839.2  | LD3839 | 24288 17,9 | 13.0470-4867.2  | LD4867 | 24853 16,0 | 13.0470-7116.2  | LD7116 | 23059 19,6 |
| 13.0470-3840.2  | LD3840 | 23981 19,6 | 13.0470-4879.2  | LD4879 | 25643 17,0 | 13.0470-7117.2  | LD7117 | 23130 19,6 |
| 13.0470-3840.2  | LD3840 | 24549 19,6 | 13.0470-4971.2  | LD4971 | 23092 16,0 | 13.0470-7117.2  | LD7117 | 23131 19,6 |
| 13.0470-3846.2  | LD3846 | 24072 17,9 | 13.0470-4971.2  | LD4971 | 23110 16,0 | 13.0470-7117.2  | LD7117 | 23187 19,6 |

# Vergleichsliste ATE → WVA

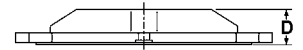
Cross reference list ATE → WVA - Tabella di conversione codici ATE → WVA

Liste des correspondances ATE → WVA - Lista referencias ATE → WVA



|  | WVA    | D     |  | WVA            | D      |  | WVA  | D              |        |       |      |
|---|--------|-------|---|----------------|--------|---|------|----------------|--------|-------|------|
| 13.0470-7122.2  | LD7122 | 20676 | 19,8  | 13.0470-7190.2 | LD7190 | 24367   | 19,1 | 13.0470-7231.2 | LD7231 | 24171 | 20,9 |
| 13.0470-7122.2  | LD7122 | 21911 | 20,3  | 13.0470-7190.2 | LD7190 | 24368   | 19,1 | 13.0470-7232.2 | LD7232 | 21282 | 17,3 |
| 13.0470-7122.2  | LD7122 | 23392 | 20,3  | 13.0470-7190.2 | LD7190 | 24556   | 19,1 | 13.0470-7232.2 | LD7232 | 23447 | 17,3 |
| 13.0470-7135.2  | LD7135 | 23076 | 17,5  | 13.0470-7191.2 | LD7191 | 23749   | 19,1 | 13.0470-7237.2 | LD7237 | 23347 | 20,3 |
| 13.0470-7135.2  | LD7135 | 23077 | 17,5  | 13.0470-7191.2 | LD7191 | 23835   | 19,6 | 13.0470-7237.2 | LD7237 | 24161 | 20,3 |
| 13.0470-7137.2  | LD7137 | 23482 | 15,8  | 13.0470-7193.2 | LD7193 | 23723   | 18,1 | 13.0470-7238.2 | LD7238 | 23313 | 20,3 |
| 13.0470-7137.2  | LD7137 | 23483 | 15,8  | 13.0470-7193.2 | LD7193 | 23724   | 18,1 | 13.0470-7238.2 | LD7238 | 24255 | 20,3 |
| 13.0470-7139.2  | LD7139 | 23140 | 19,4  | 13.0470-7194.2 | LD7194 | 23482   | 16,6 | 13.0470-7239.2 | LD7239 | 24172 | 19,0 |
| 13.0470-7139.2  | LD7139 | 23141 | 19,4  | 13.0470-7194.2 | LD7194 | 24137   | 16,6 | 13.0470-7239.2 | LD7239 | 24173 | 20,0 |
| 13.0470-7139.2  | LD7139 | 24095 | 19,4  | 13.0470-7195.2 | LD7195 | 23482   | 16,6 | 13.0470-7242.2 | LD7242 | 24332 | 19,8 |
| 13.0470-7140.2  | LD7140 | 21637 | 19,3  | 13.0470-7195.2 | LD7195 | 24137   | 16,6 | 13.0470-7242.2 | LD7242 | 24333 | 21,3 |
| 13.0470-7140.2  | LD7140 | 21641 | 19,3  | 13.0470-7200.2 | LD7200 | 23801   | 20,3 | 13.0470-7242.2 | LD7242 | 24334 | 21,3 |
| 13.0470-7140.2  | LD7140 | 23289 | 19,3  | 13.0470-7200.2 | LD7200 | 23912   | 20,3 | 13.0470-7243.2 | LD7243 | 24142 | 20,6 |
| 13.0470-7145.2  | LD7145 | 23073 | 18,8  | 13.0470-7200.2 | LD7200 | 23913   | 20,3 | 13.0470-7243.2 | LD7243 | 24521 | 19,1 |
| 13.0470-7145.2  | LD7145 | 23074 | 18,8  | 13.0470-7201.2 | LD7201 | 23763   | 20,3 | 13.0470-7244.2 | LD7244 | 24253 | 17,8 |
| 13.0470-7155.2  | LD7155 | 21676 | 20,3  | 13.0470-7201.2 | LD7201 | 23801   | 20,3 | 13.0470-7244.2 | LD7244 | 24254 | 18,0 |
| 13.0470-7155.2  | LD7155 | 23183 | 20,3  | 13.0470-7201.2 | LD7201 | 23950   | 20,3 | 13.0470-7249.2 | LD7249 | 24709 | 18,6 |
| 13.0470-7157.2  | LD7157 | 23215 | 18,3  | 13.0470-7202.2 | LD7202 | 23589   | 19,1 | 13.0470-7249.2 | LD7249 | 24710 | 18,6 |
| 13.0470-7157.2  | LD7157 | 23217 | 18,3  | 13.0470-7202.2 | LD7202 | 24153   | 19,1 | 13.0470-7251.2 | LD7251 | 23482 | 15,8 |
| 13.0470-7158.2  | LD7158 | 23245 | 18,3  | 13.0470-7203.2 | LD7203 | 21670   | 19,3 | 13.0470-7251.2 | LD7251 | 24137 | 15,8 |
| 13.0470-7158.2  | LD7158 | 23247 | 18,3  | 13.0470-7203.2 | LD7203 | 21794   | 19,3 | 13.0470-7252.2 | LD7252 | 24084 | 19,3 |
| 13.0470-7159.2  | LD7159 | 23245 | 18,3  | 13.0470-7204.2 | LD7204 | 23801   | 18,8 | 13.0470-7252.2 | LD7252 | 24332 | 18,3 |
| 13.0470-7159.2  | LD7159 | 23248 | 18,3  | 13.0470-7204.2 | LD7204 | 23912   | 18,8 | 13.0470-7256.2 | LD7256 | 24705 | 19,8 |
| 13.0470-7161.2  | LD7161 | 23281 | 18,3  | 13.0470-7210.2 | LD7210 | 23791   | 20,8 | 13.0470-7256.2 | LD7256 | 24706 | 21,3 |
| 13.0470-7161.2  | LD7161 | 23282 | 18,3  | 13.0470-7210.2 | LD7210 | 23792   | 20,8 | 13.0470-7256.2 | LD7256 | 24707 | 21,3 |
| 13.0470-7162.2  | LD7162 | 23716 | 15,8  | 13.0470-7211.2 | LD7211 | 24339   | 20,5 | 13.0470-7257.2 | LD7257 | 24253 | 18,0 |
| 13.0470-7162.2  | LD7162 | 23717 | 15,8  | 13.0470-7211.2 | LD7211 | 24340   | 20,3 | 13.0470-7257.2 | LD7257 | 24254 | 18,0 |
| 13.0470-7166.2  | LD7166 | 23762 | 20,4  | 13.0470-7215.2 | LD7215 | 23935   | 17,8 | 13.0470-7259.2 | LD7259 | 24862 | 16,7 |
| 13.0470-7166.2  | LD7166 | 23763 | 20,4  | 13.0470-7215.2 | LD7215 | 23999   | 17,8 | 13.0470-7259.2 | LD7259 | 24863 | 16,7 |
| 13.0470-7167.2  | LD7167 | 23312 | 20,3  | 13.0470-7216.2 | LD7216 | 23794   | 20,3 | 13.0470-7262.2 | LD7262 | 25031 | 19,1 |
| 13.0470-7167.2  | LD7167 | 23347 | 20,3  | 13.0470-7216.2 | LD7216 | 23968   | 20,3 | 13.0470-7262.2 | LD7262 | 25032 | 19,1 |
| 13.0470-7168.2  | LD7168 | 21282 | 17,3  | 13.0470-7217.2 | LD7217 | 23926   | 17,3 | 13.0470-7262.2 | LD7262 | 25033 | 19,1 |
| 13.0470-7168.2  | LD7168 | 23447 | 17,3  | 13.0470-7217.2 | LD7217 | 23927   | 17,3 | 13.0470-7263.2 | LD7263 | 24034 | 19,1 |
| 13.0470-7169.2  | LD7169 | 23309 | 17,3  | 13.0470-7219.2 | LD7219 | 23923   | 17,6 | 13.0470-7263.2 | LD7263 | 24035 | 19,1 |
| 13.0470-7169.2  | LD7169 | 23310 | 17,3  | 13.0470-7219.2 | LD7219 | 23924   | 17,6 | 13.0470-7263.2 | LD7263 | 24036 | 19,1 |
| 13.0470-7171.2  | LD7171 | 23334 | 16,7  | 13.0470-7220.2 | LD7220 | 23922   | 21,0 | 13.0470-7264.2 | LD7264 | 25096 | 17,0 |
| 13.0470-7171.2  | LD7171 | 23335 | 16,7  | 13.0470-7220.2 | LD7220 | 23925   | 20,5 | 13.0470-7264.2 | LD7264 | 25097 | 17,0 |
| 13.0470-7172.2  | LD7172 | 23378 | 20,1  | 13.0470-7221.2 | LD7221 | 23215   | 18,3 | 13.0470-7264.2 | LD7264 | 25098 | 17,0 |
| 13.0470-7172.2  | LD7172 | 23379 | 20,1  | 13.0470-7221.2 | LD7221 | 24535   | 18,3 | 13.0470-7266.2 | LD7266 | 24538 | 17,9 |
| 13.0470-7172.2  | LD7172 | 23402 | 20,1  | 13.0470-7223.2 | LD7223 | 23794   | 20,3 | 13.0470-7266.2 | LD7266 | 24914 | 17,9 |
| 13.0470-7172.2  | LD7172 | 23403 | 20,1  | 13.0470-7223.2 | LD7223 | 24096   | 20,3 | 13.0470-7267.2 | LD7267 | 25045 | 19,5 |
| 13.0470-7174.2  | LD7174 | 23732 | 17,3  | 13.0470-7223.2 | LD7223 | 24193   | 20,3 | 13.0470-7267.2 | LD7267 | 25046 | 18,5 |
| 13.0470-7174.2  | LD7174 | 23737 | 17,3  | 13.0470-7225.2 | LD7225 | 23550   | 17,3 | 13.0470-7268.2 | LD7268 | 23794 | 20,3 |
| 13.0470-7176.2  | LD7176 | 23793 | 20,3  | 13.0470-7225.2 | LD7225 | 23551   | 17,3 | 13.0470-7268.2 | LD7268 | 24697 | 19,3 |
| 13.0470-7176.2  | LD7176 | 23794 | 20,3  | 13.0470-7226.2 | LD7226 | 23587   | 20,8 | 13.0470-7269.2 | LD7269 | 24339 | 19,5 |
| 13.0470-7179.2  | LD7179 | 23832 | 20,2  | 13.0470-7226.2 | LD7226 | 23588   | 20,8 | 13.0470-7269.2 | LD7269 | 24340 | 19,5 |
| 13.0470-7179.2  | LD7179 | 23833 | 20,2  | 13.0470-7226.2 | LD7226 | 23589   | 20,4 | 13.0470-7273.2 | LD7273 | 24538 | 19,4 |
| 13.0470-7179.2  | LD7179 | 23844 | 20,5  | 13.0470-7227.2 | LD7227 | 23801   | 20,4 | 13.0470-7273.2 | LD7273 | 25180 | 19,0 |
| 13.0470-7181.2  | LD7181 | 21636 | 19,3  | 13.0470-7227.2 | LD7227 | 23912   | 20,3 | 13.0470-7275.2 | LD7275 | 23313 | 20,2 |
| 13.0470-7181.2  | LD7181 | 21637 | 19,3  | 13.0470-7227.2 | LD7227 | 23913   | 20,3 | 13.0470-7275.2 | LD7275 | 24688 | 19,2 |
| 13.0470-7184.2  | LD7184 | 23587 | 20,6  | 13.0470-7228.2 | LD7228 | 24123   | 20,3 | 13.0470-7280.2 | LD7280 | 25158 | 20,3 |
| 13.0470-7184.2  | LD7184 | 23588 | 20,6  | 13.0470-7228.2 | LD7228 | 24124   | 19,3 | 13.0470-7280.2 | LD7280 | 25159 | 20,3 |
| 13.0470-7184.2  | LD7184 | 23589 | 20,6  | 13.0470-7229.2 | LD7229 | 24538   | 18,5 | 13.0470-7281.2 | LD7281 | 25160 | 20,3 |
| 13.0470-7187.2  | LD7187 | 23590 | 19,5  | 13.0470-7229.2 | LD7229 | 24539   | 18,5 | 13.0470-7281.2 | LD7281 | 25161 | 20,3 |
| 13.0470-7187.2  | LD7187 | 23591 | 18,0  | 13.0470-7230.2 | LD7230 | 24557   | 19,4 | 13.0470-7282.2 | LD7282 | 25190 | 21,3 |
| 13.0470-7188.2  | LD7188 | 24141 | 19,1  | 13.0470-7230.2 | LD7230 | 24558   | 18,7 | 13.0470-7282.2 | LD7282 | 25191 | 21,3 |
| 13.0470-7188.2  | LD7188 | 24142 | 20,6  | 13.0470-7231.2 | LD7231 | 24170   | 20,2 | 13.0470-7282.2 | LD7282 | 25192 | 21,3 |











- D** Technische Übersetzungen
- EN** Technical translations
- FR** Traductions techniques
- IT** Traduzioni tecniche
- ES** Traducciones técnicas
- NL** Technische vertalingen
- DA** Tekniske oversættelser
- SV** Tekniska översättningar
- HU** Műszaki fordítás
- PT** Glossário técnico
- RU** Перевод технических терминов
- CZ** Technické překlady
- PL** Tłumaczenia techniczne
- EL** Τεχνικές μεταφράσεις
- TR** Teknik çeviriler
- ZH** 技术翻译
- JA** テクニカルトランスミッション
- AR** إستشارة تقنية وبيع

# K24-F

|  |                                       |   |
|--|---------------------------------------|---|
| 1-Kammer-Druckluftbremse               | single-chamber air brake              | frein pneumatique à 1 chambre             |
| 1-Kolbensattel D=xx                    | single-piston caliper D=xx            | étrier à 1 piston D=xx                    |
| 2-Kolbensattel D=xx                    | 2-piston caliper D=xx                 | étrier à 2 pistons D=xx                   |
| 4-Kolbensattel                         | 4-piston caliper                      | étrier à 4 pistons                        |
| 1-Kreis-Bremse                         | single-circuit brake                  | frein à 1 circuit                         |
| 2-Kreis-Bremse                         | two-circuit-brake                     | frein à deux circuits                     |
| 1-Kreis-Sättel                         | single-circuit caliper                | étriers frein à 1 circuit                 |
| 2-Kreis-Sättel                         | two-circuit-caliper                   | étriers frein à 2 circuits                |
| 1. Hinterachse                         | first rear axle                       | 1. essieu arrière                         |
| 1. und 2. Hinterachse                  | first and second rear axle            | 1. et 2. essieu arrière                   |
| 4-Loch-Bremsscheibe                    | 4-bore brake disc                     | disques de frein à 4 trous                |
| 6-Loch-Bremsscheibe                    | 6-bore brake disc                     | disques de frein à 6 trous                |
| 3-Loch-Felge                           | 3-bore wheel rim                      | jante à 3 trous                           |
| 4-Loch-Felge                           | 4-bore wheel rim                      | jante à 4 trous                           |
| 5-Loch-Felge                           | 5-bore wheel rim                      | jante à 5 trous                           |
| 6kt-Schraube                           | hexagon head screw                    | vis hex.                                  |
| 6kt-Schraube (innen)                   | hexagon socket screw                  | vis hex. (intérieure)                     |
| 6“-Tandem                              | 6“-tandem                             | 6“-tandem                                 |
| 8“-Tandem mit Gabelkopf                | 8“-tandem with yoke                   | 8“-tandem avec chape                      |
| 8“-Tandem ohne Gabelkopf               | 8“-tandem without yoke                | 8“-tandem sauf chape                      |
| ABS                                    | ABS (anti-lock brake system)          | ABS (système anti-blocage)                |
| ABS-Dichtungssatz                      | ABS-gasket kit                        | jeu de joints de ABS                      |
| Achtung: Kolbenstellung ändern !       | attention: change piston position !   | attention: position du piston à changer ! |
| Adapter für Bördel E                   | adapter for bead type E               | adapteur pour colet E                     |
| alle Typen                             | all types                             | tous types                                |
| Alu-Pumpe                              | alu-pump                              | pompe en alu                              |
| Alu-Sättel                             | alu-calipers                          | étriers en alu                            |
| am Bremssattel                         | on the brake caliper                  | sur l'étrier de frein                     |
| am Hauptzylinder                       | on the master cylinder                | sur le maître-cylindre                    |
| A-Motor                                | A engine                              | moteur A                                  |
| Anschlagschraube oben                  | stop screw, top                       | vis de butée en haut                      |
| Anschluß/Anschlüsse                    | connection/connections                | raccordement/raccordements                |
| Anti-Noise-Blech                       | shim                                  | tôle anti-bruit                           |
| ASC (Automatische Stabilitäts Control) | ASC (automatic stability control)     | ASC (contrôle de stabilité)               |
| ASR (Antriebsschlupfregelsystem)       | ASR (traction control system TCS)     | ASR (anti-patinage)                       |
| ATE nur über VAG erhältlich            | ATE only available through VAG        | ATE (Teves) en vente chez VAG seulement   |
| auf Typenschild                        | on identification plate               | sur plaque d'identification               |
| aufgeschraubt                          | screwed on                            | vissé                                     |
| Auslaß seitlich links                  | outlet lateral left-hand              | échappement latéral gauche                |
| Auslaß seitlich rechts                 | outlet lateral right-hand             | échappement latéral droit                 |
| außen                                  | outer                                 | mâle                                      |
| automatische Nachstellung              | automatic adjustment                  | ajustage automatique                      |
| Behälter                               | reservoir                             | réservoir                                 |
| Behälter Doppel-WE                     | reservoir with double warning device  | réservoir avec témoin d'usure double      |
| Behälterbefestigung                    | reservoir fastening                   | fixation réservoir                        |
| Behälterstopfen                        | reservoir plug                        | bouchon de réservoir                      |
| Behälterverschraubung                  | reservoir cap                         | vissage de réservoir                      |
| Behörde                                | authority cars                        | véhicule communal                         |
| Beläge                                 | brake pads                            | plaquettes de frein                       |
| belüftete Scheiben                     | ventilated discs                      | disques ventilés                          |
| Betätigungseinheit                     | actuation unit                        | unité de commande                         |
| blau                                   | blue                                  | bleu                                      |
| Bodenventil                            | residual pressure center valve        | soupape de pression résiduelle            |
| Bodenventile tauschen                  | change residual pressure center valve | soupape de pression résiduelle à changer  |
| Bördel x                               | flare type x                          | colet x                                   |
| braun                                  | brown                                 | marron                                    |
| breite Ausführung                      | wide design                           | exécution large                           |
| Bremse                                 | brake                                 | frein                                     |
| Bremsgerät                             | booster unit                          | servo-frein                               |
| Bremskraftregler                       | brake pressure regulator              | correcteur de freinage                    |
| Bremsleitungen erneuern !              | renew brake lines !                   | conduits de frein à renouveler !          |
| Bremslichtschalter                     | stop-light switch                     | contacteur stop                           |
| Bremsscheiben                          | brake discs                           | disques de frein                          |
| Bremsschlauch beachten !               | notice brake hose !                   | faire attention flexible de frein !       |
| Buchse + Ausgleichbügel                | bushing + compensating clip           | douille + étrier de compensation          |
| Bus                                    | bus (van)                             | autobus/car                               |
| Bypassregler                           | by-pass regulator                     | régulateur à by-pass                      |
| Citroen-Bremse                         | Citroen-brake                         | freins Citroen                            |
| D (Durchmesser) =                      | D (diameter) =                        | D (diamètre) =                            |
| Dichtring                              | sealing ring                          | rondelle d'étanchéité                     |
| Dichtung                               | seal                                  | joint                                     |
| Dichtungssatz                          | gasket kit                            | jeu de joints                             |
| Differentialsperre                     | differential lock                     | blocage de différentiel                   |
| Differenzdruckschalter                 | differential-pressure switch          | interrupteur à pression différentielle    |
| Differenzdruckventil                   | differential pressure valve           | pression différentielle de soupape        |
| diverse Typen                          | various types                         | types diverses                            |
| Doppelbereifung                        | twin tyres                            | pneu double                               |



|   |   |   |
|---|---|---|
| freno pneumatico a camera singola           | freno de aire de 1 cámara               | geluiddempende plaat                          |
| pinza freno a un pistoncino D = xx          | mordaza de freno D=xx                   | 1-zuigerklauw D=xx                            |
| pinza freno a 2 pistoncini D=xx             | mordaza con dos pistones D=xx           | 2-zuigerklauw D=xx                            |
| pinza freno a 4 pistoncini                  | mordaza con 4 pistones                  | 4-zuigerklauw                                 |
| impianto frenante circuito semplice         | freno de 1 circuito                     | enkel remcircuit                              |
| impianto frenante doppio circuito           | freno de 2 circuitos                    | gescheiden remcircuit                         |
| pinza freno a 1 circuito                    | pinza de 1 circuito                     | remklauwen voor enkel remcircuit              |
| pinza freno a 2 circuiti                    | pinza de 2 circuitos                    | remklauwen voor gescheiden remcircuit         |
| primo assale posteriore                     | 1. eje trasero                          | 1e achteras                                   |
| primo e secondo assale posteriore           | 1. + 2. eje trasero                     | 1e en 2e achteras                             |
| disco freno 4 fori                          | disco freno con 4 taladros              | 4-gats remschijf                              |
| disco freno 6 fori                          | disco freno con 6 taladros              | 6-gats remschijf                              |
| cerchione a 3 fori                          | Llantas de 3 taladros                   | 3-gats velg                                   |
| cerchione a 4 fori                          | Llantas de 4 taladros                   | 4-gats velg                                   |
| cerchione a 5 fori                          | Llantas de 5 taladros                   | 5-gats velg                                   |
| vite testa esagonale                        | ornillo hexagonal                       | zeskantbout                                   |
| brugola                                     | ornillo hexagonal ( interior)           | zeskantbout (binnen)                          |
| tandem 6"                                   | 6"-tándem                               | 6"-tandem                                     |
| tandem 8" con testa a forcella              | 8"-tándem con cabeza de horquilla       | 8"-tandem met gaffel                          |
| tandem 8" senza testa a forcella            | 8"-tándem sin cabeza de horquilla       | 8"-tandem zonder gaffel                       |
| ABS (sistema antibloccaggio in frenata)     | ABS (sistema de frenado antibloqueo)    | ABS   |
| serie guarnizioni ABS                       | juego de reparación de juntas ABS       | ABS-pakkingset                                |
| attenzione: cambiare posizione pistone !    | atención: cambiar posición pistón !     | Attentie: positie zuiger wijzigen !           |
| adattatore per bordatura E                  | adaptador para rebordes E               | adapter voor felsrand E                       |
| tutti tipi                                  | todos tipo                              | alle typen                                    |
| pompa in alluminio                          | bomba de aluminio                       | alu-pomp                                      |
| pinza in alluminio                          | mordaza de freno de aluminio            | alu-klauwen                                   |
| sulla pinza freno                           | a la pinza de freno                     | op de remklauw                                |
| sulla pompa freno                           | a la bomba principal de freno           | op de hoofdremscilinder                       |
| motore A                                    | motor de A                              | A-motor                                       |
| vite di fermo in alto                       | ornillo de tope arriba                  | aanslagschroef boven                          |
| attacco / attacchi                          | conexion/conexiones                     | aansluiting/aansluitingen                     |
| lamierino antirumore                        | placa anti-ruídos                       | geluiddempende plaat                          |
| ASC (controllo automatico stabilità)        | ASC (control automático de estabilidad) | ASC (Automatische Stabiliteits Controle)      |
| ASR (sistema antislittamento in accelerata) | ASR (sistemas antiderrapaje)            | ASR (tractieregelingssysteem)                 |
| ATE distribuito esclusivamente da VAG       | ATE solamente através de VAG            | ATE alleen verkrijgbaar via VAG               |
| vedi targhetta di identificazione           | placa de identificación                 | op typeplaatje                                |
| avvitato                                    | fijado                                  | opgeschroefd                                  |
| scarico laterale sinistro                   | salida lateral izquierda                | uitlaat opzij links                           |
| scarico laterale destro                     | salida lateral derecha                  | uitlaat opzij rechts                          |
| esterno                                     | exterior                                | buiten  |
| correzione automatica                       | reajuste automatico                     | automatische bijstelling                      |
| serbatoio                                   | recipiente                              | reservoir                                     |
| serbatoio con doppia spia                   | recipiente con doble aparato de aviso   | reservoir dubbele noodknipperlichtinstallatie |
| fissaggio serbatoio                         | recipiente de fijación                  | bevestiging reservoir                         |
| tappo serbatoio                             | tapon                                   | plug reservoir                                |
| tappo filettato serbatoio                   | fijación depósito                       | schroefkoppeling reservoir                    |
| enti statali                                | vehiculos oficiales                     | overheid                                      |
| pastiglie freno                             | pastillas de freno                      | voeringen                                     |
| dischi ventilati                            | disco ventilado                         | geventileerde schijven                        |
| unità di comando                            | unidad de accionamiento                 | bedieningseenheid                             |
| blu   | azul                                    | blauw   |
| valvola di fondo                            | válvula de fondo                        | bodemventiel                                  |
| sostituire valvola di fondo                 | cambiar válvula de fondo                | bodemventielen vervangen                      |
| bordatura tipo x                            | rebord x                                | felsrand x                                    |
| marrone                                     | marron                                  | bruin   |
| versione larga                              | variante ancha                          | brede uitvoering                              |
| freno                                       | freno                                   | rem   |
| servofreno                                  | servofreno                              | remapparaat                                   |
| correttore di frenata                       | corrector de frenado                    | remdrukregelaar                               |
| sostituire tubi freni !                     | renovar latiguillos de freno !          | remleidingen vernieuwen !                     |
| interruttore luce stop                      | interruptor de luz de freno             | remlichtschakelaar                            |
| dischi freno                                | discos de freno                         | remschijven                                   |
| attenzione ai flessibili freni !            | atención al latiguillo de freno !       | let op de remslang !                          |
| bussola + staffa di compensazione           | casquillo + estribo de compensación     | bus + expansiebeugel                          |
| autobus                                     | autobus                                 | bus   |
| regolatore by-pass                          | regulador de by-pass                    | bypassregelaar                                |
| freno Citroen                               | freno Citroen                           | citroen-rem                                   |
| D (diametro) =                              | D (diámetro) =                          | D (diameter) =                                |
| guarnizione anulare                         | reten                                   | afdichtring                                   |
| guarnizione                                 | junta                                   | pakking                                       |
| serie guarnizioni                           | juego de reparación de juntas           | pakkingset                                    |
| differenziale autobloccante                 | bloqueo diferencial                     | differentieelslot                             |
| interruttore pressione differenziale        | interruptor de presión diferencial      | verschilddrukschakelaar                       |
| valvola pressione differenziale             | válvula de presión diferencial          | verschilddrukklep                             |
| vari tipi                                   | diversos tipo                           | diverse typen                                 |
| ruote gemellate                             | cubierta doble                          | dubbele banden                                |

|                             |                                      |  |
|-----------------------------|--------------------------------------|--|
| Doppelkabine                | double cab                           | cabine double                              |
| Druckbegrenzungsventil      | pressure limiting valve              | soupape à réglage de pression              |
| Druckbolzen                 | tappet                               | boulon de pression                         |
| Druckbolzen (kurz)          | tappet (short)                       | boulon de pression (court)                 |
| Druckbolzen (lang)          | tappet (long)                        | boulon de pression (long)                  |
| Druckluftbremse             | air brake                            | frein à pneumatique                        |
| Druckluftleitung            | compressed-air line                  | conduite pneumatique                       |
| Druckluftunterstützung      | air brake assistance                 | assistance à pneumatique                   |
| Druckluftverstärker         | air brake booster                    | amplificateur à pneumatique                |
| Druck-Warnschalter          | pressure warning switch              | avertisseur d'alerte de pression           |
| DS-Regler                   | DS-valve                             | correcteur de DS                           |
| EDS                         | EDS (electronic differential lock)   | EDS (blocage de différentiel électronique) |
| EDS-Ventilblock             | EDS-valve block                      | EDS-bloc de vannes                         |
| EG-Vorschrift               | accordance with EC regulation        | aux prescriptions CEE                      |
| Einbau hinter der Achse     | installation aft of axle             | montage derrière l'essieu                  |
| Einbau vor der Achse        | installation forward of axle         | montage devant l'essieu                    |
| Einbausatz                  | installation kit                     | lot de montage                             |
| Einfachbereifung            | single tyre                          | pneu simple                                |
| Einknöpfmaß xx mm           | button-in dimension xx mm            | mesure à boutonner xx mm                   |
| Einlaß D=xx mm              | inlet diameter=xx mm                 | admission diamètre=xx mm                   |
| Einlaß mit Gummistopfen     | inlet with rubber plug               | admission avec bouchon de caoutchouc       |
| Einschraubregler            | screw-in proportioning valve         | compensateurs à visser                     |
| elektr. Vergaser            | electr. carburetor                   | carburateur électrique                     |
| Entlüfteranschluß           | bleeding connection                  | raccordement de purge                      |
| Entlüfterventil             | bleeder valve                        | soupape de purge                           |
| erhöhte Zuladung            | increased payload                    | charge utile augmentée                     |
| Ersatz für Sättel D=xx      | replacement for calipers D=xx        | remplacement pour étriers D=xx             |
| ETS                         | ETS (electronic trac control system) | ETS (contrôle trajectoire)                 |
| Europa                      | Europe                               | Europe                                     |
| Export                      | Export                               | Export                                     |
| Fahrschule                  | driving school                       | auto-école                                 |
| Faltenbalsatz               | bellow seal set                      | jeu de joints-soufflets                    |
| Faustsättel                 | fist-type calipers                   | étriers à griffe                           |
| Fenster                     | window                               | fenêtre                                    |
| Festsättel                  | fixed calipers                       | étriers fixes                              |
| Flanschdicke x mm           | flange thickness x mm                | épaisseur de la bride x mmm                |
| Flanschmaß = xx,x           | flange dimension = xx,x              | dimension de la bride = xx,x               |
| Fuller-Getriebe             | fuller-gearbox                       | boîte à vitesse fuller                     |
| für Belagsätze ohne Zubehör | for brake pads without accessories   | pour garnitures de frein sauf accessoire   |
| für Bremssättel/Vorgänger   | for calipers/predecessor             | pour étriers de frein/prédécesseur         |
| für Doppelmembran-Gerät     | for twin diaphragm booster           | pour appareil à double membrane            |
| Gabelkopfsatz               | yoke kit                             | jeu de chape                               |
| Gehäuse L=                  | housing L=                           | corps L=                                   |
| gelb                        | yellow                               | jaune                                      |
| gepanzerte Fahrzeuge        | armoured vehicles                    | véhicule blindé                            |
| Getriebe                    | gearbox                              | boîte de vitesse                           |
| Getriebe-Nr.                | gearbox-no.                          | no. boîte de vitesse                       |
| GG-Pumpe                    | cast-iron-pump                       | pompe en fonte                             |
| GG-Sättel                   | cast iron-caliper                    | étriers en fonte                           |
| GG-THz/Vorgänger            | cast-iron-TMC/predecessor            | MCT fonte/predécesseur                     |
| Golf-Staaten                | Gulf States                          | pays du Golfe Persique                     |
| Gz mit senkrechtem Flansch  | CC with vertical flange              | émetteur d'embrayage avec bride            |
| Gz (Geberzylinder)          | CC (clutch cylinder)                 | EE (émetteur d'embrayage)                  |
| Gz-Reparaturatz             | CC-repair kit                        | néc. de réparation EE                      |
| HA (Hinterachse)            | RA (rear axle)                       | AR (essieu arrière)                        |
| Haltefeder                  | retaining spring                     | ressort à retenu                           |
| Halter                      | anchor                               | support                                    |
| Haltersatz                  | anchor set                           | jeu de support                             |
| Halterschraube              | anchor screw                         | vis de support                             |
| Handbremsbetätigung         | hand brake actuation                 | frein à main                               |
| Handbremshebel              | handbrake lever                      | levier de frein à main                     |
| HA-Scheibenbremse           | rear axle disc brake                 | frein à disque essieu AR                   |
| HA-Trommelbremse            | rear axle drum brake                 | frein à tambour essieu AR                  |
| Hebel                       | lever                                | levier                                     |
| Hochdach                    | high roof                            | toit surélevé                              |
| Hohlschraube                | hollow screw                         | vis creuse                                 |
| Hosei-Bremse                | Hosei brake                          | freins Hosei                               |
| Hub                         | stroke                               | course                                     |
| Hülsensatz                  | sleeve kit                           | jeu de douilles                            |
| Hydraulikspeicher           | hydraulic accumulator                | accumulateur hydraulique                   |
| Hydraulikverstärker         | hydraulic booster                    | amplificateur hydraulique                  |
| Hydraulikzylinder           | hydraulic cylinder                   | cylindre de hydraulique                    |
| Hydr. Steuereinheit         | hydraulic unit                       | modulateur                                 |
| Hz (Hauptzylinder)          | MC (master cylinder)                 | MC (maître cylindre)                       |
| Hz-Reparaturatz             | MC-repair kit                        | néc. de réparation MC                      |
| im Fahrerhaus               | in cab                               | dans la cabine du conducteur               |
| im Motorraum                | in engine compartment                | dans compartiment moteur                   |



|  |  |                                       |
|--|--|---------------------------------------|
| cabina doppia                              | cabina doble                                 | dubbele cabine                        |
| valvola limitatrice pressione              | valvula de limitación de presión             | drukregelaar                          |
| perno pressione (oliva)                    | perno de presión                             | drukpen                               |
| perno pressione (corto) (oliva)            | perno de presión (corto)                     | drukpen (kort)                        |
| perno pressione (lungo) (oliva)            | perno de presión (largo)                     | drukpen (lang)                        |
| freno pneumatico                           | freno de aire comprimido                     | pneumatische rem                      |
| tubo aria compressa                        | aire comprimido de flexible                  | pneumatische leiding                  |
| comando aria compressa                     | freno de aire auxiliár                       | luchtdrukbekrachtiging                |
| servofreno pneumatico                      | servo de aire a presión                      | luchtdrukbekrachtiger                 |
| interruttore spia pressione                | interruptor de aviso de presión              | druk-waarschuwingsschakelaar          |
| regolatore flusso pressione                | regulador DS                                 | DS-regelaar                           |
| EDS (bloccaggio elettronico differenziale) | EDS (bloqueo diferencial electrónico)        | EDS                                   |
| gruppo valvole EDS                         | EDS válvula de bloqueo                       | EDS-kleppenblok                       |
| normativa CE                               | según normativa CEE                          | EG-voorschrift                        |
| montaggio dietro l'assale                  | instalación despues del eje                  | montage achter de as                  |
| montaggio davanti l'assale                 | instalación antes del eje                    | montage vóór de as                    |
| serie di montaggio                         | juego de montaje                             | inbouwset                             |
| ruota singola                              | cubierta simple                              | enkele banden                         |
| misura alloggiamento xx mm                 | medida de alojamiento xx mm                  | inknoopmaat xx mm                     |
| diametro mandata = xx mm                   | admision diámetro = xx mm                    | inlaat D=xx mm                        |
| mandata con tappo in gomma                 | admision con tapon de goma                   | inlaat met rubberen plug              |
| regolatore a vite                          | regulador roscado                            | inschroefregelaar                     |
| carburatore elettronico                    | carburador eléctrico                         | elektr. carburateur                   |
| attacco per spurgo                         | conexion de purga                            | ontluchtingsaansluiting               |
| valvola di spurgo                          | válvula de purga                             | ontluchtingsventiel                   |
| carico utile maggiorato                    | incremento de carga                          | verhoogd laadvermogen                 |
| ricambio per pinza freno D=xx              | sustitución para pinzas D=xx                 | reserve voor remklauwen D=xx          |
| ETS (controllo elettronico della trazione) | ETS (sistema de control electr. de tracción) | ETS                                   |
| Europa                                     | Europa                                       | Europa                                |
| export                                     | Exportación                                  | export                                |
| scuola guida                               | escuela de conducción                        | rijsschool                            |
| serie soffiati                             | juego de reparac. de suspension neumatica    | rolbalgset                            |
| pinza freno flottante                      | pinza de puno                                | zwevende remklauwen                   |
| finestrella                                | ventana                                      | venster                               |
| pinza freno fissa                          | pinza de fija                                | vaste remklauwen                      |
| spessore flangia x mm                      | grosor de la brida x mm                      | flensdikte x mm                       |
| misura flangia = xx,x                      | medida de brida = xx,x                       | flensmaat = xx,x                      |
| scatola cambio Fuller                      | Fuller caja de cambios                       | Fuller-transmissie                    |
| per pastiglie freno senza accessori        | para juego de pastilla sin accesorios        | voor remvoeringsets zonder toebehoren |
| per pinze freno / precedente               | para pinza/avisador                          | voor remklauwen/voorlopers            |
| per servofreno a doppia membrana           | para servo freno con doble membrana          | voor dubbel-membraantoestel           |
| serie forcelle                             | juego de cabeza de horquilla                 | gaffelset                             |
| carcassa L =                               | carcasa L=                                   | huis L=                               |
| giallo                                     | amarillo                                     | geel                                  |
| veicoli blindati                           | vehículo blindado                            | gepantserde voertuigen                |
| scatola cambio                             | caja de cambios                              | transmissie                           |
| scatola cambio n.                          | número de caja de cambios                    | transmissie-nr.                       |
| pompa in ghisa                             | bomba de fundición de gris                   | GG-pomp                               |
| pinza in ghisa                             | pinza de fundición de gris                   | GG-klauwen                            |
| pompa tandem in ghisa / precedente         | cil. principal de fundición de gris/avisador | GG-tandemhoofdcilinder/voorloper      |
| Stati del Golfo                            | estados del Golfo Pérsico                    | Golfstaten                            |
| pompa frizione con flangia verticale       | cilindro distribuidor con brida vertical     | hoofdcilinder met verticale flens     |
| cilindro di comando                        | CTR (cilindro distribuidor)                  | hoofdcilinder                         |
| serie riparazione cilindro di comando      | juego de reparación de juntas CTR            | reparatieset hoofdcilinder            |
| P (asse posteriore)                        | HA (eje trasero)                             | achteras                              |
| molla di ritegno                           | muelle de sujeción                           | klemveer                              |
| supporto                                   | soporte                                      | houder                                |
| serie di supporti                          | juego de soporte                             | houderset                             |
| vite supporto                              | tomillo de soporte                           | houderschroef                         |
| azionamento freno a mano                   | activación de freno de mano                  | bediening handrem                     |
| leva freno a mano                          | palanca freno de mano                        | handremhendel                         |
| dischi freno asse posteriore               | eje trasero disco de freno                   | schijfrem achteras                    |
| tamburi freno asse posteriore              | eje trasero tambores de freno                | trommelrem achteras                   |
| leva                                       | palanca                                      | hendel                                |
| tetto sopraelevato                         | techo sobrealzado                            | hoog dak                              |
| vite cava                                  | tomillo hueco                                | holle bout                            |
| freni Hosei                                | freno de Hosei                               | Hosei-rem                             |
| corsa                                      | elevación                                    | slag                                  |
| serie boccole                              | juego de vaina                               | doppenset                             |
| accumulatore idraulico                     | acumulador de hidráulico                     | hydraulisch reservoir                 |
| servofreno idraulico                       | servo hidráulico                             | hydraulische versterker               |
| cilindro idraulico                         | cilindro de hidráulico                       | hydraulische cilinder                 |
| modulatore idraulico                       | modulador de hidráulico                      | hydr. regelenheid                     |
| pompa freno                                | CM (cilindro maestro)                        | hoofdcilinder                         |
| serie riparazione pompa freno              | juego de reparación CM                       | reparatieset hoofdcilinder            |
| in cabina                                  | en cabina                                    | in de stuurcabine                     |
| nel vano motore                            | en compartimento de motor                    | in de motorruimte                     |



|                                       |                                     |  |
|---------------------------------------|-------------------------------------|--|
| innen                                 | inside                              | intérieur  |
| Innengewinde                          | inner thread                        | taraudage intérieure                               |
| Kastenwagen                           | van                                 | fourgonnette                                       |
| Katalysator                           | catalytic converter                 | catalyseur   |
| Kennzeichen: xx                       | registration number: xx             | indice: xx   |
| Kerbe am Flansch                      | notch on flange                     | entaille sur la bride                              |
| Klasse                                | class                               | classe   |
| Kleinbus                              | minibus                             | petit autobus                                      |
| Klimaanlage                           | air conditioning                    | air conditionné                                    |
| Kolbenstange D=                       | piston rod diameter=                | tige de commande diamètre=                         |
| Kolbenstange L=                       | piston rod length=                  | tige de commande longueur=                         |
| Kombiwagen                            | station wagon                       | voiture familiale                                  |
| Kompakt THz                           | compact TMC                         | MCT compact  |
| Krankenwagen                          | ambulance                           | véhicule à ambulance                               |
| Kupplung                              | clutch                              | embrayage  |
| Kupplungsabgang                       | outlet port for clutch connection   | sortie d'embrayage                                 |
| Kupplungsverstärker                   | clutch booster                      | amplificateur d'embrayage                          |
| kurzer Radstand                       | short wheel base                    | empattement court                                  |
| kurzes Bremsgerät                     | short brake booster                 | servo-frein court                                  |
| L (Länge) =                           | L (length) =                        | L (longueur) =                                     |
| langer Radstand                       | long wheel base                     | empattement long                                   |
| Leckageanzeige                        | leakage indicator                   | avertissement de fuite                             |
| lieferbar                             | available                           | disponible   |
| links oben und rechts unten           | upper left and lower right          | à gauche, en haut et à droite, en bas              |
| links vor und rechts hinter der Achse | left in front and right behind axle | à gauche devant essieu et à droite derrière essieu |
| Linkslenker                           | left hand drive                     | direction à gauche                                 |
| Luftfederung                          | pneumatic suspension                | suspension pneumatique                             |
| luftgekühlt                           | air-cooled                          | refroidir par air                                  |
| M8-Führungsbolzen                     | M8-guide pin                        | boulon de guidage M8                               |
| MA-Getriebe                           | MA gearbox                          | boîte de vitesse MA                                |
| mit 1 Haltestift                      | with 1 retaining pin                | avec 1 bouchon d'arrêt                             |
| mit 2 Haltestiften                    | with 2 retaining pins               | avec 2 bouchon d'arrêts                            |
| mit Alufelgen                         | with alu wheel rim                  | avec jante en alu                                  |
| mit angegossenem Behälter             | with cast-on reservoir              | réservoir en fonte commun                          |
| mit geregeltm Katalysator             | with controlled catalytic converter | avec cataliseur réglé                              |
| mit Laschen                           | with straps                         | avec collier                                       |
| mit Leichtmetallrädern                | with light alloy rims               | avec jantes en aluminium                           |
| MKII-Aggregat kpl.                    | MKII complete unit                  | agrégat MKII complet                               |
| Mod. (Modell)                         | Mod. (model)                        | Mod. (modèle)                                      |
| Motor                                 | engine                              | moteur   |
| Motor-Nr.                             | engine number                       | numéro de moteur                                   |
| Motor-Pumpen-Aggregat                 | motor pump unit                     | agrégat moteur pompe                               |
| Multi-Link-Achse                      | multi-link axle                     | essieu multi-link                                  |
| m.Z. (mit Zubehör)                    | m.Z. (with accessories)             | m.Z. (avec accessoire)                             |
| Nachstellteile-Satz                   | adjuster parts set                  | jeu de pièces d'ajustage                           |
| ND-Schlauch                           | ND low pressure hose                | flexible de ND                                     |
| Nebenabtrieb                          | power take-off                      | propulsion secondaire                              |
| Niveauregulierung                     | suspension level-control            | correcteur d'assiette                              |
| Nz (Nehmerzylinder)                   | SC (slave cylinder)                 | RE (récepteur d'embrayage)                         |
| Nz-Reparatursatz                      | SC-repair kit                       | néc. de réparation RE                              |
| ohne Alufelgen                        | without alu wheel rim               | sauf jante en alu                                  |
| ohne geregelten Katalysator           | uncontrolled catalytic converter    | sauf cataliseur réglé                              |
| ohne Laschen                          | without straps                      | sans collier                                       |
| ohne Leichtmetallräder                | without light alloy rim             | sauf jantes en aluminium                           |
| O-Ring                                | O-ring                              | joint torique                                      |
| Pedal Feststeller                     | lockable pedal                      | fixation des pédales                               |
| Polizei                               | Police                              | Police   |
| Rad                                   | wheel                               | roue   |
| Radsensor                             | wheel sensor                        | capteur de roue                                    |
| Radstand xxxx mm                      | wheel base xxxx mm                  | empattement xxxx mm                                |
| rechts oben und links unten           | upper right and lower left          | à droite, en haut et à gauche, en bas              |
| Rechtslenker                          | right hand drive                    | direction à droite                                 |
| Regler                                | regulator                           | régulateur   |
| Reihenmotor                           | R engine                            | moteur en ligne                                    |
| Reisebus/Hochdecker                   | tourist bus/high decker             | autobus/car avec cabine élevée                     |
| Reparatursatz                         | repair kit                          | néc. de réparation                                 |
| Ringstutzen-Satz                      | ring type nipple set                | jeux de raccord annulaire                          |
| Rohrleitung                           | pipe line                           | conduite tube                                      |
| rot                                   | red                                 | rouge  |
| roter Sattel                          | red caliper                         | étrier rouge                                       |
| Rückschlagventil                      | non-return valve                    | clapet antiretour                                  |
| Rückstellwellen-Satz                  | resetting shaft set                 | jeu d'arbres de rappel                             |
| Rz (Radzylinder)                      | WC (wheel cylinder)                 | CR (cylindre roue)                                 |
| Rz-Dichtungssatz                      | WC-seal kit                         | jeu de joints CR                                   |
| Rz-Reparatursatz                      | WC-repair kit                       | néc. de réparation CR                              |
| Salisbury-Achse                       | Salisbury axle                      | essieu Salisbury                                   |
| Sattel mit 1 Haltestift               | caliper with 1 retaining pin        | étrier avec 1 bouchon d'arrêt                      |



|  |   |                                   |
|--|---|-----------------------------------|
| interno  | interior                                | binnen                            |
| filettatura interna                              | rosca interior                          | binnendraad                       |
| furgone  | furgon                                  | bestelwagen                       |
| catalizzatore                                    | catalizador                             | katalysator                       |
| sigla: xx  | distiutivo: xx                          | kenmerk: xx                       |
| centraggio su flangia                            | muesca en brida                         | kerf in de flens                  |
| classe   | classe                                  | klasse                            |
| minibus  | mini-bus                                | kleine bus                        |
| aria condizionata                                | aire acondicionado                      | airconditioning                   |
| biella D=  | varilla de pistón diámetro =            | zuigerstang D=                    |
| biella L=  | varilla de pistón largo=                | zuigerstang L=                    |
| station wagon                                    | break (familiar)                        | stationwagen                      |
| pompa freno tandem compatta                      | cilindro maestro tándem compacto        | compacte tandemhoofdcilinder      |
| ambulanza  | ambulancia                              | ziekenwagen                       |
| frizione   | embrague                                | koppeling                         |
| uscita per frizione                              | salida conexión embrague                | koppelingsuitlaat                 |
| servofrizione                                    | refuerzo embrague                       | koppelingsbekrachtiger            |
| passo corto                                      | distancia corta entre ejes              | korte wielbasis                   |
| servofreno corto                                 | servofreno corto                        | kort remapparaat                  |
| L (lunghezza) =                                  | L (largo) =                             | L (lengte) =                      |
| passo lungo                                      | distancia larga entre ejes              | lange wielbasis                   |
| spia perdite                                     | indicador pérdida líquido de freno      | lekkagedetector                   |
| disponibile                                      | suministrable                           | leverbaar                         |
| a sinistra in alto e a destra in basso           | izquierda arriba + derecha abajo        | links boven en rechts onder       |
| davanti a sinistra e dietro a destra dell'assale | izquierda adelante+derecha atrás de eje | links voor en rechts achter de as |
| guida a sinistra                                 | volante a la izquierda                  | auto met stuur links              |
| sospensione pneumatica                           | suspensión neumática                    | luchtvering                       |
| raffreddato ad aria                              | refrigeración por aire                  | luchtgekoeld                      |
| perni di guida M8                                | perno de guía M8                        | M8-geleidingspen                  |
| scatola cambio MA                                | caja de cambios MA                      | MA-transmissie                    |
| con 1 spina di fissaggio                         | con 1 pasador                           | met 1 borgstift                   |
| con 2 spine di fissaggio                         | con 2 pasadores                         | met 2 borgstiften                 |
| con cerchioni in alluminio                       | con Llantas de aluminio                 | met aluminium velgen              |
| con serbatoio stampato                           | con depósito anadido                    | met aangegoten reservoir          |
| con catalizzatore regolato                       | con catalizador regulado                | met geregelde katalysator         |
| con coprigiunto                                  | con brida                               | met verbindingselementen          |
| con ruote in lega leggera                        | con Llantas de aluminio                 | met lichtmetalen wielen           |
| gruppo completo MKII                             | MKII sistema completo                   | MKII-aggregaat compl.             |
| mod. (modello)                                   | Mod. (modelo)                           | mod. (model)                      |
| motore   | motor                                   | motor                             |
| motore n.  | número de motor                         | motornr.                          |
| gruppo motore-pompa                              | systema motor-bomba                     | motor-pomp-aggregaat              |
| assale Multi-link                                | eje Multi-Link                          | multi-link-as                     |
| con acc. (con accessori)                         | m.Z. (con accesorios)                   | met toebehoren (met toebehoren)   |
| serie parti registrazione                        | juego de acoplamiento                   | set stoeleonderdelen              |
| flessibile bassa pressione                       | ND flexible                             | ND-slang                          |
| attacco di forza                                 | potencia adicional                      | pto                               |
| correttore d'assetto                             | regulación de altura de suspensión      | niveauregeling                    |
| cilindro ricevitore                              | CRE (cilindro receptor)                 | werkcilinder                      |
| serie riparazione cilindro ricevitore            | juego de reparación de juntas CRE       | reparatieset werkcilinder         |
| cerchioni in alluminio                           | sin Llantas de aluminio                 | zonder aluminium velgen           |
| senza catalizzatore regolato                     | sin catalizador regulado                | zonder geregelde katalysator      |
| senza coprigiunto                                | sin brida                               | zonder verbindingselementen       |
| senza ruote in lega leggera                      | sin Llantas de aluminio                 | zonder lichtmetalen wielen        |
| O-Ring   | junta torica                            | O-ring                            |
| blocca-pedale                                    | eje pedal                               | pedaalvastzetter                  |
| Polizia  | Police                                  | politie                           |
| ruota  | rueda                                   | wiel                              |
| sensore ruota                                    | sensor de rueda                         | wielsensor                        |
| passo xxxx mm                                    | distancia entre rueda xxxx mm           | wielbasis xxxx mm                 |
| a destra in alto e a sinistra in basso           | derecha arriba + izquierda abajo        | rechts boven en links onder       |
| guida a destra                                   | volante a la derecha                    | auto met het stuur rechts         |
| correttore di frenata                            | regulador                               | regelaar                          |
| motore in linea                                  | motor de R                              | lijnmotor                         |
| pullman / pianale alto                           | autobús                                 | Reisbus/hoogdekker                |
| serie di riparazione                             | juego de reparación                     | reparatieset                      |
| serie raccordi anulari                           | juego de tubuladura anular              | set ringaansluitingen             |
| tubazione  | latiguillo                              | pijpleiding                       |
| rosso  | rojo                                    | rood                              |
| pinza rossa                                      | pinza roja                              | rood zadel                        |
| valvola di non ritorno                           | valvula de retención                    | terugslagklep                     |
| serie alberi di richiamo                         | juego de onda de retroceso              | set terugstelassjes               |
| cil. ruota (cilindretto ruota)                   | CR (cilindro de rueda)                  | wielcilinder                      |
| serie guarnizioni cil. ruota                     | juego de reparación de juntas CR        | pakkingset wielcilinder           |
| serie riparazione cil. ruota                     | juego de reparación CR                  | reparatieset wielcilinder         |
| assale Salisbury                                 | Salisbury eje                           | Salisbury-as                      |
| pinza con una spina di fissaggio                 | pinza con 1 pasador                     | klauw met 1 borgstift             |

|                                |                                     |   |
|--------------------------------|-------------------------------------|---|
| Sattel mit 2 Haltestiften      | caliper with 2 retaining pins       | étrier avec 2 bouchon d'arrêt                 |
| Sättel mit Gussnoppen          | calipers with cast-naps             | étriers avec nopas en fonte                   |
| Sattelschraube                 | caliper screw                       | vis d'étrier                                  |
| Scheibenbremse                 | disc brake                          | disques de frein                              |
| Scheibenkupplung               | disc clutch                         | embrayage du disque                           |
| Scheibenschraube               | disc screw                          | disque vis                                    |
| Schlauchleitung                | line hose                           | conduite flexible                             |
| Schraubstutzen                 | screw neck                          | raccordement à vis                            |
| schwarz                        | black                               | noir  |
| Schwimmsättel                  | floating caliper                    | étrier flottant                               |
| Schwingblech WE                | sheet metal warning device          | tôle oscillante dispositif d'avertissement    |
| SCS                            | SCS (stop control system)           | SCS (système de contrôle stop)                |
| separater Behälter             | separate reservoir                  | réservoir séparé                              |
| separates Druckstück/Vorgänger | separate thrust member/predecessor  | pièce d'appui/prédécesseur                    |
| Servolenkung                   | power steering                      | direction assistée                            |
| Skandinavien                   | Scandinavia                         | Scandinavie                                   |
| Sitzplätze                     | seats                               | sièges  |
| Sonderfahrzeuge                | special vehicle                     | véhicule spécial                              |
| Spezialaufbau                  | special body                        | carrosserie spéciale                          |
| Sportfahrwerk                  | sports suspension                   | châssis sport                                 |
| Spur                           | track                               | voie  |
| Standard-Bremsgerät            | standard booster unit               | servo-frein standard                          |
| Standard-THz                   | standard tandem master cylinder     | MC-tandem standard                            |
| staubfeste Ausführung          | dustproof design                    | exécution anti poussière                      |
| Stufenheck                     | saloon                              | à coffre                                      |
| T50-Reparaturatz               | T50-repair kit                      | néc. de réparation T50                        |
| Tandemregler                   | tandem proportioning valve          | compensateur tandem                           |
| THz mit 3 Anschlüssen          | TMC with 3 connections              | MCT avec 3 raccords                           |
| THz mit Anschlagsschraube      | TMC with stop screw                 | MCT avec vis de butée                         |
| THz (Tandemhauptzylinder)      | TMC (tandem master cylinder)        | MCT (maître cylindre tandem)                  |
| THz-Reparaturatz               | TMC-repair kit                      | néc. de réparation MCT                        |
| THz-RS (Montagehülse)          | TMC-repair kit (assembly sleeve)    | néc. de réparation MCT (douille d'assemblage) |
| Timken-Achse                   | Timken axle                         | essieu Timken                                 |
| Topfmanschette                 | pot seal                            | coupelle                                      |
| Tragbolzensatz                 | supporting bolt set                 | jeu de boulons de suspension                  |
| Transporter                    | transporters                        | transporter                                   |
| Triebkopf                      | drive head                          | tête de propulsion                            |
| Trommelbremse                  | drum brake                          | frein à tambour                               |
| TBB (Trommelbremsbacken)       | DBS (drum brake shoes)              | SGT (mâchoires de frein à tambour)            |
| Umbau 1-teilig auf 2-teilig    | reconstruction 1-piece to 2-piece   | reconstruction 1 partie sur 2 parties         |
| Unterdruckverstärker           | vacuum booster                      | amplificateur à dépression                    |
| ursprüngl. verschraubte Beläge | initial screwed pads                | à l'origine garnitures vissés                 |
| VA (Vorderachse)               | FA (front axle)                     | VA (essieu avant)                             |
| VA-Girling-Bremse              | front axle girling-brake            | frein à girling essieu avant                  |
| VA-Scheibenbremse              | front axle disc brake               | frein à disque essieu avant                   |
| VA-Trommelbremse               | front axle brake drums              | tambours de frein essieu avant                |
| Ventilblock                    | valve block                         | bloc de vannes                                |
| Ventilblock kpl.               | valve block complete                | bloc de vannes complet                        |
| Verbindungsschrauben           | connection screws                   | vis de raccordement                           |
| Verschlusschraube              | screw plug                          | vis de fermeture                              |
| Verschraubung                  | screw fitting                       | couvercle                                     |
| Verschraubung kpl.             | screw fitting cpl.                  | couvercle complet                             |
| verstärkte Bremse              | heavy-duty brake                    | frein renforcé                                |
| verstärkte Stoßdämpfer         | reinforced dampers (shock absorber) | amortisseurs renforcés                        |
| verstärktes Fahrwerk           | reinforced suspension               | châssis renforcé                              |
| Verteilerstück wiederverwenden | reuse distributor piece             | distributeur à remettre                       |
| V-Motor                        | V engine                            | moteur en V                                   |
| Vorder- und Hinterachse        | front and rear axle                 | essieu avant et essieu arrière                |
| Vorderachse                    | front axle                          | essieu avant                                  |
| Vorderachse und 2. Hinterachse | front axle and second rear axle     | essieu avant et 2. essieu arrière             |
| Vordruckventil                 | residual pressure valve             | soupape pression d'admission                  |
| Vorgänger                      | predecessor                         | prédécesseur                                  |
| Vorgänger / Abschirmkappe      | predecessor / deflector cap         | prédécesseur/défecteur                        |
| Vorgänger-THz, Einlaß D=xx     | predecessor-TMC, inlet diameter=xx  | MCT prédécesseur, admission diamètre=xx       |
| Vorspannzylinder               | pre-loaded cylinder                 | cylindre relais                               |
| WK (Warnkontakt)               | WI (wear indicator)                 | TU (témoin d'usure)                           |
| Warnkontakt 1-polig            | wear indicator single connector     | témoin d'usure 1-borne                        |
| Warnkontakt 2-polig            | wear indicator twin connector       | témoin d'usure 2-bornes                       |
| Warnschalter                   | warning switch                      | interrupteur d'avertissement                  |
| WE (Warneinrichtung)           | WD (warning device)                 | DA (dispositif d'avertissement)               |
| WE-Befestigung                 | WD fixture                          | fixation de DA                                |
| Wegsensor                      | travel sensor                       | capteur de course                             |
| weiß                           | white                               | blanc   |
| Zylinderschraube               | cylinder screw                      | vis cylindre                                  |



|   |  |   |
|---|--|---|
| pinza con due spine di fissaggio                  | pinza con 2 pasadores                        | klaauw met 2 borgstiften                    |
| pinze freno con borchie fuse                      | pinzas con protuberancias de fundición       | klauwen met aangegoten noppen               |
| vite pinza  | tornillo de pinza                            | klaaubouten                                 |
| freni a disco                                     | disco de freno                               | schijfrem                                   |
| frizione a disco                                  | disco de embrague                            | plaatkoppeling                              |
| viti disco freno                                  | tornillo de disco                            | schijfbout                                  |
| flessibile (tubo flessibile)                      | latiguillo flexible                          | slangleiding                                |
| raccordo filettato                                | tornillo de fijación                         | schroefaansluiting                          |
| nero  | negro  | zwart                                       |
| pinza freno flottante                             | pinza flotante                               | zwevende klauwen                            |
| spia a lamierino vibrante                         | chapa para avisador de desgaste              | trilplaat                                   |
| SCS (sistema controllo frenata)                   | SCS (sistema de control de frenada)          | SCS   |
| serbatoio separato                                | depósito independiente                       | apart reservoir                             |
| pezzo di pressione separato / precedente          | tuberia de presión independiente/avisador    | apart drukstuk/voorloper                    |
| servosterzo                                       | dirección asistida                           | stuurbekrachtiging                          |
| Scandinavia                                       | Escandinavia                                 | Scandinavië                                 |
| posti a sedere                                    | plazas                                       | zitplaatsen                                 |
| veicolo speciale                                  | vehiculos especial                           | speciale voertuigen                         |
| carrozzeria speciale                              | construcción carrocería especial             | speciale opbouw                             |
| assetto sportivo                                  | suspensión deportiva                         | sportonderstel                              |
| carreggiata                                       | distancia entre ruedas                       | spoor                                       |
| servofreno standard                               | servo freno standard                         | standaard remapparaat                       |
| pompa freno tandem standard                       | cilindro tándem standard                     | standaard tandemhoofdcilinder               |
| versione antipolvere                              | version antipolución                         | stofvaste uitvoering                        |
| a 3 volumi  | parte trasera escalonada                     | notch-back                                  |
| serie riparazione T50                             | juego de reparación T50                      | T50-reparatieset                            |
| regolatore tandem                                 | tándem regulador                             | tandemregelaar                              |
| pompa freno tandem con 3 attacchi                 | cilindro tándem con 3 conexions              | tandemhoofdcilinder met 3 aansluitingen     |
| pompa freno tandem con vite di fermo              | cilindro tándem con tornillo de tope         | tandemhoofdcilinder met aanslagbout         |
| pompa freno tandem                                | CMT ( cilindro tándem)                       | tandemhoofdcilinder                         |
| serie riparazione pompa freno tandem              | juego de reparación CMT                      | reparatieset tandemhoofdcilinder            |
| serie rip. pompa freno tandem (bussola montaggio) | juego de reparación CMT (vainas de montaje)  | tandemhoofdcilinder RS (montagehuls)        |
| assale Timken                                     | Timken eje                                   | Timken-as                                   |
| guarnizione a tazza                               | retén  | cupmanchet                                  |
| serie perni di supporto                           | juego de tornillo de soporte                 | set draagpennen                             |
| furgoncino  | furgoneta                                    | transporter                                 |
| motrice con sola cabina (telaio nudo)             | grupo motriz                                 | aandrijfkop                                 |
| freni a tamburo                                   | tambores de freno                            | trommelrem                                  |
| ganasce freno                                     | ZDF (zapatas de freno)                       | trommelremschoenen                          |
| modifica da 1 a 2 sezioni                         | reconstrucción de 1 a 2 piezas               | ombouw 1-delig naar 2-delig                 |
| servofreno a depressione                          | amplificador de depresion                    | onderdrukbevrachtiger                       |
| pastiglie freno avvitare in origine               | pastillas inicialmente montadas              | oorspr. vastgeschroefde remvoeringen        |
| A (asse anteriore)                                | VA (eje delantero)                           | vooras                                      |
| asse anteriore con impianto Girling               | eje delantero - Girling freno                | Girling-rem vooras                          |
| dischi freno asse anteriore                       | eje delantero - disco de freno               | schijfrem vooras                            |
| tamburi freno asse anteriore                      | eje delantero - tambores de freno            | trommelrem vooras                           |
| blocco valvole                                    | válvula de bloqueo                           | kleppenblok                                 |
| blocco valvole completo                           | bloque de valvulas completo                  | kleppenblok compl.                          |
| viti di collegamento                              | tornillo de conexión                         | verbindingsschroeven                        |
| vite di chiusura                                  | tornillo de cierre                           | schroefop                                   |
| attacco filettato                                 | tornillo de fijación                         | schroefkoppeling                            |
| attacco filettato completo                        | fijación completa                            | schroefkoppeling compl.                     |
| freno rinforzato                                  | freno reforzado                              | bekrachtigde rem                            |
| ammortizzatori rinforzati                         | amortiguadores reforzados                    | versterkte schokdemper                      |
| autotelaio rinforzato                             | suspensión reforzada                         | versterkt onderstel                         |
| riutilizzare il distributore                      | distribuidor de reemplazo                    | verdeelblok opnieuw gebruiken               |
| motore a V  | motor de V                                   | V-motor                                     |
| assi anteriore e posteriore                       | eje delantero + eje trasero                  | voor- en achteras                           |
| asse anteriore                                    | eje delantero                                | vooras                                      |
| asse anteriore e secondo asse posteriore          | eje delantero + 2. eje trasero               | vooras en 2e achteras                       |
| valvola anticipo pressione                        | válvula de presión previa                    | restdrukklep                                |
| precedente  | predecesor                                   | voorloper                                   |
| precedente / calotta di protezione                | predecesor / tapa deflector                  | voorloper / verdelerkap                     |
| pompa freno tandem precedente, D mandata = xx     | predecesor cilindro principal, admision D=xx | voorloper tandemhoofdcilinder, inlaat D=xx  |
| convertitore di pressione                         | cilindro preajustado                         | voorspancilinder                            |
| RU (rilevatore usura)                             | CD (contacto de desgaste)                    | contact noodknipperlichtinstallatie         |
| rivelatore usura unipolare                        | contacto de desgaste con 1 conexión          | contact noodknipperlichtinstallatie 1-polig |
| rivelatore usura bipolare                         | contacto de desgaste con 2 conexiones        | contact noodknipperlichtinstallatie 2-polig |
| interruttore spia                                 | interruptor de desgaste                      | schakelaar noodknipperlichtinstallatie      |
| DS disp. spia (dispositivo spia)                  | DD (dispositivo de desgaste)                 | noodknipperlichtinstallatie                 |
| fissaggio dispositivo spia                        | fijación del dispositivo de desgaste         | bevestiging noodknipperlichtinstallatie     |
| sensore di corsa                                  | sensor de ruta                               | wegsensor                                   |
| bianco  | blanco                                       | wit   |
| vite cilindrica                                   | tornillo cilíndrico                          | cilinderkoppbout                            |

|  |                                      |  |
|--|--------------------------------------|--|
| 1-Kammer-Druckluftbremse               | pneumatisk bremse med et kammer      | enkammartryckluftsbroms                |
| 1-Kolbensattel D=xx                    | 1-bremseåg Ø=xx                      | 1-kolvsok d=xx                         |
| 2-Kolbensattel D=xx                    | 2-bremseåg Ø=xx                      | 2-kolvsok d=xx                         |
| 4-Kolbensattel                         | 4-bremseåg                           | 4-kolvsok                              |
| 1-Kreis-Bremse                         | 1-kreds-bremse                       | 1-krets broms                          |
| 2-Kreis-Bremse                         | 2-kreds-bremse                       | 2-krets broms                          |
| 1-Kreis-Sättel                         | 1-kreds-bremseåg                     | 1-krets bromsok                        |
| 2-Kreis-Sättel                         | 2-kreds-bremseåg                     | 2-krets bromsok                        |
| 1. Hinterachse                         | 1. bagaksel                          | 1:a bakaxeln                           |
| 1. und 2. Hinterachse                  | 1. og 2. bagaksel                    | 1:a och 2:a bakaxeln                   |
| 4-Loch-Bremsscheibe                    | 4-hul-bremsskive                     | 4-håls bromsskiva                      |
| 6-Loch-Bremsscheibe                    | 6-hul-bremsskive                     | 6-håls bromsskiva                      |
| 3-Loch-Felge                           | 3-hul-fælg                           | 3-håls fälg                            |
| 4-Loch-Felge                           | 4-hul-fælg                           | 4-håls fälg                            |
| 5-Loch-Felge                           | 5-hul-fælg                           | 5-håls fälg                            |
| 6kt-Schraube                           | 6-kant skrue                         | sexkantsskruv                          |
| 6kt-Schraube (innen)                   | 6-kant skrue (indvendigt)            | sexkanthålskruv                        |
| 6"-Tandem                              | 6"-tandem                            | 6"-tandem                              |
| 8"-Tandem mit Gabelkopf                | 8"-tandem med gaffelhoved            | 8"-tandem med gaffelhuvud              |
| 8"-Tandem ohne Gabelkopf               | 8"-tandem uden gaffelhoved           | 8"-tandem utan gaffelhuvud             |
| ABS                                    | ABS                                  | ABS (låsningsfria bromsar)             |
| ABS-Dichtungssatz                      | ABS-pakningssæt                      | ABS packningssats                      |
| Achtung: Kolbenstellung ändern !       | Bemærk: Stempelstilling skal ændres! | OBS! Ändra kolvläge !                  |
| Adapter für Bördel E                   | adapter til krave E                  | adapter för fläns E                    |
| alle Typen                             | alle typer                           | alla typer                             |
| Alu-Pumpe                              | alu-pumpe                            | aluminiumpump                          |
| Alu-Sättel                             | alu-åg                               | aluminium-ok                           |
| am Bremssattel                         | på bremseåg                          | på bromsoket                           |
| am Hauptzylinder                       | på hovedcylindren                    | på huvudcylindern                      |
| A-Motor                                | A-motor                              | A-motor                                |
| Anschlagschraube oben                  | stoppskrue oppe                      | stoppskruv upptill                     |
| Anschluß/Anschlüsse                    | tilslutning/tilslutninger            | anslutning/anslutningar                |
| Anti-Noise-Blech                       | Anti-Noise-plade                     | anti-noise-plåt                        |
| ASC (Automatische Stabilitäts Control) | ASC (automatisk stabilitetskontrol)  | ASC (automatisk stabilitetskontroll)   |
| ASR (Antriebssschlupfregelsystem)      | ASR (traktionskontrolsystem)         | ASR (antispinnreglering)               |
| ATE nur über VAG erhältlich            | ATE kan kun leveres via VAG          | ATE erhålls endast via VAG             |
| auf Typenschild                        | på typeskiltet                       | på typskylten                          |
| aufgeschraubt                          | skruet på                            | påskruvad                              |
| Auslaß seitlich links                  | udløb i siden til venstre            | utlopp vänster sida                    |
| Auslaß seitlich rechts                 | udløb i siden til højre              | utlopp höger sida                      |
| außen                                  | udvendigt                            | yttre                                  |
| automatische Nachstellung              | automatisk justering                 | automatisk efterjustering              |
| Behälter                               | beholder                             | behållare                              |
| Behälter Doppel-WE                     | beholder dobbelt advarselsudstyr     | behållare med dubbel varningsanordning |
| Behälterbefestigung                    | beholderfastgørelse                  | behållarinfastning                     |
| Behälterstopfen                        | beholderprop                         | behållareplugg                         |
| Behälterverschraubung                  | beholderforskruning                  | behållarförskruvning                   |
| Behörde                                | myndighed                            | myndighet                              |
| Beläge                                 | belægninger                          | belägg                                 |
| belüftete Scheiben                     | ventilerede skiver                   | ventilerade skivor                     |
| Betätigungseinheit                     | aktiveringsenhed                     | manövreringsenhet                      |
| blau                                   | blå                                  | blå                                    |
| Bodenventil                            | bundventil                           | bottenventil                           |
| Bodenventile tauschen                  | udskift bundventilerne               | byta bottenventil                      |
| Bördel x                               | krave x                              | fläns typ x                            |
| braun                                  | brun                                 | brun                                   |
| breite Ausführung                      | bred udførelse                       | brett utförande                        |
| Bremse                                 | bremse                               | broms                                  |
| Bremserät                              | bremseenhed                          | bromsenhet                             |
| Bremskraftregler                       | bremsekraftregulator                 | bromskraftregulator                    |
| Bremisleitungen erneuern !             | Udskift bremseledninger!             | förnya bromsledningarna !              |
| Bremslightschalter                     | bremselygtekontakt                   | bromsljusomkopplare                    |
| Bremsscheiben                          | bremsseskiver                        | bromsskivor                            |
| Bremsschlauch beachten !               | Bemærk bremseslange!                 | Observera bromsslängen !               |
| Buchse + Ausgleichbügel                | bøsning + udligningsbøjle            | bussning med utjämningsbygel           |
| Bus                                    | bus                                  | buss                                   |
| Bypassregler                           | bypass-regulator                     | bypassregulator                        |
| Citroen-Bremse                         | Citroen-bremse                       | Citroen-broms                          |
| D (Durchmesser) =                      | Ø (diameter) =                       | D (diameter) =                         |
| Dichtring                              | pakring                              | packningsring                          |
| Dichtung                               | pakning                              | packning                               |
| Dichtungssatz                          | pakningssæt                          | packningssats                          |
| Differentialsperre                     | differentialspærrer                  | differentialspär                       |
| Differenzdruckschalter                 | differenstrykkontakt                 | omkopplare för differenstryck          |
| Differenzdruckventil                   | differenstrykventil                  | differenstrycksventil                  |
| diverse Typen                          | diverse typer                        | diverse typer                          |
| Doppelbereifung                        | dobbelte dæk                         | dubbeldäck                             |





|   |   |  |
|---|---|--|
| travão pneumático de 1 câmara             | 1-kamrás sűrített levegős fék                         | однокамерный пневматический тормоз                       |
| pinça de travão de 1 pistão D=xx          | 1-dugattyús nyereg D=xx                               | однопоршневой суппорт D=xx                               |
| pinça de travão de 2 pistões D=xx         | 2-dugattyús nyereg D=xx                               | двупоршневой суппорт D=xx                                |
| pinça de travão de 4 pistões              | 4-dugattyús nyereg                                    | четырёхпоршневой суппорт                                 |
| travão mono-circuito                      | 1 fékkörös fék  | одноконтурная тормозная система                          |
| travão de circuito duplo                  | 2 fékkörös fék  | двухконтурная тормозная система                          |
| pinça de travão mono-circuito             | 1 körös nyereg  | одноконтурные суппорта                                   |
| pinça de travão de circuito duplo         | 2 körös nyereg  | двухконтурные суппорта                                   |
| 1º eixo traseiro                          | 1. hátsó tengely                                      | 1-й задний мост  |
| 1º e 2º eixos traseiros                   | 1. és 2. hátsó tengely                                | 1-й и 2-й задний мост                                    |
| disco de travão com 4 furos               | 4 lyukas féktárcsa                                    | тормозной диск с 4 отверстиями                           |
| disco de travão com 6 furos               | 6 lyukas féktárcsa                                    | тормозной диск с 6 отверстиями                           |
| jante de 3 furos                          | 3 lyukas keréktárcsa                                  | колесный обод с 3 отверстиями                            |
| jante de 4 furos                          | 4 lyukas keréktárcsa                                  | колесный обод с 4 отверстиями                            |
| jante de 5 furos                          | 5 lyukas keréktárcsa                                  | колесный обод с 5 отверстиями                            |
| parafuso hexagonal                        | Hatlapfejű csavar                                     | болт с шестигранной головкой                             |
| parafuso hexagonal (interior)             | Belső hatlapfejű csavar                               | болт с шестигранной головкой (внутренней)                |
| 6" - tandem                               | 6"-tandem   | тандем 6"  |
| 8" - tandem com cabeça de garfo           | 8"-tandem villafejvel                                 | тандем 8" с вильчатой головкой                           |
| 8" - tandem sem cabeça de garfo           | 8"-tandem villafej nélkül                             | тандем 8" без вильчатой головки                          |
| ABS - sistema de travagem anti-bloqueio   | ABS   | ABS (антиблокировочная система)                          |
| ABS - jogo de juntas                      | ABS-tömítéskészlet                                    | комплект прокладок для ABS                               |
| atenção: mudar a posição do pistão !      | Figyelem: a dugattyúk helyzetét meg kell változtatni! | Внимание: изменить положение поршня!                     |
| adaptador para rebordo E                  | Adapter az „E” peremhez                               | адаптер для бортика типа E                               |
| todos os tipos                            | valamennyi típus                                      | все типы   |
| bomba em alumínio                         | Alumíniumszivattyú                                    | алюминиевый насос  |
| pinça de travão em alumínio               | Alumíniumnyereg                                       | алюминиевые суппорта                                     |
| no pinça de travão                        | a féknyergen  | на суппорте тормоза                                      |
| na bomba central de travões               | a főfékhengeren                                       | на главном цилиндре                                      |
| motor em A                                | A-motor   | двигатель типа А   |
| parafuso limitador de curso, em cima      | felső útközőcsavar                                    | упорный винт сверху                                      |
| ligação / ligações                        | Csatlakozás/csatlakozások                             | подключение/подключения                                  |
| placa anti-ruído                          | Zajcsökkentő lemez                                    | противопопыховый экран                                   |
| ASC (controlo automático de estabilidade) | ASC (automata stabilitás-ellenőző rendszer)           | ASC (автоматическая система курсовой устойчивости)       |
| ASR (sistema de controlo de tracção)      | ASR (hajítás csúszásszabályozó rendszer)              | ASR (противобуксовочная система)                         |
| ATE só disponível através da VAG          | Az ATE csak a VAG-nál kapható                         | Приобрести продукцию ATE можно только через компанию VAG |
| na placa de identificação                 | a típustáblára  | на заводской табличке с обозначением модели              |
| aparafusado                               | felcsavarozva   | на винтах  |
| escape lateral esquerdo                   | Bal kieresztőnyílás                                   | выпускное отверстие сбоку слева                          |
| escape lateral direito                    | Jobb kieresztőnyílás                                  | выпускное отверстие сбоку справа                         |
| macho                                     | kívül   | снаружи  |
| ajuste automático                         | automatikus utánállítás                               | автоматическая подстройка (регулировка)                  |
| depósito                                  | Tartály   | емкость (бачок)  |
| depósito com sistema de avisador duplo    | Tartály, kettős WE                                    | емкость с двойным сигнальным устройством                 |
| fixação do depósito                       | Tartályrögzítés                                       | крепление емкости  |
| bujão do depósito                         | Tartálydugó   | пробка емкости   |
| tampa do depósito                         | Tartály csavarkötés                                   | винтовое крепление емкости                               |
| oficial                                   | Hivatal   | автомобили для госслужб                                  |
| pastilhas de travão de disco              | Fékbetétek  | тормозные накладки (колодки)                             |
| discos ventilados                         | Hűtött tárcsák  | вентилируемые диски                                      |
| unidade de accionamento                   | Kezelő egység   | блок включения   |
| azul                                      | kék   | синий  |
| válvula de pressão residual               | Fenékszelep   | клапан избыточного давления главного тормозного цилиндра |
| mudar válvula de pressão residual         | Fenékszelep kicserélése                               | Заменить клапаны избыточного давления                    |
| rebordo tipo X                            | Perem x   | фланец x   |
| castanho                                  | barna   | коричневый   |
| modelo largo                              | Széles kivitel  | широкая модификация                                      |
| travão                                    | Fék   | тормоз   |
| servo-assistida                           | Fékberendezés   | тормозное устройство                                     |
| regulador da força de travagem            | Fékerőszabályzó                                       | регулятор тормозного усилия                              |
| substituir tubagem do sistema de travagem | Cserélje ki a fékvezetékeket !                        | Заменить тормозные шланги !                              |
| interruptor da luz de stop                | Féklámpa kapcsoló                                     | выключатель сигнала торможения                           |
| discos de travão                          | Féktárcsák  | тормозные диски  |
| atenção ao tubo de travão !               | Ügyeljen a féktömlőre !                               | Обратить внимание на тормозной шланг!                    |
| bucha + cabo de compensação               | Hüvely + kiegyenlítő kengyel                          | втулка + компенсационная скоба                           |
| autocarro                                 | Busz  | автобус  |
| regulador by-pass                         | Bypass szabályozó                                     | байпасный регулятор                                      |
| travão Citroen                            | Citroen-fék   | тормоз „Ситроен“   |
| D (diâmetro) =                            | D (átmérő) =  | D (диаметр) =  |
| retentor                                  | Tömítőgyűrű   | уплотнительное кольцо                                    |
| junta                                     | Tömítés   | прокладка уплотнительная                                 |
| jogo de juntas                            | Tömítéskészlet  | комплект прокладок                                       |
| bloqueio do diferencial                   | Differenciálzár                                       | блокировка дифференциала                                 |
| interruptor do diferencial de pressão     | Nyomáskülönbség kapcsoló                              | дифференциальное реле давления                           |
| válvula do diferencial de pressão         | Nyomáskülönbség szelep                                | дифференциальный регулирующий клапан                     |
| diversos tipos                            | Különböző típusok                                     | различные типы   |
| pneu duplo                                | Dupla kerékkészlet                                    | сдвоенные шины   |



|                             |                                   |                                      |
|-----------------------------|-----------------------------------|--------------------------------------|
| Doppelkabine                | dobbelt kabine                    | dubbelhytt                           |
| Druckbegrenzungsventil      | trykbegrænsningsventil            | tryckbegränsningsventil              |
| Druckbolzen                 | trykbolt                          | tryckbolt                            |
| Druckbolzen (kurz)          | trykbolt (kort)                   | tryckbolt (kort)                     |
| Druckbolzen (lang)          | trykbolt (lang)                   | tryckbolt (lång)                     |
| Druckluftbremse             | trykluftbremse                    | tryckluftsbroms                      |
| Druckluftleitung            | trykluftledning                   | tryckluftsledning                    |
| Druckluftunterstützung      | trykluftunderstøttet              | tryckluftsstöd                       |
| Druckluftverstärker         | trykluftforstærker                | tryckluftsförstärkare                |
| Druck-Warnschalter          | tryk-advarselskontakt             | tryck-varningsomkopplare             |
| DS-Regler                   | DS-regulator                      | DS regulator                         |
| EDS                         | EDS                               | EDS (elektronisk differential spärr) |
| EDS-Ventilblock             | EDS-ventilblok                    | EDS ventilblock                      |
| EG-Vorschrift               | EF-forskrift                      | EG direktiv                          |
| Einbau hinter der Achse     | indbygning bagved akslen          | inmontering bakom axeln              |
| Einbau vor der Achse        | indbygning foran akslen           | inmontering framför axeln            |
| Einbausatz                  | indbygningssæt                    | monteringssats                       |
| Einfachbereifung            | enkelt dæk                        | enkeldäck                            |
| Einknopfmaß xx mm           | indknæpningsmål xx mm             | inknäppningsmått xx mm               |
| Einlaß D=xx mm              | indløb Ø=xx mm                    | inlopp D=xx mm                       |
| Einlaß mit Gummistopfen     | indløb med gummiprop              | inlopp med gummiplugg                |
| Einschraubregler            | indskruningsregulator             | insskruv-utjämningsventil            |
| elektr. Vergaser            | elektr. karburator                | elektrisk förgasare                  |
| Entlüfteranschluß           | udluftningstilslutning            | avlutningsanslutning                 |
| Entlüfterventil             | udluftningsventil                 | avlutningsventil                     |
| erhöhte Zuladung            | øget last                         | förhöjd tillsatsvikt                 |
| Ersatz für Sättel D=xx      | erstatning for åg Ø=xx            | ersättning för ok D=xx               |
| ETS                         | ETS (elektronisk traktionssystem) | ETS antispinnsystem                  |
| Europa                      | Europa                            | Europa                               |
| Export                      | eksport                           | export                               |
| Fahrschule                  | køreskole                         | körskola                             |
| Faltenbaldsatz              | foldebælgssæt                     | bälgsats                             |
| Faustsättel                 | håndåg                            | flytande bromsok                     |
| Fenster                     | vindue                            | fönster                              |
| Festsättel                  | faste åg                          | fasta ok                             |
| Flanschdicke x mm           | flangetykkelse x mm               | flänstjocklek x mm                   |
| Flanschmaß = xx,x           | flangemål = xx,x                  | flänsmått = xx,x                     |
| Fuller-Getriebe             | Fuller-gear                       | Fuller växellåda                     |
| für Belagsätze ohne Zubehör | til belægningssæt uden tilbehør   | för beläggsatser utan tillbehör      |
| für Bremssättel/Vorgänger   | til bremseåg/forgænger            | för bromsok/föregångare              |
| für Doppelmembran-Gerät     | til dobbeltmembran-enhed          | för dobbelmembran-enhet              |
| Gabelkopfsatz               | gaffelhovedsæt                    | gaffelhuvudsats                      |
| Gehäuse L=                  | hus L=                            | hus L=                               |
| gelb                        | gul                               | gul                                  |
| gepanzerte Fahrzeuge        | pansrede køretøjer                | bepansrade fordon                    |
| Getriebe                    | gear                              | växellåda                            |
| Getriebe-Nr.                | gear-nr.                          | växellåds-nr.                        |
| GG-Pumpe                    | støbejerns-pumpe                  | pump av grått gjutjärn               |
| GG-Sättel                   | støbejerns-åg                     | ok av grått gjutjärn                 |
| GG-THz/Vorgänger            | støbejerns-TMC/forgænger          | Thc av grått gjutjärn/föregångare    |
| Golf-Staaten                | Golfstaterne                      | Golfstaterna                         |
| Gz mit senkrechtem Flansch  | givercylinder med lodret flange   | givarcylinder med vertikal fläns     |
| Gz (Geberzylinder)          | givercylinder                     | Gc (givarcylinder)                   |
| Gz-Reparaturatz             | givercylinder-reparationssæt      | Gc-reparationssats                   |
| HA (Hinterachse)            | BA (bagaksel)                     | BA (bakaxel)                         |
| Haltefeder                  | holdefeder                        | spärrfjäder                          |
| Halter                      | holder                            | hållare                              |
| Haltersatz                  | holdesæt                          | hållaresats                          |
| Halterschraube              | holderskrue                       | hållareskruv                         |
| Handbremsbetätigung         | aktivering af håndbremse          | handbromsmanövrering                 |
| Handbremshebel              | håndbremsestang                   | handbromsspak                        |
| HA-Scheibenbremse           | BA-skivebremse                    | BA skivbroms                         |
| HA-Trommelbremse            | BA-tromlebremse                   | BA trumbroms                         |
| Hebel                       | håndtag                           | spak                                 |
| Hochdach                    | højt tag                          | högt tak                             |
| Hohlschraube                | hulskrue                          | ihålig skruv                         |
| Hosei-Bremse                | Hosei-bremse                      | Hosei-broms                          |
| Hub                         | slag                              | slag                                 |
| Hülsensatz                  | bøsningesæt                       | hylssats                             |
| Hydraulikspeicher           | hydraulikkakumulator              | hydraulackumulator                   |
| Hydraulikverstärker         | hydraulikforstærker               | hydraulförstärkare                   |
| Hydraulikzylinder           | hydraulikcylinder                 | hydraulicylinder                     |
| Hydr. Steuereinheit         | hydraulisk styreenhed             | hydr. styrenhet                      |
| Hz (Hauptzylinder)          | hovedcylinder                     | Hc (huvudcylinder)                   |
| Hz-Reparaturatz             | hovedcylinder-reparationssæt      | Hc-reparationssats                   |
| im Fahrerhaus               | i førerhuset                      | i förarhytten                        |
| im Motorraum                | i motorrummet                     | i motorrummet                        |



|  |                                     |   |
|--|-------------------------------------|---|
| cabina dupla                                     | Dupla vezetőfülke                   | двойная кабина  |
| válvula limitadora de pressão                    | Nyomáskorlátozó szelep              | редукционный клапан   |
| perno de pressão                                 | Nyomócsap                           | зажимный болт   |
| perno de pressão (curto)                         | Nyomócsap (rövid)                   | зажимный болт (короткий)  |
| perno de pressão (longo)                         | Nyomócsap (hosszú)                  | зажимный болт (длинный)   |
| travão pneumático                                | Sűrített levegős fék                | пневматический тормоз   |
| conduta pneumática                               | Sűrített levegő vezeték             | трубопровод сжатого воздуха   |
| assistência pneumática                           | Sűrített levegős segítség           | поддержка сжатым воздухом   |
| servofreio pneumático                            | Sűrített levegő erősítő             | пневматический усилитель (бустер)                                       |
| interruptor de aviso de pressão                  | Nyomás figyelmeztető kapcsoló       | сигнальное реле давления  |
| regulador DS                                     | DS-szabályozó                       | DS-регулятор  |
| EDS (bloqueio electrónico do diferencial )       | EDS                                 | EDS (электронная блокировка дифференциала)                              |
| EDS-válvula de bloqueio                          | EDS-szelepblokk                     | клапанный блок EDS  |
| de acordo com as normas da CE                    | EG-előírás                          | Соответствует предписаниям Европейского Сообщества                      |
| instalação atrás do eixo                         | Beszereles a tengely mögött         | установка позади оси  |
| instalação à frente do eixo                      | Beszereles a tengely előtt          | установка перед осью  |
| jogo de montagem                                 | Beszereelő készlet                  | монтажный комплект  |
| pneu simples                                     | Egyszeres kerékkészlet              | одинарные шины  |
| medida p/ instalar botão xx mm                   | Begombolási méret xx mm             | размер закрепления xx мм  |
| diâmetro de admissão = xx mm                     | Bemenőnyílás D=xx mm                | впускное отверстие D=xx мм  |
| admissão com ficha de borracha                   | Bemenőnyílás gumidugóval            | впускное отверстие с резиновой пробкой                                  |
| regulador de parafuso                            | Becsavarható szabályozó             | винчиваемый регулятор   |
| carburador eléctrico                             | Elektr. porlasztó                   | электр. карбюратор  |
| ligação de purga                                 | Légtelenítő csatlakozó              | подсоединение устройства для удаления воздуха                           |
| válvula de purga                                 | Légtelenítő szelep                  | клапан сапуна   |
| carga útil aumentada                             | Megnövelt rakomány                  | повышенная полезная нагрузка  |
| sobressalente para pinça de travão D=xx          | Nyeregpótlás D=xx                   | замена по суппортам D=xx  |
| ETS (sistema electrónico da tracção)             | ETS                                 | ETS (электронная система контроля тягового усилия)                      |
| Europa   | Európa                              | Европа  |
| exportação                                       | Export                              | экспорт   |
| escola de condução                               | Járművezető iskola                  | автошкола   |
| jogo de foles                                    | Harmonika-készlet                   | комплект гофрированных чехлов   |
| pinça de travão tipo „Faust“                     | Mozgó nyergek                       | тормозной механизм с плавающей скобой                                   |
| janela   | Ablak                               | окно  |
| pinça de travão fixa                             | Rögzített nyereg                    | фиксированная скоба дискового тормоза                                   |
| espessura da flange x mm                         | Karimavastagság x mm                | толщина фланца x мм   |
| medida da flange = xx,x                          | Karimaméret = xx,x                  | размер фланца=xx,x  |
| caixa de velocidades Fuller                      | Fuller-sebességváltó                | коробка передач Фуллера   |
| para pastilhas de travão sem acessórios          | Fékbetétkészlethez tartozék nélkül  | для комплектов колодок без принадлежностей                              |
| para pinças de travão / anterior                 | Féknyergekhez/előző kivitel         | для тормозных суппортов / предшественники                               |
| para servofreio de dupla membrana                | Kétmembrános berendezéshez          | для устройства с двойной мембраной                                      |
| jogo de cabeça de garfo                          | Villafekészlet                      | комплект вильчатых головок  |
| caixa L =  | Ház L=                              | корпус L=   |
| amarelo  | sárga                               | желтый  |
| veículos blindados                               | Páncélozott járművek                | бронированные автомобили  |
| caixa de velocidades                             | Sebességváltó                       | коробка передач   |
| caixa de velocidades nr.                         | Sebességváltó száma                 | номер коробки передач   |
| bomba em ferro fundido                           | GG-szivattyú                        | насос из серого чугуна  |
| pinça de travão em ferro fundido                 | GG-nyergek                          | суппорта из серого чугуна   |
| bomba central tandem em ferro fundido / anterior | GG-tandem főfékhenger/előző kivitel | двуколпостный главный тормозной цилиндр из серого чугуна/предшественник |
| países do Golfo Pérsico                          | Öbölmenti országok                  | государства Персидского залива  |
| bomba central de embraiagem com flange vertical  | Munkahenger függőleges karimával    | главный цилиндр сцепления с вертикальным фланцем                        |
| BCE (bomba central de embraiagem)                | Gz (munkahenger)                    | Gz (главный цилиндр привода сцепления)                                  |
| BCE-jogo de reparação                            | Munkahenger-javítókészlet           | ремкомплект главного цилиндра привода сцепления                         |
| ET (eixo traseiro)                               | HA (hátsó tengely)                  | HA (задний мост)  |
| mola de retenção                                 | Tartórugó                           | стопорная пружина   |
| suporte  | Tartó                               | держатель, крепление  |
| jogo de suportes                                 | Tartókészlet                        | комплект крепления  |
| parafuso de suporte                              | Tartócsavar                         | болт крепления  |
| actuação do travão de mão                        | Kézifék működtetés                  | устройство включения ручного тормоза                                    |
| alavanca do travão de mão                        | Kézifékkar                          | рычаг ручного тормоза   |
| disco de travão do eixo traseiro                 | Hátsó tengely tárcsafék             | дисковый тормоз задней оси  |
| tambor do eixo traseiro                          | Hátsó tengely dobfék                | барабанный тормоз задней оси  |
| alavanca   | Kar                                 | рычаг   |
| tejadilho alto                                   | Magas tető                          | высокая крыша   |
| parafuso oco                                     | Üreges csavar                       | полый болт  |
| travões Hosei                                    | Hosei-fék                           | тормоз Хосай  |
| curso  | Lökét                               | ход поршня  |
| jogo de guias                                    | Hüvelykészlet                       | комплект втулок   |
| acumulador hidráulico                            | Hidraulikai tároló                  | гидравлический аккумулятор  |
| servofreio hidráulico                            | Hidraulikus erősítő                 | гидравлический усилитель  |
| cilindro hidráulico                              | Hidraulikus henger                  | гидравлический цилиндр  |
| unidade hidráulica                               | Hidr. vezérlőegység                 | гидравлический блок управления  |
| BCT (bomba central de travões)                   | Hz (főfékhenger)                    | Hz (главный цилиндр)  |
| BCT-jogo de reparação                            | Főfékhenger javítókészlet           | ремкомплект главного цилиндра   |
| na cabina  | a vezetőfülkében                    | в кабине водителя   |
| no compartimento do motor                        | a motortérben                       | в моторном отделении  |

|                                       |  |                                       |
|---------------------------------------|--|---------------------------------------|
| innen                                 | indvendigt                                   | inuti                                 |
| Innengewinde                          | indvendigt gevind                            | innergånga                            |
| Kastenwagen                           | kassevogn                                    | skåpvagn                              |
| Katalysator                           | katalysator                                  | katalysator                           |
| Kennzeichen: xx                       | indregistreringsnr.: xx                      | registreringsnummer: xx               |
| Kerbe am Flansch                      | kærv på flangen                              | hack i flänsen                        |
| Klasse                                | klasse                                       | klass                                 |
| Kleinbus                              | minibus                                      | minibuss                              |
| Klimaanlage                           | klimaanlæg                                   | luftkonditionering                    |
| Kolbenstange D=                       | stempelstang Ø=                              | kolvstång D=                          |
| Kolbenstange L=                       | stempelstang L=                              | kolvstång L=                          |
| Kombiwagen                            | stationcar                                   | kombibil                              |
| Kompakt THz                           | kompakt TMC                                  | kompakt THC                           |
| Krankenwagen                          | ambulance                                    | ambulans                              |
| Kupplung                              | kobling                                      | koppling                              |
| Kupplungsabgang                       | koblingsudgang                               | kopplingsutlopp                       |
| Kupplungsverstärker                   | koblingsforstærker                           | kopplingsförstärkare                  |
| kurzer Radstand                       | kort hjulafstand                             | kort hjulbas                          |
| kurzes Bremsgerät                     | kort bremseenhed                             | kort bromsenhet                       |
| L (Länge) =                           | L (længde) =                                 | L (längd) =                           |
| langer Radstand                       | lang hjulafstand                             | lång hjulbas                          |
| Leckageanzeige                        | lækage-indikator                             | läckageindikator                      |
| lieferbar                             | kan leveres                                  | tillgänglig                           |
| links oben und rechts unten           | oppe til venstre og nede til højre           | vänster upptill och höger nedtill     |
| links vor und rechts hinter der Achse | til venstre foran og til højre bagved akslen | vänster framför och höger bakom axeln |
| Linkslenker                           | venstrestyret                                | vänsterstyrt fordon                   |
| Luftfederung                          | luftaffjedring                               | luftfjådring                          |
| luftgekühlt                           | luftkølet                                    | luftkyld                              |
| M8-Führungsbolzen                     | M8-styrebolt                                 | M8-styrbult                           |
| MA-Getriebe                           | MA-gear                                      | MA-växellåda                          |
| mit 1 Haltestift                      | med 1 holdetap                               | med 1 insatspinne                     |
| mit 2 Haltestiften                    | med 2 holdetapper                            | med 2 insatspinnar                    |
| mit Alufelgen                         | med alu-fælg                                 | med aluminiumfålgar                   |
| mit angegossenem Behälter             | med påstøbt beholder                         | med pågjuten behållare                |
| mit regeltem Katalysator              | med reguleret katalysator                    | med reglerad katalysator              |
| mit Laschen                           | med lasker                                   | med stroppar/flikar/länkar            |
| mit Leichtmetallrädern                | med letmetalhjul                             | med lättmetalhjul                     |
| MKII-Aggregat kpl.                    | MKII-aggregat kpl.                           | MKII-aggregat kompl.                  |
| Mod. (Modell)                         | mod. (model)                                 | mod. (modell)                         |
| Motor                                 | motor  | motor                                 |
| Motor-Nr.                             | motor-nr.                                    | motor-nr.                             |
| Motor-Pumpen-Aggregat                 | motor-pumpe-aggregat                         | motor-pump-aggregat                   |
| Multi-Link-Achse                      | multi-link-aksel                             | multilänkaxel                         |
| m.Z. (mit Zubehör)                    | m.t. (med tilbehør)                          | m.t. (med tillbehör)                  |
| Nachstellteile-Satz                   | sæt justeringsdele                           | sats med efterjusteringsdelar         |
| ND-Schlauch                           | lavtryksslange                               | LT-slang (lågtrycks-)                 |
| Nebenabtrieb                          | sekundært kraftudtag                         | extra drivning                        |
| Niveauregulierung                     | niveauregulering                             | nivåreglering                         |
| Nz (Nehmerzylinder)                   | slavecylinder                                | SC slavcylinder                       |
| Nz-Reparatursatz                      | slavecylinder-reparationssæt                 | SC reparationssats                    |
| ohne Alufelgen                        | uden alu-fælg                                | utan aluminiumfålgar                  |
| ohne regeltem Katalysator             | uden reguleret katalysator                   | utan reglerad katalysator             |
| ohne Laschen                          | uden lasker                                  | utan stroppar/flikar/länkar           |
| ohne Leichtmetallräder                | uden letmetalhjul                            | utan lättmetalhjul                    |
| O-Ring                                | O-ring                                       | O-ring                                |
| Pedal Feststeller                     | pedal lås                                    | pedallås                              |
| Polizei                               | politi                                       | polis                                 |
| Rad                                   | hjul   | hjul                                  |
| Radsensor                             | hjulsensor                                   | hjulsensor                            |
| Radstand xxxx mm                      | hjulafstand xxxx mm                          | hjulbas xxxx mm                       |
| rechts oben und links unten           | oppe til højre og nede til venstre           | höger upptill och vänster nedtill     |
| Rechtslenker                          | højrestyret                                  | högerstyrt fordon                     |
| Regler                                | regulator                                    | regulator                             |
| Reihenmotor                           | seriemotor                                   | radmotor                              |
| Reisebus/Hochdecker                   | rejsebus/høj bus                             | turistbuss/ hög buss                  |
| Reparatursatz                         | reparationssæt                               | reparationssats                       |
| Ringstutzen-Satz                      | ringstuds-sæt                                | ringstuts-sats                        |
| Rohrleitung                           | rørledning                                   | rörledning                            |
| rot                                   | rød  | röd                                   |
| roter Sattel                          | rødt åg                                      | rött ok                               |
| Rückschlagventil                      | kontraventil                                 | backventil                            |
| Rückstellwellen-Satz                  | sæt tilbagestillingsaksel                    | återställningsaxel-sats               |
| Rz (Radzylinder)                      | hjulcylinder                                 | Hc (hjulcylinder)                     |
| Rz-Dichtungssatz                      | hjulcylinder-pakningssæt                     | Hc-O268pakningssats                   |
| Rz-Reparatursatz                      | hjulcylinder-reparationssæt                  | Hc-reparationssats                    |
| Salisbury-Achse                       | Salisbury-aksel                              | Salisbury-axel                        |
| Sattel mit 1 Haltestift               | åg med 1 holdetap                            | ok med 1 insatspinne                  |



|   |   |   |
|---|---|---|
| interior                                      | belül   | внутри  |
| rosca interior                                | Belső menet   | внутренняя резьба   |
| furgão  | Szekrényes kocsi  | автомобиль-фургон   |
| catalisador                                   | Katalizátor   | катализатор   |
| identificação: xx                             | Rendszám: xx  | номер: xx   |
| corte na flange                               | Bemetszés a karimán   | насечка на фланце   |
| classe  | Osztály   | класс   |
| mini-autocarro                                | Kisbusz   | микроавтобус  |
| ar condicionado                               | Klímaberendezés   | кондиционер   |
| biela D=                                      | Dugattyúrúd D=  | поршневой шток D=   |
| biela L=                                      | Dugattyúrúd L=  | поршневой шток L=   |
| carrinha station                              | Kombikocsi  | автомобиль-универсал (пикап)  |
| bomba central tandem compacta                 | Kompakt tandem-főfékhenger                                      | компактный двухполостной главный тормозной цилиндр                                      |
| ambulância                                    | Betegszállító kocsi   | санитарный автомобиль   |
| embraíagem                                    | Tengelykapcsoló   | сцепление   |
| saída p/ ligação da embraíagem                | Tengelykapcsoló kivezetés                                       | выходное отверстие муфты  |
| servo-embraíagem                              | Tengelykapcsoló erősítő   | усилитель сцепления   |
| distância curta entre eixos                   | Rövid tengelytávolság   | короткая колесная база  |
| servofreio curto                              | Rövid fékberendezés   | короткое тормозное устройство   |
| L (comprimento) =                             | L (hosszúság) =   | L (длина) =   |
| distância longa entre eixos                   | Hosszú kerék bázis  | длинная колесная база   |
| indicador de fuga                             | Szivárgásjelző  | сигнализация утечки   |
| disponível                                    | szállítható   | может быть поставлено   |
| em cima à esquerda e em baixo à direita       | a bal oldalon fent és a jobb oldalon lent                       | слева сверху и справа вниз  |
| à esquerda à frente e à direita atrás do eixo | a baloldalon a tengely előtt és a jobb oldalon a tengely mögött | слева перед осью и справа позади оси  |
| volante à esquerda                            | Balkormányos  | леворульный автомобиль  |
| suspensão pneumática                          | Pneumatikus felfüggesztés                                       | пневматическая подвеска   |
| refrigerado por ar                            | léghűtéses  | с воздушным охлаждением   |
| perno-guia M8                                 | M8-vezetőcsap   | направляющий болт M8  |
| caixa de velocidades MA                       | MA-sebességváltó  | коробка передач MA  |
| com 1 perno retentor                          | 1 tartócsappal  | с 1 упорным болтом  |
| com 2 pernos retentores                       | 2 tartócsappal  | с двумя упорными болтами  |
| com jante em alumínio                         | alumínium keréktárcsákkal                                       | с алюминиевыми колесными дисками (ободами)  |
| com reservatório fundido                      | öntött tartállyal   | с резервуаром, выполненным литьем   |
| com catalizador regulável                     | szabályozott katalizátorral                                     | с регулируемым катализатором  |
| com encaixes                                  | hevederekkel  | с накладками  |
| com jantes em liga                            | könnyűfém kerekkel  | с колесами из легкого сплава  |
| unidade completa MKII                         | Komplett MKII-aggregát  | агрегат MKII в сборе  |
| Mod. (Modelo)                                 | Mod. (modell)   | мод. (модель)   |
| motor   | Motor   | двигатель   |
| nr. do motor                                  | Motor-szám  | номер двигателя   |
| sistema bomba-motor                           | Motor-szivattyú aggregát  | агрегат двигатель-помпа   |
| eixo multi-link                               | Multi-Link tengely  | ось „мульти-линк“   |
| com acessórios                                | m.Z. (tartozékokkal)  | m.Z. (с принадлежностями)   |
| jogo de peças de afinação                     | Utánállító alkatrész-készlet                                    | комплект деталей для регулировки  |
| tubo ND                                       | Alacsony nyomású tömlő  | шланг низкого давления  |
| propulsão secundária                          | Melléklehajtás  | вспомогательный привод  |
| regulação nível                               | Magasság szabályozó modul                                       | регулировка высоты дорожного просвета   |
| BAE-bomba auxiliar de embraíagem              | Nz (vezérelt henger)  | NZ (рабочий цилиндр привода выключения сцепления)                                       |
| BAE-jogo de reparação                         | Nz-javítókészlet  | ремкомплект рабочего цилиндра сцепления   |
| sem jante em alumínio                         | Alumínium keréktárcsák nélkül                                   | без алюминиевых ободов  |
| sem catalizador regulável                     | Szabályozott katalizátor nélkül                                 | без регулируемого катализатора  |
| sem encaixes                                  | Hevederek nélkül  | без накладок  |
| sem jantes em liga leve                       | Könnyűfém kerek nélkül  | без колес из легкого сплава   |
| vedante / O-ring                              | Körkeresztmetszetű gyűrű  | кольцо круглого сечения   |
| pedal com bloqueio                            | Padárlógzító  | фиксатор педали   |
| Polícia                                       | Rendőrség   | полиция   |
| roda  | Kerék   | колесо  |
| sensor da roda                                | Kerékérzékelő   | датчик колеса   |
| distância entre eixos xxxx mm                 | Tengelytávolság xxxx mm   | колесная база автомобиля xxx мм   |
| à direita em cima e à esquerda em baixo       | a jobb oldalon fent és a bal oldalon lent                       | справа сверху и слева вниз  |
| volante à direita                             | Jobbkormányos   | праворульный автомобиль   |
| regulador                                     | Szabályozó  | регулятор   |
| motor em linha                                | Soros motor   | рядный двигатель  |
| autocarro de turismo / cabina alta            | Autóbusz/emeletes busz  | междугородный автобус/туристский автобус с высоко расположенным пассажирским помещением |
| jogo de reparação                             | Javító készlet  | ремкомплект   |
| jogo de suportes / anilhas                    | Gyűrűs talpkészlet  | комплект кольцевых патрубков  |
| tubagem                                       | Csővezeték  | трубопровод   |
| vermelho                                      | Piros   | красный   |
| pinça de travão vermelha                      | Piros nyereg  | красный суппорт   |
| válvula de sentido único                      | Visszacsapó szelep  | обратный клапан   |
| jogo para reset de árvores                    | Visszaállító tengely-készlet                                    | комплект валов возврата в исходное положение  |
| CR (cilindro de roda)                         | Rz (kerékfékhenger)   | Rz (колесный тормозной цилиндр)   |
| CR-jogo de juntas                             | Kerékfékhenger tömítőkészlet                                    | комплект прокладок колесного тормозного цилиндра  |
| CR-jogo de reparação                          | Kerékfékhenger javítókészlet                                    | ремкомплект колесного тормозного цилиндра   |
| eixo Salisbury                                | Salisbury-tengely   | ось Солсбери  |
| pinça de travão com 1 perno retentor          | Nyereg 1 tartócsappal   | суппорт с 1 штифтовым ограничителем   |

|                                |                                     |                                  |
|--------------------------------|-------------------------------------|----------------------------------|
| Sattel mit 2 Haltestiften      | åg med 2 holdetapper                | ok med 2 insatspinnar            |
| Sättel mit Gussnoppen          | åg med støbte nopper                | ok med gjutna noppor             |
| Sattelschraube                 | ågskrue                             | okskrue                          |
| Scheibenbremse                 | skivebremse                         | skivbroms                        |
| Scheibenkupplung               | skivekobling                        | skivkoppling                     |
| Scheibenschraube               | skiveskrue                          | skivskruv                        |
| Schlauchleitung                | slangeledning                       | slangledning                     |
| Schraubstutzen                 | skruvestuds                         | skruvstuts                       |
| schwarz                        | sort                                | svart                            |
| Schwimmsättel                  | flydeåg                             | flytande ok                      |
| Schwingblech WE                | svingplade advarselsudstyr          | svängplåt VA (varningsanordning) |
| SCS                            | SCS (stop kontrolsystem)            | SCS (stopp kontroll system)      |
| separater Behälter             | separat beholder                    | separat behållare                |
| separates Druckstück/Vorgänger | separat trykstykke/forgænger        | separat trykstykke/föregångare   |
| Servolenkung                   | servostyring                        | servostyrning                    |
| Skandinavien                   | Skandinavien                        | Skandinavien                     |
| Sitzplätze                     | siddepladser                        | sittplatser                      |
| Sonderfahrzeuge                | specialkøretøj                      | speciella fordon                 |
| Spezialaufbau                  | specialopbygning                    | speciell oppbyggnad              |
| Sportfahrwerk                  | sportkøretøj                        | sportchassi                      |
| Spur                           | spor                                | spår                             |
| Standard-Bremsgerät            | standard-bremseenhed                | standard bromsenhet              |
| Standard-THz                   | standard-TMC                        | standard Thc                     |
| staubfeste Ausführung          | støvfast udførelse                  | dammsäkert utförande             |
| Stufenheck                     | sedan                               | sedan-bakdel                     |
| T50-Reparaturatz               | T50-reparationssæt                  | T50-reparationssats              |
| Tandemregler                   | tandemregulator                     | tandemregulator                  |
| THz mit 3 Anschlüssen          | TMC med 3 tilslutninger             | Thc med 3 anslutninger           |
| THz mit Anschlagsschraube      | TMC med stopskrue                   | Thc med anslagsskrue             |
| THz (Tandemhauptzylinder)      | TMC (tandemhovedcylinder)           | Thc (tandemhovedcylinder)        |
| THz-Reparaturatz               | TMC-reparationssæt                  | Thc-reparationssats              |
| THz-RS (Montagehülse)          | TMC-reparationssæt (montagebøsning) | Thc-RS (monteringshylsa)         |
| Timken-Achse                   | Timken-aksel                        | Timken-axel                      |
| Topfmanschette                 | kopmanchet                          | övergångshylsa                   |
| Tragbolzensatz                 | sæt bærebolte                       | bårskruvsats                     |
| Transporter                    | transporter                         | transportfordon                  |
| Triebkopf                      | drivhoved                           | drivhuvud                        |
| Trommelbremse                  | tromlebremse                        | trumbroms                        |
| TBB (Trommelbremsbacken)       | TBB (tromlebremsebakker)            | TBB (trumbromsbackar)            |
| Umbau 1-teilig auf 2-teilig    | ombygning fra 1 del til 2 dele      | ombyggnad 1-delad till 2-delad   |
| Unterdruckverstärker           | undertryksforstærker                | undertrycksförstärkare           |
| ursprüngl. verschraubte Beläge | oprind. fastskruede belægninger     | ursprungl. förskruvade belägg    |
| VA (Vorderachse)               | FA (foraksel)                       | FA (framaxel)                    |
| VA-Girling-Bremse              | FA-Girling-bremse                   | FA-Girling-broms                 |
| VA-Scheibenbremse              | FA-skivebremse                      | FA-skivbroms                     |
| VA-Trommelbremse               | FA-tromlebremse                     | FA-trumbroms                     |
| Ventilblock                    | ventilblok                          | ventilblock                      |
| Ventilblock kpl.               | ventilblok komplet                  | ventilblock kompl.               |
| Verbindungsschrauben           | forbindelsesskruer                  | koplingsskruevar                 |
| Verschlußschraube              | låseskrue                           | låsplugg                         |
| Verschraubung                  | forskruning                         | förskruvning                     |
| Verschraubung kpl.             | forskruning komplet                 | förskruvning kompl.              |
| verstärkte Bremse              | forstærket bremse                   | förstärkt broms                  |
| verstärkte Stoßdämpfer         | forstærket støddæmper               | förstärkta stötdämpare           |
| verstärktes Fahrwerk           | forstærket chassis                  | förstärkt chassi                 |
| Verteilerstück wiederverwenden | genbrug fordelerstykke              | återanvänd fördelarstycket       |
| V-Motor                        | V-motor                             | V-motor                          |
| Vorder- und Hinterachse        | for- og bagaksel                    | fram- och bakaxel                |
| Vorderachse                    | foraksel                            | framaxel                         |
| Vorderachse und 2. Hinterachse | foraksel og 2. bagaksel             | framaxel och 2:a bakaxeln        |
| Vordruckventil                 | fortryksventil                      | förtrycksventil                  |
| Vorgänger                      | forgænger                           | föregångare                      |
| Vorgänger / Abschirmkappe      | forgænger / afskærmningshætte       | föregångare / avskärmningskåpa   |
| Vorgänger-THz, Einlaß D=xx     | forgænger-TMC, indløb Ø=xx          | föregångare-Thc, inlopp D=xx     |
| Vorspannzylinder               | forspændecylinder                   | förspänncylinder                 |
| WK (Warnkontakt)               | advarselskontakt                    | VK (varningskontakt)             |
| Warnkontakt 1-polig            | 1-polet advarselskontakt            | varningskontakt 1-polig          |
| Warnkontakt 2-polig            | 2-polet advarselskontakt            | varningskontakt 2-polig          |
| Warnschalter                   | advarselskontakt                    | varningsbrytare                  |
| WE (Warneinrichtung)           | advarselsanordning                  | VA (varningsanordning)           |
| WE-Befestigung                 | fastgøring advarselsanordning       | infästning för varningsanordning |
| Wegsensor                      | vejsensor                           | vägsensor                        |
| weiß                           | hvid                                | vit                              |
| Zylinderschraube               | cylinderskrue                       | cylinderskrue                    |





|   |   |  |
|---|---|--|
| pinça de travão com 2 pernos retentores       | Nyereg 2 tartócsappal                                 | суппорт с 2 штифтовым ограничителем  |
| pinças de travão c/ saliências fundidas       | Nyergek öntött szemcsékkel                            | суппорта с литыми утолщениями  |
| parafuso da pinça de travão                   | Nyeregsavar   | болт суппорта  |
| discos de travão                              | Tárcsafék   | дисковый тормоз  |
| discos de embraiagem                          | Tárcsás tengelykapcsoló                               | дисковая муфта, сцепление  |
| parafuso do disco                             | Tárcsacsavar  | болт диска   |
| tubo  | Tömlővezeték  | шланг  |
| terminal roscado                              | Csavarcsonk   | горловина под резьбовую пробку   |
| preto   | Fekete  | черный   |
| pinça de travão oscilante                     | Úszónyereg  | плавающие скобы (суппорта)   |
| avisador em chapa oscilante                   | Rezgőlemez WE   | металлический лист сигнального устройства                                  |
| SCS (sistema de controlo de stop)             | SCS   | система SCS (stop control system)  |
| reservatório isolado                          | Külön tartály   | отдельный резервуар  |
| peça de pressão / anterior                    | Külön nyomóidom/előző kivétel                         | отдельный упор/предшественник  |
| direcção assistida                            | Szervokormány   | рулевое управление с сервоприводом   |
| Escandinávia                                  | Skandinávia   | Скандинавия  |
| assentos                                      | Ülőhelyek   | сидячие места  |
| veículo especial                              | Különleges gépkocsik                                  | специальные автомобили   |
| carroçaria especial                           | Különleges felépítmény                                | специальный кузов  |
| suspensão desportiva                          | Sportos futómű  | спортивная ходовая часть   |
| via   | Nyom  | полоса движения  |
| servofreio standard                           | Standard fékberendezés                                | стандартное тормозное устройство   |
| bomba central tandem standard                 | Standard tandem főfékhenger                           | стандартный двухполостной главный тормозной цилиндр                        |
| construção anti-poeiras                       | Porvédett kivétel                                     | пыленепроницаемая модификация  |
| 3 volumes                                     | Lépcsőshátú   | задняя часть кузова с углом между стеклом задка и багажником               |
| jogo de reparação T50                         | T50-javítókészlet                                     | ремкомплект T50  |
| regulador tandem                              | Tandemszabályozó                                      | двухполостной ограничитель давления  |
| BCT com 3 ligações                            | THz 3 csatlakozóval                                   | двухполостной главный тормозной цилиндр с 3 подключениями                  |
| BCT com parafuso de retenção                  | Tandem főfékhenger ütközőcsavarral                    | двухполостной главный тормозной цилиндр с упорным винтом                   |
| BCT-bomba central tandem                      | THz (tandem főfékhenger)                              | THz (двухполостной главный тормозной цилиндр)                              |
| BCT-jogo de reparação                         | Tandem főfékhenger javítókészlet                      | ремкомплект двухполостного главного тормозного цилиндра                    |
| BCT-invólucro de montagem                     | Tandem főfékhenger-RS (szerelőhüvely)                 | ремкомплект двухполостного главного тормозного цилиндра (монтажная гильза) |
| eixo Timken                                   | Timken-tengely  | ось Тимкена  |
| vedante                                       | Edénytömítőgallér                                     | пыльник стакана  |
| jogo de pernos de suporte                     | Tartócsapkészlet                                      | комплект опорных болтов  |
| furgoneta                                     | Szállítókosci   | автомобиль-фургон малой грузоподъемности                                   |
| cabeça de propulsão                           | Hajtófej  | приводной агрегат  |
| travão de tambor                              | Dobfék  | барабанный тормоз  |
| MTT (Maxilas de Travão de Tambor)             | TBB (dobfékpofák)                                     | ТВВ (колодки барабанного тормоза)  |
| reconstrução de 1 peça a partir de 2 peças    | Átéptés 1-részesről 2-részesre                        | переоборудование с 1 части на 2 части                                      |
| servofreio de vácuo                           | Vákuum erősítő  | вакуумный усилитель  |
| pastilhas aparafusadas de origem              | eredetileg felcsavarozott fékbetétek                  | первоначально прикручиваемые колодки                                       |
| ED (eixo dianteiro)                           | VA (első tengely)                                     | VA (передний мост)   |
| travões Girling do eixo dianteiro             | Első tengely Girling-fék                              | передний тормоз Girlinga   |
| travão de disco do eixo dianteiro             | Első tengely tárcsafék                                | передний дисковый тормоз   |
| travão de tambor do eixo dianteiro            | Első tengely dobfék                                   | передний барабанный тормоз   |
| válvula de bloqueio                           | Szelepblokk   | клапанный блок   |
| válvula de bloqueio - completa                | Komplett szelepblokk                                  | клапанный блок в сборе   |
| parafusos de união                            | Összekötő csavarok                                    | соединительные болты   |
| parafuso de fecho                             | Zárócsavar  | навинчивающаяся крышка   |
| aparafusamento                                | Csavarkötés   | резьбовое соединение   |
| aparafusamento completo                       | Komplett csavarkötés                                  | резьбовое соединение в сборе   |
| travão reforçado                              | Megerősített fék                                      | усиленные тормоза  |
| amortecedor reforçado                         | Megerősített lengéscsillapító                         | усиленный амортизатор  |
| suspensão reforçada                           | Megerősített futómű                                   | усиленная ходовая часть  |
| reutilizar peça de distribuição               | Az elosztóidomot újra fel kell használni              | использовать снова распределитель  |
| motor em V                                    | V-motor   | V-образный двигатель   |
| eixos dianteiro e traseiro                    | Első és hátsó tengely                                 | передний и задний мост   |
| eixo dianteiro                                | Első tengely  | передний мост  |
| eixo dianteiro e 2º eixo traseiro             | Első tengely és 2. hátsó tengely                      | передний мост и 2-й задний мост  |
| válvula de pressão dianteira                  | Előnyomásszelep                                       | подпорный клапан   |
| anterior                                      | Előző kivétel   | предшественник   |
| anterior / capa de protecção                  | Előző kivétel / árnyékoló sapka                       | предшественник/ экранирующая головка                                       |
| anterior bomba central tandem, Ø entrada = xx | Előző kivétel - tandem főfékhenger, bemenőnyílás D=xx | предшествовавший двухполостной главный тормозной цилиндр, вход D=xx        |
| cilindro pré-tensionado                       | Előfeszítő henger                                     | предварительный цилиндр  |
| AD (avisador de desgaste)                     | WK (figyelmeztető érintkező)                          | сигнальный контакт   |
| AD c/ 1 terminal                              | 1-pólusú kopásfigyelmeztető érintkező                 | сигнальный контакт 1-полюсный  |
| AD c/ 2 terminais                             | 2-pólusú kopásfigyelmeztető érintkező                 | сигнальный контакт 2-полюсный  |
| interruptor de aviso                          | Figyelmeztető kapcsoló                                | сигнальное реле  |
| DA (dispositivo de aviso)                     | WE (figyelmeztető berendezés)                         | WE (сигнальное устройство)   |
| fixação do dispositivo de aviso               | Figyelmeztető berendezés rögzítés                     | крепление сигнального устройства   |
| sensor de curso                               | Útérzékelő  | датчик скорости автомобиля   |
| branco  | fehér   | белый  |
| parafuso do cilindro                          | Hengeres fejű csavar                                  | болт головки блока цилиндров   |



|  |   |  |
|--|---|--|
| 1-Kammer-Druckluftbremse               | 1komorová pneumatická brzda             | 1 - komorowy hamulec pneumatyczny                    |
| 1-Kolbensattel D=xx                    | 1pístový třmen D=xx                     | zacisk z jednym tłoczkiem D=xx                       |
| 2-Kolbensattel D=xx                    | 2pístový třmen D=xx                     | zacisk z dwoma tłoczkami D=xx                        |
| 4-Kolbensattel                         | 4pístový třmen                          | zacisk z 4 tłoczkami                                 |
| 1-Kreis-Bremse                         | jednookruhová brzda                     | hamulec jednoobwodowy                                |
| 2-Kreis-Bremse                         | dvouokruhová brzda                      | hamulec dwuobwodowy                                  |
| 1-Kreis-Sättel                         | jednookruhový třmen                     | zaciski jednoobwodowe                                |
| 2-Kreis-Sättel                         | dvouokruhový třmen                      | zaciski dwuobwodowe                                  |
| 1. Hinterachse                         | 1. zadní náprava                        | pierwsza oś tylna                                    |
| 1. und 2. Hinterachse                  | 1. a 2. zadní náprava                   | pierwsza i druga oś tylna                            |
| 4-Loch-Bremsscheibe                    | brzdový kotouč se 4 otvory              | tarcza hamulca z 4 otworami                          |
| 6-Loch-Bremsscheibe                    | brzdový kotouč se 6 otvory              | tarcza hamulca z 6 otworami                          |
| 3-Loch-Felge                           | ráfek se 3 otvory                       | obřezč kola z 3 otvorami                             |
| 4-Loch-Felge                           | ráfek se 4 otvory                       | obřezč kola z 4 otvorami                             |
| 5-Loch-Felge                           | ráfek s 5 otvory                        | obřezč kola z 5 otvorami                             |
| 6kt-Schraube                           | šroub se 6hrannou hlavou                | šruba z 6buntem sześciokątnym                        |
| 6kt-Schraube (innen)                   | šroub se 6hrannou hlavou (vnitřní)      | šruba z 6buntem sześciokątnym (wewnątrz)             |
| 6"-Tandem                              | 6" tandem                               | tandem 6"  |
| 8"-Tandem mit Gabelkopf                | 8" tandem s vidlicovou hlavou           | tandem 8" z główką rozwidloną                        |
| 8"-Tandem ohne Gabelkopf               | 8" tandem bez vidlicové hlavy           | tandem 8" bez główki rozwidłonej                     |
| ABS                                    | ABS                                     | ABS  |
| ABS-Dichtungssatz                      | sada těsnění pro ABS                    | komplet uszczelniający do ABS                        |
| Achtung: Kolbenstellung ändern !       | Pozor! Změnit polohu pístu!             | Uwaga: zmienić położenie tłoka!                      |
| Adapter für Bördel E                   | Adaptér pro obrubu typu E               | adapter do zwinięcia obwodowego typu E               |
| alle Typen                             | všechny typy                            | wszystkie typy                                       |
| Alu-Pumpe                              | hliníkové čerpadlo                      | pompa aluminiowa                                     |
| Alu-Sättel                             | hliníkové třmeny                        | zaciski aluminiowe                                   |
| am Bremssattel                         | u třmenu kotoučové brzdy                | na zacisku aluminiowym                               |
| am Hauptzylinder                       | u hlavního válce                        | na pompie hamulca                                    |
| A-Motor                                | A motor                                 | silnik A   |
| Anschlagschraube oben                  | dorazový šroub nahoře                   | wkręt zderzakowy, góra                               |
| Anschluß/Anschlüsse                    | přípoj/přípoje                          | przyłącze / przyłącza                                |
| Anti-Noise-Blech                       | vymezovací podložka                     | blacha tłumiąca hałas                                |
| ASC (Automatische Stabilitäts Control) | ASC (automatická kontrola stability)    | ASC (automatyczny system kontroli stabilności jazdy) |
| ASR (Antriebssschlupfregelsystem)      | ASR (systém pro protismykovou regulaci) | ASR (układ antypoślizgowej stabilizacji napędu)      |
| ATE nur über VAG erhältlich            | ATE lze obdržet jen přes VAG            | ATE dostępne tylko przez VAG                         |
| auf Typenschild                        | na typovém štítku                       | na tabliczce znamionowej                             |
| aufgeschraubt                          | našroubováno                            | nakręcone  |
| Auslaß seitlich links                  | výfuk na straně vlevo                   | wylot z lewej strony z boku                          |
| Auslaß seitlich rechts                 | výfuk na straně vpravo                  | wylot z prawej strony z boku                         |
| außen                                  | vně                                     | na zewnątrz  |
| automatische Nachstellung              | automatické seřizování                  | automatyczna regulacja                               |
| Behälter                               | nádržka                                 | zbiorniczek  |
| Behälter Doppel-WE                     | dvojitě VZ nádržky                      | zbiorniczek z podwójnym urządzeniem ostrzegawczym    |
| Behälterbefestigung                    | upevnění nádržky                        | mocowanie zbiorniczka                                |
| Behälterstopfen                        | zátká nádržky                           | korek zbiorniczka                                    |
| Behälterverschraubung                  | šroubení nádržky                        | zakrętka zbiorniczka                                 |
| Behörde                                | úřad                                    | urząd  |
| Beläge                                 | obložení                                | okładziny hamulcowe                                  |
| belüftete Scheiben                     | větrané kotouče                         | tarcze wentylowane                                   |
| Betätigungseinheit                     | ovládací jednotka                       | jednostka obsługowa                                  |
| blau                                   | modrý                                   | niebieski  |
| Bodenventil                            | dnový ventil                            | zawór denny  |
| Bodenventile tauschen                  | vyměnit dnové ventily                   | wymienić zawory denne                                |
| Bördel x                               | obruba x                                | zawinięcie obwodowe x                                |
| braun                                  | hnědý                                   | brązowy  |
| breite Ausführung                      | široké provedení                        | typ szeroki  |
| Bremse                                 | brzda                                   | hamulec  |
| Bremsgerät                             | brzdové zařízení                        | urządzenie hamulcowe                                 |
| Bremskraftregler                       | regulátor brzdné síly                   | regulator siły hamowania                             |
| Bremsleitungen erneuern !              | vyměnit brzdová vedení!                 | Wymienić przewody hamulcowe!                         |
| Bremslichtschalter                     | spínač brzdového světla                 | włącznik światła stopu                               |
| Bremsscheiben                          | brzdové kotouče                         | tarcze hamulcowe                                     |
| Bremsschlauch beachten !               | Dbejte na brzdovou hadici!              | Zwrócić uwagę na przewód hamulcowy!                  |
| Buchse + Ausgleichbügel                | pouzdro + vyrovnávací třmen             | tuleja + kabłąk wyrównawczy                          |
| Bus                                    | autobus                                 | bus (van)  |
| Bypassregler                           | obtokový regulátor                      | regulator obejściowy                                 |
| Citroen-Bremse                         | brzda Citroenu                          | hamulec Citroen'a                                    |
| D (Durchmesser) =                      | D (průměr) =                            | D (średnica) =                                       |
| Dichtring                              | těsnící kroužek                         | pierścień uszczelniający                             |
| Dichtung                               | těsnění                                 | uszczelka  |
| Dichtungssatz                          | sada těsnění                            | zestaw uszczelniający                                |
| Differentialsperre                     | uzávěrka diferenciálu                   | blokada układu różnicowego                           |
| Differenzdruckschalter                 | diferenční tlakový spínač               | włącznik różnicy ciśnień                             |
| Differenzdruckventil                   | diferenční tlakový ventil               | zawór różnicy ciśnień                                |
| diverse Typen                          | různé typy                              | różne typy   |
| Doppelbereifung                        | dvojí pneumatiky                        | podwójne ogumienie                                   |



|  |   |                   |
|--|---|-------------------|
| Φρένο πεπιεσμένου αέρα 1 θαλάμου                     | tek odalı havalı fren                     | 抗噪音板              |
| Δίχαλο πέδησης 1 εμβόλου D=xx                        | 1 pistonlu kaliper D=xx                   | 1活塞制动钳 D=xx       |
| Δίχαλο πέδησης 2 εμβόλων D=xx                        | 2 pistonlu kaliper D=xx                   | 2活塞制动钳 D=xx       |
| Δίχαλο πέδησης 4 εμβόλων                             | 4 pistonlu kaliper                        | 4活塞制动钳            |
| Φρένο 1 κυκλώματος                                   | 1 devreli fren                            | 1回路制动器            |
| Φρένο 2 κυκλωμάτων                                   | 2 devreli fren                            | 2回路制动器            |
| Δίχαλα πέδησης 1 κυκλώματος                          | 1 devreli kaliperler                      | 1回路制动钳            |
| Δίχαλα πέδησης 2 κυκλωμάτων                          | 2 devreli kaliperler                      | 2回路制动钳            |
| 1ος πίσω άξονας                                      | 1. arka aks                               | 第1后桥              |
| 1ος και 2ος πίσω άξονας                              | 1. ve 2. arka aks                         | 第1和第2后桥           |
| Δίσκος φρένου 4 οπών                                 | 4 delikli fren diski                      | 4孔式制动圆盘           |
| Δίσκος φρένου 6 οπών                                 | 6 delikli fren diski                      | 6孔式制动圆盘           |
| Ζάντα 3 οπών   | 3 delikli jant                            | 3孔式轮辋             |
| Ζάντα 4 οπών   | 4 delikli jant                            | 4孔式轮辋             |
| Ζάντα 5 οπών   | 5 delikli jant                            | 5孔式轮辋             |
| Βίδα εξαγωνικής κεφαλής                              | 6 köşeli civata                           | 六角螺栓              |
| Βίδα κεφαλής κοίλου εξαγώνου                         | 6 köşeli civata (iç)                      | 内六角螺栓             |
| Δίδυμος 6"   | 6 inç tandem                              | 6英寸串联制动液缸         |
| Δίδυμος 8" με διχαλωτή κεφαλή                        | 8 inç tandem, çatal başlıklı              | 8英寸串联制动液缸带有叉头     |
| Δίδυμος 8" χωρίς διχαλωτή κεφαλή                     | 8 inç tandem, çatal başlıksız             | 8英寸串联制动液缸不带叉头     |
| Σύστημα ανιμπλοκαρίσματος (ABS)                      | ABS (anti blokaj sistemi)                 | 防抱死制动系统           |
| Σε στεγανοποίησης συστήματος ανιμπλοκαρίσματος (ABS) | ABS conta takımı                          | 防抱死制动系统密封套件       |
| Προσοχή: Αλλαγή της θέσης του εμβόλου !              | Dikkat: Piston pozisyonunu değiştirin !   | 注意: 活塞位置变更 !      |
| Προσαρμογέας για περιχέλιωση τύπου E                 | havşa E için adaptör                      | 用于卷边E的适配件         |
| όλοι οι τύποι  | tüm tipler                                | 所有型号              |
| Αλουμινένια αντλία                                   | alüminyum pompa                           | 铝制泵               |
| Αλουμινένια δίχαλα πέδησης                           | alüminyum kaliperler                      | 铝制制动钳             |
| στο δίχαλο πέδησης                                   | fren kaliperinde                          | 制动钳旁              |
| στον κεντρικό κύλινδρο                               | ana merkez silindirinde                   | 主液缸旁              |
| Κινητήρας A  | A motor                                   | A发动机              |
| Κοχλίας αναστολής επάνω                              | üst dayanak civatası                      | 上限位螺钉             |
| Σύνδεση/Συνδέσεις                                    | bağlantı/bağlantılar                      | 接口/连接             |
| Ηχομωνωτική λαμαρίνα                                 | susturucu                                 | 抗噪音板              |
| ASC (Αυτόματος Έλεγχος Ευστάθειας)                   | ASC (Otomatik Stabilite Kontrolü)         | ASC (汽车稳定性自动控制装置) |
| ASR (Διάταξη Ρύθμισης Έλξης και Ολισθησης)           | ASR (Anti Patinaj Sistemi)                | ASR (防侧滑调节系统)     |
| ATE διατίθεται μόνο μέσω VAG                         | ATE sadece VAG üzerinden temin edilebilir | 只能通过VAG购置ATE      |
| πάνω στην πινακίδα τύπου                             | tip levhası üzerinde                      | 在铭牌上              |
| βιδωμένο   | vidalanmış                                | 拧上                |
| Εξαγωγή πλάγια αριστερά                              | çıkış yeri sol yan taraf                  | 左侧排气              |
| Εξαγωγή πλάγια δεξιά                                 | çıkış yeri sağ yan taraf                  | 右侧排气              |
| εξωτερικά  | dış                                       | 外部                |
| Αυτόματη επαναρύθμιση                                | otomatik ayarlama                         | 自动调整              |
| Δοχείο   | hazne                                     | 容器                |
| Δοχείο με διπλή διάταξη προειδοποίησης (ΔΠ)          | çift ikaz sistemli hazne                  | 双层WE的容器           |
| Στήριξη δοχείου                                      | hazne tespitleme                          | 容器的固定             |
| Τάπα δοχείου   | hazne tapası                              | 容器堵头              |
| Πώμα δοχείου   | hazne vida bağlantısı                     | 容器螺帽              |
| Υψηροσία   | resmi araç                                | 政府机关              |
| Τακάκια φρένων                                       | fren balataları                           | 摩擦片               |
| Αεριζόμενοι δίσκοι                                   | havalandırılmalı diskler                  | 通风的制动盘            |
| Μονάδα χειρισμού                                     | çalıştırma ünitesi                        | 操纵单元              |
| μπλε   | mavi                                      | 蓝色                |
| Βαλβίδα πυθμένα                                      | taban valfi                               | 底阀                |
| Αντικατάσταση βαλβίδων πυθμένα                       | taban valflerini değiştirin               | 更换底阀              |
| Περιχέλιωση x  | havşa x                                   | 卷边 x              |
| καφέ   | kahverengi                                | 棕色                |
| Πλατιά έκδοση  | geniş model                               | 宽结构形式             |
| Φρένο  | fren                                      | 制动器               |
| Μονάδα πέδησης                                       | fren cihazı                               | 制动器               |
| Ρυθμιστής δύναμης πέδησης                            | fren regülatörü                           | 制动力调节器            |
| Αντικατάσταση σωλήνων φρένων !                       | fren hatlarını yenileyin !                | 更新制动管路 !          |
| Διακόπτης φώτων φρένων                               | fren lambası şalteri                      | 制动灯开关             |
| Δίσκοι φρένων  | fren diskleri                             | 制动圆盘              |
| Προσοχή στον εύκαμπο σωλήνα φρένου !                 | fren hortumunu dikkate alın !             | 注意制动软管 !          |
| Δακτύλιος + Κλιπ εξισορρόπηση                        | buç + dengeleme elemanı                   | 轴套 + 补偿卡箍         |
| Λεωφορείο  | otobüs                                    | 大客车               |
| Ρυθμιστής παράκαμψης                                 | bypass regülatörü                         | 旁路调节器             |
| Φρένο Citroen  | Citroen freni                             | 雪铁龙制动器            |
| D (Διάμετρος) =                                      | Ç (Çap) =                                 | D (直径) =          |
| Στεγανοποιητικός δακτύλιος                           | conta halkası                             | 密封圈               |
| Στεγανοποίηση  | conta                                     | 密封                |
| Σε στεγανοποίησης                                    | conta takımı                              | 密封套件              |
| Εμπλοκέας διαφορικού                                 | diferansiyal kilidi                       | 差动锁止机构            |
| Διακόπτης διαφοράς πίεσης                            | fark basınç şalteri                       | 差动压力开关            |
| Βαλβίδα διαφοράς πίεσης                              | fark basınç valfi                         | 差动压力阀             |
| διάφοροι τύποι                                       | muhtelif tipler                           | 各种型号              |
| Διπλά ελαστικά                                       | çift lastik                               | 双轮胎               |

|                             |                                       |   |
|-----------------------------|---------------------------------------|---|
| Doppelkabine                | dvojitá kabina                        | kabina podwójna   |
| Druckbegrenzungsventil      | tlakový omezovací ventil              | zawór ograniczenia ciśnienia                            |
| Druckbolzen                 | tlakový čep                           | trzcierń naciskowy                                      |
| Druckbolzen (kurz)          | tlakový čep (krátký)                  | trzcierń naciskowy (krótki)                             |
| Druckbolzen (lang)          | tlakový čep (dlouhý)                  | trzcierń naciskowy (długi)                              |
| Druckluftbremse             | vzduchová brzda                       | hamulec pneumatyczny                                    |
| Druckluftleitung            | tlakovzdušné vedení                   | przewód sprężonego powietrza                            |
| Druckluftunterstützung      | tlakovzdušná podpora                  | wspomaganie sprężonym powietrzem                        |
| Druckluftverstärker         | tlakovzdušný zesilovač                | wspomaganie pneumatyczne                                |
| Druck-Warnschalter          | výstražný spínač tlaku                | ciśnieniowy włącznik ostrzegawczy                       |
| DS-Regler                   | regulátor DS                          | regulator DS  |
| EDS                         | EDS                                   | EDS (elektronická blokada układu różnicowego)           |
| EDS-Ventilblock             | blok ventilů EDS                      | EDS - blok zaworów                                      |
| EG-Vorschrift               | předpis ES                            | przepis EC (unijný)                                     |
| Einbau hinter der Achse     | montáž za nápravou                    | montaż za osią  |
| Einbau vor der Achse        | montáž před nápravou                  | montaż przed osią                                       |
| Einbausatz                  | montážní sada                         | komplet montażowy                                       |
| Einfachbereifung            | jedna sada pneumatik                  | pojedyncze ogumienie                                    |
| Einknopfmaß xx mm           | rozměr zapínání xx mm                 | wymiar zapięcia na guzik xx mm                          |
| Einlaß D=xx mm              | sání D=xx mm                          | wlot D=xx mm  |
| Einlaß mit Gummistopfen     | sání s pryžovou zátkou                | wlot z korkiem gumowym                                  |
| Einschraubregler            | regulátor k zašroubování              | regulator wkręcany                                      |
| elektr. Vergaser            | elektr. karburátor                    | gaźnik elektroniczny                                    |
| Entlüfteranschluß           | připoj odvodušňovače                  | przyłącze odpowietrzacza                                |
| Entlüfterventil             | odvodušňovací ventil                  | zawór odpowietrzacza                                    |
| erhöhte Zuladung            | zvýšené užitečné zatížení             | zwiększone doładowanie                                  |
| Ersatz für Sättel D=xx      | náhrada za třmeny D=xx                | zastępczo za zaciski D=xx                               |
| ETS                         | ETS                                   | ETS (elektronický systém kontroli trakcji)              |
| Europa                      | Evropa                                | Europa  |
| Export                      | export                                | eksport   |
| Fahrschule                  | autoškola                             | nauka jazdy   |
| Faltenbalsatz               | sada vlnovců                          | komplet mieszków  |
| Faustsättel                 | plovoucí třmeny                       | zaciski ruchome   |
| Fenster                     | okno                                  | szyba   |
| Festsättel                  | pevné třmeny                          | zaciski stále   |
| Flanschdicke x mm           | tloušťka příruby x mm                 | grubość kołnierza x mm                                  |
| Flanschmaß = xx,x           | rozměr příruby = xx,x                 | wymiar kołnierza = xx,x                                 |
| Fuller-Getriebe             | převodovka fuller                     | przekładnia Fullera                                     |
| für Belagsätze ohne Zubehör | pro sady obložení bez příslušenství   | do kompletu klocków hamulcowych bez osprzętu            |
| für Bremssättel/Vorgänger   | pro třmeny kotoučové brzdy/předchůdce | do zacisków hamulców / poprzednicy                      |
| für Doppelmembran-Gerät     | pro zařízení s dvojitou membránou     | do urządzenia z podwójną membraną                       |
| Gabelkopfsatz               | sada vidlicových hlav                 | zestaw główek rozwidlonych                              |
| Gehäuse L=                  | plášť L=                              | obudowa L=  |
| gelb                        | žlutý                                 | żółty   |
| gepanzerte Fahrzeuge        | obměná vozidla                        | pojazdy opancerzone                                     |
| Getriebe                    | převodovka                            | skrzynia biegów   |
| Getriebe-Nr.                | čís. převodovky                       | nr skrzyni biegów                                       |
| GG-Pumpe                    | čerpadlo z šedé litiny                | pompa z żeliwa szarego                                  |
| GG-Sättel                   | třmeny z šedé litiny                  | zaciski z żeliwa szarego                                |
| GG-THz/Vorgänger            | THV ze šedé litiny/předchůdce         | pompa hamulca typu tandem z żeliwa szarego / poprzednik |
| Golf-Staaten                | Golfské státy                         | państwo Zatoki Perskiej                                 |
| Gz mit senkrechtem Flansch  | válec vysílače se vsvislou přírubou   | pompa sprzęgła z prostopadłym kołnierzem                |
| Gz (Geberzylinder)          | VV (válec vysílače)                   | pompa sprzęgła  |
| Gz-Reparaturatz             | sada dílů pro opravu VV               | zestaw naprawczy do pompy sprzęgła                      |
| HA (Hinterachse)            | ZN (zadní náprava)                    | oś tylna  |
| Haltefeder                  | přidržná pružina                      | sprężyna mocująca                                       |
| Halter                      | držák                                 | uchwyt  |
| Haltersatz                  | sada držáků                           | komplet uchwytów  |
| Halterschraube              | šroub držáků                          | šruba uchwytu   |
| Handbremsbetätigung         | ovládání ruční brzdy                  | uruchomienie hamulca ręcznego                           |
| Handbremshebel              | páka ruční brzdy                      | dźwignia hamulca ręcznego                               |
| HA-Scheibenbremse           | kotoučová brzda ZN                    | hamulec tarczowy na osi tylnej                          |
| HA-Trommelbremse            | bubnová brzda ZN                      | hamulec bębnowy na osi tylnej                           |
| Hebel                       | páka                                  | dźwignia  |
| Hochdach                    | vysoká střecha                        | wysoki dach   |
| Hohlschraube                | dutý šroub                            | śruba wydrążona   |
| Hosei-Bremse                | brzda Hosei                           | hamulec Hosei   |
| Hub                         | zdvih                                 | skok  |
| Hülsensatz                  | sada pouzder                          | komplet tulejek   |
| Hydraulikspeicher           | hydraulický zásobník                  | akumulator hydrauliczny                                 |
| Hydraulikverstärker         | hydraulický posilovač                 | hydrauliczny siłownik wspomagający                      |
| Hydraulikzylinder           | hydraulický válec                     | cylinder hydrauliczny                                   |
| Hydr. Steuereinheit         | hydraulická řídící jednotka           | hydrauliczny blok sterujący                             |
| HZ (Hauptzylinder)          | HV (hlavní válec)                     | PH (pompa hamulcowa)                                    |
| HZ-Reparaturatz             | sada dílů pro opravu HV               | zestaw naprawczy do pompy hamulcovej                    |
| im Fahrerhaus               | v kabině řidiče                       | w kabinie   |
| im Motorraum                | v motorovém prostoru                  | w maszynowni  |



|   |  |               |
|---|--|---------------|
| Διπλός θάλαμος  | çift kabin   | 双驾驶室          |
| Βαλβίδα περιορισμού της πίεσης                                  | basınç sınırlama valfi                             | 限压阀           |
| Πείρος πίεσης   | baskı pimi   | 压力销           |
| Πείρος πίεσης (κοντός)  | baskı pimi (kısa)                                  | 压力销 (短)       |
| Πείρος πίεσης (μακρύς)  | baskı pimi (uzun)                                  | 压力销 (长)       |
| Φρένο πεπιεσμένου αέρα  | havalı fren  | 压缩空气制动器       |
| Σωλήνες πεπιεσμένου αέρα  | basınçlı hava hattı                                | 压缩空气管路        |
| Υποστήριξη πεπιεσμένου αέρα                                     | basınçlı hava desteği                              | 压缩空气支承        |
| Ενισχυτής πεπιεσμένου αέρα                                      | basınçlı hava amplifikatörü                        | 压缩空气放大器       |
| Διακόπτης προειδοποίησης πίεσης                                 | basınç ikaz şalteri                                | 压力报警开关        |
| Ρυθμιστής DS  | DS regülatörü                                      | DS差动锁止装置调节器   |
| EDS (ηλεκτρονικό κλειδίωμα διαφορικού)                          | EDS  | EDS电动差动锁止装置   |
| Μπλοκ βαλβίδων EDS  | EDS valf bloğu                                     | EDS阀块         |
| Προδιαγραφή EK  | AB direktifi                                       | EG欧盟规定        |
| Τοποθέτηση πίσω από τον άξονα                                   | aksın arkasına montaj                              | 装在轴后          |
| Τοποθέτηση μπροστά από τον άξονα                                | aksın önüne montaj                                 | 装在轴前          |
| Σετ τοποθέτησης   | montaj seti  | 安装套件          |
| Μονά ελαστικά   | tek lastik   | 单轮胎           |
| Διάσταση μπουτόν xx mm  | düğümleme ölçüsü xx mm                             | 按钮尺寸 xx mm    |
| Εισαγωγή D=xx mm  | giriş Ç=xx mm                                      | 进气口 D=xx mm   |
| Εισαγωγή με λαστιχένια πώματα                                   | lastik tapalı giriş                                | 带有橡胶堵头的进气口    |
| Βιδωτός ρυθμιστής   | vidalanarak montajlı regülatör                     | 拧进调节器         |
| Ηλεκτρικό καρμπυρατέρ   | elektrikli karbüratör                              | 电气化器          |
| Σύνδεση εξαερισμού  | hava boşaltma bağlantısı                           | 排气接口          |
| Βαλβίδα εξαέρωσης   | hava boşaltma valfi                                | 排气阀           |
| Αυξημένο πρόσθετο φορτίο  | fazla yükleme                                      | 增大的载重         |
| Αντικατάσταση για δίχαρα πέδησης D=xx                           | kaliperler için yedek D=xx                         | 用于制动钳 D=xx    |
| ETS   | ETS  | ETS           |
| Ευρώπη  | Avrupa   | 欧洲            |
| Εξαγωγή   | export   | 出口            |
| Σχολή οδηγών  | sürücü kursu                                       | 驾驶学校          |
| Σετ φούσκας   | körük takımı                                       | 波纹管组          |
| Ολισθαίνοντα δίχαρα πέδησης                                     | yumruk tip kaliperler                              | 浮式制动钳         |
| Παράθυρο  | pencere  | 车窗            |
| Σταθερά δίχαρα πέδησης  | sabit kaliperler                                   | 固定式制动钳        |
| Πάχος φλάντζας x mm   | flaş kalınlığı x mm                                | 法兰厚度 x mm     |
| Διάσταση φλάντζας = xx,x  | flaş ölçüsü = xx,x                                 | 法兰尺寸 = xx, x  |
| Κιβώτιο ταχυτήτων Fuller  | Fuller şanzıman                                    | 变速箱           |
| για σετ τακακιών χωρίς εξαρτήματα                               | aksesuarsız balata takımları için                  | 用于不带辅件的刹车片组   |
| για δίχαρα πέδησης/προηγούμενος τύπος                           | fren kaliperleri için/önceki                       | 用于制动钳/牵引车     |
| για συσκευή διπλής μεμβράνης                                    | çift diyaframlı cihaz için                         | 用于双膜片装置       |
| Σετ διχαλωτής κεφαλής   | çatal başlık takımı                                | 叉头套件          |
| Περίβλημα L=  | gövde L=   | 壳体 L=         |
| κίτρινο   | sarı   | 黄色            |
| Θωρακισμένα οχήματα   | zırhlı araçlar                                     | 装甲车辆          |
| Κιβώτιο ταχυτήτων   | şanzıman   | 变速箱           |
| Αριθ. κιβωτίου ταχυτήτων  | şanzıman no.                                       | 变速箱编号         |
| Χυτοσιδηρή αντλία   | gri dökme demir pompa                              | 灰铸铁泵          |
| Χυτοσιδηρά δίχαρα πέδησης                                       | gri dökme demir kaliperler                         | 灰铸铁制动钳        |
| Χυτοσιδηρός δίδυμος κύριος κύλινδρος πέδησης/προηγούμενος τύπος | gri dökme demir tandem ana merkez silindiri/önceki | 灰铸铁串联式主液缸/牵引车 |
| Χώρες περσικού κόλπου   | Körfez Ülkeleri                                    | 海湾国家          |
| Εντολοδότης κύλινδρος με κάθετη φλάντζα                         | Dikey flaşlı kumanda silindiri                     | 带有垂直法兰的传感器缸   |
| Εντολοδότης κύλινδρος   | KS (kumanda silindiri)                             | Gz (传感器缸)     |
| Σετ επισκευής εντολοδότη κυλίνδρου                              | KS onarım seti                                     | 传感器缸维修组件      |
| ΠΑ (πίσω άξονας)  | AA (arka aks)                                      | HA (后桥)       |
| Ελατήριο συγκράτησης  | tutma yayı   | 保持弹簧          |
| Στήριγμα  | tutucu   | 保持器           |
| Σετ στήριξης  | tutucu seti  | 保持器组件         |
| Βίδα στήριξης   | ankraj civatası                                    | 保持螺钉          |
| Χειρισμός χειρόφρενου   | el freni kumandası                                 | 手刹车           |
| Μοχλός χειρόφρενου  | el freni kolu                                      | 手刹车杆          |
| Δισκόφρενο ΠΑ   | AA diskli fren                                     | 后桥盘式制动器       |
| Ταμπουρόφρενο ΠΑ  | AA kampanalı fren                                  | 后桥鼓式制动器       |
| Μοχλός  | kol  | 摇杆            |
| Ψηλή οροφή  | yüksek tavan                                       | 高顶篷           |
| Κοίλος κοχλίας  | içi oyuk vida                                      | 空心螺钉          |
| Φρένα Hosei   | Hosei freni  | Hosei制动器      |
| Διαδρομή εμβόλου  | strok  | 行程            |
| Σετ χιτωνίων  | kovan takımı                                       | 套筒组           |
| Υδραυλικό πιεστικό δοχείο                                       | hidrolik akümülatör                                | 液压蓄能器         |
| Υδραυλικός ενισχυτής  | hidrolik amplifikatör                              | 液压放大器         |
| Υδραυλικός κύλινδρος  | hidrolik silindiri                                 | 液压缸           |
| Υδραυλική μονάδα ελέγχου  | hidr. kumanda ünitesi                              | 液压控制单元        |
| Κεντρικός κύλινδρος   | AMS (ana merkez silindiri)                         | HZ (主液缸)      |
| Σετ επισκευής κεντρικού κυλίνδρου                               | AMS onarım seti                                    | 主液缸维修套件       |
| στην καμπίνα του οδηγού   | sürücü kabini içinde                               | 在驾驶室          |
| στο χώρο του κινητήρα   | motor bölümü içinde                                | 在发动机舱         |



|                                       |                                    |  |
|---------------------------------------|------------------------------------|--|
| innen                                 | uvnitř                             | wewnątrz   |
| Innengewinde                          | vnitřní závit                      | gwint wewnętrzny                                   |
| Kastenwagen                           | skříňový automobil                 | furgon   |
| Katalysator                           | katalyzátor                        | katalizator  |
| Kennzeichen: xx                       | registrační značka: xx             | numery rejestracyjne: xx                           |
| Kerbe am Flansch                      | zářež na přírubě                   | nacięcie w kołnierzu                               |
| Klasse                                | třída                              | klasa  |
| Kleinbus                              | mikrobus                           | mini bus   |
| Klimaanlage                           | klimatizační zařízení              | klimatyzacja                                       |
| Kolbenstange D=                       | pístnice D=                        | łoczysko, średnica D=                              |
| Kolbenstange L=                       | pístnice L=                        | łoczysko, długość L=                               |
| Kombiwagen                            | kombi                              | kombi  |
| Kompakt THz                           | kompaktní THV                      | kompaktowa tandemowa pompa hamulcowa               |
| Krankenwagen                          | sanitní vůz                        | karetka pogotowia                                  |
| Kupplung                              | spojka                             | sprzęgło   |
| Kupplungsabgang                       | výstup spojky                      | odprowadzenie sprzęgła                             |
| Kupplungsverstärker                   | zesilovač spojky                   | układ wspomagania sprzęgła                         |
| kurzer Radstand                       | krátký rozvor kol                  | krótki rozstaw osi                                 |
| kurzes Bremsgerät                     | krátké brzdové zařízení            | krótkie urządzenie hamujące                        |
| L (Länge) =                           | L (délka)                          | L (długość) =                                      |
| langer Radstand                       | dolouhý rozvor kol                 | duży rozstaw osi                                   |
| Leckageanzeige                        | indikátor průsaku                  | wskaźnik wycieku                                   |
| lieferbar                             | k dodání                           | dostępny   |
| links oben und rechts unten           | vlevo nahoře a vpravo dole         | z lewej strony u góry oraz z prawej strony na dole |
| links vor und rechts hinter der Achse | vlevo před a vpravo za nápravou    | z lewej strony z przodu i z prawej strony za osią  |
| Linkslenker                           | volant vlevo                       | układ kierowniczy z kierownicą z lewej strony      |
| Luftfederung                          | vzduchové odpružení                | zawieszenie pneumatyczne                           |
| luftgekühlt                           | chlazené vzduchem                  | chłodzone powietrzem                               |
| M8-Führungsbolzen                     | vodící čep M8                      | M8 - bolce prowadzące                              |
| MA-Getriebe                           | MA-převodovka                      | skrzynia biegów MA                                 |
| mit 1 Haltestift                      | s 1 přídržným kolíkem              | z 1 trzpieniem ustalajícím                         |
| mit 2 Haltestiften                    | se 2 přídržnými kolíky             | z 2 trzpieniami ustalającymi                       |
| mit Alufelgen                         | s hliníkovými ráfky                | z aluminiowymi obręczami kół                       |
| mit angegossenem Behälter             | s nalitou nádrží                   | z odlaným zbiorniczkiem                            |
| mit regeltem Katalysator              | s řízeným katalyzátorem            | z katalizatorem regulowanym                        |
| mit Laschen                           | s lamelami                         | z wypustkami                                       |
| mit Leichtmetallrädern                | s koly z lehkého kovu              | z kołami z metali lekkich                          |
| MKII-Aggregat kpl.                    | MKII kompletní jednotka            | MKII - kompletny agregat                           |
| Mod. (Modell)                         | Mod. (model)                       | mod. (model)                                       |
| Motor                                 | Motor                              | silnik   |
| Motor-Nr.                             | čís. motoru                        | nr silnika   |
| Motor-Pumpen-Aggregat                 | agregát motorového čerpadla        | silnik-pompy-agregat                               |
| Multi-Link-Achse                      | náprava multi-link                 | oś multi - link                                    |
| m.Z. (mit Zubehör)                    | m.Z. (s příslušenstvím)            | z o. (z osprzętem)                                 |
| Nachstellteile-Satz                   | sada seřizovacích dílů             | komplet części regulacyjnych                       |
| ND-Schlauch                           | nížkotlaká hadice                  | przewód n.c. (niskiego ciśnienia)                  |
| Nebenabtrieb                          | vedlejší výstupní člen             | dodatkowy odbiornik napędu                         |
| Niveauregulierung                     | regulace hladiny                   | regulacja poziomu                                  |
| Nz (Nehmerzylinder)                   | VS (válec snímače)                 | SW (silownik wysprężlający)                        |
| Nz-Reparaturatz                       | sada dílů pro opravu VS            | zestaw naprawczy SW                                |
| ohne Alufelgen                        | bez hliníkových ráfků              | bez aluminiowych obręczy kół                       |
| ohne regelten Katalysator             | bez řízeného katalyzátoru          | bez katalizatora regulowanego                      |
| ohne Laschen                          | bez lamel                          | bez wypustek                                       |
| ohne Leichtmetallräder                | bez kol z lehkého kovu             | bez kół z metali lekkich                           |
| O-Ring                                | kroužek O                          | O -ring  |
| Pedal Feststeller                     | zajištění pedálu                   | ustalacz pedálu                                    |
| Polizei                               | Policie                            | Policja  |
| Rad                                   | kolo                               | koło   |
| Radsensor                             | senzor kola                        | czujnik koła                                       |
| Radstand xxxx mm                      | rozvor kol xxxx mm                 | rozstaw osi xxxx mm                                |
| rechts oben und links unten           | vpravo nahoře a vlevo dole         | z prawej strony u góry i z lewej na dole           |
| Rechtslenker                          | volant vpravo                      | układ kierowniczy z kierownicą z prawej strony     |
| Regler                                | regulátor                          | regulator  |
| Reihenmotor                           | řadový motor                       | silnik jednorzędowy                                |
| Reisebus/Hochdecker                   | autokar/autobus s vysokou střechou | autobus wycieczkowy / wysokopokładowy              |
| Reparaturatz                          | sada dílů pro opravu               | zestaw naprawczy                                   |
| Ringstutzen-Satz                      | sada kruhových hrdel               | komplet króćców pierścieniowych                    |
| Rohrleitung                           | potrubí                            | rurociąg   |
| rot                                   | červený                            | czerwony   |
| roter Sattel                          | červený třmen                      | czerwony zacisk                                    |
| Rückschlagventil                      | zpětný ventil                      | zawór jednokierunkowy                              |
| Rückstellwellen-Satz                  | sada vratných hřídelů              | walki zwrotne                                      |
| Rz (Radzylinder)                      | KV (kolový váleček)                | CHK (cylinděrki hamulcowe koła)                    |
| Rz-Dichtungssatz                      | sada těsnění KV                    | zestaw uszczelniający CHK                          |
| Rz-Reparaturatz                       | sada dílů pro opravu KV            | zestaw naprawczy CHK                               |
| Salisbury-Achse                       | náprava Salisbury                  | oś Salisbury                                       |
| Sattel mit 1 Haltestift               | třmen s 1 přídržným kolíkem        | zacisk z 1 kolíkiem ustalajícím                    |



|   |  |             |
|---|--|-------------|
| εσωτερικά                                     | iç   | 内部          |
| εσωτερικό σπείρωμα                            | iç vida dışı                               | 内螺纹         |
| Κλούβα  | kapalı kasa araç                           | 厢式汽车        |
| Καταλυτικός μετατροπέας                       | katalitik konvertör                        | 催化器         |
| Πινάκιδα αριθμού κυκλοφορίας: xx              | plaka no: xx                               | 车牌: xx      |
| Εγκοπές στη φλάντζα                           | flanştaki çentik                           | 法兰上的刻痕      |
| Κατηγορία                                     | sınıf                                      | 等级          |
| Μικρό λεωφορείο                               | minibüs                                    | 小巴          |
| Κλιματιστικό                                  | klima sistemi                              | 空调装置        |
| Στέλεχος εμβόλου D=                           | piston kolu Ç=                             | 活塞杆D=       |
| Στέλεχος εμβόλου L=                           | piston kolu U=                             | 活塞杆L=       |
| Στέισον βάγκον                                | station wagon                              | 客货两用车       |
| Κομπάκτ διδυμος κύριος κύλινδρος πέδησης      | kompakt tandem ana merkez silindiri        | 紧凑型串联式主液缸   |
| Ασθενοφόρο αυτοκίνητο                         | ambulans                                   | 救护车         |
| Συμπλέκτης                                    | debriyaj                                   | 离合器         |
| Έξοδος συμπλέκτη                              | debriyaj çıkışı                            | 离合器输出端      |
| Ενισχυτής συμπλέκτη                           | debriyaj güçlendirici                      | 离合放大器       |
| μικρό μεταξόνιο                               | kısa aks aralığı                           | 短轴距         |
| κοντή μονάδα πέδησης                          | kısa fren cihazı                           | 短制动器        |
| L (μήκος) =                                   | U (Uzunluk) =                              | L (长) =     |
| μεγάλο μεταξόνιο                              | uzun aks aralığı                           | 长轴距         |
| Ένδειξη διαρροής                              | sızıntı göstergesi                         | 泄漏显示        |
| διαθέσιμο                                     | stokta var                                 | 可供货         |
| αριστερά επάνω και δεξιά κάτω                 | sol üst ve sağ alt                         | 左上和右下       |
| αριστερά μπροστά και δεξιά πίσω από τον άξονα | solda önde ve sağda aksın arkasında        | 轴的左前和右后     |
| Αριστεροτίμονα οχήματα                        | soldan direksiyonlu                        | 左侧驾驶的汽车     |
| Σύστημα ανάρτησης πεπιεσμένου αέρα            | havalı süspansiyon                         | 空气弹簧        |
| Αερόψυκτο                                     | hava soğutmalı                             | 风冷          |
| Πείρος οδηγός M8                              | M8 kılavuz pim                             | M8导向螺纹销     |
| Κιβώτιο ταχυτήτων MA                          | MA şanzıman                                | MA变速箱       |
| με 1 πείρο στήριξης                           | 1 tutucu pim ile                           | 带有1个固定销     |
| με 2 πείρους στήριξης                         | 2 tutucu pim ile                           | 带有2个固定销     |
| με ζάντες αλουμινίου                          | alüminyum jantlı                           | 带有铝制轮辋      |
| με χυτό δοχείο                                | dökme hazneli                              | 带有铸造容器      |
| με ρυθμιζόμενο καταλυτικό μετατροπέα          | kontrollü katalitik konvertörlü            | 带有可调节的催化器   |
| με ελάσματα                                   | bağlantı kulakları ile                     | 带有连接板       |
| με ζάντες κράματος ελαφρού μετάλλου           | hafif metal                                | 带有轻金属车轮     |
| MKII συγκρότημα πλήρες                        | MKII ünitesi komple                        | 整套MKII装置    |
| Μοντ. (μοντέλο)                               | mod. (model)                               | Mod. (车型)   |
| Κινητήρας                                     | motor                                      | 发动机         |
| Αριθμός κινητήρα                              | motor no.                                  | 发动机号码       |
| Συγκρότημα κινητήρα-αντλίας                   | motor-pompa ünitesi                        | 发动机泵组       |
| Άξονας Multi-Link                             | multi-link aks                             | 多连接轴        |
| με εξαρτ. (με εξαρτήματα)                     | aksesuarları ile                           | 带有Z. (带有辅件) |
| Σετ τεμαχίων ρύθμισης                         | ayarlama parçaları takımı                  | 调整套件        |
| ND εύκαμπτου σωλήνα                           | ND hortum                                  | 低压软管        |
| Βοηθητικός μηχανισμός κίνησης                 | yavru şanzıman                             | 辅助驱动        |
| Σύστημα οριζοντίωσης                          | seviye ayarlama sistemi                    | 水平位调节       |
| Εντολοδόχος κύλινδρος                         | AS (alıcı silindir)                        | Nz (输出缸)    |
| Σετ επισκευής εντολοδόχου κυλίνδρου           | AS onarım seti                             | 输出缸维修组件     |
| χωρίς ζάντες αλουμινίου                       | alüminyum jantsız                          | 不带铝制轮辋      |
| χωρίς ρυθμιζόμενο καταλυτικό μετατροπέα       | kontrollü katalitik konvertörsüz           | 不带可调节的催化器   |
| χωρίς λωρίδες                                 | kulaksız                                   | 不带连接板       |
| χωρίς ζάντες κράματος ελαφρού μετάλλου        | hafif metal jantsız                        | 不带轻金属车轮     |
| Δακτύλιος O                                   | O-ring                                     | O型圈         |
| Διάταξη ακινητοποίησης πεντάλ                 | pedal sabitleyici                          | 踏板限位器       |
| Αστυνομία                                     | Polis                                      | 警察          |
| Τροχός  | tekerlek                                   | 车轮          |
| Αισθητήρας τροχού                             | tekerlek sensörü                           | 车轮传感器       |
| Μεταξόνιο xxxx mm                             | aks aralığı xxxx mm                        | 轴距 xxxx mm  |
| δεξιά επάνω και αριστερά κάτω                 | sağ üst ve sol alt                         | 右上和左下       |
| Δεξιοτίμονα οχήματα                           | sağdan direksiyonlu                        | 右侧驾驶的汽车     |
| Ρυθμιστής                                     | regülatör                                  | 调节器         |
| Κινητήρας σειράς                              | sıra motor                                 | 直列式发动机      |
| Υπεραστικό λεωφορείο/Υπερυψωμένο              | şehirlerarası otobüs/yüksek tavanlı otobüs | 长途客车/高顶盖车   |
| Σετ επισκευής                                 | onarım seti                                | 维修套件        |
| Σετ στρογγυλού στομίου                        | yüzüklü rakor takımı                       | 环形管接头组件     |
| Σωλήνωση                                      | boru hattı                                 | 管道          |
| κόκκινο                                       | kırmızı                                    | 红色          |
| Κόκκινο δίχαιο πέδησης                        | kırmızı kaliper                            | 红色制动钳       |
| Βαλβίδα αντεπιστροφής                         | çekvalf                                    | 单向阀         |
| Σετ άξονα επαναφοράς                          | sıfırlama mili takımı                      | 复位轴组件       |
| Κύλινδρος τροχού                              | TFM (tekerlek fren merkezi)                | Rz (车轮制动缸)  |
| Σετ στεγανοποίησης κυλίνδρου τροχού           | TFM conta takımı                           | 车轮制动缸密封套件   |
| Σετ επισκευής κυλίνδρου τροχού                | TFM onarım seti                            | 车轮制动缸维修套件   |
| Άξονας Salisbury                              | Salisbury aks                              | 索尔兹伯里轴      |
| Δίχαιο πέδησης με 1 πείρο στήριξης            | 1 tutucu pimli kaliper                     | 制动钳带有1个固定销  |



|                                |  |  |
|--------------------------------|--|--|
| Sattel mit 2 Haltestiften      | třmen se 2 přídržnými kolíky                     | zacisk z 2 kołkami ustalającymi              |
| Sättel mit Gussnoppen          | třmen s litými noppkami                          | zaciski z odlewanyimi wypustkami             |
| Sattelschraube                 | šroub třmenu                                     | šrubu zacisku                                |
| Scheibenbremse                 | koťoučová brzda                                  | hamulec tarczowy                             |
| Scheibenkupplung               | koťoučová spojka                                 | sprzęgło tarczowe                            |
| Scheibenschraube               | koťoučový šroub                                  | šrubu tarczy                                 |
| Schlauchleitung                | hadicové vedení                                  | przewód giętki                               |
| Schraubstutzen                 | šroubovací hrdlo                                 | króciec śrubowy                              |
| schwarz                        | černý  | czarny                                       |
| Schwimmsättel                  | plovoucí třmeny                                  | zaciski pływające                            |
| Schwingblech WE                | kov výstražného zařízení                         | urządzenie ostrzegawcze z blachy wahlivej    |
| SCS                            | SCS  | SCS (system kontroli stopu)                  |
| separater Behälter             | samostatná nádrž                                 | oddzielny zbiornik                           |
| separates Druckstück/Vorgänger | samostatný tlačný element/předchůdce             | oddzielny element dociskowy / poprzednik     |
| Servolenkung                   | servořízení                                      | wspomagany układ kierowniczy                 |
| Skandinavien                   | Skandinávie                                      | Skandynawia                                  |
| Sitzplätze                     | místa k sezení                                   | miejsca siedzące                             |
| Sonderfahrzeuge                | speciální vozidla                                | pojazdy specjalne                            |
| Spezialaufbau                  | speciální karosérie                              | specjalne nadwozie                           |
| Sportfahrwerk                  | sportovní podvozek                               | podwozie sportowe                            |
| Spur                           | stopa  | rozstaw kół                                  |
| Standard-Bremsgerät            | standardní posilovač brzd                        | standardowe urządzenie hamulcowe             |
| Standard-THz                   | standardní tandemový hlavní válec                | standardowa pompa hamulcowa typu tandem      |
| staubfeste Ausführung          | provedení odolné proti prachu                    | wykonanie odporne na kurz                    |
| Stufenheck                     | stupňovitá záď                                   | tył kaskadowy                                |
| T50-Reparatursatz              | T50 sada dílů pro opravu                         | zestaw naprawczy T50                         |
| Tandemregler                   | tandemový regulátor                              | regulator tandemowy                          |
| THz mit 3 Anschlüssen          | THV se 3 přípoji                                 | pompa hamulcowa tandemowa z 3 przyłączami    |
| THz mit Anschlagschraube       | THV s dorazovým šroubem                          | PHT z wkrętem zderzakowym                    |
| THz (Tandemhauptzylinder)      | THV (tandemový hlavní válec)                     | PHT (pompa hamulcowa typu tandem)            |
| THz-Reparatursatz              | sada dílů pro opravu THV                         | PHT - zestaw naprawczy                       |
| THz-RS (Montagehülse)          | sada dílů pro opravu THV (montážní pouzdro)      | PHT - zestaw naprawczy (tuleja montażowa)    |
| Timken-Achse                   | náprava Timken                                   | oś Timkena                                   |
| Topfmanschette                 | hmcová manžeta                                   | pierścień samouszczelniający garnkowy        |
| Tragbolzensatz                 | sada nosných čepů                                | komplet trzpieni nośnych                     |
| Transporter                    | dodávkové vozidlo                                | furgonetka                                   |
| Triebkopf                      | pohonná jednotka                                 | główna napędowa                              |
| Trommelbremse                  | bubnová brzda                                    | hamulec bębnowy                              |
| TBB (Trommelbremsbacken)       | ČBB (čelisti bubnové brzdy)                      | SHB (szczęki hamulca bębnowego)              |
| Umbau 1-teilig auf 2-teilig    | přestavba z 1dílného na 2dílné                   | przebudowa z 1 - częściowej na 2 - częściową |
| Unterdruckverstärker           | podtlakový posilovač                             | wspomaganie podciśnieniowe                   |
| ursprüngl. verschraubte Beläge | původně našroubovaná obložení                    | pierwotnie przykręcone okładziny             |
| VA (Vorderachse)               | PN (přední náprava)                              | OP (oś przednia)                             |
| VA-Girling-Bremse              | brzda Girling PN                                 | hamulec Girlinga osi przedniej               |
| VA-Scheibenbremse              | koťoučová brzda PN                               | hamulec tarczowy osi przedniej               |
| VA-Trommelbremse               | bubnová brzda PN                                 | hamulec bębnowy osi przedniej                |
| Ventilblock                    | ventilový blok                                   | blok zaworów                                 |
| Ventilblock kpl.               | ventilový blok kompl.                            | blok zaworów kompletny                       |
| Verbindungsschrauben           | spojovací šrouby                                 | śruby połączeniowe                           |
| Verschlusschraube              | závěrný šroub                                    | śruby zamykające                             |
| Verschraubung                  | šroubení   | połączenie śrubowe                           |
| Verschraubung kpl.             | šroubení kompl.                                  | połączenie śrubowe kompletne                 |
| verstärkte Bremse              | zesílená brzda                                   | wzmocniony hamulec                           |
| verstärkte Stoßdämpfer         | zesílený tlumič nárazů                           | wzmocnione amortyzatory                      |
| verstärktes Fahrwerk           | zesílený podvozek                                | wzmocniony układ jezdny                      |
| Verteilerstück wiederverwenden | opět použít díl rozdělovače                      | ponowne użycie rozdzielacza                  |
| V-Motor                        | V motor  | silnik w układzie V                          |
| Vorder- und Hinterachse        | přední a zadní náprava                           | oś przednia i tylna                          |
| Vorderachse                    | přední náprava                                   | oś przednia                                  |
| Vorderachse und 2. Hinterachse | přední náprava a 2. zadní náprava                | oś przednia i druga oś tylna                 |
| Vordruckventil                 | ventil zabraňující vniku vzduchu do brzd. okruhu | zawór ciśnienia wstępnego                    |
| Vorgänger                      | předchůdce                                       | poprzednik                                   |
| Vorgänger / Abschirmkappe      | předchůdce / stínící čepička                     | poprzednik / pokrywa ekranująca              |
| Vorgänger-THz, Einlaß D=xx     | předchůdce THV, sání D=xx                        | poprzednik - PHT, wlot D=xx                  |
| Vorspannzylinder               | předpinací válec                                 | cylinder naprężenia pierwotnego              |
| WK (Warnkontakt)               | VK (výstražný kontakt)                           | SO (styk ostrzegawczy)                       |
| Warnkontakt 1-polig            | výstražný kontakt 1pólový                        | styk ostrzegawczy 1 - biegunowy              |
| Warnkontakt 2-polig            | výstražný kontakt 2pólový                        | styk ostrzegawczy 2 - biegunowy              |
| Warnschalter                   | výstražný spínač                                 | włącznik ostrzegawczy                        |
| WE (Warneinrichtung)           | VZ (výstražné zařízení)                          | UO (urządzenie ostrzegawcze)                 |
| WE-Befestigung                 | přípevnění VZ                                    | mocowanie UO                                 |
| Wegsensor                      | dráhový senzor                                   | sensor drogi                                 |
| weiß                           | bílý   | biały  |
| Zylinderschraube               | válcový šroub                                    | šrubu cylindra                               |



|   |   |                    |
|---|---|--------------------|
| Δίχαλο πέδησης με 2 πείρους στήριξης                                    | 2 tutucu pimli kaliper                                  | 制动钳带有2个固定销         |
| Δίχαλα πέδησης με μεγάλα κομβία   | dökme pimli kaliperler                                  | 制动钳带有铸造轴头          |
| Βίδα δίχαλου πέδησης  | kaliper civatası  | 制动钳螺钉              |
| Δισκόφρενο  | diskli fren   | 盘式制动器              |
| Συμπλέκτης δίσκων   | diskli debriyaj   | 盘式离合器              |
| Βίδα δίσκου   | disk civatası   | 盘式螺钉               |
| Εύκαμπτος σωλήνας   | hortum hattı  | 软管                 |
| Βιδωτά στόμια   | vidalı rakor  | 丝堵                 |
| μαύρο   | siyah   | 黑色                 |
| Πλωτά δίχαλα πέδησης  | hareketli kaliperler                                    | 浮动制动钳              |
| Έλασμα ταλάντωσης ΔΠ  | İS titreşim sacı  | 平衡板 WE             |
| SCS (σύστημα ελέγχου στοπ)  | SCS   | SCS停车控制系统          |
| Ξεχωριστό δοχείο  | ayrı hazne  | 单独的容器              |
| Ξεχωριστό τεμάχιο πίεσης/προηγούμενος τύπος                             | ayrı baskı parçası/önceki                               | 单独的压片/牵引车          |
| Ξεβρομηχανισμός διεύθυνσης  | havali direksiyon                                       | 转向助力机构             |
| Σκανδιναβία   | İskandinavya  | 斯堪地维亚              |
| Καθίσματα   | koltuk sayısı   | 座位                 |
| Ειδικά οχήματα  | özel araçlar  | 专用车辆               |
| Ειδική κατασκευή  | özel üst yapı   | 特殊结构               |
| Σπορ ανάρτηση   | spor yürüyen aksam                                      | 运动型底盘              |
| Ίχνος   | iz  | 轮距                 |
| Στάνταρ μονάδα πέδησης  | standart fren   | 标准制动器              |
| Στάνταρ δίδυμος κύριος κύλινδρος πέδησης                                | standard tandam ana merkez silindiri                    | 标准串联式主液缸           |
| Έκδοση ανθεκτική στη σκόνη  | toz geçirmez model                                      | 除尘型                |
| Σεντάν  | limuzin   | 阶背车尾               |
| Σετ επισκευής T50   | T50 onarım seti   | T50维修套件            |
| Δίδυμος ρυθμιστής   | tandem regülatörü                                       | 串联式主液缸调节器          |
| Δίδυμος κύριος κύλινδρος πέδησης με 3 συνδέσεις                         | 3 bağlantılı tandem ana merkez silindiri                | 带有3个接口的串联式主液缸      |
| Δίδυμος κύριος κύλινδρος πέδησης με κοχλία αναστολής                    | dayanak civatalı tandem ana merkez silindiri            | 带有限位螺钉的串联式主液缸      |
| Δίδυμος κύριος κύλινδρος πέδησης  | tandem ana merkez silindiri                             | 串联式主液缸             |
| Σετ επισκευής δίδυμου κύριου κυλίνδρου πέδησης                          | tandem ana merkez silindiri onarım seti                 | 串联式主液缸维修套件         |
| Σετ επισκευής δίδυμου κύριου κυλίνδρου πέδησης (χιτάμιο συναρμολόγησης) | tandem ana merkez silindiri onarım seti (montaj kovani) | 串联式主液缸维修套件(安装轴套)   |
| Άξονας Timken   | Timken aks  | 泰姆肯轴               |
| Δισκοειδής μανσέτα  | çanak conta   | 固定鼓涨圈              |
| Σετ πείρων στήριξης   | tutucu pim takımı                                       | 支承螺栓组件             |
| Μεταφορικό όχημα  | transporter   | 运输车                |
| Κεφαλή κίνησης  | tahrik kafası   | 牵引车                |
| Ταμπουρόφρενο   | kampanalı fren  | 鼓式制动器              |
| ΣΤΠ (σιαγόνες τυμπάνου πέδησης)   | KFP (kampanalı fren pabuçları)                          | TBB(鼓式制动爪)         |
| Μετατροπή 1 τεμαχίου σε 2 τεμάχια                                       | 1 parçalıdan 2 parçalıya tadilat                        | 从一体改装为两体           |
| Ενισχυτής υποπίεσης   | vakumlu güçlendirici                                    | 负压放大器              |
| Αρχ. βιδωνόμενα τακάκια φρένων  | orijinal vidalanan balatalar                            | 原有螺丝连接的刹车片         |
| ΜΑ (μπροστινός άξονας)  | ÖA (Ön Aks)   | 前桥                 |
| Φρένο ΜΑ Girling  | ÖA girling fren   | 前桥Girling制动器       |
| Δισκόφρενο ΜΑ   | ÖA diskli fren  | 前桥盘式制动器            |
| Ταμπουρόφρενο ΜΑ  | ÖA kampanalı fren                                       | 前桥鼓式制动器            |
| Συγκρότημα βαλβίδων   | valf bloğu  | 阀块                 |
| Συγκρότημα βαλβίδων πλήρες  | komple valf bloğu                                       | 阀块整体               |
| Κοχλίες σύνδεσης  | bağlantı civataları                                     | 连接螺丝               |
| Κοχλίας φραγής  | kör tapa  | 封闭螺帽               |
| Κοχλιοσύνδεση   | vidalı bağlantı   | 螺纹连接               |
| Κοχλιοσύνδεση πλήρες  | vidalı bağlantı komple                                  | 螺纹连接整体             |
| Ενισχυμένα φρένα  | güçlendirilmiş fren                                     | 增强的制动器             |
| Ενισχυμένα αμορτισέρ  | güçlendirilmiş amortisör                                | 增强的减震器             |
| Ενισχυμένο σύστημα ανάρτησης  | güçlendirilmiş yürüyen aksam                            | 增强的底盘              |
| Επαναχρησιμοποιήστε το εξάρτημα διανομέα                                | dağıtıcı parçayı tekrar kullanın                        | 重新利用分配件            |
| Κινητήρας V   | V motor   | V型发动机              |
| Μπροστινός και πίσω άξονας  | ön ve arka aks  | 前桥和后桥              |
| Μπροστινός άξονας   | ön aks  | 前桥                 |
| Μπροστινός άξονας και 2ος πίσω άξονας                                   | ön aks ve 2. arka aks                                   | 前桥和第2后桥            |
| Βαλβίδα προπίεσης   | ön basınç valfi   | 预压力阀               |
| Προηγούμενος τύπος  | önceki  | 牵引车                |
| Προηγούμενος τύπος / πτώμα θωράκισης                                    | önceki / deflektör                                      | 牵引车 / 屏蔽盖          |
| Προηγούμενος τύπος δίδυμου κύριου κυλίνδρου πέδησης, εισαγωγή D=xx      | önceki tandem ana merkez silindiri, giriş Ç=xx          | 牵引车串联式主液缸, 进口 D=xx |
| Κύλινδρος προέντασης  | ön yüklemeli silindir                                   | 预夹紧缸               |
| ΕΠ (επαφή προειδοποίησης)   | İK (İkaz Kontaklı)                                      | WK(警示触点)           |
| Επαφή προειδοποίησης 1-πολική   | 1 kutuplu ikaz kontaklı                                 | 1极警示触点             |
| Επαφή προειδοποίησης 2-πολική   | 2 kutuplu ikaz kontaklı                                 | 2极警示触点             |
| Διακόπτης προειδοποίησης  | ikaz şalteri  | 警示开关               |
| ΔΠ (διάταξη προειδοποίησης)   | İS (İkaz Sistemi)                                       | WE(警示装置)           |
| Στερέωση ΔΠ   | İS tespitleme   | 警示装置的固定            |
| Αισθητήρας διαδρομής  | hareket sensörü   | 行程传感器              |
| Λευκό   | beyaz   | 白色                 |
| Βίδα κυλινδρικής κεφαλής  | silindirik civata                                       | 圆柱头螺钉              |

|  |  |                         |
|--|--|-------------------------|
| 1-Kammer-Druckluftbremse               | جيجضليل عنام جاص حول   | 防音プレート(シングルチャンバ・エアブレーキ) |
| 1-Kolbensattel D=xx                    | D=xx دحو سابكب تيئف تيلا                                     | 1ピストンキャリパ D=xx          |
| 2-Kolbensattel D=xx                    | D=xx تاسابكلا ةجوزم تيئف تيلا                                | 2ピストンキャリパ D=xx          |
| 4-Kolbensattel                         | تاسابكلا تيغابر تيئف تيلا                                    | 4ピストンキャリパ               |
| 1-Kreis-Bremse                         | دحو تيبرك ترائب لجرف   | 1サイクルブレーキ               |
| 2-Kreis-Bremse                         | نيتيبرك نيتريئب لجرف   | 2サイクルブレーキ               |
| 1-Kreis-Sättel                         | تيبرك ترائب تيئف تيلا  | 1サイクルキャリパ               |
| 2-Kreis-Sättel                         | نيتيبرك نيتريئب تيئف تيلا                                    | 2サイクルキャリパ               |
| 1. Hinterachse                         | لوالا يفلغلا روحلا   | 1番目のリアシャフト              |
| 1. und 2. Hinterachse                  | يناشل لوالا يفلغلا روحلا                                     | 1番目と2番目のリアシャフト          |
| 4-Loch-Bremsscheibe                    | بوقثلا يجرس يجرس   | 4穴ブレーキディスク              |
| 6-Loch-Bremsscheibe                    | بوقثلا يسلس يجرس   | 6穴ブレーキディスク              |
| 3-Loch-Felge                           | تاحتف تالش طن ج  | 3穴ホイール                  |
| 4-Loch-Felge                           | تاحتف عجر ب طن ج   | 4穴ホイール                  |
| 5-Loch-Felge                           | تاحتف سرب طن ج   | 5穴ホイール                  |
| 6kt-Schraube                           | عطقلا تيسلس سرب رامس   | 6角ネジ                    |
| 6kt-Schraube (innen)                   | (لخلل) عطقلا تيسلس سرب رامس                                  | 6角ネジ(内側)                |
| 6"-Tandem                              | تصوب 6 ساقم تيغدارت نواطس                                    | 6面タンデム                  |
| 8"-Tandem mit Gabelkopf                | يفرط نرقوب جوزم تصوب 8 ساقم تيغدارت نواطس                    | ヨーク付8面タンデム              |
| 8"-Tandem ohne Gabelkopf               | يفرط نرقوب جوزم ريغ تصوب 8 ساقم تيغدارت نواطس                | ヨークなし8面タンデム             |
| ABS                                    | ABS, قال غلال عن امل لم ارغلا ماظن                           | ABS(アンチロックブレーキシステム)     |
| ABS-Dichtungssatz                      | ABS, قال غلال عن امل لم ارغلا ماظن ل                         | ABSガスケットキット             |
| Achtung: Kolbenstellung ändern !       | سابكلا تيغضول ليغتب مق : تيغنت                               | 注意:ピストンポジション変更!         |
| Adapter für Bördel E                   | E عوزلا نم ترغل تيغام  | ビードタイプE用アダプター           |
| alle Typen                             | عاونال عيجم  | 全タイプ                    |
| Alu-Pumpe                              | جويجولال نم عضم  | アルミポンプ                  |
| Alu-Sättel                             | جويجولال نم تيئف تيلا  | アルミキャリパ                 |
| am Bremssattel                         | لجرفلل تيئفلا تيلا ل ع                                       | ブレーキキャリパ上に              |
| am Hauptzylinder                       | تيس تيئلا نواطس ل ع  | マスターシリンダー上に             |
| A-Motor                                | A تيغ ل ع لجرم   | Aエンジン                   |
| Anschlagschraube oben                  | ل ع لجرم   | ストップネジ、上側               |
| Anschluß/Anschlüsse                    | تالصر/لصر  | 接続/コネクション               |
| Anti-Noise-Blech                       | جيجضليل عنام جاص حول   | 防音プレート                  |
| ASC (Automatische Stabilitäts Control) | (نازيتال) يف ليغيتاموتوالا لكحتلا ماظن ASC                   | ASC(アクティブスタビリティコントロール)  |
| ASR (Antriebschlupfregelsystem)        | (رغلا) فرق يف لكحتلا ماظن ASR                                | ASR(トラクションコントロールシステム)   |
| ATE nur über VAG erhältlich            | VAG لغول ل ل ل ATE يلهيتاموتوالا صغلا تريجت ل ع لوصغلا نلم ل | ATEはVAGを通じてのみ入手可能       |
| auf Typenschild                        | (نصغلا) فيرغلا ةحول ل ع                                      | 車種認識プレート上               |
| aufgeschraubt                          | لغولفم   | ネジ止め                    |
| Auslaß seitlich links                  | عرسلا ةهغلا ل ع يبناج جورخ نغفم                              | 左側面の出口                  |
| Auslaß seitlich rechts                 | عزميلا ةهغلا ل ع يبناج جورخ نغفم                             | 右側面の出口                  |
| außen                                  | جراغلا نم  | 外側                      |
| automatische Nachstellung              | يتاموتوالا لكشب تيغسو طبض دغ!                                | 自動調節(アジャストメント)          |
| Behälter                               | نازخ ءءءو، تيغواح  | 容器(タンク)                 |
| Behälter Doppel-WE                     | ريذيت تيغتيغتب جوزم نازخ                                     | ダブルウォーニングデバイス付容器(タンク)   |
| Behälterbefestigung                    | نازغلا تيغبت   | 容器(タンク)固定               |
| Behälterstopfen                        | نازغلا دلس   | 容器(タンク)プラグ              |
| Behälterverschraubung                  | ريملسب نازغلا تيغبت  | 容器(タンク)ネジ式キャップ          |
| Behörde                                | ظلسب لوجم ةهغ، تيغ   | 省庁、オーソリティーカー            |
| Beläge                                 | لم ارغلا لي  | ブレーキパッド                 |
| belüftete Scheiben                     | لوم صارق   | 換気付ディスク                 |
| Betätigungseinheit                     | ليغبت دغو  | アクチュエーターユニット            |
| blau                                   | قرزا   | 青色                      |
| Bodenventil                            | عقلا ماص   | 残留圧センターバルブ              |
| Bodenventile tauschen                  | عقلا تاماص ليغبت   | 残留圧センターバルブ交換            |
| Bördel x                               | x قرد، قورخ  | フレアタイプx                 |
| braun                                  | رغس، تيغ   | 茶色                      |
| breite Ausführung                      | ضيرع ميغصت   | ワイドデザイン(ワイドバージョン)       |
| Bremse                                 | لجرم   | ブレーキ                    |
| Bremsgerät                             | لم ارغلا زيغعت دغو   | ブースターユニット               |
| Bremskraftregler                       | تيلجرغلا قوقلا مظنم  | ブレーキ圧調節器                |
| Bremsleitungen erneuern !              | تيلجرغلا تالصرولا ديغت                                       | ブレーキ管刷新!                |
| Bremslichtschalter                     | لم ارغلا عوض حانغفم  | ブレーキランプスイッチ             |
| Bremsscheiben                          | لم ارغلا صارق  | ブレーキディスク                |
| Bremsschlauch beachten !               | لم ارغلا موطرغل هبتنا  | ブレーキチューブに注意!            |
| Buchse + Ausgleichbügel                | لداغم توسلق + قبل ج  | ジャック+バランスクリップ           |
| Bus                                    | لغفاح  | バス                      |
| Bypassregler                           | رورملا نغفم مظنم   | バイパス調節器                 |
| Citroen-Bremse                         | نيورتس لجرم  | シトロエンブレーキ               |
| D (Durchmesser) =                      | D (رطق) =  | D(直径) =                 |
| Dichtring                              | مكح ل ع  | 密閉リング                   |
| Dichtung                               | مكح ل عيشح، لوج  | 密閉(シーリング)               |
| Dichtungssatz                          | مكح ل ع قاط  | ガスケットキット                |
| Differentialsperre                     | يلضافت لغف   | ディフェレンシャルロック            |
| Differenzdruckschalter                 | يلضافتل طمغجل حانغفم   | ディフェレンシャル圧スイッチ          |
| Differenzdruckventil                   | يلضافتل طمغجل ماص  | ディフェレンシャル圧バルブ           |
| diverse Typen                          | ةعوزتم تازارط  | 様々な種類(タイプ)              |
| Doppelbereifung                        | ةجوزم تازارط   | ツインタイヤ                  |



|                             |   |                              |
|-----------------------------|---|------------------------------|
| Doppelkabine                | توجد في قروصوقم، قن يباك  | ダブルキャブ                       |
| Druckbegrenzungsventil      | طغضل ا مي جحت م امص   | 圧力制限バルブ                      |
| Druckbolzen                 | تيطا تخنن ا (روب ااخ) قرام غ  | タペット                         |
| Druckbolzen (kurz)          | (قري صق) تيطا تخنن ا (روب ااخ) قرام غ   | タペット (ショート)                  |
| Druckbolzen (lang)          | (قري يوط) تيطا تخنن ا (روب ااخ) قرام غ  | タペット (ロング)                   |
| Druckluftbremse             | طوغضل ا اوطاب لم عت ظمرف  | エアブレーキ                       |
| Druckluftleitung            | طوغضل ا اوطاب ا لصر   | 圧縮エア管                        |
| Druckluftunterstützung      | طوغضل ا اوطاب ا لصر ا لمر فل ا مي عت  | エアブレーキアシスト                   |
| Druckluftverstärker         | طوغضل ا اوطاب ا لصر ا لمر فل ا زرع  | エアブレーキブースター                  |
| Druck-Warnschalter          | طغضل ا ب صاخ ري ذحت ح ا تغم   | 圧力警告スイッチ                     |
| DS-Regler                   | DS، مظم   | DSバルブ                        |
| EDS                         | (يلص ا فتل ا لغؤل ا يف يزور تكل ا ل ا مك ح تل ا م اظن) EDS، م اظن             | EDS (電子式ディフェレンシャルロック)        |
| EDS-Ventilblock             | (يلص ا فتل ا تام امص ة موم جم   | EDSバルブブロック                   |
| EG-Vorschrift               | تيروروال ا ة موم جم ا تام ايل عت ة ح ا ل                                      | EGヨーロッパ共同体規則                 |
| Einbau hinter der Achse     | رو ح ا ل ا فل خ بي ا لمر تل ا   | シャフト後部への設置                   |
| Einbau vor der Achse        | رو ح ا ل ا م ا بي ا لمر تل ا  | シャフト前部への設置                   |
| Einbausatz                  | بي ا لمر تل ا م قاط   | インストールキット                    |
| Einfachbereifung            | درفم راط ا  | 一重タイヤ                        |
| Einknöpffmaß xx mm          | م م xx (لصر ل) طبرل ا ة عطق (س ا ي قم) د ع ب                                  | ボタンイン寸法xxmm                  |
| Einlaß D=xx mm              | م م D=xx لو خ ن ف نم  | 吸入直径 =xxmm                   |
| Einlaß mit Gummistopfen     | تيطلم ك ا ل ص ب دوزم لو خ ن ف نم  | ゴムプラグ付吸気部                    |
| Einschraubregler            | طبرل ا قوق مظم  | ネジ式調節バルブ                     |
| elektr. Vergaser            | يبرك نبر ا تم   | 電子式キャリブレーター                  |
| Entlüfteranschluß           | (س يفنت) تيو ت لصر  | 排気コネクタ                       |
| Entlüfterventil             | (س يفنت) تيو ت م امص  | 排気バルブ                        |
| erhöhte Zuladung            | د ا ل ليم ح ت ن ح ش   | 高くなったペイロード (負荷)              |
| Ersatz für Sättel D=xx      | D=xx تيفل ا تايل ا ل ا لي د ب ت   | キャリバーD=xxの代用パーツ              |
| ETS                         | ر ا س ا ل ا يف يزور تكل ا ل ا مك ح تل ا م اظن                                 | ETS (電子式トラクションコントロールシステム)    |
| Europa                      | ا يوروا   | ヨーロッパ                        |
| Export                      | ري د ص ر ت  | 輸出                           |
| Fahrschule                  | ق ا ي ق ل ا م ايل عت ق س ر دم   | 自動車学校                        |
| Faltenbalsatz               | ب ي ر س ت ل ل ع ن ا م خ ي ف ا ن م قاط   | シールセット                       |
| Faustsättel                 | ق ض ب ا ق تيف ا تايل ا  | げんこつ型キャブラ                    |
| Fenster                     | ق ت ف ا ن   | 窓                            |
| Festsättel                  | ق ت ب ا ق تيف ا تايل ا  | 固定式キャブラ                      |
| Flanschdicke x mm           | م م x عو ت ن ل ا فر ط ك ه س   | フランジ厚xmm                     |
| Flanschmaß = xx,x           | xx,x عو ت ن ل ا فر ط د ا ع ب ا  | フランジ寸法=xxx                   |
| Fuller-Getriebe             | ر ل ل و ف س و ر ت ق و د ن ص   | フルー式ギアボックス                   |
| für Belagsätze ohne Zubehör | توي ا ي ل ف ت ا ق ا ل م زو د ب ل م ا ر ف ل ا ل ي م ت ب ص ا خ                  | 付属品のないブレーキパッド用               |
| für Bremsättel/Vorgänger    | ق ب ا س ا ل ا م ا ر ف ل ل تيفل ا تايل ا ل ا ب ص ا خ                           | ブレーキキャブラ / 従前モデル用            |
| für Doppelmembran-Gerät     | توي ق ر ل ا تيش غ ا ل ا توي ا ن ت ز ي ز ع ت ل ا د ت ح و ب ص ا خ               | 2重皮膜ブースター用                   |
| Gabelkopfsatz               | تيفر ط ن ر ا ق م ة موم جم   | ヨークキット                       |
| Gehäuse L=                  | L= ق ب ل ع م ت ي ب م  | ハウジングL=                      |
| gelb                        | ر ف ص ا   | 黄色                           |
| gepanzerte Fahrzeuge        | ة ع ر دم ت ا ب ل ف ر م  | 防弾武装車両                       |
| Getriebe                    | س و ر ت ق و د ن ص   | ギアボックス                       |
| Getriebe-Nr.                | س و ر ت ل ا ق و د ن ص م ق ر   | ギアボックス番号                     |
| GG-Pumpe                    | ب ص ر ل ا د ي د خ ل ا ن م ة موم ص م ة مضم                                     | 鋳鉄ポンプ                        |
| GG-Sättel                   | ب ص ر ل ا د ي د خ ل ا ن م ة موم ص م تيفل ا تايل ا                             | 鋳鉄キャブラ                       |
| GG-THz/Vorgänger            | ق ب ا س ا ل ا ب ص ر ل ا د ي د خ ل ا ن م ة موم ص م تيفل ا تايل ا ق ن ا و ط س ا | 鋳鉄THz(タンデムマスターシリンダー) / 従前モデル |
| Golf-Staaten                | ج ي ل ل ا ل و د   | 湾岸諸国                         |
| Gz mit senkrecht Flansch    | ي د و م ع فر ط ب ق د و م ض ب ا ق ق ن ا و ط س ا                                | 垂直フランジ付クラッチシリンダー             |
| Gz (Geberzylinder)          | ض ب ا ق ل ا ق ن ا و ط س ا   | Gzクラッチシリンダー                  |
| Gz-Reparatursatz            | ض ب ا ق ل ا ق ن ا و ط س ا ل ا ص ا م قاط                                       | Gzクラッチシリンダー修理キット             |
| HA (Hinterachse)            | ي فل خ ل ا رو ح ا ل ا   | HA(リアシャフト)                   |
| Haltefeder                  | ت ي ب ب ت ض ب ا ن   | 固定用スプリング                     |
| Halter                      | ت ي ب ب ت و ض ع   | アンカー                         |
| Haltersatz                  | ت ي ب ب ت م قاط   | アンカーセット                      |
| Halterschraube              | ت ي ب ب ت ر ا م س م   | アンカーネジ                       |
| Handbremsbetätigung         | توي د ي ل ا لمر فل ا ل ي غ ن ت  | サイドブレーキ稼動                    |
| Handbremshebel              | توي د ي ل ا لمر فل ا ع ا ر ذ  | サイドブレーキレバー                   |
| HA-Scheibenbremse           | ي فل خ ل ا رو ح ل ل تيفر ق لمر ف  | リアシャフトディスクブレーキ               |
| HA-Trommelbremse            | ي فل خ ل ا رو ح ل ل تيفل ا ق ن ا و ط س ا لمر ف                                | リアシャフトドラムブレーキ                |
| Hebel                       | ة ع ف ا ر ، ع ا ر ذ   | レバー                          |
| Hochdach                    | ل ا ع ف ق س   | ハイルーフ                        |
| Hohlschraube                | ف و ج م ب ل ل و ل م ا ر م س م   | 空洞ネジ                         |
| Hosei-Bremse                | ي ا س ر و ه ظ م ر ف   | 豊生ブレーキ                       |
| Hub                         | ر ا و ش م ، ط و ش   | ストローク                        |
| Hülsensatz                  | ب ل ج م قاط   | スリーブキット                      |
| Hydraulikspeicher           | توي ل و ر د ي ه ق ن ا خ   | 油圧アキュムレーター (蓄圧器)             |
| Hydraulikverstärker         | ي ل و ر د ي ه ز ز ع م   | 油圧ブースター                      |
| Hydraulikzylinder           | توي ل و ر د ي ه ق ن ا و ط س ا   | 油圧シリンダー                      |
| Hydr. Steuereinheit         | توي ل و ر د ي ه م ك ح ت د ح   | 油圧制御ユニット                     |
| HZ (Hauptzylinder)          | توي ي ي ر ل ا ق ن ا و ط س ا ل ا   | HZ(マスターシリンダー)                |
| HZ-Reparatursatz            | توي ي ي ر ل ا ق ن ا و ط س ا ل ا ص ا م قاط                                     | マスターシリンダー修理キット               |
| im Fahrerhaus               | ق ا س ا ل ا ق ر و ص ق م يف  | キャブ内                         |
| im Motorraum                | لمر ح ل ا ز ي ح يف  | エンジンルーム                      |



|                                       |  |                    |
|---------------------------------------|--|--------------------|
| innen                                 | لداخل نم                                   | 内側                 |
| Innengewinde                          | يل داخل بول                                | 内側スレッド             |
| Kastenwagen                           | قويونص قبكرم                               | ワンボックスカー           |
| Katalysator                           | يزفح لوحم                                  | 触媒                 |
| Kennzeichen: xx                       | XX قريم قمالع                              | 車番: xx             |
| Kerbe am Flansch                      | (ظن الفل) قفشل اىلع قفلث                   | フランジ上のノッチ          |
| Klasse                                | قبكرم - مجرد                               | 等級                 |
| Kleinbus                              | ري خص سي بيوشوا صاب ينييم                  | ミニバス               |
| Klimaanlage                           | ءاوه فيكفم                                 | エアコン               |
| Kolbenstange D=                       | D= سابلقل ا عازذ                           | ピストンロッド径 D=        |
| Kolbenstange L=                       | L= سابلقل ا عازذ                           | ピストンロッド長 L=        |
| Kombiwagen                            | (يبهوك) رافسا قرايس                        | ステーションワゴン          |
| Kompakt THZ                           | ةجهم قيفدارت قيس يئر قن اوطنأ              | コンパクトタンデムマスターシリンダー |
| Krankenwagen                          | فاعس ا قبكرم                               | 救急車                |
| Kupplung                              | ضباقل ا                                    | クラッチ               |
| Kupplungsabgang                       | ضباقل ا لخصو جرحم                          | クラッチ接続用出力ポート       |
| Kupplungsverstärker                   | ضباقل ا مخرجم                              | クラッチブースター          |
| kurzer Radstand                       | قريصرق تال جع قذعاق                        | 短いホイールベース          |
| kurzes Bremsgerät                     | قري خص لم ارف زيزعت قذجو                   | 短いブレーキブースター        |
| L (Länge) =                           | L (لوطل) =                                 | L(長さ) =            |
| langer Radstand                       | ظليوط تال جع قذعاق                         | 長いホイールベース          |
| Leckageanzeige                        | بوسنل ا نايب بن ييم                        | 漏えいインジケター          |
| lieferbar                             | هديروت نكفم ، حاتم                         | 納品可能               |
| links oben und rechts unten           | لفسا ا ودا نيم يلا هجو ودا ا رلس يلا هجو   | 左上と右下              |
| links vor und rechts hinter der Achse | روحل ا لفسا ا نيم ييو مام ا رلس ي          | シャフトの左前部と右後部       |
| Linksenker                            | يرلس ي هي جوت                              | 左ハンドル              |
| Luftfederung                          | يئاوه قيل عت                               | エアスプリング            |
| luftgekühlt                           | ايئاوه دربم                                | 空冷式                |
| M8-Führungsbolzen                     | M8, يل يلد روباخ                           | M8ガイドピン            |
| MA-Getriebe                           | سورت قونص                                  | MAギアボックス           |
| mit 1 Haltestift                      | قنذ روباخ بوزم                             | 固定ピン1本で            |
| mit 2 Haltestiften                    | قنذ يروباخ بوزم                            | 固定ピン2本で            |
| mit Alufelgen                         | موي هول ا طنون جب بوزم                     | アルミホイール付           |
| mit angegossenem Behälter             | بص ناز جب بوزم                             | キャストオンタンク付         |
| mit geregeltm Katalysator             | موكجم يزفح لوحم بوزم                       | 制御式触媒付             |
| mit Laschen                           | (فارطا) يش او جب بوزم                      | ストラップ付             |
| mit Leichtmetallrädern                | في فح نذم نم ةمونصم تال جع بوزم            | 軽金属ホイール付           |
| MKII-Aggregat kpl.                    | ظم الكا MKII قذجو                          | MKIIユニット 全体        |
| Mod. (Modell)                         | لي بوم                                     | モデル(年式)            |
| Motor                                 | كفرجم                                      | エンジン               |
| Motor-Nr.                             | كفرجل ا مقرر                               | エンジン番号             |
| Motor-Pumpen-Aggregat                 | كفرجل ا ءضمم قذجو                          | エンジンポンプユニット        |
| Multi-Link-Achse                      | تال صول ا دد عتم روحم                      | マルチリンクシャフト         |
| m.Z. (mit Zubehör)                    | ةيل يلمقت تاقو جلب بوزم                    | m.Z.(付属品付)         |
| Nachstellteile-Satz                   | ةتي اهل او طبضل ا اذ ج ا قاط               | アジャスターパーツセット       |
| ND-Schlauch                           | ND, ضف جنهل ا طغضل ا موطرخ                 | ND低圧チューブ(ホース)      |
| Nebenabtrieb                          | ي جراح عند                                 | パワーテイクオフ           |
| Niveauregulierung                     | قيل عت ا ءوتسم يف مك حشل ا مظن             | サスペンションレベルコントロール   |
| Nz (Nehmerzylinder)                   | ةعبت قن اوطنأ                              | Nz(スレイブシリンダー)      |
| Nz-Reparaturatz                       | ةعبتل ا قن اوطنأ ا ل حالص ا قاط            | スレイブシリンダー修理キット     |
| ohne Alufelgen                        | موي هول ا طنون ج بوب                       | アルミホイールなし          |
| ohne geregelten Katalysator           | موكجم يزفح لوحم بوب                        | 制御式触媒なし            |
| ohne Laschen                          | (فارطا) يش او ج بوب                        | ストラップなし            |
| ohne Leichtmetallräder                | في فح نذم نم ةمونصم تال جع بوب             | 軽金属ホイールなし          |
| O-Ring                                | O قتيه ودا ققو ل ح                         | Oリング               |
| Pedal Feststeller                     | قن او دا تبتتم                             | ロックが可能なペダル         |
| Polizei                               | قطرشلا                                     | 警察                 |
| Rad                                   | قو ج ع                                     | 車輪                 |
| RadSENSOR                             | قو ج ع ا س لس ح                            | ホイールセンサー           |
| Radstand xxxx mm                      | مم xxxx تال ج ع ا قذعاق                    | ホイールベースxxxxmm      |
| rechts oben und links unten           | لفسا ا ودا ا رلس يلا هجو ودا ا نيم يلا هجو | 右上と左下              |
| Rechtslenker                          | ين يمي هي جوت                              | 右ハンドル              |
| Regler                                | مظنم                                       | レギュレーター            |
| Reihenmotor                           | مي قنسم كفرجم                              | 直列型エンジン Rエンジン      |
| Reisebus/Hochdecker                   | ةعبتتم بلكر قروص قمبات ل حر قذفاح          | 旅行用バス/ハイルーフ型       |
| Reparaturatz                          | حالص ا قاط                                 | 修理キット              |
| Ringstutzen-Satz                      | قيل قو ل ح تام ا ع ةموم جم                 | リング型ニッパルセット        |
| Rohrleitung                           | ي بيوبن ا طخ                               | パイプライン             |
| rot                                   | رم ح ا                                     | 赤色                 |
| roter Sattel                          | ءارم ء قيف ءيلا                            | レッド キャピラ           |
| Rückschlagventil                      | ي ع ج ر ل ءاوه م لمص                       | 逆行防止バルブ            |
| Rückstellwellen-Satz                  | طنبضل ا قذعاق ءم ع ا ءموم جم               | リセットシャフトセット        |
| Rz (Radzylinder)                      | قو ج ع ا قن اوطنأ                          | Rz(ホイールシリンダー)      |
| Rz-Dichtungssatz                      | قو ج ع ا قن اوطنأ م الك ح ا قاط            | ホイールシリンダー密閉キット     |
| Rz-Reparaturatz                       | قو ج ع ا قن اوطنأ ا ل حالص ا قاط           | ホイールシリンダー修理キット     |
| Salisbury-Achse                       | يروبس يلس روحم                             | ソールズベリー型シャフト       |
| Sattel mit 1 Haltestift               | قنذ و باخ بوزم قيف ءيلا                    | 固定ピン1つのキャピラ        |



















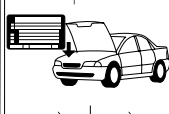



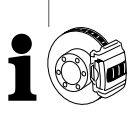
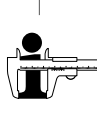

- D** So benutzen Sie den K24-F
- EN** How to use the K24-F
- FR** Utilisation du catalogue K24-F
- IT** Come consultare il catalogo K24-F
- ES** Use así el K24-F
- NL** Zo gebruikt u de K24-F
- DA** Sådan anvendes K24-F
- SV** Så använder du K24-F
- HU** How to use the K24-F
- PT** Como utilizar o K24-F
- RU** Как пользоваться каталогом K24-F
- CZ** Jak používat K24-F
- PL** Tak należy korzystać z K24-F
- EL** Έτσι χρησιμοποιείτε τον K24-F
- TR** K24-F'i Broşürünü Nasıl Kullanacaksınız
- ZH** 这样使用 K24-F
- JA** カタログNo.24-Fのご利用法
- AR** K24-F طريقة استعمال الكatalog

# K24-F

# How to use the K24-F

| Product groups   | Type of vehicle   | Installation period (from/to)   |   | ATE number  | Remark (spare part)  |   |   |                                   |            |
|--|---|---|---|---|--|---|---|-----------------------------------|------------|
| Front/rear axle  | Chassis number  | Remark (car)  |   | Short number  | Definition   |   |   |                                   |            |
|  | kW  |   |   |   |  |   |   |                                   |            |
|  |  |  |  |  |  |  |  |                                   |            |
| <b>AUDI A4 CABRIO (02-)</b>  |   |   |   |   |  |   |   |                                   |            |
|  | 1,8 T<br>1,8 T Quattro<br>2,0<br>2,0 TFSI   | ◀ 120<br>◀ 120<br>◀ 96<br>◀ 120   | 8E-55-999999<br>04.02<br>05.03<br>08.06<br>05.04<br>08.06<br>08.06                | PR: 1LB,1LE<br>PR: 1LB,1LE<br>PR: 1LB,1LE<br>PR: 1LB,1LE                          | 24.0113-0178.1<br>24.0313-0178.1   | 413178<br>513178  | <input type="checkbox"/> + ESP<br><input type="checkbox"/> + ESP                    | 256 12,9 11,0<br>256 12,9 11,0 PD | ATE<br>ATE |
| *  |   | **  |   |   |  | ***   |   | ****                              |            |

## \*Product groups

|  |                                       |   |   |
|--|---------------------------------------|---|---|
|    | <b>Disc brake pads</b><br>ATE Ceramic |    | <b>Drum brake shoes</b>                               |
|    | <b>Brake disc</b><br>ATE PowerDisc    |    | <b>Brake drum</b>                                     |
|  | <b>Wheel sensor</b>                   |  | <b>ATE Original Kit</b><br><b>ATE Original TopKit</b> |
|  |                                       |  | <b>Drum brake shoes for parking brake</b>             |

## \*\*Hand drive

- ◀ Left hand drive
- ▶ Right hand drive

## \*\*\*\*Manufacturer

|     |                         |
|-----|-------------------------|
| ADV | Advics                  |
| ATE | Continental Teves (ATE) |
| AKE | Akebono                 |
| AIS | Aisin                   |
| AP  | AP Lockheed             |
| BDX | Bendix                  |
| BOS | Bosch                   |
| BRE | Brembo                  |
| CIT | Citroën                 |
| DEL | Delco                   |
| FI  | Fiat                    |
| FTE | FTE Automotive          |
| MAN | Mando                   |
| NIS | Nissin                  |
| PER | Perrot                  |
| SUM | Sumitomo                |
| TOK | Tokico                  |
| TRW | Lucas (LUC)             |
| VW  | Volkswagen              |

## \*\*\*Installation Position















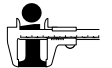





|                          |             |
|--------------------------|-------------|
| <input type="checkbox"/> | front       |
| <input type="checkbox"/> | rear        |
| <input type="checkbox"/> | left        |
| <input type="checkbox"/> | right       |
| <input type="checkbox"/> | upper left  |
| <input type="checkbox"/> | lower left  |
| <input type="checkbox"/> | upper right |
| <input type="checkbox"/> | lower right |
| <input type="checkbox"/> | center      |
| <input type="checkbox"/> | top         |
| <input type="checkbox"/> | bottom      |
| <input type="checkbox"/> | front axle  |
| <input type="checkbox"/> | front left  |
| <input type="checkbox"/> | front right |
| <input type="checkbox"/> | rear axle   |
| <input type="checkbox"/> | rear left   |
| <input type="checkbox"/> | rear right  |

All position details are based on vehicle facing forwards.

## Abbreviations

|      |   |     |   |                        |                |  |
|------|---|-----|---|------------------------|----------------|--|
| -    | Without / not                               | HEB | Lever                                     | WE                     | Warning device | Convertible                                  |
| +    | With / only / for                           | HZ  | Master cylinder                           | WK                     | Wear indicator | Bus  |
| AUT  | Automatic adjustment                        | L   | Alloyed / highly carburized               | Zub                    | Accessories    | Van / Panel van                              |
| B    | Coated                                      | L=  | Length                                    |                        |                | Fastback / Hatchback                         |
| BG   | Brake force limiter                         | Nz  | Slave cylinder                            | 2-door                 |                | Pickup/Chassis Platform truck/<br>chassis    |
| BR   | Brake pressure regulator                    | PD  | PowerDisc                                 | 3-door                 |                | Series                                       |
| BRE  | Screw-in regulator                          | Rz  | Wheel cylinder                            | 4-door                 |                | DKW master class/special class/<br>universal |
| BRES | Screw-in regulator set                      | RzR | Wheel cylinder with built-in<br>corrector | 5-door                 |                | FAUN powered cart (Kraka)                    |
| BRL  | Brake pressure regulator,<br>load sensitive | S   | Fixing screw / caliper screw              | Saloon / Sedan         |                | Transporter / Van                            |
| D=   | Diameter                                    | THz | Tandem master cylinder                    | Estate / Station wagon |                |  |
| Gz   | Clutch cylinder                             | V   | Ventilated                                | Coupe                  |                |  |

# Parts information

|    |  | SHORT NUMBER |   |  |  | SHORT NUMBER  |  |  |
|---|---|--------------|--|---|--|---|---|--|
|    | 13.0460-xxxx.2 →  | 60xxxx       | Disc brake pad   |  |  | 24.02dd-dxxx.x →  | 48nnnn  | Brake drums<br>(e.g. 24.0223-0: Ø=230)   |
|   | 13.0470-xxxx.2 →  | LDxxxx       | ATE Ceramic  |   |  |   |   | 230/231×47   |
|   | 13.0460-0xxx.2 →  | 610xxx       | Installation kit   |  |  | 03.0137-0xxx.2 →  | 650xxx  | Drum brake shoes   |
|   | 24.8190-xxxx.2 →  | 62xxxx       | Wear indicator   |   |  |   |   | 03.0137-9xxx.2 →   |
|   | 20034 15,0<br>+<br>WE<br>WK<br>S<br>Zub   |              | WVA no. / thickness<br>For further WVA no's. see appendix<br>Warning device<br>With wear indicator<br>With caliper screw<br>With accessoires |  |  | 185×31<br>AUT<br>Heb<br>Zub   |   | Diameter x width<br>With automatic adjustment<br>With lever<br>With accessories    |
| Brake pads have homologation by German Federal Road Safty Department (ABE), or homologation according to regulation ECE-R 90 i.e. the brake pads are from the same production and subject to the same quality assurance procedures as the pad provided by the vehicle manufacturer.   |   |              |  |   |  |   |    |  |
|   |   |              |  | 03.0520-xxdd.3 →  | 69xxdd   | ATE original TopKit<br>(wheel cylinder + drum brake shoes<br>+ installation kit)<br>dd = nominal dimension wheel cylinder |   |  |
|    | 24.01dd-xxxx.x →  | 4ddxxx       | Brake disc   |  |  | 03.0137-0xxx.2 →  | 650xxx  | Parking brake<br>(drum brake shoes)  |
|   | 24.03dd-xxxx.x →  | 5ddxxx       | ATE PowerDisc<br>dd = thickness<br>(e.g. 24.0322- : thickness = 22)  |   |  |   |   | 03.0137-9xxx.2 →   |
|   | 284 22 20 V L PD<br>B<br>V<br>L<br>S<br>PD  |              | Diameter / thickness / minimum thickness<br>Coated<br>Ventilated<br>Alloyed / highly carburized<br>Fixing screw<br>ATE PowerDisc             |  |  | 185×31<br>AUT<br>Heb<br>Zub   |   | Diameter x width<br>With automatic adjustment<br>With lever<br>With accessories    |
| A PowerDisc can be used on the rear axle only if there is one on the front axle.<br>The General Operating Permit (ABE) for the PowerDisc applies to operation on German roads in accordance with the German Road Traffic Registration Ordinance (StVZO).<br>Other countries may require additional type approvals for use on roads. |   |              |  |   |  |   |   | 24.07xx-xxxx.x →   |









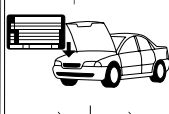

nnnn = The last four digits correspond to a running number.

dd = Nominal dimension

Complete copies or extracts of this catalog only by permission. Damage claims on the basis of data in this catalog cannot be recognized. The right of modification in construction or design is reserved. As far as we refer in our documents to part numbers of the vehicle makers, this is for comparison purposes only. The use of such information on invoices to the vehicle owner is not admissible.

The multitude of car models and spare parts from numerous vehicle manufacturers do not always allow an exact allocation. Therefore please pay attention to the corresponding remarks and spare part descriptions.

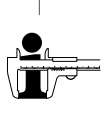
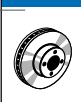
# Utilisation du catalogue K24-F

| Groupes de produit   |   | Type de véhicule  | Date de montage (du/au)   |   | Référence ATE  | Remarque (référence)  |   |   |  |                                   |            |
|--|---|---|---|---|--|---|---|---|--|-----------------------------------|------------|
| Essieu avant/arrière   | No. de châssis (du/au)  | Remarque (véhicule)   | Référence Courte  |   | Indication   |   |   |   |  |                                   |            |
|  | kW  |   |   |   |  |   |   |   |  |                                   |            |
|  |  |  |  |  |  |  |  |  |  |                                   |            |
| <b>AUDI A4 CABRIO (02-)</b>  |   |   |   |   |  |   |   |   |  |                                   |            |
|  | 1,8 T<br>1,8 T Quattro<br>2,0<br>2,0 TFSI   | ◀ 120<br>◀ 120<br>◀ 96<br>◀ 120   | 8E-55-999999  | 04.02<br>05.03<br>05.04   | 08.06<br>08.06<br>08.06  | PR: 1LB,1LE<br>PR: 1LB,1LE<br>PR: 1LB,1LE<br>PR: 1LB,1LE                            | 24.0113-0178.1<br>24.0313-0178.1  | 413178<br>513178  |  + ESP<br> + ESP | 256 12,9 11,0<br>256 12,9 11,0 PD | ATE<br>ATE |
| *  |   | **  |   |   |  |   | ***   | ****  |  |                                   |            |

## \*Groupes de produit



Plaquette de frein  
ATE Ceramic

Mâchoires de  
frein à tambour



Disque de frein  
ATE PowerDisc



Tambour de frein



Capteur ABS



Kit d'origine ATE  
TopKit d'origine ATE



Mâchoires de  
frein à tambour  
pour frein à main





## \*\*Direction

- ◀ Conduite à gauche
- ▶ Conduite à droite

## \*\*\*Fabricant

|     |                         |
|-----|-------------------------|
| ADV | Advics                  |
| ATE | Continental Teves (ATE) |
| AKE | Akebono                 |
| AIS | Aisin                   |
| AP  | AP Lockheed             |
| BDX | Bendix                  |
| BOS | Bosch                   |
| BRE | Brembo                  |
| CIT | Citroën                 |
| DEL | Delco                   |
| FI  | Fiat                    |
| FTE | FTE Automotive          |
| MAN | Mando                   |
| NIS | Nissin                  |
| PER | Perrot                  |
| SUM | Sumitomo                |
| TOK | Tokico                  |
| TRW | Lucas (LUC)             |
| VW  | Volkswagen              |

## \*\*\*Positionnement













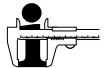

-  avant
-  arrière
-  gauche
-  droite
-  avant gauche
-  arrière gauche
-  avant droite
-  arrière droite
-  milieu
-  en haut
-  en bas
-  essieu avant
-  essieu avant gauche
-  essieu avant droite
-  essieu arrière
-  essieu arrière gauche
-  essieu arrière droite

Toutes positions vues en  
position de conduite

## Abréviations

|      |  |     |  |          |                            |   |
|------|--|-----|--|----------|----------------------------|---|
| -    | Sauf / sans                                | HEB | Levier                                   | WE       | Dispositif d'avertissement | Décapotable                                     |
| +    | Avec / seulement / pour                    | HZ  | Maître cylindre                          | WK       | Témoin d'usure             | Autobus/car                                     |
| AUT  | Ajustage Automatique                       | L   | Allié / carbonise                        | Zub      | Accessoires                | Fourgon   |
| B    | Revêtu                                     | L = | Longueur                                 |          |                            | Arrière profilé                                 |
| BG   | Limiteur de freinage                       | Nz  | Récepteur d'embrayage                    |          |                            | Camion-plateau/Châssis                          |
| BR   | Correcteur de freinage                     | PD  | PowerDisc                                | 2 portes |                            | Série   |
| BRE  | Correcteur à visser                        | Rz  | Cylindre de roue                         | 3 portes |                            | DKW Classe supérieure/Classe spéciale/Universal |
| BRES | Jeu de correcteur à visser                 | RzR | Cylindre de roue avec correcteur intégré | 4 portes |                            | FAUN Chariot motorisé (Kraka)                   |
| BRL  | Correcteur de freinage asservi à la charge | S   | Vis d'étrier / vis de fixation           | 5 portes |                            | Camionnette                                     |
| D =  | Diamètre                                   | THz | Maître cylindre tandem                   | Berline  |                            |   |
| Gz   | Emetteur 'embrayage                        | V   | Ventilé                                  | Break    |                            |   |
|      |  |     |  | Coupé    |                            |   |

# Explications des références

|    |  | RÉF. COURTE                          |   |  |  | RÉF. COURTE      |   |
|---|---|--------------------------------------|--|---|--|------------------|--|
|    | 13.0460-xxxx.2 →<br>13.0470-xxxx.2 →<br>13.0460-0xxx.2 →<br>24.8190-xxxx.2 →      | 60xxxx<br>LDxxxx<br>610xxx<br>62xxxx | Plaquette de frein<br>ATE Ceramic<br>Lot de montage<br>Témoïn d'usure  |  | 24.02dd-dxxx.x →   | 48nnnn           | Tambours de frein<br>(p.ex. 24.0223-0: Ø=230)  |
|   | 20034 15,0<br>+<br>WE<br>WK<br>S<br>Zub   |                                      | Code no. de WVA/épaisseur<br>autres no. de WVA voir annexe<br>Dispositif d'avertissement<br>avec témoïn d'usure<br>avec vis d'étrier<br>avec accessoires |  | 230/231x47   |                  | Diamètre / diamètre max. x largeur   |
|   |   |                                      |  |  | 03.0137-0xxx.2 →<br>03.0137-9xxx.2 →   | 650xxx<br>669xxx | Mâchoires de frein à tambour<br>Lot de montage   |
|   |   |                                      |  |  | 185x31<br>AUT<br>Heb<br>Zub  |                  | Diamètre x largeur<br>avec ajustage automatique<br>avec levier<br>avec accessoires   |
| Les jeux de plaquettes sont homologués par le Ministère allemand des transports (ABE) ou sont conformes aux normes ECE-R 90 ou ils proviennent de la même production et sont sujet à la même procédure qualité que ceux produits pour le constructeur.  |   |                                      |  |  | 03.0420-xxdd.3 →<br>03.0520-xxdd.3 →   | 68xxdd<br>69xxdd | Kit d'origine ATE<br>TopKit d'origine ATE<br>(cylindre de roue + mâchoires de frein à tambour + lot de montage)<br>dd = dimension nominal cylindre de roue |
|    | 24.01dd-xxxx.x →<br>24.03dd-xxxx.x →  | 4ddxxx<br>5ddxxx                     | Disques de frein<br>ATE PowerDisc<br>dd = épaisseur<br>(p.ex. 24.0322- : épaisseur = 22)   |  | 03.0137-0xxx.2 →<br>03.0137-9xxx.2 →   | 650xxx<br>669xxx | Frein à main<br>(mâchoires de frein à tambour)<br>Lot de montage   |
|   | 284 22 20 V L PD<br>B<br>V<br>L<br>S<br>PD  |                                      | Diamètre/épaisseur/épaisseur minimum<br>Revêtu<br>ventilé<br>allié/carbonisé<br>Vis de fixation<br>ATE PowerDisc   |  | 185x31<br>AUT<br>Heb<br>Zub  |                  | Diamètre x largeur<br>avec ajustage automatique<br>avec levier<br>avec accessoires   |
| L'utilisation d'un PowerDisc sur l'essieu arrière n'est autorisée qu'en combinaison avec un PowerDisc sur l'essieu avant. L'autorisation générale d'exploitation (AGE) pour le PowerDisc est valable sur les routes allemandes conformément au code de la route allemand (StVZO). Dans d'autres pays, des expertises supplémentaires sont le cas échéant nécessaires pour son utilisation dans la circulation routière. |   |                                      |  |  | 24.07xx-xxxx.x →   | 36nnnn           | Capteur ABS  |

nnnn = Les quatre derniers chiffres correspondent à un ordre numérique.

dd = Dimensione nominale

Toute reproduction totale ou partielle de ce catalogue est interdite sauf notre autorisation préalable. Une demande de dommages et intérêts qui se baserait ou aurait pour objet un renseignement donné par le présent catalogue ne saurait être retenue. Nous nous réservons le droit de modifier les spécifications de nos produits sans préavis et, si cela est nécessaire, pour assurer les performances optimales de nos gammes de produits. Les références constructeurs fournies dans le présent catalogue sont données seulement à titre indicatif. L'utilisation de telles informations dans les factures d'un détenteur de véhicule n'est pas admise.

La diversité des modèles et des pièces de rechange ne permet pas toujours une affectation correcte. Par conséquent nous vous prions de bien vouloir tenir compte des observations et des descriptions contenues dans ce catalogue.



# Come consultare il catalogo K24-F

| Gruppi prodotto             |   | Veicolo                         |              | Anno di produzione veicolo |                         |   | Codice lungo                     |                  | Altri dettagli ricambio  |                                   |            |
|-----------------------------|---|---------------------------------|--------------|----------------------------|-------------------------|---|----------------------------------|------------------|--|-----------------------------------|------------|
| Asse anteriore/posteriore   |   | Numero telaio                   |              | Altri dettagli veicolo     |                         |   | Codice breve                     |                  | Altre informazioni   |                                   |            |
| kW                          |   |                                 |              |                            |                         |   |                                  |                  |  |                                   |            |
|                             |   |                                 |              |                            |                         |   |                                  |                  |  |                                   |            |
| <b>AUDI A4 CABRIO (02-)</b> |   |                                 |              |                            |                         |   |                                  |                  |  |                                   |            |
|                             | 1,8 T<br>1,8 T Quattro<br>2,0<br>2,0 TFSI | ◀ 120<br>◀ 120<br>◀ 96<br>◀ 120 | 8E-55-999999 | 04.02<br>05.03<br>08.06    | 08.06<br>08.06<br>08.06 | PR: 1LB,1LE<br>PR: 1LB,1LE<br>PR: 1LB,1LE | 24.0113-0178.1<br>24.0313-0178.1 | 413178<br>513178 | <input type="checkbox"/> + ESP<br><input type="checkbox"/> + ESP | 256 12,9 11,0<br>256 12,9 11,0 PD | ATE<br>ATE |
| *                           |   | **                              |              |                            |                         |   |                                  |                  | ***  |                                   | ****       |

## \*Gruppi prodotto



Pastiglie freno  
ATE Ceramic



Ganasce freno



Disco freno  
ATE PowerDisc



Tamburi per freno



Sensori ruota



ATE Original Kit  
ATE Original TopKit



Freno di stazionamento  
(ganasce freno/  
pastiglie)

## \*\*Guida

- ◀ Guida sinistra
- ▶ Guida destra

## \*\*\*\*Fabricant

|     |                         |
|-----|-------------------------|
| ADV | Advics                  |
| ATE | Continental Teves (ATE) |
| AKE | Akebono                 |
| AIS | Aisin                   |
| AP  | AP Lockheed             |
| BDX | Bendix                  |
| BOS | Bosch                   |
| BRE | Brembo                  |
| CIT | Citroën                 |
| DEL | Delco                   |
| FI  | Fiat                    |
| FTE | FTE Automotive          |
| MAN | Mando                   |
| NIS | Nissin                  |
| PER | Perrot                  |
| SUM | Sumitomo                |
| TOK | Tokico                  |
| TRW | Lucas (LUC)             |
| VW  | Volkswagen              |

## \*\*\*Posizione di montaggio



















- davanti
- dietro
- a sinistra
- a destra
- davanti a sinistra
- dietro a sinistra
- davanti a destra
- dietro a destra
- al centro
- in alto
- in basso
- asse anteriore
- asse anteriore a sinistra
- asse anteriore a destra
- asse posteriore
- asse posteriore a sinistra
- asse posteriore a destra

Le indicazioni dei simboli si riferiscono alla direzione di marcia.

## Abbreviazioni

|      |  |     |  |               |                            |  |
|------|--|-----|--|---------------|----------------------------|--|
| -    | Senza / non                                  | HEB | Leva                                     | V             | Ventilato                  | Coupé  |
| +    | Con / solo / per                             | Hz  | Pompa freno                              | WE            | Rilevatore usura incollato | Cabriolet                                    |
| AUT  | Regolazione automatica                       | L   | In lega / lega di carbonio               | WK            | Rilevatore usura a clip    | Autobus                                      |
| B    | Rivestito                                    | L = | Lunghezza                                | Zub           | Accessori                  | Furgone                                      |
| BG   | Limitatore potenza freno                     | Nz  | Cilindro ricevitore frizione             | a 2 porte     |                            | Coda spiovente                               |
| BR   | Correttore di frenata                        | PD  | PowerDisc                                | a 3 porte     |                            | Autocarro cassonato/Autotelaio               |
| BRE  | Correttore avvitabile                        | Rz  | Cilindretto ruota                        | a 4 porte     |                            | Serie  |
| BRES | Correttore (da avvitare)                     | RzR | Cilindretto ruota con correttore         | a 5 porte     |                            | DKW Classe superiore/Classe spec./Universale |
| BRL  | Correttore di frenate, dipendente dal carico | S   | Viti fissaggio pinza / viti di fissaggio | Berlina       |                            | FAUN Motocarri (Kraka)                       |
| D =  | Diametro                                     | THz | Pompa freno tandem                       | Station Wagon |                            | Furgoncino                                   |
| Gz   | Pompa frizione                               |     |  |               |                            |  |

# Informazioni sugli articoli

|    |  | CODICE BREVE                         |    |  |  | CODICE BREVE   |  |   |
|---|---|--------------------------------------|---|---|--|--|---|---|
|    | 13.0460-xxxx.2 →<br>13.0470-xxxx.2 →<br>13.0460-0xxx.2 →<br>24.8190-xxxx.2 →      | 60xxxx<br>LDxxxx<br>610xxx<br>62xxxx | Pastiglie Freno<br>ATE Ceramic<br>Serie di montaggio<br>Rilevatore usura  |  |  | 24.02dd-dxxx.x →   | 48nnnn  | Tamburi per freno<br>(p. es. 24.0223-0: Ø=230)  |
|   | 20034 15,0<br>+<br>WE<br>WK<br>S<br>Zub   |                                      | Numero WVA / spessore<br>ulteriori numeri WVA v. appendice<br>Rilevatore usura in collato<br>con rilevatore usura a clip<br>con vite per pinza freno<br>con accessori |   |  |  |   | 230/231x47  |
|   |   |                                      |   |  |  | 03.0137-0xxx.2 →<br>03.0137-9xxx.2 →   | 650xxx<br>669xxx  | Ganasce freno<br>Serie di montaggio   |
|   |   |                                      |   |   |  |  | 185x31<br>AUT<br>Heb<br>Zub   |   |
| I set di pastiglie freno possiamo avere o un'autorizzazione generale all'esercizio (ABE) o una omologazione secondo la ECE-R 90; oppure provengono dalla stessa produzione e sono soggetti allo stesso controllo qualità previsto dal costruttore dell'autoveicolo.   |   |                                      |   |  |  | 03.0420-xxdd.3 →<br>03.0520-xxdd.3 →   | 68xxdd<br>69xxdd  | ATE Original Kit<br>ATE Original TopKit<br>(cilindretto ruota + ganasce freno +<br>serie di montaggio)<br>dd = dimensione cilindretto ruota |
|    | 24.01dd-xxxx.x →<br>24.03dd-xxxx.x →  | 4ddxxx<br>5ddxxx                     | Disco Freno<br>ATE PowerDisc<br>dd = spessore<br>(p.es. 24.0322- : spessore = 22)   |   |  |  |    |   |
|   | 284 22 20 V L PD<br>B<br>V<br>L<br>S<br>PD  |                                      | Diametro / spessore / spessore minimo<br>Rivestito<br>ventilato<br>in lega / lega di carbonio<br>viti di fissaggio<br>ATE PowerDisc                                   | 185x31<br>AUT<br>Heb<br>Zub   |  | Diametro x estensione<br>regolazione automatica<br>con leva<br>con accessori |   |   |
| L'utilizzo di un PowerDisc sull'asse posteriore è consentito solo unitamente all'impiego di un PowerDisc sull'asse anteriore. L'omologazione generale [ABE] per l'uso del PowerDisc è valida sulle strade tedesche, secondo il Testo Unico del Codice Stradale [StVZO]. In altri Paesi, oltre a tale omologazione, nella circolazione stradale possono essere necessarie anche altre perizie per l'uso. |   |                                      |   |  |  | 24.07xx-xxxx.x →   | 36nnnn  | Sensori ruota   |







nnnn = Nessun riferimento a codice ATE (esteso).

dd = Dimensione nominale

La ristampa anche parziale di questo catalogo può essere effettuata solo con nostro permesso. Richieste di sostituzione in base ai dati di questo catalogo non possono essere accettate. Salvo modifiche. Un riferimento nei nostri documenti ai numeri dei particolari di ricambio del produttore dell'autovettura viene fatto esclusivamente a scopo comparativo. L'utilizzo di questi dati in fatture al proprietario dell'autovettura non è ammissibile.

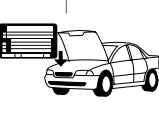
La molteplicità dei modelli e delle parti di ricambio di alcuni costruttori di autoveicoli non sempre consente una correlazione esatta. Si consiglia quindi di fare particolarmente attenzione alle osservazioni riportate nel catalogo ed alle descrizioni delle parti di ricambio.

# Use así el K24-F

| Grupo de producto  | Modelo  | Periodo de montaje (desde/hasta)  | Referencias ATE   | Indicaciones (repuesto)   |
|--|---|---|---|---|
| Eje delantero/trasero  | Número de chasis (desde/hasta)  | Indicaciones (vehículo)   | Referencia corta  | Información adicional   |
|  |  |  |  |  |
| <b>AUDI A4 CABRIO (02-)</b>  |   |   |   |   |
|  | 1,8 T<br>1,8 T Quattro<br>2,0<br>2,0 TFSI   | 8E-55-400001  | 24.0113-0178.1<br>24.0313-0178.1  | 256 12,9 11,0 ATE<br>256 12,9 11,0 PD ATE   |
|  | 120<br>120<br>96<br>120   | 04.02<br>05.03<br>08.06<br>08.06  | PR: 1LB,1LE<br>PR: 1LB,1LE<br>PR: 1LB,1LE<br>PR: 1LB,1LE                          | + ESP<br>+ ESP  |
| *  | **  |   | ***   | ****  |

## \*Grupo de producto



Pastilla de freno  
ATE Ceramic



Zapatas de freno



Disco de freno  
ATE PowerDisc



Tambores de freno



Sensor de rueda



ATE Original Kit  
ATE Original TopKit



Zapatas de freno  
para freno de esta-  
cionamiento (mano)

















## \*\*Dirección

- ◀ Volante a la izquierda
- ▶ Volante a la derecha

## \*\*\*\*Fabricante

|     |                         |
|-----|-------------------------|
| ADV | Advics                  |
| ATE | Continental Teves (ATE) |
| AKE | Akebono                 |
| AIS | Aisin                   |
| AP  | AP Lockheed             |
| BDX | Bendix                  |
| BOS | Bosch                   |
| BRE | Brembo                  |
| CIT | Citroën                 |
| DEL | Delco                   |
| FI  | Fiat                    |
| FTE | FTE Automotive          |
| MAN | Mando                   |
| NIS | Nissin                  |
| PER | Perrot                  |
| SUM | Sumitomo                |
| TOK | Tokico                  |
| TRW | Lucas (LUC)             |
| VW  | Volkswagen              |

## \*\*\*Posición de montaje















|   |                         |
|---|-------------------------|
|    | adelante                |
|    | atrás                   |
|    | izquierda               |
|    | derecha                 |
|    | izquierda adelante      |
|    | izquierda atrás         |
|    | derecha adelante        |
|  | derecha atrás           |
|  | medio                   |
|  | arriba                  |
|  | abajo                   |
|  | eje delantero           |
|  | eje delantero izquierda |
|  | eje delantero derecha   |
|  | eje trasero             |
|  | eje trasero izquierda   |
|  | eje trasero derecha     |

Todas las indicaciones de posición se refieren siempre al sentido de la marcha.

## Abreviaturas

|      |   |     |   |           |                         |  |
|------|---|-----|---|-----------|-------------------------|--|
| -    | Sin / no                                  | HEB | Palanca                                   | Thz       | Cilindro maestro tándem | Coupé                                      |
| +    | Con / solo / para                         | Hz  | Cilindro maestro                          | V         | Ventilado               | Cabriolé                                   |
| AUT  | Reajuste automático                       | L   | Aleación especial                         | WE        | Dispositivo de desgaste | Autobús                                    |
| B    | Recubierto                                | L = | Largo                                     | WK        | Contacto de desgaste    | Furgón                                     |
| BG   | Limitador de frenado                      | Nz  | Cilindro receptor de embrague             | Zub       | Accesorios              | Portón trasero alargado                    |
| BR   | Corrector de frenado                      | PD  | PowerDisc                                 | 2-puertas |                         | Camión con plataforma/Chasis               |
| BRE  | Regulador de rosca                        | Rz  | Cilindro de rueda                         | 3-puertas |                         | Serie                                      |
| BRES | Juego regulador de rosca                  | RzR | Cilindro de rueda con regulador integrado | 4-puertas |                         | DKW Clase maestra/Clase especial/Universal |
| BRL  | Corrector de frenado dependiente de carga | S   | Tornillo para pinza/tornillo querfija     | 5-puertas |                         | FAUN carretilla (Kraka)                    |
| D =  | Diámetro                                  |     |   | Berlina   |                         | Furgoneta                                  |
| Gz   | Cilindro transmisor de embrague           |     |   | Break     |                         |  |

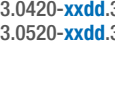
# Información artículos

|    |  | REF. CORTA  |   |  |  | REF. CORTA                           |  |   |
|---|---|---|--|---|--|--------------------------------------|---|---|
|    | 13.0460-xxxx.2 →<br>13.0470-xxxx.2 →<br>13.0460-0xxx.2 →<br>24.8190-xxxx.2 →      | 60xxxx<br>LDxxxx<br>610xxx<br>62xxxx  | Pastilla de freno<br>ATE Ceramic<br>Juego de montaje<br>Contacto de desgaste       |  |  | 24.02dd-dxxx.x →                     | 48nnnn  | Tambores de freno<br>(p. ej. 24.0223-0: Ø=230)  |
|   | 20034 15,0<br>+<br>WE<br>WK<br>S<br>Zub   | No. WVA/espesor<br>para otros números WVA, véase suplemento<br>Dispositivo de desgaste<br>con contacto de desgaste<br>con tornillo para pinza<br>con accesorios | 230/231x47   |   |  |                                      | Diámetro / diámetro max. x ancho  |   |
|   |   |   |  |  |  | 03.0137-0xxx.2 →<br>03.0137-9xxx.2 → | 65<br>669xxx  | Zapatas de freno<br>Juego de montaje  |
|   |   |   |  |   |  | 185x31<br>AUT<br>Heb<br>Zub          |   | Diámetro x ancho<br>con reajuste automático<br>con palanca<br>con accesorios  |
| Las pastillas de freno tienen un certificado general de aptitud técnica (abrev. alemana: ABE) o bien homologación según normativa ECE-R 90, es decir, proceden de la misma fabricación y están sujetas al mismo control de calidad que las de origen.   |   |   |  |  |  | 03.0420-xxdd.3 →<br>03.0520-xxdd.3 → | 68xxdd<br>69xxdd  | ATE Original Kit<br>ATE Original TopKit (juego de piezas de freno) (Cilindros de rueda + zapatas de freno + juego de montaje)<br>dd = medida interior del cilindro de rueda |
|    | 24.01dd-xxxx.x →<br>24.03dd-xxxx.x →  | 4ddxxx<br>5ddxxx  | Disco de freno<br>ATE PowerDisc<br>dd = espesor<br>(p.ex. 24.0322- : espesor = 22) |  |  | 03.0137-0xxx.2 →                     | 650xxx  | Freno de mano<br>(zapatas de freno)<br>Juego de montaje   |
|   | 284 22 20 V L PD<br>B<br>V<br>L<br>S<br>PD  | Diámetro / espesor / grosor mínimo<br>Recubierto<br>ventilado<br>aleación especial<br>Tornillo para pinza<br>ATE PowerDisc                                      | 03.0137-9xxx.2 →   |   |  | 669xxx                               |   |   |
|   |   |   |  |   |  | 185x31<br>AUT<br>Heb<br>Zub          |   | Diámetro x ancho<br>con reajuste automático<br>con palanca<br>con accesorios  |
| La utilización de un PowerDisc en el eje trasero sólo está permitida en relación con el uso de un PowerDisc en el eje delantero. El certificado general de aptitud técnica para la utilización de los discos PowerDisc es válido para la red de carreteras alemanas conforme al código de circulación alemán StVZO. Dado el caso, en otros países pueden ser necesarios otros dictámenes periciales para su utilización en el tráfico rodado. |   |   |  |  |  | 24.07xx-xxxx.x →                     | 36nnnn  | Sensor de rueda   |



nnnn = Las cuatro últimas cifras son números correlativos.

dd = Medida nominal





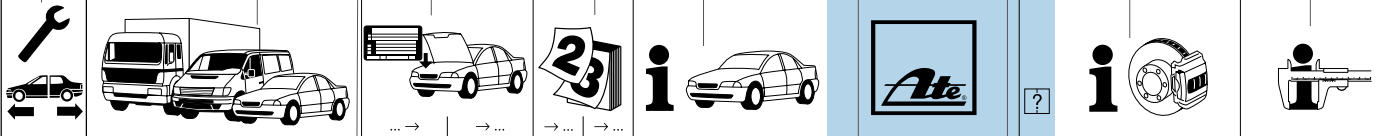

Sólo se permite la reproducción total o parcial con nuestra autorización. No se atenderán reclamaciones motivadas por los datos contenidos en este catálogo. Quedan reservados los derechos de modificaciones en la construcción. Si en nuestros documentos hacemos referencia a números de piezas de recambio de los constructores de vehículos, esto únicamente es para establecer una comparación. No está permitido el uso de datos de este tipo en las facturas emitidas al propietario del vehículo.

La variedad de modelos y de piezas de recambio de algunos constructores de vehículos no permite siempre una distribución exacta. Por este motivo, por favor fíjese atentamente en las observaciones y descripciones de las piezas de recambio detalladas en el catálogo.

# Zo gebruikt u de K24-F

| Produktgroep   | Voertuigtype                    | Inbouwperiode (van/tot)  | ATE-artikelnummer (lang)                                 | Opmerking (artikel)   |
|--|---------------------------------|--|--|---|
| Voor- achteras   | Chassisnummer (van/tot)         | Opmerking (voertuig)   | ATE-artikelnummer (kort)                                 | Info  |
| kW   |                                 |  |  |   |
|   |                                 |  |  |   |
| <b>AUDI A4 CABRIO (02-)</b>  |                                 |  |  |   |
|  1,8 T<br>1,8 T Quattro<br>2,0<br>2,0 TFSI | ◀ 120<br>▶ 120<br>▶ 96<br>▶ 120 | 8E-55-999999<br>04.02<br>05.03<br>08.06<br>05.04<br>08.06<br>08.06 | PR: 1LB,1LE<br>PR: 1LB,1LE<br>PR: 1LB,1LE<br>PR: 1LB,1LE | 24.0113-0178.1 413178<br>24.0313-0178.1 513178<br>?<br>+ ESP<br>+ ESP |
|  | 8E-55-400001                    |  |  | 256 12,9 11,0 ATE<br>256 12,9 11,0 PD ATE                             |
| *  | **                              |  |  | ***   |

## \*Productgroepen

|  |  |   |  |
|--|--|---|--|
|    | <b>Schijfremblokken</b><br>ATE Ceramic |    | <b>Remschoenset</b>                              |
|    | <b>Remschijven</b><br>ATE PowerDisc    |    | <b>Remtrommel</b>                                |
|  | <b>Wielsensor</b>                      |  | <b>ATE originele Kit</b><br>ATE originele TopKit |
|  |  |  | <b>Remschoenset voor parkeerrem</b>              |

## \*\*Soort besturing

- ◀ links gestuurd
- ▶ rechts gestuurd

## \*\*\*\*Fabrikant

|     |                         |
|-----|-------------------------|
| ADV | Advics                  |
| ATE | Continental Teves (ATE) |
| AKE | Akebono                 |
| AIS | Aisin                   |
| AP  | AP Lockheed             |
| BDX | Bendix                  |
| BOS | Bosch                   |
| BRE | Brembo                  |
| CIT | Citroën                 |
| DEL | Delco                   |
| FI  | Fiat                    |
| FTE | FTE Automotive          |
| MAN | Mando                   |
| NIS | Nissin                  |
| PER | Perrot                  |
| SUM | Sumitomo                |
| TOK | Tokico                  |
| TRW | Lucas (LUC)             |
| VW  | Volkswagen              |

## \*\*\*Inbouwpositie













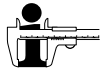

|   |                 |
|---|-----------------|
|    | voor            |
|    | achter          |
|    | links           |
|    | rechts          |
|    | links voor      |
|    | links achter    |
|    | rechts voor     |
|    | rechts achter   |
|  | midden          |
|  | boven           |
|  | onder           |
|  | vooras          |
|  | vooras links    |
|  | vooras rechts   |
|  | achteras        |
|  | achteras links  |
|  | achteras rechts |

Alle positieopgaven hebben altijd betrekking op de rijrichting.

## Afkortingen

|      |                                    |     |   |           |                       |  |
|------|------------------------------------|-----|---|-----------|-----------------------|--|
| -    | Zonder / niet                      | HEB | Handel                                  | V         | Geventileerd          | Coupé  |
| +    | Met / alleen / voor                | Hz  | Hoofdremcilinder                        | WE        | Warschuwinginrichting | Cabrio                                       |
| AUT  | Automatische instelling            | L   | Gelegerd / hoog gecarboniseerd          | WK        | Warschuwingcontact    | Bus  |
| B    | Coated                             |     |   | Zub       | Accessoires           | Bestelwagen                                  |
| BG   | Remkrachtbegrenzer                 | L = | Lengte                                  |           |                       | Fastback                                     |
| BR   | Remkrachtregelaar                  | Nz  | Hulpcilinder                            |           |                       | Pickup/chassis                               |
| BRE  | Inschroefregelaar                  | PD  | PowerDisc                               | 2-deurs   |                       | Serie  |
| BRES | Inschroefregelaarset               | Rz  | Wielcilinder                            | 3-deurs   |                       | DKW meesterklasse/speciale klasse/universeel |
| BRL  | Lastafhankelijke remkrachtregelaar | RzR | Wielcilinder met geïntegreerde regelaar | 4-deurs   |                       | FAUN trekkers                                |
| D =  | Diameter                           | S   | Fixeerschroef / zadelschroef            | 5-deurs   |                       | Vrachtauto's                                 |
| Gz   | Hoofdcilinder                      | THz | Tandem-hoofdcilinder                    | Limousine |                       |  |
|      |                                    |     |   | Combi     |                       |  |

# Artikelinformatie

|  |  | VERKORT NUMMER   |   |  |  | VERKORT NUMMER                       |  |  |  |
|---|---|--|--|---|--|--------------------------------------|---|--|--|
|  | 13.0460-xxxx.2 →<br>13.0470-xxxx.2 →<br>13.0460-0xxx.2 →<br>24.8190-xxxx.2 →      | 60xxxx<br>LDxxxx<br>610xxx<br>62xxxx   | Schijfremblokken<br>ATE Ceramic<br>Inbouwset<br>Waarschuwingcontact  |  |  | 24.02dd-dxxx.x →<br>48nnnn           | Remtrommel<br>(bijv. 24.0223-0: Ø=230)  |  |  |
|   | 20034 15,0<br>+<br>WE<br>WK<br>S<br>Zub   | WVA-nummer / Dikte<br>andere WVA-nummers zie aanhang<br>Waarschuwinginrichting<br>met waarschuwingcontact<br>met zadelschroef<br>met accessoires | 230/231×47   |   |  |                                      | Diameter /<br>maximale diameter x diepte  |  |  |
|  | 24.01dd-xxxx.x →<br>24.03dd-xxxx.x →  | 4ddxxx<br>5ddxxx   | Remschijf<br>ATE PowerDisc<br>dd = dikte<br>(p.ex. 24.0322- : dikte = 22)  |  |  | 03.0137-0xxx.2 →<br>03.0137-9xxx.2 → | 650xxx<br>669xxx  |  |  |
|   |   |  |  |   |  |                                      | 185×31<br>AUT<br>Heb<br>Zub   | Diameter x breedte<br>met automatische instelling<br>met handel<br>met accessoires |  |
|   |   |  |  |   |  |                                      | 03.0420-xxdd.3 →<br>03.0520-xxdd.3 →  | 68xxdd<br>69xxdd   | ATE origineele Kit<br>ATE origineele TopKit<br>(wielremcilinder + trommel-<br>remschoen + inbouwset)<br>dd = basismaat wielcilindere |
|   |   |  |  |   |  |                                      | 03.0137-0xxx.2 →<br>03.0137-9xxx.2 →  | 650xxx<br>669xxx   | Remschoenset<br>voor parkeerrem<br>Inbouwset   |
|  | 284 22 20 V L PD<br>B<br>V<br>L<br>S<br>PD  |  | Diameter / dikte / minimale dikte<br>Coated<br>geventileerd<br>gelegeerd / hoog gecarboniseerd<br>Fixeerschroef<br>ATE PowerDisc |  |  | 185×31<br>AUT<br>Heb<br>Zub          | Diameter x breedte<br>met automatische instelling<br>met handel<br>met accessoires  |  |  |
|   |   |  |  |   |  |                                      | 24.07xx-xxxx.x →  | 36nnnn   | Wielsensor   |

Remvoeringsets hebben een algemene wettelijke goedkeuring (ABE) of een homologatie volgens ECE-R90, resp. komen uit dezelfde fabricage en zijn onderworpen aan dezelfde kwaliteitsbeveiliging als de door de voertuigfabrikant geplande voering.

Het gebruik van een PowerDisc op de achteras is alleen toegestaan in combinatie met het gebruik van een PowerDisc op de vooras. De typegoedkeuring voor het gebruik van de PowerDisc is op het Duitse wegennet conform het Duitse wegverkeersreglement (StVZO) van toepassing. In andere landen zijn daarnaast evt. andere goedkeuringen voor het gebruik in het wegverkeer noodzakelijk.

nnnn = de laatste vier cijfers houden een tellernummer in.







dd = Standaard Maat

Het nadrukken ook gedeeltelijk, is alleen met onze toestemming toegestaan. Schadeclaims op basis van informatie in deze catalogus kunnen niet worden aanvaard. Constructiewijzigingen voorbehouden. Voor zover wij in onze documentatie refereren naar onderdeelnummers van de voertuigfabrikant, dienen die slechts om te vergelijken. Een gebruik van dergelijke gegevens in rekeningen aan de voertuigeigenaar is niet geoorloofd.







De verschillen in modellen en onderdelen van enige voertuigfabrikanten maken niet altijd een nauwkeurige indeling mogelijk. Let daarom vooral op de in de catalogus vermelde opmerkingen en onderdeelbeschrijvingen.



# Sådan anvendes K24-F

| Produktgruppe  | Køretøjstyper   | Montageperiode (fra/til)  | ATE-artikelnummer (langt)  | Bemærkning (artikel)  |
|--|---|---|--|---|
| For-/bagaksel  | Stelnummer (fra/til)<br>kW  | Bemærkning (køretøj)  | ATE-artikelnummer (kort)   | Artikel   |
|  |  |  |  |  |
| <b>AUDI A4 CABRIO (02-)</b>  |   |   |  |   |
|  | 1,8 T<br>1,8 T Quattro<br>2,0<br>2,0 TFSI   | 8E-55-999999 04.02<br>05.03 08.06<br>05.04 08.06<br>08.06                         | PR: 1LB,1LE<br>PR: 1LB,1LE<br>PR: 1LB,1LE<br>PR: 1LB,1LE                           | 24.0113-0178.1 413178<br>24.0313-0178.1 513178<br>+ ESP<br>+ ESP                    |
|  | 120<br>120<br>96<br>120   | 8E-55-400001  |  | 256 12,9 11,0 ATE<br>256 12,9 11,0 PD ATE   |
| *  | **  |   |  | ***   |

## \*Produktgruppe

|  |                                     |   |  |
|--|-------------------------------------|---|--|
|    | Skivebremsebelægning<br>ATE Ceramic |    | Tromlebremsebakker                         |
|    | Bremse-skive<br>ATE PowerDisc       |    | Bremsetromle                               |
|  | Hjulsensor                          |  | ATE Original Kit<br>ATE Original TopKit    |
|  |                                     |  | Tromlebremsebakker<br>til parkeringsbremse |

## \*\*Styring

- ◀ Venstrestyring
- ▶ Højrestyring

## \*\*\*\*Producentkode

|     |                         |
|-----|-------------------------|
| ADV | Advics                  |
| ATE | Continental Teves (ATE) |
| AKE | Akebono                 |
| AIS | Aisin                   |
| AP  | AP Lockheed             |
| BDX | Bendix                  |
| BOS | Bosch                   |
| BRE | Brembo                  |
| CIT | Citroën                 |
| DEL | Delco                   |
| FI  | Fiat                    |
| FTE | FTE Automotive          |
| MAN | Mando                   |
| NIS | Nissin                  |
| PER | Perrot                  |
| SUM | Sumitomo                |
| TOK | Tokico                  |
| TRW | Lucas (LUC)             |
| VW  | Volkswagen              |

## \*\*\*Monteringssted

















- for
- bag
- venstre
- højre
- foran til venstre
- bagved til venstre
- foran til højre
- bagved til højre
- midt
- oppe
- nede
- Foraksel
- Venstre foraksel
- Højre foraksel
- Bagaksel
- Venstre bagaksel
- Højre bagaksel

Samtlige monteringssteder er altid i relation til kørselsretningen.

## Forkortelser

|      |                                  |     |                                       |             |                    |                             |
|------|----------------------------------|-----|---------------------------------------|-------------|--------------------|-----------------------------|
| -    | Uden / ikke                      | HEB | Arm                                   | V           | Ventileret         | Coupé                       |
| +    | Med / kun / til                  | HZ  | Hovedcylinder                         | WE          | Advarselsanordning | Cabriolet                   |
| AUT  | Automatisk indstilling           | L   | Legeret / højt kulstofindhold         | WK          | Advarselskontakt   | bus                         |
| B    | Coated                           | L = | Længde                                | Zub         | Tilbehør           | kassevogn                   |
| BG   | Bremsekraftbegrænser             | Nz  | Slavecylinder                         | 2-dørs      |                    | Hatchback                   |
| BR   | Bremsekraftfordeler              | PD  | PowerDisc                             | 3-dørs      |                    | Lad/chassis                 |
| BRE  | Iskruningsregulator              | Rz  | Hjulcylinder                          | 4-dørs      |                    | Serie                       |
| BRES | Iskruningsregulatorsæt           | RzR | Hjulcylinder med integreret regulator | 5-dørs      |                    | DKW mesterklasse/særklasse/ |
| BRL  | Bremsekraftfordeler lastafhængig | S   | Fastgøringsskrue / caliperskrue       | Limousine   |                    | universal                   |
| D =  | Diameter                         | THz | Tandem-hovedcylinder                  | Kombination |                    | FAUN Kraka                  |
| Gz   | Mastercylinder                   |     |                                       |             |                    | Transporter                 |

# Artikelinformation

|  |  | KORT NUMMER                          |   |   |  | KORT NUMMER      |   |
|---|---|--------------------------------------|--|--|--|------------------|--|
|  | 13.0460-xxxx.2 →<br>13.0470-xxxx.2 →<br>13.0460-0xxx.2 →<br>24.8190-xxxx.2 →      | 60xxxx<br>LDxxxx<br>610xxx<br>62xxxx | Skivebremsebelægning<br>ATE Ceramic<br>Monterings sæt<br>Advarselskontakt  |   | 24.02dd-dxxx.x →   | 48nnnn           | Bremsetromle<br>(F.eks. 24.02223-0: [=230])  |
|   | 20034 15,0<br>+<br>WE<br>WK<br>S<br>Zub   |                                      | WVA-nummer / tykkelse<br>se bilag for yderligere WVA-numre<br>Advarselsanordning<br>med advarselskontakt<br>med caliperskrue<br>med tilbehør |   | 230/231x47   |                  | Diameter/<br>Maksimal diameter x dybde   |
|   |   |                                      |  |   | 03.0137-0xxx.2 →<br>03.0137-9xxx.2 →   | 650xxx<br>669xxx | Tromlebremsebakker<br>Monterings sæt   |
|   |   |                                      |  |   | 185x31<br>AUT<br>Heb<br>Zub  |                  | Diameter x bredde<br>med automatisk indstilling<br>med arm<br>med tilbehør   |
|   |   |                                      |  |   | 03.0420-xxdd.3 →<br>03.0520-xxdd.3 →   | 68xxdd<br>69xxdd | ATE Original Kit<br>ATE Original TopKit<br>(Hjulcylinder + Tromlebremsebakker<br>+ Monterings sæt)<br>dd = Nominelt mål hjulcylinder |
|  | 24.01dd-xxxx.x →<br>24.03dd-xxxx.x →  | 4ddxxx<br>5ddxxx                     | Bremseskive<br>ATE PowerDisc<br>dd = Tykkelse<br>(F.eks. 24.0322- : Tykkelse = 22)   |   | 03.0137-0xxx.2 →<br>03.0137-9xxx.2 →   | 650xxx<br>669xxx | Parkeringsbremse<br>(Tromlebremsebakker)<br>Monterings sæt   |
|   | 284 22 20 V L PD<br>B<br>V<br>L<br>S<br>PD  |                                      | Diameter/Tykkelse/Mindstetykkelse<br>Coated<br>ventileret<br>legeret/højt kulstofindhold<br>Fastgøringskrue<br>ATE PowerDisc                 |   | 185x31<br>AUT<br>Heb<br>Zub  |                  | Diameter x bredde<br>med automatisk indstilling<br>med arm<br>med tilbehør   |
|   |   |                                      |  |  | 24.07xx-xxxx.x →   | 36nnnn           | Hjulsensor   |

Bremsebelægningssæt har en generel standardgodkendelse (ABE) eller en homologisering iht. ECE-R90, dvs. de kommer fra en og samme produktion og har været igennem den samme kvalitetssikring som producentens egen belægning.

Det er kun tilladt at bruge en PowerDisc på bagakslen i forbindelse med brugen af en PowerDisc på forakslen. Den generelle driftstilladelse (ABE) til brug af PowerDisc er gældende på tyske veje iht. StVZO (tysk færdselslov). I andre lande kan yderligere godkendelser med henblik på brug i trafikken være påkrævet.





nnnn = De sidste fire cifre svarer til et aritmetiknummer.

dd = Nominelt mål

Eftertryk, også i uddrag, er kun tilladt efter vores godkendelse. Erstatningskrav som følge af angivelser i dette katalog godkendes ikke. Forbehold for konstruktionsændringer. Så vidt vi refererer til køretøjproducentens reservedelsnummer i vores bilag, bør disse kun anvendes til sammenligningsformål. En anvendelse af sådanne angivelser på fakturaer til ejeren af køretøjet er ikke tilladt.

Køretøjproducenterne har mange modeller og reservedele. Derfor er en nøjagtig angivelse ikke altid mulig. Vær derfor specielt opmærksom på de angivne bemærkninger og reservedelsbeskrivelser i kataloget.

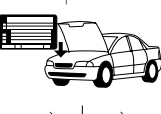
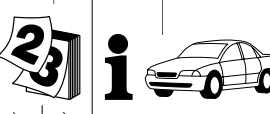
# Så använder du K24-F

| Produktgrupper   | Fordonstyper  | monteringstid (fom/tom)   | ATE-artikelnummer (långt)   | Kommentar (artikel)  |
|--|---|---|---|--|
| Fram-/bakaxel  | Chassinummer (från/till)  |   | ATE-artikelnummer (kort)  | Artikeldefinition  |
|  | kW  |   |   |  |
|  |  |  |  |  |
| <b>AUDI A4 CABRIO (02-)</b>  |   |   |   |  |
|  | 1,8 T<br>1,8 T Quattro<br>2,0<br>2,0 TFSI   | ◀ 120<br>◀ 120<br>◀ 96<br>◀ 120   | 8E-55-999999 04.02<br>05.03 08.06<br>05.04 08.06<br>08.06                         | PR: 1LB,1LE<br>PR: 1LB,1LE<br>PR: 1LB,1LE<br>PR: 1LB,1LE                           |
|  |   | 8E-55-400001  | 24.0113-0178.1 413178<br>24.0313-0178.1 513178                                    | <input type="checkbox"/> + ESP<br><input type="checkbox"/> + ESP                   |
|  |   |   |   | 256 12,9 11,0 ATE<br>256 12,9 11,0 PD ATE  |
| *  | **  |   | ***   | ****   |

## \*Produktgrupper

|  |   |   |  |
|--|---|---|--|
|    | <b>Skivbromsbeläggningar</b><br>ATE Ceramic |    | <b>Trumbromsbackar</b>                         |
|    | <b>Bromsskiva</b><br>ATE PowerDisc          |    | <b>Bromstrumma</b>                             |
|  | <b>Hjulsensor</b>                           |  | <b>ATE Original Kit</b><br>ATE Original TopKit |
|  |   |  | <b>Trumbromsbackar</b><br>för parkeringsbroms  |

## \*\*Styrning

- ◀ Vänsterstyrning
- ▶ Högerstyrning

## \*\*\*\*Tillverkarkod

|     |                         |
|-----|-------------------------|
| ADV | Advics                  |
| ATE | Continental Teves (ATE) |
| AKE | Akebono                 |
| AIS | Aisin                   |
| AP  | AP Lockheed             |
| BDX | Bendix                  |
| BOS | Bosch                   |
| BRE | Brembo                  |
| CIT | Citroën                 |
| DEL | Delco                   |
| FI  | Fiat                    |
| FTE | FTE Automotive          |
| MAN | Mando                   |
| NIS | Nissin                  |
| PER | Perrot                  |
| SUM | Sumitomo                |
| TOK | Tokico                  |
| TRW | Lucas (LUC)             |
| VW  | Volkswagen              |

## \*\*\*Inbyggnadsposition











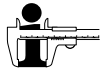

|                          |                  |
|--------------------------|------------------|
| <input type="checkbox"/> | Fram             |
| <input type="checkbox"/> | Bak              |
| <input type="checkbox"/> | Vänster          |
| <input type="checkbox"/> | Höger            |
| <input type="checkbox"/> | Vänster fram     |
| <input type="checkbox"/> | Vänster bak      |
| <input type="checkbox"/> | Höger fram       |
| <input type="checkbox"/> | Höger bak        |
| <input type="checkbox"/> | Mitten           |
| <input type="checkbox"/> | Uppe             |
| <input type="checkbox"/> | Nere             |
| <input type="checkbox"/> | Framaxel         |
| <input type="checkbox"/> | Framaxel vänster |
| <input type="checkbox"/> | Framaxel höger   |
| <input type="checkbox"/> | Bakaxel          |
| <input type="checkbox"/> | Bakaxel vänster  |
| <input type="checkbox"/> | Bakaxel höger    |

Alla positionsuppgifter ges anges alltid i färdriktning.

## Förkortningar

|      |                                 |     |                                       |           |                    |   |
|------|---------------------------------|-----|---------------------------------------|-----------|--------------------|---|
| -    | Utan / inte                     | HEB | Spak                                  | WE        | Varningsutrustning | Coupé                                   |
| +    | Med /bara / för                 | HZ  | Huvudcylinder                         | WK        | Varningskontakt    | Cabriolet                               |
| AUT  | Automatisk justering            | L   | Legerad / högkolad                    | Zub       | Tillbehör          | Buss                                    |
| B    | Beskiktad                       | L = | Längd                                 |           |                    | Skåpbil                                 |
| BG   | Bromskraftbegränsare            | Nz  | Slavcylinder                          |           |                    | Fastback                                |
| BR   | Bromskraftregulator             | PD  | PowerDisc                             |           |                    | Pickup/chassi                           |
| BRE  | Inskruvningsregulator           | Rz  | Hjulcylinder                          | 2-dörrars |                    | Serie                                   |
| BRES | Inskruvningsregulatorsats       | RzR | Hjulcylinder med integrerad regulator | 3-dörrars |                    | DKW mästarklass/specialklass/universell |
| BRL  | Bromskraftregulator lastkännare | S   | Fixeringsskruv / sadelskruv           | 4-dörrars |                    | FAUN tungdragare (Kraka)                |
| D =  | Diameter                        | THz | Tandemhuvudcylinder                   | 5-dörrars |                    | Transportbil                            |
| Gz   | Givarcylinder                   | V   | Ventilerad                            | Limousine |                    |   |
|      |                                 |     |                                       | Kombi     |                    |   |

# Produktinformationer

|   |  | KORTNUMMER  |                                       |   |  | KORTNUMMER                           |  |  |
|--|---|---|--|--|--|--------------------------------------|---|--|
|   | 13.0460-xxxx.2 →<br>13.0470-xxxx.2 →<br>13.0460-0xxx.2 →<br>24.8190-xxxx.2 →      | 60xxxx<br>LDxxxx<br>610xxx<br>62xxxx  | Skivbromsbeläggning<br>ATE Ceramic<br>Inbyggnadssats<br>Varningskontakt  |   |  | 24.02dd-dxxx.x →<br>230/231x47       | 48nnnn  | Bromstrumma<br>(t. ex. 24.0223-0: [=230])  |
|  | 20034 15,0<br>+<br>WE<br>WK<br>S<br>Zub   | WVA-Nummer / tjocklek<br>ytterligare WVAnummer se bilaga<br>varningsutrustning<br>med varningskontakt<br>med sadelskru<br>med tillbehör |  |  |  |                                      | Diameter /<br>maximal diameter x djup   |  |
|  |   |   |  |   |  | 03.0137-0xxx.2 →<br>03.0137-9xxx.2 → | 650xxx<br>669xxx  | Trumbromsbackar<br>Inbyggnadssats  |
|  |   |   |  |  |  | 185x31<br>AUT<br>Heb<br>Zub          |   | diameter x bredd<br>med automatisk justering<br>med spak<br>med tillbehör  |
| Bromsbeläggningssatser har ett Allmänt driftstillstånd (AABE) eller är typprovade och typgodkända enligt ECE-R90, resp. kommer från samma tillverkning och har genomgått samma kvalitetssäkring som den beläggning som fordonets tillverkare erbjuder.   |   |   |  |   |  | 03.0420-xxdd.3 →<br>03.0520-xxdd.3 → | 68xxdd<br>69xxdd  | ATE Original Kit<br>ATE Original TopKit<br>(hjulcylinder + trumbroms-<br>backar + inbyggnadssats)<br>dd = Nominellt mål hjulcylinder |
|   | 24.01dd-xxxx.x →<br>24.03dd-xxxx.x →  | 4ddxxx<br>5ddxxx  | Bromsskiva<br>ATE PowerDisc<br>dd = tjocklek<br>(t.ex. 24.0322- : tjocklek = 22)                                       |   |  | 03.0137-0xxx.2 →<br>03.0137-9xxx.2 → | 650xxx<br>669xxx  | Parkeringsbroms<br>(trumbromsbackar)<br>Inbyggnadssats   |
|  | 284 22 20 V L PD<br>B<br>V<br>L<br>S<br>PD  |   | diameter / tjocklek / min. tjocklek<br>Beskiktad<br>ventilerad<br>legerad / högkolad<br>Fixeringskrav<br>ATE PowerDisc |  |  | 185x31<br>AUT<br>Heb<br>Zub          |   | diameter x bredd<br>med automatisk justering<br>med spak<br>med tillbehör  |
| Användningen av en PowerDisc på bakaxeln är endast tillåten om en PowerDisc samtidigt används på framaxeln. Det allmänna typgodkännandet (ABE) för användningen av PowerDisc är giltigt på tyska vägar enligt StVZO (den tyska vägtrafikförfordningen). I andra länder krävs därutöver eventuellt ytterligare utlåtanden för användning i vägtrafik. |   |   |  |  |  | 24.07xx-xxxx.x →                     | 36nnnn  | Hjulsensor   |

nnnn = De sista fyra siffrorna motsvarar ett räknenummer.

dd = nominellt mått

Eftertryck – även delvis – är förbjudet utan vårt medgivande. Ersättningsanspråk pga uppgifterna i denna katalog godkänns ej. Konstruktionsändringar förbehålles. När vi hänvisar till fordonstillverkarens reservdelsnummer i våra underlag, så är det bara för jämförelsens skull. Dyliga uppgifter får inte anges på fakturor till fordonets ägare.

Fordonstillverkarna har många modeller och reservdelar. Därför är en exakt tillämpning inte alltid möjlig. Beakta därför de i katalogen anförda kommentarerna och reservdelsbeskrivningarna.

# Como utilizar o K24-F

| Grupos de Produto           |               | Marca e Modelo             |              | período de montagem (de/até) |             | Referência ATE       |        | Info adicional peça  |                  |     |  |
|-----------------------------|---------------|----------------------------|--------------|------------------------------|-------------|----------------------|--------|--|------------------|-----|--|
| Eixo dianteiro-/traseiro    |               | Número de chassis (de/até) |              | Info adicional Veículo       |             | Referência curta ATE |        | Especificações Técnicas  |                  |     |  |
| kW                          |               |                            |              |                              |             |                      |        |  |                  |     |  |
|                             |               |                            |              |                              |             |                      |        |  |                  |     |  |
| <b>AUDI A4 CABRIO (02-)</b> |               |                            |              |                              |             |                      |        |  |                  |     |  |
|                             | 1,8 T         | ◀ 120                      | 8E-55-999999 | 04.02                        | PR: 1LB,1LE | 24.0113-0178.1       | 413178 | <input type="checkbox"/> + ESP<br><input type="checkbox"/> + ESP | 256 12,9 11,0    | ATE |  |
|                             | 1,8 T Quattro | ◀ 120                      |              | 05.03                        | PR: 1LB,1LE | 24.0313-0178.1       | 513178 |  | 256 12,9 11,0 PD | ATE |  |
|                             | 2,0           | ◀ 96                       |              | 08.06                        | PR: 1LB,1LE |                      |        |  |                  |     |  |
|                             | 2,0 TFSI      | ◀ 120                      | 8E-55-400001 | 08.06                        | PR: 1LB,1LE |                      |        |  |                  |     |  |
|                             |               |                            |              |                              |             |                      |        |  |                  |     |  |
|                             |               |                            |              |                              |             |                      |        |  |                  |     |  |

## Grupos de Produto

Pastilhas de Travão de Disco  
ATE Ceramic

Maxilas

Disco de Travão  
ATE PowerDisc

Tambores de Travão

Sensor de Roda ABS

Kit Original ATE  
TopKit Original ATE

Maxilas para travão de mão

## \*\*Direcção

- ◀ Volante à esquerda
- ▶ Volante à direita

## \*\*\*\*Fabricante

|     |                         |
|-----|-------------------------|
| ADV | Advics                  |
| ATE | Continental Teves (ATE) |
| AKE | Akebono                 |
| AIS | Aisin                   |
| AP  | AP Lockheed             |
| BDX | Bendix                  |
| BOS | Bosch                   |
| BRE | Brembo                  |
| CIT | Citroën                 |
| DEL | Delco                   |
| FI  | Fiat                    |
| FTE | FTE Automotive          |
| MAN | Mando                   |
| NIS | Nissin                  |
| PER | Perrot                  |
| SUM | Sumitomo                |
| TOK | Tokico                  |
| TRW | Lucas (LUC)             |
| VW  | Volkswagen              |

## \*\*\*Posição de Montagem



















- à frente
- atrás
- esquerda
- direita
- esquerda à frente
- esquerda atrás
- direita à frente
- direita atrás
- centro
- em cima
- em baixo
- eixo dianteiro
- eixo dianteiro do lado esquerdo
- eixo dianteiro do lado direito
- eixo traseiro
- eixo traseiro esquerdo
- eixo traseiro direito

Todas as indicações de posição referem-se ao lado de condução.

## Abreviaturas

|      |   |     |  |             |                      |   |
|------|---|-----|--|-------------|----------------------|---|
| -    | Salvo / sem                               | HEB | Alavanca                                   | V           | Ventilado            | Cabrio  |
| +    | Com / apenas / para                       | HZ  | Bomba central de travões                   | WE          | Dispositivo de Aviso | Autocarro   |
| AUT  | Regulação automática                      | L   | Liga de Carbono                            | WK          | Avisador de Desgaste | Furgão  |
| B    | Revestido                                 | L = | Comprimento                                | Zub         | Acessórios           | Hatchback   |
| BG   | Limitador de travagem                     | Nz  | Bomba auxiliar de embraiagem               | De 2 portas |                      | Pick-Up/Chassis                                     |
| BR   | Regulador de travagem                     | PD  | PowerDisc                                  | De 3 portas |                      | Série   |
| BRE  | Regulador de parafuso                     | Rz  | Cilindro de roda                           | De 4 portas |                      | DKW Meisterklasse/Sonderklasse/                     |
| BRES | Jogo de reguladores de parafuso           | RzR | Cilindro de roda com regulador incorporado | De 5 portas |                      | Universal (classe mestre/classe especial/universal) |
| BRL  | Regulador de travagem dependente da carga | S   | Parafuso de fixação / parafuso da maxila   | Berlina     |                      | FAUN Veículo tractor (Kraka)                        |
| D =  | Diâmetro                                  | THz | Bomba central de travões tandem            | Carrinha    |                      | Furgoneta   |
| Gz   | Bomba central de embraiagem               |     |  | Coupé       |                      |   |

# Informações sobre artigos

|  |  | REF. CURTA   |    |  |  | REF. CURTA                           |  |
|---|---|--|---|---|--|--------------------------------------|---|
|  | 13.0460-xxxx.2 →<br>13.0470-xxxx.2 →<br>13.0460-0xxx.2 →<br>24.8190-xxxx.2 →      | 60xxxx<br>LDxxxx<br>610xxx<br>62xxxx   | Pastilhas de Travão de Disco<br>ATE Ceramic<br>Kit de montagem<br>Avisador de desgaste  |  |  | 24.02dd-dxxx.x →<br>48nnnn           | Tambores de Travão<br>(por ex. 24.0223-0: [=230])                                   |
|   | 20034 15,0<br>+<br>WE<br>WK<br>S<br>Zub   | Nr. WVA / Espessura<br>mais números WVA em anexo<br>Dispositivo de Aviso<br>Avisador de Desgaste<br>Com parafuso da maxila<br>Com Acessórios | 230/231x47  |   |  |                                      | Diâmetro/diâmetro<br>max. x profundidade  |
|  | 03.0137-0xxx.2 →<br>03.0137-9xxx.2 →  | 650xxx<br>669xxx   | Maxilas<br>Kit de Montagem  |  |  | 185x31<br>AUT<br>Heb<br>Zub          | Diâmetro x Lagura<br>com regulação automática<br>com alavanca<br>com acessório      |
|   |   |  | Kit original ATE<br>TopKit original ATE<br>(cilindro de roda + maxilas +<br>kit de montagem)<br>dd = medida nominal do cilindro da roda |   |  |                                      |   |
|  | 24.01dd-xxxx.x →<br>24.03dd-xxxx.x →  | 4ddxxx<br>5ddxxx   | Disco de Travão<br>Disco de Travão PowerDisc<br>dd = espessura<br>(por ex. 24.0322- : espessura = 22)                                   |  |  | 03.0420-xxdd.3 →<br>03.0520-xxdd.3 → | 68xxdd<br>69xxdd  |
|   | 284 22 20 V L PD<br>B<br>V<br>L<br>S<br>PD  | Diâmetro / espessura / espessura mínima<br>Revestido<br>Ventilado<br>Liga de Carbono<br>Parafuso de fixação<br>PowerDisc da ATE              | 03.0137-0xxx.2 →<br>03.0137-9xxx.2 →  |   |  |                                      |   |
|  | 185x31<br>AUT<br>Heb<br>Zub   |  | Diâmetro x Lagura<br>com regulação automática<br>com alavanca<br>com acessórios   |  |  | 24.07xx-xxxx.x →                     | 36nnnn  |
|   |   |  |   |   |  |                                      |   |

A utilização de um disco PowerDisc no eixo traseiro apenas está permitida em conjunto com a colocação de um disco PowerDisc no eixo dianteiro. Conforme a lei alemã respeitante ao regulamento do trânsito (StVZO), a homologação nacional (ABE-Allgemeine Betriebserlaubnis) para a utilização do PowerDisc nas estradas alemãs é válida. Em outros países podem ser necessários outras homologações para além da mencionada, para permitir a utilização no livre trânsito.

nnnn = Os quatro últimos dígitos são números sequenciais.

dd = Medida nominal

Cópias integrais ou parciais deste catálogo estão interditas salvo autorização prévia. Reclamações motivadas por informação constante neste catálogo não serão aceites. Reservamo-nos ao direito de proceder a alterações de construção ou desenho sem aviso prévio. Quando indicamos a referência de origem, tal destina-se apenas para efeito de comparação. Não é permitido utilizar essa informação nas facturas emitadas ao proprietário do veículo.

A diversidade de modelos de viaturas e de peças de substituição nem sempre permite uma conversão exacta. Por esta razão agradecemos que leia atentamente as correspondentes notas e descrições indicadas neste catálogo.



# Как пользоваться каталогом K24-F

| Группы продукции              | Тип автомобиля                            | период монтажа (от/до)   | Номер артикула ATE                                       | Ссылка (артикул)                                     |
|-------------------------------|---|--|--|--|
| Передний мост/<br>задний мост | Номер шасси томобиля<br>kW                | Ссылка<br>(автомобиль)   | Короткий номер   | артикул  |
|                               |   |  |  |  |
| <b>AUDI A4 CABRIO (02-)</b>   |   |  |  |  |
|                               | 1,8 T<br>1,8 T Quattro<br>2,0<br>2,0 TFSI | 8E-55-999999<br>04.02<br>05.03<br>08.06<br>05.04<br>08.06<br>08.06 | PR: 1LB,1LE<br>PR: 1LB,1LE<br>PR: 1LB,1LE<br>PR: 1LB,1LE | 24.0113-0178.1<br>24.0313-0178.1<br>413178<br>513178 |
|                               | 120<br>120<br>96<br>120                   | 8E-55-400001   |  | + ESP<br>+ ESP                                       |
|                               |   |  |  | 256 12,9 11,0<br>256 12,9 11,0 PD                    |
|                               |   |  |  | ATE<br>ATE   |

## \*Группы продукции

|  |   |  |  |
|--|---|--|--|
|  | Колодки дисковых тормозов ATE Ceramic             |  | Колодки барабанных тормозов                                |
|  | Тормозной диск Усиленный торм. диск ATE PowerDisc |  | Тормозной барабан  |
|  | Датчик колеса                                     |  | Комплект „ATE Original Kit“ Комплект „ATE Original TopKit“ |
|  |   |  | ормоза   |

## \*\*Вид рулевого управления

- ◀ Автомобиль с левым рулем
- ▶ Автомобиль с правым рулем

## \*\*\*Производитель

|     |                         |
|-----|-------------------------|
| ADV | Advics                  |
| ATE | Continental Teves (ATE) |
| AKE | Akebono                 |
| AIS | Aisin                   |
| AP  | AP Lockheed             |
| BDX | Bendix                  |
| BOS | Bosch                   |
| BRE | Brembo                  |
| CIT | Citroën                 |
| DEL | Delco                   |
| FI  | Fiat                    |
| FTE | FTE Automotive          |
| MAN | Mando                   |
| NIS | Nissin                  |
| PER | Perrot                  |
| SUM | Sumitomo                |
| TOK | Tokico                  |
| TRW | Lucas (LUC)             |
| VW  | Volkswagen              |

## \*\*\*Место установки















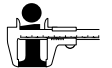



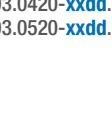

|  |                     |
|--|---------------------|
|  | спереди             |
|  | сзади               |
|  | слева               |
|  | справа              |
|  | слева спереди       |
|  | слева снизу         |
|  | справа спереди      |
|  | справа внизу        |
|  | в середине          |
|  | сверху              |
|  | снизу               |
|  | передняя ось        |
|  | передняя ось слева  |
|  | передняя ось справа |
|  | задняя ось          |
|  | задняя ось слева    |
|  | задняя ось справа   |

Все данные расположения всегда относятся к направлению движения

## Сокращения

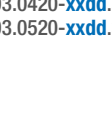
|      |  |     |  |           |  |  |
|------|--|-----|--|-----------|--|--|
| -    | без/не   | D = | диаметр  | S         | винт фиксирующий / болтом суппорта     | седан  |
| +    | с/только/для                                   | Gz  | Цилиндр датчик                                       | THz       | Двуполостной главный тормозной цилиндр | универсал                                    |
| AUT  | автоматической регулировкой                    | HEB | рычагом  | V         | вентилируемый                          | купе   |
| B    | покрытое                                       | HZ  | Главный цилиндр                                      | WE        | Сигнальное устройство                  | кабриолет                                    |
| BG   | Ограничитель тормозных сил                     | L   | легированный / высокоуглеродистый                    | WK        | сигнальным контактом                   | автобус                                      |
| BR   | Регулятор тормозного сил                       | L   | легированный / высокоуглеродистый                    | Zub       | принадлежностями                       | фургон                                       |
| BRE  | Вкручивающийся регулятор                       | L = | Длина  |           |  | хетчбэк                                      |
| BRES | Набор вкручивающихся регуляторов               | Nz  | Принимающий цилиндр                                  |           |  | платформа/шасси                              |
| BRL  | Регулятор тормозных сил, зависимый от нагрузки | PD  | PowerDisc  |           |  | серия  |
|      |  | Rz  | Колесный тормозной цилиндр                           |           |  | DKW мастер класс/ специальный/ универсальный |
|      |  | RzR | Колесный тормозной цилиндр со встроенным регулятором |           |  | FAUN электрокар (KraKa)                      |
|      |  |     |  | 2-дверный |  | грузовой автомобиль                          |
|      |  |     |  | 3-дверный |  |  |
|      |  |     |  | 4-дверный |  |  |
|      |  |     |  | 5-дверный |  |  |

# Информация об изделиях

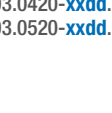
|  |  | КОРОТКИЙ НОМЕР  |  |  |  | КОРОТКИЙ НОМЕР                       |  |  |  |
|---|---|---|---|---|--|--------------------------------------|---|--|--|
|  | 13.0460-xxxx.2 →<br>13.0470-xxxx.2 →<br>13.0460-0xxx.2 →<br>24.8190-xxxx.2 →      | 60xxxx<br>LDxxxx<br>610xxx<br>62xxxx  |  |  |  | 24.02dd-dxxx.x →                     | 48nnnn  | Колодки для дисковых тормозов<br>ATE Ceramic<br>Монтажный комплект<br>Сигнальный контакт   |  |
|   | 20034 15,0<br>+<br>WE<br>WK<br>S<br>Zub   | Номер WVA / толщина<br>Прочие номера WVA см. в приложении<br>Сигнальное устройство<br>с сигнальным контактом<br>с болтом суппорта<br>с принадлежностями |   |   |  |                                      |   |   | Тормозной барабан<br>(напр., 24.0223-0: Ø=230)                           |
|  | 24.01dd-xxxx.x →<br>24.03dd-xxxx.x →  | 4ddxxx<br>5ddxxx  |  |  |  | 03.0137-0xxx.2 →<br>03.0137-9xxx.2 → | 650xxx<br>669xxx  | Комплекты тормозных колодок имеют Общий допуск к эксплуатации (нем. сокр.: ABE) или<br>гомологацию в соответствии с ECE-R90, либо произведены на том же предприятии с той же<br>системой обеспечения качества, как и колодки, предусмотренные производителем автомобиля. |  |
|   | 284 22 20 V L PD<br>B<br>V<br>L<br>S<br>PD  | Тормозной диск<br>ATE PowerDisc<br>dd = толщина<br>(напр., 24.0322- : толщина = 22)   |   |   |  |                                      |   |   | Колодки барабанных тормозов<br>Монтажный комплект                        |
|   | 03.0420-xxdd.3 →<br>03.0520-xxdd.3 →  | 68xxdd<br>69xxdd  |   |   |  |                                      |   | Комплект „ATE Original Kit“<br>Комплект „ATE Original TopKit“<br>(колесный тормозной цилиндр + колодки барабанного<br>тормоза + монтажный комплект) dd = номинальные<br>размеры колесного тормозного цилиндра  |  |
|  | 284 22 20 V L PD<br>B<br>V<br>L<br>S<br>PD  |   |  |  |  | 03.0137-0xxx.2 →<br>03.0137-9xxx.2 → | 650xxx<br>669xxx  | Диаметр / толщина / минимальная толщина<br>покрытое<br>вентилируемый<br>легированный / высокоуглеродистый<br>винт фиксирующий<br>ATE PowerDisc   |  |
|   |   |   |   |   |  |                                      |   | 185×31<br>AUT<br>Heb<br>Zub  | Стояночный тормоз<br>(Колодки барабанных тормозов)<br>Монтажный комплект |
|  | 284 22 20 V L PD<br>B<br>V<br>L<br>S<br>PD  |   |  |  |  | 185×31<br>AUT<br>Heb<br>Zub          | 650xxx<br>669xxx  | Диаметр × ширина<br>с автоматической регулировкой<br>с рычагом<br>с принадлежностями   |  |
|   |   |   |   |   |  |                                      |   | 24.07xx-xxxx.x →   | 36nnnn   |









nnnn = последние четыре цифры соответствуют номеру по порядку.

dd = номинальный размер

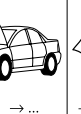

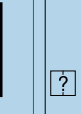



Воспроизведение данного издания, в том числе частичное, допускается только с нашего разрешения. Претензии на возмещение ущерба на основании приводимых в данном каталоге сведений не признаются. Сохраняем за собой право на изменение конструкции. Если в нашей документации содержится ссылка на номера запасных частей какого-либо производителя автомобилей, то это служит только для сравнения. Использование такого рода сведений в счетах, адресованных производителям автомобилей, не допускается.

Вследствие того, что некоторые производители автомобилей предлагают широкий спектр моделей и запасных частей, их не всегда можно точно сочетать. Просим Вас в связи с этим обращать особое внимание на примечания и описания заменяемых деталей, содержащиеся в данном каталоге.

# Jak používat K24-F

| Skupiny produktů   | Typ vozidla   | Doba vestavby (od/do)   |   | Katalogové číslo ATE  | Upozornění (díl)   |   |   |  |                                   |            |
|--|---|---|---|---|--|---|---|--|-----------------------------------|------------|
| Přední/zadní náprava   | Číslo podvozku  | Upozornění (vozidlo)  |   | Zkratkové číslo   | Definice   |   |   |  |                                   |            |
|  | kW  |   |   |   |  |   |   |  |                                   |            |
|  |  |  |  |  |  |  |  |  |                                   |            |
| <b>AUDI A4 CABRIO (02-)</b>  |   |   |   |   |  |   |   |  |                                   |            |
|  | 1,8 T<br>1,8 T Quattro<br>2,0<br>2,0 TFSI   | ◀ 120<br>◀ 120<br>◀ 96<br>◀ 120   | 8E-55-999999<br>04.02<br>05.03<br>05.04   | 08.06<br>08.06<br>08.06   | PR: 1LB,1LE<br>PR: 1LB,1LE<br>PR: 1LB,1LE<br>PR: 1LB,1LE                           | 24.0113-0178.1<br>24.0313-0178.1  | 413178<br>513178  |  + ESP<br> + ESP | 256 12,9 11,0<br>256 12,9 11,0 PD | ATE<br>ATE |
| *  |   | **  |   |   |  | ***   |   | ****   |                                   |            |

## \*Skupiny výrobků

|  |                                      |   |   |
|--|--------------------------------------|---|---|
|    | Obložení kotoučové brzdy ATE Ceramic |    | Čelisti bubnové brzdy                     |
|    | Brzdový kotouč ATE PowerDisc         |    | Brzdový buben                             |
|  | Senzor kola                          |  | ATE Original Kit ATE Original TopKit      |
|  |                                      |  | Čelisti bubnové brzdy pro parkovací brzdu |

## \*\*Druh řízení

- ◀ Volant vlevo
- ▶ Volant vpravo

## \*\*\*\*Označení výrobce

|     |                         |
|-----|-------------------------|
| ADV | Advics                  |
| ATE | Continental Teves (ATE) |
| AKE | Akebono                 |
| AIS | Aisin                   |
| AP  | AP Lockheed             |
| BDX | Bendix                  |
| BOS | Bosch                   |
| BRE | Brembo                  |
| CIT | Citroën                 |
| DEL | Delco                   |
| FI  | Fiat                    |
| FTE | FTE Automotive          |
| MAN | Mando                   |
| NIS | Nissin                  |
| PER | Perrot                  |
| SUM | Sumitomo                |
| TOK | Tokico                  |
| TRW | Lucas (LUC)             |
| VW  | Volkswagen              |

## \*\*\*Montážní poloha

















|   |               |
|---|---------------|
|    | vpředu        |
|    | vzadu         |
|    | vlevo         |
|    | vpravo        |
|    | vlevo nahoře  |
|    | vlevo dole    |
|    | vpravo nahoře |
|  | vpravo dole   |
|  | uprostřed     |
|  | nahoře        |
|  | dole          |
|  | nahoře        |
|  | vlevo nahoře  |
|  | vpravo nahoře |
|  | dole          |
|  | vlevo dole    |
|  | vpravo dole   |

Veškeré údaje o pozicích jsou vždy vztaženy na směr jízdy.

## Zkratky

|      |   |     |   |          |                      |  |
|------|---|-----|---|----------|----------------------|--|
| -    | Bez / ne                                | HEB | Pákou                                     | V        | Větraný              | Kupé   |
| +    | S / jen / pro                           | HZ  | Hlavní válec                              | WE       | Výstražné zařízení   | Kabriolet  |
| AUT  | Automatickým seřizováním                | L   | Legovaný/vysoce nauhličený                | WK       | Výstražným kontaktem | Autobus  |
| B    | Opatřený povlakem                       | L = | Délka                                     | Zub      | Příslušenstvím       | Skříňová dodávka                                       |
| BG   | Omezovač brzdné síly                    | Nz  | Válec snímače                             |          |                      | Splývavá zad'  |
| BR   | Regulátor brzdné síly                   | PD  | PowerDisc                                 |          |                      | Pick-up/podvozek                                       |
| BRE  | Regulátor k zašroubování                | Rz  | Kolový váleček                            |          |                      | Série  |
| BRES | Sada regulátorů k zašroubování          | RzR | Kolový váleček s integrovaným regulátorem | 2dvěřový |                      | DKW mistrovská třída/speciální třída/univerzální třída |
| BRL  | regulátor brzdné síly závislý na zátěži | S   | Upevňovací šroub / šroubem třmenu         | 3dvěřový |                      | FAUN čtyřkolka (Kraka)                                 |
| D =  | Průměr                                  | THz | Tandemový hlavní válec                    | 4dvěřový |                      | Dodávkový automobil                                    |
| Gz   | Válec vysílače                          |     |   | 5dvěřový |                      |  |
|      |   |     |   | Sedan    |                      |  |
|      |   |     |   | Kombi    |                      |  |

# Informace o výrobku

|   |  | ZKRATKOVÉ ČÍSLO                      |   |  |  | ZKRATKOVÉ ČÍSLO  |   |
|--|---|--------------------------------------|--|---|--|------------------|--|
|   | 13.0460-xxxx.2 →<br>13.0470-xxxx.2 →<br>13.0460-0xxx.2 →<br>24.8190-xxxx.2 →      | 60xxxx<br>LDxxxx<br>610xxx<br>62xxxx | Obložení kotoučové brzdy<br>ATE Ceramic<br>Montážní sada<br>Výstražný kontakt  |  | 24.02dd-dxxx.x →   | 48nnnn           | Brzdový buben<br>(nap. 24.0223-0: Ø=230)   |
|  | 20034 15,0<br>+<br>WE<br>WK<br>S<br>Zub   |                                      | WVA číslo / tloušťka<br>další čísla WVA viz dodatek<br>Výstražné zařízení<br>s výstražným kontaktem<br>se šroubem třmenu<br>s příslušenstvím |  | 230/231x47   |                  | Průměr / maximální průměr x hloubka  |
|  |   |                                      |  |  | 03.0137-0xxx.2 →<br>03.0137-9xxx.2 →   | 650xxx<br>669xxx | Čelisti bubnové brzd<br>Montážní sada  |
|  |   |                                      |  |  | 185x31<br>AUT<br>Heb<br>Zub  |                  | Průměr x šířka<br>s automatickým seřizováním<br>s pákou<br>s příslušenstvím  |
| Sady brzdového obložení mají Všeobecné povolení k provozu (ABE) nebo homologaci podle ECE-R90, resp. pocházejí z téže výroby a podléhají stejnému řízení jakosti jako obložení plánované výrobcem vozidla.   |   |                                      |  |  | 03.0420-xxdd.3 →<br>03.0520-xxdd.3 →   | 68xxdd<br>69xxdd | ATE Original Kit<br>ATE Original TopKit<br>(Kolový váleček + čelisti bubnové<br>brzdy + montážní sada)<br>dd = jmenovitý rozměr kolového válečku |
|   | 24.01dd-xxxx.x →<br>24.03dd-xxxx.x →  | 4ddxxx<br>5ddxxx                     | Brzdový kotouč<br>ATE PowerDisc<br>dd = tloušťka<br>(p.ex. 24.0322- : épaisseur = 22)  |  | 03.0137-0xxx.2 →<br>03.0137-9xxx.2 →   | 650xxx<br>669xxx | Parkovací brzda<br>(čelisti bubnové brzdy)<br>Montážní sada  |
|  | 284 22 20 V L PD<br>B<br>V<br>L<br>S<br>PD  |                                      | Průměr/tloušťka/minimální tloušťka<br>Opatřený povlakem<br>větraný<br>legovaný/vysoce nauhličený<br>Upevňovací šroub<br>ATE PowerDisc        |  | 185x31<br>AUT<br>Heb<br>Zub  |                  | Průměr x šířka<br>s automatickým seřizováním<br>s pákou<br>s příslušenstvím  |
| Použití kotouče PowerDisc na zadní nápravě je dovoleno jen s nasazením kotouče PowerDisc na přední nápravě. Všeobecné povolení k provozu (ABE) pro použití brzdových kotoučů PowerDisc platí na německých silnicích podle pravidel o schvalování způsobilosti k provozu na pozemních komunikacích (StVZO). V ostatních zemích jsou případně pro použití v silničním provozu navíc zapotřebí další posudky. |   |                                      |  |  | 24.07xx-xxxx.x →   | 36nnnn           | Senzor kola  |









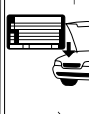
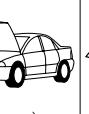

nnnn = Poslední čtyři čísla odpovídají počtu

dd = jmenovitý rozměr







Rozmnožování, i jen jednotlivých částí, je dovoleno jen s naším souhlasem. Nároky na náhradu na základě údajů v tomto katalogu nemohou být uznávány. Změny konstrukce vyhrazeny. Pokud se v našich podkladech odvoláváme na číslo náhradního dílu výrobce vozidla, slouží to jen pro účely porovnání. Používání takovýchto údajů ve fakturách vystavovaných majitelům vozidel není přípustné.

Rozmanitost modelů a náhradních dílů některých výrobců vozidel nedovoluje vždy přesné přiřazení. Věnujte proto prosím zvláštní pozornost poznámkám a popisům náhradních dílů uvedeným v katalogu.

# Tak należy korzystać z K24-F

| Grupy produktów  | Typ pojazdu   | Czas montażu (od/do)  |   | Numer artykułu ATE  | Uwaga (artykuł)  |   | Definicja   |  |   |
|--|---|---|---|---|--|---|---|--|---|
| Oś tylna / przednia  | Numer podwozia<br>kW  | Uwaga (pojazd)  |   | Numer skrócony  |  |   |   |  |   |
|  |  |  |  |  |  |  |  |  |   |
| <b>AUDI A4 CABRIO (02-)</b>  |   |   |   |   |  |   |   |  |   |
|  | 1,8 T<br>1,8 T Quattro<br>2,0<br>2,0 TFSI   | ◀ 120<br>◀ 120<br>◀ 96<br>◀ 120   | 8E-55-999999  | 04.02<br>05.03<br>05.04   | 08.06<br>08.06<br>08.06  | PR: 1LB,1LE<br>PR: 1LB,1LE<br>PR: 1LB,1LE<br>PR: 1LB,1LE                            | 24.0113-0178.1 413178<br>24.0313-0178.1 513178                                      |  + ESP<br> + ESP | 256 12,9 11,0 ATE<br>256 12,9 11,0 PD ATE |
| *  | **  |   |   |   |  | ***   | ****  |  |   |

## \*Grupy produktów

|  |   |   |  |
|--|---|---|--|
|    | Klocki do hamulców tarczowych ATE Ceramic |    | Szczęki hamulca bębnowego                        |
|    | Tarcza hamulcowa ATE PowerDisc            |    | Bęben hamulca                                    |
|  | Czujnik koła                              |  | ATE Original Kit<br>ATE Original TopKit          |
|  |   |  | Szczęki hamulca bębnowego do hamulca postojowego |

















## \*\*Rodzaj układu kierowniczego

- ◀ z kierownicą z lewej strony
- ▶ z kierownicą z prawej strony

## \*\*\*Producent

|     |                         |
|-----|-------------------------|
| ADV | Advics                  |
| ATE | Continental Teves (ATE) |
| AKE | Akebono                 |
| AIS | Aisin                   |
| AP  | AP Lockheed             |
| BDX | Bendix                  |
| BOS | Bosch                   |
| BRE | Brembo                  |
| CIT | Citroën                 |
| DEL | Delco                   |
| FI  | Fiat                    |
| FTE | FTE Automotive          |
| MAN | Mando                   |
| NIS | Nissin                  |
| PER | Perrot                  |
| SUM | Sumitomo                |
| TOK | Tokico                  |
| TRW | Lucas (LUC)             |
| VW  | Volkswagen              |

## \*\*\*Pozycja montażu













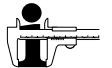

|   |                          |
|---|--------------------------|
|    | z przodu                 |
|    | z tyłu                   |
|    | z lewej strony           |
|    | z prawej strony          |
|    | z lewej strony u góry    |
|    | z lewej strony na dole   |
|    | z prawej strony u góry   |
|  | z prawej strony na dole  |
|  | po środku                |
|  | u góry                   |
|  | na dole                  |
|  | Oś przednia              |
|  | z lewej strony z przodu  |
|  | z prawej strony z przodu |
|  | Oś tylna                 |
|  | z lewej strony z tyłu    |
|  | z prawej strony z tyłu   |

Poszczególne pozycje zawsze w odniesieniu do kierunku jazdy.

## Skróty

|      |  |     |  |     |  |  |
|------|--|-----|--|-----|--|--|
| -    | Bez / nie  | Gz  | Pompa sprzęgła                                       | S   | Śruba łącząca / śrubą zacisku hamulca    | Limuzyna   |
| +    | Z / tylko / do                                   | HEB | Dźwignią   | THz | Pompa hamulcowa typu tandem              | Kombi  |
| AUT  | Automatyczną regulacją                           | HZ  | Pompa hamulcowa                                      | V   | Wentylowane                              | Coupe  |
| B    | Powlekane  | L   | Stopowe / z dużą zawartością węgla                   | WE  | Urządzenie ostrzegawcze                  | Cabriolet  |
| BG   | Ogranicznik siły hamowania                       | L = | Długość  | WK  | Stykiem ostrzegawczym                    | Bus  |
| BR   | Regulator siły hamowania                         | Nz  | Siłownik wysprężający                                | Zub | Osprzętem                                | Van  |
| BRE  | Regulator wkręcany                               | PD  | PowerDisc  |     | Przewód hamulcowy + rurociąg Dwudrzwiowy | Hatchback  |
| BRES | Zestaw regulatorów wkręcanych                    | Rz  | Cylinder hamulcowy koła                              |     | Trzydrzwiowy                             | Pickup/podwozie                                    |
| BRL  | Regulator siły hamowania w zależności obciążenia | RzR | Cylinder hamulcowy koła ze zintegrowanym regulatorem |     | Czterodrzwiowy                           | Seria  |
| D =  | Średnica   |     |  |     | Pięciodrzwiowy                           | DKW klasa master/klasa specjalna/klasa uniwersalna |
|      |  |     |  |     |  | FAUN quad  |
|      |  |     |  |     |  | Transporter  |

# Informacje o artykułach

|  |  | NUMER SKRÓCONY  |   |  |  | NUMER SKRÓCONY                       |  |   |
|---|---|---|--|---|--|--------------------------------------|---|---|
|  | 13.0460-xxxx.2 →<br>13.0470-xxxx.2 →<br>13.0460-0xxx.2 →<br>24.8190-xxxx.2 →      | 60xxxx<br>LDxxxx<br>610xxx<br>62xxxx  | klocki do hamulców tarczowych<br>ATE Ceramic<br>komplet do montażu<br>styk ostrzegawczy  |  |  | 24.02dd-dxxx.x →                     | 48nnnn  | bęben hamulcowy<br>(np. 24.0223-0: [=230])  |
|   | 20034 15,0<br>+<br>WE<br>WK<br>S<br>Zub   | numer WVA / grubość<br>dalsze numery WVA patrz w załączniku<br>urządzenie ostrzegawcze<br>ze stykiem ostrzegawczym<br>ze śrubą zacisku hamulca<br>z osprzętem | 230/231x47   |   |  |                                      | średnica /maksymalna średnica x głębokość   |   |
|  | 24.01dd-xxxx.x →<br>24.03dd-xxxx.x →  | 4ddxxx<br>5ddxxx  | tarcza hamulcowa<br>ATE PowerDisc<br>dd = grubość<br>(np. 24.0322- : grubość = 22)   |  |  | 03.0420-xxdd.3 →<br>03.0520-xxdd.3 → | 68xxdd<br>69xxdd  | ATE original Kit<br>ATE original TopKit<br>(cylinder hamulcowy koła + szczęki hamulców bębnowych + zestaw do montażu)<br>dd = wymiar znamionowy cylindra hamulcowego koła |
|   | 284 22 20 V L PD<br>B<br>V<br>L<br>S<br>PD  | średnica/grubość/minimalna grubość<br>Powlekane<br>wentylowane<br>stopowe/z dużą zawartością węgla<br>Śruba łącząca<br>ATE PowerDisc                          | 03.0137-0xxx.2 →<br>03.0137-9xxx.2 →   |   |  | 650xxx<br>669xxx                     | hamulec postojowy<br>(szczęki hamulców bębnowych)<br>zestaw do montażu              |   |
|  | 284 22 20 V L PD<br>B<br>V<br>L<br>S<br>PD  | średnica/grubość/minimalna grubość<br>Powlekane<br>wentylowane<br>stopowe/z dużą zawartością węgla<br>Śruba łącząca<br>ATE PowerDisc                          | Zastosowanie PowerDisc na osi tylnej jest dopuszczalne tylko w połączeniu z użytymi PowerDisc na osi przedniej. Zgodnie z StVZO [niemieckimi przepisami o dopuszczeniu pojazdów do ruchu drogowego] przy używaniu PowerDisc na niemieckich drogach obowiązuje świadectwo homologacji (ABE). W innych krajach do jego zastosowania w ruchu drogowym wymagane są kolejne ekspertyzy. |  |  | 185x31<br>AUT<br>Heb<br>Zub          |   | średnica x szerokość<br>z automatyczną regulacją<br>z dźwignią<br>z osprzętem   |
|   |   |   |  |   |  | 24.07xx-xxxx.x →                     | 36nnnn  | czujnik koła  |

nnnn = ostatnie cztery cyfry odpowiadają kolejnemu numerowi.









dd = wymiar znamionowy

Drukowanie, również fragmentami, dozwolone jest wyłącznie za naszą zgodą. Roszczenia odszkodowawcze wynikające z informacji zawartych w niniejszym katalogu nie będą uznawane. Zastrzega się możliwość zmian konstrukcyjnych. O ile w naszej dokumentacji odnosimy się do numeru części zamiennych producenta pojazdu, to służy to wyłącznie celom porównawczym. Stosowanie tego rodzaju informacji w rachunkach wystawianych posiadaczom pojazdów nie jest dozwolone.







Wielkość modeli i części zamiennych kilku producentów pojazdów nie zawsze pozwala na dokładne przyporządkowanie. Z tego względu prosimy o zwracanie szczególnej uwagi na podane w katalogu uwagi i opisy części zamiennych.



# Έτσι χρησιμοποιείτε τον K24-F

| Ομάδες προϊόντων   | Τύπος αυτοκινήτου   | Χρονικό διάστημα τοποθέτησης (από/έως)  | Αριθμός προϊόντος ATE  | Υπόδειξη (προϊόν)   |
|--|---|---|--|---|
| Μπροστινός άξονας/πίσω άξονας  | Αριθμός πλαισίου kW   | Υπόδειξη (όχημα)  | Σύντομος κωδικός   | Ορισμός   |
|    |  |  |  |    |
| <b>AUDI A4 CABRIO (02-)</b>  |   |   |  |   |
|  1,8 T<br>1,8 T Quattro<br>2,0<br>2,0 TFSI | ◀ 120<br>▶ 120<br>▶ 96<br>▶ 120<br>8E-55-400001                                   | 8E-55-999999<br>04.02<br>05.03<br>08.06<br>05.04<br>08.06<br>08.06                | PR: 1LB,1LE<br>24.0113-0178.1 413178<br>24.0313-0178.1 513178                      |  + ESP<br> + ESP<br>256 12,9 11,0 ATE<br>256 12,9 11,0 PD ATE |
| *  | **  |   | ***  | ****  |

## \*Μπροστινός

|  |  |   |  |
|--|--|---|--|
|    | Τακάκια δισκόφρενων (φερμουίτ) ATE Ceramic |    | Σιαγόνες τυμπάνου πέδησης                |
|    | Δίσκος φρένου ATE PowerDisc                |    | Τύμπανο πέδησης                          |
|  | Αισθητήρας τροχού                          |  | ATE Original Kit<br>ATE Original TopKit  |
|  |  |  | Σιαγόνες τυμπάνου πέδησης για χειρόφρενο |

















## \*\*Τρόπος διεύθυνσης

- ◀ Αριστεροτίμονα οχήματα
- ▶ Δεξιοτίμονα οχήματα

## \*\*\*Κατασκευαστής

|     |                         |
|-----|-------------------------|
| ADV | Advics                  |
| ATE | Continental Teves (ATE) |
| AKE | Akebono                 |
| AIS | Aisin                   |
| AP  | AP Lockheed             |
| BDX | Bendix                  |
| BOS | Bosch                   |
| BRE | Brembo                  |
| CIT | Citroën                 |
| DEL | Delco                   |
| FI  | Fiat                    |
| FTE | FTE Automotive          |
| MAN | Mando                   |
| NIS | Nissin                  |
| PER | Perrot                  |
| SUM | Sumitomo                |
| TOK | Tokico                  |
| TRW | Lucas (LUC)             |
| VW  | Volkswagen              |

## \*\*\*Θέση τοποθέτησης











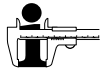

|   |                   |
|---|-------------------|
|    | μπροστά           |
|    | πίσω              |
|    | αριστερά          |
|    | δεξιά             |
|    | αριστερά επάνω    |
|    | αριστερά κάτω     |
|    | δεξιά επάνω       |
|   | δεξιά κάτω        |
|  | μέση              |
|  | επάνω             |
|  | κάτω              |
|  | Μπροστινός άξονας |
|  | αριστερά μπροστά  |
|  | δεξιά μπροστά     |
|  | Πίσω άξονας       |
|  | αριστερά πίσω     |
|  | δεξιά πίσω        |

Όλες οι ενδείξεις θέσεως ανταποκρίνονται πάντα στην κατεύθυνση οδήγησης

## Βραχυγραφίες

|      |  |     |  |         |                                       |   |
|------|--|-----|--|---------|---------------------------------------|---|
| -    | χωρίς / εκτός                                  | D = | Διάμετρος                                | S       | Βίδα στερέωσης / βίδα δίχαλου πέδησης | Λιμουζίνα   |
| +    | με / μόνο / για                                | Gz  | Εντολοδότης κύλινδρος                    | THz     | Διπλός κεντρικός κύλινδρος            | Στέισον   |
| AUT  | αυτόματη επαναρρύθμιση                         | HEB | μοχλό                                    | V       | αεριζόμενο                            | Κουπέ   |
| B    | επικαλυμμένος                                  | HZ  | Κεντρικός κύλινδρος                      | WE      | Διάταξη προειδοποίησης                | Κάμπριο   |
| BG   | Διάταξη περιορισμού δύναμης πέδησης            | L   | χαλυβόκραμα / υψηλή ανθράκωση            | WK      | επαφή προειδοποίησης                  | Λεωφορείο   |
| BR   | Ρυθμιστής δύναμης πέδησης                      | L = | Μήκος                                    | Zub     | εξαρτήματα                            | Κλούβα  |
| BRE  | Βιδωτός ρυθμιστής                              | Nz  | Εντολοδόχος κύλινδρος                    |         |                                       | Λίφτμακ   |
| BRES | Σετ βιδωτού ρυθμιστή                           | PD  | PowerDisc                                |         |                                       | Ανοιχτό φορτηγάκι/Πλαίσιο                           |
| BRL  | Ρυθμιστής δύναμης πέδησης ανάλογα της φόρτισης | Rz  | Κύλινδρος τροχού                         | 2-πορτο |                                       | Σειρά   |
|      |  | RzR | Κύλινδρο τροχού με ενσωματωμένο ρυθμιστή | 3-πορτο |                                       | DKW Κύρια κατηγορία/Ειδική κατηγορία/Γενικής χρήσης |
|      |  |     |  | 4-πορτο |                                       | FAUN Αυτοκίνητο όχημα (Kraka)                       |
|      |  |     |  | 5-πορτο |                                       | Μικρό φορτηγό                                       |

# Πληροφορίες προϊόντος

|    |  | ΣΥΝΤΟΜΟΣ ΚΩΔΙΚΟΣ |    |   |  | ΣΥΝΤΟΜΟΣ ΚΩΔΙΚΟΣ |   |
|---|---|------------------|---|--|--|------------------|--|
|    | 13.0460-xxxx.2 →  | 60xxxx           | Τακάκια δισκόφρενων<br>ATE Ceramic<br>Στάνταρ τακάκια φρένων<br>Επαφή προειδοποίησης  |   | 24.02dd-dxxx.x →   | 48nnnn           | Τύμπανο πέδησης<br>(π.χ. 24.0223-0: Ø=230)   |
|   | 13.0470-xxxx.2 →  | LDxxxx           |   |  | 230/231×47   |                  | Διάμετρος/<br>Μέγιστη διάμετρος × Βάθος  |
|   | 13.0460-0xxx.2 →  | 610xxx           | Αριθμός WVA/ Πάχος<br>για περαιτέρω αριθμούς WVA βλέπε παράρτημα<br>Διάταξη προειδοποίησης<br>με επαφή προειδοποίησης<br>με βίδα δίχαλου πέδησης<br>με εξαρτήματα |   | 03.0137-0xxx.2 →   | 650xxx           | Σιαγόνες τυμπάνου πέδησης<br>Σε τοποθέτησης  |
|   | 24.8190-xxxx.2 →  | 62xxxx           |   |  | 03.0137-9xxx.2 →   | 669xxx           | Διάμετρος × Πλάτος<br>με αυτόματη επαναρρύθμιση<br>με μοχλό<br>με εξαρτήματα   |
| <p>Τα σετ τακακιών των φρένων έχουν μια γενική άδεια λειτουργίας (ABE) ή μια κατασκευή κατά ECE-R90, ή προέρχονται από την ίδια κατασκευή και υπόκεινται στους ίδιους κανονισμούς εξασφάλισης της ποιότητας, όπως τα προβλεπόμενα από τον κατασκευαστή του οχήματος τακάκια των φρένων.</p>   |   |                  |   |  |  |                  |  |
|    | 24.01dd-xxxx.x →  | 4ddxxx           | Δίσκος φρένου<br>ATE PowerDisc<br>dd = πάχος<br>(π.χ. 24.0322- : thickness = 22)  |   | 03.0420-xxdd.3 →   | 68xxdd           | Γνήσιο Kit ATE<br>Γνήσιο TopKit ATE<br>(κύλινδροι τροχού + σιαγόνες<br>ταμπουρόφρενων + σετ τοποθέτησης)<br>Σε τοποθέτησης |
|   |   | 24.03dd-xxxx.x → |   |  | 5ddxxx   | 03.0520-xxdd.3 → |  |
|   | 284 22 20 V L PD<br>B<br>V<br>L<br>S<br>PD  |                  | Διάμετρος / Πάχος / Ελάχιστο πάχος<br>επικαλυμμένος<br>αεριζόμενο<br>χαλυβόκραμα / υψηλή ανθράκωση<br>Βίδα στερέωσης<br>ATE PowerDisc                             |   | 03.0137-0xxx.2 →   | 650xxx           | Χειρόφρενο<br>(σιαγόνες τυμπάνου πέδησης)<br>zestaw do montażu   |
|   |   |                  | 185×31<br>AUT<br>Heb<br>Zub   |  | 03.0137-9xxx.2 →   | 669xxx           | Διάμετρος × Πλάτος<br>με αυτόματη επαναρρύθμιση<br>με μοχλό<br>με εξαρτήματα   |
| <p>Η χρήση ενός PowerDisc στον πίσω άξονα επιτρέπεται μόνο σε συνδυασμό με τη χρήση ενός PowerDisc στον μπροστινό άξονα. Η Γενική Άδεια Λειτουργίας (ABE) για τη χρήση του PowerDisc στους γερμανικούς δρόμους σύμφωνα με τον StVZO (κανονισμός απογραφής, ταξινόμησης και θέσης οχημάτων σε κυκλοφορία) είναι έγκυρη. Σε άλλες χώρες πέραν αυτού είναι ενδεχομένως απαραίτητες περαιτέρω γνωμοδοτήσεις για τη χρήση στην οδική κυκλοφορία.</p> |   |                  |   |  |  |                  |  |
|   |   |                  |   |  | 24.07xx-xxxx.x →   | 36nnnn           | Αισθητήρας τροχού  |







**nnnn** = Τα τελευταία τέσσερα ψηφία αντιστοιχούν σε έναν αριθμό αριθμησης.

**dd** = Ονομαστική διάσταση

Η επανεκτύπωση, επίσης και αποσπασματικά, επιτρέπεται μόνο με την έγκρισή μας. Οι αξιώσεις αντικατάστασης βάσει των στοιχείων αυτού του καταλόγου δεν μπορούν να αναγνωριστούν. Διατηρούμε το δικαίωμα των κατασκευαστικών αλλαγών. Στο βαθμό που αναφερόμαστε στα έγγραφα μας στους αριθμούς ανταλλακτικών του κατασκευαστή του οχήματος, χρησιμεύει μόνο για λόγους σύγκρισης. Μια χρήση αυτών των στοιχείων σε λογαριασμούς που απευθύνονται στον ιδιοκτήτη του οχήματος δεν επιτρέπεται.

Ο μεγάλος αριθμός μοντέλων και ανταλλακτικών μερικών κατασκευαστών οχημάτων δεν επιτρέπει πάντοτε ένα ακριβή καταμερισμό. Προσέξτε παρακαλώ γι' αυτό ιδιαίτερα τις σχετικές παρατηρήσεις σ' αυτόν τον κατάλογο και τις περιγραφές των ανταλλακτικών εξαρτημάτων.

# K24-F'i Broşürünü Nasıl Kullanacaksınız

| Ürün grubu   | Araç tipleri  | Montaj süresi (tarih aralığı)   | ATE-Ürün numarası (uzun)  | Tanım (Ürün)  |
|--|---|---|---|---|
| Ön-/Arka aks   | Araç şasi numarası (tarih aralığı)  | Tanım (Araç)  | ATE-Ürün numarası (kısa)  | Ürün  |
|  | kW  |   |   |   |
|  |  |  |  |  |
| <b>AUDI A4 CABRIO (02-)</b>  |   |   |   |   |
|  | 1,8 T<br>1,8 T Quattro<br>2,0<br>2,0 TFSI   | 8E-55-400001  | 04.02<br>05.03<br>08.06<br>08.06<br>08.06   | PR: 1LB,1LE<br>PR: 1LB,1LE<br>PR: 1LB,1LE<br>PR: 1LB,1LE                          |
|  | 120<br>120<br>96<br>120   |   |   | 24.0113-0178.1<br>24.0313-0178.1  |
|  |   |   |   | 413178<br>513178  |
|  |   |   |   | + ESP<br>+ ESP  |
|  |   |   |   | 256 12,9 11,0<br>256 12,9 11,0 PD   |
|  |   |   |   | ATE<br>ATE  |

## \*Ürün grupları



Disk Fren Balatası (Pad) ATE Ceramic



Fren pabuçları



Fren diskisi ATE Fren Diskleri



Fren kampanası



Fren Sensörü



ATE Orijinal Tamir Takımı ATE Orijinal Komple Tamir Takımı



Tamburlu Fren Pabucu El Freni için

## \*\*Direksiyon türü

- ◀ Soldan Direksiyonlu araçlar
- ▶ Sağ direksiyon araçlar

## \*\*\*\*Üretici firma tanımı

|     |                         |
|-----|-------------------------|
| ADV | Advics                  |
| ATE | Continental Teves (ATE) |
| AKE | Akebono                 |
| AIS | Aisin                   |
| AP  | AP Lockheed             |
| BDX | Bendix                  |
| BOS | Bosch                   |
| BRE | Brembo                  |
| CIT | Citroën                 |
| DEL | Delco                   |
| FI  | Fiat                    |
| FTE | FTE Automotive          |
| MAN | Mando                   |
| NIS | Nissin                  |
| PER | Perrot                  |
| SUM | Sumitomo                |
| TOK | Tokico                  |
| TRW | Lucas (LUC)             |
| VW  | Volkswagen              |

## \*\*\*Montaj pozisyonu

















|   |              |
|---|--------------|
|    | ön           |
|    | arka         |
|    | sol          |
|    | sağ          |
|    | sol ön       |
|    | sol arka     |
|   | sağ ön       |
|  | sağ arka     |
|  | orta         |
|  | üst          |
|  | alt          |
|  | ön aks       |
|  | sol ön aks   |
|  | sağ ön aks   |
|  | arka aks     |
|  | sol arka aks |
|  | sağ arka aks |

Tüm pozisyon verileri sürüş yönüne göre dir.

## Kısaltmalar

|      |   |     |  |        |  |                                       |
|------|---|-----|--|--------|--|---------------------------------------|
| -    | Hariç / değil                           | HEB | Levyeli  | THz    | Tandem Merkezi Fren Hidrolik Silindiri | Station wagon                         |
| +    | Ile / sadece / için                     | HZ  | Fren Merkez Silindiri                                  | V      | Havalandırma                           | Coupe                                 |
| AUT  | Otomatik boşluk ayarlayıcı              | L   | Alaşım / karbonlanmış                                  | WE     | Ikaz mekanizması                       | Cabrio                                |
| B    | Kaplamalı                               | L = | Uzunluk  | WK     | Balata aşınma sensörlü                 | Otobüs                                |
| BG   | Fren Güç Regülatörü                     | Nz  | Alicı silindir   | Zub    | Aksesuarlı                             | Kapalı kasa kamyonet                  |
| BR   | Fren Basınç Regülatörü                  | PD  | PowerDisc  |        |  | Hatchback                             |
| BRE  | Vidalı tip Regülatör                    | Rz  | Hidrolik Fren Silindiri                                |        |  | Açık kasa kamyonet/Şasi               |
| BRES | Vidalı Tip Regülatör Seti               | RzR | Entegre Fren Düzeltme sistemli Fren Hidrolik Silindiri |        |  | Seri                                  |
| BRL  | Ağırlığa duyarlı Fren Basınç Regülatörü | S   | Sabitleme civatası / Kaliper civatalı                  | 2 kapı |  | DKW master sınıf/özel sınıf/üniversal |
| D =  | Çap                                     |     |  | 3 kapı |  | FAUN motorlu araç (Kraka)             |
| Gz   | Verici Silindir Debriyaj Silindiri      |     |  | 4 kapı |  | Transporter                           |
|      |   |     |  | 5 kapı |  |                                       |
|      |   |     |  | Sedan  |  |                                       |

# Ürün bilgileri

|    |  | KISA NUMARA                           |    |  |  | KISA NUMARA      |    |
|---|---|---------------------------------------|---|---|--|------------------|---|
|    | 13.0460-xxxx.2 →<br>13.0470-xxxx.2 →<br>13.0460-0xxx.2 →<br>24.8190-xxxx.2 →      | 60xxxx<br>LD0xxxx<br>610xxx<br>62xxxx | Disc Fren Balatası (Pad)<br>ATE Ceramic<br>Montaj Takımı<br>Balata Aşınma Sensörü   |  | 24.02dd-dxxx.x →   | 48nnnn           | Fren Kampanaları<br>(Örneğin: 24.02 23-0: Ø=230)  |
|   | 20034 15,0<br>+<br>WE<br>WK<br>S<br>Zub   |                                       | WVA-numarası / kalınlık<br>diğer WVA-numaraları için eke bakın<br>İkaz mekanizması<br>Balata aşınma sensörü<br>Kaliper civatalı<br>Aksesuarlı |  | 230/231x47   |                  | Çap / Maksimum çap x derinlik   |
|   |   |                                       |   |  | 03.0137-0xxx.2 →<br>03.0137-9xxx.2 →   | 650xxx<br>669xxx | Kampanalı Fren Pabuçları<br>Montaj Takımı   |
|   |   |                                       |   |  | 185x31<br>AUT<br>Heb<br>Zub  |                  | Çap x genişlik<br>Otomatik boşluk ayarlayıcı<br>Levyeli<br>Aksesuarları ile birlikte  |
| Fren Balataları Alman Federal Yol Emniyet Departmanının (ABE) ile uyumludur veya ECE - R 90 Talimatına uygundur. Yani, balatalar ana ekipman üretici firmasıyla aynı üretim ve kalite güvence süreçleri uyarınca üretilmiştir.  |   |                                       |   |  | 03.0420-xxdd.3 →<br>03.0520-xxdd.3 →   | 68xxdd<br>69xxdd | Orijinal ATE tamir takımı<br>Komple ATE Tamir Takımı<br>(Fren hidrolik silindiri + kampanalı fren pabuçları + montaj takımı)<br>dd = Fren Hidrolik silindiri nominal ölçüsü |
|    | 24.01dd-xxxx.x →<br>24.03dd-xxxx.x →  | 4ddxxx<br>5ddxxx                      | Fren Diski<br>ATE Fren Diski<br>dd = Kalınlık<br>(Örneğin: 24.0322- : Kalınlık = 22)  |  | 03.0137-0xxx.2 →<br>03.0137-9xxx.2 →   | 650xxx<br>669xxx | Park Freni<br>(Kampanalı Fren Pabuçları)<br>Montaj Tamir Takımı   |
|   | 284 22 20 V L PD<br>B<br>V<br>L<br>S<br>PD  |                                       | çap / kalınlık / asgari kalınlık<br>Kaplama<br>havalandırılmalı<br>alaşım / karbonlanmış<br>Sabitleme civatası<br>ATE PowerDisc               |  | 185x31<br>AUT<br>Heb<br>Zub  |                  | Çap x Genişlik<br>Otomatik Boşluk Ayarlayıcı<br>Levyeli<br>Aksesuarlı   |
| Arka aksta PowerDisc fren diski ancak eğer ön aksta da bir PowerDisc fren diski varsa kullanılabilir. PowerDisc fren diskinin kullanılması için verilmiş olan Genel İşletim İzni (ABE), Alman Trafik Tescil İşlemleri Yönetmeliğine uygun olarak Alman karayollarında geçerlidir. Eğer bu fren diskinin başka ülkelerin karayollarında kullanılması öngörülüyorsa, bunun için ayrıca başka rapor ve belgelerin de alınması gerekebilir. |   |                                       |   |  | 24.07xx-xxxx.x →   | 36nnnn           | Fren Balatası aşınma sensörleri   |

nnnn = Son dört rakam mevcut bir numaraya karşılıktır.

dd = Nominal çap

Bu kataloğun içeriği ve kopyaları yalnız müsaade alınarak kullanılabilir. Bu kataloğtaki bilgileri baz alarak kullanılan parçalar yüzünden zarara uğranılması durumunda mesuliyet kullanıcıya aittir. Dizayn ve montaj değişiklikleri hakkı saklıdır. Dökümanımızda kullanılan araç üreticilerinin verdikleri parça numaraları sadece karşılaştırma içindir. Faturalarda araç üreticilerinin parça numaralarının kullanılmasına müsaade edilmez.

Otomobil modellerindeki ve üretici firmaların çokluğu ve çeşitliliği her zaman her yedek parçanın tam olarak kullanılmasına imkan vermeyebilir. Bu nedenle notlara ve yedek parça talimatlarının içeriğine dikkat ediniz.

# 这样使用 K24-F

| 产品组                         | 车型  | 安装期间 (开始/结束)                    |              | 说明 (整车)  | 说明 (零件)  | ATE-零件号 (短)                      | 说明 (零件)          |  |                                   |            |
|-----------------------------|---|---------------------------------|--------------|--|--|----------------------------------|------------------|--|-----------------------------------|------------|
| 前/后轴                        | 车辆生产号 (自/至)                               | kW                              |              | 说明 (整车)  |  | ATE-零件号 (短)                      | 说明 (零件)          |  |                                   |            |
|                             |   |                                 |              |  |  |                                  |                  |  |                                   |            |
| <b>AUDI A4 CABRIO (02-)</b> |   |                                 |              |  |  |                                  |                  |  |                                   |            |
|                             | 1,8 T<br>1,8 T Quattro<br>2,0<br>2,0 TFSI | ◀ 120<br>◀ 120<br>◀ 96<br>◀ 120 | 8E-55-999999 | 04.02<br>05.03<br>08.06<br>05.04<br>08.06<br>08.06 | PR: 1LB,1LE<br>PR: 1LB,1LE<br>PR: 1LB,1LE<br>PR: 1LB,1LE | 24.0113-0178.1<br>24.0313-0178.1 | 413178<br>513178 | <input type="checkbox"/> + ESP<br><input type="checkbox"/> + ESP | 256 12,9 11,0<br>256 12,9 11,0 PD | ATE<br>ATE |
| *                           | **  |                                 |              |  |  |                                  | ***              | ****   |                                   |            |

## \*产品组

|  |                               |  |  |
|--|-------------------------------|--|--|
|  | 盘式制动摩擦片<br><b>ATE Ceramic</b> |  | 鼓式制动器后部                                |
|  | 制动盘<br><b>ATE PowerDisc</b>   |  | 制动鼓                                    |
|  | 车轮传感器                         |  | <b>ATE 原装工具箱</b><br><b>ATE 原装上等工具箱</b> |
|  |                               |  | 用于停车制动的鼓式制动器后部                         |

## \*\*转向机类型

- ◀ 左舵
- ▶ 右舵

## \*\*\*\*供应商标识

|     |                         |
|-----|-------------------------|
| ADV | Advics                  |
| ATE | Continental Teves (ATE) |
| AKE | Akebono                 |
| AIS | Aisin                   |
| AP  | AP Lockheed             |
| BDX | Bendix                  |
| BOS | Bosch                   |
| BRE | Brembo                  |
| CIT | Citroën                 |
| DEL | Delco                   |
| FI  | Fiat                    |
| FTE | FTE Automotive          |
| MAN | Mando                   |
| NIS | Nissin                  |
| PER | Perrot                  |
| SUM | Sumitomo                |
| TOK | Tokico                  |
| TRW | Lucas (LUC)             |
| VW  | Volkswagen              |

## \*\*\*安装位置

















|  |     |
|--|-----|
|  | 前   |
|  | 后   |
|  | 左   |
|  | 右   |
|  | 左前  |
|  | 右前  |
|  | 左后  |
|  | 右后  |
|  | 中   |
|  | 上   |
|  | 下   |
|  | 后轴  |
|  | 左前轴 |
|  | 右前轴 |
|  | 后轴  |
|  | 左后轴 |
|  | 右后轴 |

所有的位置说明都参照汽车行驶方向。

## 缩写

|      |             |     |                  |      |      |                    |
|------|-------------|-----|------------------|------|------|--------------------|
| -    | 无 / 否       | HEB | 带杠杆              | WE   | 报警装置 | 客货两用车              |
| +    | 含 / 仅有 / 用于 | HZ  | 主缸               | WK   | 报警触点 | 双门轿车               |
| AUT  | 带自动调整       | L   | 制成合金             | Zub  | 带有附件 | 敞篷轿车               |
| B    | 喷层的BG       | L=  | 长                |      |      | 客车                 |
| BG   | 制动力限制器      | Nz  | 输出缸              |      |      | 厢式汽车               |
| BR   | 制动力调节器      | PD  | <b>PowerDisc</b> |      |      | 阶背式车尾              |
| BRE  | 旋入调节器       | Rz  | 车轮制动缸            | 双门   |      | 载货平板 / 车辆底盘        |
| BRES | 旋入调节器组      | RzR | 车轮制动缸            | 三门   |      | 系列                 |
| BRL  | 与负载相关的制动力   | S   | 固定するネジ           | 四门   |      | DKW 大师级 / 特级 / 普通级 |
| D=   | 直径          | THz | 鼓式制动器后部          | 五门   |      | FAUN 军用越野车 (Kraka) |
| Gz   | 灰口铸铁 输出缸    | V   | 通风               | 大型轿车 |      | 轻型载货车              |

# 零件信息

|                                        |  | 编号                                   |  |  |  | 编号               |  |
|---|---|--------------------------------------|---|---|--|------------------|---|
|                                        | 13.0460-xxxx.2 →<br>13.0470-xxxx.2 →<br>13.0460-0xxx.2 →<br>24.8190-xxxx.2 →      | 60xxxx<br>LDxxxx<br>610xxx<br>62xxxx | 盘式制动摩擦片<br>ATE Ceramic<br>安装组<br>报警触点   |  | 24.02dd-dxxx.x →   | 48nnnn           | 制动鼓<br>(如. 24.02 23 -0 :厚度=230)   |
|   | 20034 15,0<br>+<br>WE<br>WK<br>S<br>Zub   |                                      | WVA-号/ 厚度<br>其他WVA-号参见附件<br>报警装置<br>报警触点<br>带有牵引螺栓<br>带有附件                        |  | 230/231x47   |                  | 直径 / 最大 直径 × 深度   |
|   |   |                                      |   |  | 03.0137-0xxx.2 →<br>03.0137-9xxx.2 →   | 650xxx<br>669xxx | 鼓式制动后部<br>安装组   |
|   |   |                                      |   |  | 185x31<br>AUT<br>Heb<br>Zub  |                  | 直径 × 宽<br>带自动调整<br>带杠杆<br>带附件   |
| 制动摩擦片组有共同的使用条件 (AABE) 或者根据ECE-R90确认, 或者来自同一生产厂, 与汽车制造厂需要的摩擦片具有同样的功能保证   |   |                                      |   |  | 03.0420-xxdd.3 →<br>03.0520-xxdd.3 →   | 68xxdd<br>69xxdd | ATE 原装工具箱<br>ATE 原装高级工具箱<br>(车轮制动缸 + 鼓式制动-后部<br>+ 安装组)<br>dd = 额定尺寸 车轮制动缸           |
|                                        | 24.01dd-xxxx.x →<br>24.03dd-xxxx.x →  | 4ddxxx<br>5ddxxx                     | 制动盘<br>ATE PowerDisc<br>dd = 厚度<br>(如.. 24.03 22 - : 厚度 = 22)                     |  | 03.0137-0xxx.2 →<br>03.0137-9xxx.2 →   | 650xxx<br>669xxx | 停车制动<br>(鼓式制动后部)<br>安装组   |
|   | 284 22 20 V L PD<br>B<br>V<br>L<br>S<br>PD  |                                      | 直径/厚度/最小厚度<br>コーティング仕上げ<br>通风<br>制成合金/高度碳化<br>固定するネジ<br>ATE PowerDisc             |  | 185x31<br>AUT<br>Heb<br>Zub  |                  | 直径 × 宽<br>带自动调整<br>带杠杆<br>带附件   |
| 只有在前轴也使用刹车盘PowerDisc的情况下才允许在后轴上使用刹车盘PowerDisc。根据道路交通许可条例, 使用PowerDisc的一般操作许可证 (ABE)在德国道路上是有效的。在其它国家道路交通中的使用可能会需要其它鉴定意见。 |   |                                      |   |  | 24.07xx-xxxx.x →   | 36nnnn           | 车轮传感器   |

nnnn = 最后四位数字是顺序号。







dd = 额定尺寸

简要的强调一下, 就是说必须经过我们的许可。基于该目录说明的替换要求没有进行说明。保留更改结构的权利。  
只要我们在我们的资料中提到了整车制造商的替代件编号, 只能用于比较。  
不允许在给用户的帐单中使用同样类型的说明。







整车制造商多样化的车型和替代件不可能做到精确的划分。所以, 请您注意目录中的说明和替代件描述。



# カタログNo.24-Fのご利用法

| 製品グループ   | 車種  | 取り付け期間 (から/まで)  | ATE商品番号(長)  | 情報(商品)  |
|--|---|---|---|---|
| 前車軸/後車軸  | 車台番号(から/まで)   | 情報(車両)  | ATE商品番号(短)  | 商品  |
|  | kW  |   |   |   |
|  |  |  |  |  |
| <b>AUDI A4 CABRIO (02-)</b>  |   |   |   |   |
|  | 1,8 T<br>1,8 T Quattro<br>2,0<br>2,0 TFSI   | ◀ 120<br>◀ 120<br>◀ 96<br>◀ 120   | 8E-55-999999<br>04.02<br>05.03<br>08.06<br>05.04<br>08.06<br>08.06                | PR: 1LB,1LE<br>PR: 1LB,1LE<br>PR: 1LB,1LE<br>PR: 1LB,1LE                          |
|  |   | 8E-55-400001  | 24.0113-0178.1<br>24.0313-0178.1  | 413178<br>513178  |
|  |   |   |   | ☑ + ESP<br>☑ + ESP  |
|  |   |   |   | 256 12,9 11,0 ATE<br>256 12,9 11,0 PD ATE   |
| *  | **  |   | ***   | ****  |

## \*製品グループ

|  |                            |   |                                   |
|--|----------------------------|---|-----------------------------------|
|    | ディスクブレーキパッド<br>ATE/Ceramic |    | ドラムブレーキシュー                        |
|    | ブレーキディスク<br>ATEパワーディスク     |    | ブレーキドラム                           |
|  | ホイールセンサー                   |  | ATEオリジナルキット<br>ATEオリジナルトップ<br>キット |
|  |                            |  | サイドブレーキ用<br>ドラムブレーキシュー            |







## \*\*ステアリング形態

- ◀ 左ハンドル
- ▶ 右ハンドル

## \*\*\*\*メーカー略号

|     |                         |
|-----|-------------------------|
| ADV | Advics                  |
| ATE | Continental Teves (ATE) |
| AKE | Akebono                 |
| AIS | Aisin                   |
| AP  | AP Lockheed             |
| BDX | Bendix                  |
| BOS | Bosch                   |
| BRE | Brembo                  |
| CIT | Citroën                 |
| DEL | Delco                   |
| FI  | Fiat                    |
| FTE | FTE Automotive          |
| MAN | Mando                   |
| NIS | Nissin                  |
| PER | Perrot                  |
| SUM | Sumitomo                |
| TOK | Tokico                  |
| TRW | Lucas (LUC)             |
| VW  | Volkswagen              |

## \*\*\*取り付け位置

















|   |       |
|---|-------|
|    | 前     |
|    | 後ろ    |
|    | 左     |
|    | 右     |
|    | 左前方   |
|    | 左後方   |
|    | 右前方   |
|  | 右後方   |
|  | 中央    |
|  | 上     |
|  | 下     |
|  | 前車軸   |
|  | 前車軸 左 |
|  | 前車軸 右 |
|  | 後車軸   |
|  | 後車軸 左 |
|  | 後車軸 右 |

位置表示は全て車の進行方向に即しています。

## 略語

|      |                               |     |                       |                   |               |                                 |
|------|-------------------------------|-----|-----------------------|-------------------|---------------|---------------------------------|
| -    | の付いていない/なし                    | D = | 直径                    | Thz               | タンデムマスターシリンダー | セダン                             |
| +    | の付いた/のみ/〜用の                   | Gz  | マスターシリンダー             | V                 | 通気機能          | ステーションワゴン                       |
| AUT  | 自動調整機能付き                      | HEB | レバー付き                 | WE                | 警告装置          | クーペ                             |
| B    | コーティング仕上げ                     | HZ  | マスターシリンダー             | WK                | ウォーニングコンタクト付き | カブリオ                            |
| BG   | ブレーキプレッシャーリ<br>レター            | L   | 合金/炭素繊維強化             | Zub               | 付属品付き         | バス                              |
| BR   | ブレーキプレッシャーレ<br>レター            | L = | 長さ                    |                   |               | バン                              |
| BRE  | スクリュエインコントローラー                | Nz  | スレーブシリンダー             |                   |               | ハッチバック                          |
| BRES | スクリュエインコントローラー<br>キット         | PD  | PowerDisc             |                   |               | ピックアップ/シャシー                     |
| BRL  | ブレーキプレッシャーレギュ<br>レーター 負荷により変化 | Rz  | ホイールシリンダー             |                   |               | シリーズ                            |
|      |                               | RzR | 調整器組み込み ホ<br>イールシリンダー | ブレーキチューブ + パイプライン |               | DKW マスタークラス/<br>スペシャルクラス/ユニバーサル |
|      |                               | S   | 固定するネジ/<br>キャリパーネジ付き  | 2ドア               |               | FAUN パワーカート(Kraka)              |
|      |                               |     |                       | 3ドア               |               | トランスポーター                        |
|      |                               |     |                       | 4ドア               |               |                                 |
|      |                               |     |                       | 5ドア               |               |                                 |

# 商品情報

|    |  | 略番                                   |  |  |  | 略番               |      |
|---|---|--------------------------------------|---|---|--|------------------|---|
|    | 13.0460-xxxx.2 →<br>13.0470-xxxx.2 →<br>13.0460-0xxx.2 →<br>24.8190-xxxx.2 →      | 60xxxx<br>LDxxxx<br>610xxx<br>62xxxx | ディスクブレーキパッド<br>ATE / Ceramic<br>組み込みキット<br>ウォーニングコンタクト                            |  | 24.02dd-dxxx.x →   | 48nnnn           | ブレーキドラム<br>(例 24.0223-0: Ø=230)   |
|   | 20034 15,0<br>+<br>WE<br>WK<br>S<br>Zub   |                                      | WVA番号 / 厚さ<br>さらなるWVA番号は補遺を参照。<br>警告装置<br>ウォーニングコンタクト付き<br>キャリパーネジ付き<br>付属品付き     |  | 230/231x47   |                  | 直径 / 最大直径 x 深さ  |
|   |   |                                      |   |  | 03.0137-0xxx.2 →<br>03.0137-9xxx.2 →   | 650xxx<br>669xxx | ドラムブレーキシュー<br>組み込みキット   |
|   |   |                                      |   |  | 185x31<br>AUT<br>Heb<br>Zub  |                  | 直径 x 幅<br>自動調整機能付き<br>レバー付き<br>付属品付き  |
| Bブレーキパッドキットは、一般使用許可(AABE)またはECE-R90による使用認可を受けているか、あるいはそれと同水準の製品であり、車両メーカーが設定したものと同等の品質保証を義務づけられています。  |   |                                      |   |  | 03.0420-xxdd.3 →<br>03.0520-xxdd.3 →   | 68xxdd<br>69xxdd | ATEオリジナルキット<br>ATE オリジナルトップキット<br>(ホイールシリンダー+ドラムブレーキシュー+組み込みキット)<br>dd = 名目寸法 ホイールシリンダー |
|    | 24.01dd-xxxx.x →<br>24.03dd-xxxx.x →  | 4ddxxx<br>5ddxxx                     | ブレーキディスク<br>ATE パワーディスク<br>dd = 厚さ<br>(例 24.0322- : 厚さ = 22)                      |  | 03.0137-0xxx.2 →<br>03.0137-9xxx.2 →   | 650xxx<br>669xxx | サイドブレーキ<br>(ドラムブレーキシュー)<br>組み込みキット  |
|   | 284 22 20 V L PD<br>B<br>V<br>L<br>S<br>PD  |                                      | 直径 / 厚さ / 最小厚<br>コーティング仕上げ<br>通気機能<br>合金 / 炭素繊維強化<br>固定するネジ<br>ATE パワーディスク        |  | 185x31<br>AUT<br>Heb<br>Zub  |                  | 直径 x 幅<br>自動調整機能付き<br>レバー付き<br>付属品付き  |
| PowerDiscをリアアクスルにご使用になる場合には、必ずフロントアクスルにもPowerDiscをご使用ください。ドイツの道路上におけるPowerDiscの使用に関する一般的なオペレーティング許可(ABE)については、ドイツの道路交通法(StVZO)に従って有効です。他国での道路交通における使用には、必要に応じてさらに専門家による判定が必要になる場合があります。 |   |                                      |   |  | 24.07xx-xxxx.x →   | 36nnnn           | ホイールセンサー  |

nnnn = 最後の4つの数字はカウントナンバーです。

dd = 名目寸法

複製は、たとえ一部であっても、必ず当社の許可が必要です。当カタログの記述内容に基づく賠償請求権は認められません。構成の変更に関しては、これを保留します。当社がその資料の中で車両メーカーの交換部品番号に触れる限りにおいては、これは単に比較目的によるものです。このような記述内容を車両所有者あての計算書の中で用いることは許されません。

車両メーカーの数は多種多様なモデルや交換部品を持つため、厳密な分類法を守ることが不可能な場合があります。従って当カタログ中に記載された内容と部品情報には特にご注意ください。部品情報には特にご注意ください。部品情報には特にご注意ください。

| مجموعة المنتجات             | موديلات العربات  | فترة التركيب (من / إلى)                           | الرقم الكامل للمنتجات                                    | ملاحظة (المنتجات)                              |
|-----------------------------|--|---|--|--|
| المحور الأمامي / الخلفي     | العدد الترتيبي بالمصنع (من / إلى)                                | ملاحظة (العربة)                                   | الرقم المختصر للمنتجات                                   | المنتجات                                       |
|                             | kW   |   |  |  |
|                             |  |   |  |  |
| <b>AUDI A4 CABRIO (02-)</b> |  |   |  |  |
|                             | 1,8 T < 120<br>1,8 T Quattro < 120<br>2,0 < 96<br>2,0 TFSI < 120 | 8E-55-999999 04.02<br>8E-55-400001 05.03<br>05.04 | PR: 1LB,1LE<br>PR: 1LB,1LE<br>PR: 1LB,1LE<br>PR: 1LB,1LE | 24.0113-0178.1 413178<br>24.0313-0178.1 513178 |
|                             |  |   |  | + ESP<br>+ ESP                                 |
|                             |  |   |  | 256 12,9 11,0 ATE<br>256 12,9 11,0 PD ATE      |

\*

\*\*

\*\*\*

\*\*\*\*

## مجموعات المنتجات \*



مزلقات المكبح القرصي  
ATE Ceramic



فكي المكبح الطبلي



أقراص المكابح  
ATE PowerDisc



طبلاات المكبح



مجس العجلة



الطقم الأصلي  
ATE الممتاز  
الطقم



فكي المكبح الطبلي  
لمكبح التثبيت

## نوع المقود \*\*



مقود على اليسار



مقود على اليمين

## شفرة التعريف للمصنعين \*\*\*\*

|     |                         |
|-----|-------------------------|
| ADV | Advics                  |
| ATE | Continental Teves (ATE) |
| AKE | Akebono                 |
| AIS | Aisin                   |
| AP  | AP Lockheed             |
| BDX | Bendix                  |
| BOS | Bosch                   |
| BRE | Brembo                  |
| CIT | Citroën                 |
| DEL | Delco                   |
| FI  | Fiat                    |
| FTE | FTE Automotive          |
| MAN | Mando                   |
| NIS | Nissin                  |
| PER | Perrot                  |
| SUM | Sumitomo                |
| TOK | Tokico                  |
| TRW | Lucas (LUC)             |
| VW  | Volkswagen              |

## موضع التركيب \*\*\*



أمام



خلف



وسط



يمين



أمام على اليسار



خلف على اليسار



أمام على اليمين



خلف على اليمين



وسط



فوق



تحت



المحور الأمامي



المحور الأمامي على اليسار



المحور الأمامي على اليمين



المحور الخلفي



المحور الخلفي على اليسار



المحور الخلفي على اليمين

المذكورة أعلاه حُدثت حسب  
اتجاه سير العربة المواضع













## اختصارات

|      |                            |
|------|----------------------------|
| -    | بدون / لا                  |
| +    | مع / إلا / ل               |
| AUT  | بضبط أوتوماتيكي            |
| B    | نطبم                       |
| BG   | محدد قوة الفرملة           |
| BR   | معدل قوة الفرملة           |
| BRE  | معدل ملولب                 |
| BRES | طقم تعديل ملولب            |
| BRL  | معدل قوة الفرملة حسب الجمل |
| D=   | تري ادل / رطق              |
| Gz   | الأسطوانة المضاعطة         |

|     |                                |
|-----|--------------------------------|
| HEB | بعنلة                          |
| Hz  | الأسطوانة الرئيسية             |
| L   | الطول                          |
| L=  | الطول                          |
| Nz  | الأسطوانة المضغوطة             |
| PD  | ATE PowerDisc قرص المكبح       |
| Rz  | أسطوانة العجلة مع              |
| RzR | أسطوانة العجلة مع<br>معدل مدمج |
| S   | بلولم تيبثت راميم              |
| THz | أسطوانة رئيسية مزدوجة          |

|     |                          |
|-----|--------------------------|
| V   | ميرد بالهواء             |
| WE  | جهاز إنذار               |
| WK  | مجهز بتماس لجهاز الإنذار |
| Zub | بتجهيزات إضافية          |
|     | ثنائية الأبواب           |
|     | ثلاثية الأبواب           |
|     | رباعية الأبواب           |
|     | خماسية الأبواب           |
|     | صالون                    |

|  |                                  |
|--|----------------------------------|
|  | اس تي شين                        |
|  | كوبيه                            |
|  | كابريو                           |
|  | حافلة                            |
|  | ناقلة صندوقية                    |
|  | هاتش باك                         |
|  | ناقلة مسطحه / شاسيه              |
|  | الفئة                            |
|  | الفاخرة / الفئة الخاصة / الشاملة |
|  | سيارة DKW من الفئة               |
|  | عربة مكشوفة FAUN                 |
|  | ناقلة                            |

|  |  | الرقم المختصر                        |    |   |  | الرقم المختصر      |    |
|---|---|--------------------------------------|---|--|--|--------------------|---|
|  | 13.0460-xxxx.2 →<br>13.0470-xxxx.2 →<br>13.0460-0xxx.2 →<br>24.8190-xxxx.2 →      | 60xxxx<br>LDxxxx<br>610xxx<br>62xxxx | مزقات المكبح القرصي<br>ATE Ceramic<br>طقم التركيب<br>تماس جهاز الإنذار  |   | 24.02dd-dxxx.x →<br>230/231x47   | 48nnnn             | طبلية المكبح<br>على سبيل المثال (24.0223-0: Ø=230)<br>القطر /<br>القطر الأقصى × العمق   |
|   | 20034 15,0<br>+<br>WE<br>WK<br>S<br>Zub   |                                      | ترقيم WVA / سمك<br>أرقام إضافية راجع الملحق WVA<br>جهاز إنذار<br>مجهز بتماس لجهاز الإنذار<br>بمحزقة مثبتة على سرج<br>تجهيزات إضافية   |   | 03.0137-0xxx.2 →<br>03.0137-9xxx.2 →<br>185x31<br>AUT<br>Heb<br>Zub                | 65 0xxx<br>66 9xxx | فكي المكبح الطبلي<br>طقم التركيب<br>القطر × العرض<br>بضبط أوتوماتيكي<br>بعتلة<br>بتجهيزات إضافية  |
|   |   |                                      | طواقم مزقات المكباح تخضع لترخيص عام للاستعمال أو لوثيقة تناظر حسب نظام المعايير المعتمد. في صورة أن تكون تابعة لنفس وحدة التصنيع فتخضع حينئذ لنفس قواعد حفظ الجودة لمزقات المكبح المنصوص عليها من طرف مصنع العربات. |   | 03.0420-xxdd.3 →<br>03.0520-xxdd.3 →   | 68 xxdd<br>69 xxdd | الطقم الأصلي ATE<br>الطقم الأصلي الممتاز ATE<br>(أسطوانة العجلة + فكي المكبح الطبلي<br>+ طقم التركيب)<br>=dd المقاييس العادية لأسطوانة العجلة |
|  | 24.01dd-xxxx.x →<br>24.03dd-xxxx.x →  | 4ddxxx<br>5ddxxx                     | قرص المكبح<br>ATE PowerDisc<br>= dd السمك<br>على سبيل المثال: (24.0322- : سمك = 22)   |   | 03.0137-0xxx.2 →<br>03.0137-9xxx.2 →<br>185x31<br>AUT<br>Heb<br>Zub                | 65 0xxx<br>66 9xxx | مكبح التثبيت<br>(فكي المكبح الطبلي)<br>طقم التركيب<br>القطر × العرض<br>بضبط أوتوماتيكي<br>بعتلة<br>بتجهيزات إضافية                            |
|   | 284 22 20 V L PD<br>B<br>V<br>L<br>S<br>PD  |                                      | القطر / السمك / الحد الأدنى للسمك<br>نظيم<br>ميرد بالهواء<br>خليط معدني / نسبة عالية من الكربون<br>بلولم تيبيثت رامسم<br>ATE PowerDisc قرص المكبح   |  | 24.07xx-xxxx.x →   | 36 nnnn            | مجنس العجلة   |

لا يتم استخدام أقرص الفرامل (PowerDisc) على المحور الخلفي إلا مع استخدامها في نفس الوقت على المحور الأمامي كذلك.\*

nnnn = الأربعة الأرقام الأخيرة تمثل العدد الترتيبي

dd = المقاييس العادية

لا يجوز إعادة طبع أو نسخ هذه الوثيقة ولو جزئياً إلا بترخيص مباشر من طرفنا. لا نعترف بأية طلبات لتعويض أضرار أو خسائر قد تلحق من جراء استعمال البيانات والمعلومات المنصوص عليها بهذا الكatalog. نحفظ بحق إجراء تعديلات على تصاميمنا. أرقام قطع الغيار لمصنعي السيارات التي ذكرها في هذه الوثيقة هي لغرض المقارنة فقط. لا يجوز استعمال مثل هذه البيانات في إصدار الفواتير لأصحاب العربات.

نظراً لتعدد موديلات العربات وقطع الغيار فإنه ليس بالإمكان دائماً الربط الدقيق بين المنتجات والأرقام. ولذلك فالرجاء الانتباه بالخصوص للملاحظات والبيانات التوضيحية الخاصة بقطع الغيار والمنصوص عليها في الكatalog.

تتأهل كل صيرورة رورملل ينامل ألأ نون اقلأ بوجوب لقلذو، ةينامل ألأ قرطلا علع مادختس الل "فسيد رواب" جتن'ب صا خلا، لئ غش'تلل ما خلا حيرص'تلأ يرس ي\*  
مقرط علع جتن'لأ اذو مادختس لاجأ نم نيينقت ءاربخ وأ تائيه نم ةينف تاداش علع لوصحلا عرخال نادلبلأ ضعب يف زلي دقف لقلذ نم مغرلا علع نأ الل (StVZO).  
ةيرورملأ







ATE – A Trademark of the  
Continental Corporation

**Continental Aftermarket GmbH**

Guerickestraße 7  
D-60488 Frankfurt am Main  
Tel. +49 (0) 69 7603-1  
Fax +49 (0) 69 76106-1

[www.ate.de](http://www.ate.de)

**Continental Automotive Trading  
Italia S.r.l.**

Divisione ATE  
Via Matteotti, 62  
I-20092 Cinisello Balsamo (MI)  
Tel. +39 02 35680 1  
Fax +39 02 35680 325  
E-Mail: [info.consumatori@continental-corporation.com](mailto:info.consumatori@continental-corporation.com)

[www.ate-freni.it](http://www.ate-freni.it)

**Continental AutomotiveFrance SAS**

Parc Ariane Bâtiment Venus  
Rue Hélène Boucher  
F-78280 Guyancourt  
Tél. +33 (0)1 39 44 10 30  
Fax +33 (0)1 39 44 10 40  
E-Mail: [OTCYFMate.technique@continental-corporation.com](mailto:OTCYFMate.technique@continental-corporation.com)

[www.ate-freinage.fr](http://www.ate-freinage.fr)

**Continental Automotive Spain, S.A.**

C/ Sepúlveda, 11  
E-28108 Alcobendas (Madrid)  
Phone +34 (0) 657 21 21  
Fax +34 (0)91 657 21 49

[www.frenos-ate.es](http://www.frenos-ate.es)